

Lenovo™ **Think**Products

PSREF



Product Specifications Reference

Version 524, May 2018

U.S.

Visit <http://psref.lenovo.com> for the latest version

Lenovo **ThinkPad** Laptops

PSREF



Product Specifications Reference

Version 524, May 2018

U.S.

Visit <http://psref.lenovo.com> for the latest version

Contents

Cover		
Contents		
Summary Of Change		
11e Series		
ThinkPad 11e (4th Gen)		
ThinkPad 11e (4th Gen) Platform Specifications	1	ThinkPad E475 - TopSeller - 20H4 34
ThinkPad 11e (4th Gen) - TopSeller - 20HV	2	ThinkPad E480 35
ThinkPad 11e (5th Gen)	5	ThinkPad E480 Platform Specifications 36
ThinkPad 11e (5th Gen) Platform Specifications	6	ThinkPad E480 - TopSeller - 20KN 37
ThinkPad 11e (5th Gen) - TopSeller - 20LQ	6	ThinkPad E570 38
ThinkPad 11e Chromebook (4th Gen)	7	ThinkPad E570 Platform Specifications 39
ThinkPad 11e Chromebook (4th Gen) Platform Specifications	8	ThinkPad E570 - TopSeller - 20H5 40
ThinkPad 11e Chromebook (4th Gen) - TopSeller - 20J0	9	ThinkPad E575 41
13 Series	10	ThinkPad E575 Platform Specifications 42
ThinkPad 13 (2nd Gen)	11	ThinkPad E575 - TopSeller - 20H8 43
ThinkPad 13 (2nd Gen) Platform Specifications	12	ThinkPad E580 44
ThinkPad 13 (2nd Gen) - TopSeller - 20J1 - 1 of 2	13	ThinkPad E580 Platform Specifications 45
ThinkPad 13 (2nd Gen) - TopSeller - 20J1 - 2 of 2	14	ThinkPad E580 - TopSeller - 20KS 46
ThinkPad 13 Chromebook	15	L Series 47
ThinkPad 13 Chromebook Platform Specifications	15	ThinkPad L380 47
ThinkPad 13 Chromebook - TopSeller - 20GL	16	ThinkPad L380 Platform Specifications 48
A Series	17	ThinkPad L380 - TopSeller - 20M5 49
ThinkPad A275	18	ThinkPad L470 50
ThinkPad A275 Platform Specifications	19	ThinkPad L470 Platform Specifications 51
ThinkPad A275 - TopSeller - 20KD	20	ThinkPad L470 - TopSeller - 20J4 52
ThinkPad A475	21	ThinkPad L470 - TopSeller - 20JU 53
ThinkPad A475 Platform Specifications	22	ThinkPad L480 54
ThinkPad A475 - TopSeller - 20KL	22	ThinkPad L480 Platform Specifications 55
E Series	23	ThinkPad L480 - TopSeller - 20LS 56
ThinkPad E470	24	ThinkPad L570 57
ThinkPad E470 Platform Specifications	25	ThinkPad L570 Platform Specifications 58
ThinkPad E470 - TopSeller - 20H1 - 1 of 2	26	ThinkPad L570 - TopSeller - 20J8 59
ThinkPad E470 - TopSeller - 20H1 - 2 of 2	27	ThinkPad L570 - TopSeller - 20JQ 60
ThinkPad E475	28	ThinkPad L580 61
ThinkPad E475 Platform Specifications	28	ThinkPad L580 Platform Specifications 62
	29	ThinkPad L580 - TopSeller - 20LW 63
	30	P Series 64
	31	ThinkPad P50 64
	32	ThinkPad P50 Platform Specifications 65
	33	ThinkPad P50 - TopSeller - 20EN - 1 of 2 66

Contents

ThinkPad P50 - TopSeller - 20EN - 2 of 2	67	ThinkPad T470s - TopSeller - 20HF - 1 of 2	101
ThinkPad P51	68	ThinkPad T470s - TopSeller - 20HF - 2 of 2	102
ThinkPad P51 Platform Specifications	69	ThinkPad T470s - TopSeller - 20JS	103
ThinkPad P51 - TopSeller - 20HH - 1 of 3	70	ThinkPad T480	104
ThinkPad P51 - TopSeller - 20HH - 2 of 3	71	ThinkPad T480 Platform Specifications	105
ThinkPad P51 - TopSeller - 20HH - 3 of 3	72	ThinkPad T480 - TopSeller - 20L5 - 1 of 2	106
ThinkPad P51s	73	ThinkPad T480 - TopSeller - 20L5 - 2 of 2	107
ThinkPad P51s Platform Specifications	74	ThinkPad T480s	108
ThinkPad P51s - TopSeller - 20HB - 1 of 2	75	ThinkPad T480s Platform Specifications	109
ThinkPad P51s - TopSeller - 20HB - 2 of 2	76	ThinkPad T480s - TopSeller - 20L7 - 1 of 2	110
ThinkPad P51s - TopSeller - 20JY	77	ThinkPad T480s - TopSeller - 20L7 - 2 of 2	111
ThinkPad P52s	78	ThinkPad T570	112
ThinkPad P52s Platform Specifications	79	ThinkPad T570 Platform Specifications	113
ThinkPad P52s - TopSeller - 20LB - 1 of 2	80	ThinkPad T570 - TopSeller - 20H9 - 1 of 2	114
ThinkPad P52s - TopSeller - 20LB - 2 of 2	81	ThinkPad T570 - TopSeller - 20H9 - 2 of 2	115
ThinkPad P70	82	ThinkPad T570 - TopSeller - 20JW	116
ThinkPad P70 Platform Specifications	83	ThinkPad T580	117
ThinkPad P70 - TopSeller - 20ER - 1 of 2	84	ThinkPad T580 Platform Specifications	118
ThinkPad P70 - TopSeller - 20ER - 2 of 2	85	ThinkPad T580 - TopSeller - 20L9 - 1 of 2	119
ThinkPad P71	86	ThinkPad T580 - TopSeller - 20L9 - 2 of 2	120
ThinkPad P71 Platform Specifications	87	X Series	121
ThinkPad P71 - TopSeller - 20HK - 1 of 3	88	ThinkPad X1 Carbon (5th Gen)	121
ThinkPad P71 - TopSeller - 20HK - 2 of 3	89	ThinkPad X1 Carbon (5th Gen) Platform Specifications	122
ThinkPad P71 - TopSeller - 20HK - 3 of 3	90	ThinkPad X1 Carbon (5th Gen) - TopSeller - 20HR - 1 of 2	123
T Series	91	ThinkPad X1 Carbon (5th Gen) - TopSeller - 20HR - 2 of 2	124
ThinkPad T470	91	ThinkPad X1 Carbon (5th Gen) - TopSeller - 20K4	125
ThinkPad T470 Platform Specifications	92	ThinkPad X1 Carbon (6th Gen)	126
ThinkPad T470 - TopSeller - 20HD - 1 of 2	93	ThinkPad X1 Carbon (6th Gen) Platform Specifications	127
ThinkPad T470 - TopSeller - 20HD - 2 of 2	94	ThinkPad X1 Carbon (6th Gen) - TopSeller - 20KH - 1 of 2	128
ThinkPad T470 - TopSeller - 20JM	95	ThinkPad X1 Carbon (6th Gen) - TopSeller - 20KH - 2 of 2	129
ThinkPad T470p	96	ThinkPad X270	130
ThinkPad T470p Platform Specifications	97	ThinkPad X270 Platform Specifications	131
ThinkPad T470p - TopSeller - 20J6	98	ThinkPad X270 - TopSeller - 20HN - 1 of 2	132
ThinkPad T470s	99	ThinkPad X270 - TopSeller - 20HN - 2 of 2	133
ThinkPad T470s Platform Specifications	100	ThinkPad X270 - TopSeller - 20K6	134

Contents

ThinkPad X280	135
ThinkPad X280 Platform Specifications	136
ThinkPad X280 - TopSeller - 20KF - 1 of 2	137
ThinkPad X280 - TopSeller - 20KF - 2 of 2	138
Legal Information	139

Summary of Changes

This section describes the technical changes made in this edition.

This edition might also include minor corrections and editorial changes which are not identified.

May 9, 2018 - Version 524

Additions in this update

▶ **New product(s)**

None

▶ **New model(s)**

ThinkPad L380 new models announced May 2018

ThinkPad L480 new models announced April and May 2018

ThinkPad L580 new models announced April and May 2018

ThinkPad T480 new models announced April 2018

ThinkPad T480s new models announced April and May 2018

ThinkPad T580 new models announced April and May 2018

ThinkPad X1 Carbon (6th Gen) new models announced May 2018

ThinkPad X280 new models announced May 2018

▶ **Others**

None

Withdrawals in this update

▶ **Withdrawn product(s)**

None



ThinkPad 11e (4th Gen) Platform Specifications

Product Specifications Reference (PSREF)

Processor	Intel® Celeron® processor or 7th Generation Intel Core™ i3 Processor								Media reader	4-in-1 reader (MMC, SD, SDHC, SDXC)
	Processor Number	# of Cores	# of Threads	Base Frequency	Burst Frequency	Cache	Memory Types	Processor Graphics	Ports	Two USB 3.1 Gen 1 (USB 3.0), HDMI 1.4b, Ethernet (RJ-45)
	Cel N3450	4	4	1.1 GHz	2.2 GHz	2MB	DDR3L-1600	Intel HD Graphics 500	Control buttons	Power button, volume control button
	i3-7100U	2	4	2.4 GHz	-	3MB	DDR4-2133	Intel HD Graphics 620	Camera	HD720p resolution, low light sensitive, fixed focus
Graphics	Intel HD Graphics 500 or 620 in processor, supports external digital monitor via HDMI™; supports dual independent display; Max resolution: 1920X1080 (HDMI) @60Hz								Audio support	HD Audio, Realtek® ALC3268 codec / stereo speakers, 2W x 2 / monaural digital microphone, combo audio/microphone jack
	Chipset	Intel SoC (System on Chip) platform								Keyboard
Memory	4GB or 8GB / 1600MHz DDR3L or 2133MHz DDR4, one DDR3L or DDR4 SO-DIMM socket								Touchpad	Buttonless touchpad below keyboard, multi-touch
Display	11.6" (295mm) HD (1366x768), anti-glare, LED backlight, 250 nits, 16:9 aspect ratio, 500:1 contrast ratio								Security	Power-on password, hard disk password, supervisor password, security keyhole
Multi-touch	None								Security chip	Discrete TPM 2.0, TCG Certified
Hinge	Normal hinge, 180 degree								vPro	None
Storage	M.2 Solid State Drive (SSD), SATA 6.0Gb/s								Fingerprint reader	None
Optical	None								Battery	Integrated Lithium Polymer 3-cell (42Wh)
Ethernet	Realtek RTL8111GUS-CG Gigabit Network Connection								Max battery life	MobileMark® 2014: 13.65 hr
WLAN	Intel Dual Band Wireless-AC 7265, Wi-Fi 2x2 802.11ac + BT4.1, M.2 card								AC adapter	45W slim tip AC adapter
Bluetooth™	Bluetooth 4.1 wireless, integrated in Wi-Fi + Bluetooth combo adapter								Preload	Some: Windows® 10 Home 64 Some: Windows 10 Pro 64 • Lenovo Companion • Lenovo Setting • Microsoft Office preloaded; purchase a product key to activate
WWAN	None								Limited warranty	One of the following, configurable by model: • 1-year depot repair service • 3-year/1-yr battery depot repair service
Dimensions	WxDxH: 11.81" x 8.27" x 0.88"; 300mm x 210mm x 22.3mm								Mil-Spec test	MIL-STD-810G military certification
Weight	Starting at 3.3 lb (1.52kg)								Environment	EPEAT™ Gold (US only); ENERGY STAR® 6.1; RoHS-compliant
Case color	Display cover: Graphite Black;				Bottom: Graphite Black					
Case material	Display cover: PC+40%GF+TPU;				Bottom: PC/ABS plastic					

Lenovo
March 2018

ThinkPad 11e (4th Gen) - TopSeller - 20HV

Product Specifications Reference (PSREF)

Model	Region	Processor	vPro	Graphics	Memory	Display	Multi-touch	Storage(HDD/SSD)	Optical	WLAN + Bluetooth	Color	Camera	Key-board	Finger-print Reader	TPM	Battery (internal)	Power Adapter	Operating System	Warranty	Ann Date (m/y)
20HV0000US	US	i3-7100U	No	Intel HD 620	8GBx1 DDR4-2133	11.6" HD (1366x768)	None	128GB SSD M.2	None	Intel 7265 ac, 2x2 + BT4.1	Black	720p	Non-backlit	None	dTPM 2.0	3-cell (42Wh)	45W Slim Tip	Win10 Pro 64	1-year, Depot	03/17
20HV0001US	US	i3-7100U	No	Intel HD 620	4GBx1 DDR4-2133	11.6" HD (1366x768)	None	128GB SSD M.2	None	Intel 7265 ac, 2x2 + BT4.1	Black	720p	Non-backlit	None	dTPM 2.0	3-cell (42Wh)	45W Slim Tip	Win10 Pro 64	1-year, Depot	03/17
20HV000MUS	US	Celeron N3450	No	Intel HD 500	4GBx1 DDR3L-1600	11.6" HD (1366x768)	None	128GB SSD M.2	None	Intel 7265 ac, 2x2 + BT4.1	Black	720p	Non-backlit	None	dTPM 2.0	3-cell (42Wh)	45W Slim Tip	Win10 Pro 64	1-year, Depot	03/17
20HV000VUS	US	Celeron N3450	No	Intel HD 500	8GBx1 DDR3L-1600	11.6" HD (1366x768)	None	128GB SSD M.2	None	Intel 7265 ac, 2x2 + BT4.1	Black	720p	Non-backlit	None	dTPM 2.0	3-cell (42Wh)	45W Slim Tip	Win10 Pro 64	1-year, Depot	03/17
20HV000XUS	US	Celeron N3450	No	Intel HD 500	8GBx1 DDR3L-1600	11.6" HD (1366x768)	None	256GB SSD M.2 Opal2	None	Intel 7265 ac, 2x2 + BT4.1	Black	720p	Non-backlit	None	dTPM 2.0	3-cell (42Wh)	45W Slim Tip	Win10 Pro 64	1-year, Depot	03/17
20HV0015US	US	i3-7100U	No	Intel HD 620	8GBx1 DDR4-2133	11.6" HD (1366x768)	None	256GB SSD M.2 Opal2	None	Intel 7265 ac, 2x2 + BT4.1	Black	720p	Non-backlit	None	dTPM 2.0	3-cell (42Wh)	45W Slim Tip	Win10 Pro 64	1-year, Depot	03/17



ThinkPad 11e (5th Gen) Platform Specifications

Product Specifications Reference (PSREF)

Processor	7th Generation Intel® Core™ m / i5 Processor, Intel Celeron® processor, or Intel Pentium® Silver processor								Dimensions	<i>WxDxH:</i> 11.81" x 8.27" x 0.86"; 300mm x 210mm x 21.9mm																																
									Weight	Starting at 2.99 lb (1.36 kg)																																
									Case color	Black																																
									Case material	<i>Display cover:</i> PC/ABS+GF; <i>Bottom:</i> PC/ABS plastic																																
									Media reader	MicroSD card reader																																
<table border="1"> <thead> <tr> <th>Processor Number</th> <th># of Cores</th> <th># of Threads</th> <th>Base Frequency</th> <th>Burst Frequency</th> <th>Cache</th> <th>Memory Types</th> <th>Processor Graphics</th> </tr> </thead> <tbody> <tr> <td>m3-7Y30</td> <td rowspan="2">2</td> <td rowspan="2">4</td> <td>1.0 GHz</td> <td>2.6 GHz</td> <td>4MB</td> <td rowspan="2">LPDDR3-1866</td> <td rowspan="2">Intel HD Graphics 615</td> </tr> <tr> <td>i5-7Y54</td> <td>1.2 GHz</td> <td>3.2 GHz</td> <td>4MB</td> </tr> <tr> <td>Cel N4100</td> <td rowspan="2">4</td> <td rowspan="2">4</td> <td>1.1 GHz</td> <td>2.4 GHz</td> <td>4MB</td> <td rowspan="2">DDR4-2400</td> <td>Intel UHD Graphics 600</td> </tr> <tr> <td>Pen N5000</td> <td>1.1 GHz</td> <td>2.7 GHz</td> <td>4MB</td> <td>Intel UHD Graphics 605</td> </tr> </tbody> </table>								Processor Number	# of Cores	# of Threads	Base Frequency	Burst Frequency	Cache	Memory Types	Processor Graphics	m3-7Y30	2	4	1.0 GHz	2.6 GHz	4MB	LPDDR3-1866	Intel HD Graphics 615	i5-7Y54	1.2 GHz	3.2 GHz	4MB	Cel N4100	4	4	1.1 GHz	2.4 GHz	4MB	DDR4-2400	Intel UHD Graphics 600	Pen N5000	1.1 GHz	2.7 GHz	4MB	Intel UHD Graphics 605	Ports	Two USB 3.1 Gen 1, one USB 3.1 Type-C Gen 1, HDMI 1.4b, Ethernet (RJ-45), headphone / microphone combo jack, microSD card reader, security keyhole
Processor Number	# of Cores	# of Threads	Base Frequency	Burst Frequency	Cache	Memory Types	Processor Graphics																																			
m3-7Y30	2	4	1.0 GHz	2.6 GHz	4MB	LPDDR3-1866	Intel HD Graphics 615																																			
i5-7Y54			1.2 GHz	3.2 GHz	4MB																																					
Cel N4100	4	4	1.1 GHz	2.4 GHz	4MB	DDR4-2400	Intel UHD Graphics 600																																			
Pen N5000			1.1 GHz	2.7 GHz	4MB		Intel UHD Graphics 605																																			
								Camera	HD720p camera, fixed focus																																	
								Audio support	HD Audio, Realtek® ALC3287 codec, Dolby® Audio™ / stereo speakers, 2W x 2 / monaural digital microphone, combo audio/microphone jack																																	
Graphics	Intel HD Graphics 615, Intel UHD Graphics 600 or 605 in processor, supports external digital monitor via HDMI or USB Type-C; supports dual independent display; Max resolution: 3840x2160@60Hz (USB Type-C); 4096x2160@30Hz (HDMI)								Keyboard	6-row, spill-resistant, multimedia Fn keys																																
Chipset	Intel SoC (System on Chip) platform								Touchpad	Buttonless Mylar surface touchpad below keyboard, multi-touch																																
Memory	4GB or 8GB / 1866MHz LPDDR3 or 2400MHz DDR4 / soldered to systemboard, no sockets								Security	Power-on password, supervisor password, security keyhole																																
Display	<i>Some:</i> 11.6" (295mm) HD (1366x768), anti-glare, LED backlight, 250 nits, 16:9 aspect ratio, 400:1 or 500:1 contrast ratio								Security chip	Discrete TPM 2.0, TCG Certified																																
	<i>Some:</i> 11.6" (295mm) HD (1366x768), anti-glare, LED backlight, IPS, multi-touch, 250 nits, 16:9 aspect ratio, 800:1 contrast ratio, 170° viewing angle								vPro	None																																
Multi-touch	Capacitive-type multi-touch, supports 10-finger gesture (HD IPS only)								Fingerprint reader	None																																
Storage	eMMC flash memory on board or M.2 SSD / PCIe NVMe, PCIe 3.0 x 2, 16Gb/s								NFC	None																																
Optical	None								Battery	Integrated Li-Ion 42Wh battery																																
Ethernet	Realtek RTL8111GUS Gigabit Network Connection								Max battery life	<i>MobileMark® 2014:</i> 13.9 hr																																
WLAN + Bluetooth™	<i>One of the following, configurable by model:</i> • Intel Wireless-AC 9260, Wi-Fi 2x2 802.11ac + Bluetooth 5.0, M.2 card • Intel Wireless-AC 9560, Wi-Fi 2x2 802.11ac + Bluetooth 5.0, M.2 card (US only)								AC adapter	45W or 65W slim tip AC adapter																																
WWAN	None								Preload	Windows® 10 Home 64 or Windows 10 Pro 64																																
								Limited warranty	<i>One of the following, configurable by model:</i> • 1-year depot repair service • 3-year/1-yr battery depot repair service																																	
								Mil-Spec test	MIL-STD-810G military certification																																	
								Environment	EPEAT™ Gold; ENERGY STAR® 6.1; RoHS-compliant																																	

ThinkPad 11e (5th Gen) - TopSeller - 20LQ

Product Specifications Reference (PSREF)

Model	Region	Processor	vPro	Graphics	Memory	Display	Multi-touch	Storage(HDD/SSD)	Optical	WLAN + Bluetooth	Camera	Key-board	Finger-print Reader	NFC	TPM	Battery (internal)	Power Adapter	Operating System	Warranty	Ann Date (m/y)
20LQ0001US	US	m3-7Y30	No	Intel HD 615	4GBx1 LPDDR3-1866	11.6" HD (1366x768)	None	128GB SSD M.2 PCIe NVMe	None	Intel 9260 ac, 2x2 + BT5.0	720p	Non-backlit	None	None	dTPM 2.0	3-cell (42Wh)	45W Slim Tip	Win10 Pro 64	1-year, Depot	03/18
20LQ0002US	US	m3-7Y30	No	Intel HD 615	4GBx1 LPDDR3-1866	11.6" HD (1366x768) IPS	10-point Multi-touch	128GB SSD M.2 PCIe NVMe	None	Intel 9260 ac, 2x2 + BT5.0	720p	Non-backlit	None	None	dTPM 2.0	3-cell (42Wh)	45W Slim Tip	Win10 Pro 64	1-year, Depot	03/18
20LQ0007US	US	m3-7Y30	No	Intel HD 615	4GBx1 LPDDR3-1866	11.6" HD (1366x768)	None	256GB SSD M.2 PCIe NVMe	None	Intel 9260 ac, 2x2 + BT5.0	720p	Non-backlit	None	None	dTPM 2.0	3-cell (42Wh)	45W Slim Tip	Win10 Pro 64	1-year, Depot	03/18
20LQ000GUS	US	Celeron N4100	No	Intel UHD 600	4GBx1 DDR4-2400	11.6" HD (1366x768)	None	128GB eMMC	None	Intel 9260 ac, 2x2 + BT5.0	720p	Non-backlit	None	None	dTPM 2.0	3-cell (42Wh)	45W Slim Tip	Win10 Pro 64	1-year, Depot	02/18
20LQ000HUS	US	Celeron N4100	No	Intel UHD 600	4GBx1 DDR4-2400	11.6" HD (1366x768)	None	128GB SSD M.2 PCIe NVMe	None	Intel 9260 ac, 2x2 + BT5.0	720p	Non-backlit	None	None	dTPM 2.0	3-cell (42Wh)	45W Slim Tip	Win10 Pro 64	1-year, Depot	02/18
20LQ000JUS	US	Celeron N4100	No	Intel UHD 600	4GBx1 DDR4-2400	11.6" HD (1366x768) IPS	10-point Multi-touch	128GB SSD M.2 PCIe NVMe	None	Intel 9260 ac, 2x2 + BT5.0	720p	Non-backlit	None	None	dTPM 2.0	3-cell (42Wh)	45W Slim Tip	Win10 Pro 64	1-year, Depot	02/18
20LQ000KUS	US	Celeron N4100	No	Intel UHD 600	4GBx1 DDR4-2400	11.6" HD (1366x768) IPS	10-point Multi-touch	128GB eMMC	None	Intel 9260 ac, 2x2 + BT5.0	720p	Non-backlit	None	None	dTPM 2.0	3-cell (42Wh)	45W Slim Tip	Win10 Pro 64	1-year, Depot	02/18
20LQ000LUS	US	Celeron N4100	No	Intel UHD 600	8GBx1 DDR4-2400	11.6" HD (1366x768)	None	128GB SSD M.2 PCIe NVMe	None	Intel 9260 ac, 2x2 + BT5.0	720p	Non-backlit	None	None	dTPM 2.0	3-cell (42Wh)	45W Slim Tip	Win10 Pro 64	1-year, Depot	02/18
20LQ000MUS	US	Pentium N5000	No	Intel UHD 605	8GBx1 DDR4-2400	11.6" HD (1366x768)	None	128GB SSD M.2 PCIe NVMe	None	Intel 9260 ac, 2x2 + BT5.0	720p	Non-backlit	None	None	dTPM 2.0	3-cell (42Wh)	45W Slim Tip	Win10 Pro 64	1-year, Depot	02/18
20LQ000NUS	US	Pentium N5000	No	Intel UHD 605	8GBx1 DDR4-2400	11.6" HD (1366x768) IPS	10-point Multi-touch	256GB SSD M.2 PCIe NVMe	None	Intel 9260 ac, 2x2 + BT5.0	720p	Non-backlit	None	None	dTPM 2.0	3-cell (42Wh)	45W Slim Tip	Win10 Pro 64	1-year, Depot	03/18



ThinkPad 11e Chromebook (4th Gen) Platform Specifications

Product Specifications Reference (PSREF)

Processor	Intel® Celeron® Processor								Dimensions	<i>WxDxH:</i> 11.81" x 8.27" x 0.90"; 300mm x 210mm x 22.8mm
	Processor Number	# of Cores	# of Threads	Base Frequency	Burst Frequency	Cache	Memory Types	Processor Graphics	Weight	Starting at 3.2 lb (1.45kg)
	Cel N3450	4	4	1.1 GHz	2.2 GHz	2MB	LPDDR4-2400	Intel HD Graphics 500	Case color	<i>Display cover:</i> Graphite Black; <i>Bottom:</i> Graphite Black
									Case material	<i>Display cover:</i> PC+40%GF+TPU; <i>Bottom:</i> PC/ABS plastic
Graphics	Intel HD Graphics 500 in processor								Media reader	MicroSD card reader (MMC, SD, SDHC, SDXC)
Chipset	Intel SoC (System on Chip) platform								Ports	One USB 3.1 Gen 1 (USB 3.0), two USB Type-C
Memory	4GB / 3200MHz LPDDR4 / soldered to systemboard, no sockets * System clocks down for processors with lower memory controller								Control buttons	None
Display	11.6" (295mm) HD (1366x768), anti-glare, LED backlight, 250 nits, 16:9 aspect ratio, 500:1 contrast ratio								Camera	HD720p resolution, low light sensitive, fixed focus
Multi-touch	None								Audio support	Dialog Semiconductor DA7219 audio codec / stereo speakers, 2W x 2 / monaural digital microphone, combo audio/microphone jack
Hinge	Normal hinge, 180 degree								Keyboard	ThinkPad Chrome keyboard, 6-row, multimedia Fn keys
Storage	32GB eMMC (embedded Multi Media Card) flash memory on board								Touchpad	Buttonless touchpad below keyboard, multi-touch
Optical	None								Security	Security keyhole
Ethernet	None								Security chip	Discrete TPM 2.0, TCG Certified
WLAN	Intel Dual Band Wireless-AC 7265, Wi-Fi 2x2 802.11ac + BT4.1, M.2 card								vPro	None
Bluetooth™	Bluetooth 4.1 wireless, integrated in Wi-Fi + Bluetooth combo adapter								Fingerprint reader	None
WWAN	None								Battery	Integrated Lithium Polymer 3-cell (42Wh)
								Max battery life	Up to 11.84 hr	
								AC adapter	45W USB Type-C AC adapter	
								Preload	Google Chrome OS	
								Limited warranty	1-year depot repair service	
								Mil-Spec test	MIL-STD-810G military certification	
								Environment	EPEAT™ Gold (US only); ENERGY STAR® 6.1; RoHS-compliant	

Lenovo
July 2017

ThinkPad 11e Chromebook (4th Gen) - TopSeller - 20J0

Product Specifications Reference (PSREF)

Model	Region	Processor	vPro	Graphics	Memory (Soldered)	Display	Multi-touch	Storage	Optical	WLAN + Bluetooth	Color	Camera	Key-board	Finger-print Reader	TPM	Battery (internal)	Power Adapter	Operating System	Warranty	Ann Date (m/y)
20J00000US	US	Celeron N3450	No	Intel HD 500	4GB Soldered	11.6" HD (1366x768)	None	32GB eMMC	None	Intel 7265 ac, 2x2 + BT4.1	Black	720p	Non-backlit	None	dTPM 2.0	3-cell (42Wh)	45W USB-C	Chrome OS	1-year, Depot	04/17



ThinkPad 13 (2nd Gen) Platform Specifications

Product Specifications Reference (PSREF)

Processor	Intel® Celeron® Processor or 7th Generation Intel Core™ i3 / i5 / i7 Processor								Smart card reader	None
	Processor Number	# of Cores	# of Threads	Base Frequency	Max Turbo Frequency	Cache	Memory Types	Processor Graphics	Media reader Ports	4-in-1 reader (MMC, SD, SDHC, SDXC) Three USB 3.1 Gen 1 (USB 3.0, one Always On), one USB Type-C, HDMI, Lenovo OneLink+ connector
	Cel 3865U	2	4	1.8 GHz	-	2MB	DDR4-2133	Intel HD Graphics 610	Camera Audio support	HD720p resolution, low light sensitive, fixed focus HD Audio, Realtek® ALC3268 codec / stereo speakers, 2W x 2 / dual array microphone, combo audio/microphone jack
	i3-7100U			2.4 GHz	-	3MB		Intel HD Graphics 620		
	i5-7200U			2.5 GHz	3.1 GHz	3MB				
	i5-7300U			2.6 GHz	3.5 GHz	3MB				
i7-7500U	2.7 GHz			3.5 GHz	4MB					
Graphics	Intel HD Graphics 610 or 620 in processor, supports external digital monitor via HDMI or USB Type-C; supports three independent displays; Max resolution: 1920x1080 (HDMI)@60Hz, 3840x2160 (USB Type-C)@60Hz								Security	Power-on password, hard disk password, supervisor password, security keyhole
Chipset	Intel SoC (System on Chip) platform								Security chip	Discrete TPM 2.0, TCG Certified
Memory	32GB max / 2133MHz DDR4, two DDR4 SO-DIMM sockets								vPro (optional)	Intel vPro Technology
Display	<i>Some:</i> 13.3" (338mm) HD (1366x768), anti-glare, LED backlight, 250 nits, 16:9 aspect ratio, 500:1 contrast ratio <i>Some:</i> 13.3" (338mm) FHD (1920x1080), anti-glare, LED backlight, IPS, 250 nits, 16:9 aspect ratio, 700:1 contrast ratio, 170° viewing angle								Fingerprint reader	<i>Optional:</i> swipe style fingerprint reader on the palm rest
Multi-touch (opt)	On-cell touch, supports 10-finger gesture (FHD only)								Battery	Integrated Lithium Polymer 3-cell (42Wh)
Storage	<i>One of the following, configurable by model:</i> <ul style="list-style-type: none"> M.2 SSD / SATA 6.0Gb/s (e.g. xxxGB SSD M.2) M.2 SSD / PCIe NVMe, PCIe 3.0 x 4, 32Gb/s (e.g. xxxGB SSD M.2 PCIe NVMe) 								Max battery life	<i>MobileMark® 2014:</i> 14.56 hr
Optical	None								AC adapter	45W slim tip AC adapter
Ethernet	Gigabit Ethernet via the accessional ThinkPad OneLink+ to RJ45 Adapter (4X90K06975) or ThinkPad OneLink+ to VGA/RJ45 adapter (4X90J31060) (by native Intel Ethernet Connection I219-V (Non-vPro) or I219-LM (vPro))								Preload	<i>Some:</i> Windows® 10 Home 64 <i>Some:</i> Windows 10 Pro 64 <ul style="list-style-type: none"> Lenovo Companion Lenovo Setting Microsoft Office preloaded; purchase a product key to activate
WLAN	Intel Dual Band Wireless-AC 8265, Wi-Fi 2x2 802.11ac + BT4.1, M.2 card								Limited warranty	<i>One of the following, configurable by model:</i> <ul style="list-style-type: none"> 1-year depot repair service 3-year/1-yr battery depot repair service 3-year/1-yr battery limited onsite service
Bluetooth™	Bluetooth 4.1 wireless, integrated in Wi-Fi + Bluetooth combo adapter * Intel 8265ac card supports Bluetooth 4.2 but is limited to BT 4.1 by Windows OS								Mil-Spec test	MIL-STD-810G military certification
WWAN	None								Environment	EPEAT™ Gold (US only); ENERGY STAR® 6.1; RoHS-compliant
Dimensions	<i>WxDxH (silver):</i> 12.69" x 8.77" x 0.75"; 322.4mm x 222.8mm x 19.1mm <i>WxDxH (black):</i> 12.69" x 8.77" x 0.78"; 322.4mm x 222.8mm x 19.8mm									
Weight	Starting at 3.17 lb / 1.44 kg									
Case color	Pure Black or Silver									
Case material	<i>Black cover:</i> PC/ABS plastic; <i>Silver cover:</i> Aluminum									

Model	Region	Processor	vPro	Graphics	Memory	Display	Multi-touch	Storage(HDD/SSD)	Optical	WLAN + Bluetooth	Color	Camera	Keyboard	Fingerprint Reader	TPM	Battery (internal)	Power Adapter	Operating System	Warranty	Ann Date (m/y)
20J10006US	US	i3-7100U	No	Intel HD 620	4GBx1	13.3" HD (1366x768)	None	128GB SSD M.2	None	Intel 8265 ac, 2x2 + BT4.1	Black	720p	Non-backlit	Fingerprint Reader	dTPM 2.0	3-cell (42Wh)	45W Slim Tip	Windows 10 Pro 64	1-year, Depot	12/16
20J1000AUS	US	i5-7200U	No	Intel HD 620	4GBx1	13.3" HD (1366x768)	None	256GB SSD M.2 Opal2	None	Intel 8265 ac, 2x2 + BT4.1	Black	720p	Non-backlit	Fingerprint Reader	dTPM 2.0	3-cell (42Wh)	45W Slim Tip	Windows 10 Pro 64	1-year, Depot	12/16
20J1000EUS	US	i5-7200U	No	Intel HD 620	8GBx1	13.3" HD (1366x768)	None	256GB SSD M.2 Opal2	None	Intel 8265 ac, 2x2 + BT4.1	Black	720p	Non-backlit	Fingerprint Reader	dTPM 2.0	3-cell (42Wh)	45W Slim Tip	Windows 10 Pro 64	1-year, Depot	12/16
20J1001BUS	US	i3-7100U	No	Intel HD 620	4GBx1	13.3" FHD (1920x1080) IPS	10-point Multi-touch	128GB SSD M.2	None	Intel 8265 ac, 2x2 + BT4.1	Black	720p	Non-backlit	Fingerprint Reader	dTPM 2.0	3-cell (42Wh)	45W Slim Tip	Windows 10 Pro 64	1-year, Depot	12/16
20J1001CUS	US	i5-7200U	No	Intel HD 620	8GBx1	13.3" FHD (1920x1080) IPS	10-point Multi-touch	256GB SSD M.2 Opal2	None	Intel 8265 ac, 2x2 + BT4.1	Black	720p	Backlit	Fingerprint Reader	dTPM 2.0	3-cell (42Wh)	45W Slim Tip	Windows 10 Pro 64	3-year, Depot	12/16
20J1001DUS	US	i5-7200U	No	Intel HD 620	4GBx1	13.3" FHD (1920x1080) IPS	10-point Multi-touch	128GB SSD M.2	None	Intel 8265 ac, 2x2 + BT4.1	Black	720p	Non-backlit	Fingerprint Reader	dTPM 2.0	3-cell (42Wh)	45W Slim Tip	Windows 10 Pro 64	1-year, Depot	12/16
20J1001EUS	US	i3-7100U	No	Intel HD 620	4GBx1	13.3" FHD (1920x1080) IPS	10-point Multi-touch	128GB SSD M.2	None	Intel 8265 ac, 2x2 + BT4.1	Silver	720p	Non-backlit	None	dTPM 2.0	3-cell (42Wh)	45W Slim Tip	Windows 10 Pro 64	1-year, Depot	12/16
20J1001FUS	US	i5-7200U	No	Intel HD 620	4GBx1	13.3" HD (1366x768)	None	128GB SSD M.2	None	Intel 8265 ac, 2x2 + BT4.1	Silver	720p	Non-backlit	None	dTPM 2.0	3-cell (42Wh)	45W Slim Tip	Windows 10 Pro 64	1-year, Depot	12/16
20J1001GUS	US	i5-7200U	No	Intel HD 620	8GBx1	13.3" FHD (1920x1080) IPS	10-point Multi-touch	256GB SSD M.2 Opal2	None	Intel 8265 ac, 2x2 + BT4.1	Silver	720p	Backlit	None	dTPM 2.0	3-cell (42Wh)	45W Slim Tip	Windows 10 Pro 64	3-year, Depot	12/16
20J1001HUS	US	i3-7100U	No	Intel HD 620	4GBx1	13.3" HD (1366x768)	None	128GB SSD M.2	None	Intel 8265 ac, 2x2 + BT4.1	Silver	720p	Non-backlit	None	dTPM 2.0	3-cell (42Wh)	45W Slim Tip	Windows 10 Pro 64	1-year, Depot	12/16
20J1001JUS	US	i5-7200U	No	Intel HD 620	8GBx1	13.3" FHD (1920x1080) IPS	10-point Multi-touch	256GB SSD M.2 Opal2	None	Intel 8265 ac, 2x2 + BT4.1	Silver	720p	Non-backlit	None	dTPM 2.0	3-cell (42Wh)	45W Slim Tip	Windows 10 Pro 64	1-year, Depot	12/16
20J10022US	US	i5-7200U	No	Intel HD 620	4GBx1	13.3" HD (1366x768)	None	180GB SSD M.2	None	Intel 8265 ac, 2x2 + BT4.1	Black	720p	Non-backlit	Fingerprint Reader	dTPM 2.0	3-cell (42Wh)	45W Slim Tip	Windows 10 Pro 64	1-year, Depot	01/17
20J10023US	US	i3-7100U	No	Intel HD 620	4GBx1	13.3" HD (1366x768)	None	180GB SSD M.2	None	Intel 8265 ac, 2x2 + BT4.1	Black	720p	Non-backlit	Fingerprint Reader	dTPM 2.0	3-cell (42Wh)	45W Slim Tip	Windows 10 Pro 64	1-year, Depot	01/17
20J10024US	US	i5-7300U	vPro	Intel HD 620	4GBx1	13.3" HD (1366x768)	None	180GB SSD M.2	None	Intel 8265 ac, 2x2 + BT4.1	Black	720p	Non-backlit	Fingerprint Reader	dTPM 2.0	3-cell (42Wh)	45W Slim Tip	Windows 10 Pro 64	3-year, Depot	03/17
20J10025US	US	i5-7300U	vPro	Intel HD 620	8GBx1	13.3" FHD (1920x1080) IPS	10-point Multi-touch	256GB SSD M.2 Opal2	None	Intel 8265 ac, 2x2 + BT4.1	Black	720p	Backlit	Fingerprint Reader	dTPM 2.0	3-cell (42Wh)	45W Slim Tip	Windows 10 Pro 64	3-year, Depot	03/17
20J10045US	US	Celeron 3865U	No	Intel HD 610	4GBx1	13.3" HD (1366x768)	None	128GB SSD M.2	None	Intel 8265 ac, 2x2 + BT4.1	Silver	720p	Non-backlit	None	dTPM 2.0	3-cell (42Wh)	45W Slim Tip	Windows 10 Pro 64	3-year, Depot	03/17
20J10046US	US	Celeron 3865U	No	Intel HD 610	4GBx1	13.3" HD (1366x768)	None	128GB SSD M.2	None	Intel 8265 ac, 2x2 + BT4.1	Black	720p	Non-backlit	Fingerprint Reader	dTPM 2.0	3-cell (42Wh)	45W Slim Tip	Windows 10 Pro 64	1-year, Depot	03/17
20J10047US	US	Celeron 3865U	No	Intel HD 610	4GBx1	13.3" FHD (1920x1080) IPS	10-point Multi-touch	128GB SSD M.2	None	Intel 8265 ac, 2x2 + BT4.1	Black	720p	Non-backlit	Fingerprint Reader	dTPM 2.0	3-cell (42Wh)	45W Slim Tip	Windows 10 Pro 64	3-year, Depot	03/17
20J10048US	US	Celeron 3865U	No	Intel HD 610	4GBx1	13.3" HD (1366x768)	None	128GB SSD M.2	None	Intel 8265 ac, 2x2 + BT4.1	Black	720p	Non-backlit	Fingerprint Reader	dTPM 2.0	3-cell (42Wh)	45W Slim Tip	Windows 10 Pro 64	3-year, Depot	03/17
20J10049US	US	Celeron 3865U	No	Intel HD 610	4GBx1	13.3" FHD (1920x1080) IPS	10-point Multi-touch	128GB SSD M.2	None	Intel 8265 ac, 2x2 + BT4.1	Silver	720p	Non-backlit	None	dTPM 2.0	3-cell (42Wh)	45W Slim Tip	Windows 10 Pro 64	3-year, Depot	03/17

Model	Region	Processor	vPro	Graphics	Memory	Display	Multi-touch	Storage(HDD/SSD)	Optical	WLAN + Bluetooth	Color	Camera	Keyboard	Fingerprint Reader	TPM	Battery (internal)	Power Adapter	Operating System	Warranty	Ann Date (m/y)
20J1004AUS	US	Celeron 3865U	No	Intel HD 610	4GBx1	13.3" FHD (1920x1080) IPS	10-point Multi-touch	128GB SSD M.2	None	Intel 8265 ac, 2x2 + BT4.1	Black	720p	Non-backlit	Fingerprint Reader	dTPM 2.0	3-cell (42Wh)	45W Slim Tip	Windows 10 Pro 64	1-year, Depot	03/17
20J1004BUS	US	Celeron 3865U	No	Intel HD 610	4GBx2	13.3" FHD (1920x1080) IPS	10-point Multi-touch	128GB SSD M.2	None	Intel 8265 ac, 2x2 + BT4.1	Black	720p	Backlit	Fingerprint Reader	dTPM 2.0	3-cell (42Wh)	45W Slim Tip	Windows 10 Pro 64	3-year, Depot	03/17
20J1004CUS	US	Celeron 3865U	No	Intel HD 610	4GBx2	13.3" HD (1366x768)	None	128GB SSD M.2	None	Intel 8265 ac, 2x2 + BT4.1	Black	720p	Backlit	Fingerprint Reader	dTPM 2.0	3-cell (42Wh)	45W Slim Tip	Windows 10 Pro 64	3-year, Depot	03/17



ThinkPad 13 Chromebook Platform Specifications

Product Specifications Reference (PSREF)

Processor	Intel® Celeron® Processor or 6th Generation Intel Core™ i3 / i5 Processor							Dimensions ³	<i>WxDxH:</i> 12.69" x 8.77" x 0.78"; 322.4mm x 222.8mm x 19.8mm
	Processor Number	# of Cores	# of Threads	Base Frequency	Max Turbo Frequency	Cache	Memory Types	Processor Graphics	Weight ² Starting at 3.1 lb / 1.41 kg
	Cel 3855U	2	2	1.6 GHz	-	2MB	LPDDR3-1866	Intel HD graphics 510	Case color Pure Black
	i3-6100U		4	2.3 GHz	-	3MB		Intel HD graphics 520	Case material PC/ABS plastic
i5-6300U	4		2.4 GHz	3.0 GHz	3MB				
								Smart card reader None	
								Media reader 4-in-1 reader (MMC, SD, SDHC, SDXC)	
								Ports Two USB 3.0 (Always On), two USB Type-C	
Graphics	Intel HD Graphics 510 or 520 in processor, supports external digital monitor via USB Type-C; supports three independent displays; Max resolution: 3840X2160 (USB Type-C) @60Hz							Camera	HD720p resolution, low light sensitive, fixed focus
								Audio support	HD Audio, Nuvoton NAU88L25B codec / stereo speakers, 2W x 2 / dual array microphone, combo audio/microphone jack
Chipset	Intel SoC (System on Chip) platform							Keyboard	ThinkPad Chrome keyboard, 6-row, multimedia Fn keys
Memory	4GB or 8GB / 1866MHz LPDDR3 / soldered to systemboard, no sockets							Touchpad	Buttonless touchpad below keyboard, multi-touch
Display	<i>Some:</i> 13.3" (338mm) HD (1366x768), anti-glare, LED backlight, 200 nits, 16:9 aspect ratio, 500:1 contrast ratio <i>Some:</i> 13.3" (338mm) FHD (1920x1080), anti-glare, LED backlight, IPS, 220 nits, 16:9 aspect ratio, 700:1 contrast ratio, 170° viewing angle <i>Some:</i> 13.3" (338mm) FHD (1920x1080), glossy, LED backlight, IPS, multi-touch, 250 nits, 16:9 aspect ratio, 800:1 contrast ratio, 170° viewing angle							Security	Security keyhole
								Security chip	Discrete TPM 1.2, TCG Certified
								vPro	None
Multi-touch (opt)	Capacitive-type multi-touch, supports 10-finger gesture							Fingerprint reader	None
								Battery	Integrated Lithium Polymer 3-cell (42Wh)
Storage	16GB or 32GB eMMC (embedded Multi Media Card) flash memory on board							Max battery life ¹⁰	10 hr
Optical	None							AC adapter	45W USB Type-C AC adapter
Ethernet	None							Preload	Google Chrome OS
WLAN ⁴	11ac+BT, Intel Dual Band Wireless-AC 7265, 2x2, M.2 card							Limited warranty ¹²	1-year depot repair service
Bluetooth™	Bluetooth 4.0 wireless, integrated in Wi-Fi + Bluetooth combo adapter							Mil-Spec test	MIL-STD-810G military certification
WWAN	None							Environment	EPEAT™ Gold (US only); ENERGY STAR® 6.1; RoHS-compliant

ThinkPad 13 Chromebook - TopSeller - 20GL

Product Specifications Reference (PSREF)

Model	Region	Processor	vPro	Graphics	Storage	Memory (Soldered)	Display	Multi-touch	Optical	WLAN + Bluetooth	Color	Camera	Keyboard	Fingerprint Reader	TPM	Battery (internal)	Power Adapter	Operating System	Warranty	Ann Date (m/y)
20GL0000US	US	Celeron 3855U	No	Intel HD 510	16GB eMMC	4GB Soldered	13.3" HD (1366x768) Anti-glare	None	None	Intel 7265 ac, 2x2 + BT4.0	Black	720p	Non-backlit	None	dTPM 1.2	3-cell (42Wh)	45W USB-C	Chrome OS	1-year, Depot	05/16
20GL0002US	US	i3-6100U	No	Intel HD 520	16GB eMMC	4GB Soldered	13.3" HD (1366x768) Anti-glare	None	None	Intel 7265 ac, 2x2 + BT4.0	Black	720p	Non-backlit	None	dTPM 1.2	3-cell (42Wh)	45W USB-C	Chrome OS	1-year, Depot	05/16
20GL0004US	US	i5-6300U	No	Intel HD 520	32GB eMMC	8GB Soldered	13.3" FHD (1920x1080) IPS Anti-glare	None	None	Intel 7265 ac, 2x2 + BT4.0	Black	720p	Non-backlit	None	dTPM 1.2	3-cell (42Wh)	45W USB-C	Chrome OS	1-year, Depot	05/16
20GL0005US	US	i5-6300U	No	Intel HD 520	32GB eMMC	8GB Soldered	13.3" HD (1366x768) Anti-glare	None	None	Intel 7265 ac, 2x2 + BT4.0	Black	720p	Non-backlit	None	dTPM 1.2	3-cell (42Wh)	45W USB-C	Chrome OS	1-year, Depot	05/16
20GL0006US	US	Celeron 3855U	No	Intel HD 510	16GB eMMC	4GB Soldered	13.3" FHD (1920x1080) IPS Glossy	10-point Multi-touch	None	Intel 7265 ac, 2x2 + BT4.0	Black	720p	Non-backlit	None	dTPM 1.2	3-cell (42Wh)	45W USB-C	Chrome OS	1-year, Depot	10/16
20GL0007US	US	i5-6300U	No	Intel HD 520	32GB eMMC	8GB Soldered	13.3" FHD (1920x1080) IPS Glossy	10-point Multi-touch	None	Intel 7265 ac, 2x2 + BT4.0	Black	720p	Non-backlit	None	dTPM 1.2	3-cell (42Wh)	45W USB-C	Chrome OS	1-year, Depot	10/16
20GL0008US	US	i3-6100U	No	Intel HD 520	16GB eMMC	4GB Soldered	13.3" FHD (1920x1080) IPS Glossy	10-point Multi-touch	None	Intel 7265 ac, 2x2 + BT4.0	Black	720p	Non-backlit	None	dTPM 1.2	3-cell (42Wh)	45W USB-C	Chrome OS	1-year, Depot	10/16



ThinkPad A275 Platform Specifications

Product Specifications Reference (PSREF)

Processor	AMD PRO A-Series APUs								Smart card reader	<i>Optional:</i> Smart card reader								
	Processor Number	# of Cores	# of Threads	Base Frequency	Max Turbo Frequency	Cache	Memory Types	Processor Graphics	Media reader Ports	4-in-1 reader (MMC, SD, SDHC, SDXC) Two USB 3.1 Gen 1 (USB 3.0, one Always On), USB 3.1 Type-C Gen 1, HDMI 1.4b, Ethernet (RJ-45)								
	PRO A10-8730B	4	4	2.4 GHz	3.3 GHz	2MB	DDR4-1866	AMD Radeon™ R5 Graphics	Monitor cable (<i>optional</i>)	<i>HDMI to VGA:</i> Lenovo HDMI to VGA Monitor Adapter <i>USB-C to VGA:</i> Lenovo USB-C to VGA Adapter <i>USB-C to DP:</i> Lenovo USB-C to DisplayPort Adapter								
	PRO A12-8830B			2.5 GHz	3.4 GHz			AMD Radeon R7 Graphics										
	PRO A10-9700B			2.5 GHz	3.4 GHz													
PRO A12-9800B	2.7 GHz			3.6 GHz														
* Windows 7 is only supported by PRO A10-8730B and PRO A12-8830B																		
Graphics	AMD Radeon R5 or R7 Graphics in processor only; supports external digital monitor via HDMI or USB Type-C; supports three independent displays; Max resolution: 4096x2160@60Hz (USB Type-C); 4096x2160@30Hz (HDMI)								Keyboard	6-row, spill-resistant, multimedia Fn keys, optional LED backlight								
Chipset	AMD SoC (System on Chip) platform								UltraNav™	TrackPoint® pointing device and buttonless Mylar surface multi-touch touchpad								
Memory	16GB max / 1866MHz DDR4, one DDR4 SO-DIMM socket								Security chip	Power-on password, hard disk password, supervisor password, security keyhole <i>dTPM 1.2:</i> discrete TPM 1.2, TCG Certified <i>dTPM 2.0:</i> discrete TPM 2.0, TCG Certified								
Display	<i>Some:</i> 12.5" (317.5mm) HD (1366x768), anti-glare, LED backlight, 220 nits, 16:9 aspect ratio, 500:1 contrast ratio <i>Some:</i> 12.5" (317.5mm) FHD (1920x1080), anti-glare, LED backlight, IPS, 300 nits, 16:9 aspect ratio, 700:1 contrast ratio, 170° viewing angle								Fingerprint reader	<i>Optional:</i> Touch style match on chip fingerprint reader on the palm rest								
Multi-touch (<i>opt</i>)	On-cell touch, supports 10-finger gesture (FHD only, US only)								NFC	None								
Storage	<i>System has one HDD slot or one M.2 2280 slot exclusively for storage</i> <i>Some:</i> HDD / SATA 6.0Gb/s, 2.5" wide, 7mm high, Active Protection System™ <i>Some:</i> SSD / SATA 6.0Gb/s, 2.5" wide, 7mm high (e.g. xxxGB SSD) <i>Some:</i> M.2 SSD / PCIe NVMe, PCIe 3.0 x 2, 16Gb/s								Internal battery	<i>Optional:</i> Integrated Li-Ion or Li-Polymer 3-cell (23Wh)								
Optical	None								External battery	Li-Ion 3-cell (23Wh) or 6-cell (48Wh)								
Ethernet	Realtek® RTL8111EPV Gigabit Ethernet connection								Max battery life (<i>MobileMark® 2014</i>)	<table border="1"> <thead> <tr> <th>Models</th> <th>No + 3-cell</th> <th>3-cell + 3-cell</th> <th>3-cell + 6-cell 48Wh</th> </tr> </thead> <tbody> <tr> <td></td> <td>5.05 hr</td> <td>10.1 hr</td> <td>15.6 hr</td> </tr> </tbody> </table>	Models	No + 3-cell	3-cell + 3-cell	3-cell + 6-cell 48Wh		5.05 hr	10.1 hr	15.6 hr
Models	No + 3-cell	3-cell + 3-cell	3-cell + 6-cell 48Wh															
	5.05 hr	10.1 hr	15.6 hr															
WLAN	Realtek RTL8822BE, Wi-Fi 2x2 802.11ac + BT4.1, M.2 card								AC adapter	45W slim tip AC adapter or 45W USB Type-C AC adapter								
Bluetooth™	Bluetooth 4.1 wireless, integrated in Wi-Fi + Bluetooth combo adapter * WLAN card supports BT4.2 but is limited to BT4.1 by Windows OS								Preload	Windows® 7 Professional 64 preinstalled through downgrade rights in Windows 10 Pro 64 • Lenovo Solution Center • Lenovo PowerEngage • ThinkVantage Product Recovery • ThinkVantage System Update • Adobe® Reader® • Microsoft® Office preloaded; purchase a product key to activate • McAfee® LiveSafe™ (30-day trial)								
WWAN (<i>optional</i>)	<i>One of the following, configurable by model:</i> • Wireless WAN upgradable • Integrated Mobile Broadband 4G LTE-A, Qualcomm® Snapdragon™ X7 LTE-A (Sierra Wireless EM7455)								AC adapter	45W slim tip AC adapter or 45W USB Type-C AC adapter								
SIM card (<i>opt</i>)	Micro-SIM card slot, opt Verizon LTE (US) SIM card								Limited warranty	<i>One of the following, configurable by model:</i> • 1-year depot repair service • 3-year/1-yr battery depot repair service • 3-year/1-yr battery limited onsite service								
Dimensions	<i>WxDxH:</i> 12.03" x 8.21" x 0.80"; 305.5mm x 208.5mm x 20.3mm								Mil-Spec test	MIL-STD-810G military certification								
Weight	<table border="1"> <thead> <tr> <th>Models</th> <th>No + 3-cell</th> <th>3-cell + 3-cell</th> <th>3 + 6-cell</th> </tr> </thead> <tbody> <tr> <td><i>Weight</i></td> <td>2.79 lb / 1.27 kg</td> <td>2.98 lb / 1.36 kg</td> <td>3.33 lb / 1.52 kg</td> </tr> </tbody> </table>								Models	No + 3-cell	3-cell + 3-cell	3 + 6-cell	<i>Weight</i>	2.79 lb / 1.27 kg	2.98 lb / 1.36 kg	3.33 lb / 1.52 kg	Environment	EPEAT™ Gold (US only); ENERGY STAR® 6.1; RoHS-compliant
Models	No + 3-cell	3-cell + 3-cell	3 + 6-cell															
<i>Weight</i>	2.79 lb / 1.27 kg	2.98 lb / 1.36 kg	3.33 lb / 1.52 kg															
Case color	Black																	
Case material	Glass-Fiber Reinforced Plastic																	

ThinkPad A275 - TopSeller - 20KD

Product Specifications Reference (PSREF)

Model	Region	Processor	Graphics	Memory	Display	Multi-touch	Storage(HDD/SSD)	Optical	WLAN + Bluetooth	WWAN	SIM Card	Smart Card Reader	Camera	Key-board	Finger-print Reader	NFC	TPM	Battery (internal+ external)	Power Adapter	Operating System	Warranty	Ann Date (m/y)
20KD0013US	US	AMD PRO A12-9800B	AMD R7 Graphics	8GBx1	12.5" FHD (1920x1080) IPS	None	256GB SSD M.2 PCIe NVMe Opal2	None	11ac, 2x2 + BT4.1	WWAN Upgradable	None	None	720p	Backlit	Finger-print Reader	None	dTPM 2.0	3-cell(23Wh) + 3-cell(23Wh)	45W Slim Tip	Win10 Pro 64	3-year, Depot	09/17
20KD0014US	US	AMD PRO A12-9800B	AMD R7 Graphics	16GBx1	12.5" FHD (1920x1080) IPS	None	256GB SSD M.2 PCIe NVMe Opal2	None	11ac, 2x2 + BT4.1	WWAN Upgradable	None	None	720p	Backlit	Finger-print Reader	None	dTPM 2.0	3-cell(23Wh) + 3-cell(23Wh)	45W Slim Tip	Win10 Pro 64	3-year, Depot	09/17
20KD0015US	US	AMD PRO A12-9800B	AMD R7 Graphics	16GBx1	12.5" FHD (1920x1080) IPS	None	512GB SSD M.2 PCIe NVMe Opal2	None	11ac, 2x2 + BT4.1	WWAN Upgradable	None	None	720p	Backlit	Finger-print Reader	None	dTPM 2.0	3-cell(23Wh) + 3-cell(23Wh)	45W Slim Tip	Win10 Pro 64	3-year, Depot	09/17
20KD0016US	US	AMD PRO A12-9800B	AMD R7 Graphics	8GBx1	12.5" HD (1366x768)	None	500GB 7200rpm	None	11ac, 2x2 + BT4.1	WWAN Upgradable	None	None	720p	Backlit	Finger-print Reader	None	dTPM 2.0	3-cell(23Wh) + 3-cell(23Wh)	45W Slim Tip	Win10 Pro 64	1-year, Depot	09/17
20KD0017US	US	AMD PRO A10-9700B	AMD R7 Graphics	4GBx1	12.5" HD (1366x768)	None	500GB 7200rpm	None	11ac, 2x2 + BT4.1	WWAN Upgradable	None	None	720p	Non-backlit	Finger-print Reader	None	dTPM 2.0	3-cell(23Wh) + 3-cell(23Wh)	45W Slim Tip	Win10 Pro 64	1-year, Depot	09/17
20KD0018US	US	AMD PRO A10-8730B	AMD R5 Graphics	8GBx1	12.5" FHD (1920x1080) IPS	None	500GB 7200rpm	None	11ac, 2x2 + BT4.1	WWAN Upgradable	None	None	720p	Backlit	Finger-print Reader	None	dTPM 2.0	3-cell(23Wh) + 3-cell(23Wh)	45W Slim Tip	Win10 DG Win7 Pro 64	1-year, Depot	09/17
20KD0019US	US	AMD PRO A10-8730B	AMD R5 Graphics	8GBx1	12.5" FHD (1920x1080) IPS	None	256GB SSD M.2 PCIe NVMe Opal2	None	11ac, 2x2 + BT4.1	WWAN Upgradable	None	None	720p	Backlit	Finger-print Reader	None	dTPM 2.0	3-cell(23Wh) + 3-cell(23Wh)	45W Slim Tip	Win10 DG Win7 Pro 64	3-year, Depot	09/17
20KD001AUS	US	AMD PRO A10-8730B	AMD R5 Graphics	4GBx1	12.5" HD (1366x768)	None	500GB 7200rpm	None	11ac, 2x2 + BT4.1	WWAN Upgradable	None	None	720p	Non-backlit	Finger-print Reader	None	dTPM 2.0	3-cell(23Wh) + 3-cell(23Wh)	45W Slim Tip	Win10 DG Win7 Pro 64	1-year, Depot	09/17
20KD001QUS	US	AMD PRO A12-8830B	AMD R7 Graphics	8GBx1	12.5" HD (1366x768)	None	500GB 7200rpm	None	11ac, 2x2 + BT4.1	WWAN Upgradable	None	None	720p	Backlit	Finger-print Reader	None	dTPM 2.0	3-cell(23Wh) + 3-cell(23Wh)	45W Slim Tip	Win10 DG Win7 Pro 64	1-year, Depot	11/17
20KD001RUS	US	AMD PRO A12-8830B	AMD R7 Graphics	16GBx1	12.5" FHD (1920x1080) IPS	None	512GB SSD M.2 PCIe NVMe Opal2	None	11ac, 2x2 + BT4.1	WWAN Upgradable	None	None	720p	Backlit	Finger-print Reader	None	dTPM 2.0	3-cell(23Wh) + 3-cell(23Wh)	45W Slim Tip	Win10 DG Win7 Pro 64	3-year, Depot	11/17
20KD001SUS	US	AMD PRO A12-8830B	AMD R7 Graphics	8GBx1	12.5" FHD (1920x1080) IPS	None	256GB SSD M.2 PCIe NVMe Opal2	None	11ac, 2x2 + BT4.1	WWAN Upgradable	None	None	720p	Backlit	Finger-print Reader	None	dTPM 2.0	3-cell(23Wh) + 3-cell(23Wh)	45W Slim Tip	Win10 DG Win7 Pro 64	3-year, Depot	11/17
20KD001TUS	US	AMD PRO A12-8830B	AMD R7 Graphics	16GBx1	12.5" FHD (1920x1080) IPS	None	256GB SSD M.2 PCIe NVMe Opal2	None	11ac, 2x2 + BT4.1	WWAN Upgradable	None	None	720p	Backlit	Finger-print Reader	None	dTPM 2.0	3-cell(23Wh) + 3-cell(23Wh)	45W Slim Tip	Win10 DG Win7 Pro 64	3-year, Depot	11/17



ThinkPad A475 Platform Specifications

Product Specifications Reference (PSREF)

Processor	AMD PRO A-Series APUs								Smart card reader	Optional: Smart card reader										
	Processor Number	# of Cores	# of Threads	Base Frequency	Max Turbo Frequency	Cache	Memory Types	Processor Graphics	Media reader	4-in-1 reader (MMC, SD, SDHC, SDXC), supports SD 3.0, UHS-I										
	PRO A10-8730B	4	4	2.4 GHz	3.3 GHz	2MB	DDR4-1866	AMD Radeon™ R5 Graphics	Ports	Three USB 3.1 Gen 1 (USB 3.0, one Always On), USB 3.1 Type-C Gen 2, HDMI 1.4b, Ethernet (RJ-45), Dock connector										
	PRO A12-8830B			2.5 GHz	3.4 GHz			AMD Radeon R7 Graphics	Optional: Lenovo USB-C to VGA Adapter											
	PRO A10-9700B			2.5 GHz	3.4 GHz															
PRO A12-9800B	2.7 GHz			3.6 GHz																
* Windows 7 is only supported by PRO A10-8730B and PRO A12-8830B																				
Graphics	AMD Radeon R5 or R7 Graphics in processor only; supports external digital monitor via HDMI or USB Type-C; supports three independent displays; Max resolution: 4096x2160@60Hz (USB Type-C); 4096x2160@30Hz (HDMI)								Security	Power-on password, hard disk password, supervisor password, security keyhole										
Chipset	AMD SoC (System on Chip) platform								Security chip	dTPM 1.2: discrete TPM 1.2, TCG Certified										
Memory	32GB max / 1866MHz DDR4, dual-channel capable, two DDR4 SO-DIMM sockets								dTPM 2.0: discrete TPM 2.0, TCG Certified	Fingerprint reader	Optional: Touch style match on chip fingerprint reader on the keyboard bezel									
Display	Some: 14.0" (355mm) HD (1366x768), anti-glare, LED backlight, 220 nits, 16:9 aspect ratio, 350:1 contrast ratio Some: 14.0" (355mm) FHD (1920x1080), anti-glare, LED backlight, IPS, 250 nits, 16:9 aspect ratio, 700:1 contrast ratio, 170° viewing angle								NFC	None										
Multi-touch (opt)	On-cell touch, supports 10-finger gesture (FHD panel with Mg cover only, US only)								Internal battery	Optional: Integrated Li-Polymer 3-cell (24Wh)										
Storage	System has one HDD slot or one M.2 2280 slot exclusively for storage Some: HDD / SATA 6.0Gb/s, 2.5" wide, 7mm high, Active Protection System™ Some: SSD / SATA 6.0Gb/s, 2.5" wide, 7mm high (e.g. xxxGB SSD) Some: M.2 SSD / PCIe NVMe, PCIe 3.0 x 4, 32Gb/s None								External battery	Li-Polymer 3-cell (24Wh) or Li-Ion 6-cell (48Wh)										
Optical	None								Max battery life (MobileMark® 2014)	<table border="1"> <thead> <tr> <th>Models</th> <th>3-cell</th> <th>3 + 3-cell</th> <th>6-cell 48Wh</th> <th>3 + 6-cell 48Wh</th> </tr> </thead> <tbody> <tr> <td>Max battery life</td> <td>5.13 hr</td> <td>10.26 hr</td> <td>10.26 hr</td> <td>15.4 hr</td> </tr> </tbody> </table>	Models	3-cell	3 + 3-cell	6-cell 48Wh	3 + 6-cell 48Wh	Max battery life	5.13 hr	10.26 hr	10.26 hr	15.4 hr
Models	3-cell	3 + 3-cell	6-cell 48Wh	3 + 6-cell 48Wh																
Max battery life	5.13 hr	10.26 hr	10.26 hr	15.4 hr																
Ethernet	Realtek® RTL8111EPV Gigabit Ethernet connection								AC adapter	45W or 65W slim tip AC adapter, 45W or 65W USB Type-C AC adapter										
WLAN	Realtek RTL8822BE, Wi-Fi 2x2 802.11ac + BT4.1, M.2 card								Preload	Windows® 7 Professional 64 preinstalled through downgrade rights in Windows 10 Pro 64 Some: Windows 10 Home 64 Some: Windows 10 Pro 64										
Bluetooth™	Bluetooth 4.1 wireless, integrated in Wi-Fi + Bluetooth combo adapter * WLAN card supports BT4.2 but is limited to BT4.1 by Windows OS									<ul style="list-style-type: none"> Lenovo Companion Lenovo Setting Microsoft Office preloaded; purchase a product key to activate 										
WWAN (optional)	One of the following, configurable by model: • Wireless WAN upgradable • Integrated Mobile Broadband 4G LTE-A, Qualcomm® Snapdragon™ X7 LTE-A (Sierra Wireless EM7455)								Limited warranty	One of the following, configurable by model: • 1-year depot repair service • 3-year/1-yr battery depot repair service • 3-year/1-yr battery limited onsite service										
SIM card (opt)	Micro-SIM card slot, opt Verizon LTE (US) SIM card								Mil-Spec test	MIL-STD-810G military certification										
Dimensions	WxDxH: 13.25" x 9.15" x 0.79"; 336.6mm x 232.5mm x 19.95mm								Environment	EPEAT™ Gold (US only); ENERGY STAR® 6.1; RoHS-compliant										
Weight	<table border="1"> <thead> <tr> <th>Models</th> <th>3-cell or 3 + 3-cell</th> <th>6-cell or 3 + 6-cell</th> </tr> </thead> <tbody> <tr> <td>Magnesium</td> <td>3.49 lb / 1.58 kg</td> <td>3.92 lb / 1.78 kg</td> </tr> <tr> <td>PPS</td> <td>3.63 lb / 1.65 kg</td> <td>4.35 lb / 1.85 kg</td> </tr> </tbody> </table>								Models	3-cell or 3 + 3-cell	6-cell or 3 + 6-cell	Magnesium	3.49 lb / 1.58 kg	3.92 lb / 1.78 kg	PPS	3.63 lb / 1.65 kg	4.35 lb / 1.85 kg			
Models	3-cell or 3 + 3-cell	6-cell or 3 + 6-cell																		
Magnesium	3.49 lb / 1.58 kg	3.92 lb / 1.78 kg																		
PPS	3.63 lb / 1.65 kg	4.35 lb / 1.85 kg																		
Case color	Black																			
Case material	Display cover: Magnesium Hybrid or PPS (Magnesium Hybrid for US only); Bottom: Glass-Fiber Reinforced Plastic																			

Lenovo
March 2018

ThinkPad A475 - TopSeller - 20KL

Product Specifications Reference (PSREF)

Model	Region	Processor	Graphics	Memory	Display	Multi-touch	Storage(HDD/SSD)	Optical	WLAN + Bluetooth	WWAN	SIM Card	Smart Card Reader	Monitor Cable	Case Material	Camera	Key-board	Finger-print Reader	NFC	TPM	Battery (internal+external)	Power Adapter	Operating System	Warranty	Ann Date (m/y)
20KL0016US	US	AMD PRO A10-9700B	AMD R7 Graphics	4GBx1	14" HD (1366x768)	None	500GB 7200rpm	None	11ac, 2x2 + BT4.1	WWAN Upgradable	None	None	None	PPS	720p	Non-backlit	Finger-print Reader	None	dTPM 2.0	3-cell(24Wh) + 3-cell(24Wh)	45W Slim Tip	Win10 Pro 64	1-year, Depot	09/17
20KL0017US	US	AMD PRO A12-9800B	AMD R7 Graphics	8GB	14" FHD (1920x1080) IPS	None	500GB 7200rpm	None	11ac, 2x2 + BT4.1	WWAN Upgradable	None	None	None	PPS	720p	Backlit	Finger-print Reader	None	dTPM 2.0	3-cell(24Wh) + 3-cell(24Wh)	45W Slim Tip	Win10 Pro 64	1-year, Depot	09/17
20KL0018US	US	AMD PRO A12-9800B	AMD R7 Graphics	8GB	14" FHD (1920x1080) IPS	None	256GB SSD M.2 PCIe NVMe Opal2	None	11ac, 2x2 + BT4.1	WWAN Upgradable	None	None	None	PPS	720p	Backlit	Finger-print Reader	None	dTPM 2.0	3-cell(24Wh) + 3-cell(24Wh)	45W Slim Tip	Win10 Pro 64	3-year, Depot	09/17
20KL0019US	US	AMD PRO A12-9800B	AMD R7 Graphics	16GBx1	14" FHD (1920x1080) IPS	None	512GB SSD M.2 PCIe NVMe Opal2	None	11ac, 2x2 + BT4.1	WWAN Upgradable	None	None	None	PPS	720p	Backlit	Finger-print Reader	None	dTPM 2.0	3-cell(24Wh) + 3-cell(24Wh)	45W Slim Tip	Win10 Pro 64	3-year, Depot	09/17
20KL001AUS	US	AMD PRO A12-9800B	AMD R7 Graphics	16GBx1	14" FHD (1920x1080) IPS	None	256GB SSD M.2 PCIe NVMe Opal2	None	11ac, 2x2 + BT4.1	WWAN Upgradable	None	None	None	PPS	720p	Backlit	Finger-print Reader	None	dTPM 2.0	3-cell(24Wh) + 3-cell(24Wh)	45W Slim Tip	Win10 Pro 64	3-year, Depot	09/17
20KL001BUS	US	AMD PRO A10-8730B	AMD R5 Graphics	8GB	14" FHD (1920x1080) IPS	None	256GB SSD M.2 PCIe NVMe Opal2	None	11ac, 2x2 + BT4.1	WWAN Upgradable	None	None	None	PPS	720p	Backlit	Finger-print Reader	None	dTPM 2.0	3-cell(24Wh) + 3-cell(24Wh)	45W Slim Tip	Win10 DG Win7 Pro 64	3-year, Depot	09/17
20KL001CUS	US	AMD PRO A10-8730B	AMD R5 Graphics	4GBx1	14" HD (1366x768)	None	500GB 7200rpm	None	11ac, 2x2 + BT4.1	WWAN Upgradable	None	None	None	PPS	720p	Non-backlit	Finger-print Reader	None	dTPM 2.0	3-cell(24Wh) + 3-cell(24Wh)	45W Slim Tip	Win10 DG Win7 Pro 64	1-year, Depot	09/17
20KL001DUS	US	AMD PRO A10-8730B	AMD R5 Graphics	8GB	14" FHD (1920x1080) IPS	None	500GB 7200rpm	None	11ac, 2x2 + BT4.1	WWAN Upgradable	None	None	None	PPS	720p	Backlit	Finger-print Reader	None	dTPM 2.0	3-cell(24Wh) + 3-cell(24Wh)	45W Slim Tip	Win10 DG Win7 Pro 64	1-year, Depot	09/17
20KL001PUS	US	AMD PRO A12-8830B	AMD R7 Graphics	8GB	14" FHD (1920x1080) IPS	None	256GB SSD M.2 PCIe NVMe Opal2	None	11ac, 2x2 + BT4.1	WWAN Upgradable	None	None	None	PPS	720p	Backlit	Finger-print Reader	None	dTPM 2.0	3-cell(24Wh) + 3-cell(24Wh)	45W Slim Tip	Win10 DG Win7 Pro 64	3-year, Depot	11/17
20KL001QUS	US	AMD PRO A12-8830B	AMD R7 Graphics	16GBx1	14" FHD (1920x1080) IPS	None	512GB SSD M.2 PCIe NVMe Opal2	None	11ac, 2x2 + BT4.1	WWAN Upgradable	None	None	None	PPS	720p	Backlit	Finger-print Reader	None	dTPM 2.0	3-cell(24Wh) + 3-cell(24Wh)	45W Slim Tip	Win10 DG Win7 Pro 64	3-year, Depot	11/17
20KL001RUS	US	AMD PRO A12-8830B	AMD R7 Graphics	16GBx1	14" FHD (1920x1080) IPS	None	256GB SSD M.2 PCIe NVMe Opal2	None	11ac, 2x2 + BT4.1	WWAN Upgradable	None	None	None	PPS	720p	Backlit	Finger-print Reader	None	dTPM 2.0	3-cell(24Wh) + 3-cell(24Wh)	45W Slim Tip	Win10 DG Win7 Pro 64	3-year, Depot	11/17
20KL001SUS	US	AMD PRO A12-8830B	AMD R7 Graphics	8GB	14" FHD (1920x1080) IPS	None	500GB 7200rpm	None	11ac, 2x2 + BT4.1	WWAN Upgradable	None	None	None	PPS	720p	Backlit	Finger-print Reader	None	dTPM 2.0	3-cell(24Wh) + 3-cell(24Wh)	45W Slim Tip	Win10 DG Win7 Pro 64	1-year, Depot	11/17



ThinkPad E470 Platform Specifications

Product Specifications Reference (PSREF)

Processor	7th Generation Intel® Core™ i3 / i5 / i7 Processor								Dimensions <i>Aluminum (WxDxH):</i> 13.35" x 9.53" x 0.88"; 339mm x 242mm x 22.4mm <i>PC/ABS (WxDxH):</i> 13.35" x 9.53" x 0.93"; 339mm x 242mm x 23.7mm	
	Processor Number	# of Cores	# of Threads	Base Frequency	Max Turbo Frequency	Cache	Memory Controller	Processor Graphics		
	i3-6100U	2	4	2.3 GHz	-	3MB	DDR4-2133	Intel HD Graphics 520		
	i5-6200U			2.3 GHz	2.8 GHz	3MB				
	i7-6500U			2.5 GHz	3.1 GHz	4MB				
	i3-7100U			2.4 GHz	-	3MB				
	i5-7200U			2.5 GHz	3.1 GHz	3MB	DDR4-2133	Intel HD Graphics 620		
	i7-7500U			2.7 GHz	3.5 GHz	4MB				
* i5-6200U, i7-6500U are not available in EMEA										
Graphics	Intel HD Graphics in processor only, or NVidia GeForce 920MX Graphics, 2GB DDR3 memory, or NVidia GeForce 940MX Graphics, 2GB DDR3 memory, digital monitor support via HDMI™ (supporting HDCP to output protected content); supports dual independent displays; Max resolution: 1920x1080 (HDMI)@60Hz								Weight Case color Case material	
Memory	32GB max / 2133MHz DDR4, non-parity, dual-channel capable, two 260-pin SO-DIMM sockets * System clocks down for processors with lower memory controller								Camera Audio support	
Display	Some: 14.0" (355mm) HD (1366x768), anti-glare, LED backlight, 220 nits, 16:9 aspect ratio, 400:1 contrast ratio Some: 14.0" (355mm) FHD (1920x1080), anti-glare, LED backlight, IPS, 250 nits, 16:9 aspect ratio, 400:1 contrast ratio Some: 14.0" (355mm) FHD (1920x1080), anti-glare, LED backlight, 220 nits, 16:9 aspect ratio, 400:1 contrast ratio								Keyboard UltraNav™ ThinkLight™	
Multi-touch	None								Fingerprint reader NFC Security Security chip	
Storage	Some: SSD / SATA 6.0Gb/s, 2.5" wide, 7mm high, removable, upgradable Some: HDD / SATA 6.0Gb/s, 2.5" wide, removable, upgradable, Active Protection System™								vPro	
M.2 SSD Optical	None None								Battery type Battery life AC adapter	
Ethernet	Gigabit Ethernet Connection, Realtek R8111GUS								Preload	
WLAN	One of the following, configurable by model: • Intel Dual Band Wireless-AC 8265, 2x2, Wi-Fi + BT combo adapter, M.2 Card • QCA, Qualcomm 344A-AC, 2x2, Wi-Fi + Bluetooth combo adapter, M.2 Card • QCA, Qualcomm 435-AC, 1x1, Wi-Fi + Bluetooth combo adapter, M.2 Card								Limited warranty	
Bluetooth™	Bluetooth wireless, integrated in Wi-Fi + Bluetooth combo adapter								Mil-Spec test	
WWAN SIM card	None None								Environment	
Smart Card Reader	None									
ExpressCard	None									
Dock	None									
Multicard Reader	4-in-1 reader (MMC, SD, SDHC, SDXC)									
Ports	Two USB 3.0 (one Always On), one USB 2.0, HDMI, Ethernet (RJ-45), combo audio / microphone jack									
Monitor cable	None									

Model	Region	Processor	vPro	Graphics	Memory	Display	Multi-touch	Storage	Optical	WLAN + Bluetooth	WWAN	SIM Card	Color	Case Material	Camera	Keyboard	Fingerprint Reader	TPM	Battery	Power Adapter	Operating System	Warranty	Ann Date (m/y)
20H10038US	US	i3-7100U	No	Intel HD 620	4GBx1	14" HD (1366x768)	None	500GB 7200rpm	None	11ac, 1x1 + BT4.1	None	None	Black	PC/ABS	720p	Non-backlit	Fingerprint Reader	dTPM 2.0	3-cell (45Wh)	45W	Win10 Pro 64	1-year, Depot	09/16
20H10039US	US	i5-7200U	No	Intel HD 620	4GBx1	14" HD (1366x768)	None	500GB 7200rpm	None	11ac, 1x1 + BT4.1	None	None	Black	PC/ABS	720p	Non-backlit	Fingerprint Reader	dTPM 2.0	3-cell (45Wh)	45W	Win10 Pro 64	1-year, Depot	09/16
20H1003AUS	US	i5-7200U	No	Intel HD 620	8GB	14" HD (1366x768)	None	256GB SSD Opal2	None	11ac, 1x1 + BT4.1	None	None	Black	PC/ABS	720p	Non-backlit	Fingerprint Reader	dTPM 2.0	3-cell (45Wh)	45W	Win10 Pro 64	1-year, Depot	09/16
20H1003DUS	US	i3-6006U	No	Intel HD 520	4GBx1	14" HD (1366x768)	None	500GB 7200rpm	None	11ac, 1x1 + BT4.1	None	None	Black	PC/ABS	720p	Non-backlit	Fingerprint Reader	dTPM 2.0	3-cell (45Wh)	45W	Win10 Pro 64	1-year, Depot	11/16
20H1004RUS	US	i7-7500U	No	940MX 2GB	8GB	14" FHD (1920x1080) IPS	None	500GB 7200rpm	None	Intel 8265 ac, 2x2 + BT4.1	None	None	Black	PC/ABS	720p	Non-backlit	Fingerprint Reader	FW TPM 2.0	3-cell (45Wh)	65W	Win10 Pro 64	1-year, Depot	09/16
20H1004SUS	US	i5-7200U	No	Intel HD 620	8GB	14" FHD (1920x1080) IPS	None	256GB SSD Opal2	None	11ac, 1x1 + BT4.1	None	None	Black	PC/ABS	720p	Non-backlit	Fingerprint Reader	dTPM 2.0	3-cell (45Wh)	45W	Win10 Pro 64	1-year, Depot	09/16
20H1004TUS	US	i7-7500U	No	940MX 2GB	8GB	14" FHD (1920x1080) IPS	None	256GB SSD Opal2	None	Intel 8265 ac, 2x2 + BT4.1	None	None	Black	PC/ABS	720p	Non-backlit	Fingerprint Reader	FW TPM 2.0	3-cell (45Wh)	65W	Win10 Pro 64	1-year, Depot	09/16
20H10055US	US	i5-7200U	No	Intel HD 620	8GB	14" FHD (1920x1080) IPS	None	180GB SSD Opal2	None	11ac, 1x1 + BT4.1	None	None	Black	PC/ABS	720p	Non-backlit	Fingerprint Reader	dTPM 2.0	3-cell (45Wh)	45W	Win10 Pro 64	1-year, Depot	03/17
20H10059US	US	i3-7100U	No	Intel HD 620	4GBx1	14" HD (1366x768)	None	180GB SSD Opal2	None	11ac, 1x1 + BT4.1	None	None	Black	PC/ABS	720p	Non-backlit	Fingerprint Reader	dTPM 2.0	3-cell (45Wh)	45W	Win10 Pro 64	1-year, Depot	01/17
20H1005AUS	US	i5-7200U	No	Intel HD 620	4GBx1	14" HD (1366x768)	None	180GB SSD Opal2	None	11ac, 1x1 + BT4.1	None	None	Black	PC/ABS	720p	Non-backlit	Fingerprint Reader	dTPM 2.0	3-cell (45Wh)	45W	Win10 Pro 64	1-year, Depot	01/17
20H1005BUS	US	i5-7200U	No	Intel HD 620	8GB	14" HD (1366x768)	None	180GB SSD Opal2	None	11ac, 1x1 + BT4.1	None	None	Black	PC/ABS	720p	Non-backlit	Fingerprint Reader	dTPM 2.0	3-cell (45Wh)	45W	Win10 Pro 64	1-year, Depot	01/17
20H10065US	US	i3-6006U	No	Intel HD 520	4GBx1	14" HD (1366x768)	None	500GB 7200rpm	None	11ac, 1x1 + BT4.1	None	None	Black	PC/ABS	720p	Non-backlit	Fingerprint Reader	dTPM 2.0	3-cell (45Wh)	45W	Win10 DG Win7 Pro 64	1-year, Depot	03/17
20H10066US	US	i7-6500U	No	940MX 2GB	8GB	14" FHD (1920x1080) IPS	None	256GB SSD Opal2	None	Intel 8265 ac, 2x2 + BT4.1	None	None	Black	PC/ABS	720p	Non-backlit	Fingerprint Reader	FW TPM 2.0	3-cell (45Wh)	65W	Win10 DG Win7 Pro 64	1-year, Depot	03/17
20H10067US	US	i5-6200U	No	Intel HD 520	8GB	14" FHD (1920x1080) IPS	None	256GB SSD Opal2	None	11ac, 1x1 + BT4.1	None	None	Black	PC/ABS	720p	Non-backlit	Fingerprint Reader	dTPM 2.0	3-cell (45Wh)	45W	Win10 DG Win7 Pro 64	1-year, Depot	03/17
20H10068US	US	i7-6500U	No	940MX 2GB	8GB	14" FHD (1920x1080) IPS	None	500GB 7200rpm	None	Intel 8265 ac, 2x2 + BT4.1	None	None	Black	PC/ABS	720p	Non-backlit	Fingerprint Reader	FW TPM 2.0	3-cell (45Wh)	65W	Win10 DG Win7 Pro 64	1-year, Depot	03/17
20H10069US	US	i5-6200U	No	Intel HD 520	4GBx1	14" HD (1366x768)	None	500GB 7200rpm	None	11ac, 1x1 + BT4.1	None	None	Black	PC/ABS	720p	Non-backlit	Fingerprint Reader	dTPM 2.0	3-cell (45Wh)	45W	Win10 DG Win7 Pro 64	1-year, Depot	03/17
20H1006AUS	US	i5-6200U	No	Intel HD 520	8GB	14" HD (1366x768)	None	256GB SSD Opal2	None	11ac, 1x1 + BT4.1	None	None	Black	PC/ABS	720p	Non-backlit	Fingerprint Reader	dTPM 2.0	3-cell (45Wh)	45W	Win10 DG Win7 Pro 64	1-year, Depot	03/17
20H1006DUS	US	i5-7200U	No	Intel HD 620	8GB	14" FHD (1920x1080) IPS	None	500GB 7200rpm	None	11ac, 1x1 + BT4.1	None	None	Black	PC/ABS	720p	Non-backlit	Fingerprint Reader	dTPM 2.0	3-cell (45Wh)	45W	Win10 Pro 64	1-year, Depot	03/17
20H1006GCA	US	i3-6006U	No	Intel HD 520	4GBx1	14" HD (1366x768)	None	500GB 7200rpm	None	11ac, 1x1 + BT4.1	None	None	Black	PC/ABS	720p	Non-backlit	None	dTPM 2.0	3-cell (45Wh)	45W	Win10 DG Win7 Pro 64	1-year, Depot	03/17
20H1006GCC	US	i3-6006U	No	Intel HD 520	4GBx1	14" HD (1366x768)	None	500GB 7200rpm	None	11ac, 1x1 + BT4.1	None	None	Black	PC/ABS	720p	Non-backlit	None	dTPM 2.0	3-cell (45Wh)	45W	Win10 DG Win7 Pro 64	1-year, Depot	03/17

Model	Region	Processor	vPro	Graphics	Memory	Display	Multi-touch	Storage	Optical	WLAN + Bluetooth	WWAN	SIM Card	Color	Case Material	Camera	Keyboard	Finger-print Reader	TPM	Battery	Power Adapter	Operating System	Warranty	Ann Date (m/y)
20H1006GUS	US	i3-6006U	No	Intel HD 520	4GBx1	14" HD (1366x768)	None	500GB 7200rpm	None	11ac, 1x1 + BT4.1	None	None	Black	PC/ABS	720p	Non-backlit	None	dTPM 2.0	3-cell (45Wh)	45W	Win10 DG Win7 Pro 64	1-year, Depot	03/17

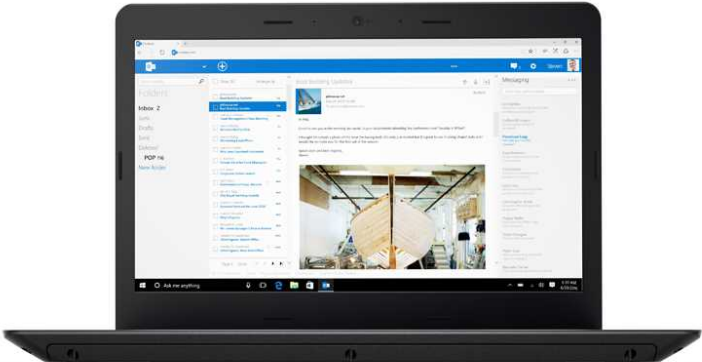

ThinkPad E475 Platform Specifications

Product Specifications Reference (PSREF)

Processor	AMD Accelerated Processor A6, or A10 APU								Dimensions Weight Case color Case material	<i>PC/ABS (WxDxH):</i> 13.35" x 9.53" x 0.93"; 339mm x 242mm x 23.7mm From 4.12 lb (1.87kg) Black <i>PC/ABS:</i> PolyCarbonate/Acrylonitrile-Butadiene-Styrene display cover
	Processor Number	# of Cores	# of Threads	Base Frequency	Max Turbo Frequency	Cache	Memory Types	Processor Graphics		
	A6-9500B	2	4	2.3 GHz	3.2 GHz	2MB	DDR4-1866	R5 Graphics		
A10-9600P	4	8	2.4 GHz	3.3 GHz	2MB					
Graphics	AMD Radeon™ R5 Graphics in processor only, or AMD Radeon R5 M430 Graphics, 2GB DDR3 memory, or digital monitor support via HDMI™ (supporting HDCP to output protected content); supports dual independent displays; Max resolution: 1920x1080 (HDMI)@60Hz								Camera	HD720p resolution, fixed focus
Chipset	AMD SoC (System on Chip) platform								Audio support	HD Audio, Conexant® CX11852 codec, Dolby® Audio™ Premium / stereo speakers, 2W x 2 / dual array microphone, combo audio / microphone jack
Memory	32GB max / 2133MHz DDR4, non-parity, dual-channel capable, two 260-pin SO-DIMM sockets *System automatically clocks down with 1866MHz DDR4 memory controller								Keyboard	6-row, spill-resistant, multimedia Fn keys
Display	Some: 14.0" (355mm) HD (1366x768), anti-glare, LED backlight, 220 nits, 16:9 aspect ratio, 400:1 contrast ratio								UltraNav™	TrackPoint® pointing device and multi-touch with 3+2 buttons click pad
Multi-touch	None								ThinkLight™	None
Storage	Some: SSD / SATA 6.0Gb/s, 2.5" wide, 7mm high, removable, upgradable Some: HDD / SATA 6.0Gb/s, 2.5" wide, removable, upgradable, Active Protection System™								Fingerprint reader	None
M.2 SSD	None								NFC	None
Optical	None								Security	Power-on password, hard disk password, supervisor password, security keyhole
Ethernet	Gigabit Ethernet Connection, Realtek R8111GUS								Security chip	<i>FW TPM2.0:</i> Firmware TPM 2.0, integrated in chipset <i>dTPM2.0:</i> Discrete TPM 2.0, TCG Certified
WLAN	One of the following, configurable by model: • QCA, Qualcomm 344A-AC, 2x2, Wi-Fi + Bluetooth combo adapter, M.2 Card • QCA, Qualcomm 435-AC, 1x1, Wi-Fi + Bluetooth combo adapter, M.2 Card Bluetooth wireless, integrated in Wi-Fi + Bluetooth combo adapter								vPro	No
Bluetooth™	Bluetooth wireless, integrated in Wi-Fi + Bluetooth combo adapter								Battery type	Li-Polymer 3-cell (45Wh)
WWAN	None								Battery life	3-cell (45Wh): up to 6.5 hr
SIM card	None								AC adapter	Some: 45-watt AC adapter Some: 65-watt AC adapter
Smart Card Reader	None								Preload	Some: Windows 10 Pro 64 Some: Windows 10 Home 64 • Lenovo Companion • Lenovo Settings • Microsoft Office preloaded; purchase a product key to activate • McAfee® Live Safe (30-day trial)
ExpressCard	None								Limited warranty	1-year - depot repair service / service upgrades available
Dock	None								Mil-Spec test	None
Multicard Reader	4-in-1 reader (MMC, SD, SDHC, SDXC)								Environment	EPEAT™ Gold; ENERGY STAR®; RoHS-compliant
Ports	Two USB 3.0 (one Always On), one USB 2.0, HDMI, Ethernet (RJ-45), combo audio / microphone jack									
Monitor cable	None									

ThinkPad E475 - TopSeller - 20H4

Product Specifications Reference (PSREF)

Model	Region	Processor	vPro	Graphics	Memory	Display	Multi-touch	Storage(HDD/SSD)	Optical	WLAN + Bluetooth	WWAN	SIM Card	Color	Case Material	Camera	Keyboard	Finger-print Reader	TPM	Battery	Power Adapter	Operating System	Warranty	Ann Date (m/y)
20H40006US	US	AMD A6-9500B	No	AMD R5 Graphics	4GBx1	14" HD (1366x768)	None	500GB 7200rpm	None	QCA435 ac, 1x1 + BT4.1	None	None	Black	PC/ABS	720p	Non-backlit	None	dTPM 2.0	3-cell (45Wh)	45W	Windows 10 Pro 64	1-year, Depot	11/16
20H40007US	US	AMD A10-9600P	No	AMD R5 M430 2GB	8GBx1	14" HD (1366x768)	None	500GB 7200rpm	None	QCA435 ac, 1x1 + BT4.1	None	None	Black	PC/ABS	720p	Non-backlit	None	FW TPM 2.0	3-cell (45Wh)	65W	Windows 10 Pro 64	1-year, Depot	11/16
20H40008US	US	AMD A10-9600P	No	AMD R5 M430 2GB	4GBx1	14" HD (1366x768)	None	500GB 7200rpm	None	QCA435 ac, 1x1 + BT4.1	None	None	Black	PC/ABS	720p	Non-backlit	None	FW TPM 2.0	3-cell (45Wh)	65W	Windows 10 Pro 64	1-year, Depot	11/16
20H40009US	US	AMD A6-9500B	No	AMD R5 Graphics	8GBx1	14" HD (1366x768)	None	500GB 7200rpm	None	QCA435 ac, 1x1 + BT4.1	None	None	Black	PC/ABS	720p	Non-backlit	None	dTPM 2.0	3-cell (45Wh)	45W	Windows 10 Pro 64	1-year, Depot	11/16
20H4000AUS	US	AMD A10-9600P	No	AMD R5 M430 2GB	8GBx1	14" HD (1366x768)	None	256GB SSD Opal2	None	QCA435 ac, 1x1 + BT4.1	None	None	Black	PC/ABS	720p	Non-backlit	None	FW TPM 2.0	3-cell (45Wh)	65W	Windows 10 Pro 64	1-year, Depot	11/16
20H4000DUS	US	AMD A10-9600P	No	AMD R5 M430 2GB	8GBx1	14" HD (1366x768)	None	180GB SSD Opal2	None	QCA435 ac, 1x1 + BT4.1	None	None	Black	PC/ABS	720p	Non-backlit	None	FW TPM 2.0	3-cell (45Wh)	65W	Windows 10 Pro 64	1-year, Depot	01/17



ThinkPad E480 Platform Specifications

Product Specifications Reference (PSREF)

Processor	7th or 8th Generation Intel® Core™ i3 / i5 / i7 Processor								Dimensions <i>Aluminum (WxDxH):</i> 12.96" x 9.53" x 0.78"; 329mm x 242mm x 19.9mm <i>PC/ABS (WxDxH):</i> 12.96" x 9.53" x 0.83"; 329mm x 242mm x 21.9mm
	Processor Number	# of Cores	# of Threads	Base Frequency	Max Turbo Frequency	Cache	Memory Controller	Processor Graphics	
	i3-7130U	2	4	2.7 GHz	-	3MB	DDR4-2133	Intel HD Graphics 620	
	i5-7200U			2.5 GHz	3.1 GHz	3MB			
	i3-8130U	2	4	2.2 GHz	3.4 GHz	4MB	DDR4-2400	Intel UHD Graphics 620	
i5-8250U	1.6 GHz			3.4 GHz	6MB				
i7-8550U	4	8	1.8 GHz	4.0 GHz	8MB	DDR4-2400	Intel UHD Graphics 620		
* i3-7130U is not available in EMEA and US									
Graphics	Intel HD Graphics in processor only, or AMD Radeon RX 550 Graphics, 2GB DDR5 memory, digital monitor support via HDMI™ (supporting HDCP to output protected content); supports dual independent displays; Max resolution: 1920x1080 (HDMI)@60Hz								Camera HD720p resolution, fixed focus
Memory	32GB max / 2400MHz DDR4, non-parity, dual-channel capable, two 260-pin SO-DIMM sockets * System clocks down for processors with lower memory controller								Audio support HD Audio, Conexant® CX11852 codec, Dolby® Advanced Audio / stereo speakers, 1.5W x 2 / dual array microphone, combo audio / microphone jack
Display	Some: 14.0" (355mm) HD (1366x768), anti-glare, LED backlight, 220 nits, 16:9 aspect ratio, 400:1 contrast ratio Some: 14.0" (355mm) FHD (1920x1080), anti-glare, LED backlight, IPS, 250 nits, 16:9 aspect ratio, 400:1 contrast ratio								Keyboard 6-row, spill-resistant, multimedia Fn keys, optional LED backlight UltraNav™ TrackPoint® pointing device and multi-touch with 3+2 buttons click pad ThinkLight™ None
Multi-touch	None								Fingerprint reader Some: Touch style fingerprint reader on the palm rest NFC None
Storage	Up to 2 drives (one M.2 SSD and one HDD) Some: M.2 SSD / PCIe NVMe Some: HDD / SATA 6.0Gb/s, 2.5" wide, removable, upgradable, Active Protection System™ Some: Dummy HDD								Security Power-on password, hard disk password, supervisor password, security keyhole Security chip <i>fTPM2.0:</i> Firmware TPM 2.0, integrated in chipset <i>dTPM2.0:</i> Discrete TPM 2.0, TCG Certified
Optical	None								vPro No
Ethernet	Gigabit Ethernet Connection, Realtek R8111GUS								Battery type 45Wh battery, supports Rapid Charge (charge up to 80% in 1hr) with 65W USB Type-C AC adapter
WLAN	One of the following, configurable by model: • Intel Dual Band Wireless-AC 3165, 1x1, Wi-Fi + BT combo adapter, M.2 Card • Realtek® RTL8822BE, Wi-Fi 2x2 802.11ac + BT4.1, M.2 card • Realtek RTL8821CE, Wi-Fi 1x1 802.11ac + BT4.1, M.2 card								Battery life up to 13.51 hr AC adapter 45W or 65W USB Type-C AC adapter
Bluetooth™	Bluetooth 4.1 wireless, integrated in Wi-Fi + Bluetooth combo adapter								Preload Some: Windows 10 Pro 64 Some: Windows 10 Home 64 Some: No operating system • Lenovo Companion • PC Manager • Microsoft Office preloaded; purchase a product key to activate • McAfee® Live Safe (30-day trial)
WWAN	None								Limited warranty 1-year - depot repair service / service upgrades available
SIM card	None								Mil-Spec test None
Smart Card Reader	None								Environment ENERGY STAR®; RoHS-compliant
ExpressCard	None								
Dock	None								
Multicard Reader	Micro SD card reader								
Ports	Two USB 3.1 (one Always On), one USB 2.0, HDMI 1.4b, Ethernet (RJ-45), One USB 3.1 Type-C Gen 2 (support data, video, and power delivery)								
Monitor cable	None								

ThinkPad E480 - TopSeller - 20KN

Product Specifications Reference (PSREF)

Model	Region	Processor	vPro	Graphics	Memory	Display	Storage(HDD/SSD)	Optical	WLAN + Bluetooth	WWAN	SIM Card	Color	Case Material	Camera	Keyboard	Finger-print Reader	TPM	Battery	Power Adapter	Operating System	Warranty	Ann Date (m/y)
20KN0032US	US	i7-8550U	No	AMD RX 550 2GB	8GBx1	14" FHD (1920x1080) IPS	256GB SSD M.2 PCIe NVMe Opal2	None	RTL8822BE, 2x2 + BT4.1	None	None	Black	Aluminum	720p	Non-backlit	Finger-print Reader	FW TPM 2.0	45Wh	65W USB-C	Win10 Pro 64	1-year, Depot	12/17
20KN0033US	US	i7-8550U	No	AMD RX 550 2GB	8GBx1	14" FHD (1920x1080) IPS	256GB SSD M.2 PCIe NVMe Opal2	None	RTL8822BE, 2x2 + BT4.1	None	None	Silver	Aluminum	720p	Non-backlit	None	FW TPM 2.0	45Wh	65W USB-C	Win10 Pro 64	1-year, Depot	12/17
20KN0034US	US	i5-8250U	No	Intel UHD 620	8GBx1	14" FHD (1920x1080) IPS	256GB SSD M.2 PCIe NVMe Opal2	None	RTL8822BE, 2x2 + BT4.1	None	None	Silver	Aluminum	720p	Non-backlit	None	dTPM 2.0	45Wh	65W USB-C	Win10 Pro 64	1-year, Depot	12/17
20KN003SUS	US	i5-7200U	No	Intel UHD 620	8GBx1	14" HD (1366x768)	500GB 7200rpm	None	RTL8822BE, 2x2 + BT4.1	None	None	Black	PC/ABS	720p	Non-backlit	Finger-print Reader	dTPM 2.0	45Wh	65W USB-C	Win10 Pro 64	1-year, Depot	12/17
20KN003UUS	US	i5-8250U	No	Intel UHD 620	8GBx1	14" FHD (1920x1080) IPS	500GB 7200rpm	None	RTL8822BE, 2x2 + BT4.1	None	None	Black	Aluminum	720p	Non-backlit	Finger-print Reader	dTPM 2.0	45Wh	65W USB-C	Win10 Pro 64	1-year, Depot	12/17
20KN003WUS	US	i7-8550U	No	AMD RX 550 2GB	4GBx2	14" FHD (1920x1080) IPS	500GB 7200rpm	None	RTL8822BE, 2x2 + BT4.1	None	None	Black	Aluminum	720p	Non-backlit	Finger-print Reader	FW TPM 2.0	45Wh	65W USB-C	Win10 Pro 64	1-year, Depot	12/17
20KN003XUS	US	i5-8250U	No	Intel UHD 620	4GBx2	14" FHD (1920x1080) IPS	256GB SSD M.2 PCIe NVMe Opal2	None	RTL8822BE, 2x2 + BT4.1	None	None	Black	Aluminum	720p	Non-backlit	Finger-print Reader	dTPM 2.0	45Wh	65W USB-C	Win10 Pro 64	1-year, Depot	12/17
20KN003YUS	US	i5-7200U	No	Intel UHD 620	4GBx2	14" FHD (1920x1080) IPS	256GB SSD M.2 PCIe NVMe Opal2	None	RTL8822BE, 2x2 + BT4.1	None	None	Black	Aluminum	720p	Non-backlit	Finger-print Reader	dTPM 2.0	45Wh	65W USB-C	Win10 Pro 64	1-year, Depot	12/17
20KN0040US	US	i5-8250U	No	Intel UHD 620	8GBx1	14" FHD (1920x1080) IPS	128GB SSD M.2 PCIe NVMe Opal2	None	RTL8822BE, 2x2 + BT4.1	None	None	Black	Aluminum	720p	Non-backlit	Finger-print Reader	dTPM 2.0	45Wh	65W USB-C	Win10 Pro 64	1-year, Depot	12/17
20KN0041US	US	i7-8550U	No	AMD RX 550 2GB	8GBx1	14" FHD (1920x1080) IPS	500GB 7200rpm	None	RTL8822BE, 2x2 + BT4.1	None	None	Silver	Aluminum	720p	Non-backlit	None	FW TPM 2.0	45Wh	65W USB-C	Win10 Pro 64	1-year, Depot	12/17



ThinkPad E570 Platform Specifications

Product Specifications Reference (PSREF)

Processor	7th Generation Intel® Core™ i3 / i5 / i7 Processor								Dimensions <i>Aluminum (WxDxH):</i> 14.92" x 10.28" x 0.94" 379mm x 261mm x 23.9mm <i>PC/ABS (WxDxH):</i> 14.92" x 10.28" x 1.00"; 379mm x 261mm x 25.4mm	
	Processor Number	# of Cores	# of Threads	Base Frequency	Max Turbo Frequency	Cache	Memory Controller	Processor Graphics		
	i3-6100U	2	4	2.3 GHz	-	3MB	DDR4-2133	Intel HD Graphics 520		
	i5-6200U			2.3 GHz	2.8 GHz	3MB				
	i7-6500U			2.5 GHz	3.1 GHz	4MB				
	i3-7100U			2.4 GHz	-	3MB				
	i5-7200U			2.5 GHz	3.1 GHz	3MB	DDR4-2133	Intel HD Graphics 620		
	i7-7500U			2.7 GHz	3.5 GHz	4MB				
* i5-6200U, i7-6500U are not available in EMEA										
Graphics	Intel HD Graphics in processor only, or NVidia GeForce 940MX Graphics, 2GB DDR5 memory, or NVidia GeForce GTX 950M Graphics, 2GB DDR5 memory, external analog monitor support via VGA DB-15 connector and digital monitor support via HDMI™ (supporting HDCP to output protected content); supports dual independent displays; Max resolution: 1920x1080 (HDMI)@60Hz								Keyboard UltraNav™ ThinkLight™	
	Memory 32GB max / 2133MHz DDR4, non-parity, dual-channel capable, two 260-pin SO-DIMM sockets * System clocks down for processors with lower memory controller								Fingerprint reader NFC	
									Security Security chip	
Display	Some: 15.6" (396mm) HD (1366x768), anti-glare, LED backlight, 220 nits, 16:9 aspect ratio, 400:1 contrast ratio								Battery type Battery life AC adapter	
	Some: 15.6" (396mm) FHD (1920x1080), anti-glare, LED backlight, IPS, 250 nits, 16:9 aspect ratio, 600:1 contrast ratio									
Multi-touch	None								vPro No	
Storage	Up to 2 drives (one M.2 SSD and one HDD) Some: M.2 SSD / SATA 6.0Gb/s Some: M.2 SSD / PCIe NVMe Some: HDD / SATA 6.0Gb/s, 2.5" wide, removable, upgradable, Active Protection System™									
Optical	Some: DVD burner, 9.0mm high, removable Some: Blank Bezel								Preload Some: Windows 10 Pro 64 Some: Windows 10 Home 64 • Lenovo Companion • Lenovo Settings • Microsoft Office preloaded; purchase a product key to activate • McAfee® Live Safe (30-day trial)	
Ethernet	Gigabit Ethernet Connection, Realtek R8111GUS									
WLAN	One of the following, configurable by model: • Intel Dual Band Wireless-AC 8265, 2x2, Wi-Fi + BT combo adapter, M.2 Card • QCA, Qualcomm 344A-AC, 2x2, Wi-Fi + Bluetooth combo adapter, M.2 Card • QCA, Qualcomm 435-AC, 1x1, Wi-Fi + Bluetooth combo adapter, M.2 Card								Limited warranty 1-year - depot repair service / service upgrades available	
Bluetooth™	Bluetooth wireless, integrated in Wi-Fi + Bluetooth combo adapter								Mil-Spec test None	
WWAN	None								Environment EPEAT™ Gold; ENERGY STAR®; RoHS-compliant	
SIM card	None									
Smart Card Reader	None									
ExpressCard	None									
Dock	None									
Multicard Reader	4-in-1 reader (MMC, SD, SDHC, SDXC)									
Ports	Two USB 3.0, one USB 2.0 (Always On), VGA, HDMI, Ethernet (RJ-45), combo audio / microphone jack, optional one USB 3.1 Type-C (standard for i5, i7 models in EMEA)									
Monitor cable	None									

ThinkPad E570 - TopSeller - 20H5

Product Specifications Reference (PSREF)

Model	Region	Processor	vPro	Graphics	Optional Ports	Memory	Display	Multi-touch	Storage(HDD/SSD)	Optical	WLAN + Bluetooth	WWAN	SIM Card	Color (LCD_Rear, Top_Cover)	Case Material	Finger-print Reader	TPM	Battery	Power Adapter	Operating System	Warranty	Ann Date (m/y)
20H50042US	US	i3-7100U	No	Intel HD 620	None	4GBx1	15.6" HD (1366x768)	None	500GB 7200rpm	DVD±RW	11ac, 1x1 + BT4.1	None	None	Black, Black	PC/ABS	Finger-print Reader	dTPM 2.0	4-cell (41Wh)	45W	Win10 Pro 64	1-year, Depot	09/16
20H50043US	US	i7-7500U	No	GTX 950M 2GB	None	8GB	15.6" FHD (1920x1080) IPS	None	500GB 7200rpm	DVD±RW	Intel 8265 ac, 2x2 + BT4.1	None	None	Black, Black	PC/ABS	Finger-print Reader	FW TPM 2.0	4-cell (41Wh)	90W	Win10 Pro 64	1-year, Depot	09/16
20H50044US	US	i3-6006U	No	Intel HD 520	None	4GBx1	15.6" HD (1366x768)	None	500GB 7200rpm	DVD±RW	11ac, 1x1 + BT4.1	None	None	Black, Black	PC/ABS	None	dTPM 2.0	4-cell (41Wh)	45W	Win10 Pro 64	1-year, Depot	11/16
20H50045US	US	i5-7200U	No	Intel HD 620	None	8GB	15.6" FHD (1920x1080) IPS	None	256GB SSD M.2 PCIe NVMe Opal2	DVD±RW	Intel 8265 ac, 2x2 + BT4.1	None	None	Black, Black	PC/ABS	Finger-print Reader	dTPM 2.0	4-cell (41Wh)	45W	Win10 Pro 64	1-year, Depot	09/16
20H50047US	US	i7-7500U	No	GTX 950M 2GB	None	8GB	15.6" FHD (1920x1080) IPS	None	256GB SSD M.2 PCIe NVMe Opal2	DVD±RW	Intel 8265 ac, 2x2 + BT4.1	None	None	Black, Black	PC/ABS	Finger-print Reader	FW TPM 2.0	4-cell (41Wh)	90W	Win10 Pro 64	1-year, Depot	09/16
20H50048US	US	i5-7200U	No	Intel HD 620	None	4GBx1	15.6" HD (1366x768)	None	500GB 7200rpm	DVD±RW	11ac, 1x1 + BT4.1	None	None	Black, Black	PC/ABS	Finger-print Reader	dTPM 2.0	4-cell (41Wh)	45W	Win10 Pro 64	1-year, Depot	09/16
20H5007UUS	US	i3-7100U	No	Intel HD 620	None	4GBx1	15.6" HD (1366x768)	None	180GB SSD M.2 Opal2	DVD±RW	11ac, 1x1 + BT4.1	None	None	Black, Black	PC/ABS	Finger-print Reader	dTPM 2.0	4-cell (41Wh)	45W	Win10 Pro 64	1-year, Depot	01/17
20H5007VUS	US	i5-6200U	No	940MX 2GB	None	8GB	15.6" HD (1366x768)	None	180GB SSD M.2 Opal2	DVD±RW	11ac, 1x1 + BT4.1	None	None	Black, Black	PC/ABS	Finger-print Reader	FW TPM 2.0	4-cell (41Wh)	65W	Win10 Pro 64	1-year, Depot	01/17
20H5007WUS	US	i5-6200U	No	940MX 2GB	None	4GBx1	15.6" HD (1366x768)	None	180GB SSD M.2 Opal2	DVD±RW	11ac, 1x1 + BT4.1	None	None	Black, Black	PC/ABS	Finger-print Reader	FW TPM 2.0	4-cell (41Wh)	65W	Win10 Pro 64	1-year, Depot	01/17
20H5009FUS	US	i3-6006U	No	Intel HD 520	None	4GBx1	15.6" HD (1366x768)	None	500GB 7200rpm	DVD±RW	11ac, 1x1 + BT4.1	None	None	Black, Black	PC/ABS	Finger-print Reader	dTPM 2.0	4-cell (41Wh)	45W	Win10 DG Win7 Pro 64	1-year, Depot	03/17
20H5009GUS	US	i7-6500U	No	940MX 2GB	None	8GB	15.6" FHD (1920x1080) IPS	None	256GB SSD M.2 PCIe NVMe Opal2	DVD±RW	Intel 8265 ac, 2x2 + BT4.1	None	None	Black, Black	PC/ABS	Finger-print Reader	FW TPM 2.0	4-cell (41Wh)	65W	Win10 DG Win7 Pro 64	1-year, Depot	03/17
20H5009HUS	US	i3-6006U	No	Intel HD 520	None	4GBx1	15.6" HD (1366x768)	None	500GB 7200rpm	DVD±RW	11ac, 1x1 + BT4.1	None	None	Black, Black	PC/ABS	None	dTPM 2.0	4-cell (41Wh)	45W	Win10 DG Win7 Pro 64	1-year, Depot	03/17
20H5009JUS	US	i7-6500U	No	940MX 2GB	None	8GB	15.6" FHD (1920x1080) IPS	None	128GB SSD M.2	DVD±RW	Intel 8265 ac, 2x2 + BT4.1	None	None	Black, Black	PC/ABS	Finger-print Reader	FW TPM 2.0	4-cell (41Wh)	65W	Win10 DG Win7 Pro 64	1-year, Depot	03/17
20H5009KUS	US	i5-6200U	No	Intel HD 520	None	4GBx1	15.6" HD (1366x768)	None	128GB SSD M.2	DVD±RW	11ac, 1x1 + BT4.1	None	None	Black, Black	PC/ABS	Finger-print Reader	dTPM 2.0	4-cell (41Wh)	45W	Win10 DG Win7 Pro 64	1-year, Depot	03/17
20H5009LUS	US	i5-6200U	No	Intel HD 520	None	8GB	15.6" FHD (1920x1080) IPS	None	256GB SSD M.2 PCIe NVMe Opal2	DVD±RW	Intel 8265 ac, 2x2 + BT4.1	None	None	Black, Black	PC/ABS	Finger-print Reader	dTPM 2.0	4-cell (41Wh)	45W	Win10 DG Win7 Pro 64	1-year, Depot	03/17
20H5009MUS	US	i7-6500U	No	940MX 2GB	None	8GB	15.6" FHD (1920x1080) IPS	None	500GB 7200rpm	DVD±RW	Intel 8265 ac, 2x2 + BT4.1	None	None	Black, Black	PC/ABS	Finger-print Reader	FW TPM 2.0	4-cell (41Wh)	65W	Win10 DG Win7 Pro 64	1-year, Depot	03/17
20H5009NUS	US	i5-6200U	No	Intel HD 520	None	4GBx1	15.6" HD (1366x768)	None	500GB 7200rpm	DVD±RW	11ac, 1x1 + BT4.1	None	None	Black, Black	PC/ABS	Finger-print Reader	dTPM 2.0	4-cell (41Wh)	45W	Win10 DG Win7 Pro 64	1-year, Depot	03/17
20H500A9US	US	i5-7200U	No	Intel HD 620	None	8GB	15.6" FHD (1920x1080) IPS	None	180GB SSD M.2 Opal2	DVD±RW	11ac, 1x1 + BT4.1	None	None	Black, Black	PC/ABS	Finger-print Reader	dTPM 2.0	4-cell (41Wh)	45W	Win10 Pro 64	1-year, Depot	03/17
20H500AAUS	US	i5-7200U	No	Intel HD 620	None	8GB	15.6" FHD (1920x1080) IPS	None	500GB 7200rpm	DVD±RW	11ac, 1x1 + BT4.1	None	None	Black, Black	PC/ABS	Finger-print Reader	dTPM 2.0	4-cell (41Wh)	45W	Win10 Pro 64	1-year, Depot	03/17



ThinkPad E575 Platform Specifications

Product Specifications Reference (PSREF)

Processor	AMD Accelerated Processor A6, A10, or A12 APU								Dimensions Weight Case color Case material	<i>PC/ABS (WxDxH):</i> 14.92" x 10.28" x 1.00"; 379mm x 261mm x 25.4mm From 5.07 lb (2.30kg) Black <i>PC/ABS:</i> PolyCarbonate/Acrylonitrile-Butadiene-Styrene display cover
	Processor Number	# of Cores	# of Threads	Base Frequency	Max Turbo Frequency	Cache	Memory Types	Processor Graphics		
	A6-9500B	2	4	2.3 GHz	3.2 GHz	2MB	DDR4-1866	R5 Graphics		
	A10-9600P	4	8	2.4 GHz	3.3 GHz	2MB		R5 Graphics		
A12-9700P	4	8	2.5 GHz	3.4 GHz	2MB	R7 Graphics				
Graphics	AMD Radeon™ R5 Graphics in processor only, or AMD Radeon R5 M430 Graphics, 2GB DDR3 memory, or external analog monitor support via VGA DB-15 connector and digital monitor support via HDMI™ (supporting HDCP to output protected content); supports dual independent displays; Max resolution: 1920x1080 (HDMI)@60Hz								Camera Audio support	<i>Some:</i> HD720p resolution, fixed focus HD Audio, Conexant® CX11852 codec, Dolby® Audio™ Premium / stereo speakers, 2W x 2 / dual array microphone, combo audio / microphone jack
Chipset	AMD SoC (System on Chip) platform								Keyboard	6-row, spill-resistant, multimedia Fn keys
Memory	32GB max / PC4-19200 2400MHz DDR4, non-parity, dual-channel capable, two 260-pin SO-DIMM sockets *System automatically clocks down with 1866MHz DDR4 memory controller								UltraNav™ ThinkLight™	TrackPoint® pointing device and multi-touch with 3+2 buttons click pad None
Display	Some: 15.6" (396mm) HD (1366x768), anti-glare, LED backlight, 220 nits, 16:9 aspect ratio, 400:1 contrast ratio Some: 15.6" (396mm) FHD (1920x1080), anti-glare, LED backlight, IPS, 250 nits, 16:9 aspect ratio, 600:1 contrast ratio (<i>not available in EMEA</i>)								Fingerprint reader	None
Multi-touch	None								NFC	None
Storage	Some: SSD / SATA 6.0Gb/s, 2.5" wide, 7mm high, removable, upgradable Some: HDD / SATA 6.0Gb/s, 2.5" wide, removable, upgradable, Active Protection System™								Security	Power-on password, hard disk password, supervisor password, security keyhole
Optical	Some: DVD burner, 9.0mm high, removable Some: Blank Bezel								Security chip	<i>FW TPM2.0:</i> Firmware TPM 2.0, integrated in chipset <i>dTPM2.0:</i> Discrete TPM 2.0, TCG Certified
Ethernet	Gigabit Ethernet Connection, Realtek R8111GUS								vPro	No
WLAN	One of the following, configurable by model: • QCA, Qualcomm 344A-AC, 2x2, Wi-Fi + Bluetooth combo adapter, M.2 Card • QCA, Qualcomm 435-AC, 1x1, Wi-Fi + Bluetooth combo adapter, M.2 Card Bluetooth wireless, integrated in Wi-Fi + Bluetooth combo adapter								Battery type	<i>Some:</i> Li-Ion 4-cell (41Wh)
Bluetooth™									Battery life	<i>Some:</i> Up to 6.5 hr
WWAN	None								AC adapter	<i>Some:</i> 45-watt AC adapter <i>Some:</i> 65-watt AC adapter
SIM card	None								Preload	<i>Some:</i> Windows 10 Pro 64 <i>Some:</i> Windows 10 Home 64 • Lenovo Companion • Lenovo Settings • Microsoft Office preloaded; purchase a product key to activate • McAfee® Live Safe (30-day trial) <i>Some:</i> No operating system
Smart Card Reader	None								Limited warranty	1-year - depot repair service / service upgrades available
ExpressCard	None								Mil-Spec test	None
Dock	None								Environment	EPEAT™ Gold; ENERGY STAR®; RoHS-compliant
Multicard Reader	4-in-1 reader (MMC, SD, SDHC, SDXC)									
Ports	Two USB 3.0, one USB 2.0 (Always On), VGA, HDMI, Ethernet (RJ-45), combo audio / microphone jack									
Monitor cable	None									

ThinkPad E575 - TopSeller - 20H8

Product Specifications Reference (PSREF)

Model	Region	Processor	vPro	Graphics	Memory	Display	Multi-touch	Storage(HDD/SSD)	Optical	WLAN + Bluetooth	WWAN	SIM Card	Color	Case Material	Camera	Keyboard	Finger-print Reader	TPM	Battery	Power Adapter	Operating System	Warranty	Ann Date (m/y)
20H8000CUS	US	AMD A10-9600P	No	AMD R5 M430 2GB	4GBx1	15.6" HD (1366x768)	None	500GB 7200rpm	DVD±RW	QCA435 ac, 1x1 + BT4.1	None	None	Black	PC/ABS	720p	Non-backlit	None	FW TPM 2.0	4-cell (41Wh)	65W	Windows 10 Pro 64	1-year, Depot	11/16
20H8000DUS	US	AMD A10-9600P	No	AMD R5 M430 2GB	8GB	15.6" FHD (1920x1080) IPS	None	500GB 7200rpm	DVD±RW	QCA435 ac, 1x1 + BT4.1	None	None	Black	PC/ABS	720p	Non-backlit	None	FW TPM 2.0	4-cell (41Wh)	65W	Windows 10 Pro 64	1-year, Depot	11/16
20H8000EUS	US	AMD A10-9600P	No	AMD R5 M430 2GB	8GB	15.6" HD (1366x768)	None	500GB 7200rpm	DVD±RW	QCA435 ac, 1x1 + BT4.1	None	None	Black	PC/ABS	720p	Non-backlit	None	FW TPM 2.0	4-cell (41Wh)	65W	Windows 10 Pro 64	1-year, Depot	11/16
20H8000FUS	US	AMD A6-9500B	No	AMD R5 Graphics	8GB	15.6" HD (1366x768)	None	500GB 7200rpm	DVD±RW	QCA435 ac, 1x1 + BT4.1	None	None	Black	PC/ABS	720p	Non-backlit	None	dTPM 1.2	4-cell (41Wh)	45W	Windows 10 Pro 64	1-year, Depot	11/16
20H8000GUS	US	AMD A10-9600P	No	AMD R5 M430 2GB	8GB	15.6" FHD (1920x1080) IPS	None	256GB SSD Opal2	DVD±RW	QCA435 ac, 1x1 + BT4.1	None	None	Black	PC/ABS	720p	Non-backlit	None	FW TPM 2.0	4-cell (41Wh)	65W	Windows 10 Pro 64	1-year, Depot	11/16
20H8000HUS	US	AMD A6-9500B	No	AMD R5 Graphics	4GBx1	15.6" HD (1366x768)	None	500GB 7200rpm	DVD±RW	QCA435 ac, 1x1 + BT4.1	None	None	Black	PC/ABS	720p	Non-backlit	None	dTPM 1.2	4-cell (41Wh)	45W	Windows 10 Pro 64	1-year, Depot	11/16
20H8000QUS	US	AMD A10-9600P	No	AMD R5 M430 2GB	8GB	15.6" HD (1366x768)	None	180GB SSD Opal2	DVD±RW	QCA435 ac, 1x1 + BT4.1	None	None	Black	PC/ABS	720p	Non-backlit	None	FW TPM 2.0	4-cell (41Wh)	65W	Windows 10 Pro 64	1-year, Depot	01/17



ThinkPad E580 Platform Specifications

Product Specifications Reference (PSREF)

Processor	7th or 8th Generation Intel® Core™ i3 / i5 / i7 Processor								Dimensions Weight Case color Case material Camera Audio support	<i>Aluminum (WxDxH):</i> 14.53" x 9.92" x 0.78" 369mm x 252mm x 19.95mm From 4.7 lb (2.1kg) <i>LCD Rear:</i> Black or Silver <i>Base Cover:</i> Black or Silver <i>Top Cover:</i> Black or Silver Aluminum display cover
	Processor Number	# of Cores	# of Threads	Base Frequency	Max Turbo Frequency	Cache	Memory Controller	Processor Graphics		
	i3-7130U	2	4	2.7 GHz	-	3MB	DDR4-2133	Intel HD Graphics 620		
	i5-7200U			2.5 GHz	3.1 GHz	3MB				
	i3-8130U	2	4	2.2 GHz	3.4 GHz	4MB	DDR4-2400	Intel UHD Graphics 620		
i5-8250U	1.6 GHz			3.4 GHz	6MB					
i7-8550U	4	8	1.8 GHz	4.0 GHz	8MB	DDR4-2400				
* i3-7130U is not available in EMEA and US										
Graphics	Intel HD Graphics in processor only, or AMD Radeon RX 550 Graphics, 2GB DDR5 memory, digital monitor support via HDMI™ (supporting HDCP to output protected content); supports dual independent displays; Max resolution: 1920x1080 (HDMI)@60Hz								Keyboard	6-row, spill-resistant, multimedia Fn keys, numeric keypad, optional LED backlight
Memory	32GB max / 2400MHz DDR4, non-parity, dual-channel capable, two 260-pin SO-DIMM sockets * System clocks down for processors with lower memory controller								UltraNav™ ThinkLight™	TrackPoint® pointing device and multi-touch with 3+2 buttons click pad None
Display	Some: 15.6" (396mm) HD (1366x768), anti-glare, LED backlight, 220 nits, 16:9 aspect ratio, 400:1 contrast ratio Some: 15.6" (396mm) FHD (1920x1080), anti-glare, LED backlight, IPS, 250 nits, 16:9 aspect ratio, 600:1 contrast ratio								Fingerprint reader	Some: Touch style fingerprint reader on the palm rest
Multi-touch	None								NFC	None
Storage	Up to 2 drives (one M.2 SSD and one HDD) Some: M.2 SSD / PCIe NVMe Some: HDD / SATA 6.0Gb/s, 2.5" wide, removable, upgradable, Active Protection System™ Some: Dummy HDD								Security	Power-on password, hard disk password, supervisor password, security keyhole
Optical	None								Security chip	fTPM2.0: Firmware TPM 2.0, integrated in chipset dTPM2.0: Discrete TPM 2.0, TCG Certified
Ethernet	Gigabit Ethernet Connection, Realtek R8111GUS								vPro	No
WLAN	One of the following, configurable by model: • Intel Dual Band Wireless-AC 3165, 1x1, Wi-Fi + BT combo adapter, M.2 Card • Realtek® RTL8822BE, Wi-Fi 2x2 802.11ac + BT4.1, M.2 card • Realtek RTL8821CE, Wi-Fi 1x1 802.11ac + BT4.1, M.2 card								Battery type	45Wh battery, supports Rapid Charge (charge up to 80% in 1hr) with 65W USB Type-C AC adapter
Bluetooth™	Bluetooth 4.1 wireless, integrated in Wi-Fi + Bluetooth combo adapter								Battery life	up to 12.23 hr
WWAN	None								AC adapter	45W or 65W USB Type-C AC adapter
SIM card	None								Preload	Some: Windows 10 Pro 64 Some: Windows 10 Home 64 • Lenovo Companion • PC Manager • Microsoft Office preloaded; purchase a product key to activate • McAfee® Live Safe (30-day trial) Some: No operating system
Smart Card Reader	None								Limited warranty	1-year - depot repair service / service upgrades available
ExpressCard	None								Mil-Spec test	MIL-STD-810G military certification
Dock	None								Environment	ENERGY STAR®; RoHS-compliant
Multicard Reader	Micro SD card reader									
Ports	Two USB 3.1 (one Always On), one USB 2.0, HDMI 1.4b, Ethernet (RJ-45), One USB 3.1 Type-C Gen 2 (support data, video, and power delivery)									
Monitor cable	None									

ThinkPad E580 - TopSeller - 20KS

Product Specifications Reference (PSREF)

Model	Region	Processor	vPro	Graphics	Memory	Display	Storage(HDD/SSD)	Optical	WLAN + Bluetooth	WWAN	SIM Card	Color	Case Material	Camera	Keyboard	Finger-print Reader	TPM	Battery	Power Adapter	Operating System	Warranty	Ann Date (m/y)
20KS003LUS	US	i7-8550U	No	Intel UHD 620	8GBx1	15.6" FHD (1920x1080) IPS	500GB 7200rpm	None	RTL8822BE, 2x2 + BT4.1	None	None	Black	Aluminum	720p	Non-backlit	Finger-print Reader	dTPM 2.0	45Wh	65W USB-C	Win10 Pro 64	1-year, Depot	01/18
20KS003MUS	US	i7-8550U	No	Intel UHD 620	8GBx1	15.6" FHD (1920x1080) IPS	500GB 7200rpm	None	RTL8822BE, 2x2 + BT4.1	None	None	Silver	Aluminum	720p	Non-backlit	Finger-print Reader	dTPM 2.0	45Wh	65W USB-C	Win10 Pro 64	1-year, Depot	01/18
20KS003NUS	US	i7-8550U	No	Intel UHD 620	8GBx1	15.6" FHD (1920x1080) IPS	256GB SSD M.2 PCIe NVMe Opal2	None	RTL8822BE, 2x2 + BT4.1	None	None	Silver	Aluminum	720p	Non-backlit	Finger-print Reader	dTPM 2.0	45Wh	65W USB-C	Win10 Pro 64	1-year, Depot	01/18
20KS003PUS	US	i7-8550U	No	Intel UHD 620	8GBx1	15.6" FHD (1920x1080) IPS	256GB SSD M.2 PCIe NVMe Opal2	None	RTL8822BE, 2x2 + BT4.1	None	None	Black	Aluminum	720p	Non-backlit	Finger-print Reader	dTPM 2.0	45Wh	65W USB-C	Win10 Pro 64	1-year, Depot	01/18
20KS003QUS	US	i5-7200U	No	Intel HD 620	8GBx1	15.6" FHD (1920x1080) IPS	256GB SSD M.2 PCIe NVMe Opal2	None	RTL8822BE, 2x2 + BT4.1	None	None	Black	Aluminum	720p	Non-backlit	Finger-print Reader	dTPM 2.0	45Wh	65W USB-C	Win10 Pro 64	1-year, Depot	12/17
20KS003RUS	US	i5-7200U	No	Intel HD 620	8GBx1	15.6" HD (1366x768)	256GB SSD M.2 PCIe NVMe Opal2	None	RTL8822BE, 2x2 + BT4.1	None	None	Black	Aluminum	720p	Non-backlit	Finger-print Reader	dTPM 2.0	45Wh	65W USB-C	Win10 Pro 64	1-year, Depot	12/17
20KS003SUS	US	i5-8250U	No	Intel UHD 620	8GBx1	15.6" FHD (1920x1080) IPS	256GB SSD M.2 PCIe NVMe Opal2	None	RTL8822BE, 2x2 + BT4.1	None	None	Black	Aluminum	720p	Non-backlit	Finger-print Reader	dTPM 2.0	45Wh	65W USB-C	Win10 Pro 64	1-year, Depot	12/17
20KS003TUS	US	i5-8250U	No	Intel UHD 620	8GBx1	15.6" FHD (1920x1080) IPS	128GB SSD M.2 PCIe NVMe Opal2	None	RTL8822BE, 2x2 + BT4.1	None	None	Black	Aluminum	720p	Non-backlit	Finger-print Reader	dTPM 2.0	45Wh	65W USB-C	Win10 Pro 64	1-year, Depot	12/17
20KS003UUS	US	i5-8250U	No	Intel UHD 620	8GBx1	15.6" FHD (1920x1080) IPS	500GB 7200rpm	None	RTL8822BE, 2x2 + BT4.1	None	None	Black	Aluminum	720p	Non-backlit	Finger-print Reader	dTPM 2.0	45Wh	65W USB-C	Win10 Pro 64	1-year, Depot	12/17
20KS003VUS	US	i5-7200U	No	Intel HD 620	8GBx1	15.6" HD (1366x768)	500GB 7200rpm	None	RTL8822BE, 2x2 + BT4.1	None	None	Black	Aluminum	720p	Non-backlit	Finger-print Reader	dTPM 2.0	45Wh	65W USB-C	Win10 Pro 64	1-year, Depot	12/17
20KS003WUS	US	i5-7200U	No	Intel HD 620	4GBx1	15.6" HD (1366x768)	500GB 7200rpm	None	RTL8822BE, 2x2 + BT4.1	None	None	Black	Aluminum	720p	Non-backlit	Finger-print Reader	dTPM 2.0	45Wh	65W USB-C	Win10 Pro 64	1-year, Depot	12/17
20KS0040US	US	i5-8250U	No	Intel UHD 620	8GBx1	15.6" FHD (1920x1080) IPS	256GB SSD M.2 PCIe NVMe Opal2	None	RTL8822BE, 2x2 + BT4.1	None	None	Silver	Aluminum	720p	Non-backlit	Finger-print Reader	dTPM 2.0	45Wh	65W USB-C	Win10 Pro 64	1-year, Depot	12/17



ThinkPad L380 Platform Specifications

Product Specifications Reference (PSREF)

Processor	Intel® Celeron® Processor, 7th Generation Intel Core™ i3 / i5 Processor or							Dimensions	<i>WxDxH:</i> 12.67" x 8.83" x 0.74"; 321.8mm x 224.2mm x 18.8mm
	Processor Number	# of Cores	# of Threads	Base Frequency	Max Turbo Frequency	Cache	Memory Types	Processor Graphics	Weight Starting at 3.22 lb / 1.46 kg Case color Black or Silver Case material <i>Display cover:</i> Aluminum <i>Bottom:</i> GFRP
	Cel 3965U	2	2	2.2 GHz	-	2MB	DDR4-2133	Intel HD Graphics 610	Smart card reader None Media reader MicroSD card reader Ports Two USB 3.1 Gen 1 (one Always On), two USB 3.1 Type-C Gen 1, HDMI 1.4b, Ethernet extension connector, headphone / microphone combo jack, microSD card reader, security keyhole Monitor cable (optional) <i>HDMI to VGA:</i> Lenovo HDMI to VGA Monitor Adapter <i>USB-C to VGA:</i> Lenovo USB-C to VGA Adapter <i>USB-C to DP:</i> Lenovo USB-C to DisplayPort Adapter
	i3-7130U		4	2.7 GHz	-	3MB		Intel HD Graphics 620	
	i5-7200U		4	2.5 GHz	3.1 GHz	3MB			
	8th Generation Intel Core i5 / i7 Processor								
	Processor Number	# of Cores	# of Threads	Base Frequency	Max Turbo Frequency	Cache	Memory Types	Processor Graphics	
	i3-8130U	2	4	2.2 GHz	3.4 GHz	4MB	DDR4-2400	Intel UHD Graphics 620	Camera HD720p camera, fixed focus Audio support HD Audio, Realtek ALC3287 codec, Dolby® Audio™ / stereo speakers, 2W x 2 / dual array microphone, headphone / microphone combo jack
	i5-8250U			1.6 GHz	3.4 GHz	6MB			
	i5-8350U			1.7 GHz	3.6 GHz	6MB			
	i7-8550U			1.8 GHz	4.0 GHz	8MB			
Graphics	Intel HD Graphics 610, 620 or Intel UHD Graphics 620 in processor; supports external digital monitor via HDMI or USB Type-C; supports three independent displays; Max resolution: 4096x2304@60Hz (USB Type-C); 4096x2160@30Hz (HDMI)							Keyboard	6-row, spill-resistant, multimedia Fn keys, optional LED backlight UltraNav™ TrackPoint® pointing device and buttonless Mylar surface touchpad, multi-touch
Chipset	Intel SoC (System on Chip) platform							Security	Power-on password, hard disk password, supervisor password, security keyhole
Memory	32GB max / 2400MHz DDR4, dual-channel capable, two DDR4 SO-DIMM sockets * System clocks down for processors with lower memory controller							Security chip	Discrete TPM 2.0, TCG Certified
Display	<i>Some:</i> 13.3" (338mm) HD (1366x768), anti-glare, LED backlight, 250 nits, 16:9 aspect ratio, 500:1 contrast ratio <i>Some:</i> 13.3" (338mm) FHD (1920x1080), anti-glare, LED backlight, IPS, 250 nits, 16:9 aspect ratio, 700:1 contrast ratio, 170° viewing angle							vPro (optional)	Intel vPro Technology
Multi-touch (opt)	On-cell touch, supports 10-finger gesture (FHD only)							Fingerprint reader	<i>Optional:</i> Touch style fingerprint reader on the keyboard bezel, anti-spoofing technology
Storage	<i>One of the following, configurable by model:</i> • M.2 SSD / SATA 6.0Gb/s (e.g. xxxGB SSD M.2) • M.2 SSD / PCIe NVMe, PCIe 3.0 x 4, 32Gb/s (e.g. xxxGB SSD M.2 PCIe NVMe)							NFC (optional)	Near Field Communication
Optical	None							Battery	Integrated Li-Ion 45Wh battery, supports Rapid Charge (charge up to 80% in 1hr) with 65W USB Type-C AC adapter
Ethernet	Native Intel Ethernet Connection I219-V (Non-vPro) or I219-LM (vPro) via optional ThinkPad Ethernet Extension Cable							Max battery life	<i>MobileMark® 2014:</i> 16.1 hr * Battery life varies significantly with settings, usage, & other factors
WLAN + Bluetooth™	Intel Dual Band Wireless-AC 8265, Wi-Fi 2x2 802.11ac + Bluetooth 4.1, M.2 card * Intel 8265ac card supports BT4.2 but is limited to BT4.1 by Windows OS							AC adapter	45W or 65W USB Type-C AC adapter
WWAN	None							Preload	Windows® 10 Home 64 or Windows 10 Pro 64
								Limited warranty	<i>One of the following, configurable by model:</i> • 1-year depot repair service • 3-year/1-yr battery depot repair service • 3-year/1-yr battery limited onsite service
								Mil-Spec test	MIL-STD-810G military certification
								Environment	EPeAT™ Gold; ENERGY STAR® 6.1; RoHS-compliant

ThinkPad L380 - TopSeller - 20M5

Product Specifications Reference (PSREF)

Model	Region	Processor	vPro	Graphics	Memory	Display	Multi-touch	Storage(HDD/SSD)	Optical	WLAN + Bluetooth	Monitor Cable	Adapter	Color	Camera	Keyboard	Fingerprint Reader	NFC	TPM	Battery (internal)	Power Adapter	Operating System	Warranty	Ann Date (m/y)
20M5000FUS	US	i5-8250U	No	Intel UHD 620	8GBx1	13.3" FHD (1920x1080) IPS	10-point Multi-touch	256GB SSD M.2 Opal2	None	Intel 8265 ac, 2x2 + BT4.1	None	None	Silver	720p	Backlit	None	None	dTPM 2.0	45Wh	65W USB-C	Windows 10 Pro 64	3-year, Depot	02/18
20M5000GUS	US	i5-8350U	vPro	Intel UHD 620	8GBx1	13.3" FHD (1920x1080) IPS	10-point Multi-touch	256GB SSD M.2 Opal2	None	Intel 8265 ac, 2x2 + BT4.1	None	None	Black	720p	Backlit	Fingerprint Reader	None	dTPM 2.0	45Wh	65W USB-C	Windows 10 Pro 64	3-year, Depot	02/18
20M5000HUS	US	i5-8250U	No	Intel UHD 620	4GBx1	13.3" HD (1366x768)	None	256GB SSD M.2 Opal2	None	Intel 8265 ac, 2x2 + BT4.1	None	None	Black	720p	Non-backlit	None	None	dTPM 2.0	45Wh	65W USB-C	Windows 10 Pro 64	1-year, Depot	02/18
20M5000KUS	US	i5-8250U	No	Intel UHD 620	4GBx1	13.3" HD (1366x768)	None	256GB SSD M.2 Opal2	None	Intel 8265 ac, 2x2 + BT4.1	None	None	Silver	720p	Non-backlit	None	None	dTPM 2.0	45Wh	65W USB-C	Windows 10 Pro 64	1-year, Depot	02/18
20M5000LUS	US	i5-7200U	No	Intel HD 620	8GBx1	13.3" HD (1366x768)	None	256GB SSD M.2 Opal2	None	Intel 8265 ac, 2x2 + BT4.1	None	None	Black	720p	Non-backlit	Fingerprint Reader	None	dTPM 2.0	45Wh	65W USB-C	Windows 10 Pro 64	3-year, Depot	02/18
20M5000NUS	US	i5-8350U	vPro	Intel UHD 620	8GBx1	13.3" FHD (1920x1080) IPS	10-point Multi-touch	256GB SSD M.2 Opal2	None	Intel 8265 ac, 2x2 + BT4.1	None	None	Silver	720p	Backlit	None	None	dTPM 2.0	45Wh	65W USB-C	Windows 10 Pro 64	3-year, Depot	02/18
20M5000QUS	US	i5-8250U	No	Intel UHD 620	8GBx1	13.3" FHD (1920x1080) IPS	10-point Multi-touch	256GB SSD M.2 Opal2	None	Intel 8265 ac, 2x2 + BT4.1	None	None	Black	720p	Backlit	Fingerprint Reader	None	dTPM 2.0	45Wh	65W USB-C	Windows 10 Pro 64	3-year, Depot	02/18
20M5000RUS	US	Celeron 3965U	No	Intel HD 610	4GBx1	13.3" HD (1366x768)	None	128GB SSD M.2	None	Intel 8265 ac, 2x2 + BT4.1	None	None	Black	720p	Non-backlit	Fingerprint Reader	None	dTPM 2.0	45Wh	65W USB-C	Windows 10 Pro 64	1-year, Depot	02/18
20M5000SUS	US	i5-8250U	No	Intel UHD 620	8GBx1	13.3" HD (1366x768)	None	256GB SSD M.2 Opal2	None	Intel 8265 ac, 2x2 + BT4.1	None	None	Black	720p	Non-backlit	Fingerprint Reader	None	dTPM 2.0	45Wh	65W USB-C	Windows 10 Pro 64	3-year, Depot	02/18
20M5003UUS	US	i3-8130U	No	Intel UHD 620	4GBx1	13.3" FHD (1920x1080) IPS	10-point Multi-touch	256GB SSD M.2 PCIe NVMe Opal2	None	Intel 8265 ac, 2x2 + BT4.1	None	None	Black	720p	Non-backlit	Fingerprint Reader	None	dTPM 2.0	45Wh	65W USB-C	Windows 10 Pro 64	1-year, Depot	04/18
20M5003VUS	US	i3-8130U	No	Intel UHD 620	4GBx1	13.3" HD (1366x768)	None	256GB SSD M.2 PCIe NVMe Opal2	None	Intel 8265 ac, 2x2 + BT4.1	None	None	Black	720p	Non-backlit	Fingerprint Reader	None	dTPM 2.0	45Wh	65W USB-C	Windows 10 Pro 64	1-year, Depot	04/18
20M5003WUS	US	i3-8130U	No	Intel UHD 620	4GBx1	13.3" HD (1366x768)	None	256GB SSD M.2 PCIe NVMe Opal2	None	Intel 8265 ac, 2x2 + BT4.1	None	None	Silver	720p	Non-backlit	None	None	dTPM 2.0	45Wh	65W USB-C	Windows 10 Pro 64	1-year, Depot	04/18
20M5003YUS	US	i3-8130U	No	Intel UHD 620	8GBx1	13.3" HD (1366x768)	None	180GB SSD M.2 Opal2	None	Intel 8265 ac, 2x2 + BT4.1	None	None	Silver	720p	Non-backlit	None	None	dTPM 2.0	45Wh	65W USB-C	Windows 10 Pro 64	1-year, Depot	05/18
20M50040US	US	i5-8250U	No	Intel UHD 620	8GBx1	13.3" HD (1366x768)	None	180GB SSD M.2 Opal2	None	Intel 8265 ac, 2x2 + BT4.1	None	None	Black	720p	Backlit	Fingerprint Reader	None	dTPM 2.0	45Wh	65W USB-C	Windows 10 Pro 64	1-year, Depot	05/18
20M50041US	US	i3-8130U	No	Intel UHD 620	8GBx1	13.3" HD (1366x768)	None	180GB SSD M.2 Opal2	None	Intel 8265 ac, 2x2 + BT4.1	None	None	Black	720p	Non-backlit	None	None	dTPM 2.0	45Wh	65W USB-C	Windows 10 Pro 64	1-year, Depot	05/18



ThinkPad L470 Platform Specifications

Product Specifications Reference (PSREF)

Processor	6th Generation Intel® Core™ i3 / i5 / i7 Processor (i7 processor is NOT available in EMEA) or <table border="1"> <thead> <tr> <th>Processor Number</th> <th># of Cores</th> <th># of Threads</th> <th>Base Frequency</th> <th>Max Turbo Frequency</th> <th>Cache</th> <th>Memory Types</th> <th>Processor Graphics</th> </tr> </thead> <tbody> <tr> <td>i3-6006U</td> <td rowspan="4">2</td> <td rowspan="4">4</td> <td>2.0 GHz</td> <td>-</td> <td>3MB</td> <td rowspan="4">DDR4-2133</td> <td rowspan="4">Intel HD Graphics 520</td> </tr> <tr> <td>i3-6100U</td> <td>2.3 GHz</td> <td>-</td> <td>3MB</td> </tr> <tr> <td>i5-6200U</td> <td>2.3 GHz</td> <td>2.8 GHz</td> <td>3MB</td> </tr> <tr> <td>i5-6300U</td> <td>2.4 GHz</td> <td>3.0 GHz</td> <td>3MB</td> </tr> </tbody> </table> Intel Celeron® Processor or 7th Generation Intel Core i3 / i5 / i7 Processor <table border="1"> <thead> <tr> <th>Processor Number</th> <th># of Cores</th> <th># of Threads</th> <th>Base Frequency</th> <th>Max Turbo Frequency</th> <th>Cache</th> <th>Memory Types</th> <th>Processor Graphics</th> </tr> </thead> <tbody> <tr> <td>Cel 3965U</td> <td rowspan="7">2</td> <td rowspan="7">4</td> <td>2.2 GHz</td> <td>-</td> <td>2MB</td> <td rowspan="7">DDR4-2133</td> <td>Intel HD Graphics 610</td> </tr> <tr> <td>i3-7100U</td> <td>2.4 GHz</td> <td>-</td> <td>3MB</td> <td rowspan="6">Intel HD Graphics 620</td> </tr> <tr> <td>i5-7200U</td> <td>2.5 GHz</td> <td>3.1 GHz</td> <td>3MB</td> </tr> <tr> <td>i5-7300U</td> <td>2.6 GHz</td> <td>3.5 GHz</td> <td>3MB</td> </tr> <tr> <td>i7-7500U</td> <td>2.7 GHz</td> <td>3.5 GHz</td> <td>4MB</td> </tr> <tr> <td>i7-7600U</td> <td>2.8 GHz</td> <td>3.9 GHz</td> <td>4MB</td> </tr> </tbody> </table>	Processor Number	# of Cores	# of Threads	Base Frequency	Max Turbo Frequency	Cache	Memory Types	Processor Graphics	i3-6006U	2	4	2.0 GHz	-	3MB	DDR4-2133	Intel HD Graphics 520	i3-6100U	2.3 GHz	-	3MB	i5-6200U	2.3 GHz	2.8 GHz	3MB	i5-6300U	2.4 GHz	3.0 GHz	3MB	Processor Number	# of Cores	# of Threads	Base Frequency	Max Turbo Frequency	Cache	Memory Types	Processor Graphics	Cel 3965U	2	4	2.2 GHz	-	2MB	DDR4-2133	Intel HD Graphics 610	i3-7100U	2.4 GHz	-	3MB	Intel HD Graphics 620	i5-7200U	2.5 GHz	3.1 GHz	3MB	i5-7300U	2.6 GHz	3.5 GHz	3MB	i7-7500U	2.7 GHz	3.5 GHz	4MB	i7-7600U	2.8 GHz	3.9 GHz	4MB	WWAN (optional) <i>One of the following, configurable by model:</i> <ul style="list-style-type: none"> Wireless WAN upgradable Integrated Mobile Broadband 4G LTE-A, Qualcomm® Snapdragon™ X7 LTE-A (Sierra Wireless EM7455), M.2 card Integrated Mobile Broadband 4G LTE, Intel XMM™ 7160 (Fibocom L831-EAU), M.2 card (EMEA only) SIM card (opt) Micro-SIM card slot, opt Verizon LTE (US) or Lenovo® Connect (EMEA) SIM card Dimensions <i>WxDxH:</i> 13.35" x 9.25" x 0.94"; 339mm x 235mm x 23.9mm Weight <table border="1"> <thead> <tr> <th>Models</th> <th>3-cell</th> <th>6-cell</th> </tr> </thead> <tbody> <tr> <td><i>Integrated model</i></td> <td>4.13 lb / 1.87 kg</td> <td>4.45 lb / 2.02 kg</td> </tr> <tr> <td><i>discrete model</i></td> <td>4.16 lb / 1.89 kg</td> <td>4.48 lb / 2.03 kg</td> </tr> </tbody> </table> Case color Black Case material PC/ABS plastic Smart card reader <i>Optional:</i> Smart card reader Media reader 4-in-1 reader (MMC, SD, SDHC, SDXC) Ports Three USB 3.1 Gen 1 (USB 3.0, one Always On), VGA, Mini DisplayPort, Ethernet (RJ-45), Dock connector Camera (optional) HD720p resolution, fixed focus Audio support HD Audio, Realtek ALC3268 codec / stereo speakers, 1W x 2 / dual array microphone, combo audio/microphone jack Keyboard 6-row, spill-resistant, multimedia Fn keys UltraNav™ TrackPoint® pointing device and buttonless Mylar surface multi-touch touchpad Security Power-on password, hard disk password, supervisor password, security keyhole Security chip Discrete TPM 2.0, TCG Certified vPro (optional) Intel vPro Technology Fingerprint reader <i>Optional:</i> Swipe style fingerprint reader on the keyboard bezel NFC None Battery Li-Ion 3-cell (24Wh) or 6-cell (48Wh or 72Wh) Max battery life ¹⁰ (MobileMark® 2014) <table border="1"> <thead> <tr> <th>Models</th> <th>3-cell</th> <th>6-cell 48Wh</th> <th>6-cell 72Wh</th> </tr> </thead> <tbody> <tr> <td><i>Integrated model</i></td> <td>7.24 hr</td> <td>14.48 hr</td> <td>21.72 hr</td> </tr> <tr> <td><i>discrete model</i></td> <td>4.34 hr</td> <td>8.68 hr</td> <td>13.02 hr</td> </tr> </tbody> </table> AC adapter 45W or 65W slim tip AC adapter Preload Windows® 7 Professional 64 preinstalled through downgrade rights in Windows 10 Pro 64 <ul style="list-style-type: none"> Lenovo Solution Center Lenovo PowerEngage ThinkVantage Product Recovery ThinkVantage System Update Adobe® Reader® Microsoft® Office preloaded; purchase a product key to activate McAfee® LiveSafe™ (30-day trial) <i>Some:</i> Windows 10 Home 64 <ul style="list-style-type: none"> Windows 10 Pro 64 Lenovo Companion Lenovo Setting Microsoft Office preloaded; purchase a product key to activate Limited warranty <i>One of the following, configurable by model:</i> <ul style="list-style-type: none"> 1-year depot repair service 3-year/1-yr battery depot repair service 3-year/1-yr battery limited onsite service Mil-Spec test MIL-STD-810G military certification Environment EPEAT™ Gold (US only); ENERGY STAR® 6.1; RoHS-compliant	Models	3-cell	6-cell	<i>Integrated model</i>	4.13 lb / 1.87 kg	4.45 lb / 2.02 kg	<i>discrete model</i>	4.16 lb / 1.89 kg	4.48 lb / 2.03 kg	Models	3-cell	6-cell 48Wh	6-cell 72Wh	<i>Integrated model</i>	7.24 hr	14.48 hr	21.72 hr	<i>discrete model</i>	4.34 hr	8.68 hr	13.02 hr
Processor Number	# of Cores	# of Threads	Base Frequency	Max Turbo Frequency	Cache	Memory Types	Processor Graphics																																																																																	
i3-6006U	2	4	2.0 GHz	-	3MB	DDR4-2133	Intel HD Graphics 520																																																																																	
i3-6100U			2.3 GHz	-	3MB																																																																																			
i5-6200U			2.3 GHz	2.8 GHz	3MB																																																																																			
i5-6300U			2.4 GHz	3.0 GHz	3MB																																																																																			
Processor Number	# of Cores	# of Threads	Base Frequency	Max Turbo Frequency	Cache	Memory Types	Processor Graphics																																																																																	
Cel 3965U	2	4	2.2 GHz	-	2MB	DDR4-2133	Intel HD Graphics 610																																																																																	
i3-7100U			2.4 GHz	-	3MB		Intel HD Graphics 620																																																																																	
i5-7200U			2.5 GHz	3.1 GHz	3MB																																																																																			
i5-7300U			2.6 GHz	3.5 GHz	3MB																																																																																			
i7-7500U			2.7 GHz	3.5 GHz	4MB																																																																																			
i7-7600U			2.8 GHz	3.9 GHz	4MB																																																																																			
Models			3-cell	6-cell																																																																																				
<i>Integrated model</i>	4.13 lb / 1.87 kg	4.45 lb / 2.02 kg																																																																																						
<i>discrete model</i>	4.16 lb / 1.89 kg	4.48 lb / 2.03 kg																																																																																						
Models	3-cell	6-cell 48Wh	6-cell 72Wh																																																																																					
<i>Integrated model</i>	7.24 hr	14.48 hr	21.72 hr																																																																																					
<i>discrete model</i>	4.34 hr	8.68 hr	13.02 hr																																																																																					
Graphics	Intel HD Graphics 610 or 620 in processor only, or Intel HD Graphics 620 in processor and AMD Radeon™ R5 M430, 2GB memory; supports external analog monitor via VGA and digital monitor via Mini DisplayPort; supports three independent displays; Max resolution: 3840x2160@60Hz (DP via mDP cable); 1920x1200@60Hz (VGA)																																																																																							
Chipset	Intel SoC (System on Chip) platform																																																																																							
Memory	32GB max / 2400MHz DDR4, dual-channel capable, two DDR4 SO-DIMM sockets * System clocks down for processors with lower memory controller																																																																																							
Display	<i>Some:</i> 14.0" (355mm) HD (1366x768), anti-glare, LED backlight, 220 nits, 16:9 aspect ratio, 500:1 contrast ratio <i>Some:</i> 14.0" (355mm) FHD (1920x1080), anti-glare, LED backlight, IPS, 250 nits, 16:9 aspect ratio, 700:1 contrast ratio, 170° viewing angle																																																																																							
Multi-touch	None																																																																																							
Storage	<i>System has one HDD slot or one M.2 2280 slot exclusively for storage</i> <i>Some:</i> HDD / SATA 6.0Gb/s, 2.5" wide, 7mm or 9.5mm high, Active Protection System™ <i>Some:</i> SSD / SATA 6.0Gb/s, 2.5" wide, 7mm high (e.g. xxxGB SSD) <i>Some:</i> M.2 SSD / PCIe NVMe, PCIe 3.0 x 2, 16Gb/s <i>Some:</i> 128GB M.2 SSD / SATA 6.0Gb/s, in WWAN slot as 2nd Storage, mutually exclusive with WWAN																																																																																							
Optical	None																																																																																							
Ethernet	<i>Non-vPro model:</i> Intel Ethernet Connection I219-V (Jacksonville) <i>vPro model:</i> Intel Ethernet Connection I219-LM (Jacksonville)																																																																																							
WLAN	<i>One of the following, configurable by model:</i> <ul style="list-style-type: none"> Realtek® RTL8822BE, Wi-Fi 2x2 802.11ac + BT4.1, M.2 card Intel Dual Band Wireless-AC 8260, Wi-Fi 2x2 802.11ac + BT4.1, M.2 card Intel Dual Band Wireless-AC 8265, Wi-Fi 2x2 802.11ac + BT4.1, M.2 card Bluetooth™ Bluetooth 4.1 wireless, integrated in Wi-Fi + Bluetooth combo adapter * Intel 8265ac card supports BT4.2 but is limited to BT4.1 by Windows OS																																																																																							

ThinkPad L470 - TopSeller - 20J4

Product Specifications Reference (PSREF)

Model	Region	Processor	vPro	Graphics	Memory	Display	Multi-touch	Storage(HDD/SSD)	Optical	WLAN + Bluetooth	WWAN	SIM Card	Smart Card Reader	Camera	Keyboard	Fingerprint Reader	TPM	Battery	Power Adapter	Operating System	Warranty	Ann Date (m/y)
20J4000RUS	US	i5-7200U	No	Intel HD 620	4GBx1	14" FHD (1920x1080) IPS	None	500GB 7200rpm	None	Intel 8265 ac, 2x2 + BT4.1	WWAN Upgradable	None	None	720p	Non-backlit	None	dTPM 2.0	6-cell (48Wh)	45W Slim Tip	Win10 Pro 64	1-year, Depot	01/17
20J4000SUS	US	i5-7200U	No	Intel HD 620	4GBx1	14" FHD (1920x1080) IPS	None	256GB SSD Opal2	None	Intel 8265 ac, 2x2 + BT4.1	WWAN Upgradable	None	None	720p	Non-backlit	None	dTPM 2.0	6-cell (48Wh)	45W Slim Tip	Win10 Pro 64	3-year, Depot	01/17
20J4000TUS	US	i5-7200U	No	Intel HD 620	4GBx1	14" HD (1366x768)	None	500GB 7200rpm	None	Intel 8265 ac, 2x2 + BT4.1	WWAN Upgradable	None	None	720p	Non-backlit	None	dTPM 2.0	6-cell (48Wh)	45W Slim Tip	Win10 Pro 64	1-year, Depot	01/17
20J4000UUS	US	i5-7200U	No	Intel HD 620	4GBx1	14" HD (1366x768)	None	256GB SSD Opal2	None	Intel 8265 ac, 2x2 + BT4.1	WWAN Upgradable	None	None	720p	Non-backlit	None	dTPM 2.0	6-cell (48Wh)	45W Slim Tip	Win10 Pro 64	3-year, Depot	01/17
20J40012US	US	i3-7100U	No	Intel HD 620	4GBx1	14" HD (1366x768)	None	500GB 7200rpm	None	Intel 8265 ac, 2x2 + BT4.1	WWAN Upgradable	None	None	720p	Non-backlit	None	dTPM 2.0	6-cell (48Wh)	45W Slim Tip	Win10 Pro 64	1-year, Depot	01/17
20J40013US	US	i5-7200U	No	Intel HD 620	8GB	14" FHD (1920x1080) IPS	None	256GB SSD Opal2	None	Intel 8265 ac, 2x2 + BT4.1	WWAN Upgradable	None	None	720p	Non-backlit	Fingerprint Reader	dTPM 2.0	6-cell (48Wh)	45W Slim Tip	Win10 Pro 64	1-year, Depot	01/17
20J40014US	US	i5-7300U	vPro	Intel HD 620	4GBx1	14" HD (1366x768)	None	500GB 7200rpm	None	Intel 8265 ac, 2x2 + BT4.1	WWAN Upgradable	None	None	720p	Non-backlit	None	dTPM 2.0	6-cell (48Wh)	45W Slim Tip	Win10 Pro 64	1-year, Depot	01/17
20J40015US	US	i5-7300U	vPro	Intel HD 620	8GB	14" FHD (1920x1080) IPS	None	256GB SSD Opal2	None	Intel 8265 ac, 2x2 + BT4.1	WWAN Upgradable	None	None	720p	Non-backlit	Fingerprint Reader	dTPM 2.0	6-cell (48Wh)	45W Slim Tip	Win10 Pro 64	1-year, Depot	01/17
20J40016US	US	i5-7200U	No	Intel HD 620	8GB	14" HD (1366x768)	None	256GB SSD Opal2	None	Intel 8265 ac, 2x2 + BT4.1	WWAN Upgradable	None	None	720p	Non-backlit	None	dTPM 2.0	6-cell (48Wh)	45W Slim Tip	Win10 Pro 64	3-year, Depot	01/17
20J4003EUS	US	i5-7200U	No	Intel HD 620	4GBx1	14" HD (1366x768)	None	500GB 7200rpm	None	Intel 8265 ac, 2x2 + BT4.1	Sierra EM7455	None	None	720p	Non-backlit	None	dTPM 2.0	6-cell (48Wh)	45W Slim Tip	Win10 Pro 64	3-year, Depot	04/17
20J4003FUS	US	i5-7300U	vPro	Intel HD 620	8GB	14" FHD (1920x1080) IPS	None	256GB SSD M.2 PCIe NVMe Opal2	None	Intel 8265 ac, 2x2 + BT4.1	WWAN Upgradable	None	None	720p	Non-backlit	Fingerprint Reader	dTPM 2.0	6-cell (48Wh)	45W Slim Tip	Win10 Pro 64	3-year, Depot	04/17
20J4003GUS	US	i5-7300U	vPro	Intel HD 620	8GB	14" FHD (1920x1080) IPS	None	256GB SSD Opal2	None	Intel 8265 ac, 2x2 + BT4.1	Sierra EM7455	None	None	720p	Non-backlit	Fingerprint Reader	dTPM 2.0	6-cell (48Wh)	45W Slim Tip	Win10 Pro 64	3-year, Depot	04/17

ThinkPad L470 - TopSeller - 20JU

Product Specifications Reference (PSREF)

Model	Region	Processor	vPro	Graphics	Memory	Display	Multi-touch	Storage(HDD/SSD)	Optical	WLAN + Bluetooth	WWAN	SIM Card	Smart Card Reader	Camera	Keyboard	Fingerprint Reader	TPM	Battery	Power Adapter	Operating System	Warranty	Ann Date (m/y)
20JU0008US	US	i5-6200U	No	Intel HD 520	4GBx1	14" FHD (1920x1080) IPS	None	500GB 7200rpm	None	Intel 8260 ac, 2x2 + BT4.1	WWAN Upgradable	None	None	720p	Non-backlit	None	dTPM 2.0	6-cell (48Wh)	45W Slim Tip	Win10 DG Win7 Pro 64	3-year, Depot	04/17
20JU0009US	US	i5-6200U	No	Intel HD 520	8GB	14" HD (1366x768)	None	180GB SSD Opal2	None	Intel 8260 ac, 2x2 + BT4.1	WWAN Upgradable	None	None	720p	Non-backlit	None	dTPM 2.0	6-cell (48Wh)	45W Slim Tip	Win10 DG Win7 Pro 64	3-year, Depot	04/17
20JU000AUS	US	i5-6200U	No	Intel HD 520	4GBx1	14" FHD (1920x1080) IPS	None	128GB SSD	None	Intel 8260 ac, 2x2 + BT4.1	WWAN Upgradable	None	None	720p	Non-backlit	None	dTPM 2.0	6-cell (48Wh)	45W Slim Tip	Win10 DG Win7 Pro 64	3-year, Depot	04/17
20JU000BUS	US	i5-6200U	No	Intel HD 520	8GB	14" FHD (1920x1080) IPS	None	180GB SSD Opal2	None	Intel 8260 ac, 2x2 + BT4.1	WWAN Upgradable	None	None	720p	Non-backlit	None	dTPM 2.0	6-cell (48Wh)	45W Slim Tip	Win10 DG Win7 Pro 64	3-year, Depot	04/17
20JU000CUS	US	i5-6200U	No	Intel HD 520	4GBx1	14" HD (1366x768)	None	128GB SSD	None	Intel 8260 ac, 2x2 + BT4.1	WWAN Upgradable	None	None	720p	Non-backlit	None	dTPM 2.0	6-cell (48Wh)	45W Slim Tip	Win10 DG Win7 Pro 64	3-year, Depot	04/17
20JU000DUS	US	i5-6200U	No	Intel HD 520	8GB	14" HD (1366x768)	None	256GB SSD Opal2	None	Intel 8260 ac, 2x2 + BT4.1	WWAN Upgradable	None	None	720p	Non-backlit	None	dTPM 2.0	6-cell (48Wh)	45W Slim Tip	Win10 DG Win7 Pro 64	3-year, Depot	04/17
20JU000EUS	US	i5-6200U	No	Intel HD 520	8GB	14" FHD (1920x1080) IPS	None	256GB SSD Opal2	None	Intel 8260 ac, 2x2 + BT4.1	WWAN Upgradable	None	None	720p	Non-backlit	None	dTPM 2.0	6-cell (48Wh)	45W Slim Tip	Win10 DG Win7 Pro 64	3-year, Depot	04/17
20JU000FUS	US	i5-6200U	No	Intel HD 520	4GBx1	14" HD (1366x768)	None	500GB 7200rpm	None	Intel 8260 ac, 2x2 + BT4.1	WWAN Upgradable	None	None	720p	Non-backlit	None	dTPM 2.0	6-cell (48Wh)	45W Slim Tip	Win10 DG Win7 Pro 64	3-year, Depot	04/17
20JU000QUS	US	i5-6200U	No	Intel HD 520	4GBx1	14" HD (1366x768)	None	500GB 7200rpm	None	Intel 8260 ac, 2x2 + BT4.1	Sierra EM7455	None	None	720p	Non-backlit	None	dTPM 2.0	6-cell (48Wh)	45W Slim Tip	Win10 DG Win7 Pro 64	3-year, Depot	04/17
20JU000RUS	US	i5-6200U	No	Intel HD 520	8GB	14" FHD (1920x1080) IPS	None	256GB SSD M.2 PCIe NVMe Opal2	None	Intel 8260 ac, 2x2 + BT4.1	WWAN Upgradable	None	None	720p	Non-backlit	Fingerprint Reader	dTPM 2.0	6-cell (48Wh)	45W Slim Tip	Win10 DG Win7 Pro 64	3-year, Depot	04/17
20JU000WUS	US	i5-6300U	vPro	Intel HD 520	8GB	14" FHD (1920x1080) IPS	None	256GB SSD Opal2	None	Intel 8260 ac, 2x2 + BT4.1	WWAN Upgradable	None	None	720p	Non-backlit	Fingerprint Reader	dTPM 2.0	6-cell (48Wh)	45W Slim Tip	Win10 DG Win7 Pro 64	1-year, Depot	05/17
20JU0018US	US	i5-6300U	vPro	Intel HD 520	4GBx1	14" HD (1366x768)	None	500GB 7200rpm	None	Intel 8260 ac, 2x2 + BT4.1	WWAN Upgradable	None	None	720p	Non-backlit	None	dTPM 2.0	6-cell (48Wh)	45W Slim Tip	Win10 DG Win7 Pro 64	1-year, Depot	05/17
20JU0019US	US	i5-6300U	vPro	Intel HD 520	4GBx1	14" HD (1366x768)	None	180GB SSD Opal2	None	Intel 8260 ac, 2x2 + BT4.1	WWAN Upgradable	None	None	720p	Non-backlit	Fingerprint Reader	dTPM 2.0	6-cell (48Wh)	45W Slim Tip	Win10 DG Win7 Pro 64	3-year, Depot	05/17



ThinkPad L480 Platform Specifications

Product Specifications Reference (PSREF)

Processor	7th Generation Intel® Core™ i3 / i5 Processor (i3-7130U is NOT available in US and EMEA) or							Dimensions	WxDxH: 13.19" x 9.25" x 0.89"; 335mm x 235mm x 22.5mm	
	Processor Number	# of Cores	# of Threads	Base Frequency	Max Turbo Frequency	Cache	Memory Types	Processor Graphics	Weight	Starting at 3.71 lb / 1.68 kg
	i3-7130U	2	4	2.7 GHz	-	3MB	DDR4-2133	Intel HD Graphics 620	Case color	Black
	i5-7200U			2.5 GHz	3.1 GHz	3MB			Case material	PC/ABS plastic
	i5-7300U			2.6 GHz	3.5 GHz	3MB				
	8th Generation Intel Core i3 / i5 / i7 Processor							Smart card reader	Optional: Smart card reader	
	Processor Number	# of Cores	# of Threads	Base Frequency	Max Turbo Frequency	Cache	Memory Types	Processor Graphics	Media reader	MicroSD card reader
	i3-8130U	2	4	2.2 GHz	3.4 GHz	4MB	DDR4-2400	Intel UHD Graphics 620	Ports	Two USB 3.1 Gen 1 (one Always On), two USB 3.1 Type-C Gen 1, HDMI 1.4b, Ethernet (RJ-45), nano-SIM card slot (WWAN models), headphone / microphone combo jack, optional smart card reader, microSD card reader, side docking connector, security keyhole
	i5-8250U	4	8	1.6 GHz	3.4 GHz	6MB			Monitor cable (optional)	HDMI to VGA: Lenovo HDMI to VGA Monitor Adapter
	i5-8350U			1.7 GHz	3.6 GHz	6MB			USB-C to VGA: Lenovo USB-C to VGA Adapter	
	i7-8550U			1.8 GHz	4.0 GHz	8MB			USB-C to DP: Lenovo USB-C to DisplayPort Adapter	
Graphics	Intel HD Graphics 620 or Intel UHD Graphics 620 in processor only or Intel HD Graphics 620 or Intel UHD Graphics 620 in processor and AMD Radeon 530, 2GB GDDR5 memory (discrete models are NOT available in EMEA); supports external digital monitor via HDMI or USB Type-C; supports three independent displays; Max resolution: 4096x2304@60Hz (USB Type-C); 4096x2160@30Hz (HDMI)							Camera (optional)	One of the following, configurable by model: • HD720p camera, fixed focus • IR camera and HD720p camera, fixed focus	
Chipset	Intel SoC (System on Chip) platform							Audio support	HD Audio, Realtek ALC3287 codec, Dolby® Audio™ / stereo speakers, 2W x 2 / dual array microphone, headphone / microphone combo jack	
Memory	32GB max / 2400MHz DDR4, dual-channel capable, two DDR4 SO-DIMM sockets * System clocks down for processors with lower memory controller							Keyboard	6-row, spill-resistant, multimedia Fn keys, optional LED backlight	
Display	Some: 14.0" (355mm) HD (1366x768), anti-glare, LED backlight, 220 nits, 16:9 aspect ratio, 500:1 contrast ratio Some: 14.0" (355mm) FHD (1920x1080), anti-glare, LED backlight, IPS, 250 nits, 16:9 aspect ratio, 800:1 contrast ratio, 170° viewing angle							UltraNav™	TrackPoint® pointing device and buttonless Mylar surface multi-touch touchpad	
Multi-touch (opt)	On-cell touch, supports 10-finger gesture (FHD only)							Security	Power-on password, hard disk password, supervisor password, security keyhole	
Storage	System has one HDD slot or one M.2 2280 slot exclusively for storage Some: HDD / SATA 6.0Gb/s, 2.5" wide, 7mm high, Active Protection System™ Some: SSD / SATA 6.0Gb/s, 2.5" wide, 7mm high (e.g. xxxGB SSD) Some: M.2 SSD / PCIe NVMe, PCIe 3.0 x 4, 32Gb/s Some: 128GB M.2 SSD / PCIe NVMe, PCIe 3.0 x 2, 16Gb/s, in WWAN slot as 2nd Storage, mutually exclusive with WWAN							Security chip vPro (optional)	Discrete TPM 2.0, TCG Certified	
Optical	None							Fingerprint reader	Optional: Touch style match on chip fingerprint reader on the keyboard bezel, anti-spoofing technology	
Ethernet	Non-vPro model: Intel Ethernet Connection I219-V (Jacksonville) vPro model: Intel Ethernet Connection I219-LM (Jacksonville)							NFC (optional)	Near Field Communication	
WLAN + Bluetooth™ (optional)	One of the following, configurable by model: • Realtek® RTL8822BE, Wi-Fi 2x2 802.11ac + Bluetooth 4.1, M.2 card (US only) • Intel Dual Band Wireless-AC 8265, Wi-Fi 2x2 802.11ac + Bluetooth 4.1, M.2 card * Intel 8265ac card supports BT4.2 but is limited to BT4.1 by Windows OS							Battery	Integrated Li-Ion 45Wh battery, supports Rapid Charge (charge up to 80% in 1hr) with 65W USB Type-C AC adapter	
WWAN (optional)	One of the following, configurable by model: • Integrated Mobile Broadband 4G LTE, Intel XMM™ 7262 (Fibocom L830-EB), M.2 card (EMEA only) • Integrated Mobile Broadband 4G LTE-A, Intel XMM™ 7360 (Fibocom L850-GL), M.2 card							Max battery life	MobileMark® 2014: 12.2 hr * Battery life varies significantly with settings, usage, & other factors	
SIM card (opt)	Nano-SIM card slot, optional Verizon LTE (US) SIM card							AC adapter	45W or 65W USB Type-C AC adapter	
								Preload	Windows® 10 Home 64 or Windows 10 Pro 64	
								Limited warranty	One of the following, configurable by model: • 1-year depot repair service • 3-year/1-yr battery depot repair service • 3-year/1-yr battery limited onsite service	
								Mil-Spec test	MIL-STD-810G military certification	
								Environment	EPEAT™ Gold; ENERGY STAR® 6.1; RoHS-compliant	

ThinkPad L480 - TopSeller - 20LS

Product Specifications Reference (PSREF)

Model	Region	Processor	vPro	Graphics	Memory	Display	Multi-touch	Storage(HDD/SSD)	Optical	WLAN + Bluetooth	WWAN	SIM Card	Smart Card Reader	Monitor Cable	Camera	Keyboard	Finger-print Reader	NFC	TPM	Battery	Power Adapter	Operating System	Warranty	Ann Date (m/y)
20LS0000US	US	i5-8250U	No	Intel UHD 620	8GBx1	14" HD (1366x768)	None	256GB SSD M.2 PCIe NVMe Opal2	None	Intel 8265 ac, 2x2 + BT4.1	None	None	None	None	720p	Non-backlit	None	None	dTPM 2.0	45Wh	65W USB-C	Win10 Pro 64	3-year, Depot	02/18
20LS0001US	US	i5-7300U	vPro	Intel HD 620	4GBx1	14" HD (1366x768)	None	500GB 7200rpm	None	Intel 8265 ac, 2x2 + BT4.1	None	None	None	None	720p	Non-backlit	Finger-print Reader	None	dTPM 2.0	45Wh	65W USB-C	Win10 Pro 64	1-year, Depot	02/18
20LS0002US	US	i5-8250U	No	Intel UHD 620	8GBx1	14" FHD (1920x1080) IPS	None	256GB SSD M.2 PCIe NVMe Opal2	None	Intel 8265 ac, 2x2 + BT4.1	None	None	None	None	720p	Non-backlit	Finger-print Reader	None	dTPM 2.0	45Wh	65W USB-C	Win10 Pro 64	3-year, Depot	02/18
20LS0003US	US	i5-8350U	vPro	Intel UHD 620	8GBx1	14" FHD (1920x1080) IPS	None	256GB SSD M.2 PCIe NVMe Opal2	None	Intel 8265 ac, 2x2 + BT4.1	None	None	None	None	720p	Non-backlit	Finger-print Reader	None	dTPM 2.0	45Wh	65W USB-C	Win10 Pro 64	3-year, Depot	02/18
20LS0004US	US	i5-8250U	No	Intel UHD 620	4GBx1	14" HD (1366x768)	None	256GB SSD M.2 PCIe NVMe Opal2	None	Intel 8265 ac, 2x2 + BT4.1	None	None	None	None	720p	Non-backlit	Finger-print Reader	None	dTPM 2.0	45Wh	65W USB-C	Win10 Pro 64	3-year, Depot	02/18
20LS0005US	US	i5-8250U	No	Intel UHD 620	8GBx1	14" HD (1366x768)	None	128GB SSD	None	Intel 8265 ac, 2x2 + BT4.1	None	None	None	None	720p	Non-backlit	Finger-print Reader	None	dTPM 2.0	45Wh	65W USB-C	Win10 Pro 64	3-year, Depot	02/18
20LS0007US	US	i5-8350U	vPro	Intel UHD 620	4GBx1	14" HD (1366x768)	None	500GB 7200rpm	None	Intel 8265 ac, 2x2 + BT4.1	None	None	None	None	720p	Non-backlit	Finger-print Reader	None	dTPM 2.0	45Wh	65W USB-C	Win10 Pro 64	1-year, Depot	02/18
20LS0008US	US	i5-7300U	vPro	Intel HD 620	8GBx1	14" FHD (1920x1080) IPS	None	256GB SSD M.2 PCIe NVMe Opal2	None	Intel 8265 ac, 2x2 + BT4.1	None	None	None	None	720p	Non-backlit	Finger-print Reader	None	dTPM 2.0	45Wh	65W USB-C	Win10 Pro 64	3-year, Depot	02/18
20LS0009US	US	i5-8250U	No	Intel UHD 620	4GBx1	14" HD (1366x768)	None	500GB 7200rpm	None	Intel 8265 ac, 2x2 + BT4.1	None	None	None	None	720p	Non-backlit	None	None	dTPM 2.0	45Wh	65W USB-C	Win10 Pro 64	1-year, Depot	02/18
20LS000UUS	US	i5-8250U	No	Intel UHD 620	8GBx1	14" FHD (1920x1080) IPS	10-point Multi-touch	256GB SSD M.2 PCIe NVMe Opal2	None	Intel 8265 ac, 2x2 + BT4.1	None	None	None	None	IR & 720p	Backlit	Finger-print Reader	None	dTPM 2.0	45Wh	65W USB-C	Win10 Pro 64	3-year, Depot	02/18
20LS0020US	US	i5-8250U	No	Intel UHD 620	4GBx1	14" HD (1366x768)	None	500GB 7200rpm	None	Intel 8265 ac, 2x2 + BT4.1	Fibocom L850-GL	None	None	None	720p	Non-backlit	None	None	dTPM 2.0	45Wh	65W USB-C	Win10 Pro 64	3-year, Depot	04/18
20LS0021US	US	i5-8350U	vPro	Intel UHD 620	8GBx1	14" FHD (1920x1080) IPS	None	256GB SSD M.2 PCIe NVMe Opal2	None	Intel 8265 ac, 2x2 + BT4.1	Fibocom L850-GL	None	None	None	720p	Non-backlit	Finger-print Reader	None	dTPM 2.0	45Wh	65W USB-C	Win10 Pro 64	3-year, Depot	04/18
20LS002GUS	US	i5-8250U	No	Intel UHD 620	8GBx1	14" HD (1366x768)	None	180GB SSD Opal2	None	Intel 8265 ac, 2x2 + BT4.1	None	None	None	None	720p	Non-backlit	Finger-print Reader	None	dTPM 2.0	45Wh	65W USB-C	Win10 Pro 64	1-year, Depot	05/18

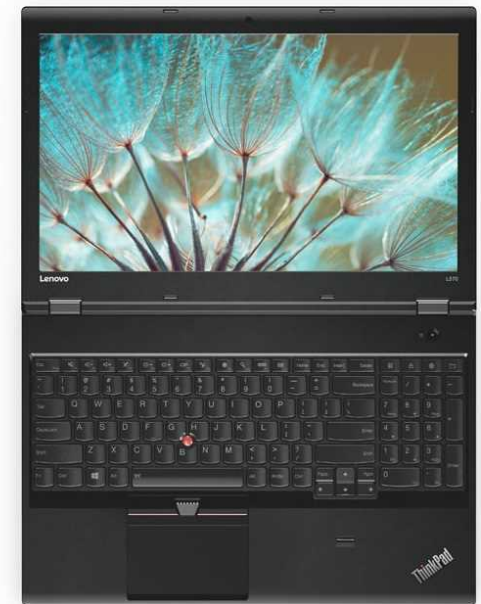

ThinkPad L570 Platform Specifications

Product Specifications Reference (PSREF)

Processor	6th Generation Intel® Core™ i3 / i5 / i7 Processor (i7 processor is NOT available in EMEA) or							WWAN (optional) <i>One of the following, configurable by model:</i> <ul style="list-style-type: none"> Wireless WAN upgradable Integrated Mobile Broadband 4G LTE-A, Qualcomm® Snapdragon™ X7 LTE-A (Sierra Wireless EM7455), M.2 card Integrated Mobile Broadband 4G LTE, Intel XMM™ 7160 (Fibocom L831-EAU), M.2 card (EMEA only) SIM card (opt) Micro-SIM card slot, opt Verizon LTE (US) or Lenovo® Connect (EMEA) SIM card
	Processor Number	# of Cores	# of Threads	Base Frequency	Max Turbo Frequency	Cache	Memory Types	
	i3-6006U	2	4	2.0 GHz	-	3MB	DDR4-2133	Intel HD Graphics 520
	i3-6100U			2.3 GHz	-	3MB		
	i5-6200U			2.3 GHz	2.8 GHz	3MB		
	i5-6300U			2.4 GHz	3.0 GHz	3MB		
	i7-6500U			2.5 GHz	3.1 GHz	4MB		
	i7-6600U	2.6 GHz	3.4 GHz	4MB				
Processor	Intel Celeron® Processor or 7th Generation Intel Core i3 / i5 / i7 Processor							ExpressCard (opt) One slot (ExpressCard/34) Smart card reader <i>Optional:</i> Smart card reader Media reader 4-in-1 reader (MMC, SD, SDHC, SDXC) Ports Four USB 3.1 Gen 1 (USB 3.0, one Always On), VGA, Mini DisplayPort, Ethernet (RJ-45), Dock connector Monitor cable <i>Optional:</i> Lenovo Mini-DisplayPort to DisplayPort Monitor Cable (MiniDP to DP) Camera (optional) HD720p resolution, fixed focus Audio support HD Audio, Realtek® ALC3245 codec / stereo speakers, 1.5W x 2 / dual array microphone, combo audio/microphone jack Keyboard 6-row, spill-resistant, multimedia Fn keys, numeric keypad UltraNav™ TrackPoint® pointing device and buttonless Mylar surface multi-touch touchpad
	Processor Number	# of Cores	# of Threads	Base Frequency	Max Turbo Frequency	Cache	Memory Types	
	Cel 3965U	2	4	2.2 GHz	-	2MB	DDR4-2133	Intel HD Graphics 610
	i3-7100U			2.4 GHz	-	3MB		
	i5-7200U			2.5 GHz	3.1 GHz	3MB		
	i5-7300U			2.6 GHz	3.5 GHz	3MB		
	i7-7500U			2.7 GHz	3.5 GHz	4MB		
	i7-7600U			2.8 GHz	3.9 GHz	4MB		
Graphics	Intel HD Graphics 520, 610, or 620 in processor only; supports external analog monitor via VGA and digital monitor via Mini DisplayPort; supports three independent displays; Max resolution: 3840x2160@60Hz (DP via mDP cable); 1920x1200@60Hz (VGA)							Security Power-on password, hard disk password, supervisor password, security keyhole Security chip Discrete TPM 2.0, TCG Certified vPro (optional) Intel vPro Technology Fingerprint reader <i>Optional:</i> Swiipe style fingerprint reader on the palm rest NFC None
Chipset	Intel SoC (System on Chip) platform							Battery Li-Ion 6-cell (48Wh)
Memory	32GB max / 2400MHz DDR4, dual-channel capable, two DDR4 SO-DIMM sockets * System clocks down for processors with lower memory controller							Max battery life <i>MobileMark® 2014:</i> 14.8 hr
Display	<i>Some:</i> 15.6" (396mm) HD (1366x768), anti-glare, LED backlight, 220 nits, 16:9 aspect ratio, 350:1 contrast ratio <i>Some:</i> 15.6" (396mm) FHD (1920x1080), anti-glare, LED backlight, 220 nits, 16:9 aspect ratio, 400:1 or 500:1 contrast ratio <i>Some:</i> 15.6" (396mm) FHD (1920x1080), anti-glare, LED backlight, IPS, 250 nits, 16:9 aspect ratio, 600:1 contrast ratio, 160° viewing angle							AC adapter 45W slim tip AC adapter
Multi-touch	None							Preload Windows® 7 Professional 64 preinstalled through downgrade rights in Windows 10 Pro 64 <i>Some:</i> Windows 10 Pro 64 <ul style="list-style-type: none"> Lenovo Companion Lenovo Setting Microsoft Office preloaded; purchase a product key to activate
Storage	<i>Some:</i> HDD / SATA 6.0Gb/s, 2.5" wide, 7mm high, Active Protection System™ <i>Some:</i> SSD / SATA 6.0Gb/s, 2.5" wide, 7mm high (e.g. xxxGB SSD) <i>Some:</i> M.2 SSD / PCIe NVMe, PCIe 3.0 x 2, 16Gb/s <i>Some:</i> 128GB M.2 SSD / SATA 6.0Gb/s, in WWAN slot as 2nd Storage, mutually exclusive with WWAN							Limited warranty <i>One of the following, configurable by model:</i> <ul style="list-style-type: none"> 1-year depot repair service 3-year/1-yr battery depot repair service 3-year/1-yr battery limited onsite service Mil-Spec test MIL-STD-810G military certification Environment EPEAT™ Gold (US only); ENERGY STAR® 6.1; RoHS-compliant
Optical (optional)	DVD-ROM or DVD burner, 9mm high, fixed, not removable, tray-in							
Ethernet	<i>Non-vPro model:</i> Intel Ethernet Connection I219-V (Jacksonville) <i>vPro model:</i> Intel Ethernet Connection I219-LM (Jacksonville)							
WLAN	<i>One of the following, configurable by model:</i> <ul style="list-style-type: none"> Realtek® RTL8822BE, Wi-Fi 2x2 802.11ac + BT4.1, M.2 card (US only) Intel Dual Band Wireless-AC 8260, Wi-Fi 2x2 802.11ac + BT4.1, M.2 card Intel Dual Band Wireless-AC 8265, Wi-Fi 2x2 802.11ac + BT4.1, M.2 card Bluetooth™ 4.1 wireless, integrated in Wi-Fi + Bluetooth combo adapter * Intel 8265ac card supports BT4.2 but is limited to BT4.1 by Windows OS							

ThinkPad L570 - TopSeller - 20J8

Product Specifications Reference (PSREF)

Model	Region	Processor	vPro	Graphics	Memory	Display	Multi-touch	Storage(HDD/SSD)	Optical	WLAN + Bluetooth	WWAN	SIM Card	Smart Card Reader	ExpressCard	Monitor Cable	Camera	Key-board	Fingerprint Reader	TPM	Battery	Power Adapter	Operating System	Warranty	Ann Date (m/y)
20J8000WUS	US	i3-7100U	No	Intel HD 620	4GBx1	15.6" HD (1366x768)	None	180GB SSD Opal2	DVD±RW	Intel 8265 ac, 2x2 + BT4.1	WWAN Upgradable	None	None	None	None	720p	Non-backlit	None	dTPM 2.0	6-cell (48Wh)	45W Slim Tip	Win10 Pro 64	1-year, Depot	03/17
20J8000XUS	US	i5-7300U	vPro	Intel HD 620	8GBx1	15.6" FHD (1920x1080) IPS	None	256GB SSD Opal2	DVD±RW	Intel 8265 ac, 2x2 + BT4.1	WWAN Upgradable	None	None	None	None	720p	Non-backlit	Fingerprint Reader	dTPM 2.0	6-cell (48Wh)	45W Slim Tip	Win10 Pro 64	1-year, Depot	03/17
20J8000YUS	US	i5-7300U	vPro	Intel HD 620	4GBx1	15.6" HD (1366x768)	None	128GB SSD	DVD±RW	Intel 8265 ac, 2x2 + BT4.1	WWAN Upgradable	None	None	None	None	720p	Non-backlit	None	dTPM 2.0	6-cell (48Wh)	45W Slim Tip	Win10 Pro 64	1-year, Depot	03/17
20J80010US	US	i5-7200U	No	Intel HD 620	4GBx1	15.6" HD (1366x768)	None	500GB 7200rpm	DVD±RW	Intel 8265 ac, 2x2 + BT4.1	WWAN Upgradable	None	None	None	None	720p	Non-backlit	None	dTPM 2.0	6-cell (48Wh)	45W Slim Tip	Win10 Pro 64	1-year, Depot	03/17
20J80011US	US	i5-7200U	No	Intel HD 620	4GBx1	15.6" HD (1366x768)	None	180GB SSD Opal2	DVD±RW	Intel 8265 ac, 2x2 + BT4.1	WWAN Upgradable	None	None	None	None	720p	Non-backlit	None	dTPM 2.0	6-cell (48Wh)	45W Slim Tip	Win10 Pro 64	1-year, Depot	03/17
20J80012US	US	i5-7200U	No	Intel HD 620	4GBx1	15.6" HD (1366x768)	None	128GB SSD	DVD±RW	Intel 8265 ac, 2x2 + BT4.1	WWAN Upgradable	None	None	None	None	720p	Non-backlit	None	dTPM 2.0	6-cell (48Wh)	45W Slim Tip	Win10 Pro 64	1-year, Depot	03/17
20J80013US	US	i5-7200U	No	Intel HD 620	8GBx1	15.6" FHD (1920x1080) IPS	None	256GB SSD Opal2	DVD±RW	Intel 8265 ac, 2x2 + BT4.1	WWAN Upgradable	None	None	None	None	720p	Non-backlit	None	dTPM 2.0	6-cell (48Wh)	45W Slim Tip	Win10 Pro 64	1-year, Depot	03/17
20J80014US	US	i5-7200U	No	Intel HD 620	4GBx1	15.6" HD (1366x768)	None	256GB SSD Opal2	DVD±RW	Intel 8265 ac, 2x2 + BT4.1	WWAN Upgradable	None	None	None	None	720p	Non-backlit	None	dTPM 2.0	6-cell (48Wh)	45W Slim Tip	Win10 Pro 64	1-year, Depot	03/17
20J80015US	US	i3-7100U	No	Intel HD 620	4GBx1	15.6" HD (1366x768)	None	256GB SSD Opal2	DVD±RW	Intel 8265 ac, 2x2 + BT4.1	WWAN Upgradable	None	None	None	None	720p	Non-backlit	None	dTPM 2.0	6-cell (48Wh)	45W Slim Tip	Win10 Pro 64	1-year, Depot	03/17
20J80016US	US	i3-7100U	No	Intel HD 620	4GBx1	15.6" HD (1366x768)	None	500GB 7200rpm	DVD±RW	Intel 8265 ac, 2x2 + BT4.1	WWAN Upgradable	None	None	None	None	720p	Non-backlit	None	dTPM 2.0	6-cell (48Wh)	45W Slim Tip	Win10 Pro 64	1-year, Depot	03/17
20J80017US	US	i5-7300U	vPro	Intel HD 620	4GBx1	15.6" HD (1366x768)	None	500GB 7200rpm	DVD±RW	Intel 8265 ac, 2x2 + BT4.1	WWAN Upgradable	None	None	None	None	720p	Non-backlit	None	dTPM 2.0	6-cell (48Wh)	45W Slim Tip	Win10 Pro 64	1-year, Depot	03/17
20J8002EUS	US	i5-7300U	vPro	Intel HD 620	8GBx1	15.6" FHD (1920x1080) IPS	None	256GB SSD Opal2	DVD±RW	Intel 8265 ac, 2x2 + BT4.1	Sierra EM7455	None	None	ExpressCard / 34	None	720p	Non-backlit	Fingerprint Reader	dTPM 2.0	6-cell (48Wh)	45W Slim Tip	Win10 Pro 64	3-year, Depot	04/17
20J8002FUS	US	i5-7200U	No	Intel HD 620	4GBx1	15.6" HD (1366x768)	None	500GB 7200rpm	DVD±RW	Intel 8265 ac, 2x2 + BT4.1	Sierra EM7455	None	None	ExpressCard / 34	None	720p	Non-backlit	None	dTPM 2.0	6-cell (48Wh)	45W Slim Tip	Win10 Pro 64	3-year, Depot	04/17
20J8002GUS	US	i5-7300U	vPro	Intel HD 620	8GBx1	15.6" FHD (1920x1080) IPS	None	256GB SSD M.2 PCIe NVMe Opal2	DVD±RW	Intel 8265 ac, 2x2 + BT4.1	WWAN Upgradable	None	None	ExpressCard / 34	None	720p	Non-backlit	Fingerprint Reader	dTPM 2.0	6-cell (48Wh)	45W Slim Tip	Win10 Pro 64	3-year, Depot	04/17
20J8002LUS	US	i7-7500U	No	Intel HD 620	8GBx1	15.6" FHD (1920x1080) IPS	None	256GB SSD Opal2	DVD±RW	Intel 8265 ac, 2x2 + BT4.1	WWAN Upgradable	None	None	ExpressCard / 34	None	720p	Non-backlit	Fingerprint Reader	dTPM 2.0	6-cell (48Wh)	45W Slim Tip	Win10 Pro 64	3-year, Depot	06/17
20J8002MUS	US	i7-7600U	vPro	Intel HD 620	8GBx1	15.6" FHD (1920x1080) IPS	None	256GB SSD Opal2	DVD±RW	Intel 8265 ac, 2x2 + BT4.1	WWAN Upgradable	None	None	ExpressCard / 34	None	720p	Non-backlit	Fingerprint Reader	dTPM 2.0	6-cell (48Wh)	45W Slim Tip	Win10 Pro 64	3-year, Depot	06/17

ThinkPad L570 - TopSeller - 20JQ

Product Specifications Reference (PSREF)

Model	Region	Processor	vPro	Graphics	Memory	Display	Multi-touch	Storage(HDD/SSD)	Optical	WLAN + Bluetooth	WWAN	SIM Card	Smart Card Reader	ExpressCard	Monitor Cable	Camera	Key-board	Fingerprint Reader	TPM	Battery	Power Adapter	Operating System	Warranty	Ann Date (m/y)
20JQ000UUS	US	i3-6006U	No	Intel HD 520	4GBx1	15.6" HD (1366x768)	None	180GB SSD Opal2	DVD±RW	Intel 8260 ac, 2x2 + BT4.1	WWAN Upgradable	None	None	ExpressCard / 34	None	720p	Non-backlit	None	dTPM 2.0	6-cell (48Wh)	45W Slim Tip	Win10 DG Win7 Pro 64	1-year, Depot	06/17
20JQ000VUS	US	i5-6300U	vPro	Intel HD 520	4GBx1	15.6" HD (1366x768)	None	180GB SSD Opal2	DVD±RW	Intel 8260 ac, 2x2 + BT4.1	WWAN Upgradable	None	None	ExpressCard / 34	None	720p	Non-backlit	None	dTPM 2.0	6-cell (48Wh)	45W Slim Tip	Win10 DG Win7 Pro 64	1-year, Depot	06/17
20JQ000WUS	US	i5-6300U	vPro	Intel HD 520	4GBx1	15.6" FHD (1920x1080) IPS	None	256GB SSD Opal2	DVD±RW	Intel 8260 ac, 2x2 + BT4.1	WWAN Upgradable	None	None	ExpressCard / 34	None	720p	Non-backlit	None	dTPM 2.0	6-cell (48Wh)	45W Slim Tip	Win10 DG Win7 Pro 64	3-year, Depot	06/17
20JQ000XUS	US	i3-6006U	No	Intel HD 520	4GBx1	15.6" HD (1366x768)	None	500GB 7200rpm	DVD±RW	Intel 8260 ac, 2x2 + BT4.1	WWAN Upgradable	None	None	ExpressCard / 34	None	720p	Non-backlit	None	dTPM 2.0	6-cell (48Wh)	45W Slim Tip	Win10 DG Win7 Pro 64	1-year, Depot	06/17
20JQ000YUS	US	i5-6300U	vPro	Intel HD 520	4GBx1	15.6" FHD (1920x1080) IPS	None	500GB 7200rpm	DVD±RW	Intel 8260 ac, 2x2 + BT4.1	WWAN Upgradable	None	None	ExpressCard / 34	None	720p	Non-backlit	None	dTPM 2.0	6-cell (48Wh)	45W Slim Tip	Win10 DG Win7 Pro 64	3-year, Depot	06/17
20JQ0010US	US	i5-6300U	vPro	Intel HD 520	8GBx1	15.6" FHD (1920x1080) IPS	None	256GB SSD Opal2	DVD±RW	Intel 8260 ac, 2x2 + BT4.1	WWAN Upgradable	None	None	ExpressCard / 34	None	720p	Non-backlit	None	dTPM 2.0	6-cell (48Wh)	45W Slim Tip	Win10 DG Win7 Pro 64	3-year, Depot	06/17
20JQ0011US	US	i5-6300U	vPro	Intel HD 520	4GBx1	15.6" HD (1366x768)	None	500GB 7200rpm	DVD±RW	Intel 8260 ac, 2x2 + BT4.1	WWAN Upgradable	None	None	ExpressCard / 34	None	720p	Non-backlit	None	dTPM 2.0	6-cell (48Wh)	45W Slim Tip	Win10 DG Win7 Pro 64	1-year, Depot	06/17



ThinkPad L580 Platform Specifications

Product Specifications Reference (PSREF)

Processor	Intel® Celeron® Processor, 7th Generation Intel Core™ i3 / i5 Processor (i3-7130U is NOT available in US and EMEA) or	Dimensions Weight Case color Case material	<i>WxDxH:</i> 14.82" x 10.02" x 0.90"; 376.5mm x 254.5mm x 22.95mm Starting at 4.46 lb / 2.0 kg Black PC/ABS plastic																														
	<table border="1"> <thead> <tr> <th>Processor Number</th> <th># of Cores</th> <th># of Threads</th> <th>Base Frequency</th> <th>Max Turbo Frequency</th> <th>Cache</th> <th>Memory Types</th> <th>Processor Graphics</th> </tr> </thead> <tbody> <tr> <td>Cel 3965U</td> <td rowspan="2">2</td> <td rowspan="2">2</td> <td>2.2 GHz</td> <td>-</td> <td>2MB</td> <td rowspan="4">DDR4-2133</td> <td>Intel HD Graphics 610</td> </tr> <tr> <td>i3-7130U</td> <td>2.7 GHz</td> <td>-</td> <td>3MB</td> <td rowspan="3">Intel HD Graphics 620</td> </tr> <tr> <td>i5-7200U</td> <td rowspan="2">4</td> <td>2.5 GHz</td> <td>3.1 GHz</td> <td>3MB</td> </tr> <tr> <td>i5-7300U</td> <td>2.6 GHz</td> <td>3.5 GHz</td> <td>3MB</td> </tr> </tbody> </table>	Processor Number	# of Cores	# of Threads	Base Frequency	Max Turbo Frequency	Cache	Memory Types	Processor Graphics	Cel 3965U	2	2	2.2 GHz	-	2MB	DDR4-2133	Intel HD Graphics 610	i3-7130U	2.7 GHz	-	3MB	Intel HD Graphics 620	i5-7200U	4	2.5 GHz	3.1 GHz	3MB	i5-7300U	2.6 GHz	3.5 GHz	3MB	ExpressCard Smart card reader Media reader Ports	None <i>Optional:</i> Smart card reader MicroSD card reader Two USB 3.1 Gen 1 (one Always On), two USB 3.1 Type-C Gen 1, HDMI 1.4b, Ethernet (RJ-45), nano-SIM card slot (WWAN models), headphone / microphone combo jack, optional smart card reader, microSD card reader, side docking connector, security keyhole <i>HDMI to VGA:</i> Lenovo HDMI to VGA Monitor Adapter <i>USB-C to VGA:</i> Lenovo USB-C to VGA Adapter
Processor Number	# of Cores	# of Threads	Base Frequency	Max Turbo Frequency	Cache	Memory Types	Processor Graphics																										
Cel 3965U	2	2	2.2 GHz	-	2MB	DDR4-2133	Intel HD Graphics 610																										
i3-7130U			2.7 GHz	-	3MB		Intel HD Graphics 620																										
i5-7200U	4	2.5 GHz	3.1 GHz	3MB																													
i5-7300U		2.6 GHz	3.5 GHz	3MB																													
	8th Generation Intel Core i3 / i5 / i7 Processor	Monitor cable (<i>optional</i>)	Camera (<i>optional</i>) Audio support																														
	<table border="1"> <thead> <tr> <th>Processor Number</th> <th># of Cores</th> <th># of Threads</th> <th>Base Frequency</th> <th>Max Turbo Frequency</th> <th>Cache</th> <th>Memory Types</th> <th>Processor Graphics</th> </tr> </thead> <tbody> <tr> <td>i3-8130U</td> <td>2</td> <td>4</td> <td>2.2 GHz</td> <td>3.4 GHz</td> <td>4MB</td> <td rowspan="4">DDR4-2400</td> <td rowspan="4">Intel UHD Graphics 620</td> </tr> <tr> <td>i5-8250U</td> <td rowspan="3">4</td> <td rowspan="3">8</td> <td>1.6 GHz</td> <td>3.4 GHz</td> <td>6MB</td> </tr> <tr> <td>i5-8350U</td> <td>1.7 GHz</td> <td>3.6 GHz</td> <td>6MB</td> </tr> <tr> <td>i7-8550U</td> <td>1.8 GHz</td> <td>4.0 GHz</td> <td>8MB</td> </tr> </tbody> </table>	Processor Number	# of Cores	# of Threads	Base Frequency	Max Turbo Frequency	Cache	Memory Types	Processor Graphics	i3-8130U	2	4	2.2 GHz	3.4 GHz	4MB	DDR4-2400	Intel UHD Graphics 620	i5-8250U	4	8	1.6 GHz	3.4 GHz	6MB	i5-8350U	1.7 GHz	3.6 GHz	6MB	i7-8550U	1.8 GHz	4.0 GHz	8MB	Keyboard UltraNav™	HD720p camera, fixed focus HD Audio, Realtek ALC3287 codec, Dolby® Audio™ / stereo speakers, 2W x 2 / dual array microphone, headphone / microphone combo jack
Processor Number	# of Cores	# of Threads	Base Frequency	Max Turbo Frequency	Cache	Memory Types	Processor Graphics																										
i3-8130U	2	4	2.2 GHz	3.4 GHz	4MB	DDR4-2400	Intel UHD Graphics 620																										
i5-8250U	4	8	1.6 GHz	3.4 GHz	6MB																												
i5-8350U			1.7 GHz	3.6 GHz	6MB																												
i7-8550U			1.8 GHz	4.0 GHz	8MB																												
Graphics	Intel HD Graphics 610, 620 or Intel UHD Graphics 620 in processor only or Intel HD Graphics 620 or Intel UHD Graphics 620 in processor and AMD Radeon 530, 2GB GDDR5 memory (discrete models are NOT available in EMEA); supports external digital monitor via HDMI or USB Type-C; supports three independent displays; Max resolution: 4096x2304@60Hz (USB Type-C); 4096x2160@30Hz (HDMI)	Security Security chip vPro (<i>optional</i>) Fingerprint reader NFC (<i>optional</i>)	Power-on password, hard disk password, supervisor password, security keyhole Discrete TPM 2.0, TCG Certified Intel vPro Technology <i>Optional:</i> Touch style match on chip fingerprint reader on the palm rest, anti-spoofing technology Near Field Communication																														
Chipset Memory	Intel SoC (System on Chip) platform 32GB max / 2400MHz DDR4, dual-channel capable, two DDR4 SO-DIMM sockets * System clocks down for processors with lower memory controller	Battery Max battery life	Integrated Li-Ion 45Wh battery, supports Rapid Charge (charge up to 80% in 1hr) with 65W USB Type-C AC adapter <i>MobileMark® 2014:</i> 12 hr * Battery life varies significantly with settings, usage, & other factors																														
Display	<i>Some:</i> 15.6" (396mm) HD (1366x768), anti-glare, LED backlight, 220 nits, 16:9 aspect ratio, 500:1 contrast ratio <i>Some:</i> 15.6" (396mm) FHD (1920x1080), anti-glare, LED backlight, IPS, 250 nits, 16:9 aspect ratio, 800:1 contrast ratio, 170° viewing angle	AC adapter Preload	45W or 65W USB Type-C AC adapter Windows® 10 Home 64 or Windows 10 Pro 64																														
Multi-touch	None	Limited warranty	<i>One of the following, configurable by model:</i> • 1-year depot repair service • 3-year/1-yr battery depot repair service • 3-year/1-yr battery limited onsite service																														
Storage	<i>System has one HDD slot or one M.2 2280 slot exclusively for storage</i> <i>Some:</i> HDD / SATA 6.0Gb/s, 2.5" wide, 7mm high, Active Protection System™ <i>Some:</i> SSD / SATA 6.0Gb/s, 2.5" wide, 7mm high (e.g. xxxGB SSD) <i>Some:</i> M.2 SSD / PCIe NVMe, PCIe 3.0 x 4, 32Gb/s <i>Some:</i> 128GB M.2 SSD / PCIe NVMe, PCIe 3.0 x 2, 16Gb/s, in WWAN slot as 2nd Storage, mutually exclusive with WWAN	Mil-Spec test Environment	MIL-STD-810G military certification EPEAT™ Gold; ENERGY STAR® 6.1; RoHS-compliant																														
Optical	None																																
Ethernet	<i>Non-vPro model:</i> Intel Ethernet Connection I219-V (Jacksonville) <i>vPro model:</i> Intel Ethernet Connection I219-LM (Jacksonville)																																
WLAN + Bluetooth™ (<i>optional</i>)	<i>One of the following, configurable by model:</i> • Realtek® RTL8822BE, Wi-Fi 2x2 802.11ac + Bluetooth 4.1, M.2 card (US only) • Intel Dual Band Wireless-AC 8265, Wi-Fi 2x2 802.11ac + Bluetooth 4.1, M.2 card * Intel 8265ac card supports BT4.2 but is limited to BT4.1 by Windows OS																																
WWAN (<i>optional</i>)	<i>One of the following, configurable by model:</i> • Integrated Mobile Broadband 4G LTE, Intel XMM™ 7262 (Fibocom L830-EB), M.2 card (EMEA only) • Integrated Mobile Broadband 4G LTE-A, Intel XMM™ 7360 (Fibocom L850-GL), M.2 card																																
SIM card (<i>opt</i>)	Nano-SIM card slot, optional Verizon LTE (US) SIM card																																

ThinkPad L580 - TopSeller - 20LW

Product Specifications Reference (PSREF)

Model	Region	Processor	vPro	Graphics	Memory	Display	Multi-touch	Storage(HDD/SSD)	Optical	WLAN + Bluetooth	WWAN	SIM Card	Smart Card Reader	Monitor Cable	Camera	Key-board	Finger-print Reader	NFC	TPM	Battery	Power Adapter	Operating System	Warranty	Ann Date (m/y)
20LW0000US	US	i5-8250U	No	Intel UHD 620	8GBx1	15.6" HD (1366x768)	None	256GB SSD M.2 PCIe NVMe Opal2	None	Intel 8265 ac, 2x2 + BT4.1	None	None	None	None	720p	Non-backlit	Finger-print Reader	None	dTPM 2.0	45Wh	65W USB-C	Win10 Pro 64	3-year, Depot	02/18
20LW0001US	US	i5-7300U	vPro	Intel HD 620	8GBx1	15.6" FHD (1920x1080) IPS	None	256GB SSD M.2 PCIe NVMe Opal2	None	Intel 8265 ac, 2x2 + BT4.1	None	None	None	None	720p	Non-backlit	Finger-print Reader	None	dTPM 2.0	45Wh	65W USB-C	Win10 Pro 64	3-year, Depot	02/18
20LW0002US	US	i5-8250U	No	Intel UHD 620	8GBx1	15.6" FHD (1920x1080) IPS	None	256GB SSD M.2 PCIe NVMe Opal2	None	Intel 8265 ac, 2x2 + BT4.1	None	None	None	None	720p	Non-backlit	Finger-print Reader	None	dTPM 2.0	45Wh	65W USB-C	Win10 Pro 64	3-year, Depot	02/18
20LW0003US	US	i5-7300U	vPro	Intel HD 620	4GBx1	15.6" HD (1366x768)	None	500GB 7200rpm	None	Intel 8265 ac, 2x2 + BT4.1	None	None	None	None	720p	Non-backlit	Finger-print Reader	None	dTPM 2.0	45Wh	65W USB-C	Win10 Pro 64	1-year, Depot	02/18
20LW0004US	US	i5-8250U	No	Intel UHD 620	4GBx1	15.6" HD (1366x768)	None	500GB 7200rpm	None	Intel 8265 ac, 2x2 + BT4.1	None	None	None	None	720p	Non-backlit	Finger-print Reader	None	dTPM 2.0	45Wh	65W USB-C	Win10 Pro 64	1-year, Depot	02/18
20LW0005US	US	i5-8250U	No	Intel UHD 620	8GBx1	15.6" HD (1366x768)	None	128GB SSD	None	Intel 8265 ac, 2x2 + BT4.1	None	None	None	None	720p	Non-backlit	Finger-print Reader	None	dTPM 2.0	45Wh	65W USB-C	Win10 Pro 64	3-year, Depot	02/18
20LW0006US	US	i5-8350U	vPro	Intel UHD 620	4GBx1	15.6" HD (1366x768)	None	500GB 7200rpm	None	Intel 8265 ac, 2x2 + BT4.1	None	None	None	None	720p	Non-backlit	Finger-print Reader	None	dTPM 2.0	45Wh	65W USB-C	Win10 Pro 64	1-year, Depot	02/18
20LW0007US	US	i5-8350U	vPro	Intel UHD 620	8GBx1	15.6" HD (1366x768)	None	128GB SSD	None	Intel 8265 ac, 2x2 + BT4.1	None	None	None	None	720p	Non-backlit	Finger-print Reader	None	dTPM 2.0	45Wh	65W USB-C	Win10 Pro 64	3-year, Depot	02/18
20LW0008US	US	i5-8350U	vPro	Intel UHD 620	8GBx1	15.6" FHD (1920x1080) IPS	None	256GB SSD M.2 PCIe NVMe Opal2	None	Intel 8265 ac, 2x2 + BT4.1	None	None	None	None	720p	Non-backlit	Finger-print Reader	None	dTPM 2.0	45Wh	65W USB-C	Win10 Pro 64	3-year, Depot	02/18
20LW002HUS	US	i5-8350U	vPro	Intel UHD 620	8GBx1	15.6" FHD (1920x1080) IPS	None	256GB SSD M.2 PCIe NVMe Opal2	None	Intel 8265 ac, 2x2 + BT4.1	Fibocom L850-GL	None	None	None	720p	Non-backlit	Finger-print Reader	None	dTPM 2.0	45Wh	65W USB-C	Win10 Pro 64	3-year, Depot	04/18
20LW002JUS	US	i5-8250U	No	Intel UHD 620	4GBx1	15.6" HD (1366x768)	None	500GB 7200rpm	None	Intel 8265 ac, 2x2 + BT4.1	Fibocom L850-GL	None	None	None	720p	Non-backlit	None	None	dTPM 2.0	45Wh	65W USB-C	Win10 Pro 64	3-year, Depot	04/18
20LW003DUS	US	i5-8250U	No	Intel UHD 620	8GBx1	15.6" HD (1366x768)	None	180GB SSD Opal2	None	Intel 8265 ac, 2x2 + BT4.1	None	None	None	None	720p	Non-backlit	Finger-print Reader	None	dTPM 2.0	45Wh	65W USB-C	Win10 Pro 64	1-year, Depot	05/18



ThinkPad P50 Platform Specifications

Product Specifications Reference (PSREF)

Processor	6th Generation Intel® Core™ i7 Processor or Intel Xeon® Processor E3 v5 Family							Smart card reader	Optional: Smart card reader									
	Processor Number	# of Cores	# of Threads	Base Frequency	Max Turbo Frequency	Cache	Memory Types	Processor Graphics	ExpressCard Media reader Ports	One slot (ExpressCard/34) 4-in-1 reader (MMC, SD, SDHC, SDXC), supports UHS-II SD card Four USB 3.0 (one Always On), USB Type-C / Thunderbolt 3, Mini DisplayPort, HDMI, Ethernet (RJ-45), Dock connector								
	i7-6700HQ	4	8	2.6 GHz	3.5 GHz	6MB	DDR4-2133	Intel HD Graphics 530	Camera (optional) Audio support	HD720p resolution, low light sensitive, fixed focus HD Audio, Realtek® ALC3268 codec / stereo speakers, 1.5W x 2 / dual array microphone, combo audio/microphone jack								
	i7-6820HQ			2.7 GHz	3.6 GHz	8MB		Intel HD Graphics 530										
E3-1505M v5	2.8 GHz			3.7 GHz	8MB	Intel HD Graphics P530												
E3-1535M v5	2.9 GHz			3.8 GHz	8MB	Intel HD Graphics P530												
Graphics	Intel HD Graphics 530 or P530 in processor and NVIDIA Quadro® M1000M (2GB or 4GB memory) or M2000M (4GB memory); supports external digital monitor via HDMI, Mini DisplayPort, or Thunderbolt™; supports four independent displays; Max resolution: 3840x2160@60Hz (DisplayPort via Mini DisplayPort cable); 3840x2160@60Hz (Thunderbolt); 3840x2160@30Hz (HDMI)							Keyboard UltraNav™	6-row, spill-resistant, multimedia Fn keys, numeric keypad, optional LED backlight 3-button TrackPoint® pointing device and 3-button crystal silk surface multi-touch touchpad									
Chipset	Mobile Intel CM236 Chipset (Intel GL82CM236 PCH)							Security Security chip ThinkEngine	Power-on password, hard disk password, supervisor password, security keyhole Discrete TPM 1.2 TCG Certified and Firmware TPM 2.0 integrated in chipset Delivers improved thermal and power efficiency, up to 30 day standby, faster resume time, enhanced security, as well as anti-tampering measures									
Memory	64GB max ⁷ / 2133MHz DDR4, ECC or non-ECC (ECC function supported only on Xeon processor), dual-channel capable, four DDR4 SO-DIMM sockets							vPro (optional) Fingerprint reader	Intel vPro Technology Touch style fingerprint reader on the palm rest									
Display	Some: 15.6" (396mm) FHD (1920x1080), anti-glare, LED backlight, IPS, 250 nits, 16:9 aspect ratio, 600:1 contrast ratio, 45% gamut, 160° viewing angle Some: 15.6" (396mm) 4K (3840x2160), anti-glare, LED backlight, IPS, 300 nits, 16:9 aspect ratio, 1000:1 contrast ratio, 100% gamut, 178° viewing angle							Color calibration	Optional: Pantone® color calibrator by X-Rite® color calibration sensor in palm rest									
Multi-touch (opt) Pen (optional)	Capacitive-type multi-touch, supports 10-finger gesture, 220 nits ThinkPad Pen Pro, active pen for multi-touch display							Battery Max battery life ¹⁰ (MobileMark® 2014)	Lithium Polymer 4-cell (66Wh) or 6-cell (90Wh)									
Storage	Up to 3 drives (two M.2 SSD and one HDD) • HDD / SATA 6.0Gb/s, 2.5" wide, 7mm high, Shock Mounted Hard Drive, Active Protection System™ • M.2 SSD / SATA 6.0Gb/s (e.g. xxxGB SSD M.2) • M.2 SSD / PCIe NVMe, PCIe 3.0 x 4, 32Gb/s (e.g. xxxGB SSD M.2 PCIe NVMe)							<table border="1"> <thead> <tr> <th>Model</th> <th>4-cell</th> <th>6-cell</th> </tr> </thead> <tbody> <tr> <td>Discrete Graphics</td> <td>7.1 hr</td> <td>9.7 hr</td> </tr> <tr> <td>Hybrid Graphics</td> <td>9.6 hr</td> <td>13.2 hr</td> </tr> </tbody> </table>		Model	4-cell	6-cell	Discrete Graphics	7.1 hr	9.7 hr	Hybrid Graphics	9.6 hr	13.2 hr
Model	4-cell	6-cell																
Discrete Graphics	7.1 hr	9.7 hr																
Hybrid Graphics	9.6 hr	13.2 hr																
Optical	None							AC adapter	170W slim tip AC adapter									
Ethernet	Non-vPro model: Intel Ethernet Connection I219-V (Jacksonville) vPro model: Intel Ethernet Connection I219-LM (Jacksonville)							Preload	<p>Some: Genuine Windows® 7 Professional 64</p> <p>Some: Windows 7 Professional 64 preinstalled through downgrade rights in Windows 10 Pro 64</p> <ul style="list-style-type: none"> Lenovo Solution Center Lenovo SHAREit ThinkVantage Product Recovery Rescue and Recovery™ ThinkVantage System Update Adobe® Reader® Microsoft® Office preloaded; purchase a product key to activate McAfee® LiveSafe™ (30-day trial) <p>For ISV certifications, please visit www.lenovo.com/support/ISV</p>									
WLAN ⁴ Bluetooth™	11ac+BT, Intel Dual Band Wireless-AC 8260, 2x2, M.2 card Bluetooth 4.1 wireless, integrated in Wi-Fi + Bluetooth combo adapter							Limited warranty ¹²	One of the following, configurable by model: <ul style="list-style-type: none"> 3-year/1-yr battery depot repair service 3-year/1-yr battery limited onsite service²⁴ 3-year/1-yr battery limited onsite service, OID (Onsite International Delivery) 									
WWAN (optional)	Wireless WAN, Sierra Wireless EM7455, Qualcomm® 4G LTE-Advanced/DC-HSPA+/HSPA/HSPA/UMTS/GNSS, M.2 card							Mil-Spec test	MIL-STD-810G military certification									
SIM card	Micro-SIM card slot							Environment	EPEAT™ Gold (US only); ENERGY STAR® 6.1; GREENGUARD®; RoHS-compliant									
Dimensions ³	WxDxH: 14.86" x 9.93" x 0.96-1.16"; 377.4mm x 252.3mm x 24.5-29.4mm WxDxH(Touch): 14.86" x 9.93" x 1.02-1.21"; 377.4mm x 252.3mm x 25.8-30.7mm																	
Weight ²	<table border="1"> <thead> <tr> <th>Models</th> <th>4-cell</th> <th>6-cell</th> </tr> </thead> <tbody> <tr> <td>Non-touch</td> <td>5.6 lb / 2.55kg</td> <td>5.9 lb / 2.67kg</td> </tr> <tr> <td>Multi-touch</td> <td>6.2 lb / 2.82kg</td> <td>6.4 lb / 2.90kg</td> </tr> </tbody> </table>							Models	4-cell	6-cell	Non-touch	5.6 lb / 2.55kg	5.9 lb / 2.67kg	Multi-touch	6.2 lb / 2.82kg	6.4 lb / 2.90kg		
Models	4-cell	6-cell																
Non-touch	5.6 lb / 2.55kg	5.9 lb / 2.67kg																
Multi-touch	6.2 lb / 2.82kg	6.4 lb / 2.90kg																
Case material	Display cover: Glass-Fiber Reinforced Plastic; Bottom: Magnesium/Aluminum																	

Model	Region	Processor	vPro	Graphics	Memory	Display	Multi-touch	Pen	Storage(HDD/SSD)	RAID	Optical	WLAN + Bluetooth	WWAN	SIM Card	Smart Card Reader	Camera	Keyboard	Fingerprint Reader	Color Calibrator	Battery	Power Adapter	Operating System	Warranty	Ann Date (m/y)
20EN0012US	US	i7-6700HQ	No	M1000M 2GB	8GBx1 non-ECC	15.6" FHD (1920x1080) IPS	None	None	256GB SSD M.2 Opal2	No	None	Intel 8260 ac, 2x2 + BT4.1	None	None	None	720p	Backlit	Fingerprint Reader	None	6-cell (90Wh)	170W Slim Tip	Win10 DG Win7 Pro 64	3-year, Depot	11/15
20EN0013US	US	i7-6700HQ	No	M1000M 2GB	8GBx1 non-ECC	15.6" FHD (1920x1080) IPS	None	None	500GB 7200rpm	No	None	Intel 8260 ac, 2x2 + BT4.1	None	None	None	720p	Backlit	Fingerprint Reader	None	6-cell (90Wh)	170W Slim Tip	Win10 DG Win7 Pro 64	3-year, Depot	11/15
20EN0014US	US	i7-6700HQ	No	M1000M 2GB	8GBx1 non-ECC	15.6" FHD (1920x1080) IPS	None	None	1TB 5400rpm	No	None	Intel 8260 ac, 2x2 + BT4.1	None	None	None	720p	Backlit	Fingerprint Reader	None	6-cell (90Wh)	170W Slim Tip	Win10 DG Win7 Pro 64	3-year, Depot	11/15
20EN0015US	US	i7-6700HQ	No	M1000M 2GB	16GBx1 non-ECC	15.6" FHD (1920x1080) IPS	None	None	512GB SSD M.2 PCIe NVMe	No	None	Intel 8260 ac, 2x2 + BT4.1	None	None	None	720p	Backlit	Fingerprint Reader	None	6-cell (90Wh)	170W Slim Tip	Win10 DG Win7 Pro 64	3-year, Depot	11/15
20EN0016US	US	i7-6820HQ	vPro	M1000M 2GB	8GBx1 non-ECC	15.6" FHD (1920x1080) IPS	None	None	500GB 7200rpm	No	None	Intel 8260 ac, 2x2 + BT4.1	None	None	None	720p	Backlit	Fingerprint Reader	None	6-cell (90Wh)	170W Slim Tip	Win10 DG Win7 Pro 64	3-year, Depot	11/15
20EN0017US	US	i7-6820HQ	vPro	M1000M 2GB	8GBx1 non-ECC	15.6" FHD (1920x1080) IPS	None	None	1TB 5400rpm	No	None	Intel 8260 ac, 2x2 + BT4.1	None	None	None	720p	Backlit	Fingerprint Reader	None	6-cell (90Wh)	170W Slim Tip	Win10 DG Win7 Pro 64	3-year, Depot	11/15
20EN0018US	US	i7-6820HQ	vPro	M1000M 2GB	8GBx1 non-ECC	15.6" FHD (1920x1080) IPS	None	None	256GB SSD M.2 Opal2	No	None	Intel 8260 ac, 2x2 + BT4.1	None	None	None	720p	Backlit	Fingerprint Reader	None	6-cell (90Wh)	170W Slim Tip	Win10 DG Win7 Pro 64	3-year, Depot	11/15
20EN0019US	US	i7-6820HQ	vPro	M1000M 2GB	16GBx1 non-ECC	15.6" FHD (1920x1080) IPS	None	None	512GB SSD M.2 PCIe NVMe	No	None	Intel 8260 ac, 2x2 + BT4.1	None	None	None	720p	Backlit	Fingerprint Reader	None	6-cell (90Wh)	170W Slim Tip	Win10 DG Win7 Pro 64	3-year, Depot	11/15
20EN001AUS	US	i7-6820HQ	vPro	M2000M 4GB	8GBx1 non-ECC	15.6" FHD (1920x1080) IPS	None	None	500GB 7200rpm	No	None	Intel 8260 ac, 2x2 + BT4.1	None	None	None	720p	Backlit	Fingerprint Reader	None	6-cell (90Wh)	170W Slim Tip	Win10 DG Win7 Pro 64	3-year, Depot	11/15
20EN001BUS	US	i7-6820HQ	vPro	M2000M 4GB	8GBx1 non-ECC	15.6" FHD (1920x1080) IPS	None	None	256GB SSD M.2 Opal2	No	None	Intel 8260 ac, 2x2 + BT4.1	None	None	None	720p	Backlit	Fingerprint Reader	None	6-cell (90Wh)	170W Slim Tip	Win10 DG Win7 Pro 64	3-year, Depot	11/15
20EN001CUS	US	i7-6820HQ	vPro	M2000M 4GB	16GBx1 non-ECC	15.6" FHD (1920x1080) IPS	None	None	512GB SSD M.2 PCIe NVMe	No	None	Intel 8260 ac, 2x2 + BT4.1	None	None	None	720p	Backlit	Fingerprint Reader	None	6-cell (90Wh)	170W Slim Tip	Win10 DG Win7 Pro 64	3-year, Depot	11/15
20EN001DUS	US	i7-6820HQ	vPro	M2000M 4GB	16GBx1 non-ECC	15.6" 4K (3840x2160) IPS	None	None	500GB 7200rpm	No	None	Intel 8260 ac, 2x2 + BT4.1	None	None	None	720p	Backlit	Fingerprint Reader	X-Rite	6-cell (90Wh)	170W Slim Tip	Win10 DG Win7 Pro 64	3-year, Depot	11/15
20EN001EUS	US	i7-6820HQ	vPro	M2000M 4GB	16GBx1 non-ECC	15.6" 4K (3840x2160) IPS	None	None	256GB SSD M.2 Opal2	No	None	Intel 8260 ac, 2x2 + BT4.1	None	None	None	720p	Backlit	Fingerprint Reader	X-Rite	6-cell (90Wh)	170W Slim Tip	Win10 DG Win7 Pro 64	3-year, Depot	11/15
20EN001FUS	US	i7-6820HQ	vPro	M2000M 4GB	16GBx1 non-ECC	15.6" 4K (3840x2160) IPS	None	None	512GB SSD M.2 PCIe NVMe	No	None	Intel 8260 ac, 2x2 + BT4.1	None	None	None	720p	Backlit	Fingerprint Reader	X-Rite	6-cell (90Wh)	170W Slim Tip	Win10 DG Win7 Pro 64	3-year, Depot	11/15
20EN001GUS	US	i7-6700HQ	No	M1000M 2GB	8GBx1 non-ECC	15.6" FHD (1920x1080) IPS	10-point Multi-touch	None	500GB 7200rpm	No	None	Intel 8260 ac, 2x2 + BT4.1	None	None	None	720p	Backlit	Fingerprint Reader	X-Rite	6-cell (90Wh)	170W Slim Tip	Win10 Pro 64	3-year, Depot	11/15
20EN001HUS	US	i7-6700HQ	No	M1000M 2GB	8GBx1 non-ECC	15.6" FHD (1920x1080) IPS	10-point Multi-touch	None	256GB SSD M.2 Opal2	No	None	Intel 8260 ac, 2x2 + BT4.1	None	None	None	720p	Backlit	Fingerprint Reader	X-Rite	6-cell (90Wh)	170W Slim Tip	Win10 Pro 64	3-year, Depot	11/15
20EN001JUS	US	i7-6820HQ	vPro	M1000M 2GB	8GBx1 non-ECC	15.6" FHD (1920x1080) IPS	10-point Multi-touch	None	500GB 7200rpm	No	None	Intel 8260 ac, 2x2 + BT4.1	None	None	None	720p	Backlit	Fingerprint Reader	X-Rite	6-cell (90Wh)	170W Slim Tip	Win10 Pro 64	3-year, Depot	11/15
20EN001KUS	US	i7-6820HQ	vPro	M1000M 2GB	8GBx1 non-ECC	15.6" FHD (1920x1080) IPS	10-point Multi-touch	None	256GB SSD M.2 Opal2	No	None	Intel 8260 ac, 2x2 + BT4.1	None	None	None	720p	Backlit	Fingerprint Reader	X-Rite	6-cell (90Wh)	170W Slim Tip	Win10 Pro 64	3-year, Depot	11/15
20EN001LUS	US	i7-6820HQ	vPro	M2000M 4GB	16GBx1 non-ECC	15.6" FHD (1920x1080) IPS	10-point Multi-touch	None	256GB SSD M.2 Opal2	No	None	Intel 8260 ac, 2x2 + BT4.1	None	None	None	720p	Backlit	Fingerprint Reader	X-Rite	6-cell (90Wh)	170W Slim Tip	Win10 Pro 64	3-year, Depot	11/15
20EN001MUS	US	i7-6820HQ	vPro	M2000M 4GB	16GBx1 non-ECC	15.6" FHD (1920x1080) IPS	10-point Multi-touch	None	512GB SSD M.2 PCIe NVMe	No	None	Intel 8260 ac, 2x2 + BT4.1	None	None	None	720p	Backlit	Fingerprint Reader	X-Rite	6-cell (90Wh)	170W Slim Tip	Win10 Pro 64	3-year, Depot	11/15

Model	Region	Processor	vPro	Graphics	Memory	Display	Multi-touch	Pen	Storage(HDD/SSD)	RAID	Optical	WLAN + Bluetooth	WWAN	SIM Card	Smart Card Reader	Camera	Keyboard	Fingerprint Reader	Color Calibrator	Battery	Power Adapter	Operating System	Warranty	Ann Date (m/y)
20EN001NUS	US	Xeon E3-1505M v5	vPro	M2000M 4GB	16GBx1 non-ECC	15.6" FHD (1920x1080) IPS	10-point Multi-touch	None	256GB SSD M.2 Opal2	No	None	Intel 8260 ac, 2x2 + BT4.1	None	None	None	720p	Backlit	Fingerprint Reader	X-Rite	6-cell (90Wh)	170W Slim Tip	Win10 Pro 64	3-year, Depot	11/15
20EN001PUS	US	Xeon E3-1505M v5	vPro	M2000M 4GB	16GBx1 non-ECC	15.6" FHD (1920x1080) IPS	10-point Multi-touch	None	512GB SSD M.2 PCIe NVMe	No	None	Intel 8260 ac, 2x2 + BT4.1	None	None	None	720p	Backlit	Fingerprint Reader	X-Rite	6-cell (90Wh)	170W Slim Tip	Win10 Pro 64	3-year, Depot	11/15
20EN001QUS	US	Xeon E3-1505M v5	vPro	M2000M 4GB	16GBx1 non-ECC	15.6" 4K (3840x2160) IPS	None	None	256GB SSD M.2 Opal2	No	None	Intel 8260 ac, 2x2 + BT4.1	None	None	None	720p	Backlit	Fingerprint Reader	X-Rite	6-cell (90Wh)	170W Slim Tip	Win10 DG Win7 Pro 64	3-year, Depot	11/15
20EN001RUS	US	Xeon E3-1505M v5	vPro	M2000M 4GB	16GBx1 non-ECC	15.6" 4K (3840x2160) IPS	None	None	512GB SSD M.2 PCIe NVMe	No	None	Intel 8260 ac, 2x2 + BT4.1	None	None	None	720p	Backlit	Fingerprint Reader	X-Rite	6-cell (90Wh)	170W Slim Tip	Win10 DG Win7 Pro 64	3-year, Depot	11/15
20EN001SUS	US	Xeon E3-1505M v5	vPro	M2000M 4GB	16GBx1 non-ECC	15.6" FHD (1920x1080) IPS	None	None	256GB SSD M.2 Opal2	No	None	Intel 8260 ac, 2x2 + BT4.1	None	None	None	720p	Backlit	Fingerprint Reader	None	6-cell (90Wh)	170W Slim Tip	Win10 DG Win7 Pro 64	3-year, Depot	11/15
20EN001TUS	US	Xeon E3-1505M v5	vPro	M2000M 4GB	16GBx1 non-ECC	15.6" FHD (1920x1080) IPS	None	None	512GB SSD M.2 PCIe NVMe	No	None	Intel 8260 ac, 2x2 + BT4.1	None	None	None	720p	Backlit	Fingerprint Reader	None	6-cell (90Wh)	170W Slim Tip	Win10 DG Win7 Pro 64	3-year, Depot	11/15
20EN002FUS	US	i7-6700HQ	No	M1000M 2GB	16GBx1 non-ECC	15.6" FHD (1920x1080) IPS	None	None	500GB 7200rpm	No	None	Intel 8260 ac, 2x2 + BT4.1	None	None	None	720p	Backlit	Fingerprint Reader	None	6-cell (90Wh)	170W Slim Tip	Win10 DG Win7 Pro 64	3-year, Depot	11/15
20EN002GUS	US	i7-6700HQ	No	M1000M 2GB	16GBx1 non-ECC	15.6" FHD (1920x1080) IPS	None	None	500GB 7200rpm	No	None	Intel 8260 ac, 2x2 + BT4.1	None	None	None	720p	Backlit	Fingerprint Reader	None	6-cell (90Wh)	170W Slim Tip	Win10 Pro 64	3-year, Depot	11/15
20EN002HUS	US	i7-6700HQ	No	M1000M 2GB	16GBx1 non-ECC	15.6" FHD (1920x1080) IPS	None	None	256GB SSD M.2 Opal2	No	None	Intel 8260 ac, 2x2 + BT4.1	None	None	None	720p	Backlit	Fingerprint Reader	None	6-cell (90Wh)	170W Slim Tip	Win10 DG Win7 Pro 64	3-year, Depot	11/15
20EN002JUS	US	i7-6700HQ	No	M1000M 2GB	16GBx1 non-ECC	15.6" FHD (1920x1080) IPS	None	None	256GB SSD M.2 Opal2	No	None	Intel 8260 ac, 2x2 + BT4.1	None	None	None	720p	Backlit	Fingerprint Reader	None	6-cell (90Wh)	170W Slim Tip	Win10 Pro 64	3-year, Depot	11/15
20EN002KUS	US	i7-6820HQ	vPro	M1000M 2GB	16GBx1 non-ECC	15.6" FHD (1920x1080) IPS	None	None	256GB SSD M.2 Opal2	No	None	Intel 8260 ac, 2x2 + BT4.1	None	None	None	720p	Backlit	Fingerprint Reader	None	6-cell (90Wh)	170W Slim Tip	Win10 DG Win7 Pro 64	3-year, Depot	11/15
20EN002LUS	US	i7-6820HQ	vPro	M1000M 2GB	16GBx1 non-ECC	15.6" FHD (1920x1080) IPS	None	None	256GB SSD M.2 Opal2	No	None	Intel 8260 ac, 2x2 + BT4.1	None	None	None	720p	Backlit	Fingerprint Reader	None	6-cell (90Wh)	170W Slim Tip	Win10 Pro 64	3-year, Depot	11/15
20EN002MUS	US	i7-6820HQ	vPro	M2000M 4GB	16GBx1 non-ECC	15.6" FHD (1920x1080) IPS	None	None	256GB SSD M.2 Opal2	No	None	Intel 8260 ac, 2x2 + BT4.1	None	None	None	720p	Backlit	Fingerprint Reader	None	6-cell (90Wh)	170W Slim Tip	Win10 DG Win7 Pro 64	3-year, Depot	11/15
20EN002NUS	US	i7-6820HQ	vPro	M2000M 4GB	16GBx1 non-ECC	15.6" FHD (1920x1080) IPS	None	None	256GB SSD M.2 Opal2	No	None	Intel 8260 ac, 2x2 + BT4.1	None	None	None	720p	Backlit	Fingerprint Reader	None	6-cell (90Wh)	170W Slim Tip	Win10 Pro 64	3-year, Depot	11/15
20EN002PUS	US	Xeon E3-1505M v5	vPro	M2000M 4GB	16GBx1 non-ECC	15.6" FHD (1920x1080) IPS	None	None	256GB SSD M.2 Opal2	No	None	Intel 8260 ac, 2x2 + BT4.1	None	None	None	720p	Backlit	Fingerprint Reader	None	6-cell (90Wh)	170W Slim Tip	Win10 Pro 64	3-year, Depot	11/15
20EN002QUS	US	i7-6820HQ	vPro	M2000M 4GB	16GBx1 non-ECC	15.6" 4K (3840x2160) IPS	None	None	256GB SSD M.2 Opal2	No	None	Intel 8260 ac, 2x2 + BT4.1	None	None	None	720p	Backlit	Fingerprint Reader	X-Rite	6-cell (90Wh)	170W Slim Tip	Win10 Pro 64	3-year, Depot	11/15
20EN003LUS	US	i7-6820HQ	vPro	M1000M 4GB	8GBx4 non-ECC	15.6" FHD (1920x1080) IPS	None	None	512GB SSD M.2 PCIe NVMe	No	None	Intel 8260 ac, 2x2 + BT4.1	None	None	Smart Card Reader	720p	Backlit	Fingerprint Reader	None	6-cell (90Wh)	170W Slim Tip	Win10 Pro 64	3-year, Depot	07/16
20EN004RUS	US	Xeon E3-1505M v5	vPro	M2000M 4GB	16GBx1 non-ECC	15.6" 4K (3840x2160) IPS	None	None	512GB SSD M.2 PCIe NVMe	No	None	Intel 8260 ac, 2x2 + BT4.1	WWAN Upgradable	None	None	720p	Backlit	Fingerprint Reader	X-Rite	6-cell (90Wh)	170W Slim Tip	Win10 DG Win7 Pro 64	3-year, Depot	02/18
20EN004SUS	US	Xeon E3-1505M v5	vPro	M2000M 4GB	16GBx1 non-ECC	15.6" FHD (1920x1080) IPS	None	None	256GB SSD M.2 Opal2	No	None	Intel 8260 ac, 2x2 + BT4.1	WWAN Upgradable	None	None	720p	Backlit	Fingerprint Reader	None	6-cell (90Wh)	170W Slim Tip	Win10 DG Win7 Pro 64	3-year, Depot	02/18
20EN004TUS	US	Xeon E3-1505M v5	vPro	M2000M 4GB	16GBx1 non-ECC	15.6" FHD (1920x1080) IPS	None	None	512GB SSD M.2 PCIe NVMe	No	None	Intel 8260 ac, 2x2 + BT4.1	WWAN Upgradable	None	None	720p	Backlit	Fingerprint Reader	None	6-cell (90Wh)	170W Slim Tip	Win10 DG Win7 Pro 64	3-year, Depot	02/18



ThinkPad P51 Platform Specifications

Product Specifications Reference (PSREF)

Processor	7th Generation Intel® Core™ i7 Processor or Intel Xeon® Processor E3 v6 Family							Dimensions <i>WxDxH:</i> 14.86" x 9.93" x 0.96-1.16"; 377.4mm x 252.3mm x 24.5-29.4mm <i>WxDxH(Touch):</i> 14.86" x 9.93" x 1.02-1.21"; 377.4mm x 252.3mm x 25.8-30.7mm										
	Processor Number	# of Cores	# of Threads	Base Frequency	Max Turbo Frequency	Cache	Memory Types		Weight <table border="1"> <thead> <tr> <th>Models</th> <th>4-cell</th> <th>6-cell</th> </tr> </thead> <tbody> <tr> <td><i>Non-touch</i></td> <td>5.6 lb / 2.55kg</td> <td>5.9 lb / 2.67kg</td> </tr> <tr> <td><i>Multi-touch</i></td> <td>6.2 lb / 2.82kg</td> <td>6.4 lb / 2.90kg</td> </tr> </tbody> </table>	Models	4-cell	6-cell	<i>Non-touch</i>	5.6 lb / 2.55kg	5.9 lb / 2.67kg	<i>Multi-touch</i>	6.2 lb / 2.82kg	6.4 lb / 2.90kg
	Models	4-cell	6-cell															
	<i>Non-touch</i>	5.6 lb / 2.55kg	5.9 lb / 2.67kg															
<i>Multi-touch</i>	6.2 lb / 2.82kg	6.4 lb / 2.90kg																
i7-7700HQ	4	8	2.8 GHz	3.8 GHz	6MB	DDR4-2400	Intel HD Graphics 630											
i7-7820HQ			2.9 GHz	3.9 GHz			Intel HD Graphics P630											
E3-1505M v6			3.0 GHz	4.0 GHz	8MB		Intel HD Graphics P630											
E3-1535M v6			3.1 GHz	4.2 GHz														

Graphics	Intel HD Graphics 630 or P630 in processor and NVIDIA Quadro® M1200 or M2200, 4GB memory; supports external digital monitor via HDMI, Mini DisplayPort, or Thunderbolt™; supports four independent displays; Max resolution: 3840x2160@60Hz (DisplayPort via Mini DisplayPort cable); 3840x2160@60Hz (Thunderbolt); 4096x2160@24Hz (HDMI)	Smart card reader ExpressCard Media reader Ports	<i>Optional:</i> Smart card reader One slot (ExpressCard/34) 4-in-1 reader (MMC, SD, SDHC, SDXC), supports UHS-II SD card Four USB 3.1 Gen 1 (USB 3.0, one Always On), USB Type-C / Thunderbolt 3, Mini DisplayPort 1.2a, HDMI 1.4b, Ethernet (RJ-45), Dock connector
----------	---	---	--

Chipset	Mobile Intel CM238 Chipset	Camera (<i>optional</i>)	HD720p resolution, fixed focus
Memory	64GB max ⁷ / 2400MHz DDR4, ECC or non-ECC (ECC function supported only on Xeon processor), dual-channel capable, four DDR4 SO-DIMM sockets	Audio support	HD Audio, Realtek® ALC3268 codec / stereo speakers, 2W x 2 / dual array microphone, combo audio/microphone jack

Display	<i>Some:</i> 15.6" (396mm) FHD (1920x1080), anti-glare, LED backlight, IPS, 250 nits, 16:9 aspect ratio, 700:1 contrast ratio, 160° viewing angle <i>Some:</i> 15.6" (396mm) 4K (3840x2160), anti-glare, LED backlight, IPS, 300 nits, 16:9 aspect ratio, 1000:1 contrast ratio, 100% gamut, 170° viewing angle	Keyboard UltraNav™	6-row, spill-resistant, multimedia Fn keys, numeric keypad, optional LED backlight 3-button TrackPoint® pointing device and 3-button Mylar surface multi-touch touchpad
---------	--	-----------------------	---

Multi-touch (<i>opt</i>) Pen (<i>optional</i>)	Capacitive-type multi-touch, supports 10-finger gesture, 220 nits (FHD only) ThinkPad Pen Pro, active pen for multi-touch display	Security Security chip vPro (<i>optional</i>)	Power-on password, hard disk password, supervisor password, security keyhole Discrete TPM 2.0, TCG Certified Intel vPro Technology
---	--	---	--

Storage	<i>Up to 3 drives (two M.2 SSD and one HDD)</i> <i>Some:</i> HDD / SATA 6.0Gb/s, 2.5" wide, 7mm high, Active Protection System™ <i>Some:</i> M.2 SSD / PCIe NVMe, PCIe 3.0 x 4, 32Gb/s	Fingerprint reader	Touch style match on chip fingerprint reader on the palm rest
---------	--	--------------------	---

Optical	None	Color calibration NFC	<i>Optional:</i> Pantone® color calibrator by X-Rite® color calibration sensor in palm rest None
---------	------	--------------------------	---

Ethernet	<i>Non-vPro model:</i> Intel Ethernet Connection I219-V (Jacksonville) <i>vPro model:</i> Intel Ethernet Connection I219-LM (Jacksonville)	Battery	Lithium Polymer 4-cell (66Wh) or 6-cell (90Wh)
----------	---	---------	--

WLAN Bluetooth™	Intel Dual Band Wireless-AC 8265, Wi-Fi 2x2 802.11ac + BT4.1, M.2 card Bluetooth 4.1 wireless, integrated in Wi-Fi + Bluetooth combo adapter * Intel 8265ac card support BT4.2 but is limited to BT4.1 by Windows OS	Max battery life ¹⁰ (MobileMark® 2014)	<table border="1"> <thead> <tr> <th>Model</th> <th>4-cell</th> <th>6-cell</th> </tr> </thead> <tbody> <tr> <td><i>Discrete Graphics</i></td> <td>4.5 hr</td> <td>6.1 hr</td> </tr> <tr> <td><i>Hybrid Graphics</i></td> <td>6.5 hr</td> <td>8.9 hr</td> </tr> </tbody> </table>	Model	4-cell	6-cell	<i>Discrete Graphics</i>	4.5 hr	6.1 hr	<i>Hybrid Graphics</i>	6.5 hr	8.9 hr
Model	4-cell	6-cell										
<i>Discrete Graphics</i>	4.5 hr	6.1 hr										
<i>Hybrid Graphics</i>	6.5 hr	8.9 hr										

WWAN (<i>optional</i>)	<i>One of the following, configurable by model:</i> • Wireless WAN upgradable • Integrated Mobile Broadband 4G LTE-A, Qualcomm® Snapdragon™ X7 LTE-A (Sierra Wireless EM7455), M.2 card	AC adapter	170W slim tip AC adapter
--------------------------	---	------------	--------------------------

SIM card (<i>opt</i>)	Micro-SIM card slot, opt Verizon LTE (US) or Lenovo® Connect (EMEA) SIM card	Preload	<i>Some:</i> Windows® 10 Home 64 <i>Some:</i> Windows 10 Pro 64 • Lenovo Companion • Lenovo Setting • Microsoft Office preloaded; purchase a product key to activate
-------------------------	--	---------	---

		Limited warranty	<i>One of the following, configurable by model:</i> • 1-year depot repair service • 3-year/1-yr battery depot repair service • 3-year/1-yr battery limited onsite service
		Mil-Spec test	MIL-STD-810G military certification
		Environment	EPEAT™ Gold (US only); ENERGY STAR® 6.1; RoHS-compliant

Model	Region	Processor	Pro	Graphics	Chipset	Memory	Display	Multi-touch	Pen	Storage (HDD/SSD)	RAID	Optical	WLAN + Bluetooth	WWAN	SIM Card	Smart Card Reader	Camera	Key-board	Finger-print Reader	NFC	Color Calibrator	TPM	Battery	Power Adapter	Operating System	Warranty	Ann Date (mly)
20HH0004US	US	i7-7700HQ	No	M1200	Intel CM238	8GBx1 non-ECC	15.6" FHD (1920x1080) IPS	None	None	512GB SSD M.2 PCIe NVMe Opal2	No	None	Intel 8265 ac, 2x2 + BT4.1	WWAN Upgradable	None	None	720p	Backlit	Finger-print Reader	None	None	dTPM 2.0	6-cell (90Wh)	170W Slim Tip	Win10 Pro 64	3-year, Depot	03/17
20HH0005US	US	Xeon E3-1505M v6	vPro	M2200	Intel CM238	8GBx2 non-ECC	15.6" FHD (1920x1080) IPS	None	None	1TB 5400rpm	No	None	Intel 8265 ac, 2x2 + BT4.1	WWAN Upgradable	None	None	720p	Backlit	Finger-print Reader	None	None	dTPM 2.0	6-cell (90Wh)	170W Slim Tip	Win10 Pro 64	3-year, Depot	03/17
20HH0006US	US	Xeon E3-1535M v6	vPro	M2200	Intel CM238	8GBx2 non-ECC	15.6" FHD (1920x1080) IPS	None	None	512GB SSD M.2 PCIe NVMe Opal2	No	None	Intel 8265 ac, 2x2 + BT4.1	WWAN Upgradable	None	None	720p	Backlit	Finger-print Reader	None	None	dTPM 2.0	6-cell (90Wh)	170W Slim Tip	Win10 Pro 64	3-year, Depot	03/17
20HH0007US	US	Xeon E3-1535M v6	vPro	M2200	Intel CM238	8GBx2 non-ECC	15.6" FHD (1920x1080) IPS	None	None	256GB SSD M.2 PCIe NVMe Opal2	No	None	Intel 8265 ac, 2x2 + BT4.1	WWAN Upgradable	None	None	720p	Backlit	Finger-print Reader	None	None	dTPM 2.0	6-cell (90Wh)	170W Slim Tip	Win10 Pro 64	3-year, Depot	03/17
20HH0008US	US	Xeon E3-1535M v6	vPro	M2200	Intel CM238	8GBx2 non-ECC	15.6" FHD (1920x1080) IPS	None	None	1TB SSD M.2 PCIe NVMe Opal2	No	None	Intel 8265 ac, 2x2 + BT4.1	WWAN Upgradable	None	None	720p	Backlit	Finger-print Reader	None	None	dTPM 2.0	6-cell (90Wh)	170W Slim Tip	Win10 Pro 64	3-year, Depot	03/17
20HH0009US	US	Xeon E3-1535M v6	vPro	M2200	Intel CM238	8GBx2 non-ECC	15.6" FHD (1920x1080) IPS	10-point Multi-touch	None	512GB SSD M.2 PCIe NVMe Opal2	No	None	Intel 8265 ac, 2x2 + BT4.1	WWAN Upgradable	None	None	720p	Backlit	Finger-print Reader	None	X-Rite	dTPM 2.0	6-cell (90Wh)	170W Slim Tip	Win10 Pro 64	3-year, Depot	03/17
20HH000AUS	US	i7-7700HQ	No	M1200	Intel CM238	8GBx2 non-ECC	15.6" FHD (1920x1080) IPS	None	None	1TB SSD M.2 PCIe NVMe Opal2	No	None	Intel 8265 ac, 2x2 + BT4.1	WWAN Upgradable	None	None	720p	Backlit	Finger-print Reader	None	None	dTPM 2.0	6-cell (90Wh)	170W Slim Tip	Win10 Pro 64	3-year, Depot	03/17
20HH000BUS	US	Xeon E3-1505M v6	vPro	M2200	Intel CM238	8GBx2 non-ECC	15.6" FHD (1920x1080) IPS	None	None	512GB SSD M.2 PCIe NVMe Opal2	No	None	Intel 8265 ac, 2x2 + BT4.1	WWAN Upgradable	None	None	720p	Backlit	Finger-print Reader	None	None	dTPM 2.0	6-cell (90Wh)	170W Slim Tip	Win10 Pro 64	3-year, Depot	03/17
20HH000CUS	US	i7-7820HQ	vPro	M2200	Intel CM238	8GBx2 non-ECC	15.6" 4K (3840x2160) IPS	None	None	512GB SSD M.2 PCIe NVMe Opal2	No	None	Intel 8265 ac, 2x2 + BT4.1	WWAN Upgradable	None	None	720p	Backlit	Finger-print Reader	None	X-Rite	dTPM 2.0	6-cell (90Wh)	170W Slim Tip	Win10 Pro 64	3-year, Depot	03/17
20HH000DUS	US	Xeon E3-1535M v6	vPro	M2200	Intel CM238	8GBx2 non-ECC	15.6" 4K (3840x2160) IPS	None	None	512GB SSD M.2 PCIe NVMe Opal2	No	None	Intel 8265 ac, 2x2 + BT4.1	WWAN Upgradable	None	None	720p	Backlit	Finger-print Reader	None	X-Rite	dTPM 2.0	6-cell (90Wh)	170W Slim Tip	Win10 Pro 64	3-year, Depot	03/17
20HH000EUS	US	Xeon E3-1505M v6	vPro	M2200	Intel CM238	8GBx2 non-ECC	15.6" FHD (1920x1080) IPS	10-point Multi-touch	None	1TB SSD M.2 PCIe NVMe Opal2	No	None	Intel 8265 ac, 2x2 + BT4.1	WWAN Upgradable	None	None	720p	Backlit	Finger-print Reader	None	X-Rite	dTPM 2.0	6-cell (90Wh)	170W Slim Tip	Win10 Pro 64	3-year, Depot	03/17
20HH000FUS	US	i7-7700HQ	No	M1200	Intel CM238	8GBx1 non-ECC	15.6" FHD (1920x1080) IPS	None	None	1TB 5400rpm	No	None	Intel 8265 ac, 2x2 + BT4.1	WWAN Upgradable	None	None	720p	Backlit	Finger-print Reader	None	None	dTPM 2.0	6-cell (90Wh)	170W Slim Tip	Win10 Pro 64	3-year, Depot	03/17
20HH000GUS	US	i7-7820HQ	vPro	M1200	Intel CM238	8GBx1 non-ECC	15.6" FHD (1920x1080) IPS	None	None	256GB SSD M.2 PCIe NVMe Opal2	No	None	Intel 8265 ac, 2x2 + BT4.1	WWAN Upgradable	None	None	720p	Backlit	Finger-print Reader	None	None	dTPM 2.0	6-cell (90Wh)	170W Slim Tip	Win10 Pro 64	3-year, Depot	03/17
20HH000HUS	US	Xeon E3-1535M v6	vPro	M2200	Intel CM238	8GBx1 non-ECC	15.6" FHD (1920x1080) IPS	None	None	512GB SSD M.2 PCIe NVMe Opal2	No	None	Intel 8265 ac, 2x2 + BT4.1	WWAN Upgradable	None	None	720p	Backlit	Finger-print Reader	None	None	dTPM 2.0	6-cell (90Wh)	170W Slim Tip	Win10 Pro 64	3-year, Depot	03/17
20HH000JUS	US	Xeon E3-1535M v6	vPro	M2200	Intel CM238	8GBx1 non-ECC	15.6" FHD (1920x1080) IPS	None	None	256GB SSD M.2 PCIe NVMe Opal2	No	None	Intel 8265 ac, 2x2 + BT4.1	WWAN Upgradable	None	None	720p	Backlit	Finger-print Reader	None	None	dTPM 2.0	6-cell (90Wh)	170W Slim Tip	Win10 Pro 64	3-year, Depot	03/17
20HH000KUS	US	Xeon E3-1505M v6	vPro	M2200	Intel CM238	8GBx2 non-ECC	15.6" FHD (1920x1080) IPS	10-point Multi-touch	None	1TB 5400rpm	No	None	Intel 8265 ac, 2x2 + BT4.1	WWAN Upgradable	None	None	720p	Backlit	Finger-print Reader	None	X-Rite	dTPM 2.0	6-cell (90Wh)	170W Slim Tip	Win10 Pro 64	3-year, Depot	03/17
20HH000LUS	US	Xeon E3-1505M v6	vPro	M2200	Intel CM238	8GBx2 non-ECC	15.6" 4K (3840x2160) IPS	None	None	512GB SSD M.2 PCIe NVMe Opal2	No	None	Intel 8265 ac, 2x2 + BT4.1	WWAN Upgradable	None	None	720p	Backlit	Finger-print Reader	None	X-Rite	dTPM 2.0	6-cell (90Wh)	170W Slim Tip	Win10 Pro 64	3-year, Depot	03/17
20HH000MUS	US	i7-7700HQ	No	M1200	Intel CM238	8GBx1 non-ECC	15.6" FHD (1920x1080) IPS	None	None	1TB SSD M.2 PCIe NVMe Opal2	No	None	Intel 8265 ac, 2x2 + BT4.1	WWAN Upgradable	None	None	720p	Backlit	Finger-print Reader	None	None	dTPM 2.0	6-cell (90Wh)	170W Slim Tip	Win10 Pro 64	3-year, Depot	03/17
20HH000NUS	US	i7-7820HQ	vPro	M1200	Intel CM238	8GBx1 non-ECC	15.6" FHD (1920x1080) IPS	None	None	512GB SSD M.2 PCIe NVMe Opal2	No	None	Intel 8265 ac, 2x2 + BT4.1	WWAN Upgradable	None	None	720p	Backlit	Finger-print Reader	None	None	dTPM 2.0	6-cell (90Wh)	170W Slim Tip	Win10 Pro 64	3-year, Depot	03/17
20HH000PUS	US	Xeon E3-1505M v6	vPro	M2200	Intel CM238	8GBx1 non-ECC	15.6" FHD (1920x1080) IPS	None	None	256GB SSD M.2 PCIe NVMe Opal2	No	None	Intel 8265 ac, 2x2 + BT4.1	WWAN Upgradable	None	None	720p	Backlit	Finger-print Reader	None	None	dTPM 2.0	6-cell (90Wh)	170W Slim Tip	Win10 Pro 64	3-year, Depot	03/17

Model	Region	Processor	vPro	Graphics	Chipset	Memory	Display	Multi-touch	Pen	Storage (HDD/SSD)	RAID	Optical	WLAN + Bluetooth	WWAN	SIM Card	Smart Card Reader	Camera	Keyboard	Fingerprint Reader	NFC	Color Calibrator	TPM	Battery	Power Adapter	Operating System	Warranty	Ann Date (m/y)
20HH000QUS	US	Xeon E3-1505M v6	vPro	M2200 4GB	Intel CM238	8GBx1 non-ECC	15.6" FHD (1920x1080) IPS	None	None	256GB SSD M.2 PCIe NVMe Opal2	No	None	Intel 8265 ac, 2x2 + BT4.1	WWAN Upgradable	None	None	720p	Backlit	Fingerprint Reader	None	None	dTPM 2.0	6-cell (90Wh)	170W Slim Tip	Win10 Pro 64	3-year, Depot	03/17
20HH000RUS	US	Xeon E3-1505M v6	vPro	M2200 4GB	Intel CM238	8GBx1 non-ECC	15.6" FHD (1920x1080) IPS	None	None	512GB SSD M.2 PCIe NVMe Opal2	No	None	Intel 8265 ac, 2x2 + BT4.1	WWAN Upgradable	None	None	720p	Backlit	Fingerprint Reader	None	None	dTPM 2.0	6-cell (90Wh)	170W Slim Tip	Win10 Pro 64	3-year, Depot	03/17
20HH000SUS	US	Xeon E3-1535M v6	vPro	M2200 4GB	Intel CM238	8GBx2 non-ECC	15.6" FHD (1920x1080) IPS	None	None	512GB SSD M.2 PCIe NVMe Opal2	No	None	Intel 8265 ac, 2x2 + BT4.1	WWAN Upgradable	None	None	720p	Backlit	Fingerprint Reader	None	None	dTPM 2.0	6-cell (90Wh)	170W Slim Tip	Win10 Pro 64	3-year, Depot	03/17
20HH000TUS	US	i7-7700HQ	No	M1200 4GB	Intel CM238	8GBx2 non-ECC	15.6" FHD (1920x1080) IPS	None	None	512GB SSD M.2 PCIe NVMe Opal2	No	None	Intel 8265 ac, 2x2 + BT4.1	WWAN Upgradable	None	None	720p	Backlit	Fingerprint Reader	None	None	dTPM 2.0	6-cell (90Wh)	170W Slim Tip	Win10 Pro 64	3-year, Depot	03/17
20HH000UUS	US	Xeon E3-1505M v6	vPro	M2200 4GB	Intel CM238	8GBx2 non-ECC	15.6" FHD (1920x1080) IPS	None	None	512GB SSD M.2 PCIe NVMe Opal2	No	None	Intel 8265 ac, 2x2 + BT4.1	WWAN Upgradable	None	None	720p	Backlit	Fingerprint Reader	None	None	dTPM 2.0	6-cell (90Wh)	170W Slim Tip	Win10 Pro 64	3-year, Depot	03/17
20HH000VUS	US	Xeon E3-1505M v6	vPro	M2200 4GB	Intel CM238	8GBx1 non-ECC	15.6" FHD (1920x1080) IPS	None	None	1TB 5400rpm	No	None	Intel 8265 ac, 2x2 + BT4.1	WWAN Upgradable	None	None	720p	Backlit	Fingerprint Reader	None	None	dTPM 2.0	6-cell (90Wh)	170W Slim Tip	Win10 Pro 64	3-year, Depot	03/17
20HH000WUS	US	i7-7700HQ	No	M1200 4GB	Intel CM238	8GBx1 non-ECC	15.6" FHD (1920x1080) IPS	None	None	256GB SSD M.2 PCIe NVMe Opal2	No	None	Intel 8265 ac, 2x2 + BT4.1	WWAN Upgradable	None	None	720p	Backlit	Fingerprint Reader	None	None	dTPM 2.0	6-cell (90Wh)	170W Slim Tip	Win10 Pro 64	3-year, Depot	03/17
20HH000XUS	US	i7-7700HQ	No	M1200 4GB	Intel CM238	8GBx1 non-ECC	15.6" FHD (1920x1080) IPS	None	None	512GB SSD M.2 PCIe NVMe Opal2	No	None	Intel 8265 ac, 2x2 + BT4.1	WWAN Upgradable	None	None	720p	Backlit	Fingerprint Reader	None	None	dTPM 2.0	6-cell (90Wh)	170W Slim Tip	Win10 Pro 64	3-year, Depot	03/17
20HH000YUS	US	i7-7700HQ	No	M1200 4GB	Intel CM238	8GBx2 non-ECC	15.6" FHD (1920x1080) IPS	None	None	1TB 5400rpm	No	None	Intel 8265 ac, 2x2 + BT4.1	WWAN Upgradable	None	None	720p	Backlit	Fingerprint Reader	None	None	dTPM 2.0	6-cell (90Wh)	170W Slim Tip	Win10 Pro 64	3-year, Depot	03/17
20HH0010US	US	Xeon E3-1505M v6	vPro	M2200 4GB	Intel CM238	8GBx1 non-ECC	15.6" FHD (1920x1080) IPS	None	None	512GB SSD M.2 PCIe NVMe Opal2	No	None	Intel 8265 ac, 2x2 + BT4.1	WWAN Upgradable	None	None	720p	Backlit	Fingerprint Reader	None	None	dTPM 2.0	6-cell (90Wh)	170W Slim Tip	Win10 Pro 64	3-year, Depot	03/17
20HH0011US	US	i7-7700HQ	No	M1200 4GB	Intel CM238	8GBx1 non-ECC	15.6" FHD (1920x1080) IPS	None	None	500GB 7200rpm	No	None	Intel 8265 ac, 2x2 + BT4.1	WWAN Upgradable	None	None	720p	Backlit	Fingerprint Reader	None	None	dTPM 2.0	6-cell (90Wh)	170W Slim Tip	Win10 Pro 64	3-year, Depot	03/17
20HH0012US	US	i7-7820HQ	vPro	M1200 4GB	Intel CM238	8GBx1 non-ECC	15.6" FHD (1920x1080) IPS	None	None	1TB SSD M.2 PCIe NVMe Opal2	No	None	Intel 8265 ac, 2x2 + BT4.1	WWAN Upgradable	None	None	720p	Backlit	Fingerprint Reader	None	None	dTPM 2.0	6-cell (90Wh)	170W Slim Tip	Win10 Pro 64	3-year, Depot	03/17
20HH0013US	US	Xeon E3-1505M v6	vPro	M2200 4GB	Intel CM238	8GBx2 non-ECC	15.6" FHD (1920x1080) IPS	None	None	1TB SSD M.2 PCIe NVMe Opal2	No	None	Intel 8265 ac, 2x2 + BT4.1	WWAN Upgradable	None	None	720p	Backlit	Fingerprint Reader	None	None	dTPM 2.0	6-cell (90Wh)	170W Slim Tip	Win10 Pro 64	3-year, Depot	03/17
20HH002LUS	US	i7-7820HQ	vPro	M2200 4GB	Intel CM238	8GBx1 non-ECC	15.6" FHD (1920x1080) IPS	None	None	1TB SSD M.2 PCIe NVMe Opal2	No	None	Intel 8265 ac, 2x2 + BT4.1	WWAN Upgradable	None	None	720p	Backlit	Fingerprint Reader	None	X-Rite	dTPM 2.0	6-cell (90Wh)	170W Slim Tip	Win10 Pro 64	3-year, Depot	05/17
20HH002MUS	US	i7-7700HQ	No	M1200 4GB	Intel CM238	8GBx1 non-ECC	15.6" FHD (1920x1080) IPS	None	None	512GB SSD M.2 PCIe NVMe Opal2	No	None	Intel 8265 ac, 2x2 + BT4.1	WWAN Upgradable	None	None	720p	Backlit	Fingerprint Reader	None	X-Rite	dTPM 2.0	6-cell (90Wh)	170W Slim Tip	Win10 Pro 64	3-year, Depot	05/17
20HH002NUS	US	i7-7820HQ	vPro	M2200 4GB	Intel CM238	8GBx1 non-ECC	15.6" FHD (1920x1080) IPS	None	None	512GB SSD M.2 PCIe NVMe Opal2	No	None	Intel 8265 ac, 2x2 + BT4.1	WWAN Upgradable	None	None	720p	Backlit	Fingerprint Reader	None	X-Rite	dTPM 2.0	6-cell (90Wh)	170W Slim Tip	Win10 Pro 64	3-year, Depot	05/17
20HH002PUS	US	i7-7820HQ	vPro	M2200 4GB	Intel CM238	8GBx1 non-ECC	15.6" FHD (1920x1080) IPS	10-point Multi-touch	None	512GB SSD M.2 PCIe NVMe Opal2	No	None	Intel 8265 ac, 2x2 + BT4.1	WWAN Upgradable	None	None	720p	Backlit	Fingerprint Reader	None	X-Rite	dTPM 2.0	6-cell (90Wh)	170W Slim Tip	Win10 Pro 64	3-year, Depot	05/17
20HH002QUS	US	i7-7700HQ	No	M1200 4GB	Intel CM238	8GBx2 non-ECC	15.6" FHD (1920x1080) IPS	10-point Multi-touch	None	512GB SSD M.2 PCIe NVMe Opal2	No	None	Intel 8265 ac, 2x2 + BT4.1	WWAN Upgradable	None	None	720p	Backlit	Fingerprint Reader	None	X-Rite	dTPM 2.0	6-cell (90Wh)	170W Slim Tip	Win10 Pro 64	3-year, Depot	05/17
20HH003AUS	US	i7-7700HQ	No	M1200 4GB	Intel CM238	16GBx1 non-ECC	15.6" FHD (1920x1080) IPS	10-point Multi-touch	None	512GB SSD M.2 PCIe NVMe Opal2	No	None	Intel 8265 ac, 2x2 + BT4.1	WWAN Upgradable	None	None	720p	Non-backlit	Fingerprint Reader	None	X-Rite	dTPM 2.0	6-cell (90Wh)	170W Slim Tip	Win10 Pro 64	3-year, Depot	11/17
20HH003BUS	US	i7-7820HQ	vPro	M1200 4GB	Intel CM238	16GBx1 non-ECC	15.6" FHD (1920x1080) IPS	10-point Multi-touch	None	512GB SSD M.2 PCIe NVMe Opal2	No	None	Intel 8265 ac, 2x2 + BT4.1	WWAN Upgradable	None	None	720p	Non-backlit	Fingerprint Reader	None	X-Rite	dTPM 2.0	6-cell (90Wh)	170W Slim Tip	Win10 Pro 64	3-year, Depot	11/17

Model	Region	Processor	Pro	Graphics	Chipset	Memory	Display	Multi-touch	Pen	Storage	(HDD/SSD)	RAID	Optical	WLAN + Bluetooth	WWAN	SIM Card	Smart Card Reader	Camera	Key-board	Finger-print Reader	NFC	Color Calibrator	TPM	Battery	Power Adapter	Operating System	Warranty	Ann Date (m/y)
20HH003CUS	US	i7-7820HQ	vPro	M1200	Intel CM238	16GBx1 non-ECC	15.6" FHD (1920x1080) IPS	None	None	512GB SSD M.2 PCIe NVMe Opal2	No	None	None	Intel 8265 ac, 2x2 + BT4.1	WWAN Upgradable	None	None	720p	Non-backlit	Finger-print Reader	None	None	dTPM 2.0	6-cell (90Wh)	170W Slim Tip	Win10 Pro 64	3-year, Depot	11/17
20HH003DUS	US	i7-7700HQ	No	M1200	Intel CM238	16GBx1 non-ECC	15.6" FHD (1920x1080) IPS	None	None	512GB SSD M.2 PCIe NVMe Opal2	No	None	None	Intel 8265 ac, 2x2 + BT4.1	WWAN Upgradable	None	None	720p	Non-backlit	Finger-print Reader	None	None	dTPM 2.0	6-cell (90Wh)	170W Slim Tip	Win10 Pro 64	3-year, Depot	11/17
20HH003EUS	US	i7-7820HQ	vPro	M1200	Intel CM238	16GBx1 non-ECC	15.6" 4K (3840x2160) IPS	None	None	512GB SSD M.2 PCIe NVMe Opal2	No	None	None	Intel 8265 ac, 2x2 + BT4.1	WWAN Upgradable	None	None	720p	Non-backlit	Finger-print Reader	None	X-Rite	dTPM 2.0	6-cell (90Wh)	170W Slim Tip	Win10 Pro 64	3-year, Depot	11/17
20HH003FUS	US	i7-7700HQ	No	M1200	Intel CM238	16GBx1 non-ECC	15.6" 4K (3840x2160) IPS	None	None	512GB SSD M.2 PCIe NVMe Opal2	No	None	None	Intel 8265 ac, 2x2 + BT4.1	WWAN Upgradable	None	None	720p	Non-backlit	Finger-print Reader	None	X-Rite	dTPM 2.0	6-cell (90Wh)	170W Slim Tip	Win10 Pro 64	3-year, Depot	11/17
20HH003VUS	US	Xeon E3-1535M v6	vPro	M2200	Intel CM238	8GBx2 non-ECC	15.6" FHD (1920x1080) IPS	None	None	512GB SSD M.2 PCIe NVMe Opal2	No	None	None	Intel 8265 ac, 2x2 + BT4.1	WWAN Upgradable	None	None	720p	Backlit	Finger-print Reader	None	None	dTPM 2.0	6-cell (90Wh)	170W Slim Tip	Win10 Pro 64	3-year, Depot	01/18
20HH003WUS	US	Xeon E3-1535M v6	vPro	M2200	Intel CM238	8GBx2 non-ECC	15.6" 4K (3840x2160) IPS	None	None	512GB SSD M.2 PCIe NVMe Opal2	No	None	None	Intel 8265 ac, 2x2 + BT4.1	WWAN Upgradable	None	None	720p	Backlit	Finger-print Reader	None	X-Rite	dTPM 2.0	6-cell (90Wh)	170W Slim Tip	Win10 Pro 64	3-year, Depot	01/18
20HH003XUS	US	Xeon E3-1505M v6	vPro	M2200	Intel CM238	8GBx2 non-ECC	15.6" FHD (1920x1080) IPS	None	None	1TB SSD M.2 PCIe NVMe Opal2	No	None	None	Intel 8265 ac, 2x2 + BT4.1	WWAN Upgradable	None	None	720p	Backlit	Finger-print Reader	None	None	dTPM 2.0	6-cell (90Wh)	170W Slim Tip	Win10 Pro 64	3-year, Depot	01/18
20HH003YUS	US	Xeon E3-1535M v6	vPro	M2200	Intel CM238	8GBx2 non-ECC	15.6" FHD (1920x1080) IPS	None	None	1TB SSD M.2 PCIe NVMe Opal2	No	None	None	Intel 8265 ac, 2x2 + BT4.1	WWAN Upgradable	None	None	720p	Backlit	Finger-print Reader	None	None	dTPM 2.0	6-cell (90Wh)	170W Slim Tip	Win10 Pro 64	3-year, Depot	01/18
20HH0040US	US	Xeon E3-1535M v6	vPro	M2200	Intel CM238	8GBx2 non-ECC	15.6" FHD (1920x1080) IPS	10-point Multi-touch	None	512GB SSD M.2 PCIe NVMe Opal2	No	None	None	Intel 8265 ac, 2x2 + BT4.1	WWAN Upgradable	None	None	720p	Backlit	Finger-print Reader	None	X-Rite	dTPM 2.0	6-cell (90Wh)	170W Slim Tip	Win10 Pro 64	3-year, Depot	01/18
20HH0041US	US	Xeon E3-1505M v6	vPro	M2200	Intel CM238	8GBx2 non-ECC	15.6" 4K (3840x2160) IPS	None	None	512GB SSD M.2 PCIe NVMe Opal2	No	None	None	Intel 8265 ac, 2x2 + BT4.1	WWAN Upgradable	None	None	720p	Backlit	Finger-print Reader	None	X-Rite	dTPM 2.0	6-cell (90Wh)	170W Slim Tip	Win10 Pro 64	3-year, Depot	01/18
20HH0042US	US	Xeon E3-1535M v6	vPro	M2200	Intel CM238	8GBx2 non-ECC	15.6" FHD (1920x1080) IPS	None	None	256GB SSD M.2 PCIe NVMe Opal2	No	None	None	Intel 8265 ac, 2x2 + BT4.1	WWAN Upgradable	None	None	720p	Backlit	Finger-print Reader	None	None	dTPM 2.0	6-cell (90Wh)	170W Slim Tip	Win10 Pro 64	3-year, Depot	01/18
20HH0043US	US	Xeon E3-1505M v6	vPro	M2200	Intel CM238	8GBx2 non-ECC	15.6" FHD (1920x1080) IPS	None	None	1TB 5400rpm	No	None	None	Intel 8265 ac, 2x2 + BT4.1	WWAN Upgradable	None	None	720p	Backlit	Finger-print Reader	None	None	dTPM 2.0	6-cell (90Wh)	170W Slim Tip	Win10 Pro 64	3-year, Depot	01/18
20HH0044US	US	Xeon E3-1505M v6	vPro	M2200	Intel CM238	8GBx1 non-ECC	15.6" FHD (1920x1080) IPS	None	None	1TB 7200rpm	No	None	None	Intel 8265 ac, 2x2 + BT4.1	WWAN Upgradable	None	None	720p	Backlit	Finger-print Reader	None	None	dTPM 2.0	6-cell (90Wh)	170W Slim Tip	Win10 Pro 64	3-year, Depot	01/18
20HH0045US	US	Xeon E3-1505M v6	vPro	M2200	Intel CM238	8GBx2 non-ECC	15.6" FHD (1920x1080) IPS	None	None	1TB 7200rpm	No	None	None	Intel 8265 ac, 2x2 + BT4.1	WWAN Upgradable	None	None	720p	Backlit	Finger-print Reader	None	None	dTPM 2.0	6-cell (90Wh)	170W Slim Tip	Win10 Pro 64	3-year, Depot	01/18
20HH0046US	US	Xeon E3-1505M v6	vPro	M2200	Intel CM238	8GBx2 non-ECC	15.6" FHD (1920x1080) IPS	None	None	512GB SSD M.2 PCIe NVMe Opal2	No	None	None	Intel 8265 ac, 2x2 + BT4.1	WWAN Upgradable	None	None	720p	Backlit	Finger-print Reader	None	None	dTPM 2.0	6-cell (90Wh)	170W Slim Tip	Win10 Pro 64	3-year, Depot	01/18
20HH0047US	US	Xeon E3-1505M v6	vPro	M2200	Intel CM238	8GBx2 non-ECC	15.6" FHD (1920x1080) IPS	10-point Multi-touch	None	1TB SSD M.2 PCIe NVMe Opal2	No	None	None	Intel 8265 ac, 2x2 + BT4.1	WWAN Upgradable	None	None	720p	Backlit	Finger-print Reader	None	X-Rite	dTPM 2.0	6-cell (90Wh)	170W Slim Tip	Win10 Pro 64	3-year, Depot	01/18
20HH0048US	US	Xeon E3-1505M v6	vPro	M2200	Intel CM238	8GBx2 non-ECC	15.6" FHD (1920x1080) IPS	None	None	512GB SSD M.2 PCIe NVMe Opal2	No	None	None	Intel 8265 ac, 2x2 + BT4.1	WWAN Upgradable	None	None	720p	Backlit	Finger-print Reader	None	None	dTPM 2.0	6-cell (90Wh)	170W Slim Tip	Win10 Pro 64	3-year, Depot	01/18
20HH0049US	US	Xeon E3-1505M v6	vPro	M2200	Intel CM238	8GBx1 non-ECC	15.6" FHD (1920x1080) IPS	None	None	1TB 5400rpm	No	None	None	Intel 8265 ac, 2x2 + BT4.1	WWAN Upgradable	None	None	720p	Backlit	Finger-print Reader	None	None	dTPM 2.0	6-cell (90Wh)	170W Slim Tip	Win10 Pro 64	3-year, Depot	01/18



ThinkPad P51s Platform Specifications

Product Specifications Reference (PSREF)

Processor	6th Generation Intel® Core™ i7 Processor								Dimensions WxDxH: 14.40" x 9.95" x 0.79-0.80"; 365.8mm x 252.8mm x 19.95-20.2mm
	Processor Number	# of Cores	# of Threads	Base Frequency	Max Turbo Frequency	Cache	Memory Types	Processor Graphics	
	i7-6500U	2	4	2.5 GHz	3.1 GHz	4MB	DDR4-2133	Intel HD Graphics 520	
	i7-6600U			2.6 GHz	3.4 GHz	4MB			
	or 7th Generation Intel Core i5 / i7 Processor								
	Processor Number	# of Cores	# of Threads	Base Frequency	Max Turbo Frequency	Cache	Memory Types	Processor Graphics	
	i5-7300U	2	4	2.6 GHz	3.5 GHz	3MB	DDR4-2133	Intel HD Graphics 620	
	i7-7500U			2.7 GHz	3.5 GHz	4MB			
	i7-7600U			2.8 GHz	3.9 GHz	4MB			
Graphics	Intel HD Graphics 520 or 620 in processor and NVIDIA Quadro® M520, 2GB 2.5GHz GDDR5 memory; supports external digital monitor via HDMI or USB Type-C; supports three independent displays; Max resolution: 4096x2304@60Hz (USB Type-C); 3840x2160@30Hz (HDMI)								Weight <i>Models</i>
Chipset	Intel SoC (System on Chip) platform								<i>4 + 3-cell</i>
Memory	32GB max / 2400MHz DDR4, dual-channel capable, two DDR4 SO-DIMM sockets * System clocks down for processors with lower memory controller								<i>6-cell</i>
Display	<i>Some:</i> 15.6" (396mm) FHD (1920x1080), anti-glare, LED backlight, IPS, 250 nits, 16:9 aspect ratio, 700:1 contrast ratio, 170° viewing angle <i>Some:</i> 15.6" (396mm) 4K (3840x2160), anti-glare, LED backlight, IPS, 300 nits, 16:9 aspect ratio, 1000:1 contrast ratio, 72% gamut, 170° viewing angle								<i>4 + 6-cell</i>
Multi-touch (opt)	On-cell touch, supports 10-finger gesture (FHD only)								<i>Non-touch model</i>
Storage	<i>System has one HDD slot or one M.2 2280 slot exclusively for storage</i> <i>Some:</i> HDD / SATA 6.0Gb/s, 2.5" wide, 7mm high, Active Protection System™ <i>Some:</i> SSD / SATA 6.0Gb/s, 2.5" wide, 7mm high (e.g. xxxGB SSD) <i>Some:</i> M.2 SSD / PCIe NVMe, PCIe 3.0 x 2, 16Gb/s <i>Some:</i> 128GB M.2 SSD / SATA 6.0Gb/s, in WWAN slot as 2nd Storage, mutually exclusive with WWAN and WiGig								<i>Multi-touch model</i>
Optical	None								Case color Black
Ethernet	<i>Non-vPro model:</i> Intel Ethernet Connection I219-V (Jacksonville) <i>vPro model:</i> Intel Ethernet Connection I219-LM (Jacksonville)								Case material <i>Display cover:</i> Glass-Fiber Reinforced Plastic (PPS); <i>Bottom:</i> Glass-Fiber Reinforced Plastic
WLAN	<i>One of the following, configurable by model (WiGig can coexist with WWAN):</i> • Realtek® RTL8822BE, Wi-Fi 2x2 802.11ac + BT4.1, M.2 card • Intel Dual Band Wireless-AC 8260, Wi-Fi 2x2 802.11ac + BT4.1, M.2 card • Intel Dual Band Wireless-AC 8265, Wi-Fi 2x2 802.11ac + BT4.1, M.2 card • Intel Tri-Band Wireless-AC 18265, WiGig 802.11ad + Wi-Fi 2x2 802.11ac + BT4.1, M.2 card								Smart card reader <i>Optional:</i> Smart card reader
Bluetooth™	Bluetooth 4.1 wireless, integrated in Wi-Fi + Bluetooth combo adapter * Intel 8265ac / 18265ac card support BT4.2 but is limited to BT4.1 by Windows OS								Media reader 4-in-1 reader (MMC, SD, SDHC, SDXC), supports SD 3.0, UHS-I
WWAN (optional)	<i>One of the following, configurable by model (WWAN can coexist with WiGig):</i> • Wireless WAN upgradable • Integrated Mobile Broadband 4G LTE-A, Qualcomm® Snapdragon™ X7 LTE-A (Sierra Wireless EM7455), M.2 card • Integrated Mobile Broadband 4G LTE, Intel XMM™ 7160 (Fibocom L831-EAU), M.2 card (EMEA only)								Ports Three USB 3.1 Gen 1 (USB 3.0, one Always On), USB 3.1 Type-C Gen 2 / Thunderbolt 3, HDMI 1.4b, Ethernet (RJ-45), Dock connector
SIM card (opt)	Micro-SIM card slot, opt Verizon LTE (US) or Lenovo® Connect (EMEA) SIM card								WiGig dock (opt) ThinkPad WiGig dock
									Monitor cable <i>HDMI to VGA:</i> Lenovo HDMI to VGA Monitor Adapter <i>USB-C to VGA:</i> Lenovo USB-C to VGA Adapter
									Camera (optional) <i>720p:</i> HD720p resolution, fixed focus <i>IR & 720p:</i> IR camera and HD720p camera (mutually exclusive with WiGig)
									Audio support HD Audio, Realtek® ALC3268 codec / stereo speakers, 2W x 2 / dual array microphone, combo audio/microphone jack
									Keyboard 6-row, spill-resistant, multimedia Fn keys, numeric keypad, optional LED backlight UltraNav™ TrackPoint® pointing device and buttonless Mylar surface multi-touch touchpad
									Security Power-on password, hard disk password, supervisor password, security keyhole Security chip Discrete TPM 2.0, TCG Certified vPro (optional) Intel vPro Technology
									Fingerprint reader <i>Optional:</i> Touch style match on chip fingerprint reader on the palm rest
									NFC (optional) Near Field Communication
									Internal battery <i>Optional:</i> Integrated Li-Polymer 4-cell (32Wh)
									External battery Li-Polymer 3-cell (24Wh) or Li-Ion 6-cell (48Wh or 72Wh)
									Max battery life <i>(MobileMark® 2014)</i>
									<i>Models</i>
									<i>4 + 3-cell</i>
									<i>6-cell 48Wh</i>
									<i>6-cell 72Wh</i>
									<i>4 + 6-cell 48Wh</i>
									<i>4 + 6-cell 72Wh</i>
									<i>Max battery life</i>
									13.8 hr
									12.5 hr
									18.5 hr
									20.0 hr
									26.8 hr
									AC adapter 65W slim tip AC adapter or 65W USB Type-C AC adapter
									Preload Windows® 7 Professional 64 preinstalled through downgrade rights in Windows 10 Pro 64 • Lenovo Solution Center • Lenovo PowerEngage • ThinkVantage Product Recovery • ThinkVantage System Update • Adobe® Reader® • Microsoft® Office preloaded; purchase a product key to activate • McAfee® LiveSafe™ (30-day trial)
									<i>Some:</i> Windows 10 Home 64 <i>Some:</i> Windows 10 Pro 64 • Lenovo Companion • Lenovo Setting • Microsoft Office preloaded; purchase a product key to activate
									Limited warranty <i>One of the following, configurable by model:</i> • 1-year depot repair service • 3-year/1-yr battery depot repair service • 3-year/1-yr battery limited onsite service
									Mil-Spec test MIL-STD-810G military certification
									Environment EPEAT™ Gold (US only); ENERGY STAR® 6.1; RoHS-compliant

Model	Region	Processor	vPro	Graphics	Memory	Display	Multi-touch	Storage(HDD/SSD)	Optical	WLAN + Bluetooth	WWAN	SIM Card	Smart Card Reader	Dock	Monitor Cable	Camera	Key-board	Finger-print Reader	NFC	TPM	Battery (internal+ external)	Power Adapter	Operating System	Warranty	Ann Date (m/y)
20HB0004US	US	i7-7500U	No	M520 2GB	8GBx1	15.6" FHD (1920x1080) IPS	None	1TB 5400rpm	None	Intel 8265 ac, 2x2 + BT4.1	WWAN Upgradable	None	None	None	None	720p	Backlit	Finger-print Reader	None	dTPM 2.0	4-cell(32Wh) + 3-cell(24Wh)	65W Slim Tip	Win10 Pro 64	3-year, Depot	03/17
20HB000AUS	US	i7-7500U	No	M520 2GB	8GBx1	15.6" FHD (1920x1080) IPS	None	256GB SSD M.2 PCIe NVMe Opal2	None	Intel 8265 ac, 2x2 + BT4.1	WWAN Upgradable	None	None	None	None	720p	Backlit	Finger-print Reader	None	dTPM 2.0	4-cell(32Wh) + 3-cell(24Wh)	65W Slim Tip	Win10 Pro 64	3-year, Depot	03/17
20HB000WUS	US	i7-7600U	vPro	M520 2GB	8GBx1	15.6" FHD (1920x1080) IPS	None	256GB SSD M.2 PCIe NVMe Opal2	None	Intel 8265 ac, 2x2 + BT4.1	WWAN Upgradable	None	None	None	None	720p	Backlit	Finger-print Reader	None	dTPM 2.0	4-cell(32Wh) + 3-cell(24Wh)	65W USB-C	Win10 Pro 64	3-year, Depot	03/17
20HB000XUS	US	i5-7300U	vPro	M520 2GB	8GBx1	15.6" FHD (1920x1080) IPS	10-point Multi-touch	256GB SSD M.2 PCIe NVMe Opal2	None	Intel 8265 ac, 2x2 + BT4.1	WWAN Upgradable	None	None	None	None	720p	Backlit	Finger-print Reader	None	dTPM 2.0	4-cell(32Wh) + 3-cell(24Wh)	65W USB-C	Win10 Pro 64	3-year, Depot	03/17
20HB000YUS	US	i5-7300U	vPro	M520 2GB	8GBx1	15.6" 4K (3840x2160) IPS	None	1TB 5400rpm	None	Intel 8265 ac, 2x2 + BT4.1	WWAN Upgradable	None	None	None	None	IR &720p	Backlit	Finger-print Reader	None	dTPM 2.0	4-cell(32Wh) + 3-cell(24Wh)	65W USB-C	Win10 Pro 64	3-year, Depot	03/17
20HB0010US	US	i5-7300U	vPro	M520 2GB	8GBx1	15.6" FHD (1920x1080) IPS	None	512GB SSD M.2 PCIe NVMe Opal2	None	Intel 8265 ac, 2x2 + BT4.1	WWAN Upgradable	None	None	None	None	720p	Backlit	Finger-print Reader	None	dTPM 2.0	4-cell(32Wh) + 3-cell(24Wh)	65W USB-C	Win10 Pro 64	3-year, Depot	03/17
20HB0011US	US	i7-7600U	vPro	M520 2GB	8GBx2	15.6" FHD (1920x1080) IPS	None	1TB SSD M.2 PCIe NVMe Opal2	None	Intel 8265 ac, 2x2 + BT4.1	WWAN Upgradable	None	None	None	None	IR &720p	Backlit	Finger-print Reader	None	dTPM 2.0	4-cell(32Wh) + 3-cell(24Wh)	65W USB-C	Win10 Pro 64	3-year, Depot	03/17
20HB0012US	US	i7-7600U	vPro	M520 2GB	8GBx2	15.6" FHD (1920x1080) IPS	None	512GB SSD M.2 PCIe NVMe Opal2	None	Intel 8265 ac, 2x2 + BT4.1	WWAN Upgradable	None	None	None	None	IR &720p	Backlit	Finger-print Reader	None	dTPM 2.0	4-cell(32Wh) + 3-cell(24Wh)	65W USB-C	Win10 Pro 64	3-year, Depot	03/17
20HB0013US	US	i7-7600U	vPro	M520 2GB	8GBx1	15.6" 4K (3840x2160) IPS	None	256GB SSD M.2 PCIe NVMe Opal2	None	Intel 8265 ac, 2x2 + BT4.1	WWAN Upgradable	None	None	None	None	IR &720p	Backlit	Finger-print Reader	None	dTPM 2.0	4-cell(32Wh) + 3-cell(24Wh)	65W USB-C	Win10 Pro 64	3-year, Depot	03/17
20HB0014US	US	i5-7300U	vPro	M520 2GB	8GBx1	15.6" FHD (1920x1080) IPS	None	256GB SSD M.2 PCIe NVMe Opal2	None	Intel 8265 ac, 2x2 + BT4.1	WWAN Upgradable	None	None	None	None	720p	Backlit	Finger-print Reader	None	dTPM 2.0	4-cell(32Wh) + 3-cell(24Wh)	65W USB-C	Win10 Pro 64	3-year, Depot	03/17
20HB0015US	US	i7-7500U	No	M520 2GB	8GBx1	15.6" FHD (1920x1080) IPS	None	512GB SSD M.2 PCIe NVMe Opal2	None	Intel 8265 ac, 2x2 + BT4.1	WWAN Upgradable	None	None	None	None	720p	Backlit	Finger-print Reader	None	dTPM 2.0	4-cell(32Wh) + 3-cell(24Wh)	65W Slim Tip	Win10 Pro 64	3-year, Depot	03/17
20HB0016US	US	i7-7600U	vPro	M520 2GB	8GBx1	15.6" FHD (1920x1080) IPS	10-point Multi-touch	1TB SSD M.2 PCIe NVMe Opal2	None	Intel 8265 ac, 2x2 + BT4.1	WWAN Upgradable	None	None	None	None	720p	Backlit	Finger-print Reader	None	dTPM 2.0	4-cell(32Wh) + 3-cell(24Wh)	65W USB-C	Win10 Pro 64	3-year, Depot	03/17
20HB0017US	US	i5-7300U	vPro	M520 2GB	8GBx1	15.6" FHD (1920x1080) IPS	None	256GB SSD M.2 PCIe NVMe Opal2	None	Intel 8265 ac, 2x2 + BT4.1	WWAN Upgradable	None	None	None	None	720p	Backlit	Finger-print Reader	None	dTPM 2.0	4-cell(32Wh) + 6-cell(72Wh)	65W USB-C	Win10 Pro 64	3-year, Depot	03/17
20HB0018US	US	i5-7300U	vPro	M520 2GB	8GBx1	15.6" FHD (1920x1080) IPS	None	500GB 7200rpm	None	Intel 8265 ac, 2x2 + BT4.1	WWAN Upgradable	None	None	None	None	720p	Backlit	Finger-print Reader	None	dTPM 2.0	4-cell(32Wh) + 3-cell(24Wh)	65W USB-C	Win10 Pro 64	3-year, Depot	03/17
20HB0019US	US	i5-7300U	vPro	M520 2GB	8GBx1	15.6" FHD (1920x1080) IPS	None	1TB 5400rpm	None	Intel 8265 ac, 2x2 + BT4.1	WWAN Upgradable	None	None	None	None	720p	Backlit	Finger-print Reader	None	dTPM 2.0	4-cell(32Wh) + 3-cell(24Wh)	65W USB-C	Win10 Pro 64	3-year, Depot	03/17
20HB001AUS	US	i5-7300U	vPro	M520 2GB	8GBx1	15.6" FHD (1920x1080) IPS	None	1TB SSD M.2 PCIe NVMe Opal2	None	Intel 8265 ac, 2x2 + BT4.1	WWAN Upgradable	None	None	None	None	720p	Backlit	Finger-print Reader	None	dTPM 2.0	4-cell(32Wh) + 3-cell(24Wh)	65W USB-C	Win10 Pro 64	3-year, Depot	03/17
20HB001BUS	US	i7-7600U	vPro	M520 2GB	8GBx1	15.6" FHD (1920x1080) IPS	None	1TB 5400rpm	None	Intel 8265 ac, 2x2 + BT4.1	WWAN Upgradable	None	None	None	None	720p	Backlit	Finger-print Reader	None	dTPM 2.0	4-cell(32Wh) + 3-cell(24Wh)	65W USB-C	Win10 Pro 64	3-year, Depot	03/17
20HB001CUS	US	i7-7600U	vPro	M520 2GB	8GBx2	15.6" FHD (1920x1080) IPS	None	256GB SSD M.2 PCIe NVMe Opal2	None	Intel 8265 ac, 2x2 + BT4.1	WWAN Upgradable	None	None	None	None	IR &720p	Backlit	Finger-print Reader	None	dTPM 2.0	4-cell(32Wh) + 3-cell(24Wh)	65W USB-C	Win10 Pro 64	3-year, Depot	03/17
20HB001DUS	US	i5-7300U	vPro	M520 2GB	8GBx2	15.6" FHD (1920x1080) IPS	None	512GB SSD M.2 PCIe NVMe Opal2	None	Intel 8265 ac, 2x2 + BT4.1	WWAN Upgradable	None	None	None	None	IR &720p	Backlit	Finger-print Reader	None	dTPM 2.0	4-cell(32Wh) + 3-cell(24Wh)	65W USB-C	Win10 Pro 64	3-year, Depot	03/17
20HB001EUS	US	i7-7600U	vPro	M520 2GB	8GBx1	15.6" FHD (1920x1080) IPS	None	1TB SSD M.2 PCIe NVMe Opal2	None	Intel 8265 ac, 2x2 + BT4.1	WWAN Upgradable	None	None	None	None	720p	Backlit	Finger-print Reader	None	dTPM 2.0	4-cell(32Wh) + 3-cell(24Wh)	65W USB-C	Win10 Pro 64	3-year, Depot	03/17

Model	Region	Processor	vPro	Graphics	Memory	Display	Multi-touch	Storage(HDD/SSD)	Optical	WLAN + Bluetooth	WWAN	SIM Card	Smart Card Reader	Dock	Monitor Cable	Camera	Key-board	Finger-print Reader	NFC	TPM	Battery (internal+external)	Power Adapter	Operating System	Warranty	Ann Date (m/y)
20HB001FUS	US	i5-7300U	vPro	M520 2GB	8GBx2	15.6" FHD (1920x1080) IPS	None	256GB SSD M.2 PCIe NVMe Opal2	None	Intel 8265 ac, 2x2 + BT4.1	WWAN Upgradable	None	None	None	None	IR &720p	Backlit	Finger-print Reader	None	dTPM 2.0	4-cell(32Wh) + 3-cell(24Wh)	65W USB-C	Win10 Pro 64	3-year, Depot	03/17
20HB001GUS	US	i7-7600U	vPro	M520 2GB	8GBx1	15.6" FHD (1920x1080) IPS	None	512GB SSD M.2 PCIe NVMe Opal2	None	Intel 8265 ac, 2x2 + BT4.1	WWAN Upgradable	None	None	None	None	720p	Backlit	Finger-print Reader	None	dTPM 2.0	4-cell(32Wh) + 3-cell(24Wh)	65W USB-C	Win10 Pro 64	3-year, Depot	03/17
20HB001HUS	US	i5-7300U	vPro	M520 2GB	4GBx1	15.6" FHD (1920x1080) IPS	None	500GB 7200rpm	None	Intel 8265 ac, 2x2 + BT4.1	WWAN Upgradable	None	None	None	None	720p	Backlit	Finger-print Reader	None	dTPM 2.0	4-cell(32Wh) + 3-cell(24Wh)	65W USB-C	Win10 Pro 64	3-year, Depot	03/17
20HB001JUS	US	i5-7300U	vPro	M520 2GB	8GBx1	15.6" 4K (3840x2160) IPS	None	256GB SSD M.2 PCIe NVMe Opal2	None	Intel 8265 ac, 2x2 + BT4.1	WWAN Upgradable	None	None	None	None	IR &720p	Backlit	Finger-print Reader	None	dTPM 2.0	4-cell(32Wh) + 3-cell(24Wh)	65W USB-C	Win10 Pro 64	3-year, Depot	03/17
20HB001KUS	US	i7-7500U	No	M520 2GB	8GBx1	15.6" FHD (1920x1080) IPS	None	500GB 7200rpm	None	Intel 8265 ac, 2x2 + BT4.1	WWAN Upgradable	None	None	None	None	720p	Backlit	Finger-print Reader	None	dTPM 2.0	4-cell(32Wh) + 3-cell(24Wh)	65W Slim Tip	Win10 Pro 64	3-year, Depot	03/17
20HB001NUS	US	i5-7300U	vPro	M520 2GB	8GBx1	15.6" FHD (1920x1080) IPS	None	500GB 7200rpm	None	Intel 8265 ac, 2x2 + BT4.1	WWAN Upgradable	None	None	None	None	720p	Backlit	Finger-print Reader	None	dTPM 2.0	4-cell(32Wh) + 3-cell(24Wh)	65W Slim Tip	Win10 Pro 64	3-year, Depot	05/17
20HB001PUS	US	i7-7500U	No	M520 2GB	16GBx1	15.6" FHD (1920x1080) IPS	10-point Multi-touch	500GB 7200rpm	None	Intel 8265 ac, 2x2 + BT4.1	WWAN Upgradable	None	None	None	None	720p	Backlit	Finger-print Reader	None	dTPM 2.0	4-cell(32Wh) + 3-cell(24Wh)	65W Slim Tip	Win10 Pro 64	3-year, Depot	05/17
20HB001QUS	US	i7-7500U	No	M520 2GB	8GBx1	15.6" FHD (1920x1080) IPS	10-point Multi-touch	500GB 7200rpm	None	Intel 8265 ac, 2x2 + BT4.1	WWAN Upgradable	None	None	None	None	720p	Backlit	Finger-print Reader	None	dTPM 2.0	4-cell(32Wh) + 3-cell(24Wh)	65W Slim Tip	Win10 Pro 64	3-year, Depot	05/17
20HB001RUS	US	i5-7300U	vPro	M520 2GB	8GBx1	15.6" FHD (1920x1080) IPS	10-point Multi-touch	500GB 7200rpm	None	Intel 8265 ac, 2x2 + BT4.1	WWAN Upgradable	None	None	None	None	720p	Backlit	Finger-print Reader	None	dTPM 2.0	4-cell(32Wh) + 3-cell(24Wh)	65W Slim Tip	Win10 Pro 64	3-year, Depot	05/17
20HB001SUS	US	i7-7500U	No	M520 2GB	16GBx1	15.6" FHD (1920x1080) IPS	None	512GB SSD M.2 PCIe NVMe Opal2	None	Intel 8265 ac, 2x2 + BT4.1	WWAN Upgradable	None	None	None	None	IR &720p	Backlit	Finger-print Reader	None	dTPM 2.0	4-cell(32Wh) + 3-cell(24Wh)	65W Slim Tip	Win10 Pro 64	3-year, Depot	05/17
20HB001TUS	US	i7-7500U	No	M520 2GB	8GBx1	15.6" FHD (1920x1080) IPS	10-point Multi-touch	256GB SSD M.2 PCIe NVMe Opal2	None	Intel 8265 ac, 2x2 + BT4.1	WWAN Upgradable	None	None	None	None	720p	Backlit	Finger-print Reader	None	dTPM 2.0	4-cell(32Wh) + 3-cell(24Wh)	65W Slim Tip	Win10 Pro 64	3-year, Depot	05/17
20HB001UUS	US	i7-7500U	No	M520 2GB	16GBx1	15.6" FHD (1920x1080) IPS	10-point Multi-touch	512GB SSD M.2 PCIe NVMe Opal2	None	Intel 8265 ac, 2x2 + BT4.1	WWAN Upgradable	None	None	None	None	720p	Backlit	Finger-print Reader	None	dTPM 2.0	4-cell(32Wh) + 3-cell(24Wh)	65W Slim Tip	Win10 Pro 64	3-year, Depot	05/17
20HB001VUS	US	i7-7500U	No	M520 2GB	16GBx1	15.6" FHD (1920x1080) IPS	None	512GB SSD M.2 PCIe NVMe Opal2	None	Intel 8265 ac, 2x2 + BT4.1	WWAN Upgradable	None	None	None	None	720p	Backlit	Finger-print Reader	None	dTPM 2.0	4-cell(32Wh) + 3-cell(24Wh)	65W Slim Tip	Win10 Pro 64	3-year, Depot	05/17
20HB001XUS	US	i7-7500U	No	M520 2GB	16GBx1	15.6" FHD (1920x1080) IPS	None	512GB SSD M.2 PCIe NVMe Opal2	None	Intel 8265 ac, 2x2 + BT4.1	WWAN Upgradable	None	None	None	None	IR &720p	Backlit	Finger-print Reader	None	dTPM 2.0	4-cell(32Wh) + 3-cell(24Wh)	65W Slim Tip	Win10 Pro 64	3-year, Depot	05/17

ThinkPad P51s - TopSeller - 20JY

Product Specifications Reference (PSREF)

Model	Region	Processor	vPro	Graphics	Memory	Display	Multi-touch	Storage(HDD/SSD)	Optical	WLAN + Bluetooth	WWAN	SIM Card	Smart Card Reader	Dock	Monitor Cable	Camera	Key-board	Finger-print Reader	NFC	TPM	Battery (internal+external)	Power Adapter	Operating System	Warranty	Ann Date (m/y)
20JY0004US	US	i7-6500U	No	M520 2GB	8GBx2	15.6" FHD (1920x1080) IPS	None	512GB SSD M.2 PCIe NVMe Opal2	None	Intel 8260 ac, 2x2 + BT4.1	WWAN Upgradable	None	None	None	None	720p	Backlit	Finger-print Reader	None	dTPM 2.0	4-cell(32Wh) + 3-cell(24Wh)	65W Slim Tip	Win10 DG Win7 Pro 64	3-year, Depot	03/17
20JY0005US	US	i7-6500U	No	M520 2GB	8GBx2	15.6" FHD (1920x1080) IPS	None	256GB SSD M.2 PCIe NVMe Opal2	None	Intel 8260 ac, 2x2 + BT4.1	WWAN Upgradable	None	None	None	None	720p	Backlit	Finger-print Reader	None	dTPM 2.0	4-cell(32Wh) + 3-cell(24Wh)	65W Slim Tip	Win10 DG Win7 Pro 64	3-year, Depot	03/17
20JY0006US	US	i7-6500U	No	M520 2GB	8GBx1	15.6" FHD (1920x1080) IPS	None	256GB SSD M.2 PCIe NVMe Opal2	None	Intel 8260 ac, 2x2 + BT4.1	WWAN Upgradable	None	None	None	None	720p	Backlit	Finger-print Reader	None	dTPM 2.0	4-cell(32Wh) + 3-cell(24Wh)	65W Slim Tip	Win10 DG Win7 Pro 64	3-year, Depot	03/17
20JY0007US	US	i7-6500U	No	M520 2GB	8GBx2	15.6" 4K (3840x2160) IPS	None	256GB SSD M.2 PCIe NVMe Opal2	None	Intel 8260 ac, 2x2 + BT4.1	WWAN Upgradable	None	None	None	None	720p	Backlit	Finger-print Reader	None	dTPM 2.0	4-cell(32Wh) + 3-cell(24Wh)	65W Slim Tip	Win10 DG Win7 Pro 64	3-year, Depot	03/17
20JY0008US	US	i7-6500U	No	M520 2GB	8GBx2	15.6" 4K (3840x2160) IPS	None	500GB 7200rpm	None	Intel 8260 ac, 2x2 + BT4.1	WWAN Upgradable	None	None	None	None	720p	Backlit	Finger-print Reader	None	dTPM 2.0	4-cell(32Wh) + 3-cell(24Wh)	65W Slim Tip	Win10 DG Win7 Pro 64	3-year, Depot	03/17
20JY0009US	US	i7-6500U	No	M520 2GB	8GBx1	15.6" FHD (1920x1080) IPS	None	500GB 7200rpm	None	Intel 8260 ac, 2x2 + BT4.1	WWAN Upgradable	None	None	None	None	720p	Backlit	Finger-print Reader	None	dTPM 2.0	4-cell(32Wh) + 3-cell(24Wh)	65W Slim Tip	Win10 DG Win7 Pro 64	3-year, Depot	03/17
20JY000AUS	US	i7-6500U	No	M520 2GB	16GBx2	15.6" FHD (1920x1080) IPS	None	1TB SSD M.2 PCIe NVMe Opal2	None	Intel 8260 ac, 2x2 + BT4.1	WWAN Upgradable	None	None	None	None	720p	Backlit	Finger-print Reader	None	dTPM 2.0	4-cell(32Wh) + 3-cell(24Wh)	65W Slim Tip	Win10 DG Win7 Pro 64	3-year, Depot	03/17
20JY000BUS	US	i7-6500U	No	M520 2GB	8GBx2	15.6" 4K (3840x2160) IPS	None	512GB SSD M.2 PCIe NVMe Opal2	None	Intel 8260 ac, 2x2 + BT4.1	WWAN Upgradable	None	None	None	None	720p	Backlit	Finger-print Reader	None	dTPM 2.0	4-cell(32Wh) + 3-cell(24Wh)	65W Slim Tip	Win10 DG Win7 Pro 64	3-year, Depot	03/17
20JY000CUS	US	i7-6500U	No	M520 2GB	16GBx2	15.6" FHD (1920x1080) IPS	None	512GB SSD M.2 PCIe NVMe Opal2	None	Intel 8260 ac, 2x2 + BT4.1	WWAN Upgradable	None	None	None	None	720p	Backlit	Finger-print Reader	None	dTPM 2.0	4-cell(32Wh) + 3-cell(24Wh)	65W Slim Tip	Win10 DG Win7 Pro 64	3-year, Depot	03/17



ThinkPad P52s Platform Specifications

Product Specifications Reference (PSREF)

Processor	8th Generation Intel® Core™ i5 / i7 Processor								Dimensions Weight	<i>WxDxH:</i> 14.40" x 9.95" x 0.79-0.80"; 365.8mm x 252.8mm x 19.95-20.2mm starting at 4.39 lb / 1.99 kg																	
	Processor Number	# of Cores	# of Threads	Base Frequency	Max Turbo Frequency	Cache	Memory Types	Processor Graphics		Case color	Black																
	i5-8350U	4	8	1.7 GHz	3.6 GHz	6MB	DDR4-2400	Intel UHD Graphics 620		Case material	<i>Display cover:</i> Glass-Fiber Reinforced Plastic (PPS); <i>Bottom:</i> Glass-Fiber Reinforced Plastic																
	i7-8550U			1.8 GHz	4.0 GHz	8MB				Smart card reader	<i>Optional:</i> Smart card reader																
i7-8650U	1.9 GHz			4.2 GHz	8MB	Media reader			4-in-1 reader (MMC, SD, SDHC, SDXC)																		
Graphics	Intel UHD Graphics 620 in processor and NVIDIA Quadro® P500, 2GB GDDR5 memory; supports external digital monitor via HDMI or USB Type-C; supports three independent displays; Max resolution: 4096x2304@60Hz (USB Type-C); 4096x2160@30Hz (HDMI)								Ports	Two USB 3.1 Gen 1 (one Always On), USB 3.1 Type-C Gen 1, USB 3.1 Type-C Gen 2 / Thunderbolt 3, HDMI 1.4b, Ethernet (RJ-45), nano-SIM card slot (WWAN models), headphone / microphone combo jack, optional smart card reader, 4-in-1 reader (MMC, SD, SDHC, SDXC), side docking connector, security keyhole																	
Chipset	Intel SoC (System on Chip) platform								Monitor cable	<i>HDMI to VGA:</i> Lenovo HDMI to VGA Monitor Adapter																	
Memory	32GB max / 2400MHz DDR4, dual-channel capable, two DDR4 SO-DIMM sockets * System clocks down for processors with lower memory controller								<i>(optional)</i>	<i>USB-C to DP:</i> Lenovo USB-C to DisplayPort Adapter																	
Display	<i>Some:</i> 15.6" (396mm) FHD (1920x1080), anti-glare, LED backlight, IPS, 250 nits, 16:9 aspect ratio, 700:1 contrast ratio, 170° viewing angle <i>Some:</i> 15.6" (396mm) UHD (3840x2160), anti-glare, LED backlight, IPS, 300 nits, 16:9 aspect ratio, 1000:1 contrast ratio, 72% gamut, 170° viewing angle								Camera	<i>(optional)</i> One of the following, configurable by model: • HD720p camera with ThinkShutter camera privacy, fixed focus • IR camera and HD720p camera, fixed focus																	
Multi-touch	<i>(opt)</i> On-cell touch, supports 10-finger gesture (FHD only)								Audio support	HD Audio, Realtek® ALC3287 codec, Dolby® Audio™ Premium / stereo speakers, 2W x 2 / dual array microphone, headphone / microphone combo jack																	
Storage	<i>System has one HDD slot or one M.2 2280 slot exclusively for storage</i> <i>Some:</i> HDD / SATA 6.0Gb/s, 2.5" wide, 7mm high, Active Protection System™ <i>Some:</i> SSD / SATA 6.0Gb/s, 2.5" wide, 7mm high (e.g. xxxGB SSD) <i>Some:</i> M.2 SSD / PCIe NVMe, PCIe 3.0 x4, 32Gb/s <i>Some:</i> 128GB M.2 SSD / PCIe NVMe, PCIe 3.0 x 2, 16Gb/s, in WWAN slot as 2nd Storage, mutually exclusive with WWAN								Keyboard	6-row, spill-resistant, multimedia Fn keys, numeric keypad, optional LED backlight																	
Optical	None								UltraNav™	TrackPoint® pointing device and buttonless Mylar surface multi-touch touchpad																	
Ethernet	<i>Non-vPro model:</i> Intel Ethernet Connection I219-V (Jacksonville) <i>vPro model:</i> Intel Ethernet Connection I219-LM (Jacksonville)								Security	Power-on password, hard disk password, supervisor password, security keyhole																	
WLAN + Bluetooth™	Intel Dual Band Wireless-AC 8265, Wi-Fi 2x2 802.11ac + Bluetooth 4.1, M.2 card * Intel 8265ac card supports BT4.2 but is limited to BT4.1 by Windows OS								Security chip	Discrete TPM 2.0, TCG Certified																	
WWAN	<i>(optional)</i> One of the following, configurable by model: • Wireless WAN upgradable • Integrated Mobile Broadband 4G LTE, Intel XMM™ 7262 (Fibocom L830-EB), M.2 card (EMEA only) • Integrated Mobile Broadband 4G LTE-A, Intel XMM™ 7360 (Fibocom L850-GL), M.2 card								vPro	<i>(optional)</i> Intel vPro Technology																	
SIM card	<i>(opt)</i> Nano-SIM card slot, optional Verizon LTE (US) SIM card								Fingerprint reader	<i>Optional:</i> Touch style match on chip fingerprint reader on the palm rest anti-spoofing technology																	
									NFC	<i>(optional)</i> Near Field Communication																	
									Battery	Optional integrated Li-Ion 32Wh battery and external Li-Ion 24Wh, 48Wh, or 72Wh battery																	
									Max battery life	<table border="1"> <thead> <tr> <th>Models</th> <th>48Wh</th> <th>72Wh</th> <th>32Wh + 24Wh</th> <th>32Wh + 48Wh</th> <th>32Wh + 72Wh</th> </tr> </thead> <tbody> <tr> <td><i>(MobileMark® 2014)</i></td> <td>12.2 hr</td> <td>18.5 hr</td> <td>13.5 hr</td> <td>20.1 hr</td> <td>26.3 hr</td> </tr> </tbody> </table>						Models	48Wh	72Wh	32Wh + 24Wh	32Wh + 48Wh	32Wh + 72Wh	<i>(MobileMark® 2014)</i>	12.2 hr	18.5 hr	13.5 hr	20.1 hr	26.3 hr
Models	48Wh	72Wh	32Wh + 24Wh	32Wh + 48Wh	32Wh + 72Wh																						
<i>(MobileMark® 2014)</i>	12.2 hr	18.5 hr	13.5 hr	20.1 hr	26.3 hr																						
									AC adapter	65W USB Type-C AC adapter																	
									Preload	Windows® 10 Home 64 or Windows 10 Pro 64																	
									Limited warranty	One of the following, configurable by model: • 1-year depot repair service • 3-year/1-yr battery depot repair service • 3-year/1-yr battery limited onsite service																	
									Mil-Spec test	MIL-STD-810G military certification																	
									Environment	EPEAT™ Gold; ENERGY STAR® 6.1; RoHS-compliant																	

Model	Region	Processor	vPro	Graphics	Memory	Display	Multi-touch	Storage(HDD/SSD)	Optical	WLAN + Bluetooth	WWAN	SIM Card	Smart Card Reader	Monitor Cable	Camera	Key-board	Finger-print Reader	NFC	TPM	Battery (internal-external)	Power Adapter	Operating System	Warranty	Ann Date (m/y)
20LB000XUS	US	i5-8350U	vPro	P500	2GB 8GBx1	15.6" UHD (3840x2160) IPS	None	256GB SSD Opal2	None	Intel 8265 ac, 2x2 + BT4.1	WWAN Upgradable	None	None	None	720p	Backlit	Finger-print Reader	None	dTPM 2.0	4-cell(32Wh) + 3-cell(24Wh)	65W USB-C	Win10 Pro 64	3-year, Depot	03/18
20LB000YUS	US	i5-8350U	vPro	P500	2GB 8GBx1	15.6" FHD (1920x1080) IPS	None	500GB 7200rpm Opal2	None	Intel 8265 ac, 2x2 + BT4.1	WWAN Upgradable	None	None	None	720p	Backlit	Finger-print Reader	None	dTPM 2.0	4-cell(32Wh) + 3-cell(24Wh)	65W USB-C	Win10 Pro 64	3-year, Depot	02/18
20LB0010US	US	i5-8350U	vPro	P500	2GB 8GBx1	15.6" FHD (1920x1080) IPS	None	256GB SSD M.2 PCIe NVMe Opal2	None	Intel 8265 ac, 2x2 + BT4.1	WWAN Upgradable	None	None	None	720p	Backlit	Finger-print Reader	None	dTPM 2.0	4-cell(32Wh) + 3-cell(24Wh)	65W USB-C	Win10 Pro 64	3-year, Depot	02/18
20LB0011US	US	i5-8350U	vPro	P500	2GB 16GBx1	15.6" FHD (1920x1080) IPS	10-point Multi-touch	256GB SSD M.2 PCIe NVMe Opal2	None	Intel 8265 ac, 2x2 + BT4.1	WWAN Upgradable	None	None	None	720p	Backlit	Finger-print Reader	None	dTPM 2.0	4-cell(32Wh) + 3-cell(24Wh)	65W USB-C	Win10 Pro 64	3-year, Depot	02/18
20LB0012US	US	i7-8650U	vPro	P500	2GB 16GBx1	15.6" UHD (3840x2160) IPS	None	512GB SSD M.2 PCIe NVMe Opal2	None	Intel 8265 ac, 2x2 + BT4.1	WWAN Upgradable	None	None	None	720p	Backlit	Finger-print Reader	None	dTPM 2.0	4-cell(32Wh) + 3-cell(24Wh)	65W USB-C	Win10 Pro 64	3-year, Depot	02/18
20LB0013US	US	i7-8650U	vPro	P500	2GB 16GBx1	15.6" FHD (1920x1080) IPS	10-point Multi-touch	1TB SSD M.2 PCIe NVMe Opal2	None	Intel 8265 ac, 2x2 + BT4.1	WWAN Upgradable	None	None	None	720p	Backlit	Finger-print Reader	None	dTPM 2.0	4-cell(32Wh) + 3-cell(24Wh)	65W USB-C	Win10 Pro 64	3-year, Depot	02/18
20LB0014US	US	i5-8350U	vPro	P500	2GB 8GBx1	15.6" FHD (1920x1080) IPS	10-point Multi-touch	256GB SSD M.2 PCIe NVMe Opal2	None	Intel 8265 ac, 2x2 + BT4.1	WWAN Upgradable	None	None	None	720p	Backlit	Finger-print Reader	None	dTPM 2.0	4-cell(32Wh) + 3-cell(24Wh)	65W USB-C	Win10 Pro 64	3-year, Depot	02/18
20LB0015US	US	i7-8650U	vPro	P500	2GB 8GBx1	15.6" UHD (3840x2160) IPS	None	256GB SSD Opal2	None	Intel 8265 ac, 2x2 + BT4.1	WWAN Upgradable	None	None	None	720p	Backlit	Finger-print Reader	None	dTPM 2.0	4-cell(32Wh) + 3-cell(24Wh)	65W USB-C	Win10 Pro 64	3-year, Depot	03/18
20LB0016US	US	i7-8650U	vPro	P500	2GB 8GBx1	15.6" FHD (1920x1080) IPS	10-point Multi-touch	256GB SSD M.2 PCIe NVMe Opal2	None	Intel 8265 ac, 2x2 + BT4.1	WWAN Upgradable	None	None	None	720p	Backlit	Finger-print Reader	None	dTPM 2.0	4-cell(32Wh) + 3-cell(24Wh)	65W USB-C	Win10 Pro 64	3-year, Depot	02/18
20LB0017US	US	i7-8650U	vPro	P500	2GB 8GBx1	15.6" FHD (1920x1080) IPS	None	500GB 7200rpm Opal2	None	Intel 8265 ac, 2x2 + BT4.1	WWAN Upgradable	None	None	None	720p	Backlit	Finger-print Reader	None	dTPM 2.0	4-cell(32Wh) + 3-cell(24Wh)	65W USB-C	Win10 Pro 64	3-year, Depot	02/18
20LB0018US	US	i7-8650U	vPro	P500	2GB 8GBx1	15.6" FHD (1920x1080) IPS	None	256GB SSD M.2 PCIe NVMe Opal2	None	Intel 8265 ac, 2x2 + BT4.1	WWAN Upgradable	None	None	None	720p	Backlit	Finger-print Reader	None	dTPM 2.0	4-cell(32Wh) + 3-cell(24Wh)	65W USB-C	Win10 Pro 64	3-year, Depot	02/18
20LB0019US	US	i7-8650U	vPro	P500	2GB 16GBx1	15.6" FHD (1920x1080) IPS	None	1TB SSD M.2 PCIe NVMe Opal2	None	Intel 8265 ac, 2x2 + BT4.1	WWAN Upgradable	None	None	None	720p	Backlit	Finger-print Reader	None	dTPM 2.0	4-cell(32Wh) + 3-cell(24Wh)	65W USB-C	Win10 Pro 64	3-year, Depot	02/18
20LB001AUS	US	i7-8650U	vPro	P500	2GB 16GBx1	15.6" FHD (1920x1080) IPS	10-point Multi-touch	256GB SSD M.2 PCIe NVMe Opal2	None	Intel 8265 ac, 2x2 + BT4.1	WWAN Upgradable	None	None	None	720p	Backlit	Finger-print Reader	None	dTPM 2.0	4-cell(32Wh) + 3-cell(24Wh)	65W USB-C	Win10 Pro 64	3-year, Depot	02/18
20LB001BUS	US	i7-8650U	vPro	P500	2GB 16GBx1	15.6" FHD (1920x1080) IPS	10-point Multi-touch	512GB SSD M.2 PCIe NVMe Opal2	None	Intel 8265 ac, 2x2 + BT4.1	WWAN Upgradable	None	None	None	720p	Backlit	Finger-print Reader	None	dTPM 2.0	4-cell(32Wh) + 3-cell(24Wh)	65W USB-C	Win10 Pro 64	3-year, Depot	02/18
20LB001CUS	US	i7-8650U	vPro	P500	2GB 8GBx1	15.6" FHD (1920x1080) IPS	None	256GB SSD Opal2	None	Intel 8265 ac, 2x2 + BT4.1	WWAN Upgradable	None	None	None	720p	Backlit	Finger-print Reader	None	dTPM 2.0	4-cell(32Wh) + 3-cell(24Wh)	65W USB-C	Win10 Pro 64	3-year, Depot	03/18
20LB001DUS	US	i5-8350U	vPro	P500	2GB 16GBx1	15.6" UHD (3840x2160) IPS	None	512GB SSD M.2 PCIe NVMe Opal2	None	Intel 8265 ac, 2x2 + BT4.1	WWAN Upgradable	None	None	None	720p	Backlit	Finger-print Reader	None	dTPM 2.0	4-cell(32Wh) + 3-cell(24Wh)	65W USB-C	Win10 Pro 64	3-year, Depot	02/18
20LB001EUS	US	i5-8350U	vPro	P500	2GB 16GBx1	15.6" FHD (1920x1080) IPS	10-point Multi-touch	512GB SSD M.2 PCIe NVMe Opal2	None	Intel 8265 ac, 2x2 + BT4.1	WWAN Upgradable	None	None	None	720p	Backlit	Finger-print Reader	None	dTPM 2.0	4-cell(32Wh) + 3-cell(24Wh)	65W USB-C	Win10 Pro 64	3-year, Depot	02/18
20LB001FUS	US	i7-8650U	vPro	P500	2GB 16GBx1	15.6" UHD (3840x2160) IPS	None	1TB SSD M.2 PCIe NVMe Opal2	None	Intel 8265 ac, 2x2 + BT4.1	WWAN Upgradable	None	None	None	720p	Backlit	Finger-print Reader	None	dTPM 2.0	4-cell(32Wh) + 3-cell(24Wh)	65W USB-C	Win10 Pro 64	3-year, Depot	02/18
20LB001GUS	US	i5-8350U	vPro	P500	2GB 8GBx1	15.6" FHD (1920x1080) IPS	None	256GB SSD Opal2	None	Intel 8265 ac, 2x2 + BT4.1	WWAN Upgradable	None	None	None	720p	Backlit	Finger-print Reader	None	dTPM 2.0	4-cell(32Wh) + 3-cell(24Wh)	65W USB-C	Win10 Pro 64	3-year, Depot	03/18
20LB0020US	US	i7-8550U	No	P500	2GB 16GBx1	15.6" UHD (3840x2160) IPS	None	512GB SSD M.2 PCIe NVMe Opal2	None	Intel 8265 ac, 2x2 + BT4.1	WWAN Upgradable	None	None	None	720p	Backlit	Finger-print Reader	None	dTPM 2.0	4-cell(32Wh) + 3-cell(24Wh)	65W USB-C	Win10 Pro 64	3-year, Depot	03/18

Model	Region	Processor	vPro	Graphics	Memory	Display	Multi-touch	Storage(HDD/SSD)	Optical	WLAN + Bluetooth	WWAN	SIM Card	Smart Card Reader	Monitor Cable	Camera	Key-board	Finger-print Reader	NFC	TPM	Battery (internal-external)	Power Adapter	Operating System	Warranty	Ann Date (m/y)
20LB0021US	US	i7-8550U	No	P500 2GB	8GBx1	15.6" FHD (1920x1080) IPS	None	500GB 7200rpm Opal2	None	Intel 8265 ac, 2x2 + BT4.1	WWAN Upgradable	None	None	None	720p	Backlit	Finger-print Reader	None	dTPM 2.0	4-cell(32Wh) + 3-cell(24Wh)	65W USB-C	Win10 Pro 64	3-year, Depot	03/18
20LB0022US	US	i7-8550U	No	P500 2GB	16GBx1	15.6" FHD (1920x1080) IPS	None	1TB SSD M.2 PCIe NVMe Opal2	None	Intel 8265 ac, 2x2 + BT4.1	WWAN Upgradable	None	None	None	720p	Backlit	Finger-print Reader	None	dTPM 2.0	4-cell(32Wh) + 3-cell(24Wh)	65W USB-C	Win10 Pro 64	3-year, Depot	03/18
20LB0023US	US	i7-8550U	No	P500 2GB	16GBx1	15.6" FHD (1920x1080) IPS	10-point Multi-touch	256GB SSD M.2 PCIe NVMe Opal2	None	Intel 8265 ac, 2x2 + BT4.1	WWAN Upgradable	None	None	None	720p	Backlit	Finger-print Reader	None	dTPM 2.0	4-cell(32Wh) + 3-cell(24Wh)	65W USB-C	Win10 Pro 64	3-year, Depot	03/18
20LB0024US	US	i7-8550U	No	P500 2GB	16GBx1	15.6" UHD (3840x2160) IPS	None	1TB SSD M.2 PCIe NVMe Opal2	None	Intel 8265 ac, 2x2 + BT4.1	WWAN Upgradable	None	None	None	720p	Backlit	Finger-print Reader	None	dTPM 2.0	4-cell(32Wh) + 3-cell(24Wh)	65W USB-C	Win10 Pro 64	3-year, Depot	03/18
20LB0025US	US	i7-8550U	No	P500 2GB	8GBx1	15.6" FHD (1920x1080) IPS	None	256GB SSD M.2 PCIe NVMe Opal2	None	Intel 8265 ac, 2x2 + BT4.1	WWAN Upgradable	None	None	None	720p	Backlit	Finger-print Reader	None	dTPM 2.0	4-cell(32Wh) + 3-cell(24Wh)	65W USB-C	Win10 Pro 64	3-year, Depot	03/18
20LB0026US	US	i7-8550U	No	P500 2GB	16GBx1	15.6" FHD (1920x1080) IPS	None	512GB SSD M.2 PCIe NVMe Opal2	None	Intel 8265 ac, 2x2 + BT4.1	WWAN Upgradable	None	None	None	720p	Backlit	Finger-print Reader	None	dTPM 2.0	4-cell(32Wh) + 3-cell(24Wh)	65W USB-C	Win10 Pro 64	3-year, Depot	03/18
20LB0027US	US	i7-8550U	No	P500 2GB	8GBx1	15.6" FHD (1920x1080) IPS	10-point Multi-touch	256GB SSD M.2 PCIe NVMe Opal2	None	Intel 8265 ac, 2x2 + BT4.1	WWAN Upgradable	None	None	None	720p	Backlit	Finger-print Reader	None	dTPM 2.0	4-cell(32Wh) + 3-cell(24Wh)	65W USB-C	Win10 Pro 64	3-year, Depot	03/18
20LB0028US	US	i7-8550U	No	P500 2GB	16GBx1	15.6" FHD (1920x1080) IPS	10-point Multi-touch	512GB SSD M.2 PCIe NVMe Opal2	None	Intel 8265 ac, 2x2 + BT4.1	WWAN Upgradable	None	None	None	720p	Backlit	Finger-print Reader	None	dTPM 2.0	4-cell(32Wh) + 3-cell(24Wh)	65W USB-C	Win10 Pro 64	3-year, Depot	03/18
20LB0029US	US	i7-8650U	vPro	P500 2GB	16GBx1	15.6" FHD (1920x1080) IPS	None	512GB SSD M.2 PCIe NVMe Opal2	None	Intel 8265 ac, 2x2 + BT4.1	WWAN Upgradable	None	None	None	720p	Backlit	Finger-print Reader	None	dTPM 2.0	4-cell(32Wh) + 3-cell(24Wh)	65W USB-C	Win10 Pro 64	3-year, Depot	03/18



ThinkPad P70 Platform Specifications

Product Specifications Reference (PSREF)

Processor	6th Generation Intel® Core™ i7 Processor or Intel Xeon® Processor E3 v5 Family							Smart card reader ExpressCard Media reader Ports	Optional: Smart card reader One slot (ExpressCard/34) 4-in-1 reader (MMC, SD, SDHC, SDXC), supports UHS-II SD card Four USB 3.0 (one Always On), two USB Type-C / Thunderbolt 3, Mini DisplayPort, HDMI, Ethernet (RJ-45), Dock connector						
	Processor Number	# of Cores	# of Threads	Base Frequency	Max Turbo Frequency	Cache	Memory Types			Processor Graphics					
	i7-6700HQ	4	8	2.6 GHz	3.5 GHz	6MB	DDR4-2133			Intel HD Graphics 530					
	i7-6820HQ			2.7 GHz	3.6 GHz	8MB				Intel HD Graphics P530					
	E3-1505M v5			2.8 GHz	3.7 GHz	8MB				Intel Iris™ Pro Graphics P580					
E3-1575M v5	3 GHz			3.9 GHz											
Graphics	Intel HD Graphics 530, Intel HD Graphics P530, or Intel Iris™ Pro Graphics P580 in processor and NVIDIA Quadro® M600M (2GB memory), M3000M (4GB memory), M4000M (4GB memory), or M5000M (8GB memory); supports external digital monitor via HDMI, Mini DisplayPort, or Thunderbolt™; supports five independent displays; Max resolution: 3840x2160@60Hz (DisplayPort via Mini DisplayPort cable); 3840x2160@60Hz (Thunderbolt); 3840x2160@30Hz (HDMI)							Camera (optional) Audio support	HD720p resolution, low light sensitive, fixed focus HD Audio, Realtek® ALC3268 codec / stereo speakers, 2W x 2 / dual array microphone, combo audio/microphone jack						
Chipset	Mobile Intel CM236 Chipset (Intel GL82CM236 PCH)							Keyboard UltraNav™	6-row, spill-resistant, multimedia Fn keys, numeric keypad, optional LED backlight 3-button TrackPoint® pointing device and 3-button crystal silk surface multi-touch touchpad						
Memory	64GB max ⁷ / 2133MHz DDR4, ECC or non-ECC (ECC function supported only on Xeon processor), dual-channel capable, four DDR4 SO-DIMM sockets							Security Security chip ThinkEngine	Power-on password, hard disk password, supervisor password, security keyhole Discrete TPM 1.2 TCG Certified and Firmware TPM 2.0 integrated in chipset Delivers improved thermal and power efficiency, up to 30 day standby, faster resume time, enhanced security, as well as anti-tampering measures						
Display	Some: 17.3" (439mm) FHD (1920x1080), anti-glare, LED backlight, IPS, 300 nits, 16:9 aspect ratio, 800:1 contrast ratio, 72% gamut, 170° viewing angle Some: 17.3" (439mm) 4K (3840x2160), anti-glare, LED backlight, IPS, 300 nits, 16:9 aspect ratio, 800:1 contrast ratio, 90% gamut, 170° viewing angle							vPro (optional) Fingerprint reader Color calibration	Intel vPro Technology Touch style fingerprint reader on the keyboard bezel Optional: Pantone® color calibrator by X-Rite® color calibration sensor in palm rest						
Multi-touch (opt) Pen (optional)	Capacitive-type multi-touch, supports 10-finger gesture, 270 nits ThinkPad Pen Pro, active pen for multi-touch display							Battery Max battery life ¹⁰ (MobileMark® 2014)	Li-Ion 8-cell (96Wh) <table border="1"> <thead> <tr> <th>Mode</th> <th>Discrete Graphics</th> <th>Hybrid Graphics</th> </tr> </thead> <tbody> <tr> <td>Max battery life</td> <td>8.5 hr</td> <td>10.8 hr</td> </tr> </tbody> </table>	Mode	Discrete Graphics	Hybrid Graphics	Max battery life	8.5 hr	10.8 hr
Mode	Discrete Graphics	Hybrid Graphics													
Max battery life	8.5 hr	10.8 hr													
Storage	Up to 4 drives (two M.2 SSD and two HDD, one of which is in the optical bay) • HDD / SATA 6.0Gb/s, 2.5" wide, 7mm high, Shock Mounted Hard Drive, Active Protection System™ • M.2 SSD / SATA 6.0Gb/s (e.g. xxxGB SSD M.2) • M.2 SSD / PCIe NVMe, PCIe 3.0 x 4, 32Gb/s (e.g. xxxGB SSD M.2 PCIe NVMe)							AC adapter	170W or 230W slim tip AC adapter						
Optical (optional)	DVD burner, 9.5mm high, fixed, tray-in							Preload	Some: Genuine Windows® 7 Professional 64 Some: Windows 7 Professional 64 preinstalled through downgrade rights in Windows 10 Pro 64 • Lenovo Solution Center • Lenovo SHAREit • ThinkVantage Product Recovery • Rescue and Recovery™ • ThinkVantage System Update • Adobe® Reader® • Microsoft® Office preloaded; purchase a product key to activate • McAfee® LiveSafe™ (30-day trial) For ISV certifications, please visit www.lenovo.com/support/ISV						
Ethernet	Non-vPro model: Intel Ethernet Connection I219-V (Jacksonville) vPro model: Intel Ethernet Connection I219-LM (Jacksonville)							Limited warranty ¹²	One of the following, configurable by model: • 3-year/1-yr battery depot repair service • 3-year/1-yr battery limited onsite service ²⁴ • 3-year/1-yr battery limited onsite service, OID (Onsite International Delivery)						
WLAN ⁴ Bluetooth™	11ac+BT, Intel Dual Band Wireless-AC 8260, 2x2, M.2 card Bluetooth 4.1 wireless, integrated in Wi-Fi + Bluetooth combo adapter							Mil-Spec test	MIL-STD-810G military certification						
WWAN (optional)	Wireless WAN, Sierra Wireless EM7455, Qualcomm® 4G LTE-Advanced/DC-HSPA+/HSPA+/HSPA/UMTS/GNSS, M.2 card							Environment	EPEAT™ Gold (US only); ENERGY STAR® 6.1; GREENGUARD®; RoHS-compliant						
SIM card	Micro-SIM card slot														
Dimensions ³	WxDxH: 16.38" x 10.85" x 1.18-1.35"; 416mm x 275.5mm x 29.9-34.2mm WxDxH(Touch): 16.38" x 10.85" x 1.20-1.37"; 416mm x 275.5mm x 30.6-34.9mm														
Weight ²	Non-touch model: starting at 7.3 lb (3.3kg); Multi-touch model: starting at 8.1 lb (3.7kg)														
Case material	Display cover: Glass-Fiber + PPS; Bottom: Magnesium/Aluminum														

Model	Region	Processor	vPro	Graphics	Memory	Display	Multi-touch	Pen	Storage(HDD/SSD)	RAID	Optical	WLAN + Bluetooth	WWAN	SIM Card	Smart Card Reader	Camera	Keyboard	Fingerprint Reader	Color Calibrator	Battery	Power Adapter	Operating System	Warranty	Ann Date (m/y)
20ER000FUS	US	i7-6700HQ	No	M600M 2GB	8GBx1 non-ECC	17.3" FHD (1920x1080) IPS	None	None	500GB 7200rpm	No	DVD±RW	Intel 8260 ac, 2x2 + BT4.1	None	None	None	720p	Backlit	Fingerprint Reader	None	8-cell (96Wh)	170W Slim Tip	Win10 DG Win7 Pro 64	3-year, Depot	10/15
20ER000GUS	US	i7-6700HQ	No	M3000M 4GB	8GBx1 non-ECC	17.3" FHD (1920x1080) IPS	None	None	500GB 7200rpm	No	DVD±RW	Intel 8260 ac, 2x2 + BT4.1	None	None	None	720p	Backlit	Fingerprint Reader	None	8-cell (96Wh)	230W Slim Tip	Win10 DG Win7 Pro 64	3-year, Depot	10/15
20ER000HUS	US	i7-6820HQ	vPro	M600M 2GB	8GBx1 non-ECC	17.3" FHD (1920x1080) IPS	None	None	500GB 7200rpm	No	DVD±RW	Intel 8260 ac, 2x2 + BT4.1	None	None	None	720p	Backlit	Fingerprint Reader	None	8-cell (96Wh)	170W Slim Tip	Win10 DG Win7 Pro 64	3-year, Depot	10/15
20ER000JUS	US	i7-6820HQ	vPro	M3000M 4GB	8GBx1 non-ECC	17.3" FHD (1920x1080) IPS	None	None	500GB 7200rpm	No	DVD±RW	Intel 8260 ac, 2x2 + BT4.1	None	None	None	720p	Backlit	Fingerprint Reader	None	8-cell (96Wh)	230W Slim Tip	Win10 DG Win7 Pro 64	3-year, Depot	10/15
20ER000LUS	US	Xeon E3-1505M v5	vPro	M600M 2GB	8GBx1 ECC	17.3" FHD (1920x1080) IPS	None	None	256GB SSD M.2 PCIe NVMe Opal2	No	DVD±RW	Intel 8260 ac, 2x2 + BT4.1	None	None	None	720p	Backlit	Fingerprint Reader	None	8-cell (96Wh)	170W Slim Tip	Win10 DG Win7 Pro 64	3-year, Depot	11/15
20ER000MUS	US	Xeon E3-1505M v5	vPro	M3000M 4GB	8GBx1 ECC	17.3" FHD (1920x1080) IPS	None	None	256GB SSD M.2 PCIe NVMe Opal2	No	DVD±RW	Intel 8260 ac, 2x2 + BT4.1	None	None	None	720p	Backlit	Fingerprint Reader	None	8-cell (96Wh)	230W Slim Tip	Win10 DG Win7 Pro 64	3-year, Depot	11/15
20ER000NUS	US	Xeon E3-1505M v5	vPro	M3000M 4GB	16GBx1 ECC	17.3" 4K (3840x2160) IPS	None	None	512GB SSD M.2 PCIe NVMe	No	DVD±RW	Intel 8260 ac, 2x2 + BT4.1	None	None	Smart Card Reader	720p	Backlit	Fingerprint Reader	X-Rite	8-cell (96Wh)	230W Slim Tip	Win10 DG Win7 Pro 64	3-year, Depot	11/15
20ER000RUS	US	i7-6820HQ	vPro	M3000M 4GB	16GBx1 non-ECC	17.3" 4K (3840x2160) IPS	None	None	512GB SSD M.2 PCIe NVMe	No	DVD±RW	Intel 8260 ac, 2x2 + BT4.1	None	None	Smart Card Reader	720p	Backlit	Fingerprint Reader	X-Rite	8-cell (96Wh)	230W Slim Tip	Win10 DG Win7 Pro 64	3-year, Depot	11/15
20ER000SUS	US	i7-6820HQ	vPro	M3000M 4GB	8GBx1 non-ECC	17.3" FHD (1920x1080) IPS	None	None	256GB SSD M.2 Opal2	No	DVD±RW	Intel 8260 ac, 2x2 + BT4.1	None	None	None	720p	Backlit	Fingerprint Reader	None	8-cell (96Wh)	230W Slim Tip	Win10 DG Win7 Pro 64	3-year, Depot	10/15
20ER000TUS	US	i7-6700HQ	No	M600M 2GB	8GBx1 non-ECC	17.3" FHD (1920x1080) IPS	None	None	1TB 5400rpm	No	DVD±RW	Intel 8260 ac, 2x2 + BT4.1	None	None	None	720p	Backlit	Fingerprint Reader	None	8-cell (96Wh)	170W Slim Tip	Win10 DG Win7 Pro 64	3-year, Depot	10/15
20ER000UUS	US	i7-6700HQ	No	M3000M 4GB	16GBx1 non-ECC	17.3" FHD (1920x1080) IPS	None	None	256GB SSD M.2 Opal2	No	DVD±RW	Intel 8260 ac, 2x2 + BT4.1	None	None	None	720p	Backlit	Fingerprint Reader	None	8-cell (96Wh)	230W Slim Tip	Win10 DG Win7 Pro 64	3-year, Depot	10/15
20ER000VUS	US	i7-6700HQ	No	M600M 2GB	8GBx1 non-ECC	17.3" FHD (1920x1080) IPS	None	None	500GB 7200rpm	No	Blank Bezel	Intel 8260 ac, 2x2 + BT4.1	None	None	None	720p	Backlit	Fingerprint Reader	None	8-cell (96Wh)	170W Slim Tip	Win10 DG Win7 Pro 64	3-year, Depot	10/15
20ER000WUS	US	i7-6820HQ	vPro	M4000M 4GB	16GBx1 non-ECC	17.3" 4K (3840x2160) IPS	None	None	512GB SSD M.2 PCIe NVMe	No	Blank Bezel	Intel 8260 ac, 2x2 + BT4.1	None	None	Smart Card Reader	720p	Backlit	Fingerprint Reader	X-Rite	8-cell (96Wh)	230W Slim Tip	Win10 DG Win7 Pro 64	3-year, Depot	11/15
20ER000XUS	US	Xeon E3-1505M v5	vPro	M4000M 4GB	16GBx1 ECC	17.3" 4K (3840x2160) IPS	None	None	512GB SSD M.2 PCIe NVMe	No	Blank Bezel	Intel 8260 ac, 2x2 + BT4.1	None	None	Smart Card Reader	720p	Backlit	Fingerprint Reader	X-Rite	8-cell (96Wh)	230W Slim Tip	Win10 DG Win7 Pro 64	3-year, Depot	11/15
20ER000YUS	US	i7-6820HQ	vPro	M3000M 4GB	8GBx1 non-ECC	17.3" FHD (1920x1080) IPS	None	None	1TB 5400rpm	No	DVD±RW	Intel 8260 ac, 2x2 + BT4.1	None	None	None	720p	Backlit	Fingerprint Reader	None	8-cell (96Wh)	230W Slim Tip	Win10 DG Win7 Pro 64	3-year, Depot	10/15
20ER002FUS	US	i7-6700HQ	No	M600M 2GB	8GBx1 non-ECC	17.3" FHD (1920x1080) IPS	None	None	500GB 7200rpm	No	DVD±RW	Intel 8260 ac, 2x2 + BT4.1	None	None	None	720p	Backlit	Fingerprint Reader	X-Rite	8-cell (96Wh)	170W Slim Tip	Win10 Pro 64	3-year, Depot	10/15
20ER002GUS	US	Xeon E3-1505M v5	vPro	M600M 2GB	16GBx1 non-ECC	17.3" FHD (1920x1080) IPS	None	None	256GB SSD M.2 Opal2	No	DVD±RW	Intel 8260 ac, 2x2 + BT4.1	None	None	None	720p	Backlit	Fingerprint Reader	None	8-cell (96Wh)	170W Slim Tip	Win10 DG Win7 Pro 64	3-year, Depot	10/15
20ER002HUS	US	Xeon E3-1505M v5	vPro	M3000M 4GB	16GBx1 non-ECC	17.3" FHD (1920x1080) IPS	None	None	256GB SSD M.2 Opal2	No	DVD±RW	Intel 8260 ac, 2x2 + BT4.1	None	None	None	720p	Backlit	Fingerprint Reader	None	8-cell (96Wh)	230W Slim Tip	Win10 Pro 64	3-year, Depot	10/15
20ER002JUS	US	i7-6820HQ	vPro	M3000M 4GB	16GBx1 non-ECC	17.3" FHD (1920x1080) IPS	None	None	256GB SSD M.2 Opal2	No	DVD±RW	Intel 8260 ac, 2x2 + BT4.1	None	None	None	720p	Backlit	Fingerprint Reader	None	8-cell (96Wh)	230W Slim Tip	Win10 Pro 64	3-year, Depot	10/15
20ER002KUS	US	i7-6700HQ	No	M600M 2GB	16GBx1 non-ECC	17.3" FHD (1920x1080) IPS	None	None	500GB 7200rpm	No	DVD±RW	Intel 8260 ac, 2x2 + BT4.1	None	None	None	720p	Backlit	Fingerprint Reader	None	8-cell (96Wh)	170W Slim Tip	Win10 DG Win7 Pro 64	3-year, Depot	10/15

Model	Region	Processor	vPro	Graphics	Memory	Display	Multi-touch	Pen	Storage(HDD/SSD)	RAID	Optical	WLAN + Bluetooth	WWAN	SIM Card	Smart Card Reader	Camera	Keyboard	Fingerprint Reader	Color Calibrator	Battery	Power Adapter	Operating System	Warranty	Ann Date (m/y)
20ER002LUS	US	i7-6820HQ	vPro	M3000M 4GB	16GBx1 non-ECC	17.3" FHD (1920x1080) IPS	None	None	256GB SSD M.2 Opal2	No	DVD±RW	Intel 8260 ac, 2x2 + BT4.1	None	None	None	720p	Backlit	Fingerprint Reader	None	8-cell (96Wh)	230W Slim Tip	Win10 DG Win7 Pro 64	3-year, Depot	10/15
20ER002MUS	US	Xeon E3-1505M v5	vPro	M3000M 4GB	16GBx1 non-ECC	17.3" FHD (1920x1080) IPS	None	None	256GB SSD M.2 Opal2	No	DVD±RW	Intel 8260 ac, 2x2 + BT4.1	None	None	None	720p	Backlit	Fingerprint Reader	None	8-cell (96Wh)	230W Slim Tip	Win10 DG Win7 Pro 64	3-year, Depot	10/15
20ER002NUS	US	i7-6700HQ	No	M600M 2GB	16GBx1 non-ECC	17.3" FHD (1920x1080) IPS	None	None	500GB 7200rpm	No	DVD±RW	Intel 8260 ac, 2x2 + BT4.1	None	None	None	720p	Backlit	Fingerprint Reader	X-Rite	8-cell (96Wh)	170W Slim Tip	Win10 Pro 64	3-year, Depot	10/15
20ER003KUS	US	Xeon E3-1575M v5	vPro	M3000M 4GB	16GBx2 non-ECC	17.3" FHD (1920x1080) IPS	None	None	1TB SSD M.2 PCIe NVMe	No	Blank Bezel	Intel 8260 ac, 2x2 + BT4.1	None	None	None	720p	Backlit	Fingerprint Reader	X-Rite	8-cell (96Wh)	230W Slim Tip	Win10 Pro 64	3-year, Depot	08/16
20ER0048US	US	Xeon E3-1505M v5	vPro	M3000M 4GB	16GBx1 non-ECC	17.3" 4K (3840x2160) IPS	None	None	512GB SSD M.2 PCIe NVMe	No	DVD±RW	Intel 8260 ac, 2x2 + BT4.1	WWAN Upgradable	None	None	720p	Backlit	Fingerprint Reader	X-Rite	8-cell (96Wh)	230W Slim Tip	Win10 DG Win7 Pro 64	3-year, Depot	02/18



ThinkPad P71 Platform Specifications

Product Specifications Reference (PSREF)

Processor	7th Generation Intel® Core™ i7 Processor or Intel Xeon® Processor E3 v6 Family							Dimensions	<i>WxDxH:</i> 16.38" x 10.85" x 1.18-1.35"; 416mm x 275.5mm x 29.9-34.2mm								
	Processor Number	# of Cores	# of Threads	Base Frequency	Max Turbo Frequency	Cache	Memory Types	Processor Graphics	Weight	Starting at 7.3 lb (3.3kg)							
	i7-7700HQ	4	8	2.8 GHz	3.8 GHz	6MB	DDR4-2400	Intel HD Graphics 630	Case color	Black							
	i7-7820HQ			2.9 GHz	3.9 GHz			Case material	<i>Display cover:</i> Glass-Fiber + PPS; <i>Bottom:</i> Magnesium/Aluminum								
E3-1505M v6	3.0 GHz			4.0 GHz	8MB	Intel HD Graphics P630		Smart card reader	<i>Optional:</i> Smart card reader								
E3-1535M v6	3.1 GHz			4.2 GHz		ExpressCard		One slot (ExpressCard/34)									
Graphics	Intel HD Graphics 630 or P630 in processor and NVIDIA Quadro® M620 (2GB memory), M2200 (4GB memory), P3000 (6GB memory), P4000 (8GB memory), or P5000 (16GB memory); supports external digital monitor via HDMI, Mini DisplayPort, or Thunderbolt™; supports four independent displays; Max resolution: 3840x2160@60Hz (DisplayPort via Mini DisplayPort cable); 3840x2160@60Hz (Thunderbolt); 4096x2160@24Hz (HDMI)							Media reader	4-in-1 reader (MMC, SD, SDHC, SDXC), supports UHS-II SD card								
Chipset	Mobile Intel CM238 Chipset							Ports	Four USB 3.1 Gen 1 (USB 3.0, one Always On), two USB Type-C / Thunderbolt 3, Mini DisplayPort 1.2a, HDMI 1.4b, Ethernet (RJ-45), Dock connector								
Memory	64GB max / 2400MHz DDR4, ECC or non-ECC (ECC function supported only on Xeon processor), dual-channel capable, four DDR4 SO-DIMM sockets							Monitor cable	<i>Optional:</i> Lenovo Mini-DisplayPort to DisplayPort Monitor Cable								
Display	<i>Some:</i> 17.3" (439mm) FHD (1920x1080), anti-glare, LED backlight, IPS, 300 nits, 16:9 aspect ratio, 800:1 contrast ratio, 72% gamut, 170° viewing angle <i>Some:</i> 17.3" (439mm) 4K (3840x2160), anti-glare, LED backlight, IPS, 300 nits, 16:9 aspect ratio, 800:1 contrast ratio, 90% gamut, 170° viewing angle							Camera (<i>optional</i>)	HD720p resolution, fixed focus								
Multi-touch	None							Audio support	HD Audio, Realtek® ALC3268 codec / stereo speakers, 2W x 2 / dual array microphone, combo audio/microphone jack								
Pen	None							Keyboard	6-row, spill-resistant, multimedia Fn keys, numeric keypad, optional LED backlight								
Storage	<i>Up to 4 drives (two M.2 SSD and two HDD, one of which is in the optical bay)</i> • HDD / SATA 6.0Gb/s, 2.5" wide, 7mm high, Active Protection System™ • M.2 SSD / PCIe NVMe, PCIe 3.0 x 4, 32Gb/s							UltraNav™	3-button TrackPoint® pointing device and 3-button Mylar surface multi-touch touchpad								
Optical (<i>optional</i>)	DVD burner, 9.5mm high, fixed, tray-in							Security	Power-on password, hard disk password, supervisor password, security keyhole								
Ethernet	<i>Non-vPro model:</i> Intel Ethernet Connection I219-V (Jacksonville) <i>vPro model:</i> Intel Ethernet Connection I219-LM (Jacksonville)							Security chip	Discrete TPM 2.0, TCG Certified								
WLAN	Intel Dual Band Wireless-AC 8265, Wi-Fi 2x2 802.11ac + BT4.1, M.2 card							vPro (<i>optional</i>)	Intel vPro Technology								
Bluetooth™	Bluetooth 4.1 wireless, integrated in Wi-Fi + Bluetooth combo adapter * Intel 8265ac card support BT4.2 but is limited to BT4.1 by Windows OS							Fingerprint reader	Touch style match on chip fingerprint reader on the keyboard bezel								
WWAN (<i>optional</i>)	<i>One of the following, configurable by model:</i> • Wireless WAN upgradable • Integrated Mobile Broadband 4G LTE-A, Qualcomm® Snapdragon™ X7 LTE-A (Sierra Wireless EM7455), M.2 card							Color calibration	<i>Optional:</i> Pantone® color calibrator by X-Rite® color calibration sensor in palm rest								
SIM card (<i>opt</i>)	Micro-SIM card slot, opt Verizon LTE (US) or Lenovo® Connect (EMEA) SIM card							NFC	None								
								Battery	Li-Ion 8-cell (96Wh)								
								Max battery life (<i>MobileMark® 2014</i>)	<table border="1"> <thead> <tr> <th>Mode</th> <th>Discrete Graphics</th> <th>Hybrid Graphics</th> </tr> </thead> <tbody> <tr> <td>Max battery life</td> <td>9.8 hr</td> <td>14.25 hr</td> </tr> </tbody> </table>			Mode	Discrete Graphics	Hybrid Graphics	Max battery life	9.8 hr	14.25 hr
Mode	Discrete Graphics	Hybrid Graphics															
Max battery life	9.8 hr	14.25 hr															
								AC adapter	170W or 230W slim tip AC adapter								
								Preload	<i>Some:</i> Windows® 10 Home 64 <i>Some:</i> Windows 10 Pro 64 • Lenovo Companion • Lenovo Setting • Microsoft Office preloaded; purchase a product key to activate								
								Limited warranty	<i>One of the following, configurable by model:</i> • 1-year depot repair service • 3-year/1-yr battery depot repair service • 3-year/1-yr battery limited onsite service								
								Mil-Spec test	MIL-STD-810G military certification								
								Environment	EPEAT™ Gold (US only); ENERGY STAR® 6.1; RoHS-compliant								

Model	Region	Processor	vPro	Graphics	Memory	Display	Multi-touch	Pen	Storage(HDD/SSD)	RAID	Optical	WLAN + Bluetooth	WWAN	SIM Card	Smart Card Reader	Monitor Cable	Camera	Key-board	Color Calibrator	Finger-print Reader	NFC	TPM	Battery	Power Adapter	OS	Warranty	Ann Date (m/y)
20HK000VUS	US	Xeon E3-1535M v6	vPro	P3000 6GB	8GBx2 ECC	17.3" 4K (3840x2160) IPS	None	None	512GB SSD M.2 PCIe NVMe Opal2	No	Blank Bezel	Intel 8265 ac, 2x2 + BT4.1	WWAN Upgradable	None	None	None	720p	Backlit	X-Rite	Finger-print Reader	None	dTPM 2.0	8-cell (96Wh)	230W Slim Tip	Win10 Pro 64	3-year, Depot	04/17
20HK000WUS	US	Xeon E3-1505M v6	vPro	P4000 8GB	16GBx2 ECC	17.3" FHD (1920x1080) IPS	None	None	1TB SSD M.2 PCIe NVMe Opal2	No	Blank Bezel	Intel 8265 ac, 2x2 + BT4.1	WWAN Upgradable	None	Smart Card Reader	None	720p	Backlit	None	Finger-print Reader	None	dTPM 2.0	8-cell (96Wh)	230W Slim Tip	Win10 Pro 64	3-year, Depot	04/17
20HK000XUS	US	Xeon E3-1535M v6	vPro	P5000 16GB	16GBx1 ECC	17.3" 4K (3840x2160) IPS	None	None	1TB SSD M.2 PCIe NVMe Opal2	No	Blank Bezel	Intel 8265 ac, 2x2 + BT4.1	WWAN Upgradable	None	None	None	720p	Backlit	X-Rite	Finger-print Reader	None	dTPM 2.0	8-cell (96Wh)	230W Slim Tip	Win10 Pro 64	3-year, Depot	04/17
20HK000YUS	US	Xeon E3-1535M v6	vPro	P4000 8GB	8GBx2 ECC	17.3" 4K (3840x2160) IPS	None	None	512GB SSD M.2 PCIe NVMe Opal2	No	Blank Bezel	Intel 8265 ac, 2x2 + BT4.1	WWAN Upgradable	None	None	None	720p	Backlit	X-Rite	Finger-print Reader	None	dTPM 2.0	8-cell (96Wh)	230W Slim Tip	Win10 Pro 64	3-year, Depot	04/17
20HK0010US	US	Xeon E3-1535M v6	vPro	P5000 16GB	16GBx1 ECC	17.3" FHD (1920x1080) IPS	None	None	512GB SSD M.2 PCIe NVMe Opal2	No	Blank Bezel	Intel 8265 ac, 2x2 + BT4.1	WWAN Upgradable	None	Smart Card Reader	None	720p	Backlit	None	Finger-print Reader	None	dTPM 2.0	8-cell (96Wh)	230W Slim Tip	Win10 Pro 64	3-year, Depot	04/17
20HK0011US	US	i7-7700HQ	No	M620 2GB	8GBx1 non-ECC	17.3" FHD (1920x1080) IPS	None	None	1TB 5400rpm	No	Blank Bezel	Intel 8265 ac, 2x2 + BT4.1	WWAN Upgradable	None	None	None	720p	Backlit	None	Finger-print Reader	None	dTPM 2.0	8-cell (96Wh)	170W Slim Tip	Win10 Pro 64	3-year, Depot	04/17
20HK0012US	US	Xeon E3-1535M v6	vPro	P4000 8GB	16GBx1 ECC	17.3" FHD (1920x1080) IPS	None	None	512GB SSD M.2 PCIe NVMe Opal2	No	Blank Bezel	Intel 8265 ac, 2x2 + BT4.1	WWAN Upgradable	None	Smart Card Reader	None	720p	Backlit	None	Finger-print Reader	None	dTPM 2.0	8-cell (96Wh)	230W Slim Tip	Win10 Pro 64	3-year, Depot	04/17
20HK0013US	US	i7-7700HQ	No	M620 2GB	8GBx1 non-ECC	17.3" FHD (1920x1080) IPS	None	None	500GB 7200rpm	No	Blank Bezel	Intel 8265 ac, 2x2 + BT4.1	WWAN Upgradable	None	None	None	720p	Backlit	None	Finger-print Reader	None	dTPM 2.0	8-cell (96Wh)	170W Slim Tip	Win10 Pro 64	3-year, Depot	04/17
20HK0014US	US	Xeon E3-1505M v6	vPro	P3000 6GB	8GBx2 ECC	17.3" FHD (1920x1080) IPS	None	None	1TB SSD M.2 PCIe NVMe Opal2	No	Blank Bezel	Intel 8265 ac, 2x2 + BT4.1	WWAN Upgradable	None	Smart Card Reader	None	720p	Backlit	None	Finger-print Reader	None	dTPM 2.0	8-cell (96Wh)	230W Slim Tip	Win10 Pro 64	3-year, Depot	04/17
20HK0015US	US	Xeon E3-1505M v6	vPro	M620 2GB	8GBx2 ECC	17.3" FHD (1920x1080) IPS	None	None	256GB SSD M.2 PCIe NVMe Opal2	No	Blank Bezel	Intel 8265 ac, 2x2 + BT4.1	WWAN Upgradable	None	Smart Card Reader	None	720p	Backlit	None	Finger-print Reader	None	dTPM 2.0	8-cell (96Wh)	170W Slim Tip	Win10 Pro 64	3-year, Depot	04/17
20HK0016US	US	Xeon E3-1505M v6	vPro	M620 2GB	8GBx1 ECC	17.3" FHD (1920x1080) IPS	None	None	256GB SSD M.2 PCIe NVMe Opal2	No	Blank Bezel	Intel 8265 ac, 2x2 + BT4.1	WWAN Upgradable	None	Smart Card Reader	None	720p	Backlit	None	Finger-print Reader	None	dTPM 2.0	8-cell (96Wh)	170W Slim Tip	Win10 Pro 64	3-year, Depot	04/17
20HK0017US	US	i7-7820HQ	vPro	M620 2GB	8GBx1 non-ECC	17.3" FHD (1920x1080) IPS	None	None	500GB 7200rpm	No	Blank Bezel	Intel 8265 ac, 2x2 + BT4.1	WWAN Upgradable	None	None	None	720p	Backlit	None	Finger-print Reader	None	dTPM 2.0	8-cell (96Wh)	170W Slim Tip	Win10 Pro 64	3-year, Depot	04/17
20HK0018US	US	i7-7700HQ	No	M620 2GB	8GBx2 non-ECC	17.3" FHD (1920x1080) IPS	None	None	512GB SSD M.2 PCIe NVMe Opal2	No	Blank Bezel	Intel 8265 ac, 2x2 + BT4.1	WWAN Upgradable	None	Smart Card Reader	None	720p	Backlit	X-Rite	Finger-print Reader	None	dTPM 2.0	8-cell (96Wh)	170W Slim Tip	Win10 Pro 64	3-year, Depot	04/17
20HK0019US	US	Xeon E3-1505M v6	vPro	P4000 8GB	8GBx2 ECC	17.3" FHD (1920x1080) IPS	None	None	1TB SSD M.2 PCIe NVMe Opal2	No	Blank Bezel	Intel 8265 ac, 2x2 + BT4.1	WWAN Upgradable	None	Smart Card Reader	None	720p	Backlit	None	Finger-print Reader	None	dTPM 2.0	8-cell (96Wh)	230W Slim Tip	Win10 Pro 64	3-year, Depot	04/17
20HK001AUS	US	Xeon E3-1535M v6	vPro	P3000 6GB	16GBx1 ECC	17.3" 4K (3840x2160) IPS	None	None	512GB SSD M.2 PCIe NVMe Opal2	No	Blank Bezel	Intel 8265 ac, 2x2 + BT4.1	WWAN Upgradable	None	None	None	720p	Backlit	X-Rite	Finger-print Reader	None	dTPM 2.0	8-cell (96Wh)	230W Slim Tip	Win10 Pro 64	3-year, Depot	04/17
20HK001BUS	US	Xeon E3-1505M v6	vPro	P3000 6GB	8GBx2 ECC	17.3" FHD (1920x1080) IPS	None	None	256GB SSD M.2 PCIe NVMe Opal2	No	Blank Bezel	Intel 8265 ac, 2x2 + BT4.1	WWAN Upgradable	None	Smart Card Reader	None	720p	Backlit	None	Finger-print Reader	None	dTPM 2.0	8-cell (96Wh)	230W Slim Tip	Win10 Pro 64	3-year, Depot	04/17
20HK001CUS	US	Xeon E3-1505M v6	vPro	P3000 6GB	8GBx2 ECC	17.3" FHD (1920x1080) IPS	None	None	512GB SSD M.2 PCIe NVMe Opal2	No	Blank Bezel	Intel 8265 ac, 2x2 + BT4.1	WWAN Upgradable	None	Smart Card Reader	None	720p	Backlit	None	Finger-print Reader	None	dTPM 2.0	8-cell (96Wh)	230W Slim Tip	Win10 Pro 64	3-year, Depot	04/17
20HK001DUS	US	Xeon E3-1535M v6	vPro	P3000 6GB	16GBx1 ECC	17.3" FHD (1920x1080) IPS	None	None	512GB SSD M.2 PCIe NVMe Opal2	No	Blank Bezel	Intel 8265 ac, 2x2 + BT4.1	WWAN Upgradable	None	Smart Card Reader	None	720p	Backlit	None	Finger-print Reader	None	dTPM 2.0	8-cell (96Wh)	230W Slim Tip	Win10 Pro 64	3-year, Depot	04/17
20HK001EUS	US	i7-7820HQ	vPro	M620 2GB	8GBx1 non-ECC	17.3" FHD (1920x1080) IPS	None	None	1TB 5400rpm	No	Blank Bezel	Intel 8265 ac, 2x2 + BT4.1	WWAN Upgradable	None	None	None	720p	Backlit	None	Finger-print Reader	None	dTPM 2.0	8-cell (96Wh)	170W Slim Tip	Win10 Pro 64	3-year, Depot	04/17
20HK001FUS	US	Xeon E3-1535M v6	vPro	P5000 16GB	16GBx2 ECC	17.3" 4K (3840x2160) IPS	None	None	1TB SSD M.2 PCIe NVMe Opal2	No	Blank Bezel	Intel 8265 ac, 2x2 + BT4.1	WWAN Upgradable	None	None	None	720p	Backlit	X-Rite	Finger-print Reader	None	dTPM 2.0	8-cell (96Wh)	230W Slim Tip	Win10 Pro 64	3-year, Depot	04/17

Model	Region	Processor	vPro	Graphics	Memory	Display	Multi-touch	Pen	Storage(HDD/SSD)	RAID	Optical	WLAN + Bluetooth	WWAN	SIM Card	Smart Card Reader	Monitor Cable	Camera	Key-board	Color Calibrator	Finger-print Reader	NFC	TPM	Battery	Power Adapter	OS	Warranty	Ann Date (m/y)
20HK001GUS	US	i7-7700HQ	No	M620 2GB	8GBx2 non-ECC	17.3" FHD (1920x1080) IPS	None	None	512GB SSD M.2 PCIe NVMe Opal2	No	Blank Bezel	Intel 8265 ac, 2x2 + BT4.1	WWAN Upgradable	None	Smart Card Reader	None	720p	Backlit	None	Finger-print Reader	None	dTPM 2.0	8-cell (96Wh)	170W Slim Tip	Win10 Pro 64	3-year, Depot	04/17
20HK001HUS	US	Xeon E3-1535M v6	vPro	P5000 16GB	8GBx2 ECC	17.3" 4K (3840x2160) IPS	None	None	512GB SSD M.2 PCIe NVMe Opal2	No	Blank Bezel	Intel 8265 ac, 2x2 + BT4.1	WWAN Upgradable	None	None	None	720p	Backlit	X-Rite	Finger-print Reader	None	dTPM 2.0	8-cell (96Wh)	230W Slim Tip	Win10 Pro 64	3-year, Depot	04/17
20HK001JUS	US	i7-7700HQ	No	M620 2GB	8GBx1 non-ECC	17.3" FHD (1920x1080) IPS	None	None	256GB SSD M.2 PCIe NVMe Opal2	No	Blank Bezel	Intel 8265 ac, 2x2 + BT4.1	WWAN Upgradable	None	Smart Card Reader	None	720p	Backlit	None	Finger-print Reader	None	dTPM 2.0	8-cell (96Wh)	170W Slim Tip	Win10 Pro 64	3-year, Depot	04/17
20HK001KUS	US	i7-7820HQ	vPro	M620 2GB	8GBx1 non-ECC	17.3" FHD (1920x1080) IPS	None	None	512GB SSD M.2 PCIe NVMe Opal2	No	Blank Bezel	Intel 8265 ac, 2x2 + BT4.1	WWAN Upgradable	None	None	None	720p	Backlit	None	Finger-print Reader	None	dTPM 2.0	8-cell (96Wh)	170W Slim Tip	Win10 Pro 64	3-year, Depot	04/17
20HK001LUS	US	Xeon E3-1535M v6	vPro	P4000 8GB	16GBx2 ECC	17.3" 4K (3840x2160) IPS	None	None	1TB SSD M.2 PCIe NVMe Opal2	No	Blank Bezel	Intel 8265 ac, 2x2 + BT4.1	WWAN Upgradable	None	None	None	720p	Backlit	X-Rite	Finger-print Reader	None	dTPM 2.0	8-cell (96Wh)	230W Slim Tip	Win10 Pro 64	3-year, Depot	04/17
20HK001MUS	US	i7-7820HQ	vPro	M620 2GB	8GBx1 non-ECC	17.3" FHD (1920x1080) IPS	None	None	256GB SSD M.2 PCIe NVMe Opal2	No	Blank Bezel	Intel 8265 ac, 2x2 + BT4.1	WWAN Upgradable	None	None	None	720p	Backlit	None	Finger-print Reader	None	dTPM 2.0	8-cell (96Wh)	170W Slim Tip	Win10 Pro 64	3-year, Depot	04/17
20HK001PUS	US	Xeon E3-1505M v6	vPro	P3000 6GB	8GBx2 non-ECC	17.3" 4K (3840x2160) IPS	None	None	512GB SSD M.2 PCIe NVMe Opal2	No	Blank Bezel	Intel 8265 ac, 2x2 + BT4.1	WWAN Upgradable	None	None	None	720p	Backlit	X-Rite	Finger-print Reader	None	dTPM 2.0	8-cell (96Wh)	230W Slim Tip	Win10 Pro 64	3-year, Depot	05/17
20HK001QUS	US	i7-7820HQ	vPro	P3000 6GB	8GBx2 non-ECC	17.3" FHD (1920x1080) IPS	None	None	1TB SSD M.2 PCIe NVMe Opal2	No	Blank Bezel	Intel 8265 ac, 2x2 + BT4.1	WWAN Upgradable	None	None	None	720p	Backlit	None	Finger-print Reader	None	dTPM 2.0	8-cell (96Wh)	230W Slim Tip	Win10 Pro 64	3-year, Depot	05/17
20HK001RUS	US	i7-7820HQ	vPro	P3000 6GB	8GBx2 non-ECC	17.3" FHD (1920x1080) IPS	None	None	512GB SSD M.2 PCIe NVMe Opal2	No	Blank Bezel	Intel 8265 ac, 2x2 + BT4.1	WWAN Upgradable	None	None	None	720p	Backlit	None	Finger-print Reader	None	dTPM 2.0	8-cell (96Wh)	230W Slim Tip	Win10 Pro 64	3-year, Depot	05/17
20HK001SUS	US	i7-7820HQ	vPro	P3000 6GB	8GBx2 non-ECC	17.3" 4K (3840x2160) IPS	None	None	512GB SSD M.2 PCIe NVMe Opal2	No	Blank Bezel	Intel 8265 ac, 2x2 + BT4.1	WWAN Upgradable	None	None	None	720p	Backlit	X-Rite	Finger-print Reader	None	dTPM 2.0	8-cell (96Wh)	230W Slim Tip	Win10 Pro 64	3-year, Depot	05/17
20HK001TUS	US	i7-7820HQ	vPro	P3000 6GB	8GBx2 non-ECC	17.3" FHD (1920x1080) IPS	None	None	500GB 7200rpm	No	Blank Bezel	Intel 8265 ac, 2x2 + BT4.1	WWAN Upgradable	None	None	None	720p	Backlit	None	Finger-print Reader	None	dTPM 2.0	8-cell (96Wh)	230W Slim Tip	Win10 Pro 64	3-year, Depot	05/17
20HK003CSS	US	Xeon E3-1535M v6	vPro	P5000 16GB	16GBx2 ECC	17.3" 4K (3840x2160) IPS	None	None	1TB SSD M.2 PCIe NVMe Opal2	No	Blank Bezel	Intel 8265 ac, 2x2 + BT4.1	WWAN Upgradable	None	None	None	720p	Backlit	X-Rite	Finger-print Reader	None	dTPM 2.0	8-cell (96Wh)	230W Slim Tip	Win10 Pro 64	3-year, Depot	01/18
20HK003CUS	US	Xeon E3-1535M v6	vPro	P5000 16GB	16GBx2 ECC	17.3" 4K (3840x2160) IPS	None	None	1TB SSD M.2 PCIe NVMe Opal2	No	Blank Bezel	Intel 8265 ac, 2x2 + BT4.1	WWAN Upgradable	None	None	None	720p	Backlit	X-Rite	Finger-print Reader	None	dTPM 2.0	8-cell (96Wh)	230W Slim Tip	Win10 Pro 64	3-year, Depot	01/18
20HK003DSS	US	Xeon E3-1535M v6	vPro	P5000 16GB	8GBx2 non-ECC	17.3" 4K (3840x2160) IPS	None	None	512GB SSD M.2 PCIe NVMe Opal2	No	Blank Bezel	Intel 8265 ac, 2x2 + BT4.1	WWAN Upgradable	None	None	None	720p	Backlit	X-Rite	Finger-print Reader	None	dTPM 2.0	8-cell (96Wh)	230W Slim Tip	Win10 Pro 64	3-year, Depot	01/18
20HK003DUS	US	Xeon E3-1535M v6	vPro	P5000 16GB	8GBx2 non-ECC	17.3" 4K (3840x2160) IPS	None	None	512GB SSD M.2 PCIe NVMe Opal2	No	Blank Bezel	Intel 8265 ac, 2x2 + BT4.1	WWAN Upgradable	None	None	None	720p	Backlit	X-Rite	Finger-print Reader	None	dTPM 2.0	8-cell (96Wh)	230W Slim Tip	Win10 Pro 64	3-year, Depot	01/18
20HK003ESS	US	Xeon E3-1535M v6	vPro	P3000 6GB	8GBx2 ECC	17.3" FHD (1920x1080) IPS	None	None	512GB SSD M.2 PCIe NVMe Opal2	No	Blank Bezel	Intel 8265 ac, 2x2 + BT4.1	WWAN Upgradable	None	None	None	720p	Backlit	None	Finger-print Reader	None	dTPM 2.0	8-cell (96Wh)	230W Slim Tip	Win10 Pro 64	3-year, Depot	01/18
20HK003EUS	US	Xeon E3-1535M v6	vPro	P3000 6GB	8GBx2 ECC	17.3" FHD (1920x1080) IPS	None	None	512GB SSD M.2 PCIe NVMe Opal2	No	Blank Bezel	Intel 8265 ac, 2x2 + BT4.1	WWAN Upgradable	None	None	None	720p	Backlit	None	Finger-print Reader	None	dTPM 2.0	8-cell (96Wh)	230W Slim Tip	Win10 Pro 64	3-year, Depot	01/18
20HK003FSS	US	Xeon E3-1535M v6	vPro	P4000 8GB	8GBx2 non-ECC	17.3" 4K (3840x2160) IPS	None	None	512GB SSD M.2 PCIe NVMe Opal2	No	Blank Bezel	Intel 8265 ac, 2x2 + BT4.1	WWAN Upgradable	None	None	None	720p	Backlit	X-Rite	Finger-print Reader	None	dTPM 2.0	8-cell (96Wh)	230W Slim Tip	Win10 Pro 64	3-year, Depot	01/18
20HK003FUS	US	Xeon E3-1535M v6	vPro	P4000 8GB	8GBx2 non-ECC	17.3" 4K (3840x2160) IPS	None	None	512GB SSD M.2 PCIe NVMe Opal2	No	Blank Bezel	Intel 8265 ac, 2x2 + BT4.1	WWAN Upgradable	None	None	None	720p	Backlit	X-Rite	Finger-print Reader	None	dTPM 2.0	8-cell (96Wh)	230W Slim Tip	Win10 Pro 64	3-year, Depot	01/18
20HK003GSS	US	Xeon E3-1505M v6	vPro	M2200 4GB	8GBx2 ECC	17.3" FHD (1920x1080) IPS	None	None	512GB SSD M.2 PCIe NVMe Opal2	No	Blank Bezel	Intel 8265 ac, 2x2 + BT4.1	WWAN Upgradable	None	None	None	720p	Backlit	None	Finger-print Reader	None	dTPM 2.0	8-cell (96Wh)	230W Slim Tip	Win10 Pro 64	3-year, Depot	01/18

Model	Region	Processor	vPro	Graphics	Memory	Display	Multi-touch	Pen	Storage(HDD/SSD)	RAID	Optical	WLAN + Bluetooth	WWAN	SIM Card	Smart Card Reader	Monitor Cable	Camera	Key-board	Color Calibrator	Finger-print Reader	NFC	dTPM	Battery	Power Adapter	OS	Warranty	Ann Date (m/y)
20HK003GUS	US	Xeon E3-1505M v6	vPro	M2200 4GB	8GBx2 ECC	17.3" FHD (1920x1080) IPS	None	None	512GB SSD M.2 PCIe NVMe Opal2	No	Blank Bezel	Intel 8265 ac, 2x2 + BT4.1	WWAN Upgradable	None	None	None	720p	Backlit	None	Finger-print Reader	None	dTPM 2.0	8-cell (96Wh)	230W Slim Tip	Win10 Pro 64	3-year, Depot	01/18
20HK003HSS	US	Xeon E3-1535M v6	vPro	M2200 4GB	8GBx2 ECC	17.3" FHD (1920x1080) IPS	None	None	512GB SSD M.2 PCIe NVMe Opal2	No	Blank Bezel	Intel 8265 ac, 2x2 + BT4.1	WWAN Upgradable	None	None	None	720p	Backlit	None	Finger-print Reader	None	dTPM 2.0	8-cell (96Wh)	230W Slim Tip	Win10 Pro 64	3-year, Depot	01/18
20HK003HUS	US	Xeon E3-1535M v6	vPro	M2200 4GB	8GBx2 ECC	17.3" FHD (1920x1080) IPS	None	None	512GB SSD M.2 PCIe NVMe Opal2	No	Blank Bezel	Intel 8265 ac, 2x2 + BT4.1	WWAN Upgradable	None	None	None	720p	Backlit	None	Finger-print Reader	None	dTPM 2.0	8-cell (96Wh)	230W Slim Tip	Win10 Pro 64	3-year, Depot	01/18
20HK003JSS	US	Xeon E3-1505M v6	vPro	P3000 6GB	8GBx2 non-ECC	17.3" 4K (3840x2160) IPS	None	None	512GB SSD M.2 PCIe NVMe Opal2	No	Blank Bezel	Intel 8265 ac, 2x2 + BT4.1	WWAN Upgradable	None	None	None	720p	Backlit	X-Rite	Finger-print Reader	None	dTPM 2.0	8-cell (96Wh)	230W Slim Tip	Win10 Pro 64	3-year, Depot	01/18
20HK003JUS	US	Xeon E3-1505M v6	vPro	P3000 6GB	8GBx2 non-ECC	17.3" 4K (3840x2160) IPS	None	None	512GB SSD M.2 PCIe NVMe Opal2	No	Blank Bezel	Intel 8265 ac, 2x2 + BT4.1	WWAN Upgradable	None	None	None	720p	Backlit	X-Rite	Finger-print Reader	None	dTPM 2.0	8-cell (96Wh)	230W Slim Tip	Win10 Pro 64	3-year, Depot	01/18
20HK003KSS	US	Xeon E3-1505M v6	vPro	P3000 6GB	8GBx2 ECC	17.3" FHD (1920x1080) IPS	None	None	512GB SSD M.2 PCIe NVMe Opal2	No	Blank Bezel	Intel 8265 ac, 2x2 + BT4.1	WWAN Upgradable	None	None	None	720p	Backlit	None	Finger-print Reader	None	dTPM 2.0	8-cell (96Wh)	230W Slim Tip	Win10 Pro 64	3-year, Depot	01/18
20HK003KUS	US	Xeon E3-1505M v6	vPro	P3000 6GB	8GBx2 ECC	17.3" FHD (1920x1080) IPS	None	None	512GB SSD M.2 PCIe NVMe Opal2	No	Blank Bezel	Intel 8265 ac, 2x2 + BT4.1	WWAN Upgradable	None	None	None	720p	Backlit	None	Finger-print Reader	None	dTPM 2.0	8-cell (96Wh)	230W Slim Tip	Win10 Pro 64	3-year, Depot	01/18
20HK003LSS	US	Xeon E3-1505M v6	vPro	P4000 8GB	16GBx2 ECC	17.3" FHD (1920x1080) IPS	None	None	1TB SSD M.2 PCIe NVMe Opal2	No	Blank Bezel	Intel 8265 ac, 2x2 + BT4.1	WWAN Upgradable	None	None	None	720p	Backlit	None	Finger-print Reader	None	dTPM 2.0	8-cell (96Wh)	230W Slim Tip	Win10 Pro 64	3-year, Depot	01/18
20HK003LUS	US	Xeon E3-1505M v6	vPro	P4000 8GB	16GBx2 ECC	17.3" FHD (1920x1080) IPS	None	None	1TB SSD M.2 PCIe NVMe Opal2	No	Blank Bezel	Intel 8265 ac, 2x2 + BT4.1	WWAN Upgradable	None	None	None	720p	Backlit	None	Finger-print Reader	None	dTPM 2.0	8-cell (96Wh)	230W Slim Tip	Win10 Pro 64	3-year, Depot	01/18
20HK003MSS	US	Xeon E3-1535M v6	vPro	P4000 8GB	16GBx2 ECC	17.3" 4K (3840x2160) IPS	None	None	1TB SSD M.2 PCIe NVMe Opal2	No	Blank Bezel	Intel 8265 ac, 2x2 + BT4.1	WWAN Upgradable	None	None	None	720p	Backlit	X-Rite	Finger-print Reader	None	dTPM 2.0	8-cell (96Wh)	230W Slim Tip	Win10 Pro 64	3-year, Depot	01/18
20HK003MUS	US	Xeon E3-1535M v6	vPro	P4000 8GB	16GBx2 ECC	17.3" 4K (3840x2160) IPS	None	None	1TB SSD M.2 PCIe NVMe Opal2	No	Blank Bezel	Intel 8265 ac, 2x2 + BT4.1	WWAN Upgradable	None	None	None	720p	Backlit	X-Rite	Finger-print Reader	None	dTPM 2.0	8-cell (96Wh)	230W Slim Tip	Win10 Pro 64	3-year, Depot	01/18



ThinkPad T470 Platform Specifications

Product Specifications Reference (PSREF)

Processor	6th Generation Intel® Core™ i5 / i7 Processor (<i>i7-6500U is NOT available in EMEA</i>)								Dimensions Weight	<i>WxDxH:</i> 13.25" x 9.15" x 0.79"; 336.6mm x 232.5mm x 19.95mm																											
	Processor Number	# of Cores	# of Threads	Base Frequency	Max Turbo Frequency	Cache	Memory Types	Processor Graphics		<i>Models</i>	<i>3-cell or 3 + 3-cell</i>		<i>6-cell or 3 + 6-cell</i>																								
	i5-6200U	2	4	2.3 GHz	2.8 GHz	3MB	DDR4-2133	Intel HD Graphics 520	<i>Magnesium</i>	3.49 lb / 1.58 kg		3.92 lb / 1.78 kg																									
	i5-6300U			2.4 GHz	3.0 GHz	3MB			<i>PPS</i>	3.63 lb / 1.65 kg		4.35 lb / 1.85 kg																									
	i7-6500U			2.5 GHz	3.1 GHz	4MB																															
	i7-6600U			2.6 GHz	3.4 GHz	4MB																															
	or 7th Generation Intel Core i3 / i5 / i7 Processor								Case color	Black																											
	Processor Number	# of Cores	# of Threads	Base Frequency	Max Turbo Frequency	Cache	Memory Types	Processor Graphics	Case material	<i>Display cover:</i> Magnesium Hybrid or PPS; <i>Bottom:</i> Glass-Fiber Reinforced Plastic																											
	i3-7100U	2	4	2.4 GHz	-	3MB	DDR4-2133	Intel HD Graphics 620	Smart card reader	<i>Optional:</i> Smart card reader																											
	i5-7200U			2.5 GHz	3.1 GHz	3MB			Media reader	4-in-1 reader (MMC, SD, SDHC, SDXC), supports SD 3.0, UHS-I																											
	i5-7300U			2.6 GHz	3.5 GHz	3MB			Ports	Three USB 3.1 Gen 1 (USB 3.0, one Always On), USB 3.1 Type-C Gen 2 / Thunderbolt 3, HDMI 1.4b, Ethernet (RJ-45), Dock connector																											
	i7-7500U			2.7 GHz	3.5 GHz	4MB			WiGig dock (<i>opt</i>)	ThinkPad WiGig dock																											
	i7-7600U			2.8 GHz	3.9 GHz	4MB			Monitor cable	<i>Optional:</i> Lenovo USB-C to VGA Adapter																											
Graphics	Intel HD Graphics 520 or 620 in processor only, or Intel HD Graphics 620 in processor and NVIDIA GeForce® 940MX, 2GB 2.5GHz GDDR5 memory (discrete models are NOT available in EMEA); supports external digital monitor via HDMI or USB Type-C; supports three independent displays; Max resolution: 4096x2304@60Hz (USB Type-C); 4096x2160@24Hz (HDMI)								Camera (<i>optional</i>)	<i>720p:</i> HD720p resolution, fixed focus <i>IR & 720p:</i> IR camera and HD720p camera (mutually exclusive with WiGig)																											
Chipset	Intel SoC (System on Chip) platform								Audio support	HD Audio, Realtek ALC3268 codec / stereo speakers, 2W x 2 / dual array microphone, combo audio/microphone jack																											
Memory	32GB max / 2400MHz DDR4, dual-channel capable, two DDR4 SO-DIMM sockets * System clocks down for processors with lower memory controller								Keyboard	6-row, spill-resistant, multimedia Fn keys, optional LED backlight																											
Display	<i>Some:</i> 14.0" (355mm) HD (1366x768), anti-glare, LED backlight, 220 nits, 16:9 aspect ratio, 400:1 contrast ratio <i>Some:</i> 14.0" (355mm) FHD (1920x1080), anti-glare, LED backlight, 220 nits, 16:9 aspect ratio, 400:1 or 500:1 contrast ratio <i>Some:</i> 14.0" (355mm) FHD (1920x1080), anti-glare, LED backlight, IPS, 250 nits, 16:9 aspect ratio, 700:1 contrast ratio, 170° viewing angle								UltraNav™	TrackPoint® pointing device and buttonless Mylar surface multi-touch touchpad																											
Multi-touch (<i>opt</i>)	On-cell touch, supports 10-finger gesture (FHD IPS panel with PPS cover only)								Security	Power-on password, hard disk password, supervisor password, security keyhole																											
Storage	<i>System has one HDD slot or one M.2 2280 slot exclusively for storage</i> <i>Some:</i> HDD / SATA 6.0Gb/s, 2.5" wide, 7mm high, Active Protection System™ <i>Some:</i> SSD / SATA 6.0Gb/s, 2.5" wide, 7mm high (e.g. xxxGB SSD) <i>Some:</i> M.2 SSD / PCIe NVMe, PCIe 3.0 x 2, 16Gb/s <i>Some:</i> 128GB M.2 SSD / SATA 6.0Gb/s, in WWAN slot as 2nd Storage, mutually exclusive with WWAN and WiGig								Security chip	Discrete TPM 2.0, TCG Certified																											
Optical	None								vPro (<i>optional</i>)	Intel vPro Technology																											
Ethernet	<i>Non-vPro model:</i> Intel Ethernet Connection I219-V (Jacksonville) <i>vPro model:</i> Intel Ethernet Connection I219-LM (Jacksonville)								Fingerprint reader	<i>Optional:</i> Touch style match on chip fingerprint reader on the keyboard bezel																											
WLAN	<i>One of the following, configurable by model (WiGig can coexist with WWAN):</i> • Realtek® RTL8822BE, Wi-Fi 2x2 802.11ac + BT4.1, M.2 card • Intel Dual Band Wireless-AC 8260, Wi-Fi 2x2 802.11ac + BT4.1, M.2 card • Intel Dual Band Wireless-AC 8265, Wi-Fi 2x2 802.11ac + BT4.1, M.2 card • Intel Tri-Band Wireless-AC 18265, WiGig 802.11ad + Wi-Fi 2x2 802.11ac + BT4.1, M.2 card								NFC (<i>optional</i>)	Near Field Communication																											
Bluetooth™	Bluetooth 4.1 wireless, integrated in Wi-Fi + Bluetooth combo adapter * <i>Intel 8265ac / 18265ac card support BT4.2 but is limited to BT4.1 by Windows OS</i>								Internal battery	<i>Optional:</i> Integrated Li-Polymer 3-cell (24Wh)																											
WWAN (<i>optional</i>)	<i>One of the following, configurable by model (WWAN can coexist with WiGig):</i> • Wireless WAN upgradable • Integrated Mobile Broadband 4G LTE-A, Qualcomm® Snapdragon™ X7 LTE-A (Sierra Wireless EM7455), M.2 card • Integrated Mobile Broadband 4G LTE, Intel XMM™ 7160 (Fibocom L831-EAU), M.2 card (EMEA only)								External battery	Li-Polymer 3-cell (24Wh) or Li-Ion 6-cell (48Wh or 72Wh)																											
SIM card (<i>opt</i>)	Micro-SIM card slot, opt Verizon LTE (US) or Lenovo® Connect (EMEA) SIM card								Max battery life (<i>MobileMark® 2014</i>)	<table border="1"> <thead> <tr> <th><i>Models</i></th> <th><i>3-cell</i></th> <th><i>3 + 3-cell</i></th> <th><i>6-cell 48Wh</i></th> <th><i>6-cell 72Wh</i></th> <th><i>3 + 6-cell 48Wh</i></th> <th><i>3 + 6-cell 72Wh</i></th> </tr> </thead> <tbody> <tr> <td><i>Integrated</i></td> <td>6.9 hr</td> <td>13.9 hr</td> <td>13.9 hr</td> <td>20.9 hr</td> <td>20.9 hr</td> <td>27.1 hr</td> </tr> <tr> <td><i>Discrete</i></td> <td>6.9 hr</td> <td>13.9 hr</td> <td>14.3 hr</td> <td>21.6 hr</td> <td>21.2 hr</td> <td>28.6 hr</td> </tr> </tbody> </table>							<i>Models</i>	<i>3-cell</i>	<i>3 + 3-cell</i>	<i>6-cell 48Wh</i>	<i>6-cell 72Wh</i>	<i>3 + 6-cell 48Wh</i>	<i>3 + 6-cell 72Wh</i>	<i>Integrated</i>	6.9 hr	13.9 hr	13.9 hr	20.9 hr	20.9 hr	27.1 hr	<i>Discrete</i>	6.9 hr	13.9 hr	14.3 hr	21.6 hr	21.2 hr	28.6 hr
<i>Models</i>	<i>3-cell</i>	<i>3 + 3-cell</i>	<i>6-cell 48Wh</i>	<i>6-cell 72Wh</i>	<i>3 + 6-cell 48Wh</i>	<i>3 + 6-cell 72Wh</i>																															
<i>Integrated</i>	6.9 hr	13.9 hr	13.9 hr	20.9 hr	20.9 hr	27.1 hr																															
<i>Discrete</i>	6.9 hr	13.9 hr	14.3 hr	21.6 hr	21.2 hr	28.6 hr																															
									AC adapter	45W or 65W slim tip AC adapter, 45W or 65W USB Type-C AC adapter																											
									Preload	Windows® 7 Professional 64 preinstalled through downgrade rights in Windows 10 Pro 64 • Lenovo Solution Center • Lenovo PowerEngage • ThinkVantage Product Recovery • ThinkVantage System Update • Adobe® Reader® • Microsoft® Office preloaded; purchase a product key to activate • McAfee® LiveSafe™ (30-day trial) <i>Some:</i> Windows 10 Home 64 <i>Some:</i> Windows 10 Pro 64 • Lenovo Companion • Lenovo Setting • Microsoft Office preloaded; purchase a product key to activate																											
									Limited warranty	<i>One of the following, configurable by model:</i> • 1-year depot repair service • 3-year/1-yr battery depot repair service • 3-year/1-yr battery limited onsite service																											
									Mil-Spec test	MIL-STD-810G military certification																											
									Environment	EPEAT™ Gold (US only); ENERGY STAR® 6.1; RoHS-compliant																											

Model	Region	Processor	vPro	Graphics	Memory	Display	Multi-touch	Storage (HDD/SSD)	Optical	WLAN + Bluetooth	WWAN	SIM Card	Smart Card Reader	Dock	Monitor Cable	Case Material	Camera	Key-board	Finger-print Reader	NFC	TPM	Battery (internal-external)	Power Adapter	Operating System	War-ranty	Ann Date (m/y)
20HD000QUS	US	i5-7200U	No	Intel HD 620	8GB	14" FHD (1920x1080) IPS	None	500GB 7200rpm	None	Intel 8265 ac, 2x2 + BT4.1	WWAN Upgradable	None	None	None	None	PPS	720p	Non-backlit	Finger-print Reader	None	dTPM 2.0	3-cell(24Wh) + 3-cell(24Wh)	45W Slim Tip	Win10 Pro 64	1-year, Depot	01/17
20HD000RUS	US	i5-7300U	vPro	Intel HD 620	8GB	14" FHD (1920x1080) IPS	None	256GB SSD M.2 PCIe NVMe Opal2	None	Intel 8265 ac, 2x2 + BT4.1	WWAN Upgradable	None	None	None	None	PPS	720p	Backlit	Finger-print Reader	None	dTPM 2.0	3-cell(24Wh) + 3-cell(24Wh)	45W Slim Tip	Win10 Pro 64	3-year, Depot	01/17
20HD000SUS	US	i5-7200U	No	Intel HD 620	8GB	14" FHD (1920x1080) IPS	None	128GB SSD	None	Intel 8265 ac, 2x2 + BT4.1	WWAN Upgradable	None	None	None	None	PPS	720p	Backlit	Finger-print Reader	None	dTPM 2.0	3-cell(24Wh) + 3-cell(24Wh)	45W Slim Tip	Win10 Pro 64	3-year, Depot	01/17
20HD000TUS	US	i5-7200U	No	Intel HD 620	8GB	14" HD (1366x768)	None	500GB 7200rpm	None	Intel 8265 ac, 2x2 + BT4.1	WWAN Upgradable	None	None	None	None	PPS	720p	Non-backlit	Finger-print Reader	None	dTPM 2.0	3-cell(24Wh) + 3-cell(24Wh)	45W Slim Tip	Win10 Pro 64	1-year, Depot	01/17
20HD000UUS	US	i5-7200U	No	Intel HD 620	8GB	14" HD (1366x768)	None	128GB SSD	None	Intel 8265 ac, 2x2 + BT4.1	WWAN Upgradable	None	None	None	None	PPS	720p	Backlit	Finger-print Reader	None	dTPM 2.0	3-cell(24Wh) + 3-cell(24Wh)	45W Slim Tip	Win10 Pro 64	3-year, Depot	01/17
20HD000VUS	US	i5-7300U	vPro	Intel HD 620	8GB	14" FHD (1920x1080) IPS	None	512GB SSD M.2 PCIe NVMe Opal2	None	Intel 8265 ac, 2x2 + BT4.1	WWAN Upgradable	None	None	None	None	PPS	720p	Backlit	Finger-print Reader	None	dTPM 2.0	3-cell(24Wh) + 3-cell(24Wh)	45W Slim Tip	Win10 Pro 64	3-year, Depot	01/17
20HD000WUS	US	i5-7200U	No	Intel HD 620	8GB	14" FHD (1920x1080) IPS	None	256GB SSD M.2 PCIe NVMe Opal2	None	Intel 8265 ac, 2x2 + BT4.1	WWAN Upgradable	None	None	None	None	PPS	720p	Backlit	Finger-print Reader	None	dTPM 2.0	3-cell(24Wh) + 3-cell(24Wh)	45W Slim Tip	Win10 Pro 64	3-year, Depot	01/17
20HD000XUS	US	i5-7300U	vPro	Intel HD 620	8GB	14" FHD (1920x1080) IPS	None	500GB 7200rpm	None	Intel 8265 ac, 2x2 + BT4.1	WWAN Upgradable	None	None	None	None	PPS	720p	Backlit	Finger-print Reader	None	dTPM 2.0	3-cell(24Wh) + 3-cell(24Wh)	45W Slim Tip	Win10 Pro 64	3-year, Depot	01/17
20HD004AUS	US	i5-7300U	vPro	Intel HD 620	8GB	14" HD (1366x768)	None	500GB 7200rpm	None	Intel 8265 ac, 2x2 + BT4.1	WWAN Upgradable	None	None	None	None	PPS	720p	Non-backlit	Finger-print Reader	None	dTPM 2.0	3-cell(24Wh) + 3-cell(24Wh)	45W Slim Tip	Win10 Pro 64	1-year, Depot	03/17
20HD004BUS	US	i5-7300U	vPro	Intel HD 620	8GB	14" FHD (1920x1080) IPS	None	180GB SSD Opal2	None	Intel 8265 ac, 2x2 + BT4.1	WWAN Upgradable	None	None	None	None	PPS	720p	Backlit	Finger-print Reader	None	dTPM 2.0	3-cell(24Wh) + 3-cell(24Wh)	45W Slim Tip	Win10 Pro 64	3-year, Depot	03/17
20HD0056US	US	i5-7300U	vPro	Intel HD 620	8GB	14" FHD (1920x1080) IPS	None	256GB SSD M.2 PCIe NVMe Opal2	None	Intel 8265 ac, 2x2 + BT4.1	WWAN Upgradable	None	None	None	None	Magnesium	IR & 720p	Backlit	Finger-print Reader	None	dTPM 2.0	3-cell(24Wh) + 3-cell(24Wh)	45W Slim Tip	Win10 Pro 64	3-year, Depot	04/17
20HD0057US	US	i7-7600U	vPro	Intel HD 620	8GB	14" FHD (1920x1080) IPS	None	256GB SSD M.2 PCIe NVMe Opal2	None	Intel 8265 ac, 2x2 + BT4.1	WWAN Upgradable	None	None	None	None	Magnesium	IR & 720p	Backlit	Finger-print Reader	None	dTPM 2.0	3-cell(24Wh) + 3-cell(24Wh)	45W Slim Tip	Win10 Pro 64	3-year, Depot	04/17
20HD0058US	US	i7-7600U	vPro	Intel HD 620	8GB	14" FHD (1920x1080) IPS	10-point Multi-touch	256GB SSD M.2 PCIe NVMe Opal2	None	Intel 8265 ac, 2x2 + BT4.1	WWAN Upgradable	None	None	None	None	PPS	720p	Backlit	Finger-print Reader	None	dTPM 2.0	3-cell(24Wh) + 3-cell(24Wh)	45W Slim Tip	Win10 Pro 64	3-year, Depot	04/17
20HD005AUS	US	i5-7300U	vPro	Intel HD 620	8GB	14" FHD (1920x1080) IPS	None	256GB SSD M.2 PCIe NVMe Opal2	None	Intel 8265 ac, 2x2 + BT4.1	WWAN Upgradable	None	None	None	None	PPS	720p	Backlit	Finger-print Reader	None	dTPM 2.0	3-cell(24Wh) + 3-cell(24Wh)	45W Slim Tip	Win10 Pro 64	3-year, Depot	04/17
20HD005BUS	US	i7-7600U	vPro	Intel HD 620	8GB	14" FHD (1920x1080) IPS	None	256GB SSD M.2 PCIe NVMe Opal2	None	Intel 8265 ac, 2x2 + BT4.1	Sierra EM7455	None	None	None	None	PPS	720p	Backlit	Finger-print Reader	None	dTPM 2.0	3-cell(24Wh) + 3-cell(24Wh)	45W Slim Tip	Win10 Pro 64	3-year, Depot	04/17
20HD005CUS	US	i5-7300U	vPro	Intel HD 620	8GB	14" FHD (1920x1080) IPS	None	256GB SSD M.2 PCIe NVMe Opal2	None	Intel 8265 ac, 2x2 + BT4.1	Sierra EM7455	None	None	None	None	PPS	720p	Backlit	Finger-print Reader	None	dTPM 2.0	3-cell(24Wh) + 3-cell(24Wh)	45W Slim Tip	Win10 Pro 64	3-year, Depot	04/17
20HD005DUS	US	i7-7600U	vPro	Intel HD 620	8GB	14" FHD (1920x1080) IPS	10-point Multi-touch	256GB SSD M.2 PCIe NVMe Opal2	None	Intel 8265 ac, 2x2 + BT4.1	Sierra EM7455	None	None	None	None	PPS	720p	Backlit	Finger-print Reader	None	dTPM 2.0	3-cell(24Wh) + 3-cell(24Wh)	45W Slim Tip	Win10 Pro 64	3-year, Depot	04/17
20HD005EUS	US	i7-7600U	vPro	Intel HD 620	16GBx1	14" FHD (1920x1080) IPS	10-point Multi-touch	512GB SSD M.2 PCIe NVMe Opal2	None	Intel 8265 ac, 2x2 + BT4.1	WWAN Upgradable	None	None	None	None	PPS	720p	Backlit	Finger-print Reader	None	dTPM 2.0	3-cell(24Wh) + 3-cell(24Wh)	45W Slim Tip	Win10 Pro 64	3-year, Depot	04/17
20HD005FUS	US	i7-7600U	vPro	Intel HD 620	8GB	14" FHD (1920x1080) IPS	10-point Multi-touch	256GB SSD M.2 PCIe NVMe Opal2	None	Intel 8265 ac, 2x2 + BT4.1	WWAN Upgradable	None	None	None	None	PPS	IR & 720p	Backlit	Finger-print Reader	None	dTPM 2.0	3-cell(24Wh) + 3-cell(24Wh)	45W Slim Tip	Win10 Pro 64	3-year, Depot	04/17
20HD005GUS	US	i7-7600U	vPro	Intel HD 620	16GBx1	14" FHD (1920x1080) IPS	None	512GB SSD M.2 PCIe NVMe Opal2	None	Intel 8265 ac, 2x2 + BT4.1	WWAN Upgradable	None	None	None	None	PPS	720p	Backlit	Finger-print Reader	None	dTPM 2.0	3-cell(24Wh) + 3-cell(24Wh)	45W Slim Tip	Win10 Pro 64	3-year, Depot	04/17

Model	Region	Processor	vPro	Graphics	Memory	Display	Multi-touch	Storage(HDD/SSD)	Optical	WLAN + Bluetooth	WWAN	SIM Card	Smart Card Reader	Dock	Monitor Cable	Case Material	Camera	Key-board	Finger-print Reader	NFC	TPM	Battery (internal+external)	Power Adapter	Operating System	War-ranty	Ann Date (m/y)
20HD0066US	US	i5-7300U	vPro	Intel HD 620	8GB	14" FHD (1920x1080) IPS	10-point Multi-touch	256GB SSD M.2 PCIe NVMe Opal2	None	Intel 8265 ac, 2x2 + BT4.1	WWAN Upgradable	None	None	None	None	PPS	IR & 720p	Backlit	Finger-print Reader	None	dTPM 2.0	3-cell(24Wh) + 3-cell(24Wh)	45W Slim Tip	Win10 Pro 64	3-year, Depot	07/17
20HD0067US	US	i5-7200U	No	Intel HD 620	8GB	14" FHD (1920x1080) IPS	10-point Multi-touch	256GB SSD M.2 PCIe NVMe Opal2	None	Intel 8265 ac, 2x2 + BT4.1	WWAN Upgradable	None	None	None	None	PPS	720p	Backlit	Finger-print Reader	None	dTPM 2.0	3-cell(24Wh) + 3-cell(24Wh)	45W Slim Tip	Win10 Pro 64	3-year, Depot	07/17
20HD0068US	US	i5-7300U	vPro	Intel HD 620	8GB	14" FHD (1920x1080) IPS	10-point Multi-touch	256GB SSD M.2 PCIe NVMe Opal2	None	Intel 8265 ac, 2x2 + BT4.1	WWAN Upgradable	None	None	None	None	PPS	720p	Backlit	Finger-print Reader	None	dTPM 2.0	3-cell(24Wh) + 3-cell(24Wh)	45W Slim Tip	Win10 Pro 64	3-year, Depot	07/17
20HD0069US	US	i5-7200U	No	Intel HD 620	8GB	14" FHD (1920x1080) IPS	10-point Multi-touch	256GB SSD M.2 PCIe NVMe Opal2	None	Intel 8265 ac, 2x2 + BT4.1	WWAN Upgradable	None	None	None	None	PPS	IR & 720p	Backlit	Finger-print Reader	None	dTPM 2.0	3-cell(24Wh) + 3-cell(24Wh)	45W Slim Tip	Win10 Pro 64	3-year, Depot	07/17
20HD006AUS	US	i5-7300U	vPro	Intel HD 620	16GBx1	14" FHD (1920x1080) IPS	10-point Multi-touch	512GB SSD M.2 PCIe NVMe Opal2	None	Intel 8265 ac, 2x2 + BT4.1	WWAN Upgradable	None	None	None	None	PPS	IR & 720p	Backlit	Finger-print Reader	None	dTPM 2.0	3-cell(24Wh) + 3-cell(24Wh)	45W Slim Tip	Win10 Pro 64	3-year, Depot	07/17
20HD006BUS	US	i5-7300U	vPro	Intel HD 620	16GBx1	14" FHD (1920x1080) IPS	10-point Multi-touch	512GB SSD M.2 PCIe NVMe Opal2	None	Intel 8265 ac, 2x2 + BT4.1	WWAN Upgradable	None	None	None	None	PPS	720p	Backlit	Finger-print Reader	None	dTPM 2.0	3-cell(24Wh) + 3-cell(24Wh)	45W Slim Tip	Win10 Pro 64	3-year, Depot	07/17
20HD006FUS	US	i7-7600U	vPro	Intel HD 620	8GB	14" FHD (1920x1080) IPS	10-point Multi-touch	256GB SSD M.2 PCIe NVMe Opal2	None	Intel 8265 ac, 2x2 + BT4.1	WWAN Upgradable	None	None	None	None	PPS	720p	Backlit	Finger-print Reader	None	dTPM 2.0	3-cell(24Wh) + 3-cell(24Wh)	45W Slim Tip	Win10 Pro 64	3-year, Depot	08/17
20HD006XUS	US	i5-7300U	vPro	Intel HD 620	8GB	14" FHD (1920x1080) IPS	None	512GB SSD Opal2	None	Intel 8265 ac, 2x2 + BT4.1	WWAN Upgradable	None	None	None	None	PPS	720p	Backlit	Finger-print Reader	NFC	dTPM 2.0	3-cell(24Wh) + 3-cell(24Wh)	45W Slim Tip	Win10 Pro 64	3-year, Depot	10/17
20HD006YUS	US	i5-7300U	vPro	Intel HD 620	8GB	14" FHD (1920x1080) IPS	None	512GB SSD M.2 PCIe NVMe Opal2	None	Intel 8265 ac, 2x2 + BT4.1	WWAN Upgradable	None	None	None	None	PPS	720p	Backlit	Finger-print Reader	NFC	dTPM 2.0	3-cell(24Wh) + 3-cell(24Wh)	45W Slim Tip	Win10 Pro 64	3-year, Depot	10/17
20HD0070US	US	i5-7300U	vPro	Intel HD 620	8GB	14" FHD (1920x1080) IPS	None	256GB SSD Opal2	None	Intel 8265 ac, 2x2 + BT4.1	WWAN Upgradable	None	None	None	None	PPS	720p	Backlit	Finger-print Reader	NFC	dTPM 2.0	3-cell(24Wh) + 3-cell(24Wh)	45W Slim Tip	Win10 Pro 64	3-year, Depot	10/17

ThinkPad T470 - TopSeller - 20JM

Model	Region	Processor	vPro	Graphics	Memory	Display	Multi-touch	Storage(HDD/SSD)	Optical	WLAN + Bluetooth	WWAN	SIM Card	Smart Card Reader	Dock	Monitor Cable	Case Material	Camera	Key-board	Finger-print Reader	NFC	TPM	Battery (internal+ external)	Power Adapter	Operating System	Warranty	Ann Date (m/y)
20JM0009US	US	i5-6300U	vPro	Intel HD 520	8GB	14" FHD (1920x1080) IPS	None	256GB SSD M.2 PCIe NVMe Opal2	None	Intel 8260 ac, 2x2 + BT4.1	WWAN Upgradable	None	None	None	None	PPS	720p	Backlit	Finger-print Reader	None	dTPM 2.0	3-cell(24Wh) + 3-cell(24Wh)	45W Slim Tip	Win10 DG Win7 Pro 64	3-year, Depot	03/17
20JM000AUS	US	i7-6600U	vPro	Intel HD 520	8GB	14" FHD (1920x1080) IPS	None	256GB SSD M.2 PCIe NVMe Opal2	None	Intel 8260 ac, 2x2 + BT4.1	WWAN Upgradable	None	None	None	None	PPS	720p	Backlit	Finger-print Reader	None	dTPM 2.0	3-cell(24Wh) + 3-cell(24Wh)	45W Slim Tip	Win10 DG Win7 Pro 64	3-year, Depot	03/17
20JM000BUS	US	i7-6500U	No	Intel HD 520	8GB	14" FHD (1920x1080) IPS	None	256GB SSD M.2 PCIe NVMe Opal2	None	Intel 8260 ac, 2x2 + BT4.1	WWAN Upgradable	None	None	None	None	PPS	720p	Backlit	Finger-print Reader	None	dTPM 2.0	3-cell(24Wh) + 3-cell(24Wh)	45W Slim Tip	Win10 DG Win7 Pro 64	3-year, Depot	03/17
20JM000CUS	US	i5-6200U	No	Intel HD 520	4GBx1	14" HD (1366x768)	None	500GB 7200rpm	None	Intel 8260 ac, 2x2 + BT4.1	WWAN Upgradable	None	None	None	None	PPS	720p	Non-backlit	Finger-print Reader	None	dTPM 2.0	3-cell(24Wh) + 3-cell(24Wh)	45W Slim Tip	Win10 DG Win7 Pro 64	1-year, Depot	03/17
20JM000EUS	US	i5-6300U	vPro	Intel HD 520	8GB	14" FHD (1920x1080) IPS	None	256GB SSD M.2 PCIe NVMe Opal2	None	Intel 8260 ac, 2x2 + BT4.1	WWAN Upgradable	None	None	None	None	PPS	720p	Backlit	Finger-print Reader	None	dTPM 2.0	3-cell(24Wh) + 3-cell(24Wh)	45W Slim Tip	Win10 DG Win7 Pro 64	3-year, Depot	04/17
20JM000FUS	US	i7-6600U	vPro	Intel HD 520	8GB	14" FHD (1920x1080) IPS	None	256GB SSD M.2 PCIe NVMe Opal2	None	Intel 8260 ac, 2x2 + BT4.1	WWAN Upgradable	None	None	None	None	PPS	720p	Backlit	Finger-print Reader	None	dTPM 2.0	3-cell(24Wh) + 3-cell(24Wh)	45W Slim Tip	Win10 DG Win7 Pro 64	3-year, Depot	04/17
20JM000GUS	US	i7-6600U	vPro	Intel HD 520	8GB	14" FHD (1920x1080) IPS	10-point Multi-touch	256GB SSD M.2 PCIe NVMe Opal2	None	Intel 8260 ac, 2x2 + BT4.1	WWAN Upgradable	None	None	None	None	PPS	720p	Backlit	Finger-print Reader	None	dTPM 2.0	3-cell(24Wh) + 3-cell(24Wh)	45W Slim Tip	Win10 DG Win7 Pro 64	3-year, Depot	04/17
20JM000HUS	US	i5-6300U	vPro	Intel HD 520	8GB	14" FHD (1920x1080) IPS	None	256GB SSD M.2 PCIe NVMe Opal2	None	Intel 8260 ac, 2x2 + BT4.1	WWAN Upgradable	Sierra EM7455	None	None	None	PPS	720p	Backlit	Finger-print Reader	None	dTPM 2.0	3-cell(24Wh) + 3-cell(24Wh)	45W Slim Tip	Win10 DG Win7 Pro 64	3-year, Depot	04/17
20JM000JUS	US	i7-6600U	vPro	Intel HD 520	8GB	14" FHD (1920x1080) IPS	10-point Multi-touch	256GB SSD M.2 PCIe NVMe Opal2	None	Intel 8260 ac, 2x2 + BT4.1	WWAN Upgradable	Sierra EM7455	None	None	None	PPS	720p	Backlit	Finger-print Reader	None	dTPM 2.0	3-cell(24Wh) + 3-cell(24Wh)	45W Slim Tip	Win10 DG Win7 Pro 64	3-year, Depot	04/17
20JM000KUS	US	i7-6600U	vPro	Intel HD 520	8GB	14" FHD (1920x1080) IPS	None	256GB SSD M.2 PCIe NVMe Opal2	None	Intel 8260 ac, 2x2 + BT4.1	WWAN Upgradable	Sierra EM7455	None	None	None	PPS	720p	Backlit	Finger-print Reader	None	dTPM 2.0	3-cell(24Wh) + 3-cell(24Wh)	45W Slim Tip	Win10 DG Win7 Pro 64	3-year, Depot	04/17
20JM000LUS	US	i7-6600U	vPro	Intel HD 520	16GBx1	14" FHD (1920x1080) IPS	10-point Multi-touch	512GB SSD M.2 PCIe NVMe Opal2	None	Intel 8260 ac, 2x2 + BT4.1	WWAN Upgradable	None	None	None	None	PPS	720p	Backlit	Finger-print Reader	None	dTPM 2.0	3-cell(24Wh) + 3-cell(24Wh)	45W Slim Tip	Win10 DG Win7 Pro 64	3-year, Depot	04/17
20JM000MUS	US	i7-6600U	vPro	Intel HD 520	16GBx1	14" FHD (1920x1080) IPS	None	512GB SSD M.2 PCIe NVMe Opal2	None	Intel 8260 ac, 2x2 + BT4.1	WWAN Upgradable	None	None	None	None	PPS	720p	Backlit	Finger-print Reader	None	dTPM 2.0	3-cell(24Wh) + 3-cell(24Wh)	45W Slim Tip	Win10 DG Win7 Pro 64	3-year, Depot	04/17
20JM000QUS	US	i5-6300U	vPro	Intel HD 520	16GBx1	14" FHD (1920x1080) IPS	10-point Multi-touch	512GB SSD M.2 PCIe NVMe Opal2	None	Intel 8260 ac, 2x2 + BT4.1	WWAN Upgradable	None	None	None	None	PPS	720p	Backlit	Finger-print Reader	None	dTPM 2.0	3-cell(24Wh) + 3-cell(24Wh)	45W Slim Tip	Win10 DG Win7 Pro 64	3-year, Depot	07/17
20JM000RUS	US	i5-6300U	vPro	Intel HD 520	8GB	14" FHD (1920x1080) IPS	10-point Multi-touch	256GB SSD M.2 PCIe NVMe Opal2	None	Intel 8260 ac, 2x2 + BT4.1	WWAN Upgradable	None	None	None	None	PPS	720p	Backlit	Finger-print Reader	None	dTPM 2.0	3-cell(24Wh) + 3-cell(24Wh)	45W Slim Tip	Win10 DG Win7 Pro 64	3-year, Depot	07/17
20JM000SUS	US	i5-6200U	No	Intel HD 520	8GB	14" HD (1366x768)	None	500GB 7200rpm	None	Intel 8260 ac, 2x2 + BT4.1	WWAN Upgradable	None	None	None	None	PPS	720p	Backlit	Finger-print Reader	None	dTPM 2.0	3-cell(24Wh) + 3-cell(24Wh)	45W Slim Tip	Win10 DG Win7 Pro 64	3-year, Depot	08/17
20JM0012US	US	i5-6300U	vPro	Intel HD 520	8GB	14" FHD (1920x1080) IPS	None	256GB SSD Opal2	None	Intel 8260 ac, 2x2 + BT4.1	WWAN Upgradable	None	None	None	None	PPS	720p	Backlit	Finger-print Reader	None	dTPM 2.0	3-cell(24Wh) + 3-cell(24Wh)	45W Slim Tip	Win10 DG Win7 Pro 64	3-year, Depot	10/17
20JM0013US	US	i5-6300U	vPro	Intel HD 520	8GB	14" FHD (1920x1080) IPS	None	512GB SSD Opal2	None	Intel 8260 ac, 2x2 + BT4.1	WWAN Upgradable	None	None	None	None	PPS	720p	Backlit	Finger-print Reader	None	dTPM 2.0	3-cell(24Wh) + 3-cell(24Wh)	45W Slim Tip	Win10 DG Win7 Pro 64	3-year, Depot	10/17
20JM0014US	US	i5-6300U	vPro	Intel HD 520	8GB	14" FHD (1920x1080) IPS	None	512GB SSD M.2 PCIe NVMe Opal2	None	Intel 8260 ac, 2x2 + BT4.1	WWAN Upgradable	None	None	None	None	PPS	720p	Backlit	Finger-print Reader	None	dTPM 2.0	3-cell(24Wh) + 3-cell(24Wh)	45W Slim Tip	Win10 DG Win7 Pro 64	3-year, Depot	10/17



ThinkPad T470p Platform Specifications

Product Specifications Reference (PSREF)

Processor	7th Generation Intel® Core™ i5 / i7 Processor							Dimensions <i>WxDxH (FHD):</i> 13.35" x 9.25" x 0.94"; 339mm x 235mm x 24mm <i>WxDxH (WQHD):</i> 13.35" x 9.25" x 0.96"; 339mm x 235mm x 24.4mm	
	Processor Number	# of Cores	# of Threads	Base Frequency	Max Turbo Frequency	Cache	Memory Types		Processor Graphics
	i5-7300HQ	4	4	2.5 GHz	3.5 GHz	6MB	DDR4-2400		Intel HD Graphics 630
	i5-7440HQ			2.8 GHz	3.8 GHz	6MB			
i7-7700HQ	8		2.8 GHz	3.8 GHz	6MB				
i7-7820HQ		2.9 GHz	3.9 GHz	8MB					
Graphics	Intel HD Graphics 630 in processor only, or Intel HD Graphics 630 in processor and NVIDIA GeForce® 940MX, 2GB 2.5GHz GDDR5 memory; supports external digital monitor via HDMI or Mini DisplayPort; supports three independent displays; Max resolution: 4096x2304@60Hz (DisplayPort via Mini DisplayPort cable); 4096x2160@24Hz (HDMI)							Weight <i>Models</i> <i>Integrated model</i> <i>discrete model</i>	
Chipset	Mobile Intel QM175 Chipset							Case color	
Memory	32GB max / 2400MHz DDR4, dual-channel capable, two DDR4 SO-DIMM sockets							Case material	
Display	<i>Some:</i> 14.0" (355mm) FHD (1920x1080), anti-glare, LED backlight, IPS, 250 nits, 16:9 aspect ratio, 600:1 contrast ratio, 160° viewing angle <i>Some:</i> 14.0" (355mm) WQHD (2560x1440), anti-glare, LED backlight, IPS, 300 nits, 16:9 aspect ratio, 700:1 contrast ratio, 160° viewing angle							Smart card reader Media reader Ports Monitor cable <i>(optional)</i>	
Multi-touch <i>(opt)</i>	On-cell touch, supports 10-finger gesture (FHD only)							Camera	
Storage	<i>System has one HDD slot or one M.2 2280 slot exclusively for storage</i> <i>Some:</i> HDD / SATA 6.0Gb/s, 2.5" wide, 7mm or 9.5mm high, Active Protection System™ <i>Some:</i> SSD / SATA 6.0Gb/s, 2.5" wide, 7mm high (e.g. xxxGB SSD) <i>Some:</i> M.2 SSD / PCIe NVMe, PCIe 3.0 x 2, 16Gb/s <i>Some:</i> 128GB M.2 SSD / SATA 6.0Gb/s, in WWAN slot as 2nd Storage, mutually exclusive with WWAN							Audio support	
Optical	None							Keyboard UltraNav™	
Ethernet	<i>Non-vPro model:</i> Intel Ethernet Connection I219-V (Jacksonville) <i>vPro model:</i> Intel Ethernet Connection I219-LM (Jacksonville)							Security Security chip <i>vPro (optional)</i> Fingerprint reader NFC	
WLAN	<i>One of the following, configurable by model:</i> • Realtek® RTL8822BE, Wi-Fi 2x2 802.11ac + BT4.1, M.2 card • Intel Dual Band Wireless-AC 8265, Wi-Fi 2x2 802.11ac + BT4.1, M.2 card							Battery Max battery life AC adapter	
Bluetooth™	Bluetooth 4.1 wireless, integrated in Wi-Fi + Bluetooth combo adapter * Intel 8265ac card support BT4.2 but is limited to BT4.1 by Windows OS							Preload	
WWAN <i>(optional)</i>	<i>One of the following, configurable by model:</i> • Wireless WAN upgradable • Integrated Mobile Broadband 4G LTE-A, Qualcomm® Snapdragon™ X7 LTE-A (Sierra Wireless EM7455), M.2 card							Limited warranty	
SIM card <i>(opt)</i>	Micro-SIM card slot, opt Verizon LTE (US) or Lenovo® Connect (EMEA) SIM card							Mil-Spec test Environment	

Model	Region	Processor	vPro	Graphics	Chipset	Memory	Display	Multi-touch	Storage(HDD/SSD)	Optical	WLAN + Bluetooth	WWAN	SIM Card	Smart Card Reader	Monitor Cable	Camera	Key-board	Finger-print Reader	NFC	TPM	Battery	Power Adapter	Operating System	Warranty	Ann Date (m/y)
20J6001BUS	US	i5-7440HQ	vPro	940MX 2GB	Intel QM175	8GB	14" FHD (1920x1080) IPS	10-point Multi-touch	512GB SSD M.2 PCIe NVMe Opal2	None	Intel 8265 ac, 2x2 + BT4.1	WWAN Upgradable	None	None	None	720p	Backlit	Finger-print Reader	None	dTPM 2.0	6-cell (48Wh)	135W Slim Tip	Win10 Pro 64	3-year, Depot	03/17
20J6001CUS	US	i5-7440HQ	vPro	940MX 2GB	Intel QM175	8GB	14" FHD (1920x1080) IPS	None	256GB SSD M.2 PCIe NVMe Opal2	None	Intel 8265 ac, 2x2 + BT4.1	WWAN Upgradable	None	None	None	720p	Backlit	Finger-print Reader	None	dTPM 2.0	6-cell (48Wh)	135W Slim Tip	Win10 Pro 64	3-year, Depot	02/17
20J6001DUS	US	i5-7440HQ	vPro	Intel HD 630	Intel QM175	4GBx2	14" FHD (1920x1080) IPS	10-point Multi-touch	256GB SSD M.2 PCIe NVMe Opal2	None	Intel 8265 ac, 2x2 + BT4.1	WWAN Upgradable	None	None	None	720p	Backlit	Finger-print Reader	None	dTPM 2.0	3-cell (24Wh)	90W Slim Tip	Win10 Pro 64	3-year, Depot	03/17
20J6001EUS	US	i5-7440HQ	vPro	940MX 2GB	Intel QM175	8GB	14" FHD (1920x1080) IPS	None	512GB SSD M.2 PCIe NVMe Opal2	None	Intel 8265 ac, 2x2 + BT4.1	WWAN Upgradable	None	None	None	720p	Backlit	Finger-print Reader	None	dTPM 2.0	6-cell (48Wh)	135W Slim Tip	Win10 Pro 64	3-year, Depot	02/17
20J6001FUS	US	i5-7440HQ	vPro	Intel HD 630	Intel QM175	4GBx2	14" FHD (1920x1080) IPS	None	256GB SSD M.2 PCIe NVMe Opal2	None	Intel 8265 ac, 2x2 + BT4.1	WWAN Upgradable	None	None	None	720p	Backlit	Finger-print Reader	None	dTPM 2.0	6-cell (48Wh)	90W Slim Tip	Win10 Pro 64	3-year, Depot	02/17
20J6001GUS	US	i5-7440HQ	vPro	Intel HD 630	Intel QM175	4GBx2	14" FHD (1920x1080) IPS	10-point Multi-touch	256GB SSD M.2 PCIe NVMe Opal2	None	Intel 8265 ac, 2x2 + BT4.1	WWAN Upgradable	None	None	None	720p	Backlit	Finger-print Reader	None	dTPM 2.0	6-cell (48Wh)	90W Slim Tip	Win10 Pro 64	3-year, Depot	03/17
20J6001HUS	US	i5-7440HQ	vPro	Intel HD 630	Intel QM175	4GBx2	14" FHD (1920x1080) IPS	None	256GB SSD M.2 PCIe NVMe Opal2	None	Intel 8265 ac, 2x2 + BT4.1	WWAN Upgradable	None	None	None	720p	Backlit	Finger-print Reader	None	dTPM 2.0	3-cell (24Wh)	90W Slim Tip	Win10 Pro 64	3-year, Depot	02/17
20J6001JUS	US	i5-7440HQ	vPro	940MX 2GB	Intel QM175	4GBx2	14" FHD (1920x1080) IPS	10-point Multi-touch	256GB SSD M.2 PCIe NVMe Opal2	None	Intel 8265 ac, 2x2 + BT4.1	WWAN Upgradable	None	None	None	720p	Backlit	Finger-print Reader	None	dTPM 2.0	6-cell (48Wh)	135W Slim Tip	Win10 Pro 64	3-year, Depot	03/17
20J6003JUS	US	i7-7820HQ	vPro	940MX 2GB	Intel QM175	16GBx1	14" WQHD (2560x1440) IPS	None	512GB SSD M.2 PCIe NVMe Opal2	None	Intel 8265 ac, 2x2 + BT4.1	WWAN Upgradable	None	None	None	720p	Backlit	Finger-print Reader	None	dTPM 2.0	6-cell (48Wh)	135W Slim Tip	Win10 Pro 64	3-year, Depot	04/17
20J6003KUS	US	i7-7820HQ	vPro	940MX 2GB	Intel QM175	16GBx1	14" FHD (1920x1080) IPS	None	512GB SSD M.2 PCIe NVMe Opal2	None	Intel 8265 ac, 2x2 + BT4.1	WWAN Upgradable	None	None	None	720p	Backlit	Finger-print Reader	None	dTPM 2.0	6-cell (48Wh)	135W Slim Tip	Win10 Pro 64	3-year, Depot	04/17
20J6003LUS	US	i7-7820HQ	vPro	940MX 2GB	Intel QM175	8GB	14" FHD (1920x1080) IPS	None	256GB SSD M.2 PCIe NVMe Opal2	None	Intel 8265 ac, 2x2 + BT4.1	WWAN Upgradable	None	None	None	720p	Backlit	Finger-print Reader	None	dTPM 2.0	6-cell (48Wh)	135W Slim Tip	Win10 Pro 64	3-year, Depot	04/17
20J6003MUS	US	i5-7440HQ	vPro	Intel HD 630	Intel QM175	8GB	14" FHD (1920x1080) IPS	None	256GB SSD M.2 PCIe NVMe Opal2	None	Intel 8265 ac, 2x2 + BT4.1	WWAN Upgradable	None	None	None	720p	Backlit	Finger-print Reader	None	dTPM 2.0	6-cell (48Wh)	90W Slim Tip	Win10 Pro 64	3-year, Depot	04/17
20J6003NUS	US	i5-7440HQ	vPro	Intel HD 630	Intel QM175	8GB	14" FHD (1920x1080) IPS	None	256GB SSD M.2 PCIe NVMe Opal2	None	Intel 8265 ac, 2x2 + BT4.1	Sierra EM7455	None	None	None	720p	Backlit	Finger-print Reader	None	dTPM 2.0	6-cell (48Wh)	90W Slim Tip	Win10 Pro 64	3-year, Depot	04/17
20J6003PUS	US	i7-7820HQ	vPro	940MX 2GB	Intel QM175	8GB	14" FHD (1920x1080) IPS	None	256GB SSD M.2 PCIe NVMe Opal2	None	Intel 8265 ac, 2x2 + BT4.1	Sierra EM7455	None	None	None	720p	Backlit	Finger-print Reader	None	dTPM 2.0	6-cell (48Wh)	135W Slim Tip	Win10 Pro 64	3-year, Depot	04/17
20J6003UUS	US	i7-7820HQ	vPro	940MX 2GB	Intel QM175	8GB	14" FHD (1920x1080) IPS	10-point Multi-touch	256GB SSD M.2 PCIe NVMe Opal2	None	Intel 8265 ac, 2x2 + BT4.1	WWAN Upgradable	None	None	None	720p	Backlit	Finger-print Reader	None	dTPM 2.0	6-cell (48Wh)	135W Slim Tip	Win10 Pro 64	3-year, Depot	06/17
20J6003VUS	US	i7-7820HQ	vPro	940MX 2GB	Intel QM175	8GB	14" FHD (1920x1080) IPS	None	256GB SSD M.2 PCIe NVMe Opal2	None	Intel 8265 ac, 2x2 + BT4.1	WWAN Upgradable	None	None	None	720p	Backlit	Finger-print Reader	None	dTPM 2.0	6-cell (48Wh)	135W Slim Tip	Win10 Pro 64	3-year, Depot	06/17
20J6003WUS	US	i5-7440HQ	vPro	Intel HD 630	Intel QM175	8GB	14" FHD (1920x1080) IPS	None	180GB SSD Opal2	None	Intel 8265 ac, 2x2 + BT4.1	WWAN Upgradable	None	None	None	720p	Backlit	Finger-print Reader	None	dTPM 2.0	6-cell (48Wh)	90W Slim Tip	Win10 Pro 64	3-year, Depot	06/17
20J6003XUS	US	i7-7820HQ	vPro	940MX 2GB	Intel QM175	16GBx1	14" FHD (1920x1080) IPS	10-point Multi-touch	512GB SSD M.2 PCIe NVMe Opal2	None	Intel 8265 ac, 2x2 + BT4.1	WWAN Upgradable	None	None	None	720p	Backlit	Finger-print Reader	None	dTPM 2.0	6-cell (48Wh)	135W Slim Tip	Win10 Pro 64	3-year, Depot	06/17
20J6003YUS	US	i5-7440HQ	vPro	Intel HD 630	Intel QM175	8GB	14" FHD (1920x1080) IPS	None	180GB SSD Opal2	None	Intel 8265 ac, 2x2 + BT4.1	WWAN Upgradable	None	None	None	720p	Backlit	Finger-print Reader	None	dTPM 2.0	3-cell (24Wh)	90W Slim Tip	Win10 Pro 64	3-year, Depot	06/17



ThinkPad T470s Platform Specifications

Product Specifications Reference (PSREF)

Processor	6th Generation Intel® Core™ i5 / i7 Processor								Dimensions Weight Case color Case material	<i>WxDxH:</i> 13.03" x 8.93" x 0.67-0.74"; 331mm x 226.8mm x 16.9-18.8mm Starting at 2.9 lb (1.32kg) Black or Silver <i>Display cover:</i> CFRP Hybrid; <i>Bottom:</i> Magnesium
	Processor Number	# of Cores	# of Threads	Base Frequency	Max Turbo Frequency	Cache	Memory Types	Processor Graphics		
	i5-6200U	2	4	2.3 GHz	2.8 GHz	3MB	DDR4-2133	Intel HD Graphics 520		
	i5-6300U			2.4 GHz	3.0 GHz	3MB				
i7-6600U	2.6 GHz			3.4 GHz	4MB					
or 7th Generation Intel Core i5 / i7 Processor										
Graphics	Intel HD Graphics 520 or 620 in processor; supports external digital monitor via HDMI or USB Type-C; supports three independent displays; Max resolution: 4096x2304@60Hz (USB Type-C); 4096x2160@24Hz (HDMI)								Smart card reader Media reader Ports WiGig dock (opt) Monitor cable (optional) Camera (optional)	<i>Optional:</i> Smart card reader 4-in-1 reader (MMC, SD, SDHC, SDXC) Three USB 3.1 Gen 1 (USB 3.0, one Always On), USB 3.1 Type-C Gen 2 / Thunderbolt 3, HDMI 1.4b, Ethernet (RJ-45), Dock connector ThinkPad WiGig dock, mutually exclusive with WWAN <i>HDMI to VGA:</i> Lenovo HDMI to VGA Monitor Adapter <i>USB-C to VGA:</i> Lenovo USB-C to VGA Adapter HD720p resolution, fixed focus (models without camera are NOT available in EMEA) HD Audio, Realtek® ALC3268 codec / stereo speakers, 1W x 2 / dual array microphone, combo audio/microphone jack
	Processor Number	# of Cores	# of Threads	Base Frequency	Max Turbo Frequency	Cache	Memory Types	Processor Graphics		
	i5-7200U	2	4	2.5 GHz	3.1 GHz	3MB	DDR4-2133	Intel HD Graphics 620		
	i5-7300U			2.6 GHz	3.5 GHz	3MB				
i7-7500U	2.7 GHz			3.5 GHz	4MB					
i7-7600U	2.8 GHz			3.9 GHz	4MB					
Chipset	Intel SoC (System on Chip) platform								Audio support	Keyboard UltraNav™
Memory	20GB or 24GB max ⁷ / 2400MHz DDR4, dual-channel capable, 4GB or 8GB memory soldered to systemboard, one DDR4 SO-DIMM socket * System clocks down for processors with lower memory controller									
Display	<i>Some:</i> 14.0" (355mm) FHD (1920x1080), anti-glare, LED backlight, IPS, 250 nits, 16:9 aspect ratio, 700:1 contrast ratio, 160° viewing angle <i>Some:</i> 14.0" (355mm) WQHD (2560x1440), anti-glare, LED backlight, IPS, 300 nits, 16:9 aspect ratio, 700:1 contrast ratio, 160° viewing angle								Security Security chip vPro (optional) Fingerprint reader NFC (optional)	6-row, spill-resistant, multimedia Fn keys, optional LED backlight TrackPoint® pointing device and buttonless Mylar surface multi-touch touchpad Power-on password, hard disk password, supervisor password, security keyhole Discrete TPM 2.0, TCG Certified Intel vPro Technology <i>Optional:</i> Touch style match on chip fingerprint reader on the palm rest Near Field Communication
Multi-touch (opt)	On-cell touch, supports 10-finger gesture, 250 nits (FHD only)									
Storage	<i>One of the following, configurable by model:</i> • M.2 SSD / SATA 6.0Gb/s (e.g. xxxGB SSD M.2) • M.2 SSD / PCIe NVMe, PCIe 3.0 x 4, 32Gb/s (e.g. xxxGB SSD M.2 PCIe NVMe)								Internal battery Max battery life AC adapter	Preload Windows® 7 Professional 64 preinstalled through downgrade rights in Windows 10 Pro 64 • Lenovo Solution Center • Lenovo PowerEngage • ThinkVantage Product Recovery • ThinkVantage System Update • Adobe® Reader® • Microsoft® Office preloaded; purchase a product key to activate • McAfee® LiveSafe™ (30-day trial)
Optical	None									
Ethernet	<i>Non-vPro model:</i> Intel Ethernet Connection I219-V (Jacksonville) <i>vPro model:</i> Intel Ethernet Connection I219-LM (Jacksonville)								Limited warranty	<i>Some:</i> Windows 10 Home 64 • Windows 10 Pro 64 • Lenovo Companion • Lenovo Setting • Microsoft Office preloaded; purchase a product key to activate
WLAN	<i>One of the following, configurable by model (WiGig is mutually exclusive with WWAN):</i> • Intel Dual Band Wireless-AC 8260, Wi-Fi 2x2 802.11ac + BT4.1, M.2 card • Intel Dual Band Wireless-AC 8265, Wi-Fi 2x2 802.11ac + BT4.1, M.2 card • Intel Tri-Band Wireless-AC 18265, WiGig 802.11ad + Wi-Fi 2x2 802.11ac + BT4.1, M.2 card									
Bluetooth™	Bluetooth 4.1 wireless, integrated in Wi-Fi + Bluetooth combo adapter * Intel 8265ac / 18265ac card support BT4.2 but is limited to BT4.1 by Windows OS								Mil-Spec test	Environment EPEAT™ Gold (US only); ENERGY STAR® 6.1; RoHS-compliant
WWAN (optional)	<i>One of the following, configurable by model (mutually exclusive with WiGig):</i> • Wireless WAN upgradable • Integrated Mobile Broadband 4G LTE-A, Qualcomm® Snapdragon™ X7 LTE-A (Sierra Wireless EM7455), M.2 card • Micro-SIM card slot, opt Verizon LTE (US) or Lenovo® Connect (EMEA) SIM card									
SIM card (opt)										

Model	Region	Processor	vPro	Graphics	Memory (Soldered +DIMM)	Display	Multi-touch	Storage(HDD/SSD)	Optical	WLAN + Bluetooth	WWAN	SIM Card	Smart Card Reader	Dock	Monitor Cable	Color	Camera	Key-board	Finger-print Reader	NFC	TPM	Battery (internal)	Power Adapter	Operating System	Warranty	Ann Date (m/y)
20HF0010US	US	i7-7600U	vPro	Intel HD 620	4GB + 8GB	14" WQHD (2560x1440) IPS	None	512GB SSD M.2 PCIe NVMe Opal2	None	Intel 8265 ac, 2x2 + BT4.1	WWAN Upgradable	None	None	None	None	Black	720p	Backlit	Finger-print Reader	None	dTPM 2.0	3-cell(23Wh) + 3-cell(26Wh)	45W Slim Tip	Win10 Pro 64	3-year, Depot	02/17
20HF0011US	US	i5-7300U	vPro	Intel HD 620	4GB + 4GB	14" FHD (1920x1080) IPS	None	256GB SSD M.2 PCIe NVMe Opal2	None	Intel 8265 ac, 2x2 + BT4.1	WWAN Upgradable	None	None	None	None	Black	720p	Backlit	Finger-print Reader	None	dTPM 2.0	3-cell(23Wh) + 3-cell(26Wh)	45W Slim Tip	Win10 Pro 64	3-year, Depot	02/17
20HF0012US	US	i5-7300U	vPro	Intel HD 620	4GB + 4GB	14" FHD (1920x1080) IPS	10-point Multi-touch	256GB SSD M.2 PCIe NVMe Opal2	None	Intel 8265 ac, 2x2 + BT4.1	WWAN Upgradable	None	None	None	None	Black	720p	Backlit	Finger-print Reader	None	dTPM 2.0	3-cell(23Wh) + 3-cell(26Wh)	45W Slim Tip	Win10 Pro 64	3-year, Depot	02/17
20HF0013US	US	i7-7600U	vPro	Intel HD 620	4GB + 4GB	14" FHD (1920x1080) IPS	None	256GB SSD M.2 PCIe NVMe Opal2	None	Intel 8265 ac, 2x2 + BT4.1	WWAN Upgradable	None	None	None	None	Black	720p	Backlit	Finger-print Reader	None	dTPM 2.0	3-cell(23Wh) + 3-cell(26Wh)	45W Slim Tip	Win10 Pro 64	3-year, Depot	02/17
20HF0014US	US	i5-7200U	No	Intel HD 620	4GB Soldered	14" FHD (1920x1080) IPS	None	128GB SSD M.2	None	Intel 8265 ac, 2x2 + BT4.1	WWAN Upgradable	None	None	None	None	Black	720p	Backlit	Finger-print Reader	None	dTPM 2.0	3-cell(23Wh) + 3-cell(26Wh)	45W Slim Tip	Win10 Pro 64	1-year, Depot	02/17
20HF0015US	US	i7-7600U	vPro	Intel HD 620	4GB + 4GB	14" FHD (1920x1080) IPS	10-point Multi-touch	256GB SSD M.2 PCIe NVMe Opal2	None	Intel 8265 ac, 2x2 + BT4.1	WWAN Upgradable	None	None	None	None	Black	720p	Backlit	Finger-print Reader	None	dTPM 2.0	3-cell(23Wh) + 3-cell(26Wh)	45W Slim Tip	Win10 Pro 64	3-year, Depot	02/17
20HF001DUS	US	i7-7600U	vPro	Intel HD 620	8GB + 16GB	14" FHD (1920x1080) IPS	None	1TB SSD M.2 PCIe NVMe Opal2	None	Intel 8265 ac, 2x2 + BT4.1	WWAN Upgradable	None	None	None	None	Black	720p	Backlit	Finger-print Reader	None	dTPM 2.0	3-cell(23Wh) + 3-cell(26Wh)	45W Slim Tip	Win10 Pro 64	3-year, Depot	04/17
20HF003QUS	US	i7-7600U	vPro	Intel HD 620	4GB + 8GB	14" WQHD (2560x1440) IPS	None	512GB SSD M.2 PCIe NVMe Opal2	None	Intel 8265 ac, 2x2 + BT4.1	WWAN Upgradable	None	None	None	None	Silver	720p	Backlit	Finger-print Reader	None	dTPM 2.0	3-cell(23Wh) + 3-cell(26Wh)	45W Slim Tip	Win10 Pro 64	3-year, Depot	02/17
20HF003RUS	US	i5-7200U	No	Intel HD 620	4GB + 4GB	14" WQHD (2560x1440) IPS	None	180GB SSD M.2 Opal2	None	Intel 8265 ac, 2x2 + BT4.1	WWAN Upgradable	None	None	None	None	Black	720p	Backlit	Finger-print Reader	None	dTPM 2.0	3-cell(23Wh) + 3-cell(26Wh)	45W Slim Tip	Win10 Pro 64	3-year, Depot	03/17
20HF003SUS	US	i5-7200U	No	Intel HD 620	4GB + 4GB	14" WQHD (2560x1440) IPS	None	180GB SSD M.2 Opal2	None	Intel 8265 ac, 2x2 + BT4.1	WWAN Upgradable	None	None	None	None	Silver	720p	Backlit	Finger-print Reader	None	dTPM 2.0	3-cell(23Wh) + 3-cell(26Wh)	45W Slim Tip	Win10 Pro 64	3-year, Depot	03/17
20HF003TUS	US	i7-7600U	vPro	Intel HD 620	4GB + 4GB	14" FHD (1920x1080) IPS	None	256GB SSD M.2 PCIe NVMe Opal2	None	Intel 8265 ac, 2x2 + BT4.1	WWAN Upgradable	None	None	None	None	Silver	720p	Backlit	Finger-print Reader	None	dTPM 2.0	3-cell(23Wh) + 3-cell(26Wh)	45W Slim Tip	Win10 Pro 64	3-year, Depot	02/17
20HF003UUS	US	i5-7300U	vPro	Intel HD 620	4GB + 4GB	14" FHD (1920x1080) IPS	10-point Multi-touch	256GB SSD M.2 PCIe NVMe Opal2	None	Intel 8265 ac, 2x2 + BT4.1	WWAN Upgradable	None	None	None	None	Silver	720p	Backlit	Finger-print Reader	None	dTPM 2.0	3-cell(23Wh) + 3-cell(26Wh)	45W Slim Tip	Win10 Pro 64	3-year, Depot	02/17
20HF003VUS	US	i5-7200U	No	Intel HD 620	4GB Soldered	14" FHD (1920x1080) IPS	None	128GB SSD M.2	None	Intel 8265 ac, 2x2 + BT4.1	WWAN Upgradable	None	None	None	None	Silver	720p	Backlit	Finger-print Reader	None	dTPM 2.0	3-cell(23Wh) + 3-cell(26Wh)	45W Slim Tip	Win10 Pro 64	1-year, Depot	02/17
20HF003WUS	US	i5-7300U	vPro	Intel HD 620	4GB + 4GB	14" FHD (1920x1080) IPS	None	256GB SSD M.2 PCIe NVMe Opal2	None	Intel 8265 ac, 2x2 + BT4.1	WWAN Upgradable	None	None	None	None	Silver	720p	Backlit	Finger-print Reader	None	dTPM 2.0	3-cell(23Wh) + 3-cell(26Wh)	45W Slim Tip	Win10 Pro 64	3-year, Depot	02/17
20HF0044US	US	i7-7600U	vPro	Intel HD 620	8GB + 8GB	14" FHD (1920x1080) IPS	None	512GB SSD M.2 PCIe NVMe Opal2	None	Intel 8265 ac, 2x2 + BT4.1	WWAN Upgradable	None	None	None	None	Black	720p	Backlit	Finger-print Reader	None	dTPM 2.0	3-cell(23Wh) + 3-cell(26Wh)	45W Slim Tip	Win10 Pro 64	3-year, Depot	07/17
20HF005GUS	US	i5-7300U	vPro	Intel HD 620	8GB Soldered	14" FHD (1920x1080) IPS	None	256GB SSD M.2 PCIe NVMe Opal2	None	Intel 8265 ac, 2x2 + BT4.1	Sierra EM7455	None	None	None	None	Black	720p	Backlit	Finger-print Reader	None	dTPM 2.0	3-cell(23Wh) + 3-cell(26Wh)	45W Slim Tip	Win10 Pro 64	3-year, Depot	04/17
20HF005HUS	US	i7-7600U	vPro	Intel HD 620	8GB Soldered	14" FHD (1920x1080) IPS	10-point Multi-touch	256GB SSD M.2 PCIe NVMe Opal2	None	Intel 8265 ac, 2x2 + BT4.1	Sierra EM7455	None	None	None	None	Black	720p	Backlit	Finger-print Reader	None	dTPM 2.0	3-cell(23Wh) + 3-cell(26Wh)	45W Slim Tip	Win10 Pro 64	3-year, Depot	04/17
20HF005JUS	US	i7-7600U	vPro	Intel HD 620	8GB Soldered	14" FHD (1920x1080) IPS	None	256GB SSD M.2 PCIe NVMe Opal2	None	Intel 8265 ac, 2x2 + BT4.1	Sierra EM7455	None	None	None	None	Black	720p	Backlit	Finger-print Reader	None	dTPM 2.0	3-cell(23Wh) + 3-cell(26Wh)	45W Slim Tip	Win10 Pro 64	3-year, Depot	04/17
20HF005KUS	US	i7-7600U	vPro	Intel HD 620	8GB + 16GB	14" FHD (1920x1080) IPS	10-point Multi-touch	1TB SSD M.2 PCIe NVMe Opal2	None	Intel 8265 ac, 2x2 + BT4.1	WWAN Upgradable	None	None	None	None	Silver	720p	Backlit	Finger-print Reader	None	dTPM 2.0	3-cell(23Wh) + 3-cell(26Wh)	45W Slim Tip	Win10 Pro 64	3-year, Depot	04/17
20HF005LUS	US	i7-7600U	vPro	Intel HD 620	8GB + 16GB	14" FHD (1920x1080) IPS	10-point Multi-touch	1TB SSD M.2 PCIe NVMe Opal2	None	Intel 8265 ac, 2x2 + BT4.1	WWAN Upgradable	None	None	None	None	Black	720p	Backlit	Finger-print Reader	None	dTPM 2.0	3-cell(23Wh) + 3-cell(26Wh)	45W Slim Tip	Win10 Pro 64	3-year, Depot	04/17

Model	Region	Processor	vPro	Graphics	Memory (Soldered +DIMM)	Display	Multi-touch	Storage(HDD/SSD)	Optical	WLAN + Bluetooth	WWAN	SIM Card	Smart Card Reader	Dock	Monitor Cable	Color	Camera	Key-board	Finger-print Reader	NFC	TPM	Battery (internal)	Power Adapter	Operating System	Warranty	Ann Date (m/y)
20HF005MUS	US	i7-7600U	vPro	Intel HD 620	8GB + 16GB	14" WQHD (2560x1440) IPS	None	1TB SSD M.2 PCIe NVMe Opal2	None	Intel 8265 ac, 2x2 + BT4.1	WWAN Upgradable	None	None	None	None	Black	720p	Backlit	Finger-print Reader	None	dTPM 2.0	3-cell(23Wh) + 3-cell(26Wh)	45W Slim Tip	Win10 Pro 64	3-year, Depot	04/17
20HF005NUS	US	i5-7200U	No	Intel HD 620	4GB Soldered	14" FHD (1920x1080) IPS	None	180GB SSD M.2 Opal2	None	Intel 8265 ac, 2x2 + BT4.1	WWAN Upgradable	None	None	None	None	Black	720p	Backlit	Finger-print Reader	None	dTPM 2.0	3-cell(23Wh) + 3-cell(26Wh)	45W Slim Tip	Win10 Pro 64	1-year, Depot	04/17
20HF0063US	US	i5-7300U	vPro	Intel HD 620	8GB Soldered	14" FHD (1920x1080) IPS	10-point Multi-touch	256GB SSD M.2 PCIe NVMe Opal2	None	Intel 8265 ac, 2x2 + BT4.1	WWAN Upgradable	None	None	None	None	Black	720p	Backlit	Finger-print Reader	None	dTPM 2.0	3-cell(23Wh) + 3-cell(26Wh)	45W Slim Tip	Win10 Pro 64	3-year, Depot	06/17
20HF0064US	US	i5-7300U	vPro	Intel HD 620	8GB + 8GB	14" FHD (1920x1080) IPS	10-point Multi-touch	512GB SSD M.2 PCIe NVMe Opal2	None	Intel 8265 ac, 2x2 + BT4.1	WWAN Upgradable	None	None	None	None	Black	720p	Backlit	Finger-print Reader	None	dTPM 2.0	3-cell(23Wh) + 3-cell(26Wh)	45W Slim Tip	Win10 Pro 64	3-year, Depot	07/17
20HF0065US	US	i7-7600U	vPro	Intel HD 620	8GB + 8GB	14" FHD (1920x1080) IPS	10-point Multi-touch	512GB SSD M.2 PCIe NVMe Opal2	None	Intel 8265 ac, 2x2 + BT4.1	WWAN Upgradable	None	None	None	None	Black	720p	Backlit	Finger-print Reader	None	dTPM 2.0	3-cell(23Wh) + 3-cell(26Wh)	45W Slim Tip	Win10 Pro 64	3-year, Depot	07/17
20HF0066US	US	i5-7300U	vPro	Intel HD 620	8GB + 8GB	14" FHD (1920x1080) IPS	None	512GB SSD M.2 PCIe NVMe Opal2	None	Intel 8265 ac, 2x2 + BT4.1	WWAN Upgradable	None	None	None	None	Black	720p	Backlit	Finger-print Reader	None	dTPM 2.0	3-cell(23Wh) + 3-cell(26Wh)	45W Slim Tip	Win10 Pro 64	3-year, Depot	07/17
20HF006KUS	US	i5-7300U	vPro	Intel HD 620	8GB Soldered	14" FHD (1920x1080) IPS	None	512GB SSD M.2 Opal2	None	Intel 8265 ac, 2x2 + BT4.1	WWAN Upgradable	None	None	None	None	Black	720p	Backlit	Finger-print Reader	None	dTPM 2.0	3-cell(23Wh) + 3-cell(26Wh)	45W Slim Tip	Win10 Pro 64	3-year, Depot	10/17
20HF006LUS	US	i5-7300U	vPro	Intel HD 620	8GB Soldered	14" FHD (1920x1080) IPS	None	512GB SSD M.2 PCIe NVMe Opal2	None	Intel 8265 ac, 2x2 + BT4.1	WWAN Upgradable	None	None	None	None	Black	720p	Backlit	Finger-print Reader	None	dTPM 2.0	3-cell(23Wh) + 3-cell(26Wh)	45W Slim Tip	Win10 Pro 64	3-year, Depot	10/17

ThinkPad T470s - TopSeller - 20JS

Product Specifications Reference (PSREF)

Model	Region	Processor	vPro	Graphics	Memory (Soldered +DIMM)	Display	Multi-touch	Storage(HDD/SSD)	Optical	WLAN + Bluetooth	WWAN	SIM Card	Smart Card Reader	Dock	Monitor Cable	Color	Camera	Key-board	Finger-print Reader	NFC	TPM	Battery (internal)	Power Adapter	Operating System	Warranty	Ann Date (m/y)
20JS0004US	US	i7-6600U	vPro	Intel HD 520	4GB + 4GB	14" FHD (1920x1080) IPS	None	256GB SSD M.2 PCIe NVMe Opal2	None	Intel 8260 ac, 2x2 + BT4.1	WWAN Upgradable	None	None	None	None	Black	720p	Backlit	Finger-print Reader	None	dTPM 2.0	3-cell(23Wh) + 3-cell(26Wh)	45W Slim Tip	Win10 DG Win7 Pro 64	3-year, Depot	03/17
20JS000MUS	US	i7-6600U	vPro	Intel HD 520	4GB + 4GB	14" FHD (1920x1080) IPS	None	256GB SSD M.2 PCIe NVMe Opal2	None	Intel 8260 ac, 2x2 + BT4.1	WWAN Upgradable	None	None	None	None	Black	720p	Backlit	Finger-print Reader	None	dTPM 2.0	3-cell(23Wh) + 3-cell(26Wh)	45W Slim Tip	Win10 DG Win7 Pro 64	3-year, Depot	06/17
20JS0014US	US	i5-6300U	vPro	Intel HD 520	4GB Soldered	14" FHD (1920x1080) IPS	None	128GB SSD M.2	None	Intel 8260 ac, 2x2 + BT4.1	WWAN Upgradable	None	None	None	None	Black	720p	Backlit	Finger-print Reader	None	dTPM 2.0	3-cell(23Wh) + 3-cell(26Wh)	45W Slim Tip	Win10 DG Win7 Pro 64	1-year, Depot	03/17
20JS0015US	US	i5-6300U	vPro	Intel HD 520	4GB + 4GB	14" FHD (1920x1080) IPS	None	256GB SSD M.2 PCIe NVMe Opal2	None	Intel 8260 ac, 2x2 + BT4.1	WWAN Upgradable	None	None	None	None	Black	720p	Backlit	Finger-print Reader	None	dTPM 2.0	3-cell(23Wh) + 3-cell(26Wh)	45W Slim Tip	Win10 DG Win7 Pro 64	3-year, Depot	03/17
20JS0016US	US	i5-6300U	vPro	Intel HD 520	4GB Soldered	14" FHD (1920x1080) IPS	None	180GB SSD M.2 Opal2	None	Intel 8260 ac, 2x2 + BT4.1	WWAN Upgradable	None	Smart Card Reader	None	None	Black	720p	Backlit	Finger-print Reader	None	dTPM 2.0	3-cell(23Wh) + 3-cell(26Wh)	45W Slim Tip	Win10 DG Win7 Pro 64	1-year, Depot	03/17
20JS0017US	US	i5-6300U	vPro	Intel HD 520	4GB + 4GB	14" FHD (1920x1080) IPS	None	180GB SSD M.2 Opal2	None	Intel 8260 ac, 2x2 + BT4.1	WWAN Upgradable	None	Smart Card Reader	None	None	Black	720p	Backlit	Finger-print Reader	None	dTPM 2.0	3-cell(23Wh) + 3-cell(26Wh)	45W Slim Tip	Win10 DG Win7 Pro 64	3-year, Depot	03/17
20JS0018US	US	i5-6300U	vPro	Intel HD 520	4GB Soldered	14" FHD (1920x1080) IPS	None	180GB SSD M.2 Opal2	None	Intel 8260 ac, 2x2 + BT4.1	WWAN Upgradable	None	None	None	None	Black	720p	Backlit	Finger-print Reader	None	dTPM 2.0	3-cell(23Wh) + 3-cell(26Wh)	45W Slim Tip	Win10 DG Win7 Pro 64	1-year, Depot	03/17
20JS0019US	US	i5-6300U	vPro	Intel HD 520	4GB + 4GB	14" FHD (1920x1080) IPS	None	256GB SSD M.2 PCIe NVMe Opal2	None	Intel 8260 ac, 2x2 + BT4.1	Sierra EM7455	None	None	None	None	Black	720p	Backlit	Finger-print Reader	None	dTPM 2.0	3-cell(23Wh) + 3-cell(26Wh)	45W Slim Tip	Win10 DG Win7 Pro 64	3-year, Depot	04/17
20JS001AUS	US	i7-6600U	vPro	Intel HD 520	4GB + 4GB	14" FHD (1920x1080) IPS	None	256GB SSD M.2 PCIe NVMe Opal2	None	Intel 8260 ac, 2x2 + BT4.1	Sierra EM7455	None	None	None	None	Black	720p	Backlit	Finger-print Reader	None	dTPM 2.0	3-cell(23Wh) + 3-cell(26Wh)	45W Slim Tip	Win10 DG Win7 Pro 64	3-year, Depot	04/17
20JS001BUS	US	i7-6600U	vPro	Intel HD 520	4GB + 4GB	14" FHD (1920x1080) IPS	10-point Multi-touch	256GB SSD M.2 PCIe NVMe Opal2	None	Intel 8260 ac, 2x2 + BT4.1	Sierra EM7455	None	None	None	None	Black	720p	Backlit	Finger-print Reader	None	dTPM 2.0	3-cell(23Wh) + 3-cell(26Wh)	45W Slim Tip	Win10 DG Win7 Pro 64	3-year, Depot	04/17
20JS001CUS	US	i7-6600U	vPro	Intel HD 520	4GB + 16GB	14" FHD (1920x1080) IPS	10-point Multi-touch	1TB SSD M.2 PCIe NVMe Opal2	None	Intel 8260 ac, 2x2 + BT4.1	Sierra EM7455	None	None	None	None	Black	720p	Backlit	Finger-print Reader	None	dTPM 2.0	3-cell(23Wh) + 3-cell(26Wh)	45W Slim Tip	Win10 DG Win7 Pro 64	3-year, Depot	04/17
20JS001DUS	US	i7-6600U	vPro	Intel HD 520	4GB + 16GB	14" FHD (1920x1080) IPS	None	1TB SSD M.2 PCIe NVMe Opal2	None	Intel 8260 ac, 2x2 + BT4.1	Sierra EM7455	None	None	None	None	Black	720p	Backlit	Finger-print Reader	None	dTPM 2.0	3-cell(23Wh) + 3-cell(26Wh)	45W Slim Tip	Win10 DG Win7 Pro 64	3-year, Depot	04/17
20JS001GUS	US	i5-6300U	vPro	Intel HD 520	4GB + 4GB	14" FHD (1920x1080) IPS	None	256GB SSD M.2 PCIe NVMe Opal2	None	Intel 8260 ac, 2x2 + BT4.1	WWAN Upgradable	None	None	None	None	Black	720p	Backlit	Finger-print Reader	None	dTPM 2.0	3-cell(23Wh) + 3-cell(26Wh)	45W Slim Tip	Win10 DG Win7 Pro 64	3-year, Depot	06/17
20JS001HUS	US	i5-6300U	vPro	Intel HD 520	4GB + 8GB	14" FHD (1920x1080) IPS	None	512GB SSD M.2 PCIe NVMe Opal2	None	Intel 8260 ac, 2x2 + BT4.1	WWAN Upgradable	None	None	None	None	Black	720p	Backlit	Finger-print Reader	None	dTPM 2.0	3-cell(23Wh) + 3-cell(26Wh)	45W Slim Tip	Win10 DG Win7 Pro 64	3-year, Depot	07/17
20JS001JUS	US	i7-6600U	vPro	Intel HD 520	4GB + 8GB	14" FHD (1920x1080) IPS	None	512GB SSD M.2 PCIe NVMe Opal2	None	Intel 8260 ac, 2x2 + BT4.1	WWAN Upgradable	None	None	None	None	Black	720p	Backlit	Finger-print Reader	None	dTPM 2.0	3-cell(23Wh) + 3-cell(26Wh)	45W Slim Tip	Win10 DG Win7 Pro 64	3-year, Depot	07/17
20JS001KUS	US	i7-6600U	vPro	Intel HD 520	4GB + 8GB	14" FHD (1920x1080) IPS	10-point Multi-touch	512GB SSD M.2 PCIe NVMe Opal2	None	Intel 8260 ac, 2x2 + BT4.1	WWAN Upgradable	None	None	None	None	Black	720p	Backlit	Finger-print Reader	None	dTPM 2.0	3-cell(23Wh) + 3-cell(26Wh)	45W Slim Tip	Win10 DG Win7 Pro 64	3-year, Depot	07/17
20JS001LUS	US	i5-6300U	vPro	Intel HD 520	4GB + 8GB	14" FHD (1920x1080) IPS	10-point Multi-touch	512GB SSD M.2 PCIe NVMe Opal2	None	Intel 8260 ac, 2x2 + BT4.1	WWAN Upgradable	None	None	None	None	Black	720p	Backlit	Finger-print Reader	None	dTPM 2.0	3-cell(23Wh) + 3-cell(26Wh)	45W Slim Tip	Win10 DG Win7 Pro 64	3-year, Depot	07/17
20JS0023US	US	i5-6300U	vPro	Intel HD 520	4GB + 4GB	14" FHD (1920x1080) IPS	None	256GB SSD M.2 Opal2	None	Intel 8260 ac, 2x2 + BT4.1	WWAN Upgradable	None	None	None	None	Black	720p	Backlit	Finger-print Reader	None	dTPM 2.0	3-cell(23Wh) + 3-cell(26Wh)	45W Slim Tip	Win10 DG Win7 Pro 64	3-year, Depot	10/17
20JS0024US	US	i5-6300U	vPro	Intel HD 520	4GB + 4GB	14" FHD (1920x1080) IPS	None	512GB SSD M.2 Opal2	None	Intel 8260 ac, 2x2 + BT4.1	WWAN Upgradable	None	None	None	None	Black	720p	Backlit	Finger-print Reader	None	dTPM 2.0	3-cell(23Wh) + 3-cell(26Wh)	45W Slim Tip	Win10 DG Win7 Pro 64	3-year, Depot	10/17
20JS0025US	US	i5-6300U	vPro	Intel HD 520	4GB + 4GB	14" FHD (1920x1080) IPS	None	512GB SSD M.2 PCIe NVMe Opal2	None	Intel 8260 ac, 2x2 + BT4.1	WWAN Upgradable	None	None	None	None	Black	720p	Backlit	Finger-print Reader	None	dTPM 2.0	3-cell(23Wh) + 3-cell(26Wh)	45W Slim Tip	Win10 DG Win7 Pro 64	3-year, Depot	10/17



ThinkPad T480 Platform Specifications

Product Specifications Reference (PSREF)

Processor	7th Generation Intel® Core™ i5 Processor							Dimensions Weight	WxDxH: 13.25" x 9.15" x 0.79"; 336.6mm x 232.5mm x 19.95mm						
	Processor Number	# of Cores	# of Threads	Base Frequency	Max Turbo Frequency	Cache	Memory Types		Processor Graphics	Models	24Wh or 24Wh + 24Wh	48Wh, 72Wh, or 24Wh + 48Wh / 72Wh			
	i5-7200U	2	4	2.5 GHz	3.1 GHz	3MB	DDR4-2133	Intel HD Graphics 620	Integrated Magnesium	3.49 lb / 1.58 kg	3.92 lb / 1.78 kg				
	i5-7300U			2.6 GHz	3.5 GHz	3MB			Discrete Magnesium	3.53 lb / 1.60 kg	3.97 lb / 1.80 kg				
	or 8th Generation Intel Core i5 / i7 Processor							Case color Case material	Black Display cover: Magnesium Hybrid or PPS; Bottom: Glass-Fiber Reinforced Plastic						
	Processor Number	# of Cores	# of Threads	Base Frequency	Max Turbo Frequency	Cache	Memory Types		Processor Graphics	Smart card reader	Optional: Smart card reader				
	i3-8130U	4	8	2.2 GHz	3.4 GHz	4MB	DDR4-2400	Intel UHD Graphics 620	Media reader	4-in-1 reader (MMC, SD, SDHC, SDXC)					
	i5-8250U			1.6 GHz	3.4 GHz	6MB			Ports	Two USB 3.1 Gen 1 (one Always On), USB 3.1 Type-C Gen 1, USB 3.1 Type-C Gen 2 / Thunderbolt 3, HDMI 1.4b, Ethernet (RJ-45), nano-SIM card slot (WWAN models), headphone / microphone combo jack, optional smart card reader, 4-in-1 reader (MMC, SD, SDHC, SDXC), side docking connector, security keyhole					
	i5-8350U			1.7 GHz	3.6 GHz	6MB			Monitor cable (optional)	USB-C to VGA: Lenovo USB-C to VGA Adapter USB-C to DP: Lenovo USB-C to DisplayPort Adapter					
	i7-8550U			1.8 GHz	4.0 GHz	8MB			Camera (optional)	One of the following, configurable by model: • HD720p camera with ThinkShutter camera privacy, fixed focus • IR camera and HD720p camera, fixed focus					
	i7-8650U			1.9 GHz	4.2 GHz	8MB			Audio support	HD Audio, Realtek® ALC3287 codec, Dolby® Audio™ Premium / stereo speakers, 2W x 2 / dual array microphone, headphone / microphone combo jack					
Graphics	Intel HD Graphics 620 or Intel UHD Graphics 620 in processor only or Intel HD Graphics 620 or Intel UHD Graphics 620 in processor and NVIDIA® GeForce® MX150, 2GB GDDR5 memory (discrete graphics is available only on i7 models in EMEA); supports external digital monitor via HDMI or USB Type-C; supports three independent displays; Max resolution: 4096x2304@60Hz (USB Type-C); 4096x2160@30Hz (HDMI)							Keyboard	6-row, spill-resistant, multimedia Fn keys, optional LED backlight UltraNav™						
Chipset	Intel SoC (System on Chip) platform							Security	Power-on password, hard disk password, supervisor password, security keyhole						
Memory	32GB max / 2400MHz DDR4, dual-channel capable, two DDR4 SO-DIMM sockets * System clocks down for processors with lower memory controller							Security chip	Discrete TPM 2.0, TCG Certified						
Display	Some: 14.0" (355mm) HD (1366x768), anti-glare, LED backlight, 220 nits, 16:9 aspect ratio, 400:1 contrast ratio Some: 14.0" (355mm) FHD (1920x1080), anti-glare, LED backlight, IPS, 250 nits, 16:9 aspect ratio, 700:1 contrast ratio, 170° viewing angle Some: 14.0" (355mm) WQHD (2560x1440), anti-glare, LED backlight, IPS, 300 nits, 16:9 aspect ratio, 700:1 contrast ratio, 72% gamut, 170° viewing angle							vPro (optional)	Intel vPro Technology						
Multi-touch (opt)	On-cell touch, supports 10-finger gesture (FHD only)							Fingerprint reader	Optional: Touch style match on chip fingerprint reader on the keyboard bezel, anti-spoofing technology						
Storage	System has one HDD slot or one M.2 2280 slot exclusively for storage Some: HDD / SATA 6.0Gb/s, 2.5" wide, 7mm high, Active Protection System™ Some: SSD / SATA 6.0Gb/s, 2.5" wide, 7mm high (e.g. xxxGB SSD) Some: M.2 SSD / PCIe NVMe, PCIe 3.0 x 4, 32Gb/s Some: 128GB M.2 SSD / PCIe NVMe, PCIe 3.0 x 2, 16Gb/s, in WWAN slot as 2nd Storage, mutually exclusive with WWAN Some: 16GB Intel Optane™ memory, PCIe NVMe, PCIe 3.0 x 2, 16Gb/s, in WWAN slot as storage cache for HDD, mutually exclusive with WWAN							NFC (optional)	Near Field Communication						
Optical	None							Battery	Optional integrated Li-Ion 24Wh battery and external Li-Ion 24Wh, 48Wh, or 72Wh battery						
Ethernet	Non-vPro model: Intel Ethernet Connection I219-V (Jacksonville) vPro model: Intel Ethernet Connection I219-LM (Jacksonville)							Max battery life (MobileMark® 2014)	Models	24Wh	48Wh	72Wh	24Wh + 24Wh	24Wh + 48Wh	24Wh + 72Wh
WLAN + Bluetooth™	Intel Dual Band Wireless-AC 8265, Wi-Fi 2x2 802.11ac + Bluetooth 4.1, M.2 card * Intel 8265ac card supports BT4.2 but is limited to BT4.1 by Windows OS							Integrated model	7.2 hr	14.4 hr	21.8 hr	14.4 hr	21.8 hr	29.0 hr	
WWAN (optional)	One of the following, configurable by model (mutually exclusive with Intel Optane memory): • Integrated Mobile Broadband 4G LTE, Intel XMM™ 7262 (Fibocom L830-EB), M.2 card (EMEA only) • Integrated Mobile Broadband 4G LTE-A, Intel XMM™ 7360 (Fibocom L850-GL), M.2 card							discrete model	6.6 hr	13.2 hr	19.8 hr	13.6 hr	19.8 hr	26.4 hr	
SIM card (opt)	Nano-SIM card slot, optional Verizon LTE (US) SIM card							AC adapter	* Battery life varies significantly with settings, usage, & other factors 45W or 65W USB Type-C AC adapter						
								Preload	Windows® 10 Home 64 or Windows 10 Pro 64						
								Limited warranty	One of the following, configurable by model: • 1-year depot repair service • 3-year/1-yr battery depot repair service • 3-year/1-yr battery limited onsite service						
								Mil-Spec test	MIL-STD-810G military certification						
								Environment	EPEAT™ Gold; ENERGY STAR® 6.1; RoHS-compliant						

Model	Region	Processor	vPro	Graphics	Memory	Display	Multi-touch	Storage(HDD/SSD)	Optical	WLAN + Bluetooth	WWAN	SIM Card	Smart Card Reader	Monitor Cable	Case Material	Camera	Key-board	Finger-print Reader	NFC	TPM	Battery (internal+external)	Power Adapter	Operating System	Warranty	Ann Date (m/y)
20L5000TUS	US	i5-8350U	vPro	Intel UHD 620	8GBx1	14" FHD (1920x1080) IPS	None	512GB SSD M.2 PCIe NVMe Opal2	None	Intel 8265 ac, 2x2 + BT4.1	None	None	None	None	PPS	720p	Backlit	Finger-print Reader	None	dTPM 2.0	24Wh + 24Wh	65W USB-C	Win10 Pro 64	3-year, Depot	02/18
20L5000UUS	US	i7-8550U	No	Intel UHD 620	8GBx1	14" FHD (1920x1080) IPS	None	256GB SSD M.2 PCIe NVMe Opal2	None	Intel 8265 ac, 2x2 + BT4.1	None	None	None	None	PPS	720p	Backlit	Finger-print Reader	None	dTPM 2.0	24Wh + 24Wh	65W USB-C	Win10 Pro 64	3-year, Depot	02/18
20L5000VUS	US	i7-8650U	vPro	Intel UHD 620	8GBx1	14" FHD (1920x1080) IPS	10-point Multi-touch	256GB SSD M.2 PCIe NVMe Opal2	None	Intel 8265 ac, 2x2 + BT4.1	None	None	None	None	PPS	720p	Backlit	Finger-print Reader	None	dTPM 2.0	24Wh + 24Wh	65W USB-C	Win10 Pro 64	3-year, Depot	02/18
20L5000WUS	US	i5-8250U	No	Intel UHD 620	4GBx1	14" HD (1366x768)	None	500GB 7200rpm	None	Intel 8265 ac, 2x2 + BT4.1	None	None	None	None	PPS	720p	Non-backlit	Finger-print Reader	None	dTPM 2.0	24Wh + 24Wh	65W USB-C	Win10 Pro 64	1-year, Depot	02/18
20L5000XUS	US	i7-8650U	vPro	MX150 2GB	16GBx1	14" WQHD (2560x1440) IPS	None	512GB SSD M.2 PCIe NVMe Opal2	None	Intel 8265 ac, 2x2 + BT4.1	None	None	None	None	PPS	IR &720p	Backlit	Finger-print Reader	None	dTPM 2.0	24Wh + 24Wh	65W USB-C	Win10 Pro 64	3-year, Depot	02/18
20L5000YUS	US	i5-8250U	No	Intel UHD 620	8GBx1	14" FHD (1920x1080) IPS	None	256GB SSD M.2 PCIe NVMe Opal2	None	Intel 8265 ac, 2x2 + BT4.1	None	None	None	None	PPS	720p	Backlit	Finger-print Reader	None	dTPM 2.0	24Wh + 24Wh	65W USB-C	Win10 Pro 64	3-year, Depot	02/18
20L50010US	US	i7-8650U	vPro	Intel UHD 620	16GBx1	14" FHD (1920x1080) IPS	10-point Multi-touch	512GB SSD M.2 PCIe NVMe Opal2	None	Intel 8265 ac, 2x2 + BT4.1	None	None	None	None	PPS	720p	Backlit	Finger-print Reader	None	dTPM 2.0	24Wh + 24Wh	65W USB-C	Win10 Pro 64	3-year, Depot	02/18
20L50011US	US	i5-8350U	vPro	Intel UHD 620	8GBx1	14" FHD (1920x1080) IPS	None	256GB SSD M.2 PCIe NVMe Opal2	None	Intel 8265 ac, 2x2 + BT4.1	None	None	None	None	PPS	720p	Backlit	Finger-print Reader	None	dTPM 2.0	24Wh + 24Wh	65W USB-C	Win10 Pro 64	3-year, Depot	02/18
20L50012US	US	i5-8250U	No	Intel UHD 620	8GBx1	14" FHD (1920x1080) IPS	None	500GB 7200rpm	None	Intel 8265 ac, 2x2 + BT4.1	None	None	None	None	PPS	720p	Non-backlit	Finger-print Reader	None	dTPM 2.0	24Wh + 24Wh	65W USB-C	Win10 Pro 64	3-year, Depot	02/18
20L50013US	US	i7-8650U	vPro	Intel UHD 620	8GBx1	14" FHD (1920x1080) IPS	None	256GB SSD M.2 PCIe NVMe Opal2	None	Intel 8265 ac, 2x2 + BT4.1	None	None	None	None	PPS	720p	Backlit	Finger-print Reader	None	dTPM 2.0	24Wh + 24Wh	65W USB-C	Win10 Pro 64	3-year, Depot	02/18
20L50014US	US	i5-8250U	No	Intel UHD 620	8GBx1	14" FHD (1920x1080) IPS	10-point Multi-touch	256GB SSD M.2 PCIe NVMe Opal2	None	Intel 8265 ac, 2x2 + BT4.1	None	None	None	None	PPS	720p	Backlit	Finger-print Reader	None	dTPM 2.0	24Wh + 24Wh	65W USB-C	Win10 Pro 64	3-year, Depot	02/18
20L50015US	US	i7-8650U	vPro	Intel UHD 620	16GBx1	14" FHD (1920x1080) IPS	10-point Multi-touch	256GB SSD M.2 PCIe NVMe Opal2	None	Intel 8265 ac, 2x2 + BT4.1	None	None	None	None	PPS	IR &720p	Backlit	Finger-print Reader	None	dTPM 2.0	24Wh + 24Wh	65W USB-C	Win10 Pro 64	3-year, Depot	02/18
20L50016US	US	i5-7300U	vPro	Intel HD 620	4GBx1	14" HD (1366x768)	None	500GB 7200rpm	None	Intel 8265 ac, 2x2 + BT4.1	None	None	None	None	PPS	720p	Non-backlit	Finger-print Reader	None	dTPM 2.0	24Wh + 24Wh	65W USB-C	Win10 Pro 64	1-year, Depot	02/18
20L50017US	US	i5-8350U	vPro	Intel UHD 620	16GBx1	14" FHD (1920x1080) IPS	None	256GB SSD M.2 PCIe NVMe Opal2	None	Intel 8265 ac, 2x2 + BT4.1	None	None	None	None	PPS	720p	Backlit	Finger-print Reader	None	dTPM 2.0	24Wh + 24Wh	65W USB-C	Win10 Pro 64	3-year, Depot	02/18
20L50018US	US	i7-8650U	vPro	Intel UHD 620	16GBx1	14" FHD (1920x1080) IPS	None	512GB SSD M.2 PCIe NVMe Opal2	None	Intel 8265 ac, 2x2 + BT4.1	None	None	None	None	PPS	720p	Backlit	Finger-print Reader	None	dTPM 2.0	24Wh + 24Wh	65W USB-C	Win10 Pro 64	3-year, Depot	02/18
20L50019US	US	i5-8350U	vPro	Intel UHD 620	8GBx1	14" FHD (1920x1080) IPS	None	500GB 7200rpm	None	Intel 8265 ac, 2x2 + BT4.1	None	None	None	None	PPS	720p	Non-backlit	Finger-print Reader	None	dTPM 2.0	24Wh + 24Wh	65W USB-C	Win10 Pro 64	3-year, Depot	02/18
20L5001AUS	US	i5-8350U	vPro	Intel UHD 620	16GBx1	14" FHD (1920x1080) IPS	10-point Multi-touch	256GB SSD M.2 PCIe NVMe Opal2	None	Intel 8265 ac, 2x2 + BT4.1	None	None	None	None	PPS	IR &720p	Backlit	Finger-print Reader	None	dTPM 2.0	24Wh + 24Wh	65W USB-C	Win10 Pro 64	3-year, Depot	02/18
20L5001BUS	US	i5-8250U	No	Intel UHD 620	8GBx1	14" FHD (1920x1080) IPS	None	128GB SSD	None	Intel 8265 ac, 2x2 + BT4.1	None	None	None	None	PPS	720p	Backlit	Finger-print Reader	None	dTPM 2.0	24Wh + 24Wh	65W USB-C	Win10 Pro 64	3-year, Depot	02/18
20L5001CUS	US	i7-8550U	No	Intel UHD 620	8GBx1	14" FHD (1920x1080) IPS	10-point Multi-touch	256GB SSD M.2 PCIe NVMe Opal2	None	Intel 8265 ac, 2x2 + BT4.1	None	None	None	None	PPS	720p	Backlit	Finger-print Reader	None	dTPM 2.0	24Wh + 24Wh	65W USB-C	Win10 Pro 64	3-year, Depot	02/18
20L5001DUS	US	i5-8350U	vPro	Intel UHD 620	8GBx1	14" FHD (1920x1080) IPS	10-point Multi-touch	256GB SSD M.2 PCIe NVMe Opal2	None	Intel 8265 ac, 2x2 + BT4.1	None	None	None	None	PPS	720p	Backlit	Finger-print Reader	None	dTPM 2.0	24Wh + 24Wh	65W USB-C	Win10 Pro 64	3-year, Depot	02/18

Model	Region	Processor	vPro	Graphics	Memory	Display	Multi-touch	Storage(HDD/SSD)	Optical	WLAN + Bluetooth	WWAN	SIM Card	Smart Card Reader	Monitor Cable	Case Material	Camera	Key-board	Finger-print Reader	NFC	TPM	Battery (internal+external)	Power Adapter	Operating System	War-ranty	Ann Date (m/y)
20L5004HUS	US	i5-8250U	No	Intel UHD 620	8GBx1	14" HD (1366x768)	None	500GB 7200rpm	None	Intel 8265 ac, 2x2 + BT4.1	None	None	None	None	PPS	720p	Non-backlit	Finger-print Reader	None	dTPM 2.0	24Wh + 24Wh	65W USB-C	Win10 Pro 64	1-year, Depot	02/18
20L5004JUS	US	i5-8250U	No	Intel UHD 620	8GBx1	14" FHD (1920x1080) IPS	None	500GB 7200rpm	None	Intel 8265 ac, 2x2 + BT4.1	Fibocom L850-GL	None	None	None	PPS	720p	Non-backlit	Finger-print Reader	None	dTPM 2.0	24Wh + 24Wh	65W USB-C	Win10 Pro 64	3-year, Depot	04/18
20L5004KUS	US	i7-8650U	vPro	Intel UHD 620	8GBx1	14" FHD (1920x1080) IPS	None	256GB SSD M.2 PCIe NVMe Opal2	None	Intel 8265 ac, 2x2 + BT4.1	Fibocom L850-GL	None	None	None	PPS	720p	Backlit	Finger-print Reader	None	dTPM 2.0	24Wh + 24Wh	65W USB-C	Win10 Pro 64	3-year, Depot	04/18
20L5004LUS	US	i5-8350U	vPro	Intel UHD 620	8GBx1	14" FHD (1920x1080) IPS	None	256GB SSD M.2 PCIe NVMe Opal2	None	Intel 8265 ac, 2x2 + BT4.1	Fibocom L850-GL	None	None	None	PPS	720p	Backlit	Finger-print Reader	None	dTPM 2.0	24Wh + 24Wh	65W USB-C	Win10 Pro 64	3-year, Depot	04/18
20L5004MUS	US	i7-8550U	No	Intel UHD 620	8GBx1	14" FHD (1920x1080) IPS	None	256GB SSD M.2 PCIe NVMe Opal2	None	Intel 8265 ac, 2x2 + BT4.1	Fibocom L850-GL	None	None	None	PPS	720p	Backlit	Finger-print Reader	None	dTPM 2.0	24Wh + 24Wh	65W USB-C	Win10 Pro 64	3-year, Depot	04/18
20L5004NUS	US	i5-7300U	vPro	Intel HD 620	8GBx1	14" FHD (1920x1080) IPS	None	256GB SSD M.2 PCIe NVMe Opal2	None	Intel 8265 ac, 2x2 + BT4.1	Fibocom L850-GL	None	None	None	PPS	720p	Backlit	Finger-print Reader	None	dTPM 2.0	24Wh + 24Wh	65W USB-C	Win10 Pro 64	3-year, Depot	04/18
20L5004PUS	US	i7-8650U	vPro	Intel UHD 620	8GBx1	14" FHD (1920x1080) IPS	10-point Multi-touch	256GB SSD M.2 PCIe NVMe Opal2	None	Intel 8265 ac, 2x2 + BT4.1	Fibocom L850-GL	None	None	None	PPS	720p	Backlit	Finger-print Reader	None	dTPM 2.0	24Wh + 24Wh	65W USB-C	Win10 Pro 64	3-year, Depot	04/18
20L5004QUS	US	i7-8650U	vPro	Intel UHD 620	16GBx1	14" FHD (1920x1080) IPS	None	512GB SSD M.2 PCIe NVMe Opal2	None	Intel 8265 ac, 2x2 + BT4.1	Fibocom L850-GL	None	None	None	PPS	720p	Backlit	Finger-print Reader	None	dTPM 2.0	24Wh + 24Wh	65W USB-C	Win10 Pro 64	3-year, Depot	04/18
20L50053US	US	i5-8250U	No	Intel UHD 620	4GBx1	14" HD (1366x768)	None	500GB 7200rpm + 16GB Optane Memory	None	Intel 8265 ac, 2x2 + BT4.1	None	None	None	None	PPS	720p	Non-backlit	Finger-print Reader	None	dTPM 2.0	24Wh + 24Wh	65W USB-C	Win10 Pro 64	1-year, Depot	04/18
20L50054US	US	i5-8350U	vPro	Intel UHD 620	4GBx1	14" FHD (1920x1080) IPS	None	500GB 7200rpm + 16GB Optane Memory	None	Intel 8265 ac, 2x2 + BT4.1	None	None	None	None	PPS	720p	Backlit	Finger-print Reader	None	dTPM 2.0	24Wh + 24Wh	65W USB-C	Win10 Pro 64	3-year, Depot	04/18
20L5005BUS	US	i5-8250U	No	Intel UHD 620	8GBx1	14" HD (1366x768)	None	180GB SSD Opal2	None	Intel 8265 ac, 2x2 + BT4.1	None	None	None	None	PPS	720p	Non-backlit	Finger-print Reader	None	dTPM 2.0	24Wh + 24Wh	65W USB-C	Win10 Pro 64	1-year, Depot	05/18
20L5005CUS	US	i5-8250U	No	Intel UHD 620	8GBx1	14" FHD (1920x1080) IPS	None	180GB SSD Opal2	None	Intel 8265 ac, 2x2 + BT4.1	None	None	None	None	PPS	720p	Backlit	Finger-print Reader	None	dTPM 2.0	24Wh + 24Wh	65W USB-C	Win10 Pro 64	3-year, Depot	05/18



ThinkPad T480s Platform Specifications

Product Specifications Reference (PSREF)

Processor	7th Generation Intel® Core™ i5 Processor								Dimensions	<i>WxDxH:</i> 13.03" x 8.93" x 0.73"; 331mm x 226.8mm x 18.45mm
	Processor Number	# of Cores	# of Threads	Base Frequency	Max Turbo Frequency	Cache	Memory Types	Processor Graphics	Weight	Starting at 2.9 lb (1.32kg)
	i5-7300U	2	4	2.6 GHz	3.5 GHz	3MB	DDR4-2133	Intel HD Graphics 620	Case color	Black or Silver
	or 8th Generation Intel Core i5 / i7 Processor								Case material	<i>Display cover:</i> CFRP Hybrid; <i>Bottom:</i> Magnesium
	Processor Number	# of Cores	# of Threads	Base Frequency	Max Turbo Frequency	Cache	Memory Types	Processor Graphics	Smart card reader	<i>Optional:</i> Smart card reader
	i5-8250U	4	8	1.6 GHz	3.4 GHz	6MB	DDR4-2400	Intel UHD Graphics 620	Media reader	4-in-1 reader (MMC, SD, SDHC, SDXC)
	i5-8350U			1.7 GHz	3.6 GHz	6MB			Ports	Two USB 3.1 Gen 1 (one Always On), USB 3.1 Type-C Gen 1, USB 3.1 Type-C Gen 2 / Thunderbolt 3, HDMI 1.4b, Ethernet (RJ-45), nano-SIM card slot (WWAN models), headphone / microphone combo jack, optional smart card reader, 4-in-1 reader (MMC, SD, SDHC, SDXC), side docking connector, security keyhole
	i7-8550U			1.8 GHz	4.0 GHz	8MB			Monitor cable (<i>optional</i>)	<i>USB-C to VGA:</i> Lenovo USB-C to VGA Adapter <i>USB-C to DP:</i> Lenovo USB-C to DisplayPort Adapter
	i7-8650U			1.9 GHz	4.2 GHz	8MB			Camera	<i>One of the following, configurable by model:</i> • HD720p camera with ThinkShutter camera privacy, fixed focus • IR camera and HD720p camera, fixed focus
Graphics	Intel HD Graphics 620 or Intel UHD Graphics 620 in processor only or Intel UHD Graphics 620 in processor and NVIDIA® GeForce® MX150, 2GB GDDR5 memory (discrete models are NOT available in EMEA); supports external digital monitor via HDMI or USB Type-C; supports three independent displays; Max resolution: 4096x2304@60Hz (USB Type-C); 4096x2160@30Hz (HDMI)								Audio support	HD Audio, Realtek® ALC3287 codec, Dolby® Audio™ Premium / stereo speakers, 1W x 2 / dual array microphone, headphone / microphone combo jack
Chipset	Intel SoC (System on Chip) platform								Keyboard	6-row, spill-resistant, multimedia Fn keys, optional LED backlight
Memory	20GB or 24GB max / 2400MHz DDR4, dual-channel capable, 4GB or 8GB memory soldered to systemboard, one DDR4 SO-DIMM socket * System clocks down for processors with lower memory controller								UltraNav™	TrackPoint® pointing device and buttonless Mylar surface multi-touch touchpad
Display	<i>Some:</i> 14.0" (355mm) FHD (1920x1080), anti-glare, LED backlight, IPS, 250 nits, 16:9 aspect ratio, 700:1 contrast ratio, 170° viewing angle <i>Some:</i> 14.0" (355mm) WQHD (2560x1440), anti-glare, LED backlight, IPS, 300 nits, 16:9 aspect ratio, 700:1 contrast ratio, 72% gamut, 170° viewing angle								Security	Power-on password, hard disk password, supervisor password, security keyhole
Multi-touch (<i>opt</i>)	On-cell touch, supports 10-finger gesture, 250 nits (FHD only)								Security chip	Discrete TPM 2.0, TCG Certified
Storage	<i>One of the following, configurable by model:</i> • M.2 SSD / SATA 6.0Gb/s (e.g. xxxGB SSD M.2) • M.2 SSD / PCIe NVMe, PCIe 3.0 x 4, 32Gb/s (e.g. xxxGB SSD M.2 PCIe NVMe)								vPro (<i>optional</i>)	Intel vPro Technology
Optical	None								Fingerprint reader	<i>Optional:</i> Touch style match on chip fingerprint reader on the palm rest, anti-spoofing technology
Ethernet	<i>Non-vPro model:</i> Intel Ethernet Connection I219-V (Jacksonville) <i>vPro model:</i> Intel Ethernet Connection I219-LM (Jacksonville)								NFC (<i>optional</i>)	Near Field Communication
WLAN + Bluetooth™	Intel Dual Band Wireless-AC 8265, Wi-Fi 2x2 802.11ac + Bluetooth 4.1, M.2 card * Intel 8265ac card supports BT4.2 but is limited to BT4.1 by Windows OS								Battery	Integrated Li-Ion 57Wh battery, supports Rapid Charge (0-80% in 60 mins) with 65W USB Type-C AC adapter
WWAN (<i>optional</i>)	<i>One of the following, configurable by model:</i> • Wireless WAN upgradable • Integrated Mobile Broadband 4G LTE, Intel XMM™ 7262 (Fibocom L830-EB), M.2 card (EMEA only) • Integrated Mobile Broadband 4G LTE-A, Intel XMM™ 7360 (Fibocom L850-GL), M.2 card								Max battery life	<i>MobileMark® 2014:</i> 15.6 hr * Battery life varies significantly with settings, usage, & other factors
SIM card (<i>opt</i>)	Nano-SIM card slot, optional Verizon LTE (US) SIM card								AC adapter	45W or 65W USB Type-C AC adapter
									Operating system	Windows® 10 Home 64 or Windows 10 Pro 64
									Limited warranty	<i>One of the following, configurable by model:</i> • 1-year depot repair service • 3-year/1-yr battery depot repair service • 3-year/1-yr battery limited onsite service
									Mil-Spec test	MIL-STD-810G military certification
									Environment	EPPEAT™ Gold; ENERGY STAR® 6.1; RoHS-compliant

Model	Region	Processor	vPro	Graphics	Memory (Soldered +DIMM)	Display	Multi-touch	Storage(HDD/SSD)	Optical	WLAN + Bluetooth	WWAN	SIM Card	Smart Card Reader	Monitor Cable	Color	Camera	Key-board	Finger-print Reader	NFC	TPM	Battery	Power Adapter	Operating System	Warranty	Ann Date (m/y)
20L7001WUS	US	i5-8250U	No	Intel UHD 620	8GB Soldered	14" FHD (1920x1080) IPS	None	128GB SSD M.2	None	Intel 8265 ac, 2x2 + BT4.1	WWAN Upgradable	None	None	None	Black	720p	Backlit	Finger-print Reader	None	dTPM 2.0	57Wh	65W USB-C	Win10 Pro 64	3-year, Depot	01/18
20L7001XUS	US	i5-8350U	vPro	Intel UHD 620	8GB + 8GB	14" FHD (1920x1080) IPS	10-point Multi-touch	256GB SSD M.2 PCIe NVMe Opal2	None	Intel 8265 ac, 2x2 + BT4.1	WWAN Upgradable	None	None	None	Black	IR &720p	Backlit	Finger-print Reader	None	dTPM 2.0	57Wh	65W USB-C	Win10 Pro 64	3-year, Depot	01/18
20L7001YUS	US	i7-8650U	vPro	Intel UHD 620	8GB + 8GB	14" WQHD (2560x1440) IPS	None	512GB SSD M.2 PCIe NVMe Opal2	None	Intel 8265 ac, 2x2 + BT4.1	WWAN Upgradable	None	None	None	Black	IR &720p	Backlit	Finger-print Reader	None	dTPM 2.0	57Wh	65W USB-C	Win10 Pro 64	3-year, Depot	01/18
20L70020US	US	i7-8650U	vPro	Intel UHD 620	8GB Soldered	14" FHD (1920x1080) IPS	10-point Multi-touch	256GB SSD M.2 PCIe NVMe Opal2	None	Intel 8265 ac, 2x2 + BT4.1	WWAN Upgradable	None	None	None	Silver	720p	Backlit	Finger-print Reader	None	dTPM 2.0	57Wh	65W USB-C	Win10 Pro 64	3-year, Depot	01/18
20L70021US	US	i5-8350U	vPro	Intel UHD 620	8GB Soldered	14" FHD (1920x1080) IPS	10-point Multi-touch	256GB SSD M.2 PCIe NVMe Opal2	None	Intel 8265 ac, 2x2 + BT4.1	WWAN Upgradable	None	None	None	Black	720p	Backlit	Finger-print Reader	None	dTPM 2.0	57Wh	65W USB-C	Win10 Pro 64	3-year, Depot	01/18
20L70022US	US	i5-8350U	vPro	Intel UHD 620	8GB Soldered	14" FHD (1920x1080) IPS	10-point Multi-touch	256GB SSD M.2 PCIe NVMe Opal2	None	Intel 8265 ac, 2x2 + BT4.1	WWAN Upgradable	None	None	None	Silver	720p	Backlit	Finger-print Reader	None	dTPM 2.0	57Wh	65W USB-C	Win10 Pro 64	3-year, Depot	01/18
20L70023US	US	i7-8550U	No	Intel UHD 620	8GB Soldered	14" FHD (1920x1080) IPS	10-point Multi-touch	256GB SSD M.2 PCIe NVMe Opal2	None	Intel 8265 ac, 2x2 + BT4.1	WWAN Upgradable	None	None	None	Black	720p	Backlit	Finger-print Reader	None	dTPM 2.0	57Wh	65W USB-C	Win10 Pro 64	3-year, Depot	01/18
20L70024US	US	i7-8650U	vPro	Intel UHD 620	8GB + 8GB	14" FHD (1920x1080) IPS	10-point Multi-touch	256GB SSD M.2 PCIe NVMe Opal2	None	Intel 8265 ac, 2x2 + BT4.1	WWAN Upgradable	None	None	None	Black	IR &720p	Backlit	Finger-print Reader	None	dTPM 2.0	57Wh	65W USB-C	Win10 Pro 64	3-year, Depot	01/18
20L70025US	US	i7-8650U	vPro	Intel UHD 620	8GB Soldered	14" FHD (1920x1080) IPS	None	256GB SSD M.2 PCIe NVMe Opal2	None	Intel 8265 ac, 2x2 + BT4.1	WWAN Upgradable	None	None	None	Black	720p	Backlit	Finger-print Reader	None	dTPM 2.0	57Wh	65W USB-C	Win10 Pro 64	3-year, Depot	01/18
20L70026US	US	i7-8650U	vPro	Intel UHD 620	8GB + 8GB	14" FHD (1920x1080) IPS	10-point Multi-touch	512GB SSD M.2 PCIe NVMe Opal2	None	Intel 8265 ac, 2x2 + BT4.1	WWAN Upgradable	None	None	None	Black	720p	Backlit	Finger-print Reader	None	dTPM 2.0	57Wh	65W USB-C	Win10 Pro 64	3-year, Depot	01/18
20L70027US	US	i7-8650U	vPro	Intel UHD 620	8GB Soldered	14" FHD (1920x1080) IPS	10-point Multi-touch	256GB SSD M.2 PCIe NVMe Opal2	None	Intel 8265 ac, 2x2 + BT4.1	WWAN Upgradable	None	None	None	Black	720p	Backlit	Finger-print Reader	None	dTPM 2.0	57Wh	65W USB-C	Win10 Pro 64	3-year, Depot	01/18
20L70029US	US	i7-8650U	vPro	Intel UHD 620	8GB + 8GB	14" WQHD (2560x1440) IPS	None	512GB SSD M.2 PCIe NVMe Opal2	None	Intel 8265 ac, 2x2 + BT4.1	WWAN Upgradable	None	None	None	Silver	IR &720p	Backlit	Finger-print Reader	None	dTPM 2.0	57Wh	65W USB-C	Win10 Pro 64	3-year, Depot	01/18
20L7002CUS	US	i5-8350U	vPro	Intel UHD 620	8GB Soldered	14" FHD (1920x1080) IPS	None	256GB SSD M.2 PCIe NVMe Opal2	None	Intel 8265 ac, 2x2 + BT4.1	WWAN Upgradable	None	None	None	Black	720p	Backlit	Finger-print Reader	None	dTPM 2.0	57Wh	65W USB-C	Win10 Pro 64	3-year, Depot	01/18
20L7002DUS	US	i5-8350U	vPro	Intel UHD 620	8GB Soldered	14" FHD (1920x1080) IPS	None	128GB SSD M.2	None	Intel 8265 ac, 2x2 + BT4.1	WWAN Upgradable	None	None	None	Black	720p	Backlit	Finger-print Reader	None	dTPM 2.0	57Wh	65W USB-C	Win10 Pro 64	3-year, Depot	01/18
20L7002EUS	US	i5-8350U	vPro	Intel UHD 620	8GB + 8GB	14" FHD (1920x1080) IPS	None	256GB SSD M.2 PCIe NVMe Opal2	None	Intel 8265 ac, 2x2 + BT4.1	WWAN Upgradable	None	None	None	Black	720p	Backlit	Finger-print Reader	None	dTPM 2.0	57Wh	65W USB-C	Win10 Pro 64	3-year, Depot	01/18
20L7002FUS	US	i5-8350U	vPro	Intel UHD 620	8GB Soldered	14" FHD (1920x1080) IPS	None	256GB SSD M.2 PCIe NVMe Opal2	None	Intel 8265 ac, 2x2 + BT4.1	WWAN Upgradable	None	None	None	Silver	720p	Backlit	Finger-print Reader	None	dTPM 2.0	57Wh	65W USB-C	Win10 Pro 64	3-year, Depot	01/18
20L7002HUS	US	i5-8250U	No	Intel UHD 620	8GB Soldered	14" FHD (1920x1080) IPS	None	256GB SSD M.2 PCIe NVMe Opal2	None	Intel 8265 ac, 2x2 + BT4.1	WWAN Upgradable	None	None	None	Black	720p	Backlit	Finger-print Reader	None	dTPM 2.0	57Wh	65W USB-C	Win10 Pro 64	3-year, Depot	01/18
20L7002KUS	US	i7-8550U	No	Intel UHD 620	8GB Soldered	14" FHD (1920x1080) IPS	None	256GB SSD M.2 PCIe NVMe Opal2	None	Intel 8265 ac, 2x2 + BT4.1	WWAN Upgradable	None	None	None	Black	720p	Backlit	Finger-print Reader	None	dTPM 2.0	57Wh	65W USB-C	Win10 Pro 64	3-year, Depot	01/18
20L7004GUS	US	i7-8650U	vPro	Intel UHD 620	8GB Soldered	14" FHD (1920x1080) IPS	10-point Multi-touch	256GB SSD M.2 PCIe NVMe Opal2	None	Intel 8265 ac, 2x2 + BT4.1	Fibocom L850-GL	None	None	None	Black	720p	Backlit	Finger-print Reader	None	dTPM 2.0	57Wh	65W USB-C	Win10 Pro 64	3-year, Depot	04/18
20L7004HUS	US	i7-8650U	vPro	Intel UHD 620	8GB + 8GB	14" FHD (1920x1080) IPS	None	1TB SSD M.2 PCIe NVMe Opal2	None	Intel 8265 ac, 2x2 + BT4.1	Fibocom L850-GL	None	None	None	Black	720p	Backlit	Finger-print Reader	None	dTPM 2.0	57Wh	65W USB-C	Win10 Pro 64	3-year, Depot	04/18

Model	Region	Processor	vPro	Graphics	Memory (Soldered +DIMM)	Display	Multi-touch	Storage(HDD/SSD)	Optical	WLAN + Bluetooth	WWAN	SIM Card	Smart Card Reader	Monitor Cable	Color	Camera	Key-board	Finger-print Reader	NFC	TPM	Battery	Power Adapter	Operating System	Warranty	Ann Date (m/y)
20L7004JUS	US	i5-7300U	vPro	Intel HD 620	4GB + 4GB	14" FHD (1920x1080) IPS	None	256GB SSD M.2 PCIe NVMe Opal2	None	Intel 8265 ac, 2x2 + BT4.1	Fibocom L850-GL	None	None	None	Black	720p	Backlit	Finger-print Reader	None	dTPM 2.0	57Wh	65W USB-C	Win10 Pro 64	3-year, Depot	04/18
20L7004KUS	US	i7-8650U	vPro	Intel UHD 620	8GB Soldered	14" FHD (1920x1080) IPS	None	256GB SSD M.2 PCIe NVMe Opal2	None	Intel 8265 ac, 2x2 + BT4.1	Fibocom L850-GL	None	None	None	Black	720p	Backlit	Finger-print Reader	None	dTPM 2.0	57Wh	65W USB-C	Win10 Pro 64	3-year, Depot	04/18
20L7004LUS	US	i5-8350U	vPro	Intel UHD 620	8GB Soldered	14" FHD (1920x1080) IPS	None	256GB SSD M.2 PCIe NVMe Opal2	None	Intel 8265 ac, 2x2 + BT4.1	Fibocom L850-GL	None	None	None	Black	720p	Backlit	Finger-print Reader	None	dTPM 2.0	57Wh	65W USB-C	Win10 Pro 64	3-year, Depot	04/18
20L70054US	US	i5-8250U	No	Intel UHD 620	8GB Soldered	14" FHD (1920x1080) IPS	None	180GB SSD M.2 Opal2	None	Intel 8265 ac, 2x2 + BT4.1	WWAN Upgradable	None	None	None	Silver	720p	Backlit	Finger-print Reader	None	dTPM 2.0	57Wh	65W USB-C	Win10 Pro 64	3-year, Depot	05/18
20L70055US	US	i5-8250U	No	Intel UHD 620	8GB Soldered	14" FHD (1920x1080) IPS	None	180GB SSD M.2 Opal2	None	Intel 8265 ac, 2x2 + BT4.1	WWAN Upgradable	None	None	None	Black	720p	Backlit	Finger-print Reader	None	dTPM 2.0	57Wh	65W USB-C	Win10 Pro 64	3-year, Depot	05/18



ThinkPad T570 Platform Specifications

Product Specifications Reference (PSREF)

Processor	6th Generation Intel® Core™ i5 / i7 Processor								Dimensions Weight Case color Case material	<i>WxDxH:</i> 14.40" x 9.95" x 0.79-0.80"; 365.8mm x 252.8mm x 19.95-20.2mm Starting at 4.34 lb / 1.97 kg Black <i>Display cover:</i> Glass-Fiber Reinforced Plastic (PPS); <i>Bottom:</i> Glass-Fiber Reinforced Plastic																	
	Processor Number	# of Cores	# of Threads	Base Frequency	Max Turbo Frequency	Cache	Memory Types	Processor Graphics																			
	i5-6200U	2	4	2.3 GHz	2.8 GHz	3MB	DDR4-2133	Intel HD Graphics 520	Smart card reader <i>Optional:</i> Smart card reader Media reader 4-in-1 reader (MMC, SD, SDHC, SDXC), supports SD 3.0, UHS-I Ports Three USB 3.1 Gen 1 (USB 3.0, one Always On), USB 3.1 Type-C Gen 2 / Thunderbolt 3, HDMI 1.4b, Ethernet (RJ-45), Dock connector WiGig dock (<i>opt</i>) ThinkPad WiGig dock (US only) Monitor cable (<i>optional</i>) <i>HDMI to VGA:</i> Lenovo HDMI to VGA Monitor Adapter <i>USB-C to VGA:</i> Lenovo USB-C to VGA Adapter Camera (<i>optional</i>) <i>720p:</i> HD720p resolution, fixed focus <i>IR & 720p:</i> IR camera and HD720p camera (mutually exclusive with WiGig) Audio support HD Audio, Realtek ALC3268 codec / stereo speakers, 2W x 2 / dual array microphone, combo audio/microphone jack Keyboard 6-row, spill-resistant, multimedia Fn keys, numeric keypad, optional LED backlight UltraNav™ TrackPoint® pointing device and buttonless Mylar surface multi-touch touchpad Security Security chip vPro (<i>optional</i>) Intel vPro Technology Fingerprint reader (<i>optional</i>) <i>Optional:</i> Touch style match on chip fingerprint reader on the palm rest NFC (<i>optional</i>) Near Field Communication Internal battery <i>Optional:</i> Integrated Li-Polymer 4-cell (32Wh) External battery Li-Polymer 3-cell (24Wh) or Li-Ion 6-cell (48Wh or 72Wh) Max battery life (<i>MobileMark® 2014</i>)																		
	i5-6300U			2.4 GHz	3.0 GHz	3MB																					
	i7-6600U			2.6 GHz	3.4 GHz	4MB																					
or 7th Generation Intel Core i5 / i7 Processor																											
	Processor Number	# of Cores	# of Threads	Base Frequency	Max Turbo Frequency	Cache	Memory Types	Processor Graphics																			
	i5-7200U	2	4	2.5 GHz	3.1 GHz	3MB	DDR4-2133	Intel HD Graphics 620																			
	i5-7300U			2.6 GHz	3.5 GHz	3MB																					
	i7-7500U			2.7 GHz	3.5 GHz	4MB																					
	i7-7600U			2.8 GHz	3.9 GHz	4MB																					
Graphics	Intel HD Graphics 520 or 620 in processor only, or Intel HD Graphics 520 or 620 in processor and NVIDIA GeForce® 940MX, 2GB 2.5GHz GDDR5 memory; supports external digital monitor via HDMI or USB Type-C; supports three independent displays; Max resolution: 4096x2304@60Hz (USB Type-C); 4096x2160@24Hz (HDMI)																										
Chipset	Intel SoC (System on Chip) platform																										
Memory	32GB max / 2400MHz DDR4, dual-channel capable, two DDR4 SO-DIMM sockets * System clocks down for processors with lower memory controller																										
Display	<i>Some:</i> 15.6" (396mm) HD (1366x768), anti-glare, LED backlight, 220 nits, 16:9 aspect ratio, 400:1 contrast ratio <i>Some:</i> 15.6" (396mm) FHD (1920x1080), anti-glare, LED backlight, IPS, 250 nits, 16:9 aspect ratio, 700:1 contrast ratio, 170° viewing angle <i>Some:</i> 15.6" (396mm) 4K (3840x2160), anti-glare, LED backlight, IPS, 300 nits, 16:9 aspect ratio, 1000:1 contrast ratio, 72% gamut, 170° viewing angle																										
Multi-touch (<i>opt</i>)	On-cell touch, supports 10-finger gesture (FHD only)																										
Storage	<i>System has one HDD slot or one M.2 2280 slot exclusively for storage</i> <i>Some:</i> HDD / SATA 6.0Gb/s, 2.5" wide, 7mm high, Active Protection System™ <i>Some:</i> SSD / SATA 6.0Gb/s, 2.5" wide, 7mm high (e.g. xxxGB SSD) <i>Some:</i> M.2 SSD / PCIe NVMe, PCIe 3.0 x 2, 16Gb/s <i>Some:</i> 128GB M.2 SSD / SATA 6.0Gb/s, in WWAN slot as 2nd Storage, mutually exclusive with WWAN and WiGig																										
Optical	None																										
Ethernet	<i>Non-vPro model:</i> Intel Ethernet Connection I219-V (Jacksonville) <i>vPro model:</i> Intel Ethernet Connection I219-LM (Jacksonville)																										
WLAN	<i>One of the following, configurable by model (WiGig can coexist with WWAN):</i> <ul style="list-style-type: none"> • Realtek® RTL8822BE, Wi-Fi 2x2 802.11ac + BT4.1, M.2 card (US only) • Intel Dual Band Wireless-AC 8260, Wi-Fi 2x2 802.11ac + BT4.1, M.2 card • Intel Dual Band Wireless-AC 8265, Wi-Fi 2x2 802.11ac + BT4.1, M.2 card • Intel Tri-Band Wireless-AC 18265, WiGig 802.11ad + Wi-Fi 2x2 802.11ac + BT4.1, M.2 card 																										
Bluetooth™	Bluetooth 4.1 wireless, integrated in Wi-Fi + Bluetooth combo adapter * Intel 8265ac / 18265ac card support BT4.2 but is limited to BT4.1 by Windows OS																										
WWAN (<i>optional</i>)	<i>One of the following, configurable by model (WWAN can coexist with WiGig):</i> <ul style="list-style-type: none"> • Wireless WAN upgradable • Integrated Mobile Broadband 4G LTE-A, Qualcomm® Snapdragon™ X7 LTE-A (Sierra Wireless EM7455), M.2 card • Integrated Mobile Broadband 4G LTE, Intel XMM™ 7160 (Fibocom L831-EAU), M.2 card (EMEA only) 																										
SIM card (<i>opt</i>)	Micro-SIM card slot, opt Verizon LTE (US) or Lenovo® Connect (EMEA) SIM card																										
									<table border="1"> <thead> <tr> <th><i>Models</i></th> <th><i>4 + 3-cell</i></th> <th><i>6-cell 48Wh</i></th> <th><i>6-cell 72Wh</i></th> <th><i>4 + 6-cell 48Wh</i></th> <th><i>4 + 6-cell 72Wh</i></th> </tr> </thead> <tbody> <tr> <td><i>Integrated</i></td> <td>13.8 hr</td> <td>12.5 hr</td> <td>18.5 hr</td> <td>20.3 hr</td> <td>27.1 hr</td> </tr> <tr> <td><i>discrete</i></td> <td>13.8 hr</td> <td>12.5 hr</td> <td>18.5 hr</td> <td>20.0 hr</td> <td>26.8 hr</td> </tr> </tbody> </table>	<i>Models</i>	<i>4 + 3-cell</i>	<i>6-cell 48Wh</i>	<i>6-cell 72Wh</i>	<i>4 + 6-cell 48Wh</i>	<i>4 + 6-cell 72Wh</i>	<i>Integrated</i>	13.8 hr	12.5 hr	18.5 hr	20.3 hr	27.1 hr	<i>discrete</i>	13.8 hr	12.5 hr	18.5 hr	20.0 hr	26.8 hr
<i>Models</i>	<i>4 + 3-cell</i>	<i>6-cell 48Wh</i>	<i>6-cell 72Wh</i>	<i>4 + 6-cell 48Wh</i>	<i>4 + 6-cell 72Wh</i>																						
<i>Integrated</i>	13.8 hr	12.5 hr	18.5 hr	20.3 hr	27.1 hr																						
<i>discrete</i>	13.8 hr	12.5 hr	18.5 hr	20.0 hr	26.8 hr																						
AC adapter	45W or 65W slim tip AC adapter, 45W or 65W USB Type-C AC adapter																										
Preload	Windows® 7 Professional 64 preinstalled through downgrade rights in Windows 10 Pro 64 • Lenovo Solution Center • Lenovo PowerEngage • ThinkVantage Product Recovery • ThinkVantage System Update • Adobe® Reader® • Microsoft® Office preloaded; purchase a product key to activate • McAfee® LiveSafe™ (30-day trial)																										
Limited warranty	<i>One of the following, configurable by model:</i> <ul style="list-style-type: none"> • 1-year depot repair service • 3-year/1-yr battery depot repair service • 3-year/1-yr battery limited onsite service 																										
Mil-Spec test	MIL-STD-810G military certification																										
Environment	EPEAT™ Gold (US only); ENERGY STAR® 6.1; RoHS-compliant																										

Model	Region	Processor	vPro	Graphics	Memory	Display	Multi-touch	Storage(HDD/SSD)	Optical	WLAN + Bluetooth	WWAN	SIM Card	Smart Card Reader	Dock	Monitor Cable	Camera	Key-board	Finger-print Reader	NFC	TPM	Battery (internal+ external)	Power Adapter	Operating System	Warranty	Ann Date (m/y)
20H9000MUS	US	i5-7200U	No	Intel HD 620	8GBx1	15.6" FHD (1920x1080) IPS	None	256GB SSD M.2 PCIe NVMe Opal2	None	Intel 8265 ac, 2x2 + BT4.1	WWAN Upgradable	None	None	None	None	720p	Backlit	Finger-print Reader	None	dTPM 2.0	4-cell(32Wh) + 3-cell(24Wh)	45W Slim Tip	Win10 Pro 64	3-year, Depot	01/17
20H9000NUS	US	i7-7600U	vPro	Intel HD 620	8GBx1	15.6" FHD (1920x1080) IPS	None	256GB SSD M.2 PCIe NVMe Opal2	None	Intel 8265 ac, 2x2 + BT4.1	WWAN Upgradable	None	None	None	None	720p	Backlit	Finger-print Reader	None	dTPM 2.0	4-cell(32Wh) + 3-cell(24Wh)	45W Slim Tip	Win10 Pro 64	3-year, Depot	01/17
20H9000PUS	US	i5-7300U	vPro	Intel HD 620	8GBx1	15.6" FHD (1920x1080) IPS	None	256GB SSD M.2 PCIe NVMe Opal2	None	Intel 8265 ac, 2x2 + BT4.1	WWAN Upgradable	None	None	None	None	720p	Backlit	Finger-print Reader	None	dTPM 2.0	4-cell(32Wh) + 3-cell(24Wh)	45W Slim Tip	Win10 Pro 64	3-year, Depot	01/17
20H9000QUS	US	i5-7200U	No	Intel HD 620	4GBx1	15.6" FHD (1920x1080) IPS	10-point Multi-touch	500GB 7200rpm	None	Intel 8265 ac, 2x2 + BT4.1	WWAN Upgradable	None	None	None	None	720p	Backlit	Finger-print Reader	None	dTPM 2.0	4-cell(32Wh) + 3-cell(24Wh)	45W Slim Tip	Win10 Pro 64	3-year, Depot	01/17
20H9000RUS	US	i5-7200U	No	Intel HD 620	8GBx1	15.6" FHD (1920x1080) IPS	10-point Multi-touch	256GB SSD M.2 PCIe NVMe Opal2	None	Intel 8265 ac, 2x2 + BT4.1	WWAN Upgradable	None	None	None	None	720p	Backlit	Finger-print Reader	None	dTPM 2.0	4-cell(32Wh) + 3-cell(24Wh)	45W Slim Tip	Win10 Pro 64	3-year, Depot	01/17
20H9000SUS	US	i5-7200U	No	Intel HD 620	4GBx1	15.6" FHD (1920x1080) IPS	None	500GB 7200rpm	None	Intel 8265 ac, 2x2 + BT4.1	WWAN Upgradable	None	None	None	None	720p	Backlit	Finger-print Reader	None	dTPM 2.0	4-cell(32Wh) + 3-cell(24Wh)	45W Slim Tip	Win10 Pro 64	1-year, Depot	01/17
20H9000TUS	US	i7-7600U	vPro	Intel HD 620	8GBx1	15.6" FHD (1920x1080) IPS	10-point Multi-touch	256GB SSD M.2 PCIe NVMe Opal2	None	Intel 8265 ac, 2x2 + BT4.1	WWAN Upgradable	None	None	None	None	720p	Backlit	Finger-print Reader	None	dTPM 2.0	4-cell(32Wh) + 3-cell(24Wh)	45W Slim Tip	Win10 Pro 64	3-year, Depot	01/17
20H9000UUS	US	i5-7300U	vPro	Intel HD 620	8GBx1	15.6" FHD (1920x1080) IPS	10-point Multi-touch	256GB SSD M.2 PCIe NVMe Opal2	None	Intel 8265 ac, 2x2 + BT4.1	WWAN Upgradable	None	None	None	None	720p	Backlit	Finger-print Reader	None	dTPM 2.0	4-cell(32Wh) + 3-cell(24Wh)	45W Slim Tip	Win10 Pro 64	3-year, Depot	01/17
20H9004FUS	US	i5-7200U	No	Intel HD 620	4GBx1	15.6" FHD (1920x1080) IPS	None	500GB 7200rpm	None	Intel 8265 ac, 2x2 + BT4.1	WWAN Upgradable	None	None	None	None	720p	Backlit	Finger-print Reader	None	dTPM 2.0	4-cell(32Wh) + 3-cell(24Wh)	45W Slim Tip	Win10 Pro 64	3-year, Depot	03/17
20H9004NUS	US	i7-7600U	vPro	Intel HD 620	8GBx1	15.6" FHD (1920x1080) IPS	None	256GB SSD M.2 PCIe NVMe Opal2	None	Intel 8265 ac, 2x2 + BT4.1	WWAN Upgradable	None	None	None	None	IR & 720p	Backlit	Finger-print Reader	None	dTPM 2.0	4-cell(32Wh) + 3-cell(24Wh)	45W Slim Tip	Win10 Pro 64	3-year, Depot	04/17
20H9004PUS	US	i7-7600U	vPro	Intel HD 620	8GBx1	15.6" FHD (1920x1080) IPS	10-point Multi-touch	256GB SSD M.2 PCIe NVMe Opal2	None	Intel 8265 ac, 2x2 + BT4.1	WWAN Upgradable	None	None	None	None	IR & 720p	Backlit	Finger-print Reader	None	dTPM 2.0	4-cell(32Wh) + 3-cell(24Wh)	45W Slim Tip	Win10 Pro 64	3-year, Depot	04/17
20H9004QUS	US	i5-7300U	vPro	Intel HD 620	8GBx1	15.6" FHD (1920x1080) IPS	None	256GB SSD M.2 PCIe NVMe Opal2	None	Intel 8265 ac, 2x2 + BT4.1	WWAN Upgradable	None	None	None	None	IR & 720p	Backlit	Finger-print Reader	None	dTPM 2.0	4-cell(32Wh) + 3-cell(24Wh)	45W Slim Tip	Win10 Pro 64	3-year, Depot	04/17
20H9004RUS	US	i7-7600U	vPro	Intel HD 620	16GBx1	15.6" 4K (3840x2160) IPS	None	512GB SSD M.2 PCIe NVMe Opal2	None	Intel 8265 ac, 2x2 + BT4.1	WWAN Upgradable	None	None	None	None	IR & 720p	Backlit	Finger-print Reader	None	dTPM 2.0	4-cell(32Wh) + 3-cell(24Wh)	45W Slim Tip	Win10 Pro 64	3-year, Depot	04/17
20H9004SUS	US	i7-7600U	vPro	Intel HD 620	16GBx1	15.6" FHD (1920x1080) IPS	10-point Multi-touch	512GB SSD M.2 PCIe NVMe Opal2	None	Intel 8265 ac, 2x2 + BT4.1	WWAN Upgradable	None	None	None	None	720p	Backlit	Finger-print Reader	None	dTPM 2.0	4-cell(32Wh) + 3-cell(24Wh)	45W Slim Tip	Win10 Pro 64	3-year, Depot	04/17
20H9004TUS	US	i7-7600U	vPro	Intel HD 620	16GBx1	15.6" FHD (1920x1080) IPS	None	512GB SSD M.2 PCIe NVMe Opal2	None	Intel 8265 ac, 2x2 + BT4.1	WWAN Upgradable	None	None	None	None	720p	Backlit	Finger-print Reader	None	dTPM 2.0	4-cell(32Wh) + 3-cell(24Wh)	45W Slim Tip	Win10 Pro 64	3-year, Depot	04/17
20H9004UUS	US	i7-7600U	vPro	Intel HD 620	8GBx1	15.6" FHD (1920x1080) IPS	10-point Multi-touch	256GB SSD M.2 PCIe NVMe Opal2	None	Intel 8265 ac, 2x2 + BT4.1	Sierra EM7455	None	None	None	None	720p	Backlit	Finger-print Reader	None	dTPM 2.0	4-cell(32Wh) + 3-cell(24Wh)	45W Slim Tip	Win10 Pro 64	3-year, Depot	04/17
20H9004VUS	US	i5-7300U	vPro	Intel HD 620	8GBx1	15.6" FHD (1920x1080) IPS	None	256GB SSD M.2 PCIe NVMe Opal2	None	Intel 8265 ac, 2x2 + BT4.1	Sierra EM7455	None	None	None	None	720p	Backlit	Finger-print Reader	None	dTPM 2.0	4-cell(32Wh) + 3-cell(24Wh)	45W Slim Tip	Win10 Pro 64	3-year, Depot	04/17
20H9004WUS	US	i7-7600U	vPro	Intel HD 620	8GBx1	15.6" FHD (1920x1080) IPS	None	256GB SSD M.2 PCIe NVMe Opal2	None	Intel 8265 ac, 2x2 + BT4.1	Sierra EM7455	None	None	None	None	720p	Backlit	Finger-print Reader	None	dTPM 2.0	4-cell(32Wh) + 3-cell(24Wh)	45W Slim Tip	Win10 Pro 64	3-year, Depot	04/17
20H90056US	US	i5-7200U	No	Intel HD 620	4GBx1	15.6" HD (1366x768)	None	500GB 7200rpm	None	Intel 8265 ac, 2x2 + BT4.1	WWAN Upgradable	None	None	None	None	720p	Backlit	Finger-print Reader	None	dTPM 2.0	4-cell(32Wh) + 3-cell(24Wh)	45W Slim Tip	Win10 Pro 64	3-year, Depot	06/17
20H90057US	US	i5-7300U	vPro	Intel HD 620	8GBx1	15.6" FHD (1920x1080) IPS	None	256GB SSD M.2 PCIe NVMe Opal2	None	Intel 8265 ac, 2x2 + BT4.1	WWAN Upgradable	None	None	None	None	720p	Backlit	Finger-print Reader	None	dTPM 2.0	4-cell(32Wh) + 3-cell(24Wh)	45W Slim Tip	Win10 Pro 64	3-year, Depot	06/17

Model	Region	Processor	vPro	Graphics	Memory	Display	Multi-touch	Storage(HDD/SSD)	Optical	WLAN + Bluetooth	WWAN	SIM Card	Smart Card Reader	Dock	Monitor Cable	Camera	Key-board	Finger-print Reader	NFC	TPM	Battery (internal+external)	Power Adapter	Operating System	Warranty	Ann Date (m/y)
20H90058US	US	i5-7200U	No	Intel HD 620	4GBx1	15.6" HD (1366x768)	None	180GB SSD Opal2	None	Intel 8265 ac, 2x2 + BT4.1	WWAN Upgradable	None	None	None	None	720p	Backlit	Finger-print Reader	None	dTPM 2.0	4-cell(32Wh) + 3-cell(24Wh)	45W Slim Tip	Win10 Pro 64	3-year, Depot	06/17
20H90059US	US	i7-7600U	vPro	Intel HD 620	8GBx1	15.6" FHD (1920x1080) IPS	10-point Multi-touch	256GB SSD M.2 PCIe NVMe Opal2	None	Intel 8265 ac, 2x2 + BT4.1	WWAN Upgradable	None	None	None	None	720p	Backlit	Finger-print Reader	None	dTPM 2.0	4-cell(32Wh) + 3-cell(24Wh)	45W Slim Tip	Win10 Pro 64	3-year, Depot	06/17
20H9005CUS	US	i5-7300U	vPro	Intel HD 620	8GBx1	15.6" FHD (1920x1080) IPS	None	512GB SSD M.2 PCIe NVMe Opal2	None	Intel 8265 ac, 2x2 + BT4.1	WWAN Upgradable	None	None	None	None	720p	Backlit	Finger-print Reader	None	dTPM 2.0	4-cell(32Wh) + 3-cell(24Wh)	45W Slim Tip	Win10 Pro 64	3-year, Depot	10/17
20H9005DUS	US	i5-7300U	vPro	Intel HD 620	8GBx1	15.6" FHD (1920x1080) IPS	None	256GB SSD Opal2	None	Intel 8265 ac, 2x2 + BT4.1	WWAN Upgradable	None	None	None	None	720p	Backlit	Finger-print Reader	None	dTPM 2.0	4-cell(32Wh) + 3-cell(24Wh)	45W Slim Tip	Win10 Pro 64	3-year, Depot	10/17

Model	Region	Processor	vPro	Graphics	Memory	Display	Multi-touch	Storage(HDD/SSD)	Optical	WLAN + Bluetooth	WWAN	SIM Card	Smart Card Reader	Dock	Monitor Cable	Camera	Key-board	Finger-print Reader	NFC	TPM	Battery (internal+external)	Power Adapter	Operating System	Warranty	Ann Date (m/y)
20JW0004US	US	i7-6600U	vPro	Intel HD 520	8GBx1	15.6" FHD (1920x1080) IPS	None	256GB SSD M.2 PCIe NVMe Opal2	None	Intel 8260 ac, 2x2 + BT4.1	WWAN Upgradable	None	None	None	None	720p	Backlit	Finger-print Reader	None	dTPM 2.0	4-cell(32Wh) + 3-cell(24Wh)	45W Slim Tip	Win10 DG Win7 Pro 64	3-year, Depot	03/17
20JW0005US	US	i5-6300U	vPro	Intel HD 520	4GBx1	15.6" FHD (1920x1080) IPS	None	500GB 7200rpm	None	Intel 8260 ac, 2x2 + BT4.1	WWAN Upgradable	None	None	None	None	720p	Backlit	Finger-print Reader	None	dTPM 2.0	4-cell(32Wh) + 3-cell(24Wh)	45W Slim Tip	Win10 DG Win7 Pro 64	3-year, Depot	03/17
20JW0006US	US	i5-6300U	vPro	Intel HD 520	8GBx1	15.6" FHD (1920x1080) IPS	None	256GB SSD M.2 PCIe NVMe Opal2	None	Intel 8260 ac, 2x2 + BT4.1	WWAN Upgradable	None	None	None	None	720p	Backlit	Finger-print Reader	None	dTPM 2.0	4-cell(32Wh) + 3-cell(24Wh)	45W Slim Tip	Win10 DG Win7 Pro 64	3-year, Depot	03/17
20JW0007US	US	i7-6600U	vPro	Intel HD 520	16GBx1	15.6" FHD (1920x1080) IPS	None	512GB SSD M.2 PCIe NVMe Opal2	None	Intel 8260 ac, 2x2 + BT4.1	WWAN Upgradable	None	None	None	None	720p	Backlit	Finger-print Reader	None	dTPM 2.0	4-cell(32Wh) + 3-cell(24Wh)	45W Slim Tip	Win10 DG Win7 Pro 64	3-year, Depot	04/17
20JW0008US	US	i5-6300U	vPro	Intel HD 520	8GBx1	15.6" FHD (1920x1080) IPS	None	256GB SSD M.2 PCIe NVMe Opal2	None	Intel 8260 ac, 2x2 + BT4.1	Sierra EM7455	None	None	None	None	720p	Backlit	Finger-print Reader	None	dTPM 2.0	4-cell(32Wh) + 3-cell(24Wh)	45W Slim Tip	Win10 DG Win7 Pro 64	3-year, Depot	04/17
20JW0009US	US	i7-6600U	vPro	Intel HD 520	8GBx1	15.6" FHD (1920x1080) IPS	None	256GB SSD M.2 PCIe NVMe Opal2	None	Intel 8260 ac, 2x2 + BT4.1	Sierra EM7455	None	None	None	None	720p	Backlit	Finger-print Reader	None	dTPM 2.0	4-cell(32Wh) + 3-cell(24Wh)	45W Slim Tip	Win10 DG Win7 Pro 64	3-year, Depot	04/17
20JW000CUS	US	i7-6600U	vPro	Intel HD 520	8GBx1	15.6" FHD (1920x1080) IPS	None	256GB SSD M.2 PCIe NVMe Opal2	None	Intel 8260 ac, 2x2 + BT4.1	WWAN Upgradable	None	None	None	None	720p	Backlit	Finger-print Reader	None	dTPM 2.0	4-cell(32Wh) + 3-cell(24Wh)	45W Slim Tip	Win10 DG Win7 Pro 64	3-year, Depot	06/17
20JW000DUS	US	i5-6300U	vPro	Intel HD 520	8GBx1	15.6" FHD (1920x1080) IPS	None	256GB SSD M.2 PCIe NVMe Opal2	None	Intel 8260 ac, 2x2 + BT4.1	WWAN Upgradable	None	None	None	None	720p	Backlit	Finger-print Reader	None	dTPM 2.0	4-cell(32Wh) + 3-cell(24Wh)	45W Slim Tip	Win10 DG Win7 Pro 64	3-year, Depot	06/17
20JW000GUS	US	i5-6300U	vPro	Intel HD 520	8GBx1	15.6" FHD (1920x1080) IPS	None	512GB SSD M.2 PCIe NVMe Opal2	None	Intel 8260 ac, 2x2 + BT4.1	WWAN Upgradable	None	None	None	None	720p	Backlit	Finger-print Reader	None	dTPM 2.0	4-cell(32Wh) + 3-cell(24Wh)	45W Slim Tip	Win10 DG Win7 Pro 64	3-year, Depot	10/17
20JW000HUS	US	i5-6300U	vPro	Intel HD 520	8GBx1	15.6" FHD (1920x1080) IPS	None	256GB SSD Opal2	None	Intel 8260 ac, 2x2 + BT4.1	WWAN Upgradable	None	None	None	None	720p	Backlit	Finger-print Reader	None	dTPM 2.0	4-cell(32Wh) + 3-cell(24Wh)	45W Slim Tip	Win10 DG Win7 Pro 64	3-year, Depot	10/17



ThinkPad T580 Platform Specifications

Product Specifications Reference (PSREF)

Processor	7th Generation Intel® Core™ i5 Processor							Dimensions Weight	<i>WxDxH:</i> 14.40" x 9.95" x 0.79-0.80"; 365.8mm x 252.8mm x 19.95-20.2mm <i>Integrated model:</i> starting at 4.29 lb / 1.95 kg; <i>Discrete model:</i> starting at 4.39 lb / 1.99 kg						
	Processor Number	# of Cores	# of Threads	Base Frequency	Max Turbo Frequency	Cache	Memory Types		Processor Graphics	Case color	Black				
	i5-7200U	2	4	2.5 GHz	3.1 GHz	3MB	DDR4-2133	Intel HD Graphics 620	Case material	<i>Display cover:</i> Glass-Fiber Reinforced Plastic (PPS); <i>Bottom:</i> Glass-Fiber Reinforced Plastic					
	i5-7300U			2.6 GHz	3.5 GHz	3MB									
	or 8th Generation Intel Core i5 / i7 Processor							Smart card reader	<i>Optional:</i> Smart card reader						
	Processor Number	# of Cores	# of Threads	Base Frequency	Max Turbo Frequency	Cache	Memory Types	Processor Graphics	Media reader	4-in-1 reader (MMC, SD, SDHC, SDXC)					
	i5-8250U	4	8	1.6 GHz	3.4 GHz	6MB	DDR4-2400	Intel UHD Graphics 620	Ports	Two USB 3.1 Gen 1 (one Always On), USB 3.1 Type-C Gen 1, USB 3.1 Type-C Gen 2 / Thunderbolt 3, HDMI 1.4b, Ethernet (RJ-45), nano-SIM card slot (WWAN models), headphone / microphone combo jack, optional smart card reader, 4-in-1 reader (MMC, SD, SDHC, SDXC), side docking connector, security keyhole					
	i5-8350U			1.7 GHz	3.6 GHz	6MB									
	i7-8550U			1.8 GHz	4.0 GHz	8MB									
	i7-8650U			1.9 GHz	4.2 GHz	8MB									
Graphics	Intel HD Graphics 620 or Intel UHD Graphics 620 in processor only or Intel HD Graphics 620 or Intel UHD Graphics 620 in processor and NVIDIA® GeForce® MX150, 2GB GDDR5 memory; supports external digital monitor via HDMI or USB Type-C; supports three independent displays; Max resolution: 4096x2304@60Hz (USB Type-C); 4096x2160@30Hz (HDMI)							Monitor cable (<i>optional</i>)	<i>HDMI to VGA:</i> Lenovo HDMI to VGA Monitor Adapter <i>USB-C to DP:</i> Lenovo USB-C to DisplayPort Adapter						
Chipset	Intel SoC (System on Chip) platform							Camera (<i>optional</i>)	<i>One of the following, configurable by model:</i>						
Memory	32GB max / 2400MHz DDR4, dual-channel capable, two DDR4 SO-DIMM sockets * System clocks down for processors with lower memory controller							Audio support	<ul style="list-style-type: none"> • HD720p camera with ThinkShutter camera privacy, fixed focus • IR camera and HD720p camera, fixed focus HD Audio, Realtek® ALC3287 codec, Dolby® Audio™ Premium / stereo speakers, 2W x 2 / dual array microphone, headphone / microphone combo jack						
Display	<i>Some:</i> 15.6" (396mm) FHD (1920x1080), anti-glare, LED backlight, IPS, 250 nits, 16:9 aspect ratio, 700:1 contrast ratio, 170° viewing angle <i>Some:</i> 15.6" (396mm) UHD (3840x2160), anti-glare, LED backlight, IPS, 300 nits, 16:9 aspect ratio, 1000:1 contrast ratio, 72% gamut, 170° viewing angle							Keyboard	6-row, spill-resistant, multimedia Fn keys, numeric keypad, optional LED backlight						
Multi-touch (<i>opt</i>)	On-cell touch, supports 10-finger gesture (FHD only)							UltraNav™	TrackPoint® pointing device and buttonless Mylar surface multi-touch touchpad						
Storage	<i>System has one HDD slot or one M.2 2280 slot exclusively for storage</i> <i>Some:</i> HDD / SATA 6.0Gb/s, 2.5" wide, 7mm high, Active Protection System™ <i>Some:</i> SSD / SATA 6.0Gb/s, 2.5" wide, 7mm high (e.g. xxxGB SSD) <i>Some:</i> M.2 SSD / PCIe NVMe, PCIe 3.0 x4, 32Gb/s <i>Some:</i> 128GB M.2 SSD / PCIe NVMe, PCIe 3.0 x 2, 16Gb/s, in WWAN slot as 2nd Storage, mutually exclusive with WWAN <i>Some:</i> 16GB Intel Optane™ memory, PCIe NVMe, PCIe 3.0 x 2, 16Gb/s, in WWAN slot as storage cache for HDD, mutually exclusive with WWAN							Security chip	Power-on password, hard disk password, supervisor password, security keyhole						
								Discrete TPM 2.0, TCG Certified							
								vPro (<i>optional</i>)	Intel vPro Technology						
								Fingerprint reader	<i>Optional:</i> Touch style match on chip fingerprint reader on the palm rest, anti-spoofing technology						
								NFC (<i>optional</i>)	Near Field Communication						
								Battery	Optional integrated Li-Ion 32Wh battery and external Li-Ion 24Wh, 48Wh, or 72Wh battery						
								Max battery life (<i>MobileMark® 2014</i>)	<i>Models</i>	<i>24Wh</i>	<i>48Wh</i>	<i>72Wh</i>	<i>32Wh + 24Wh</i>	<i>32Wh + 48Wh</i>	<i>32Wh + 72Wh</i>
									<i>Max battery life</i>	5.8 hr	12.5 hr	18.1 hr	13.8 hr	20.3 hr	26.1 hr
								AC adapter	* Battery life varies significantly with settings, usage, & other factors 45W or 65W USB Type-C AC adapter						
								Preload	Windows® 10 Home 64 or Windows 10 Pro 64						
								Limited warranty	<i>One of the following, configurable by model:</i>						
									<ul style="list-style-type: none"> • 1-year depot repair service • 3-year/1-yr battery depot repair service • 3-year/1-yr battery limited onsite service 						
								Mil-Spec test	MIL-STD-810G military certification						
WLAN + Bluetooth™	Intel Dual Band Wireless-AC 8265, Wi-Fi 2x2 802.11ac + Bluetooth 4.1, M.2 card * Intel 8265ac card supports BT4.2 but is limited to BT4.1 by Windows OS							Environment	EPEAT™ Gold; ENERGY STAR® 6.1; RoHS-compliant						
WWAN (<i>optional</i>)	<i>One of the following, configurable by model:</i>														
	<ul style="list-style-type: none"> • Integrated Mobile Broadband 4G LTE, Intel XMM™ 7262 (Fibocom L830-EB), M.2 card (EMEA only) • Integrated Mobile Broadband 4G LTE-A, Intel XMM™ 7360 (Fibocom L850-GL), M.2 card 														
SIM card (<i>opt</i>)	Nano-SIM card slot, optional Verizon LTE (US) SIM card														

Model	Region	Processor	vPro	Graphics	Memory	Display	Multi-touch	Storage(HDD/SSD)	Optical	WLAN + Bluetooth	WWAN	SIM Card	Smart Card Reader	Monitor Cable	Camera	Key-board	Finger-print Reader	NFC	TPM	Battery (Internal+external)	Power Adapter	Operating System	Warranty	Ann Date (m/y)	
20L90018US	US	i5-8250U	No	Intel UHD 620	4GBx1	15.6" FHD (1920x1080) IPS	None	500GB 7200rpm Opal2	None	Intel 8265 ac, 2x2 + BT4.1	None	None	None	None	720p	Backlit	Finger-print Reader	None	dTPM 2.0	4-cell(32Wh) + 3-cell(24Wh)	65W USB-C	Win10 Pro 64	3-year, Depot	02/18	
20L90019US	US	i5-8350U	vPro	Intel UHD 620	16GBx1	15.6" FHD (1920x1080) IPS	None	512GB SSD M.2 PCIe NVMe Opal2	None	Intel 8265 ac, 2x2 + BT4.1	None	None	None	None	720p	Backlit	Finger-print Reader	None	dTPM 2.0	4-cell(32Wh) + 3-cell(24Wh)	65W USB-C	Win10 Pro 64	3-year, Depot	02/18	
20L9001AUS	US	i7-8650U	vPro	Intel UHD 620	16GBx1	15.6" FHD (1920x1080) IPS	10-point Multi-touch	512GB SSD M.2 PCIe NVMe Opal2	None	Intel 8265 ac, 2x2 + BT4.1	None	None	None	None	720p	Backlit	Finger-print Reader	None	dTPM 2.0	4-cell(32Wh) + 3-cell(24Wh)	65W USB-C	Win10 Pro 64	3-year, Depot	02/18	
20L9001BUS	US	i7-8650U	vPro	Intel UHD 620	8GBx1	15.6" FHD (1920x1080) IPS	10-point Multi-touch	256GB SSD M.2 PCIe NVMe Opal2	None	Intel 8265 ac, 2x2 + BT4.1	None	None	None	None	720p	Backlit	Finger-print Reader	None	dTPM 2.0	4-cell(32Wh) + 3-cell(24Wh)	65W USB-C	Win10 Pro 64	3-year, Depot	02/18	
20L9001DUS	US	i7-8550U	No	Intel UHD 620	8GBx1	15.6" FHD (1920x1080) IPS	10-point Multi-touch	256GB SSD M.2 PCIe NVMe Opal2	None	Intel 8265 ac, 2x2 + BT4.1	None	None	None	None	720p	Backlit	Finger-print Reader	None	dTPM 2.0	4-cell(32Wh) + 3-cell(24Wh)	65W USB-C	Win10 Pro 64	3-year, Depot	02/18	
20L9001FUS	US	i5-8350U	vPro	Intel UHD 620	8GBx1	15.6" FHD (1920x1080) IPS	10-point Multi-touch	256GB SSD M.2 PCIe NVMe Opal2	None	Intel 8265 ac, 2x2 + BT4.1	None	None	None	None	720p	Backlit	Finger-print Reader	None	dTPM 2.0	4-cell(32Wh) + 3-cell(24Wh)	65W USB-C	Win10 Pro 64	3-year, Depot	02/18	
20L9001GUS	US	i7-8650U	vPro	Intel UHD 620	16GBx1	15.6" FHD (1920x1080) IPS	None	512GB SSD M.2 PCIe NVMe Opal2	None	Intel 8265 ac, 2x2 + BT4.1	None	None	None	None	720p	Backlit	Finger-print Reader	None	dTPM 2.0	4-cell(32Wh) + 3-cell(24Wh)	65W USB-C	Win10 Pro 64	3-year, Depot	02/18	
20L9001JUS	US	i5-8250U	No	Intel UHD 620	8GBx1	15.6" FHD (1920x1080) IPS	10-point Multi-touch	256GB SSD M.2 PCIe NVMe Opal2	None	Intel 8265 ac, 2x2 + BT4.1	None	None	None	None	720p	Backlit	Finger-print Reader	None	dTPM 2.0	4-cell(32Wh) + 3-cell(24Wh)	65W USB-C	Win10 Pro 64	3-year, Depot	02/18	
20L9001KUS	US	i5-8350U	vPro	Intel UHD 620	8GBx1	15.6" FHD (1920x1080) IPS	None	256GB SSD M.2 PCIe NVMe Opal2	None	Intel 8265 ac, 2x2 + BT4.1	None	None	None	None	720p	Backlit	Finger-print Reader	None	dTPM 2.0	4-cell(32Wh) + 3-cell(24Wh)	65W USB-C	Win10 Pro 64	3-year, Depot	02/18	
20L9001LUS	US	i7-8650U	vPro	Intel UHD 620	16GBx1	15.6" FHD (1920x1080) IPS	10-point Multi-touch	256GB SSD M.2 PCIe NVMe Opal2	None	Intel 8265 ac, 2x2 + BT4.1	None	None	None	None	IR &720p	Backlit	Finger-print Reader	None	dTPM 2.0	4-cell(32Wh) + 3-cell(24Wh)	65W USB-C	Win10 Pro 64	3-year, Depot	02/18	
20L9001MUS	US	i7-8550U	No	Intel UHD 620	8GBx1	15.6" FHD (1920x1080) IPS	None	256GB SSD M.2 PCIe NVMe Opal2	None	Intel 8265 ac, 2x2 + BT4.1	None	None	None	None	720p	Backlit	Finger-print Reader	None	dTPM 2.0	4-cell(32Wh) + 3-cell(24Wh)	65W USB-C	Win10 Pro 64	3-year, Depot	02/18	
20L9001NUS	US	i5-8250U	No	Intel UHD 620	8GBx1	15.6" FHD (1920x1080) IPS	None	256GB SSD M.2 PCIe NVMe Opal2	None	Intel 8265 ac, 2x2 + BT4.1	None	None	None	None	720p	Backlit	Finger-print Reader	None	dTPM 2.0	4-cell(32Wh) + 3-cell(24Wh)	65W USB-C	Win10 Pro 64	3-year, Depot	02/18	
20L9001PUS	US	i7-8650U	vPro	Intel UHD 620	8GBx1	15.6" FHD (1920x1080) IPS	None	256GB SSD M.2 PCIe NVMe Opal2	None	Intel 8265 ac, 2x2 + BT4.1	None	None	None	None	720p	Backlit	Finger-print Reader	None	dTPM 2.0	4-cell(32Wh) + 3-cell(24Wh)	65W USB-C	Win10 Pro 64	3-year, Depot	02/18	
20L9001QUS	US	i5-8350U	vPro	Intel UHD 620	16GBx1	15.6" FHD (1920x1080) IPS	10-point Multi-touch	512GB SSD M.2 PCIe NVMe Opal2	None	Intel 8265 ac, 2x2 + BT4.1	None	None	None	None	IR &720p	Backlit	Finger-print Reader	None	dTPM 2.0	4-cell(32Wh) + 3-cell(24Wh)	65W USB-C	Win10 Pro 64	3-year, Depot	02/18	
20L9001RUS	US	i5-7300U	vPro	Intel HD 620	4GBx1	15.6" FHD (1920x1080) IPS	None	500GB 7200rpm Opal2	None	Intel 8265 ac, 2x2 + BT4.1	None	None	None	None	720p	Backlit	Finger-print Reader	None	dTPM 2.0	4-cell(32Wh) + 3-cell(24Wh)	65W USB-C	Win10 Pro 64	1-year, Depot	02/18	
20L9001SUS	US	i7-8650U	vPro	Intel UHD 620	16GBx1	15.6" UHD (3840x2160) IPS	None	512GB SSD M.2 PCIe NVMe Opal2	None	Intel 8265 ac, 2x2 + BT4.1	None	None	None	None	IR &720p	Backlit	Finger-print Reader	None	dTPM 2.0	4-cell(32Wh) + 3-cell(24Wh)	65W USB-C	Win10 Pro 64	3-year, Depot	02/18	
20L9001UUS	US	i5-8350U	vPro	Intel UHD 620	8GBx1	15.6" FHD (1920x1080) IPS	None	500GB 7200rpm Opal2	None	Intel 8265 ac, 2x2 + BT4.1	None	None	None	None	720p	Backlit	Finger-print Reader	None	dTPM 2.0	4-cell(32Wh) + 3-cell(24Wh)	65W USB-C	Win10 Pro 64	3-year, Depot	02/18	
20L9001VUS	US	i5-8250U	No	Intel UHD 620	8GBx1	15.6" FHD (1920x1080) IPS	None	500GB 7200rpm Opal2	None	Intel 8265 ac, 2x2 + BT4.1	None	None	None	None	720p	Backlit	Finger-print Reader	None	dTPM 2.0	4-cell(32Wh) + 3-cell(24Wh)	65W USB-C	Win10 Pro 64	3-year, Depot	02/18	
20L9003EUS	US	i5-8350U	vPro	Intel UHD 620	8GBx1	15.6" FHD (1920x1080) IPS	None	256GB SSD M.2 PCIe NVMe Opal2	None	Intel 8265 ac, 2x2 + BT4.1	None	Fibocom L850-GL	None	None	None	720p	Backlit	Finger-print Reader	None	dTPM 2.0	4-cell(32Wh) + 3-cell(24Wh)	65W USB-C	Win10 Pro 64	3-year, Depot	04/18
20L9003FUS	US	i7-8650U	vPro	Intel UHD 620	8GBx1	15.6" FHD (1920x1080) IPS	10-point Multi-touch	256GB SSD M.2 PCIe NVMe Opal2	None	Intel 8265 ac, 2x2 + BT4.1	None	Fibocom L850-GL	None	None	None	720p	Backlit	Finger-print Reader	None	dTPM 2.0	4-cell(32Wh) + 3-cell(24Wh)	65W USB-C	Win10 Pro 64	3-year, Depot	04/18

Model	Region	Processor	vPro	Graphics	Memory	Display	Multi-touch	Storage(HDD/SSD)	Optical	WLAN + Bluetooth	WWAN	SIM Card	Smart Card Reader	Monitor Cable	Camera	Key-board	Finger-print Reader	NFC	TPM	Battery (internal+external)	Power Adapter	Operating System	Warranty	Ann Date (m/y)
20L9003GUS	US	i7-8550U	No	Intel UHD 620	8GBx1	15.6" FHD (1920x1080) IPS	None	256GB SSD M.2 PCIe NVMe Opal2	None	Intel 8265 ac, 2x2 + BT4.1	Fibocom L850-GL	None	None	None	720p	Backlit	Finger-print Reader	None	dTPM 2.0	4-cell(32Wh) + 3-cell(24Wh)	65W USB-C	Win10 Pro 64	3-year, Depot	04/18
20L9003HUS	US	i7-8650U	vPro	Intel UHD 620	8GBx1	15.6" FHD (1920x1080) IPS	None	256GB SSD M.2 PCIe NVMe Opal2	None	Intel 8265 ac, 2x2 + BT4.1	Fibocom L850-GL	None	None	None	720p	Backlit	Finger-print Reader	None	dTPM 2.0	4-cell(32Wh) + 3-cell(24Wh)	65W USB-C	Win10 Pro 64	3-year, Depot	04/18
20L9003JUS	US	i5-8250U	No	Intel UHD 620	8GBx1	15.6" FHD (1920x1080) IPS	None	500GB 7200rpm Opal2	None	Intel 8265 ac, 2x2 + BT4.1	Fibocom L850-GL	None	None	None	720p	Non-backlit	Finger-print Reader	None	dTPM 2.0	4-cell(32Wh) + 3-cell(24Wh)	65W USB-C	Win10 Pro 64	3-year, Depot	04/18
20L9003KUS	US	i5-7300U	vPro	Intel HD 620	8GBx1	15.6" FHD (1920x1080) IPS	None	256GB SSD M.2 PCIe NVMe Opal2	None	Intel 8265 ac, 2x2 + BT4.1	Fibocom L850-GL	None	None	None	720p	Backlit	Finger-print Reader	None	dTPM 2.0	4-cell(32Wh) + 3-cell(24Wh)	65W USB-C	Win10 Pro 64	3-year, Depot	04/18
20L9003LUS	US	i7-8650U	vPro	Intel UHD 620	16GBx1	15.6" FHD (1920x1080) IPS	None	1TB SSD M.2 PCIe NVMe Opal2	None	Intel 8265 ac, 2x2 + BT4.1	Fibocom L850-GL	None	None	None	720p	Backlit	Finger-print Reader	None	dTPM 2.0	4-cell(32Wh) + 3-cell(24Wh)	65W USB-C	Win10 Pro 64	3-year, Depot	04/18
20L90041US	US	i5-8250U	No	Intel UHD 620	4GBx1	15.6" FHD (1920x1080) IPS	None	500GB 7200rpm Opal2 + 16GB Optane Memory	None	Intel 8265 ac, 2x2 + BT4.1	None	None	None	None	720p	Backlit	Finger-print Reader	None	dTPM 2.0	4-cell(32Wh) + 3-cell(24Wh)	65W USB-C	Win10 Pro 64	3-year, Depot	04/18
20L90042US	US	i5-8350U	vPro	Intel UHD 620	4GBx1	15.6" FHD (1920x1080) IPS	None	500GB 7200rpm Opal2 + 16GB Optane Memory	None	Intel 8265 ac, 2x2 + BT4.1	None	None	None	None	720p	Backlit	Finger-print Reader	None	dTPM 2.0	4-cell(32Wh) + 3-cell(24Wh)	65W USB-C	Win10 Pro 64	3-year, Depot	04/18
20L90046US	US	i5-8250U	No	Intel UHD 620	8GBx1	15.6" FHD (1920x1080) IPS	None	180GB SSD Opal2	None	Intel 8265 ac, 2x2 + BT4.1	None	None	None	None	720p	Backlit	Finger-print Reader	None	dTPM 2.0	4-cell(32Wh) + 3-cell(24Wh)	65W USB-C	Win10 Pro 64	3-year, Depot	05/18



ThinkPad X1 Carbon (5th Gen) Platform Specifications

Product Specifications Reference (PSREF)

Processor	6th Generation Intel® Core™ i5 / i7 Processor (EMEA has only i5-6300U and i7-6600U)								Smart card reader None
	Processor Number	# of Cores	# of Threads	Base Frequency	Max Turbo Frequency	Cache	Memory Types	Processor Graphics	
	i5-6200U	2	4	2.3 GHz	2.8 GHz	3MB	LPDDR3-1866	Intel HD Graphics 520	
	i5-6300U			2.4 GHz	3.0 GHz	3MB			
	i7-6500U			2.5 GHz	3.1 GHz	4MB			
	i7-6600U			2.6 GHz	3.4 GHz	4MB			
	or 7th Generation Intel Core i5 / i7 Processor								
	Processor Number	# of Cores	# of Threads	Base Frequency	Max Turbo Frequency	Cache	Memory Types	Processor Graphics	
	i5-7200U	2	4	2.5 GHz	3.1 GHz	3MB	LPDDR3-1866	Intel HD Graphics 620	
	i5-7300U			2.6 GHz	3.5 GHz	3MB			
	i7-7500U			2.7 GHz	3.5 GHz	4MB			
	i7-7600U			2.8 GHz	3.9 GHz	4MB			
Graphics	Intel HD Graphics 520 or 620 in processor; supports external digital monitor via HDMI or USB Type-C; supports three independent displays; Max resolution: 4096x2304@60Hz (USB Type-C); 4096x2160@24Hz (HDMI)								
Chipset	Intel SoC (System on Chip) platform								
Memory	8GB or 16GB / 1866MHz LPDDR3 / soldered to systemboard, no sockets								
Display	<i>Some:</i> 14.0" (355mm) FHD (1920x1080), anti-glare, LED backlight, IPS, 300 nits, 16:9 aspect ratio, 700:1 contrast ratio, 170° viewing angle <i>Some:</i> 14.0" (355mm) WQHD (2560x1440), anti-glare, LED backlight, IPS, 300 nits, 16:9 aspect ratio, 700:1 contrast ratio, 170° viewing angle								
Multi-touch	None								
Storage	<i>One of the following, configurable by model:</i> <ul style="list-style-type: none"> M.2 SSD / SATA 6.0Gb/s (e.g. xxxGB SSD M.2) M.2 SSD / PCIe NVMe, PCIe 3.0 x 4, 32Gb/s (e.g. xxxGB SSD M.2 PCIe NVMe) 								
Optical	None								
Ethernet	Native Intel Ethernet Connection I219-V (Non-vPro) or I219-LM (vPro) via optional ThinkPad Ethernet Extension Cable								
WLAN	<i>One of the following, configurable by model (WiGig can coexist with WWAN):</i> <ul style="list-style-type: none"> Intel Dual Band Wireless-AC 8260, Wi-Fi 2x2 802.11ac + BT4.1, M.2 card Intel Dual Band Wireless-AC 8265, Wi-Fi 2x2 802.11ac + BT4.1, M.2 card Intel Tri-Band Wireless-AC 18265, WiGig 802.11ad + Wi-Fi 2x2 802.11ac + BT4.1, M.2 card 								
Bluetooth™	Bluetooth 4.1 wireless, integrated in Wi-Fi + Bluetooth combo adapter * Intel 8265ac / 18265ac card support BT4.2 but is limited to BT4.1 by Windows OS								
WWAN (optional)	Integrated Mobile Broadband 4G LTE-A, Qualcomm® Snapdragon™ X7 LTE-A (Sierra Wireless EM7455)								
SIM card (opt)	Micro-SIM card slot, opt Verizon LTE (US) or Lenovo® Connect (EMEA) SIM card								
Dimensions	WxDxH: 12.74" x 8.55" x 0.63"; 323.5mm x 217.1mm x 15.95mm								
Weight	Starting at 2.49 lb / 1.13 kg								
Case color	Black or Silver (silver is not available in EMEA)								
Case material	Display cover: CFRP/GFRP hybrid; Bottom: magnesium alloy hybrid								
Media reader	MicroSD card reader, supports UHS-II microSD card								
Ports	Two USB 3.1 Gen 1 (USB 3.0, one Always On), two USB 3.1 Type-C Gen 2 / Thunderbolt 3 (support data, video, and power delivery), HDMI 1.4b, Ethernet extension connector								
WiGig dock (opt)	ThinkPad WiGig dock								
Monitor cable (optional)	HDMI to VGA: Lenovo HDMI to VGA Monitor Adapter USB-C to VGA: Lenovo USB-C to VGA Adapter USB-C to DP: Lenovo USB-C to DisplayPort Adapter								
Camera (optional)	720p: HD720p resolution, fixed focus IR & 720p: IR camera and HD720p camera								
Audio support	HD Audio, Conexant® CX11871 codec / stereo speakers, 2W x 2 / dual array microphone, combo audio/microphone jack								
Keyboard	6-row, spill-resistant, multimedia Fn keys, LED backlight								
UltraNav™	TrackPoint® pointing device and buttonless Glass surface multi-touch touchpad								
Security	Power-on password, hard disk password, supervisor password, security keyhole								
Security chip vPro (optional)	Discrete TPM 2.0, TCG Certified								
Fingerprint reader	Intel vPro Technology								
NFC (optional)	Touch style match on chip fingerprint reader on the palm rest Near Field Communication								
Battery	Integrated Li-Polymer 3-cell (57Wh) RapidCharge battery								
Max battery life	MobileMark® 2014: 15.5 hr								
AC adapter	45W or 65W USB Type-C adapter								
RapidCharge	AC adapter			45W USB-C			65W USB-C		
	Charge to 80%			Not support			1.0 hr		
	Charge to 100%			Not support			2.5 hr		
Preload	Windows® 7 Professional 64 preinstalled through downgrade rights in Windows 10 Pro 64 • Lenovo Solution Center • Lenovo PowerEngage • ThinkVantage Product Recovery • ThinkVantage System Update • Adobe® Reader® • Microsoft® Office preloaded; purchase a product key to activate • McAfee® LiveSafe™ (30-day trial)								
Limited warranty	<i>One of the following, configurable by model:</i> <ul style="list-style-type: none"> 1-year depot repair service 3-year/1-yr battery depot repair service 3-year/1-yr battery limited onsite service 								
Mil-Spec test	MIL-STD-810G military certification								
Environment	EPEAT™ Gold (US only); ENERGY STAR® 6.1; RoHS-compliant								

Model	Region	Processor	vPro	Graphics	Memory (Soldered)	Display	Multi-touch	Storage(HDD/SSD)	Optical	WLAN + Bluetooth	WWAN	SIM Card	Dock	Monitor Cable	Adapter	Color	Camera	Key-board	Finger-print Reader	NFC	TPM	Battery (internal)	Power Adapter	Operating System	Warranty	Ann Date (m/y)
20HR000DUS	US	i5-7300U	vPro	Intel HD 620	8GB Soldered	14" FHD (1920x1080) IPS	None	256GB SSD M.2 PCIe NVMe Opal2	None	8265 ac, 2x2 + BT4.1	None	None	None	None	None	Black	720p	Backlit	Finger-print Reader	None	dTPM 2.0	3-cell (57Wh)	65W USB-C	Win10 Pro 64	3-year, Depot	02/17
20HR000EUS	US	i7-7600U	vPro	Intel HD 620	8GB Soldered	14" FHD (1920x1080) IPS	None	256GB SSD M.2 PCIe NVMe Opal2	None	8265 ac, 2x2 + BT4.1	None	None	None	None	None	Silver	720p	Backlit	Finger-print Reader	None	dTPM 2.0	3-cell (57Wh)	65W USB-C	Win10 Pro 64	3-year, Depot	03/17
20HR000FUS	US	i7-7600U	vPro	Intel HD 620	16GB Soldered	14" FHD (1920x1080) IPS	None	512GB SSD M.2 PCIe NVMe Opal2	None	8265 ac, 2x2 + BT4.1	None	None	None	None	None	Black	720p	Backlit	Finger-print Reader	None	dTPM 2.0	3-cell (57Wh)	65W USB-C	Win10 Pro 64	3-year, Depot	02/17
20HR000GUS	US	i5-7200U	No	Intel HD 620	8GB Soldered	14" FHD (1920x1080) IPS	None	256GB SSD M.2 PCIe NVMe Opal2	None	8265 ac, 2x2 + BT4.1	None	None	None	None	None	Silver	720p	Backlit	Finger-print Reader	None	dTPM 2.0	3-cell (57Wh)	65W USB-C	Win10 Pro 64	3-year, Depot	03/17
20HR000HUS	US	i7-7600U	vPro	Intel HD 620	8GB Soldered	14" FHD (1920x1080) IPS	None	256GB SSD M.2 PCIe NVMe Opal2	None	8265 ac, 2x2 + BT4.1	None	None	None	None	None	Black	720p	Backlit	Finger-print Reader	None	dTPM 2.0	3-cell (57Wh)	65W USB-C	Win10 Pro 64	3-year, Depot	02/17
20HR000JUS	US	i7-7600U	vPro	Intel HD 620	16GB Soldered	14" FHD (1920x1080) IPS	None	512GB SSD M.2 PCIe NVMe Opal2	None	8265 ac, 2x2 + BT4.1	None	None	None	None	None	Silver	720p	Backlit	Finger-print Reader	None	dTPM 2.0	3-cell (57Wh)	65W USB-C	Win10 Pro 64	3-year, Depot	03/17
20HR000KUS	US	i5-7300U	vPro	Intel HD 620	16GB Soldered	14" FHD (1920x1080) IPS	None	256GB SSD M.2 PCIe NVMe Opal2	None	8265 ac, 2x2 + BT4.1	None	None	None	None	None	Silver	720p	Backlit	Finger-print Reader	None	dTPM 2.0	3-cell (57Wh)	65W USB-C	Win10 Pro 64	3-year, Depot	03/17
20HR000LUS	US	i5-7300U	vPro	Intel HD 620	8GB Soldered	14" FHD (1920x1080) IPS	None	256GB SSD M.2 PCIe NVMe Opal2	None	8265 ac, 2x2 + BT4.1	None	None	None	None	None	Silver	720p	Backlit	Finger-print Reader	None	dTPM 2.0	3-cell (57Wh)	65W USB-C	Win10 Pro 64	3-year, Depot	03/17
20HR000MUS	US	i5-7300U	vPro	Intel HD 620	16GB Soldered	14" FHD (1920x1080) IPS	None	256GB SSD M.2 PCIe NVMe Opal2	None	8265 ac, 2x2 + BT4.1	None	None	None	None	None	Black	720p	Backlit	Finger-print Reader	None	dTPM 2.0	3-cell (57Wh)	65W USB-C	Win10 Pro 64	3-year, Depot	02/17
20HR000WUS	US	i5-7200U	No	Intel HD 620	8GB Soldered	14" FHD (1920x1080) IPS	None	256GB SSD M.2 PCIe NVMe Opal2	None	8265 ac, 2x2 + BT4.1	None	None	None	None	None	Black	720p	Backlit	Finger-print Reader	None	dTPM 2.0	3-cell (57Wh)	65W USB-C	Win10 Pro 64	3-year, Depot	02/17
20HR0011US	US	i5-7200U	No	Intel HD 620	8GB Soldered	14" FHD (1920x1080) IPS	None	128GB SSD M.2	None	8265 ac, 2x2 + BT4.1	None	None	None	None	None	Black	720p	Backlit	Finger-print Reader	None	dTPM 2.0	3-cell (57Wh)	65W USB-C	Win10 Pro 64	3-year, Depot	02/17
20HR003CUS	US	i5-7300U	vPro	Intel HD 620	16GB Soldered	14" FHD (1920x1080) IPS	None	512GB SSD M.2 PCIe NVMe Opal2	None	8265 ac, 2x2 + BT4.1	None	None	None	None	None	Black	720p	Backlit	Finger-print Reader	None	dTPM 2.0	3-cell (57Wh)	65W USB-C	Win10 Pro 64	3-year, Depot	02/17
20HR003DUS	US	i7-7600U	vPro	Intel HD 620	8GB Soldered	14" FHD (1920x1080) IPS	None	512GB SSD M.2 PCIe NVMe Opal2	None	8265 ac, 2x2 + BT4.1	None	None	None	None	None	Black	720p	Backlit	Finger-print Reader	None	dTPM 2.0	3-cell (57Wh)	65W USB-C	Win10 Pro 64	3-year, Depot	02/17
20HR003EUS	US	i5-7300U	vPro	Intel HD 620	8GB Soldered	14" FHD (1920x1080) IPS	None	512GB SSD M.2 PCIe NVMe Opal2	None	8265 ac, 2x2 + BT4.1	None	None	None	None	None	Black	720p	Backlit	Finger-print Reader	None	dTPM 2.0	3-cell (57Wh)	65W USB-C	Win10 Pro 64	3-year, Depot	02/17
20HR0053US	US	i7-7500U	No	Intel HD 620	8GB Soldered	14" WQHD (2560x1440) IPS	None	256GB SSD M.2 PCIe NVMe Opal2	None	8265 ac, 2x2 + BT4.1	None	None	None	None	None	Black	720p	Backlit	Finger-print Reader	None	dTPM 2.0	3-cell (57Wh)	65W USB-C	Win10 Pro 64	3-year, Depot	03/17
20HR0057US	US	i7-7500U	No	Intel HD 620	8GB Soldered	14" FHD (1920x1080) IPS	None	256GB SSD M.2 PCIe NVMe Opal2	None	8265 ac, 2x2 + BT4.1	None	None	None	None	None	Black	720p	Backlit	Finger-print Reader	None	dTPM 2.0	3-cell (57Wh)	65W USB-C	Win10 Pro 64	3-year, Depot	03/17
20HR0058US	US	i7-7500U	No	Intel HD 620	8GB Soldered	14" FHD (1920x1080) IPS	None	512GB SSD M.2 PCIe NVMe Opal2	None	8265 ac, 2x2 + BT4.1	None	None	None	None	None	Black	720p	Backlit	Finger-print Reader	None	dTPM 2.0	3-cell (57Wh)	65W USB-C	Win10 Pro 64	3-year, Depot	03/17
20HR005FUS	US	i7-7600U	vPro	Intel HD 620	16GB Soldered	14" FHD (1920x1080) IPS	None	512GB SSD M.2 PCIe NVMe Opal2	None	8265 ac, 2x2 + BT4.1	Sierra EM7455	None	None	None	None	Black	720p	Backlit	Finger-print Reader	None	dTPM 2.0	3-cell (57Wh)	65W USB-C	Win10 Pro 64	3-year, Depot	04/17
20HR005HUS	US	i7-7600U	vPro	Intel HD 620	8GB Soldered	14" FHD (1920x1080) IPS	None	256GB SSD M.2 PCIe NVMe Opal2	None	8265 ac, 2x2 + BT4.1	Sierra EM7455	None	None	None	None	Black	720p	Backlit	Finger-print Reader	None	dTPM 2.0	3-cell (57Wh)	65W USB-C	Win10 Pro 64	3-year, Depot	04/17
20HR005KUS	US	i5-7300U	vPro	Intel HD 620	8GB Soldered	14" FHD (1920x1080) IPS	None	256GB SSD M.2 PCIe NVMe Opal2	None	8265 ac, 2x2 + BT4.1	Sierra EM7455	None	None	None	None	Black	720p	Backlit	Finger-print Reader	None	dTPM 2.0	3-cell (57Wh)	65W USB-C	Win10 Pro 64	3-year, Depot	04/17

Model	Region	Processor	vPro	Graphics	Memory (Soldered)	Display	Multi-touch	Storage(HDD/SSD)	Optical	WLAN + Bluetooth	WWAN	SIM Card	Dock	Monitor Cable	Adapter	Color	Camera	Key-board	Finger-print Reader	NFC	TPM	Battery (internal)	Power Adapter	Operating System	Warranty	Ann Date (m/y)
20HR006HUS	US	i5-7300U	vPro	Intel HD 620	16GB Soldered	14" WQHD (2560x1440) IPS	None	512GB SSD M.2 PCIe NVMe Opal2	None	8265 ac, 2x2 + BT4.1	None	None	None	None	None	Black	720p	Backlit	Finger-print Reader	None	dTPM 2.0	3-cell (57Wh)	65W USB-C	Win10 Pro 64	3-year, Depot	07/17
20HR006JUS	US	i7-7600U	vPro	Intel HD 620	16GB Soldered	14" WQHD (2560x1440) IPS	None	512GB SSD M.2 PCIe NVMe Opal2	None	8265 ac, 2x2 + BT4.1	None	None	None	None	None	Black	720p	Backlit	Finger-print Reader	None	dTPM 2.0	3-cell (57Wh)	65W USB-C	Win10 Pro 64	3-year, Depot	07/17
20HR006KUS	US	i7-7600U	vPro	Intel HD 620	8GB Soldered	14" FHD (1920x1080) IPS	None	256GB SSD M.2 PCIe NVMe Opal2	None	8265 ac, 2x2 + BT4.1	Sierra EM7455	None	None	None	None	Silver	720p	Backlit	Finger-print Reader	None	dTPM 2.0	3-cell (57Wh)	65W USB-C	Win10 Pro 64	3-year, Depot	07/17
20HR006LUS	US	i7-7600U	vPro	Intel HD 620	8GB Soldered	14" WQHD (2560x1440) IPS	None	256GB SSD M.2 PCIe NVMe Opal2	None	8265 ac, 2x2 + BT4.1	None	None	None	None	None	Black	720p	Backlit	Finger-print Reader	None	dTPM 2.0	3-cell (57Wh)	65W USB-C	Win10 Pro 64	3-year, Depot	07/17
20HR006MUS	US	i5-7300U	vPro	Intel HD 620	16GB Soldered	14" WQHD (2560x1440) IPS	None	512GB SSD M.2 PCIe NVMe Opal2	None	8265 ac, 2x2 + BT4.1	Sierra EM7455	None	None	None	None	Black	720p	Backlit	Finger-print Reader	None	dTPM 2.0	3-cell (57Wh)	65W USB-C	Win10 Pro 64	3-year, Depot	07/17
20HR006NUS	US	i5-7300U	vPro	Intel HD 620	8GB Soldered	14" FHD (1920x1080) IPS	None	256GB SSD M.2 PCIe NVMe Opal2	None	8265 ac, 2x2 + BT4.1	Sierra EM7455	None	None	None	None	Silver	720p	Backlit	Finger-print Reader	None	dTPM 2.0	3-cell (57Wh)	65W USB-C	Win10 Pro 64	3-year, Depot	07/17
20HR006PUS	US	i5-7300U	vPro	Intel HD 620	8GB Soldered	14" WQHD (2560x1440) IPS	None	256GB SSD M.2 PCIe NVMe Opal2	None	8265 ac, 2x2 + BT4.1	Sierra EM7455	None	None	None	None	Black	720p	Backlit	Finger-print Reader	None	dTPM 2.0	3-cell (57Wh)	65W USB-C	Win10 Pro 64	3-year, Depot	07/17
20HR006QUS	US	i7-7600U	vPro	Intel HD 620	8GB Soldered	14" WQHD (2560x1440) IPS	None	256GB SSD M.2 PCIe NVMe Opal2	None	8265 ac, 2x2 + BT4.1	Sierra EM7455	None	None	None	None	Black	720p	Backlit	Finger-print Reader	None	dTPM 2.0	3-cell (57Wh)	65W USB-C	Win10 Pro 64	3-year, Depot	07/17
20HR006RUS	US	i5-7300U	vPro	Intel HD 620	8GB Soldered	14" WQHD (2560x1440) IPS	None	256GB SSD M.2 PCIe NVMe Opal2	None	8265 ac, 2x2 + BT4.1	None	None	None	None	None	Black	720p	Backlit	Finger-print Reader	None	dTPM 2.0	3-cell (57Wh)	65W USB-C	Win10 Pro 64	3-year, Depot	07/17
20HR006SUS	US	i7-7600U	vPro	Intel HD 620	16GB Soldered	14" WQHD (2560x1440) IPS	None	1TB SSD M.2 PCIe NVMe Opal2	None	8265 ac, 2x2 + BT4.1	None	None	None	None	None	Black	720p	Backlit	Finger-print Reader	None	dTPM 2.0	3-cell (57Wh)	65W USB-C	Win10 Pro 64	3-year, Depot	07/17
20HR006TUS	US	i7-7600U	vPro	Intel HD 620	16GB Soldered	14" WQHD (2560x1440) IPS	None	512GB SSD M.2 PCIe NVMe Opal2	None	8265 ac, 2x2 + BT4.1	Sierra EM7455	None	None	None	None	Black	720p	Backlit	Finger-print Reader	None	dTPM 2.0	3-cell (57Wh)	65W USB-C	Win10 Pro 64	3-year, Depot	07/17
20HR006UUS	US	i7-7600U	vPro	Intel HD 620	16GB Soldered	14" WQHD (2560x1440) IPS	None	512GB SSD M.2 PCIe NVMe Opal2	None	8265 ac, 2x2 + BT4.1	None	None	None	None	None	Silver	720p	Backlit	Finger-print Reader	None	dTPM 2.0	3-cell (57Wh)	65W USB-C	Win10 Pro 64	3-year, Depot	07/17
20HR006VUS	US	i7-7600U	vPro	Intel HD 620	8GB Soldered	14" WQHD (2560x1440) IPS	None	256GB SSD M.2 PCIe NVMe Opal2	None	8265 ac, 2x2 + BT4.1	None	None	None	None	None	Silver	720p	Backlit	Finger-print Reader	None	dTPM 2.0	3-cell (57Wh)	65W USB-C	Win10 Pro 64	3-year, Depot	07/17

ThinkPad X1 Carbon (5th Gen) - TopSeller - 20K4

Product Specifications Reference (PSREF)

Model	Region	Processor	vPro	Graphics	Memory (Soldered)	Display	Multi-touch	Storage(HDD/SSD)	Optical	WLAN + Bluetooth	WWAN	SIM Card	Dock	Monitor Cable	Adapter	Color	Camera	Key-board	Finger-print Reader	NFC	TPM	Battery (internal)	Power Adapter	Operating System	Warranty	Ann Date (m/y)
20K4001WUS	US	i5-6200U	No	Intel HD 520	8GB Soldered	14" FHD (1920x1080) IPS	None	512GB SSD M.2 PCIe NVMe Opal2	None	8260 ac, 2x2 + BT4.1	None	None	None	None	None	Black	720p	Backlit	Finger-print Reader	None	dTPM 2.0	3-cell (57Wh)	65W USB-C	Win10 DG Win7 Pro 64	3-year, Depot	03/17
20K4001XUS	US	i5-6300U	vPro	Intel HD 520	8GB Soldered	14" FHD (1920x1080) IPS	None	256GB SSD M.2 PCIe NVMe Opal2	None	8260 ac, 2x2 + BT4.1	None	None	None	None	None	Black	720p	Backlit	Finger-print Reader	None	dTPM 2.0	3-cell (57Wh)	65W USB-C	Win10 DG Win7 Pro 64	3-year, Depot	03/17
20K4001YUS	US	i7-6600U	vPro	Intel HD 520	8GB Soldered	14" FHD (1920x1080) IPS	None	256GB SSD M.2 PCIe NVMe Opal2	None	8260 ac, 2x2 + BT4.1	None	None	None	None	None	Black	720p	Backlit	Finger-print Reader	None	dTPM 2.0	3-cell (57Wh)	65W USB-C	Win10 DG Win7 Pro 64	3-year, Depot	03/17
20K40020US	US	i7-6600U	vPro	Intel HD 520	8GB Soldered	14" FHD (1920x1080) IPS	None	512GB SSD M.2 PCIe NVMe Opal2	None	8260 ac, 2x2 + BT4.1	None	None	None	None	None	Black	720p	Backlit	Finger-print Reader	None	dTPM 2.0	3-cell (57Wh)	65W USB-C	Win10 DG Win7 Pro 64	3-year, Depot	03/17
20K40021US	US	i5-6200U	No	Intel HD 520	8GB Soldered	14" FHD (1920x1080) IPS	None	256GB SSD M.2 PCIe NVMe Opal2	None	8260 ac, 2x2 + BT4.1	None	None	None	None	None	Black	720p	Backlit	Finger-print Reader	None	dTPM 2.0	3-cell (57Wh)	65W USB-C	Win10 DG Win7 Pro 64	3-year, Depot	03/17
20K4002RUS	US	i7-6500U	No	Intel HD 520	8GB Soldered	14" FHD (1920x1080) IPS	None	256GB SSD M.2 PCIe NVMe Opal2	None	8260 ac, 2x2 + BT4.1	None	None	None	None	None	Black	720p	Backlit	Finger-print Reader	None	dTPM 2.0	3-cell (57Wh)	65W USB-C	Win10 DG Win7 Pro 64	3-year, Depot	03/17
20K4002SUS	US	i7-6500U	No	Intel HD 520	8GB Soldered	14" FHD (1920x1080) IPS	None	512GB SSD M.2 PCIe NVMe Opal2	None	8260 ac, 2x2 + BT4.1	None	None	None	None	None	Black	720p	Backlit	Finger-print Reader	None	dTPM 2.0	3-cell (57Wh)	65W USB-C	Win10 DG Win7 Pro 64	3-year, Depot	03/17
20K4002TUS	US	i7-6500U	No	Intel HD 520	8GB Soldered	14" WQHD (2560x1440) IPS	None	512GB SSD M.2 PCIe NVMe Opal2	None	8260 ac, 2x2 + BT4.1	None	None	None	None	None	Black	720p	Backlit	Finger-print Reader	None	dTPM 2.0	3-cell (57Wh)	65W USB-C	Win10 DG Win7 Pro 64	3-year, Depot	03/17
20K4002UUS	US	i5-6200U	No	Intel HD 520	8GB Soldered	14" FHD (1920x1080) IPS	None	180GB SSD M.2 Opal2	None	8260 ac, 2x2 + BT4.1	None	None	None	None	None	Black	720p	Backlit	Finger-print Reader	None	dTPM 2.0	3-cell (57Wh)	65W USB-C	Win10 DG Win7 Pro 64	3-year, Depot	03/17
20K4002WUS	US	i7-6600U	vPro	Intel HD 520	16GB Soldered	14" WQHD (2560x1440) IPS	None	512GB SSD M.2 PCIe NVMe Opal2	None	8260 ac, 2x2 + BT4.1	Sierra EM7455	None	None	None	None	Black	720p	Backlit	Finger-print Reader	None	dTPM 2.0	3-cell (57Wh)	65W USB-C	Win10 DG Win7 Pro 64	3-year, Depot	07/17
20K4002XUS	US	i5-6300U	vPro	Intel HD 520	8GB Soldered	14" WQHD (2560x1440) IPS	None	256GB SSD M.2 PCIe NVMe Opal2	None	8260 ac, 2x2 + BT4.1	Sierra EM7455	None	None	None	None	Black	720p	Backlit	Finger-print Reader	None	dTPM 2.0	3-cell (57Wh)	65W USB-C	Win10 DG Win7 Pro 64	3-year, Depot	07/17
20K4002YUS	US	i5-6300U	vPro	Intel HD 520	8GB Soldered	14" WQHD (2560x1440) IPS	None	256GB SSD M.2 PCIe NVMe Opal2	None	8260 ac, 2x2 + BT4.1	None	None	None	None	None	Black	720p	Backlit	Finger-print Reader	None	dTPM 2.0	3-cell (57Wh)	65W USB-C	Win10 DG Win7 Pro 64	3-year, Depot	07/17
20K40030US	US	i5-6300U	vPro	Intel HD 520	8GB Soldered	14" FHD (1920x1080) IPS	None	256GB SSD M.2 PCIe NVMe Opal2	None	8260 ac, 2x2 + BT4.1	Sierra EM7455	None	None	None	None	Black	720p	Backlit	Finger-print Reader	None	dTPM 2.0	3-cell (57Wh)	65W USB-C	Win10 DG Win7 Pro 64	3-year, Depot	07/17



ThinkPad X1 Carbon (6th Gen) Platform Specifications

Product Specifications Reference (PSREF)

Processor	7th Generation Intel® Core™ i5 Processor								Dimensions Weight Case color Case material	<i>WxDxH:</i> 12.74" x 8.55" x 0.63"; 323.5mm x 217.1mm x 15.95mm Starting at 2.49 lb / 1.13 kg Black or Silver (silver case is NOT available in EMEA) <i>Display cover:</i> CFRP/GFRP hybrid; <i>Bottom:</i> magnesium alloy / PPS hybrid
	Processor Number	# of Cores	# of Threads	Base Frequency	Max Turbo Frequency	Cache	Memory Types	Processor Graphics		
	i5-7300U	2	4	2.6 GHz	3.5 GHz	3MB	LPDDR3-1866	Intel HD Graphics 620		
	or 8th Generation Intel Core i5 / i7 Processor									
	Processor Number	# of Cores	# of Threads	Base Frequency	Max Turbo Frequency	Cache	Memory Types	Processor Graphics		
	i5-8250U	4	8	1.6 GHz	3.4 GHz	6MB	LPDDR3-2133	Intel UHD Graphics 620	Smart card reader: None Media reader: MicroSD card reader, supports UHS-II Ports: Two USB 3.1 Gen 1 (one Always On), two USB 3.1 Type-C Gen 2 / Thunderbolt 3, HDMI 1.4b, Ethernet extension connector, nano-SIM card slot (WWAN models), headphone / microphone combo jack, microSD card reader, side docking connector, security keyhole Monitor cable: <i>Optional:</i> Lenovo HDMI to VGA Monitor Adapter Camera (<i>optional</i>): <i>One of the following, configurable by model:</i> • HD720p camera with ThinkShutter camera privacy, fixed focus • IR camera and HD720p camera, fixed focus Audio support: HD Audio, Realtek® ALC3286 codec, Dolby® Audio™ Premium / stereo speakers, 1W x 2 / dual array microphone, headphone / microphone combo jack, Dolby® Atmos™ via headphones	
	i5-8350U			1.7 GHz	3.6 GHz	6MB				
	i7-8550U			1.8 GHz	4.0 GHz	8MB				
	i7-8650U			1.9 GHz	4.2 GHz	8MB				
Graphics	Intel HD Graphics 620 or Intel UHD Graphics 620 in processor; supports external digital monitor via HDMI or USB Type-C; supports three independent displays; Max resolution: 5120x2880@60Hz (USB Type-C); 4096x2160@30Hz (HDMI)									
Chipset Memory	Intel SoC (System on Chip) platform 8GB or 16GB / 2133MHz LPDDR3 / soldered to systemboard, no sockets * System clocks down for processors with lower memory controller								Keyboard UltraNav™	6-row, spill-resistant, multimedia Fn keys, LED backlight TrackPoint® pointing device and buttonless Glass surface multi-touch touchpad
Display	<i>One of the following, configurable by model:</i> • 14.0" (355mm) FHD (1920x1080), anti-glare, LED backlight, IPS, 300 nits, 16:9 aspect ratio, 700:1 contrast ratio, 72% gamut, 170° viewing angle • 14.0" (355mm) WQHD (2560x1440), anti-glare, LED backlight, IPS, 300 nits, 16:9 aspect ratio, 700:1 contrast ratio, 72% gamut, 170° viewing angle • 14.0" (355mm) HDR WQHD (2560x1440) with Dolby Vision™, glossy, LED backlight, IPS, 500 nits, 16:9 aspect ratio, 1500:1 contrast ratio, 100% gamut, 170° viewing angle								Security Security chip vPro (<i>optional</i>) Fingerprint reader NFC (<i>optional</i>)	Power-on password, hard disk password, supervisor password, security keyhole Discrete TPM 2.0, TCG Certified Intel vPro Technology Touch style match on chip fingerprint reader on the palm rest, anti-spoofing technology Near Field Communication
Multi-touch (<i>opt</i>)	On-cell touch, supports 10-finger gesture (FHD only)								Battery	Integrated Li-Ion 57Wh battery, supports Rapid Charge (charge up to 80% in 1hr) with 65W USB Type-C AC adapter
Storage	<i>One of the following, configurable by model:</i> • M.2 SSD / SATA 6.0Gb/s (e.g. xxxGB SSD M.2) • M.2 SSD / PCIe NVMe, PCIe 3.0 x 4, 32Gb/s (e.g. xxxGB SSD M.2 PCIe NVMe)								Max battery life	<i>MobileMark® 2014:</i> 19.3 hr * Battery life varies significantly with settings, usage, & other factors
Optical	None								AC adapter	45W or 65W USB Type-C AC adapter
Ethernet	Native Intel Ethernet Connection I219-V (<i>Non-vPro</i>) or I219-LM (<i>vPro</i>) via optional ThinkPad Ethernet Extension Cable Gen 2								Preload	Windows® 10 Home 64 or Windows 10 Pro 64
WLAN + Bluetooth™	Intel Dual Band Wireless-AC 8265, Wi-Fi 2x2 802.11ac + Bluetooth 4.1, M.2 card * Intel 8265ac card supports BT4.2 but is limited to BT4.1 by Windows OS								Limited warranty	<i>One of the following, configurable by model:</i> • 1-year depot repair service • 3-year/1-yr battery depot repair service • 3-year/1-yr battery limited onsite service
WWAN (<i>optional</i>)	Integrated Mobile Broadband 4G LTE-A, Intel XMM™ 7360 (Fibocom L850-GL), M.2 card								Mil-Spec test	MIL-STD-810G military certification
SIM card (<i>opt</i>)	Nano-SIM card slot, optional Verizon LTE (US) SIM card								Environment	EPEAT™ Gold; ENERGY STAR® 6.1; RoHS-compliant

Model	Region	Processor	vPro	Graphics	Memory (Soldered)	Display(Size, Resolution, Type)	Multi-touch	Storage(HDD/SSD)	Optical	WLAN + Bluetooth	WWAN	SIM Card	Monitor Cable	Adapter	Color	Camera	Key-board	Finger-print Reader	NFC	TPM	Battery (internal)	Power Adapter	Operating System	Warranty	Ann Date (m/y)
20KH002DUS	US	i5-8350U	vPro	Intel UHD 620	16GB Soldered	14" FHD (1920x1080) IPS AG	None	256GB SSD M.2 PCIe NVMe Opal2	None	8265 ac, 2x2 + BT4.1	None	None	None	None	Black	720p	Backlit	Finger-print Reader	None	dTPM 2.0	57Wh	65W USB-C	Win10 Pro 64	3-year, Depot	02/18
20KH002EUS	US	i7-8650U	vPro	Intel UHD 620	16GB Soldered	14" FHD (1920x1080) IPS AG	None	512GB SSD M.2 PCIe NVMe Opal2	None	8265 ac, 2x2 + BT4.1	None	None	None	None	Black	720p	Backlit	Finger-print Reader	None	dTPM 2.0	57Wh	65W USB-C	Win10 Pro 64	3-year, Depot	02/18
20KH002FUS	US	i7-8650U	vPro	Intel UHD 620	16GB Soldered	14" HDR WQHD (2560x1440)IPS Glossy	None	1TB SSD M.2 PCIe NVMe Opal2	None	8265 ac, 2x2 + BT4.1	None	None	None	None	Black	720p	Backlit	Finger-print Reader	None	dTPM 2.0	57Wh	65W USB-C	Win10 Pro 64	3-year, Depot	02/18
20KH002GUS	US	i7-8650U	vPro	Intel UHD 620	16GB Soldered	14" WQHD (2560x1440) IPS AG	None	512GB SSD M.2 PCIe NVMe Opal2	None	8265 ac, 2x2 + BT4.1	None	None	None	None	Silver	IR &720p	Backlit	Finger-print Reader	None	dTPM 2.0	57Wh	65W USB-C	Win10 Pro 64	3-year, Depot	02/18
20KH002JUS	US	i7-8650U	vPro	Intel UHD 620	16GB Soldered	14" FHD (1920x1080) IPS AG	10-point Multi-touch	512GB SSD M.2 PCIe NVMe Opal2	None	8265 ac, 2x2 + BT4.1	None	None	None	None	Black	720p	Backlit	Finger-print Reader	None	dTPM 2.0	57Wh	65W USB-C	Win10 Pro 64	3-year, Depot	02/18
20KH002LUS	US	i7-8650U	vPro	Intel UHD 620	16GB Soldered	14" HDR WQHD (2560x1440)IPS Glossy	None	512GB SSD M.2 PCIe NVMe Opal2	None	8265 ac, 2x2 + BT4.1	None	None	None	None	Black	720p	Backlit	Finger-print Reader	None	dTPM 2.0	57Wh	65W USB-C	Win10 Pro 64	3-year, Depot	02/18
20KH002MUS	US	i7-8550U	No	Intel UHD 620	8GB Soldered	14" FHD (1920x1080) IPS AG	10-point Multi-touch	256GB SSD M.2 PCIe NVMe Opal2	None	8265 ac, 2x2 + BT4.1	None	None	None	None	Black	720p	Backlit	Finger-print Reader	None	dTPM 2.0	57Wh	65W USB-C	Win10 Pro 64	3-year, Depot	02/18
20KH002NUS	US	i5-8350U	vPro	Intel UHD 620	16GB Soldered	14" FHD (1920x1080) IPS AG	10-point Multi-touch	256GB SSD M.2 PCIe NVMe Opal2	None	8265 ac, 2x2 + BT4.1	None	None	None	None	Black	720p	Backlit	Finger-print Reader	None	dTPM 2.0	57Wh	65W USB-C	Win10 Pro 64	3-year, Depot	02/18
20KH002PUS	US	i5-8350U	vPro	Intel UHD 620	8GB Soldered	14" FHD (1920x1080) IPS AG	10-point Multi-touch	256GB SSD M.2 PCIe NVMe Opal2	None	8265 ac, 2x2 + BT4.1	None	None	None	None	Black	720p	Backlit	Finger-print Reader	None	dTPM 2.0	57Wh	65W USB-C	Win10 Pro 64	3-year, Depot	02/18
20KH002RUS	US	i7-8650U	vPro	Intel UHD 620	16GB Soldered	14" WQHD (2560x1440) IPS AG	None	512GB SSD M.2 PCIe NVMe Opal2	None	8265 ac, 2x2 + BT4.1	None	None	None	None	Black	IR &720p	Backlit	Finger-print Reader	None	dTPM 2.0	57Wh	65W USB-C	Win10 Pro 64	3-year, Depot	02/18
20KH002SUS	US	i5-8250U	No	Intel UHD 620	8GB Soldered	14" FHD (1920x1080) IPS AG	None	256GB SSD M.2 PCIe NVMe Opal2	None	8265 ac, 2x2 + BT4.1	None	None	None	None	Black	720p	Backlit	Finger-print Reader	None	dTPM 2.0	57Wh	65W USB-C	Win10 Pro 64	3-year, Depot	02/18
20KH002TUS	US	i7-8550U	No	Intel UHD 620	8GB Soldered	14" FHD (1920x1080) IPS AG	None	256GB SSD M.2 PCIe NVMe Opal2	None	8265 ac, 2x2 + BT4.1	None	None	None	None	Silver	720p	Backlit	Finger-print Reader	None	dTPM 2.0	57Wh	65W USB-C	Win10 Pro 64	3-year, Depot	02/18
20KH002UUS	US	i5-8350U	vPro	Intel UHD 620	8GB Soldered	14" FHD (1920x1080) IPS AG	None	256GB SSD M.2 PCIe NVMe Opal2	None	8265 ac, 2x2 + BT4.1	None	None	None	None	Silver	720p	Backlit	Finger-print Reader	None	dTPM 2.0	57Wh	65W USB-C	Win10 Pro 64	3-year, Depot	02/18
20KH002VUS	US	i5-8250U	No	Intel UHD 620	8GB Soldered	14" FHD (1920x1080) IPS AG	10-point Multi-touch	256GB SSD M.2 PCIe NVMe Opal2	None	8265 ac, 2x2 + BT4.1	None	None	None	None	Black	720p	Backlit	Finger-print Reader	None	dTPM 2.0	57Wh	65W USB-C	Win10 Pro 64	3-year, Depot	02/18
20KH002WUS	US	i5-8350U	vPro	Intel UHD 620	8GB Soldered	14" FHD (1920x1080) IPS AG	None	256GB SSD M.2 PCIe NVMe Opal2	None	8265 ac, 2x2 + BT4.1	None	None	None	None	Black	720p	Backlit	Finger-print Reader	None	dTPM 2.0	57Wh	65W USB-C	Win10 Pro 64	3-year, Depot	02/18
20KH002XUS	US	i7-8550U	No	Intel UHD 620	8GB Soldered	14" FHD (1920x1080) IPS AG	None	256GB SSD M.2 PCIe NVMe Opal2	None	8265 ac, 2x2 + BT4.1	None	None	None	None	Black	720p	Backlit	Finger-print Reader	None	dTPM 2.0	57Wh	65W USB-C	Win10 Pro 64	3-year, Depot	02/18
20KH002YUS	US	i5-8250U	No	Intel UHD 620	8GB Soldered	14" FHD (1920x1080) IPS AG	None	256GB SSD M.2 PCIe NVMe Opal2	None	8265 ac, 2x2 + BT4.1	None	None	None	None	Silver	720p	Backlit	Finger-print Reader	None	dTPM 2.0	57Wh	65W USB-C	Win10 Pro 64	3-year, Depot	02/18
20KH006XUS	US	i7-8650U	vPro	Intel UHD 620	16GB Soldered	14" WQHD (2560x1440) IPS AG	None	512GB SSD M.2 PCIe NVMe Opal2	None	8265 ac, 2x2 + BT4.1	None	Fibocom L850-GL	None	None	Black	IR &720p	Backlit	Finger-print Reader	None	dTPM 2.0	57Wh	65W USB-C	Win10 Pro 64	3-year, Depot	05/18
20KH006YUS	US	i7-8550U	No	Intel UHD 620	16GB Soldered	14" WQHD (2560x1440) IPS AG	None	512GB SSD M.2 PCIe NVMe Opal2	None	8265 ac, 2x2 + BT4.1	None	Fibocom L850-GL	None	None	Black	IR &720p	Backlit	Finger-print Reader	None	dTPM 2.0	57Wh	65W USB-C	Win10 Pro 64	3-year, Depot	05/18
20KH0070US	US	i7-8650U	vPro	Intel UHD 620	16GB Soldered	14" WQHD (2560x1440) IPS AG	None	512GB SSD M.2 PCIe NVMe Opal2	None	8265 ac, 2x2 + BT4.1	None	Fibocom L850-GL	None	None	Silver	IR &720p	Backlit	Finger-print Reader	None	dTPM 2.0	57Wh	65W USB-C	Win10 Pro 64	3-year, Depot	05/18

Model	Region	Processor	vPro	Graphics	Memory (Soldered)	Display(Size, Resolution, Type)	Multi-touch	Storage(HDD/SSD)	Optical	WLAN + Bluetooth	WWAN	SIM Card	Monitor Cable	Adapter	Color	Camera	Key-board	Finger-print Reader	NFC	TPM	Battery (internal)	Power Adapter	Operating System	Warranty	Ann Date (m/y)
20KH0071US	US	i5-8350U	vPro	Intel UHD 620	8GB Soldered	14" FHD (1920x1080) IPS AG	None	256GB SSD M.2 PCIe NVMe Opal2	None	8265 ac, 2x2 + BT4.1	Fibocom L850-GL	None	None	None	Silver	720p	Backlit	Finger-print Reader	None	dTPM 2.0	57Wh	65W USB-C	Win10 Pro 64	3-year, Depot	05/18
20KH0072US	US	i7-8650U	vPro	Intel UHD 620	8GB Soldered	14" FHD (1920x1080) IPS AG	10-point Multi-touch	256GB SSD M.2 PCIe NVMe Opal2	None	8265 ac, 2x2 + BT4.1	Fibocom L850-GL	None	None	None	Black	720p	Backlit	Finger-print Reader	None	dTPM 2.0	57Wh	65W USB-C	Win10 Pro 64	3-year, Depot	05/18
20KH0073US	US	i7-8650U	vPro	Intel UHD 620	8GB Soldered	14" FHD (1920x1080) IPS AG	None	256GB SSD M.2 PCIe NVMe Opal2	None	8265 ac, 2x2 + BT4.1	Fibocom L850-GL	None	None	None	Silver	720p	Backlit	Finger-print Reader	None	dTPM 2.0	57Wh	65W USB-C	Win10 Pro 64	3-year, Depot	05/18
20KH0074US	US	i5-8350U	vPro	Intel UHD 620	8GB Soldered	14" FHD (1920x1080) IPS AG	None	256GB SSD M.2 PCIe NVMe Opal2	None	8265 ac, 2x2 + BT4.1	Fibocom L850-GL	None	None	None	Black	720p	Backlit	Finger-print Reader	None	dTPM 2.0	57Wh	65W USB-C	Win10 Pro 64	3-year, Depot	05/18
20KH0075US	US	i7-8650U	vPro	Intel UHD 620	8GB Soldered	14" FHD (1920x1080) IPS AG	None	256GB SSD M.2 PCIe NVMe Opal2	None	8265 ac, 2x2 + BT4.1	Fibocom L850-GL	None	None	None	Black	720p	Backlit	Finger-print Reader	None	dTPM 2.0	57Wh	65W USB-C	Win10 Pro 64	3-year, Depot	05/18
20KH0076US	US	i7-8650U	vPro	Intel UHD 620	8GB Soldered	14" FHD (1920x1080) IPS AG	10-point Multi-touch	256GB SSD M.2 PCIe NVMe Opal2	None	8265 ac, 2x2 + BT4.1	Fibocom L850-GL	None	None	None	Silver	720p	Backlit	Finger-print Reader	None	dTPM 2.0	57Wh	65W USB-C	Win10 Pro 64	3-year, Depot	05/18
20KH007CUS	US	i5-8350U	vPro	Intel UHD 620	8GB Soldered	14" WQHD (2560x1440) IPS AG	None	512GB SSD M.2 PCIe NVMe Opal2	None	8265 ac, 2x2 + BT4.1	None	None	None	None	Black	IR &720p	Backlit	Finger-print Reader	None	dTPM 2.0	57Wh	65W USB-C	Win10 Pro 64	3-year, Depot	04/18
20KH007DUS	US	i5-8350U	vPro	Intel UHD 620	16GB Soldered	14" WQHD (2560x1440) IPS AG	None	512GB SSD M.2 PCIe NVMe Opal2	None	8265 ac, 2x2 + BT4.1	None	None	None	None	Black	IR &720p	Backlit	Finger-print Reader	None	dTPM 2.0	57Wh	65W USB-C	Win10 Pro 64	3-year, Depot	04/18
20KH007EUS	US	i5-8350U	vPro	Intel UHD 620	16GB Soldered	14" WQHD (2560x1440) IPS AG	None	512GB SSD M.2 PCIe NVMe Opal2	None	8265 ac, 2x2 + BT4.1	None	None	None	None	Silver	IR &720p	Backlit	Finger-print Reader	None	dTPM 2.0	57Wh	65W USB-C	Win10 Pro 64	3-year, Depot	04/18



ThinkPad X270 Platform Specifications

Product Specifications Reference (PSREF)

Processor	6th Generation Intel® Core™ i3 / i5 / i7 Processor							WWAN (optional) <i>One of the following, configurable by model (mutually exclusive with WiGig):</i> <ul style="list-style-type: none"> Wireless WAN upgradable Integrated Mobile Broadband 4G LTE-A, Qualcomm® Snapdragon™ X7 LTE-A (Sierra Wireless EM7455) Integrated Mobile Broadband 4G LTE, Intel XMM™ 7160 (Fibocom L831-EAU) (EMEA only) SIM card (opt) Micro-SIM card slot, opt Verizon LTE (US) or Lenovo® Connect (EMEA) SIM card
	Processor Number	# of Cores	# of Threads	Base Frequency	Max Turbo Frequency	Cache	Memory Types	
	i3-6006U	2	4	2.0 GHz	-	3MB	DDR4-2133	Intel HD Graphics 520
	i3-6100U			2.3 GHz	-	3MB		
	i5-6200U			2.3 GHz	2.8 GHz	3MB		
	i5-6300U			2.4 GHz	3.0 GHz	3MB		
	i7-6500U			2.5 GHz	3.1 GHz	4MB		
	i7-6600U			2.6 GHz	3.4 GHz	4MB		
	or 7th Generation Intel Core i3 / i5 / i7 Processor							
	Processor Number	# of Cores	# of Threads	Base Frequency	Max Turbo Frequency	Cache	Memory Types	Processor Graphics
	i3-7100U	2	4	2.4 GHz	-	3MB	DDR4-2133	Intel HD Graphics 620
	i5-7200U			2.5 GHz	3.1 GHz	3MB		
	i5-7300U			2.6 GHz	3.5 GHz	3MB		
	i7-7500U			2.7 GHz	3.5 GHz	4MB		
	i7-7600U			2.8 GHz	3.9 GHz	4MB		
	Graphics							
	Intel HD Graphics 520 or 620 in processor; supports external digital monitor via HDMI or USB Type-C; supports three independent displays; Max resolution: 4096x2160@60Hz (USB Type-C); 4096x2160@24Hz (HDMI)							
Chipset	Intel SoC (System on Chip) platform							
Memory	16GB max / 2400MHz DDR4, one DDR4 SO-DIMM socket * System clocks down for processors with lower memory controller							
Display	<i>Some:</i> 12.5" (317.5mm) HD (1366x768), anti-glare, LED backlight, 220 nits, 16:9 aspect ratio, 500:1 contrast ratio <i>Some:</i> 12.5" (317.5mm) HD (1366x768), anti-glare, LED backlight, IPS, 300 nits, 16:9 aspect ratio, 800:1 contrast ratio, 170° viewing angle <i>Some:</i> 12.5" (317.5mm) FHD (1920x1080), anti-glare, LED backlight, IPS, 300 nits, 16:9 aspect ratio, 700:1 contrast ratio, 170° viewing angle							
Multi-touch (opt)	On-cell touch, supports 10-finger gesture (FHD only)							
Storage	<i>System has one HDD slot or one M.2 2280 slot exclusively for storage</i> <i>Some:</i> HDD / SATA 6.0Gb/s, 2.5" wide, 7mm high, Active Protection System™ <i>Some:</i> SSD / SATA 6.0Gb/s, 2.5" wide, 7mm high (e.g. xxxGB SSD) <i>Some:</i> M.2 SSD / PCIe NVMe, PCIe 3.0 x 2, 16Gb/s <i>Some:</i> 128GB M.2 SSD / SATA 6.0Gb/s, in WWAN slot as 2nd Storage, mutually exclusive with WWAN and WiGig							
Optical	None							
Ethernet	<i>Non-vPro model:</i> Intel Ethernet Connection I219-V (Jacksonville) <i>vPro model:</i> Intel Ethernet Connection I219-LM (Jacksonville)							
WLAN	<i>One of the following, configurable by model (WiGig is mutually exclusive with WWAN):</i> <ul style="list-style-type: none"> Realtek® RTL8822BE, Wi-Fi 2x2 802.11ac + BT4.1 Intel Dual Band Wireless-AC 8260, Wi-Fi 2x2 802.11ac + BT4.1 Intel Dual Band Wireless-AC 8265, Wi-Fi 2x2 802.11ac + BT4.1 Intel Tri-Band Wireless-AC 18265, WiGig 802.11ad + Wi-Fi 2x2 802.11ac + BT4.1 (US only) Bluetooth™ 4.1 wireless, integrated in Wi-Fi + Bluetooth combo adapter * Intel 8265ac / 18265ac card support BT4.2 but is limited to BT4.1 by Windows OS							
Bluetooth™								
Camera (optional)	HD720p resolution, fixed focus							
Audio support	HD Audio, Realtek ALC3268 codec / stereo speakers, 1.5W x 2 / dual array microphone, combo audio/microphone jack							
Keyboard	6-row, spill-resistant, multimedia Fn keys, optional LED backlight							
UltraNav™	TrackPoint® pointing device and buttonless Mylar surface multi-touch touchpad							
Security	Power-on password, hard disk password, supervisor password, security keyhole							
Security chip	Discrete TPM 2.0, TCG Certified							
vPro (optional)	Intel vPro Technology							
Fingerprint reader	<i>Optional:</i> Touch style match on chip fingerprint reader on the palm rest							
NFC (optional)	Near Field Communication							
Internal battery	<i>Optional:</i> Integrated Li-Ion or Li-Polymer 3-cell (23Wh)							
External battery	Li-Ion 3-cell (23Wh) or 6-cell (48Wh or 72Wh)							
Max battery life (MobileMark® 2014)								
	<i>Models</i>	<i>No + 3-cell</i>	<i>3-cell + 3-cell</i>	<i>3-cell + 6-cell 48Wh</i>	<i>3-cell + 6-cell 72Wh</i>			
	<i>Max battery life</i>	6.52 hr	13.04 hr	20.1 hr	26.9 hr			
AC adapter	45W slim tip AC adapter or 45W USB Type-C AC adapter							
Preload	Windows® 7 Professional 64 preinstalled through downgrade rights in Windows 10 Pro 64			<i>Some:</i> Windows 10 Home 64 • Lenovo Companion • Lenovo Setting • Microsoft Office preloaded; purchase a product key to activate				
	• Lenovo Solution Center • Lenovo PowerEngage • ThinkVantage Product Recovery • ThinkVantage System Update • Adobe® Reader® • Microsoft® Office preloaded; purchase a product key to activate • McAfee® LiveSafe™ (30-day trial)							
Limited warranty	<i>One of the following, configurable by model:</i> <ul style="list-style-type: none"> 1-year depot repair service 3-year/1-yr battery depot repair service 3-year/1-yr battery limited onsite service 							
Mil-Spec test	MIL-STD-810G military certification							
Environment	EPEAT™ Gold (US only); ENERGY STAR® 6.1; RoHS-compliant							

Model	Region	Processor	vPro	Graphics	Memory	Display	Multi-touch	Storage(HDD/SSD)	Optical	WLAN + Bluetooth	WWAN	SIM Card	Smart Card Reader	Dock	Monitor Cable	Camera	Key-board	Finger-print Reader	NFC	TPM	Battery (internal+external)	Power Adapter	Operating System	Warranty	Ann Date (m/y)
20HN001FUS	US	i5-7200U	No	Intel HD 620	8GBx1	12.5" FHD (1920x1080) IPS	None	256GB SSD M.2 PCIe NVMe Opal2	None	Intel 8265 ac, 2x2 + BT4.1	WWAN Upgradable	None	None	None	None	720p	Backlit	Finger-print Reader	None	dTPM 2.0	3-cell(23Wh) + 3-cell(23Wh)	45W Slim Tip	Win10 Pro 64	3-year, Depot	02/17
20HN001GUS	US	i7-7600U	vPro	Intel HD 620	16GBx1	12.5" FHD (1920x1080) IPS	None	512GB SSD M.2 PCIe NVMe Opal2	None	Intel 8265 ac, 2x2 + BT4.1	WWAN Upgradable	None	None	None	None	720p	Backlit	Finger-print Reader	None	dTPM 2.0	3-cell(23Wh) + 3-cell(23Wh)	45W Slim Tip	Win10 Pro 64	3-year, Depot	02/17
20HN001HUS	US	i7-7500U	No	Intel HD 620	16GBx1	12.5" FHD (1920x1080) IPS	None	256GB SSD M.2 PCIe NVMe Opal2	None	Intel 8265 ac, 2x2 + BT4.1	WWAN Upgradable	None	None	None	None	720p	Backlit	Finger-print Reader	None	dTPM 2.0	3-cell(23Wh) + 3-cell(23Wh)	45W Slim Tip	Win10 Pro 64	3-year, Depot	02/17
20HN001JUS	US	i5-7300U	vPro	Intel HD 620	8GBx1	12.5" FHD (1920x1080) IPS	None	256GB SSD M.2 PCIe NVMe Opal2	None	Intel 8265 ac, 2x2 + BT4.1	WWAN Upgradable	None	None	None	None	720p	Backlit	Finger-print Reader	None	dTPM 2.0	3-cell(23Wh) + 3-cell(23Wh)	45W Slim Tip	Win10 Pro 64	3-year, Depot	02/17
20HN001KUS	US	i5-7200U	No	Intel HD 620	8GBx1	12.5" HD (1366x768) IPS	None	500GB 7200rpm	None	Intel 8265 ac, 2x2 + BT4.1	WWAN Upgradable	None	None	None	None	720p	Backlit	Finger-print Reader	None	dTPM 2.0	3-cell(23Wh) + 3-cell(23Wh)	45W Slim Tip	Win10 Pro 64	3-year, Depot	02/17
20HN001LUS	US	i5-7300U	vPro	Intel HD 620	8GBx1	12.5" HD (1366x768) IPS	None	256GB SSD M.2 PCIe NVMe Opal2	None	Intel 8265 ac, 2x2 + BT4.1	WWAN Upgradable	None	None	None	None	720p	Backlit	Finger-print Reader	None	dTPM 2.0	3-cell(23Wh) + 3-cell(23Wh)	45W Slim Tip	Win10 Pro 64	3-year, Depot	02/17
20HN001MUS	US	i7-7500U	No	Intel HD 620	16GBx1	12.5" FHD (1920x1080) IPS	None	512GB SSD M.2 PCIe NVMe Opal2	None	Intel 8265 ac, 2x2 + BT4.1	WWAN Upgradable	None	None	None	None	720p	Backlit	Finger-print Reader	None	dTPM 2.0	3-cell(23Wh) + 3-cell(23Wh)	45W Slim Tip	Win10 Pro 64	3-year, Depot	02/17
20HN001NUS	US	i7-7600U	vPro	Intel HD 620	16GBx1	12.5" FHD (1920x1080) IPS	None	256GB SSD M.2 PCIe NVMe Opal2	None	Intel 8265 ac, 2x2 + BT4.1	WWAN Upgradable	None	None	None	None	720p	Backlit	Finger-print Reader	None	dTPM 2.0	3-cell(23Wh) + 3-cell(23Wh)	45W Slim Tip	Win10 Pro 64	3-year, Depot	02/17
20HN001PUS	US	i3-7100U	No	Intel HD 620	4GBx1	12.5" HD (1366x768) IPS	None	500GB 7200rpm	None	Intel 8265 ac, 2x2 + BT4.1	WWAN Upgradable	None	None	None	None	720p	Backlit	Finger-print Reader	None	dTPM 2.0	3-cell(23Wh) + 3-cell(23Wh)	45W Slim Tip	Win10 Pro 64	3-year, Depot	02/17
20HN001QUS	US	i7-7600U	vPro	Intel HD 620	8GBx1	12.5" FHD (1920x1080) IPS	None	256GB SSD M.2 PCIe NVMe Opal2	None	Intel 8265 ac, 2x2 + BT4.1	WWAN Upgradable	None	None	None	None	720p	Backlit	Finger-print Reader	None	dTPM 2.0	3-cell(23Wh) + 3-cell(23Wh)	45W Slim Tip	Win10 Pro 64	3-year, Depot	02/17
20HN001RUS	US	i7-7500U	No	Intel HD 620	8GBx1	12.5" FHD (1920x1080) IPS	None	256GB SSD M.2 PCIe NVMe Opal2	None	Intel 8265 ac, 2x2 + BT4.1	WWAN Upgradable	None	None	None	None	720p	Backlit	Finger-print Reader	None	dTPM 2.0	3-cell(23Wh) + 3-cell(23Wh)	45W Slim Tip	Win10 Pro 64	3-year, Depot	02/17
20HN004UUS	US	i5-7200U	No	Intel HD 620	8GBx1	12.5" FHD (1920x1080) IPS	None	180GB SSD Opal2	None	Intel 8265 ac, 2x2 + BT4.1	WWAN Upgradable	None	None	None	None	720p	Backlit	Finger-print Reader	None	dTPM 2.0	3-cell(23Wh) + 3-cell(23Wh)	45W Slim Tip	Win10 Pro 64	3-year, Depot	03/17
20HN004VUS	US	i5-7200U	No	Intel HD 620	8GBx1	12.5" HD (1366x768) IPS	None	180GB SSD Opal2	None	Intel 8265 ac, 2x2 + BT4.1	WWAN Upgradable	None	None	None	None	720p	Backlit	Finger-print Reader	None	dTPM 2.0	3-cell(23Wh) + 3-cell(23Wh)	45W Slim Tip	Win10 Pro 64	3-year, Depot	03/17
20HN006AUS	US	i7-7600U	vPro	Intel HD 620	16GBx1	12.5" FHD (1920x1080) IPS	10-point Multi-touch	512GB SSD M.2 PCIe NVMe Opal2	None	Intel 8265 ac, 2x2 + BT4.1	WWAN Upgradable	None	None	None	None	720p	Backlit	Finger-print Reader	None	dTPM 2.0	3-cell(23Wh) + 3-cell(23Wh)	45W Slim Tip	Win10 Pro 64	3-year, Depot	08/17
20HN006BUS	US	i5-7200U	No	Intel HD 620	8GBx1	12.5" FHD (1920x1080) IPS	10-point Multi-touch	256GB SSD M.2 PCIe NVMe Opal2	None	Intel 8265 ac, 2x2 + BT4.1	WWAN Upgradable	None	None	None	None	720p	Backlit	Finger-print Reader	None	dTPM 2.0	3-cell(23Wh) + 3-cell(23Wh)	45W Slim Tip	Win10 Pro 64	3-year, Depot	08/17
20HN006CUS	US	i5-7300U	vPro	Intel HD 620	8GBx1	12.5" FHD (1920x1080) IPS	10-point Multi-touch	256GB SSD M.2 PCIe NVMe Opal2	None	Intel 8265 ac, 2x2 + BT4.1	WWAN Upgradable	None	None	None	None	720p	Backlit	Finger-print Reader	None	dTPM 2.0	3-cell(23Wh) + 3-cell(23Wh)	45W Slim Tip	Win10 Pro 64	3-year, Depot	08/17
20HN006DUS	US	i7-7600U	vPro	Intel HD 620	8GBx1	12.5" FHD (1920x1080) IPS	10-point Multi-touch	256GB SSD M.2 PCIe NVMe Opal2	None	Intel 8265 ac, 2x2 + BT4.1	WWAN Upgradable	None	None	None	None	720p	Backlit	Finger-print Reader	None	dTPM 2.0	3-cell(23Wh) + 3-cell(23Wh)	45W Slim Tip	Win10 Pro 64	3-year, Depot	08/17
20HN006EUS	US	i5-7300U	vPro	Intel HD 620	8GBx1	12.5" FHD (1920x1080) IPS	10-point Multi-touch	180GB SSD Opal2	None	Intel 8265 ac, 2x2 + BT4.1	WWAN Upgradable	None	None	None	None	720p	Backlit	Finger-print Reader	None	dTPM 2.0	3-cell(23Wh) + 3-cell(23Wh)	45W Slim Tip	Win10 Pro 64	3-year, Depot	08/17
20HN006FUS	US	i7-7600U	vPro	Intel HD 620	16GBx1	12.5" FHD (1920x1080) IPS	10-point Multi-touch	256GB SSD M.2 PCIe NVMe Opal2	None	Intel 8265 ac, 2x2 + BT4.1	WWAN Upgradable	None	None	None	None	720p	Backlit	Finger-print Reader	None	dTPM 2.0	3-cell(23Wh) + 3-cell(23Wh)	45W Slim Tip	Win10 Pro 64	3-year, Depot	08/17
20HN006GUS	US	i7-7500U	No	Intel HD 620	16GBx1	12.5" FHD (1920x1080) IPS	10-point Multi-touch	512GB SSD M.2 PCIe NVMe Opal2	None	Intel 8265 ac, 2x2 + BT4.1	WWAN Upgradable	None	None	None	None	720p	Backlit	Finger-print Reader	None	dTPM 2.0	3-cell(23Wh) + 3-cell(23Wh)	45W Slim Tip	Win10 Pro 64	3-year, Depot	08/17

Model	Region	Processor	vPro	Graphics	Memory	Display	Multi-touch	Storage(HDD/SSD)	Optical	WLAN + Bluetooth	WWAN	SIM Card	Smart Card Reader	Dock	Monitor Cable	Camera	Key-board	Finger-print Reader	NFC	TPM	Battery (internal+external)	Power Adapter	Operating System	Warranty	Ann Date (m/y)
20HN006HUS	US	i5-7200U	No	Intel HD 620	8GBx1	12.5" FHD (1920x1080) IPS	10-point Multi-touch	180GB SSD Opal2	None	Intel 8265 ac, 2x2 + BT4.1	WWAN Upgradable	None	None	None	None	720p	Backlit	Finger-print Reader	None	dTPM 2.0	3-cell(23Wh) + 3-cell(23Wh)	45W Slim Tip	Win10 Pro 64	3-year, Depot	08/17
20HN006JUS	US	i7-7500U	No	Intel HD 620	16GBx1	12.5" FHD (1920x1080) IPS	10-point Multi-touch	256GB SSD M.2 PCIe NVMe Opal2	None	Intel 8265 ac, 2x2 + BT4.1	WWAN Upgradable	None	None	None	None	720p	Backlit	Finger-print Reader	None	dTPM 2.0	3-cell(23Wh) + 3-cell(23Wh)	45W Slim Tip	Win10 Pro 64	3-year, Depot	08/17
20HN006KUS	US	i5-7200U	No	Intel HD 620	8GBx1	12.5" FHD (1920x1080) IPS	10-point Multi-touch	500GB 7200rpm	None	Intel 8265 ac, 2x2 + BT4.1	WWAN Upgradable	None	None	None	None	720p	Backlit	Finger-print Reader	None	dTPM 2.0	3-cell(23Wh) + 3-cell(23Wh)	45W Slim Tip	Win10 Pro 64	3-year, Depot	08/17
20HN006VUS	US	i7-7500U	No	Intel HD 620	8GBx1	12.5" FHD (1920x1080) IPS	10-point Multi-touch	256GB SSD M.2 PCIe NVMe Opal2	None	Intel 8265 ac, 2x2 + BT4.1	WWAN Upgradable	None	None	None	None	720p	Backlit	Finger-print Reader	None	dTPM 2.0	3-cell(23Wh) + 3-cell(23Wh)	45W Slim Tip	Win10 Pro 64	3-year, Depot	08/17

ThinkPad X270 - TopSeller - 20K6

Model	Region	Processor	vPro	Graphics	Memory	Display	Multi-touch	Storage(HDD/SSD)	Optical	WLAN + Bluetooth	WWAN	SIM Card	Smart Card Reader	Dock	Monitor Cable	Camera	Key-board	Finger-print Reader	NFC	TPM	Battery (internal+ external)	Power Adapter	Operating System	Warranty	Ann Date (m/y)
20K6000LUS	US	i7-6600U	vPro	Intel HD 520	16GBx1	12.5" FHD (1920x1080) IPS	None	512GB SSD M.2 PCIe NVMe Opal2	None	Intel 8260 ac, 2x2 + BT4.1	WWAN Upgradable	None	None	None	None	720p	Backlit	Finger-print Reader	None	dTPM 2.0	3-cell(23Wh) + 3-cell(23Wh)	45W Slim Tip	Win10 DG Win7 Pro 64	3-year, Depot	03/17
20K6000MUS	US	i5-6200U	No	Intel HD 520	8GBx1	12.5" FHD (1920x1080) IPS	None	256GB SSD M.2 PCIe NVMe Opal2	None	Intel 8260 ac, 2x2 + BT4.1	WWAN Upgradable	None	None	None	None	720p	Backlit	Finger-print Reader	None	dTPM 2.0	3-cell(23Wh) + 3-cell(23Wh)	45W Slim Tip	Win10 DG Win7 Pro 64	3-year, Depot	03/17
20K6000NUS	US	i7-6600U	vPro	Intel HD 520	8GBx1	12.5" FHD (1920x1080) IPS	None	256GB SSD M.2 PCIe NVMe Opal2	None	Intel 8260 ac, 2x2 + BT4.1	WWAN Upgradable	None	None	None	None	720p	Backlit	Finger-print Reader	None	dTPM 2.0	3-cell(23Wh) + 3-cell(23Wh)	45W Slim Tip	Win10 DG Win7 Pro 64	3-year, Depot	03/17
20K6000PUS	US	i5-6300U	vPro	Intel HD 520	8GBx1	12.5" HD (1366x768)	None	256GB SSD M.2 PCIe NVMe Opal2	None	Intel 8260 ac, 2x2 + BT4.1	WWAN Upgradable	None	None	None	None	720p	Backlit	Finger-print Reader	None	dTPM 2.0	3-cell(23Wh) + 3-cell(23Wh)	45W Slim Tip	Win10 DG Win7 Pro 64	3-year, Depot	03/17
20K6000QUS	US	i5-6300U	vPro	Intel HD 520	8GBx1	12.5" FHD (1920x1080) IPS	None	256GB SSD M.2 PCIe NVMe Opal2	None	Intel 8260 ac, 2x2 + BT4.1	WWAN Upgradable	None	None	None	None	720p	Backlit	Finger-print Reader	None	dTPM 2.0	3-cell(23Wh) + 3-cell(23Wh)	45W Slim Tip	Win10 DG Win7 Pro 64	3-year, Depot	03/17
20K6000RUS	US	i7-6500U	No	Intel HD 520	8GBx1	12.5" FHD (1920x1080) IPS	None	512GB SSD M.2 PCIe NVMe Opal2	None	Intel 8260 ac, 2x2 + BT4.1	WWAN Upgradable	None	None	None	None	720p	Backlit	Finger-print Reader	None	dTPM 2.0	3-cell(23Wh) + 3-cell(23Wh)	45W Slim Tip	Win10 DG Win7 Pro 64	3-year, Depot	03/17
20K6000SUS	US	i7-6500U	No	Intel HD 520	8GBx1	12.5" FHD (1920x1080) IPS	None	256GB SSD M.2 PCIe NVMe Opal2	None	Intel 8260 ac, 2x2 + BT4.1	WWAN Upgradable	None	None	None	None	720p	Backlit	Finger-print Reader	None	dTPM 2.0	3-cell(23Wh) + 3-cell(23Wh)	45W Slim Tip	Win10 DG Win7 Pro 64	3-year, Depot	03/17
20K6000TUS	US	i7-6600U	vPro	Intel HD 520	16GBx1	12.5" FHD (1920x1080) IPS	None	256GB SSD M.2 PCIe NVMe Opal2	None	Intel 8260 ac, 2x2 + BT4.1	WWAN Upgradable	None	None	None	None	720p	Backlit	Finger-print Reader	None	dTPM 2.0	3-cell(23Wh) + 3-cell(23Wh)	45W Slim Tip	Win10 DG Win7 Pro 64	3-year, Depot	05/17
20K6000UUS	US	i5-6200U	No	Intel HD 520	8GBx1	12.5" HD (1366x768)	None	500GB 7200rpm	None	Intel 8260 ac, 2x2 + BT4.1	WWAN Upgradable	None	None	None	None	720p	Backlit	Finger-print Reader	None	dTPM 2.0	3-cell(23Wh) + 3-cell(23Wh)	45W Slim Tip	Win10 DG Win7 Pro 64	3-year, Depot	03/17
20K6000VUS	US	i7-6500U	No	Intel HD 520	16GBx1	12.5" FHD (1920x1080) IPS	None	512GB SSD M.2 PCIe NVMe Opal2	None	Intel 8260 ac, 2x2 + BT4.1	WWAN Upgradable	None	None	None	None	720p	Backlit	Finger-print Reader	None	dTPM 2.0	3-cell(23Wh) + 3-cell(23Wh)	45W Slim Tip	Win10 DG Win7 Pro 64	3-year, Depot	03/17
20K6001AUS	US	i5-6300U	vPro	Intel HD 520	8GBx1	12.5" FHD (1920x1080) IPS	10-point Multi-touch	180GB SSD Opal2	None	Intel 8260 ac, 2x2 + BT4.1	WWAN Upgradable	None	None	None	None	720p	Backlit	Finger-print Reader	None	dTPM 2.0	3-cell(23Wh) + 3-cell(23Wh)	45W Slim Tip	Win10 DG Win7 Pro 64	3-year, Depot	08/17
20K6001BUS	US	i7-6600U	vPro	Intel HD 520	16GBx1	12.5" FHD (1920x1080) IPS	10-point Multi-touch	512GB SSD M.2 PCIe NVMe Opal2	None	Intel 8260 ac, 2x2 + BT4.1	WWAN Upgradable	None	None	None	None	720p	Backlit	Finger-print Reader	None	dTPM 2.0	3-cell(23Wh) + 3-cell(23Wh)	45W Slim Tip	Win10 DG Win7 Pro 64	3-year, Depot	08/17
20K6001CUS	US	i5-6200U	No	Intel HD 520	8GBx1	12.5" FHD (1920x1080) IPS	10-point Multi-touch	256GB SSD M.2 PCIe NVMe Opal2	None	Intel 8260 ac, 2x2 + BT4.1	WWAN Upgradable	None	None	None	None	720p	Backlit	Finger-print Reader	None	dTPM 2.0	3-cell(23Wh) + 3-cell(23Wh)	45W Slim Tip	Win10 DG Win7 Pro 64	3-year, Depot	08/17
20K6001DUS	US	i5-6300U	vPro	Intel HD 520	8GBx1	12.5" FHD (1920x1080) IPS	10-point Multi-touch	256GB SSD M.2 PCIe NVMe Opal2	None	Intel 8260 ac, 2x2 + BT4.1	WWAN Upgradable	None	None	None	None	720p	Backlit	Finger-print Reader	None	dTPM 2.0	3-cell(23Wh) + 3-cell(23Wh)	45W Slim Tip	Win10 DG Win7 Pro 64	3-year, Depot	08/17
20K6001EUS	US	i7-6500U	No	Intel HD 520	16GBx1	12.5" FHD (1920x1080) IPS	10-point Multi-touch	512GB SSD M.2 PCIe NVMe Opal2	None	Intel 8260 ac, 2x2 + BT4.1	WWAN Upgradable	None	None	None	None	720p	Backlit	Finger-print Reader	None	dTPM 2.0	3-cell(23Wh) + 3-cell(23Wh)	45W Slim Tip	Win10 DG Win7 Pro 64	3-year, Depot	08/17
20K6001FUS	US	i5-6200U	No	Intel HD 520	8GBx1	12.5" FHD (1920x1080) IPS	10-point Multi-touch	180GB SSD Opal2	None	Intel 8260 ac, 2x2 + BT4.1	WWAN Upgradable	None	None	None	None	720p	Backlit	Finger-print Reader	None	dTPM 2.0	3-cell(23Wh) + 3-cell(23Wh)	45W Slim Tip	Win10 DG Win7 Pro 64	3-year, Depot	08/17
20K6001GUS	US	i7-6600U	vPro	Intel HD 520	8GBx1	12.5" FHD (1920x1080) IPS	10-point Multi-touch	256GB SSD M.2 PCIe NVMe Opal2	None	Intel 8260 ac, 2x2 + BT4.1	WWAN Upgradable	None	None	None	None	720p	Backlit	Finger-print Reader	None	dTPM 2.0	3-cell(23Wh) + 3-cell(23Wh)	45W Slim Tip	Win10 DG Win7 Pro 64	3-year, Depot	08/17
20K6001HUS	US	i7-6500U	No	Intel HD 520	8GBx1	12.5" FHD (1920x1080) IPS	10-point Multi-touch	256GB SSD M.2 PCIe NVMe Opal2	None	Intel 8260 ac, 2x2 + BT4.1	WWAN Upgradable	None	None	None	None	720p	Backlit	Finger-print Reader	None	dTPM 2.0	3-cell(23Wh) + 3-cell(23Wh)	45W Slim Tip	Win10 DG Win7 Pro 64	3-year, Depot	08/17



ThinkPad X280 Platform Specifications

Product Specifications Reference (PSREF)

Processor	7th Generation Intel® Core™ i3 / i5 Processor (i3-7130U is NOT available in US and EMEA; i5-7200U is NOT available in US)							Dimensions	WxDxH: 12.11" x 8.26" x 0.69-0.70"; 307.7mm x 209.8mm x 17.4-17.8mm	
	Processor Number	# of Cores	# of Threads	Base Frequency	Max Turbo Frequency	Cache	Memory Types	Processor Graphics	Weight	FHD non-touch model: 2.49 lb / 1.13 kg; HD non-touch model: 2.78 lb / 1.26 kg; FHD multi-touch model: 2.79 lb / 1.27 kg
	i3-7130U	2	4	2.7 GHz	-	3MB	DDR4-2133	Intel HD Graphics 620	Case color	Black
	i5-7200U			2.5 GHz	3.1 GHz	3MB			Case material	Display cover: Carbon Fiber (FHD non-touch model) or Glass Fiber (HD / FHD multi-touch model);
	i5-7300U			2.6 GHz	3.5 GHz	3MB			Bottom: Magnesium/Aluminum	
	or 8th Generation Intel Core i5 / i7 Processor							Smart card reader	Optional: Smart card reader	
	Processor Number	# of Cores	# of Threads	Base Frequency	Max Turbo Frequency	Cache	Memory Types	Processor Graphics	Media reader	MicroSD card reader, in the combo slot with nano-SIM card
	i5-8250U	4	8	1.6 GHz	3.4 GHz	6MB	DDR4-2400	Intel UHD Graphics 620	Ports	Two USB 3.1 Gen 1 (one Always On), USB 3.1 Type-C Gen 1, USB 3.1 Type-C Gen 2 / Thunderbolt 3, HDMI 1.4b, Ethernet extension connector, combo slot of nano-SIM card (WWAN models) and microSD card reader, headphone / microphone combo jack, optional smart card reader, side docking connector, security keyhole
	i5-8350U			1.7 GHz	3.6 GHz	6MB			Monitor cable (optional)	HDMI to VGA: Lenovo HDMI to VGA Monitor Adapter
	i7-8550U			1.8 GHz	4.0 GHz	8MB			USB-C to VGA: Lenovo USB-C to VGA Adapter	
	i7-8650U			1.9 GHz	4.2 GHz	8MB			USB-C to DP: Lenovo USB-C to DisplayPort Adapter	
Graphics	Intel HD Graphics 620 or Intel UHD Graphics 620 in processor; supports external digital monitor via HDMI or USB Type-C; supports three independent displays; Max resolution: 4096x2304@60Hz (USB Type-C); 4096x2160@30Hz (HDMI)							Camera (optional)	One of the following, configurable by model: • HD720p camera with ThinkShutter camera privacy, fixed focus • IR camera and HD720p camera, fixed focus	
Chipset	Intel SoC (System on Chip) platform							Audio support	HD Audio, Realtek® ALC3287 codec, Dolby® Audio™ Premium / stereo speakers, 2W x 2 / dual array microphone, headphone / microphone combo jack	
Memory	4GB, 8GB, or 16GB / 2400MHz DDR4 / soldered to systemboard, no sockets (4GB memory is NOT available in US) * System clocks down for processors with lower memory controller							Keyboard	6-row, spill-resistant, multimedia Fn keys, optional LED backlight	
Display	Some: 12.5" (317.5mm) HD (1366x768), anti-glare, LED backlight, 220 nits, 16:9 aspect ratio, 400:1 contrast ratio Some: 12.5" (317.5mm) FHD (1920x1080), anti-glare, LED backlight, IPS, 300 nits, 16:9 aspect ratio, 700:1 contrast ratio, 170° viewing angle							UltraNav™	TrackPoint® pointing device and buttonless Mylar surface multi-touch touchpad	
Multi-touch (opt)	On-cell touch, supports 10-finger gesture (FHD only) (FHD non-touch model is NOT available in US)							Security	Power-on password, hard disk password, supervisor password, security keyhole	
Storage	One of the following, configurable by model: • M.2 SSD / SATA 6.0Gb/s (e.g. xxxGB SSD M.2) • M.2 SSD / PCIe NVMe, PCIe 3.0 x 4, 32Gb/s (e.g. xxxGB SSD M.2 PCIe NVMe)							Security chip	Discrete TPM 2.0, TCG Certified	
Optical	None							vPro (optional)	Intel vPro Technology	
Ethernet	Native Intel Ethernet Connection I219-V (Non-vPro) or I219-LM (vPro) via optional ThinkPad Ethernet Extension Cable Gen 2							Fingerprint reader	Optional: Touch style match on chip fingerprint reader on the palm rest, anti-spoofing technology	
WLAN + Bluetooth™	Intel Dual Band Wireless-AC 8265, Wi-Fi 2x2 802.11ac + Bluetooth 4.1, M.2 card * Intel 8265ac card supports BT4.2 but is limited to BT4.1 by Windows OS							NFC (optional)	Near Field Communication	
WWAN (optional)	One of the following, configurable by model (mutually exclusive with Intel Optane memory): • Integrated Mobile Broadband 4G LTE, Intel XMM™ 7262 (Fibocom L830-EB), M.2 card (EMEA only) • Integrated Mobile Broadband 4G LTE-A, Intel XMM™ 7360 (Fibocom L850-GL), M.2 card							Battery	Integrated Li-Ion 48Wh battery, supports Rapid Charge (charge up to 80% in 1hr) with 65W USB Type-C AC adapter	
SIM card (opt)	Nano-SIM card slot, in the combo slot with microSD card reader, optional Verizon LTE (US) SIM card							Max battery life	MobileMark® 2014: 16.6 hr * Battery life varies significantly with settings, usage, & other factors	
								AC adapter	45W or 65W USB Type-C AC adapter	
								Preload	Windows® 10 Home 64 or Windows 10 Pro 64	
								Limited warranty	One of the following, configurable by model: • 1-year depot repair service • 3-year/1-yr battery depot repair service • 3-year/1-yr battery limited onsite service	
								Mil-Spec test	MIL-STD-810G military certification	
								Environment	EPEAT™ Gold; ENERGY STAR® 6.1; RoHS-compliant	

Model	Region	Processor	vPro	Graphics	Memory	Display	Multi-touch	Storage(HDD/SSD)	Optical	WLAN + Bluetooth	WWAN	SIM Card	Smart Card Reader	Monitor Cable	Adapter	Camera	Keyboard	Finger-print Reader	NFC	TPM	Battery (internal+external)	Power Adapter	Operating System	Warranty	Ann Date (m/y)
20KF001TUS	US	i5-8250U	No	Intel UHD 620	8GB Soldered	12.5" HD (1366x768)	None	128GB SSD M.2	None	Intel 8265 ac, 2x2 + BT4.1	None	None	None	None	None	720p	Backlit	None	None	dTPM 2.0	48Wh	65W USB-C	Win10 Pro 64	3-year, Depot	02/18
20KF001YUS	US	i5-8250U	No	Intel UHD 620	8GB Soldered	12.5" HD (1366x768)	None	256GB SSD M.2 PCIe NVMe Opal2	None	Intel 8265 ac, 2x2 + BT4.1	None	None	None	None	None	720p	Non-backlit	Finger-print Reader	None	dTPM 2.0	48Wh	65W USB-C	Win10 Pro 64	3-year, Depot	02/18
20KF0020US	US	i7-8550U	No	Intel UHD 620	8GB Soldered	12.5" FHD (1920x1080) IPS	10-point Multi-touch	256GB SSD M.2 PCIe NVMe Opal2	None	Intel 8265 ac, 2x2 + BT4.1	None	None	None	None	None	720p	Backlit	Finger-print Reader	None	dTPM 2.0	48Wh	65W USB-C	Win10 Pro 64	3-year, Depot	02/18
20KF0021US	US	i7-8650U	vPro	Intel UHD 620	16GB Soldered	12.5" FHD (1920x1080) IPS	10-point Multi-touch	512GB SSD M.2 PCIe NVMe Opal2	None	Intel 8265 ac, 2x2 + BT4.1	None	None	None	None	None	IR &720p	Backlit	Finger-print Reader	None	dTPM 2.0	48Wh	65W USB-C	Win10 Pro 64	3-year, Depot	02/18
20KF0022US	US	i5-8350U	vPro	Intel UHD 620	8GB Soldered	12.5" FHD (1920x1080) IPS	10-point Multi-touch	256GB SSD M.2 PCIe NVMe Opal2	None	Intel 8265 ac, 2x2 + BT4.1	None	None	None	None	None	720p	Backlit	Finger-print Reader	None	dTPM 2.0	48Wh	65W USB-C	Win10 Pro 64	3-year, Depot	02/18
20KF0024US	US	i5-8350U	vPro	Intel UHD 620	8GB Soldered	12.5" HD (1366x768)	None	256GB SSD M.2 PCIe NVMe Opal2	None	Intel 8265 ac, 2x2 + BT4.1	None	None	None	None	None	720p	Backlit	Finger-print Reader	None	dTPM 2.0	48Wh	65W USB-C	Win10 Pro 64	3-year, Depot	02/18
20KF0025US	US	i7-8650U	vPro	Intel UHD 620	16GB Soldered	12.5" FHD (1920x1080) IPS	10-point Multi-touch	512GB SSD M.2 PCIe NVMe Opal2	None	Intel 8265 ac, 2x2 + BT4.1	None	None	None	None	None	720p	Backlit	Finger-print Reader	None	dTPM 2.0	48Wh	65W USB-C	Win10 Pro 64	3-year, Depot	02/18
20KF0029US	US	i5-7300U	vPro	Intel HD 620	8GB Soldered	12.5" HD (1366x768)	None	128GB SSD M.2	None	Intel 8265 ac, 2x2 + BT4.1	None	None	None	None	None	720p	Non-backlit	Finger-print Reader	None	dTPM 2.0	48Wh	65W USB-C	Win10 Pro 64	3-year, Depot	02/18
20KF002QUS	US	i7-8550U	No	Intel UHD 620	16GB Soldered	12.5" FHD (1920x1080) IPS	10-point Multi-touch	256GB SSD M.2 PCIe NVMe Opal2	None	Intel 8265 ac, 2x2 + BT4.1	None	None	None	None	None	720p	Backlit	Finger-print Reader	None	dTPM 2.0	48Wh	65W USB-C	Win10 Pro 64	3-year, Depot	02/18
20KF002RUS	US	i7-8550U	No	Intel UHD 620	16GB Soldered	12.5" FHD (1920x1080) IPS	10-point Multi-touch	512GB SSD M.2 PCIe NVMe Opal2	None	Intel 8265 ac, 2x2 + BT4.1	None	None	None	None	None	720p	Backlit	Finger-print Reader	None	dTPM 2.0	48Wh	65W USB-C	Win10 Pro 64	3-year, Depot	02/18
20KF002SUS	US	i5-8250U	No	Intel UHD 620	8GB Soldered	12.5" FHD (1920x1080) IPS	10-point Multi-touch	256GB SSD M.2 PCIe NVMe Opal2	None	Intel 8265 ac, 2x2 + BT4.1	None	None	None	None	None	720p	Backlit	Finger-print Reader	None	dTPM 2.0	48Wh	65W USB-C	Win10 Pro 64	3-year, Depot	02/18
20KF002TUS	US	i7-8650U	vPro	Intel UHD 620	16GB Soldered	12.5" FHD (1920x1080) IPS	10-point Multi-touch	256GB SSD M.2 PCIe NVMe Opal2	None	Intel 8265 ac, 2x2 + BT4.1	None	None	None	None	None	720p	Backlit	Finger-print Reader	None	dTPM 2.0	48Wh	65W USB-C	Win10 Pro 64	3-year, Depot	02/18
20KF005EUS	US	i5-8350U	vPro	Intel UHD 620	8GB Soldered	12.5" FHD (1920x1080) IPS	10-point Multi-touch	256GB SSD M.2 PCIe NVMe Opal2	None	Intel 8265 ac, 2x2 + BT4.1	Fibocom L850-GL	None	None	None	None	720p	Backlit	Finger-print Reader	None	dTPM 2.0	48Wh	65W USB-C	Win10 Pro 64	3-year, Depot	04/18
20KF005FUS	US	i5-8350U	vPro	Intel UHD 620	16GB Soldered	12.5" FHD (1920x1080) IPS	10-point Multi-touch	256GB SSD M.2 PCIe NVMe Opal2	None	Intel 8265 ac, 2x2 + BT4.1	Fibocom L850-GL	None	None	None	None	720p	Backlit	Finger-print Reader	None	dTPM 2.0	48Wh	65W USB-C	Win10 Pro 64	3-year, Depot	04/18
20KF005GUS	US	i5-8350U	vPro	Intel UHD 620	16GB Soldered	12.5" FHD (1920x1080) IPS	10-point Multi-touch	512GB SSD M.2 PCIe NVMe Opal2	None	Intel 8265 ac, 2x2 + BT4.1	Fibocom L850-GL	None	None	None	None	720p	Backlit	Finger-print Reader	None	dTPM 2.0	48Wh	65W USB-C	Win10 Pro 64	3-year, Depot	04/18
20KF005HUS	US	i7-8650U	vPro	Intel UHD 620	16GB Soldered	12.5" FHD (1920x1080) IPS	10-point Multi-touch	512GB SSD M.2 PCIe NVMe Opal2	None	Intel 8265 ac, 2x2 + BT4.1	Fibocom L850-GL	None	None	None	None	720p	Backlit	Finger-print Reader	None	dTPM 2.0	48Wh	65W USB-C	Win10 Pro 64	3-year, Depot	04/18
20KF005JUS	US	i7-8650U	vPro	Intel UHD 620	8GB Soldered	12.5" FHD (1920x1080) IPS	10-point Multi-touch	256GB SSD M.2 PCIe NVMe Opal2	None	Intel 8265 ac, 2x2 + BT4.1	Fibocom L850-GL	None	None	None	None	720p	Backlit	Finger-print Reader	None	dTPM 2.0	48Wh	65W USB-C	Win10 Pro 64	3-year, Depot	04/18
20KF005KUS	US	i7-8550U	No	Intel UHD 620	8GB Soldered	12.5" FHD (1920x1080) IPS	10-point Multi-touch	256GB SSD M.2 PCIe NVMe Opal2	None	Intel 8265 ac, 2x2 + BT4.1	Fibocom L850-GL	None	None	None	None	720p	Backlit	Finger-print Reader	None	dTPM 2.0	48Wh	65W USB-C	Win10 Pro 64	3-year, Depot	04/18
20KF005LUS	US	i5-8250U	No	Intel UHD 620	8GB Soldered	12.5" FHD (1920x1080) IPS	10-point Multi-touch	256GB SSD M.2 PCIe NVMe Opal2	None	Intel 8265 ac, 2x2 + BT4.1	Fibocom L850-GL	None	None	None	None	720p	Backlit	Finger-print Reader	None	dTPM 2.0	48Wh	65W USB-C	Win10 Pro 64	3-year, Depot	04/18
20KF005QUS	US	i5-8250U	No	Intel UHD 620	8GB Soldered	12.5" HD (1366x768)	None	180GB SSD M.2 Opal2	None	Intel 8265 ac, 2x2 + BT4.1	None	None	None	None	None	720p	Non-backlit	None	None	dTPM 2.0	48Wh	65W USB-C	Win10 Pro 64	3-year, Depot	05/18

Model	Region	Processor	vPro	Graphics	Memory	Display	Multi-touch	Storage(HDD/SSD)	Optical	WLAN + Bluetooth	WWAN	SIM Card	Smart Card Reader	Monitor Cable	Adapter	Camera	Key-board	Finger-print Reader	NFC	TPM	Battery (internal-external)	Power Adapter	Operating System	Warranty	Ann Date (m/y)
20KF005RUS	US	i5-8250U	No	Intel UHD 620	8GB Soldered	12.5" HD (1366x768)	None	180GB SSD M.2 Opal2	None	Intel 8265 ac, 2x2 + BT4.1	None	None	None	None	None	720p	Backlit	Finger-print Reader	None	dTPM 2.0	48Wh	65W USB-C	Win10 Pro 64	3-year, Depot	05/18
20KF005SUS	US	i5-8250U	No	Intel UHD 620	8GB Soldered	12.5" FHD (1920x1080) IPS	10-point Multi-touch	180GB SSD M.2 Opal2	None	Intel 8265 ac, 2x2 + BT4.1	None	None	None	None	None	720p	Backlit	Finger-print Reader	None	dTPM 2.0	48Wh	65W USB-C	Win10 Pro 64	3-year, Depot	05/18

This publication was developed for products and services offered in the United States and E.M.E.A countries. Lenovo may not offer the products, services or features discussed in this document in other countries. Lenovo may withdraw an offering at any time. Information is subject to change without notice. Consult your local representative for information on offerings available in your area.

Lenovo reserves the right to change specifications or other product information without notice. Lenovo is not responsible for photographic or typographical errors.

LENOVO PROVIDES THIS PUBLICATION "AS IS," WITHOUT WARRANTY OF ANY KIND, EITHER EXPRESS OR IMPLIED, INCLUDING THE IMPLIED WARRANTIES OF MERCHANTABILITY OR FITNESS FOR A PARTICULAR PURPOSE.

Some jurisdictions do not allow disclaimer of express or implied warranties in certain transactions, therefore this disclaimer may not apply to you.

Availability: All offers subject to availability. Lenovo reserves the right to alter product offerings and specifications at any time, without notice. Lenovo is not responsible for photographic or typographic errors.

General: Review key information provided by Microsoft that may apply to your system purchase, including details on Windows 10, Windows 8, Windows 7, and potential upgrades/downgrades. Lenovo makes no representation or warranty regarding third-party products or services.

Trademarks: Lenovo, ThinkPad, ThinkCentre, ThinkStation and the Lenovo logo are trademarks of Lenovo. Microsoft, Windows, Windows NT, and the Windows logo are trademarks of Microsoft Corporation. Ultrabook, Celeron, Celeron Inside, Core Inside, Intel, Intel Logo, Intel Atom, Intel Atom Inside, Intel Core, Intel Inside, Intel Inside Logo, Intel vPro, Itanium, Itanium Inside, Pentium, Pentium Inside, vPro Inside, Xeon, Xeon Phi, and Xeon Inside are trademarks of Intel Corporation in the U.S. and/or other countries. Other company, product or service names may be trademarks or service marks of others.

Warranty: For a copy of applicable warranties, write to: Lenovo Warranty Information, 1009 Think Place, Morrisville, NC, 27560. Lenovo makes no representation or warranty regarding third party products or services. The Lenovo Limited Warranty applies only to Lenovo hardware products purchased for your own use, and does not transfer upon resale.

Limited warranty: Support unrelated to a warranty issue may be subject to additional charges.

Lenovo Services:

Carry-in or Mail-in Service: Parts and labor repair coverage where the customer is responsible for shipping (including packaging) or delivery to authorized warranty provider or repair center.

Depot or Courier Service: Parts and labor repair coverage where shipping (including packaging) or delivery to the repair center is paid for by Lenovo.

Expedited Depot: Parts and labor coverage with expedited turnaround. Shipping (including packaging) or delivery to the repair center is paid for by Lenovo.

Onsite / In-home Service: Parts and labor repair coverage where labor is provided onsite at your place of business.

If Lenovo determines your product problem is covered by the product warranty and cannot be resolved over the telephone, a technician will be dispatched to arrive onsite, typically the next day.

International Warranty Service (IWS): PC repair coverage for customers who require a critical warranty repair while travelling internationally. Visit www.lenovo.com/internationalwarranty for details. Visit www.lenovo.com/warranty for Lenovo Warranty Services terms and conditions for complete details and restrictions.

Included software: may differ from its retail version (if available), and may not include user manuals or all program functionality. Software license agreements may apply.

Battery life: Battery life (and recharge times) will vary based on many factors including screen brightness, applications, features, power management, battery conditioning, and other customer preferences.

Visit <http://psref.lenovo.com/> for the latest version of Product Specifications Reference.

© Lenovo, 2018. All rights reserved.
Lenovo 1009 Think Place Morrisville, NC 27560 U.S.A.

LenovoTM

ThinkPad[®] Tablets
Convertibles

PSREF



Product Specifications Reference

Version 524, May 2018

U.S.

Visit <http://psref.lenovo.com> for the latest version

Contents

Cover		
Contents		
Summary Of Change		
ThinkPad Tablets		
ThinkPad X1 Tablet (2nd Gen)		
ThinkPad X1 Tablet (2nd Gen) Platform Specifications		
ThinkPad X1 Tablet (2nd Gen) - TopSeller - 20JB		
ThinkPad X1 Tablet (3rd Gen)		
ThinkPad X1 Tablet (3rd Gen) Platform Specifications		
ThinkPad X1 Tablet (3rd Gen) - TopSeller - 20KJ		
ThinkPad Yoga		
ThinkPad L380 Yoga		
ThinkPad L380 Yoga Platform Specifications		
ThinkPad L380 Yoga - TopSeller - 20M7		
ThinkPad P40 Yoga		
ThinkPad P40 Yoga Platform Specifications		
ThinkPad P40 Yoga - TopSeller - 20GQ		
ThinkPad X1 Yoga (2nd Gen)		
ThinkPad X1 Yoga (2nd Gen) Platform Specifications		
ThinkPad X1 Yoga (2nd Gen) - TopSeller - 20JD		
ThinkPad X1 Yoga (2nd Gen) - TopSeller - 20JF		
ThinkPad X1 Yoga (3rd Gen)		
ThinkPad X1 Yoga (3rd Gen) Platform Specifications		
ThinkPad X1 Yoga (3rd Gen) - TopSeller - 20LD		
ThinkPad X1 Yoga (3rd Gen) - TopSeller - 20LF		
ThinkPad X380 Yoga		
ThinkPad X380 Yoga Platform Specifications		
ThinkPad X380 Yoga - TopSeller - 20LH		
ThinkPad Yoga 11e (3rd Gen)		
ThinkPad Yoga 11e (3rd Gen) Platform Specifications		
ThinkPad Yoga 11e (3rd Gen) - TopSeller - 20GA		
ThinkPad Yoga 11e (4th Gen)		
ThinkPad Yoga 11e (4th Gen) Platform Specifications		
ThinkPad Yoga 11e (4th Gen) - TopSeller - 20HU		
ThinkPad Yoga 11e (5th Gen)		
1 ThinkPad Yoga 11e (5th Gen) Platform Specifications	34	
2 ThinkPad Yoga 11e (5th Gen) - TopSeller - 20LM	35	
3 ThinkPad Yoga 11e Chromebook (3rd Gen)	36	
4 ThinkPad Yoga 11e Chromebook (3rd Gen) Platform Specifications	37	
4 ThinkPad Yoga 11e Chromebook (3rd Gen) - TopSeller - 20GE	38	
5 ThinkPad Yoga 11e Chromebook (4th Gen)	39	
6 ThinkPad Yoga 11e Chromebook (4th Gen) Platform Specifications	40	
7 ThinkPad Yoga 11e Chromebook (4th Gen) - TopSeller - 20HY	41	
8 ThinkPad Yoga 370	42	
9 ThinkPad Yoga 370 Platform Specifications	43	
10 ThinkPad Yoga 370 - TopSeller - 20JH - 1 of 2	44	
10 ThinkPad Yoga 370 - TopSeller - 20JH - 2 of 2	45	
11 Legal Information	46	
12		
13		
14		
15		
16		
17		
18		
19		
20		
21		
22		
23		
24		
25		
26		
27		
28		
29		
30		
31		
32		
33		

Summary of Changes

This section describes the technical changes made in this edition.

This edition might also include minor corrections and editorial changes which are not identified.

May 9, 2018 - Version 524

Additions in this update

▶ **New product(s)**

None

▶ **New model(s)**

ThinkPad L380 Yoga new models announced May 2018

ThinkPad X380 Yoga new product announced May 2018

ThinkPad X1 Yoga (3rd Gen) new product announced April 2018

▶ **Others**

None

Changes in this update

▶ None

Withdrawals in this update

▶ **Withdrawn product(s)**

None



ThinkPad X1 Tablet (2nd Gen) Platform Specifications

Product Specifications Reference (PSREF)

Processor	7th Generation Intel® Core™ m / i5 / i7 Processor								Camera	<i>Front camera:</i> 2.0-megapixel, fixed focus <i>Rear camera:</i> 8.0-megapixel, auto focus, flash LED
	Processor Number	# of Cores	# of Threads	Base Frequency	Max Turbo Frequency	Cache	Memory Types	Processor Graphics	Video capture	1080p video capture
	i5-7Y54	2	4	1.2 GHz	3.2 GHz	4MB	LPDDR3-1866	Intel HD Graphics 615	Audio support	Realtek® ALC3268 codec / stereo speakers, 0.5W x 2 / three microphones, combo audio/microphone jack
	i5-7Y57			1.2 GHz	3.3 GHz	4MB				
i7-7Y75	1.3 GHz			3.6 GHz	4MB					
Graphics	Intel HD Graphics 615 in processor, supports 1080p video out via Mini DisplayPort connector								Pogo keyboard	Magnetic attached thin keyboard, with TrackPoint® pointing device and buttonless Mylar surface touchpad, multi-touch, backlit
Chipset	Intel SoC (System on Chip) platform								Keyboard color	Black, red, or silver
Memory	8GB, or 16GB / 1866MHz LPDDR3 / soldered to systemboard, no sockets								Security	Kensington lock slot
Display	12.0" (304.8mm) FHD+ (2160x1440), glossy, LED backlight, IPS, anti-fingerprint display with Corning® Gorilla® Glass, WideView (170° viewing), 360 nits, 3:2 aspect ratio, 800:1 contrast ratio								Security chip	Discrete TPM 2.0 TCG Certified
Multi-touch	Capacitive touch panel, supports ten-finger gesture								vPro (optional)	Intel vPro Technology
Pen	<i>Optional:</i> ThinkPad Pen Pro, active pen for multi-touch display								Fingerprint reader	<i>Optional:</i> Touch style Fingerprint reader
Kick stand	Opening angle up to 90 degrees								NFC	None
Storage	<i>Some:</i> M.2 SSD / SATA 6.0Gb/s (e.g. xxxG SSD) <i>Some:</i> M.2 SSD / PCIe NVMe, PCIe 3.0 x 4, 32Gb/s (e.g. xxxG SSD PCIe NVMe)								Module	<i>One of the following, configurable by model:</i> • Productivity module, USB3.0 x 1, HDMI, OneLink+, 5 hrs battery (24Wh) • Presenter module, Pico projector, HDMI and 10Whr battery for presenter
Optical	None								Battery	Li-Polymer 2-cell (37Wh) battery
Storage extension	One microSD card slot, supports up to 32GB microSDHC or 64GB microSDXC								Max battery life	<i>MobileMark® 2014:</i> 10 hr (local video playback)
Ethernet	None								AC adapter	45W or 65W USB Type-C AC adapter
WLAN	Intel Dual Band Wireless-AC 8265, Wi-Fi 2x2 802.11ac + BT4.1, soldered M.2 chip								Light sensor	Ambient Light Sensor
Bluetooth™	Bluetooth 4.1 wireless, integrated in Wi-Fi + Bluetooth combo chip <i>* Intel 8265ac card supports BT4.2 but is limited to BT4.1 by Windows OS</i>								G-sensor	3D accelerometer
WiGig	Intel Wireless Gigabit 11000, WiGig 802.11ad, soldered M.2 chip								Compass	3D compass
WWAN (optional)	Integrated Mobile Broadband 4G LTE-A, Qualcomm® Snapdragon™ X7 LTE-A (Sierra Wireless EM7455)								Gyroscope	3D gyrometer
SIM card (opt)	Nano-SIM card slot, opt Verizon LTE (US) or Lenovo® Connect (EMEA) SIM card								GPS	GPS function is integrated into WWAN module
Dimensions	<i>Tablet only:</i> 11.48" x 8.25" x 0.34"; 291.5mm x 209.5mm x 8.45mm <i>Tablet + keyboard:</i> 11.48" x 8.25" x 0.56"; 291.5mm x 209.5mm x 14.15mm								Preload	<i>Some:</i> Windows 10 Pro 64 <i>Some:</i> Windows 10 Home 64 • Lenovo Connect • Lenovo Companion • Lenovo Setting • Microsoft® Office preloaded; purchase a product key to activate
Weight	<i>Tablet only:</i> starting at 1.69 lb (0.77kg) <i>Tablet+keyboard:</i> starting at 2.35 lb (1.07kg)								Limited warranty	<i>One of the following, configurable by model:</i> • 1-year depot repair service • 3-year/1-yr battery depot repair service • 3-year/1-yr battery limited onsite service
Case color	Black								Mil-Spec test	MIL-STD-810G military certification
Case material	Mg + PCGF Hybrid								Environment	EPEAT™ Gold, GREENGUARD, Low Halogen, RoHS
Smart card reader	None									
Media reader	One microSD card slot (microSD, microSDHC, microSDXC)									
Ports	One USB 3.1 Gen 1 / USB 3.0, one Mini DisplayPort, one USB 3.1 Type-C Gen 1 / Power Delivery 2.0, one Pogo keyboard connector, one cartridge connector for optional modules, one nano-SIM card slot									
Control buttons	Power button, volume control button, reset switch									
WiGig dock	<i>Optional:</i> ThinkPad WiGig dock									
Monitor cable (optional)	<i>MiniDP to HDMI:</i> Lenovo Mini DisplayPort to HDMI Monitor Cable <i>MiniDP to VGA:</i> Lenovo Mini DisplayPort to VGA Monitor Cable									
Adapter (optional)	<i>USB to RJ45:</i> ThinkPad USB 3.0 Ethernet Adapter <i>USB-C to VGA:</i> Lenovo USB C to VGA Plus Power Adapter <i>USB-C to HDMI:</i> Lenovo USB-C to HDMI Plus Power Adapter									

ThinkPad X1 Tablet (2nd Gen) - TopSeller - 20JB

Product Specifications Reference (PSREF)

Model	Region	Processor	vPro	Graphics	Memory	Display	Multi-touch	Storage(HDD/SSD)	WLAN + Bluetooth	WWAN	SIM Card	Dock	Monitor Cable	Camera (Front / Rear)	Keyboard Docking	Pen	Fingerprint Reader	Module	Power Adapter	Operating System	Warranty	Global	Ann Date (mm/yy)
20JB0027US	US	i5-7Y57	vPro	Intel HD 615	8GB Soldered	12" FHD+ (2160x1440) IPS	10-point Multi-touch	512GB SSD M.2 PCIe NVMe Opal2	8265 ac, 2x2 + BT4.1	None	None	None	None	2.0MP / 8.0MP	Black Pogo Keyboard	Pen Pro	Fingerprint Reader	None	45W	Win10 Pro 64	3-year, Depot	No	03/17
20JB0029US	US	i7-7Y75	vPro	Intel HD 615	16GB Soldered	12" FHD+ (2160x1440) IPS	10-point Multi-touch	256GB SSD M.2 PCIe NVMe Opal2	8265 ac, 2x2 + BT4.1	None	None	None	None	2.0MP / 8.0MP	Black Pogo Keyboard	Pen Pro	Fingerprint Reader	None	45W	Win10 Pro 64	3-year, Depot	No	03/17
20JB002BUS	US	i7-7Y75	vPro	Intel HD 615	16GB Soldered	12" FHD+ (2160x1440) IPS	10-point Multi-touch	256GB SSD M.2 PCIe NVMe Opal2	8265 ac, 2x2 + BT4.1	Sierra EM7455	None	None	None	2.0MP / 8.0MP	Black Pogo Keyboard	Pen Pro	Fingerprint Reader	None	45W	Win10 Pro 64	3-year, Depot	No	03/17
20JB002CUS	US	i5-7Y54	No	Intel HD 615	8GB Soldered	12" FHD+ (2160x1440) IPS	10-point Multi-touch	256GB SSD M.2 PCIe NVMe Opal2	8265 ac, 2x2 + BT4.1	None	None	None	None	2.0MP / 8.0MP	Black Pogo Keyboard	Pen Pro	Fingerprint Reader	None	45W	Win10 Pro 64	1-year, Depot	No	03/17
20JB002DUS	US	i5-7Y54	No	Intel HD 615	8GB Soldered	12" FHD+ (2160x1440) IPS	10-point Multi-touch	512GB SSD M.2 PCIe NVMe Opal2	8265 ac, 2x2 + BT4.1	None	None	None	None	2.0MP / 8.0MP	Black Pogo Keyboard	Pen Pro	Fingerprint Reader	None	45W	Win10 Pro 64	1-year, Depot	No	03/17
20JB002EUS	US	i7-7Y75	vPro	Intel HD 615	16GB Soldered	12" FHD+ (2160x1440) IPS	10-point Multi-touch	512GB SSD M.2 PCIe NVMe Opal2	8265 ac, 2x2 + BT4.1	None	None	None	None	2.0MP / 8.0MP	Black Pogo Keyboard	Pen Pro	Fingerprint Reader	None	45W	Win10 Pro 64	3-year, Depot	No	03/17
20JB002FUS	US	i5-7Y57	vPro	Intel HD 615	8GB Soldered	12" FHD+ (2160x1440) IPS	10-point Multi-touch	256GB SSD M.2 PCIe NVMe Opal2	8265 ac, 2x2 + BT4.1	Sierra EM7455	None	None	None	2.0MP / 8.0MP	Black Pogo Keyboard	Pen Pro	Fingerprint Reader	None	45W	Win10 Pro 64	3-year, Depot	No	03/17
20JB002JUS	US	i5-7Y57	vPro	Intel HD 615	8GB Soldered	12" FHD+ (2160x1440) IPS	10-point Multi-touch	256GB SSD M.2 PCIe NVMe Opal2	8265 ac, 2x2 + BT4.1	None	None	None	None	2.0MP / 8.0MP	Black Pogo Keyboard	Pen Pro	Fingerprint Reader	None	45W	Win10 Pro 64	3-year, Depot	No	03/17
20JB002KUS	US	i7-7Y75	vPro	Intel HD 615	8GB Soldered	12" FHD+ (2160x1440) IPS	10-point Multi-touch	512GB SSD M.2 PCIe NVMe Opal2	8265 ac, 2x2 + BT4.1	Sierra EM7455	None	None	None	2.0MP / 8.0MP	Black Pogo Keyboard	Pen Pro	Fingerprint Reader	None	45W	Win10 Pro 64	3-year, Depot	No	03/17
20JB002LUS	US	i7-7Y75	vPro	Intel HD 615	8GB Soldered	12" FHD+ (2160x1440) IPS	10-point Multi-touch	256GB SSD M.2 PCIe NVMe Opal2	8265 ac, 2x2 + BT4.1	None	None	None	None	2.0MP / 8.0MP	Black Pogo Keyboard	Pen Pro	Fingerprint Reader	None	45W	Win10 Pro 64	3-year, Depot	No	03/17
20JB002MUS	US	i7-7Y75	vPro	Intel HD 615	8GB Soldered	12" FHD+ (2160x1440) IPS	10-point Multi-touch	256GB SSD M.2 PCIe NVMe Opal2	8265 ac, 2x2 + BT4.1	Sierra EM7455	None	None	None	2.0MP / 8.0MP	Black Pogo Keyboard	Pen Pro	Fingerprint Reader	None	45W	Win10 Pro 64	3-year, Depot	No	03/17
20JB002NUS	US	i7-7Y75	vPro	Intel HD 615	8GB Soldered	12" FHD+ (2160x1440) IPS	10-point Multi-touch	256GB SSD M.2 PCIe NVMe Opal2	8265 ac, 2x2 + BT4.1	None	None	None	None	2.0MP / 8.0MP	Black Pogo Keyboard	Pen Pro	Fingerprint Reader	None	45W	Win10 Pro 64	1-year, Depot	No	03/17
20JB0035US	US	i7-7Y75	vPro	Intel HD 615	8GB Soldered	12" FHD+ (2160x1440) IPS	10-point Multi-touch	512GB SSD M.2 PCIe NVMe Opal2	8265 ac, 2x2 + BT4.1	None	None	None	None	2.0MP / 8.0MP	Black Pogo Keyboard	Pen Pro	Fingerprint Reader	None	45W	Win10 Pro 64	3-year, Depot	No	03/17
20JB003RUS	US	i7-7Y75	vPro	Intel HD 615	16GB Soldered	12" FHD+ (2160x1440) IPS	10-point Multi-touch	512GB SSD M.2 PCIe NVMe Opal2	8265 ac, 2x2 + BT4.1	Sierra EM7455	None	None	None	2.0MP / 8.0MP	Black Pogo Keyboard	Pen Pro	Fingerprint Reader	None	45W	Win10 Pro 64	1-year, Depot	No	05/17

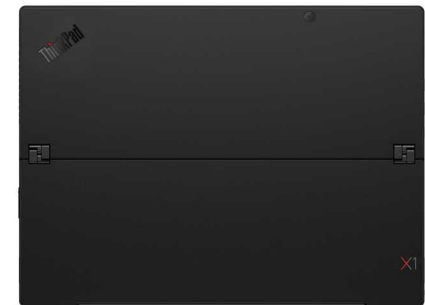

ThinkPad X1 Tablet (3rd Gen) Platform Specifications

Product Specifications Reference (PSREF)

Processor	8th Generation Intel® Core™ i5 / i7 Processor								Control buttons Power button, volume control button, reset switch Dock <i>Optional:</i> Hybrid dock Monitor cable (<i>opt</i>) None Adapter (<i>optional</i>) <i>USB-C to RJ45:</i> Lenovo USB-C to Ethernet Adapter <i>USB-C to VGA:</i> Lenovo USB C to VGA Plus Power Adapter <i>USB-C to HDMI:</i> Lenovo USB-C to HDMI Plus Power Adapter
	Processor Number	# of Cores	# of Threads	Base Frequency	Max Turbo Frequency	Cache	Memory Types	Processor Graphics	
	i5-8250U	4	8	1.6 GHz	3.4 GHz	6MB	LPDDR3-2133	Intel UHD Graphics 620	
	i5-8350U			1.7 GHz	3.6 GHz	6MB			
	i7-8550U			1.8 GHz	4.0 GHz	8MB			
i7-8650U	1.9 GHz			4.2 GHz	8MB				
Graphics	Intel UHD Graphics 620 in processor, supports external digital monitor via USB Type-C								
Chipset	Intel SoC (System on Chip) platform								
Memory	8GB, or 16GB / 2133MHz LPDDR3 / soldered to systemboard, no sockets								
Display	13.0" (330mm) QHD+ (3000x2000), glossy, LED backlight, IPS, anti-fingerprint display with Corning® Gorilla® Glass, WideView (160° viewing), 400 nits, 3:2 aspect ratio, 1200:1 contrast ratio								
Multi-touch Pen	Capacitive touch panel, supports ten-finger gesture <i>Optional:</i> Lenovo Pen Pro or Lenovo Active Pen (ThinkPad Pen Pro) for multi-touch display								
Kick stand	Opening angle up to 170 degrees								
Storage	<i>Some:</i> M.2 SSD / SATA 6.0Gb/s (e.g. xxxG SSD) <i>Some:</i> M.2 SSD / PCIe NVMe, PCIe 3.0 x 4, 32Gb/s (e.g. xxxG SSD PCIe NVMe)								
Optical	None								
Storage extension	One microSD card reader, in the combo slot with nano-SIM card, support USH-I, microSDHC, microSDXC								
Ethernet	None								
WLAN	Intel Dual Band Wireless-AC 8265, Wi-Fi 2x2 802.11ac + Bluetooth 4.1, M.2 card <i>* Intel 8265ac card supports BT4.2 but is limited to BT4.1 by Windows OS</i>								
Bluetooth™	Bluetooth 4.1 wireless, integrated in Wi-Fi + Bluetooth combo adapter								
WWAN (<i>optional</i>)	Integrated Mobile Broadband 4G LTE-A, Qualcomm® Snapdragon™ X7 LTE-A (Sierra Wireless EM7455)								
SIM card (<i>opt</i>)	Nano-SIM card slot, in the combo slot with microSD card reader								
Dimensions	<i>Tablet only:</i> 11.97" x 8.9" x 0.35"; 304.1mm x 226mm x 8.9mm <i>Tablet + keyboard:</i> 11.97" x 8.9" x 0.59"; 304.1mm x 226mm x 15.1mm								
Weight	<i>Tablet only:</i> starting at 1.96 lb (0.89kg) <i>Tablet+keyboard:</i> starting at 2.8 lb (1.27kg)								
Case color	Black								
Case material	Magnesium/Aluminum								
Smart card reader	None								
Ports	Two USB 3.1 Type-C Gen 1 / Thunderbolt 3 / Power Delivery 3.0, one Pogo keyboard connector, one Pen holder slot, headphone / microphone combo jack, combo slot of nano-SIM card (WWAN models) and microSD card reader								
Camera	<i>Front camera:</i> 2.0-megapixel, fixed focus <i>Rear camera:</i> 8.0-megapixel, auto focus, flash LED <i>Optional:</i> IR camera, fixed focus (Not available with NFC)								
IR Camera									
Audio support	Realtek® ALC3278 codec / stereo speakers, 1W x 2 / two microphones, combo audio/microphone jack								
Pogo keyboard	Magnetic attached thin keyboard, with TrackPoint® pointing device and buttonless Mylar surface touchpad, multi-touch, backlit								
Keyboard color	Black								
Security	Kensington lock slot								
Security chip	Discrete TPM 2.0 TCG Certified								
vPro (<i>optional</i>)	Intel vPro Technology								
Fingerprint reader	<i>Optional:</i> Touch style Fingerprint reader								
NFC (<i>optional</i>)	Near Field Communication (Not available with the IR camera)								
Battery	Integrated Li-Ion 42Wh battery								
Max battery life	<i>MobileMark® 2014:</i> 9.5 hr								
AC adapter	45W or 65W USB Type-C AC adapter								
Light sensor	Ambient Light Sensor								
G-sensor	3D accelerometer								
Compass	3D compass								
Gyroscope	3D gyrometer								
GPS	GPS function is integrated into WWAN module								
Preload	<i>Some:</i> Windows 10 Pro 64 <i>Some:</i> Windows 10 Home 64								
Limited warranty	<i>One of the following, configurable by model:</i> • 1-year depot repair service • 3-year/1-yr battery depot repair service • 3-year/1-yr battery limited onsite service								
Mil-Spec test	MIL-STD-810G military certification								
Environment	EPEAT™ Gold, GREENGUARD, Low Halogen, RoHS								

ThinkPad X1 Tablet (3rd Gen) - TopSeller - 20KJ

Product Specifications Reference (PSREF)

Model	Region	Processor	vPro	Graphics	Memory	Display	Multi-touch	Storage(HDD/SSD)	WLAN + Bluetooth	WWAN	SIM Card	Dock	Camera (Front / Rear)	Keyboard Docking	Pen	Fingerprint Reader	Module	Power Adapter	Operating System	Warranty	Global	Ann Date (mm/yy)
20KJ0017US	US	i7-8650U	vPro	Intel UHD 620	8GB Soldered	13" QHD+ (3000x2000) IPS	10-point Multi-touch	256GB SSD M.2 PCIe NVMe Opal2	8265 ac, 2x2 + BT4.1	None	None	None	2.0MP / 8.0MP	Black Pogo Keyboard	Pen Pro	Fingerprint Reader	None	65W USB-C	Win10 Pro 64	3-year, Depot	No	03/18
20KJ0018US	US	i7-8650U	vPro	Intel UHD 620	16GB Soldered	13" QHD+ (3000x2000) IPS	10-point Multi-touch	512GB SSD M.2 PCIe NVMe Opal2	8265 ac, 2x2 + BT4.1	None	None	None	2.0MP / 8.0MP	Black Pogo Keyboard	Pen Pro	Fingerprint Reader	None	65W USB-C	Win10 Pro 64	3-year, Depot	No	03/18
20KJ0019US	US	i5-8350U	vPro	Intel UHD 620	8GB Soldered	13" QHD+ (3000x2000) IPS	10-point Multi-touch	256GB SSD M.2 PCIe NVMe Opal2	8265 ac, 2x2 + BT4.1	None	None	None	2.0MP / 8.0MP	Black Pogo Keyboard	Pen Pro	Fingerprint Reader	None	65W USB-C	Win10 Pro 64	3-year, Depot	No	03/18
20KJ001AUS	US	i7-8650U	vPro	Intel UHD 620	16GB Soldered	13" QHD+ (3000x2000) IPS	10-point Multi-touch	256GB SSD M.2 PCIe NVMe Opal2	8265 ac, 2x2 + BT4.1	Sierra EM7455	None	None	2.0MP / 8.0MP	Black Pogo Keyboard	Pen Pro	Fingerprint Reader	None	65W USB-C	Win10 Pro 64	3-year, Depot	No	03/18
20KJ001BUS	US	i5-8250U	No	Intel UHD 620	8GB Soldered	13" QHD+ (3000x2000) IPS	10-point Multi-touch	256GB SSD M.2 PCIe NVMe Opal2	8265 ac, 2x2 + BT4.1	None	None	None	2.0MP / 8.0MP	Black Pogo Keyboard	Pen Pro	Fingerprint Reader	None	65W USB-C	Win10 Pro 64	3-year, Depot	No	03/18
20KJ001CUS	US	i7-8650U	vPro	Intel UHD 620	16GB Soldered	13" QHD+ (3000x2000) IPS	10-point Multi-touch	512GB SSD M.2 PCIe NVMe Opal2	8265 ac, 2x2 + BT4.1	None	None	None	2.0MP / 8.0MP + IR	Black Pogo Keyboard	Pen Pro	Fingerprint Reader	None	65W USB-C	Win10 Pro 64	3-year, Depot	No	03/18
20KJ001DUS	US	i5-8350U	vPro	Intel UHD 620	8GB Soldered	13" QHD+ (3000x2000) IPS	10-point Multi-touch	512GB SSD M.2 PCIe NVMe Opal2	8265 ac, 2x2 + BT4.1	None	None	None	2.0MP / 8.0MP + IR	Black Pogo Keyboard	Pen Pro	Fingerprint Reader	None	65W USB-C	Win10 Pro 64	3-year, Depot	No	03/18
20KJ001EUS	US	i7-8650U	vPro	Intel UHD 620	16GB Soldered	13" QHD+ (3000x2000) IPS	10-point Multi-touch	256GB SSD M.2 PCIe NVMe Opal2	8265 ac, 2x2 + BT4.1	None	None	None	2.0MP / 8.0MP	Black Pogo Keyboard	Pen Pro	Fingerprint Reader	None	65W USB-C	Win10 Pro 64	3-year, Depot	No	03/18
20KJ001FUS	US	i5-8350U	vPro	Intel UHD 620	8GB Soldered	13" QHD+ (3000x2000) IPS	10-point Multi-touch	256GB SSD M.2 PCIe NVMe Opal2	8265 ac, 2x2 + BT4.1	Sierra EM7455	None	None	2.0MP / 8.0MP	Black Pogo Keyboard	Pen Pro	Fingerprint Reader	None	65W USB-C	Win10 Pro 64	3-year, Depot	No	03/18



ThinkPad L380 Yoga Platform Specifications

Product Specifications Reference (PSREF)

Processor	Intel® Celeron® Processor, 7th Generation Intel Core™ i3 / i5 Processor								Dimensions	<i>WxDxH:</i> 12.67" x 8.82" x 0.74"; 322mm x 224.2mm x 18.8mm
	Processor Number	# of Cores	# of Threads	Base Frequency	Max Turbo Frequency	Cache	Memory Types	Processor Graphics	Weight	Starting at 3.44 lb / 1.56 kg
	i5-7200U	2	4	2.5 GHz	3.1 GHz	3MB	DDR4-2133	Intel HD Graphics 620	Case color	Black or Silver
	or 8th Generation Intel Core i5 / i7 Processor								Case material	<i>Display cover:</i> Aluminum <i>Bottom:</i> GFRP
Graphics	Intel HD Graphics 620 or Intel UHD Graphics 620 in processor; supports external digital monitor via HDMI or USB Type-C; supports three independent displays; Max resolution: 4096x2304@60Hz (USB Type-C); 4096x2160@30Hz (HDMI)								Smart card reader	None
	Processor Number	# of Cores	# of Threads	Base Frequency	Max Turbo Frequency	Cache	Memory Types	Processor Graphics	Media reader	MicroSD card reader
	i5-8250U	4	8	1.6 GHz	3.4 GHz	6MB	DDR4-2400	Intel UHD Graphics 620	Ports	Two USB 3.1 Gen 1 (one Always On), two USB 3.1 Type-C Gen 1, HDMI 1.4b, Ethernet extension connector, headphone / microphone combo jack, microSD card reader, security keyhole
	i5-8350U			1.7 GHz	3.6 GHz	6MB			Monitor cable	<i>HDMI to VGA:</i> Lenovo HDMI to VGA Monitor Adapter <i>USB-C to VGA:</i> Lenovo USB-C to VGA Adapter <i>USB-C to DP:</i> Lenovo USB-C to DisplayPort Adapter
i7-8550U	1.8 GHz			4.0 GHz	8MB					
Chipset	Intel SoC (System on Chip) platform								Camera	<i>720p:</i> HD720p resolution, low light sensitive, fixed focus <i>IR & 720p:</i> IR camera and HD720p camera, fixed focus <i>World facing:</i> Rear camera, 5MP resolution, auto focus (Not available in EMEA)
Memory	32GB max / 2400MHz DDR4, dual-channel capable, two DDR4 SO-DIMM sockets * System clocks down for processors with lower memory controller								Audio support	HD Audio, Realtek ALC3287 codec, Dolby® Advance / stereo speakers, 2W x 2 / dual array microphone, headphone / microphone combo jack
Display	13.3" (338mm) FHD (1920x1080), glossy, LED backlight, IPS, 300 nits, 16:9 aspect ratio, 800:1 contrast ratio, 170° viewing angle								Keyboard	6-row, multimedia Fn keys, optional LED backlight
Multi-touch (opt)	Capacitive-type multi-touch, AR (anti-reflection), supports 10-finger gesture								UltraNav™	TrackPoint® pointing device and buttonless Mylar surface touchpad, multi-touch
Hinge	Yoga hinge, 360 degree								Security	Power-on password, hard disk password, supervisor password, security keyhole
Convert-mode	Laptop, tent, stand, yoga and tablet								Security chip	Discrete TPM 2.0, TCG Certified
Pen	ThinkPad Pen Pro, active pen for multi-touch display, on-board garage								vPro (optional)	Intel vPro Technology
Storage	<i>One of the following, configurable by model:</i> • M.2 SSD / SATA 6.0Gb/s (e.g. xxxGB SSD M.2) • M.2 SSD / PCIe NVMe, PCIe 3.0 x 4, 32Gb/s (e.g. xxxGB SSD M.2 PCIe NVMe)								Fingerprint reader	<i>Optional:</i> Touch style fingerprint reader on the keyboard bezel, anti-spoofing technology
Optical	None								NFC (optional)	Near Field Communication (mutually exclusive with smart card reader)
Ethernet	Native Intel Ethernet Connection I219-V (Non-vPro) or I219-LM (vPro) via optional ThinkPad Ethernet Extension Cable								Battery	Integrated Li-Ion 45Wh battery, supports Rapid Charge (charge up to 80% in 1hr) with 65W USB Type-C AC adapter
WLAN + Bluetooth™	Intel Dual Band Wireless-AC 8265, Wi-Fi 2x2 802.11ac + Bluetooth 4.1, M.2 card * Wireless card supports BT4.2 but is limited to BT4.1 by Windows OS								Max battery life	<i>MobileMark® 2014:</i> 12.85 hr * Battery life varies significantly with settings, usage, & other factors
WWAN	None								AC adapter	45W or 65W USB Type-C AC adapter
SIM card	None								Preload	Windows® 10 Home 64 or Windows 10 Pro 64
									Limited warranty	<i>One of the following, configurable by model:</i> • 1-year depot repair service • 3-year/1-yr battery depot repair service • 3-year/1-yr battery limited onsite service
									Mil-Spec test	MIL-STD-810G military certification
									Environment	EPEAT™ Gold; ENERGY STAR® 6.1; RoHS-compliant

ThinkPad L380 Yoga - TopSeller - 20M7

Product Specifications Reference (PSREF)

Model	Region	Processor	vPro	Graphics	Memory	Display	Multi-touch	Storage(HDD/SSD)	Optical	WLAN + Bluetooth	Color	Camera (Front/WorldFacing)	Keyboard	Fingerprint Reader	NFC	TPM	Battery (internal)	Power Adapter	Operating System	Warranty	Ann Date (m/y)
20M7000FUS	US	i5-8350U	vPro	Intel UHD 620	8GBx1	13.3" FHD (1920x1080) IPS	10-point Multi-touch	256GB SSD M.2 PCIe NVMe Opal2	None	Intel 8265 ac, 2x2 + BT4.1	Black	IR &720p	Backlit	Fingerprint Reader	None	dTPM 2.0	45Wh	65W USB-C	Windows 10 Pro 64	3-year, Depot	02/18
20M7000GUS	US	i5-8250U	No	Intel UHD 620	8GBx1	13.3" FHD (1920x1080) IPS	10-point Multi-touch	256GB SSD M.2 PCIe NVMe Opal2	None	Intel 8265 ac, 2x2 + BT4.1	Black	Front 720p / World Facing 5MP	Non-backlit	None	None	dTPM 2.0	45Wh	65W USB-C	Windows 10 Pro 64	3-year, Depot	02/18
20M7000HUS	US	i5-8350U	vPro	Intel UHD 620	8GBx1	13.3" FHD (1920x1080) IPS	10-point Multi-touch	256GB SSD M.2 PCIe NVMe Opal2	None	Intel 8265 ac, 2x2 + BT4.1	Silver	Front 720p / None	Backlit	None	None	dTPM 2.0	45Wh	65W USB-C	Windows 10 Pro 64	3-year, Depot	02/18
20M7000JUS	US	i7-8550U	No	Intel UHD 620	8GBx1	13.3" FHD (1920x1080) IPS	10-point Multi-touch	512GB SSD M.2 PCIe NVMe Opal2	None	Intel 8265 ac, 2x2 + BT4.1	Black	Front 720p / None	Backlit	Fingerprint Reader	None	dTPM 2.0	45Wh	65W USB-C	Windows 10 Pro 64	3-year, Depot	02/18
20M7000KUS	US	i5-8250U	No	Intel UHD 620	8GBx1	13.3" FHD (1920x1080) IPS	10-point Multi-touch	256GB SSD M.2 PCIe NVMe Opal2	None	Intel 8265 ac, 2x2 + BT4.1	Silver	Front 720p / None	Non-backlit	None	None	dTPM 2.0	45Wh	65W USB-C	Windows 10 Pro 64	3-year, Depot	02/18
20M7000LUS	US	i5-8350U	vPro	Intel UHD 620	8GBx1	13.3" FHD (1920x1080) IPS	10-point Multi-touch	256GB SSD M.2 PCIe NVMe Opal2	None	Intel 8265 ac, 2x2 + BT4.1	Black	Front 720p / None	Backlit	Fingerprint Reader	None	dTPM 2.0	45Wh	65W USB-C	Windows 10 Pro 64	3-year, Depot	02/18
20M7000MUS	US	i5-8250U	No	Intel UHD 620	8GBx1	13.3" FHD (1920x1080) IPS	10-point Multi-touch	256GB SSD M.2 PCIe NVMe Opal2	None	Intel 8265 ac, 2x2 + BT4.1	Black	Front 720p / None	Non-backlit	Fingerprint Reader	None	dTPM 2.0	45Wh	65W USB-C	Windows 10 Pro 64	3-year, Depot	02/18
20M7000PUS	US	i5-8250U	No	Intel UHD 620	8GBx1	13.3" FHD (1920x1080) IPS	10-point Multi-touch	256GB SSD M.2 PCIe NVMe Opal2	None	Intel 8265 ac, 2x2 + BT4.1	Silver	Front 720p / World Facing 5MP	Backlit	None	None	dTPM 2.0	45Wh	65W USB-C	Windows 10 Pro 64	3-year, Depot	02/18
20M7002MUS	US	i3-8130U	No	Intel UHD 620	4GBx1	13.3" FHD (1920x1080) IPS	10-point Multi-touch	256GB SSD M.2 PCIe NVMe Opal2	None	Intel 8265 ac, 2x2 + BT4.1	Silver	Front 720p / None	Non-backlit	None	None	dTPM 2.0	45Wh	65W USB-C	Windows 10 Pro 64	1-year, Depot	04/18
20M7002NUS	US	i3-8130U	No	Intel UHD 620	4GBx1	13.3" FHD (1920x1080) IPS	10-point Multi-touch	256GB SSD M.2 PCIe NVMe Opal2	None	Intel 8265 ac, 2x2 + BT4.1	Black	Front 720p / None	Non-backlit	Fingerprint Reader	None	dTPM 2.0	45Wh	65W USB-C	Windows 10 Pro 64	1-year, Depot	04/18
20M7002PUS	US	i3-8130U	No	Intel UHD 620	4GBx1	13.3" FHD (1920x1080) IPS	10-point Multi-touch	256GB SSD M.2 PCIe NVMe Opal2	None	Intel 8265 ac, 2x2 + BT4.1	Black	Front 720p / World Facing 5MP	Non-backlit	None	None	dTPM 2.0	45Wh	65W USB-C	Windows 10 Pro 64	1-year, Depot	04/18
20M70032US	US	i3-8130U	No	Intel UHD 620	8GBx1	13.3" FHD (1920x1080) IPS	10-point Multi-touch	180GB SSD M.2 Opal2	None	Intel 8265 ac, 2x2 + BT4.1	Black	Front 720p / None	Non-backlit	None	None	dTPM 2.0	45Wh	65W USB-C	Windows 10 Pro 64	1-year, Depot	05/18
20M70033US	US	i3-8130U	No	Intel UHD 620	8GBx1	13.3" FHD (1920x1080) IPS	10-point Multi-touch	180GB SSD M.2 Opal2	None	Intel 8265 ac, 2x2 + BT4.1	Silver	Front 720p / None	Non-backlit	None	None	dTPM 2.0	45Wh	65W USB-C	Windows 10 Pro 64	1-year, Depot	05/18
20M70034US	US	i5-8250U	No	Intel UHD 620	8GBx1	13.3" FHD (1920x1080) IPS	10-point Multi-touch	180GB SSD M.2 Opal2	None	Intel 8265 ac, 2x2 + BT4.1	Black	Front 720p / None	Backlit	Fingerprint Reader	None	dTPM 2.0	45Wh	65W USB-C	Windows 10 Pro 64	1-year, Depot	05/18



ThinkPad P40 Yoga Platform Specifications

Product Specifications Reference (PSREF)

Processor	6th Generation Intel® Core™ i7 Processor									Ports Three USB 3.0 (one Always On), Mini DisplayPort, HDMI, Onelink+ connector, combo audio / microphone jack Monitor cable (optional) Adapter (optional)	Three USB 3.0 (one Always On), Mini DisplayPort, HDMI, Onelink+ connector, combo audio / microphone jack HDMI-VGA: Lenovo HDMI to VGA Monitor Cable mDP-VGA: Lenovo Mini DisplayPort to VGA Monitor Cable RJ45: ThinkPad Onelink+ to RJ45 adapter VGA/RJ45: ThinkPad Onelink+ to VGA/RJ45 adapter
	Processor Number	# of Cores	# of Threads	Base Frequency	Max Turbo Frequency	Cache	Memory Types	Processor Graphics	vPro		
	i7-6500U	2	4	2.5 GHz	3.1 GHz	4MB	DDR3L-1600	Intel HD Graphics 520	No		
i7-6600U	2.6 GHz			3.4 GHz	4MB	vPro					
Graphics	Intel HD Graphics 520 in processor and Nvidia Quadro M500M Graphics, 2GB DDR3 memory, supports external digital monitor via HDMI, or Mini DisplayPort; supports dual independent display; Max resolution: 3840x2160 (Mini DisplayPort)@60Hz; 1920x1080 (HDMI)@60Hz									Camera Audio support	HD720p resolution, fixed focus HD Audio, Conexant® CX11852 codec, Dolby® DAX2 / stereo speakers, 1.5W x 2 / dual array microphone, combo audio / microphone jack
Chipset	Intel SoC (System on Chip) platform									Keyboard UltraNav™	6-row, spill-resistant, multimedia Fn keys, LED backlit TrackPoint® pointing device and buttonless Mylar surface touchpad, multi-touch
Memory	16GB max / 1600MHz DDR3L / one 204-pin SO-DIMM sockets									Security Security chip	Power-on password, hard disk password, supervisor password, security keyhole Trusted Platform Module, TCG 1.2-compliant and Software TPM 2.0
Display	Some: 14.0" (355mm) WQHD (2560x1440), glare, LED backlight, IPS, 300 nits, 16:9 aspect ratio, 700:1 contrast ratio Some: 14.0" (355mm) FHD (1920x1080), anti-glare, LED backlight, IPS, 250 nits, 16:9 aspect ratio, 700:1 contrast ratio									vPro (optional) Fingerprint reader NFC	Intel vPro Technology Swipe fingerprint reader under C cover None
Multi-touch	Capacitive touch panel, supports 10-finger gesture									Battery type	Li-Polymer 3-cell (53Wh)
Hinge	Yoga hinge, 360 degree									Battery life	Up to 8.0 hr
Convert-mode	Laptop, tent, stand, and tablet									AC adapter	65W AC adapter
Pen	ThinkPad Pen Pro, active pen for multi-touch display									Light sensor	Ambient Light Sensor
Storage	SSD / SATA 6.0Gb/s, 2.5" wide, 7mm high									G-sensor	3D accelerometer
Optical	None									Compass	3D compass
Ethernet	Gigabit Ethernet via optional Ethernet (RJ-45) adapter (by native Intel Ethernet Connection I219-V (Non-vPro) or I219-LM (vPro))									Gyroscope	3D gyrometer
WLAN	11ac+BT, Intel Dual Band Wireless-AC 8260, 2x2, M.2 Card									Preload	Windows® 7 Professional 64 preinstalled through downgrade rights in Windows 10 Pro 64 Some: Windows 10 Pro 64 Some: Windows 10 Home 64
Bluetooth™	Bluetooth wireless, integrated in Wi-Fi + Bluetooth combo adapter										<ul style="list-style-type: none"> • Lenovo Solution Center • Lenovo SHAREit • Lenovo Companion • Lenovo Settings • Microsoft Office preloaded; purchase a product key to activate • McAfee® Live Safe (30-day trial)
WWAN (optional)	Wireless WAN, Sierra Wireless EM7455, Qualcomm® 4G LTE-Advanced/DC-HSPA+/HSPA+/HSPA/UMTS/GNSS, M.2 card										
SIM card	Micro-SIM card slot										
Dimensions	WxDxH: 13.30" x 9.30" x 0.78"; 338.0mm x 236.3mm x 19.9mm										
Weight	From 3.96 lb (1.80kg)										
Case color	Black										
Case material	Carbon-Fiber Hybrid										
Smart card reader	None									Limited warranty	One of the following, configurable by model: <ul style="list-style-type: none"> • 1-year depot repair service • 3-year/1-yr battery depot repair service
Media reader	4-in-1 reader (MMC, SD, SDHC, SDXC)									Mil-Spec test	MIL-STD-810G military certification
										Environment	EPEAT™ Gold; ENERGY STAR®; RoHS-compliant

ThinkPad P40 Yoga - TopSeller - 20GQ

Product Specifications Reference (PSREF)

Model	Region	Processor	vPro	Graphics	Memory	Display	Multi-touch	Case Material	Storage	Optical	WLAN + Bluetooth	WWAN	SIM Card	Monitor Cable	Color	Camera	Keyboard	Pen	Finger-print Reader	NFC	TPM	Battery	Power Adapter	Operating System	Warranty	Global	End of Support	Ann Date (m/y)
20GQ000BUS	US	i7-6500U	No	M500M 2GB	8GBx1	14" FHD (1920x1080) IPS AG	10-point Multi-touch	Carbon	256GB SSD Opal2	None	Intel 8260 ac, 2x2 + BT4.1	None	None	None	Black	720p	Backlit	Pen Pro	Finger-print Reader	None	dTPM1.2 + FW TPM2.0	3-cell (53Wh)	65W	Win10 Pro 64	1-year, Depot	No	Feb 2, 2021	02/16
20GQ000CUS	US	i7-6600U	vPro	M500M 2GB	8GBx1	14" FHD (1920x1080) IPS AG	10-point Multi-touch	Carbon	256GB SSD Opal2	None	Intel 8260 ac, 2x2 + BT4.1	None	None	None	Black	720p	Backlit	Pen Pro	Finger-print Reader	None	dTPM1.2 + FW TPM2.0	3-cell (53Wh)	65W	Win10 Pro 64	1-year, Depot	No	Feb 2, 2021	02/16
20GQ000EUS	US	i7-6600U	vPro	M500M 2GB	16GBx1	14" WQHD (2560x1440) IPS Gloss	10-point Multi-touch	Carbon	512GB SSD	None	Intel 8260 ac, 2x2 + BT4.1	None	None	None	Black	720p	Backlit	Pen Pro	Finger-print Reader	None	dTPM1.2 + FW TPM2.0	3-cell (53Wh)	65W	Win10 Pro 64	1-year, Depot	No	Feb 2, 2021	02/16



ThinkPad X1 Yoga (2nd Gen) Platform Specifications

Product Specifications Reference (PSREF)

Processor	7th Generation Intel® Core™ i5 / i7 Processor								Smart card readerNone Media readerMicroSD card reader, supports UHS-II microSD card PortsThree USB 3.1 Gen 1 (USB 3.0, one Always On), two USB 3.1 Type-C Gen 2 / Thunderbolt 3 (support data, video, and power delivery), HDMI 1.4b, Ethernet extension connector, combo audio / microphone jack WiGig dock (opt)ThinkPad WiGig dock Monitor cable (optional) HDMI to VGA: Lenovo HDMI to VGA Monitor Adapter USB-C to VGA: Lenovo USB-C to VGA Adapter USB-C to DP: Lenovo USB-C to DisplayPort Adapter								
	Processor Number	# of Cores	# of Threads	Base Frequency	Max Turbo Frequency	Cache	Memory Types	Processor Graphics									
	i5-7200U	2	4	2.5 GHz	3.1 GHz	3MB	LPDDR3-1866	Intel HD Graphics 620									
	i5-7300U			2.6 GHz	3.5 GHz	3MB											
	i7-7500U			2.7 GHz	3.5 GHz	4MB											
i7-7600U	2.8 GHz			3.9 GHz	4MB												
Graphics	Intel HD Graphics 620 in processor only, supports external digital monitor via HDMI or USB Type-C; supports three independent displays; Max resolution: 4096x2304@60Hz (USB Type-C); 4096x2160@24Hz (HDMI)																
Chipset	Intel SoC (System on Chip) platform																
Memory	8GB or 16GB / 1866MHz LPDDR3 / soldered to systemboard, no sockets																
Display	<i>Some:</i> 14.0" (355mm) FHD (1920x1080), glossy, LED backlight, 300 nits, 16:9 aspect ratio, 700:1 contrast ratio, 72% gamut, 170° viewing angle, IPS <i>Some:</i> 14.0" (355mm) Narrow Bezel FHD (1920x1080), glossy, LED backlight, 300 nits, 16:9 aspect ratio, 700:1 contrast ratio, 72% gamut, 170° viewing angle, IPS <i>Some:</i> 14.0" (355mm) WQHD (2560x1440), glossy, LED backlight, 300 nits, 16:9 aspect ratio, 700:1 contrast ratio, 72% gamut, 170° viewing angle, IPS <i>Some:</i> 14.0" (355mm) WQHD (2560x1440), glossy, OLED, 300 nits, 16:9 aspect ratio, 54000:1 contrast ratio, 100% gamut, 176° viewing angle <i>LED panel:</i> Capacitive-type multi-touch, AR (anti-reflection), AS (anti-smudge), supports 10-finger gesture <i>OLED panel:</i> OCTA, AS (anti-smudge), supports 10-finger gesture																
Multi-touch	Yoga hinge, 360 degree																
Hinge	Laptop, tent, stand, and tablet																
Convert-mode	ThinkPad Pen Pro, active pen for multi-touch display																
Pen (optional)	<i>Some:</i> M.2 SSD / SATA 6.0Gb/s (e.g. xxxG SSD) <i>Some:</i> M.2 SSD / PCIe NVMe, PCIe 3.0 x 4, 32Gb/s (e.g. xxxG SSD PCIe NVMe)																
Storage	None																
Optical	Native Intel Ethernet Connection I219-V (Non-vPro) or I219-LM (vPro) via optional ThinkPad Ethernet Extension Cable																
Ethernet	<i>One of the following, configurable by model (WiGig is mutually exclusive with WWAN):</i> <ul style="list-style-type: none"> Intel Dual Band Wireless-AC 8265, Wi-Fi 2x2, 802.11ac + BT4.1, M.2 Card Intel Tri-Band Wireless-AC 18265, WiGig™ 802.11ad + Wi-Fi 2x2, 802.11ac + BT4.1, M.2 Card <i>*WiGig adapter is only available in selected countries*</i>																
WLAN	Bluetooth 4.1 wireless, integrated in Wi-Fi + Bluetooth combo adapter																
Bluetooth™	* Intel 8265ac / 18265ac card support BT4.2 but is limited to BT4.1 by Windows OS																
WWAN (optional)	Integrated Mobile Broadband 4G LTE-A, Qualcomm® Snapdragon™ X7 LTE-A (Sierra Wireless EM7455)																
SIM card (opt)	Micro-SIM card slot, opt Verizon LTE (US) or Lenovo® Connect (EMEA) SIM card																
Dimensions	WxDxH: 13.11" x 9.02" x 0.69"; 333mm x 229mm x 17.4mm																
Weight	Starting at 2.99 lb (1.36kg) for OLED model; 3.13 lb (1.42kg) for other model																
Case color	Black or silver																
Case material	<i>Display cover:</i> Carbon-Fiber Hybrid; <i>Bottom:</i> magnesium-PPS hybrid																
Camera (optional)	720p: HD720p resolution, fixed focus IR & 720p: IR camera and HD720p camera (Narrow Bezel FHD panel only)																
Audio support	HD Audio, Conexant® CX11771 codec / stereo speakers, 2W x 2 / dual array microphone, combo audio / microphone jack																
Keyboard	6-row wave keyboard (rise & fall), spill-resistant, multimedia Fn keys, LED backlit																
UltraNav™	TrackPoint® pointing device and 3+2 buttons multi-touch clickpad																
Security	Power-on password, hard disk password, supervisor password, security keyhole																
Security chip	Discrete TPM 2.0 TCG Certified																
vPro (optional)	Intel vPro Technology																
Fingerprint reader	Touch style match on chip fingerprint reader on the palm rest																
NFC (optional)	Near Field Communication																
Battery	Li-Polymer 4-cell (56Wh)																
Max battery life	MobileMark® 2014: 15.5 hr																
AC adapter	45W or 65W USB Type-C AC adapter																
RapidCharge	<table border="1"> <tr> <td>AC adapter</td> <td>45W USB-C</td> <td>65W USB-C</td> </tr> <tr> <td>Charge to 80%</td> <td>Not support</td> <td>1.0 hr</td> </tr> <tr> <td>Charge to 100%</td> <td>Not support</td> <td>2.8 hr</td> </tr> </table>			AC adapter	45W USB-C	65W USB-C	Charge to 80%	Not support	1.0 hr	Charge to 100%	Not support	2.8 hr					
AC adapter	45W USB-C	65W USB-C															
Charge to 80%	Not support	1.0 hr															
Charge to 100%	Not support	2.8 hr															
Light sensor	Ambient Light Sensor																
G-sensor	3D accelerometer and 3D magnetometer																
Compass	3D compass																
Gyroscope	3D gyrometer																
Preload	<i>Some:</i> Windows 10 Home 64 <i>Some:</i> Windows 10 Pro 64 <ul style="list-style-type: none"> Lenovo Companion Lenovo Settings Microsoft Office preloaded; purchase a product key to activate 																
Limited warranty	<i>One of the following, configurable by model:</i> <ul style="list-style-type: none"> 1-year depot repair service 3-year/1-yr battery depot repair service 3-year/1-yr battery limited onsite service 																
Mil-Spec test	MIL-STD-810G military certification																
Environment	EPEAT™ Gold (US only); ENERGY STAR®; RoHS-compliant																

ThinkPad X1 Yoga (2nd Gen) - TopSeller - 20JD

Product Specifications Reference (PSREF)

Model	Region	Processor	vPro	Graphics	Memory	Display	Multi-touch	Storage(HDD/SSD)	WLAN + Bluetooth	WWAN	SIM Card	Dock	Monitor Cable	Adapter	Color	Camera	Keyboard	Pen	Finger-print Reader	NFC	Power Adapter	Operating System	Warranty	Global	Ann Date (m/y)
20JD000PUS	US	i5-7300U	vPro	Intel HD 620	8GB Soldered	14" FHD (1920x1080) IPS NB	10-point Multi-touch	256GB SSD M.2 PCIe NVMe Opal2	Intel 8265 ac, 2x2 + BT4.1	None	None	None	None	None	Black	720p	Backlit	Pen Pro	Finger-print Reader	None	65W	Win10 Pro 64	3-year, Depot	No	04/17
20JD000QUS	US	i7-7600U	vPro	Intel HD 620	8GB Soldered	14" FHD (1920x1080) IPS NB	10-point Multi-touch	256GB SSD M.2 PCIe NVMe Opal2	Intel 8265 ac, 2x2 + BT4.1	None	None	None	None	None	Black	720p	Backlit	Pen Pro	Finger-print Reader	None	65W	Win10 Pro 64	3-year, Depot	No	04/17
20JD000RUS	US	i5-7300U	vPro	Intel HD 620	8GB Soldered	14" FHD (1920x1080) IPS Gloss	10-point Multi-touch	256GB SSD M.2 PCIe NVMe Opal2	Intel 8265 ac, 2x2 + BT4.1	Sierra EM7455	None	None	None	None	Black	720p	Backlit	Pen Pro	Finger-print Reader	None	65W	Win10 Pro 64	3-year, Depot	No	04/17
20JD000SUS	US	i7-7600U	vPro	Intel HD 620	16GB Soldered	14" WQHD (2560x1440) IPS Gloss	10-point Multi-touch	512GB SSD M.2 PCIe NVMe Opal2	Intel 8265 ac, 2x2 + BT4.1	Sierra EM7455	None	None	None	None	Black	720p	Backlit	Pen Pro	Finger-print Reader	None	65W	Win10 Pro 64	3-year, Depot	No	04/17
20JD000TUS	US	i7-7600U	vPro	Intel HD 620	16GB Soldered	14" WQHD (2560x1440) IPS Gloss	10-point Multi-touch	512GB SSD M.2 PCIe NVMe Opal2	Intel 8265 ac, 2x2 + BT4.1	None	None	None	None	None	Black	720p	Backlit	Pen Pro	Finger-print Reader	None	65W	Win10 Pro 64	3-year, Depot	No	04/17
20JD000UUS	US	i5-7300U	vPro	Intel HD 620	16GB Soldered	14" FHD (1920x1080) IPS NB	10-point Multi-touch	256GB SSD M.2 PCIe NVMe Opal2	Intel 8265 ac, 2x2 + BT4.1	None	None	None	None	None	Black	720p	Backlit	Pen Pro	Finger-print Reader	None	65W	Win10 Pro 64	3-year, Depot	No	04/17
20JD000VUS	US	i7-7600U	vPro	Intel HD 620	8GB Soldered	14" WQHD (2560x1440) IPS Gloss	10-point Multi-touch	512GB SSD M.2 PCIe NVMe Opal2	Intel 8265 ac, 2x2 + BT4.1	None	None	None	None	None	Black	720p	Backlit	Pen Pro	Finger-print Reader	None	65W	Win10 Pro 64	3-year, Depot	No	04/17
20JD000WUS	US	i7-7600U	vPro	Intel HD 620	16GB Soldered	14" WQHD (2560x1440) OLED Gloss	10-point Multi-touch	512GB SSD M.2 PCIe NVMe Opal2	Intel 8265 ac, 2x2 + BT4.1	None	None	None	None	None	Black	720p	Backlit	Pen Pro	Finger-print Reader	None	65W	Win10 Pro 64	3-year, Depot	No	04/17
20JD000XUS	US	i5-7200U	No	Intel HD 620	8GB Soldered	14" WQHD (2560x1440) IPS Gloss	10-point Multi-touch	512GB SSD M.2 PCIe NVMe Opal2	Intel 8265 ac, 2x2 + BT4.1	None	None	None	None	None	Black	720p	Backlit	Pen Pro	Finger-print Reader	None	65W	Win10 Pro 64	3-year, Depot	No	04/17
20JD000YUS	US	i5-7300U	vPro	Intel HD 620	16GB Soldered	14" FHD (1920x1080) IPS Gloss	10-point Multi-touch	256GB SSD M.2 PCIe NVMe Opal2	Intel 8265 ac, 2x2 + BT4.1	Sierra EM7455	None	None	None	None	Black	720p	Backlit	Pen Pro	Finger-print Reader	None	65W	Win10 Pro 64	3-year, Depot	No	04/17
20JD0015US	US	i5-7200U	No	Intel HD 620	8GB Soldered	14" FHD (1920x1080) IPS NB	10-point Multi-touch	256GB SSD M.2 PCIe NVMe Opal2	Intel 8265 ac, 2x2 + BT4.1	None	None	None	None	None	Black	720p	Backlit	Pen Pro	Finger-print Reader	None	65W	Win10 Pro 64	3-year, Depot	No	04/17
20JD0022US	US	i5-7200U	No	Intel HD 620	8GB Soldered	14" FHD (1920x1080) IPS NB	10-point Multi-touch	180GB SSD M.2 Opal2	Intel 8265 ac, 2x2 + BT4.1	None	None	None	None	None	Black	720p	Backlit	Pen Pro	Finger-print Reader	None	65W	Win10 Pro 64	3-year, Depot	No	05/17
20JD004UUS	US	i7-7500U	No	Intel HD 620	8GB Soldered	14" WQHD (2560x1440) IPS Gloss	10-point Multi-touch	512GB SSD M.2 PCIe NVMe Opal2	Intel 8265 ac, 2x2 + BT4.1	None	None	None	None	None	Black	720p	Backlit	Pen Pro	Finger-print Reader	None	65W	Win10 Pro 64	3-year, Depot	No	05/17
20JD004VUS	US	i5-7300U	vPro	Intel HD 620	8GB Soldered	14" FHD (1920x1080) IPS NB	10-point Multi-touch	180GB SSD M.2 Opal2	Intel 8265 ac, 2x2 + BT4.1	None	None	None	None	None	Black	720p	Backlit	Pen Pro	Finger-print Reader	None	65W	Win10 Pro 64	3-year, Depot	No	05/17
20JD0060US	US	i7-7600U	vPro	Intel HD 620	16GB Soldered	14" FHD (1920x1080) IPS NB	10-point Multi-touch	512GB SSD M.2 PCIe NVMe Opal2	Intel 8265 ac, 2x2 + BT4.1	None	None	None	None	None	Black	720p	Backlit	Pen Pro	Finger-print Reader	None	65W	Win10 Pro 64	3-year, Depot	No	10/17

ThinkPad X1 Yoga (2nd Gen) - TopSeller - 20JF

Product Specifications Reference (PSREF)

Model	Region	Processor	vPro	Graphics	Memory	Display	Multi-touch	Storage(HDD/SSD)	WLAN + Bluetooth	WWAN	SIM Card	Dock	Monitor Cable	Adapter	Color	Camera	Keyboard	Pen	Finger-print Reader	NFC	Power Adapter	Operating System	Warranty	Global	Ann Date (m/y)
20JF000BUS	US	i5-7200U	No	Intel HD 620	8GB Soldered	14" FHD (1920x1080) IPS NB	10-point Multi-touch	256GB SSD M.2 PCIe NVMe Opal2	Intel 8265 ac, 2x2 + BT4.1	None	None	None	None	None	Silver	720p	Backlit	Pen Pro	Finger-print Reader	None	65W	Win10 Pro 64	3-year, Depot	No	04/17
20JF000CUS	US	i5-7300U	vPro	Intel HD 620	16GB Soldered	14" FHD (1920x1080) IPS Gloss	10-point Multi-touch	256GB SSD M.2 PCIe NVMe Opal2	Intel 8265 ac, 2x2 + BT4.1	Sierra EM7455	None	None	None	None	Silver	720p	Backlit	Pen Pro	Finger-print Reader	None	65W	Win10 Pro 64	3-year, Depot	No	04/17
20JF000DUS	US	i7-7600U	vPro	Intel HD 620	16GB Soldered	14" WQHD (2560x1440) IPS Gloss	10-point Multi-touch	512GB SSD M.2 PCIe NVMe Opal2	Intel 8265 ac, 2x2 + BT4.1	None	None	None	None	None	Silver	720p	Backlit	Pen Pro	Finger-print Reader	None	65W	Win10 Pro 64	3-year, Depot	No	04/17
20JF000EUS	US	i7-7600U	vPro	Intel HD 620	8GB Soldered	14" FHD (1920x1080) IPS NB	10-point Multi-touch	256GB SSD M.2 PCIe NVMe Opal2	Intel 8265 ac, 2x2 + BT4.1	None	None	None	None	None	Silver	720p	Backlit	Pen Pro	Finger-print Reader	None	65W	Win10 Pro 64	3-year, Depot	No	04/17
20JF000FUS	US	i5-7300U	vPro	Intel HD 620	16GB Soldered	14" FHD (1920x1080) IPS NB	10-point Multi-touch	256GB SSD M.2 PCIe NVMe Opal2	Intel 8265 ac, 2x2 + BT4.1	None	None	None	None	None	Silver	720p	Backlit	Pen Pro	Finger-print Reader	None	65W	Win10 Pro 64	3-year, Depot	No	04/17
20JF000GUS	US	i5-7300U	vPro	Intel HD 620	8GB Soldered	14" FHD (1920x1080) IPS Gloss	10-point Multi-touch	256GB SSD M.2 PCIe NVMe Opal2	Intel 8265 ac, 2x2 + BT4.1	Sierra EM7455	None	None	None	None	Silver	720p	Backlit	Pen Pro	Finger-print Reader	None	65W	Win10 Pro 64	3-year, Depot	No	04/17
20JF000HUS	US	i7-7600U	vPro	Intel HD 620	16GB Soldered	14" WQHD (2560x1440) OLED Gloss	10-point Multi-touch	512GB SSD M.2 PCIe NVMe Opal2	Intel 8265 ac, 2x2 + BT4.1	None	None	None	None	None	Silver	720p	Backlit	Pen Pro	Finger-print Reader	None	65W	Win10 Pro 64	3-year, Depot	No	04/17
20JF000JUS	US	i7-7600U	vPro	Intel HD 620	8GB Soldered	14" WQHD (2560x1440) IPS Gloss	10-point Multi-touch	512GB SSD M.2 PCIe NVMe Opal2	Intel 8265 ac, 2x2 + BT4.1	None	None	None	None	None	Silver	720p	Backlit	Pen Pro	Finger-print Reader	None	65W	Win10 Pro 64	3-year, Depot	No	04/17
20JF000KUS	US	i5-7200U	No	Intel HD 620	8GB Soldered	14" WQHD (2560x1440) IPS Gloss	10-point Multi-touch	512GB SSD M.2 PCIe NVMe Opal2	Intel 8265 ac, 2x2 + BT4.1	None	None	None	None	None	Silver	720p	Backlit	Pen Pro	Finger-print Reader	None	65W	Win10 Pro 64	3-year, Depot	No	04/17
20JF000LUS	US	i5-7300U	vPro	Intel HD 620	8GB Soldered	14" FHD (1920x1080) IPS NB	10-point Multi-touch	256GB SSD M.2 PCIe NVMe Opal2	Intel 8265 ac, 2x2 + BT4.1	None	None	None	None	None	Silver	720p	Backlit	Pen Pro	Finger-print Reader	None	65W	Win10 Pro 64	3-year, Depot	No	04/17
20JF000MUS	US	i7-7600U	vPro	Intel HD 620	16GB Soldered	14" WQHD (2560x1440) IPS Gloss	10-point Multi-touch	512GB SSD M.2 PCIe NVMe Opal2	Intel 8265 ac, 2x2 + BT4.1	Sierra EM7455	None	None	None	None	Silver	720p	Backlit	Pen Pro	Finger-print Reader	None	65W	Win10 Pro 64	3-year, Depot	No	04/17
20JF002KUS	US	i7-7600U	vPro	Intel HD 620	16GB Soldered	14" FHD (1920x1080) IPS NB	10-point Multi-touch	512GB SSD M.2 PCIe NVMe Opal2	Intel 8265 ac, 2x2 + BT4.1	None	None	None	None	None	Silver	720p	Backlit	Pen Pro	Finger-print Reader	None	65W	Win10 Pro 64	3-year, Depot	No	10/17



ThinkPad X1 Yoga (3rd Gen) Platform Specifications

Product Specifications Reference (PSREF)

Processor	8th Generation Intel® Core™ i5 / i7 Processor								Smart card reader None Media reader MicroSD card reader, supports UHS-II Ports Two USB 3.1 Gen 1 (one Always On), two USB 3.1 Type-C Gen 2 / Thunderbolt 3, HDMI 1.4, Ethernet extension connector, nano-SIM card slot (WWAN models), headphone / microphone combo jack, microSD card reader WiGig dock None Monitor cable <i>(optional)</i> HDMI to VGA: Lenovo HDMI to VGA Monitor Adapter USB-C to VGA: Lenovo USB-C to VGA Adapter USB-C to DP: Lenovo USB-C to DisplayPort Adapter
	Processor Number	# of Cores	# of Threads	Base Frequency	Max Turbo Frequency	Cache	Memory Types	Processor Graphics	
	i5-8250U	4	8	1.6 GHz	3.4 GHz	6MB	LPDDR3-2133	Intel UHD Graphics 620	
	i5-8350U			1.7 GHz	3.6 GHz	6MB			
	i7-8550U			1.8 GHz	4.0 GHz	8MB			
i7-8650U	1.9 GHz			4.2 GHz	8MB				
Graphics	Intel UHD Graphics 620 in processor; supports external digital monitor via HDMI or USB Type-C; supports three independent displays; Max resolution: 5120x2880@60Hz (USB Type-C); 4096x2160@30Hz (HDMI)								
Chipset	Intel SoC (System on Chip) platform								
Memory	8GB or 16GB / 2133MHz LPDDR3 / soldered to systemboard, no sockets								
Display	<i>Some:</i> 14.0" (355mm) FHD (1920x1080), LED backlight, 270 nits, 16:9 aspect ratio, 700:1 contrast ratio, 72% gamut, 170° viewing angle, IPS <i>Some:</i> 14.0" (355mm) WQHD (2560x1440), LED backlight, 270 nits, 16:9 aspect ratio, 700:1 contrast ratio, 72% gamut, 170° viewing angle, IPS <i>Some:</i> 14.0" (355mm) HDR WQHD (2560x1440) with Dolby Vision™, LED backlight, 500 nits, 16:9 aspect ratio, 1500:1 contrast ratio, 100% gamut, 170° viewing angle, IPS								
Multi-touch	Capacitive-type multi-touch, AR (anti-reflection), AS (anti-smudge), supports 10-finger gesture								
Hinge	Yoga hinge, 360 degree								
Convert-mode	Laptop, tent, stand, and tablet								
Pen <i>(optional)</i>	ThinkPad Pen Pro, active pen for multi-touch display, on-board rechargeable								
Storage	<i>Some:</i> M.2 SSD / SATA 6.0Gb/s (e.g. xxxG SSD) <i>Some:</i> M.2 SSD / PCIe NVMe, PCIe 3.0 x 4, 32Gb/s (e.g. xxxG SSD PCIe NVMe)								
Optical	None								
Ethernet	Native Intel Ethernet Connection WGI219-LM <i>(vPro)</i> via optional ThinkPad Ethernet Extension Cable								
WLAN	Intel Dual Band Wireless-AC 8265, Wi-Fi 2x2 802.11ac + Bluetooth 4.1, M.2 card * Intel 8265ac card supports BT4.2 but is limited to BT4.1 by Windows OS								
Bluetooth™	Bluetooth 4.1 wireless, integrated in Wi-Fi + Bluetooth combo adapter								
WWAN <i>(optional)</i>	Integrated Mobile Broadband 4G LTE-A, Intel XMM™ 7360 (Fibocom L850-GL), M.2 card								
SIM card <i>(opt)</i>	Nano-SIM card slot, optional Verizon LTE (US) SIM card								
Dimensions	WxDxH: 13.11" x 9.02" x 0.67"; 333mm x 229mm x 17.05mm								
Weight	Starting at 3.08 lb (1.4kg)								
Case color	Black or silver								
Case material	<i>Display cover:</i> Carbon-Fiber and Glass-Fiber hybrid; <i>Bottom:</i> magnesium-PPS hybrid								
Camera <i>(optional)</i>	<i>One of the following, configurable by model:</i> 720p: HD720p camera with ThinkShutter camera privacy, fixed focus IR & 720p: IR camera and HD720p camera, fixed focus * WWAN models and HDR panel models can not support IR camera								
Audio support	HD Audio, Realtek® ALC3286 codec, Dolby® Audio™ Premium / stereo speakers, 1W x 2 / dual array microphone, headphone / microphone combo jack, Dolby® Atmos™ via headphones								
Keyboard	6-row wave keyboard (rise & fall), spill-resistant, multimedia Fn keys, LED backlit								
UltraNav™	TrackPoint® pointing device and 3+2 buttons multi-touch clickpad								
Security	Power-on password, hard disk password, supervisor password, security keyhole								
Security chip	Discrete TPM 2.0 TCG Certified								
vPro <i>(optional)</i>	Intel vPro Technology								
Fingerprint reader	Touch style match on chip fingerprint reader on the palm rest								
NFC <i>(optional)</i>	Near Field Communication								
Battery	Integrated Li-Ion 54Wh battery, supports Rapid Charge (charge up to 80% in 1hr) with 65W USB Type-C AC adapter								
Max battery life	MobileMark® 2014: 15.4 hr								
AC adapter	45W or 65W USB Type-C AC adapter								
Light sensor	Ambient Light Sensor								
G-sensor	3D accelerometer and 3D magnetometer								
Compass	None								
Gyroscope	3D gyrometer								
Preload	Windows 10 Pro 64								
Limited warranty	<i>One of the following, configurable by model:</i> <ul style="list-style-type: none"> • 1-year depot repair service • 3-year/1-yr battery depot repair service 								
Mil-Spec test	MIL-STD-810G military certification								
Environment	EPEAT™ Gold; ENERGY STAR®; RoHS-compliant								

ThinkPad X1 Yoga (3rd Gen) - TopSeller - 20LD

Product Specifications Reference (PSREF)

Model	Region	Processor	vPro	Graphics	Memory	Display(Size, Resolution, Type)	Multi-touch	Storage(HDD/SSD)	WLAN + Bluetooth	WWAN	Dock	Monitor Cable	Adapter	Color	Camera	Keyboard	Pen	Finger-print Reader	NFC	Power Adapter	Operating System	Warranty	Ann Date (m/y)
20LD001CUS	US	i7-8650U	vPro	Intel UHD 620	16GB Soldered	14" HDR WQHD (2560x1440)IPS	10-point Multi-touch	1TB SSD M.2 PCIe NVMe Opal2	Intel 8265 ac, 2x2 + BT4.1	None	None	None	None	Black	720p	Backlit	Pen Pro	Finger-print Reader	None	65W USB-C	Win10 Pro 64	3-year, Depot	02/18
20LD001DUS	US	i5-8350U	vPro	Intel UHD 620	16GB Soldered	14" FHD (1920x1080) IPS	10-point Multi-touch	256GB SSD M.2 PCIe NVMe Opal2	Intel 8265 ac, 2x2 + BT4.1	None	None	None	None	Black	720p	Backlit	Pen Pro	Finger-print Reader	None	65W USB-C	Win10 Pro 64	3-year, Depot	02/18
20LD001EUS	US	i5-8350U	vPro	Intel UHD 620	16GB Soldered	14" FHD (1920x1080) IPS	10-point Multi-touch	512GB SSD M.2 PCIe NVMe Opal2	Intel 8265 ac, 2x2 + BT4.1	None	None	None	None	Black	720p	Backlit	Pen Pro	Finger-print Reader	None	65W USB-C	Win10 Pro 64	3-year, Depot	02/18
20LD001FUS	US	i7-8650U	vPro	Intel UHD 620	16GB Soldered	14" HDR WQHD (2560x1440)IPS	10-point Multi-touch	512GB SSD M.2 PCIe NVMe Opal2	Intel 8265 ac, 2x2 + BT4.1	None	None	None	None	Black	720p	Backlit	Pen Pro	Finger-print Reader	None	65W USB-C	Win10 Pro 64	3-year, Depot	02/18
20LD001GUS	US	i5-8250U	No	Intel UHD 620	8GB Soldered	14" FHD (1920x1080) IPS	10-point Multi-touch	256GB SSD M.2 PCIe NVMe Opal2	Intel 8265 ac, 2x2 + BT4.1	None	None	None	None	Black	720p	Backlit	Pen Pro	Finger-print Reader	None	65W USB-C	Win10 Pro 64	3-year, Depot	02/18
20LD001HUS	US	i7-8650U	vPro	Intel UHD 620	16GB Soldered	14" WQHD (2560x1440) IPS	10-point Multi-touch	512GB SSD M.2 PCIe NVMe Opal2	Intel 8265 ac, 2x2 + BT4.1	None	None	None	None	Black	IR &720p	Backlit	Pen Pro	Finger-print Reader	None	65W USB-C	Win10 Pro 64	3-year, Depot	02/18
20LD001JUS	US	i5-8350U	vPro	Intel UHD 620	8GB Soldered	14" FHD (1920x1080) IPS	10-point Multi-touch	256GB SSD M.2 PCIe NVMe Opal2	Intel 8265 ac, 2x2 + BT4.1	None	None	None	None	Black	720p	Backlit	Pen Pro	Finger-print Reader	None	65W USB-C	Win10 Pro 64	3-year, Depot	02/18
20LD001KUS	US	i7-8550U	No	Intel UHD 620	8GB Soldered	14" FHD (1920x1080) IPS	10-point Multi-touch	256GB SSD M.2 PCIe NVMe Opal2	Intel 8265 ac, 2x2 + BT4.1	None	None	None	None	Black	720p	Backlit	Pen Pro	Finger-print Reader	None	65W USB-C	Win10 Pro 64	3-year, Depot	02/18
20LD002NUS	US	i5-8250U	No	Intel UHD 620	8GB Soldered	14" FHD (1920x1080) IPS	10-point Multi-touch	256GB SSD M.2 PCIe NVMe Opal2	Intel 8265 ac, 2x2 + BT4.1	FIBOCOM L850	None	None	None	Black	720p	Backlit	Pen Pro	Finger-print Reader	None	65W USB-C	Win10 Pro 64	3-year, Depot	04/18
20LD002PUS	US	i5-8350U	vPro	Intel UHD 620	8GB Soldered	14" FHD (1920x1080) IPS	10-point Multi-touch	256GB SSD M.2 PCIe NVMe Opal2	Intel 8265 ac, 2x2 + BT4.1	FIBOCOM L850	None	None	None	Black	720p	Backlit	Pen Pro	Finger-print Reader	None	65W USB-C	Win10 Pro 64	3-year, Depot	04/18
20LD002QUS	US	i7-8550U	No	Intel UHD 620	8GB Soldered	14" FHD (1920x1080) IPS	10-point Multi-touch	256GB SSD M.2 PCIe NVMe Opal2	Intel 8265 ac, 2x2 + BT4.1	FIBOCOM L850	None	None	None	Black	720p	Backlit	Pen Pro	Finger-print Reader	None	65W USB-C	Win10 Pro 64	3-year, Depot	04/18
20LD002RUS	US	i5-8350U	vPro	Intel UHD 620	8GB Soldered	14" FHD (1920x1080) IPS	10-point Multi-touch	512GB SSD M.2 PCIe NVMe Opal2	Intel 8265 ac, 2x2 + BT4.1	FIBOCOM L850	None	None	None	Black	720p	Backlit	Pen Pro	Finger-print Reader	None	65W USB-C	Win10 Pro 64	3-year, Depot	04/18
20LD002SUS	US	i5-8350U	vPro	Intel UHD 620	16GB Soldered	14" FHD (1920x1080) IPS	10-point Multi-touch	256GB SSD M.2 PCIe NVMe Opal2	Intel 8265 ac, 2x2 + BT4.1	FIBOCOM L850	None	None	None	Black	720p	Backlit	Pen Pro	Finger-print Reader	None	65W USB-C	Win10 Pro 64	3-year, Depot	04/18
20LD002TUS	US	i7-8650U	vPro	Intel UHD 620	16GB Soldered	14" WQHD (2560x1440) IPS	10-point Multi-touch	512GB SSD M.2 PCIe NVMe Opal2	Intel 8265 ac, 2x2 + BT4.1	FIBOCOM L850	None	None	None	Black	720p	Backlit	Pen Pro	Finger-print Reader	None	65W USB-C	Win10 Pro 64	3-year, Depot	04/18

ThinkPad X1 Yoga (3rd Gen) - TopSeller - 20LF

Product Specifications Reference (PSREF)

Model	Region	Processor	vPro	Graphics	Memory	Display(Size, Resolution, Type)	Multi-touch	Storage(HDD/SSD)	WLAN + Bluetooth	WWAN	Dock	Monitor Cable	Adapter	Color	Camera	Keyboard	Pen	Finger-print Reader	NFC	Power Adapter	Operating System	Warranty	Ann Date (m/y)
20LF000JUS	US	i5-8250U	No	Intel UHD 620	8GB Soldered	14" FHD (1920x1080) IPS	10-point Multi-touch	256GB SSD M.2 PCIe NVMe Opal2	Intel 8265 ac, 2x2 + BT4.1	None	None	None	None	Silver	720p	Backlit	Pen Pro	Finger-print Reader	None	65W USB-C	Win10 Pro 64	3-year, Depot	02/18
20LF000KUS	US	i7-8650U	vPro	Intel UHD 620	16GB Soldered	14" WQHD (2560x1440) IPS	10-point Multi-touch	512GB SSD M.2 PCIe NVMe Opal2	Intel 8265 ac, 2x2 + BT4.1	None	None	None	None	Silver	IR &720p	Backlit	Pen Pro	Finger-print Reader	None	65W USB-C	Win10 Pro 64	3-year, Depot	02/18
20LF000LUS	US	i7-8650U	vPro	Intel UHD 620	8GB Soldered	14" FHD (1920x1080) IPS	10-point Multi-touch	256GB SSD M.2 PCIe NVMe Opal2	Intel 8265 ac, 2x2 + BT4.1	None	None	None	None	Silver	720p	Backlit	Pen Pro	Finger-print Reader	None	65W USB-C	Win10 Pro 64	3-year, Depot	02/18
20LF000MUS	US	i7-8550U	No	Intel UHD 620	8GB Soldered	14" FHD (1920x1080) IPS	10-point Multi-touch	256GB SSD M.2 PCIe NVMe Opal2	Intel 8265 ac, 2x2 + BT4.1	None	None	None	None	Silver	720p	Backlit	Pen Pro	Finger-print Reader	None	65W USB-C	Win10 Pro 64	3-year, Depot	02/18
20LF000NUS	US	i5-8350U	vPro	Intel UHD 620	8GB Soldered	14" FHD (1920x1080) IPS	10-point Multi-touch	256GB SSD M.2 PCIe NVMe Opal2	Intel 8265 ac, 2x2 + BT4.1	None	None	None	None	Silver	720p	Backlit	Pen Pro	Finger-print Reader	None	65W USB-C	Win10 Pro 64	3-year, Depot	02/18
20LF000PUS	US	i5-8350U	vPro	Intel UHD 620	16GB Soldered	14" FHD (1920x1080) IPS	10-point Multi-touch	256GB SSD M.2 PCIe NVMe Opal2	Intel 8265 ac, 2x2 + BT4.1	None	None	None	None	Silver	720p	Backlit	Pen Pro	Finger-print Reader	None	65W USB-C	Win10 Pro 64	3-year, Depot	02/18
20LF000VUS	US	i5-8350U	vPro	Intel UHD 620	8GB Soldered	14" FHD (1920x1080) IPS	10-point Multi-touch	256GB SSD M.2 PCIe NVMe Opal2	Intel 8265 ac, 2x2 + BT4.1	FIBOCOM L850	None	None	None	Silver	720p	Backlit	Pen Pro	Finger-print Reader	None	65W USB-C	Win10 Pro 64	3-year, Depot	04/18
20LF000WUS	US	i7-8650U	vPro	Intel UHD 620	16GB Soldered	14" WQHD (2560x1440) IPS	10-point Multi-touch	512GB SSD M.2 PCIe NVMe Opal2	Intel 8265 ac, 2x2 + BT4.1	FIBOCOM L850	None	None	None	Silver	720p	Backlit	Pen Pro	Finger-print Reader	None	65W USB-C	Win10 Pro 64	3-year, Depot	04/18
20LF000XUS	US	i7-8550U	No	Intel UHD 620	8GB Soldered	14" FHD (1920x1080) IPS	10-point Multi-touch	256GB SSD M.2 PCIe NVMe Opal2	Intel 8265 ac, 2x2 + BT4.1	FIBOCOM L850	None	None	None	Silver	720p	Backlit	Pen Pro	Finger-print Reader	None	65W USB-C	Win10 Pro 64	3-year, Depot	04/18
20LF000YUS	US	i5-8350U	vPro	Intel UHD 620	16GB Soldered	14" FHD (1920x1080) IPS	10-point Multi-touch	256GB SSD M.2 PCIe NVMe Opal2	Intel 8265 ac, 2x2 + BT4.1	FIBOCOM L850	None	None	None	Silver	720p	Backlit	Pen Pro	Finger-print Reader	None	65W USB-C	Win10 Pro 64	3-year, Depot	04/18



ThinkPad X380 Yoga Platform Specifications

Product Specifications Reference (PSREF)

Processor	8th Generation Intel® Core™ i5 / i7 Processor								Dimensions <i>WxDxH:</i> 12.34" x 8.75" x 0.72"; 313.5mm x 222.2mm x 18.2mm Weight Starting at 3.17 lb (1.43kg) Case color Black or silver Case Material Carbon-Fiber Hybrid
	Processor Number	# of Cores	# of Threads	Base Frequency	Max Turbo Frequency	Cache	Memory Types	Processor Graphics	
	i5-8250U	4	8	1.6 GHz	3.4 GHz	6MB	DDR4-2400	Intel UHD Graphics 620	
	i5-8350U			1.7 GHz	3.6 GHz	6MB			
	i7-8550U			1.8 GHz	4.0 GHz	8MB			
i7-8650U	1.9 GHz			4.2 GHz	8MB				
Graphics	Intel UHD Graphics 620 in processor only; supports external digital monitor via HDMI or USB Type-C; supports three independent displays; Max resolution: 4096x2304@60Hz (USB Type-C); 4096x2160@30Hz (HDMI)								Smart card reader <i>Optional:</i> Smart card reader (mutually exclusive with NFC) Media reader One microSD card slot (microSD, microSDHC, microSDXC), UHS-I Ports Two USB 3.1 Gen 1 (one Always On), Ethernet extension connector, one USB 3.1 Type-C Gen 2 / Thunderbolt 3, HDMI 1.4b, microSD card reader, nano-SIM card slot (WWAN models), headphone / microphone combo jack
Chipset	Intel SoC (System on Chip) platform								WiGig dock None
Memory	8GB or 16GB / 2400MHz DDR4 / soldered to systemboard, no sockets * System clocks down for processors with lower memory controller								Monitor cable <i>(optional)</i> <i>USB-C to VGA:</i> Lenovo USB-C to VGA Plus Power Adapter <i>USB-C to DP:</i> Lenovo USB-C to DisplayPort Adapter <i>HDMI to VGA:</i> Lenovo HDMI to VGA Monitor Adapter
Display	13.3" (337.8mm) FHD (1920x1080), glossy, LED backlight, IPS 300 nits, 16:9 aspect ratio, 800:1 contrast ratio, 170° viewing angle								Camera <i>One of the following, configurable by model:</i> 720p: HD720p camera, fixed focus IR & 720p: IR camera and HD720p camera, fixed focus
Multi-touch	Capacitive-type multi-touch, AR (anti-reflection), AS (anti-smudge), supports 10-finger gesture								Audio support HD Audio, Conexant® CX11771 codec / stereo speakers, 2W x 2 / dual array microphone, headphone / microphone combo jack
Hinge	Yoga hinge, 360 degree								Keyboard 6-row, spill-resistant, multimedia Fn keys, LED backlight
Convert-mode	Laptop, tent, stand, yoga and tablet								UltraNav™ TrackPoint® pointing device and 3+2 buttons Mylar surface multi-touch click pad
Pen	ThinkPad Pen Pro, active pen for multi-touch display, on-board rechargeable								Security Power-on password, hard disk password, supervisor password, security keyhole
Storage	<i>Some:</i> M.2 SSD / SATA 6.0Gb/s (e.g. xxxG SSD) <i>Some:</i> M.2 SSD / PCIe NVMe, PCIe 3.0 x 4, 32Gb/s (e.g. xxxG SSD PCIe NVMe)								Security chip Discrete TPM 2.0 TCG Certified
Optical	None								vPro <i>(optional)</i> Intel vPro Technology
Ethernet	Native Intel Ethernet Connection I219-V (<i>Non-vPro</i>) or I219-LM (<i>vPro</i>) via optional ThinkPad Ethernet Extension Cable								Fingerprint reader Touch style match on chip fingerprint reader on the palm rest
WLAN	Intel Dual Band Wireless-AC 8265, Wi-Fi 2x2 802.11ac + Bluetooth 4.1, M.2 card * Intel 8265ac card supports BT4.2 but is limited to BT4.1 by Windows OS								NFC <i>(optional)</i> Near Field Communication (mutually exclusive with smart card reader)
Bluetooth™	Bluetooth 4.1 wireless, integrated in Wi-Fi + Bluetooth combo adapter								Battery Li-Ion 51Wh battery, supports Rapid Charge (charge up to 80% in 1hr) with 65W USB Type-C AC adapter
WWAN <i>(optional)</i>	Integrated Mobile Broadband 4G LTE, Intel XMM™ 7262 (Fibocom L830-EB), M.2 card (EMEA only)								Max battery life <i>MobileMark® 2014:</i> 13.6 hr 45W or 65W slim tip AC adapter, 45W or 65W USB Type-C AC adapter
SIM card <i>(opt)</i>	Nano-SIM card slot								Light sensor Ambient Light Sensor
									G-sensor/ 3D accelerometer and 3D magnetometer
									eCompass 3D compass
									Gyroscope 3D gyrometer
									Preload <i>Some:</i> Windows 10 Home 64 <i>Some:</i> Windows 10 Pro 64
									Limited warranty <i>One of the following, configurable by model:</i> • 1-year depot repair service • 3-year/1-yr battery depot repair service
									Mil-Spec test MIL-STD-810G military certification
									Environment EPEAT™ Gold; ENERGY STAR®; RoHS-compliant

ThinkPad X380 Yoga - TopSeller - 20LH

Product Specifications Reference (PSREF)

Model	Region	Processor	vPro	Graphics	Memory	Display	Storage(HDD/SSD)	WLAN + Bluetooth	WWAN	SIM Card	Smart Card Reader	Dock	Monitor Cable	Adapter	Color	Pen	Fingerprint Reader	NFC	Power Adapter	Operating System	Warranty	End of Support	Ann Date (mm/yy)
20LH000VUS	US	i7-8550U	No	Intel UHD 620	8GB Soldered	13.3" FHD (1920x1080) IPS	256GB SSD M.2 PCIe NVMe Opal2	Intel 8265 ac, 2x2 + BT4.1	None	None	None	None	None	None	Black	Pen Pro	Fingerprint Reader	None	65W Slim Tip	Win10 Pro 64	3-year, Depot	Feb 6, 2023	02/18
20LH000WUS	US	i7-8550U	No	Intel UHD 620	16GB Soldered	13.3" FHD (1920x1080) IPS	512GB SSD M.2 PCIe NVMe Opal2	Intel 8265 ac, 2x2 + BT4.1	None	None	None	None	None	None	Black	Pen Pro	Fingerprint Reader	None	65W Slim Tip	Win10 Pro 64	3-year, Depot	Feb 6, 2023	02/18
20LH000XUS	US	i7-8550U	No	Intel UHD 620	16GB Soldered	13.3" FHD (1920x1080) IPS	256GB SSD M.2 PCIe NVMe Opal2	Intel 8265 ac, 2x2 + BT4.1	None	None	None	None	None	None	Black	Pen Pro	Fingerprint Reader	None	65W Slim Tip	Win10 Pro 64	3-year, Depot	Feb 6, 2023	02/18
20LH000YUS	US	i5-8350U	vPro	Intel UHD 620	8GB Soldered	13.3" FHD (1920x1080) IPS	256GB SSD M.2 PCIe NVMe Opal2	Intel 8265 ac, 2x2 + BT4.1	None	None	None	None	None	None	Black	Pen Pro	Fingerprint Reader	None	65W Slim Tip	Win10 Pro 64	3-year, Depot	Feb 6, 2023	02/18
20LH0010US	US	i5-8350U	vPro	Intel UHD 620	8GB Soldered	13.3" FHD (1920x1080) IPS	256GB SSD M.2 PCIe NVMe Opal2	Intel 8265 ac, 2x2 + BT4.1	None	None	None	None	None	None	Silver	Pen Pro	Fingerprint Reader	None	65W Slim Tip	Win10 Pro 64	3-year, Depot	Feb 6, 2023	02/18
20LH0011US	US	i7-8550U	No	Intel UHD 620	16GB Soldered	13.3" FHD (1920x1080) IPS	512GB SSD M.2 PCIe NVMe Opal2	Intel 8265 ac, 2x2 + BT4.1	None	None	None	None	None	None	Silver	Pen Pro	Fingerprint Reader	None	65W Slim Tip	Win10 Pro 64	3-year, Depot	Feb 6, 2023	02/18
20LH0012US	US	i7-8650U	vPro	Intel UHD 620	16GB Soldered	13.3" FHD (1920x1080) IPS	512GB SSD M.2 PCIe NVMe Opal2	Intel 8265 ac, 2x2 + BT4.1	None	None	None	None	None	None	Silver	Pen Pro	Fingerprint Reader	None	65W Slim Tip	Win10 Pro 64	3-year, Depot	Feb 6, 2023	02/18
20LH0013US	US	i5-8250U	No	Intel UHD 620	8GB Soldered	13.3" FHD (1920x1080) IPS	256GB SSD M.2 PCIe NVMe Opal2	Intel 8265 ac, 2x2 + BT4.1	None	None	None	None	None	None	Silver	Pen Pro	Fingerprint Reader	None	65W Slim Tip	Win10 Pro 64	3-year, Depot	Feb 6, 2023	02/18
20LH0014US	US	i5-8250U	No	Intel UHD 620	8GB Soldered	13.3" FHD (1920x1080) IPS	128GB SSD M.2	Intel 8265 ac, 2x2 + BT4.1	None	None	None	None	None	None	Black	Pen Pro	Fingerprint Reader	None	65W Slim Tip	Win10 Pro 64	3-year, Depot	Feb 6, 2023	02/18
20LH0015US	US	i5-8250U	No	Intel UHD 620	8GB Soldered	13.3" FHD (1920x1080) IPS	256GB SSD M.2 PCIe NVMe Opal2	Intel 8265 ac, 2x2 + BT4.1	None	None	None	None	None	None	Black	Pen Pro	Fingerprint Reader	None	65W Slim Tip	Win10 Pro 64	3-year, Depot	Feb 6, 2023	02/18
20LH0016US	US	i7-8650U	vPro	Intel UHD 620	16GB Soldered	13.3" FHD (1920x1080) IPS	512GB SSD M.2 PCIe NVMe Opal2	Intel 8265 ac, 2x2 + BT4.1	None	None	None	None	None	None	Black	Pen Pro	Fingerprint Reader	None	65W Slim Tip	Win10 Pro 64	3-year, Depot	Feb 6, 2023	02/18
20LH0017US	US	i7-8550U	No	Intel UHD 620	8GB Soldered	13.3" FHD (1920x1080) IPS	256GB SSD M.2 PCIe NVMe Opal2	Intel 8265 ac, 2x2 + BT4.1	None	None	None	None	None	None	Silver	Pen Pro	Fingerprint Reader	None	65W Slim Tip	Win10 Pro 64	3-year, Depot	Feb 6, 2023	02/18
20LH0018US	US	i7-8650U	vPro	Intel UHD 620	16GB Soldered	13.3" FHD (1920x1080) IPS	512GB SSD M.2 PCIe NVMe Opal2	Intel 8265 ac, 2x2 + BT4.1	None	None	None	None	None	None	Black	Pen Pro	Fingerprint Reader	None	65W Slim Tip	Win10 Pro 64	3-year, Depot	Feb 6, 2023	02/18
20LH001QUS	US	i5-8350U	vPro	Intel UHD 620	8GB Soldered	13.3" FHD (1920x1080) IPS	512GB SSD M.2 PCIe NVMe Opal2	Intel 8265 ac, 2x2 + BT4.1	None	None	None	None	None	None	Black	Pen Pro	Fingerprint Reader	None	65W Slim Tip	Win10 Pro 64	3-year, Depot	May 17, 2024	04/18
20LH001RUS	US	i5-8250U	No	Intel UHD 620	8GB Soldered	13.3" FHD (1920x1080) IPS	512GB SSD M.2 PCIe NVMe Opal2	Intel 8265 ac, 2x2 + BT4.1	None	None	None	None	None	None	Black	Pen Pro	Fingerprint Reader	None	65W Slim Tip	Win10 Pro 64	3-year, Depot	May 17, 2024	04/18
20LH001SUS	US	i5-8250U	No	Intel UHD 620	8GB Soldered	13.3" FHD (1920x1080) IPS	512GB SSD M.2 PCIe NVMe Opal2	Intel 8265 ac, 2x2 + BT4.1	None	None	None	None	None	None	Silver	Pen Pro	Fingerprint Reader	None	65W Slim Tip	Win10 Pro 64	3-year, Depot	May 17, 2024	04/18
20LH0023US	US	i5-8250U	No	Intel UHD 620	8GB Soldered	13.3" FHD (1920x1080) IPS	180GB SSD M.2 Opal2	Intel 8265 ac, 2x2 + BT4.1	None	None	None	None	None	None	Black	Pen Pro	Fingerprint Reader	None	65W Slim Tip	Win10 Pro 64	3-year, Depot	Jun 1, 2024	05/18



ThinkPad Yoga 11e (3rd Gen) Platform Specifications

Product Specifications Reference (PSREF)

Processor	Intel® Celeron® processor, Intel Pentium® Processor, or 6th Generation Intel Core™ i3 Processor								Media reader	4-in-1 reader (MMC, SD, SDHC, SDXC)	
	Processor Number	# of Cores	# of Threads	Base Frequency	Burst Frequency	Cache	Memory Types	Processor Graphics	Ports	Two USB 3.0, HDMI, Ethernet (RJ-45)	
	Cel N3150	4	4	1.6 GHz	2.08 GHz	2MB	DDR3L-1600	Intel HD graphics	Control buttons	Power button, volume control button	
	Cel N3160	4	4	1.6 GHz	2.24 GHz	2MB		Intel HD graphics	Camera	Audio support	HD720p resolution, low light sensitive, fixed focus HD Audio, Realtek® ALC3245 codec / stereo speakers, 2W x 2 / monaural digital microphone, combo audio/microphone jack
	Pen 4405U	2	4	2.1 GHz	-	2MB		Intel HD graphics 510			
i3-6100U	2.3 GHz			-	3MB	Intel HD graphics 520					
Graphics	Intel HD Graphics, Intel HD Graphics 510, or Intel HD Graphics 520 in processor, supports external digital monitor via HDMI™; supports dual independent display; Max resolution: 1920X1080 (HDMI) @30Hz								Security	Power-on password, hard disk password, supervisor password, security keyhole	
Chipset	Intel SoC (System on Chip) platform								Security chip	Trusted Platform Module, TCG 1.2-compliant	
Memory	2GB, 4GB, or 8GB / PC3-12800 1600MHz DDR3L, one DDR3L SO-DIMM socket								vPro	None	
Display	11.6" (295mm) HD (1366x768), glare, LED backlight, IPS 250 nits, 16:9 aspect ratio, 800:1 contrast ratio								Fingerprint reader	None	
MultiTouch	Yes, support 10 fingers								Battery	Integrated Lithium Polymer 3-cell (42Wh)	
Hinge	Yoga hinge, 360 degree										Max battery life ¹⁰
Convertible mode	Laptop, tent, stand and tablet								AC adapter	45-watt AC adapter	
Pen	Some: Active pen, batteries required								Preload	Some: Windows 10 Home 64 Some: Windows 10 Pro 64 • Lenovo Solution Center • Lenovo Companion • Lenovo Setting • Microsoft Office preloaded; purchase a product key to activate • McAfee® LiveSafe™ (30-day trial)	
Storage	M.2 Solid State Drive (SSD), SATA 6.0Gb/s										
Optical	None										
Ethernet	Realtek RTL8111GUS-CG Gigabit Network Connection										
WLAN ⁴	One of the following, configurable by model: • 11ac+BT, Intel Dual Band Wireless-AC 3165, 1x1, M.2 card • 11ac+BT, Intel Dual Band Wireless-AC 7265, 2x2, M.2 card										
Bluetooth™	Bluetooth 4.0 wireless, integrated in Wi-Fi + Bluetooth combo adapter								Limited warranty ¹²	One of the following, configurable by model: • 1-year depot repair service • 3-year/1-yr battery depot repair service (US only)	
WWAN	None								Mil-Spec test	MIL-STD-810G military certification	
Dimensions ³	WxDxH: 11.81" x 8.27" x 0.90"; 300mm x 210mm x 22.9mm								Environment	EPEAT™ Gold (US only); ENERGY STAR® 6.1; RoHS-compliant	
Weight ²	from 3.5 lb (1.59kg)										
Case color	Display cover: Graphite Black or Silver;				Bottom: Graphite Black						
Case material	Display cover: PC+40%GF+TPU;				Bottom: PCC						

Lenovo
July 2017

ThinkPad Yoga 11e (3rd Gen) - TopSeller - 20GA

Product Specifications Reference (PSREF)

Model	Region	Processor	Graphics	Memory	Display	Multi-touch	Storage	Optical	WLAN + Bluetooth	Color	Camera	Pen	Finger-print Reader	Battery	Power Adapter	Operating System	Warranty	Global	Ann Date (m/y)
20GA000KUS	US	Celeron N3150	Intel HD	4GBx1	11.6" HD (1366x768) IPS	10-point Multi-touch	128GB SSD	None	Intel 7265 ac, 2x2 + BT4.0	Black	720p	None	None	3-cell (42Wh)	45W	Windows 10 Pro 64	1-year, Depot	No	03/16
20GA000LUS	US	Celeron N3150	Intel HD	8GBx1	11.6" HD (1366x768) IPS	10-point Multi-touch	128GB SSD	None	Intel 7265 ac, 2x2 + BT4.0	Black	720p	None	None	3-cell (42Wh)	45W	Windows 10 Pro 64	1-year, Depot	No	03/16
20GA000MUS	US	i3-6100U	Intel HD 520	8GBx1	11.6" HD (1366x768) IPS	10-point Multi-touch	128GB SSD	None	Intel 7265 ac, 2x2 + BT4.0	Black	720p	None	None	3-cell (42Wh)	45W	Windows 10 Pro 64	1-year, Depot	No	03/16
20GA000NUS	US	i3-6100U	Intel HD 520	8GBx1	11.6" HD (1366x768) IPS	10-point Multi-touch	256GB SSD Opal2	None	Intel 7265 ac, 2x2 + BT4.0	Black	720p	None	None	3-cell (42Wh)	45W	Windows 10 Pro 64	1-year, Depot	No	03/16
20GA000QUS	US	i3-6100U	Intel HD 520	8GBx1	11.6" HD (1366x768) IPS	10-point Multi-touch	192GB SSD	None	Intel 7265 ac, 2x2 + BT4.0	Black	720p	None	None	3-cell (42Wh)	45W	Windows 10 Pro 64	1-year, Depot	No	03/16
20GA000YUS	US	i3-6100U	Intel HD 520	4GBx1	11.6" HD (1366x768) IPS	10-point Multi-touch	192GB SSD	None	Intel 7265 ac, 2x2 + BT4.0	Black	720p	None	None	3-cell (42Wh)	45W	Windows 10 Pro 64	1-year, Depot	No	03/16
20GA001EUS	US	Celeron N3160	Intel HD	8GBx1	11.6" HD (1366x768) IPS	10-point Multi-touch	128GB SSD	None	Intel 7265 ac, 2x2 + BT4.0	Black	720p	None	None	3-cell (42Wh)	45W	Windows 10 Pro 64	1-year, Depot	No	09/16
20GA001FUS	US	Celeron N3160	Intel HD	4GBx1	11.6" HD (1366x768) IPS	10-point Multi-touch	128GB SSD	None	Intel 7265 ac, 2x2 + BT4.0	Black	720p	None	None	3-cell (42Wh)	45W	Windows 10 Pro 64	1-year, Depot	No	09/16



ThinkPad Yoga 11e (4th Gen) Platform Specifications

Product Specifications Reference (PSREF)

Processor	Intel® Celeron® processor, or 7th Generation Intel Core™ i3 / i5 Processor							Media reader	4-in-1 reader (MMC, SD, SDHC, SDXC)	
	Processor Number	# of Cores	# of Threads	Base Frequency	Burst Frequency	Cache	Memory Controller	Processor Graphics	Ports	Two USB 3.1 Gen 1 / USB 3.0, HDMI, Ethernet (RJ-45)
	Cel N3450	4	4	1.1 GHz	2.2 GHz	2MB	DDR3L-1866	Intel HD graphics 500	Control buttons	Power button, volume control button
	i3-7100U	2	4	2.4 GHz	-	3MB	DDR4-2133	Intel HD graphics 620	Camera	HD720p resolution, low light sensitive, fixed focus
i5-7200U	2.5 GHz			3.1 GHz	3MB	Audio support			HD Audio, Realtek® ALC3268 codec / stereo speakers, 2W x 2 / monaural microphone, combo audio/microphone jack	
Graphics	Intel HD Graphics 500, or Intel HD Graphics 620 in processor, supports external digital monitor via HDMI™; supports dual independent display; Max resolution: 1920X1080 (HDMI) @30Hz							Keyboard	ThinkPad Windows keyboard, 6-row, multimedia Fn keys	
Chipset	Intel SoC (System on Chip) platform							UltraNav™	Two buttons click pad below keyboard, multi-touch	
Memory	4GB or 8GB / 1600MHz DDR3L or 2133MHz DDR4, one DDR3L or DDR4 SO-DIMM socket * System clocks down for processors with lower memory controller							Security	Power-on password, hard disk password, supervisor password, security keyhole	
Display	11.6" (295mm) HD (1366x768), anti-glare, LED backlight, IPS 250 nits, 16:9 aspect ratio, 800:1 contrast ratio							Security chip	Discrete TPM 2.0, TCG Certified	
MultiTouch	Yes, support 10 fingers							vPro	None	
Hinge	Yoga hinge, 360 degree							Fingerprint reader	None	
Convertible mode	Laptop, tent, stand and tablet							Battery	Integrated Lithium Polymer 3-cell (42Wh)	
Pen	Some: Active pen, batteries required							Max battery life	MobileMark® 2014: 11 hr	
Storage	M.2 Solid State Drive (SSD), SATA 6.0Gb/s							AC adapter	45-watt AC adapter	
Optical	None							Preload	Some: Windows 10 Home 64 Some: Windows 10 Pro 64 • Lenovo Connect • Lenovo Companion • Lenovo Setting • Microsoft Office preloaded; purchase a product key to activate	
Ethernet	Realtek RTL8111GUS-CG Gigabit Network Connection							Limited warranty	One of the following, configurable by model: • 1-year depot repair service • 3-year depot repair service	
WLAN	One of the following, configurable by model: • 11ac+BT, QCA NFA435, 1x1, M.2 card • 11ac+BT, Intel Dual Band Wireless-AC 7265, 2x2, M.2 card							Mil-Spec test	MIL-STD-810G military certification	
Bluetooth™	Bluetooth 4.1 wireless, integrated in Wi-Fi + Bluetooth combo adapter *Intel 7265ac card supports Bluetooth 4.2 but is limited to BT 4.1 by Windows OS							Environment	EPEAT™ Gold; ENERGY STAR® 6.1; RoHS-compliant	
WWAN	None									
Dimensions	WxDxH: 11.81" x 8.27" x 0.90"; 300mm x 210mm x 22.9mm									
Weight	from 3.5 lb (1.59kg)									
Case color	Display cover: Graphite Black;			Bottom: Graphite Black						
Case material	Display cover: PC+40%GF+TPU;			Bottom: PC+ABS						

ThinkPad Yoga 11e (4th Gen) - TopSeller - 20HU

Product Specifications Reference (PSREF)

Model	Product	Region	Processor	Graphics	Memory	Display	Multi-touch	Color	Storage	Optical	WLAN + Bluetooth	Camera	Pen	Fingerprint Reader	Battery	Power Adapter	Operating System	Warranty	Global	Ann Date (mm/yy)
20HU0000US	ThinkPad Yoga 11e (4th Gen)	US	i3-7100U	Intel HD 620	8GBx1	11.6" HD (1366x768) IPS	10-point Multi-touch	Black	128GB SSD	None	Intel 7265 ac, 2x2 + BT4.1	720p	None	None	3-cell (42Wh)	45W	Windows 10 Pro 64	1-year, Depot	No	03/17
20HU0001US	ThinkPad Yoga 11e (4th Gen)	US	i3-7100U	Intel HD 620	8GBx1	11.6" HD (1366x768) IPS	10-point Multi-touch	Black	256GB SSD Opal2	None	Intel 7265 ac, 2x2 + BT4.1	720p	None	None	3-cell (42Wh)	45W	Windows 10 Pro 64	1-year, Depot	No	03/17
20HU0003US	ThinkPad Yoga 11e (4th Gen)	US	Celeron N3450	Intel HD 500	4GBx1	11.6" HD (1366x768) IPS	10-point Multi-touch	Black	128GB SSD	None	Intel 7265 ac, 2x2 + BT4.1	720p	None	None	3-cell (42Wh)	45W	Windows 10 Pro 64	1-year, Depot	No	03/17
20HU0004US	ThinkPad Yoga 11e (4th Gen)	US	Celeron N3450	Intel HD 500	8GBx1	11.6" HD (1366x768) IPS	10-point Multi-touch	Black	128GB SSD	None	Intel 7265 ac, 2x2 + BT4.1	720p	None	None	3-cell (42Wh)	45W	Windows 10 Pro 64	1-year, Depot	No	03/17



ThinkPad Yoga 11e (5th Gen) Platform Specifications

Product Specifications Reference (PSREF)

Processor	7th Generation Intel® Core™ m / i5 Processor, Intel Celeron® processor, or Intel Pentium® Silver processor							Dimensions	<i>WxDxH:</i> 11.81" x 8.27" x 0.89"; 300mm x 210mm x 22.5mm
								Weight	from 3.4 lb (1.54kg)
								Case color	Black
								Case material	<i>Display cover:</i> PC/ABS+GF; <i>Bottom:</i> PC/ABS plastic
								Media reader	MicroSD card reader
							Ports	Two USB 3.1 Gen 1, one USB 3.1 Type-C Gen 1, HDMI 1.4, Ethernet (RJ-45), headphone / microphone combo jack, microSD card reader, security keyhole	
							Control buttons	Power button, volume control button	
							Camera	<i>One of the following, configurable by model:</i> <i>720p:</i> HD720p resolution, low light sensitive, fixed focus <i>World facing:</i> Rear camera, 5MP resolution, auto focuss	
							Audio support	HD Audio, Realtek® ALC3287 codec Dolby Audio / stereo speakers, 2W x 2 / monaural microphone, headphone / microphone combo jack	
							Keyboard	6-row, multimedia Fn keys	
							UltraNav™	Two buttons click pad below keyboard, multi-touch	
							Security	Power-on password, hard disk password, supervisor password, security keyhole	
							Security chip	Discrete TPM 2.0, TCG Certified	
							vPro	None	
							Fingerprint reader	None	
							Battery	Integrated Li-Ion 42Wh battery	
							Max battery life	<i>MobileMark® 2014:</i> 12 hr	
							AC adapter	45W or 65W slim tip AC adapter	
							Preload	<i>Some:</i> Windows 10 Home 64 <i>Some:</i> Windows 10 Pro 64	
							Limited warranty	<i>One of the following, configurable by model:</i> • 1-year depot repair service • 3-year depot repair service	
							Mil-Spec test	MIL-STD-810G military certification	
							Environment	EPEAT™ Gold; ENERGY STAR® 6.1; RoHS-compliant	
Graphics	Intel HD Graphics 615, Intel UHD Graphics 600 or 605 in processor, supports external digital monitor via HDMI or USB Type-C; supports dual independent display; Max resolution: 3840x2160@60Hz (USB Type-C); 4096x2160@30Hz (HDMI)								
Chipset	Intel SoC (System on Chip) platform								
Memory	4GB or 8GB / 1866MHz LPDDR3 or 2400MHz DDR4 / soldered to systemboard, no sockets								
Display	11.6" (295mm) HD (1366x768), anti-glare, LED backlight, IPS								
MultiTouch	250 nits, 16:9 aspect ratio, 800:1 contrast ratio, 170° viewing angle								
Hinge	Capacitive-type multi-touch, support 10 fingers								
Convertible mode	Yoga hinge, 360 degree								
Pen	Laptop, tent, stand and tablet								
	<i>Some:</i> Active pen, batteries required, on-board garage								
Storage	eMMC flash memory on board or								
	M.2 SSD / PCIe NVMe, PCIe 3.0 x 2, 16Gb/s								
Optical	None								
Ethernet	Realtek RTL8111GUS-CG Gigabit Network Connection								
WLAN	<i>One of the following, configurable by model:</i>								
	• Intel Wireless-AC 9260, Wi-Fi 2x2 802.11ac + Bluetooth 5.0, M.2 card								
	• Intel Wireless-AC 9560, Wi-Fi 2x2 802.11ac + Bluetooth 5.0, M.2 card								
Bluetooth™	Bluetooth wireless, integrated in Wi-Fi + Bluetooth combo adapter								
WWAN	None								

Lenovo
February 2018

ThinkPad Yoga 11e (5th Gen) - TopSeller - 20LM

Product Specifications Reference (PSREF)

Model	Region	Processor	Graphics	Memory	Display	Multi-touch	Color	Storage(HDD/SSD)	Optical	WLAN + Bluetooth	Camera (Front/WorldFacing)	Pen	Finger-print Reader	Battery (internal)	Power Adapter	Operating System	Warranty	Global	Ann Date (m/y)
20LM0004US	US	m3-7Y30	Intel HD 615	4GB Soldered	11.6" HD (1366x768) IPS	10-point Multi-touch	Black	256GB SSD M.2 PCIe NVMe	None	Intel 9260 ac, 2x2 + BT4.1	Front 720p / None	None	None	42Wh	45W Slim Tip	Win10 Pro 64	1-year, Depot	No	03/18
20LM0005US	US	m3-7Y30	Intel HD 615	4GB Soldered	11.6" HD (1366x768) IPS	10-point Multi-touch	Black	256GB SSD M.2 PCIe NVMe	None	Intel 9260 ac, 2x2 + BT4.1	Front 720p / None	Active Pen	None	42Wh	45W Slim Tip	Win10 Pro 64	1-year, Depot	No	03/18
20LM000UUS	US	Celeron N4100	Intel UHD 600	4GB Soldered	11.6" HD (1366x768) IPS	10-point Multi-touch	Black	128GB SSD M.2 PCIe NVMe	None	Intel 9260 ac, 2x2 + BT4.1	Front 720p / None	None	None	42Wh	45W Slim Tip	Win10 Pro 64	1-year, Depot	No	02/18
20LM000VUS	US	Celeron N4100	Intel UHD 600	4GB Soldered	11.6" HD (1366x768) IPS	10-point Multi-touch	Black	128GB eMMC	None	Intel 9260 ac, 2x2 + BT4.1	Front 720p / None	None	None	42Wh	45W Slim Tip	Win10 Pro 64	1-year, Depot	No	02/18
20LM000WUS	US	Celeron N4100	Intel UHD 600	4GB Soldered	11.6" HD (1366x768) IPS	10-point Multi-touch	Black	128GB SSD M.2 PCIe NVMe	None	Intel 9260 ac, 2x2 + BT4.1	Front 720p / None	Active Pen	None	42Wh	45W Slim Tip	Win10 Pro 64	1-year, Depot	No	02/18
20LM000XUS	US	Celeron N4100	Intel UHD 600	4GB Soldered	11.6" HD (1366x768) IPS	10-point Multi-touch	Black	128GB SSD M.2 PCIe NVMe	None	Intel 9260 ac, 2x2 + BT4.1	720p / 5.0MP	Active Pen	None	42Wh	45W Slim Tip	Win10 Pro 64	1-year, Depot	No	02/18
20LM000YUS	US	Pentium N5000	Intel UHD 605	8GB Soldered	11.6" HD (1366x768) IPS	10-point Multi-touch	Black	256GB SSD M.2 PCIe NVMe	None	Intel 9260 ac, 2x2 + BT4.1	Front 720p / None	None	None	42Wh	45W Slim Tip	Win10 Pro 64	1-year, Depot	No	03/18



ThinkPad Yoga 11e Chromebook (3rd Gen) Platform Specifications

Product Specifications Reference (PSREF)

Processor	Intel® Celeron® processor							Dimensions ³ Weight ² Case color Case material	WxDxH: 11.81" x 8.27" x 0.88"; 300mm x 210mm x 22.3mm from 3.3 lb (1.50kg) Display cover: Graphite Black or Silver; Bottom: Graphite Black Display cover: PC+40%GF+TPU; Bottom: PCC	
	Processor Number	# of Cores	# of Threads	Base Frequency	Burst Frequency	Cache	Memory Types			Processor Graphics
	Cel N3150	4	4	1.6 GHz	2.08 GHz	2MB	LPDDR3-1600			Intel HD graphics
	Cel N3160	4	4	1.6 GHz	2.24 GHz	2MB	LPDDR3-1600	Intel HD graphics		
Graphics	Intel HD Graphics in processor, supports external digital monitor via HDMI™; supports dual independent display; Max resolution: 1920X1080 (HDMI) @30Hz							Media reader	4-in-1 reader (MMC, SD, SDHC, SDXC)	
								Ports	Two USB 3.0 (one Always On), HDMI	
								Control buttons	Power button, volume control button	
								Camera	HD720p resolution, low light sensitive, fixed focus	
								Audio support	Realtek® ALC5650 codec / stereo speakers, 2W x 2 / monaural digital microphone, combo audio/microphone jack	
Chipset	Intel SoC (System on Chip) platform							Keyboard	ThinkPad Chrome keyboard, 6-row, multimedia Fn keys	
Memory	2GB or 4GB / 1600MHz LPDDR3 / soldered to systemboard, no sockets							UltraNav™	Buttonless touchpad below keyboard, multi-touch	
Display	11.6" (295mm) HD (1366x768), glare, LED backlight, IPS 200 nits, 16:9 aspect ratio, 800:1 contrast ratio							Security	Security keyhole	
MultiTouch	Yes, support 10 fingers							Security chip	Trusted Platform Module, TCG 1.2-compliant	
Hinge	Yoga hinge, 360 degree							vPro	None	
Convertible mode	Laptop, tent, stand and tablet							Fingerprint reader	None	
Pen	None							Battery	Integrated Lithium Polymer 3-cell (42Wh)	
Storage	16GB eMMC (embedded Multi Media Card) flash memory on board							Max battery life ¹⁰	Up to 12 hr	
Optical	None							AC adapter	45-watt AC adapter	
Ethernet	None							Preload	Google Chrome OS	
WLAN ⁴	11ac+BT, Intel Dual Band Wireless-AC 7265, 2x2, M.2 card							Limited warranty ¹²	1-year depot repair service	
Bluetooth™	Bluetooth 4.0 wireless, integrated in Wi-Fi + Bluetooth combo adapter							Mil-Spec test	MIL-STD-810G military certification	
WWAN	None							Environment	EPEAT™ Gold (US only); ENERGY STAR® 6.1; RoHS-compliant	

ThinkPad Yoga 11e Chromebook (3rd Gen) - TopSeller - 20GE

Product Specifications Reference (PSREF)

Model	Region	Processor	Graphics	Memory	Display	Multi-touch	Storage	Optical	WLAN + Bluetooth	Color	Camera	Pen	Finger-print Reader	Battery	Power Adapter	Operating System	Warranty	Global	Ann Date (m/y)
20GE0002US	US	Celeron N3150	Intel HD	4GBx1	11.6" HD (1366x768) IPS	10-point Multi-touch	16GB eMMC	None	Intel 7265 ac, 2x2 + BT4.0	Black	720p	None	None	3-cell (42Wh)	45W	Chrome OS	1-year, Depot	No	03/16
20GE0003US	US	Celeron N3160	Intel HD	4GBx1	11.6" HD (1366x768) IPS	10-point Multi-touch	16GB eMMC	None	Intel 7265 ac, 2x2 + BT4.0	Black	720p	None	None	3-cell (42Wh)	45W	Chrome OS	1-year, Depot	No	10/16

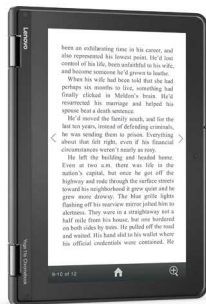

ThinkPad Yoga 11e Chromebook (4th Gen) Platform Specifications

Product Specifications Reference (PSREF)

Processor	Intel® Celeron® processor								Media reader	3-in-1 reader (SD, SDHC, SDXC)
	Processor Number	# of Cores	# of Threads	Base Frequency	Burst Frequency	Cache	Memory Controller	Processor Graphics	Ports	Two USB 3.1 Type-C Gen 1, one USB 3.1 Gen 1 / USB 3.0
	Cel N3450	4	4	1.1 GHz	2.2 GHz	2MB	LPDDR4-2400	Intel HD graphics 500	Control buttons	Power button, volume control button
Graphics	Intel HD Graphics 500 in processor								Camera	HD720p resolution, low light sensitive, fixed focus
Chipset	Intel SoC (System on Chip) platform								Audio support	HD Audio, DA7219 codec / stereo speakers, 2W x 2 / monaural microphone, combo audio/microphone jack
Memory	4GB or 8GB 3200MHz LPDDR4 / soldered to systemboard, no sockets * System clocks down for processors with lower memory controller								Keyboard	ThinkPad Chrome keyboard, 6-row, multimedia Fn keys
Display	11.6" (295mm) HD (1366x768), anti-glare, LED backlight, IPS 250 nits, 16:9 aspect ratio, 800:1 contrast ratio								UltraNav™	Two buttons click pad below keyboard, multi-touch
MultiTouch	Yes, support 10 fingers								Security	Power-on password, hard disk password, supervisor password, security keyhole
Hinge	Yoga hinge, 360 degree								Security chip	None
Convertible mode	Laptop, tent, stand and tablet								vPro	None
Pen	None								Fingerprint reader	None
Storage	32GB eMMC (embedded Multi Media Card) flash memory on board								Battery	Integrated Lithium Polymer 3-cell (42Wh)
Optical	None								Max battery life	Up to 10 hr
Ethernet	None								AC adapter	45-watt USB Type-C adapter
WLAN	11ac+BT, Intel Dual Band Wireless-AC 7265, 2x2, M.2 card								Preload	Google Chrome OS
Bluetooth™	Bluetooth 4.2 wireless, integrated in Wi-Fi + Bluetooth combo adapter								Limited warranty	• 1-year depot repair service
WWAN	None								Mil-Spec test	MIL-STD-810G military certification
Dimensions	WxDxH: 11.81" x 8.27" x 0.92"; 300mm x 210mm x 23.4mm								Environment	EPEAT™ Gold; ENERGY STAR® 6.1; RoHS-compliant
Weight	from 3.5 lb (1.59kg)									
Case color	Display cover: Graphite Black;				Bottom: Graphite Black					
Case material	Display cover: PC+40%GF+TPU;				Bottom: PC+ABS					

Lenovo
July 2017

ThinkPad Yoga 11e Chromebook (4th Gen) - TopSeller - 20HY

Product Specifications Reference (PSREF)

Model	Region	Processor	Graphics	Memory	Display	Multi-touch	Color	Storage	Optical	WLAN + Bluetooth	Camera	Pen	Finger-print Reader	Battery	Power Adapter	Operating System	Warranty	Global	Ann Date (m/y)
20HY0000US	US	Celeron N3450	Intel HD 500	4GB Soldered	11.6" HD (1366x768) IPS	10-point Multi-touch	Black	32GB eMMC	None	Intel 7265 ac, 2x2 + BT4.2	720p	None	None	3-cell (42Wh)	45W	Chrome OS	1-year, Depot	No	04/17



ThinkPad Yoga 370 Platform Specifications

Product Specifications Reference (PSREF)

Processor	7th Generation Intel® Core™ i3 / i5 / i7 Processor							Dimensions	<i>WxDxH:</i> 12.34" x 8.75" x 0.72"; 313.5mm x 222.2mm x 18.2mm	
	Processor Number	# of Cores	# of Threads	Base Frequency	Max Turbo Frequency	Cache	Memory Types	Processor Graphics	Weight	Starting at 3.03 lb (1.37kg)
	i3-7100U	2	4	2.4 GHz	-	3MB	DDR4-2133	Intel HD Graphics 620	Case color	Black or silver
	i5-7200U			2.5 GHz	3.1 GHz	3MB			Case Material	Carbon-Fiber Hybrid
	i5-7300U			2.6 GHz	3.5 GHz	3MB			Smart card reader	<i>Optional:</i> Smart card reader (mutually exclusive with NFC)
	i7-7500U			2.7 GHz	3.5 GHz	4MB			Media reader	One microSD card slot (microSD, microSDHC, microSDXC), UHS-I
i7-7600U	2.8 GHz			3.9 GHz	4MB	Ports			Two USB 3.1 Gen 1 (USB 3.0, one Always On), USB 3.1 Type-C Gen 2 / Thunderbolt 3, HDMI 1.4b, Ethernet extension connector	
Graphics	Intel HD Graphics 620 in processor only; supports external digital monitor via HDMI; supports dual independent display; Max resolution: 4096x2160 (HDMI) @24Hz							WiGig dock	<i>Optional:</i> ThinkPad WiGig dock	
Chipset	Intel SoC (System on Chip) platform							Monitor cable	<i>USB-C to VGA:</i> Lenovo USB C to VGA Plus Power Adapter	
Memory	<i>WWAN model:</i> 8GB 2133MHz DDR4 soldered to systemboard <i>Non-WWAN model:</i> 16GB max / 2133MHz DDR4, one DDR4 SO-DIMM socket							<i>(optional)</i>	<i>USB-C to DP:</i> Lenovo USB-C to DisplayPort Adapter	
Display	13.3" (337.8mm) FHD (1920x1080), glossy, LED backlight, IPS 300 nits, 16:9 aspect ratio, 700:1 contrast ratio, 170° viewing angle							Camera	HD720p resolution, fixed focus	
Multi-touch	Capacitive-type multi-touch, AR (anti-reflection), AS (anti-smudge), supports 10-finger gesture							Audio support	HD Audio, Conexant® CX11771 codec, Dolby® DAXII / stereo speakers, 2W x 2 / dual array microphone, combo audio / microphone jack	
Hinge	Yoga hinge, 360 degree							Keyboard	6-row, spill-resistant, multimedia Fn keys, LED backlight	
Convert-mode	Laptop, tent, stand, yoga and tablet							UltraNav™	TrackPoint® pointing device and 3+2 buttons Mylar surface multi-touch click pad	
Pen	ThinkPad Pen Pro, active pen for multi-touch display, on-board charging							Security	Power-on password, hard disk password, supervisor password, security keyhole	
Storage	<i>Some:</i> M.2 SSD / SATA 6.0Gb/s (e.g. xxxG SSD) <i>Some:</i> M.2 SSD / PCIe NVMe, PCIe 3.0 x 4, 32Gb/s (e.g. xxxG SSD PCIe NVMe)							Security chip	Discrete TPM 2.0 TCG Certified	
Optical	None							vPro <i>(optional)</i>	Intel vPro Technology	
Ethernet	Native Intel Ethernet Connection I219-V (<i>Non-vPro</i>) or I219-LM (<i>vPro</i>) via optional ThinkPad Ethernet Extension Cable							Fingerprint reader	<i>Optional:</i> Touch style match on chip fingerprint reader on the palm rest	
WLAN	<i>One of the following, configurable by model (WiGig is mutually exclusive with WWAN):</i> <ul style="list-style-type: none"> Intel Dual Band Wireless-AC 8265, Wi-Fi 2x2 802.11ac + BT4.1, M.2 card Intel Tri-Band Wireless-AC 18265, WiGig 802.11ad + Wi-Fi 2x2 802.11ac + BT4.1, M.2 card <i>* WiGig adapter is only available in selected countries*</i>							NFC <i>(optional)</i>	Near Field Communication (mutually exclusive with smart card reader)	
Bluetooth™	Bluetooth 4.1 wireless, integrated in Wi-Fi + Bluetooth combo adapter							Battery	Li-Polymer 4-cell (51Wh) battery	
WWAN <i>(optional)</i>	Integrated Mobile Broadband 4G LTE-A, Qualcomm® Snapdragon™ X7 LTE-A (Sierra Wireless EM7455)							Max battery life	<i>MobileMark® 2014:</i> 12.5 hr	
SIM card <i>(opt)</i>	Micro-SIM card slot, optional Lenovo Connect (EMEA) SIM card							AC adapter	45W or 65W AC adapter (slim tip), 65W USB Type-C AC adapter	
								Light sensor	Ambient Light Sensor	
								G-sensor/	3D accelerometer and 3D magnetometer	
								eCompass	3D compass	
								Gyroscope	3D gyrometer	
								Preload	<i>Some:</i> Windows 10 Home 64 <i>Some:</i> Windows 10 Pro 64 <ul style="list-style-type: none"> Lenovo Connect Lenovo Companion Lenovo Setting Microsoft Office preloaded; purchase a product key to activate 	
								Limited warranty	<i>One of the following, configurable by model:</i> <ul style="list-style-type: none"> 1-year depot repair service 3-year/1-yr battery depot repair service 3-year/1-yr battery limited onsite service 	
								Mil-Spec test	MIL-STD-810G military certification	
								Environment	EPEAT™ Gold (US only); ENERGY STAR®; RoHS-compliant	

Model	Region	Processor	vPro	Graphics	Memory	Display	Case Material	Storage(HDD/SSD)	WLAN + Bluetooth	WWAN	SIM Card	Smart Card Reader	Dock	Monitor Cable	Adapter	Color	Pen	Fingerprint Reader	NFC	TPM	Power Adapter	Operating System	Warranty	Global	End of Support	Ann Date (mm/yy)
20JH001VUS	US	i5-7300U	vPro	Intel HD 620	16GBx1	13.3" FHD (1920x1080) IPS	Carbon	512GB SSD M.2 PCIe NVMe Opal2	Intel 8265 ac, 2x2 + BT4.1	None	None	None	None	None	None	Silver	Pen Pro	Fingerprint Reader	None	dTPM 2.0	45W	Win10 Pro 64	1-year, Depot	No	Apr 14, 2023	03/17
20JH001WUS	US	i5-7200U	No	Intel HD 620	8GBx1	13.3" FHD (1920x1080) IPS	Carbon	256GB SSD M.2 PCIe NVMe Opal2	Intel 8265 ac, 2x2 + BT4.1	None	None	None	None	None	None	Silver	Pen Pro	Fingerprint Reader	None	dTPM 2.0	45W	Win10 Pro 64	1-year, Depot	No	Apr 14, 2023	03/17
20JH001XUS	US	i5-7300U	vPro	Intel HD 620	8GBx1	13.3" FHD (1920x1080) IPS	Carbon	256GB SSD M.2 PCIe NVMe Opal2	Intel 8265 ac, 2x2 + BT4.1	None	None	None	None	None	None	Silver	Pen Pro	Fingerprint Reader	None	dTPM 2.0	45W	Win10 Pro 64	1-year, Depot	No	Apr 14, 2023	03/17
20JH001YUS	US	i7-7600U	vPro	Intel HD 620	16GBx1	13.3" FHD (1920x1080) IPS	Carbon	512GB SSD M.2 PCIe NVMe Opal2	Intel 8265 ac, 2x2 + BT4.1	None	None	None	None	None	None	Silver	Pen Pro	Fingerprint Reader	None	dTPM 2.0	45W	Win10 Pro 64	1-year, Depot	No	Apr 14, 2023	03/17
20JH0020US	US	i7-7500U	No	Intel HD 620	8GBx1	13.3" FHD (1920x1080) IPS	Carbon	256GB SSD M.2 PCIe NVMe Opal2	Intel 8265 ac, 2x2 + BT4.1	None	None	None	None	None	None	Silver	Pen Pro	Fingerprint Reader	None	dTPM 2.0	45W	Win10 Pro 64	1-year, Depot	No	Apr 14, 2023	03/17
20JH0021US	US	i7-7500U	No	Intel HD 620	16GBx1	13.3" FHD (1920x1080) IPS	Carbon	512GB SSD M.2 PCIe NVMe Opal2	Intel 8265 ac, 2x2 + BT4.1	None	None	None	None	None	None	Silver	Pen Pro	Fingerprint Reader	None	dTPM 2.0	45W	Win10 Pro 64	1-year, Depot	No	Apr 14, 2023	03/17
20JH0022US	US	i7-7600U	vPro	Intel HD 620	8GBx1	13.3" FHD (1920x1080) IPS	Carbon	256GB SSD M.2 PCIe NVMe Opal2	Intel 8265 ac, 2x2 + BT4.1	None	None	None	None	None	None	Silver	Pen Pro	Fingerprint Reader	None	dTPM 2.0	45W	Win10 Pro 64	1-year, Depot	No	Apr 14, 2023	03/17
20JH0023US	US	i5-7200U	No	Intel HD 620	4GBx1	13.3" FHD (1920x1080) IPS	Carbon	128GB SSD M.2	Intel 8265 ac, 2x2 + BT4.1	None	None	None	None	None	None	Silver	Pen Pro	Fingerprint Reader	None	dTPM 2.0	45W	Win10 Pro 64	1-year, Depot	No	Apr 14, 2023	03/17
20JH0024US	US	i5-7200U	No	Intel HD 620	8GBx1	13.3" FHD (1920x1080) IPS	Carbon	256GB SSD M.2 PCIe NVMe Opal2	Intel 8265 ac, 2x2 + BT4.1	None	None	None	None	None	None	Black	Pen Pro	Fingerprint Reader	None	dTPM 2.0	45W	Win10 Pro 64	1-year, Depot	No	Apr 14, 2023	03/17
20JH0025US	US	i5-7200U	No	Intel HD 620	4GBx1	13.3" FHD (1920x1080) IPS	Carbon	128GB SSD M.2	Intel 8265 ac, 2x2 + BT4.1	None	None	None	None	None	None	Black	Pen Pro	Fingerprint Reader	None	dTPM 2.0	45W	Win10 Pro 64	1-year, Depot	No	Apr 14, 2023	03/17
20JH0026US	US	i5-7200U	No	Intel HD 620	8GBx1	13.3" FHD (1920x1080) IPS	Carbon	512GB SSD M.2 PCIe NVMe Opal2	Intel 8265 ac, 2x2 + BT4.1	None	None	None	None	None	None	Black	Pen Pro	Fingerprint Reader	None	dTPM 2.0	45W	Win10 Pro 64	1-year, Depot	No	Apr 14, 2023	03/17
20JH0027US	US	i7-7500U	No	Intel HD 620	16GBx1	13.3" FHD (1920x1080) IPS	Carbon	512GB SSD M.2 PCIe NVMe Opal2	Intel 8265 ac, 2x2 + BT4.1	None	None	None	None	None	None	Black	Pen Pro	Fingerprint Reader	None	dTPM 2.0	45W	Win10 Pro 64	1-year, Depot	No	Apr 14, 2023	03/17
20JH0028US	US	i7-7500U	No	Intel HD 620	16GBx1	13.3" FHD (1920x1080) IPS	Carbon	256GB SSD M.2 PCIe NVMe Opal2	Intel 8265 ac, 2x2 + BT4.1	None	None	None	None	None	None	Black	Pen Pro	Fingerprint Reader	None	dTPM 2.0	45W	Win10 Pro 64	1-year, Depot	No	Apr 14, 2023	03/17
20JH0029US	US	i7-7600U	vPro	Intel HD 620	16GBx1	13.3" FHD (1920x1080) IPS	Carbon	512GB SSD M.2 PCIe NVMe Opal2	Intel 8265 ac, 2x2 + BT4.1	None	None	None	None	None	None	Black	Pen Pro	Fingerprint Reader	None	dTPM 2.0	45W	Win10 Pro 64	1-year, Depot	No	Apr 14, 2023	03/17
20JH002AUS	US	i5-7300U	vPro	Intel HD 620	8GBx1	13.3" FHD (1920x1080) IPS	Carbon	256GB SSD M.2 PCIe NVMe Opal2	Intel 8265 ac, 2x2 + BT4.1	None	None	None	None	None	None	Black	Pen Pro	Fingerprint Reader	None	dTPM 2.0	45W	Win10 Pro 64	1-year, Depot	No	Apr 14, 2023	03/17
20JH002BUS	US	i5-7300U	vPro	Intel HD 620	16GBx1	13.3" FHD (1920x1080) IPS	Carbon	512GB SSD M.2 PCIe NVMe Opal2	Intel 8265 ac, 2x2 + BT4.1	None	None	None	None	None	None	Black	Pen Pro	Fingerprint Reader	None	dTPM 2.0	45W	Win10 Pro 64	1-year, Depot	No	Apr 14, 2023	03/17
20JH002CUS	US	i5-7200U	No	Intel HD 620	4GBx1	13.3" FHD (1920x1080) IPS	Carbon	256GB SSD M.2 PCIe NVMe Opal2	Intel 8265 ac, 2x2 + BT4.1	None	None	None	None	None	None	Black	Pen Pro	Fingerprint Reader	None	dTPM 2.0	45W	Win10 Pro 64	1-year, Depot	No	Apr 14, 2023	03/17
20JH002DUS	US	i7-7600U	vPro	Intel HD 620	8GBx1	13.3" FHD (1920x1080) IPS	Carbon	256GB SSD M.2 PCIe NVMe Opal2	Intel 8265 ac, 2x2 + BT4.1	None	None	None	None	None	None	Black	Pen Pro	Fingerprint Reader	None	dTPM 2.0	45W	Win10 Pro 64	1-year, Depot	No	Apr 14, 2023	03/17
20JH002FUS	US	i7-7500U	No	Intel HD 620	8GBx1	13.3" FHD (1920x1080) IPS	Carbon	256GB SSD M.2 PCIe NVMe Opal2	Intel 8265 ac, 2x2 + BT4.1	None	None	None	None	None	None	Black	Pen Pro	Fingerprint Reader	None	dTPM 2.0	45W	Win10 Pro 64	1-year, Depot	No	Apr 14, 2023	03/17
20JH002GUS	US	i5-7300U	vPro	Intel HD 620	8GBx1	13.3" FHD (1920x1080) IPS	Carbon	512GB SSD M.2 PCIe NVMe Opal2	Intel 8265 ac, 2x2 + BT4.1	None	None	None	None	None	None	Black	Pen Pro	Fingerprint Reader	None	dTPM 2.0	45W	Win10 Pro 64	1-year, Depot	No	Apr 14, 2023	03/17

Model	Region	Processor	vPro	Graphics	Memory	Display	Case Material	Storage(HDD/SSD)	WLAN + Bluetooth	WWAN	SIM Card	Smart Card Reader	Dock	Monitor Cable	Adapter	Color	Pen	Fingerprint Reader	NFC	TPM	Power Adapter	Operating System	Warranty	Global	End of Support	Ann Date (mm/yy)
20JH002JUS	US	i7-7600U	vPro	Intel HD 620	8GBx1	13.3" FHD (1920x1080) IPS	Carbon	512GB SSD M.2 PCIe NVMe Opal2	Intel 8265 ac, 2x2 + BT4.1	None	None	None	None	None	None	Black	Pen Pro	Fingerprint Reader	None	dTPM 2.0	45W	Win10 Pro 64	1-year, Depot	No	Apr 14, 2023	03/17
20JH002WUS	US	i5-7200U	No	Intel HD 620	8GBx1	13.3" FHD (1920x1080) IPS	Carbon	180GB SSD M.2 Opal2	Intel 8265 ac, 2x2 + BT4.1	None	None	None	None	None	None	Black	Pen Pro	Fingerprint Reader	None	dTPM 2.0	45W	Win10 Pro 64	3-year, Depot	No	Mar 14, 2022	03/17
20JH002XUS	US	i5-7200U	No	Intel HD 620	8GBx1	13.3" FHD (1920x1080) IPS	Carbon	180GB SSD M.2 Opal2	Intel 8265 ac, 2x2 + BT4.1	None	None	None	None	None	None	Silver	Pen Pro	Fingerprint Reader	None	dTPM 2.0	45W	Win10 Pro 64	3-year, Depot	No	Mar 14, 2022	03/17

This publication was developed for products and services offered in the United States and E.M.E.A countries. Lenovo may not offer the products, services or features discussed in this document in other countries. Lenovo may withdraw an offering at any time. Information is subject to change without notice. Consult your local representative for information on offerings available in your area.

Lenovo reserves the right to change specifications or other product information without notice. Lenovo is not responsible for photographic or typographical errors.

LENOVO PROVIDES THIS PUBLICATION "AS IS," WITHOUT WARRANTY OF ANY KIND, EITHER EXPRESS OR IMPLIED, INCLUDING THE IMPLIED WARRANTIES OF MERCHANTABILITY OR FITNESS FOR A PARTICULAR PURPOSE.

Some jurisdictions do not allow disclaimer of express or implied warranties in certain transactions, therefore this disclaimer may not apply to you.

Availability: All offers subject to availability. Lenovo reserves the right to alter product offerings and specifications at any time, without notice. Lenovo is not responsible for photographic or typographic errors.

General: Review key information provided by Microsoft that may apply to your system purchase, including details on Windows 10, Windows 8, Windows 7, and potential upgrades/downgrades. Lenovo makes no representation or warranty regarding third-party products or services.

Trademarks: Lenovo, ThinkPad, ThinkCentre, ThinkStation and the Lenovo logo are trademarks of Lenovo. Microsoft, Windows, Windows NT, and the Windows logo are trademarks of Microsoft Corporation. Ultrabook, Celeron, Celeron Inside, Core Inside, Intel, Intel Logo, Intel Atom, Intel Atom Inside, Intel Core, Intel Inside, Intel Inside Logo, Intel vPro, Itanium, Itanium Inside, Pentium, Pentium Inside, vPro Inside, Xeon, Xeon Phi, and Xeon Inside are trademarks of Intel Corporation in the U.S. and/or other countries. Other company, product or service names may be trademarks or service marks of others.

Warranty: For a copy of applicable warranties, write to: Lenovo Warranty Information, 1009 Think Place, Morrisville, NC, 27560. Lenovo makes no representation or warranty regarding third party products or services. The Lenovo Limited Warranty applies only to Lenovo hardware products purchased for your own use, and does not transfer upon resale.

Limited warranty: Support unrelated to a warranty issue may be subject to additional charges.

Lenovo Services:

Carry-in or Mail-in Service: Parts and labor repair coverage where the customer is responsible for shipping (including packaging) or delivery to authorized warranty provider or repair center.

Depot or Courier Service: Parts and labor repair coverage where shipping (including packaging) or delivery to the repair center is paid for by Lenovo.

Expedited Depot: Parts and labor coverage with expedited turnaround. Shipping (including packaging) or delivery to the repair center is paid for by Lenovo.

Onsite / In-home Service: Parts and labor repair coverage where labor is provided onsite at your place of business.

If Lenovo determines your product problem is covered by the product warranty and cannot be resolved over the telephone, a technician will be dispatched to arrive onsite, typically the next day.

International Warranty Service (IWS): PC repair coverage for customers who require a critical warranty repair while travelling internationally. Visit www.lenovo.com/internationalwarranty for details. Visit www.lenovo.com/warranty for Lenovo Warranty Services terms and conditions for complete details and restrictions.

Included software: may differ from its retail version (if available), and may not include user manuals or all program functionality. Software license agreements may apply.

Battery life: Battery life (and recharge times) will vary based on many factors including screen brightness, applications, features, power management, battery conditioning, and other customer preferences.

Visit <http://psref.lenovo.com/> for the latest version of Product Specifications Reference.

© Lenovo, 2018. All rights reserved.
Lenovo 1009 Think Place Morrisville, NC 27560 U.S.A.

Lenovo™ **ThinkCentre**®

PSREF



Product Specifications Reference

Version 522, March 2018

U.S.

Visit <http://psref.lenovo.com> for the latest version

Contents

Cover		
Contents		
Summary Of Change		
M Series AIO		
ThinkCentre M810z AIO		
ThinkCentre M810z AIO Platform Specifications	1	ThinkCentre M710 Tiny - TopSeller - 10MR - 2 of 4 35
ThinkCentre M810z AIO - TopSeller - 10NX	2	ThinkCentre M710 Tiny - TopSeller - 10MR - 3 of 4 36
ThinkCentre M810z AIO - TopSeller - 10NY - 1 of 2	4	ThinkCentre M710 Tiny - TopSeller - 10MR - 4 of 4 37
ThinkCentre M810z AIO - TopSeller - 10NY - 2 of 2	5	ThinkCentre M710 Tower 38
ThinkCentre M910z AIO	5	ThinkCentre M710 Tower Platform Specifications 39
ThinkCentre M910z AIO Platform Specifications	6	ThinkCentre M710 Tower - TopSeller - 10M9 - 1 of 3 40
ThinkCentre M910z AIO - TopSeller - 10NR	7	ThinkCentre M710 Tower - TopSeller - 10M9 - 2 of 3 41
ThinkCentre M910z AIO - TopSeller - 10NS	8	ThinkCentre M710 Tower - TopSeller - 10M9 - 3 of 3 42
M Series Desktop	9	ThinkCentre M710e SFF 43
ThinkCentre M600 Tiny	10	ThinkCentre M710e SFF Platform Specifications 44
ThinkCentre M600 Tiny Platform Specifications	11	ThinkCentre M710e SFF - TopSeller - 10UR 45
ThinkCentre M600 Tiny - TopSeller - 10G9 - 1 of 2	12	ThinkCentre M715 SFF 46
ThinkCentre M600 Tiny - TopSeller - 10G9 - 2 of 2	13	ThinkCentre M715 SFF Platform Specifications 47
ThinkCentre M600 Tiny - TopSeller - 10GB	14	ThinkCentre M715 SFF - TopSeller - 10MB - 1 of 4 48
ThinkCentre M600 Tiny - 10G8	14	ThinkCentre M715 SFF - TopSeller - 10MB - 2 of 4 49
ThinkCentre M600 Tiny - 10GA	15	ThinkCentre M715 SFF - TopSeller - 10MB - 3 of 4 50
ThinkCentre M600 Tiny - 10GC	16	ThinkCentre M715 SFF - TopSeller - 10MB - 4 of 4 51
ThinkCentre M600 Tiny - 10GE	17	ThinkCentre M715 Tiny 52
ThinkCentre M600 Tiny Thin Client	18	ThinkCentre M715 Tiny Platform Specifications 53
ThinkCentre M600 Tiny Thin Client Platform Specifications	19	ThinkCentre M715 Tiny - TopSeller - 10M3 - 1 of 2 54
ThinkCentre M600 Tiny Thin Client - TopSeller - 10KH - 1 of 2	20	ThinkCentre M715 Tiny - TopSeller - 10M3 - 2 of 2 55
ThinkCentre M600 Tiny Thin Client - TopSeller - 10KH - 2 of 2	21	ThinkCentre M715 Tiny Thin Client 56
ThinkCentre M710 SFF	22	ThinkCentre M715 Tiny Thin Client Platform Specifications 57
ThinkCentre M710 SFF Platform Specifications	23	ThinkCentre M715 Tiny Thin Client - TopSeller - 10RB - 1 of 2 58
ThinkCentre M710 SFF - TopSeller - 10M7 - 1 of 3	24	ThinkCentre M715 Tiny Thin Client - TopSeller - 10RB - 2 of 2 59
ThinkCentre M710 SFF - TopSeller - 10M7 - 2 of 3	25	ThinkCentre M910 SFF 60
ThinkCentre M710 SFF - TopSeller - 10M7 - 3 of 3	26	ThinkCentre M910 SFF Platform Specifications 61
ThinkCentre M710 Tiny	27	ThinkCentre M910 SFF - TopSeller - 10MK - 1 of 2 62
ThinkCentre M710 Tiny Platform Specifications	28	ThinkCentre M910 SFF - TopSeller - 10MK - 2 of 2 63
ThinkCentre M710 Tiny - TopSeller - 10MR - 1 of 4	29	ThinkCentre M910 Tiny 64
	30	ThinkCentre M910 Tiny Platform Specifications 65
	31	ThinkCentre M910 Tiny - TopSeller - 10MV - 1 of 3 66
	32	ThinkCentre M910 Tiny - TopSeller - 10MV - 2 of 3 67
	33	ThinkCentre M910 Tiny - TopSeller - 10MV - 3 of 3 68
	34	ThinkCentre M910 Tower 69

Contents

ThinkCentre M910 Tower Platform Specifications	70
ThinkCentre M910 Tower - TopSeller - 10MM - 1 of 2	71
ThinkCentre M910 Tower - TopSeller - 10MM - 2 of 2	72
ThinkCentre M910x Tiny	73
ThinkCentre M910x Tiny Platform Specifications	74
ThinkCentre M910x Tiny - TopSeller - 10N0 - 1 of 2	75
ThinkCentre M910x Tiny - TopSeller - 10N0 - 2 of 2	76
Smart Office	77
ThinkSmart Hub 500	77
ThinkSmart Hub 500 Platform Specifications	78
ThinkSmart Hub 500 - TopSeller - 10V5	79
Tiny-In-One	80
ThinkCentre Tiny-In-One 22	80
ThinkCentre Tiny-In-One 22 Platform Specifications	81
ThinkCentre Tiny-In-One 22 - 10LK	82
ThinkCentre Tiny-In-One 22 Gen3	83
ThinkCentre Tiny-In-One 22 Gen3 Platform Specifications	84
ThinkCentre Tiny-In-One 22 Gen3 - 10R0	85
ThinkCentre Tiny-In-One 22 Gen3 - 10R1	86
ThinkCentre Tiny-In-One 24	87
ThinkCentre Tiny-In-One 24 Platform Specifications	88
ThinkCentre Tiny-In-One 24 - 10LL	89
ThinkCentre Tiny-In-One 24 Gen3	90
ThinkCentre Tiny-In-One 24 Gen3 Platform Specifications	91
ThinkCentre Tiny-In-One 24 Gen3 - 10QX	92
ThinkCentre Tiny-In-One 24 Gen3 - 10QY	93
Legal Information	94

Summary of Changes

This section describes the technical changes made in this edition.

This edition might also include minor corrections and editorial changes which are not identified.

March 2018 - Version 522

Additions in this update

▶ **New product(s)**

None

▶ **New model(s)**

ThinkCentre M710 Tiny new models announced March 2018
ThinkCentre M710 SFF new models announced March 2018
ThinkCentre M710 Tower new models announced March 2018
ThinkCentre M910 Tiny new models announced March 2018
ThinkCentre M910 SFF new models announced March 2018
ThinkCentre M910 Tower new models announced March 2018

▶ **Others**

None

Withdrawals in this update

▶ **Withdrawn product(s)**

None

▶ **Withdrawn model(s)**

None



ThinkCentre M810z Platform Specifications

Product Specifications Reference (PSREF)

Processor	Intel® Celeron®, Intel Pentium®, or 6th / 7th Gen Intel Core™ i3 / i5 / i7 Processor						Security features	<ul style="list-style-type: none"> Security slot (in rear for attachment of optional Kensington® MicroSaver® cable; Kensington lock also locks chassis) Smart USB protection, allows keyboard/mouse only, blocks all storage devices Optional cable lock to physically lock keyboard and mouse 	<ul style="list-style-type: none"> Power-on, admin, hard disk password Boot sequence control Boot without keyboard and mouse Individual USB port disablement Optional Chassis intrusion switch
	Processor	Cores / Threads	Frequency Base/Max(GHz)	Cache	Memory Support (Up to)	Integrated Graphics			
	Pentium G4400	2 / 2	3.3G	3 MB	DDR4-2133	HD 510			
	Pentium G4560	2 / 4	3.5G	3 MB	DDR4-2400	HD 610			
	Pentium G4600	2 / 4	3.6G	3 MB	DDR4-2400	HD 630			
	Core i3-6100	2 / 4	3.7G	3 MB	DDR4-2133	HD 530			
	Core i5-6500	4 / 4	3.2G / 3.6G	6 MB	DDR4-2133	HD 530			
	Core i7-6700	4 / 8	3.4G / 4.0G	8 MB	DDR4-2133	HD 530			
	Core i3-7100	2 / 4	3.9G	3 MB	DDR4-2400	HD 630			
	Core i5-7400	4 / 4	3.0G / 3.5G	6 MB	DDR4-2400	HD 630			
	Core i5-7500	4 / 4	3.4G / 3.8G	6 MB	DDR4-2400	HD 630			
	Core i5-7600	4 / 4	3.5G / 4.1G	6 MB	DDR4-2400	HD 630			
Core i7-7700	4 / 8	3.6G / 4.2G	8 MB	DDR4-2400	HD 630				
Memory	32GB max, DDR4-2400*, two 260-pin SO-DIMM sockets, dual-channel capable * System clocks down for the processors with lower memory controller						Keyboard	<i>Some:</i> Lenovo Calliope Keyboard (USB connector), black <i>Some:</i> Lenovo Traditional Keyboard (USB connector), black <i>Some:</i> Lenovo Calliope Wireless Keyboard (2.4GHz via USB receiver), black <i>Some:</i> Lenovo Calliope Mouse (USB connector), black <i>Some:</i> Lenovo Calliope Wireless Mouse (2.4GHz via USB receiver), black	Mouse <ul style="list-style-type: none"> Business black color Toolless stand Support VESA mount (100mm)
Storage	<i>Some:</i> Hard Drive / SATA 6.0Gb/s, 2.5", 5400 rpm or 7200 rpm <i>Some:</i> Solid State Drive (SSD) / SATA 6.0Gb/s, 2.5" <i>Some:</i> M.2 Solid State Drive (SSD) / PCIe NVMe, PCIe 3.0 x 4, 32Gb/s <i>Some:</i> Intel Optane™ Memory (models with 7th gen Core processor), M.2 <i>Some:</i> DVD-ROM SATA 1.5Gb/s Drive, slim (9.5mm) <i>Some:</i> DVD Burner (DVD±RW), SATA 1.5Gb/s Drive, slim (9.5mm)								
Optical	Optional 9-in-1 media card reader								
Media reader	Optional 9-in-1 media card reader								
Graphics	Intel HD Graphics 510/530/610/630 in processor, uses main memory, DirectX® 12, external monitor support via DisplayPort™; <i>Max resolution:</i> 4096x2304 (DP)@60Hz, 1920x1080 (Panel)@60Hz 21.5" (546.1mm) Full HD 1080p (1920x1080) TFT color , MVA panel, wide viewing angle (+/- 89°), LED backlight, 250 nits, 16:9 aspect ratio, 1000:1 contrast ratio, anti-glare, support Low Blue Light Mode								
Display	Optional Projected Capacitive Touch (PCT) technology, supports 10-point touch Optional 1080p camera, fixed focus, with dual microphone, LED indicator, physical switch on/off								
Multi-touch	Physical buttons for Microphone mute, brightness up/down, and power on/off								
Camera	Physical buttons for Microphone mute, brightness up/down, and power on/off								
Controls	Physical buttons for Microphone mute, brightness up/down, and power on/off								
Chipset	Intel B250 Chipset								
Rear ports	Four USB 3.1 Gen1, ethernet (RJ-45), DisplayPort, optional serial (9-pin), Two USB 3.1 Gen1 (one is Always On and fast charge), optional card reader, one headphone / microphone combo jack (3.5mm)								
Side ports	Two M.2 Card slots (one for WLAN, one for SSD/Optane)								
M.2 card slot	Two M.2 Card slots (one for WLAN, one for SSD/Optane)								
Audio support	High Definition (HD) Audio, Realtek ALC233 / two internal speakers (2W x 2), Dolby® Audio™ certified								
WLAN ¹³	<i>Some:</i> 11ac wireless, M.2 Card, Qualcomm Atheros QCA9377A (dual band), Wi-Fi + Bluetooth 4.1 combo adapter, 1x1 <i>Some:</i> 11ac wireless, M.2 Card, Qualcomm Atheros QCA6174A (dual band), Wi-Fi + Bluetooth 4.1 combo adapter, 2x2 <i>Some:</i> 11ac wireless, M.2 Card, Intel Dual Band Wireless-AC 3165, Wi-Fi + Bluetooth 4.1 combo adapter, 1x1 <i>Some:</i> 11ac wireless, M.2 Card, Intel Dual Band Wireless-AC 8265, Wi-Fi + Bluetooth 4.1 combo adapter, 2x2								
Bluetooth™	<i>Some:</i> Bluetooth 4.1 wireless, integrated in Wi-Fi + Bluetooth combo adapter								
Ethernet	Gigabit ethernet, Realtek RTL8111G, Wake on LAN®								
Manageability	None								
Security chip	TPM (Trusted Platform Module) 2.0, TCG Certified * Downgrade to TPM1.2 for the models with Win10 DG Win7 32 OS								
Power supply	150 watts, autosensing, 85% PSU								
Limited warranty ³	<i>Some:</i> 1-year or 3-year, depot repair service / service upgrades available <i>Some:</i> 1-year or 3-year, limited onsite service / service upgrades available								
Preload	Preloaded operating system <i>Some:</i> Windows® 7 Professional 32/64 preinstalled through downgrade rights in Windows 10 Pro 64-bit <i>Some:</i> Windows 10 Pro 64-bit <i>Some:</i> Windows 10 Home 64-bit								
Environment	Preloaded applications (only some listed) <ul style="list-style-type: none"> Microsoft Office preloaded; purchase a product key to activate Only for Window 10 Lenovo Companion Only for Window 7 Lenovo Solution Center Lenovo ThinkVantage Tools ThinkVantage System Update Create Recovery Media Adobe® Reader® Cyberlink PowerDVD Create (DVD±RW) 								
MIL-SPEC test	EPEAT™ Gold rating (North America); ENERGY STAR® 6.1; TCO AIO Computer Certified; ErP Lot 3; GREENGUARD® certified; RoHS-compliant								
Accessories	MIL-STD-810G military certification (Low Pressure [Altitude], High Temperature, Low Temperature, Temperature Shock, Humidity, Sand and Dust, Vibration, Shock)								
	For compatible accessories, please go to http://www.lenovoquickpick.com								

See footnotes for more detailed information

Model	Region	Processor	Graphics	Monitor Cable	Memory	Display	Multi-touch	Power Supply	Storage(HDD/SSD)	Optical	Media Reader	USB Type-C	WLAN + Bluetooth	Optional Rear Ports	Camera	Chassis Intrusion Switch	Cable Lock	Keyboard / Mouse	Stand	Operating System	Warranty	End of Support	Ann Date (m/y)
10NX0000US	US	i5-7400	Intel HD 630	None	8GBx1	21.5" FHD (1920x1080) WVA AG	10-point Multi-touch	150W 85% Adapter	256GB SSD M.2 PCIe NVMe	DVD±RW	9-in-1	None	8265 ac, 2x2 + BT4.1	None	1080p	None	None	USB / USB	UltraFlex II Stand	Win10 Pro 64	3-year, Onsite	Apr 7, 2023	03/17
10NX0001US	US	i5-7500	Intel HD 630	None	8GBx1	21.5" FHD (1920x1080) WVA AG	10-point Multi-touch	150W 85% Adapter	256GB SSD M.2 PCIe NVMe	DVD±RW	9-in-1	None	8265 ac, 2x2 + BT4.1	None	1080p	None	None	USB / USB	UltraFlex II Stand	Win10 Pro 64	3-year, Onsite	Apr 7, 2023	03/17
10NX0002US	US	i5-7400	Intel HD 630	None	4GBx1	21.5" FHD (1920x1080) WVA AG	10-point Multi-touch	150W 85% Adapter	500GB 7200rpm 2.5" PCIe NVMe	DVD±RW	9-in-1	None	8265 ac, 2x2 + BT4.1	None	1080p	None	None	USB / USB	UltraFlex II Stand	Win10 Pro 64	3-year, Onsite	Apr 7, 2023	03/17
10NX0003US	US	i7-7700	Intel HD 630	None	8GBx1	21.5" FHD (1920x1080) WVA AG	10-point Multi-touch	150W 85% Adapter	512GB SSD M.2 PCIe NVMe	DVD±RW	9-in-1	None	8265 ac, 2x2 + BT4.1	None	1080p	None	None	USB / USB	UltraFlex II Stand	Win10 Pro 64	3-year, Onsite	Apr 7, 2023	03/17
10NX0005US	US	i7-7700	Intel HD 630	None	8GBx1	21.5" FHD (1920x1080) WVA AG	10-point Multi-touch	150W 85% Adapter	500GB 7200rpm 2.5" PCIe NVMe	DVD±RW	9-in-1	None	8265 ac, 2x2 + BT4.1	None	1080p	None	None	USB / USB	UltraFlex II Stand	Win10 Pro 64	3-year, Onsite	Apr 7, 2023	03/17
10NX0006US	US	i5-7400	Intel HD 630	None	8GBx1	21.5" FHD (1920x1080) WVA AG	10-point Multi-touch	150W 85% Adapter	500GB 7200rpm 2.5" PCIe NVMe	DVD±RW	9-in-1	None	8265 ac, 2x2 + BT4.1	None	1080p	None	None	USB / USB	UltraFlex II Stand	Win10 Pro 64	3-year, Onsite	Apr 7, 2023	03/17
10NX0007US	US	i5-7500	Intel HD 630	None	8GBx1	21.5" FHD (1920x1080) WVA AG	10-point Multi-touch	150W 85% Adapter	500GB 7200rpm 2.5" PCIe NVMe	DVD±RW	9-in-1	None	8265 ac, 2x2 + BT4.1	None	1080p	None	None	USB / USB	UltraFlex II Stand	Win10 Pro 64	3-year, Onsite	Apr 7, 2023	03/17
10NX0008US	US	i7-7700	Intel HD 630	None	8GBx1	21.5" FHD (1920x1080) WVA AG	10-point Multi-touch	150W 85% Adapter	256GB SSD M.2 PCIe NVMe	DVD±RW	9-in-1	None	8265 ac, 2x2 + BT4.1	None	1080p	None	None	USB / USB	UltraFlex II Stand	Win10 Pro 64	3-year, Onsite	Apr 7, 2023	03/17
10NX0009US	US	i5-7500	Intel HD 630	None	8GBx1	21.5" FHD (1920x1080) WVA AG	10-point Multi-touch	150W 85% Adapter	512GB SSD M.2 PCIe NVMe	DVD±RW	9-in-1	None	8265 ac, 2x2 + BT4.1	None	1080p	None	None	USB / USB	UltraFlex II Stand	Win10 Pro 64	3-year, Onsite	Apr 7, 2023	03/17
10NX000MUS	US	i5-7400	Intel HD 630	None	4GBx1	21.5" FHD (1920x1080) WVA AG	10-point Multi-touch	150W 85% Adapter	128GB SSD M.2 PCIe NVMe	DVD±RW	9-in-1	None	8265 ac, 2x2 + BT4.1	None	1080p	None	None	USB / USB	UltraFlex II Stand	Win10 Pro 64	3-year, Onsite	May 7, 2023	04/17
10NX000NUS	US	i5-7500	Intel HD 630	None	4GBx1	21.5" FHD (1920x1080) WVA AG	10-point Multi-touch	150W 85% Adapter	128GB SSD M.2 PCIe NVMe	DVD±RW	9-in-1	None	8265 ac, 2x2 + BT4.1	None	1080p	None	None	USB / USB	UltraFlex II Stand	Win10 Pro 64	3-year, Onsite	May 7, 2023	04/17
10NX000PUS	US	Pentium G4560	Intel HD 610	None	4GBx1	21.5" FHD (1920x1080) WVA AG	10-point Multi-touch	150W 85% Adapter	500GB 7200rpm 2.5" PCIe NVMe	DVD±RW	9-in-1	None	8265 ac, 2x2 + BT4.1	None	1080p	None	None	USB / USB	UltraFlex II Stand	Win10 Pro 64	3-year, Onsite	May 7, 2023	04/17
10NX000QUS	US	i3-7100	Intel HD 630	None	8GBx1	21.5" FHD (1920x1080) WVA AG	10-point Multi-touch	150W 85% Adapter	500GB 7200rpm 2.5" PCIe NVMe	DVD±RW	9-in-1	None	8265 ac, 2x2 + BT4.1	None	1080p	None	None	USB / USB	UltraFlex II Stand	Win10 Pro 64	3-year, Onsite	May 7, 2023	04/17
10NX000RUS	US	i3-7100	Intel HD 630	None	4GBx1	21.5" FHD (1920x1080) WVA AG	10-point Multi-touch	150W 85% Adapter	500GB 7200rpm 2.5" PCIe NVMe	DVD±RW	9-in-1	None	8265 ac, 2x2 + BT4.1	None	1080p	None	None	USB / USB	UltraFlex II Stand	Win10 Pro 64	3-year, Onsite	May 7, 2023	04/17

Model	Region	Processor	Graphics	Monitor Cable	Memory	Display	Multi-touch	Power Supply	Storage(HDD/SSD)	Optical	Media Reader	USB Type-C	WLAN + Bluetooth	Optional Rear Ports	Camera	Chassis Intrusion Switch	Cable Lock	Keyboard / Mouse	Stand	Operating System	Warranty	End of Support	Ann Date (m/y)
10NY0002US	US	i5-7500	Intel HD 630	None	8GBx1	21.5" FHD (1920x1080) WVA AG	None	150W 85% Adapter	512GB SSD M.2 PCIe NVMe	DVD±RW	9-in-1	None	8265 ac, 2x2 + BT4.1	None	1080p	None	None	USB / USB	UltraFlex II Stand	Win10 Pro 64	3-year, Onsite	Apr 7, 2023	03/17
10NY0003US	US	i7-7700	Intel HD 630	None	8GBx1	21.5" FHD (1920x1080) WVA AG	None	150W 85% Adapter	512GB SSD M.2 PCIe NVMe	DVD±RW	9-in-1	None	8265 ac, 2x2 + BT4.1	None	1080p	None	None	USB / USB	UltraFlex II Stand	Win10 Pro 64	3-year, Onsite	Apr 7, 2023	03/17
10NY0004US	US	i5-7500	Intel HD 630	None	8GBx1	21.5" FHD (1920x1080) WVA AG	None	150W 85% Adapter	256GB SSD M.2 PCIe NVMe	DVD±RW	9-in-1	None	8265 ac, 2x2 + BT4.1	None	1080p	None	None	USB / USB	UltraFlex II Stand	Win10 Pro 64	3-year, Onsite	Apr 7, 2023	03/17
10NY0005US	US	i7-7700	Intel HD 630	None	8GBx1	21.5" FHD (1920x1080) WVA AG	None	150W 85% Adapter	500GB 7200rpm 2.5" DVD±RW	DVD±RW	9-in-1	None	8265 ac, 2x2 + BT4.1	None	1080p	None	None	USB / USB	UltraFlex II Stand	Win10 Pro 64	3-year, Onsite	Apr 7, 2023	03/17
10NY0006US	US	i5-7400	Intel HD 630	None	8GBx1	21.5" FHD (1920x1080) WVA AG	None	150W 85% Adapter	500GB 7200rpm 2.5" DVD±RW	DVD±RW	9-in-1	None	8265 ac, 2x2 + BT4.1	None	1080p	None	None	USB / USB	UltraFlex II Stand	Win10 Pro 64	3-year, Onsite	Apr 7, 2023	03/17
10NY0007US	US	i5-7500	Intel HD 630	None	8GBx1	21.5" FHD (1920x1080) WVA AG	None	150W 85% Adapter	500GB 7200rpm 2.5" DVD±RW	DVD±RW	9-in-1	None	8265 ac, 2x2 + BT4.1	None	1080p	None	None	USB / USB	UltraFlex II Stand	Win10 Pro 64	3-year, Onsite	Apr 7, 2023	03/17
10NY0008US	US	i5-7400	Intel HD 630	None	4GBx1	21.5" FHD (1920x1080) WVA AG	None	150W 85% Adapter	500GB 7200rpm 2.5" DVD±RW	DVD±RW	9-in-1	None	8265 ac, 2x2 + BT4.1	None	1080p	None	None	USB / USB	UltraFlex II Stand	Win10 Pro 64	3-year, Onsite	Apr 7, 2023	03/17
10NY0009US	US	i5-7400	Intel HD 630	None	8GBx1	21.5" FHD (1920x1080) WVA AG	None	150W 85% Adapter	256GB SSD M.2 PCIe NVMe	DVD±RW	9-in-1	None	8265 ac, 2x2 + BT4.1	None	1080p	None	None	USB / USB	UltraFlex II Stand	Win10 Pro 64	3-year, Onsite	Apr 7, 2023	03/17
10NY000BUS	US	i7-7700	Intel HD 630	None	8GBx1	21.5" FHD (1920x1080) WVA AG	None	150W 85% Adapter	256GB SSD M.2 PCIe NVMe	DVD±RW	9-in-1	None	8265 ac, 2x2 + BT4.1	None	1080p	None	None	USB / USB	UltraFlex II Stand	Win10 Pro 64	3-year, Onsite	Apr 7, 2023	03/17
10NY000CUS	US	i5-7500	Intel HD 630	None	4GBx1	21.5" FHD (1920x1080) WVA AG	None	150W 85% Adapter	500GB 7200rpm 2.5" DVD±RW	DVD±RW	9-in-1	None	8265 ac, 2x2 + BT4.1	None	1080p	None	None	USB / USB	UltraFlex II Stand	Win10 Pro 64	3-year, Onsite	Apr 7, 2023	03/17
10NY000QUS	US	Pentium G4400	Intel HD 510	None	4GBx1	21.5" FHD (1920x1080) WVA AG	None	150W 85% Adapter	500GB 7200rpm 2.5" DVD±RW	DVD±RW	9-in-1	None	8265 ac, 2x2 + BT4.1	None	1080p	None	None	USB / USB	UltraFlex II Stand	Win10 DG Win7 Pro 64	3-year, Onsite	Apr 29, 2023	03/17
10NY000RUS	US	i5-6500	Intel HD 530	None	4GBx1	21.5" FHD (1920x1080) WVA AG	None	150W 85% Adapter	500GB 7200rpm 2.5" DVD±RW	DVD±RW	9-in-1	None	8265 ac, 2x2 + BT4.1	None	1080p	None	None	USB / USB	UltraFlex II Stand	Win10 DG Win7 Pro 64	3-year, Onsite	Apr 29, 2023	03/17
10NY000SUS	US	i5-7400	Intel HD 630	None	4GBx1	21.5" FHD (1920x1080) WVA AG	None	150W 85% Adapter	128GB SSD M.2 PCIe NVMe	DVD±RW	9-in-1	None	8265 ac, 2x2 + BT4.1	None	1080p	None	None	USB / USB	UltraFlex II Stand	Win10 Pro 64	3-year, Onsite	May 7, 2023	04/17
10NY000TUS	US	i5-6500	Intel HD 530	None	4GBx1	21.5" FHD (1920x1080) WVA AG	None	150W 85% Adapter	128GB SSD M.2 PCIe NVMe	DVD±RW	9-in-1	None	8265 ac, 2x2 + BT4.1	None	1080p	None	None	USB / USB	UltraFlex II Stand	Win10 DG Win7 Pro 64	3-year, Onsite	Apr 29, 2023	03/17
10NY000UUS	US	i7-6700	Intel HD 530	None	8GBx1	21.5" FHD (1920x1080) WVA AG	None	150W 85% Adapter	512GB SSD M.2 PCIe NVMe	DVD±RW	9-in-1	None	8265 ac, 2x2 + BT4.1	None	1080p	None	None	USB / USB	UltraFlex II Stand	Win10 DG Win7 Pro 64	3-year, Onsite	Apr 29, 2023	03/17
10NY000VUS	US	i7-6700	Intel HD 530	None	8GBx1	21.5" FHD (1920x1080) WVA AG	None	150W 85% Adapter	500GB 7200rpm 2.5" DVD±RW	DVD±RW	9-in-1	None	8265 ac, 2x2 + BT4.1	None	1080p	None	None	USB / USB	UltraFlex II Stand	Win10 DG Win7 Pro 64	3-year, Onsite	Apr 29, 2023	03/17
10NY000WUS	US	i7-6700	Intel HD 530	None	8GBx1	21.5" FHD (1920x1080) WVA AG	None	150W 85% Adapter	256GB SSD M.2 PCIe NVMe	DVD±RW	9-in-1	None	8265 ac, 2x2 + BT4.1	None	1080p	None	None	USB / USB	UltraFlex II Stand	Win10 DG Win7 Pro 64	3-year, Onsite	Apr 29, 2023	03/17
10NY000XUS	US	i5-6500	Intel HD 530	None	8GBx1	21.5" FHD (1920x1080) WVA AG	None	150W 85% Adapter	256GB SSD M.2 PCIe NVMe	DVD±RW	9-in-1	None	8265 ac, 2x2 + BT4.1	None	1080p	None	None	USB / USB	UltraFlex II Stand	Win10 DG Win7 Pro 64	3-year, Onsite	Apr 29, 2023	03/17
10NY000YUS	US	i3-6100	Intel HD 530	None	4GBx1	21.5" FHD (1920x1080) WVA AG	None	150W 85% Adapter	500GB 7200rpm 2.5" DVD±RW	DVD±RW	9-in-1	None	8265 ac, 2x2 + BT4.1	None	1080p	None	None	USB / USB	UltraFlex II Stand	Win10 DG Win7 Pro 64	3-year, Onsite	Apr 29, 2023	03/17
10NY0010US	US	i3-6100	Intel HD 530	None	8GBx1	21.5" FHD (1920x1080) WVA AG	None	150W 85% Adapter	500GB 7200rpm 2.5" DVD±RW	DVD±RW	9-in-1	None	8265 ac, 2x2 + BT4.1	None	1080p	None	None	USB / USB	UltraFlex II Stand	Win10 DG Win7 Pro 64	3-year, Onsite	Apr 29, 2023	03/17

Model	Region	Processor	Graphics	Monitor Cable	Memory	Display	Multi-touch	Power Supply	Storage(HDD/SSD)	Optical	Media Reader	USB Type-C	WLAN + Bluetooth	Optional Rear Ports	Camera	Chassis Intrusion Switch	Cable Lock	Keyboard / Mouse	Stand	Operating System	Warranty	End of Support	Ann Date (m/y)
10NY0011US	US	i5-7500	Intel HD 630	None	4GBx1	21.5" FHD (1920x1080) WVA AG	None	150W 85% Adapter	128GB SSD M.2 PCIe NVMe	DVD±RW	9-in-1	None	8265 ac, 2x2 + BT4.1	None	1080p	None	None	USB / USB	UltraFlex II Stand	Win10 Pro 64	3-year, Onsite	May 7, 2023	04/17
10NY0012US	US	i5-6500	Intel HD 530	None	8GBx1	21.5" FHD (1920x1080) WVA AG	None	150W 85% Adapter	500GB 7200rpm 2.5" PCIe NVMe	DVD±RW	9-in-1	None	8265 ac, 2x2 + BT4.1	None	1080p	None	None	USB / USB	UltraFlex II Stand	Win10 DG Win7 Pro 64	3-year, Onsite	Apr 29, 2023	03/17
10NY0013US	US	Pentium G4560	Intel HD 610	None	4GBx1	21.5" FHD (1920x1080) WVA AG	None	150W 85% Adapter	500GB 7200rpm 2.5" PCIe NVMe	DVD±RW	9-in-1	None	8265 ac, 2x2 + BT4.1	None	1080p	None	None	USB / USB	UltraFlex II Stand	Win10 Pro 64	3-year, Onsite	May 7, 2023	04/17
10NY0014US	US	i3-7100	Intel HD 630	None	8GBx1	21.5" FHD (1920x1080) WVA AG	None	150W 85% Adapter	500GB 7200rpm 2.5" PCIe NVMe	DVD±RW	9-in-1	None	8265 ac, 2x2 + BT4.1	None	1080p	None	None	USB / USB	UltraFlex II Stand	Win10 Pro 64	3-year, Onsite	May 7, 2023	04/17
10NY0015US	US	i3-7100	Intel HD 630	None	4GBx1	21.5" FHD (1920x1080) WVA AG	None	150W 85% Adapter	500GB 7200rpm 2.5" PCIe NVMe	DVD±RW	9-in-1	None	8265 ac, 2x2 + BT4.1	None	1080p	None	None	USB / USB	UltraFlex II Stand	Win10 Pro 64	3-year, Onsite	May 7, 2023	04/17

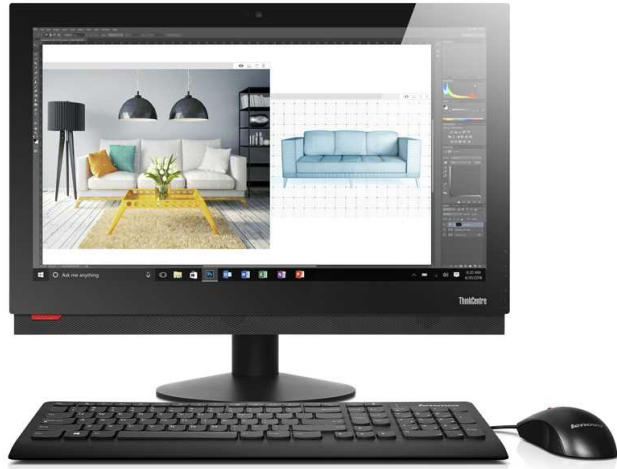

ThinkCentre M910z Platform Specifications

Product Specifications Reference (PSREF)

Processor	Intel® Celeron®, Intel Pentium®, or 6th / 7th Gen Intel Core™ i3 / i5 / i7 Processor	Security chip	TPM (Trusted Platform Module) 2.0, TCG Certified * Downgrade to TPM1.2 for the models with Win10 DG Win7 32 OS																																																						
	<table border="1"> <thead> <tr> <th>Processor</th> <th>Cores / Threads</th> <th>Frequency Base/Max(GHz)</th> <th>Cache</th> <th>Memory Support (Up to)</th> <th>Integrated Graphics</th> </tr> </thead> <tbody> <tr> <td>Core i3-6100</td> <td>2 / 4</td> <td>3.7G</td> <td>3 MB</td> <td>DDR4-2133</td> <td>HD 530</td> </tr> <tr> <td>Core i5-6500</td> <td>4 / 4</td> <td>3.2G / 3.6G</td> <td>6 MB</td> <td>DDR4-2133</td> <td>HD 530</td> </tr> <tr> <td>Core i7-6700</td> <td>4 / 8</td> <td>3.4G / 4.0G</td> <td>8 MB</td> <td>DDR4-2133</td> <td>HD 530</td> </tr> <tr> <td>Core i3-7100</td> <td>2 / 4</td> <td>3.9G</td> <td>3 MB</td> <td>DDR4-2400</td> <td>HD 630</td> </tr> <tr> <td>Core i5-7400</td> <td>4 / 4</td> <td>3.0G / 3.5G</td> <td>6 MB</td> <td>DDR4-2400</td> <td>HD 630</td> </tr> <tr> <td>Core i5-7500</td> <td>4 / 4</td> <td>3.4G / 3.8G</td> <td>6 MB</td> <td>DDR4-2400</td> <td>HD 630</td> </tr> <tr> <td>Core i5-7600</td> <td>4 / 4</td> <td>3.5G / 4.1G</td> <td>6 MB</td> <td>DDR4-2400</td> <td>HD 630</td> </tr> <tr> <td>Core i7-7700</td> <td>4 / 8</td> <td>3.6G / 4.2G</td> <td>8 MB</td> <td>DDR4-2400</td> <td>HD 630</td> </tr> </tbody> </table>	Processor	Cores / Threads	Frequency Base/Max(GHz)	Cache	Memory Support (Up to)	Integrated Graphics	Core i3-6100	2 / 4	3.7G	3 MB	DDR4-2133	HD 530	Core i5-6500	4 / 4	3.2G / 3.6G	6 MB	DDR4-2133	HD 530	Core i7-6700	4 / 8	3.4G / 4.0G	8 MB	DDR4-2133	HD 530	Core i3-7100	2 / 4	3.9G	3 MB	DDR4-2400	HD 630	Core i5-7400	4 / 4	3.0G / 3.5G	6 MB	DDR4-2400	HD 630	Core i5-7500	4 / 4	3.4G / 3.8G	6 MB	DDR4-2400	HD 630	Core i5-7600	4 / 4	3.5G / 4.1G	6 MB	DDR4-2400	HD 630	Core i7-7700	4 / 8	3.6G / 4.2G	8 MB	DDR4-2400	HD 630	Security features	<ul style="list-style-type: none"> Security slot (in rear for attachment of optional Kensington® MicroSaver® cable; Kensington lock also locks chassis) Smart USB protection, allows keyboard/mouse only, blocks all storage devices Optional cable lock to physically lock keyboard and mouse Power-on, admin, hard disk password Boot sequence control Boot without keyboard and mouse Individual USB port disablement Optional Chassis intrusion switch
Processor	Cores / Threads	Frequency Base/Max(GHz)	Cache	Memory Support (Up to)	Integrated Graphics																																																				
Core i3-6100	2 / 4	3.7G	3 MB	DDR4-2133	HD 530																																																				
Core i5-6500	4 / 4	3.2G / 3.6G	6 MB	DDR4-2133	HD 530																																																				
Core i7-6700	4 / 8	3.4G / 4.0G	8 MB	DDR4-2133	HD 530																																																				
Core i3-7100	2 / 4	3.9G	3 MB	DDR4-2400	HD 630																																																				
Core i5-7400	4 / 4	3.0G / 3.5G	6 MB	DDR4-2400	HD 630																																																				
Core i5-7500	4 / 4	3.4G / 3.8G	6 MB	DDR4-2400	HD 630																																																				
Core i5-7600	4 / 4	3.5G / 4.1G	6 MB	DDR4-2400	HD 630																																																				
Core i7-7700	4 / 8	3.6G / 4.2G	8 MB	DDR4-2400	HD 630																																																				
Memory	32GB max, DDR4-2400*, two 260-pin SO-DIMM sockets, dual-channel capable * System clocks down for the processors with lower memory controller	Keyboard	<i>Some:</i> Lenovo Calliope Keyboard (USB connector), black <i>Some:</i> Lenovo Traditional Keyboard (USB connector), black <i>Some:</i> Lenovo Calliope Wireless Keyboard (2.4GHz via USB receiver), black <i>Some:</i> Lenovo Calliope Mouse (USB connector), black <i>Some:</i> Lenovo Calliope Wireless Mouse (2.4GHz via USB receiver), black																																																						
Storage	<i>Some:</i> Hard Drive / SATA 6.0Gb/s, 2.5", 5400 rpm or 7200 rpm <i>Some:</i> Solid State Drive (SSD) / SATA 6.0Gb/s, 2.5" <i>Some:</i> M.2 Solid State Drive (SSD) / PCIe NVMe, PCIe 3.0 x 4, 32Gb/s <i>Some:</i> Intel Optane™ Memory (models with 7th gen Core processor), M.2 <i>Some:</i> DVD-ROM SATA 1.5Gb/s Drive, slim (9.5mm) <i>Some:</i> DVD Burner (DVD±RW), SATA 1.5Gb/s Drive, slim (9.5mm)	Mouse																																																							
Optical	Optional 9-in-1 media card reader	Mechanical	<ul style="list-style-type: none"> Business black color Toolless back cover, stand, disk, memory removal Support VESA mount (100mm) <table border="1"> <thead> <tr> <th></th> <th>Dimensions (WxDxH)</th> <th>Max weight (lb / kg)</th> <th>Adjustments</th> </tr> </thead> <tbody> <tr> <td>Without stand:</td> <td>23.0 X 1.8 X 15.4 (inch); 584 X 45 X 390 (mm)</td> <td>(Touch) 17.2 / 7.8 (Non-touch) 15.0 / 6.8</td> <td>N/A</td> </tr> <tr> <td>With Basic Monitor stand:</td> <td>23.0 X 9.6 X 18.0 (inch); 584 X 245 X 458 (mm)</td> <td>(Non-touch) 19.4 / 8.8</td> <td>Tilt: 45° back, -5° forward</td> </tr> <tr> <td>With UltraFlex II stand:</td> <td>23.0X 10.0 X 19.9 (inch); 584 X 253 X 505 (mm)</td> <td>(Touch) 22.7 / 10.3 (Non-touch) 20.7 / 9.4</td> <td>Tilt: 61° back, -5° forward; Lift: 110mm; Swivel: +/-45°</td> </tr> </tbody> </table>		Dimensions (WxDxH)	Max weight (lb / kg)	Adjustments	Without stand:	23.0 X 1.8 X 15.4 (inch); 584 X 45 X 390 (mm)	(Touch) 17.2 / 7.8 (Non-touch) 15.0 / 6.8	N/A	With Basic Monitor stand:	23.0 X 9.6 X 18.0 (inch); 584 X 245 X 458 (mm)	(Non-touch) 19.4 / 8.8	Tilt: 45° back, -5° forward	With UltraFlex II stand:	23.0X 10.0 X 19.9 (inch); 584 X 253 X 505 (mm)	(Touch) 22.7 / 10.3 (Non-touch) 20.7 / 9.4	Tilt: 61° back, -5° forward; Lift: 110mm; Swivel: +/-45°																																						
	Dimensions (WxDxH)	Max weight (lb / kg)	Adjustments																																																						
Without stand:	23.0 X 1.8 X 15.4 (inch); 584 X 45 X 390 (mm)	(Touch) 17.2 / 7.8 (Non-touch) 15.0 / 6.8	N/A																																																						
With Basic Monitor stand:	23.0 X 9.6 X 18.0 (inch); 584 X 245 X 458 (mm)	(Non-touch) 19.4 / 8.8	Tilt: 45° back, -5° forward																																																						
With UltraFlex II stand:	23.0X 10.0 X 19.9 (inch); 584 X 253 X 505 (mm)	(Touch) 22.7 / 10.3 (Non-touch) 20.7 / 9.4	Tilt: 61° back, -5° forward; Lift: 110mm; Swivel: +/-45°																																																						
Media reader	Optional 9-in-1 media card reader	Power supply	150 watts, autosensing, 85% PSU																																																						
Graphics	Intel HD Graphics 530/630 in processor, uses main memory, DirectX® 12, external monitor support via DisplayPort™; <i>Max resolution:</i> 4096x2304 (DP)@60Hz, 1920x1080 (Panel)@60Hz	Limited warranty ³	<i>Some:</i> 1-year or 3-year, depot repair service / service upgrades available <i>Some:</i> 1-year or 3-year, limited onsite service / service upgrades available																																																						
Display	23.8" (604.5mm) Full HD 1080p (1920x1080) TFT color , WVA panel, wide viewing angle (+/- 89°), LED backlight, 250 nits, 16:9 aspect ratio, 1000:1 contrast ratio, anti-glare, support Low Blue Light Mode, work as standalone monitor via DisplayPort (DP in / out combo)	Preload	Preloaded operating system <i>Some:</i> Windows® 7 Professional 32/64 preinstalled through downgrade rights in Windows 10 Pro 64-bit <i>Some:</i> Windows 10 Pro 64-bit <i>Some:</i> Windows 10 Home 64-bit Preloaded applications (only some listed) <ul style="list-style-type: none"> Microsoft Office preloaded; purchase a product key to activate Only for Window 10 Lenovo Companion Only for Window 7 Lenovo Solution Center Lenovo ThinkVantage Tools ThinkVantage System Update Create Recovery Media Adobe® Reader® Cyberlink PowerDVD Create (DVD±RW) 																																																						
Multi-touch	Optional Projected Capacitive Touch (PCT) technology, supports 10-point touch	Environment	EPEAT™ Gold rating (North America); ENERGY STAR® 6.1; TCO AIO Computer Certified; ULE Gold; ErP Lot 3; GREENGUARD® certified; RoHS-compliant																																																						
Camera	Optional 1080p camera, fixed focus, with dual microphone, LED indicator, physical switch on/off	MIL-SPEC test	MIL-STD-810G military certification (Low Pressure [Altitude], High Temperature, Low Temperature, Temperature Shock, Humidity, Sand and Dust, Vibration, Shock)																																																						
Controls	Physical buttons for Microphone mute, monitor mode switch, brightness up/down, and power on/off	Accessories	For compatible accessories, please go to http://www.lenovoquickpick.com																																																						
Chipset	Intel Q270 Chipset																																																								
Rear ports	Four USB 3.1 Gen1, ethernet (RJ-45), DisplayPort in/out combo port, optional serial (9-pin)																																																								
Side ports	Two USB 3.1 Gen1 (one is Always On and fast charge), optional card reader, one headphone / microphone combo jack (3.5mm), optional USB 3.1 Type-C Gen1																																																								
M.2 card slot	Two M.2 Card slots (one for WLAN, one for SSD/Optane)																																																								
Audio support	High Definition (HD) Audio, Realtek ALC233 / two internal speakers (3W x 2), Dolby® Audio™ certified																																																								
WLAN ¹³	<i>Some:</i> 11ac wireless, M.2 Card, Qualcomm Atheros QCA9377A (dual band), Wi-Fi + Bluetooth 4.1 combo adapter, 1x1 <i>Some:</i> 11ac wireless, M.2 Card, Qualcomm Atheros QCA6174A (dual band), Wi-Fi + Bluetooth 4.1 combo adapter, 2x2 <i>Some:</i> 11ac wireless, M.2 Card, Intel Dual Band Wireless-AC 3165, Wi-Fi + Bluetooth 4.1 combo adapter, 1x1 <i>Some:</i> 11ac wireless, M.2 Card, Intel Dual Band Wireless-AC 8265, Wi-Fi + Bluetooth 4.1 combo adapter, 2x2 <i>Some:</i> 11ac wireless, M.2 Card, Intel Dual Band Wireless-AC 8265, Wi-Fi + Bluetooth 4.1 combo adapter, Intel vPro technology support, 2x2																																																								
Bluetooth™	<i>Some:</i> Bluetooth 4.1 wireless, integrated in Wi-Fi + Bluetooth combo adapter																																																								
Ethernet	Gigabit ethernet, Intel Ethernet Connection I219-LM (Jacksonville), Wake on LAN®																																																								
Manageability	Intel Active Management Technology 11.0 (Intel AMT 11.0); Intel vPro technology on some models (require choosing a vPro-support Wi-Fi adapter to enable vPro function through wireless connection)																																																								

See footnotes for more detailed information

Model	Region	Processor	vPro	Graphics	Monitor Cable	Memory	Display	Multi-touch	Power Supply	Storage(HDD/SSD)	Optical	Media Reader	USB Type-C	WLAN + Bluetooth	Optional Rear Ports	Camera	Chassis Intrusion Switch	Cable Lock	Keyboard / Mouse	Stand	Operating System	Warranty	End of Support	Ann Date (m/y)
10NR000HUS	US	i5-7500	vPro	Intel HD 630	None	8GBx1	23.8" FHD (1920x1080) WVA AG	10-point Multi-touch	150W 85% Adapter	256GB SSD M.2 PCIe NVMe Opal	DVD±RW	9-in-1	None	8265 ac, 2x2, vPro + BT4.1	None	1080p	None	None	USB / USB	UltraFlex II Stand	Win10 Pro 64	3-year, Onsite	Mar 28, 2023	02/17
10NR000KUS	US	i5-7500	vPro	Intel HD 630	None	8GBx1	23.8" FHD (1920x1080) WVA AG	10-point Multi-touch	150W 85% Adapter	512GB SSD M.2 PCIe NVMe Opal	DVD±RW	9-in-1	None	8265 ac, 2x2, vPro + BT4.1	None	1080p	None	None	USB / USB	UltraFlex II Stand	Win10 Pro 64	3-year, Onsite	Mar 28, 2023	02/17
10NR000LUS	US	i7-7700	vPro	Intel HD 630	None	8GBx1	23.8" FHD (1920x1080) WVA AG	10-point Multi-touch	150W 85% Adapter	256GB SSD M.2 PCIe NVMe Opal	DVD±RW	9-in-1	None	8265 ac, 2x2, vPro + BT4.1	None	1080p	None	None	USB / USB	UltraFlex II Stand	Win10 Pro 64	3-year, Onsite	Mar 28, 2023	02/17
10NR000MUS	US	i5-7500	vPro	Intel HD 630	None	8GBx1	23.8" FHD (1920x1080) WVA AG	10-point Multi-touch	150W 85% Adapter	500GB 7200rpm 2.5"	DVD±RW	9-in-1	None	8265 ac, 2x2, vPro + BT4.1	None	1080p	None	None	USB / USB	UltraFlex II Stand	Win10 Pro 64	3-year, Onsite	Mar 28, 2023	02/17
10NR000PUS	US	i7-7700	vPro	Intel HD 630	None	8GBx1	23.8" FHD (1920x1080) WVA AG	10-point Multi-touch	150W 85% Adapter	512GB SSD M.2 PCIe NVMe Opal	DVD±RW	9-in-1	None	8265 ac, 2x2, vPro + BT4.1	None	1080p	None	None	USB / USB	UltraFlex II Stand	Win10 Pro 64	3-year, Onsite	Mar 28, 2023	02/17
10NR000QUS	US	i7-7700	vPro	Intel HD 630	None	8GBx1	23.8" FHD (1920x1080) WVA AG	10-point Multi-touch	150W 85% Adapter	500GB 7200rpm 2.5"	DVD±RW	9-in-1	None	8265 ac, 2x2, vPro + BT4.1	None	1080p	None	None	USB / USB	UltraFlex II Stand	Win10 Pro 64	3-year, Onsite	Mar 28, 2023	02/17
10NR000RUS	US	i5-7500	vPro	Intel HD 630	None	4GBx1	23.8" FHD (1920x1080) WVA AG	10-point Multi-touch	150W 85% Adapter	500GB 7200rpm 2.5"	DVD±RW	9-in-1	None	8265 ac, 2x2, vPro + BT4.1	None	1080p	None	None	USB / USB	UltraFlex II Stand	Win10 Pro 64	3-year, Onsite	Mar 28, 2023	02/17
10NR0017US	US	i5-7500	vPro	Intel HD 630	None	4GBx1	23.8" FHD (1920x1080) WVA AG	10-point Multi-touch	150W 85% Adapter	128GB SSD M.2 PCIe NVMe	DVD±RW	9-in-1	None	8265 ac, 2x2, vPro + BT4.1	None	1080p	None	None	USB / USB	UltraFlex II Stand	Win10 Pro 64	3-year, Onsite	May 7, 2023	04/17
10NR0018US	US	i7-7700	vPro	Intel HD 630	None	8GBx1	23.8" FHD (1920x1080) WVA AG	10-point Multi-touch	150W 85% Adapter	128GB SSD M.2 PCIe NVMe	DVD±RW	9-in-1	None	8265 ac, 2x2, vPro + BT4.1	None	1080p	None	None	USB / USB	UltraFlex II Stand	Win10 Pro 64	3-year, Onsite	May 7, 2023	04/17

Model	Region	Processor	vPro	Graphics	Monitor Cable	Memory	Display	Multi-touch	Power Supply	Storage(HDD/SSD)	Optical	Media Reader	USB Type-C	WLAN + Bluetooth	Optional Rear Ports	Camera	Chassis Intrusion Switch	Cable Lock	Keyboard / Mouse	Stand	Operating System	Warranty	End of Support	Ann Date (m/y)
10NS0001US	US	i5-7500	vPro	Intel HD 630	None	4GBx1	23.8" FHD (1920x1080) WVA AG	None	150W 85% Adapter	500GB 7200rpm 2.5" DVD±RW	DVD±RW	9-in-1	None	8265 ac, 2x2, vPro + BT4.1	None	1080p	None	None	USB / USB	UltraFlex II Stand	Win10 Pro 64	3-year, Onsite	Mar 28, 2023	02/17
10NS0003US	US	i5-7500	vPro	Intel HD 630	None	8GBx1	23.8" FHD (1920x1080) WVA AG	None	150W 85% Adapter	256GB SSD M.2 PCIe NVMe Opal	DVD±RW	9-in-1	None	8265 ac, 2x2, vPro + BT4.1	None	1080p	None	None	USB / USB	UltraFlex II Stand	Win10 Pro 64	3-year, Onsite	Mar 28, 2023	02/17
10NS0004US	US	i7-7700	vPro	Intel HD 630	None	8GBx1	23.8" FHD (1920x1080) WVA AG	None	150W 85% Adapter	512GB SSD M.2 PCIe NVMe Opal	DVD±RW	9-in-1	None	8265 ac, 2x2, vPro + BT4.1	None	1080p	None	None	USB / USB	UltraFlex II Stand	Win10 Pro 64	3-year, Onsite	Mar 28, 2023	02/17
10NS0006US	US	i7-7700	vPro	Intel HD 630	None	8GBx1	23.8" FHD (1920x1080) WVA AG	None	150W 85% Adapter	500GB 7200rpm 2.5" DVD±RW	DVD±RW	9-in-1	None	8265 ac, 2x2, vPro + BT4.1	None	1080p	None	None	USB / USB	UltraFlex II Stand	Win10 Pro 64	3-year, Onsite	Mar 28, 2023	02/17
10NS0007US	US	i5-7500	vPro	Intel HD 630	None	8GBx1	23.8" FHD (1920x1080) WVA AG	None	150W 85% Adapter	500GB 7200rpm 2.5" DVD±RW	DVD±RW	9-in-1	None	8265 ac, 2x2, vPro + BT4.1	None	1080p	None	None	USB / USB	UltraFlex II Stand	Win10 Pro 64	3-year, Onsite	Mar 28, 2023	02/17
10NS0008US	US	i5-7500	vPro	Intel HD 630	None	8GBx1	23.8" FHD (1920x1080) WVA AG	None	150W 85% Adapter	512GB SSD M.2 PCIe NVMe Opal	DVD±RW	9-in-1	None	8265 ac, 2x2, vPro + BT4.1	None	1080p	None	None	USB / USB	UltraFlex II Stand	Win10 Pro 64	3-year, Onsite	Mar 28, 2023	02/17
10NS000AUS	US	i7-7700	vPro	Intel HD 630	None	8GBx1	23.8" FHD (1920x1080) WVA AG	None	150W 85% Adapter	256GB SSD M.2 PCIe NVMe Opal	DVD±RW	9-in-1	None	8265 ac, 2x2, vPro + BT4.1	None	1080p	None	None	USB / USB	UltraFlex II Stand	Win10 Pro 64	3-year, Onsite	Mar 28, 2023	02/17
10NS000UUS	US	i5-6500	vPro	Intel HD 530	None	8GBx1	23.8" FHD (1920x1080) WVA AG	None	150W 85% Adapter	128GB SSD M.2 PCIe NVMe	DVD±RW	9-in-1	None	8265 ac, 2x2, vPro + BT4.1	None	1080p	None	None	USB / USB	UltraFlex II Stand	Win10 DG Win7 Pro 64	3-year, Onsite	Apr 29, 2023	03/17
10NS000VUS	US	i7-6700	vPro	Intel HD 530	None	8GBx1	23.8" FHD (1920x1080) WVA AG	None	150W 85% Adapter	500GB 7200rpm 2.5" DVD±RW	DVD±RW	9-in-1	None	8265 ac, 2x2, vPro + BT4.1	None	1080p	None	None	USB / USB	UltraFlex II Stand	Win10 DG Win7 Pro 64	3-year, Onsite	Apr 29, 2023	03/17
10NS000WUS	US	i5-6500	vPro	Intel HD 530	None	8GBx1	23.8" FHD (1920x1080) WVA AG	None	150W 85% Adapter	256GB SSD M.2 PCIe NVMe Opal	DVD±RW	9-in-1	None	8265 ac, 2x2, vPro + BT4.1	None	1080p	None	None	USB / USB	UltraFlex II Stand	Win10 DG Win7 Pro 64	3-year, Onsite	Apr 29, 2023	03/17
10NS000XUS	US	i5-6500	vPro	Intel HD 530	None	4GBx1	23.8" FHD (1920x1080) WVA AG	None	150W 85% Adapter	500GB 7200rpm 2.5" DVD±RW	DVD±RW	9-in-1	None	8265 ac, 2x2, vPro + BT4.1	None	1080p	None	None	USB / USB	UltraFlex II Stand	Win10 DG Win7 Pro 64	3-year, Onsite	Apr 29, 2023	03/17
10NS000YUS	US	i7-6700	vPro	Intel HD 530	None	8GBx1	23.8" FHD (1920x1080) WVA AG	None	150W 85% Adapter	256GB SSD M.2 PCIe NVMe Opal	DVD±RW	9-in-1	None	8265 ac, 2x2, vPro + BT4.1	None	1080p	None	None	USB / USB	UltraFlex II Stand	Win10 DG Win7 Pro 64	3-year, Onsite	Apr 29, 2023	03/17
10NS0010US	US	i5-6500	vPro	Intel HD 530	None	8GBx1	23.8" FHD (1920x1080) WVA AG	None	150W 85% Adapter	500GB 7200rpm 2.5" DVD±RW	DVD±RW	9-in-1	None	8265 ac, 2x2, vPro + BT4.1	None	1080p	None	None	USB / USB	UltraFlex II Stand	Win10 DG Win7 Pro 64	3-year, Onsite	Apr 29, 2023	03/17
10NS0011US	US	i5-7500	vPro	Intel HD 630	None	8GBx1	23.8" FHD (1920x1080) WVA AG	None	150W 85% Adapter	128GB SSD M.2 PCIe NVMe	DVD±RW	9-in-1	None	8265 ac, 2x2, vPro + BT4.1	None	1080p	None	None	USB / USB	UltraFlex II Stand	Win10 Pro 64	3-year, Onsite	May 7, 2023	04/17
10NS0012US	US	i7-6700	vPro	Intel HD 530	None	8GBx1	23.8" FHD (1920x1080) WVA AG	None	150W 85% Adapter	512GB SSD M.2 PCIe NVMe Opal	DVD±RW	9-in-1	None	8265 ac, 2x2, vPro + BT4.1	None	1080p	None	None	USB / USB	UltraFlex II Stand	Win10 DG Win7 Pro 64	3-year, Onsite	Apr 29, 2023	03/17
10NS0013US	US	i7-7700	vPro	Intel HD 630	None	8GBx1	23.8" FHD (1920x1080) WVA AG	None	150W 85% Adapter	128GB SSD M.2 PCIe NVMe	DVD±RW	9-in-1	None	8265 ac, 2x2, vPro + BT4.1	None	1080p	None	None	USB / USB	UltraFlex II Stand	Win10 Pro 64	3-year, Onsite	May 7, 2023	04/17
10NS0014US	US	i5-6500	vPro	Intel HD 530	None	8GBx1	23.8" FHD (1920x1080) WVA AG	None	150W 85% Adapter	512GB SSD M.2 PCIe NVMe Opal	DVD±RW	9-in-1	None	8265 ac, 2x2, vPro + BT4.1	None	1080p	None	None	USB / USB	UltraFlex II Stand	Win10 DG Win7 Pro 64	3-year, Onsite	Apr 29, 2023	03/17
10NS0015US	US	i7-6700	vPro	Intel HD 530	None	8GBx1	23.8" FHD (1920x1080) WVA AG	None	150W 85% Adapter	128GB SSD M.2 PCIe NVMe	DVD±RW	9-in-1	None	8265 ac, 2x2, vPro + BT4.1	None	1080p	None	None	USB / USB	UltraFlex II Stand	Win10 DG Win7 Pro 64	3-year, Onsite	Apr 29, 2023	03/17
10NS0016US	US	i5-7500	vPro	Intel HD 630	None	4GBx1	23.8" FHD (1920x1080) WVA AG	None	150W 85% Adapter	128GB SSD M.2 PCIe NVMe	DVD±RW	9-in-1	None	8265 ac, 2x2, vPro + BT4.1	None	1080p	None	None	USB / USB	UltraFlex II Stand	Win10 Pro 64	3-year, Onsite	May 7, 2023	04/17
10NS0017US	US	i5-6500	vPro	Intel HD 530	None	4GBx1	23.8" FHD (1920x1080) WVA AG	None	150W 85% Adapter	128GB SSD M.2 PCIe NVMe	DVD±RW	9-in-1	None	8265 ac, 2x2, vPro + BT4.1	None	1080p	None	None	USB / USB	UltraFlex II Stand	Win10 DG Win7 Pro 64	3-year, Onsite	Apr 29, 2023	03/17



ThinkCentre M600 Tiny Platform Specifications

Product Specifications Reference (PSREF)

Processor	Intel® Celeron® Processor N3000 Series or Intel Pentium® Processor N3000 Series						Keyboard <i>Some:</i> Preferred Pro USB Keyboard (USB connector), Lenovo logo <i>Some:</i> Lenovo USB Fingerprint Keyboard (USB connector) <i>Some:</i> Ultralim Plus Wireless Keyboard (2.4GHz via USB receiver), black <i>Some:</i> Enhanced Optical USB Mouse, black, Lenovo logo <i>Some:</i> Ultralim Plus Wireless Mouse (2.4GHz via USB receiver), black												
	Processor	Cores / Threads	Frequency (Base/Max)	Cache	Memory Types	Integrated Graphics													
	Celeron N3050	2 / 2	1.6 / 2.16 GHz	2MB	DDR3L-1600	Intel HD													
	Celeron J3060	2 / 2	1.6 / 2.48 GHz	2MB	DDR3L-1600	Intel HD 400													
	Pentium N3700	4 / 4	1.6 / 2.4 GHz	2MB	DDR3L-1600	Intel HD													
	Pentium J3710	4 / 4	1.6 / 2.64 GHz	2MB	DDR3L-1600	Intel HD 405													
Chipset	Intel Architecture (IA) SoC that integrates Intel processor core, graphics, memory controller, and I/O interfaces into a single system-on-chip solution						<table border="1"> <tr> <td></td> <td>Dimensions (WxDxH)</td> <td>Max weight (lb / kg)</td> </tr> <tr> <td>M600 Tiny only (1L)</td> <td>7.05" X 7.20" X 1.36" 179mm X 182.9mm X 34.5mm</td> <td>2.9 lb (1.3 kg)</td> </tr> <tr> <td>M600 Tiny (1L) with VESA mount & ODD box</td> <td>7.42" X 7.30" X 2.48" 188.4mm X 185.38mm X 63mm</td> <td>4.12 lb (1.87 kg)</td> </tr> <tr> <td>M600 Tiny (1L) with VESA mount & I/O box</td> <td>7.42" X 7.30" X 2.62" 188.4mm X 185.38mm X 66.6mm</td> <td>3.53 lb (1.6 kg)</td> </tr> </table>		Dimensions (WxDxH)	Max weight (lb / kg)	M600 Tiny only (1L)	7.05" X 7.20" X 1.36" 179mm X 182.9mm X 34.5mm	2.9 lb (1.3 kg)	M600 Tiny (1L) with VESA mount & ODD box	7.42" X 7.30" X 2.48" 188.4mm X 185.38mm X 63mm	4.12 lb (1.87 kg)	M600 Tiny (1L) with VESA mount & I/O box	7.42" X 7.30" X 2.62" 188.4mm X 185.38mm X 66.6mm	3.53 lb (1.6 kg)
	Dimensions (WxDxH)	Max weight (lb / kg)																	
M600 Tiny only (1L)	7.05" X 7.20" X 1.36" 179mm X 182.9mm X 34.5mm	2.9 lb (1.3 kg)																	
M600 Tiny (1L) with VESA mount & ODD box	7.42" X 7.30" X 2.48" 188.4mm X 185.38mm X 63mm	4.12 lb (1.87 kg)																	
M600 Tiny (1L) with VESA mount & I/O box	7.42" X 7.30" X 2.62" 188.4mm X 185.38mm X 66.6mm	3.53 lb (1.6 kg)																	
Graphics	Intel HD Graphics in processor, uses main memory, DirectX® 11.1, twoDisplayPort™, one optional 3rd DP (not support DP to HDMI dongle) or VGA, supports triple independent display; Maximum resolution: 3840x2160(DP)@30Hz; 1920x1200(optional VGA)@60Hz; 1920x1080(DP to VGA dongle)@60Hz; 1920x1080(DP to DVI dongle)@60Hz; 3840x2160(DP to HDMI dongle)@30Hz																		
Monitor cable	Optional DP to VGA, DP to DVI-D (single link), or DP to HDMI 1.4 dongle																		
Memory	8GB max / DDR3 Low Voltage, DDR3L-1600, non-parity, one 204-pin SO-DIMM socket																		
Storage	<i>Some:</i> hard disk, 5400 or 7200 rpm, SATA 6.0Gb/s, 2.5" Wide <i>Some:</i> 500GB (5400 rpm) Solid State Hybrid Drive (SSHD) / with 8GB MLC NAND flash memory, SATA 6.0Gb/s, 2.5" wide																		
Optical	<i>Some:</i> Solid State Drive (SSD) / SATA 6.0Gb/s, 2.5" Wide <i>Some:</i> external ODD box with DVD-ROM, 9.5mm high, via USB <i>Some:</i> external ODD box with DVD±RW, 9.5mm high, via USB <i>Some:</i> external ODD box (for TIO) with DVD-ROM, 9.5mm high, via USB <i>Some:</i> external ODD box (for TIO) with DVD±RW, 9.5mm high, via USB																		
Onboard SATA Media reader	SATA 6.0Gb/s controller, one connectors on planar None																		
Front ports	Two USB 3.0 (one is Always On and fast charge), one microphone (stereo, 3.5mm), one headphone / microphone combo jack (stereo, 3.5mm)																		
Rear ports	Two USB 2.0, two USB 3.0 (optional external optical box or I/O box occupies one or two specific USB on some models), ethernet (RJ-45), two DisplayPort, one optional port (VGA, 3rd DP, or serial on some models), one headphone																		
I/O box	Optional external I/O box, extends two USB 2.0, two USB 3.0, and one serial on rear, two USB 2.0 on front, via USB (occupy two specific USB 3.0 of M600 Tiny)																		
Audio support	High Definition (HD) Audio, Realtek ALC223 / optional internal speaker (1 watt)																		
WLAN ¹³	<i>Some:</i> 11ac wireless, M.2 Card, Realtek RTL8821AE (dual band), Wi-Fi + Bluetooth 4.0 combo adapter, 1x1 <i>Some:</i> 11ac wireless, M.2 Card, Qualcomm Atheros QCA9377 (dual band), Wi-Fi + Bluetooth 4.1 combo adapter, 1x1 <i>Some:</i> 11ac wireless, M.2 Card, Qualcomm Atheros QCA6174 (dual band), Wi-Fi + Bluetooth 4.1 combo adapter, 2x2 <i>Some:</i> 11ac wireless, M.2 Card, Intel Dual Band Wireless-AC 3165, Wi-Fi + Bluetooth 4.0 combo adapter, 1x1 <i>Some:</i> 11ac wireless, M.2 Card, Intel Dual Band Wireless-AC 8260, Wi-Fi + Bluetooth 4.1 combo adapter, 2x2																		
Bluetooth™ Ethernet Modem	<i>Some:</i> Bluetooth 4.0 or 4.1 wireless, integrated in Wi-Fi + BT combo adapter One gigabit ethernet port, Realtek RTL8111GN, Wake on LAN® None																		
Manageability Security chip	None Trusted Platform Module, TCG 1.2-compliant																		
Security features	<ul style="list-style-type: none"> Security slot (in rear for optional Kensington® MicroSaver® cable) Padlock loop Smart USB protection, allows keyboard/ mouse only, blocks all storage devices Power-on password Administrator password Hard disk password Boot sequence control Boot without keyboard and mouse Individual USB port disablement Chassis intrusion switch 																		
Environment	ENERGY STAR® 6.0*, EPEAT™ Gold rating* (*not for non-OS models); GREENGUARD®; RoHS-compliant; Cisco EnergyWise compatible; ErP Lot 3																		
Accessories	For compatible accessories, please go to TC-AQP sheet																		

See footnotes for more detailed information

© Lenovo
(M600 Tiny Spec) November 2017

Model	Region	Case 1L/2L	Processor	vPro	Graphics	Monitor Cable	Memory	Storage	External Optical / I/O Box	WLAN + Bluetooth	Optional Rear Ports	Chassis Intrusion Switch	Kensington Cable Lock	Speaker	Adapter Cage	Toolless Chassis Screw	Keyboard / Mouse	VESA Mount	Stand	Power Supply	Operating System	Warranty	Ann Date (m/y)
10G9000NUS	US	1L	Pentium N3700	No	Intel HD	None	4GBx1	500GB 7200rpm 2.5"	None	Intel 8260 ac, 2x2 + BT4.1	None	Switch	None	1Wx1	None	None	USB / USB	None	Floor Stand	65W 88% Adapter	Win10 DG Win7 Pro 64	1-year, Onsite	10/15
10G9000WUS	US	1L	Pentium N3700	No	Intel HD	None	4GBx1	500GB 7200rpm 2.5"	None	Intel 3165 ac, 1x1 + BT4.0	Serial	Switch	None	1Wx1	None	None	USB / USB	None	Floor Stand	65W 88% Adapter	Win10 DG Win7 Pro 64	1-year, Onsite	04/16
10G9000XUS	US	1L	Pentium N3700	No	Intel HD	None	4GBx1	500GB 7200rpm 2.5"	None	Intel 3165 ac, 1x1 + BT4.0	VGA	Switch	None	1Wx1	None	None	USB / USB	None	Floor Stand	65W 88% Adapter	Win10 DG Win7 Pro 64	1-year, Onsite	05/16
10G9000YUS	US	1L	Pentium N3700	No	Intel HD	None	4GBx1	500GB 7200rpm 2.5"	None	Intel 3165 ac, 1x1 + BT4.0	3rd DP	Switch	None	1Wx1	None	None	USB / USB	None	Floor Stand	65W 88% Adapter	Win10 Pro 64	1-year, Onsite	05/16
10G90010US	US	1L	Pentium N3700	No	Intel HD	None	4GBx1	500GB 7200rpm 2.5"	None	Intel 3165 ac, 1x1 + BT4.0	Serial	Switch	None	1Wx1	None	None	USB / USB	None	Floor Stand	65W 88% Adapter	Win10 Pro 64	1-year, Onsite	05/16
10G90011US	US	1L	Pentium N3700	No	Intel HD	None	4GBx1	128GB SSD	None	Intel 3165 ac, 1x1 + BT4.0	None	Switch	None	1Wx1	None	None	USB / USB	None	Floor Stand	65W 88% Adapter	Win10 Pro 64	1-year, Onsite	05/16
10G90012US	US	1L	Pentium N3700	No	Intel HD	None	4GBx1	500GB 7200rpm 2.5"	None	Intel 3165 ac, 1x1 + BT4.0	None	Switch	None	1Wx1	None	None	USB / USB	None	Floor Stand	65W 88% Adapter	Win10 Pro 64	1-year, Onsite	05/16
10G90013US	US	1L	Pentium N3700	No	Intel HD	None	4GBx1	128GB SSD	None	Intel 3165 ac, 1x1 + BT4.0	None	Switch	None	1Wx1	None	None	USB / USB	None	Floor Stand	65W 88% Adapter	Win10 DG Win7 Pro 64	1-year, Onsite	05/16
10G90014US	US	1L	Pentium N3700	No	Intel HD	None	4GBx1	500GB 7200rpm 2.5"	None	Intel 3165 ac, 1x1 + BT4.0	None	Switch	None	1Wx1	None	None	USB / USB	None	Floor Stand	65W 88% Adapter	Win10 DG Win7 Pro 64	1-year, Onsite	05/16
10G90015US	US	1L	Pentium N3700	No	Intel HD	None	4GBx1	500GB 7200rpm 2.5"	None	Intel 3165 ac, 1x1 + BT4.0	VGA	Switch	None	1Wx1	None	None	USB / USB	None	Floor Stand	65W 88% Adapter	Win10 Pro 64	1-year, Onsite	05/16
10G90016US	US	1L	Pentium N3700	No	Intel HD	None	4GBx1	500GB 7200rpm 2.5"	None	Intel 3165 ac, 1x1 + BT4.0	3rd DP	Switch	None	1Wx1	None	None	USB / USB	None	Floor Stand	65W 88% Adapter	Win10 DG Win7 Pro 64	1-year, Onsite	05/16
10G9001CUS	US	1L	Pentium J3710	No	Intel HD 405	None	4GBx1	128GB SSD	None	Intel 8260 ac, 2x2 + BT4.1	3rd DP	Switch	None	1Wx1	None	None	USB / USB	None	Floor Stand	65W 88% Adapter	Win10 Pro 64	1-year, Onsite	07/16
10G9001DUS	US	1L	Pentium J3710	No	Intel HD 405	None	4GBx1	500GB 7200rpm 2.5"	None	Intel 3165 ac, 1x1 + BT4.0	3rd DP	Switch	None	1Wx1	None	None	USB / USB	None	Floor Stand	65W 88% Adapter	Win10 Pro 64	1-year, Onsite	07/16
10G9001EUS	US	1L	Pentium J3710	No	Intel HD 405	None	4GBx1	500GB 7200rpm 2.5"	None	Intel 3165 ac, 1x1 + BT4.0	VGA	Switch	None	1Wx1	None	None	USB / USB	None	Floor Stand	65W 88% Adapter	Win10 Pro 64	1-year, Onsite	07/16
10G9001FUS	US	1L	Pentium J3710	No	Intel HD 405	None	4GBx1	500GB 7200rpm 2.5"	None	Intel 3165 ac, 1x1 + BT4.0	None	Switch	None	1Wx1	None	None	USB / USB	None	Floor Stand	65W 88% Adapter	Win10 Pro 64	1-year, Onsite	07/16
10G9001GUS	US	1L	Pentium J3710	No	Intel HD 405	None	4GBx1	128GB SSD	None	Intel 3165 ac, 1x1 + BT4.0	None	Switch	None	1Wx1	None	None	USB / USB	None	Floor Stand	65W 88% Adapter	Win10 Pro 64	1-year, Onsite	07/16
10G9001HUS	US	1L	Pentium J3710	No	Intel HD 405	None	4GBx1	500GB 7200rpm 2.5"	None	Intel 3165 ac, 1x1 + BT4.0	Serial	Switch	None	1Wx1	None	None	USB / USB	None	Floor Stand	65W 88% Adapter	Win10 Pro 64	1-year, Onsite	07/16
10G9001QUS	US	1L	Pentium J3710	No	Intel HD 405	None	4GBx1	500GB 7200rpm 2.5"	None	Intel 8260 ac, 2x2 + BT4.1	3rd DP	Switch	None	1Wx1	None	None	USB / USB	None	Floor Stand	65W 88% Adapter	Win10 DG Win7 Pro 64	1-year, Onsite	09/16
10G9001RUS	US	1L	Pentium J3710	No	Intel HD 405	None	4GBx1	128GB SSD	None	Intel 3165 ac, 1x1 + BT4.0	None	Switch	None	1Wx1	None	None	USB / USB	None	Floor Stand	65W 88% Adapter	Win10 DG Win7 Pro 64	1-year, Onsite	09/16
10G9001SUS	US	1L	Pentium J3710	No	Intel HD 405	None	4GBx1	500GB 7200rpm 2.5"	None	Intel 3165 ac, 1x1 + BT4.0	3rd DP	Switch	None	1Wx1	None	None	USB / USB	None	Floor Stand	65W 88% Adapter	Win10 DG Win7 Pro 64	1-year, Onsite	09/16

Model	Region	Case 1L/2L	Processor	vPro	Graphics	Monitor Cable	Memory	Storage	External Optical / I/O Box	WLAN + Bluetooth	Optional Rear Ports	Chassis Intrusion Switch	Kensington Cable Lock	Speaker	Adapter Cage	Toolless Chassis Screw	Keyboard / Mouse	VESA Mount	Stand	Power Supply	Operating System	Warranty	Ann Date (m/y)
10G9001TUS	US	1L	Pentium J3710	No	Intel HD 405	None	4GBx1	128GB SSD	None	Intel 8260 ac, 2x2 + BT4.1	3rd DP	Switch	None	1Wx1	None	None	USB / USB	None	Floor Stand	65W 88% Adapter	Win10 DG Win7 Pro 64	1-year, Onsite	09/16
10G9001UUS	US	1L	Pentium J3710	No	Intel HD 405	None	4GBx1	500GB 7200rpm 2.5"	None	Intel 3165 ac, 1x1 + BT4.0	None	Switch	None	1Wx1	None	None	USB / USB	None	Floor Stand	65W 88% Adapter	Win10 DG Win7 Pro 64	1-year, Onsite	09/16
10G9001VUS	US	1L	Pentium J3710	No	Intel HD 405	None	4GBx1	500GB 7200rpm 2.5"	None	Intel 3165 ac, 1x1 + BT4.0	Serial	Switch	None	1Wx1	None	None	USB / USB	None	Floor Stand	65W 88% Adapter	Win10 DG Win7 Pro 64	1-year, Onsite	09/16
10G9001WUS	US	1L	Pentium J3710	No	Intel HD 405	None	4GBx1	500GB 7200rpm 2.5"	None	Intel 3165 ac, 1x1 + BT4.0	VGA	Switch	None	1Wx1	None	None	USB / USB	None	Floor Stand	65W 88% Adapter	Win10 DG Win7 Pro 64	1-year, Onsite	09/16

ThinkCentre M600 Tiny - TopSeller - 10GB

Product Specifications Reference (PSREF)

Model	Region	Case 1L/2L	Processor	vPro	Graphics	Monitor Cable	Memory	Storage	External Optical / I/O Box	WLAN + Bluetooth	Optional Rear Ports	Chassis Intrusion Switch	Kensington Cable Lock	Speaker	Adapter Cage	Toolless Chassis Screw	Keyboard / Mouse	VESA Mount	Stand	Power Supply	Operating System	Warranty	Ann Date (m/y)
10GB000JUS	US	1L	Celeron N3050	No	Intel HD	None	4GBx1	500GB 7200rpm 2.5"	None	Intel 8260 ac, 2x2 + BT4.1	None	Switch	None	1Wx1	None	None	USB / USB	None	Floor Stand	65W 88% Adapter	Win10 Pro 64	3-year, Onsite	10/15
10GB000KUS	US	1L	Celeron N3050	No	Intel HD	None	4GBx1	500GB 7200rpm 2.5"	None	Intel 8260 ac, 2x2 + BT4.1	None	Switch	None	1Wx1	None	None	USB / USB	None	Floor Stand	65W 88% Adapter	Win10 DG Win7 Pro 64	3-year, Onsite	10/15
10GB000LUS	US	1L	Celeron N3050	No	Intel HD	None	4GBx1	120GB SSD	None	Intel 8260 ac, 2x2 + BT4.1	None	Switch	None	1Wx1	None	None	USB / USB	None	Floor Stand	65W 88% Adapter	Win10 DG Win7 Pro 64	3-year, Onsite	10/15
10GB000MUS	US	1L	Celeron N3050	No	Intel HD	None	4GBx1	120GB SSD	None	Intel 8260 ac, 2x2 + BT4.1	None	Switch	None	1Wx1	None	None	USB / USB	None	Floor Stand	65W 88% Adapter	Win10 Pro 64	3-year, Onsite	10/15

Model	Region	Case 1L/2L	Processor	vPro	Graphics	Monitor Cable	Memory	Storage	External Optical / I/O Box	WLAN + Bluetooth	Optional Rear Ports	Chassis Intrusion Switch	Kensington Cable Lock	Speaker	Adapter Cage	Toolless Chassis Screw	Keyboard / Mouse	VESA Mount	Stand	Power Supply	Operating System	Warranty	Ann Date (m/y)
10G8000QUS	US	1L	Pentium N3700	No	Intel HD	None	4GBx1	500GB 7200rpm 2.5"	DVD±RW	QCA6174 ac, 2x2 + BT4.1	None	Switch	None	1Wx1	None	None	USB / USB	VESA Mount	None	65W 88% Adapter	Win10 DG Win7 Pro 64	3-year, Onsite, OID	10/15
10G8000RUS	US	1L	Pentium N3700	No	Intel HD	None	4GBx1	500GB 7200rpm 2.5"	DVD±RW	QCA6174 ac, 2x2 + BT4.1	None	Switch	None	1Wx1	None	None	USB / USB	VESA Mount	None	65W 88% Adapter	Win10 Pro 64	3-year, Onsite, OID	10/15
10G8000SUS	US	1L	Pentium N3700	No	Intel HD	None	2GBx1	500GB 7200rpm 2.5"	None	QCA9377 ac, 1x1 + BT4.1	None	Switch	None	1Wx1	None	None	USB / USB	None	None	65W 88% Adapter	Win10 Pro 64	3-year, Onsite, OID	10/15
10G8000TUS	US	1L	Pentium N3700	No	Intel HD	None	2GBx1	500GB 7200rpm 2.5"	None	QCA9377 ac, 1x1 + BT4.1	None	Switch	None	1Wx1	None	None	USB / USB	None	None	65W 88% Adapter	Win10 DG Win7 Pro 64	3-year, Onsite, OID	10/15

ThinkCentre M600 Tiny - 10GA

Product Specifications Reference (PSREF)

Model	Region	Case 1L/2L	Processor	vPro	Graphics	Monitor Cable	Memory	Storage	External Optical / I/O Box	WLAN + Bluetooth	Optional Rear Ports	Chassis Intrusion Switch	Kensington Cable Lock	Speaker	Adapter Cage	Toolless Chassis Screw	Keyboard / Mouse	VESA Mount	Stand	Power Supply	Operating System	Warranty	Ann Date (m/y)
10GA000JUS	US	1L	Celeron N3050	No	Intel HD	None	2GBx1	500GB 7200rpm 2.5"	None	None	None	Switch	None	1Wx1	None	None	USB / USB	None	None	65W 88% Adapter	Win10 DG Win7 Pro 64	3-year, Onsite, OID	10/15
10GA000KUS	US	1L	Celeron N3050	No	Intel HD	None	2GBx1	500GB 7200rpm 2.5"	DVD±RW	None	None	Switch	None	1Wx1	None	None	USB / USB	VESA Mount	None	65W 88% Adapter	Win10 Pro 64	3-year, Onsite, OID	10/15

ThinkCentre M600 Tiny - 10GC

Product Specifications Reference (PSREF)

Model	Region	Case 1L/2L	Processor	vPro	Graphics	Monitor Cable	Memory	Storage	External Optical / I/O Box	WLAN + Bluetooth	Optional Rear Ports	Chassis Intrusion Switch	Kensington Cable Lock	Speaker	Adapter Cage	Toolless Chassis Screw	Keyboard / Mouse	VESA Mount	Stand	Power Supply	Operating System	Warranty	Ann Date (m/y)
10GC0001US	US	1L	Pentium N3700	No	Intel HD	None	4GBx1	500GB 7200rpm 2.5"	DVD±RW (TIO)	QCA6174 ac, 2x2 + BT4.1	None	Switch	None	1Wx1	None	None	USB / USB	None	None	None	Win10 Pro 64	3-year, Onsite, OID	10/15
10GC0002US	US	1L	Pentium N3700	No	Intel HD	None	4GBx1	500GB 7200rpm 2.5"	None	QCA6174 ac, 2x2 + BT4.1	None	Switch	None	1Wx1	None	None	USB / USB	None	None	None	Win10 DG Win7 Pro 64	3-year, Onsite, OID	10/15

ThinkCentre M600 Tiny - 10GE

Product Specifications Reference (PSREF)

Model	Region	Case 1L/2L	Processor	vPro	Graphics	Monitor Cable	Memory	Storage	External Optical / I/O Box	WLAN + Bluetooth	Optional Rear Ports	Chassis Intrusion Switch	Kensington Cable Lock	Speaker	Adapter Cage	Toolless Chassis Screw	Keyboard / Mouse	VESA Mount	Stand	Power Supply	Operating System	Warranty	Ann Date (m/y)
10GE0001US	US	1L	Celeron N3050	No	Intel HD	None	2GBx1	500GB 7200rpm 2.5"	None	QCA9377 ac, 1x1 + BT4.1	None	Switch	None	1Wx1	None	None	USB / USB	None	None	None	Win10 DG Win7 Pro 64	3-year, Onsite, OID	10/15



ThinkCentre M600 Tiny Thin Client Platform Specifications

Product Specifications Reference (PSREF)

Processor	Intel® Celeron® Processor N3000 Series or Intel Pentium® Processor N3000 Series	Keyboard	Some: PS/2 Keyboard (PS/2 connector), Lenovo logo (for 2L models) Some: Preferred Pro USB Keyboard (USB connector), Lenovo logo																		
	<table border="1"> <thead> <tr> <th>Processor</th> <th>Cores / Threads</th> <th>Frequency (Base/Max)</th> <th>Cache</th> <th>Memory Types</th> <th>Integrated Graphics</th> </tr> </thead> <tbody> <tr> <td>Celeron N3000</td> <td>2 / 2</td> <td>1.04 / 2.08 GHz</td> <td>2MB</td> <td>DDR3L-1600</td> <td>Intel HD</td> </tr> <tr> <td>Celeron N3010</td> <td>2 / 2</td> <td>1.04 / 2.24 GHz</td> <td>2MB</td> <td>DDR3L-1600</td> <td>Intel HD 400</td> </tr> </tbody> </table>	Processor	Cores / Threads	Frequency (Base/Max)	Cache	Memory Types	Integrated Graphics	Celeron N3000	2 / 2	1.04 / 2.08 GHz	2MB	DDR3L-1600	Intel HD	Celeron N3010	2 / 2	1.04 / 2.24 GHz	2MB	DDR3L-1600	Intel HD 400	Mouse	Some: Ultralim Plus Wireless Keyboard (2.4GHz via USB receiver), black Some: PS/2 Optical Wheel Mouse, black, Lenovo logo (for 2L models) Some: Enhanced Optical USB Mouse, black, Lenovo logo Some: Ultralim Plus Wireless Mouse (2.4GHz via USB receiver), black
Processor	Cores / Threads	Frequency (Base/Max)	Cache	Memory Types	Integrated Graphics																
Celeron N3000	2 / 2	1.04 / 2.08 GHz	2MB	DDR3L-1600	Intel HD																
Celeron N3010	2 / 2	1.04 / 2.24 GHz	2MB	DDR3L-1600	Intel HD 400																
Chipset	Intel Architecture (IA) SoC that integrates Intel processor core, graphics, memory controller, and I/O interfaces into a single system-on-chip solution	Mechanical	<ul style="list-style-type: none"> Tiny (1L or 2L), black color, metal case <table border="1"> <thead> <tr> <th></th> <th>Dimensions (WxDxH)</th> <th>Max weight (lb / kg)</th> </tr> </thead> <tbody> <tr> <td>M600 Tiny only (1L)</td> <td>7.05" X 7.20" X 1.36" 179mm X 182.9mm X 34.5mm</td> <td>2.9 lb (1.3 kg)</td> </tr> <tr> <td>M600 Tiny only (2L)</td> <td>7.05" X 7.20" X 3.15" 179mm X 182.9mm X 80mm</td> <td>4.2 lb (1.9 kg)</td> </tr> </tbody> </table>		Dimensions (WxDxH)	Max weight (lb / kg)	M600 Tiny only (1L)	7.05" X 7.20" X 1.36" 179mm X 182.9mm X 34.5mm	2.9 lb (1.3 kg)	M600 Tiny only (2L)	7.05" X 7.20" X 3.15" 179mm X 182.9mm X 80mm	4.2 lb (1.9 kg)									
	Dimensions (WxDxH)	Max weight (lb / kg)																			
M600 Tiny only (1L)	7.05" X 7.20" X 1.36" 179mm X 182.9mm X 34.5mm	2.9 lb (1.3 kg)																			
M600 Tiny only (2L)	7.05" X 7.20" X 3.15" 179mm X 182.9mm X 80mm	4.2 lb (1.9 kg)																			
Graphics	Intel HD Graphics in processor, uses main memory, DirectX® 11.1, twoDisplayPort™, one optional 3rd DP (not support DP to HDMI dongle) or VGA, supports triple independent display; Maximum resolution: 3840x2160(DP)@30Hz; 1920x1200(optional VGA)@60Hz; 1920x1080(DP to VGA dongle)@60Hz; 1920x1080(DP to DVI dongle)@60Hz; 3840x2160(DP to HDMI dongle)@30Hz	VESA mount	Optional VESA mount bracket kit, supports VESA 75mm and 100mm																		
Monitor cable	Optional DP to VGA, DP to DVI-D (single link), or DP to HDMI 1.4 dongle	Floor Stand	Optional system floor stand for vertical orientation																		
Memory	8GB max / DDR3 Low Voltage, DDR3L-1600, non-parity, one 204-pin SO-DIMM socket	Power supply	65 watts AC/DC adapter, autosensing, 88% PSU (not included for TIO models)																		
Storage	16GB, 32GB, or 128GB M.2 Solid State Drive (SSD), SATA interface	Limited warranty ³	Some: 1-year or 3-year, depot service / service upgrades available Some: 1-year or 3-year, limited onsite service / service upgrades available Some: 3-year, limited onsite service, OID (Onsite International Delivery) / service upgrades available <i>For Lenovo service upgrade options, please go to S-TC sheet</i>																		
Optical	None	Preload	Some: Windows Embedded Standard 7 (WES 7) Some: Windows Embedded Standard 7 V2 (WES 7 V2) Some: Windows 10 IoT Enterprise Some: LeTOS (Lenovo Terminal Operating System, Linux-based) Some: LeTOS V2 (Lenovo Terminal Operating System, Linux-based)																		
Onboard SATA	SATA 6.0Gb/s controller, one connectors on planar	Environment	ENERGY STAR® 6.0*, EPEAT™ Gold rating* (*not for non-OS models); GREENGUARD®; RoHS-compliant; Cisco EnergyWise compatible; ErP Lot 3																		
Media reader	None	Accessories	For compatible accessories, please go to TC-AQP sheet																		
Front ports	Two USB 3.0 (one is Always On and fast charge), one microphone (stereo, 3.5mm), one headphone / microphone combo jack (stereo, 3.5mm)																				
Rear ports	Two USB 2.0, two USB 3.0, ethernet (RJ-45), two DisplayPort, one optional port (VGA, 3rd DP, or serial on some models), one headphone; additional four serial (9-pin), one parallel (25-pin), and two PS/2 ports on 2L models																				
I/O box	None																				
Audio support	High Definition (HD) Audio, Realtek ALC223 / optional internal speaker (1 watt)																				
WLAN ¹³	Some: 11ac wireless, M.2 Card, Realtek RTL8821AE (dual band), Wi-Fi + Bluetooth 4.0 combo adapter, 1x1 Some: 11ac wireless, M.2 Card, Qualcomm Atheros QCA9377 (dual band), Wi-Fi + Bluetooth 4.1 combo adapter, 1x1 Some: 11ac wireless, M.2 Card, Qualcomm Atheros QCA6174 (dual band), Wi-Fi + Bluetooth 4.1 combo adapter, 2x2 Some: 11ac wireless, M.2 Card, Intel Dual Band Wireless-AC 3165, Wi-Fi + Bluetooth 4.0 combo adapter, 1x1 (only for 1L models)																				
Bluetooth™	Some: Bluetooth 4.0 or 4.1 wireless, integrated in Wi-Fi + BT combo adapter																				
Ethernet	One gigabit ethernet port, Realtek RTL8111GN, Wake on LAN®																				
Modem	None																				
Manageability	None																				
Security chip	Trusted Platform Module, TCG 1.2-compliant																				
Security features	<ul style="list-style-type: none"> Security slot (in rear for optional Kensington® MicroSaver® cable) Padlock loop Smart USB protection, allows keyboard/mouse only, blocks all storage devices Power-on password 	<ul style="list-style-type: none"> Administrator password Hard disk password Boot sequence control Boot without keyboard and mouse Individual USB port disablement Chassis intrusion switch 																			

See footnotes for more detailed information

© Lenovo
(M600 Tiny Thin Client Spec) November 2017

Model	Region	Case 1L/2L	Processor	vPro	Graphics	Monitor Cable	Memory	Storage	External Optical / I/O Box	WLAN + Bluetooth	Optional Rear Ports	Chassis Intrusion Switch	Kensington Cable Lock	Speaker	Adapter Cage	Toolless Chassis Screw	Keyboard / Mouse	VESA Mount	Stand	Power Supply	Operating System	Warranty	Ann Date (m/y)
10KH0001US	US	1L	Celeron N3000	No	Intel HD	None	2GBx1	16GB SSD M.2	None	RTL8821AE ac, 1x1 + BT4.0	None	Switch	None	1Wx1	None	None	USB / USB	None	Floor Stand	65W 88% Adapter	WES 7	1-year, Onsite	01/16
10KH0003US	US	1L	Celeron N3000	No	Intel HD	None	4GBx1	16GB SSD M.2	None	RTL8821AE ac, 1x1 + BT4.0	VGA	Switch	None	1Wx1	None	None	USB / USB	None	Floor Stand	65W 88% Adapter	WES 7	1-year, Onsite	01/16
10KH0007US	US	1L	Celeron N3000	No	Intel HD	None	4GBx1	16GB SSD M.2	None	RTL8821AE ac, 1x1 + BT4.0	None	Switch	None	1Wx1	None	None	USB / USB	None	Floor Stand	65W 88% Adapter	WES 7	1-year, Onsite	01/16
10KH0008US	US	1L	Celeron N3000	No	Intel HD	None	4GBx1	16GB SSD M.2	None	RTL8821AE ac, 1x1 + BT4.0	3rd DP	Switch	None	1Wx1	None	None	USB / USB	None	Floor Stand	65W 88% Adapter	WES 7	1-year, Onsite	01/16
10KH000BUS	US	1L	Celeron N3000	No	Intel HD	None	2GBx1	16GB SSD M.2	None	RTL8821AE ac, 1x1 + BT4.0	None	Switch	None	1Wx1	None	None	USB / USB	None	Floor Stand	65W 88% Adapter	LeTOS	1-year, Onsite	01/16
10KH000CUS	US	1L	Celeron N3000	No	Intel HD	None	4GBx1	16GB SSD M.2	None	RTL8821AE ac, 1x1 + BT4.0	3rd DP	Switch	None	1Wx1	None	None	USB / USB	None	Floor Stand	65W 88% Adapter	LeTOS	1-year, Onsite	01/16
10KH000FUS	US	1L	Celeron N3000	No	Intel HD	None	4GBx1	16GB SSD M.2	None	RTL8821AE ac, 1x1 + BT4.0	None	Switch	None	1Wx1	None	None	USB / USB	None	Floor Stand	65W 88% Adapter	LeTOS	1-year, Onsite	01/16
10KH0023US	US	1L	Celeron N3010	No	Intel HD 400	None	2GBx1	16GB SSD M.2	None	RTL8821AE ac, 1x1 + BT4.0	None	Switch	None	1Wx1	None	None	USB / USB	None	Floor Stand	65W 88% Adapter	LeTOS	1-year, Onsite	07/16
10KH0024US	US	1L	Celeron N3010	No	Intel HD 400	None	4GBx1	16GB SSD M.2	None	RTL8821AE ac, 1x1 + BT4.0	VGA	Switch	None	1Wx1	None	None	USB / USB	None	Floor Stand	65W 88% Adapter	LeTOS	1-year, Onsite	07/16
10KH0025US	US	1L	Celeron N3010	No	Intel HD 400	None	4GBx1	16GB SSD M.2	None	RTL8821AE ac, 1x1 + BT4.0	None	Switch	None	1Wx1	None	None	USB / USB	None	Floor Stand	65W 88% Adapter	WES 7	1-year, Onsite	07/16
10KH0026US	US	1L	Celeron N3010	No	Intel HD 400	None	4GBx1	16GB SSD M.2	None	RTL8821AE ac, 1x1 + BT4.0	VGA	Switch	None	1Wx1	None	None	USB / USB	None	Floor Stand	65W 88% Adapter	WES 7	1-year, Onsite	07/16
10KH0027US	US	1L	Celeron N3010	No	Intel HD 400	None	4GBx1	16GB SSD M.2	None	RTL8821AE ac, 1x1 + BT4.0	Serial	Switch	None	1Wx1	None	None	USB / USB	None	Floor Stand	65W 88% Adapter	LeTOS	1-year, Onsite	07/16
10KH0028US	US	1L	Celeron N3010	No	Intel HD 400	None	4GBx1	16GB SSD M.2	None	RTL8821AE ac, 1x1 + BT4.0	3rd DP	Switch	None	1Wx1	None	None	USB / USB	None	Floor Stand	65W 88% Adapter	WES 7	1-year, Onsite	07/16
10KH0029US	US	1L	Celeron N3010	No	Intel HD 400	None	4GBx1	16GB SSD M.2	None	RTL8821AE ac, 1x1 + BT4.0	Serial	Switch	None	1Wx1	None	None	USB / USB	None	Floor Stand	65W 88% Adapter	WES 7	1-year, Onsite	07/16
10KH002VUS	US	1L	Celeron N3010	No	Intel HD 400	None	2GBx1	16GB SSD M.2	None	RTL8821AE ac, 1x1 + BT4.0	None	Switch	None	1Wx1	None	None	USB / USB	None	Floor Stand	65W 88% Adapter	LeTOS V2	1-year, Onsite	01/17
10KH002WUS	US	1L	Celeron N3010	No	Intel HD 400	None	4GBx1	16GB SSD M.2	None	RTL8821AE ac, 1x1 + BT4.0	None	Switch	None	1Wx1	None	None	USB / USB	None	Floor Stand	65W 88% Adapter	LeTOS V2	1-year, Onsite	01/17
10KH002XUS	US	1L	Celeron N3010	No	Intel HD 400	None	4GBx1	16GB SSD M.2	None	RTL8821AE ac, 1x1 + BT4.0	3rd DP	Switch	None	1Wx1	None	None	USB / USB	None	Floor Stand	65W 88% Adapter	LeTOS V2	1-year, Onsite	01/17
10KH002YUS	US	1L	Celeron N3010	No	Intel HD 400	None	4GBx1	32GB SSD M.2	None	RTL8821AE ac, 1x1 + BT4.0	VGA	Switch	None	1Wx1	None	None	USB / USB	None	Floor Stand	65W 88% Adapter	WES 7 V2	1-year, Onsite	01/17
10KH0030US	US	1L	Celeron N3010	No	Intel HD 400	None	4GBx1	16GB SSD M.2	None	RTL8821AE ac, 1x1 + BT4.0	VGA	Switch	None	1Wx1	None	None	USB / USB	None	Floor Stand	65W 88% Adapter	LeTOS V2	1-year, Onsite	01/17
10KH0031US	US	1L	Celeron N3010	No	Intel HD 400	None	4GBx1	32GB SSD M.2	None	RTL8821AE ac, 1x1 + BT4.0	Serial	Switch	None	1Wx1	None	None	USB / USB	None	Floor Stand	65W 88% Adapter	WES 7 V2	1-year, Onsite	01/17
10KH0032US	US	1L	Celeron N3010	No	Intel HD 400	None	4GBx1	16GB SSD M.2	None	RTL8821AE ac, 1x1 + BT4.0	Serial	Switch	None	1Wx1	None	None	USB / USB	None	Floor Stand	65W 88% Adapter	LeTOS V2	1-year, Onsite	01/17
10KH0033US	US	1L	Celeron N3010	No	Intel HD 400	None	4GBx1	32GB SSD M.2	None	RTL8821AE ac, 1x1 + BT4.0	3rd DP	Switch	None	1Wx1	None	None	USB / USB	None	Floor Stand	65W 88% Adapter	WES 7 V2	1-year, Onsite	01/17
10KH0034US	US	1L	Celeron N3010	No	Intel HD 400	None	4GBx1	32GB SSD M.2	None	RTL8821AE ac, 1x1 + BT4.0	None	Switch	None	1Wx1	None	None	USB / USB	None	Floor Stand	65W 88% Adapter	WES 7 V2	1-year, Onsite	01/17
10KH003MUS	US	1L	Celeron N3010	No	Intel HD 400	None	4GBx1	32GB SSD M.2	None	None	None	Switch	None	1Wx1	None	None	USB / USB	None	Floor Stand	65W 88% Adapter	Windows 10 IoT Enterprise	1-year, Onsite	03/17
10KH003PUS	US	1L	Celeron N3010	No	Intel HD 400	None	4GBx1	32GB SSD M.2	None	RTL8821AE ac, 1x1 + BT4.0	3rd DP	Switch	None	1Wx1	None	None	USB / USB	None	Floor Stand	65W 88% Adapter	Windows 10 IoT Enterprise	1-year, Onsite	04/17
10KH003QUS	US	1L	Celeron N3010	No	Intel HD 400	None	4GBx1	32GB SSD M.2	None	RTL8821AE ac, 1x1 + BT4.0	None	Switch	None	1Wx1	None	None	USB / USB	None	Floor Stand	65W 88% Adapter	Windows 10 IoT Enterprise	1-year, Onsite	04/17
10KH003RUS	US	1L	Celeron N3010	No	Intel HD 400	None	4GBx1	32GB SSD M.2	None	RTL8821AE ac, 1x1 + BT4.0	VGA	Switch	None	1Wx1	None	None	USB / USB	None	Floor Stand	65W 88% Adapter	Windows 10 IoT Enterprise	1-year, Onsite	04/17
10KH003SUS	US	1L	Celeron N3010	No	Intel HD 400	None	8GBx1	32GB SSD M.2	None	RTL8821AE ac, 1x1 + BT4.0	3rd DP	Switch	None	1Wx1	None	None	USB / USB	None	Floor Stand	65W 88% Adapter	Windows 10 IoT Enterprise	1-year, Onsite	04/17

Model	Region	Case 1L/2L	Processor	vPro	Graphics	Monitor Cable	Memory	Storage	External Optical / I/O Box	WLAN + Bluetooth	Optional Rear Ports	Chassis Intrusion Switch	Kensington Cable Lock	Speaker	Adapter Cage	Toolless Chassis Screw	Keyboard / Mouse	VESA Mount	Stand	Power Supply	Operating System	Warranty	Ann Date (m/y)
10KH0047US	US	1L	Celeron N3010	No	Intel HD 400	None	4GBx1	32GB SSD M.2	None	RTL8821AE ac, 1x1 + BT4.0	3rd DP	Switch	None	1Wx1	None	None	USB / USB	None	Floor Stand	65W 88% Adapter	LeTOS V2	1-year, Onsite	05/17
10KH0048US	US	1L	Celeron N3010	No	Intel HD 400	None	4GBx1	32GB SSD M.2	None	RTL8821AE ac, 1x1 + BT4.0	None	Switch	None	1Wx1	None	None	USB / USB	None	Floor Stand	65W 88% Adapter	LeTOS V2	1-year, Onsite	05/17
10KH0049US	US	1L	Celeron N3010	No	Intel HD 400	None	2GBx1	32GB SSD M.2	None	RTL8821AE ac, 1x1 + BT4.0	None	Switch	None	1Wx1	None	None	USB / USB	None	Floor Stand	65W 88% Adapter	LeTOS V2	1-year, Onsite	05/17
10KH004AUS	US	1L	Celeron N3010	No	Intel HD 400	None	4GBx1	32GB SSD M.2	None	RTL8821AE ac, 1x1 + BT4.0	Serial	Switch	None	1Wx1	None	None	USB / USB	None	Floor Stand	65W 88% Adapter	LeTOS V2	1-year, Onsite	05/17
10KH004BUS	US	1L	Celeron N3010	No	Intel HD 400	None	4GBx1	32GB SSD M.2	None	RTL8821AE ac, 1x1 + BT4.0	VGA	Switch	None	1Wx1	None	None	USB / USB	None	Floor Stand	65W 88% Adapter	LeTOS V2	1-year, Onsite	05/17

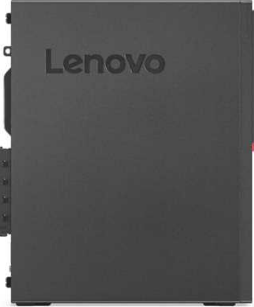

ThinkCentre M710 SFF Platform Specifications

Product Specifications Reference (PSREF)

Processor	Intel® Celeron®, Intel Pentium®, or 6/7th Generation Intel Core™ i3 / i5 / i7 Processor	Security features	<ul style="list-style-type: none"> Security slot (in rear for optional Kensington® MicroSaver® cable) Padlock loop Smart USB protection, allows keyboard/mouse only, blocks all storage devices Optional cable lock to physically lock both keyboard and mouse Power-on password Administrator password Hard disk password Boot sequence control Boot without keyboard and mouse Individual USB port disablement Optional chassis intrusion switch 																																																																								
	<table border="1"> <thead> <tr> <th>Processor</th> <th>Cores / Threads</th> <th>Frequency Base/Max(GHz)</th> <th>Cache</th> <th>Memory Support (Up to)</th> <th>Integrated Graphics</th> </tr> </thead> <tbody> <tr> <td>Pentium G4400</td> <td>2 / 2</td> <td>3.3G</td> <td>3 MB</td> <td>DDR4-2133</td> <td>HD 510</td> </tr> <tr> <td>Pentium G4560</td> <td>2 / 4</td> <td>3.5G</td> <td>3 MB</td> <td>DDR4-2400</td> <td>HD 610</td> </tr> <tr> <td>Pentium G4600</td> <td>2 / 4</td> <td>3.6G</td> <td>3 MB</td> <td>DDR4-2400</td> <td>HD 630</td> </tr> <tr> <td>Core i3-6100</td> <td>2 / 4</td> <td>3.7G</td> <td>3 MB</td> <td>DDR4-2133</td> <td>HD 530</td> </tr> <tr> <td>Core i5-6500</td> <td>4 / 4</td> <td>3.2G / 3.6G</td> <td>6 MB</td> <td>DDR4-2133</td> <td>HD 530</td> </tr> <tr> <td>Core i7-6700</td> <td>4 / 8</td> <td>3.4G / 4.0G</td> <td>8 MB</td> <td>DDR4-2133</td> <td>HD 530</td> </tr> <tr> <td>Core i3-7100</td> <td>2 / 4</td> <td>3.9G</td> <td>3 MB</td> <td>DDR4-2400</td> <td>HD 630</td> </tr> <tr> <td>Core i5-7400</td> <td>4 / 4</td> <td>3.0G / 3.5G</td> <td>6 MB</td> <td>DDR4-2400</td> <td>HD 630</td> </tr> <tr> <td>Core i5-7500</td> <td>4 / 4</td> <td>3.4G / 3.8G</td> <td>6 MB</td> <td>DDR4-2400</td> <td>HD 630</td> </tr> <tr> <td>Core i5-7600</td> <td>4 / 4</td> <td>3.5G / 4.1G</td> <td>6 MB</td> <td>DDR4-2400</td> <td>HD 630</td> </tr> <tr> <td>Core i7-7700</td> <td>4 / 8</td> <td>3.6G / 4.2G</td> <td>8 MB</td> <td>DDR4-2400</td> <td>HD 630</td> </tr> </tbody> </table>	Processor	Cores / Threads	Frequency Base/Max(GHz)	Cache	Memory Support (Up to)	Integrated Graphics	Pentium G4400	2 / 2	3.3G	3 MB	DDR4-2133	HD 510	Pentium G4560	2 / 4	3.5G	3 MB	DDR4-2400	HD 610	Pentium G4600	2 / 4	3.6G	3 MB	DDR4-2400	HD 630	Core i3-6100	2 / 4	3.7G	3 MB	DDR4-2133	HD 530	Core i5-6500	4 / 4	3.2G / 3.6G	6 MB	DDR4-2133	HD 530	Core i7-6700	4 / 8	3.4G / 4.0G	8 MB	DDR4-2133	HD 530	Core i3-7100	2 / 4	3.9G	3 MB	DDR4-2400	HD 630	Core i5-7400	4 / 4	3.0G / 3.5G	6 MB	DDR4-2400	HD 630	Core i5-7500	4 / 4	3.4G / 3.8G	6 MB	DDR4-2400	HD 630	Core i5-7600	4 / 4	3.5G / 4.1G	6 MB	DDR4-2400	HD 630	Core i7-7700	4 / 8	3.6G / 4.2G	8 MB	DDR4-2400	HD 630	Keyboard	<i>Some:</i> Lenovo Calliope Keyboard (USB connector), black <i>Some:</i> Lenovo Traditional Keyboard (USB connector), black <i>Some:</i> Lenovo Calliope Wireless Keyboard (2.4GHz via USB receiver), black <i>Some:</i> Lenovo Calliope Mouse (USB connector), black <i>Some:</i> Lenovo Calliope Wireless Mouse (2.4GHz via USB receiver), black
Processor	Cores / Threads	Frequency Base/Max(GHz)	Cache	Memory Support (Up to)	Integrated Graphics																																																																						
Pentium G4400	2 / 2	3.3G	3 MB	DDR4-2133	HD 510																																																																						
Pentium G4560	2 / 4	3.5G	3 MB	DDR4-2400	HD 610																																																																						
Pentium G4600	2 / 4	3.6G	3 MB	DDR4-2400	HD 630																																																																						
Core i3-6100	2 / 4	3.7G	3 MB	DDR4-2133	HD 530																																																																						
Core i5-6500	4 / 4	3.2G / 3.6G	6 MB	DDR4-2133	HD 530																																																																						
Core i7-6700	4 / 8	3.4G / 4.0G	8 MB	DDR4-2133	HD 530																																																																						
Core i3-7100	2 / 4	3.9G	3 MB	DDR4-2400	HD 630																																																																						
Core i5-7400	4 / 4	3.0G / 3.5G	6 MB	DDR4-2400	HD 630																																																																						
Core i5-7500	4 / 4	3.4G / 3.8G	6 MB	DDR4-2400	HD 630																																																																						
Core i5-7600	4 / 4	3.5G / 4.1G	6 MB	DDR4-2400	HD 630																																																																						
Core i7-7700	4 / 8	3.6G / 4.2G	8 MB	DDR4-2400	HD 630																																																																						
Memory	64GB max, UDIMM, DDR4-2400, four 288-pin DIMM sockets, non-ECC, dual-channel capable* * System automatically clocks down for the processors with lower memory controller	Mouse																																																																									
Storage	<i>Some:</i> Hard Drive / SATA 6.0Gb/s, 2.5" or 3.5", 5400 rpm or 7200 rpm <i>Some:</i> Solid State Drive (SSD) / SATA 6.0Gb/s, 2.5" <i>Some:</i> M.2 Solid State Drive (SSD) / PCIe NVMe, PCIe 3.0 x 4, 32Gb/s <i>Some:</i> Intel Optane™ Memory (models with 7th gen Core processor), M.2 <i>Some:</i> DVD-ROM SATA 1.5Gb/s Drive, slim (9.0mm) <i>Some:</i> DVD Burner (DVD±RW), SATA 1.5Gb/s Drive, slim (9.0mm)	Mechanical	<ul style="list-style-type: none"> SFF (8.4L), black color; metal case (WxDxH) 3.6" X 11.4" X 13.5"; 92.5mm X 290.5mm X 343.5mm Approx. 13.2 lb (6.0 kg), weight may vary by configuration Toolless cover, disk, optical removal Optional dust filter Bay 1: Slim external ODD bay Bay 2: 3.5", 1" high, internal, HDD/SSD Bay 3: 2.5", internal, HDD/SSD (optional bay) Slot 1: low-profile (length < 150mm, height < 68mm), PCIe 3.0 x16* Slot 2: low-profile (length < 150mm, height < 68mm), PCIe 3.0 x1* Slot 3: low-profile (length < 150mm, height < 68mm), PCIe 3.0 x1* Slot 4: no slot, only bracket for optional port extension* M.2 card slots: Two (one for WLAN, one for SSD/Optane) * Optional 2 front USB3.1 Type-C ports module occupies PCIe x16 slot (x4 card), optional rear 2x USB2.0 / parallel / 2nd serial occupies one expansion slot 																																																																								
Optical	Three onboard SATA 6.0Gb/s connectors Optional 7-in-1 media reader	Floor Stand	Optional system floor stand for vertical orientation																																																																								
Onboard SATA Media reader		Power supply	<i>Some:</i> 180 watts, autosensing, 85% PSU <i>Some:</i> 210 watts, autosensing, 85% PSU <i>Some:</i> 210 watts, autosensing, 92% PSU (only available via special bid)																																																																								
Graphics	Intel HD Graphics 510/530/610/630 in processor, uses main memory, DirectX® 12, one VGA, two DisplayPort™, supports 3 independent displays, works along with discrete graphics to support more displays; Max resolution: 4096x2304 (DP) @60Hz; 2048x1536 (VGA) @50Hz <i>Some:</i> NVIDIA GeForce® GT 730, DirectX 12, 2GB, PCIe 2.0 x8 adapter, two DisplayPort, 35 watts; Max resolution: 3840x2160 (DisplayPort) @60Hz;	Limited warranty ³	<i>Some:</i> 1-year or 3-year, depot service / service upgrades available <i>Some:</i> 1-year or 3-year, limited onsite service / service upgrades available																																																																								
Monitor cable	Optional DP to VGA, DP to DVI-D (single link), DP to dual DP, or DP to HDMI 1.4	Preload	Preloaded operating system <i>Some:</i> Windows® 7 Professional 32/64 preinstalled through downgrade rights in Windows 10 Pro 64-bit (not available with 7th Gen Intel processor) <i>Some:</i> Windows 10 Pro 64-bit <i>Some:</i> Windows 10 Home 64-bit Preloaded applications (only some listed) <ul style="list-style-type: none"> Microsoft Office preloaded; purchase a product key to activate Only for Window 10 Lenovo Companion Only for Window 7 Lenovo Solution Center Lenovo ThinkVantage Tools Create Recovery Media Adobe® Reader® Cyberlink Power2Go Create (DVD±RW) 																																																																								
Chipset	Intel B250 Chipset	Environment	ENERGY STAR® 6.1, EPEAT™ Gold rating (North America), ErP Lot 3, GREENGUARD®, RoHS-compliant, TUV low noise verified (on some models)																																																																								
Front ports	Four USB 3.1 Gen1, optional two USB 3.1 Type-C Gen 2 (only available via special bid), microphone (3.5mm), headphone (3.5mm)	Accessories	For compatible accessories, please go to http://www.lenovoquickpick.com																																																																								
Rear ports	Two USB 3.1 Gen1, two USB 2.0, optional two USB 2.0, serial (9-pin), optional 2nd serial (9-pin), optional parallel (25-pin), ethernet (RJ-45), one VGA, two DisplayPort, two PS/2 ports (keyboard/mouse); additional DisplayPort on optional graphics on some models																																																																										
Rear audio ports IEEE 1394	Line-in (3.5mm), line-out (3.5mm), microphone-in (3.5mm) None																																																																										
Audio support	High Definition (HD) Audio, Realtek ALC662 / optional internal speaker (1.5 watt)																																																																										
WLAN ¹³	<i>Some:</i> 11ac wireless, M.2 Card, Qualcomm Atheros QCA9377A (dual band), Wi-Fi + Bluetooth 4.1 combo adapter, 1x1 <i>Some:</i> 11ac wireless, M.2 Card, Qualcomm Atheros QCA6174A (dual band), Wi-Fi + Bluetooth 4.1 combo adapter, 2x2 <i>Some:</i> 11ac wireless, M.2 Card, Intel Dual Band Wireless-AC 3165, Wi-Fi + Bluetooth 4.1 combo adapter, 1x1 <i>Some:</i> 11ac wireless, M.2 Card, Intel Dual Band Wireless-AC 8265, Wi-Fi + Bluetooth 4.1 combo adapter, 2x2																																																																										
Bluetooth™ Ethernet Modem	<i>Some:</i> Bluetooth 4.1 wireless, integrated in Wi-Fi + BT combo adapter Gigabit ethernet, Realtek RTL8111GN, Wake on LAN® None																																																																										
Manageability Security chip	None TPM (Trusted Platform Module) 2.0, TCG Certified * Downgrade to TPM1.2 for the models with Win10 DG Win7 32 OS																																																																										

See footnotes for more detailed information

Model	Region	Processor	vPro	Graphics	Monitor Cable	Memory	Storage(HDD/SSD)	Optical	Optional 2nd 2.5" Bay	Media Reader	WLAN + Bluetooth	Optional Front Ports	Optional Rear Ports	Chassis Intrusion Switch	Cable Lock	Speaker	Dust Filter	Keyboard / Mouse	Stand	Power Supply	Operating System	Warranty	Ann Date (mm/yy)
10M7000DUS	US	i7-7700	No	GT 730 2GB	None	8GBx1	1TB 7200rpm 3.5"	DVD±RW	Optional 2nd 2.5" Bay	None	3165 ac, 1x1 + BT4.1	None	None	None	None	1.5Wx1	None	USB / USB	Floor Stand	210W 85%	Win10 Pro 64	3-year, Onsite	02/17
10M7000EUS	US	i7-7700	No	Intel HD 630	None	8GBx1	256GB SSD M.2 PCIe NVMe Opal	DVD±RW	Optional 2nd 2.5" Bay	None	3165 ac, 1x1 + BT4.1	None	None	None	None	1.5Wx1	None	USB / USB	Floor Stand	210W 85%	Win10 Pro 64	3-year, Onsite	02/17
10M7000FUS	US	i7-7700	No	Intel HD 630	None	8GBx1	1TB 7200rpm 3.5"	DVD±RW	Optional 2nd 2.5" Bay	None	None	None	None	None	None	1.5Wx1	None	USB / USB	Floor Stand	210W 85%	Win10 Pro 64	3-year, Onsite	02/17
10M7000GUS	US	i7-7700	No	Intel HD 630	None	8GBx1	512GB SSD M.2 PCIe NVMe Opal	DVD±RW	Optional 2nd 2.5" Bay	None	None	None	None	None	None	1.5Wx1	None	USB / USB	Floor Stand	210W 85%	Win10 Pro 64	3-year, Onsite	02/17
10M7000HUS	US	i5-7400	No	Intel HD 630	None	4GBx1	500GB 7200rpm 3.5"	DVD±RW	Optional 2nd 2.5" Bay	None	3165 ac, 1x1 + BT4.1	None	None	None	None	1.5Wx1	None	USB / USB	Floor Stand	210W 85%	Win10 Pro 64	3-year, Onsite	02/17
10M7000JUS	US	i5-7400	No	Intel HD 630	None	8GBx1	512GB SSD M.2 PCIe NVMe Opal	DVD±RW	Optional 2nd 2.5" Bay	None	3165 ac, 1x1 + BT4.1	None	None	None	None	1.5Wx1	None	USB / USB	Floor Stand	210W 85%	Win10 Pro 64	3-year, Onsite	02/17
10M7000KUS	US	i7-7700	No	GT 730 2GB	None	8GBx1	256GB SSD M.2 PCIe NVMe Opal	DVD±RW	Optional 2nd 2.5" Bay	None	3165 ac, 1x1 + BT4.1	None	None	None	None	1.5Wx1	None	USB / USB	Floor Stand	210W 85%	Win10 Pro 64	3-year, Onsite	02/17
10M7000LUS	US	i5-7400	No	Intel HD 630	None	8GBx1	256GB SSD M.2 PCIe NVMe Opal	DVD±RW	Optional 2nd 2.5" Bay	None	3165 ac, 1x1 + BT4.1	None	None	None	None	1.5Wx1	None	USB / USB	Floor Stand	210W 85%	Win10 Pro 64	3-year, Onsite	02/17
10M7000MUS	US	i7-7700	No	GT 730 2GB	None	8GBx1	1TB 7200rpm 3.5"	DVD±RW	Optional 2nd 2.5" Bay	None	None	None	None	None	None	1.5Wx1	None	USB / USB	Floor Stand	210W 85%	Win10 Pro 64	3-year, Onsite	02/17
10M7000NUS	US	i7-7700	No	GT 730 2GB	None	8GBx1	256GB SSD M.2 PCIe NVMe Opal	DVD±RW	Optional 2nd 2.5" Bay	None	None	None	None	None	None	1.5Wx1	None	USB / USB	Floor Stand	210W 85%	Win10 Pro 64	3-year, Onsite	02/17
10M7000PUS	US	i5-7400	No	Intel HD 630	None	4GBx1	500GB 7200rpm 3.5"	DVD±RW	Optional 2nd 2.5" Bay	None	None	None	None	None	None	1.5Wx1	None	USB / USB	Floor Stand	210W 85%	Win10 Pro 64	3-year, Onsite	02/17
10M7000QUS	US	i5-7400	No	Intel HD 630	None	8GBx1	256GB SSD M.2 PCIe NVMe Opal	DVD±RW	Optional 2nd 2.5" Bay	None	None	None	None	None	None	1.5Wx1	None	USB / USB	Floor Stand	210W 85%	Win10 Pro 64	3-year, Onsite	02/17
10M7000RUS	US	i7-7700	No	Intel HD 630	None	8GBx1	256GB SSD M.2 PCIe NVMe Opal	DVD±RW	Optional 2nd 2.5" Bay	None	None	None	None	None	None	1.5Wx1	None	USB / USB	Floor Stand	210W 85%	Win10 Pro 64	3-year, Onsite	02/17
10M7000SUS	US	i5-7400	No	Intel HD 630	None	8GBx1	1TB 7200rpm 3.5"	DVD±RW	Optional 2nd 2.5" Bay	None	None	None	None	None	None	1.5Wx1	None	USB / USB	Floor Stand	210W 85%	Win10 Pro 64	3-year, Onsite	02/17
10M7000TUS	US	i7-7700	No	Intel HD 630	None	8GBx1	1TB 7200rpm 3.5"	DVD±RW	Optional 2nd 2.5" Bay	None	3165 ac, 1x1 + BT4.1	None	None	None	None	1.5Wx1	None	USB / USB	Floor Stand	210W 85%	Win10 Pro 64	3-year, Onsite	02/17
10M7002WUS	US	i5-7400	No	Intel HD 630	None	8GBx1	1TB 7200rpm 3.5"	DVD±RW	Optional 2nd 2.5" Bay	None	3165 ac, 1x1 + BT4.1	None	None	None	None	1.5Wx1	None	USB / USB	Floor Stand	210W 85%	Win10 Pro 64	3-year, Onsite	03/17
10M7002XUS	US	Pentium G4560	No	Intel HD 610	None	4GBx1	500GB 7200rpm 3.5"	DVD±RW	Optional 2nd 2.5" Bay	None	3165 ac, 1x1 + BT4.1	None	None	None	None	1.5Wx1	None	USB / USB	Floor Stand	210W 85%	Win10 Pro 64	3-year, Onsite	03/17
10M7002YUS	US	i3-7100	No	Intel HD 630	None	8GBx1	128GB SSD M.2 PCIe NVMe	DVD±RW	Optional 2nd 2.5" Bay	None	None	None	None	None	None	1.5Wx1	None	USB / USB	Floor Stand	210W 85%	Win10 Pro 64	3-year, Onsite	03/17
10M70030US	US	i5-6500	No	Intel HD 530	None	8GBx1	1TB 7200rpm 3.5"	DVD±RW	Optional 2nd 2.5" Bay	None	None	None	None	None	None	1.5Wx1	None	USB / USB	Floor Stand	210W 85%	Win10 DG Win7 Pro 64	3-year, Onsite	03/17
10M70031US	US	i3-7100	No	Intel HD 630	None	4GBx1	500GB 7200rpm 3.5"	DVD±RW	Optional 2nd 2.5" Bay	None	None	None	None	None	None	1.5Wx1	None	USB / USB	Floor Stand	210W 85%	Win10 Pro 64	3-year, Onsite	03/17

Model	Region	Processor	vPro	Graphics	Monitor Cable	Memory	Storage(HDD/SSD)	Optical	Optional 2nd 2.5" Bay	Media Reader	WLAN + Bluetooth	Optional Front Ports	Optional Rear Ports	Chassis Intrusion Switch	Cable Lock	Speaker	Dust Filter	Keyboard / Mouse	Stand	Power Supply	Operating System	Warranty	Ann Date (mm/yy)
10M70032US	US	i7-6700	No	GT 730 2GB	None	8GBx1	256GB SSD M.2 PCIe NVMe Opal	DVD±RW	Optional 2nd 2.5" Bay	None	3165 ac, 1x1 + BT4.1	None	None	None	None	1.5Wx1	None	USB / USB	Floor Stand	210W 85%	Win10 DG Win7 Pro 64	3-year, Onsite	03/17
10M70033US	US	i7-6700	No	GT 730 2GB	None	8GBx1	1TB 7200rpm 3.5"	DVD±RW	Optional 2nd 2.5" Bay	None	3165 ac, 1x1 + BT4.1	None	None	None	None	1.5Wx1	None	USB / USB	Floor Stand	210W 85%	Win10 DG Win7 Pro 64	3-year, Onsite	03/17
10M70034US	US	i5-7400	No	Intel HD 630	None	4GBx1	128GB SSD M.2 PCIe NVMe	DVD±RW	Optional 2nd 2.5" Bay	None	None	None	None	None	None	1.5Wx1	None	USB / USB	Floor Stand	210W 85%	Win10 Pro 64	3-year, Onsite	03/17
10M70035US	US	i7-6700	No	GT 730 2GB	None	8GBx1	256GB SSD M.2 PCIe NVMe Opal	DVD±RW	Optional 2nd 2.5" Bay	None	None	None	None	None	None	1.5Wx1	None	USB / USB	Floor Stand	210W 85%	Win10 DG Win7 Pro 64	3-year, Onsite	03/17
10M70036US	US	Pentium G4400	No	Intel HD 510	None	4GBx1	500GB 7200rpm 3.5"	DVD±RW	Optional 2nd 2.5" Bay	None	3165 ac, 1x1 + BT4.1	None	None	None	None	1.5Wx1	None	USB / USB	Floor Stand	210W 85%	Win10 DG Win7 Pro 64	3-year, Onsite	03/17
10M70037US	US	i3-6100	No	Intel HD 530	None	8GBx1	1TB 7200rpm 3.5"	DVD±RW	Optional 2nd 2.5" Bay	None	None	None	None	None	None	1.5Wx1	None	USB / USB	Floor Stand	210W 85%	Win10 DG Win7 Pro 64	3-year, Onsite	03/17
10M70038US	US	i5-6500	No	Intel HD 530	None	8GBx1	1TB 7200rpm 3.5"	DVD±RW	Optional 2nd 2.5" Bay	None	3165 ac, 1x1 + BT4.1	None	None	None	None	1.5Wx1	None	USB / USB	Floor Stand	210W 85%	Win10 DG Win7 Pro 64	3-year, Onsite	03/17
10M70039US	US	i5-6500	No	Intel HD 530	None	4GBx1	500GB 7200rpm 3.5"	DVD±RW	Optional 2nd 2.5" Bay	None	None	None	None	None	None	1.5Wx1	None	USB / USB	Floor Stand	210W 85%	Win10 DG Win7 Pro 64	3-year, Onsite	03/17
10M7003AUS	US	i7-6700	No	Intel HD 530	None	8GBx1	256GB SSD M.2 PCIe NVMe Opal	DVD±RW	Optional 2nd 2.5" Bay	None	3165 ac, 1x1 + BT4.1	None	None	None	None	1.5Wx1	None	USB / USB	Floor Stand	210W 85%	Win10 DG Win7 Pro 64	3-year, Onsite	03/17
10M7003BUS	US	Pentium G4560	No	Intel HD 610	None	4GBx1	500GB 7200rpm 3.5"	DVD±RW	Optional 2nd 2.5" Bay	None	None	None	None	None	None	1.5Wx1	None	USB / USB	Floor Stand	210W 85%	Win10 Pro 64	3-year, Onsite	03/17
10M7003CUS	US	i3-6100	No	Intel HD 530	None	8GBx1	1TB 7200rpm 3.5"	DVD±RW	Optional 2nd 2.5" Bay	None	3165 ac, 1x1 + BT4.1	None	None	None	None	1.5Wx1	None	USB / USB	Floor Stand	210W 85%	Win10 DG Win7 Pro 64	3-year, Onsite	03/17
10M7003DUS	US	i3-7100	No	Intel HD 630	None	8GBx1	1TB 7200rpm 3.5"	DVD±RW	Optional 2nd 2.5" Bay	None	3165 ac, 1x1 + BT4.1	None	None	None	None	1.5Wx1	None	USB / USB	Floor Stand	210W 85%	Win10 Pro 64	3-year, Onsite	03/17
10M7003EUS	US	i7-6700	No	Intel HD 530	None	8GBx1	512GB SSD M.2 PCIe NVMe Opal	DVD±RW	Optional 2nd 2.5" Bay	None	None	None	None	None	None	1.5Wx1	None	USB / USB	Floor Stand	210W 85%	Win10 DG Win7 Pro 64	3-year, Onsite	03/17
10M7003FUS	US	i3-6100	No	Intel HD 530	None	8GBx1	128GB SSD M.2 PCIe NVMe	DVD±RW	Optional 2nd 2.5" Bay	None	None	None	None	None	None	1.5Wx1	None	USB / USB	Floor Stand	210W 85%	Win10 DG Win7 Pro 64	3-year, Onsite	03/17
10M7003GUS	US	i7-6700	No	Intel HD 530	None	8GBx1	256GB SSD M.2 PCIe NVMe Opal	DVD±RW	Optional 2nd 2.5" Bay	None	None	None	None	None	None	1.5Wx1	None	USB / USB	Floor Stand	210W 85%	Win10 DG Win7 Pro 64	3-year, Onsite	03/17
10M7003HUS	US	i7-6700	No	Intel HD 530	None	8GBx1	1TB 7200rpm 3.5"	DVD±RW	Optional 2nd 2.5" Bay	None	3165 ac, 1x1 + BT4.1	None	None	None	None	1.5Wx1	None	USB / USB	Floor Stand	210W 85%	Win10 DG Win7 Pro 64	3-year, Onsite	03/17
10M7003JUS	US	i5-6500	No	Intel HD 530	None	4GBx1	500GB 7200rpm 3.5"	DVD±RW	Optional 2nd 2.5" Bay	None	3165 ac, 1x1 + BT4.1	None	None	None	None	1.5Wx1	None	USB / USB	Floor Stand	210W 85%	Win10 DG Win7 Pro 64	3-year, Onsite	03/17
10M7003KUS	US	Pentium G4400	No	Intel HD 510	None	4GBx1	500GB 7200rpm 3.5"	DVD±RW	Optional 2nd 2.5" Bay	None	None	None	None	None	None	1.5Wx1	None	USB / USB	Floor Stand	210W 85%	Win10 DG Win7 Pro 64	3-year, Onsite	03/17
10M7003LUS	US	i3-7100	No	Intel HD 630	None	8GBx1	1TB 7200rpm 3.5"	DVD±RW	Optional 2nd 2.5" Bay	None	None	None	None	None	None	1.5Wx1	None	USB / USB	Floor Stand	210W 85%	Win10 Pro 64	3-year, Onsite	03/17
10M7003MUS	US	i5-6500	No	Intel HD 530	None	8GBx1	256GB SSD M.2 PCIe NVMe Opal	DVD±RW	Optional 2nd 2.5" Bay	None	None	None	None	None	None	1.5Wx1	None	USB / USB	Floor Stand	210W 85%	Win10 DG Win7 Pro 64	3-year, Onsite	03/17

Model	Region	Processor	vPro	Graphics	Monitor Cable	Memory	Storage(HDD/SSD)	Optical	Optional 2nd 2.5" Bay	Media Reader	WLAN + Bluetooth	Optional Front Ports	Optional Rear Ports	Chassis Intrusion Switch	Cable Lock	Speaker	Dust Filter	Keyboard / Mouse	Stand	Power Supply	Operating System	Warranty	Ann Date (mm/yy)
10M7003NUS	US	i7-6700	No	GT 730 2GB	None	8GBx1	1TB 7200rpm 3.5"	DVD±RW	Optional 2nd 2.5" Bay	None	None	None	None	None	None	1.5Wx1	None	USB / USB	Floor Stand	210W 85%	Win10 DG Win7 Pro 64	3-year, Onsite	03/17
10M7003PUS	US	i3-6100	No	Intel HD 530	None	4GBx1	1TB 7200rpm 3.5"	DVD±RW	Optional 2nd 2.5" Bay	None	None	None	None	None	None	1.5Wx1	None	USB / USB	Floor Stand	210W 85%	Win10 DG Win7 Pro 64	3-year, Onsite	03/17
10M7003QUS	US	i7-6700	No	Intel HD 530	None	8GBx1	1TB 7200rpm 3.5"	DVD±RW	Optional 2nd 2.5" Bay	None	None	None	None	None	None	1.5Wx1	None	USB / USB	Floor Stand	210W 85%	Win10 DG Win7 Pro 64	3-year, Onsite	03/17
10M7003RUS	US	i5-6500	No	Intel HD 530	None	4GBx1	128GB SSD M.2 PCIe NVMe	DVD±RW	Optional 2nd 2.5" Bay	None	None	None	None	None	None	1.5Wx1	None	USB / USB	Floor Stand	210W 85%	Win10 DG Win7 Pro 64	3-year, Onsite	03/17
10M7003SUS	US	i5-6500	No	Intel HD 530	None	8GBx1	256GB SSD M.2 PCIe NVMe Opal	DVD±RW	Optional 2nd 2.5" Bay	None	3165 ac, 1x1 + BT4.1	None	None	None	None	1.5Wx1	None	USB / USB	Floor Stand	210W 85%	Win10 DG Win7 Pro 64	3-year, Onsite	03/17
10M7003TUS	US	i3-6100	No	Intel HD 530	None	4GBx1	500GB 7200rpm 3.5"	DVD±RW	Optional 2nd 2.5" Bay	None	None	None	None	None	None	1.5Wx1	None	USB / USB	Floor Stand	210W 85%	Win10 DG Win7 Pro 64	3-year, Onsite	03/17
10M7003UUS	US	i3-7100	No	Intel HD 630	None	4GBx1	1TB 7200rpm 3.5"	DVD±RW	Optional 2nd 2.5" Bay	None	None	None	None	None	None	1.5Wx1	None	USB / USB	Floor Stand	210W 85%	Win10 Pro 64	3-year, Onsite	03/17
10M7006AUS	US	i5-7400	No	Intel HD 630	None	8GBx1	16GB Optane Memory + 1TB 7200rpm 3.5"	DVD±RW	Optional 2nd 2.5" Bay	None	None	None	None	None	None	1.5Wx1	None	USB / USB	Floor Stand	210W 85%	Win10 Pro 64	3-year, Onsite	09/17
10M7006BUS	US	i7-7700	No	Intel HD 630	None	8GBx1	16GB Optane Memory + 1TB 7200rpm 3.5"	DVD±RW	Optional 2nd 2.5" Bay	None	None	None	None	None	None	1.5Wx1	None	USB / USB	Floor Stand	210W 85%	Win10 Pro 64	3-year, Onsite	09/17
10M70070US	US	i5-7400	No	Intel HD 630	None	4GBx1	16GB Optane Memory + 1TB 7200rpm 3.5"	DVD±RW	Optional 2nd 2.5" Bay	None	None	None	None	None	None	1.5Wx1	None	USB / USB	Floor Stand	210W 85%	Win10 Pro 64	3-year, Onsite	03/18
10M70071US	US	i3-7100	No	Intel HD 630	None	4GBx1	16GB Optane Memory + 1TB 7200rpm 3.5"	DVD±RW	Optional 2nd 2.5" Bay	None	None	None	None	None	None	1.5Wx1	None	USB / USB	Floor Stand	210W 85%	Win10 Pro 64	3-year, Onsite	03/18



ThinkCentre M710 Tiny Platform Specifications

Product Specifications Reference (PSREF)

Processor	Intel® Celeron®, Intel Pentium®, or 6/7th Generation Intel Core™ i3 / i5 / i7 Processor						Security features <ul style="list-style-type: none"> Security slot (in rear for optional Kensington® MicroSaver® cable) Smart USB protection, allows keyboard/mouse only, blocks all storage devices Power-on password Administrator password Hard disk password Boot sequence control Boot without keyboard and mouse Individual USB port disablement Chassis intrusion switch
	Processor	Cores / Threads	Frequency Base/Max(GHz)	Cache	Memory Support (Up to)	Integrated Graphics	
	Pentium G4400T	2 / 2	2.9G	3 MB	DDR4-2133	HD 510	
	Pentium G4560T	2 / 4	2.9G	3 MB	DDR4-2400	HD 610	
	Pentium G4600T	2 / 4	3.0G	3 MB	DDR4-2400	HD 630	
	Core i3-6100T	2 / 4	3.2G	3 MB	DDR4-2133	HD 530	
	Core i5-6500T	4 / 4	2.5G / 3.1G	6 MB	DDR4-2133	HD 530	
	Core i7-6700T	4 / 8	2.8G / 3.6G	8 MB	DDR4-2133	HD 530	
	Core i3-7100T	2 / 4	3.4G	3 MB	DDR4-2400	HD 630	
	Core i5-7400T	4 / 4	2.4G / 3.0G	6 MB	DDR4-2400	HD 630	
	Core i5-7500T	4 / 4	2.7G / 3.3G	6 MB	DDR4-2400	HD 630	
	Core i5-7600T	4 / 4	2.8G / 3.7G	6 MB	DDR4-2400	HD 630	
Core i7-7700T	4 / 8	2.9G / 3.8G	8 MB	DDR4-2400	HD 630		
Memory	32GB max, DDR4-2400*, two 260-pin SO-DIMM sockets, non-ECC, dual-channel capable * System automatically clocks down for the processors with lower memory controller						
Storage	<i>Some:</i> Hard Drive / SATA 6.0Gb/s, 2.5", 5400 rpm or 7200 rpm <i>Some:</i> Solid State Drive (SSD) / SATA 6.0Gb/s, 2.5" <i>Some:</i> M.2 Solid State Drive (SSD) / PCIe NVMe, PCIe 3.0 x 4, 32Gb/s <i>Some:</i> Intel Optane™ Memory (models with 7th gen Core processor), M.2 <i>Some:</i> DVD-ROM, slim (9.0mm), via USB external ODD box <i>Some:</i> DVD Burner (DVD±RW), slim (9.0mm), via USB external ODD box						
Optical	One onboard SATA 6.0Gb/s connector						
Onboard SATA Media reader	None						
Graphics	Intel HD Graphics 510/530/610/630 in processor, uses main memory, DirectX® 12, two DisplayPort™, one optional video port (HDMI, VGA, 3rd DP, or USB 3.1 Type-C with DisplayPort Alternate Mode), up to 3 independent displays; <i>Max resolution:</i> 4096x2304 (DP) @60Hz; 4096x2304 (Type-C) @60Hz; 4096x2160 (HDMI) @24Hz; 1920x1200 (VGA) @60Hz						
Monitor cable	Optional DP to VGA, DP to DVI-D (single link), DP to dual DP, or DP to HDMI 1.4						
Chipset	Intel B250 Chipset						
Front ports	Two USB 3.1 Gen1 (one is Always On and fast charge), one microphone (3.5mm), one headphone / microphone combo jack (3.5mm)						
Rear ports	Four USB 3.1 Gen1 (optional external optical box or external I/O box occupies one or two specific USB 3.1 Gen1 on some models), ethernet (RJ-45), two DisplayPort, two optional ports (Port 1 for VGA / 3rd DP / HDMI / serial / USB 3.1 Type-C Gen 1 (with DisplayPort Alternate Mode), Port 2 for serial)						
I/O box	Optional external I/O box, extends two USB 2.0, two USB 3.1 Gen1, and one serial on rear, two USB 2.0 on front, via USB cable (occupy two specific USB 3.1 Gen1 of Tiny)						
Audio support	High Definition (HD) Audio, Realtek ALC294 / optional internal speaker (1w or 2w)						
WLAN ¹³	<i>Some:</i> 11ac wireless, M.2 Card, Qualcomm Atheros QCA9377A (dual band), Wi-Fi + Bluetooth 4.1 combo adapter, 1x1 <i>Some:</i> 11ac wireless, M.2 Card, Qualcomm Atheros QCA6174A (dual band), Wi-Fi + Bluetooth 4.1 combo adapter, 2x2 <i>Some:</i> 11ac wireless, M.2 Card, Intel Dual Band Wireless-AC 3165, Wi-Fi + Bluetooth 4.1 combo adapter, 1x1 <i>Some:</i> 11ac wireless, M.2 Card, Intel Dual Band Wireless-AC 8265, Wi-Fi + Bluetooth 4.1 combo adapter, 2x2						
Bluetooth™	<i>Some:</i> Bluetooth 4.1 wireless, integrated in Wi-Fi + BT combo adapter						
Ethernet	Gigabit ethernet, Intel Ethernet Connection I219-V (Jacksonville), Wake on LAN®						
Modem	None						
Manageability	None						
Security chip	TPM (Trusted Platform Module) 2.0*, TCG Certified * Downgrade to TPM1.2 for the models with Win10 DG Win7 32 OS						
VESA mount	Optional VESA mount bracket kit, supports VESA 75mm and 100mm						
Floor Stand	Optional system floor stand for vertical orientation						
Power supply	65 watts AC/DC adapter, autosensing, 88% PSU (not included for TIO models) 90 watts AC/DC adapter, autosensing, 88% PSU (only for models with I/O box)						
Limited warranty ³	<i>Some:</i> 1-year or 3-year, depot service / service upgrades available <i>Some:</i> 1-year or 3-year, limited onsite service / service upgrades available						
Preload	<i>Some:</i> Windows® 7 Professional 32/64 preinstalled through downgrade rights in Windows 10 Pro 64-bit (not available with 7th Gen Intel processor) <i>Some:</i> Windows 10 Pro 64-bit <i>Some:</i> Windows 10 Home 64-bit Preloaded applications (only some listed) <ul style="list-style-type: none"> Microsoft Office preloaded; purchase a product key to activate - Only for Window 10 Lenovo Companion - Only for Window 7 Lenovo Solution Center Lenovo ThinkVantage Tools Create Recovery Media Adobe® Reader® Cyberlink PowerDVD Create (DVD±RW) 						
Environment	ENERGY STAR® 6.1, EPEAT™ Gold rating (North America), ErP Lot 3, GREENGUARD®, RoHS-compliant, TUV low noise verified (on some models)						
MIL-SPEC test	MIL-STD-810G military certification (Low Pressure [Altitude], High Temperature, Low Temperature, Temperature Shock, Humidity, Sand and Dust, Vibration, Shock, Fungus, Solar Radiation)						
Accessories	For compatible accessories, please go to http://www.lenovoquickpick.com						

See footnotes for more detailed information

Model	Region	Processor	vPro	Graphics	Monitor Cable	Memory	Storage(HDD/SSD)	External Optical / I/O Box	WLAN + Bluetooth	Optional Rear Ports	Chassis Intrusion Switch	Kensington Cable Lock	Speaker	Adapter Cage	Toolless Chassis Screw	Dust Filter	Keyboard / Mouse	VESA Mount	Stand	Power Supply	Operating System	Warranty	End of Support	Ann Date (mm/yy)
10MR0001US	US	i7-7700T	No	Intel HD 630	None	8GB	500GB 7200rpm 2.5"	DVD±RW	8265 ac, 2x2 + BT4.1	HDMI	Switch	None	1Wx1	None	None	None	USB / USB	VESA Mount	None	65W 88% Adapter	Win10 Pro 64	3-year, Onsite	Mar 21, 2023	02/17
10MR0002US	US	i5-7500T	No	Intel HD 630	None	4GBx1	500GB 7200rpm 2.5"	None	3165 ac, 1x1 + BT4.1	VGA	Switch	None	1Wx1	None	None	None	USB / USB	None	Floor Stand	65W 88% Adapter	Win10 Pro 64	3-year, Onsite	Mar 21, 2023	02/17
10MR0003US	US	i7-7700T	No	Intel HD 630	None	8GB	256GB SSD M.2 PCIe NVMe Opal	None	8265 ac, 2x2 + BT4.1	3rd DP	Switch	None	1Wx1	None	None	None	USB / USB	None	Floor Stand	65W 88% Adapter	Win10 Pro 64	3-year, Onsite	Mar 21, 2023	02/17
10MR0004US	US	i5-7500T	No	Intel HD 630	None	8GB	256GB SSD M.2 PCIe NVMe Opal	None	8265 ac, 2x2 + BT4.1	3rd DP	Switch	None	1Wx1	None	None	None	USB / USB	None	Floor Stand	65W 88% Adapter	Win10 Pro 64	3-year, Onsite	Feb 21, 2022	02/17
10MR0005US	US	i5-7500T	No	Intel HD 630	None	8GB	128GB SSD M.2 PCIe NVMe	None	3165 ac, 1x1 + BT4.1	3rd DP	Switch	None	1Wx1	None	None	None	USB / USB	None	Floor Stand	65W 88% Adapter	Win10 Pro 64	3-year, Onsite	Mar 21, 2023	02/17
10MR0006US	US	i5-7500T	No	Intel HD 630	None	8GB	500GB 7200rpm 2.5"	DVD±RW	8265 ac, 2x2 + BT4.1	HDMI	Switch	None	1Wx1	None	None	None	USB / USB	VESA Mount	None	65W 88% Adapter	Win10 Pro 64	3-year, Onsite	Mar 21, 2023	02/17
10MR0007US	US	i5-7500T	No	Intel HD 630	None	4GBx1	500GB 7200rpm 2.5"	None	8265 ac, 2x2 + BT4.1	3rd DP	Switch	None	1Wx1	None	None	None	USB / USB	None	Floor Stand	65W 88% Adapter	Win10 Pro 64	3-year, Onsite	Mar 21, 2023	02/17
10MR0008US	US	i5-7500T	No	Intel HD 630	None	4GBx1	500GB 7200rpm 2.5"	None	3165 ac, 1x1 + BT4.1	None	Switch	None	1Wx1	None	None	None	USB / USB	None	Floor Stand	65W 88% Adapter	Win10 Pro 64	3-year, Onsite	Mar 21, 2023	02/17
10MR0009US	US	i5-7500T	No	Intel HD 630	None	4GBx1	500GB 7200rpm 2.5"	None	3165 ac, 1x1 + BT4.1	HDMI	Switch	None	1Wx1	None	None	None	USB / USB	None	Floor Stand	65W 88% Adapter	Win10 Pro 64	3-year, Onsite	Mar 21, 2023	02/17
10MR000AUS	US	i5-7500T	No	Intel HD 630	None	4GBx1	500GB 7200rpm 2.5"	None	8265 ac, 2x2 + BT4.1	None	Switch	None	1Wx1	None	None	None	USB / USB	None	Floor Stand	65W 88% Adapter	Win10 Pro 64	3-year, Onsite	Mar 21, 2023	02/17
10MR000BUS	US	i7-7700T	No	Intel HD 630	None	8GB	500GB 7200rpm 2.5"	None	8265 ac, 2x2 + BT4.1	3rd DP	Switch	None	1Wx1	None	None	None	USB / USB	None	Floor Stand	65W 88% Adapter	Win10 Pro 64	3-year, Onsite	Mar 21, 2023	02/17
10MR000CUS	US	i5-7500T	No	Intel HD 630	None	8GB	256GB SSD M.2 PCIe NVMe Opal	None	8265 ac, 2x2 + BT4.1	HDMI	Switch	None	1Wx1	None	None	None	USB / USB	None	Floor Stand	65W 88% Adapter	Win10 Pro 64	3-year, Onsite	Mar 21, 2023	02/17
10MR000DUS	US	i5-7500T	No	Intel HD 630	None	8GB	128GB SSD M.2 PCIe NVMe	None	8265 ac, 2x2 + BT4.1	HDMI	Switch	None	1Wx1	None	None	None	USB / USB	None	Floor Stand	65W 88% Adapter	Win10 Pro 64	3-year, Onsite	Mar 21, 2023	02/17
10MR000EUS	US	i7-7700T	No	Intel HD 630	None	8GB	256GB SSD M.2 PCIe NVMe Opal	None	8265 ac, 2x2 + BT4.1	HDMI	Switch	None	1Wx1	None	None	None	USB / USB	None	Floor Stand	65W 88% Adapter	Win10 Pro 64	3-year, Onsite	Mar 21, 2023	02/17
10MR000FUS	US	i5-7500T	No	Intel HD 630	None	4GBx1	500GB 7200rpm 2.5"	None	3165 ac, 1x1 + BT4.1	3rd DP	Switch	None	1Wx1	None	None	None	USB / USB	None	Floor Stand	65W 88% Adapter	Win10 Pro 64	3-year, Onsite	Mar 21, 2023	02/17
10MR000GUS	US	i5-7500T	No	Intel HD 630	None	4GBx1	500GB 7200rpm 2.5"	None	8265 ac, 2x2 + BT4.1	HDMI	Switch	None	1Wx1	None	None	None	USB / USB	None	Floor Stand	65W 88% Adapter	Win10 Pro 64	3-year, Onsite	Mar 21, 2023	02/17
10MR000HUS	US	i7-7700T	No	Intel HD 630	None	8GB	500GB 7200rpm 2.5"	None	8265 ac, 2x2 + BT4.1	HDMI	Switch	None	1Wx1	None	None	None	USB / USB	None	Floor Stand	65W 88% Adapter	Win10 Pro 64	3-year, Onsite	Mar 21, 2023	02/17
10MR000JUS	US	i5-7500T	No	Intel HD 630	None	8GB	500GB 7200rpm 2.5"	None	8265 ac, 2x2 + BT4.1	3rd DP	Switch	None	1Wx1	None	None	None	USB / USB	None	Floor Stand	65W 88% Adapter	Win10 Pro 64	3-year, Onsite	Mar 21, 2023	02/17
10MR000KUS	US	i5-7500T	No	Intel HD 630	None	4GBx1	500GB 7200rpm 2.5"	None	3165 ac, 1x1 + BT4.1	Serial	Switch	None	1Wx1	None	None	None	USB / USB	None	Floor Stand	65W 88% Adapter	Win10 Pro 64	3-year, Onsite	Mar 21, 2023	02/17
10MR002PUS	US	i3-7100T	No	Intel HD 630	None	8GB	500GB 7200rpm 2.5"	None	3165 ac, 1x1 + BT4.1	VGA	Switch	None	1Wx1	None	None	None	USB / USB	None	Floor Stand	65W 88% Adapter	Win10 Pro 64	3-year, Onsite	Apr 6, 2023	03/17

Model	Region	Processor	vPro	Graphics	Monitor Cable	Memory	Storage(HDD/SSD)	External Optical / I/O Box	WLAN + Bluetooth	Optional Rear Ports	Chassis Intrusion Switch	Kensington Cable Lock	Speaker	Adapter Cage	Toolless Chassis Screw	Dust Filter	Keyboard / Mouse	VESA Mount	Stand	Power Supply	Operating System	Warranty	End of Support	Ann Date (mm/yy)
10MR002QUS	US	i3-7100T	No	Intel HD 630	None	8GB	500GB 7200rpm 2.5"	None	3165 ac, 1x1 + BT4.1	3rd DP	Switch	None	1Wx1	None	None	None	USB / USB	None	Floor Stand	65W 88% Adapter	Win10 Pro 64	3-year, Onsite	Apr 6, 2023	03/17
10MR002RUS	US	Pentium G4560T	No	Intel HD 610	None	4GBx1	500GB 7200rpm 2.5"	None	3165 ac, 1x1 + BT4.1	None	Switch	None	1Wx1	None	None	None	USB / USB	None	Floor Stand	65W 88% Adapter	Win10 Pro 64	3-year, Onsite	Apr 6, 2023	03/17
10MR002SUS	US	i3-7100T	No	Intel HD 630	None	8GB	500GB 7200rpm 2.5"	None	3165 ac, 1x1 + BT4.1	None	Switch	None	1Wx1	None	None	None	USB / USB	None	Floor Stand	65W 88% Adapter	Win10 Pro 64	3-year, Onsite	Apr 6, 2023	03/17
10MR002TUS	US	i3-7100T	No	Intel HD 630	None	8GB	256GB SSD M.2 PCIe NVMe Opal	None	3165 ac, 1x1 + BT4.1	3rd DP	Switch	None	1Wx1	None	None	None	USB / USB	None	Floor Stand	65W 88% Adapter	Win10 Pro 64	3-year, Onsite	Apr 6, 2023	03/17
10MR002UUS	US	i3-7100T	No	Intel HD 630	None	8GB	500GB 7200rpm 2.5"	None	3165 ac, 1x1 + BT4.1	Serial	Switch	None	1Wx1	None	None	None	USB / USB	None	Floor Stand	65W 88% Adapter	Win10 Pro 64	3-year, Onsite	Apr 6, 2023	03/17
10MR002VUS	US	i3-7100T	No	Intel HD 630	None	4GBx1	500GB 7200rpm 2.5"	None	3165 ac, 1x1 + BT4.1	None	Switch	None	1Wx1	None	None	None	USB / USB	None	Floor Stand	65W 88% Adapter	Win10 Pro 64	3-year, Onsite	Apr 6, 2023	03/17
10MR002WUS	US	i3-7100T	No	Intel HD 630	None	8GB	128GB SSD M.2 PCIe NVMe	None	3165 ac, 1x1 + BT4.1	None	Switch	None	1Wx1	None	None	None	USB / USB	None	Floor Stand	65W 88% Adapter	Win10 Pro 64	3-year, Onsite	Apr 6, 2023	03/17
10MR002XUS	US	i3-7100T	No	Intel HD 630	None	8GB	128GB SSD M.2 PCIe NVMe	None	3165 ac, 1x1 + BT4.1	3rd DP	Switch	None	1Wx1	None	None	None	USB / USB	None	Floor Stand	65W 88% Adapter	Win10 Pro 64	3-year, Onsite	Apr 6, 2023	03/17
10MR003UUS	US	i5-7500T	No	Intel HD 630	None	8GB	128GB SSD M.2 PCIe NVMe	None	8265 ac, 2x2 + BT4.1	3rd DP	Switch	None	1Wx1	None	None	None	USB / USB	None	Floor Stand	65W 88% Adapter	Win10 Pro 64	3-year, Onsite	Apr 21, 2023	03/17
10MR003VUS	US	i5-7500T	No	Intel HD 630	None	8GB	512GB SSD M.2 PCIe NVMe Opal	None	8265 ac, 2x2 + BT4.1	3rd DP	Switch	None	1Wx1	None	None	None	USB / USB	None	Floor Stand	65W 88% Adapter	Win10 Pro 64	3-year, Onsite	Apr 21, 2023	03/17
10MR003WUS	US	i7-7700T	No	Intel HD 630	None	8GB	512GB SSD M.2 PCIe NVMe Opal	None	8265 ac, 2x2 + BT4.1	3rd DP	Switch	None	1Wx1	None	None	None	USB / USB	None	Floor Stand	65W 88% Adapter	Win10 Pro 64	3-year, Onsite	Apr 21, 2023	03/17
10MR003XUS	US	i5-7400T	No	Intel HD 630	None	4GBx1	500GB 7200rpm 2.5"	None	8265 ac, 2x2 + BT4.1	3rd DP	Switch	None	1Wx1	None	None	None	USB / USB	None	Floor Stand	65W 88% Adapter	Win10 Pro 64	3-year, Onsite	Apr 21, 2023	03/17
10MR003YUS	US	i5-7400T	No	Intel HD 630	None	8GB	500GB 7200rpm 2.5"	None	8265 ac, 2x2 + BT4.1	3rd DP	Switch	None	1Wx1	None	None	None	USB / USB	None	Floor Stand	65W 88% Adapter	Win10 Pro 64	3-year, Onsite	Apr 21, 2023	03/17
10MR0040US	US	i5-7400T	No	Intel HD 630	None	4GBx1	500GB 7200rpm 2.5"	None	3165 ac, 1x1 + BT4.1	3rd DP	Switch	None	1Wx1	None	None	None	USB / USB	None	Floor Stand	65W 88% Adapter	Win10 Pro 64	3-year, Onsite	Apr 21, 2023	03/17
10MR0041US	US	i5-7400T	No	Intel HD 630	None	8GB	500GB 7200rpm 2.5"	None	3165 ac, 1x1 + BT4.1	3rd DP	Switch	None	1Wx1	None	None	None	USB / USB	None	Floor Stand	65W 88% Adapter	Win10 Pro 64	3-year, Onsite	Apr 21, 2023	03/17
10MR0042US	US	i5-7400T	No	Intel HD 630	None	8GB	128GB SSD M.2 PCIe NVMe	None	3165 ac, 1x1 + BT4.1	3rd DP	Switch	None	1Wx1	None	None	None	USB / USB	None	Floor Stand	65W 88% Adapter	Win10 Pro 64	3-year, Onsite	Apr 21, 2023	03/17
10MR0043US	US	i5-7400T	No	Intel HD 630	None	8GB	128GB SSD M.2 PCIe NVMe	None	8265 ac, 2x2 + BT4.1	3rd DP	Switch	None	1Wx1	None	None	None	USB / USB	None	Floor Stand	65W 88% Adapter	Win10 Pro 64	3-year, Onsite	Apr 21, 2023	03/17
10MR0044US	US	i5-7400T	No	Intel HD 630	None	8GB	256GB SSD M.2 PCIe NVMe Opal	None	8265 ac, 2x2 + BT4.1	3rd DP	Switch	None	1Wx1	None	None	None	USB / USB	None	Floor Stand	65W 88% Adapter	Win10 Pro 64	3-year, Onsite	Apr 21, 2023	03/17
10MR0045US	US	i3-6100T	No	Intel HD 530	None	4GBx1	500GB 7200rpm 2.5"	None	3165 ac, 1x1 + BT4.1	None	Switch	None	1Wx1	None	None	None	USB / USB	None	Floor Stand	65W 88% Adapter	Win10 DG Win7 Pro 64	3-year, Onsite	Apr 21, 2023	03/17
10MR0046US	US	i7-6700T	No	Intel HD 530	None	8GB	256GB SSD M.2 PCIe NVMe Opal	None	8265 ac, 2x2 + BT4.1	3rd DP	Switch	None	1Wx1	None	None	None	USB / USB	None	Floor Stand	65W 88% Adapter	Win10 DG Win7 Pro 64	3-year, Onsite	Apr 21, 2023	03/17

Model	Region	Processor	vPro	Graphics	Monitor Cable	Memory	Storage(HDD/SSD)	External Optical / I/O Box	WLAN + Bluetooth	Optional Rear Ports	Chassis Intrusion Switch	Kensington Cable Lock	Speaker	Adapter Cage	Toolless Chassis Screw	Dust Filter	Keyboard / Mouse	VESA Mount	Stand	Power Supply	Operating System	Warranty	End of Support	Ann Date (mm/yy)
10MR0047US	US	i5-6500T	No	Intel HD 530	None	8GB	256GB SSD M.2 PCIe NVMe Opal	None	8265 ac, 2x2 + BT4.1	3rd DP	Switch	None	1Wx1	None	None	None	USB / USB	None	Floor Stand	65W 88% Adapter	Win10 DG Win7 Pro 64	3-year, Onsite	Mar 21, 2022	03/17
10MR0048US	US	i5-6500T	No	Intel HD 530	None	8GB	500GB 7200rpm 2.5"	None	3165 ac, 1x1 + BT4.1	3rd DP	Switch	None	1Wx1	None	None	None	USB / USB	None	Floor Stand	65W 88% Adapter	Win10 DG Win7 Pro 64	3-year, Onsite	Apr 21, 2023	03/17
10MR0049US	US	i3-6100T	No	Intel HD 530	None	4GBx1	500GB 7200rpm 2.5"	None	3165 ac, 1x1 + BT4.1	3rd DP	Switch	None	1Wx1	None	None	None	USB / USB	None	Floor Stand	65W 88% Adapter	Win10 DG Win7 Pro 64	3-year, Onsite	Apr 21, 2023	03/17
10MR004AUS	US	i3-6100T	No	Intel HD 530	None	4GBx1	128GB SSD M.2 PCIe NVMe	None	3165 ac, 1x1 + BT4.1	3rd DP	Switch	None	1Wx1	None	None	None	USB / USB	None	Floor Stand	65W 88% Adapter	Win10 DG Win7 Pro 64	3-year, Onsite	Apr 21, 2023	03/17
10MR004BUS	US	i5-6500T	No	Intel HD 530	None	8GB	512GB SSD M.2 PCIe NVMe Opal	None	8265 ac, 2x2 + BT4.1	3rd DP	Switch	None	1Wx1	None	None	None	USB / USB	None	Floor Stand	65W 88% Adapter	Win10 DG Win7 Pro 64	3-year, Onsite	Apr 21, 2023	03/17
10MR004CUS	US	i5-6500T	No	Intel HD 530	None	8GB	500GB 7200rpm 2.5"	DVD±RW	8265 ac, 2x2 + BT4.1	HDMI	Switch	None	1Wx1	None	None	None	USB / USB	VESA Mount	None	65W 88% Adapter	Win10 DG Win7 Pro 64	3-year, Onsite	Apr 21, 2023	03/17
10MR004DUS	US	i7-6700T	No	Intel HD 530	None	8GB	500GB 7200rpm 2.5"	None	8265 ac, 2x2 + BT4.1	3rd DP	Switch	None	1Wx1	None	None	None	USB / USB	None	Floor Stand	65W 88% Adapter	Win10 DG Win7 Pro 64	3-year, Onsite	Apr 21, 2023	03/17
10MR004EUS	US	i3-6100T	No	Intel HD 530	None	8GB	500GB 7200rpm 2.5"	None	3165 ac, 1x1 + BT4.1	3rd DP	Switch	None	1Wx1	None	None	None	USB / USB	None	Floor Stand	65W 88% Adapter	Win10 DG Win7 Pro 64	3-year, Onsite	Apr 21, 2023	03/17
10MR004FUS	US	i5-6500T	No	Intel HD 530	None	4GBx1	500GB 7200rpm 2.5"	None	3165 ac, 1x1 + BT4.1	3rd DP	Switch	None	1Wx1	None	None	None	USB / USB	None	Floor Stand	65W 88% Adapter	Win10 DG Win7 Pro 64	3-year, Onsite	Apr 21, 2023	03/17
10MR004GUS	US	i3-6100T	No	Intel HD 530	None	8GB	500GB 7200rpm 2.5"	DVD±RW	3165 ac, 1x1 + BT4.1	HDMI	Switch	None	1Wx1	None	None	None	USB / USB	VESA Mount	None	65W 88% Adapter	Win10 DG Win7 Pro 64	3-year, Onsite	Apr 21, 2023	03/17
10MR004HUS	US	i5-6500T	No	Intel HD 530	None	8GB	128GB SSD M.2 PCIe NVMe	None	8265 ac, 2x2 + BT4.1	3rd DP	Switch	None	1Wx1	None	None	None	USB / USB	None	Floor Stand	65W 88% Adapter	Win10 DG Win7 Pro 64	3-year, Onsite	Apr 21, 2023	03/17
10MR004JUS	US	i3-6100T	No	Intel HD 530	None	8GB	128GB SSD M.2 PCIe NVMe	None	3165 ac, 1x1 + BT4.1	3rd DP	Switch	None	1Wx1	None	None	None	USB / USB	None	Floor Stand	65W 88% Adapter	Win10 DG Win7 Pro 64	3-year, Onsite	Apr 21, 2023	03/17
10MR004KUS	US	i7-6700T	No	Intel HD 530	None	8GB	512GB SSD M.2 PCIe NVMe Opal	None	8265 ac, 2x2 + BT4.1	3rd DP	Switch	None	1Wx1	None	None	None	USB / USB	None	Floor Stand	65W 88% Adapter	Win10 DG Win7 Pro 64	3-year, Onsite	Apr 21, 2023	03/17
10MR004LUS	US	i7-6700T	No	Intel HD 530	None	8GB	500GB 7200rpm 2.5"	DVD±RW	8265 ac, 2x2 + BT4.1	HDMI	Switch	None	1Wx1	None	None	None	USB / USB	VESA Mount	None	65W 88% Adapter	Win10 DG Win7 Pro 64	3-year, Onsite	Apr 21, 2023	03/17
10MR004MUS	US	i5-6500T	No	Intel HD 530	None	8GB	128GB SSD M.2 PCIe NVMe	None	3165 ac, 1x1 + BT4.1	3rd DP	Switch	None	1Wx1	None	None	None	USB / USB	None	Floor Stand	65W 88% Adapter	Win10 DG Win7 Pro 64	3-year, Onsite	Apr 21, 2023	03/17
10MR0062US	US	i5-7400T	No	Intel HD 630	None	8GB	16GB Optane Memory + 500GB 7200rpm 2.5"	None	3165 ac, 1x1 + BT4.1	3rd DP	Switch	None	1Wx1	None	None	None	USB / USB	None	Floor Stand	65W 88% Adapter	Win10 Pro 64	3-year, Onsite	Sep 5, 2022	09/17
10MR0063US	US	i5-7400T	No	Intel HD 630	None	8GB	16GB Optane Memory + 500GB 7200rpm 2.5"	None	3165 ac, 1x1 + BT4.1	HDMI	Switch	None	1Wx1	None	None	None	USB / USB	None	Floor Stand	65W 88% Adapter	Win10 Pro 64	3-year, Onsite	Sep 5, 2022	09/17
10MR0064US	US	i7-7700T	No	Intel HD 630	None	8GB	16GB Optane Memory + 500GB 7200rpm 2.5"	None	3165 ac, 1x1 + BT4.1	3rd DP	Switch	None	1Wx1	None	None	None	USB / USB	None	Floor Stand	65W 88% Adapter	Win10 Pro 64	3-year, Onsite	Sep 5, 2022	09/17
10MR0065US	US	i7-7700T	No	Intel HD 630	None	8GB	16GB Optane Memory + 500GB 7200rpm 2.5"	None	3165 ac, 1x1 + BT4.1	HDMI	Switch	None	1Wx1	None	None	None	USB / USB	None	Floor Stand	65W 88% Adapter	Win10 Pro 64	3-year, Onsite	Sep 5, 2022	09/17
10MR0066US	US	i3-7100T	No	Intel HD 630	None	8GB	16GB Optane Memory + 500GB 7200rpm 2.5"	None	3165 ac, 1x1 + BT4.1	HDMI	Switch	None	1Wx1	None	None	None	USB / USB	None	Floor Stand	65W 88% Adapter	Win10 Pro 64	3-year, Onsite	Sep 5, 2022	09/17

Model	Region	Processor	vPro	Graphics	Monitor Cable	Memory	Storage(HDD/SSD)	External Optical / I/O Box	WLAN + Bluetooth	Optional Rear Ports	Chassis Intrusion Switch	Kensington Cable Lock	Speaker	Adapter Cage	Toolless Chassis Screw	Dust Filter	Keyboard / Mouse	VESA Mount	Stand	Power Supply	Operating System	Warranty	End of Support	Ann Date (mm/yy)
10MR0067US	US	i3-7100T	No	Intel HD 630	None	8GB	16GB Optane Memory + 500GB 7200rpm 2.5"	None	3165 ac, 1x1 + BT4.1	3rd DP	Switch	None	1Wx1	None	None	None	USB / USB	None	Floor Stand	65W 88% Adapter	Win10 Pro 64	3-year, Onsite	Sep 5, 2022	09/17
10MR006UUS	US	i3-7100T	No	Intel HD 630	None	4GBx1	16GB Optane Memory + 500GB 7200rpm 2.5"	None	3165 ac, 1x1 + BT4.0	3rd DP	Switch	None	1Wx1	None	None	None	USB / USB	None	Floor Stand	65W 88% Adapter	Win10 Pro 64	3-year, Onsite	Apr 27, 2024	03/18
10MR006VUS	US	i3-7100T	No	Intel HD 630	None	4GBx1	16GB Optane Memory + 500GB 7200rpm 2.5"	None	3165 ac, 1x1 + BT4.0	HDMI	Switch	None	1Wx1	None	None	None	USB / USB	None	Floor Stand	65W 88% Adapter	Win10 Pro 64	3-year, Onsite	Apr 27, 2024	03/18
10MR006WUS	US	i5-7400T	No	Intel HD 630	None	4GBx1	16GB Optane Memory + 500GB 7200rpm 2.5"	None	3165 ac, 1x1 + BT4.0	3rd DP	Switch	None	1Wx1	None	None	None	USB / USB	None	Floor Stand	65W 88% Adapter	Win10 Pro 64	3-year, Onsite	Apr 27, 2024	03/18
10MR006XUS	US	i5-7500T	No	Intel HD 630	None	4GBx1	16GB Optane Memory + 500GB 7200rpm 2.5"	None	3165 ac, 1x1 + BT4.0	3rd DP	Switch	None	1Wx1	None	None	None	USB / USB	None	Floor Stand	65W 88% Adapter	Win10 Pro 64	3-year, Onsite	Apr 27, 2024	03/18
10MR006YUS	US	i5-7500T	No	Intel HD 630	None	4GBx1	16GB Optane Memory + 500GB 7200rpm 2.5"	None	3165 ac, 1x1 + BT4.0	HDMI	Switch	None	1Wx1	None	None	None	USB / USB	None	Floor Stand	65W 88% Adapter	Win10 Pro 64	3-year, Onsite	Apr 27, 2024	03/18
10MR0070US	US	i5-7400T	No	Intel HD 630	None	4GBx1	16GB Optane Memory + 500GB 7200rpm 2.5"	None	3165 ac, 1x1 + BT4.0	HDMI	Switch	None	1Wx1	None	None	None	USB / USB	None	Floor Stand	65W 88% Adapter	Win10 Pro 64	3-year, Onsite	Apr 27, 2024	03/18

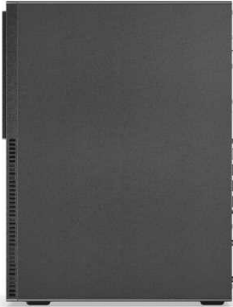

ThinkCentre M710 Tower Platform Specifications

Product Specifications Reference (PSREF)

Processor	Intel® Celeron®, Intel Pentium®, or 6/7th Generation Intel Core™ i3 / i5 / i7 Processor						Manageability None Security chip TPM (Trusted Platform Module) 2.0, TCG Certified * Downgrade to TPM1.2 for the models with Win10 DG Win7 32 OS Security features • Security slot (in rear for optional Kensington® MicroSaver® cable) • Padlock loop • Smart USB protection, allows keyboard/mouse only, blocks all storage devices • Optional cable lock to physically lock both keyboard and mouse • Power-on password • Administrator password • Hard disk password • Boot sequence control • Boot without keyboard and mouse • Individual USB port disablement • Optional chassis intrusion switch
	Processor	Cores / Threads	Frequency Base/Max(GHz)	Cache	Memory Support (Up to)	Integrated Graphics	
	Pentium G4400	2 / 2	3.3G	3 MB	DDR4-2133	HD 510	
	Pentium G4560	2 / 4	3.5G	3 MB	DDR4-2400	HD 610	
	Pentium G4600	2 / 4	3.6G	3 MB	DDR4-2400	HD 630	
	Core i3-6100	2 / 4	3.7G	3 MB	DDR4-2133	HD 530	
	Core i5-6500	4 / 4	3.2G / 3.6G	6 MB	DDR4-2133	HD 530	
	Core i7-6700	4 / 8	3.4G / 4.0G	8 MB	DDR4-2133	HD 530	
	Core i3-7100	2 / 4	3.9G	3 MB	DDR4-2400	HD 630	
	Core i5-7400	4 / 4	3.0G / 3.5G	6 MB	DDR4-2400	HD 630	
Core i5-7500	4 / 4	3.4G / 3.8G	6 MB	DDR4-2400	HD 630		
Core i5-7600	4 / 4	3.5G / 4.1G	6 MB	DDR4-2400	HD 630		
Core i7-7700	4 / 8	3.6G / 4.2G	8 MB	DDR4-2400	HD 630		
Memory	64GB max, UDIMM, DDR4-2400*, four 288-pin DIMM sockets, non-ECC, dual-channel capable * System automatically clocks down for the processors with lower memory controller						Mechanical • Tower (15L), black color, metal case • (WxDxH) 5.7" X 11.5" X 14.4"; 145mm X 292.7mm X 366mm • Approx. 14.3 lb (6.5 kg), weight may vary by configuration • Optional dust filter Bay 1: Slim external ODD bay Bay 2: 3.5", 1" high, internal, HDD/SSD Bay 3: 3.5", 1" high, internal, HDD/SSD Slot 1: half-length full-height (length < 189mm, height < 104mm), PCIe 3.0 x16* Slot 2: half-length full-height (length < 189mm, height < 104mm), PCIe 3.0 x1* Slot 3: half-length full-height (length < 189mm, height < 104mm), PCIe 3.0 x1* Slot 4: no slot, only bracket for optional port extension* M.2 card slots: Two (one for WLAN, one for SSD/Optane) * Optional 2 front USB3.1 Type-C ports module occupies PCIe x16 slot (x4 card), optional rear 2x USB2.0 / parallel occupies one expansion slot Power supply <i>Some:</i> 180 watts, autosensing, 85% PSU <i>Some:</i> 210 watts, autosensing, 85% PSU <i>Some:</i> 210 watts, autosensing, 92% PSU (only available via special bid) Limited warranty ³ <i>Some:</i> 1-year or 3-year, depot service / service upgrades available <i>Some:</i> 1-year or 3-year, limited onsite service / service upgrades available Preload Preloaded operating system <i>Some:</i> Windows® 7 Professional 32/64 preinstalled through downgrade rights in Windows 10 Pro 64-bit (not available with 7th Gen Intel processor) <i>Some:</i> Windows 10 Pro 64-bit <i>Some:</i> Windows 10 Home 64-bit Preloaded applications (only some listed) • Microsoft Office preloaded; purchase a product key to activate - Only for Window 10 • Lenovo Companion - Only for Window 7 • Lenovo Solution Center • Lenovo ThinkVantage Tools • Create Recovery Media • Adobe® Reader® • Cyberlink PowerDVD Create (DVD±RW)
Storage	<i>Some:</i> Hard Drive / SATA 6.0Gb/s, 2.5" or 3.5", 5400 rpm or 7200 rpm <i>Some:</i> Solid State Drive (SSD) / SATA 6.0Gb/s, 2.5" <i>Some:</i> M.2 Solid State Drive (SSD) / PCIe NVMe, PCIe 3.0 x 4, 32Gb/s <i>Some:</i> Intel Optane™ Memory (models with 7th gen Core processor), M.2 <i>Some:</i> DVD-ROM SATA 1.5Gb/s Drive, slim (9.0mm)						
Optical	<i>Some:</i> DVD Burner (DVD±RW), SATA 1.5Gb/s Drive, slim (9.0mm)						
Onboard SATA Media reader	Three onboard SATA 6.0Gb/s connectors Optional 7-in-1 media reader						
Graphics	Intel HD Graphics 510/530/610/630 in processor, uses main memory, DirectX® 12, one VGA, two DisplayPort™, supports 3 independent displays, works along with discrete graphics to support more displays; <i>Max resolution:</i> 4096x2304 (DP) @60Hz; 2048x1536 (VGA) @50Hz <i>Some:</i> NVIDIA GeForce® GT 730 , DirectX 12, 2GB, PCIe 2.0 x8 adapter, two DisplayPort, 35 watts; <i>Max resolution:</i> 3840x2160 (DisplayPort) @60Hz; <i>Some:</i> AMD Radeon™ R7 350 , DirectX 11, 2GB, PCIe 3.0 x8 adapter, one VGA, one HDMI, 75 watts, occupies two slots; <i>Max resolution:</i> 4096x2160 (HDMI) @24Hz; 2048x1536 (VGA) @85Hz						
Monitor Cable	Optional DP to VGA, DP to DVI-D (single link), DP to dual DP, or DP to HDMI 1.4						
Chipset	Intel B250 Chipset						
Front ports	Four USB 3.1 Gen1, optional two USB 3.1 Type-C Gen 2 (only available via special bid), microphone (3.5mm), headphone (3.5mm)						
Rear ports	Two USB 3.1 Gen1, two USB 2.0, optional two USB 2.0, serial (9-pin), optional 2nd serial (9-pin), optional parallel (25-pin), ethernet (RJ-45), one VGA, two DisplayPort, two PS/2 ports (keyboard/mouse); additional VGA, DisplayPort, or HDMI on optional graphics on some models						
Rear audio ports IEEE 1394	Line-in (3.5mm), line-out (3.5mm), microphone-in (3.5mm) None						
Audio support	High Definition (HD) Audio, Realtek ALC662 / optional internal speaker (1.5 watt)						
WLAN ¹³	<i>Some:</i> 11ac wireless, M.2 Card, Qualcomm Atheros QCA9377A (dual band), Wi-Fi + Bluetooth 4.1 combo adapter, 1x1 <i>Some:</i> 11ac wireless, M.2 Card, Qualcomm Atheros QCA6174A (dual band), Wi-Fi + Bluetooth 4.1 combo adapter, 2x2 <i>Some:</i> 11ac wireless, M.2 Card, Intel Dual Band Wireless-AC 3165, Wi-Fi + Bluetooth 4.1 combo adapter, 1x1 <i>Some:</i> 11ac wireless, M.2 Card, Intel Dual Band Wireless-AC 8265, Wi-Fi + Bluetooth 4.1 combo adapter, 2x2						
Bluetooth™	<i>Some:</i> Bluetooth 4.1 wireless, integrated in Wi-Fi + BT combo adapter						
Ethernet	Gigabit ethernet, Realtek RTL8111GN, Wake on LAN®						
Modem	None						
Environment	ENERGY STAR® 6.1, EPEAT™ Gold rating (North America), ErP Lot 3, GREENGUARD®, RoHS-compliant, TUV low noise verified (on some models)						
Accessories	For compatible accessories, please go to http://www.lenovoquickpick.com						

See footnotes for more detailed information

Model	Region	Processor	vPro	Graphics	Monitor Cable	Memory	Storage(HDD/SSD)	Optical	Media Reader	WLAN + Bluetooth	Optional Front Ports	Optional Rear Ports	Chassis Intrusion Switch	Cable Lock	Speaker	Dust Filter	Keyboard / Mouse	Power Supply	Operating System	Warranty	Ann Date (mm/yy)
10M9000EUS	US	i7-7700	No	GT 730 2GB	None	8GBx1	256GB SSD M.2 PCIe NVMe Opal	DVD±RW	None	3165 ac, 1x1 + BT4.1	None	None	None	None	1.5Wx1	None	USB / USB	210W 85%	Win10 Pro 64	3-year, Onsite	02/17
10M9000FUS	US	i5-7400	No	Intel HD 630	None	8GBx1	256GB SSD M.2 PCIe NVMe Opal	DVD±RW	None	None	None	None	None	None	1.5Wx1	None	USB / USB	210W 85%	Win10 Pro 64	3-year, Onsite	02/17
10M9000GUS	US	i7-7700	No	GT 730 2GB	None	8GBx1	1TB 7200rpm 3.5"	DVD±RW	None	None	None	None	None	None	1.5Wx1	None	USB / USB	210W 85%	Win10 Pro 64	3-year, Onsite	02/17
10M9000HUS	US	i5-7400	No	Intel HD 630	None	8GBx1	256GB SSD M.2 PCIe NVMe Opal	DVD±RW	None	3165 ac, 1x1 + BT4.1	None	None	None	None	1.5Wx1	None	USB / USB	210W 85%	Win10 Pro 64	3-year, Onsite	02/17
10M9000JUS	US	i5-7400	No	GT 730 2GB	None	8GBx1	1TB 7200rpm 3.5"	DVD±RW	None	None	None	None	None	None	1.5Wx1	None	USB / USB	210W 85%	Win10 Pro 64	3-year, Onsite	02/17
10M9000KUS	US	i7-7700	No	Intel HD 630	None	8GBx1	256GB SSD M.2 PCIe NVMe Opal	DVD±RW	None	3165 ac, 1x1 + BT4.1	None	None	None	None	1.5Wx1	None	USB / USB	210W 85%	Win10 Pro 64	3-year, Onsite	02/17
10M9000LUS	US	i7-7700	No	Intel HD 630	None	8GBx1	256GB SSD M.2 PCIe NVMe Opal	DVD±RW	None	None	None	None	None	None	1.5Wx1	None	USB / USB	210W 85%	Win10 Pro 64	3-year, Onsite	02/17
10M9000MUS	US	i5-7400	No	Intel HD 630	None	8GBx1	512GB SSD M.2 PCIe NVMe Opal	DVD±RW	None	None	None	None	None	None	1.5Wx1	None	USB / USB	210W 85%	Win10 Pro 64	3-year, Onsite	02/17
10M9000NUS	US	i5-7400	No	Intel HD 630	None	4GBx1	500GB 7200rpm 3.5"	DVD±RW	None	None	None	None	None	None	1.5Wx1	None	USB / USB	210W 85%	Win10 Pro 64	3-year, Onsite	02/17
10M9000PUS	US	i5-7400	No	GT 730 2GB	None	8GBx1	256GB SSD M.2 PCIe NVMe Opal	DVD±RW	None	None	None	None	None	None	1.5Wx1	None	USB / USB	210W 85%	Win10 Pro 64	3-year, Onsite	02/17
10M9000QUS	US	i7-7700	No	Intel HD 630	None	8GBx1	512GB SSD M.2 PCIe NVMe Opal	DVD±RW	None	None	None	None	None	None	1.5Wx1	None	USB / USB	210W 85%	Win10 Pro 64	3-year, Onsite	02/17
10M9000RUS	US	i5-7400	No	Intel HD 630	None	8GBx1	1TB 7200rpm 3.5"	DVD±RW	None	None	None	None	None	None	1.5Wx1	None	USB / USB	210W 85%	Win10 Pro 64	3-year, Onsite	02/17
10M9000SUS	US	i5-7400	No	GT 730 2GB	None	8GBx1	256GB SSD M.2 PCIe NVMe Opal	DVD±RW	None	3165 ac, 1x1 + BT4.1	None	None	None	None	1.5Wx1	None	USB / USB	210W 85%	Win10 Pro 64	3-year, Onsite	02/17
10M9000TUS	US	i7-7700	No	Intel HD 630	None	8GBx1	1TB 7200rpm 3.5"	DVD±RW	None	None	None	None	None	None	1.5Wx1	None	USB / USB	210W 85%	Win10 Pro 64	3-year, Onsite	02/17
10M9000UUS	US	i7-7700	No	GT 730 2GB	None	8GBx1	256GB SSD M.2 PCIe NVMe Opal	DVD±RW	None	None	None	None	None	None	1.5Wx1	None	USB / USB	210W 85%	Win10 Pro 64	3-year, Onsite	02/17
10M9002UUS	US	i3-6100	No	Intel HD 530	None	4GBx1	1TB 7200rpm 3.5"	DVD±RW	None	None	None	None	None	None	1.5Wx1	None	USB / USB	210W 85%	Win10 DG Win7 Pro 64	3-year, Onsite	03/17
10M9002VUS	US	i3-6100	No	Intel HD 530	None	8GBx1	1TB 7200rpm 3.5"	DVD±RW	None	None	None	None	None	None	1.5Wx1	None	USB / USB	210W 85%	Win10 DG Win7 Pro 64	3-year, Onsite	03/17
10M9002WUS	US	Pentium G4400	No	Intel HD 510	None	4GBx1	500GB 7200rpm 3.5"	DVD±RW	None	None	None	None	None	None	1.5Wx1	None	USB / USB	210W 85%	Win10 DG Win7 Pro 64	3-year, Onsite	03/17
10M9002XUS	US	i5-6500	No	Intel HD 530	None	8GBx1	256GB SSD M.2 PCIe NVMe Opal	DVD±RW	None	3165 ac, 1x1 + BT4.1	None	None	None	None	1.5Wx1	None	USB / USB	210W 85%	Win10 DG Win7 Pro 64	3-year, Onsite	03/17
10M9002YUS	US	i7-6700	No	Intel HD 530	None	8GBx1	512GB SSD M.2 PCIe NVMe Opal	DVD±RW	None	None	None	None	None	None	1.5Wx1	None	USB / USB	210W 85%	Win10 DG Win7 Pro 64	3-year, Onsite	03/17

Model	Region	Processor	vPro	Graphics	Monitor Cable	Memory	Storage(HDD/SSD)	Optical	Media Reader	WLAN + Bluetooth	Optional Front Ports	Optional Rear Ports	Chassis Intrusion Switch	Cable Lock	Speaker	Dust Filter	Keyboard / Mouse	Power Supply	Operating System	Warranty	Ann Date (mm/yy)
10M90030US	US	i7-6700	No	GT 730 2GB	None	8GBx1	1TB 7200rpm 3.5"	DVD±RW	None	None	None	None	None	None	1.5Wx1	None	USB / USB	210W 85%	Win10 DG Win7 Pro 64	3-year, Onsite	03/17
10M90031US	US	i5-6500	No	Intel HD 530	None	8GBx1	256GB SSD M.2 PCIe NVMe Opal	DVD±RW	None	None	None	None	None	None	1.5Wx1	None	USB / USB	210W 85%	Win10 DG Win7 Pro 64	3-year, Onsite	03/17
10M90032US	US	i5-7400	No	Intel HD 630	None	4GBx1	128GB SSD M.2 PCIe NVMe	DVD±RW	None	None	None	None	None	None	1.5Wx1	None	USB / USB	210W 85%	Win10 Pro 64	3-year, Onsite	03/17
10M90033US	US	i7-6700	No	GT 730 2GB	None	8GBx1	256GB SSD M.2 PCIe NVMe Opal	DVD±RW	None	3165 ac, 1x1 + BT4.1	None	None	None	None	1.5Wx1	None	USB / USB	210W 85%	Win10 DG Win7 Pro 64	3-year, Onsite	03/17
10M90034US	US	i7-6700	No	Intel HD 530	None	8GBx1	256GB SSD M.2 PCIe NVMe Opal	DVD±RW	None	3165 ac, 1x1 + BT4.1	None	None	None	None	1.5Wx1	None	USB / USB	210W 85%	Win10 DG Win7 Pro 64	3-year, Onsite	03/17
10M90035US	US	i3-7100	No	Intel HD 630	None	8GBx1	128GB SSD M.2 PCIe NVMe	DVD±RW	None	None	None	None	None	None	1.5Wx1	None	USB / USB	210W 85%	Win10 Pro 64	3-year, Onsite	03/17
10M90036US	US	i5-6500	No	Intel HD 530	None	4GBx1	500GB 7200rpm 3.5"	DVD±RW	None	None	None	None	None	None	1.5Wx1	None	USB / USB	210W 85%	Win10 DG Win7 Pro 64	3-year, Onsite	03/17
10M90037US	US	i3-7100	No	Intel HD 630	None	8GBx1	1TB 7200rpm 3.5"	DVD±RW	None	None	None	None	None	None	1.5Wx1	None	USB / USB	210W 85%	Win10 Pro 64	3-year, Onsite	03/17
10M90038US	US	i5-6500	No	GT 730 2GB	None	8GBx1	256GB SSD M.2 PCIe NVMe Opal	DVD±RW	None	3165 ac, 1x1 + BT4.1	None	None	None	None	1.5Wx1	None	USB / USB	210W 85%	Win10 DG Win7 Pro 64	3-year, Onsite	03/17
10M90039US	US	i5-6500	No	Intel HD 530	None	8GBx1	1TB 7200rpm 3.5"	DVD±RW	None	None	None	None	None	None	1.5Wx1	None	USB / USB	210W 85%	Win10 DG Win7 Pro 64	3-year, Onsite	03/17
10M9003AUS	US	i3-6100	No	Intel HD 530	None	4GBx1	500GB 7200rpm 3.5"	DVD±RW	None	None	None	None	None	None	1.5Wx1	None	USB / USB	210W 85%	Win10 DG Win7 Pro 64	3-year, Onsite	03/17
10M9003BUS	US	i3-6100	No	Intel HD 530	None	8GBx1	128GB SSD M.2 PCIe NVMe	DVD±RW	None	None	None	None	None	None	1.5Wx1	None	USB / USB	210W 85%	Win10 DG Win7 Pro 64	3-year, Onsite	03/17
10M9003CUS	US	i3-7100	No	Intel HD 630	None	4GBx1	500GB 7200rpm 3.5"	DVD±RW	None	None	None	None	None	None	1.5Wx1	None	USB / USB	210W 85%	Win10 Pro 64	3-year, Onsite	03/17
10M9003DUS	US	Pentium G4560	No	Intel HD 610	None	4GBx1	500GB 7200rpm 3.5"	DVD±RW	None	None	None	None	None	None	1.5Wx1	None	USB / USB	210W 85%	Win10 Pro 64	3-year, Onsite	03/17
10M9003EUS	US	i7-6700	No	Intel HD 530	None	8GBx1	1TB 7200rpm 3.5"	DVD±RW	None	None	None	None	None	None	1.5Wx1	None	USB / USB	210W 85%	Win10 DG Win7 Pro 64	3-year, Onsite	03/17
10M9003FUS	US	i7-6700	No	Intel HD 530	None	8GBx1	256GB SSD M.2 PCIe NVMe Opal	DVD±RW	None	None	None	None	None	None	1.5Wx1	None	USB / USB	210W 85%	Win10 DG Win7 Pro 64	3-year, Onsite	03/17
10M9003GUS	US	i5-6500	No	Intel HD 530	None	4GBx1	128GB SSD M.2 PCIe NVMe	DVD±RW	None	None	None	None	None	None	1.5Wx1	None	USB / USB	210W 85%	Win10 DG Win7 Pro 64	3-year, Onsite	03/17
10M9003HUS	US	i5-6500	No	GT 730 2GB	None	8GBx1	1TB 7200rpm 3.5"	DVD±RW	None	None	None	None	None	None	1.5Wx1	None	USB / USB	210W 85%	Win10 DG Win7 Pro 64	3-year, Onsite	03/17
10M9003JUS	US	i5-6500	No	GT 730 2GB	None	8GBx1	256GB SSD M.2 PCIe NVMe Opal	DVD±RW	None	None	None	None	None	None	1.5Wx1	None	USB / USB	210W 85%	Win10 DG Win7 Pro 64	3-year, Onsite	03/17
10M9003KUS	US	i7-6700	No	GT 730 2GB	None	8GBx1	256GB SSD M.2 PCIe NVMe Opal	DVD±RW	None	None	None	None	None	None	1.5Wx1	None	USB / USB	210W 85%	Win10 DG Win7 Pro 64	3-year, Onsite	03/17

Model	Region	Processor	vPro	Graphics	Monitor Cable	Memory	Storage(HDD/SSD)	Optical	Media Reader	WLAN + Bluetooth	Optional Front Ports	Optional Rear Ports	Chassis Intrusion Switch	Cable Lock	Speaker	Dust Filter	Keyboard / Mouse	Power Supply	Operating System	Warranty	Ann Date (mm/yy)
10M9003LUS	US	i3-7100	No	Intel HD 630	None	4GBx1	1TB 7200rpm 3.5"	DVD±RW	None	None	None	None	None	None	1.5Wx1	None	USB / USB	210W 85%	Win10 Pro 64	3-year, Onsite	03/17
10M9005NUS	US	i5-7400	No	Intel HD 630	None	8GBx1	16GB Optane Memory + 1TB 7200rpm 3.5"	None	None	None	None	None	None	None	1.5Wx1	None	USB / USB	210W 85%	Win10 Pro 64	3-year, Onsite	03/18
10M9005PUS	US	i5-7400	No	Intel HD 630	None	4GBx1	16GB Optane Memory + 1TB 7200rpm 3.5"	None	None	None	None	None	None	None	1.5Wx1	None	USB / USB	210W 85%	Win10 Pro 64	3-year, Onsite	03/18



ThinkCentre M710e SFF Platform Specifications

Product Specifications Reference (PSREF)

Processor	Intel® Celeron®, Intel Pentium®, or 6/7th Generation Intel Core™ i3 / i5 / i7 Processor						Security features <ul style="list-style-type: none"> Security slot (in rear for optional Kensington® MicroSaver® cable) Padlock loop Smart USB protection, allows keyboard/mouse only, blocks all storage devices Optional smart cable clip to physically lock both keyboard and mouse Power-on password Administrator password Hard disk password Boot sequence control Boot without keyboard and mouse Individual USB port disablement Optional chassis intrusion switch
	Processor	Cores / Threads	Frequency Base/Max(GHz)	Cache	Memory Support (Up to)	Integrated Graphics	
	Celeron G3900	2 / 2	2.8G	2 MB	DDR4-2133	HD 510	
	Celeron G3930	2 / 2	2.9G	3 MB	DDR4-2133	HD 610	
	Pentium G4400	2 / 2	3.3G	3 MB	DDR4-2133	HD 510	
	Pentium G4500	2 / 2	3.5G	3 MB	DDR4-2133	HD 530	
	Pentium G4560	2 / 4	3.5G	3 MB	DDR4-2400	HD 610	
	Pentium G4600	2 / 4	3.6G	3 MB	DDR4-2400	HD 630	
	Core i3-6100	2 / 4	3.7G	3 MB	DDR4-2133	HD 530	
	Core i5-6400	4 / 4	2.7G / 3.3G	6 MB	DDR4-2133	HD 530	
	Core i5-6500	4 / 4	3.2G / 3.6G	6 MB	DDR4-2133	HD 530	
	Core i7-6700	4 / 8	3.4G / 4.0G	8 MB	DDR4-2133	HD 530	
	Core i3-7100	2 / 4	3.9G	3 MB	DDR4-2400	HD 630	
	Core i3-7300	2 / 4	4.0G	4 MB	DDR4-2400	HD 630	
	Core i5-7400	4 / 4	3.0G / 3.5G	6 MB	DDR4-2400	HD 630	
	Core i5-7500	4 / 4	3.4G / 3.8G	6 MB	DDR4-2400	HD 630	
	Core i5-7600	4 / 4	3.5G / 4.1G	6 MB	DDR4-2400	HD 630	
Core i7-7700	4 / 8	3.6G / 4.2G	8 MB	DDR4-2400	HD 630		
Memory	32GB max, UDIMM, DDR4-2400*, two 288-pin DIMM sockets, non-ECC, dual-channel capable						Packaging <ul style="list-style-type: none"> (WxDxH) 7.7" X 15.4" X 19.7"; 195mm X 390mm X 500mm Cross weight (approx.) 14.22 lb (6.45 kg)
	*System automatically clocks down for the processors with lower memory controller						
Storage	<i>Some:</i> Hard Drive / SATA 6.0Gb/s, 2.5" or 3.5", 5400 rpm or 7200 rpm <i>Some:</i> Solid State Drive (SSD) / SATA 6.0Gb/s, 2.5" <i>Some:</i> M.2 Solid State Drive (SSD) / PCIe NVMe, PCIe 3.0 x 4, 32Gb/s						Power supply <i>Some:</i> 180 watts, autosensing, 85% PSU Limited warranty ³ <i>Some:</i> 1-year or 3-year, depot service / service upgrades available <i>Some:</i> 1-year or 3-year, limited onsite service / service upgrades available
Optical	<i>Some:</i> DVD-ROM SATA 1.5Gb/s Drive, slim (9.0mm) <i>Some:</i> DVD Burner (DVD±RW), SATA 1.5Gb/s Drive, slim (9.0mm)						
Onboard SATA Media reader	Two onboard SATA 6.0Gb/s connectors Optional 7-in-1 media reader						Preload Preloaded operating system <i>Some:</i> Windows® 10 Pro 64-bit <i>Some:</i> Windows 10 Home 64-bit <i>Some:</i> Windows 7 Professional 32/64 preinstalled through downgrade rights in Windows 10 Pro 64-bit(not available with 7th Gen Intel processor) Preloaded applications (only some listed) <ul style="list-style-type: none"> Microsoft Office preloaded; purchase a product key to activate Cyberlink PowerDVD (DVD, DVD±RW) Cyberlink PowerDVD Create (DVD±RW) - Only for Window 10 Lenovo Companion - Only for Window 7 Lenovo Solution Center Lenovo System Update Create Recovery Media Adobe® Reader®
Graphics	Intel HD Graphics 510/530/610/630 in processor, uses main memory, DirectX® 12, one VGA, one DisplayPort™, supports 2 independent displays, works along with discrete graphics to support more displays; <i>Max resolution:</i> 4096x2160 (DP)@60Hz; 1920x1200 (VGA)@60Hz <i>Some:</i> NVIDIA GeForce® GT 730 , DirectX 12, 2GB, PCIe 2.0 x8 adapter, two DisplayPort, 35 watts; <i>Max resolution:</i> 3840x2160 (DisplayPort)@60Hz;						
Monitor cable	Optional DP to VGA, DP to DVI-D (single link), DP to dual DP, or DP to HDMI 1.4						
Chipset	Intel B250 Chipset						
Front ports	Two USB 3.1 Gen1, microphone (3.5mm), one headphone / microphone combo jack (3.5mm)						
Rear ports	Two USB 3.1 Gen1, two USB 2.0, optional two USB 2.0, serial (9-pin), optional 2nd serial (9-pin), optional parallel (25-pin), ethernet (RJ-45), one VGA, one DisplayPort, optional external USB to PS/2 ports cable (for PS/2 keyboard / mouse); additional DisplayPort on optional graphics on some models						
Rear audio ports IEEE 1394	Line-out jack (3.5mm) None						
Audio support	High Definition (HD) Audio, Realtek ALC233 / internal speaker (1.5 watt)						
WLAN ¹³	None						
Bluetooth™	None						
Ethernet	Gigabit ethernet, Realtek RTL8111HN, Wake on LAN®						
Modem	None						
Manageability	None						
Security chip	TPM (Trusted Platform Module) 2.0, TCG Certified * Downgrade to TPM1.2 for the models with Win10 DG Win7 32 OS						
Floor Stand <ul style="list-style-type: none"> SFF (7.4L), black color, metal case (WxDxH) 3.9" X 11.9" X 10.8"; 100mm X 303.5mm X 273.5mm Approx. 9.37 lb (4.25 kg), weight may vary by configuration Bay 1: Slim external ODD bay Bay 2: 3.5", 1" high, internal, supports 2.5" or 3.5" HDD/SSD (2.5 to 3.5 bracket comes with disk) Slot 1: low-profile (length < 152mm, height < 64mm), PCIe 3.0 x16* Slot 2: low-profile (length < 152mm, height < 64mm), PCIe 3.0 x1* M.2 card slots: one for SSD *Optional rear 2x USB2.0 / parallel occupies one expansion slot Optional system floor stand for vertical orientation 							

See footnotes for more detailed information

ThinkCentre M710e SFF - TopSeller - 10UR

Product Specifications Reference (PSREF)

Model	Region	Processor	vPro	Graphics	Monitor Cable	Memory	Storage(HDD/SSD)	Optical	Media Reader	Optional Rear Ports	Chassis Intrusion Switch	Cable Lock	Keyboard / Mouse	Stand	Power Supply	Operating System	Warranty	Ann Date (mm/yy)
10UR001JUS	US	i5-7400	No	Intel HD 630	None	4GBx2	1TB 7200rpm 3.5"	DVD±RW	None	None	None	None	USB / USB	Floor Stand	180W 85%	Win10 Pro 64	1-year, Onsite	02/18
10UR001LUS	US	i5-7400	No	Intel HD 630	None	4GBx2	256GB SSD M.2 PCIe NVMe Opal	DVD±RW	None	None	None	None	USB / USB	Floor Stand	180W 85%	Win10 Pro 64	1-year, Onsite	02/18
10UR001MUS	US	i3-7100	No	Intel HD 630	None	4GBx1	1TB 7200rpm 3.5"	DVD±RW	None	None	None	None	USB / USB	Floor Stand	180W 85%	Win10 Pro 64	1-year, Onsite	02/18



ThinkCentre M715 SFF Platform Specifications

Product Specifications Reference (PSREF)

Processor	AMD A6 / A8 / A10 / A12 series APU and Ryzen 3 / 5 / 7 series processor	Security features	<ul style="list-style-type: none"> Security slot (in rear for optional Kensington® MicroSaver® cable) Padlock loop Smart USB protection, allows keyboard/ mouse only, blocks all storage devices Optional cable lock to physically lock both keyboard and mouse Power-on password Administrator password Hard disk password Boot sequence control Boot without keyboard and mouse Individual USB port disablement Optional chassis intrusion switch 																																																												
	<table border="1"> <thead> <tr> <th>APU / processor</th> <th>Cores / Threads</th> <th>Frequency (Base/Max)</th> <th>L2 Cache</th> <th>Integrated Graphics</th> </tr> </thead> <tbody> <tr> <td>Ryzen 3 PRO 1200</td> <td>4 / 4</td> <td>3.1 / 3.4</td> <td>2MB</td> <td>None</td> </tr> <tr> <td>Ryzen 3 PRO 1300</td> <td>4 / 4</td> <td>3.5 / 3.7</td> <td>2MB</td> <td>None</td> </tr> <tr> <td>Ryzen 5 PRO 1500</td> <td>4 / 8</td> <td>3.5 / 3.7</td> <td>2MB</td> <td>None</td> </tr> <tr> <td>Ryzen 7 PRO 1700</td> <td>8 / 16</td> <td>3.0 / 3.7</td> <td>4MB</td> <td>None</td> </tr> <tr> <td>PRO A6-8570</td> <td>2 / 2</td> <td>3.5 / 3.8</td> <td>1MB</td> <td>Radeon R5 Series</td> </tr> <tr> <td>PRO A10-8770</td> <td>4 / 4</td> <td>3.5 / 3.8</td> <td>2MB</td> <td>Radeon R7 Series</td> </tr> <tr> <td>PRO A12-8870</td> <td>4 / 4</td> <td>3.7 / 4.2</td> <td>2MB</td> <td>Radeon R7 Series</td> </tr> <tr> <td>PRO A6-9500</td> <td>2 / 2</td> <td>3.5 / 3.8</td> <td>1MB</td> <td>Radeon R5 Series</td> </tr> <tr> <td>PRO A8-9600</td> <td>4 / 4</td> <td>3.1 / 3.4</td> <td>2MB</td> <td>Radeon R7 Series</td> </tr> <tr> <td>PRO A10-9700</td> <td>4 / 4</td> <td>3.5 / 3.8</td> <td>2MB</td> <td>Radeon R7 Series</td> </tr> <tr> <td>PRO A12-9800</td> <td>4 / 4</td> <td>3.8 / 4.2</td> <td>2MB</td> <td>Radeon R7 Series</td> </tr> </tbody> </table>	APU / processor	Cores / Threads	Frequency (Base/Max)	L2 Cache	Integrated Graphics	Ryzen 3 PRO 1200	4 / 4	3.1 / 3.4	2MB	None	Ryzen 3 PRO 1300	4 / 4	3.5 / 3.7	2MB	None	Ryzen 5 PRO 1500	4 / 8	3.5 / 3.7	2MB	None	Ryzen 7 PRO 1700	8 / 16	3.0 / 3.7	4MB	None	PRO A6-8570	2 / 2	3.5 / 3.8	1MB	Radeon R5 Series	PRO A10-8770	4 / 4	3.5 / 3.8	2MB	Radeon R7 Series	PRO A12-8870	4 / 4	3.7 / 4.2	2MB	Radeon R7 Series	PRO A6-9500	2 / 2	3.5 / 3.8	1MB	Radeon R5 Series	PRO A8-9600	4 / 4	3.1 / 3.4	2MB	Radeon R7 Series	PRO A10-9700	4 / 4	3.5 / 3.8	2MB	Radeon R7 Series	PRO A12-9800	4 / 4	3.8 / 4.2	2MB	Radeon R7 Series	Keyboard	<i>Some:</i> Lenovo Calliope Keyboard (USB connector), black <i>Some:</i> Lenovo Traditional Keyboard (USB connector), black <i>Some:</i> Lenovo Calliope Wireless Keyboard (2.4GHz via USB receiver), black
APU / processor	Cores / Threads	Frequency (Base/Max)	L2 Cache	Integrated Graphics																																																											
Ryzen 3 PRO 1200	4 / 4	3.1 / 3.4	2MB	None																																																											
Ryzen 3 PRO 1300	4 / 4	3.5 / 3.7	2MB	None																																																											
Ryzen 5 PRO 1500	4 / 8	3.5 / 3.7	2MB	None																																																											
Ryzen 7 PRO 1700	8 / 16	3.0 / 3.7	4MB	None																																																											
PRO A6-8570	2 / 2	3.5 / 3.8	1MB	Radeon R5 Series																																																											
PRO A10-8770	4 / 4	3.5 / 3.8	2MB	Radeon R7 Series																																																											
PRO A12-8870	4 / 4	3.7 / 4.2	2MB	Radeon R7 Series																																																											
PRO A6-9500	2 / 2	3.5 / 3.8	1MB	Radeon R5 Series																																																											
PRO A8-9600	4 / 4	3.1 / 3.4	2MB	Radeon R7 Series																																																											
PRO A10-9700	4 / 4	3.5 / 3.8	2MB	Radeon R7 Series																																																											
PRO A12-9800	4 / 4	3.8 / 4.2	2MB	Radeon R7 Series																																																											
		Mouse	<i>Some:</i> Lenovo Calliope Mouse (USB connector), black <i>Some:</i> Lenovo Calliope Wireless Mouse (2.4GHz via USB receiver), black <i>Some:</i> Lenovo Fingerprint Mouse (USB connector), Windows Hello support, black																																																												
Memory	64GB max, UDIMM, DDR4-2400, four 288-pin DIMM sockets, non-ECC, dual-channel capable* * System automatically clocks down for the processors with lower memory controller	Mechanical	<ul style="list-style-type: none"> SFF (8.4L), black color; metal case (WxDxH) 3.6" X 11.4" X 13.5"; 92.5mm X 290.5mm X 343.5mm Approx. 13.2 lb (6.0 kg), weight may vary by configuration Toolless cover, disk, optical removal Optional dust filter Bay 1: Slim external ODD bay Bay 2: 3.5", internal, HDD/SSD Bay 3: 2.5", internal, HDD/SSD (bay only comes with 2.5" 2nd disk) Slot 1: low-profile (length < 150mm, height < 68mm), PCIe 3.0 x16* Slot 2: low-profile (length < 150mm, height < 68mm), PCIe 2.0 x1* Slot 3: low-profile (length < 150mm, height < 68mm), PCIe 2.0 x1* Slot 4: no slot, only bracket for optional port extension* M.2 card slots: two (one for WLAN, one for SSD) * Optional front USB3.1 Type-C x2 module occupies PCIe x16 slot (x4 card), optional rear 2x USB2.0 / parallel / 2nd serial occupies one expansion slot 																																																												
Storage	<i>Some:</i> Hard Drive / SATA 6.0Gb/s, 2.5" or 3.5", 5400 rpm or 7200 rpm <i>Some:</i> Solid State Drive (SSD) / SATA 6.0Gb/s, 2.5" <i>Some:</i> M.2 Solid State Drive (SSD) / PCIe NVMe, PCIe 3.0 x 4, 32Gb/s	Floor Stand	Optional system floor stand for vertical orientation																																																												
Optical	<i>Some:</i> DVD-ROM SATA 1.5Gb/s Drive, slim (9.0mm) <i>Some:</i> DVD Burner (DVD±RW), SATA 1.5Gb/s Drive, slim (9.0mm)	Power supply	<i>Some:</i> 180 watts, autosensing, 85% PSU <i>Some:</i> 210 watts, autosensing, 85% PSU <i>Some:</i> 210 watts, autosensing, 92% PSU (only available via special bid)																																																												
Onboard SATA	Three onboard SATA 6.0Gb/s connectors	Limited warranty	<i>Some:</i> 1-year or 3-year, depot service / service upgrades available <i>Some:</i> 1-year or 3-year, limited onsite service / service upgrades available																																																												
Media reader	Optional 7-in-1 media reader	Preload	Preloaded operating system <i>Some:</i> Windows® 7 Professional 32/64 preinstalled through downgrade rights in Windows 10 Pro 64-bit (Only available with Pro A6/A10/A12-8xxx APUs) <i>Some:</i> Windows 10 Pro 64-bit <i>Some:</i> Windows 10 Home 64-bit Preloaded applications (only some listed) <ul style="list-style-type: none"> Microsoft Office preloaded; purchase a product key to activate Only for Window 10 Lenovo Companion Only for Window 7 Lenovo Solution Center Lenovo ThinkVantage Tools Create Recovery Media Adobe® Reader® Cyberlink PowerDVD Create (DVD±RW) 																																																												
Graphics	AMD Radeon™ Graphics in processor (not for AMD Ryzen processor), uses main memory, DirectX® 12, one VGA, two DisplayPort™ (Onboard VGA and DP ports are invalid on the models with AMD Ryzen processor), supports 3 independent displays, works along with AMD discrete graphics to support more displays; <i>Max resolution:</i> 4096x2160 (DP)@60Hz; 1920x1200 (VGA)@60Hz <i>Some:</i> NVIDIA GeForce® GT 730 , DirectX 12, 2GB, PCIe 2.0 x8 adapter, two DisplayPort, 35 watts; <i>Max resolution:</i> 3840x2160 (DisplayPort)@60Hz;	Monitor cable	Optional DP to VGA, DP to DVI-D (single link), DP to dual DP, or DP to HDMI 1.4																																																												
Monitor cable	Optional DP to VGA, DP to DVI-D (single link), DP to dual DP, or DP to HDMI 1.4	Chipset	AMD B350 Chipset																																																												
Chipset	AMD B350 Chipset	Front ports	Two USB 3.1 Gen2, two USB 3.1 Gen1, optional two USB 3.1 Type-C Gen 2 (only available via special bid), microphone (3.5mm), headphone (3.5mm)																																																												
Front ports	Two USB 3.1 Gen2, two USB 3.1 Gen1, optional two USB 3.1 Type-C Gen 2 (only available via special bid), microphone (3.5mm), headphone (3.5mm)	Rear ports	Two USB 3.1 Gen1, two USB 2.0, optional two USB 2.0, serial (9-pin), optional 2nd serial (9-pin), optional parallel (25-pin), ethernet (RJ-45), one VGA and two DisplayPort (not available on models with AMD Ryzen processor), two PS/2 ports (keyboard / mouse); additional DisplayPort on optional graphics on some models																																																												
Rear ports	Two USB 3.1 Gen1, two USB 2.0, optional two USB 2.0, serial (9-pin), optional 2nd serial (9-pin), optional parallel (25-pin), ethernet (RJ-45), one VGA and two DisplayPort (not available on models with AMD Ryzen processor), two PS/2 ports (keyboard / mouse); additional DisplayPort on optional graphics on some models	Rear audio ports	Line-in (3.5mm), line-out (3.5mm), microphone-in (3.5mm)																																																												
Rear audio ports	Line-in (3.5mm), line-out (3.5mm), microphone-in (3.5mm)	IEEE 1394	None																																																												
IEEE 1394	None	Audio support	High Definition (HD) Audio, Realtek ALC662 / optional internal speaker (1.5 watt)																																																												
Audio support	High Definition (HD) Audio, Realtek ALC662 / optional internal speaker (1.5 watt)	WLAN	<i>Some:</i> 11ac wireless, M.2 Card, Realtek RTL8821AE (dual band), Wi-Fi + Bluetooth 4.0 combo adapter, 1x1 <i>Some:</i> 11ac wireless, M.2 Card, Qualcomm Atheros QCA6174A (dual band), Wi-Fi + Bluetooth 4.1 combo adapter, 2x2 <i>Some:</i> 11ac wireless, M.2 Card, Qualcomm Atheros QCA9377 (dual band), Wi-Fi + Bluetooth 4.1 combo adapter, 1x1																																																												
WLAN	<i>Some:</i> 11ac wireless, M.2 Card, Realtek RTL8821AE (dual band), Wi-Fi + Bluetooth 4.0 combo adapter, 1x1 <i>Some:</i> 11ac wireless, M.2 Card, Qualcomm Atheros QCA6174A (dual band), Wi-Fi + Bluetooth 4.1 combo adapter, 2x2 <i>Some:</i> 11ac wireless, M.2 Card, Qualcomm Atheros QCA9377 (dual band), Wi-Fi + Bluetooth 4.1 combo adapter, 1x1	Bluetooth™	<i>Some:</i> Bluetooth 4.0 or 4.1 wireless, integrated in Wi-Fi + BT combo adapter																																																												
Bluetooth™	<i>Some:</i> Bluetooth 4.0 or 4.1 wireless, integrated in Wi-Fi + BT combo adapter	Ethernet	Gigabit ethernet, Realtek RTL8111EPV, Wake on LAN®																																																												
Ethernet	Gigabit ethernet, Realtek RTL8111EPV, Wake on LAN®	Modem	None																																																												
Modem	None	Manageability	DASH																																																												
Manageability	DASH	Security chip	TPM (Trusted Platform Module) 2.0, TCG Certified																																																												
Security chip	TPM (Trusted Platform Module) 2.0, TCG Certified		* Downgrade to TPM1.2 for the models with Win10 DG Win7 32 OS																																																												
	* Downgrade to TPM1.2 for the models with Win10 DG Win7 32 OS	Accessories	For compatible accessories, please go to http://www.lenovoquickpick.com																																																												

Model	Region	Processor	vPro	Graphics	Monitor Cable	Memory	Storage(HDD/SSD)	Optical	Media Reader	WLAN + Bluetooth	Optional Front Ports	Optional Rear Ports	Chassis Intrusion Switch	Cable Lock	Speaker	Dust Filter	Keyboard / Mouse	Stand	Power Supply	Operating System	Warranty	Ann Date (mm/yy)
10MB0018US	US	AMD PRO A8-9600	No	AMD R7 Graphics	None	4GBx1	1TB 7200rpm 3.5"	DVD±RW	None	None	None	None	None	None	1.5Wx1	None	USB / USB	Floor Stand	210W 85%	Win10 Pro 64	3-year, Onsite	06/17
10MB0019US	US	AMD PRO A12-9800	No	AMD R7 Graphics	None	4GBx1	1TB 7200rpm 3.5"	DVD±RW	None	None	None	None	None	None	1.5Wx1	None	USB / USB	Floor Stand	210W 85%	Win10 Pro 64	3-year, Onsite	06/17
10MB001AUS	US	AMD PRO A10-9700	No	AMD R7 Graphics	None	8GBx1	256GB SSD M.2 PCIe NVMe Opal	DVD±RW	None	None	None	None	None	None	1.5Wx1	None	USB / USB	Floor Stand	210W 85%	Win10 Pro 64	3-year, Onsite	06/17
10MB001BUS	US	AMD PRO A12-9800	No	AMD R7 Graphics	None	8GBx1	256GB SSD M.2 PCIe NVMe Opal	DVD±RW	None	None	None	None	None	None	1.5Wx1	None	USB / USB	Floor Stand	210W 85%	Win10 Pro 64	3-year, Onsite	06/17
10MB001CUS	US	AMD PRO A8-9600	No	AMD R7 Graphics	None	4GBx1	500GB 7200rpm 3.5"	DVD±RW	None	None	None	None	None	None	1.5Wx1	None	USB / USB	Floor Stand	210W 85%	Win10 Pro 64	3-year, Onsite	06/17
10MB001DUS	US	AMD PRO A10-9700	No	AMD R7 Graphics	None	8GBx1	128GB SSD M.2 PCIe NVMe	DVD±RW	None	None	None	None	None	None	1.5Wx1	None	USB / USB	Floor Stand	210W 85%	Win10 Pro 64	3-year, Onsite	06/17
10MB001EUS	US	AMD PRO A6-9500	No	AMD R5 Graphics	None	4GBx1	1TB 7200rpm 3.5"	DVD±RW	None	None	None	None	None	None	1.5Wx1	None	USB / USB	Floor Stand	210W 85%	Win10 Pro 64	3-year, Onsite	06/17
10MB001FUS	US	AMD PRO A6-9500	No	AMD R5 Graphics	None	8GBx1	1TB 7200rpm 3.5"	DVD±RW	None	None	None	None	None	None	1.5Wx1	None	USB / USB	Floor Stand	210W 85%	Win10 Pro 64	3-year, Onsite	06/17
10MB001GUS	US	AMD PRO A12-9800	No	AMD R7 Graphics	None	4GBx1	500GB 7200rpm 3.5"	DVD±RW	None	None	None	None	None	None	1.5Wx1	None	USB / USB	Floor Stand	210W 85%	Win10 Pro 64	3-year, Onsite	06/17
10MB001HUS	US	AMD PRO A10-9700	No	AMD R7 Graphics	None	8GBx1	1TB 7200rpm 3.5"	DVD±RW	None	None	None	None	None	None	1.5Wx1	None	USB / USB	Floor Stand	210W 85%	Win10 Pro 64	3-year, Onsite	06/17
10MB001JUS	US	AMD PRO A6-9500	No	AMD R5 Graphics	None	4GBx1	500GB 7200rpm 3.5"	DVD±RW	None	None	None	None	None	None	1.5Wx1	None	USB / USB	Floor Stand	210W 85%	Win10 Pro 64	3-year, Onsite	06/17
10MB001KUS	US	AMD PRO A6-9500	No	AMD R5 Graphics	None	8GBx1	128GB SSD M.2 PCIe NVMe	DVD±RW	None	None	None	None	None	None	1.5Wx1	None	USB / USB	Floor Stand	210W 85%	Win10 Pro 64	3-year, Onsite	06/17
10MB001LUS	US	AMD PRO A8-9600	No	AMD R7 Graphics	None	8GBx1	128GB SSD M.2 PCIe NVMe	DVD±RW	None	None	None	None	None	None	1.5Wx1	None	USB / USB	Floor Stand	210W 85%	Win10 Pro 64	3-year, Onsite	06/17
10MB001MUS	US	AMD PRO A12-9800	No	AMD R7 Graphics	None	8GBx1	128GB SSD M.2 PCIe NVMe	DVD±RW	None	None	None	None	None	None	1.5Wx1	None	USB / USB	Floor Stand	210W 85%	Win10 Pro 64	3-year, Onsite	06/17
10MB001NUS	US	AMD PRO A8-9600	No	AMD R7 Graphics	None	8GBx1	1TB 7200rpm 3.5"	DVD±RW	None	None	None	None	None	None	1.5Wx1	None	USB / USB	Floor Stand	210W 85%	Win10 Pro 64	3-year, Onsite	06/17
10MB001PUS	US	AMD PRO A10-9700	No	AMD R7 Graphics	None	4GBx1	1TB 7200rpm 3.5"	DVD±RW	None	None	None	None	None	None	1.5Wx1	None	USB / USB	Floor Stand	210W 85%	Win10 Pro 64	3-year, Onsite	06/17
10MB001QUS	US	AMD PRO A10-9700	No	AMD R7 Graphics	None	4GBx1	500GB 7200rpm 3.5"	DVD±RW	None	None	None	None	None	None	1.5Wx1	None	USB / USB	Floor Stand	210W 85%	Win10 Pro 64	3-year, Onsite	06/17
10MB001RUS	US	AMD PRO A12-9800	No	AMD R7 Graphics	None	8GBx1	1TB 7200rpm 3.5"	DVD±RW	None	None	None	None	None	None	1.5Wx1	None	USB / USB	Floor Stand	210W 85%	Win10 Pro 64	3-year, Onsite	06/17
10MB001SUS	US	AMD PRO A6-8570	No	AMD R5 Graphics	None	8GBx1	1TB 7200rpm 3.5"	DVD±RW	None	None	None	None	None	None	1.5Wx1	None	USB / USB	Floor Stand	210W 85%	Win10 DG Win7 Pro 64	3-year, Onsite	07/17
10MB001TUS	US	AMD PRO A12-8870	No	AMD R7 Graphics	None	8GBx1	128GB SSD M.2 PCIe NVMe	DVD±RW	None	None	None	None	None	None	1.5Wx1	None	USB / USB	Floor Stand	210W 85%	Win10 DG Win7 Pro 64	3-year, Onsite	07/17

Model	Region	Processor	vPro	Graphics	Monitor Cable	Memory	Storage(HDD/SSD)	Optical	Media Reader	WLAN + Bluetooth	Optional Front Ports	Optional Rear Ports	Chassis Intrusion Switch	Cable Lock	Speaker	Dust Filter	Keyboard / Mouse	Stand	Power Supply	Operating System	Warranty	Ann Date (mm/yy)
10MB001UUS	US	AMD PRO A6-8570	No	AMD R5 Graphics	None	8GBx1	128GB SSD M.2 PCIe NVMe	DVD±RW	None	None	None	None	None	None	1.5Wx1	None	USB / USB	Floor Stand	210W 85%	Win10 DG Win7 Pro 64	3-year, Onsite	07/17
10MB001VUS	US	AMD PRO A10-8770	No	AMD R7 Graphics	None	8GBx1	128GB SSD M.2 PCIe NVMe	DVD±RW	None	None	None	None	None	None	1.5Wx1	None	USB / USB	Floor Stand	210W 85%	Win10 DG Win7 Pro 64	3-year, Onsite	07/17
10MB001WUS	US	AMD PRO A10-8770	No	AMD R7 Graphics	None	4GBx1	500GB 7200rpm 3.5"	DVD±RW	None	None	None	None	None	None	1.5Wx1	None	USB / USB	Floor Stand	210W 85%	Win10 DG Win7 Pro 64	3-year, Onsite	07/17
10MB001XUS	US	AMD PRO A12-8870	No	AMD R7 Graphics	None	4GBx1	1TB 7200rpm 3.5"	DVD±RW	None	None	None	None	None	None	1.5Wx1	None	USB / USB	Floor Stand	210W 85%	Win10 DG Win7 Pro 64	3-year, Onsite	07/17
10MB001YUS	US	AMD PRO A10-8770	No	AMD R7 Graphics	None	8GBx1	1TB 7200rpm 3.5"	DVD±RW	None	RTL8821AE ac, 1x1 + BT4.0	None	None	None	None	1.5Wx1	None	USB / USB	Floor Stand	210W 85%	Win10 DG Win7 Pro 64	3-year, Onsite	07/17
10MB0020US	US	AMD PRO A12-8870	No	AMD R7 Graphics	None	4GBx1	500GB 7200rpm 3.5"	DVD±RW	None	None	None	None	None	None	1.5Wx1	None	USB / USB	Floor Stand	210W 85%	Win10 DG Win7 Pro 64	3-year, Onsite	07/17
10MB0021US	US	AMD PRO A10-8770	No	AMD R7 Graphics	None	8GBx1	256GB SSD M.2 PCIe NVMe Opal	DVD±RW	None	RTL8821AE ac, 1x1 + BT4.0	None	None	None	None	1.5Wx1	None	USB / USB	Floor Stand	210W 85%	Win10 DG Win7 Pro 64	3-year, Onsite	07/17
10MB0022US	US	AMD PRO A6-8570	No	AMD R5 Graphics	None	4GBx1	500GB 7200rpm 3.5"	DVD±RW	None	None	None	None	None	None	1.5Wx1	None	USB / USB	Floor Stand	210W 85%	Win10 DG Win7 Pro 64	3-year, Onsite	07/17
10MB0023US	US	AMD PRO A6-8570	No	AMD R5 Graphics	None	4GBx1	1TB 7200rpm 3.5"	DVD±RW	None	RTL8821AE ac, 1x1 + BT4.0	None	None	None	None	1.5Wx1	None	USB / USB	Floor Stand	210W 85%	Win10 DG Win7 Pro 64	3-year, Onsite	07/17
10MB0024US	US	AMD PRO A12-8870	No	AMD R7 Graphics	None	8GBx1	1TB 7200rpm 3.5"	DVD±RW	None	RTL8821AE ac, 1x1 + BT4.0	None	None	None	None	1.5Wx1	None	USB / USB	Floor Stand	210W 85%	Win10 DG Win7 Pro 64	3-year, Onsite	07/17
10MB0025US	US	AMD PRO A10-8770	No	AMD R7 Graphics	None	4GBx1	1TB 7200rpm 3.5"	DVD±RW	None	RTL8821AE ac, 1x1 + BT4.0	None	None	None	None	1.5Wx1	None	USB / USB	Floor Stand	210W 85%	Win10 DG Win7 Pro 64	3-year, Onsite	07/17
10MB0026US	US	AMD PRO A12-8870	No	AMD R7 Graphics	None	8GBx1	256GB SSD M.2 PCIe NVMe Opal	DVD±RW	None	None	None	None	None	None	1.5Wx1	None	USB / USB	Floor Stand	210W 85%	Win10 DG Win7 Pro 64	3-year, Onsite	07/17
10MB0027US	US	AMD PRO A10-8770	No	AMD R7 Graphics	None	8GBx1	1TB 7200rpm 3.5"	DVD±RW	None	None	None	None	None	None	1.5Wx1	None	USB / USB	Floor Stand	210W 85%	Win10 DG Win7 Pro 64	3-year, Onsite	07/17
10MB0028US	US	AMD PRO A10-8770	No	AMD R7 Graphics	None	8GBx1	256GB SSD M.2 PCIe NVMe Opal	DVD±RW	None	None	None	None	None	None	1.5Wx1	None	USB / USB	Floor Stand	210W 85%	Win10 DG Win7 Pro 64	3-year, Onsite	07/17
10MB0029US	US	AMD PRO A6-8570	No	AMD R5 Graphics	None	4GBx1	1TB 7200rpm 3.5"	DVD±RW	None	None	None	None	None	None	1.5Wx1	None	USB / USB	Floor Stand	210W 85%	Win10 DG Win7 Pro 64	3-year, Onsite	07/17
10MB002AUS	US	AMD PRO A12-8870	No	AMD R7 Graphics	None	8GBx1	1TB 7200rpm 3.5"	DVD±RW	None	None	None	None	None	None	1.5Wx1	None	USB / USB	Floor Stand	210W 85%	Win10 DG Win7 Pro 64	3-year, Onsite	07/17
10MB002BUS	US	AMD PRO A10-8770	No	AMD R7 Graphics	None	4GBx1	1TB 7200rpm 3.5"	DVD±RW	None	None	None	None	None	None	1.5Wx1	None	USB / USB	Floor Stand	210W 85%	Win10 DG Win7 Pro 64	3-year, Onsite	07/17
10MB002CUS	US	AMD PRO A12-8870	No	AMD R7 Graphics	None	8GBx1	256GB SSD M.2 PCIe NVMe Opal	DVD±RW	None	RTL8821AE ac, 1x1 + BT4.0	None	None	None	None	1.5Wx1	None	USB / USB	Floor Stand	210W 85%	Win10 DG Win7 Pro 64	3-year, Onsite	07/17
10MB002DUS	US	AMD PRO A10-9700	No	AMD R7 Graphics	None	4GBx1	1TB 7200rpm 3.5"	DVD±RW	None	RTL8821AE ac, 1x1 + BT4.0	None	None	None	None	1.5Wx1	None	USB / USB	Floor Stand	210W 85%	Win10 Pro 64	3-year, Onsite	06/17
10MB002EUS	US	AMD PRO A10-9700	No	AMD R7 Graphics	None	8GBx1	256GB SSD M.2 PCIe NVMe Opal	DVD±RW	None	RTL8821AE ac, 1x1 + BT4.0	None	None	None	None	1.5Wx1	None	USB / USB	Floor Stand	210W 85%	Win10 Pro 64	3-year, Onsite	07/17

Model	Region	Processor	vPro	Graphics	Monitor Cable	Memory	Storage(HDD/SSD)	Optical	Media Reader	WLAN + Bluetooth	Optional Front Ports	Optional Rear Ports	Chassis Intrusion Switch	Cable Lock	Speaker	Dust Filter	Keyboard / Mouse	Stand	Power Supply	Operating System	Warranty	Ann Date (mm/yy)
10MB002FUS	US	AMD PRO A8-9600	No	AMD R7 Graphics	None	4GBx1	1TB 7200rpm 3.5"	DVD±RW	None	RTL8821Ae ac, 1x1 + BT4.0	None	None	None	None	1.5Wx1	None	USB / USB	Floor Stand	210W 85%	Win10 Pro 64	3-year, Onsite	06/17
10MB002GUS	US	AMD PRO A8-9600	No	AMD R7 Graphics	None	8GBx1	1TB 7200rpm 3.5"	DVD±RW	None	RTL8821Ae ac, 1x1 + BT4.0	None	None	None	None	1.5Wx1	None	USB / USB	Floor Stand	210W 85%	Win10 Pro 64	3-year, Onsite	06/17
10MB002HUS	US	AMD PRO A12-9800	No	AMD R7 Graphics	None	8GBx1	1TB 7200rpm 3.5"	DVD±RW	None	RTL8821Ae ac, 1x1 + BT4.0	None	None	None	None	1.5Wx1	None	USB / USB	Floor Stand	210W 85%	Win10 Pro 64	3-year, Onsite	06/17
10MB002JUS	US	AMD PRO A10-9700	No	AMD R7 Graphics	None	8GBx1	1TB 7200rpm 3.5"	DVD±RW	None	RTL8821Ae ac, 1x1 + BT4.0	None	None	None	None	1.5Wx1	None	USB / USB	Floor Stand	210W 85%	Win10 Pro 64	3-year, Onsite	06/17
10MB002KUS	US	AMD PRO A12-9800	No	AMD R7 Graphics	None	8GBx1	256GB SSD M.2 PCIe NVMe Opal	DVD±RW	None	RTL8821Ae ac, 1x1 + BT4.0	None	None	None	None	1.5Wx1	None	USB / USB	Floor Stand	210W 85%	Win10 Pro 64	3-year, Onsite	06/17
10MB002LUS	US	AMD PRO A8-9600	No	AMD R7 Graphics	None	8GBx1	128GB SSD M.2 PCIe NVMe	DVD±RW	None	RTL8821Ae ac, 1x1 + BT4.0	None	None	None	None	1.5Wx1	None	USB / USB	Floor Stand	210W 85%	Win10 Pro 64	3-year, Onsite	06/17
10MB002MUS	US	AMD PRO A6-9500	No	AMD R5 Graphics	None	4GBx1	1TB 7200rpm 3.5"	DVD±RW	None	RTL8821Ae ac, 1x1 + BT4.0	None	None	None	None	1.5Wx1	None	USB / USB	Floor Stand	210W 85%	Win10 Pro 64	3-year, Onsite	06/17
10MB002PUS	US	AMD Ryzen 5 PRO 1500	No	GT 730 2GB	None	8GBx1	1TB 7200rpm 3.5"	DVD±RW	None	None	None	None	None	None	1.5Wx1	None	USB / USB	Floor Stand	210W 85%	Win10 Pro 64	3-year, Onsite	07/17
10MB002QUS	US	AMD Ryzen 5 PRO 1500	No	GT 730 2GB	None	8GBx1	128GB SSD M.2 PCIe NVMe	DVD±RW	None	None	None	None	None	None	1.5Wx1	None	USB / USB	Floor Stand	210W 85%	Win10 Pro 64	3-year, Onsite	07/17
10MB002RUS	US	AMD Ryzen 5 PRO 1500	No	GT 730 2GB	None	8GBx1	1TB 7200rpm 3.5"	DVD±RW	None	RTL8821Ae ac, 1x1 + BT4.0	None	None	None	None	1.5Wx1	None	USB / USB	Floor Stand	210W 85%	Win10 Pro 64	3-year, Onsite	07/17
10MB002SUS	US	AMD Ryzen 3 PRO 1200	No	GT 730 2GB	None	8GBx1	256GB SSD M.2 PCIe NVMe Opal	DVD±RW	None	None	None	None	None	None	1.5Wx1	None	USB / USB	Floor Stand	210W 85%	Win10 Pro 64	3-year, Onsite	07/17
10MB002TUS	US	AMD Ryzen 3 PRO 1200	No	GT 730 2GB	None	4GBx1	1TB 7200rpm 3.5"	DVD±RW	None	RTL8821Ae ac, 1x1 + BT4.0	None	None	None	None	1.5Wx1	None	USB / USB	Floor Stand	210W 85%	Win10 Pro 64	3-year, Onsite	07/17
10MB002UUS	US	AMD Ryzen 3 PRO 1200	No	GT 730 2GB	None	4GBx1	128GB SSD	DVD±RW	None	None	None	None	None	None	1.5Wx1	None	USB / USB	Floor Stand	210W 85%	Win10 Pro 64	3-year, Onsite	07/17
10MB002VUS	US	AMD Ryzen 3 PRO 1200	No	GT 730 2GB	None	8GBx1	128GB SSD M.2 PCIe NVMe	DVD±RW	None	None	None	None	None	None	1.5Wx1	None	USB / USB	Floor Stand	210W 85%	Win10 Pro 64	3-year, Onsite	07/17
10MB002WUS	US	AMD Ryzen 5 PRO 1500	No	GT 730 2GB	None	8GBx1	128GB SSD	DVD±RW	None	None	None	None	None	None	1.5Wx1	None	USB / USB	Floor Stand	210W 85%	Win10 Pro 64	3-year, Onsite	07/17
10MB002XUS	US	AMD Ryzen 7 PRO 1700	No	GT 730 2GB	None	8GBx1	1TB 7200rpm 3.5"	DVD±RW	None	RTL8821Ae ac, 1x1 + BT4.0	None	None	None	None	1.5Wx1	None	USB / USB	Floor Stand	210W 85%	Win10 Pro 64	3-year, Onsite	07/17
10MB002YUS	US	AMD Ryzen 5 PRO 1500	No	GT 730 2GB	None	4GBx1	500GB 7200rpm 3.5"	DVD±RW	None	RTL8821Ae ac, 1x1 + BT4.0	None	None	None	None	1.5Wx1	None	USB / USB	Floor Stand	210W 85%	Win10 Pro 64	3-year, Onsite	07/17
10MB0030US	US	AMD Ryzen 5 PRO 1500	No	GT 730 2GB	None	8GBx1	512GB SSD M.2 PCIe NVMe Opal	DVD±RW	None	None	None	None	None	None	1.5Wx1	None	USB / USB	Floor Stand	210W 85%	Win10 Pro 64	3-year, Onsite	07/17
10MB0031US	US	AMD Ryzen 3 PRO 1200	No	GT 730 2GB	None	8GBx1	256GB SSD M.2 PCIe NVMe Opal	DVD±RW	None	RTL8821Ae ac, 1x1 + BT4.0	None	None	None	None	1.5Wx1	None	USB / USB	Floor Stand	210W 85%	Win10 Pro 64	3-year, Onsite	07/17
10MB0032US	US	AMD Ryzen 5 PRO 1500	No	GT 730 2GB	None	8GBx1	256GB SSD M.2 PCIe NVMe Opal	DVD±RW	None	None	None	None	None	None	1.5Wx1	None	USB / USB	Floor Stand	210W 85%	Win10 Pro 64	3-year, Onsite	07/17

Model	Region	Processor	vPro	Graphics	Monitor Cable	Memory	Storage(HDD/SSD)	Optical	Media Reader	WLAN + Bluetooth	Optional Front Ports	Optional Rear Ports	Chassis Intrusion Switch	Cable Lock	Speaker	Dust Filter	Keyboard / Mouse	Stand	Power Supply	Operating System	Warranty	Ann Date (mm/yy)
10MB0033US	US	AMD Ryzen 7 PRO 1700	No	GT 730 2GB	None	8GBx1	1TB 7200rpm 3.5"	DVD±RW	None	None	None	None	None	None	1.5Wx1	None	USB / USB	Floor Stand	210W 85%	Win10 Pro 64	3-year, Onsite	07/17
10MB0034US	US	AMD Ryzen 5 PRO 1500	No	GT 730 2GB	None	4GBx1	500GB 7200rpm 3.5"	DVD±RW	None	None	None	None	None	None	1.5Wx1	None	USB / USB	Floor Stand	210W 85%	Win10 Pro 64	3-year, Onsite	07/17
10MB0035US	US	AMD Ryzen 3 PRO 1200	No	GT 730 2GB	None	8GBx1	1TB 7200rpm 3.5"	DVD±RW	None	None	None	None	None	None	1.5Wx1	None	USB / USB	Floor Stand	210W 85%	Win10 Pro 64	3-year, Onsite	07/17
10MB0036US	US	AMD Ryzen 3 PRO 1200	No	GT 730 2GB	None	8GBx1	128GB SSD	DVD±RW	None	None	None	None	None	None	1.5Wx1	None	USB / USB	Floor Stand	210W 85%	Win10 Pro 64	3-year, Onsite	07/17
10MB0037US	US	AMD Ryzen 7 PRO 1700	No	GT 730 2GB	None	8GBx1	256GB SSD M.2 PCIe NVMe Opal	DVD±RW	None	None	None	None	None	None	1.5Wx1	None	USB / USB	Floor Stand	210W 85%	Win10 Pro 64	3-year, Onsite	07/17
10MB0038US	US	AMD Ryzen 3 PRO 1200	No	GT 730 2GB	None	4GBx1	500GB 7200rpm 3.5"	DVD±RW	None	None	None	None	None	None	1.5Wx1	None	USB / USB	Floor Stand	210W 85%	Win10 Pro 64	3-year, Onsite	07/17
10MB0039US	US	AMD Ryzen 5 PRO 1500	No	GT 730 2GB	None	4GBx1	128GB SSD M.2 PCIe NVMe	DVD±RW	None	None	None	None	None	None	1.5Wx1	None	USB / USB	Floor Stand	210W 85%	Win10 Pro 64	3-year, Onsite	07/17
10MB003AUS	US	AMD Ryzen 7 PRO 1700	No	GT 730 2GB	None	8GBx1	256GB SSD M.2 PCIe NVMe Opal	DVD±RW	None	RTL8821AE ac, 1x1 + BT4.0	None	None	None	None	1.5Wx1	None	USB / USB	Floor Stand	210W 85%	Win10 Pro 64	3-year, Onsite	07/17
10MB003BUS	US	AMD Ryzen 3 PRO 1200	No	GT 730 2GB	None	4GBx1	1TB 7200rpm 3.5"	DVD±RW	None	None	None	None	None	None	1.5Wx1	None	USB / USB	Floor Stand	210W 85%	Win10 Pro 64	3-year, Onsite	07/17
10MB003CUS	US	AMD Ryzen 5 PRO 1500	No	GT 730 2GB	None	4GBx1	128GB SSD	DVD±RW	None	None	None	None	None	None	1.5Wx1	None	USB / USB	Floor Stand	210W 85%	Win10 Pro 64	3-year, Onsite	07/17
10MB003DUS	US	AMD Ryzen 5 PRO 1500	No	GT 730 2GB	None	8GBx1	256GB SSD M.2 PCIe NVMe Opal	DVD±RW	None	RTL8821AE ac, 1x1 + BT4.0	None	None	None	None	1.5Wx1	None	USB / USB	Floor Stand	210W 85%	Win10 Pro 64	3-year, Onsite	07/17
10MB003EUS	US	AMD Ryzen 3 PRO 1200	No	GT 730 2GB	None	4GBx1	128GB SSD M.2 PCIe NVMe	DVD±RW	None	RTL8821AE ac, 1x1 + BT4.0	None	None	None	None	1.5Wx1	None	USB / USB	Floor Stand	210W 85%	Win10 Pro 64	3-year, Onsite	07/17
10MB003FUS	US	AMD Ryzen 3 PRO 1200	No	GT 730 2GB	None	4GBx1	128GB SSD M.2 PCIe NVMe	DVD±RW	None	None	None	None	None	None	1.5Wx1	None	USB / USB	Floor Stand	210W 85%	Win10 Pro 64	3-year, Onsite	07/17
10MB003GUS	US	AMD Ryzen 7 PRO 1700	No	GT 730 2GB	None	8GBx1	512GB SSD M.2 PCIe NVMe Opal	DVD±RW	None	None	None	None	None	None	1.5Wx1	None	USB / USB	Floor Stand	210W 85%	Win10 Pro 64	3-year, Onsite	07/17
10MB003HUS	US	AMD Ryzen 3 PRO 1200	No	GT 730 2GB	None	8GBx1	1TB 7200rpm 3.5"	DVD±RW	None	RTL8821AE ac, 1x1 + BT4.0	None	None	None	None	1.5Wx1	None	USB / USB	Floor Stand	210W 85%	Win10 Pro 64	3-year, Onsite	07/17



ThinkCentre M715 Tiny Platform Specifications

Product Specifications Reference (PSREF)

Processor	AMD A6, A10, or A12 series APUs						Keyboard	<i>Some:</i> Fullsize USB Keyboard (USB connector), Lenovo logo <i>Some:</i> Lenovo New Slim USB Keyboard (USB connector), black, Lenovo logo <i>Some:</i> USB Optical Wheel Mouse, black, Lenovo logo																												
	APU	Cores	Frequency Base/Max	L2 Cache	Memory Types	Integrated Graphics	Mouse																													
	PRO A6-9500E	2	3.0 / 3.4 GHz	1 MB	DDR4-2400	Radeon R5 Series	Mechanical	Tiny (1L), black color; metal case M715 Tiny only: 7.05" W X 7.20" D X 1.36" H 179mm W X 182.9mm D X 34.5mm H 2.9 lb (1.3 kg), weight may vary by configuration With VESA mount & ODD box: 7.42" W X 7.30" D X 2.48" H 188.4mm W X 185.38mm D X 63mm H 4.12 lb (1.87 kg), weight may vary by configuration With VESA mount & I/O box: 7.42" W X 7.30" D X 2.62" H 188.4mm W X 185.38mm D X 66.6mm H 3.53 lb (1.6 kg), weight may vary by configuration Optional VESA mount bracket kit, supports VESA 75mm and 100mm Optional system floor stand for vertical orientation																												
	PRO A10-9700E	4	3.0 / 3.5 GHz	2 MB	DDR4-2400	Radeon R7 Series	VESA mount																													
	PRO A12-9800E	4	3.1 / 3.8 GHz	2 MB	DDR4-2400	Radeon R7 Series	Floor Stand																													
	PRO A6-8570E	2	3.0 / 3.4 GHz	1 MB	DDR4-2400	Radeon R5 Series	Power supply	65 watts AC/DC adapter, autosensing, 88% PSU (not included for TIO models) 90 watts AC/DC adapter, autosensing, 88% PSU (only for models with I/O box)																												
	PRO A10-8770E	4	2.8 / 3.5 GHz	2 MB	DDR4-2400	Radeon R7 Series	Limited warranty ³	<i>Some:</i> 1-year or 3-year, depot service / service upgrades available <i>Some:</i> 1-year or 3-year, limited onsite service / service upgrades available																												
PRO A12-8870E	4	2.9 / 3.8 GHz	2 MB	DDR4-2400	Radeon R7 Series	Preload	<table border="0"> <tr> <td>Preloaded operating system</td> <td>Preloaded applications (only some listed)</td> </tr> <tr> <td><i>Some:</i> Windows 10 Pro 64-bit</td> <td>- Windows 10 only</td> </tr> <tr> <td><i>Some:</i> Windows 10 Home 64-bit</td> <td>• Lenovo Companion</td> </tr> <tr> <td><i>Some:</i> Windows® 7 Professional 64</td> <td>• Microsoft Office preloaded;</td> </tr> <tr> <td>preinstalled through downgrade</td> <td>purchase a product key to activate</td> </tr> <tr> <td>rights in Windows 10 Pro 64-bit</td> <td>- Windows 7 only</td> </tr> <tr> <td></td> <td>• Lenovo Solution Center</td> </tr> <tr> <td></td> <td>• ThinkVantage System Update</td> </tr> <tr> <td></td> <td>• Create Recovery Media</td> </tr> <tr> <td></td> <td>• Lenovo ThinkVantage Tools</td> </tr> <tr> <td></td> <td>• CyberlinkPowerDVD Create(DVD±RW)</td> </tr> <tr> <td></td> <td>• Microsoft Office preloaded;</td> </tr> <tr> <td></td> <td>purchase a product key to activate</td> </tr> <tr> <td></td> <td>• Adobe® Reader®</td> </tr> </table>		Preloaded operating system	Preloaded applications (only some listed)	<i>Some:</i> Windows 10 Pro 64-bit	- Windows 10 only	<i>Some:</i> Windows 10 Home 64-bit	• Lenovo Companion	<i>Some:</i> Windows® 7 Professional 64	• Microsoft Office preloaded;	preinstalled through downgrade	purchase a product key to activate	rights in Windows 10 Pro 64-bit	- Windows 7 only		• Lenovo Solution Center		• ThinkVantage System Update		• Create Recovery Media		• Lenovo ThinkVantage Tools		• CyberlinkPowerDVD Create(DVD±RW)		• Microsoft Office preloaded;		purchase a product key to activate		• Adobe® Reader®
Preloaded operating system	Preloaded applications (only some listed)																																			
<i>Some:</i> Windows 10 Pro 64-bit	- Windows 10 only																																			
<i>Some:</i> Windows 10 Home 64-bit	• Lenovo Companion																																			
<i>Some:</i> Windows® 7 Professional 64	• Microsoft Office preloaded;																																			
preinstalled through downgrade	purchase a product key to activate																																			
rights in Windows 10 Pro 64-bit	- Windows 7 only																																			
	• Lenovo Solution Center																																			
	• ThinkVantage System Update																																			
	• Create Recovery Media																																			
	• Lenovo ThinkVantage Tools																																			
	• CyberlinkPowerDVD Create(DVD±RW)																																			
	• Microsoft Office preloaded;																																			
	purchase a product key to activate																																			
	• Adobe® Reader®																																			
Memory	32GB max, DDR4 2400, two 260-pin SO-DIMM sockets, dual-channel capable *16GB single SO-DIMM memory is only available via special bid models																																			
Disk	<i>Some:</i> SATA 6.0Gb/s, 2.5" Wide, 5400 rpm or 7200 rpm <i>Some:</i> Solid State Drive (SSD) / SATA 6.0Gb/s, 2.5" <i>Some:</i> M.2 Solid State Drive (SSD) / SATA interface or PCIe NVMe interface																																			
Optical	<i>Some:</i> DVD-ROM, 9.0mm high, via USB external ODD box <i>Some:</i> DVD±RW, 9.0mm high, via USB external ODD box																																			
Onboard SATA Media reader	One SATA cable (1-drop to device), one SATA 6.0Gb/s connector on planar None																																			
Graphics	AMD Radeon™ Graphics in processor, uses main memory, DirectX® 12, two DisplayPort™, one optional port (HDMI, VGA, or 3rd DP), supports 3 independent displays (supports maximum of 2 concurrent HDMI/DVI displays when using HDMI port or DP to DVI/HDMI dongles); <i>Max resolution:</i> 4096x2160 (DP) @60Hz; 4096x2160 (HDMI) @60Hz; 1920x1200 (VGA) @60Hz																																			
DP cable	Optional DP to VGA, DP to DVI-D (single link), or DP to HDMI 1.4 dongle																																			
Chipset	AMD B300 Chipset																																			
Front ports	Two USB 3.0 (one is Always On and fast charge), one microphone (stereo, 3.5mm), one headphone / microphone combo jack (stereo, 3.5mm)																																			
Rear ports	One USB 3.0 and three USB 2.0 (optional external optical box or I/O box occupies one specific USB 2.0 on some models), ethernet (RJ-45), two DisplayPort, one optional port (VGA, 3rd DP, HDMI, or serial on some models), one headphone																																			
I/O box	Optional external I/O box, extends four USB 2.0 (two on front and two on rear), one serial, and two PS/2, via USB port (occupy one specific USB 2.0 of M715q Tiny)																																			
Audio support	High Definition (HD) Audio, Realtek ALC233-CG / internal speaker (1.5 watt)																																			
WLAN ¹³	<i>Some:</i> 11ac wireless, M.2 Card, Realtek RTL8821AE (dual band), Wi-Fi + Bluetooth 4.0 combo adapter, 1x1 <i>Some:</i> 11ac wireless, M.2 Card, Realtek RTL8822BE (dual band), Wi-Fi + Bluetooth 4.1 combo adapter, 2x2 <i>Some:</i> 11ac wireless, M.2 Card, Qualcomm Atheros QCA9377 (dual band), Wi-Fi + Bluetooth 4.1 combo adapter, 1x1						Environment	ENERGY STAR® 6.1*, EPEAT™ Gold rating* (*Not for non-OS models); ErP Lot 3; GREENGUARD®; RoHS-compliant																												
Bluetooth™	<i>Some:</i> Bluetooth 4.0 or 4.1 wireless, integrated in Wi-Fi + BT combo adapter						Accessories	For compatible accessories, please go to http://www.lenovoquickpick.com																												
Ethernet	Gigabit ethernet, Realtek RTL8111EPV, Wake on LAN®																																			
Modem	None																																			
Manageability	DASH 1.0/1.1																																			
Security chip	Discrete TPM 2.0, TCG Certified																																			
Security features	<ul style="list-style-type: none"> • Security slot (in rear for optional Kensington® MicroSaver® cable) • Padlock loop • Smart USB protection, allows keyboard/mouse only, blocks all storage devices • Power-on password • Administrator password • Hard disk password • Boot sequence control • Boot without keyboard and mouse • Individual USB port disablement • Chassis intrusion switch 																																			

Model	Region	Processor	vPro	Graphics	Monitor Cable	Memory	Storage(HDD/SSD)	External Optical / I/O Box	WLAN + Bluetooth	Optional Rear Ports	Speaker	Adapter Cage	Toolless Chassis Screw	Dust Filter	Keyboard / Mouse	VESA Mount	Stand	Power Supply	OS	Warranty	Ann Date (m/y)
10M30001US	US	AMD PRO A6-9500E	No	AMD R5 Graphics	None	4GBx1	500GB 7200rpm 2.5"	None	RTL8821AE ac, 1x1 + BT4.0	None	1Wx1	None	None	None	USB / USB	None	Floor Stand	65W 88% Adapter	Win10 Pro 64	3-year, Onsite	11/16
10M30002US	US	AMD PRO A10-9700E	No	AMD R7 Graphics	None	4GBx1	500GB 7200rpm 2.5"	None	RTL8821AE ac, 1x1 + BT4.0	Serial	1Wx1	None	None	None	USB / USB	None	Floor Stand	65W 88% Adapter	Win10 Pro 64	3-year, Onsite	10/16
10M30003US	US	AMD A10-9700E	No	AMD R7 Graphics	None	4GBx1	500GB 7200rpm 2.5"	None	RTL8821AE ac, 1x1 + BT4.0	VGA	1Wx1	None	None	None	USB / USB	None	Floor Stand	65W 88% Adapter	Win10 Pro 64	3-year, Onsite	10/16
10M30004US	US	AMD A10-9700E	No	AMD R7 Graphics	None	4GBx1	500GB 7200rpm 2.5"	None	RTL8821AE ac, 1x1 + BT4.0	3rd DP	1Wx1	None	None	None	USB / USB	None	Floor Stand	65W 88% Adapter	Win10 Pro 64	3-year, Onsite	10/16
10M30005US	US	AMD PRO A12-9800E	No	AMD R7 Graphics	None	4GBx1	500GB 7200rpm 2.5"	None	RTL8821AE ac, 1x1 + BT4.0	3rd DP	1Wx1	None	None	None	USB / USB	None	Floor Stand	65W 88% Adapter	Win10 Pro 64	3-year, Onsite	10/16
10M30006US	US	AMD PRO A10-9700E	No	AMD R7 Graphics	None	8GBx1	128GB SSD M.2 PCIe NVMe	None	RTL8821AE ac, 1x1 + BT4.0	3rd DP	1Wx1	None	None	None	USB / USB	None	Floor Stand	65W 88% Adapter	Win10 Pro 64	3-year, Onsite	10/16
10M30007US	US	AMD PRO A6-9500E	No	AMD R5 Graphics	None	4GBx1	500GB 7200rpm 2.5"	None	RTL8821AE ac, 1x1 + BT4.0	None	1Wx1	None	None	None	USB / USB	None	Floor Stand	65W 88% Adapter	Win10 Pro 64	3-year, Onsite	10/16
10M30008US	US	AMD PRO A10-9700E	No	AMD R7 Graphics	None	8GBx1	500GB 7200rpm 2.5"	None	RTL8821AE ac, 1x1 + BT4.0	None	1Wx1	None	None	None	USB / USB	None	Floor Stand	65W 88% Adapter	Win10 Pro 64	3-year, Onsite	10/16
10M30009US	US	AMD PRO A12-9800E	No	AMD R7 Graphics	None	8GBx1	128GB SSD M.2 PCIe NVMe	None	RTL8821AE ac, 1x1 + BT4.0	3rd DP	1Wx1	None	None	None	USB / USB	None	Floor Stand	65W 88% Adapter	Win10 Pro 64	3-year, Onsite	10/16
10M3000AUS	US	AMD PRO A12-9800E	No	AMD R7 Graphics	None	4GBx1	128GB SSD M.2 PCIe NVMe	None	RTL8821AE ac, 1x1 + BT4.0	None	1Wx1	None	None	None	USB / USB	None	Floor Stand	65W 88% Adapter	Win10 Pro 64	3-year, Onsite	10/16
10M3000BUS	US	AMD A10-9700E	No	AMD R7 Graphics	None	4GBx1	500GB 7200rpm 2.5"	None	RTL8821AE ac, 1x1 + BT4.0	None	1Wx1	None	None	None	USB / USB	None	Floor Stand	65W 88% Adapter	Win10 Pro 64	3-year, Onsite	10/16
10M3000CUS	US	AMD PRO A10-9700E	No	AMD R7 Graphics	None	4GBx1	128GB SSD M.2 PCIe NVMe	None	RTL8821AE ac, 1x1 + BT4.0	3rd DP	1Wx1	None	None	None	USB / USB	None	Floor Stand	65W 88% Adapter	Win10 Pro 64	3-year, Onsite	10/16
10M3000DUS	US	AMD PRO A10-9700E	No	AMD R7 Graphics	None	4GBx1	500GB 7200rpm 2.5"	DVD±RW	RTL8821AE ac, 1x1 + BT4.0	HDMI	1Wx1	None	None	None	USB / USB	VESA Mount	None	65W 88% Adapter	Win10 Pro 64	3-year, Onsite	10/16
10M3000NUS	US	AMD PRO A12-8870E	No	AMD R7 Graphics	None	8GBx2	512GB SSD M.2 PCIe NVMe	None	RTL8821AE ac, 1x1 + BT4.0	None	1Wx1	None	None	None	USB / USB	None	Floor Stand	65W 88% Adapter	Win10 DG Win7 Pro 64	3-year, Onsite	01/17
10M3000PUS	US	AMD PRO A12-9800E	No	AMD R7 Graphics	None	8GBx2	512GB SSD M.2 PCIe NVMe	None	RTL8821AE ac, 1x1 + BT4.0	None	1Wx1	None	None	None	USB / USB	None	Floor Stand	65W 88% Adapter	Win10 Pro 64	3-year, Onsite	01/17
10M3000QUS	US	AMD PRO A10-8770E	No	AMD R7 Graphics	None	8GBx1	256GB SSD M.2 PCIe NVMe	None	RTL8821AE ac, 1x1 + BT4.0	None	1Wx1	None	None	None	USB / USB	None	Floor Stand	65W 88% Adapter	Win10 DG Win7 Pro 64	3-year, Onsite	01/17
10M3000RUS	US	AMD PRO A10-8770E	No	AMD R7 Graphics	None	8GBx1	500GB 7200rpm 2.5"	None	RTL8821AE ac, 1x1 + BT4.0	None	1Wx1	None	None	None	USB / USB	None	Floor Stand	65W 88% Adapter	Win10 DG Win7 Pro 64	3-year, Onsite	01/17
10M3000SUS	US	AMD PRO A10-8770E	No	AMD R7 Graphics	None	8GBx1	500GB 7200rpm 2.5"	DVD±RW	RTL8821AE ac, 1x1 + BT4.0	3rd DP	1Wx1	None	None	None	USB / USB	VESA Mount	None	65W 88% Adapter	Win10 DG Win7 Pro 64	3-year, Onsite	01/17
10M3000TUS	US	AMD PRO A10-8770E	No	AMD R7 Graphics	None	4GBx1	500GB 7200rpm 2.5"	None	RTL8821AE ac, 1x1 + BT4.0	None	1Wx1	None	None	None	USB / USB	None	Floor Stand	65W 88% Adapter	Win10 DG Win7 Pro 64	3-year, Onsite	01/17

Model	Region	Processor	vPro	Graphics	Monitor Cable	Memory	Storage(HDD/SSD)	External Optical / I/O Box	WLAN + Bluetooth	Optional Rear Ports	Speaker	Adapter Cage	Toolless Chassis Screw	Dust Filter	Keyboard / Mouse	VESA Mount	Stand	Power Supply	OS	War-ranty	Ann Date (m/y)
10M3000UUS	US	AMD PRO A10-8770E	No	AMD R7 Graphics	None	8GBx1	128GB SSD M.2 PCIe NVMe	None	RTL8821AE ac, 1x1 + BT4.0	3rd DP	1Wx1	None	None	None	USB / USB	None	Floor Stand	65W 88% Adapter	Win10 DG Win7 Pro 64	3-year, Onsite	01/17
10M3000VUS	US	AMD PRO A10-8770E	No	AMD R7 Graphics	None	8GBx1	256GB SSD M.2 PCIe NVMe	None	RTL8821AE ac, 1x1 + BT4.0	3rd DP	1Wx1	None	None	None	USB / USB	None	Floor Stand	65W 88% Adapter	Win10 DG Win7 Pro 64	3-year, Onsite	01/17
10M3000WUS	US	AMD PRO A10-9700E	No	AMD R7 Graphics	None	8GBx1	256GB SSD M.2 PCIe NVMe	None	RTL8821AE ac, 1x1 + BT4.0	None	1Wx1	None	None	None	USB / USB	None	Floor Stand	65W 88% Adapter	Win10 Pro 64	3-year, Onsite	01/17
10M3000XUS	US	AMD PRO A12-8870E	No	AMD R7 Graphics	None	8GBx1	256GB SSD M.2 PCIe NVMe	None	RTL8821AE ac, 1x1 + BT4.0	3rd DP	1Wx1	None	None	None	USB / USB	None	Floor Stand	65W 88% Adapter	Win10 DG Win7 Pro 64	3-year, Onsite	01/17
10M3000YUS	US	AMD PRO A10-8770E	No	AMD R7 Graphics	None	8GBx1	500GB 7200rpm 2.5"	None	RTL8821AE ac, 1x1 + BT4.0	3rd DP	1Wx1	None	None	None	USB / USB	None	Floor Stand	65W 88% Adapter	Win10 DG Win7 Pro 64	3-year, Onsite	01/17
10M30010US	US	AMD PRO A10-9700E	No	AMD R7 Graphics	None	4GBx1	500GB 7200rpm 2.5"	None	RTL8821AE ac, 1x1 + BT4.0	None	1Wx1	None	None	None	USB / USB	None	Floor Stand	65W 88% Adapter	Win10 Pro 64	3-year, Onsite	01/17
10M30011US	US	AMD PRO A12-8870E	No	AMD R7 Graphics	None	8GBx1	128GB SSD M.2 PCIe NVMe	None	RTL8821AE ac, 1x1 + BT4.0	None	1Wx1	None	None	None	USB / USB	None	Floor Stand	65W 88% Adapter	Win10 DG Win7 Pro 64	3-year, Onsite	01/17



ThinkCentre M715 Tiny Thin Client Platform Specifications

Product Specifications Reference (PSREF)

Processor	AMD A6, A10, or A12 series APUs						Keyboard Mouse	<i>Some:</i> Fullsize USB Keyboard (USB connector), Lenovo logo <i>Some:</i> USB Optical Wheel Mouse, black, Lenovo logo
	APU	Cores	Frequency Base/Max	L2 Cache	Memory Types	Integrated Graphics	Mechanical	Tiny (1L), black color; metal case M715 Tiny only: 7.05" W X 7.20" D X 1.36" H 179mm W X 182.9mm D X 34.5mm H 2.9 lb (1.3 kg), weight may vary by configuration Optional VESA mount bracket kit, supports VESA 75mm and 100mm Optional system floor stand for vertical orientation
	PRO A6-8570E	2	3.0 / 3.4 GHz	1 MB	DDR4-2400	Radeon R5 Series		
	PRO A10-8770E	4	2.8 / 3.5 GHz	2 MB	DDR4-2400	Radeon R7 Series		
PRO A12-8870E*	4	2.9 / 3.8 GHz	2 MB	DDR4-2400	Radeon R7 Series	VESA mount Floor Stand	Optional VESA mount bracket kit, supports VESA 75mm and 100mm Optional system floor stand for vertical orientation	
*PRO A12-8870E (support Windows 10 IOT only) is only available via special bid models							Power supply	65 watts AC/DC adapter, autosensing, 88% PSU (not included for TIO models)
Memory	4GB max, DDR4 2400, two 260-pin SO-DIMM sockets						Limited warranty ³	<i>Some:</i> 1-year or 3-year, depot service / service upgrades available <i>Some:</i> 1-year or 3-year, limited onsite service / service upgrades available
Disk	<i>Some:</i> 256GB Solid State Drive (SSD) / SATA 6.0Gb/s, 2.5" <i>*256GB SATA (support Windows 10 IOT only) is only available via special bid models</i> <i>Some:</i> 32GB M.2 Solid State Drive (SSD) / SATA interface <i>Some:</i> 128GB M.2 Solid State Drive (SSD) / PCIe NVMe interface						Preload	Preloaded operating system <i>Some:</i> Windows Embedded Standard 7 V2 (WES 7 V2) <i>Some:</i> Windows 10 IoT Enterprise <i>Some:</i> LeTOS V2 (Lenovo Terminal Operating System, Linux-based)
Optical	None						Environment	ENERGY STAR [®] 6.1*, EPEAT [™] Gold rating* (*not for non-OS models); ErP Lot 3; GREENGUARD [®] ; RoHS-compliant
Onboard SATA	One SATA cable (1-drop to device), one SATA 6.0Gb/s connector on planar							
Media reader	None						Accessories	For compatible accessories, please go to http://www.lenovoquickpick.com
Graphics	AMD Radeon™ Graphics in processor, uses main memory, DirectX [®] 12, two DisplayPort [™] , one optional port (HDMI, VGA, or 3rd DP), supports 3 independent displays (supports maximum of 2 concurrent HDMI/DVI displays when using HDMI port or DP to DVI/HDMI dongles); <i>Max resolution:</i> 4096x2160 (DP) @60Hz; 4096x2160 (HDMI) @60Hz; 1920x1200 (VGA) @60Hz							
DP cable	Optional DP to VGA, DP to DVI-D (single link), or DP to HDMI 1.4 dongle							
Chipset	AMD B300 Chipset							
Front ports	Two USB 3.0 (one is Always On and fast charge), one microphone (stereo, 3.5mm), one headphone / microphone combo jack (stereo, 3.5mm)							
Rear ports	One USB 3.0 and three USB 2.0 (optional external optical box or I/O box occupies one specific USB 2.0 on some models), ethernet (RJ-45), two DisplayPort, one optional port (VGA, 3rd DP, HDMI, or serial on some models), one headphone							
I/O box	None							
Audio support	High Definition (HD) Audio, Realtek ALC233-CG / internal speaker (1.5 watt)							
WLAN ¹³	<i>Some:</i> 11ac wireless, M.2 Card, Realtek RTL8821AE (dual band), Wi-Fi + Bluetooth 4.0 combo adapter, 1x1							
Bluetooth [™]	<i>Some:</i> Bluetooth 4.0 or 4.1 wireless, integrated in Wi-Fi + BT combo adapter							
Ethernet	Gigabit ethernet, Realtek RTL8111EPV, Wake on LAN [®]							
Modem	None							
Manageability	DASH 1.0/1.1							
Security chip	Discrete TPM 2.0, TCG Certified							
Security features	<ul style="list-style-type: none"> Security slot (in rear for optional Kensington[®] MicroSaver[®] cable) Padlock loop Smart USB protection, allows keyboard/ mouse only, blocks all storage devices Power-on password 		<ul style="list-style-type: none"> Administrator password Hard disk password Boot sequence control Boot without keyboard and mouse Individual USB port disablement Chassis intrusion switch 					

Model	Region	Processor	vPro	Graphics	Monitor Cable	Memory	Storage(HDD/SSD)	External Optical / I/O Box	WLAN + Bluetooth	Optional Rear Ports	Speaker	Adapter Cage	Toolless Chassis Screw	Dust Filter	Keyboard / Mouse	VESA Mount	Stand	Power Supply	OS	Warranty	Ann Date (m/y)
10RB0000US	US	AMD PRO A6-8570E	No	AMD R5 Graphics	None	4GBx1	32GB SSD M.2 SATA	None	RTL8821AE ac, 1x1 + BT4.0	None	1Wx1	None	None	None	USB / USB	None	Floor Stand	65W 88% Adapter	WES 7 V2	3-year, Onsite	07/17
10RB0001US	US	AMD PRO A10-8770E	No	AMD R7 Graphics	None	4GBx1	32GB SSD M.2 SATA	None	RTL8821AE ac, 1x1 + BT4.0	None	1Wx1	None	None	None	USB / USB	None	Floor Stand	65W 88% Adapter	Windows 10 IoT Enterprise	3-year, Onsite	07/17
10RB0002US	US	AMD PRO A10-8770E	No	AMD R7 Graphics	None	4GBx1	32GB SSD M.2 SATA	None	RTL8821AE ac, 1x1 + BT4.0	HDMI	1Wx1	None	None	None	USB / USB	None	Floor Stand	65W 88% Adapter	WES 7 V2	3-year, Onsite	07/17
10RB0003US	US	AMD PRO A10-8770E	No	AMD R7 Graphics	None	4GBx1	32GB SSD M.2 SATA	None	RTL8821AE ac, 1x1 + BT4.0	3rd DP	1Wx1	None	None	None	USB / USB	None	Floor Stand	65W 88% Adapter	WES 7 V2	3-year, Onsite	07/17
10RB0004US	US	AMD PRO A10-8770E	No	AMD R7 Graphics	None	4GBx1	32GB SSD M.2 SATA	None	RTL8821AE ac, 1x1 + BT4.0	Serial	1Wx1	None	None	None	USB / USB	None	Floor Stand	65W 88% Adapter	LeTOS V2	3-year, Onsite	07/17
10RB0005US	US	AMD PRO A10-8770E	No	AMD R7 Graphics	None	4GBx1	32GB SSD M.2 SATA	None	RTL8821AE ac, 1x1 + BT4.0	3rd DP	1Wx1	None	None	None	USB / USB	None	Floor Stand	65W 88% Adapter	LeTOS V2	3-year, Onsite	07/17
10RB0006US	US	AMD PRO A6-8570E	No	AMD R5 Graphics	None	4GBx1	32GB SSD M.2 SATA	None	RTL8821AE ac, 1x1 + BT4.0	Serial	1Wx1	None	None	None	USB / USB	None	Floor Stand	65W 88% Adapter	LeTOS V2	3-year, Onsite	07/17
10RB0007US	US	AMD PRO A6-8570E	No	AMD R5 Graphics	None	4GBx1	32GB SSD M.2 SATA	None	RTL8821AE ac, 1x1 + BT4.0	VGA	1Wx1	None	None	None	USB / USB	None	Floor Stand	65W 88% Adapter	Windows 10 IoT Enterprise	3-year, Onsite	07/17
10RB0008US	US	AMD PRO A6-8570E	No	AMD R5 Graphics	None	4GBx1	32GB SSD M.2 SATA	None	RTL8821AE ac, 1x1 + BT4.0	HDMI	1Wx1	None	None	None	USB / USB	None	Floor Stand	65W 88% Adapter	Windows 10 IoT Enterprise	3-year, Onsite	07/17
10RB0009US	US	AMD PRO A10-8770E	No	AMD R7 Graphics	None	4GBx1	32GB SSD M.2 SATA	None	RTL8821AE ac, 1x1 + BT4.0	VGA	1Wx1	None	None	None	USB / USB	None	Floor Stand	65W 88% Adapter	WES 7 V2	3-year, Onsite	07/17
10RB000AUS	US	AMD PRO A10-8770E	No	AMD R7 Graphics	None	4GBx1	32GB SSD M.2 SATA	None	RTL8821AE ac, 1x1 + BT4.0	3rd DP	1Wx1	None	None	None	USB / USB	None	Floor Stand	65W 88% Adapter	Windows 10 IoT Enterprise	3-year, Onsite	07/17
10RB000BUS	US	AMD PRO A6-8570E	No	AMD R5 Graphics	None	4GBx1	32GB SSD M.2 SATA	None	RTL8821AE ac, 1x1 + BT4.0	Serial	1Wx1	None	None	None	USB / USB	None	Floor Stand	65W 88% Adapter	Windows 10 IoT Enterprise	3-year, Onsite	07/17
10RB000CUS	US	AMD PRO A10-8770E	No	AMD R7 Graphics	None	4GBx1	32GB SSD M.2 SATA	None	RTL8821AE ac, 1x1 + BT4.0	VGA	1Wx1	None	None	None	USB / USB	None	Floor Stand	65W 88% Adapter	LeTOS V2	3-year, Onsite	07/17
10RB000DUS	US	AMD PRO A10-8770E	No	AMD R7 Graphics	None	4GBx1	32GB SSD M.2 SATA	None	RTL8821AE ac, 1x1 + BT4.0	Serial	1Wx1	None	None	None	USB / USB	None	Floor Stand	65W 88% Adapter	Windows 10 IoT Enterprise	3-year, Onsite	07/17
10RB000EUS	US	AMD PRO A6-8570E	No	AMD R5 Graphics	None	4GBx1	32GB SSD M.2 SATA	None	RTL8821AE ac, 1x1 + BT4.0	None	1Wx1	None	None	None	USB / USB	None	Floor Stand	65W 88% Adapter	LeTOS V2	3-year, Onsite	07/17
10RB000FUS	US	AMD PRO A6-8570E	No	AMD R5 Graphics	None	4GBx1	32GB SSD M.2 SATA	None	RTL8821AE ac, 1x1 + BT4.0	None	1Wx1	None	None	None	USB / USB	None	Floor Stand	65W 88% Adapter	Windows 10 IoT Enterprise	3-year, Onsite	07/17
10RB000GUS	US	AMD PRO A10-8770E	No	AMD R7 Graphics	None	4GBx1	32GB SSD M.2 SATA	None	RTL8821AE ac, 1x1 + BT4.0	HDMI	1Wx1	None	None	None	USB / USB	None	Floor Stand	65W 88% Adapter	Windows 10 IoT Enterprise	3-year, Onsite	07/17
10RB000HUS	US	AMD PRO A6-8570E	No	AMD R5 Graphics	None	4GBx1	32GB SSD M.2 SATA	None	RTL8821AE ac, 1x1 + BT4.0	Serial	1Wx1	None	None	None	USB / USB	None	Floor Stand	65W 88% Adapter	WES 7 V2	3-year, Onsite	07/17
10RB000JUS	US	AMD PRO A6-8570E	No	AMD R5 Graphics	None	4GBx1	32GB SSD M.2 SATA	None	RTL8821AE ac, 1x1 + BT4.0	3rd DP	1Wx1	None	None	None	USB / USB	None	Floor Stand	65W 88% Adapter	Windows 10 IoT Enterprise	3-year, Onsite	07/17
10RB000KUS	US	AMD PRO A6-8570E	No	AMD R5 Graphics	None	4GBx1	32GB SSD M.2 SATA	None	RTL8821AE ac, 1x1 + BT4.0	3rd DP	1Wx1	None	None	None	USB / USB	None	Floor Stand	65W 88% Adapter	LeTOS V2	3-year, Onsite	07/17

Model	Region	Processor	vPro	Graphics	Monitor Cable	Memory	Storage(HDD/SSD)	External Optical / I/O Box	WLAN + Bluetooth	Optional Rear Ports	Speaker	Adapter Cage	Toolless Chassis Screw	Dust Filter	Keyboard / Mouse	VESA Mount	Stand	Power Supply	OS	Warranty	Ann Date (m/y)
10RB000LUS	US	AMD PRO A10-8770E	No	AMD R7 Graphics	None	4GBx1	32GB SSD M.2 SATA	None	RTL8821Ae ac, 1x1 + BT4.0	VGA	1Wx1	None	None	None	USB / USB	None	Floor Stand	65W 88% Adapter	Windows 10 IoT Enterprise	3-year, Onsite	07/17
10RB000MUS	US	AMD PRO A10-8770E	No	AMD R7 Graphics	None	4GBx1	32GB SSD M.2 SATA	None	RTL8821Ae ac, 1x1 + BT4.0	None	1Wx1	None	None	None	USB / USB	None	Floor Stand	65W 88% Adapter	LeTOS V2	3-year, Onsite	07/17
10RB000NUS	US	AMD PRO A6-8570E	No	AMD R5 Graphics	None	4GBx1	32GB SSD M.2 SATA	None	RTL8821Ae ac, 1x1 + BT4.0	HDMI	1Wx1	None	None	None	USB / USB	None	Floor Stand	65W 88% Adapter	LeTOS V2	3-year, Onsite	07/17
10RB000PUS	US	AMD PRO A6-8570E	No	AMD R5 Graphics	None	4GBx1	32GB SSD M.2 SATA	None	RTL8821Ae ac, 1x1 + BT4.0	HDMI	1Wx1	None	None	None	USB / USB	None	Floor Stand	65W 88% Adapter	WES 7 V2	3-year, Onsite	07/17
10RB000QUS	US	AMD PRO A10-8770E	No	AMD R7 Graphics	None	4GBx1	32GB SSD M.2 SATA	None	RTL8821Ae ac, 1x1 + BT4.0	Serial	1Wx1	None	None	None	USB / USB	None	Floor Stand	65W 88% Adapter	WES 7 V2	3-year, Onsite	07/17
10RB000RUS	US	AMD PRO A10-8770E	No	AMD R7 Graphics	None	4GBx1	32GB SSD M.2 SATA	None	RTL8821Ae ac, 1x1 + BT4.0	None	1Wx1	None	None	None	USB / USB	None	Floor Stand	65W 88% Adapter	WES 7 V2	3-year, Onsite	07/17
10RB000SUS	US	AMD PRO A6-8570E	No	AMD R5 Graphics	None	4GBx1	32GB SSD M.2 SATA	None	RTL8821Ae ac, 1x1 + BT4.0	VGA	1Wx1	None	None	None	USB / USB	None	Floor Stand	65W 88% Adapter	LeTOS V2	3-year, Onsite	07/17
10RB000TUS	US	AMD PRO A6-8570E	No	AMD R5 Graphics	None	4GBx1	32GB SSD M.2 SATA	None	RTL8821Ae ac, 1x1 + BT4.0	3rd DP	1Wx1	None	None	None	USB / USB	None	Floor Stand	65W 88% Adapter	WES 7 V2	3-year, Onsite	07/17
10RB000UUS	US	AMD PRO A10-8770E	No	AMD R7 Graphics	None	4GBx1	32GB SSD M.2 SATA	None	RTL8821Ae ac, 1x1 + BT4.0	HDMI	1Wx1	None	None	None	USB / USB	None	Floor Stand	65W 88% Adapter	LeTOS V2	3-year, Onsite	07/17
10RB000VUS	US	AMD PRO A6-8570E	No	AMD R5 Graphics	None	4GBx1	32GB SSD M.2 SATA	None	RTL8821Ae ac, 1x1 + BT4.0	VGA	1Wx1	None	None	None	USB / USB	None	Floor Stand	65W 88% Adapter	WES 7 V2	3-year, Onsite	07/17

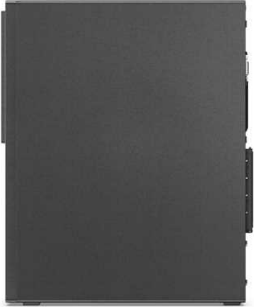

ThinkCentre M910 SFF Platform Specifications

Product Specifications Reference (PSREF)

Processor	Intel® Celeron®, Intel Pentium®, or 6/7th Generation Intel Core™ i3 / i5 / i7 Processor						Security features <ul style="list-style-type: none"> Security slot (in rear for optional Kensington® MicroSaver® cable) Padlock loop Smart USB protection, allows keyboard/mouse only, blocks all storage devices Optional cable lock to physically lock both keyboard and mouse Power-on password Administrator password Hard disk password Boot sequence control Boot without keyboard and mouse Individual USB port disablement Optional chassis intrusion switch
	Processor	Cores / Threads	Frequency Base/Max(GHz)	Cache	Memory Support (Up to)	Integrated Graphics	
	Core i5-6500	4 / 4	3.2G / 3.6G	6 MB	DDR4-2133	HD 530	
	Core i7-6700	4 / 8	3.4G / 4.0G	8 MB	DDR4-2133	HD 530	
	Core i3-7300	2 / 4	4.0G / --	4 MB	DDR4-2400	HD 630	
	Core i5-7400	4 / 4	3.0G / 3.5G	6 MB	DDR4-2400	HD 630	
	Core i5-7500	4 / 4	3.4G / 3.8G	6 MB	DDR4-2400	HD 630	
	Core i5-7600	4 / 4	3.5G / 4.1G	6 MB	DDR4-2400	HD 630	
Core i7-7700	4 / 8	3.6G / 4.2G	8 MB	DDR4-2400	HD 630		
Memory	64GB max, UDIMM, DDR4-2400*, four 288-pin DIMM sockets, non-ECC, dual-channel capable * System automatically clocks down for the processors with lower memory controller						
Storage	<i>Some:</i> Hard Drive / SATA 6.0Gb/s, 2.5" or 3.5", 5400 rpm or 7200 rpm <i>Some:</i> Solid State Drive (SSD) / SATA 6.0Gb/s, 2.5" <i>Some:</i> M.2 Solid State Drive (SSD) / PCIe NVMe, PCIe 3.0 x 4, 32Gb/s <i>Some:</i> Intel Optane™ Memory (models with 7th gen Core processor), M.2 <i>Some:</i> DVD-ROM SATA 1.5Gb/s Drive, slim (9.0mm) <i>Some:</i> DVD Burner (DVD±RW), SATA 1.5Gb/s Drive, slim (9.0mm)						
Optical	Four onboard SATA 6.0Gb/s connectors, RAID 0/1 support (RAID preset only available via special bid model)						
Onboard SATA	Optional 7-in-1 media reader						
Media reader	Intel HD Graphics 510/530/610/630 in processor, uses main memory, DirectX® 12, one VGA, two DisplayPort™, supports 3 independent displays, works along with discrete graphics to support more displays; <i>Max resolution:</i> 4096x2304 (DP)@60Hz; 2048x1536 (VGA)@50Hz <i>Some:</i> NVIDIA GeForce® GT 730 , DirectX 12, 2GB, PCIe 2.0 x8 adapter, two DisplayPort, 35 watts; <i>Max resolution:</i> 3840x2160 (DisplayPort)@60Hz;						
Graphics	<i>Some:</i> NVIDIA GeForce® GT 730, DirectX 12, 2GB, PCIe 2.0 x8 adapter, two DisplayPort, 35 watts; <i>Max resolution:</i> 3840x2160 (DisplayPort)@60Hz;						
Monitor cable	Optional DP to VGA, DP to DVI-D (single link), DP to dual DP, or DP to HDMI 1.4						
Chipset	Intel Q270 Chipset						
Front ports	Four USB 3.1 Gen1, optional two USB 3.1 Type-C Gen 2 (only available via special bid), microphone (3.5mm), headphone (3.5mm)						
Rear ports	Four USB 3.1 Gen1, optional two USB 2.0, serial (9-pin), optional 2nd serial (9-pin), optional parallel (25-pin), ethernet (RJ-45), one VGA, two DisplayPort, optional two PS/2 ports (keyboard/mouse); additional DisplayPort on optional graphics on some models						
Rear audio ports IEEE 1394	Line-in (3.5mm), line-out (3.5mm), microphone-in (3.5mm) None						
Audio support	High Definition (HD) Audio, Realtek ALC662 / optional internal speaker (1.5 watt)						
WLAN ¹³	<i>Some:</i> 11ac wireless, M.2 Card, Qualcomm Atheros QCA9377A (dual band), Wi-Fi + Bluetooth 4.1 combo adapter, 1x1 <i>Some:</i> 11ac wireless, M.2 Card, Qualcomm Atheros QCA6174A (dual band), Wi-Fi + Bluetooth 4.1 combo adapter, 2x2 <i>Some:</i> 11ac wireless, M.2 Card, Intel Dual Band Wireless-AC 3165, Wi-Fi + Bluetooth 4.1 combo adapter, 1x1 <i>Some:</i> 11ac wireless, M.2 Card, Intel Dual Band Wireless-AC 8265, Wi-Fi + Bluetooth 4.1 combo adapter, 2x2 <i>Some:</i> 11ac wireless, M.2 Card, Intel Dual Band Wireless-AC 8265, Wi-Fi + Bluetooth 4.1 combo adapter, Intel vPro technology support, 2x2						
Bluetooth™	<i>Some:</i> Bluetooth 4.1 wireless, integrated in Wi-Fi + BT combo adapter						
Ethernet	Gigabit ethernet, Intel Ethernet Connection I219-LM(Jacksonville), Wake on LAN®						
Modem	None						
Manageability	Intel Active Management Technology 11.0 (Intel AMT 11.0); Intel vPro technology on some models (require choosing a vPro-support Wi-Fi adapter to enable vPro function through wireless connection)						
Security chip	TPM (Trusted Platform Module) 2.0, TCG Certified * Downgrade to TPM1.2 for the models with Win10 DG Win7 32 OS						
Mechanical	<ul style="list-style-type: none"> SFF (8.4L), black color, metal case (WxDxH) 3.6" X 11.4" X 13.5"; 92.5mm X 290.5mm X 343.5mm Approx. 11.92 lb (5.4 kg), weight may vary by configuration Toolless cover, disk, optical, graphic card removal Optional dust filter Bay 1: Slim external ODD bay Bay 2: 3.5", 1" high, internal, HDD/SSD Bay 3: 2.5", internal, HDD/SSD (optional bay) Slot 1: low-profile (length < 150mm, height < 68mm), PCIe 3.0 x16* Slot 2: low-profile (length < 150mm, height < 68mm), PCIe 3.0 x1* Slot 3: low-profile (length < 150mm, height < 68mm), PCIe 3.0 x16 (x4 signal)* Slot 4: no slot, only bracket for optional port extension* M.2 card slots: Two (one for WLAN, one for SSD/Optane) * Optional 2 front USB3.1 Type-C ports module occupies PCIe x16 (x4 signal) slot, optional rear 2x USB2.0 / parallel / 2nd serial / cable lock / Wi-Fi antenna occupies one expansion slot 						
Floor Stand	Optional system floor stand for vertical orientation						
Power supply	<i>Some:</i> 180 watts, autosensing, 85% PSU <i>Some:</i> 210 watts, autosensing, 85% PSU <i>Some:</i> 210 watts, autosensing, 92% PSU (only available via special bid)						
Limited warranty ³	<i>Some:</i> 1-year or 3-year, depot service / service upgrades available <i>Some:</i> 1-year or 3-year, limited onsite service / service upgrades available						
Preload	Preloaded operating system <i>Some:</i> Windows® 7 Professional 32/64 preinstalled through downgrade rights in Windows 10 Pro 64-bit (not available with 7th Gen Intel processor) <i>Some:</i> Windows 10 Pro 64-bit <i>Some:</i> Windows 10 Home 64-bit		Preloaded applications (only some listed) <ul style="list-style-type: none"> Microsoft Office preloaded; purchase a product key to activate Only for Window 10 Lenovo Companion Only for Window 7 Lenovo Solution Center Lenovo ThinkVantage Tools Create Recovery Media Adobe® Reader® Cyberlink PowerDVD Create (DVD±RW) 				
Environment	ENERGY STAR® 6.1, EPEAT™ Gold rating (North America), ErP Lot 3, GREENGUARD®, RoHS-compliant, TUV low noise verified (on some models)						
Accessories	For compatible accessories, please go to http://www.lenovoquickpick.com						

Model	Region	Processor	vPro	Graphics	Monitor Cable	Memory	Storage(HDD/SSD)	Optical	Optional 2nd 2.5" Bay	Media Reader	WLAN + Bluetooth	Optional Front Ports	Optional Rear Ports	Chassis Intrusion Switch	Cable Lock	Front Access HDD	Speaker	Dust Filter	Keyboard / Mouse	Stand	Power Supply	Operating System	Warranty	End of Support	Ann Date (mm/yy)
10MK000AUS	US	i7-7700	vPro	Intel HD 630	None	8GBx1	1TB 7200rpm 3.5"	DVD±RW	Optional 2nd 2.5" Bay	None	8265 ac, 2x2, vPro + BT4.1	None	None	None	None	None	1.5Wx1	None	USB / USB	Floor Stand	210W 85%	Win10 Pro 64	3-year, Onsite	Mar 21, 2023	02/17
10MK000BUS	US	i7-7700	vPro	Intel HD 630	None	8GBx1	256GB SSD M.2 PCIe NVMe	DVD±RW	Optional 2nd 2.5" Bay	None	8265 ac, 2x2, vPro + BT4.1	None	None	None	None	None	1.5Wx1	None	USB / USB	Floor Stand	210W 85%	Win10 Pro 64	3-year, Onsite	Mar 21, 2023	02/17
10MK000CUS	US	i5-7500	vPro	GT 730 2GB	None	8GBx1	1TB 7200rpm 3.5"	DVD±RW	Optional 2nd 2.5" Bay	None	None	None	None	None	None	None	1.5Wx1	None	USB / USB	Floor Stand	210W 85%	Win10 Pro 64	3-year, Onsite	Mar 21, 2023	02/17
10MK000DUS	US	i5-7500	vPro	GT 730 2GB	None	8GBx1	512GB SSD M.2 PCIe NVMe	DVD±RW	Optional 2nd 2.5" Bay	None	8265 ac, 2x2, vPro + BT4.1	None	None	None	None	None	1.5Wx1	None	USB / USB	Floor Stand	210W 85%	Win10 Pro 64	3-year, Onsite	Mar 21, 2023	02/17
10MK000EUS	US	i7-7700	vPro	GT 730 2GB	None	8GBx1	256GB SSD M.2 PCIe NVMe	DVD±RW	Optional 2nd 2.5" Bay	None	None	None	None	None	None	None	1.5Wx1	None	USB / USB	Floor Stand	210W 85%	Win10 Pro 64	3-year, Onsite	Mar 21, 2023	02/17
10MK000FUS	US	i7-7700	vPro	GT 730 2GB	None	8GBx1	512GB SSD M.2 PCIe NVMe	DVD±RW	Optional 2nd 2.5" Bay	None	8265 ac, 2x2, vPro + BT4.1	None	None	None	None	None	1.5Wx1	None	USB / USB	Floor Stand	210W 85%	Win10 Pro 64	3-year, Onsite	Mar 21, 2023	02/17
10MK000GUS	US	i5-7500	vPro	Intel HD 630	None	4GBx1	500GB 7200rpm 3.5"	DVD±RW	Optional 2nd 2.5" Bay	None	None	None	None	None	None	None	1.5Wx1	None	USB / USB	Floor Stand	210W 85%	Win10 Pro 64	3-year, Onsite	Mar 21, 2023	02/17
10MK000HUS	US	i5-7500	vPro	Intel HD 630	None	8GBx1	256GB SSD M.2 PCIe NVMe	DVD±RW	Optional 2nd 2.5" Bay	None	None	None	None	None	None	None	1.5Wx1	None	USB / USB	Floor Stand	210W 85%	Win10 Pro 64	3-year, Onsite	Mar 21, 2023	02/17
10MK000KUS	US	i5-7500	vPro	GT 730 2GB	None	8GBx1	256GB SSD M.2 PCIe NVMe	DVD±RW	Optional 2nd 2.5" Bay	None	None	None	None	None	None	None	1.5Wx1	None	USB / USB	Floor Stand	210W 85%	Win10 Pro 64	3-year, Onsite	Mar 21, 2023	02/17
10MK000LUS	US	i7-7700	vPro	GT 730 2GB	None	8GBx1	1TB 7200rpm 3.5"	DVD±RW	Optional 2nd 2.5" Bay	None	None	None	None	None	None	None	1.5Wx1	None	USB / USB	Floor Stand	210W 85%	Win10 Pro 64	3-year, Onsite	Mar 21, 2023	02/17
10MK000MUS	US	i7-7700	vPro	Intel HD 630	None	8GBx1	512GB SSD M.2 PCIe NVMe	DVD±RW	Optional 2nd 2.5" Bay	None	None	None	None	None	None	None	1.5Wx1	None	USB / USB	Floor Stand	210W 85%	Win10 Pro 64	3-year, Onsite	Mar 21, 2023	02/17
10MK000NUS	US	i7-7700	vPro	Intel HD 630	None	8GBx1	1TB 7200rpm 3.5"	DVD±RW	Optional 2nd 2.5" Bay	None	None	None	None	None	None	None	1.5Wx1	None	USB / USB	Floor Stand	210W 85%	Win10 Pro 64	3-year, Onsite	Mar 21, 2023	02/17
10MK000PUS	US	i7-7700	vPro	Intel HD 630	None	8GBx1	256GB SSD M.2 PCIe NVMe	DVD±RW	Optional 2nd 2.5" Bay	None	None	None	None	None	None	None	1.5Wx1	None	USB / USB	Floor Stand	210W 85%	Win10 Pro 64	3-year, Onsite	Mar 21, 2023	02/17
10MK000QUS	US	i5-7500	vPro	Intel HD 630	None	8GBx1	1TB 7200rpm 3.5"	DVD±RW	Optional 2nd 2.5" Bay	None	None	None	None	None	None	None	1.5Wx1	None	USB / USB	Floor Stand	210W 85%	Win10 Pro 64	3-year, Onsite	Mar 21, 2023	02/17
10MK000RUS	US	i5-7500	vPro	Intel HD 630	None	8GBx1	1TB 7200rpm 3.5"	DVD±RW	Optional 2nd 2.5" Bay	None	8265 ac, 2x2, vPro + BT4.1	None	None	None	None	None	1.5Wx1	None	USB / USB	Floor Stand	210W 85%	Win10 Pro 64	3-year, Onsite	Mar 21, 2023	02/17
10MK000SUS	US	i5-7500	vPro	Intel HD 630	None	8GBx1	512GB SSD M.2 PCIe NVMe	DVD±RW	Optional 2nd 2.5" Bay	None	None	None	None	None	None	None	1.5Wx1	None	USB / USB	Floor Stand	210W 85%	Win10 Pro 64	3-year, Onsite	Mar 21, 2023	02/17
10MK000TUS	US	i5-7500	vPro	Intel HD 630	None	8GBx1	256GB SSD M.2 PCIe NVMe	DVD±RW	Optional 2nd 2.5" Bay	None	8265 ac, 2x2, vPro + BT4.1	None	None	None	None	None	1.5Wx1	None	USB / USB	Floor Stand	210W 85%	Win10 Pro 64	3-year, Onsite	Mar 21, 2023	02/17
10MK0035US	US	i5-6500	vPro	GT 730 2GB	None	8GBx1	512GB SSD M.2 PCIe NVMe	DVD±RW	Optional 2nd 2.5" Bay	None	8265 ac, 2x2, vPro + BT4.1	None	None	None	None	None	1.5Wx1	None	USB / USB	Floor Stand	210W 85%	Win10 DG Win7 Pro 64	3-year, Onsite	Apr 28, 2023	03/17
10MK0036US	US	i5-6500	vPro	Intel HD 530	None	4GBx1	128GB SSD M.2 PCIe NVMe	DVD±RW	Optional 2nd 2.5" Bay	None	None	None	None	None	None	None	1.5Wx1	None	USB / USB	Floor Stand	210W 85%	Win10 DG Win7 Pro 64	3-year, Onsite	Apr 28, 2023	03/17
10MK0037US	US	i5-6500	vPro	Intel HD 530	None	8GBx1	256GB SSD M.2 PCIe NVMe	DVD±RW	Optional 2nd 2.5" Bay	None	8265 ac, 2x2, vPro + BT4.1	None	None	None	None	None	1.5Wx1	None	USB / USB	Floor Stand	210W 85%	Win10 DG Win7 Pro 64	3-year, Onsite	Apr 28, 2023	03/17

Model	Region	Processor	vPro	Graphics	Monitor Cable	Memory	Storage(HDD/SSD)	Optical	Optional 2nd 2.5" Bay	Media Reader	WLAN + Bluetooth	Optional Front Ports	Optional Rear Ports	Chassis Intrusion Switch	Cable Lock	Front Access HDD	Speaker	Dust Filter	Keyboard / Mouse	Stand	Power Supply	Operating System	Warranty	End of Support	Ann Date (mm/yy)
10MK0038US	US	i7-6700	vPro	Intel HD 530	None	8GBx1	256GB SSD M.2 PCIe NVMe	DVD±RW	Optional 2nd 2.5" Bay	None	None	None	None	None	None	None	1.5Wx1	None	USB / USB	Floor Stand	210W 85%	Win10 DG Win7 Pro 64	3-year, Onsite	Apr 28, 2023	03/17
10MK0039US	US	i5-6500	vPro	Intel HD 530	None	8GBx1	1TB 7200rpm 3.5"	DVD±RW	Optional 2nd 2.5" Bay	None	None	None	None	None	None	None	1.5Wx1	None	USB / USB	Floor Stand	210W 85%	Win10 DG Win7 Pro 64	3-year, Onsite	Apr 28, 2023	03/17
10MK003AUS	US	i7-6700	vPro	GT 730 2GB	None	8GBx1	512GB SSD M.2 PCIe NVMe	DVD±RW	Optional 2nd 2.5" Bay	None	8265 ac, 2x2, vPro + BT4.1	None	None	None	None	None	1.5Wx1	None	USB / USB	Floor Stand	210W 85%	Win10 DG Win7 Pro 64	3-year, Onsite	Apr 28, 2023	03/17
10MK003BUS	US	i7-6700	vPro	Intel HD 530	None	8GBx1	1TB 7200rpm 3.5"	DVD±RW	Optional 2nd 2.5" Bay	None	None	None	None	None	None	None	1.5Wx1	None	USB / USB	Floor Stand	210W 85%	Win10 DG Win7 Pro 64	3-year, Onsite	Apr 28, 2023	03/17
10MK003CUS	US	i5-6500	vPro	GT 730 2GB	None	8GBx1	1TB 7200rpm 3.5"	DVD±RW	Optional 2nd 2.5" Bay	None	None	None	None	None	None	None	1.5Wx1	None	USB / USB	Floor Stand	210W 85%	Win10 DG Win7 Pro 64	3-year, Onsite	Apr 28, 2023	03/17
10MK003DUS	US	i5-6500	vPro	Intel HD 530	None	8GBx1	1TB 7200rpm 3.5"	DVD±RW	Optional 2nd 2.5" Bay	None	8265 ac, 2x2, vPro + BT4.1	None	None	None	None	None	1.5Wx1	None	USB / USB	Floor Stand	210W 85%	Win10 DG Win7 Pro 64	3-year, Onsite	Apr 28, 2023	03/17
10MK003EUS	US	i5-6500	vPro	GT 730 2GB	None	8GBx1	256GB SSD M.2 PCIe NVMe	DVD±RW	Optional 2nd 2.5" Bay	None	None	None	None	None	None	None	1.5Wx1	None	USB / USB	Floor Stand	210W 85%	Win10 DG Win7 Pro 64	3-year, Onsite	Apr 28, 2023	03/17
10MK003FUS	US	i5-6500	vPro	Intel HD 530	None	8GBx1	512GB SSD M.2 PCIe NVMe	DVD±RW	Optional 2nd 2.5" Bay	None	None	None	None	None	None	None	1.5Wx1	None	USB / USB	Floor Stand	210W 85%	Win10 DG Win7 Pro 64	3-year, Onsite	Apr 28, 2023	03/17
10MK003GUS	US	i7-6700	vPro	Intel HD 530	None	8GBx1	256GB SSD M.2 PCIe NVMe	DVD±RW	Optional 2nd 2.5" Bay	None	8265 ac, 2x2, vPro + BT4.1	None	None	None	None	None	1.5Wx1	None	USB / USB	Floor Stand	210W 85%	Win10 DG Win7 Pro 64	3-year, Onsite	Apr 28, 2023	03/17
10MK003HUS	US	i7-6700	vPro	GT 730 2GB	None	8GBx1	1TB 7200rpm 3.5"	DVD±RW	Optional 2nd 2.5" Bay	None	None	None	None	None	None	None	1.5Wx1	None	USB / USB	Floor Stand	210W 85%	Win10 DG Win7 Pro 64	3-year, Onsite	Apr 28, 2023	03/17
10MK003JUS	US	i5-6500	vPro	Intel HD 530	None	4GBx1	500GB 7200rpm 3.5"	DVD±RW	Optional 2nd 2.5" Bay	None	None	None	None	None	None	None	1.5Wx1	None	USB / USB	Floor Stand	210W 85%	Win10 DG Win7 Pro 64	3-year, Onsite	Apr 28, 2023	03/17
10MK003KUS	US	i5-6500	vPro	Intel HD 530	None	8GBx1	256GB SSD M.2 PCIe NVMe	DVD±RW	Optional 2nd 2.5" Bay	None	None	None	None	None	None	None	1.5Wx1	None	USB / USB	Floor Stand	210W 85%	Win10 DG Win7 Pro 64	3-year, Onsite	Apr 28, 2023	03/17
10MK003LUS	US	i7-6700	vPro	GT 730 2GB	None	8GBx1	256GB SSD M.2 PCIe NVMe	DVD±RW	Optional 2nd 2.5" Bay	None	None	None	None	None	None	None	1.5Wx1	None	USB / USB	Floor Stand	210W 85%	Win10 DG Win7 Pro 64	3-year, Onsite	Apr 28, 2023	03/17
10MK003MUS	US	i5-7500	vPro	Intel HD 630	None	4GBx1	128GB SSD M.2 PCIe NVMe	DVD±RW	Optional 2nd 2.5" Bay	None	None	None	None	None	None	None	1.5Wx1	None	USB / USB	Floor Stand	210W 85%	Win10 Pro 64	3-year, Onsite	Apr 28, 2023	03/17
10MK003NUS	US	i7-6700	vPro	Intel HD 530	None	8GBx1	512GB SSD M.2 PCIe NVMe	DVD±RW	Optional 2nd 2.5" Bay	None	None	None	None	None	None	None	1.5Wx1	None	USB / USB	Floor Stand	210W 85%	Win10 DG Win7 Pro 64	3-year, Onsite	Apr 28, 2023	03/17
10MK003PUS	US	i7-6700	vPro	Intel HD 530	None	8GBx1	1TB 7200rpm 3.5"	DVD±RW	Optional 2nd 2.5" Bay	None	8265 ac, 2x2, vPro + BT4.1	None	None	None	None	None	1.5Wx1	None	USB / USB	Floor Stand	210W 85%	Win10 DG Win7 Pro 64	3-year, Onsite	Apr 28, 2023	03/17
10MK004WUS	US	i5-7500	vPro	Intel HD 630	None	8GBx1	16GB Optane Memory + 1TB 7200rpm 3.5"	DVD±RW	Optional 2nd 2.5" Bay	None	None	None	None	None	None	None	1.5Wx1	None	USB / USB	Floor Stand	210W 85%	Win10 Pro 64	3-year, Onsite	Sep 5, 2022	09/17
10MK004XUS	US	i7-7700	vPro	Intel HD 630	None	8GBx1	16GB Optane Memory + 1TB 7200rpm 3.5"	DVD±RW	Optional 2nd 2.5" Bay	None	None	None	None	None	None	None	1.5Wx1	None	USB / USB	Floor Stand	210W 85%	Win10 Pro 64	3-year, Onsite	Sep 5, 2022	09/17
10MK0052US	US	i7-7700	vPro	Intel HD 630	None	4GBx1	16GB Optane Memory + 1TB 7200rpm 3.5"	DVD±RW	Optional 2nd 2.5" Bay	None	None	None	None	None	None	None	1.5Wx1	None	USB / USB	Floor Stand	210W 85%	Win10 Pro 64	3-year, Onsite	Apr 27, 2024	03/18
10MK0053US	US	i5-7500	vPro	Intel HD 630	None	4GBx1	16GB Optane Memory + 1TB 7200rpm 3.5"	DVD±RW	Optional 2nd 2.5" Bay	None	None	None	None	None	None	None	1.5Wx1	None	USB / USB	Floor Stand	210W 85%	Win10 Pro 64	3-year, Onsite	Apr 27, 2024	03/18



ThinkCentre M910 Tiny Platform Specifications

Product Specifications Reference (PSREF)

Processor	Intel® Celeron®, Intel Pentium®, or 6/7th Generation Intel Core™ i3 / i5 / i7 Processor						Security features <ul style="list-style-type: none"> Security slot (in rear for optional Kensington® MicroSaver® cable) Smart USB protection, allows keyboard/mouse only, blocks all storage devices Power-on password Administrator password Hard disk password Boot sequence control Boot without keyboard and mouse Individual USB port disablement Chassis intrusion switch
	Processor	Cores / Threads	Frequency Base/Max(GHz)	Cache	Memory Support (Up to)	Integrated Graphics	
	Core i5-6500T	4 / 4	2.5G / 3.1G	6 MB	DDR4-2133	HD 530	
	Core i7-6700T	4 / 8	2.8G / 3.6G	8 MB	DDR4-2133	HD 530	
	Core i5-7500T	4 / 4	2.7G / 3.3G	6 MB	DDR4-2400	HD 630	
	Core i5-7600T	4 / 4	2.8G / 3.7G	6 MB	DDR4-2400	HD 630	
Core i7-7700T	4 / 8	2.9G / 3.8G	8 MB	DDR4-2400	HD 630		
Memory	32GB max, DDR4-2400*, two 260-pin SO-DIMM sockets, non-ECC, dual-channel capable * System automatically clocks down for the processors with lower memory controller						
Storage	<i>Some:</i> Hard Drive / SATA 6.0Gb/s, 2.5", 5400 rpm or 7200 rpm, APS <i>Some:</i> Solid State Drive (SSD) / SATA 6.0Gb/s, 2.5" <i>Some:</i> M.2 Solid State Drive (SSD) / PCIe NVMe, PCIe 3.0 x 4, 32Gb/s <i>Some:</i> Intel Optane™ Memory (models with 7th gen Core processor), M.2 <i>Some:</i> DVD-ROM, slim (9.0mm), via USB external ODD box <i>Some:</i> DVD Burner (DVD±RW), slim (9.0mm), via USB external ODD box						
Optical	One onboard SATA 6.0Gb/s connector						
Onboard SATA Media reader	None						
Graphics	Intel HD Graphics 510/530/610/630 in processor, uses main memory, DirectX® 12, two DisplayPort™, one optional video port (HDMI, VGA, 3rd DP, or USB 3.1 Type-C with DisplayPort Alternate Mode), up to 3 independent displays; <i>Max resolution:</i> 4096x2304 (DP)@60Hz; 4096x2304 (Type-C)@60Hz; 4096x2160 (HDMI)@24Hz; 1920x1200 (VGA)@60Hz						
Monitor cable	Optional DP to VGA, DP to DVI-D (single link), DP to dual DP, or DP to HDMI 1.4						
Chipset	Intel Q270 Chipset						
Front ports	Two USB 3.1 Gen1 (one is Always On and fast charge), one microphone (3.5mm), one headphone / microphone combo jack (3.5mm)						
Rear ports	Four USB 3.1 Gen1 (optional external optical box or external I/O box occupies one or two specific USB 3.1 Gen1 on some models), ethernet (RJ-45), two DisplayPort, two optional ports (Port 1 for VGA / 3rd DP / HDMI / serial / USB 3.1 Type-C Gen 1 (with DisplayPort Alternate Mode), Port 2 for serial)						
I/O box	Optional external I/O box, extends two USB 2.0, two USB 3.1 Gen1, and one serial on rear, two USB 2.0 on front, via USB cable (occupy two specific USB 3.1 Gen1 of Tiny)						
Audio support	High Definition (HD) Audio, Realtek ALC294 / optional internal speaker (1w or 2w)						
WLAN ¹³	<i>Some:</i> 11ac wireless, M.2 Card, Qualcomm Atheros QCA9377A (dual band), Wi-Fi + Bluetooth 4.1 combo adapter, 1x1 <i>Some:</i> 11ac wireless, M.2 Card, Qualcomm Atheros QCA6174A (dual band), Wi-Fi + Bluetooth 4.1 combo adapter, 2x2 <i>Some:</i> 11ac wireless, M.2 Card, Intel Dual Band Wireless-AC 3165, Wi-Fi + Bluetooth 4.1 combo adapter, 1x1 <i>Some:</i> 11ac wireless, M.2 Card, Intel Dual Band Wireless-AC 8265, Wi-Fi + Bluetooth 4.1 combo adapter, 2x2						
Bluetooth™	<i>Some:</i> 11ac wireless, M.2 Card, Intel Dual Band Wireless-AC 8265, Wi-Fi + Bluetooth 4.1 combo adapter, Intel vPro technology support, 2x2 <i>Some:</i> Bluetooth 4.1 wireless, integrated in Wi-Fi + BT combo adapter						
Ethernet Modem	Gigabit ethernet, Intel Ethernet Connection I219-LM(Jacksonville), Wake on LAN® None						
Manageability	Intel Active Management Technology 11.0 (Intel AMT 11.0); Intel vPro technology on some models (require choosing a vPro-support Wi-Fi adapter to enable vPro function through wireless connection)						
Security chip	TPM (Trusted Platform Module) 2.0*, TCG Certified * Downgrade to TPM1.2 for the models with Win10 DG Win7 32 OS						
Mechanical	Tiny (1L), black color; metal case <ul style="list-style-type: none"> Toolless chassis open Toolless HDD, SSD, memory removal Optional toolless chassis screw Optional dust filter 						
Keyboard	<i>Some:</i> Lenovo Calliope Keyboard (USB connector), black <i>Some:</i> Lenovo Traditional Keyboard (USB connector), black <i>Some:</i> Lenovo Calliope Wireless Keyboard (2.4GHz via USB receiver), black <i>Some:</i> Lenovo Calliope Mouse (USB connector), black <i>Some:</i> Lenovo Calliope Wireless Mouse (2.4GHz via USB receiver), black						
Mouse							
VESA mount Floor Stand	Optional VESA mount bracket kit, supports VESA 75mm and 100mm Optional system floor stand for vertical orientation						
Power supply	65 watts AC/DC adapter, autosensing, 88% PSU (not included for TIO models) 90 watts AC/DC adapter, autosensing, 88% PSU (only for models with I/O box)						
Limited warranty ³	<i>Some:</i> 1-year or 3-year, depot service / service upgrades available <i>Some:</i> 1-year or 3-year, limited onsite service / service upgrades available						
Preload	<i>Some:</i> Windows® 7 Professional 32/64 preinstalled through downgrade rights in Windows 10 Pro 64-bit (not available with 7th Gen Intel processor) <i>Some:</i> Windows 10 Pro 64-bit <i>Some:</i> Windows 10 Home 64-bit						
Environment	ENERGY STAR® 6.1, EPEAT™ Gold rating (North America), ErP Lot 3, GREENGUARD®, RoHS-compliant, TUV low noise verified (on some models)						
MIL-SPEC test	MIL-STD-810G military certification (Low Pressure [Altitude], High Temperature, Low Temperature, Temperature Shock, Humidity, Sand and Dust, Vibration, Shock, Fungus, Solar Radiation)						
Accessories	For compatible accessories, please go to http://www.lenovoquickpick.com						

See footnotes for more detailed information

© Lenovo
(M910 Tiny-Spec) February 2017

Model	Region	Processor	vPro	Graphics	Monitor Cable	Memory	Storage(HDD/SSD)	External Optical / I/O Box	WLAN + Bluetooth	Optional Rear Ports	Chassis Intrusion Switch	Kensington Cable Lock	Speaker	Adapter Cage	Toolless Chassis Screw	Dust Filter	Keyboard / Mouse	VESA Mount	Stand	Power Supply	Operating System	Warranty	End of Support	Ann Date (mm/yy)
10MV000JUS	US	i5-7500T	vPro	Intel HD 630	None	4GBx1	128GB SSD M.2 PCIe NVMe	None	8265 ac, 2x2, vPro + BT4.1	3rd DP	Switch	None	1Wx1	None	None	None	USB / USB	None	Floor Stand	65W 88% Adapter	Win10 Pro 64	3-year, Onsite	Mar 21, 2023	02/17
10MV000KUS	US	i7-7700T	vPro	Intel HD 630	None	8GB	256GB SSD M.2 PCIe NVMe	DVD±RW	8265 ac, 2x2, vPro + BT4.1	HDMI	Switch	None	1Wx1	None	None	None	USB / USB	VESA Mount	None	65W 88% Adapter	Win10 Pro 64	3-year, Onsite	Mar 21, 2023	02/17
10MV000LUS	US	i5-7500T	vPro	Intel HD 630	None	4GBx1	500GB 7200rpm 2.5"	None	8265 ac, 2x2, vPro + BT4.1	3rd DP	Switch	None	1Wx1	None	None	None	USB / USB	None	Floor Stand	65W 88% Adapter	Win10 Pro 64	3-year, Onsite	Mar 21, 2023	02/17
10MV000MUS	US	i5-7500T	vPro	Intel HD 630	None	8GB	500GB 7200rpm 2.5"	None	8265 ac, 2x2, vPro + BT4.1	HDMI	Switch	None	1Wx1	None	None	None	USB / USB	None	Floor Stand	65W 88% Adapter	Win10 Pro 64	3-year, Onsite	Mar 21, 2023	02/17
10MV000NUS	US	i5-7500T	vPro	Intel HD 630	None	8GB	256GB SSD M.2 PCIe NVMe	None	8265 ac, 2x2, vPro + BT4.1	3rd DP	Switch	None	1Wx1	None	None	None	USB / USB	None	Floor Stand	65W 88% Adapter	Win10 Pro 64	3-year, Onsite	Mar 21, 2023	02/17
10MV000PUS	US	i5-7500T	vPro	Intel HD 630	None	8GB	500GB 7200rpm 2.5"	DVD±RW	8265 ac, 2x2, vPro + BT4.1	HDMI	Switch	None	1Wx1	None	None	None	USB / USB	VESA Mount	None	65W 88% Adapter	Win10 Pro 64	3-year, Onsite	Mar 21, 2023	02/17
10MV000QUS	US	i5-7500T	vPro	Intel HD 630	None	8GB	256GB SSD M.2 PCIe NVMe	None	8265 ac, 2x2, vPro + BT4.1	HDMI	Switch	None	1Wx1	None	None	None	USB / USB	None	Floor Stand	65W 88% Adapter	Win10 Pro 64	3-year, Onsite	Mar 21, 2023	02/17
10MV000RUS	US	i5-7500T	vPro	Intel HD 630	None	4GBx1	128GB SSD M.2 PCIe NVMe	None	8265 ac, 2x2, vPro + BT4.1	None	Switch	None	1Wx1	None	None	None	USB / USB	None	Floor Stand	65W 88% Adapter	Win10 Pro 64	3-year, Onsite	Mar 21, 2023	02/17
10MV000SUS	US	i5-7500T	vPro	Intel HD 630	None	8GB	128GB SSD M.2 PCIe NVMe	None	8265 ac, 2x2, vPro + BT4.1	3rd DP	Switch	None	1Wx1	None	None	None	USB / USB	None	Floor Stand	65W 88% Adapter	Win10 Pro 64	3-year, Onsite	Mar 21, 2023	02/17
10MV000TUS	US	i5-7500T	vPro	Intel HD 630	None	8GB	500GB 7200rpm 2.5"	None	8265 ac, 2x2, vPro + BT4.1	3rd DP	Switch	None	1Wx1	None	None	None	USB / USB	None	Floor Stand	65W 88% Adapter	Win10 Pro 64	3-year, Onsite	Mar 21, 2023	02/17
10MV000UUS	US	i7-7700T	vPro	Intel HD 630	None	8GB	256GB SSD M.2 PCIe NVMe	None	8265 ac, 2x2, vPro + BT4.1	HDMI	Switch	None	1Wx1	None	None	None	USB / USB	None	Floor Stand	65W 88% Adapter	Win10 Pro 64	3-year, Onsite	Mar 21, 2023	02/17
10MV000VUS	US	i5-7500T	vPro	Intel HD 630	None	4GBx1	500GB 7200rpm 2.5"	None	8265 ac, 2x2, vPro + BT4.1	Serial	Switch	None	1Wx1	None	None	None	USB / USB	None	Floor Stand	65W 88% Adapter	Win10 Pro 64	3-year, Onsite	Mar 21, 2023	02/17
10MV000XUS	US	i5-7500T	vPro	Intel HD 630	None	4GBx1	500GB 7200rpm 2.5"	None	8265 ac, 2x2, vPro + BT4.1	None	Switch	None	1Wx1	None	None	None	USB / USB	None	Floor Stand	65W 88% Adapter	Win10 Pro 64	3-year, Onsite	Mar 21, 2023	02/17
10MV000YUS	US	i7-7700T	vPro	Intel HD 630	None	8GB	128GB SSD M.2 PCIe NVMe	None	8265 ac, 2x2, vPro + BT4.1	HDMI	Switch	None	1Wx1	None	None	None	USB / USB	None	Floor Stand	65W 88% Adapter	Win10 Pro 64	3-year, Onsite	Mar 21, 2023	02/17
10MV0010US	US	i7-7700T	vPro	Intel HD 630	None	8GB	500GB 7200rpm 2.5"	None	8265 ac, 2x2, vPro + BT4.1	HDMI	Switch	None	1Wx1	None	None	None	USB / USB	None	Floor Stand	65W 88% Adapter	Win10 Pro 64	3-year, Onsite	Mar 21, 2023	02/17
10MV0011US	US	i5-7500T	vPro	Intel HD 630	None	4GBx1	256GB SSD M.2 PCIe NVMe	None	8265 ac, 2x2, vPro + BT4.1	3rd DP	Switch	None	1Wx1	None	None	None	USB / USB	None	Floor Stand	65W 88% Adapter	Win10 Pro 64	3-year, Onsite	Mar 21, 2023	02/17
10MV0012US	US	i5-7500T	vPro	Intel HD 630	None	8GB	512GB SSD M.2 PCIe NVMe	None	8265 ac, 2x2, vPro + BT4.1	HDMI	Switch	None	1Wx1	None	None	None	USB / USB	None	Floor Stand	65W 88% Adapter	Win10 Pro 64	3-year, Onsite	Mar 21, 2023	02/17
10MV0013US	US	i7-7700T	vPro	Intel HD 630	None	8GB	512GB SSD M.2 PCIe NVMe	None	8265 ac, 2x2, vPro + BT4.1	HDMI	Switch	None	1Wx1	None	None	None	USB / USB	None	Floor Stand	65W 88% Adapter	Win10 Pro 64	3-year, Onsite	Mar 21, 2023	02/17
10MV0014US	US	i5-7500T	vPro	Intel HD 630	None	8GB	256GB SSD M.2 PCIe NVMe	DVD±RW	8265 ac, 2x2, vPro + BT4.1	HDMI	Switch	None	1Wx1	None	None	None	USB / USB	VESA Mount	None	65W 88% Adapter	Win10 Pro 64	3-year, Onsite	Mar 21, 2023	02/17
10MV002MUS	US	i7-6700T	vPro	Intel HD 530	None	8GB	512GB SSD M.2 PCIe NVMe	None	8265 ac, 2x2, vPro + BT4.1	HDMI	Switch	None	1Wx1	None	None	None	USB / USB	None	Floor Stand	65W 88% Adapter	Win10 DG Win7 Pro 64	3-year, Onsite	Apr 21, 2023	03/17

Model	Region	Processor	vPro	Graphics	Monitor Cable	Memory	Storage(HDD/SSD)	External Optical / I/O Box	WLAN + Bluetooth	Optional Rear Ports	Chassis Intrusion Switch	Kensington Cable Lock	Speaker	Adapter Cage	Toolless Chassis Screw	Dust Filter	Keyboard / Mouse	VESA Mount	Stand	Power Supply	Operating System	Warranty	End of Support	Ann Date (mm/yy)
10MV002NUS	US	i5-6500T	vPro	Intel HD 530	None	4GBx1	500GB 7200rpm 2.5"	None	8265 ac, 2x2, vPro + BT4.1	Serial	Switch	None	1Wx1	None	None	None	USB / USB	None	Floor Stand	65W 88% Adapter	Win10 DG Win7 Pro 64	3-year, Onsite	Apr 21, 2023	03/17
10MV002PUS	US	i5-7500T	vPro	Intel HD 630	None	8GBx2	512GB SSD M.2 PCIe NVMe	None	8265 ac, 2x2, vPro + BT4.1	3rd DP	Switch	None	1Wx1	None	None	None	USB / USB	None	Floor Stand	65W 88% Adapter	Win10 Pro 64	3-year, Onsite	Apr 21, 2023	03/17
10MV002QUS	US	i7-7700T	vPro	Intel HD 630	None	8GBx2	512GB SSD M.2 PCIe NVMe	None	8265 ac, 2x2, vPro + BT4.1	3rd DP	Switch	None	1Wx1	None	None	None	USB / USB	None	Floor Stand	65W 88% Adapter	Win10 Pro 64	3-year, Onsite	Apr 21, 2023	03/17
10MV002RUS	US	i7-7700T	vPro	Intel HD 630	None	8GB	500GB 7200rpm 2.5"	None	8265 ac, 2x2, vPro + BT4.1	3rd DP	Switch	None	1Wx1	None	None	None	USB / USB	None	Floor Stand	65W 88% Adapter	Win10 Pro 64	3-year, Onsite	Apr 21, 2023	03/17
10MV002SUS	US	i5-6500T	vPro	Intel HD 530	None	8GB	512GB SSD M.2 PCIe NVMe	None	8265 ac, 2x2, vPro + BT4.1	3rd DP	Switch	None	1Wx1	None	None	None	USB / USB	None	Floor Stand	65W 88% Adapter	Win10 DG Win7 Pro 64	3-year, Onsite	Apr 21, 2023	03/17
10MV002TUS	US	i7-6700T	vPro	Intel HD 530	None	16GBx1	512GB SSD M.2 PCIe NVMe	None	8265 ac, 2x2, vPro + BT4.1	3rd DP	Switch	None	1Wx1	None	None	None	USB / USB	None	Floor Stand	65W 88% Adapter	Win10 DG Win7 Pro 64	3-year, Onsite	Apr 21, 2023	03/17
10MV002UUS	US	i7-6700T	vPro	Intel HD 530	None	8GB	500GB 7200rpm 2.5"	None	8265 ac, 2x2, vPro + BT4.1	3rd DP	Switch	None	1Wx1	None	None	None	USB / USB	None	Floor Stand	65W 88% Adapter	Win10 DG Win7 Pro 64	3-year, Onsite	Apr 21, 2023	03/17
10MV002VUS	US	i7-7700T	vPro	Intel HD 630	None	8GBx2	500GB 7200rpm 2.5"	None	8265 ac, 2x2, vPro + BT4.1	3rd DP	Switch	None	1Wx1	None	None	None	USB / USB	None	Floor Stand	65W 88% Adapter	Win10 Pro 64	3-year, Onsite	Apr 21, 2023	03/17
10MV002WUS	US	i7-6700T	vPro	Intel HD 530	None	8GB	256GB SSD M.2 PCIe NVMe	None	8265 ac, 2x2, vPro + BT4.1	HDMI	Switch	None	1Wx1	None	None	None	USB / USB	None	Floor Stand	65W 88% Adapter	Win10 DG Win7 Pro 64	3-year, Onsite	Apr 21, 2023	03/17
10MV002XUS	US	i5-7500T	vPro	Intel HD 630	None	8GBx2	256GB SSD M.2 PCIe NVMe	None	8265 ac, 2x2, vPro + BT4.1	3rd DP	Switch	None	1Wx1	None	None	None	USB / USB	None	Floor Stand	65W 88% Adapter	Win10 Pro 64	3-year, Onsite	Apr 21, 2023	03/17
10MV002YUS	US	i5-6500T	vPro	Intel HD 530	None	8GBx2	512GB SSD M.2 PCIe NVMe	None	8265 ac, 2x2, vPro + BT4.1	3rd DP	Switch	None	1Wx1	None	None	None	USB / USB	None	Floor Stand	65W 88% Adapter	Win10 DG Win7 Pro 64	3-year, Onsite	Apr 21, 2023	03/17
10MV0030US	US	i5-6500T	vPro	Intel HD 530	None	4GBx1	500GB 7200rpm 2.5"	None	8265 ac, 2x2, vPro + BT4.1	None	Switch	None	1Wx1	None	None	None	USB / USB	None	Floor Stand	65W 88% Adapter	Win10 DG Win7 Pro 64	3-year, Onsite	Apr 21, 2023	03/17
10MV0031US	US	i5-6500T	vPro	Intel HD 530	None	4GBx1	500GB 7200rpm 2.5"	None	8265 ac, 2x2, vPro + BT4.1	VGA	Switch	None	1Wx1	None	None	None	USB / USB	None	Floor Stand	65W 88% Adapter	Win10 DG Win7 Pro 64	3-year, Onsite	Apr 21, 2023	03/17
10MV0032US	US	i5-6500T	vPro	Intel HD 530	None	8GB	256GB SSD M.2 PCIe NVMe	None	8265 ac, 2x2, vPro + BT4.1	3rd DP	Switch	None	1Wx1	None	None	None	USB / USB	None	Floor Stand	65W 88% Adapter	Win10 DG Win7 Pro 64	3-year, Onsite	Mar 21, 2022	03/17
10MV0033US	US	i7-6700T	vPro	Intel HD 530	None	8GB	512GB SSD M.2 PCIe NVMe	None	8265 ac, 2x2, vPro + BT4.1	3rd DP	Switch	None	1Wx1	None	None	None	USB / USB	None	Floor Stand	65W 88% Adapter	Win10 DG Win7 Pro 64	3-year, Onsite	Apr 21, 2023	03/17
10MV0034US	US	i5-6500T	vPro	Intel HD 530	None	8GB	128GB SSD M.2 PCIe NVMe	None	8265 ac, 2x2, vPro + BT4.1	3rd DP	Switch	None	1Wx1	None	None	None	USB / USB	None	Floor Stand	65W 88% Adapter	Win10 DG Win7 Pro 64	3-year, Onsite	Apr 21, 2023	03/17
10MV0035US	US	i7-7700T	vPro	Intel HD 630	None	8GBx2	256GB SSD M.2 PCIe NVMe	None	8265 ac, 2x2, vPro + BT4.1	3rd DP	Switch	None	1Wx1	None	None	None	USB / USB	None	Floor Stand	65W 88% Adapter	Win10 Pro 64	3-year, Onsite	Apr 21, 2023	03/17
10MV0036US	US	i5-6500T	vPro	Intel HD 530	None	8GB	500GB 7200rpm 2.5"	None	8265 ac, 2x2, vPro + BT4.1	3rd DP	Switch	None	1Wx1	None	None	None	USB / USB	None	Floor Stand	65W 88% Adapter	Win10 DG Win7 Pro 64	3-year, Onsite	Apr 21, 2023	03/17
10MV0037US	US	i5-6500T	vPro	Intel HD 530	None	8GBx2	256GB SSD M.2 PCIe NVMe	None	8265 ac, 2x2, vPro + BT4.1	3rd DP	Switch	None	1Wx1	None	None	None	USB / USB	None	Floor Stand	65W 88% Adapter	Win10 DG Win7 Pro 64	3-year, Onsite	Apr 21, 2023	03/17
10MV0038US	US	i5-6500T	vPro	Intel HD 530	None	4GBx1	500GB 7200rpm 2.5"	None	8265 ac, 2x2, vPro + BT4.1	3rd DP	Switch	None	1Wx1	None	None	None	USB / USB	None	Floor Stand	65W 88% Adapter	Win10 DG Win7 Pro 64	3-year, Onsite	Apr 21, 2023	03/17

Model	Region	Processor	vPro	Graphics	Monitor Cable	Memory	Storage(HDD/SSD)	External Optical / I/O Box	WLAN + Bluetooth	Optional Rear Ports	Chassis Intrusion Switch	Kensington Cable Lock	Speaker	Adapter Cage	Toolless Chassis Screw	Dust Filter	Keyboard / Mouse	VESA Mount	Stand	Power Supply	Operating System	Warranty	End of Support	Ann Date (mm/yy)
10MV0039US	US	i7-6700T	vPro	Intel HD 530	None	8GB	256GB SSD M.2 PCIe NVMe	None	8265 ac, 2x2, vPro + BT4.1	3rd DP	Switch	None	1Wx1	None	None	None	USB / USB	None	Floor Stand	65W 88% Adapter	Win10 DG Win7 Pro 64	3-year, Onsite	Apr 21, 2023	03/17
10MV003KUS	US	i7-7700T	vPro	Intel HD 630	None	8GB	16GB Optane Memory + 500GB 7200rpm 2.5"	None	8265 ac, 2x2, vPro + BT4.1	HDMI	Switch	None	1Wx1	None	None	None	USB / USB	None	Floor Stand	65W 88% Adapter	Win10 Pro 64	3-year, Onsite	Sep 5, 2022	09/17
10MV003LUS	US	i5-7500T	vPro	Intel HD 630	None	8GB	16GB Optane Memory + 500GB 7200rpm 2.5"	None	8265 ac, 2x2, vPro + BT4.1	3rd DP	Switch	None	1Wx1	None	None	None	USB / USB	None	Floor Stand	65W 88% Adapter	Win10 Pro 64	3-year, Onsite	Sep 5, 2022	09/17
10MV003MUS	US	i5-7500T	vPro	Intel HD 630	None	8GB	16GB Optane Memory + 500GB 7200rpm 2.5"	None	8265 ac, 2x2, vPro + BT4.1	HDMI	Switch	None	1Wx1	None	None	None	USB / USB	None	Floor Stand	65W 88% Adapter	Win10 Pro 64	3-year, Onsite	Sep 5, 2022	09/17
10MV003NUS	US	i7-7700T	vPro	Intel HD 630	None	8GB	16GB Optane Memory + 500GB 7200rpm 2.5"	None	8265 ac, 2x2, vPro + BT4.1	3rd DP	Switch	None	1Wx1	None	None	None	USB / USB	None	Floor Stand	65W 88% Adapter	Win10 Pro 64	3-year, Onsite	Sep 5, 2022	09/17
10MV003TUS	US	i5-7500T	vPro	Intel HD 630	None	4GBx1	16GB Optane Memory + 500GB 7200rpm 2.5"	None	8265 ac, 2x2, vPro + BT4.1	HDMI	Switch	None	1Wx1	None	None	None	USB / USB	None	Floor Stand	65W 88% Adapter	Win10 Pro 64	3-year, Onsite	Apr 27, 2024	03/18
10MV003UUS	US	i5-7500T	vPro	Intel HD 630	None	4GBx1	16GB Optane Memory + 500GB 7200rpm 2.5"	None	8265 ac, 2x2, vPro + BT4.1	3rd DP	Switch	None	1Wx1	None	None	None	USB / USB	None	Floor Stand	65W 88% Adapter	Win10 Pro 64	3-year, Onsite	Apr 27, 2024	03/18
10MV003VUS	US	i7-7700T	vPro	Intel HD 630	None	4GBx1	16GB Optane Memory + 500GB 7200rpm 2.5"	None	8265 ac, 2x2, vPro + BT4.1	3rd DP	Switch	None	1Wx1	None	None	None	USB / USB	None	Floor Stand	65W 88% Adapter	Win10 Pro 64	3-year, Onsite	Apr 27, 2024	03/18
10MV003WUS	US	i7-7700T	vPro	Intel HD 630	None	4GBx1	16GB Optane Memory + 500GB 7200rpm 2.5"	None	8265 ac, 2x2, vPro + BT4.1	HDMI	Switch	None	1Wx1	None	None	None	USB / USB	None	Floor Stand	65W 88% Adapter	Win10 Pro 64	3-year, Onsite	Apr 27, 2024	03/18

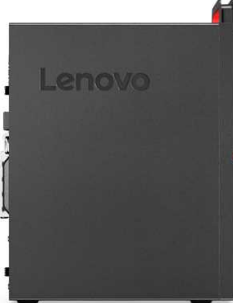

ThinkCentre M910 Tower Platform Specifications

Product Specifications Reference (PSREF)

Processor	Intel® Celeron®, Intel Pentium®, or 6/7th Generation Intel Core™ i3 / i5 / i7 Processor	Manageability	Intel Active Management Technology 11.0 (Intel AMT 11.0); Intel vPro technology on some models (require choosing a vPro-support Wi-Fi adapter to enable vPro function through wireless connection)																																																
	<table border="1"> <thead> <tr> <th>Processor</th> <th>Cores / Threads</th> <th>Frequency Base/Max(GHz)</th> <th>Cache</th> <th>Memory Support (Up to)</th> <th>Integrated Graphics</th> </tr> </thead> <tbody> <tr> <td>Core i5-6500</td> <td>4 / 4</td> <td>3.2G / 3.6G</td> <td>6 MB</td> <td>DDR4-2133</td> <td>HD 530</td> </tr> <tr> <td>Core i7-6700</td> <td>4 / 8</td> <td>3.4G / 4.0G</td> <td>8 MB</td> <td>DDR4-2133</td> <td>HD 530</td> </tr> <tr> <td>Core i3-7300</td> <td>2 / 4</td> <td>4.0G / --</td> <td>4 MB</td> <td>DDR4-2400</td> <td>HD 630</td> </tr> <tr> <td>Core i5-7400</td> <td>4 / 4</td> <td>3.0G / 3.5G</td> <td>6 MB</td> <td>DDR4-2400</td> <td>HD 630</td> </tr> <tr> <td>Core i5-7500</td> <td>4 / 4</td> <td>3.4G / 3.8G</td> <td>6 MB</td> <td>DDR4-2400</td> <td>HD 630</td> </tr> <tr> <td>Core i5-7600</td> <td>4 / 4</td> <td>3.5G / 4.1G</td> <td>6 MB</td> <td>DDR4-2400</td> <td>HD 630</td> </tr> <tr> <td>Core i7-7700</td> <td>4 / 8</td> <td>3.6G / 4.2G</td> <td>8 MB</td> <td>DDR4-2400</td> <td>HD 630</td> </tr> </tbody> </table>	Processor	Cores / Threads	Frequency Base/Max(GHz)	Cache	Memory Support (Up to)	Integrated Graphics	Core i5-6500	4 / 4	3.2G / 3.6G	6 MB	DDR4-2133	HD 530	Core i7-6700	4 / 8	3.4G / 4.0G	8 MB	DDR4-2133	HD 530	Core i3-7300	2 / 4	4.0G / --	4 MB	DDR4-2400	HD 630	Core i5-7400	4 / 4	3.0G / 3.5G	6 MB	DDR4-2400	HD 630	Core i5-7500	4 / 4	3.4G / 3.8G	6 MB	DDR4-2400	HD 630	Core i5-7600	4 / 4	3.5G / 4.1G	6 MB	DDR4-2400	HD 630	Core i7-7700	4 / 8	3.6G / 4.2G	8 MB	DDR4-2400	HD 630	Security chip	TPM (Trusted Platform Module) 2.0, TCG Certified * Downgrade to TPM1.2 for the models with Win10 DG Win7 32 OS
Processor	Cores / Threads	Frequency Base/Max(GHz)	Cache	Memory Support (Up to)	Integrated Graphics																																														
Core i5-6500	4 / 4	3.2G / 3.6G	6 MB	DDR4-2133	HD 530																																														
Core i7-6700	4 / 8	3.4G / 4.0G	8 MB	DDR4-2133	HD 530																																														
Core i3-7300	2 / 4	4.0G / --	4 MB	DDR4-2400	HD 630																																														
Core i5-7400	4 / 4	3.0G / 3.5G	6 MB	DDR4-2400	HD 630																																														
Core i5-7500	4 / 4	3.4G / 3.8G	6 MB	DDR4-2400	HD 630																																														
Core i5-7600	4 / 4	3.5G / 4.1G	6 MB	DDR4-2400	HD 630																																														
Core i7-7700	4 / 8	3.6G / 4.2G	8 MB	DDR4-2400	HD 630																																														
		Security features	<ul style="list-style-type: none"> Security slot (in rear for optional Kensington® MicroSaver® cable) Padlock loop Smart USB protection, allows keyboard/ mouse only, blocks all storage devices Optional cable lock to physically lock both keyboard and mouse Power-on password Administrator password Hard disk password Boot sequence control Boot without keyboard and mouse Individual USB port disablement Optional chassis intrusion switch 																																																
Memory	64GB max, UDIMM, DDR4-2400*, four 288-pin DIMM sockets, non-ECC, dual-channel capable * System automatically clocks down for the processors with lower memory controller	Keyboard	<i>Some:</i> Lenovo Calliope Keyboard (USB connector), black <i>Some:</i> Lenovo Traditional Keyboard (USB connector), black <i>Some:</i> Lenovo Calliope Wireless Keyboard (2.4GHz via USB receiver), black <i>Some:</i> Lenovo Calliope Mouse (USB connector), black <i>Some:</i> Lenovo Calliope Wireless Mouse (2.4GHz via USB receiver), black																																																
Storage	<i>Some:</i> Hard Drive / SATA 6.0Gb/s, 2.5" or 3.5", 5400 rpm or 7200 rpm <i>Some:</i> Solid State Drive (SSD) / SATA 6.0Gb/s, 2.5" <i>Some:</i> M.2 Solid State Drive (SSD) / PCIe NVMe, PCIe 3.0 x 4, 32Gb/s <i>Some:</i> Intel Optane™ Memory (models with 7th gen Core processor), M.2 <i>Some:</i> Front accessible and removable HDD, 3.5", lockable via physical key	Mouse	<i>Some:</i> Lenovo Calliope Mouse (USB connector), black <i>Some:</i> Lenovo Calliope Wireless Mouse (2.4GHz via USB receiver), black																																																
Optical	<i>Some:</i> DVD-ROM, SATA 1.5Gb/s, 5.25" or slim (9.0mm) <i>Some:</i> DVD Burner (DVD±RW), SATA 1.5Gb/s, 5.25" or slim (9.0mm)	Mechanical	<ul style="list-style-type: none"> Tower (18L), black color, metal case (WxDxH) 6.5" X 12.65" X 16.15"; 165mm X 321.35mm X 410.25mm Approx. 15.45 lb (7 kg), weight may vary by configuration Toolless cover, disk, optical, graphic card removal Optional carry handle, dust filter Bay 1: Slim external ODD bay Bay 2: 5.25", 1.6" high, external, ODD / optional front access HDD Bay 3: 3.5", 1" high, internal, HDD/SSD Bay 4: 3.5", 1" high, internal, HDD/SSD (optional bay, bay 3 comes with disk) Bay 5: 2.5", internal, HDD/SSD (optional bay) Notes: M910 Tower supports up to 3 SATA devices (ODD/HDD/SSD) and 1 eSATA device (front access HDD) Slot 1: full-length full-height (length < 268mm, height < 112mm), PCIe 3.0 x16* Slot 2: full-length full-height (length < 268mm, height < 112mm), PCIe 3.0 x1* Slot 3: full-length full-height (length < 268mm, height < 112mm), PCIe 3.0 x16 (x4 signal)* Slot 4: no slot, only bracket for optional port extension* M.2 card slots: Two (one for WLAN, one for SSD/Optane) * Optional 2 front USB3.1 Type-C ports module occupies PCIe x16 (x4 signal) slot, optional rear 2x USB2.0 / parallel / 2nd serial occupies one expansion slot 																																																
Onboard SATA	Four onboard SATA 6.0Gb/s connectors (1x eSATA and 3x SATA), RAID 0/1 support (RAID preset only available via special bid model)	Power supply	<i>Some:</i> 180 watts, autosensing, 85% PSU <i>Some:</i> 250 watts, autosensing, 85% PSU <i>Some:</i> 400 watts, autosensing, 92% PSU (only available via special bid)																																																
Media reader	Optional 7-in-1 media reader	Limited warranty	<i>Some:</i> 1-year or 3-year, depot service / service upgrades available <i>Some:</i> 1-year or 3-year, limited onsite service / service upgrades available																																																
Graphics	Intel HD Graphics 510/530/610/630 in processor, uses main memory, DirectX® 12, one VGA, two DisplayPort™, supports 3 independent displays, works along with discrete graphics to support more displays; <i>Max resolution:</i> 4096x2304 (DP) @60Hz; 2048x1536 (VGA) @50Hz <i>Some:</i> NVIDIA GeForce® GT 730 , DirectX 12, 2GB, PCIe 2.0 x8 adapter, two DisplayPort, 35 watts; <i>Max resolution:</i> 3840x2160 (DisplayPort) @60Hz; <i>Some:</i> AMD Radeon™ R7 350 , DirectX 11, 2GB, PCIe 3.0 x8 adapter, one VGA, one HDMI, 75 watts, occupies two slots; <i>Max resolution:</i> 4096x2160 (HDMI) @24Hz; 2048x1536 (VGA) @85Hz <i>Some:</i> NVIDIA GeForce GTX™ 1080 (only available via special bid model), DirectX 12, 8GB, PCIe 3.0 x16 adapter, one DVI-D, one HDMI, three DisplayPort, 180 watts, occupies two slots; <i>Max resolution:</i> 2560x1600 (DVI-D) @60Hz; 4096x2160 (HDMI) @60Hz 7680x4320 (with Single DP) @60Hz	Preload	Preloaded operating system <i>Some:</i> Windows® 7 Professional 32/64 preinstalled through downgrade rights in Windows 10 Pro 64-bit (not available with 7th Gen Intel processor) <i>Some:</i> Windows 10 Pro 64-bit <i>Some:</i> Windows 10 Home 64-bit Preloaded applications (only some listed) <ul style="list-style-type: none"> Microsoft Office preloaded; purchase a product key to activate Only for Window 10 <ul style="list-style-type: none"> Lenovo Companion Only for Window 7 Lenovo Solution Center Lenovo ThinkVantage Tools Create Recovery Media Adobe® Reader® Cyberlink PowerDVD Create (DVD±RW) 																																																
Monitor Cable	Optional DP to VGA, DP to DVI-D (single link), DP to dual DP, or DP to HDMI 1.4	Environment	ENERGY STAR® 6.1, EPEAT™ Gold rating (North America), ErP Lot 3, GREENGUARD®, RoHS-compliant, TUV low noise verified (on some models)																																																
Chipset	Intel Q270 Chipset	Accessories	For compatible accessories, please go to http://www.lenovoquickpick.com																																																
Front ports	Four USB 3.1 Gen1, optional two USB 3.1 Type-C Gen 2 (only available via special bid), microphone (3.5mm), headphone (3.5mm)																																																		
Rear ports	Four USB 3.1 Gen1, optional two USB 2.0, serial (9-pin), optional 2nd serial (9-pin), optional parallel (25-pin), ethernet (RJ-45), one VGA, two DisplayPort, optional two PS/2 ports (keyboard/mouse); additional VGA, DisplayPort, DVI-D, or HDMI on optional graphics on some models																																																		
Rear audio ports IEEE 1394	Line-in (3.5mm), line-out (3.5mm), microphone-in (3.5mm) None																																																		
Audio support	High Definition (HD) Audio, Realtek ALC662 / optional internal speaker (1.5 watt)																																																		
WLAN	<i>Some:</i> 11ac wireless, M.2 Card, Qualcomm Atheros QCA9377A (dual band), Wi-Fi + Bluetooth 4.1 combo adapter, 1x1 <i>Some:</i> 11ac wireless, M.2 Card, Qualcomm Atheros QCA6174A (dual band), Wi-Fi + Bluetooth 4.1 combo adapter, 2x2 <i>Some:</i> 11ac wireless, M.2 Card, Intel Dual Band Wireless-AC 3165, Wi-Fi + Bluetooth 4.1 combo adapter, 1x1 <i>Some:</i> 11ac wireless, M.2 Card, Intel Dual Band Wireless-AC 8265, Wi-Fi + Bluetooth 4.1 combo adapter, 2x2 <i>Some:</i> 11ac wireless, M.2 Card, Intel Dual Band Wireless-AC 8265, Wi-Fi + Bluetooth 4.1 combo adapter, Intel vPro technology support, 2x2																																																		
Bluetooth™	<i>Some:</i> Bluetooth 4.1 wireless, integrated in Wi-Fi + BT combo adapter																																																		
Ethernet	Gigabit ethernet, Intel Ethernet Connection I219-LM(Jacksonville), Wake on LAN®																																																		
Modem	None																																																		

Model	Region	Processor	vPro	Graphics	Monitor Cable	Memory	Storage(HDD/SSD)	Optical	Optional 2.5" Bay	Media Reader	WLAN + Bluetooth	Optional Front Ports	Optional Rear Ports	Chassis Intrusion Switch	Cable Lock	Front Access HDD	Speaker	Dust Filter	Keyboard / Mouse	Carry Handle	Power Supply	Operating System	Warranty	End of Support	Ann Date (mm/yy)
10MM000AUS	US	i5-7500	vPro	Intel HD 630	None	4GBx1	500GB 7200rpm 3.5"	DVD±RW	Optional 2.5" Bay	None	None	None	None	None	None	None	1.5Wx1	None	USB / USB	Carry Handle	250W 85%	Win10 Pro 64	3-year, Onsite	Mar 21, 2023	02/17
10MM000BUS	US	i7-7700	vPro	GT 730 2GB	None	8GBx1	256GB SSD M.2 PCIe NVMe	DVD±RW	Optional 2.5" Bay	None	None	None	None	None	None	None	1.5Wx1	None	USB / USB	Carry Handle	250W 85%	Win10 Pro 64	3-year, Onsite	Mar 21, 2023	02/17
10MM000CUS	US	i5-7500	vPro	Intel HD 630	None	8GBx1	512GB SSD M.2 PCIe NVMe	DVD±RW	Optional 2.5" Bay	None	None	None	None	None	None	None	1.5Wx1	None	USB / USB	Carry Handle	250W 85%	Win10 Pro 64	3-year, Onsite	Mar 21, 2023	02/17
10MM000DUS	US	i7-7700	vPro	Intel HD 630	None	8GBx1	256GB SSD M.2 PCIe NVMe	DVD±RW	Optional 2.5" Bay	None	None	None	None	None	None	None	1.5Wx1	None	USB / USB	Carry Handle	250W 85%	Win10 Pro 64	3-year, Onsite	Mar 21, 2023	02/17
10MM000EUS	US	i5-7500	vPro	GT 730 2GB	None	8GBx1	512GB SSD M.2 PCIe NVMe	DVD±RW	Optional 2.5" Bay	None	None	None	None	None	None	None	1.5Wx1	None	USB / USB	Carry Handle	250W 85%	Win10 Pro 64	3-year, Onsite	Mar 21, 2023	02/17
10MM000FUS	US	i5-7500	vPro	Intel HD 630	None	8GBx1	1TB 7200rpm 3.5"	DVD±RW	Optional 2.5" Bay	None	None	None	None	None	None	None	1.5Wx1	None	USB / USB	Carry Handle	250W 85%	Win10 Pro 64	3-year, Onsite	Mar 21, 2023	02/17
10MM000GUS	US	i5-7500	vPro	GT 730 2GB	None	8GBx1	1TB 7200rpm 3.5"	DVD±RW	Optional 2.5" Bay	None	None	None	None	None	None	None	1.5Wx1	None	USB / USB	Carry Handle	250W 85%	Win10 Pro 64	3-year, Onsite	Mar 21, 2023	02/17
10MM000HUS	US	i5-7500	vPro	Intel HD 630	None	8GBx1	256GB SSD M.2 PCIe NVMe	DVD±RW	Optional 2.5" Bay	None	None	None	None	None	None	None	1.5Wx1	None	USB / USB	Carry Handle	250W 85%	Win10 Pro 64	3-year, Onsite	Mar 21, 2023	02/17
10MM000JUS	US	i7-7700	vPro	GT 730 2GB	None	8GBx1	1TB 7200rpm 3.5"	DVD±RW	Optional 2.5" Bay	None	None	None	None	None	None	None	1.5Wx1	None	USB / USB	Carry Handle	250W 85%	Win10 Pro 64	3-year, Onsite	Mar 21, 2023	02/17
10MM000KUS	US	i7-7700	vPro	Intel HD 630	None	8GBx1	512GB SSD M.2 PCIe NVMe	DVD±RW	Optional 2.5" Bay	None	None	None	None	None	None	None	1.5Wx1	None	USB / USB	Carry Handle	250W 85%	Win10 Pro 64	3-year, Onsite	Mar 21, 2023	02/17
10MM000LUS	US	i7-7700	vPro	Intel HD 630	None	8GBx1	256GB SSD M.2 PCIe NVMe	DVD±RW	Optional 2.5" Bay	None	8265 ac, 2x2, vPro + BT4.1	None	None	None	None	None	1.5Wx1	None	USB / USB	Carry Handle	250W 85%	Win10 Pro 64	3-year, Onsite	Mar 21, 2023	02/17
10MM000MUS	US	i7-7700	vPro	GT 730 2GB	None	8GBx1	512GB SSD M.2 PCIe NVMe	DVD±RW	Optional 2.5" Bay	None	None	None	None	None	None	None	1.5Wx1	None	USB / USB	Carry Handle	250W 85%	Win10 Pro 64	3-year, Onsite	Mar 21, 2023	02/17
10MM000NUS	US	i5-7500	vPro	Intel HD 630	None	8GBx1	256GB SSD M.2 PCIe NVMe	DVD±RW	Optional 2.5" Bay	None	8265 ac, 2x2, vPro + BT4.1	None	None	None	None	None	1.5Wx1	None	USB / USB	Carry Handle	250W 85%	Win10 Pro 64	3-year, Onsite	Mar 21, 2023	02/17
10MM000PUS	US	i7-7700	vPro	Intel HD 630	None	8GBx1	1TB 7200rpm 3.5"	DVD±RW	Optional 2.5" Bay	None	None	None	None	None	None	None	1.5Wx1	None	USB / USB	Carry Handle	250W 85%	Win10 Pro 64	3-year, Onsite	Mar 21, 2023	02/17
10MM000QUS	US	i5-7500	vPro	GT 730 2GB	None	8GBx1	256GB SSD M.2 PCIe NVMe	DVD±RW	Optional 2.5" Bay	None	None	None	None	None	None	None	1.5Wx1	None	USB / USB	Carry Handle	250W 85%	Win10 Pro 64	3-year, Onsite	Mar 21, 2023	02/17
10MM002JUS	US	i5-6500	vPro	GT 730 2GB	None	8GBx1	256GB SSD M.2 PCIe NVMe	DVD±RW	Optional 2.5" Bay	None	8265 ac, 2x2, vPro + BT4.1	None	None	None	None	None	1.5Wx1	None	USB / USB	Carry Handle	250W 85%	Win10 DG Win7 Pro 64	3-year, Onsite	Apr 28, 2023	03/17
10MM002KUS	US	i5-6500	vPro	GT 730 2GB	None	8GBx1	512GB SSD M.2 PCIe NVMe	DVD±RW	Optional 2.5" Bay	None	None	None	None	None	None	None	1.5Wx1	None	USB / USB	Carry Handle	250W 85%	Win10 DG Win7 Pro 64	3-year, Onsite	Apr 28, 2023	03/17
10MM002LUS	US	i5-6500	vPro	Intel HD 530	None	8GBx1	256GB SSD M.2 PCIe NVMe	DVD±RW	Optional 2.5" Bay	None	None	None	None	None	None	None	1.5Wx1	None	USB / USB	Carry Handle	250W 85%	Win10 DG Win7 Pro 64	3-year, Onsite	Apr 28, 2023	03/17
10MM002MUS	US	i5-6500	vPro	Intel HD 530	None	4GBx1	128GB SSD M.2 PCIe NVMe	DVD±RW	Optional 2.5" Bay	None	None	None	None	None	None	None	1.5Wx1	None	USB / USB	Carry Handle	250W 85%	Win10 DG Win7 Pro 64	3-year, Onsite	Apr 28, 2023	03/17
10MM002NUS	US	i7-6700	vPro	GT 730 2GB	None	8GBx1	512GB SSD M.2 PCIe NVMe	DVD±RW	Optional 2.5" Bay	None	None	None	None	None	None	None	1.5Wx1	None	USB / USB	Carry Handle	250W 85%	Win10 DG Win7 Pro 64	3-year, Onsite	Apr 28, 2023	03/17

Model	Region	Processor	vPro	Graphics	Monitor Cable	Memory	Storage(HDD/SSD)	Optical	Optional 2.5" Bay	Media Reader	WLAN + Bluetooth	Optional Front Ports	Optional Rear Ports	Chassis Intrusion Switch	Cable Lock	Front Access HDD	Speaker	Dust Filter	Keyboard / Mouse	Carry Handle	Power Supply	Operating System	Warranty	End of Support	Ann Date (mm/yy)
10MM002PUS	US	i7-6700	vPro	GT 730 2GB	None	8GBx1	256GB SSD M.2 PCIe NVMe	DVD±RW	Optional 2.5" Bay	None	None	None	None	None	None	None	1.5Wx1	None	USB / USB	Carry Handle	250W 85%	Win10 DG Win7 Pro 64	3-year, Onsite	Apr 28, 2023	03/17
10MM002QUS	US	i5-7500	vPro	Intel HD 630	None	4GBx1	128GB SSD M.2 PCIe NVMe	DVD±RW	Optional 2.5" Bay	None	None	None	None	None	None	None	1.5Wx1	None	USB / USB	Carry Handle	250W 85%	Win10 Pro 64	3-year, Onsite	Apr 28, 2023	03/17
10MM002RUS	US	i7-6700	vPro	GT 730 2GB	None	8GBx1	1TB 7200rpm 3.5"	DVD±RW	Optional 2.5" Bay	None	None	None	None	None	None	None	1.5Wx1	None	USB / USB	Carry Handle	250W 85%	Win10 DG Win7 Pro 64	3-year, Onsite	Apr 28, 2023	03/17
10MM002SUS	US	i7-6700	vPro	Intel HD 530	None	8GBx1	256GB SSD M.2 PCIe NVMe	DVD±RW	Optional 2.5" Bay	None	None	None	None	None	None	None	1.5Wx1	None	USB / USB	Carry Handle	250W 85%	Win10 DG Win7 Pro 64	3-year, Onsite	Apr 28, 2023	03/17
10MM002TUS	US	i5-6500	vPro	Intel HD 530	None	4GBx1	500GB 7200rpm 3.5"	DVD±RW	Optional 2.5" Bay	None	None	None	None	None	None	None	1.5Wx1	None	USB / USB	Carry Handle	250W 85%	Win10 DG Win7 Pro 64	3-year, Onsite	Apr 28, 2023	03/17
10MM002UUS	US	i5-6500	vPro	GT 730 2GB	None	8GBx1	256GB SSD M.2 PCIe NVMe	DVD±RW	Optional 2.5" Bay	None	None	None	None	None	None	None	1.5Wx1	None	USB / USB	Carry Handle	250W 85%	Win10 DG Win7 Pro 64	3-year, Onsite	Apr 28, 2023	03/17
10MM002VUS	US	i5-6500	vPro	Intel HD 530	None	8GBx1	1TB 7200rpm 3.5"	DVD±RW	Optional 2.5" Bay	None	None	None	None	None	None	None	1.5Wx1	None	USB / USB	Carry Handle	250W 85%	Win10 DG Win7 Pro 64	3-year, Onsite	Apr 28, 2023	03/17
10MM002WUS	US	i5-6500	vPro	Intel HD 530	None	8GBx1	512GB SSD M.2 PCIe NVMe	DVD±RW	Optional 2.5" Bay	None	None	None	None	None	None	None	1.5Wx1	None	USB / USB	Carry Handle	250W 85%	Win10 DG Win7 Pro 64	3-year, Onsite	Apr 28, 2023	03/17
10MM002XUS	US	i7-6700	vPro	Intel HD 530	None	8GBx1	512GB SSD M.2 PCIe NVMe	DVD±RW	Optional 2.5" Bay	None	None	None	None	None	None	None	1.5Wx1	None	USB / USB	Carry Handle	250W 85%	Win10 DG Win7 Pro 64	3-year, Onsite	Apr 28, 2023	03/17
10MM002YUS	US	i5-6500	vPro	GT 730 2GB	None	8GBx1	1TB 7200rpm 3.5"	DVD±RW	Optional 2.5" Bay	None	None	None	None	None	None	None	1.5Wx1	None	USB / USB	Carry Handle	250W 85%	Win10 DG Win7 Pro 64	3-year, Onsite	Apr 28, 2023	03/17
10MM0030US	US	i7-6700	vPro	Intel HD 530	None	8GBx1	1TB 7200rpm 3.5"	DVD±RW	Optional 2.5" Bay	None	None	None	None	None	None	None	1.5Wx1	None	USB / USB	Carry Handle	250W 85%	Win10 DG Win7 Pro 64	3-year, Onsite	Apr 28, 2023	03/17
10MM0031US	US	i7-6700	vPro	GT 730 2GB	None	8GBx1	256GB SSD M.2 PCIe NVMe	DVD±RW	Optional 2.5" Bay	None	8265 ac, 2x2, vPro + BT4.1	None	None	None	None	None	1.5Wx1	None	USB / USB	Carry Handle	250W 85%	Win10 DG Win7 Pro 64	3-year, Onsite	Apr 28, 2023	03/17
10MM003AUS	US	i5-6500	vPro	Intel HD 530	None	8GBx1	256GB SSD M.2 PCIe NVMe	DVD±RW	Optional 2.5" Bay	None	8265 ac, 2x2, vPro + BT4.1	None	None	None	None	None	1.5Wx1	None	USB / USB	Carry Handle	250W 85%	Win10 DG Win7 Pro 64	3-year, Onsite	Apr 28, 2023	03/17
10MM003BUS	US	i7-6700	vPro	Intel HD 530	None	8GBx1	256GB SSD M.2 PCIe NVMe	DVD±RW	Optional 2.5" Bay	None	8265 ac, 2x2, vPro + BT4.1	None	None	None	None	None	1.5Wx1	None	USB / USB	Carry Handle	250W 85%	Win10 DG Win7 Pro 64	3-year, Onsite	Apr 28, 2023	03/17
10MM003NUS	US	i5-7500	vPro	Intel HD 630	None	4GBx1	16GB Optane Memory + 1TB 7200rpm 3.5"	DVD±RW	Optional 2.5" Bay	None	None	None	None	None	None	None	1.5Wx1	None	USB / USB	Carry Handle	250W 85%	Win10 Pro 64	3-year, Onsite	Apr 27, 2024	03/18
10MM003PUS	US	i7-7700	vPro	Intel HD 630	None	4GBx1	16GB Optane Memory + 1TB 7200rpm 3.5"	DVD±RW	Optional 2.5" Bay	None	None	None	None	None	None	None	1.5Wx1	None	USB / USB	Carry Handle	250W 85%	Win10 Pro 64	3-year, Onsite	Apr 27, 2024	03/18



ThinkCentre M910x Tiny Platform Specifications

Product Specifications Reference (PSREF)

Processor	Intel® Celeron®, Intel Pentium®, or 6/7th Generation Intel Core™ i3 / i5 / i7 Processor						Manageability Intel Active Management Technology 11.0 (Intel AMT 11.0); Intel vPro technology on some models (require choosing a vPro-support Wi-Fi adapter to enable vPro function through wireless connection) Security chip TPM (Trusted Platform Module) 2.0*, TCG Certified * Downgrade to TPM1.2 for the models with Win10 DG Win7 32 OS
	Processor	Cores / Threads	Frequency Base/Max(GHz)	Cache	Memory Support (Up to)	Integrated Graphics	
	Core i5-6500T	4 / 4	2.5G / 3.1G	6 MB	DDR4-2133	HD 530	
	Core i7-6700T	4 / 8	2.8G / 3.6G	8 MB	DDR4-2133	HD 530	
	Core i5-7500T	4 / 4	2.7G / 3.3G	6 MB	DDR4-2400	HD 630	
	Core i5-7600T	4 / 4	2.8G / 3.7G	6 MB	DDR4-2400	HD 630	
	Core i7-7700T	4 / 8	2.9G / 3.8G	8 MB	DDR4-2400	HD 630	
	Core i5-6500	4 / 4	3.2G / 3.6G	6 MB	DDR4-2133	HD 530	
	Core i7-6700	4 / 8	3.4G / 4.0G	8 MB	DDR4-2133	HD 530	
	Core i5-7500	4 / 4	3.4G / 3.8G	6 MB	DDR4-2400	HD 630	
Core i5-7600	4 / 4	3.5G / 4.1G	6 MB	DDR4-2400	HD 630		
Core i7-7700	4 / 8	3.6G / 4.2G	8 MB	DDR4-2400	HD 630		
Memory	32GB max, DDR4-2400*, two 260-pin SO-DIMM sockets, non-ECC, dual-channel capable * System automatically clocks down for the processors with lower memory controller						Security features <ul style="list-style-type: none"> • Security slot (in rear for optional Kensington® MicroSaver® cable) • Smart USB protection, allows keyboard/mouse only, blocks all storage devices • Power-on password • Administrator password • Hard disk password • Boot sequence control • Boot without keyboard and mouse • Individual USB port disablement • Chassis intrusion switch
Storage	<i>Some:</i> Hard Drive* / SATA 6.0Gb/s, 2.5", 5400 rpm or 7200 rpm, APS <i>Some:</i> Solid State Drive (SSD)* / SATA 6.0Gb/s, 2.5" (* 2.5" HDD/SSD and RX 460 graphics are mutually exclusive) <i>Some:</i> M.2 SSD (support up to two M.2 SSD) / PCIe NVMe, PCIe 3.0 x 4, 32Gb/s, RAID 0/1 support (RAID preset only available via special bid model)						
Optical	<i>Some:</i> Intel Optane™ Memory (models with 7th gen Core processor), M.2 <i>Some:</i> DVD-ROM, slim (9.0mm), via USB external ODD box <i>Some:</i> DVD Burner (DVD±RW), slim (9.0mm), via USB external ODD box						
Onboard SATA Media reader	One onboard SATA 6.0Gb/s connector None						
Graphics	Intel HD Graphics 510/530/610/630 in processor, uses main memory, DirectX® 12, two DisplayPort™, one optional video port (HDMI, VGA, 3rd DP, or USB 3.1 Type-C with DisplayPort Alternate Mode), up to 3 independent displays; <i>Max resolution:</i> 4096x2304 (DP) @60Hz; 4096x2304 (Type-C) @60Hz; 4096x2160 (HDMI) @24Hz; 1920x1200 (VGA) @60Hz <i>Some:</i> AMD Radeon™ RX 460 , DirectX 12, 4GB, PCIe 3.0 x8 adapter (low profile), four mini DisplayPort, 35 watts (TDP), up to 4 independent displays, works along with 2 onboard DisplayPort to support up to 6 independent displays; <i>Max resolution:</i> 5120x2880 @60Hz (up to 2 mini DisplayPort); 4096x2160 @60Hz (up to 4 mini DisplayPort)						
VESA mount Floor Stand	Optional VESA mount bracket kit, supports VESA 75mm and 100mm Optional system floor stand for vertical orientation						
Power supply	135 watts AC/DC adapter, autosensing, 88% PSU						
Limited warranty ³	<i>Some:</i> 1-year or 3-year, depot service / service upgrades available <i>Some:</i> 1-year or 3-year, limited onsite service / service upgrades available						
Preload	<i>Some:</i> Windows® 7 Professional 32/64 preinstalled through downgrade rights in Windows 10 Pro 64-bit (not available with 7th Gen Intel processor) <i>Some:</i> Windows 10 Pro 64-bit <i>Some:</i> Windows 10 Home 64-bit						
Monitor cable	Optional DP to VGA, DP to DVI-D, DP to dual DP, mini DP to DP, or DP to HDMI 1.4						
Chipset	Intel Q270 Chipset						
Front ports	Two USB 3.1 Gen1 (one is Always On and fast charge), one microphone (3.5mm), one headphone / microphone combo jack (3.5mm)						
Rear ports	Four USB 3.1 Gen1 (optional optical box or I/O box occupies one or two specific USB 3.1 Gen1), ethernet (RJ-45), two DisplayPort, two optional ports (not available for the models with RX 460 graphics): Port 1 for [VGA / 3rd DP / HDMI / serial / USB 3.1 Type-C Gen 1 (with DisplayPort Alternate Mode)]; Port 2 for [serial]						
I/O box	Optional external I/O box, extends two USB 2.0, two USB 3.1 Gen1, and one serial on rear, two USB 2.0 on front, via USB cable (occupy 2 specific USB 3.1 G1 of Tiny)						
Audio support	High Definition (HD) Audio, Realtek ALC294 / optional internal speaker (1w or 2w)						
WLAN ¹³	<i>Some:</i> 11ac wireless, M.2 Card, Qualcomm Atheros QCA9377A (dual band), Wi-Fi + Bluetooth 4.1 combo adapter, 1x1 <i>Some:</i> 11ac wireless, M.2 Card, Qualcomm Atheros QCA6174A (dual band), Wi-Fi + Bluetooth 4.1 combo adapter, 2x2 <i>Some:</i> 11ac wireless, M.2 Card, Intel Dual Band Wireless-AC 3165, Wi-Fi + Bluetooth 4.1 combo adapter, 1x1 <i>Some:</i> 11ac wireless, M.2 Card, Intel Dual Band Wireless-AC 8265, Wi-Fi + Bluetooth 4.1 combo adapter, 2x2						
Bluetooth™	<i>Some:</i> 11ac wireless, M.2 Card, Intel Dual Band Wireless-AC 8265, Wi-Fi + Bluetooth 4.1 combo adapter, Intel vPro technology support, 2x2 <i>Some:</i> Bluetooth 4.1 wireless, integrated in Wi-Fi + BT combo adapter						
Ethernet Modem	Gigabit ethernet, Intel Ethernet Connection I219-LM(Jacksonville), Wake on LAN® None						
Environment	ENERGY STAR® 6.1, EPEAT™ Gold rating (North America), ErP Lot 3, GREENGUARD®, RoHS-compliant, TUV low noise verified (on some models)						
MIL-SPEC test	MIL-STD-810G military certification (Low Pressure [Altitude], High Temperature, Low Temperature, Temperature Shock, Humidity, Sand and Dust, Vibration, Shock, Fungus, Solar Radiation)						
Accessories	For compatible accessories, please go to http://www.lenovoquickpick.com						

See footnotes for more detailed information

© Lenovo (M910x Tiny-Spec) May 2017

Model	Region	Processor	vPro	Graphics	Monitor Cable	Memory	Storage(HDD/SSD)	External Optical / I/O Box	WLAN + Bluetooth	Optional Rear Ports	Chassis Intrusion Switch	Kensington Cable Lock	Speaker	Adapter Cage	Toolless Chassis Screw	Dust Filter	Keyboard / Mouse	VESA Mount	Stand	Power Supply	Operating System	Warranty	Ann Date (mm/yy)
10N00007US	US	i5-7600	vPro	Intel HD 630	None	8GBx1	256GB SSD M.2 PCIe NVMe	None	8265 ac, 2x2, vPro + BT4.1	3rd DP	Switch	None	1Wx1	None	None	None	USB / USB	None	Floor Stand	135W 88% Adapter	Win10 Pro 64	3-year, Onsite	04/17
10N00008US	US	i5-7500	vPro	Intel HD 630	None	4GBx1	500GB 7200rpm 2.5"	None	8265 ac, 2x2, vPro + BT4.1	3rd DP	Switch	None	1Wx1	None	None	None	USB / USB	None	Floor Stand	135W 88% Adapter	Win10 Pro 64	3-year, Onsite	04/17
10N00009US	US	i7-7700	vPro	Intel HD 630	None	8GBx1	500GB 7200rpm 2.5"	None	8265 ac, 2x2, vPro + BT4.1	3rd DP	Switch	None	1Wx1	None	None	None	USB / USB	None	Floor Stand	135W 88% Adapter	Win10 Pro 64	3-year, Onsite	04/17
10N0000AUS	US	i5-7500	vPro	Intel HD 630	None	8GBx1	256GB SSD M.2 PCIe NVMe	None	8265 ac, 2x2, vPro + BT4.1	3rd DP	Switch	None	1Wx1	None	None	None	USB / USB	None	Floor Stand	135W 88% Adapter	Win10 Pro 64	3-year, Onsite	04/17
10N0000BUS	US	i5-7500	vPro	Intel HD 630	None	8GBx1	500GB 7200rpm 2.5"	None	8265 ac, 2x2, vPro + BT4.1	3rd DP	Switch	None	1Wx1	None	None	None	USB / USB	None	Floor Stand	135W 88% Adapter	Win10 Pro 64	3-year, Onsite	04/17
10N00014US	US	i5-6500T	vPro	AMD RX460 4GB	None	8GBx1	256GB SSD M.2 PCIe NVMe	None	8265 ac, 2x2, vPro + BT4.1	None	Switch	None	1Wx1	None	None	None	USB / USB	None	Floor Stand	135W 88% Adapter	Win10 DG Win7 Pro 64	3-year, Onsite	04/17
10N00015US	US	i5-6500	vPro	Intel HD 530	None	8GBx1	512GB SSD M.2 PCIe NVMe	None	8265 ac, 2x2, vPro + BT4.1	3rd DP	Switch	None	1Wx1	None	None	None	USB / USB	None	Floor Stand	135W 88% Adapter	Win10 DG Win7 Pro 64	3-year, Onsite	04/17
10N00016US	US	i7-6700	vPro	Intel HD 530	None	8GBx1	256GB SSD M.2 PCIe NVMe	None	8265 ac, 2x2, vPro + BT4.1	3rd DP	Switch	None	1Wx1	None	None	None	USB / USB	None	Floor Stand	135W 88% Adapter	Win10 DG Win7 Pro 64	3-year, Onsite	04/17
10N00017US	US	i7-6700T	vPro	AMD RX460 4GB	None	8GBx1	256GB SSD M.2 PCIe NVMe	None	8265 ac, 2x2, vPro + BT4.1	None	Switch	None	1Wx1	None	None	None	USB / USB	None	Floor Stand	135W 88% Adapter	Win10 DG Win7 Pro 64	3-year, Onsite	04/17
10N00018US	US	i5-7500T	vPro	AMD RX460 4GB	None	8GBx1	256GB SSD M.2 PCIe NVMe	None	8265 ac, 2x2, vPro + BT4.1	None	Switch	None	1Wx1	None	None	None	USB / USB	None	Floor Stand	135W 88% Adapter	Win10 Pro 64	3-year, Onsite	04/17
10N00019US	US	i5-6500T	vPro	AMD RX460 4GB	None	8GBx1	512GB SSD M.2 PCIe NVMe	None	8265 ac, 2x2, vPro + BT4.1	None	Switch	None	1Wx1	None	None	None	USB / USB	None	Floor Stand	135W 88% Adapter	Win10 DG Win7 Pro 64	3-year, Onsite	04/17
10N0001AUS	US	i7-6700	vPro	Intel HD 530	None	8GBx1	500GB 7200rpm 2.5"	None	8265 ac, 2x2, vPro + BT4.1	3rd DP	Switch	None	1Wx1	None	None	None	USB / USB	None	Floor Stand	135W 88% Adapter	Win10 DG Win7 Pro 64	3-year, Onsite	04/17
10N0001BUS	US	i5-6500	vPro	Intel HD 530	None	8GBx1	256GB SSD M.2 PCIe NVMe	None	8265 ac, 2x2, vPro + BT4.1	3rd DP	Switch	None	1Wx1	None	None	None	USB / USB	None	Floor Stand	135W 88% Adapter	Win10 DG Win7 Pro 64	3-year, Onsite	04/17
10N0001CUS	US	i5-6500	vPro	Intel HD 530	None	8GBx1	500GB 7200rpm 2.5"	None	8265 ac, 2x2, vPro + BT4.1	3rd DP	Switch	None	1Wx1	None	None	None	USB / USB	None	Floor Stand	135W 88% Adapter	Win10 DG Win7 Pro 64	3-year, Onsite	04/17
10N0001DUS	US	i5-7500T	vPro	AMD RX460 4GB	None	8GBx1	512GB SSD M.2 PCIe NVMe	None	8265 ac, 2x2, vPro + BT4.1	None	Switch	None	1Wx1	None	None	None	USB / USB	None	Floor Stand	135W 88% Adapter	Win10 Pro 64	3-year, Onsite	04/17
10N0001EUS	US	i7-6700	vPro	Intel HD 530	None	8GBx1	512GB SSD M.2 PCIe NVMe	None	8265 ac, 2x2, vPro + BT4.1	3rd DP	Switch	None	1Wx1	None	None	None	USB / USB	None	Floor Stand	135W 88% Adapter	Win10 DG Win7 Pro 64	3-year, Onsite	04/17
10N0001FUS	US	i7-7700T	vPro	AMD RX460 4GB	None	8GBx1	256GB SSD M.2 PCIe NVMe	None	8265 ac, 2x2, vPro + BT4.1	None	Switch	None	1Wx1	None	None	None	USB / USB	None	Floor Stand	135W 88% Adapter	Win10 Pro 64	3-year, Onsite	04/17
10N0001GUS	US	i7-7700T	vPro	AMD RX460 4GB	None	8GBx1	512GB SSD M.2 PCIe NVMe	None	8265 ac, 2x2, vPro + BT4.1	None	Switch	None	1Wx1	None	None	None	USB / USB	None	Floor Stand	135W 88% Adapter	Win10 Pro 64	3-year, Onsite	04/17
10N0001HUS	US	i7-6700T	vPro	AMD RX460 4GB	None	8GBx1	512GB SSD M.2 PCIe NVMe	None	8265 ac, 2x2, vPro + BT4.1	None	Switch	None	1Wx1	None	None	None	USB / USB	None	Floor Stand	135W 88% Adapter	Win10 DG Win7 Pro 64	3-year, Onsite	04/17
10N0001JUS	US	i7-7700	vPro	Intel HD 630	None	8GBx1	256GB SSD M.2 PCIe NVMe	None	8265 ac, 2x2, vPro + BT4.1	3rd DP	Switch	None	1Wx1	None	None	None	USB / USB	None	Floor Stand	135W 88% Adapter	Win10 Pro 64	3-year, Onsite	07/17

Model	Region	Processor	vPro	Graphics	Monitor Cable	Memory	Storage(HDD/SSD)	External Optical / I/O Box	WLAN + Bluetooth	Optional Rear Ports	Chassis Intrusion Switch	Kensington Cable Lock	Speaker	Adapter Cage	Toolless Chassis Screw	Dust Filter	Keyboard / Mouse	VESA Mount	Stand	Power Supply	Operating System	Warranty	Ann Date (mm/yy)
10N0001KUS	US	i7-7700	vPro	Intel HD 630	None	8GBx1	512GB SSD M.2 PCIe NVMe	None	8265 ac, 2x2, vPro + BT4.1	3rd DP	Switch	None	1Wx1	None	None	None	USB / USB	None	Floor Stand	135W 88% Adapter	Win10 Pro 64	3-year, Onsite	07/17



ThinkSmart Hub 500 Platform Specifications

Product Specifications Reference (PSREF)

Positioning	Purpose-built Skype Room Systems device						Security chip	TPM (Trusted Platform Module) 2.0, TCG Certified
Processor	7th Gen Intel Core™ i5 Processor with vPro						Security features	<ul style="list-style-type: none"> • Security slot (in rear for attachment of optional Kensington® MicroSaver® cable; Kensington lock also locks chassis) • Secure cable management door • Power-on, admin, hard disk password • Boot sequence control • Boot without keyboard and mouse • USB port disablement
	Processor	Cores / Threads	Frequency Base/Max(GHz)	Cache	Memory Support (Up to)	Integrated Graphics		
	Core i5-7500T	4 / 4	2.7G / 3.3G	6 MB	DDR4-2400	HD 630		
Memory	4GBx2, DDR4-2400, two 260-pin SO-DIMM sockets, dual-channel capable						Keyboard	None
Storage	128GB M.2 Solid State Drive (SSD) / PCIe NVMe, PCIe 3.0 x 4, 32Gb/s						Mouse	None
Graphics Display	Intel HD Graphics 630 in processor, uses main memory, DirectX® 12 11.6" (294.64mm) Full HD 1080p (1920x1080) TFT color , wide viewing angle (+/- 85°), LED backlight, 300 nits, 16:9 aspect ratio, 800:1 contrast ratio, anti-glare, smudge resistant						Mechanical	<ul style="list-style-type: none"> • Business black color • (WxDxH) 7.60" X 10.98" X 7.02"; 193.25mm X 278.9mm X 178.45mm • Approx. 5.51 lb (2.5 kg) • Secure Cable Management Door, secures physical ports and prevents cables being accidentally disconnected • 360 degree rotatable Display
Multi-touch Sensor	Supports 10-point touch, OGS IR Presence/Motion sensor, automatically dim / brighten display (Detection angle: +/- 45% (from display); detection distance: 3 meters at minimum)						Power supply	90 watts adapter, autosensing, 88% efficiency
LED indicators	360 degree LED ring on hinge neck, indicates Skype status for all users in the room; power LED on power button						Limited warranty ³	3-year, limited onsite service / service upgrades available
Chipset	Intel Q270 Chipset						Preload	Preloaded operating system Windows® 10 IoT Enterprise CBB X64 (RS3) Preloaded applications Microsoft Skype Room Systems App
Ports	Four USB 3.1 Gen1(Type A), two HDMI-out, one HDMI-in (1920x1080@60Hz at maximum), one ethernet (RJ-45), one headphone / microphone combo jack (3.5mm), one power connector						Certification	Skype for Business Group Certified
M.2 card slot	Two M.2 Card slots (one for WLAN, one for SSD)						Environment	ErP Lot 26, GREENGUARD® certified, RoHS, WEEE
Audio support	Dual 4W speakers, 2 omnidirectional microphones for 360 degree audio capture						Accessories	For compatible accessories, please go to http://www.lenovoquickpick.com
WLAN ¹³	11ac wireless, M.2 Card, Intel Dual Band Wireless-AC 8265,Wi-Fi + Bluetooth 4.1* combo adapter, Intel vPro technology support, 2x2							
Bluetooth™	Bluetooth 4.1* wireless, integrated in Wi-Fi + Bluetooth combo adapter * Hardware supports Bluetooth 4.2, but Win10 RS3 only supports Bluetooth 4.1							
Ethernet	Gigabit ethernet, Intel Ethernet Connection I219-LM (Jacksonville), Wake on LAN®							
Manageability	Intel Active Management Technology 11.0 (Intel AMT 11.0), Intel vPro technology							

See footnotes for more detailed information

© Lenovo
(Hub500-Spec) March 2018

ThinkSmart Hub 500 - TopSeller - 10V5

Product Specifications Reference (PSREF)

Model	Region	Processor	vPro	Graphics	Monitor Cable	Memory	Display	Multi-touch	Power Supply	Storage(HDD/SSD)	WLAN + Bluetooth	Keyboard / Mouse	Operating System	Warranty	End of Support	Ann Date (m/y)
10V50000US	US	i5-7500T	vPro	Intel HD 630	None	4GBx2	11.6" FHD (1920x1080) WVA Anti-glare, smudge resistant	10-point Multi-touch	90W 88% Adapter	128GB SSD M.2 PCIe NVMe	8265 ac, 2x2, vPro + BT4.1	None / None	Windows 10 IoT Enterprise	3-year, Onsite	May 28, 2024	02/18



ThinkCentre Tiny-in-One (TIO) 22

Product Specifications Reference (PSREF)

Model	10LKPAR6++ / 10LKPAT6++		
Form factor	Tiny-in-One, offers a full All-In-One experience when optional Tiny slots into the back of TIO 22, clean cabling and effortless setup		
Compatible Tiny:	M900 Tiny, M700 Tiny, M600 Tiny, M93/p Tiny*, M83 Tiny, M73 Tiny*, or M53 Tiny, Chromebox * Non-TIO models can't be turned on by pressing power button of TIO 22		
Panel	TFT-LCD, In-Plane Switching (IPS), White LED backlight		
Viewable image size	21.5" (546.1mm) diagonal		
Max view area (W x H)	18.74" x 10.54" / 476.06mm x 267.79mm		
Bezel Width	Top / Side: 2mm, Bottom: 16.3mm		
Optimum resolution	1920x1080		
Aspect ratio	16:9		
Pixel pitch (mm)	0.24795mm		
Dot/Pixel per Inch	102.4 dpi		
Brightness	250 nits or cd/m ² (typical)		
Contrast ratio	1000:1 (typical)		
Pixel response time	7ms		
Color gamut	72%		
Anti-reflective	Anti-glare		
Viewing angle at 10:1 CR	178° (+/- 89°) horizontal, 178° (+/- 89°) vertical		
Preset resolutions	640x350 @ 70Hz 640x480 @ 60Hz, 66Hz, 72Hz, 75Hz 720x400 @ 70Hz 800x600 @ 60Hz, 72Hz, 75Hz 1024x768 @ 60Hz, 70Hz, 75Hz 1152x864 @ 75Hz 1280x800 @ 60Hz 1280x1024 @ 60Hz, 72Hz, 75Hz 1366x768 @ 60Hz 1440x900 @ 60Hz, 75Hz 1600x1200 @ 60Hz, 70Hz, 75Hz 1680x1050 @ 60Hz 1920x1080 @ 60Hz		
Presets / user settings	Presets: 25; user settings: 25		
On screen display	On screen display with digital user controls (8 languages)		
Control features	Mode-switching (TIO mode / standalone monitor mode, switches video / audio / USB input sources) / Back button, Left shift button, Right shift / Brightness button, Selection button / Menu button, Power button		
Tiny-in-One Power On	Pressing Alt + P on keyboard or pressing Power button positioned on TIO can turn on both TIO and Tiny (only some Tiny support, see compatible list)		
Front ports	Two USB 3.0 or two USB 2.0 (when M73 or M53 installed or USB 2.0 connected via USB upstream port), one headphone / microphone combo jack (3.5mm) * The USB ports are only available when a Tiny is installed or a PC is connected via USB upstream port		
Side ports	Side ports offered by installed Tiny (optional)		
Rear ports	One DisplayPort 1.2 port, one USB upstream port, one power connector		
3-in-1 Cable	Undetachable 3-in-1 cable (Power connector, USB 3.0 [supports USB 3.0/USB 2.0], DisplayPort 1.2), only for connecting to Tiny installed (optional)		
Internal Speaker	1.5 watt x1		
Security	Security keyhole for attachment of optional cable lock (Kensington® lock compatible), locks optional Tiny with TIO 22 together, more security features offered by Tiny installed (optional)		
Mechanical	Dimensions	TIO 22 without stand	TIO 22 with stand
	W x D x H (inch)	19.25 x 2.65 x 12.47	19.25 x 9.90 x 14.02 - 18.35
	W x D x H (mm)	489.06 x 67.2 x 316.78	489.06 x 251.4 x 356.07 - 466.07
	Weight (approximately)	11.27 lb /5.11 kg (with stand)	
Mounting features	Wall or desk mounting using the extend arm or third-party accessories meeting the VESA FPMPI® (100mm mount) <i>Tilt: 35° back, -5° forward; lift: 4.3" (110mm); swivel: +/-45°</i>		
Adjustable stand			
Power supply	90 watts AC/DC adapter, 88% PSU, universal		
Power consumption	15.57 watts typical, 35 watts maximum, <0.5 watts standby / suspend		
Limited warranty ³	3-years , Customer Carry-In or Mail-In via Rapid Replacement Service		
VESA-compliant ²	VESA DDC2B/CI, VESA DPMS-compliant		
Ergonomics	ISO 9241-307		
Emission standards	FCC Class B		
Environmental	TCO 7.0, TCO Edge 2.0, WEEE, RoHS, ENERGY STAR® 7.0 EPEAT™ Gold rating, ULE Gold, TUV, VOC		
Windows certifications	Windows 7, Windows 8/8.1, and Windows 10 certified		
Ship group	TIO 22 (Monitor), detachable stand, AC/DC power adapter, power cord, user's guide and driver CD, quick start and safety poster		
Accessories	For compatible accessories, please go to http://www.lenovoquickpick.com		
ThinkCentre Tiny-in-One 22 Compatible list			
Model	M900 Tiny, M700 Tiny, M600 Tiny, M83 Tiny, M53 Tiny	M93/p Tiny, M73 Tiny	Chromebox
Turn on TIO and Tiny together via Alt + P on USB KB	All models	All models	Not support
Turn on TIO and Tiny together via TIO Power Button	All models	TIO models	All models

See footnotes for more detailed information

Model	Region	Color	Display Size	Resolution	Aspect Ratio	Pixel Pitch	Dot / Pixel Per Inch	Brightness	Contrast Ratio	Pixel Response Time	Color Gamut	View Angle (H / V)	Stand	Power Consumption (Typical / Maximum)	Power Supply	Warranty	Ann Date (mm/yy)
10LKPAR6US	US	Black	21.5"	1920x1080	16:9	0.24795 mm	102.4 dpi	250 nits	1000:1	7 ms	72%	178 / 178	Adjustable Stand	15.57W / 35W	90W 88% Adapter	3-year	04/16
10LKPAT6US	US	Black	21.5"	1920x1080	16:9	0.24795 mm	102.4 dpi	250 nits	1000:1	7 ms	72%	178 / 178	Adjustable Stand	15.57W / 35W	90W 88% Adapter	3-year	04/16



ThinkCentre Tiny-in-One (TIO) 22 Gen3

Product Specifications Reference (PSREF)

Model	<i>Non-touch model:</i> 10R1PAR1++/10R1PAT1++; <i>Touch model:</i> 10R0PAR1++/10R0PAT1++			Mounting features	Wall or desk mounting using the extend arm or third-party accessories meeting the VESA FPMPI® (100mm mount)																
Form factor	Tiny-in-One, offers a full All-In-One experience when optional Tiny slots into the back of TIO, clean cabling and effortless setup			Adjustable stand	<i>Tilt:</i> 30° back, -5° forward; <i>lift:</i> 4.3" (110mm); <i>swivel:</i> +/-45°; <i>Pivot:</i> clockwise 0° to 90°																
Compatible Tiny:	M910 / M710 / M900 / M700 / M600 / M715 / M93/p* / M83 / M73* / M53 / Chromebox Tiny * Non-TIO models can't be turned on by pressing power button of TIO			Power supply	90 watts AC/DC adapter, 88% PSU, universal																
Panel	TFT-LCD, In-Plane Switching technology**, White LED backlight <i>Notes:</i> In-Plane Switching may refer to VA, PLS, and IPS panels			Power consumption	19 watts typical, 32 watts maximum, <0.5 watts standby / suspend																
Viewable image size	21.5" (546.1mm) diagonal			Limited warranty	3-years , Customer Carry-In or Mail-In via Rapid Replacement Service																
Max view area (W x H)	18.74" x 10.54" / 476.1mm x 267.8mm			VESA-compliant	VESA DDC2B/CI, VESA DPMS-compliant																
Bezel Width	Top / Side: 2mm, Bottom: 22.1mm			Ergonomics	ISO 9241-307, TUV Eye Comfort certified																
Native resolution	1920x1080			Emission standards	FCC Class B																
Multi-touch	Optional 10-point multi-touch, supports Wake on Touch			Environmental	TCO 7.0, TCO Edge 2.0, WEEE, RoHS, ENERGY STAR® 7.0, EPEAT™ Gold rating, ULE Gold, TUV, VOC																
Aspect ratio	16:9			Windows certifications	Windows 7 and Windows 10 certified																
Pixel pitch (mm)	0.24795mm			Ship group	TIO (Monitor), detachable stand, AC/DC power adapter, power cord, user's guide and driver CD, quick start and safety poster																
Dot/Pixel per Inch	102.4 dpi			Accessories	For compatible accessories, please go to http://www.lenovoquickpick.com																
Brightness	250 nits or cd/m² (typical)			<table border="1"> <thead> <tr> <th colspan="4">ThinkCentre Tiny-in-One 22 Gen3 Compatible list</th> </tr> <tr> <th>Model</th> <th>M910 / M710 / M900 / M700 / M600 / M715 / M83 / M53 Tiny</th> <th>M93/p Tiny, M73 Tiny</th> <th>Chromebox</th> </tr> </thead> <tbody> <tr> <td>Turn on TIO and Tiny together via Alt + P on USB KB</td> <td>All models</td> <td>All models</td> <td>Not support</td> </tr> <tr> <td>Turn on TIO and Tiny together via TIO Power Button</td> <td>All models</td> <td>TIO models</td> <td>All models</td> </tr> </tbody> </table>		ThinkCentre Tiny-in-One 22 Gen3 Compatible list				Model	M910 / M710 / M900 / M700 / M600 / M715 / M83 / M53 Tiny	M93/p Tiny, M73 Tiny	Chromebox	Turn on TIO and Tiny together via Alt + P on USB KB	All models	All models	Not support	Turn on TIO and Tiny together via TIO Power Button	All models	TIO models	All models
ThinkCentre Tiny-in-One 22 Gen3 Compatible list																					
Model	M910 / M710 / M900 / M700 / M600 / M715 / M83 / M53 Tiny	M93/p Tiny, M73 Tiny	Chromebox																		
Turn on TIO and Tiny together via Alt + P on USB KB	All models	All models	Not support																		
Turn on TIO and Tiny together via TIO Power Button	All models	TIO models	All models																		
Contrast ratio	1000:1 (typical)																				
Pixel response time	14ms (default), over drive to 4ms, 6ms																				
Color gamut	72%																				
Anti-reflective	Anti-glare																				
Viewing angle at 10:1 CR	178° (+/- 89°) horizontal, 178° (+/- 89°) vertical																				
Preset resolutions	640x350 @ 70Hz 640x480 @ 60Hz, 66Hz, 72Hz, 75Hz 720x400 @ 70Hz 800x600 @ 60Hz, 72Hz, 75Hz 1024x768 @ 60Hz, 70Hz, 75Hz 1152x864 @ 75Hz 1280x800 @ 60Hz 1280x1024 @ 60Hz, 72Hz, 75Hz 1366x768 @ 60Hz 1440x900 @ 60Hz, 75Hz 1600x1200 @ 60Hz, 70Hz, 75Hz 1680x1050 @ 60Hz 1920x1080 @ 60Hz																				
Presets / user settings	Presets: 25; user settings: 25																				
On screen display	On screen display with digital user controls (8 languages)																				
Control features	<i>Font:</i> Exit button, Left / Mode-switching button (TIO / monitor mode), Right / Brightness button, Enter / Menu button, Power button <i>Bottom:</i> Volume up button, Volume down button																				
Tiny-in-One Power On	Pressing Alt + P on keyboard or pressing Power button positioned on TIO can turn on both TIO and Tiny (only some Tiny support, see compatible list)																				
Side ports (TIO)	One USB 3.1 Gen1 / USB 2.0 (when M73 or M53 installed or USB 2.0 connected via USB upstream port) <i>Notes:</i> The USB port is only available when a Tiny is installed or a PC is connected via USB upstream port																				
Side ports (Tiny)	Side ports offered by installed Tiny (optional)																				
Rear ports	One DisplayPort in port, one USB upstream port, one power connector																				
3-in-1 Cable	Undetachable 3-in-1 cable (Power connector, USB [supports USB 3.1 Gen1 / USB 2.0], DisplayPort), only for connecting to Tiny installed (optional)																				
Camera	720p camera with dual microphone for VOIP, LED indicator																				
Internal Speaker	2 watt x2																				
Security	Security keyhole for attachment of optional cable lock (Kensington® lock compatible), locks optional Tiny with TIO together, more security features offered by Tiny installed (optional)																				
Mechanical	<table border="1"> <thead> <tr> <th>Dimensions</th> <th>TIO without stand</th> <th>TIO with stand</th> </tr> </thead> <tbody> <tr> <td>W x D x H (inch)</td> <td>19.26 x 2.85 x 13.35</td> <td>19.26 x 10.76 x 14.59 - 18.93</td> </tr> <tr> <td>W x D x H (mm)</td> <td>489.3 x 72.5 x 339</td> <td>489.3 x 273.3 x 370.7 - 480.7</td> </tr> <tr> <td>Weight (Approx.)</td> <td>7.01 lb / 3.19 kg</td> <td>11.77 lb / 5.34 kg</td> </tr> </tbody> </table>			Dimensions	TIO without stand	TIO with stand	W x D x H (inch)	19.26 x 2.85 x 13.35	19.26 x 10.76 x 14.59 - 18.93	W x D x H (mm)	489.3 x 72.5 x 339	489.3 x 273.3 x 370.7 - 480.7	Weight (Approx.)	7.01 lb / 3.19 kg	11.77 lb / 5.34 kg						
Dimensions	TIO without stand	TIO with stand																			
W x D x H (inch)	19.26 x 2.85 x 13.35	19.26 x 10.76 x 14.59 - 18.93																			
W x D x H (mm)	489.3 x 72.5 x 339	489.3 x 273.3 x 370.7 - 480.7																			
Weight (Approx.)	7.01 lb / 3.19 kg	11.77 lb / 5.34 kg																			

ThinkCentre Tiny-In-One 22 Gen3 - 10R0

Product Specifications Reference (PSREF)

Model	Product	Region	Color	Display Size	Multi-touch	Resolution	Aspect Ratio	Pixel Pitch	Dot / Pixel Per Inch	Brightness	Contrast Ratio	Pixel Response Time	Color Gamut	View Angle (H / V)	Stand	Power Consumption (Typical / Maximum)	Power Supply	Warranty	Ann Date (mm/yy)
10R0PAR1US	ThinkCentre Tiny-in-One 22 Gen3	US	Black	21.5"	10-point Multi-touch	1920x1080	16:9	0.24795 mm	102.4 dpi	250 nits	1000:1	4-14 ms	72%	178 / 178	Adjustable Stand	19W / 32W	90W 88% Adapter	3-year	07/17
10R0PAT1US	ThinkCentre Tiny-in-One 22 Gen3	US	Black	21.5"	10-point Multi-touch	1920x1080	16:9	0.24795 mm	102.4 dpi	250 nits	1000:1	4-14 ms	72%	178 / 178	Adjustable Stand	19W / 32W	90W 88% Adapter	3-year	07/17

ThinkCentre Tiny-In-One 22 Gen3 - 10R1

Product Specifications Reference (PSREF)

Model	Product	Region	Color	Display Size	Multi-touch	Resolution	Aspect Ratio	Pixel Pitch	Dot / Pixel Per Inch	Brightness	Contrast Ratio	Pixel Response Time	Color Gamut	View Angle (H / V)	Stand	Power Consumption (Typical / Maximum)	Power Supply	Warranty	Ann Date (mm/yy)
10R1PAR1US	ThinkCentre Tiny-in-One 22 Gen3	US	Black	21.5"	None	1920x1080	16:9	0.24795 mm	102.4 dpi	250 nits	1000:1	4-14 ms	72%	178 / 178	Adjustable Stand	19W / 32W	90W 88% Adapter	3-year	07/17
10R1PAT1US	ThinkCentre Tiny-in-One 22 Gen3	US	Black	21.5"	None	1920x1080	16:9	0.24795 mm	102.4 dpi	250 nits	1000:1	4-14 ms	72%	178 / 178	Adjustable Stand	19W / 32W	90W 88% Adapter	3-year	07/17



ThinkCentre Tiny-in-One (TIO) 24

Product Specifications Reference (PSREF)

Model	10LLPAR6++ / 10LLPAT6++		
Form factor	Tiny-in-One, offers a full All-In-One experience when optional Tiny slots into the back of TIO 24, clean cabling and effortless setup		
Compatible Tiny:	M900 Tiny, M700 Tiny, M600 Tiny, M93/p Tiny*, M83 Tiny, M73 Tiny*, or M53 Tiny, Chromebox * Non-TIO models can't be turned on by pressing power button of TIO 24		
Panel	TFT-LCD, In-Plane Switching (IPS), White LED backlight		
Viewable image size	23.8" (604.7mm) diagonal		
Max view area (W x H)	21.06" x 12.32" / 535.0mm x 313.0mm		
Bezel Width	Top / Side: 2mm, Bottom: 16.3mm		
Optimum resolution	1920x1080		
Aspect ratio	16:9		
Pixel pitch (mm)	0.2745mm		
Dot/Pixel per Inch	92.6 dpi		
Brightness	250 nits or cd/m ² (typical)		
Contrast ratio	1000:1 (typical)		
Pixel response time	7ms		
Color gamut	72%		
Anti-reflective	Anti-glare		
Viewing angle at 10:1 CR	178° (+/- 89°) horizontal, 178° (+/- 89°) vertical		
Preset resolutions	640x350 @ 70Hz 640x480 @ 60Hz, 66Hz, 72Hz, 75Hz 720x400 @ 70Hz 800x600 @ 60Hz, 72Hz, 75Hz 1024x768 @ 60Hz, 70Hz, 75Hz 1152x864 @ 75Hz 1280x800 @ 60Hz 1280x1024 @ 60Hz, 72Hz, 75Hz 1366x768 @ 60Hz 1440x900 @ 60Hz, 75Hz 1600x1200 @ 60Hz, 70Hz, 75Hz 1680x1050 @ 60Hz 1920x1080 @ 60Hz		
Presets / user settings	Presets: 25; user settings: 25		
On screen display	On screen display with digital user controls (8 languages)		
Control features	Mode-switching (TIO mode / standalone monitor mode, switches video / audio / USB input sources) / Back button, Left shift button, Right shift / Brightness button, Selection button / Menu button, Power button		
Tiny-in-One Power On	Pressing Alt + P on keyboard or pressing Power button positioned on TIO can turn on both TIO and Tiny (only some Tiny support, see compatible list)		
Front ports	Two USB 3.0 or two USB 2.0 (when M73 or M53 installed or USB 2.0 connected via USB upstream port), one headphone / microphone combo jack (3.5mm) * The USB ports are only available when a Tiny is installed or a PC is connected via USB upstream port		
Side ports	Side ports offered by installed Tiny (optional)		
Rear ports	One DisplayPort 1.2 port, one USB upstream port, one power connector		
3-in-1 Cable	Undetachable 3-in-1 cable (Power connector, USB 3.0 [supports USB 3.0/USB 2.0], DisplayPort 1.2), only for connecting to Tiny installed (optional)		
Internal Speaker	1.5 watt x1		
Security	Security keyhole for attachment of optional cable lock (Kensington® lock compatible), locks optional Tiny with TIO 24 together, more security features offered by Tiny installed (optional)		
Mechanical	Dimensions	TIO 24 without stand	TIO 24 with stand
	W x D x H (inch)	21.24 x 2.7 x 13.64	21.24 x 9.90 x 15.16 - 19.46
	W x D x H (mm)	539.6 x 68.2 x 346.45	539.6 x 251.4 x 385.08 - 495.08
	Weight (approximately)	12.25 lb /5.57 kg (with stand)	
Mounting features	Wall or desk mounting using the extend arm or third-party accessories meeting the VESA FPMPMI® (100mm mount)		
Adjustable stand	Tilt: 35° back, -5° forward; lift: 4.3" (110mm); swivel: +/-45°		
Power supply	90 watts AC/DC adapter, 88% PSU, universal		
Power consumption	16.7 watts typical, 35 watts maximum, <0.5 watts standby / suspend		
Limited warranty ³	3-years , Customer Carry-In or Mail-In via Rapid Replacement Service		
VESA-compliant ²	VESA DDC2B/CI, VESA DPMS-compliant		
Ergonomics	ISO 9241-307		
Emission standards	FCC Class B		
Environmental	TCO 7.0, TCO Edge 2.0, WEEE, RoHS, ENERGY STAR® 7.0		
Windows certifications	EPEAT™ Gold rating, ULE Gold, TUV, VOC Windows 7, Windows 8/8.1, and Windows 10 certified		
Ship group	TIO 24 (Monitor), detachable stand, AC/DC power adapter, power cord, user's guide and driver CD, quick start and safety poster		
Accessories	For compatible accessories, please go to http://www.lenovoquickpick.com		
ThinkCentre Tiny-in-One 24 Compatible list			
Model	M900 Tiny, M700 Tiny, M600 Tiny, M83 Tiny, M53 Tiny	M93/p Tiny, M73 Tiny	Chromebox
Turn on TIO and Tiny together via Alt + P on USB KB	All models	All models	Not support
Turn on TIO and Tiny together via TIO Power Button	All models	TIO models	All models

See footnotes for more detailed information

Model	Region	Color	Display Size	Resolution	Aspect Ratio	Pixel Pitch	Dot / Pixel Per Inch	Brightness	Contrast Ratio	Pixel Response Time	Color Gamut	View Angle (H / V)	Stand	Power Consumption (Typical / Maximum)	Power Supply	Warranty	Ann Date (mm/yy)
10LLPAR6US	US	Black	23.8"	1920x1080	16:9	0.2745 mm	92.6 dpi	250 nits	1000:1	7 ms	72%	178 / 178	Adjustable Stand	16.7W / 35W	90W 88% Adapter	3-year	05/16
10LLPAT6US	US	Black	23.8"	1920x1080	16:9	0.2745 mm	92.6 dpi	250 nits	1000:1	7 ms	72%	178 / 178	Adjustable Stand	16.7W / 35W	90W 88% Adapter	3-year	05/16



ThinkCentre Tiny-in-One (TIO) 24 Gen3

Product Specifications Reference (PSREF)

Model	<i>Non-touch model:</i> 10QYPAR1++/10QYPAT1++; <i>Touch model:</i> 10QXPAR1++/10QXPAT1++	Mounting features	Wall or desk mounting using the extend arm or third-party accessories meeting the VESA FPMPI® (100mm mount)
Form factor	Tiny-in-One, offers a full All-In-One experience when optional Tiny slots into the back of TIO, clean cabling and effortless setup	Adjustable stand	<i>Tilt:</i> 30° back, -5° forward; <i>lift:</i> 4.3" (110mm); <i>swivel:</i> +/-45°; <i>Pivot:</i> clockwise 0° to 90°
Compatible Tiny:	M910 / M710 / M900 / M700 / M600 / M715 / M93/p* / M83 / M73* / M53 / Chromebox Tiny * Non-TIO models can't be turned on by pressing power button of TIO	Power supply	90 watts AC/DC adapter, 88% PSU, universal
Panel	TFT-LCD, In-Plane Switching technology**, White LED backlight <i>Notes:</i> In-Plane Switching may refer to VA, PLS, and IPS panels	Power consumption	19 watts typical, 32 watts maximum, <0.5 watts standby / suspend
Viewable image size	23.8" (604.7mm) diagonal	Limited warranty	3-years , Customer Carry-In or Mail-In via Rapid Replacement Service
Max view area (W x H)	21.06" x 12.32" / 535.0mm x 313.0mm	VESA-compliant	VESA DDC2B/CI, VESA DPMS-compliant
Bezel Width	Top / Side: 2mm, Bottom: 22.1mm	Ergonomics	ISO 9241-307, TUV Eye Comfort certified
Native resolution	1920x1080	Emission standards	FCC Class B
Multi-touch	Optional 10-point multi-touch, supports Wake on Touch	Environmental	TCO 7.0, TCO Edge 2.0, WEEE, RoHS, ENERGY STAR® 7.0, EPEAT™ Gold rating, ULE Gold, TUV, VOC
Aspect ratio	16:9	Windows certifications	Windows 7 and Windows 10 certified
Pixel pitch (mm)	0.2745mm	Ship group	TIO 24 (Monitor), detachable stand, AC/DC power adapter, power cord, user's guide and driver CD, quick start and safety poster
Dot/Pixel per Inch	92.6 dpi	Accessories	For compatible accessories, please go to http://www.lenovoquickpick.com
Brightness	250 nits or cd/m² (typical)		
Contrast ratio	1000:1 (typical)		
Pixel response time	14ms (default), over drive to 4ms, 6ms		
Color gamut	72%		
Anti-reflective	Anti-glare		
Viewing angle at 10:1 CR	178° (+/- 89°) horizontal, 178° (+/- 89°) vertical		

Preset resolutions	640x350 @ 70Hz 640x480 @ 60Hz, 67Hz, 72Hz, 75Hz 720x400 @ 70Hz 800x600 @ 60Hz, 72Hz, 75Hz 1024x768 @ 60Hz, 70Hz, 75Hz 1152x864 @ 75Hz 1280x800 @ 60Hz 1280x1024 @ 60Hz, 72Hz, 75Hz 1366x768 @ 60Hz 1440x900 @ 60Hz, 75Hz 1600x1200 @ 60Hz, 70Hz, 75Hz 1680x1050 @ 60Hz 1920x1080 @ 60Hz
Presets / user settings	Presets: 25; user settings: 25
On screen display	On screen display with digital user controls (8 languages)
Control features	Font: Exit button, Left / Mode-switching button (TIO / monitor mode), Right / Brightness button, Enter / Menu button, Power button Bottom: Volume up button, Volume down button
Tiny-in-One Power On	Pressing Alt + P on keyboard or pressing Power button positioned on TIO can turn on both TIO and Tiny (only some Tiny support, see compatible list)
Side ports (TIO)	One USB 3.1 Gen1 / USB 2.0 (when M73 or M53 installed or USB 2.0 connected via USB upstream port) <i>Notes:</i> The USB port is only available when a Tiny is installed or a PC is connected via USB upstream port
Side ports (Tiny)	Side ports offered by installed Tiny (optional)
Rear ports	One DisplayPort in port, one USB upstream port, one power connector
3-in-1 Cable	Undetachable 3-in-1 cable (Power connector, USB [supports USB 3.1 Gen1 / USB 2.0], DisplayPort), only for connecting to Tiny installed (optional)
Camera	1080p camera with dual microphone for VOIP, LED indicator
Internal Speaker	2 watt x2
Security	Security keyhole for attachment of optional cable lock (Kensington® lock compatible), locks optional Tiny with TIO together, more security features offered by Tiny installed (optional)

Mechanical	Dimensions	TIO without stand	TIO with stand
	W x D x H (inch)	21.25 x 2.85 x 14.47	21.25 x 11.11 x 15.72 - 20.06
	W x D x H (mm)	539.8 x 72.5 x 367.6	539.8 x 282.3 x 399.4 - 509.4
	Weight (Approx.)	7.96 lb /3.61 kg	12.92 lb /5.86 kg

ThinkCentre Tiny-in-One 24 Gen3 Compatible list			
Model	M910 / M710 / M900 / M700 / M600 / M715 / M83 / M53 Tiny	M93/p Tiny, M73 Tiny	Chromebox
Turn on TIO and Tiny together via Alt + P on USB KB	All models	All models	Not support
Turn on TIO and Tiny together via TIO Power Button	All models	TIO models	All models

ThinkCentre Tiny-In-One 24 Gen3 - 10QX

Product Specifications Reference (PSREF)

Model	Product	Region	Color	Display Size	Multi-touch	Resolution	Aspect Ratio	Pixel Pitch	Dot / Pixel Per Inch	Brightness	Contrast Ratio	Pixel Response Time	Color Gamut	View Angle (H / V)	Stand	Power Consumption (Typical / Maximum)	Power Supply	Warranty	Ann Date (mm/yy)
10QXPAR1US	ThinkCentre Tiny-in-One 24 Gen3	US	Black	23.8"	10-point Multi-touch	1920x1080	16:9	0.2745 mm	92.6 dpi	250 nits	1000:1	4-14 ms	72%	178 / 178	Adjustable Stand	19W / 32W	90W 88% Adapter	3-year	07/17
10QXPAT1US	ThinkCentre Tiny-in-One 24 Gen3	US	Black	23.8"	10-point Multi-touch	1920x1080	16:9	0.2745 mm	92.6 dpi	250 nits	1000:1	4-14 ms	72%	178 / 178	Adjustable Stand	19W / 32W	90W 88% Adapter	3-year	07/17

ThinkCentre Tiny-In-One 24 Gen3 - 10QY

Product Specifications Reference (PSREF)

Model	Product	Region	Color	Display Size	Multi-touch	Resolution	Aspect Ratio	Pixel Pitch	Dot / Pixel Per Inch	Brightness	Contrast Ratio	Pixel Response Time	Color Gamut	View Angle (H / V)	Stand	Power Consumption (Typical / Maximum)	Power Supply	Warranty	Ann Date (mm/yy)
10QYPAR1US	ThinkCentre Tiny-in-One 24 Gen3	US	Black	23.8"	None	1920x1080	16:9	0.2745 mm	92.6 dpi	250 nits	1000:1	4-14 ms	72%	178 / 178	Adjustable Stand	19W / 32W	90W 88% Adapter	3-year	07/17
10QYPAT1US	ThinkCentre Tiny-in-One 24 Gen3	US	Black	23.8"	None	1920x1080	16:9	0.2745 mm	92.6 dpi	250 nits	1000:1	4-14 ms	72%	178 / 178	Adjustable Stand	19W / 32W	90W 88% Adapter	3-year	07/17

This publication was developed for products and services offered in the United States and E.M.E.A countries. Lenovo may not offer the products, services or features discussed in this document in other countries. Lenovo may withdraw an offering at any time. Information is subject to change without notice. Consult your local representative for information on offerings available in your area.

Lenovo reserves the right to change specifications or other product information without notice. Lenovo is not responsible for photographic or typographical errors.

LENOVO PROVIDES THIS PUBLICATION "AS IS," WITHOUT WARRANTY OF ANY KIND, EITHER EXPRESS OR IMPLIED, INCLUDING THE IMPLIED WARRANTIES OF MERCHANTABILITY OR FITNESS FOR A PARTICULAR PURPOSE.

Some jurisdictions do not allow disclaimer of express or implied warranties in certain transactions, therefore this disclaimer may not apply to you.

Availability: All offers subject to availability. Lenovo reserves the right to alter product offerings and specifications at any time, without notice. Lenovo is not responsible for photographic or typographic errors.

General: Review key information provided by Microsoft that may apply to your system purchase, including details on Windows 10, Windows 8, Windows 7, and potential upgrades/downgrades. Lenovo makes no representation or warranty regarding third-party products or services.

Trademarks: Lenovo, ThinkPad, ThinkCentre, ThinkStation and the Lenovo logo are trademarks of Lenovo. Microsoft, Windows, Windows NT, and the Windows logo are trademarks of Microsoft Corporation. Ultrabook, Celeron, Celeron Inside, Core Inside, Intel, Intel Logo, Intel Atom, Intel Atom Inside, Intel Core, Intel Inside, Intel Inside Logo, Intel vPro, Itanium, Itanium Inside, Pentium, Pentium Inside, vPro Inside, Xeon, Xeon Phi, and Xeon Inside are trademarks of Intel Corporation in the U.S. and/or other countries. Other company, product or service names may be trademarks or service marks of others.

Warranty: For a copy of applicable warranties, write to: Lenovo Warranty Information, 1009 Think Place, Morrisville, NC, 27560. Lenovo makes no representation or warranty regarding third party products or services. The Lenovo Limited Warranty applies only to Lenovo hardware products purchased for your own use, and does not transfer upon resale.

Limited warranty: Support unrelated to a warranty issue may be subject to additional charges.

Lenovo Services:

Carry-in or Mail-in Service: Parts and labor repair coverage where the customer is responsible for shipping (including packaging) or delivery to authorized warranty provider or repair center.

Depot or Courier Service: Parts and labor repair coverage where shipping (including packaging) or delivery to the repair center is paid for by Lenovo.

Expedited Depot: Parts and labor coverage with expedited turnaround. Shipping (including packaging) or delivery to the repair center is paid for by Lenovo.

Onsite / In-home Service: Parts and labor repair coverage where labor is provided onsite at your place of business.

If Lenovo determines your product problem is covered by the product warranty and cannot be resolved over the telephone, a technician will be dispatched to arrive onsite, typically the next day.

International Warranty Service (IWS): PC repair coverage for customers who require a critical warranty repair while travelling internationally. Visit www.lenovo.com/internationalwarranty for details. Visit www.lenovo.com/warranty for Lenovo Warranty Services terms and conditions for complete details and restrictions.

Included software: may differ from its retail version (if available), and may not include user manuals or all program functionality. Software license agreements may apply.

Battery life: Battery life (and recharge times) will vary based on many factors including screen brightness, applications, features, power management, battery conditioning, and other customer preferences.

Visit <http://psref.lenovo.com/> for the latest version of Product Specifications Reference.

© Lenovo, 2018. All rights reserved.
Lenovo 1009 Think Place Morrisville, NC 27560 U.S.A.

Lenovo ThinkStation.

PSREF

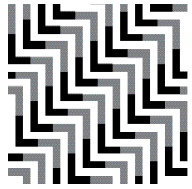

Product Specifications Reference

Version 522, March 2018

U.S.

EMEA

Visit <http://psref.lenovo.com> for the latest version

Contents

Cover	1	ThinkStation P320 Tower - TopSeller - 30BH - 7 of 32	40
Contents	2	ThinkStation P320 Tower - TopSeller - 30BH - 8 of 32	41
Summary Of Change	6	ThinkStation P320 Tower - TopSeller - 30BH - 9 of 32	42
P Series	9	ThinkStation P320 Tower - TopSeller - 30BH - 10 of 32	43
ThinkStation P320 SFF	9	ThinkStation P320 Tower - TopSeller - 30BH - 11 of 32	44
ThinkStation P320 SFF Platform Specifications	10	ThinkStation P320 Tower - TopSeller - 30BH - 12 of 32	45
ThinkStation P320 SFF - TopSeller - 30BK - 1 of 9	11	ThinkStation P320 Tower - TopSeller - 30BH - 13 of 32	46
ThinkStation P320 SFF - TopSeller - 30BK - 2 of 9	12	ThinkStation P320 Tower - TopSeller - 30BH - 14 of 32	47
ThinkStation P320 SFF - TopSeller - 30BK - 3 of 9	13	ThinkStation P320 Tower - TopSeller - 30BH - 15 of 32	48
ThinkStation P320 SFF - TopSeller - 30BK - 4 of 9	14	ThinkStation P320 Tower - TopSeller - 30BH - 16 of 32	49
ThinkStation P320 SFF - TopSeller - 30BK - 5 of 9	15	ThinkStation P320 Tower - TopSeller - 30BH - 17 of 32	50
ThinkStation P320 SFF - TopSeller - 30BK - 6 of 9	16	ThinkStation P320 Tower - TopSeller - 30BH - 18 of 32	51
ThinkStation P320 SFF - TopSeller - 30BK - 7 of 9	17	ThinkStation P320 Tower - TopSeller - 30BH - 19 of 32	52
ThinkStation P320 SFF - TopSeller - 30BK - 8 of 9	18	ThinkStation P320 Tower - TopSeller - 30BH - 20 of 32	53
ThinkStation P320 SFF - TopSeller - 30BK - 9 of 9	19	ThinkStation P320 Tower - TopSeller - 30BH - 21 of 32	54
ThinkStation P320 Tiny	20	ThinkStation P320 Tower - TopSeller - 30BH - 22 of 32	55
ThinkStation P320 Tiny Platform Specifications	21	ThinkStation P320 Tower - TopSeller - 30BH - 23 of 32	56
ThinkStation P320 Tiny - TopSeller - 30C2 - 1 of 10	22	ThinkStation P320 Tower - TopSeller - 30BH - 24 of 32	57
ThinkStation P320 Tiny - TopSeller - 30C2 - 2 of 10	23	ThinkStation P320 Tower - TopSeller - 30BH - 25 of 32	58
ThinkStation P320 Tiny - TopSeller - 30C2 - 3 of 10	24	ThinkStation P320 Tower - TopSeller - 30BH - 26 of 32	59
ThinkStation P320 Tiny - TopSeller - 30C2 - 4 of 10	25	ThinkStation P320 Tower - TopSeller - 30BH - 27 of 32	60
ThinkStation P320 Tiny - TopSeller - 30C2 - 5 of 10	26	ThinkStation P320 Tower - TopSeller - 30BH - 28 of 32	61
ThinkStation P320 Tiny - TopSeller - 30C2 - 6 of 10	27	ThinkStation P320 Tower - TopSeller - 30BH - 29 of 32	62
ThinkStation P320 Tiny - TopSeller - 30C2 - 7 of 10	28	ThinkStation P320 Tower - TopSeller - 30BH - 30 of 32	63
ThinkStation P320 Tiny - TopSeller - 30C2 - 8 of 10	29	ThinkStation P320 Tower - TopSeller - 30BH - 31 of 32	64
ThinkStation P320 Tiny - TopSeller - 30C2 - 9 of 10	30	ThinkStation P320 Tower - TopSeller - 30BH - 32 of 32	65
ThinkStation P320 Tiny - TopSeller - 30C2 - 10 of 10	31	ThinkStation P410	66
ThinkStation P320 Tower	32	ThinkStation P410 Platform Specifications	66
ThinkStation P320 Tower Platform Specifications	33	ThinkStation P410 - TopSeller - 30B3 - 1 of 32	67
ThinkStation P320 Tower - TopSeller - 30BH - 1 of 32	34	ThinkStation P410 - TopSeller - 30B3 - 2 of 32	68
ThinkStation P320 Tower - TopSeller - 30BH - 2 of 32	35	ThinkStation P410 - TopSeller - 30B3 - 3 of 32	69
ThinkStation P320 Tower - TopSeller - 30BH - 3 of 32	36	ThinkStation P410 - TopSeller - 30B3 - 4 of 32	70
ThinkStation P320 Tower - TopSeller - 30BH - 4 of 32	37	ThinkStation P410 - TopSeller - 30B3 - 5 of 32	71
ThinkStation P320 Tower - TopSeller - 30BH - 5 of 32	38	ThinkStation P410 - TopSeller - 30B3 - 6 of 32	72
ThinkStation P320 Tower - TopSeller - 30BH - 6 of 32	39	ThinkStation P410 - TopSeller - 30B3 - 7 of 32	73

Contents

ThinkStation P410 - TopSeller - 30B3 - 8 of 32	74	ThinkStation P510 - TopSeller - 30B5 - 9 of 28	108
ThinkStation P410 - TopSeller - 30B3 - 9 of 32	75	ThinkStation P510 - TopSeller - 30B5 - 10 of 28	109
ThinkStation P410 - TopSeller - 30B3 - 10 of 32	76	ThinkStation P510 - TopSeller - 30B5 - 11 of 28	110
ThinkStation P410 - TopSeller - 30B3 - 11 of 32	77	ThinkStation P510 - TopSeller - 30B5 - 12 of 28	111
ThinkStation P410 - TopSeller - 30B3 - 12 of 32	78	ThinkStation P510 - TopSeller - 30B5 - 13 of 28	112
ThinkStation P410 - TopSeller - 30B3 - 13 of 32	79	ThinkStation P510 - TopSeller - 30B5 - 14 of 28	113
ThinkStation P410 - TopSeller - 30B3 - 14 of 32	80	ThinkStation P510 - TopSeller - 30B5 - 15 of 28	114
ThinkStation P410 - TopSeller - 30B3 - 15 of 32	81	ThinkStation P510 - TopSeller - 30B5 - 16 of 28	115
ThinkStation P410 - TopSeller - 30B3 - 16 of 32	82	ThinkStation P510 - TopSeller - 30B5 - 17 of 28	116
ThinkStation P410 - TopSeller - 30B3 - 17 of 32	83	ThinkStation P510 - TopSeller - 30B5 - 18 of 28	117
ThinkStation P410 - TopSeller - 30B3 - 18 of 32	84	ThinkStation P510 - TopSeller - 30B5 - 19 of 28	118
ThinkStation P410 - TopSeller - 30B3 - 19 of 32	85	ThinkStation P510 - TopSeller - 30B5 - 20 of 28	119
ThinkStation P410 - TopSeller - 30B3 - 20 of 32	86	ThinkStation P510 - TopSeller - 30B5 - 21 of 28	120
ThinkStation P410 - TopSeller - 30B3 - 21 of 32	87	ThinkStation P510 - TopSeller - 30B5 - 22 of 28	121
ThinkStation P410 - TopSeller - 30B3 - 22 of 32	88	ThinkStation P510 - TopSeller - 30B5 - 23 of 28	122
ThinkStation P410 - TopSeller - 30B3 - 23 of 32	89	ThinkStation P510 - TopSeller - 30B5 - 24 of 28	123
ThinkStation P410 - TopSeller - 30B3 - 24 of 32	90	ThinkStation P510 - TopSeller - 30B5 - 25 of 28	124
ThinkStation P410 - TopSeller - 30B3 - 25 of 32	91	ThinkStation P510 - TopSeller - 30B5 - 26 of 28	125
ThinkStation P410 - TopSeller - 30B3 - 26 of 32	92	ThinkStation P510 - TopSeller - 30B5 - 27 of 28	126
ThinkStation P410 - TopSeller - 30B3 - 27 of 32	93	ThinkStation P510 - TopSeller - 30B5 - 28 of 28	127
ThinkStation P410 - TopSeller - 30B3 - 28 of 32	94	ThinkStation P520	128
ThinkStation P410 - TopSeller - 30B3 - 29 of 32	95	ThinkStation P520 Platform Specifications	129
ThinkStation P410 - TopSeller - 30B3 - 30 of 32	96	ThinkStation P520 - TopSeller - 30BE - 1 of 38	130
ThinkStation P410 - TopSeller - 30B3 - 31 of 32	97	ThinkStation P520 - TopSeller - 30BE - 2 of 38	131
ThinkStation P410 - TopSeller - 30B3 - 32 of 32	98	ThinkStation P520 - TopSeller - 30BE - 3 of 38	132
ThinkStation P510	99	ThinkStation P520 - TopSeller - 30BE - 4 of 38	133
ThinkStation P510 Platform Specifications	99	ThinkStation P520 - TopSeller - 30BE - 5 of 38	134
ThinkStation P510 - TopSeller - 30B5 - 1 of 28	100	ThinkStation P520 - TopSeller - 30BE - 6 of 38	135
ThinkStation P510 - TopSeller - 30B5 - 2 of 28	101	ThinkStation P520 - TopSeller - 30BE - 7 of 38	136
ThinkStation P510 - TopSeller - 30B5 - 3 of 28	102	ThinkStation P520 - TopSeller - 30BE - 8 of 38	137
ThinkStation P510 - TopSeller - 30B5 - 4 of 28	103	ThinkStation P520 - TopSeller - 30BE - 9 of 38	138
ThinkStation P510 - TopSeller - 30B5 - 5 of 28	104	ThinkStation P520 - TopSeller - 30BE - 10 of 38	139
ThinkStation P510 - TopSeller - 30B5 - 6 of 28	105	ThinkStation P520 - TopSeller - 30BE - 11 of 38	140
ThinkStation P510 - TopSeller - 30B5 - 7 of 28	106	ThinkStation P520 - TopSeller - 30BE - 12 of 38	141
ThinkStation P510 - TopSeller - 30B5 - 8 of 28	107	ThinkStation P520 - TopSeller - 30BE - 13 of 38	142

Contents

ThinkStation P520 - TopSeller - 30BE - 14 of 38	143	ThinkStation P520c - TopSeller - 30BX - 9 of 16	178
ThinkStation P520 - TopSeller - 30BE - 15 of 38	144	ThinkStation P520c - TopSeller - 30BX - 10 of 16	179
ThinkStation P520 - TopSeller - 30BE - 16 of 38	145	ThinkStation P520c - TopSeller - 30BX - 11 of 16	180
ThinkStation P520 - TopSeller - 30BE - 17 of 38	146	ThinkStation P520c - TopSeller - 30BX - 12 of 16	181
ThinkStation P520 - TopSeller - 30BE - 18 of 38	147	ThinkStation P520c - TopSeller - 30BX - 13 of 16	182
ThinkStation P520 - TopSeller - 30BE - 19 of 38	148	ThinkStation P520c - TopSeller - 30BX - 14 of 16	183
ThinkStation P520 - TopSeller - 30BE - 20 of 38	149	ThinkStation P520c - TopSeller - 30BX - 15 of 16	184
ThinkStation P520 - TopSeller - 30BE - 21 of 38	150	ThinkStation P520c - TopSeller - 30BX - 16 of 16	185
ThinkStation P520 - TopSeller - 30BE - 22 of 38	151	ThinkStation P710	186
ThinkStation P520 - TopSeller - 30BE - 23 of 38	152	ThinkStation P710 Platform Specifications	186
ThinkStation P520 - TopSeller - 30BE - 24 of 38	153	ThinkStation P710 - TopSeller - 30B7 - 1 of 12	187
ThinkStation P520 - TopSeller - 30BE - 25 of 38	154	ThinkStation P710 - TopSeller - 30B7 - 2 of 12	188
ThinkStation P520 - TopSeller - 30BE - 26 of 38	155	ThinkStation P710 - TopSeller - 30B7 - 3 of 12	189
ThinkStation P520 - TopSeller - 30BE - 27 of 38	156	ThinkStation P710 - TopSeller - 30B7 - 4 of 12	190
ThinkStation P520 - TopSeller - 30BE - 28 of 38	157	ThinkStation P710 - TopSeller - 30B7 - 5 of 12	191
ThinkStation P520 - TopSeller - 30BE - 29 of 38	158	ThinkStation P710 - TopSeller - 30B7 - 6 of 12	192
ThinkStation P520 - TopSeller - 30BE - 30 of 38	159	ThinkStation P710 - TopSeller - 30B7 - 7 of 12	193
ThinkStation P520 - TopSeller - 30BE - 31 of 38	160	ThinkStation P710 - TopSeller - 30B7 - 8 of 12	194
ThinkStation P520 - TopSeller - 30BE - 32 of 38	161	ThinkStation P710 - TopSeller - 30B7 - 9 of 12	195
ThinkStation P520 - TopSeller - 30BE - 33 of 38	162	ThinkStation P710 - TopSeller - 30B7 - 10 of 12	196
ThinkStation P520 - TopSeller - 30BE - 34 of 38	163	ThinkStation P710 - TopSeller - 30B7 - 11 of 12	197
ThinkStation P520 - TopSeller - 30BE - 35 of 38	164	ThinkStation P710 - TopSeller - 30B7 - 12 of 12	198
ThinkStation P520 - TopSeller - 30BE - 36 of 38	165	ThinkStation P720	199
ThinkStation P520 - TopSeller - 30BE - 37 of 38	166	ThinkStation P720 Platform Specifications	199
ThinkStation P520 - TopSeller - 30BE - 38 of 38	167	ThinkStation P720 - TopSeller - 30BA - 1 of 11	200
ThinkStation P520c	168	ThinkStation P720 - TopSeller - 30BA - 2 of 11	201
ThinkStation P520c Platform Specifications	169	ThinkStation P720 - TopSeller - 30BA - 3 of 11	202
ThinkStation P520c - TopSeller - 30BX - 1 of 16	170	ThinkStation P720 - TopSeller - 30BA - 4 of 11	203
ThinkStation P520c - TopSeller - 30BX - 2 of 16	171	ThinkStation P720 - TopSeller - 30BA - 5 of 11	204
ThinkStation P520c - TopSeller - 30BX - 3 of 16	172	ThinkStation P720 - TopSeller - 30BA - 6 of 11	205
ThinkStation P520c - TopSeller - 30BX - 4 of 16	173	ThinkStation P720 - TopSeller - 30BA - 7 of 11	206
ThinkStation P520c - TopSeller - 30BX - 5 of 16	174	ThinkStation P720 - TopSeller - 30BA - 8 of 11	207
ThinkStation P520c - TopSeller - 30BX - 6 of 16	175	ThinkStation P720 - TopSeller - 30BA - 9 of 11	208
ThinkStation P520c - TopSeller - 30BX - 7 of 16	176	ThinkStation P720 - TopSeller - 30BA - 10 of 11	209
ThinkStation P520c - TopSeller - 30BX - 8 of 16	177	ThinkStation P720 - TopSeller - 30BA - 11 of 11	210

Contents

ThinkStation P910	211
ThinkStation P910 Platform Specifications	211
ThinkStation P910 - TopSeller - 30B9 - 1 of 18	212
ThinkStation P910 - TopSeller - 30B9 - 2 of 18	213
ThinkStation P910 - TopSeller - 30B9 - 3 of 18	214
ThinkStation P910 - TopSeller - 30B9 - 4 of 18	215
ThinkStation P910 - TopSeller - 30B9 - 5 of 18	216
ThinkStation P910 - TopSeller - 30B9 - 6 of 18	217
ThinkStation P910 - TopSeller - 30B9 - 7 of 18	218
ThinkStation P910 - TopSeller - 30B9 - 8 of 18	219
ThinkStation P910 - TopSeller - 30B9 - 9 of 18	220
ThinkStation P910 - TopSeller - 30B9 - 10 of 18	221
ThinkStation P910 - TopSeller - 30B9 - 11 of 18	222
ThinkStation P910 - TopSeller - 30B9 - 12 of 18	223
ThinkStation P910 - TopSeller - 30B9 - 13 of 18	224
ThinkStation P910 - TopSeller - 30B9 - 14 of 18	225
ThinkStation P910 - TopSeller - 30B9 - 15 of 18	226
ThinkStation P910 - TopSeller - 30B9 - 16 of 18	227
ThinkStation P910 - TopSeller - 30B9 - 17 of 18	228
ThinkStation P910 - TopSeller - 30B9 - 18 of 18	229
ThinkStation P920	230
ThinkStation P920 Platform Specifications	230
ThinkStation P920 - TopSeller - 30BC - 1 of 10	231
ThinkStation P920 - TopSeller - 30BC - 2 of 10	232
ThinkStation P920 - TopSeller - 30BC - 3 of 10	233
ThinkStation P920 - TopSeller - 30BC - 4 of 10	234
ThinkStation P920 - TopSeller - 30BC - 5 of 10	235
ThinkStation P920 - TopSeller - 30BC - 6 of 10	236
ThinkStation P920 - TopSeller - 30BC - 7 of 10	237
ThinkStation P920 - TopSeller - 30BC - 8 of 10	238
ThinkStation P920 - TopSeller - 30BC - 9 of 10	239
ThinkStation P920 - TopSeller - 30BC - 10 of 10	240
Legal Information	241

Summary of Changes

This section describes the changes made in this version of ThinkStation PSREF and in previous version. This edition might also include minor corrections and editorial changes which are not identified.

April 18, 2018 - Version 523

- ▶ New ThinkStation P320 Tower/ P320 SFF/P520c/P520/P720/P920 models announced on April 2018

March 7, 2018 - Version 522

- ▶ New ThinkStation P320 Tower/ P320 SFF/P520c/P520/P920 announced on March 2018

March 7, 2018 - Version 521

- ▶ New ThinkStation P320 Tower/ P320 SFF/P720/P920 announced on February 2018

January 30, 2018 - Version 519

- ▶ New ThinkStation P520c and P520 announced on January 2018
- ▶ New ThinkStation P320 Tower/P320 SFF announced on January 2018

December 20, 2017 - Version 517

- ▶ New ThinkStation P920 models announced on December 2017
- ▶ Add Optional Ports on ThinkStation P320 Tiny

September 29, 2017 - Version 513

- ▶ New ThinkStation P920 and P720 announced on September 2017
- ▶ New ThinkStation P320 Tower/P320 SFF/P410/P510/P710/P910 announced on September 2017

September 12, 2017 - Version 512

- ▶ New ThinkStation P320 Tower and P320 SFF models announced on August 2017

August 23, 2017 - Version 511

- ▶ New ThinkStation P320 Tiny models announced on August 2017

August 2, 2017 - Version 510

- ▶ New ThinkStation P320 Tiny/P320 Tower/ P320 SFF/P410/P510 models announced on July 2017

June 21, 2017 - Version 508

- ▶ New ThinkStation P320 Tiny announced on June 2017

May 26, 2017 - Version 507

- ▶ Add ThinkStation P410/P510/P710/P910 Refresh 3.0 Wave 1 models and update platform specifications

April 19, 2017 - Version 505

- ▶ New ThinkStation P320 Tower announced on April 2017
- ▶ New ThinkStation P320 SFF announced on April 2017

March 29, 2017 - Version 504

- ▶ Added ThinkStation P310 Tower and SFF models announced on March 2017
- ▶ Added ThinkStation P410 models announced on March 2017

January 25, 2017 - Version 501

- ▶ Update quantity of PCIe SSD adapter in ThinkStation P510/P910

January 4, 2017 - Version 500

- ▶ Added ThinkStation P310 models announced on December 2016

December 14, 2016 - Version 499

- ▶ Added ThinkStation P410/P510/P710/P910 EMEA models
- ▶ Added 1TB M.2 PCIe SSD, Quadro P5000, Quadro P6000 support on ThinkStation P510/P710/P910
- ▶ Added Quadro P5000 support on ThinkStation P410
- ▶ Added 6TB 7.2K SATA6Gbs HDD support on ThinkStation P410/P510/P710/P910
- ▶ Added ThinkStation P410/P510/P710/P910 models announced on December 2016

November 23, 2016 - Version 498

- ▶ Removed ThinkStation P500/P900 due to EOL
- ▶ Added ThinkStation P310 Tower and SFF models announced on November 2016

October 12, 2016 - Version 496

- ▶ Removed flash option on ThinkStation P510/P710/P910
- ▶ Added ThinkStation P310/P410/P510/P710/P910 models announced on September 2016

August 3, 2016 - Version 493

- ▶ Removed ThinkStation P500/P700/P900 Windows 7 DG from Win8.1 U.S. models
- ▶ Added keyboard and mouse features on all ThinkStation

July 13, 2016 - Version 492

- ▶ Added ThinkStation P500, P700, and P900 Windows 10 downgrade to Windows 7 models
- ▶ Updated Maximum configuration weight of ThinkStation P410
- ▶ Added ThinkStation P710 and P910 models announced on on July 2016
- ▶ Added "Maximum drives in 3.5" bay" feature on ThinkStation P500/P510/P700/P710/P900/P910

June 22, 2016 - Version 491

- ▶ Added new product ThinkStation P410/P510
- ▶ Added NVIDIA Quadro M2000 on ThinkStation P310 Tower
- ▶ Added keyboard and mouse information on ThinkStation P710/P910
- ▶ Added internal USB information on ThinkStation P710/P910

June 2, 2016 - Version 490

- ▶ Added ThinkStation P710/P910 US models
- ▶ Updated ThinkStation P710/P910 processor information

May 19, 2016 - Version 489

- ▶ Added NVIDIA Quadro M2000 on compatible product
- ▶ Updated maximum weight on ThinkStation P710
- ▶ Removed 30AT000BUS

April 27, 2016 - Version 488

- ▶ Added ThinkStation P710 and P910 models for EMEA, announced on April 2016
- ▶ Updated Energy star information on ThinkStation P500/P700/P710/P900/P910

April 6, 2016 - Version 487

- ▶ New ThinkStation P710 and P910, announced April 5, 2016 (specification only)

March 23, 2016 - Version 486

- ▶ Added processors specifications for P310/P500/P700/P900

February 24, 2016 - Version 485

- ▶ Added ThinkStation P310 and P700 models for US, announced on February 2016
- ▶ Added ThinkStation P700 and P900 models for EMEA, announced on February 2016

December 9, 2015 - Version 482

- ▶ New ThinkStation P310 Tower and SFF, announced November 24, 2015

November 18, 2015 - Version 481

- ▶ Combines ThinkStation PSREF United States version and Western Europe version.
- ▶ Extends the supported GEO into Europe, Middle East and Africa.
- ▶ Covers all TopSeller and Relationship models for US and all focus models for EMEA



ThinkStation P320 SFF Platform Specifications

Product Specifications Reference (PSREF)

Components	Specification																																			
Chipset	Intel C236 Chipset																																			
Intel AMT	Intel Active Management Technology 11 on Xeon models, Intel Standard Manageability on other models																																			
Processor	One Intel "Kabylake" or "Skylake" processor as listed: "Kaby Lake"																																			
	Xeon E3-1280 v6	4C/3.9GHz/8MB/72W/DDR4-2400																																		
	Xeon E3-1275 v6	4C/3.8GHz/8MB/73W/DDR4-2400																																		
	Xeon E3-1270 v6	4C/3.8GHz/8MB/72W/DDR4-2400																																		
	Xeon E3-1245 v6	4C/3.7GHz/8MB/73W/DDR4-2400																																		
	Xeon E3-1240 v6	4C/3.7GHz/8MB/72W/DDR4-2400																																		
	Xeon E3-1230 v6	4C/3.5GHz/8MB/72W/DDR4-2400																																		
	Xeon E3-1225 v6	4C/3.3GHz/8MB/73W/DDR4-2400																																		
	Xeon E3-1220 v6	4C/3GHz/8MB/72W/DDR4-2400																																		
	Core i7-7700	4C/3.6GHz/8MB/65W/DDR4-2400																																		
	Core i5-7600	4C/3.5GHz/6MB/65W/DDR4-2400																																		
	Core i5-7500	4C/3.4GHz/6MB/65W/DDR4-2400																																		
	Core i5-7400	4C/3GHz/6MB/65W/DDR4-2400																																		
	Core i3-7300	2C/4GHz/4MB/51W/DDR4-2400																																		
	Core i3-7100	2C/3.9GHz/3MB/51W/DDR4-2400																																		
	"Skylake"																																			
	Xeon E3-1245 v5	4C/3.5GHz/8MB/80W/DDR4-2133																																		
Xeon E3-1240 v5	4C/3.5GHz/8MB/80W/DDR4-2133																																			
Xeon E3-1230 v5	4C/3.4GHz/8MB/80W/DDR4-2133																																			
Xeon E3-1225 v5	4C/3.3GHz/8MB/80W/DDR4-2133																																			
Xeon E3-1220 v5	4C/3GHz/8MB/80W/DDR4-2133																																			
Core i7-6700	4C/3.4GHz/8MB/65W/DDR4-2133																																			
Core i5-6500	4C/3.2GHz/6MB/65W/DDR4-2133																																			
Core i5-6400	4C/2.7GHz/6MB/65W/DDR4-2133																																			
Core i3-6100	2C/3.7GHz/3MB/51W/DDR4-2133																																			
Memory DIMM slots	4 DIMM slots, 2-channel (integrated memory controller in processor)																																			
Memory type/capacity	Up to 64GB ECC/non-ECC (4 x 16GB), DDR4-2400. UDIMM. "Skylake" processor supports up to DDR4-2133. Core i7 and i5 processors cannot support ECC.																																			
Intel HD Graphics in processor	Integrated Intel HD P530 in Xeon E3-12x5 v5 processors, or Intel HD P630 in Xeon E3-12x5 v6 processors, or Intel HD 530 in Core i7, i5, or i3 6000 processors. or Intel HD 630 in Core i7, i5, or i3 7000 processors. Works along with discrete graphics to support multi-display, enables three display connectors (2 DP, 1 VGA) on rear.																																			
Discrete graphics	Two PCI Express 3.0 x16 slots for graphics adapters. Up to two NVIDIA Quadro P1000. Supports the following NVIDIA graphic adapters:																																			
	<table border="1"> <thead> <tr> <th>Adapter</th> <th>Cores</th> <th>Memory</th> <th>Power</th> <th>Connector</th> </tr> </thead> <tbody> <tr> <td>NVS 310</td> <td>48</td> <td>1GB</td> <td>19.5W</td> <td>2xDP</td> </tr> <tr> <td>NVS 315</td> <td>48</td> <td>1GB</td> <td>19.5W</td> <td>2xDVI-I SL/2xDP</td> </tr> <tr> <td>NVS 510</td> <td>192</td> <td>2GB</td> <td>33.4W</td> <td>4xmini DP</td> </tr> <tr> <td>Quadro P400</td> <td>256</td> <td>2GB</td> <td>30W</td> <td>3xminiDP</td> </tr> <tr> <td>Quadro P600</td> <td>384</td> <td>2GB</td> <td>40W</td> <td>4xminiDP</td> </tr> <tr> <td>Quadro P1000</td> <td>640</td> <td>4GB</td> <td>47W</td> <td>4xminiDP</td> </tr> </tbody> </table>	Adapter	Cores	Memory	Power	Connector	NVS 310	48	1GB	19.5W	2xDP	NVS 315	48	1GB	19.5W	2xDVI-I SL/2xDP	NVS 510	192	2GB	33.4W	4xmini DP	Quadro P400	256	2GB	30W	3xminiDP	Quadro P600	384	2GB	40W	4xminiDP	Quadro P1000	640	4GB	47W	4xminiDP
	Adapter	Cores	Memory	Power	Connector																															
	NVS 310	48	1GB	19.5W	2xDP																															
	NVS 315	48	1GB	19.5W	2xDVI-I SL/2xDP																															
	NVS 510	192	2GB	33.4W	4xmini DP																															
	Quadro P400	256	2GB	30W	3xminiDP																															
	Quadro P600	384	2GB	40W	4xminiDP																															
Quadro P1000	640	4GB	47W	4xminiDP																																
Onboard drive controller	Five onboard SATA 6.0Gb/s connectors for optical and disk drives plus one SATA connector for optional eSATA. RAID 0, 1, 5* support * RAID 5 needs three 2.5" SSD drives.																																			
Drive Bays	One external 5.25" bay, one internal 3.5" bay (see right). Up to one 9mm optical + 2 x 3.5" disk drive bays + 1 x 2.5" disk drive bay + two M.2 NVMe SSD																																			
Supporting disk drives	3.5" SATA HDD (7.2K 6Gbs)	1TB/2TB/4TB/1TB hybrid/2TB hybrid																																		
	2.5" SATA SSD (6Gbs)	256GB Opal/512GB/512GB Opal/1TB Opal/2TB opal																																		
	M.2 NVMe SSD, via PCIe adapter	256GB Opal/512GB Opal/1TB Opal, via PCIe 3.0 x4 adapter, up to 2; or 16GB Intel Optane Memory, PCIe 3.0 x2																																		
Max internal storage	10TB (2 x 4TB 3.5" HDDs + 1 x 2TB 2.5" SSD) plus two 1TB M.2 NVMe SSD																																			
Media reader	9-in-1 card reader. Optional 29-in-1 card reader on selected models																																			
Power supply	210 watts with variable speed fan, autosensing, Climate Savers Computing Bronze, 80 PLUS Bronze qualified																																			
Onboard Ethernet	One onboard gigabit ethernet, Intel I219LM, supports Wake-on-LAN																																			
HD Audio	Realtek ALC662 codec																																			
TPM	Standard, TCG 2.0-compliant																																			

Components	Specification
Front ports	Two USB 3.0, microphone (3.5mm), headphone (3.5mm)
Rear ports	1 VGA and 2 DisplayPort (for Intel HD Graphics models only), two USB 2.0, four USB 3.0, one serial (9-pin), one ethernet (RJ-45), three analog audio ports (line-in, line-out, mic-in)
Mechanical	<ul style="list-style-type: none"> Raven black color; metal case 4.02"W x 15.53"D x 13.31"H 102mm W x 394.5mm D x 338mm H 17.2 lb (7.9kg) max configuration 12.9-liter
Environmental certifications	GREENGUARD certified/RoHS-compliant/EPEAT Gold rating/ENERGY STAR 6.1 qualified
Limited warranty	1 or 3-year limited onsite service with 9x5/NBD. Some parts are Customer Replaceable Units.
ISV certifications	Please visit www.thinkworkstations.com/isv-certifications/

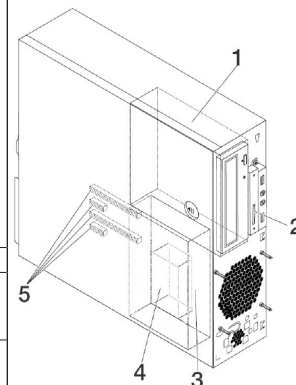

Drive Bays and PCIe Slots

Bay 1	5.25", supports one of the following: HH optical/flex module***/9mm optical+3.5" HDD bay/ 3.5" HDD bay/Front Access Storage Enclosure *** Flex module supports one or more of the following: 9mm optical/ 29-in-1 reader/front IEEE 1394/front eSATA. Up to one flex module is supported per system.
Bay 2	Optional 9-in-1 single slot reader
Bay 3	Standard 3.5" HDD bay
Bay 4	Optional 2.5" HDD bay (under Bay 3)
5 -Slots	Four PCIe slots (top-down): Slot 1: Low Profile, PCIe 3.0 x16 (near CPU) Slot 2: Low Profile, PCIe 3.0 x1 Slot 3: Low Profile, PCIe 3.0 x16 (x4 elec) Slot 4: Low Profile, PCIe 3.0 x1

Model	Region	Processor	Graphics	Memory	Disks	M.2 Drives	Optical	Media Reader	Power Supply	Optional Ports	Keyboard / Mouse	Operating System	Warranty	Global	Ann Date (mm/yy)
30BK0000--	EMEA	Core i5-7500 4C/3.4GHz/6MB/65W/DDR4-2400	Intel HD 630	1x8GB UDIMM DDR4-2400 Non-ECC	1x1TB HDD 7.2K 3.5" SATA6Gbps	None	HH DVD±RW	9-in-1	210W Bronze Fixed	None	USB / USB Optical	Windows 10 Pro 64	3-year, Onsite	No	04/17
30BK0000**	EMEA	Core i5-7500 4C/3.4GHz/6MB/65W/DDR4-2400	Intel HD 630	1x8GB UDIMM DDR4-2400 Non-ECC	1x1TB HDD 7.2K 3.5" SATA6Gbps	None	HH DVD±RW	9-in-1	210W Bronze Fixed	None	USB / USB Optical	Windows 10 Pro 64	3-year, Onsite	No	04/17
30BK0000xx	EMEA	Core i5-7500 4C/3.4GHz/6MB/65W/DDR4-2400	Intel HD 630	1x8GB UDIMM DDR4-2400 Non-ECC	1x1TB HDD 7.2K 3.5" SATA6Gbps	None	HH DVD±RW	9-in-1	210W Bronze Fixed	None	USB / USB Optical	Windows 10 Pro 64	3-year, Onsite	No	04/17
30BK0001--	EMEA	Core i7-7700 4C/3.6GHz/8MB/65W/DDR4-2400	Intel HD 630	1x8GB UDIMM DDR4-2400 Non-ECC	1x256GB SSD 2.5" SATA6Gbps Opal	None	HH DVD±RW	9-in-1	210W Bronze Fixed	None	USB / USB Optical	Windows 10 Pro 64	3-year, Onsite	No	04/17
30BK0001**	EMEA	Core i7-7700 4C/3.6GHz/8MB/65W/DDR4-2400	Intel HD 630	1x8GB UDIMM DDR4-2400 Non-ECC	1x256GB SSD 2.5" SATA6Gbps Opal	None	HH DVD±RW	9-in-1	210W Bronze Fixed	None	USB / USB Optical	Windows 10 Pro 64	3-year, Onsite	No	04/17
30BK0001xx	EMEA	Core i7-7700 4C/3.6GHz/8MB/65W/DDR4-2400	Intel HD 630	1x8GB UDIMM DDR4-2400 Non-ECC	1x256GB SSD 2.5" SATA6Gbps Opal	None	HH DVD±RW	9-in-1	210W Bronze Fixed	None	USB / USB Optical	Windows 10 Pro 64	3-year, Onsite	No	04/17
30BK0002--	EMEA	Core i7-7700 4C/3.6GHz/8MB/65W/DDR4-2400	Intel HD 630	1x8GB UDIMM DDR4-2400 Non-ECC	1x1TB HDD 7.2K 3.5" SATA6Gbps	None	HH DVD±RW	9-in-1	210W Bronze Fixed	None	USB / USB Optical	Windows 10 Pro 64	3-year, Onsite	No	04/17
30BK0002**	EMEA	Core i7-7700 4C/3.6GHz/8MB/65W/DDR4-2400	Intel HD 630	1x8GB UDIMM DDR4-2400 Non-ECC	1x1TB HDD 7.2K 3.5" SATA6Gbps	None	HH DVD±RW	9-in-1	210W Bronze Fixed	None	USB / USB Optical	Windows 10 Pro 64	3-year, Onsite	No	04/17
30BK0002xx	EMEA	Core i7-7700 4C/3.6GHz/8MB/65W/DDR4-2400	Intel HD 630	1x8GB UDIMM DDR4-2400 Non-ECC	1x1TB HDD 7.2K 3.5" SATA6Gbps	None	HH DVD±RW	9-in-1	210W Bronze Fixed	None	USB / USB Optical	Windows 10 Pro 64	3-year, Onsite	No	04/17
30BK0003--	EMEA	Xeon E3-1230 v6 4C/3.5GHz/8MB/72W/DDR4-2400	NVIDIA Quadro P400 2GB	1x8GB UDIMM DDR4-2400 ECC	1x256GB SSD 2.5" SATA6Gbps Opal	None	HH DVD±RW	9-in-1	210W Bronze Fixed	None	USB / USB Optical	Windows 10 Pro 64	3-year, Onsite	No	04/17
30BK0003**	EMEA	Xeon E3-1230 v6 4C/3.5GHz/8MB/72W/DDR4-2400	NVIDIA Quadro P400 2GB	1x8GB UDIMM DDR4-2400 ECC	1x256GB SSD 2.5" SATA6Gbps Opal	None	HH DVD±RW	9-in-1	210W Bronze Fixed	None	USB / USB Optical	Windows 10 Pro 64	3-year, Onsite	No	04/17
30BK0003xx	EMEA	Xeon E3-1230 v6 4C/3.5GHz/8MB/72W/DDR4-2400	NVIDIA Quadro P400 2GB	1x8GB UDIMM DDR4-2400 ECC	1x256GB SSD 2.5" SATA6Gbps Opal	None	HH DVD±RW	9-in-1	210W Bronze Fixed	None	USB / USB Optical	Windows 10 Pro 64	3-year, Onsite	No	04/17
30BK0004--	EMEA	Xeon E3-1245 v6 4C/3.7GHz/8MB/73W/DDR4-2400	Intel HD P630	1x8GB UDIMM DDR4-2400 ECC	Open	1x256GB SSD M.2 PCIe Opal	HH DVD±RW	9-in-1	210W Bronze Fixed	None	USB / USB Optical	Windows 10 Pro 64	3-year, Onsite	No	04/17
30BK0004**	EMEA	Xeon E3-1245 v6 4C/3.7GHz/8MB/73W/DDR4-2400	Intel HD P630	1x8GB UDIMM DDR4-2400 ECC	Open	1x256GB SSD M.2 PCIe Opal	HH DVD±RW	9-in-1	210W Bronze Fixed	None	USB / USB Optical	Windows 10 Pro 64	3-year, Onsite	No	04/17
30BK0004xx	EMEA	Xeon E3-1245 v6 4C/3.7GHz/8MB/73W/DDR4-2400	Intel HD P630	1x8GB UDIMM DDR4-2400 ECC	Open	1x256GB SSD M.2 PCIe Opal	HH DVD±RW	9-in-1	210W Bronze Fixed	None	USB / USB Optical	Windows 10 Pro 64	3-year, Onsite	No	04/17

Model	Region	Processor	Graphics	Memory	Disks	M.2 Drives	Optical	Media Reader	Power Supply	Optional Ports	Keyboard / Mouse	Operating System	Warranty	Global	Ann Date (mm/yy)
30BK0007--	EMEA	Core i5-6500 4C/3.2GHz/6MB/65W/DDR4-2133	Intel HD 530	1x8GB UDIMM DDR4-2400 Non-ECC	1x1TB HDD 7.2K 3.5" SATA6Gbps	None	HH DVD±RW	9-in-1	210W Bronze Fixed	None	USB / USB Optical	Windows 10 DG Windows 7 Pro 64	3-year, Onsite	No	04/17
30BK0007**	EMEA	Core i5-6500 4C/3.2GHz/6MB/65W/DDR4-2133	Intel HD 530	1x8GB UDIMM DDR4-2400 Non-ECC	1x1TB HDD 7.2K 3.5" SATA6Gbps	None	HH DVD±RW	9-in-1	210W Bronze Fixed	None	USB / USB Optical	Windows 10 DG Windows 7 Pro 64	3-year, Onsite	No	04/17
30BK0007xx	EMEA	Core i5-6500 4C/3.2GHz/6MB/65W/DDR4-2133	Intel HD 530	1x8GB UDIMM DDR4-2400 Non-ECC	1x1TB HDD 7.2K 3.5" SATA6Gbps	None	HH DVD±RW	9-in-1	210W Bronze Fixed	None	USB / USB Optical	Windows 10 DG Windows 7 Pro 64	3-year, Onsite	No	04/17
30BK0008--	EMEA	Core i7-6700 4C/3.4GHz/8MB/65W/DDR4-2133	Intel HD 530	1x8GB UDIMM DDR4-2400 Non-ECC	1x256GB SSD 2.5" SATA6Gbps Opal	None	HH DVD±RW	9-in-1	210W Bronze Fixed	None	USB / USB Optical	Windows 10 DG Windows 7 Pro 64	3-year, Onsite	No	04/17
30BK0008**	EMEA	Core i7-6700 4C/3.4GHz/8MB/65W/DDR4-2133	Intel HD 530	1x8GB UDIMM DDR4-2400 Non-ECC	1x256GB SSD 2.5" SATA6Gbps Opal	None	HH DVD±RW	9-in-1	210W Bronze Fixed	None	USB / USB Optical	Windows 10 DG Windows 7 Pro 64	3-year, Onsite	No	04/17
30BK0008xx	EMEA	Core i7-6700 4C/3.4GHz/8MB/65W/DDR4-2133	Intel HD 530	1x8GB UDIMM DDR4-2400 Non-ECC	1x256GB SSD 2.5" SATA6Gbps Opal	None	HH DVD±RW	9-in-1	210W Bronze Fixed	None	USB / USB Optical	Windows 10 DG Windows 7 Pro 64	3-year, Onsite	No	04/17
30BK0009--	EMEA	Core i7-6700 4C/3.4GHz/8MB/65W/DDR4-2133	Intel HD 530	1x8GB UDIMM DDR4-2400 Non-ECC	1x1TB HDD 7.2K 3.5" SATA6Gbps	None	HH DVD±RW	9-in-1	210W Bronze Fixed	None	USB / USB Optical	Windows 10 DG Windows 7 Pro 64	3-year, Onsite	No	04/17
30BK0009**	EMEA	Core i7-6700 4C/3.4GHz/8MB/65W/DDR4-2133	Intel HD 530	1x8GB UDIMM DDR4-2400 Non-ECC	1x1TB HDD 7.2K 3.5" SATA6Gbps	None	HH DVD±RW	9-in-1	210W Bronze Fixed	None	USB / USB Optical	Windows 10 DG Windows 7 Pro 64	3-year, Onsite	No	04/17
30BK0009xx	EMEA	Core i7-6700 4C/3.4GHz/8MB/65W/DDR4-2133	Intel HD 530	1x8GB UDIMM DDR4-2400 Non-ECC	1x1TB HDD 7.2K 3.5" SATA6Gbps	None	HH DVD±RW	9-in-1	210W Bronze Fixed	None	USB / USB Optical	Windows 10 DG Windows 7 Pro 64	3-year, Onsite	No	04/17
30BK000A--	EMEA	Xeon E3-1245 v5 4C/3.5GHz/8MB/80W/DDR4-2133	Intel HD P530	1x8GB UDIMM DDR4-2400 ECC	Open	1x256GB SSD M.2 PCIe Opal	HH DVD±RW	9-in-1	210W Bronze Fixed	None	USB / USB Optical	Windows 10 DG Windows 7 Pro 64	3-year, Onsite	No	04/17
30BK000A**	EMEA	Xeon E3-1245 v5 4C/3.5GHz/8MB/80W/DDR4-2133	Intel HD P530	1x8GB UDIMM DDR4-2400 ECC	Open	1x256GB SSD M.2 PCIe Opal	HH DVD±RW	9-in-1	210W Bronze Fixed	None	USB / USB Optical	Windows 10 DG Windows 7 Pro 64	3-year, Onsite	No	04/17
30BK000Axx	EMEA	Xeon E3-1245 v5 4C/3.5GHz/8MB/80W/DDR4-2133	Intel HD P530	1x8GB UDIMM DDR4-2400 ECC	Open	1x256GB SSD M.2 PCIe Opal	HH DVD±RW	9-in-1	210W Bronze Fixed	None	USB / USB Optical	Windows 10 DG Windows 7 Pro 64	3-year, Onsite	No	04/17
30BK0012**	EMEA	Core i7-7700 4C/3.6GHz/8MB/65W/DDR4-2400	Intel HD 630	1x8GB UDIMM DDR4-2400 Non-ECC	1x1TB HDD 7.2K 3.5" SATA6Gbps	None	HH DVD±RW	9-in-1	210W Bronze Fixed	None	USB / USB Optical	Windows 10 Pro 64	3-year, Onsite	No	05/17
30BK0017**	EMEA	Xeon E3-1225 v6 4C/3.3GHz/8MB/73W/DDR4-2400	Intel HD P630	1x8GB UDIMM DDR4-2400 Non-ECC	1x1TB HDD 7.2K 3.5" SATA6Gbps	None	HH DVD±RW	9-in-1	210W Bronze Fixed	None	USB / USB Optical	Windows 10 Pro 64	3-year, Onsite	No	05/17
30BK001D**	EMEA	Core i7-6700 4C/3.4GHz/8MB/65W/DDR4-2133	Intel HD 530	1x8GB UDIMM DDR4-2400 Non-ECC	1x1TB HDD 7.2K 3.5" SATA6Gbps	None	HH DVD±RW	9-in-1	210W Bronze Fixed	None	USB / USB Optical	Windows 10 DG Windows 7 Pro 64	3-year, Onsite	No	05/17

Model	Region	Processor	Graphics	Memory	Disks	M.2 Drives	Optical	Media Reader	Power Supply	Optional Ports	Keyboard / Mouse	Operating System	Warranty	Global	Ann Date (mm/yy)
30BK001H**	EMEA	Core i5-6500 4C/3.2GHz/6MB/65W/DDR4-2133	Intel HD 530	1x8GB UDIMM DDR4-2400 Non-ECC	1x1TB HDD 7.2K 3.5" SATA6Gbps	None	HH DVD±RW	9-in-1	210W Bronze Fixed	None	USB / USB Optical	Windows 10 DG Windows 7 Pro 64	3-year, Onsite	No	05/17
30BK001P**	EMEA	Core i7-7700 4C/3.6GHz/8MB/65W/DDR4-2400	Intel HD 630 + NVIDIA Quadro P600 2GB	1x8GB UDIMM DDR4-2400 Non-ECC	1x1TB HDD 7.2K 3.5" SATA6Gbps	None	HH DVD±RW	9-in-1	210W Bronze Fixed	None	USB / USB Optical	Windows 10 Pro 64	3-year, Onsite	No	05/17
30BK001Q**	EMEA	Xeon E3-1245 v5 4C/3.5GHz/8MB/80W/DDR4-2133	Intel HD P530	1x8GB UDIMM DDR4-2400 Non-ECC	1x1TB HDD 7.2K 3.5" SATA6Gbps	None	HH DVD±RW	9-in-1	210W Bronze Fixed	None	USB / USB Optical	Windows 10 DG Windows 7 Pro 64	3-year, Onsite	No	05/17
30BK001R**	EMEA	Core i7-7700 4C/3.6GHz/8MB/65W/DDR4-2400	Intel HD 630 + NVIDIA Quadro P1000 4GB	1x8GB UDIMM DDR4-2400 Non-ECC	1x1TB HDD 7.2K 3.5" SATA6Gbps	None	HH DVD±RW	9-in-1	210W Bronze Fixed	None	USB / USB Optical	Windows 10 Pro 64	3-year, Onsite	No	05/17
30BK001S**	EMEA	Xeon E3-1275 v6 4C/3.8GHz/8MB/73W/DDR4-2400	Intel HD P630	1x8GB UDIMM DDR4-2400 Non-ECC	1x1TB HDD 7.2K 3.5" SATA6Gbps	None	HH DVD±RW	9-in-1	210W Bronze Fixed	None	USB / USB Optical	Windows 10 Pro 64	3-year, Onsite	No	05/17
30BK001T**	EMEA	Xeon E3-1245 v6 4C/3.7GHz/8MB/73W/DDR4-2400	Intel HD P630	1x8GB UDIMM DDR4-2400 Non-ECC	1x1TB HDD 7.2K 3.5" SATA6Gbps	None	HH DVD±RW	9-in-1	210W Bronze Fixed	None	USB / USB Optical	Windows 10 Pro 64	3-year, Onsite	No	05/17
30BK001V--	EMEA	Core i5-6500 4C/3.2GHz/6MB/65W/DDR4-2133	Intel HD 530	1x8GB UDIMM DDR4-2400 Non-ECC	1x256GB SSD 2.5" SATA6Gbps Opal	None	HH DVD±RW	9-in-1	210W Bronze Fixed	None	USB / USB Optical	Windows 10 DG Windows 7 Pro 64	3-year, Onsite	No	06/17
30BK001V**	EMEA	Core i5-6500 4C/3.2GHz/6MB/65W/DDR4-2133	Intel HD 530	1x8GB UDIMM DDR4-2400 Non-ECC	1x256GB SSD 2.5" SATA6Gbps Opal	None	HH DVD±RW	9-in-1	210W Bronze Fixed	None	USB / USB Optical	Windows 10 DG Windows 7 Pro 64	3-year, Onsite	No	06/17
30BK001Vxx	EMEA	Core i5-6500 4C/3.2GHz/6MB/65W/DDR4-2133	Intel HD 530	1x8GB UDIMM DDR4-2400 Non-ECC	1x256GB SSD 2.5" SATA6Gbps Opal	None	HH DVD±RW	9-in-1	210W Bronze Fixed	None	USB / USB Optical	Windows 10 DG Windows 7 Pro 64	3-year, Onsite	No	06/17
30BK001W--	EMEA	Xeon E3-1245 v6 4C/3.7GHz/8MB/73W/DDR4-2400	Intel HD P630	2x8GB UDIMM DDR4-2400 ECC	Open	1x256GB SSD M.2 PCIe Opal	HH DVD±RW	9-in-1	210W Bronze Fixed	None	USB / USB Optical	Windows 10 Pro 64	3-year, Onsite	No	08/17
30BK001W**	EMEA	Xeon E3-1245 v6 4C/3.7GHz/8MB/73W/DDR4-2400	Intel HD P630	2x8GB UDIMM DDR4-2400 ECC	Open	1x256GB SSD M.2 PCIe Opal	HH DVD±RW	9-in-1	210W Bronze Fixed	None	USB / USB Optical	Windows 10 Pro 64	3-year, Onsite	No	08/17
30BK001Wxx	EMEA	Xeon E3-1245 v6 4C/3.7GHz/8MB/73W/DDR4-2400	Intel HD P630	2x8GB UDIMM DDR4-2400 ECC	Open	1x256GB SSD M.2 PCIe Opal	HH DVD±RW	9-in-1	210W Bronze Fixed	None	USB / USB Optical	Windows 10 Pro 64	3-year, Onsite	No	08/17
30BK001X--	EMEA	Core i7-7700 4C/3.6GHz/8MB/65W/DDR4-2400	Intel HD 630	2x8GB UDIMM DDR4-2400 Non-ECC	1x256GB SSD 2.5" SATA6Gbps Opal	None	HH DVD±RW	9-in-1	210W Bronze Fixed	None	USB / USB Optical	Windows 10 Pro 64	3-year, Onsite	No	08/17
30BK001X**	EMEA	Core i7-7700 4C/3.6GHz/8MB/65W/DDR4-2400	Intel HD 630	2x8GB UDIMM DDR4-2400 Non-ECC	1x256GB SSD 2.5" SATA6Gbps Opal	None	HH DVD±RW	9-in-1	210W Bronze Fixed	None	USB / USB Optical	Windows 10 Pro 64	3-year, Onsite	No	08/17
30BK001Xxx	EMEA	Core i7-7700 4C/3.6GHz/8MB/65W/DDR4-2400	Intel HD 630	2x8GB UDIMM DDR4-2400 Non-ECC	1x256GB SSD 2.5" SATA6Gbps Opal	None	HH DVD±RW	9-in-1	210W Bronze Fixed	None	USB / USB Optical	Windows 10 Pro 64	3-year, Onsite	No	08/17

Model	Region	Processor	Graphics	Memory	Disks	M.2 Drives	Optical	Media Reader	Power Supply	Optional Ports	Keyboard / Mouse	Operating System	Warranty	Global	Ann Date (mm/yy)
30BK001Y--	EMEA	Core i5-7400 4C/3.0GHz/6MB/65W/DDR4-2400	Intel HD 630	1x4GB UDIMM DDR4-2400 Non-ECC	1x1TB HDD 7.2K 3.5" SATA6Gbps	None	HH DVD±RW	9-in-1	210W Bronze Fixed	None	USB / USB Optical	Windows 10 Pro 64	3-year, Onsite	No	08/17
30BK001Y**	EMEA	Core i5-7400 4C/3.0GHz/6MB/65W/DDR4-2400	Intel HD 630	1x4GB UDIMM DDR4-2400 Non-ECC	1x1TB HDD 7.2K 3.5" SATA6Gbps	None	HH DVD±RW	9-in-1	210W Bronze Fixed	None	USB / USB Optical	Windows 10 Pro 64	3-year, Onsite	No	08/17
30BK001Yxx	EMEA	Core i5-7400 4C/3.0GHz/6MB/65W/DDR4-2400	Intel HD 630	1x4GB UDIMM DDR4-2400 Non-ECC	1x1TB HDD 7.2K 3.5" SATA6Gbps	None	HH DVD±RW	9-in-1	210W Bronze Fixed	None	USB / USB Optical	Windows 10 Pro 64	3-year, Onsite	No	08/17
30BK0020--	EMEA	Xeon E3-1230 v6 4C/3.5GHz/8MB/72W/DDR4-2400	NVIDIA Quadro P400 2GB	1x8GB UDIMM DDR4-2400 ECC	1x256GB SSD 2.5" SATA6Gbps Opal	None	HH DVD±RW	9-in-1	210W Bronze Fixed	None	USB / USB Optical	Windows 10 Pro 64	3-year, Onsite	No	09/17
30BK0020**	EMEA	Xeon E3-1230 v6 4C/3.5GHz/8MB/72W/DDR4-2400	NVIDIA Quadro P400 2GB	1x8GB UDIMM DDR4-2400 ECC	1x256GB SSD 2.5" SATA6Gbps Opal	None	HH DVD±RW	9-in-1	210W Bronze Fixed	None	USB / USB Optical	Windows 10 Pro 64	3-year, Onsite	No	09/17
30BK0020xx	EMEA	Xeon E3-1230 v6 4C/3.5GHz/8MB/72W/DDR4-2400	NVIDIA Quadro P400 2GB	1x8GB UDIMM DDR4-2400 ECC	1x256GB SSD 2.5" SATA6Gbps Opal	None	HH DVD±RW	9-in-1	210W Bronze Fixed	None	USB / USB Optical	Windows 10 Pro 64	3-year, Onsite	No	09/17
30BK0021--	EMEA	Xeon E3-1245 v6 4C/3.7GHz/8MB/73W/DDR4-2400	Intel HD P630	1x8GB UDIMM DDR4-2400 ECC	Open	1x256GB SSD M.2 PCIe Opal	HH DVD±RW	9-in-1	210W Bronze Fixed	Serial	USB / USB Optical	Windows 10 Pro 64	3-year, Onsite	No	09/17
30BK0021**	EMEA	Xeon E3-1245 v6 4C/3.7GHz/8MB/73W/DDR4-2400	Intel HD P630	1x8GB UDIMM DDR4-2400 ECC	Open	1x256GB SSD M.2 PCIe Opal	HH DVD±RW	9-in-1	210W Bronze Fixed	Serial	USB / USB Optical	Windows 10 Pro 64	3-year, Onsite	No	09/17
30BK0021xx	EMEA	Xeon E3-1245 v6 4C/3.7GHz/8MB/73W/DDR4-2400	Intel HD P630	1x8GB UDIMM DDR4-2400 ECC	Open	1x256GB SSD M.2 PCIe Opal	HH DVD±RW	9-in-1	210W Bronze Fixed	Serial	USB / USB Optical	Windows 10 Pro 64	3-year, Onsite	No	09/17
30BK0022--	EMEA	Core i5-6500 4C/3.2GHz/6MB/65W/DDR4-2133	Intel HD 530	1x8GB UDIMM DDR4-2400 Non-ECC	1x256GB SSD 2.5" SATA6Gbps Opal	None	HH DVD±RW	9-in-1	210W Bronze Fixed	Serial	USB / USB Optical	Windows 10 DG Windows 7 Pro 64	3-year, Onsite	No	09/17
30BK0022**	EMEA	Core i5-6500 4C/3.2GHz/6MB/65W/DDR4-2133	Intel HD 530	1x8GB UDIMM DDR4-2400 Non-ECC	1x256GB SSD 2.5" SATA6Gbps Opal	None	HH DVD±RW	9-in-1	210W Bronze Fixed	Serial	USB / USB Optical	Windows 10 DG Windows 7 Pro 64	3-year, Onsite	No	09/17
30BK0022xx	EMEA	Core i5-6500 4C/3.2GHz/6MB/65W/DDR4-2133	Intel HD 530	1x8GB UDIMM DDR4-2400 Non-ECC	1x256GB SSD 2.5" SATA6Gbps Opal	None	HH DVD±RW	9-in-1	210W Bronze Fixed	Serial	USB / USB Optical	Windows 10 DG Windows 7 Pro 64	3-year, Onsite	No	09/17
30BK0023--	EMEA	Xeon E3-1245 v6 4C/3.7GHz/8MB/73W/DDR4-2400	Intel HD P630	2x8GB UDIMM DDR4-2400 ECC	Open	1x256GB SSD M.2 PCIe Opal	HH DVD±RW	9-in-1	210W Bronze Fixed	Serial	USB / USB Optical	Windows 10 Pro 64	3-year, Onsite	No	09/17
30BK0023**	EMEA	Xeon E3-1245 v6 4C/3.7GHz/8MB/73W/DDR4-2400	Intel HD P630	2x8GB UDIMM DDR4-2400 ECC	Open	1x256GB SSD M.2 PCIe Opal	HH DVD±RW	9-in-1	210W Bronze Fixed	Serial	USB / USB Optical	Windows 10 Pro 64	3-year, Onsite	No	09/17
30BK0023xx	EMEA	Xeon E3-1245 v6 4C/3.7GHz/8MB/73W/DDR4-2400	Intel HD P630	2x8GB UDIMM DDR4-2400 ECC	Open	1x256GB SSD M.2 PCIe Opal	HH DVD±RW	9-in-1	210W Bronze Fixed	Serial	USB / USB Optical	Windows 10 Pro 64	3-year, Onsite	No	09/17

Model	Region	Processor	Graphics	Memory	Disks	M.2 Drives	Optical	Media Reader	Power Supply	Optional Ports	Keyboard / Mouse	Operating System	Warranty	Global	Ann Date (mm/yy)
30BK002L--	EMEA	Xeon E3-1230 v6 4C/3.5GHz/8MB/72W/DDR4-2400	NVIDIA Quadro P400 2GB	1x8GB UDIMM DDR4-2400 ECC	1x256GB SSD 2.5" SATA6Gbps Opal	None	HH DVD±RW	9-in-1	210W Bronze Fixed	Serial + Parallel	USB / USB Optical	Windows 10 Pro 64	3-year, Onsite	No	02/18
30BK002L**	EMEA	Xeon E3-1230 v6 4C/3.5GHz/8MB/72W/DDR4-2400	NVIDIA Quadro P400 2GB	1x8GB UDIMM DDR4-2400 ECC	1x256GB SSD 2.5" SATA6Gbps Opal	None	HH DVD±RW	9-in-1	210W Bronze Fixed	Serial + Parallel	USB / USB Optical	Windows 10 Pro 64	3-year, Onsite	No	02/18
30BK002Lxx	EMEA	Xeon E3-1230 v6 4C/3.5GHz/8MB/72W/DDR4-2400	NVIDIA Quadro P400 2GB	1x8GB UDIMM DDR4-2400 ECC	1x256GB SSD 2.5" SATA6Gbps Opal	None	HH DVD±RW	9-in-1	210W Bronze Fixed	Serial + Parallel	USB / USB Optical	Windows 10 Pro 64	3-year, Onsite	No	02/18
30BK002M--	EMEA	Xeon E3-1245 v6 4C/3.7GHz/8MB/73W/DDR4-2400	Intel HD P630	1x8GB UDIMM DDR4-2400 ECC	Open	1x256GB SSD M.2 PCIe Opal	HH DVD±RW	9-in-1	210W Bronze Fixed	Serial + Parallel	USB / USB Optical	Windows 10 Pro 64	3-year, Onsite	No	02/18
30BK002M**	EMEA	Xeon E3-1245 v6 4C/3.7GHz/8MB/73W/DDR4-2400	Intel HD P630	1x8GB UDIMM DDR4-2400 ECC	Open	1x256GB SSD M.2 PCIe Opal	HH DVD±RW	9-in-1	210W Bronze Fixed	Serial + Parallel	USB / USB Optical	Windows 10 Pro 64	3-year, Onsite	No	02/18
30BK002Mxx	EMEA	Xeon E3-1245 v6 4C/3.7GHz/8MB/73W/DDR4-2400	Intel HD P630	1x8GB UDIMM DDR4-2400 ECC	Open	1x256GB SSD M.2 PCIe Opal	HH DVD±RW	9-in-1	210W Bronze Fixed	Serial + Parallel	USB / USB Optical	Windows 10 Pro 64	3-year, Onsite	No	02/18
30BK002N--	EMEA	Xeon E3-1245 v6 4C/3.7GHz/8MB/73W/DDR4-2400	Intel HD P630	1x16GB UDIMM DDR4-2400 ECC	Open	1x256GB SSD M.2 PCIe Opal	HH DVD±RW	9-in-1	210W Bronze Fixed	Serial + Parallel	USB / USB Optical	Windows 10 Pro 64	3-year, Onsite	No	02/18
30BK002N**	EMEA	Xeon E3-1245 v6 4C/3.7GHz/8MB/73W/DDR4-2400	Intel HD P630	1x16GB UDIMM DDR4-2400 ECC	Open	1x256GB SSD M.2 PCIe Opal	HH DVD±RW	9-in-1	210W Bronze Fixed	Serial + Parallel	USB / USB Optical	Windows 10 Pro 64	3-year, Onsite	No	02/18
30BK002Nxx	EMEA	Xeon E3-1245 v6 4C/3.7GHz/8MB/73W/DDR4-2400	Intel HD P630	1x16GB UDIMM DDR4-2400 ECC	Open	1x256GB SSD M.2 PCIe Opal	HH DVD±RW	9-in-1	210W Bronze Fixed	Serial + Parallel	USB / USB Optical	Windows 10 Pro 64	3-year, Onsite	No	02/18
30BK002P--	EMEA	Xeon E3-1225 v6 4C/3.3GHz/8MB/73W/DDR4-2400	Intel HD P630 + NVIDIA Quadro P600 2GB	1x8GB UDIMM DDR4-2400 ECC	1x1TB HDD 7.2K 3.5" SATA6Gbps	None	HH DVD±RW	9-in-1	210W Bronze Fixed	Serial + Parallel	USB / USB Optical	Windows 10 Pro 64	3-year, Onsite	No	02/18
30BK002P**	EMEA	Xeon E3-1225 v6 4C/3.3GHz/8MB/73W/DDR4-2400	Intel HD P630 + NVIDIA Quadro P600 2GB	1x8GB UDIMM DDR4-2400 ECC	1x1TB HDD 7.2K 3.5" SATA6Gbps	None	HH DVD±RW	9-in-1	210W Bronze Fixed	Serial + Parallel	USB / USB Optical	Windows 10 Pro 64	3-year, Onsite	No	02/18
30BK002Pxx	EMEA	Xeon E3-1225 v6 4C/3.3GHz/8MB/73W/DDR4-2400	Intel HD P630 + NVIDIA Quadro P600 2GB	1x8GB UDIMM DDR4-2400 ECC	1x1TB HDD 7.2K 3.5" SATA6Gbps	None	HH DVD±RW	9-in-1	210W Bronze Fixed	Serial + Parallel	USB / USB Optical	Windows 10 Pro 64	3-year, Onsite	No	02/18
30BK002Q--	EMEA	Xeon E3-1230 v6 4C/3.5GHz/8MB/72W/DDR4-2400	NVIDIA Quadro P600 2GB	1x8GB UDIMM DDR4-2400 ECC	1x256GB SSD 2.5" SATA6Gbps Opal	None	HH DVD±RW	9-in-1	210W Bronze Fixed	Serial + Parallel	USB / USB Optical	Windows 10 Pro 64	3-year, Onsite	No	02/18
30BK002Q**	EMEA	Xeon E3-1230 v6 4C/3.5GHz/8MB/72W/DDR4-2400	NVIDIA Quadro P600 2GB	1x8GB UDIMM DDR4-2400 ECC	1x256GB SSD 2.5" SATA6Gbps Opal	None	HH DVD±RW	9-in-1	210W Bronze Fixed	Serial + Parallel	USB / USB Optical	Windows 10 Pro 64	3-year, Onsite	No	02/18
30BK002Qxx	EMEA	Xeon E3-1230 v6 4C/3.5GHz/8MB/72W/DDR4-2400	NVIDIA Quadro P600 2GB	1x8GB UDIMM DDR4-2400 ECC	1x256GB SSD 2.5" SATA6Gbps Opal	None	HH DVD±RW	9-in-1	210W Bronze Fixed	Serial + Parallel	USB / USB Optical	Windows 10 Pro 64	3-year, Onsite	No	02/18

Model	Region	Processor	Graphics	Memory	Disks	M.2 Drives	Optical	Media Reader	Power Supply	Optional Ports	Keyboard / Mouse	Operating System	Warranty	Global	Ann Date (mm/yy)
30BK002R--	EMEA	Xeon E3-1245 v6 4C/3.7GHz/8MB/73W/DDR4-2400	Intel HD P630	1x8GB UDIMM DDR4-2400 ECC	Open	1x256GB SSD M.2 PCIe Opal	HH DVD±RW	9-in-1	210W Bronze Fixed	None	USB / USB Optical	Windows 10 Pro 64	3-year, Onsite	No	03/18
30BK002R**	EMEA	Xeon E3-1245 v6 4C/3.7GHz/8MB/73W/DDR4-2400	Intel HD P630	1x8GB UDIMM DDR4-2400 ECC	Open	1x256GB SSD M.2 PCIe Opal	HH DVD±RW	9-in-1	210W Bronze Fixed	None	USB / USB Optical	Windows 10 Pro 64	3-year, Onsite	No	03/18
30BK002Rxx	EMEA	Xeon E3-1245 v6 4C/3.7GHz/8MB/73W/DDR4-2400	Intel HD P630	1x8GB UDIMM DDR4-2400 ECC	Open	1x256GB SSD M.2 PCIe Opal	HH DVD±RW	9-in-1	210W Bronze Fixed	None	USB / USB Optical	Windows 10 Pro 64	3-year, Onsite	No	03/18
30BK002B--	EMEA	Xeon E3-1225 v6 4C/3.3GHz/8MB/73W/DDR4-2400	Intel HD P630 + NVIDIA Quadro P600 2GB	1x8GB UDIMM DDR4-2400 ECC	1x1TB HDD 7.2K 3.5" SATA6Gbps	None	HH DVD±RW	9-in-1	210W Platinum Fixed	None	None / USB Optical	Windows 10 Pro 64	3-year, Onsite	No	12/17
30BK002C--	EMEA	Xeon E3-1225 v6 4C/3.3GHz/8MB/73W/DDR4-2400	Intel HD P630 + NVIDIA Quadro P600 2GB	1x8GB UDIMM DDR4-2400 ECC	1x1TB HDD 7.2K 3.5" SATA6Gbps	None	HH DVD±RW	9-in-1	210W Platinum Fixed	None	USB / USB Optical	Windows 10 Pro 64	3-year, Onsite	No	01/18
30BK002C**	EMEA	Xeon E3-1225 v6 4C/3.3GHz/8MB/73W/DDR4-2400	Intel HD P630 + NVIDIA Quadro P600 2GB	1x8GB UDIMM DDR4-2400 ECC	1x1TB HDD 7.2K 3.5" SATA6Gbps	None	HH DVD±RW	9-in-1	210W Platinum Fixed	None	USB / USB Optical	Windows 10 Pro 64	3-year, Onsite	No	01/18
30BK002Cxx	EMEA	Xeon E3-1225 v6 4C/3.3GHz/8MB/73W/DDR4-2400	Intel HD P630 + NVIDIA Quadro P600 2GB	1x8GB UDIMM DDR4-2400 ECC	1x1TB HDD 7.2K 3.5" SATA6Gbps	None	HH DVD±RW	9-in-1	210W Platinum Fixed	None	USB / USB Optical	Windows 10 Pro 64	3-year, Onsite	No	01/18
30BK002D--	EMEA	Xeon E3-1230 v6 4C/3.5GHz/8MB/72W/DDR4-2400	NVIDIA Quadro P600 2GB	1x8GB UDIMM DDR4-2400 ECC	Open	1x256GB SSD M.2 PCIe Opal	HH DVD±RW	9-in-1	210W Platinum Fixed	None	USB / USB Optical	Windows 10 Pro 64	3-year, Onsite	No	01/18
30BK002D**	EMEA	Xeon E3-1230 v6 4C/3.5GHz/8MB/72W/DDR4-2400	NVIDIA Quadro P600 2GB	1x8GB UDIMM DDR4-2400 ECC	Open	1x256GB SSD M.2 PCIe Opal	HH DVD±RW	9-in-1	210W Platinum Fixed	None	USB / USB Optical	Windows 10 Pro 64	3-year, Onsite	No	01/18
30BK002Dxx	EMEA	Xeon E3-1230 v6 4C/3.5GHz/8MB/72W/DDR4-2400	NVIDIA Quadro P600 2GB	1x8GB UDIMM DDR4-2400 ECC	Open	1x256GB SSD M.2 PCIe Opal	HH DVD±RW	9-in-1	210W Platinum Fixed	None	USB / USB Optical	Windows 10 Pro 64	3-year, Onsite	No	01/18
30BK001C**	EMEA	Core i5-7500 4C/3.4GHz/6MB/65W/DDR4-2400	Intel HD 630	1x8GB UDIMM DDR4-2400 Non-ECC	1x1TB HDD 7.2K 3.5" SATA6Gbps	None	HH DVD±RW	9-in-1	210W Bronze Fixed	None	USB / USB Optical	Windows 10 Pro 64	3-year, Onsite	No	05/17
30BK001M**	EMEA	Xeon E3-1225 v5 4C/3.3GHz/8MB/80W/DDR4-2133	Intel HD P530	1x8GB UDIMM DDR4-2400 Non-ECC	1x1TB HDD 7.2K 3.5" SATA6Gbps	None	HH DVD±RW	9-in-1	210W Bronze Fixed	None	USB / USB Optical	Windows 10 DG Windows 7 Pro 64	3-year, Onsite	No	05/17
30BK001MUS	US	Xeon E3-1225 v5 4C/3.3GHz/8MB/80W/DDR4-2133	Intel HD P530	1x8GB UDIMM DDR4-2400 Non-ECC	1x1TB HDD 7.2K 3.5" SATA6Gbps	None	HH DVD±RW	9-in-1	210W Bronze Fixed	None	USB / USB Optical	Windows 10 DG Windows 7 Pro 64	3-year, Onsite	No	04/17
30BK001NUS	US	Core i5-6500 4C/3.2GHz/6MB/65W/DDR4-2133	Intel HD 530 + NVIDIA Quadro P400 2GB	1x8GB UDIMM DDR4-2400 Non-ECC	1x1TB HDD 7.2K 3.5" SATA6Gbps	None	HH DVD±RW	9-in-1	210W Bronze Fixed	None	USB / USB Optical	Windows 10 DG Windows 7 Pro 64	3-year, Onsite	No	04/17
30BK001CUS	US	Core i5-7500 4C/3.4GHz/6MB/65W/DDR4-2400	Intel HD 630	1x8GB UDIMM DDR4-2400 Non-ECC	1x1TB HDD 7.2K 3.5" SATA6Gbps	None	HH DVD±RW	9-in-1	210W Bronze Fixed	None	USB / USB Optical	Windows 10 Pro 64	3-year, Onsite	No	04/17

Model	Region	Processor	Graphics	Memory	Disks	M.2 Drives	Optical	Media Reader	Power Supply	Optional Ports	Keyboard / Mouse	Operating System	Warranty	Global	Ann Date (mm/yy)
30BK002EUS	US	Xeon E3-1245 v6 4C/3.7GHz/8MB/73W/DDR4-2400	Intel HD P630	1x8GB UDIMM DDR4-2400 Non-ECC	Open	1x256GB SSD M.2 PCIe Opal	HH DVD±RW	9-in-1	210W Platinum Fixed	None	USB / USB Optical	Windows 10 Pro 64	3-year, Onsite	No	01/18
30BK002FUS	US	Xeon E3-1240 v6 4C/3.7GHz/8MB/72W/DDR4-2400	NVIDIA Quadro P600 2GB	1x16GB UDIMM DDR4- 2400 Non-ECC	1x1TB HDD 7.2K 3.5" SATA6Gbps	None	HH DVD±RW	9-in-1	210W Platinum Fixed	None	USB / USB Optical	Windows 10 Pro 64	3-year, Onsite	No	01/18
30BK002GUS	US	Xeon E3-1240 v5 4C/3.5GHz/8MB/80W/DDR4-2133	NVIDIA Quadro P600 2GB	1x8GB UDIMM DDR4-2400 Non-ECC	1x1TB HDD 7.2K 3.5" SATA6Gbps	None	HH DVD±RW	9-in-1	210W Platinum Fixed	None	USB / USB Optical	Windows 10 DG Windows 7 Pro 64	3-year, Onsite	No	01/18
30BK002HUS	US	Xeon E3-1245 v6 4C/3.7GHz/8MB/73W/DDR4-2400	Intel HD P630	1x16GB UDIMM DDR4- 2400 Non-ECC	Open	1x512GB SSD M.2 PCIe Opal	HH DVD±RW	9-in-1	210W Platinum Fixed	None	USB / USB Optical	Windows 10 Pro 64	3-year, Onsite	No	01/18
30BK002JUS	US	Xeon E3-1245 v5 4C/3.5GHz/8MB/80W/DDR4-2133	Intel HD P530	1x8GB UDIMM DDR4-2400 Non-ECC	Open	1x512GB SSD M.2 PCIe Opal	HH DVD±RW	9-in-1	210W Platinum Fixed	None	USB / USB Optical	Windows 10 DG Windows 7 Pro 64	3-year, Onsite	No	01/18
30BK002KUS	US	Xeon E3-1240 v5 4C/3.5GHz/8MB/80W/DDR4-2133	NVIDIA Quadro P1000 4GB	1x16GB UDIMM DDR4- 2400 Non-ECC	Open	1x512GB SSD M.2 PCIe Opal	HH DVD±RW	9-in-1	210W Platinum Fixed	None	USB / USB Optical	Windows 10 DG Windows 7 Pro 64	3-year, Onsite	No	01/18
30BK002SUS	US	Core i7-7700 4C/3.6GHz/8MB/65W/DDR4-2400	Intel HD 630 + NVIDIA Quadro P600 2GB	1x16GB UDIMM DDR4- 2400 Non-ECC	1x1TB HDD 7.2K 3.5" SATA6Gbps	None	HH DVD±RW	9-in-1	210W Platinum Fixed	None	USB / USB Optical	Windows 10 Pro 64	3-year, Onsite	No	03/18
30BK002TUS	US	Core i5-7500 4C/3.4GHz/6MB/65W/DDR4-2400	Intel HD 630 + NVIDIA Quadro P600 2GB	1x8GB UDIMM DDR4-2400 Non-ECC	1x1TB HDD 7.2K 3.5" SATA6Gbps	None	HH DVD±RW	9-in-1	210W Platinum Fixed	None	USB / USB Optical	Windows 10 Pro 64	3-year, Onsite	No	03/18
30BK0024US	US	Core i7-7700 4C/3.6GHz/8MB/65W/DDR4-2400	Intel HD 630	1x8GB UDIMM DDR4-2400 Non-ECC	1x1TB HDD 7.2K 3.5" SATA6Gbps	16GB Optane Memory	HH DVD±RW	9-in-1	210W Platinum Fixed	None	USB / USB Optical	Windows 10 Pro 64	3-year, Onsite	No	09/17
30BK001HUS	US	Core i5-6500 4C/3.2GHz/6MB/65W/DDR4-2133	Intel HD 530	1x8GB UDIMM DDR4-2400 Non-ECC	1x1TB HDD 7.2K 3.5" SATA6Gbps	None	HH DVD±RW	9-in-1	210W Bronze Fixed	None	USB / USB Optical	Windows 10 DG Windows 7 Pro 64	3-year, Onsite	No	04/17
30BK001JUS	US	Core i3-7100 2C/3.9GHz/3MB/51W/DDR4-2400	Intel HD 630	1x8GB UDIMM DDR4-2400 Non-ECC	1x1TB HDD 7.2K 3.5" SATA6Gbps	None	HH DVD±RW	9-in-1	210W Bronze Fixed	None	USB / USB Optical	Windows 10 Pro 64	3-year, Onsite	No	04/17
30BK001KUS	US	Xeon E3-1245 v6 4C/3.7GHz/8MB/73W/DDR4-2400	Intel HD P630	1x8GB UDIMM DDR4-2400 Non-ECC	Open	1x256GB SSD M.2 PCIe Opal	HH DVD±RW	9-in-1	210W Bronze Fixed	None	USB / USB Optical	Windows 10 Pro 64	3-year, Onsite	No	04/17
30BK001LUS	US	Core i7-7700 4C/3.6GHz/8MB/65W/DDR4-2400	Intel HD 630 + NVIDIA Quadro P1000 4GB	2x8GB UDIMM DDR4-2400 Non-ECC	Open	1x512GB SSD M.2 PCIe Opal	HH DVD±RW	9-in-1	210W Bronze Fixed	None	USB / USB Optical	Windows 10 Pro 64	3-year, Onsite	No	04/17
30BK001DUS	US	Core i7-6700 4C/3.4GHz/8MB/65W/DDR4-2133	Intel HD 530	1x8GB UDIMM DDR4-2400 Non-ECC	1x1TB HDD 7.2K 3.5" SATA6Gbps	None	HH DVD±RW	9-in-1	210W Bronze Fixed	None	USB / USB Optical	Windows 10 DG Windows 7 Pro 64	3-year, Onsite	No	04/17
30BK001EUS	US	Xeon E3-1240 v5 4C/3.5GHz/8MB/80W/DDR4-2133	NVIDIA Quadro P600 2GB	2x8GB UDIMM DDR4-2400 Non-ECC	Open	1x512GB SSD M.2 PCIe Opal	HH DVD±RW	9-in-1	210W Bronze Fixed	None	USB / USB Optical	Windows 10 DG Windows 7 Pro 64	3-year, Onsite	No	04/17

Model	Region	Processor	Graphics	Memory	Disks	M.2 Drives	Optical	Media Reader	Power Supply	Optional Ports	Keyboard / Mouse	Operating System	Warranty	Global	Ann Date (mm/yy)
30BK001FUS	US	Core i3-7100 2C/3.9GHz/3MB/51W/DDR4-2400	Intel HD 630 + NVIDIA Quadro P400 2GB	1x8GB UDIMM DDR4-2400 Non-ECC	1x1TB HDD 7.2K 3.5" SATA6Gbps	None	HH DVD±RW	9-in-1	210W Bronze Fixed	None	USB / USB Optical	Windows 10 Pro 64	3-year, Onsite	No	04/17
30BK001GUS	US	Xeon E3-1240 v5 4C/3.5GHz/8MB/80W/DDR4-2133	NVIDIA Quadro P1000 4GB	2x8GB UDIMM DDR4-2400 Non-ECC	Open	1x512GB SSD M.2 PCIe Opal	HH DVD±RW	9-in-1	210W Bronze Fixed	PS/2	USB / USB Optical	Windows 10 DG Windows 7 Pro 64	3-year, Onsite	No	04/17
30BK0017US	US	Xeon E3-1225 v6 4C/3.3GHz/8MB/73W/DDR4-2400	Intel HD P630	1x8GB UDIMM DDR4-2400 Non-ECC	1x1TB HDD 7.2K 3.5" SATA6Gbps	None	HH DVD±RW	9-in-1	210W Bronze Fixed	None	USB / USB Optical	Windows 10 Pro 64	3-year, Onsite	No	04/17
30BK0018US	US	Core i3-6100 2C/3.7GHz/3MB/51W/DDR4-2133	Intel HD 530	1x8GB UDIMM DDR4-2400 Non-ECC	1x1TB HDD 7.2K 3.5" SATA6Gbps	None	HH DVD±RW	9-in-1	210W Bronze Fixed	None	USB / USB Optical	Windows 10 DG Windows 7 Pro 64	3-year, Onsite	No	04/17
30BK0019US	US	Xeon E3-1245 v5 4C/3.5GHz/8MB/80W/DDR4-2133	Intel HD P530	1x8GB UDIMM DDR4-2400 Non-ECC	Open	1x512GB SSD M.2 PCIe Opal	HH DVD±RW	9-in-1	210W Bronze Fixed	PS/2	USB / USB Optical	Windows 10 DG Windows 7 Pro 64	3-year, Onsite	No	04/17
30BK001AUS	US	Core i7-6700 4C/3.4GHz/8MB/65W/DDR4-2133	Intel HD 530 + NVIDIA Quadro P600 2GB	1x8GB UDIMM DDR4-2400 Non-ECC	1x1TB HDD 7.2K 3.5" SATA6Gbps	None	HH DVD±RW	9-in-1	210W Bronze Fixed	None	USB / USB Optical	Windows 10 DG Windows 7 Pro 64	3-year, Onsite	No	04/17
30BK001BUS	US	Core i7-7700 4C/3.6GHz/8MB/65W/DDR4-2400	Intel HD 630	1x8GB UDIMM DDR4-2400 Non-ECC	Open	1x256GB SSD M.2 PCIe Opal	HH DVD±RW	9-in-1	210W Bronze Fixed	PS/2	USB / USB Optical	Windows 10 Pro 64	3-year, Onsite	No	04/17
30BK0012US	US	Core i7-7700 4C/3.6GHz/8MB/65W/DDR4-2400	Intel HD 630	1x8GB UDIMM DDR4-2400 Non-ECC	1x1TB HDD 7.2K 3.5" SATA6Gbps	None	HH DVD±RW	9-in-1	210W Bronze Fixed	None	USB / USB Optical	Windows 10 Pro 64	3-year, Onsite	No	04/17
30BK0013US	US	Core i3-6100 2C/3.7GHz/3MB/51W/DDR4-2133	Intel HD 530 + NVIDIA Quadro P400 2GB	1x8GB UDIMM DDR4-2400 Non-ECC	1x1TB HDD 7.2K 3.5" SATA6Gbps	None	HH DVD±RW	9-in-1	210W Bronze Fixed	None	USB / USB Optical	Windows 10 DG Windows 7 Pro 64	3-year, Onsite	No	04/17
30BK0014US	US	Xeon E3-1240 v6 4C/3.7GHz/8MB/72W/DDR4-2400	NVIDIA Quadro P1000 4GB	1x8GB UDIMM DDR4-2400 Non-ECC	1x1TB HDD 7.2K 3.5" SATA6Gbps	None	HH DVD±RW	9-in-1	210W Bronze Fixed	None	USB / USB Optical	Windows 10 Pro 64	3-year, Onsite	No	04/17
30BK0015US	US	Core i5-6500 4C/3.2GHz/6MB/65W/DDR4-2133	Intel HD 530 + NVIDIA Quadro P400 2GB	1x8GB UDIMM DDR4-2400 Non-ECC	1x512GB SSD 2.5" SATA6Gbps Opal	None	HH DVD±RW	9-in-1	210W Bronze Fixed	None	USB / USB Optical	Windows 10 DG Windows 7 Pro 64	3-year, Onsite	No	04/17
30BK0016US	US	Core i5-7500 4C/3.4GHz/6MB/65W/DDR4-2400	Intel HD 630 + NVIDIA Quadro P400 2GB	1x8GB UDIMM DDR4-2400 Non-ECC	1x512GB SSD 2.5" SATA6Gbps Opal	None	HH DVD±RW	9-in-1	210W Bronze Fixed	None	USB / USB Optical	Windows 10 Pro 64	3-year, Onsite	No	04/17
30BK000LUS	US	Core i5-6500 4C/3.2GHz/6MB/65W/DDR4-2133	Intel HD 530	1x8GB UDIMM DDR4-2400 Non-ECC	Open	1x256GB SSD M.2 PCIe Opal	HH DVD±RW	9-in-1	210W Bronze Fixed	None	USB / USB Optical	Windows 10 DG Windows 7 Pro 64	3-year, Onsite	No	04/17
30BK000MUS	US	Xeon E3-1240 v6 4C/3.7GHz/8MB/72W/DDR4-2400	NVIDIA Quadro P600 2GB	2x8GB UDIMM DDR4-2400 Non-ECC	1x1TB HDD 7.2K 3.5" SATA6Gbps	None	HH DVD±RW	9-in-1	210W Bronze Fixed	None	USB / USB Optical	Windows 10 Pro 64	3-year, Onsite	No	04/17
30BK000NUS	US	Core i7-7700 4C/3.6GHz/8MB/65W/DDR4-2400	Intel HD 630 + NVIDIA Quadro P600 2GB	1x8GB UDIMM DDR4-2400 Non-ECC	1x1TB HDD 7.2K 3.5" SATA6Gbps	None	HH DVD±RW	9-in-1	210W Bronze Fixed	None	USB / USB Optical	Windows 10 Pro 64	3-year, Onsite	No	04/17

Model	Region	Processor	Graphics	Memory	Disks	M.2 Drives	Optical	Media Reader	Power Supply	Optional Ports	Keyboard / Mouse	Operating System	Warranty	Global	Ann Date (mm/yy)
30BK000PUS	US	Core i5-7500 4C/3.4GHz/6MB/65W/DDR4-2400	Intel HD 630 + NVIDIA Quadro P400 2GB	1x8GB UDIMM DDR4-2400 Non-ECC	1x1TB HDD 7.2K 3.5" SATA6Gbps	None	HH DVD±RW	9-in-1	210W Bronze Fixed	None	USB / USB Optical	Windows 10 Pro 64	3-year, Onsite	No	04/17
30BK000QUS	US	Core i7-6700 4C/3.4GHz/8MB/65W/DDR4-2133	Intel HD 530 + NVIDIA Quadro P1000 4GB	1x8GB UDIMM DDR4-2400 Non-ECC	1x1TB HDD 7.2K 3.5" SATA6Gbps	None	HH DVD±RW	9-in-1	210W Bronze Fixed	None	USB / USB Optical	Windows 10 DG Windows 7 Pro 64	3-year, Onsite	No	04/17
30BK000RUS	US	Xeon E3-1245 v5 4C/3.5GHz/8MB/80W/DDR4-2133	Intel HD P530	1x8GB UDIMM DDR4-2400 Non-ECC	Open	1x256GB SSD M.2 PCIe Opal	HH DVD±RW	9-in-1	210W Bronze Fixed	None	USB / USB Optical	Windows 10 DG Windows 7 Pro 64	3-year, Onsite	No	04/17
30BK000SUS	US	Xeon E3-1240 v5 4C/3.5GHz/8MB/80W/DDR4-2133	NVIDIA Quadro P600 2GB	1x8GB UDIMM DDR4-2400 Non-ECC	1x1TB HDD 7.2K 3.5" SATA6Gbps	None	HH DVD±RW	9-in-1	210W Bronze Fixed	None	USB / USB Optical	Windows 10 DG Windows 7 Pro 64	3-year, Onsite	No	04/17
30BK000TUS	US	Core i5-7600 4C/3.5GHz/6MB/65W/DDR4-2400	Intel HD 630	1x8GB UDIMM DDR4-2400 Non-ECC	1x1TB HDD 7.2K 3.5" SATA6Gbps	None	HH DVD±RW	9-in-1	210W Bronze Fixed	None	USB / USB Optical	Windows 10 Pro 64	3-year, Onsite	No	04/17
30BK000UUS	US	Core i7-6700 4C/3.4GHz/8MB/65W/DDR4-2133	Intel HD 530	1x8GB UDIMM DDR4-2400 Non-ECC	Open	1x256GB SSD M.2 PCIe Opal	HH DVD±RW	9-in-1	210W Bronze Fixed	PS/2	USB / USB Optical	Windows 10 DG Windows 7 Pro 64	3-year, Onsite	No	04/17
30BK000VUS	US	Xeon E3-1245 v6 4C/3.7GHz/8MB/73W/DDR4-2400	Intel HD P630	2x8GB UDIMM DDR4-2400 Non-ECC	Open	1x512GB SSD M.2 PCIe Opal	HH DVD±RW	9-in-1	210W Bronze Fixed	PS/2	USB / USB Optical	Windows 10 Pro 64	3-year, Onsite	No	04/17
30BK000WUS	US	Core i7-6700 4C/3.4GHz/8MB/65W/DDR4-2133	Intel HD 530 + NVIDIA Quadro P1000 4GB	2x8GB UDIMM DDR4-2400 Non-ECC	Open	1x512GB SSD M.2 PCIe Opal	HH DVD±RW	9-in-1	210W Bronze Fixed	None	USB / USB Optical	Windows 10 DG Windows 7 Pro 64	3-year, Onsite	No	04/17
30BK000XUS	US	Xeon E3-1240 v6 4C/3.7GHz/8MB/72W/DDR4-2400	NVIDIA Quadro P600 2GB	2x8GB UDIMM DDR4-2400 Non-ECC	Open	1x512GB SSD M.2 PCIe Opal	HH DVD±RW	9-in-1	210W Bronze Fixed	None	USB / USB Optical	Windows 10 Pro 64	3-year, Onsite	No	04/17
30BK000YUS	US	Core i7-7700 4C/3.6GHz/8MB/65W/DDR4-2400	Intel HD 630 + NVIDIA Quadro P1000 4GB	1x8GB UDIMM DDR4-2400 Non-ECC	1x1TB HDD 7.2K 3.5" SATA6Gbps	None	HH DVD±RW	9-in-1	210W Bronze Fixed	None	USB / USB Optical	Windows 10 Pro 64	3-year, Onsite	No	04/17
30BK0010US	US	Xeon E3-1240 v5 4C/3.5GHz/8MB/80W/DDR4-2133	NVIDIA Quadro P1000 4GB	1x8GB UDIMM DDR4-2400 Non-ECC	1x1TB HDD 7.2K 3.5" SATA6Gbps	None	HH DVD±RW	9-in-1	210W Bronze Fixed	None	USB / USB Optical	Windows 10 DG Windows 7 Pro 64	3-year, Onsite	No	04/17
30BK0011US	US	Core i5-7500 4C/3.4GHz/6MB/65W/DDR4-2400	Intel HD 630	1x8GB UDIMM DDR4-2400 Non-ECC	Open	1x256GB SSD M.2 PCIe Opal	HH DVD±RW	9-in-1	210W Bronze Fixed	None	USB / USB Optical	Windows 10 Pro 64	3-year, Onsite	No	04/17



ThinkStation P320 Tiny Platform Specifications

Components	Specification									
Chipset	Intel Q270 Chipset									
Intel AMT	Intel Active Management Technology 11									
Processor	One Intel "Kaby Lake" or "Skylake" processor as listed: "Kaby Lake"									
	Core i7-7700T 4C/2.9GHz/8MB/35W/DDR4-2400/Intel HD 630									
	Core i7-7700 4C/3.6GHz/8MB/65W/DDR4-2400/Intel HD 630									
	Core i5-7600T 4C/2.8GHz/6MB/35W/DDR4-2400/Intel HD 630									
	Core i5-7600 4C/3.5GHz/6MB/65W/DDR4-2400/Intel HD 630									
	Core i5-7500T 4C/2.7GHz/6MB/35W/DDR4-2400/Intel HD 630									
	Core i5-7500 4C/3.4GHz/6MB/65W/DDR4-2400/Intel HD 630									
	Core i5-7400T 4C/2.4GHz/6MB/35W/DDR4-2400/Intel HD 630									
	Core i5-7400 4C/3.0GHz/6MB/65W/DDR4-2400/Intel HD 630									
	Core i3-7300T 2C/3.5GHz/4MB/35W/DDR4-2400/Intel HD 630									
	Core i3-7300 2C/4.0GHz/4MB/51W/DDR4-2400/Intel HD 630									
	Core i3-7100T 2C/3.4GHz/3MB/35W/DDR4-2400/Intel HD 630									
	Core i3-7100 2C/3.9GHz/3MB/51W/DDR4-2400/Intel HD 630									
	"Skylake"									
	Core i7-6700T 4C/2.8GHz/8MB/35W/DDR4-2133/Intel HD 530									
Core i7-6700 4C/3.4GHz/8MB/65W/DDR4-2133/Intel HD 530										
Core i5-6500T 4C/2.5GHz/6MB/35W/DDR4-2133/Intel HD 530										
Core i5-6500 4C/3.2GHz/6MB/65W/DDR4-2133/Intel HD 530										
Core i3-6100T 2C/3.2GHz/3MB/35W/DDR4-2133/Intel HD 530										
Core i3-6100 2C/3.7GHz/3MB/51W/DDR4-2133/Intel HD 530										
"Kaby Lake" processors cannot support Windows 7										
Memory DIMM slots	2 DIMM slots, 2-channel (integrated memory controller in processor)									
Memory type/capacity	Up to 32GB (2 x 16GB), non-ECC, DDR4-2400. SO-DIMM. "Skylake" processor supports up to DDR4-2133									
Graphics	Integrated Intel HD 630 in "Kaby Lake" processors; or Intel HD 530 in "Skylake" processors. Works along with optional discrete graphics to support multi-display, enables two display connectors (2 DP) on rear. Supports one optional NVIDIA Quadro P600 on 35W processor models									
	<table border="1"> <thead> <tr> <th>Adapter</th> <th>Cores</th> <th>Memory</th> <th>Power</th> <th>Connectors</th> </tr> </thead> <tbody> <tr> <td>Quadro P600</td> <td>384</td> <td>2GB</td> <td>40W</td> <td>4xmDP</td> </tr> </tbody> </table>	Adapter	Cores	Memory	Power	Connectors	Quadro P600	384	2GB	40W
Adapter	Cores	Memory	Power	Connectors						
Quadro P600	384	2GB	40W	4xmDP						
Max simultaneous displays	Up to 6 displays (2 x DP plus 4 x mDP) with integrated Intel HD (2 x DP) and NVIDIA Quadro P600 (4 x mDP)									
Storage	Up to one 2.5" disk drive (HDD or SSD) plus one M.2 NVMe SSD, or up to two M.2 SSD on Intel HD only models. Or up to one M.2 SSD on Quadro P600 models. 2nd M.2 SSD on Quadro P600 models is special bid only. 2.5" drive cannot work with Quadro P600. All US models come with Quadro P600 and only support M.2 SSD									
Supporting disk drives	2.5" SATA6Gbs HDD 500GB 7.2K/1TB 5.4K									
	2.5" SATA6Gbs SSD 128GB									
	M.2 NVMe SSD 128GB/256GB Opal/512GB Opal/1TB Opal									
Optical drive	Optional one 9.0mm optical drive via optical drive kit, DVD-ROM or DVD±RW. VESA mount is needed, consumes one USB 3.0 port									
Media reader	None									
Power supply	135W AC/DC adapter, autosensing, 88% PSU									
Onboard Ethernet	One onboard gigabit ethernet. Intel I219LM. supports Wake-on-LAN									
WLAN/Bluetooth	Supports the following 11ac wireless, M.2 card: <ul style="list-style-type: none"> Qualcomm Atheros QCA9377A, dual band, Wi-Fi + Bluetooth 4.2, 1x1 (BT4.0 for Egypt models) Qualcomm Atheros QCA6174A, dual band, Wi-Fi + Bluetooth 4.2, 2x2 (BT4.0 for Egypt and US models) Intel Dual Band Wireless-AC 3165, Wi-Fi + Bluetooth 4.0, 1x1 Intel Dual Band Wireless-AC 8265, Wi-Fi + Bluetooth 4.2, 2x2 Intel Dual Band Wireless-AC 8265, Wi-Fi + Bluetooth 4.2, 2x2, vPro 									
HD Audio	Realtek ALC294 codec									
TPM	Standard, TCG 2.0-compliant									
Front ports	Two USB 3.0 (one Always On), one microphone (3.5mm), one combo audio/microphone jack (3.5mm)									
Rear ports	2 DisplayPort (for Intel HD Graphics), four USB 3.0, one ethernet (RJ-45). Optional 4 mDP for Quadro P600									

Components	Specification
Mechanical	<ul style="list-style-type: none"> Raven black color; metal case 1.36"W x 7.05"D x 7.20"H 34.5mm W x 179mm D x 182.9mm H 2.9 lb (1.3kg) typical weight 1-liter
	VESA mount
I/O box	Optional I/O expansion box, extends additional two USB 2.0, two USB 3.0, and one serial on rear, two USB 2.0 on front. I/O box consumes two USB 3.0 ports. I/O box requires VESA mount
Floor stand	Optional system floor stand for vertical orientation
Environmental certifications	GREENGUARD certified/RoHS-compliant/EPEAT Gold rating/ENERGY STAR 6.1 qualified
Limited warranty	1 or 3-year limited onsite service with 9x5/NBD. Some parts are Customer Replaceable Units.
ISV certifications	Please visit www.thinkworkstations.com/isv-certifications/

Popular and system-unique options:

Lenovo 4GB DDR4 2400MHz SoDIMM Memory	4X70M60573
Lenovo 8GB DDR4 2400MHz SoDIMM Memory	4X70M60574
Lenovo 16GB DDR4 2400MHz SoDIMM Memory	4X70N24889
Lenovo 256GB PCIe NVMe M.2 SSD	4XB0M52449
ThinkStation 256GB OPAL 2.5" Solid State Drive	4XB0N67290
256GB M.2 TLC PCIe OPAL 2.0 SSD	4XB0P01014
Lenovo 128GB M.2 PCIe NVMe SSD	4XB0N26469
Tiny IV DVD Burner Kit (VESA Mount needed)	4XA0N06917
Tiny IV DVD ROM Kit (VESA Mount needed)	4XA0N06918
Tiny 4 IO Expansion Box (VESA Mount needed)	4XH0N06919
Tiny Under Desk Mount	0B47097
Tiny IV Vertical Stand	4XF0N03160
Tiny VESA Mount II	4XF0N03161
Tiny Power Cage II	4XH0N23158
Tiny Sandwich Kit II	4XH0N04098
Tiny Clamp Bracket Mounting Kit II (VESA Mount needed)	4XF0N82412
Tiny IV 1L Dust Shield	4XH0N04885

Model	Product	Region	Processor	Intel HD Graphics	Discrete Graphics	Memory	Disks	M.2 Drives	Optical	WLAN + Bluetooth	Optional Ports	Stand	Cable Lock	Keyboard / Mouse	Operating System	Warranty	Global	Ann Date (mm/yy)
30C2000Y**	ThinkStation P320 Tiny	MEA	Core i7-6700T 4C/2.8GHz/8MB/35W/DDR4-2133	Intel HD 530	NVIDIA Quadro P600 2GB	1x 16GB SO-DIMM DDR4-2400 Non-ECC	None	1x 512GB SSD M.2 PCIe NVMe Opal	None	Intel 8265 ac, 2x2, vPro + BT4.1	None	None	None	USB / USB Optical	Windows 10 DG Windows 7 Pro 64	3-year, Onsite	No	06/17
30C20009**	ThinkStation P320 Tiny	MEA	Core i7-7700 4C/3.6GHz/8MB/65W/DDR4-2400	Intel HD 630	None	1x 8GB SO-DIMM DDR4-2400 Non-ECC	1x500GB HDD 7.2K 2.5" SATA6Gbps	None	9.0mm DVD±RW	Intel 8265 ac, 2x2, vPro + BT4.1	1x Serial	None	None	USB / USB Optical	Windows 10 Pro 64	3-year, Onsite	No	06/17
30C2000J**	ThinkStation P320 Tiny	MEA	Core i5-7500 4C/3.4GHz/6MB/65W/DDR4-2400	Intel HD 630	None	1x 4GB SO-DIMM DDR4-2400 Non-ECC	1x500GB HDD 7.2K 2.5" SATA6Gbps	None	9.0mm DVD±RW	Intel 8265 ac, 2x2, vPro + BT4.1	1x Serial	None	None	USB / USB Optical	Windows 10 Pro 64	3-year, Onsite	No	06/17
30C2001S**	ThinkStation P320 Tiny	MEA	Core i7-7700T 4C/2.9GHz/8MB/35W/DDR4-2400	Intel HD 630	NVIDIA Quadro P600 2GB	1x 8GB SO-DIMM DDR4-2400 Non-ECC	None	1x 256GB SSD M.2 PCIe NVMe Opal	None	Intel 8265 ac, 2x2, vPro + BT4.1	None	None	Cable Lock	USB / USB Optical	Windows 10 Pro 64	3-year, Onsite	No	06/17
30C2001T**	ThinkStation P320 Tiny	MEA	Core i7-7700T 4C/2.9GHz/8MB/35W/DDR4-2400	Intel HD 630	NVIDIA Quadro P600 2GB	1x 16GB SO-DIMM DDR4-2400 Non-ECC	None	1x 512GB SSD M.2 PCIe NVMe Opal	None	Intel 8265 ac, 2x2, vPro + BT4.1	None	None	Cable Lock	USB / USB Optical	Windows 10 Pro 64	3-year, Onsite	No	06/17
30C2001U**	ThinkStation P320 Tiny	MEA	Core i5-7500T 4C/2.7GHz/6MB/35W/DDR4-2400	Intel HD 630	NVIDIA Quadro P600 2GB	1x 8GB SO-DIMM DDR4-2400 Non-ECC	None	1x 256GB SSD M.2 PCIe NVMe Opal	None	Intel 3165 ac, 1x1 + BT4.0	None	None	Cable Lock	USB / USB Optical	Windows 10 Pro 64	3-year, Onsite	No	06/17
30C2001V**	ThinkStation P320 Tiny	MEA	Core i5-7500T 4C/2.7GHz/6MB/35W/DDR4-2400	Intel HD 630	NVIDIA Quadro P600 2GB	1x 8GB SO-DIMM DDR4-2400 Non-ECC	None	1x 256GB SSD M.2 PCIe NVMe Opal	None	Intel 3165 ac, 1x1 + BT4.0	None	None	Cable Lock	USB / USB Optical	Windows 10 Pro 64	3-year, Onsite	No	06/17
30C2001W**	ThinkStation P320 Tiny	MEA	Core i7-7700T 4C/2.9GHz/8MB/35W/DDR4-2400	Intel HD 630	NVIDIA Quadro P600 2GB	1x 16GB SO-DIMM DDR4-2400 Non-ECC	None	1x 512GB SSD M.2 PCIe NVMe Opal	None	Intel 8265 ac, 2x2, vPro + BT4.1	None	None	Cable Lock	USB / USB Optical	Windows 10 Pro 64	3-year, Onsite	No	06/17
30C2001X**	ThinkStation P320 Tiny	MEA	Core i7-7700T 4C/2.9GHz/8MB/35W/DDR4-2400	Intel HD 630	NVIDIA Quadro P600 2GB	1x 16GB SO-DIMM DDR4-2400 Non-ECC	None	1x 512GB SSD M.2 PCIe NVMe Opal	None	Intel 8265 ac, 2x2, vPro + BT4.1	None	None	Cable Lock	USB / USB Optical	Windows 10 Pro 64	3-year, Onsite	No	06/17

Model	Product	Region	Processor	Intel HD Graphics	Discrete Graphics	Memory	Disks	M.2 Drives	Optical	WLAN + Bluetooth	Optional Ports	Stand	Cable Lock	Keyboard / Mouse	Operating System	Warranty	Global	Ann Date (mm/yy)
30C2001Y**	ThinkStation P320 Tiny	MEA	Core i7-7700 4C/3.6GHz/8MB/65W/DDR4-2400	Intel HD 630	None	1x 16GB SO-DIMM DDR4-2400 Non-ECC	None	1x 256GB SSD M.2 PCIe NVMe Opal	None	Intel 8265 ac, 2x2, vPro + BT4.1	None	None	Cable Lock	USB / USB Optical	Windows 10 Pro 64	3-year, Onsite	No	06/17
30C20020**	ThinkStation P320 Tiny	MEA	Core i7-7700 4C/3.6GHz/8MB/65W/DDR4-2400	Intel HD 630	None	1x 16GB SO-DIMM DDR4-2400 Non-ECC	None	1x 256GB SSD M.2 PCIe NVMe Opal	None	Intel 8265 ac, 2x2, vPro + BT4.1	None	None	Cable Lock	USB / USB Optical	Windows 10 Pro 64	3-year, Onsite	No	06/17
30C20021**	ThinkStation P320 Tiny	MEA	Core i7-6700T 4C/2.8GHz/8MB/35W/DDR4-2133	Intel HD 530	NVIDIA Quadro P600 2GB	1x 16GB SO-DIMM DDR4-2400 Non-ECC	None	1x 512GB SSD M.2 PCIe NVMe Opal	None	Intel 8265 ac, 2x2, vPro + BT4.1	None	None	Cable Lock	USB / USB Optical	Windows 10 DG Windows 7 Pro 64	3-year, Onsite	No	06/17
30C20022**	ThinkStation P320 Tiny	MEA	Core i7-7700T 4C/2.9GHz/8MB/35W/DDR4-2400	Intel HD 630	NVIDIA Quadro P600 2GB	1x 16GB SO-DIMM DDR4-2400 Non-ECC	None	1x 1TB SSD M.2 PCIe NVMe Opal	None	Intel 8265 ac, 2x2, vPro + BT4.1	None	None	Cable Lock	USB / USB Optical	Windows 10 Pro 64	3-year, Onsite	No	06/17
30C20023**	ThinkStation P320 Tiny	MEA	Core i7-7700 4C/3.6GHz/8MB/65W/DDR4-2400	Intel HD 630	None	1x 8GB SO-DIMM DDR4-2400 Non-ECC	None	1x 256GB SSD M.2 PCIe NVMe Opal	None	Intel 8265 ac, 2x2, vPro + BT4.1	1x Serial	None	Cable Lock	USB / USB Optical	Windows 10 Pro 64	3-year, Onsite	No	06/17
30C2002S**	ThinkStation P320 Tiny	MEA	Core i5-6500 4C/3.2GHz/8MB/65W/DDR4-2133	Intel HD 530	None	1x 4GB SO-DIMM DDR4-2400 Non-ECC	1x500GB HDD 7.2K 2.5" SATA6Gbps	None	9.0mm DVD±RW	Intel 8265 ac, 2x2, vPro + BT4.1	1x Serial	None	None	USB / USB Optical	Windows 10 DG Windows 7 Pro 64	3-year, Onsite	No	07/17
30C2002T**	ThinkStation P320 Tiny	MEA	Core i7-7700T 4C/2.9GHz/8MB/35W/DDR4-2400	Intel HD 630	NVIDIA Quadro P600 2GB	1x 8GB SO-DIMM DDR4-2400 Non-ECC	None	1x 256GB SSD M.2 PCIe NVMe Opal	9.0mm DVD±RW	Intel 8265 ac, 2x2, vPro + BT4.1	None	None	None	USB / USB Optical	Windows 10 Pro 64	3-year, Onsite	No	07/17
30C2002U**	ThinkStation P320 Tiny	MEA	Core i5-7500 4C/3.4GHz/6MB/65W/DDR4-2400	Intel HD 630	None	1x 8GB SO-DIMM DDR4-2400 Non-ECC	None	1x 256GB SSD M.2 PCIe NVMe Opal	9.0mm DVD±RW	Intel 8265 ac, 2x2, vPro + BT4.1	1x Serial	None	None	USB / USB Optical	Windows 10 Pro 64	3-year, Onsite	No	07/17
30C2002V**	ThinkStation P320 Tiny	MEA	Core i5-7500 4C/3.4GHz/6MB/65W/DDR4-2400	Intel HD 630	None	1x 8GB SO-DIMM DDR4-2400 Non-ECC	1x500GB HDD 7.2K 2.5" SATA6Gbps	None	9.0mm DVD±RW	Intel 8265 ac, 2x2, vPro + BT4.1	1x Serial	None	None	USB / USB Optical	Windows 10 Pro 64	3-year, Onsite	No	07/17

Model	Product	Region	Processor	Intel HD Graphics	Discrete Graphics	Memory	Disks	M.2 Drives	Optical	WLAN + Bluetooth	Optional Ports	Stand	Cable Lock	Keyboard / Mouse	Operating System	Warranty	Global	Ann Date (mm/yy)
30C2002W**	ThinkStation P320 Tiny	MEA	Core i7-7700T 4C/2.9GHz/8MB/35W/DDR4-2400	Intel HD 630	NVIDIA Quadro P600 2GB	1x 8GB SO-DIMM DDR4-2400 Non-ECC	None	1x 512GB SSD M.2 PCIe NVMe Opal	9.0mm DVD±RW	Intel 8265 ac, 2x2, vPro + BT4.1	None	None	None	USB / USB Optical	Windows 10 Pro 64	3-year, Onsite	No	07/17
30C2002X**	ThinkStation P320 Tiny	MEA	Core i5-6500T 4C/2.5GHz/6MB/35W/DDR4-2133	Intel HD 530	NVIDIA Quadro P600 2GB	1x 8GB SO-DIMM DDR4-2400 Non-ECC	None	1x 256GB SSD M.2 PCIe NVMe Opal	9.0mm DVD±RW	Intel 8265 ac, 2x2, vPro + BT4.1	None	None	None	USB / USB Optical	Windows 10 DG Windows 7 Pro 64	3-year, Onsite	No	07/17
30C2002Y**	ThinkStation P320 Tiny	MEA	Core i7-7700T 4C/2.9GHz/8MB/35W/DDR4-2400	Intel HD 630	NVIDIA Quadro P600 2GB	2x 8GB SO-DIMM DDR4-2400 Non-ECC	None	1x 512GB SSD M.2 PCIe NVMe Opal	9.0mm DVD±RW	Intel 8265 ac, 2x2, vPro + BT4.1	None	None	None	USB / USB Optical	Windows 10 Pro 64	3-year, Onsite	No	07/17
30C20030**	ThinkStation P320 Tiny	MEA	Core i7-7700 4C/3.6GHz/8MB/65W/DDR4-2400	Intel HD 630	None	1x 8GB SO-DIMM DDR4-2400 Non-ECC	None	1x 512GB SSD M.2 PCIe NVMe Opal	9.0mm DVD±RW	Intel 8265 ac, 2x2, vPro + BT4.1	1x Serial	None	None	USB / USB Optical	Windows 10 Pro 64	3-year, Onsite	No	07/17
30C20031**	ThinkStation P320 Tiny	MEA	Core i7-6700T 4C/2.8GHz/8MB/35W/DDR4-2133	Intel HD 530	NVIDIA Quadro P600 2GB	2x 8GB SO-DIMM DDR4-2400 Non-ECC	None	1x 512GB SSD M.2 PCIe NVMe Opal	9.0mm DVD±RW	Intel 8265 ac, 2x2, vPro + BT4.1	None	None	None	USB / USB Optical	Windows 10 DG Windows 7 Pro 64	3-year, Onsite	No	07/17
30C20032**	ThinkStation P320 Tiny	MEA	Core i7-6700 4C/3.4GHz/8MB/65W/DDR4-2133	Intel HD 530	None	1x 8GB SO-DIMM DDR4-2400 Non-ECC	1x500GB HDD 7.2K 2.5" SATA6Gbps	None	9.0mm DVD±RW	Intel 8265 ac, 2x2, vPro + BT4.1	1x Serial	None	None	USB / USB Optical	Windows 10 DG Windows 7 Pro 64	3-year, Onsite	No	07/17
30C20033**	ThinkStation P320 Tiny	MEA	Core i7-6700T 4C/2.8GHz/8MB/35W/DDR4-2133	Intel HD 530	NVIDIA Quadro P600 2GB	1x 8GB SO-DIMM DDR4-2400 Non-ECC	None	1x 512GB SSD M.2 PCIe NVMe Opal	9.0mm DVD±RW	Intel 8265 ac, 2x2, vPro + BT4.1	None	None	None	USB / USB Optical	Windows 10 DG Windows 7 Pro 64	3-year, Onsite	No	07/17
30C20034**	ThinkStation P320 Tiny	MEA	Core i5-7500T 4C/2.7GHz/6MB/35W/DDR4-2400	Intel HD 630	NVIDIA Quadro P600 2GB	1x 8GB SO-DIMM DDR4-2400 Non-ECC	None	1x 256GB SSD M.2 PCIe NVMe Opal	9.0mm DVD±RW	Intel 8265 ac, 2x2, vPro + BT4.1	None	None	None	USB / USB Optical	Windows 10 Pro 64	3-year, Onsite	No	07/17
30C20035**	ThinkStation P320 Tiny	MEA	Core i5-6500T 4C/2.5GHz/6MB/35W/DDR4-2133	Intel HD 530	NVIDIA Quadro P600 2GB	1x 4GB SO-DIMM DDR4-2400 Non-ECC	None	1x 256GB SSD M.2 PCIe NVMe Opal	9.0mm DVD±RW	Intel 8265 ac, 2x2, vPro + BT4.1	None	None	None	USB / USB Optical	Windows 10 DG Windows 7 Pro 64	3-year, Onsite	No	07/17

ThinkStation P320 Tiny - TopSeller - 30C2 - 4 of 10

Product Specifications Reference (PSREF)

Model	Product	Region	Processor	Intel HD Graphics	Discrete Graphics	Memory	Disks	M.2 Drives	Optical	WLAN + Bluetooth	Optional Ports	Stand	Cable Lock	Keyboard / Mouse	Operating System	Warranty	Global	Ann Date (mm/yy)
30C20036**	ThinkStation P320 Tiny	MEA	Core i7-6700T 4C/2.8GHz/8MB/35W/DDR4-2133	Intel HD 530	NVIDIA Quadro P600 2GB	1x 8GB SO-DIMM DDR4-2400 Non-ECC	None	1x 256GB SSD M.2 PCIe NVMe Opal	9.0mm DVD±RW	Intel 8265 ac, 2x2, vPro + BT4.1	None	None	None	USB / USB Optical	Windows 10 DG Windows 7 Pro 64	3-year, Onsite	No	07/17
30C20024**	ThinkStation P320 Tiny	MEA	Core i7-7700 4C/3.6GHz/8MB/65W/DDR4-2400	Intel HD 630	None	1x 16GB SO-DIMM DDR4-2400 Non-ECC	None	1x 512GB SSD M.2 PCIe NVMe Opal	None	Intel 8265 ac, 2x2, vPro + BT4.1	1x Serial	None	Cable Lock	USB / USB Optical	Windows 10 Pro 64	3-year, Onsite	No	06/17
30C20037**	ThinkStation P320 Tiny	MEA	Core i7-7700T 4C/2.9GHz/8MB/35W/DDR4-2400	Intel HD 630	NVIDIA Quadro P600 2GB	1x 16GB SO-DIMM DDR4-2400 Non-ECC	None	1x 256GB SSD M.2 PCIe NVMe Opal	None	Intel 8265 ac, 2x2, vPro + BT4.1	None	None	Cable Lock	USB / USB Optical	Windows 10 Pro 64	3-year, Onsite	No	07/17
30C20038**	ThinkStation P320 Tiny	MEA	Core i7-7700 4C/3.6GHz/8MB/65W/DDR4-2400	Intel HD 630	None	1x 8GB SO-DIMM DDR4-2400 Non-ECC	1x1TB HDD 5.4K 2.5" SATA6Gbps	None	None	Intel 8265 ac, 2x2, vPro + BT4.1	None	None	Cable Lock	USB / USB Optical	Windows 10 Pro 64	3-year, Onsite	No	07/17
30C20039**	ThinkStation P320 Tiny	MEA	Core i3-7300 2C/4.0GHz/4MB/51W/DDR4-2400	Intel HD 630	None	1x 4GB SO-DIMM DDR4-2400 Non-ECC	1x128GB SSD 2.5" SATA6Gbps	None	None	Intel 8265 ac, 2x2, vPro + BT4.1	None	None	Cable Lock	USB / USB Optical	Windows 10 Pro 64	3-year, Onsite	No	07/17
30C20039xx	ThinkStation P320 Tiny	Russia/EET/CIS	Core i3-7300 2C/4.0GHz/4MB/51W/DDR4-2400	Intel HD 630	None	1x 4GB SO-DIMM DDR4-2400 Non-ECC	1x128GB SSD 2.5" SATA6Gbps	None	None	Intel 8265 ac, 2x2, vPro + BT4.1	None	None	Cable Lock	USB / USB Optical	Windows 10 Pro 64	3-year, Onsite	No	07/17
30C20038xx	ThinkStation P320 Tiny	Russia/EET/CIS	Core i7-7700 4C/3.6GHz/8MB/65W/DDR4-2400	Intel HD 630	None	1x 8GB SO-DIMM DDR4-2400 Non-ECC	1x1TB HDD 5.4K 2.5" SATA6Gbps	None	None	Intel 8265 ac, 2x2, vPro + BT4.1	None	None	Cable Lock	USB / USB Optical	Windows 10 Pro 64	3-year, Onsite	No	07/17
30C20037xx	ThinkStation P320 Tiny	Russia/EET/CIS	Core i7-7700T 4C/2.9GHz/8MB/35W/DDR4-2400	Intel HD 630	NVIDIA Quadro P600 2GB	1x 16GB SO-DIMM DDR4-2400 Non-ECC	None	1x 256GB SSD M.2 PCIe NVMe Opal	None	Intel 8265 ac, 2x2, vPro + BT4.1	None	None	Cable Lock	USB / USB Optical	Windows 10 Pro 64	3-year, Onsite	No	07/17
30C20024xx	ThinkStation P320 Tiny	Russia/EET/CIS	Core i7-7700 4C/3.6GHz/8MB/65W/DDR4-2400	Intel HD 630	None	1x 16GB SO-DIMM DDR4-2400 Non-ECC	None	1x 512GB SSD M.2 PCIe NVMe Opal	None	Intel 8265 ac, 2x2, vPro + BT4.1	1x Serial	None	Cable Lock	USB / USB Optical	Windows 10 Pro 64	3-year, Onsite	No	06/17

ThinkStation P320 Tiny - TopSeller - 30C2 - 5 of 10

Product Specifications Reference (PSREF)

Model	Product	Region	Processor	Intel HD Graphics	Discrete Graphics	Memory	Disks	M.2 Drives	Optical	WLAN + Bluetooth	Optional Ports	Stand	Cable Lock	Keyboard / Mouse	Operating System	Warranty	Global	Ann Date (mm/yy)
30C20023xx	ThinkStation P320 Tiny	Russia/EET/CIS	Core i7-7700 4C/3.6GHz/8MB/65W/DDR4-2400	Intel HD 630	None	1x 8GB SO-DIMM DDR4-2400 Non-ECC	None	1x 256GB SSD M.2 PCIe NVMe Opal	None	Intel 8265 ac, 2x2, vPro + BT4.1	1x Serial	None	Cable Lock	USB / USB Optical	Windows 10 Pro 64	3-year, Onsite	No	06/17
30C20022xx	ThinkStation P320 Tiny	Russia/EET/CIS	Core i7-7700T 4C/2.9GHz/8MB/35W/DDR4-2400	Intel HD 630	NVIDIA Quadro P600 2GB	1x 16GB SO-DIMM DDR4-2400 Non-ECC	None	1x 1TB SSD M.2 PCIe NVMe Opal	None	Intel 8265 ac, 2x2, vPro + BT4.1	None	None	Cable Lock	USB / USB Optical	Windows 10 Pro 64	3-year, Onsite	No	06/17
30C20021xx	ThinkStation P320 Tiny	Russia/EET/CIS	Core i7-6700T 4C/2.8GHz/8MB/35W/DDR4-2133	Intel HD 530	NVIDIA Quadro P600 2GB	1x 16GB SO-DIMM DDR4-2400 Non-ECC	None	1x 512GB SSD M.2 PCIe NVMe Opal	None	Intel 8265 ac, 2x2, vPro + BT4.1	None	None	Cable Lock	USB / USB Optical	Windows 10 DG Windows 7 Pro 64	3-year, Onsite	No	06/17
30C20020xx	ThinkStation P320 Tiny	Russia/EET/CIS	Core i7-7700 4C/3.6GHz/8MB/65W/DDR4-2400	Intel HD 630	None	1x 16GB SO-DIMM DDR4-2400 Non-ECC	None	1x 256GB SSD M.2 PCIe NVMe Opal	None	Intel 8265 ac, 2x2, vPro + BT4.1	None	None	Cable Lock	USB / USB Optical	Windows 10 Pro 64	3-year, Onsite	No	06/17
30C2001Yxx	ThinkStation P320 Tiny	Russia/EET/CIS	Core i7-7700 4C/3.6GHz/8MB/65W/DDR4-2400	Intel HD 630	None	1x 16GB SO-DIMM DDR4-2400 Non-ECC	None	1x 256GB SSD M.2 PCIe NVMe Opal	None	Intel 8265 ac, 2x2, vPro + BT4.1	None	None	Cable Lock	USB / USB Optical	Windows 10 Pro 64	3-year, Onsite	No	06/17
30C2001Xxx	ThinkStation P320 Tiny	Russia/EET/CIS	Core i7-7700T 4C/2.9GHz/8MB/35W/DDR4-2400	Intel HD 630	NVIDIA Quadro P600 2GB	1x 16GB SO-DIMM DDR4-2400 Non-ECC	None	1x 512GB SSD M.2 PCIe NVMe Opal	None	Intel 8265 ac, 2x2, vPro + BT4.1	None	None	Cable Lock	USB / USB Optical	Windows 10 Pro 64	3-year, Onsite	No	06/17
30C2001Wxx	ThinkStation P320 Tiny	Russia/EET/CIS	Core i7-7700T 4C/2.9GHz/8MB/35W/DDR4-2400	Intel HD 630	NVIDIA Quadro P600 2GB	1x 16GB SO-DIMM DDR4-2400 Non-ECC	None	1x 512GB SSD M.2 PCIe NVMe Opal	None	Intel 8265 ac, 2x2, vPro + BT4.1	None	None	Cable Lock	USB / USB Optical	Windows 10 Pro 64	3-year, Onsite	No	06/17
30C2001Vxx	ThinkStation P320 Tiny	Russia/EET/CIS	Core i5-7500T 4C/2.7GHz/6MB/35W/DDR4-2400	Intel HD 630	NVIDIA Quadro P600 2GB	1x 8GB SO-DIMM DDR4-2400 Non-ECC	None	1x 256GB SSD M.2 PCIe NVMe Opal	None	Intel 3165 ac, 1x1 + BT4.0	None	None	Cable Lock	USB / USB Optical	Windows 10 Pro 64	3-year, Onsite	No	06/17
30C2001Uxx	ThinkStation P320 Tiny	Russia/EET/CIS	Core i5-7500T 4C/2.7GHz/6MB/35W/DDR4-2400	Intel HD 630	NVIDIA Quadro P600 2GB	1x 8GB SO-DIMM DDR4-2400 Non-ECC	None	1x 256GB SSD M.2 PCIe NVMe Opal	None	Intel 3165 ac, 1x1 + BT4.0	None	None	Cable Lock	USB / USB Optical	Windows 10 Pro 64	3-year, Onsite	No	06/17

Model	Product	Region	Processor	Intel HD Graphics	Discrete Graphics	Memory	Disks	M.2 Drives	Optical	WLAN + Bluetooth	Optional Ports	Stand	Cable Lock	Keyboard / Mouse	Operating System	Warranty	Global	Ann Date (mm/yy)
30C2001Txx	ThinkStation P320 Tiny	Russia/EET/CIS	Core i7-7700T 4C/2.9GHz/8MB/35W/DDR4-2400	Intel HD 630	NVIDIA Quadro P600 2GB	1x 16GB SO-DIMM DDR4-2400 Non-ECC	None	1x 512GB SSD M.2 PCIe NVMe Opal	None	Intel 8265 ac, 2x2, vPro + BT4.1	None	None	Cable Lock	USB / USB Optical	Windows 10 Pro 64	3-year, Onsite	No	06/17
30C2001Sxx	ThinkStation P320 Tiny	Russia/EET/CIS	Core i7-7700T 4C/2.9GHz/8MB/35W/DDR4-2400	Intel HD 630	NVIDIA Quadro P600 2GB	1x 8GB SO-DIMM DDR4-2400 Non-ECC	None	1x 256GB SSD M.2 PCIe NVMe Opal	None	Intel 8265 ac, 2x2, vPro + BT4.1	None	None	Cable Lock	USB / USB Optical	Windows 10 Pro 64	3-year, Onsite	No	06/17
30C2000Yxx	ThinkStation P320 Tiny	Russia/EET/CIS	Core i7-6700T 4C/2.8GHz/8MB/35W/DDR4-2133	Intel HD 530	NVIDIA Quadro P600 2GB	1x 16GB SO-DIMM DDR4-2400 Non-ECC	None	1x 512GB SSD M.2 PCIe NVMe Opal	None	Intel 8265 ac, 2x2, vPro + BT4.1	None	None	None	USB / USB Optical	Windows 10 DG Windows 7 Pro 64	3-year, Onsite	No	06/17
30C20014US	ThinkStation P320 Tiny	US	Core i5-7500T 4C/2.7GHz/6MB/35W/DDR4-2400	Intel HD 630	NVIDIA Quadro P600 2GB	1x 16GB SO-DIMM DDR4-2400 Non-ECC	None	1x 512GB SSD M.2 PCIe NVMe Opal	None	Intel 8265 ac, 2x2, vPro + BT4.1	None	Stand	None	USB / USB Optical	Windows 10 Pro 64	3-year, Onsite	No	06/17
30C20015US	ThinkStation P320 Tiny	US	Core i5-6500T 4C/2.5GHz/6MB/35W/DDR4-2133	Intel HD 530	NVIDIA Quadro P600 2GB	1x 8GB SO-DIMM DDR4-2400 Non-ECC	None	1x 512GB SSD M.2 PCIe NVMe Opal	None	Intel 8265 ac, 2x2, vPro + BT4.1	None	Stand	None	USB / USB Optical	Windows 10 DG Windows 7 Pro 64	3-year, Onsite	No	06/17
30C20016US	ThinkStation P320 Tiny	US	Core i7-6700T 4C/2.8GHz/8MB/35W/DDR4-2133	Intel HD 530	NVIDIA Quadro P600 2GB	1x 8GB SO-DIMM DDR4-2400 Non-ECC	None	1x 256GB SSD M.2 PCIe NVMe Opal	None	Intel 8265 ac, 2x2, vPro + BT4.1	None	Stand	None	USB / USB Optical	Windows 10 DG Windows 7 Pro 64	3-year, Onsite	No	06/17
30C20017US	ThinkStation P320 Tiny	US	Core i3-7100T 2C/3.4GHz/3MB/35W/DDR4-2400	Intel HD 630	NVIDIA Quadro P600 2GB	1x 16GB SO-DIMM DDR4-2400 Non-ECC	None	1x 256GB SSD M.2 PCIe NVMe Opal	None	Intel 8265 ac, 2x2 + BT4.1	None	Stand	None	USB / USB Optical	Windows 10 Pro 64	3-year, Onsite	No	06/17
30C20018US	ThinkStation P320 Tiny	US	Core i5-6500T 4C/2.5GHz/6MB/35W/DDR4-2133	Intel HD 530	NVIDIA Quadro P600 2GB	1x 8GB SO-DIMM DDR4-2400 Non-ECC	None	1x 256GB SSD M.2 PCIe NVMe Opal	None	Intel 8265 ac, 2x2, vPro + BT4.1	None	Stand	None	USB / USB Optical	Windows 10 DG Windows 7 Pro 64	3-year, Onsite	No	06/17
30C20019US	ThinkStation P320 Tiny	US	Core i3-6100T 2C/3.2GHz/3MB/35W/DDR4-2133	Intel HD 530	NVIDIA Quadro P600 2GB	1x 16GB SO-DIMM DDR4-2400 Non-ECC	None	1x 512GB SSD M.2 PCIe NVMe Opal	None	Intel 3165 ac, 1x1 + BT4.0	None	Stand	None	USB / USB Optical	Windows 10 DG Windows 7 Pro 64	3-year, Onsite	No	06/17

Model	Product	Region	Processor	Intel HD Graphics	Discrete Graphics	Memory	Disks	M.2 Drives	Optical	WLAN + Bluetooth	Optional Ports	Stand	Cable Lock	Keyboard / Mouse	Operating System	Warranty	Global	Ann Date (mm/yy)
30C2001AUS	ThinkStation P320 Tiny	US	Core i3-7100T 2C/3.4GHz/3MB/35W/DDR4-2400	Intel HD 630	NVIDIA Quadro P600 2GB	1x 8GB SO-DIMM DDR4-2400 Non-ECC	None	1x 256GB SSD M.2 PCIe NVMe Opal	None	Intel 8265 ac, 2x2 + BT4.1	None	Stand	None	USB / USB Optical	Windows 10 Pro 64	3-year, Onsite	No	06/17
30C2001BUS	ThinkStation P320 Tiny	US	Core i3-7100T 2C/3.4GHz/3MB/35W/DDR4-2400	Intel HD 630	NVIDIA Quadro P600 2GB	1x 16GB SO-DIMM DDR4-2400 Non-ECC	None	1x 512GB SSD M.2 PCIe NVMe Opal	None	Intel 8265 ac, 2x2 + BT4.1	None	Stand	None	USB / USB Optical	Windows 10 Pro 64	3-year, Onsite	No	06/17
30C2001CUS	ThinkStation P320 Tiny	US	Core i7-7700T 4C/2.9GHz/8MB/35W/DDR4-2400	Intel HD 630	NVIDIA Quadro P600 2GB	1x 8GB SO-DIMM DDR4-2400 Non-ECC	None	1x 512GB SSD M.2 PCIe NVMe Opal	None	Intel 8265 ac, 2x2, vPro + BT4.1	None	Stand	None	USB / USB Optical	Windows 10 Pro 64	3-year, Onsite	No	06/17
30C2001DUS	ThinkStation P320 Tiny	US	Core i7-6700T 4C/2.8GHz/8MB/35W/DDR4-2133	Intel HD 530	NVIDIA Quadro P600 2GB	1x 16GB SO-DIMM DDR4-2400 Non-ECC	None	1x 512GB SSD M.2 PCIe NVMe Opal	None	Intel 8265 ac, 2x2, vPro + BT4.1	None	Stand	None	USB / USB Optical	Windows 10 DG Windows 7 Pro 64	3-year, Onsite	No	06/17
30C2001EUS	ThinkStation P320 Tiny	US	Core i7-7700T 4C/2.9GHz/8MB/35W/DDR4-2400	Intel HD 630	NVIDIA Quadro P600 2GB	1x 8GB SO-DIMM DDR4-2400 Non-ECC	None	1x 256GB SSD M.2 PCIe NVMe Opal	None	Intel 8265 ac, 2x2, vPro + BT4.1	None	Stand	None	USB / USB Optical	Windows 10 Pro 64	3-year, Onsite	No	06/17
30C2001FUS	ThinkStation P320 Tiny	US	Core i3-7100T 2C/3.4GHz/3MB/35W/DDR4-2400	Intel HD 630	NVIDIA Quadro P600 2GB	1x 4GB SO-DIMM DDR4-2400 Non-ECC	None	1x 256GB SSD M.2 PCIe NVMe Opal	None	Intel 8265 ac, 2x2 + BT4.1	None	Stand	None	USB / USB Optical	Windows 10 Pro 64	3-year, Onsite	No	06/17
30C2001GUS	ThinkStation P320 Tiny	US	Core i3-6100T 2C/3.2GHz/3MB/35W/DDR4-2133	Intel HD 530	NVIDIA Quadro P600 2GB	1x 4GB SO-DIMM DDR4-2400 Non-ECC	None	1x 256GB SSD M.2 PCIe NVMe Opal	None	Intel 3165 ac, 1x1 + BT4.0	None	Stand	None	USB / USB Optical	Windows 10 DG Windows 7 Pro 64	3-year, Onsite	No	06/17
30C2001HUS	ThinkStation P320 Tiny	US	Core i5-7500T 4C/2.7GHz/6MB/35W/DDR4-2400	Intel HD 630	NVIDIA Quadro P600 2GB	1x 8GB SO-DIMM DDR4-2400 Non-ECC	None	1x 512GB SSD M.2 PCIe NVMe Opal	None	Intel 8265 ac, 2x2, vPro + BT4.1	None	Stand	None	USB / USB Optical	Windows 10 Pro 64	3-year, Onsite	No	06/17
30C2001JUS	ThinkStation P320 Tiny	US	Core i5-6500T 4C/2.5GHz/6MB/35W/DDR4-2133	Intel HD 530	NVIDIA Quadro P600 2GB	1x 16GB SO-DIMM DDR4-2400 Non-ECC	None	1x 512GB SSD M.2 PCIe NVMe Opal	None	Intel 8265 ac, 2x2, vPro + BT4.1	None	Stand	None	USB / USB Optical	Windows 10 DG Windows 7 Pro 64	3-year, Onsite	No	06/17

Model	Product	Region	Processor	Intel HD Graphics	Discrete Graphics	Memory	Disks	M.2 Drives	Optical	WLAN + Bluetooth	Optional Ports	Stand	Cable Lock	Keyboard / Mouse	Operating System	Warranty	Global	Ann Date (mm/yy)
30C2001KUS	ThinkStation P320 Tiny	US	Core i7-7700T 4C/2.9GHz/8MB/35W/DDR4-2400	Intel HD 630	NVIDIA Quadro P600 2GB	1x 16GB SO-DIMM DDR4-2400 Non-ECC	None	1x 512GB SSD M.2 PCIe NVMe Opal	None	Intel 8265 ac, 2x2, vPro + BT4.1	None	Stand	None	USB / USB Optical	Windows 10 Pro 64	3-year, Onsite	No	06/17
30C2001LUS	ThinkStation P320 Tiny	US	Core i5-7500T 4C/2.7GHz/6MB/35W/DDR4-2400	Intel HD 630	NVIDIA Quadro P600 2GB	1x 8GB SO-DIMM DDR4-2400 Non-ECC	None	1x 256GB SSD M.2 PCIe NVMe Opal	None	Intel 8265 ac, 2x2, vPro + BT4.1	None	Stand	None	USB / USB Optical	Windows 10 Pro 64	3-year, Onsite	No	06/17
30C2001MUS	ThinkStation P320 Tiny	US	Core i3-6100T 2C/3.2GHz/3MB/35W/DDR4-2133	Intel HD 530	NVIDIA Quadro P600 2GB	1x 16GB SO-DIMM DDR4-2400 Non-ECC	None	1x 256GB SSD M.2 PCIe NVMe Opal	None	Intel 3165 ac, 1x1 + BT4.0	None	Stand	None	USB / USB Optical	Windows 10 DG Windows 7 Pro 64	3-year, Onsite	No	06/17
30C2001NUS	ThinkStation P320 Tiny	US	Core i7-6700T 4C/2.8GHz/8MB/35W/DDR4-2133	Intel HD 530	NVIDIA Quadro P600 2GB	1x 8GB SO-DIMM DDR4-2400 Non-ECC	None	1x 512GB SSD M.2 PCIe NVMe Opal	None	Intel 8265 ac, 2x2, vPro + BT4.1	None	Stand	None	USB / USB Optical	Windows 10 DG Windows 7 Pro 64	3-year, Onsite	No	06/17
30C20025US	ThinkStation P320 Tiny	US	Core i5-7500T 4C/2.7GHz/6MB/35W/DDR4-2400	Intel HD 630	NVIDIA Quadro P600 2GB	1x 16GB SO-DIMM DDR4-2400 Non-ECC	None	1x 1TB SSD M.2 PCIe NVMe Opal	None	Intel 8265 ac, 2x2, vPro + BT4.1	None	Stand	None	USB / USB Optical	Windows 10 Pro 64	3-year, Onsite	No	06/17
30C20026US	ThinkStation P320 Tiny	US	Core i7-7700T 4C/2.9GHz/8MB/35W/DDR4-2400	Intel HD 630	NVIDIA Quadro P600 2GB	1x 16GB SO-DIMM DDR4-2400 Non-ECC	None	1x 1TB SSD M.2 PCIe NVMe Opal	None	Intel 8265 ac, 2x2, vPro + BT4.1	None	Stand	None	USB / USB Optical	Windows 10 Pro 64	3-year, Onsite	No	06/17
30C20027US	ThinkStation P320 Tiny	US	Core i7-6700T 4C/2.8GHz/8MB/35W/DDR4-2133	Intel HD 530	NVIDIA Quadro P600 2GB	1x 16GB SO-DIMM DDR4-2400 Non-ECC	None	1x 1TB SSD M.2 PCIe NVMe Opal	None	Intel 8265 ac, 2x2, vPro + BT4.1	None	Stand	None	USB / USB Optical	Windows 10 DG Windows 7 Pro 64	3-year, Onsite	No	06/17
30C20028US	ThinkStation P320 Tiny	US	Core i5-6500T 4C/2.5GHz/6MB/35W/DDR4-2133	Intel HD 530	NVIDIA Quadro P600 2GB	1x 16GB SO-DIMM DDR4-2400 Non-ECC	None	1x 1TB SSD M.2 PCIe NVMe Opal	None	Intel 8265 ac, 2x2, vPro + BT4.1	None	Stand	None	USB / USB Optical	Windows 10 DG Windows 7 Pro 64	3-year, Onsite	No	06/17
30C20038--	ThinkStation P320 Tiny	WE	Core i7-7700 4C/3.6GHz/8MB/65W/DDR4-2400	Intel HD 630	None	1x 8GB SO-DIMM DDR4-2400 Non-ECC	1x1TB HDD 5.4K 2.5" SATA6Gbps	None	None	Intel 8265 ac, 2x2, vPro + BT4.1	None	None	Cable Lock	USB / USB Optical	Windows 10 Pro 64	3-year, Onsite	No	07/17

Model	Product	Region	Processor	Intel HD Graphics	Discrete Graphics	Memory	Disks	M.2 Drives	Optical	WLAN + Bluetooth	Optional Ports	Stand	Cable Lock	Keyboard / Mouse	Operating System	Warranty	Global	Ann Date (mm/yy)
30C20039--	ThinkStation P320 Tiny	WE	Core i3-7300 2C/4.0GHz/4MB/51W/DDR4-2400	Intel HD 630	None	1x 4GB SO-DIMM DDR4-2400 Non-ECC	1x128GB SSD 2.5" SATA6Gbps	None	None	Intel 8265 ac, 2x2, vPro + BT4.1	None	None	Cable Lock	USB / USB Optical	Windows 10 Pro 64	3-year, Onsite	No	07/17
30C20021--	ThinkStation P320 Tiny	WE	Core i7-6700T 4C/2.8GHz/8MB/35W/DDR4-2133	Intel HD 530	NVIDIA Quadro P600 2GB	1x 16GB SO-DIMM DDR4-2400 Non-ECC	None	1x 512GB SSD M.2 PCIe NVMe Opal	None	Intel 8265 ac, 2x2, vPro + BT4.1	None	None	Cable Lock	USB / USB Optical	Windows 10 DG Windows 7 Pro 64	3-year, Onsite	No	06/17
30C20022--	ThinkStation P320 Tiny	WE	Core i7-7700T 4C/2.9GHz/8MB/35W/DDR4-2400	Intel HD 630	NVIDIA Quadro P600 2GB	1x 16GB SO-DIMM DDR4-2400 Non-ECC	None	1x 1TB SSD M.2 PCIe NVMe Opal	None	Intel 8265 ac, 2x2, vPro + BT4.1	None	None	Cable Lock	USB / USB Optical	Windows 10 Pro 64	3-year, Onsite	No	06/17
30C20023--	ThinkStation P320 Tiny	WE	Core i7-7700 4C/3.6GHz/8MB/65W/DDR4-2400	Intel HD 630	None	1x 8GB SO-DIMM DDR4-2400 Non-ECC	None	1x 256GB SSD M.2 PCIe NVMe Opal	None	Intel 8265 ac, 2x2, vPro + BT4.1	1x Serial	None	Cable Lock	USB / USB Optical	Windows 10 Pro 64	3-year, Onsite	No	06/17
30C20024--	ThinkStation P320 Tiny	WE	Core i7-7700 4C/3.6GHz/8MB/65W/DDR4-2400	Intel HD 630	None	1x 16GB SO-DIMM DDR4-2400 Non-ECC	None	1x 512GB SSD M.2 PCIe NVMe Opal	None	Intel 8265 ac, 2x2, vPro + BT4.1	1x Serial	None	Cable Lock	USB / USB Optical	Windows 10 Pro 64	3-year, Onsite	No	06/17
30C20037--	ThinkStation P320 Tiny	WE	Core i7-7700T 4C/2.9GHz/8MB/35W/DDR4-2400	Intel HD 630	NVIDIA Quadro P600 2GB	1x 16GB SO-DIMM DDR4-2400 Non-ECC	None	1x 256GB SSD M.2 PCIe NVMe Opal	None	Intel 8265 ac, 2x2, vPro + BT4.1	None	None	Cable Lock	USB / USB Optical	Windows 10 Pro 64	3-year, Onsite	No	07/17
30C2001S--	ThinkStation P320 Tiny	WE	Core i7-7700T 4C/2.9GHz/8MB/35W/DDR4-2400	Intel HD 630	NVIDIA Quadro P600 2GB	1x 8GB SO-DIMM DDR4-2400 Non-ECC	None	1x 256GB SSD M.2 PCIe NVMe Opal	None	Intel 8265 ac, 2x2, vPro + BT4.1	None	None	Cable Lock	USB / USB Optical	Windows 10 Pro 64	3-year, Onsite	No	06/17
30C2001T--	ThinkStation P320 Tiny	WE	Core i7-7700T 4C/2.9GHz/8MB/35W/DDR4-2400	Intel HD 630	NVIDIA Quadro P600 2GB	1x 16GB SO-DIMM DDR4-2400 Non-ECC	None	1x 512GB SSD M.2 PCIe NVMe Opal	None	Intel 8265 ac, 2x2, vPro + BT4.1	None	None	Cable Lock	USB / USB Optical	Windows 10 Pro 64	3-year, Onsite	No	06/17
30C2000Y--	ThinkStation P320 Tiny	WE	Core i7-6700T 4C/2.8GHz/8MB/35W/DDR4-2133	Intel HD 530	NVIDIA Quadro P600 2GB	1x 16GB SO-DIMM DDR4-2400 Non-ECC	None	1x 512GB SSD M.2 PCIe NVMe Opal	None	Intel 8265 ac, 2x2, vPro + BT4.1	None	None	None	USB / USB Optical	Windows 10 DG Windows 7 Pro 64	3-year, Onsite	No	06/17

Model	Product	Region	Processor	Intel HD Graphics	Discrete Graphics	Memory	Disks	M.2 Drives	Optical	WLAN + Bluetooth	Optional Ports	Stand	Cable Lock	Keyboard / Mouse	Operating System	Warranty	Global	Ann Date (mm/yy)
30C2001U--	ThinkStation P320 Tiny	WE	Core i5-7500T 4C/2.7GHz/6MB/35W/DDR4-2400	Intel HD 630	NVIDIA Quadro P600 2GB	1x 8GB SO-DIMM DDR4-2400 Non-ECC	None	1x 256GB SSD M.2 PCIe NVMe Opal	None	Intel 3165 ac, 1x1 + BT4.0	None	None	Cable Lock	USB / USB Optical	Windows 10 Pro 64	3-year, Onsite	No	06/17
30C2001V--	ThinkStation P320 Tiny	WE	Core i5-7500T 4C/2.7GHz/6MB/35W/DDR4-2400	Intel HD 630	NVIDIA Quadro P600 2GB	1x 8GB SO-DIMM DDR4-2400 Non-ECC	None	1x 256GB SSD M.2 PCIe NVMe Opal	None	Intel 3165 ac, 1x1 + BT4.0	None	None	Cable Lock	USB / USB Optical	Windows 10 Pro 64	3-year, Onsite	No	06/17
30C2001W--	ThinkStation P320 Tiny	WE	Core i7-7700T 4C/2.9GHz/8MB/35W/DDR4-2400	Intel HD 630	NVIDIA Quadro P600 2GB	1x 16GB SO-DIMM DDR4-2400 Non-ECC	None	1x 512GB SSD M.2 PCIe NVMe Opal	None	Intel 8265 ac, 2x2, vPro + BT4.1	None	None	Cable Lock	USB / USB Optical	Windows 10 Pro 64	3-year, Onsite	No	06/17
30C2001X--	ThinkStation P320 Tiny	WE	Core i7-7700T 4C/2.9GHz/8MB/35W/DDR4-2400	Intel HD 630	NVIDIA Quadro P600 2GB	1x 16GB SO-DIMM DDR4-2400 Non-ECC	None	1x 512GB SSD M.2 PCIe NVMe Opal	None	Intel 8265 ac, 2x2, vPro + BT4.1	None	None	Cable Lock	USB / USB Optical	Windows 10 Pro 64	3-year, Onsite	No	06/17
30C2001Y--	ThinkStation P320 Tiny	WE	Core i7-7700 4C/3.6GHz/8MB/65W/DDR4-2400	Intel HD 630	None	1x 16GB SO-DIMM DDR4-2400 Non-ECC	None	1x 256GB SSD M.2 PCIe NVMe Opal	None	Intel 8265 ac, 2x2, vPro + BT4.1	None	None	Cable Lock	USB / USB Optical	Windows 10 Pro 64	3-year, Onsite	No	06/17
30C20020--	ThinkStation P320 Tiny	WE	Core i7-7700 4C/3.6GHz/8MB/65W/DDR4-2400	Intel HD 630	None	1x 16GB SO-DIMM DDR4-2400 Non-ECC	None	1x 256GB SSD M.2 PCIe NVMe Opal	None	Intel 8265 ac, 2x2, vPro + BT4.1	None	None	Cable Lock	USB / USB Optical	Windows 10 Pro 64	3-year, Onsite	No	06/17



ThinkStation P320 Tower Platform Specifications

Product Specifications Reference (PSREF)

Components	Specification				
Chipset	Intel C236 Chipset				
Intel AMT	Intel Active Management Technology 11 on Xeon models, Intel Standard Manageability on other models				
Processor	One Intel "Kaby Lake" or "Skylake" processor as listed: "Kaby Lake"				
	Xeon E3-1280 v6	4C/3.9GHz/8MB/72W/DDR4-2400			
	Xeon E3-1275 v6	4C/3.8GHz/8MB/73W/DDR4-2400			
	Xeon E3-1270 v6	4C/3.8GHz/8MB/72W/DDR4-2400			
	Xeon E3-1245 v6	4C/3.7GHz/8MB/73W/DDR4-2400			
	Xeon E3-1240 v6	4C/3.7GHz/8MB/72W/DDR4-2400			
	Xeon E3-1230 v6	4C/3.5GHz/8MB/72W/DDR4-2400			
	Xeon E3-1225 v6	4C/3.3GHz/8MB/73W/DDR4-2400			
	Xeon E3-1220 v6	4C/3GHz/8MB/72W/DDR4-2400			
	Core i7-7700K	4C/4.2GHz/8MB/91W/DDR4-2400			
	Core i7-7700	4C/3.6GHz/8MB/65W/DDR4-2400			
	Core i5-7600	4C/3.5GHz/6MB/65W/DDR4-2400			
	Core i5-7500	4C/3.4GHz/6MB/65W/DDR4-2400			
	Core i5-7400	4C/3GHz/6MB/65W/DDR4-2400			
	Core i3-7300	2C/4GHz/4MB/51W/DDR4-2400			
	Core i3-7100	2C/3.9GHz/3MB/51W/DDR4-2400			
	Processor	"Skylake"			
Xeon E3-1245 v5		4C/3.5GHz/8MB/80W/DDR4-2133			
Xeon E3-1240 v5		4C/3.5GHz/8MB/80W/DDR4-2133			
Xeon E3-1230 v5		4C/3.4GHz/8MB/80W/DDR4-2133			
Xeon E3-1225 v5		4C/3.3GHz/8MB/80W/DDR4-2133			
Xeon E3-1220 v5		4C/3GHz/8MB/80W/DDR4-2133			
Core i7-6700		4C/3.4GHz/8MB/65W/DDR4-2133			
Core i5-6500		4C/3.2GHz/6MB/65W/DDR4-2133			
Core i5-6400		4C/2.7GHz/6MB/65W/DDR4-2133			
Core i3-6100		2C/3GHz/3MB/51W/DDR4-2133			
Memory DIMM slots	4 DIMM slots, 2-channel (integrated memory controller in processor)				
Memory type/capacity	Up to 64GB ECC/non-ECC (4 x 16GB), DDR4-2400. UDIMM. "Skylake" processor supports up to DDR4-2133. Core i7 and i5 processors cannot support ECC.				
Intel HD Graphics in processor	Integrated Intel HD P530 in Xeon E3-12x5 v5 processors, or Intel HD P630 in Xeon E3-12x5 v6 processors, or Intel HD 530 in Core i7, i5, or i3 6000 processors, or Intel HD 630 in Core i7, i5, or i3 7000 processors. Works along with discrete graphics to support multi-display, enables three display connectors (2 DP, 1 VGA) on rear.				
Discrete graphics	Two PCI Express 3.0 x16 slots for graphics adapters. Up to two Quadro P1000 on 250 watts models. Or up to two Quadro P2000, or up to one Quadro P4000 on 400 watts models. Supports the following NVIDIA graphics adapters:				
	Adapter	Cores	Memory	Power	Connector
	NVS 310	48	1GB	19.5W	2xDP
	NVS 315	48	1GB	19.5W	2xDVI-I SL/2xDP
	NVS 510	192	2GB	33.4W	4xmini DP
	NVS 810	1024	4GB	68W	8xmini DP
	Quadro P400	256	2GB	30W	3xminiDP
	Quadro P600	384	2GB	40W	4xminiDP
	Quadro P1000	640	4GB	47W	4xminiDP
	Quadro P2000	1024	5GB	75W	4xDP
Quadro P4000	1792	8GB	105W	4xDP	
Onboard drive controller	Five onboard SATA 6.0Gb/s connectors for optical and disk drives plus one SATA connector for optional eSATA. RAID 0, 1, 5, 10 support				
Drive Bays	Two external 5.25" bays, two internal 3.5" bays (see right). Up to one 9mm optical plus 4 x 3.5" disk drive bays plus two M.2 NVMe SSD				
Supporting disk drives	3.5" SATA HDD (7.2K 6Gbs)	1TB/2TB/4TB/1TB hybrid/2TB hybrid			
	2.5" SATA SSD (6Gbs)	256GB Opal/512GB/512GB Opal/1TB Opal/2TB opal			
	M.2 NVMe SSD, via PCIe adapter	256GB Opal/512GB Opal/1TB Opal, PCIe 3.0 x4, up to 2; or 16GB Intel Optane Memory, PCIe 3.0 x2			
Max internal storage	16TB (4 x 4TB 3.5" HDDs) plus 2TB (2 x 1TB) M.2 NVMe SSD				
Media reader	9-in-1 card reader. Optional 29-in-1 card reader on selected models				

Components	Specification
Power supply	One 250 watts with variable speed fan, autosensing, Climate Savers Computing Bronze, 80 PLUS Bronze qualified. Or one 400 watts with variable speed fan, autosensing, Climate Savers Computing Platinum, 80 PLUS Platinum qualified.
Onboard Ethernet	One onboard gigabit ethernet, Intel I219LM, supports Wake-on-LAN
HD Audio	Realtek ALC662 codec
TPM	Standard, TCG 2.0-compliant
Front ports	Two USB 3.0, microphone (3.5mm), headphone (3.5mm)
Rear ports	1 VGA and 2 DisplayPort (for Intel HD Graphics models only), two USB 2.0, four USB 3.0, one serial (9-pin), one ethernet (RJ-45), three analog audio ports (line-in, line-out, mic-in)
Mechanical	<ul style="list-style-type: none"> Raven black color; metal case 6.89"W x 16.77"D x 14.8"H 175mm W x 426mm D x 376mm H 28.66 lb (13kg) max configuration 25-liter
Environmental certifications	GREENGUARD certified/RoHS-compliant/EPEAT Gold rating/ENERGY STAR 6.1 qualified
Limited warranty	1 or 3-year limited onsite service with 9x5/NBD. Some parts are Customer Replaceable Units.
ISV certifications	Please visit www.thinkworkstations.com/isv-certifications/

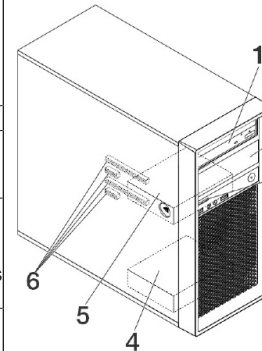

Drive Bays and PCIe Slots

Bay 1 and Bay 2	5.25", support one of the following: HH optical/flex module/9mm optical+3.5" HDD bay/ 3.5" HDD bay/Front Access Storage Enclosure (FASE) <i>Note:</i> 1. Flex module supports one or more of the following: 9mm optical/ 29-in-1 reader/front IEEE 1394/front eSATA. 2. Up to one flex module/FASE per system.
Bay 3	Optional 9-in-1 single slot reader
Bay 4	Standard 3.5" HDD bay
Bay 5	Standard 3.5" HDD bay
6 -Slots	Four PCIe slots (top-down): Slot 1: Half length, full height, PCIe 3.0 x16 (near CPU) Slot 2: Half length, full height, PCIe 3.0 x16 Slot 3: Half length, full height, PCIe 3.0 x16 (x4 elec) Slot 4: Half length, full height, PCIe 3.0 x1 <i>Note:</i> 1. Both discrete graphics adapter and M.2 NVMe SSD should be installed on slot 1 or slot 3, the maximum quantity of discrete graphics adapter and M.2 NVMe SSD is 2. 2. When two discrete graphics adapters are used, no other PCIe card can be used.

Model	Region	Processor	Graphics	Memory	Disks	M.2 Drives	Optical	Media Reader	Power Supply	Optional Ports	Keyboard / Mouse	Operating System	Warranty	Global	Ann Date (mm/yy)
30BH0002--	EMEA	Core i5-7500 4C/3.4GHz/65W/DDR4-2400	Intel HD 630	1x8GB UDIMM DDR4-2400 Non-ECC	1x1TB HDD 7.2K 3.5" SATA6Gbps	None	HH DVD±RW	9-in-1	250W Bronze Fixed	None	USB / USB Optical	Windows 10 Pro 64	3-year, Onsite	No	04/17
30BH0002**	EMEA	Core i5-7500 4C/3.4GHz/65W/DDR4-2400	Intel HD 630	1x8GB UDIMM DDR4-2400 Non-ECC	1x1TB HDD 7.2K 3.5" SATA6Gbps	None	HH DVD±RW	9-in-1	250W Bronze Fixed	None	USB / USB Optical	Windows 10 Pro 64	3-year, Onsite	No	04/17
30BH0002xx	EMEA	Core i5-7500 4C/3.4GHz/65W/DDR4-2400	Intel HD 630	1x8GB UDIMM DDR4-2400 Non-ECC	1x1TB HDD 7.2K 3.5" SATA6Gbps	None	HH DVD±RW	9-in-1	250W Bronze Fixed	None	USB / USB Optical	Windows 10 Pro 64	3-year, Onsite	No	04/17
30BH0003--	EMEA	Core i7-7700 4C/3.6GHz/85W/DDR4-2400	Intel HD 630	1x8GB UDIMM DDR4-2400 Non-ECC	1x1TB HDD 7.2K 3.5" SATA6Gbps	None	HH DVD±RW	9-in-1	250W Bronze Fixed	None	USB / USB Optical	Windows 10 Pro 64	3-year, Onsite	No	04/17
30BH0003**	EMEA	Core i7-7700 4C/3.6GHz/85W/DDR4-2400	Intel HD 630	1x8GB UDIMM DDR4-2400 Non-ECC	1x1TB HDD 7.2K 3.5" SATA6Gbps	None	HH DVD±RW	9-in-1	250W Bronze Fixed	None	USB / USB Optical	Windows 10 Pro 64	3-year, Onsite	No	04/17
30BH0003xx	EMEA	Core i7-7700 4C/3.6GHz/85W/DDR4-2400	Intel HD 630	1x8GB UDIMM DDR4-2400 Non-ECC	1x1TB HDD 7.2K 3.5" SATA6Gbps	None	HH DVD±RW	9-in-1	250W Bronze Fixed	None	USB / USB Optical	Windows 10 Pro 64	3-year, Onsite	No	04/17
30BH0004--	EMEA	Core i7-7700 4C/3.6GHz/85W/DDR4-2400	Intel HD 630 + NVIDIA Quadro P2000 5GB	1x8GB UDIMM DDR4-2400 Non-ECC	1x1TB HDD 7.2K 3.5" SATA6Gbps	None	HH DVD±RW	9-in-1	250W Bronze Fixed	None	USB / USB Optical	Windows 10 Pro 64	3-year, Onsite	No	04/17
30BH0004**	EMEA	Core i7-7700 4C/3.6GHz/85W/DDR4-2400	Intel HD 630 + NVIDIA Quadro P2000 5GB	1x8GB UDIMM DDR4-2400 Non-ECC	1x1TB HDD 7.2K 3.5" SATA6Gbps	None	HH DVD±RW	9-in-1	250W Bronze Fixed	None	USB / USB Optical	Windows 10 Pro 64	3-year, Onsite	No	04/17
30BH0004xx	EMEA	Core i7-7700 4C/3.6GHz/85W/DDR4-2400	Intel HD 630 + NVIDIA Quadro P2000 5GB	1x8GB UDIMM DDR4-2400 Non-ECC	1x1TB HDD 7.2K 3.5" SATA6Gbps	None	HH DVD±RW	9-in-1	250W Bronze Fixed	None	USB / USB Optical	Windows 10 Pro 64	3-year, Onsite	No	04/17
30BH0005--	EMEA	Core i7-7700 4C/3.6GHz/85W/DDR4-2400	Intel HD 630 + NVIDIA Quadro P400 2GB	1x8GB UDIMM DDR4-2400 Non-ECC	1x1TB HDD 7.2K 3.5" SATA6Gbps	None	HH DVD±RW	9-in-1	250W Bronze Fixed	None	USB / USB Optical	Windows 10 Pro 64	3-year, Onsite	No	04/17
30BH0005**	EMEA	Core i7-7700 4C/3.6GHz/85W/DDR4-2400	Intel HD 630 + NVIDIA Quadro P400 2GB	1x8GB UDIMM DDR4-2400 Non-ECC	1x1TB HDD 7.2K 3.5" SATA6Gbps	None	HH DVD±RW	9-in-1	250W Bronze Fixed	None	USB / USB Optical	Windows 10 Pro 64	3-year, Onsite	No	04/17
30BH0005xx	EMEA	Core i7-7700 4C/3.6GHz/85W/DDR4-2400	Intel HD 630 + NVIDIA Quadro P400 2GB	1x8GB UDIMM DDR4-2400 Non-ECC	1x1TB HDD 7.2K 3.5" SATA6Gbps	None	HH DVD±RW	9-in-1	250W Bronze Fixed	None	USB / USB Optical	Windows 10 Pro 64	3-year, Onsite	No	04/17
30BH0006--	EMEA	Core i7-7700 4C/3.6GHz/85W/DDR4-2400	Intel HD 630 + NVIDIA Quadro P600 2GB	1x8GB UDIMM DDR4-2400 Non-ECC	1x1TB HDD 7.2K 3.5" SATA6Gbps	None	HH DVD±RW	9-in-1	250W Bronze Fixed	None	USB / USB Optical	Windows 10 Pro 64	3-year, Onsite	No	04/17

Model	Region	Processor	Graphics	Memory	Disks	M.2 Drives	Optical	Media Reader	Power Supply	Optional Ports	Keyboard / Mouse	Operating System	Warranty	Global	Ann Date (mm/yy)
30BH0006**	EMEA	Core i7-7700 4C/3.6GHz/8MB/65W/DDR4-2400	Intel HD 630 + NVIDIA Quadro P600 2GB	1x8GB UDIMM DDR4-2400 Non-ECC	1x1TB HDD 7.2K 3.5" SATA6Gbps	None	HH DVD±RW	9-in-1	250W Bronze Fixed	None	USB / USB Optical	Windows 10 Pro 64	3-year, Onsite	No	04/17
30BH0006xx	EMEA	Core i7-7700 4C/3.6GHz/8MB/65W/DDR4-2400	Intel HD 630 + NVIDIA Quadro P600 2GB	1x8GB UDIMM DDR4-2400 Non-ECC	1x1TB HDD 7.2K 3.5" SATA6Gbps	None	HH DVD±RW	9-in-1	250W Bronze Fixed	None	USB / USB Optical	Windows 10 Pro 64	3-year, Onsite	No	04/17
30BH0007--	EMEA	Core i7-7700 4C/3.6GHz/8MB/65W/DDR4-2400	Intel HD 630	1x8GB UDIMM DDR4-2400 Non-ECC	1x256GB SSD 2.5" SATA6Gbps Opal	None	HH DVD±RW	9-in-1	250W Bronze Fixed	None	USB / USB Optical	Windows 10 Pro 64	3-year, Onsite	No	04/17
30BH0007**	EMEA	Core i7-7700 4C/3.6GHz/8MB/65W/DDR4-2400	Intel HD 630	1x8GB UDIMM DDR4-2400 Non-ECC	1x256GB SSD 2.5" SATA6Gbps Opal	None	HH DVD±RW	9-in-1	250W Bronze Fixed	None	USB / USB Optical	Windows 10 Pro 64	3-year, Onsite	No	04/17
30BH0007xx	EMEA	Core i7-7700 4C/3.6GHz/8MB/65W/DDR4-2400	Intel HD 630	1x8GB UDIMM DDR4-2400 Non-ECC	1x256GB SSD 2.5" SATA6Gbps Opal	None	HH DVD±RW	9-in-1	250W Bronze Fixed	None	USB / USB Optical	Windows 10 Pro 64	3-year, Onsite	No	04/17
30BH0008--	EMEA	Core i7-7700 4C/3.6GHz/8MB/65W/DDR4-2400	Intel HD 630 + NVIDIA Quadro P2000 5GB	2x8GB UDIMM DDR4-2400 Non-ECC	1x256GB SSD 2.5" SATA6Gbps Opal	None	HH DVD±RW	9-in-1	250W Bronze Fixed	None	USB / USB Optical	Windows 10 Pro 64	3-year, Onsite	No	04/17
30BH0008**	EMEA	Core i7-7700 4C/3.6GHz/8MB/65W/DDR4-2400	Intel HD 630 + NVIDIA Quadro P2000 5GB	2x8GB UDIMM DDR4-2400 Non-ECC	1x256GB SSD 2.5" SATA6Gbps Opal	None	HH DVD±RW	9-in-1	250W Bronze Fixed	None	USB / USB Optical	Windows 10 Pro 64	3-year, Onsite	No	04/17
30BH0008xx	EMEA	Core i7-7700 4C/3.6GHz/8MB/65W/DDR4-2400	Intel HD 630 + NVIDIA Quadro P2000 5GB	2x8GB UDIMM DDR4-2400 Non-ECC	1x256GB SSD 2.5" SATA6Gbps Opal	None	HH DVD±RW	9-in-1	250W Bronze Fixed	None	USB / USB Optical	Windows 10 Pro 64	3-year, Onsite	No	04/17
30BH0009--	EMEA	Core i7-7700 4C/3.6GHz/8MB/65W/DDR4-2400	Intel HD 630 + NVIDIA Quadro P600 2GB	2x8GB UDIMM DDR4-2400 Non-ECC	1x256GB SSD 2.5" SATA6Gbps Opal	None	HH DVD±RW	9-in-1	250W Bronze Fixed	None	USB / USB Optical	Windows 10 Pro 64	3-year, Onsite	No	04/17
30BH0009**	EMEA	Core i7-7700 4C/3.6GHz/8MB/65W/DDR4-2400	Intel HD 630 + NVIDIA Quadro P600 2GB	2x8GB UDIMM DDR4-2400 Non-ECC	1x256GB SSD 2.5" SATA6Gbps Opal	None	HH DVD±RW	9-in-1	250W Bronze Fixed	None	USB / USB Optical	Windows 10 Pro 64	3-year, Onsite	No	04/17
30BH0009xx	EMEA	Core i7-7700 4C/3.6GHz/8MB/65W/DDR4-2400	Intel HD 630 + NVIDIA Quadro P600 2GB	2x8GB UDIMM DDR4-2400 Non-ECC	1x256GB SSD 2.5" SATA6Gbps Opal	None	HH DVD±RW	9-in-1	250W Bronze Fixed	None	USB / USB Optical	Windows 10 Pro 64	3-year, Onsite	No	04/17
30BH000A--	EMEA	Core i7-7700 4C/3.6GHz/8MB/65W/DDR4-2400	Intel HD 630	2x8GB UDIMM DDR4-2400 Non-ECC	Open	1x256GB SSD M.2 PCIe Opal	HH DVD±RW	9-in-1	250W Bronze Fixed	None	USB / USB Optical	Windows 10 Pro 64	3-year, Onsite	No	05/17
30BH000A**	EMEA	Core i7-7700 4C/3.6GHz/8MB/65W/DDR4-2400	Intel HD 630	2x8GB UDIMM DDR4-2400 Non-ECC	Open	1x256GB SSD M.2 PCIe Opal	HH DVD±RW	9-in-1	250W Bronze Fixed	None	USB / USB Optical	Windows 10 Pro 64	3-year, Onsite	No	04/17

Model	Region	Processor	Graphics	Memory	Disks	M.2 Drives	Optical	Media Reader	Power Supply	Optional Ports	Keyboard / Mouse	Operating System	Warranty	Global	Ann Date (mm/yy)
30BH000Axx	EMEA	Core i7-7700 4C/3.6GHz/8MB/65W/DDR4-2400	Intel HD 630	2x8GB UDIMM DDR4-2400 Non-ECC	Open	1x256GB SSD M.2 PCIe Opal	HH DVD±RW	9-in-1	250W Bronze Fixed	None	USB / USB Optical	Windows 10 Pro 64	3-year, Onsite	No	04/17
30BH000B--	EMEA	Core i7-7700K 4C/4.2GHz/8MB/91W/DDR4-2400	Intel HD 630	2x8GB UDIMM DDR4-2400 Non-ECC	Open	1x512GB SSD M.2 PCIe Opal	HH DVD±RW	9-in-1	400W Platinum Fixed	None	USB / USB Optical	Windows 10 Pro 64	3-year, Onsite	No	04/17
30BH000B**	EMEA	Core i7-7700K 4C/4.2GHz/8MB/91W/DDR4-2400	Intel HD 630	2x8GB UDIMM DDR4-2400 Non-ECC	Open	1x512GB SSD M.2 PCIe Opal	HH DVD±RW	9-in-1	400W Platinum Fixed	None	USB / USB Optical	Windows 10 Pro 64	3-year, Onsite	No	04/17
30BH000Bxx	EMEA	Core i7-7700K 4C/4.2GHz/8MB/91W/DDR4-2400	Intel HD 630	2x8GB UDIMM DDR4-2400 Non-ECC	Open	1x512GB SSD M.2 PCIe Opal	HH DVD±RW	9-in-1	400W Platinum Fixed	None	USB / USB Optical	Windows 10 Pro 64	3-year, Onsite	No	04/17
30BH000C--	EMEA	Core i7-7700K 4C/4.2GHz/8MB/91W/DDR4-2400	Intel HD 630 + NVIDIA Quadro P2000 5GB	2x16GB UDIMM DDR4-2400 Non-ECC	1x512GB SSD 2.5" SATA6Gbps Opal	None	HH DVD±RW	9-in-1	400W Platinum Fixed	None	USB / USB Optical	Windows 10 Pro 64	3-year, Onsite	No	04/17
30BH000C**	EMEA	Core i7-7700K 4C/4.2GHz/8MB/91W/DDR4-2400	Intel HD 630 + NVIDIA Quadro P2000 5GB	2x16GB UDIMM DDR4-2400 Non-ECC	1x512GB SSD 2.5" SATA6Gbps Opal	None	HH DVD±RW	9-in-1	400W Platinum Fixed	None	USB / USB Optical	Windows 10 Pro 64	3-year, Onsite	No	04/17
30BH000Cxx	EMEA	Core i7-7700K 4C/4.2GHz/8MB/91W/DDR4-2400	Intel HD 630 + NVIDIA Quadro P2000 5GB	2x16GB UDIMM DDR4-2400 Non-ECC	1x512GB SSD 2.5" SATA6Gbps Opal	None	HH DVD±RW	9-in-1	400W Platinum Fixed	None	USB / USB Optical	Windows 10 Pro 64	3-year, Onsite	No	04/17
30BH000D--	EMEA	Core i7-7700 4C/3.6GHz/8MB/65W/DDR4-2400	Intel HD 630	2x8GB UDIMM DDR4-2400 Non-ECC	1x512GB SSD 2.5" SATA6Gbps Opal	None	HH DVD±RW	9-in-1	400W Platinum Fixed	None	USB / USB Optical	Windows 10 Pro 64	3-year, Onsite	No	04/17
30BH000D**	EMEA	Core i7-7700 4C/3.6GHz/8MB/65W/DDR4-2400	Intel HD 630	2x8GB UDIMM DDR4-2400 Non-ECC	1x512GB SSD 2.5" SATA6Gbps Opal	None	HH DVD±RW	9-in-1	400W Platinum Fixed	None	USB / USB Optical	Windows 10 Pro 64	3-year, Onsite	No	04/17
30BH000Dxx	EMEA	Core i7-7700 4C/3.6GHz/8MB/65W/DDR4-2400	Intel HD 630	2x8GB UDIMM DDR4-2400 Non-ECC	1x512GB SSD 2.5" SATA6Gbps Opal	None	HH DVD±RW	9-in-1	400W Platinum Fixed	None	USB / USB Optical	Windows 10 Pro 64	3-year, Onsite	No	04/17
30BH000E--	EMEA	Core i7-7700 4C/3.6GHz/8MB/65W/DDR4-2400	Intel HD 630	1x8GB UDIMM DDR4-2400 Non-ECC	1x256GB SSD 2.5" SATA6Gbps Opal	None	HH DVD±RW	9-in-1	400W Platinum Fixed	None	USB / USB Optical	Windows 10 Pro 64	3-year, Onsite	No	04/17
30BH000E**	EMEA	Core i7-7700 4C/3.6GHz/8MB/65W/DDR4-2400	Intel HD 630	1x8GB UDIMM DDR4-2400 Non-ECC	1x256GB SSD 2.5" SATA6Gbps Opal	None	HH DVD±RW	9-in-1	400W Platinum Fixed	None	USB / USB Optical	Windows 10 Pro 64	3-year, Onsite	No	04/17
30BH000Exx	EMEA	Core i7-7700 4C/3.6GHz/8MB/65W/DDR4-2400	Intel HD 630	1x8GB UDIMM DDR4-2400 Non-ECC	1x256GB SSD 2.5" SATA6Gbps Opal	None	HH DVD±RW	9-in-1	400W Platinum Fixed	None	USB / USB Optical	Windows 10 Pro 64	3-year, Onsite	No	04/17

Model	Region	Processor	Graphics	Memory	Disks	M.2 Drives	Optical	Media Reader	Power Supply	Optional Ports	Keyboard / Mouse	Operating System	Warranty	Global	Ann Date (mm/yy)
30BH000F--	EMEA	Core i7-7700 4C/3.6GHz/8MB/65W/DDR4-2400	Intel HD 630	2x8GB UDIMM DDR4-2400 Non-ECC	1x256GB SSD 2.5" SATA6Gbps Opal	None	HH DVD±RW	9-in-1	400W Platinum Fixed	None	USB / USB Optical	Windows 10 Pro 64	3-year, Onsite	No	04/17
30BH000F**	EMEA	Core i7-7700 4C/3.6GHz/8MB/65W/DDR4-2400	Intel HD 630	2x8GB UDIMM DDR4-2400 Non-ECC	1x256GB SSD 2.5" SATA6Gbps Opal	None	HH DVD±RW	9-in-1	400W Platinum Fixed	None	USB / USB Optical	Windows 10 Pro 64	3-year, Onsite	No	04/17
30BH000Fxx	EMEA	Core i7-7700 4C/3.6GHz/8MB/65W/DDR4-2400	Intel HD 630	2x8GB UDIMM DDR4-2400 Non-ECC	1x256GB SSD 2.5" SATA6Gbps Opal	None	HH DVD±RW	9-in-1	400W Platinum Fixed	None	USB / USB Optical	Windows 10 Pro 64	3-year, Onsite	No	04/17
30BH000G--	EMEA	Core i7-7700 4C/3.6GHz/8MB/65W/DDR4-2400	Intel HD 630	2x8GB UDIMM DDR4-2400 Non-ECC	1x256GB SSD 2.5" SATA6Gbps Opal+1x1TB HDD 7.2K 3.5" SATA6Gbps	None	HH DVD±RW	9-in-1	400W Platinum Fixed	None	USB / USB Optical	Windows 10 Pro 64	3-year, Onsite	No	04/17
30BH000G**	EMEA	Core i7-7700 4C/3.6GHz/8MB/65W/DDR4-2400	Intel HD 630	2x8GB UDIMM DDR4-2400 Non-ECC	1x256GB SSD 2.5" SATA6Gbps Opal+1x1TB HDD 7.2K 3.5" SATA6Gbps	None	HH DVD±RW	9-in-1	400W Platinum Fixed	None	USB / USB Optical	Windows 10 Pro 64	3-year, Onsite	No	04/17
30BH000Gxx	EMEA	Core i7-7700 4C/3.6GHz/8MB/65W/DDR4-2400	Intel HD 630	2x8GB UDIMM DDR4-2400 Non-ECC	1x256GB SSD 2.5" SATA6Gbps Opal+1x1TB HDD 7.2K 3.5" SATA6Gbps	None	HH DVD±RW	9-in-1	400W Platinum Fixed	None	USB / USB Optical	Windows 10 Pro 64	3-year, Onsite	No	05/17
30BH000H--	EMEA	Core i7-7700 4C/3.6GHz/8MB/65W/DDR4-2400	Intel HD 630 + NVIDIA Quadro P4000 8GB	2x8GB UDIMM DDR4-2400 Non-ECC	1x256GB SSD 2.5" SATA6Gbps Opal	None	HH DVD±RW	9-in-1	400W Platinum Fixed	None	USB / USB Optical	Windows 10 Pro 64	3-year, Onsite	No	04/17
30BH000H**	EMEA	Core i7-7700 4C/3.6GHz/8MB/65W/DDR4-2400	Intel HD 630 + NVIDIA Quadro P4000 8GB	2x8GB UDIMM DDR4-2400 Non-ECC	1x256GB SSD 2.5" SATA6Gbps Opal	None	HH DVD±RW	9-in-1	400W Platinum Fixed	None	USB / USB Optical	Windows 10 Pro 64	3-year, Onsite	No	04/17
30BH000Hxx	EMEA	Core i7-7700 4C/3.6GHz/8MB/65W/DDR4-2400	Intel HD 630 + NVIDIA Quadro P4000 8GB	2x8GB UDIMM DDR4-2400 Non-ECC	1x256GB SSD 2.5" SATA6Gbps Opal	None	HH DVD±RW	9-in-1	400W Platinum Fixed	None	USB / USB Optical	Windows 10 Pro 64	3-year, Onsite	No	04/17
30BH000J--	EMEA	Core i7-7700 4C/3.6GHz/8MB/65W/DDR4-2400	Intel HD 630	2x8GB UDIMM DDR4-2400 Non-ECC	Open	1x512GB SSD M.2 PCIe Opal	HH DVD±RW	9-in-1	400W Platinum Fixed	None	USB / USB Optical	Windows 10 Pro 64	3-year, Onsite	No	04/17
30BH000J**	EMEA	Core i7-7700 4C/3.6GHz/8MB/65W/DDR4-2400	Intel HD 630	2x8GB UDIMM DDR4-2400 Non-ECC	Open	1x512GB SSD M.2 PCIe Opal	HH DVD±RW	9-in-1	400W Platinum Fixed	None	USB / USB Optical	Windows 10 Pro 64	3-year, Onsite	No	04/17
30BH000Jxx	EMEA	Core i7-7700 4C/3.6GHz/8MB/65W/DDR4-2400	Intel HD 630	2x8GB UDIMM DDR4-2400 Non-ECC	Open	1x512GB SSD M.2 PCIe Opal	HH DVD±RW	9-in-1	400W Platinum Fixed	None	USB / USB Optical	Windows 10 Pro 64	3-year, Onsite	No	04/17
30BH000L--	EMEA	Xeon E3-1245 v6 4C/3.7GHz/8MB/73W/DDR4-2400	Intel HD P630	1x8GB UDIMM DDR4-2400 ECC	1x256GB SSD 2.5" SATA6Gbps Opal	None	HH DVD±RW	9-in-1	400W Platinum Fixed	None	USB / USB Optical	Windows 10 Pro 64	3-year, Onsite	No	05/17

Model	Region	Processor	Graphics	Memory	Disks	M.2 Drives	Optical	Media Reader	Power Supply	Optional Ports	Keyboard / Mouse	Operating System	Warranty	Global	Ann Date (mm/yy)
30BH000L**	EMEA	Xeon E3-1245 v6 4C/3.7GHz/8MB/73W/DDR4-2400	Intel HD P630	1x8GB UDIMM DDR4-2400 ECC	1x256GB SSD 2.5" SATA6Gbps Opal	None	HH DVD±RW	9-in-1	400W Platinum Fixed	None	USB / USB Optical	Windows 10 Pro 64	3-year, Onsite	No	04/17
30BH000Lxx	EMEA	Xeon E3-1245 v6 4C/3.7GHz/8MB/73W/DDR4-2400	Intel HD P630	1x8GB UDIMM DDR4-2400 ECC	1x256GB SSD 2.5" SATA6Gbps Opal	None	HH DVD±RW	9-in-1	400W Platinum Fixed	None	USB / USB Optical	Windows 10 Pro 64	3-year, Onsite	No	04/17
30BH000N--	EMEA	Xeon E3-1270 v6 4C/3.8GHz/8MB/72W/DDR4-2400	Open	2x8GB UDIMM DDR4-2400 ECC	Open	1x256GB SSD M.2 PCIe Opal	HH DVD±RW	9-in-1	400W Platinum Fixed	None	USB / USB Optical	Windows 10 Pro 64	3-year, Onsite	No	04/17
30BH000N**	EMEA	Xeon E3-1270 v6 4C/3.8GHz/8MB/72W/DDR4-2400	Open	2x8GB UDIMM DDR4-2400 ECC	Open	1x256GB SSD M.2 PCIe Opal	HH DVD±RW	9-in-1	400W Platinum Fixed	None	USB / USB Optical	Windows 10 Pro 64	3-year, Onsite	No	04/17
30BH000Nxx	EMEA	Xeon E3-1270 v6 4C/3.8GHz/8MB/72W/DDR4-2400	Open	2x8GB UDIMM DDR4-2400 ECC	Open	1x256GB SSD M.2 PCIe Opal	HH DVD±RW	9-in-1	400W Platinum Fixed	None	USB / USB Optical	Windows 10 Pro 64	3-year, Onsite	No	04/17
30BH000Q--	EMEA	Xeon E3-1225 v6 4C/3.3GHz/8MB/73W/DDR4-2400	Intel HD P630	1x8GB UDIMM DDR4-2400 ECC	1x1TB HDD 7.2K 3.5" SATA6Gbps	None	HH DVD±RW	9-in-1	250W Bronze Fixed	None	USB / USB Optical	Windows 10 Pro 64	3-year, Onsite	No	04/17
30BH000Q**	EMEA	Xeon E3-1225 v6 4C/3.3GHz/8MB/73W/DDR4-2400	Intel HD P630	1x8GB UDIMM DDR4-2400 ECC	1x1TB HDD 7.2K 3.5" SATA6Gbps	None	HH DVD±RW	9-in-1	250W Bronze Fixed	None	USB / USB Optical	Windows 10 Pro 64	3-year, Onsite	No	04/17
30BH000Qxx	EMEA	Xeon E3-1225 v6 4C/3.3GHz/8MB/73W/DDR4-2400	Intel HD P630	1x8GB UDIMM DDR4-2400 ECC	1x1TB HDD 7.2K 3.5" SATA6Gbps	None	HH DVD±RW	9-in-1	250W Bronze Fixed	None	USB / USB Optical	Windows 10 Pro 64	3-year, Onsite	No	04/17
30BH000T--	EMEA	Xeon E3-1245 v6 4C/3.7GHz/8MB/73W/DDR4-2400	Intel HD P630	1x8GB UDIMM DDR4-2400 ECC	1x256GB SSD 2.5" SATA6Gbps Opal	None	HH DVD±RW	9-in-1	250W Bronze Fixed	None	USB / USB Optical	Windows 10 Pro 64	3-year, Onsite	No	05/17
30BH000T**	EMEA	Xeon E3-1245 v6 4C/3.7GHz/8MB/73W/DDR4-2400	Intel HD P630	1x8GB UDIMM DDR4-2400 ECC	1x256GB SSD 2.5" SATA6Gbps Opal	None	HH DVD±RW	9-in-1	250W Bronze Fixed	None	USB / USB Optical	Windows 10 Pro 64	3-year, Onsite	No	04/17
30BH000Txx	EMEA	Xeon E3-1245 v6 4C/3.7GHz/8MB/73W/DDR4-2400	Intel HD P630	1x8GB UDIMM DDR4-2400 ECC	1x256GB SSD 2.5" SATA6Gbps Opal	None	HH DVD±RW	9-in-1	250W Bronze Fixed	None	USB / USB Optical	Windows 10 Pro 64	3-year, Onsite	No	04/17
30BH000X--	EMEA	Xeon E3-1245 v6 4C/3.7GHz/8MB/73W/DDR4-2400	Intel HD P630	1x8GB UDIMM DDR4-2400 ECC	1x1TB HDD 7.2K 3.5" SATA6Gbps	None	HH DVD±RW	9-in-1	250W Bronze Fixed	None	USB / USB Optical	Windows 10 Pro 64	3-year, Onsite	No	04/17
30BH000X**	EMEA	Xeon E3-1245 v6 4C/3.7GHz/8MB/73W/DDR4-2400	Intel HD P630	1x8GB UDIMM DDR4-2400 ECC	1x1TB HDD 7.2K 3.5" SATA6Gbps	None	HH DVD±RW	9-in-1	250W Bronze Fixed	None	USB / USB Optical	Windows 10 Pro 64	3-year, Onsite	No	04/17

Model	Region	Processor	Graphics	Memory	Disks	M.2 Drives	Optical	Media Reader	Power Supply	Optional Ports	Keyboard / Mouse	Operating System	Warranty	Global	Ann Date (mm/yy)
30BH000Xxx	EMEA	Xeon E3-1245 v6 4C/3.7GHz/8MB/73W/DDR4-2400	Intel HD P630	1x8GB UDIMM DDR4-2400 ECC	1x1TB HDD 7.2K 3.5" SATA6Gbps	None	HH DVD±RW	9-in-1	250W Bronze Fixed	None	USB / USB Optical	Windows 10 Pro 64	3-year, Onsite	No	04/17
30BH000Y--	EMEA	Xeon E3-1275 v6 4C/3.8GHz/8MB/73W/DDR4-2400	Intel HD P630	1x8GB UDIMM DDR4-2400 ECC	1x256GB SSD 2.5" SATA6Gbps Opal	None	HH DVD±RW	9-in-1	250W Bronze Fixed	None	USB / USB Optical	Windows 10 Pro 64	3-year, Onsite	No	04/17
30BH000Y**	EMEA	Xeon E3-1275 v6 4C/3.8GHz/8MB/73W/DDR4-2400	Intel HD P630	1x8GB UDIMM DDR4-2400 ECC	1x256GB SSD 2.5" SATA6Gbps Opal	None	HH DVD±RW	9-in-1	250W Bronze Fixed	None	USB / USB Optical	Windows 10 Pro 64	3-year, Onsite	No	04/17
30BH000Yxx	EMEA	Xeon E3-1275 v6 4C/3.8GHz/8MB/73W/DDR4-2400	Intel HD P630	1x8GB UDIMM DDR4-2400 ECC	1x256GB SSD 2.5" SATA6Gbps Opal	None	HH DVD±RW	9-in-1	250W Bronze Fixed	None	USB / USB Optical	Windows 10 Pro 64	3-year, Onsite	No	04/17
30BH0011--	EMEA	Xeon E3-1245 v6 4C/3.7GHz/8MB/73W/DDR4-2400	Intel HD P630 + NVIDIA Quadro P2000 5GB	2x8GB UDIMM DDR4-2400 ECC	1x256GB SSD 2.5" SATA6Gbps Opal	None	HH DVD±RW	9-in-1	250W Bronze Fixed	None	USB / USB Optical	Windows 10 Pro 64	3-year, Onsite	No	04/17
30BH0011**	EMEA	Xeon E3-1245 v6 4C/3.7GHz/8MB/73W/DDR4-2400	Intel HD P630 + NVIDIA Quadro P2000 5GB	2x8GB UDIMM DDR4-2400 ECC	1x256GB SSD 2.5" SATA6Gbps Opal	None	HH DVD±RW	9-in-1	250W Bronze Fixed	None	USB / USB Optical	Windows 10 Pro 64	3-year, Onsite	No	04/17
30BH0011xx	EMEA	Xeon E3-1245 v6 4C/3.7GHz/8MB/73W/DDR4-2400	Intel HD P630 + NVIDIA Quadro P2000 5GB	2x8GB UDIMM DDR4-2400 ECC	1x256GB SSD 2.5" SATA6Gbps Opal	None	HH DVD±RW	9-in-1	250W Bronze Fixed	None	USB / USB Optical	Windows 10 Pro 64	3-year, Onsite	No	05/17
30BH0012--	EMEA	Xeon E3-1230 v6 4C/3.5GHz/8MB/72W/DDR4-2400	NVIDIA Quadro P1000 4GB	2x8GB UDIMM DDR4-2400 ECC	1x256GB SSD 2.5" SATA6Gbps Opal	None	HH DVD±RW	9-in-1	250W Bronze Fixed	None	USB / USB Optical	Windows 10 Pro 64	3-year, Onsite	No	04/17
30BH0012**	EMEA	Xeon E3-1230 v6 4C/3.5GHz/8MB/72W/DDR4-2400	NVIDIA Quadro P1000 4GB	2x8GB UDIMM DDR4-2400 ECC	1x256GB SSD 2.5" SATA6Gbps Opal	None	HH DVD±RW	9-in-1	250W Bronze Fixed	None	USB / USB Optical	Windows 10 Pro 64	3-year, Onsite	No	04/17
30BH0012xx	EMEA	Xeon E3-1230 v6 4C/3.5GHz/8MB/72W/DDR4-2400	NVIDIA Quadro P1000 4GB	2x8GB UDIMM DDR4-2400 ECC	1x256GB SSD 2.5" SATA6Gbps Opal	None	HH DVD±RW	9-in-1	250W Bronze Fixed	None	USB / USB Optical	Windows 10 Pro 64	3-year, Onsite	No	04/17
30BH0013--	EMEA	Core i5-6500 4C/3.2GHz/6MB/65W/DDR4-2133	Intel HD 530	1x8GB UDIMM DDR4-2400 Non-ECC	1x1TB HDD 7.2K 3.5" SATA6Gbps	None	HH DVD±RW	9-in-1	250W Bronze Fixed	None	USB / USB Optical	Windows 10 DG Windows 7 Pro 64	3-year, Onsite	No	04/17
30BH0013**	EMEA	Core i5-6500 4C/3.2GHz/6MB/65W/DDR4-2133	Intel HD 530	1x8GB UDIMM DDR4-2400 Non-ECC	1x1TB HDD 7.2K 3.5" SATA6Gbps	None	HH DVD±RW	9-in-1	250W Bronze Fixed	None	USB / USB Optical	Windows 10 DG Windows 7 Pro 64	3-year, Onsite	No	04/17
30BH0013xx	EMEA	Core i5-6500 4C/3.2GHz/6MB/65W/DDR4-2133	Intel HD 530	1x8GB UDIMM DDR4-2400 Non-ECC	1x1TB HDD 7.2K 3.5" SATA6Gbps	None	HH DVD±RW	9-in-1	250W Bronze Fixed	None	USB / USB Optical	Windows 10 DG Windows 7 Pro 64	3-year, Onsite	No	04/17

Model	Region	Processor	Graphics	Memory	Disks	M.2 Drives	Optical	Media Reader	Power Supply	Optional Ports	Keyboard / Mouse	Operating System	Warranty	Global	Ann Date (mm/yy)
30BH0014--	EMEA	Core i7-6700 4C/3.4GHz/8MB/65W/DDR4-2133	Intel HD 530	1x8GB UDIMM DDR4-2400 Non-ECC	1x1TB HDD 7.2K 3.5" SATA6Gbps	None	HH DVD±RW	9-in-1	250W Bronze Fixed	None	USB / USB Optical	Windows 10 DG Windows 7 Pro 64	3-year, Onsite	No	04/17
30BH0014**	EMEA	Core i7-6700 4C/3.4GHz/8MB/65W/DDR4-2133	Intel HD 530	1x8GB UDIMM DDR4-2400 Non-ECC	1x1TB HDD 7.2K 3.5" SATA6Gbps	None	HH DVD±RW	9-in-1	250W Bronze Fixed	None	USB / USB Optical	Windows 10 DG Windows 7 Pro 64	3-year, Onsite	No	04/17
30BH0014xx	EMEA	Core i7-6700 4C/3.4GHz/8MB/65W/DDR4-2133	Intel HD 530	1x8GB UDIMM DDR4-2400 Non-ECC	1x1TB HDD 7.2K 3.5" SATA6Gbps	None	HH DVD±RW	9-in-1	250W Bronze Fixed	None	USB / USB Optical	Windows 10 DG Windows 7 Pro 64	3-year, Onsite	No	04/17
30BH0015--	EMEA	Core i7-6700 4C/3.4GHz/8MB/65W/DDR4-2133	Intel HD 530 + NVIDIA Quadro P2000 5GB	1x8GB UDIMM DDR4-2400 Non-ECC	1x1TB HDD 7.2K 3.5" SATA6Gbps	None	HH DVD±RW	9-in-1	250W Bronze Fixed	None	USB / USB Optical	Windows 10 DG Windows 7 Pro 64	3-year, Onsite	No	04/17
30BH0015**	EMEA	Core i7-6700 4C/3.4GHz/8MB/65W/DDR4-2133	Intel HD 530 + NVIDIA Quadro P2000 5GB	1x8GB UDIMM DDR4-2400 Non-ECC	1x1TB HDD 7.2K 3.5" SATA6Gbps	None	HH DVD±RW	9-in-1	250W Bronze Fixed	None	USB / USB Optical	Windows 10 DG Windows 7 Pro 64	3-year, Onsite	No	04/17
30BH0015xx	EMEA	Core i7-6700 4C/3.4GHz/8MB/65W/DDR4-2133	Intel HD 530 + NVIDIA Quadro P2000 5GB	1x8GB UDIMM DDR4-2400 Non-ECC	1x1TB HDD 7.2K 3.5" SATA6Gbps	None	HH DVD±RW	9-in-1	250W Bronze Fixed	None	USB / USB Optical	Windows 10 DG Windows 7 Pro 64	3-year, Onsite	No	04/17
30BH0016--	EMEA	Core i7-6700 4C/3.4GHz/8MB/65W/DDR4-2133	Intel HD 530 + NVIDIA Quadro P400 2GB	1x8GB UDIMM DDR4-2400 Non-ECC	1x1TB HDD 7.2K 3.5" SATA6Gbps	None	HH DVD±RW	9-in-1	250W Bronze Fixed	None	USB / USB Optical	Windows 10 DG Windows 7 Pro 64	3-year, Onsite	No	04/17
30BH0016**	EMEA	Core i7-6700 4C/3.4GHz/8MB/65W/DDR4-2133	Intel HD 530 + NVIDIA Quadro P400 2GB	1x8GB UDIMM DDR4-2400 Non-ECC	1x1TB HDD 7.2K 3.5" SATA6Gbps	None	HH DVD±RW	9-in-1	250W Bronze Fixed	None	USB / USB Optical	Windows 10 DG Windows 7 Pro 64	3-year, Onsite	No	04/17
30BH0016xx	EMEA	Core i7-6700 4C/3.4GHz/8MB/65W/DDR4-2133	Intel HD 530 + NVIDIA Quadro P400 2GB	1x8GB UDIMM DDR4-2400 Non-ECC	1x1TB HDD 7.2K 3.5" SATA6Gbps	None	HH DVD±RW	9-in-1	250W Bronze Fixed	None	USB / USB Optical	Windows 10 DG Windows 7 Pro 64	3-year, Onsite	No	05/17
30BH0017--	EMEA	Core i7-6700 4C/3.4GHz/8MB/65W/DDR4-2133	Intel HD 530	1x8GB UDIMM DDR4-2400 Non-ECC	1x256GB SSD 2.5" SATA6Gbps Opal	None	HH DVD±RW	9-in-1	250W Bronze Fixed	None	USB / USB Optical	Windows 10 DG Windows 7 Pro 64	3-year, Onsite	No	04/17
30BH0017**	EMEA	Core i7-6700 4C/3.4GHz/8MB/65W/DDR4-2133	Intel HD 530	1x8GB UDIMM DDR4-2400 Non-ECC	1x256GB SSD 2.5" SATA6Gbps Opal	None	HH DVD±RW	9-in-1	250W Bronze Fixed	None	USB / USB Optical	Windows 10 DG Windows 7 Pro 64	3-year, Onsite	No	04/17
30BH0017xx	EMEA	Core i7-6700 4C/3.4GHz/8MB/65W/DDR4-2133	Intel HD 530	1x8GB UDIMM DDR4-2400 Non-ECC	1x256GB SSD 2.5" SATA6Gbps Opal	None	HH DVD±RW	9-in-1	250W Bronze Fixed	None	USB / USB Optical	Windows 10 DG Windows 7 Pro 64	3-year, Onsite	No	04/17
30BH0018--	EMEA	Core i7-6700 4C/3.4GHz/8MB/65W/DDR4-2133	Intel HD 530 + NVIDIA Quadro P600 2GB	1x8GB UDIMM DDR4-2400 Non-ECC	1x1TB HDD 7.2K 3.5" SATA6Gbps	None	HH DVD±RW	9-in-1	250W Bronze Fixed	None	USB / USB Optical	Windows 10 DG Windows 7 Pro 64	3-year, Onsite	No	04/17

Model	Region	Processor	Graphics	Memory	Disks	M.2 Drives	Optical	Media Reader	Power Supply	Optional Ports	Keyboard / Mouse	Operating System	Warranty	Global	Ann Date (mm/yy)
30BH0018**	EMEA	Core i7-6700 4C/3.4GHz/8MB/65W/DDR4-2133	Intel HD 530 + NVIDIA Quadro P600 2GB	1x8GB UDIMM DDR4-2400 Non-ECC	1x1TB HDD 7.2K 3.5" SATA6Gbps	None	HH DVD±RW	9-in-1	250W Bronze Fixed	None	USB / USB Optical	Windows 10 DG Windows 7 Pro 64	3-year, Onsite	No	04/17
30BH0018xx	EMEA	Core i7-6700 4C/3.4GHz/8MB/65W/DDR4-2133	Intel HD 530 + NVIDIA Quadro P600 2GB	1x8GB UDIMM DDR4-2400 Non-ECC	1x1TB HDD 7.2K 3.5" SATA6Gbps	None	HH DVD±RW	9-in-1	250W Bronze Fixed	None	USB / USB Optical	Windows 10 DG Windows 7 Pro 64	3-year, Onsite	No	04/17
30BH0019--	EMEA	Core i7-6700 4C/3.4GHz/8MB/65W/DDR4-2133	Intel HD 530 + NVIDIA Quadro P2000 5GB	2x8GB UDIMM DDR4-2400 Non-ECC	1x256GB SSD 2.5" SATA6Gbps Opal	None	HH DVD±RW	9-in-1	250W Bronze Fixed	None	USB / USB Optical	Windows 10 DG Windows 7 Pro 64	3-year, Onsite	No	04/17
30BH0019**	EMEA	Core i7-6700 4C/3.4GHz/8MB/65W/DDR4-2133	Intel HD 530 + NVIDIA Quadro P2000 5GB	2x8GB UDIMM DDR4-2400 Non-ECC	1x256GB SSD 2.5" SATA6Gbps Opal	None	HH DVD±RW	9-in-1	250W Bronze Fixed	None	USB / USB Optical	Windows 10 DG Windows 7 Pro 64	3-year, Onsite	No	04/17
30BH0019xx	EMEA	Core i7-6700 4C/3.4GHz/8MB/65W/DDR4-2133	Intel HD 530 + NVIDIA Quadro P2000 5GB	2x8GB UDIMM DDR4-2400 Non-ECC	1x256GB SSD 2.5" SATA6Gbps Opal	None	HH DVD±RW	9-in-1	250W Bronze Fixed	None	USB / USB Optical	Windows 10 DG Windows 7 Pro 64	3-year, Onsite	No	04/17
30BH001A--	EMEA	Core i7-6700 4C/3.4GHz/8MB/65W/DDR4-2133	Intel HD 530	2x8GB UDIMM DDR4-2400 Non-ECC	Open	1x256GB SSD M.2 PCIe Opal	HH DVD±RW	9-in-1	250W Bronze Fixed	None	USB / USB Optical	Windows 10 DG Windows 7 Pro 64	3-year, Onsite	No	04/17
30BH001A**	EMEA	Core i7-6700 4C/3.4GHz/8MB/65W/DDR4-2133	Intel HD 530	2x8GB UDIMM DDR4-2400 Non-ECC	Open	1x256GB SSD M.2 PCIe Opal	HH DVD±RW	9-in-1	250W Bronze Fixed	None	USB / USB Optical	Windows 10 DG Windows 7 Pro 64	3-year, Onsite	No	04/17
30BH001Axx	EMEA	Core i7-6700 4C/3.4GHz/8MB/65W/DDR4-2133	Intel HD 530	2x8GB UDIMM DDR4-2400 Non-ECC	Open	1x256GB SSD M.2 PCIe Opal	HH DVD±RW	9-in-1	250W Bronze Fixed	None	USB / USB Optical	Windows 10 DG Windows 7 Pro 64	3-year, Onsite	No	04/17
30BH001B--	EMEA	Core i7-6700 4C/3.4GHz/8MB/65W/DDR4-2133	Intel HD 530	2x8GB UDIMM DDR4-2400 Non-ECC	1x256GB SSD 2.5" SATA6Gbps Opal	None	HH DVD±RW	9-in-1	400W Platinum Fixed	None	USB / USB Optical	Windows 10 DG Windows 7 Pro 64	3-year, Onsite	No	04/17
30BH001B**	EMEA	Core i7-6700 4C/3.4GHz/8MB/65W/DDR4-2133	Intel HD 530	2x8GB UDIMM DDR4-2400 Non-ECC	1x256GB SSD 2.5" SATA6Gbps Opal	None	HH DVD±RW	9-in-1	400W Platinum Fixed	None	USB / USB Optical	Windows 10 DG Windows 7 Pro 64	3-year, Onsite	No	04/17
30BH001Bxx	EMEA	Core i7-6700 4C/3.4GHz/8MB/65W/DDR4-2133	Intel HD 530	2x8GB UDIMM DDR4-2400 Non-ECC	1x256GB SSD 2.5" SATA6Gbps Opal	None	HH DVD±RW	9-in-1	400W Platinum Fixed	None	USB / USB Optical	Windows 10 DG Windows 7 Pro 64	3-year, Onsite	No	04/17
30BH001C--	EMEA	Core i7-6700 4C/3.4GHz/8MB/65W/DDR4-2133	Intel HD 530	2x8GB UDIMM DDR4-2400 Non-ECC	1x512GB SSD 2.5" SATA6Gbps Opal	None	HH DVD±RW	9-in-1	400W Platinum Fixed	None	USB / USB Optical	Windows 10 DG Windows 7 Pro 64	3-year, Onsite	No	04/17
30BH001C**	EMEA	Core i7-6700 4C/3.4GHz/8MB/65W/DDR4-2133	Intel HD 530	2x8GB UDIMM DDR4-2400 Non-ECC	1x512GB SSD 2.5" SATA6Gbps Opal	None	HH DVD±RW	9-in-1	400W Platinum Fixed	None	USB / USB Optical	Windows 10 DG Windows 7 Pro 64	3-year, Onsite	No	04/17

Model	Region	Processor	Graphics	Memory	Disks	M.2 Drives	Optical	Media Reader	Power Supply	Optional Ports	Keyboard / Mouse	Operating System	Warranty	Global	Ann Date (mm/yy)
30BH001Cxx	EMEA	Core i7-6700 4C/3.4GHz/8MB/65W/DDR4-2133	Intel HD 530	2x8GB UDIMM DDR4-2400 Non-ECC	1x512GB SSD 2.5" SATA6Gbps Opal	None	HH DVD±RW	9-in-1	400W Platinum Fixed	None	USB / USB Optical	Windows 10 DG Windows 7 Pro 64	3-year, Onsite	No	04/17
30BH001D--	EMEA	Core i7-6700 4C/3.4GHz/8MB/65W/DDR4-2133	Intel HD 530 + NVIDIA Quadro P4000 8GB	2x8GB UDIMM DDR4-2400 Non-ECC	1x256GB SSD 2.5" SATA6Gbps Opal	None	HH DVD±RW	9-in-1	400W Platinum Fixed	None	USB / USB Optical	Windows 10 DG Windows 7 Pro 64	3-year, Onsite	No	04/17
30BH001D**	EMEA	Core i7-6700 4C/3.4GHz/8MB/65W/DDR4-2133	Intel HD 530 + NVIDIA Quadro P4000 8GB	2x8GB UDIMM DDR4-2400 Non-ECC	1x256GB SSD 2.5" SATA6Gbps Opal	None	HH DVD±RW	9-in-1	400W Platinum Fixed	None	USB / USB Optical	Windows 10 DG Windows 7 Pro 64	3-year, Onsite	No	04/17
30BH001Dxx	EMEA	Core i7-6700 4C/3.4GHz/8MB/65W/DDR4-2133	Intel HD 530 + NVIDIA Quadro P4000 8GB	2x8GB UDIMM DDR4-2400 Non-ECC	1x256GB SSD 2.5" SATA6Gbps Opal	None	HH DVD±RW	9-in-1	400W Platinum Fixed	None	USB / USB Optical	Windows 10 DG Windows 7 Pro 64	3-year, Onsite	No	04/17
30BH001E--	EMEA	Core i7-6700 4C/3.4GHz/8MB/65W/DDR4-2133	Intel HD 530	2x8GB UDIMM DDR4-2400 Non-ECC	1x256GB SSD 2.5" SATA6Gbps Opal+1x1TB HDD 7.2K 3.5" SATA6Gbps	None	HH DVD±RW	9-in-1	400W Platinum Fixed	None	USB / USB Optical	Windows 10 DG Windows 7 Pro 64	3-year, Onsite	No	04/17
30BH001E**	EMEA	Core i7-6700 4C/3.4GHz/8MB/65W/DDR4-2133	Intel HD 530	2x8GB UDIMM DDR4-2400 Non-ECC	1x256GB SSD 2.5" SATA6Gbps Opal+1x1TB HDD 7.2K 3.5" SATA6Gbps	None	HH DVD±RW	9-in-1	400W Platinum Fixed	None	USB / USB Optical	Windows 10 DG Windows 7 Pro 64	3-year, Onsite	No	04/17
30BH001Exx	EMEA	Core i7-6700 4C/3.4GHz/8MB/65W/DDR4-2133	Intel HD 530	2x8GB UDIMM DDR4-2400 Non-ECC	1x256GB SSD 2.5" SATA6Gbps Opal+1x1TB HDD 7.2K 3.5" SATA6Gbps	None	HH DVD±RW	9-in-1	400W Platinum Fixed	None	USB / USB Optical	Windows 10 DG Windows 7 Pro 64	3-year, Onsite	No	04/17
30BH001F--	EMEA	Core i7-6700 4C/3.4GHz/8MB/65W/DDR4-2133	Intel HD 530	2x8GB UDIMM DDR4-2400 Non-ECC	Open	1x512GB SSD M.2 PCIe Opal	HH DVD±RW	9-in-1	400W Platinum Fixed	None	USB / USB Optical	Windows 10 DG Windows 7 Pro 64	3-year, Onsite	No	05/17
30BH001F**	EMEA	Core i7-6700 4C/3.4GHz/8MB/65W/DDR4-2133	Intel HD 530	2x8GB UDIMM DDR4-2400 Non-ECC	Open	1x512GB SSD M.2 PCIe Opal	HH DVD±RW	9-in-1	400W Platinum Fixed	None	USB / USB Optical	Windows 10 DG Windows 7 Pro 64	3-year, Onsite	No	04/17
30BH001Fxx	EMEA	Core i7-6700 4C/3.4GHz/8MB/65W/DDR4-2133	Intel HD 530	2x8GB UDIMM DDR4-2400 Non-ECC	Open	1x512GB SSD M.2 PCIe Opal	HH DVD±RW	9-in-1	400W Platinum Fixed	None	USB / USB Optical	Windows 10 DG Windows 7 Pro 64	3-year, Onsite	No	05/17
30BH001G--	EMEA	Xeon E3-1225 v5 4C/3.3GHz/8MB/80W/DDR4-2133	Intel HD P530	1x8GB UDIMM DDR4-2400 ECC	1x1TB HDD 7.2K 3.5" SATA6Gbps	None	HH DVD±RW	9-in-1	250W Bronze Fixed	None	USB / USB Optical	Windows 10 DG Windows 7 Pro 64	3-year, Onsite	No	05/17
30BH001G**	EMEA	Xeon E3-1225 v5 4C/3.3GHz/8MB/80W/DDR4-2133	Intel HD P530	1x8GB UDIMM DDR4-2400 ECC	1x1TB HDD 7.2K 3.5" SATA6Gbps	None	HH DVD±RW	9-in-1	250W Bronze Fixed	None	USB / USB Optical	Windows 10 DG Windows 7 Pro 64	3-year, Onsite	No	04/17
30BH001Gxx	EMEA	Xeon E3-1225 v5 4C/3.3GHz/8MB/80W/DDR4-2133	Intel HD P530	1x8GB UDIMM DDR4-2400 ECC	1x1TB HDD 7.2K 3.5" SATA6Gbps	None	HH DVD±RW	9-in-1	250W Bronze Fixed	None	USB / USB Optical	Windows 10 DG Windows 7 Pro 64	3-year, Onsite	No	04/17

Model	Region	Processor	Graphics	Memory	Disks	M.2 Drives	Optical	Media Reader	Power Supply	Optional Ports	Keyboard / Mouse	Operating System	Warranty	Global	Ann Date (mm/yy)
30BH001H--	EMEA	Xeon E3-1245 v5 4C/3.5GHz/8MB/80W/DDR4-2133	Intel HD P530	1x8GB UDIMM DDR4-2400 ECC	1x1TB HDD 7.2K 3.5" SATA6Gbps	None	HH DVD±RW	9-in-1	250W Bronze Fixed	None	USB / USB Optical	Windows 10 DG Windows 7 Pro 64	3-year, Onsite	No	04/17
30BH001H**	EMEA	Xeon E3-1245 v5 4C/3.5GHz/8MB/80W/DDR4-2133	Intel HD P530	1x8GB UDIMM DDR4-2400 ECC	1x1TB HDD 7.2K 3.5" SATA6Gbps	None	HH DVD±RW	9-in-1	250W Bronze Fixed	None	USB / USB Optical	Windows 10 DG Windows 7 Pro 64	3-year, Onsite	No	04/17
30BH001Hxx	EMEA	Xeon E3-1245 v5 4C/3.5GHz/8MB/80W/DDR4-2133	Intel HD P530	1x8GB UDIMM DDR4-2400 ECC	1x1TB HDD 7.2K 3.5" SATA6Gbps	None	HH DVD±RW	9-in-1	250W Bronze Fixed	None	USB / USB Optical	Windows 10 DG Windows 7 Pro 64	3-year, Onsite	No	04/17
30BH001J--	EMEA	Xeon E3-1245 v5 4C/3.5GHz/8MB/80W/DDR4-2133	Intel HD P530 + NVIDIA Quadro P2000 5GB	2x8GB UDIMM DDR4-2400 ECC	1x256GB SSD 2.5" SATA6Gbps Opal	None	HH DVD±RW	9-in-1	250W Bronze Fixed	None	USB / USB Optical	Windows 10 DG Windows 7 Pro 64	3-year, Onsite	No	04/17
30BH001J**	EMEA	Xeon E3-1245 v5 4C/3.5GHz/8MB/80W/DDR4-2133	Intel HD P530 + NVIDIA Quadro P2000 5GB	2x8GB UDIMM DDR4-2400 ECC	1x256GB SSD 2.5" SATA6Gbps Opal	None	HH DVD±RW	9-in-1	250W Bronze Fixed	None	USB / USB Optical	Windows 10 DG Windows 7 Pro 64	3-year, Onsite	No	04/17
30BH001Jxx	EMEA	Xeon E3-1245 v5 4C/3.5GHz/8MB/80W/DDR4-2133	Intel HD P530 + NVIDIA Quadro P2000 5GB	2x8GB UDIMM DDR4-2400 ECC	1x256GB SSD 2.5" SATA6Gbps Opal	None	HH DVD±RW	9-in-1	250W Bronze Fixed	None	USB / USB Optical	Windows 10 DG Windows 7 Pro 64	3-year, Onsite	No	04/17
30BH001K--	EMEA	Xeon E3-1245 v5 4C/3.5GHz/8MB/80W/DDR4-2133	Intel HD P530	1x8GB UDIMM DDR4-2400 ECC	1x256GB SSD 2.5" SATA6Gbps Opal	None	HH DVD±RW	9-in-1	250W Bronze Fixed	None	USB / USB Optical	Windows 10 DG Windows 7 Pro 64	3-year, Onsite	No	04/17
30BH001K**	EMEA	Xeon E3-1245 v5 4C/3.5GHz/8MB/80W/DDR4-2133	Intel HD P530	1x8GB UDIMM DDR4-2400 ECC	1x256GB SSD 2.5" SATA6Gbps Opal	None	HH DVD±RW	9-in-1	250W Bronze Fixed	None	USB / USB Optical	Windows 10 DG Windows 7 Pro 64	3-year, Onsite	No	04/17
30BH001Kxx	EMEA	Xeon E3-1245 v5 4C/3.5GHz/8MB/80W/DDR4-2133	Intel HD P530	1x8GB UDIMM DDR4-2400 ECC	1x256GB SSD 2.5" SATA6Gbps Opal	None	HH DVD±RW	9-in-1	250W Bronze Fixed	None	USB / USB Optical	Windows 10 DG Windows 7 Pro 64	3-year, Onsite	No	04/17
30BH001L--	EMEA	Core i7-6700 4C/3.4GHz/8MB/65W/DDR4-2133	Intel HD 530	1x8GB UDIMM DDR4-2400 Non-ECC	1x256GB SSD 2.5" SATA6Gbps Opal	None	HH DVD±RW	9-in-1	400W Platinum Fixed	None	USB / USB Optical	Windows 10 DG Windows 7 Pro 64	3-year, Onsite	No	04/17
30BH001L**	EMEA	Core i7-6700 4C/3.4GHz/8MB/65W/DDR4-2133	Intel HD 530	1x8GB UDIMM DDR4-2400 Non-ECC	1x256GB SSD 2.5" SATA6Gbps Opal	None	HH DVD±RW	9-in-1	400W Platinum Fixed	None	USB / USB Optical	Windows 10 DG Windows 7 Pro 64	3-year, Onsite	No	04/17
30BH001Lxx	EMEA	Core i7-6700 4C/3.4GHz/8MB/65W/DDR4-2133	Intel HD 530	1x8GB UDIMM DDR4-2400 Non-ECC	1x256GB SSD 2.5" SATA6Gbps Opal	None	HH DVD±RW	9-in-1	400W Platinum Fixed	None	USB / USB Optical	Windows 10 DG Windows 7 Pro 64	3-year, Onsite	No	04/17
30BH0022**	EMEA	Core i7-7700 4C/3.6GHz/8MB/65W/DDR4-2400	Intel HD 630	1x8GB UDIMM DDR4-2400 Non-ECC	1x1TB HDD 7.2K 3.5" SATA6Gbps	None	HH DVD±RW	9-in-1	250W Bronze Fixed	None	USB / USB Optical	Windows 10 Pro 64	3-year, Onsite	No	05/17

Model	Region	Processor	Graphics	Memory	Disks	M.2 Drives	Optical	Media Reader	Power Supply	Optional Ports	Keyboard / Mouse	Operating System	Warranty	Global	Ann Date (mm/yy)
30BH003F**	EMEA	Xeon E3-1245 v5 4C/3.5GHz/8MB/80W/DDR4-2133	Intel HD P530	1x8GB UDIMM DDR4-2400 Non-ECC	1x1TB HDD 7.2K 3.5" SATA6Gbps	None	HH DVD±RW	9-in-1	250W Bronze Fixed	None	USB / USB Optical	Windows 10 DG Windows 7 Pro 64	3-year, Onsite	No	05/17
30BH003G**	EMEA	Core i7-7700K 4C/4.2GHz/8MB/91W/DDR4-2400	Intel HD 630 + NVIDIA Quadro P600 2GB	1x8GB UDIMM DDR4-2400 Non-ECC	1x1TB HDD 7.2K 3.5" SATA6Gbps	None	HH DVD±RW	9-in-1	250W Bronze Fixed	None	USB / USB Optical	Windows 10 Pro 64	3-year, Onsite	No	05/17
30BH003H**	EMEA	Core i7-7700 4C/3.6GHz/8MB/65W/DDR4-2400	Intel HD 630 + NVIDIA Quadro P1000 4GB	1x8GB UDIMM DDR4-2400 Non-ECC	1x1TB HDD 7.2K 3.5" SATA6Gbps	None	HH DVD±RW	9-in-1	250W Bronze Fixed	None	USB / USB Optical	Windows 10 Pro 64	3-year, Onsite	No	05/17
30BH003J**	EMEA	Xeon E3-1225 v6 4C/3.3GHz/8MB/73W/DDR4-2400	Intel HD P630	1x8GB UDIMM DDR4-2400 Non-ECC	1x1TB HDD 7.2K 3.5" SATA6Gbps	None	HH DVD±RW	9-in-1	250W Bronze Fixed	None	USB / USB Optical	Windows 10 Pro 64	3-year, Onsite	No	05/17
30BH003K**	EMEA	Core i7-7700K 4C/4.2GHz/8MB/91W/DDR4-2400	Intel HD 630 + NVIDIA Quadro P1000 4GB	1x8GB UDIMM DDR4-2400 Non-ECC	1x1TB HDD 7.2K 3.5" SATA6Gbps	None	HH DVD±RW	9-in-1	250W Bronze Fixed	None	USB / USB Optical	Windows 10 Pro 64	3-year, Onsite	No	05/17
30BH003L**	EMEA	Core i7-7700 4C/3.6GHz/8MB/65W/DDR4-2400	Intel HD 630 + NVIDIA Quadro P600 2GB	1x8GB UDIMM DDR4-2400 Non-ECC	1x1TB HDD 7.2K 3.5" SATA6Gbps	None	HH DVD±RW	9-in-1	250W Bronze Fixed	None	USB / USB Optical	Windows 10 Pro 64	3-year, Onsite	No	05/17
30BH003M**	EMEA	Core i5-6500 4C/3.2GHz/6MB/65W/DDR4-2133	Intel HD 530	1x8GB UDIMM DDR4-2400 Non-ECC	1x1TB HDD 7.2K 3.5" SATA6Gbps	None	HH DVD±RW	9-in-1	250W Bronze Fixed	None	USB / USB Optical	Windows 10 DG Windows 7 Pro 64	3-year, Onsite	No	05/17
30BH003N**	EMEA	Core i7-7700K 4C/4.2GHz/8MB/91W/DDR4-2400	Intel HD 630	1x8GB UDIMM DDR4-2400 Non-ECC	1x1TB HDD 7.2K 3.5" SATA6Gbps	None	HH DVD±RW	9-in-1	250W Bronze Fixed	None	USB / USB Optical	Windows 10 Pro 64	3-year, Onsite	No	05/17
30BH003P**	EMEA	Xeon E3-1245 v6 4C/3.7GHz/8MB/73W/DDR4-2400	Intel HD P630	1x8GB UDIMM DDR4-2400 Non-ECC	1x1TB HDD 7.2K 3.5" SATA6Gbps	None	HH DVD±RW	9-in-1	250W Bronze Fixed	None	USB / USB Optical	Windows 10 Pro 64	3-year, Onsite	No	05/17
30BH003Q**	EMEA	Xeon E3-1275 v6 4C/3.8GHz/8MB/73W/DDR4-2400	Intel HD P630	1x8GB UDIMM DDR4-2400 Non-ECC	1x1TB HDD 7.2K 3.5" SATA6Gbps	None	HH DVD±RW	9-in-1	250W Bronze Fixed	None	USB / USB Optical	Windows 10 Pro 64	3-year, Onsite	No	05/17
30BH003R**	EMEA	Core i7-7700K 4C/4.2GHz/8MB/91W/DDR4-2400	Intel HD 630	1x8GB UDIMM DDR4-2400 Non-ECC	1x1TB HDD 7.2K 3.5" SATA6Gbps	1x256GB SSD M.2 PCIe Opal	HH DVD±RW	9-in-1	250W Bronze Fixed	None	USB / USB Optical	Windows 10 Pro 64	3-year, Onsite	No	05/17
30BH003S**	EMEA	Core i7-6700 4C/3.4GHz/8MB/65W/DDR4-2133	Intel HD 530	1x8GB UDIMM DDR4-2400 Non-ECC	1x1TB HDD 7.2K 3.5" SATA6Gbps	None	HH DVD±RW	9-in-1	250W Bronze Fixed	None	USB / USB Optical	Windows 10 DG Windows 7 Pro 64	3-year, Onsite	No	05/17
30BH003T**	EMEA	Xeon E3-1225 v5 4C/3.3GHz/8MB/80W/DDR4-2133	Intel HD P530	1x8GB UDIMM DDR4-2400 Non-ECC	1x1TB HDD 7.2K 3.5" SATA6Gbps	None	HH DVD±RW	9-in-1	250W Bronze Fixed	None	USB / USB Optical	Windows 10 DG Windows 7 Pro 64	3-year, Onsite	No	05/17

Model	Region	Processor	Graphics	Memory	Disks	M.2 Drives	Optical	Media Reader	Power Supply	Optional Ports	Keyboard / Mouse	Operating System	Warranty	Global	Ann Date (mm/yy)
30BH003W--	EMEA	Xeon E3-1230 v6 4C/3.5GHz/8MB/72W/DDR4-2400	NVIDIA Quadro P400 2GB	1x8GB UDIMM DDR4-2400 ECC	1x1TB HDD 7.2K 3.5" SATA6Gbps	None	HH DVD±RW	9-in-1	400W Platinum Fixed	None	USB / USB Optical	Windows 10 Pro 64	3-year, Onsite	No	07/17
30BH003W**	EMEA	Xeon E3-1230 v6 4C/3.5GHz/8MB/72W/DDR4-2400	NVIDIA Quadro P400 2GB	1x8GB UDIMM DDR4-2400 ECC	1x1TB HDD 7.2K 3.5" SATA6Gbps	None	HH DVD±RW	9-in-1	400W Platinum Fixed	None	USB / USB Optical	Windows 10 Pro 64	3-year, Onsite	No	07/17
30BH003Wxx	EMEA	Xeon E3-1230 v6 4C/3.5GHz/8MB/72W/DDR4-2400	NVIDIA Quadro P400 2GB	1x8GB UDIMM DDR4-2400 ECC	1x1TB HDD 7.2K 3.5" SATA6Gbps	None	HH DVD±RW	9-in-1	400W Platinum Fixed	None	USB / USB Optical	Windows 10 Pro 64	3-year, Onsite	No	07/17
30BH003X--	EMEA	Xeon E3-1240 v6 4C/3.7GHz/8MB/72W/DDR4-2400	NVIDIA Quadro P600 2GB	1x16GB UDIMM DDR4-2400 ECC	1x1TB HDD 7.2K 3.5" SATA6Gbps	None	HH DVD±RW	9-in-1	400W Platinum Fixed	None	USB / USB Optical	Windows 10 Pro 64	3-year, Onsite	No	07/17
30BH003X**	EMEA	Xeon E3-1240 v6 4C/3.7GHz/8MB/72W/DDR4-2400	NVIDIA Quadro P600 2GB	1x16GB UDIMM DDR4-2400 ECC	1x1TB HDD 7.2K 3.5" SATA6Gbps	None	HH DVD±RW	9-in-1	400W Platinum Fixed	None	USB / USB Optical	Windows 10 Pro 64	3-year, Onsite	No	07/17
30BH003Xxx	EMEA	Xeon E3-1240 v6 4C/3.7GHz/8MB/72W/DDR4-2400	NVIDIA Quadro P600 2GB	1x16GB UDIMM DDR4-2400 ECC	1x1TB HDD 7.2K 3.5" SATA6Gbps	None	HH DVD±RW	9-in-1	400W Platinum Fixed	None	USB / USB Optical	Windows 10 Pro 64	3-year, Onsite	No	07/17
30BH003Y--	EMEA	Xeon E3-1245 v6 4C/3.7GHz/8MB/73W/DDR4-2400	Intel HD P630 + NVIDIA Quadro P1000 4GB	1x16GB UDIMM DDR4-2400 ECC	1x1TB HDD 7.2K 3.5" SATA6Gbps	None	HH DVD±RW	9-in-1	400W Platinum Fixed	None	USB / USB Optical	Windows 10 Pro 64	3-year, Onsite	No	07/17
30BH003Y**	EMEA	Xeon E3-1245 v6 4C/3.7GHz/8MB/73W/DDR4-2400	Intel HD P630 + NVIDIA Quadro P1000 4GB	1x16GB UDIMM DDR4-2400 ECC	1x1TB HDD 7.2K 3.5" SATA6Gbps	None	HH DVD±RW	9-in-1	400W Platinum Fixed	None	USB / USB Optical	Windows 10 Pro 64	3-year, Onsite	No	07/17
30BH003Yxx	EMEA	Xeon E3-1245 v6 4C/3.7GHz/8MB/73W/DDR4-2400	Intel HD P630 + NVIDIA Quadro P1000 4GB	1x16GB UDIMM DDR4-2400 ECC	1x1TB HDD 7.2K 3.5" SATA6Gbps	None	HH DVD±RW	9-in-1	400W Platinum Fixed	None	USB / USB Optical	Windows 10 Pro 64	3-year, Onsite	No	06/17
30BH0040--	EMEA	Xeon E3-1270 v6 4C/3.8GHz/8MB/72W/DDR4-2400	NVIDIA Quadro P2000 5GB	1x16GB UDIMM DDR4-2400 ECC	1x256GB SSD 2.5" SATA6Gbps Opal+1x2TB HDD 7.2K 3.5" SATA6Gbps	None	HH DVD±RW	9-in-1	400W Platinum Fixed	None	USB / USB Optical	Windows 10 Pro 64	3-year, Onsite	No	07/17
30BH0040**	EMEA	Xeon E3-1270 v6 4C/3.8GHz/8MB/72W/DDR4-2400	NVIDIA Quadro P2000 5GB	1x16GB UDIMM DDR4-2400 ECC	1x256GB SSD 2.5" SATA6Gbps Opal+1x2TB HDD 7.2K 3.5" SATA6Gbps	None	HH DVD±RW	9-in-1	400W Platinum Fixed	None	USB / USB Optical	Windows 10 Pro 64	3-year, Onsite	No	07/17
30BH0040xx	EMEA	Xeon E3-1270 v6 4C/3.8GHz/8MB/72W/DDR4-2400	NVIDIA Quadro P2000 5GB	1x16GB UDIMM DDR4-2400 ECC	1x256GB SSD 2.5" SATA6Gbps Opal+1x2TB HDD 7.2K 3.5" SATA6Gbps	None	HH DVD±RW	9-in-1	400W Platinum Fixed	None	USB / USB Optical	Windows 10 Pro 64	3-year, Onsite	No	06/17
30BH0041--	EMEA	Xeon E3-1245 v6 4C/3.7GHz/8MB/73W/DDR4-2400	Intel HD P630	1x8GB UDIMM DDR4-2400 ECC	1x256GB SSD 2.5" SATA6Gbps Opal	None	HH DVD±RW	9-in-1	250W Bronze Fixed	Serial	USB / USB Optical	Windows 10 Pro 64	3-year, Onsite	No	07/17

Model	Region	Processor	Graphics	Memory	Disks	M.2 Drives	Optical	Media Reader	Power Supply	Optional Ports	Keyboard / Mouse	Operating System	Warranty	Global	Ann Date (mm/yy)
30BH0041**	EMEA	Xeon E3-1245 v6 4C/3.7GHz/8MB/73W/DDR4-2400	Intel HD P630	1x8GB UDIMM DDR4-2400 ECC	1x256GB SSD 2.5" SATA6Gbps Opal	None	HH DVD±RW	9-in-1	250W Bronze Fixed	Serial	USB / USB Optical	Windows 10 Pro 64	3-year, Onsite	No	07/17
30BH0041xx	EMEA	Xeon E3-1245 v6 4C/3.7GHz/8MB/73W/DDR4-2400	Intel HD P630	1x8GB UDIMM DDR4-2400 ECC	1x256GB SSD 2.5" SATA6Gbps Opal	None	HH DVD±RW	9-in-1	250W Bronze Fixed	Serial	USB / USB Optical	Windows 10 Pro 64	3-year, Onsite	No	07/17
30BH0042--	EMEA	Xeon E3-1240 v6 4C/3.7GHz/8MB/72W/DDR4-2400	NVIDIA Quadro P600 2GB	1x8GB UDIMM DDR4-2400 ECC	1x256GB SSD 2.5" SATA6Gbps Opal	None	HH DVD±RW	9-in-1	250W Bronze Fixed	Serial	USB / USB Optical	Windows 10 Pro 64	3-year, Onsite	No	07/17
30BH0042**	EMEA	Xeon E3-1240 v6 4C/3.7GHz/8MB/72W/DDR4-2400	NVIDIA Quadro P600 2GB	1x8GB UDIMM DDR4-2400 ECC	1x256GB SSD 2.5" SATA6Gbps Opal	None	HH DVD±RW	9-in-1	250W Bronze Fixed	Serial	USB / USB Optical	Windows 10 Pro 64	3-year, Onsite	No	07/17
30BH0042xx	EMEA	Xeon E3-1240 v6 4C/3.7GHz/8MB/72W/DDR4-2400	NVIDIA Quadro P600 2GB	1x8GB UDIMM DDR4-2400 ECC	1x256GB SSD 2.5" SATA6Gbps Opal	None	HH DVD±RW	9-in-1	250W Bronze Fixed	Serial	USB / USB Optical	Windows 10 Pro 64	3-year, Onsite	No	07/17
30BH0043--	EMEA	Xeon E3-1225 v6 4C/3.3GHz/8MB/73W/DDR4-2400	Intel HD P630 + NVIDIA Quadro P600 2GB	1x8GB UDIMM DDR4-2400 ECC	1x1TB HDD 7.2K 3.5" SATA6Gbps	None	HH DVD±RW	9-in-1	250W Bronze Fixed	Serial	USB / USB Optical	Windows 10 Pro 64	3-year, Onsite	No	07/17
30BH0043**	EMEA	Xeon E3-1225 v6 4C/3.3GHz/8MB/73W/DDR4-2400	Intel HD P630 + NVIDIA Quadro P600 2GB	1x8GB UDIMM DDR4-2400 ECC	1x1TB HDD 7.2K 3.5" SATA6Gbps	None	HH DVD±RW	9-in-1	250W Bronze Fixed	Serial	USB / USB Optical	Windows 10 Pro 64	3-year, Onsite	No	07/17
30BH0043xx	EMEA	Xeon E3-1225 v6 4C/3.3GHz/8MB/73W/DDR4-2400	Intel HD P630 + NVIDIA Quadro P600 2GB	1x8GB UDIMM DDR4-2400 ECC	1x1TB HDD 7.2K 3.5" SATA6Gbps	None	HH DVD±RW	9-in-1	250W Bronze Fixed	Serial	USB / USB Optical	Windows 10 Pro 64	3-year, Onsite	No	07/17
30BH0044--	EMEA	Xeon E3-1230 v6 4C/3.5GHz/8MB/72W/DDR4-2400	Open	2x8GB UDIMM DDR4-2400 ECC	1x256GB SSD 2.5" SATA6Gbps Opal	None	HH DVD±RW	9-in-1	250W Bronze Fixed	Serial	USB / USB Optical	Windows 10 Pro 64	3-year, Onsite	No	07/17
30BH0044**	EMEA	Xeon E3-1230 v6 4C/3.5GHz/8MB/72W/DDR4-2400	Open	2x8GB UDIMM DDR4-2400 ECC	1x256GB SSD 2.5" SATA6Gbps Opal	None	HH DVD±RW	9-in-1	250W Bronze Fixed	Serial	USB / USB Optical	Windows 10 Pro 64	3-year, Onsite	No	07/17
30BH0044xx	EMEA	Xeon E3-1230 v6 4C/3.5GHz/8MB/72W/DDR4-2400	Open	2x8GB UDIMM DDR4-2400 ECC	1x256GB SSD 2.5" SATA6Gbps Opal	None	HH DVD±RW	9-in-1	250W Bronze Fixed	Serial	USB / USB Optical	Windows 10 Pro 64	3-year, Onsite	No	07/17
30BH0045--	EMEA	Core i7-7700 4C/3.6GHz/8MB/65W/DDR4-2400	Intel HD 630	2x8GB UDIMM DDR4-2400 Non-ECC	1x256GB SSD 2.5" SATA6Gbps Opal	None	HH DVD±RW	9-in-1	250W Bronze Fixed	None	USB / USB Optical	Windows 10 Pro 64	3-year, Onsite	No	06/17
30BH0045**	EMEA	Core i7-7700 4C/3.6GHz/8MB/65W/DDR4-2400	Intel HD 630	2x8GB UDIMM DDR4-2400 Non-ECC	1x256GB SSD 2.5" SATA6Gbps Opal	None	HH DVD±RW	9-in-1	250W Bronze Fixed	None	USB / USB Optical	Windows 10 Pro 64	3-year, Onsite	No	06/17

Model	Region	Processor	Graphics	Memory	Disks	M.2 Drives	Optical	Media Reader	Power Supply	Optional Ports	Keyboard / Mouse	Operating System	Warranty	Global	Ann Date (mm/yy)
30BH0045xx	EMEA	Core i7-7700 4C/3.6GHz/8MB/65W/DDR4-2400	Intel HD 630	2x8GB UDIMM DDR4-2400 Non-ECC	1x256GB SSD 2.5" SATA6Gbps Opal	None	HH DVD±RW	9-in-1	250W Bronze Fixed	None	USB / USB Optical	Windows 10 Pro 64	3-year, Onsite	No	06/17
30BH0046--	EMEA	Core i5-6500 4C/3.2GHz/6MB/65W/DDR4-2133	Intel HD 530	1x8GB UDIMM DDR4-2400 Non-ECC	1x256GB SSD 2.5" SATA6Gbps Opal	None	HH DVD±RW	9-in-1	250W Bronze Fixed	None	USB / USB Optical	Windows 10 DG Windows 7 Pro 64	3-year, Onsite	No	06/17
30BH0046**	EMEA	Core i5-6500 4C/3.2GHz/6MB/65W/DDR4-2133	Intel HD 530	1x8GB UDIMM DDR4-2400 Non-ECC	1x256GB SSD 2.5" SATA6Gbps Opal	None	HH DVD±RW	9-in-1	250W Bronze Fixed	None	USB / USB Optical	Windows 10 DG Windows 7 Pro 64	3-year, Onsite	No	06/17
30BH0046xx	EMEA	Core i5-6500 4C/3.2GHz/6MB/65W/DDR4-2133	Intel HD 530	1x8GB UDIMM DDR4-2400 Non-ECC	1x256GB SSD 2.5" SATA6Gbps Opal	None	HH DVD±RW	9-in-1	250W Bronze Fixed	None	USB / USB Optical	Windows 10 DG Windows 7 Pro 64	3-year, Onsite	No	06/17
30BH0047--	EMEA	Core i7-6700 4C/3.4GHz/8MB/65W/DDR4-2133	Intel HD 530	1x16GB UDIMM DDR4-2400 Non-ECC	1x512GB SSD 2.5" SATA6Gbps Opal	None	HH DVD±RW	9-in-1	400W Platinum Fixed	None	USB / USB Optical	Windows 10 DG Windows 7 Pro 64	3-year, Onsite	No	06/17
30BH0047**	EMEA	Core i7-6700 4C/3.4GHz/8MB/65W/DDR4-2133	Intel HD 530	1x16GB UDIMM DDR4-2400 Non-ECC	1x512GB SSD 2.5" SATA6Gbps Opal	None	HH DVD±RW	9-in-1	400W Platinum Fixed	None	USB / USB Optical	Windows 10 DG Windows 7 Pro 64	3-year, Onsite	No	06/17
30BH0047xx	EMEA	Core i7-6700 4C/3.4GHz/8MB/65W/DDR4-2133	Intel HD 530	1x16GB UDIMM DDR4-2400 Non-ECC	1x512GB SSD 2.5" SATA6Gbps Opal	None	HH DVD±RW	9-in-1	400W Platinum Fixed	None	USB / USB Optical	Windows 10 DG Windows 7 Pro 64	3-year, Onsite	No	06/17
30BH0048--	EMEA	Core i7-6700 4C/3.4GHz/8MB/65W/DDR4-2133	Intel HD 530 + NVIDIA Quadro P4000 8GB	2x8GB UDIMM DDR4-2400 Non-ECC	1x256GB SSD 2.5" SATA6Gbps Opal	None	HH DVD±RW	9-in-1	400W Platinum Fixed	None	USB / USB Optical	Windows 10 DG Windows 7 Pro 64	3-year, Onsite	No	06/17
30BH0048**	EMEA	Core i7-6700 4C/3.4GHz/8MB/65W/DDR4-2133	Intel HD 530 + NVIDIA Quadro P4000 8GB	2x8GB UDIMM DDR4-2400 Non-ECC	1x256GB SSD 2.5" SATA6Gbps Opal	None	HH DVD±RW	9-in-1	400W Platinum Fixed	None	USB / USB Optical	Windows 10 DG Windows 7 Pro 64	3-year, Onsite	No	06/17
30BH0048xx	EMEA	Core i7-6700 4C/3.4GHz/8MB/65W/DDR4-2133	Intel HD 530 + NVIDIA Quadro P4000 8GB	2x8GB UDIMM DDR4-2400 Non-ECC	1x256GB SSD 2.5" SATA6Gbps Opal	None	HH DVD±RW	9-in-1	400W Platinum Fixed	None	USB / USB Optical	Windows 10 DG Windows 7 Pro 64	3-year, Onsite	No	06/17
30BH0049--	EMEA	Core i7-6700 4C/3.4GHz/8MB/65W/DDR4-2133	Intel HD 530 + NVIDIA Quadro P2000 5GB	2x8GB UDIMM DDR4-2400 Non-ECC	1x256GB SSD 2.5" SATA6Gbps Opal	None	HH DVD±RW	9-in-1	400W Platinum Fixed	None	USB / USB Optical	Windows 10 DG Windows 7 Pro 64	3-year, Onsite	No	06/17
30BH0049**	EMEA	Core i7-6700 4C/3.4GHz/8MB/65W/DDR4-2133	Intel HD 530 + NVIDIA Quadro P2000 5GB	2x8GB UDIMM DDR4-2400 Non-ECC	1x256GB SSD 2.5" SATA6Gbps Opal	None	HH DVD±RW	9-in-1	400W Platinum Fixed	None	USB / USB Optical	Windows 10 DG Windows 7 Pro 64	3-year, Onsite	No	06/17
30BH0049xx	EMEA	Core i7-6700 4C/3.4GHz/8MB/65W/DDR4-2133	Intel HD 530 + NVIDIA Quadro P2000 5GB	2x8GB UDIMM DDR4-2400 Non-ECC	1x256GB SSD 2.5" SATA6Gbps Opal	None	HH DVD±RW	9-in-1	400W Platinum Fixed	None	USB / USB Optical	Windows 10 DG Windows 7 Pro 64	3-year, Onsite	No	06/17

Model	Region	Processor	Graphics	Memory	Disks	M.2 Drives	Optical	Media Reader	Power Supply	Optional Ports	Keyboard / Mouse	Operating System	Warranty	Global	Ann Date (mm/yy)
30BH004A--	EMEA	Xeon E3-1245 v6 4C/3.7GHz/8MB/73W/DDR4-2400	Intel HD P630	2x8GB UDIMM DDR4-2400 ECC	Open	1x256GB SSD M.2 PCIe Opal	HH DVD±RW	9-in-1	250W Bronze Fixed	None	USB / USB Optical	Windows 10 Pro 64	3-year, Onsite	No	06/17
30BH004A**	EMEA	Xeon E3-1245 v6 4C/3.7GHz/8MB/73W/DDR4-2400	Intel HD P630	2x8GB UDIMM DDR4-2400 ECC	Open	1x256GB SSD M.2 PCIe Opal	HH DVD±RW	9-in-1	250W Bronze Fixed	None	USB / USB Optical	Windows 10 Pro 64	3-year, Onsite	No	06/17
30BH004Axx	EMEA	Xeon E3-1245 v6 4C/3.7GHz/8MB/73W/DDR4-2400	Intel HD P630	2x8GB UDIMM DDR4-2400 ECC	Open	1x256GB SSD M.2 PCIe Opal	HH DVD±RW	9-in-1	250W Bronze Fixed	None	USB / USB Optical	Windows 10 Pro 64	3-year, Onsite	No	06/17
30BH004B--	EMEA	Core i5-7600 4C/3.5GHz/6MB/65W/DDR4-2400	Intel HD 630 + NVIDIA Quadro P4000 8GB	2x8GB UDIMM DDR4-2400 Non-ECC	1x256GB SSD 2.5" SATA6Gbps Opal	None	HH DVD±RW	9-in-1	400W Platinum Fixed	None	USB / USB Optical	Windows 10 Pro 64	3-year, Onsite	No	07/17
30BH004B**	EMEA	Core i5-7600 4C/3.5GHz/6MB/65W/DDR4-2400	Intel HD 630 + NVIDIA Quadro P4000 8GB	2x8GB UDIMM DDR4-2400 Non-ECC	1x256GB SSD 2.5" SATA6Gbps Opal	None	HH DVD±RW	9-in-1	400W Platinum Fixed	None	USB / USB Optical	Windows 10 Pro 64	3-year, Onsite	No	07/17
30BH004Bxx	EMEA	Core i5-7600 4C/3.5GHz/6MB/65W/DDR4-2400	Intel HD 630 + NVIDIA Quadro P4000 8GB	2x8GB UDIMM DDR4-2400 Non-ECC	1x256GB SSD 2.5" SATA6Gbps Opal	None	HH DVD±RW	9-in-1	400W Platinum Fixed	None	USB / USB Optical	Windows 10 Pro 64	3-year, Onsite	No	07/17
30BH004C--	EMEA	Core i5-7600 4C/3.5GHz/6MB/65W/DDR4-2400	Intel HD 630 + NVIDIA Quadro P2000 5GB	2x8GB UDIMM DDR4-2400 Non-ECC	1x256GB SSD 2.5" SATA6Gbps Opal	None	HH DVD±RW	9-in-1	400W Platinum Fixed	None	USB / USB Optical	Windows 10 Pro 64	3-year, Onsite	No	07/17
30BH004C**	EMEA	Core i5-7600 4C/3.5GHz/6MB/65W/DDR4-2400	Intel HD 630 + NVIDIA Quadro P2000 5GB	2x8GB UDIMM DDR4-2400 Non-ECC	1x256GB SSD 2.5" SATA6Gbps Opal	None	HH DVD±RW	9-in-1	400W Platinum Fixed	None	USB / USB Optical	Windows 10 Pro 64	3-year, Onsite	No	07/17
30BH004Cxx	EMEA	Core i5-7600 4C/3.5GHz/6MB/65W/DDR4-2400	Intel HD 630 + NVIDIA Quadro P2000 5GB	2x8GB UDIMM DDR4-2400 Non-ECC	1x256GB SSD 2.5" SATA6Gbps Opal	None	HH DVD±RW	9-in-1	400W Platinum Fixed	None	USB / USB Optical	Windows 10 Pro 64	3-year, Onsite	No	07/17
30BH004D--	EMEA	Core i5-7400 4C/3.0GHz/6MB/65W/DDR4-2400	Intel HD 630	1x4GB UDIMM DDR4-2400 Non-ECC	1x1TB HDD 7.2K 3.5" SATA6Gbps	None	HH DVD±RW	9-in-1	250W Bronze Fixed	None	USB / USB Optical	Windows 10 Pro 64	3-year, Onsite	No	07/17
30BH004D**	EMEA	Core i5-7400 4C/3.0GHz/6MB/65W/DDR4-2400	Intel HD 630	1x4GB UDIMM DDR4-2400 Non-ECC	1x1TB HDD 7.2K 3.5" SATA6Gbps	None	HH DVD±RW	9-in-1	250W Bronze Fixed	None	USB / USB Optical	Windows 10 Pro 64	3-year, Onsite	No	07/17
30BH004Dxx	EMEA	Core i5-7400 4C/3.0GHz/6MB/65W/DDR4-2400	Intel HD 630	1x4GB UDIMM DDR4-2400 Non-ECC	1x1TB HDD 7.2K 3.5" SATA6Gbps	None	HH DVD±RW	9-in-1	250W Bronze Fixed	None	USB / USB Optical	Windows 10 Pro 64	3-year, Onsite	No	07/17
30BH004E--	EMEA	Xeon E3-1245 v6 4C/3.7GHz/8MB/73W/DDR4-2400	Intel HD P630 + NVIDIA Quadro P1000 4GB	1x8GB UDIMM DDR4-2400 ECC	1x256GB SSD 2.5" SATA6Gbps Opal	None	HH DVD±RW	9-in-1	400W Platinum Fixed	None	USB / USB Optical	Windows 10 Pro 64	3-year, Onsite	No	07/17

Model	Region	Processor	Graphics	Memory	Disks	M.2 Drives	Optical	Media Reader	Power Supply	Optional Ports	Keyboard / Mouse	Operating System	Warranty	Global	Ann Date (mm/yy)
30BH004E**	EMEA	Xeon E3-1245 v6 4C/3.7GHz/8MB/73W/DDR4-2400	Intel HD P630 + NVIDIA Quadro P1000 4GB	1x8GB UDIMM DDR4-2400 ECC	1x256GB SSD 2.5" SATA6Gbps Opal	None	HH DVD±RW	9-in-1	400W Platinum Fixed	None	USB / USB Optical	Windows 10 Pro 64	3-year, Onsite	No	07/17
30BH004Exx	EMEA	Xeon E3-1245 v6 4C/3.7GHz/8MB/73W/DDR4-2400	Intel HD P630 + NVIDIA Quadro P1000 4GB	1x8GB UDIMM DDR4-2400 ECC	1x256GB SSD 2.5" SATA6Gbps Opal	None	HH DVD±RW	9-in-1	400W Platinum Fixed	None	USB / USB Optical	Windows 10 Pro 64	3-year, Onsite	No	07/17
30BH004F--	EMEA	Core i5-7500 4C/3.4GHz/6MB/65W/DDR4-2400	Intel HD 630	1x4GB UDIMM DDR4-2400 Non-ECC	1x1TB HDD 7.2K 3.5" SATA6Gbps	None	HH DVD±RW	9-in-1	250W Bronze Fixed	None	USB / USB Optical	Windows 10 Pro 64	3-year, Onsite	No	08/17
30BH004F**	EMEA	Core i5-7500 4C/3.4GHz/6MB/65W/DDR4-2400	Intel HD 630	1x4GB UDIMM DDR4-2400 Non-ECC	1x1TB HDD 7.2K 3.5" SATA6Gbps	None	HH DVD±RW	9-in-1	250W Bronze Fixed	None	USB / USB Optical	Windows 10 Pro 64	3-year, Onsite	No	08/17
30BH004Fxx	EMEA	Core i5-7500 4C/3.4GHz/6MB/65W/DDR4-2400	Intel HD 630	1x4GB UDIMM DDR4-2400 Non-ECC	1x1TB HDD 7.2K 3.5" SATA6Gbps	None	HH DVD±RW	9-in-1	250W Bronze Fixed	None	USB / USB Optical	Windows 10 Pro 64	3-year, Onsite	No	08/17
30BH004G--	EMEA	Core i7-7700 4C/3.6GHz/8MB/65W/DDR4-2400	Intel HD 630	2x8GB UDIMM DDR4-2400 Non-ECC	1x256GB SSD 2.5" SATA6Gbps Opal	16GB Optane Memory	HH DVD±RW	9-in-1	250W Bronze Fixed	None	USB / USB Optical	Windows 10 Pro 64	3-year, Onsite	No	08/17
30BH004G**	EMEA	Core i7-7700 4C/3.6GHz/8MB/65W/DDR4-2400	Intel HD 630	2x8GB UDIMM DDR4-2400 Non-ECC	1x256GB SSD 2.5" SATA6Gbps Opal	16GB Optane Memory	HH DVD±RW	9-in-1	250W Bronze Fixed	None	USB / USB Optical	Windows 10 Pro 64	3-year, Onsite	No	08/17
30BH004Gxx	EMEA	Core i7-7700 4C/3.6GHz/8MB/65W/DDR4-2400	Intel HD 630	2x8GB UDIMM DDR4-2400 Non-ECC	1x256GB SSD 2.5" SATA6Gbps Opal	16GB Optane Memory	HH DVD±RW	9-in-1	250W Bronze Fixed	None	USB / USB Optical	Windows 10 Pro 64	3-year, Onsite	No	08/17
30BH004H--	EMEA	Xeon E3-1245 v6 4C/3.7GHz/8MB/73W/DDR4-2400	Intel HD P630	2x8GB UDIMM DDR4-2400 ECC	1x256GB SSD 2.5" SATA6Gbps Opal	16GB Optane Memory	HH DVD±RW	9-in-1	400W Platinum Fixed	None	USB / USB Optical	Windows 10 Pro 64	3-year, Onsite	No	08/17
30BH004H**	EMEA	Xeon E3-1245 v6 4C/3.7GHz/8MB/73W/DDR4-2400	Intel HD P630	2x8GB UDIMM DDR4-2400 ECC	1x256GB SSD 2.5" SATA6Gbps Opal	16GB Optane Memory	HH DVD±RW	9-in-1	400W Platinum Fixed	None	USB / USB Optical	Windows 10 Pro 64	3-year, Onsite	No	08/17
30BH004Hxx	EMEA	Xeon E3-1245 v6 4C/3.7GHz/8MB/73W/DDR4-2400	Intel HD P630	2x8GB UDIMM DDR4-2400 ECC	1x256GB SSD 2.5" SATA6Gbps Opal	16GB Optane Memory	HH DVD±RW	9-in-1	400W Platinum Fixed	None	USB / USB Optical	Windows 10 Pro 64	3-year, Onsite	No	08/17
30BH004J--	EMEA	Core i7-7700K 4C/4.2GHz/8MB/91W/DDR4-2400	Intel HD 630	2x8GB UDIMM DDR4-2400 Non-ECC	1x256GB SSD 2.5" SATA6Gbps Opal	16GB Optane Memory	HH DVD±RW	9-in-1	400W Platinum Fixed	None	USB / USB Optical	Windows 10 Pro 64	3-year, Onsite	No	08/17
30BH004J**	EMEA	Core i7-7700K 4C/4.2GHz/8MB/91W/DDR4-2400	Intel HD 630	2x8GB UDIMM DDR4-2400 Non-ECC	1x256GB SSD 2.5" SATA6Gbps Opal	16GB Optane Memory	HH DVD±RW	9-in-1	400W Platinum Fixed	None	USB / USB Optical	Windows 10 Pro 64	3-year, Onsite	No	08/17

Model	Region	Processor	Graphics	Memory	Disks	M.2 Drives	Optical	Media Reader	Power Supply	Optional Ports	Keyboard / Mouse	Operating System	Warranty	Global	Ann Date (mm/yy)
30BH004Jxx	EMEA	Core i7-7700K 4C/4.2GHz/8MB/91W/DDR4-2400	Intel HD 630	2x8GB UDIMM DDR4-2400 Non-ECC	1x256GB SSD 2.5" SATA6Gbps Opal	16GB Optane Memory	HH DVD±RW	9-in-1	400W Platinum Fixed	None	USB / USB Optical	Windows 10 Pro 64	3-year, Onsite	No	08/17
30BH004K--	EMEA	Xeon E3-1225 v5 4C/3.3GHz/8MB/80W/DDR4-2133	Intel HD P530	1x8GB UDIMM DDR4-2400 ECC	1x1TB HDD 7.2K 3.5" SATA6Gbps	None	HH DVD±RW	9-in-1	250W Bronze Fixed	Serial	USB / USB Optical	Windows 10 DG Windows 7 Pro 64	3-year, Onsite	No	09/17
30BH004K**	EMEA	Xeon E3-1225 v5 4C/3.3GHz/8MB/80W/DDR4-2133	Intel HD P530	1x8GB UDIMM DDR4-2400 ECC	1x1TB HDD 7.2K 3.5" SATA6Gbps	None	HH DVD±RW	9-in-1	250W Bronze Fixed	Serial	USB / USB Optical	Windows 10 DG Windows 7 Pro 64	3-year, Onsite	No	09/17
30BH004Kxx	EMEA	Xeon E3-1225 v5 4C/3.3GHz/8MB/80W/DDR4-2133	Intel HD P530	1x8GB UDIMM DDR4-2400 ECC	1x1TB HDD 7.2K 3.5" SATA6Gbps	None	HH DVD±RW	9-in-1	250W Bronze Fixed	Serial	USB / USB Optical	Windows 10 DG Windows 7 Pro 64	3-year, Onsite	No	09/17
30BH004L--	EMEA	Xeon E3-1230 v6 4C/3.5GHz/8MB/72W/DDR4-2400	NVIDIA Quadro P2000 5GB	2x8GB UDIMM DDR4-2400 ECC	1x256GB SSD 2.5" SATA6Gbps Opal	None	HH DVD±RW	9-in-1	250W Bronze Fixed	Serial	USB / USB Optical	Windows 10 Pro 64	3-year, Onsite	No	09/17
30BH004L**	EMEA	Xeon E3-1230 v6 4C/3.5GHz/8MB/72W/DDR4-2400	NVIDIA Quadro P2000 5GB	2x8GB UDIMM DDR4-2400 ECC	1x256GB SSD 2.5" SATA6Gbps Opal	None	HH DVD±RW	9-in-1	250W Bronze Fixed	Serial	USB / USB Optical	Windows 10 Pro 64	3-year, Onsite	No	09/17
30BH004Lxx	EMEA	Xeon E3-1230 v6 4C/3.5GHz/8MB/72W/DDR4-2400	NVIDIA Quadro P2000 5GB	2x8GB UDIMM DDR4-2400 ECC	1x256GB SSD 2.5" SATA6Gbps Opal	None	HH DVD±RW	9-in-1	250W Bronze Fixed	Serial	USB / USB Optical	Windows 10 Pro 64	3-year, Onsite	No	09/17
30BH004M--	EMEA	Core i7-7700 4C/3.6GHz/8MB/65W/DDR4-2400	Intel HD 630 + NVIDIA Quadro P1000 4GB	2x8GB UDIMM DDR4-2400 Non-ECC	1x256GB SSD 2.5" SATA6Gbps Opal	None	HH DVD±RW	9-in-1	250W Bronze Fixed	Serial	USB / USB Optical	Windows 10 Pro 64	3-year, Onsite	No	09/17
30BH004M**	EMEA	Core i7-7700 4C/3.6GHz/8MB/65W/DDR4-2400	Intel HD 630 + NVIDIA Quadro P1000 4GB	2x8GB UDIMM DDR4-2400 Non-ECC	1x256GB SSD 2.5" SATA6Gbps Opal	None	HH DVD±RW	9-in-1	250W Bronze Fixed	Serial	USB / USB Optical	Windows 10 Pro 64	3-year, Onsite	No	09/17
30BH004Mxx	EMEA	Core i7-7700 4C/3.6GHz/8MB/65W/DDR4-2400	Intel HD 630 + NVIDIA Quadro P1000 4GB	2x8GB UDIMM DDR4-2400 Non-ECC	1x256GB SSD 2.5" SATA6Gbps Opal	None	HH DVD±RW	9-in-1	250W Bronze Fixed	Serial	USB / USB Optical	Windows 10 Pro 64	3-year, Onsite	No	09/17
30BH004N--	EMEA	Xeon E3-1225 v6 4C/3.3GHz/8MB/73W/DDR4-2400	Intel HD P630	1x8GB UDIMM DDR4-2400 ECC	1x1TB HDD 7.2K 3.5" SATA6Gbps	None	HH DVD±RW	9-in-1	250W Bronze Fixed	Serial	USB / USB Optical	Windows 10 Pro 64	3-year, Onsite	No	09/17
30BH004N**	EMEA	Xeon E3-1225 v6 4C/3.3GHz/8MB/73W/DDR4-2400	Intel HD P630	1x8GB UDIMM DDR4-2400 ECC	1x1TB HDD 7.2K 3.5" SATA6Gbps	None	HH DVD±RW	9-in-1	250W Bronze Fixed	Serial	USB / USB Optical	Windows 10 Pro 64	3-year, Onsite	No	09/17
30BH004Nxx	EMEA	Xeon E3-1225 v6 4C/3.3GHz/8MB/73W/DDR4-2400	Intel HD P630	1x8GB UDIMM DDR4-2400 ECC	1x1TB HDD 7.2K 3.5" SATA6Gbps	None	HH DVD±RW	9-in-1	250W Bronze Fixed	Serial	USB / USB Optical	Windows 10 Pro 64	3-year, Onsite	No	09/17

Model	Region	Processor	Graphics	Memory	Disks	M.2 Drives	Optical	Media Reader	Power Supply	Optional Ports	Keyboard / Mouse	Operating System	Warranty	Global	Ann Date (mm/yy)
30BH004P--	EMEA	Xeon E3-1275 v6 4C/3.8GHz/8MB/73W/DDR4-2400	Intel HD P630	1x8GB UDIMM DDR4-2400 ECC	1x256GB SSD 2.5" SATA6Gbps Opal	None	HH DVD±RW	9-in-1	250W Bronze Fixed	Serial	USB / USB Optical	Windows 10 Pro 64	3-year, Onsite	No	09/17
30BH004P**	EMEA	Xeon E3-1275 v6 4C/3.8GHz/8MB/73W/DDR4-2400	Intel HD P630	1x8GB UDIMM DDR4-2400 ECC	1x256GB SSD 2.5" SATA6Gbps Opal	None	HH DVD±RW	9-in-1	250W Bronze Fixed	Serial	USB / USB Optical	Windows 10 Pro 64	3-year, Onsite	No	09/17
30BH004Pxx	EMEA	Xeon E3-1275 v6 4C/3.8GHz/8MB/73W/DDR4-2400	Intel HD P630	1x8GB UDIMM DDR4-2400 ECC	1x256GB SSD 2.5" SATA6Gbps Opal	None	HH DVD±RW	9-in-1	250W Bronze Fixed	Serial	USB / USB Optical	Windows 10 Pro 64	3-year, Onsite	No	09/17
30BH004Q--	EMEA	Xeon E3-1270 v6 4C/3.8GHz/8MB/72W/DDR4-2400	Open	2x8GB UDIMM DDR4-2400 ECC	Open	1x256GB SSD M.2 PCIe Opal	HH DVD±RW	9-in-1	400W Platinum Fixed	Serial	USB / USB Optical	Windows 10 Pro 64	3-year, Onsite	No	09/17
30BH004Q**	EMEA	Xeon E3-1270 v6 4C/3.8GHz/8MB/72W/DDR4-2400	Open	2x8GB UDIMM DDR4-2400 ECC	Open	1x256GB SSD M.2 PCIe Opal	HH DVD±RW	9-in-1	400W Platinum Fixed	Serial	USB / USB Optical	Windows 10 Pro 64	3-year, Onsite	No	09/17
30BH004Qxx	EMEA	Xeon E3-1270 v6 4C/3.8GHz/8MB/72W/DDR4-2400	Open	2x8GB UDIMM DDR4-2400 ECC	Open	1x256GB SSD M.2 PCIe Opal	HH DVD±RW	9-in-1	400W Platinum Fixed	Serial	USB / USB Optical	Windows 10 Pro 64	3-year, Onsite	No	09/17
30BH004R--	EMEA	Xeon E3-1245 v6 4C/3.7GHz/8MB/73W/DDR4-2400	Intel HD P630	1x8GB UDIMM DDR4-2400 ECC	1x256GB SSD 2.5" SATA6Gbps Opal	None	HH DVD±RW	9-in-1	400W Platinum Fixed	Serial	USB / USB Optical	Windows 10 Pro 64	3-year, Onsite	No	09/17
30BH004R**	EMEA	Xeon E3-1245 v6 4C/3.7GHz/8MB/73W/DDR4-2400	Intel HD P630	1x8GB UDIMM DDR4-2400 ECC	1x256GB SSD 2.5" SATA6Gbps Opal	None	HH DVD±RW	9-in-1	400W Platinum Fixed	Serial	USB / USB Optical	Windows 10 Pro 64	3-year, Onsite	No	09/17
30BH004Rxx	EMEA	Xeon E3-1245 v6 4C/3.7GHz/8MB/73W/DDR4-2400	Intel HD P630	1x8GB UDIMM DDR4-2400 ECC	1x256GB SSD 2.5" SATA6Gbps Opal	None	HH DVD±RW	9-in-1	400W Platinum Fixed	Serial	USB / USB Optical	Windows 10 Pro 64	3-year, Onsite	No	09/17
30BH004S--	EMEA	Xeon E3-1245 v6 4C/3.7GHz/8MB/73W/DDR4-2400	Intel HD P630	1x8GB UDIMM DDR4-2400 ECC	1x1TB HDD 7.2K 3.5" SATA6Gbps	None	HH DVD±RW	9-in-1	250W Bronze Fixed	Serial	USB / USB Optical	Windows 10 Pro 64	3-year, Onsite	No	09/17
30BH004S**	EMEA	Xeon E3-1245 v6 4C/3.7GHz/8MB/73W/DDR4-2400	Intel HD P630	1x8GB UDIMM DDR4-2400 ECC	1x1TB HDD 7.2K 3.5" SATA6Gbps	None	HH DVD±RW	9-in-1	250W Bronze Fixed	Serial	USB / USB Optical	Windows 10 Pro 64	3-year, Onsite	No	09/17
30BH004Sxx	EMEA	Xeon E3-1245 v6 4C/3.7GHz/8MB/73W/DDR4-2400	Intel HD P630	1x8GB UDIMM DDR4-2400 ECC	1x1TB HDD 7.2K 3.5" SATA6Gbps	None	HH DVD±RW	9-in-1	250W Bronze Fixed	Serial	USB / USB Optical	Windows 10 Pro 64	3-year, Onsite	No	09/17
30BH004T--	EMEA	Xeon E3-1230 v6 4C/3.5GHz/8MB/72W/DDR4-2400	NVIDIA Quadro P1000 4GB	2x8GB UDIMM DDR4-2400 ECC	1x256GB SSD 2.5" SATA6Gbps Opal	None	HH DVD±RW	9-in-1	250W Bronze Fixed	Serial	USB / USB Optical	Windows 10 Pro 64	3-year, Onsite	No	09/17

Model	Region	Processor	Graphics	Memory	Disks	M.2 Drives	Optical	Media Reader	Power Supply	Optional Ports	Keyboard / Mouse	Operating System	Warranty	Global	Ann Date (mm/yy)
30BH004T**	EMEA	Xeon E3-1230 v6 4C/3.5GHz/8MB/72W/DDR4-2400	NVIDIA Quadro P1000 4GB	2x8GB UDIMM DDR4-2400 ECC	1x256GB SSD 2.5" SATA6Gbps Opal	None	HH DVD±RW	9-in-1	250W Bronze Fixed	Serial	USB / USB Optical	Windows 10 Pro 64	3-year, Onsite	No	09/17
30BH004Txx	EMEA	Xeon E3-1230 v6 4C/3.5GHz/8MB/72W/DDR4-2400	NVIDIA Quadro P1000 4GB	2x8GB UDIMM DDR4-2400 ECC	1x256GB SSD 2.5" SATA6Gbps Opal	None	HH DVD±RW	9-in-1	250W Bronze Fixed	Serial	USB / USB Optical	Windows 10 Pro 64	3-year, Onsite	No	09/17
30BH004U--	EMEA	Xeon E3-1245 v6 4C/3.7GHz/8MB/73W/DDR4-2400	Intel HD P630 + NVIDIA Quadro P2000 5GB	2x8GB UDIMM DDR4-2400 ECC	1x256GB SSD 2.5" SATA6Gbps Opal	None	HH DVD±RW	9-in-1	250W Bronze Fixed	Serial	USB / USB Optical	Windows 10 Pro 64	3-year, Onsite	No	09/17
30BH004U**	EMEA	Xeon E3-1245 v6 4C/3.7GHz/8MB/73W/DDR4-2400	Intel HD P630 + NVIDIA Quadro P2000 5GB	2x8GB UDIMM DDR4-2400 ECC	1x256GB SSD 2.5" SATA6Gbps Opal	None	HH DVD±RW	9-in-1	250W Bronze Fixed	Serial	USB / USB Optical	Windows 10 Pro 64	3-year, Onsite	No	09/17
30BH004Uxx	EMEA	Xeon E3-1245 v6 4C/3.7GHz/8MB/73W/DDR4-2400	Intel HD P630 + NVIDIA Quadro P2000 5GB	2x8GB UDIMM DDR4-2400 ECC	1x256GB SSD 2.5" SATA6Gbps Opal	None	HH DVD±RW	9-in-1	250W Bronze Fixed	Serial	USB / USB Optical	Windows 10 Pro 64	3-year, Onsite	No	09/17
30BH004V--	EMEA	Xeon E3-1230 v6 4C/3.5GHz/8MB/72W/DDR4-2400	NVIDIA Quadro P400 2GB	1x8GB UDIMM DDR4-2400 ECC	1x1TB HDD 7.2K 3.5" SATA6Gbps	None	HH DVD±RW	9-in-1	400W Platinum Fixed	Serial	USB / USB Optical	Windows 10 Pro 64	3-year, Onsite	No	09/17
30BH004V**	EMEA	Xeon E3-1230 v6 4C/3.5GHz/8MB/72W/DDR4-2400	NVIDIA Quadro P400 2GB	1x8GB UDIMM DDR4-2400 ECC	1x1TB HDD 7.2K 3.5" SATA6Gbps	None	HH DVD±RW	9-in-1	400W Platinum Fixed	Serial	USB / USB Optical	Windows 10 Pro 64	3-year, Onsite	No	09/17
30BH004Vxx	EMEA	Xeon E3-1230 v6 4C/3.5GHz/8MB/72W/DDR4-2400	NVIDIA Quadro P400 2GB	1x8GB UDIMM DDR4-2400 ECC	1x1TB HDD 7.2K 3.5" SATA6Gbps	None	HH DVD±RW	9-in-1	400W Platinum Fixed	Serial	USB / USB Optical	Windows 10 Pro 64	3-year, Onsite	No	09/17
30BH004W--	EMEA	Xeon E3-1240 v6 4C/3.7GHz/8MB/72W/DDR4-2400	NVIDIA Quadro P600 2GB	1x16GB UDIMM DDR4-2400 ECC	1x1TB HDD 7.2K 3.5" SATA6Gbps	None	HH DVD±RW	9-in-1	400W Platinum Fixed	Serial	USB / USB Optical	Windows 10 Pro 64	3-year, Onsite	No	09/17
30BH004W**	EMEA	Xeon E3-1240 v6 4C/3.7GHz/8MB/72W/DDR4-2400	NVIDIA Quadro P600 2GB	1x16GB UDIMM DDR4-2400 ECC	1x1TB HDD 7.2K 3.5" SATA6Gbps	None	HH DVD±RW	9-in-1	400W Platinum Fixed	Serial	USB / USB Optical	Windows 10 Pro 64	3-year, Onsite	No	09/17
30BH004Wxx	EMEA	Xeon E3-1240 v6 4C/3.7GHz/8MB/72W/DDR4-2400	NVIDIA Quadro P600 2GB	1x16GB UDIMM DDR4-2400 ECC	1x1TB HDD 7.2K 3.5" SATA6Gbps	None	HH DVD±RW	9-in-1	400W Platinum Fixed	Serial	USB / USB Optical	Windows 10 Pro 64	3-year, Onsite	No	09/17
30BH004X--	EMEA	Xeon E3-1245 v6 4C/3.7GHz/8MB/73W/DDR4-2400	Intel HD P630 + NVIDIA Quadro P1000 4GB	1x16GB UDIMM DDR4-2400 ECC	1x1TB HDD 7.2K 3.5" SATA6Gbps	None	HH DVD±RW	9-in-1	400W Platinum Fixed	Serial	USB / USB Optical	Windows 10 Pro 64	3-year, Onsite	No	09/17
30BH004X**	EMEA	Xeon E3-1245 v6 4C/3.7GHz/8MB/73W/DDR4-2400	Intel HD P630 + NVIDIA Quadro P1000 4GB	1x16GB UDIMM DDR4-2400 ECC	1x1TB HDD 7.2K 3.5" SATA6Gbps	None	HH DVD±RW	9-in-1	400W Platinum Fixed	Serial	USB / USB Optical	Windows 10 Pro 64	3-year, Onsite	No	09/17

Model	Region	Processor	Graphics	Memory	Disks	M.2 Drives	Optical	Media Reader	Power Supply	Optional Ports	Keyboard / Mouse	Operating System	Warranty	Global	Ann Date (mm/yy)
30BH004Xxx	EMEA	Xeon E3-1245 v6 4C/3.7GHz/8MB/73W/DDR4-2400	Intel HD P630 + NVIDIA Quadro P1000 4GB	1x16GB UDIMM DDR4-2400 ECC	1x1TB HDD 7.2K 3.5" SATA6Gbps	None	HH DVD±RW	9-in-1	400W Platinum Fixed	Serial	USB / USB Optical	Windows 10 Pro 64	3-year, Onsite	No	09/17
30BH004Y--	EMEA	Xeon E3-1270 v6 4C/3.8GHz/8MB/72W/DDR4-2400	NVIDIA Quadro P2000 5GB	1x16GB UDIMM DDR4-2400 ECC	1x256GB SSD 2.5" SATA6Gbps Opal+1x2TB HDD 7.2K 3.5" SATA6Gbps	None	HH DVD±RW	9-in-1	400W Platinum Fixed	Serial	USB / USB Optical	Windows 10 Pro 64	3-year, Onsite	No	09/17
30BH004Y**	EMEA	Xeon E3-1270 v6 4C/3.8GHz/8MB/72W/DDR4-2400	NVIDIA Quadro P2000 5GB	1x16GB UDIMM DDR4-2400 ECC	1x256GB SSD 2.5" SATA6Gbps Opal+1x2TB HDD 7.2K 3.5" SATA6Gbps	None	HH DVD±RW	9-in-1	400W Platinum Fixed	Serial	USB / USB Optical	Windows 10 Pro 64	3-year, Onsite	No	09/17
30BH004Yxx	EMEA	Xeon E3-1270 v6 4C/3.8GHz/8MB/72W/DDR4-2400	NVIDIA Quadro P2000 5GB	1x16GB UDIMM DDR4-2400 ECC	1x256GB SSD 2.5" SATA6Gbps Opal+1x2TB HDD 7.2K 3.5" SATA6Gbps	None	HH DVD±RW	9-in-1	400W Platinum Fixed	Serial	USB / USB Optical	Windows 10 Pro 64	3-year, Onsite	No	09/17
30BH0050--	EMEA	Xeon E3-1245 v6 4C/3.7GHz/8MB/73W/DDR4-2400	Intel HD P630	2x8GB UDIMM DDR4-2400 ECC	Open	1x256GB SSD M.2 PCIe Opal	HH DVD±RW	9-in-1	250W Bronze Fixed	Serial	USB / USB Optical	Windows 10 Pro 64	3-year, Onsite	No	09/17
30BH0050**	EMEA	Xeon E3-1245 v6 4C/3.7GHz/8MB/73W/DDR4-2400	Intel HD P630	2x8GB UDIMM DDR4-2400 ECC	Open	1x256GB SSD M.2 PCIe Opal	HH DVD±RW	9-in-1	250W Bronze Fixed	Serial	USB / USB Optical	Windows 10 Pro 64	3-year, Onsite	No	09/17
30BH0050xx	EMEA	Xeon E3-1245 v6 4C/3.7GHz/8MB/73W/DDR4-2400	Intel HD P630	2x8GB UDIMM DDR4-2400 ECC	Open	1x256GB SSD M.2 PCIe Opal	HH DVD±RW	9-in-1	250W Bronze Fixed	Serial	USB / USB Optical	Windows 10 Pro 64	3-year, Onsite	No	09/17
30BH0051--	EMEA	Core i5-6500 4C/3.2GHz/6MB/65W/DDR4-2133	Intel HD 530	1x8GB UDIMM DDR4-2400 Non-ECC	1x256GB SSD 2.5" SATA6Gbps Opal	None	HH DVD±RW	9-in-1	250W Bronze Fixed	Serial	USB / USB Optical	Windows 10 DG Windows 7 Pro 64	3-year, Onsite	No	09/17
30BH0051**	EMEA	Core i5-6500 4C/3.2GHz/6MB/65W/DDR4-2133	Intel HD 530	1x8GB UDIMM DDR4-2400 Non-ECC	1x256GB SSD 2.5" SATA6Gbps Opal	None	HH DVD±RW	9-in-1	250W Bronze Fixed	Serial	USB / USB Optical	Windows 10 DG Windows 7 Pro 64	3-year, Onsite	No	09/17
30BH0051xx	EMEA	Core i5-6500 4C/3.2GHz/6MB/65W/DDR4-2133	Intel HD 530	1x8GB UDIMM DDR4-2400 Non-ECC	1x256GB SSD 2.5" SATA6Gbps Opal	None	HH DVD±RW	9-in-1	250W Bronze Fixed	Serial	USB / USB Optical	Windows 10 DG Windows 7 Pro 64	3-year, Onsite	No	09/17
30BH0052--	EMEA	Core i7-6700 4C/3.4GHz/8MB/65W/DDR4-2133	Intel HD 530	1x8GB UDIMM DDR4-2400 Non-ECC	1x256GB SSD 2.5" SATA6Gbps Opal	None	HH DVD±RW	9-in-1	400W Platinum Fixed	Serial	USB / USB Optical	Windows 10 DG Windows 7 Pro 64	3-year, Onsite	No	09/17
30BH0052**	EMEA	Core i7-6700 4C/3.4GHz/8MB/65W/DDR4-2133	Intel HD 530	1x8GB UDIMM DDR4-2400 Non-ECC	1x256GB SSD 2.5" SATA6Gbps Opal	None	HH DVD±RW	9-in-1	400W Platinum Fixed	Serial	USB / USB Optical	Windows 10 DG Windows 7 Pro 64	3-year, Onsite	No	09/17
30BH0052xx	EMEA	Core i7-6700 4C/3.4GHz/8MB/65W/DDR4-2133	Intel HD 530	1x8GB UDIMM DDR4-2400 Non-ECC	1x256GB SSD 2.5" SATA6Gbps Opal	None	HH DVD±RW	9-in-1	400W Platinum Fixed	Serial	USB / USB Optical	Windows 10 DG Windows 7 Pro 64	3-year, Onsite	No	09/17

Model	Region	Processor	Graphics	Memory	Disks	M.2 Drives	Optical	Media Reader	Power Supply	Optional Ports	Keyboard / Mouse	Operating System	Warranty	Global	Ann Date (mm/yy)
30BH0053--	EMEA	Core i7-6700 4C/3.4GHz/8MB/65W/DDR4-2133	Intel HD 530	1x16GB UDIMM DDR4-2400 Non-ECC	1x512GB SSD 2.5" SATA6Gbps Opal	None	HH DVD±RW	9-in-1	400W Platinum Fixed	Serial	USB / USB Optical	Windows 10 DG Windows 7 Pro 64	3-year, Onsite	No	09/17
30BH0053**	EMEA	Core i7-6700 4C/3.4GHz/8MB/65W/DDR4-2133	Intel HD 530	1x16GB UDIMM DDR4-2400 Non-ECC	1x512GB SSD 2.5" SATA6Gbps Opal	None	HH DVD±RW	9-in-1	400W Platinum Fixed	Serial	USB / USB Optical	Windows 10 DG Windows 7 Pro 64	3-year, Onsite	No	09/17
30BH0053xx	EMEA	Core i7-6700 4C/3.4GHz/8MB/65W/DDR4-2133	Intel HD 530	1x16GB UDIMM DDR4-2400 Non-ECC	1x512GB SSD 2.5" SATA6Gbps Opal	None	HH DVD±RW	9-in-1	400W Platinum Fixed	Serial	USB / USB Optical	Windows 10 DG Windows 7 Pro 64	3-year, Onsite	No	09/17
30BH0054--	EMEA	Core i7-6700 4C/3.4GHz/8MB/65W/DDR4-2133	Intel HD 530 + NVIDIA Quadro P4000 8GB	2x8GB UDIMM DDR4-2400 Non-ECC	1x256GB SSD 2.5" SATA6Gbps Opal	None	HH DVD±RW	9-in-1	400W Platinum Fixed	Serial	USB / USB Optical	Windows 10 DG Windows 7 Pro 64	3-year, Onsite	No	09/17
30BH0054**	EMEA	Core i7-6700 4C/3.4GHz/8MB/65W/DDR4-2133	Intel HD 530 + NVIDIA Quadro P4000 8GB	2x8GB UDIMM DDR4-2400 Non-ECC	1x256GB SSD 2.5" SATA6Gbps Opal	None	HH DVD±RW	9-in-1	400W Platinum Fixed	Serial	USB / USB Optical	Windows 10 DG Windows 7 Pro 64	3-year, Onsite	No	09/17
30BH0054xx	EMEA	Core i7-6700 4C/3.4GHz/8MB/65W/DDR4-2133	Intel HD 530 + NVIDIA Quadro P4000 8GB	2x8GB UDIMM DDR4-2400 Non-ECC	1x256GB SSD 2.5" SATA6Gbps Opal	None	HH DVD±RW	9-in-1	400W Platinum Fixed	Serial	USB / USB Optical	Windows 10 DG Windows 7 Pro 64	3-year, Onsite	No	09/17
30BH0055--	EMEA	Core i7-6700 4C/3.4GHz/8MB/65W/DDR4-2133	Intel HD 530 + NVIDIA Quadro P2000 5GB	2x8GB UDIMM DDR4-2400 Non-ECC	1x256GB SSD 2.5" SATA6Gbps Opal	None	HH DVD±RW	9-in-1	400W Platinum Fixed	Serial	USB / USB Optical	Windows 10 DG Windows 7 Pro 64	3-year, Onsite	No	09/17
30BH0055**	EMEA	Core i7-6700 4C/3.4GHz/8MB/65W/DDR4-2133	Intel HD 530 + NVIDIA Quadro P2000 5GB	2x8GB UDIMM DDR4-2400 Non-ECC	1x256GB SSD 2.5" SATA6Gbps Opal	None	HH DVD±RW	9-in-1	400W Platinum Fixed	Serial	USB / USB Optical	Windows 10 DG Windows 7 Pro 64	3-year, Onsite	No	09/17
30BH0055xx	EMEA	Core i7-6700 4C/3.4GHz/8MB/65W/DDR4-2133	Intel HD 530 + NVIDIA Quadro P2000 5GB	2x8GB UDIMM DDR4-2400 Non-ECC	1x256GB SSD 2.5" SATA6Gbps Opal	None	HH DVD±RW	9-in-1	400W Platinum Fixed	Serial	USB / USB Optical	Windows 10 DG Windows 7 Pro 64	3-year, Onsite	No	09/17
30BH0056--	EMEA	Xeon E3-1245 v6 4C/3.7GHz/8MB/73W/DDR4-2400	Intel HD P630	1x8GB UDIMM DDR4-2400 ECC	1x256GB SSD 2.5" SATA6Gbps Opal	None	HH DVD	9-in-1	250W Bronze Fixed	Serial	USB / USB Optical	Windows 10 Pro 64	3-year, Onsite	No	09/17
30BH0056**	EMEA	Xeon E3-1245 v6 4C/3.7GHz/8MB/73W/DDR4-2400	Intel HD P630	1x8GB UDIMM DDR4-2400 ECC	1x256GB SSD 2.5" SATA6Gbps Opal	None	HH DVD	9-in-1	250W Bronze Fixed	Serial	USB / USB Optical	Windows 10 Pro 64	3-year, Onsite	No	09/17
30BH0056xx	EMEA	Xeon E3-1245 v6 4C/3.7GHz/8MB/73W/DDR4-2400	Intel HD P630	1x8GB UDIMM DDR4-2400 ECC	1x256GB SSD 2.5" SATA6Gbps Opal	None	HH DVD	9-in-1	250W Bronze Fixed	Serial	USB / USB Optical	Windows 10 Pro 64	3-year, Onsite	No	09/17
30BH0066--	EMEA	Xeon E3-1225 v6 4C/3.3GHz/8MB/73W/DDR4-2400	Intel HD P630	1x8GB UDIMM DDR4-2400 ECC	1x1TB HDD 7.2K 3.5" SATA6Gbps	None	HH DVD±RW	9-in-1	250W Bronze Fixed	Serial	USB / USB Optical	Windows 10 Pro 64	3-year, Onsite	No	02/18

Model	Region	Processor	Graphics	Memory	Disks	M.2 Drives	Optical	Media Reader	Power Supply	Optional Ports	Keyboard / Mouse	Operating System	Warranty	Global	Ann Date (mm/yy)
30BH0066**	EMEA	Xeon E3-1225 v6 4C/3.3GHz/8MB/73W/DDR4-2400	Intel HD P630	1x8GB UDIMM DDR4-2400 ECC	1x1TB HDD 7.2K 3.5" SATA6Gbps	None	HH DVD±RW	9-in-1	250W Bronze Fixed	Serial	USB / USB Optical	Windows 10 Pro 64	3-year, Onsite	No	02/18
30BH0066xx	EMEA	Xeon E3-1225 v6 4C/3.3GHz/8MB/73W/DDR4-2400	Intel HD P630	1x8GB UDIMM DDR4-2400 ECC	1x1TB HDD 7.2K 3.5" SATA6Gbps	None	HH DVD±RW	9-in-1	250W Bronze Fixed	Serial	USB / USB Optical	Windows 10 Pro 64	3-year, Onsite	No	02/18
30BH0067--	EMEA	Xeon E3-1245 v6 4C/3.7GHz/8MB/73W/DDR4-2400	Intel HD P630	1x8GB UDIMM DDR4-2400 ECC	1x256GB SSD 2.5" SATA6Gbps Opal	None	HH DVD±RW	9-in-1	250W Bronze Fixed	Serial	USB / USB Optical	Windows 10 Pro 64	3-year, Onsite	No	02/18
30BH0067**	EMEA	Xeon E3-1245 v6 4C/3.7GHz/8MB/73W/DDR4-2400	Intel HD P630	1x8GB UDIMM DDR4-2400 ECC	1x256GB SSD 2.5" SATA6Gbps Opal	None	HH DVD±RW	9-in-1	250W Bronze Fixed	Serial	USB / USB Optical	Windows 10 Pro 64	3-year, Onsite	No	02/18
30BH0067xx	EMEA	Xeon E3-1245 v6 4C/3.7GHz/8MB/73W/DDR4-2400	Intel HD P630	1x8GB UDIMM DDR4-2400 ECC	1x256GB SSD 2.5" SATA6Gbps Opal	None	HH DVD±RW	9-in-1	250W Bronze Fixed	Serial	USB / USB Optical	Windows 10 Pro 64	3-year, Onsite	No	02/18
30BH0068--	EMEA	Xeon E3-1275 v6 4C/3.8GHz/8MB/73W/DDR4-2400	Intel HD P630	1x8GB UDIMM DDR4-2400 ECC	1x256GB SSD 2.5" SATA6Gbps Opal	None	HH DVD±RW	9-in-1	250W Bronze Fixed	Serial	USB / USB Optical	Windows 10 Pro 64	3-year, Onsite	No	02/18
30BH0068**	EMEA	Xeon E3-1275 v6 4C/3.8GHz/8MB/73W/DDR4-2400	Intel HD P630	1x8GB UDIMM DDR4-2400 ECC	1x256GB SSD 2.5" SATA6Gbps Opal	None	HH DVD±RW	9-in-1	250W Bronze Fixed	Serial	USB / USB Optical	Windows 10 Pro 64	3-year, Onsite	No	02/18
30BH0068xx	EMEA	Xeon E3-1275 v6 4C/3.8GHz/8MB/73W/DDR4-2400	Intel HD P630	1x8GB UDIMM DDR4-2400 ECC	1x256GB SSD 2.5" SATA6Gbps Opal	None	HH DVD±RW	9-in-1	250W Bronze Fixed	Serial	USB / USB Optical	Windows 10 Pro 64	3-year, Onsite	No	02/18
30BH0069--	EMEA	Xeon E3-1245 v6 4C/3.7GHz/8MB/73W/DDR4-2400	Intel HD P630	1x8GB UDIMM DDR4-2400 ECC	1x256GB SSD 2.5" SATA6Gbps Opal	None	HH DVD±RW	9-in-1	400W Platinum Fixed	Serial	USB / USB Optical	Windows 10 Pro 64	3-year, Onsite	No	02/18
30BH0069**	EMEA	Xeon E3-1245 v6 4C/3.7GHz/8MB/73W/DDR4-2400	Intel HD P630	1x8GB UDIMM DDR4-2400 ECC	1x256GB SSD 2.5" SATA6Gbps Opal	None	HH DVD±RW	9-in-1	400W Platinum Fixed	Serial	USB / USB Optical	Windows 10 Pro 64	3-year, Onsite	No	02/18
30BH0069xx	EMEA	Xeon E3-1245 v6 4C/3.7GHz/8MB/73W/DDR4-2400	Intel HD P630	1x8GB UDIMM DDR4-2400 ECC	1x256GB SSD 2.5" SATA6Gbps Opal	None	HH DVD±RW	9-in-1	400W Platinum Fixed	Serial	USB / USB Optical	Windows 10 Pro 64	3-year, Onsite	No	02/18
30BH006A--	EMEA	Xeon E3-1245 v6 4C/3.7GHz/8MB/73W/DDR4-2400	Intel HD P630	1x8GB UDIMM DDR4-2400 ECC	1x1TB HDD 7.2K 3.5" SATA6Gbps	None	HH DVD±RW	9-in-1	250W Bronze Fixed	Serial	USB / USB Optical	Windows 10 Pro 64	3-year, Onsite	No	02/18
30BH006A**	EMEA	Xeon E3-1245 v6 4C/3.7GHz/8MB/73W/DDR4-2400	Intel HD P630	1x8GB UDIMM DDR4-2400 ECC	1x1TB HDD 7.2K 3.5" SATA6Gbps	None	HH DVD±RW	9-in-1	250W Bronze Fixed	Serial	USB / USB Optical	Windows 10 Pro 64	3-year, Onsite	No	02/18

Model	Region	Processor	Graphics	Memory	Disks	M.2 Drives	Optical	Media Reader	Power Supply	Optional Ports	Keyboard / Mouse	Operating System	Warranty	Global	Ann Date (mm/yy)
30BH006Axx	EMEA	Xeon E3-1245 v6 4C/3.7GHz/8MB/73W/DDR4-2400	Intel HD P630	1x8GB UDIMM DDR4-2400 ECC	1x1TB HDD 7.2K 3.5" SATA6Gbps	None	HH DVD±RW	9-in-1	250W Bronze Fixed	Serial	USB / USB Optical	Windows 10 Pro 64	3-year, Onsite	No	02/18
30BH006B--	EMEA	Xeon E3-1230 v6 4C/3.5GHz/8MB/72W/DDR4-2400	NVIDIA Quadro P1000 4GB	1x16GB UDIMM DDR4-2400 ECC	1x256GB SSD 2.5" SATA6Gbps Opal	None	HH DVD±RW	9-in-1	250W Bronze Fixed	Serial	USB / USB Optical	Windows 10 Pro 64	3-year, Onsite	No	02/18
30BH006B**	EMEA	Xeon E3-1230 v6 4C/3.5GHz/8MB/72W/DDR4-2400	NVIDIA Quadro P1000 4GB	1x16GB UDIMM DDR4-2400 ECC	1x256GB SSD 2.5" SATA6Gbps Opal	None	HH DVD±RW	9-in-1	250W Bronze Fixed	Serial	USB / USB Optical	Windows 10 Pro 64	3-year, Onsite	No	02/18
30BH006Bxx	EMEA	Xeon E3-1230 v6 4C/3.5GHz/8MB/72W/DDR4-2400	NVIDIA Quadro P1000 4GB	1x16GB UDIMM DDR4-2400 ECC	1x256GB SSD 2.5" SATA6Gbps Opal	None	HH DVD±RW	9-in-1	250W Bronze Fixed	Serial	USB / USB Optical	Windows 10 Pro 64	3-year, Onsite	No	02/18
30BH006C--	EMEA	Xeon E3-1245 v6 4C/3.7GHz/8MB/73W/DDR4-2400	Intel HD P630 + NVIDIA Quadro P2000 5GB	1x16GB UDIMM DDR4-2400 ECC	1x256GB SSD 2.5" SATA6Gbps Opal	None	HH DVD±RW	9-in-1	250W Bronze Fixed	Serial	USB / USB Optical	Windows 10 Pro 64	3-year, Onsite	No	02/18
30BH006C**	EMEA	Xeon E3-1245 v6 4C/3.7GHz/8MB/73W/DDR4-2400	Intel HD P630 + NVIDIA Quadro P2000 5GB	1x16GB UDIMM DDR4-2400 ECC	1x256GB SSD 2.5" SATA6Gbps Opal	None	HH DVD±RW	9-in-1	250W Bronze Fixed	Serial	USB / USB Optical	Windows 10 Pro 64	3-year, Onsite	No	02/18
30BH006Cxx	EMEA	Xeon E3-1245 v6 4C/3.7GHz/8MB/73W/DDR4-2400	Intel HD P630 + NVIDIA Quadro P2000 5GB	1x16GB UDIMM DDR4-2400 ECC	1x256GB SSD 2.5" SATA6Gbps Opal	None	HH DVD±RW	9-in-1	250W Bronze Fixed	Serial	USB / USB Optical	Windows 10 Pro 64	3-year, Onsite	No	02/18
30BH006D--	EMEA	Xeon E3-1230 v6 4C/3.5GHz/8MB/72W/DDR4-2400	NVIDIA Quadro P400 2GB	1x8GB UDIMM DDR4-2400 ECC	1x1TB HDD 7.2K 3.5" SATA6Gbps	None	HH DVD±RW	9-in-1	400W Platinum Fixed	Serial	USB / USB Optical	Windows 10 Pro 64	3-year, Onsite	No	02/18
30BH006D**	EMEA	Xeon E3-1230 v6 4C/3.5GHz/8MB/72W/DDR4-2400	NVIDIA Quadro P400 2GB	1x8GB UDIMM DDR4-2400 ECC	1x1TB HDD 7.2K 3.5" SATA6Gbps	None	HH DVD±RW	9-in-1	400W Platinum Fixed	Serial	USB / USB Optical	Windows 10 Pro 64	3-year, Onsite	No	02/18
30BH006Dxx	EMEA	Xeon E3-1230 v6 4C/3.5GHz/8MB/72W/DDR4-2400	NVIDIA Quadro P400 2GB	1x8GB UDIMM DDR4-2400 ECC	1x1TB HDD 7.2K 3.5" SATA6Gbps	None	HH DVD±RW	9-in-1	400W Platinum Fixed	Serial	USB / USB Optical	Windows 10 Pro 64	3-year, Onsite	No	02/18
30BH006E--	EMEA	Xeon E3-1240 v6 4C/3.7GHz/8MB/72W/DDR4-2400	NVIDIA Quadro P600 2GB	1x16GB UDIMM DDR4-2400 ECC	1x1TB HDD 7.2K 3.5" SATA6Gbps	None	HH DVD±RW	9-in-1	400W Platinum Fixed	Serial	USB / USB Optical	Windows 10 Pro 64	3-year, Onsite	No	02/18
30BH006E**	EMEA	Xeon E3-1240 v6 4C/3.7GHz/8MB/72W/DDR4-2400	NVIDIA Quadro P600 2GB	1x16GB UDIMM DDR4-2400 ECC	1x1TB HDD 7.2K 3.5" SATA6Gbps	None	HH DVD±RW	9-in-1	400W Platinum Fixed	Serial	USB / USB Optical	Windows 10 Pro 64	3-year, Onsite	No	02/18
30BH006Exx	EMEA	Xeon E3-1240 v6 4C/3.7GHz/8MB/72W/DDR4-2400	NVIDIA Quadro P600 2GB	1x16GB UDIMM DDR4-2400 ECC	1x1TB HDD 7.2K 3.5" SATA6Gbps	None	HH DVD±RW	9-in-1	400W Platinum Fixed	Serial	USB / USB Optical	Windows 10 Pro 64	3-year, Onsite	No	02/18

Model	Region	Processor	Graphics	Memory	Disks	M.2 Drives	Optical	Media Reader	Power Supply	Optional Ports	Keyboard / Mouse	Operating System	Warranty	Global	Ann Date (mm/yy)
30BH006F--	EMEA	Xeon E3-1245 v6 4C/3.7GHz/8MB/73W/DDR4-2400	Intel HD P630 + NVIDIA Quadro P1000 4GB	1x16GB UDIMM DDR4-2400 ECC	1x1TB HDD 7.2K 3.5" SATA6Gbps	None	HH DVD±RW	9-in-1	400W Platinum Fixed	Serial	USB / USB Optical	Windows 10 Pro 64	3-year, Onsite	No	02/18
30BH006F**	EMEA	Xeon E3-1245 v6 4C/3.7GHz/8MB/73W/DDR4-2400	Intel HD P630 + NVIDIA Quadro P1000 4GB	1x16GB UDIMM DDR4-2400 ECC	1x1TB HDD 7.2K 3.5" SATA6Gbps	None	HH DVD±RW	9-in-1	400W Platinum Fixed	Serial	USB / USB Optical	Windows 10 Pro 64	3-year, Onsite	No	02/18
30BH006Fxx	EMEA	Xeon E3-1245 v6 4C/3.7GHz/8MB/73W/DDR4-2400	Intel HD P630 + NVIDIA Quadro P1000 4GB	1x16GB UDIMM DDR4-2400 ECC	1x1TB HDD 7.2K 3.5" SATA6Gbps	None	HH DVD±RW	9-in-1	400W Platinum Fixed	Serial	USB / USB Optical	Windows 10 Pro 64	3-year, Onsite	No	02/18
30BH006G--	EMEA	Xeon E3-1270 v6 4C/3.8GHz/8MB/72W/DDR4-2400	NVIDIA Quadro P2000 5GB	1x16GB UDIMM DDR4-2400 ECC	1x256GB SSD 2.5" SATA6Gbps Opal+1x2TB HDD 7.2K 3.5" SATA6Gbps	None	HH DVD±RW	9-in-1	400W Platinum Fixed	Serial	USB / USB Optical	Windows 10 Pro 64	3-year, Onsite	No	02/18
30BH006G**	EMEA	Xeon E3-1270 v6 4C/3.8GHz/8MB/72W/DDR4-2400	NVIDIA Quadro P2000 5GB	1x16GB UDIMM DDR4-2400 ECC	1x256GB SSD 2.5" SATA6Gbps Opal+1x2TB HDD 7.2K 3.5" SATA6Gbps	None	HH DVD±RW	9-in-1	400W Platinum Fixed	Serial	USB / USB Optical	Windows 10 Pro 64	3-year, Onsite	No	02/18
30BH006Gxx	EMEA	Xeon E3-1270 v6 4C/3.8GHz/8MB/72W/DDR4-2400	NVIDIA Quadro P2000 5GB	1x16GB UDIMM DDR4-2400 ECC	1x256GB SSD 2.5" SATA6Gbps Opal+1x2TB HDD 7.2K 3.5" SATA6Gbps	None	HH DVD±RW	9-in-1	400W Platinum Fixed	Serial	USB / USB Optical	Windows 10 Pro 64	3-year, Onsite	No	02/18
30BH006H--	EMEA	Xeon E3-1225 v6 4C/3.3GHz/8MB/73W/DDR4-2400	Intel HD P630 + NVIDIA Quadro P600 2GB	1x8GB UDIMM DDR4-2400 ECC	1x1TB HDD 7.2K 3.5" SATA6Gbps	None	HH DVD±RW	9-in-1	250W Bronze Fixed	Serial	USB / USB Optical	Windows 10 Pro 64	3-year, Onsite	No	02/18
30BH006H**	EMEA	Xeon E3-1225 v6 4C/3.3GHz/8MB/73W/DDR4-2400	Intel HD P630 + NVIDIA Quadro P600 2GB	1x8GB UDIMM DDR4-2400 ECC	1x1TB HDD 7.2K 3.5" SATA6Gbps	None	HH DVD±RW	9-in-1	250W Bronze Fixed	Serial	USB / USB Optical	Windows 10 Pro 64	3-year, Onsite	No	02/18
30BH006Hxx	EMEA	Xeon E3-1225 v6 4C/3.3GHz/8MB/73W/DDR4-2400	Intel HD P630 + NVIDIA Quadro P600 2GB	1x8GB UDIMM DDR4-2400 ECC	1x1TB HDD 7.2K 3.5" SATA6Gbps	None	HH DVD±RW	9-in-1	250W Bronze Fixed	Serial	USB / USB Optical	Windows 10 Pro 64	3-year, Onsite	No	02/18
30BH006J--	EMEA	Xeon E3-1245 v5 4C/3.5GHz/8MB/80W/DDR4-2133	Intel HD P530 + NVIDIA Quadro P1000 4GB	1x16GB UDIMM DDR4-2400 ECC	1x256GB SSD 2.5" SATA6Gbps Opal	None	HH DVD±RW	9-in-1	400W Platinum Fixed	Serial	USB / USB Optical	Windows 10 Pro 64	3-year, Onsite	No	02/18
30BH006J**	EMEA	Xeon E3-1245 v5 4C/3.5GHz/8MB/80W/DDR4-2133	Intel HD P530 + NVIDIA Quadro P1000 4GB	1x16GB UDIMM DDR4-2400 ECC	1x256GB SSD 2.5" SATA6Gbps Opal	None	HH DVD±RW	9-in-1	400W Platinum Fixed	Serial	USB / USB Optical	Windows 10 Pro 64	3-year, Onsite	No	02/18
30BH006Jxx	EMEA	Xeon E3-1245 v5 4C/3.5GHz/8MB/80W/DDR4-2133	Intel HD P530 + NVIDIA Quadro P1000 4GB	1x16GB UDIMM DDR4-2400 ECC	1x256GB SSD 2.5" SATA6Gbps Opal	None	HH DVD±RW	9-in-1	400W Platinum Fixed	Serial	USB / USB Optical	Windows 10 Pro 64	3-year, Onsite	No	02/18
30BH006K--	EMEA	Xeon E3-1245 v5 4C/3.5GHz/8MB/80W/DDR4-2133	Intel HD P530	1x16GB UDIMM DDR4-2400 ECC	Open	1x256GB SSD M.2 PCIe Opal	HH DVD±RW	9-in-1	250W Bronze Fixed	Serial	USB / USB Optical	Windows 10 Pro 64	3-year, Onsite	No	02/18

Model	Region	Processor	Graphics	Memory	Disks	M.2 Drives	Optical	Media Reader	Power Supply	Optional Ports	Keyboard / Mouse	Operating System	Warranty	Global	Ann Date (mm/yy)
30BH006K**	EMEA	Xeon E3-1245 v5 4C/3.5GHz/8MB/80W/DDR4-2133	Intel HD P530	1x16GB UDIMM DDR4-2400 ECC	Open	1x256GB SSD M.2 PCIe Opal	HH DVD±RW	9-in-1	250W Bronze Fixed	Serial	USB / USB Optical	Windows 10 Pro 64	3-year, Onsite	No	02/18
30BH006Kxx	EMEA	Xeon E3-1245 v5 4C/3.5GHz/8MB/80W/DDR4-2133	Intel HD P530	1x16GB UDIMM DDR4-2400 ECC	Open	1x256GB SSD M.2 PCIe Opal	HH DVD±RW	9-in-1	250W Bronze Fixed	Serial	USB / USB Optical	Windows 10 Pro 64	3-year, Onsite	No	02/18
30BH006L--	EMEA	Xeon E3-1270 v6 4C/3.8GHz/8MB/72W/DDR4-2400	Open	1x16GB UDIMM DDR4-2400 ECC	Open	1x256GB SSD M.2 PCIe Opal	HH DVD±RW	9-in-1	400W Platinum Fixed	Serial	USB / USB Optical	Windows 10 Pro 64	3-year, Onsite	No	02/18
30BH006L**	EMEA	Xeon E3-1270 v6 4C/3.8GHz/8MB/72W/DDR4-2400	Open	1x16GB UDIMM DDR4-2400 ECC	Open	1x256GB SSD M.2 PCIe Opal	HH DVD±RW	9-in-1	400W Platinum Fixed	Serial	USB / USB Optical	Windows 10 Pro 64	3-year, Onsite	No	02/18
30BH006Lxx	EMEA	Xeon E3-1270 v6 4C/3.8GHz/8MB/72W/DDR4-2400	Open	1x16GB UDIMM DDR4-2400 ECC	Open	1x256GB SSD M.2 PCIe Opal	HH DVD±RW	9-in-1	400W Platinum Fixed	Serial	USB / USB Optical	Windows 10 Pro 64	3-year, Onsite	No	02/18
30BH006M--	EMEA	Core i7-7700K 4C/4.2GHz/8MB/91W/DDR4-2400	Intel HD 630 + NVIDIA Quadro P600 2GB	1x8GB UDIMM DDR4-2400 Non-ECC	Open	1x256GB SSD M.2 PCIe Opal	HH DVD±RW	9-in-1	400W Platinum Fixed	None	None / USB Optical	Windows 10 Pro 64	3-year, Onsite	No	02/18
30BH006Q--	EMEA	Xeon E3-1245 v6 4C/3.7GHz/8MB/73W/DDR4-2400	Intel HD P630 + NVIDIA Quadro P1000 4GB	1x16GB UDIMM DDR4-2400 ECC	1x256GB SSD 2.5" SATA6Gbps Opal	None	HH DVD±RW	9-in-1	400W Platinum Fixed	Serial	None / USB Optical	Windows 10 Pro 64	3-year, Onsite	No	03/18
30BH006R--	EMEA	Xeon E3-1220 v6 4C/3.0GHz/8MB/72W/DDR4-2400	NVIDIA Quadro P400 2GB	1x8GB UDIMM DDR4-2400 ECC	1x1TB HDD 7.2K 3.5" SATA6Gbps	None	HH DVD±RW	9-in-1	400W Platinum Fixed	Serial	None / USB Optical	Windows 10 Pro 64	3-year, Onsite	No	03/18
30BH006S--	EMEA	Xeon E3-1245 v6 4C/3.7GHz/8MB/73W/DDR4-2400	Intel HD P630 + NVIDIA Quadro P600 2GB	1x16GB UDIMM DDR4-2400 ECC	1x1TB HDD 7.2K 3.5" SATA6Gbps	None	HH DVD±RW	9-in-1	400W Platinum Fixed	Serial	None / USB Optical	Windows 10 Pro 64	3-year, Onsite	No	03/18
30BH006T--	EMEA	Core i7-7700K 4C/4.2GHz/8MB/91W/DDR4-2400	Intel HD 630	1x8GB UDIMM DDR4-2400 Non-ECC	1x256GB SSD 2.5" SATA6Gbps Opal	None	HH DVD±RW	9-in-1	400W Platinum Fixed	None	USB / USB Optical	Windows 10 Pro 64	3-year, Onsite	No	03/18
30BH006T**	EMEA	Core i7-7700K 4C/4.2GHz/8MB/91W/DDR4-2400	Intel HD 630	1x8GB UDIMM DDR4-2400 Non-ECC	1x256GB SSD 2.5" SATA6Gbps Opal	None	HH DVD±RW	9-in-1	400W Platinum Fixed	None	USB / USB Optical	Windows 10 Pro 64	3-year, Onsite	No	03/18
30BH006Txx	EMEA	Core i7-7700K 4C/4.2GHz/8MB/91W/DDR4-2400	Intel HD 630	1x8GB UDIMM DDR4-2400 Non-ECC	1x256GB SSD 2.5" SATA6Gbps Opal	None	HH DVD±RW	9-in-1	400W Platinum Fixed	None	USB / USB Optical	Windows 10 Pro 64	3-year, Onsite	No	03/18
30BH006U--	EMEA	Core i7-7700 4C/3.6GHz/8MB/65W/DDR4-2400	Intel HD 630 + NVIDIA Quadro P2000 5GB	2x8GB UDIMM DDR4-2400 Non-ECC	1x256GB SSD 2.5" SATA6Gbps Opal+1x1TB HDD 7.2K 3.5" SATA6Gbps	None	HH DVD±RW	9-in-1	250W Bronze Fixed	None	USB / USB Optical	Windows 10 Pro 64	3-year, Onsite	No	03/18

Model	Region	Processor	Graphics	Memory	Disks	M.2 Drives	Optical	Media Reader	Power Supply	Optional Ports	Keyboard / Mouse	Operating System	Warranty	Global	Ann Date (mm/yy)
30BH006U**	EMEA	Core i7-7700 4C/3.6GHz/8MB/65W/DDR4-2400	Intel HD 630 + NVIDIA Quadro P2000 5GB	2x8GB UDIMM DDR4-2400 Non-ECC	1x256GB SSD 2.5" SATA6Gbps Opal+1x1TB HDD 7.2K 3.5" SATA6Gbps	None	HH DVD±RW	9-in-1	250W Bronze Fixed	None	USB / USB Optical	Windows 10 Pro 64	3-year, Onsite	No	03/18
30BH006Uxx	EMEA	Core i7-7700 4C/3.6GHz/8MB/65W/DDR4-2400	Intel HD 630 + NVIDIA Quadro P2000 5GB	2x8GB UDIMM DDR4-2400 Non-ECC	1x256GB SSD 2.5" SATA6Gbps Opal+1x1TB HDD 7.2K 3.5" SATA6Gbps	None	HH DVD±RW	9-in-1	250W Bronze Fixed	None	USB / USB Optical	Windows 10 Pro 64	3-year, Onsite	No	03/18
30BH006V--	EMEA	Xeon E3-1245 v6 4C/3.7GHz/8MB/73W/DDR4-2400	Intel HD P630 + NVIDIA Quadro P2000 5GB	2x8GB UDIMM DDR4-2400 ECC	1x256GB SSD 2.5" SATA6Gbps Opal	None	HH DVD±RW	9-in-1	250W Bronze Fixed	None	USB / USB Optical	Windows 10 Pro 64	3-year, Onsite	No	03/18
30BH006V**	EMEA	Xeon E3-1245 v6 4C/3.7GHz/8MB/73W/DDR4-2400	Intel HD P630 + NVIDIA Quadro P2000 5GB	2x8GB UDIMM DDR4-2400 ECC	1x256GB SSD 2.5" SATA6Gbps Opal	None	HH DVD±RW	9-in-1	250W Bronze Fixed	None	USB / USB Optical	Windows 10 Pro 64	3-year, Onsite	No	03/18
30BH006Vxx	EMEA	Xeon E3-1245 v6 4C/3.7GHz/8MB/73W/DDR4-2400	Intel HD P630 + NVIDIA Quadro P2000 5GB	2x8GB UDIMM DDR4-2400 ECC	1x256GB SSD 2.5" SATA6Gbps Opal	None	HH DVD±RW	9-in-1	250W Bronze Fixed	None	USB / USB Optical	Windows 10 Pro 64	3-year, Onsite	No	03/18
30BH006W--	EMEA	Xeon E3-1230 v6 4C/3.5GHz/8MB/72W/DDR4-2400	NVIDIA Quadro P1000 4GB	2x8GB UDIMM DDR4-2400 ECC	1x256GB SSD 2.5" SATA6Gbps Opal	None	HH DVD±RW	9-in-1	250W Bronze Fixed	None	USB / USB Optical	Windows 10 Pro 64	3-year, Onsite	No	03/18
30BH006W**	EMEA	Xeon E3-1230 v6 4C/3.5GHz/8MB/72W/DDR4-2400	NVIDIA Quadro P1000 4GB	2x8GB UDIMM DDR4-2400 ECC	1x256GB SSD 2.5" SATA6Gbps Opal	None	HH DVD±RW	9-in-1	250W Bronze Fixed	None	USB / USB Optical	Windows 10 Pro 64	3-year, Onsite	No	03/18
30BH006Wxx	EMEA	Xeon E3-1230 v6 4C/3.5GHz/8MB/72W/DDR4-2400	NVIDIA Quadro P1000 4GB	2x8GB UDIMM DDR4-2400 ECC	1x256GB SSD 2.5" SATA6Gbps Opal	None	HH DVD±RW	9-in-1	250W Bronze Fixed	None	USB / USB Optical	Windows 10 Pro 64	3-year, Onsite	No	03/18
30BH006X--	EMEA	Core i7-7700K 4C/4.2GHz/8MB/91W/DDR4-2400	Intel HD 630 + NVIDIA Quadro P600 2GB	1x8GB UDIMM DDR4-2400 Non-ECC	Open	1x256GB SSD M.2 PCIe Opal	HH DVD±RW	9-in-1	400W Platinum Fixed	None	USB / USB Optical	Windows 10 Pro 64	3-year, Onsite	No	04/18
30BH006X**	EMEA	Core i7-7700K 4C/4.2GHz/8MB/91W/DDR4-2400	Intel HD 630 + NVIDIA Quadro P600 2GB	1x8GB UDIMM DDR4-2400 Non-ECC	Open	1x256GB SSD M.2 PCIe Opal	HH DVD±RW	9-in-1	400W Platinum Fixed	None	USB / USB Optical	Windows 10 Pro 64	3-year, Onsite	No	04/18
30BH006Xxx	EMEA	Core i7-7700K 4C/4.2GHz/8MB/91W/DDR4-2400	Intel HD 630 + NVIDIA Quadro P600 2GB	1x8GB UDIMM DDR4-2400 Non-ECC	Open	1x256GB SSD M.2 PCIe Opal	HH DVD±RW	9-in-1	400W Platinum Fixed	None	USB / USB Optical	Windows 10 Pro 64	3-year, Onsite	No	04/18
30BH006Y--	EMEA	Xeon E3-1220 v6 4C/3.0GHz/8MB/72W/DDR4-2400	NVIDIA Quadro P400 2GB	1x8GB UDIMM DDR4-2400 ECC	1x1TB HDD 7.2K 3.5" SATA6Gbps	None	HH DVD±RW	9-in-1	400W Platinum Fixed	Serial	USB / USB Optical	Windows 10 Pro 64	3-year, Onsite	No	04/18
30BH006Y**	EMEA	Xeon E3-1220 v6 4C/3.0GHz/8MB/72W/DDR4-2400	NVIDIA Quadro P400 2GB	1x8GB UDIMM DDR4-2400 ECC	1x1TB HDD 7.2K 3.5" SATA6Gbps	None	HH DVD±RW	9-in-1	400W Platinum Fixed	Serial	USB / USB Optical	Windows 10 Pro 64	3-year, Onsite	No	04/18

Model	Region	Processor	Graphics	Memory	Disks	M.2 Drives	Optical	Media Reader	Power Supply	Optional Ports	Keyboard / Mouse	Operating System	Warranty	Global	Ann Date (mm/yy)
30BH006Yxx	EMEA	Xeon E3-1220 v6 4C/3.0GHz/8MB/72W/DDR4-2400	NVIDIA Quadro P400 2GB	1x8GB UDIMM DDR4-2400 ECC	1x1TB HDD 7.2K 3.5" SATA6Gbps	None	HH DVD±RW	9-in-1	400W Platinum Fixed	Serial	USB / USB Optical	Windows 10 Pro 64	3-year, Onsite	No	04/18
30BH0070--	EMEA	Xeon E3-1245 v6 4C/3.7GHz/8MB/73W/DDR4-2400	Intel HD P630 + NVIDIA Quadro P600 2GB	1x16GB UDIMM DDR4-2400 ECC	1x1TB HDD 7.2K 3.5" SATA6Gbps	None	HH DVD±RW	9-in-1	400W Platinum Fixed	Serial	USB / USB Optical	Windows 10 Pro 64	3-year, Onsite	No	04/18
30BH0070**	EMEA	Xeon E3-1245 v6 4C/3.7GHz/8MB/73W/DDR4-2400	Intel HD P630 + NVIDIA Quadro P600 2GB	1x16GB UDIMM DDR4-2400 ECC	1x1TB HDD 7.2K 3.5" SATA6Gbps	None	HH DVD±RW	9-in-1	400W Platinum Fixed	Serial	USB / USB Optical	Windows 10 Pro 64	3-year, Onsite	No	04/18
30BH0070xx	EMEA	Xeon E3-1245 v6 4C/3.7GHz/8MB/73W/DDR4-2400	Intel HD P630 + NVIDIA Quadro P600 2GB	1x16GB UDIMM DDR4-2400 ECC	1x1TB HDD 7.2K 3.5" SATA6Gbps	None	HH DVD±RW	9-in-1	400W Platinum Fixed	Serial	USB / USB Optical	Windows 10 Pro 64	3-year, Onsite	No	04/18
30BH0071--	EMEA	Xeon E3-1245 v6 4C/3.7GHz/8MB/73W/DDR4-2400	Intel HD P630 + NVIDIA Quadro P1000 4GB	1x16GB UDIMM DDR4-2400 ECC	1x256GB SSD 2.5" SATA6Gbps Opal	None	HH DVD±RW	9-in-1	400W Platinum Fixed	Serial	USB / USB Optical	Windows 10 Pro 64	3-year, Onsite	No	04/18
30BH0071**	EMEA	Xeon E3-1245 v6 4C/3.7GHz/8MB/73W/DDR4-2400	Intel HD P630 + NVIDIA Quadro P1000 4GB	1x16GB UDIMM DDR4-2400 ECC	1x256GB SSD 2.5" SATA6Gbps Opal	None	HH DVD±RW	9-in-1	400W Platinum Fixed	Serial	USB / USB Optical	Windows 10 Pro 64	3-year, Onsite	No	04/18
30BH0071xx	EMEA	Xeon E3-1245 v6 4C/3.7GHz/8MB/73W/DDR4-2400	Intel HD P630 + NVIDIA Quadro P1000 4GB	1x16GB UDIMM DDR4-2400 ECC	1x256GB SSD 2.5" SATA6Gbps Opal	None	HH DVD±RW	9-in-1	400W Platinum Fixed	Serial	USB / USB Optical	Windows 10 Pro 64	3-year, Onsite	No	04/18
30BH0028**	EMEA	Core i5-7500 4C/3.4GHz/6MB/65W/DDR4-2400	Intel HD 630	1x8GB UDIMM DDR4-2400 Non-ECC	1x1TB HDD 7.2K 3.5" SATA6Gbps	None	HH DVD±RW	9-in-1	250W Bronze Fixed	None	USB / USB Optical	Windows 10 Pro 64	3-year, Onsite	No	05/17
30BH005V--	EMEA	Xeon E3-1225 v6 4C/3.3GHz/8MB/73W/DDR4-2400	Intel HD P630 + NVIDIA Quadro P600 2GB	1x8GB UDIMM DDR4-2400 ECC	1x1TB HDD 7.2K 3.5" SATA6Gbps	None	HH DVD±RW	9-in-1	250W Bronze Fixed	None	None / None	Windows 10 Pro 64	3-year, Onsite	No	12/17
30BH005W--	EMEA	Core i7-7700 4C/3.6GHz/8MB/65W/DDR4-2400	Intel HD 630 + NVIDIA Quadro P2000 5GB	1x16GB UDIMM DDR4-2400 Non-ECC	1x1TB HDD 7.2K 3.5" SATA6Gbps	1x256GB SSD M.2 PCIe Opal	HH DVD±RW	9-in-1	400W Platinum Fixed	PS/2	None / USB Optical	Windows 10 Pro 64	3-year, Onsite	No	01/18
30BH005X--	EMEA	Xeon E3-1225 v6 4C/3.3GHz/8MB/73W/DDR4-2400	Intel HD P630 + NVIDIA Quadro P600 2GB	1x8GB UDIMM DDR4-2400 ECC	1x1TB HDD 7.2K 3.5" SATA6Gbps	None	HH DVD±RW	9-in-1	250W Bronze Fixed	None	USB / USB Optical	Windows 10 Pro 64	3-year, Onsite	No	01/18
30BH005X**	EMEA	Xeon E3-1225 v6 4C/3.3GHz/8MB/73W/DDR4-2400	Intel HD P630 + NVIDIA Quadro P600 2GB	1x8GB UDIMM DDR4-2400 ECC	1x1TB HDD 7.2K 3.5" SATA6Gbps	None	HH DVD±RW	9-in-1	250W Bronze Fixed	None	USB / USB Optical	Windows 10 Pro 64	3-year, Onsite	No	01/18
30BH005Xxx	EMEA	Xeon E3-1225 v6 4C/3.3GHz/8MB/73W/DDR4-2400	Intel HD P630 + NVIDIA Quadro P600 2GB	1x8GB UDIMM DDR4-2400 ECC	1x1TB HDD 7.2K 3.5" SATA6Gbps	None	HH DVD±RW	9-in-1	250W Bronze Fixed	None	USB / USB Optical	Windows 10 Pro 64	3-year, Onsite	No	01/18

Model	Region	Processor	Graphics	Memory	Disks	M.2 Drives	Optical	Media Reader	Power Supply	Optional Ports	Keyboard / Mouse	Operating System	Warranty	Global	Ann Date (mm/yy)
30BH005Y--	EMEA	Xeon E3-1245 v6 4C/3.7GHz/8MB/73W/DDR4-2400	Intel HD P630 + NVIDIA Quadro P1000 4GB	1x16GB UDIMM DDR4-2400 ECC	Open	1x256GB SSD M.2 PCIe Opal	HH DVD±RW	9-in-1	400W Platinum Fixed	None	USB / USB Optical	Windows 10 Pro 64	3-year, Onsite	No	01/18
30BH005Y**	EMEA	Xeon E3-1245 v6 4C/3.7GHz/8MB/73W/DDR4-2400	Intel HD P630 + NVIDIA Quadro P1000 4GB	1x16GB UDIMM DDR4-2400 ECC	Open	1x256GB SSD M.2 PCIe Opal	HH DVD±RW	9-in-1	400W Platinum Fixed	None	USB / USB Optical	Windows 10 Pro 64	3-year, Onsite	No	01/18
30BH005Yxx	EMEA	Xeon E3-1245 v6 4C/3.7GHz/8MB/73W/DDR4-2400	Intel HD P630 + NVIDIA Quadro P1000 4GB	1x16GB UDIMM DDR4-2400 ECC	Open	1x256GB SSD M.2 PCIe Opal	HH DVD±RW	9-in-1	400W Platinum Fixed	None	USB / USB Optical	Windows 10 Pro 64	3-year, Onsite	No	01/18
30BH0060US	US	Xeon E3-1245 v5 4C/3.5GHz/8MB/80W/DDR4-2133	Intel HD P530	1x16GB UDIMM DDR4-2400 Non-ECC	Open	1x512GB SSD M.2 PCIe Opal	HH DVD±RW	9-in-1	250W Bronze Fixed	None	USB / USB Optical	Windows 10 Pro 64	3-year, Onsite	No	01/18
30BH0061US	US	Xeon E3-1245 v5 4C/3.5GHz/8MB/80W/DDR4-2133	Intel HD P530	1x8GB UDIMM DDR4-2400 Non-ECC	Open	1x512GB SSD M.2 PCIe Opal	HH DVD±RW	9-in-1	250W Bronze Fixed	None	USB / USB Optical	Windows 10 DG Windows 7 Pro 64	3-year, Onsite	No	01/18
30BH0062US	US	Xeon E3-1240 v5 4C/3.5GHz/8MB/80W/DDR4-2133	NVIDIA Quadro P2000 5GB	1x16GB UDIMM DDR4-2400 Non-ECC	Open	1x512GB SSD M.2 PCIe Opal	HH DVD±RW	9-in-1	250W Bronze Fixed	None	USB / USB Optical	Windows 10 DG Windows 7 Pro 64	3-year, Onsite	No	01/18
30BH0063US	US	Xeon E3-1240 v5 4C/3.5GHz/8MB/80W/DDR4-2133	NVIDIA Quadro P600 2GB	1x8GB UDIMM DDR4-2400 Non-ECC	1x1TB HDD 7.2K 3.5" SATA6Gbps	None	HH DVD±RW	9-in-1	250W Bronze Fixed	None	USB / USB Optical	Windows 10 DG Windows 7 Pro 64	3-year, Onsite	No	01/18
30BH0064US	US	Xeon E3-1240 v6 4C/3.7GHz/8MB/72W/DDR4-2400	NVIDIA Quadro P2000 5GB	1x16GB UDIMM DDR4-2400 Non-ECC	Open	1x512GB SSD M.2 PCIe Opal	HH DVD±RW	9-in-1	250W Bronze Fixed	None	USB / USB Optical	Windows 10 Pro 64	3-year, Onsite	No	01/18
30BH0065US	US	Xeon E3-1240 v5 4C/3.5GHz/8MB/80W/DDR4-2133	NVIDIA Quadro P2000 5GB	1x16GB UDIMM DDR4-2400 Non-ECC	1x1TB HDD 7.2K 3.5" SATA6Gbps	None	HH DVD±RW	9-in-1	250W Bronze Fixed	None	USB / USB Optical	Windows 10 DG Windows 7 Pro 64	3-year, Onsite	No	01/18
30BH0028US	US	Core i5-7500 4C/3.4GHz/6MB/65W/DDR4-2400	Intel HD 630	1x8GB UDIMM DDR4-2400 Non-ECC	1x1TB HDD 7.2K 3.5" SATA6Gbps	None	HH DVD±RW	9-in-1	250W Bronze Fixed	None	USB / USB Optical	Windows 10 Pro 64	3-year, Onsite	No	04/17
30BH0029US	US	Core i7-7700 4C/3.6GHz/8MB/65W/DDR4-2400	Intel HD 630	2x8GB UDIMM DDR4-2400 Non-ECC	Open	1x512GB SSD M.2 PCIe Opal	HH DVD±RW	9-in-1	250W Bronze Fixed	None	USB / USB Optical	Windows 10 Pro 64	3-year, Onsite	No	04/17
30BH002AUS	US	Core i5-6500 4C/3.2GHz/6MB/65W/DDR4-2133	Intel HD 530	1x8GB UDIMM DDR4-2400 Non-ECC	1x1TB HDD 7.2K 3.5" SATA6Gbps	None	HH DVD±RW	9-in-1	250W Bronze Fixed	None	USB / USB Optical	Windows 10 DG Windows 7 Pro 64	3-year, Onsite	No	04/17
30BH002BUS	US	Xeon E3-1240 v5 4C/3.5GHz/8MB/80W/DDR4-2133	NVIDIA Quadro P600 2GB	1x8GB UDIMM DDR4-2400 Non-ECC	1x1TB HDD 7.2K 3.5" SATA6Gbps	None	HH DVD±RW	9-in-1	250W Bronze Fixed	None	USB / USB Optical	Windows 10 DG Windows 7 Pro 64	3-year, Onsite	No	04/17

Model	Region	Processor	Graphics	Memory	Disks	M.2 Drives	Optical	Media Reader	Power Supply	Optional Ports	Keyboard / Mouse	Operating System	Warranty	Global	Ann Date (mm/yy)
30BH002CUS	US	Core i3-7100 2C/3.9GHz/3MB/51W/DDR4-2400	Intel HD 630	1x8GB UDIMM DDR4-2400 Non-ECC	1x1TB HDD 7.2K 3.5" SATA6Gbps	None	HH DVD±RW	9-in-1	250W Bronze Fixed	None	USB / USB Optical	Windows 10 Pro 64	3-year, Onsite	No	04/17
30BH002DUS	US	Core i7-7700K 4C/4.2GHz/8MB/91W/DDR4-2400	Intel HD 630	2x8GB UDIMM DDR4-2400 Non-ECC	1x1TB HDD 7.2K 3.5" SATA6Gbps	None	HH DVD±RW	9-in-1	250W Bronze Fixed	None	USB / USB Optical	Windows 10 Pro 64	3-year, Onsite	No	04/17
30BH002EUS	US	Core i7-7700 4C/3.6GHz/8MB/65W/DDR4-2400	Intel HD 630 + NVIDIA Quadro P1000 4GB	2x8GB UDIMM DDR4-2400 Non-ECC	1x1TB HDD 7.2K 3.5" SATA6Gbps	None	HH DVD±RW	9-in-1	250W Bronze Fixed	None	USB / USB Optical	Windows 10 Pro 64	3-year, Onsite	No	04/17
30BH002FUS	US	Core i3-6100 2C/3.7GHz/3MB/51W/DDR4-2133	Intel HD 530	1x8GB UDIMM DDR4-2400 Non-ECC	1x1TB HDD 7.2K 3.5" SATA6Gbps	None	HH DVD±RW	9-in-1	250W Bronze Fixed	None	USB / USB Optical	Windows 10 DG Windows 7 Pro 64	3-year, Onsite	No	04/17
30BH002GUS	US	Core i5-6500 4C/3.2GHz/6MB/65W/DDR4-2133	Intel HD 530	1x8GB UDIMM DDR4-2400 Non-ECC	Open	1x256GB SSD M.2 PCIe Opal	HH DVD±RW	9-in-1	250W Bronze Fixed	None	USB / USB Optical	Windows 10 DG Windows 7 Pro 64	3-year, Onsite	No	04/17
30BH002HUS	US	Xeon E3-1240 v6 4C/3.7GHz/8MB/72W/DDR4-2400	NVIDIA Quadro P2000 5GB	2x8GB UDIMM DDR4-2400 Non-ECC	Open	1x512GB SSD M.2 PCIe Opal	HH DVD±RW	9-in-1	250W Bronze Fixed	None	USB / USB Optical	Windows 10 Pro 64	3-year, Onsite	No	04/17
30BH002JUS	US	Core i7-6700 4C/3.4GHz/8MB/65W/DDR4-2133	Intel HD 530 + NVIDIA Quadro P1000 4GB	2x8GB UDIMM DDR4-2400 Non-ECC	1x1TB HDD 7.2K 3.5" SATA6Gbps	None	HH DVD±RW	9-in-1	250W Bronze Fixed	None	USB / USB Optical	Windows 10 DG Windows 7 Pro 64	3-year, Onsite	No	04/17
30BH002KUS	US	Core i7-7700 4C/3.6GHz/8MB/65W/DDR4-2400	Intel HD 630	2x8GB UDIMM DDR4-2400 Non-ECC	Open	1x256GB SSD M.2 PCIe Opal	HH DVD±RW	9-in-1	250W Bronze Fixed	None	USB / USB Optical	Windows 10 Pro 64	3-year, Onsite	No	04/17
30BH002LUS	US	Core i7-7700 4C/3.6GHz/8MB/65W/DDR4-2400	Intel HD 630 + NVIDIA Quadro P2000 5GB	2x8GB UDIMM DDR4-2400 Non-ECC	Open	1x512GB SSD M.2 PCIe Opal	HH DVD±RW	9-in-1	250W Bronze Fixed	None	USB / USB Optical	Windows 10 Pro 64	3-year, Onsite	No	04/17
30BH002MUS	US	Core i7-7700 4C/3.6GHz/8MB/65W/DDR4-2400	Intel HD 630 + NVIDIA Quadro P2000 5GB	2x8GB UDIMM DDR4-2400 Non-ECC	1x2TB HDD 7.2K 3.5" SATA6Gbps	1x512GB SSD M.2 PCIe Opal	HH DVD±RW	9-in-1	250W Bronze Fixed	None	USB / USB Optical	Windows 10 Pro 64	3-year, Onsite	No	04/17
30BH002NUS	US	Xeon E3-1230 v6 4C/3.5GHz/8MB/72W/DDR4-2400	NVIDIA Quadro P400 2GB	1x8GB UDIMM DDR4-2400 Non-ECC	1x1TB HDD 7.2K 3.5" SATA6Gbps	None	HH DVD±RW	9-in-1	250W Bronze Fixed	None	USB / USB Optical	Windows 10 Pro 64	3-year, Onsite	No	04/17
30BH002PUS	US	Core i7-7700 4C/3.6GHz/8MB/65W/DDR4-2400	Intel HD 630	2x8GB UDIMM DDR4-2400 Non-ECC	Open	1x1TB SSD M.2 PCIe Opal	HH DVD±RW	9-in-1	250W Bronze Fixed	None	USB / USB Optical	Windows 10 Pro 64	3-year, Onsite	No	04/17
30BH002QUS	US	Core i7-6700 4C/3.4GHz/8MB/65W/DDR4-2133	Intel HD 530	2x8GB UDIMM DDR4-2400 Non-ECC	Open	1x256GB SSD M.2 PCIe Opal	HH DVD±RW	9-in-1	250W Bronze Fixed	None	USB / USB Optical	Windows 10 DG Windows 7 Pro 64	3-year, Onsite	No	04/17

Model	Region	Processor	Graphics	Memory	Disks	M.2 Drives	Optical	Media Reader	Power Supply	Optional Ports	Keyboard / Mouse	Operating System	Warranty	Global	Ann Date (mm/yy)
30BH002RUS	US	Core i7-6700 4C/3.4GHz/8MB/65W/DDR4-2133	Intel HD 530	1x8GB UDIMM DDR4-2400 Non-ECC	1x1TB HDD 7.2K 3.5" SATA6Gbps	None	HH DVD±RW	9-in-1	250W Bronze Fixed	None	USB / USB Optical	Windows 10 DG Windows 7 Pro 64	3-year, Onsite	No	04/17
30BH002SUS	US	Xeon E3-1245 v6 4C/3.7GHz/8MB/73W/DDR4-2400	Intel HD P630	2x8GB UDIMM DDR4-2400 Non-ECC	Open	1x512GB SSD M.2 PCIe Opal	HH DVD±RW	9-in-1	250W Bronze Fixed	None	USB / USB Optical	Windows 10 Pro 64	3-year, Onsite	No	04/17
30BH002TUS	US	Core i5-7500 4C/3.4GHz/6MB/65W/DDR4-2400	Intel HD 630	1x8GB UDIMM DDR4-2400 Non-ECC	Open	1x256GB SSD M.2 PCIe Opal	HH DVD±RW	9-in-1	250W Bronze Fixed	None	USB / USB Optical	Windows 10 Pro 64	3-year, Onsite	No	04/17
30BH002UUS	US	Core i7-6700 4C/3.4GHz/8MB/65W/DDR4-2133	Intel HD 530 + NVIDIA Quadro P2000 5GB	2x8GB UDIMM DDR4-2400 Non-ECC	Open	1x512GB SSD M.2 PCIe Opal	HH DVD±RW	9-in-1	250W Bronze Fixed	None	USB / USB Optical	Windows 10 DG Windows 7 Pro 64	3-year, Onsite	No	04/17
30BH002VUS	US	Xeon E3-1240 v5 4C/3.5GHz/8MB/80W/DDR4-2133	NVIDIA Quadro P2000 5GB	2x8GB UDIMM DDR4-2400 Non-ECC	1x1TB HDD 7.2K 3.5" SATA6Gbps	None	HH DVD±RW	9-in-1	250W Bronze Fixed	None	USB / USB Optical	Windows 10 DG Windows 7 Pro 64	3-year, Onsite	No	04/17
30BH002WUS	US	Xeon E3-1245 v6 4C/3.7GHz/8MB/73W/DDR4-2400	Intel HD P630	1x8GB UDIMM DDR4-2400 Non-ECC	Open	1x512GB SSD M.2 PCIe Opal	HH DVD±RW	9-in-1	250W Bronze Fixed	None	USB / USB Optical	Windows 10 Pro 64	3-year, Onsite	No	04/17
30BH002XUS	US	Xeon E3-1230 v5 4C/3.4GHz/8MB/80W/DDR4-2133	NVIDIA Quadro P400 2GB	1x8GB UDIMM DDR4-2400 Non-ECC	1x1TB HDD 7.2K 3.5" SATA6Gbps	None	HH DVD±RW	9-in-1	250W Bronze Fixed	None	USB / USB Optical	Windows 10 DG Windows 7 Pro 64	3-year, Onsite	No	04/17
30BH002YUS	US	Xeon E3-1270 v6 4C/3.8GHz/8MB/72W/DDR4-2400	NVIDIA Quadro P2000 5GB	2x8GB UDIMM DDR4-2400 Non-ECC	Open	1x512GB SSD M.2 PCIe Opal	HH DVD±RW	9-in-1	250W Bronze Fixed	None	USB / USB Optical	Windows 10 Pro 64	3-year, Onsite	No	04/17
30BH0030US	US	Xeon E3-1240 v5 4C/3.5GHz/8MB/80W/DDR4-2133	NVIDIA Quadro P2000 5GB	2x8GB UDIMM DDR4-2400 Non-ECC	Open	1x512GB SSD M.2 PCIe Opal	HH DVD±RW	9-in-1	250W Bronze Fixed	None	USB / USB Optical	Windows 10 DG Windows 7 Pro 64	3-year, Onsite	No	04/17
30BH0031US	US	Core i7-6700 4C/3.4GHz/8MB/65W/DDR4-2133	Intel HD 530 + NVIDIA Quadro P2000 5GB	2x8GB UDIMM DDR4-2400 Non-ECC	1x2TB HDD 7.2K 3.5" SATA6Gbps	1x512GB SSD M.2 PCIe Opal	HH DVD±RW	9-in-1	250W Bronze Fixed	None	USB / USB Optical	Windows 10 DG Windows 7 Pro 64	3-year, Onsite	No	04/17
30BH0032US	US	Xeon E3-1240 v6 4C/3.7GHz/8MB/72W/DDR4-2400	NVIDIA Quadro P600 2GB	1x8GB UDIMM DDR4-2400 Non-ECC	1x1TB HDD 7.2K 3.5" SATA6Gbps	None	HH DVD±RW	9-in-1	250W Bronze Fixed	None	USB / USB Optical	Windows 10 Pro 64	3-year, Onsite	No	04/17
30BH0033US	US	Xeon E3-1245 v5 4C/3.5GHz/8MB/80W/DDR4-2133	Intel HD P530	2x8GB UDIMM DDR4-2400 Non-ECC	Open	1x512GB SSD M.2 PCIe Opal	HH DVD±RW	9-in-1	250W Bronze Fixed	None	USB / USB Optical	Windows 10 DG Windows 7 Pro 64	3-year, Onsite	No	04/17
30BH0034US	US	Core i7-6700 4C/3.4GHz/8MB/65W/DDR4-2133	Intel HD 530	2x8GB UDIMM DDR4-2400 Non-ECC	Open	1x512GB SSD M.2 PCIe Opal	HH DVD±RW	9-in-1	250W Bronze Fixed	None	USB / USB Optical	Windows 10 DG Windows 7 Pro 64	3-year, Onsite	No	04/17

Model	Region	Processor	Graphics	Memory	Disks	M.2 Drives	Optical	Media Reader	Power Supply	Optional Ports	Keyboard / Mouse	Operating System	Warranty	Global	Ann Date (mm/yy)
30BH0035US	US	Core i7-7700K 4C/4.2GHz/8MB/91W/DDR4-2400	Intel HD 630 + NVIDIA Quadro P1000 4GB	1x8GB UDIMM DDR4-2400 Non-ECC	1x1TB SSD 2.5" SATA6Gbps Opal	None	HH DVD±RW	9-in-1	250W Bronze Fixed	None	USB / USB Optical	Windows 10 Pro 64	3-year, Onsite	No	04/17
30BH0036US	US	Xeon E3-1245 v6 4C/3.7GHz/8MB/73W/DDR4-2400	Intel HD P630	2x8GB UDIMM DDR4-2400 ECC	Open	1x512GB SSD M.2 PCIe Opal	HH DVD±RW	9-in-1	250W Bronze Fixed	None	USB / USB Optical	Windows 10 Pro 64	3-year, Onsite	No	04/17
30BH0037US	US	Core i5-7500 4C/3.4GHz/6MB/65W/DDR4-2400	Intel HD 630 + NVIDIA Quadro P600 2GB	1x8GB UDIMM DDR4-2400 Non-ECC	1x512GB SSD 2.5" SATA6Gbps Opal	None	HH DVD±RW	9-in-1	250W Bronze Fixed	None	USB / USB Optical	Windows 10 Pro 64	3-year, Onsite	No	04/17
30BH0038US	US	Core i7-7700K 4C/4.2GHz/8MB/91W/DDR4-2400	Intel HD 630 + NVIDIA Quadro P400 2GB	1x8GB UDIMM DDR4-2400 Non-ECC	1x1TB SSD 2.5" SATA6Gbps Opal	None	HH DVD±RW	9-in-1	250W Bronze Fixed	None	USB / USB Optical	Windows 10 Pro 64	3-year, Onsite	No	04/17
30BH0039US	US	Core i3-7100 2C/3.9GHz/3MB/51W/DDR4-2400	Intel HD 630 + NVIDIA Quadro P600 2GB	1x8GB UDIMM DDR4-2400 Non-ECC	1x1TB HDD 7.2K 3.5" SATA6Gbps	None	HH DVD±RW	9-in-1	250W Bronze Fixed	None	USB / USB Optical	Windows 10 Pro 64	3-year, Onsite	No	04/17
30BH003AUS	US	Core i7-7700 4C/3.6GHz/8MB/65W/DDR4-2400	Intel HD 630 + NVIDIA Quadro P600 2GB	1x8GB UDIMM DDR4-2400 Non-ECC	1x512GB SSD 2.5" SATA6Gbps Opal	None	HH DVD±RW	9-in-1	250W Bronze Fixed	None	USB / USB Optical	Windows 10 Pro 64	3-year, Onsite	No	04/17
30BH003BUS	US	Core i7-7700K 4C/4.2GHz/8MB/91W/DDR4-2400	Intel HD 630 + NVIDIA Quadro P600 2GB	1x8GB UDIMM DDR4-2400 Non-ECC	1x1TB SSD 2.5" SATA6Gbps Opal	None	HH DVD±RW	9-in-1	250W Bronze Fixed	None	USB / USB Optical	Windows 10 Pro 64	3-year, Onsite	No	04/17
30BH003CUS	US	Core i7-7700 4C/3.6GHz/8MB/65W/DDR4-2400	Intel HD 630 + NVIDIA Quadro P600 2GB	1x8GB UDIMM DDR4-2400 Non-ECC	1x1TB HDD 7.2K 3.5" SATA6Gbps	None	HH DVD±RW	9-in-1	250W Bronze Fixed	None	USB / USB Optical	Windows 10 Pro 64	3-year, Onsite	No	04/17
30BH003DUS	US	Core i5-7500 4C/3.4GHz/6MB/65W/DDR4-2400	Intel HD 630 + NVIDIA Quadro P600 2GB	1x8GB UDIMM DDR4-2400 Non-ECC	1x1TB HDD 7.2K 3.5" SATA6Gbps	None	HH DVD±RW	9-in-1	250W Bronze Fixed	None	USB / USB Optical	Windows 10 Pro 64	3-year, Onsite	No	04/17
30BH003EUS	US	Core i3-7100 2C/3.9GHz/3MB/51W/DDR4-2400	Intel HD 630 + NVIDIA Quadro P600 2GB	1x8GB UDIMM DDR4-2400 Non-ECC	1x512GB SSD 2.5" SATA6Gbps Opal	None	HH DVD±RW	9-in-1	250W Bronze Fixed	None	USB / USB Optical	Windows 10 Pro 64	3-year, Onsite	No	04/17
30BH0057US	US	Core i7-7700 4C/3.6GHz/8MB/65W/DDR4-2400	Intel HD 630	1x16GB UDIMM DDR4-2400 Non-ECC	1x1TB HDD 7.2K 3.5" SATA6Gbps	16GB Optane Memory	HH DVD±RW	9-in-1	250W Bronze Fixed	None	USB / USB Optical	Windows 10 Pro 64	3-year, Onsite	No	09/17
30BH005SUS	US	Core i7-7700K 4C/4.2GHz/8MB/91W/DDR4-2400	Intel HD 630	1x16GB UDIMM DDR4-2400 Non-ECC	Open	1x512GB SSD M.2 PCIe Opal	HH DVD±RW	9-in-1	400W Platinum Fixed	None	USB / USB Optical	Windows 10 Pro 64	3-year, Onsite	No	12/17
30BH005TUS	US	Core i7-6700 4C/3.4GHz/8MB/65W/DDR4-2133	Intel HD 530	1x16GB UDIMM DDR4-2400 Non-ECC	Open	1x512GB SSD M.2 PCIe Opal	HH DVD±RW	9-in-1	400W Platinum Fixed	None	USB / USB Optical	Windows 10 DG Windows 7 Pro 64	3-year, Onsite	No	12/17

Model	Region	Processor	Graphics	Memory	Disks	M.2 Drives	Optical	Media Reader	Power Supply	Optional Ports	Keyboard / Mouse	Operating System	Warranty	Global	Ann Date (mm/yy)
30BH005UUS	US	Core i7-7700 4C/3.6GHz/8MB/65W/DDR4-2400	Intel HD 630	1x16GB UDIMM DDR4-2400 Non-ECC	Open	1x512GB SSD M.2 PCIe Opal	HH DVD±RW	9-in-1	400W Platinum Fixed	None	USB / USB Optical	Windows 10 Pro 64	3-year, Onsite	No	12/17
30BH0022US	US	Core i7-7700 4C/3.6GHz/8MB/65W/DDR4-2400	Intel HD 630	1x8GB UDIMM DDR4-2400 Non-ECC	1x1TB HDD 7.2K 3.5" SATA6Gbps	None	HH DVD±RW	9-in-1	250W Bronze Fixed	None	USB / USB Optical	Windows 10 Pro 64	3-year, Onsite	No	04/17
30BH0023US	US	Xeon E3-1245 v5 4C/3.5GHz/8MB/80W/DDR4-2133	Intel HD P530	1x8GB UDIMM DDR4-2400 Non-ECC	Open	1x512GB SSD M.2 PCIe Opal	HH DVD±RW	9-in-1	250W Bronze Fixed	None	USB / USB Optical	Windows 10 DG Windows 7 Pro 64	3-year, Onsite	No	04/17
30BH0024US	US	Core i7-7700 4C/3.6GHz/8MB/65W/DDR4-2400	Intel HD 630	1x8GB UDIMM DDR4-2400 Non-ECC	Open	1x512GB SSD M.2 PCIe Opal	HH DVD±RW	9-in-1	250W Bronze Fixed	None	USB / USB Optical	Windows 10 Pro 64	3-year, Onsite	No	04/17
30BH0025US	US	Core i7-6700 4C/3.4GHz/8MB/65W/DDR4-2133	Intel HD 530	1x8GB UDIMM DDR4-2400 Non-ECC	Open	1x512GB SSD M.2 PCIe Opal	HH DVD±RW	9-in-1	250W Bronze Fixed	None	USB / USB Optical	Windows 10 DG Windows 7 Pro 64	3-year, Onsite	No	04/17
30BH0026US	US	Xeon E3-1240 v6 4C/3.7GHz/8MB/72W/DDR4-2400	NVIDIA Quadro P2000 5GB	2x8GB UDIMM DDR4-2400 Non-ECC	1x1TB HDD 7.2K 3.5" SATA6Gbps	None	HH DVD±RW	9-in-1	250W Bronze Fixed	None	USB / USB Optical	Windows 10 Pro 64	3-year, Onsite	No	04/17
30BH0027US	US	Core i7-7700K 4C/4.2GHz/8MB/91W/DDR4-2400	Intel HD 630	2x8GB UDIMM DDR4-2400 Non-ECC	Open	1x256GB SSD M.2 PCIe Opal	HH DVD±RW	9-in-1	250W Bronze Fixed	None	USB / USB Optical	Windows 10 Pro 64	3-year, Onsite	No	04/17

ThinkStation P410 Platform Specifications

Product Specifications Reference (PSREF)

Components	Specification																																																																																																						
Chipset	Intel C612 Platform Controller Hub (PCH)																																																																																																						
System mgmt	Intel Active Management Technology 9																																																																																																						
Processor	Up to one 140W Intel Xeon E5-1600 v4 family processors. Some Intel Xeon E5-2600 v4 processors are also available:																																																																																																						
	E5-2637 v4	4C/3.5GHz/15MB/135W/DDR4-2400																																																																																																					
	E5-2623 v4	4C/2.6GHz/10MB/85W/DDR4-2133																																																																																																					
	E5-2620 v4	8C/2.1GHz/20MB/85W/DDR4-2133																																																																																																					
	E5-1680 v4	8C/3.4GHz/20MB/140W/DDR4-2400 333																																																																																																					
	E5-1660 v4	8C/3.2GHz/20MB/140W/DDR4-2400																																																																																																					
	E5-1650 v4	6C/3.6GHz/15MB/140W/DDR4-2400																																																																																																					
	E5-1630 v4	4C/3.7GHz/10MB/140W/DDR4-2400																																																																																																					
	E5-1620 v4	4C/3.5GHz/10MB/140W/DDR4-2400																																																																																																					
E5-1607 v4	4C/3.1GHz/10MB/140W/DDR4-2133																																																																																																						
E5-1603 v4	4C/2.8GHz/10MB/140W/DDR4-2133																																																																																																						
Coprocessor	None																																																																																																						
Memory DIMM slots	4 DIMM sockets. 4-channel capable. RDIMM. ECC. DDR4-2400																																																																																																						
Memory capacity	128GB (32GB x 4)																																																																																																						
Graphics	Two PCIe 3.0 x16 slots, up to two NVIDIA Quadro M4000, or up to one Quadro P5000																																																																																																						
Supporting Graphics and GPU computing	<table border="1"> <thead> <tr> <th>Adapter</th> <th>Cores</th> <th>Memory</th> <th>Power</th> <th>Connector***</th> <th>SLI</th> </tr> </thead> <tbody> <tr> <td>NVS 310</td> <td>48</td> <td>1GB</td> <td>19.5W</td> <td>2xDP</td> <td></td> </tr> <tr> <td>NVS 315</td> <td>48</td> <td>1GB</td> <td>19.5W</td> <td>2xDVI-I SL/2xDP</td> <td></td> </tr> <tr> <td>NVS 510</td> <td>192</td> <td>2GB</td> <td>35W</td> <td>4xmini DP</td> <td></td> </tr> <tr> <td>NVS 810</td> <td>1024</td> <td>4GB</td> <td>68W</td> <td>8xmini DP</td> <td></td> </tr> <tr> <td>Quadro K420</td> <td>192</td> <td>2GB</td> <td>41W</td> <td>DVI-I DL+DP</td> <td></td> </tr> <tr> <td>Quadro K620</td> <td>384</td> <td>2GB</td> <td>45W</td> <td>DVI-I DL+DP</td> <td></td> </tr> <tr> <td>Quadro K1200</td> <td>512</td> <td>4GB</td> <td>45W</td> <td>4xmini DP</td> <td></td> </tr> <tr> <td>Quadro M2000</td> <td>768</td> <td>4GB</td> <td>75W</td> <td>4xDP</td> <td></td> </tr> <tr> <td>Quadro M4000</td> <td>1664</td> <td>8GB</td> <td>120W</td> <td>4xDP</td> <td></td> </tr> <tr> <td>Quadro M5000</td> <td>2048</td> <td>8GB</td> <td>150W</td> <td>DVI-I DL+4xDP</td> <td></td> </tr> <tr> <td>Quadro P400</td> <td>256</td> <td>2GB</td> <td>30W</td> <td>3xminiDP</td> <td></td> </tr> <tr> <td>Quadro P600</td> <td>384</td> <td>2GB</td> <td>40W</td> <td>4xminiDP</td> <td></td> </tr> <tr> <td>Quadro P1000</td> <td>640</td> <td>4GB</td> <td>47W</td> <td>4xminiDP</td> <td></td> </tr> <tr> <td>Quadro P2000</td> <td>1024</td> <td>5GB</td> <td>75W</td> <td>4xDP</td> <td></td> </tr> <tr> <td>Quadro P4000</td> <td>1792</td> <td>8GB</td> <td>105W</td> <td>4xDP</td> <td>SLI</td> </tr> <tr> <td>Quadro P5000</td> <td>2560</td> <td>16GB</td> <td>180W</td> <td>DVI-D DL+4xDP</td> <td></td> </tr> </tbody> </table>	Adapter	Cores	Memory	Power	Connector***	SLI	NVS 310	48	1GB	19.5W	2xDP		NVS 315	48	1GB	19.5W	2xDVI-I SL/2xDP		NVS 510	192	2GB	35W	4xmini DP		NVS 810	1024	4GB	68W	8xmini DP		Quadro K420	192	2GB	41W	DVI-I DL+DP		Quadro K620	384	2GB	45W	DVI-I DL+DP		Quadro K1200	512	4GB	45W	4xmini DP		Quadro M2000	768	4GB	75W	4xDP		Quadro M4000	1664	8GB	120W	4xDP		Quadro M5000	2048	8GB	150W	DVI-I DL+4xDP		Quadro P400	256	2GB	30W	3xminiDP		Quadro P600	384	2GB	40W	4xminiDP		Quadro P1000	640	4GB	47W	4xminiDP		Quadro P2000	1024	5GB	75W	4xDP		Quadro P4000	1792	8GB	105W	4xDP	SLI	Quadro P5000	2560	16GB	180W	DVI-D DL+4xDP	
	Adapter	Cores	Memory	Power	Connector***	SLI																																																																																																	
	NVS 310	48	1GB	19.5W	2xDP																																																																																																		
	NVS 315	48	1GB	19.5W	2xDVI-I SL/2xDP																																																																																																		
	NVS 510	192	2GB	35W	4xmini DP																																																																																																		
	NVS 810	1024	4GB	68W	8xmini DP																																																																																																		
	Quadro K420	192	2GB	41W	DVI-I DL+DP																																																																																																		
	Quadro K620	384	2GB	45W	DVI-I DL+DP																																																																																																		
	Quadro K1200	512	4GB	45W	4xmini DP																																																																																																		
	Quadro M2000	768	4GB	75W	4xDP																																																																																																		
	Quadro M4000	1664	8GB	120W	4xDP																																																																																																		
	Quadro M5000	2048	8GB	150W	DVI-I DL+4xDP																																																																																																		
	Quadro P400	256	2GB	30W	3xminiDP																																																																																																		
	Quadro P600	384	2GB	40W	4xminiDP																																																																																																		
	Quadro P1000	640	4GB	47W	4xminiDP																																																																																																		
	Quadro P2000	1024	5GB	75W	4xDP																																																																																																		
	Quadro P4000	1792	8GB	105W	4xDP	SLI																																																																																																	
Quadro P5000	2560	16GB	180W	DVI-D DL+4xDP																																																																																																			
Disk drive controller	RAID 0, 1, 5, 10 with onboard SATA controller in chipset, SATA 6Gb/s. Optional RAID 0, 1, 10 with optional LSI 9340-8i PCIe adapter, 12Gb/s SAS and SATA, optional upgrade to RAID 5 is available																																																																																																						
Drive Bays	Two external 5.25" flex bays, two internal 3.5" bays. Up to one 9.5mm optical plus four 3.5"/2.5" disk drives plus three M.2 PCIe SSD (see right)																																																																																																						
Supporting storage	3.5" HDD, 7.2K SATA6Gbs	500GB/1TB/2TB/3TB/4TB/6TB, 1TB/2TB hybrid																																																																																																					
	2.5" HDD, 10K SAS12Gbs	300GB/600GB																																																																																																					
	2.5" SSD, SATA6Gbs	180GB/240GB/256GB/480GB/512GB with OPAL, 256GB/512GB/1TB without OPAL																																																																																																					
	PCIe SSD, M.2 via PCIe 3.0 x4 adapter	256GB/512GB/1TB, NVMe																																																																																																					
Flex connector	None																																																																																																						
Network interfaces	One onboard gigabit ethernet, Intel I218LM, supports Wake-on-LAN. Optional discrete ethernet adapters are available																																																																																																						
HD Audio	Realtek ALC662 codec																																																																																																						
TPM	TCG 1.2-compliant																																																																																																						
Power supply	One fixed 450 watts, autosensing, 92%, 80 PLUS Platinum qualified																																																																																																						
Front ports	Two USB 3.0, microphone (3.5mm), headphone (3.5mm)																																																																																																						
Rear ports	Two USB 2.0, four USB 3.0, one ethernet (RJ-45), three analog audio ports (line-in, line-out, mic-in)																																																																																																						

Components	Specification	
Additional ports	Supports the following optional ports: Two IEEE 1394 (one on rear and one on front flex module) via PCIe adapter, up to one adapter per system. Two rear USB 3.0 per PCIe adapter, up to three adapters per system. One rear Thunderbolt via PCIe adapter, or two front Thunderbolt (on flex module) via PCIe adapter, front and rear Thunderbolt cannot be intermixed. One rear serial via cable, up to one per system. One front eSATA (on flex module), or one rear eSATA via cable and PCIe slot bracket, up to one eSATA port per system	
Media reader	9-in-1 USB 2.0 card reader. Optional 29-in-1 USB 2.0 card reader on flex module	
Mechanical	<ul style="list-style-type: none"> 6.89"W x 16.77"D x 14.8"H 175mm W x 426mm D x 376mm H 30.86 lb (14kg) max configuration 25-liter 	
Environmental specification	Temperature - operating	50 °F to 95 °F (10 °C to 35 °C)
	Temperature - non operating (no package)	14 °F to 140 °F (-10 °C to 60 °C)
	Temperature - non operating (with package)	-40 °F to 140 °F (-40 °C to 60 °C)
	Altitude - operating	(Unpressurized): 0-10000ft (0-3048m)
	Humidity - operating	10%-80%, non-condensing
	Humidity - storage (with package)	10%-90%, non-condensing
	RoHS-compliant, GREENGUARD on all models. EPEAT Gold rating, ENERGY STAR 6.1 qualified on selected models.	
Base warranty	1 or 3-year limited onsite service with 9x5/NBD	
ISV certifications	Please visit www.thinkworkstations.com/isv-certifications/	

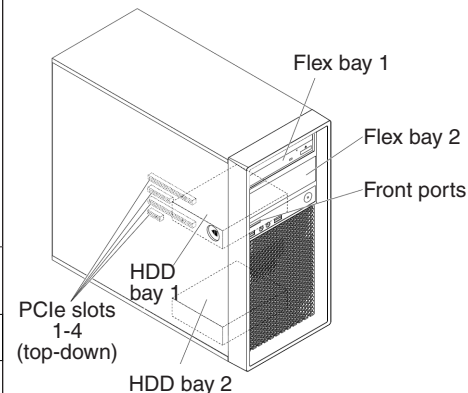

Expansion slots

Slot 1	PCIe 3.0 x16, full length, full height
Slot 2	PCIe 3.0 x8, full length, full height
Slot 3	PCIe 3.0 x16, full length, full height
Slot 4	PCIe 2.0 x4, half length, full height

Drive Bays

HDD bay 1	3.5", for one 3.5"/2.5" drive
HDD bay 2	3.5", for one 3.5"/2.5" drive
Flex bay 1	HH optical, or 3.5" HDD bay via optional conversion kit, or slim optical+3.5" HDD bay kit via optional conversion kit, or flex module
Flex bay 2	HH optical, or 3.5" HDD bay via optional conversion kit, or slim optical+3.5" HDD bay kit via optional conversion kit, or flex module

Note:

1. HDD bay 2 is not available when one Quadro M5000, two Quadro M4000, or two NVS 810 are used.

2. Flex module supports one or more of the following options: 9.5mm optical/29-in-1 USB 2.0 reader/one front IEEE 1394/one front eSATA/two front Thunderbolt. Up to one flex module is supported per system.

3. Up to one slim optical+3.5" HDD bay kit is supported per system.

Model	Region	Processor	Graphics	Memory	Storage Controller	Disks	M.2 Drives	Optical	Media Reader	Power Supply	Optional Ports	Keyboard / Mouse	Operating System	Warranty	Ann Date (mm/yy)
30B3000F**	MEA	Xeon E5-2620 v4 8C/2.1GHz/20MB/85W/DDR4-2133	NVIDIA Quadro M2000 4GB	1x 8GB RDIMM DDR4-2400 ECC	Integrated Intel SATA	1x256GB SSD 2.5" SATA6Gbps Opal	None	HH DVD±RW	9-in-1	450W 92%	None	USB / USB Optical	Windows 10 Pro 64	3-year, Onsite	05/16
30B3001B**	MEA	Xeon E5-1620 v4 4C/3.5GHz/10MB/140W/DDR4-2400	Open	1x 8GB RDIMM DDR4-2400 ECC	Integrated Intel SATA	1x256GB SSD 2.5" SATA6Gbps Opal	None	HH DVD±RW	9-in-1	450W 92%	None	USB / USB Optical	Windows 10 Pro 64	3-year, Onsite	06/16
30B3001C**	MEA	Xeon E5-1630 v4 4C/3.7GHz/10MB/140W/DDR4-2400	Open	1x 8GB RDIMM DDR4-2400 ECC	Integrated Intel SATA	1x256GB SSD 2.5" SATA6Gbps Opal	None	HH DVD±RW	9-in-1	450W 92%	None	USB / USB Optical	Windows 10 Pro 64	3-year, Onsite	06/16
30B3001D**	MEA	Xeon E5-1650 v4 6C/3.6GHz/15MB/140W/DDR4-2400	Open	2x 8GB RDIMM DDR4-2400 ECC	Integrated Intel SATA	1x1TB HDD 7.2K 3.5" SATA6Gbps	None	HH DVD±RW	9-in-1	450W 92%	None	USB / USB Optical	Windows 10 Pro 64	3-year, Onsite	06/16
30B3001E**	MEA	Xeon E5-1650 v4 6C/3.6GHz/15MB/140W/DDR4-2400	Open	2x 8GB RDIMM DDR4-2400 ECC	Integrated Intel SATA	1x256GB SSD 2.5" SATA6Gbps Opal	None	HH DVD±RW	9-in-1	450W 92%	None	USB / USB Optical	Windows 10 Pro 64	3-year, Onsite	06/16
30B3001F**	MEA	Xeon E5-1630 v4 4C/3.7GHz/10MB/140W/DDR4-2400	NVIDIA Quadro K1200 4GB	1x 8GB RDIMM DDR4-2400 ECC	Integrated Intel SATA	1x256GB SSD 2.5" SATA6Gbps Opal	None	HH DVD±RW	9-in-1	450W 92%	None	USB / USB Optical	Windows 10 Pro 64	3-year, Onsite	06/16
30B3001G**	MEA	Xeon E5-1650 v4 6C/3.6GHz/15MB/140W/DDR4-2400	NVIDIA Quadro M4000 8GB	2x 8GB RDIMM DDR4-2400 ECC	Integrated Intel SATA	1x512GB SSD 2.5" SATA6Gbps	None	HH DVD±RW	9-in-1	450W 92%	None	USB / USB Optical	Windows 10 Pro 64	3-year, Onsite	06/16
30B3001H**	MEA	Xeon E5-1630 v4 4C/3.7GHz/10MB/140W/DDR4-2400	NVIDIA Quadro M2000 4GB	1x 8GB RDIMM DDR4-2400 ECC	Integrated Intel SATA	1x256GB SSD 2.5" SATA6Gbps Opal	None	HH DVD±RW	9-in-1	450W 92%	None	USB / USB Optical	Windows 10 Pro 64	3-year, Onsite	06/16
30B3001J**	MEA	Xeon E5-1630 v4 4C/3.7GHz/10MB/140W/DDR4-2400	Open	2x 8GB RDIMM DDR4-2400 ECC	Integrated Intel SATA	None	1x256GB SSD M.2 PCIe Opal	HH DVD±RW	9-in-1	450W 92%	None	USB / USB Optical	Windows 10 Pro 64	3-year, Onsite	06/16
30B3001K**	MEA	Xeon E5-1630 v4 4C/3.7GHz/10MB/140W/DDR4-2400	NVIDIA Quadro M2000 4GB	2x 8GB RDIMM DDR4-2400 ECC	Integrated Intel SATA	None	1x256GB SSD M.2 PCIe Opal	HH DVD±RW	9-in-1	450W 92%	None	USB / USB Optical	Windows 10 Pro 64	3-year, Onsite	06/16
30B3001M**	MEA	Xeon E5-1650 v4 6C/3.6GHz/15MB/140W/DDR4-2400	Open	2x 8GB RDIMM DDR4-2400 ECC	Integrated Intel SATA	None	1x512GB SSD M.2 PCIe	HH DVD±RW	9-in-1	450W 92%	None	USB / USB Optical	Windows 10 Pro 64	3-year, Onsite	06/16
30B3002B**	MEA	Xeon E5-1607 v4 4C/3.1GHz/10MB/140W/DDR4-2133	NVIDIA Quadro K1200 4GB	1x 8GB RDIMM DDR4-2400 ECC	Integrated Intel SATA	1x1TB HDD 7.2K 3.5" SATA6Gbps	None	HH DVD±RW	9-in-1	450W 92%	None	USB / USB Optical	Windows 10 DG Windows 7 Pro 64	3-year, Onsite	07/16

Model	Region	Processor	Graphics	Memory	Storage Controller	Disks	M.2 Drives	Optical	Media Reader	Power Supply	Optional Ports	Keyboard / Mouse	Operating System	Warranty	Ann Date (mm/yy)
30B3002C**	MEA	Xeon E5-1650 v4 6C/3.6GHz/15MB/140W/DDR4-2400	NVIDIA Quadro M4000 8GB	2x 16GB RDIMM DDR4-2400 ECC	Integrated Intel SATA	1x2TB HDD 7.2K 3.5" SATA6Gbps	None	HH DVD±RW	9-in-1	450W 92%	None	USB / USB Optical	Windows 10 DG Windows 7 Pro 64	3-year, Onsite	07/16
30B3002D**	MEA	Xeon E5-1630 v4 4C/3.7GHz/10MB/140W/DDR4-2400	NVIDIA Quadro K1200 4GB	2x 8GB RDIMM DDR4-2400 ECC	Integrated Intel SATA	1x1TB HDD 7.2K 3.5" SATA6Gbps	None	HH DVD±RW	9-in-1	450W 92%	None	USB / USB Optical	Windows 10 DG Windows 7 Pro 64	3-year, Onsite	07/16
30B3002E**	MEA	Xeon E5-1603 v4 4C/2.8GHz/10MB/140W/DDR4-2133	NVIDIA Quadro K1200 4GB	1x 8GB RDIMM DDR4-2400 ECC	Integrated Intel SATA	1x1TB HDD 7.2K 3.5" SATA6Gbps	None	HH DVD±RW	9-in-1	450W 92%	None	USB / USB Optical	Windows 10 DG Windows 7 Pro 64	3-year, Onsite	07/16
30B3002F**	MEA	Xeon E5-1620 v4 4C/3.5GHz/10MB/140W/DDR4-2400	NVIDIA Quadro K1200 4GB	1x 8GB RDIMM DDR4-2400 ECC	Integrated Intel SATA	1x1TB HDD 7.2K 3.5" SATA6Gbps	None	HH DVD±RW	9-in-1	450W 92%	None	USB / USB Optical	Windows 10 DG Windows 7 Pro 64	3-year, Onsite	07/16
30B3002G**	MEA	Xeon E5-1603 v4 4C/2.8GHz/10MB/140W/DDR4-2133	Open	1x 8GB RDIMM DDR4-2400 ECC	Integrated Intel SATA	1x1TB HDD 7.2K 3.5" SATA6Gbps	None	HH DVD±RW	9-in-1	450W 92%	None	USB / USB Optical	Windows 10 DG Windows 7 Pro 64	3-year, Onsite	07/16
30B3002H**	MEA	Xeon E5-1620 v4 4C/3.5GHz/10MB/140W/DDR4-2400	Open	1x 8GB RDIMM DDR4-2400 ECC	Integrated Intel SATA	1x1TB HDD 7.2K 3.5" SATA6Gbps	None	HH DVD±RW	9-in-1	450W 92%	None	USB / USB Optical	Windows 10 DG Windows 7 Pro 64	3-year, Onsite	07/16
30B3002J**	MEA	Xeon E5-1630 v4 4C/3.7GHz/10MB/140W/DDR4-2400	Open	1x 8GB RDIMM DDR4-2400 ECC	Integrated Intel SATA	1x1TB HDD 7.2K 3.5" SATA6Gbps	None	HH DVD±RW	9-in-1	450W 92%	None	USB / USB Optical	Windows 10 DG Windows 7 Pro 64	3-year, Onsite	07/16
30B3002K**	MEA	Xeon E5-1630 v4 4C/3.7GHz/10MB/140W/DDR4-2400	NVIDIA Quadro K1200 4GB	1x 8GB RDIMM DDR4-2400 ECC	Integrated Intel SATA	1x1TB HDD 7.2K 3.5" SATA6Gbps	None	HH DVD±RW	9-in-1	450W 92%	None	USB / USB Optical	Windows 10 DG Windows 7 Pro 64	3-year, Onsite	07/16
30B3002L**	MEA	Xeon E5-1620 v4 4C/3.5GHz/10MB/140W/DDR4-2400	NVIDIA Quadro M2000 4GB	2x 8GB RDIMM DDR4-2400 ECC	Integrated Intel SATA	1x1TB Hybrid HDD 7.2K 3.5" SATA6Gbps	None	HH DVD±RW	9-in-1	450W 92%	None	USB / USB Optical	Windows 10 DG Windows 7 Pro 64	3-year, Onsite	07/16
30B3002M**	MEA	Xeon E5-1630 v4 4C/3.7GHz/10MB/140W/DDR4-2400	NVIDIA Quadro M2000 4GB	2x 8GB RDIMM DDR4-2400 ECC	Integrated Intel SATA	1x1TB HDD 7.2K 3.5" SATA6Gbps	None	HH DVD±RW	9-in-1	450W 92%	None	USB / USB Optical	Windows 10 DG Windows 7 Pro 64	3-year, Onsite	07/16
30B3002N**	MEA	Xeon E5-1620 v4 4C/3.5GHz/10MB/140W/DDR4-2400	Open	2x 8GB RDIMM DDR4-2400 ECC	Integrated Intel SATA	1x1TB HDD 7.2K 3.5" SATA6Gbps	None	HH DVD±RW	9-in-1	450W 92%	None	USB / USB Optical	Windows 10 DG Windows 7 Pro 64	3-year, Onsite	07/16
30B3002P**	MEA	Xeon E5-1650 v4 6C/3.6GHz/15MB/140W/DDR4-2400	NVIDIA Quadro M2000 4GB	2x 16GB RDIMM DDR4-2400 ECC	Integrated Intel SATA	1x1TB HDD 7.2K 3.5" SATA6Gbps	None	HH DVD±RW	9-in-1	450W 92%	None	USB / USB Optical	Windows 10 DG Windows 7 Pro 64	3-year, Onsite	07/16

Model	Region	Processor	Graphics	Memory	Storage Controller	Disks	M.2 Drives	Optical	Media Reader	Power Supply	Optional Ports	Keyboard / Mouse	Operating System	Warranty	Ann Date (mm/yy)
30B3002Q**	MEA	Xeon E5-1620 v4 4C/3.5GHz/10MB/140W/DDR4-2400	NVIDIA Quadro K1200 4GB	2x 8GB RDIMM DDR4-2400 ECC	Integrated Intel SATA	1x1TB HDD 7.2K 3.5" SATA6Gbps	None	HH DVD±RW	9-in-1	450W 92%	None	USB / USB Optical	Windows 10 DG Windows 7 Pro 64	3-year, Onsite	07/16
30B30026**	MEA	Xeon E5-1620 v4 4C/3.5GHz/10MB/140W/DDR4-2400	NVIDIA Quadro M2000 4GB	2x 8GB RDIMM DDR4-2400 ECC	Integrated Intel SATA	1x1TB HDD 7.2K 3.5" SATA6Gbps	None	HH DVD±RW	9-in-1	450W 92%	None	USB / USB Optical	Windows 10 DG Windows 7 Pro 64	3-year, Onsite	07/16
30B30027**	MEA	Xeon E5-1620 v4 4C/3.5GHz/10MB/140W/DDR4-2400	NVIDIA Quadro M2000 4GB	1x 8GB RDIMM DDR4-2400 ECC	Integrated Intel SATA	1x1TB Hybrid HDD 7.2K 3.5" SATA6Gbps	None	HH DVD±RW	9-in-1	450W 92%	None	USB / USB Optical	Windows 10 DG Windows 7 Pro 64	3-year, Onsite	07/16
30B30028**	MEA	Xeon E5-1650 v4 6C/3.6GHz/15MB/140W/DDR4-2400	NVIDIA Quadro M2000 4GB	2x 8GB RDIMM DDR4-2400 ECC	Integrated Intel SATA	1x1TB HDD 7.2K 3.5" SATA6Gbps	None	HH DVD±RW	9-in-1	450W 92%	None	USB / USB Optical	Windows 10 DG Windows 7 Pro 64	3-year, Onsite	07/16
30B30029**	MEA	Xeon E5-1630 v4 4C/3.7GHz/10MB/140W/DDR4-2400	Open	2x 8GB RDIMM DDR4-2400 ECC	Integrated Intel SATA	1x1TB HDD 7.2K 3.5" SATA6Gbps	None	HH DVD±RW	9-in-1	450W 92%	None	USB / USB Optical	Windows 10 DG Windows 7 Pro 64	3-year, Onsite	07/16
30B3002A**	MEA	Xeon E5-1607 v4 4C/3.1GHz/10MB/140W/DDR4-2133	Open	1x 8GB RDIMM DDR4-2400 ECC	Integrated Intel SATA	1x1TB HDD 7.2K 3.5" SATA6Gbps	None	HH DVD±RW	9-in-1	450W 92%	None	USB / USB Optical	Windows 10 DG Windows 7 Pro 64	3-year, Onsite	07/16
30B3001L**	MEA	Xeon E5-1630 v4 4C/3.7GHz/10MB/140W/DDR4-2400	NVIDIA Quadro M4000 8GB	2x 8GB RDIMM DDR4-2400 ECC	Integrated Intel SATA	None	1x256GB SSD M.2 PCIe Opal	HH DVD±RW	9-in-1	450W 92%	None	USB / USB Optical	Windows 10 Pro 64	3-year, Onsite	06/16
30B3002R**	MEA	Xeon E5-1603 v4 4C/2.8GHz/10MB/140W/DDR4-2133	Open	1x 8GB RDIMM DDR4-2400 ECC	Integrated Intel SATA	1x1TB HDD 7.2K 3.5" SATA6Gbps	None	None	29-in-1	450W 92%	Front eSATA	USB / USB Optical	Windows 10 Pro 64	3-year, Onsite	07/16
30B3002S**	MEA	Xeon E5-1620 v4 4C/3.5GHz/10MB/140W/DDR4-2400	Open	1x 8GB RDIMM DDR4-2400 ECC	Integrated Intel SATA	1x256GB SSD 2.5" SATA6Gbps Opal	None	None	29-in-1	450W 92%	Front eSATA	USB / USB Optical	Windows 10 Pro 64	3-year, Onsite	07/16
30B3002T**	MEA	Xeon E5-1630 v4 4C/3.7GHz/10MB/140W/DDR4-2400	Open	2x 8GB RDIMM DDR4-2400 ECC	Integrated Intel SATA	1x256GB SSD 2.5" SATA6Gbps Opal	None	None	29-in-1	450W 92%	Front eSATA	USB / USB Optical	Windows 10 Pro 64	3-year, Onsite	07/16
30B3002U**	MEA	Xeon E5-1603 v4 4C/2.8GHz/10MB/140W/DDR4-2133	Open	2x 8GB RDIMM DDR4-2400 ECC	Integrated Intel SATA	1x256GB SSD 2.5" SATA6Gbps Opal	None	HH DVD±RW	9-in-1	450W 92%	None	USB / USB Optical	Windows 10 Pro 64	3-year, Onsite	07/16
30B3002V**	MEA	Xeon E5-1650 v4 6C/3.6GHz/15MB/140W/DDR4-2400	Open	2x 8GB RDIMM DDR4-2400 ECC	Integrated Intel SATA	None	1x256GB SSD M.2 PCIe Opal	None	29-in-1	450W 92%	Front eSATA	USB / USB Optical	Windows 10 Pro 64	3-year, Onsite	07/16

Model	Region	Processor	Graphics	Memory	Storage Controller	Disks	M.2 Drives	Optical	Media Reader	Power Supply	Optional Ports	Keyboard / Mouse	Operating System	Warranty	Ann Date (mm/yy)
30B3002W**	MEA	Xeon E5-1630 v4 4C/3.7GHz/10MB/140W/DDR4-2400	NVIDIA Quadro M4000 8GB	4x 8GB RDIMM DDR4-2400 ECC	Integrated Intel SATA	1x256GB SSD 2.5" SATA6Gbps Opal, 1x1TB HDD 7.2K 3.5" SATA6Gbps	None	HH DVD±RW	9-in-1	450W 92%	None	USB / USB Optical	Windows 10 Pro 64	3-year, Onsite	07/16
30B3002X**	MEA	Xeon E5-1620 v4 4C/3.5GHz/10MB/140W/DDR4-2400	NVIDIA Quadro M2000 4GB	2x 8GB RDIMM DDR4-2400 ECC	Integrated Intel SATA	1x256GB SSD 2.5" SATA6Gbps Opal, 1x1TB HDD 7.2K 3.5" SATA6Gbps	None	HH DVD±RW	9-in-1	450W 92%	None	USB / USB Optical	Windows 10 Pro 64	3-year, Onsite	07/16
30B3002Y**	MEA	Xeon E5-1620 v4 4C/3.5GHz/10MB/140W/DDR4-2400	Open	2x 8GB RDIMM DDR4-2400 ECC	Integrated Intel SATA	1x256GB SSD 2.5" SATA6Gbps Opal, 1x1TB HDD 7.2K 3.5" SATA6Gbps	None	HH DVD±RW	9-in-1	450W 92%	None	USB / USB Optical	Windows 10 Pro 64	3-year, Onsite	07/16
30B30032**	MEA	Xeon E5-1620 v4 4C/3.5GHz/10MB/140W/DDR4-2400	Open	1x 8GB RDIMM DDR4-2400 ECC	Integrated Intel SATA	1x256GB SSD 2.5" SATA6Gbps Opal	None	HH DVD±RW	9-in-1	450W 92%	2xUSB3.0, 1xSerial	USB / USB Optical	Windows 10 DG Windows 7 Pro 64	3-year, Onsite	09/16
30B30033**	MEA	Xeon E5-1630 v4 4C/3.7GHz/10MB/140W/DDR4-2400	Open	1x 8GB RDIMM DDR4-2400 ECC	Integrated Intel SATA	1x256GB SSD 2.5" SATA6Gbps Opal	None	HH DVD±RW	9-in-1	450W 92%	2xUSB3.0, 1xSerial	USB / USB Optical	Windows 10 DG Windows 7 Pro 64	3-year, Onsite	09/16
30B30034**	MEA	Xeon E5-1650 v4 6C/3.6GHz/15MB/140W/DDR4-2400	Open	2x 8GB RDIMM DDR4-2400 ECC	Integrated Intel SATA	1x1TB HDD 7.2K 3.5" SATA6Gbps	None	HH DVD±RW	9-in-1	450W 92%	2xUSB3.0, 1xSerial	USB / USB Optical	Windows 10 DG Windows 7 Pro 64	3-year, Onsite	09/16
30B30035**	MEA	Xeon E5-1650 v4 6C/3.6GHz/15MB/140W/DDR4-2400	Open	2x 8GB RDIMM DDR4-2400 ECC	Integrated Intel SATA	1x256GB SSD 2.5" SATA6Gbps Opal	None	HH DVD±RW	9-in-1	450W 92%	2xUSB3.0, 1xSerial	USB / USB Optical	Windows 10 DG Windows 7 Pro 64	3-year, Onsite	09/16
30B30036**	MEA	Xeon E5-1630 v4 4C/3.7GHz/10MB/140W/DDR4-2400	NVIDIA Quadro K1200 4GB	1x 8GB RDIMM DDR4-2400 ECC	Integrated Intel SATA	1x256GB SSD 2.5" SATA6Gbps Opal	None	HH DVD±RW	9-in-1	450W 92%	2xUSB3.0, 1xSerial	USB / USB Optical	Windows 10 DG Windows 7 Pro 64	3-year, Onsite	09/16
30B30037**	MEA	Xeon E5-1603 v4 4C/2.8GHz/10MB/140W/DDR4-2133	Open	2x 8GB RDIMM DDR4-2400 ECC	Integrated Intel SATA	1x256GB SSD 2.5" SATA6Gbps Opal	None	HH DVD±RW	9-in-1	450W 92%	2xUSB3.0, 1xSerial	USB / USB Optical	Windows 10 DG Windows 7 Pro 64	3-year, Onsite	09/16
30B30038**	MEA	Xeon E5-1620 v4 4C/3.5GHz/10MB/140W/DDR4-2400	Open	2x 8GB RDIMM DDR4-2400 ECC	Integrated Intel SATA	1x256GB SSD 2.5" SATA6Gbps Opal, 1x1TB HDD 7.2K 3.5" SATA6Gbps	None	HH DVD±RW	9-in-1	450W 92%	2xUSB3.0, 1xSerial	USB / USB Optical	Windows 10 DG Windows 7 Pro 64	3-year, Onsite	09/16
30B30039**	MEA	Xeon E5-1620 v4 4C/3.5GHz/10MB/140W/DDR4-2400	NVIDIA Quadro M2000 4GB	2x 8GB RDIMM DDR4-2400 ECC	Integrated Intel SATA	1x256GB SSD 2.5" SATA6Gbps Opal, 1x1TB HDD 7.2K 3.5" SATA6Gbps	None	HH DVD±RW	9-in-1	450W 92%	2xUSB3.0, 1xSerial	USB / USB Optical	Windows 10 DG Windows 7 Pro 64	3-year, Onsite	09/16
30B3003A**	MEA	Xeon E5-1630 v4 4C/3.7GHz/10MB/140W/DDR4-2400	NVIDIA Quadro M4000 8GB	4x 8GB RDIMM DDR4-2400 ECC	Integrated Intel SATA	1x256GB SSD 2.5" SATA6Gbps Opal, 1x1TB HDD 7.2K 3.5" SATA6Gbps	None	HH DVD±RW	9-in-1	450W 92%	2xUSB3.0, 1xSerial	USB / USB Optical	Windows 10 DG Windows 7 Pro 64	3-year, Onsite	09/16

Model	Region	Processor	Graphics	Memory	Storage Controller	Disks	M.2 Drives	Optical	Media Reader	Power Supply	Optional Ports	Keyboard / Mouse	Operating System	Warranty	Ann Date (mm/yy)
30B3003B**	MEA	Xeon E5-1630 v4 4C/3.7GHz/10MB/140W/DDR4-2400	Open	2x 8GB RDIMM DDR4-2400 ECC	Integrated Intel SATA	None	1x256GB SSD M.2 PCIe Opal	HH DVD±RW	9-in-1	450W 92%	1xSerial	USB / USB Optical	Windows 10 DG Windows 7 Pro 64	3-year, Onsite	09/16
30B3003C**	MEA	Xeon E5-1630 v4 4C/3.7GHz/10MB/140W/DDR4-2400	NVIDIA Quadro M2000 4GB	2x 8GB RDIMM DDR4-2400 ECC	Integrated Intel SATA	None	1x256GB SSD M.2 PCIe Opal	HH DVD±RW	9-in-1	450W 92%	1xSerial	USB / USB Optical	Windows 10 DG Windows 7 Pro 64	3-year, Onsite	09/16
30B3003D**	MEA	Xeon E5-1630 v4 4C/3.7GHz/10MB/140W/DDR4-2400	NVIDIA Quadro M4000 8GB	2x 8GB RDIMM DDR4-2400 ECC	Integrated Intel SATA	None	1x256GB SSD M.2 PCIe Opal	HH DVD±RW	9-in-1	450W 92%	1xSerial	USB / USB Optical	Windows 10 DG Windows 7 Pro 64	3-year, Onsite	09/16
30B3003E**	MEA	Xeon E5-1650 v4 6C/3.6GHz/15MB/140W/DDR4-2400	Open	2x 8GB RDIMM DDR4-2400 ECC	Integrated Intel SATA	None	1x512GB SSD M.2 PCIe	HH DVD±RW	9-in-1	450W 92%	1xSerial	USB / USB Optical	Windows 10 DG Windows 7 Pro 64	3-year, Onsite	09/16
30B3003J**	MEA	Xeon E5-1650 v4 6C/3.6GHz/15MB/140W/DDR4-2400	Open	2x 8GB RDIMM DDR4-2400 ECC	Integrated Intel SATA	None	1x256GB SSD M.2 PCIe Opal	9.5mm DVD±RW	29-in-1	450W 92%	1xSerial	USB / USB Optical	Windows 10 DG Windows 7 Pro 64	3-year, Onsite	09/16
30B30042**	MEA	Xeon E5-1620 v4 4C/3.5GHz/10MB/140W/DDR4-2400	Open	1x 8GB RDIMM DDR4-2400 ECC	Integrated Intel SATA	1x256GB SSD 2.5" SATA6Gbps Opal	None	HH DVD±RW	9-in-1	450W 92%	2xUSB3.0, 1xSerial	USB / USB Optical	Windows 10 DG Windows 7 Pro 64	3-year, Onsite	05/17
30B3003F**	MEA	Xeon E5-1603 v4 4C/2.8GHz/10MB/140W/DDR4-2133	Open	1x 8GB RDIMM DDR4-2400 ECC	Integrated Intel SATA	1x1TB HDD 7.2K 3.5" SATA6Gbps	None	9.5mm DVD±RW	29-in-1	450W 92%	1xSerial	USB / USB Optical	Windows 10 DG Windows 7 Pro 64	3-year, Onsite	09/16
30B3003G**	MEA	Xeon E5-1620 v4 4C/3.5GHz/10MB/140W/DDR4-2400	Open	1x 8GB RDIMM DDR4-2400 ECC	Integrated Intel SATA	1x256GB SSD 2.5" SATA6Gbps Opal	None	9.5mm DVD±RW	29-in-1	450W 92%	1xSerial	USB / USB Optical	Windows 10 DG Windows 7 Pro 64	3-year, Onsite	09/16
30B3004F**	MEA	Xeon E5-1603 v4 4C/2.8GHz/10MB/140W/DDR4-2133	Open	1x 8GB RDIMM DDR4-2400 ECC	Integrated Intel SATA	1x1TB HDD 7.2K 3.5" SATA6Gbps	None	9.5mm DVD±RW	29-in-1	450W 92%	1xSerial	USB / USB Optical	Windows 10 DG Windows 7 Pro 64	3-year, Onsite	05/17
30B3004L**	MEA	Xeon E5-1630 v4 4C/3.7GHz/10MB/140W/DDR4-2400	Open	1x 8GB RDIMM DDR4-2400 ECC	Integrated Intel SATA	None	1x1TB SSD M.2 PCIe NVMe Opal	HH DVD±RW	9-in-1	450W 92%	1xSerial	USB / USB Optical	Windows 10 DG Windows 7 Pro 64	3-year, Onsite	12/16
30B3003H**	MEA	Xeon E5-1630 v4 4C/3.7GHz/10MB/140W/DDR4-2400	Open	2x 8GB RDIMM DDR4-2400 ECC	Integrated Intel SATA	1x256GB SSD 2.5" SATA6Gbps Opal	None	9.5mm DVD±RW	29-in-1	450W 92%	1xSerial	USB / USB Optical	Windows 10 DG Windows 7 Pro 64	3-year, Onsite	09/16
30B3004K**	MEA	Xeon E5-1620 v4 4C/3.5GHz/10MB/140W/DDR4-2400	Open	1x 8GB RDIMM DDR4-2400 ECC	Integrated Intel SATA	None	1x1TB SSD M.2 PCIe NVMe Opal	HH DVD±RW	9-in-1	450W 92%	1xSerial	USB / USB Optical	Windows 10 DG Windows 7 Pro 64	3-year, Onsite	12/16

Model	Region	Processor	Graphics	Memory	Storage Controller	Disks	M.2 Drives	Optical	Media Reader	Power Supply	Optional Ports	Keyboard / Mouse	Operating System	Warranty	Ann Date (mm/yy)
30B30053**	MEA	Xeon E5-1620 v4 4C/3.5GHz/10MB/140W/DDR4-2400	Open	1x 8GB RDIMM DDR4-2400 ECC	Integrated Intel SATA	1x1TB HDD 7.2K 3.5" SATA6Gbps	None	HH DVD±RW	9-in-1	450W 92%	1xSerial	USB / USB Optical	Windows 10 Pro 64	3-year, Onsite	12/16
30B30054**	MEA	Xeon E5-1620 v4 4C/3.5GHz/10MB/140W/DDR4-2400	Open	1x 8GB RDIMM DDR4-2400 ECC	Integrated Intel SATA	1x1TB HDD 7.2K 3.5" SATA6Gbps	None	HH DVD±RW	9-in-1	450W 92%	1xSerial	USB / USB Optical	Windows 10 DG Windows 7 Pro 64	3-year, Onsite	12/16
30B30055**	MEA	Xeon E5-1620 v4 4C/3.5GHz/10MB/140W/DDR4-2400	Open	1x 8GB RDIMM DDR4-2400 ECC	Integrated Intel SATA	1x1TB HDD 7.2K 3.5" SATA6Gbps	None	HH DVD±RW	9-in-1	450W 92%	None	USB / USB Optical	Windows 10 DG Windows 7 Pro 64	3-year, Onsite	12/16
30B30056**	MEA	Xeon E5-1620 v4 4C/3.5GHz/10MB/140W/DDR4-2400	Open	2x 8GB RDIMM DDR4-2400 ECC	Integrated Intel SATA	1x1TB HDD 7.2K 3.5" SATA6Gbps	None	HH DVD±RW	9-in-1	450W 92%	None	USB / USB Optical	Windows 10 DG Windows 7 Pro 64	3-year, Onsite	12/16
30B30057**	MEA	Xeon E5-1620 v4 4C/3.5GHz/10MB/140W/DDR4-2400	Open	2x 8GB RDIMM DDR4-2400 ECC	Integrated Intel SATA	1x1TB HDD 7.2K 3.5" SATA6Gbps	None	HH DVD±RW	9-in-1	450W 92%	1xSerial	USB / USB Optical	Windows 10 DG Windows 7 Pro 64	3-year, Onsite	03/17
30B30058**	MEA	Xeon E5-1620 v4 4C/3.5GHz/10MB/140W/DDR4-2400	Open	2x 8GB RDIMM DDR4-2400 ECC	Integrated Intel SATA	1x1TB HDD 7.2K 3.5" SATA6Gbps	None	HH DVD±RW	9-in-1	450W 92%	2xUSB3.0, 1xSerial	USB / USB Optical	Windows 10 Pro 64	3-year, Onsite	03/17
30B30059**	MEA	Xeon E5-1650 v4 6C/3.6GHz/15MB/140W/DDR4-2400	Open	2x 8GB RDIMM DDR4-2400 ECC	Integrated Intel SATA	1x256GB SSD 2.5" SATA6Gbps Opal, 1x1TB HDD 7.2K 3.5" SATA6Gbps	None	HH DVD±RW	9-in-1	450W 92%	1xSerial	USB / USB Optical	Windows 10 DG Windows 7 Pro 64	3-year, Onsite	03/17
30B3005A**	MEA	Xeon E5-1620 v4 4C/3.5GHz/10MB/140W/DDR4-2400	Open	2x 8GB RDIMM DDR4-2400 ECC	Integrated Intel SATA	1x1TB HDD 7.2K 3.5" SATA6Gbps	None	HH DVD±RW	9-in-1	450W 92%	2xUSB3.0	USB / USB Optical	Windows 10 Pro 64	3-year, Onsite	03/17
30B3005B**	MEA	Xeon E5-1620 v4 4C/3.5GHz/10MB/140W/DDR4-2400	Open	2x 8GB RDIMM DDR4-2400 ECC	Integrated Intel SATA	None	1x256GB SSD M.2 PCIe Opal	HH DVD±RW	9-in-1	450W 92%	2xUSB3.0, 1xSerial	USB / USB Optical	Windows 10 Pro 64	3-year, Onsite	03/17
30B3005C**	MEA	Xeon E5-1620 v4 4C/3.5GHz/10MB/140W/DDR4-2400	Open	2x 8GB RDIMM DDR4-2400 ECC	Integrated Intel SATA	None	1x256GB SSD M.2 PCIe Opal	HH DVD±RW	9-in-1	450W 92%	1xSerial	USB / USB Optical	Windows 10 DG Windows 7 Pro 64	3-year, Onsite	03/17
30B3005D**	MEA	Xeon E5-1650 v4 6C/3.6GHz/15MB/140W/DDR4-2400	Open	2x 8GB RDIMM DDR4-2400 ECC	Integrated Intel SATA	1x256GB SSD 2.5" SATA6Gbps Opal, 1x1TB HDD 7.2K 3.5" SATA6Gbps	None	HH DVD±RW	9-in-1	450W 92%	2xUSB3.0, 1xSerial	USB / USB Optical	Windows 10 Pro 64	3-year, Onsite	03/17
30B3005F**	MEA	Xeon E5-1630 v4 4C/3.7GHz/10MB/140W/DDR4-2400	NVIDIA Quadro P4000 8GB	4x 8GB RDIMM DDR4-2400 ECC	Integrated Intel SATA	1x256GB SSD 2.5" SATA6Gbps Opal, 1x1TB HDD 7.2K 3.5" SATA6Gbps	None	HH DVD±RW	9-in-1	450W 92%	1xSerial	USB / USB Optical	Windows 10 DG Windows 7 Pro 64	3-year, Onsite	04/17

Model	Region	Processor	Graphics	Memory	Storage Controller	Disks	M.2 Drives	Optical	Media Reader	Power Supply	Optional Ports	Keyboard / Mouse	Operating System	Warranty	Ann Date (mm/yy)
30B3005G**	MEA	Xeon E5-1630 v4 4C/3.7GHz/10MB/140W/DDR4-2400	NVIDIA Quadro P4000 8GB	2x 8GB RDIMM DDR4-2400 ECC	Integrated Intel SATA	None	1x256GB SSD M.2 PCIe Opal	HH DVD±RW	9-in-1	450W 92%	1xSerial	USB / USB Optical	Windows 10 DG Windows 7 Pro 64	3-year, Onsite	04/17
30B3005H**	MEA	Xeon E5-1630 v4 4C/3.7GHz/10MB/140W/DDR4-2400	NVIDIA Quadro P2000 5GB	2x 8GB RDIMM DDR4-2400 ECC	Integrated Intel SATA	None	1x256GB SSD M.2 PCIe Opal	HH DVD±RW	9-in-1	450W 92%	1xSerial	USB / USB Optical	Windows 10 DG Windows 7 Pro 64	3-year, Onsite	04/17
30B3005J**	MEA	Xeon E5-1620 v4 4C/3.5GHz/10MB/140W/DDR4-2400	NVIDIA Quadro P2000 5GB	2x 8GB RDIMM DDR4-2400 ECC	Integrated Intel SATA	1x256GB SSD 2.5"	None	HH DVD±RW	9-in-1	450W 92%	1xSerial	USB / USB Optical	Windows 10 Pro 64	3-year, Onsite	04/17
30B3005R**	MEA	Xeon E5-1620 v4 4C/3.5GHz/10MB/140W/DDR4-2400	NVIDIA Quadro P2000 5GB	2x 8GB RDIMM DDR4-2400 ECC	Integrated Intel SATA	1x256GB SSD 2.5"	None	HH DVD±RW	9-in-1	450W 92%	1xSerial	USB / USB Optical	Windows 10 DG Windows 7 Pro 64	3-year, Onsite	04/17
30B3005K**	MEA	Xeon E5-1630 v4 4C/3.7GHz/10MB/140W/DDR4-2400	NVIDIA Quadro P4000 8GB	4x 8GB RDIMM DDR4-2400 ECC	Integrated Intel SATA	1x256GB SSD 2.5"	None	HH DVD±RW	9-in-1	450W 92%	1xSerial	USB / USB Optical	Windows 10 Pro 64	3-year, Onsite	04/17
30B3005L**	MEA	Xeon E5-1620 v4 4C/3.5GHz/10MB/140W/DDR4-2400	Open	1x 8GB RDIMM DDR4-2400 ECC	Integrated Intel SATA	1x1TB HDD 7.2K 3.5"	None	HH DVD±RW	9-in-1	450W 92%	1xSerial	USB / USB Optical	Windows 10 Pro 64	3-year, Onsite	04/17
30B3005M**	MEA	Xeon E5-1620 v4 4C/3.5GHz/10MB/140W/DDR4-2400	NVIDIA Quadro P2000 5GB	2x 8GB RDIMM DDR4-2400 ECC	Integrated Intel SATA	1x1TB HDD 7.2K 3.5"	None	HH DVD±RW	9-in-1	450W 92%	1xSerial	USB / USB Optical	Windows 10 Pro 64	3-year, Onsite	04/17
30B3005N**	MEA	Xeon E5-1630 v4 4C/3.7GHz/10MB/140W/DDR4-2400	NVIDIA Quadro P2000 5GB	2x 8GB RDIMM DDR4-2400 ECC	Integrated Intel SATA	None	1x256GB SSD M.2 PCIe Opal	HH DVD±RW	9-in-1	450W 92%	1xSerial	USB / USB Optical	Windows 10 Pro 64	3-year, Onsite	04/17
30B3005P**	MEA	Xeon E5-1630 v4 4C/3.7GHz/10MB/140W/DDR4-2400	NVIDIA Quadro P4000 8GB	2x 8GB RDIMM DDR4-2400 ECC	Integrated Intel SATA	None	1x256GB SSD M.2 PCIe Opal	HH DVD±RW	9-in-1	450W 92%	1xSerial	USB / USB Optical	Windows 10 Pro 64	3-year, Onsite	04/17
30B3005Q**	MEA	Xeon E5-1620 v4 4C/3.5GHz/10MB/140W/DDR4-2400	Open	1x 8GB RDIMM DDR4-2400 ECC	Integrated Intel SATA	1x1TB HDD 7.2K 3.5"	None	HH DVD±RW	9-in-1	450W 92%	1xSerial	USB / USB Optical	Windows 10 DG Windows 7 Pro 64	3-year, Onsite	04/17
30B3006G**	MEA	Xeon E5-1630 v4 4C/3.7GHz/10MB/140W/DDR4-2400	NVIDIA Quadro P5000 16GB	2x 16GB RDIMM DDR4-2400 ECC	Integrated Intel SATA	1x2TB HDD 7.2K 3.5"	1x1TB SSD M.2 PCIe NVMe Opal	HH DVD±RW	9-in-1	450W 92%	1xSerial	USB / USB Optical	Windows 10 Pro 64	3-year, Onsite	06/17
30B3006L**	MEA	Xeon E5-1650 v4 6C/3.6GHz/15MB/140W/DDR4-2400	Open	2x 8GB RDIMM DDR4-2400 ECC	Integrated Intel SATA	1x 1TB HDD 7.2K 3.5"	None	HH DVD±RW	9-in-1	450W 92%	1x Serial	USB / USB Optical	Windows 10 Pro 64	3-year, Onsite	09/17

Model	Region	Processor	Graphics	Memory	Storage Controller	Disks	M.2 Drives	Optical	Media Reader	Power Supply	Optional Ports	Keyboard / Mouse	Operating System	Warranty	Ann Date (mm/yy)
30B3006M**	MEA	Xeon E5-1650 v4 6C/3.6GHz/15MB/140W/DDR4-2400	Open	2x 8GB RDIMM DDR4-2400 ECC	Integrated Intel SATA	1x 256GB SSD 2.5" SATA6Gbps Opal	None	HH DVD±RW	9-in-1	450W 92%	1x Serial	USB / USB Optical	Windows 10 Pro 64	3-year, Onsite	09/17
30B3006N**	MEA	Xeon E5-1630 v4 4C/3.7GHz/10MB/140W/DDR4-2400	Open	1x 8GB RDIMM DDR4-2400 ECC	Integrated Intel SATA	1x 256GB SSD 2.5" SATA6Gbps Opal	None	HH DVD±RW	9-in-1	450W 92%	1x Serial	USB / USB Optical	Windows 10 Pro 64	3-year, Onsite	09/17
30B3006P**	MEA	Xeon E5-1650 v4 6C/3.6GHz/15MB/140W/DDR4-2400	Open	2x 8GB RDIMM DDR4-2400 ECC	Integrated Intel SATA	1x 256GB SSD 2.5" SATA6Gbps Opal, 1x 1TB HDD 7.2K 3.5" SATA6Gbps	None	HH DVD±RW	9-in-1	450W 92%	1x Serial	USB / USB Optical	Windows 10 Pro 64	3-year, Onsite	09/17
30B3006Q**	MEA	Xeon E5-1630 v4 4C/3.7GHz/10MB/140W/DDR4-2400	Open	2x 8GB RDIMM DDR4-2400 ECC	Integrated Intel SATA	1x 256GB SSD 2.5" SATA6Gbps Opal	None	9.0mm DVD±RW	29-in-1	450W 92%	1x Front eSATA, 1x Serial	USB / USB Optical	Windows 10 Pro 64	3-year, Onsite	09/17
30B3006R**	MEA	Xeon E5-1620 v4 4C/3.5GHz/10MB/140W/DDR4-2400	Open	2x 8GB RDIMM DDR4-2400 ECC	Integrated Intel SATA	1x 1TB HDD 7.2K 3.5" SATA6Gbps	None	HH DVD±RW	9-in-1	450W 92%	1x Serial	USB / USB Optical	Windows 10 Pro 64	3-year, Onsite	09/17
30B3006S**	MEA	Xeon E5-1620 v4 4C/3.5GHz/10MB/140W/DDR4-2400	Open	2x 8GB RDIMM DDR4-2400 ECC	Integrated Intel SATA	None	1x 256GB SSD M.2 PCIe Opal	HH DVD±RW	9-in-1	450W 92%	1x Serial	USB / USB Optical	Windows 10 Pro 64	3-year, Onsite	09/17
30B3006T**	MEA	Xeon E5-1620 v4 4C/3.5GHz/10MB/140W/DDR4-2400	NVIDIA Quadro P2000 5GB	2x 8GB RDIMM DDR4-2400 ECC	Integrated Intel SATA	1x 256GB SSD 2.5" SATA6Gbps Opal, 1x 1TB HDD 7.2K 3.5" SATA6Gbps	None	HH DVD±RW	9-in-1	450W 92%	1x Serial	USB / USB Optical	Windows 10 Pro 64	3-year, Onsite	09/17
30B3006U**	MEA	Xeon E5-1630 v4 4C/3.7GHz/10MB/140W/DDR4-2400	NVIDIA Quadro P1000 4GB	1x 8GB RDIMM DDR4-2400 ECC	Integrated Intel SATA	1x 256GB SSD 2.5" SATA6Gbps Opal	None	HH DVD±RW	9-in-1	450W 92%	1x Serial	USB / USB Optical	Windows 10 Pro 64	3-year, Onsite	09/17
30B3006V**	MEA	Xeon E5-1630 v4 4C/3.7GHz/10MB/140W/DDR4-2400	NVIDIA Quadro P4000 8GB	2x 8GB RDIMM DDR4-2400 ECC	Integrated Intel SATA	None	1x 256GB SSD M.2 PCIe Opal	HH DVD±RW	9-in-1	450W 92%	1x Serial	USB / USB Optical	Windows 10 Pro 64	3-year, Onsite	09/17
30B3006W**	MEA	Xeon E5-1650 v4 6C/3.6GHz/15MB/140W/DDR4-2400	Open	2x 8GB RDIMM DDR4-2400 ECC	Integrated Intel SATA	None	1x 512GB SSD M.2 PCIe	HH DVD±RW	9-in-1	450W 92%	1x Serial	USB / USB Optical	Windows 10 Pro 64	3-year, Onsite	09/17
30B3006X**	MEA	Xeon E5-1630 v4 4C/3.7GHz/10MB/140W/DDR4-2400	Open	2x 8GB RDIMM DDR4-2400 ECC	Integrated Intel SATA	None	1x 256GB SSD M.2 PCIe Opal	HH DVD±RW	9-in-1	450W 92%	1x Serial	USB / USB Optical	Windows 10 Pro 64	3-year, Onsite	09/17
30B3006Y**	MEA	Xeon E5-1620 v4 4C/3.5GHz/10MB/140W/DDR4-2400	Open	2x 8GB RDIMM DDR4-2400 ECC	Integrated Intel SATA	1x 256GB SSD 2.5" SATA6Gbps Opal, 1x 1TB HDD 7.2K 3.5" SATA6Gbps	None	HH DVD±RW	9-in-1	450W 92%	1x Serial	USB / USB Optical	Windows 10 Pro 64	3-year, Onsite	09/17

Model	Region	Processor	Graphics	Memory	Storage Controller	Disks	M.2 Drives	Optical	Media Reader	Power Supply	Optional Ports	Keyboard / Mouse	Operating System	Warranty	Ann Date (mm/yy)
30B30070**	MEA	Xeon E5-1620 v4 4C/3.5GHz/10MB/140W/DDR4-2400	Open	1x 8GB RDIMM DDR4-2400 ECC	Integrated Intel SATA	1x 256GB SSD 2.5" SATA6Gbps Opal	None	HH DVD±RW	9-in-1	450W 92%	1x Serial	USB / USB Optical	Windows 10 Pro 64	3-year, Onsite	09/17
30B30071**	MEA	Xeon E5-1630 v4 4C/3.7GHz/10MB/140W/DDR4-2400	NVIDIA Quadro P4000 8GB	4x 8GB RDIMM DDR4-2400 ECC	Integrated Intel SATA	1x 256GB SSD 2.5" SATA6Gbps Opal, 1x 1TB HDD 7.2K 3.5" SATA6Gbps	None	HH DVD±RW	9-in-1	450W 92%	1x Serial	USB / USB Optical	Windows 10 Pro 64	3-year, Onsite	09/17
30B30072**	MEA	Xeon E5-1620 v4 4C/3.5GHz/10MB/140W/DDR4-2400	NVIDIA Quadro P2000 5GB	2x 8GB RDIMM DDR4-2400 ECC	Integrated Intel SATA	1x 1TB HDD 7.2K 3.5" SATA6Gbps	None	HH DVD±RW	9-in-1	450W 92%	1x Serial	USB / USB Optical	Windows 10 Pro 64	3-year, Onsite	09/17
30B30073**	MEA	Xeon E5-1630 v4 4C/3.7GHz/10MB/140W/DDR4-2400	NVIDIA Quadro P2000 5GB	2x 8GB RDIMM DDR4-2400 ECC	Integrated Intel SATA	None	1x 256GB SSD M.2 PCIe Opal	HH DVD±RW	9-in-1	450W 92%	1x Serial	USB / USB Optical	Windows 10 Pro 64	3-year, Onsite	09/17
30B30074**	MEA	Xeon E5-1620 v4 4C/3.5GHz/10MB/140W/DDR4-2400	Open	1x 8GB RDIMM DDR4-2400 ECC	Integrated Intel SATA	1x 256GB SSD 2.5" SATA6Gbps Opal	None	HH DVD	9-in-1	450W 92%	2x USB3.0, 1x Serial	USB / USB Optical	Windows 10 DG Windows 7 Pro 64	3-year, Onsite	09/17
30B30075**	MEA	Xeon E5-1630 v4 4C/3.7GHz/10MB/140W/DDR4-2400	Open	1x 8GB RDIMM DDR4-2400 ECC	Integrated Intel SATA	1x 256GB SSD 2.5" SATA6Gbps Opal	None	HH DVD	9-in-1	450W 92%	2x USB3.0, 1x Serial	USB / USB Optical	Windows 10 DG Windows 7 Pro 64	3-year, Onsite	09/17
30B30076**	MEA	Xeon E5-1650 v4 6C/3.6GHz/15MB/140W/DDR4-2400	Open	2x 8GB RDIMM DDR4-2400 ECC	Integrated Intel SATA	1x 256GB SSD 2.5" SATA6Gbps Opal	None	HH DVD	9-in-1	450W 92%	2x USB3.0, 1x Serial	USB / USB Optical	Windows 10 DG Windows 7 Pro 64	3-year, Onsite	09/17
30B30077**	MEA	Xeon E5-1603 v4 4C/2.8GHz/10MB/140W/DDR4-2133	Open	1x 8GB RDIMM DDR4-2400 ECC	Integrated Intel SATA	1x 1TB HDD 7.2K 3.5" SATA6Gbps	None	HH DVD	9-in-1	450W 92%	2x USB3.0, 1x Serial	USB / USB Optical	Windows 10 DG Windows 7 Pro 64	3-year, Onsite	09/17
30B30078**	MEA	Xeon E5-1620 v4 4C/3.5GHz/10MB/140W/DDR4-2400	Open	1x 8GB RDIMM DDR4-2400 ECC	Integrated Intel SATA	1x 1TB HDD 7.2K 3.5" SATA6Gbps	None	HH DVD	9-in-1	450W 92%	2x USB3.0, 1x Serial	USB / USB Optical	Windows 10 DG Windows 7 Pro 64	3-year, Onsite	09/17
30B30079**	MEA	Xeon E5-1620 v4 4C/3.5GHz/10MB/140W/DDR4-2400	Open	2x 8GB RDIMM DDR4-2400 ECC	Integrated Intel SATA	1x 1TB HDD 7.2K 3.5" SATA6Gbps	None	HH DVD	9-in-1	450W 92%	2x USB3.0, 1x Serial	USB / USB Optical	Windows 10 DG Windows 7 Pro 64	3-year, Onsite	09/17
30B3007A**	MEA	Xeon E5-1650 v4 6C/3.6GHz/15MB/140W/DDR4-2400	Open	2x 8GB RDIMM DDR4-2400 ECC	Integrated Intel SATA	1x 256GB SSD 2.5" SATA6Gbps Opal, 1x 1TB HDD 7.2K 3.5" SATA6Gbps	None	HH DVD	9-in-1	450W 92%	2x USB3.0, 1x Serial	USB / USB Optical	Windows 10 DG Windows 7 Pro 64	3-year, Onsite	09/17
30B3007B**	MEA	Xeon E5-1620 v4 4C/3.5GHz/10MB/140W/DDR4-2400	NVIDIA Quadro P2000 5GB	2x 8GB RDIMM DDR4-2400 ECC	Integrated Intel SATA	1x 256GB SSD 2.5" SATA6Gbps Opal, 1x 1TB HDD 7.2K 3.5" SATA6Gbps	None	HH DVD	9-in-1	450W 92%	2x USB3.0, 1x Serial	USB / USB Optical	Windows 10 DG Windows 7 Pro 64	3-year, Onsite	09/17

Model	Region	Processor	Graphics	Memory	Storage Controller	Disks	M.2 Drives	Optical	Media Reader	Power Supply	Optional Ports	Keyboard / Mouse	Operating System	Warranty	Ann Date (mm/yy)
30B3007C**	MEA	Xeon E5-1630 v4 4C/3.7GHz/10MB/140W/DDR4-2400	NVIDIA Quadro P4000 8GB	4x 8GB RDIMM DDR4-2400 ECC	Integrated Intel SATA	1x 256GB SSD 2.5" SATA6Gbps Opal, 1x 1TB HDD 7.2K 3.5" SATA6Gbps	None	HH DVD	9-in-1	450W 92%	2x USB3.0, 1x Serial	USB / USB Optical	Windows 10 DG Windows 7 Pro 64	3-year, Onsite	09/17
30B3007D**	MEA	Xeon E5-1650 v4 6C/3.6GHz/15MB/140W/DDR4-2400	Open	2x 8GB RDIMM DDR4-2400 ECC	Integrated Intel SATA	None	1x 512GB SSD M.2 PCIe	HH DVD	9-in-1	450W 92%	1x Serial	USB / USB Optical	Windows 10 DG Windows 7 Pro 64	3-year, Onsite	09/17
30B3007E**	MEA	Xeon E5-1620 v4 4C/3.5GHz/10MB/140W/DDR4-2400	Open	2x 8GB RDIMM DDR4-2400 ECC	Integrated Intel SATA	None	1x 256GB SSD M.2 PCIe Opal	HH DVD	9-in-1	450W 92%	1x Serial	USB / USB Optical	Windows 10 DG Windows 7 Pro 64	3-year, Onsite	09/17
30B3007F**	MEA	Xeon E5-1630 v4 4C/3.7GHz/10MB/140W/DDR4-2400	NVIDIA Quadro P2000 5GB	2x 8GB RDIMM DDR4-2400 ECC	Integrated Intel SATA	None	1x 256GB SSD M.2 PCIe Opal	HH DVD	9-in-1	450W 92%	1x Serial	USB / USB Optical	Windows 10 DG Windows 7 Pro 64	3-year, Onsite	09/17
30B3007G**	MEA	Xeon E5-1630 v4 4C/3.7GHz/10MB/140W/DDR4-2400	NVIDIA Quadro P4000 8GB	2x 8GB RDIMM DDR4-2400 ECC	Integrated Intel SATA	None	1x 256GB SSD M.2 PCIe Opal	HH DVD	9-in-1	450W 92%	1x Serial	USB / USB Optical	Windows 10 DG Windows 7 Pro 64	3-year, Onsite	09/17
30B3007H**	MEA	Xeon E5-1620 v4 4C/3.5GHz/10MB/140W/DDR4-2400	Open	1x 8GB RDIMM DDR4-2400 ECC	Integrated Intel SATA	1x 1TB HDD 7.2K 3.5" SATA6Gbps	None	HH DVD	9-in-1	450W 92%	1x Serial	USB / USB Optical	Windows 10 Pro 64	3-year, Onsite	09/17
30B3007Hxx	Russia/EET/CIS	Xeon E5-1620 v4 4C/3.5GHz/10MB/140W/DDR4-2400	Open	1x 8GB RDIMM DDR4-2400 ECC	Integrated Intel SATA	1x 1TB HDD 7.2K 3.5" SATA6Gbps	None	HH DVD	9-in-1	450W 92%	1x Serial	USB / USB Optical	Windows 10 Pro 64	3-year, Onsite	09/17
30B3007Gxx	Russia/EET/CIS	Xeon E5-1630 v4 4C/3.7GHz/10MB/140W/DDR4-2400	NVIDIA Quadro P4000 8GB	2x 8GB RDIMM DDR4-2400 ECC	Integrated Intel SATA	None	1x 256GB SSD M.2 PCIe Opal	HH DVD	9-in-1	450W 92%	1x Serial	USB / USB Optical	Windows 10 DG Windows 7 Pro 64	3-year, Onsite	09/17
30B3007Fxx	Russia/EET/CIS	Xeon E5-1630 v4 4C/3.7GHz/10MB/140W/DDR4-2400	NVIDIA Quadro P2000 5GB	2x 8GB RDIMM DDR4-2400 ECC	Integrated Intel SATA	None	1x 256GB SSD M.2 PCIe Opal	HH DVD	9-in-1	450W 92%	1x Serial	USB / USB Optical	Windows 10 DG Windows 7 Pro 64	3-year, Onsite	09/17
30B3007Exx	Russia/EET/CIS	Xeon E5-1620 v4 4C/3.5GHz/10MB/140W/DDR4-2400	Open	2x 8GB RDIMM DDR4-2400 ECC	Integrated Intel SATA	None	1x 256GB SSD M.2 PCIe Opal	HH DVD	9-in-1	450W 92%	1x Serial	USB / USB Optical	Windows 10 DG Windows 7 Pro 64	3-year, Onsite	09/17
30B3007Dxx	Russia/EET/CIS	Xeon E5-1650 v4 6C/3.6GHz/15MB/140W/DDR4-2400	Open	2x 8GB RDIMM DDR4-2400 ECC	Integrated Intel SATA	None	1x 512GB SSD M.2 PCIe	HH DVD	9-in-1	450W 92%	1x Serial	USB / USB Optical	Windows 10 DG Windows 7 Pro 64	3-year, Onsite	09/17
30B3007Cxx	Russia/EET/CIS	Xeon E5-1630 v4 4C/3.7GHz/10MB/140W/DDR4-2400	NVIDIA Quadro P4000 8GB	4x 8GB RDIMM DDR4-2400 ECC	Integrated Intel SATA	1x 256GB SSD 2.5" SATA6Gbps Opal, 1x 1TB HDD 7.2K 3.5" SATA6Gbps	None	HH DVD	9-in-1	450W 92%	2x USB3.0, 1x Serial	USB / USB Optical	Windows 10 DG Windows 7 Pro 64	3-year, Onsite	09/17

Model	Region	Processor	Graphics	Memory	Storage Controller	Disks	M.2 Drives	Optical	Media Reader	Power Supply	Optional Ports	Keyboard / Mouse	Operating System	Warranty	Ann Date (mm/yy)
30B3007Bxx	Russia/EET/CIS	Xeon E5-1620 v4 4C/3.5GHz/10MB/140W/DDR4-2400	NVIDIA Quadro P2000 5GB	2x 8GB RDIMM DDR4-2400 ECC	Integrated Intel SATA	1x 256GB SSD 2.5" SATA6Gbps Opal, 1x 1TB HDD 7.2K 3.5" SATA6Gbps	None	HH DVD	9-in-1	450W 92%	2x USB3.0, 1x Serial	USB / USB Optical	Windows 10 DG Windows 7 Pro 64	3-year, Onsite	09/17
30B3007Axx	Russia/EET/CIS	Xeon E5-1650 v4 6C/3.6GHz/15MB/140W/DDR4-2400	Open	2x 8GB RDIMM DDR4-2400 ECC	Integrated Intel SATA	1x 256GB SSD 2.5" SATA6Gbps Opal, 1x 1TB HDD 7.2K 3.5" SATA6Gbps	None	HH DVD	9-in-1	450W 92%	2x USB3.0, 1x Serial	USB / USB Optical	Windows 10 DG Windows 7 Pro 64	3-year, Onsite	09/17
30B30079xx	Russia/EET/CIS	Xeon E5-1620 v4 4C/3.5GHz/10MB/140W/DDR4-2400	Open	2x 8GB RDIMM DDR4-2400 ECC	Integrated Intel SATA	1x 1TB HDD 7.2K 3.5" SATA6Gbps	None	HH DVD	9-in-1	450W 92%	2x USB3.0, 1x Serial	USB / USB Optical	Windows 10 DG Windows 7 Pro 64	3-year, Onsite	09/17
30B30078xx	Russia/EET/CIS	Xeon E5-1620 v4 4C/3.5GHz/10MB/140W/DDR4-2400	Open	1x 8GB RDIMM DDR4-2400 ECC	Integrated Intel SATA	1x 1TB HDD 7.2K 3.5" SATA6Gbps	None	HH DVD	9-in-1	450W 92%	2x USB3.0, 1x Serial	USB / USB Optical	Windows 10 DG Windows 7 Pro 64	3-year, Onsite	09/17
30B30077xx	Russia/EET/CIS	Xeon E5-1603 v4 4C/2.8GHz/10MB/140W/DDR4-2133	Open	1x 8GB RDIMM DDR4-2400 ECC	Integrated Intel SATA	1x 1TB HDD 7.2K 3.5" SATA6Gbps	None	HH DVD	9-in-1	450W 92%	2x USB3.0, 1x Serial	USB / USB Optical	Windows 10 DG Windows 7 Pro 64	3-year, Onsite	09/17
30B30076xx	Russia/EET/CIS	Xeon E5-1650 v4 6C/3.6GHz/15MB/140W/DDR4-2400	Open	2x 8GB RDIMM DDR4-2400 ECC	Integrated Intel SATA	1x 256GB SSD 2.5" SATA6Gbps Opal	None	HH DVD	9-in-1	450W 92%	2x USB3.0, 1x Serial	USB / USB Optical	Windows 10 DG Windows 7 Pro 64	3-year, Onsite	09/17
30B30075xx	Russia/EET/CIS	Xeon E5-1630 v4 4C/3.7GHz/10MB/140W/DDR4-2400	Open	1x 8GB RDIMM DDR4-2400 ECC	Integrated Intel SATA	1x 256GB SSD 2.5" SATA6Gbps Opal	None	HH DVD	9-in-1	450W 92%	2x USB3.0, 1x Serial	USB / USB Optical	Windows 10 DG Windows 7 Pro 64	3-year, Onsite	09/17
30B30074xx	Russia/EET/CIS	Xeon E5-1620 v4 4C/3.5GHz/10MB/140W/DDR4-2400	Open	1x 8GB RDIMM DDR4-2400 ECC	Integrated Intel SATA	1x 256GB SSD 2.5" SATA6Gbps Opal	None	HH DVD	9-in-1	450W 92%	2x USB3.0, 1x Serial	USB / USB Optical	Windows 10 DG Windows 7 Pro 64	3-year, Onsite	09/17
30B30073xx	Russia/EET/CIS	Xeon E5-1630 v4 4C/3.7GHz/10MB/140W/DDR4-2400	NVIDIA Quadro P2000 5GB	2x 8GB RDIMM DDR4-2400 ECC	Integrated Intel SATA	None	1x 256GB SSD M.2 PCIe Opal	HH DVD±RW	9-in-1	450W 92%	1x Serial	USB / USB Optical	Windows 10 Pro 64	3-year, Onsite	09/17
30B30072xx	Russia/EET/CIS	Xeon E5-1620 v4 4C/3.5GHz/10MB/140W/DDR4-2400	NVIDIA Quadro P2000 5GB	2x 8GB RDIMM DDR4-2400 ECC	Integrated Intel SATA	1x 1TB HDD 7.2K 3.5" SATA6Gbps	None	HH DVD±RW	9-in-1	450W 92%	1x Serial	USB / USB Optical	Windows 10 Pro 64	3-year, Onsite	09/17
30B30071xx	Russia/EET/CIS	Xeon E5-1630 v4 4C/3.7GHz/10MB/140W/DDR4-2400	NVIDIA Quadro P4000 8GB	4x 8GB RDIMM DDR4-2400 ECC	Integrated Intel SATA	1x 256GB SSD 2.5" SATA6Gbps Opal, 1x 1TB HDD 7.2K 3.5" SATA6Gbps	None	HH DVD±RW	9-in-1	450W 92%	1x Serial	USB / USB Optical	Windows 10 Pro 64	3-year, Onsite	09/17
30B30070xx	Russia/EET/CIS	Xeon E5-1620 v4 4C/3.5GHz/10MB/140W/DDR4-2400	Open	1x 8GB RDIMM DDR4-2400 ECC	Integrated Intel SATA	1x 256GB SSD 2.5" SATA6Gbps Opal	None	HH DVD±RW	9-in-1	450W 92%	1x Serial	USB / USB Optical	Windows 10 Pro 64	3-year, Onsite	09/17

Model	Region	Processor	Graphics	Memory	Storage Controller	Disks	M.2 Drives	Optical	Media Reader	Power Supply	Optional Ports	Keyboard / Mouse	Operating System	Warranty	Ann Date (mm/yy)
30B3006Yxx	Russia/EET/CIS	Xeon E5-1620 v4 4C/3.5GHz/10MB/140W/DDR4-2400	Open	2x 8GB RDIMM DDR4-2400 ECC	Integrated Intel SATA	1x 256GB SSD 2.5" SATA6Gbps Opal, 1x 1TB HDD 7.2K 3.5" SATA6Gbps	None	HH DVD±RW	9-in-1	450W 92%	1x Serial	USB / USB Optical	Windows 10 Pro 64	3-year, Onsite	09/17
30B3006Xxx	Russia/EET/CIS	Xeon E5-1630 v4 4C/3.7GHz/10MB/140W/DDR4-2400	Open	2x 8GB RDIMM DDR4-2400 ECC	Integrated Intel SATA	None	1x 256GB SSD M.2 PCIe Opal	HH DVD±RW	9-in-1	450W 92%	1x Serial	USB / USB Optical	Windows 10 Pro 64	3-year, Onsite	09/17
30B3006Wxx	Russia/EET/CIS	Xeon E5-1650 v4 6C/3.6GHz/15MB/140W/DDR4-2400	Open	2x 8GB RDIMM DDR4-2400 ECC	Integrated Intel SATA	None	1x 512GB SSD M.2 PCIe	HH DVD±RW	9-in-1	450W 92%	1x Serial	USB / USB Optical	Windows 10 Pro 64	3-year, Onsite	09/17
30B3006Vxx	Russia/EET/CIS	Xeon E5-1630 v4 4C/3.7GHz/10MB/140W/DDR4-2400	NVIDIA Quadro P4000 8GB	2x 8GB RDIMM DDR4-2400 ECC	Integrated Intel SATA	None	1x 256GB SSD M.2 PCIe Opal	HH DVD±RW	9-in-1	450W 92%	1x Serial	USB / USB Optical	Windows 10 Pro 64	3-year, Onsite	09/17
30B3006Uxx	Russia/EET/CIS	Xeon E5-1630 v4 4C/3.7GHz/10MB/140W/DDR4-2400	NVIDIA Quadro P1000 4GB	1x 8GB RDIMM DDR4-2400 ECC	Integrated Intel SATA	1x 256GB SSD 2.5" SATA6Gbps Opal	None	HH DVD±RW	9-in-1	450W 92%	1x Serial	USB / USB Optical	Windows 10 Pro 64	3-year, Onsite	09/17
30B3006Txx	Russia/EET/CIS	Xeon E5-1620 v4 4C/3.5GHz/10MB/140W/DDR4-2400	NVIDIA Quadro P2000 5GB	2x 8GB RDIMM DDR4-2400 ECC	Integrated Intel SATA	1x 256GB SSD 2.5" SATA6Gbps Opal, 1x 1TB HDD 7.2K 3.5" SATA6Gbps	None	HH DVD±RW	9-in-1	450W 92%	1x Serial	USB / USB Optical	Windows 10 Pro 64	3-year, Onsite	09/17
30B3006Sxx	Russia/EET/CIS	Xeon E5-1620 v4 4C/3.5GHz/10MB/140W/DDR4-2400	Open	2x 8GB RDIMM DDR4-2400 ECC	Integrated Intel SATA	None	1x 256GB SSD M.2 PCIe Opal	HH DVD±RW	9-in-1	450W 92%	1x Serial	USB / USB Optical	Windows 10 Pro 64	3-year, Onsite	09/17
30B3006Rxx	Russia/EET/CIS	Xeon E5-1620 v4 4C/3.5GHz/10MB/140W/DDR4-2400	Open	2x 8GB RDIMM DDR4-2400 ECC	Integrated Intel SATA	1x 1TB HDD 7.2K 3.5" SATA6Gbps	None	HH DVD±RW	9-in-1	450W 92%	1x Serial	USB / USB Optical	Windows 10 Pro 64	3-year, Onsite	09/17
30B3006Qxx	Russia/EET/CIS	Xeon E5-1630 v4 4C/3.7GHz/10MB/140W/DDR4-2400	Open	2x 8GB RDIMM DDR4-2400 ECC	Integrated Intel SATA	1x 256GB SSD 2.5" SATA6Gbps Opal	None	9.0mm DVD±RW	29-in-1	450W 92%	1x Front eSATA, 1x Serial	USB / USB Optical	Windows 10 Pro 64	3-year, Onsite	09/17
30B3006Pxx	Russia/EET/CIS	Xeon E5-1650 v4 6C/3.6GHz/15MB/140W/DDR4-2400	Open	2x 8GB RDIMM DDR4-2400 ECC	Integrated Intel SATA	1x 256GB SSD 2.5" SATA6Gbps Opal, 1x 1TB HDD 7.2K 3.5" SATA6Gbps	None	HH DVD±RW	9-in-1	450W 92%	1x Serial	USB / USB Optical	Windows 10 Pro 64	3-year, Onsite	09/17
30B3006Nxx	Russia/EET/CIS	Xeon E5-1630 v4 4C/3.7GHz/10MB/140W/DDR4-2400	Open	1x 8GB RDIMM DDR4-2400 ECC	Integrated Intel SATA	1x 256GB SSD 2.5" SATA6Gbps Opal	None	HH DVD±RW	9-in-1	450W 92%	1x Serial	USB / USB Optical	Windows 10 Pro 64	3-year, Onsite	09/17
30B3006Mxx	Russia/EET/CIS	Xeon E5-1650 v4 6C/3.6GHz/15MB/140W/DDR4-2400	Open	2x 8GB RDIMM DDR4-2400 ECC	Integrated Intel SATA	1x 256GB SSD 2.5" SATA6Gbps Opal	None	HH DVD±RW	9-in-1	450W 92%	1x Serial	USB / USB Optical	Windows 10 Pro 64	3-year, Onsite	09/17

Model	Region	Processor	Graphics	Memory	Storage Controller	Disks	M.2 Drives	Optical	Media Reader	Power Supply	Optional Ports	Keyboard / Mouse	Operating System	Warranty	Ann Date (mm/yy)
30B3006Lxx	Russia/EET/CIS	Xeon E5-1650 v4 6C/3.6GHz/15MB/140W/DDR4-2400	Open	2x 8GB RDIMM DDR4-2400 ECC	Integrated Intel SATA	1x 1TB HDD 7.2K 3.5" SATA6Gbps	None	HH DVD±RW	9-in-1	450W 92%	1x Serial	USB / USB Optical	Windows 10 Pro 64	3-year, Onsite	09/17
30B3006Gxx	Russia/EET/CIS	Xeon E5-1630 v4 4C/3.7GHz/10MB/140W/DDR4-2400	NVIDIA Quadro P5000 16GB	2x 16GB RDIMM DDR4-2400 ECC	Integrated Intel SATA	1x2TB HDD 7.2K 3.5" SATA6Gbps	1x1TB SSD M.2 PCIe NVMe Opal	HH DVD±RW	9-in-1	450W 92%	1xSerial	USB / USB Optical	Windows 10 Pro 64	3-year, Onsite	06/17
30B3005Qxx	Russia/EET/CIS	Xeon E5-1620 v4 4C/3.5GHz/10MB/140W/DDR4-2400	Open	1x 8GB RDIMM DDR4-2400 ECC	Integrated Intel SATA	1x1TB HDD 7.2K 3.5" SATA6Gbps	None	HH DVD±RW	9-in-1	450W 92%	1xSerial	USB / USB Optical	Windows 10 DG Windows 7 Pro 64	3-year, Onsite	04/17
30B3005Pxx	Russia/EET/CIS	Xeon E5-1630 v4 4C/3.7GHz/10MB/140W/DDR4-2400	NVIDIA Quadro P4000 8GB	2x 8GB RDIMM DDR4-2400 ECC	Integrated Intel SATA	None	1x256GB SSD M.2 PCIe Opal	HH DVD±RW	9-in-1	450W 92%	1xSerial	USB / USB Optical	Windows 10 Pro 64	3-year, Onsite	04/17
30B3005Nxx	Russia/EET/CIS	Xeon E5-1630 v4 4C/3.7GHz/10MB/140W/DDR4-2400	NVIDIA Quadro P2000 5GB	2x 8GB RDIMM DDR4-2400 ECC	Integrated Intel SATA	None	1x256GB SSD M.2 PCIe Opal	HH DVD±RW	9-in-1	450W 92%	1xSerial	USB / USB Optical	Windows 10 Pro 64	3-year, Onsite	04/17
30B3005Mxx	Russia/EET/CIS	Xeon E5-1620 v4 4C/3.5GHz/10MB/140W/DDR4-2400	NVIDIA Quadro P2000 5GB	2x 8GB RDIMM DDR4-2400 ECC	Integrated Intel SATA	1x1TB HDD 7.2K 3.5" SATA6Gbps	None	HH DVD±RW	9-in-1	450W 92%	1xSerial	USB / USB Optical	Windows 10 Pro 64	3-year, Onsite	04/17
30B3005Lxx	Russia/EET/CIS	Xeon E5-1620 v4 4C/3.5GHz/10MB/140W/DDR4-2400	Open	1x 8GB RDIMM DDR4-2400 ECC	Integrated Intel SATA	1x1TB HDD 7.2K 3.5" SATA6Gbps	None	HH DVD±RW	9-in-1	450W 92%	1xSerial	USB / USB Optical	Windows 10 Pro 64	3-year, Onsite	04/17
30B3005Kxx	Russia/EET/CIS	Xeon E5-1630 v4 4C/3.7GHz/10MB/140W/DDR4-2400	NVIDIA Quadro P4000 8GB	4x 8GB RDIMM DDR4-2400 ECC	Integrated Intel SATA	1x256GB SSD 2.5" SATA6Gbps Opal, 1x1TB HDD 7.2K 3.5" SATA6Gbps 1x256GB SSD 2.5"	None	HH DVD±RW	9-in-1	450W 92%	1xSerial	USB / USB Optical	Windows 10 Pro 64	3-year, Onsite	04/17
30B3005Rxx	Russia/EET/CIS	Xeon E5-1620 v4 4C/3.5GHz/10MB/140W/DDR4-2400	NVIDIA Quadro P2000 5GB	2x 8GB RDIMM DDR4-2400 ECC	Integrated Intel SATA	1x256GB SSD 2.5" SATA6Gbps Opal, 1x1TB HDD 7.2K 3.5" SATA6Gbps 1x256GB SSD 2.5"	None	HH DVD±RW	9-in-1	450W 92%	1xSerial	USB / USB Optical	Windows 10 DG Windows 7 Pro 64	3-year, Onsite	04/17
30B3005Jxx	Russia/EET/CIS	Xeon E5-1620 v4 4C/3.5GHz/10MB/140W/DDR4-2400	NVIDIA Quadro P2000 5GB	2x 8GB RDIMM DDR4-2400 ECC	Integrated Intel SATA	1x256GB SSD 2.5" SATA6Gbps Opal, 1x1TB HDD 7.2K 3.5" SATA6Gbps	None	HH DVD±RW	9-in-1	450W 92%	1xSerial	USB / USB Optical	Windows 10 Pro 64	3-year, Onsite	04/17
30B3005Hxx	Russia/EET/CIS	Xeon E5-1630 v4 4C/3.7GHz/10MB/140W/DDR4-2400	NVIDIA Quadro P2000 5GB	2x 8GB RDIMM DDR4-2400 ECC	Integrated Intel SATA	None	1x256GB SSD M.2 PCIe Opal	HH DVD±RW	9-in-1	450W 92%	1xSerial	USB / USB Optical	Windows 10 DG Windows 7 Pro 64	3-year, Onsite	04/17
30B3005Gxx	Russia/EET/CIS	Xeon E5-1630 v4 4C/3.7GHz/10MB/140W/DDR4-2400	NVIDIA Quadro P4000 8GB	2x 8GB RDIMM DDR4-2400 ECC	Integrated Intel SATA	None	1x256GB SSD M.2 PCIe Opal	HH DVD±RW	9-in-1	450W 92%	1xSerial	USB / USB Optical	Windows 10 DG Windows 7 Pro 64	3-year, Onsite	04/17

Model	Region	Processor	Graphics	Memory	Storage Controller	Disks	M.2 Drives	Optical	Media Reader	Power Supply	Optional Ports	Keyboard / Mouse	Operating System	Warranty	Ann Date (mm/yy)
30B3005Fxx	Russia/EET/CIS	Xeon E5-1630 v4 4C/3.7GHz/10MB/140W/DDR4-2400	NVIDIA Quadro P4000 8GB	4x 8GB RDIMM DDR4-2400 ECC	Integrated Intel SATA	1x256GB SSD 2.5" SATA6Gbps Opal, 1x1TB HDD 7.2K 3.5" SATA6Gbps	None	HH DVD±RW	9-in-1	450W 92%	1xSerial	USB / USB Optical	Windows 10 DG Windows 7 Pro 64	3-year, Onsite	04/17
30B3005Dxx	Russia/EET/CIS	Xeon E5-1650 v4 6C/3.6GHz/15MB/140W/DDR4-2400	Open	2x 8GB RDIMM DDR4-2400 ECC	Integrated Intel SATA	1x256GB SSD 2.5" SATA6Gbps Opal, 1x1TB HDD 7.2K 3.5" SATA6Gbps	None	HH DVD±RW	9-in-1	450W 92%	2xUSB3.0, 1xSerial	USB / USB Optical	Windows 10 Pro 64	3-year, Onsite	03/17
30B3005Cxx	Russia/EET/CIS	Xeon E5-1620 v4 4C/3.5GHz/10MB/140W/DDR4-2400	Open	2x 8GB RDIMM DDR4-2400 ECC	Integrated Intel SATA	None	1x256GB SSD M.2 PCIe Opal	HH DVD±RW	9-in-1	450W 92%	1xSerial	USB / USB Optical	Windows 10 DG Windows 7 Pro 64	3-year, Onsite	03/17
30B3005Bxx	Russia/EET/CIS	Xeon E5-1620 v4 4C/3.5GHz/10MB/140W/DDR4-2400	Open	2x 8GB RDIMM DDR4-2400 ECC	Integrated Intel SATA	None	1x256GB SSD M.2 PCIe Opal	HH DVD±RW	9-in-1	450W 92%	2xUSB3.0, 1xSerial	USB / USB Optical	Windows 10 Pro 64	3-year, Onsite	03/17
30B3005Axx	Russia/EET/CIS	Xeon E5-1620 v4 4C/3.5GHz/10MB/140W/DDR4-2400	Open	2x 8GB RDIMM DDR4-2400 ECC	Integrated Intel SATA	1x1TB HDD 7.2K 3.5" SATA6Gbps	None	HH DVD±RW	9-in-1	450W 92%	2xUSB3.0	USB / USB Optical	Windows 10 Pro 64	3-year, Onsite	03/17
30B30059xx	Russia/EET/CIS	Xeon E5-1650 v4 6C/3.6GHz/15MB/140W/DDR4-2400	Open	2x 8GB RDIMM DDR4-2400 ECC	Integrated Intel SATA	1x256GB SSD 2.5" SATA6Gbps Opal, 1x1TB HDD 7.2K 3.5" SATA6Gbps	None	HH DVD±RW	9-in-1	450W 92%	1xSerial	USB / USB Optical	Windows 10 DG Windows 7 Pro 64	3-year, Onsite	03/17
30B30058xx	Russia/EET/CIS	Xeon E5-1620 v4 4C/3.5GHz/10MB/140W/DDR4-2400	Open	2x 8GB RDIMM DDR4-2400 ECC	Integrated Intel SATA	1x1TB HDD 7.2K 3.5" SATA6Gbps	None	HH DVD±RW	9-in-1	450W 92%	2xUSB3.0, 1xSerial	USB / USB Optical	Windows 10 Pro 64	3-year, Onsite	03/17
30B30057xx	Russia/EET/CIS	Xeon E5-1620 v4 4C/3.5GHz/10MB/140W/DDR4-2400	Open	2x 8GB RDIMM DDR4-2400 ECC	Integrated Intel SATA	1x1TB HDD 7.2K 3.5" SATA6Gbps	None	HH DVD±RW	9-in-1	450W 92%	1xSerial	USB / USB Optical	Windows 10 DG Windows 7 Pro 64	3-year, Onsite	03/17
30B30054xx	Russia/EET/CIS	Xeon E5-1620 v4 4C/3.5GHz/10MB/140W/DDR4-2400	Open	1x 8GB RDIMM DDR4-2400 ECC	Integrated Intel SATA	1x1TB HDD 7.2K 3.5" SATA6Gbps	None	HH DVD±RW	9-in-1	450W 92%	1xSerial	USB / USB Optical	Windows 10 DG Windows 7 Pro 64	3-year, Onsite	12/16
30B30053xx	Russia/EET/CIS	Xeon E5-1620 v4 4C/3.5GHz/10MB/140W/DDR4-2400	Open	1x 8GB RDIMM DDR4-2400 ECC	Integrated Intel SATA	1x1TB HDD 7.2K 3.5" SATA6Gbps	None	HH DVD±RW	9-in-1	450W 92%	1xSerial	USB / USB Optical	Windows 10 Pro 64	3-year, Onsite	12/16
30B3004Kxx	Russia/EET/CIS	Xeon E5-1620 v4 4C/3.5GHz/10MB/140W/DDR4-2400	Open	1x 8GB RDIMM DDR4-2400 ECC	Integrated Intel SATA	None	1x1TB SSD M.2 PCIe NVMe Opal	HH DVD±RW	9-in-1	450W 92%	1xSerial	USB / USB Optical	Windows 10 DG Windows 7 Pro 64	3-year, Onsite	12/16
30B3003Hxx	Russia/EET/CIS	Xeon E5-1630 v4 4C/3.7GHz/10MB/140W/DDR4-2400	Open	2x 8GB RDIMM DDR4-2400 ECC	Integrated Intel SATA	1x256GB SSD 2.5" SATA6Gbps Opal	None	9.5mm DVD±RW	29-in-1	450W 92%	1xSerial	USB / USB Optical	Windows 10 DG Windows 7 Pro 64	3-year, Onsite	09/16

Model	Region	Processor	Graphics	Memory	Storage Controller	Disks	M.2 Drives	Optical	Media Reader	Power Supply	Optional Ports	Keyboard / Mouse	Operating System	Warranty	Ann Date (mm/yy)
30B3004Lxx	Russia/EET/CIS	Xeon E5-1630 v4 4C/3.7GHz/10MB/140W/DDR4-2400	Open	1x 8GB RDIMM DDR4- 2400 ECC	Integrated Intel SATA	None	1x1TB SSD M.2 PCIe NVMe Opal	HH DVD±RW	9-in-1	450W 92%	1xSerial	USB / USB Optical	Windows 10 DG Windows 7 Pro 64	3-year, Onsite	12/16
30B3004Fxx	Russia/EET/CIS	Xeon E5-1603 v4 4C/2.8GHz/10MB/140W/DDR4-2133	Open	1x 8GB RDIMM DDR4- 2400 ECC	Integrated Intel SATA	1x1TB HDD 7.2K 3.5" SATA6Gbps	None	9.5mm DVD±RW	29-in-1	450W 92%	1xSerial	USB / USB Optical	Windows 10 DG Windows 7 Pro 64	3-year, Onsite	09/16
30B3004Gxx	Russia/EET/CIS	Xeon E5-1620 v4 4C/3.5GHz/10MB/140W/DDR4-2400	Open	1x 8GB RDIMM DDR4- 2400 ECC	Integrated Intel SATA	1x256GB SSD 2.5" SATA6Gbps Opal	None	9.5mm DVD±RW	29-in-1	450W 92%	1xSerial	USB / USB Optical	Windows 10 DG Windows 7 Pro 64	3-year, Onsite	09/16
30B3004Hxx	Russia/EET/CIS	Xeon E5-1630 v4 4C/3.7GHz/10MB/140W/DDR4-2400	Open	2x 8GB RDIMM DDR4- 2400 ECC	Integrated Intel SATA	1x256GB SSD 2.5" SATA6Gbps Opal	None	9.5mm DVD±RW	29-in-1	450W 92%	1xSerial	USB / USB Optical	Windows 10 DG Windows 7 Pro 64	3-year, Onsite	09/16
30B3003Gxx	Russia/EET/CIS	Xeon E5-1620 v4 4C/3.5GHz/10MB/140W/DDR4-2400	Open	1x 8GB RDIMM DDR4- 2400 ECC	Integrated Intel SATA	1x256GB SSD 2.5" SATA6Gbps Opal	None	9.5mm DVD±RW	29-in-1	450W 92%	1xSerial	USB / USB Optical	Windows 10 DG Windows 7 Pro 64	3-year, Onsite	09/16
30B3003Fxx	Russia/EET/CIS	Xeon E5-1603 v4 4C/2.8GHz/10MB/140W/DDR4-2133	Open	1x 8GB RDIMM DDR4- 2400 ECC	Integrated Intel SATA	1x1TB HDD 7.2K 3.5" SATA6Gbps	None	9.5mm DVD±RW	29-in-1	450W 92%	1xSerial	USB / USB Optical	Windows 10 DG Windows 7 Pro 64	3-year, Onsite	09/16
30B30042xx	Russia/EET/CIS	Xeon E5-1620 v4 4C/3.5GHz/10MB/140W/DDR4-2400	Open	1x 8GB RDIMM DDR4- 2400 ECC	Integrated Intel SATA	1x256GB SSD 2.5" SATA6Gbps Opal	None	HH DVD±RW	9-in-1	450W 92%	2xUSB3.0, 1xSerial	USB / USB Optical	Windows 10 DG Windows 7 Pro 64	3-year, Onsite	05/17
30B30043xx	Russia/EET/CIS	Xeon E5-1630 v4 4C/3.7GHz/10MB/140W/DDR4-2400	Open	1x 8GB RDIMM DDR4- 2400 ECC	Integrated Intel SATA	1x256GB SSD 2.5" SATA6Gbps Opal	None	HH DVD±RW	9-in-1	450W 92%	2xUSB3.0, 1xSerial	USB / USB Optical	Windows 10 DG Windows 7 Pro 64	3-year, Onsite	09/16
30B30044xx	Russia/EET/CIS	Xeon E5-1650 v4 6C/3.6GHz/15MB/140W/DDR4-2400	Open	2x 8GB RDIMM DDR4- 2400 ECC	Integrated Intel SATA	1x1TB HDD 7.2K 3.5" SATA6Gbps	None	HH DVD±RW	9-in-1	450W 92%	2xUSB3.0, 1xSerial	USB / USB Optical	Windows 10 DG Windows 7 Pro 64	3-year, Onsite	09/16
30B30045xx	Russia/EET/CIS	Xeon E5-1650 v4 6C/3.6GHz/15MB/140W/DDR4-2400	Open	2x 8GB RDIMM DDR4- 2400 ECC	Integrated Intel SATA	1x256GB SSD 2.5" SATA6Gbps Opal	None	HH DVD±RW	9-in-1	450W 92%	2xUSB3.0, 1xSerial	USB / USB Optical	Windows 10 DG Windows 7 Pro 64	3-year, Onsite	09/16
30B30046xx	Russia/EET/CIS	Xeon E5-1630 v4 4C/3.7GHz/10MB/140W/DDR4-2400	NVIDIA Quadro K1200 4GB	1x 8GB RDIMM DDR4- 2400 ECC	Integrated Intel SATA	1x256GB SSD 2.5" SATA6Gbps Opal	None	HH DVD±RW	9-in-1	450W 92%	2xUSB3.0, 1xSerial	USB / USB Optical	Windows 10 DG Windows 7 Pro 64	3-year, Onsite	09/16
30B30047xx	Russia/EET/CIS	Xeon E5-1603 v4 4C/2.8GHz/10MB/140W/DDR4-2133	Open	2x 8GB RDIMM DDR4- 2400 ECC	Integrated Intel SATA	1x256GB SSD 2.5" SATA6Gbps Opal	None	HH DVD±RW	9-in-1	450W 92%	2xUSB3.0, 1xSerial	USB / USB Optical	Windows 10 DG Windows 7 Pro 64	3-year, Onsite	09/16

Model	Region	Processor	Graphics	Memory	Storage Controller	Disks	M.2 Drives	Optical	Media Reader	Power Supply	Optional Ports	Keyboard / Mouse	Operating System	Warranty	Ann Date (mm/yy)
30B30048xx	Russia/EET/CIS	Xeon E5-1620 v4 4C/3.5GHz/10MB/140W/DDR4-2400	Open	2x 8GB RDIMM DDR4-2400 ECC	Integrated Intel SATA	1x256GB SSD 2.5" SATA6Gbps Opal, 1x1TB HDD 7.2K 3.5" SATA6Gbps	None	HH DVD±RW	9-in-1	450W 92%	2xUSB3.0, 1xSerial	USB / USB Optical	Windows 10 DG Windows 7 Pro 64	3-year, Onsite	09/16
30B30049xx	Russia/EET/CIS	Xeon E5-1620 v4 4C/3.5GHz/10MB/140W/DDR4-2400	NVIDIA Quadro M2000 4GB	2x 8GB RDIMM DDR4-2400 ECC	Integrated Intel SATA	1x256GB SSD 2.5" SATA6Gbps Opal, 1x1TB HDD 7.2K 3.5" SATA6Gbps	None	HH DVD±RW	9-in-1	450W 92%	2xUSB3.0, 1xSerial	USB / USB Optical	Windows 10 DG Windows 7 Pro 64	3-year, Onsite	09/16
30B3004Axx	Russia/EET/CIS	Xeon E5-1630 v4 4C/3.7GHz/10MB/140W/DDR4-2400	NVIDIA Quadro M4000 8GB	4x 8GB RDIMM DDR4-2400 ECC	Integrated Intel SATA	1x256GB SSD 2.5" SATA6Gbps Opal, 1x1TB HDD 7.2K 3.5" SATA6Gbps	None	HH DVD±RW	9-in-1	450W 92%	2xUSB3.0, 1xSerial	USB / USB Optical	Windows 10 DG Windows 7 Pro 64	3-year, Onsite	09/16
30B3004Bxx	Russia/EET/CIS	Xeon E5-1630 v4 4C/3.7GHz/10MB/140W/DDR4-2400	Open	2x 8GB RDIMM DDR4-2400 ECC	Integrated Intel SATA	None	1x256GB SSD M.2 PCIe Opal	HH DVD±RW	9-in-1	450W 92%	1xSerial	USB / USB Optical	Windows 10 DG Windows 7 Pro 64	3-year, Onsite	09/16
30B3004Cxx	Russia/EET/CIS	Xeon E5-1630 v4 4C/3.7GHz/10MB/140W/DDR4-2400	NVIDIA Quadro M2000 4GB	2x 8GB RDIMM DDR4-2400 ECC	Integrated Intel SATA	None	1x256GB SSD M.2 PCIe Opal	HH DVD±RW	9-in-1	450W 92%	1xSerial	USB / USB Optical	Windows 10 DG Windows 7 Pro 64	3-year, Onsite	09/16
30B3004Dxx	Russia/EET/CIS	Xeon E5-1630 v4 4C/3.7GHz/10MB/140W/DDR4-2400	NVIDIA Quadro M4000 8GB	2x 8GB RDIMM DDR4-2400 ECC	Integrated Intel SATA	None	1x256GB SSD M.2 PCIe Opal	HH DVD±RW	9-in-1	450W 92%	1xSerial	USB / USB Optical	Windows 10 DG Windows 7 Pro 64	3-year, Onsite	09/16
30B3004Exx	Russia/EET/CIS	Xeon E5-1650 v4 6C/3.6GHz/15MB/140W/DDR4-2400	Open	2x 8GB RDIMM DDR4-2400 ECC	Integrated Intel SATA	None	1x512GB SSD M.2 PCIe	HH DVD±RW	9-in-1	450W 92%	1xSerial	USB / USB Optical	Windows 10 DG Windows 7 Pro 64	3-year, Onsite	09/16
30B3003Jxx	Russia/EET/CIS	Xeon E5-1650 v4 6C/3.6GHz/15MB/140W/DDR4-2400	Open	2x 8GB RDIMM DDR4-2400 ECC	Integrated Intel SATA	None	1x256GB SSD M.2 PCIe Opal	9.5mm DVD±RW	29-in-1	450W 92%	1xSerial	USB / USB Optical	Windows 10 DG Windows 7 Pro 64	3-year, Onsite	09/16
30B3003Exx	Russia/EET/CIS	Xeon E5-1650 v4 6C/3.6GHz/15MB/140W/DDR4-2400	Open	2x 8GB RDIMM DDR4-2400 ECC	Integrated Intel SATA	None	1x512GB SSD M.2 PCIe	HH DVD±RW	9-in-1	450W 92%	1xSerial	USB / USB Optical	Windows 10 DG Windows 7 Pro 64	3-year, Onsite	09/16
30B3003Dxx	Russia/EET/CIS	Xeon E5-1630 v4 4C/3.7GHz/10MB/140W/DDR4-2400	NVIDIA Quadro M4000 8GB	2x 8GB RDIMM DDR4-2400 ECC	Integrated Intel SATA	None	1x256GB SSD M.2 PCIe Opal	HH DVD±RW	9-in-1	450W 92%	1xSerial	USB / USB Optical	Windows 10 DG Windows 7 Pro 64	3-year, Onsite	09/16
30B3003Cxx	Russia/EET/CIS	Xeon E5-1630 v4 4C/3.7GHz/10MB/140W/DDR4-2400	NVIDIA Quadro M2000 4GB	2x 8GB RDIMM DDR4-2400 ECC	Integrated Intel SATA	None	1x256GB SSD M.2 PCIe Opal	HH DVD±RW	9-in-1	450W 92%	1xSerial	USB / USB Optical	Windows 10 DG Windows 7 Pro 64	3-year, Onsite	09/16
30B3003Bxx	Russia/EET/CIS	Xeon E5-1630 v4 4C/3.7GHz/10MB/140W/DDR4-2400	Open	2x 8GB RDIMM DDR4-2400 ECC	Integrated Intel SATA	None	1x256GB SSD M.2 PCIe Opal	HH DVD±RW	9-in-1	450W 92%	1xSerial	USB / USB Optical	Windows 10 DG Windows 7 Pro 64	3-year, Onsite	09/16

Model	Region	Processor	Graphics	Memory	Storage Controller	Disks	M.2 Drives	Optical	Media Reader	Power Supply	Optional Ports	Keyboard / Mouse	Operating System	Warranty	Ann Date (mm/yy)
30B3003Axx	Russia/EET/CIS	Xeon E5-1630 v4 4C/3.7GHz/10MB/140W/DDR4-2400	NVIDIA Quadro M4000 8GB	4x 8GB RDIMM DDR4-2400 ECC	Integrated Intel SATA	1x256GB SSD 2.5" SATA6Gbps Opal, 1x1TB HDD 7.2K 3.5" SATA6Gbps	None	HH DVD±RW	9-in-1	450W 92%	2xUSB3.0, 1xSerial	USB / USB Optical	Windows 10 DG Windows 7 Pro 64	3-year, Onsite	09/16
30B30039xx	Russia/EET/CIS	Xeon E5-1620 v4 4C/3.5GHz/10MB/140W/DDR4-2400	NVIDIA Quadro M2000 4GB	2x 8GB RDIMM DDR4-2400 ECC	Integrated Intel SATA	1x256GB SSD 2.5" SATA6Gbps Opal, 1x1TB HDD 7.2K 3.5" SATA6Gbps	None	HH DVD±RW	9-in-1	450W 92%	2xUSB3.0, 1xSerial	USB / USB Optical	Windows 10 DG Windows 7 Pro 64	3-year, Onsite	09/16
30B30038xx	Russia/EET/CIS	Xeon E5-1620 v4 4C/3.5GHz/10MB/140W/DDR4-2400	Open	2x 8GB RDIMM DDR4-2400 ECC	Integrated Intel SATA	1x256GB SSD 2.5" SATA6Gbps Opal, 1x1TB HDD 7.2K 3.5" SATA6Gbps	None	HH DVD±RW	9-in-1	450W 92%	2xUSB3.0, 1xSerial	USB / USB Optical	Windows 10 DG Windows 7 Pro 64	3-year, Onsite	09/16
30B30037xx	Russia/EET/CIS	Xeon E5-1603 v4 4C/2.8GHz/10MB/140W/DDR4-2133	Open	2x 8GB RDIMM DDR4-2400 ECC	Integrated Intel SATA	1x256GB SSD 2.5" SATA6Gbps Opal	None	HH DVD±RW	9-in-1	450W 92%	2xUSB3.0, 1xSerial	USB / USB Optical	Windows 10 DG Windows 7 Pro 64	3-year, Onsite	09/16
30B30036xx	Russia/EET/CIS	Xeon E5-1630 v4 4C/3.7GHz/10MB/140W/DDR4-2400	NVIDIA Quadro K1200 4GB	1x 8GB RDIMM DDR4-2400 ECC	Integrated Intel SATA	1x256GB SSD 2.5" SATA6Gbps Opal	None	HH DVD±RW	9-in-1	450W 92%	2xUSB3.0, 1xSerial	USB / USB Optical	Windows 10 DG Windows 7 Pro 64	3-year, Onsite	09/16
30B30035xx	Russia/EET/CIS	Xeon E5-1650 v4 6C/3.6GHz/15MB/140W/DDR4-2400	Open	2x 8GB RDIMM DDR4-2400 ECC	Integrated Intel SATA	1x256GB SSD 2.5" SATA6Gbps Opal	None	HH DVD±RW	9-in-1	450W 92%	2xUSB3.0, 1xSerial	USB / USB Optical	Windows 10 DG Windows 7 Pro 64	3-year, Onsite	09/16
30B30034xx	Russia/EET/CIS	Xeon E5-1650 v4 6C/3.6GHz/15MB/140W/DDR4-2400	Open	2x 8GB RDIMM DDR4-2400 ECC	Integrated Intel SATA	1x1TB HDD 7.2K 3.5" SATA6Gbps	None	HH DVD±RW	9-in-1	450W 92%	2xUSB3.0, 1xSerial	USB / USB Optical	Windows 10 DG Windows 7 Pro 64	3-year, Onsite	09/16
30B30033xx	Russia/EET/CIS	Xeon E5-1630 v4 4C/3.7GHz/10MB/140W/DDR4-2400	Open	1x 8GB RDIMM DDR4-2400 ECC	Integrated Intel SATA	1x256GB SSD 2.5" SATA6Gbps Opal	None	HH DVD±RW	9-in-1	450W 92%	2xUSB3.0, 1xSerial	USB / USB Optical	Windows 10 DG Windows 7 Pro 64	3-year, Onsite	09/16
30B30032xx	Russia/EET/CIS	Xeon E5-1620 v4 4C/3.5GHz/10MB/140W/DDR4-2400	Open	1x 8GB RDIMM DDR4-2400 ECC	Integrated Intel SATA	1x256GB SSD 2.5" SATA6Gbps Opal	None	HH DVD±RW	9-in-1	450W 92%	2xUSB3.0, 1xSerial	USB / USB Optical	Windows 10 DG Windows 7 Pro 64	3-year, Onsite	09/16
30B3002Yxx	Russia/EET/CIS	Xeon E5-1620 v4 4C/3.5GHz/10MB/140W/DDR4-2400	Open	2x 8GB RDIMM DDR4-2400 ECC	Integrated Intel SATA	1x256GB SSD 2.5" SATA6Gbps Opal, 1x1TB HDD 7.2K 3.5" SATA6Gbps	None	HH DVD±RW	9-in-1	450W 92%	None	USB / USB Optical	Windows 10 Pro 64	3-year, Onsite	07/16
30B3002Xxx	Russia/EET/CIS	Xeon E5-1620 v4 4C/3.5GHz/10MB/140W/DDR4-2400	NVIDIA Quadro M2000 4GB	2x 8GB RDIMM DDR4-2400 ECC	Integrated Intel SATA	1x256GB SSD 2.5" SATA6Gbps Opal, 1x1TB HDD 7.2K 3.5" SATA6Gbps	None	HH DVD±RW	9-in-1	450W 92%	None	USB / USB Optical	Windows 10 Pro 64	3-year, Onsite	07/16
30B3002Wxx	Russia/EET/CIS	Xeon E5-1630 v4 4C/3.7GHz/10MB/140W/DDR4-2400	NVIDIA Quadro M4000 8GB	4x 8GB RDIMM DDR4-2400 ECC	Integrated Intel SATA	1x256GB SSD 2.5" SATA6Gbps Opal, 1x1TB HDD 7.2K 3.5" SATA6Gbps	None	HH DVD±RW	9-in-1	450W 92%	None	USB / USB Optical	Windows 10 Pro 64	3-year, Onsite	07/16

Model	Region	Processor	Graphics	Memory	Storage Controller	Disks	M.2 Drives	Optical	Media Reader	Power Supply	Optional Ports	Keyboard / Mouse	Operating System	Warranty	Ann Date (mm/yy)
30B3002Vxx	Russia/EET/CIS	Xeon E5-1650 v4 6C/3.6GHz/15MB/140W/DDR4-2400	Open	2x 8GB RDIMM DDR4-2400 ECC	Integrated Intel SATA	None	1x256GB SSD M.2 PCIe Opal	None	29-in-1	450W 92%	Front eSATA	USB / USB Optical	Windows 10 Pro 64	3-year, Onsite	07/16
30B3002Uxx	Russia/EET/CIS	Xeon E5-1603 v4 4C/2.8GHz/10MB/140W/DDR4-2133	Open	2x 8GB RDIMM DDR4-2400 ECC	Integrated Intel SATA	1x256GB SSD 2.5" SATA6Gbps Opal	None	HH DVD±RW	9-in-1	450W 92%	None	USB / USB Optical	Windows 10 Pro 64	3-year, Onsite	07/16
30B3002Txx	Russia/EET/CIS	Xeon E5-1630 v4 4C/3.7GHz/10MB/140W/DDR4-2400	Open	2x 8GB RDIMM DDR4-2400 ECC	Integrated Intel SATA	1x256GB SSD 2.5" SATA6Gbps Opal	None	None	29-in-1	450W 92%	Front eSATA	USB / USB Optical	Windows 10 Pro 64	3-year, Onsite	07/16
30B3002Sxx	Russia/EET/CIS	Xeon E5-1620 v4 4C/3.5GHz/10MB/140W/DDR4-2400	Open	1x 8GB RDIMM DDR4-2400 ECC	Integrated Intel SATA	1x256GB SSD 2.5" SATA6Gbps Opal	None	None	29-in-1	450W 92%	Front eSATA	USB / USB Optical	Windows 10 Pro 64	3-year, Onsite	07/16
30B3002Rxx	Russia/EET/CIS	Xeon E5-1603 v4 4C/2.8GHz/10MB/140W/DDR4-2133	Open	1x 8GB RDIMM DDR4-2400 ECC	Integrated Intel SATA	1x1TB HDD 7.2K 3.5" SATA6Gbps	None	None	29-in-1	450W 92%	Front eSATA	USB / USB Optical	Windows 10 Pro 64	3-year, Onsite	07/16
30B3001Lxx	Russia/EET/CIS	Xeon E5-1630 v4 4C/3.7GHz/10MB/140W/DDR4-2400	NVIDIA Quadro M4000 8GB	2x 8GB RDIMM DDR4-2400 ECC	Integrated Intel SATA	None	1x256GB SSD M.2 PCIe Opal	HH DVD±RW	9-in-1	450W 92%	None	USB / USB Optical	Windows 10 Pro 64	3-year, Onsite	06/16
30B3001Mxx	Russia/EET/CIS	Xeon E5-1650 v4 6C/3.6GHz/15MB/140W/DDR4-2400	Open	2x 8GB RDIMM DDR4-2400 ECC	Integrated Intel SATA	None	1x512GB SSD M.2 PCIe	HH DVD±RW	9-in-1	450W 92%	None	USB / USB Optical	Windows 10 Pro 64	3-year, Onsite	06/16
30B3001Kxx	Russia/EET/CIS	Xeon E5-1630 v4 4C/3.7GHz/10MB/140W/DDR4-2400	NVIDIA Quadro M2000 4GB	2x 8GB RDIMM DDR4-2400 ECC	Integrated Intel SATA	None	1x256GB SSD M.2 PCIe Opal	HH DVD±RW	9-in-1	450W 92%	None	USB / USB Optical	Windows 10 Pro 64	3-year, Onsite	06/16
30B3001Jxx	Russia/EET/CIS	Xeon E5-1630 v4 4C/3.7GHz/10MB/140W/DDR4-2400	Open	2x 8GB RDIMM DDR4-2400 ECC	Integrated Intel SATA	None	1x256GB SSD M.2 PCIe Opal	HH DVD±RW	9-in-1	450W 92%	None	USB / USB Optical	Windows 10 Pro 64	3-year, Onsite	06/16
30B3001Hxx	Russia/EET/CIS	Xeon E5-1630 v4 4C/3.7GHz/10MB/140W/DDR4-2400	NVIDIA Quadro M2000 4GB	1x 8GB RDIMM DDR4-2400 ECC	Integrated Intel SATA	1x256GB SSD 2.5" SATA6Gbps Opal	None	HH DVD±RW	9-in-1	450W 92%	None	USB / USB Optical	Windows 10 Pro 64	3-year, Onsite	06/16
30B3001Gxx	Russia/EET/CIS	Xeon E5-1650 v4 6C/3.6GHz/15MB/140W/DDR4-2400	NVIDIA Quadro M4000 8GB	2x 8GB RDIMM DDR4-2400 ECC	Integrated Intel SATA	1x512GB SSD 2.5" SATA6Gbps	None	HH DVD±RW	9-in-1	450W 92%	None	USB / USB Optical	Windows 10 Pro 64	3-year, Onsite	06/16
30B3001Fxx	Russia/EET/CIS	Xeon E5-1630 v4 4C/3.7GHz/10MB/140W/DDR4-2400	NVIDIA Quadro K1200 4GB	1x 8GB RDIMM DDR4-2400 ECC	Integrated Intel SATA	1x256GB SSD 2.5" SATA6Gbps Opal	None	HH DVD±RW	9-in-1	450W 92%	None	USB / USB Optical	Windows 10 Pro 64	3-year, Onsite	06/16

Model	Region	Processor	Graphics	Memory	Storage Controller	Disks	M.2 Drives	Optical	Media Reader	Power Supply	Optional Ports	Keyboard / Mouse	Operating System	Warranty	Ann Date (mm/yy)
30B3001Exx	Russia/EET/CIS	Xeon E5-1650 v4 6C/3.6GHz/15MB/140W/DDR4-2400	Open	2x 8GB RDIMM DDR4- 2400 ECC	Integrated Intel SATA	1x256GB SSD 2.5" SATA6Gbps Opal	None	HH DVD±RW	9-in-1	450W 92%	None	USB / USB Optical	Windows 10 Pro 64	3-year, Onsite	06/16
30B3001Dxx	Russia/EET/CIS	Xeon E5-1650 v4 6C/3.6GHz/15MB/140W/DDR4-2400	Open	2x 8GB RDIMM DDR4- 2400 ECC	Integrated Intel SATA	1x1TB HDD 7.2K 3.5" SATA6Gbps	None	HH DVD±RW	9-in-1	450W 92%	None	USB / USB Optical	Windows 10 Pro 64	3-year, Onsite	06/16
30B3001Cxx	Russia/EET/CIS	Xeon E5-1630 v4 4C/3.7GHz/10MB/140W/DDR4-2400	Open	1x 8GB RDIMM DDR4- 2400 ECC	Integrated Intel SATA	1x256GB SSD 2.5" SATA6Gbps Opal	None	HH DVD±RW	9-in-1	450W 92%	None	USB / USB Optical	Windows 10 Pro 64	3-year, Onsite	06/16
30B3001Bxx	Russia/EET/CIS	Xeon E5-1620 v4 4C/3.5GHz/10MB/140W/DDR4-2400	Open	1x 8GB RDIMM DDR4- 2400 ECC	Integrated Intel SATA	1x256GB SSD 2.5" SATA6Gbps Opal	None	HH DVD±RW	9-in-1	450W 92%	None	USB / USB Optical	Windows 10 Pro 64	3-year, Onsite	06/16
30B3000Fxx	Russia/EET/CIS	Xeon E5-2620 v4 8C/2.1GHz/20MB/85W/DDR4-2133	NVIDIA Quadro M2000 4GB	1x 8GB RDIMM DDR4- 2400 ECC	Integrated Intel SATA	1x256GB SSD 2.5" SATA6Gbps Opal	None	HH DVD±RW	9-in-1	450W 92%	None	USB / USB Optical	Windows 10 Pro 64	3-year, Onsite	05/16
30B3001PUS	US	Xeon E5-1620 v4 4C/3.5GHz/10MB/140W/DDR4-2400	NVIDIA Quadro K620 2GB	1x 8GB RDIMM DDR4- 2400 ECC	Integrated Intel SATA	None	1x256GB SSD M.2 PCIe Opal	HH DVD±RW	9-in-1	450W 92%	None	USB / USB Optical	Windows 10 Pro 64	3-year, Onsite	06/16
30B3001QUS	US	Xeon E5-1607 v4 4C/3.1GHz/10MB/140W/DDR4-2133	Open	1x 8GB RDIMM DDR4- 2400 ECC	Integrated Intel SATA	1x1TB HDD 7.2K 3.5" SATA6Gbps	None	HH DVD±RW	9-in-1	450W 92%	None	USB / USB Optical	Windows 10 Pro 64	3-year, Onsite	06/16
30B3001RUS	US	Xeon E5-1630 v4 4C/3.7GHz/10MB/140W/DDR4-2400	NVIDIA Quadro K1200 4GB	1x 8GB RDIMM DDR4- 2400 ECC	Integrated Intel SATA	None	1x256GB SSD M.2 PCIe Opal	HH DVD±RW	9-in-1	450W 92%	None	USB / USB Optical	Windows 10 Pro 64	3-year, Onsite	06/16
30B3001SUS	US	Xeon E5-1630 v4 4C/3.7GHz/10MB/140W/DDR4-2400	NVIDIA Quadro M2000 4GB	2x 8GB RDIMM DDR4- 2400 ECC	Integrated Intel SATA	1x256GB SSD 2.5" SATA6Gbps Opal	None	HH DVD±RW	9-in-1	450W 92%	None	USB / USB Optical	Windows 10 Pro 64	3-year, Onsite	06/16
30B3001TUS	US	Xeon E5-1620 v4 4C/3.5GHz/10MB/140W/DDR4-2400	NVIDIA Quadro K620 2GB	2x 8GB RDIMM DDR4- 2400 ECC	Integrated Intel SATA	1x1TB SSD 2.5" SATA6Gbps	None	HH DVD±RW	9-in-1	450W 92%	None	USB / USB Optical	Windows 10 Pro 64	3-year, Onsite	06/16
30B3001UUS	US	Xeon E5-1620 v4 4C/3.5GHz/10MB/140W/DDR4-2400	Open	1x 8GB RDIMM DDR4- 2400 ECC	Integrated Intel SATA	1x1TB HDD 7.2K 3.5" SATA6Gbps	None	HH DVD±RW	9-in-1	450W 92%	None	USB / USB Optical	Windows 10 Pro 64	3-year, Onsite	06/16
30B3001VUS	US	Xeon E5-1650 v4 6C/3.6GHz/15MB/140W/DDR4-2400	NVIDIA Quadro M2000 4GB	2x 8GB RDIMM DDR4- 2400 ECC	Integrated Intel SATA	1x256GB SSD 2.5" SATA6Gbps Opal	None	HH DVD±RW	9-in-1	450W 92%	None	USB / USB Optical	Windows 10 Pro 64	3-year, Onsite	06/16

Model	Region	Processor	Graphics	Memory	Storage Controller	Disks	M.2 Drives	Optical	Media Reader	Power Supply	Optional Ports	Keyboard / Mouse	Operating System	Warranty	Ann Date (mm/yy)
30B3001WUS	US	Xeon E5-1620 v4 4C/3.5GHz/10MB/140W/DDR4-2400	NVIDIA Quadro K620 2GB	1x 8GB RDIMM DDR4-2400 ECC	Integrated Intel SATA	1x1TB HDD 7.2K 3.5" SATA6Gbps	None	HH DVD±RW	9-in-1	450W 92%	None	USB / USB Optical	Windows 10 Pro 64	3-year, Onsite	06/16
30B3001XUS	US	Xeon E5-1630 v4 4C/3.7GHz/10MB/140W/DDR4-2400	NVIDIA Quadro K620 2GB	2x 8GB RDIMM DDR4-2400 ECC	Integrated Intel SATA	1x256GB SSD 2.5" SATA6Gbps Opal	None	HH DVD±RW	9-in-1	450W 92%	None	USB / USB Optical	Windows 10 Pro 64	3-year, Onsite	06/16
30B3001YUS	US	Xeon E5-1650 v4 6C/3.6GHz/15MB/140W/DDR4-2400	NVIDIA Quadro M4000 8GB	2x 8GB RDIMM DDR4-2400 ECC	Integrated Intel SATA	1x1TB SSD 2.5" SATA6Gbps	None	HH DVD±RW	9-in-1	450W 92%	None	USB / USB Optical	Windows 10 Pro 64	3-year, Onsite	06/16
30B30020US	US	Xeon E5-1650 v4 6C/3.6GHz/15MB/140W/DDR4-2400	Open	2x 8GB RDIMM DDR4-2400 ECC	Integrated Intel SATA	1x1TB HDD 7.2K 3.5" SATA6Gbps	None	HH DVD±RW	9-in-1	450W 92%	None	USB / USB Optical	Windows 10 Pro 64	3-year, Onsite	06/16
30B30021US	US	Xeon E5-1620 v4 4C/3.5GHz/10MB/140W/DDR4-2400	NVIDIA Quadro K1200 4GB	1x 8GB RDIMM DDR4-2400 ECC	Integrated Intel SATA	None	1x256GB SSD M.2 PCIe Opal	HH DVD±RW	9-in-1	450W 92%	None	USB / USB Optical	Windows 10 Pro 64	3-year, Onsite	06/16
30B30022US	US	Xeon E5-1650 v4 6C/3.6GHz/15MB/140W/DDR4-2400	NVIDIA Quadro K1200 4GB	2x 8GB RDIMM DDR4-2400 ECC	Integrated Intel SATA	None	1x512GB SSD M.2 PCIe	HH DVD±RW	9-in-1	450W 92%	None	USB / CadMouse	Windows 10 Pro 64	3-year, Onsite	06/16
30B3002AUS	US	Xeon E5-1607 v4 4C/3.1GHz/10MB/140W/DDR4-2133	Open	1x 8GB RDIMM DDR4-2400 ECC	Integrated Intel SATA	1x1TB HDD 7.2K 3.5" SATA6Gbps	None	HH DVD±RW	9-in-1	450W 92%	None	USB / USB Optical	Windows 10 DG Windows 7 Pro 64	3-year, Onsite	09/16
30B3002HUS	US	Xeon E5-1620 v4 4C/3.5GHz/10MB/140W/DDR4-2400	Open	1x 8GB RDIMM DDR4-2400 ECC	Integrated Intel SATA	1x1TB HDD 7.2K 3.5" SATA6Gbps	None	HH DVD±RW	9-in-1	450W 92%	None	USB / USB Optical	Windows 10 DG Windows 7 Pro 64	3-year, Onsite	09/16
30B3003KUS	US	Xeon E5-1620 v4 4C/3.5GHz/10MB/140W/DDR4-2400	NVIDIA Quadro K620 2GB	1x 8GB RDIMM DDR4-2400 ECC	Integrated Intel SATA	None	1x256GB SSD M.2 PCIe Opal	HH DVD±RW	9-in-1	450W 92%	None	USB / USB Optical	Windows 10 DG Windows 7 Pro 64	3-year, Onsite	09/16
30B3003LUS	US	Xeon E5-1620 v4 4C/3.5GHz/10MB/140W/DDR4-2400	NVIDIA Quadro K620 2GB	2x 8GB RDIMM DDR4-2400 ECC	Integrated Intel SATA	1x1TB SSD 2.5" SATA6Gbps	None	HH DVD±RW	9-in-1	450W 92%	None	USB / USB Optical	Windows 10 DG Windows 7 Pro 64	3-year, Onsite	09/16
30B3003MUS	US	Xeon E5-1630 v4 4C/3.7GHz/10MB/140W/DDR4-2400	NVIDIA Quadro K620 2GB	2x 8GB RDIMM DDR4-2400 ECC	Integrated Intel SATA	1x256GB SSD 2.5" SATA6Gbps Opal	None	HH DVD±RW	9-in-1	450W 92%	None	USB / USB Optical	Windows 10 DG Windows 7 Pro 64	3-year, Onsite	09/16
30B3003NUS	US	Xeon E5-1650 v4 6C/3.6GHz/15MB/140W/DDR4-2400	NVIDIA Quadro M4000 8GB	2x 8GB RDIMM DDR4-2400 ECC	Integrated Intel SATA	1x1TB SSD 2.5" SATA6Gbps	None	HH DVD±RW	9-in-1	450W 92%	None	USB / USB Optical	Windows 10 DG Windows 7 Pro 64	3-year, Onsite	09/16

Model	Region	Processor	Graphics	Memory	Storage Controller	Disks	M.2 Drives	Optical	Media Reader	Power Supply	Optional Ports	Keyboard / Mouse	Operating System	Warranty	Ann Date (mm/yy)
30B3003PUS	US	Xeon E5-1620 v4 4C/3.5GHz/10MB/140W/DDR4-2400	NVIDIA Quadro K620 2GB	1x 8GB RDIMM DDR4-2400 ECC	Integrated Intel SATA	1x1TB HDD 7.2K 3.5" SATA6Gbps	None	HH DVD±RW	9-in-1	450W 92%	None	USB / USB Optical	Windows 10 DG Windows 7 Pro 64	3-year, Onsite	09/16
30B3003QUS	US	Xeon E5-1650 v4 6C/3.6GHz/15MB/140W/DDR4-2400	NVIDIA Quadro K1200 4GB	2x 8GB RDIMM DDR4-2400 ECC	Integrated Intel SATA	None	1x512GB SSD M.2 PCIe	HH DVD±RW	9-in-1	450W 92%	None	USB / CadMouse	Windows 10 DG Windows 7 Pro 64	3-year, Onsite	09/16
30B3003RUS	US	Xeon E5-1650 v4 6C/3.6GHz/15MB/140W/DDR4-2400	Open	2x 8GB RDIMM DDR4-2400 ECC	Integrated Intel SATA	1x1TB HDD 7.2K 3.5" SATA6Gbps	None	HH DVD±RW	9-in-1	450W 92%	None	USB / USB Optical	Windows 10 DG Windows 7 Pro 64	3-year, Onsite	09/16
30B3003SUS	US	Xeon E5-1630 v4 4C/3.7GHz/10MB/140W/DDR4-2400	NVIDIA Quadro M2000 4GB	2x 8GB RDIMM DDR4-2400 ECC	Integrated Intel SATA	1x256GB SSD 2.5" SATA6Gbps Opal	None	HH DVD±RW	9-in-1	450W 92%	None	USB / USB Optical	Windows 10 DG Windows 7 Pro 64	3-year, Onsite	09/16
30B3003TUS	US	Xeon E5-1620 v4 4C/3.5GHz/10MB/140W/DDR4-2400	NVIDIA Quadro K1200 4GB	1x 8GB RDIMM DDR4-2400 ECC	Integrated Intel SATA	None	1x256GB SSD M.2 PCIe Opal	HH DVD±RW	9-in-1	450W 92%	None	USB / USB Optical	Windows 10 DG Windows 7 Pro 64	3-year, Onsite	09/16
30B3003UUS	US	Xeon E5-1650 v4 6C/3.6GHz/15MB/140W/DDR4-2400	NVIDIA Quadro M2000 4GB	2x 8GB RDIMM DDR4-2400 ECC	Integrated Intel SATA	1x256GB SSD 2.5" SATA6Gbps Opal	None	HH DVD±RW	9-in-1	450W 92%	None	USB / USB Optical	Windows 10 DG Windows 7 Pro 64	3-year, Onsite	09/16
30B3003VUS	US	Xeon E5-1630 v4 4C/3.7GHz/10MB/140W/DDR4-2400	NVIDIA Quadro K1200 4GB	1x 8GB RDIMM DDR4-2400 ECC	Integrated Intel SATA	None	1x256GB SSD M.2 PCIe Opal	HH DVD±RW	9-in-1	450W 92%	None	USB / USB Optical	Windows 10 DG Windows 7 Pro 64	3-year, Onsite	09/16
30B3004JUS	US	Xeon E5-1630 v4 4C/3.7GHz/10MB/140W/DDR4-2400	NVIDIA Quadro M2000 4GB	2x 16GB RDIMM DDR4-2400 ECC	Integrated Intel SATA	1x512GB SSD 2.5" SATA6Gbps	1x256GB SSD M.2 PCIe Opal	None	None	450W 92%	None	USB / USB Optical	Windows 10 DG Windows 7 Pro 64	3-year, Onsite	09/16
30B3004MUS	US	Xeon E5-1620 v4 4C/3.5GHz/10MB/140W/DDR4-2400	NVIDIA Quadro K1200 4GB	2x 8GB RDIMM DDR4-2400 ECC	Integrated Intel SATA	None	1x1TB SSD M.2 PCIe NVMe Opal	HH DVD±RW	9-in-1	450W 92%	None	USB / USB Optical	Windows 10 DG Windows 7 Pro 64	3-year, Onsite	12/16
30B3004NUS	US	Xeon E5-1620 v4 4C/3.5GHz/10MB/140W/DDR4-2400	Open	2x 8GB RDIMM DDR4-2400 ECC	Integrated Intel SATA	None	1x1TB SSD M.2 PCIe NVMe Opal	HH DVD±RW	9-in-1	450W 92%	None	USB / USB Optical	Windows 10 DG Windows 7 Pro 64	3-year, Onsite	12/16
30B3004PUS	US	Xeon E5-1620 v4 4C/3.5GHz/10MB/140W/DDR4-2400	Open	2x 8GB RDIMM DDR4-2400 ECC	Integrated Intel SATA	1x1TB HDD 7.2K 3.5" SATA6Gbps	None	HH DVD±RW	9-in-1	450W 92%	None	USB / USB Optical	Windows 10 DG Windows 7 Pro 64	3-year, Onsite	12/16
30B3004QUS	US	Xeon E5-1630 v4 4C/3.7GHz/10MB/140W/DDR4-2400	NVIDIA Quadro P5000 16GB	2x 8GB RDIMM DDR4-2400 ECC	Integrated Intel SATA	None	1x1TB SSD M.2 PCIe NVMe Opal	HH DVD±RW	9-in-1	450W 92%	None	USB / USB Optical	Windows 10 DG Windows 7 Pro 64	3-year, Onsite	12/16

Model	Region	Processor	Graphics	Memory	Storage Controller	Disks	M.2 Drives	Optical	Media Reader	Power Supply	Optional Ports	Keyboard / Mouse	Operating System	Warranty	Ann Date (mm/yy)
30B3004RUS	US	Xeon E5-1620 v4 4C/3.5GHz/10MB/140W/DDR4-2400	Open	2x 8GB RDIMM DDR4-2400 ECC	Integrated Intel SATA	1x1TB HDD 7.2K 3.5" SATA6Gbps	None	None	9-in-1	450W 92%	None	USB / USB Optical	Windows 10 DG Windows 7 Pro 64	3-year, Onsite	12/16
30B3004SUS	US	Xeon E5-1630 v4 4C/3.7GHz/10MB/140W/DDR4-2400	Open	2x 8GB RDIMM DDR4-2400 ECC	Integrated Intel SATA	None	1x1TB SSD M.2 PCIe NVMe Opal	HH DVD±RW	9-in-1	450W 92%	None	USB / USB Optical	Windows 10 DG Windows 7 Pro 64	3-year, Onsite	12/16
30B3004TUS	US	Xeon E5-1650 v4 6C/3.6GHz/15MB/140W/DDR4-2400	Open	2x 8GB RDIMM DDR4-2400 ECC	Integrated Intel SATA	None	1x1TB SSD M.2 PCIe NVMe Opal	HH DVD±RW	9-in-1	450W 92%	None	USB / USB Optical	Windows 10 DG Windows 7 Pro 64	3-year, Onsite	12/16
30B3004UUS	US	Xeon E5-1620 v4 4C/3.5GHz/10MB/140W/DDR4-2400	Open	2x 8GB RDIMM DDR4-2400 ECC	9340-8i PCIe	None	1x256GB SSD M.2 PCIe Opal	HH DVD±RW	9-in-1	450W 92%	None	USB / USB Optical	Windows 10 DG Windows 7 Pro 64	3-year, Onsite	12/16
30B3004VUS	US	Xeon E5-1607 v4 4C/3.1GHz/10MB/140W/DDR4-2133	Open	2x 8GB RDIMM DDR4-2400 ECC	Integrated Intel SATA	None	1x1TB SSD M.2 PCIe NVMe Opal	HH DVD±RW	9-in-1	450W 92%	None	USB / USB Optical	Windows 10 DG Windows 7 Pro 64	3-year, Onsite	12/16
30B3005SUS	US	Xeon E5-1630 v4 4C/3.7GHz/10MB/140W/DDR4-2400	NVIDIA Quadro P600 2GB	2x 8GB RDIMM DDR4-2400 ECC	Integrated Intel SATA	1x256GB SSD 2.5" SATA6Gbps Opal	None	HH DVD±RW	9-in-1	450W 92%	None	USB / USB Optical	Windows 10 Pro 64	3-year, Onsite	04/17
30B3005TUS	US	Xeon E5-1630 v4 4C/3.7GHz/10MB/140W/DDR4-2400	NVIDIA Quadro P1000 4GB	1x 8GB RDIMM DDR4-2400 ECC	Integrated Intel SATA	None	1x256GB SSD M.2 PCIe Opal	HH DVD±RW	9-in-1	450W 92%	None	USB / USB Optical	Windows 10 DG Windows 7 Pro 64	3-year, Onsite	04/17
30B3005UUS	US	Xeon E5-1620 v4 4C/3.5GHz/10MB/140W/DDR4-2400	NVIDIA Quadro P600 2GB	2x 8GB RDIMM DDR4-2400 ECC	Integrated Intel SATA	1x1TB SSD 2.5" SATA6Gbps	None	HH DVD±RW	9-in-1	450W 92%	None	USB / USB Optical	Windows 10 Pro 64	3-year, Onsite	04/17
30B3005VUS	US	Xeon E5-1620 v4 4C/3.5GHz/10MB/140W/DDR4-2400	NVIDIA Quadro P600 2GB	1x 8GB RDIMM DDR4-2400 ECC	Integrated Intel SATA	1x1TB HDD 7.2K 3.5" SATA6Gbps	None	HH DVD±RW	9-in-1	450W 92%	None	USB / USB Optical	Windows 10 Pro 64	3-year, Onsite	04/17
30B3005WUS	US	Xeon E5-1630 v4 4C/3.7GHz/10MB/140W/DDR4-2400	NVIDIA Quadro P2000 5GB	2x 8GB RDIMM DDR4-2400 ECC	Integrated Intel SATA	1x256GB SSD 2.5" SATA6Gbps Opal	None	HH DVD±RW	9-in-1	450W 92%	None	USB / USB Optical	Windows 10 DG Windows 7 Pro 64	3-year, Onsite	04/17
30B3005XUS	US	Xeon E5-1630 v4 4C/3.7GHz/10MB/140W/DDR4-2400	NVIDIA Quadro P600 2GB	2x 8GB RDIMM DDR4-2400 ECC	Integrated Intel SATA	1x256GB SSD 2.5" SATA6Gbps Opal	None	HH DVD±RW	9-in-1	450W 92%	None	USB / USB Optical	Windows 10 DG Windows 7 Pro 64	3-year, Onsite	04/17
30B3005YUS	US	Xeon E5-1630 v4 4C/3.7GHz/10MB/140W/DDR4-2400	NVIDIA Quadro P1000 4GB	1x 8GB RDIMM DDR4-2400 ECC	Integrated Intel SATA	None	1x256GB SSD M.2 PCIe Opal	HH DVD±RW	9-in-1	450W 92%	None	USB / USB Optical	Windows 10 Pro 64	3-year, Onsite	04/17

Model	Region	Processor	Graphics	Memory	Storage Controller	Disks	M.2 Drives	Optical	Media Reader	Power Supply	Optional Ports	Keyboard / Mouse	Operating System	Warranty	Ann Date (mm/yy)
30B30060US	US	Xeon E5-1620 v4 4C/3.5GHz/10MB/140W/DDR4-2400	NVIDIA Quadro P600 2GB	1x 8GB RDIMM DDR4-2400 ECC	Integrated Intel SATA	1x1TB HDD 7.2K 3.5" SATA6Gbps	None	HH DVD±RW	9-in-1	450W 92%	None	USB / USB Optical	Windows 10 DG Windows 7 Pro 64	3-year, Onsite	04/17
30B30061US	US	Xeon E5-1650 v4 6C/3.6GHz/15MB/140W/DDR4-2400	NVIDIA Quadro P1000 4GB	2x 8GB RDIMM DDR4-2400 ECC	Integrated Intel SATA	None	1x512GB SSD M.2 PCIe	HH DVD±RW	9-in-1	450W 92%	None	USB / USB Optical	Windows 10 DG Windows 7 Pro 64	3-year, Onsite	04/17
30B30062US	US	Xeon E5-1650 v4 6C/3.6GHz/15MB/140W/DDR4-2400	NVIDIA Quadro P4000 8GB	2x 8GB RDIMM DDR4-2400 ECC	Integrated Intel SATA	1x1TB SSD 2.5" SATA6Gbps	None	HH DVD±RW	9-in-1	450W 92%	None	USB / USB Optical	Windows 10 Pro 64	3-year, Onsite	04/17
30B30063US	US	Xeon E5-1620 v4 4C/3.5GHz/10MB/140W/DDR4-2400	NVIDIA Quadro P1000 4GB	1x 8GB RDIMM DDR4-2400 ECC	Integrated Intel SATA	None	1x256GB SSD M.2 PCIe Opal	HH DVD±RW	9-in-1	450W 92%	None	USB / USB Optical	Windows 10 DG Windows 7 Pro 64	3-year, Onsite	04/17
30B30064US	US	Xeon E5-1620 v4 4C/3.5GHz/10MB/140W/DDR4-2400	NVIDIA Quadro P1000 4GB	1x 8GB RDIMM DDR4-2400 ECC	Integrated Intel SATA	None	1x256GB SSD M.2 PCIe Opal	HH DVD±RW	9-in-1	450W 92%	None	USB / USB Optical	Windows 10 Pro 64	3-year, Onsite	04/17
30B30065US	US	Xeon E5-1650 v4 6C/3.6GHz/15MB/140W/DDR4-2400	NVIDIA Quadro P2000 5GB	2x 8GB RDIMM DDR4-2400 ECC	Integrated Intel SATA	1x256GB SSD 2.5" SATA6Gbps Opal	None	HH DVD±RW	9-in-1	450W 92%	None	USB / USB Optical	Windows 10 DG Windows 7 Pro 64	3-year, Onsite	04/17
30B30066US	US	Xeon E5-1650 v4 6C/3.6GHz/15MB/140W/DDR4-2400	NVIDIA Quadro P2000 5GB	2x 8GB RDIMM DDR4-2400 ECC	Integrated Intel SATA	1x256GB SSD 2.5" SATA6Gbps Opal	None	HH DVD±RW	9-in-1	450W 92%	None	USB / USB Optical	Windows 10 Pro 64	3-year, Onsite	04/17
30B30067US	US	Xeon E5-1650 v4 6C/3.6GHz/15MB/140W/DDR4-2400	NVIDIA Quadro P4000 8GB	2x 8GB RDIMM DDR4-2400 ECC	Integrated Intel SATA	1x1TB SSD 2.5" SATA6Gbps	None	HH DVD±RW	9-in-1	450W 92%	None	USB / USB Optical	Windows 10 DG Windows 7 Pro 64	3-year, Onsite	04/17
30B30068US	US	Xeon E5-1620 v4 4C/3.5GHz/10MB/140W/DDR4-2400	NVIDIA Quadro P600 2GB	1x 8GB RDIMM DDR4-2400 ECC	Integrated Intel SATA	None	1x256GB SSD M.2 PCIe Opal	HH DVD±RW	9-in-1	450W 92%	None	USB / USB Optical	Windows 10 Pro 64	3-year, Onsite	04/17
30B30069US	US	Xeon E5-1630 v4 4C/3.7GHz/10MB/140W/DDR4-2400	NVIDIA Quadro P2000 5GB	2x 8GB RDIMM DDR4-2400 ECC	Integrated Intel SATA	1x256GB SSD 2.5" SATA6Gbps Opal	None	HH DVD±RW	9-in-1	450W 92%	None	USB / USB Optical	Windows 10 Pro 64	3-year, Onsite	04/17
30B3006AUS	US	Xeon E5-1650 v4 6C/3.6GHz/15MB/140W/DDR4-2400	NVIDIA Quadro P1000 4GB	2x 8GB RDIMM DDR4-2400 ECC	Integrated Intel SATA	None	1x512GB SSD M.2 PCIe	HH DVD±RW	9-in-1	450W 92%	None	USB / USB Optical	Windows 10 Pro 64	3-year, Onsite	04/17
30B3006BUS	US	Xeon E5-1620 v4 4C/3.5GHz/10MB/140W/DDR4-2400	NVIDIA Quadro P600 2GB	2x 8GB RDIMM DDR4-2400 ECC	Integrated Intel SATA	1x1TB SSD 2.5" SATA6Gbps	None	HH DVD±RW	9-in-1	450W 92%	None	USB / USB Optical	Windows 10 DG Windows 7 Pro 64	3-year, Onsite	04/17

Model	Region	Processor	Graphics	Memory	Storage Controller	Disks	M.2 Drives	Optical	Media Reader	Power Supply	Optional Ports	Keyboard / Mouse	Operating System	Warranty	Ann Date (mm/yy)
30B3006DUS	US	Xeon E5-1650 v4 6C/3.6GHz/15MB/140W/DDR4-2400	Open	1x 16GB RDIMM DDR4-2400 ECC	Integrated Intel SATA	None	1x512GB SSD M.2 PCIe	HH DVD±RW	9-in-1	450W 92%	None	USB / USB Optical	Windows 10 DG Windows 7 Pro 64	3-year, Onsite	07/17
30B3006EUS	US	Xeon E5-1630 v4 4C/3.7GHz/10MB/140W/DDR4-2400	Open	1x 16GB RDIMM DDR4-2400 ECC	Integrated Intel SATA	None	1x256GB SSD M.2 PCIe Opal	HH DVD±RW	9-in-1	450W 92%	None	USB / USB Optical	Windows 10 DG Windows 7 Pro 64	3-year, Onsite	07/17
30B3006FUS	US	Xeon E5-1620 v4 4C/3.5GHz/10MB/140W/DDR4-2400	Open	1x 8GB RDIMM DDR4-2400 ECC	Integrated Intel SATA	None	1x256GB SSD M.2 PCIe Opal	HH DVD±RW	9-in-1	450W 92%	None	USB / USB Optical	Windows 10 DG Windows 7 Pro 64	3-year, Onsite	07/17
30B3006G--	WE	Xeon E5-1630 v4 4C/3.7GHz/10MB/140W/DDR4-2400	NVIDIA Quadro P5000 16GB	2x 16GB RDIMM DDR4-2400 ECC	Integrated Intel SATA	1x2TB HDD 7.2K 3.5" SATA6Gbps	1x1TB SSD M.2 PCIe NVMe Opal	HH DVD±RW	9-in-1	450W 92%	1xSerial	USB / USB Optical	Windows 10 Pro 64	3-year, Onsite	06/17
30B3005L--	WE	Xeon E5-1620 v4 4C/3.5GHz/10MB/140W/DDR4-2400	Open	1x 8GB RDIMM DDR4-2400 ECC	Integrated Intel SATA	1x1TB HDD 7.2K 3.5" SATA6Gbps	None	HH DVD±RW	9-in-1	450W 92%	1xSerial	USB / USB Optical	Windows 10 Pro 64	3-year, Onsite	04/17
30B3005M--	WE	Xeon E5-1620 v4 4C/3.5GHz/10MB/140W/DDR4-2400	NVIDIA Quadro P2000 5GB	2x 8GB RDIMM DDR4-2400 ECC	Integrated Intel SATA	1x1TB HDD 7.2K 3.5" SATA6Gbps	None	HH DVD±RW	9-in-1	450W 92%	1xSerial	USB / USB Optical	Windows 10 Pro 64	3-year, Onsite	04/17
30B3005N--	WE	Xeon E5-1630 v4 4C/3.7GHz/10MB/140W/DDR4-2400	NVIDIA Quadro P2000 5GB	2x 8GB RDIMM DDR4-2400 ECC	Integrated Intel SATA	None	1x256GB SSD M.2 PCIe Opal	HH DVD±RW	9-in-1	450W 92%	1xSerial	USB / USB Optical	Windows 10 Pro 64	3-year, Onsite	04/17
30B3005P--	WE	Xeon E5-1630 v4 4C/3.7GHz/10MB/140W/DDR4-2400	NVIDIA Quadro P4000 8GB	2x 8GB RDIMM DDR4-2400 ECC	Integrated Intel SATA	None	1x256GB SSD M.2 PCIe Opal	HH DVD±RW	9-in-1	450W 92%	1xSerial	USB / USB Optical	Windows 10 Pro 64	3-year, Onsite	04/17
30B3005Q--	WE	Xeon E5-1620 v4 4C/3.5GHz/10MB/140W/DDR4-2400	Open	1x 8GB RDIMM DDR4-2400 ECC	Integrated Intel SATA	1x1TB HDD 7.2K 3.5" SATA6Gbps	None	HH DVD±RW	9-in-1	450W 92%	1xSerial	USB / USB Optical	Windows 10 DG Windows 7 Pro 64	3-year, Onsite	04/17
30B3005R--	WE	Xeon E5-1620 v4 4C/3.5GHz/10MB/140W/DDR4-2400	NVIDIA Quadro P2000 5GB	2x 8GB RDIMM DDR4-2400 ECC	Integrated Intel SATA	1x256GB SSD 2.5" SATA6Gbps Opal, 1x1TB HDD 7.2K 3.5" SATA6Gbps	None	HH DVD±RW	9-in-1	450W 92%	1xSerial	USB / USB Optical	Windows 10 DG Windows 7 Pro 64	3-year, Onsite	04/17
30B3006L--	WE	Xeon E5-1650 v4 6C/3.6GHz/15MB/140W/DDR4-2400	Open	2x 8GB RDIMM DDR4-2400 ECC	Integrated Intel SATA	1x 1TB HDD 7.2K 3.5" SATA6Gbps	None	HH DVD±RW	9-in-1	450W 92%	1x Serial	USB / USB Optical	Windows 10 Pro 64	3-year, Onsite	09/17
30B3006M--	WE	Xeon E5-1650 v4 6C/3.6GHz/15MB/140W/DDR4-2400	Open	2x 8GB RDIMM DDR4-2400 ECC	Integrated Intel SATA	1x 256GB SSD 2.5" SATA6Gbps Opal	None	HH DVD±RW	9-in-1	450W 92%	1x Serial	USB / USB Optical	Windows 10 Pro 64	3-year, Onsite	09/17

Model	Region	Processor	Graphics	Memory	Storage Controller	Disks	M.2 Drives	Optical	Media Reader	Power Supply	Optional Ports	Keyboard / Mouse	Operating System	Warranty	Ann Date (mm/yy)
30B3003J--	WE	Xeon E5-1650 v4 6C/3.6GHz/15MB/140W/DDR4-2400	Open	2x 8GB RDIMM DDR4-2400 ECC	Integrated Intel SATA	None	1x256GB SSD M.2 PCIe Opal	9.5mm DVD±RW	29-in-1	450W 92%	1xSerial	USB / USB Optical	Windows 10 DG Windows 7 Pro 64	3-year, Onsite	09/16
30B3004L--	WE	Xeon E5-1630 v4 4C/3.7GHz/10MB/140W/DDR4-2400	Open	1x 8GB RDIMM DDR4-2400 ECC	Integrated Intel SATA	None	1x1TB SSD M.2 PCIe NVMe Opal	HH DVD±RW	9-in-1	450W 92%	1xSerial	USB / USB Optical	Windows 10 DG Windows 7 Pro 64	3-year, Onsite	12/16
30B30054--	WE	Xeon E5-1620 v4 4C/3.5GHz/10MB/140W/DDR4-2400	Open	1x 8GB RDIMM DDR4-2400 ECC	Integrated Intel SATA	1x1TB HDD 7.2K 3.5" SATA6Gbps	None	HH DVD±RW	9-in-1	450W 92%	1xSerial	USB / USB Optical	Windows 10 DG Windows 7 Pro 64	3-year, Onsite	12/16
30B30058--	WE	Xeon E5-1620 v4 4C/3.5GHz/10MB/140W/DDR4-2400	Open	2x 8GB RDIMM DDR4-2400 ECC	Integrated Intel SATA	1x1TB HDD 7.2K 3.5" SATA6Gbps	None	HH DVD±RW	9-in-1	450W 92%	2xUSB3.0, 1xSerial	USB / USB Optical	Windows 10 Pro 64	3-year, Onsite	03/17
30B30057--	WE	Xeon E5-1620 v4 4C/3.5GHz/10MB/140W/DDR4-2400	Open	2x 8GB RDIMM DDR4-2400 ECC	Integrated Intel SATA	1x1TB HDD 7.2K 3.5" SATA6Gbps	None	HH DVD±RW	9-in-1	450W 92%	1xSerial	USB / USB Optical	Windows 10 DG Windows 7 Pro 64	3-year, Onsite	03/17
30B30059--	WE	Xeon E5-1650 v4 6C/3.6GHz/15MB/140W/DDR4-2400	Open	2x 8GB RDIMM DDR4-2400 ECC	Integrated Intel SATA	1x256GB SSD 2.5" SATA6Gbps Opal, 1x1TB HDD 7.2K 3.5" SATA6Gbps	None	HH DVD±RW	9-in-1	450W 92%	1xSerial	USB / USB Optical	Windows 10 DG Windows 7 Pro 64	3-year, Onsite	03/17
30B3005A--	WE	Xeon E5-1620 v4 4C/3.5GHz/10MB/140W/DDR4-2400	Open	2x 8GB RDIMM DDR4-2400 ECC	Integrated Intel SATA	1x1TB HDD 7.2K 3.5" SATA6Gbps	None	HH DVD±RW	9-in-1	450W 92%	2xUSB3.0	USB / USB Optical	Windows 10 Pro 64	3-year, Onsite	03/17
30B3005B--	WE	Xeon E5-1620 v4 4C/3.5GHz/10MB/140W/DDR4-2400	Open	2x 8GB RDIMM DDR4-2400 ECC	Integrated Intel SATA	None	1x256GB SSD M.2 PCIe Opal	HH DVD±RW	9-in-1	450W 92%	2xUSB3.0, 1xSerial	USB / USB Optical	Windows 10 Pro 64	3-year, Onsite	03/17
30B3005C--	WE	Xeon E5-1620 v4 4C/3.5GHz/10MB/140W/DDR4-2400	Open	2x 8GB RDIMM DDR4-2400 ECC	Integrated Intel SATA	None	1x256GB SSD M.2 PCIe Opal	HH DVD±RW	9-in-1	450W 92%	1xSerial	USB / USB Optical	Windows 10 DG Windows 7 Pro 64	3-year, Onsite	03/17
30B3005D--	WE	Xeon E5-1650 v4 6C/3.6GHz/15MB/140W/DDR4-2400	Open	2x 8GB RDIMM DDR4-2400 ECC	Integrated Intel SATA	1x256GB SSD 2.5" SATA6Gbps Opal, 1x1TB HDD 7.2K 3.5" SATA6Gbps	None	HH DVD±RW	9-in-1	450W 92%	2xUSB3.0, 1xSerial	USB / USB Optical	Windows 10 Pro 64	3-year, Onsite	03/17
30B3005F--	WE	Xeon E5-1630 v4 4C/3.7GHz/10MB/140W/DDR4-2400	NVIDIA Quadro P4000 8GB	4x 8GB RDIMM DDR4-2400 ECC	Integrated Intel SATA	1x256GB SSD 2.5" SATA6Gbps Opal, 1x1TB HDD 7.2K 3.5" SATA6Gbps	None	HH DVD±RW	9-in-1	450W 92%	1xSerial	USB / USB Optical	Windows 10 DG Windows 7 Pro 64	3-year, Onsite	04/17
30B3005G--	WE	Xeon E5-1630 v4 4C/3.7GHz/10MB/140W/DDR4-2400	NVIDIA Quadro P4000 8GB	2x 8GB RDIMM DDR4-2400 ECC	Integrated Intel SATA	None	1x256GB SSD M.2 PCIe Opal	HH DVD±RW	9-in-1	450W 92%	1xSerial	USB / USB Optical	Windows 10 DG Windows 7 Pro 64	3-year, Onsite	04/17

Model	Region	Processor	Graphics	Memory	Storage Controller	Disks	M.2 Drives	Optical	Media Reader	Power Supply	Optional Ports	Keyboard / Mouse	Operating System	Warranty	Ann Date (mm/yy)
30B3005H--	WE	Xeon E5-1630 v4 4C/3.7GHz/10MB/140W/DDR4-2400	NVIDIA Quadro P2000 5GB	2x 8GB RDIMM DDR4-2400 ECC	Integrated Intel SATA	None	1x256GB SSD M.2 PCIe Opal	HH DVD±RW	9-in-1	450W 92%	1xSerial	USB / USB Optical	Windows 10 DG Windows 7 Pro 64	3-year, Onsite	04/17
30B3005J--	WE	Xeon E5-1620 v4 4C/3.5GHz/10MB/140W/DDR4-2400	NVIDIA Quadro P2000 5GB	2x 8GB RDIMM DDR4-2400 ECC	Integrated Intel SATA	None	1x256GB SSD 2.5" SATA6Gbps Opal, 1x1TB HDD 7.2K 3.5" SATA6Gbps	HH DVD±RW	9-in-1	450W 92%	1xSerial	USB / USB Optical	Windows 10 Pro 64	3-year, Onsite	04/17
30B3005K--	WE	Xeon E5-1630 v4 4C/3.7GHz/10MB/140W/DDR4-2400	NVIDIA Quadro P4000 8GB	4x 8GB RDIMM DDR4-2400 ECC	Integrated Intel SATA	None	1x256GB SSD 2.5" SATA6Gbps Opal, 1x1TB HDD 7.2K 3.5" SATA6Gbps	HH DVD±RW	9-in-1	450W 92%	1xSerial	USB / USB Optical	Windows 10 Pro 64	3-year, Onsite	04/17
30B3006N--	WE	Xeon E5-1630 v4 4C/3.7GHz/10MB/140W/DDR4-2400	Open	1x 8GB RDIMM DDR4-2400 ECC	Integrated Intel SATA	None	1x 256GB SSD 2.5" SATA6Gbps Opal	HH DVD±RW	9-in-1	450W 92%	1x Serial	USB / USB Optical	Windows 10 Pro 64	3-year, Onsite	09/17
30B3006P--	WE	Xeon E5-1650 v4 6C/3.6GHz/15MB/140W/DDR4-2400	Open	2x 8GB RDIMM DDR4-2400 ECC	Integrated Intel SATA	None	1x 256GB SSD 2.5" SATA6Gbps Opal, 1x 1TB HDD 7.2K 3.5" SATA6Gbps	HH DVD±RW	9-in-1	450W 92%	1x Serial	USB / USB Optical	Windows 10 Pro 64	3-year, Onsite	09/17
30B3006Q--	WE	Xeon E5-1630 v4 4C/3.7GHz/10MB/140W/DDR4-2400	Open	2x 8GB RDIMM DDR4-2400 ECC	Integrated Intel SATA	None	1x 256GB SSD 2.5" SATA6Gbps Opal	9.0mm DVD±RW	29-in-1	450W 92%	1x Front eSATA, 1x Serial	USB / USB Optical	Windows 10 Pro 64	3-year, Onsite	09/17
30B3006R--	WE	Xeon E5-1620 v4 4C/3.5GHz/10MB/140W/DDR4-2400	Open	2x 8GB RDIMM DDR4-2400 ECC	Integrated Intel SATA	None	1x 1TB HDD 7.2K 3.5" SATA6Gbps	HH DVD±RW	9-in-1	450W 92%	1x Serial	USB / USB Optical	Windows 10 Pro 64	3-year, Onsite	09/17
30B3006S--	WE	Xeon E5-1620 v4 4C/3.5GHz/10MB/140W/DDR4-2400	Open	2x 8GB RDIMM DDR4-2400 ECC	Integrated Intel SATA	None	1x 256GB SSD M.2 PCIe Opal	HH DVD±RW	9-in-1	450W 92%	1x Serial	USB / USB Optical	Windows 10 Pro 64	3-year, Onsite	09/17
30B3006T--	WE	Xeon E5-1620 v4 4C/3.5GHz/10MB/140W/DDR4-2400	NVIDIA Quadro P2000 5GB	2x 8GB RDIMM DDR4-2400 ECC	Integrated Intel SATA	None	1x 256GB SSD 2.5" SATA6Gbps Opal, 1x 1TB HDD 7.2K 3.5" SATA6Gbps	HH DVD±RW	9-in-1	450W 92%	1x Serial	USB / USB Optical	Windows 10 Pro 64	3-year, Onsite	09/17
30B3006U--	WE	Xeon E5-1630 v4 4C/3.7GHz/10MB/140W/DDR4-2400	NVIDIA Quadro P1000 4GB	1x 8GB RDIMM DDR4-2400 ECC	Integrated Intel SATA	None	1x 256GB SSD 2.5" SATA6Gbps Opal	HH DVD±RW	9-in-1	450W 92%	1x Serial	USB / USB Optical	Windows 10 Pro 64	3-year, Onsite	09/17
30B3006V--	WE	Xeon E5-1630 v4 4C/3.7GHz/10MB/140W/DDR4-2400	NVIDIA Quadro P4000 8GB	2x 8GB RDIMM DDR4-2400 ECC	Integrated Intel SATA	None	1x 256GB SSD M.2 PCIe Opal	HH DVD±RW	9-in-1	450W 92%	1x Serial	USB / USB Optical	Windows 10 Pro 64	3-year, Onsite	09/17
30B3006W--	WE	Xeon E5-1650 v4 6C/3.6GHz/15MB/140W/DDR4-2400	Open	2x 8GB RDIMM DDR4-2400 ECC	Integrated Intel SATA	None	1x 512GB SSD M.2 PCIe	HH DVD±RW	9-in-1	450W 92%	1x Serial	USB / USB Optical	Windows 10 Pro 64	3-year, Onsite	09/17

Model	Region	Processor	Graphics	Memory	Storage Controller	Disks	M.2 Drives	Optical	Media Reader	Power Supply	Optional Ports	Keyboard / Mouse	Operating System	Warranty	Ann Date (mm/yy)
30B3006X--	WE	Xeon E5-1630 v4 4C/3.7GHz/10MB/140W/DDR4-2400	Open	2x 8GB RDIMM DDR4-2400 ECC	Integrated Intel SATA	None	1x 256GB SSD M.2 PCIe Opal	HH DVD±RW	9-in-1	450W 92%	1x Serial	USB / USB Optical	Windows 10 Pro 64	3-year, Onsite	09/17
30B3006Y--	WE	Xeon E5-1620 v4 4C/3.5GHz/10MB/140W/DDR4-2400	Open	2x 8GB RDIMM DDR4-2400 ECC	Integrated Intel SATA	1x 256GB SSD 2.5" SATA6Gbps Opal, 1x 1TB HDD 7.2K 3.5" SATA6Gbps	None	HH DVD±RW	9-in-1	450W 92%	1x Serial	USB / USB Optical	Windows 10 Pro 64	3-year, Onsite	09/17
30B30070--	WE	Xeon E5-1620 v4 4C/3.5GHz/10MB/140W/DDR4-2400	Open	1x 8GB RDIMM DDR4-2400 ECC	Integrated Intel SATA	1x 256GB SSD 2.5" SATA6Gbps Opal	None	HH DVD±RW	9-in-1	450W 92%	1x Serial	USB / USB Optical	Windows 10 Pro 64	3-year, Onsite	09/17
30B30071--	WE	Xeon E5-1630 v4 4C/3.7GHz/10MB/140W/DDR4-2400	NVIDIA Quadro P4000 8GB	4x 8GB RDIMM DDR4-2400 ECC	Integrated Intel SATA	1x 256GB SSD 2.5" SATA6Gbps Opal, 1x 1TB HDD 7.2K 3.5" SATA6Gbps	None	HH DVD±RW	9-in-1	450W 92%	1x Serial	USB / USB Optical	Windows 10 Pro 64	3-year, Onsite	09/17
30B30072--	WE	Xeon E5-1620 v4 4C/3.5GHz/10MB/140W/DDR4-2400	NVIDIA Quadro P2000 5GB	2x 8GB RDIMM DDR4-2400 ECC	Integrated Intel SATA	1x 1TB HDD 7.2K 3.5" SATA6Gbps	None	HH DVD±RW	9-in-1	450W 92%	1x Serial	USB / USB Optical	Windows 10 Pro 64	3-year, Onsite	09/17
30B30073--	WE	Xeon E5-1630 v4 4C/3.7GHz/10MB/140W/DDR4-2400	NVIDIA Quadro P2000 5GB	2x 8GB RDIMM DDR4-2400 ECC	Integrated Intel SATA	None	1x 256GB SSD M.2 PCIe Opal	HH DVD±RW	9-in-1	450W 92%	1x Serial	USB / USB Optical	Windows 10 Pro 64	3-year, Onsite	09/17
30B30074--	WE	Xeon E5-1620 v4 4C/3.5GHz/10MB/140W/DDR4-2400	Open	1x 8GB RDIMM DDR4-2400 ECC	Integrated Intel SATA	1x 256GB SSD 2.5" SATA6Gbps Opal	None	HH DVD	9-in-1	450W 92%	2x USB3.0, 1x Serial	USB / USB Optical	Windows 10 DG Windows 7 Pro 64	3-year, Onsite	09/17
30B30075--	WE	Xeon E5-1630 v4 4C/3.7GHz/10MB/140W/DDR4-2400	Open	1x 8GB RDIMM DDR4-2400 ECC	Integrated Intel SATA	1x 256GB SSD 2.5" SATA6Gbps Opal	None	HH DVD	9-in-1	450W 92%	2x USB3.0, 1x Serial	USB / USB Optical	Windows 10 DG Windows 7 Pro 64	3-year, Onsite	09/17
30B30076--	WE	Xeon E5-1650 v4 6C/3.6GHz/15MB/140W/DDR4-2400	Open	2x 8GB RDIMM DDR4-2400 ECC	Integrated Intel SATA	1x 256GB SSD 2.5" SATA6Gbps Opal	None	HH DVD	9-in-1	450W 92%	2x USB3.0, 1x Serial	USB / USB Optical	Windows 10 DG Windows 7 Pro 64	3-year, Onsite	09/17
30B30077--	WE	Xeon E5-1603 v4 4C/2.8GHz/10MB/140W/DDR4-2133	Open	1x 8GB RDIMM DDR4-2400 ECC	Integrated Intel SATA	1x 1TB HDD 7.2K 3.5" SATA6Gbps	None	HH DVD	9-in-1	450W 92%	2x USB3.0, 1x Serial	USB / USB Optical	Windows 10 DG Windows 7 Pro 64	3-year, Onsite	09/17
30B30078--	WE	Xeon E5-1620 v4 4C/3.5GHz/10MB/140W/DDR4-2400	Open	1x 8GB RDIMM DDR4-2400 ECC	Integrated Intel SATA	1x 1TB HDD 7.2K 3.5" SATA6Gbps	None	HH DVD	9-in-1	450W 92%	2x USB3.0, 1x Serial	USB / USB Optical	Windows 10 DG Windows 7 Pro 64	3-year, Onsite	09/17
30B30079--	WE	Xeon E5-1620 v4 4C/3.5GHz/10MB/140W/DDR4-2400	Open	2x 8GB RDIMM DDR4-2400 ECC	Integrated Intel SATA	1x 1TB HDD 7.2K 3.5" SATA6Gbps	None	HH DVD	9-in-1	450W 92%	2x USB3.0, 1x Serial	USB / USB Optical	Windows 10 DG Windows 7 Pro 64	3-year, Onsite	09/17

Model	Region	Processor	Graphics	Memory	Storage Controller	Disks	M.2 Drives	Optical	Media Reader	Power Supply	Optional Ports	Keyboard / Mouse	Operating System	Warranty	Ann Date (mm/yy)
30B3007A--	WE	Xeon E5-1650 v4 6C/3.6GHz/15MB/140W/DDR4-2400	Open	2x 8GB RDIMM DDR4-2400 ECC	Integrated Intel SATA	1x 256GB SSD 2.5" SATA6Gbps Opal, 1x 1TB HDD 7.2K 3.5" SATA6Gbps	None	HH DVD	9-in-1	450W 92%	2x USB3.0, 1x Serial	USB / USB Optical	Windows 10 DG Windows 7 Pro 64	3-year, Onsite	09/17
30B3007B--	WE	Xeon E5-1620 v4 4C/3.5GHz/10MB/140W/DDR4-2400	NVIDIA Quadro P2000 5GB	2x 8GB RDIMM DDR4-2400 ECC	Integrated Intel SATA	1x 256GB SSD 2.5" SATA6Gbps Opal, 1x 1TB HDD 7.2K 3.5" SATA6Gbps	None	HH DVD	9-in-1	450W 92%	2x USB3.0, 1x Serial	USB / USB Optical	Windows 10 DG Windows 7 Pro 64	3-year, Onsite	09/17
30B3007C--	WE	Xeon E5-1630 v4 4C/3.7GHz/10MB/140W/DDR4-2400	NVIDIA Quadro P4000 8GB	4x 8GB RDIMM DDR4-2400 ECC	Integrated Intel SATA	1x 256GB SSD 2.5" SATA6Gbps Opal, 1x 1TB HDD 7.2K 3.5" SATA6Gbps	None	HH DVD	9-in-1	450W 92%	2x USB3.0, 1x Serial	USB / USB Optical	Windows 10 DG Windows 7 Pro 64	3-year, Onsite	09/17
30B3007D--	WE	Xeon E5-1650 v4 6C/3.6GHz/15MB/140W/DDR4-2400	Open	2x 8GB RDIMM DDR4-2400 ECC	Integrated Intel SATA	None	1x 512GB SSD M.2 PCIe	HH DVD	9-in-1	450W 92%	1x Serial	USB / USB Optical	Windows 10 DG Windows 7 Pro 64	3-year, Onsite	09/17
30B3007E--	WE	Xeon E5-1620 v4 4C/3.5GHz/10MB/140W/DDR4-2400	Open	2x 8GB RDIMM DDR4-2400 ECC	Integrated Intel SATA	None	1x 256GB SSD M.2 PCIe Opal	HH DVD	9-in-1	450W 92%	1x Serial	USB / USB Optical	Windows 10 DG Windows 7 Pro 64	3-year, Onsite	09/17
30B3007F--	WE	Xeon E5-1630 v4 4C/3.7GHz/10MB/140W/DDR4-2400	NVIDIA Quadro P2000 5GB	2x 8GB RDIMM DDR4-2400 ECC	Integrated Intel SATA	None	1x 256GB SSD M.2 PCIe Opal	HH DVD	9-in-1	450W 92%	1x Serial	USB / USB Optical	Windows 10 DG Windows 7 Pro 64	3-year, Onsite	09/17
30B3007G--	WE	Xeon E5-1630 v4 4C/3.7GHz/10MB/140W/DDR4-2400	NVIDIA Quadro P4000 8GB	2x 8GB RDIMM DDR4-2400 ECC	Integrated Intel SATA	None	1x 256GB SSD M.2 PCIe Opal	HH DVD	9-in-1	450W 92%	1x Serial	USB / USB Optical	Windows 10 DG Windows 7 Pro 64	3-year, Onsite	09/17
30B3007H--	WE	Xeon E5-1620 v4 4C/3.5GHz/10MB/140W/DDR4-2400	Open	1x 8GB RDIMM DDR4-2400 ECC	Integrated Intel SATA	1x 1TB HDD 7.2K 3.5" SATA6Gbps	None	HH DVD	9-in-1	450W 92%	1x Serial	USB / USB Optical	Windows 10 Pro 64	3-year, Onsite	09/17
30B30053--	WE	Xeon E5-1620 v4 4C/3.5GHz/10MB/140W/DDR4-2400	Open	1x 8GB RDIMM DDR4-2400 ECC	Integrated Intel SATA	1x 1TB HDD 7.2K 3.5" SATA6Gbps	None	HH DVD±RW	9-in-1	450W 92%	1xSerial	USB / USB Optical	Windows 10 Pro 64	3-year, Onsite	12/16
30B3004K--	WE	Xeon E5-1620 v4 4C/3.5GHz/10MB/140W/DDR4-2400	Open	1x 8GB RDIMM DDR4-2400 ECC	Integrated Intel SATA	None	1x1TB SSD M.2 PCIe NVMe Opal	HH DVD±RW	9-in-1	450W 92%	1xSerial	USB / USB Optical	Windows 10 DG Windows 7 Pro 64	3-year, Onsite	12/16
30B3003G--	WE	Xeon E5-1620 v4 4C/3.5GHz/10MB/140W/DDR4-2400	Open	1x 8GB RDIMM DDR4-2400 ECC	Integrated Intel SATA	1x256GB SSD 2.5" SATA6Gbps Opal	None	9.5mm DVD±RW	29-in-1	450W 92%	1xSerial	USB / USB Optical	Windows 10 DG Windows 7 Pro 64	3-year, Onsite	09/16
30B3003H--	WE	Xeon E5-1630 v4 4C/3.7GHz/10MB/140W/DDR4-2400	Open	2x 8GB RDIMM DDR4-2400 ECC	Integrated Intel SATA	1x256GB SSD 2.5" SATA6Gbps Opal	None	9.5mm DVD±RW	29-in-1	450W 92%	1xSerial	USB / USB Optical	Windows 10 DG Windows 7 Pro 64	3-year, Onsite	09/16

Model	Region	Processor	Graphics	Memory	Storage Controller	Disks	M.2 Drives	Optical	Media Reader	Power Supply	Optional Ports	Keyboard / Mouse	Operating System	Warranty	Ann Date (mm/yy)
30B3002X--	WE	Xeon E5-1620 v4 4C/3.5GHz/10MB/140W/DDR4-2400	NVIDIA Quadro M2000 4GB	2x 8GB RDIMM DDR4-2400 ECC	Integrated Intel SATA	1x256GB SSD 2.5" SATA6Gbps Opal, 1x1TB HDD 7.2K 3.5" SATA6Gbps	None	HH DVD±RW	9-in-1	450W 92%	None	USB / USB Optical	Windows 10 Pro 64	3-year, Onsite	07/16
30B3002Y--	WE	Xeon E5-1620 v4 4C/3.5GHz/10MB/140W/DDR4-2400	Open	2x 8GB RDIMM DDR4-2400 ECC	Integrated Intel SATA	1x256GB SSD 2.5" SATA6Gbps Opal, 1x1TB HDD 7.2K 3.5" SATA6Gbps	None	HH DVD±RW	9-in-1	450W 92%	None	USB / USB Optical	Windows 10 Pro 64	3-year, Onsite	07/16
30B30032--	WE	Xeon E5-1620 v4 4C/3.5GHz/10MB/140W/DDR4-2400	Open	1x 8GB RDIMM DDR4-2400 ECC	Integrated Intel SATA	1x256GB SSD 2.5" SATA6Gbps Opal	None	HH DVD±RW	9-in-1	450W 92%	2xUSB3.0, 1xSerial	USB / USB Optical	Windows 10 DG Windows 7 Pro 64	3-year, Onsite	09/16
30B30033--	WE	Xeon E5-1630 v4 4C/3.7GHz/10MB/140W/DDR4-2400	Open	1x 8GB RDIMM DDR4-2400 ECC	Integrated Intel SATA	1x256GB SSD 2.5" SATA6Gbps Opal	None	HH DVD±RW	9-in-1	450W 92%	2xUSB3.0, 1xSerial	USB / USB Optical	Windows 10 DG Windows 7 Pro 64	3-year, Onsite	09/16
30B30034--	WE	Xeon E5-1650 v4 6C/3.6GHz/15MB/140W/DDR4-2400	Open	2x 8GB RDIMM DDR4-2400 ECC	Integrated Intel SATA	1x1TB HDD 7.2K 3.5" SATA6Gbps	None	HH DVD±RW	9-in-1	450W 92%	2xUSB3.0, 1xSerial	USB / USB Optical	Windows 10 DG Windows 7 Pro 64	3-year, Onsite	09/16
30B30035--	WE	Xeon E5-1650 v4 6C/3.6GHz/15MB/140W/DDR4-2400	Open	2x 8GB RDIMM DDR4-2400 ECC	Integrated Intel SATA	1x256GB SSD 2.5" SATA6Gbps Opal	None	HH DVD±RW	9-in-1	450W 92%	2xUSB3.0, 1xSerial	USB / USB Optical	Windows 10 DG Windows 7 Pro 64	3-year, Onsite	09/16
30B30036--	WE	Xeon E5-1630 v4 4C/3.7GHz/10MB/140W/DDR4-2400	NVIDIA Quadro K1200 4GB	1x 8GB RDIMM DDR4-2400 ECC	Integrated Intel SATA	1x256GB SSD 2.5" SATA6Gbps Opal	None	HH DVD±RW	9-in-1	450W 92%	2xUSB3.0, 1xSerial	USB / USB Optical	Windows 10 DG Windows 7 Pro 64	3-year, Onsite	09/16
30B30037--	WE	Xeon E5-1603 v4 4C/2.8GHz/10MB/140W/DDR4-2133	Open	2x 8GB RDIMM DDR4-2400 ECC	Integrated Intel SATA	1x256GB SSD 2.5" SATA6Gbps Opal	None	HH DVD±RW	9-in-1	450W 92%	2xUSB3.0, 1xSerial	USB / USB Optical	Windows 10 DG Windows 7 Pro 64	3-year, Onsite	09/16
30B30038--	WE	Xeon E5-1620 v4 4C/3.5GHz/10MB/140W/DDR4-2400	Open	2x 8GB RDIMM DDR4-2400 ECC	Integrated Intel SATA	1x256GB SSD 2.5" SATA6Gbps Opal, 1x1TB HDD 7.2K 3.5" SATA6Gbps	None	HH DVD±RW	9-in-1	450W 92%	2xUSB3.0, 1xSerial	USB / USB Optical	Windows 10 DG Windows 7 Pro 64	3-year, Onsite	09/16
30B30039--	WE	Xeon E5-1620 v4 4C/3.5GHz/10MB/140W/DDR4-2400	NVIDIA Quadro M2000 4GB	2x 8GB RDIMM DDR4-2400 ECC	Integrated Intel SATA	1x256GB SSD 2.5" SATA6Gbps Opal, 1x1TB HDD 7.2K 3.5" SATA6Gbps	None	HH DVD±RW	9-in-1	450W 92%	2xUSB3.0, 1xSerial	USB / USB Optical	Windows 10 DG Windows 7 Pro 64	3-year, Onsite	09/16
30B3003A--	WE	Xeon E5-1630 v4 4C/3.7GHz/10MB/140W/DDR4-2400	NVIDIA Quadro M4000 8GB	4x 8GB RDIMM DDR4-2400 ECC	Integrated Intel SATA	1x256GB SSD 2.5" SATA6Gbps Opal, 1x1TB HDD 7.2K 3.5" SATA6Gbps	None	HH DVD±RW	9-in-1	450W 92%	2xUSB3.0, 1xSerial	USB / USB Optical	Windows 10 DG Windows 7 Pro 64	3-year, Onsite	09/16
30B3003B--	WE	Xeon E5-1630 v4 4C/3.7GHz/10MB/140W/DDR4-2400	Open	2x 8GB RDIMM DDR4-2400 ECC	Integrated Intel SATA	None	1x256GB SSD M.2 PCIe Opal	HH DVD±RW	9-in-1	450W 92%	1xSerial	USB / USB Optical	Windows 10 DG Windows 7 Pro 64	3-year, Onsite	09/16

Model	Region	Processor	Graphics	Memory	Storage Controller	Disks	M.2 Drives	Optical	Media Reader	Power Supply	Optional Ports	Keyboard / Mouse	Operating System	Warranty	Ann Date (mm/yy)
30B3003C--	WE	Xeon E5-1630 v4 4C/3.7GHz/10MB/140W/DDR4-2400	NVIDIA Quadro M2000 4GB	2x 8GB RDIMM DDR4-2400 ECC	Integrated Intel SATA	None	1x256GB SSD M.2 PCIe Opal	HH DVD±RW	9-in-1	450W 92%	1xSerial	USB / USB Optical	Windows 10 DG Windows 7 Pro 64	3-year, Onsite	09/16
30B3003D--	WE	Xeon E5-1630 v4 4C/3.7GHz/10MB/140W/DDR4-2400	NVIDIA Quadro M4000 8GB	2x 8GB RDIMM DDR4-2400 ECC	Integrated Intel SATA	None	1x256GB SSD M.2 PCIe Opal	HH DVD±RW	9-in-1	450W 92%	1xSerial	USB / USB Optical	Windows 10 DG Windows 7 Pro 64	3-year, Onsite	09/16
30B3003E--	WE	Xeon E5-1650 v4 6C/3.6GHz/15MB/140W/DDR4-2400	Open	2x 8GB RDIMM DDR4-2400 ECC	Integrated Intel SATA	None	1x512GB SSD M.2 PCIe	HH DVD±RW	9-in-1	450W 92%	1xSerial	USB / USB Optical	Windows 10 DG Windows 7 Pro 64	3-year, Onsite	09/16
30B3003F--	WE	Xeon E5-1603 v4 4C/2.8GHz/10MB/140W/DDR4-2133	Open	1x 8GB RDIMM DDR4-2400 ECC	Integrated Intel SATA	1x1TB HDD 7.2K 3.5" SATA6Gbps	None	9.5mm DVD±RW	29-in-1	450W 92%	1xSerial	USB / USB Optical	Windows 10 DG Windows 7 Pro 64	3-year, Onsite	09/16
30B3002R--	WE	Xeon E5-1603 v4 4C/2.8GHz/10MB/140W/DDR4-2133	Open	1x 8GB RDIMM DDR4-2400 ECC	Integrated Intel SATA	1x1TB HDD 7.2K 3.5" SATA6Gbps	None	None	29-in-1	450W 92%	Front eSATA	USB / USB Optical	Windows 10 Pro 64	3-year, Onsite	07/16
30B3001M--	WE	Xeon E5-1650 v4 6C/3.6GHz/15MB/140W/DDR4-2400	Open	2x 8GB RDIMM DDR4-2400 ECC	Integrated Intel SATA	None	1x512GB SSD M.2 PCIe	HH DVD±RW	9-in-1	450W 92%	None	USB / USB Optical	Windows 10 Pro 64	3-year, Onsite	06/16
30B3002S--	WE	Xeon E5-1620 v4 4C/3.5GHz/10MB/140W/DDR4-2400	Open	1x 8GB RDIMM DDR4-2400 ECC	Integrated Intel SATA	1x256GB SSD 2.5" SATA6Gbps Opal	None	None	29-in-1	450W 92%	Front eSATA	USB / USB Optical	Windows 10 Pro 64	3-year, Onsite	07/16
30B3002T--	WE	Xeon E5-1630 v4 4C/3.7GHz/10MB/140W/DDR4-2400	Open	2x 8GB RDIMM DDR4-2400 ECC	Integrated Intel SATA	1x256GB SSD 2.5" SATA6Gbps Opal	None	None	29-in-1	450W 92%	Front eSATA	USB / USB Optical	Windows 10 Pro 64	3-year, Onsite	07/16
30B3002U--	WE	Xeon E5-1603 v4 4C/2.8GHz/10MB/140W/DDR4-2133	Open	2x 8GB RDIMM DDR4-2400 ECC	Integrated Intel SATA	1x256GB SSD 2.5" SATA6Gbps Opal	None	HH DVD±RW	9-in-1	450W 92%	None	USB / USB Optical	Windows 10 Pro 64	3-year, Onsite	07/16
30B3002V--	WE	Xeon E5-1650 v4 6C/3.6GHz/15MB/140W/DDR4-2400	Open	2x 8GB RDIMM DDR4-2400 ECC	Integrated Intel SATA	None	1x256GB SSD M.2 PCIe Opal	None	29-in-1	450W 92%	Front eSATA	USB / USB Optical	Windows 10 Pro 64	3-year, Onsite	07/16
30B3002W--	WE	Xeon E5-1630 v4 4C/3.7GHz/10MB/140W/DDR4-2400	NVIDIA Quadro M4000 8GB	4x 8GB RDIMM DDR4-2400 ECC	Integrated Intel SATA	1x256GB SSD 2.5" SATA6Gbps Opal, 1x1TB HDD 7.2K 3.5" SATA6Gbps	None	HH DVD±RW	9-in-1	450W 92%	None	USB / USB Optical	Windows 10 Pro 64	3-year, Onsite	07/16
30B3001H--	WE	Xeon E5-1630 v4 4C/3.7GHz/10MB/140W/DDR4-2400	NVIDIA Quadro M2000 4GB	1x 8GB RDIMM DDR4-2400 ECC	Integrated Intel SATA	1x256GB SSD 2.5" SATA6Gbps Opal	None	HH DVD±RW	9-in-1	450W 92%	None	USB / USB Optical	Windows 10 Pro 64	3-year, Onsite	06/16

Model	Region	Processor	Graphics	Memory	Storage Controller	Disks	M.2 Drives	Optical	Media Reader	Power Supply	Optional Ports	Keyboard / Mouse	Operating System	Warranty	Ann Date (mm/yy)
30B3001J--	WE	Xeon E5-1630 v4 4C/3.7GHz/10MB/140W/DDR4-2400	Open	2x 8GB RDIMM DDR4-2400 ECC	Integrated Intel SATA	None	1x256GB SSD M.2 PCIe Opal	HH DVD±RW	9-in-1	450W 92%	None	USB / USB Optical	Windows 10 Pro 64	3-year, Onsite	06/16
30B3001K--	WE	Xeon E5-1630 v4 4C/3.7GHz/10MB/140W/DDR4-2400	NVIDIA Quadro M2000 4GB	2x 8GB RDIMM DDR4-2400 ECC	Integrated Intel SATA	None	1x256GB SSD M.2 PCIe Opal	HH DVD±RW	9-in-1	450W 92%	None	USB / USB Optical	Windows 10 Pro 64	3-year, Onsite	06/16
30B3001L--	WE	Xeon E5-1630 v4 4C/3.7GHz/10MB/140W/DDR4-2400	NVIDIA Quadro M4000 8GB	2x 8GB RDIMM DDR4-2400 ECC	Integrated Intel SATA	None	1x256GB SSD M.2 PCIe Opal	HH DVD±RW	9-in-1	450W 92%	None	USB / USB Optical	Windows 10 Pro 64	3-year, Onsite	06/16
30B3001B--	WE	Xeon E5-1620 v4 4C/3.5GHz/10MB/140W/DDR4-2400	Open	1x 8GB RDIMM DDR4-2400 ECC	Integrated Intel SATA	1x256GB SSD 2.5" SATA6Gbps Opal	None	HH DVD±RW	9-in-1	450W 92%	None	USB / USB Optical	Windows 10 Pro 64	3-year, Onsite	06/16
30B3001C--	WE	Xeon E5-1630 v4 4C/3.7GHz/10MB/140W/DDR4-2400	Open	1x 8GB RDIMM DDR4-2400 ECC	Integrated Intel SATA	1x256GB SSD 2.5" SATA6Gbps Opal	None	HH DVD±RW	9-in-1	450W 92%	None	USB / USB Optical	Windows 10 Pro 64	3-year, Onsite	06/16
30B30002--	WE	Xeon E5-2620 v4 8C/2.1GHz/20MB/85W/DDR4-2133	NVIDIA Quadro K1200 4GB	1x 8GB RDIMM DDR4-2400 ECC	Integrated Intel SATA	1x1TB HDD 7.2K 3.5" SATA6Gbps	None	HH DVD±RW	9-in-1	450W 92%	None	USB Fingerprint / USB	Windows 10 DG Windows 7 Pro 64	3-year, Onsite	05/16
30B30006--	WE	Xeon E5-2623 v4 4C/2.6GHz/10MB/85W/DDR4-2133	NVIDIA Quadro M2000 4GB	1x 8GB RDIMM DDR4-2400 ECC	Integrated Intel SATA	1x256GB SSD 2.5" SATA6Gbps Opal, 1x1TB HDD 7.2K 3.5" SATA6Gbps	None	HH DVD±RW	9-in-1	450W 92%	None	USB Fingerprint / USB	Windows 10 DG Windows 7 Pro 64	3-year, Onsite	05/16
30B30009--	WE	Xeon E5-2623 v4 4C/2.6GHz/10MB/85W/DDR4-2133	NVIDIA Quadro M4000 8GB	1x 16GB RDIMM DDR4- 2400 ECC	Integrated Intel SATA	1x512GB SSD 2.5" SATA6Gbps, 1x1TB HDD 7.2K 3.5" SATA6Gbps	None	HH DVD±RW	9-in-1	450W 92%	None	USB Fingerprint / USB	Windows 10 DG Windows 7 Pro 64	3-year, Onsite	05/16
30B3000C--	WE	Xeon E5-2620 v4 8C/2.1GHz/20MB/85W/DDR4-2133	Open	1x 8GB RDIMM DDR4-2400 ECC	Integrated Intel SATA	1x256GB SSD 2.5" SATA6Gbps Opal	None	HH DVD±RW	9-in-1	450W 92%	None	USB / USB Optical	Windows 10 Pro 64	3-year, Onsite	05/16
30B3000D--	WE	Xeon E5-2620 v4 8C/2.1GHz/20MB/85W/DDR4-2133	Open	1x 8GB RDIMM DDR4-2400 ECC	Integrated Intel SATA	1x256GB SSD 2.5" SATA6Gbps Opal	None	HH DVD±RW	9-in-1	450W 92%	None	USB / USB Optical	Windows 10 DG Windows 7 Pro 64	3-year, Onsite	05/16
30B3000E--	WE	Xeon E5-2620 v4 8C/2.1GHz/20MB/85W/DDR4-2133	NVIDIA Quadro M2000 4GB	1x 8GB RDIMM DDR4-2400 ECC	Integrated Intel SATA	1x256GB SSD 2.5" SATA6Gbps Opal	None	HH DVD±RW	9-in-1	450W 92%	None	USB / USB Optical	Windows 10 DG Windows 7 Pro 64	3-year, Onsite	05/16
30B3000F--	WE	Xeon E5-2620 v4 8C/2.1GHz/20MB/85W/DDR4-2133	NVIDIA Quadro M2000 4GB	1x 8GB RDIMM DDR4-2400 ECC	Integrated Intel SATA	1x256GB SSD 2.5" SATA6Gbps Opal	None	HH DVD±RW	9-in-1	450W 92%	None	USB / USB Optical	Windows 10 Pro 64	3-year, Onsite	05/16

Model	Region	Processor	Graphics	Memory	Storage Controller	Disks	M.2 Drives	Optical	Media Reader	Power Supply	Optional Ports	Keyboard / Mouse	Operating System	Warranty	Ann Date (mm/yy)
30B3001D--	WE	Xeon E5-1650 v4 6C/3.6GHz/15MB/140W/DDR4-2400	Open	2x 8GB RDIMM DDR4-2400 ECC	Integrated Intel SATA	1x1TB HDD 7.2K 3.5" SATA6Gbps	None	HH DVD±RW	9-in-1	450W 92%	None	USB / USB Optical	Windows 10 Pro 64	3-year, Onsite	06/16
30B3001E--	WE	Xeon E5-1650 v4 6C/3.6GHz/15MB/140W/DDR4-2400	Open	2x 8GB RDIMM DDR4-2400 ECC	Integrated Intel SATA	1x256GB SSD 2.5" SATA6Gbps Opal	None	HH DVD±RW	9-in-1	450W 92%	None	USB / USB Optical	Windows 10 Pro 64	3-year, Onsite	06/16
30B3001F--	WE	Xeon E5-1630 v4 4C/3.7GHz/10MB/140W/DDR4-2400	NVIDIA Quadro K1200 4GB	1x 8GB RDIMM DDR4-2400 ECC	Integrated Intel SATA	1x256GB SSD 2.5" SATA6Gbps Opal	None	HH DVD±RW	9-in-1	450W 92%	None	USB / USB Optical	Windows 10 Pro 64	3-year, Onsite	06/16
30B3001G--	WE	Xeon E5-1650 v4 6C/3.6GHz/15MB/140W/DDR4-2400	NVIDIA Quadro M4000 8GB	2x 8GB RDIMM DDR4-2400 ECC	Integrated Intel SATA	1x512GB SSD 2.5" SATA6Gbps	None	HH DVD±RW	9-in-1	450W 92%	None	USB / USB Optical	Windows 10 Pro 64	3-year, Onsite	06/16

ThinkStation P510 Platform Specifications

Components	Specification																																																																																																																																										
Chipset	Intel C612 Platform Controller Hub (PCH)																																																																																																																																										
System mgmt	Intel Active Management Technology 9																																																																																																																																										
Processor	Up to one 145W Intel Xeon E5-2600 v4 or E5-1600 v4 family processors. 22 cores up to 2.2GHz, 16 cores up to 2.6GHz, 14 cores up to 2.6GHz, 12 cores up to 2.2GHz, 10 cores up to 2.4GHz, 8 cores up to 3.4GHz, 6 cores up to 3.6GHz, 4 cores up to 3.7GHz Or up to one Intel Xeon E5-2600 v3 or E5-1600 v3 processors (not available in EMEA).																																																																																																																																										
Coprocessor	None																																																																																																																																										
Memory DIMM slots	8 DIMM sockets, 4-channel capable. RDIMM, ECC, DDR4, 2400MHz																																																																																																																																										
Memory capacity	256GB																																																																																																																																										
Graphics, GPU computing	Two PCIe 3.0 x16 slots for graphics and GPU computing adapters. Up to two NVIDIA Quadro M5000 SLI																																																																																																																																										
Supporting Graphics and GPU computing	<table border="1"> <thead> <tr> <th>Adapter</th> <th>Cores</th> <th>Memory</th> <th>Power</th> <th>Connector***</th> <th>SLI</th> </tr> </thead> <tbody> <tr> <td>NVS 310</td> <td>48</td> <td>1GB</td> <td>19.5W</td> <td>2xDP</td> <td></td> </tr> <tr> <td>NVS 315</td> <td>48</td> <td>1GB</td> <td>19.5W</td> <td>2xDVI-I SL/2xDP</td> <td></td> </tr> <tr> <td>NVS 510</td> <td>192</td> <td>2GB</td> <td>35W</td> <td>4xmini DP</td> <td></td> </tr> <tr> <td>NVS 810</td> <td>1024</td> <td>4GB</td> <td>68W</td> <td>8xmini DP</td> <td></td> </tr> <tr> <td>Quadro K420</td> <td>192</td> <td>2GB</td> <td>41W</td> <td>DVI-I DL+DP</td> <td></td> </tr> <tr> <td>Quadro K620</td> <td>384</td> <td>2GB</td> <td>45W</td> <td>DVI-I DL+DP</td> <td></td> </tr> <tr> <td>Quadro K1200</td> <td>512</td> <td>4GB</td> <td>45W</td> <td>4xmini DP</td> <td></td> </tr> <tr> <td>Quadro K2200</td> <td>640</td> <td>4GB</td> <td>68W</td> <td>DVI-I DL+2xDP</td> <td></td> </tr> <tr> <td>Quadro K4200</td> <td>1344</td> <td>4GB</td> <td>108W</td> <td>DVI-I DL+2xDP</td> <td></td> </tr> <tr> <td>Quadro K5200</td> <td>2304</td> <td>8GB</td> <td>150W</td> <td>DVI-I DL+DVI-D DL+2xDP</td> <td>SLI</td> </tr> <tr> <td>Quadro M2000</td> <td>768</td> <td>4GB</td> <td>75W</td> <td>4xDP</td> <td></td> </tr> <tr> <td>Quadro M4000</td> <td>1664</td> <td>8GB</td> <td>120W</td> <td>4xDP</td> <td></td> </tr> <tr> <td>Quadro M5000</td> <td>2048</td> <td>8GB</td> <td>150W</td> <td>DVI-I DL+4xDP</td> <td>SLI</td> </tr> <tr> <td>Quadro M6000</td> <td>3072</td> <td>24GB</td> <td>250W</td> <td>DVI-I DL+4xDP</td> <td></td> </tr> <tr> <td>Quadro P400</td> <td>256</td> <td>2GB</td> <td>30W</td> <td>3xminiDP</td> <td></td> </tr> <tr> <td>Quadro P600</td> <td>384</td> <td>2GB</td> <td>40W</td> <td>4xminiDP</td> <td></td> </tr> <tr> <td>Quadro P1000</td> <td>640</td> <td>4GB</td> <td>47W</td> <td>4xminiDP</td> <td></td> </tr> <tr> <td>Quadro P2000</td> <td>1024</td> <td>5GB</td> <td>75W</td> <td>4xDP</td> <td></td> </tr> <tr> <td>Quadro P4000</td> <td>1792</td> <td>8GB</td> <td>105W</td> <td>4xDP</td> <td>SLI</td> </tr> <tr> <td>Quadro P5000</td> <td>2560</td> <td>16GB</td> <td>180W</td> <td>DVI-D DL+4xDP</td> <td>SLI</td> </tr> <tr> <td>Quadro P6000</td> <td>3840</td> <td>24GB</td> <td>250W</td> <td>DVI-D DL+4xDP</td> <td></td> </tr> <tr> <td>Tesla K40</td> <td>2880</td> <td>12GB</td> <td>235W</td> <td></td> <td></td> </tr> </tbody> </table>	Adapter	Cores	Memory	Power	Connector***	SLI	NVS 310	48	1GB	19.5W	2xDP		NVS 315	48	1GB	19.5W	2xDVI-I SL/2xDP		NVS 510	192	2GB	35W	4xmini DP		NVS 810	1024	4GB	68W	8xmini DP		Quadro K420	192	2GB	41W	DVI-I DL+DP		Quadro K620	384	2GB	45W	DVI-I DL+DP		Quadro K1200	512	4GB	45W	4xmini DP		Quadro K2200	640	4GB	68W	DVI-I DL+2xDP		Quadro K4200	1344	4GB	108W	DVI-I DL+2xDP		Quadro K5200	2304	8GB	150W	DVI-I DL+DVI-D DL+2xDP	SLI	Quadro M2000	768	4GB	75W	4xDP		Quadro M4000	1664	8GB	120W	4xDP		Quadro M5000	2048	8GB	150W	DVI-I DL+4xDP	SLI	Quadro M6000	3072	24GB	250W	DVI-I DL+4xDP		Quadro P400	256	2GB	30W	3xminiDP		Quadro P600	384	2GB	40W	4xminiDP		Quadro P1000	640	4GB	47W	4xminiDP		Quadro P2000	1024	5GB	75W	4xDP		Quadro P4000	1792	8GB	105W	4xDP	SLI	Quadro P5000	2560	16GB	180W	DVI-D DL+4xDP	SLI	Quadro P6000	3840	24GB	250W	DVI-D DL+4xDP		Tesla K40	2880	12GB	235W		
	Adapter	Cores	Memory	Power	Connector***	SLI																																																																																																																																					
	NVS 310	48	1GB	19.5W	2xDP																																																																																																																																						
	NVS 315	48	1GB	19.5W	2xDVI-I SL/2xDP																																																																																																																																						
	NVS 510	192	2GB	35W	4xmini DP																																																																																																																																						
	NVS 810	1024	4GB	68W	8xmini DP																																																																																																																																						
	Quadro K420	192	2GB	41W	DVI-I DL+DP																																																																																																																																						
	Quadro K620	384	2GB	45W	DVI-I DL+DP																																																																																																																																						
	Quadro K1200	512	4GB	45W	4xmini DP																																																																																																																																						
	Quadro K2200	640	4GB	68W	DVI-I DL+2xDP																																																																																																																																						
	Quadro K4200	1344	4GB	108W	DVI-I DL+2xDP																																																																																																																																						
	Quadro K5200	2304	8GB	150W	DVI-I DL+DVI-D DL+2xDP	SLI																																																																																																																																					
	Quadro M2000	768	4GB	75W	4xDP																																																																																																																																						
	Quadro M4000	1664	8GB	120W	4xDP																																																																																																																																						
	Quadro M5000	2048	8GB	150W	DVI-I DL+4xDP	SLI																																																																																																																																					
	Quadro M6000	3072	24GB	250W	DVI-I DL+4xDP																																																																																																																																						
	Quadro P400	256	2GB	30W	3xminiDP																																																																																																																																						
	Quadro P600	384	2GB	40W	4xminiDP																																																																																																																																						
	Quadro P1000	640	4GB	47W	4xminiDP																																																																																																																																						
	Quadro P2000	1024	5GB	75W	4xDP																																																																																																																																						
Quadro P4000	1792	8GB	105W	4xDP	SLI																																																																																																																																						
Quadro P5000	2560	16GB	180W	DVI-D DL+4xDP	SLI																																																																																																																																						
Quadro P6000	3840	24GB	250W	DVI-D DL+4xDP																																																																																																																																							
Tesla K40	2880	12GB	235W																																																																																																																																								
RAID controller	Supports one of the following: RAID 0, 1, 5, 10 with onboard SATA controller in chipset, SATA 6Gb/s. RAID 0, 1, 5, 10 with optional LSI RAID flex adapter, 12Gb/s SAS and SATA. RAID 0, 1, 5, 6, 10 with optional LSI 9364-8i PCIe adapter, 1GB memory, 12Gb/s SAS and SATA																																																																																																																																										
Drive Bays	Two external 5.25" flex bays for flex module, optical drives, or optional disk drives. Four 3.5" internal bays. Each 3.5" bay can support dual drives on selected models (see right).																																																																																																																																										
Flex bay	Two 5.25" flex bays for optical drives, Front Access Storage Enclosure drives, Flex Bay Storage Enclosure drives, or flex module. • Up to two half-height optical drives or up to one 9.5mm optical drive, DVD-ROM, DVD±RW, or Blu-Ray burner • Up to one Front Access Storage Enclosure for one 3.5" or 2.5" SATA drive. • Up to two Flex Bay Storage Enclosure for two 3.5" or 2.5" SATA drives.																																																																																																																																										
Supporting storage	3.5" HDD, 7.2K SATA6Gbs	500GB/1TB/2TB/3TB/4TB/6TB/1TB hybrid/2TB hybrid																																																																																																																																									
	2.5" HDD, 15K SAS12Gbs	300GB/600GB																																																																																																																																									
	2.5" SSD, SAS12Gbs	200GB/400GB/800GB																																																																																																																																									
	2.5" SAS HDD, 10K 12Gbs	300GB																																																																																																																																									
	2.5" SSD, SATA6Gbs	180GB/240GB/256GB/480GB/512GB with OPAL, 256GB/512GB/1TB without OPAL																																																																																																																																									
	PCIe SSD, U.2	400GB																																																																																																																																									
	PCIe SSD, M.2	256 GB/512GB/1TB																																																																																																																																									
PCIe SSD adapter	400GB (up to 3 per system)																																																																																																																																										
Flex connector	One flex connector, supports one of the following: • Up to one LSI RAID flex adapter for SATA/SAS RAID • Up to one Multi-I/O flex adapters for one 2.5" PCIe SSD • Up to one M.2 flex adapters for one M.2 PCIe SSD																																																																																																																																										

Components	Specification	
Network interfaces	Integrated one Gigabit Ethernet (Intel i218LM), supports Wake-on-LAN. Optional discrete Ethernet is available	
HD Audio	Realtek ALC662 codec	
TPM	TCG 1.2-compliant	
Power supply	One fixed 490 watts, autosensing, 90%, 80 PLUS Gold qualified. Or one fixed 650 watts, autosensing, 92%, 80 PLUS Platinum qualified	
Front ports	Four USB 3.0 (one Diagnostic, one Always On), one combo audio/microphone jack (3.5mm)	
Rear ports	Four USB 2.0, four USB 3.0, one serial (9-pin), one ethernet (RJ-45), three analog audio ports (line-in, line-out, mic-in), two PS/2	
Add-on ports	Supports the following optional ports: Two IEEE 1394 (one on rear and one on front flex module) via PCIe adapter, up to one adapter per system. Two rear USB 3.0 per PCIe adapter, up to three adapters per system. One rear Thunderbolt via PCIe adapter. One front eSATA (on flex module), or one rear eSATA via cable (also needs one PCIe slot), up to one eSATA port per system. One internal USB 3.0 port via cable, cannot be intermixed with 29-in-1 reader	
Media reader	9-in-1 USB 2.0 or 29-in-1 USB 3.0 card reader	
Mechanical	<ul style="list-style-type: none"> 36-liter: 175mm/6.89" W x 470mm/18.5" D x 440mm/17.32" H (with feet) Tool-less parts: all except CPU fansink 48.94 lb (22.2kg) max configuration 	
Environmental specification	Temperature - operating	50 °F to 95 °F (10 °C to 35 °C)
	Temperature - non operating (no package)	14 °F to 140 °F (-10 °C to 60 °C)
	Temperature - non operating (with package)	-40 °F to 140 °F (-40 °C to 60 °C)
	Altitude - operating	(Unpressurized): 0-10000ft (0-3048m)
	Humidity - operating	10%-80%, non-condensing
	Humidity - storage (with package)	10%-90%, non-condensing
	RoHS-compliant, GREENGUARD on all models. EPEAT Gold rating, ENERGY STAR 6.1 qualified on selected models.	
Base warranty	3-year limited onsite service with 9x5/NBD	
ISV certifications	Please visit www.thinkworkstations.com/isv-certifications/	

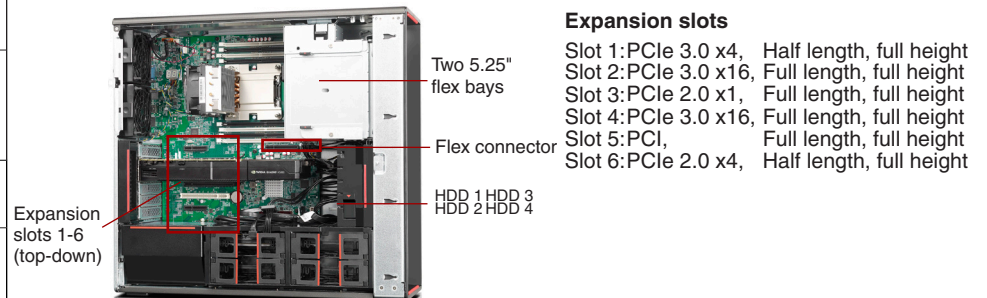

Expansion slots
Slot 1: PCIe 3.0 x4, Half length, full height
Slot 2: PCIe 3.0 x16, Full length, full height
Slot 3: PCIe 2.0 x1, Full length, full height
Slot 4: PCIe 3.0 x16, Full length, full height
Slot 5: PCI, Full length, full height
Slot 6: PCIe 2.0 x4, Half length, full height

Drive Bays
HDD 1-4: Standard 3.5" HDD bay, up to four 3.5" or 2.5" disk drives.
On selected models, each 3.5" bay can supports 2.5" (9mm or less) drive plus 3.5" drive, or two 2.5" (15mm or less) drives.
Flex bay: Two 5.25" flex bays, for HH optical drives.
Or up to one optional flex module (Flex module supports one or more of the following options: 9.5mm optical/29-in-1 USB 3.0 reader/front IEEE 1394/front eSATA).
Or up to two HDD bays for two drives, 3.5" or 2.5" each, SATA only.

Model	Region	Processor	Graphics	Memory	Storage Controller	Max Drives in 3.5" Bays	Disks	M.2 Drives	Optical	Media Reader	Power Supply	Optional Ports	Keyboard / Mouse	Operating System	Warranty	End of Support	Ann Date (mm/yy)
30B50005**	MEA	Xeon E5-1650 v3 6C/3.5GHz/15MB/140W/DDR4-2133	NVIDIA Quadro M2000 4GB	4x8GB RDIMM DDR4-2400 ECC	Onboard	4	1x 1TB HDD 7.2K 3.5" SATA6Gbps	None	HH DVD±RW	9-in-1	490W 90%	None	USB / USB Optical	Windows 10 DG Windows 7 Pro 64	3-year, Onsite	Jul 14, 2022	06/16
30B50006**	MEA	Xeon E5-1620 v4 4C/3.5GHz/10MB/140W/DDR4-2400	Open	1x8GB RDIMM DDR4-2400 ECC	Onboard	4	1x 1TB Hybrid HDD 7.2K 3.5" SATA6Gbps	None	HH DVD±RW	9-in-1	490W 90%	None	USB / USB Optical	Windows 10 DG Windows 7 Pro 64	3-year, Onsite	Jul 14, 2022	06/16
30B50007**	MEA	Xeon E5-1620 v4 4C/3.5GHz/10MB/140W/DDR4-2400	Open	1x8GB RDIMM DDR4-2400 ECC	Onboard	4	1x 1TB Hybrid HDD 7.2K 3.5" SATA6Gbps	None	HH DVD±RW	9-in-1	490W 90%	None	USB / USB Optical	Windows 10 Pro 64	3-year, Onsite	Jul 14, 2022	06/16
30B50008**	MEA	Xeon E5-2603 v4 6C/1.7GHz/15MB/85W/DDR4-1866	NVIDIA Quadro M2000 4GB	2x8GB RDIMM DDR4-2400 ECC	Onboard	4	1x 256GB SSD SATA6Gbps Opal	None	HH DVD±RW	9-in-1	490W 90%	None	USB / USB Optical	Windows 10 DG Windows 7 Pro 64	3-year, Onsite	Jul 14, 2022	06/16
30B50009**	MEA	Xeon E5-1650 v3 6C/3.5GHz/15MB/140W/DDR4-2133	NVIDIA Quadro M2000 4GB	1x8GB RDIMM DDR4-2400 ECC	Onboard	4	1x 256GB SSD 2.5" SATA6Gbps Opal	None	HH DVD±RW	9-in-1	490W 90%	None	USB / USB Optical	Windows 10 DG Windows 7 Pro 64	3-year, Onsite	Jul 14, 2022	06/16
30B5000A**	MEA	Xeon E5-1620 v4 4C/3.5GHz/10MB/140W/DDR4-2400	Open	1x8GB RDIMM DDR4-2400 ECC	Onboard	4	1x 256GB SSD 2.5" SATA6Gbps Opal	None	HH DVD±RW	9-in-1	650W 92%	None	USB / USB Optical	Windows 10 DG Windows 7 Pro 64	3-year, Onsite	Jul 14, 2022	06/16
30B5000B**	MEA	Xeon E5-1650 v4 6C/3.6GHz/15MB/140W/DDR4-2400	Open	1x8GB RDIMM DDR4-2400 ECC	Onboard	4	1x 512GB SSD 2.5" SATA6Gbps	None	HH DVD±RW	9-in-1	650W 92%	None	USB / USB Optical	Windows 10 DG Windows 7 Pro 64	3-year, Onsite	Jul 14, 2022	06/16
30B5000C**	MEA	Xeon E5-1620 v4 4C/3.5GHz/10MB/140W/DDR4-2400	Open	1x8GB RDIMM DDR4-2400 ECC	Onboard	4	None	1x 256GB SSD M.2 PCIe Opal	HH DVD±RW	9-in-1	490W 90%	None	USB / USB Optical	Windows 10 Pro 64	3-year, Onsite	Jul 14, 2022	06/16
30B5000D**	MEA	Xeon E5-1650 v4 6C/3.6GHz/15MB/140W/DDR4-2400	NVIDIA Quadro M2000 4GB	1x8GB RDIMM DDR4-2400 ECC	Onboard	4	1x 256GB SSD 2.5" SATA6Gbps Opal	None	HH DVD±RW	9-in-1	490W 90%	None	USB / USB Optical	Windows 10 Pro 64	3-year, Onsite	Jul 14, 2022	06/16
30B5000E**	MEA	Xeon E5-1620 v4 4C/3.5GHz/10MB/140W/DDR4-2400	Open	1x8GB RDIMM DDR4-2400 ECC	Onboard	4	1x 240GB SSD 2.5" SATA6Gbps Opal	None	HH DVD±RW	9-in-1	490W 90%	None	USB / USB Optical	Windows 10 DG Windows 7 Pro 64	3-year, Onsite	Jul 14, 2022	06/16
30B5000F**	MEA	Xeon E5-1650 v3 6C/3.5GHz/15MB/140W/DDR4-2133	Open	1x8GB RDIMM DDR4-2400 ECC	Onboard	4	1x 1TB HDD 7.2K 3.5" SATA6Gbps	None	HH DVD±RW	9-in-1	490W 90%	None	USB / USB Optical	Windows 10 DG Windows 7 Pro 64	3-year, Onsite	Jul 14, 2022	06/16
30B5000G**	MEA	Xeon E5-1620 v4 4C/3.5GHz/10MB/140W/DDR4-2400	Open	1x8GB RDIMM DDR4-2400 ECC	Onboard	4	1x 1TB Hybrid HDD 7.2K 3.5" SATA6Gbps	None	HH DVD±RW	9-in-1	650W 92%	None	USB / USB Optical	Windows 10 DG Windows 7 Pro 64	3-year, Onsite	Jul 14, 2022	06/16

Model	Region	Processor	Graphics	Memory	Storage Controller	Max Drives in 3.5" Bays	Disks	M.2 Drives	Optical	Media Reader	Power Supply	Optional Ports	Keyboard / Mouse	Operating System	Warranty	End of Support	Ann Date (mm/yy)
30B5000H**	MEA	Xeon E5-1650 v4 6C/3.6GHz/15MB/140W/DDR4-2400	Open	2x8GB RDIMM DDR4-2400 ECC	Onboard	4	None	1x 512GB SSD M.2 PCIe	HH DVD±RW	9-in-1	650W 92%	None	USB / USB Optical	Windows 10 Pro 64	3-year, Onsite	Jul 14, 2022	06/16
30B5000J**	MEA	Xeon E5-1650 v4 6C/3.6GHz/15MB/140W/DDR4-2400	Open	1x8GB RDIMM DDR4-2400 ECC	Onboard	4	1x 1TB HDD 7.2K 3.5" SATA6Gbps	None	HH DVD±RW	9-in-1	490W 90%	None	USB / USB Optical	Windows 10 Pro 64	3-year, Onsite	Jul 14, 2022	06/16
30B5000K**	MEA	Xeon E5-1650 v4 6C/3.6GHz/15MB/140W/DDR4-2400	Open	1x8GB RDIMM DDR4-2400 ECC	Onboard	4	1x 1TB HDD 7.2K 3.5" SATA6Gbps	None	HH DVD±RW	9-in-1	650W 92%	None	USB / USB Optical	Windows 10 DG Windows 7 Pro 64	3-year, Onsite	Jul 14, 2022	06/16
30B5000L**	MEA	Xeon E5-1680 v4 8C/3.4GHz/20MB/140W/DDR4-2400	NVIDIA Quadro M4000 8GB	2x8GB RDIMM DDR4-2400 ECC	Onboard	4	None	1x 512GB SSD M.2 PCIe	HH DVD±RW	9-in-1	650W 92%	None	USB / USB Optical	Windows 10 Pro 64	3-year, Onsite	Jul 14, 2022	06/16
30B5000M**	MEA	Xeon E5-2603 v4 6C/1.7GHz/15MB/85W/DDR4-1866	NVIDIA Quadro M2000 4GB	2x8GB RDIMM DDR4-2400 ECC	Onboard	4	1x 256GB SSD 2.5" SATA6Gbps Opal	None	HH DVD±RW	9-in-1	490W 90%	None	USB / USB Optical	Windows 10 Pro 64	3-year, Onsite	Jul 14, 2022	06/16
30B5000N**	MEA	Xeon E5-1620 v4 4C/3.5GHz/10MB/140W/DDR4-2400	Open	1x8GB RDIMM DDR4-2400 ECC	Onboard	4	1x 1TB Hybrid HDD 7.2K 3.5" SATA6Gbps	None	HH DVD±RW	9-in-1	650W 92%	None	USB / USB Optical	Windows 10 Pro 64	3-year, Onsite	Jul 14, 2022	06/16
30B5000P**	MEA	Xeon E5-1620 v4 4C/3.5GHz/10MB/140W/DDR4-2400	Open	1x8GB RDIMM DDR4-2400 ECC	Onboard	4	None	1x 256GB SSD M.2 PCIe Opal	HH DVD±RW	9-in-1	490W 90%	None	USB / USB Optical	Windows 10 DG Windows 7 Pro 64	3-year, Onsite	Jul 14, 2022	06/16
30B5000Q**	MEA	Xeon E5-1650 v4 6C/3.6GHz/15MB/140W/DDR4-2400	Open	1x8GB RDIMM DDR4-2400 ECC	Onboard	4	None	1x 256GB SSD M.2 PCIe Opal	HH DVD±RW	9-in-1	650W 92%	None	USB / USB Optical	Windows 10 DG Windows 7 Pro 64	3-year, Onsite	Jul 14, 2022	06/16
30B5000R**	MEA	Xeon E5-1650 v4 6C/3.6GHz/15MB/140W/DDR4-2400	NVIDIA Quadro M2000 4GB	4x8GB RDIMM DDR4-2400 ECC	Onboard	4	1x 1TB HDD 7.2K 3.5" SATA6Gbps	None	HH DVD±RW	9-in-1	490W 90%	None	USB / USB Optical	Windows 10 Pro 64	3-year, Onsite	Jul 14, 2022	06/16
30B5000S**	MEA	Xeon E5-1620 v4 4C/3.5GHz/10MB/140W/DDR4-2400	Open	1x8GB RDIMM DDR4-2400 ECC	Onboard	4	None	1x 512GB SSD M.2 PCIe	HH DVD±RW	9-in-1	650W 92%	None	USB / USB Optical	Windows 10 Pro 64	3-year, Onsite	Jul 14, 2022	06/16
30B5000T**	MEA	Xeon E5-1650 v4 6C/3.6GHz/15MB/140W/DDR4-2400	Open	2x8GB RDIMM DDR4-2400 ECC	Onboard	4	None	1x 256GB SSD M.2 PCIe Opal	HH DVD±RW	9-in-1	650W 92%	None	USB / USB Optical	Windows 10 Pro 64	3-year, Onsite	Jul 14, 2022	06/16
30B5000U**	MEA	Xeon E5-1620 v4 4C/3.5GHz/10MB/140W/DDR4-2400	Open	1x8GB RDIMM DDR4-2400 ECC	Onboard	4	1x 240GB SSD 2.5" SATA6Gbps Opal	None	HH DVD±RW	9-in-1	490W 90%	None	USB / USB Optical	Windows 10 Pro 64	3-year, Onsite	Jul 14, 2022	06/16

Model	Region	Processor	Graphics	Memory	Storage Controller	Max Drives in 3.5" Bays	Disks	M.2 Drives	Optical	Media Reader	Power Supply	Optional Ports	Keyboard / Mouse	Operating System	Warranty	End of Support	Ann Date (mm/yy)
30B5000V**	MEA	Xeon E5-1650 v4 6C/3.6GHz/15MB/140W/DDR4-2400	Open	1x8GB RDIMM DDR4-2400 ECC	Onboard	4	1x 1TB HDD 7.2K 3.5" SATA6Gbps	None	HH DVD±RW	9-in-1	650W 92%	None	USB / USB Optical	Windows 10 Pro 64	3-year, Onsite	Jul 14, 2022	06/16
30B5000W**	MEA	Xeon E5-1620 v4 4C/3.5GHz/10MB/140W/DDR4-2400	NVIDIA Quadro M2000 4GB	1x8GB RDIMM DDR4-2400 ECC	Onboard	4	None	1x 512GB SSD M.2 PCIe	HH DVD±RW	9-in-1	650W 92%	None	USB / USB Optical	Windows 10 DG Windows 7 Pro 64	3-year, Onsite	Jul 14, 2022	06/16
30B5000X**	MEA	Xeon E5-1650 v4 6C/3.6GHz/15MB/140W/DDR4-2400	Open	2x8GB RDIMM DDR4-2400 ECC	Onboard	4	None	1x 512GB SSD M.2 PCIe	HH DVD±RW	9-in-1	650W 92%	None	USB / USB Optical	Windows 10 DG Windows 7 Pro 64	3-year, Onsite	Jul 14, 2022	06/16
30B5000Y**	MEA	Xeon E5-1620 v4 4C/3.5GHz/10MB/140W/DDR4-2400	NVIDIA Quadro M2000 4GB	1x8GB RDIMM DDR4-2400 ECC	Onboard	4	None	1x 512GB SSD M.2 PCIe	HH DVD±RW	9-in-1	650W 92%	None	USB / USB Optical	Windows 10 Pro 64	3-year, Onsite	Jul 14, 2022	06/16
30B50010**	MEA	Xeon E5-1680 v4 8C/3.4GHz/20MB/140W/DDR4-2400	NVIDIA Quadro M4000 8GB	2x8GB RDIMM DDR4-2400 ECC	Onboard	4	None	1x 512GB SSD M.2 PCIe	HH DVD±RW	9-in-1	650W 92%	None	USB / USB Optical	Windows 10 DG Windows 7 Pro 64	3-year, Onsite	Jul 14, 2022	06/16
30B50011**	MEA	Xeon E5-1620 v4 4C/3.5GHz/10MB/140W/DDR4-2400	Open	1x8GB RDIMM DDR4-2400 ECC	Onboard	4	1x 256GB SSD 2.5" SATA6Gbps Opal	None	HH DVD±RW	9-in-1	650W 92%	None	USB / USB Optical	Windows 10 Pro 64	3-year, Onsite	Jul 14, 2022	06/16
30B50012**	MEA	Xeon E5-1650 v4 6C/3.6GHz/15MB/140W/DDR4-2400	Open	1x8GB RDIMM DDR4-2400 ECC	Onboard	4	1x 512GB SSD 2.5" SATA6Gbps	None	HH DVD±RW	9-in-1	650W 92%	None	USB / USB Optical	Windows 10 Pro 64	3-year, Onsite	Jul 14, 2022	06/16
30B50013**	MEA	Xeon E5-1620 v4 4C/3.5GHz/10MB/140W/DDR4-2400	Open	1x8GB RDIMM DDR4-2400 ECC	Onboard	4	None	1x 512GB SSD M.2 PCIe	HH DVD±RW	9-in-1	650W 92%	None	USB / USB Optical	Windows 10 DG Windows 7 Pro 64	3-year, Onsite	Jul 14, 2022	06/16
30B50017**	MEA	Xeon E5-1620 v4 4C/3.5GHz/10MB/140W/DDR4-2400	Open	2x8GB RDIMM DDR4-2400 ECC	Onboard	4	1x 256GB SSD 2.5" SATA6Gbps Opal	None	HH DVD±RW	9-in-1	650W 92%	None	USB / USB Optical	Windows 10 DG Windows 7 Pro 64	3-year, Onsite	Jul 14, 2022	06/16
30B50018**	MEA	Xeon E5-1620 v4 4C/3.5GHz/10MB/140W/DDR4-2400	Open	2x8GB RDIMM DDR4-2400 ECC	Onboard	4	1x 256GB SSD 2.5" SATA6Gbps Opal	None	HH DVD±RW	9-in-1	650W 92%	None	USB / USB Optical	Windows 10 Pro 64	3-year, Onsite	Jul 14, 2022	06/16
30B50019**	MEA	Xeon E5-1630 v4 4C/3.7GHz/10MB/140W/DDR4-2400	Open	2x8GB RDIMM DDR4-2400 ECC	Onboard	4	1x 256GB SSD 2.5" SATA6Gbps Opal	None	HH DVD±RW	9-in-1	650W 92%	None	USB / USB Optical	Windows 10 Pro 64	3-year, Onsite	Jul 14, 2022	06/16
30B5001A**	MEA	Xeon E5-1630 v4 4C/3.7GHz/10MB/140W/DDR4-2400	Open	2x8GB RDIMM DDR4-2400 ECC	Onboard	4	1x 256GB SSD 2.5" SATA6Gbps Opal	None	HH DVD±RW	9-in-1	650W 92%	None	USB / USB Optical	Windows 10 DG Windows 7 Pro 64	3-year, Onsite	Jul 14, 2022	06/16

Model	Region	Processor	Graphics	Memory	Storage Controller	Max Drives in 3.5" Bays	Disks	M.2 Drives	Optical	Media Reader	Power Supply	Optional Ports	Keyboard / Mouse	Operating System	Warranty	End of Support	Ann Date (mm/yy)
30B5001B**	MEA	Xeon E5-1650 v4 6C/3.6GHz/15MB/140W/DDR4-2400	Open	2x8GB RDIMM DDR4-2400 ECC	Onboard	4	1x 512GB SSD 2.5" SATA6Gbps	None	HH DVD±RW	9-in-1	650W 92%	None	USB / USB Optical	Windows 10 DG Windows 7 Pro 64	3-year, Onsite	Jul 14, 2022	06/16
30B5001C**	MEA	Xeon E5-1650 v4 6C/3.6GHz/15MB/140W/DDR4-2400	Open	2x8GB RDIMM DDR4-2400 ECC	Onboard	4	1x 512GB SSD 2.5" SATA6Gbps	None	HH DVD±RW	9-in-1	650W 92%	None	USB / USB Optical	Windows 10 Pro 64	3-year, Onsite	Jul 14, 2022	06/16
30B5001T**	MEA	Xeon E5-1620 v4 4C/3.5GHz/10MB/140W/DDR4-2400	NVIDIA Quadro K620 2GB	2x8GB RDIMM DDR4-2400 ECC	Onboard	4	1x 1TB HDD 7.2K 3.5" SATA6Gbps	None	HH DVD±RW	9-in-1	490W 90%	None	USB / USB Optical	Windows 10 DG Windows 7 Pro 64	3-year, Onsite	Aug 26, 2022	07/16
30B5001E**	MEA	Xeon E5-1630 v4 4C/3.7GHz/10MB/140W/DDR4-2400	Open	2x8GB RDIMM DDR4-2400 ECC	Onboard	4	None	1x 256GB SSD M.2 PCIe Opal	HH DVD±RW	9-in-1	650W 92%	None	USB / USB Optical	Windows 10 Pro 64	3-year, Onsite	Jul 14, 2022	06/16
30B5001D**	MEA	Xeon E5-1630 v4 4C/3.7GHz/10MB/140W/DDR4-2400	Open	2x8GB RDIMM DDR4-2400 ECC	Onboard	4	None	1x 256GB SSD M.2 PCIe Opal	HH DVD±RW	9-in-1	650W 92%	None	USB / USB Optical	Windows 10 DG Windows 7 Pro 64	3-year, Onsite	Jul 14, 2022	06/16
30B50037**	MEA	Xeon E5-1620 v4 4C/3.5GHz/10MB/140W/DDR4-2400	Open	2x8GB RDIMM DDR4-2400 ECC	Onboard	4	1x 256GB SSD 2.5" SATA6Gbps Opal	None	HH DVD±RW	29-in-1	650W 92%	None	USB / USB Optical	Windows 10 Pro 64	3-year, Onsite	Aug 26, 2022	07/16
30B50038**	MEA	Xeon E5-1630 v4 4C/3.7GHz/10MB/140W/DDR4-2400	Open	2x8GB RDIMM DDR4-2400 ECC	Onboard	4	1x 256GB SSD 2.5" SATA6Gbps Opal	None	HH DVD±RW	29-in-1	650W 92%	None	USB / USB Optical	Windows 10 Pro 64	3-year, Onsite	Aug 26, 2022	07/16
30B50039**	MEA	Xeon E5-1650 v4 6C/3.6GHz/15MB/140W/DDR4-2400	Open	4x8GB RDIMM DDR4-2400 ECC	Onboard	4	None	1x 512GB SSD M.2 PCIe	HH DVD±RW	29-in-1	650W 92%	None	USB / USB Optical	Windows 10 Pro 64	3-year, Onsite	Aug 26, 2022	07/16
30B5003A**	MEA	Xeon E5-2630 v4 10C/2.2GHz/25MB/85W/DDR4-2133	Open	2x8GB RDIMM DDR4-2400 ECC	Onboard	4	1x 2TB HDD 7.2K 3.5" SATA6Gbps	1x 512GB SSD M.2 PCIe	HH DVD±RW	9-in-1	650W 92%	None	USB / USB Optical	Windows 10 Pro 64	3-year, Onsite	Aug 26, 2022	07/16
30B5003B**	MEA	Xeon E5-1630 v4 4C/3.7GHz/10MB/140W/DDR4-2400	NVIDIA Quadro M5000 8GB	2x8GB RDIMM DDR4-2400 ECC	Onboard	4	None	1x 512GB SSD M.2 PCIe	HH DVD±RW	9-in-1	650W 92%	None	USB / USB Optical	Windows 10 Pro 64	3-year, Onsite	Aug 26, 2022	07/16
30B5003F**	MEA	Xeon E5-1630 v4 4C/3.7GHz/10MB/140W/DDR4-2400	Open	1x8GB RDIMM DDR4-2400 ECC	Onboard	4	1x 1TB HDD 7.2K 3.5" SATA6Gbps	None	HH DVD±RW	9-in-1	490W 90%	None	USB / USB Optical	Windows 10 DG Windows 7 Pro 64	3-year, Onsite	Aug 26, 2022	07/16
30B5003G**	MEA	Xeon E5-1650 v4 6C/3.6GHz/15MB/140W/DDR4-2400	Open	2x8GB RDIMM DDR4-2400 ECC	Onboard	4	1x 1TB HDD 7.2K 3.5" SATA6Gbps	None	HH DVD±RW	9-in-1	490W 90%	None	USB / USB Optical	Windows 10 DG Windows 7 Pro 64	3-year, Onsite	Aug 26, 2022	07/16

Model	Region	Processor	Graphics	Memory	Storage Controller	Max Drives in 3.5" Bays	Disks	M.2 Drives	Optical	Media Reader	Power Supply	Optional Ports	Keyboard / Mouse	Operating System	Warranty	End of Support	Ann Date (mm/yy)
30B5003H**	MEA	Xeon E5-1620 v4 4C/3.5GHz/10MB/140W/DDR4-2400	Open	1x16GB RDIMM DDR4-2400 ECC	Onboard	4	1x 1TB HDD 7.2K 3.5" SATA6Gbps	None	HH DVD±RW	9-in-1	490W 90%	None	USB / USB Optical	Windows 10 DG Windows 7 Pro 64	3-year, Onsite	Aug 26, 2022	07/16
30B5003J**	MEA	Xeon E5-1630 v4 4C/3.7GHz/10MB/140W/DDR4-2400	Open	2x8GB RDIMM DDR4-2400 ECC	Onboard	4	1x 1TB HDD 7.2K 3.5" SATA6Gbps	None	HH DVD±RW	9-in-1	490W 90%	None	USB / USB Optical	Windows 10 DG Windows 7 Pro 64	3-year, Onsite	Aug 26, 2022	07/16
30B5003K**	MEA	Xeon E5-1607 v4 4C/3.1GHz/10MB/140W/DDR4-2133	Open	1x8GB RDIMM DDR4-2400 ECC	Onboard	4	1x 1TB HDD 7.2K 3.5" SATA6Gbps	None	HH DVD±RW	9-in-1	490W 90%	None	USB / USB Optical	Windows 10 DG Windows 7 Pro 64	3-year, Onsite	Aug 26, 2022	07/16
30B5003L**	MEA	Xeon E5-1650 v4 6C/3.6GHz/15MB/140W/DDR4-2400	NVIDIA Quadro M2000 4GB	2x8GB RDIMM DDR4-2400 ECC	Onboard	4	1x 1TB HDD 7.2K 3.5" SATA6Gbps	1x 256GB SSD M.2 PCIe Opal	HH DVD±RW	9-in-1	650W 92%	None	USB / USB Optical	Windows 10 DG Windows 7 Pro 64	3-year, Onsite	Aug 26, 2022	07/16
30B5003M**	MEA	Xeon E5-1650 v4 6C/3.6GHz/15MB/140W/DDR4-2400	NVIDIA Quadro M4000 8GB	2x8GB RDIMM DDR4-2400 ECC	Onboard	4	1x 1TB HDD 7.2K 3.5" SATA6Gbps	1x 256GB SSD M.2 PCIe Opal	HH DVD±RW	9-in-1	650W 92%	None	USB / USB Optical	Windows 10 DG Windows 7 Pro 64	3-year, Onsite	Aug 26, 2022	07/16
30B5003N**	MEA	Xeon E5-1620 v4 4C/3.5GHz/10MB/140W/DDR4-2400	NVIDIA Quadro M4000 8GB	2x8GB RDIMM DDR4-2400 ECC	Onboard	4	1x 1TB HDD 7.2K 3.5" SATA6Gbps	None	HH DVD±RW	9-in-1	650W 92%	None	USB / USB Optical	Windows 10 DG Windows 7 Pro 64	3-year, Onsite	Aug 26, 2022	07/16
30B5003P**	MEA	Xeon E5-1620 v4 4C/3.5GHz/10MB/140W/DDR4-2400	NVIDIA Quadro M2000 4GB	2x8GB RDIMM DDR4-2400 ECC	Onboard	4	1x 1TB HDD 7.2K 3.5" SATA6Gbps	None	HH DVD±RW	9-in-1	490W 90%	None	USB / USB Optical	Windows 10 DG Windows 7 Pro 64	3-year, Onsite	Aug 26, 2022	07/16
30B5003Q**	MEA	Xeon E5-1650 v4 6C/3.6GHz/15MB/140W/DDR4-2400	Open	2x8GB RDIMM DDR4-2400 ECC	Onboard	4	1x 1TB HDD 7.2K 3.5" SATA6Gbps	1x 256GB SSD M.2 PCIe Opal	HH DVD±RW	9-in-1	650W 92%	None	USB / USB Optical	Windows 10 DG Windows 7 Pro 64	3-year, Onsite	Aug 26, 2022	07/16
30B5003R**	MEA	Xeon E5-1620 v4 4C/3.5GHz/10MB/140W/DDR4-2400	Open	2x8GB RDIMM DDR4-2400 ECC	Onboard	4	1x 1TB HDD 7.2K 3.5" SATA6Gbps	None	HH DVD±RW	9-in-1	490W 90%	None	USB / USB Optical	Windows 10 DG Windows 7 Pro 64	3-year, Onsite	Aug 26, 2022	07/16
30B5003S**	MEA	Xeon E5-1650 v4 6C/3.6GHz/15MB/140W/DDR4-2400	Open	2x8GB RDIMM DDR4-2400 ECC	Onboard	4	1x 1TB HDD 7.2K 3.5" SATA6Gbps	1x 256GB SSD M.2 PCIe Opal	HH DVD±RW	9-in-1	490W 90%	None	USB / USB Optical	Windows 10 DG Windows 7 Pro 64	3-year, Onsite	Aug 26, 2022	07/16
30B5003T**	MEA	Xeon E5-1620 v4 4C/3.5GHz/10MB/140W/DDR4-2400	NVIDIA Quadro M2000 4GB	2x8GB RDIMM DDR4-2400 ECC	Onboard	4	1x 1TB HDD 7.2K 3.5" SATA6Gbps	None	HH DVD±RW	9-in-1	650W 92%	None	USB / USB Optical	Windows 10 DG Windows 7 Pro 64	3-year, Onsite	Aug 26, 2022	07/16
30B5003U**	MEA	Xeon E5-1620 v4 4C/3.5GHz/10MB/140W/DDR4-2400	Open	1x8GB RDIMM DDR4-2400 ECC	Onboard	4	1x 1TB HDD 7.2K 3.5" SATA6Gbps	None	HH DVD±RW	9-in-1	490W 90%	None	USB / USB Optical	Windows 10 DG Windows 7 Pro 64	3-year, Onsite	Aug 26, 2022	07/16

Model	Region	Processor	Graphics	Memory	Storage Controller	Max Drives in 3.5" Bays	Disks	M.2 Drives	Optical	Media Reader	Power Supply	Optional Ports	Keyboard / Mouse	Operating System	Warranty	End of Support	Ann Date (mm/yy)
30B5003V**	MEA	Xeon E5-1650 v4 6C/3.6GHz/15MB/140W/DDR4-2400	Open	1x8GB RDIMM DDR4-2400 ECC	Onboard	4	1x 1TB HDD 7.2K 3.5" SATA6Gbps	1x 256GB SSD M.2 PCIe Opal	HH DVD±RW	9-in-1	490W 90%	None	USB / USB Optical	Windows 10 DG Windows 7 Pro 64	3-year, Onsite	Aug 26, 2022	07/16
30B5003W**	MEA	Xeon E5-1650 v4 6C/3.6GHz/15MB/140W/DDR4-2400	NVIDIA Quadro K620 2GB	2x8GB RDIMM DDR4-2400 ECC	Onboard	4	1x 1TB HDD 7.2K 3.5" SATA6Gbps	1x 256GB SSD M.2 PCIe Opal	HH DVD±RW	9-in-1	490W 90%	None	USB / USB Optical	Windows 10 DG Windows 7 Pro 64	3-year, Onsite	Aug 26, 2022	07/16
30B5003X**	MEA	Xeon E5-1603 v4 4C/2.8GHz/10MB/140W/DDR4-2133	Open	1x8GB RDIMM DDR4-2400 ECC	Onboard	4	1x 1TB HDD 7.2K 3.5" SATA6Gbps	None	HH DVD±RW	9-in-1	490W 90%	None	USB / USB Optical	Windows 10 DG Windows 7 Pro 64	3-year, Onsite	Aug 26, 2022	07/16
30B5003Y**	MEA	Xeon E5-1650 v4 6C/3.6GHz/15MB/140W/DDR4-2400	NVIDIA Quadro M2000 4GB	2x8GB RDIMM DDR4-2400 ECC	Onboard	4	1x 1TB HDD 7.2K 3.5" SATA6Gbps	1x 256GB SSD M.2 PCIe Opal	HH DVD±RW	9-in-1	490W 90%	None	USB / USB Optical	Windows 10 DG Windows 7 Pro 64	3-year, Onsite	Aug 26, 2022	07/16
30B50040**	MEA	Xeon E5-1620 v4 4C/3.5GHz/10MB/140W/DDR4-2400	Open	2x8GB RDIMM DDR4-2400 ECC	Onboard	4	1x 1TB HDD 7.2K 3.5" SATA6Gbps	None	HH DVD±RW	9-in-1	650W 92%	None	USB / USB Optical	Windows 10 DG Windows 7 Pro 64	3-year, Onsite	Aug 26, 2022	07/16
30B5004N**	MEA	Xeon E5-1650 v4 6C/3.6GHz/15MB/140W/DDR4-2400	NVIDIA Quadro M2000 4GB	1x8GB RDIMM DDR4-2400 ECC	Onboard	4	1x 256GB SSD 2.5" SATA6Gbps Opal	None	HH DVD±RW	9-in-1	490W 90%	None	USB / USB Optical	Windows 10 DG Windows 7 Pro 64	3-year, Onsite	Oct 20, 2022	09/16
30B5004P**	MEA	Xeon E5-1650 v4 6C/3.6GHz/15MB/140W/DDR4-2400	NVIDIA Quadro M2000 4GB	4x8GB RDIMM DDR4-2400 ECC	Onboard	4	1x 1TB HDD 7.2K 3.5" SATA6Gbps	None	HH DVD±RW	9-in-1	490W 90%	None	USB / USB Optical	Windows 10 DG Windows 7 Pro 64	3-year, Onsite	Oct 20, 2022	09/16
30B5004Q**	MEA	Xeon E5-2630 v4 10C/2.2GHz/25MB/85W/DDR4-2133	Open	2x8GB RDIMM DDR4-2400 ECC	Onboard	4	1x 2TB HDD 7.2K 3.5" SATA6Gbps	1x 512GB SSD M.2 PCIe	HH DVD±RW	9-in-1	650W 92%	None	USB / USB Optical	Windows 10 DG Windows 7 Pro 64	3-year, Onsite	Oct 20, 2022	09/16
30B5004R**	MEA	Xeon E5-1620 v4 4C/3.5GHz/10MB/140W/DDR4-2400	Open	2x8GB RDIMM DDR4-2400 ECC	Onboard	4	1x 256GB SSD 2.5" SATA6Gbps Opal	None	9.5mm DVD±RW	29-in-1	650W 92%	None	USB / USB Optical	Windows 10 DG Windows 7 Pro 64	3-year, Onsite	Oct 20, 2022	09/16
30B5004S**	MEA	Xeon E5-1630 v4 4C/3.7GHz/10MB/140W/DDR4-2400	Open	2x8GB RDIMM DDR4-2400 ECC	Onboard	4	1x 256GB SSD 2.5" SATA6Gbps Opal	None	9.5mm DVD±RW	29-in-1	650W 92%	None	USB / USB Optical	Windows 10 DG Windows 7 Pro 64	3-year, Onsite	Oct 20, 2022	09/16
30B5004T**	MEA	Xeon E5-1650 v4 6C/3.6GHz/15MB/140W/DDR4-2400	Open	4x8GB RDIMM DDR4-2400 ECC	Onboard	4	None	1x 512GB SSD M.2 PCIe	9.5mm DVD±RW	29-in-1	650W 92%	None	USB / USB Optical	Windows 10 DG Windows 7 Pro 64	3-year, Onsite	Oct 20, 2022	09/16
30B5004W**	MEA	Xeon E5-1650 v4 6C/3.6GHz/15MB/140W/DDR4-2400	Open	4x8GB RDIMM DDR4-2400 ECC	Onboard	4	None	1x 512GB SSD M.2 PCIe	9.5mm DVD±RW	29-in-1	650W 92%	None	USB / USB Optical	Windows 10 Pro 64	3-year, Onsite	Oct 20, 2022	09/16

Model	Region	Processor	Graphics	Memory	Storage Controller	Max Drives in 3.5" Bays	Disks	M.2 Drives	Optical	Media Reader	Power Supply	Optional Ports	Keyboard / Mouse	Operating System	Warranty	End of Support	Ann Date (mm/yy)
30B5004U**	MEA	Xeon E5-1620 v4 4C/3.5GHz/10MB/140W/DDR4-2400	Open	2x8GB RDIMM DDR4-2400 ECC	Onboard	4	1x 256GB SSD 2.5" SATA6Gbps Opal	None	9.5mm DVD±RW	29-in-1	650W 92%	None	USB / USB Optical	Windows 10 Pro 64	3-year, Onsite	Oct 20, 2022	09/16
30B5004V**	MEA	Xeon E5-1630 v4 4C/3.7GHz/10MB/140W/DDR4-2400	Open	2x8GB RDIMM DDR4-2400 ECC	Onboard	4	1x 256GB SSD 2.5" SATA6Gbps Opal	None	9.5mm DVD±RW	29-in-1	650W 92%	None	USB / USB Optical	Windows 10 Pro 64	3-year, Onsite	Oct 20, 2022	09/16
30B5005U**	MEA	Xeon E5-1650 v4 6C/3.6GHz/15MB/140W/DDR4-2400	NVIDIA Quadro P2000 5GB	1x8GB RDIMM DDR4-2400 ECC	Onboard	4	1x 256GB SSD 2.5" SATA6Gbps Opal	None	HH DVD±RW	9-in-1	490W 90%	None	USB / USB Optical	Windows 10 Pro 64	3-year, Onsite	May 24, 2023	04/17
30B5005E**	MEA	Xeon E5-1650 v4 6C/3.6GHz/15MB/140W/DDR4-2400	Open	2x8GB RDIMM DDR4-2400 ECC	Onboard	4	1x 256GB SSD 2.5" SATA6Gbps Opal	None	HH DVD±RW	9-in-1	650W 92%	None	USB / USB Optical	Windows 10 DG Windows 7 Pro 64	3-year, Onsite	Oct 20, 2022	09/16
30B5006D**	MEA	Xeon E5-1607 v4 4C/3.1GHz/10MB/140W/DDR4-2133	NVIDIA Quadro P600 2GB	1x8GB RDIMM DDR4-2400 ECC	Onboard	4	1x 1TB HDD 7.2K 3.5" SATA6Gbps	None	9.5mm DVD±RW	29-in-1	650W 92%	Front eSATA	USB / USB Optical	Windows 10 Pro 64	3-year, Onsite	Aug 4, 2023	07/17
30B5006E**	MEA	Xeon E5-1620 v4 4C/3.5GHz/10MB/140W/DDR4-2400	NVIDIA Quadro P2000 5GB	1x16GB RDIMM DDR4-2400 ECC	Onboard	4	1x 1TB HDD 7.2K 3.5" SATA6Gbps	None	9.5mm DVD±RW	29-in-1	650W 92%	Front eSATA	USB / USB Optical	Windows 10 Pro 64	3-year, Onsite	Aug 4, 2023	07/17
30B5006F**	MEA	Xeon E5-1650 v4 6C/3.6GHz/15MB/140W/DDR4-2400	NVIDIA Quadro P4000 8GB	2x16GB RDIMM DDR4-2400 ECC	Onboard	4	1x 256GB SSD 2.5" SATA6Gbps Opal, 1x 1TB HDD 7.2K 3.5" SATA6Gbps	None	9.5mm DVD±RW	29-in-1	650W 92%	Front eSATA	USB / USB Optical	Windows 10 Pro 64	3-year, Onsite	Aug 4, 2023	07/17
30B5006G**	MEA	Xeon E5-1650 v4 6C/3.6GHz/15MB/140W/DDR4-2400	NVIDIA Quadro P2000 5GB	2x16GB RDIMM DDR4-2400 ECC	Onboard	4	2x 1TB HDD 7.2K 3.5" SATA6Gbps	None	9.5mm DVD±RW	29-in-1	650W 92%	Front eSATA	USB / USB Optical	Windows 10 Pro 64	3-year, Onsite	Aug 4, 2023	07/17
30B5006N**	MEA	Xeon E5-1650 v4 6C/3.6GHz/15MB/140W/DDR4-2400	NVIDIA Quadro P2000 5GB	1x8GB RDIMM DDR4-2400 ECC	Onboard	4	1x 256GB SSD 2.5" SATA6Gbps Opal	None	HH DVD±RW	9-in-1	490W 90%	None	USB / USB Optical	Windows 10 Pro 64	3-year, Onsite	Sep 26, 2022	09/17
30B5006P**	MEA	Xeon E5-2630 v4 10C/2.2GHz/25MB/85W/DDR4-2133	Open	2x8GB RDIMM DDR4-2400 ECC	Onboard	4	1x 2TB HDD 7.2K 3.5" SATA6Gbps	1x 512GB SSD M.2 PCIe	HH DVD±RW	9-in-1	650W 92%	None	USB / USB Optical	Windows 10 Pro 64	3-year, Onsite	Sep 26, 2022	09/17
30B5006Q**	MEA	Xeon E5-1620 v4 4C/3.5GHz/10MB/140W/DDR4-2400	Open	1x8GB RDIMM DDR4-2400 ECC	Onboard	4	None	1x 256GB SSD M.2 PCIe Opal	HH DVD±RW	9-in-1	490W 90%	None	USB / USB Optical	Windows 10 Pro 64	3-year, Onsite	Sep 26, 2022	09/17
30B5006R**	MEA	Xeon E5-1630 v4 4C/3.7GHz/10MB/140W/DDR4-2400	Open	2x8GB RDIMM DDR4-2400 ECC	Onboard	4	1x 256GB SSD 2.5" SATA6Gbps Opal	None	HH DVD±RW, 9.0mm DVD±RW	29-in-1	650W 92%	None	USB / USB Optical	Windows 10 Pro 64	3-year, Onsite	Sep 26, 2022	09/17

Model	Region	Processor	Graphics	Memory	Storage Controller	Max Drives in 3.5" Bays	Disks	M.2 Drives	Optical	Media Reader	Power Supply	Optional Ports	Keyboard / Mouse	Operating System	Warranty	End of Support	Ann Date (mm/yy)
30B5006S**	MEA	Xeon E5-1607 v4 4C/3.1GHz/10MB/140W/DDR4-2133	NVIDIA Quadro P600 2GB	1x8GB RDIMM DDR4-2400 ECC	Onboard	4	1x 1TB HDD 7.2K 3.5" SATA6Gbps	None	HH DVD±RW, 9.0mm DVD±RW	29-in-1	650W 92%	None	USB / USB Optical	Windows 10 Pro 64	3-year, Onsite	Sep 26, 2022	09/17
30B5006T**	MEA	Xeon E5-1620 v4 4C/3.5GHz/10MB/140W/DDR4-2400	NVIDIA Quadro P2000 5GB	1x16GB RDIMM DDR4-2400 ECC	Onboard	4	1x 1TB HDD 7.2K 3.5" SATA6Gbps	None	HH DVD±RW, 9.0mm DVD±RW	29-in-1	650W 92%	None	USB / USB Optical	Windows 10 Pro 64	3-year, Onsite	Sep 26, 2022	09/17
30B5006U**	MEA	Xeon E5-1650 v4 6C/3.6GHz/15MB/140W/DDR4-2400	NVIDIA Quadro P4000 8GB	2x16GB RDIMM DDR4-2400 ECC	Onboard	4	1x 256GB SSD 2.5" SATA6Gbps Opal, 1x 1TB HDD 7.2K 3.5" SATA6Gbps	None	HH DVD±RW, 9.0mm DVD±RW	29-in-1	650W 92%	None	USB / USB Optical	Windows 10 Pro 64	3-year, Onsite	Sep 26, 2022	09/17
30B5006V**	MEA	Xeon E5-1650 v4 6C/3.6GHz/15MB/140W/DDR4-2400	NVIDIA Quadro P2000 5GB	1x16GB RDIMM DDR4-2400 ECC	Onboard	4	2x 1TB HDD 7.2K 3.5" SATA6Gbps	None	HH DVD±RW, 9.0mm DVD±RW	29-in-1	650W 92%	None	USB / USB Optical	Windows 10 Pro 64	3-year, Onsite	Sep 26, 2022	09/17
30B5006W**	MEA	Xeon E5-1620 v4 4C/3.5GHz/10MB/140W/DDR4-2400	Open	1x8GB RDIMM DDR4-2400 ECC	Onboard	4	1x 1TB Hybrid HDD 7.2K 3.5" SATA6Gbps	None	HH DVD	9-in-1	490W 90%	None	USB / USB Optical	Windows 10 DG Windows 7 Pro 64	3-year, Onsite	Sep 26, 2022	09/17
30B5006X**	MEA	Xeon E5-1620 v4 4C/3.5GHz/10MB/140W/DDR4-2400	Open	1x8GB RDIMM DDR4-2400 ECC	Onboard	4	1x 1TB Hybrid HDD 7.2K 3.5" SATA6Gbps	None	HH DVD	9-in-1	650W 92%	None	USB / USB Optical	Windows 10 DG Windows 7 Pro 64	3-year, Onsite	Sep 26, 2022	09/17
30B5006Y**	MEA	Xeon E5-1620 v4 4C/3.5GHz/10MB/140W/DDR4-2400	Open	1x8GB RDIMM DDR4-2400 ECC	Onboard	4	1x 256GB SSD 2.5" SATA6Gbps Opal	None	HH DVD	9-in-1	650W 92%	None	USB / USB Optical	Windows 10 DG Windows 7 Pro 64	3-year, Onsite	Sep 26, 2022	09/17
30B50070**	MEA	Xeon E5-1630 v4 4C/3.7GHz/10MB/140W/DDR4-2400	Open	2x8GB RDIMM DDR4-2400 ECC	Onboard	4	None	1x 256GB SSD M.2 PCIe Opal	HH DVD	9-in-1	650W 92%	None	USB / USB Optical	Windows 10 DG Windows 7 Pro 64	3-year, Onsite	Sep 26, 2022	09/17
30B50071**	MEA	Xeon E5-1620 v4 4C/3.5GHz/10MB/140W/DDR4-2400	Open	1x8GB RDIMM DDR4-2400 ECC	Onboard	4	1x 1TB Hybrid HDD 7.2K 3.5" SATA6Gbps	None	HH DVD	9-in-1	490W 90%	None	USB / USB Optical	Windows 10 Pro 64	3-year, Onsite	Sep 26, 2022	09/17
30B50072**	MEA	Xeon E5-1620 v4 4C/3.5GHz/10MB/140W/DDR4-2400	Open	1x8GB RDIMM DDR4-2400 ECC	Onboard	4	1x 256GB SSD 2.5" SATA6Gbps Opal	None	HH DVD	9-in-1	650W 92%	None	USB / USB Optical	Windows 10 Pro 64	3-year, Onsite	Sep 26, 2022	09/17
30B50073**	MEA	Xeon E5-1650 v4 6C/3.6GHz/15MB/140W/DDR4-2400	Open	1x8GB RDIMM DDR4-2400 ECC	Onboard	4	1x 512GB SSD 2.5" SATA6Gbps	None	HH DVD	9-in-1	650W 92%	None	USB / USB Optical	Windows 10 Pro 64	3-year, Onsite	Sep 26, 2022	09/17
30B50074**	MEA	Xeon E5-1630 v4 4C/3.7GHz/10MB/140W/DDR4-2400	Open	2x8GB RDIMM DDR4-2400 ECC	Onboard	4	1x 256GB SSD 2.5" SATA6Gbps Opal	None	HH DVD	9-in-1	650W 92%	None	USB / USB Optical	Windows 10 Pro 64	3-year, Onsite	Sep 26, 2022	09/17

Model	Region	Processor	Graphics	Memory	Storage Controller	Max Drives in 3.5" Bays	Disks	M.2 Drives	Optical	Media Reader	Power Supply	Optional Ports	Keyboard / Mouse	Operating System	Warranty	End of Support	Ann Date (mm/yy)
30B50075**	MEA	Xeon E5-1650 v4 6C/3.6GHz/15MB/140W/DDR4-2400	Open	2x8GB RDIMM DDR4-2400 ECC	Onboard	4	1x 512GB SSD 2.5" SATA6Gbps	None	HH DVD	9-in-1	650W 92%	None	USB / USB Optical	Windows 10 Pro 64	3-year, Onsite	Sep 26, 2022	09/17
30B50076**	MEA	Xeon E5-1620 v4 4C/3.5GHz/10MB/140W/DDR4-2400	Open	1x8GB RDIMM DDR4-2400 ECC	Onboard	4	1x 1TB Hybrid HDD 7.2K 3.5" SATA6Gbps	None	HH DVD	9-in-1	650W 92%	None	USB / USB Optical	Windows 10 Pro 64	3-year, Onsite	Sep 26, 2022	09/17
30B50076xx	Russia/EET/CIS	Xeon E5-1620 v4 4C/3.5GHz/10MB/140W/DDR4-2400	Open	1x8GB RDIMM DDR4-2400 ECC	Onboard	4	1x 1TB Hybrid HDD 7.2K 3.5" SATA6Gbps	None	HH DVD	9-in-1	650W 92%	None	USB / USB Optical	Windows 10 Pro 64	3-year, Onsite	Sep 26, 2022	09/17
30B50075xx	Russia/EET/CIS	Xeon E5-1650 v4 6C/3.6GHz/15MB/140W/DDR4-2400	Open	2x8GB RDIMM DDR4-2400 ECC	Onboard	4	1x 512GB SSD 2.5" SATA6Gbps	None	HH DVD	9-in-1	650W 92%	None	USB / USB Optical	Windows 10 Pro 64	3-year, Onsite	Sep 26, 2022	09/17
30B50074xx	Russia/EET/CIS	Xeon E5-1630 v4 4C/3.7GHz/10MB/140W/DDR4-2400	Open	2x8GB RDIMM DDR4-2400 ECC	Onboard	4	1x 256GB SSD SATA6Gbps Opal	None	HH DVD	9-in-1	650W 92%	None	USB / USB Optical	Windows 10 Pro 64	3-year, Onsite	Sep 26, 2022	09/17
30B50073xx	Russia/EET/CIS	Xeon E5-1650 v4 6C/3.6GHz/15MB/140W/DDR4-2400	Open	1x8GB RDIMM DDR4-2400 ECC	Onboard	4	1x 512GB SSD 2.5" SATA6Gbps	None	HH DVD	9-in-1	650W 92%	None	USB / USB Optical	Windows 10 Pro 64	3-year, Onsite	Sep 26, 2022	09/17
30B50072xx	Russia/EET/CIS	Xeon E5-1620 v4 4C/3.5GHz/10MB/140W/DDR4-2400	Open	1x8GB RDIMM DDR4-2400 ECC	Onboard	4	1x 256GB SSD SATA6Gbps Opal	None	HH DVD	9-in-1	650W 92%	None	USB / USB Optical	Windows 10 Pro 64	3-year, Onsite	Sep 26, 2022	09/17
30B50071xx	Russia/EET/CIS	Xeon E5-1620 v4 4C/3.5GHz/10MB/140W/DDR4-2400	Open	1x8GB RDIMM DDR4-2400 ECC	Onboard	4	1x 1TB Hybrid HDD 7.2K 3.5" SATA6Gbps	None	HH DVD	9-in-1	490W 90%	None	USB / USB Optical	Windows 10 Pro 64	3-year, Onsite	Sep 26, 2022	09/17
30B50070xx	Russia/EET/CIS	Xeon E5-1630 v4 4C/3.7GHz/10MB/140W/DDR4-2400	Open	2x8GB RDIMM DDR4-2400 ECC	Onboard	4	None	1x 256GB SSD M.2 HH DVD PCIe Opal	HH DVD	9-in-1	650W 92%	None	USB / USB Optical	Windows 10 DG Windows 7 Pro 64	3-year, Onsite	Sep 26, 2022	09/17
30B5006Yxx	Russia/EET/CIS	Xeon E5-1620 v4 4C/3.5GHz/10MB/140W/DDR4-2400	Open	1x8GB RDIMM DDR4-2400 ECC	Onboard	4	1x 256GB SSD 2.5" SATA6Gbps Opal	None	HH DVD	9-in-1	650W 92%	None	USB / USB Optical	Windows 10 DG Windows 7 Pro 64	3-year, Onsite	Sep 26, 2022	09/17
30B5006Xxx	Russia/EET/CIS	Xeon E5-1620 v4 4C/3.5GHz/10MB/140W/DDR4-2400	Open	1x8GB RDIMM DDR4-2400 ECC	Onboard	4	1x 1TB Hybrid HDD 7.2K 3.5" SATA6Gbps	None	HH DVD	9-in-1	650W 92%	None	USB / USB Optical	Windows 10 DG Windows 7 Pro 64	3-year, Onsite	Sep 26, 2022	09/17
30B5006Wxx	Russia/EET/CIS	Xeon E5-1620 v4 4C/3.5GHz/10MB/140W/DDR4-2400	Open	1x8GB RDIMM DDR4-2400 ECC	Onboard	4	1x 1TB Hybrid HDD 7.2K 3.5" SATA6Gbps	None	HH DVD	9-in-1	490W 90%	None	USB / USB Optical	Windows 10 DG Windows 7 Pro 64	3-year, Onsite	Sep 26, 2022	09/17

Model	Region	Processor	Graphics	Memory	Storage Controller	Max Drives in 3.5" Bays	Disks	M.2 Drives	Optical	Media Reader	Power Supply	Optional Ports	Keyboard / Mouse	Operating System	Warranty	End of Support	Ann Date (mm/yy)
30B5006Vxx	Russia/EET/CIS	Xeon E5-1650 v4 6C/3.6GHz/15MB/140W/DDR4-2400	NVIDIA Quadro P2000 5GB	1x16GB RDIMM DDR4-2400 ECC	Onboard	4	2x 1TB HDD 7.2K 3.5" SATA6Gbps	None	HH DVD±RW, 9.0mm DVD±RW	29-in-1	650W 92%	None	USB / USB Optical	Windows 10 Pro 64	3-year, Onsite	Sep 26, 2022	09/17
30B5006Uxx	Russia/EET/CIS	Xeon E5-1650 v4 6C/3.6GHz/15MB/140W/DDR4-2400	NVIDIA Quadro P4000 8GB	2x16GB RDIMM DDR4-2400 ECC	Onboard	4	1x 256GB SSD 2.5" SATA6Gbps Opal, 1x 1TB HDD 7.2K 3.5" SATA6Gbps	None	HH DVD±RW, 9.0mm DVD±RW	29-in-1	650W 92%	None	USB / USB Optical	Windows 10 Pro 64	3-year, Onsite	Sep 26, 2022	09/17
30B5006Txx	Russia/EET/CIS	Xeon E5-1620 v4 4C/3.5GHz/10MB/140W/DDR4-2400	NVIDIA Quadro P2000 5GB	1x16GB RDIMM DDR4-2400 ECC	Onboard	4	1x 1TB HDD 7.2K 3.5" SATA6Gbps	None	HH DVD±RW, 9.0mm DVD±RW	29-in-1	650W 92%	None	USB / USB Optical	Windows 10 Pro 64	3-year, Onsite	Sep 26, 2022	09/17
30B5006Sxx	Russia/EET/CIS	Xeon E5-1607 v4 4C/3.1GHz/10MB/140W/DDR4-2133	NVIDIA Quadro P600 2GB	1x8GB RDIMM DDR4-2400 ECC	Onboard	4	1x 1TB HDD 7.2K 3.5" SATA6Gbps	None	HH DVD±RW, 9.0mm DVD±RW	29-in-1	650W 92%	None	USB / USB Optical	Windows 10 Pro 64	3-year, Onsite	Sep 26, 2022	09/17
30B5006Rxx	Russia/EET/CIS	Xeon E5-1630 v4 4C/3.7GHz/10MB/140W/DDR4-2400	Open	2x8GB RDIMM DDR4-2400 ECC	Onboard	4	1x 256GB SSD 2.5" SATA6Gbps Opal	None	HH DVD±RW, 9.0mm DVD±RW	29-in-1	650W 92%	None	USB / USB Optical	Windows 10 Pro 64	3-year, Onsite	Sep 26, 2022	09/17
30B5006Qxx	Russia/EET/CIS	Xeon E5-1620 v4 4C/3.5GHz/10MB/140W/DDR4-2400	Open	1x8GB RDIMM DDR4-2400 ECC	Onboard	4	None	1x 256GB SSD M.2 PCIe Opal	HH DVD±RW	9-in-1	490W 90%	None	USB / USB Optical	Windows 10 Pro 64	3-year, Onsite	Sep 26, 2022	09/17
30B5006Pxx	Russia/EET/CIS	Xeon E5-2630 v4 10C/2.2GHz/25MB/85W/DDR4-2133	Open	2x8GB RDIMM DDR4-2400 ECC	Onboard	4	1x 2TB HDD 7.2K 3.5" SATA6Gbps	512GB SSD M.2 PCIe	HH DVD±RW	9-in-1	650W 92%	None	USB / USB Optical	Windows 10 Pro 64	3-year, Onsite	Sep 26, 2022	09/17
30B5006Nxx	Russia/EET/CIS	Xeon E5-1650 v4 6C/3.6GHz/15MB/140W/DDR4-2400	NVIDIA Quadro P2000 5GB	1x8GB RDIMM DDR4-2400 ECC	Onboard	4	1x 256GB SSD 2.5" SATA6Gbps Opal	None	HH DVD±RW	9-in-1	490W 90%	None	USB / USB Optical	Windows 10 Pro 64	3-year, Onsite	Sep 26, 2022	09/17
30B5006Gxx	Russia/EET/CIS	Xeon E5-1650 v4 6C/3.6GHz/15MB/140W/DDR4-2400	NVIDIA Quadro P2000 5GB	2x16GB RDIMM DDR4-2400 ECC	Onboard	4	2x 1TB HDD 7.2K 3.5" SATA6Gbps	None	9.5mm DVD±RW	29-in-1	650W 92%	Front eSATA	USB / USB Optical	Windows 10 Pro 64	3-year, Onsite	Aug 4, 2023	07/17
30B5006Fxx	Russia/EET/CIS	Xeon E5-1650 v4 6C/3.6GHz/15MB/140W/DDR4-2400	NVIDIA Quadro P4000 8GB	2x16GB RDIMM DDR4-2400 ECC	Onboard	4	1x 256GB SSD 2.5" SATA6Gbps Opal, 1x 1TB HDD 7.2K 3.5" SATA6Gbps	None	9.5mm DVD±RW	29-in-1	650W 92%	Front eSATA	USB / USB Optical	Windows 10 Pro 64	3-year, Onsite	Aug 4, 2023	07/17
30B5006Exx	Russia/EET/CIS	Xeon E5-1620 v4 4C/3.5GHz/10MB/140W/DDR4-2400	NVIDIA Quadro P2000 5GB	1x16GB RDIMM DDR4-2400 ECC	Onboard	4	1x 1TB HDD 7.2K 3.5" SATA6Gbps	None	9.5mm DVD±RW	29-in-1	650W 92%	Front eSATA	USB / USB Optical	Windows 10 Pro 64	3-year, Onsite	Aug 4, 2023	07/17
30B5006Dxx	Russia/EET/CIS	Xeon E5-1607 v4 4C/3.1GHz/10MB/140W/DDR4-2133	NVIDIA Quadro P600 2GB	1x8GB RDIMM DDR4-2400 ECC	Onboard	4	1x 1TB HDD 7.2K 3.5" SATA6Gbps	None	9.5mm DVD±RW	29-in-1	650W 92%	Front eSATA	USB / USB Optical	Windows 10 Pro 64	3-year, Onsite	Aug 4, 2023	07/17

Model	Region	Processor	Graphics	Memory	Storage Controller	Max Drives in 3.5" Bays	Disks	M.2 Drives	Optical	Media Reader	Power Supply	Optional Ports	Keyboard / Mouse	Operating System	Warranty	End of Support	Ann Date (mm/yy)
30B5005Uxx	Russia/EET/CIS	Xeon E5-1650 v4 6C/3.6GHz/15MB/140W/DDR4-2400	NVIDIA Quadro P2000 5GB	1x8GB RDIMM DDR4-2400 ECC	Onboard	4	1x 256GB SSD 2.5" SATA6Gbps Opal	None	HH DVD±RW	9-in-1	490W 90%	None	USB / USB Optical	Windows 10 Pro 64	3-year, Onsite	May 24, 2023	04/17
30B5004Vxx	Russia/EET/CIS	Xeon E5-1630 v4 4C/3.7GHz/10MB/140W/DDR4-2400	Open	2x8GB RDIMM DDR4-2400 ECC	Onboard	4	1x 256GB SSD 2.5" SATA6Gbps Opal	None	9.5mm DVD±RW	29-in-1	650W 92%	None	USB / USB Optical	Windows 10 Pro 64	3-year, Onsite	Oct 20, 2022	09/16
30B5004Uxx	Russia/EET/CIS	Xeon E5-1620 v4 4C/3.5GHz/10MB/140W/DDR4-2400	Open	2x8GB RDIMM DDR4-2400 ECC	Onboard	4	1x 256GB SSD 2.5" SATA6Gbps Opal	None	9.5mm DVD±RW	29-in-1	650W 92%	None	USB / USB Optical	Windows 10 Pro 64	3-year, Onsite	Oct 20, 2022	09/16
30B5005Exx	Russia/EET/CIS	Xeon E5-1650 v4 6C/3.6GHz/15MB/140W/DDR4-2400	Open	2x8GB RDIMM DDR4-2400 ECC	Onboard	4	1x 256GB SSD 2.5" SATA6Gbps Opal	None	HH DVD±RW	9-in-1	650W 92%	None	USB / USB Optical	Windows 10 DG Windows 7 Pro 64	3-year, Onsite	Oct 20, 2022	09/16
30B5005Jxx	Russia/EET/CIS	Xeon E5-1630 v4 4C/3.7GHz/10MB/140W/DDR4-2400	NVIDIA Quadro P5000 16GB	2x16GB RDIMM DDR4-2400 ECC	Onboard	4	1x 2TB HDD 7.2K 3.5" SATA6Gbps	1x 256GB SSD M.2 PCIe Opal	HH DVD±RW	9-in-1	650W 92%	None	USB / USB Optical	Windows 10 Pro 64	3-year, Onsite	Jan 5, 2023	12/16
30B5004Wxx	Russia/EET/CIS	Xeon E5-1650 v4 6C/3.6GHz/15MB/140W/DDR4-2400	Open	4x8GB RDIMM DDR4-2400 ECC	Onboard	4	None	1x 512GB SSD M.2 PCIe	9.5mm DVD±RW	29-in-1	650W 92%	None	USB / USB Optical	Windows 10 Pro 64	3-year, Onsite	Oct 20, 2022	09/16
30B5004Txx	Russia/EET/CIS	Xeon E5-1650 v4 6C/3.6GHz/15MB/140W/DDR4-2400	Open	4x8GB RDIMM DDR4-2400 ECC	Onboard	4	None	1x 512GB SSD M.2 PCIe	9.5mm DVD±RW	29-in-1	650W 92%	None	USB / USB Optical	Windows 10 DG Windows 7 Pro 64	3-year, Onsite	Oct 20, 2022	09/16
30B5004Sxx	Russia/EET/CIS	Xeon E5-1630 v4 4C/3.7GHz/10MB/140W/DDR4-2400	Open	2x8GB RDIMM DDR4-2400 ECC	Onboard	4	1x 256GB SSD 2.5" SATA6Gbps Opal	None	9.5mm DVD±RW	29-in-1	650W 92%	None	USB / USB Optical	Windows 10 DG Windows 7 Pro 64	3-year, Onsite	Oct 20, 2022	09/16
30B5004Rxx	Russia/EET/CIS	Xeon E5-1620 v4 4C/3.5GHz/10MB/140W/DDR4-2400	Open	2x8GB RDIMM DDR4-2400 ECC	Onboard	4	1x 256GB SSD 2.5" SATA6Gbps Opal	None	9.5mm DVD±RW	29-in-1	650W 92%	None	USB / USB Optical	Windows 10 DG Windows 7 Pro 64	3-year, Onsite	Oct 20, 2022	09/16
30B5004Qxx	Russia/EET/CIS	Xeon E5-2630 v4 10C/2.2GHz/25MB/85W/DDR4-2133	Open	2x8GB RDIMM DDR4-2400 ECC	Onboard	4	1x 2TB HDD 7.2K 3.5" SATA6Gbs	1x 512GB SSD M.2 PCIe	HH DVD±RW	9-in-1	650W 92%	None	USB / USB Optical	Windows 10 DG Windows 7 Pro 64	3-year, Onsite	Oct 20, 2022	09/16
30B5004Pxx	Russia/EET/CIS	Xeon E5-1650 v4 6C/3.6GHz/15MB/140W/DDR4-2400	NVIDIA Quadro M2000 4GB	4x8GB RDIMM DDR4-2400 ECC	Onboard	4	1x 1TB HDD 7.2K 3.5" SATA6Gbps	None	HH DVD±RW	9-in-1	490W 90%	None	USB / USB Optical	Windows 10 DG Windows 7 Pro 64	3-year, Onsite	Oct 20, 2022	09/16
30B5004Nxx	Russia/EET/CIS	Xeon E5-1650 v4 6C/3.6GHz/15MB/140W/DDR4-2400	NVIDIA Quadro M2000 4GB	1x8GB RDIMM DDR4-2400 ECC	Onboard	4	1x 256GB SSD 2.5" SATA6Gbps Opal	None	HH DVD±RW	9-in-1	490W 90%	None	USB / USB Optical	Windows 10 DG Windows 7 Pro 64	3-year, Onsite	Oct 20, 2022	09/16

Model	Region	Processor	Graphics	Memory	Storage Controller	Max Drives in 3.5" Bays	Disks	M.2 Drives	Optical	Media Reader	Power Supply	Optional Ports	Keyboard / Mouse	Operating System	Warranty	End of Support	Ann Date (mm/yy)
30B5003Bxx	Russia/EET/CIS	Xeon E5-1630 v4 4C/3.7GHz/ 10MB/140W/DDR4-2400	NVIDIA Quadro M5000 8GB	2x8GB RDIMM DDR4-2400 ECC	Onboard	4	None	1x 512GB SSD M.2 PCIe	HH DVD±RW	9-in-1	650W 92%	None	USB / USB Optical	Windows 10 Pro 64	3-year, Onsite	Aug 26, 2022	07/16
30B5003Axx	Russia/EET/CIS	Xeon E5-2630 v4 10C/2.2GHz/ 25MB/85W/DDR4-2133	Open	2x8GB RDIMM DDR4-2400 ECC	Onboard	4	1x 2TB HDD 7.2K 3.5" SATA6Gbps	1x 512GB SSD M.2 PCIe	HH DVD±RW	9-in-1	650W 92%	None	USB / USB Optical	Windows 10 Pro 64	3-year, Onsite	Aug 26, 2022	07/16
30B50039xx	Russia/EET/CIS	Xeon E5-1650 v4 6C/3.6GHz/ 15MB/140W/DDR4-2400	Open	4x8GB RDIMM DDR4-2400 ECC	Onboard	4	None	1x 512GB SSD M.2 PCIe	HH DVD±RW	29-in-1	650W 92%	None	USB / USB Optical	Windows 10 Pro 64	3-year, Onsite	Aug 26, 2022	07/16
30B50038xx	Russia/EET/CIS	Xeon E5-1630 v4 4C/3.7GHz/ 10MB/140W/DDR4-2400	Open	2x8GB RDIMM DDR4-2400 ECC	Onboard	4	1x 256GB SSD 2.5" SATA6Gbps Opal	None	HH DVD±RW	29-in-1	650W 92%	None	USB / USB Optical	Windows 10 Pro 64	3-year, Onsite	Aug 26, 2022	07/16
30B50037xx	Russia/EET/CIS	Xeon E5-1620 v4 4C/3.5GHz/ 10MB/140W/DDR4-2400	Open	2x8GB RDIMM DDR4-2400 ECC	Onboard	4	1x 256GB SSD 2.5" SATA6Gbps Opal	None	HH DVD±RW	29-in-1	650W 92%	None	USB / USB Optical	Windows 10 Pro 64	3-year, Onsite	Aug 26, 2022	07/16
30B5001Dxx	Russia/EET/CIS	Xeon E5-1630 v4 4C/3.7GHz/ 10MB/140W/DDR4-2400	Open	2x8GB RDIMM DDR4-2400 ECC	Onboard	4	None	1x 256GB SSD M.2 PCIe Opal	HH DVD±RW	9-in-1	650W 92%	None	USB / USB Optical	Windows 10 DG Windows 7 Pro 64	3-year, Onsite	Jul 14, 2022	06/16
30B5001Exx	Russia/EET/CIS	Xeon E5-1630 v4 4C/3.7GHz/ 10MB/140W/DDR4-2400	Open	2x8GB RDIMM DDR4-2400 ECC	Onboard	4	None	1x 256GB SSD M.2 PCIe Opal	HH DVD±RW	9-in-1	650W 92%	None	USB / USB Optical	Windows 10 Pro 64	3-year, Onsite	Jul 14, 2022	06/16
30B5001Cxx	Russia/EET/CIS	Xeon E5-1650 v4 6C/3.6GHz/ 15MB/140W/DDR4-2400	Open	2x8GB RDIMM DDR4-2400 ECC	Onboard	4	1x 512GB SSD 2.5" SATA6Gbps	None	HH DVD±RW	9-in-1	650W 92%	None	USB / USB Optical	Windows 10 Pro 64	3-year, Onsite	Jul 14, 2022	06/16
30B5001Bxx	Russia/EET/CIS	Xeon E5-1650 v4 6C/3.6GHz/ 15MB/140W/DDR4-2400	Open	2x8GB RDIMM DDR4-2400 ECC	Onboard	4	1x 512GB SSD 2.5" SATA6Gbps	None	HH DVD±RW	9-in-1	650W 92%	None	USB / USB Optical	Windows 10 DG Windows 7 Pro 64	3-year, Onsite	Jul 14, 2022	06/16
30B5001Axx	Russia/EET/CIS	Xeon E5-1630 v4 4C/3.7GHz/ 10MB/140W/DDR4-2400	Open	2x8GB RDIMM DDR4-2400 ECC	Onboard	4	1x 256GB SSD 2.5" SATA6Gbps Opal	None	HH DVD±RW	9-in-1	650W 92%	None	USB / USB Optical	Windows 10 DG Windows 7 Pro 64	3-year, Onsite	Jul 14, 2022	06/16
30B50019xx	Russia/EET/CIS	Xeon E5-1630 v4 4C/3.7GHz/ 10MB/140W/DDR4-2400	Open	2x8GB RDIMM DDR4-2400 ECC	Onboard	4	1x 256GB SSD 2.5" SATA6Gbps Opal	None	HH DVD±RW	9-in-1	650W 92%	None	USB / USB Optical	Windows 10 Pro 64	3-year, Onsite	Jul 14, 2022	06/16
30B50018xx	Russia/EET/CIS	Xeon E5-1620 v4 4C/3.5GHz/ 10MB/140W/DDR4-2400	Open	2x8GB RDIMM DDR4-2400 ECC	Onboard	4	1x 256GB SSD 2.5" SATA6Gbps Opal	None	HH DVD±RW	9-in-1	650W 92%	None	USB / USB Optical	Windows 10 Pro 64	3-year, Onsite	Jul 14, 2022	06/16

Model	Region	Processor	Graphics	Memory	Storage Controller	Max Drives in 3.5" Bays	Disks	M.2 Drives	Optical	Media Reader	Power Supply	Optional Ports	Keyboard / Mouse	Operating System	Warranty	End of Support	Ann Date (mm/yy)
30B50017xx	Russia/EET/CIS	Xeon E5-1620 v4 4C/3.5GHz/10MB/140W/DDR4-2400	Open	2x8GB RDIMM DDR4-2400 ECC	Onboard	4	1x 256GB SSD 2.5" SATA6Gbps Opal	None	HH DVD±RW	9-in-1	650W 92%	None	USB / USB Optical	Windows 10 DG Windows 7 Pro 64	3-year, Onsite	Jul 14, 2022	06/16
30B50013xx	Russia/EET/CIS	Xeon E5-1620 v4 4C/3.5GHz/10MB/140W/DDR4-2400	Open	1x8GB RDIMM DDR4-2400 ECC	Onboard	4	None	1x 512GB SSD M.2 PCIe	HH DVD±RW	9-in-1	650W 92%	None	USB / USB Optical	Windows 10 DG Windows 7 Pro 64	3-year, Onsite	Jul 14, 2022	06/16
30B50012xx	Russia/EET/CIS	Xeon E5-1650 v4 6C/3.6GHz/15MB/140W/DDR4-2400	Open	1x8GB RDIMM DDR4-2400 ECC	Onboard	4	1x 512GB SSD 2.5" SATA6Gbps	None	HH DVD±RW	9-in-1	650W 92%	None	USB / USB Optical	Windows 10 Pro 64	3-year, Onsite	Jul 14, 2022	06/16
30B50011xx	Russia/EET/CIS	Xeon E5-1620 v4 4C/3.5GHz/10MB/140W/DDR4-2400	Open	1x8GB RDIMM DDR4-2400 ECC	Onboard	4	1x 256GB SSD 2.5" SATA6Gbps Opal	None	HH DVD±RW	9-in-1	650W 92%	None	USB / USB Optical	Windows 10 Pro 64	3-year, Onsite	Jul 14, 2022	06/16
30B50010xx	Russia/EET/CIS	Xeon E5-1680 v4 8C/3.4GHz/20MB/140W/DDR4-2400	NVIDIA Quadro M4000 8GB	2x8GB RDIMM DDR4-2400 ECC	Onboard	4	None	1x 512GB SSD M.2 PCIe	HH DVD±RW	9-in-1	650W 92%	None	USB / USB Optical	Windows 10 DG Windows 7 Pro 64	3-year, Onsite	Jul 14, 2022	06/16
30B5000Yxx	Russia/EET/CIS	Xeon E5-1620 v4 4C/3.5GHz/10MB/140W/DDR4-2400	NVIDIA Quadro M2000 4GB	1x8GB RDIMM DDR4-2400 ECC	Onboard	4	None	1x 512GB SSD M.2 PCIe	HH DVD±RW	9-in-1	650W 92%	None	USB / USB Optical	Windows 10 Pro 64	3-year, Onsite	Jul 14, 2022	06/16
30B5000Xxx	Russia/EET/CIS	Xeon E5-1650 v4 6C/3.6GHz/15MB/140W/DDR4-2400	Open	2x8GB RDIMM DDR4-2400 ECC	Onboard	4	None	1x 512GB SSD M.2 PCIe	HH DVD±RW	9-in-1	650W 92%	None	USB / USB Optical	Windows 10 DG Windows 7 Pro 64	3-year, Onsite	Jul 14, 2022	06/16
30B5000Wxx	Russia/EET/CIS	Xeon E5-1620 v4 4C/3.5GHz/10MB/140W/DDR4-2400	NVIDIA Quadro M2000 4GB	1x8GB RDIMM DDR4-2400 ECC	Onboard	4	None	1x 512GB SSD M.2 PCIe	HH DVD±RW	9-in-1	650W 92%	None	USB / USB Optical	Windows 10 DG Windows 7 Pro 64	3-year, Onsite	Jul 14, 2022	06/16
30B5000Vxx	Russia/EET/CIS	Xeon E5-1650 v4 6C/3.6GHz/15MB/140W/DDR4-2400	Open	1x8GB RDIMM DDR4-2400 ECC	Onboard	4	1x 1TB HDD 7.2K 3.5" SATA6Gbps	None	HH DVD±RW	9-in-1	650W 92%	None	USB / USB Optical	Windows 10 Pro 64	3-year, Onsite	Jul 14, 2022	06/16
30B5000Uxx	Russia/EET/CIS	Xeon E5-1620 v4 4C/3.5GHz/10MB/140W/DDR4-2400	Open	1x8GB RDIMM DDR4-2400 ECC	Onboard	4	1x 240GB SSD 2.5" SATA6Gbps Opal	None	HH DVD±RW	9-in-1	490W 90%	None	USB / USB Optical	Windows 10 Pro 64	3-year, Onsite	Jul 14, 2022	06/16
30B5000Txx	Russia/EET/CIS	Xeon E5-1650 v4 6C/3.6GHz/15MB/140W/DDR4-2400	Open	2x8GB RDIMM DDR4-2400 ECC	Onboard	4	None	1x 256GB SSD M.2 PCIe Opal	HH DVD±RW	9-in-1	650W 92%	None	USB / USB Optical	Windows 10 Pro 64	3-year, Onsite	Jul 14, 2022	06/16
30B5000Sxx	Russia/EET/CIS	Xeon E5-1620 v4 4C/3.5GHz/10MB/140W/DDR4-2400	Open	1x8GB RDIMM DDR4-2400 ECC	Onboard	4	None	1x 512GB SSD M.2 PCIe	HH DVD±RW	9-in-1	650W 92%	None	USB / USB Optical	Windows 10 Pro 64	3-year, Onsite	Jul 14, 2022	06/16

Model	Region	Processor	Graphics	Memory	Storage Controller	Max Drives in 3.5" Bays	Disks	M.2 Drives	Optical	Media Reader	Power Supply	Optional Ports	Keyboard / Mouse	Operating System	Warranty	End of Support	Ann Date (mm/yy)
30B5000Rxx	Russia/EET/CIS	Xeon E5-1650 v4 6C/3.6GHz/15MB/140W/DDR4-2400	NVIDIA Quadro M2000 4GB	4x8GB RDIMM DDR4-2400 ECC	Onboard	4	1x 1TB HDD 7.2K 3.5" SATA6Gbps	None	HH DVD±RW	9-in-1	490W 90%	None	USB / USB Optical	Windows 10 Pro 64	3-year, Onsite	Jul 14, 2022	06/16
30B5000Qxx	Russia/EET/CIS	Xeon E5-1650 v4 6C/3.6GHz/15MB/140W/DDR4-2400	Open	1x8GB RDIMM DDR4-2400 ECC	Onboard	4	None	1x 256GB SSD M.2 PCIe Opal	HH DVD±RW	9-in-1	650W 92%	None	USB / USB Optical	Windows 10 DG Windows 7 Pro 64	3-year, Onsite	Jul 14, 2022	06/16
30B5000Pxx	Russia/EET/CIS	Xeon E5-1620 v4 4C/3.5GHz/10MB/140W/DDR4-2400	Open	1x8GB RDIMM DDR4-2400 ECC	Onboard	4	None	1x 256GB SSD M.2 PCIe Opal	HH DVD±RW	9-in-1	490W 90%	None	USB / USB Optical	Windows 10 DG Windows 7 Pro 64	3-year, Onsite	Jul 14, 2022	06/16
30B5000Nxx	Russia/EET/CIS	Xeon E5-1620 v4 4C/3.5GHz/10MB/140W/DDR4-2400	Open	1x8GB RDIMM DDR4-2400 ECC	Onboard	4	1x 1TB Hybrid HDD 7.2K 3.5" SATA6Gbps	None	HH DVD±RW	9-in-1	650W 92%	None	USB / USB Optical	Windows 10 Pro 64	3-year, Onsite	Jul 14, 2022	06/16
30B5000Mxx	Russia/EET/CIS	Xeon E5-2603 v4 6C/1.7GHz/15MB/85W/DDR4-1866	NVIDIA Quadro M2000 4GB	2x8GB RDIMM DDR4-2400 ECC	Onboard	4	1x 256GB SSD 2.5" SATA6Gbps Opal	None	HH DVD±RW	9-in-1	490W 90%	None	USB / USB Optical	Windows 10 Pro 64	3-year, Onsite	Jul 14, 2022	06/16
30B5000Lxx	Russia/EET/CIS	Xeon E5-1680 v4 8C/3.4GHz/20MB/140W/DDR4-2400	NVIDIA Quadro M4000 8GB	2x8GB RDIMM DDR4-2400 ECC	Onboard	4	None	1x 512GB SSD M.2 PCIe	HH DVD±RW	9-in-1	650W 92%	None	USB / USB Optical	Windows 10 Pro 64	3-year, Onsite	Jul 14, 2022	06/16
30B5000Kxx	Russia/EET/CIS	Xeon E5-1650 v4 6C/3.6GHz/15MB/140W/DDR4-2400	Open	1x8GB RDIMM DDR4-2400 ECC	Onboard	4	1x 1TB HDD 7.2K 3.5" SATA6Gbps	None	HH DVD±RW	9-in-1	650W 92%	None	USB / USB Optical	Windows 10 DG Windows 7 Pro 64	3-year, Onsite	Jul 14, 2022	06/16
30B5000Jxx	Russia/EET/CIS	Xeon E5-1650 v4 6C/3.6GHz/15MB/140W/DDR4-2400	Open	1x8GB RDIMM DDR4-2400 ECC	Onboard	4	1x 1TB HDD 7.2K 3.5" SATA6Gbps	None	HH DVD±RW	9-in-1	490W 90%	None	USB / USB Optical	Windows 10 Pro 64	3-year, Onsite	Jul 14, 2022	06/16
30B5000Hxx	Russia/EET/CIS	Xeon E5-1650 v4 6C/3.6GHz/15MB/140W/DDR4-2400	Open	2x8GB RDIMM DDR4-2400 ECC	Onboard	4	None	1x 512GB SSD M.2 PCIe	HH DVD±RW	9-in-1	650W 92%	None	USB / USB Optical	Windows 10 Pro 64	3-year, Onsite	Jul 14, 2022	06/16
30B5000Gxx	Russia/EET/CIS	Xeon E5-1620 v4 4C/3.5GHz/10MB/140W/DDR4-2400	Open	1x8GB RDIMM DDR4-2400 ECC	Onboard	4	1x 1TB Hybrid HDD 7.2K 3.5" SATA6Gbps	None	HH DVD±RW	9-in-1	650W 92%	None	USB / USB Optical	Windows 10 DG Windows 7 Pro 64	3-year, Onsite	Jul 14, 2022	06/16
30B5000Fxx	Russia/EET/CIS	Xeon E5-1650 v3 6C/3.5GHz/15MB/140W/DDR4-2133	Open	1x8GB RDIMM DDR4-2400 ECC	Onboard	4	1x 1TB HDD 7.2K 3.5" SATA6Gbps	None	HH DVD±RW	9-in-1	490W 90%	None	USB / USB Optical	Windows 10 DG Windows 7 Pro 64	3-year, Onsite	Jul 14, 2022	06/16
30B5000Exx	Russia/EET/CIS	Xeon E5-1620 v4 4C/3.5GHz/10MB/140W/DDR4-2400	Open	1x8GB RDIMM DDR4-2400 ECC	Onboard	4	1x 240GB SSD 2.5" SATA6Gbps Opal	None	HH DVD±RW	9-in-1	490W 90%	None	USB / USB Optical	Windows 10 DG Windows 7 Pro 64	3-year, Onsite	Jul 14, 2022	06/16

Model	Region	Processor	Graphics	Memory	Storage Controller	Max Drives in 3.5" Bays	Disks	M.2 Drives	Optical	Media Reader	Power Supply	Optional Ports	Keyboard / Mouse	Operating System	Warranty	End of Support	Ann Date (mm/yy)
30B5000Dxx	Russia/EET/CIS	Xeon E5-1650 v4 6C/3.6GHz/15MB/140W/DDR4-2400	NVIDIA Quadro M2000 4GB	1x8GB RDIMM DDR4-2400 ECC	Onboard	4	1x 256GB SSD 2.5" SATA6Gbps Opal	None	HH DVD±RW	9-in-1	490W 90%	None	USB / USB Optical	Windows 10 Pro 64	3-year, Onsite	Jul 14, 2022	06/16
30B5000Cxx	Russia/EET/CIS	Xeon E5-1620 v4 4C/3.5GHz/10MB/140W/DDR4-2400	Open	1x8GB RDIMM DDR4-2400 ECC	Onboard	4	None	1x 256GB SSD M.2 PCIe Opal	HH DVD±RW	9-in-1	490W 90%	None	USB / USB Optical	Windows 10 Pro 64	3-year, Onsite	Jul 14, 2022	06/16
30B5000Bxx	Russia/EET/CIS	Xeon E5-1650 v4 6C/3.6GHz/15MB/140W/DDR4-2400	Open	1x8GB RDIMM DDR4-2400 ECC	Onboard	4	1x 512GB SSD 2.5" SATA6Gbps	None	HH DVD±RW	9-in-1	650W 92%	None	USB / USB Optical	Windows 10 DG Windows 7 Pro 64	3-year, Onsite	Jul 14, 2022	06/16
30B5000Axx	Russia/EET/CIS	Xeon E5-1620 v4 4C/3.5GHz/10MB/140W/DDR4-2400	Open	1x8GB RDIMM DDR4-2400 ECC	Onboard	4	1x 256GB SSD 2.5" SATA6Gbps Opal	None	HH DVD±RW	9-in-1	650W 92%	None	USB / USB Optical	Windows 10 DG Windows 7 Pro 64	3-year, Onsite	Jul 14, 2022	06/16
30B50009xx	Russia/EET/CIS	Xeon E5-1650 v3 6C/3.5GHz/15MB/140W/DDR4-2133	NVIDIA Quadro M2000 4GB	1x8GB RDIMM DDR4-2400 ECC	Onboard	4	1x 256GB SSD 2.5" SATA6Gbps Opal	None	HH DVD±RW	9-in-1	490W 90%	None	USB / USB Optical	Windows 10 DG Windows 7 Pro 64	3-year, Onsite	Jul 14, 2022	06/16
30B50008xx	Russia/EET/CIS	Xeon E5-2603 v4 6C/1.7GHz/15MB/85W/DDR4-1866	NVIDIA Quadro M2000 4GB	2x8GB RDIMM DDR4-2400 ECC	Onboard	4	1x 256GB SSD 2.5" SATA6Gbps Opal	None	HH DVD±RW	9-in-1	490W 90%	None	USB / USB Optical	Windows 10 DG Windows 7 Pro 64	3-year, Onsite	Jul 14, 2022	06/16
30B50007xx	Russia/EET/CIS	Xeon E5-1620 v4 4C/3.5GHz/10MB/140W/DDR4-2400	Open	1x8GB RDIMM DDR4-2400 ECC	Onboard	4	1x 1TB Hybrid HDD 7.2K 3.5" SATA6Gbps	None	HH DVD±RW	9-in-1	490W 90%	None	USB / USB Optical	Windows 10 Pro 64	3-year, Onsite	Jul 14, 2022	06/16
30B50006xx	Russia/EET/CIS	Xeon E5-1620 v4 4C/3.5GHz/10MB/140W/DDR4-2400	Open	1x8GB RDIMM DDR4-2400 ECC	Onboard	4	1x 1TB Hybrid HDD 7.2K 3.5" SATA6Gbps	None	HH DVD±RW	9-in-1	490W 90%	None	USB / USB Optical	Windows 10 DG Windows 7 Pro 64	3-year, Onsite	Jul 14, 2022	06/16
30B50005xx	Russia/EET/CIS	Xeon E5-1650 v3 6C/3.5GHz/15MB/140W/DDR4-2133	NVIDIA Quadro M2000 4GB	4x8GB RDIMM DDR4-2400 ECC	Onboard	4	1x 1TB HDD 7.2K 3.5" SATA6Gbps	None	HH DVD±RW	9-in-1	490W 90%	None	USB / USB Optical	Windows 10 DG Windows 7 Pro 64	3-year, Onsite	Jul 14, 2022	06/16
30B5000VUS	US	Xeon E5-1650 v4 6C/3.6GHz/15MB/140W/DDR4-2400	Open	1x8GB RDIMM DDR4-2400 ECC	Onboard	4	1x 1TB HDD 7.2K 3.5" SATA6Gbps	None	HH DVD±RW	9-in-1	650W 92%	None	USB / USB Optical	Windows 10 Pro 64	3-year, Onsite	Jul 14, 2022	06/16
30B50019US	US	Xeon E5-1630 v4 4C/3.7GHz/10MB/140W/DDR4-2400	Open	2x8GB RDIMM DDR4-2400 ECC	Onboard	4	1x 256GB SSD 2.5" SATA6Gbps Opal	None	HH DVD±RW	9-in-1	650W 92%	None	USB / USB Optical	Windows 10 Pro 64	3-year, Onsite	Jul 14, 2022	06/16
30B50022US	US	Xeon E5-1650 v4 6C/3.6GHz/15MB/140W/DDR4-2400	Open	1x8GB RDIMM DDR4-2400 ECC	Onboard	4	1x 1TB HDD 7.2K 3.5" SATA6Gbps	None	HH DVD±RW	9-in-1	650W 92%	None	USB / USB Optical	Windows 10 DG Windows 7 Pro 64	3-year, Onsite	Oct 20, 2022	09/16

Model	Region	Processor	Graphics	Memory	Storage Controller	Max Drives in 3.5" Bays	Disks	M.2 Drives	Optical	Media Reader	Power Supply	Optional Ports	Keyboard / Mouse	Operating System	Warranty	End of Support	Ann Date (mm/yy)
30B5002EUS	US	Xeon E5-1630 v4 4C/3.7GHz/10MB/140W/DDR4-2400	Open	2x8GB RDIMM DDR4-2400 ECC	Onboard	4	1x 256GB SSD 2.5" SATA6Gbps Opal	None	HH DVD±RW	9-in-1	650W 92%	None	USB / USB Optical	Windows 10 DG Windows 7 Pro 64	3-year, Onsite	Oct 20, 2022	09/16
30B5002TUS	US	Xeon E5-1620 v4 4C/3.5GHz/10MB/140W/DDR4-2400	NVIDIA Quadro K620 2GB	1x8GB RDIMM DDR4-2400 ECC	Onboard	4	1x 1TB HDD 7.2K 3.5" SATA6Gbps	None	HH DVD±RW	9-in-1	490W 90%	None	USB / USB Optical	Windows 10 Pro 64	3-year, Onsite	Jul 14, 2022	06/16
30B5002UUS	US	Xeon E5-1630 v4 4C/3.7GHz/10MB/140W/DDR4-2400	Open	1x8GB RDIMM DDR4-2400 ECC	Onboard	4	1x 256GB SSD 2.5" SATA6Gbps Opal	None	HH DVD±RW	9-in-1	490W 90%	None	USB / USB Optical	Windows 10 Pro 64	3-year, Onsite	Jul 14, 2022	06/16
30B5002VUS	US	Xeon E5-1630 v4 4C/3.7GHz/10MB/140W/DDR4-2400	NVIDIA Quadro K1200 4GB	1x8GB RDIMM DDR4-2400 ECC	Onboard	4	1x 256GB SSD 2.5" SATA6Gbps Opal	None	HH DVD±RW	9-in-1	490W 90%	None	USB / USB Optical	Windows 10 Pro 64	3-year, Onsite	Jul 14, 2022	06/16
30B5002WUS	US	Xeon E5-1630 v4 4C/3.7GHz/10MB/140W/DDR4-2400	NVIDIA Quadro M2000 4GB	1x8GB RDIMM DDR4-2400 ECC	Onboard	4	1x 256GB SSD 2.5" SATA6Gbps Opal	None	HH DVD±RW	9-in-1	490W 90%	None	USB / USB Optical	Windows 10 Pro 64	3-year, Onsite	Jul 14, 2022	06/16
30B5002XUS	US	Xeon E5-1630 v4 4C/3.7GHz/10MB/140W/DDR4-2400	NVIDIA Quadro K1200 4GB	1x8GB RDIMM DDR4-2400 ECC	Onboard	4	1x 1TB HDD 7.2K 3.5" SATA6Gbps	None	HH DVD±RW	9-in-1	490W 90%	None	USB / USB Optical	Windows 10 Pro 64	3-year, Onsite	Jul 14, 2022	06/16
30B5002YUS	US	Xeon E5-1620 v4 4C/3.5GHz/10MB/140W/DDR4-2400	NVIDIA Quadro M4000 8GB	2x8GB RDIMM DDR4-2400 ECC	Onboard	4	1x 1TB HDD 7.2K 3.5" SATA6Gbps	None	HH DVD±RW	9-in-1	650W 92%	None	USB / USB Optical	Windows 10 Pro 64	3-year, Onsite	Jul 14, 2022	06/16
30B50030US	US	Xeon E5-1630 v4 4C/3.7GHz/10MB/140W/DDR4-2400	Open	1x8GB RDIMM DDR4-2400 ECC	Onboard	4	1x 256GB SSD 2.5" SATA6Gbps Opal	None	HH DVD±RW	9-in-1	650W 92%	None	USB / USB Optical	Windows 10 Pro 64	3-year, Onsite	Jul 14, 2022	06/16
30B50031US	US	Xeon E5-1630 v4 4C/3.7GHz/10MB/140W/DDR4-2400	NVIDIA Quadro M2000 4GB	1x8GB RDIMM DDR4-2400 ECC	Onboard	4	1x 256GB SSD 2.5" SATA6Gbps Opal	None	HH DVD±RW	9-in-1	650W 92%	None	USB / USB Optical	Windows 10 Pro 64	3-year, Onsite	Jul 14, 2022	06/16
30B50032US	US	Xeon E5-1650 v4 6C/3.6GHz/15MB/140W/DDR4-2400	Open	2x8GB RDIMM DDR4-2400 ECC	Onboard	4	1x 256GB SSD 2.5" SATA6Gbps Opal	None	HH DVD±RW	9-in-1	650W 92%	None	USB / USB Optical	Windows 10 Pro 64	3-year, Onsite	Jul 14, 2022	06/16
30B50033US	US	Xeon E5-1650 v4 6C/3.6GHz/15MB/140W/DDR4-2400	NVIDIA Quadro M2000 4GB	2x8GB RDIMM DDR4-2400 ECC	Onboard	4	1x 1TB HDD 7.2K 3.5" SATA6Gbps	None	HH DVD±RW	9-in-1	650W 92%	None	USB / USB Optical	Windows 10 Pro 64	3-year, Onsite	Jul 14, 2022	06/16
30B50034US	US	Xeon E5-1650 v4 6C/3.6GHz/15MB/140W/DDR4-2400	NVIDIA Quadro M4000 8GB	2x8GB RDIMM DDR4-2400 ECC	Onboard	4	1x 1TB HDD 7.2K 3.5" SATA6Gbps	None	HH DVD±RW	9-in-1	650W 92%	None	USB / USB Optical	Windows 10 Pro 64	3-year, Onsite	Jul 14, 2022	06/16

Model	Region	Processor	Graphics	Memory	Storage Controller	Max Drives in 3.5" Bays	Disks	M.2 Drives	Optical	Media Reader	Power Supply	Optional Ports	Keyboard / Mouse	Operating System	Warranty	End of Support	Ann Date (mm/yy)
30B50035US	US	Xeon E5-1650 v4 6C/3.6GHz/15MB/140W/DDR4-2400	NVIDIA Quadro M4000 8GB	2x8GB RDIMM DDR4-2400 ECC	Onboard	4	1x 512GB SSD 2.5" SATA6Gbps	None	HH DVD±RW	9-in-1	650W 92%	None	USB / USB Optical	Windows 10 Pro 64	3-year, Onsite	Jul 14, 2022	06/16
30B50036US	US	Xeon E5-1650 v4 6C/3.6GHz/15MB/140W/DDR4-2400	NVIDIA Quadro M5000 8GB	2x8GB RDIMM DDR4-2400 ECC	Onboard	4	1x 512GB SSD 2.5" SATA6Gbps	None	HH DVD±RW	9-in-1	650W 92%	None	USB / USB Optical	Windows 10 Pro 64	3-year, Onsite	Jul 14, 2022	06/16
30B5001GUS	US	Xeon E5-1620 v4 4C/3.5GHz/10MB/140W/DDR4-2400	NVIDIA Quadro M2000 4GB	1x8GB RDIMM DDR4-2400 ECC	Onboard	4	1x 1TB HDD 7.2K 3.5" SATA6Gbps	None	HH DVD±RW	9-in-1	490W 90%	None	USB / USB Optical	Windows 10 Pro 64	3-year, Onsite	Jul 14, 2022	06/16
30B5001HUS	US	Xeon E5-1620 v4 4C/3.5GHz/10MB/140W/DDR4-2400	Open	1x8GB RDIMM DDR4-2400 ECC	Onboard	4	1x 1TB HDD 7.2K 3.5" SATA6Gbps	None	HH DVD±RW	9-in-1	650W 92%	None	USB / USB Optical	Windows 10 Pro 64	3-year, Onsite	Jul 14, 2022	06/16
30B5001JUS	US	Xeon E5-1620 v4 4C/3.5GHz/10MB/140W/DDR4-2400	NVIDIA Quadro M2000 4GB	2x8GB RDIMM DDR4-2400 ECC	Onboard	4	1x 512GB SSD 2.5" SATA6Gbps	None	HH DVD±RW	9-in-1	490W 90%	None	USB / USB Optical	Windows 10 Pro 64	3-year, Onsite	Jul 14, 2022	06/16
30B5001KUS	US	Xeon E5-1620 v4 4C/3.5GHz/10MB/140W/DDR4-2400	Open	1x8GB RDIMM DDR4-2400 ECC	Onboard	4	1x 1TB HDD 7.2K 3.5" SATA6Gbps	None	HH DVD±RW	9-in-1	490W 90%	None	USB / USB Optical	Windows 10 Pro 64	3-year, Onsite	Jul 14, 2022	06/16
30B5001LUS	US	Xeon E5-1607 v4 4C/3.1GHz/10MB/140W/DDR4-2133	NVIDIA Quadro K620 2GB	1x8GB RDIMM DDR4-2400 ECC	Onboard	4	1x 1TB HDD 7.2K 3.5" SATA6Gbps	None	HH DVD±RW	9-in-1	490W 90%	None	USB / USB Optical	Windows 10 Pro 64	3-year, Onsite	Jul 14, 2022	06/16
30B5001MUS	US	Xeon E5-1607 v4 4C/3.1GHz/10MB/140W/DDR4-2133	NVIDIA Quadro K620 2GB	1x8GB RDIMM DDR4-2400 ECC	Onboard	4	1x 500GB HDD 7.2K 3.5" SATA6Gbps	None	HH DVD±RW	9-in-1	490W 90%	None	USB / USB Optical	Windows 10 Pro 64	3-year, Onsite	Jul 14, 2022	06/16
30B5001NUS	US	Xeon E5-1630 v4 4C/3.7GHz/10MB/140W/DDR4-2400	NVIDIA Quadro M4000 8GB	2x8GB RDIMM DDR4-2400 ECC	Onboard	4	1x 512GB SSD 2.5" SATA6Gbps	None	HH DVD±RW	9-in-1	650W 92%	None	USB / USB Optical	Windows 10 Pro 64	3-year, Onsite	Jul 14, 2022	06/16
30B5001PUS	US	Xeon E5-1607 v4 4C/3.1GHz/10MB/140W/DDR4-2133	Open	1x8GB RDIMM DDR4-2400 ECC	Onboard	4	1x 1TB HDD 7.2K 3.5" SATA6Gbps	None	HH DVD±RW	9-in-1	490W 90%	None	USB / USB Optical	Windows 10 Pro 64	3-year, Onsite	Jul 14, 2022	06/16
30B5001QUS	US	Xeon E5-1630 v4 4C/3.7GHz/10MB/140W/DDR4-2400	NVIDIA Quadro M4000 8GB	2x8GB RDIMM DDR4-2400 ECC	Onboard	4	1x 1TB HDD 7.2K 3.5" SATA6Gbps	None	HH DVD±RW	9-in-1	650W 92%	None	USB / USB Optical	Windows 10 Pro 64	3-year, Onsite	Jul 14, 2022	06/16
30B5003KUS	US	Xeon E5-1607 v4 4C/3.1GHz/10MB/140W/DDR4-2133	Open	1x8GB RDIMM DDR4-2400 ECC	Onboard	4	1x 1TB HDD 7.2K 3.5" SATA6Gbps	None	HH DVD±RW	9-in-1	490W 90%	None	USB / USB Optical	Windows 10 DG Windows 7 Pro 64	3-year, Onsite	Oct 20, 2022	09/16

Model	Region	Processor	Graphics	Memory	Storage Controller	Max Drives in 3.5" Bays	Disks	M.2 Drives	Optical	Media Reader	Power Supply	Optional Ports	Keyboard / Mouse	Operating System	Warranty	End of Support	Ann Date (mm/yy)
30B5003UUS	US	Xeon E5-1620 v4 4C/3.5GHz/10MB/140W/DDR4-2400	Open	1x8GB RDIMM DDR4-2400 ECC	Onboard	4	1x 1TB HDD 7.2K 3.5" SATA6Gbps	None	HH DVD±RW	9-in-1	490W 90%	None	USB / USB Optical	Windows 10 DG Windows 7 Pro 64	3-year, Onsite	Oct 20, 2022	09/16
30B5003NUS	US	Xeon E5-1620 v4 4C/3.5GHz/10MB/140W/DDR4-2400	NVIDIA Quadro M4000 8GB	2x8GB RDIMM DDR4-2400 ECC	Onboard	4	1x 1TB HDD 7.2K 3.5" SATA6Gbps	None	HH DVD±RW	9-in-1	650W 92%	None	USB / USB Optical	Windows 10 DG Windows 7 Pro 64	3-year, Onsite	Oct 20, 2022	09/16
30B5004YUS	US	Xeon E5-1630 v4 4C/3.7GHz/10MB/140W/DDR4-2400	NVIDIA Quadro M4000 8GB	2x8GB RDIMM DDR4-2400 ECC	Onboard	4	1x 1TB HDD 7.2K 3.5" SATA6Gbps	None	HH DVD±RW	9-in-1	650W 92%	None	USB / USB Optical	Windows 10 DG Windows 7 Pro 64	3-year, Onsite	Oct 20, 2022	09/16
30B50050US	US	Xeon E5-1630 v4 4C/3.7GHz/10MB/140W/DDR4-2400	NVIDIA Quadro M4000 8GB	2x8GB RDIMM DDR4-2400 ECC	Onboard	4	1x 512GB SSD 2.5" SATA6Gbps	None	HH DVD±RW	9-in-1	650W 92%	None	USB / USB Optical	Windows 10 DG Windows 7 Pro 64	3-year, Onsite	Oct 20, 2022	09/16
30B50051US	US	Xeon E5-1620 v4 4C/3.5GHz/10MB/140W/DDR4-2400	NVIDIA Quadro M2000 4GB	2x8GB RDIMM DDR4-2400 ECC	Onboard	4	1x 512GB SSD 2.5" SATA6Gbps	None	HH DVD±RW	9-in-1	490W 90%	None	USB / USB Optical	Windows 10 DG Windows 7 Pro 64	3-year, Onsite	Oct 20, 2022	09/16
30B50052US	US	Xeon E5-1607 v4 4C/3.1GHz/10MB/140W/DDR4-2133	NVIDIA Quadro K620 2GB	1x8GB RDIMM DDR4-2400 ECC	Onboard	4	1x 500GB HDD 7.2K 3.5" SATA6Gbps	None	HH DVD±RW	9-in-1	490W 90%	None	USB / USB Optical	Windows 10 DG Windows 7 Pro 64	3-year, Onsite	Oct 20, 2022	09/16
30B50053US	US	Xeon E5-1620 v4 4C/3.5GHz/10MB/140W/DDR4-2400	Open	1x8GB RDIMM DDR4-2400 ECC	Onboard	4	1x 1TB HDD 7.2K 3.5" SATA6Gbps	None	HH DVD±RW	9-in-1	650W 92%	None	USB / USB Optical	Windows 10 DG Windows 7 Pro 64	3-year, Onsite	Oct 20, 2022	09/16
30B50054US	US	Xeon E5-1607 v4 4C/3.1GHz/10MB/140W/DDR4-2133	NVIDIA Quadro K620 2GB	1x8GB RDIMM DDR4-2400 ECC	Onboard	4	1x 1TB HDD 7.2K 3.5" SATA6Gbps	None	HH DVD±RW	9-in-1	490W 90%	None	USB / USB Optical	Windows 10 DG Windows 7 Pro 64	3-year, Onsite	Oct 20, 2022	09/16
30B50055US	US	Xeon E5-1620 v4 4C/3.5GHz/10MB/140W/DDR4-2400	NVIDIA Quadro M2000 4GB	1x8GB RDIMM DDR4-2400 ECC	Onboard	4	1x 1TB HDD 7.2K 3.5" SATA6Gbps	None	HH DVD±RW	9-in-1	490W 90%	None	USB / USB Optical	Windows 10 DG Windows 7 Pro 64	3-year, Onsite	Oct 20, 2022	09/16
30B50056US	US	Xeon E5-1650 v4 6C/3.6GHz/15MB/140W/DDR4-2400	NVIDIA Quadro M4000 8GB	2x8GB RDIMM DDR4-2400 ECC	Onboard	4	1x 1TB HDD 7.2K 3.5" SATA6Gbps	None	HH DVD±RW	9-in-1	650W 92%	None	USB / USB Optical	Windows 10 DG Windows 7 Pro 64	3-year, Onsite	Oct 20, 2022	09/16
30B50057US	US	Xeon E5-1630 v4 4C/3.7GHz/10MB/140W/DDR4-2400	NVIDIA Quadro K1200 4GB	1x8GB RDIMM DDR4-2400 ECC	Onboard	4	1x 1TB HDD 7.2K 3.5" SATA6Gbps	None	HH DVD±RW	9-in-1	490W 90%	None	USB / USB Optical	Windows 10 DG Windows 7 Pro 64	3-year, Onsite	Oct 20, 2022	09/16
30B50058US	US	Xeon E5-1630 v4 4C/3.7GHz/10MB/140W/DDR4-2400	Open	1x8GB RDIMM DDR4-2400 ECC	Onboard	4	1x 256GB SSD 2.5" SATA6Gbps Opal	None	HH DVD±RW	9-in-1	490W 90%	None	USB / USB Optical	Windows 10 DG Windows 7 Pro 64	3-year, Onsite	Oct 20, 2022	09/16

Model	Region	Processor	Graphics	Memory	Storage Controller	Max Drives in 3.5" Bays	Disks	M.2 Drives	Optical	Media Reader	Power Supply	Optional Ports	Keyboard / Mouse	Operating System	Warranty	End of Support	Ann Date (mm/yy)
30B50059US	US	Xeon E5-1630 v4 4C/3.7GHz/10MB/140W/DDR4-2400	NVIDIA Quadro M2000 4GB	1x8GB RDIMM DDR4-2400 ECC	Onboard	4	1x 256GB SSD 2.5" SATA6Gbps Opal	None	HH DVD±RW	9-in-1	490W 90%	None	USB / USB Optical	Windows 10 DG Windows 7 Pro 64	3-year, Onsite	Oct 20, 2022	09/16
30B5005AUS	US	Xeon E5-1650 v4 6C/3.6GHz/15MB/140W/DDR4-2400	NVIDIA Quadro M5000 8GB	2x8GB RDIMM DDR4-2400 ECC	Onboard	4	1x 512GB SSD 2.5" SATA6Gbps Opal	None	HH DVD±RW	9-in-1	650W 92%	None	USB / USB Optical	Windows 10 DG Windows 7 Pro 64	3-year, Onsite	Oct 20, 2022	09/16
30B5005BUS	US	Xeon E5-1630 v4 4C/3.7GHz/10MB/140W/DDR4-2400	NVIDIA Quadro K1200 4GB	1x8GB RDIMM DDR4-2400 ECC	Onboard	4	1x 256GB SSD 2.5" SATA6Gbps Opal	None	HH DVD±RW	9-in-1	490W 90%	None	USB / USB Optical	Windows 10 DG Windows 7 Pro 64	3-year, Onsite	Oct 20, 2022	09/16
30B5005CUS	US	Xeon E5-1650 v4 6C/3.6GHz/15MB/140W/DDR4-2400	NVIDIA Quadro M2000 4GB	2x8GB RDIMM DDR4-2400 ECC	Onboard	4	1x 1TB HDD 7.2K 3.5" SATA6Gbps Opal	None	HH DVD±RW	9-in-1	650W 92%	None	USB / USB Optical	Windows 10 DG Windows 7 Pro 64	3-year, Onsite	Oct 20, 2022	09/16
30B5005DUS	US	Xeon E5-1630 v4 4C/3.7GHz/10MB/140W/DDR4-2400	Open	1x8GB RDIMM DDR4-2400 ECC	Onboard	4	1x 256GB SSD 2.5" SATA6Gbps Opal	None	HH DVD±RW	9-in-1	650W 92%	None	USB / USB Optical	Windows 10 DG Windows 7 Pro 64	3-year, Onsite	Oct 20, 2022	09/16
30B5005KUS	US	Xeon E5-1620 v4 4C/3.5GHz/10MB/140W/DDR4-2400	Open	2x8GB RDIMM DDR4-2400 ECC	9364-8i PCIe	4	None	1x 1TB SSD M.2 PCIe Opal	HH DVD±RW	9-in-1	650W 92%	None	USB / USB Optical	Windows 10 DG Windows 7 Pro 64	3-year, Onsite	Jan 5, 2023	12/16
30B5005LUS	US	Xeon E5-1650 v4 6C/3.6GHz/15MB/140W/DDR4-2400	Open	2x8GB RDIMM DDR4-2400 ECC	Onboard	4	None	1x 1TB SSD M.2 PCIe Opal	HH DVD±RW	9-in-1	650W 92%	None	USB / USB Optical	Windows 10 DG Windows 7 Pro 64	3-year, Onsite	Jan 5, 2023	12/16
30B5005MUS	US	Xeon E5-1620 v4 4C/3.5GHz/10MB/140W/DDR4-2400	Open	2x8GB RDIMM DDR4-2400 ECC	Onboard	4	None	1x 1TB SSD M.2 PCIe Opal	HH DVD±RW	9-in-1	650W 92%	None	USB / USB Optical	Windows 10 DG Windows 7 Pro 64	3-year, Onsite	Jan 5, 2023	12/16
30B5005NUS	US	Xeon E5-1607 v4 4C/3.1GHz/10MB/140W/DDR4-2133	Open	2x8GB RDIMM DDR4-2400 ECC	Onboard	4	None	1x 1TB SSD M.2 PCIe Opal	HH DVD±RW	9-in-1	650W 92%	None	USB / USB Optical	Windows 10 DG Windows 7 Pro 64	3-year, Onsite	Jan 5, 2023	12/16
30B5005PUS	US	Xeon E5-1607 v4 4C/3.1GHz/10MB/140W/DDR4-2133	NVIDIA Quadro P5000 16GB	2x8GB RDIMM DDR4-2400 ECC	Onboard	4	None	1x 1TB SSD M.2 PCIe Opal	HH DVD±RW	9-in-1	650W 92%	None	USB / USB Optical	Windows 10 DG Windows 7 Pro 64	3-year, Onsite	Jan 5, 2023	12/16
30B5005QUS	US	Xeon E5-1650 v4 6C/3.6GHz/15MB/140W/DDR4-2400	NVIDIA Quadro P5000 16GB	2x8GB RDIMM DDR4-2400 ECC	Onboard	4	None	1x 1TB SSD M.2 PCIe Opal	HH DVD±RW	9-in-1	650W 92%	None	USB / USB Optical	Windows 10 DG Windows 7 Pro 64	3-year, Onsite	Jan 5, 2023	12/16
30B5005RUS	US	Xeon E5-1630 v4 4C/3.7GHz/10MB/140W/DDR4-2400	Open	2x8GB RDIMM DDR4-2400 ECC	Onboard	4	None	1x 1TB SSD M.2 PCIe Opal	HH DVD±RW	9-in-1	650W 92%	None	USB / USB Optical	Windows 10 DG Windows 7 Pro 64	3-year, Onsite	Jan 5, 2023	12/16

Model	Region	Processor	Graphics	Memory	Storage Controller	Max Drives in 3.5" Bays	Disks	M.2 Drives	Optical	Media Reader	Power Supply	Optional Ports	Keyboard / Mouse	Operating System	Warranty	End of Support	Ann Date (mm/yy)
30B5005SUS	US	Xeon E5-1620 v4 4C/3.5GHz/10MB/140W/DDR4-2400	Open	2x8GB RDIMM DDR4-2400 ECC	Onboard	4	None	1x 1TB SSD M.2 PCIe Opal	HH DVD±RW	9-in-1	650W 92%	None	USB / USB Optical	Windows 10 DG Windows 7 Pro 64	3-year, Onsite	Jan 5, 2023	12/16
30B5005FUS	US	Xeon E5-1650 v4 6C/3.6GHz/15MB/140W/DDR4-2400	NVIDIA Quadro M4000 8GB	2x8GB RDIMM DDR4-2400 ECC	Onboard	4	1x 512GB SSD 2.5" SATA6Gbps	None	HH DVD±RW	9-in-1	650W 92%	None	USB / USB Optical	Windows 10 DG Windows 7 Pro 64	3-year, Onsite	Oct 20, 2022	09/16
30B5005GUS	US	Xeon E5-1620 v4 4C/3.5GHz/10MB/140W/DDR4-2400	NVIDIA Quadro K620 2GB	1x8GB RDIMM DDR4-2400 ECC	Onboard	4	1x 1TB HDD 7.2K 3.5" SATA6Gbps	None	HH DVD±RW	9-in-1	490W 90%	None	USB / USB Optical	Windows 10 DG Windows 7 Pro 64	3-year, Onsite	Oct 20, 2022	09/16
30B5005HUS	US	Xeon E5-1630 v4 4C/3.7GHz/10MB/140W/DDR4-2400	NVIDIA Quadro M2000 4GB	1x8GB RDIMM DDR4-2400 ECC	Onboard	4	1x 256GB SSD 2.5" SATA6Gbps Opal	None	HH DVD±RW	9-in-1	650W 92%	None	USB / USB Optical	Windows 10 DG Windows 7 Pro 64	3-year, Onsite	Oct 20, 2022	09/16
30B5005VUS	US	Xeon E5-1620 v4 4C/3.5GHz/10MB/140W/DDR4-2400	NVIDIA Quadro P600 2GB	1x8GB RDIMM DDR4-2400 ECC	Onboard	4	1x 1TB HDD 7.2K 3.5" SATA6Gbps	None	HH DVD±RW	9-in-1	490W 90%	None	USB / USB Optical	Windows 10 DG Windows 7 Pro 64	3-year, Onsite	May 24, 2023	04/17
30B5005WUS	US	Xeon E5-1620 v4 4C/3.5GHz/10MB/140W/DDR4-2400	NVIDIA Quadro P2000 5GB	2x8GB RDIMM DDR4-2400 ECC	Onboard	4	1x 512GB SSD 2.5" SATA6Gbps	None	HH DVD±RW	9-in-1	490W 90%	None	USB / USB Optical	Windows 10 DG Windows 7 Pro 64	3-year, Onsite	May 24, 2023	04/17
30B5005XUS	US	Xeon E5-1650 v4 6C/3.6GHz/15MB/140W/DDR4-2400	NVIDIA Quadro P2000 5GB	2x8GB RDIMM DDR4-2400 ECC	Onboard	4	1x 1TB HDD 7.2K 3.5" SATA6Gbps	None	HH DVD±RW	9-in-1	650W 92%	None	USB / USB Optical	Windows 10 DG Windows 7 Pro 64	3-year, Onsite	May 24, 2023	04/17
30B5005YUS	US	Xeon E5-1620 v4 4C/3.5GHz/10MB/140W/DDR4-2400	NVIDIA Quadro P4000 8GB	2x8GB RDIMM DDR4-2400 ECC	Onboard	4	1x 1TB HDD 7.2K 3.5" SATA6Gbps	None	HH DVD±RW	9-in-1	650W 92%	None	USB / USB Optical	Windows 10 DG Windows 7 Pro 64	3-year, Onsite	May 24, 2023	04/17
30B50060US	US	Xeon E5-1650 v4 6C/3.6GHz/15MB/140W/DDR4-2400	NVIDIA Quadro P4000 8GB	2x8GB RDIMM DDR4-2400 ECC	Onboard	4	1x 1TB HDD 7.2K 3.5" SATA6Gbps	None	HH DVD±RW	9-in-1	650W 92%	None	USB / USB Optical	Windows 10 DG Windows 7 Pro 64	3-year, Onsite	May 24, 2023	04/17
30B50061US	US	Xeon E5-1650 v4 6C/3.6GHz/15MB/140W/DDR4-2400	NVIDIA Quadro P2000 5GB	2x8GB RDIMM DDR4-2400 ECC	Onboard	4	1x 1TB HDD 7.2K 3.5" SATA6Gbps	None	HH DVD±RW	9-in-1	490W 90%	None	USB / USB Optical	Windows 10 DG Windows 7 Pro 64	3-year, Onsite	May 24, 2023	04/17
30B50062US	US	Xeon E5-1630 v4 4C/3.7GHz/10MB/140W/DDR4-2400	NVIDIA Quadro P4000 8GB	2x8GB RDIMM DDR4-2400 ECC	Onboard	4	1x 512GB SSD 2.5" SATA6Gbps	None	HH DVD±RW	9-in-1	650W 92%	None	USB / USB Optical	Windows 10 DG Windows 7 Pro 64	3-year, Onsite	May 24, 2023	04/17
30B50063US	US	Xeon E5-1650 v4 6C/3.6GHz/15MB/140W/DDR4-2400	NVIDIA Quadro P2000 5GB	1x8GB RDIMM DDR4-2400 ECC	Onboard	4	1x 1TB HDD 7.2K 3.5" SATA6Gbps	None	HH DVD±RW	9-in-1	490W 90%	None	USB / USB Optical	Windows 10 DG Windows 7 Pro 64	3-year, Onsite	May 24, 2023	04/17

Model	Region	Processor	Graphics	Memory	Storage Controller	Max Drives in 3.5" Bays	Disks	M.2 Drives	Optical	Media Reader	Power Supply	Optional Ports	Keyboard / Mouse	Operating System	Warranty	End of Support	Ann Date (mm/yy)
30B50064US	US	Xeon E5-1630 v4 4C/3.7GHz/10MB/140W/DDR4-2400	NVIDIA Quadro P2000 5GB	1x8GB RDIMM DDR4-2400 ECC	Onboard	4	1x 256GB SSD 2.5" SATA6Gbps Opal	None	HH DVD±RW	9-in-1	490W 90%	None	USB / USB Optical	Windows 10 DG Windows 7 Pro 64	3-year, Onsite	May 24, 2023	04/17
30B50065US	US	Xeon E5-1630 v4 4C/3.7GHz/10MB/140W/DDR4-2400	NVIDIA Quadro P1000 4GB	1x8GB RDIMM DDR4-2400 ECC	Onboard	4	1x 256GB SSD 2.5" SATA6Gbps Opal	None	HH DVD±RW	9-in-1	490W 90%	None	USB / USB Optical	Windows 10 DG Windows 7 Pro 64	3-year, Onsite	May 24, 2023	04/17
30B50066US	US	Xeon E5-1630 v4 4C/3.7GHz/10MB/140W/DDR4-2400	NVIDIA Quadro P2000 5GB	1x8GB RDIMM DDR4-2400 ECC	Onboard	4	1x 256GB SSD 2.5" SATA6Gbps Opal	None	HH DVD±RW	9-in-1	650W 92%	None	USB / USB Optical	Windows 10 DG Windows 7 Pro 64	3-year, Onsite	May 24, 2023	04/17
30B50067US	US	Xeon E5-1630 v4 4C/3.7GHz/10MB/140W/DDR4-2400	NVIDIA Quadro P1000 4GB	1x8GB RDIMM DDR4-2400 ECC	Onboard	4	1x 1TB HDD 7.2K 3.5" SATA6Gbps	None	HH DVD±RW	9-in-1	490W 90%	None	USB / USB Optical	Windows 10 DG Windows 7 Pro 64	3-year, Onsite	May 24, 2023	04/17
30B50068US	US	Xeon E5-1650 v4 6C/3.6GHz/15MB/140W/DDR4-2400	NVIDIA Quadro P4000 8GB	2x8GB RDIMM DDR4-2400 ECC	Onboard	4	1x 512GB SSD 2.5" SATA6Gbps	None	HH DVD±RW	9-in-1	650W 92%	None	USB / USB Optical	Windows 10 DG Windows 7 Pro 64	3-year, Onsite	May 24, 2023	04/17
30B50069US	US	Xeon E5-1607 v4 4C/3.1GHz/10MB/140W/DDR4-2133	NVIDIA Quadro P600 2GB	1x8GB RDIMM DDR4-2400 ECC	Onboard	4	1x 1TB HDD 7.2K 3.5" SATA6Gbps	None	HH DVD±RW	9-in-1	490W 90%	None	USB / USB Optical	Windows 10 DG Windows 7 Pro 64	3-year, Onsite	May 24, 2023	04/17
30B5006AUS	US	Xeon E5-1630 v4 4C/3.7GHz/10MB/140W/DDR4-2400	NVIDIA Quadro P600 2GB	1x8GB RDIMM DDR4-2400 ECC	Onboard	4	1x 1TB HDD 7.2K 3.5" SATA6Gbps	None	HH DVD±RW	9-in-1	490W 90%	None	USB / USB Optical	Windows 10 DG Windows 7 Pro 64	3-year, Onsite	May 24, 2023	04/17
30B5006BUS	US	Xeon E5-1630 v4 4C/3.7GHz/10MB/140W/DDR4-2400	NVIDIA Quadro P600 2GB	1x8GB RDIMM DDR4-2400 ECC	Onboard	4	1x 256GB SSD 2.5" SATA6Gbps Opal	None	HH DVD±RW	9-in-1	490W 90%	None	USB / USB Optical	Windows 10 DG Windows 7 Pro 64	3-year, Onsite	May 24, 2023	04/17
30B5006CUS	US	Xeon E5-1630 v4 4C/3.7GHz/10MB/140W/DDR4-2400	NVIDIA Quadro P4000 8GB	2x8GB RDIMM DDR4-2400 ECC	Onboard	4	1x 1TB HDD 7.2K 3.5" SATA6Gbps	None	HH DVD±RW	9-in-1	650W 92%	None	USB / USB Optical	Windows 10 DG Windows 7 Pro 64	3-year, Onsite	May 24, 2023	04/17
30B5005EUS	US	Xeon E5-1650 v4 6C/3.6GHz/15MB/140W/DDR4-2400	Open	2x8GB RDIMM DDR4-2400 ECC	Onboard	4	1x 256GB SSD 2.5" SATA6Gbps Opal	None	HH DVD±RW	9-in-1	650W 92%	None	USB / USB Optical	Windows 10 DG Windows 7 Pro 64	3-year, Onsite	Oct 20, 2022	09/16
30B5006HUS	US	Xeon E5-1650 v4 6C/3.6GHz/15MB/140W/DDR4-2400	Open	1x16GB RDIMM DDR4-2400 ECC	Onboard	4	None	1x 512GB SSD M.2 PCIe	HH DVD±RW	9-in-1	650W 92%	None	USB / USB Optical	Windows 10 DG Windows 7 Pro 64	3-year, Onsite	Aug 31, 2023	07/17
30B5006JUS	US	Xeon E5-1630 v4 4C/3.7GHz/10MB/140W/DDR4-2400	Open	1x16GB RDIMM DDR4-2400 ECC	Onboard	4	None	1x 256GB SSD M.2 PCIe Opal	HH DVD±RW	9-in-1	650W 92%	None	USB / USB Optical	Windows 10 DG Windows 7 Pro 64	3-year, Onsite	Aug 31, 2023	07/17

Model	Region	Processor	Graphics	Memory	Storage Controller	Max Drives in 3.5" Bays	Disks	M.2 Drives	Optical	Media Reader	Power Supply	Optional Ports	Keyboard / Mouse	Operating System	Warranty	End of Support	Ann Date (mm/yy)
30B5006KUS	US	Xeon E5-1620 v4 4C/3.5GHz/10MB/140W/DDR4-2400	Open	1x8GB RDIMM DDR4-2400 ECC	Onboard	4	None	1x 256GB SSD M.2 PCIe Opal	HH DVD±RW	9-in-1	650W 92%	None	USB / USB Optical	Windows 10 DG Windows 7 Pro 64	3-year, Onsite	Aug 31, 2023	07/17
30B5006N--	WE	Xeon E5-1650 v4 6C/3.6GHz/15MB/140W/DDR4-2400	NVIDIA Quadro P2000 5GB	1x8GB RDIMM DDR4-2400 ECC	Onboard	4	1x 256GB SSD 2.5" SATA6Gbps Opal	None	HH DVD±RW	9-in-1	490W 90%	None	USB / USB Optical	Windows 10 Pro 64	3-year, Onsite	Sep 26, 2022	09/17
30B5006P--	WE	Xeon E5-2630 v4 10C/2.2GHz/25MB/85W/DDR4-2133	Open	2x8GB RDIMM DDR4-2400 ECC	Onboard	4	1x 2TB HDD 7.2K 3.5" SATA6Gbps	1x 512GB SSD M.2 PCIe Opal	HH DVD±RW	9-in-1	650W 92%	None	USB / USB Optical	Windows 10 Pro 64	3-year, Onsite	Sep 26, 2022	09/17
30B5006Q--	WE	Xeon E5-1620 v4 4C/3.5GHz/10MB/140W/DDR4-2400	Open	1x8GB RDIMM DDR4-2400 ECC	Onboard	4	None	1x 256GB SSD M.2 PCIe Opal	HH DVD±RW	9-in-1	490W 90%	None	USB / USB Optical	Windows 10 Pro 64	3-year, Onsite	Sep 26, 2022	09/17
30B5006E--	WE	Xeon E5-1620 v4 4C/3.5GHz/10MB/140W/DDR4-2400	NVIDIA Quadro P2000 5GB	1x16GB RDIMM DDR4-2400 ECC	Onboard	4	1x 1TB HDD 7.2K 3.5" SATA6Gbps	None	9.5mm DVD±RW	29-in-1	650W 92%	Front eSATA	USB / USB Optical	Windows 10 Pro 64	3-year, Onsite	Aug 4, 2023	07/17
30B5006F--	WE	Xeon E5-1650 v4 6C/3.6GHz/15MB/140W/DDR4-2400	NVIDIA Quadro P4000 8GB	2x16GB RDIMM DDR4-2400 ECC	Onboard	4	1x 256GB SSD 2.5" SATA6Gbps Opal, 1x 1TB HDD 7.2K 3.5" SATA6Gbps	None	9.5mm DVD±RW	29-in-1	650W 92%	Front eSATA	USB / USB Optical	Windows 10 Pro 64	3-year, Onsite	Aug 4, 2023	07/17
30B5006G--	WE	Xeon E5-1650 v4 6C/3.6GHz/15MB/140W/DDR4-2400	NVIDIA Quadro P2000 5GB	2x16GB RDIMM DDR4-2400 ECC	Onboard	4	2x 1TB HDD 7.2K 3.5" SATA6Gbps	None	9.5mm DVD±RW	29-in-1	650W 92%	Front eSATA	USB / USB Optical	Windows 10 Pro 64	3-year, Onsite	Aug 4, 2023	07/17
30B5006R--	WE	Xeon E5-1630 v4 4C/3.7GHz/10MB/140W/DDR4-2400	Open	2x8GB RDIMM DDR4-2400 ECC	Onboard	4	1x 256GB SSD 2.5" SATA6Gbps Opal	None	HH DVD±RW, 9.0mm DVD±RW	29-in-1	650W 92%	None	USB / USB Optical	Windows 10 Pro 64	3-year, Onsite	Sep 26, 2022	09/17
30B5006S--	WE	Xeon E5-1607 v4 4C/3.1GHz/10MB/140W/DDR4-2133	NVIDIA Quadro P600 2GB	1x8GB RDIMM DDR4-2400 ECC	Onboard	4	1x 1TB HDD 7.2K 3.5" SATA6Gbps	None	HH DVD±RW, 9.0mm DVD±RW	29-in-1	650W 92%	None	USB / USB Optical	Windows 10 Pro 64	3-year, Onsite	Sep 26, 2022	09/17
30B5006T--	WE	Xeon E5-1620 v4 4C/3.5GHz/10MB/140W/DDR4-2400	NVIDIA Quadro P2000 5GB	1x16GB RDIMM DDR4-2400 ECC	Onboard	4	1x 1TB HDD 7.2K 3.5" SATA6Gbps	None	HH DVD±RW, 9.0mm DVD±RW	29-in-1	650W 92%	None	USB / USB Optical	Windows 10 Pro 64	3-year, Onsite	Sep 26, 2022	09/17
30B5006U--	WE	Xeon E5-1650 v4 6C/3.6GHz/15MB/140W/DDR4-2400	NVIDIA Quadro P4000 8GB	2x16GB RDIMM DDR4-2400 ECC	Onboard	4	1x 256GB SSD 2.5" SATA6Gbps Opal, 1x 1TB HDD 7.2K 3.5" SATA6Gbps	None	HH DVD±RW, 9.0mm DVD±RW	29-in-1	650W 92%	None	USB / USB Optical	Windows 10 Pro 64	3-year, Onsite	Sep 26, 2022	09/17
30B5006V--	WE	Xeon E5-1650 v4 6C/3.6GHz/15MB/140W/DDR4-2400	NVIDIA Quadro P2000 5GB	1x16GB RDIMM DDR4-2400 ECC	Onboard	4	2x 1TB HDD 7.2K 3.5" SATA6Gbps	None	HH DVD±RW, 9.0mm DVD±RW	29-in-1	650W 92%	None	USB / USB Optical	Windows 10 Pro 64	3-year, Onsite	Sep 26, 2022	09/17

Model	Region	Processor	Graphics	Memory	Storage Controller	Max Drives in 3.5" Bays	Disks	M.2 Drives	Optical	Media Reader	Power Supply	Optional Ports	Keyboard / Mouse	Operating System	Warranty	End of Support	Ann Date (mm/yy)
30B5006W--	WE	Xeon E5-1620 v4 4C/3.5GHz/10MB/140W/DDR4-2400	Open	1x8GB RDIMM DDR4-2400 ECC	Onboard	4	1x 1TB Hybrid HDD 7.2K 3.5" SATA6Gbps	None	HH DVD	9-in-1	490W 90%	None	USB / USB Optical	Windows 10 DG Windows 7 Pro 64	3-year, Onsite	Sep 26, 2022	09/17
30B5006X--	WE	Xeon E5-1620 v4 4C/3.5GHz/10MB/140W/DDR4-2400	Open	1x8GB RDIMM DDR4-2400 ECC	Onboard	4	1x 1TB Hybrid HDD 7.2K 3.5" SATA6Gbps	None	HH DVD	9-in-1	650W 92%	None	USB / USB Optical	Windows 10 DG Windows 7 Pro 64	3-year, Onsite	Sep 26, 2022	09/17
30B5006Y--	WE	Xeon E5-1620 v4 4C/3.5GHz/10MB/140W/DDR4-2400	Open	1x8GB RDIMM DDR4-2400 ECC	Onboard	4	1x 256GB SSD 2.5" SATA6Gbps Opal	None	HH DVD	9-in-1	650W 92%	None	USB / USB Optical	Windows 10 DG Windows 7 Pro 64	3-year, Onsite	Sep 26, 2022	09/17
30B50070--	WE	Xeon E5-1630 v4 4C/3.7GHz/10MB/140W/DDR4-2400	Open	2x8GB RDIMM DDR4-2400 ECC	Onboard	4	None	1x 256GB SSD M.2 PCIe Opal	HH DVD	9-in-1	650W 92%	None	USB / USB Optical	Windows 10 DG Windows 7 Pro 64	3-year, Onsite	Sep 26, 2022	09/17
30B50071--	WE	Xeon E5-1620 v4 4C/3.5GHz/10MB/140W/DDR4-2400	Open	1x8GB RDIMM DDR4-2400 ECC	Onboard	4	1x 1TB Hybrid HDD 7.2K 3.5" SATA6Gbps	None	HH DVD	9-in-1	490W 90%	None	USB / USB Optical	Windows 10 Pro 64	3-year, Onsite	Sep 26, 2022	09/17
30B50072--	WE	Xeon E5-1620 v4 4C/3.5GHz/10MB/140W/DDR4-2400	Open	1x8GB RDIMM DDR4-2400 ECC	Onboard	4	1x 256GB SSD 2.5" SATA6Gbps Opal	None	HH DVD	9-in-1	650W 92%	None	USB / USB Optical	Windows 10 Pro 64	3-year, Onsite	Sep 26, 2022	09/17
30B50073--	WE	Xeon E5-1650 v4 6C/3.6GHz/15MB/140W/DDR4-2400	Open	1x8GB RDIMM DDR4-2400 ECC	Onboard	4	1x 512GB SSD 2.5" SATA6Gbps	None	HH DVD	9-in-1	650W 92%	None	USB / USB Optical	Windows 10 Pro 64	3-year, Onsite	Sep 26, 2022	09/17
30B50074--	WE	Xeon E5-1630 v4 4C/3.7GHz/10MB/140W/DDR4-2400	Open	2x8GB RDIMM DDR4-2400 ECC	Onboard	4	1x 256GB SSD 2.5" SATA6Gbps Opal	None	HH DVD	9-in-1	650W 92%	None	USB / USB Optical	Windows 10 Pro 64	3-year, Onsite	Sep 26, 2022	09/17
30B50075--	WE	Xeon E5-1650 v4 6C/3.6GHz/15MB/140W/DDR4-2400	Open	2x8GB RDIMM DDR4-2400 ECC	Onboard	4	1x 512GB SSD 2.5" SATA6Gbps	None	HH DVD	9-in-1	650W 92%	None	USB / USB Optical	Windows 10 Pro 64	3-year, Onsite	Sep 26, 2022	09/17
30B50076--	WE	Xeon E5-1620 v4 4C/3.5GHz/10MB/140W/DDR4-2400	Open	1x8GB RDIMM DDR4-2400 ECC	Onboard	4	1x 1TB Hybrid HDD 7.2K 3.5" SATA6Gbps	None	HH DVD	9-in-1	650W 92%	None	USB / USB Optical	Windows 10 Pro 64	3-year, Onsite	Sep 26, 2022	09/17
30B50005--	WE	Xeon E5-1650 v3 6C/3.5GHz/15MB/140W/DDR4-2133	NVIDIA Quadro M2000 4GB	4x8GB RDIMM DDR4-2400 ECC	Onboard	4	1x 1TB HDD 7.2K 3.5" SATA6Gbps	None	HH DVD±RW	9-in-1	490W 90%	None	USB / USB Optical	Windows 10 DG Windows 7 Pro 64	3-year, Onsite	Jul 14, 2022	06/16
30B5006D--	WE	Xeon E5-1607 v4 4C/3.1GHz/10MB/140W/DDR4-2133	NVIDIA Quadro P600 2GB	1x8GB RDIMM DDR4-2400 ECC	Onboard	4	1x 1TB HDD 7.2K 3.5" SATA6Gbps	None	9.5mm DVD±RW	29-in-1	650W 92%	Front eSATA	USB / USB Optical	Windows 10 Pro 64	3-year, Onsite	Aug 4, 2023	07/17

Model	Region	Processor	Graphics	Memory	Storage Controller	Max Drives in 3.5" Bays	Disks	M.2 Drives	Optical	Media Reader	Power Supply	Optional Ports	Keyboard / Mouse	Operating System	Warranty	End of Support	Ann Date (mm/yy)
30B5004V--	WE	Xeon E5-1630 v4 4C/3.7GHz/10MB/140W/DDR4-2400	Open	2x8GB RDIMM DDR4-2400 ECC	Onboard	4	1x 256GB SSD 2.5" SATA6Gbps Opal	None	9.5mm DVD±RW	29-in-1	650W 92%	None	USB / USB Optical	Windows 10 Pro 64	3-year, Onsite	Oct 20, 2022	09/16
30B5004W--	WE	Xeon E5-1650 v4 6C/3.6GHz/15MB/140W/DDR4-2400	Open	4x8GB RDIMM DDR4-2400 ECC	Onboard	4	None	1x 512GB SSD M.2 PCIe	9.5mm DVD±RW	29-in-1	650W 92%	None	USB / USB Optical	Windows 10 Pro 64	3-year, Onsite	Oct 20, 2022	09/16
30B5005U--	WE	Xeon E5-1650 v4 6C/3.6GHz/15MB/140W/DDR4-2400	NVIDIA Quadro P2000 5GB	1x8GB RDIMM DDR4-2400 ECC	Onboard	4	1x 256GB SSD 2.5" SATA6Gbps Opal	None	HH DVD±RW	9-in-1	490W 90%	None	USB / USB Optical	Windows 10 Pro 64	3-year, Onsite	May 24, 2023	04/17
30B5005E--	WE	Xeon E5-1650 v4 6C/3.6GHz/15MB/140W/DDR4-2400	Open	2x8GB RDIMM DDR4-2400 ECC	Onboard	4	1x 256GB SSD 2.5" SATA6Gbps Opal	None	HH DVD±RW	9-in-1	650W 92%	None	USB / USB Optical	Windows 10 DG Windows 7 Pro 64	3-year, Onsite	Oct 20, 2022	09/16
30B5004P--	WE	Xeon E5-1650 v4 6C/3.6GHz/15MB/140W/DDR4-2400	NVIDIA Quadro M2000 4GB	4x8GB RDIMM DDR4-2400 ECC	Onboard	4	1x 1TB HDD 7.2K 3.5" SATA6Gbps	None	HH DVD±RW	9-in-1	490W 90%	None	USB / USB Optical	Windows 10 DG Windows 7 Pro 64	3-year, Onsite	Oct 20, 2022	09/16
30B5004Q--	WE	Xeon E5-2630 v4 10C/2.2GHz/25MB/85W/DDR4-2133	Open	2x8GB RDIMM DDR4-2400 ECC	Onboard	4	1x 2TB HDD 7.2K 3.5" SATA6Gbps	1x 512GB SSD M.2 PCIe	HH DVD±RW	9-in-1	650W 92%	None	USB / USB Optical	Windows 10 DG Windows 7 Pro 64	3-year, Onsite	Oct 20, 2022	09/16
30B5004N--	WE	Xeon E5-1650 v4 6C/3.6GHz/15MB/140W/DDR4-2400	NVIDIA Quadro M2000 4GB	1x8GB RDIMM DDR4-2400 ECC	Onboard	4	1x 256GB SSD 2.5" SATA6Gbps Opal	None	HH DVD±RW	9-in-1	490W 90%	None	USB / USB Optical	Windows 10 DG Windows 7 Pro 64	3-year, Onsite	Oct 20, 2022	09/16
30B5004R--	WE	Xeon E5-1620 v4 4C/3.5GHz/10MB/140W/DDR4-2400	Open	2x8GB RDIMM DDR4-2400 ECC	Onboard	4	1x 256GB SSD 2.5" SATA6Gbps Opal	None	9.5mm DVD±RW	29-in-1	650W 92%	None	USB / USB Optical	Windows 10 DG Windows 7 Pro 64	3-year, Onsite	Oct 20, 2022	09/16
30B5004S--	WE	Xeon E5-1630 v4 4C/3.7GHz/10MB/140W/DDR4-2400	Open	2x8GB RDIMM DDR4-2400 ECC	Onboard	4	1x 256GB SSD 2.5" SATA6Gbps Opal	None	9.5mm DVD±RW	29-in-1	650W 92%	None	USB / USB Optical	Windows 10 DG Windows 7 Pro 64	3-year, Onsite	Oct 20, 2022	09/16
30B5004T--	WE	Xeon E5-1650 v4 6C/3.6GHz/15MB/140W/DDR4-2400	Open	4x8GB RDIMM DDR4-2400 ECC	Onboard	4	None	1x 512GB SSD M.2 PCIe	9.5mm DVD±RW	29-in-1	650W 92%	None	USB / USB Optical	Windows 10 DG Windows 7 Pro 64	3-year, Onsite	Oct 20, 2022	09/16
30B5004U--	WE	Xeon E5-1620 v4 4C/3.5GHz/10MB/140W/DDR4-2400	Open	2x8GB RDIMM DDR4-2400 ECC	Onboard	4	1x 256GB SSD 2.5" SATA6Gbps Opal	None	9.5mm DVD±RW	29-in-1	650W 92%	None	USB / USB Optical	Windows 10 Pro 64	3-year, Onsite	Oct 20, 2022	09/16
30B5003B--	WE	Xeon E5-1630 v4 4C/3.7GHz/10MB/140W/DDR4-2400	NVIDIA Quadro M5000 8GB	2x8GB RDIMM DDR4-2400 ECC	Onboard	4	None	1x 512GB SSD M.2 PCIe	HH DVD±RW	9-in-1	650W 92%	None	USB / USB Optical	Windows 10 Pro 64	3-year, Onsite	Aug 26, 2022	07/16

Model	Region	Processor	Graphics	Memory	Storage Controller	Max Drives in 3.5" Bays	Disks	M.2 Drives	Optical	Media Reader	Power Supply	Optional Ports	Keyboard / Mouse	Operating System	Warranty	End of Support	Ann Date (mm/yy)
30B5001E--	WE	Xeon E5-1630 v4 4C/3.7GHz/10MB/140W/DDR4-2400	Open	2x8GB RDIMM DDR4-2400 ECC	Onboard	4	None	1x 256GB SSD M.2 PCIe Opal	HH DVD±RW	9-in-1	650W 92%	None	USB / USB Optical	Windows 10 Pro 64	3-year, Onsite	Jul 14, 2022	06/16
30B50038--	WE	Xeon E5-1630 v4 4C/3.7GHz/10MB/140W/DDR4-2400	Open	2x8GB RDIMM DDR4-2400 ECC	Onboard	4	1x 256GB SSD 2.5" SATA6Gbps Opal	None	HH DVD±RW	29-in-1	650W 92%	None	USB / USB Optical	Windows 10 Pro 64	3-year, Onsite	Aug 26, 2022	07/16
30B50039--	WE	Xeon E5-1650 v4 6C/3.6GHz/15MB/140W/DDR4-2400	Open	4x8GB RDIMM DDR4-2400 ECC	Onboard	4	None	1x 512GB SSD M.2 PCIe	HH DVD±RW	29-in-1	650W 92%	None	USB / USB Optical	Windows 10 Pro 64	3-year, Onsite	Aug 26, 2022	07/16
30B5003A--	WE	Xeon E5-2630 v4 10C/2.2GHz/25MB/85W/DDR4-2133	Open	2x8GB RDIMM DDR4-2400 ECC	Onboard	4	1x 2TB HDD 7.2K 3.5" SATA6Gbps	1x 512GB SSD M.2 PCIe	HH DVD±RW	9-in-1	650W 92%	None	USB / USB Optical	Windows 10 Pro 64	3-year, Onsite	Aug 26, 2022	07/16
30B50037--	WE	Xeon E5-1620 v4 4C/3.5GHz/10MB/140W/DDR4-2400	Open	2x8GB RDIMM DDR4-2400 ECC	Onboard	4	1x 256GB SSD 2.5" SATA6Gbps Opal	None	HH DVD±RW	29-in-1	650W 92%	None	USB / USB Optical	Windows 10 Pro 64	3-year, Onsite	Aug 26, 2022	07/16
30B50019--	WE	Xeon E5-1630 v4 4C/3.7GHz/10MB/140W/DDR4-2400	Open	2x8GB RDIMM DDR4-2400 ECC	Onboard	4	1x 256GB SSD 2.5" SATA6Gbps Opal	None	HH DVD±RW	9-in-1	650W 92%	None	USB / USB Optical	Windows 10 Pro 64	3-year, Onsite	Jul 14, 2022	06/16
30B50017--	WE	Xeon E5-1620 v4 4C/3.5GHz/10MB/140W/DDR4-2400	Open	2x8GB RDIMM DDR4-2400 ECC	Onboard	4	1x 256GB SSD 2.5" SATA6Gbps Opal	None	HH DVD±RW	9-in-1	650W 92%	None	USB / USB Optical	Windows 10 DG Windows 7 Pro 64	3-year, Onsite	Jul 14, 2022	06/16
30B50018--	WE	Xeon E5-1620 v4 4C/3.5GHz/10MB/140W/DDR4-2400	Open	2x8GB RDIMM DDR4-2400 ECC	Onboard	4	1x 256GB SSD 2.5" SATA6Gbps Opal	None	HH DVD±RW	9-in-1	650W 92%	None	USB / USB Optical	Windows 10 Pro 64	3-year, Onsite	Jul 14, 2022	06/16
30B5001A--	WE	Xeon E5-1630 v4 4C/3.7GHz/10MB/140W/DDR4-2400	Open	2x8GB RDIMM DDR4-2400 ECC	Onboard	4	1x 256GB SSD 2.5" SATA6Gbps Opal	None	HH DVD±RW	9-in-1	650W 92%	None	USB / USB Optical	Windows 10 DG Windows 7 Pro 64	3-year, Onsite	Jul 14, 2022	06/16
30B5001B--	WE	Xeon E5-1650 v4 6C/3.6GHz/15MB/140W/DDR4-2400	Open	2x8GB RDIMM DDR4-2400 ECC	Onboard	4	1x 512GB SSD 2.5" SATA6Gbps	None	HH DVD±RW	9-in-1	650W 92%	None	USB / USB Optical	Windows 10 DG Windows 7 Pro 64	3-year, Onsite	Jul 14, 2022	06/16
30B5001C--	WE	Xeon E5-1650 v4 6C/3.6GHz/15MB/140W/DDR4-2400	Open	2x8GB RDIMM DDR4-2400 ECC	Onboard	4	1x 512GB SSD 2.5" SATA6Gbps	None	HH DVD±RW	9-in-1	650W 92%	None	USB / USB Optical	Windows 10 Pro 64	3-year, Onsite	Jul 14, 2022	06/16
30B5001D--	WE	Xeon E5-1630 v4 4C/3.7GHz/10MB/140W/DDR4-2400	Open	2x8GB RDIMM DDR4-2400 ECC	Onboard	4	None	1x 256GB SSD M.2 PCIe Opal	HH DVD±RW	9-in-1	650W 92%	None	USB / USB Optical	Windows 10 DG Windows 7 Pro 64	3-year, Onsite	Jul 14, 2022	06/16

Model	Region	Processor	Graphics	Memory	Storage Controller	Max Drives in 3.5" Bays	Disks	M.2 Drives	Optical	Media Reader	Power Supply	Optional Ports	Keyboard / Mouse	Operating System	Warranty	End of Support	Ann Date (mm/yy)
30B5000W--	WE	Xeon E5-1620 v4 4C/3.5GHz/10MB/140W/DDR4-2400	NVIDIA Quadro M2000 4GB	1x8GB RDIMM DDR4-2400 ECC	Onboard	4	None	1x 512GB SSD M.2 PCIe	HH DVD±RW	9-in-1	650W 92%	None	USB / USB Optical	Windows 10 DG Windows 7 Pro 64	3-year, Onsite	Jul 14, 2022	06/16
30B5000X--	WE	Xeon E5-1650 v4 6C/3.6GHz/15MB/140W/DDR4-2400	Open	2x8GB RDIMM DDR4-2400 ECC	Onboard	4	None	1x 512GB SSD M.2 PCIe	HH DVD±RW	9-in-1	650W 92%	None	USB / USB Optical	Windows 10 DG Windows 7 Pro 64	3-year, Onsite	Jul 14, 2022	06/16
30B5000Y--	WE	Xeon E5-1620 v4 4C/3.5GHz/10MB/140W/DDR4-2400	NVIDIA Quadro M2000 4GB	1x8GB RDIMM DDR4-2400 ECC	Onboard	4	None	1x 512GB SSD M.2 PCIe	HH DVD±RW	9-in-1	650W 92%	None	USB / USB Optical	Windows 10 Pro 64	3-year, Onsite	Jul 14, 2022	06/16
30B50010--	WE	Xeon E5-1680 v4 8C/3.4GHz/20MB/140W/DDR4-2400	NVIDIA Quadro M4000 8GB	2x8GB RDIMM DDR4-2400 ECC	Onboard	4	None	1x 512GB SSD M.2 PCIe	HH DVD±RW	9-in-1	650W 92%	None	USB / USB Optical	Windows 10 DG Windows 7 Pro 64	3-year, Onsite	Jul 14, 2022	06/16
30B50011--	WE	Xeon E5-1620 v4 4C/3.5GHz/10MB/140W/DDR4-2400	Open	1x8GB RDIMM DDR4-2400 ECC	Onboard	4	1x 256GB SSD 2.5" SATA6Gbps Opal	None	HH DVD±RW	9-in-1	650W 92%	None	USB / USB Optical	Windows 10 Pro 64	3-year, Onsite	Jul 14, 2022	06/16
30B50012--	WE	Xeon E5-1650 v4 6C/3.6GHz/15MB/140W/DDR4-2400	Open	1x8GB RDIMM DDR4-2400 ECC	Onboard	4	1x 512GB SSD 2.5" SATA6Gbps	None	HH DVD±RW	9-in-1	650W 92%	None	USB / USB Optical	Windows 10 Pro 64	3-year, Onsite	Jul 14, 2022	06/16
30B50013--	WE	Xeon E5-1620 v4 4C/3.5GHz/10MB/140W/DDR4-2400	Open	1x8GB RDIMM DDR4-2400 ECC	Onboard	4	None	1x 512GB SSD M.2 PCIe	HH DVD±RW	9-in-1	650W 92%	None	USB / USB Optical	Windows 10 DG Windows 7 Pro 64	3-year, Onsite	Jul 14, 2022	06/16
30B5000N--	WE	Xeon E5-1620 v4 4C/3.5GHz/10MB/140W/DDR4-2400	Open	1x8GB RDIMM DDR4-2400 ECC	Onboard	4	1x 1TB Hybrid HDD 7.2K 3.5" SATA6Gbps	None	HH DVD±RW	9-in-1	650W 92%	None	USB / USB Optical	Windows 10 Pro 64	3-year, Onsite	Jul 14, 2022	06/16
30B5000P--	WE	Xeon E5-1620 v4 4C/3.5GHz/10MB/140W/DDR4-2400	Open	1x8GB RDIMM DDR4-2400 ECC	Onboard	4	None	1x 256GB SSD M.2 PCIe Opal	HH DVD±RW	9-in-1	490W 90%	None	USB / USB Optical	Windows 10 DG Windows 7 Pro 64	3-year, Onsite	Jul 14, 2022	06/16
30B5000Q--	WE	Xeon E5-1650 v4 6C/3.6GHz/15MB/140W/DDR4-2400	Open	1x8GB RDIMM DDR4-2400 ECC	Onboard	4	None	1x 256GB SSD M.2 PCIe Opal	HH DVD±RW	9-in-1	650W 92%	None	USB / USB Optical	Windows 10 DG Windows 7 Pro 64	3-year, Onsite	Jul 14, 2022	06/16
30B5000R--	WE	Xeon E5-1650 v4 6C/3.6GHz/15MB/140W/DDR4-2400	NVIDIA Quadro M2000 4GB	4x8GB RDIMM DDR4-2400 ECC	Onboard	4	1x 1TB HDD 7.2K 3.5" SATA6Gbps	None	HH DVD±RW	9-in-1	490W 90%	None	USB / USB Optical	Windows 10 Pro 64	3-year, Onsite	Jul 14, 2022	06/16
30B5000S--	WE	Xeon E5-1620 v4 4C/3.5GHz/10MB/140W/DDR4-2400	Open	1x8GB RDIMM DDR4-2400 ECC	Onboard	4	None	1x 512GB SSD M.2 PCIe	HH DVD±RW	9-in-1	650W 92%	None	USB / USB Optical	Windows 10 Pro 64	3-year, Onsite	Jul 14, 2022	06/16

Model	Region	Processor	Graphics	Memory	Storage Controller	Max Drives in 3.5" Bays	Disks	M.2 Drives	Optical	Media Reader	Power Supply	Optional Ports	Keyboard / Mouse	Operating System	Warranty	End of Support	Ann Date (mm/yy)
30B5000T--	WE	Xeon E5-1650 v4 6C/3.6GHz/15MB/140W/DDR4-2400	Open	2x8GB RDIMM DDR4-2400 ECC	Onboard	4	None	1x 256GB SSD M.2 PCIe Opal	HH DVD±RW	9-in-1	650W 92%	None	USB / USB Optical	Windows 10 Pro 64	3-year, Onsite	Jul 14, 2022	06/16
30B5000U--	WE	Xeon E5-1620 v4 4C/3.5GHz/10MB/140W/DDR4-2400	Open	1x8GB RDIMM DDR4-2400 ECC	Onboard	4	1x 240GB SSD 2.5" SATA6Gbps Opal	None	HH DVD±RW	9-in-1	490W 90%	None	USB / USB Optical	Windows 10 Pro 64	3-year, Onsite	Jul 14, 2022	06/16
30B5000V--	WE	Xeon E5-1650 v4 6C/3.6GHz/15MB/140W/DDR4-2400	Open	1x8GB RDIMM DDR4-2400 ECC	Onboard	4	1x 1TB HDD 7.2K 3.5" SATA6Gbps	None	HH DVD±RW	9-in-1	650W 92%	None	USB / USB Optical	Windows 10 Pro 64	3-year, Onsite	Jul 14, 2022	06/16
30B50006--	WE	Xeon E5-1620 v4 4C/3.5GHz/10MB/140W/DDR4-2400	Open	1x8GB RDIMM DDR4-2400 ECC	Onboard	4	1x 1TB Hybrid HDD 7.2K 3.5" SATA6Gbps	None	HH DVD±RW	9-in-1	490W 90%	None	USB / USB Optical	Windows 10 DG Windows 7 Pro 64	3-year, Onsite	Jul 14, 2022	06/16
30B50007--	WE	Xeon E5-1620 v4 4C/3.5GHz/10MB/140W/DDR4-2400	Open	1x8GB RDIMM DDR4-2400 ECC	Onboard	4	1x 1TB Hybrid HDD 7.2K 3.5" SATA6Gbps	None	HH DVD±RW	9-in-1	490W 90%	None	USB / USB Optical	Windows 10 Pro 64	3-year, Onsite	Jul 14, 2022	06/16
30B50008--	WE	Xeon E5-2603 v4 6C/1.7GHz/15MB/85W/DDR4-1866	NVIDIA Quadro M2000 4GB	2x8GB RDIMM DDR4-2400 ECC	Onboard	4	1x 256GB SSD 2.5" SATA6Gbps Opal	None	HH DVD±RW	9-in-1	490W 90%	None	USB / USB Optical	Windows 10 DG Windows 7 Pro 64	3-year, Onsite	Jul 14, 2022	06/16
30B50009--	WE	Xeon E5-1650 v3 6C/3.5GHz/15MB/140W/DDR4-2133	NVIDIA Quadro M2000 4GB	1x8GB RDIMM DDR4-2400 ECC	Onboard	4	1x 256GB SSD 2.5" SATA6Gbps Opal	None	HH DVD±RW	9-in-1	490W 90%	None	USB / USB Optical	Windows 10 DG Windows 7 Pro 64	3-year, Onsite	Jul 14, 2022	06/16
30B5000A--	WE	Xeon E5-1620 v4 4C/3.5GHz/10MB/140W/DDR4-2400	Open	1x8GB RDIMM DDR4-2400 ECC	Onboard	4	1x 256GB SSD 2.5" SATA6Gbps Opal	None	HH DVD±RW	9-in-1	650W 92%	None	USB / USB Optical	Windows 10 DG Windows 7 Pro 64	3-year, Onsite	Jul 14, 2022	06/16
30B5000B--	WE	Xeon E5-1650 v4 6C/3.6GHz/15MB/140W/DDR4-2400	Open	1x8GB RDIMM DDR4-2400 ECC	Onboard	4	1x 512GB SSD 2.5" SATA6Gbps	None	HH DVD±RW	9-in-1	650W 92%	None	USB / USB Optical	Windows 10 DG Windows 7 Pro 64	3-year, Onsite	Jul 14, 2022	06/16
30B5000C--	WE	Xeon E5-1620 v4 4C/3.5GHz/10MB/140W/DDR4-2400	Open	1x8GB RDIMM DDR4-2400 ECC	Onboard	4	None	1x 256GB SSD M.2 PCIe Opal	HH DVD±RW	9-in-1	490W 90%	None	USB / USB Optical	Windows 10 Pro 64	3-year, Onsite	Jul 14, 2022	06/16
30B5000D--	WE	Xeon E5-1650 v4 6C/3.6GHz/15MB/140W/DDR4-2400	NVIDIA Quadro M2000 4GB	1x8GB RDIMM DDR4-2400 ECC	Onboard	4	1x 256GB SSD 2.5" SATA6Gbps Opal	None	HH DVD±RW	9-in-1	490W 90%	None	USB / USB Optical	Windows 10 Pro 64	3-year, Onsite	Jul 14, 2022	06/16
30B5000E--	WE	Xeon E5-1620 v4 4C/3.5GHz/10MB/140W/DDR4-2400	Open	1x8GB RDIMM DDR4-2400 ECC	Onboard	4	1x 240GB SSD 2.5" SATA6Gbps Opal	None	HH DVD±RW	9-in-1	490W 90%	None	USB / USB Optical	Windows 10 DG Windows 7 Pro 64	3-year, Onsite	Jul 14, 2022	06/16

Model	Region	Processor	Graphics	Memory	Storage Controller	Max Drives in 3.5" Bays	Disks	M.2 Drives	Optical	Media Reader	Power Supply	Optional Ports	Keyboard / Mouse	Operating System	Warranty	End of Support	Ann Date (mm/yy)
30B5000F--	WE	Xeon E5-1650 v3 6C/3.5GHz/ 15MB/140W/DDR4-2133	Open	1x8GB RDIMM DDR4-2400 ECC	Onboard	4	1x 1TB HDD 7.2K 3.5" SATA6Gbps	None	HH DVD±RW	9-in-1	490W 90%	None	USB / USB Optical	Windows 10 DG Windows 7 Pro 64	3-year, Onsite	Jul 14, 2022	06/16
30B5000G--	WE	Xeon E5-1620 v4 4C/3.5GHz/ 10MB/140W/DDR4-2400	Open	1x8GB RDIMM DDR4-2400 ECC	Onboard	4	1x 1TB Hybrid HDD 7.2K 3.5" SATA6Gbps	None	HH DVD±RW	9-in-1	650W 92%	None	USB / USB Optical	Windows 10 DG Windows 7 Pro 64	3-year, Onsite	Jul 14, 2022	06/16
30B5000H--	WE	Xeon E5-1650 v4 6C/3.6GHz/ 15MB/140W/DDR4-2400	Open	2x8GB RDIMM DDR4-2400 ECC	Onboard	4	None	1x 512GB SSD M.2 PCIe	HH DVD±RW	9-in-1	650W 92%	None	USB / USB Optical	Windows 10 Pro 64	3-year, Onsite	Jul 14, 2022	06/16
30B5000J--	WE	Xeon E5-1650 v4 6C/3.6GHz/ 15MB/140W/DDR4-2400	Open	1x8GB RDIMM DDR4-2400 ECC	Onboard	4	1x 1TB HDD 7.2K 3.5" SATA6Gbps	None	HH DVD±RW	9-in-1	490W 90%	None	USB / USB Optical	Windows 10 Pro 64	3-year, Onsite	Jul 14, 2022	06/16
30B5000K--	WE	Xeon E5-1650 v4 6C/3.6GHz/ 15MB/140W/DDR4-2400	Open	1x8GB RDIMM DDR4-2400 ECC	Onboard	4	1x 1TB HDD 7.2K 3.5" SATA6Gbps	None	HH DVD±RW	9-in-1	650W 92%	None	USB / USB Optical	Windows 10 DG Windows 7 Pro 64	3-year, Onsite	Jul 14, 2022	06/16
30B5000L--	WE	Xeon E5-1680 v4 8C/3.4GHz/20MB/140W/DDR4-2400	NVIDIA Quadro M4000 8GB	2x8GB RDIMM DDR4-2400 ECC	Onboard	4	None	1x 512GB SSD M.2 PCIe	HH DVD±RW	9-in-1	650W 92%	None	USB / USB Optical	Windows 10 Pro 64	3-year, Onsite	Jul 14, 2022	06/16
30B5000M--	WE	Xeon E5-2603 v4 6C/1.7GHz/ 15MB/85W/DDR4-1866	NVIDIA Quadro M2000 4GB	2x8GB RDIMM DDR4-2400 ECC	Onboard	4	1x 256GB SSD 2.5" SATA6Gbps Opal	None	HH DVD±RW	9-in-1	490W 90%	None	USB / USB Optical	Windows 10 Pro 64	3-year, Onsite	Jul 14, 2022	06/16



ThinkStation P520 Platform Specifications

Product Specifications Reference (PSREF)

Components	Specification																																																																								
Form factor	33L Tower																																																																								
Dimensions	165mm/6.5" W x 460mm/18.1" D x 440mm/17.3" H (with feet)																																																																								
Weight	Maximum configuration: 52.91 lb (24kg)																																																																								
Processor	Up to one 140W Intel Xeon W family processor. Up to 18 cores at 2.3GHz, up to 4.0GHz with 4 cores. Memory speed up to DDR4-2666																																																																								
Chipset	Intel C422 Chipset																																																																								
Memory	8 DIMM sockets with 4 channels. RDIMMs. DDR4-2666																																																																								
Memory capacity	Up to 256GB with 8 x 32GB RDIMMs																																																																								
Memory protection	ECC																																																																								
Graphics	Two PCIe 3.0 x16 slots (see Expansion slots section). Up to two NVIDIA Quadro P6000 (900W PSU is needed). Supports the following graphics adapters:																																																																								
	<table border="1"> <thead> <tr> <th>Adapter</th> <th>Cores</th> <th>Memory</th> <th>Power</th> <th>Connector</th> <th>SLI</th> </tr> </thead> <tbody> <tr> <td>NVS 310</td> <td>48</td> <td>1GB</td> <td>19.5W</td> <td>2xDP</td> <td></td> </tr> <tr> <td>NVS 315</td> <td>48</td> <td>1GB</td> <td>19.3W</td> <td>2xDVI-I SL/2xDP</td> <td></td> </tr> <tr> <td>NVS 510</td> <td>192</td> <td>2GB</td> <td>33.4W</td> <td>4xmini DP</td> <td></td> </tr> <tr> <td>NVS 810</td> <td>1024</td> <td>4GB</td> <td>68W</td> <td>8xmini DP</td> <td></td> </tr> <tr> <td>Quadro P400</td> <td>256</td> <td>2GB</td> <td>30W</td> <td>3xminiDP</td> <td></td> </tr> <tr> <td>Quadro P600</td> <td>384</td> <td>2GB</td> <td>45W</td> <td>4xminiDP</td> <td></td> </tr> <tr> <td>Quadro P1000</td> <td>640</td> <td>4GB</td> <td>50W</td> <td>4xminiDP</td> <td></td> </tr> <tr> <td>Quadro P2000</td> <td>1024</td> <td>5GB</td> <td>75W</td> <td>4xDP</td> <td></td> </tr> <tr> <td>Quadro P4000</td> <td>1792</td> <td>8GB</td> <td>120W</td> <td>4xDP</td> <td></td> </tr> <tr> <td>Quadro P5000</td> <td>2560</td> <td>16GB</td> <td>180W</td> <td>DVI-D DL+4xDP</td> <td>SLI</td> </tr> <tr> <td>Quadro P6000</td> <td>3840</td> <td>24GB</td> <td>250W</td> <td>DVI-D DL+4xDP</td> <td></td> </tr> </tbody> </table>	Adapter	Cores	Memory	Power	Connector	SLI	NVS 310	48	1GB	19.5W	2xDP		NVS 315	48	1GB	19.3W	2xDVI-I SL/2xDP		NVS 510	192	2GB	33.4W	4xmini DP		NVS 810	1024	4GB	68W	8xmini DP		Quadro P400	256	2GB	30W	3xminiDP		Quadro P600	384	2GB	45W	4xminiDP		Quadro P1000	640	4GB	50W	4xminiDP		Quadro P2000	1024	5GB	75W	4xDP		Quadro P4000	1792	8GB	120W	4xDP		Quadro P5000	2560	16GB	180W	DVI-D DL+4xDP	SLI	Quadro P6000	3840	24GB	250W	DVI-D DL+4xDP	
	Adapter	Cores	Memory	Power	Connector	SLI																																																																			
	NVS 310	48	1GB	19.5W	2xDP																																																																				
	NVS 315	48	1GB	19.3W	2xDVI-I SL/2xDP																																																																				
	NVS 510	192	2GB	33.4W	4xmini DP																																																																				
	NVS 810	1024	4GB	68W	8xmini DP																																																																				
	Quadro P400	256	2GB	30W	3xminiDP																																																																				
	Quadro P600	384	2GB	45W	4xminiDP																																																																				
	Quadro P1000	640	4GB	50W	4xminiDP																																																																				
Quadro P2000	1024	5GB	75W	4xDP																																																																					
Quadro P4000	1792	8GB	120W	4xDP																																																																					
Quadro P5000	2560	16GB	180W	DVI-D DL+4xDP	SLI																																																																				
Quadro P6000	3840	24GB	250W	DVI-D DL+4xDP																																																																					
Storage controllers	Integrated Intel SATA AHCI/RAID controller in chipset, 6Gbps SATA, RAID 0/1/10/5. Integrated Intel PCIe host in processor for M.2 PCIe NVMe drives, optional RAID 0/1/10 with Intel NVMe RAID upgrade basic, optional RAID 0/1/10/5 with Intel NVMe RAID upgrade premium. Optional Broadcom 9440-8i, PCIe adapter, 12Gbps, SATA/SAS, RAID 0/1/10/5. Or optional Broadcom 9460-16i with 4GB DDR4 memory and SuperCap, PCIe adapter, 12Gbps, SATA/SAS, RAID 0/1/10/5/6																																																																								
5.25" flex bay	Two 5.25" flex bays, supports the following options: <ul style="list-style-type: none"> Up to two half-height optical drives. Up to two 5.25" slim ODD cages. Up to two 5.25" slim ODD and HDD cages. Up to one Front Access Storage Enclosure. Up to one flex module for one or more of the following options: 9.0mm optical/15-in-1 USB 3.0 reader/front eSATA/front Thunderbolt/4-digit diagnostic display <i>Note: Only one can be supported from 15-in-1 reader, Thunderbolt, and 4-digit display</i>																																																																								
Disk drive bays	Up to four internal 3.5" drive bays. Two standard, two optional. Each bay supports one 3.5" or 2.5" disk. Up to two 2.5" or 3.5" SATA/SAS disk drives on 5.25" flex bays via 5.25" Front Access Storage Enclosure supports SATA or 5.25" slim ODD and HDD cage																																																																								
M.2 slots	Up to 9 x M.2 PCIe NVMe SSD: <ul style="list-style-type: none"> Two onboard M.2 slots. Up to one full height, full length PCIe 3.0 x16 adapter, supports four M.2 slots. Up to three PCIe 3.0 x4 adapters, each adapter supports one M.2 slot Supports RAID 0/1 on onboard M.2 disks and RAID 0/1/10/5 on quad M.2 PCIe x16 adapter, optional NVMe RAID upgrade is needed																																																																								
Internal storage	<table border="1"> <thead> <tr> <th>HDD 7.2K 3.5" SATA6Gbps</th> <th>1TB/2TB/4TB/6TB</th> </tr> </thead> <tbody> <tr> <td>SSD 2.5" SATA6Gbps</td> <td>256GB Opal/512GB/512GB Opal/1TB Opal/2TB Opal</td> </tr> <tr> <td>M.2 PCIe NVMe, PCIe 3.0 x4</td> <td>256GB Opal/512GB Opal/1TB Opal</td> </tr> </tbody> </table>	HDD 7.2K 3.5" SATA6Gbps	1TB/2TB/4TB/6TB	SSD 2.5" SATA6Gbps	256GB Opal/512GB/512GB Opal/1TB Opal/2TB Opal	M.2 PCIe NVMe, PCIe 3.0 x4	256GB Opal/512GB Opal/1TB Opal																																																																		
HDD 7.2K 3.5" SATA6Gbps	1TB/2TB/4TB/6TB																																																																								
SSD 2.5" SATA6Gbps	256GB Opal/512GB/512GB Opal/1TB Opal/2TB Opal																																																																								
M.2 PCIe NVMe, PCIe 3.0 x4	256GB Opal/512GB Opal/1TB Opal																																																																								
Media reader	9-in-1 USB 2.0 card reader on most models. Optional UHS-II 15-in-1 USB 3.0 reader on flex module																																																																								
Network interfaces	Integrated one gigabit ethernet (Intel i219LM), supports Wake-on-LAN. Optional PCIe ethernet or wireless adapters are available																																																																								
Security features	Power-on and admin password. Trusted Platform Module, TCG 2.0 compliant, switch to 1.2 via UEFI setting. Optional access panel lock, Kensington lock, and pad lock																																																																								
Systems management	Intel Active Management Technology 11. Front panel warning LED. ThinkStation Diagnostics for Windows. Photo-audio transfer with Lenovo PC Diagnostics for Android and iOS. Optional front 4-digit diagnostic display on flex module																																																																								

Components	Specification		
Base warranty	1 or 3-year limited onsite service with 9x5/NBD		
HD Audio	Realtek ALC662 codec for rear audio ports, Realtek ALC233 codec for front audio port		
Front ports	Four USB 3.0 (includes one 11W charging), one combo audio/microphone jack (3.5mm)		
Rear ports	Two USB 2.0, four USB 3.0, one ethernet (RJ-45), three analog audio ports (line-in, line-out, mic-in), two PS/2		
Optional ports	Supports the following optional ports: <ul style="list-style-type: none"> Optional COM port Two USB Type-C ports via PCIe adapter, USB 3.1 gen 2. One 15W, one 5W Two Thunderbolt ports (USB Type-C) on flex module, one of two ports supports video-out. One eSATA on flex module One internal USB 3.0 port 		
Power supply	One fixed 690W or 900W, autosensing, 92%, 80 PLUS Platinum qualified		
Environmental specification	Temperature - operating	50 °F to 95 °F (10 °C to 35 °C)	
	Temperature - non operating (no package)	14 °F to 140 °F (-10 °C to 60 °C)	
	Temperature - non operating (with package)	-40 °F to 140 °F (-40 °C to 60 °C)	
	Altitude - operating	(Unpressurized): -50ft-10000ft (-15.2m-3048m)	
	Humidity - operating	10%-80%, non-condensing	
	Humidity - storage (with package)	10%-90%, non-condensing	
	RoHS-compliant. GREENGUARD. EPEAT Gold rating and ENERGY STAR 6.1 qualified on following models:		
	Model	30BE0008US	30BE0009US
	Processor	Intel Xeon W-2123	Intel Xeon W-2123
	Memory	2 x 8GB RDIMM DDR4-2666 ECC	2 x 8GB RDIMM DDR4-2666 ECC
Disks	2x1TB HDD 7.2K 3.5" SATA6Gbps	2 x 256GB SSD 2.5" SATA6Gbps Opal	
Graphics	NVIDIA Quadro P400 2GB	NVIDIA Quadro P4000 8GB	
Optical	HH DVD±RW	HH DVD±RW	
PSU	690W	690W	
OS	Win10 Pro 64	Win10 Pro 64	
ISV certifications	Please visit www.thinkworkstations.com/isv-certifications/		

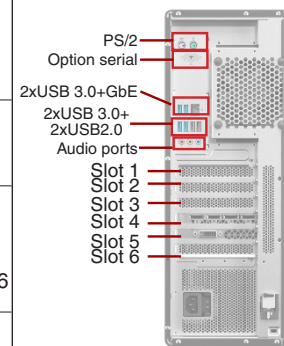

Note: All expansion cards are optional

Expansion slots

Slot 1 (CPU)	PCIe 3.0 x8, full height, full length, 25W, open ended
Slot 2 (CPU)	PCIe 3.0 x16, full height, full length, 75W, double-width
Slot 3 (PCH)	PCIe 3.0 x4, full height, half length, 25W, open ended
Slot 4 (CPU)	PCIe 3.0 x16, full height, full length, 75W, double-width
Slot 5	PCI, full height, full length, 25W
Slot 6 (PCH)	PCIe 3.0 x4, full height, half length, 25W, open ended

Model	Product	Region	Processor	Graphics	Memory	Storage Controller	M.2 RAID Upgrade	Disks	M.2 Drives	Optical	Media Reader	Additional Networking	Power Supply	Optional Ports	Front Diagnostic LED	Keyboard / Mouse	Operating System	Warranty	Global	End of Support	Ann Date (mm/yy)
30BE0014xx	ThinkStation P520	CIS	Xeon W-2104 4C/3.2GHz/8.25MB/120W/DDR4-2400	Open	1x 16GB RDIMM DDR4-2666	Integrated Intel SATA	None	1x 256GB SSD 2.5" SATA6Gbps Opal	None	1x 9.0mm DVD±RW	15-in-1	None	Fixed 690W Platinum	1x Front eSATA	None	USB / USB Optical	Windows 10 Pro 64	3-year, Onsite	No	Feb 25, 2024	01/18
30BE001Xxx	ThinkStation P520	CIS	Xeon W-2123 4C/3.6GHz/8.25MB/120W/DDR4-2666	Open	1x 8GB RDIMM DDR4-2666	Integrated Intel SATA	None	1x 256GB SSD 2.5" SATA6Gbps Opal	None	1x HH DVD±RW	9-in-1	None	Fixed 690W Platinum	1x Serial	None	USB / USB Optical	Windows 10 DG Windows 7 Pro 64	3-year, Onsite	No	Feb 25, 2024	01/18
30BE0032xx	ThinkStation P520	CIS	Xeon W-2133 6C/3.6GHz/8.25MB/140W/DDR4-2666	Open	1x 16GB RDIMM DDR4-2666	Integrated Intel SATA	None	1x 256GB SSD 2.5" SATA6Gbps Opal	None	1x HH DVD±RW	9-in-1	None	Fixed 690W Platinum	1x Serial	None	USB / USB Optical	Windows 10 DG Windows 7 Pro 64	3-year, Onsite	No	Feb 25, 2024	01/18
30BE006Qxx	ThinkStation P520	CIS	Xeon W-2123 4C/3.6GHz/8.25MB/120W/DDR4-2666	Open	1x 8GB RDIMM DDR4-2666	Integrated Intel SATA	None	1x 256GB SSD 2.5" SATA6Gbps Opal	None	1x HH DVD±RW	9-in-1	None	Fixed 900W Platinum	1x Serial	None	USB / USB Optical	Windows 10 Pro 64	3-year, Onsite	No	Feb 25, 2024	01/18
30BE006Sxx	ThinkStation P520	CIS	Xeon W-2133 6C/3.6GHz/8.25MB/140W/DDR4-2666	Open	1x 16GB RDIMM DDR4-2666	Integrated Intel SATA	None	1x 256GB SSD 2.5" SATA6Gbps Opal	None	1x HH DVD±RW	9-in-1	None	Fixed 900W Platinum	1x Serial	None	USB / USB Optical	Windows 10 Pro 64	3-year, Onsite	No	Feb 25, 2024	01/18
30BE006Uxx	ThinkStation P520	CIS	Xeon W-2104 4C/3.2GHz/8.25MB/120W/DDR4-2400	Open	1x 16GB RDIMM DDR4-2666	Integrated Intel SATA	None	1x 256GB SSD 2.5" SATA6Gbps Opal	None	1x HH DVD±RW	9-in-1	None	Fixed 900W Platinum	1x Serial	None	USB / USB Optical	Windows 10 Pro 64	3-year, Onsite	No	Feb 25, 2024	01/18
30BE006Vxx	ThinkStation P520	CIS	Xeon W-2123 4C/3.6GHz/8.25MB/120W/DDR4-2666	Open	1x 8GB RDIMM DDR4-2666	Integrated Intel SATA	None	1x 1TB HDD 7.2K 3.5" SATA6Gbps	None	1x HH DVD±RW	9-in-1	None	Fixed 900W Platinum	1x Serial	None	USB / USB Optical	Windows 10 Pro 64	3-year, Onsite	No	Feb 25, 2024	01/18
30BE006Yxx	ThinkStation P520	CIS	Xeon W-2133 6C/3.6GHz/8.25MB/140W/DDR4-2666	Open	1x 16GB RDIMM DDR4-2666	Integrated Intel SATA	None	2x 1TB HDD 7.2K 3.5" SATA6Gbps	None	1x HH DVD±RW	9-in-1	None	Fixed 900W Platinum	1x Serial	None	USB / USB Optical	Windows 10 Pro 64	3-year, Onsite	No	Feb 25, 2024	01/18

Model	Product	Region	Processor	Graphics	Memory	Storage Controller	M.2 RAID Upgrade	Disks	M.2 Drives	Optical	Media Reader	Additional Networking	Power Supply	Optional Ports	Front Diagnostic LED	Keyboard / Mouse	Operating System	Warranty	Global	End of Support	Ann Date (mm/yy)
30BE0072xx	ThinkStation P520	CIS	Xeon W-2133 6C/3.6GHz/8.25MB/140W/DDR4-2666	Open	1x 16GB RDIMM DDR4-2666 ECC	Integrated Intel SATA	None	1x 256GB SSD 2.5" SATA6Gbps Opal	None	1x HH DVD±RW	9-in-1	None	Fixed 900W Platinum	1x Serial	None	USB / USB Optical	Windows 10 DG Windows 7 Pro 64	3-year, Onsite	No	Feb 25, 2024	01/18
30BE0074xx	ThinkStation P520	CIS	Xeon W-2125 4C/4.0GHz/8.25MB/120W/DDR4-2666	1x NVIDIA Quadro P2000 5GB	1x 32GB RDIMM DDR4-2666 ECC	Integrated Intel SATA	None	1x 512GB SSD 2.5" SATA6Gbps Opal	None	1x HH DVD±RW	9-in-1	None	Fixed 690W Platinum	1x Serial	None	USB / USB Optical	Windows 10 Pro 64	3-year, Onsite	No	Feb 25, 2024	01/18
30BE007Xxx	ThinkStation P520	CIS	Xeon W-2123 4C/3.6GHz/8.25MB/120W/DDR4-2666	Open	1x 16GB RDIMM DDR4-2666 ECC	Integrated Intel SATA	None	1x 1TB HDD 7.2K 3.5" SATA6Gbps	1x 256GB SSD M.2 PCIe Opal, Onboard	1x HH DVD±RW	9-in-1	None	Fixed 900W Platinum	1x Serial, 1x Internal USB 3.0	4-digit LED	USB / USB Optical	Windows 10 Pro 64	3-year, Onsite	No	May 3, 2024	04/18
30BE007Yxx	ThinkStation P520	EET	Xeon W-2123 4C/3.6GHz/8.25MB/120W/DDR4-2666	Open	1x 16GB RDIMM DDR4-2666 ECC	Integrated Intel SATA	None	1x 512GB SSD 2.5" SATA6Gbps Opal	None	1x HH DVD±RW	9-in-1	None	Fixed 900W Platinum	1x Serial	None	USB / USB Optical	Windows 10 Pro 64	3-year, Onsite	No	May 3, 2024	04/18
30BE007Sxx	ThinkStation P520	EET	Xeon W-2133 6C/3.6GHz/8.25MB/140W/DDR4-2666	Open	1x 16GB RDIMM DDR4-2666 ECC	Integrated Intel SATA	None	None	1x 512GB SSD M.2 PCIe Opal, Onboard	1x HH DVD±RW	9-in-1	None	Fixed 900W Platinum	1x Serial	None	USB / USB Optical	Windows 10 Pro 64	3-year, Onsite	No	Apr 27, 2024	03/18
30BE007Vxx	ThinkStation P520	EET	Xeon W-2145 8C/3.7GHz/11MB/140W/DDR4-2666	Open	1x 16GB RDIMM DDR4-2666 ECC	Integrated Intel SATA	None	1x 1TB HDD 7.2K 3.5" SATA6Gbps	1x 256GB SSD M.2 PCIe Opal, Onboard	1x HH DVD±RW	9-in-1	None	Fixed 900W Platinum	1x Serial, 1x Internal USB 3.0	4-digit LED	USB / USB Optical	Windows 10 Pro 64	3-year, Onsite	No	May 3, 2024	04/18
30BE007Wxx	ThinkStation P520	EET	Xeon W-2133 6C/3.6GHz/8.25MB/140W/DDR4-2666	Open	1x 16GB RDIMM DDR4-2666 ECC	Integrated Intel SATA	None	1x 1TB HDD 7.2K 3.5" SATA6Gbps	1x 256GB SSD M.2 PCIe Opal, Onboard	1x HH DVD±RW	9-in-1	None	Fixed 900W Platinum	1x Serial, 1x Internal USB 3.0	4-digit LED	USB / USB Optical	Windows 10 Pro 64	3-year, Onsite	No	May 3, 2024	04/18
30BE006Wxx	ThinkStation P520	EET	Xeon W-2123 4C/3.6GHz/8.25MB/120W/DDR4-2666	1x NVIDIA Quadro P2000 5GB	1x 16GB RDIMM DDR4-2666 ECC	Integrated Intel SATA	None	1x 256GB SSD 2.5" SATA6Gbps Opal	None	1x HH DVD±RW	9-in-1	None	Fixed 900W Platinum	1x Serial	None	USB / USB Optical	Windows 10 Pro 64	3-year, Onsite	No	Feb 25, 2024	01/18

Model	Product	Region	Processor	Graphics	Memory	Storage Controller	M.2 RAID Upgrade	Disks	M.2 Drives	Optical	Media Reader	Additional Networking	Power Supply	Optional Ports	Front Diagnostic LED	Keyboard / Mouse	Operating System	Warranty	Global	End of Support	Ann Date (mm/yy)
30BE0015xx	ThinkStation P520	EET	Xeon W-2123 4C/3.6GHz/8.25MB/120W/DDR4-2666	1x NVIDIA Quadro P600 2GB	1x 8GB RDIMM DDR4-2666 ECC	Integrated Intel SATA	None	1x 1TB HDD 7.2K 3.5" SATA6Gbps	None	1x 9.0mm DVD±RW	15-in-1	None	Fixed 690W Platinum	1x Front eSATA	None	USB / USB Optical	Windows 10 Pro 64	3-year, Onsite	No	Feb 25, 2024	01/18
30BE0016xx	ThinkStation P520	EET	Xeon W-2133 6C/3.6GHz/8.25MB/140W/DDR4-2666	1x NVIDIA Quadro P2000 5GB	1x 16GB RDIMM DDR4-2666 ECC	Integrated Intel SATA	None	1x 256GB SSD 2.5" SATA6Gbps Opal	None	1x 9.0mm DVD±RW	15-in-1	None	Fixed 690W Platinum	1x Front eSATA	None	USB / USB Optical	Windows 10 Pro 64	3-year, Onsite	No	Feb 25, 2024	01/18
30BE0017xx	ThinkStation P520	EET	Xeon W-2133 6C/3.6GHz/8.25MB/140W/DDR4-2666	1x NVIDIA Quadro P4000 8GB	1x 32GB RDIMM DDR4-2666 ECC	Integrated Intel SATA	None	1x 256GB SSD 2.5" SATA6Gbps Opal, 1x 1TB HDD 7.2K 3.5" SATA6Gbps	None	1x 9.0mm DVD±RW	15-in-1	None	Fixed 690W Platinum	1x Front eSATA	None	USB / USB Optical	Windows 10 Pro 64	3-year, Onsite	No	Feb 25, 2024	01/18
30BE006Nxx	ThinkStation P520	EET	Xeon W-2123 4C/3.6GHz/8.25MB/120W/DDR4-2666	Open	1x 8GB RDIMM DDR4-2666 ECC	Integrated Intel SATA	None	1x 1TB HDD 7.2K 3.5" SATA6Gbps	None	1x HH DVD±RW	9-in-1	None	Fixed 900W Platinum	1x Serial	None	USB / USB Optical	Windows 10 Pro 64	3-year, Onsite	No	Feb 25, 2024	01/18
30BE002Fxx	ThinkStation P520	EET	Xeon W-2133 6C/3.6GHz/8.25MB/140W/DDR4-2666	Open	1x 16GB RDIMM DDR4-2666 ECC	Integrated Intel SATA	None	1x 256GB SSD 2.5" SATA6Gbps Opal	None	1x HH DVD±RW	9-in-1	None	Fixed 690W Platinum	1x Serial	None	USB / USB Optical	Windows 10 DG Windows 7 Pro 64	3-year, Onsite	No	Feb 25, 2024	01/18
30BE002Gxx	ThinkStation P520	EET	Xeon W-2133 6C/3.6GHz/8.25MB/140W/DDR4-2666	Open	1x 16GB RDIMM DDR4-2666 ECC	Integrated Intel SATA	None	1x 256GB SSD 2.5" SATA6Gbps Opal	None	1x HH DVD±RW	9-in-1	None	Fixed 690W Platinum	1x Serial	None	USB / USB Optical	Windows 10 DG Windows 7 Pro 64	3-year, Onsite	No	Feb 25, 2024	01/18
30BE002Hxx	ThinkStation P520	EET	Xeon W-2133 6C/3.6GHz/8.25MB/140W/DDR4-2666	Open	1x 16GB RDIMM DDR4-2666 ECC	Integrated Intel SATA	None	1x 256GB SSD 2.5" SATA6Gbps Opal	None	1x HH DVD±RW	9-in-1	None	Fixed 690W Platinum	1x Serial	None	USB / USB Optical	Windows 10 DG Windows 7 Pro 64	3-year, Onsite	No	Feb 25, 2024	01/18
30BE002Jxx	ThinkStation P520	EET	Xeon W-2133 6C/3.6GHz/8.25MB/140W/DDR4-2666	Open	1x 16GB RDIMM DDR4-2666 ECC	Integrated Intel SATA	None	1x 256GB SSD 2.5" SATA6Gbps Opal	None	1x HH DVD±RW	9-in-1	None	Fixed 690W Platinum	1x Serial	None	USB / USB Optical	Windows 10 DG Windows 7 Pro 64	3-year, Onsite	No	Feb 25, 2024	01/18

Model	Product	Region	Processor	Graphics	Memory	Storage Controller	M.2 RAID Upgrade	Disks	M.2 Drives	Optical	Media Reader	Additional Networking	Power Supply	Optional Ports	Front Diagnostic LED	Keyboard / Mouse	Operating System	Warranty	Global	End of Support	Ann Date (mm/yy)
30BE002Kxx	ThinkStation P520	EET	Xeon W-2133 6C/3.6GHz/8.25MB/140W/DDR4-2666	Open	1x 16GB RDIMM DDR4-2666	Integrated Intel SATA	None	1x 256GB SSD 2.5" SATA6Gbps Opal	None	1x HH DVD±RW	9-in-1	None	Fixed 690W Platinum	1x Serial	None	USB / USB Optical	Windows 10 DG Windows 7 Pro 64	3-year, Onsite	No	Feb 25, 2024	01/18
30BE002Lxx	ThinkStation P520	EET	Xeon W-2133 6C/3.6GHz/8.25MB/140W/DDR4-2666	Open	1x 16GB RDIMM DDR4-2666	Integrated Intel SATA	None	1x 256GB SSD 2.5" SATA6Gbps Opal	None	1x HH DVD±RW	9-in-1	None	Fixed 690W Platinum	1x Serial	None	USB / USB Optical	Windows 10 DG Windows 7 Pro 64	3-year, Onsite	No	Feb 25, 2024	01/18
30BE002Mxx	ThinkStation P520	EET	Xeon W-2133 6C/3.6GHz/8.25MB/140W/DDR4-2666	Open	1x 16GB RDIMM DDR4-2666	Integrated Intel SATA	None	1x 256GB SSD 2.5" SATA6Gbps Opal	None	1x HH DVD±RW	9-in-1	None	Fixed 690W Platinum	1x Serial	None	USB / USB Optical	Windows 10 DG Windows 7 Pro 64	3-year, Onsite	No	Feb 25, 2024	01/18
30BE002Nxx	ThinkStation P520	EET	Xeon W-2133 6C/3.6GHz/8.25MB/140W/DDR4-2666	Open	1x 16GB RDIMM DDR4-2666	Integrated Intel SATA	None	1x 256GB SSD 2.5" SATA6Gbps Opal	None	1x HH DVD±RW	9-in-1	None	Fixed 690W Platinum	1x Serial	None	USB / USB Optical	Windows 10 DG Windows 7 Pro 64	3-year, Onsite	No	Feb 25, 2024	01/18
30BE002Pxx	ThinkStation P520	EET	Xeon W-2133 6C/3.6GHz/8.25MB/140W/DDR4-2666	Open	1x 16GB RDIMM DDR4-2666	Integrated Intel SATA	None	1x 256GB SSD 2.5" SATA6Gbps Opal	None	1x HH DVD±RW	9-in-1	None	Fixed 690W Platinum	1x Serial	None	USB / USB Optical	Windows 10 DG Windows 7 Pro 64	3-year, Onsite	No	Feb 25, 2024	01/18
30BE002Qxx	ThinkStation P520	EET	Xeon W-2133 6C/3.6GHz/8.25MB/140W/DDR4-2666	Open	1x 16GB RDIMM DDR4-2666	Integrated Intel SATA	None	1x 256GB SSD 2.5" SATA6Gbps Opal	None	1x HH DVD±RW	9-in-1	None	Fixed 690W Platinum	1x Serial	None	USB / USB Optical	Windows 10 DG Windows 7 Pro 64	3-year, Onsite	No	Feb 25, 2024	01/18
30BE002Rxx	ThinkStation P520	EET	Xeon W-2133 6C/3.6GHz/8.25MB/140W/DDR4-2666	Open	1x 16GB RDIMM DDR4-2666	Integrated Intel SATA	None	1x 256GB SSD 2.5" SATA6Gbps Opal	None	1x HH DVD±RW	9-in-1	None	Fixed 690W Platinum	1x Serial	None	USB / USB Optical	Windows 10 DG Windows 7 Pro 64	3-year, Onsite	No	Feb 25, 2024	01/18
30BE002Sxx	ThinkStation P520	EET	Xeon W-2133 6C/3.6GHz/8.25MB/140W/DDR4-2666	Open	1x 16GB RDIMM DDR4-2666	Integrated Intel SATA	None	1x 256GB SSD 2.5" SATA6Gbps Opal	None	1x HH DVD±RW	9-in-1	None	Fixed 690W Platinum	1x Serial	None	USB / USB Optical	Windows 10 DG Windows 7 Pro 64	3-year, Onsite	No	Feb 25, 2024	01/18

Model	Product	Region	Processor	Graphics	Memory	Storage Controller	M.2 RAID Upgrade	Disks	M.2 Drives	Optical	Media Reader	Additional Networking	Power Supply	Optional Ports	Front Diagnostic LED	Keyboard / Mouse	Operating System	Warranty	Global	End of Support	Ann Date (mm/yy)
30BE002Txx	ThinkStation P520	EET	Xeon W-2133 6C/3.6GHz/8.25MB/140W/DDR4-2666	Open	1x 16GB RDIMM DDR4-2666	Integrated Intel SATA	None	1x 256GB SSD 2.5" SATA6Gbps Opal	None	1x HH DVD±RW	9-in-1	None	Fixed 690W Platinum	1x Serial	None	USB / USB Optical	Windows 10 DG Windows 7 Pro 64	3-year, Onsite	No	Feb 25, 2024	01/18
30BE001Bxx	ThinkStation P520	EET	Xeon W-2123 4C/3.6GHz/8.25MB/120W/DDR4-2666	Open	1x 8GB RDIMM DDR4-2666	Integrated Intel SATA	None	1x 256GB SSD 2.5" SATA6Gbps Opal	None	1x HH DVD±RW	9-in-1	None	Fixed 690W Platinum	1x Serial	None	USB / USB Optical	Windows 10 DG Windows 7 Pro 64	3-year, Onsite	No	Feb 25, 2024	01/18
30BE001Cxx	ThinkStation P520	EET	Xeon W-2123 4C/3.6GHz/8.25MB/120W/DDR4-2666	Open	1x 8GB RDIMM DDR4-2666	Integrated Intel SATA	None	1x 256GB SSD 2.5" SATA6Gbps Opal	None	1x HH DVD±RW	9-in-1	None	Fixed 690W Platinum	1x Serial	None	USB / USB Optical	Windows 10 DG Windows 7 Pro 64	3-year, Onsite	No	Feb 25, 2024	01/18
30BE001Dxx	ThinkStation P520	EET	Xeon W-2123 4C/3.6GHz/8.25MB/120W/DDR4-2666	Open	1x 8GB RDIMM DDR4-2666	Integrated Intel SATA	None	1x 256GB SSD 2.5" SATA6Gbps Opal	None	1x HH DVD±RW	9-in-1	None	Fixed 690W Platinum	1x Serial	None	USB / USB Optical	Windows 10 DG Windows 7 Pro 64	3-year, Onsite	No	Feb 25, 2024	01/18
30BE001Exx	ThinkStation P520	EET	Xeon W-2123 4C/3.6GHz/8.25MB/120W/DDR4-2666	Open	1x 8GB RDIMM DDR4-2666	Integrated Intel SATA	None	1x 256GB SSD 2.5" SATA6Gbps Opal	None	1x HH DVD±RW	9-in-1	None	Fixed 690W Platinum	1x Serial	None	USB / USB Optical	Windows 10 DG Windows 7 Pro 64	3-year, Onsite	No	Feb 25, 2024	01/18
30BE001Fxx	ThinkStation P520	EET	Xeon W-2123 4C/3.6GHz/8.25MB/120W/DDR4-2666	Open	1x 8GB RDIMM DDR4-2666	Integrated Intel SATA	None	1x 256GB SSD 2.5" SATA6Gbps Opal	None	1x HH DVD±RW	9-in-1	None	Fixed 690W Platinum	1x Serial	None	USB / USB Optical	Windows 10 DG Windows 7 Pro 64	3-year, Onsite	No	Feb 25, 2024	01/18
30BE001Gxx	ThinkStation P520	EET	Xeon W-2123 4C/3.6GHz/8.25MB/120W/DDR4-2666	Open	1x 8GB RDIMM DDR4-2666	Integrated Intel SATA	None	1x 256GB SSD 2.5" SATA6Gbps Opal	None	1x HH DVD±RW	9-in-1	None	Fixed 690W Platinum	1x Serial	None	USB / USB Optical	Windows 10 DG Windows 7 Pro 64	3-year, Onsite	No	Feb 25, 2024	01/18
30BE001Hxx	ThinkStation P520	EET	Xeon W-2123 4C/3.6GHz/8.25MB/120W/DDR4-2666	Open	1x 8GB RDIMM DDR4-2666	Integrated Intel SATA	None	1x 256GB SSD 2.5" SATA6Gbps Opal	None	1x HH DVD±RW	9-in-1	None	Fixed 690W Platinum	1x Serial	None	USB / USB Optical	Windows 10 DG Windows 7 Pro 64	3-year, Onsite	No	Feb 25, 2024	01/18

Model	Product	Region	Processor	Graphics	Memory	Storage Controller	M.2 RAID Upgrade	Disks	M.2 Drives	Optical	Media Reader	Additional Networking	Power Supply	Optional Ports	Front Diagnostic LED	Keyboard / Mouse	Operating System	Warranty	Global	End of Support	Ann Date (mm/yy)
30BE001Jxx	ThinkStation P520	EET	Xeon W-2123 4C/3.6GHz/8.25MB/120W/DDR4-2666	Open	1x 8GB RDIMM DDR4-2666	Integrated Intel SATA	None	1x 256GB SSD 2.5" SATA6Gbps Opal	None	1x HH DVD±RW	9-in-1	None	Fixed 690W Platinum	1x Serial	None	USB / USB Optical	Windows 10 DG Windows 7 Pro 64	3-year, Onsite	No	Feb 25, 2024	01/18
30BE001Kxx	ThinkStation P520	EET	Xeon W-2123 4C/3.6GHz/8.25MB/120W/DDR4-2666	Open	1x 8GB RDIMM DDR4-2666	Integrated Intel SATA	None	1x 256GB SSD 2.5" SATA6Gbps Opal	None	1x HH DVD±RW	9-in-1	None	Fixed 690W Platinum	1x Serial	None	USB / USB Optical	Windows 10 DG Windows 7 Pro 64	3-year, Onsite	No	Feb 25, 2024	01/18
30BE001Lxx	ThinkStation P520	EET	Xeon W-2123 4C/3.6GHz/8.25MB/120W/DDR4-2666	Open	1x 8GB RDIMM DDR4-2666	Integrated Intel SATA	None	1x 256GB SSD 2.5" SATA6Gbps Opal	None	1x HH DVD±RW	9-in-1	None	Fixed 690W Platinum	1x Serial	None	USB / USB Optical	Windows 10 DG Windows 7 Pro 64	3-year, Onsite	No	Feb 25, 2024	01/18
30BE001Mxx	ThinkStation P520	EET	Xeon W-2123 4C/3.6GHz/8.25MB/120W/DDR4-2666	Open	1x 8GB RDIMM DDR4-2666	Integrated Intel SATA	None	1x 256GB SSD 2.5" SATA6Gbps Opal	None	1x HH DVD±RW	9-in-1	None	Fixed 690W Platinum	1x Serial	None	USB / USB Optical	Windows 10 DG Windows 7 Pro 64	3-year, Onsite	No	Feb 25, 2024	01/18
30BE001Nxx	ThinkStation P520	EET	Xeon W-2123 4C/3.6GHz/8.25MB/120W/DDR4-2666	Open	1x 8GB RDIMM DDR4-2666	Integrated Intel SATA	None	1x 256GB SSD 2.5" SATA6Gbps Opal	None	1x HH DVD±RW	9-in-1	None	Fixed 690W Platinum	1x Serial	None	USB / USB Optical	Windows 10 DG Windows 7 Pro 64	3-year, Onsite	No	Feb 25, 2024	01/18
30BE001Pxx	ThinkStation P520	EET	Xeon W-2123 4C/3.6GHz/8.25MB/120W/DDR4-2666	Open	1x 8GB RDIMM DDR4-2666	Integrated Intel SATA	None	1x 256GB SSD 2.5" SATA6Gbps Opal	None	1x HH DVD±RW	9-in-1	None	Fixed 690W Platinum	1x Serial	None	USB / USB Optical	Windows 10 DG Windows 7 Pro 64	3-year, Onsite	No	Feb 25, 2024	01/18
30BE000Yxx	ThinkStation P520	EET	Xeon W-2125 4C/4.0GHz/8.25MB/120W/DDR4-2666	Open	1x 8GB RDIMM DDR4-2666	Integrated Intel SATA	None	1x 512GB SSD 2.5" SATA6Gbps Opal	None	1x HH DVD±RW	9-in-1	None	Fixed 690W Platinum	1x Serial	None	USB / USB Optical	Windows 10 Pro 64	3-year, Onsite	No	Feb 25, 2024	01/18
30BE0010xx	ThinkStation P520	EET	Xeon W-2133 6C/3.6GHz/8.25MB/140W/DDR4-2666	Open	1x 16GB RDIMM DDR4-2666	Integrated Intel SATA	None	1x 256GB SSD 2.5" SATA6Gbps Opal	None	1x HH DVD±RW	9-in-1	None	Fixed 690W Platinum	1x Serial	None	USB / USB Optical	Windows 10 Pro 64	3-year, Onsite	No	Feb 25, 2024	01/18

Model	Product	Region	Processor	Graphics	Memory	Storage Controller	M.2 RAID Upgrade	Disks	M.2 Drives	Optical	Media Reader	Additional Networking	Power Supply	Optional Ports	Front Diagnostic LED	Keyboard / Mouse	Operating System	Warranty	Global	End of Support	Ann Date (mm/yy)
30BE0011xx	ThinkStation P520	EET	Xeon W-2133 6C/3.6GHz/8.25MB/140W/DDR4-2666	Open	1x 16GB RDIMM DDR4-2666	Integrated Intel SATA	None	1x 512GB SSD 2.5" SATA6Gbps Opal	None	1x HH DVD±RW	9-in-1	None	Fixed 690W Platinum	1x Serial	None	USB / USB Optical	Windows 10 Pro 64	3-year, Onsite	No	Feb 25, 2024	01/18
30BE000Txx	ThinkStation P520	EET	Xeon W-2123 4C/3.6GHz/8.25MB/120W/DDR4-2666	Open	1x 8GB RDIMM DDR4-2666	Integrated Intel SATA	None	2x 1TB HDD 7.2K 3.5" SATA6Gbps	None	1x HH DVD±RW	9-in-1	None	Fixed 690W Platinum	1x Serial	None	USB / USB Optical	Windows 10 Pro 64	3-year, Onsite	No	Feb 25, 2024	01/18
30BE000Uxx	ThinkStation P520	EET	Xeon W-2125 4C/4.0GHz/8.25MB/120W/DDR4-2666	Open	1x 8GB RDIMM DDR4-2666	Integrated Intel SATA	None	2x 1TB HDD 7.2K 3.5" SATA6Gbps	None	1x HH DVD±RW	9-in-1	None	Fixed 690W Platinum	1x Serial	None	USB / USB Optical	Windows 10 Pro 64	3-year, Onsite	No	Feb 25, 2024	01/18
30BE000Vxx	ThinkStation P520	EET	Xeon W-2123 4C/3.6GHz/8.25MB/120W/DDR4-2666	Open	1x 8GB RDIMM DDR4-2666	Integrated Intel SATA	None	1x 1TB HDD 7.2K 3.5" SATA6Gbps	None	1x HH DVD±RW	9-in-1	None	Fixed 690W Platinum	1x Serial	None	USB / USB Optical	Windows 10 Pro 64	3-year, Onsite	No	Feb 25, 2024	01/18
30BE000Wxx	ThinkStation P520	EET	Xeon W-2125 4C/4.0GHz/8.25MB/120W/DDR4-2666	Open	1x 8GB RDIMM DDR4-2666	Integrated Intel SATA	None	1x 1TB HDD 7.2K 3.5" SATA6Gbps	None	1x HH DVD±RW	9-in-1	None	Fixed 690W Platinum	1x Serial	None	USB / USB Optical	Windows 10 Pro 64	3-year, Onsite	No	Feb 25, 2024	01/18
30BE000Xxx	ThinkStation P520	EET	Xeon W-2123 4C/3.6GHz/8.25MB/120W/DDR4-2666	Open	1x 8GB RDIMM DDR4-2666	Integrated Intel SATA	None	1x 256GB SSD 2.5" SATA6Gbps Opal	None	1x HH DVD±RW	9-in-1	None	Fixed 690W Platinum	1x Serial	None	USB / USB Optical	Windows 10 Pro 64	3-year, Onsite	No	Feb 25, 2024	01/18
30BE000W**	ThinkStation P520	MEA	Xeon W-2125 4C/4.0GHz/8.25MB/120W/DDR4-2666	Open	1x 8GB RDIMM DDR4-2666	Integrated Intel SATA	None	1x 1TB HDD 7.2K 3.5" SATA6Gbps	None	1x HH DVD±RW	9-in-1	None	Fixed 690W Platinum	1x Serial	None	USB / USB Optical	Windows 10 Pro 64	3-year, Onsite	No	Feb 25, 2024	01/18
30BE000X**	ThinkStation P520	MEA	Xeon W-2123 4C/3.6GHz/8.25MB/120W/DDR4-2666	Open	1x 8GB RDIMM DDR4-2666	Integrated Intel SATA	None	1x 256GB SSD 2.5" SATA6Gbps Opal	None	1x HH DVD±RW	9-in-1	None	Fixed 690W Platinum	1x Serial	None	USB / USB Optical	Windows 10 Pro 64	3-year, Onsite	No	Feb 25, 2024	01/18

Model	Product	Region	Processor	Graphics	Memory	Storage Controller	M.2 RAID Upgrade	Disks	M.2 Drives	Optical	Media Reader	Additional Networking	Power Supply	Optional Ports	Front Diagnostic LED	Keyboard / Mouse	Operating System	Warranty	Global	End of Support	Ann Date (mm/yy)
30BE000U**	ThinkStation P520	MEA	Xeon W-2125 4C/4.0GHz/8.25MB/120W/DDR4-2666	Open	1x 8GB RDIMM DDR4-2666	Integrated Intel SATA ECC	None	2x 1TB HDD 7.2K 3.5" SATA6Gbps	None	1x HH DVD±RW	9-in-1	None	Fixed 690W Platinum	1x Serial	None	USB / USB Optical	Windows 10 Pro 64	3-year, Onsite	No	Feb 25, 2024	01/18
30BE000V**	ThinkStation P520	MEA	Xeon W-2123 4C/3.6GHz/8.25MB/120W/DDR4-2666	Open	1x 8GB RDIMM DDR4-2666	Integrated Intel SATA ECC	None	1x 1TB HDD 7.2K 3.5" SATA6Gbps	None	1x HH DVD±RW	9-in-1	None	Fixed 690W Platinum	1x Serial	None	USB / USB Optical	Windows 10 Pro 64	3-year, Onsite	No	Feb 25, 2024	01/18
30BE000T**	ThinkStation P520	MEA	Xeon W-2123 4C/3.6GHz/8.25MB/120W/DDR4-2666	Open	1x 8GB RDIMM DDR4-2666	Integrated Intel SATA ECC	None	2x 1TB HDD 7.2K 3.5" SATA6Gbps	None	1x HH DVD±RW	9-in-1	None	Fixed 690W Platinum	1x Serial	None	USB / USB Optical	Windows 10 Pro 64	3-year, Onsite	No	Feb 25, 2024	01/18
30BE000Y**	ThinkStation P520	MEA	Xeon W-2125 4C/4.0GHz/8.25MB/120W/DDR4-2666	Open	1x 8GB RDIMM DDR4-2666	Integrated Intel SATA ECC	None	1x 512GB SSD 2.5" SATA6Gbps Opal	None	1x HH DVD±RW	9-in-1	None	Fixed 690W Platinum	1x Serial	None	USB / USB Optical	Windows 10 Pro 64	3-year, Onsite	No	Feb 25, 2024	01/18
30BE0010**	ThinkStation P520	MEA	Xeon W-2133 6C/3.6GHz/8.25MB/140W/DDR4-2666	Open	1x 16GB RDIMM DDR4-2666	Integrated Intel SATA ECC	None	1x 256GB SSD 2.5" SATA6Gbps Opal	None	1x HH DVD±RW	9-in-1	None	Fixed 690W Platinum	1x Serial	None	USB / USB Optical	Windows 10 Pro 64	3-year, Onsite	No	Feb 25, 2024	01/18
30BE0011**	ThinkStation P520	MEA	Xeon W-2133 6C/3.6GHz/8.25MB/140W/DDR4-2666	Open	1x 16GB RDIMM DDR4-2666	Integrated Intel SATA ECC	None	1x 512GB SSD 2.5" SATA6Gbps Opal	None	1x HH DVD±RW	9-in-1	None	Fixed 690W Platinum	1x Serial	None	USB / USB Optical	Windows 10 Pro 64	3-year, Onsite	No	Feb 25, 2024	01/18
30BE0014**	ThinkStation P520	MEA	Xeon W-2104 4C/3.2GHz/8.25MB/120W/DDR4-2400	Open	1x 16GB RDIMM DDR4-2666	Integrated Intel SATA ECC	None	1x 256GB SSD 2.5" SATA6Gbps Opal	None	1x 9.0mm DVD±RW	15-in-1	None	Fixed 690W Platinum	1x Front eSATA	None	USB / USB Optical	Windows 10 Pro 64	3-year, Onsite	No	Feb 25, 2024	01/18
30BE0012**	ThinkStation P520	MEA	Xeon W-2123 4C/3.6GHz/8.25MB/120W/DDR4-2666	Open	1x 16GB RDIMM DDR4-2666	Integrated Intel SATA ECC	None	1x 2TB SSD 2.5" SATA6Gbps Opal	1x 512GB SSD M.2 PCIe Opal, Onboard	1x HH DVD±RW	9-in-1	None	Fixed 690W Platinum	1x Serial	None	USB / USB Optical	Windows 10 Pro 64	3-year, Onsite	No	Feb 25, 2024	01/18

Model	Product	Region	Processor	Graphics	Memory	Storage Controller	M.2 RAID Upgrade	Disks	M.2 Drives	Optical	Media Reader	Additional Networking	Power Supply	Optional Ports	Front Diagnostic LED	Keyboard / Mouse	Operating System	Warranty	Global	End of Support	Ann Date (mm/yy)
30BE0013**	ThinkStation P520	MEA	Xeon W-2125 4C/4.0GHz/8.25MB/120W/DDR4-2666	Open	1x 8GB RDIMM DDR4-2666	Integrated Intel SATA	None	None	1x 256GB SSD M.2 PCIe Opal, Onboard	1x HH DVD±RW	9-in-1	None	Fixed 690W Platinum	1x Serial	None	USB / USB Optical	Windows 10 Pro 64	3-year, Onsite	No	Feb 25, 2024	01/18
30BE001Q**	ThinkStation P520	MEA	Xeon W-2123 4C/3.6GHz/8.25MB/120W/DDR4-2666	Open	1x 8GB RDIMM DDR4-2666	Integrated Intel SATA	None	1x 256GB SSD 2.5" SATA6Gbps Opal	None	1x HH DVD±RW	9-in-1	None	Fixed 690W Platinum	1x Serial	None	USB / USB Optical	Windows 10 DG Windows 7 Pro 64	3-year, Onsite	No	Feb 25, 2024	01/18
30BE001R**	ThinkStation P520	MEA	Xeon W-2123 4C/3.6GHz/8.25MB/120W/DDR4-2666	Open	1x 8GB RDIMM DDR4-2666	Integrated Intel SATA	None	1x 256GB SSD 2.5" SATA6Gbps Opal	None	1x HH DVD±RW	9-in-1	None	Fixed 690W Platinum	1x Serial	None	USB / USB Optical	Windows 10 DG Windows 7 Pro 64	3-year, Onsite	No	Feb 25, 2024	01/18
30BE001S**	ThinkStation P520	MEA	Xeon W-2123 4C/3.6GHz/8.25MB/120W/DDR4-2666	Open	1x 8GB RDIMM DDR4-2666	Integrated Intel SATA	None	1x 256GB SSD 2.5" SATA6Gbps Opal	None	1x HH DVD±RW	9-in-1	None	Fixed 690W Platinum	1x Serial	None	USB / USB Optical	Windows 10 DG Windows 7 Pro 64	3-year, Onsite	No	Feb 25, 2024	01/18
30BE001T**	ThinkStation P520	MEA	Xeon W-2123 4C/3.6GHz/8.25MB/120W/DDR4-2666	Open	1x 8GB RDIMM DDR4-2666	Integrated Intel SATA	None	1x 256GB SSD 2.5" SATA6Gbps Opal	None	1x HH DVD±RW	9-in-1	None	Fixed 690W Platinum	1x Serial	None	USB / USB Optical	Windows 10 DG Windows 7 Pro 64	3-year, Onsite	No	Feb 25, 2024	01/18
30BE001U**	ThinkStation P520	MEA	Xeon W-2123 4C/3.6GHz/8.25MB/120W/DDR4-2666	Open	1x 8GB RDIMM DDR4-2666	Integrated Intel SATA	None	1x 256GB SSD 2.5" SATA6Gbps Opal	None	1x HH DVD±RW	9-in-1	None	Fixed 690W Platinum	1x Serial	None	USB / USB Optical	Windows 10 DG Windows 7 Pro 64	3-year, Onsite	No	Feb 25, 2024	01/18
30BE003K**	ThinkStation P520	MEA	Xeon W-2125 4C/4.0GHz/8.25MB/120W/DDR4-2666	Open	2x 8GB RDIMM DDR4-2666	Integrated Intel SATA	None	1x 1TB HDD 7.2K 3.5" SATA6Gbps	None	1x HH DVD±RW	9-in-1	None	Fixed 690W Platinum	None	None	USB / USB Optical	Windows 10 Pro 64	3-year, Onsite	No	Feb 25, 2024	01/18
30BE003L**	ThinkStation P520	MEA	Xeon W-2133 6C/3.6GHz/8.25MB/140W/DDR4-2666	Open	2x 8GB RDIMM DDR4-2666	Integrated Intel SATA	None	1x 1TB HDD 7.2K 3.5" SATA6Gbps	1x 256GB SSD M.2 PCIe Opal, Onboard	1x HH DVD±RW	9-in-1	None	Fixed 690W Platinum	None	None	USB / USB Optical	Windows 10 Pro 64	3-year, Onsite	No	Feb 25, 2024	01/18

Model	Product	Region	Processor	Graphics	Memory	Storage Controller	M.2 RAID Upgrade	Disks	M.2 Drives	Optical	Media Reader	Additional Networking	Power Supply	Optional Ports	Front Diagnostic LED	Keyboard / Mouse	Operating System	Warranty	Global	End of Support	Ann Date (mm/yy)
30BE003M**	ThinkStation P520	MEA	Xeon W-2123 4C/3.6GHz/8.25MB/120W/DDR4-2666	Open	2x 8GB RDIMM DDR4-2666	Integrated Intel SATA ECC	None	1x 1TB HDD 7.2K 3.5" SATA6Gbps	None	1x HH DVD±RW	9-in-1	None	Fixed 690W Platinum	None	None	USB / USB Optical	Windows 10 Pro 64	3-year, Onsite	No	Feb 25, 2024	01/18
30BE003N**	ThinkStation P520	MEA	Xeon W-2102 4C/2.9GHz/8.25MB/120W/DDR4-2400	Open	1x 8GB RDIMM DDR4-2666	Integrated Intel SATA ECC	None	1x 1TB HDD 7.2K 3.5" SATA6Gbps	None	1x HH DVD±RW	9-in-1	None	Fixed 690W Platinum	None	None	USB / USB Optical	Windows 10 Pro 64	3-year, Onsite	No	Feb 25, 2024	01/18
30BE002U**	ThinkStation P520	MEA	Xeon W-2133 6C/3.6GHz/8.25MB/140W/DDR4-2666	Open	1x 16GB RDIMM DDR4-2666	Integrated Intel SATA ECC	None	1x 256GB SSD 2.5" SATA6Gbps	None	1x HH DVD±RW	9-in-1	None	Fixed 690W Platinum	1x Serial	None	USB / USB Optical	Windows 10 DG Windows 7 Pro 64	3-year, Onsite	No	Feb 25, 2024	01/18
30BE002V**	ThinkStation P520	MEA	Xeon W-2133 6C/3.6GHz/8.25MB/140W/DDR4-2666	Open	1x 16GB RDIMM DDR4-2666	Integrated Intel SATA ECC	None	1x 256GB SSD 2.5" SATA6Gbps	None	1x HH DVD±RW	9-in-1	None	Fixed 690W Platinum	1x Serial	None	USB / USB Optical	Windows 10 DG Windows 7 Pro 64	3-year, Onsite	No	Feb 25, 2024	01/18
30BE002W**	ThinkStation P520	MEA	Xeon W-2133 6C/3.6GHz/8.25MB/140W/DDR4-2666	Open	1x 16GB RDIMM DDR4-2666	Integrated Intel SATA ECC	None	1x 256GB SSD 2.5" SATA6Gbps	None	1x HH DVD±RW	9-in-1	None	Fixed 690W Platinum	1x Serial	None	USB / USB Optical	Windows 10 DG Windows 7 Pro 64	3-year, Onsite	No	Feb 25, 2024	01/18
30BE002X**	ThinkStation P520	MEA	Xeon W-2133 6C/3.6GHz/8.25MB/140W/DDR4-2666	Open	1x 16GB RDIMM DDR4-2666	Integrated Intel SATA ECC	None	1x 256GB SSD 2.5" SATA6Gbps	None	1x HH DVD±RW	9-in-1	None	Fixed 690W Platinum	1x Serial	None	USB / USB Optical	Windows 10 DG Windows 7 Pro 64	3-year, Onsite	No	Feb 25, 2024	01/18
30BE002Y**	ThinkStation P520	MEA	Xeon W-2133 6C/3.6GHz/8.25MB/140W/DDR4-2666	Open	1x 16GB RDIMM DDR4-2666	Integrated Intel SATA ECC	None	1x 256GB SSD 2.5" SATA6Gbps	None	1x HH DVD±RW	9-in-1	None	Fixed 690W Platinum	1x Serial	None	USB / USB Optical	Windows 10 DG Windows 7 Pro 64	3-year, Onsite	No	Feb 25, 2024	01/18
30BE0017**	ThinkStation P520	MEA	Xeon W-2133 6C/3.6GHz/8.25MB/140W/DDR4-2666	1x NVIDIA Quadro P4000 8GB	1x 32GB RDIMM DDR4-2666	Integrated Intel SATA ECC	None	1x 256GB SSD 2.5" SATA6Gbps Opal, 1x 1TB HDD 7.2K 3.5" SATA6Gbps	None	1x 9.0mm DVD±RW	15-in-1	None	Fixed 690W Platinum	1x Front eSATA	None	USB / USB Optical	Windows 10 Pro 64	3-year, Onsite	No	Feb 25, 2024	01/18

Model	Product	Region	Processor	Graphics	Memory	Storage Controller	M.2 RAID Upgrade	Disks	M.2 Drives	Optical	Media Reader	Additional Networking	Power Supply	Optional Ports	Front Diagnostic LED	Keyboard / Mouse	Operating System	Warranty	Global	End of Support	Ann Date (mm/yy)
30BE006N**	ThinkStation P520	MEA	Xeon W-2123 4C/3.6GHz/8.25MB/120W/DDR4-2666	Open	1x 8GB RDIMM DDR4-2666	Integrated Intel SATA	None	1x 1TB HDD 7.2K 3.5" SATA6Gbps	None	1x HH DVD±RW	9-in-1	None	Fixed 900W Platinum	1x Serial	None	USB / USB Optical	Windows 10 Pro 64	3-year, Onsite	No	Feb 25, 2024	01/18
30BE0018**	ThinkStation P520	MEA	Xeon W-2133 6C/3.6GHz/8.25MB/140W/DDR4-2666	1x NVIDIA Quadro P2000 5GB	1x 16GB RDIMM DDR4-2666	Integrated Intel SATA	None	2x 1TB HDD 7.2K 3.5" SATA6Gbps	None	1x 9.0mm DVD±RW	15-in-1	None	Fixed 690W Platinum	1x Front eSATA	None	USB / USB Optical	Windows 10 Pro 64	3-year, Onsite	No	Feb 25, 2024	01/18
30BE0015**	ThinkStation P520	MEA	Xeon W-2123 4C/3.6GHz/8.25MB/120W/DDR4-2666	1x NVIDIA Quadro P600 2GB	1x 8GB RDIMM DDR4-2666	Integrated Intel SATA	None	1x 1TB HDD 7.2K 3.5" SATA6Gbps	None	1x 9.0mm DVD±RW	15-in-1	None	Fixed 690W Platinum	1x Front eSATA	None	USB / USB Optical	Windows 10 Pro 64	3-year, Onsite	No	Feb 25, 2024	01/18
30BE0016**	ThinkStation P520	MEA	Xeon W-2133 6C/3.6GHz/8.25MB/140W/DDR4-2666	1x NVIDIA Quadro P2000 5GB	1x 16GB RDIMM DDR4-2666	Integrated Intel SATA	None	1x 256GB SSD 2.5" SATA6Gbps Opal	None	1x 9.0mm DVD±RW	15-in-1	None	Fixed 690W Platinum	1x Front eSATA	None	USB / USB Optical	Windows 10 Pro 64	3-year, Onsite	No	Feb 25, 2024	01/18
30BE006U**	ThinkStation P520	MEA	Xeon W-2104 4C/3.2GHz/8.25MB/120W/DDR4-2400	Open	1x 16GB RDIMM DDR4-2666	Integrated Intel SATA	None	1x 256GB SSD 2.5" SATA6Gbps Opal	None	1x HH DVD±RW	9-in-1	None	Fixed 900W Platinum	1x Serial	None	USB / USB Optical	Windows 10 Pro 64	3-year, Onsite	No	Feb 25, 2024	01/18
30BE006V**	ThinkStation P520	MEA	Xeon W-2123 4C/3.6GHz/8.25MB/120W/DDR4-2666	1x NVIDIA Quadro P600 2GB	1x 8GB RDIMM DDR4-2666	Integrated Intel SATA	None	1x 1TB HDD 7.2K 3.5" SATA6Gbps	None	1x HH DVD±RW	9-in-1	None	Fixed 900W Platinum	1x Serial	None	USB / USB Optical	Windows 10 Pro 64	3-year, Onsite	No	Feb 25, 2024	01/18
30BE006T**	ThinkStation P520	MEA	Xeon W-2133 6C/3.6GHz/8.25MB/140W/DDR4-2666	Open	1x 16GB RDIMM DDR4-2666	Integrated Intel SATA	None	1x 512GB SSD 2.5" SATA6Gbps Opal	None	1x HH DVD±RW	9-in-1	None	Fixed 900W Platinum	1x Serial	None	USB / USB Optical	Windows 10 Pro 64	3-year, Onsite	No	Feb 25, 2024	01/18
30BE006P**	ThinkStation P520	MEA	Xeon W-2125 4C/4.0GHz/8.25MB/120W/DDR4-2666	Open	1x 8GB RDIMM DDR4-2666	Integrated Intel SATA	None	1x 1TB HDD 7.2K 3.5" SATA6Gbps	None	1x HH DVD±RW	9-in-1	None	Fixed 900W Platinum	1x Serial	None	USB / USB Optical	Windows 10 Pro 64	3-year, Onsite	No	Feb 25, 2024	01/18

Model	Product	Region	Processor	Graphics	Memory	Storage Controller	M.2 RAID Upgrade	Disks	M.2 Drives	Optical	Media Reader	Additional Networking	Power Supply	Optional Ports	Front Diagnostic LED	Keyboard / Mouse	Operating System	Warranty	Global	End of Support	Ann Date (mm/yy)
30BE006R**	ThinkStation P520	MEA	Xeon W-2125 4C/4.0GHz/8.25MB/120W/DDR4-2666	Open	1x 8GB RDIMM DDR4-2666	Integrated Intel SATA	None	1x 512GB SSD 2.5" SATA6Gbps Opal	None	1x HH DVD±RW	9-in-1	None	Fixed 900W Platinum	1x Serial	None	USB / USB Optical	Windows 10 Pro 64	3-year, Onsite	No	Feb 25, 2024	01/18
30BE006Q**	ThinkStation P520	MEA	Xeon W-2123 4C/3.6GHz/8.25MB/120W/DDR4-2666	Open	1x 8GB RDIMM DDR4-2666	Integrated Intel SATA	None	1x 256GB SSD 2.5" SATA6Gbps Opal	None	1x HH DVD±RW	9-in-1	None	Fixed 900W Platinum	1x Serial	None	USB / USB Optical	Windows 10 Pro 64	3-year, Onsite	No	Feb 25, 2024	01/18
30BE006S**	ThinkStation P520	MEA	Xeon W-2133 6C/3.6GHz/8.25MB/140W/DDR4-2666	Open	1x 16GB RDIMM DDR4-2666	Integrated Intel SATA	None	1x 256GB SSD 2.5" SATA6Gbps Opal	None	1x HH DVD±RW	9-in-1	None	Fixed 900W Platinum	1x Serial	None	USB / USB Optical	Windows 10 Pro 64	3-year, Onsite	No	Feb 25, 2024	01/18
30BE006X**	ThinkStation P520	MEA	Xeon W-2133 6C/3.6GHz/8.25MB/140W/DDR4-2666	Open	1x 32GB RDIMM DDR4-2666	Integrated Intel SATA	None	1x 256GB SSD 2.5" SATA6Gbps Opal, 1x 1TB HDD 7.2K 3.5" SATA6Gbps	None	1x HH DVD±RW	9-in-1	None	Fixed 900W Platinum	1x Serial	None	USB / USB Optical	Windows 10 Pro 64	3-year, Onsite	No	Feb 25, 2024	01/18
30BE006W**	ThinkStation P520	MEA	Xeon W-2123 4C/3.6GHz/8.25MB/120W/DDR4-2666	Open	1x 16GB RDIMM DDR4-2666	Integrated Intel SATA	None	1x 256GB SSD 2.5" SATA6Gbps Opal	None	1x HH DVD±RW	9-in-1	None	Fixed 900W Platinum	1x Serial	None	USB / USB Optical	Windows 10 Pro 64	3-year, Onsite	No	Feb 25, 2024	01/18
30BE006Y**	ThinkStation P520	MEA	Xeon W-2133 6C/3.6GHz/8.25MB/140W/DDR4-2666	Open	1x 16GB RDIMM DDR4-2666	Integrated Intel SATA	None	2x 1TB HDD 7.2K 3.5" SATA6Gbps	None	1x HH DVD±RW	9-in-1	None	Fixed 900W Platinum	1x Serial	None	USB / USB Optical	Windows 10 Pro 64	3-year, Onsite	No	Feb 25, 2024	01/18
30BE0071**	ThinkStation P520	MEA	Xeon W-2125 4C/4.0GHz/8.25MB/120W/DDR4-2666	Open	1x 8GB RDIMM DDR4-2666	Integrated Intel SATA	None	None	1x 256GB SSD M.2 PCIe Opal, Onboard	1x HH DVD±RW	9-in-1	None	Fixed 900W Platinum	1x Serial	None	USB / USB Optical	Windows 10 Pro 64	3-year, Onsite	No	Feb 25, 2024	01/18
30BE0070**	ThinkStation P520	MEA	Xeon W-2123 4C/3.6GHz/8.25MB/120W/DDR4-2666	Open	1x 16GB RDIMM DDR4-2666	Integrated Intel SATA	None	1x 2TB HDD 7.2K 3.5" SATA6Gbps	1x 512GB SSD M.2 PCIe Opal, Onboard	1x HH DVD±RW	9-in-1	None	Fixed 900W Platinum	1x Serial	None	USB / USB Optical	Windows 10 Pro 64	3-year, Onsite	No	Feb 25, 2024	01/18

Model	Product	Region	Processor	Graphics	Memory	Storage Controller	M.2 RAID Upgrade	Disks	M.2 Drives	Optical	Media Reader	Additional Networking	Power Supply	Optional Ports	Front Diagnostic LED	Keyboard / Mouse	Operating System	Warranty	Global	End of Support	Ann Date (mm/yy)	
30BE007W**	ThinkStation P520	MEA	Xeon W-2133 6C/3.6GHz/8.25MB/140W/DDR4-2666	Open	1x 16GB RDIMM DDR4-2666 ECC	Integrated Intel SATA	None	1x 1TB HDD 7.2K 3.5" SATA6Gbps	1x 256GB SSD M.2 PCIe Opal, Onboard	1x HH DVD±RW	9-in-1	None	Fixed 900W Platinum	1x Serial, 1x Internal USB 3.0	4-digit LED	USB / USB Optical	Windows 10 Pro 64	3-year, Onsite	No	May 3, 2024	04/18	
30BE007X**	ThinkStation P520	MEA	Xeon W-2123 4C/3.6GHz/8.25MB/120W/DDR4-2666	Open	1x 16GB RDIMM DDR4-2666 ECC	Integrated Intel SATA	None	1x 1TB HDD 7.2K 3.5" SATA6Gbps	1x 256GB SSD M.2 PCIe Opal, Onboard	1x HH DVD±RW	9-in-1	None	Fixed 900W Platinum	1x Serial, 1x Internal USB 3.0	4-digit LED	USB / USB Optical	Windows 10 Pro 64	3-year, Onsite	No	May 3, 2024	04/18	
30BE007S**	ThinkStation P520	MEA	Xeon W-2133 6C/3.6GHz/8.25MB/140W/DDR4-2666	Open	1x 16GB RDIMM DDR4-2666 ECC	Integrated Intel SATA	None	None	1x 512GB SSD M.2 PCIe Opal, Onboard	1x HH DVD±RW	9-in-1	None	Fixed 900W Platinum	1x Serial	None	USB / USB Optical	Windows 10 Pro 64	3-year, Onsite	No	Apr 27, 2024	03/18	
30BE007V**	ThinkStation P520	MEA	Xeon W-2145 8C/3.7GHz/11MB/140W/DDR4-2666	Open	1x 16GB RDIMM DDR4-2666 ECC	Integrated Intel SATA	None	1x 1TB HDD 7.2K 3.5" SATA6Gbps	1x 256GB SSD M.2 PCIe Opal, Onboard	1x HH DVD±RW	9-in-1	None	Fixed 900W Platinum	1x Serial, 1x Internal USB 3.0	4-digit LED	USB / USB Optical	Windows 10 Pro 64	3-year, Onsite	No	May 3, 2024	04/18	
30BE007U**	ThinkStation P520	MEA	Xeon W-2133 6C/3.6GHz/8.25MB/140W/DDR4-2666	Open	1x NVIDIA Quadro P4000 8GB	2x 16GB RDIMM DDR4-2666 ECC	Integrated Intel SATA	None	1x 1TB HDD 7.2K 3.5" SATA6Gbps	1x 512GB SSD M.2 PCIe Opal, Onboard	1x HH DVD±RW	9-in-1	None	Fixed 900W Platinum	1x Serial, 1x Internal USB 3.0	4-digit LED	USB / USB Optical	Windows 10 Pro 64	3-year, Onsite	No	May 3, 2024	04/18
30BE0073**	ThinkStation P520	MEA	Xeon W-2125 4C/4.0GHz/8.25MB/120W/DDR4-2666	Open	1x 16GB RDIMM DDR4-2666 ECC	Integrated Intel SATA	None	1x 512GB SSD 2.5" SATA6Gbps Opal	None	1x HH DVD±RW	9-in-1	None	Fixed 900W Platinum	1x Serial	None	USB / USB Optical	Windows 10 Pro 64	3-year, Onsite	No	Feb 25, 2024	01/18	
30BE0072**	ThinkStation P520	MEA	Xeon W-2133 6C/3.6GHz/8.25MB/140W/DDR4-2666	Open	1x 16GB RDIMM DDR4-2666 ECC	Integrated Intel SATA	None	1x 256GB SSD 2.5" SATA6Gbps Opal	None	1x HH DVD±RW	9-in-1	None	Fixed 900W Platinum	1x Serial	None	USB / USB Optical	Windows 10 DG Windows 7 Pro 64	3-year, Onsite	No	Feb 25, 2024	01/18	
30BE0074**	ThinkStation P520	MEA	Xeon W-2125 4C/4.0GHz/8.25MB/120W/DDR4-2666	Open	1x 32GB RDIMM DDR4-2666 ECC	Integrated Intel SATA	None	1x 512GB SSD 2.5" SATA6Gbps Opal	None	1x HH DVD±RW	9-in-1	None	Fixed 690W Platinum	1x Serial	None	USB / USB Optical	Windows 10 Pro 64	3-year, Onsite	No	Feb 25, 2024	01/18	

Model	Product	Region	Processor	Graphics	Memory	Storage Controller	M.2 RAID Upgrade	Disks	M.2 Drives	Optical	Media Reader	Additional Networking	Power Supply	Optional Ports	Front Diagnostic LED	Keyboard / Mouse	Operating System	Warranty	Global Support	End of Support	Ann Date (mm/yy)	
30BE007Y**	ThinkStation P520	MEA	Xeon W-2123 4C/3.6GHz/8.25MB/120W/DDR4-2666	Open	1x 16GB RDIMM DDR4-2666 ECC	Integrated Intel SATA	None	1x 512GB SSD 2.5" SATA6Gbps Opal	None	1x HH DVD±RW	9-in-1	None	Fixed 900W Platinum	1x Serial	None	USB / USB Optical	Windows 10 Pro 64	3-year, Onsite	No	May 3, 2024	04/18	
30BE0073xx	ThinkStation P520	Russia	Xeon W-2125 4C/4.0GHz/8.25MB/120W/DDR4-2666	Open	1x 16GB RDIMM DDR4-2666 ECC	Integrated Intel SATA	None	1x 512GB SSD 2.5" SATA6Gbps Opal	None	1x HH DVD±RW	9-in-1	None	Fixed 900W Platinum	1x Serial	None	USB / USB Optical	Windows 10 Pro 64	3-year, Onsite	No	Feb 25, 2024	01/18	
30BE007Uxx	ThinkStation P520	Russia	Xeon W-2133 6C/3.6GHz/8.25MB/140W/DDR4-2666	Open	1x NVIDIA Quadro P4000 8GB	2x 16GB RDIMM DDR4-2666 ECC	Integrated Intel SATA	None	1x 1TB HDD 7.2K 3.5" SATA6Gbps	1x 512GB SSD M.2 PCIe Opal, Onboard	1x HH DVD±RW	9-in-1	None	Fixed 900W Platinum	1x Serial, 1x Internal USB 3.0	4-digit LED	USB / USB Optical	Windows 10 Pro 64	3-year, Onsite	No	May 3, 2024	04/18
30BE0070xx	ThinkStation P520	Russia	Xeon W-2123 4C/3.6GHz/8.25MB/120W/DDR4-2666	Open	1x 16GB RDIMM DDR4-2666 ECC	Integrated Intel SATA	None	1x 2TB HDD 7.2K 3.5" SATA6Gbps	1x 512GB SSD M.2 PCIe Opal, Onboard	1x HH DVD±RW	9-in-1	None	Fixed 900W Platinum	1x Serial	None	USB / USB Optical	Windows 10 Pro 64	3-year, Onsite	No	Feb 25, 2024	01/18	
30BE0071xx	ThinkStation P520	Russia	Xeon W-2125 4C/4.0GHz/8.25MB/120W/DDR4-2666	Open	1x 8GB RDIMM DDR4-2666 ECC	Integrated Intel SATA	None	None	1x 256GB SSD M.2 PCIe Opal, Onboard	1x HH DVD±RW	9-in-1	None	Fixed 900W Platinum	1x Serial	None	USB / USB Optical	Windows 10 Pro 64	3-year, Onsite	No	Feb 25, 2024	01/18	
30BE006Xxx	ThinkStation P520	Russia	Xeon W-2133 6C/3.6GHz/8.25MB/140W/DDR4-2666	Open	1x NVIDIA Quadro P4000 8GB	1x 32GB RDIMM DDR4-2666 ECC	Integrated Intel SATA	None	1x 256GB SSD 2.5" SATA6Gbps Opal, 1x 1TB HDD 7.2K 3.5" SATA6Gbps	None	1x HH DVD±RW	9-in-1	None	Fixed 900W Platinum	1x Serial	None	USB / USB Optical	Windows 10 Pro 64	3-year, Onsite	No	Feb 25, 2024	01/18
30BE006Rxx	ThinkStation P520	Russia	Xeon W-2125 4C/4.0GHz/8.25MB/120W/DDR4-2666	Open	1x 8GB RDIMM DDR4-2666 ECC	Integrated Intel SATA	None	1x 512GB SSD 2.5" SATA6Gbps Opal	None	1x HH DVD±RW	9-in-1	None	Fixed 900W Platinum	1x Serial	None	USB / USB Optical	Windows 10 Pro 64	3-year, Onsite	No	Feb 25, 2024	01/18	
30BE006Pxx	ThinkStation P520	Russia	Xeon W-2125 4C/4.0GHz/8.25MB/120W/DDR4-2666	Open	1x 8GB RDIMM DDR4-2666 ECC	Integrated Intel SATA	None	1x 1TB HDD 7.2K 3.5" SATA6Gbps	None	1x HH DVD±RW	9-in-1	None	Fixed 900W Platinum	1x Serial	None	USB / USB Optical	Windows 10 Pro 64	3-year, Onsite	No	Feb 25, 2024	01/18	

Model	Product	Region	Processor	Graphics	Memory	Storage Controller	M.2 RAID Upgrade	Disks	M.2 Drives	Optical	Media Reader	Additional Networking	Power Supply	Optional Ports	Front Diagnostic LED	Keyboard / Mouse	Operating System	Warranty	Global	End of Support	Ann Date (mm/yy)
30BE006Txx	ThinkStation P520	Russia	Xeon W-2133 6C/3.6GHz/8.25MB/140W/DDR4-2666	Open	1x 16GB RDIMM DDR4-2666 ECC	Integrated Intel SATA	None	1x 512GB SSD 2.5" SATA6Gbps Opal	None	1x HH DVD±RW	9-in-1	None	Fixed 900W Platinum	1x Serial	None	USB / USB Optical	Windows 10 Pro 64	3-year, Onsite	No	Feb 25, 2024	01/18
30BE0018xx	ThinkStation P520	Russia	Xeon W-2133 6C/3.6GHz/8.25MB/140W/DDR4-2666	Open	1x 16GB RDIMM DDR4-2666 ECC	Integrated Intel SATA	None	2x 1TB HDD 7.2K 3.5" SATA6Gbps	None	1x 9.0mm DVD±RW	15-in-1	None	Fixed 690W Platinum	1x Front eSATA	None	USB / USB Optical	Windows 10 Pro 64	3-year, Onsite	No	Feb 25, 2024	01/18
30BE0030xx	ThinkStation P520	Russia	Xeon W-2133 6C/3.6GHz/8.25MB/140W/DDR4-2666	Open	1x 16GB RDIMM DDR4-2666 ECC	Integrated Intel SATA	None	1x 256GB SSD 2.5" SATA6Gbps Opal	None	1x HH DVD±RW	9-in-1	None	Fixed 690W Platinum	1x Serial	None	USB / USB Optical	Windows 10 DG Windows 7 Pro 64	3-year, Onsite	No	Feb 25, 2024	01/18
30BE0031xx	ThinkStation P520	Russia	Xeon W-2133 6C/3.6GHz/8.25MB/140W/DDR4-2666	Open	1x 16GB RDIMM DDR4-2666 ECC	Integrated Intel SATA	None	1x 256GB SSD 2.5" SATA6Gbps Opal	None	1x HH DVD±RW	9-in-1	None	Fixed 690W Platinum	1x Serial	None	USB / USB Optical	Windows 10 DG Windows 7 Pro 64	3-year, Onsite	No	Feb 25, 2024	01/18
30BE001Vxx	ThinkStation P520	Russia	Xeon W-2123 4C/3.6GHz/8.25MB/120W/DDR4-2666	Open	1x 8GB RDIMM DDR4-2666 ECC	Integrated Intel SATA	None	1x 256GB SSD 2.5" SATA6Gbps Opal	None	1x HH DVD±RW	9-in-1	None	Fixed 690W Platinum	1x Serial	None	USB / USB Optical	Windows 10 DG Windows 7 Pro 64	3-year, Onsite	No	Feb 25, 2024	01/18
30BE001Wxx	ThinkStation P520	Russia	Xeon W-2123 4C/3.6GHz/8.25MB/120W/DDR4-2666	Open	1x 8GB RDIMM DDR4-2666 ECC	Integrated Intel SATA	None	1x 256GB SSD 2.5" SATA6Gbps Opal	None	1x HH DVD±RW	9-in-1	None	Fixed 690W Platinum	1x Serial	None	USB / USB Optical	Windows 10 DG Windows 7 Pro 64	3-year, Onsite	No	Feb 25, 2024	01/18
30BE0013xx	ThinkStation P520	Russia	Xeon W-2125 4C/4.0GHz/8.25MB/120W/DDR4-2666	Open	1x 8GB RDIMM DDR4-2666 ECC	Integrated Intel SATA	None	None	1x 256GB SSD M.2 PCIe Opal, Onboard	1x HH DVD±RW	9-in-1	None	Fixed 690W Platinum	1x Serial	None	USB / USB Optical	Windows 10 Pro 64	3-year, Onsite	No	Feb 25, 2024	01/18
30BE0012xx	ThinkStation P520	Russia	Xeon W-2123 4C/3.6GHz/8.25MB/120W/DDR4-2666	Open	1x 16GB RDIMM DDR4-2666 ECC	Integrated Intel SATA	None	1x 2TB SSD 2.5" SATA6Gbps Opal	1x 512GB SSD M.2 PCIe Opal, Onboard	1x HH DVD±RW	9-in-1	None	Fixed 690W Platinum	1x Serial	None	USB / USB Optical	Windows 10 Pro 64	3-year, Onsite	No	Feb 25, 2024	01/18

Model	Product	Region	Processor	Graphics	Memory	Storage Controller	M.2 RAID Upgrade	Disks	M.2 Drives	Optical	Media Reader	Additional Networking	Power Supply	Optional Ports	Front Diagnostic LED	Keyboard / Mouse	Operating System	Warranty	Global	End of Support	Ann Date (mm/yy)
30BE003PUS	ThinkStation P520	US	Xeon W-2145 8C/3.7GHz/11MB/140W/DDR4-2666	1x NVIDIA Quadro P4000 8GB	1x 16GB RDIMM DDR4-2666 ECC	Integrated Intel SATA	None	None	1x 512GB SSD M.2 PCIe Opal, Onboard	1x HH DVD±RW	9-in-1	None	Fixed 690W Platinum	None	None	USB / USB Optical	Windows 10 Pro 64	3-year, Onsite	No	Feb 25, 2024	01/18
30BE003QUS	ThinkStation P520	US	Xeon W-2123 4C/3.6GHz/8.25MB/120W/DDR4-2666	1x NVIDIA Quadro P2000 5GB	1x 16GB RDIMM DDR4-2666 ECC	Integrated Intel SATA	None	None	1x 512GB SSD M.2 PCIe Opal, Onboard	1x HH DVD±RW	9-in-1	None	Fixed 690W Platinum	None	None	USB / USB Optical	Windows 10 DG Windows 7 Pro 64	3-year, Onsite	No	Feb 25, 2024	01/18
30BE003RUS	ThinkStation P520	US	Xeon W-2133 6C/3.6GHz/8.25MB/140W/DDR4-2666	1x NVIDIA Quadro P1000 4GB	1x 16GB RDIMM DDR4-2666 ECC	Integrated Intel SATA	None	None	1x 512GB SSD M.2 PCIe Opal, Onboard	1x HH DVD±RW	9-in-1	None	Fixed 690W Platinum	None	None	USB / USB Optical	Windows 10 Pro 64	3-year, Onsite	No	Feb 25, 2024	01/18
30BE003SUS	ThinkStation P520	US	Xeon W-2123 4C/3.6GHz/8.25MB/120W/DDR4-2666	1x NVIDIA Quadro P600 2GB	1x 8GB RDIMM DDR4-2666 ECC	Integrated Intel SATA	None	1x 1TB HDD 7.2K 3.5" SATA6Gbps	None	1x HH DVD±RW	9-in-1	None	Fixed 690W Platinum	None	None	USB / USB Optical	Windows 10 Pro 64	3-year, Onsite	No	Feb 25, 2024	01/18
30BE003TUS	ThinkStation P520	US	Xeon W-2133 6C/3.6GHz/8.25MB/140W/DDR4-2666	1x NVIDIA Quadro P2000 5GB	1x 8GB RDIMM DDR4-2666 ECC	Integrated Intel SATA	None	1x 1TB HDD 7.2K 3.5" SATA6Gbps	None	1x HH DVD±RW	9-in-1	None	Fixed 690W Platinum	None	None	USB / USB Optical	Windows 10 Pro 64	3-year, Onsite	No	Feb 25, 2024	01/18
30BE003UUS	ThinkStation P520	US	Xeon W-2145 8C/3.7GHz/11MB/140W/DDR4-2666	Open	1x 16GB RDIMM DDR4-2666 ECC	Integrated Intel SATA	None	None	1x 512GB SSD M.2 PCIe Opal, Onboard	1x HH DVD±RW	9-in-1	None	Fixed 690W Platinum	None	None	USB / USB Optical	Windows 10 Pro 64	3-year, Onsite	No	Feb 25, 2024	01/18
30BE003VUS	ThinkStation P520	US	Xeon W-2104 4C/3.2GHz/8.25MB/120W/DDR4-2400	Open	1x 16GB RDIMM DDR4-2666 ECC	Integrated Intel SATA	None	None	1x 512GB SSD M.2 PCIe Opal, Onboard	1x HH DVD±RW	9-in-1	None	Fixed 690W Platinum	None	None	USB / USB Optical	Windows 10 DG Windows 7 Pro 64	3-year, Onsite	No	Feb 25, 2024	01/18
30BE003WUS	ThinkStation P520	US	Xeon W-2155 10C/3.3GHz/13.75MB/140W/DDR4-2666	1x NVIDIA Quadro P2000 5GB	1x 8GB RDIMM DDR4-2666 ECC	Integrated Intel SATA	None	1x 1TB HDD 7.2K 3.5" SATA6Gbps	None	1x HH DVD±RW	9-in-1	None	Fixed 690W Platinum	None	None	USB / USB Optical	Windows 10 Pro 64	3-year, Onsite	No	Feb 25, 2024	01/18

Model	Product	Region	Processor	Graphics	Memory	Storage Controller	M.2 RAID Upgrade	Disks	M.2 Drives	Optical	Media Reader	Additional Networking	Power Supply	Optional Ports	Front Diagnostic LED	Keyboard / Mouse	Operating System	Warranty	Global	End of Support	Ann Date (mm/yy)
30BE003XUS	ThinkStation P520	US	Xeon W-2135 6C/3.7GHz/8.25MB/140W/DDR4-2666	Open	1x 16GB RDIMM DDR4-2666 ECC	Integrated Intel SATA	None	None	1x 512GB SSD M.2 PCIe Opal, Onboard	1x HH DVD±RW	9-in-1	None	Fixed 690W Platinum	None	None	USB / USB Optical	Windows 10 Pro 64	3-year, Onsite	No	Feb 25, 2024	01/18
30BE003YUS	ThinkStation P520	US	Xeon W-2123 4C/3.6GHz/8.25MB/120W/DDR4-2666	1x NVIDIA Quadro P1000 4GB	1x 8GB RDIMM DDR4-2666 ECC	Integrated Intel SATA	None	1x 1TB HDD 7.2K 3.5" SATA6Gbps	None	1x HH DVD±RW	9-in-1	None	Fixed 690W Platinum	None	None	USB / USB Optical	Windows 10 Pro 64	3-year, Onsite	No	Feb 25, 2024	01/18
30BE0040US	ThinkStation P520	US	Xeon W-2125 4C/4.0GHz/8.25MB/120W/DDR4-2666	1x NVIDIA Quadro P600 2GB	1x 8GB RDIMM DDR4-2666 ECC	Integrated Intel SATA	None	1x 1TB HDD 7.2K 3.5" SATA6Gbps	None	1x HH DVD±RW	9-in-1	None	Fixed 690W Platinum	None	None	USB / USB Optical	Windows 10 Pro 64	3-year, Onsite	No	Feb 25, 2024	01/18
30BE0041US	ThinkStation P520	US	Xeon W-2135 6C/3.7GHz/8.25MB/140W/DDR4-2666	1x NVIDIA Quadro P5000 16GB	1x 16GB RDIMM DDR4-2666 ECC	Integrated Intel SATA	None	None	1x 512GB SSD M.2 PCIe Opal, Onboard	1x HH DVD±RW	9-in-1	None	Fixed 690W Platinum	None	None	USB / USB Optical	Windows 10 DG Windows 7 Pro 64	3-year, Onsite	No	Feb 25, 2024	01/18
30BE0042US	ThinkStation P520	US	Xeon W-2125 4C/4.0GHz/8.25MB/120W/DDR4-2666	1x NVIDIA Quadro P1000 4GB	1x 16GB RDIMM DDR4-2666 ECC	Integrated Intel SATA	None	None	1x 512GB SSD M.2 PCIe Opal, Onboard	1x HH DVD±RW	9-in-1	None	Fixed 690W Platinum	None	None	USB / USB Optical	Windows 10 Pro 64	3-year, Onsite	No	Feb 25, 2024	01/18
30BE0043US	ThinkStation P520	US	Xeon W-2125 4C/4.0GHz/8.25MB/120W/DDR4-2666	1x NVIDIA Quadro P4000 8GB	1x 16GB RDIMM DDR4-2666 ECC	Integrated Intel SATA	None	None	1x 512GB SSD M.2 PCIe Opal, Onboard	1x HH DVD±RW	9-in-1	None	Fixed 690W Platinum	None	None	USB / USB Optical	Windows 10 Pro 64	3-year, Onsite	No	Feb 25, 2024	01/18
30BE0044US	ThinkStation P520	US	Xeon W-2125 4C/4.0GHz/8.25MB/120W/DDR4-2666	1x NVIDIA Quadro P4000 8GB	1x 16GB RDIMM DDR4-2666 ECC	Integrated Intel SATA	None	None	1x 512GB SSD M.2 PCIe Opal, Onboard	1x HH DVD±RW	9-in-1	None	Fixed 690W Platinum	None	None	USB / USB Optical	Windows 10 DG Windows 7 Pro 64	3-year, Onsite	No	Feb 25, 2024	01/18
30BE0045US	ThinkStation P520	US	Xeon W-2135 6C/3.7GHz/8.25MB/140W/DDR4-2666	1x NVIDIA Quadro P2000 5GB	1x 8GB RDIMM DDR4-2666 ECC	Integrated Intel SATA	None	1x 1TB HDD 7.2K 3.5" SATA6Gbps	None	1x HH DVD±RW	9-in-1	None	Fixed 690W Platinum	None	None	USB / USB Optical	Windows 10 DG Windows 7 Pro 64	3-year, Onsite	No	Feb 25, 2024	01/18

Model	Product	Region	Processor	Graphics	Memory	Storage Controller	M.2 RAID Upgrade	Disks	M.2 Drives	Optical	Media Reader	Additional Networking	Power Supply	Optional Ports	Front Diagnostic LED	Keyboard / Mouse	Operating System	Warranty	Global	End of Support	Ann Date (mm/yy)
30BE0046US	ThinkStation P520	US	Xeon W-2123 4C/3.6GHz/8.25MB/120W/DDR4-2666	1x NVIDIA Quadro P2000 5GB	1x 8GB RDIMM DDR4-2666 ECC	Integrated Intel SATA	None	1x 1TB HDD 7.2K 3.5" SATA6Gbps	None	1x HH DVD±RW	9-in-1	None	Fixed 690W Platinum	None	None	USB / USB Optical	Windows 10 DG Windows 7 Pro 64	3-year, Onsite	No	Feb 25, 2024	01/18
30BE0047US	ThinkStation P520	US	Xeon W-2133 6C/3.6GHz/8.25MB/140W/DDR4-2666	1x NVIDIA Quadro P1000 4GB	1x 16GB RDIMM DDR4-2666 ECC	Integrated Intel SATA	None	None	1x 512GB SSD M.2 PCIe Opal, Onboard	1x HH DVD±RW	9-in-1	None	Fixed 690W Platinum	None	None	USB / USB Optical	Windows 10 DG Windows 7 Pro 64	3-year, Onsite	No	Feb 25, 2024	01/18
30BE0048US	ThinkStation P520	US	Xeon W-2155 10C/3.3GHz/13.75MB/140W/DDR4-2666	Open	1x 16GB RDIMM DDR4-2666 ECC	Integrated Intel SATA	None	None	1x 512GB SSD M.2 PCIe Opal, Onboard	1x HH DVD±RW	9-in-1	None	Fixed 690W Platinum	None	None	USB / USB Optical	Windows 10 DG Windows 7 Pro 64	3-year, Onsite	No	Feb 25, 2024	01/18
30BE0049US	ThinkStation P520	US	Xeon W-2135 6C/3.7GHz/8.25MB/140W/DDR4-2666	1x NVIDIA Quadro P5000 16GB	1x 16GB RDIMM DDR4-2666 ECC	Integrated Intel SATA	None	None	1x 512GB SSD M.2 PCIe Opal, Onboard	1x HH DVD±RW	9-in-1	None	Fixed 690W Platinum	None	None	USB / USB Optical	Windows 10 Pro 64	3-year, Onsite	No	Feb 25, 2024	01/18
30BE004AUS	ThinkStation P520	US	Xeon W-2135 6C/3.7GHz/8.25MB/140W/DDR4-2666	1x NVIDIA Quadro P4000 8GB	1x 16GB RDIMM DDR4-2666 ECC	Integrated Intel SATA	None	None	1x 512GB SSD M.2 PCIe Opal, Onboard	1x HH DVD±RW	9-in-1	None	Fixed 690W Platinum	None	None	USB / USB Optical	Windows 10 DG Windows 7 Pro 64	3-year, Onsite	No	Feb 25, 2024	01/18
30BE004BUS	ThinkStation P520	US	Xeon W-2145 8C/3.7GHz/11MB/140W/DDR4-2666	Open	1x 16GB RDIMM DDR4-2666 ECC	Integrated Intel SATA	None	None	1x 512GB SSD M.2 PCIe Opal, Onboard	1x HH DVD±RW	9-in-1	None	Fixed 690W Platinum	None	None	USB / USB Optical	Windows 10 DG Windows 7 Pro 64	3-year, Onsite	No	Feb 25, 2024	01/18
30BE004CUS	ThinkStation P520	US	Xeon W-2125 4C/4.0GHz/8.25MB/120W/DDR4-2666	1x NVIDIA Quadro P2000 5GB	1x 8GB RDIMM DDR4-2666 ECC	Integrated Intel SATA	None	1x 1TB HDD 7.2K 3.5" SATA6Gbps	None	1x HH DVD±RW	9-in-1	None	Fixed 690W Platinum	None	None	USB / USB Optical	Windows 10 DG Windows 7 Pro 64	3-year, Onsite	No	Feb 25, 2024	01/18
30BE004DUS	ThinkStation P520	US	Xeon W-2125 4C/4.0GHz/8.25MB/120W/DDR4-2666	1x NVIDIA Quadro P600 2GB	1x 8GB RDIMM DDR4-2666 ECC	Integrated Intel SATA	None	1x 1TB HDD 7.2K 3.5" SATA6Gbps	None	1x HH DVD±RW	9-in-1	None	Fixed 690W Platinum	None	None	USB / USB Optical	Windows 10 DG Windows 7 Pro 64	3-year, Onsite	No	Feb 25, 2024	01/18

Model	Product	Region	Processor	Graphics	Memory	Storage Controller	M.2 RAID Upgrade	Disks	M.2 Drives	Optical	Media Reader	Additional Networking	Power Supply	Optional Ports	Front Diagnostic LED	Keyboard / Mouse	Operating System	Warranty	Global	End of Support	Ann Date (mm/yy)
30BE004EUS	ThinkStation P520	US	Xeon W-2155 10C/3.3GHz/13.75MB/140W/DDR4-2666	Open	1x 16GB RDIMM DDR4-2666 ECC	Integrated Intel SATA	None	None	1x 512GB SSD M.2 PCIe Opal, Onboard	1x HH DVD±RW	9-in-1	None	Fixed 690W Platinum	None	None	USB / USB Optical	Windows 10 Pro 64	3-year, Onsite	No	Feb 25, 2024	01/18
30BE004FUS	ThinkStation P520	US	Xeon W-2123 4C/3.6GHz/8.25MB/120W/DDR4-2666	Open	1x 8GB RDIMM DDR4-2666 ECC	Integrated Intel SATA	None	None	1x 256GB SSD M.2 PCIe Opal, Onboard	1x HH DVD±RW	9-in-1	None	Fixed 690W Platinum	None	None	USB / USB Optical	Windows 10 Pro 64	3-year, Onsite	No	Feb 25, 2024	01/18
30BE004GUS	ThinkStation P520	US	Xeon W-2133 6C/3.6GHz/8.25MB/140W/DDR4-2666	1x NVIDIA Quadro P5000 16GB	1x 16GB RDIMM DDR4-2666 ECC	Integrated Intel SATA	None	None	1x 512GB SSD M.2 PCIe Opal, Onboard	1x HH DVD±RW	9-in-1	None	Fixed 690W Platinum	None	None	USB / USB Optical	Windows 10 DG Windows 7 Pro 64	3-year, Onsite	No	Feb 25, 2024	01/18
30BE004HUS	ThinkStation P520	US	Xeon W-2133 6C/3.6GHz/8.25MB/140W/DDR4-2666	1x NVIDIA Quadro P4000 8GB	1x 16GB RDIMM DDR4-2666 ECC	Integrated Intel SATA	None	None	1x 512GB SSD M.2 PCIe Opal, Onboard	1x HH DVD±RW	9-in-1	None	Fixed 690W Platinum	None	None	USB / USB Optical	Windows 10 Pro 64	3-year, Onsite	No	Feb 25, 2024	01/18
30BE004JUS	ThinkStation P520	US	Xeon W-2104 4C/3.2GHz/8.25MB/120W/DDR4-2400	1x NVIDIA Quadro P600 2GB	1x 8GB RDIMM DDR4-2666 ECC	Integrated Intel SATA	None	1x 1TB HDD 7.2K 3.5" SATA6Gbps	None	1x HH DVD±RW	9-in-1	None	Fixed 690W Platinum	None	None	USB / USB Optical	Windows 10 Pro 64	3-year, Onsite	No	Feb 25, 2024	01/18
30BE004KUS	ThinkStation P520	US	Xeon W-2125 4C/4.0GHz/8.25MB/120W/DDR4-2666	Open	1x 8GB RDIMM DDR4-2666 ECC	Integrated Intel SATA	None	1x 1TB HDD 7.2K 3.5" SATA6Gbps	None	1x HH DVD±RW	9-in-1	None	Fixed 690W Platinum	None	None	USB / USB Optical	Windows 10 DG Windows 7 Pro 64	3-year, Onsite	No	Feb 25, 2024	01/18
30BE004LUS	ThinkStation P520	US	Xeon W-2145 8C/3.7GHz/11MB/140W/DDR4-2666	Open	1x 8GB RDIMM DDR4-2666 ECC	Integrated Intel SATA	None	1x 1TB HDD 7.2K 3.5" SATA6Gbps	None	1x HH DVD±RW	9-in-1	None	Fixed 690W Platinum	None	None	USB / USB Optical	Windows 10 DG Windows 7 Pro 64	3-year, Onsite	No	Feb 25, 2024	01/18
30BE004MUS	ThinkStation P520	US	Xeon W-2145 8C/3.7GHz/11MB/140W/DDR4-2666	Open	1x 8GB RDIMM DDR4-2666 ECC	Integrated Intel SATA	None	1x 1TB HDD 7.2K 3.5" SATA6Gbps	None	1x HH DVD±RW	9-in-1	None	Fixed 690W Platinum	None	None	USB / USB Optical	Windows 10 Pro 64	3-year, Onsite	No	Feb 25, 2024	01/18

Model	Product	Region	Processor	Graphics	Memory	Storage Controller	M.2 RAID Upgrade	Disks	M.2 Drives	Optical	Media Reader	Additional Networking	Power Supply	Optional Ports	Front Diagnostic LED	Keyboard / Mouse	Operating System	Warranty	Global	End of Support	Ann Date (mm/yy)
30BE004NUS	ThinkStation P520	US	Xeon W-2145 8C/3.7GHz/11MB/140W/DDR4-2666	1x NVIDIA Quadro P2000 5GB	1x 8GB RDIMM DDR4-2666 ECC	Integrated Intel SATA	None	1x 1TB HDD 7.2K 3.5" SATA6Gbps	None	1x HH DVD±RW	9-in-1	None	Fixed 690W Platinum	None	None	USB / USB Optical	Windows 10 DG Windows 7 Pro 64	3-year, Onsite	No	Feb 25, 2024	01/18
30BE004PUS	ThinkStation P520	US	Xeon W-2125 4C/4.0GHz/8.25MB/120W/DDR4-2666	1x NVIDIA Quadro P2000 5GB	1x 16GB RDIMM DDR4-2666 ECC	Integrated Intel SATA	None	None	1x 512GB SSD M.2 PCIe Opal, Onboard	1x HH DVD±RW	9-in-1	None	Fixed 690W Platinum	None	None	USB / USB Optical	Windows 10 DG Windows 7 Pro 64	3-year, Onsite	No	Feb 25, 2024	01/18
30BE004QUS	ThinkStation P520	US	Xeon W-2133 6C/3.6GHz/8.25MB/140W/DDR4-2666	1x NVIDIA Quadro P2000 5GB	1x 16GB RDIMM DDR4-2666 ECC	Integrated Intel SATA	None	None	1x 512GB SSD M.2 PCIe Opal, Onboard	1x HH DVD±RW	9-in-1	None	Fixed 690W Platinum	None	None	USB / USB Optical	Windows 10 Pro 64	3-year, Onsite	No	Feb 25, 2024	01/18
30BE004RUS	ThinkStation P520	US	Xeon W-2135 6C/3.7GHz/8.25MB/140W/DDR4-2666	1x NVIDIA Quadro P4000 8GB	1x 16GB RDIMM DDR4-2666 ECC	Integrated Intel SATA	None	None	1x 512GB SSD M.2 PCIe Opal, Onboard	1x HH DVD±RW	9-in-1	None	Fixed 690W Platinum	None	None	USB / USB Optical	Windows 10 Pro 64	3-year, Onsite	No	Feb 25, 2024	01/18
30BE004SUS	ThinkStation P520	US	Xeon W-2155 10C/3.3GHz/13.75MB/140W/DDR4-2666	1x NVIDIA Quadro P2000 5GB	1x 16GB RDIMM DDR4-2666 ECC	Integrated Intel SATA	None	None	1x 512GB SSD M.2 PCIe Opal, Onboard	1x HH DVD±RW	9-in-1	None	Fixed 690W Platinum	None	None	USB / USB Optical	Windows 10 Pro 64	3-year, Onsite	No	Feb 25, 2024	01/18
30BE004TUS	ThinkStation P520	US	Xeon W-2123 4C/3.6GHz/8.25MB/120W/DDR4-2666	1x NVIDIA Quadro P1000 4GB	1x 16GB RDIMM DDR4-2666 ECC	Integrated Intel SATA	None	None	1x 512GB SSD M.2 PCIe Opal, Onboard	1x HH DVD±RW	9-in-1	None	Fixed 690W Platinum	None	None	USB / USB Optical	Windows 10 DG Windows 7 Pro 64	3-year, Onsite	No	Feb 25, 2024	01/18
30BE004UUS	ThinkStation P520	US	Xeon W-2133 6C/3.6GHz/8.25MB/140W/DDR4-2666	Open	1x 8GB RDIMM DDR4-2666 ECC	Integrated Intel SATA	None	1x 1TB HDD 7.2K 3.5" SATA6Gbps	None	1x HH DVD±RW	9-in-1	None	Fixed 690W Platinum	None	None	USB / USB Optical	Windows 10 Pro 64	3-year, Onsite	No	Feb 25, 2024	01/18
30BE004VUS	ThinkStation P520	US	Xeon W-2125 4C/4.0GHz/8.25MB/120W/DDR4-2666	Open	1x 16GB RDIMM DDR4-2666 ECC	Integrated Intel SATA	None	None	1x 512GB SSD M.2 PCIe Opal, Onboard	1x HH DVD±RW	9-in-1	None	Fixed 690W Platinum	None	None	USB / USB Optical	Windows 10 Pro 64	3-year, Onsite	No	Feb 25, 2024	01/18

Model	Product	Region	Processor	Graphics	Memory	Storage Controller	M.2 RAID Upgrade	Disks	M.2 Drives	Optical	Media Reader	Additional Networking	Power Supply	Optional Ports	Front Diagnostic LED	Keyboard / Mouse	Operating System	Warranty	Global	End of Support	Ann Date (mm/yy)
30BE004WUS	ThinkStation P520	US	Xeon W-2102 4C/2.9GHz/8.25MB/120W/DDR4-2400	Open	1x 8GB RDIMM DDR4-2666 ECC	Integrated Intel SATA	None	1x 1TB HDD 7.2K 3.5" SATA6Gbps	None	1x HH DVD±RW	9-in-1	None	Fixed 690W Platinum	None	None	USB / USB Optical	Windows 10 DG Windows 7 Pro 64	3-year, Onsite	No	Feb 25, 2024	01/18
30BE004XUS	ThinkStation P520	US	Xeon W-2123 4C/3.6GHz/8.25MB/120W/DDR4-2666	Open	1x 8GB RDIMM DDR4-2666 ECC	Integrated Intel SATA	None	None	1x 256GB SSD M.2 PCIe Opal, Onboard	1x HH DVD±RW	9-in-1	None	Fixed 690W Platinum	None	None	USB / USB Optical	Windows 10 DG Windows 7 Pro 64	3-year, Onsite	No	Feb 25, 2024	01/18
30BE004YUS	ThinkStation P520	US	Xeon W-2123 4C/3.6GHz/8.25MB/120W/DDR4-2666	Open	1x 16GB RDIMM DDR4-2666 ECC	Integrated Intel SATA	None	None	1x 512GB SSD M.2 PCIe Opal, Onboard	1x HH DVD±RW	9-in-1	None	Fixed 690W Platinum	None	None	USB / USB Optical	Windows 10 Pro 64	3-year, Onsite	No	Feb 25, 2024	01/18
30BE0050US	ThinkStation P520	US	Xeon W-2125 4C/4.0GHz/8.25MB/120W/DDR4-2666	Open	1x 8GB RDIMM DDR4-2666 ECC	Integrated Intel SATA	None	None	1x 256GB SSD M.2 PCIe Opal, Onboard	1x HH DVD±RW	9-in-1	None	Fixed 690W Platinum	None	None	USB / USB Optical	Windows 10 Pro 64	3-year, Onsite	No	Feb 25, 2024	01/18
30BE0051US	ThinkStation P520	US	Xeon W-2155 10C/3.3GHz/13.75MB/140W/DDR4-2666	1x NVIDIA Quadro P4000 8GB	1x 16GB RDIMM DDR4-2666 ECC	Integrated Intel SATA	None	None	1x 512GB SSD M.2 PCIe Opal, Onboard	1x HH DVD±RW	9-in-1	None	Fixed 690W Platinum	None	None	USB / USB Optical	Windows 10 Pro 64	3-year, Onsite	No	Feb 25, 2024	01/18
30BE0052US	ThinkStation P520	US	Xeon W-2133 6C/3.6GHz/8.25MB/140W/DDR4-2666	1x NVIDIA Quadro P1000 4GB	1x 8GB RDIMM DDR4-2666 ECC	Integrated Intel SATA	None	1x 1TB HDD 7.2K 3.5" SATA6Gbps	None	1x HH DVD±RW	9-in-1	None	Fixed 690W Platinum	None	None	USB / USB Optical	Windows 10 Pro 64	3-year, Onsite	No	Feb 25, 2024	01/18
30BE0053US	ThinkStation P520	US	Xeon W-2135 6C/3.7GHz/8.25MB/140W/DDR4-2666	Open	1x 16GB RDIMM DDR4-2666 ECC	Integrated Intel SATA	None	None	1x 512GB SSD M.2 PCIe Opal, Onboard	1x HH DVD±RW	9-in-1	None	Fixed 690W Platinum	None	None	USB / USB Optical	Windows 10 DG Windows 7 Pro 64	3-year, Onsite	No	Feb 25, 2024	01/18
30BE0054US	ThinkStation P520	US	Xeon W-2145 8C/3.7GHz/11MB/140W/DDR4-2666	1x NVIDIA Quadro P2000 5GB	1x 16GB RDIMM DDR4-2666 ECC	Integrated Intel SATA	None	None	1x 512GB SSD M.2 PCIe Opal, Onboard	1x HH DVD±RW	9-in-1	None	Fixed 690W Platinum	None	None	USB / USB Optical	Windows 10 Pro 64	3-year, Onsite	No	Feb 25, 2024	01/18

Model	Product	Region	Processor	Graphics	Memory	Storage Controller	M.2 RAID Upgrade	Disks	M.2 Drives	Optical	Media Reader	Additional Networking	Power Supply	Optional Ports	Front Diagnostic LED	Keyboard / Mouse	Operating System	Warranty	Global	End of Support	Ann Date (mm/yy)
30BE0055US	ThinkStation P520	US	Xeon W-2145 8C/3.7GHz/11MB/140W/DDR4-2666	1x NVIDIA Quadro P5000 16GB	1x 16GB RDIMM DDR4-2666 ECC	Integrated Intel SATA	None	None	1x 512GB SSD M.2 PCIe Opal, Onboard	1x HH DVD±RW	9-in-1	None	Fixed 690W Platinum	None	None	USB / USB Optical	Windows 10 DG Windows 7 Pro 64	3-year, Onsite	No	Feb 25, 2024	01/18
30BE0056US	ThinkStation P520	US	Xeon W-2155 10C/3.3GHz/13.75MB/140W/DDR4-2666	1x NVIDIA Quadro P2000 5GB	1x 8GB RDIMM DDR4-2666 ECC	Integrated Intel SATA	None	1x 1TB HDD 7.2K 3.5" SATA6Gbps	None	1x HH DVD±RW	9-in-1	None	Fixed 690W Platinum	None	None	USB / USB Optical	Windows 10 DG Windows 7 Pro 64	3-year, Onsite	No	Feb 25, 2024	01/18
30BE0057US	ThinkStation P520	US	Xeon W-2125 4C/4.0GHz/8.25MB/120W/DDR4-2666	Open	1x 8GB RDIMM DDR4-2666 ECC	Integrated Intel SATA	None	None	1x 256GB SSD M.2 PCIe Opal, Onboard	1x HH DVD±RW	9-in-1	None	Fixed 690W Platinum	None	None	USB / USB Optical	Windows 10 DG Windows 7 Pro 64	3-year, Onsite	No	Feb 25, 2024	01/18
30BE0058US	ThinkStation P520	US	Xeon W-2104 4C/3.2GHz/8.25MB/120W/DDR4-2400	1x NVIDIA Quadro P600 2GB	1x 8GB RDIMM DDR4-2666 ECC	Integrated Intel SATA	None	1x 1TB HDD 7.2K 3.5" SATA6Gbps	None	1x HH DVD±RW	9-in-1	None	Fixed 690W Platinum	None	None	USB / USB Optical	Windows 10 DG Windows 7 Pro 64	3-year, Onsite	No	Feb 25, 2024	01/18
30BE0059US	ThinkStation P520	US	Xeon W-2102 4C/2.9GHz/8.25MB/120W/DDR4-2400	Open	1x 8GB RDIMM DDR4-2666 ECC	Integrated Intel SATA	None	1x 1TB HDD 7.2K 3.5" SATA6Gbps	None	1x HH DVD±RW	9-in-1	None	Fixed 690W Platinum	None	None	USB / USB Optical	Windows 10 Pro 64	3-year, Onsite	No	Feb 25, 2024	01/18
30BE005AUS	ThinkStation P520	US	Xeon W-2145 8C/3.7GHz/11MB/140W/DDR4-2666	1x NVIDIA Quadro P5000 16GB	1x 16GB RDIMM DDR4-2666 ECC	Integrated Intel SATA	None	None	1x 512GB SSD M.2 PCIe Opal, Onboard	1x HH DVD±RW	9-in-1	None	Fixed 690W Platinum	None	None	USB / USB Optical	Windows 10 Pro 64	3-year, Onsite	No	Feb 25, 2024	01/18
30BE005BUS	ThinkStation P520	US	Xeon W-2145 8C/3.7GHz/11MB/140W/DDR4-2666	1x NVIDIA Quadro P4000 8GB	1x 16GB RDIMM DDR4-2666 ECC	Integrated Intel SATA	None	None	1x 512GB SSD M.2 PCIe Opal, Onboard	1x HH DVD±RW	9-in-1	None	Fixed 690W Platinum	None	None	USB / USB Optical	Windows 10 DG Windows 7 Pro 64	3-year, Onsite	No	Feb 25, 2024	01/18
30BE005CUS	ThinkStation P520	US	Xeon W-2125 4C/4.0GHz/8.25MB/120W/DDR4-2666	1x NVIDIA Quadro P2000 5GB	1x 16GB RDIMM DDR4-2666 ECC	Integrated Intel SATA	None	None	1x 512GB SSD M.2 PCIe Opal, Onboard	1x HH DVD±RW	9-in-1	None	Fixed 690W Platinum	None	None	USB / USB Optical	Windows 10 Pro 64	3-year, Onsite	No	Feb 25, 2024	01/18

Model	Product	Region	Processor	Graphics	Memory	Storage Controller	M.2 RAID Upgrade	Disks	M.2 Drives	Optical	Media Reader	Additional Networking	Power Supply	Optional Ports	Front Diagnostic LED	Keyboard / Mouse	Operating System	Warranty	Global	End of Support	Ann Date (mm/yy)
30BE005DUS	ThinkStation P520	US	Xeon W-2133 6C/3.6GHz/8.25MB/140W/DDR4-2666	Open	1x 8GB RDIMM DDR4-2666 ECC	Integrated Intel SATA	None	1x 1TB HDD 7.2K 3.5" SATA6Gbps	None	1x HH DVD±RW	9-in-1	None	Fixed 690W Platinum	None	None	USB / USB Optical	Windows 10 DG Windows 7 Pro 64	3-year, Onsite	No	Feb 25, 2024	01/18
30BE005EUS	ThinkStation P520	US	Xeon W-2133 6C/3.6GHz/8.25MB/140W/DDR4-2666	Open	1x 16GB RDIMM DDR4-2666 ECC	Integrated Intel SATA	None	None	1x 512GB SSD M.2 PCIe Opal, Onboard	1x HH DVD±RW	9-in-1	None	Fixed 690W Platinum	None	None	USB / USB Optical	Windows 10 DG Windows 7 Pro 64	3-year, Onsite	No	Feb 25, 2024	01/18
30BE005FUS	ThinkStation P520	US	Xeon W-2125 4C/4.0GHz/8.25MB/120W/DDR4-2666	Open	1x 16GB RDIMM DDR4-2666 ECC	Integrated Intel SATA	None	None	1x 512GB SSD M.2 PCIe Opal, Onboard	1x HH DVD±RW	9-in-1	None	Fixed 690W Platinum	None	None	USB / USB Optical	Windows 10 DG Windows 7 Pro 64	3-year, Onsite	No	Feb 25, 2024	01/18
30BE005GUS	ThinkStation P520	US	Xeon W-2133 6C/3.6GHz/8.25MB/140W/DDR4-2666	Open	1x 16GB RDIMM DDR4-2666 ECC	Integrated Intel SATA	None	None	1x 512GB SSD M.2 PCIe Opal, Onboard	1x HH DVD±RW	9-in-1	None	Fixed 690W Platinum	None	None	USB / USB Optical	Windows 10 Pro 64	3-year, Onsite	No	Feb 25, 2024	01/18
30BE005HUS	ThinkStation P520	US	Xeon W-2104 4C/3.2GHz/8.25MB/120W/DDR4-2400	Open	1x 8GB RDIMM DDR4-2666 ECC	Integrated Intel SATA	None	1x 1TB HDD 7.2K 3.5" SATA6Gbps	None	1x HH DVD±RW	9-in-1	None	Fixed 690W Platinum	None	None	USB / USB Optical	Windows 10 DG Windows 7 Pro 64	3-year, Onsite	No	Feb 25, 2024	01/18
30BE005JUS	ThinkStation P520	US	Xeon W-2125 4C/4.0GHz/8.25MB/120W/DDR4-2666	1x NVIDIA Quadro P1000 4GB	1x 8GB RDIMM DDR4-2666 ECC	Integrated Intel SATA	None	1x 1TB HDD 7.2K 3.5" SATA6Gbps	None	1x HH DVD±RW	9-in-1	None	Fixed 690W Platinum	None	None	USB / USB Optical	Windows 10 Pro 64	3-year, Onsite	No	Feb 25, 2024	01/18
30BE005KUS	ThinkStation P520	US	Xeon W-2155 10C/3.3GHz/13.75MB/140W/DDR4-2666	1x NVIDIA Quadro P4000 8GB	1x 16GB RDIMM DDR4-2666 ECC	Integrated Intel SATA	None	None	1x 512GB SSD M.2 PCIe Opal, Onboard	1x HH DVD±RW	9-in-1	None	Fixed 690W Platinum	None	None	USB / USB Optical	Windows 10 DG Windows 7 Pro 64	3-year, Onsite	No	Feb 25, 2024	01/18
30BE005LUS	ThinkStation P520	US	Xeon W-2135 6C/3.7GHz/8.25MB/140W/DDR4-2666	1x NVIDIA Quadro P2000 5GB	1x 8GB RDIMM DDR4-2666 ECC	Integrated Intel SATA	None	1x 1TB HDD 7.2K 3.5" SATA6Gbps	None	1x HH DVD±RW	9-in-1	None	Fixed 690W Platinum	None	None	USB / USB Optical	Windows 10 Pro 64	3-year, Onsite	No	Feb 25, 2024	01/18

Model	Product	Region	Processor	Graphics	Memory	Storage Controller	M.2 RAID Upgrade	Disks	M.2 Drives	Optical	Media Reader	Additional Networking	Power Supply	Optional Ports	Front Diagnostic LED	Keyboard / Mouse	Operating System	Warranty	Global	End of Support	Ann Date (mm/yy)
30BE005MUS	ThinkStation P520	US	Xeon W-2123 4C/3.6GHz/8.25MB/120W/DDR4-2666	1x NVIDIA Quadro P2000 5GB	1x 8GB RDIMM DDR4-2666 ECC	Integrated Intel SATA	None	1x 1TB HDD 7.2K 3.5" SATA6Gbps	None	1x HH DVD±RW	9-in-1	None	Fixed 690W Platinum	None	None	USB / USB Optical	Windows 10 Pro 64	3-year, Onsite	No	Feb 25, 2024	01/18
30BE005NUS	ThinkStation P520	US	Xeon W-2104 4C/3.2GHz/8.25MB/120W/DDR4-2400	Open	1x 16GB RDIMM DDR4-2666 ECC	Integrated Intel SATA	None	None	1x 256GB SSD M.2 PCIe Opal, Onboard	1x HH DVD±RW	9-in-1	None	Fixed 690W Platinum	None	None	USB / USB Optical	Windows 10 DG Windows 7 Pro 64	3-year, Onsite	No	Feb 25, 2024	01/18
30BE005PUS	ThinkStation P520	US	Xeon W-2125 4C/4.0GHz/8.25MB/120W/DDR4-2666	1x NVIDIA Quadro P1000 4GB	1x 8GB RDIMM DDR4-2666 ECC	Integrated Intel SATA	None	1x 1TB HDD 7.2K 3.5" SATA6Gbps	None	1x HH DVD±RW	9-in-1	None	Fixed 690W Platinum	None	None	USB / USB Optical	Windows 10 DG Windows 7 Pro 64	3-year, Onsite	No	Feb 25, 2024	01/18
30BE005QUS	ThinkStation P520	US	Xeon W-2104 4C/3.2GHz/8.25MB/120W/DDR4-2400	Open	1x 8GB RDIMM DDR4-2666 ECC	Integrated Intel SATA	None	1x 1TB HDD 7.2K 3.5" SATA6Gbps	None	1x HH DVD±RW	9-in-1	None	Fixed 690W Platinum	None	None	USB / USB Optical	Windows 10 Pro 64	3-year, Onsite	No	Feb 25, 2024	01/18
30BE005RUS	ThinkStation P520	US	Xeon W-2125 4C/4.0GHz/8.25MB/120W/DDR4-2666	1x NVIDIA Quadro P2000 5GB	1x 8GB RDIMM DDR4-2666 ECC	Integrated Intel SATA	None	1x 1TB HDD 7.2K 3.5" SATA6Gbps	None	1x HH DVD±RW	9-in-1	None	Fixed 690W Platinum	None	None	USB / USB Optical	Windows 10 Pro 64	3-year, Onsite	No	Feb 25, 2024	01/18
30BE005SUS	ThinkStation P520	US	Xeon W-2135 6C/3.7GHz/8.25MB/140W/DDR4-2666	Open	1x 8GB RDIMM DDR4-2666 ECC	Integrated Intel SATA	None	1x 1TB HDD 7.2K 3.5" SATA6Gbps	None	1x HH DVD±RW	9-in-1	None	Fixed 690W Platinum	None	None	USB / USB Optical	Windows 10 Pro 64	3-year, Onsite	No	Feb 25, 2024	01/18
30BE005TUS	ThinkStation P520	US	Xeon W-2155 10C/3.3GHz/13.75MB/140W/DDR4-2666	1x NVIDIA Quadro P2000 5GB	1x 16GB RDIMM DDR4-2666 ECC	Integrated Intel SATA	None	None	1x 512GB SSD M.2 PCIe Opal, Onboard	1x HH DVD±RW	9-in-1	None	Fixed 690W Platinum	None	None	USB / USB Optical	Windows 10 DG Windows 7 Pro 64	3-year, Onsite	No	Feb 25, 2024	01/18
30BE005UUS	ThinkStation P520	US	Xeon W-2133 6C/3.6GHz/8.25MB/140W/DDR4-2666	1x NVIDIA Quadro P2000 5GB	1x 8GB RDIMM DDR4-2666 ECC	Integrated Intel SATA	None	1x 1TB HDD 7.2K 3.5" SATA6Gbps	None	1x HH DVD±RW	9-in-1	None	Fixed 690W Platinum	None	None	USB / USB Optical	Windows 10 DG Windows 7 Pro 64	3-year, Onsite	No	Feb 25, 2024	01/18

Model	Product	Region	Processor	Graphics	Memory	Storage Controller	M.2 RAID Upgrade	Disks	M.2 Drives	Optical	Media Reader	Additional Networking	Power Supply	Optional Ports	Front Diagnostic LED	Keyboard / Mouse	Operating System	Warranty	Global	End of Support	Ann Date (mm/yy)
30BE005VUS	ThinkStation P520	US	Xeon W-2123 4C/3.6GHz/8.25MB/120W/DDR4-2666	1x NVIDIA Quadro P600 2GB	1x 8GB RDIMM DDR4-2666 ECC	Integrated Intel SATA	None	1x 1TB HDD 7.2K 3.5" SATA6Gbps	None	1x HH DVD±RW	9-in-1	None	Fixed 690W Platinum	None	None	USB / USB Optical	Windows 10 DG Windows 7 Pro 64	3-year, Onsite	No	Feb 25, 2024	01/18
30BE005WUS	ThinkStation P520	US	Xeon W-2135 6C/3.7GHz/8.25MB/140W/DDR4-2666	Open	1x 8GB RDIMM DDR4-2666 ECC	Integrated Intel SATA	None	1x 1TB HDD 7.2K 3.5" SATA6Gbps	None	1x HH DVD±RW	9-in-1	None	Fixed 690W Platinum	None	None	USB / USB Optical	Windows 10 DG Windows 7 Pro 64	3-year, Onsite	No	Feb 25, 2024	01/18
30BE005XUS	ThinkStation P520	US	Xeon W-2125 4C/4.0GHz/8.25MB/120W/DDR4-2666	Open	1x 8GB RDIMM DDR4-2666 ECC	Integrated Intel SATA	None	1x 1TB HDD 7.2K 3.5" SATA6Gbps	None	1x HH DVD±RW	9-in-1	None	Fixed 690W Platinum	None	None	USB / USB Optical	Windows 10 Pro 64	3-year, Onsite	No	Feb 25, 2024	01/18
30BE005YUS	ThinkStation P520	US	Xeon W-2123 4C/3.6GHz/8.25MB/120W/DDR4-2666	1x NVIDIA Quadro P2000 5GB	1x 16GB RDIMM DDR4-2666 ECC	Integrated Intel SATA	None	None	1x 512GB SSD M.2 PCIe Opal, Onboard	1x HH DVD±RW	9-in-1	None	Fixed 690W Platinum	None	None	USB / USB Optical	Windows 10 Pro 64	3-year, Onsite	No	Feb 25, 2024	01/18
30BE0060US	ThinkStation P520	US	Xeon W-2133 6C/3.6GHz/8.25MB/140W/DDR4-2666	1x NVIDIA Quadro P2000 5GB	1x 16GB RDIMM DDR4-2666 ECC	Integrated Intel SATA	None	None	1x 512GB SSD M.2 PCIe Opal, Onboard	1x HH DVD±RW	9-in-1	None	Fixed 690W Platinum	None	None	USB / USB Optical	Windows 10 DG Windows 7 Pro 64	3-year, Onsite	No	Feb 25, 2024	01/18
30BE0061US	ThinkStation P520	US	Xeon W-2155 10C/3.3GHz/13.75MB/140W/DDR4-2666	Open	1x 8GB RDIMM DDR4-2666 ECC	Integrated Intel SATA	None	1x 1TB HDD 7.2K 3.5" SATA6Gbps	None	1x HH DVD±RW	9-in-1	None	Fixed 690W Platinum	None	None	USB / USB Optical	Windows 10 Pro 64	3-year, Onsite	No	Feb 25, 2024	01/18
30BE0062US	ThinkStation P520	US	Xeon W-2133 6C/3.6GHz/8.25MB/140W/DDR4-2666	1x NVIDIA Quadro P1000 4GB	1x 8GB RDIMM DDR4-2666 ECC	Integrated Intel SATA	None	1x 1TB HDD 7.2K 3.5" SATA6Gbps	None	1x HH DVD±RW	9-in-1	None	Fixed 690W Platinum	None	None	USB / USB Optical	Windows 10 DG Windows 7 Pro 64	3-year, Onsite	No	Feb 25, 2024	01/18
30BE0063US	ThinkStation P520	US	Xeon W-2135 6C/3.7GHz/8.25MB/140W/DDR4-2666	1x NVIDIA Quadro P2000 5GB	1x 16GB RDIMM DDR4-2666 ECC	Integrated Intel SATA	None	None	1x 512GB SSD M.2 PCIe Opal, Onboard	1x HH DVD±RW	9-in-1	None	Fixed 690W Platinum	None	None	USB / USB Optical	Windows 10 DG Windows 7 Pro 64	3-year, Onsite	No	Feb 25, 2024	01/18

Model	Product	Region	Processor	Graphics	Memory	Storage Controller	M.2 RAID Upgrade	Disks	M.2 Drives	Optical	Media Reader	Additional Networking	Power Supply	Optional Ports	Front Diagnostic LED	Keyboard / Mouse	Operating System	Warranty	Global	End of Support	Ann Date (mm/yy)
30BE0064US	ThinkStation P520	US	Xeon W-2125 4C/4.0GHz/8.25MB/120W/DDR4-2666	1x NVIDIA Quadro P1000 4GB	1x 16GB RDIMM DDR4-2666 ECC	Integrated Intel SATA	None	None	1x 512GB SSD M.2 PCIe Opal, Onboard	1x HH DVD±RW	9-in-1	None	Fixed 690W Platinum	None	None	USB / USB Optical	Windows 10 DG Windows 7 Pro 64	3-year, Onsite	No	Feb 25, 2024	01/18
30BE0065US	ThinkStation P520	US	Xeon W-2123 4C/3.6GHz/8.25MB/120W/DDR4-2666	1x NVIDIA Quadro P1000 4GB	1x 16GB RDIMM DDR4-2666 ECC	Integrated Intel SATA	None	None	1x 512GB SSD M.2 PCIe Opal, Onboard	1x HH DVD±RW	9-in-1	None	Fixed 690W Platinum	None	None	USB / USB Optical	Windows 10 Pro 64	3-year, Onsite	No	Feb 25, 2024	01/18
30BE0066US	ThinkStation P520	US	Xeon W-2104 4C/3.2GHz/8.25MB/120W/DDR4-2400	Open	1x 16GB RDIMM DDR4-2666 ECC	Integrated Intel SATA	None	None	1x 512GB SSD M.2 PCIe Opal, Onboard	1x HH DVD±RW	9-in-1	None	Fixed 690W Platinum	None	None	USB / USB Optical	Windows 10 Pro 64	3-year, Onsite	No	Feb 25, 2024	01/18
30BE0067US	ThinkStation P520	US	Xeon W-2133 6C/3.6GHz/8.25MB/140W/DDR4-2666	1x NVIDIA Quadro P4000 8GB	1x 16GB RDIMM DDR4-2666 ECC	Integrated Intel SATA	None	None	1x 512GB SSD M.2 PCIe Opal, Onboard	1x HH DVD±RW	9-in-1	None	Fixed 690W Platinum	None	None	USB / USB Optical	Windows 10 DG Windows 7 Pro 64	3-year, Onsite	No	Feb 25, 2024	01/18
30BE0068US	ThinkStation P520	US	Xeon W-2145 8C/3.7GHz/11MB/140W/DDR4-2666	1x NVIDIA Quadro P2000 5GB	1x 16GB RDIMM DDR4-2666 ECC	Integrated Intel SATA	None	None	1x 512GB SSD M.2 PCIe Opal, Onboard	1x HH DVD±RW	9-in-1	None	Fixed 690W Platinum	None	None	USB / USB Optical	Windows 10 DG Windows 7 Pro 64	3-year, Onsite	No	Feb 25, 2024	01/18
30BE0069US	ThinkStation P520	US	Xeon W-2123 4C/3.6GHz/8.25MB/120W/DDR4-2666	Open	1x 16GB RDIMM DDR4-2666 ECC	Integrated Intel SATA	None	None	1x 512GB SSD M.2 PCIe Opal, Onboard	1x HH DVD±RW	9-in-1	None	Fixed 690W Platinum	None	None	USB / USB Optical	Windows 10 DG Windows 7 Pro 64	3-year, Onsite	No	Feb 25, 2024	01/18
30BE006AUS	ThinkStation P520	US	Xeon W-2135 6C/3.7GHz/8.25MB/140W/DDR4-2666	1x NVIDIA Quadro P2000 5GB	1x 16GB RDIMM DDR4-2666 ECC	Integrated Intel SATA	None	None	1x 512GB SSD M.2 PCIe Opal, Onboard	1x HH DVD±RW	9-in-1	None	Fixed 690W Platinum	None	None	USB / USB Optical	Windows 10 Pro 64	3-year, Onsite	No	Feb 25, 2024	01/18
30BE006BUS	ThinkStation P520	US	Xeon W-2155 10C/3.3GHz/13.75MB/140W/DDR4-2666	Open	1x 8GB RDIMM DDR4-2666 ECC	Integrated Intel SATA	None	1x 1TB HDD 7.2K 3.5" SATA6Gbps	None	1x HH DVD±RW	9-in-1	None	Fixed 690W Platinum	None	None	USB / USB Optical	Windows 10 DG Windows 7 Pro 64	3-year, Onsite	No	Feb 25, 2024	01/18

Model	Product	Region	Processor	Graphics	Memory	Storage Controller	M.2 RAID Upgrade	Disks	M.2 Drives	Optical	Media Reader	Additional Networking	Power Supply	Optional Ports	Front Diagnostic LED	Keyboard / Mouse	Operating System	Warranty	Global	End of Support	Ann Date (mm/yy)
30BE006CUS	ThinkStation P520	US	Xeon W-2123 4C/3.6GHz/8.25MB/120W/DDR4-2666	Open	1x 8GB RDIMM DDR4-2666 ECC	Integrated Intel SATA	None	1x 1TB HDD 7.2K 3.5" SATA6Gbps	None	1x HH DVD±RW	9-in-1	None	Fixed 690W Platinum	None	None	USB / USB Optical	Windows 10 DG Windows 7 Pro 64	3-year, Onsite	No	Feb 25, 2024	01/18
30BE006DUS	ThinkStation P520	US	Xeon W-2133 6C/3.6GHz/8.25MB/140W/DDR4-2666	1x NVIDIA Quadro P5000 16GB	1x 16GB RDIMM DDR4-2666 ECC	Integrated Intel SATA	None	None	1x 512GB SSD M.2 PCIe Opal, Onboard	1x HH DVD±RW	9-in-1	None	Fixed 690W Platinum	None	None	USB / USB Optical	Windows 10 Pro 64	3-year, Onsite	No	Feb 25, 2024	01/18
30BE006EUS	ThinkStation P520	US	Xeon W-2145 8C/3.7GHz/11MB/140W/DDR4-2666	1x NVIDIA Quadro P2000 5GB	1x 8GB RDIMM DDR4-2666 ECC	Integrated Intel SATA	None	1x 1TB HDD 7.2K 3.5" SATA6Gbps	None	1x HH DVD±RW	9-in-1	None	Fixed 690W Platinum	None	None	USB / USB Optical	Windows 10 Pro 64	3-year, Onsite	No	Feb 25, 2024	01/18
30BE006FUS	ThinkStation P520	US	Xeon W-2123 4C/3.6GHz/8.25MB/120W/DDR4-2666	Open	1x 8GB RDIMM DDR4-2666 ECC	Integrated Intel SATA	None	1x 1TB HDD 7.2K 3.5" SATA6Gbps	None	1x HH DVD±RW	9-in-1	None	Fixed 690W Platinum	None	None	USB / USB Optical	Windows 10 Pro 64	3-year, Onsite	No	Feb 25, 2024	01/18
30BE006GUS	ThinkStation P520	US	Xeon W-2123 4C/3.6GHz/8.25MB/120W/DDR4-2666	1x NVIDIA Quadro P1000 4GB	1x 8GB RDIMM DDR4-2666 ECC	Integrated Intel SATA	None	1x 1TB HDD 7.2K 3.5" SATA6Gbps	None	1x HH DVD±RW	9-in-1	None	Fixed 690W Platinum	None	None	USB / USB Optical	Windows 10 DG Windows 7 Pro 64	3-year, Onsite	No	Feb 25, 2024	01/18
30BE0075US	ThinkStation P520	US	Xeon W-2133 6C/3.6GHz/8.25MB/140W/DDR4-2666	1x NVIDIA Quadro P5000 16GB	1x 16GB RDIMM DDR4-2666 ECC	Integrated Intel SATA	None	1x 1TB HDD 7.2K 3.5" SATA6Gbps	None	1x HH DVD±RW	9-in-1	None	Fixed 900W Platinum	None	None	USB / USB Optical	Windows 10 Pro 64	3-year, Onsite	No	Feb 25, 2024	01/18
30BE0076US	ThinkStation P520	US	Xeon W-2104 4C/3.2GHz/8.25MB/120W/DDR4-2400	Open	1x 8GB RDIMM DDR4-2666 ECC	Integrated Intel SATA	None	1x 1TB HDD 7.2K 3.5" SATA6Gbps	None	1x HH DVD±RW	9-in-1	None	Fixed 900W Platinum	None	None	USB / USB Optical	Windows 10 Pro 64	3-year, Onsite	No	Feb 25, 2024	01/18
30BE0077US	ThinkStation P520	US	Xeon W-2123 4C/3.6GHz/8.25MB/120W/DDR4-2666	Open	1x 16GB RDIMM DDR4-2666 ECC	Integrated Intel SATA	None	None	1x 512GB SSD M.2 PCIe Opal, Onboard	1x HH DVD±RW	9-in-1	None	Fixed 900W Platinum	None	None	USB / USB Optical	Windows 10 DG Windows 7 Pro 64	3-year, Onsite	No	Feb 25, 2024	01/18

Model	Product	Region	Processor	Graphics	Memory	Storage Controller	M.2 RAID Upgrade	Disks	M.2 Drives	Optical	Media Reader	Additional Networking	Power Supply	Optional Ports	Front Diagnostic LED	Keyboard / Mouse	Operating System	Warranty	Global	End of Support	Ann Date (mm/yy)
30BE0078US	ThinkStation P520	US	Xeon W-2125 4C/4.0GHz/8.25MB/120W/DDR4-2666	Open	1x 16GB RDIMM DDR4-2666 ECC	Integrated Intel SATA	None	None	1x 512GB SSD M.2 PCIe Opal, Onboard	1x HH DVD±RW	9-in-1	None	Fixed 900W Platinum	None	None	USB / USB Optical	Windows 10 Pro 64	3-year, Onsite	No	Feb 25, 2024	01/18
30BE0079US	ThinkStation P520	US	Xeon W-2123 4C/3.6GHz/8.25MB/120W/DDR4-2666	Open	1x 8GB RDIMM DDR4-2666 ECC	Integrated Intel SATA	None	1x 1TB HDD 7.2K 3.5" SATA6Gbps	None	1x HH DVD±RW	9-in-1	None	Fixed 900W Platinum	None	None	USB / USB Optical	Windows 10 DG Windows 7 Pro 64	3-year, Onsite	No	Feb 25, 2024	01/18
30BE007AUS	ThinkStation P520	US	Xeon W-2135 6C/3.7GHz/8.25MB/140W/DDR4-2666	1x NVIDIA Quadro P5000 16GB	1x 16GB RDIMM DDR4-2666 ECC	Integrated Intel SATA	None	1x 1TB HDD 7.2K 3.5" SATA6Gbps	None	1x HH DVD±RW	9-in-1	None	Fixed 900W Platinum	None	None	USB / USB Optical	Windows 10 Pro 64	3-year, Onsite	No	Feb 25, 2024	01/18
30BE007BUS	ThinkStation P520	US	Xeon W-2125 4C/4.0GHz/8.25MB/120W/DDR4-2666	Open	1x 16GB RDIMM DDR4-2666 ECC	Integrated Intel SATA	None	None	1x 512GB SSD M.2 PCIe Opal, Onboard	1x HH DVD±RW	9-in-1	None	Fixed 900W Platinum	None	None	USB / USB Optical	Windows 10 DG Windows 7 Pro 64	3-year, Onsite	No	Feb 25, 2024	01/18
30BE007CUS	ThinkStation P520	US	Xeon W-2133 6C/3.6GHz/8.25MB/140W/DDR4-2666	Open	1x 16GB RDIMM DDR4-2666 ECC	Integrated Intel SATA	None	None	1x 512GB SSD M.2 PCIe Opal, Onboard	1x HH DVD±RW	9-in-1	None	Fixed 900W Platinum	None	None	USB / USB Optical	Windows 10 DG Windows 7 Pro 64	3-year, Onsite	No	Feb 25, 2024	01/18
30BE007DUS	ThinkStation P520	US	Xeon W-2123 4C/3.6GHz/8.25MB/120W/DDR4-2666	Open	1x 16GB RDIMM DDR4-2666 ECC	Integrated Intel SATA	None	None	1x 512GB SSD M.2 PCIe Opal, Onboard	1x HH DVD±RW	9-in-1	None	Fixed 900W Platinum	None	None	USB / USB Optical	Windows 10 Pro 64	3-year, Onsite	No	Feb 25, 2024	01/18
30BE007EUS	ThinkStation P520	US	Xeon W-2123 4C/3.6GHz/8.25MB/120W/DDR4-2666	Open	1x 8GB RDIMM DDR4-2666 ECC	Integrated Intel SATA	None	1x 1TB HDD 7.2K 3.5" SATA6Gbps	None	1x HH DVD±RW	9-in-1	None	Fixed 900W Platinum	None	None	USB / USB Optical	Windows 10 Pro 64	3-year, Onsite	No	Feb 25, 2024	01/18
30BE007FUS	ThinkStation P520	US	Xeon W-2145 8C/3.7GHz/11MB/140W/DDR4-2666	1x NVIDIA Quadro P5000 16GB	1x 16GB RDIMM DDR4-2666 ECC	Integrated Intel SATA	None	1x 1TB HDD 7.2K 3.5" SATA6Gbps	None	1x HH DVD±RW	9-in-1	None	Fixed 900W Platinum	None	None	USB / USB Optical	Windows 10 Pro 64	3-year, Onsite	No	Feb 25, 2024	01/18

Model	Product	Region	Processor	Graphics	Memory	Storage Controller	M.2 RAID Upgrade	Disks	M.2 Drives	Optical	Media Reader	Additional Networking	Power Supply	Optional Ports	Front Diagnostic LED	Keyboard / Mouse	Operating System	Warranty	Global	End of Support	Ann Date (mm/yy)
30BE007GUS	ThinkStation P520	US	Xeon W-2133 6C/3.6GHz/8.25MB/140W/DDR4-2666	Open	1x 16GB RDIMM DDR4-2666 ECC	Integrated Intel SATA	None	None	1x 512GB SSD M.2 PCIe Opal, Onboard	1x HH DVD±RW	9-in-1	None	Fixed 900W Platinum	None	None	USB / USB Optical	Windows 10 Pro 64	3-year, Onsite	No	Feb 25, 2024	01/18
30BE007K--	ThinkStation P520	WE	Xeon W-2123 4C/3.6GHz/8.25MB/120W/DDR4-2666	Open	1x 16GB RDIMM DDR4-2666 ECC	Integrated Intel SATA	None	1x 1TB HDD 7.2K 3.5" SATA6Gbps	1x 256GB SSD M.2 PCIe Opal, Onboard	1x HH DVD±RW	9-in-1	1x GbE RJ-45	Fixed 900W Platinum	1x Serial, 1x Internal USB 3.0, 1x Front eSATA	4-digit LED	None / USB Optical	Windows 10 Pro 64	3-year, Onsite	No	Apr 27, 2024	03/18
30BE007L--	ThinkStation P520	WE	Xeon W-2133 6C/3.6GHz/8.25MB/140W/DDR4-2666	Open	1x 16GB RDIMM DDR4-2666 ECC	Integrated Intel SATA	None	1x 1TB HDD 7.2K 3.5" SATA6Gbps	1x 256GB SSD M.2 PCIe Opal, Onboard	1x HH DVD±RW	9-in-1	1x GbE RJ-45	Fixed 900W Platinum	1x Serial, 1x Internal USB 3.0	4-digit LED	None / USB Optical	Windows 10 Pro 64	3-year, Onsite	No	Apr 27, 2024	03/18
30BE007M--	ThinkStation P520	WE	Xeon W-2145 8C/3.7GHz/11MB/140W/DDR4-2666	Open	1x 16GB RDIMM DDR4-2666 ECC	Integrated Intel SATA	None	1x 1TB HDD 7.2K 3.5" SATA6Gbps	1x 256GB SSD M.2 PCIe Opal, Onboard	1x HH DVD±RW	9-in-1	1x GbE RJ-45	Fixed 900W Platinum	1x Serial, 1x Internal USB 3.0	4-digit LED	None / USB Optical	Windows 10 Pro 64	3-year, Onsite	No	Apr 27, 2024	03/18
30BE007N--	ThinkStation P520	WE	Xeon W-2133 6C/3.6GHz/8.25MB/140W/DDR4-2666	1x NVIDIA Quadro P4000 8GB	2x 16GB RDIMM DDR4-2666 ECC	Integrated Intel SATA	None	1x 2TB HDD 7.2K 3.5" SATA6Gbps	1x 512GB SSD M.2 PCIe Opal, Onboard	1x HH DVD±RW	9-in-1	1x GbE RJ-45	Fixed 900W Platinum	1x Serial, 1x Internal USB 3.0	4-digit LED	None / USB Optical	Windows 10 Pro 64	3-year, Onsite	No	Apr 27, 2024	03/18
30BE007P--	ThinkStation P520	WE	Xeon W-2123 4C/3.6GHz/8.25MB/120W/DDR4-2666	Open	1x 8GB RDIMM DDR4-2666 ECC	Integrated Intel SATA	None	1x 1TB HDD 7.2K 3.5" SATA6Gbps	1x 256GB SSD M.2 PCIe Opal, Onboard	1x HH DVD±RW	9-in-1	None	Fixed 900W Platinum	1x Serial, 1x Internal USB 3.0	None	None / USB Optical	Windows 10 Pro 64	3-year, Onsite	No	Apr 27, 2024	03/18
30BE007Q--	ThinkStation P520	WE	Xeon W-2133 6C/3.6GHz/8.25MB/140W/DDR4-2666	Open	1x 16GB RDIMM DDR4-2666 ECC	Integrated Intel SATA	None	1x 1TB HDD 7.2K 3.5" SATA6Gbps	1x 256GB SSD M.2 PCIe Opal, Onboard	1x HH DVD±RW	9-in-1	None	Fixed 900W Platinum	1x Serial, 1x Internal USB 3.0	None	None / USB Optical	Windows 10 Pro 64	3-year, Onsite	No	Apr 27, 2024	03/18
30BE007R--	ThinkStation P520	WE	Xeon W-2145 8C/3.7GHz/11MB/140W/DDR4-2666	Open	1x 16GB RDIMM DDR4-2666 ECC	Integrated Intel SATA	None	1x 1TB HDD 7.2K 3.5" SATA6Gbps	1x 256GB SSD M.2 PCIe Opal, Onboard	1x HH DVD±RW	9-in-1	None	Fixed 900W Platinum	1x Serial, 1x Internal USB 3.0	None	None / USB Optical	Windows 10 Pro 64	3-year, Onsite	No	Apr 27, 2024	03/18

Model	Product	Region	Processor	Graphics	Memory	Storage Controller	M.2 RAID Upgrade	Disks	M.2 Drives	Optical	Media Reader	Additional Networking	Power Supply	Optional Ports	Front Diagnostic LED	Keyboard / Mouse	Operating System	Warranty	Global	End of Support	Ann Date (mm/yy)
30BE007S--	ThinkStation P520	WE	Xeon W-2133 6C/3.6GHz/8.25MB/140W/DDR4-2666	Open	1x 16GB RDIMM DDR4-2666	Integrated Intel SATA	None	None	1x 512GB SSD M.2 PCIe Opal, Onboard	1x HH DVD±RW	9-in-1	None	Fixed 900W Platinum	1x Serial	None	USB / USB Optical	Windows 10 Pro 64	3-year, Onsite	No	Apr 27, 2024	03/18
30BE006Y--	ThinkStation P520	WE	Xeon W-2133 6C/3.6GHz/8.25MB/140W/DDR4-2666	1x NVIDIA Quadro P2000 5GB	1x 16GB RDIMM DDR4-2666	Integrated Intel SATA	None	2x 1TB HDD 7.2K 3.5" SATA6Gbps	None	1x HH DVD±RW	9-in-1	None	Fixed 900W Platinum	1x Serial	None	USB / USB Optical	Windows 10 Pro 64	3-year, Onsite	No	Feb 25, 2024	01/18
30BE006X--	ThinkStation P520	WE	Xeon W-2133 6C/3.6GHz/8.25MB/140W/DDR4-2666	1x NVIDIA Quadro P4000 8GB	1x 32GB RDIMM DDR4-2666	Integrated Intel SATA	None	1x 256GB SSD 2.5" SATA6Gbps Opal, 1x 1TB HDD 7.2K 3.5" SATA6Gbps	None	1x HH DVD±RW	9-in-1	None	Fixed 900W Platinum	1x Serial	None	USB / USB Optical	Windows 10 Pro 64	3-year, Onsite	No	Feb 25, 2024	01/18
30BE006W--	ThinkStation P520	WE	Xeon W-2123 4C/3.6GHz/8.25MB/120W/DDR4-2666	1x NVIDIA Quadro P2000 5GB	1x 16GB RDIMM DDR4-2666	Integrated Intel SATA	None	1x 256GB SSD 2.5" SATA6Gbps Opal	None	1x HH DVD±RW	9-in-1	None	Fixed 900W Platinum	1x Serial	None	USB / USB Optical	Windows 10 Pro 64	3-year, Onsite	No	Feb 25, 2024	01/18
30BE0072--	ThinkStation P520	WE	Xeon W-2133 6C/3.6GHz/8.25MB/140W/DDR4-2666	Open	1x 16GB RDIMM DDR4-2666	Integrated Intel SATA	None	1x 256GB SSD 2.5" SATA6Gbps Opal	None	1x HH DVD±RW	9-in-1	None	Fixed 900W Platinum	1x Serial	None	USB / USB Optical	Windows 10 DG Windows 7 Pro 64	3-year, Onsite	No	Feb 25, 2024	01/18
30BE0073--	ThinkStation P520	WE	Xeon W-2125 4C/4.0GHz/8.25MB/120W/DDR4-2666	Open	1x 16GB RDIMM DDR4-2666	Integrated Intel SATA	None	1x 512GB SSD 2.5" SATA6Gbps Opal	None	1x HH DVD±RW	9-in-1	None	Fixed 900W Platinum	1x Serial	None	USB / USB Optical	Windows 10 Pro 64	3-year, Onsite	No	Feb 25, 2024	01/18
30BE0071--	ThinkStation P520	WE	Xeon W-2125 4C/4.0GHz/8.25MB/120W/DDR4-2666	Open	1x 8GB RDIMM DDR4-2666	Integrated Intel SATA	None	None	1x 256GB SSD M.2 PCIe Opal, Onboard	1x HH DVD±RW	9-in-1	None	Fixed 900W Platinum	1x Serial	None	USB / USB Optical	Windows 10 Pro 64	3-year, Onsite	No	Feb 25, 2024	01/18
30BE0070--	ThinkStation P520	WE	Xeon W-2123 4C/3.6GHz/8.25MB/120W/DDR4-2666	Open	1x 16GB RDIMM DDR4-2666	Integrated Intel SATA	None	1x 2TB HDD 7.2K 3.5" SATA6Gbps	1x 512GB SSD M.2 PCIe Opal, Onboard	1x HH DVD±RW	9-in-1	None	Fixed 900W Platinum	1x Serial	None	USB / USB Optical	Windows 10 Pro 64	3-year, Onsite	No	Feb 25, 2024	01/18

Model	Product	Region	Processor	Graphics	Memory	Storage Controller	M.2 RAID Upgrade	Disks	M.2 Drives	Optical	Media Reader	Additional Networking	Power Supply	Optional Ports	Front Diagnostic LED	Keyboard / Mouse	Operating System	Warranty	Global	End of Support	Ann Date (mm/yy)
30BE007V--	ThinkStation P520	WE	Xeon W-2145 8C/3.7GHz/11MB/140W/DDR4-2666	Open	1x 16GB RDIMM DDR4-2666 ECC	Integrated Intel SATA	None	1x 1TB HDD 7.2K 3.5" SATA6Gbps	1x 256GB SSD M.2 PCIe Opal, Onboard	1x HH DVD±RW	9-in-1	None	Fixed 900W Platinum	1x Serial, 1x Internal USB 3.0	4-digit LED	USB / USB Optical	Windows 10 Pro 64	3-year, Onsite	No	May 3, 2024	04/18
30BE007T--	ThinkStation P520	WE	Xeon W-2123 4C/3.6GHz/8.25MB/120W/DDR4-2666	Open	1x 16GB RDIMM DDR4-2666 ECC	Integrated Intel SATA	None	1x 512GB SSD 2.5" SATA6Gbps Opal	None	1x HH DVD±RW	9-in-1	None	Fixed 900W Platinum	1x Serial	None	None / USB Optical	Windows 10 Pro 64	3-year, Onsite	No	Apr 27, 2024	03/18
30BE007U--	ThinkStation P520	WE	Xeon W-2133 6C/3.6GHz/8.25MB/140W/DDR4-2666	1x NVIDIA Quadro P4000 8GB	2x 16GB RDIMM DDR4-2666 ECC	Integrated Intel SATA	None	1x 1TB HDD 7.2K 3.5" SATA6Gbps	1x 512GB SSD M.2 PCIe Opal, Onboard	1x HH DVD±RW	9-in-1	None	Fixed 900W Platinum	1x Serial, 1x Internal USB 3.0	4-digit LED	USB / USB Optical	Windows 10 Pro 64	3-year, Onsite	No	May 3, 2024	04/18
30BE0074--	ThinkStation P520	WE	Xeon W-2125 4C/4.0GHz/8.25MB/120W/DDR4-2666	1x NVIDIA Quadro P2000 5GB	1x 32GB RDIMM DDR4-2666 ECC	Integrated Intel SATA	None	1x 512GB SSD 2.5" SATA6Gbps Opal	None	1x HH DVD±RW	9-in-1	None	Fixed 690W Platinum	1x Serial	None	USB / USB Optical	Windows 10 Pro 64	3-year, Onsite	No	Feb 25, 2024	01/18
30BE007W--	ThinkStation P520	WE	Xeon W-2133 6C/3.6GHz/8.25MB/140W/DDR4-2666	Open	1x 16GB RDIMM DDR4-2666 ECC	Integrated Intel SATA	None	1x 1TB HDD 7.2K 3.5" SATA6Gbps	1x 256GB SSD M.2 PCIe Opal, Onboard	1x HH DVD±RW	9-in-1	None	Fixed 900W Platinum	1x Serial, 1x Internal USB 3.0	4-digit LED	USB / USB Optical	Windows 10 Pro 64	3-year, Onsite	No	May 3, 2024	04/18
30BE007X--	ThinkStation P520	WE	Xeon W-2123 4C/3.6GHz/8.25MB/120W/DDR4-2666	Open	1x 16GB RDIMM DDR4-2666 ECC	Integrated Intel SATA	None	1x 1TB HDD 7.2K 3.5" SATA6Gbps	1x 256GB SSD M.2 PCIe Opal, Onboard	1x HH DVD±RW	9-in-1	None	Fixed 900W Platinum	1x Serial, 1x Internal USB 3.0	4-digit LED	USB / USB Optical	Windows 10 Pro 64	3-year, Onsite	No	May 3, 2024	04/18
30BE007Y--	ThinkStation P520	WE	Xeon W-2123 4C/3.6GHz/8.25MB/120W/DDR4-2666	Open	1x 16GB RDIMM DDR4-2666 ECC	Integrated Intel SATA	None	1x 512GB SSD 2.5" SATA6Gbps Opal	None	1x HH DVD±RW	9-in-1	None	Fixed 900W Platinum	1x Serial	None	USB / USB Optical	Windows 10 Pro 64	3-year, Onsite	No	May 3, 2024	04/18
30BE0033--	ThinkStation P520	WE	Xeon W-2133 6C/3.6GHz/8.25MB/140W/DDR4-2666	Open	1x 16GB RDIMM DDR4-2666 ECC	Integrated Intel SATA	None	1x 256GB SSD 2.5" SATA6Gbps Opal	None	1x HH DVD±RW	9-in-1	None	Fixed 690W Platinum	1x Serial	None	USB / USB Optical	Windows 10 DG Windows 7 Pro 64	3-year, Onsite	No	Feb 25, 2024	01/18

Model	Product	Region	Processor	Graphics	Memory	Storage Controller	M.2 RAID Upgrade	Disks	M.2 Drives	Optical	Media Reader	Additional Networking	Power Supply	Optional Ports	Front Diagnostic LED	Keyboard / Mouse	Operating System	Warranty	Global	End of Support	Ann Date (mm/yy)
30BE0034--	ThinkStation P520	WE	Xeon W-2133 6C/3.6GHz/8.25MB/140W/DDR4-2666	Open	1x 16GB RDIMM DDR4-2666 ECC	Integrated Intel SATA	None	1x 256GB SSD 2.5" SATA6Gbps Opal	None	1x HH DVD±RW	9-in-1	None	Fixed 690W Platinum	1x Serial	None	USB / USB Optical	Windows 10 DG Windows 7 Pro 64	3-year, Onsite	No	Feb 25, 2024	01/18
30BE0035--	ThinkStation P520	WE	Xeon W-2133 6C/3.6GHz/8.25MB/140W/DDR4-2666	Open	1x 16GB RDIMM DDR4-2666 ECC	Integrated Intel SATA	None	1x 256GB SSD 2.5" SATA6Gbps Opal	None	1x HH DVD±RW	9-in-1	None	Fixed 690W Platinum	1x Serial	None	USB / USB Optical	Windows 10 DG Windows 7 Pro 64	3-year, Onsite	No	Feb 25, 2024	01/18
30BE0036--	ThinkStation P520	WE	Xeon W-2133 6C/3.6GHz/8.25MB/140W/DDR4-2666	Open	1x 16GB RDIMM DDR4-2666 ECC	Integrated Intel SATA	None	1x 256GB SSD 2.5" SATA6Gbps Opal	None	1x HH DVD±RW	9-in-1	None	Fixed 690W Platinum	1x Serial	None	USB / USB Optical	Windows 10 DG Windows 7 Pro 64	3-year, Onsite	No	Feb 25, 2024	01/18
30BE0037--	ThinkStation P520	WE	Xeon W-2133 6C/3.6GHz/8.25MB/140W/DDR4-2666	Open	1x 16GB RDIMM DDR4-2666 ECC	Integrated Intel SATA	None	1x 256GB SSD 2.5" SATA6Gbps Opal	None	1x HH DVD±RW	9-in-1	None	Fixed 690W Platinum	1x Serial	None	USB / USB Optical	Windows 10 DG Windows 7 Pro 64	3-year, Onsite	No	Feb 25, 2024	01/18
30BE0038--	ThinkStation P520	WE	Xeon W-2133 6C/3.6GHz/8.25MB/140W/DDR4-2666	Open	1x 16GB RDIMM DDR4-2666 ECC	Integrated Intel SATA	None	1x 256GB SSD 2.5" SATA6Gbps Opal	None	1x HH DVD±RW	9-in-1	None	Fixed 690W Platinum	1x Serial	None	USB / USB Optical	Windows 10 DG Windows 7 Pro 64	3-year, Onsite	No	Feb 25, 2024	01/18
30BE0039--	ThinkStation P520	WE	Xeon W-2133 6C/3.6GHz/8.25MB/140W/DDR4-2666	Open	1x 16GB RDIMM DDR4-2666 ECC	Integrated Intel SATA	None	1x 256GB SSD 2.5" SATA6Gbps Opal	None	1x HH DVD±RW	9-in-1	None	Fixed 690W Platinum	1x Serial	None	USB / USB Optical	Windows 10 DG Windows 7 Pro 64	3-year, Onsite	No	Feb 25, 2024	01/18
30BE003A--	ThinkStation P520	WE	Xeon W-2133 6C/3.6GHz/8.25MB/140W/DDR4-2666	Open	1x 16GB RDIMM DDR4-2666 ECC	Integrated Intel SATA	None	1x 256GB SSD 2.5" SATA6Gbps Opal	None	1x HH DVD±RW	9-in-1	None	Fixed 690W Platinum	1x Serial	None	USB / USB Optical	Windows 10 DG Windows 7 Pro 64	3-year, Onsite	No	Feb 25, 2024	01/18
30BE003B--	ThinkStation P520	WE	Xeon W-2133 6C/3.6GHz/8.25MB/140W/DDR4-2666	Open	1x 16GB RDIMM DDR4-2666 ECC	Integrated Intel SATA	None	1x 256GB SSD 2.5" SATA6Gbps Opal	None	1x HH DVD±RW	9-in-1	None	Fixed 690W Platinum	1x Serial	None	USB / USB Optical	Windows 10 DG Windows 7 Pro 64	3-year, Onsite	No	Feb 25, 2024	01/18

Model	Product	Region	Processor	Graphics	Memory	Storage Controller	M.2 RAID Upgrade	Disks	M.2 Drives	Optical	Media Reader	Additional Networking	Power Supply	Optional Ports	Front Diagnostic LED	Keyboard / Mouse	Operating System	Warranty	Global	End of Support	Ann Date (mm/yy)
30BE003C--	ThinkStation P520	WE	Xeon W-2133 6C/3.6GHz/8.25MB/140W/DDR4-2666	Open	1x 16GB RDIMM DDR4-2666	Integrated Intel SATA ECC	None	1x 256GB SSD 2.5" SATA6Gbps Opal	None	1x HH DVD±RW	9-in-1	None	Fixed 690W Platinum	1x Serial	None	USB / USB Optical	Windows 10 DG Windows 7 Pro 64	3-year, Onsite	No	Feb 25, 2024	01/18
30BE003D--	ThinkStation P520	WE	Xeon W-2133 6C/3.6GHz/8.25MB/140W/DDR4-2666	Open	1x 16GB RDIMM DDR4-2666	Integrated Intel SATA ECC	None	1x 256GB SSD 2.5" SATA6Gbps Opal	None	1x HH DVD±RW	9-in-1	None	Fixed 690W Platinum	1x Serial	None	USB / USB Optical	Windows 10 DG Windows 7 Pro 64	3-year, Onsite	No	Feb 25, 2024	01/18
30BE003E--	ThinkStation P520	WE	Xeon W-2133 6C/3.6GHz/8.25MB/140W/DDR4-2666	Open	1x 16GB RDIMM DDR4-2666	Integrated Intel SATA ECC	None	1x 256GB SSD 2.5" SATA6Gbps Opal	None	1x HH DVD±RW	9-in-1	None	Fixed 690W Platinum	1x Serial	None	USB / USB Optical	Windows 10 DG Windows 7 Pro 64	3-year, Onsite	No	Feb 25, 2024	01/18
30BE003F--	ThinkStation P520	WE	Xeon W-2133 6C/3.6GHz/8.25MB/140W/DDR4-2666	Open	1x 16GB RDIMM DDR4-2666	Integrated Intel SATA ECC	None	1x 256GB SSD 2.5" SATA6Gbps Opal	None	1x HH DVD±RW	9-in-1	None	Fixed 690W Platinum	1x Serial	None	USB / USB Optical	Windows 10 DG Windows 7 Pro 64	3-year, Onsite	No	Feb 25, 2024	01/18
30BE003G--	ThinkStation P520	WE	Xeon W-2133 6C/3.6GHz/8.25MB/140W/DDR4-2666	Open	1x 16GB RDIMM DDR4-2666	Integrated Intel SATA ECC	None	1x 256GB SSD 2.5" SATA6Gbps Opal	None	1x HH DVD±RW	9-in-1	None	Fixed 690W Platinum	1x Serial	None	USB / USB Optical	Windows 10 DG Windows 7 Pro 64	3-year, Onsite	No	Feb 25, 2024	01/18
30BE003H--	ThinkStation P520	WE	Xeon W-2133 6C/3.6GHz/8.25MB/140W/DDR4-2666	Open	1x 16GB RDIMM DDR4-2666	Integrated Intel SATA ECC	None	1x 256GB SSD 2.5" SATA6Gbps Opal	None	1x HH DVD±RW	9-in-1	None	Fixed 690W Platinum	1x Serial	None	USB / USB Optical	Windows 10 DG Windows 7 Pro 64	3-year, Onsite	No	Feb 25, 2024	01/18
30BE003J--	ThinkStation P520	WE	Xeon W-2133 6C/3.6GHz/8.25MB/140W/DDR4-2666	Open	1x 16GB RDIMM DDR4-2666	Integrated Intel SATA ECC	None	1x 256GB SSD 2.5" SATA6Gbps Opal	None	1x HH DVD±RW	9-in-1	None	Fixed 690W Platinum	1x Serial	None	USB / USB Optical	Windows 10 DG Windows 7 Pro 64	3-year, Onsite	No	Feb 25, 2024	01/18
30BE0019--	ThinkStation P520	WE	Xeon W-2123 4C/3.6GHz/8.25MB/120W/DDR4-2666	Open	1x 8GB RDIMM DDR4-2666	Integrated Intel SATA ECC	None	1x 256GB SSD 2.5" SATA6Gbps Opal	None	1x HH DVD±RW	9-in-1	None	Fixed 690W Platinum	1x Serial	None	USB / USB Optical	Windows 10 DG Windows 7 Pro 64	3-year, Onsite	No	Feb 25, 2024	01/18

Model	Product	Region	Processor	Graphics	Memory	Storage Controller	M.2 RAID Upgrade	Disks	M.2 Drives	Optical	Media Reader	Additional Networking	Power Supply	Optional Ports	Front Diagnostic LED	Keyboard / Mouse	Operating System	Warranty	Global	End of Support	Ann Date (mm/yy)
30BE001A--	ThinkStation P520	WE	Xeon W-2133 6C/3.6GHz/8.25MB/140W/DDR4-2666	Open	1x 16GB RDIMM DDR4-2666	Integrated Intel SATA	None	1x 256GB SSD 2.5" SATA6Gbps Opal	None	1x HH DVD±RW	9-in-1	None	Fixed 690W Platinum	1x Serial	None	USB / USB Optical	Windows 10 DG Windows 7 Pro 64	3-year, Onsite	No	Feb 25, 2024	01/18
30BE006P--	ThinkStation P520	WE	Xeon W-2125 4C/4.0GHz/8.25MB/120W/DDR4-2666	Open	1x 8GB RDIMM DDR4-2666	Integrated Intel SATA	None	1x 1TB HDD 7.2K 3.5" SATA6Gbps	None	1x HH DVD±RW	9-in-1	None	Fixed 900W Platinum	1x Serial	None	USB / USB Optical	Windows 10 Pro 64	3-year, Onsite	No	Feb 25, 2024	01/18
30BE0016--	ThinkStation P520	WE	Xeon W-2133 6C/3.6GHz/8.25MB/140W/DDR4-2666	1x NVIDIA Quadro P2000 5GB	1x 16GB RDIMM DDR4-2666	Integrated Intel SATA	None	1x 256GB SSD 2.5" SATA6Gbps Opal	None	1x 9.0mm DVD±RW	15-in-1	None	Fixed 690W Platinum	1x Front eSATA	None	USB / USB Optical	Windows 10 Pro 64	3-year, Onsite	No	Feb 25, 2024	01/18
30BE0018--	ThinkStation P520	WE	Xeon W-2133 6C/3.6GHz/8.25MB/140W/DDR4-2666	1x NVIDIA Quadro P2000 5GB	1x 16GB RDIMM DDR4-2666	Integrated Intel SATA	None	2x 1TB HDD 7.2K 3.5" SATA6Gbps	None	1x 9.0mm DVD±RW	15-in-1	None	Fixed 690W Platinum	1x Front eSATA	None	USB / USB Optical	Windows 10 Pro 64	3-year, Onsite	No	Feb 25, 2024	01/18
30BE0017--	ThinkStation P520	WE	Xeon W-2133 6C/3.6GHz/8.25MB/140W/DDR4-2666	1x NVIDIA Quadro P4000 8GB	1x 32GB RDIMM DDR4-2666	Integrated Intel SATA	None	1x 256GB SSD 2.5" SATA6Gbps Opal, 1x 1TB HDD 7.2K 3.5" SATA6Gbps	None	1x 9.0mm DVD±RW	15-in-1	None	Fixed 690W Platinum	1x Front eSATA	None	USB / USB Optical	Windows 10 Pro 64	3-year, Onsite	No	Feb 25, 2024	01/18
30BE006U--	ThinkStation P520	WE	Xeon W-2104 4C/3.2GHz/8.25MB/120W/DDR4-2400	Open	1x 16GB RDIMM DDR4-2666	Integrated Intel SATA	None	1x 256GB SSD 2.5" SATA6Gbps Opal	None	1x HH DVD±RW	9-in-1	None	Fixed 900W Platinum	1x Serial	None	USB / USB Optical	Windows 10 Pro 64	3-year, Onsite	No	Feb 25, 2024	01/18
30BE006T--	ThinkStation P520	WE	Xeon W-2133 6C/3.6GHz/8.25MB/140W/DDR4-2666	Open	1x 16GB RDIMM DDR4-2666	Integrated Intel SATA	None	1x 512GB SSD 2.5" SATA6Gbps Opal	None	1x HH DVD±RW	9-in-1	None	Fixed 900W Platinum	1x Serial	None	USB / USB Optical	Windows 10 Pro 64	3-year, Onsite	No	Feb 25, 2024	01/18
30BE006V--	ThinkStation P520	WE	Xeon W-2123 4C/3.6GHz/8.25MB/120W/DDR4-2666	1x NVIDIA Quadro P600 2GB	1x 8GB RDIMM DDR4-2666	Integrated Intel SATA	None	1x 1TB HDD 7.2K 3.5" SATA6Gbps	None	1x HH DVD±RW	9-in-1	None	Fixed 900W Platinum	1x Serial	None	USB / USB Optical	Windows 10 Pro 64	3-year, Onsite	No	Feb 25, 2024	01/18

Model	Product	Region	Processor	Graphics	Memory	Storage Controller	M.2 RAID Upgrade	Disks	M.2 Drives	Optical	Media Reader	Additional Networking	Power Supply	Optional Ports	Front Diagnostic LED	Keyboard / Mouse	Operating System	Warranty	Global	End of Support	Ann Date (mm/yy)
30BE006Q--	ThinkStation P520	WE	Xeon W-2123 4C/3.6GHz/8.25MB/120W/DDR4-2666	Open	1x 8GB RDIMM DDR4-2666	Integrated Intel SATA	None	1x 256GB SSD 2.5" SATA6Gbps Opal	None	1x HH DVD±RW	9-in-1	None	Fixed 900W Platinum	1x Serial	None	USB / USB Optical	Windows 10 Pro 64	3-year, Onsite	No	Feb 25, 2024	01/18
30BE006R--	ThinkStation P520	WE	Xeon W-2125 4C/4.0GHz/8.25MB/120W/DDR4-2666	Open	1x 8GB RDIMM DDR4-2666	Integrated Intel SATA	None	1x 512GB SSD 2.5" SATA6Gbps Opal	None	1x HH DVD±RW	9-in-1	None	Fixed 900W Platinum	1x Serial	None	USB / USB Optical	Windows 10 Pro 64	3-year, Onsite	No	Feb 25, 2024	01/18
30BE006S--	ThinkStation P520	WE	Xeon W-2133 6C/3.6GHz/8.25MB/140W/DDR4-2666	Open	1x 16GB RDIMM DDR4-2666	Integrated Intel SATA	None	1x 256GB SSD 2.5" SATA6Gbps Opal	None	1x HH DVD±RW	9-in-1	None	Fixed 900W Platinum	1x Serial	None	USB / USB Optical	Windows 10 Pro 64	3-year, Onsite	No	Feb 25, 2024	01/18
30BE006N--	ThinkStation P520	WE	Xeon W-2123 4C/3.6GHz/8.25MB/120W/DDR4-2666	Open	1x 8GB RDIMM DDR4-2666	Integrated Intel SATA	None	1x 1TB HDD 7.2K 3.5" SATA6Gbps	None	1x HH DVD±RW	9-in-1	None	Fixed 900W Platinum	1x Serial	None	USB / USB Optical	Windows 10 Pro 64	3-year, Onsite	No	Feb 25, 2024	01/18
30BE0013--	ThinkStation P520	WE	Xeon W-2125 4C/4.0GHz/8.25MB/120W/DDR4-2666	Open	1x 8GB RDIMM DDR4-2666	Integrated Intel SATA	None	None	1x 256GB SSD M.2 PCIe Opal, Onboard	1x HH DVD±RW	9-in-1	None	Fixed 690W Platinum	1x Serial	None	USB / USB Optical	Windows 10 Pro 64	3-year, Onsite	No	Feb 25, 2024	01/18
30BE0014--	ThinkStation P520	WE	Xeon W-2104 4C/3.2GHz/8.25MB/120W/DDR4-2400	Open	1x 16GB RDIMM DDR4-2666	Integrated Intel SATA	None	1x 256GB SSD 2.5" SATA6Gbps Opal	None	1x 9.0mm DVD±RW	15-in-1	None	Fixed 690W Platinum	1x Front eSATA	None	USB / USB Optical	Windows 10 Pro 64	3-year, Onsite	No	Feb 25, 2024	01/18
30BE0015--	ThinkStation P520	WE	Xeon W-2123 4C/3.6GHz/8.25MB/120W/DDR4-2666	Open	1x 8GB RDIMM DDR4-2666	Integrated Intel SATA	None	1x 1TB HDD 7.2K 3.5" SATA6Gbps	None	1x 9.0mm DVD±RW	15-in-1	None	Fixed 690W Platinum	1x Front eSATA	None	USB / USB Optical	Windows 10 Pro 64	3-year, Onsite	No	Feb 25, 2024	01/18
30BE0010--	ThinkStation P520	WE	Xeon W-2133 6C/3.6GHz/8.25MB/140W/DDR4-2666	Open	1x 16GB RDIMM DDR4-2666	Integrated Intel SATA	None	1x 256GB SSD 2.5" SATA6Gbps Opal	None	1x HH DVD±RW	9-in-1	None	Fixed 690W Platinum	1x Serial	None	USB / USB Optical	Windows 10 Pro 64	3-year, Onsite	No	Feb 25, 2024	01/18

Model	Product	Region	Processor	Graphics	Memory	Storage Controller	M.2 RAID Upgrade	Disks	M.2 Drives	Optical	Media Reader	Additional Networking	Power Supply	Optional Ports	Front Diagnostic LED	Keyboard / Mouse	Operating System	Warranty	Global	End of Support	Ann Date (mm/yy)
30BE0012--	ThinkStation P520	WE	Xeon W-2123 4C/3.6GHz/8.25MB/120W/DDR4-2666	Open	1x 16GB RDIMM DDR4-2666 ECC	Integrated Intel SATA	None	1x 2TB SSD 2.5" SATA6Gbps Opal	1x 512GB SSD M.2 PCIe Opal, Onboard	1x HH DVD±RW	9-in-1	None	Fixed 690W Platinum	1x Serial	None	USB / USB Optical	Windows 10 Pro 64	3-year, Onsite	No	Feb 25, 2024	01/18
30BE0011--	ThinkStation P520	WE	Xeon W-2133 6C/3.6GHz/8.25MB/140W/DDR4-2666	Open	1x 16GB RDIMM DDR4-2666 ECC	Integrated Intel SATA	None	1x 512GB SSD 2.5" SATA6Gbps Opal	None	1x HH DVD±RW	9-in-1	None	Fixed 690W Platinum	1x Serial	None	USB / USB Optical	Windows 10 Pro 64	3-year, Onsite	No	Feb 25, 2024	01/18
30BE000T--	ThinkStation P520	WE	Xeon W-2123 4C/3.6GHz/8.25MB/120W/DDR4-2666	Open	1x 8GB RDIMM DDR4-2666 ECC	Integrated Intel SATA	None	2x 1TB HDD 7.2K 3.5" SATA6Gbps	None	1x HH DVD±RW	9-in-1	None	Fixed 690W Platinum	1x Serial	None	USB / USB Optical	Windows 10 Pro 64	3-year, Onsite	No	Feb 25, 2024	01/18
30BE000U--	ThinkStation P520	WE	Xeon W-2125 4C/4.0GHz/8.25MB/120W/DDR4-2666	Open	1x 8GB RDIMM DDR4-2666 ECC	Integrated Intel SATA	None	2x 1TB HDD 7.2K 3.5" SATA6Gbps	None	1x HH DVD±RW	9-in-1	None	Fixed 690W Platinum	1x Serial	None	USB / USB Optical	Windows 10 Pro 64	3-year, Onsite	No	Feb 25, 2024	01/18
30BE000V--	ThinkStation P520	WE	Xeon W-2123 4C/3.6GHz/8.25MB/120W/DDR4-2666	Open	1x 8GB RDIMM DDR4-2666 ECC	Integrated Intel SATA	None	1x 1TB HDD 7.2K 3.5" SATA6Gbps	None	1x HH DVD±RW	9-in-1	None	Fixed 690W Platinum	1x Serial	None	USB / USB Optical	Windows 10 Pro 64	3-year, Onsite	No	Feb 25, 2024	01/18
30BE000Y--	ThinkStation P520	WE	Xeon W-2125 4C/4.0GHz/8.25MB/120W/DDR4-2666	Open	1x 8GB RDIMM DDR4-2666 ECC	Integrated Intel SATA	None	1x 512GB SSD 2.5" SATA6Gbps Opal	None	1x HH DVD±RW	9-in-1	None	Fixed 690W Platinum	1x Serial	None	USB / USB Optical	Windows 10 Pro 64	3-year, Onsite	No	Feb 25, 2024	01/18
30BE000X--	ThinkStation P520	WE	Xeon W-2123 4C/3.6GHz/8.25MB/120W/DDR4-2666	Open	1x 8GB RDIMM DDR4-2666 ECC	Integrated Intel SATA	None	1x 256GB SSD 2.5" SATA6Gbps Opal	None	1x HH DVD±RW	9-in-1	None	Fixed 690W Platinum	1x Serial	None	USB / USB Optical	Windows 10 Pro 64	3-year, Onsite	No	Feb 25, 2024	01/18
30BE000W--	ThinkStation P520	WE	Xeon W-2125 4C/4.0GHz/8.25MB/120W/DDR4-2666	Open	1x 8GB RDIMM DDR4-2666 ECC	Integrated Intel SATA	None	1x 1TB HDD 7.2K 3.5" SATA6Gbps	None	1x HH DVD±RW	9-in-1	None	Fixed 690W Platinum	1x Serial	None	USB / USB Optical	Windows 10 Pro 64	3-year, Onsite	No	Feb 25, 2024	01/18

Model	Product	Region	Processor	Graphics	Memory	Storage Controller	M.2 RAID Upgrade	Disks	M.2 Drives	Optical	Media Reader	Additional Networking	Power Supply	Optional Ports	Front Diagnostic LED	Keyboard / Mouse	Operating System	Warranty	Global	End of Support	Ann Date (mm/yy)
30BE001Y--	ThinkStation P520	WE	Xeon W-2123 4C/3.6GHz/8.25MB/120W/DDR4-2666	Open	1x 8GB RDIMM DDR4-2666	Integrated Intel SATA	None	1x 256GB SSD 2.5" SATA6Gbps Opal	None	1x HH DVD±RW	9-in-1	None	Fixed 690W Platinum	1x Serial	None	USB / USB Optical	Windows 10 DG Windows 7 Pro 64	3-year, Onsite	No	Feb 25, 2024	01/18
30BE0020--	ThinkStation P520	WE	Xeon W-2123 4C/3.6GHz/8.25MB/120W/DDR4-2666	Open	1x 8GB RDIMM DDR4-2666	Integrated Intel SATA	None	1x 256GB SSD 2.5" SATA6Gbps Opal	None	1x HH DVD±RW	9-in-1	None	Fixed 690W Platinum	1x Serial	None	USB / USB Optical	Windows 10 DG Windows 7 Pro 64	3-year, Onsite	No	Feb 25, 2024	01/18
30BE0021--	ThinkStation P520	WE	Xeon W-2123 4C/3.6GHz/8.25MB/120W/DDR4-2666	Open	1x 8GB RDIMM DDR4-2666	Integrated Intel SATA	None	1x 256GB SSD 2.5" SATA6Gbps Opal	None	1x HH DVD±RW	9-in-1	None	Fixed 690W Platinum	1x Serial	None	USB / USB Optical	Windows 10 DG Windows 7 Pro 64	3-year, Onsite	No	Feb 25, 2024	01/18
30BE0022--	ThinkStation P520	WE	Xeon W-2123 4C/3.6GHz/8.25MB/120W/DDR4-2666	Open	1x 8GB RDIMM DDR4-2666	Integrated Intel SATA	None	1x 256GB SSD 2.5" SATA6Gbps Opal	None	1x HH DVD±RW	9-in-1	None	Fixed 690W Platinum	1x Serial	None	USB / USB Optical	Windows 10 DG Windows 7 Pro 64	3-year, Onsite	No	Feb 25, 2024	01/18
30BE0023--	ThinkStation P520	WE	Xeon W-2123 4C/3.6GHz/8.25MB/120W/DDR4-2666	Open	1x 8GB RDIMM DDR4-2666	Integrated Intel SATA	None	1x 256GB SSD 2.5" SATA6Gbps Opal	None	1x HH DVD±RW	9-in-1	None	Fixed 690W Platinum	1x Serial	None	USB / USB Optical	Windows 10 DG Windows 7 Pro 64	3-year, Onsite	No	Feb 25, 2024	01/18
30BE0024--	ThinkStation P520	WE	Xeon W-2123 4C/3.6GHz/8.25MB/120W/DDR4-2666	Open	1x 8GB RDIMM DDR4-2666	Integrated Intel SATA	None	1x 256GB SSD 2.5" SATA6Gbps Opal	None	1x HH DVD±RW	9-in-1	None	Fixed 690W Platinum	1x Serial	None	USB / USB Optical	Windows 10 DG Windows 7 Pro 64	3-year, Onsite	No	Feb 25, 2024	01/18
30BE0025--	ThinkStation P520	WE	Xeon W-2123 4C/3.6GHz/8.25MB/120W/DDR4-2666	Open	1x 8GB RDIMM DDR4-2666	Integrated Intel SATA	None	1x 256GB SSD 2.5" SATA6Gbps Opal	None	1x HH DVD±RW	9-in-1	None	Fixed 690W Platinum	1x Serial	None	USB / USB Optical	Windows 10 DG Windows 7 Pro 64	3-year, Onsite	No	Feb 25, 2024	01/18
30BE0026--	ThinkStation P520	WE	Xeon W-2123 4C/3.6GHz/8.25MB/120W/DDR4-2666	Open	1x 8GB RDIMM DDR4-2666	Integrated Intel SATA	None	1x 256GB SSD 2.5" SATA6Gbps Opal	None	1x HH DVD±RW	9-in-1	None	Fixed 690W Platinum	1x Serial	None	USB / USB Optical	Windows 10 DG Windows 7 Pro 64	3-year, Onsite	No	Feb 25, 2024	01/18

Model	Product	Region	Processor	Graphics	Memory	Storage Controller	M.2 RAID Upgrade	Disks	M.2 Drives	Optical	Media Reader	Additional Networking	Power Supply	Optional Ports	Front Diagnostic LED	Keyboard / Mouse	Operating System	Warranty	Global	End of Support	Ann Date (mm/yy)
30BE0027--	ThinkStation P520	WE	Xeon W-2123 4C/3.6GHz/8.25MB/120W/DDR4-2666	Open	1x 8GB RDIMM DDR4-2666	Integrated Intel SATA	None	1x 256GB SSD 2.5" SATA6Gbps Opal	None	1x HH DVD±RW	9-in-1	None	Fixed 690W Platinum	1x Serial	None	USB / USB Optical	Windows 10 DG Windows 7 Pro 64	3-year, Onsite	No	Feb 25, 2024	01/18
30BE0028--	ThinkStation P520	WE	Xeon W-2123 4C/3.6GHz/8.25MB/120W/DDR4-2666	Open	1x 8GB RDIMM DDR4-2666	Integrated Intel SATA	None	1x 256GB SSD 2.5" SATA6Gbps Opal	None	1x HH DVD±RW	9-in-1	None	Fixed 690W Platinum	1x Serial	None	USB / USB Optical	Windows 10 DG Windows 7 Pro 64	3-year, Onsite	No	Feb 25, 2024	01/18
30BE0029--	ThinkStation P520	WE	Xeon W-2123 4C/3.6GHz/8.25MB/120W/DDR4-2666	Open	1x 8GB RDIMM DDR4-2666	Integrated Intel SATA	None	1x 256GB SSD 2.5" SATA6Gbps Opal	None	1x HH DVD±RW	9-in-1	None	Fixed 690W Platinum	1x Serial	None	USB / USB Optical	Windows 10 DG Windows 7 Pro 64	3-year, Onsite	No	Feb 25, 2024	01/18
30BE002A--	ThinkStation P520	WE	Xeon W-2123 4C/3.6GHz/8.25MB/120W/DDR4-2666	Open	1x 8GB RDIMM DDR4-2666	Integrated Intel SATA	None	1x 256GB SSD 2.5" SATA6Gbps Opal	None	1x HH DVD±RW	9-in-1	None	Fixed 690W Platinum	1x Serial	None	USB / USB Optical	Windows 10 DG Windows 7 Pro 64	3-year, Onsite	No	Feb 25, 2024	01/18
30BE002B--	ThinkStation P520	WE	Xeon W-2123 4C/3.6GHz/8.25MB/120W/DDR4-2666	Open	1x 8GB RDIMM DDR4-2666	Integrated Intel SATA	None	1x 256GB SSD 2.5" SATA6Gbps Opal	None	1x HH DVD±RW	9-in-1	None	Fixed 690W Platinum	1x Serial	None	USB / USB Optical	Windows 10 DG Windows 7 Pro 64	3-year, Onsite	No	Feb 25, 2024	01/18
30BE002C--	ThinkStation P520	WE	Xeon W-2123 4C/3.6GHz/8.25MB/120W/DDR4-2666	Open	1x 8GB RDIMM DDR4-2666	Integrated Intel SATA	None	1x 256GB SSD 2.5" SATA6Gbps Opal	None	1x HH DVD±RW	9-in-1	None	Fixed 690W Platinum	1x Serial	None	USB / USB Optical	Windows 10 DG Windows 7 Pro 64	3-year, Onsite	No	Feb 25, 2024	01/18
30BE002D--	ThinkStation P520	WE	Xeon W-2123 4C/3.6GHz/8.25MB/120W/DDR4-2666	Open	1x 8GB RDIMM DDR4-2666	Integrated Intel SATA	None	1x 256GB SSD 2.5" SATA6Gbps Opal	None	1x HH DVD±RW	9-in-1	None	Fixed 690W Platinum	1x Serial	None	USB / USB Optical	Windows 10 DG Windows 7 Pro 64	3-year, Onsite	No	Feb 25, 2024	01/18
30BE002E--	ThinkStation P520	WE	Xeon W-2123 4C/3.6GHz/8.25MB/120W/DDR4-2666	Open	1x 8GB RDIMM DDR4-2666	Integrated Intel SATA	None	1x 256GB SSD 2.5" SATA6Gbps Opal	None	1x HH DVD±RW	9-in-1	None	Fixed 690W Platinum	1x Serial	None	USB / USB Optical	Windows 10 DG Windows 7 Pro 64	3-year, Onsite	No	Feb 25, 2024	01/18



ThinkStation P520c Platform Specifications

Product Specifications Reference (PSREF)

Components	Specification																																																																		
Form factor	25L Tower																																																																		
Dimensions	175mm/6.89" W x 426mm/16.77" D x 376mm/14.8" H (with feet)																																																																		
Weight	Maximum configuration: 31.97 lb (14.5kg)																																																																		
Processor	Up to one 140W Intel Xeon W family processor. Up to 18 cores at 2.3GHz, up to 4.0GHz with 4 cores. Memory speed up to DDR4-2666																																																																		
Chipset	Intel C422 Chipset																																																																		
Memory	4 DIMM sockets with 4 channels. RDIMMs. DDR4-2666																																																																		
Memory capacity	Up to 128GB with 4 x 32GB RDIMMs																																																																		
Memory protection	ECC																																																																		
Graphics	Two PCIe 3.0 x16 slots (see Expansion slots section). Up to one NVIDIA Quadro P5000 plus one Quadro P2000, or up to two Quadro P4000. Other graphics adapters under 75W up to 2. Supports the following graphics adapters:																																																																		
	<table border="1"> <thead> <tr> <th>Adapter</th> <th>Cores</th> <th>Memory</th> <th>Power</th> <th>Connector</th> <th>SLI</th> </tr> </thead> <tbody> <tr> <td>NVS 310</td> <td>48</td> <td>1GB</td> <td>19.5W</td> <td>2xDP</td> <td></td> </tr> <tr> <td>NVS 315</td> <td>48</td> <td>1GB</td> <td>19.3W</td> <td>2xDVI-I SL/2xDP</td> <td></td> </tr> <tr> <td>NVS 510</td> <td>192</td> <td>2GB</td> <td>33.4W</td> <td>4xmini DP</td> <td></td> </tr> <tr> <td>NVS 810</td> <td>1024</td> <td>4GB</td> <td>68W</td> <td>8xmini DP</td> <td></td> </tr> <tr> <td>Quadro P400</td> <td>256</td> <td>2GB</td> <td>30W</td> <td>3xminiDP</td> <td></td> </tr> <tr> <td>Quadro P600</td> <td>384</td> <td>2GB</td> <td>45W</td> <td>4xminiDP</td> <td></td> </tr> <tr> <td>Quadro P1000</td> <td>640</td> <td>4GB</td> <td>50W</td> <td>4xminiDP</td> <td></td> </tr> <tr> <td>Quadro P2000</td> <td>1024</td> <td>5GB</td> <td>75W</td> <td>4xDP</td> <td></td> </tr> <tr> <td>Quadro P4000</td> <td>1792</td> <td>8GB</td> <td>120W</td> <td>4xDP</td> <td></td> </tr> <tr> <td>Quadro P5000</td> <td>2560</td> <td>16GB</td> <td>180W</td> <td>DVI-D DL+4xDP</td> <td></td> </tr> </tbody> </table>	Adapter	Cores	Memory	Power	Connector	SLI	NVS 310	48	1GB	19.5W	2xDP		NVS 315	48	1GB	19.3W	2xDVI-I SL/2xDP		NVS 510	192	2GB	33.4W	4xmini DP		NVS 810	1024	4GB	68W	8xmini DP		Quadro P400	256	2GB	30W	3xminiDP		Quadro P600	384	2GB	45W	4xminiDP		Quadro P1000	640	4GB	50W	4xminiDP		Quadro P2000	1024	5GB	75W	4xDP		Quadro P4000	1792	8GB	120W	4xDP		Quadro P5000	2560	16GB	180W	DVI-D DL+4xDP	
	Adapter	Cores	Memory	Power	Connector	SLI																																																													
	NVS 310	48	1GB	19.5W	2xDP																																																														
	NVS 315	48	1GB	19.3W	2xDVI-I SL/2xDP																																																														
	NVS 510	192	2GB	33.4W	4xmini DP																																																														
	NVS 810	1024	4GB	68W	8xmini DP																																																														
	Quadro P400	256	2GB	30W	3xminiDP																																																														
	Quadro P600	384	2GB	45W	4xminiDP																																																														
	Quadro P1000	640	4GB	50W	4xminiDP																																																														
Quadro P2000	1024	5GB	75W	4xDP																																																															
Quadro P4000	1792	8GB	120W	4xDP																																																															
Quadro P5000	2560	16GB	180W	DVI-D DL+4xDP																																																															
Storage controllers	Integrated Intel SATA AHCI/RAID controller in chipset, 6Gbps SATA, RAID 0/1/10/5. Integrated Intel PCIe host in processor for M.2 PCIe NVMe drives, optional RAID 0/1 with Intel NVMe RAID upgrade basic. Optional Broadcom 9440-8i, PCIe adapter, 12Gbps, SATA/SAS, RAID 0/1/10/5																																																																		
5.25" flex bay	Two 5.25" flex bays, supports the following options: <ul style="list-style-type: none"> Up to two half-height optical drives. Up to two 5.25" slim ODD cages. Up to two 5.25" slim ODD and HDD cages. Up to one Front Access Storage Enclosure. Up to one flex module for one or more of the following options: 9.0mm optical/15-in-1 USB 3.0 reader/front eSATA/front Thunderbolt/4-digit diagnostic display <i>Note: Only one can be supported from 15-in-1 reader, Thunderbolt, and 4-digit display</i>																																																																		
Disk drive bays	Up to two internal 3.5" drive bays. Each bay supports one 3.5" or 2.5" disk. Up to two 2.5" or 3.5" SATA/SAS disk drives on 5.25" flex bays via 5.25" Front Access Storage Enclosure supports SATA or 5.25" slim ODD and HDD cage																																																																		
M.2 slots	Up to 5 x M.2 PCIe NVMe SSD: <ul style="list-style-type: none"> Two onboard M.2 slots. Up to three PCIe 3.0 x4 adapters, each adapter supports one M.2 slot Supports RAID 0/1 on onboard M.2 disks, optional NVMe RAID upgrade is needed																																																																		
Internal storage	<table border="1"> <thead> <tr> <th>HDD 7.2K 3.5" SATA6Gbps</th> <th>1TB/2TB/4TB</th> </tr> </thead> <tbody> <tr> <td>SSD 2.5" SATA6Gbps</td> <td>256GB Opal/512GB/512GB Opal/1TB Opal/2TB Opal</td> </tr> <tr> <td>M.2 PCIe NVMe, PCIe 3.0 x4</td> <td>256GB Opal/512GB Opal/1TB Opal</td> </tr> </tbody> </table>	HDD 7.2K 3.5" SATA6Gbps	1TB/2TB/4TB	SSD 2.5" SATA6Gbps	256GB Opal/512GB/512GB Opal/1TB Opal/2TB Opal	M.2 PCIe NVMe, PCIe 3.0 x4	256GB Opal/512GB Opal/1TB Opal																																																												
HDD 7.2K 3.5" SATA6Gbps	1TB/2TB/4TB																																																																		
SSD 2.5" SATA6Gbps	256GB Opal/512GB/512GB Opal/1TB Opal/2TB Opal																																																																		
M.2 PCIe NVMe, PCIe 3.0 x4	256GB Opal/512GB Opal/1TB Opal																																																																		
Media reader	9-in-1 USB 2.0 card reader on most models. Optional UHS-II 15-in-1 USB 3.0 reader on flex module																																																																		
Network interfaces	Integrated one gigabit ethernet (Intel i219LM), supports Wake-on-LAN. Optional PCIe ethernet or wireless adapters are available																																																																		
Security features	Power-on and admin password. Trusted Platform Module, TCG 2.0 compliant, switch to 1.2 via UEFI setting. Optional Kensington lock, and pad lock																																																																		
Systems management	Intel Active Management Technology 11. ThinkStation Diagnostics for Windows. Optional front 4-digit diagnostic display on flex module																																																																		
Base warranty	1 or 3-year limited onsite service with 9x5/NBD																																																																		
HD Audio	Realtek ALC662 codec																																																																		
Front ports	Two USB 3.0, microphone (3.5mm), headphone (3.5mm)																																																																		
Rear ports	Two USB 2.0, four USB 3.0, one ethernet (RJ-45), three analog audio ports (line-in, line-out, mic-in), two PS/2																																																																		

Components	Specification																									
Optional ports	Supports the following optional ports: <ul style="list-style-type: none"> Optional COM port Two USB Type-C ports via PCIe adapter, USB 3.1 gen 2. One 15W, one 5W Two Thunderbolt ports (USB Type-C) on flex module, one of two ports supports video-out. One eSATA on flex module One internal USB 3.0 port 																									
Power supply	One fixed 500W, autosenesing, 92%, 80 PLUS Platinum qualified																									
Environmental specification	<table border="1"> <tbody> <tr> <td>Temperature - operating</td> <td>50 °F to 95 °F (10 °C to 35 °C)</td> </tr> <tr> <td>Temperature - non operating (no package)</td> <td>14 °F to 140 °F (-10 °C to 60 °C)</td> </tr> <tr> <td>Temperature - non operating (with package)</td> <td>-40 °F to 140 °F (-40 °C to 60 °C)</td> </tr> <tr> <td>Altitude - operating</td> <td>(Unpressurized): -50ft-10000ft (-15.2m-3048m)</td> </tr> <tr> <td>Humidity - operating</td> <td>10%-80%, non-condensing</td> </tr> <tr> <td>Humidity - storage (with package)</td> <td>10%-90%, non-condensing</td> </tr> </tbody> </table>	Temperature - operating	50 °F to 95 °F (10 °C to 35 °C)	Temperature - non operating (no package)	14 °F to 140 °F (-10 °C to 60 °C)	Temperature - non operating (with package)	-40 °F to 140 °F (-40 °C to 60 °C)	Altitude - operating	(Unpressurized): -50ft-10000ft (-15.2m-3048m)	Humidity - operating	10%-80%, non-condensing	Humidity - storage (with package)	10%-90%, non-condensing													
	Temperature - operating	50 °F to 95 °F (10 °C to 35 °C)																								
	Temperature - non operating (no package)	14 °F to 140 °F (-10 °C to 60 °C)																								
	Temperature - non operating (with package)	-40 °F to 140 °F (-40 °C to 60 °C)																								
	Altitude - operating	(Unpressurized): -50ft-10000ft (-15.2m-3048m)																								
	Humidity - operating	10%-80%, non-condensing																								
	Humidity - storage (with package)	10%-90%, non-condensing																								
	RoHS-compliant. GREENGUARD. EPEAT Gold rating and ENERGY STAR 6.1 qualified on following models:																									
	<table border="1"> <thead> <tr> <th>Model</th> <th>30BX0008US</th> <th>30BX0009US</th> </tr> </thead> <tbody> <tr> <td>Processor</td> <td>Intel Xeon W-2123</td> <td>Intel Xeon W-2123</td> </tr> <tr> <td>Memory</td> <td>2x 8GB RDIMM DDR4-2666 ECC</td> <td>2x 8GB RDIMM DDR4-2666 ECC</td> </tr> <tr> <td>Disks</td> <td>2x 1TB HDD 7.2K 3.5" SATA6Gbps</td> <td>2x 256GB SSD 2.5" SATA6Gbps Opal</td> </tr> <tr> <td>Graphics</td> <td>NVIDIA Quadro P400 2GB</td> <td>NVIDIA Quadro P4000 8GB</td> </tr> <tr> <td>Optical</td> <td>HH DVD±RW</td> <td>HH DVD±RW</td> </tr> <tr> <td>PSU</td> <td>500W</td> <td>500W</td> </tr> <tr> <td>OS</td> <td>Win10 Pro 64</td> <td>Win10 Pro 64</td> </tr> </tbody> </table>	Model	30BX0008US	30BX0009US	Processor	Intel Xeon W-2123	Intel Xeon W-2123	Memory	2x 8GB RDIMM DDR4-2666 ECC	2x 8GB RDIMM DDR4-2666 ECC	Disks	2x 1TB HDD 7.2K 3.5" SATA6Gbps	2x 256GB SSD 2.5" SATA6Gbps Opal	Graphics	NVIDIA Quadro P400 2GB	NVIDIA Quadro P4000 8GB	Optical	HH DVD±RW	HH DVD±RW	PSU	500W	500W	OS	Win10 Pro 64	Win10 Pro 64	
	Model	30BX0008US	30BX0009US																							
Processor	Intel Xeon W-2123	Intel Xeon W-2123																								
Memory	2x 8GB RDIMM DDR4-2666 ECC	2x 8GB RDIMM DDR4-2666 ECC																								
Disks	2x 1TB HDD 7.2K 3.5" SATA6Gbps	2x 256GB SSD 2.5" SATA6Gbps Opal																								
Graphics	NVIDIA Quadro P400 2GB	NVIDIA Quadro P4000 8GB																								
Optical	HH DVD±RW	HH DVD±RW																								
PSU	500W	500W																								
OS	Win10 Pro 64	Win10 Pro 64																								
ISV certifications	Please visit www.thinkworkstations.com/isv-certifications/																									

PS/2
Option serial
2xUSB 3.0+GbE
2xUSB 3.0+
2xUSB2.0
Audio ports
Slot 1
Slot 2
Slot 3
Slot 4

Note: All expansion cards are optional

Expansion slots

Slot 1 (CPU)	PCIe 3.0 x16, full height, full length, 75W,
Slot 2 (CPU)	PCIe 3.0 x8, full height, full length, 25W, open ended
Slot 3 (CPU)	PCIe 3.0 x16, full height, full length, 75W
Slot 4 (PCH)	PCIe 3.0 x4, full height, half length, 25W, open ended

Note: When NVIDIA Quadro P5000, dual Quadro NVS 810, or dual Quadro P4000 is used, the HDD bay on the bottom will be unavailable

Model	Product	Region	Processor	Graphics	Memory	Storage Controller	M.2 RAID Upgrade	Disks	M.2 Drives	Optical	Media Reader	Power Supply	Optional Ports	Front Diagnostic LED	Keyboard / Mouse	Operating System	Warranty	Global	End of Support	Ann Date (mm/yy)
30BX003Uxx	ThinkStation P520c	CIS	Xeon W-2133 6C/3.6GHz/8.25MB/140W/DDR4-2666	Open	1x 16GB RDIMM DDR4-2666 ECC	Integrated Intel SATA	RAID 0/1/10	None	1x 512GB SSD M.2 PCIe Opal, Onboard	1x HH DVD±RW	9-in-1	Fixed 500W Platinum	1x Serial	None	USB / USB Optical	Windows 10 Pro 64	3-year, Onsite	No	Feb 25, 2024	01/18
30BX004Axx	ThinkStation P520c	CIS	Xeon W-2125 4C/4.0GHz/8.25MB/120W/DDR4-2666	NVIDIA Quadro P2000 5GB	1x 16GB RDIMM DDR4-2666 ECC	Integrated Intel SATA	None	1x 256GB SSD 2.5" SATA6Gbps Opal	None	1x HH DVD±RW	9-in-1	Fixed 500W Platinum	1x Serial	None	USB / USB Optical	Windows 10 Pro 64	3-year, Onsite	No	Feb 25, 2024	01/18
30BX003Xxx	ThinkStation P520c	EET	Xeon W-2133 6C/3.6GHz/8.25MB/140W/DDR4-2666	NVIDIA Quadro P4000 8GB	1x 16GB RDIMM DDR4-2666 ECC	Integrated Intel SATA	RAID 0/1/10	None	1x 256GB SSD M.2 PCIe Opal, Onboard	1x HH DVD±RW	9-in-1	Fixed 500W Platinum	1x Serial	None	USB / USB Optical	Windows 10 Pro 64	3-year, Onsite	No	Feb 25, 2024	01/18
30BX003Vxx	ThinkStation P520c	EET	Xeon W-2133 6C/3.6GHz/8.25MB/140W/DDR4-2666	Open	1x 16GB RDIMM DDR4-2666 ECC	Integrated Intel SATA	RAID 0/1/10	None	1x 256GB SSD M.2 PCIe Opal, Onboard	1x HH DVD±RW	9-in-1	Fixed 500W Platinum	1x Serial	None	USB / USB Optical	Windows 10 Pro 64	3-year, Onsite	No	Feb 25, 2024	01/18
30BX003Txx	ThinkStation P520c	EET	Xeon W-2125 4C/4.0GHz/8.25MB/120W/DDR4-2666	Open	1x 16GB RDIMM DDR4-2666 ECC	Integrated Intel SATA	RAID 0/1/10	None	1x 256GB SSD M.2 PCIe Opal, Onboard	1x HH DVD±RW	9-in-1	Fixed 500W Platinum	1x Serial	None	USB / USB Optical	Windows 10 Pro 64	3-year, Onsite	No	Feb 25, 2024	01/18
30BX000Yxx	ThinkStation P520c	EET	Xeon W-2125 4C/4.0GHz/8.25MB/120W/DDR4-2666	Open	1x 8GB RDIMM DDR4-2666 ECC	Integrated Intel SATA	None	1x 256GB SSD 2.5" SATA6Gbps Opal	None	1x HH DVD±RW	9-in-1	Fixed 500W Platinum	1x Serial	None	USB / USB Optical	Windows 10 DG Windows 7 Pro 64	3-year, Onsite	No	Feb 25, 2024	01/18
30BX000Jxx	ThinkStation P520c	EET	Xeon W-2123 4C/3.6GHz/8.25MB/120W/DDR4-2666	Open	1x 8GB RDIMM DDR4-2666 ECC	Integrated Intel SATA	None	1x 256GB SSD 2.5" SATA6Gbps Opal	None	1x HH DVD±RW	9-in-1	Fixed 500W Platinum	1x Serial	None	USB / USB Optical	Windows 10 Pro 64	3-year, Onsite	No	Feb 25, 2024	01/18
30BX000Lxx	ThinkStation P520c	EET	Xeon W-2125 4C/4.0GHz/8.25MB/120W/DDR4-2666	Open	1x 16GB RDIMM DDR4-2666 ECC	Integrated Intel SATA	None	1x 1TB HDD 7.2K 3.5" SATA6Gbps	None	1x HH DVD±RW	9-in-1	Fixed 500W Platinum	1x Serial	None	USB / USB Optical	Windows 10 Pro 64	3-year, Onsite	No	Feb 25, 2024	01/18
30BX000Nxx	ThinkStation P520c	EET	Xeon W-2123 4C/3.6GHz/8.25MB/120W/DDR4-2666	Open	1x 16GB RDIMM DDR4-2666 ECC	Integrated Intel SATA	None	1x 256GB SSD 2.5" SATA6Gbps Opal, 1x 1TB HDD 7.2K 3.5" SATA6Gbps	None	1x HH DVD±RW	9-in-1	Fixed 500W Platinum	1x Serial	None	USB / USB Optical	Windows 10 Pro 64	3-year, Onsite	No	Feb 25, 2024	01/18
30BX000Pxx	ThinkStation P520c	EET	Xeon W-2125 4C/4.0GHz/8.25MB/120W/DDR4-2666	Open	1x 8GB RDIMM DDR4-2666 ECC	Integrated Intel SATA	None	1x 1TB HDD 7.2K 3.5" SATA6Gbps	None	1x HH DVD±RW	9-in-1	Fixed 500W Platinum	1x Serial	None	USB / USB Optical	Windows 10 Pro 64	3-year, Onsite	No	Feb 25, 2024	01/18
30BX000Rxx	ThinkStation P520c	EET	Xeon W-2125 4C/4.0GHz/8.25MB/120W/DDR4-2666	Open	1x 16GB RDIMM DDR4-2666 ECC	Integrated Intel SATA	None	1x 256GB SSD 2.5" SATA6Gbps Opal, 1x 1TB HDD 7.2K 3.5" SATA6Gbps	None	1x HH DVD±RW	9-in-1	Fixed 500W Platinum	1x Serial	None	USB / USB Optical	Windows 10 Pro 64	3-year, Onsite	No	Feb 25, 2024	01/18

Model	Product	Region	Processor	Graphics	Memory	Storage Controller	M.2 RAID Upgrade	Disks	M.2 Drives	Optical	Media Reader	Power Supply	Optional Ports	Front Diagnostic LED	Keyboard / Mouse	Operating System	Warranty	Global	End of Support	Ann Date (mm/yy)
30BX000Sxx	ThinkStation P520c	EET	Xeon W-2123 4C/3.6GHz/8.25MB/120W/DDR4-2666	NVIDIA Quadro P1000 4GB	1x 8GB RDIMM DDR4-2666 ECC	Integrated Intel SATA	None	1x 256GB SSD 2.5" SATA6Gbps Opal	None	1x HH DVD±RW	9-in-1	Fixed 500W Platinum	1x Serial	None	USB / USB Optical	Windows 10 Pro 64	3-year, Onsite	No	Feb 25, 2024	01/18
30BX000Txx	ThinkStation P520c	EET	Xeon W-2123 4C/3.6GHz/8.25MB/120W/DDR4-2666	NVIDIA Quadro P600 2GB	1x 8GB RDIMM DDR4-2666 ECC	Integrated Intel SATA	None	1x 256GB SSD 2.5" SATA6Gbps Opal	None	1x HH DVD±RW	9-in-1	Fixed 500W Platinum	1x Serial	None	USB / USB Optical	Windows 10 Pro 64	3-year, Onsite	No	Feb 25, 2024	01/18
30BX000Vxx	ThinkStation P520c	EET	Xeon W-2123 4C/3.6GHz/8.25MB/120W/DDR4-2666	NVIDIA Quadro P4000 8GB	1x 32GB RDIMM DDR4-2666 ECC	Integrated Intel SATA	None	1x 256GB SSD 2.5" SATA6Gbps Opal, 1x 1TB HDD 7.2K 3.5" SATA6Gbps	None	1x HH DVD±RW	9-in-1	Fixed 500W Platinum	1x Serial	None	USB / USB Optical	Windows 10 Pro 64	3-year, Onsite	No	Feb 25, 2024	01/18
30BX004Kxx	ThinkStation P520c	EET	Xeon W-2125 4C/4.0GHz/8.25MB/120W/DDR4-2666	NVIDIA Quadro P2000 5GB	1x 16GB RDIMM DDR4-2666 ECC	Integrated Intel SATA	None	1x 1TB HDD 7.2K 3.5" SATA6Gbps	1x 256GB SSD M.2 PCIe Opal, Onboard	1x HH DVD±RW	9-in-1	Fixed 500W Platinum	None	None	USB / USB Optical	Windows 10 Pro 64	3-year, Onsite	No	May 3, 2024	04/18
30BX004Lxx	ThinkStation P520c	EET	Xeon W-2123 4C/3.6GHz/8.25MB/120W/DDR4-2666	Open	1x 16GB RDIMM DDR4-2666 ECC	Integrated Intel SATA	RAID 0/1/10	None	1x 512GB SSD M.2 PCIe Opal, Onboard	1x HH DVD±RW	9-in-1	Fixed 500W Platinum	1x Serial	None	USB / USB Optical	Windows 10 Pro 64	3-year, Onsite	No	May 3, 2024	04/18
30BX004L**	ThinkStation P520c	MEA	Xeon W-2123 4C/3.6GHz/8.25MB/120W/DDR4-2666	Open	1x 16GB RDIMM DDR4-2666 ECC	Integrated Intel SATA	RAID 0/1/10	None	1x 512GB SSD M.2 PCIe Opal, Onboard	1x HH DVD±RW	9-in-1	Fixed 500W Platinum	1x Serial	None	USB / USB Optical	Windows 10 Pro 64	3-year, Onsite	No	May 3, 2024	04/18
30BX004J**	ThinkStation P520c	MEA	Xeon W-2123 4C/3.6GHz/8.25MB/120W/DDR4-2666	Open	1x 16GB RDIMM DDR4-2666 ECC	Integrated Intel SATA	None	None	1x 512GB SSD M.2 PCIe Opal, Onboard	1x HH DVD±RW	9-in-1	Fixed 500W Platinum	1x Serial	None	USB / USB Optical	Windows 10 Pro 64	3-year, Onsite	No	Apr 27, 2024	03/18
30BX004A**	ThinkStation P520c	MEA	Xeon W-2125 4C/4.0GHz/8.25MB/120W/DDR4-2666	NVIDIA Quadro P2000 5GB	1x 16GB RDIMM DDR4-2666 ECC	Integrated Intel SATA	None	1x 256GB SSD 2.5" SATA6Gbps Opal	None	1x HH DVD±RW	9-in-1	Fixed 500W Platinum	1x Serial	None	USB / USB Optical	Windows 10 Pro 64	3-year, Onsite	No	Feb 25, 2024	01/18
30BX004K**	ThinkStation P520c	MEA	Xeon W-2125 4C/4.0GHz/8.25MB/120W/DDR4-2666	NVIDIA Quadro P2000 5GB	1x 16GB RDIMM DDR4-2666 ECC	Integrated Intel SATA	None	1x 1TB HDD 7.2K 3.5" SATA6Gbps	1x 256GB SSD M.2 PCIe Opal, Onboard	1x HH DVD±RW	9-in-1	Fixed 500W Platinum	None	None	USB / USB Optical	Windows 10 Pro 64	3-year, Onsite	No	May 3, 2024	04/18
30BX000U**	ThinkStation P520c	MEA	Xeon W-2125 4C/4.0GHz/8.25MB/120W/DDR4-2666	NVIDIA Quadro P2000 5GB	1x 16GB RDIMM DDR4-2666 ECC	Integrated Intel SATA	None	1x 256GB SSD 2.5" SATA6Gbps Opal, 1x 1TB HDD 7.2K 3.5" SATA6Gbps	None	1x HH DVD±RW	9-in-1	Fixed 500W Platinum	1x Serial	None	USB / USB Optical	Windows 10 Pro 64	3-year, Onsite	No	Feb 25, 2024	01/18
30BX000S**	ThinkStation P520c	MEA	Xeon W-2123 4C/3.6GHz/8.25MB/120W/DDR4-2666	NVIDIA Quadro P1000 4GB	1x 8GB RDIMM DDR4-2666 ECC	Integrated Intel SATA	None	1x 256GB SSD 2.5" SATA6Gbps Opal	None	1x HH DVD±RW	9-in-1	Fixed 500W Platinum	1x Serial	None	USB / USB Optical	Windows 10 Pro 64	3-year, Onsite	No	Feb 25, 2024	01/18

Model	Product	Region	Processor	Graphics	Memory	Storage Controller	M.2 RAID Upgrade	Disks	M.2 Drives	Optical	Media Reader	Power Supply	Optional Ports	Front Diagnostic LED	Keyboard / Mouse	Operating System	Warranty	Global	End of Support	Ann Date (mm/yy)
30BX000T**	ThinkStation P520c	MEA	Xeon W-2123 4C/3.6GHz/8.25MB/120W/DDR4-2666	NVIDIA Quadro P600 2GB	1x 8GB RDIMM DDR4-2666	Integrated Intel SATA	None	1x 256GB SSD 2.5" SATA6Gbps Opal	None	1x HH DVD±RW	9-in-1	Fixed 500W Platinum	1x Serial	None	USB / USB Optical	Windows 10 Pro 64	3-year, Onsite	No	Feb 25, 2024	01/18
30BX000Q**	ThinkStation P520c	MEA	Xeon W-2123 4C/3.6GHz/8.25MB/120W/DDR4-2666	Open	1x 16GB RDIMM DDR4-2666	Integrated Intel SATA	None	1x 1TB HDD 7.2K 3.5" SATA6Gbps	None	1x HH DVD±RW	9-in-1	Fixed 500W Platinum	1x Serial	None	USB / USB Optical	Windows 10 Pro 64	3-year, Onsite	No	Feb 25, 2024	01/18
30BX000P**	ThinkStation P520c	MEA	Xeon W-2125 4C/4.0GHz/8.25MB/120W/DDR4-2666	Open	1x 8GB RDIMM DDR4-2666	Integrated Intel SATA	None	1x 1TB HDD 7.2K 3.5" SATA6Gbps	None	1x HH DVD±RW	9-in-1	Fixed 500W Platinum	1x Serial	None	USB / USB Optical	Windows 10 Pro 64	3-year, Onsite	No	Feb 25, 2024	01/18
30BX000R**	ThinkStation P520c	MEA	Xeon W-2125 4C/4.0GHz/8.25MB/120W/DDR4-2666	Open	1x 16GB RDIMM DDR4-2666	Integrated Intel SATA	None	1x 256GB SSD 2.5" SATA6Gbps Opal, 1x 1TB HDD 7.2K 3.5" SATA6Gbps	None	1x HH DVD±RW	9-in-1	Fixed 500W Platinum	1x Serial	None	USB / USB Optical	Windows 10 Pro 64	3-year, Onsite	No	Feb 25, 2024	01/18
30BX000M**	ThinkStation P520c	MEA	Xeon W-2123 4C/3.6GHz/8.25MB/120W/DDR4-2666	Open	1x 16GB RDIMM DDR4-2666	Integrated Intel SATA	None	1x 256GB SSD 2.5" SATA6Gbps Opal	None	1x HH DVD±RW	9-in-1	Fixed 500W Platinum	1x Serial	None	USB / USB Optical	Windows 10 Pro 64	3-year, Onsite	No	Feb 25, 2024	01/18
30BX000L**	ThinkStation P520c	MEA	Xeon W-2125 4C/4.0GHz/8.25MB/120W/DDR4-2666	Open	1x 16GB RDIMM DDR4-2666	Integrated Intel SATA	None	1x 1TB HDD 7.2K 3.5" SATA6Gbps	None	1x HH DVD±RW	9-in-1	Fixed 500W Platinum	1x Serial	None	USB / USB Optical	Windows 10 Pro 64	3-year, Onsite	No	Feb 25, 2024	01/18
30BX000N**	ThinkStation P520c	MEA	Xeon W-2123 4C/3.6GHz/8.25MB/120W/DDR4-2666	Open	1x 16GB RDIMM DDR4-2666	Integrated Intel SATA	None	1x 256GB SSD 2.5" SATA6Gbps Opal, 1x 1TB HDD 7.2K 3.5" SATA6Gbps	None	1x HH DVD±RW	9-in-1	Fixed 500W Platinum	1x Serial	None	USB / USB Optical	Windows 10 Pro 64	3-year, Onsite	No	Feb 25, 2024	01/18
30BX000K**	ThinkStation P520c	MEA	Xeon W-2125 4C/4.0GHz/8.25MB/120W/DDR4-2666	Open	1x 8GB RDIMM DDR4-2666	Integrated Intel SATA	None	1x 256GB SSD 2.5" SATA6Gbps Opal	None	1x HH DVD±RW	9-in-1	Fixed 500W Platinum	1x Serial	None	USB / USB Optical	Windows 10 Pro 64	3-year, Onsite	No	Feb 25, 2024	01/18
30BX000J**	ThinkStation P520c	MEA	Xeon W-2123 4C/3.6GHz/8.25MB/120W/DDR4-2666	Open	1x 8GB RDIMM DDR4-2666	Integrated Intel SATA	None	1x 256GB SSD 2.5" SATA6Gbps Opal	None	1x HH DVD±RW	9-in-1	Fixed 500W Platinum	1x Serial	None	USB / USB Optical	Windows 10 Pro 64	3-year, Onsite	No	Feb 25, 2024	01/18
30BX001H**	ThinkStation P520c	MEA	Xeon W-2102 4C/2.9GHz/8.25MB/120W/DDR4-2400	Open	1x 8GB RDIMM DDR4-2666	Integrated Intel SATA	None	1x 1TB HDD 7.2K 3.5" SATA6Gbps	None	1x HH DVD±RW	9-in-1	Fixed 500W Platinum	None	None	USB / USB Optical	Windows 10 Pro 64	3-year, Onsite	No	Feb 25, 2024	01/18
30BX0010**	ThinkStation P520c	MEA	Xeon W-2133 6C/3.6GHz/8.25MB/140W/DDR4-2666	Open	2x 8GB RDIMM DDR4-2666	Integrated Intel SATA	None	1x 1TB HDD 7.2K 3.5" SATA6Gbps	None	1x HH DVD±RW	9-in-1	Fixed 500W Platinum	None	None	USB / USB Optical	Windows 10 Pro 64	3-year, Onsite	No	Feb 25, 2024	01/18

Model	Product	Region	Processor	Graphics	Memory	Storage Controller	M.2 RAID Upgrade	Disks	M.2 Drives	Optical	Media Reader	Power Supply	Optional Ports	Front Diagnostic LED	Keyboard / Mouse	Operating System	Warranty	Global	End of Support	Ann Date (mm/yy)
30BX0011**	ThinkStation P520c	MEA	Xeon W-2125 4C/4.0GHz/8.25MB/120W/DDR4-2666	Open	2x 8GB RDIMM DDR4-2666 ECC	Integrated Intel SATA	None	1x 1TB HDD 7.2K 3.5" SATA6Gbps	None	1x HH DVD±RW	9-in-1	Fixed 500W Platinum	None	None	USB / USB Optical	Windows 10 Pro 64	3-year, Onsite	No	Feb 25, 2024	01/18
30BX0012**	ThinkStation P520c	MEA	Xeon W-2133 6C/3.6GHz/8.25MB/140W/DDR4-2666	Open	2x 8GB RDIMM DDR4-2666 ECC	Integrated Intel SATA	None	1x 1TB HDD 7.2K 3.5" SATA6Gbps	1x 256GB SSD M.2 PCIe Opal, Onboard	1x HH DVD±RW	9-in-1	Fixed 500W Platinum	None	None	USB / USB Optical	Windows 10 Pro 64	3-year, Onsite	No	Feb 25, 2024	01/18
30BX0013**	ThinkStation P520c	MEA	Xeon W-2123 4C/3.6GHz/8.25MB/120W/DDR4-2666	Open	2x 8GB RDIMM DDR4-2666 ECC	Integrated Intel SATA	None	1x 1TB HDD 7.2K 3.5" SATA6Gbps	None	1x HH DVD±RW	9-in-1	Fixed 500W Platinum	None	None	USB / USB Optical	Windows 10 Pro 64	3-year, Onsite	No	Feb 25, 2024	01/18
30BX002H**	ThinkStation P520c	MEA	Xeon W-2123 4C/3.6GHz/8.25MB/120W/DDR4-2666	Open	1x 8GB RDIMM DDR4-2666 ECC	Integrated Intel SATA	None	1x 1TB HDD 7.2K 3.5" SATA6Gbps	None	1x HH DVD±RW	9-in-1	Fixed 500W Platinum	None	None	USB / USB Optical	Windows 10 Pro 64	3-year, Onsite	No	Feb 25, 2024	01/18
30BX000V**	ThinkStation P520c	MEA	Xeon W-2123 4C/3.6GHz/8.25MB/120W/DDR4-2666	NVIDIA Quadro P4000 8GB	1x 32GB RDIMM DDR4-2666 ECC	Integrated Intel SATA	None	1x 256GB SSD 2.5" SATA6Gbps Opal, 1x 1TB HDD 7.2K 3.5" SATA6Gbps	None	1x HH DVD±RW	9-in-1	Fixed 500W Platinum	1x Serial	None	USB / USB Optical	Windows 10 Pro 64	3-year, Onsite	No	Feb 25, 2024	01/18
30BX000Y**	ThinkStation P520c	MEA	Xeon W-2125 4C/4.0GHz/8.25MB/120W/DDR4-2666	Open	1x 8GB RDIMM DDR4-2666 ECC	Integrated Intel SATA	None	1x 256GB SSD 2.5" SATA6Gbps Opal	None	1x HH DVD±RW	9-in-1	Fixed 500W Platinum	1x Serial	None	USB / USB Optical	Windows 10 DG Windows 7 Pro 64	3-year, Onsite	No	Feb 25, 2024	01/18
30BX000W**	ThinkStation P520c	MEA	Xeon W-2125 4C/4.0GHz/8.25MB/120W/DDR4-2666	NVIDIA Quadro P2000 5GB	1x 16GB RDIMM DDR4-2666 ECC	Integrated Intel SATA	None	1x 1TB HDD 7.2K 3.5" SATA6Gbps	None	1x HH DVD±RW	9-in-1	Fixed 500W Platinum	1x Serial	None	USB / USB Optical	Windows 10 Pro 64	3-year, Onsite	No	Feb 25, 2024	01/18
30BX000X**	ThinkStation P520c	MEA	Xeon W-2123 4C/3.6GHz/8.25MB/120W/DDR4-2666	Open	1x 8GB RDIMM DDR4-2666 ECC	Integrated Intel SATA	RAID 0/1/10	1x 256GB SSD 2.5" SATA6Gbps Opal	None	1x HH DVD±RW	9-in-1	Fixed 500W Platinum	1x Serial	None	USB / USB Optical	Windows 10 DG Windows 7 Pro 64	3-year, Onsite	No	Feb 25, 2024	01/18
30BX003D**	ThinkStation P520c	MEA	Xeon W-2104 4C/3.2GHz/8.25MB/120W/DDR4-2400	Open	1x 8GB RDIMM DDR4-2666 ECC	Integrated Intel SATA	None	1x 1TB HDD 7.2K 3.5" SATA6Gbps	None	1x HH DVD±RW	9-in-1	Fixed 500W Platinum	None	None	USB / USB Optical	Windows 10 Pro 64	3-year, Onsite	No	Feb 25, 2024	01/18
30BX003W**	ThinkStation P520c	MEA	Xeon W-2133 6C/3.6GHz/8.25MB/140W/DDR4-2666	NVIDIA Quadro P2000 5GB	1x 16GB RDIMM DDR4-2666 ECC	Integrated Intel SATA	RAID 0/1/10	None	1x 256GB SSD M.2 PCIe Opal, Onboard	1x HH DVD±RW	9-in-1	Fixed 500W Platinum	1x Serial	None	USB / USB Optical	Windows 10 Pro 64	3-year, Onsite	No	Feb 25, 2024	01/18
30BX003T**	ThinkStation P520c	MEA	Xeon W-2125 4C/4.0GHz/8.25MB/120W/DDR4-2666	Open	1x 16GB RDIMM DDR4-2666 ECC	Integrated Intel SATA	RAID 0/1/10	None	1x 256GB SSD M.2 PCIe Opal, Onboard	1x HH DVD±RW	9-in-1	Fixed 500W Platinum	1x Serial	None	USB / USB Optical	Windows 10 Pro 64	3-year, Onsite	No	Feb 25, 2024	01/18

Model	Product	Region	Processor	Graphics	Memory	Storage Controller	M.2 RAID Upgrade	Disks	M.2 Drives	Optical	Media Reader	Power Supply	Optional Ports	Front Diagnostic LED	Keyboard / Mouse	Operating System	Warranty	Global	End of Support	Ann Date (mm/yy)
30BX003U**	ThinkStation P520c	MEA	Xeon W-2133 6C/3.6GHz/8.25MB/140W/DDR4-2666	Open	1x 16GB RDIMM DDR4-2666	Integrated Intel SATA	RAID 0/1/10	None	1x 512GB SSD M.2 PCIe Opal, Onboard	1x HH DVD±RW	9-in-1	Fixed 500W Platinum	1x Serial	None	USB / USB Optical	Windows 10 Pro 64	3-year, Onsite	No	Feb 25, 2024	01/18
30BX003V**	ThinkStation P520c	MEA	Xeon W-2133 6C/3.6GHz/8.25MB/140W/DDR4-2666	Open	1x 16GB RDIMM DDR4-2666	Integrated Intel SATA	RAID 0/1/10	None	1x 256GB SSD M.2 PCIe Opal, Onboard	1x HH DVD±RW	9-in-1	Fixed 500W Platinum	1x Serial	None	USB / USB Optical	Windows 10 Pro 64	3-year, Onsite	No	Feb 25, 2024	01/18
30BX003X**	ThinkStation P520c	MEA	Xeon W-2133 6C/3.6GHz/8.25MB/140W/DDR4-2666	NVIDIA Quadro P4000 8GB	1x 16GB RDIMM DDR4-2666	Integrated Intel SATA	RAID 0/1/10	None	1x 256GB SSD M.2 PCIe Opal, Onboard	1x HH DVD±RW	9-in-1	Fixed 500W Platinum	1x Serial	None	USB / USB Optical	Windows 10 Pro 64	3-year, Onsite	No	Feb 25, 2024	01/18
30BX003Wxx	ThinkStation P520c	Russia	Xeon W-2133 6C/3.6GHz/8.25MB/140W/DDR4-2666	NVIDIA Quadro P2000 5GB	1x 16GB RDIMM DDR4-2666	Integrated Intel SATA	RAID 0/1/10	None	1x 256GB SSD M.2 PCIe Opal, Onboard	1x HH DVD±RW	9-in-1	Fixed 500W Platinum	1x Serial	None	USB / USB Optical	Windows 10 Pro 64	3-year, Onsite	No	Feb 25, 2024	01/18
30BX000Xxx	ThinkStation P520c	Russia	Xeon W-2123 4C/3.6GHz/8.25MB/120W/DDR4-2666	Open	1x 8GB RDIMM DDR4-2666	Integrated Intel SATA	RAID 0/1/10	1x 256GB SSD 2.5" SATA6Gbps Opal	None	1x HH DVD±RW	9-in-1	Fixed 500W Platinum	1x Serial	None	USB / USB Optical	Windows 10 DG Windows 7 Pro 64	3-year, Onsite	No	Feb 25, 2024	01/18
30BX000Wxx	ThinkStation P520c	Russia	Xeon W-2125 4C/4.0GHz/8.25MB/120W/DDR4-2666	NVIDIA Quadro P2000 5GB	1x 16GB RDIMM DDR4-2666	Integrated Intel SATA	None	1x 1TB HDD 7.2K 3.5" SATA6Gbps	None	1x HH DVD±RW	9-in-1	Fixed 500W Platinum	1x Serial	None	USB / USB Optical	Windows 10 Pro 64	3-year, Onsite	No	Feb 25, 2024	01/18
30BX000Kxx	ThinkStation P520c	Russia	Xeon W-2125 4C/4.0GHz/8.25MB/120W/DDR4-2666	Open	1x 8GB RDIMM DDR4-2666	Integrated Intel SATA	None	1x 256GB SSD 2.5" SATA6Gbps Opal	None	1x HH DVD±RW	9-in-1	Fixed 500W Platinum	1x Serial	None	USB / USB Optical	Windows 10 Pro 64	3-year, Onsite	No	Feb 25, 2024	01/18
30BX000Mxx	ThinkStation P520c	Russia	Xeon W-2123 4C/3.6GHz/8.25MB/120W/DDR4-2666	Open	1x 16GB RDIMM DDR4-2666	Integrated Intel SATA	None	1x 256GB SSD 2.5" SATA6Gbps Opal	None	1x HH DVD±RW	9-in-1	Fixed 500W Platinum	1x Serial	None	USB / USB Optical	Windows 10 Pro 64	3-year, Onsite	No	Feb 25, 2024	01/18
30BX000Qxx	ThinkStation P520c	Russia	Xeon W-2123 4C/3.6GHz/8.25MB/120W/DDR4-2666	Open	1x 16GB RDIMM DDR4-2666	Integrated Intel SATA	None	1x 1TB HDD 7.2K 3.5" SATA6Gbps	None	1x HH DVD±RW	9-in-1	Fixed 500W Platinum	1x Serial	None	USB / USB Optical	Windows 10 Pro 64	3-year, Onsite	No	Feb 25, 2024	01/18
30BX000Uxx	ThinkStation P520c	Russia	Xeon W-2125 4C/4.0GHz/8.25MB/120W/DDR4-2666	NVIDIA Quadro P2000 5GB	1x 16GB RDIMM DDR4-2666	Integrated Intel SATA	None	1x 256GB SSD 2.5" SATA6Gbps Opal, 1x 1TB HDD 7.2K 3.5" SATA6Gbps	None	1x HH DVD±RW	9-in-1	Fixed 500W Platinum	1x Serial	None	USB / USB Optical	Windows 10 Pro 64	3-year, Onsite	No	Feb 25, 2024	01/18
30BX004Jxx	ThinkStation P520c	Russia	Xeon W-2123 4C/3.6GHz/8.25MB/120W/DDR4-2666	Open	1x 16GB RDIMM DDR4-2666	Integrated Intel SATA	None	None	1x 512GB SSD M.2 PCIe Opal, Onboard	1x HH DVD±RW	9-in-1	Fixed 500W Platinum	1x Serial	None	USB / USB Optical	Windows 10 Pro 64	3-year, Onsite	No	Apr 27, 2024	03/18

Model	Product	Region	Processor	Graphics	Memory	Storage Controller	M.2 RAID Upgrade	Disks	M.2 Drives	Optical	Media Reader	Power Supply	Optional Ports	Front Diagnostic LED	Keyboard / Mouse	Operating System	Warranty	Global	End of Support	Ann Date (mm/yy)
30BX001HUS	ThinkStation P520c	US	Xeon W-2102 4C/2.9GHz/8.25MB/120W/DDR4-2400	Open	1x 8GB RDIMM DDR4-2666	Integrated Intel SATA	None	1x 1TB HDD 7.2K 3.5" SATA6Gbps	None	1x HH DVD±RW	9-in-1	Fixed 500W Platinum	None	None	USB / USB Optical	Windows 10 Pro 64	3-year, Onsite	No	Feb 25, 2024	01/18
30BX001JUS	ThinkStation P520c	US	Xeon W-2104 4C/3.2GHz/8.25MB/120W/DDR4-2400	Open	1x 16GB RDIMM DDR4-2666	Integrated Intel SATA	None	None	1x 512GB SSD M.2 PCIe	1x HH DVD±RW Opal, Onboard	9-in-1	Fixed 500W Platinum	None	None	USB / USB Optical	Windows 10 Pro 64	3-year, Onsite	No	Feb 25, 2024	01/18
30BX001KUS	ThinkStation P520c	US	Xeon W-2125 4C/4.0GHz/8.25MB/120W/DDR4-2666	NVIDIA Quadro P2000 5GB	1x 8GB RDIMM DDR4-2666	Integrated Intel SATA	None	1x 1TB HDD 7.2K 3.5" SATA6Gbps	None	1x HH DVD±RW	9-in-1	Fixed 500W Platinum	None	None	USB / USB Optical	Windows 10 Pro 64	3-year, Onsite	No	Feb 25, 2024	01/18
30BX001LUS	ThinkStation P520c	US	Xeon W-2135 6C/3.7GHz/8.25MB/140W/DDR4-2666	NVIDIA Quadro P2000 5GB	1x 8GB RDIMM DDR4-2666	Integrated Intel SATA	None	1x 1TB HDD 7.2K 3.5" SATA6Gbps	None	1x HH DVD±RW	9-in-1	Fixed 500W Platinum	None	None	USB / USB Optical	Windows 10 Pro 64	3-year, Onsite	No	Feb 25, 2024	01/18
30BX001MUS	ThinkStation P520c	US	Xeon W-2133 6C/3.6GHz/8.25MB/140W/DDR4-2666	NVIDIA Quadro P1000 4GB	1x 16GB RDIMM DDR4-2666	Integrated Intel SATA	None	None	1x 512GB SSD M.2 PCIe	1x HH DVD±RW Opal, Onboard	9-in-1	Fixed 500W Platinum	None	None	USB / USB Optical	Windows 10 Pro 64	3-year, Onsite	No	Feb 25, 2024	01/18
30BX001NUS	ThinkStation P520c	US	Xeon W-2125 4C/4.0GHz/8.25MB/120W/DDR4-2666	Open	1x 8GB RDIMM DDR4-2666	Integrated Intel SATA	None	None	1x 256GB SSD M.2 PCIe	1x HH DVD±RW Opal, Onboard	9-in-1	Fixed 500W Platinum	None	None	USB / USB Optical	Windows 10 Pro 64	3-year, Onsite	No	Feb 25, 2024	01/18
30BX001PUS	ThinkStation P520c	US	Xeon W-2155 10C/3.3GHz/13.75MB/140W/DDR4-2666	NVIDIA Quadro P4000 8GB	1x 16GB RDIMM DDR4-2666	Integrated Intel SATA	None	None	1x 512GB SSD M.2 PCIe	1x HH DVD±RW Opal, Onboard	9-in-1	Fixed 500W Platinum	None	None	USB / USB Optical	Windows 10 Pro 64	3-year, Onsite	No	Feb 25, 2024	01/18
30BX001QUS	ThinkStation P520c	US	Xeon W-2145 8C/3.7GHz/11MB/140W/DDR4-2666	NVIDIA Quadro P4000 8GB	1x 16GB RDIMM DDR4-2666	Integrated Intel SATA	None	None	1x 512GB SSD M.2 PCIe	1x HH DVD±RW Opal, Onboard	9-in-1	Fixed 500W Platinum	None	None	USB / USB Optical	Windows 10 DG Windows 7 Pro 64	3-year, Onsite	No	Feb 25, 2024	01/18
30BX001RUS	ThinkStation P520c	US	Xeon W-2104 4C/3.2GHz/8.25MB/120W/DDR4-2400	Open	1x 16GB RDIMM DDR4-2666	Integrated Intel SATA	None	None	1x 512GB SSD M.2 PCIe	1x HH DVD±RW Opal, Onboard	9-in-1	Fixed 500W Platinum	None	None	USB / USB Optical	Windows 10 DG Windows 7 Pro 64	3-year, Onsite	No	Feb 25, 2024	01/18
30BX001SUS	ThinkStation P520c	US	Xeon W-2135 6C/3.7GHz/8.25MB/140W/DDR4-2666	Open	1x 8GB RDIMM DDR4-2666	Integrated Intel SATA	None	1x 1TB HDD 7.2K 3.5" SATA6Gbps	None	1x HH DVD±RW	9-in-1	Fixed 500W Platinum	None	None	USB / USB Optical	Windows 10 Pro 64	3-year, Onsite	No	Feb 25, 2024	01/18
30BX001TUS	ThinkStation P520c	US	Xeon W-2125 4C/4.0GHz/8.25MB/120W/DDR4-2666	NVIDIA Quadro P1000 4GB	1x 16GB RDIMM DDR4-2666	Integrated Intel SATA	None	None	1x 512GB SSD M.2 PCIe	1x HH DVD±RW Opal, Onboard	9-in-1	Fixed 500W Platinum	None	None	USB / USB Optical	Windows 10 DG Windows 7 Pro 64	3-year, Onsite	No	Feb 25, 2024	01/18

Model	Product	Region	Processor	Graphics	Memory	Storage Controller	M.2 RAID Upgrade	Disks	M.2 Drives	Optical	Media Reader	Power Supply	Optional Ports	Front Diagnostic LED	Keyboard / Mouse	Operating System	Warranty	Global	End of Support	Ann Date (mm/yy)
30BX001UUS	ThinkStation P520c	US	Xeon W-2133 6C/3.6GHz/8.25MB/140W/DDR4-2666	NVIDIA Quadro P1000 4GB	1x 8GB DDR4-2666 ECC	Integrated Intel SATA	None	1x 1TB HDD 7.2K 3.5" SATA6Gbps	None	1x HH DVD±RW	9-in-1	Fixed 500W Platinum	None	None	USB / USB Optical	Windows 10 DG Windows 7 Pro 64	3-year, Onsite	No	Feb 25, 2024	01/18
30BX001VUS	ThinkStation P520c	US	Xeon W-2155 10C/3.3GHz/13.75MB/140W/DDR4-2666	NVIDIA Quadro P2000 5GB	1x 16GB RDIMM DDR4-2666 ECC	Integrated Intel SATA	None	None	1x 512GB SSD M.2 PCIe Opal, Onboard	1x HH DVD±RW	9-in-1	Fixed 500W Platinum	None	None	USB / USB Optical	Windows 10 Pro 64	3-year, Onsite	No	Feb 25, 2024	01/18
30BX001WUS	ThinkStation P520c	US	Xeon W-2123 4C/3.6GHz/8.25MB/120W/DDR4-2666	NVIDIA Quadro P1000 4GB	1x 8GB RDIMM DDR4-2666 ECC	Integrated Intel SATA	None	1x 1TB HDD 7.2K 3.5" SATA6Gbps	None	1x HH DVD±RW	9-in-1	Fixed 500W Platinum	None	None	USB / USB Optical	Windows 10 Pro 64	3-year, Onsite	No	Feb 25, 2024	01/18
30BX001XUS	ThinkStation P520c	US	Xeon W-2125 4C/4.0GHz/8.25MB/120W/DDR4-2666	NVIDIA Quadro P600 2GB	1x 8GB RDIMM DDR4-2666 ECC	Integrated Intel SATA	None	1x 1TB HDD 7.2K 3.5" SATA6Gbps	None	1x HH DVD±RW	9-in-1	Fixed 500W Platinum	None	None	USB / USB Optical	Windows 10 DG Windows 7 Pro 64	3-year, Onsite	No	Feb 25, 2024	01/18
30BX001YUS	ThinkStation P520c	US	Xeon W-2145 8C/3.7GHz/11MB/140W/DDR4-2666	Open	1x 16GB RDIMM DDR4-2666 ECC	Integrated Intel SATA	None	None	1x 512GB SSD M.2 PCIe Opal, Onboard	1x HH DVD±RW	9-in-1	Fixed 500W Platinum	None	None	USB / USB Optical	Windows 10 DG Windows 7 Pro 64	3-year, Onsite	No	Feb 25, 2024	01/18
30BX0020US	ThinkStation P520c	US	Xeon W-2155 10C/3.3GHz/13.75MB/140W/DDR4-2666	NVIDIA Quadro P4000 8GB	1x 16GB RDIMM DDR4-2666 ECC	Integrated Intel SATA	None	None	1x 512GB SSD M.2 PCIe Opal, Onboard	1x HH DVD±RW	9-in-1	Fixed 500W Platinum	None	None	USB / USB Optical	Windows 10 DG Windows 7 Pro 64	3-year, Onsite	No	Feb 25, 2024	01/18
30BX0021US	ThinkStation P520c	US	Xeon W-2123 4C/3.6GHz/8.25MB/120W/DDR4-2666	NVIDIA Quadro P2000 5GB	1x 8GB RDIMM DDR4-2666 ECC	Integrated Intel SATA	None	1x 1TB HDD 7.2K 3.5" SATA6Gbps	None	1x HH DVD±RW	9-in-1	Fixed 500W Platinum	None	None	USB / USB Optical	Windows 10 Pro 64	3-year, Onsite	No	Feb 25, 2024	01/18
30BX0022US	ThinkStation P520c	US	Xeon W-2145 8C/3.7GHz/11MB/140W/DDR4-2666	Open	1x 8GB RDIMM DDR4-2666 ECC	Integrated Intel SATA	None	1x 1TB HDD 7.2K 3.5" SATA6Gbps	None	1x HH DVD±RW	9-in-1	Fixed 500W Platinum	None	None	USB / USB Optical	Windows 10 DG Windows 7 Pro 64	3-year, Onsite	No	Feb 25, 2024	01/18
30BX0023US	ThinkStation P520c	US	Xeon W-2135 6C/3.7GHz/8.25MB/140W/DDR4-2666	Open	1x 16GB RDIMM DDR4-2666 ECC	Integrated Intel SATA	None	None	1x 512GB SSD M.2 PCIe Opal, Onboard	1x HH DVD±RW	9-in-1	Fixed 500W Platinum	None	None	USB / USB Optical	Windows 10 Pro 64	3-year, Onsite	No	Feb 25, 2024	01/18
30BX0024US	ThinkStation P520c	US	Xeon W-2133 6C/3.6GHz/8.25MB/140W/DDR4-2666	Open	1x 8GB RDIMM DDR4-2666 ECC	Integrated Intel SATA	None	1x 1TB HDD 7.2K 3.5" SATA6Gbps	None	1x HH DVD±RW	9-in-1	Fixed 500W Platinum	None	None	USB / USB Optical	Windows 10 Pro 64	3-year, Onsite	No	Feb 25, 2024	01/18
30BX0025US	ThinkStation P520c	US	Xeon W-2125 4C/4.0GHz/8.25MB/120W/DDR4-2666	NVIDIA Quadro P4000 8GB	1x 16GB RDIMM DDR4-2666 ECC	Integrated Intel SATA	None	None	1x 512GB SSD M.2 PCIe Opal, Onboard	1x HH DVD±RW	9-in-1	Fixed 500W Platinum	None	None	USB / USB Optical	Windows 10 Pro 64	3-year, Onsite	No	Feb 25, 2024	01/18

Model	Product	Region	Processor	Graphics	Memory	Storage Controller	M.2 RAID Upgrade	Disks	M.2 Drives	Optical	Media Reader	Power Supply	Optional Ports	Front Diagnostic LED	Keyboard / Mouse	Operating System	Warranty	Global	End of Support	Ann Date (mm/yy)
30BX0026US	ThinkStation P520c	US	Xeon W-2125 4C/4.0GHz/8.25MB/120W/DDR4-2666	NVIDIA Quadro P1000 4GB	1x 16GB RDIMM DDR4-2666 ECC	Integrated Intel SATA	None	None	1x 512GB SSD M.2 PCIe Opal, Onboard	1x HH DVD±RW	9-in-1	Fixed 500W Platinum	None	None	USB / USB Optical	Windows 10 Pro 64	3-year, Onsite	No	Feb 25, 2024	01/18
30BX0027US	ThinkStation P520c	US	Xeon W-2125 4C/4.0GHz/8.25MB/120W/DDR4-2666	NVIDIA Quadro P2000 5GB	1x 8GB RDIMM DDR4-2666 ECC	Integrated Intel SATA	None	1x 1TB HDD 7.2K 3.5" SATA6Gbps	None	1x HH DVD±RW	9-in-1	Fixed 500W Platinum	None	None	USB / USB Optical	Windows 10 DG Windows 7 Pro 64	3-year, Onsite	No	Feb 25, 2024	01/18
30BX0028US	ThinkStation P520c	US	Xeon W-2133 6C/3.6GHz/8.25MB/140W/DDR4-2666	NVIDIA Quadro P2000 5GB	1x 8GB RDIMM DDR4-2666 ECC	Integrated Intel SATA	None	1x 1TB HDD 7.2K 3.5" SATA6Gbps	None	1x HH DVD±RW	9-in-1	Fixed 500W Platinum	None	None	USB / USB Optical	Windows 10 Pro 64	3-year, Onsite	No	Feb 25, 2024	01/18
30BX0029US	ThinkStation P520c	US	Xeon W-2133 6C/3.6GHz/8.25MB/140W/DDR4-2666	Open	1x 16GB RDIMM DDR4-2666 ECC	Integrated Intel SATA	None	None	1x 512GB SSD M.2 PCIe Opal, Onboard	1x HH DVD±RW	9-in-1	Fixed 500W Platinum	None	None	USB / USB Optical	Windows 10 Pro 64	3-year, Onsite	No	Feb 25, 2024	01/18
30BX002AUS	ThinkStation P520c	US	Xeon W-2135 6C/3.7GHz/8.25MB/140W/DDR4-2666	NVIDIA Quadro P2000 5GB	1x 16GB RDIMM DDR4-2666 ECC	Integrated Intel SATA	None	None	1x 512GB SSD M.2 PCIe Opal, Onboard	1x HH DVD±RW	9-in-1	Fixed 500W Platinum	None	None	USB / USB Optical	Windows 10 DG Windows 7 Pro 64	3-year, Onsite	No	Feb 25, 2024	01/18
30BX002BUS	ThinkStation P520c	US	Xeon W-2155 10C/3.3GHz/13.75MB/140W/DDR4-2666	NVIDIA Quadro P2000 5GB	1x 16GB RDIMM DDR4-2666 ECC	Integrated Intel SATA	None	None	1x 512GB SSD M.2 PCIe Opal, Onboard	1x HH DVD±RW	9-in-1	Fixed 500W Platinum	None	None	USB / USB Optical	Windows 10 DG Windows 7 Pro 64	3-year, Onsite	No	Feb 25, 2024	01/18
30BX002CUS	ThinkStation P520c	US	Xeon W-2135 6C/3.7GHz/8.25MB/140W/DDR4-2666	NVIDIA Quadro P4000 8GB	1x 16GB RDIMM DDR4-2666 ECC	Integrated Intel SATA	None	None	1x 512GB SSD M.2 PCIe Opal, Onboard	1x HH DVD±RW	9-in-1	Fixed 500W Platinum	None	None	USB / USB Optical	Windows 10 Pro 64	3-year, Onsite	No	Feb 25, 2024	01/18
30BX002DUS	ThinkStation P520c	US	Xeon W-2123 4C/3.6GHz/8.25MB/120W/DDR4-2666	Open	1x 16GB RDIMM DDR4-2666 ECC	Integrated Intel SATA	None	None	1x 512GB SSD M.2 PCIe Opal, Onboard	1x HH DVD±RW	9-in-1	Fixed 500W Platinum	None	None	USB / USB Optical	Windows 10 Pro 64	3-year, Onsite	No	Feb 25, 2024	01/18
30BX002EUS	ThinkStation P520c	US	Xeon W-2135 6C/3.7GHz/8.25MB/140W/DDR4-2666	NVIDIA Quadro P2000 5GB	1x 8GB RDIMM DDR4-2666 ECC	Integrated Intel SATA	None	1x 1TB HDD 7.2K 3.5" SATA6Gbps	None	1x HH DVD±RW	9-in-1	Fixed 500W Platinum	None	None	USB / USB Optical	Windows 10 DG Windows 7 Pro 64	3-year, Onsite	No	Feb 25, 2024	01/18
30BX002FUS	ThinkStation P520c	US	Xeon W-2125 4C/4.0GHz/8.25MB/120W/DDR4-2666	Open	1x 16GB RDIMM DDR4-2666 ECC	Integrated Intel SATA	None	None	1x 512GB SSD M.2 PCIe Opal, Onboard	1x HH DVD±RW	9-in-1	Fixed 500W Platinum	None	None	USB / USB Optical	Windows 10 DG Windows 7 Pro 64	3-year, Onsite	No	Feb 25, 2024	01/18
30BX002GUS	ThinkStation P520c	US	Xeon W-2145 8C/3.7GHz/11MB/140W/DDR4-2666	Open	1x 16GB RDIMM DDR4-2666 ECC	Integrated Intel SATA	None	None	1x 512GB SSD M.2 PCIe Opal, Onboard	1x HH DVD±RW	9-in-1	Fixed 500W Platinum	None	None	USB / USB Optical	Windows 10 Pro 64	3-year, Onsite	No	Feb 25, 2024	01/18

Model	Product	Region	Processor	Graphics	Memory	Storage Controller	M.2 RAID Upgrade	Disks	M.2 Drives	Optical	Media Reader	Power Supply	Optional Ports	Front Diagnostic LED	Keyboard / Mouse	Operating System	Warranty	Global	End of Support	Ann Date (mm/yy)
30BX003DUS	ThinkStation P520c	US	Xeon W-2104 4C/3.2GHz/8.25MB/120W/DDR4-2400	Open	1x 8GB RDIMM DDR4-2666	Integrated Intel SATA	None	1x 1TB HDD 7.2K 3.5" SATA6Gbps	None	1x HH DVD±RW	9-in-1	Fixed 500W Platinum	None	None	USB / USB Optical	Windows 10 Pro 64	3-year, Onsite	No	Feb 25, 2024	01/18
30BX003EUS	ThinkStation P520c	US	Xeon W-2123 4C/3.6GHz/8.25MB/120W/DDR4-2666	NVIDIA Quadro P1000 4GB	1x 8GB RDIMM DDR4-2666	Integrated Intel SATA	None	1x 1TB HDD 7.2K 3.5" SATA6Gbps	None	1x HH DVD±RW	9-in-1	Fixed 500W Platinum	None	None	USB / USB Optical	Windows 10 DG Windows 7 Pro 64	3-year, Onsite	No	Feb 25, 2024	01/18
30BX003FUS	ThinkStation P520c	US	Xeon W-2102 4C/2.9GHz/8.25MB/120W/DDR4-2400	Open	1x 8GB RDIMM DDR4-2666	Integrated Intel SATA	None	1x 1TB HDD 7.2K 3.5" SATA6Gbps	None	1x HH DVD±RW	9-in-1	Fixed 500W Platinum	None	None	USB / USB Optical	Windows 10 DG Windows 7 Pro 64	3-year, Onsite	No	Feb 25, 2024	01/18
30BX003GUS	ThinkStation P520c	US	Xeon W-2155 10C/3.3GHz/13.75MB/140W/DDR4-2666	NVIDIA Quadro P2000 5GB	1x 8GB RDIMM DDR4-2666	Integrated Intel SATA	None	1x 1TB HDD 7.2K 3.5" SATA6Gbps	None	1x HH DVD±RW	9-in-1	Fixed 500W Platinum	None	None	USB / USB Optical	Windows 10 Pro 64	3-year, Onsite	No	Feb 25, 2024	01/18
30BX003HUS	ThinkStation P520c	US	Xeon W-2123 4C/3.6GHz/8.25MB/120W/DDR4-2666	Open	1x 8GB RDIMM DDR4-2666	Integrated Intel SATA	None	1x 1TB HDD 7.2K 3.5" SATA6Gbps	None	1x HH DVD±RW	9-in-1	Fixed 500W Platinum	None	None	USB / USB Optical	Windows 10 DG Windows 7 Pro 64	3-year, Onsite	No	Feb 25, 2024	01/18
30BX003JUS	ThinkStation P520c	US	Xeon W-2125 4C/4.0GHz/8.25MB/120W/DDR4-2666	Open	1x 8GB RDIMM DDR4-2666	Integrated Intel SATA	None	None	1x 256GB SSD M.2 PCIe Opal, Onboard	1x HH DVD±RW	9-in-1	Fixed 500W Platinum	None	None	USB / USB Optical	Windows 10 DG Windows 7 Pro 64	3-year, Onsite	No	Feb 25, 2024	01/18
30BX003KUS	ThinkStation P520c	US	Xeon W-2155 10C/3.3GHz/13.75MB/140W/DDR4-2666	Open	1x 8GB RDIMM DDR4-2666	Integrated Intel SATA	None	1x 1TB HDD 7.2K 3.5" SATA6Gbps	None	1x HH DVD±RW	9-in-1	Fixed 500W Platinum	None	None	USB / USB Optical	Windows 10 DG Windows 7 Pro 64	3-year, Onsite	No	Feb 25, 2024	01/18
30BX003LUS	ThinkStation P520c	US	Xeon W-2145 8C/3.7GHz/11MB/140W/DDR4-2666	NVIDIA Quadro P2000 5GB	1x 16GB RDIMM DDR4-2666	Integrated Intel SATA	None	None	1x 512GB SSD M.2 PCIe Opal, Onboard	1x HH DVD±RW	9-in-1	Fixed 500W Platinum	None	None	USB / USB Optical	Windows 10 Pro 64	3-year, Onsite	No	Feb 25, 2024	01/18
30BX003MUS	ThinkStation P520c	US	Xeon W-2125 4C/4.0GHz/8.25MB/120W/DDR4-2666	NVIDIA Quadro P2000 5GB	1x 16GB RDIMM DDR4-2666	Integrated Intel SATA	None	None	1x 512GB SSD M.2 PCIe Opal, Onboard	1x HH DVD±RW	9-in-1	Fixed 500W Platinum	None	None	USB / USB Optical	Windows 10 Pro 64	3-year, Onsite	No	Feb 25, 2024	01/18
30BX003NUS	ThinkStation P520c	US	Xeon W-2145 8C/3.7GHz/11MB/140W/DDR4-2666	NVIDIA Quadro P2000 5GB	1x 16GB RDIMM DDR4-2666	Integrated Intel SATA	None	None	1x 512GB SSD M.2 PCIe Opal, Onboard	1x HH DVD±RW	9-in-1	Fixed 500W Platinum	None	None	USB / USB Optical	Windows 10 DG Windows 7 Pro 64	3-year, Onsite	No	Feb 25, 2024	01/18
30BX003PUS	ThinkStation P520c	US	Xeon W-2135 6C/3.7GHz/8.25MB/140W/DDR4-2666	NVIDIA Quadro P4000 8GB	1x 16GB RDIMM DDR4-2666	Integrated Intel SATA	None	None	1x 512GB SSD M.2 PCIe Opal, Onboard	1x HH DVD±RW	9-in-1	Fixed 500W Platinum	None	None	USB / USB Optical	Windows 10 DG Windows 7 Pro 64	3-year, Onsite	No	Feb 25, 2024	01/18

Model	Product	Region	Processor	Graphics	Memory	Storage Controller	M.2 RAID Upgrade	Disks	M.2 Drives	Optical	Media Reader	Power Supply	Optional Ports	Front Diagnostic LED	Keyboard / Mouse	Operating System	Warranty	Global	End of Support	Ann Date (mm/yy)
30BX002HUS	ThinkStation P520c	US	Xeon W-2123 4C/3.6GHz/8.25MB/120W/DDR4-2666	Open	1x 8GB RDIMM DDR4-2666	Integrated Intel SATA	None	1x 1TB HDD 7.2K 3.5" SATA6Gbps	None	1x HH DVD±RW	9-in-1	Fixed 500W Platinum	None	None	USB / USB Optical	Windows 10 Pro 64	3-year, Onsite	No	Feb 25, 2024	01/18
30BX002JUS	ThinkStation P520c	US	Xeon W-2123 4C/3.6GHz/8.25MB/120W/DDR4-2666	Open	1x 8GB RDIMM DDR4-2666	Integrated Intel SATA	None	None	1x 256GB SSD M.2 PCIe Opal, Onboard	1x HH DVD±RW	9-in-1	Fixed 500W Platinum	None	None	USB / USB Optical	Windows 10 DG Windows 7 Pro 64	3-year, Onsite	No	Feb 25, 2024	01/18
30BX002KUS	ThinkStation P520c	US	Xeon W-2133 6C/3.6GHz/8.25MB/140W/DDR4-2666	NVIDIA Quadro P1000 4GB	1x 8GB RDIMM DDR4-2666	Integrated Intel SATA	None	1x 1TB HDD 7.2K 3.5" SATA6Gbps	None	1x HH DVD±RW	9-in-1	Fixed 500W Platinum	None	None	USB / USB Optical	Windows 10 Pro 64	3-year, Onsite	No	Feb 25, 2024	01/18
30BX002LUS	ThinkStation P520c	US	Xeon W-2155 10C/3.3GHz/13.75MB/140W/DDR4-2666	Open	1x 8GB RDIMM DDR4-2666	Integrated Intel SATA	None	1x 1TB HDD 7.2K 3.5" SATA6Gbps	None	1x HH DVD±RW	9-in-1	Fixed 500W Platinum	None	None	USB / USB Optical	Windows 10 Pro 64	3-year, Onsite	No	Feb 25, 2024	01/18
30BX002MUS	ThinkStation P520c	US	Xeon W-2123 4C/3.6GHz/8.25MB/120W/DDR4-2666	Open	1x 8GB RDIMM DDR4-2666	Integrated Intel SATA	None	None	1x 256GB SSD M.2 PCIe Opal, Onboard	1x HH DVD±RW	9-in-1	Fixed 500W Platinum	None	None	USB / USB Optical	Windows 10 Pro 64	3-year, Onsite	No	Feb 25, 2024	01/18
30BX002NUS	ThinkStation P520c	US	Xeon W-2123 4C/3.6GHz/8.25MB/120W/DDR4-2666	NVIDIA Quadro P600 2GB	1x 8GB RDIMM DDR4-2666	Integrated Intel SATA	None	1x 1TB HDD 7.2K 3.5" SATA6Gbps	None	1x HH DVD±RW	9-in-1	Fixed 500W Platinum	None	None	USB / USB Optical	Windows 10 Pro 64	3-year, Onsite	No	Feb 25, 2024	01/18
30BX002PUS	ThinkStation P520c	US	Xeon W-2133 6C/3.6GHz/8.25MB/140W/DDR4-2666	NVIDIA Quadro P1000 4GB	1x 16GB RDIMM DDR4-2666	Integrated Intel SATA	None	None	1x 512GB SSD M.2 PCIe Opal, Onboard	1x HH DVD±RW	9-in-1	Fixed 500W Platinum	None	None	USB / USB Optical	Windows 10 DG Windows 7 Pro 64	3-year, Onsite	No	Feb 25, 2024	01/18
30BX002QUS	ThinkStation P520c	US	Xeon W-2133 6C/3.6GHz/8.25MB/140W/DDR4-2666	NVIDIA Quadro P2000 5GB	1x 16GB RDIMM DDR4-2666	Integrated Intel SATA	None	None	1x 512GB SSD M.2 PCIe Opal, Onboard	1x HH DVD±RW	9-in-1	Fixed 500W Platinum	None	None	USB / USB Optical	Windows 10 DG Windows 7 Pro 64	3-year, Onsite	No	Feb 25, 2024	01/18
30BX002RUS	ThinkStation P520c	US	Xeon W-2125 4C/4.0GHz/8.25MB/120W/DDR4-2666	NVIDIA Quadro P4000 8GB	1x 16GB RDIMM DDR4-2666	Integrated Intel SATA	None	None	1x 512GB SSD M.2 PCIe Opal, Onboard	1x HH DVD±RW	9-in-1	Fixed 500W Platinum	None	None	USB / USB Optical	Windows 10 DG Windows 7 Pro 64	3-year, Onsite	No	Feb 25, 2024	01/18
30BX002SUS	ThinkStation P520c	US	Xeon W-2145 8C/3.7GHz/11MB/140W/DDR4-2666	Open	1x 8GB RDIMM DDR4-2666	Integrated Intel SATA	None	1x 1TB HDD 7.2K 3.5" SATA6Gbps	None	1x HH DVD±RW	9-in-1	Fixed 500W Platinum	None	None	USB / USB Optical	Windows 10 Pro 64	3-year, Onsite	No	Feb 25, 2024	01/18
30BX002TUS	ThinkStation P520c	US	Xeon W-2125 4C/4.0GHz/8.25MB/120W/DDR4-2666	NVIDIA Quadro P1000 4GB	1x 8GB RDIMM DDR4-2666	Integrated Intel SATA	None	1x 1TB HDD 7.2K 3.5" SATA6Gbps	None	1x HH DVD±RW	9-in-1	Fixed 500W Platinum	None	None	USB / USB Optical	Windows 10 DG Windows 7 Pro 64	3-year, Onsite	No	Feb 25, 2024	01/18

Model	Product	Region	Processor	Graphics	Memory	Storage Controller	M.2 RAID Upgrade	Disks	M.2 Drives	Optical	Media Reader	Power Supply	Optional Ports	Front Diagnostic LED	Keyboard / Mouse	Operating System	Warranty	Global	End of Support	Ann Date (mm/yy)
30BX002UUS	ThinkStation P520c	US	Xeon W-2104 4C/3.2GHz/8.25MB/120W/DDR4-2400	Open	1x 8GB RDIMM DDR4-2666	Integrated Intel SATA	None	1x 1TB HDD 7.2K 3.5" SATA6Gbps	None	1x HH DVD±RW	9-in-1	Fixed 500W Platinum	None	None	USB / USB Optical	Windows 10 DG Windows 7 Pro 64	3-year, Onsite	No	Feb 25, 2024	01/18
30BX002VUS	ThinkStation P520c	US	Xeon W-2125 4C/4.0GHz/8.25MB/120W/DDR4-2666	Open	1x 8GB RDIMM DDR4-2666	Integrated Intel SATA	None	1x 1TB HDD 7.2K 3.5" SATA6Gbps	None	1x HH DVD±RW	9-in-1	Fixed 500W Platinum	None	None	USB / USB Optical	Windows 10 DG Windows 7 Pro 64	3-year, Onsite	No	Feb 25, 2024	01/18
30BX002WUS	ThinkStation P520c	US	Xeon W-2133 6C/3.6GHz/8.25MB/140W/DDR4-2666	Open	1x 16GB RDIMM DDR4-2666	Integrated Intel SATA	None	None	1x 512GB SSD M.2 PCIe	1x HH DVD±RW	9-in-1	Fixed 500W Platinum	None	None	USB / USB Optical	Windows 10 DG Windows 7 Pro 64	3-year, Onsite	No	Feb 25, 2024	01/18
30BX002XUS	ThinkStation P520c	US	Xeon W-2135 6C/3.7GHz/8.25MB/140W/DDR4-2666	Open	1x 16GB RDIMM DDR4-2666	Integrated Intel SATA	None	None	1x 512GB SSD M.2 PCIe	1x HH DVD±RW	9-in-1	Fixed 500W Platinum	None	None	USB / USB Optical	Windows 10 DG Windows 7 Pro 64	3-year, Onsite	No	Feb 25, 2024	01/18
30BX002YUS	ThinkStation P520c	US	Xeon W-2123 4C/3.6GHz/8.25MB/120W/DDR4-2666	NVIDIA Quadro P600 2GB	1x 8GB RDIMM DDR4-2666	Integrated Intel SATA	None	1x 1TB HDD 7.2K 3.5" SATA6Gbps	None	1x HH DVD±RW	9-in-1	Fixed 500W Platinum	None	None	USB / USB Optical	Windows 10 DG Windows 7 Pro 64	3-year, Onsite	No	Feb 25, 2024	01/18
30BX0030US	ThinkStation P520c	US	Xeon W-2145 8C/3.7GHz/11MB/140W/DDR4-2666	NVIDIA Quadro P2000 5GB	1x 8GB RDIMM DDR4-2666	Integrated Intel SATA	None	1x 1TB HDD 7.2K 3.5" SATA6Gbps	None	1x HH DVD±RW	9-in-1	Fixed 500W Platinum	None	None	USB / USB Optical	Windows 10 Pro 64	3-year, Onsite	No	Feb 25, 2024	01/18
30BX0031US	ThinkStation P520c	US	Xeon W-2123 4C/3.6GHz/8.25MB/120W/DDR4-2666	NVIDIA Quadro P1000 4GB	1x 16GB RDIMM DDR4-2666	Integrated Intel SATA	None	None	1x 512GB SSD M.2 PCIe	1x HH DVD±RW	9-in-1	Fixed 500W Platinum	None	None	USB / USB Optical	Windows 10 Pro 64	3-year, Onsite	No	Feb 25, 2024	01/18
30BX0032US	ThinkStation P520c	US	Xeon W-2133 6C/3.6GHz/8.25MB/140W/DDR4-2666	NVIDIA Quadro P2000 5GB	1x 16GB RDIMM DDR4-2666	Integrated Intel SATA	None	None	1x 512GB SSD M.2 PCIe	1x HH DVD±RW	9-in-1	Fixed 500W Platinum	None	None	USB / USB Optical	Windows 10 Pro 64	3-year, Onsite	No	Feb 25, 2024	01/18
30BX0033US	ThinkStation P520c	US	Xeon W-2133 6C/3.6GHz/8.25MB/140W/DDR4-2666	NVIDIA Quadro P2000 5GB	1x 8GB RDIMM DDR4-2666	Integrated Intel SATA	None	1x 1TB HDD 7.2K 3.5" SATA6Gbps	None	1x HH DVD±RW	9-in-1	Fixed 500W Platinum	None	None	USB / USB Optical	Windows 10 DG Windows 7 Pro 64	3-year, Onsite	No	Feb 25, 2024	01/18
30BX0034US	ThinkStation P520c	US	Xeon W-2123 4C/3.6GHz/8.25MB/120W/DDR4-2666	NVIDIA Quadro P2000 5GB	1x 16GB RDIMM DDR4-2666	Integrated Intel SATA	None	None	1x 512GB SSD M.2 PCIe	1x HH DVD±RW	9-in-1	Fixed 500W Platinum	None	None	USB / USB Optical	Windows 10 DG Windows 7 Pro 64	3-year, Onsite	No	Feb 25, 2024	01/18
30BX0035US	ThinkStation P520c	US	Xeon W-2123 4C/3.6GHz/8.25MB/120W/DDR4-2666	NVIDIA Quadro P2000 5GB	1x 8GB RDIMM DDR4-2666	Integrated Intel SATA	None	1x 1TB HDD 7.2K 3.5" SATA6Gbps	None	1x HH DVD±RW	9-in-1	Fixed 500W Platinum	None	None	USB / USB Optical	Windows 10 DG Windows 7 Pro 64	3-year, Onsite	No	Feb 25, 2024	01/18

Model	Product	Region	Processor	Graphics	Memory	Storage Controller	M.2 RAID Upgrade	Disks	M.2 Drives	Optical	Media Reader	Power Supply	Optional Ports	Front Diagnostic LED	Keyboard / Mouse	Operating System	Warranty	Global	End of Support	Ann Date (mm/yy)
30BX0036US	ThinkStation P520c	US	Xeon W-2125 4C/4.0GHz/8.25MB/120W/DDR4-2666	NVIDIA Quadro P2000 5GB	1x 16GB RDIMM DDR4-2666 ECC	Integrated Intel SATA	None	None	1x 512GB SSD M.2 PCIe Opal, Onboard	1x HH DVD±RW	9-in-1	Fixed 500W Platinum	None	None	USB / USB Optical	Windows 10 DG Windows 7 Pro 64	3-year, Onsite	No	Feb 25, 2024	01/18
30BX0037US	ThinkStation P520c	US	Xeon W-2155 10C/3.3GHz/13.75MB/140W/DDR4-2666	NVIDIA Quadro P2000 5GB	1x 8GB RDIMM DDR4-2666 ECC	Integrated Intel SATA	None	1x 1TB HDD 7.2K 3.5" SATA6Gbps	None	1x HH DVD±RW	9-in-1	Fixed 500W Platinum	None	None	USB / USB Optical	Windows 10 DG Windows 7 Pro 64	3-year, Onsite	No	Feb 25, 2024	01/18
30BX0038US	ThinkStation P520c	US	Xeon W-2135 6C/3.7GHz/8.25MB/140W/DDR4-2666	Open	1x 8GB RDIMM DDR4-2666 ECC	Integrated Intel SATA	None	1x 1TB HDD 7.2K 3.5" SATA6Gbps	None	1x HH DVD±RW	9-in-1	Fixed 500W Platinum	None	None	USB / USB Optical	Windows 10 DG Windows 7 Pro 64	3-year, Onsite	No	Feb 25, 2024	01/18
30BX0039US	ThinkStation P520c	US	Xeon W-2155 10C/3.3GHz/13.75MB/140W/DDR4-2666	Open	1x 16GB RDIMM DDR4-2666 ECC	Integrated Intel SATA	None	None	1x 512GB SSD M.2 PCIe Opal, Onboard	1x HH DVD±RW	9-in-1	Fixed 500W Platinum	None	None	USB / USB Optical	Windows 10 DG Windows 7 Pro 64	3-year, Onsite	No	Feb 25, 2024	01/18
30BX003AUS	ThinkStation P520c	US	Xeon W-2133 6C/3.6GHz/8.25MB/140W/DDR4-2666	Open	1x 8GB RDIMM DDR4-2666 ECC	Integrated Intel SATA	None	1x 1TB HDD 7.2K 3.5" SATA6Gbps	None	1x HH DVD±RW	9-in-1	Fixed 500W Platinum	None	None	USB / USB Optical	Windows 10 DG Windows 7 Pro 64	3-year, Onsite	No	Feb 25, 2024	01/18
30BX003BUS	ThinkStation P520c	US	Xeon W-2104 4C/3.2GHz/8.25MB/120W/DDR4-2400	NVIDIA Quadro P600 2GB	1x 8GB RDIMM DDR4-2666 ECC	Integrated Intel SATA	None	1x 1TB HDD 7.2K 3.5" SATA6Gbps	None	1x HH DVD±RW	9-in-1	Fixed 500W Platinum	None	None	USB / USB Optical	Windows 10 Pro 64	3-year, Onsite	No	Feb 25, 2024	01/18
30BX003CUS	ThinkStation P520c	US	Xeon W-2125 4C/4.0GHz/8.25MB/120W/DDR4-2666	Open	1x 16GB RDIMM DDR4-2666 ECC	Integrated Intel SATA	None	None	1x 512GB SSD M.2 PCIe Opal, Onboard	1x HH DVD±RW	9-in-1	Fixed 500W Platinum	None	None	USB / USB Optical	Windows 10 Pro 64	3-year, Onsite	No	Feb 25, 2024	01/18
30BX0014US	ThinkStation P520c	US	Xeon W-2104 4C/3.2GHz/8.25MB/120W/DDR4-2400	NVIDIA Quadro P600 2GB	1x 8GB RDIMM DDR4-2666 ECC	Integrated Intel SATA	None	1x 1TB HDD 7.2K 3.5" SATA6Gbps	None	1x HH DVD±RW	9-in-1	Fixed 500W Platinum	None	None	USB / USB Optical	Windows 10 DG Windows 7 Pro 64	3-year, Onsite	No	Feb 25, 2024	01/18
30BX0015US	ThinkStation P520c	US	Xeon W-2145 8C/3.7GHz/11MB/140W/DDR4-2666	NVIDIA Quadro P2000 5GB	1x 8GB RDIMM DDR4-2666 ECC	Integrated Intel SATA	None	1x 1TB HDD 7.2K 3.5" SATA6Gbps	None	1x HH DVD±RW	9-in-1	Fixed 500W Platinum	None	None	USB / USB Optical	Windows 10 DG Windows 7 Pro 64	3-year, Onsite	No	Feb 25, 2024	01/18
30BX0016US	ThinkStation P520c	US	Xeon W-2135 6C/3.7GHz/8.25MB/140W/DDR4-2666	NVIDIA Quadro P2000 5GB	1x 16GB RDIMM DDR4-2666 ECC	Integrated Intel SATA	None	None	1x 512GB SSD M.2 PCIe Opal, Onboard	1x HH DVD±RW	9-in-1	Fixed 500W Platinum	None	None	USB / USB Optical	Windows 10 Pro 64	3-year, Onsite	No	Feb 25, 2024	01/18
30BX0017US	ThinkStation P520c	US	Xeon W-2145 8C/3.7GHz/11MB/140W/DDR4-2666	NVIDIA Quadro P4000 8GB	1x 16GB RDIMM DDR4-2666 ECC	Integrated Intel SATA	None	None	1x 512GB SSD M.2 PCIe Opal, Onboard	1x HH DVD±RW	9-in-1	Fixed 500W Platinum	None	None	USB / USB Optical	Windows 10 Pro 64	3-year, Onsite	No	Feb 25, 2024	01/18

Model	Product	Region	Processor	Graphics	Memory	Storage Controller	M.2 RAID Upgrade	Disks	M.2 Drives	Optical	Media Reader	Power Supply	Optional Ports	Front Diagnostic LED	Keyboard / Mouse	Operating System	Warranty	Global	End of Support	Ann Date (mm/yy)
30BX0018US	ThinkStation P520c	US	Xeon W-2133 6C/3.6GHz/8.25MB/140W/DDR4-2666	NVIDIA Quadro P4000 8GB	1x 16GB RDIMM DDR4-2666 ECC	Integrated Intel SATA	None	None	1x 512GB SSD M.2 PCIe Opal, Onboard	1x HH DVD±RW	9-in-1	Fixed 500W Platinum	None	None	USB / USB Optical	Windows 10 DG Windows 7 Pro 64	3-year, Onsite	No	Feb 25, 2024	01/18
30BX0019US	ThinkStation P520c	US	Xeon W-2123 4C/3.6GHz/8.25MB/120W/DDR4-2666	Open	1x 16GB RDIMM DDR4-2666 ECC	Integrated Intel SATA	None	None	1x 512GB SSD M.2 PCIe Opal, Onboard	1x HH DVD±RW	9-in-1	Fixed 500W Platinum	None	None	USB / USB Optical	Windows 10 DG Windows 7 Pro 64	3-year, Onsite	No	Feb 25, 2024	01/18
30BX001AUS	ThinkStation P520c	US	Xeon W-2123 4C/3.6GHz/8.25MB/120W/DDR4-2666	NVIDIA Quadro P2000 5GB	1x 16GB RDIMM DDR4-2666 ECC	Integrated Intel SATA	None	None	1x 512GB SSD M.2 PCIe Opal, Onboard	1x HH DVD±RW	9-in-1	Fixed 500W Platinum	None	None	USB / USB Optical	Windows 10 Pro 64	3-year, Onsite	No	Feb 25, 2024	01/18
30BX001BUS	ThinkStation P520c	US	Xeon W-2123 4C/3.6GHz/8.25MB/120W/DDR4-2666	NVIDIA Quadro P1000 4GB	1x 16GB RDIMM DDR4-2666 ECC	Integrated Intel SATA	None	None	1x 512GB SSD M.2 PCIe Opal, Onboard	1x HH DVD±RW	9-in-1	Fixed 500W Platinum	None	None	USB / USB Optical	Windows 10 DG Windows 7 Pro 64	3-year, Onsite	No	Feb 25, 2024	01/18
30BX001CUS	ThinkStation P520c	US	Xeon W-2125 4C/4.0GHz/8.25MB/120W/DDR4-2666	NVIDIA Quadro P600 2GB	1x 8GB RDIMM DDR4-2666 ECC	Integrated Intel SATA	None	1x 1TB HDD 7.2K 3.5" SATA6Gbps	None	1x HH DVD±RW	9-in-1	Fixed 500W Platinum	None	None	USB / USB Optical	Windows 10 Pro 64	3-year, Onsite	No	Feb 25, 2024	01/18
30BX001DUS	ThinkStation P520c	US	Xeon W-2125 4C/4.0GHz/8.25MB/120W/DDR4-2666	Open	1x 8GB RDIMM DDR4-2666 ECC	Integrated Intel SATA	None	1x 1TB HDD 7.2K 3.5" SATA6Gbps	None	1x HH DVD±RW	9-in-1	Fixed 500W Platinum	None	None	USB / USB Optical	Windows 10 Pro 64	3-year, Onsite	No	Feb 25, 2024	01/18
30BX001EUS	ThinkStation P520c	US	Xeon W-2133 6C/3.6GHz/8.25MB/140W/DDR4-2666	NVIDIA Quadro P4000 8GB	1x 16GB RDIMM DDR4-2666 ECC	Integrated Intel SATA	None	None	1x 512GB SSD M.2 PCIe Opal, Onboard	1x HH DVD±RW	9-in-1	Fixed 500W Platinum	None	None	USB / USB Optical	Windows 10 Pro 64	3-year, Onsite	No	Feb 25, 2024	01/18
30BX001FUS	ThinkStation P520c	US	Xeon W-2155 10C/3.3GHz/13.75MB/140W/DDR4-2666	Open	1x 16GB RDIMM DDR4-2666 ECC	Integrated Intel SATA	None	None	1x 512GB SSD M.2 PCIe Opal, Onboard	1x HH DVD±RW	9-in-1	Fixed 500W Platinum	None	None	USB / USB Optical	Windows 10 Pro 64	3-year, Onsite	No	Feb 25, 2024	01/18
30BX001GUS	ThinkStation P520c	US	Xeon W-2125 4C/4.0GHz/8.25MB/120W/DDR4-2666	NVIDIA Quadro P1000 4GB	1x 8GB RDIMM DDR4-2666 ECC	Integrated Intel SATA	None	1x 1TB HDD 7.2K 3.5" SATA6Gbps	None	1x HH DVD±RW	9-in-1	Fixed 500W Platinum	None	None	USB / USB Optical	Windows 10 Pro 64	3-year, Onsite	No	Feb 25, 2024	01/18
30BX003T--	ThinkStation P520c	WE	Xeon W-2125 4C/4.0GHz/8.25MB/120W/DDR4-2666	Open	1x 16GB RDIMM DDR4-2666 ECC	Integrated Intel SATA	RAID 0/1/10	None	1x 256GB SSD M.2 PCIe Opal, Onboard	1x HH DVD±RW	9-in-1	Fixed 500W Platinum	1x Serial	None	USB / USB Optical	Windows 10 Pro 64	3-year, Onsite	No	Feb 25, 2024	01/18
30BX000X--	ThinkStation P520c	WE	Xeon W-2123 4C/3.6GHz/8.25MB/120W/DDR4-2666	Open	1x 8GB RDIMM DDR4-2666 ECC	Integrated Intel SATA	RAID 0/1/10	1x 256GB SSD 2.5" SATA6Gbps Opal	None	1x HH DVD±RW	9-in-1	Fixed 500W Platinum	1x Serial	None	USB / USB Optical	Windows 10 DG Windows 7 Pro 64	3-year, Onsite	No	Feb 25, 2024	01/18

Model	Product	Region	Processor	Graphics	Memory	Storage Controller	M.2 RAID Upgrade	Disks	M.2 Drives	Optical	Media Reader	Power Supply	Optional Ports	Front Diagnostic LED	Keyboard / Mouse	Operating System	Warranty	Global	End of Support	Ann Date (mm/yy)
30BX000Y--	ThinkStation P520c	WE	Xeon W-2125 4C/4.0GHz/8.25MB/120W/DDR4-2666	Open	1x 8GB RDIMM DDR4-2666 ECC	Integrated Intel SATA	None	1x 256GB SSD 2.5" SATA6Gbps Opal	None	1x HH DVD±RW	9-in-1	Fixed 500W Platinum	1x Serial	None	USB / USB Optical	Windows 10 DG Windows 7 Pro 64	3-year, Onsite	No	Feb 25, 2024	01/18
30BX003U--	ThinkStation P520c	WE	Xeon W-2133 6C/3.6GHz/8.25MB/140W/DDR4-2666	Open	1x 16GB RDIMM DDR4-2666 ECC	Integrated Intel SATA	RAID 0/1/10	None	1x 512GB SSD M.2 PCIe Opal, Onboard	1x HH DVD±RW	9-in-1	Fixed 500W Platinum	1x Serial	None	USB / USB Optical	Windows 10 Pro 64	3-year, Onsite	No	Feb 25, 2024	01/18
30BX003X--	ThinkStation P520c	WE	Xeon W-2133 6C/3.6GHz/8.25MB/140W/DDR4-2666	NVIDIA Quadro P4000 8GB	1x 16GB RDIMM DDR4-2666 ECC	Integrated Intel SATA	RAID 0/1/10	None	1x 256GB SSD M.2 PCIe Opal, Onboard	1x HH DVD±RW	9-in-1	Fixed 500W Platinum	1x Serial	None	USB / USB Optical	Windows 10 Pro 64	3-year, Onsite	No	Feb 25, 2024	01/18
30BX003W--	ThinkStation P520c	WE	Xeon W-2133 6C/3.6GHz/8.25MB/140W/DDR4-2666	NVIDIA Quadro P2000 5GB	1x 16GB RDIMM DDR4-2666 ECC	Integrated Intel SATA	RAID 0/1/10	None	1x 256GB SSD M.2 PCIe Opal, Onboard	1x HH DVD±RW	9-in-1	Fixed 500W Platinum	1x Serial	None	USB / USB Optical	Windows 10 Pro 64	3-year, Onsite	No	Feb 25, 2024	01/18
30BX003V--	ThinkStation P520c	WE	Xeon W-2133 6C/3.6GHz/8.25MB/140W/DDR4-2666	Open	1x 16GB RDIMM DDR4-2666 ECC	Integrated Intel SATA	RAID 0/1/10	None	1x 256GB SSD M.2 PCIe Opal, Onboard	1x HH DVD±RW	9-in-1	Fixed 500W Platinum	1x Serial	None	USB / USB Optical	Windows 10 Pro 64	3-year, Onsite	No	Feb 25, 2024	01/18
30BX004A--	ThinkStation P520c	WE	Xeon W-2125 4C/4.0GHz/8.25MB/120W/DDR4-2666	NVIDIA Quadro P2000 5GB	1x 16GB RDIMM DDR4-2666 ECC	Integrated Intel SATA	None	1x 256GB SSD 2.5" SATA6Gbps Opal	None	1x HH DVD±RW	9-in-1	Fixed 500W Platinum	1x Serial	None	USB / USB Optical	Windows 10 Pro 64	3-year, Onsite	No	Feb 25, 2024	01/18
30BX004G--	ThinkStation P520c	WE	Xeon W-2125 4C/4.0GHz/8.25MB/120W/DDR4-2666	NVIDIA Quadro P2000 5GB	1x 16GB RDIMM DDR4-2666 ECC	Integrated Intel SATA	None	1x 1TB HDD 7.2K 3.5" SATA6Gbps	1x 256GB SSD M.2 PCIe Opal, Onboard	1x HH DVD±RW	9-in-1	Fixed 500W Platinum	None	None	None / USB Optical	Windows 10 Pro 64	3-year, Onsite	No	Apr 27, 2024	03/18
30BX004H--	ThinkStation P520c	WE	Xeon W-2123 4C/3.6GHz/8.25MB/120W/DDR4-2666	Open	1x 16GB RDIMM DDR4-2666 ECC	Integrated Intel SATA	RAID 0/1/10	None	1x 512GB SSD M.2 PCIe Opal, Onboard	1x HH DVD±RW	9-in-1	Fixed 500W Platinum	1x Serial	None	None / USB Optical	Windows 10 Pro 64	3-year, Onsite	No	Apr 27, 2024	03/18
30BX004J--	ThinkStation P520c	WE	Xeon W-2123 4C/3.6GHz/8.25MB/120W/DDR4-2666	Open	1x 16GB RDIMM DDR4-2666 ECC	Integrated Intel SATA	None	None	1x 512GB SSD M.2 PCIe Opal, Onboard	1x HH DVD±RW	9-in-1	Fixed 500W Platinum	1x Serial	None	USB / USB Optical	Windows 10 Pro 64	3-year, Onsite	No	Apr 27, 2024	03/18
30BX000V--	ThinkStation P520c	WE	Xeon W-2123 4C/3.6GHz/8.25MB/120W/DDR4-2666	NVIDIA Quadro P4000 8GB	1x 32GB RDIMM DDR4-2666 ECC	Integrated Intel SATA	None	1x 256GB SSD 2.5" SATA6Gbps Opal, 1x 1TB HDD 7.2K 3.5" SATA6Gbps	None	1x HH DVD±RW	9-in-1	Fixed 500W Platinum	1x Serial	None	USB / USB Optical	Windows 10 Pro 64	3-year, Onsite	No	Feb 25, 2024	01/18
30BX000W--	ThinkStation P520c	WE	Xeon W-2125 4C/4.0GHz/8.25MB/120W/DDR4-2666	NVIDIA Quadro P2000 5GB	1x 16GB RDIMM DDR4-2666 ECC	Integrated Intel SATA	None	1x 1TB HDD 7.2K 3.5" SATA6Gbps	None	1x HH DVD±RW	9-in-1	Fixed 500W Platinum	1x Serial	None	USB / USB Optical	Windows 10 Pro 64	3-year, Onsite	No	Feb 25, 2024	01/18

Model	Product	Region	Processor	Graphics	Memory	Storage Controller	M.2 RAID Upgrade	Disks	M.2 Drives	Optical	Media Reader	Power Supply	Optional Ports	Front Diagnostic LED	Keyboard / Mouse	Operating System	Warranty	Global	End of Support	Ann Date (mm/yy)
30BX000U--	ThinkStation P520c	WE	Xeon W-2125 4C/4.0GHz/8.25MB/120W/DDR4-2666	NVIDIA Quadro P2000 5GB	1x 16GB RDIMM DDR4-2666 ECC	Integrated Intel SATA	None	1x 256GB SSD 2.5" SATA6Gbps Opal, 1x 1TB HDD 7.2K 3.5"	None	1x HH DVD±RW	9-in-1	Fixed 500W Platinum	1x Serial	None	USB / USB Optical	Windows 10 Pro 64	3-year, Onsite	No	Feb 25, 2024	01/18
30BX000R--	ThinkStation P520c	WE	Xeon W-2125 4C/4.0GHz/8.25MB/120W/DDR4-2666	Open	1x 16GB RDIMM DDR4-2666 ECC	Integrated Intel SATA	None	1x 256GB SSD 2.5" SATA6Gbps Opal, 1x 1TB HDD 7.2K 3.5"	None	1x HH DVD±RW	9-in-1	Fixed 500W Platinum	1x Serial	None	USB / USB Optical	Windows 10 Pro 64	3-year, Onsite	No	Feb 25, 2024	01/18
30BX000T--	ThinkStation P520c	WE	Xeon W-2123 4C/3.6GHz/8.25MB/120W/DDR4-2666	NVIDIA Quadro P600 2GB	1x 8GB RDIMM DDR4-2666 ECC	Integrated Intel SATA	None	1x 256GB SSD 2.5" SATA6Gbps Opal	None	1x HH DVD±RW	9-in-1	Fixed 500W Platinum	1x Serial	None	USB / USB Optical	Windows 10 Pro 64	3-year, Onsite	No	Feb 25, 2024	01/18
30BX000S--	ThinkStation P520c	WE	Xeon W-2123 4C/3.6GHz/8.25MB/120W/DDR4-2666	NVIDIA Quadro P1000 4GB	1x 8GB RDIMM DDR4-2666 ECC	Integrated Intel SATA	None	1x 256GB SSD 2.5" SATA6Gbps Opal	None	1x HH DVD±RW	9-in-1	Fixed 500W Platinum	1x Serial	None	USB / USB Optical	Windows 10 Pro 64	3-year, Onsite	No	Feb 25, 2024	01/18
30BX000N--	ThinkStation P520c	WE	Xeon W-2123 4C/3.6GHz/8.25MB/120W/DDR4-2666	Open	1x 16GB RDIMM DDR4-2666 ECC	Integrated Intel SATA	None	1x 256GB SSD 2.5" SATA6Gbps Opal, 1x 1TB HDD 7.2K 3.5"	None	1x HH DVD±RW	9-in-1	Fixed 500W Platinum	1x Serial	None	USB / USB Optical	Windows 10 Pro 64	3-year, Onsite	No	Feb 25, 2024	01/18
30BX000Q--	ThinkStation P520c	WE	Xeon W-2123 4C/3.6GHz/8.25MB/120W/DDR4-2666	Open	1x 16GB RDIMM DDR4-2666 ECC	Integrated Intel SATA	None	1x 1TB HDD 7.2K 3.5" SATA6Gbps	None	1x HH DVD±RW	9-in-1	Fixed 500W Platinum	1x Serial	None	USB / USB Optical	Windows 10 Pro 64	3-year, Onsite	No	Feb 25, 2024	01/18
30BX000P--	ThinkStation P520c	WE	Xeon W-2125 4C/4.0GHz/8.25MB/120W/DDR4-2666	Open	1x 8GB RDIMM DDR4-2666 ECC	Integrated Intel SATA	None	1x 1TB HDD 7.2K 3.5" SATA6Gbps	None	1x HH DVD±RW	9-in-1	Fixed 500W Platinum	1x Serial	None	USB / USB Optical	Windows 10 Pro 64	3-year, Onsite	No	Feb 25, 2024	01/18
30BX000L--	ThinkStation P520c	WE	Xeon W-2125 4C/4.0GHz/8.25MB/120W/DDR4-2666	Open	1x 16GB RDIMM DDR4-2666 ECC	Integrated Intel SATA	None	1x 1TB HDD 7.2K 3.5" SATA6Gbps	None	1x HH DVD±RW	9-in-1	Fixed 500W Platinum	1x Serial	None	USB / USB Optical	Windows 10 Pro 64	3-year, Onsite	No	Feb 25, 2024	01/18
30BX000M--	ThinkStation P520c	WE	Xeon W-2123 4C/3.6GHz/8.25MB/120W/DDR4-2666	Open	1x 16GB RDIMM DDR4-2666 ECC	Integrated Intel SATA	None	1x 256GB SSD 2.5" SATA6Gbps Opal	None	1x HH DVD±RW	9-in-1	Fixed 500W Platinum	1x Serial	None	USB / USB Optical	Windows 10 Pro 64	3-year, Onsite	No	Feb 25, 2024	01/18
30BX000J--	ThinkStation P520c	WE	Xeon W-2123 4C/3.6GHz/8.25MB/120W/DDR4-2666	Open	1x 8GB RDIMM DDR4-2666 ECC	Integrated Intel SATA	None	1x 256GB SSD 2.5" SATA6Gbps Opal	None	1x HH DVD±RW	9-in-1	Fixed 500W Platinum	1x Serial	None	USB / USB Optical	Windows 10 Pro 64	3-year, Onsite	No	Feb 25, 2024	01/18
30BX000K--	ThinkStation P520c	WE	Xeon W-2125 4C/4.0GHz/8.25MB/120W/DDR4-2666	Open	1x 8GB RDIMM DDR4-2666 ECC	Integrated Intel SATA	None	1x 256GB SSD 2.5" SATA6Gbps Opal	None	1x HH DVD±RW	9-in-1	Fixed 500W Platinum	1x Serial	None	USB / USB Optical	Windows 10 Pro 64	3-year, Onsite	No	Feb 25, 2024	01/18

Model	Product	Region	Processor	Graphics	Memory	Storage Controller	M.2 RAID Upgrade	Disks	M.2 Drives	Optical	Media Reader	Power Supply	Optional Ports	Front Diagnostic LED	Keyboard / Mouse	Operating System	Warranty	Global	End of Support	Ann Date (mm/yy)
30BX004K--	ThinkStation P520c	WE	Xeon W-2125 4C/4.0GHz/8.25MB/120W/DDR4-2666	NVIDIA Quadro P2000 5GB	1x 16GB RDIMM DDR4-2666 ECC	Integrated Intel SATA	None	1x 1TB HDD 7.2K 3.5" SATA6Gbps	1x 256GB SSD M.2 PCIe Opal, Onboard	1x HH DVD±RW	9-in-1	Fixed 500W Platinum	None	None	USB / USB Optical	Windows 10 Pro 64	3-year, Onsite	No	May 3, 2024	04/18
30BX004L--	ThinkStation P520c	WE	Xeon W-2123 4C/3.6GHz/8.25MB/120W/DDR4-2666	Open	1x 16GB RDIMM DDR4-2666 ECC	Integrated Intel SATA	RAID 0/1/10	None	1x 512GB SSD M.2 PCIe Opal, Onboard	1x HH DVD±RW	9-in-1	Fixed 500W Platinum	1x Serial	None	USB / USB Optical	Windows 10 Pro 64	3-year, Onsite	No	May 3, 2024	04/18

ThinkStation P710 Platform Specifications

Components	Specification																																																																																																																																										
Chipset	Intel C612 Platform Controller Hub (PCH)																																																																																																																																										
System mgmt	Intel Active Management Technology 9																																																																																																																																										
Processor	Up to two 145W Intel Xeon E5-2600 v4 family processors. Each processor supports up to 22 cores up to 2.2GHz, 16 cores up to 2.6GHz, 14 cores up to 2.6GHz, 12 cores up to 2.2GHz, 10 cores up to 2.4GHz, 8 cores up to 3.2GHz, 6 cores up to 3.4GHz, 4 cores up to 3.5GHz. Or up to two Intel Xeon E5-2620 v3 or E5-2609 v3 processors (not available in EMEA)																																																																																																																																										
Coprocessor	None																																																																																																																																										
Memory DIMM slots	12 DIMM sockets (6 DIMMs per processor), 8-channel capable (4-channel per processor). RDIMM, ECC, DDR4-2400																																																																																																																																										
Memory capacity	384GB, 2nd CPU is needed																																																																																																																																										
Graphics, GPU computing	Three PCIe 3.0 x16 slots, two via CPU1, one via CPU2. Up to three graphics and GPU computing adapters, 2nd CPU is needed																																																																																																																																										
	PSU Maximum quantity of PCIe x16 adapters per system (by power)																																																																																																																																										
	650W 1x150W+2x75W with onboard SATA controller and up to two 120W CPU each 850W 1x300W+2x75W (up to two 120W CPU each), or 2x150W+1x75W																																																																																																																																										
Supporting Graphics and GPU computing	<table border="1"> <thead> <tr> <th>Adapter</th> <th>Cores</th> <th>Memory</th> <th>Power</th> <th>Connector***</th> <th>SLI</th> </tr> </thead> <tbody> <tr> <td>NVS 310</td> <td>48</td> <td>1GB</td> <td>19.5W</td> <td>2xDP</td> <td></td> </tr> <tr> <td>NVS 315</td> <td>48</td> <td>1GB</td> <td>19.5W</td> <td>2xDVI-I SL/2xDP</td> <td></td> </tr> <tr> <td>NVS 510</td> <td>192</td> <td>2GB</td> <td>35W</td> <td>4xmini DP</td> <td></td> </tr> <tr> <td>NVS 810</td> <td>1024</td> <td>4GB</td> <td>68W</td> <td>8xmini DP</td> <td></td> </tr> <tr> <td>Quadro K420</td> <td>192</td> <td>2GB</td> <td>41W</td> <td>DVI-I DL+DP</td> <td></td> </tr> <tr> <td>Quadro K620</td> <td>384</td> <td>2GB</td> <td>45W</td> <td>DVI-I DL+DP</td> <td></td> </tr> <tr> <td>Quadro K1200</td> <td>512</td> <td>4GB</td> <td>45W</td> <td>4xmini DP</td> <td></td> </tr> <tr> <td>Quadro K2200</td> <td>640</td> <td>4GB</td> <td>68W</td> <td>DVI-I DL+2xDP</td> <td></td> </tr> <tr> <td>Quadro K4200</td> <td>1344</td> <td>4GB</td> <td>108W</td> <td>DVI-I DL+2xDP</td> <td></td> </tr> <tr> <td>Quadro K5200</td> <td>2304</td> <td>8GB</td> <td>150W</td> <td>DVI-I DL+DVI-D DL+2xDP</td> <td>SLI</td> </tr> <tr> <td>Quadro M2000</td> <td>768</td> <td>4GB</td> <td>75W</td> <td>4xDP</td> <td></td> </tr> <tr> <td>Quadro M4000</td> <td>1664</td> <td>8GB</td> <td>120W</td> <td>4xDP</td> <td></td> </tr> <tr> <td>Quadro M5000</td> <td>2048</td> <td>8GB</td> <td>150W</td> <td>DVI-I DL+4xDP</td> <td>SLI</td> </tr> <tr> <td>Quadro M6000</td> <td>3072</td> <td>24GB</td> <td>250W</td> <td>DVI-I DL+4xDP</td> <td>SLI</td> </tr> <tr> <td>Quadro P400</td> <td>256</td> <td>2GB</td> <td>30W</td> <td>3xminiDP</td> <td></td> </tr> <tr> <td>Quadro P600</td> <td>384</td> <td>2GB</td> <td>40W</td> <td>4xminiDP</td> <td></td> </tr> <tr> <td>Quadro P1000</td> <td>640</td> <td>4GB</td> <td>47W</td> <td>4xminiDP</td> <td></td> </tr> <tr> <td>Quadro P2000</td> <td>1024</td> <td>5GB</td> <td>75W</td> <td>4xDP</td> <td></td> </tr> <tr> <td>Quadro P4000</td> <td>1792</td> <td>8GB</td> <td>105W</td> <td>4xDP</td> <td>SLI</td> </tr> <tr> <td>Quadro P5000</td> <td>2560</td> <td>16GB</td> <td>180W</td> <td>DVI-D DL+4xDP</td> <td>SLI</td> </tr> <tr> <td>Quadro P6000</td> <td>3840</td> <td>24GB</td> <td>250W</td> <td>DVI-D DL+4xDP</td> <td>SLI</td> </tr> <tr> <td>Tesla K40</td> <td>2880</td> <td>12GB</td> <td>235W</td> <td></td> <td></td> </tr> </tbody> </table>	Adapter	Cores	Memory	Power	Connector***	SLI	NVS 310	48	1GB	19.5W	2xDP		NVS 315	48	1GB	19.5W	2xDVI-I SL/2xDP		NVS 510	192	2GB	35W	4xmini DP		NVS 810	1024	4GB	68W	8xmini DP		Quadro K420	192	2GB	41W	DVI-I DL+DP		Quadro K620	384	2GB	45W	DVI-I DL+DP		Quadro K1200	512	4GB	45W	4xmini DP		Quadro K2200	640	4GB	68W	DVI-I DL+2xDP		Quadro K4200	1344	4GB	108W	DVI-I DL+2xDP		Quadro K5200	2304	8GB	150W	DVI-I DL+DVI-D DL+2xDP	SLI	Quadro M2000	768	4GB	75W	4xDP		Quadro M4000	1664	8GB	120W	4xDP		Quadro M5000	2048	8GB	150W	DVI-I DL+4xDP	SLI	Quadro M6000	3072	24GB	250W	DVI-I DL+4xDP	SLI	Quadro P400	256	2GB	30W	3xminiDP		Quadro P600	384	2GB	40W	4xminiDP		Quadro P1000	640	4GB	47W	4xminiDP		Quadro P2000	1024	5GB	75W	4xDP		Quadro P4000	1792	8GB	105W	4xDP	SLI	Quadro P5000	2560	16GB	180W	DVI-D DL+4xDP	SLI	Quadro P6000	3840	24GB	250W	DVI-D DL+4xDP	SLI	Tesla K40	2880	12GB	235W		
	Adapter	Cores	Memory	Power	Connector***	SLI																																																																																																																																					
	NVS 310	48	1GB	19.5W	2xDP																																																																																																																																						
	NVS 315	48	1GB	19.5W	2xDVI-I SL/2xDP																																																																																																																																						
	NVS 510	192	2GB	35W	4xmini DP																																																																																																																																						
	NVS 810	1024	4GB	68W	8xmini DP																																																																																																																																						
	Quadro K420	192	2GB	41W	DVI-I DL+DP																																																																																																																																						
	Quadro K620	384	2GB	45W	DVI-I DL+DP																																																																																																																																						
	Quadro K1200	512	4GB	45W	4xmini DP																																																																																																																																						
	Quadro K2200	640	4GB	68W	DVI-I DL+2xDP																																																																																																																																						
	Quadro K4200	1344	4GB	108W	DVI-I DL+2xDP																																																																																																																																						
	Quadro K5200	2304	8GB	150W	DVI-I DL+DVI-D DL+2xDP	SLI																																																																																																																																					
	Quadro M2000	768	4GB	75W	4xDP																																																																																																																																						
	Quadro M4000	1664	8GB	120W	4xDP																																																																																																																																						
	Quadro M5000	2048	8GB	150W	DVI-I DL+4xDP	SLI																																																																																																																																					
	Quadro M6000	3072	24GB	250W	DVI-I DL+4xDP	SLI																																																																																																																																					
	Quadro P400	256	2GB	30W	3xminiDP																																																																																																																																						
	Quadro P600	384	2GB	40W	4xminiDP																																																																																																																																						
	Quadro P1000	640	4GB	47W	4xminiDP																																																																																																																																						
	Quadro P2000	1024	5GB	75W	4xDP																																																																																																																																						
Quadro P4000	1792	8GB	105W	4xDP	SLI																																																																																																																																						
Quadro P5000	2560	16GB	180W	DVI-D DL+4xDP	SLI																																																																																																																																						
Quadro P6000	3840	24GB	250W	DVI-D DL+4xDP	SLI																																																																																																																																						
Tesla K40	2880	12GB	235W																																																																																																																																								
Disk drive controller	RAID 0, 1, 5, 10 with onboard SATA controller in chipset, SATA 6Gb/s. RAID 0, 1, 5, 10 with optional LSI RAID flex adapter, 12Gb/s SAS and SATA. RAID 0, 1, 5, 6, 10 with optional LSI 9364-8i PCIe adapter, 1GB memory, 12Gb/s SAS and SATA																																																																																																																																										
Drive Bays	Two external 5.25" flex bays, four 3.5" internal bays. Each 3.5" bay can support dual drives on selected models (see right)																																																																																																																																										
Flex bay	Two 5.25" flex bays for optical drives, Front Access Storage Enclosure drives, Flex Bay Storage Enclosure drives, or flex module. • Up to two half-height optical drives or up to one 9.5mm optical drive, DVD-ROM, DVD±RW, or Blu-Ray burner • Up to one Front Access Storage Enclosure for one 3.5" or 2.5" SATA drive. • Up to two Flex Bay Storage Enclosure for two 3.5" or 2.5" SATA drives.																																																																																																																																										
Supporting storage	3.5" SATA HDD, 7.2K 6Gbs	500GB/1TB/2TB/3TB/4TB/6TB/1TB hybrid/2TB hybrid																																																																																																																																									
	2.5" SAS HDD, 15K 12Gbs	300GB/600GB																																																																																																																																									
	2.5" SAS SSD, 12Gbs	200GB/400GB/800GB																																																																																																																																									
	2.5" SAS HDD, 10K 12Gbs	300GB																																																																																																																																									
	2.5" SSD, SATA6Gbs	180GB/240GB/256GB/480GB/512GB with OPAL, 256GB/512GB/1TB without OPAL																																																																																																																																									
	PCIe SSD, 2.5"	400GB																																																																																																																																									
	PCIe SSD, M.2	256 GB/512GB/1TB																																																																																																																																									
PCIe SSD adapter	400GB (up to 4 per system, 2nd CPU is needed)																																																																																																																																										

Components	Specification	
Flex connector	One flex connectors (see right), supports one of the following: • Up to one LSI RAID flex adapter for SATA/SAS RAID • Up to one Multi-I/O flex adapters for two PCIe SSD • Up to one M.2 flex adapters for two M.2 PCIe SSD	
Network interfaces	Integrated two-port gigabit ethernet (Intel i218LM and i210AT), supports Wake-on-LAN. Optional discrete ethernet adapters are available	
HD Audio	Realtek ALC662 codec	
TPM	TCG 1.2-compliant	
Power supply	One fixed 650 watts or 850 watts, autosensing, 92%, 80 PLUS Platinum qualified	
Front ports	Four USB 3.0 (one Diagnostic, one Always On), one combo audio/microphone jack (3.5mm)	
Rear ports	Four USB 2.0, four USB 3.0 (blue), one serial (9-pin), two ethernet (RJ-45), three analog audio ports (line-in, line-out, mic-in), two PS/2	
Add-on ports	Supports the following optional ports: Two IEEE 1394 (one on rear and one on front flex module) via PCIe adapter, up to one adapter per system. Two rear USB 3.0 per PCIe adapter, up to three adapters per system. One rear Thunderbolt via PCIe adapter. One front eSATA (on flex module), or one rear eSATA via cable (also needs one PCIe slot), up to one eSATA port per system. One internal USB 3.0 port via cable, cannot be intermixed with 29-in-1 reader	
	Media reader	9-in-1 USB 2.0 card reader. Optional 29-in-1 USB 3.0 card reader on flex module
	Mechanical	• 36-liter: 175mm/6.89" W x 485mm/19.1" D x 446mm/17.6" H (with feet) • Tool-less parts: all except CPU fansink • 52.25 lb (23.7kg) max configuration
Environmental specification	Temperature - operating	50 °F to 95 °F (10 °C to 35 °C)
	Temperature - non operating (no package)	14 °F to 140 °F (-10 °C to 60 °C)
	Temperature - non operating (with package)	-40 °F to 140 °F (-40 °C to 60 °C)
	Altitude - operating	(Unpressurized): 0-10000ft (0-3048m)
	Humidity - operating	10%-80%, non-condensing
	Humidity - storage (with package)	10%-90%, non-condensing
	RoHS-compliant, GREENGUARD on all models. EPEAT Gold rating, ENERGY STAR 6.1 qualified on selected models.	
Base warranty	3-year limited onsite service with 9x5/NBD	
ISV certifications	Please visit www.thinkworkstations.com/isv-certifications/	

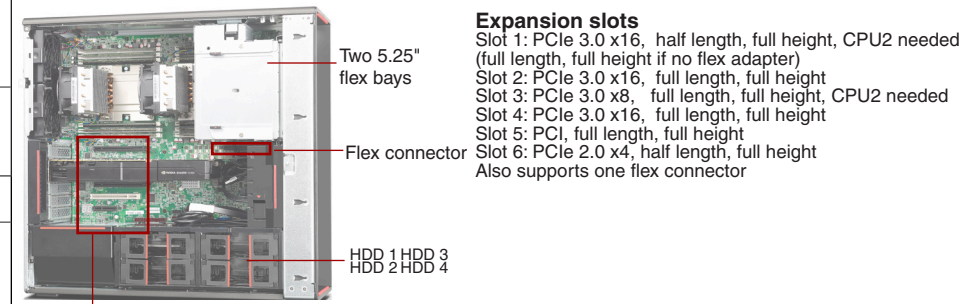

Expansion slots
Slot 1: PCIe 3.0 x16, half length, full height, CPU2 needed (full length, full height if no flex adapter)
Slot 2: PCIe 3.0 x16, full length, full height
Slot 3: PCIe 3.0 x8, full length, full height, CPU2 needed
Slot 4: PCIe 3.0 x16, full length, full height
Slot 5: PCI, full length, full height
Slot 6: PCIe 2.0 x4, half length, full height
Also supports one flex connector

Expansion slots 1-6 (top-down)

Drive Bays
HDD 1-4: Standard 3.5" HDD bay, up to four 3.5" or 2.5" disk drives.
On selected models, each 3.5" bay can supports 2.5" (9mm or less) drive plus 3.5" drive, or two 2.5" (15mm or less) drives.
Flex bay: Two 5.25" flex bays, for HH optical drives.
Or up to one optional flex module (Flex module supports one or more of the following options: 9.5mm optical/29-in-1 USB 3.0 reader/front IEEE 1394/front eSATA).
Or up to two HDD bays for two drives, 3.5" or 2.5" each, SATA only.

Model	Region	Processor	Graphics	Memory	Storage Controller	Max Drives in 3.5" Bays	Disks	M.2 Drives	Optical	Media Reader	Power Supply	Optional Ports	Keyboard / Mouse	Operating System	Warranty	Global	Ann Date (mm/yy)
30B70004**	MEA	1xXeon E5-2620 v4 8C/2.1GHz/20MB/85W/DDR4-2133	Open	1x8GB RDIMM DDR4-2400 ECC	Onboard	4	1x256GB SSD 2.5" SATA6Gbs Opal	None	HH DVD±RW	9-in-1	650W 92%	None	USB / USB Optical	Windows 10 DG Windows 7 Pro 64	3-year, Onsite	No	04/16
30B70005**	MEA	2xXeon E5-2630 v4 10C/2.2GHz/25MB/85W/DDR4-2133	Open	4x8GB RDIMM DDR4-2400 ECC	Onboard	4	None	1x512GB SSD M.2 PCIe	HH DVD±RW	9-in-1	650W 92%	None	USB / USB Optical	Windows 10 Pro 64	3-year, Onsite	No	04/16
30B70006**	MEA	1xXeon E5-2620 v4 8C/2.1GHz/20MB/85W/DDR4-2133	Open	4x8GB RDIMM DDR4-2400 ECC	Onboard	4	None	1x512GB SSD M.2 PCIe	HH DVD±RW	9-in-1	650W 92%	None	USB / USB Optical	Windows 10 Pro 64	3-year, Onsite	No	04/16
30B70007**	MEA	1xXeon E5-2620 v4 8C/2.1GHz/20MB/85W/DDR4-2133	Open	1x8GB RDIMM DDR4-2400 ECC	Onboard	4	1x256GB SSD 2.5" SATA6Gbs Opal	None	HH DVD±RW	9-in-1	650W 92%	None	USB / USB Optical	Windows 10 Pro 64	3-year, Onsite	No	04/16
30B70008**	MEA	1xXeon E5-2620 v4 8C/2.1GHz/20MB/85W/DDR4-2133	Open	4x8GB RDIMM DDR4-2400 ECC	Onboard	4	None	1x512GB SSD M.2 PCIe	HH DVD±RW	9-in-1	650W 92%	None	USB / USB Optical	Windows 10 DG Windows 7 Pro 64	3-year, Onsite	No	04/16
30B70009**	MEA	2xXeon E5-2630 v4 10C/2.2GHz/25MB/85W/DDR4-2133	Open	4x8GB RDIMM DDR4-2400 ECC	Onboard	4	None	1x512GB SSD M.2 PCIe	HH DVD±RW	9-in-1	650W 92%	None	USB / USB Optical	Windows 10 DG Windows 7 Pro 64	3-year, Onsite	No	04/16
30B7000A**	MEA	2xXeon E5-2650 v4 12C/2.2GHz/30MB/105W/DDR4-2400	Open	2x8GB RDIMM DDR4-2400 ECC	Onboard	4	1x1TB SSD 2.5" SATA6Gbs	None	HH DVD±RW	9-in-1	850W 92%	None	USB / USB Optical	Windows 10 DG Windows 7 Pro 64	3-year, Onsite	No	04/16
30B7000B**	MEA	1xXeon E5-2650 v4 12C/2.2GHz/30MB/105W/DDR4-2400	Open	2x8GB RDIMM DDR4-2400 ECC	Onboard	4	1x512GB SSD 2.5" SATA6Gbs	None	HH DVD±RW	9-in-1	850W 92%	None	USB / USB Optical	Windows 10 DG Windows 7 Pro 64	3-year, Onsite	No	04/16
30B7000C**	MEA	1xXeon E5-2630 v4 10C/2.2GHz/25MB/85W/DDR4-2133	Open	1x8GB RDIMM DDR4-2400 ECC	Onboard	4	1x512GB SSD 2.5" SATA6Gbs	None	HH DVD±RW	9-in-1	850W 92%	None	USB / USB Optical	Windows 10 DG Windows 7 Pro 64	3-year, Onsite	No	04/16
30B7000D**	MEA	2xXeon E5-2650 v4 12C/2.2GHz/30MB/105W/DDR4-2400	Open	2x8GB RDIMM DDR4-2400 ECC	Onboard	4	1x1TB SSD 2.5" SATA6Gbs	None	HH DVD±RW	9-in-1	850W 92%	None	USB / USB Optical	Windows 10 Pro 64	3-year, Onsite	No	04/16
30B7000E**	MEA	1xXeon E5-2650 v4 12C/2.2GHz/30MB/105W/DDR4-2400	Open	2x8GB RDIMM DDR4-2400 ECC	Onboard	4	1x512GB SSD 2.5" SATA6Gbs	None	HH DVD±RW	9-in-1	850W 92%	None	USB / USB Optical	Windows 10 Pro 64	3-year, Onsite	No	04/16
30B7000F**	MEA	1xXeon E5-2630 v4 10C/2.2GHz/25MB/85W/DDR4-2133	Open	1x8GB RDIMM DDR4-2400 ECC	Onboard	4	1x512GB SSD 2.5" SATA6Gbs	None	HH DVD±RW	9-in-1	850W 92%	None	USB / USB Optical	Windows 10 Pro 64	3-year, Onsite	No	04/16
30B7000G**	MEA	1xE5-2680 v4 14C/2.4GHz/35MB/120W/DDR4-2400	NVIDIA Quadro M6000 12GB	4x8GB RDIMM DDR4-2400 ECC	Onboard	4	1x512GB SSD 2.5" SATA6Gbs	None	HH DVD±RW	9-in-1	850W 92%	None	USB / USB Optical	Windows 10 DG Windows 7 Pro 64	3-year, Onsite	No	04/16

Model	Region	Processor	Graphics	Memory	Storage Controller	Max Drives in 3.5" Bays	Disks	M.2 Drives	Optical	Media Reader	Power Supply	Optional Ports	Keyboard / Mouse	Operating System	Warranty	Global	Ann Date (mm/yy)
30B7000H**	MEA	1xE5-2680 v4 14C/2.4GHz/35MB/120W/DDR4-2400	NVIDIA Quadro M6000 12GB	4x8GB RDIMM DDR4-2400 ECC	Onboard	4	1x512GB SSD 2.5" SATA6Gbs	None	HH DVD±RW	9-in-1	850W 92%	None	USB / USB Optical	Windows 10 Pro 64	3-year, Onsite	No	04/16
30B7000J**	MEA	2xXeon E5-2650 v4 12C/2.2GHz/30MB/105W/DDR4-2400	NVIDIA Quadro M5000 8GB	2x8GB RDIMM DDR4-2400 ECC	Onboard	4	None	1x512GB SSD M.2 PCIe	HH DVD±RW	9-in-1	850W 92%	None	USB / USB Optical	Windows 10 DG Windows 7 Pro 64	3-year, Onsite	No	04/16
30B7000K**	MEA	2xXeon E5-2650 v4 12C/2.2GHz/30MB/105W/DDR4-2400	NVIDIA Quadro M5000 8GB	2x8GB RDIMM DDR4-2400 ECC	Onboard	4	None	1x512GB SSD M.2 PCIe	HH DVD±RW	9-in-1	850W 92%	None	USB / USB Optical	Windows 10 Pro 64	3-year, Onsite	No	04/16
30B7000L**	MEA	1xXeon E5-2650 v4 12C/2.2GHz/30MB/105W/DDR4-2400	Open	2x8GB RDIMM DDR4-2400 ECC	Onboard	4	None	1x512GB SSD M.2 PCIe	HH DVD±RW	9-in-1	850W 92%	None	USB / USB Optical	Windows 10 DG Windows 7 Pro 64	3-year, Onsite	Global	04/16
30B7000M**	MEA	1xXeon E5-2650 v4 12C/2.2GHz/30MB/105W/DDR4-2400	NVIDIA Quadro M4000 8GB	2x8GB RDIMM DDR4-2400 ECC	Onboard	4	None	1x512GB SSD M.2 PCIe	HH DVD±RW	9-in-1	850W 92%	None	USB / USB Optical	Windows 10 DG Windows 7 Pro 64	3-year, Onsite	Global	04/16
30B7000N**	MEA	1xXeon E5-2650 v4 12C/2.2GHz/30MB/105W/DDR4-2400	NVIDIA Quadro M4000 8GB	2x8GB RDIMM DDR4-2400 ECC	Onboard	4	None	1x512GB SSD M.2 PCIe	HH DVD±RW	9-in-1	850W 92%	None	USB / USB Optical	Windows 10 Pro 64	3-year, Onsite	Global	04/16
30B7000P**	MEA	1xXeon E5-2620 v4 8C/2.1GHz/20MB/85W/DDR4-2133	Open	2x8GB RDIMM DDR4-2400 ECC	Onboard	4	1x256GB SSD 2.5" SATA6Gbs Opal	None	HH DVD±RW	9-in-1	850W 92%	None	USB / USB Optical	Windows 10 Pro 64	3-year, Onsite	No	04/16
30B7000Q**	MEA	1xXeon E5-2620 v4 8C/2.1GHz/20MB/85W/DDR4-2133	Open	2x8GB RDIMM DDR4-2400 ECC	Onboard	4	1x256GB SSD 2.5" SATA6Gbs Opal	None	HH DVD±RW	9-in-1	850W 92%	None	USB / USB Optical	Windows 10 DG Windows 7 Pro 64	3-year, Onsite	No	04/16
30B7001C**	MEA	1xXeon E5-2630 v4 10C/2.2GHz/25MB/85W/DDR4-2133	Open	2x8GB RDIMM DDR4-2400 ECC	Onboard	4	1x1TB HDD 7.2K 3.5" SATA6Gbs	None	HH DVD±RW	9-in-1	650W 92%	None	USB / USB Optical	Windows 10 Pro 64	3-year, Onsite	No	07/16
30B7001D**	MEA	1xE5-2603 v4 6C/1.7GHz/15MB/85W/DDR4-1866	Open	1x8GB RDIMM DDR4-2400 ECC	Onboard	4	1x1TB HDD 7.2K 3.5" SATA6Gbs	None	HH DVD±RW	9-in-1	650W 92%	None	USB / USB Optical	Windows 10 Pro 64	3-year, Onsite	No	07/16
30B7001E**	MEA	1xE5-2603 v4 6C/1.7GHz/15MB/85W/DDR4-1866	Open	1x8GB RDIMM DDR4-2400 ECC	Onboard	4	1x1TB HDD 7.2K 3.5" SATA6Gbs	None	HH DVD±RW	9-in-1	650W 92%	None	USB / USB Optical	Windows 10 DG Windows 7 Pro 64	3-year, Onsite	No	07/16
30B7001F**	MEA	1xE5-2620 v3 6C/2.4GHz/15MB/85W/DDR4-1866	Open	1x8GB RDIMM DDR4-2400 ECC	Onboard	4	1x1TB HDD 7.2K 3.5" SATA6Gbs	None	HH DVD±RW	9-in-1	650W 92%	None	USB / USB Optical	Windows 10 DG Windows 7 Pro 64	3-year, Onsite	No	07/16
30B7001G**	MEA	1xE5-2620 v3 6C/2.4GHz/15MB/85W/DDR4-1866	Open	1x8GB RDIMM DDR4-2400 ECC	Onboard	4	1x1TB HDD 7.2K 3.5" SATA6Gbs	None	HH DVD±RW	9-in-1	650W 92%	None	USB / USB Optical	Windows 10 Pro 64	3-year, Onsite	No	07/16

Model	Region	Processor	Graphics	Memory	Storage Controller	Max Drives in 3.5" Bays	Disks	M.2 Drives	Optical	Media Reader	Power Supply	Optional Ports	Keyboard / Mouse	Operating System	Warranty	Global	Ann Date (mm/yy)
30B7001H**	MEA	1xE5-2620 v3 6C/2.4GHz/15MB/85W/DDR4-1866	Open	2x8GB RDIMM DDR4-2400 ECC	Onboard	4	1x1TB HDD 7.2K 3.5" SATA6Gbs	None	HH DVD±RW	9-in-1	650W 92%	None	USB / USB Optical	Windows 10 Pro 64	3-year, Onsite	No	07/16
30B7001J**	MEA	1xXeon E5-2630 v4 10C/2.2GHz/25MB/85W/DDR4-2133	Open	2x8GB RDIMM DDR4-2400 ECC	Onboard	4	1x1TB HDD 7.2K 3.5" SATA6Gbs	None	HH DVD±RW	9-in-1	650W 92%	None	USB / USB Optical	Windows 10 DG Windows 7 Pro 64	3-year, Onsite	No	07/16
30B7001K**	MEA	1xE5-2620 v3 6C/2.4GHz/15MB/85W/DDR4-1866	Open	2x8GB RDIMM DDR4-2400 ECC	Onboard	4	1x1TB HDD 7.2K 3.5" SATA6Gbs	None	HH DVD±RW	9-in-1	650W 92%	None	USB / USB Optical	Windows 10 DG Windows 7 Pro 64	3-year, Onsite	No	07/16
30B7001L**	MEA	2xXeon E5-2620 v4 8C/2.1GHz/20MB/85W/DDR4-2133	Open	4x8GB RDIMM DDR4-2400 ECC	Onboard	4	1x1TB HDD 7.2K 3.5" SATA6Gbs	1x256GB SSD M.2 PCIe	HH DVD±RW	9-in-1	650W 92%	None	USB / USB Optical	Windows 10 Pro 64	3-year, Onsite	No	07/16
30B70026**	MEA	2xXeon E5-2620 v4 8C/2.1GHz/20MB/85W/DDR4-2133	Open	4x8GB RDIMM DDR4-2400 ECC	Onboard	4	1x1TB HDD 7.2K 3.5" SATA6Gbs	1x256GB SSD M.2 PCIe	HH DVD±RW	9-in-1	650W 92%	None	USB / USB Optical	Windows 10 DG Windows 7 Pro 64	3-year, Onsite	No	09/16
30B7002X**	MEA	2xXeon E5-2620 v4 8C/2.1GHz/20MB/85W/DDR4-2133	NVIDIA Quadro P2000 5GB	2x8GB RDIMM DDR4-2400 ECC	Onboard	4	1x256GB SSD 2.5" SATA6Gbs Opal+1x1TB HDD 7.2K 3.5" SATA6Gbs	None	9.5mm DVD±RW	29-in-1	850W 92%	Front eSATA	USB / USB Optical	Windows 10 Pro 64	3-year, Onsite	No	07/17
30B7002Y**	MEA	2xXeon E5-2630 v4 10C/2.2GHz/25MB/85W/DDR4-2133	NVIDIA Quadro P4000 8GB	2x16GB RDIMM DDR4-2400 ECC	Onboard	4	1x256GB SSD 2.5" SATA6Gbs Opal+1x1TB HDD 7.2K 3.5" SATA6Gbs	None	9.5mm DVD±RW	29-in-1	850W 92%	Front eSATA	USB / USB Optical	Windows 10 Pro 64	3-year, Onsite	No	07/17
30B70030**	MEA	1xXeon E5-2620 v4 8C/2.1GHz/20MB/85W/DDR4-2133	Open	1x8GB RDIMM DDR4-2400 ECC	Onboard	4	1x256GB SSD 2.5" SATA6Gbs Opal	None	HH DVD	9-in-1	650W 92%	None	USB / USB Optical	Windows 10 Pro 64	3-year, Onsite	No	09/17
30B70031**	MEA	1xXeon E5-2630 v4 10C/2.2GHz/25MB/85W/DDR4-2133	Open	1x8GB RDIMM DDR4-2400 ECC	Onboard	4	1x512GB SSD 2.5" SATA6Gbs	None	HH DVD	9-in-1	850W 92%	None	USB / USB Optical	Windows 10 Pro 64	3-year, Onsite	No	09/17
30B70032**	MEA	1xXeon E5-2650 v4 12C/2.2GHz/30MB/105W/DDR4-2400	Open	2x8GB RDIMM DDR4-2400 ECC	Onboard	4	1x512GB SSD 2.5" SATA6Gbs	None	HH DVD	9-in-1	850W 92%	None	USB / USB Optical	Windows 10 Pro 64	3-year, Onsite	No	09/17
30B70033**	MEA	1xXeon E5-2620 v4 8C/2.1GHz/20MB/85W/DDR4-2133	Open	4x8GB RDIMM DDR4-2400 ECC	Onboard	4	None	1x512GB SSD M.2 PCIe	HH DVD	9-in-1	650W 92%	None	USB / USB Optical	Windows 10 Pro 64	3-year, Onsite	No	09/17
30B70034**	MEA	2xXeon E5-2630 v4 10C/2.2GHz/25MB/85W/DDR4-2133	Open	4x8GB RDIMM DDR4-2400 ECC	Onboard	4	None	1x512GB SSD M.2 PCIe	HH DVD	9-in-1	650W 92%	None	USB / USB Optical	Windows 10 Pro 64	3-year, Onsite	No	09/17
30B70035**	MEA	2xXeon E5-2620 v4 8C/2.1GHz/20MB/85W/DDR4-2133	Open	4x8GB RDIMM DDR4-2400 ECC	Onboard	4	1x1TB HDD 7.2K 3.5" SATA6Gbs	1x256GB SSD M.2 PCIe	HH DVD	9-in-1	650W 92%	None	USB / USB Optical	Windows 10 Pro 64	3-year, Onsite	No	09/17

Model	Region	Processor	Graphics	Memory	Storage Controller	Max Drives in 3.5" Bays	Disks	M.2 Drives	Optical	Media Reader	Power Supply	Optional Ports	Keyboard / Mouse	Operating System	Warranty	Global	Ann Date (mm/yy)
30B70036**	MEA	2xXeon E5-2630 v4 10C/2.2GHz/25MB/85W/DDR4-2133	Open	2x8GB RDIMM DDR4-2400 ECC	Onboard	4	1x256GB SSD 2.5" SATA6Gbs Opal+1x1TB HDD 7.2K 3.5" SATA6Gbs	None	9.0mm DVD±RW	29-in-1	850W 92%	None	USB / USB Optical	Windows 10 Pro 64	3-year, Onsite	No	09/17
30B70037**	MEA	2xXeon E5-2620 v4 8C/2.1GHz/20MB/85W/DDR4-2133	Open	2x8GB RDIMM DDR4-2400 ECC	Onboard	4	1x256GB SSD 2.5" SATA6Gbs Opal+1x1TB HDD 7.2K 3.5" SATA6Gbs	None	9.0mm DVD±RW	29-in-1	850W 92%	None	USB / USB Optical	Windows 10 Pro 64	3-year, Onsite	No	09/17
30B70038**	MEA	1xXeon E5-2620 v4 8C/2.1GHz/20MB/85W/DDR4-2133	Open	1x8GB RDIMM DDR4-2400 ECC	Onboard	4	1x256GB SSD 2.5" SATA6Gbs Opal	None	HH DVD	9-in-1	650W 92%	None	USB / USB Optical	Windows 10 DG Windows 7 Pro 64	3-year, Onsite	No	09/17
30B70039**	MEA	1xXeon E5-2630 v4 10C/2.2GHz/25MB/85W/DDR4-2133	Open	1x8GB RDIMM DDR4-2400 ECC	Onboard	4	1x512GB SSD 2.5" SATA6Gbs	None	HH DVD	9-in-1	850W 92%	None	USB / USB Optical	Windows 10 DG Windows 7 Pro 64	3-year, Onsite	No	09/17
30B7003A**	MEA	1xXeon E5-2620 v4 8C/2.1GHz/20MB/85W/DDR4-2133	Open	2x8GB RDIMM DDR4-2400 ECC	Onboard	4	1x256GB SSD 2.5" SATA6Gbs Opal	None	HH DVD	9-in-1	850W 92%	None	USB / USB Optical	Windows 10 DG Windows 7 Pro 64	3-year, Onsite	No	09/17
30B7003B**	MEA	2xXeon E5-2630 v4 10C/2.2GHz/25MB/85W/DDR4-2133	Open	4x8GB RDIMM DDR4-2400 ECC	Onboard	4	None	1x512GB SSD M.2 PCIe	HH DVD	9-in-1	650W 92%	None	USB / USB Optical	Windows 10 DG Windows 7 Pro 64	3-year, Onsite	No	09/17
30B7003Bxx	Russia/EET/CIS	2xXeon E5-2630 v4 10C/2.2GHz/25MB/85W/DDR4-2133	Open	4x8GB RDIMM DDR4-2400 ECC	Onboard	4	None	1x512GB SSD M.2 PCIe	HH DVD	9-in-1	650W 92%	None	USB / USB Optical	Windows 10 DG Windows 7 Pro 64	3-year, Onsite	No	09/17
30B7003Axx	Russia/EET/CIS	1xXeon E5-2620 v4 8C/2.1GHz/20MB/85W/DDR4-2133	Open	2x8GB RDIMM DDR4-2400 ECC	Onboard	4	1x256GB SSD 2.5" SATA6Gbs Opal	None	HH DVD	9-in-1	850W 92%	None	USB / USB Optical	Windows 10 DG Windows 7 Pro 64	3-year, Onsite	No	09/17
30B70039xx	Russia/EET/CIS	1xXeon E5-2630 v4 10C/2.2GHz/25MB/85W/DDR4-2133	Open	1x8GB RDIMM DDR4-2400 ECC	Onboard	4	1x512GB SSD 2.5" SATA6Gbs	None	HH DVD	9-in-1	850W 92%	None	USB / USB Optical	Windows 10 DG Windows 7 Pro 64	3-year, Onsite	No	09/17
30B70038xx	Russia/EET/CIS	1xXeon E5-2620 v4 8C/2.1GHz/20MB/85W/DDR4-2133	Open	1x8GB RDIMM DDR4-2400 ECC	Onboard	4	1x256GB SSD 2.5" SATA6Gbs Opal	None	HH DVD	9-in-1	650W 92%	None	USB / USB Optical	Windows 10 DG Windows 7 Pro 64	3-year, Onsite	No	09/17
30B70037xx	Russia/EET/CIS	2xXeon E5-2620 v4 8C/2.1GHz/20MB/85W/DDR4-2133	Open	2x8GB RDIMM DDR4-2400 ECC	Onboard	4	1x256GB SSD 2.5" SATA6Gbs Opal+1x1TB HDD 7.2K 3.5" SATA6Gbs	None	9.0mm DVD±RW	29-in-1	850W 92%	None	USB / USB Optical	Windows 10 Pro 64	3-year, Onsite	No	09/17
30B70036xx	Russia/EET/CIS	2xXeon E5-2630 v4 10C/2.2GHz/25MB/85W/DDR4-2133	Open	2x8GB RDIMM DDR4-2400 ECC	Onboard	4	1x256GB SSD 2.5" SATA6Gbs Opal+1x1TB HDD 7.2K 3.5" SATA6Gbs	None	9.0mm DVD±RW	29-in-1	850W 92%	None	USB / USB Optical	Windows 10 Pro 64	3-year, Onsite	No	09/17
30B70035xx	Russia/EET/CIS	2xXeon E5-2620 v4 8C/2.1GHz/20MB/85W/DDR4-2133	Open	4x8GB RDIMM DDR4-2400 ECC	Onboard	4	1x1TB HDD 7.2K 3.5" SATA6Gbs	1x256GB SSD M.2 PCIe	HH DVD	9-in-1	650W 92%	None	USB / USB Optical	Windows 10 Pro 64	3-year, Onsite	No	09/17

Model	Region	Processor	Graphics	Memory	Storage Controller	Max Drives in 3.5" Bays	Disks	M.2 Drives	Optical	Media Reader	Power Supply	Optional Ports	Keyboard / Mouse	Operating System	Warranty	Global	Ann Date (mm/yy)
30B70034xx	Russia/EET/CIS	2xXeon E5-2630 v4 10C/2.2GHz/25MB/85W/DDR4-2133	Open	4x8GB RDIMM DDR4-2400 ECC	Onboard	4	None	1x512GB SSD M.2 PCIe	HH DVD	9-in-1	650W 92%	None	USB / USB Optical	Windows 10 Pro 64	3-year, Onsite	No	09/17
30B70033xx	Russia/EET/CIS	1xXeon E5-2620 v4 8C/2.1GHz/20MB/85W/DDR4-2133	Open	4x8GB RDIMM DDR4-2400 ECC	Onboard	4	None	1x512GB SSD M.2 PCIe	HH DVD	9-in-1	650W 92%	None	USB / USB Optical	Windows 10 Pro 64	3-year, Onsite	No	09/17
30B70032xx	Russia/EET/CIS	1xXeon E5-2650 v4 12C/2.2GHz/30MB/105W/DDR4-2400	Open	2x8GB RDIMM DDR4-2400 ECC	Onboard	4	1x512GB SSD 2.5" SATA6Gbs	None	HH DVD	9-in-1	850W 92%	None	USB / USB Optical	Windows 10 Pro 64	3-year, Onsite	No	09/17
30B70031xx	Russia/EET/CIS	1xXeon E5-2630 v4 10C/2.2GHz/25MB/85W/DDR4-2133	Open	1x8GB RDIMM DDR4-2400 ECC	Onboard	4	1x512GB SSD 2.5" SATA6Gbs	None	HH DVD	9-in-1	850W 92%	None	USB / USB Optical	Windows 10 Pro 64	3-year, Onsite	No	09/17
30B70030xx	Russia/EET/CIS	1xXeon E5-2620 v4 8C/2.1GHz/20MB/85W/DDR4-2133	Open	1x8GB RDIMM DDR4-2400 ECC	Onboard	4	1x256GB SSD 2.5" SATA6Gbs Opal	None	HH DVD	9-in-1	650W 92%	None	USB / USB Optical	Windows 10 Pro 64	3-year, Onsite	No	09/17
30B7002Yxx	Russia/EET/CIS	2xXeon E5-2630 v4 10C/2.2GHz/25MB/85W/DDR4-2133	NVIDIA Quadro P4000 8GB	2x16GB RDIMM DDR4-2400 ECC	Onboard	4	1x256GB SSD 2.5" SATA6Gbs Opal+1x1TB HDD 7.2K 3.5" SATA6Gbs	None	9.5mm DVD±RW	29-in-1	850W 92%	Front eSATA	USB / USB Optical	Windows 10 Pro 64	3-year, Onsite	No	07/17
30B7002Xxx	Russia/EET/CIS	2xXeon E5-2620 v4 8C/2.1GHz/20MB/85W/DDR4-2133	NVIDIA Quadro P2000 5GB	2x8GB RDIMM DDR4-2400 ECC	Onboard	4	1x256GB SSD 2.5" SATA6Gbs Opal+1x1TB HDD 7.2K 3.5" SATA6Gbs	None	9.5mm DVD±RW	29-in-1	850W 92%	Front eSATA	USB / USB Optical	Windows 10 Pro 64	3-year, Onsite	No	07/17
30B70026xx	Russia/EET/CIS	2xXeon E5-2620 v4 8C/2.1GHz/20MB/85W/DDR4-2133	Open	4x8GB RDIMM DDR4-2400 ECC	Onboard	4	1x1TB HDD 7.2K 3.5" SATA6Gbs	1x256GB SSD M.2 PCIe	HH DVD±RW	9-in-1	650W 92%	None	USB / USB Optical	Windows 10 DG Windows 7 Pro 64	3-year, Onsite	No	09/16
30B7002Hxx	Russia/EET/CIS	2xE5-2680 v4 14C/2.4GHz/35MB/120W/DDR4-2400	Open	4x16GB RDIMM DDR4-2400 ECC	9364-8i PCIe	8	4x240GB SSD 2.5" SATA6Gbs Opal	None	HH DVD±RW	9-in-1	850W 92%	None	USB / USB Optical	Windows 10 Pro 64	3-year, Onsite	No	12/16
30B7002Jxx	Russia/EET/CIS	2xXeon E5-2643 v4 6C/3.4GHz/20MB/135W/DDR4-2400	Open	2x16GB RDIMM DDR4-2400 ECC	9364-8i PCIe	8	4x240GB SSD 2.5" SATA6Gbs Opal	None	HH DVD±RW	9-in-1	850W 92%	None	USB / USB Optical	Windows 10 Pro 64	3-year, Onsite	No	12/16
30B7002Kxx	Russia/EET/CIS	2xXeon E5-2650 v4 12C/2.2GHz/30MB/105W/DDR4-2400	Open	2x16GB RDIMM DDR4-2400 ECC	Onboard	4	None	1x256GB SSD M.2 PCIe	HH DVD±RW	9-in-1	850W 92%	None	USB / USB Optical	Windows 10 Pro 64	3-year, Onsite	No	12/16
30B7001Lxx	Russia/EET/CIS	2xXeon E5-2620 v4 8C/2.1GHz/20MB/85W/DDR4-2133	Open	4x8GB RDIMM DDR4-2400 ECC	Onboard	4	1x1TB HDD 7.2K 3.5" SATA6Gbs	1x256GB SSD M.2 PCIe	HH DVD±RW	9-in-1	650W 92%	None	USB / USB Optical	Windows 10 Pro 64	3-year, Onsite	No	07/16
30B7001Sxx	Russia/EET/CIS	2xXeon E5-2637 v4 4C/3.5GHz/15MB/135W/DDR4-2400	Open	2x16GB RDIMM DDR4-2400 ECC	Onboard	4	1x512GB SSD 2.5" SATA6Gbs+1x2TB HDD 7.2K 3.5" SATA6Gbs	None	HH DVD±RW	9-in-1	850W 92%	None	USB / USB Optical	Windows 10 Pro 64	3-year, Onsite	No	08/16

Model	Region	Processor	Graphics	Memory	Storage Controller	Max Drives in 3.5" Bays	Disks	M.2 Drives	Optical	Media Reader	Power Supply	Optional Ports	Keyboard / Mouse	Operating System	Warranty	Global	Ann Date (mm/yy)
30B7001Txx	Russia/EET/CIS	2xE5-2620 v3 6C/2.4GHz/15MB/85W/DDR4-1866	Open	2x8GB RDIMM DDR4-2400 ECC	Onboard	4	1x256GB SSD 2.5" SATA6Gbs Opal+1x2TB HDD 7.2K 3.5" SATA6Gbs	None	HH DVD±RW	9-in-1	650W 92%	None	USB / USB Optical	Windows 10 Pro 64	3-year, Onsite	No	08/16
30B7000Qxx	Russia/EET/CIS	1xXeon E5-2620 v4 8C/2.1GHz/20MB/85W/DDR4-2133	Open	2x8GB RDIMM DDR4-2400 ECC	Onboard	4	1x256GB SSD 2.5" SATA6Gbs Opal	None	HH DVD±RW	9-in-1	850W 92%	None	USB / USB Optical	Windows 10 DG Windows 7 Pro 64	3-year, Onsite	No	04/16
30B7000Pxx	Russia/EET/CIS	1xXeon E5-2620 v4 8C/2.1GHz/20MB/85W/DDR4-2133	Open	2x8GB RDIMM DDR4-2400 ECC	Onboard	4	1x256GB SSD 2.5" SATA6Gbs Opal	None	HH DVD±RW	9-in-1	850W 92%	None	USB / USB Optical	Windows 10 Pro 64	3-year, Onsite	No	04/16
30B7000Nxx	Russia/EET/CIS	1xXeon E5-2650 v4 12C/2.2GHz/30MB/105W/DDR4-2400	NVIDIA Quadro M4000 8GB	2x8GB RDIMM DDR4-2400 ECC	Onboard	4	None	1x512GB SSD M.2 PCIe	HH DVD±RW	9-in-1	850W 92%	None	USB / USB Optical	Windows 10 Pro 64	3-year, Onsite	Global	04/16
30B7000Mxx	Russia/EET/CIS	1xXeon E5-2650 v4 12C/2.2GHz/30MB/105W/DDR4-2400	NVIDIA Quadro M4000 8GB	2x8GB RDIMM DDR4-2400 ECC	Onboard	4	None	1x512GB SSD M.2 PCIe	HH DVD±RW	9-in-1	850W 92%	None	USB / USB Optical	Windows 10 DG Windows 7 Pro 64	3-year, Onsite	Global	04/16
30B7000Lxx	Russia/EET/CIS	1xXeon E5-2650 v4 12C/2.2GHz/30MB/105W/DDR4-2400	Open	2x8GB RDIMM DDR4-2400 ECC	Onboard	4	None	1x512GB SSD M.2 PCIe	HH DVD±RW	9-in-1	850W 92%	None	USB / USB Optical	Windows 10 DG Windows 7 Pro 64	3-year, Onsite	Global	04/16
30B7000Kxx	Russia/EET/CIS	2xXeon E5-2650 v4 12C/2.2GHz/30MB/105W/DDR4-2400	NVIDIA Quadro M5000 8GB	2x8GB RDIMM DDR4-2400 ECC	Onboard	4	None	1x512GB SSD M.2 PCIe	HH DVD±RW	9-in-1	850W 92%	None	USB / USB Optical	Windows 10 Pro 64	3-year, Onsite	No	04/16
30B7000Jxx	Russia/EET/CIS	2xXeon E5-2650 v4 12C/2.2GHz/30MB/105W/DDR4-2400	NVIDIA Quadro M5000 8GB	2x8GB RDIMM DDR4-2400 ECC	Onboard	4	None	1x512GB SSD M.2 PCIe	HH DVD±RW	9-in-1	850W 92%	None	USB / USB Optical	Windows 10 DG Windows 7 Pro 64	3-year, Onsite	No	04/16
30B7000Hxx	Russia/EET/CIS	1xE5-2680 v4 14C/2.4GHz/35MB/120W/DDR4-2400	NVIDIA Quadro M6000 12GB	4x8GB RDIMM DDR4-2400 ECC	Onboard	4	1x512GB SSD 2.5" SATA6Gbs	None	HH DVD±RW	9-in-1	850W 92%	None	USB / USB Optical	Windows 10 Pro 64	3-year, Onsite	No	04/16
30B7000Gxx	Russia/EET/CIS	1xE5-2680 v4 14C/2.4GHz/35MB/120W/DDR4-2400	NVIDIA Quadro M6000 12GB	4x8GB RDIMM DDR4-2400 ECC	Onboard	4	1x512GB SSD 2.5" SATA6Gbs	None	HH DVD±RW	9-in-1	850W 92%	None	USB / USB Optical	Windows 10 DG Windows 7 Pro 64	3-year, Onsite	No	04/16
30B7000Fxx	Russia/EET/CIS	1xXeon E5-2630 v4 10C/2.2GHz/25MB/85W/DDR4-2133	Open	1x8GB RDIMM DDR4-2400 ECC	Onboard	4	1x512GB SSD 2.5" SATA6Gbs	None	HH DVD±RW	9-in-1	850W 92%	None	USB / USB Optical	Windows 10 Pro 64	3-year, Onsite	No	04/16
30B7000Exx	Russia/EET/CIS	1xXeon E5-2650 v4 12C/2.2GHz/30MB/105W/DDR4-2400	Open	2x8GB RDIMM DDR4-2400 ECC	Onboard	4	1x512GB SSD 2.5" SATA6Gbs	None	HH DVD±RW	9-in-1	850W 92%	None	USB / USB Optical	Windows 10 Pro 64	3-year, Onsite	No	04/16
30B7000Dxx	Russia/EET/CIS	2xXeon E5-2650 v4 12C/2.2GHz/30MB/105W/DDR4-2400	Open	2x8GB RDIMM DDR4-2400 ECC	Onboard	4	1x1TB SSD 2.5" SATA6Gbs	None	HH DVD±RW	9-in-1	850W 92%	None	USB / USB Optical	Windows 10 Pro 64	3-year, Onsite	No	04/16

Model	Region	Processor	Graphics	Memory	Storage Controller	Max Drives in 3.5" Bays	Disks	M.2 Drives	Optical	Media Reader	Power Supply	Optional Ports	Keyboard / Mouse	Operating System	Warranty	Global	Ann Date (mm/yy)
30B7000Cxx	Russia/EET/CIS	1xXeon E5-2630 v4 10C/2.2GHz/25MB/85W/DDR4-2133	Open	1x8GB RDIMM DDR4-2400 ECC	Onboard	4	1x512GB SSD 2.5" SATA6Gbs	None	HH DVD±RW	9-in-1	850W 92%	None	USB / USB Optical	Windows 10 DG Windows 7 Pro 64	3-year, Onsite	No	04/16
30B7000Bxx	Russia/EET/CIS	1xXeon E5-2650 v4 12C/2.2GHz/30MB/105W/DDR4-2400	Open	2x8GB RDIMM DDR4-2400 ECC	Onboard	4	1x512GB SSD 2.5" SATA6Gbs	None	HH DVD±RW	9-in-1	850W 92%	None	USB / USB Optical	Windows 10 DG Windows 7 Pro 64	3-year, Onsite	No	04/16
30B7000Axx	Russia/EET/CIS	2xXeon E5-2650 v4 12C/2.2GHz/30MB/105W/DDR4-2400	Open	2x8GB RDIMM DDR4-2400 ECC	Onboard	4	1x1TB SSD 2.5" SATA6Gbs	None	HH DVD±RW	9-in-1	850W 92%	None	USB / USB Optical	Windows 10 DG Windows 7 Pro 64	3-year, Onsite	No	04/16
30B70009xx	Russia/EET/CIS	2xXeon E5-2630 v4 10C/2.2GHz/25MB/85W/DDR4-2133	Open	4x8GB RDIMM DDR4-2400 ECC	Onboard	4	None	1x512GB SSD M.2 PCIe	HH DVD±RW	9-in-1	650W 92%	None	USB / USB Optical	Windows 10 DG Windows 7 Pro 64	3-year, Onsite	No	04/16
30B70008xx	Russia/EET/CIS	1xXeon E5-2620 v4 8C/2.1GHz/20MB/85W/DDR4-2133	Open	4x8GB RDIMM DDR4-2400 ECC	Onboard	4	None	1x512GB SSD M.2 PCIe	HH DVD±RW	9-in-1	650W 92%	None	USB / USB Optical	Windows 10 DG Windows 7 Pro 64	3-year, Onsite	No	04/16
30B70007xx	Russia/EET/CIS	1xXeon E5-2620 v4 8C/2.1GHz/20MB/85W/DDR4-2133	Open	1x8GB RDIMM DDR4-2400 ECC	Onboard	4	1x256GB SSD 2.5" SATA6Gbs Opal	None	HH DVD±RW	9-in-1	650W 92%	None	USB / USB Optical	Windows 10 DG Windows 7 Pro 64	3-year, Onsite	No	04/16
30B70006xx	Russia/EET/CIS	1xXeon E5-2620 v4 8C/2.1GHz/20MB/85W/DDR4-2133	Open	4x8GB RDIMM DDR4-2400 ECC	Onboard	4	None	1x512GB SSD M.2 PCIe	HH DVD±RW	9-in-1	650W 92%	None	USB / USB Optical	Windows 10 DG Windows 7 Pro 64	3-year, Onsite	No	04/16
30B70005xx	Russia/EET/CIS	2xXeon E5-2630 v4 10C/2.2GHz/25MB/85W/DDR4-2133	Open	4x8GB RDIMM DDR4-2400 ECC	Onboard	4	None	1x512GB SSD M.2 PCIe	HH DVD±RW	9-in-1	650W 92%	None	USB / USB Optical	Windows 10 DG Windows 7 Pro 64	3-year, Onsite	No	04/16
30B70004xx	Russia/EET/CIS	1xXeon E5-2620 v4 8C/2.1GHz/20MB/85W/DDR4-2133	Open	1x8GB RDIMM DDR4-2400 ECC	Onboard	4	1x256GB SSD 2.5" SATA6Gbs Opal	None	HH DVD±RW	9-in-1	650W 92%	None	USB / USB Optical	Windows 10 DG Windows 7 Pro 64	3-year, Onsite	No	04/16
30B7000RUS	US	2xXeon E5-2623 v4 4C/2.6GHz/10MB/85W/DDR4-2133	Open	2x8GB RDIMM DDR4-2400 ECC	Onboard	4	1x256GB SSD 2.5" SATA6Gbs Opal	None	HH DVD±RW	9-in-1	650W 92%	None	USB / USB Optical	Windows 10 DG Windows 7 Pro 64	3-year, Onsite	No	04/16
30B7000SUS	US	1xXeon E5-2623 v4 4C/2.6GHz/10MB/85W/DDR4-2133	Open	2x8GB RDIMM DDR4-2400 ECC	Onboard	4	1x256GB SSD 2.5" SATA6Gbs Opal	None	HH DVD±RW	9-in-1	650W 92%	None	USB / USB Optical	Windows 10 DG Windows 7 Pro 64	3-year, Onsite	No	04/16
30B7000TUS	US	2xXeon E5-2620 v4 8C/2.1GHz/20MB/85W/DDR4-2133	Open	2x8GB RDIMM DDR4-2400 ECC	Onboard	4	1x1TB HDD 7.2K 3.5" SATA6Gbs	None	HH DVD±RW	9-in-1	850W 92%	None	USB / USB Optical	Windows 10 DG Windows 7 Pro 64	3-year, Onsite	No	04/16
30B7000UUS	US	2xXeon E5-2637 v4 4C/3.5GHz/15MB/135W/DDR4-2400	Open	2x8GB RDIMM DDR4-2400 ECC	Onboard	4	1x256GB SSD 2.5" SATA6Gbs Opal	None	HH DVD±RW	9-in-1	850W 92%	None	USB / USB Optical	Windows 10 DG Windows 7 Pro 64	3-year, Onsite	No	04/16

Model	Region	Processor	Graphics	Memory	Storage Controller	Max Drives in 3.5" Bays	Disks	M.2 Drives	Optical	Media Reader	Power Supply	Optional Ports	Keyboard / Mouse	Operating System	Warranty	Global	Ann Date (mm/yy)
30B7000VUS	US	1xXeon E5-2637 v4 4C/3.5GHz/15MB/135W/DDR4-2400	Open	2x8GB RDIMM DDR4-2400 ECC	Onboard	4	1x256GB SSD 2.5" SATA6Gbs Opal	None	HH DVD±RW	9-in-1	850W 92%	None	USB / USB Optical	Windows 10 Pro 64	3-year, Onsite	No	04/16
30B7000WUS	US	2xXeon E5-2643 v4 6C/3.4GHz/20MB/135W/DDR4-2400	NVIDIA Quadro M4000 8GB	4x8GB RDIMM DDR4-2400 ECC	Onboard	4	1x1TB SSD 2.5" SATA6Gbs	None	HH DVD±RW	9-in-1	850W 92%	None	USB / USB Optical	Windows 10 Pro 64	3-year, Onsite	No	04/16
30B7000XUS	US	2xXeon E5-2623 v4 4C/2.6GHz/10MB/85W/DDR4-2133	NVIDIA Quadro M2000 4GB	2x8GB RDIMM DDR4-2400 ECC	Onboard	4	1x256GB SSD 2.5" SATA6Gbs Opal	None	HH DVD±RW	9-in-1	650W 92%	None	USB / USB Optical	Windows 10 Pro 64	3-year, Onsite	No	04/16
30B7000YUS	US	1xXeon E5-2620 v4 8C/2.1GHz/20MB/85W/DDR4-2133	Open	2x8GB RDIMM DDR4-2400 ECC	Onboard	4	1x1TB HDD 7.2K 3.5" SATA6Gbs	None	HH DVD±RW	9-in-1	850W 92%	None	USB / USB Optical	Windows 10 Pro 64	3-year, Onsite	No	04/16
30B70023US	US	2xXeon E5-2620 v4 8C/2.1GHz/20MB/85W/DDR4-2133	Open	2x8GB RDIMM DDR4-2400 ECC	Onboard	4	1x1TB HDD 7.2K 3.5" SATA6Gbs	1x256GB SSD M.2 PCIe	HH DVD±RW	9-in-1	850W 92%	None	USB / USB Optical	Windows 10 DG Windows 7 Pro 64	3-year, Onsite	No	09/16
30B70024US	US	1xXeon E5-2650 v4 12C/2.2GHz/30MB/105W/DDR4-2400	NVIDIA Quadro M4000 8GB	2x8GB RDIMM DDR4-2400 ECC	Onboard	4	1x1TB HDD 7.2K 3.5" SATA6Gbs	1x256GB SSD M.2 PCIe	HH DVD±RW	9-in-1	850W 92%	None	USB / USB Optical	Windows 10 DG Windows 7 Pro 64	3-year, Onsite	No	09/16
30B70025US	US	2xXeon E5-2620 v4 8C/2.1GHz/20MB/85W/DDR4-2133	NVIDIA Quadro M2000 4GB	2x8GB RDIMM DDR4-2400 ECC	Onboard	4	1x1TB HDD 7.2K 3.5" SATA6Gbs	1x256GB SSD M.2 PCIe	HH DVD±RW	9-in-1	850W 92%	None	USB / USB Optical	Windows 10 DG Windows 7 Pro 64	3-year, Onsite	No	09/16
30B7001MUS	US	1xXeon E5-2650 v4 12C/2.2GHz/30MB/105W/DDR4-2400	NVIDIA Quadro M4000 8GB	2x8GB RDIMM DDR4-2400 ECC	Onboard	4	1x1TB HDD 7.2K 3.5" SATA6Gbs	1x256GB SSD M.2 PCIe	HH DVD±RW	9-in-1	850W 92%	None	USB / USB Optical	Windows 10 Pro 64	3-year, Onsite	No	07/16
30B7001NUS	US	2xXeon E5-2620 v4 8C/2.1GHz/20MB/85W/DDR4-2133	Open	2x8GB RDIMM DDR4-2400 ECC	Onboard	4	1x1TB HDD 7.2K 3.5" SATA6Gbs	1x256GB SSD M.2 PCIe	HH DVD±RW	9-in-1	850W 92%	None	USB / USB Optical	Windows 10 Pro 64	3-year, Onsite	No	07/16
30B7001PUS	US	2xXeon E5-2620 v4 8C/2.1GHz/20MB/85W/DDR4-2133	NVIDIA Quadro M2000 4GB	2x8GB RDIMM DDR4-2400 ECC	Onboard	4	1x1TB HDD 7.2K 3.5" SATA6Gbs	1x256GB SSD M.2 PCIe	HH DVD±RW	9-in-1	850W 92%	None	USB / USB Optical	Windows 10 Pro 64	3-year, Onsite	No	07/16
30B7002MUS	US	2xXeon E5-2623 v4 4C/2.6GHz/10MB/85W/DDR4-2133	NVIDIA Quadro P2000 5GB	2x8GB RDIMM DDR4-2400 ECC	Onboard	4	1x256GB SSD 2.5" SATA6Gbs Opal	None	HH DVD±RW	9-in-1	850W 92%	None	USB / USB Optical	Windows 10 DG Windows 7 Pro 64	3-year, Onsite	No	04/17
30B7002NUS	US	1xXeon E5-2650 v4 12C/2.2GHz/30MB/105W/DDR4-2400	NVIDIA Quadro P4000 8GB	2x8GB RDIMM DDR4-2400 ECC	Onboard	4	1x1TB HDD 7.2K 3.5" SATA6Gbs	1x256GB SSD M.2 PCIe	HH DVD±RW	9-in-1	850W 92%	None	USB / USB Optical	Windows 10 DG Windows 7 Pro 64	3-year, Onsite	No	04/17
30B7002PUS	US	1xXeon E5-2623 v4 4C/2.6GHz/10MB/85W/DDR4-2133	NVIDIA Quadro P2000 5GB	2x8GB RDIMM DDR4-2400 ECC	Onboard	4	1x512GB SSD 2.5" SATA6Gbs	None	HH DVD±RW	9-in-1	850W 92%	None	USB / USB Optical	Windows 10 DG Windows 7 Pro 64	3-year, Onsite	No	04/17

Model	Region	Processor	Graphics	Memory	Storage Controller	Max Drives in 3.5" Bays	Disks	M.2 Drives	Optical	Media Reader	Power Supply	Optional Ports	Keyboard / Mouse	Operating System	Warranty	Global	Ann Date (mm/yy)
30B7002QUS	US	2xXeon E5-2623 v4 4C/2.6GHz/10MB/85W/DDR4-2133	NVIDIA Quadro P2000 5GB	2x8GB RDIMM DDR4-2400 ECC	Onboard	4	1x256GB SSD 2.5" SATA6Gbs Opal	None	HH DVD±RW	9-in-1	650W 92%	None	USB / USB Optical	Windows 10 DG Windows 7 Pro 64	3-year, Onsite	No	04/17
30B7002RUS	US	1xXeon E5-2620 v4 8C/2.1GHz/20MB/85W/DDR4-2133	NVIDIA Quadro P2000 5GB	2x8GB RDIMM DDR4-2400 ECC	Onboard	4	1x1TB HDD 7.2K 3.5" SATA6Gbs	None	HH DVD±RW	9-in-1	850W 92%	None	USB / USB Optical	Windows 10 DG Windows 7 Pro 64	3-year, Onsite	No	04/17
30B7002SUS	US	2xXeon E5-2643 v4 6C/3.4GHz/20MB/135W/DDR4-2400	NVIDIA Quadro P4000 8GB	4x8GB RDIMM DDR4-2400 ECC	Onboard	4	1x1TB HDD 7.2K 3.5" SATA6Gbs	None	HH DVD±RW	9-in-1	850W 92%	None	USB / USB Optical	Windows 10 Pro 64	3-year, Onsite	No	04/17
30B7002TUS	US	2xXeon E5-2643 v4 6C/3.4GHz/20MB/135W/DDR4-2400	NVIDIA Quadro P4000 8GB	4x8GB RDIMM DDR4-2400 ECC	Onboard	4	1x1TB HDD 7.2K 3.5" SATA6Gbs	None	HH DVD±RW	9-in-1	850W 92%	None	USB / USB Optical	Windows 10 DG Windows 7 Pro 64	3-year, Onsite	No	04/17
30B7002UUS	US	2xXeon E5-2623 v4 4C/2.6GHz/10MB/85W/DDR4-2133	NVIDIA Quadro P2000 5GB	2x8GB RDIMM DDR4-2400 ECC	Onboard	4	1x512GB SSD 2.5" SATA6Gbs	None	HH DVD±RW	9-in-1	850W 92%	None	USB / USB Optical	Windows 10 DG Windows 7 Pro 64	3-year, Onsite	No	04/17
30B7002VUS	US	1xXeon E5-2620 v4 8C/2.1GHz/20MB/85W/DDR4-2133	NVIDIA Quadro P2000 5GB	2x8GB RDIMM DDR4-2400 ECC	Onboard	4	1x1TB HDD 7.2K 3.5" SATA6Gbs	1x256GB SSD M.2 PCIe	HH DVD±RW	9-in-1	850W 92%	None	USB / USB Optical	Windows 10 DG Windows 7 Pro 64	3-year, Onsite	No	04/17
30B7002WUS	US	1xXeon E5-2650 v4 12C/2.2GHz/30MB/105W/DDR4-2400	NVIDIA Quadro P4000 8GB	2x8GB RDIMM DDR4-2400 ECC	Onboard	4	1x1TB HDD 7.2K 3.5" SATA6Gbs	1x256GB SSD M.2 PCIe	HH DVD±RW	9-in-1	850W 92%	None	USB / USB Optical	Windows 10 Pro 64	3-year, Onsite	No	04/17
30B70029US	US	2xXeon E5-2623 v4 4C/2.6GHz/10MB/85W/DDR4-2133	NVIDIA Quadro P5000 16GB	2x8GB RDIMM DDR4-2400 ECC	Onboard	4	None	1x1TB SSD M.2 PCIe	HH DVD±RW	9-in-1	850W 92%	Rear eSATA	USB / USB Optical	Windows 10 DG Windows 7 Pro 64	3-year, Onsite	No	12/16
30B7002AUS	US	1xXeon E5-2623 v4 4C/2.6GHz/10MB/85W/DDR4-2133	NVIDIA Quadro M2000 4GB	2x8GB RDIMM DDR4-2400 ECC	Onboard	4	1x512GB SSD 2.5" SATA6Gbs	None	HH DVD±RW	9-in-1	850W 92%	None	USB / USB Optical	Windows 10 DG Windows 7 Pro 64	3-year, Onsite	No	12/16
30B7002BUS	US	1xXeon E5-2623 v4 4C/2.6GHz/10MB/85W/DDR4-2133	NVIDIA Quadro P5000 16GB	2x8GB RDIMM DDR4-2400 ECC	Onboard	4	None	1x1TB SSD M.2 PCIe	HH DVD±RW	9-in-1	850W 92%	Rear eSATA	USB / USB Optical	Windows 10 DG Windows 7 Pro 64	3-year, Onsite	No	12/16
30B7002CUS	US	1xXeon E5-2623 v4 4C/2.6GHz/10MB/85W/DDR4-2133	NVIDIA Quadro M2000 4GB	2x8GB RDIMM DDR4-2400 ECC	Onboard	4	1x256GB SSD 2.5" SATA6Gbs Opal	None	HH DVD±RW	9-in-1	650W 92%	None	USB / USB Optical	Windows 10 DG Windows 7 Pro 64	3-year, Onsite	No	12/16
30B7002DUS	US	2xXeon E5-2637 v4 4C/3.5GHz/15MB/135W/DDR4-2400	NVIDIA Quadro P5000 16GB	2x16GB RDIMM DDR4-2400 ECC	Onboard	4	None	1x1TB SSD M.2 PCIe	HH DVD±RW	9-in-1	850W 92%	Rear eSATA	USB / USB Optical	Windows 10 DG Windows 7 Pro 64	3-year, Onsite	No	12/16
30B7002EUS	US	1xXeon E5-2623 v4 4C/2.6GHz/10MB/85W/DDR4-2133	NVIDIA Quadro M2000 4GB	2x8GB RDIMM DDR4-2400 ECC	Onboard	4	1x256GB SSD 2.5" SATA6Gbs Opal	None	HH DVD±RW	9-in-1	850W 92%	None	USB / USB Optical	Windows 10 DG Windows 7 Pro 64	3-year, Onsite	No	12/16

Model	Region	Processor	Graphics	Memory	Storage Controller	Max Drives in 3.5" Bays	Disks	M.2 Drives	Optical	Media Reader	Power Supply	Optional Ports	Keyboard / Mouse	Operating System	Warranty	Global	Ann Date (mm/yy)
30B7002FUS	US	2xXeon E5-2643 v4 6C/3.4GHz/20MB/135W/DDR4-2400	NVIDIA Quadro M4000 8GB	4x8GB RDIMM DDR4-2400 ECC	Onboard	4	1x1TB HDD 7.2K 3.5" SATA6Gbs	None	HH DVD±RW	9-in-1	850W 92%	None	USB / USB Optical	Windows 10 DG Windows 7 Pro 64	3-year, Onsite	No	12/16
30B7002GUS	US	1xXeon E5-2623 v4 4C/2.6GHz/10MB/85W/DDR4-2133	Open	2x8GB RDIMM DDR4-2400 ECC	Onboard	4	None	1x1TB SSD M.2 PCIe	HH DVD±RW	9-in-1	850W 92%	Rear eSATA	USB / USB Optical	Windows 10 DG Windows 7 Pro 64	3-year, Onsite	No	12/16
30B7002X--	WE	2xXeon E5-2620 v4 8C/2.1GHz/20MB/85W/DDR4-2133	NVIDIA Quadro P2000 5GB	2x8GB RDIMM DDR4-2400 ECC	Onboard	4	1x256GB SSD 2.5" SATA6Gbs Opal+1x1TB HDD 7.2K 3.5" SATA6Gbs	None	9.5mm DVD±RW	29-in-1	850W 92%	Front eSATA	USB / USB Optical	Windows 10 Pro 64	3-year, Onsite	No	07/17
30B7002Y--	WE	2xXeon E5-2630 v4 10C/2.2GHz/25MB/85W/DDR4-2133	NVIDIA Quadro P4000 8GB	2x16GB RDIMM DDR4-2400 ECC	Onboard	4	1x256GB SSD 2.5" SATA6Gbs Opal+1x1TB HDD 7.2K 3.5" SATA6Gbs	None	9.5mm DVD±RW	29-in-1	850W 92%	Front eSATA	USB / USB Optical	Windows 10 Pro 64	3-year, Onsite	No	07/17
30B70030--	WE	1xXeon E5-2620 v4 8C/2.1GHz/20MB/85W/DDR4-2133	Open	1x8GB RDIMM DDR4-2400 ECC	Onboard	4	1x256GB SSD 2.5" SATA6Gbs Opal	None	HH DVD	9-in-1	650W 92%	None	USB / USB Optical	Windows 10 Pro 64	3-year, Onsite	No	09/17
30B70031--	WE	1xXeon E5-2630 v4 10C/2.2GHz/25MB/85W/DDR4-2133	Open	1x8GB RDIMM DDR4-2400 ECC	Onboard	4	1x512GB SSD 2.5" SATA6Gbs	None	HH DVD	9-in-1	850W 92%	None	USB / USB Optical	Windows 10 Pro 64	3-year, Onsite	No	09/17
30B70032--	WE	1xXeon E5-2650 v4 12C/2.2GHz/30MB/105W/DDR4-2400	Open	2x8GB RDIMM DDR4-2400 ECC	Onboard	4	1x512GB SSD 2.5" SATA6Gbs	None	HH DVD	9-in-1	850W 92%	None	USB / USB Optical	Windows 10 Pro 64	3-year, Onsite	No	09/17
30B70033--	WE	1xXeon E5-2620 v4 8C/2.1GHz/20MB/85W/DDR4-2133	Open	4x8GB RDIMM DDR4-2400 ECC	Onboard	4	None	1x512GB SSD M.2 PCIe	HH DVD	9-in-1	650W 92%	None	USB / USB Optical	Windows 10 Pro 64	3-year, Onsite	No	09/17
30B70034--	WE	2xXeon E5-2630 v4 10C/2.2GHz/25MB/85W/DDR4-2133	Open	4x8GB RDIMM DDR4-2400 ECC	Onboard	4	None	1x512GB SSD M.2 PCIe	HH DVD	9-in-1	650W 92%	None	USB / USB Optical	Windows 10 Pro 64	3-year, Onsite	No	09/17
30B70035--	WE	2xXeon E5-2620 v4 8C/2.1GHz/20MB/85W/DDR4-2133	Open	4x8GB RDIMM DDR4-2400 ECC	Onboard	4	1x1TB HDD 7.2K 3.5" SATA6Gbs	1x256GB SSD M.2 PCIe	HH DVD	9-in-1	650W 92%	None	USB / USB Optical	Windows 10 Pro 64	3-year, Onsite	No	09/17
30B70036--	WE	2xXeon E5-2630 v4 10C/2.2GHz/25MB/85W/DDR4-2133	Open	2x8GB RDIMM DDR4-2400 ECC	Onboard	4	1x256GB SSD 2.5" SATA6Gbs Opal+1x1TB HDD 7.2K 3.5" SATA6Gbs	None	9.0mm DVD±RW	29-in-1	850W 92%	None	USB / USB Optical	Windows 10 Pro 64	3-year, Onsite	No	09/17
30B70037--	WE	2xXeon E5-2620 v4 8C/2.1GHz/20MB/85W/DDR4-2133	Open	2x8GB RDIMM DDR4-2400 ECC	Onboard	4	1x256GB SSD 2.5" SATA6Gbs Opal+1x1TB HDD 7.2K 3.5" SATA6Gbs	None	9.0mm DVD±RW	29-in-1	850W 92%	None	USB / USB Optical	Windows 10 Pro 64	3-year, Onsite	No	09/17
30B70038--	WE	1xXeon E5-2620 v4 8C/2.1GHz/20MB/85W/DDR4-2133	Open	1x8GB RDIMM DDR4-2400 ECC	Onboard	4	1x256GB SSD 2.5" SATA6Gbs Opal	None	HH DVD	9-in-1	650W 92%	None	USB / USB Optical	Windows 10 DG Windows 7 Pro 64	3-year, Onsite	No	09/17

Model	Region	Processor	Graphics	Memory	Storage Controller	Max Drives in 3.5" Bays	Disks	M.2 Drives	Optical	Media Reader	Power Supply	Optional Ports	Keyboard / Mouse	Operating System	Warranty	Global	Ann Date (mm/yy)
30B70039--	WE	1xXeon E5-2630 v4 10C/2.2GHz/25MB/85W/DDR4-2133	Open	1x8GB RDIMM DDR4-2400 ECC	Onboard	4	1x512GB SSD 2.5" SATA6Gbs	None	HH DVD	9-in-1	850W 92%	None	USB / USB Optical	Windows 10 DG Windows 7 Pro 64	3-year, Onsite	No	09/17
30B7003A--	WE	1xXeon E5-2620 v4 8C/2.1GHz/20MB/85W/DDR4-2133	Open	2x8GB RDIMM DDR4-2400 ECC	Onboard	4	1x256GB SSD 2.5" SATA6Gbs Opal	None	HH DVD	9-in-1	850W 92%	None	USB / USB Optical	Windows 10 DG Windows 7 Pro 64	3-year, Onsite	No	09/17
30B7003B--	WE	2xXeon E5-2630 v4 10C/2.2GHz/25MB/85W/DDR4-2133	Open	4x8GB RDIMM DDR4-2400 ECC	Onboard	4	None	1x512GB SSD M.2 PCIe	HH DVD	9-in-1	650W 92%	None	USB / USB Optical	Windows 10 DG Windows 7 Pro 64	3-year, Onsite	No	09/17
30B70004--	WE	1xXeon E5-2620 v4 8C/2.1GHz/20MB/85W/DDR4-2133	Open	1x8GB RDIMM DDR4-2400 ECC	Onboard	4	1x256GB SSD 2.5" SATA6Gbs Opal	None	HH DVD±RW	9-in-1	650W 92%	None	USB / USB Optical	Windows 10 DG Windows 7 Pro 64	3-year, Onsite	No	04/16
30B70026--	WE	2xXeon E5-2620 v4 8C/2.1GHz/20MB/85W/DDR4-2133	Open	4x8GB RDIMM DDR4-2400 ECC	Onboard	4	1x1TB HDD 7.2K 3.5" SATA6Gbs	1x256GB SSD M.2 PCIe	HH DVD±RW	9-in-1	650W 92%	None	USB / USB Optical	Windows 10 DG Windows 7 Pro 64	3-year, Onsite	No	09/16
30B7001L--	WE	2xXeon E5-2620 v4 8C/2.1GHz/20MB/85W/DDR4-2133	Open	4x8GB RDIMM DDR4-2400 ECC	Onboard	4	1x1TB HDD 7.2K 3.5" SATA6Gbs	1x256GB SSD M.2 PCIe	HH DVD±RW	9-in-1	650W 92%	None	USB / USB Optical	Windows 10 Pro 64	3-year, Onsite	No	07/16
30B7000M--	WE	1xXeon E5-2650 v4 12C/2.2GHz/30MB/105W/DDR4-2400	NVIDIA Quadro M4000 8GB	2x8GB RDIMM DDR4-2400 ECC	Onboard	4	None	1x512GB SSD M.2 PCIe	HH DVD±RW	9-in-1	850W 92%	None	USB / USB Optical	Windows 10 DG Windows 7 Pro 64	3-year, Onsite	Global	04/16
30B7000N--	WE	1xXeon E5-2650 v4 12C/2.2GHz/30MB/105W/DDR4-2400	NVIDIA Quadro M4000 8GB	2x8GB RDIMM DDR4-2400 ECC	Onboard	4	None	1x512GB SSD M.2 PCIe	HH DVD±RW	9-in-1	850W 92%	None	USB / USB Optical	Windows 10 Pro 64	3-year, Onsite	Global	04/16
30B7000P--	WE	1xXeon E5-2620 v4 8C/2.1GHz/20MB/85W/DDR4-2133	Open	2x8GB RDIMM DDR4-2400 ECC	Onboard	4	1x256GB SSD 2.5" SATA6Gbs Opal	None	HH DVD±RW	9-in-1	850W 92%	None	USB / USB Optical	Windows 10 Pro 64	3-year, Onsite	No	04/16
30B7000Q--	WE	1xXeon E5-2620 v4 8C/2.1GHz/20MB/85W/DDR4-2133	Open	2x8GB RDIMM DDR4-2400 ECC	Onboard	4	1x256GB SSD 2.5" SATA6Gbs Opal	None	HH DVD±RW	9-in-1	850W 92%	None	USB / USB Optical	Windows 10 DG Windows 7 Pro 64	3-year, Onsite	No	04/16
30B70005--	WE	2xXeon E5-2630 v4 10C/2.2GHz/25MB/85W/DDR4-2133	Open	4x8GB RDIMM DDR4-2400 ECC	Onboard	4	None	1x512GB SSD M.2 PCIe	HH DVD±RW	9-in-1	650W 92%	None	USB / USB Optical	Windows 10 Pro 64	3-year, Onsite	No	04/16
30B70006--	WE	1xXeon E5-2620 v4 8C/2.1GHz/20MB/85W/DDR4-2133	Open	4x8GB RDIMM DDR4-2400 ECC	Onboard	4	None	1x512GB SSD M.2 PCIe	HH DVD±RW	9-in-1	650W 92%	None	USB / USB Optical	Windows 10 Pro 64	3-year, Onsite	No	04/16
30B70007--	WE	1xXeon E5-2620 v4 8C/2.1GHz/20MB/85W/DDR4-2133	Open	1x8GB RDIMM DDR4-2400 ECC	Onboard	4	1x256GB SSD 2.5" SATA6Gbs Opal	None	HH DVD±RW	9-in-1	650W 92%	None	USB / USB Optical	Windows 10 Pro 64	3-year, Onsite	No	04/16

Model	Region	Processor	Graphics	Memory	Storage Controller	Max Drives in 3.5" Bays	Disks	M.2 Drives	Optical	Media Reader	Power Supply	Optional Ports	Keyboard / Mouse	Operating System	Warranty	Global	Ann Date (mm/yy)
30B70008--	WE	1xXeon E5-2620 v4 8C/2.1GHz/20MB/85W/DDR4-2133	Open	4x8GB RDIMM DDR4-2400 ECC	Onboard	4	None	1x512GB SSD M.2 PCIe	HH DVD±RW	9-in-1	650W 92%	None	USB / USB Optical	Windows 10 DG Windows 7 Pro 64	3-year, Onsite	No	04/16
30B70009--	WE	2xXeon E5-2630 v4 10C/2.2GHz/25MB/85W/DDR4-2133	Open	4x8GB RDIMM DDR4-2400 ECC	Onboard	4	None	1x512GB SSD M.2 PCIe	HH DVD±RW	9-in-1	650W 92%	None	USB / USB Optical	Windows 10 DG Windows 7 Pro 64	3-year, Onsite	No	04/16
30B7000A--	WE	2xXeon E5-2650 v4 12C/2.2GHz/30MB/105W/DDR4-2400	Open	2x8GB RDIMM DDR4-2400 ECC	Onboard	4	1x1TB SSD 2.5" SATA6Gbs	None	HH DVD±RW	9-in-1	850W 92%	None	USB / USB Optical	Windows 10 DG Windows 7 Pro 64	3-year, Onsite	No	04/16
30B7000B--	WE	1xXeon E5-2650 v4 12C/2.2GHz/30MB/105W/DDR4-2400	Open	2x8GB RDIMM DDR4-2400 ECC	Onboard	4	1x512GB SSD 2.5" SATA6Gbs	None	HH DVD±RW	9-in-1	850W 92%	None	USB / USB Optical	Windows 10 DG Windows 7 Pro 64	3-year, Onsite	No	04/16
30B7000C--	WE	1xXeon E5-2630 v4 10C/2.2GHz/25MB/85W/DDR4-2133	Open	1x8GB RDIMM DDR4-2400 ECC	Onboard	4	1x512GB SSD 2.5" SATA6Gbs	None	HH DVD±RW	9-in-1	850W 92%	None	USB / USB Optical	Windows 10 DG Windows 7 Pro 64	3-year, Onsite	No	04/16
30B7000D--	WE	2xXeon E5-2650 v4 12C/2.2GHz/30MB/105W/DDR4-2400	Open	2x8GB RDIMM DDR4-2400 ECC	Onboard	4	1x1TB SSD 2.5" SATA6Gbs	None	HH DVD±RW	9-in-1	850W 92%	None	USB / USB Optical	Windows 10 Pro 64	3-year, Onsite	No	04/16
30B7000E--	WE	1xXeon E5-2650 v4 12C/2.2GHz/30MB/105W/DDR4-2400	Open	2x8GB RDIMM DDR4-2400 ECC	Onboard	4	1x512GB SSD 2.5" SATA6Gbs	None	HH DVD±RW	9-in-1	850W 92%	None	USB / USB Optical	Windows 10 Pro 64	3-year, Onsite	No	04/16
30B7000F--	WE	1xXeon E5-2630 v4 10C/2.2GHz/25MB/85W/DDR4-2133	Open	1x8GB RDIMM DDR4-2400 ECC	Onboard	4	1x512GB SSD 2.5" SATA6Gbs	None	HH DVD±RW	9-in-1	850W 92%	None	USB / USB Optical	Windows 10 Pro 64	3-year, Onsite	No	04/16
30B7000G--	WE	1xE5-2680 v4 14C/2.4GHz/35MB/120W/DDR4-2400	NVIDIA Quadro M6000 12GB	4x8GB RDIMM DDR4-2400 ECC	Onboard	4	1x512GB SSD 2.5" SATA6Gbs	None	HH DVD±RW	9-in-1	850W 92%	None	USB / USB Optical	Windows 10 DG Windows 7 Pro 64	3-year, Onsite	No	04/16
30B7000H--	WE	1xE5-2680 v4 14C/2.4GHz/35MB/120W/DDR4-2400	NVIDIA Quadro M6000 12GB	4x8GB RDIMM DDR4-2400 ECC	Onboard	4	1x512GB SSD 2.5" SATA6Gbs	None	HH DVD±RW	9-in-1	850W 92%	None	USB / USB Optical	Windows 10 Pro 64	3-year, Onsite	No	04/16
30B7000J--	WE	2xXeon E5-2650 v4 12C/2.2GHz/30MB/105W/DDR4-2400	NVIDIA Quadro M5000 8GB	2x8GB RDIMM DDR4-2400 ECC	Onboard	4	None	1x512GB SSD M.2 PCIe	HH DVD±RW	9-in-1	850W 92%	None	USB / USB Optical	Windows 10 DG Windows 7 Pro 64	3-year, Onsite	No	04/16
30B7000K--	WE	2xXeon E5-2650 v4 12C/2.2GHz/30MB/105W/DDR4-2400	NVIDIA Quadro M5000 8GB	2x8GB RDIMM DDR4-2400 ECC	Onboard	4	None	1x512GB SSD M.2 PCIe	HH DVD±RW	9-in-1	850W 92%	None	USB / USB Optical	Windows 10 Pro 64	3-year, Onsite	No	04/16
30B7000L--	WE	1xXeon E5-2650 v4 12C/2.2GHz/30MB/105W/DDR4-2400	Open	2x8GB RDIMM DDR4-2400 ECC	Onboard	4	None	1x512GB SSD M.2 PCIe	HH DVD±RW	9-in-1	850W 92%	None	USB / USB Optical	Windows 10 DG Windows 7 Pro 64	3-year, Onsite	Global	04/16

ThinkStation P720 Platform Specifications

Product Specifications Reference (PSREF)

Components	Specification																																																																								
Form factor	36L Tower																																																																								
Dimensions	175mm/6.89" W x 485mm/19.1" D x 446mm/17.6" H (with feet)																																																																								
Weight	Maximum configuration: 52.25 lb (23.7kg)																																																																								
Processor	Up to two 150W Intel Xeon Scalable family processors, Bronze, Silver, Gold, or Platinum. Up to 26 cores at 2.0GHz, up to 3.6GHz with 4 cores. Two processors are connected with two UPI (Ultra Path Interconnect) links up to 10.4GT/s																																																																								
Chipset	Intel C621 Chipset																																																																								
Memory	Up to 12 DIMM sockets. Each processor supports up to 6 DIMM sockets with 6 channels. RDIMMs. DDR4-2666																																																																								
Memory capacity	Up to 384GB with 12 x 32GB RDIMMs and two processors																																																																								
Memory protection	ECC																																																																								
Graphics	Up to three PCIe 3.0 x16 slots depending on the processors installed (see Expansion slots section). Up to one NVIDIA Quadro P6000, or up to two Quadro P5000, Quadro P4000, or NVS 810, other graphics adapters under 75W up to 3, 900W PSU is needed. Supports the following graphics adapters:																																																																								
	<table border="1"> <thead> <tr> <th>Adapter</th> <th>Cores</th> <th>Memory</th> <th>Power</th> <th>Connector</th> <th>SLI</th> </tr> </thead> <tbody> <tr> <td>NVS 310</td> <td>48</td> <td>1GB</td> <td>19.5W</td> <td>2xDP</td> <td></td> </tr> <tr> <td>NVS 315</td> <td>48</td> <td>1GB</td> <td>19.3W</td> <td>2xDVI-I SL/2xDP</td> <td></td> </tr> <tr> <td>NVS 510</td> <td>192</td> <td>2GB</td> <td>33.4W</td> <td>4xmini DP</td> <td></td> </tr> <tr> <td>NVS 810</td> <td>1024</td> <td>4GB</td> <td>68W</td> <td>8xmini DP</td> <td></td> </tr> <tr> <td>Quadro P400</td> <td>256</td> <td>2GB</td> <td>30W</td> <td>3xminiDP</td> <td></td> </tr> <tr> <td>Quadro P600</td> <td>384</td> <td>2GB</td> <td>45W</td> <td>4xminiDP</td> <td></td> </tr> <tr> <td>Quadro P1000</td> <td>640</td> <td>4GB</td> <td>50W</td> <td>4xminiDP</td> <td></td> </tr> <tr> <td>Quadro P2000</td> <td>1024</td> <td>5GB</td> <td>75W</td> <td>4xDP</td> <td></td> </tr> <tr> <td>Quadro P4000</td> <td>1792</td> <td>8GB</td> <td>120W</td> <td>4xDP</td> <td></td> </tr> <tr> <td>Quadro P5000</td> <td>2560</td> <td>16GB</td> <td>180W</td> <td>DVI-D DL+4xDP</td> <td>SLI</td> </tr> <tr> <td>Quadro P6000</td> <td>3840</td> <td>24GB</td> <td>250W</td> <td>DVI-D DL+4xDP</td> <td></td> </tr> </tbody> </table>	Adapter	Cores	Memory	Power	Connector	SLI	NVS 310	48	1GB	19.5W	2xDP		NVS 315	48	1GB	19.3W	2xDVI-I SL/2xDP		NVS 510	192	2GB	33.4W	4xmini DP		NVS 810	1024	4GB	68W	8xmini DP		Quadro P400	256	2GB	30W	3xminiDP		Quadro P600	384	2GB	45W	4xminiDP		Quadro P1000	640	4GB	50W	4xminiDP		Quadro P2000	1024	5GB	75W	4xDP		Quadro P4000	1792	8GB	120W	4xDP		Quadro P5000	2560	16GB	180W	DVI-D DL+4xDP	SLI	Quadro P6000	3840	24GB	250W	DVI-D DL+4xDP	
	Adapter	Cores	Memory	Power	Connector	SLI																																																																			
	NVS 310	48	1GB	19.5W	2xDP																																																																				
	NVS 315	48	1GB	19.3W	2xDVI-I SL/2xDP																																																																				
	NVS 510	192	2GB	33.4W	4xmini DP																																																																				
	NVS 810	1024	4GB	68W	8xmini DP																																																																				
	Quadro P400	256	2GB	30W	3xminiDP																																																																				
	Quadro P600	384	2GB	45W	4xminiDP																																																																				
	Quadro P1000	640	4GB	50W	4xminiDP																																																																				
Quadro P2000	1024	5GB	75W	4xDP																																																																					
Quadro P4000	1792	8GB	120W	4xDP																																																																					
Quadro P5000	2560	16GB	180W	DVI-D DL+4xDP	SLI																																																																				
Quadro P6000	3840	24GB	250W	DVI-D DL+4xDP																																																																					
Storage controllers	Integrated Intel SATA AHCI/RAID controller in chipset, 6Gbps SATA, RAID 0/1/10/5. Integrated Intel PCIe host in processor for M.2 PCIe NVMe drives, optional RAID 0/1/10 with Intel NVMe RAID upgrade basic, optional RAID 0/1/10/5 with Intel NVMe RAID upgrade premium. Optional Broadcom 9440-8i, PCIe adapter, 12Gbps, SATA/SAS, RAID 0/1/10/5. Or optional Broadcom 9460-16i with 4GB DDR4 memory and SuperCap, PCIe adapter, 12Gbps, SATA/SAS, RAID 0/1/10/5/6																																																																								
5.25" flex bay	Two 5.25" flex bays, supports the following options: <ul style="list-style-type: none"> Up to two half-height optical drives. Up to two 5.25" slim ODD cages, each supports one 9.0mm optical drive. Up to one 5.25" slim ODD and HDD cage for one 9.0mm optical drive plus one 3.5" or 2.5" SATA disk. Up to one Front Access Storage Enclosure for one 3.5" or 2.5" SATA disk Up to one flex module for one or more of the following options: 9.0mm optical/ 15-in-1 USB 3.0 reader/front eSATA/front Thunderbolt/4-digit diagnostic display <i>Note: Only one can be supported from 15-in-1 reader, Thunderbolt, and 4-digit display</i>																																																																								
Disk drive bays	Up to four internal 3.5" drive bays. Two standard, two optional. Each bay supports one 3.5" or 2.5" SATA/SAS disk (SAS disk support needs 9440-8i or 9460-16i). Selected models supports four internal 3.5" dual drive bays, each bay supports one 3.5" HDD plus one 2.5" SATA SSD, or two 2.5" SATA/SAS disks. Supports up to four 2.5" U.2 SSD on selected models. Up to two 2.5" or 3.5" SATA disk drives on 5.25" flex bays via one 5.25" Front Access Storage Enclosure plus one 5.25" slim ODD and HDD cage																																																																								
M.2 slots	Up to 9 x M.2 PCIe NVMe SSD: <ul style="list-style-type: none"> Two onboard M.2 slots. Up to one full height, full length PCIe 3.0 x16 adapter, supports four M.2 slots. Up to three PCIe 3.0 x4 adapters, each adapter supports one M.2 slot <i>Note: Supports RAID 0/1 on onboard M.2 disks and RAID 0/1/10/5 on quad M.2 PCIe x16 adapter, NVMe RAID upgrade is needed</i>																																																																								
Internal storage	<table border="1"> <tbody> <tr> <td>HDD 7.2K 3.5" SATA6Gbps</td> <td>1TB/2TB/4TB/6TB</td> </tr> <tr> <td>SSD 2.5" SATA6Gbps</td> <td>256GB Opal/512GB/512GB Opal/1TB Opal/2TB Opal</td> </tr> <tr> <td>M.2 PCIe NVMe, PCIe 3.0 x4</td> <td>256GB Opal/512GB Opal/1TB Opal</td> </tr> </tbody> </table>	HDD 7.2K 3.5" SATA6Gbps	1TB/2TB/4TB/6TB	SSD 2.5" SATA6Gbps	256GB Opal/512GB/512GB Opal/1TB Opal/2TB Opal	M.2 PCIe NVMe, PCIe 3.0 x4	256GB Opal/512GB Opal/1TB Opal																																																																		
HDD 7.2K 3.5" SATA6Gbps	1TB/2TB/4TB/6TB																																																																								
SSD 2.5" SATA6Gbps	256GB Opal/512GB/512GB Opal/1TB Opal/2TB Opal																																																																								
M.2 PCIe NVMe, PCIe 3.0 x4	256GB Opal/512GB Opal/1TB Opal																																																																								
Media reader	9-in-1 USB 2.0 card reader on most models. Optional UHS-II 15-in-1 USB 3.0 reader on flex module																																																																								
Network interfaces	Integrated two-port gigabit ethernet (Intel i219LM and i210AT), supports Wake-on-LAN on both two ports. Optional PCIe ethernet or wireless adapters are available																																																																								

Components	Specification																								
Security features	Power-on and admin password. Trusted Platform Module, TCG 2.0 compliant, switch to 1.2 via UEFI setting. Chassis intrusion switch. Optional access panel lock, Kensington lock, and pad lock																								
Systems management	Intel Active Management Technology 11. Front panel warning LED. ThinkStation Diagnostics for Windows. Photo-audio transfer with Lenovo PC Diagnostics for Android and iOS. Optional front 4-digit diagnostic display on flex module																								
Base warranty	1 or 3-year limited onsite service with 9x5/NBD																								
HD Audio	Realtek ALC662 codec																								
Front ports	Four USB 3.0 (includes one 11W charging), one combo audio/microphone jack (3.5mm)																								
Rear ports	Two USB 2.0, four USB 3.0, two ethernet (RJ-45), three analog audio ports (line-in, line-out, mic-in), two PS/2																								
Optional ports	Supports the following optional ports: <ul style="list-style-type: none"> Optional COM port Two USB Type-C ports via PCIe adapter, USB 3.1 gen 2. One 15W, one 5W Two Thunderbolt ports (USB Type-C) on flex module, one of two ports supports video-out. One eSATA on flex module One internal USB 3.0 port 																								
Power supply	One fixed 690W or 900W, autosensing, 92%, 80 PLUS Platinum qualified <table border="1"> <tbody> <tr> <td>Temperature - operating</td> <td>50 °F to 95 °F (10 °C to 35 °C)</td> </tr> <tr> <td>Temperature - non operating (no package)</td> <td>14 °F to 140 °F (-10 °C to 60 °C)</td> </tr> <tr> <td>Temperature - non operating (with package)</td> <td>-40 °F to 140 °F (-40 °C to 60 °C)</td> </tr> <tr> <td>Altitude - operating</td> <td>(Unpressurized): 0-10000ft (0-3048m)</td> </tr> <tr> <td>Humidity - operating</td> <td>10%-80%, non-condensing</td> </tr> <tr> <td>Humidity - storage (with package)</td> <td>10%-90%, non-condensing</td> </tr> </tbody> </table>	Temperature - operating	50 °F to 95 °F (10 °C to 35 °C)	Temperature - non operating (no package)	14 °F to 140 °F (-10 °C to 60 °C)	Temperature - non operating (with package)	-40 °F to 140 °F (-40 °C to 60 °C)	Altitude - operating	(Unpressurized): 0-10000ft (0-3048m)	Humidity - operating	10%-80%, non-condensing	Humidity - storage (with package)	10%-90%, non-condensing												
Temperature - operating	50 °F to 95 °F (10 °C to 35 °C)																								
Temperature - non operating (no package)	14 °F to 140 °F (-10 °C to 60 °C)																								
Temperature - non operating (with package)	-40 °F to 140 °F (-40 °C to 60 °C)																								
Altitude - operating	(Unpressurized): 0-10000ft (0-3048m)																								
Humidity - operating	10%-80%, non-condensing																								
Humidity - storage (with package)	10%-90%, non-condensing																								
Environmental specification	RoHS-compliant. GREENGUARD. EPEAT Gold rating and ENERGY STAR 6.1 qualified on following models: <table border="1"> <thead> <tr> <th>Model</th> <th>30BA0007US</th> <th>30BA0008US</th> </tr> </thead> <tbody> <tr> <td>Processor</td> <td>2 x Intel Xeon Silver 4110</td> <td>2 x Intel Xeon Gold 5122</td> </tr> <tr> <td>Memory</td> <td>2 x 8GB RDIMM DDR4-2666 ECC</td> <td>2 x 8GB RDIMM DDR4-2666 ECC</td> </tr> <tr> <td>Disks</td> <td>2x1TB HDD 7.2K 3.5" SATA6Gbps</td> <td>2 x 256GB SSD 2.5" SATA6Gbps Opal</td> </tr> <tr> <td>Graphics</td> <td>NVIDIA Quadro P4000 8GB</td> <td>NVIDIA Quadro P4000 8GB</td> </tr> <tr> <td>Optical</td> <td>HH DVD±RW</td> <td>HH DVD±RW</td> </tr> <tr> <td>PSU</td> <td>690W</td> <td>900W</td> </tr> <tr> <td>OS</td> <td>Win10 Pro 64</td> <td>Win10 Pro 64</td> </tr> </tbody> </table>	Model	30BA0007US	30BA0008US	Processor	2 x Intel Xeon Silver 4110	2 x Intel Xeon Gold 5122	Memory	2 x 8GB RDIMM DDR4-2666 ECC	2 x 8GB RDIMM DDR4-2666 ECC	Disks	2x1TB HDD 7.2K 3.5" SATA6Gbps	2 x 256GB SSD 2.5" SATA6Gbps Opal	Graphics	NVIDIA Quadro P4000 8GB	NVIDIA Quadro P4000 8GB	Optical	HH DVD±RW	HH DVD±RW	PSU	690W	900W	OS	Win10 Pro 64	Win10 Pro 64
Model	30BA0007US	30BA0008US																							
Processor	2 x Intel Xeon Silver 4110	2 x Intel Xeon Gold 5122																							
Memory	2 x 8GB RDIMM DDR4-2666 ECC	2 x 8GB RDIMM DDR4-2666 ECC																							
Disks	2x1TB HDD 7.2K 3.5" SATA6Gbps	2 x 256GB SSD 2.5" SATA6Gbps Opal																							
Graphics	NVIDIA Quadro P4000 8GB	NVIDIA Quadro P4000 8GB																							
Optical	HH DVD±RW	HH DVD±RW																							
PSU	690W	900W																							
OS	Win10 Pro 64	Win10 Pro 64																							
ISV certifications	Please visit www.thinkworkstations.com/isv-certifications/																								

Audio ports
Option serial
PS/2
2xUSB 2.0
2xUSB 3.0+GbE
2xUSB 3.0+GbE

Slot 1
Slot 2
Slot 3
Slot 4
Slot 5
Slot 6

Expansion slots

Slot 1 (CPU2)	PCIe 3.0 x16, full height, full length, 75W
Slot 2 (CPU1)	PCIe 3.0 x16, full height, full length, 75W, double-width
Slot 3 (CPU1)	PCIe 3.0 x8, full height, full length, 25W, open ended
Slot 4 (CPU1)	PCIe 3.0 x16, full height, full length, 75W, double-width
Slot 5	PCI, full height, full length, 25W
Slot 6 (PCH)	PCIe 3.0 x4, full height, half length, 25W, open ended

900W PSU supports two 6+2-pin aux power connectors. 690W PSU supports one 6+2-pin aux power connector.

Note: All expansion cards are optional

Model	Region	Processor	Graphics	Memory	Storage Controller	M.2 RAID Upgrade	Disks	M.2 Drives	Optical	Media Reader	Additional Networking	Power Supply	Optional Ports	Front Diagnostic LED	Keyboard / Mouse	Operating System	Warranty	Global	Ann Date (mm/yy)
30BA00CBxx	CIS	2x Xeon Silver 4108 8C/1.8GHz/11MB/85W/DDR4-2400	NVIDIA Quadro P2000 5GB	2x 8GB RDIMM DDR4-2666 ECC	Integrated Intel SATA	None	1x 2TB HDD 7.2K 3.5" SATA6Gbps	1x 256GB SSD M.2 PCIe Opal, Onboard	1x HH DVD±RW	9-in-1	None	Fixed 900W Platinum	1x Serial, 1x Internal USB 3.0	4-digit LED	USB / USB Opt	Windows 10 Pro 64	3-year, Onsite	No	04/18
30BA00CCxx	CIS	2x Xeon Silver 4114 10C/2.2GHz/13.75MB/85W/DDR4-2400	Open	2x 16GB RDIMM DDR4-2666 ECC	Integrated Intel SATA	None	1x 2TB HDD 7.2K 3.5" SATA6Gbps	1x 256GB SSD M.2 PCIe Opal, Onboard	1x HH DVD±RW	9-in-1	None	Fixed 900W Platinum	1x Serial, 1x Internal USB 3.0	4-digit LED	USB / USB Opt	Windows 10 Pro 64	3-year, Onsite	No	04/18
30BA00C4xx	EET	2x Xeon Silver 4110 8C/2.1GHz/11MB/85W/DDR4-2400	Open	2x 16GB RDIMM DDR4-2666 ECC	Integrated Intel SATA	None	1x 1TB HDD 7.2K 3.5" SATA6Gbps	1x 256GB SSD M.2 PCIe Opal, Onboard	1x HH DVD±RW	9-in-1	None	Fixed 690W Platinum	1x Serial	None	USB / USB Opt	Windows 10 Pro 64	3-year, Onsite	No	02/18
30BA00C3xx	EET	1x Xeon Silver 4110 8C/2.1GHz/11MB/85W/DDR4-2400	Open	2x 16GB RDIMM DDR4-2666 ECC	Integrated Intel SATA	None	None	1x 512GB SSD M.2 PCIe Opal, Onboard	1x HH DVD±RW	9-in-1	None	Fixed 690W Platinum	1x Serial	None	USB / USB Opt	Windows 10 Pro 64	3-year, Onsite	No	02/18
30BA00BXxx	EET	1x Xeon Silver 4114 10C/2.2GHz/13.75MB/85W/DDR4-2400	Open	1x 16GB RDIMM DDR4-2666 ECC	Integrated Intel SATA	None	1x 512GB SSD 2.5" SATA6Gbps Opal	None	1x HH DVD±RW	9-in-1	None	Fixed 900W Platinum	1x Serial	None	USB / USB Opt	Windows 10 Pro 64	3-year, Onsite	No	02/18
30BA00BYxx	EET	1x Xeon Gold 5118 12C/2.3GHz/16.5MB/105W/DDR4-2400	Open	1x 16GB RDIMM DDR4-2666 ECC	Integrated Intel SATA	None	1x 512GB SSD 2.5" SATA6Gbps Opal	None	1x HH DVD±RW	9-in-1	None	Fixed 900W Platinum	1x Serial	None	USB / USB Opt	Windows 10 Pro 64	3-year, Onsite	No	02/18
30BA00C0xx	EET	2x Xeon Silver 4110 8C/2.1GHz/11MB/85W/DDR4-2400	Open	2x 16GB RDIMM DDR4-2666 ECC	Integrated Intel SATA	None	1x 256GB SSD 2.5" SATA6Gbps Opal, 1x 1TB HDD 7.2K 3.5" SATA6Gbps	None	1x HH DVD±RW	9-in-1	None	Fixed 900W Platinum	1x Serial	None	USB / USB Opt	Windows 10 Pro 64	3-year, Onsite	No	02/18
30BA00C1xx	EET	2x Xeon Silver 4114 10C/2.2GHz/13.75MB/85W/DDR4-2400	Open	2x 16GB RDIMM DDR4-2666 ECC	Integrated Intel SATA	None	1x 512GB SSD 2.5" SATA6Gbps Opal, 1x 1TB HDD 7.2K 3.5" SATA6Gbps	None	1x HH DVD±RW	9-in-1	None	Fixed 900W Platinum	1x Serial	None	USB / USB Opt	Windows 10 Pro 64	3-year, Onsite	No	02/18
30BA0019xx	EET	1x Xeon Silver 4110 8C/2.1GHz/11MB/85W/DDR4-2400	Open	1x 8GB RDIMM DDR4-2666 ECC	Integrated Intel SATA	None	1x 256GB SSD 2.5" SATA6Gbps Opal	None	1x HH DVD±RW	9-in-1	None	Fixed 690W Platinum	None	None	USB / USB Opt	Windows 10 DG Windows 7 Pro 64	3-year, Onsite	No	09/17
30BA001Axx	EET	1x Xeon Silver 4114 10C/2.2GHz/13.75MB/85W/DDR4-2400	Open	2x 8GB RDIMM DDR4-2666 ECC	Integrated Intel SATA	None	1x 512GB SSD 2.5" SATA6Gbps Opal	None	1x HH DVD±RW	9-in-1	None	Fixed 900W Platinum	None	None	USB / USB Opt	Windows 10 DG Windows 7 Pro 64	3-year, Onsite	No	09/17

Model	Region	Processor	Graphics	Memory	Storage Controller	M.2 RAID Upgrade	Disks	M.2 Drives	Optical	Media Reader	Additional Networking	Power Supply	Optional Ports	Front Diagnostic LED	Keyboard / Mouse	Operating System	Warranty	Global	Ann Date (mm/yy)
30BA001Bxx	EET	1x Xeon Silver 4110 8C/2.1GHz/11MB/85W/DDR4-2400	Open	2x 8GB RDIMM DDR4-2666 ECC	Integrated Intel SATA	None	1x 512GB SSD 2.5" SATA6Gbps Opal	None	1x HH DVD±RW	9-in-1	None	Fixed 900W Platinum	None	None	USB / USB Opt	Windows 10 DG Windows 7 Pro 64	3-year, Onsite	No	09/17
30BA001Cxx	EET	2x Xeon Silver 4114 10C/2.2GHz/13.75MB/85W/DDR4-2400	Open	4x 8GB RDIMM DDR4-2666 ECC	Integrated Intel SATA	None	None	1x 512GB SSD M.2 PCIe Opal, Onboard	1x HH DVD±RW	9-in-1	None	Fixed 690W Platinum	None	None	USB / USB Opt	Windows 10 DG Windows 7 Pro 64	3-year, Onsite	No	09/17
30BA001Dxx	EET	1x Xeon Silver 4110 8C/2.1GHz/11MB/85W/DDR4-2400	Open	2x 8GB RDIMM DDR4-2666 ECC	Integrated Intel SATA	None	1x 256GB SSD 2.5" SATA6Gbps Opal	None	1x HH DVD±RW	9-in-1	None	Fixed 690W Platinum	None	None	USB / USB Opt	Windows 10 Pro 64	3-year, Onsite	No	09/17
30BA001Fxx	EET	1x Xeon Gold 5118 12C/2.3GHz/16.5MB/105W/DDR4-2400	Open	2x 8GB RDIMM DDR4-2666 ECC	Integrated Intel SATA	None	1x 512GB SSD 2.5" SATA6Gbps Opal	None	1x HH DVD±RW	9-in-1	None	Fixed 900W Platinum	None	None	USB / USB Opt	Windows 10 Pro 64	3-year, Onsite	No	09/17
30BA001Hxx	EET	2x Xeon Silver 4114 10C/2.2GHz/13.75MB/85W/DDR4-2400	Open	2x 16GB RDIMM DDR4-2666 ECC	Integrated Intel SATA	None	1x 512GB SSD 2.5" SATA6Gbps, 1x 1TB HDD 7.2K 3.5" SATA6Gbps	None	1x HH DVD±RW	9-in-1	None	Fixed 900W Platinum	None	None	USB / USB Opt	Windows 10 Pro 64	3-year, Onsite	No	09/17
30BA001Jxx	EET	1x Xeon Silver 4110 8C/2.1GHz/11MB/85W/DDR4-2400	Open	4x 8GB RDIMM DDR4-2666 ECC	Integrated Intel SATA	None	None	1x 512GB SSD M.2 PCIe Opal, Onboard	1x HH DVD±RW	9-in-1	None	Fixed 690W Platinum	None	None	USB / USB Opt	Windows 10 Pro 64	3-year, Onsite	No	09/17
30BA001Kxx	EET	2x Xeon Silver 4114 10C/2.2GHz/13.75MB/85W/DDR4-2400	Open	4x 8GB RDIMM DDR4-2666 ECC	Integrated Intel SATA	None	None	1x 512GB SSD M.2 PCIe Opal, Onboard	1x HH DVD±RW	9-in-1	None	Fixed 690W Platinum	None	None	USB / USB Opt	Windows 10 Pro 64	3-year, Onsite	No	09/17
30BA001Lxx	EET	2x Xeon Silver 4110 8C/2.1GHz/11MB/85W/DDR4-2400	Open	4x 8GB RDIMM DDR4-2666 ECC	Integrated Intel SATA	None	1x 1TB HDD 7.2K 3.5" SATA6Gbps	1x 256GB SSD M.2 PCIe Opal, Onboard	1x HH DVD±RW	9-in-1	None	Fixed 690W Platinum	None	None	USB / USB Opt	Windows 10 Pro 64	3-year, Onsite	No	09/17
30BA0024xx	EET	1x Xeon Silver 4110 8C/2.1GHz/11MB/85W/DDR4-2400	Open	1x 8GB RDIMM DDR4-2666 ECC	Integrated Intel SATA	None	1x 256GB SSD 2.5" SATA6Gbps Opal	None	1x HH DVD±RW	9-in-1	None	Fixed 690W Platinum	1x Serial	None	USB / USB Opt	Windows 10 DG Windows 7 Pro 64	3-year, Onsite	No	02/18
30BA0061xx	EET	2x Xeon Silver 4110 8C/2.1GHz/11MB/85W/DDR4-2400	Open	2x 16GB RDIMM DDR4-2666 ECC	Integrated Intel SATA	None	1x 256GB SSD 2.5" SATA6Gbps Opal, 1x 1TB HDD 7.2K 3.5" SATA6Gbps	None	1x HH DVD±RW	9-in-1	None	Fixed 900W Platinum	1x Serial	None	USB / USB Opt	Windows 10 Pro 64	3-year, Onsite	No	02/18

Model	Region	Processor	Graphics	Memory	Storage Controller	M.2 RAID Upgrade	Disks	M.2 Drives	Optical	Media Reader	Additional Networking	Power Supply	Optional Ports	Front Diagnostic LED	Keyboard / Mouse	Operating System	Warranty	Global	Ann Date (mm/yy)
30BA0074xx	EET	2x Xeon Silver 4114 10C/2.2GHz/13.75MB/85W/DDR4-2400	Open	2x 16GB RDIMM DDR4-2666 ECC	Integrated Intel SATA	None	1x 512GB SSD 2.5" SATA6Gbps Opal, 1x 1TB HDD 7.2K 3.5" SATA6Gbps	None	1x HH DVD±RW	9-in-1	None	Fixed 900W Platinum	1x Serial	None	USB / USB Opt	Windows 10 Pro 64	3-year, Onsite	No	02/18
30BA003Sxx	EET	1x Xeon Silver 4114 10C/2.2GHz/13.75MB/85W/DDR4-2400	Open	1x 16GB RDIMM DDR4-2666 ECC	Integrated Intel SATA	None	1x 512GB SSD 2.5" SATA6Gbps Opal	None	1x HH DVD±RW	9-in-1	None	Fixed 900W Platinum	1x Serial	None	USB / USB Opt	Windows 10 Pro 64	3-year, Onsite	No	02/18
30BA00BWxx	EET	1x Xeon Silver 4110 8C/2.1GHz/11MB/85W/DDR4-2400	Open	1x 16GB RDIMM DDR4-2666 ECC	Integrated Intel SATA	None	1x 256GB SSD 2.5" SATA6Gbps Opal	None	1x HH DVD±RW	9-in-1	None	Fixed 690W Platinum	1x Serial	None	USB / USB Opt	Windows 10 Pro 64	3-year, Onsite	No	02/18
30BA001L**	MEA	2x Xeon Silver 4110 8C/2.1GHz/11MB/85W/DDR4-2400	Open	4x 8GB RDIMM DDR4-2666 ECC	Integrated Intel SATA	None	1x 1TB HDD 7.2K 3.5" SATA6Gbps	1x 256GB SSD M.2 PCIe Opal, Onboard	1x HH DVD±RW	9-in-1	None	Fixed 690W Platinum	None	None	USB / USB Opt	Windows 10 Pro 64	3-year, Onsite	No	09/17
30BA0024**	MEA	1x Xeon Silver 4110 8C/2.1GHz/11MB/85W/DDR4-2400	Open	1x 8GB RDIMM DDR4-2666 ECC	Integrated Intel SATA	None	1x 256GB SSD 2.5" SATA6Gbps Opal	None	1x HH DVD±RW	9-in-1	None	Fixed 690W Platinum	1x Serial	None	USB / USB Opt	Windows 10 DG Windows 7 Pro 64	3-year, Onsite	No	02/18
30BA0025**	MEA	1x Xeon Silver 4114 10C/2.2GHz/13.75MB/85W/DDR4-2400	Open	1x 16GB RDIMM DDR4-2666 ECC	Integrated Intel SATA	None	1x 512GB SSD 2.5" SATA6Gbps Opal	None	1x HH DVD±RW	9-in-1	None	Fixed 900W Platinum	1x Serial	None	USB / USB Opt	Windows 10 DG Windows 7 Pro 64	3-year, Onsite	No	02/18
30BA0026**	MEA	1x Xeon Silver 4110 8C/2.1GHz/11MB/85W/DDR4-2400	Open	1x 16GB RDIMM DDR4-2666 ECC	Integrated Intel SATA	None	1x 512GB SSD 2.5" SATA6Gbps Opal	None	1x HH DVD±RW	9-in-1	None	Fixed 900W Platinum	1x Serial	None	USB / USB Opt	Windows 10 DG Windows 7 Pro 64	3-year, Onsite	No	02/18
30BA001J**	MEA	1x Xeon Silver 4110 8C/2.1GHz/11MB/85W/DDR4-2400	Open	4x 8GB RDIMM DDR4-2666 ECC	Integrated Intel SATA	None	None	1x 512GB SSD M.2 PCIe Opal, Onboard	1x HH DVD±RW	9-in-1	None	Fixed 690W Platinum	None	None	USB / USB Opt	Windows 10 Pro 64	3-year, Onsite	No	09/17
30BA001K**	MEA	2x Xeon Silver 4114 10C/2.2GHz/13.75MB/85W/DDR4-2400	Open	4x 8GB RDIMM DDR4-2666 ECC	Integrated Intel SATA	None	None	1x 512GB SSD M.2 PCIe Opal, Onboard	1x HH DVD±RW	9-in-1	None	Fixed 690W Platinum	None	None	USB / USB Opt	Windows 10 Pro 64	3-year, Onsite	No	09/17
30BA001W**	MEA	1x Xeon Gold 5118 12C/2.3GHz/16.5MB/105W/DDR4-2400	Open	1x 16GB RDIMM DDR4-2666 ECC	Integrated Intel SATA	RAID 0/1/10	None	4x 256GB SSD M.2 PCIe Opal	1x HH DVD±RW	9-in-1	None	Fixed 900W Platinum	1x Serial	None	USB / USB Opt	Windows 10 Pro 64	3-year, Onsite	No	02/18

Model	Region	Processor	Graphics	Memory	Storage Controller	M.2 RAID Upgrade	Disks	M.2 Drives	Optical	Media Reader	Additional Networking	Power Supply	Optional Ports	Front Diagnostic LED	Keyboard / Mouse	Operating System	Warranty	Global	Ann Date (mm/yy)
30BA001G**	MEA	2x Xeon Silver 4110 8C/2.1GHz/11MB/85W/DDR4-2400	Open	2x 8GB RDIMM DDR4-2666 ECC	Integrated Intel SATA	None	1x 256GB SSD 2.5" SATA6Gbps Opal, 1x 1TB HDD 7.2K 3.5" SATA6Gbps	None	1x HH DVD±RW	9-in-1	None	Fixed 900W Platinum	None	None	USB / USB Opt	Windows 10 Pro 64	3-year, Onsite	No	09/17
30BA001F**	MEA	1x Xeon Gold 5118 12C/2.3GHz/16.5MB/105W/DDR4-2400	Open	2x 8GB RDIMM DDR4-2666 ECC	Integrated Intel SATA	None	1x 512GB SSD 2.5" SATA6Gbps Opal	None	1x HH DVD±RW	9-in-1	None	Fixed 900W Platinum	None	None	USB / USB Opt	Windows 10 Pro 64	3-year, Onsite	No	09/17
30BA001H**	MEA	2x Xeon Silver 4114 10C/2.2GHz/13.75MB/85W/DDR4-2400	Open	2x 16GB RDIMM DDR4-2666 ECC	Integrated Intel SATA	None	1x 512GB SSD 2.5" SATA6Gbps, 1x 1TB HDD 7.2K 3.5" SATA6Gbps	None	1x HH DVD±RW	9-in-1	None	Fixed 900W Platinum	None	None	USB / USB Opt	Windows 10 Pro 64	3-year, Onsite	No	09/17
30BA001E**	MEA	1x Xeon Silver 4114 10C/2.2GHz/13.75MB/85W/DDR4-2400	Open	2x 8GB RDIMM DDR4-2666 ECC	Integrated Intel SATA	None	1x 512GB SSD 2.5" SATA6Gbps Opal	None	1x HH DVD±RW	9-in-1	None	Fixed 900W Platinum	None	None	USB / USB Opt	Windows 10 Pro 64	3-year, Onsite	No	09/17
30BA001C**	MEA	2x Xeon Silver 4114 10C/2.2GHz/13.75MB/85W/DDR4-2400	Open	4x 8GB RDIMM DDR4-2666 ECC	Integrated Intel SATA	None	None	1x 512GB SSD M.2 PCIe Opal, Onboard	1x HH DVD±RW	9-in-1	None	Fixed 690W Platinum	None	None	USB / USB Opt	Windows 10 DG Windows 7 Pro 64	3-year, Onsite	No	09/17
30BA001D**	MEA	1x Xeon Silver 4110 8C/2.1GHz/11MB/85W/DDR4-2400	Open	2x 8GB RDIMM DDR4-2666 ECC	Integrated Intel SATA	None	1x 256GB SSD 2.5" SATA6Gbps Opal	None	1x HH DVD±RW	9-in-1	None	Fixed 690W Platinum	None	None	USB / USB Opt	Windows 10 Pro 64	3-year, Onsite	No	09/17
30BA001A**	MEA	1x Xeon Silver 4114 10C/2.2GHz/13.75MB/85W/DDR4-2400	Open	2x 8GB RDIMM DDR4-2666 ECC	Integrated Intel SATA	None	1x 512GB SSD 2.5" SATA6Gbps Opal	None	1x HH DVD±RW	9-in-1	None	Fixed 900W Platinum	None	None	USB / USB Opt	Windows 10 DG Windows 7 Pro 64	3-year, Onsite	No	09/17
30BA001B**	MEA	1x Xeon Silver 4110 8C/2.1GHz/11MB/85W/DDR4-2400	Open	2x 8GB RDIMM DDR4-2666 ECC	Integrated Intel SATA	None	1x 512GB SSD 2.5" SATA6Gbps Opal	None	1x HH DVD±RW	9-in-1	None	Fixed 900W Platinum	None	None	USB / USB Opt	Windows 10 DG Windows 7 Pro 64	3-year, Onsite	No	09/17
30BA0019**	MEA	1x Xeon Silver 4110 8C/2.1GHz/11MB/85W/DDR4-2400	Open	1x 8GB RDIMM DDR4-2666 ECC	Integrated Intel SATA	None	1x 256GB SSD 2.5" SATA6Gbps Opal	None	1x HH DVD±RW	9-in-1	None	Fixed 690W Platinum	None	None	USB / USB Opt	Windows 10 DG Windows 7 Pro 64	3-year, Onsite	No	09/17
30BA00C2**	MEA	2x Xeon Silver 4114 10C/2.2GHz/13.75MB/85W/DDR4-2400	Open	2x 16GB RDIMM DDR4-2666 ECC	Integrated Intel SATA	None	None	1x 512GB SSD M.2 PCIe Opal, Onboard	1x HH DVD±RW	9-in-1	None	Fixed 690W Platinum	1x Serial	None	USB / USB Opt	Windows 10 Pro 64	3-year, Onsite	No	02/18

Model	Region	Processor	Graphics	Memory	Storage Controller	M.2 RAID Upgrade	Disks	M.2 Drives	Optical	Media Reader	Additional Networking	Power Supply	Optional Ports	Front Diagnostic LED	Keyboard / Mouse	Operating System	Warranty	Global	Ann Date (mm/yy)
30BA00C1**	MEA	2x Xeon Silver 4114 10C/2.2GHz/13.75MB/85W/DDR4-2400	Open	2x 16GB RDIMM DDR4-2666 ECC	Integrated Intel SATA	None	1x 512GB SSD 2.5" SATA6Gbps Opal, 1x 1TB HDD 7.2K 3.5" SATA6Gbps	None	1x HH DVD±RW	9-in-1	None	Fixed 900W Platinum	1x Serial	None	USB / USB Opt	Windows 10 Pro 64	3-year, Onsite	No	02/18
30BA00C3**	MEA	1x Xeon Silver 4110 8C/2.1GHz/11MB/85W/DDR4-2400	Open	2x 16GB RDIMM DDR4-2666 ECC	Integrated Intel SATA	None	None	1x 512GB SSD M.2 PCIe Opal, Onboard	1x HH DVD±RW	9-in-1	None	Fixed 690W Platinum	1x Serial	None	USB / USB Opt	Windows 10 Pro 64	3-year, Onsite	No	02/18
30BA00BY**	MEA	1x Xeon Gold 5118 12C/2.3GHz/16.5MB/105W/DDR4-2400	Open	1x 16GB RDIMM DDR4-2666 ECC	Integrated Intel SATA	None	1x 512GB SSD 2.5" SATA6Gbps Opal	None	1x HH DVD±RW	9-in-1	None	Fixed 900W Platinum	1x Serial	None	USB / USB Opt	Windows 10 Pro 64	3-year, Onsite	No	02/18
30BA00C0**	MEA	2x Xeon Silver 4110 8C/2.1GHz/11MB/85W/DDR4-2400	Open	2x 16GB RDIMM DDR4-2666 ECC	Integrated Intel SATA	None	1x 256GB SSD 2.5" SATA6Gbps Opal, 1x 1TB HDD 7.2K 3.5" SATA6Gbps	None	1x HH DVD±RW	9-in-1	None	Fixed 900W Platinum	1x Serial	None	USB / USB Opt	Windows 10 Pro 64	3-year, Onsite	No	02/18
30BA00BW**	MEA	1x Xeon Silver 4110 8C/2.1GHz/11MB/85W/DDR4-2400	Open	1x 16GB RDIMM DDR4-2666 ECC	Integrated Intel SATA	None	1x 256GB SSD 2.5" SATA6Gbps Opal	None	1x HH DVD±RW	9-in-1	None	Fixed 690W Platinum	1x Serial	None	USB / USB Opt	Windows 10 Pro 64	3-year, Onsite	No	02/18
30BA00BX**	MEA	1x Xeon Silver 4114 10C/2.2GHz/13.75MB/85W/DDR4-2400	Open	1x 16GB RDIMM DDR4-2666 ECC	Integrated Intel SATA	None	1x 512GB SSD 2.5" SATA6Gbps Opal	None	1x HH DVD±RW	9-in-1	None	Fixed 900W Platinum	1x Serial	None	USB / USB Opt	Windows 10 Pro 64	3-year, Onsite	No	02/18
30BA00C4**	MEA	2x Xeon Silver 4110 8C/2.1GHz/11MB/85W/DDR4-2400	Open	2x 16GB RDIMM DDR4-2666 ECC	Integrated Intel SATA	None	1x 1TB HDD 7.2K 3.5" SATA6Gbps	1x 256GB SSD M.2 PCIe Opal, Onboard	1x HH DVD±RW	9-in-1	None	Fixed 690W Platinum	1x Serial	None	USB / USB Opt	Windows 10 Pro 64	3-year, Onsite	No	02/18
30BA00CB**	MEA	2x Xeon Silver 4108 8C/1.8GHz/11MB/85W/DDR4-2400	NVIDIA Quadro P2000 5GB	2x 8GB RDIMM DDR4-2666 ECC	Integrated Intel SATA	None	1x 2TB HDD 7.2K 3.5" SATA6Gbps	1x 256GB SSD M.2 PCIe Opal, Onboard	1x HH DVD±RW	9-in-1	None	Fixed 900W Platinum	1x Serial, 1x Internal USB 3.0	4-digit LED	USB / USB Opt	Windows 10 Pro 64	3-year, Onsite	No	04/18
30BA00CD**	MEA	2x Xeon Silver 4110 8C/2.1GHz/11MB/85W/DDR4-2400	Open	2x 8GB RDIMM DDR4-2666 ECC	Integrated Intel SATA	None	1x 1TB HDD 7.2K 3.5" SATA6Gbps	1x 256GB SSD M.2 PCIe Opal, Onboard	1x HH DVD±RW	9-in-1	None	Fixed 900W Platinum	1x Serial, 1x Internal USB 3.0	4-digit LED	USB / USB Opt	Windows 10 Pro 64	3-year, Onsite	No	04/18
30BA00CC**	MEA	2x Xeon Silver 4114 10C/2.2GHz/13.75MB/85W/DDR4-2400	Open	2x 16GB RDIMM DDR4-2666 ECC	Integrated Intel SATA	None	1x 2TB HDD 7.2K 3.5" SATA6Gbps	1x 256GB SSD M.2 PCIe Opal, Onboard	1x HH DVD±RW	9-in-1	None	Fixed 900W Platinum	1x Serial, 1x Internal USB 3.0	4-digit LED	USB / USB Opt	Windows 10 Pro 64	3-year, Onsite	No	04/18

Model	Region	Processor	Graphics	Memory	Storage Controller	M.2 RAID Upgrade	Disks	M.2 Drives	Optical	Media Reader	Additional Networking	Power Supply	Optional Ports	Front Diagnostic LED	Keyboard / Mouse	Operating System	Warranty	Global	Ann Date (mm/yy)
30BA00CDxx	Russia	2x Xeon Silver 4110 8C/2.1GHz/11MB/85W/DDR4-2400	Open	2x 8GB RDIMM DDR4-2666 ECC	Integrated Intel SATA	None	1x 1TB HDD 7.2K 3.5" SATA6Gbps	1x 256GB SSD M.2 PCIe Opal, Onboard	1x HH DVD±RW	9-in-1	None	Fixed 900W Platinum	1x Serial, 1x Internal USB 3.0	4-digit LED	USB / USB Opt	Windows 10 Pro 64	3-year, Onsite	No	04/18
30BA00C2xx	Russia	2x Xeon Silver 4114 10C/2.2GHz/13.75MB/85W/DDR4-2400	Open	2x 16GB RDIMM DDR4-2666 ECC	Integrated Intel SATA	None	None	1x 512GB SSD M.2 PCIe Opal, Onboard	1x HH DVD±RW	9-in-1	None	Fixed 690W Platinum	1x Serial	None	USB / USB Opt	Windows 10 Pro 64	3-year, Onsite	No	02/18
30BA001Exx	Russia	1x Xeon Silver 4114 10C/2.2GHz/13.75MB/85W/DDR4-2400	Open	2x 8GB RDIMM DDR4-2666 ECC	Integrated Intel SATA	None	1x 512GB SSD 2.5" SATA6Gbps Opal	None	1x HH DVD±RW	9-in-1	None	Fixed 900W Platinum	None	None	USB / USB Opt	Windows 10 Pro 64	3-year, Onsite	No	09/17
30BA001Gxx	Russia	2x Xeon Silver 4110 8C/2.1GHz/11MB/85W/DDR4-2400	Open	2x 8GB RDIMM DDR4-2666 ECC	Integrated Intel SATA	None	1x 256GB SSD 2.5" SATA6Gbps Opal, 1x 1TB HDD 7.2K 3.5" SATA6Gbps	None	1x HH DVD±RW	9-in-1	None	Fixed 900W Platinum	None	None	USB / USB Opt	Windows 10 Pro 64	3-year, Onsite	No	09/17
30BA001Wxx	Russia	1x Xeon Gold 5118 12C/2.3GHz/16.5MB/105W/DDR4-2400	Open	1x 16GB RDIMM DDR4-2666 ECC	Integrated Intel SATA	RAID 0/1/10	None	4x 256GB SSD M.2 PCIe Opal	1x HH DVD±RW	9-in-1	None	Fixed 900W Platinum	1x Serial	None	USB / USB Opt	Windows 10 Pro 64	3-year, Onsite	No	02/18
30BA0026xx	Russia	1x Xeon Silver 4110 8C/2.1GHz/11MB/85W/DDR4-2400	Open	1x 16GB RDIMM DDR4-2666 ECC	Integrated Intel SATA	None	1x 512GB SSD 2.5" SATA6Gbps Opal	None	1x HH DVD±RW	9-in-1	None	Fixed 900W Platinum	1x Serial	None	USB / USB Opt	Windows 10 DG Windows 7 Pro 64	3-year, Onsite	No	02/18
30BA0025xx	Russia	1x Xeon Silver 4114 10C/2.2GHz/13.75MB/85W/DDR4-2400	Open	1x 16GB RDIMM DDR4-2666 ECC	Integrated Intel SATA	None	1x 512GB SSD 2.5" SATA6Gbps Opal	None	1x HH DVD±RW	9-in-1	None	Fixed 900W Platinum	1x Serial	None	USB / USB Opt	Windows 10 DG Windows 7 Pro 64	3-year, Onsite	No	02/18
30BA001YUS	US	2x Xeon Silver 4110 8C/2.1GHz/11MB/85W/DDR4-2400	Open	2x 8GB RDIMM DDR4-2666 ECC	Integrated Intel SATA	None	None	1x 512GB SSD M.2 PCIe Opal, Onboard	1x HH DVD±RW	9-in-1	None	Fixed 900W Platinum	None	None	USB / USB Opt	Windows 10 Pro 64	3-year, Onsite	No	02/18
30BA0020US	US	1x Xeon Gold 5118 12C/2.3GHz/16.5MB/105W/DDR4-2400	Open	2x 8GB RDIMM DDR4-2666 ECC	Integrated Intel SATA	None	None	1x 512GB SSD M.2 PCIe Opal, Onboard	1x HH DVD±RW	9-in-1	None	Fixed 900W Platinum	None	None	USB / USB Opt	Windows 10 Pro 64	3-year, Onsite	No	02/18
30BA0021US	US	2x Xeon Silver 4110 8C/2.1GHz/11MB/85W/DDR4-2400	Open	2x 8GB RDIMM DDR4-2666 ECC	Integrated Intel SATA	None	1x 1TB HDD 7.2K 3.5" SATA6Gbps	1x 256GB SSD M.2 PCIe Opal, Onboard	1x HH DVD±RW	9-in-1	None	Fixed 900W Platinum	None	None	USB / USB Opt	Windows 10 Pro 64	3-year, Onsite	No	02/18

Model	Region	Processor	Graphics	Memory	Storage Controller	M.2 RAID Upgrade	Disks	M.2 Drives	Optical	Media Reader	Additional Networking	Power Supply	Optional Ports	Front Diagnostic LED	Keyboard / Mouse	Operating System	Warranty	Global	Ann Date (mm/yy)
30BA0022US	US	1x Xeon Silver 4110 8C/2.1GHz/11MB/85W/DDR4-2400	Open	1x 8GB RDIMM DDR4-2666 ECC	Integrated Intel SATA	None	1x 1TB HDD 7.2K 3.5" SATA6Gbps	None	1x HH DVD±RW	9-in-1	None	Fixed 900W Platinum	None	None	USB / USB Opt	Windows 10 Pro 64	3-year, Onsite	No	02/18
30BA0023US	US	1x Xeon Silver 4114 10C/2.2GHz/13.75MB/85W/DDR4-2400	Open	2x 8GB RDIMM DDR4-2666 ECC	Integrated Intel SATA	None	None	1x 512GB SSD M.2 PCIe Opal, Onboard	1x HH DVD±RW	9-in-1	None	Fixed 900W Platinum	None	None	USB / USB Opt	Windows 10 Pro 64	3-year, Onsite	No	02/18
30BA001MUS	US	1x Xeon Gold 5118 12C/2.3GHz/16.5MB/105W/DDR4-2400	Open	2x 8GB RDIMM DDR4-2666 ECC	Integrated Intel SATA	None	None	1x 512GB SSD M.2 PCIe Opal, Onboard	1x HH DVD±RW	9-in-1	None	Fixed 900W Platinum	None	None	USB / USB Opt	Windows 10 Pro 64	3-year, Onsite	No	09/17
30BA001NUS	US	1x Xeon Silver 4110 8C/2.1GHz/11MB/85W/DDR4-2400	Open	1x 8GB RDIMM DDR4-2666 ECC	Integrated Intel SATA	None	1x 1TB HDD 7.2K 3.5" SATA6Gbps	None	1x HH DVD±RW	9-in-1	None	Fixed 900W Platinum	None	None	USB / USB Opt	Windows 10 Pro 64	3-year, Onsite	No	09/17
30BA001PUS	US	2x Xeon Silver 4110 8C/2.1GHz/11MB/85W/DDR4-2400	Open	2x 8GB RDIMM DDR4-2666 ECC	Integrated Intel SATA	None	None	1x 512GB SSD M.2 PCIe Opal, Onboard	1x HH DVD±RW	9-in-1	None	Fixed 900W Platinum	None	None	USB / USB Opt	Windows 10 Pro 64	3-year, Onsite	No	09/17
30BA001QUS	US	1x Xeon Silver 4114 10C/2.2GHz/13.75MB/85W/DDR4-2400	Open	2x 8GB RDIMM DDR4-2666 ECC	Integrated Intel SATA	None	None	1x 512GB SSD M.2 PCIe Opal, Onboard	1x HH DVD±RW	9-in-1	None	Fixed 900W Platinum	None	None	USB / USB Opt	Windows 10 Pro 64	3-year, Onsite	No	09/17
30BA000FUS	US	2x Xeon Silver 4110 8C/2.1GHz/11MB/85W/DDR4-2400	NVIDIA Quadro P4000 8GB	2x 8GB RDIMM DDR4-2666 ECC	Integrated Intel SATA	None	1x 1TB HDD 7.2K 3.5" SATA6Gbps	1x 256GB SSD M.2 PCIe Opal, Onboard	1x HH DVD±RW	9-in-1	None	Fixed 900W Platinum	None	None	USB / USB Opt	Windows 10 DG Windows 7 Pro 64	3-year, Onsite	No	09/17
30BA000GUS	US	2x Xeon Gold 5122 4C/3.6GHz/16.5MB/105W/DDR4-2400	Open	2x 8GB RDIMM DDR4-2666 ECC	Integrated Intel SATA	None	1x 1TB HDD 7.2K 3.5" SATA6Gbps	1x 256GB SSD M.2 PCIe Opal, Onboard	1x HH DVD±RW	9-in-1	None	Fixed 900W Platinum	None	None	USB / USB Opt	Windows 10 DG Windows 7 Pro 64	3-year, Onsite	No	09/17
30BA000HUS	US	2x Xeon Silver 4110 8C/2.1GHz/11MB/85W/DDR4-2400	Open	2x 8GB RDIMM DDR4-2666 ECC	Integrated Intel SATA	None	1x 1TB HDD 7.2K 3.5" SATA6Gbps	1x 256GB SSD M.2 PCIe Opal, Onboard	1x HH DVD±RW	9-in-1	None	Fixed 900W Platinum	None	None	USB / USB Opt	Windows 10 DG Windows 7 Pro 64	3-year, Onsite	No	09/17
30BA000JUS	US	2x Xeon Silver 4110 8C/2.1GHz/11MB/85W/DDR4-2400	Open	2x 8GB RDIMM DDR4-2666 ECC	Integrated Intel SATA	None	1x 1TB HDD 7.2K 3.5" SATA6Gbps	1x 256GB SSD M.2 PCIe Opal, Onboard	1x HH DVD±RW	9-in-1	None	Fixed 900W Platinum	None	None	USB / USB Opt	Windows 10 Pro 64	3-year, Onsite	No	09/17

Model	Region	Processor	Graphics	Memory	Storage Controller	M.2 RAID Upgrade	Disks	M.2 Drives	Optical	Media Reader	Additional Networking	Power Supply	Optional Ports	Front Diagnostic LED	Keyboard / Mouse	Operating System	Warranty	Global	Ann Date (mm/yy)
30BA0019--	WE	1x Xeon Silver 4110 8C/2.1GHz/11MB/85W/DDR4-2400	Open	1x 8GB RDIMM DDR4-2666 ECC	Integrated Intel SATA	None	1x 256GB SSD 2.5" SATA6Gbps Opal	None	1x HH DVD±RW	9-in-1	None	Fixed 690W Platinum	None	None	USB / USB Opt	Windows 10 DG Windows 7 Pro 64	3-year, Onsite	No	09/17
30BA0000--	WE	2x Xeon Silver 4108 8C/1.8GHz/11MB/85W/DDR4-2400	NVIDIA Quadro P2000 5GB	2x 16GB RDIMM DDR4-2666 ECC	Integrated Intel SATA	None	1x 256GB SSD 2.5" SATA6Gbps Opal	None	1x HH DVD±RW	9-in-1	None	Fixed 900W Platinum	None	None	None	Windows 10 Pro 64	1-year, Onsite	No	09/17
30BA001A--	WE	1x Xeon Silver 4114 10C/2.2GHz/13.75MB/85W/DDR4-2400	Open	2x 8GB RDIMM DDR4-2666 ECC	Integrated Intel SATA	None	1x 512GB SSD 2.5" SATA6Gbps Opal	None	1x HH DVD±RW	9-in-1	None	Fixed 900W Platinum	None	None	USB / USB Opt	Windows 10 DG Windows 7 Pro 64	3-year, Onsite	No	09/17
30BA001B--	WE	1x Xeon Silver 4110 8C/2.1GHz/11MB/85W/DDR4-2400	Open	2x 8GB RDIMM DDR4-2666 ECC	Integrated Intel SATA	None	1x 512GB SSD 2.5" SATA6Gbps Opal	None	1x HH DVD±RW	9-in-1	None	Fixed 900W Platinum	None	None	USB / USB Opt	Windows 10 DG Windows 7 Pro 64	3-year, Onsite	No	09/17
30BA001D--	WE	1x Xeon Silver 4110 8C/2.1GHz/11MB/85W/DDR4-2400	Open	2x 8GB RDIMM DDR4-2666 ECC	Integrated Intel SATA	None	1x 256GB SSD 2.5" SATA6Gbps Opal	None	1x HH DVD±RW	9-in-1	None	Fixed 690W Platinum	None	None	USB / USB Opt	Windows 10 Pro 64	3-year, Onsite	No	09/17
30BA001C--	WE	2x Xeon Silver 4114 10C/2.2GHz/13.75MB/85W/DDR4-2400	Open	4x 8GB RDIMM DDR4-2666 ECC	Integrated Intel SATA	None	None	1x 512GB SSD M.2 PCIe Opal, Onboard	1x HH DVD±RW	9-in-1	None	Fixed 690W Platinum	None	None	USB / USB Opt	Windows 10 DG Windows 7 Pro 64	3-year, Onsite	No	09/17
30BA001H--	WE	2x Xeon Silver 4114 10C/2.2GHz/13.75MB/85W/DDR4-2400	Open	2x 16GB RDIMM DDR4-2666 ECC	Integrated Intel SATA	None	1x 512GB SSD 2.5" SATA6Gbps, 1x 1TB HDD 7.2K 3.5" SATA6Gbps	None	1x HH DVD±RW	9-in-1	None	Fixed 900W Platinum	None	None	USB / USB Opt	Windows 10 Pro 64	3-year, Onsite	No	09/17
30BA001K--	WE	2x Xeon Silver 4114 10C/2.2GHz/13.75MB/85W/DDR4-2400	Open	4x 8GB RDIMM DDR4-2666 ECC	Integrated Intel SATA	None	None	1x 512GB SSD M.2 PCIe Opal, Onboard	1x HH DVD±RW	9-in-1	None	Fixed 690W Platinum	None	None	USB / USB Opt	Windows 10 Pro 64	3-year, Onsite	No	09/17
30BA001J--	WE	1x Xeon Silver 4110 8C/2.1GHz/11MB/85W/DDR4-2400	Open	4x 8GB RDIMM DDR4-2666 ECC	Integrated Intel SATA	None	None	1x 512GB SSD M.2 PCIe Opal, Onboard	1x HH DVD±RW	9-in-1	None	Fixed 690W Platinum	None	None	USB / USB Opt	Windows 10 Pro 64	3-year, Onsite	No	09/17
30BA001F--	WE	1x Xeon Gold 5118 12C/2.3GHz/16.5MB/105W/DDR4-2400	Open	2x 8GB RDIMM DDR4-2666 ECC	Integrated Intel SATA	None	1x 512GB SSD 2.5" SATA6Gbps Opal	None	1x HH DVD±RW	9-in-1	None	Fixed 900W Platinum	None	None	USB / USB Opt	Windows 10 Pro 64	3-year, Onsite	No	09/17

Model	Region	Processor	Graphics	Memory	Storage Controller	M.2 RAID Upgrade	Disks	M.2 Drives	Optical	Media Reader	Additional Networking	Power Supply	Optional Ports	Front Diagnostic LED	Keyboard / Mouse	Operating System	Warranty	Global	Ann Date (mm/yy)
30BA001G--	WE	2x Xeon Silver 4110 8C/2.1GHz/11MB/85W/DDR4-2400	Open	2x 8GB RDIMM DDR4-2666 ECC	Integrated Intel SATA	None	1x 256GB SSD 2.5" SATA6Gbps Opal, 1x 1TB HDD 7.2K 3.5" SATA6Gbps	None	1x HH DVD±RW	9-in-1	None	Fixed 900W Platinum	None	None	USB / USB Opt	Windows 10 Pro 64	3-year, Onsite	No	09/17
30BA001E--	WE	1x Xeon Silver 4114 10C/2.2GHz/13.75MB/85W/DDR4-2400	Open	2x 8GB RDIMM DDR4-2666 ECC	Integrated Intel SATA	None	1x 512GB SSD 2.5" SATA6Gbps Opal	None	1x HH DVD±RW	9-in-1	None	Fixed 900W Platinum	None	None	USB / USB Opt	Windows 10 Pro 64	3-year, Onsite	No	09/17
30BA001W--	WE	1x Xeon Gold 5118 12C/2.3GHz/16.5MB/105W/DDR4-2400	Open	1x 16GB RDIMM DDR4-2666 ECC	Integrated Intel SATA	RAID 0/1/10	None	4x 256GB SSD M.2 PCIe Opal	1x HH DVD±RW	9-in-1	None	Fixed 900W Platinum	1x Serial	None	USB / USB Opt	Windows 10 Pro 64	3-year, Onsite	No	02/18
30BA001L--	WE	2x Xeon Silver 4110 8C/2.1GHz/11MB/85W/DDR4-2400	Open	4x 8GB RDIMM DDR4-2666 ECC	Integrated Intel SATA	None	1x 1TB HDD 7.2K 3.5" SATA6Gbps	1x 256GB SSD M.2 PCIe Opal, Onboard	1x HH DVD±RW	9-in-1	None	Fixed 900W Platinum	None	None	USB / USB Opt	Windows 10 Pro 64	3-year, Onsite	No	09/17
30BA0024--	WE	1x Xeon Silver 4110 8C/2.1GHz/11MB/85W/DDR4-2400	Open	1x 8GB RDIMM DDR4-2666 ECC	Integrated Intel SATA	None	1x 256GB SSD 2.5" SATA6Gbps Opal	None	1x HH DVD±RW	9-in-1	None	Fixed 690W Platinum	1x Serial	None	USB / USB Opt	Windows 10 DG Windows 7 Pro 64	3-year, Onsite	No	02/18
30BA0026--	WE	1x Xeon Silver 4110 8C/2.1GHz/11MB/85W/DDR4-2400	Open	1x 16GB RDIMM DDR4-2666 ECC	Integrated Intel SATA	None	1x 512GB SSD 2.5" SATA6Gbps Opal	None	1x HH DVD±RW	9-in-1	None	Fixed 900W Platinum	1x Serial	None	USB / USB Opt	Windows 10 DG Windows 7 Pro 64	3-year, Onsite	No	02/18
30BA003F--	WE	1x Xeon Silver 4110 8C/2.1GHz/11MB/85W/DDR4-2400	Open	1x 16GB RDIMM DDR4-2666 ECC	Integrated Intel SATA	None	1x 256GB SSD 2.5" SATA6Gbps Opal	None	1x HH DVD±RW	9-in-1	None	Fixed 690W Platinum	1x Serial	None	USB / USB Opt	Windows 10 Pro 64	3-year, Onsite	No	02/18
30BA0025--	WE	1x Xeon Silver 4114 10C/2.2GHz/13.75MB/85W/DDR4-2400	Open	1x 16GB RDIMM DDR4-2666 ECC	Integrated Intel SATA	None	1x 512GB SSD 2.5" SATA6Gbps Opal	None	1x HH DVD±RW	9-in-1	None	Fixed 900W Platinum	1x Serial	None	USB / USB Opt	Windows 10 DG Windows 7 Pro 64	3-year, Onsite	No	02/18
30BA00BX--	WE	1x Xeon Silver 4114 10C/2.2GHz/13.75MB/85W/DDR4-2400	Open	1x 16GB RDIMM DDR4-2666 ECC	Integrated Intel SATA	None	1x 512GB SSD 2.5" SATA6Gbps Opal	None	1x HH DVD±RW	9-in-1	None	Fixed 900W Platinum	1x Serial	None	USB / USB Opt	Windows 10 Pro 64	3-year, Onsite	No	02/18
30BA005L--	WE	1x Xeon Gold 5118 12C/2.3GHz/16.5MB/105W/DDR4-2400	Open	1x 16GB RDIMM DDR4-2666 ECC	Integrated Intel SATA	None	1x 512GB SSD 2.5" SATA6Gbps Opal	None	1x HH DVD±RW	9-in-1	None	Fixed 900W Platinum	1x Serial	None	USB / USB Opt	Windows 10 Pro 64	3-year, Onsite	No	02/18

Model	Region	Processor	Graphics	Memory	Storage Controller	M.2 RAID Upgrade	Disks	M.2 Drives	Optical	Media Reader	Additional Networking	Power Supply	Optional Ports	Front Diagnostic LED	Keyboard / Mouse	Operating System	Warranty	Global	Ann Date (mm/yy)
30BA009D--	WE	2x Xeon Silver 4114 10C/2.2GHz/13.75MB/85W/DDR4-2400	Open	2x 16GB RDIMM DDR4-2666 ECC	Integrated Intel SATA	None	None	1x 512GB SSD M.2 PCIe Opal, Onboard	1x HH DVD±RW	9-in-1	None	Fixed 690W Platinum	1x Serial	None	USB / USB Opt	Windows 10 Pro 64	3-year, Onsite	No	02/18
30BA00AN--	WE	1x Xeon Silver 4110 8C/2.1GHz/11MB/85W/DDR4-2400	Open	2x 16GB RDIMM DDR4-2666 ECC	Integrated Intel SATA	None	None	1x 512GB SSD M.2 PCIe Opal, Onboard	1x HH DVD±RW	9-in-1	None	Fixed 690W Platinum	1x Serial	None	USB / USB Opt	Windows 10 Pro 64	3-year, Onsite	No	02/18
30BA00BE--	WE	2x Xeon Silver 4110 8C/2.1GHz/11MB/85W/DDR4-2400	Open	2x 16GB RDIMM DDR4-2666 ECC	Integrated Intel SATA	None	1x 1TB HDD 7.2K 3.5" SATA6Gbps	1x 256GB SSD M.2 PCIe Opal, Onboard	1x HH DVD±RW	9-in-1	None	Fixed 690W Platinum	1x Serial	None	USB / USB Opt	Windows 10 Pro 64	3-year, Onsite	No	02/18
30BA00BW--	WE	1x Xeon Silver 4110 8C/2.1GHz/11MB/85W/DDR4-2400	Open	1x 16GB RDIMM DDR4-2666 ECC	Integrated Intel SATA	None	1x 256GB SSD 2.5" SATA6Gbps Opal	None	1x HH DVD±RW	9-in-1	None	Fixed 690W Platinum	1x Serial	None	USB / USB Opt	Windows 10 Pro 64	3-year, Onsite	No	02/18
30BA00C3--	WE	1x Xeon Silver 4110 8C/2.1GHz/11MB/85W/DDR4-2400	Open	2x 16GB RDIMM DDR4-2666 ECC	Integrated Intel SATA	None	None	1x 512GB SSD M.2 PCIe Opal, Onboard	1x HH DVD±RW	9-in-1	None	Fixed 690W Platinum	1x Serial	None	USB / USB Opt	Windows 10 Pro 64	3-year, Onsite	No	02/18
30BA00C2--	WE	2x Xeon Silver 4114 10C/2.2GHz/13.75MB/85W/DDR4-2400	Open	2x 16GB RDIMM DDR4-2666 ECC	Integrated Intel SATA	None	None	1x 512GB SSD M.2 PCIe Opal, Onboard	1x HH DVD±RW	9-in-1	None	Fixed 690W Platinum	1x Serial	None	USB / USB Opt	Windows 10 Pro 64	3-year, Onsite	No	02/18
30BA00C1--	WE	2x Xeon Silver 4114 10C/2.2GHz/13.75MB/85W/DDR4-2400	Open	2x 16GB RDIMM DDR4-2666 ECC	Integrated Intel SATA	None	1x 512GB SSD 2.5" SATA6Gbps Opal, 1x 1TB HDD 7.2K 3.5" SATA6Gbps	None	1x HH DVD±RW	9-in-1	None	Fixed 900W Platinum	1x Serial	None	USB / USB Opt	Windows 10 Pro 64	3-year, Onsite	No	02/18
30BA00BY--	WE	1x Xeon Gold 5118 12C/2.3GHz/16.5MB/105W/DDR4-2400	Open	1x 16GB RDIMM DDR4-2666 ECC	Integrated Intel SATA	None	1x 512GB SSD 2.5" SATA6Gbps Opal	None	1x HH DVD±RW	9-in-1	None	Fixed 900W Platinum	1x Serial	None	USB / USB Opt	Windows 10 Pro 64	3-year, Onsite	No	02/18
30BA00C0--	WE	2x Xeon Silver 4110 8C/2.1GHz/11MB/85W/DDR4-2400	Open	2x 16GB RDIMM DDR4-2666 ECC	Integrated Intel SATA	None	1x 256GB SSD 2.5" SATA6Gbps Opal, 1x 1TB HDD 7.2K 3.5" SATA6Gbps	None	1x HH DVD±RW	9-in-1	None	Fixed 900W Platinum	1x Serial	None	USB / USB Opt	Windows 10 Pro 64	3-year, Onsite	No	02/18
30BA00CD--	WE	2x Xeon Silver 4110 8C/2.1GHz/11MB/85W/DDR4-2400	Open	2x 8GB RDIMM DDR4-2666 ECC	Integrated Intel SATA	None	1x 1TB HDD 7.2K 3.5" SATA6Gbps	1x 256GB SSD M.2 PCIe Opal, Onboard	1x HH DVD±RW	9-in-1	None	Fixed 900W Platinum	1x Serial, 1x Internal USB 3.0	4-digit LED	USB / USB Opt	Windows 10 Pro 64	3-year, Onsite	No	04/18

Model	Region	Processor	Graphics	Memory	Storage Controller	M.2 RAID Upgrade	Disks	M.2 Drives	Optical	Media Reader	Additional Networking	Power Supply	Optional Ports	Front Diagnostic LED	Keyboard / Mouse	Operating System	Warranty	Global	Ann Date (mm/yy)
30BA00CC--	WE	2x Xeon Silver 4114 10C/2.2GHz/13.75MB/85W/DDR4-2400	Open	2x 16GB RDIMM DDR4-2666 ECC	Integrated Intel SATA	None	1x 2TB HDD 7.2K 3.5" SATA6Gbps	1x 256GB SSD M.2 PCIe Opal, Onboard	1x HH DVD±RW	9-in-1	None	Fixed 900W Platinum	1x Serial, 1x Internal USB 3.0	4-digit LED	USB / USB Opt	Windows 10 Pro 64	3-year, Onsite	No	04/18
30BA00C4--	WE	2x Xeon Silver 4110 8C/2.1GHz/11MB/85W/DDR4-2400	Open	2x 16GB RDIMM DDR4-2666 ECC	Integrated Intel SATA	None	1x 1TB HDD 7.2K 3.5" SATA6Gbps	1x 256GB SSD M.2 PCIe Opal, Onboard	1x HH DVD±RW	9-in-1	None	Fixed 690W Platinum	1x Serial	None	USB / USB Opt	Windows 10 Pro 64	3-year, Onsite	No	02/18
30BA00C5--	WE	2x Xeon Silver 4108 8C/1.8GHz/11MB/85W/DDR4-2400	NVIDIA Quadro P2000 5GB	2x 8GB RDIMM DDR4-2666 ECC	Integrated Intel SATA	None	1x 2TB HDD 7.2K 3.5" SATA6Gbps	1x 256GB SSD M.2 PCIe Opal, Onboard	1x HH DVD±RW	9-in-1	None	Fixed 900W Platinum	1x Serial, 1x Internal USB 3.0	4-digit LED	None / USB Opt	Windows 10 Pro 64	3-year, Onsite	No	03/18
30BA00C6--	WE	2x Xeon Silver 4114 10C/2.2GHz/13.75MB/85W/DDR4-2400	Open	2x 16GB RDIMM DDR4-2666 ECC	Integrated Intel SATA	None	1x 2TB HDD 7.2K 3.5" SATA6Gbps	1x 256GB SSD M.2 PCIe Opal, Onboard	1x HH DVD±RW	9-in-1	None	Fixed 900W Platinum	1x Serial, 1x Internal USB 3.0	4-digit LED	None / USB Opt	Windows 10 Pro 64	3-year, Onsite	No	03/18
30BA00C7--	WE	2x Xeon Silver 4110 8C/2.1GHz/11MB/85W/DDR4-2400	Open	2x 8GB RDIMM DDR4-2666 ECC	Integrated Intel SATA	None	1x 1TB HDD 7.2K 3.5" SATA6Gbps	1x 256GB SSD M.2 PCIe Opal, Onboard	1x HH DVD±RW	9-in-1	None	Fixed 900W Platinum	1x Serial, 1x Internal USB 3.0	4-digit LED	None / USB Opt	Windows 10 Pro 64	3-year, Onsite	No	03/18
30BA00C8--	WE	2x Xeon Silver 4110 8C/2.1GHz/11MB/85W/DDR4-2400	NVIDIA Quadro P4000 8GB	2x 16GB RDIMM DDR4-2666 ECC	Integrated Intel SATA	None	None	1x 256GB SSD M.2 PCIe Opal, Onboard	1x HH DVD±RW	9-in-1	None	Fixed 900W Platinum	None	None	None	Windows 10 Pro 64	3-year, Onsite	No	03/18
30BA00CB--	WE	2x Xeon Silver 4108 8C/1.8GHz/11MB/85W/DDR4-2400	NVIDIA Quadro P2000 5GB	2x 8GB RDIMM DDR4-2666 ECC	Integrated Intel SATA	None	1x 2TB HDD 7.2K 3.5" SATA6Gbps	1x 256GB SSD M.2 PCIe Opal, Onboard	1x HH DVD±RW	9-in-1	None	Fixed 900W Platinum	1x Serial, 1x Internal USB 3.0	4-digit LED	USB / USB Opt	Windows 10 Pro 64	3-year, Onsite	No	04/18

ThinkStation P910 Platform Specifications

Components	Specification					
Chipset	Intel C612 Platform Controller Hub (PCH)					
System mgmt	Intel Active Management Technology 9					
Processor	Up to two 160W Intel Xeon E5-2600 v4 family processors. Each processor supports up to 22 cores up to 2.2GHz, 16 cores up to 2.6GHz, 14 cores up to 2.6GHz, 12 cores up to 3GHz, 10 cores up to 2.4GHz, 8 cores up to 3.2GHz, 6 cores up to 3.4GHz, 4 cores up to 3.5GHz. Or up to two Intel Xeon E5-2620 v3 or E5-2609 v3 processors (not available in EMEA)					
Coprocessor	Optional. Up to one Intel Xeon Phi Coprocessor 3120A, PCIe 2.0 x16 adapter, 57 cores, 1.1GHz, 28.5MB L2 cache, 6GB memory, 300W					
Memory DIMM slots	16 DIMM sockets (8 DIMMs per processor), 8-channel capable (4-channel per processor). RDIMM or LRDIMM (cannot be intermixed), ECC, DDR4, 2400MHz					
Memory capacity	896GB (LRDIMM, 14x64GB)/512GB (RDIMM, 16x32GB), 2nd CPU is needed					
Graphics and GPU computing	Four PCIe 3.0 x16 slots for graphics and GPU computing cards, two slots per processor					
	Installed CPU	Maximum quantity of PCIe x16 adapters per system (by power)				
	1	1x300W+1x75W or 2x150W				
2	2x300W+2x75W, or 1x300W+2x150W+1x75W, or 4x150W					
Supporting Graphics and GPU computing	Adapter	Cores	Memory	Power	Connector***	SLI
	NVS 310	48	1GB	19.5W	2xDP	
	NVS 315	48	1GB	19.5W	2xDVI-I SL/2xDP	
	NVS 510	192	2GB	35W	4xmini DP	
	NVS 810	1024	4GB	68W	8xmini DP	
	Quadro K420	192	2GB	41W	DVI-I DL+DP	
	Quadro K620	384	2GB	45W	DVI-I DL+DP	
	Quadro K1200	512	4GB	45W	4xmini DP	
	Quadro K2200	640	4GB	68W	DVI-I DL+2xDP	
	Quadro K4200	1344	4GB	108W	DVI-I DL+2xDP	
	Quadro K5200	2304	8GB	150W	DVI-I DL+DVI-D DL+2xDP	SLI
	Quadro M2000	768	4GB	75W	4xDP	
	Quadro M4000	1664	8GB	120W	4xDP	
	Quadro M5000	2048	8GB	150W	DVI-I DL+4xDP	SLI
	Quadro M6000	3072	24GB	250W	DVI-I DL+4xDP	SLI
	Quadro P400	256	2GB	30W	3xminiDP	
	Quadro P600	384	2GB	40W	4xminiDP	
	Quadro P1000	640	4GB	47W	4xminiDP	
	Quadro P2000	1024	5GB	75W	4xDP	
	Quadro P4000	1792	8GB	105W	4xDP	SLI
Quadro P5000	2560	16GB	180W	DVI-D DL+4xDP	SLI	
Quadro P6000	3840	24GB	250W	DVI-D DL+4xDP	SLI	
Tesla K40	2880	12GB	235W			
Disk drive controller	RAID 0, 1, 5, 10 with onboard SATA controller in chipset, 6Gb/s SATA. RAID 0, 1, 5, 10 with optional LSI RAID flex adapter, 12Gb/s SAS and SATA. RAID 0, 1, 5, 6, 10 with optional LSI 9364-8i PCIe adapter, 1GB memory, 12Gb/s SAS and SATA					
Drive Bays	Three external 5.25" bays, four internal 3.5" dual drives bays (see right)					
Flex bay	Three 5.25" flex bays for optical drives, Front Access Storage Enclosure drives, Flex Bay Storage Enclosure drives, or flex module. • Up to three half-height optical drives or up to one 9.5mm optical drive, DVD-ROM, DVD±RW, or Blu-Ray burner • Up to one Front Access Storage Enclosure for one 3.5" or 2.5" SATA drive. • Up to two Flex Bay Storage Enclosure for two 3.5" or 2.5" SATA drives.					
Supporting storage	3.5" SATA HDD, 7.2K 6Gbs	500GB/1TB/2TB/3TB/4TB/6TB/1TB hybrid/2TB hybrid				
	2.5" SAS HDD, 15K 12Gbs	300GB/600GB				
	2.5" SAS HDD, 10K 12Gbs	300GB				
	2.5" SAS SSD, 12Gbs	200GB/400GB/800GB				
	2.5" SSD, SATA6Gbs	180GB/240GB/256GB/480GB/512GB with OPAL, 256GB/512GB/1TB without OPAL				
	PCIe SSD, 2.5"	400GB				
	PCIe SSD, M.2	256 GB/512GB/1TB				
PCIe SSD adapter	400GB (up to 4 per system, 2nd CPU is needed)					

Components	Specification	
Flex connector	Two flex connectors (see right), one per processor. Supports one of the following: <ul style="list-style-type: none"> Up to one LSI RAID flex adapter for SATA/SAS RAID. Up to two Multi-I/O adapters for four PCIe SSD (two PCIe SSD per adapter). Up to two M.2 flex adapters for four M.2 PCIe SSD (two M.2 PCIe SSD per adapter) 	
Network interfaces	Integrated two-port gigabit ethernet (Intel i218LM and i210AT), supports Wake-on-LAN. Optional discrete ethernet adapters are available	
HD Audio	Realtek ALC662 codec	
TPM	TCG 1.2-compliant	
Power supply	One fixed 1300 watts, autosensing, 92% PSU, 80 PLUS Platinum qualified <i>Note: PSU will automatically operate in 1120W (restricted mode) if the system line input is 100-110V. For other supported system line input voltages, the PSU will operate at the full 1300W.</i>	
Front ports	Four USB 3.0 (one Diagnostic, one Always On), one combo audio/microphone jack (3.5mm)	
Rear ports	Four USB 2.0, four USB 3.0 (blue), one serial (9-pin), two ethernet (RJ-45), three analog audio ports (line-in, line-out, mic-in), two PS/2	
Add-on ports	Supports the following optional ports: Two IEEE 1394 (one on rear and one on front flex module) via PCIe adapter, up to one adapter per system. Two rear USB 3.0 per USB add-on PCIe adapter, up to 3 adapters per system. One rear Thunderbolt via PCIe adapter. One front eSATA (on flex module), or one rear eSATA via cable (also needs one PCIe slot), up to one eSATA port per system. One internal USB 3.0 port via cable, cannot be intermixed with 29-in-1 reader	
	Media reader	9-in-1 USB 2.0 card reader. Optional 29-in-1 USB 3.0 card reader on flex module
Mechanical	<ul style="list-style-type: none"> 55-liter: 200mm/7.87" W x 620mm/24.4" D x 446mm/17.56" H (with feet) Tool-less parts: all except CPU fansink 71.3 lb (32.3kg) max configuration 	
Environmental specification	Temperature - operating	50 °F to 95 °F (10 °C to 35 °C)
	Temperature - non operating (no package)	14 °F to 140 °F (-10 °C to 60 °C)
	Temperature - non operating (with package)	-40 °F to 140 °F (-40 °C to 60 °C)
	Altitude - operating	(Unpressurized): 0-10000ft (0-3048m)
	Humidity - operating	10%-80%, non-condensing
Humidity - storage (with package)	10%-90%, non-condensing	
RoHS-compliant, GREENGUARD on all models. EPEAT Gold rating, ENERGY STAR 6.1 qualified on selected models.		
Base warranty	3-year limited onsite service with 9x5/NBD	
ISV certifications	Please visit www.thinkworkstations.com/isv-certifications/	

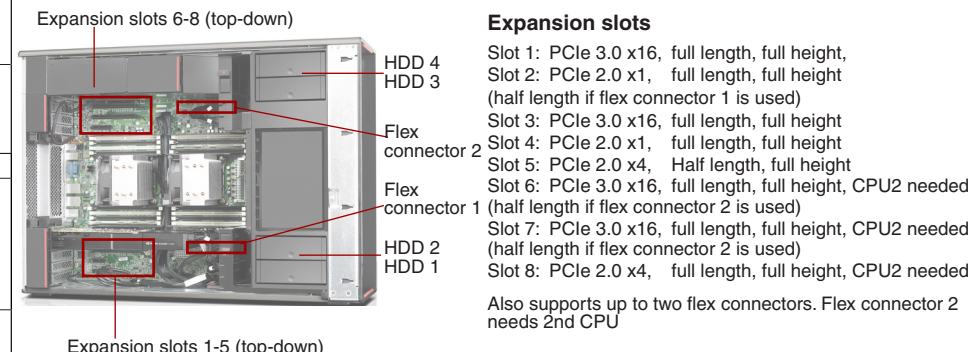

Drive bays
HDD 1-4: Standard 3.5" HDD bay, up to four 3.5" or 2.5" disk drives.
Each 3.5" bay supports 2.5" (9mm or less) drive plus 3.5" drive, or two 2.5" (15mm or less) drives. More than 4 drives requires LSI RAID flex adapter or 9364-8i adapter,
Flex bay: Three 5.25" flex bays, for HH optical drives.
Or up to one optional flex module (Flex module supports one or more of the following options: 9.5mm optical/29-in-1 USB 3.0 reader/front IEEE 1394/front eSATA).
Or up to two HDD bays for two drives, 3.5" or 2.5" each, SATA only.

Model	Region	Processor	Graphics	Memory	Storage Controller	Max Drives in 3.5" Bays	Disks	M.2 Drives	Optical	Media Reader	Power Supply	Optional Ports	Keyboard / Mouse	Operating System	Warranty	Global	Ann Date (mm/yy)
30B90003++	EMEA Focus	2xXeon E5-2620 v4 8C/2.1GHz/20MB/85W/DDR4-2133	Open	2x8GB RDIMM DDR4-2400 ECC	Integrated Intel SATA	4	1x1TB Hybrid HDD 7.2K 3.5" SATA6Gbps	None	HH DVD±RW	9-in-1	1300W 92%	None	USB / USB Optical	Windows 10 Pro 64	3-year, Onsite	No	04/16
30B90004++	EMEA Focus	1xXeon E5-2630 v4 10C/2.2GHz/25MB/85W/DDR4-2133	Open	1x8GB RDIMM DDR4-2400 ECC	Integrated Intel SATA	4	1x256GB SSD 2.5" SATA6Gbps Opal	None	HH DVD±RW	9-in-1	1300W 92%	None	USB / USB Optical	Windows 10 Pro 64	3-year, Onsite	No	04/16
30B90005++	EMEA Focus	1xXeon E5-2620 v4 8C/2.1GHz/20MB/85W/DDR4-2133	Open	1x8GB RDIMM DDR4-2400 ECC	Integrated Intel SATA	4	1x1TB HDD 7.2K 3.5" SATA6Gbps	None	HH DVD±RW	9-in-1	1300W 92%	None	USB / USB Optical	Windows 10 Pro 64	3-year, Onsite	No	04/16
30B90006++	EMEA Focus	2xXeon E5-2630 v4 10C/2.2GHz/25MB/85W/DDR4-2133	Open	4x8GB RDIMM DDR4-2400 ECC	Integrated Intel SATA	4	1x512GB SSD 2.5" SATA6Gbps	None	HH DVD±RW	9-in-1	1300W 92%	None	USB / USB Optical	Windows 10 Pro 64	3-year, Onsite	No	04/16
30B9000A++	EMEA Focus	2xXeon E5-2650 v4 12C/2.2GHz/30MB/105W/DDR4-2400	NVIDIA Quadro M5000 8GB	2x16GB RDIMM DDR4-2400 ECC	Integrated Intel SATA	4	Open	1x512GB SSD M.2 PCIe	HH DVD±RW	9-in-1	1300W 92%	None	USB / USB Optical	Windows 10 Pro 64	3-year, Onsite	No	04/16
30B9000D++	EMEA Focus	2xXeon E5-2620 v4 8C/2.1GHz/20MB/85W/DDR4-2133	Open	4x8GB RDIMM DDR4-2400 ECC	Integrated Intel SATA	4	1x256GB SSD 2.5" SATA6Gbps Opal	None	HH DVD±RW	9-in-1	1300W 92%	None	USB / USB Optical	Windows 10 Pro 64	3-year, Onsite	No	04/16
30B9000C**	MEA	1xXeon E5-2650 v4 12C/2.2GHz/30MB/105W/DDR4-2400	NVIDIA Quadro M4000 8GB	2x8GB RDIMM DDR4-2400 ECC	Integrated Intel SATA	4	Open	1x512GB SSD M.2 PCIe	HH DVD±RW	9-in-1	1300W 92%	None	USB / USB Optical	Windows 10 Pro 64	3-year, Onsite	Global	04/16
30B9000M**	MEA	1xXeon E5-2620 v3 6C/2.4GHz/15MB/85W/DDR4-1866	Open	1x8GB RDIMM DDR4-2400 ECC	Integrated Intel SATA	4	1x1TB HDD 7.2K 3.5" SATA6Gbps	None	Open	9-in-1	1300W 92%	2xUSB3.0	USB / USB Optical	Windows 10 DG Windows 7 Pro 64	3-year, Onsite	No	04/16
30B9000B**	MEA	1xXeon E5-2650 v4 12C/2.2GHz/30MB/105W/DDR4-2400	Open	2x8GB RDIMM DDR4-2400 ECC	Integrated Intel SATA	4	Open	1x512GB SSD M.2 PCIe	HH DVD±RW	9-in-1	1300W 92%	None	USB / USB Optical	Windows 10 Pro 64	3-year, Onsite	Global	04/16
30B90009**	MEA	1xXeon E5-2680 v4 14C/2.4GHz/35MB/120W/DDR4-2400	NVIDIA Quadro M6000 12GB	4x8GB RDIMM DDR4-2400 ECC	Integrated Intel SATA	4	Open	1x512GB SSD M.2 PCIe	HH DVD±RW	9-in-1	1300W 92%	None	USB / USB Optical	Windows 10 Pro 64	3-year, Onsite	No	04/16
30B90006**	MEA	2xXeon E5-2630 v4 10C/2.2GHz/25MB/85W/DDR4-2133	Open	4x8GB RDIMM DDR4-2400 ECC	Integrated Intel SATA	4	1x512GB SSD 2.5" SATA6Gbps	None	HH DVD±RW	9-in-1	1300W 92%	None	USB / USB Optical	Windows 10 Pro 64	3-year, Onsite	No	04/16
30B9000A**	MEA	2xXeon E5-2650 v4 12C/2.2GHz/30MB/105W/DDR4-2400	NVIDIA Quadro M5000 8GB	2x16GB RDIMM DDR4-2400 ECC	Integrated Intel SATA	4	Open	1x512GB SSD M.2 PCIe	HH DVD±RW	9-in-1	1300W 92%	None	USB / USB Optical	Windows 10 Pro 64	3-year, Onsite	No	04/16
30B90007**	MEA	1xXeon E5-2643 v4 6C/3.4GHz/20MB/135W/DDR4-2400	Open	2x8GB RDIMM DDR4-2400 ECC	Integrated Intel SATA	4	1x1TB Hybrid HDD 7.2K 3.5" SATA6Gbps	None	HH DVD±RW	9-in-1	1300W 92%	None	USB / USB Optical	Windows 10 Pro 64	3-year, Onsite	No	04/16

Model	Region	Processor	Graphics	Memory	Storage Controller	Max Drives in 3.5" Bays	Disks	M.2 Drives	Optical	Media Reader	Power Supply	Optional Ports	Keyboard / Mouse	Operating System	Warranty	Global	Ann Date (mm/yy)
30B90008**	MEA	2xXeon E5-2620 v4 8C/2.1GHz/20MB/85W/DDR4-2133	Open	2x8GB RDIMM DDR4-2400 ECC	Integrated Intel SATA	4	1x256GB SSD 2.5" SATA6Gbps Opal	None	HH DVD±RW	9-in-1	1300W 92%	None	USB / USB Optical	Windows 10 Pro 64	3-year, Onsite	No	04/16
30B90004**	MEA	1xXeon E5-2630 v4 10C/2.2GHz/25MB/85W/DDR4-2133	Open	1x8GB RDIMM DDR4-2400 ECC	Integrated Intel SATA	4	1x256GB SSD 2.5" SATA6Gbps Opal	None	HH DVD±RW	9-in-1	1300W 92%	None	USB / USB Optical	Windows 10 Pro 64	3-year, Onsite	No	04/16
30B90005**	MEA	1xXeon E5-2620 v4 8C/2.1GHz/20MB/85W/DDR4-2133	Open	1x8GB RDIMM DDR4-2400 ECC	Integrated Intel SATA	4	1x1TB HDD 7.2K 3.5" SATA6Gbps	None	HH DVD±RW	9-in-1	1300W 92%	None	USB / USB Optical	Windows 10 Pro 64	3-year, Onsite	No	04/16
30B90003**	MEA	2xXeon E5-2620 v4 8C/2.1GHz/20MB/85W/DDR4-2133	Open	2x8GB RDIMM DDR4-2400 ECC	Integrated Intel SATA	4	1x1TB Hybrid HDD 7.2K 3.5" SATA6Gbps	None	HH DVD±RW	9-in-1	1300W 92%	None	USB / USB Optical	Windows 10 Pro 64	3-year, Onsite	No	04/16
30B9000N**	MEA	1xXeon E5-2630 v4 10C/2.2GHz/25MB/85W/DDR4-2133	Open	1x8GB RDIMM DDR4-2400 ECC	Integrated Intel SATA	4	1x256GB SSD 2.5" SATA6Gbps Opal	None	Open	9-in-1	1300W 92%	2xUSB3.0	USB / USB Optical	Windows 10 DG Windows 7 Pro 64	3-year, Onsite	No	04/16
30B9000P**	MEA	1xXeon E5-2643 v4 6C/3.4GHz/20MB/135W/DDR4-2400	Open	2x8GB RDIMM DDR4-2400 ECC	Integrated Intel SATA	4	1x1TB Hybrid HDD 7.2K 3.5" SATA6Gbps	None	Open	9-in-1	1300W 92%	2xUSB3.0	USB / USB Optical	Windows 10 DG Windows 7 Pro 64	3-year, Onsite	No	04/16
30B9000Q**	MEA	2xXeon E5-2620 v4 8C/2.1GHz/20MB/85W/DDR4-2133	Open	2x8GB RDIMM DDR4-2400 ECC	Integrated Intel SATA	4	1x1TB Hybrid HDD 7.2K 3.5" SATA6Gbps	None	HH DVD±RW	9-in-1	1300W 92%	None	USB / USB Optical	Windows 10 DG Windows 7 Pro 64	3-year, Onsite	No	04/16
30B9000R**	MEA	2xXeon E5-2630 v4 10C/2.2GHz/25MB/85W/DDR4-2133	Open	4x8GB RDIMM DDR4-2400 ECC	Integrated Intel SATA	4	1x512GB SSD 2.5" SATA6Gbps	None	HH DVD±RW	9-in-1	1300W 92%	None	USB / USB Optical	Windows 10 DG Windows 7 Pro 64	3-year, Onsite	No	04/16
30B9000S**	MEA	2xXeon E5-2620 v4 8C/2.1GHz/20MB/85W/DDR4-2133	Open	2x8GB RDIMM DDR4-2400 ECC	Integrated Intel SATA	4	1x256GB SSD 2.5" SATA6Gbps Opal	None	HH DVD±RW	9-in-1	1300W 92%	None	USB / USB Optical	Windows 10 DG Windows 7 Pro 64	3-year, Onsite	No	04/16
30B9000T**	MEA	1xXeon E5-2680 v4 14C/2.4GHz/35MB/120W/DDR4-2400	NVIDIA Quadro M6000 12GB	4x8GB RDIMM DDR4-2400 ECC	Integrated Intel SATA	4	Open	1x512GB SSD M.2 PCIe	HH DVD±RW	9-in-1	1300W 92%	None	USB / USB Optical	Windows 10 DG Windows 7 Pro 64	3-year, Onsite	No	04/16
30B9000U**	MEA	1xXeon E5-2650 v4 12C/2.2GHz/30MB/105W/DDR4-2400	NVIDIA Quadro M4000 8GB	2x8GB RDIMM DDR4-2400 ECC	Integrated Intel SATA	4	Open	1x512GB SSD M.2 PCIe	HH DVD±RW	9-in-1	1300W 92%	None	USB / USB Optical	Windows 10 DG Windows 7 Pro 64	3-year, Onsite	No	04/16
30B9000V**	MEA	2xXeon E5-2650 v4 12C/2.2GHz/30MB/105W/DDR4-2400	NVIDIA Quadro M5000 8GB	2x16GB RDIMM DDR4-2400 ECC	Integrated Intel SATA	4	Open	1x512GB SSD M.2 PCIe	HH DVD±RW	9-in-1	1300W 92%	None	USB / USB Optical	Windows 10 DG Windows 7 Pro 64	3-year, Onsite	No	04/16
30B9000Y**	MEA	1xXeon E5-2643 v4 6C/3.4GHz/20MB/135W/DDR4-2400	Open	2x8GB RDIMM DDR4-2400 ECC	Integrated Intel SATA	4	1x1TB Hybrid HDD 7.2K 3.5" SATA6Gbps	1x256GB SSD M.2 PCIe Opal	HH DVD±RW	9-in-1	1300W 92%	None	USB / USB Optical	Windows 10 Pro 64	3-year, Onsite	No	07/16

Model	Region	Processor	Graphics	Memory	Storage Controller	Max Drives in 3.5" Bays	Disks	M.2 Drives	Optical	Media Reader	Power Supply	Optional Ports	Keyboard / Mouse	Operating System	Warranty	Global	Ann Date (mm/yy)
30B90010**	MEA	1xXeon E5-2630 v4 10C/2.2GHz/25MB/85W/DDR4-2133	Open	2x8GB RDIMM DDR4-2400 ECC	Integrated Intel SATA	4	1x1TB HDD 7.2K 3.5" SATA6Gbps	None	HH DVD±RW	9-in-1	1300W 92%	None	USB / USB Optical	Windows 10 Pro 64	3-year, Onsite	No	07/16
30B90011**	MEA	1xXeon E5-2643 v4 6C/3.4GHz/20MB/135W/DDR4-2400	Open	2x8GB RDIMM DDR4-2400 ECC	Integrated Intel SATA	4	1x1TB HDD 7.2K 3.5" SATA6Gbps	1x256GB SSD M.2 PCIe Opal	HH DVD±RW	9-in-1	1300W 92%	None	USB / USB Optical	Windows 10 Pro 64	3-year, Onsite	No	07/16
30B90012**	MEA	1xXeon E5-2620 v3 6C/2.4GHz/15MB/85W/DDR4-1866	NVIDIA NVS 310 1GB	2x8GB RDIMM DDR4-2400 ECC	Integrated Intel SATA	4	1x1TB HDD 7.2K 3.5" SATA6Gbps	None	HH DVD±RW	9-in-1	1300W 92%	None	USB / USB Optical	Windows 10 Pro 64	3-year, Onsite	No	07/16
30B90013**	MEA	1xXeon E5-2650 v4 12C/2.2GHz/30MB/105W/DDR4-2400	Open	2x8GB RDIMM DDR4-2400 ECC	Integrated Intel SATA	4	1x1TB HDD 7.2K 3.5" SATA6Gbps	1x256GB SSD M.2 PCIe Opal	HH DVD±RW	9-in-1	1300W 92%	None	USB / USB Optical	Windows 10 Pro 64	3-year, Onsite	No	07/16
30B90014**	MEA	1xXeon E5-2667 v4 8C/3.2GHz/25MB/135W/DDR4-2400	Open	2x8GB RDIMM DDR4-2400 ECC	Integrated Intel SATA	4	1x1TB HDD 7.2K 3.5" SATA6Gbps	1x256GB SSD M.2 PCIe Opal	HH DVD±RW	9-in-1	1300W 92%	None	USB / USB Optical	Windows 10 Pro 64	3-year, Onsite	No	07/16
30B90015**	MEA	1xXeon E5-2643 v4 6C/3.4GHz/20MB/135W/DDR4-2400	Open	2x8GB RDIMM DDR4-2400 ECC	Integrated Intel SATA	4	1x1TB HDD 7.2K 3.5" SATA6Gbps	1x256GB SSD M.2 PCIe Opal	HH DVD±RW	9-in-1	1300W 92%	None	USB / USB Optical	Windows 10 Pro 64	3-year, Onsite	No	07/16
30B90016**	MEA	1xXeon E5-2687W v4 12C/3.0GHz/30MB/160W/DDR4-2400	Open	2x16GB RDIMM DDR4-2400 ECC	Integrated Intel SATA	4	1x1TB HDD 7.2K 3.5" SATA6Gbps	1x512GB SSD M.2 PCIe	HH DVD±RW	9-in-1	1300W 92%	None	USB / USB Optical	Windows 10 Pro 64	3-year, Onsite	No	07/16
30B90017**	MEA	1xXeon E5-2620 v3 6C/2.4GHz/15MB/85W/DDR4-1866	Open	1x8GB RDIMM DDR4-2400 ECC	Integrated Intel SATA	4	1x1TB HDD 7.2K 3.5" SATA6Gbps	None	HH DVD±RW	9-in-1	1300W 92%	None	USB / USB Optical	Windows 10 Pro 64	3-year, Onsite	No	07/16
30B90018**	MEA	1xXeon E5-2637 v4 4C/3.5GHz/15MB/135W/DDR4-2400	Open	2x8GB RDIMM DDR4-2400 ECC	Integrated Intel SATA	4	1x1TB HDD 7.2K 3.5" SATA6Gbps	1x256GB SSD M.2 PCIe Opal	HH DVD±RW	9-in-1	1300W 92%	None	USB / USB Optical	Windows 10 Pro 64	3-year, Onsite	No	07/16
30B90019**	MEA	1xXeon E5-2637 v4 4C/3.5GHz/15MB/135W/DDR4-2400	Open	2x8GB RDIMM DDR4-2400 ECC	Integrated Intel SATA	4	1x1TB HDD 7.2K 3.5" SATA6Gbps	1x256GB SSD M.2 PCIe Opal	HH DVD±RW	9-in-1	1300W 92%	None	USB / USB Optical	Windows 10 Pro 64	3-year, Onsite	No	07/16
30B9001A**	MEA	1xXeon E5-2620 v3 6C/2.4GHz/15MB/85W/DDR4-1866	Open	2x8GB RDIMM DDR4-2400 ECC	Integrated Intel SATA	4	1x1TB HDD 7.2K 3.5" SATA6Gbps	None	HH DVD±RW	9-in-1	1300W 92%	None	USB / USB Optical	Windows 10 Pro 64	3-year, Onsite	No	07/16
30B9001B**	MEA	1xXeon E5-2667 v4 8C/3.2GHz/25MB/135W/DDR4-2400	Open	2x16GB RDIMM DDR4-2400 ECC	Integrated Intel SATA	4	1x1TB HDD 7.2K 3.5" SATA6Gbps	1x512GB SSD M.2 PCIe	HH DVD±RW	9-in-1	1300W 92%	None	USB / USB Optical	Windows 10 Pro 64	3-year, Onsite	No	07/16
30B9001C**	MEA	1xXeon E5-2620 v3 6C/2.4GHz/15MB/85W/DDR4-1866	Open	2x16GB RDIMM DDR4-2400 ECC	Integrated Intel SATA	4	1x1TB HDD 7.2K 3.5" SATA6Gbps	None	HH DVD±RW	9-in-1	1300W 92%	None	USB / USB Optical	Windows 10 Pro 64	3-year, Onsite	No	07/16

Model	Region	Processor	Graphics	Memory	Storage Controller	Max Drives in 3.5" Bays	Disks	M.2 Drives	Optical	Media Reader	Power Supply	Optional Ports	Keyboard / Mouse	Operating System	Warranty	Global	Ann Date (mm/yy)
30B9001D**	MEA	1xXeon E5-2630 v4 10C/2.2GHz/25MB/85W/DDR4-2133	Open	2x8GB RDIMM DDR4-2400 ECC	Integrated Intel SATA	4	1x1TB HDD 7.2K 3.5" SATA6Gbps	1x256GB SSD M.2 PCIe Opal	HH DVD±RW	9-in-1	1300W 92%	None	USB / USB Optical	Windows 10 Pro 64	3-year, Onsite	No	07/16
30B9001E**	MEA	1xXeon E5-2667 v4 8C/3.2GHz/25MB/135W/DDR4-2400	Open	2x8GB RDIMM DDR4-2400 ECC	Integrated Intel SATA	4	1x1TB HDD 7.2K 3.5" SATA6Gbps	1x256GB SSD M.2 PCIe Opal	HH DVD±RW	9-in-1	1300W 92%	None	USB / USB Optical	Windows 10 Pro 64	3-year, Onsite	No	07/16
30B9001F**	MEA	1xXeon E5-2650 v4 12C/2.2GHz/30MB/105W/DDR4-2400	Open	2x8GB RDIMM DDR4-2400 ECC	Integrated Intel SATA	4	1x1TB HDD 7.2K 3.5" SATA6Gbps	1x256GB SSD M.2 PCIe Opal	HH DVD±RW	9-in-1	1300W 92%	None	USB / USB Optical	Windows 10 Pro 64	3-year, Onsite	No	07/16
30B9001G**	MEA	1xXeon E5-2630 v4 10C/2.2GHz/25MB/85W/DDR4-2133	Open	2x8GB RDIMM DDR4-2400 ECC	Integrated Intel SATA	4	1x1TB HDD 7.2K 3.5" SATA6Gbps	1x256GB SSD M.2 PCIe Opal	HH DVD±RW	9-in-1	1300W 92%	None	USB / USB Optical	Windows 10 Pro 64	3-year, Onsite	No	07/16
30B9001H**	MEA	1xXeon E5-2630 v4 10C/2.2GHz/25MB/85W/DDR4-2133	Open	1x8GB RDIMM DDR4-2400 ECC	Integrated Intel SATA	4	1x1TB HDD 7.2K 3.5" SATA6Gbps	None	HH DVD±RW	9-in-1	1300W 92%	None	USB / USB Optical	Windows 10 Pro 64	3-year, Onsite	No	07/16
30B9001J**	MEA	1xXeon E5-2640 v4 10C/2.4GHz/25MB/90W/DDR4-2133	Open	2x8GB RDIMM DDR4-2400 ECC	Integrated Intel SATA	4	1x1TB HDD 7.2K 3.5" SATA6Gbps	1x256GB SSD M.2 PCIe Opal	HH DVD±RW	9-in-1	1300W 92%	None	USB / USB Optical	Windows 10 Pro 64	3-year, Onsite	No	07/16
30B9001K**	MEA	2xXeon E5-2680 v4 14C/2.4GHz/35MB/120W/DDR4-2400	Open	2x16GB RDIMM DDR4-2400 ECC	Integrated Intel SATA	4	1x1TB HDD 7.2K 3.5" SATA6Gbps	1x512GB SSD M.2 PCIe	HH DVD±RW	9-in-1	1300W 92%	None	USB / USB Optical	Windows 10 Pro 64	3-year, Onsite	No	07/16
30B9001L**	MEA	2xXeon E5-2620 v4 8C/2.1GHz/20MB/85W/DDR4-2133	Open	2x16GB RDIMM DDR4-2400 ECC	Integrated Intel SATA	4	1x1TB HDD 7.2K 3.5" SATA6Gbps	None	HH DVD±RW	9-in-1	1300W 92%	None	USB / USB Optical	Windows 10 Pro 64	3-year, Onsite	No	07/16
30B9001M**	MEA	2xXeon E5-2640 v4 10C/2.4GHz/25MB/90W/DDR4-2133	Open	2x8GB RDIMM DDR4-2400 ECC	Integrated Intel SATA	4	1x1TB HDD 7.2K 3.5" SATA6Gbps	1x256GB SSD M.2 PCIe Opal	HH DVD±RW	9-in-1	1300W 92%	None	USB / USB Optical	Windows 10 Pro 64	3-year, Onsite	No	07/16
30B9002GAW	MEA	1xXeon E5-2667 v4 8C/3.2GHz/25MB/135W/DDR4-2400	NVIDIA Quadro P5000 16GB	2x8GB RDIMM DDR4-2400 ECC	Integrated Intel SATA	4	1x1TB HDD 7.2K 3.5" SATA6Gbps	1x256GB SSD M.2 PCIe Opal	HH DVD±RW	9-in-1	1300W 92%	None	USB / USB Optical	Windows 10 DG Windows 7 Pro 64	3-year, Onsite	No	12/16
30B9002GAX	MEA	1xXeon E5-2667 v4 8C/3.2GHz/25MB/135W/DDR4-2400	NVIDIA Quadro P5000 16GB	2x8GB RDIMM DDR4-2400 ECC	Integrated Intel SATA	4	1x1TB HDD 7.2K 3.5" SATA6Gbps	1x256GB SSD M.2 PCIe Opal	HH DVD±RW	9-in-1	1300W 92%	None	USB / USB Optical	Windows 10 DG Windows 7 Pro 64	3-year, Onsite	No	12/16
30B9002GFM	MEA	1xXeon E5-2667 v4 8C/3.2GHz/25MB/135W/DDR4-2400	NVIDIA Quadro P5000 16GB	2x8GB RDIMM DDR4-2400 ECC	Integrated Intel SATA	4	1x1TB HDD 7.2K 3.5" SATA6Gbps	1x256GB SSD M.2 PCIe Opal	HH DVD±RW	9-in-1	1300W 92%	None	USB / USB Optical	Windows 10 DG Windows 7 Pro 64	3-year, Onsite	No	12/16
30B9002GPM	MEA	1xXeon E5-2667 v4 8C/3.2GHz/25MB/135W/DDR4-2400	NVIDIA Quadro P5000 16GB	2x8GB RDIMM DDR4-2400 ECC	Integrated Intel SATA	4	1x1TB HDD 7.2K 3.5" SATA6Gbps	1x256GB SSD M.2 PCIe Opal	HH DVD±RW	9-in-1	1300W 92%	None	USB / USB Optical	Windows 10 DG Windows 7 Pro 64	3-year, Onsite	No	12/16

Model	Region	Processor	Graphics	Memory	Storage Controller	Max Drives in 3.5" Bays	Disks	M.2 Drives	Optical	Media Reader	Power Supply	Optional Ports	Keyboard / Mouse	Operating System	Warranty	Global	Ann Date (mm/yy)
30B9002GSA	MEA	1xXeon E5-2667 v4 8C/3.2GHz/25MB/135W/DDR4-2400	NVIDIA Quadro P5000 16GB	2x8GB RDIMM DDR4-2400 ECC	Integrated Intel SATA	4	1x1TB HDD 7.2K 3.5" SATA6Gbps	1x256GB SSD M.2 PCIe Opal	HH DVD±RW	9-in-1	1300W 92%	None	USB / USB Optical	Windows 10 DG Windows 7 Pro 64	3-year, Onsite	No	12/16
30B9002GUM	MEA	1xXeon E5-2667 v4 8C/3.2GHz/25MB/135W/DDR4-2400	NVIDIA Quadro P5000 16GB	2x8GB RDIMM DDR4-2400 ECC	Integrated Intel SATA	4	1x1TB HDD 7.2K 3.5" SATA6Gbps	1x256GB SSD M.2 PCIe Opal	HH DVD±RW	9-in-1	1300W 92%	None	USB / USB Optical	Windows 10 DG Windows 7 Pro 64	3-year, Onsite	No	12/16
30B9002HAW	MEA	1xXeon E5-2667 v4 8C/3.2GHz/25MB/135W/DDR4-2400	NVIDIA Quadro P6000 24GB	2x8GB RDIMM DDR4-2400 ECC	Integrated Intel SATA	4	1x1TB HDD 7.2K 3.5" SATA6Gbps	1x256GB SSD M.2 PCIe Opal	HH DVD±RW	9-in-1	1300W 92%	None	USB / USB Optical	Windows 10 DG Windows 7 Pro 64	3-year, Onsite	No	12/16
30B9002HAX	MEA	1xXeon E5-2667 v4 8C/3.2GHz/25MB/135W/DDR4-2400	NVIDIA Quadro P6000 24GB	2x8GB RDIMM DDR4-2400 ECC	Integrated Intel SATA	4	1x1TB HDD 7.2K 3.5" SATA6Gbps	1x256GB SSD M.2 PCIe Opal	HH DVD±RW	9-in-1	1300W 92%	None	USB / USB Optical	Windows 10 DG Windows 7 Pro 64	3-year, Onsite	No	12/16
30B9002HFM	MEA	1xXeon E5-2667 v4 8C/3.2GHz/25MB/135W/DDR4-2400	NVIDIA Quadro P6000 24GB	2x8GB RDIMM DDR4-2400 ECC	Integrated Intel SATA	4	1x1TB HDD 7.2K 3.5" SATA6Gbps	1x256GB SSD M.2 PCIe Opal	HH DVD±RW	9-in-1	1300W 92%	None	USB / USB Optical	Windows 10 DG Windows 7 Pro 64	3-year, Onsite	No	12/16
30B9002HPM	MEA	1xXeon E5-2667 v4 8C/3.2GHz/25MB/135W/DDR4-2400	NVIDIA Quadro P6000 24GB	2x8GB RDIMM DDR4-2400 ECC	Integrated Intel SATA	4	1x1TB HDD 7.2K 3.5" SATA6Gbps	1x256GB SSD M.2 PCIe Opal	HH DVD±RW	9-in-1	1300W 92%	None	USB / USB Optical	Windows 10 DG Windows 7 Pro 64	3-year, Onsite	No	12/16
30B9002HSA	MEA	1xXeon E5-2667 v4 8C/3.2GHz/25MB/135W/DDR4-2400	NVIDIA Quadro P6000 24GB	2x8GB RDIMM DDR4-2400 ECC	Integrated Intel SATA	4	1x1TB HDD 7.2K 3.5" SATA6Gbps	1x256GB SSD M.2 PCIe Opal	HH DVD±RW	9-in-1	1300W 92%	None	USB / USB Optical	Windows 10 DG Windows 7 Pro 64	3-year, Onsite	No	12/16
30B9002HUM	MEA	1xXeon E5-2667 v4 8C/3.2GHz/25MB/135W/DDR4-2400	NVIDIA Quadro P6000 24GB	2x8GB RDIMM DDR4-2400 ECC	Integrated Intel SATA	4	1x1TB HDD 7.2K 3.5" SATA6Gbps	1x256GB SSD M.2 PCIe Opal	HH DVD±RW	9-in-1	1300W 92%	None	USB / USB Optical	Windows 10 DG Windows 7 Pro 64	3-year, Onsite	No	12/16
30B9002JAW	MEA	1xXeon E5-2630 v4 10C/2.2GHz/25MB/85W/DDR4-2133	Open	2x8GB RDIMM DDR4-2400 ECC	Integrated Intel SATA	4	1x1TB HDD 7.2K 3.5" SATA6Gbps	None	HH DVD±RW	9-in-1	1300W 92%	None	USB / USB Optical	Windows 10 DG Windows 7 Pro 64	3-year, Onsite	No	12/16
30B9002JAX	MEA	1xXeon E5-2630 v4 10C/2.2GHz/25MB/85W/DDR4-2133	Open	2x8GB RDIMM DDR4-2400 ECC	Integrated Intel SATA	4	1x1TB HDD 7.2K 3.5" SATA6Gbps	None	HH DVD±RW	9-in-1	1300W 92%	None	USB / USB Optical	Windows 10 DG Windows 7 Pro 64	3-year, Onsite	No	12/16
30B9002JFM	MEA	1xXeon E5-2630 v4 10C/2.2GHz/25MB/85W/DDR4-2133	Open	2x8GB RDIMM DDR4-2400 ECC	Integrated Intel SATA	4	1x1TB HDD 7.2K 3.5" SATA6Gbps	None	HH DVD±RW	9-in-1	1300W 92%	None	USB / USB Optical	Windows 10 DG Windows 7 Pro 64	3-year, Onsite	No	12/16
30B9002JPM	MEA	1xXeon E5-2630 v4 10C/2.2GHz/25MB/85W/DDR4-2133	Open	2x8GB RDIMM DDR4-2400 ECC	Integrated Intel SATA	4	1x1TB HDD 7.2K 3.5" SATA6Gbps	None	HH DVD±RW	9-in-1	1300W 92%	None	USB / USB Optical	Windows 10 DG Windows 7 Pro 64	3-year, Onsite	No	12/16
30B9002JSA	MEA	1xXeon E5-2630 v4 10C/2.2GHz/25MB/85W/DDR4-2133	Open	2x8GB RDIMM DDR4-2400 ECC	Integrated Intel SATA	4	1x1TB HDD 7.2K 3.5" SATA6Gbps	None	HH DVD±RW	9-in-1	1300W 92%	None	USB / USB Optical	Windows 10 DG Windows 7 Pro 64	3-year, Onsite	No	12/16

Model	Region	Processor	Graphics	Memory	Storage Controller	Max Drives in 3.5" Bays	Disks	M.2 Drives	Optical	Media Reader	Power Supply	Optional Ports	Keyboard / Mouse	Operating System	Warranty	Global	Ann Date (mm/yy)
30B9002JUM	MEA	1xXeon E5-2630 v4 10C/2.2GHz/25MB/85W/DDR4-2133	Open	2x8GB RDIMM DDR4-2400 ECC	Integrated Intel SATA	4	1x1TB HDD 7.2K 3.5" SATA6Gbps	None	HH DVD±RW	9-in-1	1300W 92%	None	USB / USB Optical	Windows 10 DG Windows 7 Pro 64	3-year, Onsite	No	12/16
30B9002KAW	MEA	1xXeon E5-2620 v4 8C/2.1GHz/20MB/85W/DDR4-2133	Open	2x8GB RDIMM DDR4-2400 ECC	Integrated Intel SATA	4	1x1TB HDD 7.2K 3.5" SATA6Gbps	None	HH DVD±RW	9-in-1	1300W 92%	None	USB / USB Optical	Windows 10 DG Windows 7 Pro 64	3-year, Onsite	No	12/16
30B9002KAX	MEA	1xXeon E5-2620 v4 8C/2.1GHz/20MB/85W/DDR4-2133	Open	2x8GB RDIMM DDR4-2400 ECC	Integrated Intel SATA	4	1x1TB HDD 7.2K 3.5" SATA6Gbps	None	HH DVD±RW	9-in-1	1300W 92%	None	USB / USB Optical	Windows 10 DG Windows 7 Pro 64	3-year, Onsite	No	12/16
30B9002KFM	MEA	1xXeon E5-2620 v4 8C/2.1GHz/20MB/85W/DDR4-2133	Open	2x8GB RDIMM DDR4-2400 ECC	Integrated Intel SATA	4	1x1TB HDD 7.2K 3.5" SATA6Gbps	None	HH DVD±RW	9-in-1	1300W 92%	None	USB / USB Optical	Windows 10 DG Windows 7 Pro 64	3-year, Onsite	No	12/16
30B9002KPM	MEA	1xXeon E5-2620 v4 8C/2.1GHz/20MB/85W/DDR4-2133	Open	2x8GB RDIMM DDR4-2400 ECC	Integrated Intel SATA	4	1x1TB HDD 7.2K 3.5" SATA6Gbps	None	HH DVD±RW	9-in-1	1300W 92%	None	USB / USB Optical	Windows 10 DG Windows 7 Pro 64	3-year, Onsite	No	12/16
30B9002KSA	MEA	1xXeon E5-2620 v4 8C/2.1GHz/20MB/85W/DDR4-2133	Open	2x8GB RDIMM DDR4-2400 ECC	Integrated Intel SATA	4	1x1TB HDD 7.2K 3.5" SATA6Gbps	None	HH DVD±RW	9-in-1	1300W 92%	None	USB / USB Optical	Windows 10 DG Windows 7 Pro 64	3-year, Onsite	No	12/16
30B9002KUM	MEA	1xXeon E5-2620 v4 8C/2.1GHz/20MB/85W/DDR4-2133	Open	2x8GB RDIMM DDR4-2400 ECC	Integrated Intel SATA	4	1x1TB HDD 7.2K 3.5" SATA6Gbps	None	HH DVD±RW	9-in-1	1300W 92%	None	USB / USB Optical	Windows 10 DG Windows 7 Pro 64	3-year, Onsite	No	12/16
30B9002LAW	MEA	2xXeon E5-2620 v4 8C/2.1GHz/20MB/85W/DDR4-2133	Open	2x16GB RDIMM DDR4-2400 ECC	Integrated Intel SATA	4	1x1TB HDD 7.2K 3.5" SATA6Gbps	1x256GB SSD M.2 PCIe Opal	HH DVD±RW	9-in-1	1300W 92%	None	USB / USB Optical	Windows 10 DG Windows 7 Pro 64	3-year, Onsite	No	12/16
30B9002LAX	MEA	2xXeon E5-2620 v4 8C/2.1GHz/20MB/85W/DDR4-2133	Open	2x16GB RDIMM DDR4-2400 ECC	Integrated Intel SATA	4	1x1TB HDD 7.2K 3.5" SATA6Gbps	1x256GB SSD M.2 PCIe Opal	HH DVD±RW	9-in-1	1300W 92%	None	USB / USB Optical	Windows 10 DG Windows 7 Pro 64	3-year, Onsite	No	12/16
30B9002LFM	MEA	2xXeon E5-2620 v4 8C/2.1GHz/20MB/85W/DDR4-2133	Open	2x16GB RDIMM DDR4-2400 ECC	Integrated Intel SATA	4	1x1TB HDD 7.2K 3.5" SATA6Gbps	1x256GB SSD M.2 PCIe Opal	HH DVD±RW	9-in-1	1300W 92%	None	USB / USB Optical	Windows 10 DG Windows 7 Pro 64	3-year, Onsite	No	12/16
30B9002LPM	MEA	2xXeon E5-2620 v4 8C/2.1GHz/20MB/85W/DDR4-2133	Open	2x16GB RDIMM DDR4-2400 ECC	Integrated Intel SATA	4	1x1TB HDD 7.2K 3.5" SATA6Gbps	1x256GB SSD M.2 PCIe Opal	HH DVD±RW	9-in-1	1300W 92%	None	USB / USB Optical	Windows 10 DG Windows 7 Pro 64	3-year, Onsite	No	12/16
30B9002LSA	MEA	2xXeon E5-2620 v4 8C/2.1GHz/20MB/85W/DDR4-2133	Open	2x16GB RDIMM DDR4-2400 ECC	Integrated Intel SATA	4	1x1TB HDD 7.2K 3.5" SATA6Gbps	1x256GB SSD M.2 PCIe Opal	HH DVD±RW	9-in-1	1300W 92%	None	USB / USB Optical	Windows 10 DG Windows 7 Pro 64	3-year, Onsite	No	12/16
30B9002LUM	MEA	2xXeon E5-2620 v4 8C/2.1GHz/20MB/85W/DDR4-2133	Open	2x16GB RDIMM DDR4-2400 ECC	Integrated Intel SATA	4	1x1TB HDD 7.2K 3.5" SATA6Gbps	1x256GB SSD M.2 PCIe Opal	HH DVD±RW	9-in-1	1300W 92%	None	USB / USB Optical	Windows 10 DG Windows 7 Pro 64	3-year, Onsite	No	12/16

Model	Region	Processor	Graphics	Memory	Storage Controller	Max Drives in 3.5" Bays	Disks	M.2 Drives	Optical	Media Reader	Power Supply	Optional Ports	Keyboard / Mouse	Operating System	Warranty	Global	Ann Date (mm/yy)
30B9002MAW	MEA	1xXeon E5-2620 v4 8C/2.1GHz/20MB/85W/DDR4-2133	Open	1x8GB RDIMM DDR4-2400 ECC	Integrated Intel SATA	4	1x1TB HDD 7.2K 3.5" SATA6Gbps	None	HH DVD±RW	9-in-1	1300W 92%	None	USB / USB Optical	Windows 10 DG Windows 7 Pro 64	3-year, Onsite	No	12/16
30B9002MAX	MEA	1xXeon E5-2620 v4 8C/2.1GHz/20MB/85W/DDR4-2133	Open	1x8GB RDIMM DDR4-2400 ECC	Integrated Intel SATA	4	1x1TB HDD 7.2K 3.5" SATA6Gbps	None	HH DVD±RW	9-in-1	1300W 92%	None	USB / USB Optical	Windows 10 DG Windows 7 Pro 64	3-year, Onsite	No	12/16
30B9002MFM	MEA	1xXeon E5-2620 v4 8C/2.1GHz/20MB/85W/DDR4-2133	Open	1x8GB RDIMM DDR4-2400 ECC	Integrated Intel SATA	4	1x1TB HDD 7.2K 3.5" SATA6Gbps	None	HH DVD±RW	9-in-1	1300W 92%	None	USB / USB Optical	Windows 10 DG Windows 7 Pro 64	3-year, Onsite	No	12/16
30B9002MPM	MEA	1xXeon E5-2620 v4 8C/2.1GHz/20MB/85W/DDR4-2133	Open	1x8GB RDIMM DDR4-2400 ECC	Integrated Intel SATA	4	1x1TB HDD 7.2K 3.5" SATA6Gbps	None	HH DVD±RW	9-in-1	1300W 92%	None	USB / USB Optical	Windows 10 DG Windows 7 Pro 64	3-year, Onsite	No	12/16
30B9002MSA	MEA	1xXeon E5-2620 v4 8C/2.1GHz/20MB/85W/DDR4-2133	Open	1x8GB RDIMM DDR4-2400 ECC	Integrated Intel SATA	4	1x1TB HDD 7.2K 3.5" SATA6Gbps	None	HH DVD±RW	9-in-1	1300W 92%	None	USB / USB Optical	Windows 10 DG Windows 7 Pro 64	3-year, Onsite	No	12/16
30B9002MUM	MEA	1xXeon E5-2620 v4 8C/2.1GHz/20MB/85W/DDR4-2133	Open	1x8GB RDIMM DDR4-2400 ECC	Integrated Intel SATA	4	1x1TB HDD 7.2K 3.5" SATA6Gbps	None	HH DVD±RW	9-in-1	1300W 92%	None	USB / USB Optical	Windows 10 DG Windows 7 Pro 64	3-year, Onsite	No	12/16
30B9002NAW	MEA	2xXeon E5-2640 v4 10C/2.4GHz/25MB/90W/DDR4-2133	NVIDIA Quadro P5000 16GB	2x16GB RDIMM DDR4-2400 ECC	Integrated Intel SATA	4	1x1TB HDD 7.2K 3.5" SATA6Gbps	1x256GB SSD M.2 PCIe Opal	HH DVD±RW	9-in-1	1300W 92%	None	USB / USB Optical	Windows 10 DG Windows 7 Pro 64	3-year, Onsite	No	12/16
30B9002NAX	MEA	2xXeon E5-2640 v4 10C/2.4GHz/25MB/90W/DDR4-2133	NVIDIA Quadro P5000 16GB	2x16GB RDIMM DDR4-2400 ECC	Integrated Intel SATA	4	1x1TB HDD 7.2K 3.5" SATA6Gbps	1x256GB SSD M.2 PCIe Opal	HH DVD±RW	9-in-1	1300W 92%	None	USB / USB Optical	Windows 10 DG Windows 7 Pro 64	3-year, Onsite	No	12/16
30B9002NFM	MEA	2xXeon E5-2640 v4 10C/2.4GHz/25MB/90W/DDR4-2133	NVIDIA Quadro P5000 16GB	2x16GB RDIMM DDR4-2400 ECC	Integrated Intel SATA	4	1x1TB HDD 7.2K 3.5" SATA6Gbps	1x256GB SSD M.2 PCIe Opal	HH DVD±RW	9-in-1	1300W 92%	None	USB / USB Optical	Windows 10 DG Windows 7 Pro 64	3-year, Onsite	No	12/16
30B9002NPM	MEA	2xXeon E5-2640 v4 10C/2.4GHz/25MB/90W/DDR4-2133	NVIDIA Quadro P5000 16GB	2x16GB RDIMM DDR4-2400 ECC	Integrated Intel SATA	4	1x1TB HDD 7.2K 3.5" SATA6Gbps	1x256GB SSD M.2 PCIe Opal	HH DVD±RW	9-in-1	1300W 92%	None	USB / USB Optical	Windows 10 DG Windows 7 Pro 64	3-year, Onsite	No	12/16
30B9002NSA	MEA	2xXeon E5-2640 v4 10C/2.4GHz/25MB/90W/DDR4-2133	NVIDIA Quadro P5000 16GB	2x16GB RDIMM DDR4-2400 ECC	Integrated Intel SATA	4	1x1TB HDD 7.2K 3.5" SATA6Gbps	1x256GB SSD M.2 PCIe Opal	HH DVD±RW	9-in-1	1300W 92%	None	USB / USB Optical	Windows 10 DG Windows 7 Pro 64	3-year, Onsite	No	12/16
30B9002NUM	MEA	2xXeon E5-2640 v4 10C/2.4GHz/25MB/90W/DDR4-2133	NVIDIA Quadro P5000 16GB	2x16GB RDIMM DDR4-2400 ECC	Integrated Intel SATA	4	1x1TB HDD 7.2K 3.5" SATA6Gbps	1x256GB SSD M.2 PCIe Opal	HH DVD±RW	9-in-1	1300W 92%	None	USB / USB Optical	Windows 10 DG Windows 7 Pro 64	3-year, Onsite	No	12/16
30B9002PAW	MEA	1xXeon E5-2667 v4 8C/3.2GHz/25MB/135W/DDR4-2400	Open	2x8GB RDIMM DDR4-2400 ECC	Integrated Intel SATA	4	1x1TB HDD 7.2K 3.5" SATA6Gbps	1x256GB SSD M.2 PCIe Opal	HH DVD±RW	9-in-1	1300W 92%	None	USB / USB Optical	Windows 10 DG Windows 7 Pro 64	3-year, Onsite	No	12/16

Model	Region	Processor	Graphics	Memory	Storage Controller	Max Drives in 3.5" Bays	Disks	M.2 Drives	Optical	Media Reader	Power Supply	Optional Ports	Keyboard / Mouse	Operating System	Warranty	Global	Ann Date (mm/yy)
30B9002PAX	MEA	1xXeon E5-2667 v4 8C/3.2GHz/25MB/135W/DDR4-2400	Open	2x8GB RDIMM DDR4-2400 ECC	Integrated Intel SATA	4	1x1TB HDD 7.2K 3.5" SATA6Gbps	1x256GB SSD M.2 PCIe Opal	HH DVD±RW	9-in-1	1300W 92%	None	USB / USB Optical	Windows 10 DG Windows 7 Pro 64	3-year, Onsite	No	12/16
30B9002PFM	MEA	1xXeon E5-2667 v4 8C/3.2GHz/25MB/135W/DDR4-2400	Open	2x8GB RDIMM DDR4-2400 ECC	Integrated Intel SATA	4	1x1TB HDD 7.2K 3.5" SATA6Gbps	1x256GB SSD M.2 PCIe Opal	HH DVD±RW	9-in-1	1300W 92%	None	USB / USB Optical	Windows 10 DG Windows 7 Pro 64	3-year, Onsite	No	12/16
30B9002PPM	MEA	1xXeon E5-2667 v4 8C/3.2GHz/25MB/135W/DDR4-2400	Open	2x8GB RDIMM DDR4-2400 ECC	Integrated Intel SATA	4	1x1TB HDD 7.2K 3.5" SATA6Gbps	1x256GB SSD M.2 PCIe Opal	HH DVD±RW	9-in-1	1300W 92%	None	USB / USB Optical	Windows 10 DG Windows 7 Pro 64	3-year, Onsite	No	12/16
30B9002PSA	MEA	1xXeon E5-2667 v4 8C/3.2GHz/25MB/135W/DDR4-2400	Open	2x8GB RDIMM DDR4-2400 ECC	Integrated Intel SATA	4	1x1TB HDD 7.2K 3.5" SATA6Gbps	1x256GB SSD M.2 PCIe Opal	HH DVD±RW	9-in-1	1300W 92%	None	USB / USB Optical	Windows 10 DG Windows 7 Pro 64	3-year, Onsite	No	12/16
30B9002PUM	MEA	1xXeon E5-2667 v4 8C/3.2GHz/25MB/135W/DDR4-2400	Open	2x8GB RDIMM DDR4-2400 ECC	Integrated Intel SATA	4	1x1TB HDD 7.2K 3.5" SATA6Gbps	1x256GB SSD M.2 PCIe Opal	HH DVD±RW	9-in-1	1300W 92%	None	USB / USB Optical	Windows 10 DG Windows 7 Pro 64	3-year, Onsite	No	12/16
30B9002QAW	MEA	1xXeon E5-2643 v4 6C/3.4GHz/20MB/135W/DDR4-2400	Open	2x8GB RDIMM DDR4-2400 ECC	Integrated Intel SATA	4	1x1TB HDD 7.2K 3.5" SATA6Gbps	1x256GB SSD M.2 PCIe Opal	HH DVD±RW	9-in-1	1300W 92%	None	USB / USB Optical	Windows 10 DG Windows 7 Pro 64	3-year, Onsite	No	12/16
30B9002QAX	MEA	1xXeon E5-2643 v4 6C/3.4GHz/20MB/135W/DDR4-2400	Open	2x8GB RDIMM DDR4-2400 ECC	Integrated Intel SATA	4	1x1TB HDD 7.2K 3.5" SATA6Gbps	1x256GB SSD M.2 PCIe Opal	HH DVD±RW	9-in-1	1300W 92%	None	USB / USB Optical	Windows 10 DG Windows 7 Pro 64	3-year, Onsite	No	12/16
30B9002QFM	MEA	1xXeon E5-2643 v4 6C/3.4GHz/20MB/135W/DDR4-2400	Open	2x8GB RDIMM DDR4-2400 ECC	Integrated Intel SATA	4	1x1TB HDD 7.2K 3.5" SATA6Gbps	1x256GB SSD M.2 PCIe Opal	HH DVD±RW	9-in-1	1300W 92%	None	USB / USB Optical	Windows 10 DG Windows 7 Pro 64	3-year, Onsite	No	12/16
30B9002QPM	MEA	1xXeon E5-2643 v4 6C/3.4GHz/20MB/135W/DDR4-2400	Open	2x8GB RDIMM DDR4-2400 ECC	Integrated Intel SATA	4	1x1TB HDD 7.2K 3.5" SATA6Gbps	1x256GB SSD M.2 PCIe Opal	HH DVD±RW	9-in-1	1300W 92%	None	USB / USB Optical	Windows 10 DG Windows 7 Pro 64	3-year, Onsite	No	12/16
30B9002QSA	MEA	1xXeon E5-2643 v4 6C/3.4GHz/20MB/135W/DDR4-2400	Open	2x8GB RDIMM DDR4-2400 ECC	Integrated Intel SATA	4	1x1TB HDD 7.2K 3.5" SATA6Gbps	1x256GB SSD M.2 PCIe Opal	HH DVD±RW	9-in-1	1300W 92%	None	USB / USB Optical	Windows 10 DG Windows 7 Pro 64	3-year, Onsite	No	12/16
30B9002QUM	MEA	1xXeon E5-2643 v4 6C/3.4GHz/20MB/135W/DDR4-2400	Open	2x8GB RDIMM DDR4-2400 ECC	Integrated Intel SATA	4	1x1TB HDD 7.2K 3.5" SATA6Gbps	1x256GB SSD M.2 PCIe Opal	HH DVD±RW	9-in-1	1300W 92%	None	USB / USB Optical	Windows 10 DG Windows 7 Pro 64	3-year, Onsite	No	12/16
30B9002RAW	MEA	1xXeon E5-2637 v4 4C/3.5GHz/15MB/135W/DDR4-2400	Open	2x8GB RDIMM DDR4-2400 ECC	Integrated Intel SATA	4	1x1TB HDD 7.2K 3.5" SATA6Gbps	1x256GB SSD M.2 PCIe Opal	HH DVD±RW	9-in-1	1300W 92%	None	USB / USB Optical	Windows 10 DG Windows 7 Pro 64	3-year, Onsite	No	12/16
30B9002RAX	MEA	1xXeon E5-2637 v4 4C/3.5GHz/15MB/135W/DDR4-2400	Open	2x8GB RDIMM DDR4-2400 ECC	Integrated Intel SATA	4	1x1TB HDD 7.2K 3.5" SATA6Gbps	1x256GB SSD M.2 PCIe Opal	HH DVD±RW	9-in-1	1300W 92%	None	USB / USB Optical	Windows 10 DG Windows 7 Pro 64	3-year, Onsite	No	12/16

Model	Region	Processor	Graphics	Memory	Storage Controller	Max Drives in 3.5" Bays	Disks	M.2 Drives	Optical	Media Reader	Power Supply	Optional Ports	Keyboard / Mouse	Operating System	Warranty	Global	Ann Date (mm/yy)
30B9002RFM	MEA	1xXeon E5-2637 v4 4C/3.5GHz/15MB/135W/DDR4-2400	Open	2x8GB RDIMM DDR4-2400 ECC	Integrated Intel SATA	4	1x1TB HDD 7.2K 3.5" SATA6Gbps	1x256GB SSD M.2 PCIe Opal	HH DVD±RW	9-in-1	1300W 92%	None	USB / USB Optical	Windows 10 DG Windows 7 Pro 64	3-year, Onsite	No	12/16
30B9002RPM	MEA	1xXeon E5-2637 v4 4C/3.5GHz/15MB/135W/DDR4-2400	Open	2x8GB RDIMM DDR4-2400 ECC	Integrated Intel SATA	4	1x1TB HDD 7.2K 3.5" SATA6Gbps	1x256GB SSD M.2 PCIe Opal	HH DVD±RW	9-in-1	1300W 92%	None	USB / USB Optical	Windows 10 DG Windows 7 Pro 64	3-year, Onsite	No	12/16
30B9002RSA	MEA	1xXeon E5-2637 v4 4C/3.5GHz/15MB/135W/DDR4-2400	Open	2x8GB RDIMM DDR4-2400 ECC	Integrated Intel SATA	4	1x1TB HDD 7.2K 3.5" SATA6Gbps	1x256GB SSD M.2 PCIe Opal	HH DVD±RW	9-in-1	1300W 92%	None	USB / USB Optical	Windows 10 DG Windows 7 Pro 64	3-year, Onsite	No	12/16
30B9002RUM	MEA	1xXeon E5-2637 v4 4C/3.5GHz/15MB/135W/DDR4-2400	Open	2x8GB RDIMM DDR4-2400 ECC	Integrated Intel SATA	4	1x1TB HDD 7.2K 3.5" SATA6Gbps	1x256GB SSD M.2 PCIe Opal	HH DVD±RW	9-in-1	1300W 92%	None	USB / USB Optical	Windows 10 DG Windows 7 Pro 64	3-year, Onsite	No	12/16
30B9002SAW	MEA	1xXeon E5-2630 v4 10C/2.2GHz/25MB/85W/DDR4-2133	Open	2x8GB RDIMM DDR4-2400 ECC	Integrated Intel SATA	4	1x1TB HDD 7.2K 3.5" SATA6Gbps	1x256GB SSD M.2 PCIe Opal	HH DVD±RW	9-in-1	1300W 92%	None	USB / USB Optical	Windows 10 DG Windows 7 Pro 64	3-year, Onsite	No	12/16
30B9002SAX	MEA	1xXeon E5-2630 v4 10C/2.2GHz/25MB/85W/DDR4-2133	Open	2x8GB RDIMM DDR4-2400 ECC	Integrated Intel SATA	4	1x1TB HDD 7.2K 3.5" SATA6Gbps	1x256GB SSD M.2 PCIe Opal	HH DVD±RW	9-in-1	1300W 92%	None	USB / USB Optical	Windows 10 DG Windows 7 Pro 64	3-year, Onsite	No	12/16
30B9002SFM	MEA	1xXeon E5-2630 v4 10C/2.2GHz/25MB/85W/DDR4-2133	Open	2x8GB RDIMM DDR4-2400 ECC	Integrated Intel SATA	4	1x1TB HDD 7.2K 3.5" SATA6Gbps	1x256GB SSD M.2 PCIe Opal	HH DVD±RW	9-in-1	1300W 92%	None	USB / USB Optical	Windows 10 DG Windows 7 Pro 64	3-year, Onsite	No	12/16
30B9002SPM	MEA	1xXeon E5-2630 v4 10C/2.2GHz/25MB/85W/DDR4-2133	Open	2x8GB RDIMM DDR4-2400 ECC	Integrated Intel SATA	4	1x1TB HDD 7.2K 3.5" SATA6Gbps	1x256GB SSD M.2 PCIe Opal	HH DVD±RW	9-in-1	1300W 92%	None	USB / USB Optical	Windows 10 DG Windows 7 Pro 64	3-year, Onsite	No	12/16
30B9002SSA	MEA	1xXeon E5-2630 v4 10C/2.2GHz/25MB/85W/DDR4-2133	Open	2x8GB RDIMM DDR4-2400 ECC	Integrated Intel SATA	4	1x1TB HDD 7.2K 3.5" SATA6Gbps	1x256GB SSD M.2 PCIe Opal	HH DVD±RW	9-in-1	1300W 92%	None	USB / USB Optical	Windows 10 DG Windows 7 Pro 64	3-year, Onsite	No	12/16
30B9002SUM	MEA	1xXeon E5-2630 v4 10C/2.2GHz/25MB/85W/DDR4-2133	Open	2x8GB RDIMM DDR4-2400 ECC	Integrated Intel SATA	4	1x1TB HDD 7.2K 3.5" SATA6Gbps	1x256GB SSD M.2 PCIe Opal	HH DVD±RW	9-in-1	1300W 92%	None	USB / USB Optical	Windows 10 DG Windows 7 Pro 64	3-year, Onsite	No	12/16
30B9002TAW	MEA	2xXeon E5-2680 v4 14C/2.4GHz/35MB/120W/DDR4-2400	NVIDIA Quadro P5000 16GB	2x16GB RDIMM DDR4-2400 ECC	Integrated Intel SATA	4	1x1TB HDD 7.2K 3.5" SATA6Gbps	1x256GB SSD M.2 PCIe Opal	HH DVD±RW	9-in-1	1300W 92%	None	USB / USB Optical	Windows 10 DG Windows 7 Pro 64	3-year, Onsite	No	12/16
30B9002TAX	MEA	2xXeon E5-2680 v4 14C/2.4GHz/35MB/120W/DDR4-2400	NVIDIA Quadro P5000 16GB	2x16GB RDIMM DDR4-2400 ECC	Integrated Intel SATA	4	1x1TB HDD 7.2K 3.5" SATA6Gbps	1x256GB SSD M.2 PCIe Opal	HH DVD±RW	9-in-1	1300W 92%	None	USB / USB Optical	Windows 10 DG Windows 7 Pro 64	3-year, Onsite	No	12/16
30B9002TFM	MEA	2xXeon E5-2680 v4 14C/2.4GHz/35MB/120W/DDR4-2400	NVIDIA Quadro P5000 16GB	2x16GB RDIMM DDR4-2400 ECC	Integrated Intel SATA	4	1x1TB HDD 7.2K 3.5" SATA6Gbps	1x256GB SSD M.2 PCIe Opal	HH DVD±RW	9-in-1	1300W 92%	None	USB / USB Optical	Windows 10 DG Windows 7 Pro 64	3-year, Onsite	No	12/16

Model	Region	Processor	Graphics	Memory	Storage Controller	Max Drives in 3.5" Bays	Disks	M.2 Drives	Optical	Media Reader	Power Supply	Optional Ports	Keyboard / Mouse	Operating System	Warranty	Global	Ann Date (mm/yy)
30B9002TPM	MEA	2xXeon E5-2680 v4 14C/2.4GHz/35MB/120W/DDR4-2400	NVIDIA Quadro P5000 16GB	2x16GB RDIMM DDR4-2400 ECC	Integrated Intel SATA	4	1x1TB HDD 7.2K 3.5" SATA6Gbps	1x256GB SSD M.2 PCIe Opal	HH DVD±RW	9-in-1	1300W 92%	None	USB / USB Optical	Windows 10 DG Windows 7 Pro 64	3-year, Onsite	No	12/16
30B9002TSA	MEA	2xXeon E5-2680 v4 14C/2.4GHz/35MB/120W/DDR4-2400	NVIDIA Quadro P5000 16GB	2x16GB RDIMM DDR4-2400 ECC	Integrated Intel SATA	4	1x1TB HDD 7.2K 3.5" SATA6Gbps	1x256GB SSD M.2 PCIe Opal	HH DVD±RW	9-in-1	1300W 92%	None	USB / USB Optical	Windows 10 DG Windows 7 Pro 64	3-year, Onsite	No	12/16
30B9002TUM	MEA	2xXeon E5-2680 v4 14C/2.4GHz/35MB/120W/DDR4-2400	NVIDIA Quadro P5000 16GB	2x16GB RDIMM DDR4-2400 ECC	Integrated Intel SATA	4	1x1TB HDD 7.2K 3.5" SATA6Gbps	1x256GB SSD M.2 PCIe Opal	HH DVD±RW	9-in-1	1300W 92%	None	USB / USB Optical	Windows 10 DG Windows 7 Pro 64	3-year, Onsite	No	12/16
30B9002UAW	MEA	2xXeon E5-2680 v4 14C/2.4GHz/35MB/120W/DDR4-2400	NVIDIA Quadro P6000 24GB	2x16GB RDIMM DDR4-2400 ECC	Integrated Intel SATA	4	1x1TB HDD 7.2K 3.5" SATA6Gbps	1x256GB SSD M.2 PCIe Opal	HH DVD±RW	9-in-1	1300W 92%	None	USB / USB Optical	Windows 10 DG Windows 7 Pro 64	3-year, Onsite	No	12/16
30B9002UAX	MEA	2xXeon E5-2680 v4 14C/2.4GHz/35MB/120W/DDR4-2400	NVIDIA Quadro P6000 24GB	2x16GB RDIMM DDR4-2400 ECC	Integrated Intel SATA	4	1x1TB HDD 7.2K 3.5" SATA6Gbps	1x256GB SSD M.2 PCIe Opal	HH DVD±RW	9-in-1	1300W 92%	None	USB / USB Optical	Windows 10 DG Windows 7 Pro 64	3-year, Onsite	No	12/16
30B9002UFM	MEA	2xXeon E5-2680 v4 14C/2.4GHz/35MB/120W/DDR4-2400	NVIDIA Quadro P6000 24GB	2x16GB RDIMM DDR4-2400 ECC	Integrated Intel SATA	4	1x1TB HDD 7.2K 3.5" SATA6Gbps	1x256GB SSD M.2 PCIe Opal	HH DVD±RW	9-in-1	1300W 92%	None	USB / USB Optical	Windows 10 DG Windows 7 Pro 64	3-year, Onsite	No	12/16
30B9002UPM	MEA	2xXeon E5-2680 v4 14C/2.4GHz/35MB/120W/DDR4-2400	NVIDIA Quadro P6000 24GB	2x16GB RDIMM DDR4-2400 ECC	Integrated Intel SATA	4	1x1TB HDD 7.2K 3.5" SATA6Gbps	1x256GB SSD M.2 PCIe Opal	HH DVD±RW	9-in-1	1300W 92%	None	USB / USB Optical	Windows 10 DG Windows 7 Pro 64	3-year, Onsite	No	12/16
30B9002USA	MEA	2xXeon E5-2680 v4 14C/2.4GHz/35MB/120W/DDR4-2400	NVIDIA Quadro P6000 24GB	2x16GB RDIMM DDR4-2400 ECC	Integrated Intel SATA	4	1x1TB HDD 7.2K 3.5" SATA6Gbps	1x256GB SSD M.2 PCIe Opal	HH DVD±RW	9-in-1	1300W 92%	None	USB / USB Optical	Windows 10 DG Windows 7 Pro 64	3-year, Onsite	No	12/16
30B9002UUM	MEA	2xXeon E5-2680 v4 14C/2.4GHz/35MB/120W/DDR4-2400	NVIDIA Quadro P6000 24GB	2x16GB RDIMM DDR4-2400 ECC	Integrated Intel SATA	4	1x1TB HDD 7.2K 3.5" SATA6Gbps	1x256GB SSD M.2 PCIe Opal	HH DVD±RW	9-in-1	1300W 92%	None	USB / USB Optical	Windows 10 DG Windows 7 Pro 64	3-year, Onsite	No	12/16
30B9002VAW	MEA	2xXeon E5-2680 v4 14C/2.4GHz/35MB/120W/DDR4-2400	Open	2x16GB RDIMM DDR4-2400 ECC	Integrated Intel SATA	4	1x1TB HDD 7.2K 3.5" SATA6Gbps	1x256GB SSD M.2 PCIe Opal	HH DVD±RW	9-in-1	1300W 92%	None	USB / USB Optical	Windows 10 DG Windows 7 Pro 64	3-year, Onsite	No	12/16
30B9002VAX	MEA	2xXeon E5-2680 v4 14C/2.4GHz/35MB/120W/DDR4-2400	Open	2x16GB RDIMM DDR4-2400 ECC	Integrated Intel SATA	4	1x1TB HDD 7.2K 3.5" SATA6Gbps	1x256GB SSD M.2 PCIe Opal	HH DVD±RW	9-in-1	1300W 92%	None	USB / USB Optical	Windows 10 DG Windows 7 Pro 64	3-year, Onsite	No	12/16
30B9002VFM	MEA	2xXeon E5-2680 v4 14C/2.4GHz/35MB/120W/DDR4-2400	Open	2x16GB RDIMM DDR4-2400 ECC	Integrated Intel SATA	4	1x1TB HDD 7.2K 3.5" SATA6Gbps	1x256GB SSD M.2 PCIe Opal	HH DVD±RW	9-in-1	1300W 92%	None	USB / USB Optical	Windows 10 DG Windows 7 Pro 64	3-year, Onsite	No	12/16
30B9002VPM	MEA	2xXeon E5-2680 v4 14C/2.4GHz/35MB/120W/DDR4-2400	Open	2x16GB RDIMM DDR4-2400 ECC	Integrated Intel SATA	4	1x1TB HDD 7.2K 3.5" SATA6Gbps	1x256GB SSD M.2 PCIe Opal	HH DVD±RW	9-in-1	1300W 92%	None	USB / USB Optical	Windows 10 DG Windows 7 Pro 64	3-year, Onsite	No	12/16

Model	Region	Processor	Graphics	Memory	Storage Controller	Max Drives in 3.5" Bays	Disks	M.2 Drives	Optical	Media Reader	Power Supply	Optional Ports	Keyboard / Mouse	Operating System	Warranty	Global	Ann Date (mm/yy)
30B9002VSA	MEA	2xXeon E5-2680 v4 14C/2.4GHz/35MB/120W/DDR4-2400	Open	2x16GB RDIMM DDR4-2400 ECC	Integrated Intel SATA	4	1x1TB HDD 7.2K 3.5" SATA6Gbps	1x256GB SSD M.2 PCIe Opal	HH DVD±RW	9-in-1	1300W 92%	None	USB / USB Optical	Windows 10 DG Windows 7 Pro 64	3-year, Onsite	No	12/16
30B9002VUM	MEA	2xXeon E5-2680 v4 14C/2.4GHz/35MB/120W/DDR4-2400	Open	2x16GB RDIMM DDR4-2400 ECC	Integrated Intel SATA	4	1x1TB HDD 7.2K 3.5" SATA6Gbps	1x256GB SSD M.2 PCIe Opal	HH DVD±RW	9-in-1	1300W 92%	None	USB / USB Optical	Windows 10 DG Windows 7 Pro 64	3-year, Onsite	No	12/16
30B9002WAW	MEA	2xXeon E5-2640 v4 10C/2.4GHz/25MB/90W/DDR4-2133	Open	2x8GB RDIMM DDR4-2400 ECC	Integrated Intel SATA	4	1x1TB HDD 7.2K 3.5" SATA6Gbps	1x256GB SSD M.2 PCIe Opal	HH DVD±RW	9-in-1	1300W 92%	None	USB / USB Optical	Windows 10 DG Windows 7 Pro 64	3-year, Onsite	No	12/16
30B9002WAX	MEA	2xXeon E5-2640 v4 10C/2.4GHz/25MB/90W/DDR4-2133	Open	2x8GB RDIMM DDR4-2400 ECC	Integrated Intel SATA	4	1x1TB HDD 7.2K 3.5" SATA6Gbps	1x256GB SSD M.2 PCIe Opal	HH DVD±RW	9-in-1	1300W 92%	None	USB / USB Optical	Windows 10 DG Windows 7 Pro 64	3-year, Onsite	No	12/16
30B9002WFM	MEA	2xXeon E5-2640 v4 10C/2.4GHz/25MB/90W/DDR4-2133	Open	2x8GB RDIMM DDR4-2400 ECC	Integrated Intel SATA	4	1x1TB HDD 7.2K 3.5" SATA6Gbps	1x256GB SSD M.2 PCIe Opal	HH DVD±RW	9-in-1	1300W 92%	None	USB / USB Optical	Windows 10 DG Windows 7 Pro 64	3-year, Onsite	No	12/16
30B9002WPM	MEA	2xXeon E5-2640 v4 10C/2.4GHz/25MB/90W/DDR4-2133	Open	2x8GB RDIMM DDR4-2400 ECC	Integrated Intel SATA	4	1x1TB HDD 7.2K 3.5" SATA6Gbps	1x256GB SSD M.2 PCIe Opal	HH DVD±RW	9-in-1	1300W 92%	None	USB / USB Optical	Windows 10 DG Windows 7 Pro 64	3-year, Onsite	No	12/16
30B9002WSA	MEA	2xXeon E5-2640 v4 10C/2.4GHz/25MB/90W/DDR4-2133	Open	2x8GB RDIMM DDR4-2400 ECC	Integrated Intel SATA	4	1x1TB HDD 7.2K 3.5" SATA6Gbps	1x256GB SSD M.2 PCIe Opal	HH DVD±RW	9-in-1	1300W 92%	None	USB / USB Optical	Windows 10 DG Windows 7 Pro 64	3-year, Onsite	No	12/16
30B9002WUM	MEA	2xXeon E5-2640 v4 10C/2.4GHz/25MB/90W/DDR4-2133	Open	2x8GB RDIMM DDR4-2400 ECC	Integrated Intel SATA	4	1x1TB HDD 7.2K 3.5" SATA6Gbps	1x256GB SSD M.2 PCIe Opal	HH DVD±RW	9-in-1	1300W 92%	None	USB / USB Optical	Windows 10 DG Windows 7 Pro 64	3-year, Onsite	No	12/16
30B90030**	MEA	2xXeon E5-2650 v4 12C/2.2GHz/30MB/105W/DDR4-2400	NVIDIA Quadro P5000 16GB	2x16GB RDIMM DDR4-2400 ECC	Integrated Intel SATA	4	1x512GB SSD 2.5" SATA6Gbps Opal+1x2TB HDD 7.2K 3.5" SATA6Gbps	None	9.5mm DVD±RW	29-in-1	1300W 92%	Front eSATA	USB / USB Optical	Windows 10 Pro 64	3-year, Onsite	No	07/17
30B90031**	MEA	2xXeon E5-2640 v4 10C/2.4GHz/25MB/90W/DDR4-2133	NVIDIA Quadro P4000 8GB	2x16GB RDIMM DDR4-2400 ECC	Integrated Intel SATA	4	1x256GB SSD 2.5" SATA6Gbps Opal+1x2TB HDD 7.2K 3.5" SATA6Gbps	None	9.5mm DVD±RW	29-in-1	1300W 92%	Front eSATA	USB / USB Optical	Windows 10 Pro 64	3-year, Onsite	No	07/17
30B90032**	MEA	1xXeon E5-2620 v4 8C/2.1GHz/20MB/85W/DDR4-2133	Open	1x8GB RDIMM DDR4-2400 ECC	Integrated Intel SATA	4	1x1TB HDD 7.2K 3.5" SATA6Gbps	None	HH DVD±RW	9-in-1	1300W 92%	Internal USB 3.0	USB / USB Optical	Windows 10 Pro 64	3-year, Onsite	No	09/17
30B90033**	MEA	1xXeon E5-2630 v4 10C/2.2GHz/25MB/85W/DDR4-2133	Open	1x8GB RDIMM DDR4-2400 ECC	Integrated Intel SATA	4	1x256GB SSD 2.5" SATA6Gbps Opal	None	HH DVD±RW	9-in-1	1300W 92%	Internal USB 3.0	USB / USB Optical	Windows 10 Pro 64	3-year, Onsite	No	09/17
30B90034**	MEA	2xXeon E5-2630 v4 10C/2.2GHz/25MB/85W/DDR4-2133	Open	4x8GB RDIMM DDR4-2400 ECC	Integrated Intel SATA	4	1x512GB SSD 2.5" SATA6Gbps	None	HH DVD±RW	9-in-1	1300W 92%	Internal USB 3.0	USB / USB Optical	Windows 10 Pro 64	3-year, Onsite	No	09/17

Model	Region	Processor	Graphics	Memory	Storage Controller	Max Drives in 3.5" Bays	Disks	M.2 Drives	Optical	Media Reader	Power Supply	Optional Ports	Keyboard / Mouse	Operating System	Warranty	Global	Ann Date (mm/yy)
30B90035**	MEA	2xXeon E5-2620 v4 8C/2.1GHz/20MB/85W/DDR4-2133	Open	4x8GB RDIMM DDR4-2400 ECC	Integrated Intel SATA	4	1x256GB SSD 2.5" SATA6Gbps Opal	None	HH DVD±RW	9-in-1	1300W 92%	Internal USB 3.0	USB / USB Optical	Windows 10 Pro 64	3-year, Onsite	No	09/17
30B90036**	MEA	2xXeon E5-2650 v4 12C/2.2GHz/30MB/105W/DDR4-2400	NVIDIA Quadro P5000 16GB	2x16GB RDIMM DDR4-2400 ECC	Integrated Intel SATA	4	1x512GB SSD 2.5" SATA6Gbps+1x1TB HDD 7.2K 3.5" SATA6Gbps	None	9.0mm DVD	29-in-1	1300W 92%	None	USB / USB Optical	Windows 10 Pro 64	3-year, Onsite	No	09/17
30B90037**	MEA	2xXeon E5-2640 v4 10C/2.4GHz/25MB/90W/DDR4-2133	NVIDIA Quadro P4000 8GB	2x16GB RDIMM DDR4-2400 ECC	Integrated Intel SATA	4	1x256GB SSD 2.5" SATA6Gbps Opal+1x1TB HDD 7.2K 3.5" SATA6Gbps	None	9.0mm DVD	29-in-1	1300W 92%	None	USB / USB Optical	Windows 10 Pro 64	3-year, Onsite	No	09/17
30B9000D**	MEA	2xXeon E5-2620 v4 8C/2.1GHz/20MB/85W/DDR4-2133	Open	4x8GB RDIMM DDR4-2400 ECC	Integrated Intel SATA	4	1x256GB SSD 2.5" SATA6Gbps Opal	None	HH DVD±RW	9-in-1	1300W 92%	None	USB / USB Optical	Windows 10 Pro 64	3-year, Onsite	No	04/16
30B90037xx	Russia/EET/CIS	2xXeon E5-2640 v4 10C/2.4GHz/25MB/90W/DDR4-2133	NVIDIA Quadro P4000 8GB	2x16GB RDIMM DDR4-2400 ECC	Integrated Intel SATA	4	1x256GB SSD 2.5" SATA6Gbps Opal+1x1TB HDD 7.2K 3.5" SATA6Gbps	None	9.0mm DVD	29-in-1	1300W 92%	None	USB / USB Optical	Windows 10 Pro 64	3-year, Onsite	No	09/17
30B90036xx	Russia/EET/CIS	2xXeon E5-2650 v4 12C/2.2GHz/30MB/105W/DDR4-2400	NVIDIA Quadro P5000 16GB	2x16GB RDIMM DDR4-2400 ECC	Integrated Intel SATA	4	1x512GB SSD 2.5" SATA6Gbps+1x1TB HDD 7.2K 3.5" SATA6Gbps	None	9.0mm DVD	29-in-1	1300W 92%	None	USB / USB Optical	Windows 10 Pro 64	3-year, Onsite	No	09/17
30B90035xx	Russia/EET/CIS	2xXeon E5-2620 v4 8C/2.1GHz/20MB/85W/DDR4-2133	Open	4x8GB RDIMM DDR4-2400 ECC	Integrated Intel SATA	4	1x256GB SSD 2.5" SATA6Gbps Opal	None	HH DVD±RW	9-in-1	1300W 92%	Internal USB 3.0	USB / USB Optical	Windows 10 Pro 64	3-year, Onsite	No	09/17
30B90034xx	Russia/EET/CIS	2xXeon E5-2630 v4 10C/2.2GHz/25MB/85W/DDR4-2133	Open	4x8GB RDIMM DDR4-2400 ECC	Integrated Intel SATA	4	1x512GB SSD 2.5" SATA6Gbps	None	HH DVD±RW	9-in-1	1300W 92%	Internal USB 3.0	USB / USB Optical	Windows 10 Pro 64	3-year, Onsite	No	09/17
30B90033xx	Russia/EET/CIS	1xXeon E5-2630 v4 10C/2.2GHz/25MB/85W/DDR4-2133	Open	1x8GB RDIMM DDR4-2400 ECC	Integrated Intel SATA	4	1x256GB SSD 2.5" SATA6Gbps Opal	None	HH DVD±RW	9-in-1	1300W 92%	Internal USB 3.0	USB / USB Optical	Windows 10 Pro 64	3-year, Onsite	No	09/17
30B90032xx	Russia/EET/CIS	1xXeon E5-2620 v4 8C/2.1GHz/20MB/85W/DDR4-2133	Open	1x8GB RDIMM DDR4-2400 ECC	Integrated Intel SATA	4	1x1TB HDD 7.2K 3.5" SATA6Gbps	None	HH DVD±RW	9-in-1	1300W 92%	Internal USB 3.0	USB / USB Optical	Windows 10 Pro 64	3-year, Onsite	No	09/17
30B90031xx	Russia/EET/CIS	2xXeon E5-2640 v4 10C/2.4GHz/25MB/90W/DDR4-2133	NVIDIA Quadro P4000 8GB	2x16GB RDIMM DDR4-2400 ECC	Integrated Intel SATA	4	1x256GB SSD 2.5" SATA6Gbps Opal+1x2TB HDD 7.2K 3.5" SATA6Gbps	None	9.5mm DVD±RW	29-in-1	1300W 92%	Front eSATA	USB / USB Optical	Windows 10 Pro 64	3-year, Onsite	No	07/17
30B90030xx	Russia/EET/CIS	2xXeon E5-2650 v4 12C/2.2GHz/30MB/105W/DDR4-2400	NVIDIA Quadro P5000 16GB	2x16GB RDIMM DDR4-2400 ECC	Integrated Intel SATA	4	1x512GB SSD 2.5" SATA6Gbps Opal+1x2TB HDD 7.2K 3.5" SATA6Gbps	None	9.5mm DVD±RW	29-in-1	1300W 92%	Front eSATA	USB / USB Optical	Windows 10 Pro 64	3-year, Onsite	No	07/17
30B9001Sxx	Russia/EET/CIS	2xXeon E5-2680 v4 14C/2.4GHz/35MB/120W/DDR4-2400	Open	4x16GB RDIMM DDR4-2400 ECC	9364-8i PCIe	8	1x2TB HDD 7.2K 3.5" SATA6Gbps	1x512GB SSD M.2 PCIe	HH DVD±RW	9-in-1	1300W 92%	None	USB / USB Optical	Windows 10 Pro 64	3-year, Onsite	No	08/16

Model	Region	Processor	Graphics	Memory	Storage Controller	Max Drives in 3.5" Bays	Disks	M.2 Drives	Optical	Media Reader	Power Supply	Optional Ports	Keyboard / Mouse	Operating System	Warranty	Global	Ann Date (mm/yy)
30B9001Txx	Russia/EET/CIS	2xXeon E5-2699 v4 22C/2.2GHz/55MB/145W/DDR4-2400	Open	4x16GB RDIMM DDR4-2400 ECC	9364-8i PCIe	8	2x512GB SSD 2.5" SATA6Gbps	None	HH DVD±RW	9-in-1	1300W 92%	None	USB / USB Optical	Windows 10 Pro 64	3-year, Onsite	No	08/16
30B9000Vxx	Russia/EET/CIS	2xXeon E5-2650 v4 12C/2.2GHz/30MB/105W/DDR4-2400	NVIDIA Quadro M5000 8GB	2x16GB RDIMM DDR4-2400 ECC	Integrated Intel SATA	4	Open	1x512GB SSD M.2 PCIe	HH DVD±RW	9-in-1	1300W 92%	None	USB / USB Optical	Windows 10 DG Windows 7 Pro 64	3-year, Onsite	No	04/16
30B9000Uxx	Russia/EET/CIS	1xXeon E5-2650 v4 12C/2.2GHz/30MB/105W/DDR4-2400	NVIDIA Quadro M4000 8GB	2x8GB RDIMM DDR4-2400 ECC	Integrated Intel SATA	4	Open	1x512GB SSD M.2 PCIe	HH DVD±RW	9-in-1	1300W 92%	None	USB / USB Optical	Windows 10 DG Windows 7 Pro 64	3-year, Onsite	No	04/16
30B9000Txx	Russia/EET/CIS	1xXeon E5-2680 v4 14C/2.4GHz/35MB/120W/DDR4-2400	NVIDIA Quadro M6000 12GB	4x8GB RDIMM DDR4-2400 ECC	Integrated Intel SATA	4	Open	1x512GB SSD M.2 PCIe	HH DVD±RW	9-in-1	1300W 92%	None	USB / USB Optical	Windows 10 DG Windows 7 Pro 64	3-year, Onsite	No	04/16
30B9000Sxx	Russia/EET/CIS	2xXeon E5-2620 v4 8C/2.1GHz/20MB/85W/DDR4-2133	Open	2x8GB RDIMM DDR4-2400 ECC	Integrated Intel SATA	4	1x256GB SSD 2.5" SATA6Gbps Opal	None	HH DVD±RW	9-in-1	1300W 92%	None	USB / USB Optical	Windows 10 DG Windows 7 Pro 64	3-year, Onsite	No	04/16
30B9000Rxx	Russia/EET/CIS	2xXeon E5-2630 v4 10C/2.2GHz/25MB/85W/DDR4-2133	Open	4x8GB RDIMM DDR4-2400 ECC	Integrated Intel SATA	4	1x512GB SSD 2.5" SATA6Gbps	None	HH DVD±RW	9-in-1	1300W 92%	None	USB / USB Optical	Windows 10 DG Windows 7 Pro 64	3-year, Onsite	No	04/16
30B9000Qxx	Russia/EET/CIS	2xXeon E5-2620 v4 8C/2.1GHz/20MB/85W/DDR4-2133	Open	2x8GB RDIMM DDR4-2400 ECC	Integrated Intel SATA	4	1x1TB Hybrid HDD 7.2K 3.5" SATA6Gbps	None	HH DVD±RW	9-in-1	1300W 92%	None	USB / USB Optical	Windows 10 DG Windows 7 Pro 64	3-year, Onsite	No	04/16
30B9000Pxx	Russia/EET/CIS	1xXeon E5-2643 v4 6C/3.4GHz/20MB/135W/DDR4-2400	Open	2x8GB RDIMM DDR4-2400 ECC	Integrated Intel SATA	4	1x1TB Hybrid HDD 7.2K 3.5" SATA6Gbps	None	Open	9-in-1	1300W 92%	2xUSB3.0	USB / USB Optical	Windows 10 DG Windows 7 Pro 64	3-year, Onsite	No	04/16
30B9000Nxx	Russia/EET/CIS	1xXeon E5-2630 v4 10C/2.2GHz/25MB/85W/DDR4-2133	Open	1x8GB RDIMM DDR4-2400 ECC	Integrated Intel SATA	4	1x256GB SSD 2.5" SATA6Gbps Opal	None	Open	9-in-1	1300W 92%	2xUSB3.0	USB / USB Optical	Windows 10 DG Windows 7 Pro 64	3-year, Onsite	No	04/16
30B90003xx	Russia/EET/CIS	2xXeon E5-2620 v4 8C/2.1GHz/20MB/85W/DDR4-2133	Open	2x8GB RDIMM DDR4-2400 ECC	Integrated Intel SATA	4	1x1TB Hybrid HDD 7.2K 3.5" SATA6Gbps	None	HH DVD±RW	9-in-1	1300W 92%	None	USB / USB Optical	Windows 10 Pro 64	3-year, Onsite	No	04/16
30B90004xx	Russia/EET/CIS	1xXeon E5-2630 v4 10C/2.2GHz/25MB/85W/DDR4-2133	Open	1x8GB RDIMM DDR4-2400 ECC	Integrated Intel SATA	4	1x256GB SSD 2.5" SATA6Gbps Opal	None	HH DVD±RW	9-in-1	1300W 92%	None	USB / USB Optical	Windows 10 Pro 64	3-year, Onsite	No	04/16
30B90008xx	Russia/EET/CIS	2xXeon E5-2620 v4 8C/2.1GHz/20MB/85W/DDR4-2133	Open	2x8GB RDIMM DDR4-2400 ECC	Integrated Intel SATA	4	1x256GB SSD 2.5" SATA6Gbps Opal	None	HH DVD±RW	9-in-1	1300W 92%	None	USB / USB Optical	Windows 10 Pro 64	3-year, Onsite	No	04/16
30B90007xx	Russia/EET/CIS	1xXeon E5-2643 v4 6C/3.4GHz/20MB/135W/DDR4-2400	Open	2x8GB RDIMM DDR4-2400 ECC	Integrated Intel SATA	4	1x1TB Hybrid HDD 7.2K 3.5" SATA6Gbps	None	HH DVD±RW	9-in-1	1300W 92%	None	USB / USB Optical	Windows 10 Pro 64	3-year, Onsite	No	04/16

Model	Region	Processor	Graphics	Memory	Storage Controller	Max Drives in 3.5" Bays	Disks	M.2 Drives	Optical	Media Reader	Power Supply	Optional Ports	Keyboard / Mouse	Operating System	Warranty	Global	Ann Date (mm/yy)
30B90006xx	Russia/EET/CIS	2xXeon E5-2630 v4 10C/2.2GHz/25MB/85W/DDR4-2133	Open	4x8GB RDIMM DDR4-2400 ECC	Integrated Intel SATA	4	1x512GB SSD 2.5" SATA6Gbps	None	HH DVD±RW	9-in-1	1300W 92%	None	USB / USB Optical	Windows 10 Pro 64	3-year, Onsite	No	04/16
30B90005xx	Russia/EET/CIS	1xXeon E5-2620 v4 8C/2.1GHz/20MB/85W/DDR4-2133	Open	1x8GB RDIMM DDR4-2400 ECC	Integrated Intel SATA	4	1x1TB HDD 7.2K 3.5" SATA6Gbps	None	HH DVD±RW	9-in-1	1300W 92%	None	USB / USB Optical	Windows 10 Pro 64	3-year, Onsite	No	04/16
30B90009xx	Russia/EET/CIS	1xXeon E5-2680 v4 14C/2.4GHz/35MB/120W/DDR4-2400	NVIDIA Quadro M6000 12GB	4x8GB RDIMM DDR4-2400 ECC	Integrated Intel SATA	4	Open	1x512GB SSD M.2 PCIe	HH DVD±RW	9-in-1	1300W 92%	None	USB / USB Optical	Windows 10 Pro 64	3-year, Onsite	No	04/16
30B9000Bxx	Russia/EET/CIS	1xXeon E5-2650 v4 12C/2.2GHz/30MB/105W/DDR4-2400	Open	2x8GB RDIMM DDR4-2400 ECC	Integrated Intel SATA	4	Open	1x512GB SSD M.2 PCIe	HH DVD±RW	9-in-1	1300W 92%	None	USB / USB Optical	Windows 10 Pro 64	3-year, Onsite	Global	04/16
30B9000Axx	Russia/EET/CIS	2xXeon E5-2650 v4 12C/2.2GHz/30MB/105W/DDR4-2400	NVIDIA Quadro M5000 8GB	2x16GB RDIMM DDR4-2400 ECC	Integrated Intel SATA	4	Open	1x512GB SSD M.2 PCIe	HH DVD±RW	9-in-1	1300W 92%	None	USB / USB Optical	Windows 10 Pro 64	3-year, Onsite	No	04/16
30B9000Mxx	Russia/EET/CIS	1xXeon E5-2620 v3 6C/2.4GHz/15MB/85W/DDR4-1866	Open	1x8GB RDIMM DDR4-2400 ECC	Integrated Intel SATA	4	1x1TB HDD 7.2K 3.5" SATA6Gbps	None	Open	9-in-1	1300W 92%	2xUSB3.0	USB / USB Optical	Windows 10 DG Windows 7 Pro 64	3-year, Onsite	No	04/16
30B9000Cxx	Russia/EET/CIS	1xXeon E5-2650 v4 12C/2.2GHz/30MB/105W/DDR4-2400	NVIDIA Quadro M4000 8GB	2x8GB RDIMM DDR4-2400 ECC	Integrated Intel SATA	4	Open	1x512GB SSD M.2 PCIe	HH DVD±RW	9-in-1	1300W 92%	None	USB / USB Optical	Windows 10 Pro 64	3-year, Onsite	Global	04/16
30B9000Dxx	Russia/EET/CIS	2xXeon E5-2620 v4 8C/2.1GHz/20MB/85W/DDR4-2133	Open	4x8GB RDIMM DDR4-2400 ECC	Integrated Intel SATA	4	1x256GB SSD 2.5" SATA6Gbps Opal	None	HH DVD±RW	9-in-1	1300W 92%	None	USB / USB Optical	Windows 10 Pro 64	3-year, Onsite	No	04/16
30B9000EUS	US	1xXeon E5-2643 v4 6C/3.4GHz/20MB/135W/DDR4-2400	Open	2x8GB RDIMM DDR4-2400 ECC	Integrated Intel SATA	4	1x512GB SSD 2.5" SATA6Gbps	None	HH DVD±RW	9-in-1	1300W 92%	None	USB / USB Optical	Windows 10 Pro 64	3-year, Onsite	No	04/16
30B9000FUS	US	2xXeon E5-2650 v4 12C/2.2GHz/30MB/105W/DDR4-2400	NVIDIA Quadro M5000 8GB	4x8GB RDIMM DDR4-2400 ECC	Integrated Intel SATA	4	1x1TB SSD 2.5" SATA6Gbps	None	HH DVD±RW	9-in-1	1300W 92%	None	USB / USB Optical	Windows 10 Pro 64	3-year, Onsite	No	04/16
30B9000GUS	US	2xXeon E5-2643 v4 6C/3.4GHz/20MB/135W/DDR4-2400	Open	4x8GB RDIMM DDR4-2400 ECC	Integrated Intel SATA	4	1x1TB SSD 2.5" SATA6Gbps	None	HH DVD±RW	9-in-1	1300W 92%	None	USB / USB Optical	Windows 10 Pro 64	3-year, Onsite	No	04/16
30B9000HUS	US	1xXeon E5-2623 v4 4C/2.6GHz/10MB/85W/DDR4-2133	Open	2x8GB RDIMM DDR4-2400 ECC	Integrated Intel SATA	4	1x512GB SSD 2.5" SATA6Gbps	None	HH DVD±RW	9-in-1	1300W 92%	None	USB / USB Optical	Windows 10 Pro 64	3-year, Onsite	No	04/16
30B9001NUS	US	2xXeon E5-2650 v4 12C/2.2GHz/30MB/105W/DDR4-2400	NVIDIA Quadro M4000 8GB	4x8GB RDIMM DDR4-2400 ECC	Integrated Intel SATA	4	1x1TB HDD 7.2K 3.5" SATA6Gbps	1x512GB SSD M.2 PCIe	HH DVD±RW	9-in-1	1300W 92%	None	USB / USB Optical	Windows 10 Pro 64	3-year, Onsite	No	07/16

Model	Region	Processor	Graphics	Memory	Storage Controller	Max Drives in 3.5" Bays	Disks	M.2 Drives	Optical	Media Reader	Power Supply	Optional Ports	Keyboard / Mouse	Operating System	Warranty	Global	Ann Date (mm/yy)
30B9001PUS	US	2xXeon E5-2650 v4 12C/2.2GHz/30MB/105W/DDR4-2400	Open	4x8GB RDIMM DDR4-2400 ECC	Integrated Intel SATA	4	1x1TB HDD 7.2K 3.5" SATA6Gbps	1x512GB SSD M.2 PCIe	HH DVD±RW	9-in-1	1300W 92%	None	USB / USB Optical	Windows 10 Pro 64	3-year, Onsite	No	07/16
30B9002XCA	US	1xXeon E5-2650 v4 12C/2.2GHz/30MB/105W/DDR4-2400	NVIDIA Quadro P4000 8GB	4x8GB RDIMM DDR4-2400 ECC	Integrated Intel SATA	4	1x1TB HDD 7.2K 3.5" SATA6Gbps	1x512GB SSD M.2 PCIe	HH DVD±RW	9-in-1	1300W 92%	None	USB / USB Optical	Windows 10 Pro 64	3-year, Onsite	No	04/17
30B9002XCC	US	1xXeon E5-2650 v4 12C/2.2GHz/30MB/105W/DDR4-2400	NVIDIA Quadro P4000 8GB	4x8GB RDIMM DDR4-2400 ECC	Integrated Intel SATA	4	1x1TB HDD 7.2K 3.5" SATA6Gbps	1x512GB SSD M.2 PCIe	HH DVD±RW	9-in-1	1300W 92%	None	USB / USB Optical	Windows 10 Pro 64	3-year, Onsite	No	04/17
30B9002XSS	US	1xXeon E5-2650 v4 12C/2.2GHz/30MB/105W/DDR4-2400	NVIDIA Quadro P4000 8GB	4x8GB RDIMM DDR4-2400 ECC	Integrated Intel SATA	4	1x1TB HDD 7.2K 3.5" SATA6Gbps	1x512GB SSD M.2 PCIe	HH DVD±RW	9-in-1	1300W 92%	None	USB / USB Optical	Windows 10 Pro 64	3-year, Onsite	No	04/17
30B9002XUS	US	1xXeon E5-2650 v4 12C/2.2GHz/30MB/105W/DDR4-2400	NVIDIA Quadro P4000 8GB	4x8GB RDIMM DDR4-2400 ECC	Integrated Intel SATA	4	1x1TB HDD 7.2K 3.5" SATA6Gbps	1x512GB SSD M.2 PCIe	HH DVD±RW	9-in-1	1300W 92%	None	USB / USB Optical	Windows 10 Pro 64	3-year, Onsite	No	04/17
30B9002YCA	US	1xXeon E5-2650 v4 12C/2.2GHz/30MB/105W/DDR4-2400	NVIDIA Quadro P4000 8GB	4x8GB RDIMM DDR4-2400 ECC	Integrated Intel SATA	4	1x1TB HDD 7.2K 3.5" SATA6Gbps	1x512GB SSD M.2 PCIe	HH DVD±RW	9-in-1	1300W 92%	None	USB / USB Optical	Windows 10 DG Windows 7 Pro 64	3-year, Onsite	No	04/17
30B9002YCC	US	1xXeon E5-2650 v4 12C/2.2GHz/30MB/105W/DDR4-2400	NVIDIA Quadro P4000 8GB	4x8GB RDIMM DDR4-2400 ECC	Integrated Intel SATA	4	1x1TB HDD 7.2K 3.5" SATA6Gbps	1x512GB SSD M.2 PCIe	HH DVD±RW	9-in-1	1300W 92%	None	USB / USB Optical	Windows 10 DG Windows 7 Pro 64	3-year, Onsite	No	04/17
30B9002YSS	US	1xXeon E5-2650 v4 12C/2.2GHz/30MB/105W/DDR4-2400	NVIDIA Quadro P4000 8GB	4x8GB RDIMM DDR4-2400 ECC	Integrated Intel SATA	4	1x1TB HDD 7.2K 3.5" SATA6Gbps	1x512GB SSD M.2 PCIe	HH DVD±RW	9-in-1	1300W 92%	None	USB / USB Optical	Windows 10 DG Windows 7 Pro 64	3-year, Onsite	No	04/17
30B9002YUS	US	1xXeon E5-2650 v4 12C/2.2GHz/30MB/105W/DDR4-2400	NVIDIA Quadro P4000 8GB	4x8GB RDIMM DDR4-2400 ECC	Integrated Intel SATA	4	1x1TB HDD 7.2K 3.5" SATA6Gbps	1x512GB SSD M.2 PCIe	HH DVD±RW	9-in-1	1300W 92%	None	USB / USB Optical	Windows 10 DG Windows 7 Pro 64	3-year, Onsite	No	04/17
30B9001UUS	US	2xXeon E5-2650 v4 12C/2.2GHz/30MB/105W/DDR4-2400	NVIDIA Quadro M4000 8GB	4x8GB RDIMM DDR4-2400 ECC	Integrated Intel SATA	4	1x1TB HDD 7.2K 3.5" SATA6Gbps	1x512GB SSD M.2 PCIe	HH DVD±RW	9-in-1	1300W 92%	None	USB / USB Optical	Windows 10 DG Windows 7 Pro 64	3-year, Onsite	No	09/16
30B9001VUS	US	2xXeon E5-2650 v4 12C/2.2GHz/30MB/105W/DDR4-2400	Open	4x8GB RDIMM DDR4-2400 ECC	Integrated Intel SATA	4	1x1TB HDD 7.2K 3.5" SATA6Gbps	1x512GB SSD M.2 PCIe	HH DVD±RW	9-in-1	1300W 92%	None	USB / USB Optical	Windows 10 DG Windows 7 Pro 64	3-year, Onsite	No	09/16
30B9001WUS	US	1xXeon E5-2643 v4 6C/3.4GHz/20MB/135W/DDR4-2400	Open	2x8GB RDIMM DDR4-2400 ECC	Integrated Intel SATA	4	1x512GB SSD 2.5" SATA6Gbps	None	HH DVD±RW	9-in-1	1300W 92%	None	USB / USB Optical	Windows 10 DG Windows 7 Pro 64	3-year, Onsite	No	09/16
30B9001XUS	US	2xXeon E5-2650 v4 12C/2.2GHz/30MB/105W/DDR4-2400	NVIDIA Quadro M5000 8GB	4x8GB RDIMM DDR4-2400 ECC	Integrated Intel SATA	4	1x1TB SSD 2.5" SATA6Gbps	None	HH DVD±RW	9-in-1	1300W 92%	None	USB / USB Optical	Windows 10 DG Windows 7 Pro 64	3-year, Onsite	No	09/16

Model	Region	Processor	Graphics	Memory	Storage Controller	Max Drives in 3.5" Bays	Disks	M.2 Drives	Optical	Media Reader	Power Supply	Optional Ports	Keyboard / Mouse	Operating System	Warranty	Global	Ann Date (mm/yy)
30B9001YUS	US	2xXeon E5-2643 v4 6C/3.4GHz/20MB/135W/DDR4-2400	Open	4x8GB RDIMM DDR4-2400 ECC	Integrated Intel SATA	4	1x1TB SSD 2.5" SATA6Gbps	None	HH DVD±RW	9-in-1	1300W 92%	None	USB / USB Optical	Windows 10 DG Windows 7 Pro 64	3-year, Onsite	No	09/16
30B90020US	US	1xXeon E5-2623 v4 4C/2.6GHz/10MB/85W/DDR4-2133	Open	2x8GB RDIMM DDR4-2400 ECC	Integrated Intel SATA	4	1x512GB SSD 2.5" SATA6Gbps	None	HH DVD±RW	9-in-1	1300W 92%	None	USB / USB Optical	Windows 10 DG Windows 7 Pro 64	3-year, Onsite	No	09/16
30B9002DUS	US	2xXeon E5-2620 v4 8C/2.1GHz/20MB/85W/DDR4-2133	Open	2x16GB RDIMM DDR4-2400 ECC	Integrated Intel SATA	4	Open	1x1TB SSD M.2 PCIe NVMe Opal	HH DVD±RW	9-in-1	1300W 92%	None	USB / USB Optical	Windows 10 DG Windows 7 Pro 64	3-year, Onsite	No	12/16
30B9002EUS	US	2xXeon E5-2620 v4 8C/2.1GHz/20MB/85W/DDR4-2133	NVIDIA Quadro P5000 16GB	2x16GB RDIMM DDR4-2400 ECC	Integrated Intel SATA	4	Open	1x1TB SSD M.2 PCIe NVMe Opal	HH DVD±RW	9-in-1	1300W 92%	None	USB / USB Optical	Windows 10 DG Windows 7 Pro 64	3-year, Onsite	No	12/16
30B9002FUS	US	2xXeon E5-2620 v4 8C/2.1GHz/20MB/85W/DDR4-2133	NVIDIA Quadro P6000 24GB	2x16GB RDIMM DDR4-2400 ECC	Integrated Intel SATA	4	Open	1x1TB SSD M.2 PCIe NVMe Opal	HH DVD±RW	9-in-1	1300W 92%	None	USB / USB Optical	Windows 10 DG Windows 7 Pro 64	3-year, Onsite	No	12/16
30B90031--	WE	2xXeon E5-2640 v4 10C/2.4GHz/25MB/90W/DDR4-2133	NVIDIA Quadro P4000 8GB	2x16GB RDIMM DDR4-2400 ECC	Integrated Intel SATA	4	1x256GB SSD 2.5" SATA6Gbps Opal+1x2TB HDD 7.2K 3.5" SATA6Gbps	None	9.5mm DVD±RW	29-in-1	1300W 92%	Front eSATA	USB / USB Optical	Windows 10 Pro 64	3-year, Onsite	No	07/17
30B90032--	WE	1xXeon E5-2620 v4 8C/2.1GHz/20MB/85W/DDR4-2133	Open	1x8GB RDIMM DDR4-2400 ECC	Integrated Intel SATA	4	1x1TB HDD 7.2K 3.5" SATA6Gbps	None	HH DVD±RW	9-in-1	1300W 92%	Internal USB 3.0	USB / USB Optical	Windows 10 Pro 64	3-year, Onsite	No	09/17
30B90033--	WE	1xXeon E5-2630 v4 10C/2.2GHz/25MB/85W/DDR4-2133	Open	1x8GB RDIMM DDR4-2400 ECC	Integrated Intel SATA	4	1x256GB SSD 2.5" SATA6Gbps Opal	None	HH DVD±RW	9-in-1	1300W 92%	Internal USB 3.0	USB / USB Optical	Windows 10 Pro 64	3-year, Onsite	No	09/17
30B90034--	WE	2xXeon E5-2630 v4 10C/2.2GHz/25MB/85W/DDR4-2133	Open	4x8GB RDIMM DDR4-2400 ECC	Integrated Intel SATA	4	1x512GB SSD 2.5" SATA6Gbps	None	HH DVD±RW	9-in-1	1300W 92%	Internal USB 3.0	USB / USB Optical	Windows 10 Pro 64	3-year, Onsite	No	09/17
30B90035--	WE	2xXeon E5-2620 v4 8C/2.1GHz/20MB/85W/DDR4-2133	Open	4x8GB RDIMM DDR4-2400 ECC	Integrated Intel SATA	4	1x256GB SSD 2.5" SATA6Gbps Opal	None	HH DVD±RW	9-in-1	1300W 92%	Internal USB 3.0	USB / USB Optical	Windows 10 Pro 64	3-year, Onsite	No	09/17
30B90036--	WE	2xXeon E5-2650 v4 12C/2.2GHz/30MB/105W/DDR4-2400	NVIDIA Quadro P5000 16GB	2x16GB RDIMM DDR4-2400 ECC	Integrated Intel SATA	4	1x512GB SSD 2.5" SATA6Gbps+1x1TB HDD 7.2K 3.5" SATA6Gbps	None	9.0mm DVD	29-in-1	1300W 92%	None	USB / USB Optical	Windows 10 Pro 64	3-year, Onsite	No	09/17
30B90037--	WE	2xXeon E5-2640 v4 10C/2.4GHz/25MB/90W/DDR4-2133	NVIDIA Quadro P4000 8GB	2x16GB RDIMM DDR4-2400 ECC	Integrated Intel SATA	4	1x256GB SSD 2.5" SATA6Gbps Opal+1x1TB HDD 7.2K 3.5" SATA6Gbps	None	9.0mm DVD	29-in-1	1300W 92%	None	USB / USB Optical	Windows 10 Pro 64	3-year, Onsite	No	09/17
30B90030--	WE	2xXeon E5-2650 v4 12C/2.2GHz/30MB/105W/DDR4-2400	NVIDIA Quadro P5000 16GB	2x16GB RDIMM DDR4-2400 ECC	Integrated Intel SATA	4	1x512GB SSD 2.5" SATA6Gbps Opal+1x2TB HDD 7.2K 3.5" SATA6Gbps	None	9.5mm DVD±RW	29-in-1	1300W 92%	Front eSATA	USB / USB Optical	Windows 10 Pro 64	3-year, Onsite	No	07/17

Model	Region	Processor	Graphics	Memory	Storage Controller	Max Drives in 3.5" Bays	Disks	M.2 Drives	Optical	Media Reader	Power Supply	Optional Ports	Keyboard / Mouse	Operating System	Warranty	Global	Ann Date (mm/yy)
30B9000P--	WE	1xXeon E5-2643 v4 6C/3.4GHz/20MB/135W/DDR4-2400	Open	2x8GB RDIMM DDR4-2400 ECC	Integrated Intel SATA	4	1x1TB Hybrid HDD 7.2K 3.5" SATA6Gbps	None	Open	9-in-1	1300W 92%	2xUSB3.0	USB / USB Optical	Windows 10 DG Windows 7 Pro 64	3-year, Onsite	No	04/16
30B9000Q--	WE	2xXeon E5-2620 v4 8C/2.1GHz/20MB/85W/DDR4-2133	Open	2x8GB RDIMM DDR4-2400 ECC	Integrated Intel SATA	4	1x1TB Hybrid HDD 7.2K 3.5" SATA6Gbps	None	HH DVD±RW	9-in-1	1300W 92%	None	USB / USB Optical	Windows 10 DG Windows 7 Pro 64	3-year, Onsite	No	04/16
30B9000R--	WE	2xXeon E5-2630 v4 10C/2.2GHz/25MB/85W/DDR4-2133	Open	4x8GB RDIMM DDR4-2400 ECC	Integrated Intel SATA	4	1x512GB SSD 2.5" SATA6Gbps	None	HH DVD±RW	9-in-1	1300W 92%	None	USB / USB Optical	Windows 10 DG Windows 7 Pro 64	3-year, Onsite	No	04/16
30B9000S--	WE	2xXeon E5-2620 v4 8C/2.1GHz/20MB/85W/DDR4-2133	Open	2x8GB RDIMM DDR4-2400 ECC	Integrated Intel SATA	4	1x256GB SSD 2.5" SATA6Gbps Opal	None	HH DVD±RW	9-in-1	1300W 92%	None	USB / USB Optical	Windows 10 DG Windows 7 Pro 64	3-year, Onsite	No	04/16
30B9000T--	WE	1xXeon E5-2680 v4 14C/2.4GHz/35MB/120W/DDR4-2400	NVIDIA Quadro M6000 12GB	4x8GB RDIMM DDR4-2400 ECC	Integrated Intel SATA	4	Open	1x512GB SSD M.2 PCIe	HH DVD±RW	9-in-1	1300W 92%	None	USB / USB Optical	Windows 10 DG Windows 7 Pro 64	3-year, Onsite	No	04/16
30B9000U--	WE	1xXeon E5-2650 v4 12C/2.2GHz/30MB/105W/DDR4-2400	NVIDIA Quadro M4000 8GB	2x8GB RDIMM DDR4-2400 ECC	Integrated Intel SATA	4	Open	1x512GB SSD M.2 PCIe	HH DVD±RW	9-in-1	1300W 92%	None	USB / USB Optical	Windows 10 DG Windows 7 Pro 64	3-year, Onsite	No	04/16
30B9000V--	WE	2xXeon E5-2650 v4 12C/2.2GHz/30MB/105W/DDR4-2400	NVIDIA Quadro M5000 8GB	2x16GB RDIMM DDR4-2400 ECC	Integrated Intel SATA	4	Open	1x512GB SSD M.2 PCIe	HH DVD±RW	9-in-1	1300W 92%	None	USB / USB Optical	Windows 10 DG Windows 7 Pro 64	3-year, Onsite	No	04/16
30B9000M--	WE	1xXeon E5-2620 v3 6C/2.4GHz/15MB/85W/DDR4-1866	Open	1x8GB RDIMM DDR4-2400 ECC	Integrated Intel SATA	4	1x1TB HDD 7.2K 3.5" SATA6Gbps	None	Open	9-in-1	1300W 92%	2xUSB3.0	USB / USB Optical	Windows 10 DG Windows 7 Pro 64	3-year, Onsite	No	04/16
30B9000D--	WE	2xXeon E5-2620 v4 8C/2.1GHz/20MB/85W/DDR4-2133	Open	4x8GB RDIMM DDR4-2400 ECC	Integrated Intel SATA	4	1x256GB SSD 2.5" SATA6Gbps Opal	None	HH DVD±RW	9-in-1	1300W 92%	None	USB / USB Optical	Windows 10 Pro 64	3-year, Onsite	No	04/16
30B9000N--	WE	1xXeon E5-2630 v4 10C/2.2GHz/25MB/85W/DDR4-2133	Open	1x8GB RDIMM DDR4-2400 ECC	Integrated Intel SATA	4	1x256GB SSD 2.5" SATA6Gbps Opal	None	Open	9-in-1	1300W 92%	2xUSB3.0	USB / USB Optical	Windows 10 DG Windows 7 Pro 64	3-year, Onsite	No	04/16
30B9000B--	WE	1xXeon E5-2650 v4 12C/2.2GHz/30MB/105W/DDR4-2400	Open	2x8GB RDIMM DDR4-2400 ECC	Integrated Intel SATA	4	Open	1x512GB SSD M.2 PCIe	HH DVD±RW	9-in-1	1300W 92%	None	USB / USB Optical	Windows 10 Pro 64	3-year, Onsite	Global	04/16
30B9000C--	WE	1xXeon E5-2650 v4 12C/2.2GHz/30MB/105W/DDR4-2400	NVIDIA Quadro M4000 8GB	2x8GB RDIMM DDR4-2400 ECC	Integrated Intel SATA	4	Open	1x512GB SSD M.2 PCIe	HH DVD±RW	9-in-1	1300W 92%	None	USB / USB Optical	Windows 10 Pro 64	3-year, Onsite	Global	04/16
30B9000A--	WE	2xXeon E5-2650 v4 12C/2.2GHz/30MB/105W/DDR4-2400	NVIDIA Quadro M5000 8GB	2x16GB RDIMM DDR4-2400 ECC	Integrated Intel SATA	4	Open	1x512GB SSD M.2 PCIe	HH DVD±RW	9-in-1	1300W 92%	None	USB / USB Optical	Windows 10 Pro 64	3-year, Onsite	No	04/16

Model	Region	Processor	Graphics	Memory	Storage Controller	Max Drives in 3.5" Bays	Disks	M.2 Drives	Optical	Media Reader	Power Supply	Optional Ports	Keyboard / Mouse	Operating System	Warranty	Global	Ann Date (mm/yy)
30B90006--	WE	2xXeon E5-2630 v4 10C/2.2GHz/25MB/85W/DDR4-2133	Open	4x8GB RDIMM DDR4-2400 ECC	Integrated Intel SATA	4	1x512GB SSD 2.5" SATA6Gbps	None	HH DVD±RW	9-in-1	1300W 92%	None	USB / USB Optical	Windows 10 Pro 64	3-year, Onsite	No	04/16
30B90007--	WE	1xXeon E5-2643 v4 6C/3.4GHz/20MB/135W/DDR4-2400	Open	2x8GB RDIMM DDR4-2400 ECC	Integrated Intel SATA	4	1x1TB Hybrid HDD 7.2K 3.5" SATA6Gbps	None	HH DVD±RW	9-in-1	1300W 92%	None	USB / USB Optical	Windows 10 Pro 64	3-year, Onsite	No	04/16
30B90008--	WE	2xXeon E5-2620 v4 8C/2.1GHz/20MB/85W/DDR4-2133	Open	2x8GB RDIMM DDR4-2400 ECC	Integrated Intel SATA	4	1x256GB SSD 2.5" SATA6Gbps Opal	None	HH DVD±RW	9-in-1	1300W 92%	None	USB / USB Optical	Windows 10 Pro 64	3-year, Onsite	No	04/16
30B90009--	WE	1xXeon E5-2680 v4 14C/2.4GHz/35MB/120W/DDR4-2400	NVIDIA Quadro M6000 12GB	4x8GB RDIMM DDR4-2400 ECC	Integrated Intel SATA	4	Open	1x512GB SSD M.2 PCIe	HH DVD±RW	9-in-1	1300W 92%	None	USB / USB Optical	Windows 10 Pro 64	3-year, Onsite	No	04/16
30B90005--	WE	1xXeon E5-2620 v4 8C/2.1GHz/20MB/85W/DDR4-2133	Open	1x8GB RDIMM DDR4-2400 ECC	Integrated Intel SATA	4	1x1TB HDD 7.2K 3.5" SATA6Gbps	None	HH DVD±RW	9-in-1	1300W 92%	None	USB / USB Optical	Windows 10 Pro 64	3-year, Onsite	No	04/16
30B90004--	WE	1xXeon E5-2630 v4 10C/2.2GHz/25MB/85W/DDR4-2133	Open	1x8GB RDIMM DDR4-2400 ECC	Integrated Intel SATA	4	1x256GB SSD 2.5" SATA6Gbps Opal	None	HH DVD±RW	9-in-1	1300W 92%	None	USB / USB Optical	Windows 10 Pro 64	3-year, Onsite	No	04/16
30B90003--	WE	2xXeon E5-2620 v4 8C/2.1GHz/20MB/85W/DDR4-2133	Open	2x8GB RDIMM DDR4-2400 ECC	Integrated Intel SATA	4	1x1TB Hybrid HDD 7.2K 3.5" SATA6Gbps	None	HH DVD±RW	9-in-1	1300W 92%	None	USB / USB Optical	Windows 10 Pro 64	3-year, Onsite	No	04/16

ThinkStation P920 Platform Specifications

Product Specifications Reference (PSREF)

Components	Specification																																																																								
Form factor	55L Tower																																																																								
Dimensions	200mm/7.87" W x 620mm/24.4" D x 446mm/17.56" H (with feet)																																																																								
Weight	Maximum configuration: 71.3 lb (32.3kg)																																																																								
Processor	Up to two 205W Intel Xeon Scalable family processors, Bronze, Silver, Gold, or Platinum. Up to 28 cores at 2.5GHz, up to 3.6GHz with 4 cores. Two processors are connected with two UPI (Ultra Path Interconnect) links up to 10.4GT/s																																																																								
Chipset	Intel C621 Chipset																																																																								
Memory	Up to 16 DIMM sockets. Each processor supports up to 8 DIMM sockets with 6 channels. DDR4-2666. RDIMMs and LRDIMMs are supported, but memory types cannot be intermixed																																																																								
Memory capacity	Up to 512GB with 16 x 32GB RDIMMs and two processors. Or up to 1TB with 16 x 64GB LRDIMMs and two processors																																																																								
Memory protection	ECC																																																																								
Graphics	Up to five PCIe 3.0 x16 slots depending on the processors installed (see Expansion slots section). Up to three NVIDIA Quadro P6000 or Quadro P5000, or up to four Quadro P4000, or up to two NVS 810. Other graphics adapters under 75W up to 5. Supports the following graphics adapters:																																																																								
	<table border="1"> <thead> <tr> <th>Adapter</th> <th>Cores</th> <th>Memory</th> <th>Power</th> <th>Connector</th> <th>SLI</th> </tr> </thead> <tbody> <tr> <td>NVS 310</td> <td>48</td> <td>1GB</td> <td>19.5W</td> <td>2xDP</td> <td></td> </tr> <tr> <td>NVS 315</td> <td>48</td> <td>1GB</td> <td>19.3W</td> <td>2xDVI-I SL/2xDP</td> <td></td> </tr> <tr> <td>NVS 510</td> <td>192</td> <td>2GB</td> <td>33.4W</td> <td>4xmini DP</td> <td></td> </tr> <tr> <td>NVS 810</td> <td>1024</td> <td>4GB</td> <td>68W</td> <td>8xmini DP</td> <td></td> </tr> <tr> <td>Quadro P400</td> <td>256</td> <td>2GB</td> <td>30W</td> <td>3xminiDP</td> <td></td> </tr> <tr> <td>Quadro P600</td> <td>384</td> <td>2GB</td> <td>45W</td> <td>4xminiDP</td> <td></td> </tr> <tr> <td>Quadro P1000</td> <td>640</td> <td>4GB</td> <td>50W</td> <td>4xminiDP</td> <td></td> </tr> <tr> <td>Quadro P2000</td> <td>1024</td> <td>5GB</td> <td>75W</td> <td>4xDP</td> <td></td> </tr> <tr> <td>Quadro P4000</td> <td>1792</td> <td>8GB</td> <td>120W</td> <td>4xDP</td> <td></td> </tr> <tr> <td>Quadro P5000</td> <td>2560</td> <td>16GB</td> <td>180W</td> <td>DVI-D DL+4xDP</td> <td>SLI</td> </tr> <tr> <td>Quadro P6000</td> <td>3840</td> <td>24GB</td> <td>250W</td> <td>DVI-D DL+4xDP</td> <td>SLI</td> </tr> </tbody> </table>	Adapter	Cores	Memory	Power	Connector	SLI	NVS 310	48	1GB	19.5W	2xDP		NVS 315	48	1GB	19.3W	2xDVI-I SL/2xDP		NVS 510	192	2GB	33.4W	4xmini DP		NVS 810	1024	4GB	68W	8xmini DP		Quadro P400	256	2GB	30W	3xminiDP		Quadro P600	384	2GB	45W	4xminiDP		Quadro P1000	640	4GB	50W	4xminiDP		Quadro P2000	1024	5GB	75W	4xDP		Quadro P4000	1792	8GB	120W	4xDP		Quadro P5000	2560	16GB	180W	DVI-D DL+4xDP	SLI	Quadro P6000	3840	24GB	250W	DVI-D DL+4xDP	SLI
	Adapter	Cores	Memory	Power	Connector	SLI																																																																			
	NVS 310	48	1GB	19.5W	2xDP																																																																				
	NVS 315	48	1GB	19.3W	2xDVI-I SL/2xDP																																																																				
	NVS 510	192	2GB	33.4W	4xmini DP																																																																				
	NVS 810	1024	4GB	68W	8xmini DP																																																																				
	Quadro P400	256	2GB	30W	3xminiDP																																																																				
	Quadro P600	384	2GB	45W	4xminiDP																																																																				
	Quadro P1000	640	4GB	50W	4xminiDP																																																																				
Quadro P2000	1024	5GB	75W	4xDP																																																																					
Quadro P4000	1792	8GB	120W	4xDP																																																																					
Quadro P5000	2560	16GB	180W	DVI-D DL+4xDP	SLI																																																																				
Quadro P6000	3840	24GB	250W	DVI-D DL+4xDP	SLI																																																																				
Storage controllers	Integrated Intel SATA AHCI/RAID controller in chipset, 6Gbps SATA, RAID 0/1/10/5. Integrated Intel PCIe host in processor for M.2 PCIe NVMe drives, optional RAID 0/1/10 with Intel NVMe RAID upgrade basic, optional RAID 0/1/10/5 with Intel NVMe RAID upgrade premium. Optional Broadcom 9440-8i, PCIe adapter, 12Gbps, SATA/SAS, RAID 0/1/10/5. Or optional Broadcom 9460-16i with 4GB DDR4 memory and SuperCap, PCIe adapter, 12Gbps, SATA/SAS, RAID 0/1/10/5/6																																																																								
5.25" flex bay	Three 5.25" flex bays, supports the following: <ul style="list-style-type: none"> Up to three half-height optical drives. Up to two 5.25" slim ODD cages, each supports one 9.0mm optical drive. Up to one 5.25" slim ODD and HDD cage for one 9.0mm optical drive plus one 3.5" or 2.5" SATA disk. Up to one Front Access Storage Enclosure for one 3.5" or 2.5" SATA disk. Up to one flex module for one or more of the following options: 9.0mm optical/15-in-1 USB 3.0 reader/front eSATA/front Thunderbolt) <i>Note: Only one can be supported from 15-in-1 reader and Thunderbolt</i>																																																																								
Disk drive bays	Four internal 3.5" dual drive bays (two standard, two optional), supports up to eight 2.5" SATA SSD or 2.5" SAS HDD, or up to four 3.5" SATA HDD (over 6 disk drives or SAS disk support needs 9440-8i or 9460-16i). Supports up to four 2.5" U.2 SSD on selected models. Supports up to two 2.5" or 3.5" SATA disks on 5.25" flex bays via one 5.25" Front Access Storage Enclosure plus one 5.25" slim ODD and HDD cage																																																																								
M.2 slots	Up to 9 x M.2 PCIe NVMe SSD: <ul style="list-style-type: none"> Two onboard M.2 slots. Up to one full height, full length PCIe 3.0 x16 adapter, supports four M.2 slots. Up to three PCIe 3.0 x4 adapters, each adapter supports one M.2 slot <i>Note: Supports RAID 0/1 on onboard M.2 disks and RAID 0/1/10/5 on quad M.2 PCIe x16 adapter, NVMe RAID upgrade is needed</i>																																																																								
Internal storage	<table border="1"> <thead> <tr> <th>HDD 7.2K 3.5" SATA6Gbps</th> <th>1TB/2TB/4TB/6TB</th> </tr> </thead> <tbody> <tr> <td>SSD 2.5" SATA6Gbps</td> <td>256GB Opal/512GB/512GB Opal/1TB Opal/2TB Opal</td> </tr> <tr> <td>M.2 PCIe NVMe, PCIe 3.0 x4</td> <td>256GB Opal/512GB Opal/1TB Opal</td> </tr> </tbody> </table>	HDD 7.2K 3.5" SATA6Gbps	1TB/2TB/4TB/6TB	SSD 2.5" SATA6Gbps	256GB Opal/512GB/512GB Opal/1TB Opal/2TB Opal	M.2 PCIe NVMe, PCIe 3.0 x4	256GB Opal/512GB Opal/1TB Opal																																																																		
HDD 7.2K 3.5" SATA6Gbps	1TB/2TB/4TB/6TB																																																																								
SSD 2.5" SATA6Gbps	256GB Opal/512GB/512GB Opal/1TB Opal/2TB Opal																																																																								
M.2 PCIe NVMe, PCIe 3.0 x4	256GB Opal/512GB Opal/1TB Opal																																																																								
Media reader	9-in-1 USB 2.0 card reader on most models. Optional UHS-II 15-in-1 USB 3.0 reader on flex module																																																																								
Network interfaces	Integrated two-port gigabit ethernet (Intel i219LM and i210AT), supports Wake-on-LAN on both two ports. Optional PCIe ethernet or wireless adapters are available																																																																								

Components	Specification		
Security features	Power-on and admin password. Trusted Platform Module, TCG 2.0 compliant, switch to 1.2 via UEFI setting. Chassis intrusion switch. Optional access panel lock, Kensington lock, and pad lock		
Systems management	Intel Active Management Technology 11. Front 4-digit diagnostic display. ThinkStation Diagnostics for Windows. Photo-audio transfer with Lenovo PC Diagnostics for Android and iOS		
Base warranty	1 or 3-year limited onsite service with 9x5/NBD		
HD Audio	Realtek ALC662 codec		
Front ports	Four USB 3.0 (includes one 11W charging), one combo audio/microphone jack (3.5mm)		
Rear ports	Two USB 2.0, four USB 3.0, two ethernet (RJ-45), three analog audio ports (line-in, line-out, mic-in), two PS/2		
Optional ports	Supports the following optional ports: <ul style="list-style-type: none"> Optional COM port Two USB Type-C ports via PCIe adapter, USB 3.1 gen 2. One 15W, one 5W Two Thunderbolt ports (USB Type-C) on flex module, one of two ports supports video-out. One eSATA on flex module One internal USB 3.0 port 		
Power supply	One fixed 1400 watts, autosensing, 92% PSU, 80 PLUS Platinum qualified. Countries with input voltage under 115V, output power limited to 1125 watts		
Environmental specification	Temperature - operating	50 °F to 95 °F (10 °C to 35 °C)	
	Temperature - non operating (no package)	14 °F to 140 °F (-10 °C to 60 °C)	
	Temperature - non operating (with package)	-40 °F to 140 °F (-40 °C to 60 °C)	
	Altitude - operating	(Unpressurized): 0-10000ft (0-3048m)	
	Humidity - operating	10%-80%, non-condensing	
	Humidity - storage (with package)	10%-90%, non-condensing	
	RoHS-compliant. GREENGUARD. EPEAT Gold rating and ENERGY STAR 6.1 qualified on following models:		
	Model	30BC0008US	30BC0009US
	Processor	2 x Intel Xeon Gold 5115	2 x Intel Xeon Gold 5120
	Memory	4 x 8GB RDIMM DDR4-2666 ECC	4 x 8GB RDIMM DDR4-2666 ECC
Disks	2 x 256GB SSD 2.5" SATA6Gbps Opal	2 x 512GB SSD 2.5" SATA6Gbps	
Graphics	NVIDIA Quadro P4000 8GB	NVIDIA Quadro P5000 16GB	
Optical	HH DVD±RW	HH DVD±RW	
PSU	1400W PSU	1400W PSU	
OS	Win10 Pro 64	Win10 Pro 64	
ISV certifications	Please visit www.thinkworkstations.com/isv-certifications/		

Expansion slots

Slot 1 (CPU1)	PCIe 3.0 x16, full height, full length, 75W, double-width
Slot 2 (CPU1)	PCIe 3.0 x4, full height, full length, 25W, open ended
Slot 3 (CPU1)	PCIe 3.0 x16, full height, full length, 75W, double-width
Slot 4 (CPU1)	PCIe 3.0 x4, full height, full length, 25W, open ended
Slot 5 (PCH)	PCIe 3.0 x4, full height, half length, 25W, open ended
Slot 6 (CPU2)	PCIe 3.0 x16, full height, half length, 75W
Slot 7 (CPU2)	PCIe 3.0 x16, full height, full length, 75W, double-width
Slot 8 (CPU2)	PCIe 3.0 x16, full height, full length, 75W

Supports two 6+2-pin aux power connectors on slot 1 - 5, one 6+2-pin and one 6-pin aux power connectors on slot 6 - 8.

Note: All expansion cards are optional

Model	Region	Processor	Graphics	Memory	Storage Controller	M.2 RAID Upgrade	Disks	M.2 Drives	Optical	Media Reader	Power Supply	Optional Ports	Front Diagnostic LED	Keyboard / Mouse	Operating System	Warranty	Global	Ann Date (mm/yy)
30BC000Qxx	CIS	2x Xeon Silver 4114 10C/2.2GHz/13.75MB/85W/DDR4-2400	Open	4x 8GB RDIMM DDR4-2666 ECC	Integrated Intel SATA	None	1x 512GB SSD 2.5" SATA6Gbps Opal	None	1x HH DVD±RW	9-in-1	Fixed 1400W Platinum	1x Serial	4-digit LED	USB / USB Optical	Windows 10 Pro 64	3-year, Onsite	No	09/17
30BC0015xx	CIS	2x Xeon Gold 6136 12C/3.0GHz/24.75MB/150W/DDR4-2666	Open	2x 16GB RDIMM DDR4-2666 ECC	Integrated Intel SATA	RAID 0/1/10	1x 2TB HDD 7.2K 3.5" SATA6Gbps	1x 512GB SSD M.2 PCIe Opal	1x HH DVD±RW	15-in-1	Fixed 1400W Platinum	1x Serial, 2x USB 3.1 Gen 2 Type-C	4-digit LED	USB / USB Optical	Windows 10 Pro 64	3-year, Onsite	No	12/17
30BC001Mxx	CIS	2x Xeon Silver 4114 10C/2.2GHz/13.75MB/85W/DDR4-2400	Open	2x 16GB RDIMM DDR4-2666 ECC	Integrated Intel SATA	None	None	1x 512GB SSD M.2 PCIe Opal	1x HH DVD±RW	9-in-1	Fixed 1400W Platinum	1x Serial	4-digit LED	USB / USB Optical	Windows 10 Pro 64	3-year, Onsite	No	03/18
30BC001Kxx	EET	2x Xeon Gold 6136 12C/3.0GHz/24.75MB/150W/DDR4-2666	Open	2x 16GB RDIMM DDR4-2666 ECC	Integrated Intel SATA	RAID 0/1/10	1x 2TB HDD 7.2K 3.5" SATA6Gbps	1x 512GB SSD M.2 PCIe Opal	1x HH DVD±RW	15-in-1	Fixed 1400W Platinum	1x Serial, 2x USB 3.1 Gen 2 Type-C	4-digit LED	USB / USB Optical	Windows 10 Pro 64	3-year, Onsite	No	03/18
30BC001Qxx	EET	2x Xeon Gold 5118 12C/2.3GHz/16.5MB/105W/DDR4-2400	Open	2x 16GB RDIMM DDR4-2666 ECC	Integrated Intel SATA	None	1x 1TB HDD 7.2K 3.5" SATA6Gbps	1x 512GB SSD M.2 PCIe Opal	1x HH DVD±RW	15-in-1	Fixed 1400W Platinum	1x Serial, 1x Internal USB 3.0	4-digit LED	USB / USB Optical	Windows 10 Pro 64	3-year, Onsite	No	04/18
30BC0014xx	EET	1x Xeon Gold 5118 12C/2.3GHz/16.5MB/105W/DDR4-2400	Open	1x 16GB RDIMM DDR4-2666 ECC	Integrated Intel SATA	RAID 0/1/10	None	4x 512GB SSD M.2 PCIe Opal	1x HH DVD±RW	9-in-1	Fixed 1400W Platinum	1x Serial	4-digit LED	USB / USB Optical	Windows 10 Pro 64	3-year, Onsite	No	02/18
30BC001Bxx	EET	1x Xeon Silver 4110 8C/2.1GHz/11MB/85W/DDR4-2400	Open	1x 8GB RDIMM DDR4-2666 ECC	Integrated Intel SATA	None	1x 1TB HDD 7.2K 3.5" SATA6Gbps	None	1x HH DVD±RW	9-in-1	Fixed 1400W Platinum	1x Serial	4-digit LED	USB / USB Optical	Windows 10 Pro 64	3-year, Onsite	No	02/18
30BC001Cxx	EET	1x Xeon Silver 4114 10C/2.2GHz/13.75MB/85W/DDR4-2400	Open	1x 16GB RDIMM DDR4-2666 ECC	Integrated Intel SATA	None	1x 512GB SSD 2.5" SATA6Gbps Opal	None	1x HH DVD±RW	9-in-1	Fixed 1400W Platinum	1x Serial	4-digit LED	USB / USB Optical	Windows 10 Pro 64	3-year, Onsite	No	02/18
30BC001Dxx	EET	2x Xeon Silver 4114 10C/2.2GHz/13.75MB/85W/DDR4-2400	Open	2x 16GB RDIMM DDR4-2666 ECC	Integrated Intel SATA	None	1x 512GB SSD 2.5" SATA6Gbps Opal	None	1x HH DVD±RW	9-in-1	Fixed 1400W Platinum	1x Serial	4-digit LED	USB / USB Optical	Windows 10 Pro 64	3-year, Onsite	No	02/18
30BC001Exx	EET	2x Xeon Silver 4110 8C/2.1GHz/11MB/85W/DDR4-2400	Open	2x 16GB RDIMM DDR4-2666 ECC	Integrated Intel SATA	None	1x 512GB SSD 2.5" SATA6Gbps Opal	None	1x HH DVD±RW	9-in-1	Fixed 1400W Platinum	1x Serial	4-digit LED	USB / USB Optical	Windows 10 Pro 64	3-year, Onsite	No	02/18

Model	Region	Processor	Graphics	Memory	Storage Controller	M.2 RAID Upgrade	Disks	M.2 Drives	Optical	Media Reader	Power Supply	Optional Ports	Front Diagnostic LED	Keyboard / Mouse	Operating System	Warranty	Global	Ann Date (mm/yy)
30BC001Fxx	EET	2x Xeon Gold 5118 12C/2.3GHz/16.5MB/105W/DDR4-2400	1x NVIDIA Quadro P5000 16GB	4x 16GB RDIMM DDR4-2666 ECC	Integrated Intel SATA	None	1x 512GB SSD 2.5" SATA6Gbps Opal, 1x 1TB HDD 7.2K 3.5"	None	1x HH DVD±RW	9-in-1	Fixed 1400W Platinum	1x Serial	4-digit LED	USB / USB Optical	Windows 10 Pro 64	3-year, Onsite	No	02/18
30BC001Gxx	EET	2x Xeon Silver 4116 12C/2.1GHz/16.5MB/85W/DDR4-2400	1x NVIDIA Quadro P4000 8GB	4x 16GB RDIMM DDR4-2666 ECC	Integrated Intel SATA	None	1x 512GB SSD 2.5" SATA6Gbps Opal, 1x 1TB HDD 7.2K 3.5"	None	1x HH DVD±RW	9-in-1	Fixed 1400W Platinum	1x Serial	4-digit LED	USB / USB Optical	Windows 10 Pro 64	3-year, Onsite	No	02/18
30BC000Rxx	EET	2x Xeon Silver 4110 8C/2.1GHz/11MB/85W/DDR4-2400	Open	4x 8GB RDIMM DDR4-2666 ECC	Integrated Intel SATA	None	1x 512GB SSD 2.5" SATA6Gbps Opal	None	1x HH DVD±RW	9-in-1	Fixed 1400W Platinum	1x Serial	4-digit LED	USB / USB Optical	Windows 10 Pro 64	3-year, Onsite	No	09/17
30BC000Sxx	EET	2x Xeon Gold 5118 12C/2.3GHz/16.5MB/105W/DDR4-2400	1x NVIDIA Quadro P5000 16GB	4x 16GB RDIMM DDR4-2666 ECC	Integrated Intel SATA	None	1x 512GB SSD 2.5" SATA6Gbps Opal, 1x 1TB HDD 7.2K 3.5"	None	1x HH DVD±RW	9-in-1	Fixed 1400W Platinum	1x Serial	4-digit LED	USB / USB Optical	Windows 10 Pro 64	3-year, Onsite	No	09/17
30BC000Txx	EET	2x Xeon Silver 4116 12C/2.1GHz/16.5MB/85W/DDR4-2400	1x NVIDIA Quadro P4000 8GB	4x 16GB RDIMM DDR4-2666 ECC	Integrated Intel SATA	None	1x 512GB SSD 2.5" SATA6Gbps Opal, 1x 1TB HDD 7.2K 3.5"	None	1x HH DVD±RW	9-in-1	Fixed 1400W Platinum	1x Serial	4-digit LED	USB / USB Optical	Windows 10 Pro 64	3-year, Onsite	No	09/17
30BC000Nxx	EET	1x Xeon Silver 4110 8C/2.1GHz/11MB/85W/DDR4-2400	Open	1x 8GB RDIMM DDR4-2666 ECC	Integrated Intel SATA	None	1x 1TB HDD 7.2K 3.5" SATA6Gbps	None	1x HH DVD±RW	9-in-1	Fixed 1400W Platinum	1x Serial	4-digit LED	USB / USB Optical	Windows 10 Pro 64	3-year, Onsite	No	09/17
30BC000Pxx	EET	1x Xeon Silver 4114 10C/2.2GHz/13.75MB/85W/DDR4-2400	Open	2x 8GB RDIMM DDR4-2666 ECC	Integrated Intel SATA	None	1x 512GB SSD 2.5" SATA6Gbps Opal	None	1x HH DVD±RW	9-in-1	Fixed 1400W Platinum	1x Serial	4-digit LED	USB / USB Optical	Windows 10 Pro 64	3-year, Onsite	No	09/17
30BC000P**	MEA	1x Xeon Silver 4114 10C/2.2GHz/13.75MB/85W/DDR4-2400	Open	2x 8GB RDIMM DDR4-2666 ECC	Integrated Intel SATA	None	1x 512GB SSD 2.5" SATA6Gbps Opal	None	1x HH DVD±RW	9-in-1	Fixed 1400W Platinum	1x Serial	4-digit LED	USB / USB Optical	Windows 10 Pro 64	3-year, Onsite	No	09/17
30BC000Q**	MEA	2x Xeon Silver 4114 10C/2.2GHz/13.75MB/85W/DDR4-2400	Open	4x 8GB RDIMM DDR4-2666 ECC	Integrated Intel SATA	None	1x 512GB SSD 2.5" SATA6Gbps Opal	None	1x HH DVD±RW	9-in-1	Fixed 1400W Platinum	1x Serial	4-digit LED	USB / USB Optical	Windows 10 Pro 64	3-year, Onsite	No	09/17
30BC000N**	MEA	1x Xeon Silver 4110 8C/2.1GHz/11MB/85W/DDR4-2400	Open	1x 8GB RDIMM DDR4-2666 ECC	Integrated Intel SATA	None	1x 1TB HDD 7.2K 3.5" SATA6Gbps	None	1x HH DVD±RW	9-in-1	Fixed 1400W Platinum	1x Serial	4-digit LED	USB / USB Optical	Windows 10 Pro 64	3-year, Onsite	No	09/17

Model	Region	Processor	Graphics	Memory	Storage Controller	M.2 RAID Upgrade	Disks	M.2 Drives	Optical	Media Reader	Power Supply	Optional Ports	Front Diagnostic LED	Keyboard / Mouse	Operating System	Warranty	Global	Ann Date (mm/yy)
30BC000R**	MEA	2x Xeon Silver 4110 8C/2.1GHz/11MB/85W/DDR4-2400	Open	4x 8GB RDIMM DDR4-2666 ECC	Integrated Intel SATA	None	1x 512GB SSD 2.5" SATA6Gbps Opal	None	1x HH DVD±RW	9-in-1	Fixed 1400W Platinum	1x Serial	4-digit LED	USB / USB Optical	Windows 10 Pro 64	3-year, Onsite	No	09/17
30BC000S**	MEA	2x Xeon Gold 5118 12C/2.3GHz/16.5MB/105W/DDR4-2400	1x NVIDIA Quadro P5000 16GB	4x 16GB RDIMM DDR4-2666 ECC	Integrated Intel SATA	None	1x 512GB SSD 2.5" SATA6Gbps Opal, 1x 1TB HDD 7.2K 3.5"	None	1x HH DVD±RW	9-in-1	Fixed 1400W Platinum	1x Serial	4-digit LED	USB / USB Optical	Windows 10 Pro 64	3-year, Onsite	No	09/17
30BC001E**	MEA	2x Xeon Silver 4110 8C/2.1GHz/11MB/85W/DDR4-2400	Open	2x 16GB RDIMM DDR4-2666 ECC	Integrated Intel SATA	None	1x 512GB SSD 2.5" SATA6Gbps Opal	None	1x HH DVD±RW	9-in-1	Fixed 1400W Platinum	1x Serial	4-digit LED	USB / USB Optical	Windows 10 Pro 64	3-year, Onsite	No	02/18
30BC001F**	MEA	2x Xeon Gold 5118 12C/2.3GHz/16.5MB/105W/DDR4-2400	1x NVIDIA Quadro P5000 16GB	4x 16GB RDIMM DDR4-2666 ECC	Integrated Intel SATA	None	1x 512GB SSD 2.5" SATA6Gbps Opal, 1x 1TB HDD 7.2K 3.5"	None	1x HH DVD±RW	9-in-1	Fixed 1400W Platinum	1x Serial	4-digit LED	USB / USB Optical	Windows 10 Pro 64	3-year, Onsite	No	02/18
30BC001C**	MEA	1x Xeon Silver 4114 10C/2.2GHz/13.75MB/85W/DDR4-2400	Open	1x 16GB RDIMM DDR4-2666 ECC	Integrated Intel SATA	None	1x 512GB SSD 2.5" SATA6Gbps Opal	None	1x HH DVD±RW	9-in-1	Fixed 1400W Platinum	1x Serial	4-digit LED	USB / USB Optical	Windows 10 Pro 64	3-year, Onsite	No	02/18
30BC001D**	MEA	2x Xeon Silver 4114 10C/2.2GHz/13.75MB/85W/DDR4-2400	Open	2x 16GB RDIMM DDR4-2666 ECC	Integrated Intel SATA	None	1x 512GB SSD 2.5" SATA6Gbps Opal	None	1x HH DVD±RW	9-in-1	Fixed 1400W Platinum	1x Serial	4-digit LED	USB / USB Optical	Windows 10 Pro 64	3-year, Onsite	No	02/18
30BC0015**	MEA	2x Xeon Gold 6136 12C/3.0GHz/24.75MB/150W/DDR4-2666	Open	2x 16GB RDIMM DDR4-2666 ECC	Integrated Intel SATA	RAID 0/1/10	1x 2TB HDD 7.2K 3.5" SATA6Gbps	1x 512GB SSD M.2 PCIe Opal	1x HH DVD±RW	15-in-1	Fixed 1400W Platinum	1x Serial, 2x USB 3.1 Gen 2 Type-C	4-digit LED	USB / USB Optical	Windows 10 Pro 64	3-year, Onsite	No	12/17
30BC001B**	MEA	1x Xeon Silver 4110 8C/2.1GHz/11MB/85W/DDR4-2400	Open	1x 8GB RDIMM DDR4-2666 ECC	Integrated Intel SATA	None	1x 1TB HDD 7.2K 3.5" SATA6Gbps	None	1x HH DVD±RW	9-in-1	Fixed 1400W Platinum	1x Serial	4-digit LED	USB / USB Optical	Windows 10 Pro 64	3-year, Onsite	No	02/18
30BC000T**	MEA	2x Xeon Silver 4116 12C/2.1GHz/16.5MB/85W/DDR4-2400	1x NVIDIA Quadro P4000 8GB	4x 16GB RDIMM DDR4-2666 ECC	Integrated Intel SATA	None	1x 512GB SSD 2.5" SATA6Gbps Opal, 1x 1TB HDD 7.2K 3.5" SATA6Gbps	None	1x HH DVD±RW	9-in-1	Fixed 1400W Platinum	1x Serial	4-digit LED	USB / USB Optical	Windows 10 Pro 64	3-year, Onsite	No	09/17
30BC0014**	MEA	1x Xeon Gold 5118 12C/2.3GHz/16.5MB/105W/DDR4-2400	Open	1x 16GB RDIMM DDR4-2666 ECC	Integrated Intel SATA	RAID 0/1/10	None	4x 512GB SSD M.2 PCIe Opal	1x HH DVD±RW	9-in-1	Fixed 1400W Platinum	1x Serial	4-digit LED	USB / USB Optical	Windows 10 Pro 64	3-year, Onsite	No	02/18

Model	Region	Processor	Graphics	Memory	Storage Controller	M.2 RAID Upgrade	Disks	M.2 Drives	Optical	Media Reader	Power Supply	Optional Ports	Front Diagnostic LED	Keyboard / Mouse	Operating System	Warranty	Global	Ann Date (mm/yy)
30BC001R**	MEA	2x Xeon Gold 6136 12C/3.0GHz/24.75MB/150W/DDR4-2666	Open	2x 16GB RDIMM DDR4-2666 ECC	Integrated Intel SATA	RAID 0/1/10	1x 2TB HDD 7.2K 3.5" SATA6Gbps	1x 512GB SSD M.2 PCIe Opal	1x HH DVD±RW	15-in-1	Fixed 1400W Platinum	1x Serial, 1x Internal USB 3.0, 2x USB 3.1 Gen 2 Type-C	4-digit LED	USB / USB Optical	Windows 10 Pro 64	3-year, Onsite	No	04/18
30BC001G**	MEA	2x Xeon Silver 4116 12C/2.1GHz/16.5MB/85W/DDR4-2400	1x NVIDIA Quadro P4000 8GB	4x 16GB RDIMM DDR4-2666 ECC	Integrated Intel SATA	None	1x 512GB SSD 2.5" SATA6Gbps Opal, 1x 1TB HDD 7.2K 3.5" SATA6Gbps	None	1x HH DVD±RW	9-in-1	Fixed 1400W Platinum	1x Serial	4-digit LED	USB / USB Optical	Windows 10 Pro 64	3-year, Onsite	No	02/18
30BC001K**	MEA	2x Xeon Gold 6136 12C/3.0GHz/24.75MB/150W/DDR4-2666	Open	2x 16GB RDIMM DDR4-2666 ECC	Integrated Intel SATA	RAID 0/1/10	1x 2TB HDD 7.2K 3.5" SATA6Gbps	1x 512GB SSD M.2 PCIe Opal	1x HH DVD±RW	15-in-1	Fixed 1400W Platinum	1x Serial, 2x USB 3.1 Gen 2 Type-C	4-digit LED	USB / USB Optical	Windows 10 Pro 64	3-year, Onsite	No	03/18
30BC001M**	MEA	2x Xeon Silver 4114 10C/2.2GHz/13.75MB/85W/DDR4-2400	Open	2x 16GB RDIMM DDR4-2666 ECC	Integrated Intel SATA	None	None	1x 512GB SSD M.2 PCIe Opal	1x HH DVD±RW	9-in-1	Fixed 1400W Platinum	1x Serial	4-digit LED	USB / USB Optical	Windows 10 Pro 64	3-year, Onsite	No	03/18
30BC001Q**	MEA	2x Xeon Gold 5118 12C/2.3GHz/16.5MB/105W/DDR4-2400	Open	2x 16GB RDIMM DDR4-2666 ECC	Integrated Intel SATA	None	1x 1TB HDD 7.2K 3.5" SATA6Gbps	1x 512GB SSD M.2 PCIe Opal	1x HH DVD±RW	15-in-1	Fixed 1400W Platinum	1x Serial, 1x Internal USB 3.0	4-digit LED	USB / USB Optical	Windows 10 Pro 64	3-year, Onsite	No	04/18
30BC001Rxx	Russia	2x Xeon Gold 6136 12C/3.0GHz/24.75MB/150W/DDR4-2666	Open	2x 16GB RDIMM DDR4-2666 ECC	Integrated Intel SATA	RAID 0/1/10	1x 2TB HDD 7.2K 3.5" SATA6Gbps	1x 512GB SSD M.2 PCIe Opal	1x HH DVD±RW	15-in-1	Fixed 1400W Platinum	1x Serial, 1x Internal USB 3.0, 2x USB 3.1 Gen 2 Type-C	4-digit LED	USB / USB Optical	Windows 10 Pro 64	3-year, Onsite	No	04/18
30BC0017CA	US	2x Xeon Silver 4110 8C/2.1GHz/11MB/85W/DDR4-2400	Open	2x 8GB RDIMM DDR4-2666 ECC	Integrated Intel SATA	None	None	1x 512GB SSD M.2 PCIe Opal	1x HH DVD±RW	9-in-1	Fixed 1400W Platinum	None	4-digit LED	USB / USB Optical	Windows 10 Pro 64	3-year, Onsite	No	02/18
30BC0017CC	US	2x Xeon Silver 4110 8C/2.1GHz/11MB/85W/DDR4-2400	Open	2x 8GB RDIMM DDR4-2666 ECC	Integrated Intel SATA	None	None	1x 512GB SSD M.2 PCIe Opal	1x HH DVD±RW	9-in-1	Fixed 1400W Platinum	None	4-digit LED	USB / USB Optical	Windows 10 Pro 64	3-year, Onsite	No	02/18
30BC0017US	US	2x Xeon Silver 4110 8C/2.1GHz/11MB/85W/DDR4-2400	Open	2x 8GB RDIMM DDR4-2666 ECC	Integrated Intel SATA	None	None	1x 512GB SSD M.2 PCIe Opal	1x HH DVD±RW	9-in-1	Fixed 1400W Platinum	None	4-digit LED	USB / USB Optical	Windows 10 Pro 64	3-year, Onsite	No	02/18
30BC0018CA	US	1x Xeon Silver 4114 10C/2.2GHz/13.75MB/85W/DDR4-2400	Open	2x 8GB RDIMM DDR4-2666 ECC	Integrated Intel SATA	None	1x 1TB HDD 7.2K 3.5" SATA6Gbps	None	1x HH DVD±RW	9-in-1	Fixed 1400W Platinum	None	4-digit LED	USB / None	Windows 10 Pro 64	3-year, Onsite	No	02/18

Model	Region	Processor	Graphics	Memory	Storage Controller	M.2 RAID Upgrade	Disks	M.2 Drives	Optical	Media Reader	Power Supply	Optional Ports	Front Diagnostic LED	Keyboard / Mouse	Operating System	Warranty	Global	Ann Date (mm/yy)
30BC0018CC	US	1x Xeon Silver 4114 10C/2.2GHz/13.75MB/85W/DDR4-2400	Open	2x 8GB RDIMM DDR4-2666 ECC	Integrated Intel SATA	None	1x 1TB HDD 7.2K 3.5" SATA6Gbps	None	1x HH DVD±RW	9-in-1	Fixed 1400W Platinum	None	4-digit LED	USB / None	Windows 10 Pro 64	3-year, Onsite	No	02/18
30BC0018US	US	1x Xeon Silver 4114 10C/2.2GHz/13.75MB/85W/DDR4-2400	Open	2x 8GB RDIMM DDR4-2666 ECC	Integrated Intel SATA	None	1x 1TB HDD 7.2K 3.5" SATA6Gbps	None	1x HH DVD±RW	9-in-1	Fixed 1400W Platinum	None	4-digit LED	USB / None	Windows 10 Pro 64	3-year, Onsite	No	02/18
30BC0019CA	US	1x Xeon Gold 5118 12C/2.3GHz/16.5MB/105W/DDR4-2400	Open	2x 8GB RDIMM DDR4-2666 ECC	Integrated Intel SATA	None	None	1x 512GB SSD M.2 PCIe Opal	1x HH DVD±RW	9-in-1	Fixed 1400W Platinum	None	4-digit LED	USB / USB Optical	Windows 10 Pro 64	3-year, Onsite	No	02/18
30BC0019CC	US	1x Xeon Gold 5118 12C/2.3GHz/16.5MB/105W/DDR4-2400	Open	2x 8GB RDIMM DDR4-2666 ECC	Integrated Intel SATA	None	None	1x 512GB SSD M.2 PCIe Opal	1x HH DVD±RW	9-in-1	Fixed 1400W Platinum	None	4-digit LED	USB / USB Optical	Windows 10 Pro 64	3-year, Onsite	No	02/18
30BC0019US	US	1x Xeon Gold 5118 12C/2.3GHz/16.5MB/105W/DDR4-2400	Open	2x 8GB RDIMM DDR4-2666 ECC	Integrated Intel SATA	None	None	1x 512GB SSD M.2 PCIe Opal	1x HH DVD±RW	9-in-1	Fixed 1400W Platinum	None	4-digit LED	USB / USB Optical	Windows 10 Pro 64	3-year, Onsite	No	02/18
30BC001ACA	US	1x Xeon Gold 5122 4C/3.6GHz/16.5MB/105W/DDR4-2400	Open	2x 8GB RDIMM DDR4-2666 ECC	Integrated Intel SATA	None	None	1x 512GB SSD M.2 PCIe Opal	1x HH DVD±RW	9-in-1	Fixed 1400W Platinum	None	4-digit LED	USB / USB Optical	Windows 10 Pro 64	3-year, Onsite	No	02/18
30BC001ACC	US	1x Xeon Gold 5122 4C/3.6GHz/16.5MB/105W/DDR4-2400	Open	2x 8GB RDIMM DDR4-2666 ECC	Integrated Intel SATA	None	None	1x 512GB SSD M.2 PCIe Opal	1x HH DVD±RW	9-in-1	Fixed 1400W Platinum	None	4-digit LED	USB / USB Optical	Windows 10 Pro 64	3-year, Onsite	No	02/18
30BC001AUS	US	1x Xeon Gold 5122 4C/3.6GHz/16.5MB/105W/DDR4-2400	Open	2x 8GB RDIMM DDR4-2666 ECC	Integrated Intel SATA	None	None	1x 512GB SSD M.2 PCIe Opal	1x HH DVD±RW	9-in-1	Fixed 1400W Platinum	None	4-digit LED	USB / USB Optical	Windows 10 Pro 64	3-year, Onsite	No	02/18
30BC000UCA	US	2x Xeon Silver 4110 8C/2.1GHz/11MB/85W/DDR4-2400	Open	2x 8GB RDIMM DDR4-2666 ECC	Integrated Intel SATA	None	None	1x 512GB SSD M.2 PCIe Opal	1x HH DVD±RW	9-in-1	Fixed 1400W Platinum	None	4-digit LED	USB / USB Optical	Windows 10 Pro 64	3-year, Onsite	No	09/17
30BC000UCC	US	2x Xeon Silver 4110 8C/2.1GHz/11MB/85W/DDR4-2400	Open	2x 8GB RDIMM DDR4-2666 ECC	Integrated Intel SATA	None	None	1x 512GB SSD M.2 PCIe Opal	1x HH DVD±RW	9-in-1	Fixed 1400W Platinum	None	4-digit LED	USB / USB Optical	Windows 10 Pro 64	3-year, Onsite	No	09/17

Model	Region	Processor	Graphics	Memory	Storage Controller	M.2 RAID Upgrade	Disks	M.2 Drives	Optical	Media Reader	Power Supply	Optional Ports	Front Diagnostic LED	Keyboard / Mouse	Operating System	Warranty	Global	Ann Date (mm/yy)
30BC000UUS	US	2x Xeon Silver 4110 8C/2.1GHz/11MB/85W/DDR4-2400	Open	2x 8GB RDIMM DDR4-2666 ECC	Integrated Intel SATA	None	None	1x 512GB SSD M.2 PCIe Opal	1x HH DVD±RW	9-in-1	Fixed 1400W Platinum	None	4-digit LED	USB / USB Optical	Windows 10 Pro 64	3-year, Onsite	No	09/17
30BC000VCA	US	1x Xeon Gold 5122 4C/3.6GHz/16.5MB/105W/DDR4-2400	Open	2x 8GB RDIMM DDR4-2666 ECC	Integrated Intel SATA	None	None	1x 512GB SSD M.2 PCIe Opal	1x HH DVD±RW	9-in-1	Fixed 1400W Platinum	None	4-digit LED	USB / USB Optical	Windows 10 Pro 64	3-year, Onsite	No	09/17
30BC000VCC	US	1x Xeon Gold 5122 4C/3.6GHz/16.5MB/105W/DDR4-2400	Open	2x 8GB RDIMM DDR4-2666 ECC	Integrated Intel SATA	None	None	1x 512GB SSD M.2 PCIe Opal	1x HH DVD±RW	9-in-1	Fixed 1400W Platinum	None	4-digit LED	USB / USB Optical	Windows 10 Pro 64	3-year, Onsite	No	09/17
30BC000VUS	US	1x Xeon Gold 5122 4C/3.6GHz/16.5MB/105W/DDR4-2400	Open	2x 8GB RDIMM DDR4-2666 ECC	Integrated Intel SATA	None	None	1x 512GB SSD M.2 PCIe Opal	1x HH DVD±RW	9-in-1	Fixed 1400W Platinum	None	4-digit LED	USB / USB Optical	Windows 10 Pro 64	3-year, Onsite	No	09/17
30BC000WCA	US	1x Xeon Gold 5118 12C/2.3GHz/16.5MB/105W/DDR4-2400	Open	2x 8GB RDIMM DDR4-2666 ECC	Integrated Intel SATA	None	None	1x 512GB SSD M.2 PCIe Opal	1x HH DVD±RW	9-in-1	Fixed 1400W Platinum	None	4-digit LED	USB / USB Optical	Windows 10 Pro 64	3-year, Onsite	No	09/17
30BC000WCC	US	1x Xeon Gold 5118 12C/2.3GHz/16.5MB/105W/DDR4-2400	Open	2x 8GB RDIMM DDR4-2666 ECC	Integrated Intel SATA	None	None	1x 512GB SSD M.2 PCIe Opal	1x HH DVD±RW	9-in-1	Fixed 1400W Platinum	None	4-digit LED	USB / USB Optical	Windows 10 Pro 64	3-year, Onsite	No	09/17
30BC000WUS	US	1x Xeon Gold 5118 12C/2.3GHz/16.5MB/105W/DDR4-2400	Open	2x 8GB RDIMM DDR4-2666 ECC	Integrated Intel SATA	None	None	1x 512GB SSD M.2 PCIe Opal	1x HH DVD±RW	9-in-1	Fixed 1400W Platinum	None	4-digit LED	USB / USB Optical	Windows 10 Pro 64	3-year, Onsite	No	09/17
30BC000XCA	US	1x Xeon Silver 4114 10C/2.2GHz/13.75MB/85W/DDR4-2400	Open	1x 8GB RDIMM DDR4-2666 ECC	Integrated Intel SATA	None	1x 1TB HDD 7.2K 3.5" SATA6Gbps	None	1x HH DVD±RW	9-in-1	Fixed 1400W Platinum	None	4-digit LED	USB / USB Optical	Windows 10 Pro 64	3-year, Onsite	No	09/17
30BC000XCC	US	1x Xeon Silver 4114 10C/2.2GHz/13.75MB/85W/DDR4-2400	Open	1x 8GB RDIMM DDR4-2666 ECC	Integrated Intel SATA	None	1x 1TB HDD 7.2K 3.5" SATA6Gbps	None	1x HH DVD±RW	9-in-1	Fixed 1400W Platinum	None	4-digit LED	USB / USB Optical	Windows 10 Pro 64	3-year, Onsite	No	09/17
30BC000XUS	US	1x Xeon Silver 4114 10C/2.2GHz/13.75MB/85W/DDR4-2400	Open	1x 8GB RDIMM DDR4-2666 ECC	Integrated Intel SATA	None	1x 1TB HDD 7.2K 3.5" SATA6Gbps	None	1x HH DVD±RW	9-in-1	Fixed 1400W Platinum	None	4-digit LED	USB / USB Optical	Windows 10 Pro 64	3-year, Onsite	No	09/17

Model	Region	Processor	Graphics	Memory	Storage Controller	M.2 RAID Upgrade	Disks	M.2 Drives	Optical	Media Reader	Power Supply	Optional Ports	Front Diagnostic LED	Keyboard / Mouse	Operating System	Warranty	Global	Ann Date (mm/yy)
30BC000DCA	US	2x Xeon Gold 5118 12C/2.3GHz/16.5MB/105W/DDR4-2400	Open	2x 16GB RDIMM DDR4-2666 ECC	Integrated Intel SATA	None	1x 1TB HDD 7.2K 3.5" SATA6Gbps	1x 512GB SSD M.2 PCIe Opal	1x HH DVD±RW	9-in-1	Fixed 1400W Platinum	None	4-digit LED	USB / USB Optical	Windows 10 DG Windows 7 Pro 64	3-year, Onsite	No	09/17
30BC000DCC	US	2x Xeon Gold 5118 12C/2.3GHz/16.5MB/105W/DDR4-2400	Open	2x 16GB RDIMM DDR4-2666 ECC	Integrated Intel SATA	None	1x 1TB HDD 7.2K 3.5" SATA6Gbps	1x 512GB SSD M.2 PCIe Opal	1x HH DVD±RW	9-in-1	Fixed 1400W Platinum	None	4-digit LED	USB / USB Optical	Windows 10 DG Windows 7 Pro 64	3-year, Onsite	No	09/17
30BC000DUS	US	2x Xeon Gold 5118 12C/2.3GHz/16.5MB/105W/DDR4-2400	Open	2x 16GB RDIMM DDR4-2666 ECC	Integrated Intel SATA	None	1x 1TB HDD 7.2K 3.5" SATA6Gbps	1x 512GB SSD M.2 PCIe Opal	1x HH DVD±RW	9-in-1	Fixed 1400W Platinum	None	4-digit LED	USB / USB Optical	Windows 10 DG Windows 7 Pro 64	3-year, Onsite	No	09/17
30BC000ECA	US	2x Xeon Gold 6128 6C/3.4GHz/19.25MB/115W/DDR4-2666	Open	2x 16GB RDIMM DDR4-2666 ECC	Integrated Intel SATA	None	1x 1TB HDD 7.2K 3.5" SATA6Gbps	1x 512GB SSD M.2 PCIe Opal	1x HH DVD±RW	9-in-1	Fixed 1400W Platinum	None	4-digit LED	USB / USB Optical	Windows 10 DG Windows 7 Pro 64	3-year, Onsite	No	09/17
30BC000ECC	US	2x Xeon Gold 6128 6C/3.4GHz/19.25MB/115W/DDR4-2666	Open	2x 16GB RDIMM DDR4-2666 ECC	Integrated Intel SATA	None	1x 1TB HDD 7.2K 3.5" SATA6Gbps	1x 512GB SSD M.2 PCIe Opal	1x HH DVD±RW	9-in-1	Fixed 1400W Platinum	None	4-digit LED	USB / USB Optical	Windows 10 DG Windows 7 Pro 64	3-year, Onsite	No	09/17
30BC000EUS	US	2x Xeon Gold 6128 6C/3.4GHz/19.25MB/115W/DDR4-2666	Open	2x 16GB RDIMM DDR4-2666 ECC	Integrated Intel SATA	None	1x 1TB HDD 7.2K 3.5" SATA6Gbps	1x 512GB SSD M.2 PCIe Opal	1x HH DVD±RW	9-in-1	Fixed 1400W Platinum	None	4-digit LED	USB / USB Optical	Windows 10 DG Windows 7 Pro 64	3-year, Onsite	No	09/17
30BC000FCA	US	2x Xeon Silver 4110 8C/2.1GHz/11MB/85W/DDR4-2400	Open	2x 8GB RDIMM DDR4-2666 ECC	Integrated Intel SATA	None	1x 1TB HDD 7.2K 3.5" SATA6Gbps	1x 512GB SSD M.2 PCIe Opal	1x HH DVD±RW	9-in-1	Fixed 1400W Platinum	None	4-digit LED	USB / USB Optical	Windows 10 DG Windows 7 Pro 64	3-year, Onsite	No	09/17
30BC000FCC	US	2x Xeon Silver 4110 8C/2.1GHz/11MB/85W/DDR4-2400	Open	2x 8GB RDIMM DDR4-2666 ECC	Integrated Intel SATA	None	1x 1TB HDD 7.2K 3.5" SATA6Gbps	1x 512GB SSD M.2 PCIe Opal	1x HH DVD±RW	9-in-1	Fixed 1400W Platinum	None	4-digit LED	USB / USB Optical	Windows 10 DG Windows 7 Pro 64	3-year, Onsite	No	09/17
30BC000FUS	US	2x Xeon Silver 4110 8C/2.1GHz/11MB/85W/DDR4-2400	Open	2x 8GB RDIMM DDR4-2666 ECC	Integrated Intel SATA	None	1x 1TB HDD 7.2K 3.5" SATA6Gbps	1x 512GB SSD M.2 PCIe Opal	1x HH DVD±RW	9-in-1	Fixed 1400W Platinum	None	4-digit LED	USB / USB Optical	Windows 10 DG Windows 7 Pro 64	3-year, Onsite	No	09/17
30BC000N--	WE	1x Xeon Silver 4110 8C/2.1GHz/11MB/85W/DDR4-2400	Open	1x 8GB RDIMM DDR4-2666 ECC	Integrated Intel SATA	None	1x 1TB HDD 7.2K 3.5" SATA6Gbps	None	1x HH DVD±RW	9-in-1	Fixed 1400W Platinum	1x Serial	4-digit LED	USB / USB Optical	Windows 10 Pro 64	3-year, Onsite	No	09/17

Model	Region	Processor	Graphics	Memory	Storage Controller	M.2 RAID Upgrade	Disks	M.2 Drives	Optical	Media Reader	Power Supply	Optional Ports	Front Diagnostic LED	Keyboard / Mouse	Operating System	Warranty	Global	Ann Date (mm/yy)
30BC0000--	WE	2x Xeon Silver 4110 8C/2.1GHz/11MB/85W/DDR4-2400	1x NVIDIA Quadro P2000 5GB	2x 8GB RDIMM DDR4-2666 ECC	Integrated Intel SATA	None	None	1x 256GB SSD M.2 PCIe Opal	1x HH DVD±RW	9-in-1	Fixed 1400W Platinum	None	4-digit LED	None	Windows 10 Pro 64	1-year, Onsite	No	09/17
30BC000P--	WE	1x Xeon Silver 4114 10C/2.2GHz/13.75MB/85W/DDR4-2400	Open	2x 8GB RDIMM DDR4-2666 ECC	Integrated Intel SATA	None	1x 512GB SSD 2.5" SATA6Gbps Opal	None	1x HH DVD±RW	9-in-1	Fixed 1400W Platinum	1x Serial	4-digit LED	USB / USB Optical	Windows 10 Pro 64	3-year, Onsite	No	09/17
30BC000Q--	WE	2x Xeon Silver 4114 10C/2.2GHz/13.75MB/85W/DDR4-2400	Open	4x 8GB RDIMM DDR4-2666 ECC	Integrated Intel SATA	None	1x 512GB SSD 2.5" SATA6Gbps Opal	None	1x HH DVD±RW	9-in-1	Fixed 1400W Platinum	1x Serial	4-digit LED	USB / USB Optical	Windows 10 Pro 64	3-year, Onsite	No	09/17
30BC0014--	WE	1x Xeon Gold 5118 12C/2.3GHz/16.5MB/105W/DDR4-2400	Open	1x 16GB RDIMM DDR4-2666 ECC	Integrated Intel SATA	RAID 0/1/10	None	4x 512GB SSD M.2 PCIe Opal	1x HH DVD±RW	9-in-1	Fixed 1400W Platinum	1x Serial	4-digit LED	USB / USB Optical	Windows 10 Pro 64	3-year, Onsite	No	02/18
30BC000T--	WE	2x Xeon Silver 4116 12C/2.1GHz/16.5MB/85W/DDR4-2400	1x NVIDIA Quadro P4000 8GB	4x 16GB RDIMM DDR4-2666 ECC	Integrated Intel SATA	None	1x 512GB SSD 2.5" SATA6Gbps Opal, 1x 1TB HDD 7.2K 3.5" SATA6Gbps	None	1x HH DVD±RW	9-in-1	Fixed 1400W Platinum	1x Serial	4-digit LED	USB / USB Optical	Windows 10 Pro 64	3-year, Onsite	No	09/17
30BC000S--	WE	2x Xeon Gold 5118 12C/2.3GHz/16.5MB/105W/DDR4-2400	1x NVIDIA Quadro P5000 16GB	4x 16GB RDIMM DDR4-2666 ECC	Integrated Intel SATA	None	1x 512GB SSD 2.5" SATA6Gbps Opal, 1x 1TB HDD 7.2K 3.5" SATA6Gbps	None	1x HH DVD±RW	9-in-1	Fixed 1400W Platinum	1x Serial	4-digit LED	USB / USB Optical	Windows 10 Pro 64	3-year, Onsite	No	09/17
30BC000R--	WE	2x Xeon Silver 4110 8C/2.1GHz/11MB/85W/DDR4-2400	Open	4x 8GB RDIMM DDR4-2666 ECC	Integrated Intel SATA	None	1x 512GB SSD 2.5" SATA6Gbps Opal	None	1x HH DVD±RW	9-in-1	Fixed 1400W Platinum	1x Serial	4-digit LED	USB / USB Optical	Windows 10 Pro 64	3-year, Onsite	No	09/17
30BC001B--	WE	1x Xeon Silver 4110 8C/2.1GHz/11MB/85W/DDR4-2400	Open	1x 8GB RDIMM DDR4-2666 ECC	Integrated Intel SATA	None	1x 1TB HDD 7.2K 3.5" SATA6Gbps	None	1x HH DVD±RW	9-in-1	Fixed 1400W Platinum	1x Serial	4-digit LED	USB / USB Optical	Windows 10 Pro 64	3-year, Onsite	No	02/18
30BC0015--	WE	2x Xeon Gold 6136 12C/3.0GHz/24.75MB/150W/DDR4-2666	Open	2x 16GB RDIMM DDR4-2666 ECC	Integrated Intel SATA	RAID 0/1/10	1x 2TB HDD 7.2K 3.5" SATA6Gbps	1x 512GB SSD M.2 PCIe Opal	1x HH DVD±RW	15-in-1	Fixed 1400W Platinum	1x Serial, 2x USB 3.1 Gen 2 Type-C	4-digit LED	USB / USB Optical	Windows 10 Pro 64	3-year, Onsite	No	12/17
30BC001C--	WE	1x Xeon Silver 4114 10C/2.2GHz/13.75MB/85W/DDR4-2400	Open	1x 16GB RDIMM DDR4-2666 ECC	Integrated Intel SATA	None	1x 512GB SSD 2.5" SATA6Gbps Opal	None	1x HH DVD±RW	9-in-1	Fixed 1400W Platinum	1x Serial	4-digit LED	USB / USB Optical	Windows 10 Pro 64	3-year, Onsite	No	02/18

Model	Region	Processor	Graphics	Memory	Storage Controller	M.2 RAID Upgrade	Disks	M.2 Drives	Optical	Media Reader	Power Supply	Optional Ports	Front Diagnostic LED	Keyboard / Mouse	Operating System	Warranty	Global	Ann Date (mm/yy)
30BC001D--	WE	2x Xeon Silver 4114 10C/2.2GHz/13.75MB/85W/DDR4-2400	Open	2x 16GB RDIMM DDR4-2666 ECC	Integrated Intel SATA	None	1x 512GB SSD 2.5" SATA6Gbps Opal	None	1x HH DVD±RW	9-in-1	Fixed 1400W Platinum	1x Serial	4-digit LED	USB / USB Optical	Windows 10 Pro 64	3-year, Onsite	No	02/18
30BC001F--	WE	2x Xeon Gold 5118 12C/2.3GHz/16.5MB/105W/DDR4-2400	1x NVIDIA Quadro P5000 16GB	4x 16GB RDIMM DDR4-2666 ECC	Integrated Intel SATA	None	1x 512GB SSD 2.5" SATA6Gbps Opal, 1x 1TB HDD 7.2K 3.5" SATA6Gbps	None	1x HH DVD±RW	9-in-1	Fixed 1400W Platinum	1x Serial	4-digit LED	USB / USB Optical	Windows 10 Pro 64	3-year, Onsite	No	02/18
30BC001E--	WE	2x Xeon Silver 4110 8C/2.1GHz/11MB/85W/DDR4-2400	Open	2x 16GB RDIMM DDR4-2666 ECC	Integrated Intel SATA	None	1x 512GB SSD 2.5" SATA6Gbps Opal	None	1x HH DVD±RW	9-in-1	Fixed 1400W Platinum	1x Serial	4-digit LED	USB / USB Optical	Windows 10 Pro 64	3-year, Onsite	No	02/18
30BC001G--	WE	2x Xeon Silver 4116 12C/2.1GHz/16.5MB/85W/DDR4-2400	1x NVIDIA Quadro P4000 8GB	4x 16GB RDIMM DDR4-2666 ECC	Integrated Intel SATA	None	1x 512GB SSD 2.5" SATA6Gbps Opal, 1x 1TB HDD 7.2K 3.5" SATA6Gbps	None	1x HH DVD±RW	9-in-1	Fixed 1400W Platinum	1x Serial	4-digit LED	USB / USB Optical	Windows 10 Pro 64	3-year, Onsite	No	02/18
30BC001H--	WE	2x Xeon Gold 6136 12C/3.0GHz/24.75MB/150W/DDR4-2666	Open	2x 16GB RDIMM DDR4-2666 ECC	Integrated Intel SATA	RAID 0/1/10	1x 2TB HDD 7.2K 3.5" SATA6Gbps	1x 512GB SSD M.2 PCIe Opal	1x HH DVD±RW	15-in-1	Fixed 1400W Platinum	1x Serial, 1x Internal USB 3.0, 2x USB 3.1 Gen 2 Type-C	4-digit LED	None / USB Optical	Windows 10 Pro 64	3-year, Onsite	No	03/18
30BC001J--	WE	2x Xeon Gold 5118 12C/2.3GHz/16.5MB/105W/DDR4-2400	Open	2x 16GB RDIMM DDR4-2666 ECC	Integrated Intel SATA	None	1x 1TB HDD 7.2K 3.5" SATA6Gbps	1x 512GB SSD M.2 PCIe Opal	1x HH DVD±RW	15-in-1	Fixed 1400W Platinum	1x Serial, 1x Internal USB 3.0	4-digit LED	None / USB Optical	Windows 10 Pro 64	3-year, Onsite	No	03/18
30BC001K--	WE	2x Xeon Gold 6136 12C/3.0GHz/24.75MB/150W/DDR4-2666	Open	2x 16GB RDIMM DDR4-2666 ECC	Integrated Intel SATA	RAID 0/1/10	1x 2TB HDD 7.2K 3.5" SATA6Gbps	1x 512GB SSD M.2 PCIe Opal	1x HH DVD±RW	15-in-1	Fixed 1400W Platinum	1x Serial, 2x USB 3.1 Gen 2 Type-C	4-digit LED	USB / USB Optical	Windows 10 Pro 64	3-year, Onsite	No	03/18
30BC001R--	WE	2x Xeon Gold 6136 12C/3.0GHz/24.75MB/150W/DDR4-2666	Open	2x 16GB RDIMM DDR4-2666 ECC	Integrated Intel SATA	RAID 0/1/10	1x 2TB HDD 7.2K 3.5" SATA6Gbps	1x 512GB SSD M.2 PCIe Opal	1x HH DVD±RW	15-in-1	Fixed 1400W Platinum	1x Serial, 1x Internal USB 3.0, 2x USB 3.1 Gen 2 Type-C	4-digit LED	USB / USB Optical	Windows 10 Pro 64	3-year, Onsite	No	04/18
30BC001Q--	WE	2x Xeon Gold 5118 12C/2.3GHz/16.5MB/105W/DDR4-2400	Open	2x 16GB RDIMM DDR4-2666 ECC	Integrated Intel SATA	None	1x 1TB HDD 7.2K 3.5" SATA6Gbps	1x 512GB SSD M.2 PCIe Opal	1x HH DVD±RW	15-in-1	Fixed 1400W Platinum	1x Serial, 1x Internal USB 3.0	4-digit LED	USB / USB Optical	Windows 10 Pro 64	3-year, Onsite	No	04/18
30BC001L--	WE	2x Xeon Gold 5122 4C/3.6GHz/16.5MB/105W/DDR4-2400	1x NVIDIA Quadro P4000 8GB	2x 16GB RDIMM DDR4-2666 ECC	Integrated Intel SATA	None	None	1x 256GB SSD M.2 PCIe Opal	1x HH DVD±RW	9-in-1	Fixed 1400W Platinum	None	4-digit LED	None	Windows 10 Pro 64	1-year, Onsite	No	03/18

Model	Region	Processor	Graphics	Memory	Storage Controller	M.2 RAID Upgrade	Disks	M.2 Drives	Optical	Media Reader	Power Supply	Optional Ports	Front Diagnostic LED	Keyboard / Mouse	Operating System	Warranty	Global	Ann Date (mm/yy)
30BC001M--	WE	2x Xeon Silver 4114 10C/2.2GHz/13.75MB/85W/DDR4-2400	Open	2x 16GB RDIMM DDR4-2666 ECC	Integrated Intel SATA	None	None	1x 512GB SSD M.2 PCIe Opal	1x HH DVD±RW	9-in-1	Fixed 1400W Platinum	1x Serial	4-digit LED	USB / USB Optical	Windows 10 Pro 64	3-year, Onsite	No	03/18

This publication was developed for products and services offered in the United States and E.M.E.A countries. Lenovo may not offer the products, services or features discussed in this document in other countries. Lenovo may withdraw an offering at any time. Information is subject to change without notice. Consult your local representative for information on offerings available in your area.

Lenovo reserves the right to change specifications or other product information without notice. Lenovo is not responsible for photographic or typographical errors.

LENOVO PROVIDES THIS PUBLICATION "AS IS," WITHOUT WARRANTY OF ANY KIND, EITHER EXPRESS OR IMPLIED, INCLUDING THE IMPLIED WARRANTIES OF MERCHANTABILITY OR FITNESS FOR A PARTICULAR PURPOSE.

Some jurisdictions do not allow disclaimer of express or implied warranties in certain transactions, therefore this disclaimer may not apply to you.

Availability: All offers subject to availability. Lenovo reserves the right to alter product offerings and specifications at any time, without notice. Lenovo is not responsible for photographic or typographic errors.

General: Review key information provided by Microsoft that may apply to your system purchase, including details on Windows 10, Windows 8, Windows 7, and potential upgrades/downgrades. Lenovo makes no representation or warranty regarding third-party products or services.

Trademarks: Lenovo, ThinkPad, ThinkCentre, ThinkStation and the Lenovo logo are trademarks of Lenovo. Microsoft, Windows, Windows NT, and the Windows logo are trademarks of Microsoft Corporation. Ultrabook, Celeron, Celeron Inside, Core Inside, Intel, Intel Logo, Intel Atom, Intel Atom Inside, Intel Core, Intel Inside, Intel Inside Logo, Intel vPro, Itanium, Itanium Inside, Pentium, Pentium Inside, vPro Inside, Xeon, Xeon Phi, and Xeon Inside are trademarks of Intel Corporation in the U.S. and/or other countries. Other company, product or service names may be trademarks or service marks of others.

Warranty: For a copy of applicable warranties, write to: Lenovo Warranty Information, 1009 Think Place, Morrisville, NC, 27560. Lenovo makes no representation or warranty regarding third party products or services. The Lenovo Limited Warranty applies only to Lenovo hardware products purchased for your own use, and does not transfer upon resale.

Limited warranty: Support unrelated to a warranty issue may be subject to additional charges.

Lenovo Services:

Carry-in or Mail-in Service: Parts and labor repair coverage where the customer is responsible for shipping (including packaging) or delivery to authorized warranty provider or repair center.

Depot or Courier Service: Parts and labor repair coverage where shipping (including packaging) or delivery to the repair center is paid for by Lenovo.

Expedited Depot: Parts and labor coverage with expedited turnaround. Shipping (including packaging) or delivery to the repair center is paid for by Lenovo.

Onsite / In-home Service: Parts and labor repair coverage where labor is provided onsite at your place of business.

If Lenovo determines your product problem is covered by the product warranty and cannot be resolved over the telephone, a technician will be dispatched to arrive onsite, typically the next day.

International Warranty Service (IWS): PC repair coverage for customers who require a critical warranty repair while travelling internationally. Visit www.lenovo.com/internationalwarranty for details. Visit www.lenovo.com/warranty for Lenovo Warranty Services terms and conditions for complete details and restrictions.

Included software: may differ from its retail version (if available), and may not include user manuals or all program functionality. Software license agreements may apply.

Battery life: Battery life (and recharge times) will vary based on many factors including screen brightness, applications, features, power management, battery conditioning, and other customer preferences.

Visit <http://psref.lenovo.com/> for the latest version of Product Specifications Reference.

© Lenovo, 2018. All rights reserved.
Lenovo 1009 Think Place Morrisville, NC 27560 U.S.A.

Lenovo ThinkServer

PSREF

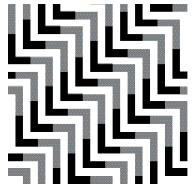

Product Specifications Reference

Version 511, August 2017

U.S.

Visit <http://psref.lenovo.com> for the latest version

Contents

Cover	1
Contents	2
Summary Of Change	3
Racks	5
ThinkServer RS160	5
ThinkServer RS160 Platform Specifications	6
ThinkServer RS160 - TopSeller - 70TE	7
ThinkServer RS160 - TopSeller - 70TG	8
Towers	9
ThinkServer TS150	9
ThinkServer TS150 Platform Specifications	9
ThinkServer TS150 - TopSeller - 70LV	10
ThinkServer TS150 - TopSeller - 70LX	11
ThinkServer TS150 - TopSeller - 70UB	12
ThinkServer TS460	13
ThinkServer TS460 Platform Specifications	14
ThinkServer TS460 - TopSeller - 70TR - 1 of 2	15
ThinkServer TS460 - TopSeller - 70TR - 2 of 2	16
ThinkServer TS460 - TopSeller - 70TT	17
Legal Information	18

Summary of Changes

This section describes the changes made in this version of ThinkServer PSREF and in previous version
This edition might also include minor corrections and editorial changes which are not identified

August 23, 2017 - Version 511

Additions in this update

- ▶ Update ThinkServer RD650/RD550/RD450/RD350/TD350/TS460/RS160 platform specifications, add 12TB 7.2K SATA6Gbs HDD support

June 21, 2017 - Version 508

Additions in this update

- ▶ Add ThinkServer TS460 models announced June 2017
- ▶ Add ThinkServer RS160 models announced June 2017
- ▶ Update ThinkServer TS460 platform specifications, add new SBB support: Kaby Lake Xeon, Core i3, and Pentium processors. DDR4-2400 memory. 10TB 7.2K SATA6Gbs HDD, 10TB 7.2K SAS12Gbs HDD, 300GB/600GB 15K 2.5" SAS. Red Hat Enterprise Linux 7.3. SUSE Linux Enterprise Server 12 SP2/11 SP4
- ▶ Update ThinkServer RS160 platform specifications, add new SBB support: Kaby Lake Xeon, Core i3, Pentium, and Celeron processors. DDR4-2400 memory. 10TB 7.2K SATA6Gbs HDD, 10TB 7.2K SAS12Gbs HDD, 900GB 15K 2.5" SAS

May 26, 2017 - Version 507

Additions in this update

- ▶ Update ThinkServer RD650/RD550 platform specifications, add DDR4-2400 RDIMM memory, up to 1.92TB easy-swap NVMe SSD, and up to 3.84TB NVMe flash adapter

April 19, 2017 - Version 505

Additions in this update

- ▶ Add ThinkServer TS460 models announced April 2017
- ▶ Add ThinkServer TD350 models announced April 2017
- ▶ Add ThinkServer TS150 models announced April 2017
- ▶ Update ThinkServer TS150 platform specifications, add new Kaby Lake processors, DDR4-2400 memory, 10TB hard drive supports

February 15, 2017 - Version 502

Additions in this update

- ▶ Add ThinkServer RS160 models announced September 2016

Withdrawals in this update

- ▶ ThinkServer TS140 had been end of life

October 12, 2016 - Version 496

Additions in this update

- ▶ New ThinkServer RS160 product announced September 2016
- ▶ New ThinkServer TS150 models announced August and October 2016

September 14, 2016 - Version 495

Additions in this update

- ▶ New ThinkServer RS160 product announced September 2016
- ▶ New ThinkServer TS140 models announced September 2016

April 6, 2016 - Version 487

Additions in this update

- ▶ New ThinkServer TD350, RD350, and RD450 models announced April 2016
- ▶ Add Intel Xeon E5-2600 v4 processors

March 23, 2016 - Version 486

Additions in this update

- ▶ New ThinkServer TS140 models announced March 2016

February 24, 2016 - Version 485

Additions in this update

- ▶ Add 8TB SATA and SAS 72K 6Gbs hard drive on ThinkServer RD350/RD450/RD550/RD650/TD350

December 30, 2015 - Version 483

Additions in this update

- ▶ Updates ThinkServer RS140, TD340 specifications
- ▶ Updates the most recent ThinkServer RS140, TD340 models

December 9, 2015 - Version 482

Additions in this update

- ▶ Updates ThinkServer TS140, TS440 specifications
- ▶ Updates the most recent ThinkServer TS140, TS440, RD350, RD450, RD550, RD650 models

October 28, 2015 - Version 480

Additions in this update

- ▶ New ThinkServer TS140 models announced October 2015

July 30, 2015 - Version 476

Additions in this update

- ▶ New ThinkServer TD350, RD550, and RD650 models announced July 2015

May 6, 2015 - Version 473

Additions in this update

- ▶ Add 95mm optical support on TD350
- ▶ Add Red Hat Enterprise Linux 7 support on RD350/RD450/RD550/RD650/TD350
- ▶ Add 32 x 25" bay support on TD350
- ▶ Add AnyBay and 25" PCIe SSD support on RD550/RD650

April 15, 2015 - Version 471

Additions in this update

- ▶ New ThinkServer TD350 models announced March 2015

March 25, 2015 - Version 470

Additions in this update

- ▶ New ThinkServer TS140 and TS440 models announced March 2015



ThinkServer RS160 Platform Specifications

Product Specifications Reference (PSREF)

Components	Specification																																					
Dimensions	1U rack. Height: 43.2 mm (1.7 in), width: 438.5 mm (17.26 in), depth: 393.7 mm (15.5 in)																																					
Weight	Minimum configuration: 6.2 kg (13.67 lb), maximum: 7.6 kg (16.76 lb)																																					
Processor	Supports one of the following Intel "Kaby Lake" processors:																																					
	<table border="1"> <tbody> <tr><td>Xeon E3-1280 v6</td><td>4C/3.9GHz/8MB/72W/DDR4-2400</td></tr> <tr><td>Xeon E3-1270 v6</td><td>4C/3.8GHz/8MB/72W/DDR4-2400</td></tr> <tr><td>Xeon E3-1240 v6</td><td>4C/3.7GHz/8MB/72W/DDR4-2400</td></tr> <tr><td>Xeon E3-1230 v6</td><td>4C/3.5GHz/8MB/72W/DDR4-2400</td></tr> <tr><td>Xeon E3-1225 v6</td><td>4C/3.3GHz/8MB/73W/DDR4-2400</td></tr> <tr><td>Xeon E3-1220 v6</td><td>4C/3GHz/8MB/72W/DDR4-2400</td></tr> <tr><td>Core i3-7320</td><td>2C/4.1GHz/4MB/51W/DDR4-2400</td></tr> <tr><td>Core i3-7300</td><td>2C/4GHz/4MB/51W/DDR4-2400</td></tr> <tr><td>Core i3-7300T</td><td>2C/3.5GHz/4MB/35W/DDR4-2400</td></tr> <tr><td>Core i3-7100</td><td>2C/3.9GHz/3MB/51W/DDR4-2400</td></tr> <tr><td>Core i3-7100T</td><td>2C/3.4GHz/3MB/35W/DDR4-2400</td></tr> <tr><td>Pentium G4620</td><td>2C/3.7GHz/3MB/51W/DDR4-2400</td></tr> <tr><td>Pentium G4600</td><td>2C/3.6GHz/3MB/51W/DDR4-2400</td></tr> <tr><td>Pentium G4600T</td><td>2C/3GHz/3MB/35W/DDR4-2400</td></tr> <tr><td>Pentium G4560</td><td>2C/3.5GHz/3MB/54W/DDR4-2400</td></tr> <tr><td>Pentium G4560T</td><td>2C/2.9GHz/3MB/35W/DDR4-2400</td></tr> <tr><td>Celeron G3950</td><td>2C/3GHz/2MB/51W/DDR4-2133</td></tr> <tr><td>Celeron G3930</td><td>2C/2.9GHz/2MB/51W/DDR4-2133</td></tr> <tr><td>Celeron G3930T</td><td>2C/2.7GHz/2MB/35W/DDR4-2133</td></tr> </tbody> </table>	Xeon E3-1280 v6	4C/3.9GHz/8MB/72W/DDR4-2400	Xeon E3-1270 v6	4C/3.8GHz/8MB/72W/DDR4-2400	Xeon E3-1240 v6	4C/3.7GHz/8MB/72W/DDR4-2400	Xeon E3-1230 v6	4C/3.5GHz/8MB/72W/DDR4-2400	Xeon E3-1225 v6	4C/3.3GHz/8MB/73W/DDR4-2400	Xeon E3-1220 v6	4C/3GHz/8MB/72W/DDR4-2400	Core i3-7320	2C/4.1GHz/4MB/51W/DDR4-2400	Core i3-7300	2C/4GHz/4MB/51W/DDR4-2400	Core i3-7300T	2C/3.5GHz/4MB/35W/DDR4-2400	Core i3-7100	2C/3.9GHz/3MB/51W/DDR4-2400	Core i3-7100T	2C/3.4GHz/3MB/35W/DDR4-2400	Pentium G4620	2C/3.7GHz/3MB/51W/DDR4-2400	Pentium G4600	2C/3.6GHz/3MB/51W/DDR4-2400	Pentium G4600T	2C/3GHz/3MB/35W/DDR4-2400	Pentium G4560	2C/3.5GHz/3MB/54W/DDR4-2400	Pentium G4560T	2C/2.9GHz/3MB/35W/DDR4-2400	Celeron G3950	2C/3GHz/2MB/51W/DDR4-2133	Celeron G3930	2C/2.9GHz/2MB/51W/DDR4-2133	Celeron G3930T
Xeon E3-1280 v6	4C/3.9GHz/8MB/72W/DDR4-2400																																					
Xeon E3-1270 v6	4C/3.8GHz/8MB/72W/DDR4-2400																																					
Xeon E3-1240 v6	4C/3.7GHz/8MB/72W/DDR4-2400																																					
Xeon E3-1230 v6	4C/3.5GHz/8MB/72W/DDR4-2400																																					
Xeon E3-1225 v6	4C/3.3GHz/8MB/73W/DDR4-2400																																					
Xeon E3-1220 v6	4C/3GHz/8MB/72W/DDR4-2400																																					
Core i3-7320	2C/4.1GHz/4MB/51W/DDR4-2400																																					
Core i3-7300	2C/4GHz/4MB/51W/DDR4-2400																																					
Core i3-7300T	2C/3.5GHz/4MB/35W/DDR4-2400																																					
Core i3-7100	2C/3.9GHz/3MB/51W/DDR4-2400																																					
Core i3-7100T	2C/3.4GHz/3MB/35W/DDR4-2400																																					
Pentium G4620	2C/3.7GHz/3MB/51W/DDR4-2400																																					
Pentium G4600	2C/3.6GHz/3MB/51W/DDR4-2400																																					
Pentium G4600T	2C/3GHz/3MB/35W/DDR4-2400																																					
Pentium G4560	2C/3.5GHz/3MB/54W/DDR4-2400																																					
Pentium G4560T	2C/2.9GHz/3MB/35W/DDR4-2400																																					
Celeron G3950	2C/3GHz/2MB/51W/DDR4-2133																																					
Celeron G3930	2C/2.9GHz/2MB/51W/DDR4-2133																																					
Celeron G3930T	2C/2.7GHz/2MB/35W/DDR4-2133																																					
Processor	Supports one of the following Intel "Skylake" processors:																																					
	<table border="1"> <tbody> <tr><td>Xeon E3-1280 v5</td><td>4C/3.7GHz/8MB/80W/DDR4-2133</td></tr> <tr><td>Xeon E3-1270 v5</td><td>4C/3.6GHz/8MB/80W/DDR4-2133</td></tr> <tr><td>Xeon E3-1240 v5</td><td>4C/3.5GHz/8MB/80W/DDR4-2133</td></tr> <tr><td>Xeon E3-1230 v5</td><td>4C/3.4GHz/8MB/80W/DDR4-2133</td></tr> <tr><td>Xeon E3-1220 v5</td><td>4C/3GHz/8MB/80W/DDR4-2133</td></tr> <tr><td>Xeon E3-1260L v5</td><td>4C/2.9GHz/8MB/45W/DDR4-2133</td></tr> <tr><td>Xeon E3-1240L v5</td><td>4C/2.1GHz/8MB/25W/DDR4-2133</td></tr> <tr><td>Xeon E3-1225 v5</td><td>4C/3.3GHz/8MB/80W/DDR4-2133</td></tr> <tr><td>Core i3-6320</td><td>2C/3.9GHz/4MB/51W/DDR4-2133</td></tr> <tr><td>Core i3-6300</td><td>2C/3.8GHz/4MB/51W/DDR4-2133</td></tr> <tr><td>Core i3-6100</td><td>2C/3.7GHz/3MB/51W/DDR4-2133</td></tr> <tr><td>Pentium G4520</td><td>2C/3.6GHz/3MB/51W/DDR4-2133</td></tr> <tr><td>Pentium G4500</td><td>2C/3.5GHz/3MB/51W/DDR4-2133</td></tr> <tr><td>Pentium G4400</td><td>2C/3.3GHz/3MB/54W/DDR4-2133</td></tr> <tr><td>Celeron G3920</td><td>2C/2.9GHz/2MB/51W/DDR4-2133</td></tr> <tr><td>Celeron G3900</td><td>2C/2.8GHz/2MB/51W/DDR4-2133</td></tr> <tr><td>Celeron G3900T</td><td>2C/2.6GHz/2MB/35W/DDR4-2133</td></tr> </tbody> </table>	Xeon E3-1280 v5	4C/3.7GHz/8MB/80W/DDR4-2133	Xeon E3-1270 v5	4C/3.6GHz/8MB/80W/DDR4-2133	Xeon E3-1240 v5	4C/3.5GHz/8MB/80W/DDR4-2133	Xeon E3-1230 v5	4C/3.4GHz/8MB/80W/DDR4-2133	Xeon E3-1220 v5	4C/3GHz/8MB/80W/DDR4-2133	Xeon E3-1260L v5	4C/2.9GHz/8MB/45W/DDR4-2133	Xeon E3-1240L v5	4C/2.1GHz/8MB/25W/DDR4-2133	Xeon E3-1225 v5	4C/3.3GHz/8MB/80W/DDR4-2133	Core i3-6320	2C/3.9GHz/4MB/51W/DDR4-2133	Core i3-6300	2C/3.8GHz/4MB/51W/DDR4-2133	Core i3-6100	2C/3.7GHz/3MB/51W/DDR4-2133	Pentium G4520	2C/3.6GHz/3MB/51W/DDR4-2133	Pentium G4500	2C/3.5GHz/3MB/51W/DDR4-2133	Pentium G4400	2C/3.3GHz/3MB/54W/DDR4-2133	Celeron G3920	2C/2.9GHz/2MB/51W/DDR4-2133	Celeron G3900	2C/2.8GHz/2MB/51W/DDR4-2133	Celeron G3900T	2C/2.6GHz/2MB/35W/DDR4-2133			
Xeon E3-1280 v5	4C/3.7GHz/8MB/80W/DDR4-2133																																					
Xeon E3-1270 v5	4C/3.6GHz/8MB/80W/DDR4-2133																																					
Xeon E3-1240 v5	4C/3.5GHz/8MB/80W/DDR4-2133																																					
Xeon E3-1230 v5	4C/3.4GHz/8MB/80W/DDR4-2133																																					
Xeon E3-1220 v5	4C/3GHz/8MB/80W/DDR4-2133																																					
Xeon E3-1260L v5	4C/2.9GHz/8MB/45W/DDR4-2133																																					
Xeon E3-1240L v5	4C/2.1GHz/8MB/25W/DDR4-2133																																					
Xeon E3-1225 v5	4C/3.3GHz/8MB/80W/DDR4-2133																																					
Core i3-6320	2C/3.9GHz/4MB/51W/DDR4-2133																																					
Core i3-6300	2C/3.8GHz/4MB/51W/DDR4-2133																																					
Core i3-6100	2C/3.7GHz/3MB/51W/DDR4-2133																																					
Pentium G4520	2C/3.6GHz/3MB/51W/DDR4-2133																																					
Pentium G4500	2C/3.5GHz/3MB/51W/DDR4-2133																																					
Pentium G4400	2C/3.3GHz/3MB/54W/DDR4-2133																																					
Celeron G3920	2C/2.9GHz/2MB/51W/DDR4-2133																																					
Celeron G3900	2C/2.8GHz/2MB/51W/DDR4-2133																																					
Celeron G3900T	2C/2.6GHz/2MB/35W/DDR4-2133																																					
Chipset	Intel C232 Platform Controller Hub (PCH)																																					
Memory DIMMs	4 DIMM sockets with 2-channels. UDIMM. DDR4-2133 or DDR4-2400																																					
Memory capacity	64GB (16GB x 4)																																					
Memory protection	ECC																																					
RAID controller	<table border="1"> <thead> <tr> <th>RAID controller</th> <th>Drive type</th> <th>RAID support</th> <th>Compatible models</th> </tr> </thead> <tbody> <tr> <td>Onboard RAID121i</td> <td>6Gbs SATA</td> <td>0/1/5/10</td> <td>2x3.5", 4x2.5"</td> </tr> <tr> <td>RAID520i PCIe</td> <td>12Gbs SAS/SATA</td> <td>0/1/10, 5 with optional key</td> <td>2x3.5", 4x2.5"</td> </tr> <tr> <td>RAID720i PCIe</td> <td>12Gbs SAS/SATA</td> <td>0/1/10/5, 6 with optional cache</td> <td>2x3.5", 4x2.5"</td> </tr> </tbody> </table>	RAID controller	Drive type	RAID support	Compatible models	Onboard RAID121i	6Gbs SATA	0/1/5/10	2x3.5", 4x2.5"	RAID520i PCIe	12Gbs SAS/SATA	0/1/10, 5 with optional key	2x3.5", 4x2.5"	RAID720i PCIe	12Gbs SAS/SATA	0/1/10/5, 6 with optional cache	2x3.5", 4x2.5"																					
	RAID controller	Drive type	RAID support	Compatible models																																		
	Onboard RAID121i	6Gbs SATA	0/1/5/10	2x3.5", 4x2.5"																																		
RAID520i PCIe	12Gbs SAS/SATA	0/1/10, 5 with optional key	2x3.5", 4x2.5"																																			
RAID720i PCIe	12Gbs SAS/SATA	0/1/10/5, 6 with optional cache	2x3.5", 4x2.5"																																			
	Optional cache for RAID720i: 1GB memory. 1GB, 2GB, or 4GB flash with super capacitor.																																					
Disk drive bays	Supports two 3.5" or four 2.5" disk drive bays. Non-hot swap. Cables are connected to onboard SATA connectors or PCIe RAID controller. Also supports one M.2 SATA SSD																																					
Supporting storage	3.5" HDD, 7.2K SATA6Gbs	1TB/2TB/4TB/6TB/8TB/10TB/12TB																																				
	3.5" HDD, 7.2K SAS12Gbs	1TB/2TB/4TB/6TB/8TB/10TB																																				
	3.5" SSD, SATA6Gbs (2.5" SSD with 3.5" tray)	240GB/480GB/960GB																																				
	2.5" HDD, 7.2K SATA6Gbs	1TB/2TB																																				
	2.5" HDD, 10K SAS12Gbs	300GB/600GB/900GB/1.2TB/2.4TB																																				
	2.5" HDD, 15K SAS12Gbs	900GB																																				
	2.5" SSD, SATA6Gbs	120GB/240GB/480GB/960GB																																				
	M.2 SATA SSD	32GB/128GB																																				

Components	Specification	
Optical drive	Optional one 9.5mm optical. DVD-ROM or DVD±RW	
Network interfaces	One dedicated management port, two Gigabit Ethernet ports. Supports optional discrete network adapters via riser card	
Security features	Power-on and administrator password. Optional TPM, TCG 1.2 or 2.0 compliant.	
Systems management	UEFI. Onboard Aspeed AST2400 graphics/management processor, IPMI 2.0-compliant baseboard management controller (BMC). Control Panel LEDs shows the status of power, ID, disk drives, network, system. Supports the following management software: EasyStartup, Power Planner. On November 2016, EasyUpdate, Lenovo ThinkServer Diagnostics Standalone, ToolsCenter Suite CLI inventory module on ThinkServer, and Lenovo xClarity Administrator will be available	
Operating systems	Microsoft Windows Server 2016 (Standard and Essentials)/2012 R2/2012. Windows 10 Pro. Red Hat Enterprise Linux 6.7/6.8/7.2. SUSE Linux Enterprise Server 11/12. VMware vSphere (ESXi) 6.0U0/U2	
Base warranty	1 or 3-year limited onsite service with 9x5/NBD	
Power supply	One fixed 300 watts power supply, Non-hot swap. 80 PLUS Gold qualified	
Graphics	Onboard Aspeed AST2400	
Front ports	Two USB 2.0	
Rear ports	One VGA, four USB 3.0, one RJ-45 (dedicated mgmt), two ethernet, one serial (9-pin)	
Cooling	3 fans for processor, PCIe slot, and disk drives	
Noise emissions	Operating: < 5.9 Bels. Idle: < 5.2 Bels (Maximum configuration)	
Environmental specification	Temperature - operating	50 °F to 95 °F (10 °C to 35 °C)
	Temperature - non operating (with package)	-40 °C to 60 °C
	Altitude - operating	(Unpressurized): 0-10000ft (0-3048m)
	Humidity - operating	8%~80%, non-condensing
	Humidity - storage (with package)	10%~90%, non-condensing

Expansion slots and disk bays

Supports one PCIe slot via optional riser card, PCIe 3.0 x16, half length, half height

Core options for ThinkServer RS160 (partial)

ThinkServer 8GB 2RX8 PC4-2133-E CL15 DDR4-2133 ECC-UDIMM	4X70G88316
ThinkServer 16GB 2RX8 PC4-2133-E CL15 DDR4-2133 ECC-UDIMM	4X70G88317
ThinkServer 3.5" 8TB 7.2K Enterprise SATA 6Gbps 512e Hard Drive for RS-Series	4XB0K12297
ThinkServer 2.5" 1.2TB 10K Enterprise SAS 12Gbps Hard Drive for RS-Series	4XB0K12306
ThinkServer 2.5" 2TB 7.2K Enterprise SATA 6Gbps Hard Drive for RS-Series	4XB0K12302
ThinkServer 2.5" 480GB S3510 Enterprise Entry SATA 6Gbps SSD for RS-Series	4XB0K12321
ThinkServer M.2 32GB Value Read-Optimized SATA 6Gbps Solid State Drive	4XB0K12310
ThinkServer RAID 520i RAID 5 Upgrade	4XC0G88841
ThinkServer RS160 Slim SATA DVD-RW Optical Disk Drive	4XA0G88613
Lenovo ThinkServer Gen 5 Trusted Platform Module v1.2 (Worldwide except China)	4XF0G45868

Model	Region	Processor	Memory	Storage Controller	Disk Bays	Disks	Optical	Add-on NIC	Slots	TPM	OS	Warranty	Power Supply	Ann Date (m/y)
70TE000DUX	US	Xeon E3-1220 v5 4C/3.0GHz/8MB/80W/DDR4-2133	1x8GB UDIMM DDR4-2133 ECC	RAID 121i	4x2.5" NHS	Open	None	None	None	TPM	None	1-year	300W 85% Fixed	09/16
70TE000EUX	US	Xeon E3-1230 v5 4C/3.4GHz/8MB/80W/DDR4-2133	1x8GB UDIMM DDR4-2133 ECC	RAID 121i	4x2.5" NHS	Open	None	None	None	TPM	None	1-year	300W 85% Fixed	09/16
70TE000FUX	US	Xeon E3-1240 v5 4C/3.5GHz/8MB/80W/DDR4-2133	1x8GB UDIMM DDR4-2133 ECC	RAID 121i	4x2.5" NHS	Open	None	None	None	TPM	None	1-year	300W 85% Fixed	09/16
70TE000GUX	US	Xeon E3-1270 v5 4C/3.6GHz/8MB/80W/DDR4-2133	1x8GB UDIMM DDR4-2133 ECC	RAID 121i	4x2.5" NHS	Open	None	None	None	TPM	None	1-year	300W 85% Fixed	09/16
70TE000HUX	US	Xeon E3-1280 v5 4C/3.7GHz/8MB/80W/DDR4-2133	1x8GB UDIMM DDR4-2133 ECC	RAID 121i	4x2.5" NHS	Open	None	None	None	TPM	None	1-year	300W 85% Fixed	09/16
70TE000YUX	US	Xeon E3-1220 v6 4C/3.0GHz/8MB/72W/DDR4-2400	1x8GB UDIMM DDR4-2400 ECC	RAID121i	4x2.5" NHS	Open	None	None	None	TPM2.0	None	1-year	300W 85% Fixed	06/17
70TE0010UX	US	Xeon E3-1230 v6 4C/3.5GHz/8MB/72W/DDR4-2400	1x8GB UDIMM DDR4-2400 ECC	RAID121i	4x2.5" NHS	Open	None	None	None	TPM2.0	None	1-year	300W 85% Fixed	06/17
70TE0011UX	US	Xeon E3-1240 v6 4C/3.7GHz/8MB/72W/DDR4-2400	1x8GB UDIMM DDR4-2400 ECC	RAID121i	4x2.5" NHS	Open	None	None	None	TPM2.0	None	1-year	300W 85% Fixed	06/17
70TE0012UX	US	Xeon E3-1270 v6 4C/3.8GHz/8MB/72W/DDR4-2400	1x8GB UDIMM DDR4-2400 ECC	RAID121i	4x2.5" NHS	Open	None	None	None	TPM2.0	None	1-year	300W 85% Fixed	06/17
70TE0013UX	US	Xeon E3-1280 v6 4C/3.9GHz/8MB/72W/DDR4-2400	1x8GB UDIMM DDR4-2400 ECC	RAID121i	4x2.5" NHS	Open	None	None	None	TPM2.0	None	1-year	300W 85% Fixed	06/17
70TER001UX	US	Xeon E3-1220 v5 4C/3.0GHz/8MB/80W/DDR4-2133	1x8GB UDIMM DDR4-2133 ECC	RAID 121i	4x2.5" NHS	Open	None	None	1xHHHL	TPM	None	1-year	300W 85% Fixed	09/16
70TER002UX	US	Xeon E3-1230 v5 4C/3.4GHz/8MB/80W/DDR4-2133	1x8GB UDIMM DDR4-2133 ECC	RAID 121i	4x2.5" NHS	Open	None	None	1xHHHL	TPM	None	1-year	300W 85% Fixed	09/16
70TER003UX	US	Xeon E3-1270 v5 4C/3.6GHz/8MB/80W/DDR4-2133	1x8GB UDIMM DDR4-2133 ECC	RAID 121i	4x2.5" NHS	Open	None	None	1xHHHL	TPM	None	1-year	300W 85% Fixed	09/16

Model	Region	Processor	Memory	Storage Controller	Disk Bays	Disks	Optical	Add-on NIC	Slots	TPM	OS	Warranty	Power Supply	Ann Date (m/y)
70TG000JUX	US	Pentium G4400 2C/3.3GHz/3MB/54W/DDR4-2133	1x8GB UDIMM DDR4-2133 ECC	RAID 121i	2x3.5" NHS	Open	None	None	None	TPM	None	1-year	300W 85% Fixed	09/16
70TG000KUX	US	Xeon E3-1220 v5 4C/3.0GHz/8MB/80W/DDR4-2133	1x8GB UDIMM DDR4-2133 ECC	RAID 121i	2x3.5" NHS	Open	None	None	None	TPM	None	1-year	300W 85% Fixed	09/16
70TG000LUX	US	Xeon E3-1230 v5 4C/3.4GHz/8MB/80W/DDR4-2133	1x8GB UDIMM DDR4-2133 ECC	RAID 121i	2x3.5" NHS	Open	None	None	None	TPM	None	1-year	300W 85% Fixed	09/16
70TG000MUX	US	Xeon E3-1240 v5 4C/3.5GHz/8MB/80W/DDR4-2133	1x8GB UDIMM DDR4-2133 ECC	RAID 121i	2x3.5" NHS	Open	None	None	None	TPM	None	1-year	300W 85% Fixed	09/16
70TG000NUX	US	Xeon E3-1270 v5 4C/3.6GHz/8MB/80W/DDR4-2133	1x8GB UDIMM DDR4-2133 ECC	RAID 121i	2x3.5" NHS	Open	None	None	None	TPM	None	1-year	300W 85% Fixed	09/16
70TG000PUX	US	Xeon E3-1280 v5 4C/3.7GHz/8MB/80W/DDR4-2133	1x8GB UDIMM DDR4-2133 ECC	RAID 121i	2x3.5" NHS	Open	None	None	None	TPM	None	1-year	300W 85% Fixed	09/16
70TG001RUX	US	Xeon E3-1220 v6 4C/3.0GHz/8MB/72W/DDR4-2400	1x8GB UDIMM DDR4-2400 ECC	RAID121i	2x3.5" NHS	Open	None	None	None	TPM2.0	None	1-year	300W 85% Fixed	06/17
70TG001SUX	US	Xeon E3-1230 v6 4C/3.5GHz/8MB/72W/DDR4-2400	1x8GB UDIMM DDR4-2400 ECC	RAID121i	2x3.5" NHS	Open	None	None	None	TPM2.0	None	1-year	300W 85% Fixed	06/17
70TG001TUX	US	Xeon E3-1240 v6 4C/3.7GHz/8MB/72W/DDR4-2400	1x8GB UDIMM DDR4-2400 ECC	RAID121i	2x3.5" NHS	Open	None	None	None	TPM2.0	None	1-year	300W 85% Fixed	06/17
70TG001UUX	US	Xeon E3-1270 v6 4C/3.8GHz/8MB/72W/DDR4-2400	1x8GB UDIMM DDR4-2400 ECC	RAID121i	2x3.5" NHS	Open	None	None	None	TPM2.0	None	1-year	300W 85% Fixed	06/17
70TG001VUX	US	Xeon E3-1280 v6 4C/3.9GHz/8MB/72W/DDR4-2400	1x8GB UDIMM DDR4-2400 ECC	RAID121i	2x3.5" NHS	Open	None	None	None	TPM2.0	None	1-year	300W 85% Fixed	06/17
70TGR001UX	US	Pentium G4400 2C/3.3GHz/3MB/54W/DDR4-2133	1x8GB UDIMM DDR4-2133 ECC	RAID 121i	2x3.5" NHS	Open	None	None	1xHHHL	TPM	None	1-year	300W 85% Fixed	09/16
70TGR002UX	US	Xeon E3-1220 v5 4C/3.0GHz/8MB/80W/DDR4-2133	1x8GB UDIMM DDR4-2133 ECC	RAID 121i	2x3.5" NHS	Open	None	None	1xHHHL	TPM	None	1-year	300W 85% Fixed	09/16
70TGR003UX	US	Xeon E3-1230 v5 4C/3.4GHz/8MB/80W/DDR4-2133	1x8GB UDIMM DDR4-2133 ECC	RAID 121i	2x3.5" NHS	Open	None	None	1xHHHL	TPM	None	1-year	300W 85% Fixed	09/16

ThinkServer TS150 Platform Specifications

Product Specifications Reference (PSREF)

Components	Specification
Dimensions	Tower or 4U rack. Height: 375 mm (14.76 in), width: 175 mm (6.89 in), depth: 431 mm (16.97 in)
Weight	Maximum configuration: 27.6 lb (12.5kg)
Processor	One Intel "Kaby Lake" or "Skylake" processor as listed: "Kaby Lake" processors:
	Xeon E3-1280 v6 4C/3.9GHz/8MB/72W/DDR4-2400
	Xeon E3-1275 v6 4C/3.8GHz/8MB/73W/DDR4-2400
	Xeon E3-1270 v6 4C/3.8GHz/8MB/72W/DDR4-2400
	Xeon E3-1245 v6 4C/3.7GHz/8MB/73W/DDR4-2400
	Xeon E3-1240 v6 4C/3.7GHz/8MB/72W/DDR4-2400
	Xeon E3-1230 v6 4C/3.5GHz/8MB/72W/DDR4-2400
	Xeon E3-1225 v6 4C/3.3GHz/8MB/73W/DDR4-2400
	Xeon E3-1220 v6 4C/3GHz/8MB/72W/DDR4-2400
	Core i3-7320 2C/4.1GHz/4MB/51W/DDR4-2400
	Core i3-7300T 2C/3.5GHz/4MB/35W/DDR4-2400
	Core i3-7300 2C/4GHz/4MB/51W/DDR4-2400
	Core i3-7100T 2C/3.4GHz/3MB/35W/DDR4-2400
	Core i3-7100 2C/3.9GHz/3MB/51W/DDR4-2400
	Pentium G4620 2C/3.7GHz/3MB/51W/DDR4-2400
	Pentium G4600T 2C/3GHz/3MB/35W/DDR4-2400
	Pentium G4600 2C/3.6GHz/3MB/51W/DDR4-2400
	Pentium G4560T 2C/2.9GHz/3MB/35W/DDR4-2400
	Pentium G4560 2C/3.5GHz/3MB/54W/DDR4-2400
	Celeron G3950 2C/3GHz/2MB/51W/DDR4-2133
	Celeron G3930T 2C/2.7GHz/2MB/35W/DDR4-2133
	Celeron G3930 2C/2.9GHz/2MB/51W/DDR4-2133
	"Skylake" processors:
	Xeon E3-1280 v5 4C/3.7GHz/8MB/80W/DDR4-2133
	Xeon E3-1270 v5 4C/3.6GHz/8MB/80W/DDR4-2133
	Xeon E3-1240 v5 4C/3.5GHz/8MB/80W/DDR4-2133
	Xeon E3-1230 v5 4C/3.4GHz/8MB/80W/DDR4-2133
	Xeon E3-1220 v5 4C/3GHz/8MB/80W/DDR4-2133
	Xeon E3-1275 v5 4C/3.6GHz/8MB/80W/DDR4-2133
	Xeon E3-1245 v5 4C/3.5GHz/8MB/80W/DDR4-2133
	Xeon E3-1225 v5 4C/3.3GHz/8MB/80W/DDR4-2133
	Core i3-6320 2C/3.9GHz/4MB/51W/DDR4-2133
	Core i3-6300 2C/3.8GHz/4MB/51W/DDR4-2133
	Core i3-6300T 2C/3.3GHz/4MB/35W/DDR4-2133
	Core i3-6100 2C/3.7GHz/3MB/51W/DDR4-2133
	Core i3-6100T 2C/3.2GHz/3MB/35W/DDR4-2133
	Pentium G4520 2C/3.6GHz/3MB/51W/DDR4-2133
	Pentium G4500 2C/3.5GHz/3MB/51W/DDR4-2133
	Pentium G4500T 2C/3GHz/3MB/35W/DDR4-2133
	Pentium G4400 2C/3.3GHz/3MB/54W/DDR4-2133
Pentium G4400T 2C/2.9GHz/3MB/35W/DDR4-2133	
Celeron G3920 2C/2.9GHz/2MB/51W/DDR4-2133	
Celeron G3900 2C/2.8GHz/2MB/51W/DDR4-2133	
Celeron G3900T 2C/2.6GHz/2MB/35W/DDR4-2133	
Chipset	Intel C236 Platform Controller Hub (PCH)
Memory DIMMs	4 DIMM sockets with 2 channels, 2 DIMMs per channel. UDIMM. Up to DDR4-2400
Memory capacity	64GB (16GB x 4)
Memory protection	ECC
RAID controller	RAID controller
	Drive type
RAID controller	Onboard RAID121i 6Gbs SATA 0/1/5/10
	RAID520i PCIe 12Gbs SAS/SATA 0/1/10, 5 with optional key
Disk bays	Supports up to four 3.5" or hybrid 3.5" + 2.5" disk drives, or up to five 2.5" disk drives, one 9.5mm optical (see right). Non-hot swap. Cables are connected to onboard SATA connectors or PCIe RAID controller. Supports one optional internal USB RDX Tape drive
Supporting storage	3.5" HDD, 7.2K SATA6Gbs 500GB/1TB/2TB/3TB/4TB/5TB/6TB/10TB
	2.5" HDD, 7.2K SATA6Gbs 500GB/1TB/2TB
	2.5" SSD, SATA6Gbs 120GB/240GB/480GB/600GB/800GB/960GB

Components	Specification
SD module	Optional. Up to 2 SDHC flash cards via SD module, 8GB each
Optical drive	Up to two half-height optical drives or one 9.5mm optical. DVD-ROM or DVD±RW
Network interfaces	One Gigabit Ethernet port, Intel i219LM. Supports optional discrete network adapters via PCIe slots
Security features	Power-on and administrator password. TPM (TCG 1.2-compliant)
Systems management	UEFI, system LEDs, EasyStartup, EasyUpdate, Power Planner, and Diagnostics. Intel Active Management Technology 11 on models with Xeon processors. Intel Standard Manageability on models with Core i3, Pentium, or Celeron processors. KVM is supported on models with Xeon E3-12x5 v5 processors
Operating systems	Microsoft Windows Server 2016/2012 R2/2012, Windows MultiPoint Server 2012, Windows 10 Pro. Red Hat Enterprise Linux 6.7/7.2. SUSE Linux Enterprise Server 11/12. VMware vSphere (ESXi) 5.5U3/6.0U2
Base warranty	1 or 3-year limited onsite service with 9x5/NBD
Power supply	Supports one of the following: • One fixed 250 watts, autosensing, 85%, 80 PLUS Bronze qualified • One fixed 400 watts, autosensing, 92%, 80 PLUS Platinum qualified
Graphics	Integrated Intel HD Graphics on Xeon E3-12x5 v5, Core i3, Pentium, and Celeron processors. Uses main memory, works along with discrete graphics to support multi-display, enables two display connectors (1 DP, 1 VGA) on rear ports. Also supports the following discrete graphics adapter options: • NVIDIA Quadro NVS 315, 1GB • NVIDIA Quadro K620, 2GB
HD Audio	Realtek ALC662 codec
Front ports	Two USB 3.0
Rear ports	One VGA, one DisplayPort, six USB 3.0, one RJ-45, one serial (9-pin), three analog audio ports (line-in, line-out, mic-in). Optional parallel or serial ports via PCIe adapters
Noise emissions	Operating: < 35 dB(A). Idle: < 34 dB(A) (Maximum configuration)
Environmental specification	Temperature - operating 50 °F to 95 °F (10 °C to 35 °C)
	Temperature - non operating (with package) -40 °C to 60 °C
	Altitude - operating (Unpressurized): 0-10000ft (0-3048m)
	Humidity - operating 8%-80%, non-condensing
	Humidity - storage (with package) 10%-90%, non-condensing

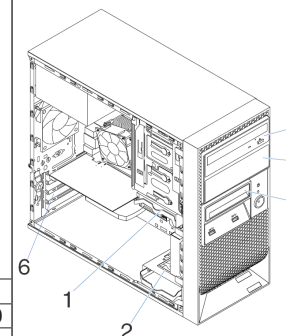

Note:
1. PCIe cards are optional.
2. Disk tray comes with the disk drive.

Disk Bays and PCIe Slots			
	4 x 3.5"	5 x 2.5"	4 x hybrid 3.5" + 2.5"
Bay 1	1st HDD bay	1st HDD bay	1st HDD bay, 3.5"/2.5"
Bay 2	2nd HDD bay	2nd HDD bay	2nd HDD bay, 3.5"/2.5"
Bay 3	Not supported	3rd HDD bay	Not supported on standard models. Supports one 2.5" disk drive for special bid only
Bay 4	2nd half-height optical, or RDX tape drive, or 3rd HDD bay	2nd half-height optical, or RDX tape drive, or 4th HDD bay	2nd half-height optical, or RDX tape drive, or 3rd HDD bay (3.5"/2.5")
Bay 5	1st half-height optical, or 9.5mm optical + 4th HDD bay	1st half-height optical, or 9.5mm optical + 5th HDD bay	1st half-height optical, or 9.5mm optical + 4th HDD bay (3.5"/2.5")
6	Four PCIe slots (top-down): Slot 1: PCIe 3.0 x16, full height, half length (near CPU) Slot 2: PCIe 3.0 x1, full height, half length Slot 3: PCIe 3.0 x16 (x4 elec), full height, half length Slot 4: PCIe 3.0 x1, full height, half length		

ThinkServer TS150 - TopSeller - 70LV

Product Specifications Reference (PSREF)

Model	Region	Processor	Memory	Storage Controller	Disk Bays	Disks	Optical	Add-on NIC	Add-on Ports	System Mgmt	OS	Warranty	Power Supply	Ann Date (m/y)
70LV002XUX	US	Xeon E3-1225 v5 4C/3.3GHz/8MB/80W/DDR4-2133	1x8GB UDIMM DDR4-2133 ECC	RAID 121i	Up to 5x2.5" DC	Open	None	None	None	AMT	None	1-year	Fixed 250W Bronze	08/16
70LV002YUX	US	Xeon E3-1245 v5 4C/3.5GHz/8MB/80W/DDR4-2133	1x8GB UDIMM DDR4-2133 ECC	RAID 121i	Up to 5x2.5" DC	Open	None	None	None	AMT	None	1-year	Fixed 250W Bronze	08/16
70LV0030UX	US	Xeon E3-1275 v5 4C/3.6GHz/8MB/80W/DDR4-2133	1x8GB UDIMM DDR4-2133 ECC	RAID 121i	Up to 5x2.5" DC	Open	None	None	None	AMT	None	1-year	Fixed 250W Bronze	08/16
70LV0031UX	US	Xeon E3-1225 v5 4C/3.3GHz/8MB/80W/DDR4-2133	1x8GB UDIMM DDR4-2133 ECC	RAID 121i	Up to 4x3.5" DC	Open	None	None	None	AMT	None	1-year	Fixed 250W Bronze	08/16
70LV0032UX	US	Xeon E3-1245 v5 4C/3.5GHz/8MB/80W/DDR4-2133	1x8GB UDIMM DDR4-2133 ECC	RAID 121i	Up to 4x3.5" DC	Open	None	None	None	AMT	None	1-year	Fixed 250W Bronze	08/16
70LV0033UX	US	Xeon E3-1275 v5 4C/3.6GHz/8MB/80W/DDR4-2133	1x8GB UDIMM DDR4-2133 ECC	RAID 121i	Up to 4x3.5" DC	Open	None	None	None	AMT	None	1-year	Fixed 250W Bronze	08/16
70LV0034UX	US	Core i3-6100T 2C/3.2GHz/3MB/35W/DDR4-2133	1x8GB UDIMM DDR4-2133 ECC	RAID 121i	Up to 4x3.5" DC/3 available	Open	HH DVD±RW	None	None	ISM	None	1-year	Fixed 250W Bronze	08/16
70LV0035UX	US	Core i3-6100T 2C/3.2GHz/3MB/35W/DDR4-2133	1x8GB UDIMM DDR4-2133 ECC	RAID 121i	Up to 4x3.5" DC	Open	None	None	None	ISM	None	1-year	Fixed 250W Bronze	08/16
70LV0036UX	US	Xeon E3-1225 v5 4C/3.3GHz/8MB/80W/DDR4-2133	1x8GB UDIMM DDR4-2133 ECC	RAID 121i	Up to 4x3.5" DC	Open	9.5mm DVD±RW	None	None	AMT	None	1-year	Fixed 250W Bronze	08/16
70LV0037UX	US	Xeon E3-1245 v5 4C/3.5GHz/8MB/80W/DDR4-2133	1x8GB UDIMM DDR4-2133 ECC	RAID 121i	Up to 4x3.5" DC	Open	9.5mm DVD±RW	None	None	AMT	None	1-year	Fixed 250W Bronze	08/16
70LV0038UX	US	Xeon E3-1275 v5 4C/3.6GHz/8MB/80W/DDR4-2133	1x8GB UDIMM DDR4-2133 ECC	RAID 121i	Up to 4x3.5" DC	Open	9.5mm DVD±RW	None	None	AMT	None	1-year	Fixed 250W Bronze	08/16
70LV0039UX	US	Xeon E3-1225 v5 4C/3.3GHz/8MB/80W/DDR4-2133	1x8GB UDIMM DDR4-2133 ECC	RAID 121i	Up to 5x2.5" DC	Open	9.5mm DVD±RW	None	None	AMT	None	1-year	Fixed 250W Bronze	08/16
70LV003AUX	US	Xeon E3-1245 v5 4C/3.5GHz/8MB/80W/DDR4-2133	1x8GB UDIMM DDR4-2133 ECC	RAID 121i	Up to 5x2.5" DC	Open	9.5mm DVD±RW	None	None	AMT	None	1-year	Fixed 250W Bronze	08/16
70LV003BUX	US	Xeon E3-1275 v5 4C/3.6GHz/8MB/80W/DDR4-2133	1x8GB UDIMM DDR4-2133 ECC	RAID 121i	Up to 5x2.5" DC	Open	9.5mm DVD±RW	None	None	AMT	None	1-year	Fixed 250W Bronze	08/16

Model	Region	Processor	Memory	Storage Controller	Disk Bays	Disks	Optical	Add-on NIC	Add-on Ports	System Mgmt	OS	Warranty	Power Supply	Ann Date (m/y)
70LX0017UX	US	Xeon E3-1275 v5 4C/3.6GHz/8MB/80W/DDR4-2133	1x8GB UDIMM DDR4-2133 ECC	RAID 121i	Up to 4x3.5" DC	Open	None	None	None	AMT	None	1-year	Fixed 400W Platinum	08/16
70LX0018UX	US	Xeon E3-1275 v5 4C/3.6GHz/8MB/80W/DDR4-2133	1x8GB UDIMM DDR4-2133 ECC	RAID 121i	Up to 5x2.5" DC	Open	None	None	None	AMT	None	1-year	Fixed 400W Platinum	08/16

ThinkServer TS150 - TopSeller - 70UB

Product Specifications Reference (PSREF)

Model	Region	Processor	Memory	Storage Controller	Disk Bays	Disks	Optical	Add-on NIC	Add-on Ports	System Mgmt	OS	Warranty	Power Supply	Ann Date (m/y)
70UB0009UX	US	Xeon E3-1225 v6 4C/3.3GHz/8MB/73W/DDR4-2400	1x8GB UDIMM DDR4-2400 ECC	RAID 121i	Up to 4x3.5" DC	Open	None	None	None	AMT	None	1-year	Fixed 250W Bronze	04/17
70UB000AUX	US	Xeon E3-1225 v6 4C/3.3GHz/8MB/73W/DDR4-2400	1x8GB UDIMM DDR4-2400 ECC	RAID 121i	Up to 4x3.5" DC	Open	9.5mm DVD±RW	None	None	AMT	None	1-year	Fixed 250W Bronze	04/17
70UB000BUX	US	Xeon E3-1245 v6 4C/3.7GHz/8MB/73W/DDR4-2400	1x8GB UDIMM DDR4-2400 ECC	RAID 121i	Up to 4x3.5" DC	Open	9.5mm DVD±RW	None	None	AMT	None	1-year	Fixed 250W Bronze	04/17
70UB000CUX	US	Xeon E3-1245 v6 4C/3.7GHz/8MB/73W/DDR4-2400	1x8GB UDIMM DDR4-2400 ECC	RAID 121i	Up to 4x3.5" DC	Open	None	None	None	AMT	None	1-year	Fixed 250W Bronze	04/17
70UB000DUX	US	Xeon E3-1275 v6 4C/3.8GHz/8MB/73W/DDR4-2400	1x8GB UDIMM DDR4-2400 ECC	RAID 121i	Up to 4x3.5" DC	Open	None	None	None	AMT	None	1-year	Fixed 250W Bronze	04/17
70UB000EUX	US	Xeon E3-1275 v6 4C/3.8GHz/8MB/73W/DDR4-2400	1x8GB UDIMM DDR4-2400 ECC	RAID 121i	Up to 4x3.5" DC	Open	9.5mm DVD±RW	None	None	AMT	None	1-year	Fixed 250W Bronze	04/17
70UB001WUX	US	Core i3-6100T 2C/3.2GHz/3MB/35W/DDR4-2133	1x8GB UDIMM DDR4-2400 ECC	RAID 121i	Up to 4x3.5" DC/3 available	Open	HH DVD±RW	None	None	ISM	None	1-year	Fixed 250W Bronze	04/17
70UB001XUX	US	Core i3-6100T 2C/3.2GHz/3MB/35W/DDR4-2133	1x8GB UDIMM DDR4-2400 ECC	RAID 121i	Up to 4x3.5" DC	Open	None	None	None	ISM	None	1-year	Fixed 250W Bronze	04/17

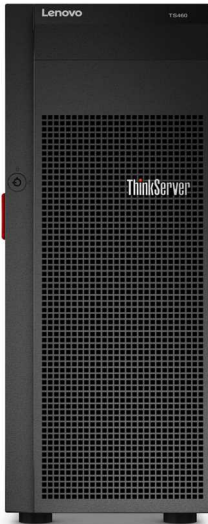

ThinkServer TS460 Platform Specifications

Product Specifications Reference (PSREF)

Components	Specification			
Dimensions	42L tower or 4U rack. Height: 443.5 mm (17.46 in) with foot stands. Width: 173 mm (6.81 in). Depth: 593 mm (23.35 in) including front door and handle of hot-swap power supply			
Weight	Maximum configuration: 57.32 lb (26.5 kg)			
Processor	Supports one of the following Intel "Kaby Lake" processors:			
	Xeon E3-1280 v6	4C/3.9GHz/8MB/72W/DDR4-2400		
	Xeon E3-1270 v6	4C/3.8GHz/8MB/72W/DDR4-2400		
	Xeon E3-1240 v6	4C/3.7GHz/8MB/72W/DDR4-2400		
	Xeon E3-1230 v6	4C/3.5GHz/8MB/72W/DDR4-2400		
	Xeon E3-1220 v6	4C/3GHz/8MB/72W/DDR4-2400		
	Core i3-7320	2C/4.1GHz/4MB/51W/DDR4-2400		
	Core i3-7300	2C/4GHz/4MB/51W/DDR4-2400		
	Core i3-7300T	2C/3.5GHz/4MB/35W/DDR4-2400		
	Core i3-7100	2C/3.9GHz/3MB/51W/DDR4-2400		
Core i3-7100T	2C/3.4GHz/3MB/35W/DDR4-2400			
Pentium G4620	2C/3.7GHz/3MB/51W/DDR4-2400			
Pentium G4600	2C/3.6GHz/3MB/51W/DDR4-2400			
Pentium G4600T	2C/3GHz/3MB/35W/DDR4-2400			
Pentium G4560	2C/3.5GHz/3MB/54W/DDR4-2400			
Pentium G4560T	2C/2.9GHz/3MB/35W/DDR4-2400			
Processor	Supports one of the following Intel "Skylake" processors:			
	Xeon E3-1280 v5	4C/3.7GHz/8MB/80W/DDR4-2133		
	Xeon E3-1270 v5	4C/3.6GHz/8MB/80W/DDR4-2133		
	Xeon E3-1240 v5	4C/3.5GHz/8MB/80W/DDR4-2133		
	Xeon E3-1230 v5	4C/3.4GHz/8MB/80W/DDR4-2133		
	Xeon E3-1220 v5	4C/3GHz/8MB/80W/DDR4-2133		
	Core i3-6320	2C/3.9GHz/4MB/51W/DDR4-2133		
	Core i3-6300T	2C/3.3GHz/4MB/35W/DDR4-2133		
	Core i3-6300	2C/3.8GHz/4MB/51W/DDR4-2133		
	Core i3-6100T	2C/3.2GHz/3MB/35W/DDR4-2133		
Core i3-6100	2C/3.7GHz/3MB/51W/DDR4-2133			
Pentium G4520	2C/3.6GHz/3MB/51W/DDR4-2133			
Pentium G4500T	2C/3GHz/3MB/35W/DDR4-2133			
Pentium G4500	2C/3.5GHz/3MB/51W/DDR4-2133			
Pentium G4400T	2C/2.9GHz/3MB/35W/DDR4-2133			
Pentium G4400	2C/3.3GHz/3MB/54W/DDR4-2133			
Chipset	Intel C232 Platform Controller Hub (PCH)			
Memory DIMMs	4 DIMM sockets with 2-channels. UDIMM. DDR4-2133 or DDR4-2400			
Memory capacity	Up to 64GB (16GB x 4)			
Memory protection	ECC			
RAID controller	RAID controller	Drive type	RAID support	
	Onboard RAID121i	6Gbs SATA	0/1/5/10	
	RAID520i PCIe	12Gbs SAS/SATA	0/1/10, 5 with optional key	
RAID720i PCIe	12Gbs SAS/SATA	0/1/10/5/50, 6/60 with optional cache		
	Optional cache for RAID720i: 1GB memory, or 1GB, 2GB, 4GB flash with super capacitor.			
Disk drive bays	Supports one of the following configurations:			
	Disk bays configuration	RAID controller	Optical	Tape drive
	4x3.5" SATA non-hot swap	121i	up to 2	RDX up to 1 LTO -
	4x3.5" SATA hot-swap	121i	up to 2	up to 1 -
	4x3.5" SATA/SAS hot-swap	520i or 720i	up to 2	up to 1 up to 1, 520i only
	8x3.5" SATA/SAS hot-swap	520i or 720i	up to 2	up to 1 -
	8x2.5" SATA/SAS hot-swap	520i or 720i	up to 2	up to 1 -
	16x2.5" SATA/SAS hot-swap	520i or 720i	up to 2	up to 1 -
	4x3.5" + 8x2.5" SATA/SAS hot-swap	520i or 720i	up to 2	up to 1 -
	4 x 3.5" HS can be upgraded to 8 x 3.5" HS or 4 x 3.5" + 8 x 2.5" HS, 8 x 2.5" HS can be upgraded to 16 x 2.5" HS or 4 x 3.5" + 8 x 2.5" HS, redundant PSU models only, RAID520i/RAID720i and expansion kit is needed, more that 8 disk bays needs expander card. Also supports one M.2 SATA SSD, 32GB or 128GB.			
Supporting disk drives	3.5" SATA HDD, 7.2K 6Gbs, HS or NHS	1TB/2TB/3TB/4TB/6TB/8TB/10TB/12TB		
	3.5" SAS HDD, 7.2K 12Gbs, HS	1TB/2TB/3TB/4TB/6TB/8TB/10TB		
	2.5" SAS HDD, 10K 12Gbs, HS, 2.5" or 3.5" bay	300GB/600GB/900GB/1.2TB/1.8TB/2.4TB		
	2.5" SAS HDD, 15K 12Gbs, HS, 2.5" or 3.5" bay	300GB/600GB		
	2.5" SATA SSD, 6Gbs, HS, 2.5" or 3.5" bay	120GB/240GB/480GB/800GB/960GB		
	2.5" SATA HDD, 7.2K 6Gbs, HS	1TB/2TB		
M.2 SATA SSD	32GB/128GB			

Components	Specification			
Maximum internal storage	Up to 64TB with 8TB 3.5" SAS or SATA HDDs, 8 x 3.5" HS bay			
Optical drive	Two 5.25" bays. Up to 2 optical drives. DVD-ROM or DVD±RW. Half-height. 2nd optical drive will be disable if M.2 SATA SSD is used			
Tape drive	Supports one tape drive in 5.25" bay. RDX or LTO. LTO Tape drive needs RAID520i			
Network interfaces	Two integrated Gigabit Ethernet 1000BASE-T ports (RJ-45) with Intel i210. One dedicate management port with Realtek RTL8211E			
Systems management	UEFI. Onboard Aspeed AST2400 graphics/management processor, IPMI 2.0-compliant baseboard management controller (BMC). Control Panel LEDs shows the status of power, disk drives, network, system. On rear system ID. Supports EasyStartup, Power Planner, Lenovo ThinkServer Diagnostics Standalone, ToolsCenter Suite CLI inventory module on ThinkServ-er, Lenovo xClarity Administrator			
Security features	Power-on and administrator password. Optional TPM, TCG 1.2 or 2.0 compliant.			
Operating systems	Microsoft Windows Server 2016/2012 R2. Red Hat Enterprise Linux 6.8/7.3(6.8 cannot support Kaby Lake processors). SUSE Linux Enterprise Server 12 SP2/11 SP4. VMware vSphere (ESXi) 6.0U2/6.5			
Base warranty	1 or 3-year limited onsite service with 9x5/NBD.			
Power supply	Supports one of the following, depending on models: • One fixed 300 watts, universal, 80 PLUS Bronze qualified. • Up to two redundant 450 watts, two maximum, rear access, hot-swap, 80 PLUS Gold qualified, universal, redundant with two power supplies			
Graphics	Integrated in onboard Aspeed AST2400 graphics/management processor. Optional NVIDIA Quadro K420			
Front ports	Two USB 3.0 (blue)			
Rear ports	One VGA, four USB 3.0, one RJ-45 (dedicated mgmt), two ethernet, one serial (9-pin). Add-on parallel or serial ports via optional PCIe adapters			
Noise emissions	Operating: < 43.6 dB(A). Idle: < 33 dB(A) (Maximum configuration)			
Environmental specification	All models supports ASHARE B. Models with the following configuration supports ASHARE A3: Xeon E3-1230 v5/8GBx2/DVD±RW/1TB SATAx4/RAID520i/450Wx2/TPM			
		ASHRAE A2	ASHRAE A3	ASHRAE B
	Temperature - operating	10°C to 35°C (50°F to 95°F)	5°C to 40°C (41°F to 104°F)	5°C to 35°C (41°F to 95°F)
	Temperature - storage (with package)	-40°C to 60°C (-40°F to 140°F)	-40°C to 60°C (-40°F to 140°F)	-40°C to 60°C (-40°F to 140°F)
	Altitude - operating	20% to 80% (non-condensing)	8% to 85% (non-condensing)	8% to 80% (non-condensing)
	Humidity - storage (with package)	10% to 90% (non-condensing)	10% to 90% (non-condensing)	10% to 90% (non-condensing)
	Altitude - operating	0 m to 3048 m (0 ft to 10 000 ft) in an unpressurized environment		
	GREENGUARD certified, RoHS-compliant, Energy Star Server 2.1 qualified on redundant PSU models			

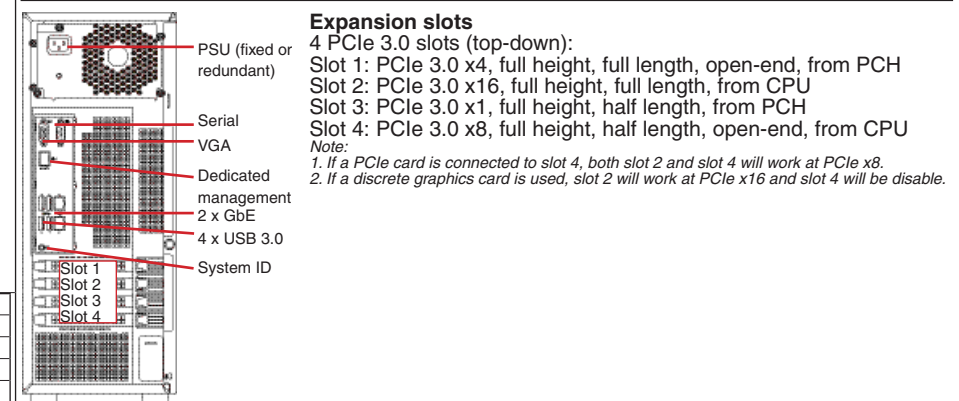

Model	Region	Processor	Memory	Storage Controller	Disk Bays	Disks	Optical	Add-on NIC	Add-on Ports	System Management	Operating System	Warranty	Power Supply	Ann Date (mm/yy)
70TR000LUX	US	Xeon E3-1220 v5 4C/3.0GHz/8MB/80W/DDR4-2133	1x8GB UDIMM DDR4-2133 ECC	RAID121i	4x3.5" HS	Open	Open	None	None	TPM 2.0	None	1-year	Fixed 300W Bronze	02/17
70TR000MUX	US	Xeon E3-1230 v5 4C/3.4GHz/8MB/80W/DDR4-2133	1x8GB UDIMM DDR4-2133 ECC	RAID121i	4x3.5" HS	Open	Open	None	None	TPM 2.0	None	1-year	Fixed 300W Bronze	02/17
70TR000NUX	US	Xeon E3-1240 v5 4C/3.5GHz/8MB/80W/DDR4-2133	1x8GB UDIMM DDR4-2133 ECC	RAID121i	4x3.5" HS	Open	Open	None	None	TPM 2.0	None	1-year	Fixed 300W Bronze	02/17
70TR000PUX	US	Xeon E3-1270 v5 4C/3.6GHz/8MB/80W/DDR4-2133	1x8GB UDIMM DDR4-2133 ECC	RAID121i	4x3.5" HS	Open	Open	None	None	TPM 2.0	None	1-year	Fixed 300W Bronze	02/17
70TR000QUX	US	Xeon E3-1220 v5 4C/3.0GHz/8MB/80W/DDR4-2133	1x8GB UDIMM DDR4-2133 ECC	RAID520i	8x2.5" HS	Open	Open	None	None	TPM 2.0	None	1-year	Fixed 300W Bronze	02/17
70TR000RUX	US	Xeon E3-1230 v5 4C/3.4GHz/8MB/80W/DDR4-2133	1x8GB UDIMM DDR4-2133 ECC	RAID520i	8x2.5" HS	Open	Open	None	None	TPM 2.0	None	1-year	Fixed 300W Bronze	02/17
70TR000SUX	US	Xeon E3-1240 v5 4C/3.5GHz/8MB/80W/DDR4-2133	1x8GB UDIMM DDR4-2133 ECC	RAID520i	8x2.5" HS	Open	Open	None	None	TPM 2.0	None	1-year	Fixed 300W Bronze	02/17
70TR000TUX	US	Xeon E3-1270 v5 4C/3.6GHz/8MB/80W/DDR4-2133	1x8GB UDIMM DDR4-2133 ECC	RAID520i	8x2.5" HS	Open	Open	None	None	TPM 2.0	None	1-year	Fixed 300W Bronze	02/17
70TR000UUX	US	Xeon E3-1220 v5 4C/3.0GHz/8MB/80W/DDR4-2133	1x8GB UDIMM DDR4-2133 ECC	RAID121i	4x3.5" NHS	Open	Open	None	None	TPM 2.0	None	1-year	Fixed 300W Bronze	02/17
70TR000VUX	US	Xeon E3-1230 v5 4C/3.4GHz/8MB/80W/DDR4-2133	1x8GB UDIMM DDR4-2133 ECC	RAID121i	4x3.5" NHS	Open	Open	None	None	TPM 2.0	None	1-year	Fixed 300W Bronze	02/17
70TR000WUX	US	Xeon E3-1240 v5 4C/3.5GHz/8MB/80W/DDR4-2133	1x8GB UDIMM DDR4-2133 ECC	RAID121i	4x3.5" NHS	Open	Open	None	None	TPM 2.0	None	1-year	Fixed 300W Bronze	02/17
70TR000XUX	US	Xeon E3-1270 v5 4C/3.6GHz/8MB/80W/DDR4-2133	1x8GB UDIMM DDR4-2133 ECC	RAID121i	4x3.5" NHS	Open	Open	None	None	TPM 2.0	None	1-year	Fixed 300W Bronze	02/17
70TR000YUX	US	Pentium G4400 2C/3.3GHz/3MB/54W/DDR4-2133	1x8GB UDIMM DDR4-2133 ECC	RAID121i	4x3.5" NHS	Open	Open	None	None	TPM 2.0	None	1-year	Fixed 300W Bronze	02/17
70TR0016UX	US	Xeon E3-1220 v6 4C/3.0GHz/8MB/72W/DDR4-2400	1x8GB UDIMM DDR4-2400 ECC	RAID121i	4x3.5" HS	Open	Open	None	None	TPM 2.0	None	1-year	Fixed 300W Bronze	06/17
70TR0017UX	US	Xeon E3-1230 v6 4C/3.5GHz/8MB/72W/DDR4-2400	1x8GB UDIMM DDR4-2400 ECC	RAID121i	4x3.5" HS	Open	Open	None	None	TPM 2.0	None	1-year	Fixed 300W Bronze	06/17
70TR0018UX	US	Xeon E3-1240 v6 4C/3.7GHz/8MB/72W/DDR4-2400	1x8GB UDIMM DDR4-2400 ECC	RAID121i	4x3.5" HS	Open	Open	None	None	TPM 2.0	None	1-year	Fixed 300W Bronze	06/17
70TR0019UX	US	Xeon E3-1270 v6 4C/3.8GHz/8MB/72W/DDR4-2400	1x8GB UDIMM DDR4-2400 ECC	RAID121i	4x3.5" HS	Open	Open	None	None	TPM 2.0	None	1-year	Fixed 300W Bronze	06/17

Model	Region	Processor	Memory	Storage Controller	Disk Bays	Disks	Optical	Add-on NIC	Add-on Ports	System Management	Operating System	Warranty	Power Supply	Ann Date (mm/yy)
70TR001AUX	US	Xeon E3-1220 v6 4C/3.0GHz/8MB/72W/DDR4-2400	1x8GB UDIMM DDR4-2400 ECC	RAID520i	8x2.5" HS	Open	Open	None	None	TPM 2.0	None	1-year	Fixed 300W Bronze	06/17
70TR001BUX	US	Xeon E3-1230 v6 4C/3.5GHz/8MB/72W/DDR4-2400	1x8GB UDIMM DDR4-2400 ECC	RAID520i	8x2.5" HS	Open	Open	None	None	TPM 2.0	None	1-year	Fixed 300W Bronze	06/17
70TR001CUX	US	Xeon E3-1240 v6 4C/3.7GHz/8MB/72W/DDR4-2400	1x8GB UDIMM DDR4-2400 ECC	RAID520i	8x2.5" HS	Open	Open	None	None	TPM 2.0	None	1-year	Fixed 300W Bronze	06/17
70TR001DUX	US	Xeon E3-1270 v6 4C/3.8GHz/8MB/72W/DDR4-2400	1x8GB UDIMM DDR4-2400 ECC	RAID520i	8x2.5" HS	Open	Open	None	None	TPM 2.0	None	1-year	Fixed 300W Bronze	06/17

Model	Region	Processor	Memory	Storage Controller	Disk Bays	Disks	Optical	Add-on NIC	Add-on Ports	System Management	Operating System	Warranty	Power Supply	Ann Date (mm/yy)
70TT000JUX	US	Xeon E3-1220 v5 4C/3.0GHz/8MB/80W/DDR4-2133	1x8GB UDIMM DDR4-2133 ECC	RAID121i	4x3.5" HS	Open	Open	None	None	TPM 2.0	None	1-year	1x450W Gold	02/17
70TT000KUX	US	Xeon E3-1230 v5 4C/3.4GHz/8MB/80W/DDR4-2133	1x8GB UDIMM DDR4-2133 ECC	RAID121i	4x3.5" HS	Open	Open	None	None	TPM 2.0	None	1-year	1x450W Gold	02/17
70TT000LUX	US	Xeon E3-1240 v5 4C/3.5GHz/8MB/80W/DDR4-2133	1x8GB UDIMM DDR4-2133 ECC	RAID121i	4x3.5" HS	Open	Open	None	None	TPM 2.0	None	1-year	1x450W Gold	02/17
70TT000MUX	US	Xeon E3-1270 v5 4C/3.6GHz/8MB/80W/DDR4-2133	1x8GB UDIMM DDR4-2133 ECC	RAID121i	4x3.5" HS	Open	Open	None	None	TPM 2.0	None	1-year	1x450W Gold	02/17
70TT000NUX	US	Xeon E3-1220 v5 4C/3.0GHz/8MB/80W/DDR4-2133	1x8GB UDIMM DDR4-2133 ECC	RAID520i	8x2.5" HS	Open	Open	None	None	TPM 2.0	None	1-year	1x450W Gold	02/17
70TT000PUX	US	Xeon E3-1230 v5 4C/3.4GHz/8MB/80W/DDR4-2133	1x8GB UDIMM DDR4-2133 ECC	RAID520i	8x2.5" HS	Open	Open	None	None	TPM 2.0	None	1-year	1x450W Gold	02/17
70TT000QUX	US	Xeon E3-1240 v5 4C/3.5GHz/8MB/80W/DDR4-2133	1x8GB UDIMM DDR4-2133 ECC	RAID520i	8x2.5" HS	Open	Open	None	None	TPM 2.0	None	1-year	1x450W Gold	02/17
70TT000RUX	US	Xeon E3-1270 v5 4C/3.6GHz/8MB/80W/DDR4-2133	1x8GB UDIMM DDR4-2133 ECC	RAID520i	8x2.5" HS	Open	Open	None	None	TPM 2.0	None	1-year	1x450W Gold	02/17
70TT001YUX	US	Xeon E3-1220 v6 4C/3.0GHz/8MB/72W/DDR4-2400	1x8GB UDIMM DDR4-2400 ECC	RAID121i	4x3.5" HS	Open	Open	None	None	TPM 2.0	None	1-year	1x450W Gold	06/17
70TT0020UX	US	Xeon E3-1230 v6 4C/3.5GHz/8MB/72W/DDR4-2400	1x8GB UDIMM DDR4-2400 ECC	RAID121i	4x3.5" HS	Open	Open	None	None	TPM 2.0	None	1-year	1x450W Gold	06/17
70TT0021UX	US	Xeon E3-1240 v6 4C/3.7GHz/8MB/72W/DDR4-2400	1x8GB UDIMM DDR4-2400 ECC	RAID121i	4x3.5" HS	Open	Open	None	None	TPM 2.0	None	1-year	1x450W Gold	06/17
70TT0022UX	US	Xeon E3-1270 v6 4C/3.8GHz/8MB/72W/DDR4-2400	1x8GB UDIMM DDR4-2400 ECC	RAID121i	4x3.5" HS	Open	Open	None	None	TPM 2.0	None	1-year	1x450W Gold	06/17
70TT0023UX	US	Xeon E3-1220 v6 4C/3.0GHz/8MB/72W/DDR4-2400	1x8GB UDIMM DDR4-2400 ECC	RAID520i	8x2.5" HS	Open	Open	None	None	TPM 2.0	None	1-year	1x450W Gold	06/17
70TT0024UX	US	Xeon E3-1230 v6 4C/3.5GHz/8MB/72W/DDR4-2400	1x8GB UDIMM DDR4-2400 ECC	RAID520i	8x2.5" HS	Open	Open	None	None	TPM 2.0	None	1-year	1x450W Gold	06/17
70TT0025UX	US	Xeon E3-1240 v6 4C/3.7GHz/8MB/72W/DDR4-2400	1x8GB UDIMM DDR4-2400 ECC	RAID520i	8x2.5" HS	Open	Open	None	None	TPM 2.0	None	1-year	1x450W Gold	06/17
70TT0026UX	US	Xeon E3-1270 v6 4C/3.8GHz/8MB/72W/DDR4-2400	1x8GB UDIMM DDR4-2400 ECC	RAID520i	8x2.5" HS	Open	Open	None	None	TPM 2.0	None	1-year	1x450W Gold	06/17

This publication was developed for products and services offered in the United States and E.M.E.A countries. Lenovo may not offer the products, services or features discussed in this document in other countries. Lenovo may withdraw an offering at any time. Information is subject to change without notice. Consult your local representative for information on offerings available in your area.

Lenovo reserves the right to change specifications or other product information without notice. Lenovo is not responsible for photographic or typographical errors.

LENOVO PROVIDES THIS PUBLICATION "AS IS," WITHOUT WARRANTY OF ANY KIND, EITHER EXPRESS OR IMPLIED, INCLUDING THE IMPLIED WARRANTIES OF MERCHANTABILITY OR FITNESS FOR A PARTICULAR PURPOSE.

Some jurisdictions do not allow disclaimer of express or implied warranties in certain transactions, therefore this disclaimer may not apply to you.

Availability: All offers subject to availability. Lenovo reserves the right to alter product offerings and specifications at any time, without notice. Lenovo is not responsible for photographic or typographic errors.

General: Review key information provided by Microsoft that may apply to your system purchase, including details on Windows 10, Windows 8, Windows 7, and potential upgrades/downgrades. Lenovo makes no representation or warranty regarding third-party products or services.

Trademarks: Lenovo, ThinkPad, ThinkCentre, ThinkStation and the Lenovo logo are trademarks of Lenovo. Microsoft, Windows, Windows NT, and the Windows logo are trademarks of Microsoft Corporation. Ultrabook, Celeron, Celeron Inside, Core Inside, Intel, Intel Logo, Intel Atom, Intel Atom Inside, Intel Core, Intel Inside, Intel Inside Logo, Intel vPro, Itanium, Itanium Inside, Pentium, Pentium Inside, vPro Inside, Xeon, Xeon Phi, and Xeon Inside are trademarks of Intel Corporation in the U.S. and/or other countries. Other company, product or service names may be trademarks or service marks of others.

Warranty: For a copy of applicable warranties, write to: Lenovo Warranty Information, 1009 Think Place, Morrisville, NC, 27560. Lenovo makes no representation or warranty regarding third party products or services. The Lenovo Limited Warranty applies only to Lenovo hardware products purchased for your own use, and does not transfer upon resale.

Limited warranty: Support unrelated to a warranty issue may be subject to additional charges.

Lenovo Services:

Carry-in or Mail-in Service: Parts and labor repair coverage where the customer is responsible for shipping (including packaging) or delivery to authorized warranty provider or repair center.

Depot or Courier Service: Parts and labor repair coverage where shipping (including packaging) or delivery to the repair center is paid for by Lenovo.

Expedited Depot: Parts and labor coverage with expedited turnaround. Shipping (including packaging) or delivery to the repair center is paid for by Lenovo.

Onsite / In-home Service: Parts and labor repair coverage where labor is provided onsite at your place of business.

If Lenovo determines your product problem is covered by the product warranty and cannot be resolved over the telephone, a technician will be dispatched to arrive onsite, typically the next day.

International Warranty Service (IWS): PC repair coverage for customers who require a critical warranty repair while travelling internationally. Visit www.lenovo.com/internationalwarranty for details. Visit www.lenovo.com/warranty for Lenovo Warranty Services terms and conditions for complete details and restrictions.

Included software: may differ from its retail version (if available), and may not include user manuals or all program functionality. Software license agreements may apply.

Battery life: Battery life (and recharge times) will vary based on many factors including screen brightness, applications, features, power management, battery conditioning, and other customer preferences.

Visit <http://psref.lenovo.com/> for the latest version of Product Specifications Reference.

© Lenovo, 2018. All rights reserved.
Lenovo 1009 Think Place Morrisville, NC 27560 U.S.A.

Lenovo **ThinkSystem**

PSREF

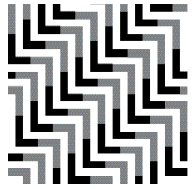

Product Specifications Reference

Version 524, May 2018

Visit <http://psref.lenovo.com> for the latest version

Contents

Cover	1	ThinkSystem D2 Enclosure - Non TopSeller - ASEAN	38
Contents	2	ThinkSystem D2 Enclosure - Non TopSeller - EET, MEA, RUCIS, WE	39
Summary Of Change	7	ThinkSystem D2 Enclosure - Non TopSeller - HTK	40
Blades	8	ThinkSystem D2 Enclosure - Non TopSeller - INDIA	41
ThinkSystem SN550	8	ThinkSystem D2 Enclosure - Non TopSeller - JAPAN	42
ThinkSystem SN550 Platform Specifications	9	ThinkSystem D2 Enclosure - Non TopSeller - NA	43
ThinkSystem SN550 - TopSeller - LA	10	ThinkSystem SD530	44
ThinkSystem SN550 - Non TopSeller - ANZ - 1 of 2	11	ThinkSystem SD530 Platform Specifications	45
ThinkSystem SN550 - Non TopSeller - ANZ - 2 of 2	12	ThinkSystem SD530 - TopSeller - EET, MEA, RUCIS, WE	46
ThinkSystem SN550 - Non TopSeller - ASEAN	13	ThinkSystem SD530 - Non TopSeller - ANZ - 1 of 2	47
ThinkSystem SN550 - Non TopSeller - Brazil	14	ThinkSystem SD530 - Non TopSeller - ANZ - 2 of 2	48
ThinkSystem SN550 - Non TopSeller - EET, MEA, RUCIS, WE - 1 of 2	15	ThinkSystem SD530 - Non TopSeller - ASEAN	49
ThinkSystem SN550 - Non TopSeller - EET, MEA, RUCIS, WE - 2 of 2	16	ThinkSystem SD530 - Non TopSeller - Brazil - 1 of 2	50
ThinkSystem SN550 - Non TopSeller - HTK	17	ThinkSystem SD530 - Non TopSeller - Brazil - 2 of 2	51
ThinkSystem SN550 - Non TopSeller - INDIA - 1 of 2	18	ThinkSystem SD530 - Non TopSeller - EET, MEA, RUCIS, WE - 1 of 2	52
ThinkSystem SN550 - Non TopSeller - INDIA - 2 of 2	19	ThinkSystem SD530 - Non TopSeller - EET, MEA, RUCIS, WE - 2 of 2	53
ThinkSystem SN550 - Non TopSeller - JAPAN	20	ThinkSystem SD530 - Non TopSeller - HTK	54
ThinkSystem SN550 - Non TopSeller - LA	21	ThinkSystem SD530 - Non TopSeller - INDIA	55
ThinkSystem SN550 - Non TopSeller - NA	22	ThinkSystem SD530 - Non TopSeller - JAPAN	56
ThinkSystem SN850	23	ThinkSystem SD530 - Non TopSeller - LA - 1 of 2	57
ThinkSystem SN850 Platform Specifications	24	ThinkSystem SD530 - Non TopSeller - LA - 2 of 2	58
ThinkSystem SN850 - Non TopSeller - ANZ	25	ThinkSystem SD530 - Non TopSeller - NA	59
ThinkSystem SN850 - Non TopSeller - ASEAN	26	Mission-Critical	60
ThinkSystem SN850 - Non TopSeller - Brazil	27	ThinkSystem SR850	60
ThinkSystem SN850 - Non TopSeller - EET, MEA, RUCIS, WE	28	ThinkSystem SR850 Platform Specifications	61
ThinkSystem SN850 - Non TopSeller - HTK - 1 of 2	29	ThinkSystem SR850 - Non TopSeller - ANZ - 1 of 2	62
ThinkSystem SN850 - Non TopSeller - HTK - 2 of 2	30	ThinkSystem SR850 - Non TopSeller - ANZ - 2 of 2	63
ThinkSystem SN850 - Non TopSeller - INDIA	31	ThinkSystem SR850 - Non TopSeller - ASEAN	64
ThinkSystem SN850 - Non TopSeller - JAPAN	32	ThinkSystem SR850 - Non TopSeller - EMEA - 1 of 2	65
ThinkSystem SN850 - Non TopSeller - LA	33	ThinkSystem SR850 - Non TopSeller - EMEA - 2 of 2	66
ThinkSystem SN850 - Non TopSeller - NA	34	ThinkSystem SR850 - Non TopSeller - HTK - 1 of 2	67
High-Density	35	ThinkSystem SR850 - Non TopSeller - HTK - 2 of 2	68
ThinkSystem D2 Enclosure	35	ThinkSystem SR850 - Non TopSeller - INDIA - 1 of 2	69
ThinkSystem D2 Enclosure Platform Specifications	36	ThinkSystem SR850 - Non TopSeller - INDIA - 2 of 2	70
ThinkSystem D2 Enclosure - Non TopSeller - ANZ	37	ThinkSystem SR850 - Non TopSeller - JAPAN	71

Contents

ThinkSystem SR850 - Non TopSeller - LA - 1 of 2	72	ThinkSystem SR530	106
ThinkSystem SR850 - Non TopSeller - LA - 2 of 2	73	ThinkSystem SR530 Platform Specifications	107
ThinkSystem SR850 - Non TopSeller - NA - 1 of 2	74	ThinkSystem SR530 - TopSeller - ANZ	108
ThinkSystem SR850 - Non TopSeller - NA - 2 of 2	75	ThinkSystem SR530 - TopSeller - Brazil	109
ThinkSystem SR860	76	ThinkSystem SR530 - TopSeller - Chile	110
ThinkSystem SR860 Platform Specifications	77	ThinkSystem SR530 - TopSeller - Colombia	111
ThinkSystem SR860 - Non TopSeller - EMEA	78	ThinkSystem SR530 - TopSeller - EMEA - 1 of 2	112
ThinkSystem SR950	79	ThinkSystem SR530 - TopSeller - EMEA - 2 of 2	113
ThinkSystem SR950 Platform Specifications	80	ThinkSystem SR530 - TopSeller - JAPAN	114
ThinkSystem SR950 - Non TopSeller - ANZ - 1 of 4	81	ThinkSystem SR530 - TopSeller - LA	115
ThinkSystem SR950 - Non TopSeller - ANZ - 2 of 4	82	ThinkSystem SR530 - TopSeller - LA (except Brazil)	116
ThinkSystem SR950 - Non TopSeller - ANZ - 3 of 4	83	ThinkSystem SR530 - TopSeller - LA (except Chile)	117
ThinkSystem SR950 - Non TopSeller - ANZ - 4 of 4	84	ThinkSystem SR530 - TopSeller - NA	118
ThinkSystem SR950 - Non TopSeller - Argentina	85	ThinkSystem SR530 - Non TopSeller - ANZ - 1 of 4	119
ThinkSystem SR950 - Non TopSeller - ASEAN	86	ThinkSystem SR530 - Non TopSeller - ANZ - 2 of 4	120
ThinkSystem SR950 - Non TopSeller - Brazil	87	ThinkSystem SR530 - Non TopSeller - ANZ - 3 of 4	121
ThinkSystem SR950 - Non TopSeller - EMEA - 1 of 3	88	ThinkSystem SR530 - Non TopSeller - ANZ - 4 of 4	122
ThinkSystem SR950 - Non TopSeller - EMEA - 2 of 3	89	ThinkSystem SR530 - Non TopSeller - ASEAN - 1 of 2	123
ThinkSystem SR950 - Non TopSeller - EMEA - 3 of 3	90	ThinkSystem SR530 - Non TopSeller - ASEAN - 2 of 2	124
ThinkSystem SR950 - Non TopSeller - HTK - 1 of 4	91	ThinkSystem SR530 - Non TopSeller - Brazil - 1 of 3	125
ThinkSystem SR950 - Non TopSeller - HTK - 2 of 4	92	ThinkSystem SR530 - Non TopSeller - Brazil - 2 of 3	126
ThinkSystem SR950 - Non TopSeller - HTK - 3 of 4	93	ThinkSystem SR530 - Non TopSeller - Brazil - 3 of 3	127
ThinkSystem SR950 - Non TopSeller - HTK - 4 of 4	94	ThinkSystem SR530 - Non TopSeller - EMEA - 1 of 2	128
ThinkSystem SR950 - Non TopSeller - INDIA - 1 of 3	95	ThinkSystem SR530 - Non TopSeller - EMEA - 2 of 2	129
ThinkSystem SR950 - Non TopSeller - INDIA - 2 of 3	96	ThinkSystem SR530 - Non TopSeller - HTK - 1 of 3	130
ThinkSystem SR950 - Non TopSeller - INDIA - 3 of 3	97	ThinkSystem SR530 - Non TopSeller - HTK - 2 of 3	131
ThinkSystem SR950 - Non TopSeller - JAPAN - 1 of 2	98	ThinkSystem SR530 - Non TopSeller - HTK - 3 of 3	132
ThinkSystem SR950 - Non TopSeller - JAPAN - 2 of 2	99	ThinkSystem SR530 - Non TopSeller - INDIA - 1 of 2	133
ThinkSystem SR950 - Non TopSeller - LA - 1 of 3	100	ThinkSystem SR530 - Non TopSeller - INDIA - 2 of 2	134
ThinkSystem SR950 - Non TopSeller - LA - 2 of 3	101	ThinkSystem SR530 - Non TopSeller - JAPAN	135
ThinkSystem SR950 - Non TopSeller - LA - 3 of 3	102	ThinkSystem SR530 - Non TopSeller - LA - 1 of 2	136
ThinkSystem SR950 - Non TopSeller - NA - 1 of 3	103	ThinkSystem SR530 - Non TopSeller - LA - 2 of 2	137
ThinkSystem SR950 - Non TopSeller - NA - 2 of 3	104	ThinkSystem SR530 - Non TopSeller - NA - 1 of 2	138
ThinkSystem SR950 - Non TopSeller - NA - 3 of 3	105	ThinkSystem SR530 - Non TopSeller - NA - 2 of 2	139
Racks	106	ThinkSystem SR550	140

Contents

ThinkSystem SR550 Platform Specifications	141	ThinkSystem SR570 - TopSeller - ANZ	176
ThinkSystem SR550 - TopSeller - ANZ - 1 of 3	142	ThinkSystem SR570 - TopSeller - EMEA	177
ThinkSystem SR550 - TopSeller - ANZ - 2 of 3	143	ThinkSystem SR570 - TopSeller - NA	178
ThinkSystem SR550 - TopSeller - ANZ - 3 of 3	144	ThinkSystem SR570 - Non TopSeller - ANZ - 1 of 2	179
ThinkSystem SR550 - TopSeller - Brazil	145	ThinkSystem SR570 - Non TopSeller - ANZ - 2 of 2	180
ThinkSystem SR550 - TopSeller - Chile	146	ThinkSystem SR570 - Non TopSeller - ASEAN - 1 of 3	181
ThinkSystem SR550 - TopSeller - Colombia	147	ThinkSystem SR570 - Non TopSeller - ASEAN - 2 of 3	182
ThinkSystem SR550 - TopSeller - EMEA - 1 of 2	148	ThinkSystem SR570 - Non TopSeller - ASEAN - 3 of 3	183
ThinkSystem SR550 - TopSeller - EMEA - 2 of 2	149	ThinkSystem SR570 - Non TopSeller - EMEA - 1 of 2	184
ThinkSystem SR550 - TopSeller - JAPAN	150	ThinkSystem SR570 - Non TopSeller - EMEA - 2 of 2	185
ThinkSystem SR550 - TopSeller - LA	151	ThinkSystem SR570 - Non TopSeller - HTK - 1 of 3	186
ThinkSystem SR550 - TopSeller - LA (except Brazil)	152	ThinkSystem SR570 - Non TopSeller - HTK - 2 of 3	187
ThinkSystem SR550 - TopSeller - LA (except Chile)	153	ThinkSystem SR570 - Non TopSeller - HTK - 3 of 3	188
ThinkSystem SR550 - TopSeller - NA	154	ThinkSystem SR570 - Non TopSeller - INDIA	189
ThinkSystem SR550 - Non TopSeller - ANZ - 1 of 2	155	ThinkSystem SR570 - Non TopSeller - JAPAN	190
ThinkSystem SR550 - Non TopSeller - ANZ - 2 of 2	156	ThinkSystem SR570 - Non TopSeller - NA - 1 of 2	191
ThinkSystem SR550 - Non TopSeller - ASEAN - 1 of 2	157	ThinkSystem SR570 - Non TopSeller - NA - 2 of 2	192
ThinkSystem SR550 - Non TopSeller - ASEAN - 2 of 2	158	ThinkSystem SR590	193
ThinkSystem SR550 - Non TopSeller - Brazil - 1 of 2	159	ThinkSystem SR590 Platform Specifications	194
ThinkSystem SR550 - Non TopSeller - Brazil - 2 of 2	160	ThinkSystem SR590 - TopSeller - ANZ	195
ThinkSystem SR550 - Non TopSeller - EMEA - 1 of 2	161	ThinkSystem SR590 - TopSeller - EMEA	196
ThinkSystem SR550 - Non TopSeller - EMEA - 2 of 2	162	ThinkSystem SR590 - TopSeller - HTK - 1 of 3	197
ThinkSystem SR550 - Non TopSeller - HTK - 1 of 3	163	ThinkSystem SR590 - TopSeller - HTK - 2 of 3	198
ThinkSystem SR550 - Non TopSeller - HTK - 2 of 3	164	ThinkSystem SR590 - TopSeller - HTK - 3 of 3	199
ThinkSystem SR550 - Non TopSeller - HTK - 3 of 3	165	ThinkSystem SR590 - TopSeller - JAPAN	200
ThinkSystem SR550 - Non TopSeller - INDIA - 1 of 2	166	ThinkSystem SR590 - TopSeller - NA	201
ThinkSystem SR550 - Non TopSeller - INDIA - 2 of 2	167	ThinkSystem SR590 - Non TopSeller - ANZ - 1 of 2	202
ThinkSystem SR550 - Non TopSeller - JAPAN	168	ThinkSystem SR590 - Non TopSeller - ANZ - 2 of 2	203
ThinkSystem SR550 - Non TopSeller - LA - 1 of 2	169	ThinkSystem SR590 - Non TopSeller - Argentina	204
ThinkSystem SR550 - Non TopSeller - LA - 2 of 2	170	ThinkSystem SR590 - Non TopSeller - ASEAN - 1 of 3	205
ThinkSystem SR550 - Non TopSeller - LA (except Chile)	171	ThinkSystem SR590 - Non TopSeller - ASEAN - 2 of 3	206
ThinkSystem SR550 - Non TopSeller - NA - 1 of 2	172	ThinkSystem SR590 - Non TopSeller - ASEAN - 3 of 3	207
ThinkSystem SR550 - Non TopSeller - NA - 2 of 2	173	ThinkSystem SR590 - Non TopSeller - EMEA - 1 of 2	208
ThinkSystem SR570	174	ThinkSystem SR590 - Non TopSeller - EMEA - 2 of 2	209
ThinkSystem SR570 Platform Specifications	175	ThinkSystem SR590 - Non TopSeller - INDIA	210

Contents

ThinkSystem SR590 - Non TopSeller - JAPAN	211	ThinkSystem SR630 - Non TopSeller - HTK - 2 of 3	246
ThinkSystem SR590 - Non TopSeller - LA - 1 of 4	212	ThinkSystem SR630 - Non TopSeller - HTK - 3 of 3	247
ThinkSystem SR590 - Non TopSeller - LA - 2 of 4	213	ThinkSystem SR630 - Non TopSeller - INDIA - 1 of 2	248
ThinkSystem SR590 - Non TopSeller - LA - 3 of 4	214	ThinkSystem SR630 - Non TopSeller - INDIA - 2 of 2	249
ThinkSystem SR590 - Non TopSeller - LA - 4 of 4	215	ThinkSystem SR630 - Non TopSeller - JAPAN - 1 of 2	250
ThinkSystem SR590 - Non TopSeller - NA - 1 of 2	216	ThinkSystem SR630 - Non TopSeller - JAPAN - 2 of 2	251
ThinkSystem SR590 - Non TopSeller - NA - 2 of 2	217	ThinkSystem SR630 - Non TopSeller - LA - 1 of 2	252
ThinkSystem SR630	218	ThinkSystem SR630 - Non TopSeller - LA - 2 of 2	253
ThinkSystem SR630 Platform Specifications	219	ThinkSystem SR630 - Non TopSeller - NA - 1 of 2	254
ThinkSystem SR630 - TopSeller - ANZ - 1 of 2	220	ThinkSystem SR630 - Non TopSeller - NA - 2 of 2	255
ThinkSystem SR630 - TopSeller - ANZ - 2 of 2	221	ThinkSystem SR630 - Non TopSeller - Taiwan - 1 of 2	256
ThinkSystem SR630 - TopSeller - Brazil	222	ThinkSystem SR630 - Non TopSeller - Taiwan - 2 of 2	257
ThinkSystem SR630 - TopSeller - Chile	223	ThinkSystem SR650	258
ThinkSystem SR630 - TopSeller - Colombia	224	ThinkSystem SR650 Platform Specifications	259
ThinkSystem SR630 - TopSeller - EMEA - 1 of 4	225	ThinkSystem SR650 - TopSeller - ANZ - 1 of 4	260
ThinkSystem SR630 - TopSeller - EMEA - 2 of 4	226	ThinkSystem SR650 - TopSeller - ANZ - 2 of 4	261
ThinkSystem SR630 - TopSeller - EMEA - 3 of 4	227	ThinkSystem SR650 - TopSeller - ANZ - 3 of 4	262
ThinkSystem SR630 - TopSeller - EMEA - 4 of 4	228	ThinkSystem SR650 - TopSeller - ANZ - 4 of 4	263
ThinkSystem SR630 - TopSeller - HTK	229	ThinkSystem SR650 - TopSeller - Brazil	264
ThinkSystem SR630 - TopSeller - JAPAN	230	ThinkSystem SR650 - TopSeller - Chile	265
ThinkSystem SR630 - TopSeller - LA	231	ThinkSystem SR650 - TopSeller - Colombia	266
ThinkSystem SR630 - TopSeller - NA	232	ThinkSystem SR650 - TopSeller - EMEA - 1 of 6	267
ThinkSystem SR630 - Non TopSeller - ANZ - 1 of 6	233	ThinkSystem SR650 - TopSeller - EMEA - 2 of 6	268
ThinkSystem SR630 - Non TopSeller - ANZ - 2 of 6	234	ThinkSystem SR650 - TopSeller - EMEA - 3 of 6	269
ThinkSystem SR630 - Non TopSeller - ANZ - 3 of 6	235	ThinkSystem SR650 - TopSeller - EMEA - 4 of 6	270
ThinkSystem SR630 - Non TopSeller - ANZ - 4 of 6	236	ThinkSystem SR650 - TopSeller - EMEA - 5 of 6	271
ThinkSystem SR630 - Non TopSeller - ANZ - 5 of 6	237	ThinkSystem SR650 - TopSeller - EMEA - 6 of 6	272
ThinkSystem SR630 - Non TopSeller - ANZ - 6 of 6	238	ThinkSystem SR650 - TopSeller - JAPAN	273
ThinkSystem SR630 - Non TopSeller - ASEAN	239	ThinkSystem SR650 - TopSeller - LA (except Chile)	274
ThinkSystem SR630 - Non TopSeller - CHINA	240	ThinkSystem SR650 - TopSeller - NA	275
ThinkSystem SR630 - Non TopSeller - EMEA - 1 of 3	241	ThinkSystem SR650 - TopSeller - Taiwan	276
ThinkSystem SR630 - Non TopSeller - EMEA - 2 of 3	242	ThinkSystem SR650 - Non TopSeller - ANZ - 1 of 4	277
ThinkSystem SR630 - Non TopSeller - EMEA - 3 of 3	243	ThinkSystem SR650 - Non TopSeller - ANZ - 2 of 4	278
ThinkSystem SR630 - Non TopSeller - Hong Kong	244	ThinkSystem SR650 - Non TopSeller - ANZ - 3 of 4	279
ThinkSystem SR630 - Non TopSeller - HTK - 1 of 3	245	ThinkSystem SR650 - Non TopSeller - ANZ - 4 of 4	280

Contents

ThinkSystem SR650 - Non TopSeller - ASEAN	281	ThinkSystem ST550 - TopSeller - NA	315
ThinkSystem SR650 - Non TopSeller - EMEA - 1 of 3	282	ThinkSystem ST550 - Non TopSeller - ANZ - 1 of 5	316
ThinkSystem SR650 - Non TopSeller - EMEA - 2 of 3	283	ThinkSystem ST550 - Non TopSeller - ANZ - 2 of 5	317
ThinkSystem SR650 - Non TopSeller - EMEA - 3 of 3	284	ThinkSystem ST550 - Non TopSeller - ANZ - 3 of 5	318
ThinkSystem SR650 - Non TopSeller - Hong Kong	285	ThinkSystem ST550 - Non TopSeller - ANZ - 4 of 5	319
ThinkSystem SR650 - Non TopSeller - HTK - 1 of 4	286	ThinkSystem ST550 - Non TopSeller - ANZ - 5 of 5	320
ThinkSystem SR650 - Non TopSeller - HTK - 2 of 4	287	ThinkSystem ST550 - Non TopSeller - Argentina - 1 of 2	321
ThinkSystem SR650 - Non TopSeller - HTK - 3 of 4	288	ThinkSystem ST550 - Non TopSeller - Argentina - 2 of 2	322
ThinkSystem SR650 - Non TopSeller - HTK - 4 of 4	289	ThinkSystem ST550 - Non TopSeller - ASEAN - 1 of 2	323
ThinkSystem SR650 - Non TopSeller - INDIA	290	ThinkSystem ST550 - Non TopSeller - ASEAN - 2 of 2	324
ThinkSystem SR650 - Non TopSeller - JAPAN - 1 of 2	291	ThinkSystem ST550 - Non TopSeller - Brazil	325
ThinkSystem SR650 - Non TopSeller - JAPAN - 2 of 2	292	ThinkSystem ST550 - Non TopSeller - EMEA - 1 of 2	326
ThinkSystem SR650 - Non TopSeller - LA	293	ThinkSystem ST550 - Non TopSeller - EMEA - 2 of 2	327
ThinkSystem SR650 - Non TopSeller - NA - 1 of 2	294	ThinkSystem ST550 - Non TopSeller - HTK - 1 of 2	328
ThinkSystem SR650 - Non TopSeller - NA - 2 of 2	295	ThinkSystem ST550 - Non TopSeller - HTK - 2 of 2	329
ThinkSystem SR650 - Non TopSeller - Taiwan	296	ThinkSystem ST550 - Non TopSeller - INDIA - 1 of 4	330
Towers	297	ThinkSystem ST550 - Non TopSeller - INDIA - 2 of 4	331
ThinkSystem ST550	297	ThinkSystem ST550 - Non TopSeller - INDIA - 3 of 4	332
ThinkSystem ST550 Platform Specifications	298	ThinkSystem ST550 - Non TopSeller - INDIA - 4 of 4	333
ThinkSystem ST550 - TopSeller - ANZ - 1 of 3	299	ThinkSystem ST550 - Non TopSeller - JAPAN	334
ThinkSystem ST550 - TopSeller - ANZ - 2 of 3	300	ThinkSystem ST550 - Non TopSeller - NA - 1 of 2	335
ThinkSystem ST550 - TopSeller - ANZ - 3 of 3	301	ThinkSystem ST550 - Non TopSeller - NA - 2 of 2	336
ThinkSystem ST550 - TopSeller - Argentina - 1 of 2	302	Legal Information	337
ThinkSystem ST550 - TopSeller - Argentina - 2 of 2	303		
ThinkSystem ST550 - TopSeller - Chile	304		
ThinkSystem ST550 - TopSeller - Colombia	305		
ThinkSystem ST550 - TopSeller - EMEA - 1 of 4	306		
ThinkSystem ST550 - TopSeller - EMEA - 2 of 4	307		
ThinkSystem ST550 - TopSeller - EMEA - 3 of 4	308		
ThinkSystem ST550 - TopSeller - EMEA - 4 of 4	309		
ThinkSystem ST550 - TopSeller - HTK - 1 of 2	310		
ThinkSystem ST550 - TopSeller - HTK - 2 of 2	311		
ThinkSystem ST550 - TopSeller - JAPAN	312		
ThinkSystem ST550 - TopSeller - LA (except Brazil)	313		
ThinkSystem ST550 - TopSeller - LA (except Chile)	314		

Summary of Changes

This section describes the changes made in this version of ThinkSystem PSREF and in previous version
This edition might also include minor corrections and editorial changes which are not identified

May 9, 2018 - Version 524

- ▶ Withdraw ThinkSystem SR650/SR630/SR550/SR530/SR850/ST550 LFOs to April 2018
- ▶ Update ThinkSystem SR650/SR630/SR590/SR530 LA LFOs to April 2018

April 18, 2018 - Version 523

- ▶ Update ThinkSystem SR650/630/550/530 LFOs to April 2018

November 29, 2017 - Version 516

- ▶ Add new ThinkSystem SR860/SR590/SR570
- ▶ Add 128GB 3DS RDIMM, 480GB M.2 SSD, VMware ESXi 6.5U1, Red Hat Enterprise Linux 7.4 supports on compatible ThinkSystem servers

November 8, 2017 - Version 515

- ▶ Add ThinkSystem SN850/SN550/SD530 and ThinkSystem D2 Enclosure

July 12, 2017 - Version 509

- ▶ Initial version, includes ThinkSystem rack servers SR650/SR630/SR550/SR530, tower server ST550, and mission-critical servers SR850 and SR950.

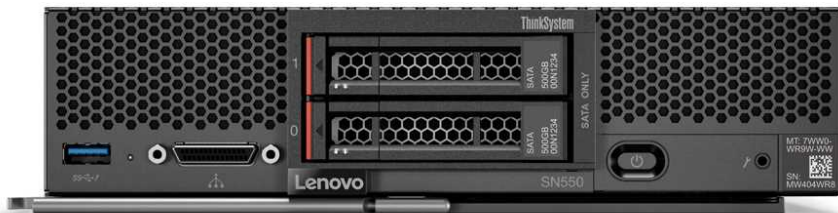

ThinkSystem SN550 Platform Specifications

Components	Specification																															
Form factor	Standard-width Flex System compute node																															
Dimensions	Height: 51 mm (2.0 in). Width: 215 mm (8.5 in). Depth: 493 mm (19.4 in)																															
Chassis support	Flex System Enterprise Chassis with CMM2																															
Weight	Maximum configuration: 15.6 lb (7.1 kg)																															
Processor	Up to two 165W Intel Xeon Scalable family processors, Bronze, Silver, Gold, or Platinum. Up to 28 cores at 2.1GHz, up to 3.6GHz with 4 cores. Up to two UPI (Ultra Path Interconnect) links at maximum 10.4GT/s each																															
Chipset	Intel C624 Platform Controller Hub																															
Memory	Up to 24 DIMM sockets. Each processor supports up to 12 DIMM sockets with 6 channels. DDR4-2666. RDIMMs, LRDIMMs, and 3DS RDIMMs are supported, but memory types cannot be intermixed. 3DS RDIMM is planned to available later																															
Memory capacity	Up to 768GB with 24 x 32GB RDIMMs and two processors. Or up to 1.5TB with 24 x 64GB LRDIMMs and two processors. Or up to 3TB with 24 x 128GB 3DS RDIMMs and two -M suffix processors. -M suffix processor supports 1.5TB memory per socket, non -M suffix processor supports 768GB memory per socket																															
Memory protection	ECC, SDDC (for x4-based memory DIMMs), ADDDC (for x4-based memory DIMMs, requires Gold or Platinum processors), memory mirroring, and memory sparing																															
Storage controllers	Supports the following RAID/HBA adapters:																															
	<table border="1"> <thead> <tr> <th>Adapter</th> <th>Interface</th> <th>Drive type</th> <th>RAID levels</th> <th>JBOD</th> <th>Cache</th> <th>Cache protection</th> <th>FastPath</th> </tr> </thead> <tbody> <tr> <td>Onboard Intel RSTe</td> <td>6Gbps SATA</td> <td>SATA</td> <td>0/1</td> <td>Yes</td> <td>None</td> <td>None</td> <td>No</td> </tr> <tr> <td>530-4i</td> <td>12Gbps SAS</td> <td>SATA/SAS</td> <td>0/1</td> <td>Yes</td> <td>None</td> <td>None</td> <td>Yes</td> </tr> <tr> <td>930-4i</td> <td>12Gbps SAS</td> <td>SATA/SAS</td> <td>0/1</td> <td>Yes</td> <td>2GB</td> <td>Flash backup</td> <td>Yes</td> </tr> </tbody> </table>	Adapter	Interface	Drive type	RAID levels	JBOD	Cache	Cache protection	FastPath	Onboard Intel RSTe	6Gbps SATA	SATA	0/1	Yes	None	None	No	530-4i	12Gbps SAS	SATA/SAS	0/1	Yes	None	None	Yes	930-4i	12Gbps SAS	SATA/SAS	0/1	Yes	2GB	Flash backup
Adapter	Interface	Drive type	RAID levels	JBOD	Cache	Cache protection	FastPath																									
Onboard Intel RSTe	6Gbps SATA	SATA	0/1	Yes	None	None	No																									
530-4i	12Gbps SAS	SATA/SAS	0/1	Yes	None	None	Yes																									
930-4i	12Gbps SAS	SATA/SAS	0/1	Yes	2GB	Flash backup	Yes																									
Disk drive bays	Two 2.5" hot-swap disk bays. Depending on server configuration and installed backplanes, the two bays can supports SATA, SATA/SAS, or SATA/NVMe disks. Optional one or two internal M.2 SSD for boot, dual M.2 SSD supports mirroring																															
Internal storage	2.5" NVMe SSD	800GB/960GB/1.6TB/1.92TB/3.84TB																														
	2.5" HDD, SATA6Gbps, 7,2K	1TB/2TB																														
	2.5" HDD, SAS12Gbps, 7,2K	1TB/2TB																														
	2.5" HDD, SAS12Gbps, 15K	300GB/600GB/900GB																														
	2.5" HDD, SAS12Gbps, 10K	300GB/600GB/900GB/1.2TB/1.8TB/2.4TB																														
	2.5" HDD, SAS12Gbps, 10K, SED	300GB/600GB																														
	2.5" SSD, SATA6Gbps	240GB/480GB/960GB/1.92TB/3.84TB																														
	2.5" SSD, SAS12Gbps	400GB/800GB/1.6TB/3.84TB/7.68TB/15.36TB																														
M.2 SATA SSD	32GB/128GB/480GB																															
Network interfaces	Optional 4x 10GbE LOM with fabric connector. The fabric connector is supported to routes the four 10GbE ports to Flex system chassis midplane. Optional adapters are supported, up to 2 adapters, up to 40GbE																															
Security features	Power-on and admin password. Trusted Platform Module, TCG 1.2 and 2.0 compliant. Optional TCM, China only																															
Operating systems supported	Microsoft Windows Server 2016, 2012 R2, Red Hat Enterprise Linux 6 and 7 x64, SUSE Linux Enterprise Server 11 and 12 x64, VMware vSphere 6.0 and 6.5																															
Systems management	UEFI. Lenovo XClarity Controller with Pilot4 XE401 baseboard management controller (BMC), Predictive Failure Analysis, light path diagnostics panel, automatic server restart, remote presence. Support for Lenovo XClarity Administrator and Lenovo XClarity Energy Manager																															
GPU support	None																															
Base warranty	MT 7X16: 3-year limited onsite service with 9x5/NBD																															
Power supply	Power to the blade server is derived from the power supplies that are installed in the chassis. There are no server options regarding power supplies.																															
Video	Integrated Matrox G200 in XClarity Controller																															
Front ports	One USB 3.0, one console breakout cable port that provides local KVM and serial ports (cable standard with chassis, more cables optional).																															
Environmental specification	Supports ASHRAE A3.																															
	Temperature - operating	A3: 5°C to 40°C (41°F to 104°F) A2: 10°C to 35°C (50°F to 95°F)																														
	Temperature - non operating (no package)	5°C to 45°C (41°F to 113°F)																														
	Temperature - non operating (with package)	-40°C to 60°C (-40°F to 140°F)																														
	Altitude - operating	(Unpressurized): 0-10000ft (0-3048m)																														
	Humidity - operating, non-condensing	A3:8%~85%. A2:8%~80%																														
Humidity - storage (with package), non-condensing	8%~90%																															

Expansion slots

Supports two PCIe 3.0 x16 I/O expansion connectors for attaching I/O adapter cards, each connector uses high-density, 216-pin PCIe connection. Please see I/O adapters below:

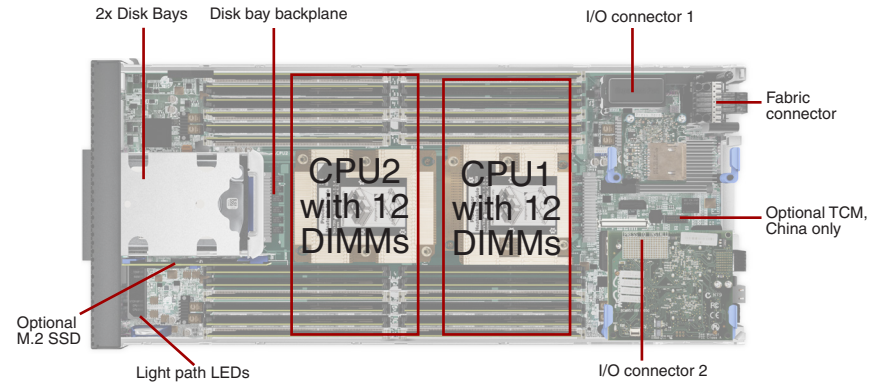

System unique options

7M27A03915	Lenovo SATA HDD/SSD Backplane for SN550
7M27A03916	Lenovo NVMe/SATA Backplane for SN550
7M27A03917	Lenovo RAID 930-4i-2GB 2 Drive Adapter Kit for SN550
7M27A03918	Lenovo RAID 530-4i 2 Drive Adapter Kit for SN550
7X77A01301	Lenovo 8GB TruDDR4 2666 MHz (1Rx8 1.2V) RDIMM
7X77A01302	Lenovo 16GB TruDDR4 2666 MHz (1Rx4 1.2V) RDIMM
7X77A01303	Lenovo 16GB TruDDR4 2666 MHz (2Rx8 1.2V) RDIMM
7X77A01304	Lenovo 32GB TruDDR4 2666 MHz (2Rx4 1.2V) RDIMM
7X77A01305	Lenovo 64GB TruDDR4 2666 MHz (4Rx4 1.2V) LRDIMM
00AG540	Flex System CN4052S 2-port 10Gb Virtual Fabric Adapter
00AG590	Flex System CN4054S 4-port 10Gb Virtual Fabric Adapter
01CV780	Flex System CN4052S 2-port 10Gb Virtual Fabric Adapter Advanced
01CV790	Flex System CN4054S 4-port 10Gb Virtual Fabric Adapter Advanced
7ZT7A00502	Lenovo Mellanox ConnectX-3 Mezz 40Gb 2-Port Ethernet Adapter
7ZT7A00520	Lenovo QLogic QML2692 Mezz 16Gb 2-Port Fibre Channel Adapter
7ZT7A00521	Lenovo Emulex LPm16002B-L Mezz 16Gb 2-Port Fibre Channel Adapter
7ZT7A00522	Lenovo Emulex LPm16004B-L Mezz 16Gb 4-Port Fibre Channel Adapter
7ZT7A00508	Lenovo Mellanox ConnectX-3 Mezz FDR 2-Port InfiniBand Adapter
7Y37A01092	Lenovo M.2 Enablement Kit
7Y37A01093	Lenovo M.2 with Mirroring Enablement Kit
7N47A00129	Lenovo M.2 32GB SATA 6Gbps Non-Hot-Swap SSD
7N47A00130	Lenovo M.2 128GB SATA 6Gbps Non-Hot-Swap SSD

ThinkSystem SN550 - TopSeller - LA

Product Specifications Reference (PSREF)

Model	Product	Region	Processor	Memory	Disk Bays	Storage Controller	Disks	M.2 Drives	Networking	I/O Slots	Warranty	Ann Date (mm/yy)
7X16A00YLA	ThinkSystem SN550	LA	1x Xeon Silver 4116 12C/2.1GHz/16.5MB/85W/DDR4-2400	1x 8GB RDIMM DDR4-2666	2x 2.5" SATA/SAS HS	1x 530-4i	None	None	4x 10GbE LOM + Fabric connector	1 used/2 max	3-year, Onsite	07/17
7X16A00RLA	ThinkSystem SN550	LA	1x Xeon Gold 5115 10C/2.4GHz/13.75MB/85W/DDR4-2400	1x 8GB RDIMM DDR4-2666	2x 2.5" SATA/SAS HS	1x 530-4i	None	None	4x 10GbE LOM + Fabric connector	1 used/2 max	3-year, Onsite	07/17
7X16A03JLA	ThinkSystem SN550	LA	1x Xeon Silver 4110 8C/2.1GHz/11MB/85W/DDR4-2400	1x 8GB RDIMM DDR4-2666	2x 2.5" SATA/SAS HS	1x 530-4i	None	None	4x 10GbE LOM + Fabric connector	1 used/2 max	3-year, Onsite	07/17
7X16A03LLA	ThinkSystem SN550	LA	1x Xeon Silver 4108 8C/1.8GHz/11MB/85W/DDR4-2400	1x 8GB RDIMM DDR4-2666	2x 2.5" SATA/SAS HS	1x 530-4i	None	None	4x 10GbE LOM + Fabric connector	1 used/2 max	3-year, Onsite	07/17
7X16A03MLA	ThinkSystem SN550	LA	1x Xeon Bronze 3106 8C/1.7GHz/11MB/85W/DDR4-2133	1x 8GB RDIMM DDR4-2666	2x 2.5" SATA/SAS HS	1x 530-4i	None	None	4x 10GbE LOM + Fabric connector	1 used/2 max	3-year, Onsite	07/17
7X16A032LA	ThinkSystem SN550	LA	1x Xeon Silver 4114 10C/2.2GHz/13.75MB/85W/DDR4-2400	1x 8GB RDIMM DDR4-2666	2x 2.5" SATA/SAS HS	1x 530-4i	None	None	4x 10GbE LOM + Fabric connector	1 used/2 max	3-year, Onsite	07/17
7X16A030LA	ThinkSystem SN550	LA	1x Xeon Bronze 3104 6C/1.7GHz/8.25MB/85W/DDR4-2133	1x 8GB RDIMM DDR4-2666	2x 2.5" SATA/SAS HS	1x 530-4i	None	None	4x 10GbE LOM + Fabric connector	1 used/2 max	3-year, Onsite	07/17

Model	Product	Region	Processor	Memory	Disk Bays	Storage Controller	Disks	M.2 Drives	Networking	I/O Slots	Warranty	Ann Date (mm/yy)
7X16A00FAU	ThinkSystem SN550	ANZ	1x Xeon Silver 4116 12C/2.1GHz/16.5MB/85W/DDR4-2400	1x 16GB RDIMM DDR4-2666	2x 2.5" SATA/NVMe HS	Onboard SATA	None	None	4x 10GbE LOM + Fabric connector	1 used/2 max	3-year, Onsite	07/17
7X16A00MAU	ThinkSystem SN550	ANZ	1x Xeon Gold 5115 10C/2.4GHz/13.75MB/85W/DDR4-2400	1x 16GB RDIMM DDR4-2666	2x 2.5" SATA/NVMe HS	Onboard SATA	None	None	4x 10GbE LOM + Fabric connector	1 used/2 max	3-year, Onsite	07/17
7X16A00WAU	ThinkSystem SN550	ANZ	1x Xeon Gold 6126 12C/2.6GHz/19.25MB/125W/DDR4-2666	1x 16GB RDIMM DDR4-2666	2x 2.5" SATA/NVMe HS	Onboard SATA	None	None	4x 10GbE LOM + Fabric connector	1 used/2 max	3-year, Onsite	07/17
7X16A01EAU	ThinkSystem SN550	ANZ	1x Xeon Gold 6148 20C/2.4GHz/27.5MB/150W/DDR4-2666	1x 32GB RDIMM DDR4-2666	2x 2.5" SATA/NVMe HS	Onboard SATA	None	None	4x 10GbE LOM + Fabric connector	1 used/2 max	3-year, Onsite	07/17
7X16A020AU	ThinkSystem SN550	ANZ	1x Xeon Gold 6152 22C/2.1GHz/30.25MB/140W/DDR4-2666	1x 32GB RDIMM DDR4-2666	2x 2.5" SATA/NVMe HS	Onboard SATA	None	None	4x 10GbE LOM + Fabric connector	1 used/2 max	3-year, Onsite	07/17
7X16A022AU	ThinkSystem SN550	ANZ	1x Xeon Gold 6140 18C/2.3GHz/24.75MB/140W/DDR4-2666	1x 16GB RDIMM DDR4-2666	2x 2.5" SATA/NVMe HS	Onboard SATA	None	None	4x 10GbE LOM + Fabric connector	1 used/2 max	3-year, Onsite	07/17
7X16A023AU	ThinkSystem SN550	ANZ	1x Xeon Gold 6150 18C/2.7GHz/24.75MB/165W/DDR4-2666	1x 32GB RDIMM DDR4-2666	2x 2.5" SATA/NVMe HS	Onboard SATA	None	None	4x 10GbE LOM + Fabric connector	1 used/2 max	3-year, Onsite	07/17
7X16A02DAU	ThinkSystem SN550	ANZ	1x Xeon Gold 5118 12C/2.3GHz/16.5MB/105W/DDR4-2400	1x 16GB RDIMM DDR4-2666	2x 2.5" SATA/NVMe HS	Onboard SATA	None	None	4x 10GbE LOM + Fabric connector	1 used/2 max	3-year, Onsite	07/17
7X16A02EAU	ThinkSystem SN550	ANZ	1x Xeon Gold 5120 14C/2.2GHz/19.25MB/105W/DDR4-2400	1x 16GB RDIMM DDR4-2666	2x 2.5" SATA/NVMe HS	Onboard SATA	None	None	4x 10GbE LOM + Fabric connector	1 used/2 max	3-year, Onsite	07/17
7X16A025AU	ThinkSystem SN550	ANZ	1x Xeon Gold 6130 16C/2.1GHz/22MB/125W/DDR4-2666	1x 16GB RDIMM DDR4-2666	2x 2.5" SATA/NVMe HS	Onboard SATA	None	None	4x 10GbE LOM + Fabric connector	1 used/2 max	3-year, Onsite	07/17
7X16A028AU	ThinkSystem SN550	ANZ	1x Xeon Gold 6136 12C/3.0GHz/24.75MB/150W/DDR4-2666	1x 16GB RDIMM DDR4-2666	2x 2.5" SATA/NVMe HS	Onboard SATA	None	None	4x 10GbE LOM + Fabric connector	1 used/2 max	3-year, Onsite	07/17
7X16A02BAU	ThinkSystem SN550	ANZ	1x Xeon Platinum 8176 28C/2.1GHz/38.5MB/165W/DDR4-2666	1x 32GB RDIMM DDR4-2666	2x 2.5" SATA/NVMe HS	Onboard SATA	None	None	4x 10GbE LOM + Fabric connector	1 used/2 max	3-year, Onsite	07/17
7X16A02YAU	ThinkSystem SN550	ANZ	1x Xeon Gold 5120 14C/2.2GHz/19.25MB/105W/DDR4-2400	1x 32GB RDIMM DDR4-2666	2x 2.5" SATA/NVMe HS	Onboard SATA	None	None	4x 10GbE LOM + Fabric connector	1 used/2 max	3-year, Onsite	07/17
7X16A033AU	ThinkSystem SN550	ANZ	1x Xeon Gold 6126 12C/2.6GHz/19.25MB/125W/DDR4-2666	1x 32GB RDIMM DDR4-2666	2x 2.5" SATA/NVMe HS	Onboard SATA	None	None	4x 10GbE LOM + Fabric connector	1 used/2 max	3-year, Onsite	07/17
7X16A037AU	ThinkSystem SN550	ANZ	1x Xeon Gold 6140 18C/2.3GHz/24.75MB/140W/DDR4-2666	1x 32GB RDIMM DDR4-2666	2x 2.5" SATA/NVMe HS	Onboard SATA	None	None	4x 10GbE LOM + Fabric connector	1 used/2 max	3-year, Onsite	07/17

Model	Product	Region	Processor	Memory	Disk Bays	Storage Controller	Disks	M.2 Drives	Networking	I/O Slots	Warranty	Ann Date (mm/yy)
7X16A03DAU	ThinkSystem SN550	ANZ	1x Xeon Gold 6134 8C/3.2GHz/24.75MB/130W/DDR4-2666	1x 32GB RDIMM DDR4-2666	2x 2.5" SATA/NVMe HS	Onboard SATA	None	None	4x 10GbE LOM + Fabric connector	1 used/2 max	3-year, Onsite	07/17
7X16A03EAU	ThinkSystem SN550	ANZ	1x Xeon Silver 4116 12C/2.1GHz/16.5MB/85W/DDR4-2400	1x 32GB RDIMM DDR4-2666	2x 2.5" SATA/NVMe HS	Onboard SATA	None	None	4x 10GbE LOM + Fabric connector	1 used/2 max	3-year, Onsite	07/17
7X16A03KAU	ThinkSystem SN550	ANZ	1x Xeon Gold 5118 12C/2.3GHz/16.5MB/105W/DDR4-2400	1x 32GB RDIMM DDR4-2666	2x 2.5" SATA/NVMe HS	Onboard SATA	None	None	4x 10GbE LOM + Fabric connector	1 used/2 max	3-year, Onsite	07/17
7X16A03PAU	ThinkSystem SN550	ANZ	1x Xeon Gold 6138 20C/2.0GHz/27.5MB/125W/DDR4-2666	1x 32GB RDIMM DDR4-2666	2x 2.5" SATA/NVMe HS	Onboard SATA	None	None	4x 10GbE LOM + Fabric connector	1 used/2 max	3-year, Onsite	07/17
7X16A03RAU	ThinkSystem SN550	ANZ	1x Xeon Platinum 8160 24C/2.1GHz/33MB/150W/DDR4-2666	1x 32GB RDIMM DDR4-2666	2x 2.5" SATA/NVMe HS	Onboard SATA	None	None	4x 10GbE LOM + Fabric connector	1 used/2 max	3-year, Onsite	07/17
7X16A03SAU	ThinkSystem SN550	ANZ	1x Xeon Gold 6130 16C/2.1GHz/22MB/125W/DDR4-2666	1x 32GB RDIMM DDR4-2666	2x 2.5" SATA/NVMe HS	Onboard SATA	None	None	4x 10GbE LOM + Fabric connector	1 used/2 max	3-year, Onsite	07/17

ThinkSystem SN550 - Non TopSeller - ASEAN

Product Specifications Reference (PSREF)

Model	Product	Region	Processor	Memory	Disk Bays	Storage Controller	Disks	M.2 Drives	Networking	I/O Slots	Warranty	Ann Date (mm/yy)
7X16A01VSG	ThinkSystem SN550	ASEAN	1x Xeon Bronze 3104 6C/1.7GHz/8.25MB/85W/DDR4-2133	1x 8GB RDIMM DDR4-2666	2x 2.5" SATA HS	Onboard SATA	None	None	None	0 used/2 max	3-year, Onsite	07/17
7X16A01XSG	ThinkSystem SN550	ASEAN	1x Xeon Bronze 3106 8C/1.7GHz/11MB/85W/DDR4-2133	1x 8GB RDIMM DDR4-2666	2x 2.5" SATA HS	Onboard SATA	None	None	None	0 used/2 max	3-year, Onsite	07/17
7X16A01YSG	ThinkSystem SN550	ASEAN	1x Xeon Silver 4110 8C/2.1GHz/11MB/85W/DDR4-2400	1x 8GB RDIMM DDR4-2666	2x 2.5" SATA HS	Onboard SATA	None	None	None	0 used/2 max	3-year, Onsite	07/17
7X16A01ZSG	ThinkSystem SN550	ASEAN	1x Xeon Silver 4114 10C/2.2GHz/13.75MB/85W/DDR4-2400	1x 8GB RDIMM DDR4-2666	2x 2.5" SATA HS	Onboard SATA	None	None	None	0 used/2 max	3-year, Onsite	07/17
7X16A01GSG	ThinkSystem SN550	ASEAN	1x Xeon Gold 6130 16C/2.1GHz/22MB/125W/DDR4-2666	1x 16GB RDIMM DDR4-2666	2x 2.5" SATA HS	Onboard SATA	None	None	None	0 used/2 max	3-year, Onsite	07/17
7X16A01BSG	ThinkSystem SN550	ASEAN	1x Xeon Silver 4116 12C/2.1GHz/16.5MB/85W/DDR4-2400	1x 8GB RDIMM DDR4-2666	2x 2.5" SATA HS	Onboard SATA	None	None	None	0 used/2 max	3-year, Onsite	07/17
7X16A01DSG	ThinkSystem SN550	ASEAN	1x Xeon Gold 5120 14C/2.2GHz/19.25MB/105W/DDR4-2400	1x 16GB RDIMM DDR4-2666	2x 2.5" SATA HS	Onboard SATA	None	None	None	0 used/2 max	3-year, Onsite	07/17
7X16A01KSG	ThinkSystem SN550	ASEAN	1x Xeon Gold 6138 20C/2.0GHz/27.5MB/125W/DDR4-2666	1x 16GB RDIMM DDR4-2666	2x 2.5" SATA HS	Onboard SATA	None	None	None	0 used/2 max	3-year, Onsite	07/17

Model	Product	Region	Processor	Memory	Disk Bays	Storage Controller	Disks	M.2 Drives	Networking	I/O Slots	Warranty	Ann Date (mm/yy)
7X16A03SBR	ThinkSystem SN550	Brazil	1x Xeon Gold 6130 16C/2.1GHz/22MB/125W/DDR4-2666	1x 32GB RDIMM DDR4-2666	2x 2.5" SATA/NVMe HS	Onboard SATA	None	None	4x 10GbE LOM + Fabric connector	1 used/2 max	3-year, Onsite	07/17
7X16A03VBR	ThinkSystem SN550	Brazil	1x Xeon Gold 6152 22C/2.1GHz/30.25MB/140W/DDR4-2666	1x 32GB RDIMM DDR4-2666	2x 2.5" SATA/NVMe HS	Onboard SATA	None	None	4x 10GbE LOM + Fabric connector	1 used/2 max	3-year, Onsite	07/17
7X16A03WBR	ThinkSystem SN550	Brazil	1x Xeon Gold 6148 20C/2.4GHz/27.5MB/150W/DDR4-2666	1x 32GB RDIMM DDR4-2666	2x 2.5" SATA/NVMe HS	Onboard SATA	None	None	4x 10GbE LOM + Fabric connector	1 used/2 max	3-year, Onsite	07/17
7X16A03XBR	ThinkSystem SN550	Brazil	1x Xeon Platinum 8176 28C/2.1GHz/38.5MB/165W/DDR4-2666	1x 32GB RDIMM DDR4-2666	2x 2.5" SATA/NVMe HS	Onboard SATA	None	None	4x 10GbE LOM + Fabric connector	1 used/2 max	3-year, Onsite	07/17
7X16A03RBR	ThinkSystem SN550	Brazil	1x Xeon Platinum 8160 24C/2.1GHz/33MB/150W/DDR4-2666	1x 32GB RDIMM DDR4-2666	2x 2.5" SATA/NVMe HS	Onboard SATA	None	None	4x 10GbE LOM + Fabric connector	1 used/2 max	3-year, Onsite	07/17
7X16A03PBR	ThinkSystem SN550	Brazil	1x Xeon Gold 6138 20C/2.0GHz/27.5MB/125W/DDR4-2666	1x 32GB RDIMM DDR4-2666	2x 2.5" SATA/NVMe HS	Onboard SATA	None	None	4x 10GbE LOM + Fabric connector	1 used/2 max	3-year, Onsite	07/17
7X16A03KBR	ThinkSystem SN550	Brazil	1x Xeon Gold 5118 12C/2.3GHz/16.5MB/105W/DDR4-2400	1x 32GB RDIMM DDR4-2666	2x 2.5" SATA/NVMe HS	Onboard SATA	None	None	4x 10GbE LOM + Fabric connector	1 used/2 max	3-year, Onsite	07/17
7X16A03EBR	ThinkSystem SN550	Brazil	1x Xeon Silver 4116 12C/2.1GHz/16.5MB/85W/DDR4-2400	1x 32GB RDIMM DDR4-2666	2x 2.5" SATA/NVMe HS	Onboard SATA	None	None	4x 10GbE LOM + Fabric connector	1 used/2 max	3-year, Onsite	07/17
7X16A03DBR	ThinkSystem SN550	Brazil	1x Xeon Gold 6134 8C/3.2GHz/24.75MB/130W/DDR4-2666	1x 32GB RDIMM DDR4-2666	2x 2.5" SATA/NVMe HS	Onboard SATA	None	None	4x 10GbE LOM + Fabric connector	1 used/2 max	3-year, Onsite	07/17
7X16A037BR	ThinkSystem SN550	Brazil	1x Xeon Gold 6140 18C/2.3GHz/24.75MB/140W/DDR4-2666	1x 32GB RDIMM DDR4-2666	2x 2.5" SATA/NVMe HS	Onboard SATA	None	None	4x 10GbE LOM + Fabric connector	1 used/2 max	3-year, Onsite	07/17
7X16A033BR	ThinkSystem SN550	Brazil	1x Xeon Gold 6126 12C/2.6GHz/19.25MB/125W/DDR4-2666	1x 32GB RDIMM DDR4-2666	2x 2.5" SATA/NVMe HS	Onboard SATA	None	None	4x 10GbE LOM + Fabric connector	1 used/2 max	3-year, Onsite	07/17
7X16A02YBR	ThinkSystem SN550	Brazil	1x Xeon Gold 5120 14C/2.2GHz/19.25MB/105W/DDR4-2400	1x 32GB RDIMM DDR4-2666	2x 2.5" SATA/NVMe HS	Onboard SATA	None	None	4x 10GbE LOM + Fabric connector	1 used/2 max	3-year, Onsite	07/17

Model	Product	Region	Processor	Memory	Disk Bays	Storage Controller	Disks	M.2 Drives	Networking	I/O Slots	Warranty	Ann Date (mm/yy)
7X16A02CEA	ThinkSystem SN550	EET, MEA, RUCIS, WE	1x Xeon Bronze 3106 8C/1.7GHz/11MB/85W/DDR4-2133	1x 16GB RDIMM DDR4-2666	2x 2.5" SATA/NVMe HS	Onboard SATA	None	None	4x 10GbE LOM + Fabric connector	1 used/2 max	3-year, Onsite	07/17
7X16A029EA	ThinkSystem SN550	EET, MEA, RUCIS, WE	1x Xeon Silver 4108 8C/1.8GHz/11MB/85W/DDR4-2400	1x 32GB RDIMM DDR4-2666	2x 2.5" SATA/NVMe HS	Onboard SATA	None	None	4x 10GbE LOM + Fabric connector	1 used/2 max	3-year, Onsite	07/17
7X16A026EA	ThinkSystem SN550	EET, MEA, RUCIS, WE	1x Xeon Silver 4110 8C/2.1GHz/11MB/85W/DDR4-2400	1x 32GB RDIMM DDR4-2666	2x 2.5" SATA/NVMe HS	Onboard SATA	None	None	4x 10GbE LOM + Fabric connector	1 used/2 max	3-year, Onsite	07/17
7X16A02KEA	ThinkSystem SN550	EET, MEA, RUCIS, WE	1x Xeon Platinum 8176 28C/2.1GHz/38.5MB/165W/DDR4-2666	1x 32GB RDIMM DDR4-2666	2x 2.5" SATA/NVMe HS	Onboard SATA	None	None	4x 10GbE LOM + Fabric connector	1 used/2 max	3-year, Onsite	07/17
7X16A02LEA	ThinkSystem SN550	EET, MEA, RUCIS, WE	1x Xeon Gold 6134 8C/3.2GHz/24.75MB/130W/DDR4-2666	1x 32GB RDIMM DDR4-2666	2x 2.5" SATA/NVMe HS	Onboard SATA	None	None	4x 10GbE LOM + Fabric connector	1 used/2 max	3-year, Onsite	07/17
7X16A02MEA	ThinkSystem SN550	EET, MEA, RUCIS, WE	1x Xeon Platinum 8160 24C/2.1GHz/33MB/150W/DDR4-2666	1x 32GB RDIMM DDR4-2666	2x 2.5" SATA/NVMe HS	Onboard SATA	None	None	4x 10GbE LOM + Fabric connector	1 used/2 max	3-year, Onsite	07/17
7X16A02NEA	ThinkSystem SN550	EET, MEA, RUCIS, WE	1x Xeon Silver 4116 12C/2.1GHz/16.5MB/85W/DDR4-2400	1x 32GB RDIMM DDR4-2666	2x 2.5" SATA/NVMe HS	Onboard SATA	None	None	4x 10GbE LOM + Fabric connector	1 used/2 max	3-year, Onsite	07/17
7X16A02PEA	ThinkSystem SN550	EET, MEA, RUCIS, WE	1x Xeon Gold 6126 12C/2.6GHz/19.25MB/125W/DDR4-2666	1x 32GB RDIMM DDR4-2666	2x 2.5" SATA/NVMe HS	Onboard SATA	None	None	4x 10GbE LOM + Fabric connector	1 used/2 max	3-year, Onsite	07/17
7X16A02QEA	ThinkSystem SN550	EET, MEA, RUCIS, WE	1x Xeon Gold 5120 14C/2.2GHz/19.25MB/105W/DDR4-2400	1x 32GB RDIMM DDR4-2666	2x 2.5" SATA/NVMe HS	Onboard SATA	None	None	4x 10GbE LOM + Fabric connector	1 used/2 max	3-year, Onsite	07/17
7X16A02REA	ThinkSystem SN550	EET, MEA, RUCIS, WE	1x Xeon Gold 5118 12C/2.3GHz/16.5MB/105W/DDR4-2400	1x 32GB RDIMM DDR4-2666	2x 2.5" SATA/NVMe HS	Onboard SATA	None	None	4x 10GbE LOM + Fabric connector	1 used/2 max	3-year, Onsite	07/17
7X16A02SEA	ThinkSystem SN550	EET, MEA, RUCIS, WE	1x Xeon Gold 6148 20C/2.4GHz/27.5MB/150W/DDR4-2666	1x 32GB RDIMM DDR4-2666	2x 2.5" SATA/NVMe HS	Onboard SATA	None	None	4x 10GbE LOM + Fabric connector	1 used/2 max	3-year, Onsite	07/17
7X16A02TEA	ThinkSystem SN550	EET, MEA, RUCIS, WE	1x Xeon Gold 6140 18C/2.3GHz/24.75MB/140W/DDR4-2666	1x 32GB RDIMM DDR4-2666	2x 2.5" SATA/NVMe HS	Onboard SATA	None	None	4x 10GbE LOM + Fabric connector	1 used/2 max	3-year, Onsite	07/17
7X16A02UEA	ThinkSystem SN550	EET, MEA, RUCIS, WE	1x Xeon Gold 6152 22C/2.1GHz/30.25MB/140W/DDR4-2666	1x 32GB RDIMM DDR4-2666	2x 2.5" SATA/NVMe HS	Onboard SATA	None	None	4x 10GbE LOM + Fabric connector	1 used/2 max	3-year, Onsite	07/17
7X16A02VEA	ThinkSystem SN550	EET, MEA, RUCIS, WE	1x Xeon Gold 6130 16C/2.1GHz/22MB/125W/DDR4-2666	1x 32GB RDIMM DDR4-2666	2x 2.5" SATA/NVMe HS	Onboard SATA	None	None	4x 10GbE LOM + Fabric connector	1 used/2 max	3-year, Onsite	07/17
7X16A02WEA	ThinkSystem SN550	EET, MEA, RUCIS, WE	1x Xeon Gold 6138 20C/2.0GHz/27.5MB/125W/DDR4-2666	1x 32GB RDIMM DDR4-2666	2x 2.5" SATA/NVMe HS	Onboard SATA	None	None	4x 10GbE LOM + Fabric connector	1 used/2 max	3-year, Onsite	07/17

Model	Product	Region	Processor	Memory	Disk Bays	Storage Controller	Disks	M.2 Drives	Networking	I/O Slots	Warranty	Ann Date (mm/yy)
7X16A00CEA	ThinkSystem SN550	EET, MEA, RUCIS, WE	1x Xeon Silver 4114 10C/2.2GHz/13.75MB/85W/DDR4-2400	1x 32GB RDIMM DDR4-2666	2x 2.5" SATA/NVMe HS	Onboard SATA	None	None	4x 10GbE LOM + Fabric connector	1 used/2 max	3-year, Onsite	07/17

ThinkSystem SN550 - Non TopSeller - HTK

Product Specifications Reference (PSREF)

Model	Product	Region	Processor	Memory	Disk Bays	Storage Controller	Disks	M.2 Drives	Networking	I/O Slots	Warranty	Ann Date (mm/yy)
7X16A003CN	ThinkSystem SN550	HTK	1x Xeon Gold 5115 10C/2.4GHz/13.75MB/85W/DDR4-2400	1x 16GB RDIMM DDR4-2666	2x 2.5" SATA HS	Onboard SATA	None	None	None	0 used/2 max	3-year, Onsite	07/17
7X16A016CN	ThinkSystem SN550	HTK	2x Xeon Platinum 8170 26C/2.1GHz/35.75MB/165W/DDR4-2666	2x 16GB RDIMM DDR4-2666	2x 2.5" SATA HS	Onboard SATA	None	None	None	0 used/2 max	3-year, Onsite	07/17
7X16A01LCN	ThinkSystem SN550	HTK	1x Xeon Platinum 8160 24C/2.1GHz/33MB/150W/DDR4-2666	2x 16GB RDIMM DDR4-2666	2x 2.5" SATA HS	Onboard SATA	None	None	None	0 used/2 max	3-year, Onsite	07/17
7X16A01NCN	ThinkSystem SN550	HTK	1x Xeon Gold 6142 16C/2.6GHz/22MB/150W/DDR4-2666	1x 16GB RDIMM DDR4-2666	2x 2.5" SATA HS	Onboard SATA	None	None	None	0 used/2 max	3-year, Onsite	07/17
7X16A01PCN	ThinkSystem SN550	HTK	1x Xeon Gold 6142 16C/2.6GHz/22MB/150W/DDR4-2666	1x 32GB RDIMM DDR4-2666	2x 2.5" SATA HS	Onboard SATA	None	None	None	0 used/2 max	3-year, Onsite	07/17
7X16A01QCN	ThinkSystem SN550	HTK	1x Xeon Gold 6130 16C/2.1GHz/22MB/125W/DDR4-2666	1x 32GB RDIMM DDR4-2666	2x 2.5" SATA HS	Onboard SATA	None	None	None	0 used/2 max	3-year, Onsite	07/17
7X16A01RCN	ThinkSystem SN550	HTK	1x Xeon Gold 6140 18C/2.3GHz/24.75MB/140W/DDR4-2666	1x 32GB RDIMM DDR4-2666	2x 2.5" SATA HS	Onboard SATA	None	None	None	0 used/2 max	3-year, Onsite	07/17
7X16A01SCN	ThinkSystem SN550	HTK	1x Xeon Gold 6140 18C/2.3GHz/24.75MB/140W/DDR4-2666	1x 16GB RDIMM DDR4-2666	2x 2.5" SATA HS	Onboard SATA	None	None	None	0 used/2 max	3-year, Onsite	07/17
7X16A01TCN	ThinkSystem SN550	HTK	1x Xeon Gold 5120 14C/2.2GHz/19.25MB/105W/DDR4-2400	1x 16GB RDIMM DDR4-2666	2x 2.5" SATA HS	Onboard SATA	None	None	None	0 used/2 max	3-year, Onsite	07/17
7X16A01UCN	ThinkSystem SN550	HTK	1x Xeon Gold 6130 16C/2.1GHz/22MB/125W/DDR4-2666	1x 16GB RDIMM DDR4-2666	2x 2.5" SATA HS	Onboard SATA	None	None	None	0 used/2 max	3-year, Onsite	07/17
7X16A02ACN	ThinkSystem SN550	HTK	1x Xeon Gold 5118 12C/2.3GHz/16.5MB/105W/DDR4-2400	1x 16GB RDIMM DDR4-2666	2x 2.5" SATA HS	Onboard SATA	None	None	None	0 used/2 max	3-year, Onsite	07/17
7X16A031CN	ThinkSystem SN550	HTK	1x Xeon Silver 4110 8C/2.1GHz/11MB/85W/DDR4-2400	1x 16GB RDIMM DDR4-2666	2x 2.5" SATA HS	Onboard SATA	None	None	None	0 used/2 max	3-year, Onsite	07/17
7X16A03GCN	ThinkSystem SN550	HTK	1x Xeon Silver 4112 4C/2.6GHz/8.25MB/85W/DDR4-2400	1x 16GB RDIMM DDR4-2666	2x 2.5" SATA HS	Onboard SATA	None	None	None	0 used/2 max	3-year, Onsite	07/17
7X16A03HCN	ThinkSystem SN550	HTK	1x Xeon Silver 4114 10C/2.2GHz/13.75MB/85W/DDR4-2400	1x 16GB RDIMM DDR4-2666	2x 2.5" SATA HS	Onboard SATA	None	None	None	0 used/2 max	3-year, Onsite	07/17
7X16A03TCN	ThinkSystem SN550	HTK	1x Xeon Bronze 3106 8C/1.7GHz/11MB/85W/DDR4-2133	1x 16GB RDIMM DDR4-2666	2x 2.5" SATA HS	Onboard SATA	None	None	None	0 used/2 max	3-year, Onsite	07/17

Model	Product	Region	Processor	Memory	Disk Bays	Storage Controller	Disks	M.2 Drives	Networking	I/O Slots	Warranty	Ann Date (mm/yy)
7X16A014SG	ThinkSystem SN550	INDIA	1x Xeon Gold 6148 20C/2.4GHz/27.5MB/150W/DDR4-2666	1x 32GB RDIMM DDR4-2666	2x 2.5" SATA/SAS HS	1x 530-4i	None	None	4x 10GbE LOM + Fabric connector	1 used/2 max	3-year, Onsite	07/17
7X16A01HSG	ThinkSystem SN550	INDIA	1x Xeon Platinum 8176 28C/2.1GHz/38.5MB/165W/DDR4-2666	1x 32GB RDIMM DDR4-2666	2x 2.5" SATA HS	Onboard SATA	None	None	4x 10GbE LOM + Fabric connector	1 used/2 max	3-year, Onsite	07/17
7X16A017SG	ThinkSystem SN550	INDIA	1x Xeon Gold 6150 18C/2.7GHz/24.75MB/165W/DDR4-2666	1x 16GB RDIMM DDR4-2666	2x 2.5" SATA/SAS HS	1x 530-4i	None	None	4x 10GbE LOM + Fabric connector	1 used/2 max	3-year, Onsite	07/17
7X16A018SG	ThinkSystem SN550	INDIA	1x Xeon Gold 6148 20C/2.4GHz/27.5MB/150W/DDR4-2666	1x 32GB RDIMM DDR4-2666	2x 2.5" SATA HS	Onboard SATA	None	None	4x 10GbE LOM + Fabric connector	1 used/2 max	3-year, Onsite	07/17
7X16A019SG	ThinkSystem SN550	INDIA	1x Xeon Gold 6152 22C/2.1GHz/30.25MB/140W/DDR4-2666	1x 32GB RDIMM DDR4-2666	2x 2.5" SATA/SAS HS	1x 530-4i	None	None	4x 10GbE LOM + Fabric connector	1 used/2 max	3-year, Onsite	07/17
7X16A01ASG	ThinkSystem SN550	INDIA	1x Xeon Platinum 8176 28C/2.1GHz/38.5MB/165W/DDR4-2666	1x 32GB RDIMM DDR4-2666	2x 2.5" SATA/SAS HS	1x 530-4i	None	None	4x 10GbE LOM + Fabric connector	1 used/2 max	3-year, Onsite	07/17
7X16A00XSG	ThinkSystem SN550	INDIA	1x Xeon Gold 6140 18C/2.3GHz/24.75MB/140W/DDR4-2666	1x 16GB RDIMM DDR4-2666	2x 2.5" SATA/SAS HS	1x 530-4i	None	None	4x 10GbE LOM + Fabric connector	1 used/2 max	3-year, Onsite	07/17
7X16A00ZSG	ThinkSystem SN550	INDIA	1x Xeon Gold 6130 16C/2.1GHz/22MB/125W/DDR4-2666	1x 16GB RDIMM DDR4-2666	2x 2.5" SATA/SAS HS	1x 530-4i	None	None	4x 10GbE LOM + Fabric connector	1 used/2 max	3-year, Onsite	07/17
7X16A010SG	ThinkSystem SN550	INDIA	1x Xeon Gold 6150 18C/2.7GHz/24.75MB/165W/DDR4-2666	1x 16GB RDIMM DDR4-2666	2x 2.5" SATA HS	Onboard SATA	None	None	4x 10GbE LOM + Fabric connector	1 used/2 max	3-year, Onsite	07/17
7X16A00NSG	ThinkSystem SN550	INDIA	1x Xeon Gold 5118 12C/2.3GHz/16.5MB/105W/DDR4-2400	1x 16GB RDIMM DDR4-2666	2x 2.5" SATA HS	Onboard SATA	None	None	4x 10GbE LOM + Fabric connector	1 used/2 max	3-year, Onsite	07/17
7X16A00PSG	ThinkSystem SN550	INDIA	1x Xeon Gold 5115 10C/2.4GHz/13.75MB/85W/DDR4-2400	1x 16GB RDIMM DDR4-2666	2x 2.5" SATA/SAS HS	1x 530-4i	None	None	4x 10GbE LOM + Fabric connector	1 used/2 max	3-year, Onsite	07/17
7X16A00QSG	ThinkSystem SN550	INDIA	1x Xeon Silver 4116 12C/2.1GHz/16.5MB/85W/DDR4-2400	1x 16GB RDIMM DDR4-2666	2x 2.5" SATA HS	Onboard SATA	None	None	4x 10GbE LOM + Fabric connector	1 used/2 max	3-year, Onsite	07/17
7X16A00SSG	ThinkSystem SN550	INDIA	1x Xeon Gold 6136 12C/3.0GHz/24.75MB/150W/DDR4-2666	1x 16GB RDIMM DDR4-2666	2x 2.5" SATA/SAS HS	1x 530-4i	None	None	4x 10GbE LOM + Fabric connector	1 used/2 max	3-year, Onsite	07/17
7X16A00VSG	ThinkSystem SN550	INDIA	1x Xeon Gold 6126 12C/2.6GHz/19.25MB/125W/DDR4-2666	1x 16GB RDIMM DDR4-2666	2x 2.5" SATA/SAS HS	1x 530-4i	None	None	4x 10GbE LOM + Fabric connector	1 used/2 max	3-year, Onsite	07/17
7X16A004SG	ThinkSystem SN550	INDIA	1x Xeon Gold 6136 12C/3.0GHz/24.75MB/150W/DDR4-2666	1x 16GB RDIMM DDR4-2666	2x 2.5" SATA HS	Onboard SATA	None	None	4x 10GbE LOM + Fabric connector	1 used/2 max	3-year, Onsite	07/17

Model	Product	Region	Processor	Memory	Disk Bays	Storage Controller	Disks	M.2 Drives	Networking	I/O Slots	Warranty	Ann Date (mm/yy)
7X16A002SG	ThinkSystem SN550	INDIA	1x Xeon Gold 6140 18C/2.3GHz/24.75MB/140W/DDR4-2666	1x 16GB RDIMM DDR4-2666	2x 2.5" SATA HS	Onboard SATA	None	None	4x 10GbE LOM + Fabric connector	1 used/2 max	3-year, Onsite	07/17
7X16A008SG	ThinkSystem SN550	INDIA	1x Xeon Gold 6152 22C/2.1GHz/30.25MB/140W/DDR4-2666	1x 32GB RDIMM DDR4-2666	2x 2.5" SATA HS	Onboard SATA	None	None	4x 10GbE LOM + Fabric connector	1 used/2 max	3-year, Onsite	07/17
7X16A009SG	ThinkSystem SN550	INDIA	1x Xeon Gold 6130 16C/2.1GHz/22MB/125W/DDR4-2666	1x 16GB RDIMM DDR4-2666	2x 2.5" SATA HS	Onboard SATA	None	None	4x 10GbE LOM + Fabric connector	1 used/2 max	3-year, Onsite	07/17
7X16A00DSG	ThinkSystem SN550	INDIA	1x Xeon Silver 4116 12C/2.1GHz/16.5MB/85W/DDR4-2400	1x 16GB RDIMM DDR4-2666	2x 2.5" SATA/SAS HS	1x 530-4i	None	None	4x 10GbE LOM + Fabric connector	1 used/2 max	3-year, Onsite	07/17
7X16A00ESG	ThinkSystem SN550	INDIA	1x Xeon Gold 5118 12C/2.3GHz/16.5MB/105W/DDR4-2400	1x 16GB RDIMM DDR4-2666	2x 2.5" SATA/SAS HS	1x 530-4i	None	None	4x 10GbE LOM + Fabric connector	1 used/2 max	3-year, Onsite	07/17
7X16A00KSG	ThinkSystem SN550	INDIA	1x Xeon Gold 5120 14C/2.2GHz/19.25MB/105W/DDR4-2400	1x 16GB RDIMM DDR4-2666	2x 2.5" SATA HS	Onboard SATA	None	None	4x 10GbE LOM + Fabric connector	1 used/2 max	3-year, Onsite	07/17
7X16A00LSG	ThinkSystem SN550	INDIA	1x Xeon Gold 5120 14C/2.2GHz/19.25MB/105W/DDR4-2400	1x 16GB RDIMM DDR4-2666	2x 2.5" SATA/SAS HS	1x 530-4i	None	None	4x 10GbE LOM + Fabric connector	1 used/2 max	3-year, Onsite	07/17
7X16A00GSG	ThinkSystem SN550	INDIA	1x Xeon Gold 6126 12C/2.6GHz/19.25MB/125W/DDR4-2666	1x 16GB RDIMM DDR4-2666	2x 2.5" SATA HS	Onboard SATA	None	None	4x 10GbE LOM + Fabric connector	1 used/2 max	3-year, Onsite	07/17
7X16A00HSG	ThinkSystem SN550	INDIA	1x Xeon Gold 5115 10C/2.4GHz/13.75MB/85W/DDR4-2400	1x 16GB RDIMM DDR4-2666	2x 2.5" SATA HS	Onboard SATA	None	None	4x 10GbE LOM + Fabric connector	1 used/2 max	3-year, Onsite	07/17

ThinkSystem SN550 - Non TopSeller - JAPAN

Product Specifications Reference (PSREF)

Model	Product	Region	Processor	Memory	Disk Bays	Storage Controller	Disks	M.2 Drives	Networking	I/O Slots	Warranty	Ann Date (mm/yy)
7X16A00JJP	ThinkSystem SN550	JAPAN	1x Xeon Silver 4110 8C/2.1GHz/11MB/85W/DDR4-2400	1x 16GB RDIMM DDR4-2666	2x 2.5" SATA/NVMe HS	Onboard SATA	None	None	4x 10GbE LOM + Fabric connector	1 used/2 max	3-year, Onsite	07/17
7X16A00TJP	ThinkSystem SN550	JAPAN	1x Xeon Bronze 3104 6C/1.7GHz/8.25MB/85W/DDR4-2133	1x 16GB RDIMM DDR4-2666	2x 2.5" SATA HS	Onboard SATA	None	None	4x 10GbE LOM + Fabric connector	1 used/2 max	3-year, Onsite	07/17
7X16A012JP	ThinkSystem SN550	JAPAN	1x Xeon Silver 4110 8C/2.1GHz/11MB/85W/DDR4-2400	1x 16GB RDIMM DDR4-2666	2x 2.5" SATA/SAS HS	1x 530-4i	None	None	4x 10GbE LOM + Fabric connector	1 used/2 max	3-year, Onsite	07/17

ThinkSystem SN550 - Non TopSeller - LA

Product Specifications Reference (PSREF)

Model	Product	Region	Processor	Memory	Disk Bays	Storage Controller	Disks	M.2 Drives	Networking	I/O Slots	Warranty	Ann Date (mm/yy)
7X16A00ULA	ThinkSystem SN550	LA	1x Xeon Gold 5118 12C/2.3GHz/16.5MB/105W/DDR4-2400	1x 16GB RDIMM DDR4-2666	2x 2.5" SATA/SAS HS	1x 530-4i	None	None	4x 10GbE LOM + Fabric connector	1 used/2 max	3-year, Onsite	07/17
7X16A00BLA	ThinkSystem SN550	LA	1x Xeon Platinum 8160 24C/2.1GHz/33MB/150W/DDR4-2666	1x 16GB RDIMM DDR4-2666	2x 2.5" SATA/SAS HS	1x 530-4i	None	None	4x 10GbE LOM + Fabric connector	1 used/2 max	3-year, Onsite	07/17
7X16A007LA	ThinkSystem SN550	LA	1x Xeon Gold 6148 20C/2.4GHz/27.5MB/150W/DDR4-2666	1x 16GB RDIMM DDR4-2666	2x 2.5" SATA/SAS HS	1x 530-4i	None	None	4x 10GbE LOM + Fabric connector	1 used/2 max	3-year, Onsite	07/17
7X16A01JLA	ThinkSystem SN550	LA	1x Xeon Gold 5120 14C/2.2GHz/19.25MB/105W/DDR4-2400	1x 16GB RDIMM DDR4-2666	2x 2.5" SATA/SAS HS	1x 530-4i	None	None	4x 10GbE LOM + Fabric connector	1 used/2 max	3-year, Onsite	07/17
7X16A01FLA	ThinkSystem SN550	LA	1x Xeon Gold 6130 16C/2.1GHz/22MB/125W/DDR4-2666	1x 16GB RDIMM DDR4-2666	2x 2.5" SATA/SAS HS	1x 530-4i	None	None	4x 10GbE LOM + Fabric connector	1 used/2 max	3-year, Onsite	07/17
7X16A01CLA	ThinkSystem SN550	LA	1x Xeon Gold 6140 18C/2.3GHz/24.75MB/140W/DDR4-2666	1x 16GB RDIMM DDR4-2666	2x 2.5" SATA/SAS HS	1x 530-4i	None	None	4x 10GbE LOM + Fabric connector	1 used/2 max	3-year, Onsite	07/17

ThinkSystem SN550 - Non TopSeller - NA

Product Specifications Reference (PSREF)

Model	Product	Region	Processor	Memory	Disk Bays	Storage Controller	Disks	M.2 Drives	Networking	I/O Slots	Warranty	Ann Date (mm/yy)
7X16A01WNA	ThinkSystem SN550	NA	1x Xeon Silver 4114 10C/2.2GHz/13.75MB/85W/DDR4-2400	1x 16GB RDIMM DDR4-2666	None	Open	None	None	None	0 used/2 max	3-year, Onsite	07/17
7X16A024NA	ThinkSystem SN550	NA	1x Xeon Gold 6130 16C/2.1GHz/22MB/125W/DDR4-2666	1x 32GB RDIMM DDR4-2666	None	Open	None	None	None	0 used/2 max	3-year, Onsite	07/17
7X16A021NA	ThinkSystem SN550	NA	1x Xeon Platinum 8160 24C/2.1GHz/33MB/150W/DDR4-2666	1x 32GB RDIMM DDR4-2666	None	Open	None	None	None	0 used/2 max	3-year, Onsite	07/17
7X16A00ANA	ThinkSystem SN550	NA	1x Xeon Silver 4110 8C/2.1GHz/11MB/85W/DDR4-2400	1x 16GB RDIMM DDR4-2666	None	Open	None	None	None	0 used/2 max	3-year, Onsite	07/17
7X16A005NA	ThinkSystem SN550	NA	1x Xeon Gold 5120 14C/2.2GHz/19.25MB/105W/DDR4-2400	1x 16GB RDIMM DDR4-2666	None	Open	None	None	None	0 used/2 max	3-year, Onsite	07/17
7X16A006NA	ThinkSystem SN550	NA	1x Xeon Gold 5118 12C/2.3GHz/16.5MB/105W/DDR4-2400	1x 16GB RDIMM DDR4-2666	None	Open	None	None	None	0 used/2 max	3-year, Onsite	07/17

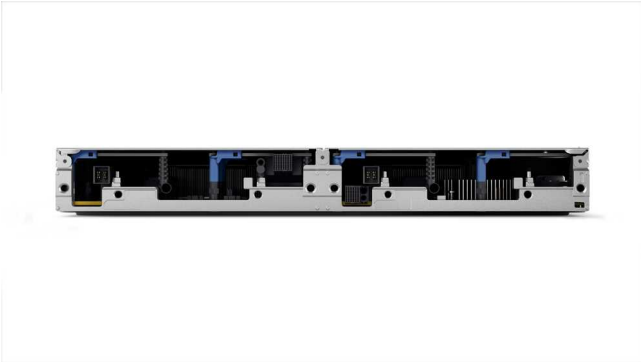
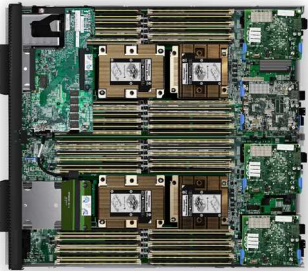
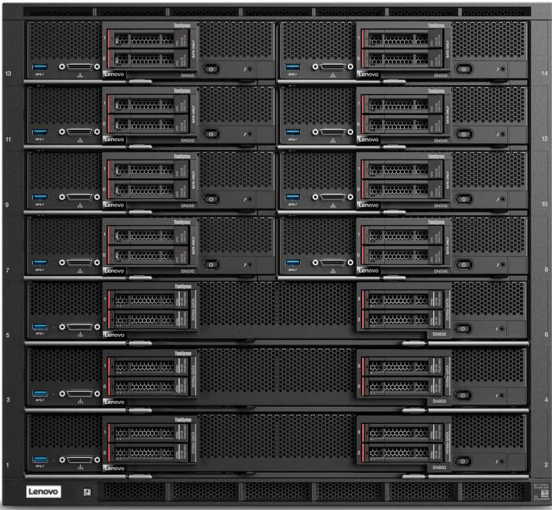

ThinkSystem SN850 Platform Specifications

Components	Specification																																
Form factor	Double-width Flex System compute node																																
Dimensions	Height: 55 mm (2.2 in). Width: 435 mm (17.1 in). Depth: 493 mm (19.4 in)																																
Chassis support	Flex System Enterprise Chassis with CMM2																																
Weight	Maximum configuration: 27 lb (12.3 kg)																																
Processor	Supports up to four 165W Intel Xeon Scalable family processors, Gold or Platinum. Up to 28 cores at 2.1GHz, up to 3.6GHz with 4 cores. Up to three UPI (Ultra Path Interconnect) links at maximum 10.4GT/s each																																
Chipset	Intel C624 Platform Controller Hub																																
Memory	Up to 48 DIMM sockets. Each processor supports up to 12 DIMM sockets with 6 channels. DDR4-2666. RDIMMs, LRDIMMs, and 3DS RDIMMs are supported, but memory types cannot be intermixed. 3DS RDIMM is planned to be available later																																
Memory capacity	Up to 1.5TB with 48 x 32GB RDIMMs and four processors. Or up to 3TB with 48 x 64GB LRDIMMs and four processors. Or up to 6TB with 48 x 128GB 3DS RDIMMs and four -M suffix processors. -M suffix processor supports 1.5TB memory per socket, non -M suffix processor supports 768GB memory per socket																																
Memory protection	ECC, SDDC (for x4-based memory DIMMs), ADDDC (for x4-based memory DIMMs), memory mirroring, and memory sparing.																																
Storage controllers	Supports the following RAID/HBA adapters: <table border="1" style="width: 100%; border-collapse: collapse;"> <thead> <tr> <th>Adapter</th> <th>Interface</th> <th>Drive type</th> <th>RAID levels</th> <th>JBOD</th> <th>Cache</th> <th>Cache protection</th> <th>FastPath</th> </tr> </thead> <tbody> <tr> <td>Onboard Intel RSTe</td> <td>6Gbps SATA</td> <td>SATA</td> <td>0/1/10/5</td> <td>Yes</td> <td>None</td> <td>None</td> <td>No</td> </tr> <tr> <td>530-4i</td> <td>12Gbps SAS</td> <td>SATA/SAS</td> <td>0/1/10/5</td> <td>Yes</td> <td>None</td> <td>None</td> <td>Yes</td> </tr> <tr> <td>930-4i</td> <td>12Gbps SAS</td> <td>SATA/SAS</td> <td>0/1/10/5/6</td> <td>Yes</td> <td>2GB</td> <td>Flash backup</td> <td>Yes</td> </tr> </tbody> </table>	Adapter	Interface	Drive type	RAID levels	JBOD	Cache	Cache protection	FastPath	Onboard Intel RSTe	6Gbps SATA	SATA	0/1/10/5	Yes	None	None	No	530-4i	12Gbps SAS	SATA/SAS	0/1/10/5	Yes	None	None	Yes	930-4i	12Gbps SAS	SATA/SAS	0/1/10/5/6	Yes	2GB	Flash backup	Yes
Adapter	Interface	Drive type	RAID levels	JBOD	Cache	Cache protection	FastPath																										
Onboard Intel RSTe	6Gbps SATA	SATA	0/1/10/5	Yes	None	None	No																										
530-4i	12Gbps SAS	SATA/SAS	0/1/10/5	Yes	None	None	Yes																										
930-4i	12Gbps SAS	SATA/SAS	0/1/10/5/6	Yes	2GB	Flash backup	Yes																										
Disk drive bays	Four 2.5" hot-swap disk bays. Depending on server configuration and installed backplanes, the four bays can support SATA, SATA/SAS, or SATA/NVMe disks. Optional one or two internal M.2 SSD for boot, dual M.2 SSD supports mirroring																																
Internal storage	<table border="1" style="width: 100%; border-collapse: collapse;"> <tbody> <tr> <td>2.5" NVMe SSD</td> <td>800GB/960GB/1.6TB/1.92TB/3.84TB</td> </tr> <tr> <td>2.5" HDD, SATA6Gbps, 7,2K</td> <td>1TB/2TB</td> </tr> <tr> <td>2.5" HDD, SAS12Gbps, 7,2K</td> <td>1TB/2TB</td> </tr> <tr> <td>2.5" HDD, SAS12Gbps, 15K</td> <td>300GB/600GB/900GB</td> </tr> <tr> <td>2.5" HDD, SAS12Gbps, 10K</td> <td>300GB/600GB/900GB/1.2TB/1.8TB/2.4TB</td> </tr> <tr> <td>2.5" HDD, SAS12Gbps, 10K, SED</td> <td>300GB/600GB</td> </tr> <tr> <td>2.5" SSD, SATA6Gbps</td> <td>240GB/480GB/960GB/1.92TB/3.84TB</td> </tr> <tr> <td>2.5" SSD, SAS12Gbps</td> <td>400GB/1.6TB/15.36TB</td> </tr> <tr> <td>M.2 SATA SSD</td> <td>32GB/128GB/480GB</td> </tr> </tbody> </table>	2.5" NVMe SSD	800GB/960GB/1.6TB/1.92TB/3.84TB	2.5" HDD, SATA6Gbps, 7,2K	1TB/2TB	2.5" HDD, SAS12Gbps, 7,2K	1TB/2TB	2.5" HDD, SAS12Gbps, 15K	300GB/600GB/900GB	2.5" HDD, SAS12Gbps, 10K	300GB/600GB/900GB/1.2TB/1.8TB/2.4TB	2.5" HDD, SAS12Gbps, 10K, SED	300GB/600GB	2.5" SSD, SATA6Gbps	240GB/480GB/960GB/1.92TB/3.84TB	2.5" SSD, SAS12Gbps	400GB/1.6TB/15.36TB	M.2 SATA SSD	32GB/128GB/480GB														
2.5" NVMe SSD	800GB/960GB/1.6TB/1.92TB/3.84TB																																
2.5" HDD, SATA6Gbps, 7,2K	1TB/2TB																																
2.5" HDD, SAS12Gbps, 7,2K	1TB/2TB																																
2.5" HDD, SAS12Gbps, 15K	300GB/600GB/900GB																																
2.5" HDD, SAS12Gbps, 10K	300GB/600GB/900GB/1.2TB/1.8TB/2.4TB																																
2.5" HDD, SAS12Gbps, 10K, SED	300GB/600GB																																
2.5" SSD, SATA6Gbps	240GB/480GB/960GB/1.92TB/3.84TB																																
2.5" SSD, SAS12Gbps	400GB/1.6TB/15.36TB																																
M.2 SATA SSD	32GB/128GB/480GB																																
Network interfaces	Optional 4x 10GbE LOM with fabric connector. The fabric connector is supported to routes the four 10GbE ports to Flex system chassis midplane. Optional adapters are supported, up to 4 adapters, up to 40GbE																																
Security features	Power-on and admin password. Trusted Platform Module, TCG 1.2 and 2.0 compliant. Optional TCM, China only																																
Operating systems supported	Microsoft Windows Server 2016, 2012 R2, Red Hat Enterprise Linux 6 and 7 x64, SUSE Linux Enterprise Server 11 and 12 x64, VMware vSphere 6.0 and 6.5																																
Systems management	UEFI. Lenovo XClarity Controller with Pilot4 XE401 baseboard management controller (BMC), Predictive Failure Analysis, light path diagnostics panel, automatic server restart, remote presence. Support for Lenovo XClarity Administrator and Lenovo XClarity Energy Manager																																
GPU support	None																																
Base warranty	MT 7X15: 3-year limited onsite service with 9x5/NBD																																
Power supply	Power to the blade server is derived from the power supplies that are installed in the chassis. There are no server options regarding power supplies.																																
Video	Integrated Matrox G200 in XClarity Controller																																
Front ports	One USB 3.0, one console breakout cable port that provides local KVM and serial ports (cable standard with chassis, more cables optional).																																
Environmental specification	Supports ASHRAE A3. <table border="1" style="width: 100%; border-collapse: collapse;"> <tbody> <tr> <td>Temperature - operating</td> <td>A3: 5°C to 40°C (41°F to 104°F) A2: 10°C to 35°C (50°F to 95°F)</td> </tr> <tr> <td>Temperature - non operating (no package)</td> <td>5°C to 45°C (41°F to 113°F)</td> </tr> <tr> <td>Temperature - non operating (with package)</td> <td>-40°C to 60°C (-40°F to 140°F)</td> </tr> <tr> <td>Altitude - operating</td> <td>(Unpressurized): 0-10000ft (0-3048m)</td> </tr> <tr> <td>Humidity - operating, non-condensing</td> <td>A3:8%~85%. A2:8%~80%</td> </tr> <tr> <td>Humidity - storage (with package), non-condensing</td> <td>8%~90%</td> </tr> </tbody> </table>	Temperature - operating	A3: 5°C to 40°C (41°F to 104°F) A2: 10°C to 35°C (50°F to 95°F)	Temperature - non operating (no package)	5°C to 45°C (41°F to 113°F)	Temperature - non operating (with package)	-40°C to 60°C (-40°F to 140°F)	Altitude - operating	(Unpressurized): 0-10000ft (0-3048m)	Humidity - operating, non-condensing	A3:8%~85%. A2:8%~80%	Humidity - storage (with package), non-condensing	8%~90%																				
Temperature - operating	A3: 5°C to 40°C (41°F to 104°F) A2: 10°C to 35°C (50°F to 95°F)																																
Temperature - non operating (no package)	5°C to 45°C (41°F to 113°F)																																
Temperature - non operating (with package)	-40°C to 60°C (-40°F to 140°F)																																
Altitude - operating	(Unpressurized): 0-10000ft (0-3048m)																																
Humidity - operating, non-condensing	A3:8%~85%. A2:8%~80%																																
Humidity - storage (with package), non-condensing	8%~90%																																

Expansion slots

Supports four PCIe 3.0 x16 I/O expansion connectors for attaching I/O adapter cards, each connector uses high-density, 216-pin PCIe connection. Please see I/O adapters below:

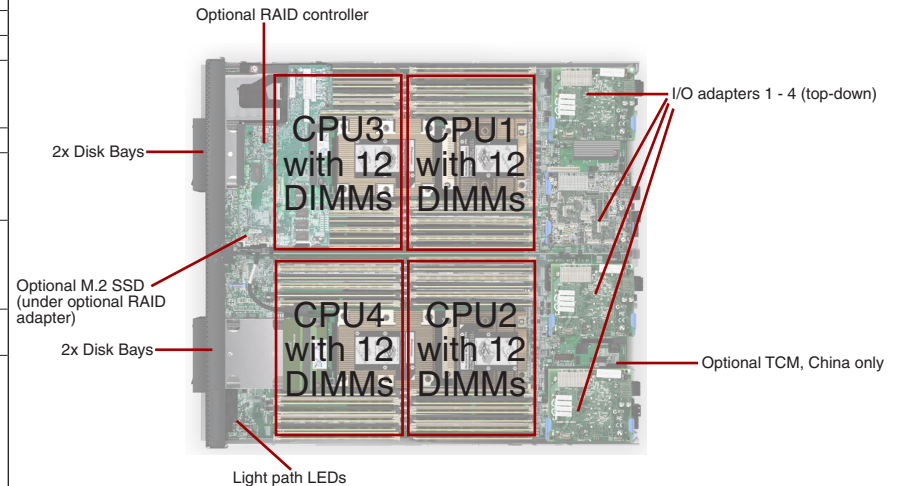

System unique options

7M17A03930	Lenovo SATA HDD/SSD kit for SN850
7M17A03931	Lenovo NVMe/SATA Enablement Kit for SN850
7M17A03932	Lenovo RAID 530-4i 4 Drive Adapter Kit for SN850
7M17A03933	Lenovo RAID 930-4i-2GB 4 Drive Adapter Kit for SN850
7X77A01301	Lenovo 8GB TruDDR4 2666 MHz (1Rx8 1.2V) RDIMM
7X77A01302	Lenovo 16GB TruDDR4 2666 MHz (1Rx4 1.2V) RDIMM
7X77A01303	Lenovo 16GB TruDDR4 2666 MHz (2Rx8 1.2V) RDIMM
7X77A01304	Lenovo 32GB TruDDR4 2666 MHz (2Rx4 1.2V) RDIMM
7X77A01305	Lenovo 64GB TruDDR4 2666 MHz (4Rx4 1.2V) LRDIMM
00AG540	Flex System CN4052S 2-port 10Gb Virtual Fabric Adapter
00AG590	Flex System CN4054S 4-port 10Gb Virtual Fabric Adapter
01CV780	Flex System CN4052S 2-port 10Gb Virtual Fabric Adapter Advanced
01CV790	Flex System CN4054S 4-port 10Gb Virtual Fabric Adapter Advanced
7ZT7A00502	Lenovo Mellanox ConnectX-3 Mezz 40Gb 2-Port Ethernet Adapter
7ZT7A00520	Lenovo QLogic QML2692 Mezz 16Gb 2-Port Fibre Channel Adapter
7ZT7A00521	Lenovo Emulex LPm16002B-L Mezz 16Gb 2-Port Fibre Channel Adapter
7ZT7A00522	Lenovo Emulex LPm16004B-L Mezz 16Gb 4-Port Fibre Channel Adapter
7ZT7A00508	Lenovo Mellanox ConnectX-3 Mezz FDR 2-Port InfiniBand Adapter
7Y37A01092	Lenovo M.2 Enablement Kit
7Y37A01093	Lenovo M.2 with Mirroring Enablement Kit
7N47A00129	Lenovo M.2 32GB SATA 6Gbps Non-Hot-Swap SSD
7N47A00130	Lenovo M.2 128GB SATA 6Gbps Non-Hot-Swap SSD

ThinkSystem SN850 - Non TopSeller - ANZ

Product Specifications Reference (PSREF)

Model	Product	Region	Processor	Memory	Disk Bays	Storage Controller	Disks	M.2 Drives	Networking	I/O Slots	Warranty	Ann Date (mm/yy)
7X15A00JAU	ThinkSystem SN850	ANZ	2x Xeon Gold 5118 12C/2.3GHz/16.5MB/105W/DDR4-2400	2x 16GB RDIMM DDR4-2666	4x 2.5" SATA/NVMe HS	Onboard SATA	None	None	4x 10GbE LOM + Fabric connector	1 used/4 max	3-year, Onsite	07/17
7X15A02XAU	ThinkSystem SN850	ANZ	2x Xeon Platinum 8160 24C/2.1GHz/33MB/150W/DDR4-2666	2x 32GB RDIMM DDR4-2666	4x 2.5" SATA/NVMe HS	Onboard SATA	None	None	4x 10GbE LOM + Fabric connector	1 used/4 max	3-year, Onsite	07/17
7X15A02YAU	ThinkSystem SN850	ANZ	2x Xeon Gold 6134 8C/3.2GHz/24.75MB/130W/DDR4-2666	2x 32GB RDIMM DDR4-2666	4x 2.5" SATA/NVMe HS	Onboard SATA	None	None	4x 10GbE LOM + Fabric connector	1 used/4 max	3-year, Onsite	07/17
7X15A02ZAU	ThinkSystem SN850	ANZ	2x Xeon Gold 5118 12C/2.3GHz/16.5MB/105W/DDR4-2400	2x 32GB RDIMM DDR4-2666	4x 2.5" SATA/NVMe HS	Onboard SATA	None	None	4x 10GbE LOM + Fabric connector	1 used/4 max	3-year, Onsite	07/17
7X15A030AU	ThinkSystem SN850	ANZ	2x Xeon Gold 5120 14C/2.2GHz/19.25MB/105W/DDR4-2400	2x 32GB RDIMM DDR4-2666	4x 2.5" SATA/NVMe HS	Onboard SATA	None	None	4x 10GbE LOM + Fabric connector	1 used/4 max	3-year, Onsite	07/17
7X15A031AU	ThinkSystem SN850	ANZ	2x Xeon Gold 6126 12C/2.6GHz/19.25MB/125W/DDR4-2666	2x 32GB RDIMM DDR4-2666	4x 2.5" SATA/NVMe HS	Onboard SATA	None	None	4x 10GbE LOM + Fabric connector	1 used/4 max	3-year, Onsite	07/17
7X15A032AU	ThinkSystem SN850	ANZ	2x Xeon Gold 6130 16C/2.1GHz/22MB/125W/DDR4-2666	2x 32GB RDIMM DDR4-2666	4x 2.5" SATA/NVMe HS	Onboard SATA	None	None	4x 10GbE LOM + Fabric connector	1 used/4 max	3-year, Onsite	07/17
7X15A033AU	ThinkSystem SN850	ANZ	2x Xeon Gold 6140 18C/2.3GHz/24.75MB/140W/DDR4-2666	2x 32GB RDIMM DDR4-2666	4x 2.5" SATA/NVMe HS	Onboard SATA	None	None	4x 10GbE LOM + Fabric connector	1 used/4 max	3-year, Onsite	07/17
7X15A034AU	ThinkSystem SN850	ANZ	2x Xeon Gold 6148 20C/2.4GHz/27.5MB/150W/DDR4-2666	2x 32GB RDIMM DDR4-2666	4x 2.5" SATA/NVMe HS	Onboard SATA	None	None	4x 10GbE LOM + Fabric connector	1 used/4 max	3-year, Onsite	07/17
7X15A035AU	ThinkSystem SN850	ANZ	2x Xeon Gold 5115 10C/2.4GHz/13.75MB/85W/DDR4-2400	2x 16GB RDIMM DDR4-2666	4x 2.5" SATA/NVMe HS	Onboard SATA	None	None	4x 10GbE LOM + Fabric connector	1 used/4 max	3-year, Onsite	07/17
7X15A036AU	ThinkSystem SN850	ANZ	2x Xeon Gold 6152 22C/2.1GHz/30.25MB/140W/DDR4-2666	2x 32GB RDIMM DDR4-2666	4x 2.5" SATA/NVMe HS	Onboard SATA	None	None	4x 10GbE LOM + Fabric connector	1 used/4 max	3-year, Onsite	07/17
7X15A037AU	ThinkSystem SN850	ANZ	2x Xeon Platinum 8176 28C/2.1GHz/38.5MB/165W/DDR4-2666	2x 32GB RDIMM DDR4-2666	4x 2.5" SATA/NVMe HS	Onboard SATA	None	None	4x 10GbE LOM + Fabric connector	1 used/4 max	3-year, Onsite	07/17

ThinkSystem SN850 - Non TopSeller - ASEAN

Product Specifications Reference (PSREF)

Model	Product	Region	Processor	Memory	Disk Bays	Storage Controller	Disks	M.2 Drives	Networking	I/O Slots	Warranty	Ann Date (mm/yy)
7X15A00RSG	ThinkSystem SN850	ASEAN	2x Xeon Gold 6152 22C/2.1GHz/30.25MB/140W/DDR4-2666	2x 32GB RDIMM DDR4-2666	4x 2.5" SATA/SAS HS	1x 530-4i	None	None	None	0 used/4 max	3-year, Onsite	07/17
7X15A00USG	ThinkSystem SN850	ASEAN	2x Xeon Gold 6148 20C/2.4GHz/27.5MB/150W/DDR4-2666	2x 32GB RDIMM DDR4-2666	4x 2.5" SATA/SAS HS	1x 530-4i	None	None	None	0 used/4 max	3-year, Onsite	07/17
7X15A012SG	ThinkSystem SN850	ASEAN	2x Xeon Platinum 8160 24C/2.1GHz/33MB/150W/DDR4-2666	2x 32GB RDIMM DDR4-2666	4x 2.5" SATA/SAS HS	1x 530-4i	None	None	None	0 used/4 max	3-year, Onsite	07/17
7X15A013SG	ThinkSystem SN850	ASEAN	2x Xeon Platinum 8176 28C/2.1GHz/38.5MB/165W/DDR4-2666	2x 32GB RDIMM DDR4-2666	4x 2.5" SATA/SAS HS	1x 530-4i	None	None	None	0 used/4 max	3-year, Onsite	07/17
7X15A00ZSG	ThinkSystem SN850	ASEAN	2x Xeon Platinum 8170 26C/2.1GHz/35.75MB/165W/DDR4-2666	2x 32GB RDIMM DDR4-2666	4x 2.5" SATA/SAS HS	1x 530-4i	None	None	None	0 used/4 max	3-year, Onsite	07/17
7X15A010SG	ThinkSystem SN850	ASEAN	2x Xeon Gold 6140 18C/2.3GHz/24.75MB/140W/DDR4-2666	2x 32GB RDIMM DDR4-2666	4x 2.5" SATA/SAS HS	1x 530-4i	None	None	None	0 used/4 max	3-year, Onsite	07/17
7X15A01FSG	ThinkSystem SN850	ASEAN	2x Xeon Gold 6134 8C/3.2GHz/24.75MB/130W/DDR4-2666	2x 16GB RDIMM DDR4-2666	4x 2.5" SATA/SAS HS	1x 530-4i	None	None	None	0 used/4 max	3-year, Onsite	07/17
7X15A01QSG	ThinkSystem SN850	ASEAN	2x Xeon Gold 6130 16C/2.1GHz/22MB/125W/DDR4-2666	2x 16GB RDIMM DDR4-2666	4x 2.5" SATA/SAS HS	1x 530-4i	None	None	None	0 used/4 max	3-year, Onsite	07/17
7X15A01SSG	ThinkSystem SN850	ASEAN	2x Xeon Gold 6126 12C/2.6GHz/19.25MB/125W/DDR4-2666	2x 16GB RDIMM DDR4-2666	4x 2.5" SATA/SAS HS	1x 530-4i	None	None	None	0 used/4 max	3-year, Onsite	07/17
7X15A01WSG	ThinkSystem SN850	ASEAN	2x Xeon Gold 5118 12C/2.3GHz/16.5MB/105W/DDR4-2400	2x 16GB RDIMM DDR4-2666	4x 2.5" SATA/SAS HS	1x 530-4i	None	None	None	0 used/4 max	3-year, Onsite	07/17
7X15A01XSG	ThinkSystem SN850	ASEAN	2x Xeon Gold 5120 14C/2.2GHz/19.25MB/105W/DDR4-2400	2x 16GB RDIMM DDR4-2666	4x 2.5" SATA/SAS HS	1x 530-4i	None	None	None	0 used/4 max	3-year, Onsite	07/17
7X15A028SG	ThinkSystem SN850	ASEAN	2x Xeon Gold 5115 10C/2.4GHz/13.75MB/85W/DDR4-2400	2x 16GB RDIMM DDR4-2666	4x 2.5" SATA/SAS HS	1x 530-4i	None	None	None	0 used/4 max	3-year, Onsite	07/17

Model	Product	Region	Processor	Memory	Disk Bays	Storage Controller	Disks	M.2 Drives	Networking	I/O Slots	Warranty	Ann Date (mm/yy)
7X15A02LBR	ThinkSystem SN850	Brazil	2x Xeon Gold 6140 18C/2.3GHz/24.75MB/140W/DDR4-2666	2x 32GB RDIMM DDR4-2666	4x 2.5" SATA/NVMe HS	Onboard SATA	None	None	4x 10GbE LOM + Fabric connector	1 used/4 max	3-year, Onsite	07/17
7X15A02MBR	ThinkSystem SN850	Brazil	2x Xeon Gold 6126 12C/2.6GHz/19.25MB/125W/DDR4-2666	2x 32GB RDIMM DDR4-2666	4x 2.5" SATA/NVMe HS	Onboard SATA	None	None	4x 10GbE LOM + Fabric connector	1 used/4 max	3-year, Onsite	07/17
7X15A02NBR	ThinkSystem SN850	Brazil	2x Xeon Gold 6130 16C/2.1GHz/22MB/125W/DDR4-2666	2x 32GB RDIMM DDR4-2666	4x 2.5" SATA/NVMe HS	Onboard SATA	None	None	4x 10GbE LOM + Fabric connector	1 used/4 max	3-year, Onsite	07/17
7X15A02PBR	ThinkSystem SN850	Brazil	2x Xeon Gold 5120 14C/2.2GHz/19.25MB/105W/DDR4-2400	2x 32GB RDIMM DDR4-2666	4x 2.5" SATA/NVMe HS	Onboard SATA	None	None	4x 10GbE LOM + Fabric connector	1 used/4 max	3-year, Onsite	07/17
7X15A02QBR	ThinkSystem SN850	Brazil	2x Xeon Platinum 8160 24C/2.1GHz/33MB/150W/DDR4-2666	2x 32GB RDIMM DDR4-2666	4x 2.5" SATA/NVMe HS	Onboard SATA	None	None	4x 10GbE LOM + Fabric connector	1 used/4 max	3-year, Onsite	07/17
7X15A02RBR	ThinkSystem SN850	Brazil	2x Xeon Platinum 8176 28C/2.1GHz/38.5MB/165W/DDR4-2666	2x 32GB RDIMM DDR4-2666	4x 2.5" SATA/NVMe HS	Onboard SATA	None	None	4x 10GbE LOM + Fabric connector	1 used/4 max	3-year, Onsite	07/17
7X15A02SBR	ThinkSystem SN850	Brazil	2x Xeon Gold 5118 12C/2.3GHz/16.5MB/105W/DDR4-2400	2x 32GB RDIMM DDR4-2666	4x 2.5" SATA/NVMe HS	Onboard SATA	None	None	4x 10GbE LOM + Fabric connector	1 used/4 max	3-year, Onsite	07/17
7X15A02TBR	ThinkSystem SN850	Brazil	2x Xeon Gold 6134 8C/3.2GHz/24.75MB/130W/DDR4-2666	2x 32GB RDIMM DDR4-2666	4x 2.5" SATA/NVMe HS	Onboard SATA	None	None	4x 10GbE LOM + Fabric connector	1 used/4 max	3-year, Onsite	07/17
7X15A02UBR	ThinkSystem SN850	Brazil	2x Xeon Gold 5115 10C/2.4GHz/13.75MB/85W/DDR4-2400	2x 16GB RDIMM DDR4-2666	4x 2.5" SATA/NVMe HS	Onboard SATA	None	None	4x 10GbE LOM + Fabric connector	1 used/4 max	3-year, Onsite	07/17
7X15A02VBR	ThinkSystem SN850	Brazil	2x Xeon Gold 6152 22C/2.1GHz/30.25MB/140W/DDR4-2666	2x 32GB RDIMM DDR4-2666	4x 2.5" SATA/NVMe HS	Onboard SATA	None	None	4x 10GbE LOM + Fabric connector	1 used/4 max	3-year, Onsite	07/17
7X15A02WBR	ThinkSystem SN850	Brazil	2x Xeon Gold 6148 20C/2.4GHz/27.5MB/150W/DDR4-2666	2x 32GB RDIMM DDR4-2666	4x 2.5" SATA/NVMe HS	Onboard SATA	None	None	4x 10GbE LOM + Fabric connector	1 used/4 max	3-year, Onsite	07/17

ThinkSystem SN850 - Non TopSeller - EET, MEA, RUCIS, WE

Product Specifications Reference (PSREF)

Model	Product	Region	Processor	Memory	Disk Bays	Storage Controller	Disks	M.2 Drives	Networking	I/O Slots	Warranty	Ann Date (mm/yy)
7X15A029EA	ThinkSystem SN850	EET, MEA, RUCIS, WE	2x Xeon Gold 6126 12C/2.6GHz/19.25MB/125W/DDR4-2666	2x 32GB RDIMM DDR4-2666	4x 2.5" SATA/NVMe HS	Onboard SATA	None	None	4x 10GbE LOM + Fabric connector	1 used/4 max	3-year, Onsite	07/17
7X15A02AEA	ThinkSystem SN850	EET, MEA, RUCIS, WE	2x Xeon Gold 5120 14C/2.2GHz/19.25MB/105W/DDR4-2400	2x 32GB RDIMM DDR4-2666	4x 2.5" SATA/NVMe HS	Onboard SATA	None	None	4x 10GbE LOM + Fabric connector	1 used/4 max	3-year, Onsite	07/17
7X15A02BEA	ThinkSystem SN850	EET, MEA, RUCIS, WE	2x Xeon Gold 5115 10C/2.4GHz/13.75MB/85W/DDR4-2400	2x 16GB RDIMM DDR4-2666	4x 2.5" SATA/NVMe HS	Onboard SATA	None	None	4x 10GbE LOM + Fabric connector	1 used/4 max	3-year, Onsite	07/17
7X15A02CEA	ThinkSystem SN850	EET, MEA, RUCIS, WE	2x Xeon Gold 6148 20C/2.4GHz/27.5MB/150W/DDR4-2666	2x 32GB RDIMM DDR4-2666	4x 2.5" SATA/NVMe HS	Onboard SATA	None	None	4x 10GbE LOM + Fabric connector	1 used/4 max	3-year, Onsite	07/17
7X15A02DEA	ThinkSystem SN850	EET, MEA, RUCIS, WE	2x Xeon Platinum 8176 28C/2.1GHz/38.5MB/165W/DDR4-2666	2x 32GB RDIMM DDR4-2666	4x 2.5" SATA/NVMe HS	Onboard SATA	None	None	4x 10GbE LOM + Fabric connector	1 used/4 max	3-year, Onsite	07/17
7X15A02EEA	ThinkSystem SN850	EET, MEA, RUCIS, WE	2x Xeon Gold 6140 18C/2.3GHz/24.75MB/140W/DDR4-2666	2x 32GB RDIMM DDR4-2666	4x 2.5" SATA/NVMe HS	Onboard SATA	None	None	4x 10GbE LOM + Fabric connector	1 used/4 max	3-year, Onsite	07/17
7X15A02FEA	ThinkSystem SN850	EET, MEA, RUCIS, WE	2x Xeon Gold 5118 12C/2.3GHz/16.5MB/105W/DDR4-2400	2x 32GB RDIMM DDR4-2666	4x 2.5" SATA/NVMe HS	Onboard SATA	None	None	4x 10GbE LOM + Fabric connector	1 used/4 max	3-year, Onsite	07/17
7X15A02GEA	ThinkSystem SN850	EET, MEA, RUCIS, WE	2x Xeon Gold 6134 8C/3.2GHz/24.75MB/130W/DDR4-2666	2x 32GB RDIMM DDR4-2666	4x 2.5" SATA/NVMe HS	Onboard SATA	None	None	4x 10GbE LOM + Fabric connector	1 used/4 max	3-year, Onsite	07/17
7X15A02HEA	ThinkSystem SN850	EET, MEA, RUCIS, WE	2x Xeon Gold 6152 22C/2.1GHz/30.25MB/140W/DDR4-2666	2x 32GB RDIMM DDR4-2666	4x 2.5" SATA/NVMe HS	Onboard SATA	None	None	4x 10GbE LOM + Fabric connector	1 used/4 max	3-year, Onsite	07/17
7X15A02JEA	ThinkSystem SN850	EET, MEA, RUCIS, WE	2x Xeon Gold 6130 16C/2.1GHz/22MB/125W/DDR4-2666	2x 32GB RDIMM DDR4-2666	4x 2.5" SATA/NVMe HS	Onboard SATA	None	None	4x 10GbE LOM + Fabric connector	1 used/4 max	3-year, Onsite	07/17
7X15A02KEA	ThinkSystem SN850	EET, MEA, RUCIS, WE	2x Xeon Platinum 8160 24C/2.1GHz/33MB/150W/DDR4-2666	2x 32GB RDIMM DDR4-2666	4x 2.5" SATA/NVMe HS	Onboard SATA	None	None	4x 10GbE LOM + Fabric connector	1 used/4 max	3-year, Onsite	07/17
7X15A019EA	ThinkSystem SN850	EET, MEA, RUCIS, WE	2x Xeon Gold 6138 20C/2.0GHz/27.5MB/125W/DDR4-2666	2x 32GB RDIMM DDR4-2666	4x 2.5" SATA/NVMe HS	Onboard SATA	None	None	4x 10GbE LOM + Fabric connector	1 used/4 max	3-year, Onsite	07/17

Model	Product	Region	Processor	Memory	Disk Bays	Storage Controller	Disks	M.2 Drives	Networking	I/O Slots	Warranty	Ann Date (mm/yy)
7X15A01BCN	ThinkSystem SN850	HTK	2x Xeon Platinum 8176 28C/2.1GHz/38.5MB/165W/DDR4-2666	2x 32GB RDIMM DDR4-2666	4x 2.5" SATA HS	Onboard SATA	None	1x 128GB	None	0 used/4 max	3-year, Onsite	07/17
7X15A01HCN	ThinkSystem SN850	HTK	2x Xeon Gold 6142 16C/2.6GHz/22MB/150W/DDR4-2666	2x 32GB RDIMM DDR4-2666	4x 2.5" SATA HS	Onboard SATA	None	1x 32GB	None	0 used/4 max	3-year, Onsite	07/17
7X15A01JCN	ThinkSystem SN850	HTK	2x Xeon Gold 6140 18C/2.3GHz/24.75MB/140W/DDR4-2666	2x 32GB RDIMM DDR4-2666	4x 2.5" SATA HS	Onboard SATA	None	1x 32GB	None	0 used/4 max	3-year, Onsite	07/17
7X15A018CN	ThinkSystem SN850	HTK	2x Xeon Platinum 8170 26C/2.1GHz/35.75MB/165W/DDR4-2666	2x 32GB RDIMM DDR4-2666	4x 2.5" SATA HS	Onboard SATA	None	None	None	0 used/4 max	3-year, Onsite	07/17
7X15A00WCN	ThinkSystem SN850	HTK	2x Xeon Platinum 8170 26C/2.1GHz/35.75MB/165W/DDR4-2666	2x 32GB RDIMM DDR4-2666	4x 2.5" SATA HS	Onboard SATA	None	1x 128GB	None	0 used/4 max	3-year, Onsite	07/17
7X15A00YCN	ThinkSystem SN850	HTK	2x Xeon Platinum 8160 24C/2.1GHz/33MB/150W/DDR4-2666	2x 32GB RDIMM DDR4-2666	4x 2.5" SATA HS	Onboard SATA	None	None	None	0 used/4 max	3-year, Onsite	07/17
7X15A00LCN	ThinkSystem SN850	HTK	2x Xeon Platinum 8160 24C/2.1GHz/33MB/150W/DDR4-2666	2x 16GB RDIMM DDR4-2666	4x 2.5" SATA HS	Onboard SATA	None	None	None	0 used/4 max	3-year, Onsite	07/17
7X15A00MCN	ThinkSystem SN850	HTK	2x Xeon Platinum 8160 24C/2.1GHz/33MB/150W/DDR4-2666	2x 32GB RDIMM DDR4-2666	4x 2.5" SATA HS	Onboard SATA	None	1x 128GB	None	0 used/4 max	3-year, Onsite	07/17
7X15A00PCN	ThinkSystem SN850	HTK	2x Xeon Platinum 8176 28C/2.1GHz/38.5MB/165W/DDR4-2666	2x 32GB RDIMM DDR4-2666	4x 2.5" SATA HS	Onboard SATA	None	1x 32GB	None	0 used/4 max	3-year, Onsite	07/17
7X15A020CN	ThinkSystem SN850	HTK	2x Xeon Gold 5120 14C/2.2GHz/19.25MB/105W/DDR4-2400	2x 32GB RDIMM DDR4-2666	4x 2.5" SATA HS	Onboard SATA	None	None	None	0 used/4 max	3-year, Onsite	07/17
7X15A01UCN	ThinkSystem SN850	HTK	2x Xeon Gold 6140 18C/2.3GHz/24.75MB/140W/DDR4-2666	2x 16GB RDIMM DDR4-2666	4x 2.5" SATA HS	Onboard SATA	None	None	None	0 used/4 max	3-year, Onsite	07/17
7X15A01RCN	ThinkSystem SN850	HTK	2x Xeon Gold 6140 18C/2.3GHz/24.75MB/140W/DDR4-2666	2x 32GB RDIMM DDR4-2666	4x 2.5" SATA HS	Onboard SATA	None	None	None	0 used/4 max	3-year, Onsite	07/17
7X15A01ECN	ThinkSystem SN850	HTK	2x Xeon Gold 6142 16C/2.6GHz/22MB/150W/DDR4-2666	2x 32GB RDIMM DDR4-2666	4x 2.5" SATA HS	Onboard SATA	None	None	None	0 used/4 max	3-year, Onsite	07/17
7X15A01LCN	ThinkSystem SN850	HTK	2x Xeon Gold 6142 16C/2.6GHz/22MB/150W/DDR4-2666	2x 16GB RDIMM DDR4-2666	4x 2.5" SATA HS	Onboard SATA	None	None	None	0 used/4 max	3-year, Onsite	07/17
7X15A026CN	ThinkSystem SN850	HTK	2x Xeon Gold 5120 14C/2.2GHz/19.25MB/105W/DDR4-2400	2x 16GB RDIMM DDR4-2666	4x 2.5" SATA HS	Onboard SATA	None	None	None	0 used/4 max	3-year, Onsite	07/17

Model	Product	Region	Processor	Memory	Disk Bays	Storage Controller	Disks	M.2 Drives	Networking	I/O Slots	Warranty	Ann Date (mm/yy)
7X15A027CN	ThinkSystem SN850	HTK	2x Xeon Platinum 8170 26C/2.1GHz/35.75MB/165W/DDR4-2666	2x 16GB RDIMM DDR4-2666	4x 2.5" SATA HS	Onboard SATA	None	None	None	0 used/4 max	3-year, Onsite	07/17
7X15A01PCN	ThinkSystem SN850	HTK	2x Xeon Gold 5120 14C/2.2GHz/19.25MB/105W/DDR4-2400	2x 32GB RDIMM DDR4-2666	4x 2.5" SATA HS	Onboard SATA	None	1x 32GB	None	0 used/4 max	3-year, Onsite	07/17

Model	Product	Region	Processor	Memory	Disk Bays	Storage Controller	Disks	M.2 Drives	Networking	I/O Slots	Warranty	Ann Date (mm/yy)
7X15A01MSG	ThinkSystem SN850	INDIA	2x Xeon Gold 6140 18C/2.3GHz/24.75MB/140W/DDR4-2666	2x 32GB RDIMM DDR4-2666	4x 2.5" SATA/SAS HS	1x 930-4i 2GB Flash	None	None	4x 10GbE LOM + Fabric connector	1 used/4 max	3-year, Onsite	07/17
7X15A01NSG	ThinkSystem SN850	INDIA	2x Xeon Gold 6130 16C/2.1GHz/22MB/125W/DDR4-2666	2x 16GB RDIMM DDR4-2666	4x 2.5" SATA/SAS HS	1x 930-4i 2GB Flash	None	None	4x 10GbE LOM + Fabric connector	1 used/4 max	3-year, Onsite	07/17
7X15A01DSG	ThinkSystem SN850	INDIA	2x Xeon Gold 6138 20C/2.0GHz/27.5MB/125W/DDR4-2666	2x 32GB RDIMM DDR4-2666	4x 2.5" SATA/SAS HS	1x 930-4i 2GB Flash	None	None	4x 10GbE LOM + Fabric connector	1 used/4 max	3-year, Onsite	07/17
7X15A01VSG	ThinkSystem SN850	INDIA	2x Xeon Gold 6142 16C/2.6GHz/22MB/150W/DDR4-2666	2x 16GB RDIMM DDR4-2666	4x 2.5" SATA/SAS HS	1x 530-4i	None	None	4x 10GbE LOM + Fabric connector	1 used/4 max	3-year, Onsite	07/17
7X15A024SG	ThinkSystem SN850	INDIA	2x Xeon Gold 6152 22C/2.1GHz/30.25MB/140W/DDR4-2666	2x 32GB RDIMM DDR4-2666	4x 2.5" SATA/SAS HS	1x 930-4i 2GB Flash	None	None	4x 10GbE LOM + Fabric connector	1 used/4 max	3-year, Onsite	07/17
7X15A025SG	ThinkSystem SN850	INDIA	2x Xeon Platinum 8176 28C/2.1GHz/38.5MB/165W/DDR4-2666	2x 32GB RDIMM DDR4-2666	4x 2.5" SATA/SAS HS	1x 930-4i 2GB Flash	None	None	4x 10GbE LOM + Fabric connector	1 used/4 max	3-year, Onsite	07/17
7X15A00QSG	ThinkSystem SN850	INDIA	2x Xeon Gold 5120 14C/2.2GHz/19.25MB/105W/DDR4-2400	2x 16GB RDIMM DDR4-2666	4x 2.5" SATA/SAS HS	1x 530-4i	None	None	4x 10GbE LOM + Fabric connector	1 used/4 max	3-year, Onsite	07/17
7X15A006SG	ThinkSystem SN850	INDIA	2x Xeon Gold 5120 14C/2.2GHz/19.25MB/105W/DDR4-2400	2x 32GB RDIMM DDR4-2666	4x 2.5" SATA/SAS HS	1x 530-4i	None	None	4x 10GbE LOM + Fabric connector	1 used/4 max	3-year, Onsite	07/17
7X15A009SG	ThinkSystem SN850	INDIA	2x Xeon Gold 5118 12C/2.3GHz/16.5MB/105W/DDR4-2400	2x 16GB RDIMM DDR4-2666	4x 2.5" SATA HS	Onboard SATA	None	None	4x 10GbE LOM + Fabric connector	1 used/4 max	3-year, Onsite	07/17
7X15A00CSG	ThinkSystem SN850	INDIA	2x Xeon Gold 5120 14C/2.2GHz/19.25MB/105W/DDR4-2400	2x 32GB RDIMM DDR4-2666	4x 2.5" SATA/SAS HS	1x 930-4i 2GB Flash	None	None	4x 10GbE LOM + Fabric connector	1 used/4 max	3-year, Onsite	07/17
7X15A00DSG	ThinkSystem SN850	INDIA	2x Xeon Gold 5118 12C/2.3GHz/16.5MB/105W/DDR4-2400	2x 16GB RDIMM DDR4-2666	4x 2.5" SATA/SAS HS	1x 530-4i	None	None	4x 10GbE LOM + Fabric connector	1 used/4 max	3-year, Onsite	07/17
7X15A00ESG	ThinkSystem SN850	INDIA	2x Xeon Gold 6126 12C/2.6GHz/19.25MB/125W/DDR4-2666	2x 16GB RDIMM DDR4-2666	4x 2.5" SATA/SAS HS	1x 530-4i	None	None	4x 10GbE LOM + Fabric connector	1 used/4 max	3-year, Onsite	07/17
7X15A00FSG	ThinkSystem SN850	INDIA	2x Xeon Gold 6130 16C/2.1GHz/22MB/125W/DDR4-2666	2x 16GB RDIMM DDR4-2666	4x 2.5" SATA/SAS HS	1x 530-4i	None	None	4x 10GbE LOM + Fabric connector	1 used/4 max	3-year, Onsite	07/17
7X15A01KSG	ThinkSystem SN850	INDIA	2x Xeon Gold 6142 16C/2.6GHz/22MB/150W/DDR4-2666	2x 16GB RDIMM DDR4-2666	4x 2.5" SATA/SAS HS	1x 930-4i 2GB Flash	None	None	4x 10GbE LOM + Fabric connector	1 used/4 max	3-year, Onsite	07/17

ThinkSystem SN850 - Non TopSeller - JAPAN

Product Specifications Reference (PSREF)

Model	Product	Region	Processor	Memory	Disk Bays	Storage Controller	Disks	M.2 Drives	Networking	I/O Slots	Warranty	Ann Date (mm/yy)
7X15A008JP	ThinkSystem SN850	JAPAN	2x Xeon Gold 5115 10C/2.4GHz/13.75MB/85W/DDR4-2400	2x 16GB RDIMM DDR4-2666	4x 2.5" SATA HS	Onboard SATA	None	None	4x 10GbE LOM + Fabric connector	1 used/4 max	3-year, Onsite	07/17
7X15A00SJP	ThinkSystem SN850	JAPAN	2x Xeon Gold 6126 12C/2.6GHz/19.25MB/125W/DDR4-2666	2x 16GB RDIMM DDR4-2666	4x 2.5" SATA/SAS HS	1x 930-4i 2GB Flash	None	None	4x 10GbE LOM + Fabric connector	1 used/4 max	3-year, Onsite	07/17

ThinkSystem SN850 - Non TopSeller - LA

Product Specifications Reference (PSREF)

Model	Product	Region	Processor	Memory	Disk Bays	Storage Controller	Disks	M.2 Drives	Networking	I/O Slots	Warranty	Ann Date (mm/yy)
7X15A007LA	ThinkSystem SN850	LA	2x Xeon Platinum 8160 24C/2.1GHz/33MB/150W/DDR4-2666	2x 32GB RDIMM DDR4-2666	4x 2.5" SATA/SAS HS	1x 930-4i 2GB Flash	None	None	4x 10GbE LOM + Fabric connector	1 used/4 max	3-year, Onsite	07/17
7X15A01CLA	ThinkSystem SN850	LA	2x Xeon Gold 6140 18C/2.3GHz/24.75MB/140W/DDR4-2666	2x 32GB RDIMM DDR4-2666	4x 2.5" SATA/SAS HS	1x 930-4i 2GB Flash	None	None	4x 10GbE LOM + Fabric connector	1 used/4 max	3-year, Onsite	07/17
7X15A01ALA	ThinkSystem SN850	LA	2x Xeon Gold 6148 20C/2.4GHz/27.5MB/150W/DDR4-2666	2x 32GB RDIMM DDR4-2666	4x 2.5" SATA/SAS HS	1x 930-4i 2GB Flash	None	None	4x 10GbE LOM + Fabric connector	1 used/4 max	3-year, Onsite	07/17
7X15A021LA	ThinkSystem SN850	LA	2x Xeon Gold 5118 12C/2.3GHz/16.5MB/105W/DDR4-2400	2x 16GB RDIMM DDR4-2666	4x 2.5" SATA/SAS HS	1x 530-4i	None	None	4x 10GbE LOM + Fabric connector	1 used/4 max	3-year, Onsite	07/17
7X15A022LA	ThinkSystem SN850	LA	2x Xeon Gold 5115 10C/2.4GHz/13.75MB/85W/DDR4-2400	2x 16GB RDIMM DDR4-2666	4x 2.5" SATA/SAS HS	1x 530-4i	None	None	4x 10GbE LOM + Fabric connector	1 used/4 max	3-year, Onsite	07/17
7X15A01YLA	ThinkSystem SN850	LA	2x Xeon Gold 6130 16C/2.1GHz/22MB/125W/DDR4-2666	2x 32GB RDIMM DDR4-2666	4x 2.5" SATA/SAS HS	1x 930-4i 2GB Flash	None	None	4x 10GbE LOM + Fabric connector	1 used/4 max	3-year, Onsite	07/17
7X15A01ZLA	ThinkSystem SN850	LA	2x Xeon Gold 5120 14C/2.2GHz/19.25MB/105W/DDR4-2400	2x 32GB RDIMM DDR4-2666	4x 2.5" SATA/SAS HS	1x 930-4i 2GB Flash	None	None	4x 10GbE LOM + Fabric connector	1 used/4 max	3-year, Onsite	07/17

ThinkSystem SN850 - Non TopSeller - NA

Product Specifications Reference (PSREF)

Model	Product	Region	Processor	Memory	Disk Bays	Storage Controller	Disks	M.2 Drives	Networking	I/O Slots	Warranty	Ann Date (mm/yy)
7X15A011NA	ThinkSystem SN850	NA	2x Xeon Gold 5118 12C/2.3GHz/16.5MB/105W/DDR4-2400	2x 32GB RDIMM DDR4-2666	None	Open	None	None	None	0 used/4 max	3-year, Onsite	07/17
7X15A014NA	ThinkSystem SN850	NA	2x Xeon Gold 5120 14C/2.2GHz/19.25MB/105W/DDR4-2400	2x 32GB RDIMM DDR4-2666	None	Open	None	None	None	0 used/4 max	3-year, Onsite	07/17
7X15A015NA	ThinkSystem SN850	NA	2x Xeon Gold 6150 18C/2.7GHz/24.75MB/165W/DDR4-2666	2x 32GB RDIMM DDR4-2666	None	Open	None	None	None	0 used/4 max	3-year, Onsite	07/17
7X15A016NA	ThinkSystem SN850	NA	2x Xeon Gold 6130 16C/2.1GHz/22MB/125W/DDR4-2666	2x 32GB RDIMM DDR4-2666	None	Open	None	None	None	0 used/4 max	3-year, Onsite	07/17
7X15A00BNA	ThinkSystem SN850	NA	2x Xeon Platinum 8170 26C/2.1GHz/35.75MB/165W/DDR4-2666	2x 32GB RDIMM DDR4-2666	None	Open	None	None	None	0 used/4 max	3-year, Onsite	07/17



ThinkSystem D2 Enclosure Platform Specifications

Components	Specification
Form factor	2U rack
Dimensions	Height: 87 mm (3.5 in). Width: 488 mm (19.3 in). Depth: 892 mm (35.1 in)
Server support	Per enclosure: up to 4 servers per chassis Per 42U rack: up to 84 servers in 21 enclosures
Weight	Maximum configuration with four fully configured nodes: 121.2 lb (55 kg)
Network interfaces	Optional 8x 10 GbE ports Ethernet I/O Module (EIOM), SFP+ or RJ-45, two ports per server from chipset
Security features	Power-on and admin password. Trusted Platform Module, TCG 1.2 and 2.0 compliant. Optional TCM, China only
Systems management	The hot-swappable System Management Module (SMM) is the management device for the enclosure. Provides integrated systems management functions and controls the power and cooling features of the enclosure. Provides remote browser and CLI-based user interfaces for remote access via the dedicated Gigabit Ethernet port. Remote access is to both the management functions of the enclosure as well as the XClarity Controller (XCC) in each server. SMM provides four LEDs: system error, identification, status, and system power. Each power supply has AC, DC and error LEDs
Base warranty	MT 7X20: 3-year limited onsite service with 9x5/NBD
Power supply	Up to two redundant hot-swap 1100W/1600W/2000W 80 PLUS Platinum qualified AC power supplies. 1600W and 2000W are 200V - 240V, 1100W is 100V - 240V
Cooling	Five hot-swap system fans, accessible via removable panel in the top cover of the enclosure

Expansion slots for PCIe 3.0 x16 models

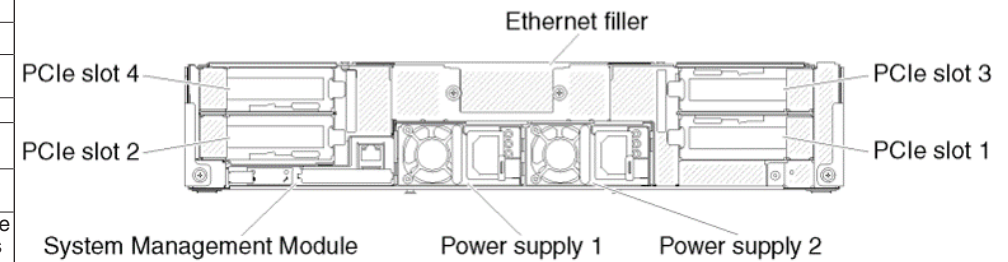

Shuttle

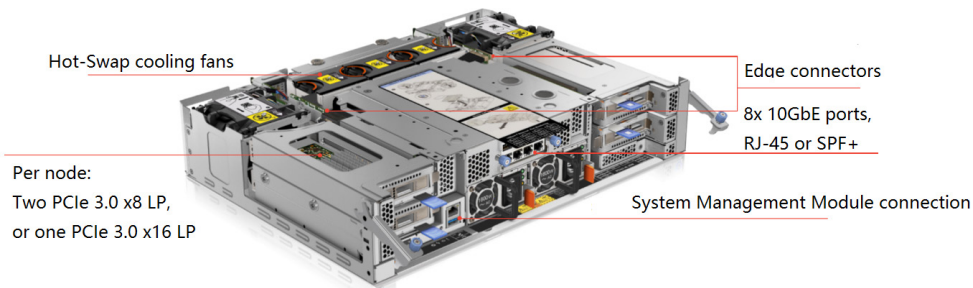

Expansion slots for PCIe 3.0 x8 models

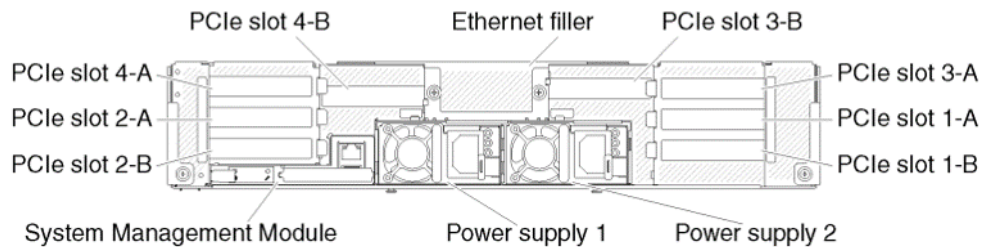

ThinkSystem D2 Enclosure - Non TopSeller - ANZ

Product Specifications Reference (PSREF)

Model	Product	Region	I/O Shuttle	External I/O Module	Power Supply	Power cords	Rail Kit	CMA	Warranty	Ann Date (mm/yy)
7X20A00SAU	ThinkSystem D2 Enclosure	ANZ	4x PCIe x16	None	2x 1100W Platinum	2x 2.8m C13-C14	D2 Slide Rail	CMA	3-year, Onsite	07/17
7X20A00TAU	ThinkSystem D2 Enclosure	ANZ	4x PCIe x16	None	2x 2000W Platinum	2x 2.8m C13-C14	D2 Slide Rail	CMA	3-year, Onsite	07/17
7X20A00UAAU	ThinkSystem D2 Enclosure	ANZ	8x PCIe x8	None	2x 1600W Platinum	2x 2.8m C13-C14	D2 Slide Rail	CMA	3-year, Onsite	07/17
7X20A00VAU	ThinkSystem D2 Enclosure	ANZ	4x PCIe x16	None	2x 1600W Platinum	2x 2.8m C13-C14	D2 Slide Rail	CMA	3-year, Onsite	07/17
7X20A00WAU	ThinkSystem D2 Enclosure	ANZ	8x PCIe x8	None	2x 1100W Platinum	2x 2.8m C13-C14	D2 Slide Rail	CMA	3-year, Onsite	07/17
7X20A00XAU	ThinkSystem D2 Enclosure	ANZ	8x PCIe x8	None	2x 2000W Platinum	2x 2.8m C13-C14	D2 Slide Rail	CMA	3-year, Onsite	07/17
7X20A00YAU	ThinkSystem D2 Enclosure	ANZ	8x PCIe x8	None	2x 1600W Platinum	2x 2.8m C13-C14	D2 Slide Rail	CMA	3-year, Onsite	07/17
7X20A00ZAU	ThinkSystem D2 Enclosure	ANZ	8x PCIe x8	None	2x 1100W Platinum	2x 2.8m C13-C14	D2 Slide Rail	CMA	3-year, Onsite	07/17
7X20A010AU	ThinkSystem D2 Enclosure	ANZ	8x PCIe x8	None	2x 2000W Platinum	2x 2.8m C13-C14	D2 Slide Rail	CMA	3-year, Onsite	07/17
7X20A011AU	ThinkSystem D2 Enclosure	ANZ	4x PCIe x16	None	2x 1100W Platinum	2x 2.8m C13-C14	D2 Slide Rail	CMA	3-year, Onsite	07/17
7X20A012AU	ThinkSystem D2 Enclosure	ANZ	4x PCIe x16	None	2x 1600W Platinum	2x 2.8m C13-C14	D2 Slide Rail	CMA	3-year, Onsite	07/17
7X20A013AU	ThinkSystem D2 Enclosure	ANZ	4x PCIe x16	None	2x 2000W Platinum	2x 2.8m C13-C14	D2 Slide Rail	CMA	3-year, Onsite	07/17

ThinkSystem D2 Enclosure - Non TopSeller - ASEAN

Product Specifications Reference (PSREF)

Model	Product	Region	I/O Shuttle	External I/O Module	Power Supply	Power cords	Rail Kit	CMA	Warranty	Ann Date (mm/yy)
7X20A00FSG	ThinkSystem D2 Enclosure	ASEAN	8x PCIe x8	None	2x 2000W Platinum	2x 2.8m C13-C14	D2 Slide Rail	None	3-year, Onsite	07/17
7X20A00GSG	ThinkSystem D2 Enclosure	ASEAN	4x PCIe x16	None	2x 2000W Platinum	2x 2.8m C13-C14	D2 Slide Rail	None	3-year, Onsite	07/17

ThinkSystem D2 Enclosure - Non TopSeller - EET, MEA, RUCIS, WE

Product Specifications Reference (PSREF)

Model	Product	Region	I/O Shuttle	External I/O Module	Power Supply	Power cords	Rail Kit	CMA	Warranty	Ann Date (mm/yy)
7X20A00HEA	ThinkSystem D2 Enclosure	EET, MEA, RUCIS, WE	4x PCIe x16	None	2x 1600W Platinum	2x 2.8m C13-C14	D2 Slide Rail	CMA	3-year, Onsite	07/17
7X20A004EA	ThinkSystem D2 Enclosure	EET, MEA, RUCIS, WE	8x PCIe x8	None	2x 1600W Platinum	2x 2.8m C13-C14	D2 Slide Rail	CMA	3-year, Onsite	07/17
7X20A005EA	ThinkSystem D2 Enclosure	EET, MEA, RUCIS, WE	8x PCIe x8	None	2x 2000W Platinum	2x 2.8m C13-C14	D2 Slide Rail	CMA	3-year, Onsite	07/17
7X20A006EA	ThinkSystem D2 Enclosure	EET, MEA, RUCIS, WE	4x PCIe x16	None	2x 1100W Platinum	2x 2.8m C13-C14	D2 Slide Rail	CMA	3-year, Onsite	07/17
7X20A00AEA	ThinkSystem D2 Enclosure	EET, MEA, RUCIS, WE	4x PCIe x16	None	2x 2000W Platinum	2x 2.8m C13-C14	D2 Slide Rail	CMA	3-year, Onsite	07/17
7X20A00CEA	ThinkSystem D2 Enclosure	EET, MEA, RUCIS, WE	8x PCIe x8	None	2x 1100W Platinum	2x 2.8m C13-C14	D2 Slide Rail	CMA	3-year, Onsite	07/17

ThinkSystem D2 Enclosure - Non TopSeller - HTK

Product Specifications Reference (PSREF)

Model	Product	Region	I/O Shuttle	External I/O Module	Power Supply	Power cords	Rail Kit	CMA	Warranty	Ann Date (mm/yy)
7X20A00BCN	ThinkSystem D2 Enclosure	HTK	8x PCIe x8	8x 10GbE SFP+	2x 1600W Platinum	2x 2.8m C13-C14	D2 Slide Rail	None	3-year, Onsite	07/17

ThinkSystem D2 Enclosure - Non TopSeller - INDIA

Product Specifications Reference (PSREF)

Model	Product	Region	I/O Shuttle	External I/O Module	Power Supply	Power cords	Rail Kit	CMA	Warranty	Ann Date (mm/yy)
7X20A00KSG	ThinkSystem D2 Enclosure	INDIA	4x PCIe x16	None	2x 1100W Platinum	2x 2.8m C13-C14, 2x 2.8m IS6538	D2 Slide Rail	CMA	3-year, Onsite	07/17
7X20A00LSG	ThinkSystem D2 Enclosure	INDIA	8x PCIe x8	None	2x 2000W Platinum	2x 2.8m C13-C14, 2x 2.8m IS6538	D2 Slide Rail	CMA	3-year, Onsite	07/17
7X20A00MSG	ThinkSystem D2 Enclosure	INDIA	8x PCIe x8	None	2x 1600W Platinum	2x 2.8m C13-C14, 2x 2.8m IS6538	D2 Slide Rail	CMA	3-year, Onsite	07/17
7X20A00NSG	ThinkSystem D2 Enclosure	INDIA	8x PCIe x8	None	2x 1100W Platinum	2x 2.8m C13-C14, 2x 2.8m IS6538	D2 Slide Rail	CMA	3-year, Onsite	07/17
7X20A00PSG	ThinkSystem D2 Enclosure	INDIA	4x PCIe x16	None	2x 2000W Platinum	2x 2.8m C13-C14, 2x 2.8m IS6538	D2 Slide Rail	CMA	3-year, Onsite	07/17
7X20A00QSG	ThinkSystem D2 Enclosure	INDIA	4x PCIe x16	None	2x 1600W Platinum	2x 2.8m C13-C14, 2x 2.8m IS6538	D2 Slide Rail	CMA	3-year, Onsite	07/17

ThinkSystem D2 Enclosure - Non TopSeller - JAPAN

Product Specifications Reference (PSREF)

Model	Product	Region	I/O Shuttle	External I/O Module	Power Supply	Power cords	Rail Kit	CMA	Warranty	Ann Date (mm/yy)
7X20A007JP	ThinkSystem D2 Enclosure	JAPAN	8x PCIe x8	8x 10GbE RJ-45	2x 2000W Platinum	2x 1.0m C13-C14	D2 Slide Rail	CMA	3-year, Onsite	07/17
7X20A008JP	ThinkSystem D2 Enclosure	JAPAN	8x PCIe x8	8x 10GbE SFP+	2x 2000W Platinum	2x 1.0m C13-C14	D2 Slide Rail	CMA	3-year, Onsite	07/17
7X20A009JP	ThinkSystem D2 Enclosure	JAPAN	4x PCIe x16	8x 10GbE SFP+	2x 2000W Platinum	2x 1.0m C13-C14	D2 Slide Rail	CMA	3-year, Onsite	07/17
7X20A00DJP	ThinkSystem D2 Enclosure	JAPAN	4x PCIe x16	8x 10GbE RJ-45	2x 2000W Platinum	2x 1.0m C13-C14	D2 Slide Rail	CMA	3-year, Onsite	07/17

ThinkSystem D2 Enclosure - Non TopSeller - NA

Product Specifications Reference (PSREF)

Model	Product	Region	I/O Shuttle	External I/O Module	Power Supply	Power cords	Rail Kit	CMA	Warranty	Ann Date (mm/yy)
7X20A002NA	ThinkSystem D2 Enclosure	NA	8x PCIe x8	8x 10GbE RJ-45	2x 2000W Platinum	2x 1.0m C13-C14	D2 Slide Rail	None	3-year, Onsite	07/17
7X20A003NA	ThinkSystem D2 Enclosure	NA	4x PCIe x16	8x 10GbE SFP+	2x 2000W Platinum	2x 1.0m C13-C14	D2 Slide Rail	None	3-year, Onsite	07/17
7X20A00RNA	ThinkSystem D2 Enclosure	NA	4x PCIe x16	8x 10GbE SFP+	2x 2000W Platinum	2x 2.0m C13-C14	D2 Slide Rail	None	3-year, Onsite	07/17
7X20A00JNA	ThinkSystem D2 Enclosure	NA	4x PCIe x16	8x 10GbE RJ-45	2x 2000W Platinum	2x 1.0m C13-C14	D2 Slide Rail	None	3-year, Onsite	07/17



ThinkSystem SD530 Platform Specifications

Components	Specification																								
Form factor	Half-wide, 1U compute node																								
Dimensions	Height: 41 mm (1.7 in). Width: 222 mm (8.8 in). Depth: 562 mm (22.2 in)																								
Chassis support	ThinkSystem D2 Enclosure. 2U. Up to 4 ThinkSystem SD530 servers per enclosure																								
Weight	Maximum configuration: 16.6 lb (7.5 kg)																								
Processor	Up to two 165W Intel Xeon Scalable family processors, Bronze, Silver, Gold, or Platinum. Up to 28 cores at 2.1GHz, up to 3.6GHz with 4 cores. Up to two UPI (Ultra Path Interconnect) links at maximum 10.4GT/s each																								
Chipset	Intel C624 Platform Controller Hub																								
Memory	Up to 12 or 16 DIMM sockets depending on the processor selected. Each processor supports up to 6 or 8 DIMM sockets. DDR4-2666. RDIMMs and LRDIMMs are supported, but memory types cannot be intermixed.																								
Memory capacity	16 DIMMs models: RDIMMs: Up to 512GB with 16x 32GB RDIMMs and two processors LRDIMMs: Up to 1TB with 16x 64GB LRDIMMs and two processors 12 DIMMs models: RDIMMs: Up to 384GB with 12x 32GB RDIMMs and two processors LRDIMMs: Up to 768GB with 12x 64GB LRDIMMs and two processors																								
Memory protection	ECC, Chipkill protection (for x4-based memory DIMMs), memory mirroring, and memory sparing																								
Storage controllers	Supports the following RAID adapters: <table border="1"> <thead> <tr> <th>Adapter</th> <th>Interface</th> <th>Drive type</th> <th>RAID levels</th> <th>JBOD</th> <th>Cache</th> <th>Cache protection</th> <th>FastPath</th> </tr> </thead> <tbody> <tr> <td>Onboard Intel RSTe</td> <td>6Gbps SATA</td> <td>SATA</td> <td>0/1/10/5</td> <td>Yes</td> <td>None</td> <td>None</td> <td>No</td> </tr> <tr> <td>530-8i</td> <td>12Gbps SAS</td> <td>SATA/SAS</td> <td>0/1/10/5</td> <td>Yes</td> <td>None</td> <td>None</td> <td>Yes</td> </tr> </tbody> </table>	Adapter	Interface	Drive type	RAID levels	JBOD	Cache	Cache protection	FastPath	Onboard Intel RSTe	6Gbps SATA	SATA	0/1/10/5	Yes	None	None	No	530-8i	12Gbps SAS	SATA/SAS	0/1/10/5	Yes	None	None	Yes
Adapter	Interface	Drive type	RAID levels	JBOD	Cache	Cache protection	FastPath																		
Onboard Intel RSTe	6Gbps SATA	SATA	0/1/10/5	Yes	None	None	No																		
530-8i	12Gbps SAS	SATA/SAS	0/1/10/5	Yes	None	None	Yes																		
Disk drive bays	Up to four 2.5" hot-swap disk bays, or up to six 2.5" hot-swap disk bays, or up to six 2.5" hot-swap disk bays with two AnyBay. SAS support requires 530-8i. Optional one or two internal M.2 SSD for boot, dual M.2 SSD supports mirroring																								
Internal storage	<table border="1"> <tbody> <tr> <td>2.5" NVMe SSD</td> <td>800GB/960GB/1.6TB/1.92TB</td> </tr> <tr> <td>2.5" HDD, SATA6Gbps, 7,2K</td> <td>1TB/2TB</td> </tr> <tr> <td>2.5" HDD, SAS12Gbps, 7,2K</td> <td>2TB</td> </tr> <tr> <td>2.5" HDD, SAS12Gbps, 7,2K, SED</td> <td>1TB/2TB</td> </tr> <tr> <td>2.5" HDD, SAS12Gbps, 15K</td> <td>300GB/600GB/900GB</td> </tr> <tr> <td>2.5" HDD, SAS12Gbps, 10K</td> <td>300GB/600GB/900GB/1.2TB/1.8TB/2.4TB</td> </tr> <tr> <td>2.5" HDD, SAS12Gbps, 10K, SED</td> <td>2.4TB</td> </tr> <tr> <td>2.5" SSD, SATA6Gbps</td> <td>240GB/480GB/960GB/1.92TB/3.84TB</td> </tr> <tr> <td>2.5" SSD, SAS12Gbps</td> <td>400GB/800GB/1.6TB/3.84TB/7.68TB/15.36TB</td> </tr> <tr> <td>M.2 SATA SSD</td> <td>32GB/128GB</td> </tr> </tbody> </table>	2.5" NVMe SSD	800GB/960GB/1.6TB/1.92TB	2.5" HDD, SATA6Gbps, 7,2K	1TB/2TB	2.5" HDD, SAS12Gbps, 7,2K	2TB	2.5" HDD, SAS12Gbps, 7,2K, SED	1TB/2TB	2.5" HDD, SAS12Gbps, 15K	300GB/600GB/900GB	2.5" HDD, SAS12Gbps, 10K	300GB/600GB/900GB/1.2TB/1.8TB/2.4TB	2.5" HDD, SAS12Gbps, 10K, SED	2.4TB	2.5" SSD, SATA6Gbps	240GB/480GB/960GB/1.92TB/3.84TB	2.5" SSD, SAS12Gbps	400GB/800GB/1.6TB/3.84TB/7.68TB/15.36TB	M.2 SATA SSD	32GB/128GB				
2.5" NVMe SSD	800GB/960GB/1.6TB/1.92TB																								
2.5" HDD, SATA6Gbps, 7,2K	1TB/2TB																								
2.5" HDD, SAS12Gbps, 7,2K	2TB																								
2.5" HDD, SAS12Gbps, 7,2K, SED	1TB/2TB																								
2.5" HDD, SAS12Gbps, 15K	300GB/600GB/900GB																								
2.5" HDD, SAS12Gbps, 10K	300GB/600GB/900GB/1.2TB/1.8TB/2.4TB																								
2.5" HDD, SAS12Gbps, 10K, SED	2.4TB																								
2.5" SSD, SATA6Gbps	240GB/480GB/960GB/1.92TB/3.84TB																								
2.5" SSD, SAS12Gbps	400GB/800GB/1.6TB/3.84TB/7.68TB/15.36TB																								
M.2 SATA SSD	32GB/128GB																								
Network interfaces	Two 10 GbE ports, SFP+ or RJ-45, routed through the Ethernet I/O Module at the rear of the D2 Enclosure. Networking ports are based on Intel Ethernet Connection X722 in chipset																								
Security features	Power-on and admin password. Trusted Platform Module, TCG 1.2 and 2.0 compliant. Optional TCM, China only																								
Operating systems supported	Microsoft Windows Server 2016, 2012 R2, Red Hat Enterprise Linux 6 and 7 x64, SUSE Linux Enterprise Server 11 and 12 x64, VMware ESXi 6.0 and 6.5																								
Systems management	Operator panel with system error LED and ID and power controls. XClarity Controller embedded management, XClarity Administrator centralized infrastructure delivery, XClarity Integrator plugins, and XClarity Energy Manager centralized server power management. Optional XClarity Controller Advanced to enable remote control functions. System Management Module (SMM) in the D2 Enclosure provides additional systemsmanagement functions																								
GPU support	None																								
Base warranty	MT 7X21: 3-year limited onsite service with 9x5/NBD																								
Power supply	Supplied by D2 Enclosure																								
Video	Integrated Matrox G200 in XClarity Controller																								
Front ports	Optional KVM breakout module for one USB 3.0 and one console breakout cable port for local KVM and serial ports. KVM breakout module will occupy one disk bay on 6x 2.5" disk bay model																								

Components	Specification	
Environmental specification	Supports ASHRAE A4 with limitations.	
	Temperature - operating	A4: 5°C to 45°C (41°F to 113°F) A3: 5°C to 40°C (41°F to 104°F) A2: 10°C to 35°C (50°F to 95°F)
	Temperature - non operating (no package)	-10°C to 60°C (14°F to 140°F)
	Temperature - non operating (with package)	-40°C to 70°C (-40°F to 158°F)
	Altitude - operating	(Unpressurized); 0-10000ft (0-3048m)
	Humidity - operating, non-condensing	A4: 8%-90%. A3:8%-85%. A2:20%-80%
	Humidity - storage (with package), non-condensing	8%-90%
Models should meet the following requirements to support A3 and A4: <ul style="list-style-type: none"> NVMe drives not installed M.2 drives not installed 		

Expansion slots

Supports one PCIe 3.0 x16 low-profile slot, or two PCIe 3.0 x8 low-profile slots. Slots are housed in I/O shuttle in rear of the D2 Enclosure

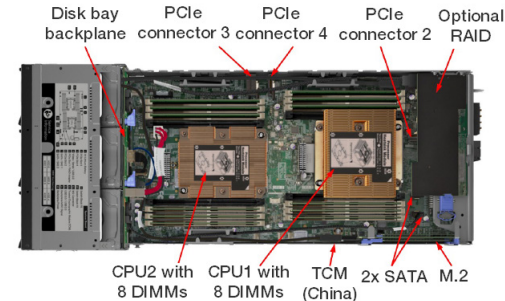

Backplane and memory DIMM sockets supports by processor

Maxium DIMM Sockets	12 DIMMs		16 DIMMs	
Backplane	2x2	2x3	2x2	2x3
Xeon Bronze 3104	Yes	Yes	Yes	No
Xeon Bronze 3106	Yes	Yes	Yes	No
Xeon Silver 4108	Yes	Yes	Yes	No
Xeon Silver 4109T	Yes	No	No	No
Xeon Silver 4110	Yes	Yes	Yes	No
Xeon Silver 4112	Yes	Yes	Yes	No
Xeon Silver 4114	Yes	Yes	Yes	No
Xeon Silver 4116	Yes	Yes	Yes	No
Xeon Gold 5115	Yes	Yes	Yes	No
Xeon Gold 5118	Yes	Yes	Yes	No
Xeon Gold 5120	Yes	Yes	Yes	No
Xeon Gold 5120T	Yes	No	No	No
Xeon Gold 5122	Yes	No	No	No
Xeon Gold 6126	Yes	Yes	No	No
Xeon Gold 6130	Yes	Yes	Yes	No
Xeon Gold 6130T	Yes	No	No	No
Xeon Gold 6134	Yes	No	No	No
Xeon Gold 6136	Yes	No	No	No
Xeon Gold 6138	Yes	Yes	No	No
Xeon Gold 6138T	Yes	No	No	No
Xeon Gold 6140	Yes	Yes	No	No
Xeon Gold 6142	Yes	No	No	No
Xeon Gold 6148	Yes	No	No	No
Xeon Gold 6150	Yes	No	No	No
Xeon Gold 6152	Yes	Yes	No	No
Xeon Platinum 8153	Yes	Yes	Yes	No
Xeon Platinum 8156	Yes	No	No	No
Xeon Platinum 8158	Yes	No	No	No
Xeon Platinum 8160	Yes	No	No	No
Xeon Platinum 8164	Yes	No	No	No
Xeon Platinum 8170	Yes	No	No	No
Xeon Platinum 8176	Yes	No	No	No

Model	Product	Region	Processor	Memory	Storage Controller	DiskBays	Disks	KVM Breakout Module	M.2 Drives	System Management	Warranty	Ann Date (mm/yy)
7X21A039EA	ThinkSystem SD530	EET, MEA, RUCIS, WE	1x Xeon Gold 5120 14C/2.2GHz/19.25MB/105W/DDR4-2400	1x 16GB RDIMM DDR4-2666	1x 530-8i	4x 2.5" SATA/SAS HS	None	None	None	XClarity Enterprise	3-year, Onsite	09/17
7X21A03AEA	ThinkSystem SD530	EET, MEA, RUCIS, WE	1x Xeon Gold 6126 12C/2.6GHz/19.25MB/125W/DDR4-2666	1x 16GB RDIMM DDR4-2666	1x 530-8i	4x 2.5" SATA/SAS HS	None	None	None	XClarity Enterprise	3-year, Onsite	09/17
7X21A03BEA	ThinkSystem SD530	EET, MEA, RUCIS, WE	1x Xeon Gold 6130 16C/2.1GHz/22MB/125W/DDR4-2666	1x 16GB RDIMM DDR4-2666	1x 530-8i	4x 2.5" SATA/SAS HS	None	None	None	XClarity Enterprise	3-year, Onsite	09/17
7X21A03CEA	ThinkSystem SD530	EET, MEA, RUCIS, WE	1x Xeon Gold 6134 8C/3.2GHz/24.75MB/130W/DDR4-2666	1x 16GB RDIMM DDR4-2666	1x 530-8i	4x 2.5" SATA/SAS HS	None	None	None	XClarity Enterprise	3-year, Onsite	09/17
7X21A03DEA	ThinkSystem SD530	EET, MEA, RUCIS, WE	1x Xeon Gold 6136 12C/3.0GHz/24.75MB/150W/DDR4-2666	1x 16GB RDIMM DDR4-2666	1x 530-8i	4x 2.5" SATA/SAS HS	None	None	None	XClarity Enterprise	3-year, Onsite	09/17
7X21A03EEA	ThinkSystem SD530	EET, MEA, RUCIS, WE	1x Xeon Gold 6142 16C/2.6GHz/22MB/150W/DDR4-2666	1x 16GB RDIMM DDR4-2666	1x 530-8i	4x 2.5" SATA/SAS HS	None	None	None	XClarity Enterprise	3-year, Onsite	09/17
7X21A03FEA	ThinkSystem SD530	EET, MEA, RUCIS, WE	1x Xeon Gold 6150 18C/2.7GHz/24.75MB/165W/DDR4-2666	1x 16GB RDIMM DDR4-2666	1x 530-8i	4x 2.5" SATA/SAS HS	None	None	None	XClarity Enterprise	3-year, Onsite	09/17

Model	Product	Region	Processor	Memory	Storage Controller	DiskBays	Disks	KVM Breakout Module	M.2 Drives	System Management	Warranty	Ann Date (mm/yy)
7X21A01VAU	ThinkSystem SD530	ANZ	1x Xeon Bronze 3104 6C/1.7GHz/8.25MB/85W/DDR4-2133	1x 16GB RDIMM DDR4-2666	Onboard SATA	6x 2.5" SATA/SAS HS	None	None	None	XClarity Standard	3-year, Onsite	07/17
7X21A01ZAU	ThinkSystem SD530	ANZ	2x Xeon Gold 6130 16C/2.1GHz/22MB/125W/DDR4-2666	2x 32GB RDIMM DDR4-2666	Onboard SATA	4x 2.5" SATA/SAS HS	None	None	None	XClarity Standard	3-year, Onsite	07/17
7X21A020AU	ThinkSystem SD530	ANZ	2x Xeon Silver 4114 10C/2.2GHz/13.75MB/85W/DDR4-2400	2x 16GB RDIMM DDR4-2666	1x 530-8i	6x 2.5" HS (4 SATA/SAS, 2 AnyBay)	None	None	None	XClarity Standard	3-year, Onsite	07/17
7X21A021AU	ThinkSystem SD530	ANZ	2x Xeon Gold 6148 20C/2.4GHz/27.5MB/150W/DDR4-2666	2x 32GB RDIMM DDR4-2666	Onboard SATA	4x 2.5" SATA/SAS HS	None	None	None	XClarity Standard	3-year, Onsite	07/17
7X21A022AU	ThinkSystem SD530	ANZ	2x Xeon Silver 4116 12C/2.1GHz/16.5MB/85W/DDR4-2400	2x 32GB RDIMM DDR4-2666	1x 530-8i	6x 2.5" HS (4 SATA/SAS, 2 AnyBay)	None	None	None	XClarity Standard	3-year, Onsite	07/17
7X21A023AU	ThinkSystem SD530	ANZ	2x Xeon Gold 6138 20C/2.0GHz/27.5MB/125W/DDR4-2666	2x 32GB RDIMM DDR4-2666	Onboard SATA	4x 2.5" SATA/SAS HS	None	None	None	XClarity Standard	3-year, Onsite	07/17
7X21A024AU	ThinkSystem SD530	ANZ	2x Xeon Silver 4116 12C/2.1GHz/16.5MB/85W/DDR4-2400	2x 16GB RDIMM DDR4-2666	Onboard SATA	4x 2.5" SATA/SAS HS	None	None	None	XClarity Standard	3-year, Onsite	07/17
7X21A025AU	ThinkSystem SD530	ANZ	1x Xeon Silver 4108 8C/1.8GHz/11MB/85W/DDR4-2400	1x 16GB RDIMM DDR4-2666	Onboard SATA	6x 2.5" SATA/SAS HS	None	None	None	XClarity Standard	3-year, Onsite	07/17
7X21A026AU	ThinkSystem SD530	ANZ	2x Xeon Gold 6126 12C/2.6GHz/19.25MB/125W/DDR4-2666	2x 32GB RDIMM DDR4-2666	1x 530-8i	6x 2.5" HS (4 SATA/SAS, 2 AnyBay)	None	None	None	XClarity Standard	3-year, Onsite	07/17
7X21A02AAU	ThinkSystem SD530	ANZ	2x Xeon Gold 6140 18C/2.3GHz/24.75MB/140W/DDR4-2666	2x 32GB RDIMM DDR4-2666	Onboard SATA	4x 2.5" SATA/SAS HS	None	None	None	XClarity Standard	3-year, Onsite	07/17
7X21A02BAU	ThinkSystem SD530	ANZ	2x Xeon Gold 6134 8C/3.2GHz/24.75MB/130W/DDR4-2666	2x 32GB RDIMM DDR4-2666	Onboard SATA	4x 2.5" SATA/SAS HS	None	None	None	XClarity Standard	3-year, Onsite	07/17
7X21A02DAU	ThinkSystem SD530	ANZ	2x Xeon Silver 4108 8C/1.8GHz/11MB/85W/DDR4-2400	2x 16GB RDIMM DDR4-2666	1x 530-8i	6x 2.5" SATA/SAS HS	None	None	None	XClarity Standard	3-year, Onsite	07/17
7X21A02FAU	ThinkSystem SD530	ANZ	2x Xeon Gold 5118 12C/2.3GHz/16.5MB/105W/DDR4-2400	2x 16GB RDIMM DDR4-2666	Onboard SATA	4x 2.5" SATA/SAS HS	None	None	None	XClarity Standard	3-year, Onsite	07/17
7X21A02HAU	ThinkSystem SD530	ANZ	2x Xeon Gold 6126 12C/2.6GHz/19.25MB/125W/DDR4-2666	2x 16GB RDIMM DDR4-2666	Onboard SATA	4x 2.5" SATA/SAS HS	None	None	None	XClarity Standard	3-year, Onsite	07/17
7X21A02JAU	ThinkSystem SD530	ANZ	2x Xeon Silver 4112 4C/2.6GHz/8.25MB/85W/DDR4-2400	2x 16GB RDIMM DDR4-2666	Onboard SATA	6x 2.5" HS (4 SATA/SAS, 2 AnyBay)	None	None	None	XClarity Standard	3-year, Onsite	07/17

Model	Product	Region	Processor	Memory	Storage Controller	DiskBays	Disks	KVM Breakout Module	M.2 Drives	System Management	Warranty	Ann Date (mm/yy)
7X21A02KAU	ThinkSystem SD530	ANZ	2x Xeon Gold 5118 12C/2.3GHz/16.5MB/105W/DDR4-2400	2x 32GB RDIMM DDR4-2666	1x 530-8i	6x 2.5" HS (4 SATA/SAS, 2 AnyBay)	None	None	None	XClarity Standard	3-year, Onsite	07/17
7X21A02LAU	ThinkSystem SD530	ANZ	2x Xeon Silver 4110 8C/2.1GHz/11MB/85W/DDR4-2400	2x 16GB RDIMM DDR4-2666	1x 530-8i	6x 2.5" SATA/SAS HS	None	None	None	XClarity Standard	3-year, Onsite	07/17
7X21A02NAU	ThinkSystem SD530	ANZ	2x Xeon Silver 4114 10C/2.2GHz/13.75MB/85W/DDR4-2400	2x 16GB RDIMM DDR4-2666	Onboard SATA	6x 2.5" HS (4 SATA/SAS, 2 AnyBay)	None	None	None	XClarity Standard	3-year, Onsite	07/17
7X21A02PAU	ThinkSystem SD530	ANZ	2x Xeon Silver 4110 8C/2.1GHz/11MB/85W/DDR4-2400	2x 16GB RDIMM DDR4-2666	Onboard SATA	6x 2.5" SATA/SAS HS	None	None	None	XClarity Standard	3-year, Onsite	07/17

ThinkSystem SD530 - Non TopSeller - ASEAN

Product Specifications Reference (PSREF)

Model	Product	Region	Processor	Memory	Storage Controller	DiskBays	Disks	KVM Breakout Module	M.2 Drives	System Management	Warranty	Ann Date (mm/yy)
7X21A004SG	ThinkSystem SD530	ASEAN	1x Xeon Bronze 3106 8C/1.7GHz/11MB/85W/DDR4-2133	1x 8GB RDIMM DDR4-2666	1x 530-8i	4x 2.5" SATA/SAS HS	None	None	None	XClarity Standard	3-year, Onsite	07/17
7X21A006SG	ThinkSystem SD530	ASEAN	1x Xeon Gold 5120 14C/2.2GHz/19.25MB/105W/DDR4-2400	1x 8GB RDIMM DDR4-2666	1x 530-8i	4x 2.5" SATA/SAS HS	None	None	None	XClarity Standard	3-year, Onsite	07/17
7X21A008SG	ThinkSystem SD530	ASEAN	1x Xeon Silver 4116 12C/2.1GHz/16.5MB/85W/DDR4-2400	1x 8GB RDIMM DDR4-2666	1x 530-8i	4x 2.5" SATA/SAS HS	None	None	None	XClarity Standard	3-year, Onsite	07/17
7X21A00HSG	ThinkSystem SD530	ASEAN	1x Xeon Bronze 3104 6C/1.7GHz/8.25MB/85W/DDR4-2133	1x 8GB RDIMM DDR4-2666	1x 530-8i	4x 2.5" SATA/SAS HS	None	None	None	XClarity Standard	3-year, Onsite	07/17
7X21A00DSG	ThinkSystem SD530	ASEAN	1x Xeon Gold 6130 16C/2.1GHz/22MB/125W/DDR4-2666	1x 8GB RDIMM DDR4-2666	1x 530-8i	4x 2.5" SATA/SAS HS	None	None	None	XClarity Standard	3-year, Onsite	07/17
7X21A00NSG	ThinkSystem SD530	ASEAN	1x Xeon Gold 6138 20C/2.0GHz/27.5MB/125W/DDR4-2666	1x 8GB RDIMM DDR4-2666	1x 530-8i	4x 2.5" SATA/SAS HS	None	None	None	XClarity Standard	3-year, Onsite	07/17
7X21A011SG	ThinkSystem SD530	ASEAN	1x Xeon Silver 4114 10C/2.2GHz/13.75MB/85W/DDR4-2400	1x 8GB RDIMM DDR4-2666	1x 530-8i	4x 2.5" SATA/SAS HS	None	None	None	XClarity Standard	3-year, Onsite	07/17
7X21A016SG	ThinkSystem SD530	ASEAN	1x Xeon Silver 4110 8C/2.1GHz/11MB/85W/DDR4-2400	1x 8GB RDIMM DDR4-2666	1x 530-8i	4x 2.5" SATA/SAS HS	None	None	None	XClarity Standard	3-year, Onsite	07/17

Model	Product	Region	Processor	Memory	Storage Controller	DiskBays	Disks	KVM Breakout Module	M.2 Drives	System Management	Warranty	Ann Date (mm/yy)
7X21A02QBR	ThinkSystem SD530	Brazil	1x Xeon Silver 4108 8C/1.8GHz/11MB/85W/DDR4-2400	1x 16GB RDIMM DDR4-2666	Onboard SATA	6x 2.5" SATA/SAS HS	None	None	None	XClarity Standard	3-year, Onsite	07/17
7X21A02RBR	ThinkSystem SD530	Brazil	2x Xeon Silver 4112 4C/2.6GHz/8.25MB/85W/DDR4-2400	2x 16GB RDIMM DDR4-2666	Onboard SATA	6x 2.5" HS (4 SATA/SAS, 2 AnyBay)	None	None	None	XClarity Standard	3-year, Onsite	07/17
7X21A02SBR	ThinkSystem SD530	Brazil	2x Xeon Silver 4112 4C/2.6GHz/8.25MB/85W/DDR4-2400	2x 16GB RDIMM DDR4-2666	Onboard SATA	6x 2.5" HS (4 SATA/SAS, 2 AnyBay)	None	None	None	XClarity Standard	3-year, Onsite	07/17
7X21A02TBR	ThinkSystem SD530	Brazil	1x Xeon Bronze 3104 6C/1.7GHz/8.25MB/85W/DDR4-2133	1x 16GB RDIMM DDR4-2666	Onboard SATA	6x 2.5" SATA/SAS HS	None	None	None	XClarity Standard	3-year, Onsite	07/17
7X21A02UBR	ThinkSystem SD530	Brazil	1x Xeon Bronze 3104 6C/1.7GHz/8.25MB/85W/DDR4-2133	1x 16GB RDIMM DDR4-2666	Onboard SATA	6x 2.5" SATA/SAS HS	None	None	None	XClarity Standard	3-year, Onsite	07/17
7X21A02VBR	ThinkSystem SD530	Brazil	2x Xeon Silver 4108 8C/1.8GHz/11MB/85W/DDR4-2400	2x 16GB RDIMM DDR4-2666	1x 530-8i	6x 2.5" SATA/SAS HS	None	None	None	XClarity Standard	3-year, Onsite	07/17
7X21A02WBR	ThinkSystem SD530	Brazil	2x Xeon Silver 4114 10C/2.2GHz/13.75MB/85W/DDR4-2400	2x 16GB RDIMM DDR4-2666	Onboard SATA	6x 2.5" HS (4 SATA/SAS, 2 AnyBay)	None	None	None	XClarity Standard	3-year, Onsite	07/17
7X21A02XBR	ThinkSystem SD530	Brazil	2x Xeon Silver 4108 8C/1.8GHz/11MB/85W/DDR4-2400	2x 16GB RDIMM DDR4-2666	1x 530-8i	6x 2.5" SATA/SAS HS	None	None	None	XClarity Standard	3-year, Onsite	07/17
7X21A02YBR	ThinkSystem SD530	Brazil	2x Xeon Silver 4110 8C/2.1GHz/11MB/85W/DDR4-2400	2x 16GB RDIMM DDR4-2666	Onboard SATA	6x 2.5" SATA/SAS HS	None	None	None	XClarity Standard	3-year, Onsite	07/17
7X21A02ZBR	ThinkSystem SD530	Brazil	2x Xeon Silver 4114 10C/2.2GHz/13.75MB/85W/DDR4-2400	2x 16GB RDIMM DDR4-2666	1x 530-8i	6x 2.5" HS (4 SATA/SAS, 2 AnyBay)	None	None	None	XClarity Standard	3-year, Onsite	07/17
7X21A030BR	ThinkSystem SD530	Brazil	2x Xeon Silver 4110 8C/2.1GHz/11MB/85W/DDR4-2400	2x 16GB RDIMM DDR4-2666	Onboard SATA	6x 2.5" SATA/SAS HS	None	None	None	XClarity Standard	3-year, Onsite	07/17
7X21A031BR	ThinkSystem SD530	Brazil	2x Xeon Silver 4110 8C/2.1GHz/11MB/85W/DDR4-2400	2x 16GB RDIMM DDR4-2666	1x 530-8i	6x 2.5" SATA/SAS HS	None	None	None	XClarity Standard	3-year, Onsite	07/17
7X21A032BR	ThinkSystem SD530	Brazil	2x Xeon Silver 4110 8C/2.1GHz/11MB/85W/DDR4-2400	2x 16GB RDIMM DDR4-2666	1x 530-8i	6x 2.5" SATA/SAS HS	None	None	None	XClarity Standard	3-year, Onsite	07/17
7X21A033BR	ThinkSystem SD530	Brazil	1x Xeon Silver 4108 8C/1.8GHz/11MB/85W/DDR4-2400	1x 16GB RDIMM DDR4-2666	Onboard SATA	6x 2.5" SATA/SAS HS	None	None	None	XClarity Standard	3-year, Onsite	07/17
7X21A034BR	ThinkSystem SD530	Brazil	2x Xeon Silver 4114 10C/2.2GHz/13.75MB/85W/DDR4-2400	2x 16GB RDIMM DDR4-2666	Onboard SATA	6x 2.5" HS (4 SATA/SAS, 2 AnyBay)	None	None	None	XClarity Standard	3-year, Onsite	07/17

Model	Product	Region	Processor	Memory	Storage Controller	DiskBays	Disks	KVM Breakout Module	M.2 Drives	System Management	Warranty	Ann Date (mm/yy)
7X21A035BR	ThinkSystem SD530	Brazil	2x Xeon Silver 4114 10C/2.2GHz/13.75MB/85W/DDR4-2400	2x 16GB RDIMM DDR4-2666	1x 530-8i	6x 2.5" HS (4 SATA/SAS, 2 AnyBay)	None	None	None	XClarity Standard	3-year, Onsite	07/17

Model	Product	Region	Processor	Memory	Storage Controller	DiskBays	Disks	KVM Breakout Module	M.2 Drives	System Management	Warranty	Ann Date (mm/yy)
7X21A018EA	ThinkSystem SD530	EET, MEA, RUCIS, WE	2x Xeon Silver 4110 8C/2.1GHz/11MB/85W/DDR4-2400	2x 16GB RDIMM DDR4-2666	1x 530-8i	6x 2.5" SATA/SAS HS	None	None	None	XClarity Standard	3-year, Onsite	07/17
7X21A019EA	ThinkSystem SD530	EET, MEA, RUCIS, WE	2x Xeon Gold 6134 8C/3.2GHz/24.75MB/130W/DDR4-2666	2x 32GB RDIMM DDR4-2666	Onboard SATA	4x 2.5" SATA/SAS HS	None	None	None	XClarity Standard	3-year, Onsite	07/17
7X21A013EA	ThinkSystem SD530	EET, MEA, RUCIS, WE	2x Xeon Gold 6148 20C/2.4GHz/27.5MB/150W/DDR4-2666	2x 32GB RDIMM DDR4-2666	Onboard SATA	4x 2.5" SATA/SAS HS	None	None	None	XClarity Standard	3-year, Onsite	07/17
7X21A014EA	ThinkSystem SD530	EET, MEA, RUCIS, WE	2x Xeon Silver 4116 12C/2.1GHz/16.5MB/85W/DDR4-2400	2x 32GB RDIMM DDR4-2666	1x 530-8i	6x 2.5" HS (4 SATA/SAS, 2 AnyBay)	None	None	None	XClarity Standard	3-year, Onsite	07/17
7X21A003EA	ThinkSystem SD530	EET, MEA, RUCIS, WE	1x Xeon Bronze 3104 6C/1.7GHz/8.25MB/85W/DDR4-2133	1x 16GB RDIMM DDR4-2666	Onboard SATA	6x 2.5" SATA/SAS HS	None	None	None	XClarity Standard	3-year, Onsite	07/17
7X21A010EA	ThinkSystem SD530	EET, MEA, RUCIS, WE	2x Xeon Gold 6126 12C/2.6GHz/19.25MB/125W/DDR4-2666	2x 32GB RDIMM DDR4-2666	1x 530-8i	6x 2.5" HS (4 SATA/SAS, 2 AnyBay)	None	None	None	XClarity Standard	3-year, Onsite	07/17
7X21A00REA	ThinkSystem SD530	EET, MEA, RUCIS, WE	2x Xeon Gold 5118 12C/2.3GHz/16.5MB/105W/DDR4-2400	2x 16GB RDIMM DDR4-2666	Onboard SATA	4x 2.5" SATA/SAS HS	None	None	None	XClarity Standard	3-year, Onsite	07/17
7X21A00SEA	ThinkSystem SD530	EET, MEA, RUCIS, WE	2x Xeon Silver 4114 10C/2.2GHz/13.75MB/85W/DDR4-2400	2x 16GB RDIMM DDR4-2666	1x 530-8i	6x 2.5" HS (4 SATA/SAS, 2 AnyBay)	None	None	None	XClarity Standard	3-year, Onsite	07/17
7X21A00TEA	ThinkSystem SD530	EET, MEA, RUCIS, WE	2x Xeon Silver 4112 4C/2.6GHz/8.25MB/85W/DDR4-2400	2x 16GB RDIMM DDR4-2666	Onboard SATA	6x 2.5" HS (4 SATA/SAS, 2 AnyBay)	None	None	None	XClarity Standard	3-year, Onsite	07/17
7X21A00WEA	ThinkSystem SD530	EET, MEA, RUCIS, WE	2x Xeon Gold 6126 12C/2.6GHz/19.25MB/125W/DDR4-2666	2x 16GB RDIMM DDR4-2666	Onboard SATA	4x 2.5" SATA/SAS HS	None	None	None	XClarity Standard	3-year, Onsite	07/17
7X21A00YEA	ThinkSystem SD530	EET, MEA, RUCIS, WE	2x Xeon Silver 4108 8C/1.8GHz/11MB/85W/DDR4-2400	2x 16GB RDIMM DDR4-2666	1x 530-8i	6x 2.5" SATA/SAS HS	None	None	None	XClarity Standard	3-year, Onsite	07/17
7X21A01BEA	ThinkSystem SD530	EET, MEA, RUCIS, WE	2x Xeon Gold 6130 16C/2.1GHz/22MB/125W/DDR4-2666	2x 32GB RDIMM DDR4-2666	Onboard SATA	4x 2.5" SATA/SAS HS	None	None	None	XClarity Standard	3-year, Onsite	07/17
7X21A01CEA	ThinkSystem SD530	EET, MEA, RUCIS, WE	2x Xeon Silver 4110 8C/2.1GHz/11MB/85W/DDR4-2400	2x 16GB RDIMM DDR4-2666	Onboard SATA	6x 2.5" SATA/SAS HS	None	None	None	XClarity Standard	3-year, Onsite	07/17
7X21A01DEA	ThinkSystem SD530	EET, MEA, RUCIS, WE	2x Xeon Gold 5118 12C/2.3GHz/16.5MB/105W/DDR4-2400	2x 32GB RDIMM DDR4-2666	1x 530-8i	6x 2.5" HS (4 SATA/SAS, 2 AnyBay)	None	None	None	XClarity Standard	3-year, Onsite	07/17
7X21A01EEA	ThinkSystem SD530	EET, MEA, RUCIS, WE	2x Xeon Silver 4116 12C/2.1GHz/16.5MB/85W/DDR4-2400	2x 16GB RDIMM DDR4-2666	Onboard SATA	4x 2.5" SATA/SAS HS	None	None	None	XClarity Standard	3-year, Onsite	07/17

Model	Product	Region	Processor	Memory	Storage Controller	DiskBays	Disks	KVM Breakout Module	M.2 Drives	System Management	Warranty	Ann Date (mm/yy)
7X21A00GEA	ThinkSystem SD530	EET, MEA, RUCIS, WE	2x Xeon Silver 4114 10C/2.2GHz/13.75MB/85W/DDR4-2400	2x 16GB RDIMM DDR4-2666	Onboard SATA	6x 2.5" HS (4 SATA/SAS, 2 AnyBay)	None	None	None	XClarity Standard	3-year, Onsite	07/17
7X21A00JEA	ThinkSystem SD530	EET, MEA, RUCIS, WE	2x Xeon Gold 6138 20C/2.0GHz/27.5MB/125W/DDR4-2666	2x 32GB RDIMM DDR4-2666	Onboard SATA	4x 2.5" SATA/SAS HS	None	None	None	XClarity Standard	3-year, Onsite	07/17
7X21A007EA	ThinkSystem SD530	EET, MEA, RUCIS, WE	1x Xeon Silver 4108 8C/1.8GHz/11MB/85W/DDR4-2400	1x 16GB RDIMM DDR4-2666	Onboard SATA	6x 2.5" SATA/SAS HS	None	None	None	XClarity Standard	3-year, Onsite	07/17
7X21A005EA	ThinkSystem SD530	EET, MEA, RUCIS, WE	2x Xeon Gold 6140 18C/2.3GHz/24.75MB/140W/DDR4-2666	2x 32GB RDIMM DDR4-2666	Onboard SATA	4x 2.5" SATA/SAS HS	None	None	None	XClarity Standard	3-year, Onsite	07/17

Model	Product	Region	Processor	Memory	Storage Controller	DiskBays	Disks	KVM Breakout Module	M.2 Drives	System Management	Warranty	Ann Date (mm/yy)
7X21A01FCN	ThinkSystem SD530	HTK	1x Xeon Gold 6138 20C/2.0GHz/27.5MB/125W/DDR4-2666	1x 16GB RDIMM DDR4-2666	Onboard SATA	6x 2.5" SATA/SAS HS	None	None	None	XClarity Standard	3-year, Onsite	07/17
7X21A01GCN	ThinkSystem SD530	HTK	1x Xeon Gold 6148 20C/2.4GHz/27.5MB/150W/DDR4-2666	1x 16GB RDIMM DDR4-2666	Onboard SATA	4x 2.5" SATA/SAS HS	None	None	None	XClarity Standard	3-year, Onsite	07/17
7X21A01HCN	ThinkSystem SD530	HTK	1x Xeon Gold 5118 12C/2.3GHz/16.5MB/105W/DDR4-2400	1x 16GB RDIMM DDR4-2666	Onboard SATA	6x 2.5" SATA/SAS HS	None	None	None	XClarity Standard	3-year, Onsite	07/17
7X21A01JCN	ThinkSystem SD530	HTK	1x Xeon Gold 6140 18C/2.3GHz/24.75MB/140W/DDR4-2666	1x 16GB RDIMM DDR4-2666	Onboard SATA	6x 2.5" SATA/SAS HS	None	None	None	XClarity Standard	3-year, Onsite	07/17
7X21A01KCN	ThinkSystem SD530	HTK	1x Xeon Gold 6150 18C/2.7GHz/24.75MB/165W/DDR4-2666	1x 16GB RDIMM DDR4-2666	Onboard SATA	4x 2.5" SATA/SAS HS	None	None	None	XClarity Standard	3-year, Onsite	07/17
7X21A01LCN	ThinkSystem SD530	HTK	1x Xeon Gold 6130 16C/2.1GHz/22MB/125W/DDR4-2666	1x 16GB RDIMM DDR4-2666	Onboard SATA	6x 2.5" SATA/SAS HS	None	None	None	XClarity Standard	3-year, Onsite	07/17
7X21A01MCN	ThinkSystem SD530	HTK	1x Xeon Gold 6152 22C/2.1GHz/30.25MB/140W/DDR4-2666	1x 16GB RDIMM DDR4-2666	Onboard SATA	6x 2.5" SATA/SAS HS	None	None	None	XClarity Standard	3-year, Onsite	07/17
7X21A01NCN	ThinkSystem SD530	HTK	1x Xeon Gold 6142 16C/2.6GHz/22MB/150W/DDR4-2666	1x 16GB RDIMM DDR4-2666	Onboard SATA	4x 2.5" SATA/SAS HS	None	None	None	XClarity Standard	3-year, Onsite	07/17
7X21A01PCN	ThinkSystem SD530	HTK	1x Xeon Gold 6126 12C/2.6GHz/19.25MB/125W/DDR4-2666	1x 16GB RDIMM DDR4-2666	Onboard SATA	6x 2.5" SATA/SAS HS	None	None	None	XClarity Standard	3-year, Onsite	07/17
7X21A01QCN	ThinkSystem SD530	HTK	1x Xeon Gold 5122 4C/3.6GHz/16.5MB/105W/DDR4-2400	1x 16GB RDIMM DDR4-2666	Onboard SATA	4x 2.5" SATA/SAS HS	None	None	None	XClarity Standard	3-year, Onsite	07/17
7X21A01RCN	ThinkSystem SD530	HTK	1x Xeon Gold 6134 8C/3.2GHz/24.75MB/130W/DDR4-2666	1x 16GB RDIMM DDR4-2666	Onboard SATA	4x 2.5" SATA/SAS HS	None	None	None	XClarity Standard	3-year, Onsite	07/17
7X21A01SCN	ThinkSystem SD530	HTK	1x Xeon Gold 5120 14C/2.2GHz/19.25MB/105W/DDR4-2400	1x 16GB RDIMM DDR4-2666	Onboard SATA	6x 2.5" SATA/SAS HS	None	None	None	XClarity Standard	3-year, Onsite	07/17
7X21A01TCN	ThinkSystem SD530	HTK	1x Xeon Gold 6136 12C/3.0GHz/24.75MB/150W/DDR4-2666	1x 16GB RDIMM DDR4-2666	Onboard SATA	4x 2.5" SATA/SAS HS	None	None	None	XClarity Standard	3-year, Onsite	07/17

Model	Product	Region	Processor	Memory	Storage Controller	DiskBays	Disks	KVM Breakout Module	M.2 Drives	System Management	Warranty	Ann Date (mm/yy)
7X21A015SG	ThinkSystem SD530	INDIA	1x Xeon Gold 5118 12C/2.3GHz/16.5MB/105W/DDR4-2400	1x 16GB RDIMM DDR4-2666	1x 530-8i	6x 2.5" SATA/SAS HS	None	None	None	XClarity Standard	3-year, Onsite	07/17
7X21A009SG	ThinkSystem SD530	INDIA	1x Xeon Silver 4110 8C/2.1GHz/11MB/85W/DDR4-2400	1x 16GB RDIMM DDR4-2666	1x 530-8i	6x 2.5" SATA/SAS HS	None	None	None	XClarity Standard	3-year, Onsite	07/17
7X21A00KSG	ThinkSystem SD530	INDIA	1x Xeon Gold 6152 22C/2.1GHz/30.25MB/140W/DDR4-2666	1x 16GB RDIMM DDR4-2666	1x 530-8i	6x 2.5" SATA/SAS HS	None	None	None	XClarity Standard	3-year, Onsite	07/17
7X21A00LSG	ThinkSystem SD530	INDIA	1x Xeon Gold 6138 20C/2.0GHz/27.5MB/125W/DDR4-2666	1x 16GB RDIMM DDR4-2666	1x 530-8i	6x 2.5" SATA/SAS HS	None	None	None	XClarity Standard	3-year, Onsite	07/17
7X21A00MSG	ThinkSystem SD530	INDIA	1x Xeon Gold 5120 14C/2.2GHz/19.25MB/105W/DDR4-2400	1x 16GB RDIMM DDR4-2666	1x 530-8i	6x 2.5" SATA/SAS HS	None	None	None	XClarity Standard	3-year, Onsite	07/17
7X21A00PSG	ThinkSystem SD530	INDIA	1x Xeon Bronze 3104 6C/1.7GHz/8.25MB/85W/DDR4-2133	1x 16GB RDIMM DDR4-2666	1x 530-8i	6x 2.5" SATA/SAS HS	None	None	None	XClarity Standard	3-year, Onsite	07/17
7X21A00QSG	ThinkSystem SD530	INDIA	1x Xeon Silver 4114 10C/2.2GHz/13.75MB/85W/DDR4-2400	1x 16GB RDIMM DDR4-2666	1x 530-8i	6x 2.5" SATA/SAS HS	None	None	None	XClarity Standard	3-year, Onsite	07/17
7X21A01ASG	ThinkSystem SD530	INDIA	1x Xeon Silver 4108 8C/1.8GHz/11MB/85W/DDR4-2400	1x 16GB RDIMM DDR4-2666	1x 530-8i	6x 2.5" SATA/SAS HS	None	None	None	XClarity Standard	3-year, Onsite	07/17

ThinkSystem SD530 - Non TopSeller - JAPAN

Product Specifications Reference (PSREF)

Model	Product	Region	Processor	Memory	Storage Controller	DiskBays	Disks	KVM Breakout Module	M.2 Drives	System Management	Warranty	Ann Date (mm/yy)
7X21A036JP	ThinkSystem SD530	JAPAN	1x Xeon Bronze 3104 6C/1.7GHz/8.25MB/85W/DDR4-2133	1x 16GB RDIMM DDR4-2666	Onboard SATA	4x 2.5" SATA/SAS HS	None	KVM Breakout Module with Cable	None	XClarity Standard	3-year, Onsite	07/17
7X21A00AJP	ThinkSystem SD530	JAPAN	1x Xeon Bronze 3104 6C/1.7GHz/8.25MB/85W/DDR4-2133	1x 16GB RDIMM DDR4-2666	1x 530-8i	6x 2.5" SATA/SAS HS	None	None	None	XClarity Standard	3-year, Onsite	07/17
7X21A00CJP	ThinkSystem SD530	JAPAN	1x Xeon Silver 4110 8C/2.1GHz/11MB/85W/DDR4-2400	1x 16GB RDIMM DDR4-2666	1x 530-8i	6x 2.5" SATA/SAS HS	None	None	None	XClarity Standard	3-year, Onsite	07/17
7X21A00UJP	ThinkSystem SD530	JAPAN	1x Xeon Bronze 3104 6C/1.7GHz/8.25MB/85W/DDR4-2133	1x 16GB RDIMM DDR4-2666	Onboard SATA	5x 2.5" SATA/SAS HS	None	KVM Breakout Module with Cable	None	XClarity Standard	3-year, Onsite	07/17

Model	Product	Region	Processor	Memory	Storage Controller	DiskBays	Disks	KVM Breakout Module	M.2 Drives	System Management	Warranty	Ann Date (mm/yy)
7X211003LA	ThinkSystem SD530	LA	1x Xeon Bronze 3104 6C/1.7GHz/8.25MB/85W/DDR4-2133	1x 16GB RDIMM DDR4-2666	1x 530-8i	6x 2.5" SATA/SAS HS	None	None	None	XClarity Standard	3-year, Onsite	09/17
7X211004LA	ThinkSystem SD530	LA	1x Xeon Bronze 3106 8C/1.7GHz/11MB/85W/DDR4-2133	1x 16GB RDIMM DDR4-2666	1x 530-8i	6x 2.5" SATA/SAS HS	None	None	None	XClarity Standard	3-year, Onsite	09/17
7X211005LA	ThinkSystem SD530	LA	1x Xeon Silver 4116 12C/2.1GHz/16.5MB/85W/DDR4-2400	1x 16GB RDIMM DDR4-2666	1x 530-8i	6x 2.5" SATA/SAS HS	None	None	None	XClarity Standard	3-year, Onsite	09/17
7X211006LA	ThinkSystem SD530	LA	1x Xeon Gold 5120 14C/2.2GHz/19.25MB/105W/DDR4-2400	1x 16GB RDIMM DDR4-2666	1x 530-8i	6x 2.5" SATA/SAS HS	None	None	None	XClarity Standard	3-year, Onsite	09/17
7X211007LA	ThinkSystem SD530	LA	1x Xeon Gold 6140 18C/2.3GHz/24.75MB/140W/DDR4-2666	1x 16GB RDIMM DDR4-2666	1x 530-8i	6x 2.5" SATA/SAS HS	None	None	None	XClarity Standard	3-year, Onsite	09/17
7X211008LA	ThinkSystem SD530	LA	1x Xeon Bronze 3104 6C/1.7GHz/8.25MB/85W/DDR4-2133	1x 16GB RDIMM DDR4-2666	1x 530-8i	4x 2.5" SATA/SAS HS	None	KVM Breakout Module with Cable	None	XClarity Standard	3-year, Onsite	09/17
7X211009LA	ThinkSystem SD530	LA	1x Xeon Bronze 3106 8C/1.7GHz/11MB/85W/DDR4-2133	1x 16GB RDIMM DDR4-2666	1x 530-8i	4x 2.5" SATA/SAS HS	None	KVM Breakout Module with Cable	None	XClarity Standard	3-year, Onsite	09/17
7X21100ALA	ThinkSystem SD530	LA	1x Xeon Silver 4116 12C/2.1GHz/16.5MB/85W/DDR4-2400	1x 16GB RDIMM DDR4-2666	1x 530-8i	4x 2.5" SATA/SAS HS	None	KVM Breakout Module with Cable	None	XClarity Standard	3-year, Onsite	09/17
7X21100BLA	ThinkSystem SD530	LA	1x Xeon Gold 5120 14C/2.2GHz/19.25MB/105W/DDR4-2400	1x 16GB RDIMM DDR4-2666	1x 530-8i	4x 2.5" SATA/SAS HS	None	KVM Breakout Module with Cable	None	XClarity Standard	3-year, Onsite	09/17
7X21100CLA	ThinkSystem SD530	LA	1x Xeon Gold 6140 18C/2.3GHz/24.75MB/140W/DDR4-2666	1x 16GB RDIMM DDR4-2666	1x 530-8i	4x 2.5" SATA/SAS HS	None	KVM Breakout Module with Cable	None	XClarity Standard	3-year, Onsite	09/17
7X21100DLA	ThinkSystem SD530	LA	1x Xeon Bronze 3104 6C/1.7GHz/8.25MB/85W/DDR4-2133	1x 16GB RDIMM DDR4-2666	1x 530-8i	6x 2.5" SATA/SAS HS	None	None	None	XClarity Standard	3-year, Onsite	09/17
7X21100ELA	ThinkSystem SD530	LA	1x Xeon Bronze 3106 8C/1.7GHz/11MB/85W/DDR4-2133	1x 16GB RDIMM DDR4-2666	1x 530-8i	6x 2.5" SATA/SAS HS	None	None	None	XClarity Standard	3-year, Onsite	09/17
7X21100FLA	ThinkSystem SD530	LA	1x Xeon Silver 4116 12C/2.1GHz/16.5MB/85W/DDR4-2400	1x 16GB RDIMM DDR4-2666	1x 530-8i	6x 2.5" SATA/SAS HS	None	None	None	XClarity Standard	3-year, Onsite	09/17
7X21100GLA	ThinkSystem SD530	LA	1x Xeon Gold 5120 14C/2.2GHz/19.25MB/105W/DDR4-2400	1x 16GB RDIMM DDR4-2666	1x 530-8i	6x 2.5" SATA/SAS HS	None	None	None	XClarity Standard	3-year, Onsite	09/17
7X21100HLA	ThinkSystem SD530	LA	1x Xeon Gold 6140 18C/2.3GHz/24.75MB/140W/DDR4-2666	1x 16GB RDIMM DDR4-2666	1x 530-8i	6x 2.5" SATA/SAS HS	None	None	None	XClarity Standard	3-year, Onsite	09/17

Model	Product	Region	Processor	Memory	Storage Controller	DiskBays	Disks	KVM Breakout Module	M.2 Drives	System Management	Warranty	Ann Date (mm/yy)
7X21100JLA	ThinkSystem SD530	LA	1x Xeon Bronze 3104 6C/1.7GHz/8.25MB/85W/DDR4-2133	1x 16GB RDIMM DDR4-2666	1x 530-8i	4x 2.5" SATA/SAS HS	None	KVM Breakout Module with Cable	None	XClarity Standard	3-year, Onsite	09/17
7X21100KLA	ThinkSystem SD530	LA	1x Xeon Bronze 3106 8C/1.7GHz/11MB/85W/DDR4-2133	1x 16GB RDIMM DDR4-2666	1x 530-8i	4x 2.5" SATA/SAS HS	None	KVM Breakout Module with Cable	None	XClarity Standard	3-year, Onsite	09/17
7X21100LLA	ThinkSystem SD530	LA	1x Xeon Silver 4116 12C/2.1GHz/16.5MB/85W/DDR4-2400	1x 16GB RDIMM DDR4-2666	1x 530-8i	4x 2.5" SATA/SAS HS	None	KVM Breakout Module with Cable	None	XClarity Standard	3-year, Onsite	09/17
7X21100MLA	ThinkSystem SD530	LA	1x Xeon Gold 5120 14C/2.2GHz/19.25MB/105W/DDR4-2400	1x 16GB RDIMM DDR4-2666	1x 530-8i	4x 2.5" SATA/SAS HS	None	KVM Breakout Module with Cable	None	XClarity Standard	3-year, Onsite	09/17
7X21100NLA	ThinkSystem SD530	LA	1x Xeon Gold 6140 18C/2.3GHz/24.75MB/140W/DDR4-2666	1x 16GB RDIMM DDR4-2666	1x 530-8i	4x 2.5" SATA/SAS HS	None	KVM Breakout Module with Cable	None	XClarity Standard	3-year, Onsite	09/17
7X21A038LA	ThinkSystem SD530	LA	1x Xeon Bronze 3104 6C/1.7GHz/8.25MB/85W/DDR4-2133	1x 8GB RDIMM DDR4-2666	Onboard SATA	4x 2.5" SATA/SAS HS	None	KVM Breakout Module with Cable	None	XClarity Standard	3-year, Onsite	08/17

ThinkSystem SD530 - Non TopSeller - NA

Product Specifications Reference (PSREF)

Model	Product	Region	Processor	Memory	Storage Controller	DiskBays	Disks	KVM Breakout Module	M.2 Drives	System Management	Warranty	Ann Date (mm/yy)
7X21A00VNA	ThinkSystem SD530	NA	1x Xeon Silver 4110 8C/2.1GHz/11MB/85W/DDR4-2400	1x 16GB RDIMM DDR4-2666	Onboard SATA	6x 2.5" HS (4 SATA/SAS, 2 AnyBay)	None	None	None	XClarity Standard	3-year, Onsite	07/17
7X21A00ZNA	ThinkSystem SD530	NA	1x Xeon Silver 4114 10C/2.2GHz/13.75MB/85W/DDR4-2400	1x 16GB RDIMM DDR4-2666	Onboard SATA	6x 2.5" HS (4 SATA/SAS, 2 AnyBay)	None	None	None	XClarity Standard	3-year, Onsite	07/17
7X21A00XNA	ThinkSystem SD530	NA	1x Xeon Gold 5118 12C/2.3GHz/16.5MB/105W/DDR4-2400	1x 16GB RDIMM DDR4-2666	Onboard SATA	6x 2.5" HS (4 SATA/SAS, 2 AnyBay)	None	None	None	XClarity Standard	3-year, Onsite	07/17
7X21A017NA	ThinkSystem SD530	NA	1x Xeon Gold 6130 16C/2.1GHz/22MB/125W/DDR4-2666	1x 16GB RDIMM DDR4-2666	Onboard SATA	6x 2.5" HS (4 SATA/SAS, 2 AnyBay)	None	None	None	XClarity Standard	3-year, Onsite	07/17
7X21A012NA	ThinkSystem SD530	NA	1x Xeon Gold 6140 18C/2.3GHz/24.75MB/140W/DDR4-2666	1x 16GB RDIMM DDR4-2666	Onboard SATA	6x 2.5" HS (4 SATA/SAS, 2 AnyBay)	None	None	None	XClarity Standard	3-year, Onsite	07/17



ThinkSystem SR850 Platform Specifications

Components	Specification																																																																																										
Form factor	2U rack																																																																																										
Dimensions	Height: 86.5 mm (3.4 in). Width: 482 mm (19.0 in) with rack latches. Depth: 763.7 mm (30.1 in) without security bezel																																																																																										
Weight	Maximum configuration: 59.52 lb (27 kg)																																																																																										
Processor	Supports up to four 165W Intel Xeon Scalable family processors, Gold or Platinum. 2 processor sockets on system board, 2 processor sockets on optional processor and memory expansion tray. Up to 28 cores at 2.1GHz, up to 3.6GHz with 4 cores. Four processors are connected in ring topology with two 10.4GT/s UPI (Ultra Path Interconnect)																																																																																										
Chipset	Intel C624 Platform Controller Hub																																																																																										
Memory	Up to 48 DIMM sockets. 24 DIMM sockets on system main board, 24 DIMM sockets on optional processor and memory expansion tray. Each processor supports up to 12 DIMM sockets with 6 channels. DDR4-2666. RDIMMs, LRDIMMs, 3DS RDIMMs are supported, but memory types cannot be intermixed. 3DS RDIMM is planned to available later																																																																																										
Memory capacity	Up to 1.5TB with 48 x 32GB RDIMMs and four processors. Or up to 3TB with 48 x 64GB LRDIMMs and four processors. Or up to 6TB with 48 x 128GB 3DS RDIMMs and four -M suffix processors. -M suffix processor supports 1.5TB memory per socket, non -M suffix processor supports 768GB memory per socket																																																																																										
Memory protection	ECC, memory mirroring, and memory sparing																																																																																										
Storage controllers	Supports the following RAID/HBA adapters:																																																																																										
	<table border="1"> <thead> <tr> <th>Feature</th> <th>Interface</th> <th>Drive type</th> <th>RAID levels</th> <th>JBOD</th> <th>Cache</th> <th>Cache protection</th> <th>FastPath</th> <th>Max qty</th> </tr> </thead> <tbody> <tr> <td>530-8i</td> <td>12Gbps SAS</td> <td>SATA/SAS</td> <td>0/1/10/5/50</td> <td>Yes</td> <td>None</td> <td>None</td> <td>Yes</td> <td>2</td> </tr> <tr> <td>730-8i</td> <td>12Gbps SAS</td> <td>SATA/SAS</td> <td>0/1/10/5/50</td> <td>Yes</td> <td>1GB</td> <td>None</td> <td>No</td> <td>2</td> </tr> <tr> <td>930-8i</td> <td>12Gbps SAS</td> <td>SATA/SAS</td> <td>0/1/10/5/50/6/60</td> <td>Yes</td> <td>2GB</td> <td>Flash backup</td> <td>Yes</td> <td>2</td> </tr> <tr> <td>930-16i</td> <td>12Gbps SAS</td> <td>SATA/SAS</td> <td>0/1/10/5/50/6/60</td> <td>Yes</td> <td>4GB</td> <td>Flash backup</td> <td>Yes</td> <td>1</td> </tr> <tr> <td>430-8i</td> <td>12Gbps SAS</td> <td>SATA/SAS</td> <td>-</td> <td>Yes</td> <td>None</td> <td>None</td> <td>-</td> <td>2</td> </tr> <tr> <td>430-16i</td> <td>12Gbps SAS</td> <td>SATA/SAS</td> <td>-</td> <td>Yes</td> <td>None</td> <td>None</td> <td>-</td> <td>1</td> </tr> <tr> <td>930-8e</td> <td>12Gbps SAS</td> <td>SATA/SAS</td> <td>0/1/10/5/50/6/60</td> <td>Yes</td> <td>4GB</td> <td>Flash backup</td> <td>Yes</td> <td>4</td> </tr> <tr> <td>430-8e</td> <td>12Gbps SAS</td> <td>SATA/SAS</td> <td>-</td> <td>Yes</td> <td>None</td> <td>None</td> <td>-</td> <td>8</td> </tr> <tr> <td>430-16e</td> <td>12Gbps SAS</td> <td>SATA/SAS</td> <td>-</td> <td>Yes</td> <td>None</td> <td>None</td> <td>-</td> <td>8</td> </tr> </tbody> </table>	Feature	Interface	Drive type	RAID levels	JBOD	Cache	Cache protection	FastPath	Max qty	530-8i	12Gbps SAS	SATA/SAS	0/1/10/5/50	Yes	None	None	Yes	2	730-8i	12Gbps SAS	SATA/SAS	0/1/10/5/50	Yes	1GB	None	No	2	930-8i	12Gbps SAS	SATA/SAS	0/1/10/5/50/6/60	Yes	2GB	Flash backup	Yes	2	930-16i	12Gbps SAS	SATA/SAS	0/1/10/5/50/6/60	Yes	4GB	Flash backup	Yes	1	430-8i	12Gbps SAS	SATA/SAS	-	Yes	None	None	-	2	430-16i	12Gbps SAS	SATA/SAS	-	Yes	None	None	-	1	930-8e	12Gbps SAS	SATA/SAS	0/1/10/5/50/6/60	Yes	4GB	Flash backup	Yes	4	430-8e	12Gbps SAS	SATA/SAS	-	Yes	None	None	-	8	430-16e	12Gbps SAS	SATA/SAS	-	Yes	None	None	-	8
	Feature	Interface	Drive type	RAID levels	JBOD	Cache	Cache protection	FastPath	Max qty																																																																																		
	530-8i	12Gbps SAS	SATA/SAS	0/1/10/5/50	Yes	None	None	Yes	2																																																																																		
	730-8i	12Gbps SAS	SATA/SAS	0/1/10/5/50	Yes	1GB	None	No	2																																																																																		
	930-8i	12Gbps SAS	SATA/SAS	0/1/10/5/50/6/60	Yes	2GB	Flash backup	Yes	2																																																																																		
	930-16i	12Gbps SAS	SATA/SAS	0/1/10/5/50/6/60	Yes	4GB	Flash backup	Yes	1																																																																																		
	430-8i	12Gbps SAS	SATA/SAS	-	Yes	None	None	-	2																																																																																		
	430-16i	12Gbps SAS	SATA/SAS	-	Yes	None	None	-	1																																																																																		
	930-8e	12Gbps SAS	SATA/SAS	0/1/10/5/50/6/60	Yes	4GB	Flash backup	Yes	4																																																																																		
430-8e	12Gbps SAS	SATA/SAS	-	Yes	None	None	-	8																																																																																			
430-16e	12Gbps SAS	SATA/SAS	-	Yes	None	None	-	8																																																																																			
	<i>Note: 730-8i is available in China only</i>																																																																																										
Disk drive bays	Supports 8 front 2.5" SATA/SAS HS bays with maximum 4 AnyBay, or 16 front 2.5" SATA/SAS HS bays with maximum 8 AnyBay Optional one or two internal M.2 SSD for boot, dual M.2 SSD supports mirroring																																																																																										
Internal storage	2.5" HDD, SAS12Gbps, 7.2K																																																																																										
	2.5" HDD, SAS12Gbps, 10K																																																																																										
	2.5" HDD, SAS12Gbps, 15K																																																																																										
	2.5" SSD, SAS12Gbps																																																																																										
	2.5" SSD, SATA6Gbps																																																																																										
	2.5" NVMe SSD, AnyBay																																																																																										
	NVMe SSD, PCIe 3.0 x4, HHHL adapter																																																																																										
M.2 SATA SSD for boot																																																																																											
Optical	No internal optical bay. Optional USB DVD±RW optical drive																																																																																										
Network interfaces	One dedicated management port. One LOM slot for customized LOM with up to four RJ-45 or SFP+ ports, up to 10GbE. Wake-on-LAN and NC-SI are available on one port of LOM. Optional ML2 or PCIe adapters are supported. ML2 adapter requires riser card with ML2 slot.																																																																																										
Security features	Power-on and admin password. Trusted Platform Module, TCG 1.2 compliant, upgrade to 2.0 via UEFI setting. Optional TCM in China only. Optional lockable security bezel																																																																																										
Operating systems supported	Microsoft Windows Server 2016/2012 R2. Red Hat Enterprise Linux 7.3/6.9. SUSE Linux Enterprise Server 12 SP2/11 SP4. VMware vSphere (ESXi) 6.5/6.0 U3																																																																																										
Systems management	XClarity Controller Advanced, optional upgrades to Enterprise is available. Energy Manager. XClarity Administrator. Lenovo Capacity Planner. Light Path Diagnostics with optional LCD diagnostic pull-out panel																																																																																										
GPU support	None																																																																																										
Base warranty	MT 7X18: 1-year limited onsite service with 9x5/NBD MT 7X19: 3-year limited onsite service with 9x5/NBD																																																																																										
Power supply	Up to two redundant hot-swap 750W/1100W/1600W 80 PLUS Platinum qualified AC power supplies. 1600W Platinum are 200V - 240V, others are 100V - 240V																																																																																										

Components	Specification	
Video	Integrated Matrox G200 in XClarity Controller	
Cooling	Six hot-swap fans, N + 1 redundancy	
Front ports	One XClarity Controller USB connector, one USB 2.0 or USB 3.0 (model dependent), one optional VGA	
Rear ports	One VGA, two USB 3.0, one serial, one XClarity Controller network connector	
Environmental specification	Supports ASHRAE A4 with limitations.	
	Temperature - operating	A4: 5°C to 45°C (41°F to 113°F) A3: 5°C to 40°C (41°F to 104°F) A2: 10°C to 35°C (50°F to 95°F)
	Temperature - non operating (no package)	-10°C to 60°C (14°F to 140°F)
	Temperature - non operating (with package)	-40°C to 70°C (-40°F to 158°F)
	Altitude - operating	(Unpressurized): 0-10000ft (0-3048m)
	Humidity - operating, non-condensing	A4: 8%-90%. A3:8%-85%. A2:20%~80%
Humidity - storage (with package), non-condensing	8%~90%	
	<i>Models should meet the following requirements to support A3 and A4:</i>	
	<ul style="list-style-type: none"> • NVMe drives not installed • PCIe flash adapter not installed • M.2 SSD not installed 	
Environmental certification	Energy Star Server 2.1 certified. More environmental information please see: www.lenovo.com/social_responsibility/us/en/environment/	

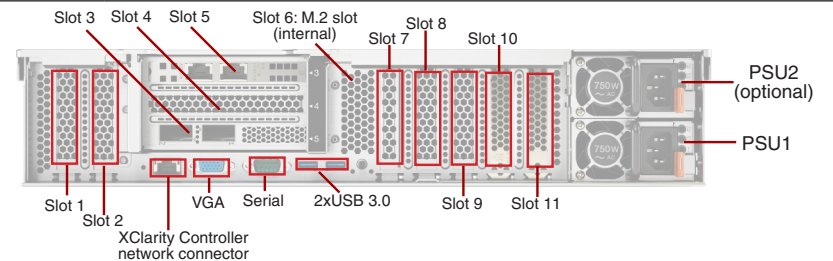

Note: All riser cards, expansion cards, and LOM adapters are optional. Slots are labelled as 1, 2, 3, 4, 5, 7, 8, 9, 10, 11. Slot 6 is internal M.2 slot for optional M.2 enablement kit

Expansion slots

Slot 1 (onboard)	PCIe 3.0 x16, low profile, requires 2nd CPU
Slot 2 (onboard)	PCIe 3.0 x8, low profile, requires 2nd CPU
Slot 3-5 (riser card)	Supports one of the following for riser card: Option 1: PCIe 3.0 x8/x8/x8 (slot 3-5). Full height, half length. Option 2: PCIe 3.0 x8/x8/x8 ML2 (slot 3-5). Full height, half length Option 4: PCIe 3.0 x8/x16 ML2 (slot 3 and 5). Full height, half length Slot 3 - 5 requires 2nd CPU
Slot 7 (onboard)	LOM, low profile
Slot 8 (onboard)	PCIe 3.0 x8, low profile
Slot 9 (onboard)	PCIe 3.0 x8, low profile
Slot 10 (onboard)	PCIe 3.0 x8, low profile
Slot 11 (onboard)	PCIe 3.0 x16, low profile

System unique options for ThinkSystem SR850

7B27A03953	ThinkSystem SR850/SR860 Processor and Memory Expansion Tray
7C57A03999	ThinkSystem SR850/SR860 2.5" Anybay 8-Bay BP Kit
7C57A03998	ThinkSystem SR850/SR860 2.5" SATA/SAS 8-Bay BP Kit
7X97A03954	ThinkSystem SR850 Front VGA Connector Upgrade Kit
7C57A03950	ThinkSystem SR850/SR860 x8/x8/x8 PCIe FH Riser Kit
7C57A03951	ThinkSystem SR850/SR860 x8/x8/x8ML2 PCIe FH Riser Kit
7C57A03952	ThinkSystem SR850/SR860 x8/x16ML2 PCIe FH Riser Kit

Model	Region	Processor	Memory	Storage Controller	Disk Bays	Disks	M.2 Drives	Networking (LOM/ML2/PCIe)	Available PCIe Slots	Front VGA	Front Panel	Front USB	Security	System Management	Power Supply	Warranty	Ann Date (mm/yy)
7X19A003AU	ANZ	2x Xeon Gold 5115 10C/2.4GHz/13.75MB/85W/DDR4-2400	2x 8GB RDIMM DDR4-2666	1x 530-8i	8x 2.5" SATA/SAS HS	Open	None	4xGbE RJ-45 LOM	2x LP x16/4x LP x8	None	Basic	USB 2.0	TPM 1.2	XClarity Advanced	1x 750W Platinum	3-year	07/17
7X19A009AU	ANZ	2x Xeon Gold 5115 10C/2.4GHz/13.75MB/85W/DDR4-2400	2x 16GB RDIMM DDR4-2666	1x 930-8i 2GB Flash	8x 2.5" SATA/SAS HS	Open	None	4xGbE RJ-45 LOM	2x LP x16/4x LP x8	None	Basic	USB 2.0	TPM 1.2	XClarity Advanced	1x 750W Platinum	3-year	07/17
7X19A00DAU	ANZ	2x Xeon Gold 6134 8C/3.2GHz/24.75MB/130W/DDR4-2666	2x 16GB RDIMM DDR4-2666	1x 930-8i 2GB Flash	8x 2.5" SATA/SAS HS	Open	None	4xGbE RJ-45 LOM	2x LP x16/4x LP x8	None	Pull-out LCD	USB 3.0	TPM 1.2	XClarity Advanced	1x 1100W Platinum	3-year	07/17
7X19A00MAU	ANZ	2x Xeon Platinum 8176 28C/2.1GHz/38.5MB/165W/DDR4-2666	2x 16GB RDIMM DDR4-2666	1x 930-8i 2GB Flash	8x 2.5" SATA/SAS HS	Open	None	4xGbE RJ-45 LOM	2x LP x16/4x LP x8	None	Pull-out LCD	USB 3.0	TPM 1.2	XClarity Advanced	1x 1600W Platinum	3-year	07/17
7X19A00NAU	ANZ	2x Xeon Gold 6142 16C/2.6GHz/22MB/150W/DDR4-2666	2x 16GB RDIMM DDR4-2666	1x 930-8i 2GB Flash	8x 2.5" SATA/SAS HS	Open	None	4xGbE RJ-45 LOM	2x LP x16/4x LP x8	None	Pull-out LCD	USB 3.0	TPM 1.2	XClarity Advanced	1x 1100W Platinum	3-year	07/17
7X19A00PAU	ANZ	2x Xeon Platinum 8170 26C/2.1GHz/35.75MB/165W/DDR4-2666	2x 16GB RDIMM DDR4-2666	1x 930-8i 2GB Flash	8x 2.5" SATA/SAS HS	Open	None	4xGbE RJ-45 LOM	2x LP x16/4x LP x8	None	Pull-out LCD	USB 3.0	TPM 1.2	XClarity Advanced	1x 1600W Platinum	3-year	07/17
7X19A010AU	ANZ	2x Xeon Gold 6136 12C/3.0GHz/24.75MB/150W/DDR4-2666	2x 16GB RDIMM DDR4-2666	1x 930-8i 2GB Flash	8x 2.5" SATA/SAS HS	Open	None	4xGbE RJ-45 LOM	2x LP x16/4x LP x8	None	Pull-out LCD	USB 3.0	TPM 1.2	XClarity Advanced	1x 1100W Platinum	3-year	07/17
7X19A01AAU	ANZ	2x Xeon Platinum 8153 16C/2.0GHz/22MB/125W/DDR4-2666	2x 16GB RDIMM DDR4-2666	1x 930-8i 2GB Flash	8x 2.5" SATA/SAS HS	Open	None	4xGbE RJ-45 LOM	2x LP x16/4x LP x8	None	Pull-out LCD	USB 3.0	TPM 1.2	XClarity Advanced	1x 1100W Platinum	3-year	07/17
7X19A01DAU	ANZ	2x Xeon Platinum 8160 24C/2.1GHz/33MB/150W/DDR4-2666	2x 16GB RDIMM DDR4-2666	1x 930-8i 2GB Flash	8x 2.5" SATA/SAS HS	Open	None	4xGbE RJ-45 LOM	2x LP x16/4x LP x8	None	Pull-out LCD	USB 3.0	TPM 1.2	XClarity Advanced	1x 1100W Platinum	3-year	07/17
7X19A01GAU	ANZ	2x Xeon Gold 5120 14C/2.2GHz/19.25MB/105W/DDR4-2400	2x 16GB RDIMM DDR4-2666	1x 930-8i 2GB Flash	8x 2.5" SATA/SAS HS	Open	None	4xGbE RJ-45 LOM	2x LP x16/4x LP x8	None	Pull-out LCD	USB 3.0	TPM 1.2	XClarity Advanced	1x 750W Platinum	3-year	07/17

Model	Region	Processor	Memory	Storage Controller	Disk Bays	Disks	M.2 Drives	Networking (LOM/ML2/PCIe)	Available PCIe Slots	Front VGA	Front Panel	Front USB	Security	System Management	Power Supply	Warranty	Ann Date (mm/yy)
7X19A01MAU	ANZ	2x Xeon Gold 6140 18C/2.3GHz/24.75MB/140W/DDR4-2666	2x 16GB RDIMM DDR4-2666	1x 930-8i 2GB Flash	8x 2.5" SATA/SAS HS	Open	None	4xGbE RJ-45 LOM	2x LP x16/4x LP x8	None	Pull-out LCD	USB 3.0	TPM 1.2	XClarity Advanced	1x 1100W Platinum	3-year	07/17
7X19A01VAU	ANZ	2x Xeon Gold 6138 20C/2.0GHz/27.5MB/125W/DDR4-2666	2x 16GB RDIMM DDR4-2666	1x 930-8i 2GB Flash	8x 2.5" SATA/SAS HS	Open	None	4xGbE RJ-45 LOM	2x LP x16/4x LP x8	None	Pull-out LCD	USB 3.0	TPM 1.2	XClarity Advanced	1x 1100W Platinum	3-year	07/17
7X19A01ZAU	ANZ	2x Xeon Platinum 8164 26C/2.0GHz/35.75MB/150W/DDR4-2666	2x 16GB RDIMM DDR4-2666	1x 930-8i 2GB Flash	8x 2.5" SATA/SAS HS	Open	None	4xGbE RJ-45 LOM	2x LP x16/4x LP x8	None	Pull-out LCD	USB 3.0	TPM 1.2	XClarity Advanced	1x 1100W Platinum	3-year	07/17
7X19A025AU	ANZ	2x Xeon Gold 5118 12C/2.3GHz/16.5MB/105W/DDR4-2400	2x 16GB RDIMM DDR4-2666	1x 530-8i	8x 2.5" SATA/SAS HS	Open	None	4xGbE RJ-45 LOM	2x LP x16/4x LP x8	None	Basic	USB 2.0	TPM 1.2	XClarity Advanced	1x 750W Platinum	3-year	07/17
7X19A029AU	ANZ	2x Xeon Gold 5118 12C/2.3GHz/16.5MB/105W/DDR4-2400	2x 16GB RDIMM DDR4-2666	1x 930-8i 2GB Flash	8x 2.5" SATA/SAS HS	Open	None	4xGbE RJ-45 LOM	2x LP x16/4x LP x8	None	Basic	USB 2.0	TPM 1.2	XClarity Advanced	1x 750W Platinum	3-year	07/17
7X19A02CAU	ANZ	2x Xeon Gold 6152 22C/2.1GHz/30.25MB/140W/DDR4-2666	2x 16GB RDIMM DDR4-2666	1x 930-8i 2GB Flash	8x 2.5" SATA/SAS HS	Open	None	4xGbE RJ-45 LOM	2x LP x16/4x LP x8	None	Pull-out LCD	USB 3.0	TPM 1.2	XClarity Advanced	1x 1100W Platinum	3-year	07/17

ThinkSystem SR850 - Non TopSeller - ASEAN

Product Specifications Reference (PSREF)

Model	Region	Processor	Memory	Storage Controller	Disk Bays	Disks	M.2 Drives	Networking (LOM/ML2/PCIe)	Available PCIe Slots	Front VGA	Front Panel	Front USB	Security	System Management	Power Supply	Warranty	Ann Date (mm/yy)
7X19A02BSG	ASEAN	2x Xeon Gold 6126 12C/2.6GHz/19.25MB/125W/DDR4-2666	2x 16GB RDIMM DDR4-2666	1x 530-8i	8x 2.5" SATA/SAS HS	Open	None	4x10GbE RJ-45 LOM	2x LP x16/4x LP x8/3x FHHL x8	Front VGA	Pull-out LCD	USB 3.0	TPM 1.2	XClarity Advanced	1x 1100W Platinum	3-year	07/17
7X19A01JSG	ASEAN	2x Xeon Gold 6148 20C/2.4GHz/27.5MB/150W/DDR4-2666	2x 32GB RDIMM DDR4-2666	1x 530-8i	8x 2.5" SATA/SAS HS	Open	None	4x10GbE RJ-45 LOM	2x LP x16/4x LP x8/3x FHHL x8	Front VGA	Pull-out LCD	USB 3.0	TPM 1.2	XClarity Advanced	1x 1600W Platinum	3-year	07/17
7X19A01BSG	ASEAN	2x Xeon Gold 6152 22C/2.1GHz/30.25MB/140W/DDR4-2666	2x 32GB RDIMM DDR4-2666	1x 530-8i	8x 2.5" SATA/SAS HS	Open	None	4x10GbE RJ-45 LOM	2x LP x16/4x LP x8/3x FHHL x8	Front VGA	Pull-out LCD	USB 3.0	TPM 1.2	XClarity Advanced	1x 1600W Platinum	3-year	07/17
7X19A017SG	ASEAN	2x Xeon Gold 6134 8C/3.2GHz/24.75MB/130W/DDR4-2666	2x 16GB RDIMM DDR4-2666	1x 530-8i	8x 2.5" SATA/SAS HS	Open	None	4x10GbE RJ-45 LOM	2x LP x16/4x LP x8/3x FHHL x8	Front VGA	Pull-out LCD	USB 3.0	TPM 1.2	XClarity Advanced	1x 1100W Platinum	3-year	07/17
7X19A00QSG	ASEAN	2x Xeon Gold 5118 12C/2.3GHz/16.5MB/105W/DDR4-2400	2x 16GB RDIMM DDR4-2666	1x 530-8i	8x 2.5" SATA/SAS HS	Open	None	4x10GbE RJ-45 LOM	2x LP x16/4x LP x8/3x FHHL x8	Front VGA	Pull-out LCD	USB 3.0	TPM 1.2	XClarity Advanced	1x 1100W Platinum	3-year	07/17
7X19A00VSG	ASEAN	2x Xeon Gold 6140 18C/2.3GHz/24.75MB/140W/DDR4-2666	2x 32GB RDIMM DDR4-2666	1x 530-8i	8x 2.5" SATA/SAS HS	Open	None	4x10GbE RJ-45 LOM	2x LP x16/4x LP x8/3x FHHL x8	Front VGA	Pull-out LCD	USB 3.0	TPM 1.2	XClarity Advanced	1x 1600W Platinum	3-year	07/17
7X19A00XSG	ASEAN	2x Xeon Gold 6130 16C/2.1GHz/22MB/125W/DDR4-2666	2x 32GB RDIMM DDR4-2666	1x 530-8i	8x 2.5" SATA/SAS HS	Open	None	4x10GbE RJ-45 LOM	2x LP x16/4x LP x8/3x FHHL x8	Front VGA	Pull-out LCD	USB 3.0	TPM 1.2	XClarity Advanced	1x 1100W Platinum	3-year	07/17
7X19A012SG	ASEAN	2x Xeon Gold 5120 14C/2.2GHz/19.25MB/105W/DDR4-2400	2x 16GB RDIMM DDR4-2666	1x 530-8i	8x 2.5" SATA/SAS HS	Open	None	4x10GbE RJ-45 LOM	2x LP x16/4x LP x8/3x FHHL x8	Front VGA	Pull-out LCD	USB 3.0	TPM 1.2	XClarity Advanced	1x 1100W Platinum	3-year	07/17
7X19A00GSG	ASEAN	2x Xeon Gold 5115 10C/2.4GHz/13.75MB/85W/DDR4-2400	2x 16GB RDIMM DDR4-2666	1x 530-8i	8x 2.5" SATA/SAS HS	Open	None	4x10GbE RJ-45 LOM	2x LP x16/4x LP x8/3x FHHL x8	Front VGA	Pull-out LCD	USB 3.0	TPM 1.2	XClarity Advanced	1x 1100W Platinum	3-year	07/17

Model	Region	Processor	Memory	Storage Controller	Disk Bays	Disks	M.2 Drives	Networking (LOM/ML2/PCIe)	Available PCIe Slots	Front VGA	Front Panel	Front USB	Security	System Management	Power Supply	Warranty	Ann Date (mm/yy)
7X19A02GEA	EMEA	4x Xeon Gold 5115 10C/2.4GHz/13.75MB/85W/DDR4-2400	4x 32GB RDIMM DDR4-2666	1x 930-8i 2GB Flash	8x 2.5" HS (4 SATA/SAS, 4 AnyBay)	Open	None	None	2x LP x16/4x LP x8/3x FHHL x8	Front VGA	Pull-out LCD	USB 3.0	TPM 1.2	XClarity Advanced	2x 1100W Platinum	3-year	07/17
7X19A02HEA	EMEA	4x Xeon Gold 5118 12C/2.3GHz/16.5MB/105W/DDR4-2400	4x 32GB RDIMM DDR4-2666	1x 930-8i 2GB Flash	8x 2.5" HS (4 SATA/SAS, 4 AnyBay)	Open	None	None	2x LP x16/4x LP x8/3x FHHL x8	Front VGA	Pull-out LCD	USB 3.0	TPM 1.2	XClarity Advanced	2x 1100W Platinum	3-year	07/17
7X19A02JEA	EMEA	4x Xeon Gold 5120 14C/2.2GHz/19.25MB/105W/DDR4-2400	4x 32GB RDIMM DDR4-2666	1x 930-8i 2GB Flash	8x 2.5" HS (4 SATA/SAS, 4 AnyBay)	Open	None	None	2x LP x16/4x LP x8/3x FHHL x8	Front VGA	Pull-out LCD	USB 3.0	TPM 1.2	XClarity Advanced	2x 1100W Platinum	3-year	07/17
7X19A02KEA	EMEA	4x Xeon Gold 6126 12C/2.6GHz/19.25MB/125W/DDR4-2666	4x 32GB RDIMM DDR4-2666	1x 930-8i 2GB Flash	8x 2.5" HS (4 SATA/SAS, 4 AnyBay)	Open	None	None	2x LP x16/4x LP x8/3x FHHL x8	Front VGA	Pull-out LCD	USB 3.0	TPM 1.2	XClarity Advanced	2x 1100W Platinum	3-year	07/17
7X19A02LEA	EMEA	4x Xeon Gold 6130 16C/2.1GHz/22MB/125W/DDR4-2666	4x 32GB RDIMM DDR4-2666	1x 930-8i 2GB Flash	8x 2.5" HS (4 SATA/SAS, 4 AnyBay)	Open	None	None	2x LP x16/4x LP x8/3x FHHL x8	Front VGA	Pull-out LCD	USB 3.0	TPM 1.2	XClarity Advanced	2x 1100W Platinum	3-year	07/17
7X19A02MEA	EMEA	4x Xeon Gold 6138 20C/2.0GHz/27.5MB/125W/DDR4-2666	4x 32GB RDIMM DDR4-2666	1x 930-8i 2GB Flash	8x 2.5" HS (4 SATA/SAS, 4 AnyBay)	Open	None	None	2x LP x16/4x LP x8/3x FHHL x8	Front VGA	Pull-out LCD	USB 3.0	TPM 1.2	XClarity Advanced	2x 1100W Platinum	3-year	07/17
7X19A02NEA	EMEA	4x Xeon Gold 6148 20C/2.4GHz/27.5MB/150W/DDR4-2666	4x 32GB RDIMM DDR4-2666	1x 930-8i 2GB Flash	8x 2.5" HS (4 SATA/SAS, 4 AnyBay)	Open	None	None	2x LP x16/4x LP x8/3x FHHL x8	Front VGA	Pull-out LCD	USB 3.0	TPM 1.2	XClarity Advanced	2x 1600W Platinum	3-year	07/17
7X19A02PEA	EMEA	4x Xeon Gold 6150 18C/2.7GHz/24.75MB/165W/DDR4-2666	4x 32GB RDIMM DDR4-2666	1x 930-8i 2GB Flash	8x 2.5" HS (4 SATA/SAS, 4 AnyBay)	Open	None	None	2x LP x16/4x LP x8/3x FHHL x8	Front VGA	Pull-out LCD	USB 3.0	TPM 1.2	XClarity Advanced	2x 1600W Platinum	3-year	07/17
7X19A02QEA	EMEA	4x Xeon Gold 6152 22C/2.1GHz/30.25MB/140W/DDR4-2666	4x 32GB RDIMM DDR4-2666	1x 930-8i 2GB Flash	8x 2.5" HS (4 SATA/SAS, 4 AnyBay)	Open	None	None	2x LP x16/4x LP x8/3x FHHL x8	Front VGA	Pull-out LCD	USB 3.0	TPM 1.2	XClarity Advanced	2x 1600W Platinum	3-year	07/17
7X19A02REA	EMEA	4x Xeon Platinum 8160 24C/2.1GHz/33MB/150W/DDR4-2666	4x 32GB RDIMM DDR4-2666	1x 930-8i 2GB Flash	8x 2.5" HS (4 SATA/SAS, 4 AnyBay)	Open	None	None	2x LP x16/4x LP x8/3x FHHL x8	Front VGA	Pull-out LCD	USB 3.0	TPM 1.2	XClarity Advanced	2x 1600W Platinum	3-year	07/17

Model	Region	Processor	Memory	Storage Controller	Disk Bays	Disks	M.2 Drives	Networking (LOM/ML2/PCIe)	Available PCIe Slots	Front VGA	Front Panel	Front USB	Security	System Management	Power Supply	Warranty	Ann Date (mm/yy)
7X19A02SEA	EMEA	4x Xeon Platinum 8164 26C/2.0GHz/35.75MB/150W/DDR4-2666	4x 32GB RDIMM DDR4-2666	1x 930-8i 2GB Flash	8x 2.5" HS (4 SATA/SAS, 4 AnyBay)	Open	None	None	2x LP x16/4x LP x8/3x FHHL x8	Front VGA	Pull-out LCD	USB 3.0	TPM 1.2	XClarity Advanced	2x 1600W Platinum	3-year	07/17
7X19A02TEA	EMEA	4x Xeon Platinum 8170 26C/2.1GHz/35.75MB/165W/DDR4-2666	4x 32GB RDIMM DDR4-2666	1x 930-8i 2GB Flash	8x 2.5" HS (4 SATA/SAS, 4 AnyBay)	Open	None	None	2x LP x16/4x LP x8/3x FHHL x8	Front VGA	Pull-out LCD	USB 3.0	TPM 1.2	XClarity Advanced	2x 1600W Platinum	3-year	07/17
7X19A02UEA	EMEA	4x Xeon Platinum 8176 28C/2.1GHz/38.5MB/165W/DDR4-2666	4x 32GB RDIMM DDR4-2666	1x 930-8i 2GB Flash	8x 2.5" HS (4 SATA/SAS, 4 AnyBay)	Open	None	None	2x LP x16/4x LP x8/3x FHHL x8	Front VGA	Pull-out LCD	USB 3.0	TPM 1.2	XClarity Advanced	2x 1600W Platinum	3-year	07/17

Model	Region	Processor	Memory	Storage Controller	Disk Bays	Disks	M.2 Drives	Networking (LOM/ML2/PCIe)	Available PCIe Slots	Front VGA	Front Panel	Front USB	Security	System Management	Power Supply	Warranty	Ann Date (mm/yy)
7X19A02DCN	HTK	2x Xeon Gold 6134 8C/3.2GHz/24.75MB/130W/DDR4-2666	2x 16GB RDIMM DDR4-2666	1x 930-16i 4GB Flash	16x 2.5" SATA/SAS HS	Open	None	4xGbE RJ-45 LOM	2x LP x16/4x LP x8/3x FHHL x8	None	Basic	USB 3.0	TPM 1.2	XClarity Advanced	1x 750W Platinum	3-year	07/17
7X19A00ECN	HTK	2x Xeon Platinum 8176 28C/2.1GHz/38.5MB/165W/DDR4-2666	2x 16GB RDIMM DDR4-2666	1x 930-16i 4GB Flash	16x 2.5" SATA/SAS HS	Open	None	4xGbE RJ-45 LOM	2x LP x16/4x LP x8/3x FHHL x8	None	Basic	USB 3.0	TPM 1.2	XClarity Advanced	1x 750W Platinum	3-year	07/17
7X19A00FCN	HTK	2x Xeon Platinum 8170 26C/2.1GHz/35.75MB/165W/DDR4-2666	2x 16GB RDIMM DDR4-2666	1x 930-16i 4GB Flash	16x 2.5" SATA/SAS HS	Open	None	4xGbE RJ-45 LOM	2x LP x16/4x LP x8/3x FHHL x8	None	Basic	USB 3.0	TPM 1.2	XClarity Advanced	1x 750W Platinum	3-year	07/17
7X19A00BCN	HTK	2x Xeon Gold 6152 22C/2.1GHz/30.25MB/140W/DDR4-2666	2x 16GB RDIMM DDR4-2666	1x 930-16i 4GB Flash	16x 2.5" SATA/SAS HS	Open	None	4xGbE RJ-45 LOM	2x LP x16/4x LP x8/3x FHHL x8	None	Basic	USB 3.0	TPM 1.2	XClarity Advanced	1x 750W Platinum	3-year	07/17
7X19A00CCN	HTK	2x Xeon Platinum 8164 26C/2.0GHz/35.75MB/150W/DDR4-2666	2x 16GB RDIMM DDR4-2666	1x 930-16i 4GB Flash	16x 2.5" SATA/SAS HS	Open	None	4xGbE RJ-45 LOM	2x LP x16/4x LP x8/3x FHHL x8	None	Basic	USB 3.0	TPM 1.2	XClarity Advanced	1x 750W Platinum	3-year	07/17
7X19A007CN	HTK	2x Xeon Platinum 8153 16C/2.0GHz/22MB/125W/DDR4-2666	2x 16GB RDIMM DDR4-2666	1x 930-16i 4GB Flash	16x 2.5" SATA/SAS HS	Open	None	4xGbE RJ-45 LOM	2x LP x16/4x LP x8/3x FHHL x8	None	Basic	USB 3.0	TPM 1.2	XClarity Advanced	1x 750W Platinum	3-year	07/17
7X19A004CN	HTK	2x Xeon Platinum 8160 24C/2.1GHz/33MB/150W/DDR4-2666	2x 16GB RDIMM DDR4-2666	1x 930-16i 4GB Flash	16x 2.5" SATA/SAS HS	Open	None	4xGbE RJ-45 LOM	2x LP x16/4x LP x8/3x FHHL x8	None	Basic	USB 3.0	TPM 1.2	XClarity Advanced	1x 750W Platinum	3-year	07/17
7X19A00ZCN	HTK	2x Xeon Gold 6142 16C/2.6GHz/22MB/150W/DDR4-2666	2x 16GB RDIMM DDR4-2666	1x 930-16i 4GB Flash	16x 2.5" SATA/SAS HS	Open	None	4xGbE RJ-45 LOM	2x LP x16/4x LP x8/3x FHHL x8	None	Basic	USB 3.0	TPM 1.2	XClarity Advanced	1x 750W Platinum	3-year	07/17
7X19A00RCN	HTK	2x Xeon Gold 6140 18C/2.3GHz/24.75MB/140W/DDR4-2666	2x 16GB RDIMM DDR4-2666	1x 930-16i 4GB Flash	16x 2.5" SATA/SAS HS	Open	None	4xGbE RJ-45 LOM	2x LP x16/4x LP x8/3x FHHL x8	None	Basic	USB 3.0	TPM 1.2	XClarity Advanced	1x 750W Platinum	3-year	07/17
7X19A011CN	HTK	2x Xeon Gold 6150 18C/2.7GHz/24.75MB/165W/DDR4-2666	2x 16GB RDIMM DDR4-2666	1x 930-16i 4GB Flash	16x 2.5" SATA/SAS HS	Open	None	4xGbE RJ-45 LOM	2x LP x16/4x LP x8/3x FHHL x8	None	Basic	USB 3.0	TPM 1.2	XClarity Advanced	1x 750W Platinum	3-year	07/17

Model	Region	Processor	Memory	Storage Controller	Disk Bays	Disks	M.2 Drives	Networking (LOM/ML2/PCIe)	Available PCIe Slots	Front VGA	Front Panel	Front USB	Security	System Management	Power Supply	Warranty	Ann Date (mm/yy)
7X19A01PCN	HTK	2x Xeon Gold 5122 4C/3.6GHz/16.5MB/105W/DDR4-2400	2x 16GB RDIMM DDR4-2666	1x 930-16i 4GB Flash	16x 2.5" SATA/SAS HS	Open	None	4xGbE RJ-45 LOM	2x LP x16/4x LP x8/3x FHHL x8	None	Basic	USB 3.0	TPM 1.2	XClarity Advanced	1x 750W Platinum	3-year	07/17
7X19A02ACN	HTK	2x Xeon Gold 6136 12C/3.0GHz/24.75MB/150W/DDR4-2666	2x 16GB RDIMM DDR4-2666	1x 930-16i 4GB Flash	16x 2.5" SATA/SAS HS	Open	None	4xGbE RJ-45 LOM	2x LP x16/4x LP x8/3x FHHL x8	None	Basic	USB 3.0	TPM 1.2	XClarity Advanced	1x 750W Platinum	3-year	07/17
7X19A024CN	HTK	2x Xeon Platinum 8156 4C/3.6GHz/16.5MB/105W/DDR4-2666	2x 16GB RDIMM DDR4-2666	1x 930-16i 4GB Flash	16x 2.5" SATA/SAS HS	Open	None	4xGbE RJ-45 LOM	2x LP x16/4x LP x8/3x FHHL x8	None	Basic	USB 3.0	TPM 1.2	XClarity Advanced	1x 750W Platinum	3-year	07/17
7X19A026CN	HTK	2x Xeon Platinum 8158 12C/3.0GHz/24.75MB/150W/DDR4-2666	2x 16GB RDIMM DDR4-2666	1x 930-16i 4GB Flash	16x 2.5" SATA/SAS HS	Open	None	4xGbE RJ-45 LOM	2x LP x16/4x LP x8/3x FHHL x8	None	Basic	USB 3.0	TPM 1.2	XClarity Advanced	1x 750W Platinum	3-year	07/17
7X19A027CN	HTK	2x Xeon Gold 5120T 14C/2.2GHz/19.25MB/105W/DDR4-2400	2x 16GB RDIMM DDR4-2666	1x 930-16i 4GB Flash	16x 2.5" SATA/SAS HS	Open	None	4xGbE RJ-45 LOM	2x LP x16/4x LP x8/3x FHHL x8	None	Basic	USB 3.0	TPM 1.2	XClarity Advanced	1x 750W Platinum	3-year	07/17
7X19A021CN	HTK	2x Xeon Gold 5115 10C/2.4GHz/13.75MB/85W/DDR4-2400	2x 16GB RDIMM DDR4-2666	2x 930-8i 2GB Flash	16x 2.5" SATA/SAS HS	Open	None	4xGbE RJ-45 LOM	2x LP x16/4x LP x8	None	Basic	USB 2.0	TPM 1.2	XClarity Advanced	1x 750W Platinum	3-year	07/17
7X19A022CN	HTK	2x Xeon Gold 6126 12C/2.6GHz/19.25MB/125W/DDR4-2666	2x 16GB RDIMM DDR4-2666	1x 930-16i 4GB Flash	16x 2.5" SATA/SAS HS	Open	None	4xGbE RJ-45 LOM	2x LP x16/4x LP x8/3x FHHL x8	None	Basic	USB 3.0	TPM 1.2	XClarity Advanced	1x 750W Platinum	3-year	07/17
7X19A01WCN	HTK	2x Xeon Gold 6130 16C/2.1GHz/22MB/125W/DDR4-2666	2x 16GB RDIMM DDR4-2666	1x 930-16i 4GB Flash	16x 2.5" SATA/SAS HS	Open	None	4xGbE RJ-45 LOM	2x LP x16/4x LP x8/3x FHHL x8	None	Basic	USB 3.0	TPM 1.2	XClarity Advanced	1x 750W Platinum	3-year	07/17
7X19A01RCN	HTK	2x Xeon Gold 5120 14C/2.2GHz/19.25MB/105W/DDR4-2400	2x 16GB RDIMM DDR4-2666	1x 930-16i 4GB Flash	16x 2.5" SATA/SAS HS	Open	None	4xGbE RJ-45 LOM	2x LP x16/4x LP x8/3x FHHL x8	None	Basic	USB 3.0	TPM 1.2	XClarity Advanced	1x 750W Platinum	3-year	07/17
7X19A01TCN	HTK	2x Xeon Gold 5118 12C/2.3GHz/16.5MB/105W/DDR4-2400	2x 16GB RDIMM DDR4-2666	1x 930-16i 4GB Flash	16x 2.5" SATA/SAS HS	Open	None	4xGbE RJ-45 LOM	2x LP x16/4x LP x8/3x FHHL x8	None	Basic	USB 3.0	TPM 1.2	XClarity Advanced	1x 750W Platinum	3-year	07/17

Model	Region	Processor	Memory	Storage Controller	Disk Bays	Disks	M.2 Drives	Networking (LOM/ML2/PCIe)	Available PCIe Slots	Front VGA	Front Panel	Front USB	Security	System Management	Power Supply	Warranty	Ann Date (mm/yy)
7X19A023SG	INDIA	2x Xeon Gold 5115 10C/2.4GHz/13.75MB/85W/DDR4-2400	2x 8GB RDIMM DDR4-2666	1x 530-8i	8x 2.5" SATA/SAS HS	Open	None	4xGbE RJ-45 LOM	2x LP x16/4x LP x8	None	Basic	USB 2.0	TPM 1.2	XClarity Advanced	1x 750W Platinum	3-year	07/17
7X19A020SG	INDIA	2x Xeon Gold 5120 14C/2.2GHz/19.25MB/105W/DDR4-2400	2x 16GB RDIMM DDR4-2666	1x 930-8i 2GB Flash	8x 2.5" SATA/SAS HS	Open	None	4xGbE RJ-45 LOM	2x LP x16/4x LP x8	Front VGA	Basic	USB 3.0	TPM 1.2	XClarity Advanced	1x 750W Platinum	3-year	07/17
7X19A028SG	INDIA	2x Xeon Gold 6138 20C/2.0GHz/27.5MB/125W/DDR4-2666	2x 16GB RDIMM DDR4-2666	1x 930-8i 2GB Flash	8x 2.5" SATA/SAS HS	Open	None	4xGbE RJ-45 LOM	2x LP x16/4x LP x8	None	Pull-out LCD	USB 3.0	TPM 1.2	XClarity Advanced	1x 1100W Platinum	3-year	07/17
7X19A016SG	INDIA	2x Xeon Gold 5118 12C/2.3GHz/16.5MB/105W/DDR4-2400	2x 16GB RDIMM DDR4-2666	1x 530-8i	8x 2.5" SATA/SAS HS	Open	None	4xGbE RJ-45 LOM	2x LP x16/4x LP x8	None	Basic	USB 2.0	TPM 1.2	XClarity Advanced	1x 750W Platinum	3-year	07/17
7X19A01QSG	INDIA	2x Xeon Gold 6134 8C/3.2GHz/24.75MB/130W/DDR4-2666	2x 16GB RDIMM DDR4-2666	1x 930-8i 2GB Flash	8x 2.5" SATA/SAS HS	Open	None	4xGbE RJ-45 LOM	2x LP x16/4x LP x8	None	Pull-out LCD	USB 3.0	TPM 1.2	XClarity Advanced	1x 1100W Platinum	3-year	07/17
7X19A01NSG	INDIA	2x Xeon Gold 6136 12C/3.0GHz/24.75MB/150W/DDR4-2666	2x 16GB RDIMM DDR4-2666	1x 930-8i 2GB Flash	8x 2.5" SATA/SAS HS	Open	None	4xGbE RJ-45 LOM	2x LP x16/4x LP x8	None	Pull-out LCD	USB 3.0	TPM 1.2	XClarity Advanced	1x 1100W Platinum	3-year	07/17
7X19A01KSG	INDIA	2x Xeon Gold 5120 14C/2.2GHz/19.25MB/105W/DDR4-2400	2x 16GB RDIMM DDR4-2666	1x 930-8i 2GB Flash	8x 2.5" SATA/SAS HS	Open	None	4xGbE RJ-45 LOM	2x LP x16/4x LP x8	None	Pull-out LCD	USB 3.0	TPM 1.2	XClarity Advanced	1x 750W Platinum	3-year	07/17
7X19A01HSG	INDIA	2x Xeon Gold 6140 18C/2.3GHz/24.75MB/140W/DDR4-2666	2x 16GB RDIMM DDR4-2666	1x 930-8i 2GB Flash	8x 2.5" SATA/SAS HS	Open	None	4xGbE RJ-45 LOM	2x LP x16/4x LP x8	None	Pull-out LCD	USB 3.0	TPM 1.2	XClarity Advanced	1x 1100W Platinum	3-year	07/17
7X19A01ESG	INDIA	2x Xeon Gold 5118 12C/2.3GHz/16.5MB/105W/DDR4-2400	2x 16GB RDIMM DDR4-2666	1x 930-8i 2GB Flash	8x 2.5" SATA/SAS HS	Open	None	4xGbE RJ-45 LOM	2x LP x16/4x LP x8	None	Basic	USB 2.0	TPM 1.2	XClarity Advanced	1x 750W Platinum	3-year	07/17
7X19A01FSG	INDIA	2x Xeon Gold 6142 16C/2.6GHz/22MB/150W/DDR4-2666	2x 16GB RDIMM DDR4-2666	1x 930-8i 2GB Flash	8x 2.5" SATA/SAS HS	Open	None	4xGbE RJ-45 LOM	2x LP x16/4x LP x8	None	Pull-out LCD	USB 3.0	TPM 1.2	XClarity Advanced	1x 1100W Platinum	3-year	07/17

Model	Region	Processor	Memory	Storage Controller	Disk Bays	Disks	M.2 Drives	Networking (LOM/ML2/PCIe)	Available PCIe Slots	Front VGA	Front Panel	Front USB	Security	System Management	Power Supply	Warranty	Ann Date (mm/yy)
7X19A002SG	INDIA	2x Xeon Platinum 8160 24C/2.1GHz/33MB/150W/DDR4-2666	2x 16GB RDIMM DDR4-2666	1x 930-8i 2GB Flash	8x 2.5" SATA/SAS HS	Open	None	4xGbE RJ-45 LOM	2x LP x16/4x LP x8	None	Pull-out LCD	USB 3.0	TPM 1.2	XClarity Advanced	1x 1100W Platinum	3-year	07/17
7X19A013SG	INDIA	2x Xeon Gold 5115 10C/2.4GHz/13.75MB/85W/DDR4-2400	2x 16GB RDIMM DDR4-2666	1x 930-8i 2GB Flash	8x 2.5" SATA/SAS HS	Open	None	4xGbE RJ-45 LOM	2x LP x16/4x LP x8	None	Basic	USB 2.0	TPM 1.2	XClarity Advanced	1x 750W Platinum	3-year	07/17
7X19A005SG	INDIA	2x Xeon Gold 5118 12C/2.3GHz/16.5MB/105W/DDR4-2400	2x 16GB RDIMM DDR4-2666	1x 530-8i	8x 2.5" SATA/SAS HS	Open	None	4xGbE RJ-45 LOM	2x LP x16/4x LP x8	Front VGA	Basic	USB 3.0	TPM 1.2	XClarity Advanced	1x 750W Platinum	3-year	07/17
7X19A006SG	INDIA	2x Xeon Platinum 8153 16C/2.0GHz/22MB/125W/DDR4-2666	2x 16GB RDIMM DDR4-2666	1x 930-8i 2GB Flash	8x 2.5" SATA/SAS HS	Open	None	4xGbE RJ-45 LOM	2x LP x16/4x LP x8	None	Pull-out LCD	USB 3.0	TPM 1.2	XClarity Advanced	1x 1100W Platinum	3-year	07/17
7X19A00ASG	INDIA	2x Xeon Gold 6152 22C/2.1GHz/30.25MB/140W/DDR4-2666	2x 16GB RDIMM DDR4-2666	1x 930-8i 2GB Flash	8x 2.5" SATA/SAS HS	Open	None	4xGbE RJ-45 LOM	2x LP x16/4x LP x8	None	Pull-out LCD	USB 3.0	TPM 1.2	XClarity Advanced	1x 1100W Platinum	3-year	07/17
7X19A00HSG	INDIA	2x Xeon Platinum 8176 28C/2.1GHz/38.5MB/165W/DDR4-2666	2x 16GB RDIMM DDR4-2666	1x 930-8i 2GB Flash	8x 2.5" SATA/SAS HS	Open	None	4xGbE RJ-45 LOM	2x LP x16/4x LP x8	None	Pull-out LCD	USB 3.0	TPM 1.2	XClarity Advanced	1x 1600W Platinum	3-year	07/17
7X19A00KSG	INDIA	2x Xeon Platinum 8170 26C/2.1GHz/35.75MB/165W/DDR4-2666	2x 16GB RDIMM DDR4-2666	1x 930-8i 2GB Flash	8x 2.5" SATA/SAS HS	Open	None	4xGbE RJ-45 LOM	2x LP x16/4x LP x8	None	Pull-out LCD	USB 3.0	TPM 1.2	XClarity Advanced	1x 1600W Platinum	3-year	07/17
7X19A00LSG	INDIA	2x Xeon Platinum 8164 26C/2.0GHz/35.75MB/150W/DDR4-2666	2x 16GB RDIMM DDR4-2666	1x 930-8i 2GB Flash	8x 2.5" SATA/SAS HS	Open	None	4xGbE RJ-45 LOM	2x LP x16/4x LP x8	None	Pull-out LCD	USB 3.0	TPM 1.2	XClarity Advanced	1x 1100W Platinum	3-year	07/17

ThinkSystem SR850 - Non TopSeller - JAPAN

Product Specifications Reference (PSREF)

Model	Region	Processor	Memory	Storage Controller	Disk Bays	Disks	M.2 Drives	Networking (LOM/ML2/PCIe)	Available PCIe Slots	Front VGA	Front Panel	Front USB	Security	System Management	Power Supply	Warranty	Ann Date (mm/yy)
7X19A01UJP	JAPAN	2x Xeon Gold 5115 10C/2.4GHz/13.75MB/85W/DDR4-2400	2x 16GB RDIMM DDR4-2666	1x 930-8i 2GB Flash	8x 2.5" SATA/SAS HS	Open	None	4x10GbE RJ-45 LOM	2x LP x16/4x LP x8/3x FHH x8	Front VGA	Pull-out LCD	USB 2.0	TPM 1.2	XClarity Advanced	1x 1100W Platinum	3-year	07/17
7X19A02EJP	JAPAN	2x Xeon Platinum 8176 28C/2.1GHz/38.5MB/165W/DDR4-2666	2x 16GB RDIMM DDR4-2666	1x 930-8i 2GB Flash	8x 2.5" SATA/SAS HS	Open	None	4x10GbE SFP+ LOM	2x LP x16/4x LP x8	Front VGA	Pull-out LCD	USB 3.0	TPM 1.2	XClarity Enterprise	1x 1600W Platinum	3-year	07/17
7X19A02FJP	JAPAN	2x Xeon Gold 6150 18C/2.7GHz/24.75MB/165W/DDR4-2666	2x 16GB RDIMM DDR4-2666	1x 930-8i 2GB Flash	8x 2.5" SATA/SAS HS	Open	None	4x10GbE SFP+ LOM	2x LP x16/4x LP x8	Front VGA	Pull-out LCD	USB 3.0	TPM 1.2	XClarity Enterprise	1x 1600W Platinum	3-year	07/17

Model	Region	Processor	Memory	Storage Controller	Disk Bays	Disks	M.2 Drives	Networking (LOM/ML2/PCIe)	Available PCIe Slots	Front VGA	Front Panel	Front USB	Security	System Management	Power Supply	Warranty	Ann Date (mm/yy)
7X19A032LA	LA	2x Xeon Platinum 8153 16C/2.0GHz/22MB/125W/DDR4-2666	12x 32GB RDIMM DDR4-2666	1x 930-8i 2GB Flash	8x 2.5" SATA/SAS HS	Open	None	None	2x LP x16/4x LP x8/3x FHHL x8	Front VGA	Pull-out LCD	USB 3.0	TPM 1.2	XClarity Enterprise	2x 1100W Platinum	3-year	07/17
7X19A033LA	LA	2x Xeon Gold 6148 20C/2.4GHz/27.5MB/150W/DDR4-2666	12x 16GB RDIMM DDR4-2666	1x 930-8i 2GB Flash	8x 2.5" SATA/SAS HS	Open	None	None	2x LP x16/4x LP x8/3x FHHL x8	Front VGA	Pull-out LCD	USB 3.0	TPM 1.2	XClarity Enterprise	2x 1100W Platinum	3-year	07/17
7X19A037LA	LA	2x Xeon Gold 6140 18C/2.3GHz/24.75MB/140W/DDR4-2666	12x 16GB RDIMM DDR4-2666	1x 930-8i 2GB Flash	8x 2.5" SATA/SAS HS	Open	None	None	2x LP x16/4x LP x8/3x FHHL x8	Front VGA	Pull-out LCD	USB 3.0	TPM 1.2	XClarity Enterprise	2x 1100W Platinum	3-year	07/17
7X19A03ALA	LA	2x Xeon Platinum 8176 28C/2.1GHz/38.5MB/165W/DDR4-2666	12x 32GB RDIMM DDR4-2666	1x 930-8i 2GB Flash	8x 2.5" SATA/SAS HS	Open	None	None	2x LP x16/4x LP x8/3x FHHL x8	Front VGA	Pull-out LCD	USB 3.0	TPM 1.2	XClarity Enterprise	2x 1600W Platinum	3-year	07/17
7X19A03BLA	LA	2x Xeon Platinum 8170 26C/2.1GHz/35.75MB/165W/DDR4-2666	12x 32GB RDIMM DDR4-2666	1x 930-8i 2GB Flash	8x 2.5" SATA/SAS HS	Open	None	None	2x LP x16/4x LP x8/3x FHHL x8	Front VGA	Pull-out LCD	USB 3.0	TPM 1.2	XClarity Enterprise	2x 1600W Platinum	3-year	07/17
7X19A03CLA	LA	2x Xeon Platinum 8164 26C/2.0GHz/35.75MB/150W/DDR4-2666	12x 32GB RDIMM DDR4-2666	1x 930-8i 2GB Flash	8x 2.5" SATA/SAS HS	Open	None	None	2x LP x16/4x LP x8/3x FHHL x8	Front VGA	Pull-out LCD	USB 3.0	TPM 1.2	XClarity Enterprise	2x 1600W Platinum	3-year	07/17
7X19A03ELA	LA	2x Xeon Platinum 8160 24C/2.1GHz/33MB/150W/DDR4-2666	12x 32GB RDIMM DDR4-2666	1x 930-8i 2GB Flash	8x 2.5" SATA/SAS HS	Open	None	None	2x LP x16/4x LP x8/3x FHHL x8	Front VGA	Pull-out LCD	USB 3.0	TPM 1.2	XClarity Enterprise	2x 1100W Platinum	3-year	07/17
7X19A03FLA	LA	4x Xeon Platinum 8170 26C/2.1GHz/35.75MB/165W/DDR4-2666	16x 32GB RDIMM DDR4-2666	2x FC dual- port HBA + 1x 930-16i 4GB Flash	16x 2.5" HS (12 SATA/SAS, 4 AnyBay)	Open	None	4xGbE RJ-45 LOM/2x 2x10GbE SFP+ PCIe	2x LP x16/4x LP x8/3x FHHL x8	Front VGA	Pull-out LCD	USB 3.0	TPM 1.2	XClarity Advanced	2x 1600W Platinum	3-year	07/17
7X19A03GLA	LA	4x Xeon Platinum 8176 28C/2.1GHz/38.5MB/165W/DDR4-2666	16x 32GB RDIMM DDR4-2666	2x FC dual- port HBA + 1x 930-16i 4GB Flash	16x 2.5" HS (12 SATA/SAS, 4 AnyBay)	Open	None	4xGbE RJ-45 LOM/2x 2x10GbE SFP+ PCIe	2x LP x16/4x LP x8/3x FHHL x8	Front VGA	Pull-out LCD	USB 3.0	TPM 1.2	XClarity Advanced	2x 1600W Platinum	3-year	07/17
7X19A03HLA	LA	4x Xeon Platinum 8170 26C/2.1GHz/35.75MB/165W/DDR4-2666	32x 16GB RDIMM DDR4-2666	2x FC dual- port HBA + 1x 930-16i 4GB Flash	16x 2.5" HS (12 SATA/SAS, 4 AnyBay)	Open	None	4xGbE RJ-45 LOM/2x 2x10GbE SFP+ PCIe	2x LP x16/4x LP x8/3x FHHL x8	Front VGA	Pull-out LCD	USB 3.0	TPM 1.2	XClarity Advanced	2x 1600W Platinum	3-year	07/17

Model	Region	Processor	Memory	Storage Controller	Disk Bays	Disks	M.2 Drives	Networking (LOM/ML2/PCIe)	Available PCIe Slots	Front VGA	Front Panel	Front USB	Security	System Management	Power Supply	Warranty	Ann Date (mm/yy)
7X19A03JLA	LA	4x Xeon Platinum 8176 28C/2.1GHz/38.5MB/165W/DDR4-2666	32x 16GB RDIMM DDR4-2666	2x FC dual-port HBA + 1x 930-16i 4GB Flash	16x 2.5" HS (12 SATA/SAS, 4 AnyBay)	Open	None	4xGbE RJ-45 LOM/2x 2x10GbE SFP+ PCIe	2x LP x16/4x LP x8/3x FHHL x8	Front VGA	Pull-out LCD	USB 3.0	TPM 1.2	XClarity Advanced	2x 1600W Platinum	3-year	07/17

Model	Region	Processor	Memory	Storage Controller	Disk Bays	Disks	M.2 Drives	Networking (LOM/ML2/PCIe)	Available PCIe Slots	Front VGA	Front Panel	Front USB	Security	System Management	Power Supply	Warranty	Ann Date (mm/yy)
7X19A01YNA	NA	4x Xeon Platinum 8164 26C/2.0GHz/35.75MB/150W/DDR4-2666	4x 32GB RDIMM DDR4-2666	1x 930-8i 2GB Flash	8x 2.5" HS (4 SATA/SAS, 4 AnyBay)	Open	None	None	2x LP x16/4x LP x8/3x FHHL x8	Front VGA	Pull-out LCD	USB 2.0	TPM 1.2	XClarity Advanced	2x 1600W Platinum	3-year	07/17
7X19A01CNA	NA	4x Xeon Gold 6126 12C/2.6GHz/19.25MB/125W/DDR4-2666	4x 32GB RDIMM DDR4-2666	1x 930-8i 2GB Flash	8x 2.5" HS (4 SATA/SAS, 4 AnyBay)	Open	None	None	2x LP x16/4x LP x8/3x FHHL x8	Front VGA	Pull-out LCD	USB 2.0	TPM 1.2	XClarity Advanced	2x 1100W Platinum	3-year	07/17
7X19A018NA	NA	4x Xeon Gold 5118 12C/2.3GHz/16.5MB/105W/DDR4-2400	4x 32GB RDIMM DDR4-2666	1x 930-8i 2GB Flash	8x 2.5" HS (4 SATA/SAS, 4 AnyBay)	Open	None	None	2x LP x16/4x LP x8/3x FHHL x8	Front VGA	Pull-out LCD	USB 2.0	TPM 1.2	XClarity Advanced	2x 1100W Platinum	3-year	07/17
7X19A019NA	NA	4x Xeon Gold 5120 14C/2.2GHz/19.25MB/105W/DDR4-2400	4x 32GB RDIMM DDR4-2666	1x 930-8i 2GB Flash	8x 2.5" HS (4 SATA/SAS, 4 AnyBay)	Open	None	None	2x LP x16/4x LP x8/3x FHHL x8	Front VGA	Pull-out LCD	USB 2.0	TPM 1.2	XClarity Advanced	2x 1100W Platinum	3-year	07/17
7X19A01LNA	NA	4x Xeon Platinum 8160 24C/2.1GHz/33MB/150W/DDR4-2666	4x 32GB RDIMM DDR4-2666	1x 930-8i 2GB Flash	8x 2.5" HS (4 SATA/SAS, 4 AnyBay)	Open	None	None	2x LP x16/4x LP x8/3x FHHL x8	Front VGA	Pull-out LCD	USB 2.0	TPM 1.2	XClarity Advanced	2x 1600W Platinum	3-year	07/17
7X19A00JNA	NA	4x Xeon Platinum 8170 26C/2.1GHz/35.75MB/165W/DDR4-2666	4x 32GB RDIMM DDR4-2666	1x 930-8i 2GB Flash	8x 2.5" HS (4 SATA/SAS, 4 AnyBay)	Open	None	None	2x LP x16/4x LP x8/3x FHHL x8	Front VGA	Pull-out LCD	USB 2.0	TPM 1.2	XClarity Advanced	2x 1600W Platinum	3-year	07/17
7X19A008NA	NA	4x Xeon Gold 5115 10C/2.4GHz/13.75MB/85W/DDR4-2400	4x 32GB RDIMM DDR4-2666	1x 930-8i 2GB Flash	8x 2.5" HS (4 SATA/SAS, 4 AnyBay)	Open	None	None	2x LP x16/4x LP x8/3x FHHL x8	Front VGA	Pull-out LCD	USB 2.0	TPM 1.2	XClarity Advanced	2x 1100W Platinum	3-year	07/17
7X19A014NA	NA	4x Xeon Gold 6150 18C/2.7GHz/24.75MB/165W/DDR4-2666	4x 32GB RDIMM DDR4-2666	1x 930-8i 2GB Flash	8x 2.5" HS (4 SATA/SAS, 4 AnyBay)	Open	None	None	2x LP x16/4x LP x8/3x FHHL x8	Front VGA	Pull-out LCD	USB 2.0	TPM 1.2	XClarity Advanced	2x 1600W Platinum	3-year	07/17
7X19A015NA	NA	4x Xeon Gold 6152 22C/2.1GHz/30.25MB/140W/DDR4-2666	4x 32GB RDIMM DDR4-2666	1x 930-8i 2GB Flash	8x 2.5" HS (4 SATA/SAS, 4 AnyBay)	Open	None	None	2x LP x16/4x LP x8/3x FHHL x8	Front VGA	Pull-out LCD	USB 2.0	TPM 1.2	XClarity Advanced	2x 1600W Platinum	3-year	07/17
7X19A00YNA	NA	4x Xeon Gold 6148 20C/2.4GHz/27.5MB/150W/DDR4-2666	4x 32GB RDIMM DDR4-2666	1x 930-8i 2GB Flash	8x 2.5" HS (4 SATA/SAS, 4 AnyBay)	Open	None	None	2x LP x16/4x LP x8/3x FHHL x8	Front VGA	Pull-out LCD	USB 2.0	TPM 1.2	XClarity Advanced	2x 1600W Platinum	3-year	07/17

Model	Region	Processor	Memory	Storage Controller	Disk Bays	Disks	M.2 Drives	Networking (LOM/ML2/PCIe)	Available PCIe Slots	Front VGA	Front Panel	Front USB	Security	System Management	Power Supply	Warranty	Ann Date (mm/yy)
7X19A00SNA	NA	4x Xeon Gold 6130 16C/2.1GHz/22MB/125W/DDR4-2666	4x 32GB RDIMM DDR4-2666	1x 930-8i 2GB Flash	8x 2.5" HS (4 SATA/SAS, 4 AnyBay)	Open	None	None	2x LP x16/4x LP x8/3x FHH x8	Front VGA	Pull-out LCD	USB 2.0	TPM 1.2	XClarity Advanced	2x 1100W Platinum	3-year	07/17
7X19A00TNA	NA	4x Xeon Platinum 8176 28C/2.1GHz/38.5MB/165W/DDR4-2666	4x 32GB RDIMM DDR4-2666	1x 930-8i 2GB Flash	8x 2.5" HS (4 SATA/SAS, 4 AnyBay)	Open	None	None	2x LP x16/4x LP x8/3x FHH x8	Front VGA	Pull-out LCD	USB 2.0	TPM 1.2	XClarity Advanced	2x 1600W Platinum	3-year	07/17
7X19A00UNA	NA	4x Xeon Gold 6138 20C/2.0GHz/27.5MB/125W/DDR4-2666	4x 32GB RDIMM DDR4-2666	1x 930-8i 2GB Flash	8x 2.5" HS (4 SATA/SAS, 4 AnyBay)	Open	None	None	2x LP x16/4x LP x8/3x FHH x8	Front VGA	Pull-out LCD	USB 2.0	TPM 1.2	XClarity Advanced	2x 1100W Platinum	3-year	07/17



ThinkSystem SR860 Platform Specifications

Product Specifications Reference (PSREF)

Components	Specification																																																																																									
Form factor	4U rack																																																																																									
Dimensions	Height: 175 mm (6.9 in). Width: 482 mm (19.0 in) with rack latches. Depth: 765.88 mm (30.15 in) without security bezel																																																																																									
Weight	Maximum configuration: 87.74 lb (39.8 kg)																																																																																									
Processor	Supports up to four 165W Intel Xeon Scalable family processors, Gold or Platinum. 2 processor sockets on system board, 2 processor sockets on optional processor and memory expansion tray. Up to 28 cores at 2.1GHz, up to 3.6GHz with 4 cores. Four processors are connected in ring topology with two 10.4GT/s UPI (Ultra Path Interconnect) per processor																																																																																									
Chipset	Intel C624 Platform Controller Hub																																																																																									
Memory	Up to 48 DIMM sockets. 24 DIMM sockets on system main board, 24 DIMM sockets on optional processor and memory expansion tray. Each processor supports up to 12 DIMM sockets with 6 channels. DDR4-2666. RDIMMs, LRDIMMs, 3DS RDIMMs are supported, but memory types cannot be intermixed. 3DS RDIMM is planned to available later																																																																																									
Memory capacity	Up to 1.5TB with 48 x 32GB RDIMMs and four processors. Or up to 3TB with 48 x 64GB LRDIMMs and four processors. Or up to 6TB with 48 x 128GB 3DS RDIMMs and four -M suffix processors. Or up to 3TB with 24 x 128GB 3DS RDIMMs and four non -M suffix processors. -M suffix processor supports 1.5TB memory per socket, non -M suffix processor supports 768GB memory per socket																																																																																									
Memory protection	ECC, memory mirroring, and memory sparing																																																																																									
Storage controllers	Supports the following RAID/HBA adapters:																																																																																									
	<table border="1"> <thead> <tr> <th>Feature</th> <th>Interface</th> <th>Drive type</th> <th>RAID levels</th> <th>JBOD</th> <th>Cache</th> <th>Cache protection</th> <th>FastPath</th> <th>Max qty</th> </tr> </thead> <tbody> <tr> <td>530-8i</td> <td>12Gbps SAS</td> <td>SATA/SAS</td> <td>0/1/10/5/50</td> <td>Yes</td> <td>None</td> <td>None</td> <td>Yes</td> <td>2</td> </tr> <tr> <td>730-8i</td> <td>12Gbps SAS</td> <td>SATA/SAS</td> <td>0/1/10/5/50</td> <td>Yes</td> <td>1GB</td> <td>None</td> <td>No</td> <td>2</td> </tr> <tr> <td>930-8i</td> <td>12Gbps SAS</td> <td>SATA/SAS</td> <td>0/1/10/5/50/6/60</td> <td>Yes</td> <td>2GB</td> <td>Flash backup</td> <td>Yes</td> <td>2</td> </tr> <tr> <td>930-16i</td> <td>12Gbps SAS</td> <td>SATA/SAS</td> <td>0/1/10/5/50/6/60</td> <td>Yes</td> <td>4GB</td> <td>Flash backup</td> <td>Yes</td> <td>1</td> </tr> <tr> <td>430-8i</td> <td>12Gbps SAS</td> <td>SATA/SAS</td> <td>-</td> <td>Yes</td> <td>None</td> <td>None</td> <td>-</td> <td>2</td> </tr> <tr> <td>430-16i</td> <td>12Gbps SAS</td> <td>SATA/SAS</td> <td>-</td> <td>Yes</td> <td>None</td> <td>None</td> <td>-</td> <td>1</td> </tr> <tr> <td>930-8e</td> <td>12Gbps SAS</td> <td>SATA/SAS</td> <td>0/1/10/5/50/6/60</td> <td>Yes</td> <td>4GB</td> <td>Flash backup</td> <td>Yes</td> <td>4</td> </tr> <tr> <td>430-8e</td> <td>12Gbps SAS</td> <td>SATA/SAS</td> <td>-</td> <td>Yes</td> <td>None</td> <td>None</td> <td>-</td> <td>10</td> </tr> <tr> <td>430-16e</td> <td>12Gbps SAS</td> <td>SATA/SAS</td> <td>-</td> <td>Yes</td> <td>None</td> <td>None</td> <td>-</td> <td>10</td> </tr> </tbody> </table> <p>Note: 730-8i is available in China only</p>	Feature	Interface	Drive type	RAID levels	JBOD	Cache	Cache protection	FastPath	Max qty	530-8i	12Gbps SAS	SATA/SAS	0/1/10/5/50	Yes	None	None	Yes	2	730-8i	12Gbps SAS	SATA/SAS	0/1/10/5/50	Yes	1GB	None	No	2	930-8i	12Gbps SAS	SATA/SAS	0/1/10/5/50/6/60	Yes	2GB	Flash backup	Yes	2	930-16i	12Gbps SAS	SATA/SAS	0/1/10/5/50/6/60	Yes	4GB	Flash backup	Yes	1	430-8i	12Gbps SAS	SATA/SAS	-	Yes	None	None	-	2	430-16i	12Gbps SAS	SATA/SAS	-	Yes	None	None	-	1	930-8e	12Gbps SAS	SATA/SAS	0/1/10/5/50/6/60	Yes	4GB	Flash backup	Yes	4	430-8e	12Gbps SAS	SATA/SAS	-	Yes	None	None	-	10	430-16e	12Gbps SAS	SATA/SAS	-	Yes	None	None	-
Feature	Interface	Drive type	RAID levels	JBOD	Cache	Cache protection	FastPath	Max qty																																																																																		
530-8i	12Gbps SAS	SATA/SAS	0/1/10/5/50	Yes	None	None	Yes	2																																																																																		
730-8i	12Gbps SAS	SATA/SAS	0/1/10/5/50	Yes	1GB	None	No	2																																																																																		
930-8i	12Gbps SAS	SATA/SAS	0/1/10/5/50/6/60	Yes	2GB	Flash backup	Yes	2																																																																																		
930-16i	12Gbps SAS	SATA/SAS	0/1/10/5/50/6/60	Yes	4GB	Flash backup	Yes	1																																																																																		
430-8i	12Gbps SAS	SATA/SAS	-	Yes	None	None	-	2																																																																																		
430-16i	12Gbps SAS	SATA/SAS	-	Yes	None	None	-	1																																																																																		
930-8e	12Gbps SAS	SATA/SAS	0/1/10/5/50/6/60	Yes	4GB	Flash backup	Yes	4																																																																																		
430-8e	12Gbps SAS	SATA/SAS	-	Yes	None	None	-	10																																																																																		
430-16e	12Gbps SAS	SATA/SAS	-	Yes	None	None	-	10																																																																																		
Disk drive bays	Supports 8 front 2.5" SATA/SAS HS bays with maximum 4 AnyBay, or 16 front 2.5" SATA/SAS HS bays with maximum 8 AnyBay Optional one or two internal M.2 SSD for boot, dual M.2 SSD supports mirroring																																																																																									
Internal storage	2.5" HDD, SATA6Gbps, 7.2K																																																																																									
	2.5" HDD, SAS12Gbps, 7.2K																																																																																									
	2.5" HDD, SAS12Gbps, 10K																																																																																									
	2.5" HDD, SAS12Gbps, 15K																																																																																									
	2.5" SSD, SATA6Gbps																																																																																									
	2.5" SSD, SAS12Gbps																																																																																									
	2.5" SSD, SATA6Gbps																																																																																									
2.5" NVMe SSD, AnyBay																																																																																										
NVMe SSD, PCIe 3.0 x4, HHL adapter																																																																																										
M.2 SATA SSD for boot																																																																																										
Optical	No internal optical bay. Optional USB DVD±RW optical drive																																																																																									
Network interfaces	One dedicated management port. One LOM slot for customized LOM with up to four RJ-45 or SFP+ ports, up to 10GbE. Wake-on-LAN and NC-SI are available on one port of LOM. Optional ML2 or PCIe adapters are supported. ML2 adapter requires riser card with ML2 slot.																																																																																									
Security features	Power-on and admin password. Trusted Platform Module, TCG 1.2 compliant, upgrade to 2.0 via UEFI setting. Optional TCM in China only. Optional lockable security bezel																																																																																									
Operating systems supported	Microsoft Windows Server 2016/2012 R2. Red Hat Enterprise Linux 7.4/6.9. SUSE Linux Enterprise Server 12 SP3/11 SP4. VMware ESXi 6.5 U1/6.0 U3																																																																																									
Systems management	XClarity Controller Advanced, optional upgrades to Enterprise is available. Energy Manager. XClarity Administrator. Lenovo Capacity Planner. Light Path Diagnostics with optional LCD diagnostic pull-out panel																																																																																									
GPU support	Up to two NVIDIA Tesla M60 GPU accelerator, 300W each																																																																																									
Base warranty	MT 7X69: 3-year limited onsite service with 9x5/NBD MT 7X70: 1-year limited onsite service with 9x5/NBD																																																																																									
Power supply	Up to two redundant hot-swap 750W/1100W/1600W/2000W 80 PLUS Platinum qualified AC power supplies. 1600W and 2000W are 200V - 240V, others are 100V - 240V																																																																																									
Video	Integrated Matrox G200 in XClarity Controller																																																																																									

Components	Specification	
Cooling	Six hot-swap fans, N + 1 redundancy	
Front ports	One XClarity Controller USB connector, one USB 2.0 or USB 3.0 (model dependent), one VGA	
Rear ports	One VGA, two USB 3.0, one serial, one XClarity Controller network connector	
Environmental specification	Supports ASHRAE A4 with limitations.	
	Temperature - operating	A4: 5°C to 45°C (41°F to 113°F) A3: 5°C to 40°C (41°F to 104°F) A2: 10°C to 35°C (50°F to 95°F)
	Temperature - non operating (no package)	-10°C to 60°C (14°F to 140°F)
	Temperature - non operating (with package)	-40°C to 70°C (-40°F to 158°F)
	Altitude - operating	(Unpressurized): 0-10000ft (0-3048m)
	Humidity - operating, non-condensing	A4: 8%-90%. A3:8%-85%. A2:8%-80%
Humidity - storage (with package), non-condensing	8%-90%	
Models should meet the following requirements to support A3 and A4:		
<ul style="list-style-type: none"> • Two PSU installed • NVMe drives not installed • PCIe flash adapter not installed • GPU not installed 		
Environmental certification	Energy Star Server 2.1 certified. More environmental information please see: www.lenovo.com/social_responsibility/us/en/environment/	

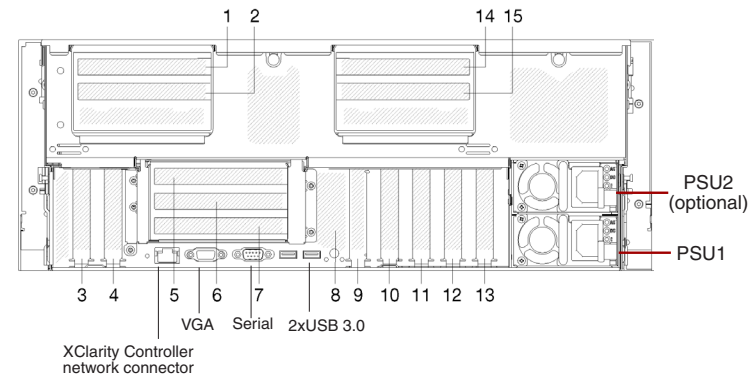

Expansion slots

Up to 13 PCIe slots with one LOM slot and one M.2 slot

Slot 1-2 (riser card 2)	One PCIe 3.0 x16 for GPU or two PCIe 3.0 x8, full height, full length
Slot 3 (onboard)	PCIe 3.0 x16, for riser card 2 or used as a low profile slot if riser card 2 not used
Slot 4 (onboard)	PCIe 3.0 x8, low profile
Slot 5-7 (riser card 1)	Supports one of the following for riser card: Option 1: PCIe 3.0 x8/x8/x8 (slot 5-7). Full height, half length Option 2: PCIe 3.0 x8/x8/x8 ML2 (slot 5-7). Full height, half length Option 4: PCIe 3.0 x8/x16 ML2 (slot 5 and 7). Full height, half length
Slot 8 (onboard)	M.2 slot for M.2 enablement kit, internal
Slot 9 (onboard)	LOM slot, low profile
Slot 10 -12(onboard)	PCIe 3.0 x8, low profile
Slot 13 (onboard)	PCIe 3.0 x16, for riser card 3 or used as a low profile slot if riser card 3 not used
Slot 14-15 (riser card 3)	One PCIe 3.0 x16 for GPU or two PCIe 3.0 x8, full height, full length, 4 CPU required

System unique options for ThinkSystem SR850

7B27A03953	ThinkSystem SR850/SR860 Processor and Memory Expansion Tray
7C57A03999	ThinkSystem SR850/SR860 2.5" Anybay 8-Bay BP Kit
7C57A03998	ThinkSystem SR850/SR860 2.5" SATA/SAS 8-Bay BP Kit
7C57A03950	ThinkSystem 2U x8/x8/x8 PCIE FH Riser 1
7C57A03951	ThinkSystem 2U x8/x8/x8ML2 PCIE FH Riser 1
7C57A03952	ThinkSystem 2U x8/x16ML2 PCIE FH Riser 1
4C57A08184	ThinkSystem SR860 2x8 PCIe FH Riser 2 (Slot 1 & 2)
4C57A08186	ThinkSystem SR860 1x16 PCIe FH Riser 2 (Slot 1)
4C57A08185	ThinkSystem SR860 2x8 PCIe FH Riser 3 (Slot 14 & 15)
4C57A08187	ThinkSystem SR860 1x16 PCIe FHFL Riser 3 (Slot 14)
00KG655	NVIDIA Tesla M60 GPU, PCIe (Passive)

Model	Product	Region	Processor	Memory	Storage Controller	Disk Bays	Disks	M.2 Drives	Onboard Networking Ports	Additional Networking (LOM/ML2/PCIe)	Standard Extension Slots	Available Extension Slots via Riser Card	Front VGA	Front Panel	Front USB	Security	System Management	Power Supply	Warranty	Ann Date (mm/yy)
7X69A001EA	ThinkSystem SR860	EMEA	4x Xeon Gold 6130 16C/2.1GHz/22MB/125W/DDR4-2666	4x 32GB RDIMM DDR4-2666 (2Rx4)	1x 930-8i 2GB Flash	8x 2.5" HS (4 SATA/SAS, 4 AnyBay)	None	None	1x Mgmt	None	4x PCIe x8 LP, 1x LOM	2x PCIe x16 FHFL, 3x PCIe x8 FHHL	None	Operator panel with LCD	1x XCC USB port, 1x USB 3.0	TPM 1.2	XClarity Enterprise	2x 2000W Platinum	3-year	11/17
7X69A002EA	ThinkSystem SR860	EMEA	4x Xeon Gold 5118 12C/2.3GHz/16.5MB/105W/DDR4-2400	4x 32GB RDIMM DDR4-2666 (2Rx4)	1x 930-8i 2GB Flash	8x 2.5" HS (4 SATA/SAS, 4 AnyBay)	None	None	1x Mgmt	None	4x PCIe x8 LP, 1x LOM	2x PCIe x16 FHFL, 3x PCIe x8 FHHL	None	Operator panel with LCD	1x XCC USB port, 1x USB 3.0	TPM 1.2	XClarity Enterprise	2x 2000W Platinum	3-year	11/17

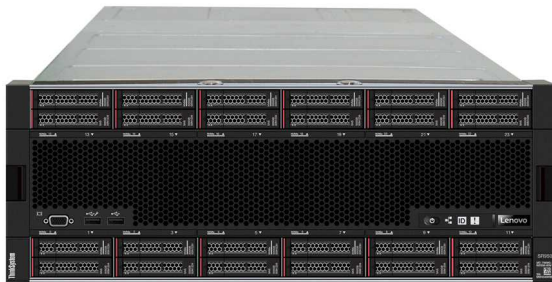
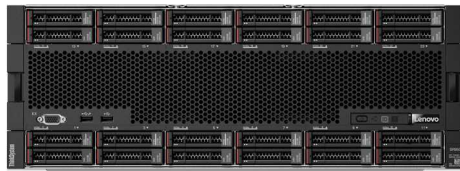

ThinkSystem SR950 Platform Specifications

Components	Specification																																																																																	
Form factor	4U rack																																																																																	
Dimensions	Height: 175.8 mm (6.9 in). Width: 483 mm (19.0 in) at EIA Flange. Depth: 853 mm (33.6 in)																																																																																	
Weight	Maximum configuration: 129.4 lb (58.7 kg)																																																																																	
Processor	Supports up to four Intel Xeon Scalable family processors, Gold or Platinum. Or up to eight Intel Xeon Scalable family processors, Platinum only. Processors and memory are located on system boards installed in compute trays: 2 processors per system board, 2 system boards per compute tray, up to 2 compute tray per system. Up to 28 cores at 2.5GHz, up to 3.6GHz with 4 cores. Up to three UPI (Ultra Path Interconnect) links at maximum 10.4GT/s each																																																																																	
Chipset	Intel C624 Platform Controller Hub																																																																																	
Memory	Up to 96 DIMM sockets. Each processor supports up to 12 DIMM sockets with 6 channels. DDR4-2666. RDIMMs, LRDIMMs, and 3DS RDIMMs are supported, but memory types cannot be intermixed.																																																																																	
Memory capacity	Up to 3TB with 96 x 32GB RDIMMs and eight processors. Or up to 6TB with 96 x 64GB LRDIMMs and eight processors. Or up to 12TB with 96 x 128GB 3DS RDIMMs and eight -M suffix processors. -M suffix processor supports 1.5TB memory per socket, non -M suffix processor supports 768GB memory per socket																																																																																	
Memory protection	ECC, memory mirroring, and memory rank sparing.																																																																																	
Storage controllers	Up to two dedicated internal RAID slots for most RAID/HBA adapters. Supports the following RAID/HBA adapters: <table border="1"> <thead> <tr> <th>Feature</th> <th>Interface</th> <th>Drive type</th> <th>RAID levels</th> <th>JBOD</th> <th>Cache</th> <th>Cache protection</th> <th>FastPath</th> <th>Max qty</th> </tr> </thead> <tbody> <tr> <td>530-8i</td> <td>12Gbps SAS</td> <td>SATA/SAS</td> <td>0/1/10/5/50</td> <td>Yes</td> <td>None</td> <td>None</td> <td>Yes</td> <td>2</td> </tr> <tr> <td>730-8i</td> <td>12Gbps SAS</td> <td>SATA/SAS</td> <td>0/1/10/5/50</td> <td>Yes</td> <td>1GB</td> <td>None</td> <td>No</td> <td>2</td> </tr> <tr> <td>930-8i</td> <td>12Gbps SAS</td> <td>SATA/SAS</td> <td>0/1/10/5/50/6/60</td> <td>Yes</td> <td>2GB</td> <td>Flash backup</td> <td>Yes</td> <td>2</td> </tr> <tr> <td>930-16i</td> <td>12Gbps SAS</td> <td>SATA/SAS</td> <td>0/1/10/5/50/6/60</td> <td>Yes</td> <td>4GB</td> <td>Flash backup</td> <td>Yes</td> <td>2</td> </tr> <tr> <td>430-8i</td> <td>12Gbps SAS</td> <td>SATA/SAS</td> <td>-</td> <td>Yes</td> <td>None</td> <td>None</td> <td>-</td> <td>2</td> </tr> <tr> <td>430-16i</td> <td>12Gbps SAS</td> <td>SATA/SAS</td> <td>-</td> <td>Yes</td> <td>None</td> <td>None</td> <td>-</td> <td>2</td> </tr> <tr> <td>930-8e</td> <td>12Gbps SAS</td> <td>SATA/SAS</td> <td>0/1/10/5/50/6/60</td> <td>Yes</td> <td>4GB</td> <td>Flash backup</td> <td>Yes</td> <td>4</td> </tr> <tr> <td>430-8e</td> <td>12Gbps SAS</td> <td>SATA/SAS</td> <td>-</td> <td>Yes</td> <td>None</td> <td>None</td> <td>-</td> <td>14</td> </tr> </tbody> </table> <p>Note: 730-8i is available in China only. 930-8e should be placed in slot 7 firstly. 430-8e should be placed in slot 5 firstly.</p>	Feature	Interface	Drive type	RAID levels	JBOD	Cache	Cache protection	FastPath	Max qty	530-8i	12Gbps SAS	SATA/SAS	0/1/10/5/50	Yes	None	None	Yes	2	730-8i	12Gbps SAS	SATA/SAS	0/1/10/5/50	Yes	1GB	None	No	2	930-8i	12Gbps SAS	SATA/SAS	0/1/10/5/50/6/60	Yes	2GB	Flash backup	Yes	2	930-16i	12Gbps SAS	SATA/SAS	0/1/10/5/50/6/60	Yes	4GB	Flash backup	Yes	2	430-8i	12Gbps SAS	SATA/SAS	-	Yes	None	None	-	2	430-16i	12Gbps SAS	SATA/SAS	-	Yes	None	None	-	2	930-8e	12Gbps SAS	SATA/SAS	0/1/10/5/50/6/60	Yes	4GB	Flash backup	Yes	4	430-8e	12Gbps SAS	SATA/SAS	-	Yes	None	None	-	14
Feature	Interface	Drive type	RAID levels	JBOD	Cache	Cache protection	FastPath	Max qty																																																																										
530-8i	12Gbps SAS	SATA/SAS	0/1/10/5/50	Yes	None	None	Yes	2																																																																										
730-8i	12Gbps SAS	SATA/SAS	0/1/10/5/50	Yes	1GB	None	No	2																																																																										
930-8i	12Gbps SAS	SATA/SAS	0/1/10/5/50/6/60	Yes	2GB	Flash backup	Yes	2																																																																										
930-16i	12Gbps SAS	SATA/SAS	0/1/10/5/50/6/60	Yes	4GB	Flash backup	Yes	2																																																																										
430-8i	12Gbps SAS	SATA/SAS	-	Yes	None	None	-	2																																																																										
430-16i	12Gbps SAS	SATA/SAS	-	Yes	None	None	-	2																																																																										
930-8e	12Gbps SAS	SATA/SAS	0/1/10/5/50/6/60	Yes	4GB	Flash backup	Yes	4																																																																										
430-8e	12Gbps SAS	SATA/SAS	-	Yes	None	None	-	14																																																																										
Disk drive bays	Up to 12 disk bays with maximum 6 AnyBay, or up to 24 disk bays with maximum 12 AnyBay. Optional one or two internal M.2 SSD for boot, dual M.2 SSD supports mirroring																																																																																	
Internal storage	<table border="1"> <tbody> <tr> <td>2.5" NVMe SSD, AnyBay</td> <td>800GB/960GB/1.6TB/1.92TB/3.84TB</td> </tr> <tr> <td>2.5" HDD, SAS12Gbps, 7,2K</td> <td>1TB/2TB</td> </tr> <tr> <td>2.5" HDD, SAS12Gbps, 15K</td> <td>300GB/600GB/900GB</td> </tr> <tr> <td>2.5" HDD, SAS12Gbps, 10K</td> <td>300GB/600GB/900GB/1.2TB/1.8TB</td> </tr> <tr> <td>2.5" HDD, SAS12Gbps, 10K, SED</td> <td>300GB/600GB</td> </tr> <tr> <td>2.5" SSD, SATA6Gbps</td> <td>240GB/480GB</td> </tr> <tr> <td>2.5" SSD, SAS12Gbps</td> <td>400GB/800GB/3.84TB/7.68TB</td> </tr> <tr> <td>NVMe SSD, PCIe x4 HHHL adapter</td> <td>1.6TB/1.92TB/3.2TB/3.84TB</td> </tr> <tr> <td>M.2 SATA SSD</td> <td>32GB/128GB</td> </tr> </tbody> </table>	2.5" NVMe SSD, AnyBay	800GB/960GB/1.6TB/1.92TB/3.84TB	2.5" HDD, SAS12Gbps, 7,2K	1TB/2TB	2.5" HDD, SAS12Gbps, 15K	300GB/600GB/900GB	2.5" HDD, SAS12Gbps, 10K	300GB/600GB/900GB/1.2TB/1.8TB	2.5" HDD, SAS12Gbps, 10K, SED	300GB/600GB	2.5" SSD, SATA6Gbps	240GB/480GB	2.5" SSD, SAS12Gbps	400GB/800GB/3.84TB/7.68TB	NVMe SSD, PCIe x4 HHHL adapter	1.6TB/1.92TB/3.2TB/3.84TB	M.2 SATA SSD	32GB/128GB																																																															
2.5" NVMe SSD, AnyBay	800GB/960GB/1.6TB/1.92TB/3.84TB																																																																																	
2.5" HDD, SAS12Gbps, 7,2K	1TB/2TB																																																																																	
2.5" HDD, SAS12Gbps, 15K	300GB/600GB/900GB																																																																																	
2.5" HDD, SAS12Gbps, 10K	300GB/600GB/900GB/1.2TB/1.8TB																																																																																	
2.5" HDD, SAS12Gbps, 10K, SED	300GB/600GB																																																																																	
2.5" SSD, SATA6Gbps	240GB/480GB																																																																																	
2.5" SSD, SAS12Gbps	400GB/800GB/3.84TB/7.68TB																																																																																	
NVMe SSD, PCIe x4 HHHL adapter	1.6TB/1.92TB/3.2TB/3.84TB																																																																																	
M.2 SATA SSD	32GB/128GB																																																																																	
Network interfaces	One dedicated management port. One LOM slot for customized LOM with up to four RJ-45 or SFP+ ports, up to 10GbE. Wake-on-LAN and NC-SI are available on Port 0 of LOM. Optional ML2 or PCIe adapters are supported. One standard ML2 slot, one optional ML2 slot via optional riser card																																																																																	
Security features	Power-on and admin password. Trusted Platform Module, TCG 1.2 compliant, upgrade to 2.0 via UEFI setting. Optional TCM, China only																																																																																	
Operating systems supported	Microsoft Windows Server 2016/2012 R2. Red Hat Enterprise Linux 7.3/6.9. SUSE Linux Enterprise Server 12 SP2/11 SP4. VMware vSphere (ESXi) 6.5/6.0 U3																																																																																	
Systems management	XClarity Controller Enterprise. XClarity Administrator. XClarity Energy Manager. XClarity Provisioning Manager. XClarity Essentials. Lenovo Capacity Planner. Light Path Diagnostics with LCD diagnostic pull-out panel																																																																																	
GPU support	None																																																																																	
Base warranty	MT 7X11: 1-year limited onsite service with 9x5/NBD MT 7X12: 3-year limited onsite service with 9x5/NBD MT 7X13: 3-year limited onsite service with 9x5/NBD, SAP HANA optimized																																																																																	
Power supply	Supports one, two or four hot-swap 1100W/1600W 80 PLUS Platinum qualified AC power supplies. Redundant with two or four power supplies (N+N, N = 1 or 2). 1600W Platinum is 200V - 240V, 1100W is 100V - 240V and de-rated to 1050W for operation from 110V input																																																																																	

Components	Specification												
Video	Integrated Matrox G200 in XClarity Controller												
Cooling	Up to 12 hot-swap fans. N +1 redundancy. 6 fans per compute tray, 3 fans per storage tray												
Front ports	One XClarity Controller USB connector, one USB 2.0, one VGA												
Rear ports	One VGA, two USB 3.0, one serial, one XClarity Controller network connector												
Environmental specification	Supports ASHRAE A4 with limitations. <table border="1"> <tbody> <tr> <td>Temperature - operating</td> <td>A4: 5°C to 45°C (41°F to 113°F) A3: 5°C to 40°C (41°F to 104°F) A2: 10°C to 35°C (50°F to 95°F)</td> </tr> <tr> <td>Temperature - non operating (no package)</td> <td>-10°C to 60°C (14°F to 140°F)</td> </tr> <tr> <td>Temperature - non operating (with package)</td> <td>-40°C to 70°C (-40°F to 158°F)</td> </tr> <tr> <td>Altitude - operating</td> <td>(Unpressurized): 0-10000ft (0-3048m)</td> </tr> <tr> <td>Humidity - operating, non-condensing</td> <td>A4: 8%-90%. A3:8%-85%. A2:20%-80%</td> </tr> <tr> <td>Humidity - storage (with package), non-condensing</td> <td>8%-90%</td> </tr> </tbody> </table> <p>Models should meet the following requirements to support A3 and A4: • 2.5" NVMe SSD and PCIe NVMe flash adapter not installed (NVMe devices are supported up to 35°C) • Processors with TDP more than or equal to 150-watt not installed</p>	Temperature - operating	A4: 5°C to 45°C (41°F to 113°F) A3: 5°C to 40°C (41°F to 104°F) A2: 10°C to 35°C (50°F to 95°F)	Temperature - non operating (no package)	-10°C to 60°C (14°F to 140°F)	Temperature - non operating (with package)	-40°C to 70°C (-40°F to 158°F)	Altitude - operating	(Unpressurized): 0-10000ft (0-3048m)	Humidity - operating, non-condensing	A4: 8%-90%. A3:8%-85%. A2:20%-80%	Humidity - storage (with package), non-condensing	8%-90%
Temperature - operating	A4: 5°C to 45°C (41°F to 113°F) A3: 5°C to 40°C (41°F to 104°F) A2: 10°C to 35°C (50°F to 95°F)												
Temperature - non operating (no package)	-10°C to 60°C (14°F to 140°F)												
Temperature - non operating (with package)	-40°C to 70°C (-40°F to 158°F)												
Altitude - operating	(Unpressurized): 0-10000ft (0-3048m)												
Humidity - operating, non-condensing	A4: 8%-90%. A3:8%-85%. A2:20%-80%												
Humidity - storage (with package), non-condensing	8%-90%												
Environmental certification	Energy Star Server 2.1 certified. More environmental information please see: www.lenovo.com/social_responsibility/us/en/environment/												

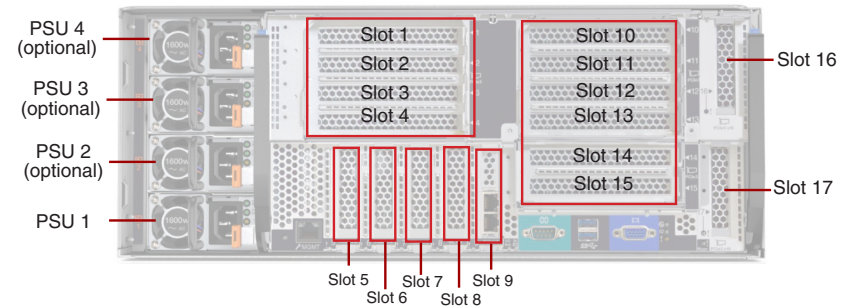

Note: All riser cards, expansion cards, and LOM adapters are optional.

Expansion slots

Supports five standard expansion slots (slot 5 - 9) and up to 12 optional expansion slots (slot 1 - 4, 10 - 15, 16 - 17) via 3 riser cards. The slots are as follows:

Slot 1-4 (riser card 1)	Supports one of the following for riser card 1: Option 1: PCIe 3.0 x8/x8/x8/x8 (slot 1-4). Full height, half length Option 2: PCIe 3.0 x16/x16 (slot 3 and 4). Full height, half length Option 3: PCIe 3.0 x16/x16/x16/x16 (slot 1-4). Full height, half length
Slot 5 (on main I/O tray)	PCIe 3.0 x16, low profile
Slot 6 (on main I/O tray)	PCIe 3.0 x16, low profile
Slot 7 (on main I/O tray)	PCIe 3.0 x8, low profile
Slot 8 (on main I/O tray)	PCIe 3.0 x16 ML2, low profile
Slot 9 (on main I/O tray)	LOM slot, low profile
Slot 10-15 (riser card 2)	Supports one of the following for riser card 2: Option 1: PCIe 3.0 x8/x8/x8/x8 (slot 10-13). Full height, half length Option 2: PCIe 3.0 x16/x16 (slot 12 and 13). Full height, half length Option 3: PCIe 3.0 x16/x16/x16/x16 ML2 (slot 10-15). Full height, half length
Slot 16-17 (riser card 3)	PCIe 3.0 x8, low profile

For riser cards configuration of each model, please see model configuration table.

Model	Region	Processor	CPU Sockets (std)	CPU Sockets (max)	Memory	Memory Sockets (std)	Memory Sockets (max)	Storage Controller	Disk Bays	Max Disk Bays	Disks	PCIe Flash Adapter	M.2 Drives	Onboard Networking Ports	Additional Networking (LOM/ML2/PCIe)	Standard Extension Slots	Available Extension Slots via Riser Cards	Front Panel	TPM	System Management	Power Supply	Warranty	Ann Date (mm/yy)
7X12A003AU	ANZ	8x Xeon Platinum 8160 24C/2.1GHz/33MB/150W/DDR4-2666	8	8	8x 32GB RDIMM DDR4-2666 (2Rx4)	96	96	2x 930-16i 4GB Flash	24x 2.5" SATA/SAS HS	24	None	None	None	1xMgmt	None	2x RAID slot, 2x PCIe x16 LP, 1x PCIe x8 LP, 1x ML2 x16 LP, 1x LOM	9x PCIe x16 FHHL, 1x ML2 x16 FHHL, 2x PCIe x8 LP	Operator panel with LCD	TPM 1.2	XClarity Enterprise	4x 1600W Platinum	3-year	07/17
7X12A00BAU	ANZ	2x Xeon Gold 6130 16C/2.1GHz/22MB/125W/DDR4-2666	2	4	2x 32GB RDIMM DDR4-2666 (2Rx4)	24	48	1x 930-8i 2GB Flash	8x 2.5" SATA/SAS HS	12	None	None	None	1xMgmt	None	1x RAID slot, 2x PCIe x16 LP, 1x PCIe x8 LP, 1x ML2 x16 LP, 1x LOM	None	Operator panel with LCD	TPM 1.2	XClarity Enterprise	2x 1100W Platinum	3-year	07/17
7X12A00CAU	ANZ	4x Xeon Gold 5120 14C/2.2GHz/19.25MB/105W/DDR4-2400	4	4	4x 32GB RDIMM DDR4-2666 (2Rx4)	48	48	1x 930-8i 2GB Flash	8x 2.5" SATA/SAS HS	12	None	None	None	1xMgmt	None	1x RAID slot, 2x PCIe x16 LP, 1x PCIe x8 LP, 1x ML2 x16 LP, 1x LOM	4x PCIe x16 FHHL, 2x PCIe x8 LP	Operator panel with LCD	TPM 1.2	XClarity Enterprise	2x 1600W Platinum	3-year	07/17
7X12A00EAU	ANZ	8x Xeon Platinum 8160 24C/2.1GHz/33MB/150W/DDR4-2666	8	8	8x 32GB RDIMM DDR4-2666 (2Rx4)	96	96	2x 930-16i 4GB Flash	24x 2.5" SATA/SAS HS	24	None	None	None	1xMgmt	None	2x RAID slot, 2x PCIe x16 LP, 1x PCIe x8 LP, 1x ML2 x16 LP, 1x LOM	9x PCIe x16 FHHL, 1x ML2 x16 FHHL, 2x PCIe x8 LP	Operator panel with LCD	TPM 1.2	XClarity Enterprise	4x 1600W Platinum	3-year	07/17
7X12A00FAU	ANZ	2x Xeon Gold 6130 16C/2.1GHz/22MB/125W/DDR4-2666	2	4	2x 32GB RDIMM DDR4-2666 (2Rx4)	24	48	1x 930-8i 2GB Flash	8x 2.5" SATA/SAS HS	12	None	None	None	1xMgmt	None	1x RAID slot, 2x PCIe x16 LP, 1x PCIe x8 LP, 1x ML2 x16 LP, 1x LOM	None	Operator panel with LCD	TPM 1.2	XClarity Enterprise	2x 1100W Platinum	3-year	07/17
7X12A00HAU	ANZ	4x Xeon Platinum 8153 16C/2.0GHz/22MB/125W/DDR4-2666	4	8	4x 32GB RDIMM DDR4-2666 (2Rx4)	48	96	1x 930-8i 2GB Flash	8x 2.5" SATA/SAS HS	12	None	None	None	1xMgmt	None	1x RAID slot, 2x PCIe x16 LP, 1x PCIe x8 LP, 1x ML2 x16 LP, 1x LOM	4x PCIe x16 FHHL, 2x PCIe x8 LP	Operator panel with LCD	TPM 1.2	XClarity Enterprise	2x 1600W Platinum	3-year	07/17
7X12A00LAU	ANZ	4x Xeon Platinum 8153 16C/2.0GHz/22MB/125W/DDR4-2666	4	8	4x 32GB RDIMM DDR4-2666 (2Rx4)	48	96	1x 930-8i 2GB Flash	8x 2.5" SATA/SAS HS	12	None	None	None	1xMgmt	None	1x RAID slot, 2x PCIe x16 LP, 1x PCIe x8 LP, 1x ML2 x16 LP, 1x LOM	4x PCIe x16 FHHL, 2x PCIe x8 LP	Operator panel with LCD	TPM 1.2	XClarity Enterprise	2x 1600W Platinum	3-year	07/17

Model	Region	Processor	CPU Sockets (std)	CPU Sockets (max)	Memory Memory Sockets (std)	Memory Memory Sockets (max)	Storage Controller	Disk Bays	Max Disk Bays	Disks	PCIe Flash Adapter	M.2 Drives	Onboard Networking Ports	Additional Networking (LOM/ML2/PCIe)	Standard Extension Slots	Available Extension Slots via Riser Cards	Front Panel	TPM	System Management	Power Supply	Warranty	Ann Date (mm/yy)	
7X12A00NAU	ANZ	8x Xeon Platinum 8160 24C/2.1GHz/33MB/150W/DDR4-2666	8	8	8x 32GB RDIMM DDR4-2666 (2Rx4)	96	96	2x 930-16i 4GB Flash	24x 2.5" SATA/SAS HS	24	None	None	None	1xMgmt	None	2x RAID slot, 2x PCIe x16 LP, 1x PCIe x8 LP, 1x ML2 x16 LP, 1x LOM	9x PCIe x16 FHHLL, 1x ML2 x16 FHHLL, 2x PCIe x8 LP	Operator panel with LCD	TPM 1.2	XClarity Enterprise	4x 1600W Platinum	3-year	07/17
7X12A00QAU	ANZ	4x Xeon Platinum 8153 16C/2.0GHz/22MB/125W/DDR4-2666	4	8	4x 32GB RDIMM DDR4-2666 (2Rx4)	48	96	1x 930-8i 2GB Flash	8x 2.5" SATA/SAS HS	12	None	None	None	1xMgmt	None	1x RAID slot, 2x PCIe x16 LP, 1x PCIe x8 LP, 1x ML2 x16 LP, 1x LOM	4x PCIe x16 FHHLL, 2x PCIe x8 LP	Operator panel with LCD	TPM 1.2	XClarity Enterprise	2x 1600W Platinum	3-year	07/17
7X12A00RAU	ANZ	4x Xeon Gold 5120 14C/2.2GHz/19.25MB/105W/DDR4-2400	4	4	4x 32GB RDIMM DDR4-2666 (2Rx4)	48	48	1x 930-8i 2GB Flash	8x 2.5" SATA/SAS HS	12	None	None	None	1xMgmt	None	1x RAID slot, 2x PCIe x16 LP, 1x PCIe x8 LP, 1x ML2 x16 LP, 1x LOM	4x PCIe x16 FHHLL, 2x PCIe x8 LP	Operator panel with LCD	TPM 1.2	XClarity Enterprise	2x 1600W Platinum	3-year	07/17
7X12A00SAU	ANZ	4x Xeon Gold 5120 14C/2.2GHz/19.25MB/105W/DDR4-2400	4	4	4x 32GB RDIMM DDR4-2666 (2Rx4)	48	48	1x 930-8i 2GB Flash	8x 2.5" SATA/SAS HS	12	None	None	None	1xMgmt	None	1x RAID slot, 2x PCIe x16 LP, 1x PCIe x8 LP, 1x ML2 x16 LP, 1x LOM	4x PCIe x16 FHHLL, 2x PCIe x8 LP	Operator panel with LCD	TPM 1.2	XClarity Enterprise	2x 1600W Platinum	3-year	07/17
7X12A00UAU	ANZ	2x Xeon Gold 6130 16C/2.1GHz/22MB/125W/DDR4-2666	2	4	2x 32GB RDIMM DDR4-2666 (2Rx4)	24	48	1x 930-8i 2GB Flash	8x 2.5" SATA/SAS HS	12	None	None	None	1xMgmt	None	1x RAID slot, 2x PCIe x16 LP, 1x PCIe x8 LP, 1x ML2 x16 LP, 1x LOM	None	Operator panel with LCD	TPM 1.2	XClarity Enterprise	2x 1100W Platinum	3-year	07/17
7X13A002AU	ANZ	8x Xeon Platinum 8176 28C/2.1GHz/38.5MB/165W/DDR4-2666	8	8	96x 64GB LRDIMM DDR4-2666 (4Rx4)	96	96	1x 930-16i 4GB Flash	12x 2.5" SATA/SAS HS	24	2x 400GB SSD SAS12Gbps, 9x 3.84TB SSD SAS12Gbps	None	None	1xMgmt	2x 2x 25GbE SFP28 PCIe, 4x GbE RJ-45 ML2	2x RAID slot, 2x PCIe x16 LP, 1x PCIe x8 LP, 1x ML2 x16 LP, 1x LOM	None	Operator panel with LCD	TPM 1.2	XClarity Enterprise	4x 1600W Platinum	3-year	11/17
7X13A003AU	ANZ	2x Xeon Platinum 8176 28C/2.1GHz/38.5MB/165W/DDR4-2666	2	4	12x 64GB LRDIMM DDR4-2666 (4Rx4)	24	48	1x 930-16i 4GB Flash	12x 2.5" SATA/SAS HS	12	2x 400GB SSD SAS12Gbps, 3x 3.84TB SSD SAS12Gbps	None	None	1xMgmt	2x 2x 25GbE SFP28 PCIe, 4x GbE RJ-45 ML2	1x RAID slot, 2x PCIe x16 LP, 1x PCIe x8 LP, 1x ML2 x16 LP, 1x LOM	None	Operator panel with LCD	TPM 1.2	XClarity Enterprise	4x 1600W Platinum	3-year	11/17

Model	Region	Processor	CPU Sockets (std)	CPU Sockets (max)	Memory	Memory Sockets (std)	Memory Sockets (max)	Storage Controller	Disk Bays	Max Disk Bays	Disks	PCIe Flash Adapter	M.2 Drives	Onboard Networking Ports	Additional Networking (LOM/ML2/PCIe)	Standard Extension Slots	Available Extension Slots via Riser Cards	Front Panel	TPM	System Management	Power Supply	Warranty	Ann Date (mm/yy)
7X13A004AU	ANZ	4x Xeon Platinum 8176M 28C/2.1GHz/38.5MB/165W/DDR4-2666	4	4	48x 128GB 3DS RDIMM DDR4-2666 (8Rx4)	48	48	1x 930-16i 4GB Flash	12x 2.5" SATA/SAS HS	12	2x 400GB SSD SAS12Gbps, 9x 3.84TB SSD SAS12Gbps	None	None	1xMgmt	2x 2x 25GbE SFP28 PCIe, 4x GbE RJ-45 ML2	1x RAID slot, 2x PCIe x16 LP, 1x PCIe x8 LP, 1x ML2 x16 LP, 1x LOM	None	Operator panel with LCD	TPM 1.2	XClarity Enterprise	4x 1600W Platinum	3-year	11/17
7X13A005AU	ANZ	4x Xeon Platinum 8176 28C/2.1GHz/38.5MB/165W/DDR4-2666	4	4	48x 64GB LRDIMM DDR4-2666 (4Rx4)	48	48	1x 930-16i 4GB Flash	12x 2.5" SATA/SAS HS	12	2x 400GB SSD SAS12Gbps, 5x 3.84TB SSD SAS12Gbps	None	None	1xMgmt	2x 2x 25GbE SFP28 PCIe, 4x GbE RJ-45 ML2	1x RAID slot, 2x PCIe x16 LP, 1x PCIe x8 LP, 1x ML2 x16 LP, 1x LOM	None	Operator panel with LCD	TPM 1.2	XClarity Enterprise	4x 1600W Platinum	3-year	11/17
7X13A006AU	ANZ	4x Xeon Platinum 8176M 28C/2.1GHz/38.5MB/165W/DDR4-2666	4	4	24x 128GB 3DS RDIMM DDR4-2666 (8Rx4)	48	48	1x 930-16i 4GB Flash	12x 2.5" SATA/SAS HS	12	2x 400GB SSD SAS12Gbps, 5x 3.84TB SSD SAS12Gbps	None	None	1xMgmt	2x 2x 25GbE SFP28 PCIe, 4x GbE RJ-45 ML2	1x RAID slot, 2x PCIe x16 LP, 1x PCIe x8 LP, 1x ML2 x16 LP, 1x LOM	None	Operator panel with LCD	TPM 1.2	XClarity Enterprise	4x 1600W Platinum	3-year	11/17
7X13A007AU	ANZ	8x Xeon Platinum 8176M 28C/2.1GHz/38.5MB/165W/DDR4-2666	8	8	96x 128GB 3DS RDIMM DDR4-2666 (8Rx4)	96	96	2x 930-16i 4GB Flash	24x 2.5" SATA/SAS HS	24	2x 400GB SSD SAS12Gbps, 18x 3.84TB SSD SAS12Gbps	None	None	1xMgmt	2x 2x 25GbE SFP28 PCIe, 4x GbE RJ-45 ML2	2x RAID slot, 2x PCIe x16 LP, 1x PCIe x8 LP, 1x ML2 x16 LP, 1x LOM	None	Operator panel with LCD	TPM 1.2	XClarity Enterprise	4x 1600W Platinum	3-year	11/17
7X13A008AU	ANZ	4x Xeon Platinum 8176 28C/2.1GHz/38.5MB/165W/DDR4-2666	4	4	24x 64GB LRDIMM DDR4-2666 (4Rx4)	48	48	1x 930-16i 4GB Flash	12x 2.5" SATA/SAS HS	12	2x 400GB SSD SAS12Gbps, 3x 3.84TB SSD SAS12Gbps	None	None	1xMgmt	2x 2x 25GbE SFP28 PCIe, 4x GbE RJ-45 ML2	1x RAID slot, 2x PCIe x16 LP, 1x PCIe x8 LP, 1x ML2 x16 LP, 1x LOM	None	Operator panel with LCD	TPM 1.2	XClarity Enterprise	4x 1600W Platinum	3-year	11/17
7X13A009AU	ANZ	2x Xeon Platinum 8176 28C/2.1GHz/38.5MB/165W/DDR4-2666	2	4	12x 16GB RDIMM DDR4-2666 (2Rx8)	24	48	1x 930-16i 4GB Flash	12x 2.5" SATA/SAS HS	12	2x 400GB SSD SAS12Gbps, 3x 3.84TB SSD SAS12Gbps	None	None	1xMgmt	2x 2x 25GbE SFP28 PCIe, 4x GbE RJ-45 ML2	1x RAID slot, 2x PCIe x16 LP, 1x PCIe x8 LP, 1x ML2 x16 LP, 1x LOM	None	Operator panel with LCD	TPM 1.2	XClarity Enterprise	4x 1600W Platinum	3-year	11/17
7X13A00AAU	ANZ	8x Xeon Platinum 8176M 28C/2.1GHz/38.5MB/165W/DDR4-2666	8	8	48x 128GB 3DS RDIMM DDR4-2666 (8Rx4)	96	96	1x 930-16i 4GB Flash	12x 2.5" SATA/SAS HS	24	2x 400GB SSD SAS12Gbps, 9x 3.84TB SSD SAS12Gbps	None	None	1xMgmt	2x 2x 25GbE SFP28 PCIe, 4x GbE RJ-45 ML2	2x RAID slot, 2x PCIe x16 LP, 1x PCIe x8 LP, 1x ML2 x16 LP, 1x LOM	None	Operator panel with LCD	TPM 1.2	XClarity Enterprise	4x 1600W Platinum	3-year	11/17

Model	Region	Processor	CPU Sockets (std)	CPU Sockets (max)	Memory	Memory Sockets (std)	Memory Sockets (max)	Storage Controller	Disk Bays	Max Disk Bays	Disks	PCIe Flash Adapter	M.2 Drives	Onboard Networking Ports	Additional Networking (LOM/ML2/PCIe)	Standard Extension Slots	Available Extension Slots via Riser Cards	Front Panel	TPM	System Management	Power Supply	Warranty	Ann Date (mm/yy)
7X13A00BAU	ANZ	2x Xeon Platinum 8176M 28C/2.1GHz/38.5MB/165W/DDR4-2666	2	4	24x 128GB 3DS RDIMM DDR4-2666 (8Rx4)	24	48	1x 930-16i 4GB Flash	12x 2.5" SATA/SAS HS	12	2x 400GB SSD SAS12Gbps, 5x 3.84TB SSD SAS12Gbps	None	None	1xMgmt	2x 2x 25GbE SFP28 PCIe, 4x GbE RJ-45 ML2	1x RAID slot, 2x PCIe x16 LP, 1x PCIe x8 LP, 1x ML2 x16 LP, 1x LOM	None	Operator panel with LCD	TPM 1.2	XClarity Enterprise	4x 1600W Platinum	3-year	11/17
7X13A00CAU	ANZ	2x Xeon Platinum 8176 28C/2.1GHz/38.5MB/165W/DDR4-2666	2	4	12x 32GB RDIMM DDR4-2666 (2Rx4)	24	48	1x 930-16i 4GB Flash	12x 2.5" SATA/SAS HS	12	2x 400GB SSD SAS12Gbps, 3x 3.84TB SSD SAS12Gbps	None	None	1xMgmt	2x 2x 25GbE SFP28 PCIe, 4x GbE RJ-45 ML2	1x RAID slot, 2x PCIe x16 LP, 1x PCIe x8 LP, 1x ML2 x16 LP, 1x LOM	None	Operator panel with LCD	TPM 1.2	XClarity Enterprise	4x 1600W Platinum	3-year	11/17

ThinkSystem SR950 - Non TopSeller - Argentina

Product Specifications Reference (PSREF)

Model	Region	Processor	CPU Sockets (std)	CPU Sockets (max)	Memory	Memory Sockets (std)	Memory Sockets (max)	Storage Controller	Disk Bays	Max Disk Bays	Disk Bays	PCIe Flash Adapter	M.2 Drives	Onboard Networking Ports	Additional Networking (LOM/ML2/PCIe)	Standard Extension Slots	Available Extension Slots via Riser Cards	Front Panel	TPM	System Management	Power Supply	Warranty	Ann Date (mm/yy)
7X12A021LA	Argentina	8x Xeon Platinum 8180M 28C/2.5GHz/38.5MB/205W/DDR4-2666	8	8	48x 32GB RDIMM DDR4-2666 (2Rx4)	96	96	2x 930-16i 4GB Flash	8x 2.5" HS (4x SATA/SAS, 4x AnyBay)	24	None	None	None	1xMgmt	4x 10GbE SFP+ LOM	2x RAID slot, 2x PCIe x16 LP, 1x PCIe x8 LP, 1x ML2 x16 LP, 1x LOM	5x PCIe x16 FHHL, 1x ML2 x16 FHHL	Operator panel with LCD	TPM 2.0	XClarity Enterprise	4x 1600W Platinum	3-year	08/17

ThinkSystem SR950 - Non TopSeller - ASEAN

Product Specifications Reference (PSREF)

Model	Region	Processor	CPU Sockets (std)	CPU Sockets (max)	Memory Sockets (std)	Memory Sockets (max)	Storage Controller	Disk Bays	Max Disk Bays	Disk Bays	PCIe Flash Adapter	M.2 Drives	Onboard Networking Ports	Additional Networking (LOM/ML2/PCIe)	Standard Extension Slots	Available Extension Slots via Riser Cards	Front Panel	TPM	System Management	Power Supply	Warranty	Ann Date (mm/yy)
7X12A014SG	ASEAN	2x Xeon Platinum 8160 24C/2.1GHz/33MB/150W/DDR4-2666	2	8	4x 32GB RDIMM DDR4-2666 (2Rx4)	24	96	1x 930-16i 4GB Flash	12	None	None	None	1xMgmt	4x 10GbE RJ-45 LOM	1x RAID slot, 2x PCIe x16 LP, 1x PCIe x8 LP, 1x ML2 x16 LP, 1x LOM	None	Operator panel with LCD	TPM 1.2	XClarity Enterprise	2x 1600W Platinum	3-year	07/17
7X12A015SG	ASEAN	2x Xeon Platinum 8153 16C/2.0GHz/22MB/125W/DDR4-2666	2	8	4x 32GB RDIMM DDR4-2666 (2Rx4)	24	96	1x 930-16i 4GB Flash	12	None	None	None	1xMgmt	4x 10GbE RJ-45 LOM	1x RAID slot, 2x PCIe x16 LP, 1x PCIe x8 LP, 1x ML2 x16 LP, 1x LOM	None	Operator panel with LCD	TPM 1.2	XClarity Enterprise	2x 1600W Platinum	3-year	07/17
7X12A016SG	ASEAN	2x Xeon Platinum 8158 12C/3.0GHz/24.75MB/150W/DDR4-2666	2	8	4x 32GB RDIMM DDR4-2666 (2Rx4)	24	96	1x 930-16i 4GB Flash	12	None	None	None	1xMgmt	4x 10GbE RJ-45 LOM	1x RAID slot, 2x PCIe x16 LP, 1x PCIe x8 LP, 1x ML2 x16 LP, 1x LOM	None	Operator panel with LCD	TPM 1.2	XClarity Enterprise	2x 1600W Platinum	3-year	07/17
7X12A01BSG	ASEAN	2x Xeon Platinum 8164 26C/2.0GHz/35.75MB/150W/DDR4-2666	2	8	4x 32GB RDIMM DDR4-2666 (2Rx4)	24	96	1x 930-16i 4GB Flash	12	None	None	None	1xMgmt	4x 10GbE RJ-45 LOM	1x RAID slot, 2x PCIe x16 LP, 1x PCIe x8 LP, 1x ML2 x16 LP, 1x LOM	None	Operator panel with LCD	TPM 1.2	XClarity Enterprise	2x 1600W Platinum	3-year	07/17
7X12A01CSG	ASEAN	2x Xeon Platinum 8176 28C/2.1GHz/38.5MB/165W/DDR4-2666	2	8	4x 32GB RDIMM DDR4-2666 (2Rx4)	24	96	1x 930-16i 4GB Flash	12	None	None	None	1xMgmt	4x 10GbE RJ-45 LOM	1x RAID slot, 2x PCIe x16 LP, 1x PCIe x8 LP, 1x ML2 x16 LP, 1x LOM	None	Operator panel with LCD	TPM 1.2	XClarity Enterprise	2x 1600W Platinum	3-year	07/17

Model	Region	Processor	CPU Sockets (std)	CPU Sockets (max)	Memory Memory Sockets (std)	Memory Memory Sockets (max)	Storage Controller	Disk Bays	Max Disk Bays	Disk Bays	PCIe Flash Adapter	M.2 Drives	Onboard Networking Ports	Additional Networking (LOM/ML2/PCIe)	Standard Extension Slots	Available Extension Slots via Riser Cards	Front Panel	TPM	System Management	Power Supply	Warranty	Ann Date (mm/yy)	
7X12A01TBR	Brazil	2x Xeon Gold 6130 16C/2.1GHz/22MB/125W/DDR4-2666	2	4	2x 32GB RDIMM DDR4-2666 (2Rx4)	24	48	1x 930-8i 2GB Flash	8x 2.5" SATA/SAS HS	12	None	None	None	1xMgmt	None	1x RAID slot, 2x PCIe x16 LP, 1x PCIe x8 LP, 1x ML2 x16 LP, 1x LOM	Operator panel with LCD	TPM 1.2	XClarity Enterprise	2x 1100W Platinum	3-year	07/17	
7X12A01UBR	Brazil	8x Xeon Platinum 8160 24C/2.1GHz/33MB/150W/DDR4-2666	8	8	8x 32GB RDIMM DDR4-2666 (2Rx4)	96	96	2x 930-16i 4GB Flash	24x 2.5" SATA/SAS HS	24	None	None	None	1xMgmt	None	2x RAID slot, 2x PCIe x16 LP, 1x PCIe x8 LP, 1x ML2 x16 LP, 1x LOM	9x PCIe x16 FHHL, 1x ML2 x16 FHHL, 2x PCIe x8 LP	Operator panel with LCD	TPM 1.2	XClarity Enterprise	4x 1600W Platinum	3-year	07/17
7X12A01VBR	Brazil	4x Xeon Platinum 8153 16C/2.0GHz/22MB/125W/DDR4-2666	4	8	4x 32GB RDIMM DDR4-2666 (2Rx4)	48	96	1x 930-8i 2GB Flash	8x 2.5" SATA/SAS HS	12	None	None	None	1xMgmt	None	1x RAID slot, 2x PCIe x16 LP, 1x PCIe x8 LP, 1x ML2 x16 LP, 1x LOM	4x PCIe x16 FHHL, 2x PCIe x8 LP	Operator panel with LCD	TPM 1.2	XClarity Enterprise	2x 1600W Platinum	3-year	07/17
7X12A01WBR	Brazil	4x Xeon Gold 5120 14C/2.2GHz/19.25MB/105W/DDR4-2400	4	4	4x 32GB RDIMM DDR4-2666 (2Rx4)	48	48	1x 930-8i 2GB Flash	8x 2.5" SATA/SAS HS	12	None	None	None	1xMgmt	None	1x RAID slot, 2x PCIe x16 LP, 1x PCIe x8 LP, 1x ML2 x16 LP, 1x LOM	4x PCIe x16 FHHL, 2x PCIe x8 LP	Operator panel with LCD	TPM 1.2	XClarity Enterprise	2x 1600W Platinum	3-year	07/17

Model	Region	Processor	CPU Sockets (std)	CPU Sockets (max)	Memory	Memory Sockets (std)	Memory Sockets (max)	Storage Controller	Disk Bays	Max Disk Bays	Disks	PCIe Flash Adapter	M.2 Drives	Onboard Networking Ports	Additional Networking (LOM/ML2/PCIe)	Standard Extension Slots	Available Extension Slots via Riser Cards	Front Panel	TPM	System Management	Power Supply	Warranty	Ann Date (mm/yy)
7X13A005EA	EMEA	4x Xeon Platinum 8176 28C/2.1GHz/38.5MB/165W/DDR4-2666	4	4	48x 64GB LRDIMM DDR4-2666 (4Rx4)	48	48	1x 930-16i 4GB Flash	12x 2.5" SATA/SAS HS	12	2x 400GB SSD SAS12Gbps, 5x 3.84TB SSD SAS12Gbps	None	None	1xMgmt	2x 2x 25GbE SFP28 PCIe, 4x GbE RJ-45 ML2	1x RAID slot, 2x PCIe x16 LP, 1x PCIe x8 LP, 1x ML2 x16 LP, 1x LOM	None	Operator panel with LCD	TPM 1.2	XClarity Enterprise	4x 1600W Platinum	3-year	12/17
7X13A004EA	EMEA	4x Xeon Platinum 8176M 28C/2.1GHz/38.5MB/165W/DDR4-2666	4	4	48x 128GB 3DS RDIMM DDR4-2666 (8Rx4)	48	48	1x 930-16i 4GB Flash	12x 2.5" SATA/SAS HS	12	2x 400GB SSD SAS12Gbps, 9x 3.84TB SSD SAS12Gbps	None	None	1xMgmt	2x 2x 25GbE SFP28 PCIe, 4x GbE RJ-45 ML2	1x RAID slot, 2x PCIe x16 LP, 1x PCIe x8 LP, 1x ML2 x16 LP, 1x LOM	None	Operator panel with LCD	TPM 1.2	XClarity Enterprise	4x 1600W Platinum	3-year	12/17
7X13A003EA	EMEA	2x Xeon Platinum 8176 28C/2.1GHz/38.5MB/165W/DDR4-2666	2	4	12x 64GB LRDIMM DDR4-2666 (4Rx4)	24	48	1x 930-16i 4GB Flash	12x 2.5" SATA/SAS HS	12	2x 400GB SSD SAS12Gbps, 3x 3.84TB SSD SAS12Gbps	None	None	1xMgmt	2x 2x 25GbE SFP28 PCIe, 4x GbE RJ-45 ML2	1x RAID slot, 2x PCIe x16 LP, 1x PCIe x8 LP, 1x ML2 x16 LP, 1x LOM	None	Operator panel with LCD	TPM 1.2	XClarity Enterprise	4x 1600W Platinum	3-year	12/17
7X13A002EA	EMEA	8x Xeon Platinum 8176 28C/2.1GHz/38.5MB/165W/DDR4-2666	8	8	96x 64GB LRDIMM DDR4-2666 (4Rx4)	96	96	1x 930-16i 4GB Flash	12x 2.5" SATA/SAS HS	24	2x 400GB SSD SAS12Gbps, 9x 3.84TB SSD SAS12Gbps	None	None	1xMgmt	2x 2x 25GbE SFP28 PCIe, 4x GbE RJ-45 ML2	2x RAID slot, 2x PCIe x16 LP, 1x PCIe x8 LP, 1x ML2 x16 LP, 1x LOM	None	Operator panel with LCD	TPM 1.2	XClarity Enterprise	4x 1600W Platinum	3-year	12/17
7X12A017EA	EMEA	8x Xeon Platinum 8160 24C/2.1GHz/33MB/150W/DDR4-2666	8	8	8x 32GB RDIMM DDR4-2666 (2Rx4)	96	96	2x 930-16i 4GB Flash	24x 2.5" HS (12x SATA/SAS, 12x AnyBay)	24	None	None	None	1xMgmt	None	2x RAID slot, 2x PCIe x16 LP, 1x PCIe x8 LP, 1x ML2 x16 LP, 1x LOM	9x PCIe x16 FHHL, 1x ML2 x16 FHHL, 2x PCIe x8 LP	Operator panel with LCD	TPM 1.2	XClarity Enterprise	4x 1600W Platinum	3-year	07/17
7X12A018EA	EMEA	4x Xeon Platinum 8153 16C/2.0GHz/22MB/125W/DDR4-2666	4	8	4x 32GB RDIMM DDR4-2666 (2Rx4)	48	96	1x 930-16i 4GB Flash	12x 2.5" HS (6x SATA/SAS, 6x AnyBay)	12	None	None	None	1xMgmt	None	1x RAID slot, 2x PCIe x16 LP, 1x PCIe x8 LP, 1x ML2 x16 LP, 1x LOM	4x PCIe x16 FHHL, 2x PCIe x8 LP	Operator panel with LCD	TPM 1.2	XClarity Enterprise	2x 1600W Platinum	3-year	07/17
7X12A019EA	EMEA	4x Xeon Gold 5120 14C/2.2GHz/19.25MB/105W/DDR4-2400	4	4	4x 32GB RDIMM DDR4-2666 (2Rx4)	48	48	1x 930-16i 4GB Flash	12x 2.5" HS (6x SATA/SAS, 6x AnyBay)	12	None	None	None	1xMgmt	None	1x RAID slot, 2x PCIe x16 LP, 1x PCIe x8 LP, 1x ML2 x16 LP, 1x LOM	4x PCIe x16 FHHL, 2x PCIe x8 LP	Operator panel with LCD	TPM 1.2	XClarity Enterprise	2x 1600W Platinum	3-year	07/17

Model	Region	Processor	CPU Sockets (std)	CPU Sockets (max)	Memory	Memory Sockets (std)	Memory Sockets (max)	Storage Controller	Disk Bays	Max Disk Bays	Disks	PCIe Flash Adapter	M.2 Drives	Onboard Networking Ports	Additional Networking (LOM/ML2/PCIe)	Standard Extension Slots	Available Extension Slots via Riser Cards	Front Panel	TPM	System Management	Power Supply	Warranty	Ann Date (mm/yy)
7X12A01AEA	EMEA	2x Xeon Gold 6130 16C/2.1GHz/22MB/125W/DDR4-2666	2	4	2x 32GB RDIMM DDR4-2666 (2Rx4)	24	48	1x 930-8i 2GB Flash	8x 2.5" SATA/SAS HS	12	None	None	None	1xMgmt	None	1x RAID slot, 2x PCIe x16 LP, 1x PCIe x8 LP, 1x ML2 x16 LP, 1x LOM	None	Operator panel with LCD	TPM 1.2	XClarity Enterprise	2x 1600W Platinum	3-year	07/17
7X13A00CEA	EMEA	2x Xeon Platinum 8176 28C/2.1GHz/38.5MB/165W/DDR4-2666	2	4	12x 32GB RDIMM DDR4-2666 (2Rx4)	24	48	1x 930-16i 4GB Flash	12x 2.5" SATA/SAS HS	12	2x 400GB SSD SAS12Gbps, 3x 3.84TB SSD SAS12Gbps	None	None	1xMgmt	2x 2x 25GbE SFP28 PCIe, 4x GbE RJ-45 ML2	1x RAID slot, 2x PCIe x16 LP, 1x PCIe x8 LP, 1x ML2 x16 LP, 1x LOM	None	Operator panel with LCD	TPM 1.2	XClarity Enterprise	4x 1600W Platinum	3-year	12/17
7X13A00AEA	EMEA	8x Xeon Platinum 8176M 28C/2.1GHz/38.5MB/165W/DDR4-2666	8	8	48x 128GB 3DS RDIMM DDR4-2666 (8Rx4)	96	96	1x 930-16i 4GB Flash	12x 2.5" SATA/SAS HS	24	2x 400GB SSD SAS12Gbps, 9x 3.84TB SSD SAS12Gbps	None	None	1xMgmt	2x 2x 25GbE SFP28 PCIe, 4x GbE RJ-45 ML2	2x RAID slot, 2x PCIe x16 LP, 1x PCIe x8 LP, 1x ML2 x16 LP, 1x LOM	None	Operator panel with LCD	TPM 1.2	XClarity Enterprise	4x 1600W Platinum	3-year	12/17
7X13A009EA	EMEA	2x Xeon Platinum 8176 28C/2.1GHz/38.5MB/165W/DDR4-2666	2	4	12x 16GB RDIMM DDR4-2666 (2Rx8)	24	48	1x 930-16i 4GB Flash	12x 2.5" SATA/SAS HS	12	2x 400GB SSD SAS12Gbps, 3x 3.84TB SSD SAS12Gbps	None	None	1xMgmt	2x 2x 25GbE SFP28 PCIe, 4x GbE RJ-45 ML2	1x RAID slot, 2x PCIe x16 LP, 1x PCIe x8 LP, 1x ML2 x16 LP, 1x LOM	None	Operator panel with LCD	TPM 1.2	XClarity Enterprise	4x 1600W Platinum	3-year	12/17
7X13A008EA	EMEA	4x Xeon Platinum 8176 28C/2.1GHz/38.5MB/165W/DDR4-2666	4	4	24x 64GB LRDIMM DDR4-2666 (4Rx4)	48	48	1x 930-16i 4GB Flash	12x 2.5" SATA/SAS HS	12	2x 400GB SSD SAS12Gbps, 3x 3.84TB SSD SAS12Gbps	None	None	1xMgmt	2x 2x 25GbE SFP28 PCIe, 4x GbE RJ-45 ML2	1x RAID slot, 2x PCIe x16 LP, 1x PCIe x8 LP, 1x ML2 x16 LP, 1x LOM	None	Operator panel with LCD	TPM 1.2	XClarity Enterprise	4x 1600W Platinum	3-year	12/17
7X13A006EA	EMEA	4x Xeon Platinum 8176M 28C/2.1GHz/38.5MB/165W/DDR4-2666	4	4	24x 128GB 3DS RDIMM DDR4-2666 (8Rx4)	48	48	1x 930-16i 4GB Flash	12x 2.5" SATA/SAS HS	12	2x 400GB SSD SAS12Gbps, 5x 3.84TB SSD SAS12Gbps	None	None	1xMgmt	2x 2x 25GbE SFP28 PCIe, 4x GbE RJ-45 ML2	1x RAID slot, 2x PCIe x16 LP, 1x PCIe x8 LP, 1x ML2 x16 LP, 1x LOM	None	Operator panel with LCD	TPM 1.2	XClarity Enterprise	4x 1600W Platinum	3-year	12/17
7X13A00HEA	EMEA	2x Xeon Platinum 8176M 28C/2.1GHz/38.5MB/165W/DDR4-2666	2	4	24x 128GB 3DS RDIMM DDR4-2666 (8Rx4)	24	48	1x 930-16i 4GB Flash	12x 2.5" SATA/SAS HS	12	2x 400GB SSD SAS12Gbps, 5x 3.84TB SSD SAS12Gbps	None	None	1xMgmt	2x 2x 25GbE SFP28 PCIe, 4x GbE RJ-45 ML2	1x RAID slot, 2x PCIe x16 LP, 1x PCIe x8 LP, 1x ML2 x16 LP, 1x LOM	None	Operator panel with LCD	TPM 1.2	XClarity Enterprise	4x 1600W Platinum	3-year	12/17

Model	Region	Processor	CPU Sockets (std)	CPU Sockets (max)	Memory	Memory Sockets (std)	Memory Sockets (max)	Storage Controller	Disk Bays	Max Disk Bays	Disks	PCIe Flash Adapter	M.2 Drives	Onboard Networking Ports	Additional Networking (LOM/ML2/PCIe)	Standard Extension Slots	Available Extension Slots via Riser Cards	Front Panel	TPM	System Management	Power Supply	Warranty	Ann Date (mm/yy)
7X13A00QEA	EMEA	8x Xeon Platinum 8176M 28C/2.1GHz/38.5MB/165W/DDR4-2666	8	8	96x 128GB 3DS RDIMM DDR4-2666 (8Rx4)	96	96	2x 930-16i 4GB Flash	24x 2.5" SATA/SAS HS	24	2x 400GB SSD SAS12Gbps, 18x 3.84TB SSD SAS12Gbps	None	None	1xMgmt	2x 2x 25GbE SFP28 PCIe, 4x GbE RJ-45 ML2	2x RAID slot, 2x PCIe x16 LP, 1x PCIe x8 LP, 1x ML2 x16 LP, 1x LOM	None	Operator panel with LCD	TPM 1.2	XClarity Enterprise	4x 1600W Platinum	3-year	12/17

Model	Region	Processor	CPU Sockets (std)	CPU Sockets (max)	Memory	Memory Sockets (std)	Memory Sockets (max)	Storage Controller	Disk Bays	Max Disk Bays	Disks	PCIe Flash Adapter	M.2 Drives	Onboard Networking Ports	Additional Networking (LOM/ML2/PCIe)	Standard Extension Slots	Available Extension Slots via Riser Cards	Front Panel	TPM	System Management	Power Supply	Warranty	Ann Date (mm/yy)
7X13A006CN	HTK	4x Xeon Platinum 8176M 28C/2.1GHz/38.5MB/165W/DDR4-2666	4	4	24x 128GB 3DS RDIMM DDR4-2666 (8Rx4)	48	48	1x 930-16i 4GB Flash	12x 2.5" SATA/SAS HS	12	2x 400GB SSD SAS12Gbps, 5x 3.84TB SSD SAS12Gbps	None	None	1xMgmt	2x 2x 25GbE SFP28 PCIe, 4x GbE RJ-45 ML2	1x RAID slot, 2x PCIe x16 LP, 1x PCIe x8 LP, 1x ML2 x16 LP, 1x LOM	None	Operator panel with LCD	TPM 1.2	XClarity Enterprise	4x 1600W Platinum	3-year	11/17
7X13A007CN	HTK	8x Xeon Platinum 8176M 28C/2.1GHz/38.5MB/165W/DDR4-2666	8	8	96x 128GB 3DS RDIMM DDR4-2666 (8Rx4)	96	96	2x 930-16i 4GB Flash	24x 2.5" SATA/SAS HS	24	2x 400GB SSD SAS12Gbps, 18x 3.84TB SSD SAS12Gbps	None	None	1xMgmt	2x 2x 25GbE SFP28 PCIe, 4x GbE RJ-45 ML2	2x RAID slot, 2x PCIe x16 LP, 1x PCIe x8 LP, 1x ML2 x16 LP, 1x LOM	None	Operator panel with LCD	TPM 1.2	XClarity Enterprise	4x 1600W Platinum	3-year	11/17
7X13A008CN	HTK	4x Xeon Platinum 8176 28C/2.1GHz/38.5MB/165W/DDR4-2666	4	4	24x 64GB LRDIMM DDR4-2666 (4Rx4)	48	48	1x 930-16i 4GB Flash	12x 2.5" SATA/SAS HS	12	2x 400GB SSD SAS12Gbps, 3x 3.84TB SSD SAS12Gbps	None	None	1xMgmt	2x 2x 25GbE SFP28 PCIe, 4x GbE RJ-45 ML2	1x RAID slot, 2x PCIe x16 LP, 1x PCIe x8 LP, 1x ML2 x16 LP, 1x LOM	None	Operator panel with LCD	TPM 1.2	XClarity Enterprise	4x 1600W Platinum	3-year	11/17
7X13A009CN	HTK	2x Xeon Platinum 8176 28C/2.1GHz/38.5MB/165W/DDR4-2666	2	4	12x 16GB RDIMM DDR4-2666 (2Rx8)	24	48	1x 930-16i 4GB Flash	12x 2.5" SATA/SAS HS	12	2x 400GB SSD SAS12Gbps, 3x 3.84TB SSD SAS12Gbps	None	None	1xMgmt	2x 2x 25GbE SFP28 PCIe, 4x GbE RJ-45 ML2	1x RAID slot, 2x PCIe x16 LP, 1x PCIe x8 LP, 1x ML2 x16 LP, 1x LOM	None	Operator panel with LCD	TPM 1.2	XClarity Enterprise	4x 1600W Platinum	3-year	11/17
7X13A00ACN	HTK	8x Xeon Platinum 8176M 28C/2.1GHz/38.5MB/165W/DDR4-2666	8	8	48x 128GB 3DS RDIMM DDR4-2666 (8Rx4)	96	96	1x 930-16i 4GB Flash	12x 2.5" SATA/SAS HS	24	2x 400GB SSD SAS12Gbps, 9x 3.84TB SSD SAS12Gbps	None	None	1xMgmt	2x 2x 25GbE SFP28 PCIe, 4x GbE RJ-45 ML2	2x RAID slot, 2x PCIe x16 LP, 1x PCIe x8 LP, 1x ML2 x16 LP, 1x LOM	None	Operator panel with LCD	TPM 1.2	XClarity Enterprise	4x 1600W Platinum	3-year	11/17
7X13A00BCN	HTK	2x Xeon Platinum 8176M 28C/2.1GHz/38.5MB/165W/DDR4-2666	2	4	24x 128GB 3DS RDIMM DDR4-2666 (8Rx4)	24	48	1x 930-16i 4GB Flash	12x 2.5" SATA/SAS HS	12	2x 400GB SSD SAS12Gbps, 5x 3.84TB SSD SAS12Gbps	None	None	1xMgmt	2x 2x 25GbE SFP28 PCIe, 4x GbE RJ-45 ML2	1x RAID slot, 2x PCIe x16 LP, 1x PCIe x8 LP, 1x ML2 x16 LP, 1x LOM	None	Operator panel with LCD	TPM 1.2	XClarity Enterprise	4x 1600W Platinum	3-year	11/17
7X13A00CCN	HTK	2x Xeon Platinum 8176 28C/2.1GHz/38.5MB/165W/DDR4-2666	2	4	12x 32GB RDIMM DDR4-2666 (2Rx4)	24	48	1x 930-16i 4GB Flash	12x 2.5" SATA/SAS HS	12	2x 400GB SSD SAS12Gbps, 3x 3.84TB SSD SAS12Gbps	None	None	1xMgmt	2x 2x 25GbE SFP28 PCIe, 4x GbE RJ-45 ML2	1x RAID slot, 2x PCIe x16 LP, 1x PCIe x8 LP, 1x ML2 x16 LP, 1x LOM	None	Operator panel with LCD	TPM 1.2	XClarity Enterprise	4x 1600W Platinum	3-year	11/17

Model	Region	Processor	CPU Sockets (std)	CPU Sockets (max)	Memory	Memory Sockets (std)	Memory Sockets (max)	Storage Controller	Disk Bays	Max Disk Bays	Disks	PCIe Flash Adapter	M.2 Drives	Onboard Networking Ports	Additional Networking (LOM/ML2/PCle)	Standard Extension Slots	Available Extension Slots via Riser Cards	Front Panel	TPM	System Management	Power Supply	Warranty	Ann Date (mm/yy)
7X13A00DCN	HTK	2x Xeon Platinum 8176M 28C/2.1GHz/38.5MB/165W/DDR4-2666	2	4	12x 128GB 3DS RDIMM DDR4-2666 (8Rx4)	24	48	1x 930-16i 4GB Flash	12x 2.5" SATA/SAS HS	12	2x 400GB SSD SAS12Gbps, 3x 3.84TB SSD SAS12Gbps	None	None	1xMgmt	2x 2x 25GbE SFP28 PCle, 4x GbE RJ-45 ML2	1x RAID slot, 2x PCle x16 LP, 1x PCle x8 LP, 1x ML2 x16 LP, 1x LOM	None	Operator panel with LCD	TPM 1.2	XClarity Enterprise	4x 1600W Platinum	3-year	11/17
7X12A01ECN	HTK	2x Xeon Platinum 8180 28C/2.5GHz/38.5MB/205W/DDR4-2666	2	8	2x 16GB RDIMM DDR4-2666 (2Rx8)	24	96	1x 930-16i 4GB Flash	12x 2.5" SATA/SAS HS	12	None	None	None	1xMgmt	4x GbE RJ-45 LOM	1x RAID slot, 2x PCle x16 LP, 1x PCle x8 LP, 1x ML2 x16 LP, 1x LOM	None	Operator panel with LCD	TPM 1.2	XClarity Enterprise	2x 1600W Platinum	3-year	07/17
7X12A01FCN	HTK	2x Xeon Platinum 8170 26C/2.1GHz/35.75MB/165W/DDR4-2666	2	8	2x 16GB RDIMM DDR4-2666 (2Rx8)	24	96	1x 930-16i 4GB Flash	12x 2.5" SATA/SAS HS	12	None	None	None	1xMgmt	4x GbE RJ-45 LOM	1x RAID slot, 2x PCle x16 LP, 1x PCle x8 LP, 1x ML2 x16 LP, 1x LOM	None	Operator panel with LCD	TPM 1.2	XClarity Enterprise	2x 1600W Platinum	3-year	07/17
7X13A002CN	HTK	8x Xeon Platinum 8176 28C/2.1GHz/38.5MB/165W/DDR4-2666	8	8	96x 64GB LRDIMM DDR4-2666 (4Rx4)	96	96	1x 930-16i 4GB Flash	12x 2.5" SATA/SAS HS	24	2x 400GB SSD SAS12Gbps, 9x 3.84TB SSD SAS12Gbps	None	None	1xMgmt	2x 2x 25GbE SFP28 PCle, 4x GbE RJ-45 ML2	2x RAID slot, 2x PCle x16 LP, 1x PCle x8 LP, 1x ML2 x16 LP, 1x LOM	None	Operator panel with LCD	TPM 1.2	XClarity Enterprise	4x 1600W Platinum	3-year	11/17
7X13A003CN	HTK	2x Xeon Platinum 8176 28C/2.1GHz/38.5MB/165W/DDR4-2666	2	4	12x 64GB LRDIMM DDR4-2666 (4Rx4)	24	48	1x 930-16i 4GB Flash	12x 2.5" SATA/SAS HS	12	2x 400GB SSD SAS12Gbps, 3x 3.84TB SSD SAS12Gbps	None	None	1xMgmt	2x 2x 25GbE SFP28 PCle, 4x GbE RJ-45 ML2	1x RAID slot, 2x PCle x16 LP, 1x PCle x8 LP, 1x ML2 x16 LP, 1x LOM	None	Operator panel with LCD	TPM 1.2	XClarity Enterprise	4x 1600W Platinum	3-year	11/17
7X13A004CN	HTK	4x Xeon Platinum 8176M 28C/2.1GHz/38.5MB/165W/DDR4-2666	4	4	48x 128GB 3DS RDIMM DDR4-2666 (8Rx4)	48	48	1x 930-16i 4GB Flash	12x 2.5" SATA/SAS HS	12	2x 400GB SSD SAS12Gbps, 9x 3.84TB SSD SAS12Gbps	None	None	1xMgmt	2x 2x 25GbE SFP28 PCle, 4x GbE RJ-45 ML2	1x RAID slot, 2x PCle x16 LP, 1x PCle x8 LP, 1x ML2 x16 LP, 1x LOM	None	Operator panel with LCD	TPM 1.2	XClarity Enterprise	4x 1600W Platinum	3-year	11/17
7X13A005CN	HTK	4x Xeon Platinum 8176 28C/2.1GHz/38.5MB/165W/DDR4-2666	4	4	48x 64GB LRDIMM DDR4-2666 (4Rx4)	48	48	1x 930-16i 4GB Flash	12x 2.5" SATA/SAS HS	12	2x 400GB SSD SAS12Gbps, 5x 3.84TB SSD SAS12Gbps	None	None	1xMgmt	2x 2x 25GbE SFP28 PCle, 4x GbE RJ-45 ML2	1x RAID slot, 2x PCle x16 LP, 1x PCle x8 LP, 1x ML2 x16 LP, 1x LOM	None	Operator panel with LCD	TPM 1.2	XClarity Enterprise	4x 1600W Platinum	3-year	11/17

Model	Region	Processor	CPU Sockets (std)	CPU Sockets (max)	Memory	Memory Sockets (std)	Memory Sockets (max)	Storage Controller	Disk Bays	Max Disk Bays	Disk	PCle Flash Adapter	M.2 Drives	Onboard Networking Ports	Additional Networking (LOM/ML2/PCle)	Standard Extension Slots	Available Extension Slots via Riser Cards	Front Panel	TPM	System Management	Power Supply	Warranty	Ann Date (mm/yy)
7X12A01HCN	HTK	2x Xeon Platinum 8156 4C/3.6GHz/16.5MB/105W/DDR4-2666	2	8	2x 16GB RDIMM DDR4-2666 (2Rx8)	24	96	1x 930-16i 4GB Flash	12x 2.5" SATA/SAS HS	12	None	None	None	1xMgmt	4x GbE RJ-45 LOM	1x RAID slot, 2x PCIe x16 LP, 1x PCIe x8 LP, 1x ML2 x16 LP, 1x LOM	None	Operator panel with LCD	TPM 1.2	XClarity Enterprise	2x 1600W Platinum	3-year	07/17
7X12A01JCN	HTK	2x Xeon Platinum 8153 16C/2.0GHz/22MB/125W/DDR4-2666	2	8	2x 16GB RDIMM DDR4-2666 (2Rx8)	24	96	1x 930-16i 4GB Flash	12x 2.5" SATA/SAS HS	12	None	None	None	1xMgmt	4x GbE RJ-45 LOM	1x RAID slot, 2x PCIe x16 LP, 1x PCIe x8 LP, 1x ML2 x16 LP, 1x LOM	None	Operator panel with LCD	TPM 1.2	XClarity Enterprise	2x 1600W Platinum	3-year	07/17
7X12A01KCN	HTK	2x Xeon Gold 6130 16C/2.1GHz/22MB/125W/DDR4-2666	2	4	2x 16GB RDIMM DDR4-2666 (2Rx8)	24	48	1x 930-16i 4GB Flash	12x 2.5" SATA/SAS HS	12	None	None	None	1xMgmt	4x GbE RJ-45 LOM	1x RAID slot, 2x PCIe x16 LP, 1x PCIe x8 LP, 1x ML2 x16 LP, 1x LOM	None	Operator panel with LCD	TPM 1.2	XClarity Enterprise	2x 1600W Platinum	3-year	07/17
7X12A01LCN	HTK	2x Xeon Gold 6152 22C/2.1GHz/30.25MB/140W/DDR4-2666	2	4	2x 16GB RDIMM DDR4-2666 (2Rx8)	24	48	1x 930-16i 4GB Flash	12x 2.5" SATA/SAS HS	12	None	None	None	1xMgmt	4x GbE RJ-45 LOM	1x RAID slot, 2x PCIe x16 LP, 1x PCIe x8 LP, 1x ML2 x16 LP, 1x LOM	None	Operator panel with LCD	TPM 1.2	XClarity Enterprise	2x 1600W Platinum	3-year	07/17
7X12A01NCN	HTK	2x Xeon Gold 6148 20C/2.4GHz/27.5MB/150W/DDR4-2666	2	4	2x 16GB RDIMM DDR4-2666 (2Rx8)	24	48	1x 930-16i 4GB Flash	12x 2.5" SATA/SAS HS	12	None	None	None	1xMgmt	4x GbE RJ-45 LOM	1x RAID slot, 2x PCIe x16 LP, 1x PCIe x8 LP, 1x ML2 x16 LP, 1x LOM	None	Operator panel with LCD	TPM 1.2	XClarity Enterprise	2x 1600W Platinum	3-year	07/17
7X12A01PCN	HTK	2x Xeon Gold 6142 16C/2.6GHz/22MB/150W/DDR4-2666	2	4	2x 16GB RDIMM DDR4-2666 (2Rx8)	24	48	1x 930-16i 4GB Flash	12x 2.5" SATA/SAS HS	12	None	None	None	1xMgmt	4x GbE RJ-45 LOM	1x RAID slot, 2x PCIe x16 LP, 1x PCIe x8 LP, 1x ML2 x16 LP, 1x LOM	None	Operator panel with LCD	TPM 1.2	XClarity Enterprise	2x 1600W Platinum	3-year	07/17
7X12A01QCN	HTK	2x Xeon Platinum 8160 24C/2.1GHz/33MB/150W/DDR4-2666	2	8	2x 16GB RDIMM DDR4-2666 (2Rx8)	24	96	1x 930-16i 4GB Flash	12x 2.5" SATA/SAS HS	12	None	None	None	1xMgmt	4x GbE RJ-45 LOM	1x RAID slot, 2x PCIe x16 LP, 1x PCIe x8 LP, 1x ML2 x16 LP, 1x LOM	None	Operator panel with LCD	TPM 1.2	XClarity Enterprise	2x 1600W Platinum	3-year	07/17

Model	Region	Processor	CPU Sockets (std)	CPU Sockets (max)	Memory	Memory Sockets (std)	Memory Sockets (max)	Storage Controller	Disk Bays	Max Disk Bays	Disk Bays	PCIe Flash Adapter	M.2 Drives	Onboard Networking Ports	Additional Networking (LOM/ML2/PCIe)	Standard Extension Slots	Available Extension Slots via Riser Cards	Front Panel	TPM	System Management	Power Supply	Warranty	Ann Date (mm/yy)
7X12A01RCN	HTK	2x Xeon Gold 6140 18C/2.3GHz/24.75MB/140W/DDR4-2666	2	4	2x 16GB RDIMM DDR4-2666 (2Rx8)	24	48	1x 930-16i 4GB Flash	12x 2.5" SATA/SAS HS	12	None	None	None	1xMgmt	4x GbE RJ-45 LOM	1x RAID slot, 2x PCIe x16 LP, 1x PCIe x8 LP, 1x ML2 x16 LP, 1x LOM	None	Operator panel with LCD	TPM 1.2	XClarity Enterprise	2x 1600W Platinum	3-year	07/17

Model	Region	Processor	CPU Sockets (std)	CPU Sockets (max)	Memory (std)	Memory Sockets (std)	Memory Sockets (max)	Storage Controller	Disk Bays	Max Disk Bays	Disk Bays	PCIe Flash Adapter	M.2 Drives	Onboard Networking Ports	Additional Networking (LOM/ML2/PCle)	Standard Extension Slots	Available Extension Slots via Riser Cards	Front Panel	TPM	System Management	Power Supply	Warranty	Ann Date (mm/yy)
7X12A00VSG	INDIA	2x Xeon Gold 6126 12C/2.6GHz/19.25MB/125W/DDR4-2666	2	4	2x 16GB RDIMM DDR4-2666 (1Rx4)	24	48	1x 930-16i 4GB Flash	4x 2.5" SATA/SAS HS	12	None	None	None	1xMgmt	4x GbE RJ-45 LOM	1x RAID slot, 2x PCle x16 LP, 1x PCle x8 LP, 1x ML2 x16 LP, 1x LOM	None	Operator panel with LCD	TPM 1.2	XClarity Enterprise	2x 1100W Platinum	3-year	07/17
7X12A00YSG	INDIA	2x Xeon Platinum 8180 28C/2.5GHz/38.5MB/205W/DDR4-2666	2	8	2x 16GB RDIMM DDR4-2666 (1Rx4)	24	96	1x 930-16i 4GB Flash	4x 2.5" SATA/SAS HS	12	None	None	None	1xMgmt	4x GbE RJ-45 LOM	1x RAID slot, 2x PCle x16 LP, 1x PCle x8 LP, 1x ML2 x16 LP, 1x LOM	None	Operator panel with LCD	TPM 1.2	XClarity Enterprise	2x 1100W Platinum	3-year	07/17
7X12A00ZSG	INDIA	2x Xeon Platinum 8160M 24C/2.1GHz/33MB/150W/DDR4-2666	2	4	2x 32GB RDIMM DDR4-2666 (2Rx4)	24	48	1x 930-16i 4GB Flash	4x 2.5" SATA/SAS HS	12	None	None	None	1xMgmt	4x GbE RJ-45 LOM	1x RAID slot, 2x PCle x16 LP, 1x PCle x8 LP, 1x ML2 x16 LP, 1x LOM	None	Operator panel with LCD	TPM 1.2	XClarity Enterprise	2x 1100W Platinum	3-year	07/17
7X12A010SG	INDIA	2x Xeon Gold 6142M 16C/2.6GHz/22MB/150W/DDR4-2666	2	4	2x 16GB RDIMM DDR4-2666 (1Rx4)	24	48	1x 930-16i 4GB Flash	4x 2.5" SATA/SAS HS	12	None	None	None	1xMgmt	4x GbE RJ-45 LOM	1x RAID slot, 2x PCle x16 LP, 1x PCle x8 LP, 1x ML2 x16 LP, 1x LOM	None	Operator panel with LCD	TPM 1.2	XClarity Enterprise	2x 1100W Platinum	3-year	07/17
7X12A011SG	INDIA	2x Xeon Platinum 8164 26C/2.0GHz/35.75MB/150W/DDR4-2666	2	8	2x 16GB RDIMM DDR4-2666 (1Rx4)	24	96	1x 930-16i 4GB Flash	4x 2.5" SATA/SAS HS	12	None	None	None	1xMgmt	4x GbE RJ-45 LOM	1x RAID slot, 2x PCle x16 LP, 1x PCle x8 LP, 1x ML2 x16 LP, 1x LOM	None	Operator panel with LCD	TPM 1.2	XClarity Enterprise	2x 1100W Platinum	3-year	07/17
7X12A00PSG	INDIA	2x Xeon Platinum 8158 12C/3.0GHz/24.75MB/150W/DDR4-2666	2	4	2x 16GB RDIMM DDR4-2666 (1Rx4)	24	48	1x 930-16i 4GB Flash	4x 2.5" SATA/SAS HS	12	None	None	None	1xMgmt	4x GbE RJ-45 LOM	1x RAID slot, 2x PCle x16 LP, 1x PCle x8 LP, 1x ML2 x16 LP, 1x LOM	None	Operator panel with LCD	TPM 1.2	XClarity Enterprise	2x 1100W Platinum	3-year	07/17
7X12A00JSG	INDIA	2x Xeon Gold 6134M 8C/3.2GHz/24.75MB/130W/DDR4-2666	2	4	2x 16GB RDIMM DDR4-2666 (1Rx4)	24	48	1x 930-16i 4GB Flash	4x 2.5" SATA/SAS HS	12	None	None	None	1xMgmt	4x GbE RJ-45 LOM	1x RAID slot, 2x PCle x16 LP, 1x PCle x8 LP, 1x ML2 x16 LP, 1x LOM	None	Operator panel with LCD	TPM 1.2	XClarity Enterprise	2x 1100W Platinum	3-year	07/17

Model	Region	Processor	CPU Sockets (std)	CPU Sockets (max)	Memory	Memory Sockets (std)	Memory Sockets (max)	Storage Controller	Disk Bays	Max Disk Bays	Disks	PCIe Flash Adapter	M.2 Drives	Onboard Networking Ports	Additional Networking (LOM/ML2/PCle)	Standard Extension Slots	Available Extension Slots via Riser Cards	Front Panel	TPM	System Management	Power Supply	Warranty	Ann Date (mm/yy)
7X12A00KSG	INDIA	2x Xeon Gold 6134M 8C/3.2GHz/24.75MB/130W/DDR4-2666	2	4	2x 32GB RDIMM DDR4-2666 (2Rx4)	24	48	1x 930-16i 4GB Flash	4x 2.5" SATA/SAS HS	12	None	None	None	1xMgmt	4x GbE RJ-45 LOM	1x RAID slot, 2x PCle x16 LP, 1x PCle x8 LP, 1x ML2 x16 LP, 1x LOM	None	Operator panel with LCD	TPM 1.2	XClarity Enterprise	2x 1100W Platinum	3-year	07/17
7X12A00DSG	INDIA	2x Xeon Platinum 8160M 24C/2.1GHz/33MB/150W/DDR4-2666	2	4	2x 16GB RDIMM DDR4-2666 (1Rx4)	24	48	1x 930-16i 4GB Flash	4x 2.5" SATA/SAS HS	12	None	None	None	1xMgmt	4x GbE RJ-45 LOM	1x RAID slot, 2x PCle x16 LP, 1x PCle x8 LP, 1x ML2 x16 LP, 1x LOM	None	Operator panel with LCD	TPM 1.2	XClarity Enterprise	2x 1100W Platinum	3-year	07/17
7X12A001SG	INDIA	2x Xeon Gold 6142M 16C/2.6GHz/22MB/150W/DDR4-2666	2	4	2x 32GB RDIMM DDR4-2666 (2Rx4)	24	48	1x 930-16i 4GB Flash	4x 2.5" SATA/SAS HS	12	None	None	None	1xMgmt	4x GbE RJ-45 LOM	1x RAID slot, 2x PCle x16 LP, 1x PCle x8 LP, 1x ML2 x16 LP, 1x LOM	None	Operator panel with LCD	TPM 1.2	XClarity Enterprise	2x 1100W Platinum	3-year	07/17
7X12A002SG	INDIA	2x Xeon Gold 6132 14C/2.6GHz/19.25MB/140W/DDR4-2666	2	4	2x 16GB RDIMM DDR4-2666 (1Rx4)	24	48	1x 930-16i 4GB Flash	4x 2.5" SATA/SAS HS	12	None	None	None	1xMgmt	4x GbE RJ-45 LOM	1x RAID slot, 2x PCle x16 LP, 1x PCle x8 LP, 1x ML2 x16 LP, 1x LOM	None	Operator panel with LCD	TPM 1.2	XClarity Enterprise	2x 1100W Platinum	3-year	07/17
7X12A004SG	INDIA	2x Xeon Gold 6142 16C/2.6GHz/22MB/150W/DDR4-2666	2	4	2x 16GB RDIMM DDR4-2666 (1Rx4)	24	48	1x 930-16i 4GB Flash	4x 2.5" SATA/SAS HS	12	None	None	None	1xMgmt	4x GbE RJ-45 LOM	1x RAID slot, 2x PCle x16 LP, 1x PCle x8 LP, 1x ML2 x16 LP, 1x LOM	None	Operator panel with LCD	TPM 1.2	XClarity Enterprise	2x 1100W Platinum	3-year	07/17
7X12A005SG	INDIA	2x Xeon Gold 6152 22C/2.1GHz/30.25MB/140W/DDR4-2666	2	4	2x 16GB RDIMM DDR4-2666 (1Rx4)	24	48	1x 930-16i 4GB Flash	4x 2.5" SATA/SAS HS	12	None	None	None	1xMgmt	4x GbE RJ-45 LOM	1x RAID slot, 2x PCle x16 LP, 1x PCle x8 LP, 1x ML2 x16 LP, 1x LOM	None	Operator panel with LCD	TPM 1.2	XClarity Enterprise	2x 1100W Platinum	3-year	07/17
7X12A006SG	INDIA	2x Xeon Gold 6140M 18C/2.3GHz/24.75MB/140W/DDR4-2666	2	4	2x 16GB RDIMM DDR4-2666 (1Rx4)	24	48	1x 930-16i 4GB Flash	4x 2.5" SATA/SAS HS	12	None	None	None	1xMgmt	4x GbE RJ-45 LOM	1x RAID slot, 2x PCle x16 LP, 1x PCle x8 LP, 1x ML2 x16 LP, 1x LOM	None	Operator panel with LCD	TPM 1.2	XClarity Enterprise	2x 1100W Platinum	3-year	07/17

Model	Region	Processor	CPU Sockets (std)	CPU Sockets (max)	Memory (std)	Memory Sockets (std)	Memory Sockets (max)	Storage Controller	Disk Bays	Max Disk Bays	Disk Bays	PCIe Flash Adapter	M.2 Drives	Onboard Networking Ports	Additional Networking (LOM/ML2/PCle)	Standard Extension Slots	Available Extension Slots via Riser Cards	Front Panel	TPM	System Management	Power Supply	Warranty	Ann Date (mm/yy)
7X12A008SG	INDIA	2x Xeon Gold 6140 18C/2.3GHz/24.75MB/140W/DDR4-2666	2	4	2x 16GB RDIMM DDR4-2666 (1Rx4)	24	48	1x 930-16i 4GB Flash	4x 2.5" SATA/SAS HS	12	None	None	None	1xMgmt	4x GbE RJ-45 LOM	1x RAID slot, 2x PCIe x16 LP, 1x PCIe x8 LP, 1x ML2 x16 LP, 1x LOM	None	Operator panel with LCD	TPM 1.2	XClarity Enterprise	2x 1100W Platinum	3-year	07/17
7X12A009SG	INDIA	2x Xeon Gold 6150 18C/2.7GHz/24.75MB/165W/DDR4-2666	2	4	2x 16GB RDIMM DDR4-2666 (1Rx4)	24	48	1x 930-16i 4GB Flash	4x 2.5" SATA/SAS HS	12	None	None	None	1xMgmt	4x GbE RJ-45 LOM	1x RAID slot, 2x PCIe x16 LP, 1x PCIe x8 LP, 1x ML2 x16 LP, 1x LOM	None	Operator panel with LCD	TPM 1.2	XClarity Enterprise	2x 1100W Platinum	3-year	07/17
7X12A00ASG	INDIA	2x Xeon Gold 6148 20C/2.4GHz/27.5MB/150W/DDR4-2666	2	4	2x 16GB RDIMM DDR4-2666 (1Rx4)	24	48	1x 930-16i 4GB Flash	4x 2.5" SATA/SAS HS	12	None	None	None	1xMgmt	4x GbE RJ-45 LOM	1x RAID slot, 2x PCIe x16 LP, 1x PCIe x8 LP, 1x ML2 x16 LP, 1x LOM	None	Operator panel with LCD	TPM 1.2	XClarity Enterprise	2x 1100W Platinum	3-year	07/17

Model	Region	Processor	CPU Sockets (std)	CPU Sockets (max)	Memory	Memory Sockets (std)	Memory Sockets (max)	Storage Controller	Disk Bays	Max Disk Bays	Disks	PCIe Flash Adapter	M.2 Drives	Onboard Networking Ports	Additional Networking (LOM/ML2/PCIe)	Standard Extension Slots	Available Extension Slots via Riser Cards	Front Panel	TPM	System Management	Power Supply	Warranty	Ann Date (mm/yy)
7X12A00MJP	JAPAN	2x Xeon Gold 6128 6C/3.4GHz/19.25MB/115W/DDR4-2666	2	4	4x 16GB RDIMM DDR4-2666 (1Rx4)	24	48	1x 930-16i 4GB Flash	4x 2.5" HS (2x SATA/SAS, 2x AnyBay)	12	None	None	None	1xMgmt	4x 10GbE RJ-45 LOM	1x RAID slot, 2x PCIe x16 LP, 1x PCIe x8 LP, 1x ML2 x16 LP, 1x LOM	2x PCIe x8 LP	Operator panel with LCD	TPM 1.2	XClarity Enterprise	4x 1100W Platinum	3-year	07/17
7X12A012JP	JAPAN	4x Xeon Platinum 8180 28C/2.5GHz/38.5MB/205W/DDR4-2666	4	8	4x 16GB RDIMM DDR4-2666 (1Rx4)	48	96	1x 930-16i 4GB Flash	4x 2.5" HS (2x SATA/SAS, 2x AnyBay)	12	None	None	None	1xMgmt	4x 10GbE RJ-45 LOM	1x RAID slot, 2x PCIe x16 LP, 1x PCIe x8 LP, 1x ML2 x16 LP, 1x LOM	2x PCIe x8 LP	Operator panel with LCD	TPM 1.2	XClarity Enterprise	4x 1600W Platinum	3-year	07/17
7X12A013JP	JAPAN	2x Xeon Gold 6154 18C/3.0GHz/24.75MB/200W/DDR4-2666	2	4	2x 16GB RDIMM DDR4-2666 (1Rx4)	24	48	1x 930-16i 4GB Flash	4x 2.5" HS (2x SATA/SAS, 2x AnyBay)	12	None	None	None	1xMgmt	4x 10GbE RJ-45 LOM	1x RAID slot, 2x PCIe x16 LP, 1x PCIe x8 LP, 1x ML2 x16 LP, 1x LOM	2x PCIe x8 LP	Operator panel with LCD	TPM 1.2	XClarity Enterprise	2x 1600W Platinum	3-year	07/17
7X13A005JP	JAPAN	4x Xeon Platinum 8176 28C/2.1GHz/38.5MB/165W/DDR4-2666	4	4	48x 64GB LRDIMM DDR4-2666 (4Rx4)	48	48	1x 930-16i 4GB Flash	12x 2.5" SATA/SAS HS	12	2x 400GB SSD SAS12Gbps, 5x 3.84TB SSD SAS12Gbps	None	None	1xMgmt	2x 2x 25GbE SFP28 PCIe, 4x GbE RJ-45 ML2	1x RAID slot, 2x PCIe x16 LP, 1x PCIe x8 LP, 1x ML2 x16 LP, 1x LOM	None	Operator panel with LCD	TPM 1.2	XClarity Enterprise	4x 1600W Platinum	3-year	11/17
7X13A004JP	JAPAN	4x Xeon Platinum 8176M 28C/2.1GHz/38.5MB/165W/DDR4-2666	4	4	48x 128GB 3DS RDIMM DDR4-2666 (8Rx4)	48	48	1x 930-16i 4GB Flash	12x 2.5" SATA/SAS HS	12	2x 400GB SSD SAS12Gbps, 9x 3.84TB SSD SAS12Gbps	None	None	1xMgmt	2x 2x 25GbE SFP28 PCIe, 4x GbE RJ-45 ML2	1x RAID slot, 2x PCIe x16 LP, 1x PCIe x8 LP, 1x ML2 x16 LP, 1x LOM	None	Operator panel with LCD	TPM 1.2	XClarity Enterprise	4x 1600W Platinum	3-year	11/17
7X13A003JP	JAPAN	2x Xeon Platinum 8176 28C/2.1GHz/38.5MB/165W/DDR4-2666	2	4	12x 64GB LRDIMM DDR4-2666 (4Rx4)	24	48	1x 930-16i 4GB Flash	12x 2.5" SATA/SAS HS	12	2x 400GB SSD SAS12Gbps, 3x 3.84TB SSD SAS12Gbps	None	None	1xMgmt	2x 2x 25GbE SFP28 PCIe, 4x GbE RJ-45 ML2	1x RAID slot, 2x PCIe x16 LP, 1x PCIe x8 LP, 1x ML2 x16 LP, 1x LOM	None	Operator panel with LCD	TPM 1.2	XClarity Enterprise	4x 1600W Platinum	3-year	11/17
7X13A002JP	JAPAN	8x Xeon Platinum 8176 28C/2.1GHz/38.5MB/165W/DDR4-2666	8	8	96x 64GB LRDIMM DDR4-2666 (4Rx4)	96	96	1x 930-16i 4GB Flash	12x 2.5" SATA/SAS HS	24	2x 400GB SSD SAS12Gbps, 9x 3.84TB SSD SAS12Gbps	None	None	1xMgmt	2x 2x 25GbE SFP28 PCIe, 4x GbE RJ-45 ML2	2x RAID slot, 2x PCIe x16 LP, 1x PCIe x8 LP, 1x ML2 x16 LP, 1x LOM	None	Operator panel with LCD	TPM 1.2	XClarity Enterprise	4x 1600W Platinum	3-year	11/17

Model	Region	Processor	CPU Sockets (std)	CPU Sockets (max)	Memory	Memory Sockets (std)	Memory Sockets (max)	Storage Controller	Disk Bays	Max Disk Bays	Disks	PCIe Flash Adapter	M.2 Drives	Onboard Networking Ports	Additional Networking (LOM/ML2/PCIe)	Standard Extension Slots	Available Extension Slots via Riser Cards	Front Panel	TPM	System Management	Power Supply	Warranty	Ann Date (mm/yy)
7X13A00CJP	JAPAN	2x Xeon Platinum 8176 28C/2.1GHz/38.5MB/165W/DDR4-2666	2	4	12x 32GB RDIMM DDR4-2666 (2Rx4)	24	48	1x 930-16i 4GB Flash	12x 2.5" SATA/SAS HS	12	2x 400GB SSD SAS12Gbps, 3x 3.84TB SSD SAS12Gbps	None	None	1xMgmt	2x 2x 25GbE SFP28 PCIe, 4x GbE RJ-45 ML2	1x RAID slot, 2x PCIe x16 LP, 1x PCIe x8 LP, 1x ML2 x16 LP, 1x LOM	None	Operator panel with LCD	TPM 1.2	XClarity Enterprise	4x 1600W Platinum	3-year	11/17
7X13A00BJP	JAPAN	2x Xeon Platinum 8176M 28C/2.1GHz/38.5MB/165W/DDR4-2666	2	4	24x 128GB 3DS RDIMM DDR4-2666 (8Rx4)	24	48	1x 930-16i 4GB Flash	12x 2.5" SATA/SAS HS	12	2x 400GB SSD SAS12Gbps, 5x 3.84TB SSD SAS12Gbps	None	None	1xMgmt	2x 2x 25GbE SFP28 PCIe, 4x GbE RJ-45 ML2	1x RAID slot, 2x PCIe x16 LP, 1x PCIe x8 LP, 1x ML2 x16 LP, 1x LOM	None	Operator panel with LCD	TPM 1.2	XClarity Enterprise	4x 1600W Platinum	3-year	11/17
7X13A00AJP	JAPAN	8x Xeon Platinum 8176M 28C/2.1GHz/38.5MB/165W/DDR4-2666	8	8	48x 128GB 3DS RDIMM DDR4-2666 (8Rx4)	96	96	1x 930-16i 4GB Flash	12x 2.5" SATA/SAS HS	24	2x 400GB SSD SAS12Gbps, 9x 3.84TB SSD SAS12Gbps	None	None	1xMgmt	2x 2x 25GbE SFP28 PCIe, 4x GbE RJ-45 ML2	2x RAID slot, 2x PCIe x16 LP, 1x PCIe x8 LP, 1x ML2 x16 LP, 1x LOM	None	Operator panel with LCD	TPM 1.2	XClarity Enterprise	4x 1600W Platinum	3-year	11/17
7X13A009JP	JAPAN	2x Xeon Platinum 8176 28C/2.1GHz/38.5MB/165W/DDR4-2666	2	4	12x 16GB RDIMM DDR4-2666 (2Rx8)	24	48	1x 930-16i 4GB Flash	12x 2.5" SATA/SAS HS	12	2x 400GB SSD SAS12Gbps, 3x 3.84TB SSD SAS12Gbps	None	None	1xMgmt	2x 2x 25GbE SFP28 PCIe, 4x GbE RJ-45 ML2	1x RAID slot, 2x PCIe x16 LP, 1x PCIe x8 LP, 1x ML2 x16 LP, 1x LOM	None	Operator panel with LCD	TPM 1.2	XClarity Enterprise	4x 1600W Platinum	3-year	11/17
7X13A008JP	JAPAN	4x Xeon Platinum 8176 28C/2.1GHz/38.5MB/165W/DDR4-2666	4	4	24x 64GB LRDIMM DDR4-2666 (4Rx4)	48	48	1x 930-16i 4GB Flash	12x 2.5" SATA/SAS HS	12	2x 400GB SSD SAS12Gbps, 3x 3.84TB SSD SAS12Gbps	None	None	1xMgmt	2x 2x 25GbE SFP28 PCIe, 4x GbE RJ-45 ML2	1x RAID slot, 2x PCIe x16 LP, 1x PCIe x8 LP, 1x ML2 x16 LP, 1x LOM	None	Operator panel with LCD	TPM 1.2	XClarity Enterprise	4x 1600W Platinum	3-year	11/17
7X13A007JP	JAPAN	8x Xeon Platinum 8176M 28C/2.1GHz/38.5MB/165W/DDR4-2666	8	8	96x 128GB 3DS RDIMM DDR4-2666 (8Rx4)	96	96	2x 930-16i 4GB Flash	24x 2.5" SATA/SAS HS	24	2x 400GB SSD SAS12Gbps, 18x 3.84TB SSD SAS12Gbps	None	None	1xMgmt	2x 2x 25GbE SFP28 PCIe, 4x GbE RJ-45 ML2	2x RAID slot, 2x PCIe x16 LP, 1x PCIe x8 LP, 1x ML2 x16 LP, 1x LOM	None	Operator panel with LCD	TPM 1.2	XClarity Enterprise	4x 1600W Platinum	3-year	11/17
7X13A006JP	JAPAN	4x Xeon Platinum 8176M 28C/2.1GHz/38.5MB/165W/DDR4-2666	4	4	24x 128GB 3DS RDIMM DDR4-2666 (8Rx4)	48	48	1x 930-16i 4GB Flash	12x 2.5" SATA/SAS HS	12	2x 400GB SSD SAS12Gbps, 5x 3.84TB SSD SAS12Gbps	None	None	1xMgmt	2x 2x 25GbE SFP28 PCIe, 4x GbE RJ-45 ML2	1x RAID slot, 2x PCIe x16 LP, 1x PCIe x8 LP, 1x ML2 x16 LP, 1x LOM	None	Operator panel with LCD	TPM 1.2	XClarity Enterprise	4x 1600W Platinum	3-year	11/17

Model	Region	Processor	CPU Sockets (std)	CPU Sockets (max)	Memory	Memory Sockets (std)	Memory Sockets (max)	Storage Controller	Disk Bays	Max Disk Bays	Disks	PCIe Flash Adapter	M.2 Drives	Onboard Networking Ports	Additional Networking (LOM/ML2/PCIe)	Standard Extension Slots	Available Extension Slots via Riser Cards	Front Panel	TPM	System Management	Power Supply	Warranty	Ann Date (mm/yy)
7X13A00ELA	LA	2x Xeon Platinum 8176 28C/2.1GHz/38.5MB/165W/DDR4-2666	2	4	12x 16GB RDIMM DDR4-2666 (2Rx8)	24	48	1x 930-16i 4GB Flash	12x 2.5" SATA/SAS HS	12	2x 400GB SSD SAS12Gbps, 3x 3.84TB SSD SAS12Gbps	None	None	1xMgmt	2x 2x 25GbE SFP28 PCIe, 4x GbE RJ-45 ML2	1x RAID slot, 2x PCIe x16 LP, 1x PCIe x8 LP, 1x ML2 x16 LP, 1x LOM	None	Operator panel with LCD	TPM 1.2	XClarity Enterprise	4x 1600W Platinum	3-year	11/17
7X13A00FLA	LA	2x Xeon Platinum 8176 28C/2.1GHz/38.5MB/165W/DDR4-2666	2	4	12x 32GB RDIMM DDR4-2666 (2Rx4)	24	48	1x 930-16i 4GB Flash	12x 2.5" SATA/SAS HS	12	2x 400GB SSD SAS12Gbps, 3x 3.84TB SSD SAS12Gbps	None	None	1xMgmt	2x 2x 25GbE SFP28 PCIe, 4x GbE RJ-45 ML2	1x RAID slot, 2x PCIe x16 LP, 1x PCIe x8 LP, 1x ML2 x16 LP, 1x LOM	None	Operator panel with LCD	TPM 1.2	XClarity Enterprise	4x 1600W Platinum	3-year	11/17
7X13A00GLA	LA	2x Xeon Platinum 8176 28C/2.1GHz/38.5MB/165W/DDR4-2666	2	4	12x 64GB LRDIMM DDR4-2666 (4Rx4)	24	48	1x 930-16i 4GB Flash	12x 2.5" SATA/SAS HS	12	2x 400GB SSD SAS12Gbps, 3x 3.84TB SSD SAS12Gbps	None	None	1xMgmt	2x 2x 25GbE SFP28 PCIe, 4x GbE RJ-45 ML2	1x RAID slot, 2x PCIe x16 LP, 1x PCIe x8 LP, 1x ML2 x16 LP, 1x LOM	None	Operator panel with LCD	TPM 1.2	XClarity Enterprise	4x 1600W Platinum	3-year	11/17
7X13A00QLA	LA	8x Xeon Platinum 8176M 28C/2.1GHz/38.5MB/165W/DDR4-2666	8	8	96x 128GB 3DS RDIMM DDR4-2666 (8Rx4)	96	96	2x 930-16i 4GB Flash	24x 2.5" SATA/SAS HS	24	2x 400GB SSD SAS12Gbps, 18x 3.84TB SSD SAS12Gbps	None	None	1xMgmt	2x 2x 25GbE SFP28 PCIe, 4x GbE RJ-45 ML2	2x RAID slot, 2x PCIe x16 LP, 1x PCIe x8 LP, 1x ML2 x16 LP, 1x LOM	None	Operator panel with LCD	TPM 1.2	XClarity Enterprise	4x 1600W Platinum	3-year	11/17
7X13A00HLA	LA	2x Xeon Platinum 8176M 28C/2.1GHz/38.5MB/165W/DDR4-2666	2	4	24x 128GB 3DS RDIMM DDR4-2666 (8Rx4)	24	48	1x 930-16i 4GB Flash	12x 2.5" SATA/SAS HS	12	2x 400GB SSD SAS12Gbps, 5x 3.84TB SSD SAS12Gbps	None	None	1xMgmt	2x 2x 25GbE SFP28 PCIe, 4x GbE RJ-45 ML2	1x RAID slot, 2x PCIe x16 LP, 1x PCIe x8 LP, 1x ML2 x16 LP, 1x LOM	None	Operator panel with LCD	TPM 1.2	XClarity Enterprise	4x 1600W Platinum	3-year	11/17
7X13A00JLA	LA	4x Xeon Platinum 8176 28C/2.1GHz/38.5MB/165W/DDR4-2666	4	4	24x 64GB LRDIMM DDR4-2666 (4Rx4)	48	48	1x 930-16i 4GB Flash	12x 2.5" SATA/SAS HS	12	2x 400GB SSD SAS12Gbps, 3x 3.84TB SSD SAS12Gbps	None	None	1xMgmt	2x 2x 25GbE SFP28 PCIe, 4x GbE RJ-45 ML2	1x RAID slot, 2x PCIe x16 LP, 1x PCIe x8 LP, 1x ML2 x16 LP, 1x LOM	None	Operator panel with LCD	TPM 1.2	XClarity Enterprise	4x 1600W Platinum	3-year	11/17
7X13A00KLA	LA	4x Xeon Platinum 8176 28C/2.1GHz/38.5MB/165W/DDR4-2666	4	4	48x 64GB LRDIMM DDR4-2666 (4Rx4)	48	48	1x 930-16i 4GB Flash	12x 2.5" SATA/SAS HS	12	2x 400GB SSD SAS12Gbps, 5x 3.84TB SSD SAS12Gbps	None	None	1xMgmt	2x 2x 25GbE SFP28 PCIe, 4x GbE RJ-45 ML2	1x RAID slot, 2x PCIe x16 LP, 1x PCIe x8 LP, 1x ML2 x16 LP, 1x LOM	None	Operator panel with LCD	TPM 1.2	XClarity Enterprise	4x 1600W Platinum	3-year	11/17

Model	Region	Processor	CPU Sockets (std)	CPU Sockets (max)	Memory	Memory Sockets (std)	Memory Sockets (max)	Storage Controller	Disk Bays	Max Disk Bays	Disks	PCIe Flash Adapter	M.2 Drives	Onboard Networking Ports	Additional Networking (LOM/ML2/PCIe)	Standard Extension Slots	Available Extension Slots via Riser Cards	Front Panel	TPM	System Management	Power Supply	Warranty	Ann Date (mm/yy)
7X13A00LLA	LA	4x Xeon Platinum 8176M 28C/2.1GHz/38.5MB/165W/DDR4-2666	4	4	24x 128GB 3DS RDIMM DDR4-2666 (8Rx4)	48	48	1x 930-16i 4GB Flash	12x 2.5" SATA/SAS HS	12	2x 400GB SSD SAS12Gbps, 5x 3.84TB SSD SAS12Gbps	None	None	1xMgmt	2x 2x 25GbE SFP28 PCIe, 4x GbE RJ-45 ML2	1x RAID slot, 2x PCIe x16 LP, 1x PCIe x8 LP, 1x ML2 x16 LP, 1x LOM	None	Operator panel with LCD	TPM 1.2	XClarity Enterprise	4x 1600W Platinum	3-year	11/17
7X13A00MLA	LA	4x Xeon Platinum 8176M 28C/2.1GHz/38.5MB/165W/DDR4-2666	4	4	48x 128GB 3DS RDIMM DDR4-2666 (8Rx4)	48	48	1x 930-16i 4GB Flash	12x 2.5" SATA/SAS HS	12	2x 400GB SSD SAS12Gbps, 9x 3.84TB SSD SAS12Gbps	None	None	1xMgmt	2x 2x 25GbE SFP28 PCIe, 4x GbE RJ-45 ML2	1x RAID slot, 2x PCIe x16 LP, 1x PCIe x8 LP, 1x ML2 x16 LP, 1x LOM	None	Operator panel with LCD	TPM 1.2	XClarity Enterprise	4x 1600W Platinum	3-year	11/17
7X13A00NLA	LA	8x Xeon Platinum 8176 28C/2.1GHz/38.5MB/165W/DDR4-2666	8	8	96x 64GB LRDIMM DDR4-2666 (4Rx4)	96	96	1x 930-16i 4GB Flash	12x 2.5" SATA/SAS HS	24	2x 400GB SSD SAS12Gbps, 9x 3.84TB SSD SAS12Gbps	None	None	1xMgmt	2x 2x 25GbE SFP28 PCIe, 4x GbE RJ-45 ML2	2x RAID slot, 2x PCIe x16 LP, 1x PCIe x8 LP, 1x ML2 x16 LP, 1x LOM	None	Operator panel with LCD	TPM 1.2	XClarity Enterprise	4x 1600W Platinum	3-year	11/17
7X13A00PLA	LA	8x Xeon Platinum 8176M 28C/2.1GHz/38.5MB/165W/DDR4-2666	8	8	48x 128GB 3DS RDIMM DDR4-2666 (8Rx4)	96	96	1x 930-16i 4GB Flash	12x 2.5" SATA/SAS HS	24	2x 400GB SSD SAS12Gbps, 9x 3.84TB SSD SAS12Gbps	None	None	1xMgmt	2x 2x 25GbE SFP28 PCIe, 4x GbE RJ-45 ML2	2x RAID slot, 2x PCIe x16 LP, 1x PCIe x8 LP, 1x ML2 x16 LP, 1x LOM	None	Operator panel with LCD	TPM 1.2	XClarity Enterprise	4x 1600W Platinum	3-year	11/17
7X12A01YLA	LA	4x Xeon Platinum 8176 28C/2.1GHz/38.5MB/165W/DDR4-2666	4	8	24x 16GB RDIMM DDR4-2666 (2Rx8)	48	96	2x 930-16i 4GB Flash	8x 2.5" HS (4x SATA/SAS, 4x AnyBay)	24	None	None	None	1xMgmt	4x 10GbE SFP+ LOM	2x RAID slot, 2x PCIe x16 LP, 1x PCIe x8 LP, 1x ML2 x16 LP, 1x LOM	5x PCIe x16 FHHL, 1x ML2 x16 FHHL	Operator panel with LCD	TPM 2.0	XClarity Enterprise	4x 1600W Platinum	3-year	08/17
7X12A01ZLA	LA	4x Xeon Platinum 8176 28C/2.1GHz/38.5MB/165W/DDR4-2666	4	8	24x 32GB RDIMM DDR4-2666 (2Rx4)	48	96	2x 930-16i 4GB Flash	8x 2.5" HS (4x SATA/SAS, 4x AnyBay)	24	None	None	None	1xMgmt	4x 10GbE SFP+ LOM	2x RAID slot, 2x PCIe x16 LP, 1x PCIe x8 LP, 1x ML2 x16 LP, 1x LOM	5x PCIe x16 FHHL, 1x ML2 x16 FHHL	Operator panel with LCD	TPM 2.0	XClarity Enterprise	4x 1600W Platinum	3-year	08/17
7X12A020LA	LA	4x Xeon Platinum 8170 26C/2.1GHz/35.75MB/165W/DDR4-2666	4	8	24x 16GB RDIMM DDR4-2666 (2Rx8)	48	96	2x 930-16i 4GB Flash	8x 2.5" HS (4x SATA/SAS, 4x AnyBay)	24	None	None	None	1xMgmt	4x 10GbE SFP+ LOM	2x RAID slot, 2x PCIe x16 LP, 1x PCIe x8 LP, 1x ML2 x16 LP, 1x LOM	5x PCIe x16 FHHL, 1x ML2 x16 FHHL	Operator panel with LCD	TPM 2.0	XClarity Enterprise	4x 1600W Platinum	3-year	08/17

Model	Region	Processor	CPU Sockets (std)	CPU Sockets (max)	Memory	Memory Sockets (std)	Memory Sockets (max)	Storage Controller	Disk Bays	Max Disk Bays	Disk	PCle Flash Adapter	M.2 Drives	Onboard Networking Ports	Additional Networking (LOM/ML2/PCle)	Standard Extension Slots	Available Extension Slots via Riser Cards	Front Panel	TPM	System Management	Power Supply	Warranty	Ann Date (mm/yy)
7X12A022LA	LA	4x Xeon Platinum 8164 26C/2.0GHz/35.75MB/150W/DDR4-2666	4	8	24x 16GB RDIMM DDR4-2666 (2Rx8)	48	96	2x 930-16i 4GB Flash	8x 2.5" HS (4x SATA/SAS, 4x AnyBay)	24	None	None	None	1xMgmt	4x 10GbE SFP+ LOM	2x RAID slot, 2x PCle x16 LP, 1x PCle x8 LP, 1x ML2 x16 LP, 1x LOM	5x PCIe x16 FHHL, 1x ML2 x16 FHHL	Operator panel with LCD	TPM 2.0	XClarity Enterprise	4x 1600W Platinum	3-year	08/17
7X12A023LA	LA	4x Xeon Platinum 8180 28C/2.5GHz/38.5MB/205W/DDR4-2666	4	8	24x 32GB RDIMM DDR4-2666 (2Rx4)	48	96	2x 930-16i 4GB Flash	8x 2.5" HS (4x SATA/SAS, 4x AnyBay)	24	None	None	None	1xMgmt	4x 10GbE SFP+ LOM	2x RAID slot, 2x PCle x16 LP, 1x PCle x8 LP, 1x ML2 x16 LP, 1x LOM	5x PCIe x16 FHHL, 1x ML2 x16 FHHL	Operator panel with LCD	TPM 2.0	XClarity Enterprise	4x 1600W Platinum	3-year	08/17
7X12A024LA	LA	4x Xeon Platinum 8153 16C/2.0GHz/22MB/125W/DDR4-2666	4	8	24x 16GB RDIMM DDR4-2666 (2Rx8)	48	96	2x 930-16i 4GB Flash	8x 2.5" HS (4x SATA/SAS, 4x AnyBay)	24	None	None	None	1xMgmt	4x 10GbE SFP+ LOM	2x RAID slot, 2x PCle x16 LP, 1x PCle x8 LP, 1x ML2 x16 LP, 1x LOM	5x PCIe x16 FHHL, 1x ML2 x16 FHHL	Operator panel with LCD	TPM 2.0	XClarity Enterprise	4x 1600W Platinum	3-year	08/17
7X12A025LA	LA	4x Xeon Platinum 8180 28C/2.5GHz/38.5MB/205W/DDR4-2666	4	8	24x 16GB RDIMM DDR4-2666 (2Rx8)	48	96	2x 930-16i 4GB Flash	8x 2.5" HS (4x SATA/SAS, 4x AnyBay)	24	None	None	None	1xMgmt	4x 10GbE SFP+ LOM	2x RAID slot, 2x PCle x16 LP, 1x PCle x8 LP, 1x ML2 x16 LP, 1x LOM	5x PCIe x16 FHHL, 1x ML2 x16 FHHL	Operator panel with LCD	TPM 2.0	XClarity Enterprise	4x 1600W Platinum	3-year	08/17

Model	Region	Processor	CPU Sockets (std)	CPU Sockets (max)	Memory	Memory Sockets (std)	Memory Sockets (max)	Storage Controller	Disk Bays	Max Disk Bays	Disks	PCIe Flash Adapter	M.2 Drives	Onboard Networking Ports	Additional Networking (LOM/ML2/PCle)	Standard Extension Slots	Available Extension Slots via Riser Cards	Front Panel	TPM	System Management	Power Supply	Warranty	Ann Date (mm/yy)
7X12A027NA	NA	4x Xeon Platinum 8180 28C/2.5GHz/38.5MB/205W/DDR4-2666	4	4	48x 32GB RDIMM DDR4-2666 (2Rx4)	48	48	1x 530-8i	8x 2.5" SATA/SAS HS	12	2x 480GB SSD SATA6Gbps, 6x 800GB SSD SAS12Gbps	8x 3.84TB PCIe 3.0 HHHL	None	1xMgmt	2x GbE RJ-45 LOM	1x RAID slot, 2x PCIe x16 LP, 1x PCIe x8 LP, 1x ML2 x16 LP, 1x LOM	8x PCIe x8 FHHL, 2x PCIe x8 LP	Operator panel with LCD	TPM 2.0	XClarity Enterprise	4x 1100W Platinum	3-year	02/18
7X12A01SNA	NA	8x Xeon Platinum 8160 24C/2.1GHz/33MB/150W/DDR4-2666	8	8	8x 32GB RDIMM DDR4-2666 (2Rx4)	96	96	2x 930-16i 4GB Flash	24x 2.5" HS (12x SATA/SAS, 12x AnyBay)	24	None	None	None	1xMgmt	None	2x RAID slot, 2x PCIe x16 LP, 1x PCIe x8 LP, 1x ML2 x16 LP, 1x LOM	9x PCIe x16 FHHL, 1x ML2 x16 FHHL, 2x PCIe x8 LP	Operator panel with LCD	TPM 1.2	XClarity Enterprise	4x 1600W Platinum	3-year	07/17
7X12A01MNA	NA	4x Xeon Platinum 8153 16C/2.0GHz/22MB/125W/DDR4-2666	4	8	4x 32GB RDIMM DDR4-2666 (2Rx4)	48	96	1x 930-8i 2GB Flash	8x 2.5" HS (4x SATA/SAS, 4x AnyBay)	12	None	None	None	1xMgmt	None	1x RAID slot, 2x PCIe x16 LP, 1x PCIe x8 LP, 1x ML2 x16 LP, 1x LOM	4x PCIe x16 FHHL, 2x PCIe x8 LP	Operator panel with LCD	TPM 1.2	XClarity Enterprise	2x 1600W Platinum	3-year	07/17
7X13A002NA	NA	8x Xeon Platinum 8176 28C/2.1GHz/38.5MB/165W/DDR4-2666	8	8	96x 64GB LRDIMM DDR4-2666 (4Rx4)	96	96	1x 930-16i 4GB Flash	12x 2.5" SATA/SAS HS	24	2x 400GB SSD SAS12Gbps, 9x 3.84TB SSD SAS12Gbps	None	None	1xMgmt	2x 2x 25GbE PCIe, 4x GbE RJ-45 ML2	2x RAID slot, 2x PCIe x16 LP, 1x PCIe x8 LP, 1x ML2 x16 LP, 1x LOM	None	Operator panel with LCD	TPM 1.2	XClarity Enterprise	4x 1600W Platinum	3-year	11/17
7X13A003NA	NA	2x Xeon Platinum 8176 28C/2.1GHz/38.5MB/165W/DDR4-2666	2	4	12x 64GB LRDIMM DDR4-2666 (4Rx4)	24	48	1x 930-16i 4GB Flash	12x 2.5" SATA/SAS HS	12	2x 400GB SSD SAS12Gbps, 3x 3.84TB SSD SAS12Gbps	None	None	1xMgmt	2x 2x 25GbE SFP28 PCIe, 4x GbE RJ-45 ML2	1x RAID slot, 2x PCIe x16 LP, 1x PCIe x8 LP, 1x ML2 x16 LP, 1x LOM	None	Operator panel with LCD	TPM 1.2	XClarity Enterprise	4x 1600W Platinum	3-year	11/17
7X13A004NA	NA	4x Xeon Platinum 8176M 28C/2.1GHz/38.5MB/165W/DDR4-2666	4	4	48x 128GB 3DS RDIMM DDR4-2666 (8Rx4)	48	48	1x 930-16i 4GB Flash	12x 2.5" SATA/SAS HS	12	2x 400GB SSD SAS12Gbps, 9x 3.84TB SSD SAS12Gbps	None	None	1xMgmt	2x 2x 25GbE SFP28 PCIe, 4x GbE RJ-45 ML2	1x RAID slot, 2x PCIe x16 LP, 1x PCIe x8 LP, 1x ML2 x16 LP, 1x LOM	None	Operator panel with LCD	TPM 1.2	XClarity Enterprise	4x 1600W Platinum	3-year	11/17
7X13A005NA	NA	4x Xeon Platinum 8176 28C/2.1GHz/38.5MB/165W/DDR4-2666	4	4	48x 64GB LRDIMM DDR4-2666 (4Rx4)	48	48	1x 930-16i 4GB Flash	12x 2.5" SATA/SAS HS	12	2x 400GB SSD SAS12Gbps, 5x 3.84TB SSD SAS12Gbps	None	None	1xMgmt	2x 2x 25GbE SFP28 PCIe, 4x GbE RJ-45 ML2	1x RAID slot, 2x PCIe x16 LP, 1x PCIe x8 LP, 1x ML2 x16 LP, 1x LOM	None	Operator panel with LCD	TPM 1.2	XClarity Enterprise	4x 1600W Platinum	3-year	11/17

Model	Region	Processor	CPU Sockets (std)	CPU Sockets (max)	Memory	Memory Sockets (std)	Memory Sockets (max)	Storage Controller	Disk Bays	Max Disk Bays	Disks	PCIe Flash Adapter	M.2 Drives	Onboard Networking Ports	Additional Networking (LOM/ML2/PCIe)	Standard Extension Slots	Available Extension Slots via Riser Cards	Front Panel	TPM	System Management	Power Supply	Warranty	Ann Date (mm/yy)
7X12A01GNA	NA	4x Xeon Gold 5120 14C/2.2GHz/19.25MB/105W/DDR4-2400	4	4	4x 32GB RDIMM DDR4-2666 (2Rx4)	48	48	1x 930-8i 2GB Flash	8x 2.5" HS (4x SATA/SAS, 4x AnyBay)	12	None	None	None	1xMgmt	None	1x RAID slot, 2x PCIe x16 LP, 1x PCIe x8 LP, 1x ML2 x16 LP, 1x LOM	4x PCIe x16 FHHLL, 2x PCIe x8 LP	Operator panel with LCD	TPM 1.2	XClarity Enterprise	2x 1600W Platinum	3-year	07/17
7X12A01DNA	NA	2x Xeon Gold 6130 16C/2.1GHz/22MB/125W/DDR4-2666	2	4	2x 32GB RDIMM DDR4-2666 (2Rx4)	24	48	1x 930-8i 2GB Flash	4x 2.5" HS (2x SATA/SAS, 2x AnyBay)	12	None	None	None	1xMgmt	None	1x RAID slot, 2x PCIe x16 LP, 1x PCIe x8 LP, 1x ML2 x16 LP, 1x LOM	None	Operator panel with LCD	TPM 1.2	XClarity Enterprise	2x 1100W Platinum	3-year	07/17
7X13A00CNA	NA	2x Xeon Platinum 8176 28C/2.1GHz/38.5MB/165W/DDR4-2666	2	4	12x 32GB RDIMM DDR4-2666 (2Rx4)	24	48	1x 930-16i 4GB Flash	12x 2.5" SATA/SAS HS	12	2x 400GB SSD SAS12Gbps, 3x 3.84TB SSD SAS12Gbps	None	None	1xMgmt	2x 2x 25GbE SFP28 PCIe, 4x GbE RJ-45 ML2	1x RAID slot, 2x PCIe x16 LP, 1x PCIe x8 LP, 1x ML2 x16 LP, 1x LOM	None	Operator panel with LCD	TPM 1.2	XClarity Enterprise	4x 1600W Platinum	3-year	11/17
7X13A00ANA	NA	8x Xeon Platinum 8176M 28C/2.1GHz/38.5MB/165W/DDR4-2666	8	8	48x 128GB 3DS RDIMM DDR4-2666 (8Rx4)	96	96	1x 930-16i 4GB Flash	12x 2.5" SATA/SAS HS	24	2x 400GB SSD SAS12Gbps, 9x 3.84TB SSD SAS12Gbps	None	None	1xMgmt	2x 2x 25GbE SFP28 PCIe, 4x GbE RJ-45 ML2	2x RAID slot, 2x PCIe x16 LP, 1x PCIe x8 LP, 1x ML2 x16 LP, 1x LOM	None	Operator panel with LCD	TPM 1.2	XClarity Enterprise	4x 1600W Platinum	3-year	11/17
7X13A00BNA	NA	2x Xeon Platinum 8176M 28C/2.1GHz/38.5MB/165W/DDR4-2666	2	4	24x 128GB 3DS RDIMM DDR4-2666 (8Rx4)	24	48	1x 930-16i 4GB Flash	12x 2.5" SATA/SAS HS	12	2x 400GB SSD SAS12Gbps, 5x 3.84TB SSD SAS12Gbps	None	None	1xMgmt	2x 2x 25GbE SFP28 PCIe, 4x GbE RJ-45 ML2	1x RAID slot, 2x PCIe x16 LP, 1x PCIe x8 LP, 1x ML2 x16 LP, 1x LOM	None	Operator panel with LCD	TPM 1.2	XClarity Enterprise	4x 1600W Platinum	3-year	11/17
7X13A006NA	NA	4x Xeon Platinum 8176M 28C/2.1GHz/38.5MB/165W/DDR4-2666	4	4	24x 128GB 3DS RDIMM DDR4-2666 (8Rx4)	48	48	1x 930-16i 4GB Flash	12x 2.5" SATA/SAS HS	12	2x 400GB SSD SAS12Gbps, 5x 3.84TB SSD SAS12Gbps	None	None	1xMgmt	2x 2x 25GbE SFP28 PCIe, 4x GbE RJ-45 ML2	1x RAID slot, 2x PCIe x16 LP, 1x PCIe x8 LP, 1x ML2 x16 LP, 1x LOM	None	Operator panel with LCD	TPM 1.2	XClarity Enterprise	4x 1600W Platinum	3-year	11/17
7X13A007NA	NA	8x Xeon Platinum 8176M 28C/2.1GHz/38.5MB/165W/DDR4-2666	8	8	96x 128GB 3DS RDIMM DDR4-2666 (8Rx4)	96	96	2x 930-16i 4GB Flash	24x 2.5" SATA/SAS HS	24	2x 400GB SSD SAS12Gbps, 18x 3.84TB SSD SAS12Gbps	None	None	1xMgmt	2x 2x 25GbE SFP28 PCIe, 4x GbE RJ-45 ML2	2x RAID slot, 2x PCIe x16 LP, 1x PCIe x8 LP, 1x ML2 x16 LP, 1x LOM	None	Operator panel with LCD	TPM 1.2	XClarity Enterprise	4x 1600W Platinum	3-year	11/17

Model	Region	Processor	CPU Sockets (std)	CPU Sockets (max)	Memory	Memory Sockets (std)	Memory Sockets (max)	Storage Controller	Disk Bays	Max Disk Bays	Disks	PCIe Flash Adapter	M.2 Drives	Onboard Networking Ports	Additional Networking (LOM/ML2/PCIe)	Standard Extension Slots	Available Extension Slots via Riser Cards	Front Panel	TPM	System Management	Power Supply	Warranty	Ann Date (mm/yy)
7X13A008NA	NA	4x Xeon Platinum 8176 28C/2.1GHz/38.5MB/165W/DDR4-2666	4	4	24x 64GB LRDIMM DDR4-2666 (4Rx4)	48	48	1x 930-16i 4GB Flash	12x 2.5" SATA/SAS HS	12	2x 400GB SSD SAS12Gbps, 3x 3.84TB SSD SAS12Gbps	None	None	1xMgmt	2x 2x 25GbE SFP28 PCIe, 4x GbE RJ-45 ML2	1x RAID slot, 2x PCIe x16 LP, 1x PCIe x8 LP, 1x ML2 x16 LP, 1x LOM	None	Operator panel with LCD	TPM 1.2	XClarity Enterprise	4x 1600W Platinum	3-year	11/17
7X13A009NA	NA	2x Xeon Platinum 8176 28C/2.1GHz/38.5MB/165W/DDR4-2666	2	4	12x 16GB RDIMM DDR4-2666 (2Rx8)	24	48	1x 930-16i 4GB Flash	12x 2.5" SATA/SAS HS	12	2x 400GB SSD SAS12Gbps, 3x 3.84TB SSD SAS12Gbps	None	None	1xMgmt	2x 2x 25GbE SFP28 PCIe, 4x GbE RJ-45 ML2	1x RAID slot, 2x PCIe x16 LP, 1x PCIe x8 LP, 1x ML2 x16 LP, 1x LOM	None	Operator panel with LCD	TPM 1.2	XClarity Enterprise	4x 1600W Platinum	3-year	11/17



ThinkSystem SR530 Platform Specifications

Product Specifications Reference (PSREF)

Components	Specification
Form factor	1U rack
Dimensions	Height: 43 mm (1.7 in). Width: 482 mm (19.0 in) with rack latches. Depth: 778.3 mm (30.64 in)
Weight	Maximum configuration: 35.27 lb (16 kg)
Processor	Up to two 125W Intel Xeon Scalable family processors, Bronze, Silver, Gold, or Platinum. Up to 20 cores at 2.0GHz, up to 3.6GHz with 4 cores. Two processors are connected with two UPI (Ultra Path Interconnect) links up to 10.4GT/s
Chipset	Intel C622 Platform Controller Hub
Memory	Up to 12 DIMM sockets. Each processor supports up to 6 DIMM sockets with 6 channels. DDR4-2666. RDIMMs and LRDIMMs are supported, but memory types cannot be intermixed
Memory capacity	With RDIMMs: Up to 384GB with 12 x 32 GB RDIMMs and two processors With LRDIMMs: Up to 768GB with 12 x 64 GB LRDIMMs and two processors
Memory protection	ECC, memory mirroring, and memory sparing
Storage controllers	Supports the following RAID/HBA adapters:
Disk drive bays	Support 4 front 3.5" SATA simple-swap bays, or 4 front 3.5" SATA/SAS HS bays, or 8 front 2.5" SATA/SAS HS bays. Optional one or two internal M.2 SSD for boot, dual M.2 SSD supports mirroring
Internal storage	For 3.5" SS bay
Optical	No internal optical bay. Optional USB DVD±RW optical drive
Network interfaces	Integrated one dedicated management port plus two GbE ports. One LOM slot for customized LOM with two RJ-45 or SFP+ ports, up to 10GbE. Optional ML2 or PCIe adapters are supported. ML2 adapter requires riser card with ML2 slot. Up to two ports supports Wake-on-LAN and NC-SI (see right)
Security features	Power-on and admin password. Trusted Platform Module, TCG 1.2 compliant, upgrade to 2.0 via UEFI setting. Optional TCM in China only. Optional lockable security bezel
Operating systems supported	Microsoft Windows Server 2016/2012 R2. Red Hat Enterprise Linux 7.4/7.3/6.9. SUSE Linux Enterprise Server 12 SP3/12 SP2/11 SP4. VMware ESXi 6.5U1/6.5/6.0 U3
Systems management	XClarity Controller Standard, optional upgrades to Advanced or Enterprise are available. Energy Manager. XClarity Administrator. Lenovo Capacity Planner. Provisioning Manager. Essentials. Light Path Diagnostics
GPU support	None

Components	Specification	
Base warranty	MT 7X07: 1-year limited onsite service with 9x5/NBD MT 7X08: 3-year limited onsite service with 9x5/NBD	
Power supply	Up to two redundant hot-swap 550W and 750W 80 PLUS Platinum qualified AC power supplies. Or up to two redundant hot-swap 750W Titanium qualified AC power supplies. 750W Titanium is 200V - 240V, others are 100V - 240V	
Video	Integrated Matrox G200 in XClarity Controller	
Cooling	Four fans (3+1) for single processor model, six fans (5+1) for dual processor model	
Front ports	One XClarity Controller USB, one USB 3.0, one optional VGA	
Rear ports	One VGA, two USB 3.0, two ethernet (RJ-45), one XClarity Controller connector. Optional COM port	
Environmental specification	Supports ASHRAE A4 with limitations.	
	Temperature - operating	A4: 5°C to 45°C (41°F to 113°F) A3: 5°C to 40°C (41°F to 104°F) A2: 10°C to 35°C (50°F to 95°F)
	Temperature - non operating (no package)	-10°C to 60°C (-14°F to 140°F)
	Temperature - non operating (with package)	-40°C to 70°C (-40°F to 158°F)
	Altitude - operating	(Unpressurized): 0-10000ft (0-3048m)
Humidity - operating, non-condensing	A4: 8%-90%. A3:8%-85%. A2:20%-80%	
Humidity - storage (with package), non-condensing	8%-90%	
Models should meet the following requirements to support A3 and A4: • Redundant power supplies required • No system fan fails		
Environmental certification	Energy Star Server 2.1 certified. More environmental information please see: www.lenovo.com/social_responsibility/us/en/environment/	

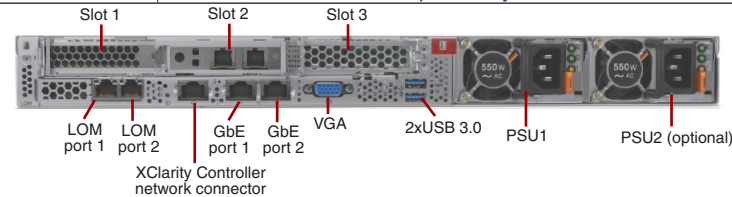

Note: GbE port 1 and LOM port 1 support Wake-on-LAN and NC-SI. Riser cards, expansion cards, and LOM adapters are optional.

Expansion slots	
Slot 1-2 (riser card 1)	Supports one of the following for riser card 1: Option 1: PCIe 3.0 x8/x16 (slot 1-2). Low profile for x8, low profile or full height half length for x16 Option 2: PCIe 3.0 x8/x8 ML2 (slot 1-2). Low profile
Slot 3 (riser card 2)	Option 1: PCIe 3.0 x 8, low profile, for single processor model Option 2: PCIe 3.0 x 16, low profile, for dual processor model When slot 2 is full height, slot 3 cannot be used

System unique options	
Option	Description
7XH7A05892	ThinkSystem SR530/SR570 x8/x8ML2 PCIe LP+LP Riser 1 kit
7XH7A02682	ThinkSystem SR530/SR570/SR630 x8/x16 PCIe LP+LP Riser 1 Kit
7XH7A05893	ThinkSystem SR530/SR570/SR630 x8/x16 PCIe LP+FH Riser 1 Kit
7XH7A05891	ThinkSystem SR530/SR570 x8 PCIe LP Riser 2 kit
7XH7A02685	ThinkSystem SR530/SR570/SR630 x16 PCIe LP Riser 2 Kit
7Z17A02579	ThinkSystem SR530/SR570/SR630 Front VGA Connector Upgrade Kit
7Z17A02581	ThinkSystem 1U Security Bezel
7Z17A02577	ThinkSystem COM Port Upgrade Kit
7XH7A05896	ThinkSystem SR530/SR630 2.5" SATA/SAS 8-Bay Backplane Kit

Model	Region	Processor	Memory	Storage Controller	Chassis	Disk Bays	Disks	M.2 Drives	Onboard Networking Ports	Additional Networking (LOM/ML2/PCIe)	Standard Extension Slots	Available Extension Slots via Riser Cards	Front VGA	Optical	TPM	System Management	Power Supply	Preload	Warranty	Ann Date (mm/yy)	
7X081003AU	ANZ	1x Xeon Bronze 3104 6C/1.7GHz/8.25MB/85W/DDR4-2133	1x 16GB RDIMM DDR4-2666 (1Rx4)	1x 530-8i	8x 2.5"	8x 2.5"	SATA/SAS HS	Open	None	2x GbE RJ-45, 1x Mgmt	None	1x LOM	1x PCIe x8 LP, 1x PCIe x16 LP	Front VGA	None	TPM 1.2	XClarity Enterprise	1x 750W Platinum	None	3-year	09/17
7X081004AU	ANZ	1x Xeon Bronze 3106 8C/1.7GHz/11MB/85W/DDR4-2133	1x 16GB RDIMM DDR4-2666 (1Rx4)	1x 530-8i	8x 2.5"	8x 2.5"	SATA/SAS HS	Open	None	2x GbE RJ-45, 1x Mgmt	None	1x LOM	1x PCIe x8 LP, 1x PCIe x16 LP	Front VGA	None	TPM 1.2	XClarity Enterprise	1x 750W Platinum	None	3-year	09/17
7X081005AU	ANZ	1x Xeon Silver 4110 8C/2.1GHz/11MB/85W/DDR4-2400	1x 16GB RDIMM DDR4-2666 (1Rx4)	1x 530-8i	8x 2.5"	8x 2.5"	SATA/SAS HS	Open	None	2x GbE RJ-45, 1x Mgmt	None	1x LOM	1x PCIe x8 LP, 1x PCIe x16 LP	Front VGA	None	TPM 1.2	XClarity Enterprise	1x 750W Platinum	None	3-year	09/17
7X081006AU	ANZ	1x Xeon Bronze 3104 6C/1.7GHz/8.25MB/85W/DDR4-2133	1x 16GB RDIMM DDR4-2666 (1Rx4)	Onboard Intel RSTe	4x 3.5"	4x 3.5"	SATA SS	Open	None	2x GbE RJ-45, 1x Mgmt	None	1x LOM	None	Front VGA	None	TPM 1.2	XClarity Enterprise	1x 750W Platinum	None	3-year	09/17
7X081007AU	ANZ	1x Xeon Bronze 3106 8C/1.7GHz/11MB/85W/DDR4-2133	1x 16GB RDIMM DDR4-2666 (1Rx4)	Onboard Intel RSTe	4x 3.5"	4x 3.5"	SATA SS	Open	None	2x GbE RJ-45, 1x Mgmt	None	1x LOM	None	Front VGA	None	TPM 1.2	XClarity Enterprise	1x 750W Platinum	None	3-year	09/17
7X081008AU	ANZ	1x Xeon Silver 4110 8C/2.1GHz/11MB/85W/DDR4-2400	1x 16GB RDIMM DDR4-2666 (1Rx4)	Onboard Intel RSTe	4x 3.5"	4x 3.5"	SATA SS	Open	None	2x GbE RJ-45, 1x Mgmt	None	1x LOM	None	Front VGA	None	TPM 1.2	XClarity Enterprise	1x 750W Platinum	None	3-year	09/17

Model	Region	Processor	Memory	Storage Controller	Chassis	Disk Bays	Disks	M.2 Drives	Onboard Networking Ports	Additional Networking (LOM/ML2/PCIe)	Standard Extension Slots	Available Extension Slots via Riser Cards	Front VGA	Optical	TPM	System Management	Power Supply	Preload Warranty	Warranty	Ann Date (mm/yy)
7X08100HBR	Brazil	1x Xeon Bronze 3106 8C/1.7GHz/11MB/85W/DDR4-2133	1x 16GB RDIMM DDR4-2666 (2Rx8)	1x 930-8i 2GB Flash	8x 2.5"	SATA/SAS HS	Open	None	2x GbE RJ-45, 1x Mgmt	2x GbE RJ-45 LOM	1x LOM	1x PCIe x8 LP, 1x PCIe x16 LP	Front VGA	None	TPM 1.2	XClarity Enterprise	1x 550W Platinum	None	3-year	04/18

Model	Region	Processor	Memory	Storage Controller	Chassis	Disk Bays	Disks	M.2 Drives	Onboard Networking Ports	Additional Networking (LOM/ML2/PCIe)	Standard Extension Slots	Available Extension Slots via Riser Cards	Front VGA	Optical	TPM	System Management	Power Supply	Preload	Warranty	Ann Date (mm/yy)
7X08A05ALA	Chile	1x Xeon Silver 4108 8C/1.8GHz/11MB/85W/DDR4-2400	1x 16GB RDIMM DDR4-2666 (1Rx4)	1x 530-8i	4x 3.5"	4x 3.5" SATA/SAS HS	2x 2TB HDD 7.2K 3.5" SAS12Gbps	None	2x GbE RJ-45, 1x Mgmt	None	1x LOM	1x PCIe x8 LP, 1x PCIe x16 LP	Front VGA	None	TPM 1.2	XClarity Advanced	2x 750W Platinum	None	3-year	07/17
7X08A05LLA	Chile	1x Xeon Silver 4114 10C/2.2GHz/13.75MB/85W/DDR4-2400	2x 16GB RDIMM DDR4-2666 (1Rx4)	1x 530-8i	4x 3.5"	4x 3.5" SATA/SAS HS	3x 600GB HDD 15K 3.5" SAS12Gbps	None	2x GbE RJ-45, 1x Mgmt	None	1x LOM	1x PCIe x8 LP, 1x PCIe x16 LP	Front VGA	None	TPM 1.2	XClarity Advanced	2x 750W Platinum	None	3-year	07/17
7X081000LA	Chile	1x Xeon Bronze 3104 6C/1.7GHz/8.25MB/85W/DDR4-2133	1x 16GB RDIMM DDR4-2666 (1Rx4)	1x 930-8i 2GB Flash	8x 2.5"	8x 2.5" SATA/SAS HS	Open	None	2x GbE RJ-45, 1x Mgmt	2x GbE RJ-45 LOM	1x LOM	2x PCIe x8 LP, 1x PCIe x16 LP	Front VGA	None	TPM 2.0	XClarity Enterprise	2x 550W Platinum	None	3-year	09/17
7X081001LA	Chile	1x Xeon Silver 4110 8C/2.1GHz/11MB/85W/DDR4-2400	1x 16GB RDIMM DDR4-2666 (1Rx4)	1x 930-8i 2GB Flash	8x 2.5"	8x 2.5" SATA/SAS HS	Open	None	2x GbE RJ-45, 1x Mgmt	2x GbE RJ-45 LOM	1x LOM	2x PCIe x8 LP, 1x PCIe x16 LP	Front VGA	None	TPM 2.0	XClarity Enterprise	2x 750W Platinum	None	3-year	09/17
7X081002LA	Chile	1x Xeon Silver 4114 10C/2.2GHz/13.75MB/85W/DDR4-2400	1x 16GB RDIMM DDR4-2666 (1Rx4)	1x 930-8i 2GB Flash	8x 2.5"	8x 2.5" SATA/SAS HS	Open	None	2x GbE RJ-45, 1x Mgmt	2x GbE RJ-45 LOM	1x LOM	2x PCIe x8 LP, 1x PCIe x16 LP	Front VGA	None	TPM 2.0	XClarity Enterprise	2x 750W Platinum	None	3-year	09/17

Model	Region	Processor	Memory	Storage Controller	Chassis	Disk Bays	Disks	M.2 Drives	Onboard Networking Ports	Additional Networking (LOM/ML2/PCIe)	Standard Extension Slots	Available Extension Slots via Riser Cards	Front VGA	Optical	TPM	System Management	Power Supply	Preload Warranty	Ann Date (mm/yy)	
7X08A066LA	Colombia	1x Xeon Bronze 3106 8C/1.7GHz/11MB/85W/DDR4-2133	1x 16GB RDIMM DDR4-2666 (1Rx4)	1x 530-8i	4x 3.5"	4x 3.5"	SATA/SAS Open HS	None	2x GbE RJ-45, 1x Mgmt	None	1x LOM	1x PCIe x8 LP, 1x PCIe x16 LP	Front VGA	None	TPM 2.0	XClarity Enterprise	1x 550W Platinum	None	3-year	12/17

Model	Region	Processor	Memory	Storage Controller	Chassis	Disk Bays	Disks	M.2 Drives	Onboard Networking Ports	Additional Networking (LOM/ML2/PCIe)	Standard Extension Slots	Available Extension Slots via Riser Cards	Front VGA	Optical	TPM	System Management	Power Supply	Preload	Warranty	Ann Date (mm/yy)	
7X08A01HEA	EMEA	1x Xeon Gold 6130 16C/2.1GHz/22MB/125W/DDR4-2666	1x 32GB RDIMM	1x 930-8i 2GB Flash	8x 2.5"	8x 2.5"	SATA/SAS HS	Open	None	2x GbE RJ-45, 1x Mgmt	None	1x LOM	1x PCIe x8 LP, 1x PCIe x16 LP	Front VGA	None	TPM 1.2	XClarity Standard	1x 750W Platinum	None	3-year	07/17
7X08A04GEA	EMEA	1x Xeon Silver 4110 8C/2.1GHz/11MB/85W/DDR4-2400	4x 32GB RDIMM	1x 930-8i 2GB Flash	8x 2.5"	8x 2.5"	SATA/SAS HS	3x 600GB HDD 10K 2.5" SAS12Gbps	None	2x GbE RJ-45, 1x Mgmt	None	1x LOM	1x PCIe x8 LP, 1x PCIe x16 LP	Front VGA	None	TPM 1.2	XClarity Enterprise	2x 750W Platinum	None	3-year	07/17
7X08A009EA	EMEA	1x Xeon Gold 5118 12C/2.3GHz/16.5MB/105W/DDR4-2400	1x 16GB RDIMM	1x 930-8i 2GB Flash	8x 2.5"	8x 2.5"	SATA/SAS HS	Open	None	2x GbE RJ-45, 1x Mgmt	None	1x LOM	1x PCIe x8 LP, 1x PCIe x16 LP	Front VGA	None	TPM 1.2	XClarity Enterprise	1x 750W Platinum	None	3-year	07/17
7X08A01UEA	EMEA	1x Xeon Silver 4108 8C/1.8GHz/11MB/85W/DDR4-2400	1x 16GB RDIMM	1x 930-8i 2GB Flash	8x 2.5"	8x 2.5"	SATA/SAS HS	Open	None	2x GbE RJ-45, 1x Mgmt	None	1x LOM	1x PCIe x8 LP, 1x PCIe x16 LP	Front VGA	None	TPM 1.2	XClarity Advanced	1x 750W Platinum	None	3-year	07/17
7X08A01VEA	EMEA	1x Xeon Silver 4110 8C/2.1GHz/11MB/85W/DDR4-2400	1x 16GB RDIMM	1x 930-8i 2GB Flash	4x 3.5"	4x 3.5"	SATA/SAS HS	Open	None	2x GbE RJ-45, 1x Mgmt	None	1x LOM	1x PCIe x8 LP, 1x PCIe x16 LP	Front VGA	None	TPM 1.2	XClarity Advanced	1x 750W Platinum	None	3-year	07/17
7X08A01WEA	EMEA	1x Xeon Silver 4108 8C/1.8GHz/11MB/85W/DDR4-2400	1x 16GB RDIMM	1x 530-8i 2GB Flash	8x 2.5"	8x 2.5"	SATA/SAS HS	Open	None	2x GbE RJ-45, 1x Mgmt	None	1x LOM	1x PCIe x8 LP, 1x PCIe x16 LP	None	None	TPM 1.2	XClarity Standard	1x 750W Platinum	None	3-year	07/17
7X08A01XEA	EMEA	1x Xeon Silver 4116 12C/2.1GHz/16.5MB/85W/DDR4-2400	1x 16GB RDIMM	1x 930-8i 2GB Flash	8x 2.5"	8x 2.5"	SATA/SAS HS	Open	None	2x GbE RJ-45, 1x Mgmt	None	1x LOM	1x PCIe x8 LP, 1x PCIe x16 LP	Front VGA	None	TPM 1.2	XClarity Advanced	1x 750W Platinum	None	3-year	07/17
7X08A020EA	EMEA	1x Xeon Silver 4108 8C/1.8GHz/11MB/85W/DDR4-2400	1x 16GB RDIMM	1x 530-8i 2GB Flash	8x 2.5"	8x 2.5"	SATA/SAS HS	Open	None	2x GbE RJ-45, 1x Mgmt	None	1x LOM	1x PCIe x8 LP, 1x PCIe x16 LP	Front VGA	None	TPM 1.2	XClarity Advanced	1x 750W Platinum	None	3-year	07/17
7X08A022EA	EMEA	1x Xeon Bronze 3104 6C/1.7GHz/8.25MB/85W/DDR4-2133	1x 16GB RDIMM	Onboard Intel RSTe	4x 3.5"	4x 3.5"	SATA SS	Open	None	2x GbE RJ-45, 1x Mgmt	None	1x LOM	None	Front VGA	None	TPM 1.2	XClarity Standard	1x 550W Platinum	None	3-year	07/17
7X08A024EA	EMEA	1x Xeon Silver 4114 10C/2.2GHz/13.75MB/85W/DDR4-2400	1x 16GB RDIMM	1x 930-8i 2GB Flash	8x 2.5"	8x 2.5"	SATA/SAS HS	Open	None	2x GbE RJ-45, 1x Mgmt	None	1x LOM	1x PCIe x8 LP, 1x PCIe x16 LP	Front VGA	None	TPM 1.2	XClarity Advanced	1x 750W Platinum	None	3-year	07/17

Model	Region	Processor	Memory	Storage Controller	Chassis	Disk Bays	Disks	M.2 Drives	Onboard Networking Ports	Additional Networking (LOM/ML2/PCIe)	Standard Extension Slots	Available Extension Slots via Riser Cards	Front VGA	Optical	TPM	System Management	Power Supply	Preload	Warranty	Ann Date (mm/yy)
7X08A025EA	EMEA	1x Xeon Bronze 3104 6C/1.7GHz/8.25MB/85W/DDR4-2133	1x 16GB RDIMM DDR4-2666 (1Rx4)	1x 530-8i	8x 2.5"	8x 2.5" SATA/SAS HS	Open	None	2x GbE RJ-45, 1x Mgmt	None	1x LOM	1x PCIe x8 LP, 1x PCIe x16 LP	Front VGA	None	TPM 1.2	XClarity Advanced	1x 750W Platinum	None	3-year	07/17
7X08A027EA	EMEA	1x Xeon Silver 4110 8C/2.1GHz/11MB/85W/DDR4-2400	2x 32GB RDIMM DDR4-2666 (2Rx4)	1x 930-8i 2GB Flash	8x 2.5"	8x 2.5" SATA/SAS HS	2x 600GB HDD 10K 2.5" SAS12Gbps	None	2x GbE RJ-45, 1x Mgmt	None	1x LOM	1x PCIe x8 LP, 1x PCIe x16 LP	Front VGA	None	TPM 1.2	XClarity Advanced	2x 750W Platinum	None	3-year	07/17
7X08A028EA	EMEA	1x Xeon Bronze 3104 6C/1.7GHz/8.25MB/85W/DDR4-2133	1x 16GB RDIMM DDR4-2666 (1Rx4)	1x 530-8i	4x 3.5"	4x 3.5" SATA/SAS HS	Open	None	2x GbE RJ-45, 1x Mgmt	None	1x LOM	1x PCIe x8 LP, 1x PCIe x16 LP	Front VGA	None	TPM 1.2	XClarity Standard	1x 550W Platinum	None	3-year	07/17
7X08A029EA	EMEA	1x Xeon Silver 4110 8C/2.1GHz/11MB/85W/DDR4-2400	1x 16GB RDIMM DDR4-2666 (1Rx4)	1x 930-8i 2GB Flash	8x 2.5"	8x 2.5" SATA/SAS HS	Open	None	2x GbE RJ-45, 1x Mgmt	None	1x LOM	1x PCIe x8 LP, 1x PCIe x16 LP	Front VGA	None	TPM 1.2	XClarity Advanced	1x 750W Platinum	None	3-year	07/17
7X08A02BEA	EMEA	1x Xeon Silver 4114 10C/2.2GHz/13.75MB/85W/DDR4-2400	1x 16GB RDIMM DDR4-2666 (1Rx4)	1x 930-8i 2GB Flash	8x 2.5"	8x 2.5" SATA/SAS HS	2x 300GB HDD 10K 2.5" SAS12Gbps	None	2x GbE RJ-45, 1x Mgmt	None	1x LOM	1x PCIe x8 LP, 1x PCIe x16 LP	Front VGA	None	TPM 1.2	XClarity Advanced	2x 750W Platinum	None	3-year	07/17
7X08A00XEA	EMEA	1x Xeon Gold 6138 20C/2.0GHz/27.5MB/125W/DDR4-2666	1x 32GB RDIMM DDR4-2666 (2Rx4)	1x 930-8i 2GB Flash	8x 2.5"	8x 2.5" SATA/SAS HS	Open	None	2x GbE RJ-45, 1x Mgmt	None	1x LOM	1x PCIe x8 LP, 1x PCIe x16 LP	Front VGA	None	TPM 1.2	XClarity Standard	1x 750W Platinum	None	3-year	07/17
7X08A04TEA	EMEA	1x Xeon Gold 5115 10C/2.4GHz/13.75MB/85W/DDR4-2400	1x 16GB RDIMM DDR4-2666 (1Rx4)	1x 930-8i 2GB Flash	8x 2.5"	8x 2.5" SATA/SAS HS	Open	None	2x GbE RJ-45, 1x Mgmt	None	1x LOM	1x PCIe x8 LP, 1x PCIe x16 LP	Front VGA	None	TPM 1.2	XClarity Enterprise	1x 750W Platinum	None	3-year	07/17

Model	Region	Processor	Memory	Storage Controller	Chassis	Disk Bays	Disks	M.2 Drives	Onboard Networking Ports	Additional Networking (LOM/ML2/PCIe)	Standard Extension Slots	Available Extension Slots via Riser Cards	Front VGA	Optical	TPM	System Management	Power Supply	Preload	Warranty	Ann Date (mm/yy)
7X08A04UJP	JAPAN	1x Xeon Silver 4110 8C/2.1GHz/11MB/85W/DDR4-2400	1x 8GB RDIMM DDR4-2666 (1Rx8)	1x 930-8i 2GB Flash	8x 2.5"	8x 2.5"	SATA/SAS Open	None	2x GbE RJ-45, 1x Mgmt	None	1x LOM	1x PCIe x8 LP, 1x PCIe x16 LP	None	None	TPM 1.2	XClarity Advanced	1x 550W Platinum	None	3-year	07/17
7X08A04VJP	JAPAN	1x Xeon Bronze 3104 6C/1.7GHz/8.25MB/85W/DDR4-2133	1x 8GB RDIMM DDR4-2666 (1Rx8)	1x 930-8i 2GB Flash	8x 2.5"	8x 2.5"	SATA/SAS Open	None	2x GbE RJ-45, 1x Mgmt	None	1x LOM	1x PCIe x8 LP, 1x PCIe x16 LP	None	None	TPM 1.2	XClarity Advanced	1x 550W Platinum	None	3-year	07/17
7X08A04YJP	JAPAN	1x Xeon Silver 4112 4C/2.6GHz/8.25MB/85W/DDR4-2400	1x 8GB RDIMM DDR4-2666 (1Rx8)	1x 930-8i 2GB Flash	8x 2.5"	8x 2.5"	SATA/SAS Open	None	2x GbE RJ-45, 1x Mgmt	None	1x LOM	1x PCIe x8 LP, 1x PCIe x16 LP	None	None	TPM 1.2	XClarity Advanced	1x 550W Platinum	None	3-year	07/17
7X08A04ZJP	JAPAN	1x Xeon Bronze 3104 6C/1.7GHz/8.25MB/85W/DDR4-2133	1x 8GB RDIMM DDR4-2666 (1Rx8)	1x 530-8i	4x 3.5"	4x 3.5"	SATA/SAS Open	None	2x GbE RJ-45, 1x Mgmt	None	1x LOM	1x PCIe x8 LP, 1x PCIe x16 LP	None	None	TPM 1.2	XClarity Advanced	1x 550W Platinum	None	3-year	07/17
7X08A050JP	JAPAN	1x Xeon Bronze 3106 8C/1.7GHz/11MB/85W/DDR4-2133	1x 8GB RDIMM DDR4-2666 (1Rx8)	1x 930-8i 2GB Flash	8x 2.5"	8x 2.5"	SATA/SAS Open	None	2x GbE RJ-45, 1x Mgmt	None	1x LOM	1x PCIe x8 LP, 1x PCIe x16 LP	None	None	TPM 1.2	XClarity Advanced	1x 550W Platinum	None	3-year	07/17
7X08A061JP	JAPAN	1x Xeon Silver 4114 10C/2.2GHz/13.75MB/85W/DDR4-2400	1x 16GB RDIMM DDR4-2666 (1Rx4)	1x 930-8i 2GB Flash	8x 2.5"	8x 2.5"	SATA/SAS Open	None	2x GbE RJ-45, 1x Mgmt	None	1x LOM	1x PCIe x8 LP, 1x PCIe x16 LP	None	None	TPM 1.2	XClarity Advanced	1x 550W Platinum	None	3-year	08/17

Model	Region	Processor	Memory	Storage Controller	Chassis	Disk Bays	Disks	M.2 Drives	Onboard Networking Ports	Additional Networking (LOM/ML2/PCIe)	Standard Extension Slots	Available Extension Slots via Riser Cards	Front VGA	Optical	TPM	System Management	Power Supply	Preload	Warranty	Ann Date (mm/yy)
7X08A05ULA	LA	1x Xeon Silver 4114 10C/2.2GHz/13.75MB/85W/DDR4-2400	1x 8GB RDIMM DDR4-2666 (1Rx8)	1x 530-8i	8x 2.5"	8x 2.5"	SATA/SAS Open HS	None	2x GbE RJ-45, 1x Mgmt	None	1x LOM	1x PCIe x8 LP, 1x PCIe x16 LP	Front VGA	None	TPM 1.2	XClarity Standard	1x 550W Platinum	None	3-year	07/17
7X08A05VLA	LA	1x Xeon Silver 4110 8C/2.1GHz/11MB/85W/DDR4-2400	1x 8GB RDIMM DDR4-2666 (1Rx8)	1x 530-8i	4x 3.5"	4x 3.5"	SATA/SAS Open HS	None	2x GbE RJ-45, 1x Mgmt	None	1x LOM	1x PCIe x8 LP, 1x PCIe x16 LP	Front VGA	None	TPM 1.2	XClarity Standard	1x 550W Platinum	None	3-year	07/17
7X08A05YLA	LA	1x Xeon Bronze 3106 8C/1.7GHz/11MB/85W/DDR4-2133	1x 8GB RDIMM DDR4-2666 (1Rx8)	1x 530-8i	4x 3.5"	4x 3.5"	SATA/SAS Open HS	None	2x GbE RJ-45, 1x Mgmt	None	1x LOM	1x PCIe x8 LP, 1x PCIe x16 LP	Front VGA	None	TPM 1.2	XClarity Standard	1x 550W Platinum	None	3-year	07/17
7X08A054LA	LA	1x Xeon Bronze 3104 6C/1.7GHz/8.25MB/85W/DDR4-2133	1x 8GB RDIMM DDR4-2666 (1Rx8)	1x 530-8i	8x 2.5"	8x 2.5"	SATA/SAS Open HS	None	2x GbE RJ-45, 1x Mgmt	None	1x LOM	1x PCIe x8 LP, 1x PCIe x16 LP	Front VGA	None	TPM 1.2	XClarity Standard	1x 550W Platinum	None	3-year	07/17
7X08A05CLA	LA	1x Xeon Silver 4110 8C/2.1GHz/11MB/85W/DDR4-2400	1x 8GB RDIMM DDR4-2666 (1Rx8)	1x 530-8i	8x 2.5"	8x 2.5"	SATA/SAS Open HS	None	2x GbE RJ-45, 1x Mgmt	None	1x LOM	1x PCIe x8 LP, 1x PCIe x16 LP	Front VGA	None	TPM 1.2	XClarity Standard	1x 550W Platinum	None	3-year	07/17
7X08A05FLA	LA	1x Xeon Bronze 3106 8C/1.7GHz/11MB/85W/DDR4-2133	1x 8GB RDIMM DDR4-2666 (1Rx8)	1x 530-8i	8x 2.5"	8x 2.5"	SATA/SAS Open HS	None	2x GbE RJ-45, 1x Mgmt	None	1x LOM	1x PCIe x8 LP, 1x PCIe x16 LP	Front VGA	None	TPM 1.2	XClarity Standard	1x 550W Platinum	None	3-year	07/17
7X08A05GLA	LA	1x Xeon Silver 4108 8C/1.8GHz/11MB/85W/DDR4-2400	1x 8GB RDIMM DDR4-2666 (1Rx8)	1x 530-8i	4x 3.5"	4x 3.5"	SATA/SAS Open HS	None	2x GbE RJ-45, 1x Mgmt	None	1x LOM	1x PCIe x8 LP, 1x PCIe x16 LP	Front VGA	None	TPM 1.2	XClarity Standard	1x 550W Platinum	None	3-year	07/17
7X08A05HLA	LA	1x Xeon Silver 4108 8C/1.8GHz/11MB/85W/DDR4-2400	1x 8GB RDIMM DDR4-2666 (1Rx8)	1x 530-8i	8x 2.5"	8x 2.5"	SATA/SAS Open HS	None	2x GbE RJ-45, 1x Mgmt	None	1x LOM	1x PCIe x8 LP, 1x PCIe x16 LP	Front VGA	None	TPM 1.2	XClarity Standard	1x 550W Platinum	None	3-year	07/17
7X08A05JLA	LA	1x Xeon Silver 4114 10C/2.2GHz/13.75MB/85W/DDR4-2400	1x 8GB RDIMM DDR4-2666 (1Rx8)	1x 530-8i	4x 3.5"	4x 3.5"	SATA/SAS Open HS	None	2x GbE RJ-45, 1x Mgmt	None	1x LOM	1x PCIe x8 LP, 1x PCIe x16 LP	Front VGA	None	TPM 1.2	XClarity Standard	1x 550W Platinum	None	3-year	07/17
7X08A051LA	LA	1x Xeon Bronze 3104 6C/1.7GHz/8.25MB/85W/DDR4-2133	1x 8GB RDIMM DDR4-2666 (1Rx8)	1x 530-8i	4x 3.5"	4x 3.5"	SATA/SAS Open HS	None	2x GbE RJ-45, 1x Mgmt	None	1x LOM	1x PCIe x8 LP, 1x PCIe x16 LP	Front VGA	None	TPM 1.2	XClarity Standard	1x 550W Platinum	None	3-year	07/17

Model	Region	Processor	Memory	Storage Controller	Chassis	Disk Bays	Disks	M.2 Drives	Onboard Networking Ports	Additional Networking (LOM/ML2/PCIe)	Standard Extension Slots	Available Extension Slots via Riser Cards	Front VGA	Optical	TPM	System Management	Power Supply	Preload	Warranty	Ann Date (mm/yy)
7X08A053LA	LA (except Brazil)	1x Xeon Silver 4108 8C/1.8GHz/11MB/85W/DDR4-2400	1x 16GB RDIMM DDR4-2666 (1Rx4)	1x 530-8i	4x 3.5"	4x 3.5" SATA/SAS HS	2x 600GB HDD 15K 3.5" SAS12Gbps	None	2x GbE RJ-45, 1x Mgmt	None	1x LOM	1x PCIe x8 LP, 1x PCIe x16 LP	Front VGA	None	TPM 1.2	XClarity Advanced	2x 750W Platinum	None	3-year	07/17
7X08A059LA	LA (except Brazil)	1x Xeon Silver 4108 8C/1.8GHz/11MB/85W/DDR4-2400	1x 16GB RDIMM DDR4-2666 (1Rx4)	1x 530-8i	4x 3.5"	4x 3.5" SATA/SAS HS	2x 2TB HDD 7.2K 3.5" SAS12Gbps	None	2x GbE RJ-45, 1x Mgmt	None	1x LOM	1x PCIe x8 LP, 1x PCIe x16 LP	Front VGA	None	TPM 1.2	XClarity Advanced	2x 750W Platinum	None	3-year	07/17
7X08A05QLA	LA (except Brazil)	1x Xeon Silver 4110 8C/2.1GHz/11MB/85W/DDR4-2400	2x 16GB RDIMM DDR4-2666 (1Rx4)	1x 530-8i	4x 3.5"	4x 3.5" SATA/SAS HS	2x 2TB HDD 7.2K 3.5" SAS12Gbps	None	2x GbE RJ-45, 1x Mgmt	None	1x LOM	1x PCIe x8 LP, 1x PCIe x16 LP	Front VGA	None	TPM 1.2	XClarity Advanced	2x 750W Platinum	None	3-year	07/17

Model	Region	Processor	Memory	Storage Controller	Chassis	Disk Bays	Disks	M.2 Drives	Onboard Networking Ports	Additional Networking (LOM/ML2/PCIe)	Standard Extension Slots	Available Extension Slots via Riser Cards	Front VGA	Optical	TPM	System Management	Power Supply	Preload	Warranty	Ann Date (mm/yy)	
7X081009LA	LA (except Chile)	1x Xeon Bronze 3106 8C/1.7GHz/11MB/85W/DDR4-2133	1x 8GB RDIMM DDR4-2666 (1Rx8)	1x 530-8i	4x 3.5"	4x 3.5"	SATA/SAS HS	Open	None	2x GbE RJ-45, 1x Mgmt	2x GbE RJ-45 LOM	1x LOM	2x PCIe x8 LP, 1x PCIe x16 LP	Front VGA	None	TPM 2.0	XClarity Standard	1x 550W Platinum	None	3-year	09/17
7X08100ALA	LA (except Chile)	1x Xeon Bronze 3106 8C/1.7GHz/11MB/85W/DDR4-2133	1x 8GB RDIMM DDR4-2666 (1Rx8)	1x 530-8i	8x 2.5"	8x 2.5"	SATA/SAS HS	Open	None	2x GbE RJ-45, 1x Mgmt	2x GbE RJ-45 LOM	1x LOM	2x PCIe x8 LP, 1x PCIe x16 LP	Front VGA	None	TPM 2.0	XClarity Standard	1x 550W Platinum	None	3-year	09/17
7X08100BLA	LA (except Chile)	1x Xeon Silver 4110 8C/2.1GHz/11MB/85W/DDR4-2400	1x 16GB RDIMM DDR4-2666 (1Rx4)	1x 530-8i	8x 2.5"	8x 2.5"	SATA/SAS HS	Open	None	2x GbE RJ-45, 1x Mgmt	2x GbE RJ-45 LOM	1x LOM	2x PCIe x8 LP, 1x PCIe x16 LP	Front VGA	None	TPM 2.0	XClarity Standard	2x 750W Platinum	None	3-year	09/17

Model	Region	Processor	Memory	Storage Controller	Chassis	Disk Bays	Disks	M.2 Drives	Onboard Networking Ports	Additional Networking (LOM/ML2/PCIe)	Standard Extension Slots	Available Extension Slots via Riser Cards	Front VGA	Optical	TPM	System Management	Power Supply	Preload	Warranty	Ann Date (mm/yy)
7X08A03SNA	NA	1x Xeon Silver 4110 8C/2.1GHz/11MB/85W/DDR4-2400	1x 16GB RDIMM DDR4-2666 (1Rx4)	1x 530-8i	4x 3.5"	4x 3.5"	SATA/SAS Open HS	None	2x GbE RJ-45, 1x Mgmt	None	1x LOM	1x PCIe x8 LP, 1x PCIe x16 LP	Front VGA	None	TPM 1.2	XClarity Enterprise	1x 750W Platinum	None	3-year	07/17
7X08A04FNA	NA	1x Xeon Bronze 3106 8C/1.7GHz/11MB/85W/DDR4-2133	1x 16GB RDIMM DDR4-2666 (1Rx4)	1x 530-8i	4x 3.5"	4x 3.5"	SATA/SAS Open HS	None	2x GbE RJ-45, 1x Mgmt	None	1x LOM	1x PCIe x8 LP, 1x PCIe x16 LP	Front VGA	None	TPM 1.2	XClarity Enterprise	1x 750W Platinum	None	3-year	07/17
7X08A045NA	NA	1x Xeon Silver 4116 12C/2.1GHz/16.5MB/85W/DDR4-2400	1x 32GB RDIMM DDR4-2666 (2Rx4)	1x 530-8i	4x 3.5"	4x 3.5"	SATA/SAS Open HS	None	2x GbE RJ-45, 1x Mgmt	None	1x LOM	1x PCIe x8 LP, 1x PCIe x16 LP	Front VGA	None	TPM 1.2	XClarity Enterprise	1x 750W Platinum	None	3-year	07/17

Model	Region	Processor	Memory	Storage Controller	Chassis	Disk Bays	Disks	M.2 Drives	Onboard Networking Ports	Additional Networking (LOM/ML2/PCIe)	Standard Extension Slots	Available Extension Slots via Riser Cards	Front VGA	Optical	TPM	System Management	Power Supply	Preload	Warranty	Ann Date (mm/yy)
7X08A006AU	ANZ	1x Xeon Gold 5120 14C/2.2GHz/19.25MB/105W/DDR4-2400	1x 8GB RDIMM DDR4-2666 (1Rx8)	1x 530-8i	8x 2.5"	8x 2.5"	SATA/SAS Open HS	None	2x GbE RJ-45, 1x Mgmt	None	1x LOM	1x PCIe x8 LP, 1x ML2 x8 LP	Front VGA	None	TPM 1.2	XClarity Standard	1x 550W Platinum	None	3-year	07/17
7X08A00DAU	ANZ	1x Xeon Gold 5120 14C/2.2GHz/19.25MB/105W/DDR4-2400	1x 8GB RDIMM DDR4-2666 (1Rx8)	1x 530-8i	4x 3.5"	4x 3.5"	SATA/SAS Open HS	None	2x GbE RJ-45, 1x Mgmt	None	1x LOM	1x PCIe x8 LP, 1x ML2 x8 LP	Front VGA	None	TPM 1.2	XClarity Standard	1x 550W Platinum	None	3-year	07/17
7X08A00YAU	ANZ	1x Xeon Gold 5120 14C/2.2GHz/19.25MB/105W/DDR4-2400	1x 16GB RDIMM DDR4-2666 (1Rx4)	1x 930-8i 2GB Flash	8x 2.5"	8x 2.5"	SATA/SAS Open HS	None	2x GbE RJ-45, 1x Mgmt	None	1x LOM	1x PCIe x8 LP, 1x PCIe x16 LP	Front VGA	None	TPM 1.2	XClarity Standard	1x 550W Platinum	None	3-year	07/17
7X08A010AU	ANZ	1x Xeon Gold 6126 12C/2.6GHz/19.25MB/125W/DDR4-2666	1x 16GB RDIMM DDR4-2666 (1Rx4)	1x 930-8i 2GB Flash	8x 2.5"	8x 2.5"	SATA/SAS Open HS	None	2x GbE RJ-45, 1x Mgmt	None	1x LOM	1x PCIe x8 LP, 1x PCIe x16 LP	Front VGA	None	TPM 1.2	XClarity Standard	1x 750W Platinum	None	3-year	07/17
7X08A01EAU	ANZ	1x Xeon Gold 5118 12C/2.3GHz/16.5MB/105W/DDR4-2400	1x 16GB RDIMM DDR4-2666 (1Rx4)	1x 930-8i 2GB Flash	8x 2.5"	8x 2.5"	SATA/SAS Open HS	None	2x GbE RJ-45, 1x Mgmt	None	1x LOM	1x PCIe x8 LP, 1x ML2 x8 LP	Front VGA	None	TPM 1.2	XClarity Standard	1x 550W Platinum	None	3-year	07/17
7X08A01JAU	ANZ	1x Xeon Gold 5118 12C/2.3GHz/16.5MB/105W/DDR4-2400	1x 8GB RDIMM DDR4-2666 (1Rx8)	1x 530-8i	4x 3.5"	4x 3.5"	SATA/SAS Open HS	None	2x GbE RJ-45, 1x Mgmt	None	1x LOM	1x PCIe x8 LP, 1x ML2 x8 LP	Front VGA	None	TPM 1.2	XClarity Standard	1x 550W Platinum	None	3-year	07/17
7X08A01KAU	ANZ	1x Xeon Gold 5118 12C/2.3GHz/16.5MB/105W/DDR4-2400	1x 16GB RDIMM DDR4-2666 (1Rx4)	1x 530-8i	8x 2.5"	8x 2.5"	SATA/SAS Open HS	None	2x GbE RJ-45, 1x Mgmt	None	1x LOM	1x PCIe x8 LP, 1x ML2 x8 LP	Front VGA	None	TPM 1.2	XClarity Standard	1x 550W Platinum	None	3-year	07/17
7X08A01NAU	ANZ	1x Xeon Gold 5118 12C/2.3GHz/16.5MB/105W/DDR4-2400	1x 8GB RDIMM DDR4-2666 (1Rx8)	Onboard Intel RSTe	4x 3.5"	4x 3.5"	SATA SS	None	2x GbE RJ-45, 1x Mgmt	None	1x LOM	None	Front VGA	None	TPM 1.2	XClarity Standard	1x 550W Platinum	None	3-year	07/17
7X08A01PAU	ANZ	1x Xeon Gold 5118 12C/2.3GHz/16.5MB/105W/DDR4-2400	1x 8GB RDIMM DDR4-2666 (1Rx8)	1x 530-8i	8x 2.5"	8x 2.5"	SATA/SAS Open HS	None	2x GbE RJ-45, 1x Mgmt	None	1x LOM	1x PCIe x8 LP, 1x ML2 x8 LP	Front VGA	None	TPM 1.2	XClarity Standard	1x 550W Platinum	None	3-year	07/17
7X08A01QAU	ANZ	1x Xeon Gold 6138 20C/2.0GHz/27.5MB/125W/DDR4-2666	1x 16GB RDIMM DDR4-2666 (1Rx4)	1x 930-8i 2GB Flash	8x 2.5"	8x 2.5"	SATA/SAS Open HS	None	2x GbE RJ-45, 1x Mgmt	None	1x LOM	1x PCIe x8 LP, 1x PCIe x16 LP	Front VGA	None	TPM 1.2	XClarity Standard	1x 750W Platinum	None	3-year	07/17

Model	Region	Processor	Memory	Storage Controller	Chassis	Disk Bays	Disks	M.2 Drives	Onboard Networking Ports	Additional Networking (LOM/ML2/PCIe)	Standard Extension Slots	Available Extension Slots via Riser Cards	Front VGA	Optical	TPM	System Management	Power Supply	Preload	Warranty	Ann Date (mm/yy)
7X08A01RAU	ANZ	1x Xeon Gold 6126 12C/2.6GHz/19.25MB/125W/DDR4-2666	1x 16GB RDIMM DDR4-2666 (1Rx4)	1x 530-8i	8x 2.5"	8x 2.5" SATA/SAS HS	Open	None	2x GbE RJ-45, 1x Mgmt	None	1x LOM	1x PCIe x8 LP, 1x ML2 x8 LP	Front VGA	None	TPM 1.2	XClarity Standard	1x 750W Platinum	None	3-year	07/17
7X08A01SAU	ANZ	1x Xeon Gold 6130 16C/2.1GHz/22MB/125W/DDR4-2666	1x 16GB RDIMM DDR4-2666 (1Rx4)	1x 930-8i	8x 2.5"	8x 2.5" SATA/SAS HS	Open	None	2x GbE RJ-45, 1x Mgmt	None	1x LOM	1x PCIe x8 LP, 1x PCIe x16 LP	Front VGA	None	TPM 1.2	XClarity Standard	1x 750W Platinum	None	3-year	07/17
7X08A02RAU	ANZ	1x Xeon Silver 4110 8C/2.1GHz/11MB/85W/DDR4-2400	1x 16GB RDIMM DDR4-2666 (1Rx4)	1x 930-8i	8x 2.5"	8x 2.5" SATA/SAS HS	Open	None	2x GbE RJ-45, 1x Mgmt	None	1x LOM	1x PCIe x8 LP, 1x PCIe x16 LP	Front VGA	None	TPM 1.2	XClarity Advanced	1x 750W Platinum	None	3-year	07/17
7X08A02SAU	ANZ	1x Xeon Silver 4110 8C/2.1GHz/11MB/85W/DDR4-2400	1x 16GB RDIMM DDR4-2666 (1Rx4)	1x 530-8i	8x 2.5"	8x 2.5" SATA/SAS HS	Open	None	2x GbE RJ-45, 1x Mgmt	None	1x LOM	1x PCIe x8 LP, 1x PCIe x16 LP	None	None	TPM 1.2	XClarity Standard	1x 750W Platinum	None	3-year	07/17
7X08A02XAU	ANZ	1x Xeon Silver 4110 8C/2.1GHz/11MB/85W/DDR4-2400	1x 16GB RDIMM DDR4-2666 (1Rx4)	1x 930-8i	8x 2.5"	8x 2.5" SATA/SAS HS	Open	None	2x GbE RJ-45, 1x Mgmt	None	1x LOM	1x PCIe x8 LP, 1x PCIe x16 LP	None	None	TPM 1.2	XClarity Standard	1x 750W Platinum	None	3-year	07/17
7X08A030AU	ANZ	1x Xeon Bronze 3104 6C/1.7GHz/8.25MB/85W/DDR4-2133	1x 16GB RDIMM DDR4-2666 (1Rx4)	Onboard Intel RSTe	4x 3.5"	4x 3.5" SATA SS	Open	None	2x GbE RJ-45, 1x Mgmt	None	1x LOM	None	Front VGA	None	TPM 1.2	XClarity Standard	1x 550W Platinum	None	3-year	07/17
7X08A032AU	ANZ	1x Xeon Silver 4110 8C/2.1GHz/11MB/85W/DDR4-2400	1x 16GB RDIMM DDR4-2666 (1Rx4)	1x 930-8i	4x 3.5"	4x 3.5" SATA/SAS HS	Open	None	2x GbE RJ-45, 1x Mgmt	None	1x LOM	1x PCIe x8 LP, 1x PCIe x16 LP	Front VGA	None	TPM 1.2	XClarity Advanced	1x 750W Platinum	None	3-year	07/17
7X08A033AU	ANZ	1x Xeon Silver 4114 10C/2.2GHz/13.75MB/85W/DDR4-2400	1x 16GB RDIMM DDR4-2666 (1Rx4)	1x 930-8i	8x 2.5"	8x 2.5" SATA/SAS HS	Open	None	2x GbE RJ-45, 1x Mgmt	None	1x LOM	1x PCIe x8 LP, 1x PCIe x16 LP	None	None	TPM 1.2	XClarity Standard	1x 750W Platinum	None	3-year	07/17
7X08A034AU	ANZ	1x Xeon Silver 4110 8C/2.1GHz/11MB/85W/DDR4-2400	2x 32GB RDIMM DDR4-2666 (2Rx4)	1x 930-8i	8x 2.5"	8x 2.5" SATA/SAS HS	2x 600GB HDD 10K 2.5" SAS12Gbps	None	2x GbE RJ-45, 1x Mgmt	None	1x LOM	1x PCIe x8 LP, 1x PCIe x16 LP	Front VGA	None	TPM 1.2	XClarity Advanced	2x 750W Platinum	None	3-year	07/17
7X08A035AU	ANZ	1x Xeon Silver 4114 10C/2.2GHz/13.75MB/85W/DDR4-2400	1x 16GB RDIMM DDR4-2666 (1Rx4)	1x 930-8i	8x 2.5"	8x 2.5" SATA/SAS HS	2x 300GB HDD 10K 2.5" SAS12Gbps	None	2x GbE RJ-45, 1x Mgmt	None	1x LOM	1x PCIe x8 LP, 1x PCIe x16 LP	Front VGA	None	TPM 1.2	XClarity Advanced	2x 750W Platinum	None	3-year	07/17

Model	Region	Processor	Memory	Storage Controller	Chassis	Disk Bays	Disks	M.2 Drives	Onboard Networking Ports	Additional Networking (LOM/ML2/PCle)	Standard Extension Slots	Available Extension Slots via Riser Cards	Front VGA	Optical	TPM	System Management	Power Supply	Preload	Warranty	Ann Date (mm/yy)
7X08A03AAU	ANZ	1x Xeon Silver 4108 8C/1.8GHz/11MB/85W/DDR4-2400	1x 16GB RDIMM DDR4-2666 (1Rx4)	1x 530-8i	8x 2.5"	8x 2.5"	SATA/SAS Open	None	2x GbE RJ-45, 1x Mgmt	None	1x LOM	1x PCIe x8 LP, 1x PCIe x16 LP	Front VGA	None	TPM 1.2	XClarity Advanced	1x 750W Platinum	None	3-year	07/17
7X08A037AU	ANZ	1x Xeon Bronze 3106 8C/1.7GHz/11MB/85W/DDR4-2133	1x 16GB RDIMM DDR4-2666 (1Rx4)	1x 530-8i	8x 2.5"	8x 2.5"	SATA/SAS Open	None	2x GbE RJ-45, 1x Mgmt	None	1x LOM	1x PCIe x8 LP, 1x PCIe x16 LP	None	None	TPM 1.2	XClarity Standard	1x 750W Platinum	None	3-year	07/17
7X08A038AU	ANZ	1x Xeon Silver 4108 8C/1.8GHz/11MB/85W/DDR4-2400	1x 16GB RDIMM DDR4-2666 (1Rx4)	1x 930-8i 2GB Flash	8x 2.5"	8x 2.5"	SATA/SAS Open	None	2x GbE RJ-45, 1x Mgmt	None	1x LOM	1x PCIe x8 LP, 1x PCIe x16 LP	Front VGA	None	TPM 1.2	XClarity Advanced	1x 750W Platinum	None	3-year	07/17
7X08A03FAU	ANZ	1x Xeon Silver 4108 8C/1.8GHz/11MB/85W/DDR4-2400	1x 16GB RDIMM DDR4-2666 (1Rx4)	1x 530-8i	8x 2.5"	8x 2.5"	SATA/SAS Open	None	2x GbE RJ-45, 1x Mgmt	None	1x LOM	1x PCIe x8 LP, 1x PCIe x16 LP	None	None	TPM 1.2	XClarity Standard	1x 750W Platinum	None	3-year	07/17
7X08A03LAU	ANZ	1x Xeon Silver 4116 12C/2.1GHz/16.5MB/85W/DDR4-2400	1x 16GB RDIMM DDR4-2666 (1Rx4)	1x 930-8i 2GB Flash	8x 2.5"	8x 2.5"	SATA/SAS Open	None	2x GbE RJ-45, 1x Mgmt	None	1x LOM	1x PCIe x8 LP, 1x PCIe x16 LP	None	None	TPM 1.2	XClarity Standard	1x 750W Platinum	None	3-year	07/17
7X08A03MAU	ANZ	1x Xeon Bronze 3104 6C/1.7GHz/8.25MB/85W/DDR4-2133	1x 16GB RDIMM DDR4-2666 (1Rx4)	1x 530-8i	4x 3.5"	4x 3.5"	SATA/SAS Open	None	2x GbE RJ-45, 1x Mgmt	None	1x LOM	1x PCIe x8 LP, 1x PCIe x16 LP	Front VGA	None	TPM 1.2	XClarity Standard	1x 550W Platinum	None	3-year	07/17
7X08A03NAU	ANZ	1x Xeon Bronze 3104 6C/1.7GHz/8.25MB/85W/DDR4-2133	1x 16GB RDIMM DDR4-2666 (1Rx4)	1x 530-8i	8x 2.5"	8x 2.5"	SATA/SAS Open	None	2x GbE RJ-45, 1x Mgmt	None	1x LOM	1x PCIe x8 LP, 1x PCIe x16 LP	None	None	TPM 1.2	XClarity Standard	1x 750W Platinum	None	3-year	07/17
7X08A03HAU	ANZ	1x Xeon Silver 4108 8C/1.8GHz/11MB/85W/DDR4-2400	1x 16GB RDIMM DDR4-2666 (1Rx4)	1x 530-8i	4x 3.5"	4x 3.5"	SATA/SAS Open	None	2x GbE RJ-45, 1x Mgmt	None	1x LOM	1x PCIe x8 LP, 1x PCIe x16 LP	None	None	TPM 1.2	XClarity Standard	1x 750W Platinum	None	3-year	07/17
7X08A03JAU	ANZ	1x Xeon Silver 4116 12C/2.1GHz/16.5MB/85W/DDR4-2400	1x 16GB RDIMM DDR4-2666 (1Rx4)	1x 930-8i 2GB Flash	8x 2.5"	8x 2.5"	SATA/SAS Open	None	2x GbE RJ-45, 1x Mgmt	None	1x LOM	1x PCIe x8 LP, 1x PCIe x16 LP	Front VGA	None	TPM 1.2	XClarity Advanced	1x 750W Platinum	None	3-year	07/17
7X08A03QAU	ANZ	1x Xeon Bronze 3104 6C/1.7GHz/8.25MB/85W/DDR4-2133	1x 16GB RDIMM DDR4-2666 (1Rx4)	1x 530-8i	8x 2.5"	8x 2.5"	SATA/SAS Open	None	2x GbE RJ-45, 1x Mgmt	None	1x LOM	1x PCIe x8 LP, 1x PCIe x16 LP	Front VGA	None	TPM 1.2	XClarity Advanced	1x 750W Platinum	None	3-year	07/17

Model	Region	Processor	Memory	Storage Controller	Chassis	Disk Bays	Disks	M.2 Drives	Onboard Networking Ports	Additional Networking (LOM/ML2/PCIe)	Standard Extension Slots	Available Extension Slots via Riser Cards	Front VGA	Optical	TPM	System Management	Power Supply	Preload	Warranty	Ann Date (mm/yy)
7X08A03RAU	ANZ	1x Xeon Silver 4114 10C/2.2GHz/13.75MB/85W/DDR4-2400	1x 16GB RDIMM DDR4-2666	1x 930-8i 2GB Flash (1Rx4)	8x 2.5"	8x 2.5"	SATA/SAS Open HS	None	2x GbE RJ-45, 1x Mgmt	None	1x LOM	1x PCIe x8 LP, 1x PCIe x16 LP	Front VGA	None	TPM 1.2	XClarity Advanced	1x 750W Platinum	None	3-year	07/17
7X08A03TAU	ANZ	1x Xeon Gold 5118 12C/2.3GHz/16.5MB/105W/DDR4-2400	1x 16GB RDIMM DDR4-2666	1x 930-8i 2GB Flash (1Rx4)	8x 2.5"	8x 2.5"	SATA/SAS Open HS	None	2x GbE RJ-45, 1x Mgmt	None	1x LOM	1x PCIe x8 LP, 1x PCIe x16 LP	Front VGA	None	TPM 1.2	XClarity Enterprise	1x 750W Platinum	None	3-year	07/17
7X08A03UUAU	ANZ	1x Xeon Gold 6138 20C/2.0GHz/27.5MB/125W/DDR4-2666	1x 32GB RDIMM DDR4-2666	1x 930-8i 2GB Flash (2Rx4)	8x 2.5"	8x 2.5"	SATA/SAS Open HS	None	2x GbE RJ-45, 1x Mgmt	None	1x LOM	1x PCIe x8 LP, 1x PCIe x16 LP	Front VGA	None	TPM 1.2	XClarity Standard	1x 750W Platinum	None	3-year	07/17
7X08A03VAU	ANZ	1x Xeon Gold 5118 12C/2.3GHz/16.5MB/105W/DDR4-2400	1x 32GB RDIMM DDR4-2666	1x 930-8i 2GB Flash (2Rx4)	8x 2.5"	8x 2.5"	SATA/SAS Open HS	None	2x GbE RJ-45, 1x Mgmt	None	1x LOM	1x PCIe x8 LP, 1x PCIe x16 LP	Front VGA	None	TPM 1.2	XClarity Standard	1x 750W Platinum	None	3-year	07/17
7X08A04MAU	ANZ	1x Xeon Gold 5118 12C/2.3GHz/16.5MB/105W/DDR4-2400	1x 16GB RDIMM DDR4-2666	1x 930-8i 2GB Flash (1Rx4)	8x 2.5"	8x 2.5"	SATA/SAS Open HS	None	2x GbE RJ-45, 1x Mgmt	None	1x LOM	1x PCIe x8 LP, 1x PCIe x16 LP	Front VGA	None	TPM 1.2	XClarity Standard	1x 750W Platinum	None	3-year	07/17
7X08A041AU	ANZ	1x Xeon Gold 5120 14C/2.2GHz/19.25MB/105W/DDR4-2400	1x 16GB RDIMM DDR4-2666	1x 930-8i 2GB Flash (1Rx4)	8x 2.5"	8x 2.5"	SATA/SAS Open HS	None	2x GbE RJ-45, 1x Mgmt	None	1x LOM	1x PCIe x8 LP, 1x PCIe x16 LP	Front VGA	None	TPM 1.2	XClarity Standard	1x 750W Platinum	None	3-year	07/17
7X08A03ZAU	ANZ	1x Xeon Gold 6130 16C/2.1GHz/22MB/125W/DDR4-2666	1x 32GB RDIMM DDR4-2666	1x 930-8i 2GB Flash (2Rx4)	8x 2.5"	8x 2.5"	SATA/SAS Open HS	None	2x GbE RJ-45, 1x Mgmt	None	1x LOM	1x PCIe x8 LP, 1x PCIe x16 LP	Front VGA	None	TPM 1.2	XClarity Standard	1x 750W Platinum	None	3-year	07/17

Model	Region	Processor	Memory	Storage Controller	Chassis	Disk Bays	Disks	M.2 Drives	Onboard Networking Ports	Additional Networking (LOM/ML2/PCIe)	Standard Extension Slots	Available Extension Slots via Riser Cards	Front VGA	Optical	TPM	System Management	Power Supply	Preload	Warranty	Ann Date (mm/yy)
7X08A02CSG	ASEAN	1x Xeon Gold 5118 12C/2.3GHz/16.5MB/105W/DDR4-2400	1x 8GB RDIMM DDR4-2666 (1Rx8)	1x 530-8i	8x 2.5"	8x 2.5"	SATA/SAS Open HS	None	2x GbE RJ-45, 1x Mgmt	2x GbE RJ-45 LOM	1x LOM	1x PCIe x8 LP, 1x PCIe x16 LP	Front VGA	None	TPM 1.2	XClarity Standard	1x 550W Platinum	None	3-year	07/17
7X08A02DSG	ASEAN	1x Xeon Gold 5120 14C/2.2GHz/19.25MB/105W/DDR4-2400	1x 8GB RDIMM DDR4-2666 (1Rx8)	1x 530-8i	8x 2.5"	8x 2.5"	SATA/SAS Open HS	None	2x GbE RJ-45, 1x Mgmt	2x GbE RJ-45 LOM	1x LOM	1x PCIe x8 LP, 1x PCIe x16 LP	Front VGA	None	TPM 1.2	XClarity Standard	1x 550W Platinum	None	3-year	07/17
7X08A02ESG	ASEAN	1x Xeon Gold 5122 4C/3.6GHz/16.5MB/105W/DDR4-2666	1x 8GB RDIMM DDR4-2666 (1Rx8)	1x 530-8i	8x 2.5"	8x 2.5"	SATA/SAS Open HS	None	2x GbE RJ-45, 1x Mgmt	2x GbE RJ-45 LOM	1x LOM	1x PCIe x8 LP, 1x PCIe x16 LP	Front VGA	None	TPM 1.2	XClarity Standard	1x 550W Platinum	None	3-year	07/17
7X08A02FSG	ASEAN	1x Xeon Gold 6130 16C/2.1GHz/22MB/125W/DDR4-2666	1x 8GB RDIMM DDR4-2666 (1Rx8)	1x 530-8i	8x 2.5"	8x 2.5"	SATA/SAS Open HS	None	2x GbE RJ-45, 1x Mgmt	2x GbE RJ-45 LOM	1x LOM	1x PCIe x8 LP, 1x PCIe x16 LP	Front VGA	None	TPM 1.2	XClarity Standard	1x 550W Platinum	None	3-year	07/17
7X08A02GSG	ASEAN	1x Xeon Gold 6138 20C/2.0GHz/27.5MB/125W/DDR4-2666	1x 8GB RDIMM DDR4-2666 (1Rx8)	1x 530-8i	8x 2.5"	8x 2.5"	SATA/SAS Open HS	None	2x GbE RJ-45, 1x Mgmt	2x GbE RJ-45 LOM	1x LOM	1x PCIe x8 LP, 1x PCIe x16 LP	Front VGA	None	TPM 1.2	XClarity Standard	1x 550W Platinum	None	3-year	07/17
7X08A02HSG	ASEAN	1x Xeon Gold 5122 4C/3.6GHz/16.5MB/105W/DDR4-2666	1x 8GB RDIMM DDR4-2666 (1Rx8)	1x 530-8i	4x 3.5"	4x 3.5"	SATA/SAS Open HS	None	2x GbE RJ-45, 1x Mgmt	2x GbE RJ-45 LOM	1x LOM	1x PCIe x8 LP, 1x PCIe x16 LP	Front VGA	None	TPM 1.2	XClarity Standard	1x 550W Platinum	None	3-year	07/17
7X08A02JSG	ASEAN	1x Xeon Silver 4110 8C/2.1GHz/11MB/85W/DDR4-2400	1x 8GB RDIMM DDR4-2666 (1Rx8)	1x 530-8i	8x 2.5"	8x 2.5"	SATA/SAS Open HS	None	2x GbE RJ-45, 1x Mgmt	None	1x LOM	1x PCIe x8 LP, 1x PCIe x16 LP	None	None	TPM 1.2	XClarity Standard	1x 550W Platinum	None	3-year	07/17
7X08A02KSG	ASEAN	1x Xeon Silver 4112 4C/2.6GHz/8.25MB/85W/DDR4-2400	1x 8GB RDIMM DDR4-2666 (1Rx8)	1x 530-8i	8x 2.5"	8x 2.5"	SATA/SAS Open HS	None	2x GbE RJ-45, 1x Mgmt	None	1x LOM	1x PCIe x8 LP, 1x PCIe x16 LP	None	None	TPM 1.2	XClarity Standard	1x 550W Platinum	None	3-year	07/17
7X08A02LSG	ASEAN	1x Xeon Bronze 3104 6C/1.7GHz/8.25MB/85W/DDR4-2133	1x 8GB RDIMM DDR4-2666 (1Rx8)	1x 530-8i	8x 2.5"	8x 2.5"	SATA/SAS Open HS	None	2x GbE RJ-45, 1x Mgmt	None	1x LOM	1x PCIe x8 LP, 1x PCIe x16 LP	None	None	TPM 1.2	XClarity Standard	1x 550W Platinum	None	3-year	07/17
7X08A02MSG	ASEAN	1x Xeon Bronze 3106 8C/1.7GHz/11MB/85W/DDR4-2133	1x 8GB RDIMM DDR4-2666 (1Rx8)	1x 530-8i	8x 2.5"	8x 2.5"	SATA/SAS Open HS	None	2x GbE RJ-45, 1x Mgmt	None	1x LOM	1x PCIe x8 LP, 1x PCIe x16 LP	None	None	TPM 1.2	XClarity Standard	1x 550W Platinum	None	3-year	07/17

Model	Region	Processor	Memory	Storage Controller	Chassis	Disk Bays	Disks	M.2 Drives	Onboard Networking Ports	Additional Networking (LOM/ML2/PCIe)	Standard Extension Slots	Available Extension Slots via Riser Cards	Front VGA	Optical	TPM	System Management	Power Supply	Preload	Warranty	Ann Date (mm/yy)
7X08A02NSG	ASEAN	1x Xeon Silver 4114 10C/2.2GHz/13.75MB/85W/DDR4-2400	1x 8GB RDIMM DDR4-2666 (1Rx8)	1x 530-8i	8x 2.5"	8x 2.5"	SATA/SAS Open	None	2x GbE RJ-45, 1x Mgmt	None	1x LOM	1x PCIe x8 LP, 1x PCIe x16 LP	None	None	TPM 1.2	XClarity Standard	1x 550W Platinum	None	3-year	07/17
7X08A02PSG	ASEAN	1x Xeon Silver 4116 12C/2.1GHz/16.5MB/85W/DDR4-2400	1x 8GB RDIMM DDR4-2666 (1Rx8)	1x 530-8i	8x 2.5"	8x 2.5"	SATA/SAS Open	None	2x GbE RJ-45, 1x Mgmt	None	1x LOM	1x PCIe x8 LP, 1x PCIe x16 LP	None	None	TPM 1.2	XClarity Standard	1x 550W Platinum	None	3-year	07/17
7X08A02QSG	ASEAN	1x Xeon Silver 4112 4C/2.6GHz/8.25MB/85W/DDR4-2400	1x 8GB RDIMM DDR4-2666 (1Rx8)	1x 530-8i	4x 3.5"	4x 3.5"	SATA/SAS Open	None	2x GbE RJ-45, 1x Mgmt	None	1x LOM	1x PCIe x8 LP, 1x PCIe x16 LP	None	None	TPM 1.2	XClarity Standard	1x 550W Platinum	None	3-year	07/17

Model	Region	Processor	Memory	Storage Controller	Chassis	Disk Bays	Disks	M.2 Drives	Onboard Networking Ports	Additional Networking (LOM/ML2/PCle)	Standard Extension Slots	Available Extension Slots via Riser Cards	Front VGA	Optical	TPM	System Management	Power Supply	Preload	Warranty	Ann Date (mm/yy)
7X08A04NBR	Brazil	1x Xeon Gold 6130 16C/2.1GHz/22MB/125W/DDR4-2666	1x 16GB RDIMM DDR4-2666 (1Rx4)	1x 530-8i	8x 2.5"	SATA/SAS HS	1x 600GB HDD 10K 2.5" SAS12Gbps	None	2x GbE RJ-45, 1x Mgmt	None	1x LOM	1x PCIe x8 LP, 1x PCIe x16 LP	Front VGA	None	TPM 1.2	XClarity Standard	1x 750W Platinum	None	3-year	07/17
7X08A04PBR	Brazil	1x Xeon Gold 5120 14C/2.2GHz/19.25MB/105W/DDR4-2400	1x 8GB RDIMM DDR4-2666 (1Rx8)	1x 530-8i	8x 2.5"	SATA/SAS HS	1x 600GB HDD 10K 2.5" SAS12Gbps	None	2x GbE RJ-45, 1x Mgmt	None	1x LOM	1x PCIe x8 LP, 1x PCIe x16 LP	Front VGA	None	TPM 1.2	XClarity Standard	1x 750W Platinum	None	3-year	07/17
7X08A04QBR	Brazil	1x Xeon Gold 5118 12C/2.3GHz/16.5MB/105W/DDR4-2400	1x 32GB RDIMM DDR4-2666 (2Rx4)	1x 530-8i	8x 2.5"	SATA/SAS HS	Open	None	2x GbE RJ-45, 1x Mgmt	None	1x LOM	1x PCIe x8 LP, 1x PCIe x16 LP	Front VGA	None	TPM 1.2	XClarity Standard	1x 750W Platinum	None	3-year	07/17
7X08A04RBR	Brazil	1x Xeon Gold 5120 14C/2.2GHz/19.25MB/105W/DDR4-2400	1x 16GB RDIMM DDR4-2666 (1Rx4)	1x 530-8i	8x 2.5"	SATA/SAS HS	1x 600GB HDD 10K 2.5" SAS12Gbps	None	2x GbE RJ-45, 1x Mgmt	None	1x LOM	1x PCIe x8 LP, 1x PCIe x16 LP	Front VGA	None	TPM 1.2	XClarity Standard	1x 750W Platinum	None	3-year	07/17
7X08A03WBR	Brazil	1x Xeon Gold 5120 14C/2.2GHz/19.25MB/105W/DDR4-2400	1x 32GB RDIMM DDR4-2666 (2Rx4)	1x 530-8i	8x 2.5"	SATA/SAS HS	Open	None	2x GbE RJ-45, 1x Mgmt	None	1x LOM	1x PCIe x8 LP, 1x PCIe x16 LP	Front VGA	None	TPM 1.2	XClarity Standard	1x 750W Platinum	None	3-year	07/17
7X08A03XBR	Brazil	1x Xeon Gold 6130 16C/2.1GHz/22MB/125W/DDR4-2666	1x 16GB RDIMM DDR4-2666 (1Rx4)	1x 530-8i	8x 2.5"	SATA/SAS HS	Open	None	2x GbE RJ-45, 1x Mgmt	None	1x LOM	1x PCIe x8 LP, 1x PCIe x16 LP	Front VGA	None	TPM 1.2	XClarity Standard	1x 750W Platinum	None	3-year	07/17
7X08A03YBR	Brazil	1x Xeon Gold 5120 14C/2.2GHz/19.25MB/105W/DDR4-2400	1x 32GB RDIMM DDR4-2666 (2Rx4)	1x 530-8i	8x 2.5"	SATA/SAS HS	1x 600GB HDD 10K 2.5" SAS12Gbps	None	2x GbE RJ-45, 1x Mgmt	None	1x LOM	1x PCIe x8 LP, 1x PCIe x16 LP	Front VGA	None	TPM 1.2	XClarity Standard	1x 750W Platinum	None	3-year	07/17
7X08A046BR	Brazil	1x Xeon Gold 6130 16C/2.1GHz/22MB/125W/DDR4-2666	1x 8GB RDIMM DDR4-2666 (1Rx8)	1x 530-8i	8x 2.5"	SATA/SAS HS	Open	None	2x GbE RJ-45, 1x Mgmt	None	1x LOM	1x PCIe x8 LP, 1x PCIe x16 LP	Front VGA	None	TPM 1.2	XClarity Standard	1x 750W Platinum	None	3-year	07/17
7X08A047BR	Brazil	1x Xeon Gold 5120 14C/2.2GHz/19.25MB/105W/DDR4-2400	1x 64GB LRDIMM DDR4-2666 (4Rx4)	1x 530-8i	8x 2.5"	SATA/SAS HS	1x 600GB HDD 10K 2.5" SAS12Gbps	None	2x GbE RJ-45, 1x Mgmt	None	1x LOM	1x PCIe x8 LP, 1x PCIe x16 LP	Front VGA	None	TPM 1.2	XClarity Standard	1x 750W Platinum	None	3-year	07/17
7X08A048BR	Brazil	1x Xeon Gold 5120 14C/2.2GHz/19.25MB/105W/DDR4-2400	1x 16GB RDIMM DDR4-2666 (1Rx4)	1x 530-8i	8x 2.5"	SATA/SAS HS	Open	None	2x GbE RJ-45, 1x Mgmt	None	1x LOM	1x PCIe x8 LP, 1x PCIe x16 LP	Front VGA	None	TPM 1.2	XClarity Standard	1x 750W Platinum	None	3-year	07/17

Model	Region	Processor	Memory	Storage Controller	Chassis	Disk Bays	Disks	M.2 Drives	Onboard Networking Ports	Additional Networking (LOM/ML2/PCIe)	Standard Extension Slots	Available Extension Slots via Riser Cards	Front VGA	Optical	TPM	System Management	Power Supply	Preload	Warranty	Ann Date (mm/yy)
7X08A049BR	Brazil	1x Xeon Gold 5120 14C/2.2GHz/19.25MB/105W/DDR4-2400	1x 8GB RDIMM DDR4-2666 (1Rx8)	1x 530-8i	8x 2.5"	8x 2.5" SATA/SAS HS	Open	None	2x GbE RJ-45, 1x Mgmt	None	1x LOM	1x PCIe x8 LP, 1x PCIe x16 LP	Front VGA	None	TPM 1.2	XClarity Standard	1x 750W Platinum	None	3-year	07/17
7X08A04ABR	Brazil	1x Xeon Gold 5120 14C/2.2GHz/19.25MB/105W/DDR4-2400	1x 64GB LRDIMM DDR4-2666 (4Rx4)	1x 530-8i	8x 2.5"	8x 2.5" SATA/SAS HS	Open	None	2x GbE RJ-45, 1x Mgmt	None	1x LOM	1x PCIe x8 LP, 1x PCIe x16 LP	Front VGA	None	TPM 1.2	XClarity Standard	1x 750W Platinum	None	3-year	07/17
7X08A04BBR	Brazil	1x Xeon Gold 6130 16C/2.1GHz/22MB/125W/DDR4-2666	1x 32GB RDIMM DDR4-2666 (2Rx4)	1x 530-8i	8x 2.5"	8x 2.5" SATA/SAS HS	Open	None	2x GbE RJ-45, 1x Mgmt	None	1x LOM	1x PCIe x8 LP, 1x PCIe x16 LP	Front VGA	None	TPM 1.2	XClarity Standard	1x 750W Platinum	None	3-year	07/17
7X08A04CBR	Brazil	1x Xeon Gold 6130 16C/2.1GHz/22MB/125W/DDR4-2666	1x 32GB RDIMM DDR4-2666 (2Rx4)	1x 530-8i	8x 2.5"	8x 2.5" SATA/SAS HS	1x 600GB HDD 10K 2.5"	None	2x GbE RJ-45, 1x Mgmt	None	1x LOM	1x PCIe x8 LP, 1x PCIe x16 LP	Front VGA	None	TPM 1.2	XClarity Standard	1x 750W Platinum	None	3-year	07/17
7X08A04DBR	Brazil	1x Xeon Gold 6130 16C/2.1GHz/22MB/125W/DDR4-2666	1x 8GB RDIMM DDR4-2666 (1Rx8)	1x 530-8i	8x 2.5"	8x 2.5" SATA/SAS HS	1x 600GB HDD 10K 2.5"	None	2x GbE RJ-45, 1x Mgmt	None	1x LOM	1x PCIe x8 LP, 1x PCIe x16 LP	Front VGA	None	TPM 1.2	XClarity Standard	1x 750W Platinum	None	3-year	07/17
7X08A04EBR	Brazil	1x Xeon Gold 6130 16C/2.1GHz/22MB/125W/DDR4-2666	1x 64GB LRDIMM DDR4-2666 (4Rx4)	1x 530-8i	8x 2.5"	8x 2.5" SATA/SAS HS	1x 600GB HDD 10K 2.5"	None	2x GbE RJ-45, 1x Mgmt	None	1x LOM	1x PCIe x8 LP, 1x PCIe x16 LP	Front VGA	None	TPM 1.2	XClarity Standard	1x 750W Platinum	None	3-year	07/17
7X08A040BR	Brazil	1x Xeon Gold 5118 12C/2.3GHz/16.5MB/105W/DDR4-2400	1x 64GB LRDIMM DDR4-2666 (4Rx4)	1x 530-8i	8x 2.5"	8x 2.5" SATA/SAS HS	Open	None	2x GbE RJ-45, 1x Mgmt	None	1x LOM	1x PCIe x8 LP, 1x PCIe x16 LP	Front VGA	None	TPM 1.2	XClarity Standard	1x 750W Platinum	None	3-year	07/17
7X08A042BR	Brazil	1x Xeon Gold 5118 12C/2.3GHz/16.5MB/105W/DDR4-2400	1x 16GB RDIMM DDR4-2666 (1Rx4)	1x 530-8i	8x 2.5"	8x 2.5" SATA/SAS HS	1x 600GB HDD 10K 2.5"	None	2x GbE RJ-45, 1x Mgmt	None	1x LOM	1x PCIe x8 LP, 1x PCIe x16 LP	Front VGA	None	TPM 1.2	XClarity Standard	1x 750W Platinum	None	3-year	07/17
7X08A043BR	Brazil	1x Xeon Gold 5118 12C/2.3GHz/16.5MB/105W/DDR4-2400	1x 8GB RDIMM DDR4-2666 (1Rx8)	1x 530-8i	8x 2.5"	8x 2.5" SATA/SAS HS	Open	None	2x GbE RJ-45, 1x Mgmt	None	1x LOM	1x PCIe x8 LP, 1x PCIe x16 LP	Front VGA	None	TPM 1.2	XClarity Standard	1x 750W Platinum	None	3-year	07/17
7X08A044BR	Brazil	1x Xeon Gold 5118 12C/2.3GHz/16.5MB/105W/DDR4-2400	1x 32GB RDIMM DDR4-2666 (2Rx4)	1x 530-8i	8x 2.5"	8x 2.5" SATA/SAS HS	1x 600GB HDD 10K 2.5"	None	2x GbE RJ-45, 1x Mgmt	None	1x LOM	1x PCIe x8 LP, 1x PCIe x16 LP	Front VGA	None	TPM 1.2	XClarity Standard	1x 750W Platinum	None	3-year	07/17

Model	Region	Processor	Memory	Storage Controller	Chassis	Disk Bays	Disks	M.2 Drives	Onboard Networking Ports	Additional Networking (LOM/ML2/PCIe)	Standard Extension Slots	Available Extension Slots via Riser Cards	Front VGA	Optical	TPM	System Management	Power Supply	Preload	Warranty	Ann Date (mm/yy)
7X08A04HBR	Brazil	1x Xeon Gold 5118 12C/2.3GHz/16.5MB/105W/DDR4-2400	1x 64GB LRDIMM DDR4-2666 (4Rx4)	1x 530-8i	8x 2.5"	8x 2.5" SATA/SAS HS	1x 600GB HDD 10K 2.5" SAS12Gbps	None	2x GbE RJ-45, 1x Mgmt	None	1x LOM	1x PCIe x8 LP, 1x PCIe x16 LP	Front VGA	None	TPM 1.2	XClarity Standard	1x 750W Platinum	None	3-year	07/17
7X08A04JBR	Brazil	1x Xeon Gold 5118 12C/2.3GHz/16.5MB/105W/DDR4-2400	1x 16GB RDIMM DDR4-2666 (1Rx4)	1x 530-8i	8x 2.5"	8x 2.5" SATA/SAS HS	Open	None	2x GbE RJ-45, 1x Mgmt	None	1x LOM	1x PCIe x8 LP, 1x PCIe x16 LP	Front VGA	None	TPM 1.2	XClarity Standard	1x 750W Platinum	None	3-year	07/17
7X08A04KBR	Brazil	1x Xeon Gold 6130 16C/2.1GHz/22MB/125W/DDR4-2666	1x 64GB LRDIMM DDR4-2666 (4Rx4)	1x 530-8i	8x 2.5"	8x 2.5" SATA/SAS HS	Open	None	2x GbE RJ-45, 1x Mgmt	None	1x LOM	1x PCIe x8 LP, 1x PCIe x16 LP	Front VGA	None	TPM 1.2	XClarity Standard	1x 750W Platinum	None	3-year	07/17
7X08A04LBR	Brazil	1x Xeon Gold 5118 12C/2.3GHz/16.5MB/105W/DDR4-2400	1x 8GB RDIMM DDR4-2666 (1Rx8)	1x 530-8i	8x 2.5"	8x 2.5" SATA/SAS HS	1x 600GB HDD 10K 2.5" SAS12Gbps	None	2x GbE RJ-45, 1x Mgmt	None	1x LOM	1x PCIe x8 LP, 1x PCIe x16 LP	Front VGA	None	TPM 1.2	XClarity Standard	1x 750W Platinum	None	3-year	07/17

Model	Region	Processor	Memory	Storage Controller	Chassis	Disk Bays	Disks	M.2 Drives	Onboard Networking Ports	Additional Networking (LOM/ML2/PCIe)	Standard Extension Slots	Available Extension Slots via Riser Cards	Front VGA	Optical	TPM	System Management	Power Supply	Preload	Warranty	Ann Date (mm/yy)
7X08A003EA	EMEA	1x Xeon Gold 5118 12C/2.3GHz/16.5MB/105W/DDR4-2400	1x 16GB RDIMM DDR4-2666 (1Rx4)	1x 930-8i 2GB Flash	8x 2.5"	8x 2.5"	SATA/SAS Open HS	None	2x GbE RJ-45, 1x Mgmt	None	1x LOM	1x PCIe x8 LP, 1x PCIe x16 LP	None	None	TPM 1.2	XClarity Standard	1x 750W Platinum	None	3-year	07/17
7X08A00JEA	EMEA	1x Xeon Gold 5120 14C/2.2GHz/19.25MB/105W/DDR4-2400	1x 16GB RDIMM DDR4-2666 (1Rx4)	1x 930-8i 2GB Flash	8x 2.5"	8x 2.5"	SATA/SAS Open HS	None	2x GbE RJ-45, 1x Mgmt	None	1x LOM	1x PCIe x8 LP, 1x PCIe x16 LP	None	None	TPM 1.2	XClarity Standard	1x 750W Platinum	None	3-year	07/17
7X08A00NEA	EMEA	1x Xeon Gold 6126 12C/2.6GHz/19.25MB/125W/DDR4-2666	1x 16GB RDIMM DDR4-2666 (1Rx4)	1x 930-8i 2GB Flash	8x 2.5"	8x 2.5"	SATA/SAS Open HS	None	2x GbE RJ-45, 1x Mgmt	None	1x LOM	1x PCIe x8 LP, 1x PCIe x16 LP	None	None	TPM 1.2	XClarity Standard	1x 750W Platinum	None	3-year	07/17
7X08A00PEA	EMEA	1x Xeon Gold 5118 12C/2.3GHz/16.5MB/105W/DDR4-2400	1x 32GB RDIMM DDR4-2666 (2Rx4)	1x 930-8i 2GB Flash	8x 2.5"	8x 2.5"	SATA/SAS Open HS	None	2x GbE RJ-45, 1x Mgmt	None	1x LOM	1x PCIe x8 LP, 1x PCIe x16 LP	None	None	TPM 1.2	XClarity Standard	1x 750W Platinum	None	3-year	07/17
7X08A01TEA	EMEA	1x Xeon Bronze 3106 8C/1.7GHz/11MB/85W/DDR4-2133	1x 16GB RDIMM DDR4-2666 (1Rx4)	1x 530-8i 2GB Flash	8x 2.5"	8x 2.5"	SATA/SAS Open HS	None	2x GbE RJ-45, 1x Mgmt	None	1x LOM	1x PCIe x8 LP, 1x PCIe x16 LP	None	None	TPM 1.2	XClarity Standard	1x 750W Platinum	None	3-year	07/17
7X08A01YEA	EMEA	1x Xeon Silver 4114 10C/2.2GHz/13.75MB/85W/DDR4-2400	1x 16GB RDIMM DDR4-2666 (1Rx4)	1x 930-8i 2GB Flash	8x 2.5"	8x 2.5"	SATA/SAS Open HS	None	2x GbE RJ-45, 1x Mgmt	None	1x LOM	1x PCIe x8 LP, 1x PCIe x16 LP	None	None	TPM 1.2	XClarity Standard	1x 750W Platinum	None	3-year	07/17
7X08A01ZEA	EMEA	1x Xeon Silver 4108 8C/1.8GHz/11MB/85W/DDR4-2400	1x 16GB RDIMM DDR4-2666 (1Rx4)	1x 530-8i 2GB Flash	4x 3.5"	4x 3.5"	SATA/SAS Open HS	None	2x GbE RJ-45, 1x Mgmt	None	1x LOM	1x PCIe x8 LP, 1x PCIe x16 LP	None	None	TPM 1.2	XClarity Standard	1x 750W Platinum	None	3-year	07/17
7X08A021EA	EMEA	1x Xeon Silver 4116 12C/2.1GHz/16.5MB/85W/DDR4-2400	1x 16GB RDIMM DDR4-2666 (1Rx4)	1x 930-8i 2GB Flash	8x 2.5"	8x 2.5"	SATA/SAS Open HS	None	2x GbE RJ-45, 1x Mgmt	None	1x LOM	1x PCIe x8 LP, 1x PCIe x16 LP	None	None	TPM 1.2	XClarity Standard	1x 750W Platinum	None	3-year	07/17
7X08A023EA	EMEA	1x Xeon Silver 4110 8C/2.1GHz/11MB/85W/DDR4-2400	1x 16GB RDIMM DDR4-2666 (1Rx4)	1x 930-8i 2GB Flash	8x 2.5"	8x 2.5"	SATA/SAS Open HS	None	2x GbE RJ-45, 1x Mgmt	None	1x LOM	1x PCIe x8 LP, 1x PCIe x16 LP	None	None	TPM 1.2	XClarity Standard	1x 750W Platinum	None	3-year	07/17
7X08A026EA	EMEA	1x Xeon Bronze 3104 6C/1.7GHz/8.25MB/85W/DDR4-2133	1x 16GB RDIMM DDR4-2666 (1Rx4)	1x 530-8i 2GB Flash	8x 2.5"	8x 2.5"	SATA/SAS Open HS	None	2x GbE RJ-45, 1x Mgmt	None	1x LOM	1x PCIe x8 LP, 1x PCIe x16 LP	None	None	TPM 1.2	XClarity Standard	1x 750W Platinum	None	3-year	07/17

Model	Region	Processor	Memory	Storage Controller	Chassis	Disk Bays	Disks	M.2 Drives	Onboard Networking Ports	Additional Networking (LOM/ML2/PCIe)	Standard Extension Slots	Available Extension Slots via Riser Cards	Front VGA	Optical	TPM	System Management	Power Supply	Preload	Warranty	Ann Date (mm/yy)
7X08A02AEA	EMEA	1x Xeon Silver 4110 8C/2.1GHz/11MB/85W/DDR4-2400	1x 16GB RDIMM DDR4-2666 (1Rx4)	1x 530-8i	8x 2.5"	8x 2.5"	SATA/SAS Open	None	2x GbE RJ-45, 1x Mgmt	None	1x LOM	1x PCIe x8 LP, 1x PCIe x16 LP	None	None	TPM 1.2	XClarity Standard	1x 750W Platinum	None	3-year	07/17
7X08A018EA	EMEA	1x Xeon Gold 6138 20C/2.0GHz/27.5MB/125W/DDR4-2666	1x 32GB RDIMM DDR4-2666 (2Rx4)	1x 930-8i 2GB Flash	8x 2.5"	8x 2.5"	SATA/SAS Open	None	2x GbE RJ-45, 1x Mgmt	None	1x LOM	1x PCIe x8 LP, 1x PCIe x16 LP	None	None	TPM 1.2	XClarity Standard	1x 750W Platinum	None	3-year	07/17
7X08A04SEA	EMEA	1x Xeon Gold 5115 10C/2.4GHz/13.75MB/85W/DDR4-2400	1x 16GB RDIMM DDR4-2666 (1Rx4)	1x 930-8i 2GB Flash	8x 2.5"	8x 2.5"	SATA/SAS Open	None	2x GbE RJ-45, 1x Mgmt	None	1x LOM	1x PCIe x8 LP, 1x PCIe x16 LP	None	None	TPM 1.2	XClarity Standard	1x 750W Platinum	None	3-year	07/17

Model	Region	Processor	Memory	Storage Controller	Chassis	Disk Bays	Disks	M.2 Drives	Onboard Networking Ports	Additional Networking (LOM/ML2/PCle)	Standard Extension Slots	Available Extension Slots via Riser Cards	Front VGA	Optical	TPM	System Management	Power Supply	Preload	Warranty	Ann Date (mm/yy)
7X08A03KCN	HTK	1x Xeon Silver 4108 8C/1.8GHz/11MB/85W/DDR4-2400	1x 16GB RDIMM DDR4-2666 (1Rx4)	1x 930-8i 2GB Flash	4x 3.5"	4x 3.5"	SATA/SAS Open	None	2x GbE RJ-45, 1x Mgmt	2x GbE RJ-45 LOM	1x LOM	1x PCIe x8 LP, 1x PCIe x16 LP	None	None	TPM 1.2	XClarity Standard	1x 750W Platinum	None	3-year	07/17
7X08A031CN	HTK	1x Xeon Bronze 3106 8C/1.7GHz/11MB/85W/DDR4-2133	1x 16GB RDIMM DDR4-2666 (1Rx4)	1x 930-8i 2GB Flash	4x 3.5"	4x 3.5"	SATA/SAS Open	None	2x GbE RJ-45, 1x Mgmt	2x GbE RJ-45 LOM	1x LOM	1x PCIe x8 LP, 1x PCIe x16 LP	None	None	TPM 1.2	XClarity Standard	1x 750W Platinum	None	3-year	07/17
7X08A02YCN	HTK	1x Xeon Silver 4116 12C/2.1GHz/16.5MB/85W/DDR4-2400	1x 16GB RDIMM DDR4-2666 (1Rx4)	1x 930-8i 2GB Flash	8x 2.5"	8x 2.5"	SATA/SAS Open	None	2x GbE RJ-45, 1x Mgmt	2x GbE RJ-45 LOM	1x LOM	1x PCIe x8 LP, 1x PCIe x16 LP	None	None	TPM 1.2	XClarity Standard	1x 750W Platinum	None	3-year	07/17
7X08A02ZCN	HTK	1x Xeon Bronze 3104 6C/1.7GHz/8.25MB/85W/DDR4-2133	1x 16GB RDIMM DDR4-2666 (1Rx4)	1x 930-8i 2GB Flash	4x 3.5"	4x 3.5"	SATA/SAS Open	None	2x GbE RJ-45, 1x Mgmt	2x GbE RJ-45 LOM	1x LOM	1x PCIe x8 LP, 1x PCIe x16 LP	None	None	TPM 1.2	XClarity Standard	1x 750W Platinum	None	3-year	07/17
7X08A02TCN	HTK	1x Xeon Bronze 3106 8C/1.7GHz/11MB/85W/DDR4-2133	1x 16GB RDIMM DDR4-2666 (1Rx4)	1x 930-8i 2GB Flash	8x 2.5"	8x 2.5"	SATA/SAS Open	None	2x GbE RJ-45, 1x Mgmt	2x GbE RJ-45 LOM	1x LOM	1x PCIe x8 LP, 1x PCIe x16 LP	None	None	TPM 1.2	XClarity Standard	1x 750W Platinum	None	3-year	07/17
7X08A02UCN	HTK	1x Xeon Silver 4114 10C/2.2GHz/13.75MB/85W/DDR4-2400	1x 16GB RDIMM DDR4-2666 (1Rx4)	1x 930-8i 2GB Flash	8x 2.5"	8x 2.5"	SATA/SAS Open	None	2x GbE RJ-45, 1x Mgmt	2x GbE RJ-45 LOM	1x LOM	1x PCIe x8 LP, 1x PCIe x16 LP	None	None	TPM 1.2	XClarity Standard	1x 750W Platinum	None	3-year	07/17
7X08A02VCN	HTK	1x Xeon Gold 5115 10C/2.4GHz/13.75MB/85W/DDR4-2400	1x 16GB RDIMM DDR4-2666 (1Rx4)	1x 930-8i 2GB Flash	4x 3.5"	4x 3.5"	SATA/SAS Open	None	2x GbE RJ-45, 1x Mgmt	2x GbE RJ-45 LOM	1x LOM	1x PCIe x8 LP, 1x PCIe x16 LP	None	None	TPM 1.2	XClarity Standard	1x 750W Platinum	None	3-year	07/17
7X08A02WCN	HTK	1x Xeon Silver 4116 12C/2.1GHz/16.5MB/85W/DDR4-2400	1x 16GB RDIMM DDR4-2666 (1Rx4)	1x 930-8i 2GB Flash	4x 3.5"	4x 3.5"	SATA/SAS Open	None	2x GbE RJ-45, 1x Mgmt	2x GbE RJ-45 LOM	1x LOM	1x PCIe x8 LP, 1x PCIe x16 LP	None	None	TPM 1.2	XClarity Standard	1x 750W Platinum	None	3-year	07/17
7X08A03PCN	HTK	1x Xeon Silver 4110 8C/2.1GHz/11MB/85W/DDR4-2400	1x 16GB RDIMM DDR4-2666 (1Rx4)	1x 930-8i 2GB Flash	8x 2.5"	8x 2.5"	SATA/SAS Open	None	2x GbE RJ-45, 1x Mgmt	2x GbE RJ-45 LOM	1x LOM	1x PCIe x8 LP, 1x PCIe x16 LP	None	None	TPM 1.2	XClarity Standard	1x 750W Platinum	None	3-year	07/17
7X08A03GCN	HTK	1x Xeon Silver 4110 8C/2.1GHz/11MB/85W/DDR4-2400	1x 16GB RDIMM DDR4-2666 (1Rx4)	1x 930-8i 2GB Flash	4x 3.5"	4x 3.5"	SATA/SAS Open	None	2x GbE RJ-45, 1x Mgmt	2x GbE RJ-45 LOM	1x LOM	1x PCIe x8 LP, 1x PCIe x16 LP	None	None	TPM 1.2	XClarity Standard	1x 750W Platinum	None	3-year	07/17

Model	Region	Processor	Memory	Storage Controller	Chassis	Disk Bays	Disks	M.2 Drives	Onboard Networking Ports	Additional Networking (LOM/ML2/PCle)	Standard Extension Slots	Available Extension Slots via Riser Cards	Front VGA	Optical	TPM	System Management	Power Supply	Preload	Warranty	Ann Date (mm/yy)
7X08A039CN	HTK	1x Xeon Silver 4108 8C/1.8GHz/11MB/85W/DDR4-2400	1x 16GB RDIMM DDR4-2666 (1Rx4)	1x 930-8i 2GB Flash	8x 2.5"	8x 2.5"	SATA/SAS Open HS	None	2x GbE RJ-45, 1x Mgmt	2x GbE RJ-45 LOM	1x LOM	1x PCIe x8 LP, 1x PCIe x16 LP	None	None	TPM 1.2	XClarity Standard	1x 750W Platinum	None	3-year	07/17
7X08A03BCN	HTK	1x Xeon Bronze 3104 6C/1.7GHz/8.25MB/85W/DDR4-2133	1x 16GB RDIMM DDR4-2666 (1Rx4)	1x 930-8i 2GB Flash	8x 2.5"	8x 2.5"	SATA/SAS Open HS	None	2x GbE RJ-45, 1x Mgmt	2x GbE RJ-45 LOM	1x LOM	1x PCIe x8 LP, 1x PCIe x16 LP	None	None	TPM 1.2	XClarity Standard	1x 750W Platinum	None	3-year	07/17
7X08A03CCN	HTK	1x Xeon Silver 4112 4C/2.6GHz/8.25MB/85W/DDR4-2400	1x 16GB RDIMM DDR4-2666 (1Rx4)	1x 930-8i 2GB Flash	4x 3.5"	4x 3.5"	SATA/SAS Open HS	None	2x GbE RJ-45, 1x Mgmt	2x GbE RJ-45 LOM	1x LOM	1x PCIe x8 LP, 1x PCIe x16 LP	None	None	TPM 1.2	XClarity Standard	1x 750W Platinum	None	3-year	07/17
7X08A03DCN	HTK	1x Xeon Silver 4112 4C/2.6GHz/8.25MB/85W/DDR4-2400	1x 16GB RDIMM DDR4-2666 (1Rx4)	1x 930-8i 2GB Flash	8x 2.5"	8x 2.5"	SATA/SAS Open HS	None	2x GbE RJ-45, 1x Mgmt	2x GbE RJ-45 LOM	1x LOM	1x PCIe x8 LP, 1x PCIe x16 LP	None	None	TPM 1.2	XClarity Standard	1x 750W Platinum	None	3-year	07/17
7X08A03ECN	HTK	1x Xeon Gold 5115 10C/2.4GHz/13.75MB/85W/DDR4-2400	1x 16GB RDIMM DDR4-2666 (1Rx4)	1x 930-8i 2GB Flash	8x 2.5"	8x 2.5"	SATA/SAS Open HS	None	2x GbE RJ-45, 1x Mgmt	2x GbE RJ-45 LOM	1x LOM	1x PCIe x8 LP, 1x PCIe x16 LP	None	None	TPM 1.2	XClarity Standard	1x 750W Platinum	None	3-year	07/17
7X08A036CN	HTK	1x Xeon Silver 4114 10C/2.2GHz/13.75MB/85W/DDR4-2400	1x 16GB RDIMM DDR4-2666 (1Rx4)	1x 930-8i 2GB Flash	4x 3.5"	4x 3.5"	SATA/SAS Open HS	None	2x GbE RJ-45, 1x Mgmt	2x GbE RJ-45 LOM	1x LOM	1x PCIe x8 LP, 1x PCIe x16 LP	None	None	TPM 1.2	XClarity Standard	1x 750W Platinum	None	3-year	07/17
7X08A016CN	HTK	1x Xeon Gold 6126 12C/2.6GHz/19.25MB/125W/DDR4-2666	1x 16GB RDIMM DDR4-2666 (1Rx4)	1x 930-8i 2GB Flash	8x 2.5"	8x 2.5"	SATA/SAS Open HS	None	2x GbE RJ-45, 1x Mgmt	2x GbE RJ-45 LOM	1x LOM	1x PCIe x8 LP, 1x PCIe x16 FHHL	None	None	TPM 1.2	XClarity Standard	1x 750W Platinum	None	3-year	07/17
7X08A014CN	HTK	1x Xeon Gold 5122 4C/3.6GHz/16.5MB/105W/DDR4-2666	1x 16GB RDIMM DDR4-2666 (1Rx4)	1x 930-8i 2GB Flash	8x 2.5"	8x 2.5"	SATA/SAS Open HS	None	2x GbE RJ-45, 1x Mgmt	2x GbE RJ-45 LOM	1x LOM	1x PCIe x8 LP, 1x PCIe x16 FHHL	None	None	TPM 1.2	XClarity Standard	1x 750W Platinum	None	3-year	07/17
7X08A01DCN	HTK	1x Xeon Gold 6130 16C/2.1GHz/22MB/125W/DDR4-2666	1x 16GB RDIMM DDR4-2666 (1Rx4)	1x 930-8i 2GB Flash	8x 2.5"	8x 2.5"	SATA/SAS Open HS	None	2x GbE RJ-45, 1x Mgmt	2x GbE RJ-45 LOM	1x LOM	1x PCIe x8 LP, 1x PCIe x16 FHHL	None	None	TPM 1.2	XClarity Standard	1x 750W Platinum	None	3-year	07/17
7X08A01LCN	HTK	1x Xeon Gold 5118 12C/2.3GHz/16.5MB/105W/DDR4-2400	1x 16GB RDIMM DDR4-2666 (1Rx4)	1x 930-8i 2GB Flash	8x 2.5"	8x 2.5"	SATA/SAS Open HS	None	2x GbE RJ-45, 1x Mgmt	2x GbE RJ-45 LOM	1x LOM	1x PCIe x8 LP, 1x PCIe x16 FHHL	None	None	TPM 1.2	XClarity Standard	1x 750W Platinum	None	3-year	07/17

Model	Region	Processor	Memory	Storage Controller	Chassis	Disk Bays	Disks	M.2 Drives	Onboard Networking Ports	Additional Networking (LOM/ML2/PCIe)	Standard Extension Slots	Available Extension Slots via Riser Cards	Front VGA	Optical	TPM	System Management	Power Supply	Preload	Warranty	Ann Date (mm/yy)	
7X08A01GCN	HTK	1x Xeon Gold 5120 14C/2.2GHz/19.25MB/105W/DDR4-2400	1x 16GB RDIMM DDR4-2666	1x 930-8i 2GB Flash (1Rx4)	8x 2.5"	8x 2.5"	SATA/SAS HS	Open	None	2x GbE RJ-45, 1x Mgmt	2x GbE RJ-45 LOM	1x LOM	1x PCIe x8 LP, 1x PCIe x16 FHHL	None	None	TPM 1.2	XClarity Standard	1x 750W Platinum	None	3-year	07/17
7X08A00SCN	HTK	1x Xeon Gold 6130 16C/2.1GHz/22MB/125W/DDR4-2666	1x 16GB RDIMM DDR4-2666	1x 930-8i 2GB Flash (1Rx4)	4x 3.5"	4x 3.5"	SATA/SAS HS	Open	None	2x GbE RJ-45, 1x Mgmt	2x GbE RJ-45 LOM	1x LOM	1x PCIe x8 LP, 1x PCIe x16 FHHL	None	None	TPM 1.2	XClarity Standard	1x 750W Platinum	None	3-year	07/17
7X08A00TCN	HTK	1x Xeon Gold 6126 12C/2.6GHz/19.25MB/125W/DDR4-2666	1x 16GB RDIMM DDR4-2666	1x 930-8i 2GB Flash (1Rx4)	4x 3.5"	4x 3.5"	SATA/SAS HS	Open	None	2x GbE RJ-45, 1x Mgmt	2x GbE RJ-45 LOM	1x LOM	1x PCIe x8 LP, 1x PCIe x16 FHHL	None	None	TPM 1.2	XClarity Standard	1x 750W Platinum	None	3-year	07/17
7X08A00UCN	HTK	1x Xeon Gold 5122 4C/3.6GHz/16.5MB/105W/DDR4-2666	1x 16GB RDIMM DDR4-2666	1x 930-8i 2GB Flash (1Rx4)	4x 3.5"	4x 3.5"	SATA/SAS HS	Open	None	2x GbE RJ-45, 1x Mgmt	2x GbE RJ-45 LOM	1x LOM	1x PCIe x8 LP, 1x PCIe x16 FHHL	None	None	TPM 1.2	XClarity Standard	1x 750W Platinum	None	3-year	07/17
7X08A00WCN	HTK	1x Xeon Gold 5120 14C/2.2GHz/19.25MB/105W/DDR4-2400	1x 16GB RDIMM DDR4-2666	1x 930-8i 2GB Flash (1Rx4)	4x 3.5"	4x 3.5"	SATA/SAS HS	Open	None	2x GbE RJ-45, 1x Mgmt	2x GbE RJ-45 LOM	1x LOM	1x PCIe x8 LP, 1x PCIe x16 FHHL	None	None	TPM 1.2	XClarity Standard	1x 750W Platinum	None	3-year	07/17
7X08A00ZCN	HTK	1x Xeon Gold 5118 12C/2.3GHz/16.5MB/105W/DDR4-2400	1x 16GB RDIMM DDR4-2666	1x 930-8i 2GB Flash (1Rx4)	4x 3.5"	4x 3.5"	SATA/SAS HS	Open	None	2x GbE RJ-45, 1x Mgmt	2x GbE RJ-45 LOM	1x LOM	1x PCIe x8 LP, 1x PCIe x16 FHHL	None	None	TPM 1.2	XClarity Standard	1x 750W Platinum	None	3-year	07/17

Model	Region	Processor	Memory	Storage Controller	Chassis	Disk Bays	Disks	M.2 Drives	Onboard Networking Ports	Additional Networking (LOM/ML2/PCIe)	Standard Extension Slots	Available Extension Slots via Riser Cards	Front VGA	Optical	TPM	System Management	Power Supply	Preload	Warranty	Ann Date (mm/yy)
7X08A00ASG	INDIA	1x Xeon Gold 5118 12C/2.3GHz/16.5MB/105W/DDR4-2400	1x 8GB RDIMM DDR4-2666 (1Rx8)	1x 530-8i	8x 2.5"	8x 2.5"	SATA/SAS Open HS	None	2x GbE RJ-45, 1x Mgmt	2x GbE RJ-45 LOM	1x LOM	1x PCIe x8 LP, 1x ML2 x8 LP	Front VGA	None	TPM 1.2	XClarity Standard	1x 550W Platinum	None	3-year	07/17
7X08A00BSG	INDIA	1x Xeon Gold 5120 14C/2.2GHz/19.25MB/105W/DDR4-2400	1x 8GB RDIMM DDR4-2666 (1Rx8)	1x 530-8i	8x 2.5"	8x 2.5"	SATA/SAS Open HS	None	2x GbE RJ-45, 1x Mgmt	2x GbE RJ-45 LOM	1x LOM	1x PCIe x8 LP, 1x ML2 x8 LP	Front VGA	None	TPM 1.2	XClarity Standard	1x 550W Platinum	None	3-year	07/17
7X08A00CSG	INDIA	1x Xeon Gold 5118 12C/2.3GHz/16.5MB/105W/DDR4-2400	1x 16GB RDIMM DDR4-2666 (1Rx4)	1x 930-8i	8x 2.5"	8x 2.5"	SATA/SAS Open HS	None	2x GbE RJ-45, 1x Mgmt	2x GbE RJ-45 LOM	1x LOM	1x PCIe x8 LP, 1x ML2 x8 LP	Front VGA	None	TPM 1.2	XClarity Standard	1x 550W Platinum	None	3-year	07/17
7X08A00FSG	INDIA	1x Xeon Gold 5120 14C/2.2GHz/19.25MB/105W/DDR4-2400	1x 8GB RDIMM DDR4-2666 (1Rx8)	1x 530-8i	4x 3.5"	4x 3.5"	SATA/SAS Open HS	None	2x GbE RJ-45, 1x Mgmt	2x GbE RJ-45 LOM	1x LOM	1x PCIe x8 LP, 1x ML2 x8 LP	Front VGA	None	TPM 1.2	XClarity Standard	1x 550W Platinum	None	3-year	07/17
7X08A00GSG	INDIA	1x Xeon Gold 5120 14C/2.2GHz/19.25MB/105W/DDR4-2400	1x 8GB RDIMM DDR4-2666 (1Rx8)	1x 930-8i	8x 2.5"	8x 2.5"	SATA/SAS Open HS	None	2x GbE RJ-45, 1x Mgmt	2x GbE RJ-45 LOM	1x LOM	1x PCIe x8 LP, 1x ML2 x8 LP	Front VGA	None	TPM 1.2	XClarity Standard	1x 550W Platinum	None	3-year	07/17
7X08A004SG	INDIA	1x Xeon Gold 5118 12C/2.3GHz/16.5MB/105W/DDR4-2400	1x 8GB RDIMM DDR4-2666 (1Rx8)	1x 530-8i	4x 3.5"	4x 3.5"	SATA/SAS Open HS	None	2x GbE RJ-45, 1x Mgmt	2x GbE RJ-45 LOM	1x LOM	1x PCIe x8 LP, 1x ML2 x8 LP	Front VGA	None	TPM 1.2	XClarity Standard	1x 550W Platinum	None	3-year	07/17
7X08A007SG	INDIA	1x Xeon Gold 5118 12C/2.3GHz/16.5MB/105W/DDR4-2400	1x 8GB RDIMM DDR4-2666 (1Rx8)	Onboard Intel RSTe	4x 3.5"	4x 3.5"	SATA SS	None	2x GbE RJ-45, 1x Mgmt	2x GbE RJ-45 LOM	1x LOM	None	Front VGA	None	TPM 1.2	XClarity Standard	1x 550W Platinum	None	3-year	07/17
7X08A008SG	INDIA	1x Xeon Gold 5118 12C/2.3GHz/16.5MB/105W/DDR4-2400	1x 16GB RDIMM DDR4-2666 (1Rx4)	1x 530-8i	8x 2.5"	8x 2.5"	SATA/SAS Open HS	None	2x GbE RJ-45, 1x Mgmt	2x GbE RJ-45 LOM	1x LOM	1x PCIe x8 LP, 1x ML2 x8 LP	Front VGA	None	TPM 1.2	XClarity Standard	1x 550W Platinum	None	3-year	07/17
7X08A01BSG	INDIA	1x Xeon Gold 6138 20C/2.0GHz/27.5MB/125W/DDR4-2666	1x 16GB RDIMM DDR4-2666 (1Rx4)	1x 930-8i	8x 2.5"	8x 2.5"	SATA/SAS Open HS	None	2x GbE RJ-45, 1x Mgmt	2x GbE RJ-45 LOM	1x LOM	1x PCIe x8 LP, 1x ML2 x8 LP	Front VGA	None	TPM 1.2	XClarity Standard	1x 750W Platinum	None	3-year	07/17
7X08A015SG	INDIA	1x Xeon Gold 6130 16C/2.1GHz/22MB/125W/DDR4-2666	1x 16GB RDIMM DDR4-2666 (1Rx4)	1x 930-8i	8x 2.5"	8x 2.5"	SATA/SAS Open HS	None	2x GbE RJ-45, 1x Mgmt	2x GbE RJ-45 LOM	1x LOM	1x PCIe x8 LP, 1x ML2 x8 LP	Front VGA	None	TPM 1.2	XClarity Standard	1x 750W Platinum	None	3-year	07/17

Model	Region	Processor	Memory	Storage Controller	Chassis	Disk Bays	Disks	M.2 Drives	Onboard Networking Ports	Additional Networking (LOM/ML2/PCIe)	Standard Extension Slots	Available Extension Slots via Riser Cards	Front VGA	Optical	TPM	System Management	Power Supply	Preload	Warranty	Ann Date (mm/yy)	
7X08A011SG	INDIA	1x Xeon Gold 6126 12C/2.6GHz/19.25MB/125W/DDR4-2666	1x 16GB RDIMM DDR4-2666 (1Rx4)	1x 930-8i 2GB Flash	8x 2.5"	8x 2.5"	SATA/SAS HS	Open	None	2x GbE RJ-45, 1x Mgmt	2x GbE RJ-45 LOM	1x LOM	1x PCIe x8 LP, 1x ML2 x8 LP	Front VGA	None	TPM 1.2	XClarity Standard	1x 750W Platinum	None	3-year	07/17
7X08A013SG	INDIA	1x Xeon Gold 6126 12C/2.6GHz/19.25MB/125W/DDR4-2666	1x 16GB RDIMM DDR4-2666 (1Rx4)	1x 530-8i	8x 2.5"	8x 2.5"	SATA/SAS HS	Open	None	2x GbE RJ-45, 1x Mgmt	2x GbE RJ-45 LOM	1x LOM	1x PCIe x8 LP, 1x ML2 x8 LP	Front VGA	None	TPM 1.2	XClarity Standard	1x 750W Platinum	None	3-year	07/17

Model	Region	Processor	Memory	Storage Controller	Chassis	Disk Bays	Disks	M.2 Drives	Onboard Networking Ports	Additional Networking (LOM/ML2/PCIe)	Standard Extension Slots	Available Extension Slots via Riser Cards	Front VGA	Optical	TPM	System Management	Power Supply	Preload	Warranty	Ann Date (mm/yy)
7X08A04WJP	JAPAN	1x Xeon Gold 6138 20C/2.0GHz/27.5MB/125W/DDR4-2666	1x 8GB RDIMM DDR4-2666 (1Rx8)	1x 930-8i 2GB Flash	8x 2.5"	8x 2.5"	SATA/SAS Open	None	2x GbE RJ-45, 1x Mgmt	None	1x LOM	1x PCIe x8 LP, 1x PCIe x16 LP	None	None	TPM 1.2	XClarity Advanced	1x 550W Platinum	None	3-year	07/17
7X08A04XJP	JAPAN	1x Xeon Gold 5122 4C/3.6GHz/16.5MB/105W/DDR4-2666	1x 8GB RDIMM DDR4-2666 (1Rx8)	1x 930-8i 2GB Flash	8x 2.5"	8x 2.5"	SATA/SAS Open	None	2x GbE RJ-45, 1x Mgmt	None	1x LOM	1x PCIe x8 LP, 1x PCIe x16 LP	None	None	TPM 1.2	XClarity Advanced	1x 550W Platinum	None	3-year	07/17
7X08A063JP	JAPAN	1x Xeon Gold 5118 12C/2.3GHz/16.5MB/105W/DDR4-2400	1x 16GB RDIMM DDR4-2666 (1Rx4)	1x 930-8i 2GB Flash	8x 2.5"	8x 2.5"	SATA/SAS Open	None	2x GbE RJ-45, 1x Mgmt	None	1x LOM	1x PCIe x8 LP, 1x PCIe x16 LP	None	None	TPM 1.2	XClarity Advanced	1x 550W Platinum	None	3-year	11/17
7X08A064JP	JAPAN	1x Xeon Silver 4108 8C/1.8GHz/11MB/85W/DDR4-2400	1x 16GB RDIMM DDR4-2666 (1Rx4)	1x 930-8i 2GB Flash	8x 2.5"	8x 2.5"	SATA/SAS Open	None	2x GbE RJ-45, 1x Mgmt	None	1x LOM	1x PCIe x8 LP, 1x PCIe x16 LP	None	None	TPM 1.2	XClarity Advanced	1x 550W Platinum	None	3-year	11/17
7X08A065JP	JAPAN	1x Xeon Gold 6130 16C/2.1GHz/22MB/125W/DDR4-2666	1x 16GB RDIMM DDR4-2666 (1Rx4)	1x 930-8i 2GB Flash	8x 2.5"	8x 2.5"	SATA/SAS Open	None	2x GbE RJ-45, 1x Mgmt	None	1x LOM	1x PCIe x8 LP, 1x PCIe x16 LP	None	None	TPM 1.2	XClarity Advanced	1x 750W Platinum	None	3-year	11/17

Model	Region	Processor	Memory	Storage Controller	Chassis	Disk Bays	Disks	M.2 Drives	Onboard Networking Ports	Additional Networking (LOM/ML2/PCIe)	Standard Extension Slots	Available Extension Slots via Riser Cards	Front VGA	Optical	TPM	System Management	Power Supply	Preload	Warranty	Ann Date (mm/yy)
7X08A067LA	LA	1x Xeon Bronze 3106 8C/1.7GHz/11MB/85W/DDR4-2133	1x 16GB RDIMM DDR4-2666 (1Rx4)	1x 930-8i 2GB Flash	4x 3.5"	4x 3.5" SATA/SAS HS	4x 2TB HDD 7.2K 3.5" SAS12Gbps	2x 128GB SSD M.2 SATA	2x GbE RJ-45, 1x Mgmt	2x GbE RJ-45 LOM	1x LOM, 2x M.2	1x PCIe x8 LP, 1x PCIe x16 LP	Front VGA	None	TPM 2.0	XClarity Enterprise	2x 750W Platinum	None	3-year	04/18
7X08A068LA	LA	1x Xeon Bronze 3106 8C/1.7GHz/11MB/85W/DDR4-2133	1x 16GB RDIMM DDR4-2666 (1Rx4)	1x 930-8i 2GB Flash	4x 3.5"	4x 3.5" SATA/SAS HS	4x 4TB HDD 7.2K 3.5" SAS12Gbps	2x 128GB SSD M.2 SATA	2x GbE RJ-45, 1x Mgmt	2x GbE RJ-45 LOM	1x LOM, 2x M.2	1x PCIe x8 LP, 1x PCIe x16 LP	Front VGA	None	TPM 2.0	XClarity Enterprise	2x 750W Platinum	None	3-year	04/18
7X08A069LA	LA	1x Xeon Bronze 3106 8C/1.7GHz/11MB/85W/DDR4-2133	1x 16GB RDIMM DDR4-2666 (1Rx4)	930-8i 2GB Flash	4x 3.5"	4x 3.5" SATA/SAS HS	4x 4TB HDD 7.2K 3.5" SAS12Gbps	None	2x GbE RJ-45, 1x Mgmt	2x GbE RJ-45 LOM	1x LOM	1x PCIe x8 LP, 1x PCIe x16 LP	Front VGA	None	TPM 2.0	XClarity Enterprise	2x 750W Platinum	Windows Storage Server 2016 Standard	3-year	04/18
7X08A06ALA	LA	1x Xeon Bronze 3106 8C/1.7GHz/11MB/85W/DDR4-2133	1x 16GB RDIMM DDR4-2666 (1Rx4)	930-8i 2GB Flash	4x 3.5"	4x 3.5" SATA/SAS HS	4x 4TB HDD 7.2K 3.5" SAS12Gbps	2x 128GB SSD M.2 SATA	2x GbE RJ-45, 1x Mgmt	2x GbE RJ-45 LOM	1x LOM, 2x M.2	1x PCIe x8 LP, 1x PCIe x16 LP	Front VGA	None	TPM 2.0	XClarity Enterprise	2x 750W Platinum	Windows Storage Server 2016 Standard (Not Pre-installed)	3-year	04/18
7X08A06BLA	LA	1x Xeon Bronze 3106 8C/1.7GHz/11MB/85W/DDR4-2133	1x 16GB RDIMM DDR4-2666 (1Rx4)	930-8i 2GB Flash	4x 3.5"	4x 3.5" SATA/SAS HS	4x 2TB HDD 7.2K 3.5" SAS12Gbps	2x 128GB SSD M.2 SATA	2x GbE RJ-45, 1x Mgmt	2x GbE RJ-45 LOM	1x LOM, 2x M.2	1x PCIe x8 LP, 1x PCIe x16 LP	Front VGA	None	TPM 2.0	XClarity Enterprise	2x 750W Platinum	Windows Storage Server 2016 Standard (Not Pre-installed)	3-year	04/18
7X08A06CLA	LA	1x Xeon Bronze 3106 8C/1.7GHz/11MB/85W/DDR4-2133	1x 16GB RDIMM DDR4-2666 (1Rx4)	930-8i 2GB Flash	4x 3.5"	4x 3.5" SATA/SAS HS	4x 2TB HDD 7.2K 3.5" SAS12Gbps	None	2x GbE RJ-45, 1x Mgmt	2x GbE RJ-45 LOM	1x LOM	1x PCIe x8 LP, 1x PCIe x16 LP	Front VGA	None	TPM 2.0	XClarity Enterprise	2x 750W Platinum	Windows Storage Server 2016 Standard	3-year	04/18
7X08A05NLA	LA	1x Xeon Gold 5115 10C/2.4GHz/13.75MB/85W/DDR4-2400	1x 8GB RDIMM DDR4-2666 (1Rx8)	1x 530-8i	8x 2.5"	8x 2.5" SATA/SAS HS	Open	None	2x GbE RJ-45, 1x Mgmt	None	1x LOM	1x PCIe x8 LP, 1x PCIe x16 LP	Front VGA	None	TPM 1.2	XClarity Standard	1x 550W Platinum	None	3-year	07/17
7X08A05DLA	LA	1x Xeon Gold 5115 10C/2.4GHz/13.75MB/85W/DDR4-2400	1x 8GB RDIMM DDR4-2666 (1Rx8)	1x 530-8i	4x 3.5"	4x 3.5" SATA/SAS HS	Open	None	2x GbE RJ-45, 1x Mgmt	None	1x LOM	1x PCIe x8 LP, 1x PCIe x16 LP	Front VGA	None	TPM 1.2	XClarity Standard	1x 550W Platinum	None	3-year	07/17
7X08A017LA	LA	1x Xeon Gold 5118 12C/2.3GHz/16.5MB/105W/DDR4-2400	1x 8GB RDIMM DDR4-2666 (1Rx8)	1x 530-8i	4x 3.5"	4x 3.5" SATA/SAS HS	Open	None	2x GbE RJ-45, 1x Mgmt	None	1x LOM	1x PCIe x8 LP, 1x PCIe x16 LP	Front VGA	None	TPM 1.2	XClarity Standard	1x 750W Platinum	None	3-year	07/17
7X08A019LA	LA	1x Xeon Gold 5120 14C/2.2GHz/19.25MB/105W/DDR4-2400	1x 8GB RDIMM DDR4-2666 (1Rx8)	1x 530-8i	4x 3.5"	4x 3.5" SATA/SAS HS	Open	None	2x GbE RJ-45, 1x Mgmt	None	1x LOM	1x PCIe x8 LP, 1x PCIe x16 LP	Front VGA	None	TPM 1.2	XClarity Standard	1x 750W Platinum	None	3-year	07/17

Model	Region	Processor	Memory	Storage Controller	Chassis	Disk Bays	Disks	M.2 Drives	Onboard Networking Ports	Additional Networking (LOM/ML2/PCIe)	Standard Extension Slots	Available Extension Slots via Riser Cards	Front VGA	Optical	TPM	System Management	Power Supply	Preload	Warranty	Ann Date (mm/yy)
7X08A01CLA	LA	1x Xeon Gold 6130 16C/2.1GHz/22MB/125W/DDR4-2666	1x 8GB RDIMM DDR4-2666 (1Rx8)	1x 530-8i	4x 3.5"	4x 3.5" SATA/SAS HS	Open	None	2x GbE RJ-45, 1x Mgmt	None	1x LOM	1x PCIe x8 LP, 1x PCIe x16 LP	Front VGA	None	TPM 1.2	XClarity Standard	1x 750W Platinum	None	3-year	07/17
7X08100CLA	LA	1x Xeon Bronze 3106 8C/1.7GHz/11MB/85W/DDR4-2133	1x 16GB RDIMM DDR4-2666 (1Rx4)	1x 930-8i 2GB Flash	4x 3.5"	4x 3.5" SATA/SAS HS	4x 2TB HDD 7.2K 3.5" SAS12Gbps	None	2x GbE RJ-45, 1x Mgmt	2x GbE RJ-45 LOM	1x LOM	1x PCIe x8 LP, 1x PCIe x16 LP	Front VGA	None	TPM 2.0	XClarity Enterprise	2x 750W Platinum	None	3-year	02/18
7X08100DLA	LA	1x Xeon Bronze 3106 8C/1.7GHz/11MB/85W/DDR4-2133	1x 16GB RDIMM DDR4-2666 (1Rx4)	1x 930-8i 2GB Flash	4x 3.5"	4x 3.5" SATA/SAS HS	4x 4TB HDD 7.2K 3.5" SAS12Gbps	None	2x GbE RJ-45, 1x Mgmt	2x GbE RJ-45 LOM	1x LOM	1x PCIe x8 LP, 1x PCIe x16 LP	Front VGA	None	TPM 2.0	XClarity Enterprise	2x 750W Platinum	None	3-year	02/18
7X08A00HLA	LA	1x Xeon Gold 6130 16C/2.1GHz/22MB/125W/DDR4-2666	1x 8GB RDIMM DDR4-2666 (1Rx8)	1x 530-8i	8x 2.5"	8x 2.5" SATA/SAS HS	Open	None	2x GbE RJ-45, 1x Mgmt	None	1x LOM	1x PCIe x8 LP, 1x PCIe x16 LP	Front VGA	None	TPM 1.2	XClarity Standard	1x 750W Platinum	None	3-year	07/17
7X08A00KLA	LA	1x Xeon Gold 5120 14C/2.2GHz/19.25MB/105W/DDR4-2400	1x 8GB RDIMM DDR4-2666 (1Rx8)	1x 530-8i	8x 2.5"	8x 2.5" SATA/SAS HS	Open	None	2x GbE RJ-45, 1x Mgmt	None	1x LOM	1x PCIe x8 LP, 1x PCIe x16 LP	Front VGA	None	TPM 1.2	XClarity Standard	1x 750W Platinum	None	3-year	07/17
7X08A00MLA	LA	1x Xeon Gold 5118 12C/2.3GHz/16.5MB/105W/DDR4-2400	1x 8GB RDIMM DDR4-2666 (1Rx8)	1x 530-8i	8x 2.5"	8x 2.5" SATA/SAS HS	Open	None	2x GbE RJ-45, 1x Mgmt	None	1x LOM	1x PCIe x8 LP, 1x PCIe x16 LP	Front VGA	None	TPM 1.2	XClarity Standard	1x 750W Platinum	None	3-year	07/17

Model	Region	Processor	Memory	Storage Controller	Chassis	Disk Bays	Disks	M.2 Drives	Onboard Networking Ports	Additional Networking (LOM/ML2/PCIe)	Standard Extension Slots	Available Extension Slots via Riser Cards	Front VGA	Optical	TPM	System Management	Power Supply	Preload	Warranty	Ann Date (mm/yy)
7X08A052NA	NA	1x Xeon Gold 6138 20C/2.0GHz/27.5MB/125W/DDR4-2666	1x 32GB RDIMM	1x 930-8i 2GB Flash (2Rx4)	8x 2.5"	8x 2.5"	SATA/SAS Open	None	2x GbE RJ-45, 1x Mgmt	None	1x LOM	1x PCIe x8 LP, 1x PCIe x16 LP	Front VGA	None	TPM 1.2	XClarity Standard	1x 750W Platinum	None	3-year	07/17
7X08A05RNA	NA	1x Xeon Gold 5120 14C/2.2GHz/19.25MB/105W/DDR4-2400	1x 16GB RDIMM	1x 930-8i 2GB Flash (1Rx4)	8x 2.5"	8x 2.5"	SATA/SAS Open	None	2x GbE RJ-45, 1x Mgmt	None	1x LOM	1x PCIe x8 LP, 1x PCIe x16 LP	Front VGA	None	TPM 1.2	XClarity Standard	1x 750W Platinum	None	3-year	07/17
7X08A05SNA	NA	1x Xeon Gold 5118 12C/2.3GHz/16.5MB/105W/DDR4-2400	1x 16GB RDIMM	1x 930-8i 2GB Flash (1Rx4)	8x 2.5"	8x 2.5"	SATA/SAS Open	None	2x GbE RJ-45, 1x Mgmt	None	1x LOM	1x PCIe x8 LP, 1x PCIe x16 LP	Front VGA	None	TPM 1.2	XClarity Standard	1x 750W Platinum	None	3-year	07/17
7X08A05TNA	NA	1x Xeon Silver 4108 8C/1.8GHz/11MB/85W/DDR4-2400	1x 16GB RDIMM	1x 930-8i 2GB Flash (1Rx4)	4x 3.5"	4x 3.5"	SATA/SAS Open	None	2x GbE RJ-45, 1x Mgmt	None	1x LOM	1x PCIe x8 LP, 1x PCIe x16 LP	None	None	TPM 1.2	XClarity Standard	1x 750W Platinum	None	3-year	07/17
7X08A05MNA	NA	1x Xeon Silver 4114 10C/2.2GHz/13.75MB/85W/DDR4-2400	1x 16GB RDIMM	1x 930-8i 2GB Flash (1Rx4)	8x 2.5"	8x 2.5"	SATA/SAS Open	None	2x GbE RJ-45, 1x Mgmt	None	1x LOM	1x PCIe x8 LP, 1x PCIe x16 LP	None	None	TPM 1.2	XClarity Standard	1x 750W Platinum	None	3-year	07/17
7X08A05KNA	NA	1x Xeon Silver 4116 12C/2.1GHz/16.5MB/85W/DDR4-2400	1x 16GB RDIMM	1x 930-8i 2GB Flash (1Rx4)	8x 2.5"	8x 2.5"	SATA/SAS Open	None	2x GbE RJ-45, 1x Mgmt	None	1x LOM	1x PCIe x8 LP, 1x PCIe x16 LP	None	None	TPM 1.2	XClarity Standard	1x 750W Platinum	None	3-year	07/17
7X08A05ENA	NA	1x Xeon Gold 5115 10C/2.4GHz/13.75MB/85W/DDR4-2400	1x 16GB RDIMM	1x 930-8i 2GB Flash (1Rx4)	8x 2.5"	8x 2.5"	SATA/SAS Open	None	2x GbE RJ-45, 1x Mgmt	None	1x LOM	1x PCIe x8 LP, 1x PCIe x16 LP	None	None	TPM 1.2	XClarity Standard	1x 750W Platinum	None	3-year	07/17
7X08A055NA	NA	1x Xeon Silver 4110 8C/2.1GHz/11MB/85W/DDR4-2400	1x 16GB RDIMM	1x 930-8i 2GB Flash (1Rx4)	8x 2.5"	8x 2.5"	SATA/SAS Open	None	2x GbE RJ-45, 1x Mgmt	None	1x LOM	1x PCIe x8 LP, 1x PCIe x16 LP	None	None	TPM 1.2	XClarity Standard	1x 750W Platinum	None	3-year	07/17
7X08A056NA	NA	1x Xeon Bronze 3104 6C/1.7GHz/8.25MB/85W/DDR4-2133	1x 16GB RDIMM	1x 930-8i 2GB Flash (1Rx4)	8x 2.5"	8x 2.5"	SATA/SAS Open	None	2x GbE RJ-45, 1x Mgmt	None	1x LOM	1x PCIe x8 LP, 1x PCIe x16 LP	None	None	TPM 1.2	XClarity Standard	1x 750W Platinum	None	3-year	07/17
7X08A057NA	NA	1x Xeon Silver 4110 8C/2.1GHz/11MB/85W/DDR4-2400	1x 16GB RDIMM	1x 930-8i 2GB Flash (1Rx4)	8x 2.5"	8x 2.5"	SATA/SAS Open	None	2x GbE RJ-45, 1x Mgmt	None	1x LOM	1x PCIe x8 LP, 1x PCIe x16 LP	None	None	TPM 1.2	XClarity Standard	1x 750W Platinum	None	3-year	07/17

Model	Region	Processor	Memory	Storage Controller	Chassis Disk Bays	Disks	M.2 Drives	Onboard Networking Ports	Additional Networking (LOM/ML2/PCIe)	Standard Extension Slots	Available Extension Slots via Riser Cards	Front VGA	Optical	TPM	System Management	Power Supply	Preload	Warranty	Ann Date (mm/yy)	
7X08A058NA	NA	1x Xeon Gold 5118 12C/2.3GHz/16.5MB/105W/DDR4-2400	1x 32GB RDIMM	1x 930-8i 2GB Flash (2Rx4)	8x 2.5"	8x 2.5" SATA/SAS HS	Open	None	2x GbE RJ-45, 1x Mgmt	None	1x LOM	1x PCIe x8 LP, 1x PCIe x16 LP	Front VGA	None	TPM 1.2	XClarity Standard	1x 750W Platinum	None	3-year	07/17
7X08A05PNA	NA	1x Xeon Gold 6126 12C/2.6GHz/19.25MB/125W/DDR4-2666	1x 16GB RDIMM	1x 930-8i 2GB Flash (1Rx4)	8x 2.5"	8x 2.5" SATA/SAS HS	Open	None	2x GbE RJ-45, 1x Mgmt	None	1x LOM	1x PCIe x8 LP, 1x PCIe x16 LP	Front VGA	None	TPM 1.2	XClarity Standard	1x 750W Platinum	None	3-year	07/17
7X08A05WNA	NA	1x Xeon Bronze 3106 8C/1.7GHz/11MB/85W/DDR4-2133	1x 16GB RDIMM	1x 530-8i DDR4-2666 (1Rx4)	8x 2.5"	8x 2.5" SATA/SAS HS	Open	None	2x GbE RJ-45, 1x Mgmt	None	1x LOM	1x PCIe x8 LP, 1x PCIe x16 LP	None	None	TPM 1.2	XClarity Standard	1x 750W Platinum	None	3-year	07/17
7X08A05XNA	NA	1x Xeon Silver 4108 8C/1.8GHz/11MB/85W/DDR4-2400	1x 16GB RDIMM	1x 530-8i DDR4-2666 (1Rx4)	8x 2.5"	8x 2.5" SATA/SAS HS	Open	None	2x GbE RJ-45, 1x Mgmt	None	1x LOM	1x PCIe x8 LP, 1x PCIe x16 LP	None	None	TPM 1.2	XClarity Standard	1x 750W Platinum	None	3-year	07/17



ThinkSystem SR550 Platform Specifications

Product Specifications Reference (PSREF)

Components	Specification																																																																																																						
Form factor	2U rack																																																																																																						
Dimensions	Height: 86.5 mm (3.4 in). Width: 482 mm (19.0 in) with rack latches. Depth: 763.7 mm (30.1 in)																																																																																																						
Weight	Maximum configuration: 57.32 lb (26 kg)																																																																																																						
Processor	Up to two 125W Intel Xeon Scalable family processors, Bronze, Silver, Gold, or Platinum. Up to 20 cores at 2.0GHz, up to 3.6GHz with 4 cores. Two processors are connected with two UPI (Ultra Path Interconnect) links up to 10.4GT/s																																																																																																						
Chipset	Intel C622 Platform Controller Hub																																																																																																						
Memory	Up to 12 DIMM sockets. Each processor supports up to 6 DIMM sockets with 6 channels. DDR4-2666. RDIMMs and LRDIMMs are supported, but memory types cannot be intermixed																																																																																																						
Memory capacity	With RDIMMs: Up to 384GB with 12 x 32 GB RDIMMs and two processors With LRDIMMs: Up to 768GB with 12 x 64 GB LRDIMMs and two processors																																																																																																						
Memory protection	ECC, memory mirroring, and memory sparing																																																																																																						
Storage controllers	Supports the following RAID/HBA adapters:																																																																																																						
	<table border="1"> <thead> <tr> <th></th> <th>RAID adapter</th> <th>Interface</th> <th>Drive type</th> <th>RAID levels</th> <th>JBOD</th> <th>Cache</th> <th>Cache protection</th> <th>FastPath</th> <th>Max qty</th> </tr> </thead> <tbody> <tr> <td rowspan="3">For SS bays</td> <td>Onboard SATA</td> <td>6Gb SATA</td> <td>SATA</td> <td>0/1/10/5</td> <td>Yes</td> <td>None</td> <td>None</td> <td>No</td> <td>-</td> </tr> <tr> <td>530-8i</td> <td>12Gbs SAS</td> <td>SATA/SAS</td> <td>0/1/10/5/50</td> <td>Yes</td> <td>None</td> <td>None</td> <td>Yes</td> <td>2</td> </tr> <tr> <td>730-8i</td> <td>12Gbs SAS</td> <td>SATA/SAS</td> <td>0/1/10/5/50</td> <td>Yes</td> <td>1GB</td> <td>None</td> <td>No</td> <td>2</td> </tr> <tr> <td rowspan="7">For HS bays</td> <td>930-8i</td> <td>12Gbs SAS</td> <td>SATA/SAS</td> <td>0/1/10/5/50/6/60</td> <td>Yes</td> <td>2GB</td> <td>Flash backup</td> <td>Yes</td> <td>2</td> </tr> <tr> <td>930-16i</td> <td>12Gbs SAS</td> <td>SATA/SAS</td> <td>0/1/10/5/50/6/60</td> <td>Yes</td> <td>4GB</td> <td>Flash backup</td> <td>Yes</td> <td>1</td> </tr> <tr> <td>430-8i</td> <td>12Gbs SAS</td> <td>SATA/SAS</td> <td>-</td> <td>Yes</td> <td>None</td> <td>None</td> <td>-</td> <td>2</td> </tr> <tr> <td>430-16i</td> <td>12Gbs SAS</td> <td>SATA/SAS</td> <td>-</td> <td>Yes</td> <td>None</td> <td>None</td> <td>-</td> <td>1</td> </tr> <tr> <td>430-8e</td> <td>12Gbs SAS</td> <td>SATA/SAS</td> <td>-</td> <td>Yes</td> <td>None</td> <td>None</td> <td>-</td> <td>6</td> </tr> <tr> <td>430-16e</td> <td>12Gbs SAS</td> <td>SATA/SAS</td> <td>-</td> <td>Yes</td> <td>None</td> <td>None</td> <td>-</td> <td>6</td> </tr> <tr> <td>930-8e</td> <td>12Gbs SAS</td> <td>SATA/SAS</td> <td>0/1/10/5/50/6/60</td> <td>Yes</td> <td>4GB</td> <td>Flash backup</td> <td>Yes</td> <td>6</td> </tr> </tbody> </table>		RAID adapter	Interface	Drive type	RAID levels	JBOD	Cache	Cache protection	FastPath	Max qty	For SS bays	Onboard SATA	6Gb SATA	SATA	0/1/10/5	Yes	None	None	No	-	530-8i	12Gbs SAS	SATA/SAS	0/1/10/5/50	Yes	None	None	Yes	2	730-8i	12Gbs SAS	SATA/SAS	0/1/10/5/50	Yes	1GB	None	No	2	For HS bays	930-8i	12Gbs SAS	SATA/SAS	0/1/10/5/50/6/60	Yes	2GB	Flash backup	Yes	2	930-16i	12Gbs SAS	SATA/SAS	0/1/10/5/50/6/60	Yes	4GB	Flash backup	Yes	1	430-8i	12Gbs SAS	SATA/SAS	-	Yes	None	None	-	2	430-16i	12Gbs SAS	SATA/SAS	-	Yes	None	None	-	1	430-8e	12Gbs SAS	SATA/SAS	-	Yes	None	None	-	6	430-16e	12Gbs SAS	SATA/SAS	-	Yes	None	None	-	6	930-8e	12Gbs SAS	SATA/SAS	0/1/10/5/50/6/60	Yes	4GB	Flash backup	Yes	6
		RAID adapter	Interface	Drive type	RAID levels	JBOD	Cache	Cache protection	FastPath	Max qty																																																																																													
	For SS bays	Onboard SATA	6Gb SATA	SATA	0/1/10/5	Yes	None	None	No	-																																																																																													
		530-8i	12Gbs SAS	SATA/SAS	0/1/10/5/50	Yes	None	None	Yes	2																																																																																													
		730-8i	12Gbs SAS	SATA/SAS	0/1/10/5/50	Yes	1GB	None	No	2																																																																																													
	For HS bays	930-8i	12Gbs SAS	SATA/SAS	0/1/10/5/50/6/60	Yes	2GB	Flash backup	Yes	2																																																																																													
		930-16i	12Gbs SAS	SATA/SAS	0/1/10/5/50/6/60	Yes	4GB	Flash backup	Yes	1																																																																																													
		430-8i	12Gbs SAS	SATA/SAS	-	Yes	None	None	-	2																																																																																													
		430-16i	12Gbs SAS	SATA/SAS	-	Yes	None	None	-	1																																																																																													
430-8e		12Gbs SAS	SATA/SAS	-	Yes	None	None	-	6																																																																																														
430-16e		12Gbs SAS	SATA/SAS	-	Yes	None	None	-	6																																																																																														
930-8e		12Gbs SAS	SATA/SAS	0/1/10/5/50/6/60	Yes	4GB	Flash backup	Yes	6																																																																																														
<i>Note: 730-8i is available in China only. All RAID/HBA adapters should be placed in slot 4 firstly.</i>																																																																																																							
Disk drive bays	Support 8 front 3.5" SATA simple-swap bays, or 8 front 3.5" SATA/SAS HS bays, or 12 front 3.5" SATA/SAS HS bays, or 8 front 2.5" SATA/SAS HS bays, or 16 front 2.5" SATA/SAS HS bays. Optional one or two internal M.2 SSD for boot, dual M.2 SSD supports mirroring																																																																																																						
Internal storage	For 3.5" SS bay	3.5" HDD, SATA6Gbs, 7.2K	1TB/2TB/4TB/6TB/8TB/10TB																																																																																																				
	For 3.5" bay (3.5" disks or 2.5" disks with 3.5" tray)	3.5" HDD, SATA6Gbs, 7.2K	1TB/2TB/4TB/6TB/8TB/10TB																																																																																																				
		3.5" HDD, SAS12Gbs, 7.2K	1TB/2TB/4TB/6TB/8TB/10TB																																																																																																				
		2.5" HDD, SAS12Gbs, 15K	300GB/600GB																																																																																																				
		2.5" SSD, SATA6Gbs	240GB/480GB																																																																																																				
	For 2.5" bay	2.5" HDD, SATA6Gbs, 7.2K	1TB/2TB																																																																																																				
		2.5" HDD, SAS12Gbs, 7.2K	1TB/2TB																																																																																																				
		2.5" HDD, SAS12Gbs, 10K	300GB/600GB/900GB/1.2TB/1.8TB																																																																																																				
		2.5" HDD, SAS12Gbs, 15K	300GB/600GB																																																																																																				
		2.5" SSD, SAS12Gbs	400GB/800GB/3.84TB																																																																																																				
2.5" SSD, SATA6Gbs		240GB/480GB																																																																																																					
M.2 SATA SSD	32GB/128GB																																																																																																						
Optical	No internal optical bay. Optional USB DVD±RW optical drive																																																																																																						
Network interfaces	Integrated one dedicated management port plus two GbE ports. One LOM slot for customized LOM with two RJ-45 or SFP+ ports, up to 10GbE. Optional ML2 or PCIe adapters are supported. ML2 adapter requires riser card with ML2 slot. Up to two ports supports Wake-on-LAN and NC-SI (see right)																																																																																																						
Security features	Power-on and admin password. Trusted Platform Module, TCG 1.2 compliant, upgrade to 2.0 via UEFI setting. Optional TCM in China only. Optional lockable security bezel																																																																																																						
Operating systems supported	Microsoft Windows Server 2016/2012 R2. Red Hat Enterprise Linux 7.4/7.3/6.9. SUSE Linux Enterprise Server 12 SP3/12 SP2/11 SP4. VMware ESXi 6.5U1/6.5/6.0 U3																																																																																																						
Systems management	XClarity Controller Standard, optional upgrades to Advanced or Enterprise are available. Energy Manager. XClarity Administrator. Lenovo Capacity Planner. Provisioning Manager. Essentials. Light Path Diagnostics																																																																																																						
GPU support	None																																																																																																						

Components	Specification	
Base warranty	MT 7X03: 1-year limited onsite service with 9x5/NBD MT 7X04: 3-year limited onsite service with 9x5/NBD	
Power supply	Up to two redundant hot-swap 550W and 750W 80 PLUS Platinum qualified AC power supplies. Or up to two redundant hot-swap 750W Titanium qualified AC power supplies. 750W Titanium is 200V - 240V, others are 100V - 240V	
Video	Integrated Matrox G200 in XClarity Controller	
Cooling	Three fans (2+1) for single processor model, four fans (3+1) for dual processor model	
Front ports	One XClarity Controller USB, one USB 3.0, one optional VGA	
Rear ports	One VGA, two USB 3.0, two ethernet (RJ-45) one XClarity Controller connector. Optional COM port	
Environmental specification	Supports ASHRAE A4 with limitations.	
	Temperature - operating	A4: 5°C to 45°C (41°F to 113°F) A3: 5°C to 40°C (41°F to 104°F) A2: 10°C to 35°C (50°F to 95°F)
	Temperature - non operating (no package)	-10°C to 60°C (14°F to 140°F)
	Temperature - non operating (with package)	-40°C to 70°C (-40°F to 158°F)
	Altitude - operating	(Unpressurized): 0-10000ft (0-3048m)
Humidity - operating, non-condensing	A4: 8%-90%. A3:8%-85%. A2:20%-80%	
Humidity - storage (with package), non-condensing	8%-90%	
<i>Models should meet the following requirements to support A3 and A4:</i>		
• Redundant power supplies required		
• No system fan fails		
Environmental certification	Energy Star Server 2.1 certified. More environmental information please see: www.lenovo.com/social_responsibility/us/en/environment/	

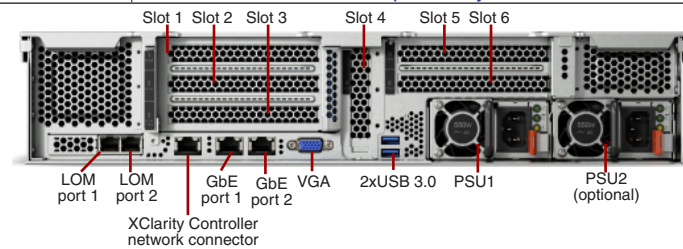

Note: GbE port 1 and LOM port 1 support Wake-on-LAN and NC-SI. Riser cards, expansion cards, and LOM adapters are optional.

Expansion slots	
Slot 1-3 (riser card 1)	Supports one of the following for riser card 1: Option 1: PCIe 3.0 x8/x8/x8 (slot 1-3). Full height, half length. Option 2: PCIe 3.0 x16/x8 (slot 1 and 3). Full height, half length Option 3: PCIe 3.0 x8/x8/x8 ML2 (slot 1-3). Full height, half length
Slot 4 (onboard)	PCIe 3.0 x8, low profile
Slot 5 (riser card 2)	PCIe 3.0 x16, full height, half length, requires 2nd CPU
Slot 6 (riser card 2)	PCIe 3.0 x8, full height, half length

System unique options	
7XH7A02680	Lenovo SR550/SR590/SR650 x8/x8/x8ML2 PCIe FH Riser 1 Kit
7XH7A02679	Lenovo SR550/SR590/SR650 (x16/x8)/(x16/x16) PCIe FH Riser 2 Kit
7XH7A02678	Lenovo SR550/SR590/SR650 x16/x8 PCIe FH Riser 1 Kit
7XH7A02677	Lenovo SR550/SR590/SR650 x8/x8/x8 PCIe FH Riser 1 Kit
7Z17A02578	Lenovo SR550/SR590/SR650 EIA Latch w/ VGA Upgrade Kit
7XH7A06254	Lenovo SR550/SR650 2.5" SATA/SAS 8-Bay Backplane Kit
7Z17A02580	Lenovo 2U Security Bezel
7Z17A02577	Lenovo COM Port Upgrade Kit

Model	Region	Processor	Memory	Storage Controller	Chassis	Disk Bays	Disks	M.2 Drives	Onboard Networking Ports	Additional Networking (LOM/ML2/PCIe)	Standard Extension Slots	Available Extension Slots via Riser Cards	Front VGA	Optical	TPM	System Management	Power Supply	Preload	Warranty	Ann Date (mm/yy)
7X041003AU	ANZ	1x Xeon Bronze 3104 6C/1.7GHz/8.25MB/85W/DDR4-2133	1x 16GB RDIMM DDR4-2666 (1Rx4)	1x 530-8i	16x 2.5"	8x 2.5" SATA/SAS HS	Open	None	2x GbE RJ-45, 1x Mgmt	None	1x LOM, 1x PCIe x8 LP	None	Front VGA	None	TPM 1.2	XClarity Enterprise	1x 750W Platinum	None	3-year	09/17
7X041004AU	ANZ	1x Xeon Bronze 3106 8C/1.7GHz/11MB/85W/DDR4-2133	1x 16GB RDIMM DDR4-2666 (1Rx4)	1x 530-8i	16x 2.5"	8x 2.5" SATA/SAS HS	Open	None	2x GbE RJ-45, 1x Mgmt	None	1x LOM, 1x PCIe x8 LP	None	Front VGA	None	TPM 1.2	XClarity Enterprise	1x 750W Platinum	None	3-year	09/17
7X041005AU	ANZ	1x Xeon Silver 4110 8C/2.1GHz/11MB/85W/DDR4-2400	1x 16GB RDIMM DDR4-2666 (1Rx4)	1x 530-8i	16x 2.5"	8x 2.5" SATA/SAS HS	Open	None	2x GbE RJ-45, 1x Mgmt	None	1x LOM, 1x PCIe x8 LP	None	Front VGA	None	TPM 1.2	XClarity Enterprise	1x 750W Platinum	None	3-year	09/17
7X041006AU	ANZ	1x Xeon Bronze 3104 6C/1.7GHz/8.25MB/85W/DDR4-2133	1x 16GB RDIMM DDR4-2666 (1Rx4)	Onboard Intel RSTe	12x 3.5"	8x 3.5" SATA SS	Open	None	2x GbE RJ-45, 1x Mgmt	None	1x LOM, 1x PCIe x8 LP	None	Front VGA	None	TPM 1.2	XClarity Enterprise	1x 750W Platinum	None	3-year	09/17
7X041007AU	ANZ	1x Xeon Bronze 3106 8C/1.7GHz/11MB/85W/DDR4-2133	1x 16GB RDIMM DDR4-2666 (1Rx4)	Onboard Intel RSTe	12x 3.5"	8x 3.5" SATA SS	Open	None	2x GbE RJ-45, 1x Mgmt	None	1x LOM, 1x PCIe x8 LP	None	Front VGA	None	TPM 1.2	XClarity Enterprise	1x 750W Platinum	None	3-year	09/17
7X041008AU	ANZ	1x Xeon Silver 4110 8C/2.1GHz/11MB/85W/DDR4-2400	1x 16GB RDIMM DDR4-2666 (1Rx4)	Onboard Intel RSTe	12x 3.5"	8x 3.5" SATA SS	Open	None	2x GbE RJ-45, 1x Mgmt	None	1x LOM, 1x PCIe x8 LP	None	Front VGA	None	TPM 1.2	XClarity Enterprise	1x 750W Platinum	None	3-year	09/17
7X04A02AAU	ANZ	1x Xeon Silver 4108 8C/1.8GHz/11MB/85W/DDR4-2400	1x 16GB RDIMM DDR4-2666 (1Rx4)	1x 930-8i 2GB Flash	16x 2.5"	8x 2.5" SATA/SAS HS	Open	None	2x GbE RJ-45, 1x Mgmt	None	1x LOM, 1x PCIe x8 LP	None	Front VGA	None	TPM 1.2	XClarity Advanced	1x 750W Platinum	None	3-year	07/17
7X04A02BAU	ANZ	1x Xeon Silver 4108 8C/1.8GHz/11MB/85W/DDR4-2400	1x 16GB RDIMM DDR4-2666 (1Rx4)	1x 930-8i 2GB Flash	16x 2.5"	8x 2.5" SATA/SAS HS	2x 300GB HDD 10K 2.5" SAS12Gbps	None	2x GbE RJ-45, 1x Mgmt	None	1x LOM, 1x PCIe x8 LP	None	Front VGA	None	TPM 1.2	XClarity Advanced	2x 750W Platinum	None	3-year	07/17
7X04A02GAU	ANZ	1x Xeon Bronze 3104 6C/1.7GHz/8.25MB/85W/DDR4-2133	1x 16GB RDIMM DDR4-2666 (1Rx4)	Onboard Intel RSTe	12x 3.5"	8x 3.5" SATA SS	Open	None	2x GbE RJ-45, 1x Mgmt	None	1x LOM, 1x PCIe x8 LP	None	Front VGA	None	TPM 1.2	XClarity Standard	1x 750W Platinum	None	3-year	07/17
7X04A02JAU	ANZ	1x Xeon Silver 4110 8C/2.1GHz/11MB/85W/DDR4-2400	1x 16GB RDIMM DDR4-2666 (1Rx4)	1x 930-8i 2GB Flash	12x 3.5"	8x 3.5" SATA/SAS HS	Open	None	2x GbE RJ-45, 1x Mgmt	None	1x LOM, 1x PCIe x8 LP	None	Front VGA	None	TPM 1.2	XClarity Advanced	1x 750W Platinum	None	3-year	07/17

Model	Region	Processor	Memory	Storage Controller	Chassis	Disk Bays	Disks	M.2 Drives	Onboard Networking Ports	Additional Networking (LOM/ML2/PCIe)	Standard Extension Slots	Available Extension Slots via Riser Cards	Front VGA	Optical	TPM	System Management	Power Supply	Preload	Warranty	Ann Date (mm/yy)
7X04A02RAU	ANZ	1x Xeon Gold 6126 12C/2.6GHz/19.25MB/125W	32GB DDR4-2666 (2Rx4)	1x 930-8i 2GB Flash	16x 2.5"	8x 2.5" SATA/SAS HS	Open	None	2x GbE RJ-45, 1x Mgmt	None	1x LOM, 1x PCIe x8 LP	3x PCIe x8 FHHL	Front VGA	None	TPM 1.2	XClarity Advanced	1x 750W Platinum	None	3-year	07/17
7X04A02VAU	ANZ	1x Xeon Silver 4116 12C/2.1GHz/16.5MB/85W	16GB DDR4-2666 (1Rx4)	1x 930-8i 2GB Flash	16x 2.5"	8x 2.5" SATA/SAS HS	Open	None	2x GbE RJ-45, 1x Mgmt	None	1x LOM, 1x PCIe x8 LP	None	Front VGA	None	TPM 1.2	XClarity Advanced	1x 750W Platinum	None	3-year	07/17
7X04A02WAU	ANZ	1x Xeon Silver 4110 8C/2.1GHz/11MB/85W	16GB DDR4-2666 (1Rx4)	1x 930-8i 2GB Flash	16x 2.5"	8x 2.5" SATA/SAS HS	Open	None	2x GbE RJ-45, 1x Mgmt	None	1x LOM, 1x PCIe x8 LP	None	Front VGA	None	TPM 1.2	XClarity Advanced	1x 750W Platinum	None	3-year	07/17
7X04A02YAU	ANZ	1x Xeon Bronze 3106 8C/1.7GHz/11MB/85W	16GB DDR4-2666 (1Rx4)	1x 530-8i 2GB Flash	16x 2.5"	8x 2.5" SATA/SAS HS	Open	None	2x GbE RJ-45, 1x Mgmt	None	1x LOM, 1x PCIe x8 LP	None	Front VGA	None	TPM 1.2	XClarity Advanced	1x 750W Platinum	None	3-year	07/17
7X04A034AU	ANZ	1x Xeon Gold 6138 20C/2.0GHz/27.5MB/125W	32GB DDR4-2666 (2Rx4)	1x 930-8i 2GB Flash	16x 2.5"	8x 2.5" SATA/SAS HS	Open	None	2x GbE RJ-45, 1x Mgmt	None	1x LOM, 1x PCIe x8 LP	3x PCIe x8 FHHL	Front VGA	None	TPM 1.2	XClarity Advanced	1x 750W Platinum	None	3-year	07/17
7X04A035AU	ANZ	1x Xeon Gold 6130 16C/2.1GHz/22MB/125W	32GB DDR4-2666 (2Rx4)	1x 930-8i 2GB Flash	16x 2.5"	8x 2.5" SATA/SAS HS	Open	None	2x GbE RJ-45, 1x Mgmt	None	1x LOM, 1x PCIe x8 LP	3x PCIe x8 FHHL	Front VGA	None	TPM 1.2	XClarity Advanced	1x 750W Platinum	None	3-year	07/17
7X04A039AU	ANZ	1x Xeon Gold 5118 12C/2.3GHz/16.5MB/105W	16GB DDR4-2666 (1Rx4)	1x 930-8i 2GB Flash	16x 2.5"	8x 2.5" SATA/SAS HS	Open	None	2x GbE RJ-45, 1x Mgmt	None	1x LOM, 1x PCIe x8 LP	3x PCIe x8 FHHL	Front VGA	None	TPM 1.2	XClarity Advanced	1x 750W Platinum	None	3-year	07/17
7X04A03EAU	ANZ	1x Xeon Gold 5122 4C/3.6GHz/16.5MB/105W	16GB DDR4-2666 (1Rx4)	1x 930-8i 2GB Flash	16x 2.5"	8x 2.5" SATA/SAS HS	Open	None	2x GbE RJ-45, 1x Mgmt	None	1x LOM, 1x PCIe x8 LP	3x PCIe x8 FHHL	Front VGA	None	TPM 1.2	XClarity Advanced	1x 750W Platinum	None	3-year	07/17
7X04A03KAU	ANZ	1x Xeon Silver 4110 8C/2.1GHz/11MB/85W	16GB DDR4-2666 (1Rx4)	1x 930-8i 2GB Flash	16x 2.5"	8x 2.5" SATA/SAS HS	Open	None	2x GbE RJ-45, 1x Mgmt	None	1x LOM, 1x PCIe x8 LP	None	Front VGA	None	TPM 1.2	XClarity Advanced	2x 750W Platinum	None	3-year	07/17
7X04A03SAU	ANZ	1x Xeon Gold 5120 14C/2.2GHz/19.25MB/105W	16GB DDR4-2666 (1Rx4)	1x 930-8i 2GB Flash	16x 2.5"	8x 2.5" SATA/SAS HS	Open	None	2x GbE RJ-45, 1x Mgmt	None	1x LOM, 1x PCIe x8 LP	3x PCIe x8 FHHL	Front VGA	None	TPM 1.2	XClarity Advanced	1x 750W Platinum	None	3-year	07/17

Model	Region	Processor	Memory	Storage Controller	Chassis	Disk Bays	Disks	M.2 Drives	Onboard Networking Ports	Additional Networking (LOM/ML2/PCIe)	Standard Extension Slots	Available Extension Slots via Riser Cards	Front VGA	Optical	TPM	System Management	Power Supply	Preload	Warranty	Ann Date (mm/yy)
7X04A03TAU	ANZ	1x Xeon Bronze 3104 6C/1.7GHz/8.25MB/85W/DDR4-2133	1x 16GB RDIMM DDR4-2666 (1Rx4)	1x 530-8i	16x 2.5"	8x 2.5"	SATA/SAS Open	None	2x GbE RJ-45, 1x Mgmt	None	1x LOM, 1x PCIe x8 LP	None	Front VGA	None	TPM 1.2	XClarity Advanced	1x 750W Platinum	None	3-year	07/17
7X04A03ZAU	ANZ	1x Xeon Gold 6126T 12C/2.6GHz/19.25MB/125W/DDR4-2666	1x 32GB RDIMM DDR4-2666 (2Rx4)	1x 930-8i	16x 2.5"	8x 2.5"	SATA/SAS Open	None	2x GbE RJ-45, 1x Mgmt	None	1x LOM, 1x PCIe x8 LP	3x PCIe x8 FHHL	None	None	TPM 1.2	XClarity Enterprise	1x 750W Platinum	None	3-year	07/17
7X04A040AU	ANZ	1x Xeon Gold 5120 14C/2.2GHz/19.25MB/105W/DDR4-2400	1x 16GB RDIMM DDR4-2666 (1Rx4)	1x 930-8i	16x 2.5"	8x 2.5"	SATA/SAS Open	None	2x GbE RJ-45, 1x Mgmt	None	1x LOM, 1x PCIe x8 LP	3x PCIe x8 FHHL	None	None	TPM 1.2	XClarity Enterprise	1x 750W Platinum	None	3-year	07/17
7X04A045AU	ANZ	1x Xeon Gold 5118 12C/2.3GHz/16.5MB/105W/DDR4-2400	1x 16GB RDIMM DDR4-2666 (1Rx4)	1x 930-8i	16x 2.5"	8x 2.5"	SATA/SAS Open	None	2x GbE RJ-45, 1x Mgmt	None	1x LOM, 1x PCIe x8 LP	3x PCIe x8 FHHL	None	None	TPM 1.2	XClarity Enterprise	1x 750W Platinum	None	3-year	07/17
7X04A046AU	ANZ	1x Xeon Gold 6130 16C/2.1GHz/22MB/125W/DDR4-2666	1x 32GB RDIMM DDR4-2666 (2Rx4)	1x 930-8i	16x 2.5"	8x 2.5"	SATA/SAS Open	None	2x GbE RJ-45, 1x Mgmt	None	1x LOM, 1x PCIe x8 LP	3x PCIe x8 FHHL	None	None	TPM 1.2	XClarity Enterprise	1x 750W Platinum	None	3-year	07/17
7X04A047AU	ANZ	1x Xeon Gold 6138 20C/2.0GHz/27.5MB/125W/DDR4-2666	1x 16GB RDIMM DDR4-2666 (1Rx4)	1x 930-8i	16x 2.5"	8x 2.5"	SATA/SAS Open	None	2x GbE RJ-45, 1x Mgmt	None	1x LOM, 1x PCIe x8 LP	3x PCIe x8 FHHL	None	None	TPM 1.2	XClarity Enterprise	1x 750W Platinum	None	3-year	07/17
7X04A048AU	ANZ	1x Xeon Gold 5122 4C/3.6GHz/16.5MB/105W/DDR4-2666	1x 16GB RDIMM DDR4-2666 (1Rx4)	1x 930-8i	16x 2.5"	8x 2.5"	SATA/SAS Open	None	2x GbE RJ-45, 1x Mgmt	None	1x LOM, 1x PCIe x8 LP	3x PCIe x8 FHHL	None	None	TPM 1.2	XClarity Enterprise	1x 750W Platinum	None	3-year	07/17
7X04A03VAU	ANZ	1x Xeon Silver 4114 10C/2.2GHz/13.75MB/85W/DDR4-2400	1x 16GB RDIMM DDR4-2666 (1Rx4)	1x 930-8i	16x 2.5"	8x 2.5"	SATA/SAS Open	None	2x GbE RJ-45, 1x Mgmt	None	1x LOM, 1x PCIe x8 LP	None	Front VGA	None	TPM 1.2	XClarity Advanced	1x 750W Platinum	None	3-year	07/17
7X04A03WAU	ANZ	1x Xeon Silver 4108 8C/1.8GHz/11MB/85W/DDR4-2400	1x 16GB RDIMM DDR4-2666 (1Rx4)	1x 930-8i	12x 3.5"	8x 3.5"	SATA/SAS Open	None	2x GbE RJ-45, 1x Mgmt	None	1x LOM, 1x PCIe x8 LP	None	Front VGA	None	TPM 1.2	XClarity Advanced	1x 750W Platinum	None	3-year	07/17

ThinkSystem SR550 - TopSeller - Brazil

Product Specifications Reference (PSREF)

Model	Region	Processor	Memory	Storage Controller	Chassis	Disk Bays	Disks	M.2 Drives	Onboard Networking Ports	Additional Networking (LOM/ML2/PCIe)	Standard Extension Slots	Available Extension Slots via Riser Cards	Front VGA	Optical	TPM	System Management	Power Supply	Preload	Warranty	Ann Date (mm/yy)
7X04100GBR	Brazil	1x Xeon Bronze 3106 8C/1.7GHz/11MB/85W/DDR4-2133	1x 16GB RDIMM DDR4-2666 (2Rx8)	1x 930-8i 2GB Flash	16x 2.5"	8x 2.5" SATA/SAS HS	Open	None	2x GbE RJ-45, 1x Mgmt	2x GbE RJ-45 LOM	1x LOM, 1x PCIe x8 LP	3x PCIe x8 FHHL	None	None	TPM 1.2	XClarity Standard	1x 550W Platinum	None	3-year	04/18

Model	Region	Processor	Memory	Storage Controller	Chassis Disk Bays	Disks	M.2 Drives	Onboard Networking Ports	Additional Networking (LOM/ML2/PCIe)	Standard Extension Slots	Available Extension Slots via Riser Cards	Front VGA	Optical	TPM	System Management	Power Supply	Preload Warranty	Warranty	Ann Date (mm/yy)	
7X04A04WLA	Chile	1x Xeon Silver 4108 8C/1.8GHz/11MB/85W/DDR4-2400	2x 16GB RDIMM DDR4-2666 (1Rx4)	1x 530-8i	12x 3.5" SATA/SAS HS	8x 3.5" HDD 15K 3.5" SAS12Gbps	3x 600GB HDD 15K 3.5"	None	2x GbE RJ-45, 1x Mgmt	None	1x LOM, 1x PCIe x8 LP	3x PCIe x8 FHHL	1x Front VGA	None	TPM 1.2	XClarity Advanced	2x 750W Platinum	None	3-year	07/17
7X04A058LA	Chile	1x Xeon Gold 5115 10C/2.4GHz/13.75MB/85W/DDR4-2400	1x 16GB RDIMM DDR4-2666 (1Rx4)	1x 530-8i	12x 3.5" SATA/SAS HS	2x 2TB HDD 7.2K 3.5" SAS12Gbps	None	2x GbE RJ-45, 1x Mgmt	None	1x LOM, 1x PCIe x8 LP	3x PCIe x8 FHHL	1x Front VGA	None	TPM 1.2	XClarity Advanced	2x 750W Platinum	None	3-year	07/17	
7X041001LA	Chile	1x Xeon Silver 4110 8C/2.1GHz/11MB/85W/DDR4-2400	1x 16GB RDIMM DDR4-2666 (1Rx4)	1x 930-16i	16x 2.5" SATA/SAS HS	4GB Flash	Open	None	2x GbE RJ-45, 1x Mgmt	2x GbE RJ-45 LOM	1x LOM, 1x PCIe x8 LP	2x PCIe x8 FHHL, 1x ML2 x8 FHHL	1x Front VGA	None	TPM 2.0	XClarity Enterprise	2x 750W Platinum	None	3-year	09/17
7X041002LA	Chile	1x Xeon Silver 4114 10C/2.2GHz/13.75MB/85W/DDR4-2400	1x 16GB RDIMM DDR4-2666 (1Rx4)	1x 930-16i	16x 2.5" SATA/SAS HS	4GB Flash	Open	None	2x GbE RJ-45, 1x Mgmt	2x GbE RJ-45 LOM	1x LOM, 1x PCIe x8 LP	2x PCIe x8 FHHL, 1x ML2 x8 FHHL	1x Front VGA	None	TPM 2.0	XClarity Enterprise	2x 750W Platinum	None	3-year	09/17

Model	Region	Processor	Memory	Storage Controller	Chassis	Disk Bays	Disks	M.2 Drives	Onboard Networking Ports	Additional Networking (LOM/ML2/PCIe)	Standard Extension Slots	Available Extension Slots via Riser Cards	Front VGA	Optical	TPM	System Management	Power Supply	Preload	Warranty	Ann Date (mm/yy)
7X04A06NLA	Colombia	1x Xeon Silver 4114 10C/2.2GHz/13.75MB/85W/DDR4-2400	1x 16GB RDIMM DDR4-2666 (1Rx4)	1x 530-8i	12x 3.5"	8x 3.5"	SATA/SAS Open HS	None	2x GbE RJ-45, 1x Mgmt	None	1x LOM, 1x PCIe x8 LP	3x PCIe x8 FHHL	8 Front VGA	None	TPM 2.0	XClarity Enterprise	1x 550W Platinum	None	3-year	12/17

Model	Region	Processor	Memory	Storage Controller	Chassis	Disk Bays	Disks	M.2 Drives	Onboard Networking Ports	Additional Networking (LOM/ML2/PCIe)	Standard Extension Slots	Available Extension Slots via Riser Cards	Front VGA	Optical	TPM	System Management	Power Supply	Preload	Warranty	Ann Date (mm/yy)
7X04A06PEA	EMEA	1x Xeon Silver 4110 8C/2.1GHz/11MB/85W/DDR4-2400	1x 16GB RDIMM DDR4-2666 (1Rx4)	1x 930-8i 4GB Flash	12x 3.5"	12x 3.5" SATA/SAS HS	Open	None	2x GbE RJ-45, 1x Mgmt	None	1x LOM, 1x PCIe x8 LP	None	None	None	TPM 1.2	XClarity Standard	1x 750W Platinum	None	3-year	12/17
7X04A007EA	EMEA	1x Xeon Silver 4110 8C/2.1GHz/11MB/85W/DDR4-2400	1x 16GB RDIMM DDR4-2666 (1Rx4)	1x 930-8i 2GB Flash	16x 2.5"	8x 2.5" SATA/SAS HS	2x 300GB HDD 10K 2.5" SAS12Gbps	None	2x GbE RJ-45, 1x Mgmt	None	1x LOM, 1x PCIe x8 LP	None	Front VGA	None	TPM 1.2	XClarity Advanced	2x 750W Platinum	None	3-year	07/17
7X04A002EA	EMEA	1x Xeon Silver 4110 8C/2.1GHz/11MB/85W/DDR4-2400	1x 16GB RDIMM DDR4-2666 (1Rx4)	1x 930-8i 2GB Flash	16x 2.5"	8x 2.5" SATA/SAS HS	Open	None	2x GbE RJ-45, 1x Mgmt	None	1x LOM, 1x PCIe x8 LP	None	Front VGA	None	TPM 1.2	XClarity Advanced	1x 750W Platinum	None	3-year	07/17
7X04A003EA	EMEA	1x Xeon Silver 4116 12C/2.1GHz/16.5MB/85W/DDR4-2400	1x 16GB RDIMM DDR4-2666 (1Rx4)	1x 930-8i 2GB Flash	16x 2.5"	8x 2.5" SATA/SAS HS	Open	None	2x GbE RJ-45, 1x Mgmt	None	1x LOM, 1x PCIe x8 LP	None	Front VGA	None	TPM 1.2	XClarity Advanced	1x 750W Platinum	None	3-year	07/17
7X04A005EA	EMEA	1x Xeon Silver 4108 8C/1.8GHz/11MB/85W/DDR4-2400	1x 16GB RDIMM DDR4-2666 (1Rx4)	1x 530-8i	16x 2.5"	8x 2.5" SATA/SAS HS	Open	None	2x GbE RJ-45, 1x Mgmt	None	1x LOM, 1x PCIe x8 LP	None	None	None	TPM 1.2	XClarity Standard	1x 750W Platinum	None	3-year	07/17
7X04A000MEA	EMEA	1x Xeon Bronze 3104 6C/1.7GHz/8.25MB/85W/DDR4-2133	1x 16GB RDIMM DDR4-2666 (1Rx4)	Onboard Intel RSTe	12x 3.5"	8x 3.5" SATA SS	Open	None	2x GbE RJ-45, 1x Mgmt	None	1x LOM, 1x PCIe x8 LP	None	Front VGA	None	TPM 1.2	XClarity Standard	1x 750W Platinum	None	3-year	07/17
7X04A000NEA	EMEA	1x Xeon Silver 4108 8C/1.8GHz/11MB/85W/DDR4-2400	1x 16GB RDIMM DDR4-2666 (1Rx4)	1x 930-8i 2GB Flash	12x 3.5"	8x 3.5" SATA/SAS HS	Open	None	2x GbE RJ-45, 1x Mgmt	None	1x LOM, 1x PCIe x8 LP	None	Front VGA	None	TPM 1.2	XClarity Advanced	1x 750W Platinum	None	3-year	07/17
7X04A000QEA	EMEA	1x Xeon Silver 4108 8C/1.8GHz/11MB/85W/DDR4-2400	1x 16GB RDIMM DDR4-2666 (1Rx4)	1x 930-8i 2GB Flash	16x 2.5"	8x 2.5" SATA/SAS HS	Open	None	2x GbE RJ-45, 1x Mgmt	None	1x LOM, 1x PCIe x8 LP	None	Front VGA	None	TPM 1.2	XClarity Advanced	1x 750W Platinum	None	3-year	07/17
7X04A000HEA	EMEA	1x Xeon Silver 4108 8C/1.8GHz/11MB/85W/DDR4-2400	1x 16GB RDIMM DDR4-2666 (1Rx4)	1x 930-8i 2GB Flash	16x 2.5"	8x 2.5" SATA/SAS HS	2x 300GB HDD 10K 2.5" SAS12Gbps	None	2x GbE RJ-45, 1x Mgmt	None	1x LOM, 1x PCIe x8 LP	None	Front VGA	None	TPM 1.2	XClarity Advanced	2x 750W Platinum	None	3-year	07/17
7X04A000AEA	EMEA	1x Xeon Silver 4114 10C/2.2GHz/13.75MB/85W/DDR4-2400	1x 16GB RDIMM DDR4-2666 (1Rx4)	1x 930-8i 2GB Flash	16x 2.5"	8x 2.5" SATA/SAS HS	Open	None	2x GbE RJ-45, 1x Mgmt	None	1x LOM, 1x PCIe x8 LP	None	Front VGA	None	TPM 1.2	XClarity Advanced	1x 750W Platinum	None	3-year	07/17

Model	Region	Processor	Memory	Storage Controller	Chassis	Disk Bays	Disks	M.2 Drives	Onboard Networking Ports	Additional Networking (LOM/ML2/PCIe)	Standard Extension Slots	Available Extension Slots via Riser Cards	Front VGA	Optical	TPM	System Management	Power Supply	Preload	Warranty	Ann Date (mm/yy)
7X04A00CEA	EMEA	1x Xeon Bronze 3106 8C/1.7GHz/11MB/85W/DDR4-2133	1x 16GB RDIMM DDR4-2666 (1Rx4)	1x 530-8i	16x 2.5"	8x 2.5" SATA/SAS HS	Open	None	2x GbE RJ-45, 1x Mgmt	None	1x LOM, 1x PCIe x8 LP	None	Front VGA	None	TPM 1.2	XClarity Advanced	1x 750W Platinum	None	3-year	07/17
7X04A00DEA	EMEA	1x Xeon Bronze 3104 6C/1.7GHz/8.25MB/85W/DDR4-2133	1x 16GB RDIMM DDR4-2666 (1Rx4)	1x 530-8i	16x 2.5"	8x 2.5" SATA/SAS HS	Open	None	2x GbE RJ-45, 1x Mgmt	None	1x LOM, 1x PCIe x8 LP	None	Front VGA	None	TPM 1.2	XClarity Advanced	1x 750W Platinum	None	3-year	07/17
7X04A00FEA	EMEA	1x Xeon Silver 4110 8C/2.1GHz/11MB/85W/DDR4-2400	1x 16GB RDIMM DDR4-2666 (1Rx4)	1x 930-8i 2GB Flash	12x 3.5"	8x 3.5" SATA/SAS HS	Open	None	2x GbE RJ-45, 1x Mgmt	None	1x LOM, 1x PCIe x8 LP	None	Front VGA	None	TPM 1.2	XClarity Advanced	1x 750W Platinum	None	3-year	07/17
7X04A01YEA	EMEA	1x Xeon Gold 5122 4C/3.6GHz/16.5MB/105W/DDR4-2666	1x 16GB RDIMM DDR4-2666 (1Rx4)	1x 930-8i 2GB Flash	16x 2.5"	8x 2.5" SATA/SAS HS	Open	None	2x GbE RJ-45, 1x Mgmt	None	1x LOM, 1x PCIe x8 LP	None	Front VGA	None	TPM 1.2	XClarity Advanced	1x 750W Platinum	None	3-year	07/17
7X04A01ZEA	EMEA	1x Xeon Gold 5120 14C/2.2GHz/19.25MB/105W/DDR4-2400	1x 16GB RDIMM DDR4-2666 (1Rx4)	1x 930-8i 2GB Flash	16x 2.5"	8x 2.5" SATA/SAS HS	Open	None	2x GbE RJ-45, 1x Mgmt	None	1x LOM, 1x PCIe x8 LP	None	Front VGA	None	TPM 1.2	XClarity Advanced	1x 750W Platinum	None	3-year	07/17
7X04A020EA	EMEA	1x Xeon Gold 5118 12C/2.3GHz/16.5MB/105W/DDR4-2400	1x 16GB RDIMM DDR4-2666 (1Rx4)	1x 930-8i 2GB Flash	16x 2.5"	8x 2.5" SATA/SAS HS	Open	None	2x GbE RJ-45, 1x Mgmt	None	1x LOM, 1x PCIe x8 LP	None	Front VGA	None	TPM 1.2	XClarity Advanced	1x 750W Platinum	None	3-year	07/17
7X04A023EA	EMEA	1x Xeon Gold 6138 20C/2.0GHz/27.5MB/125W/DDR4-2666	1x 32GB RDIMM DDR4-2666 (2Rx4)	1x 930-8i 2GB Flash	16x 2.5"	8x 2.5" SATA/SAS HS	Open	None	2x GbE RJ-45, 1x Mgmt	None	1x LOM, 1x PCIe x8 LP	None	Front VGA	None	TPM 1.2	XClarity Advanced	1x 750W Platinum	None	3-year	07/17
7X04A024EA	EMEA	1x Xeon Gold 6130 16C/2.1GHz/22MB/125W/DDR4-2666	1x 32GB RDIMM DDR4-2666 (2Rx4)	1x 930-8i 2GB Flash	16x 2.5"	8x 2.5" SATA/SAS HS	Open	None	2x GbE RJ-45, 1x Mgmt	None	1x LOM, 1x PCIe x8 LP	None	Front VGA	None	TPM 1.2	XClarity Advanced	1x 750W Platinum	None	3-year	07/17
7X04A028EA	EMEA	1x Xeon Gold 6126 12C/2.6GHz/19.25MB/125W/DDR4-2666	1x 32GB RDIMM DDR4-2666 (2Rx4)	1x 930-8i 2GB Flash	16x 2.5"	8x 2.5" SATA/SAS HS	Open	None	2x GbE RJ-45, 1x Mgmt	None	1x LOM, 1x PCIe x8 LP	None	Front VGA	None	TPM 1.2	XClarity Advanced	1x 750W Platinum	None	3-year	07/17
7X04A04BEA	EMEA	1x Xeon Gold 5115 10C/2.4GHz/13.75MB/85W/DDR4-2400	1x 16GB RDIMM DDR4-2666 (1Rx4)	1x 930-8i 2GB Flash	16x 2.5"	8x 2.5" SATA/SAS HS	Open	None	2x GbE RJ-45, 1x Mgmt	None	1x LOM, 1x PCIe x8 LP	None	Front VGA	None	TPM 1.2	XClarity Enterprise	1x 750W Platinum	None	3-year	07/17

Model	Region	Processor	Memory	Storage Controller	Chassis	Disk Bays	Disks	M.2 Drives	Onboard Networking Ports	Additional Networking (LOM/ML2/PCIe)	Standard Extension Slots	Available Extension Slots via Riser Cards	Front VGA	Optical	TPM	System Management	Power Supply	Preload	Warranty	Ann Date (mm/yy)
7X04A04EJP	JAPAN	1x Xeon Silver 4112 4C/2.6GHz/8.25MB/85W/DDR4-2400	1x 8GB RDIMM DDR4-2666 (1Rx8)	1x 930-8i 2GB Flash	16x 2.5"	8x 2.5" SATA/SAS HS	Open	None	2x GbE RJ-45, 1x Mgmt	None	1x LOM, 1x PCIe x8 LP	3x PCIe x8 FHHL	None	None	TPM 1.2	XClarity Advanced	1x 550W Platinum	None	3-year	07/17
7X04A04FJP	JAPAN	1x Xeon Silver 4110 8C/2.1GHz/11MB/85W/DDR4-2400	1x 8GB RDIMM DDR4-2666 (1Rx8)	1x 930-8i 2GB Flash	16x 2.5"	8x 2.5" SATA/SAS HS	Open	None	2x GbE RJ-45, 1x Mgmt	None	1x LOM, 1x PCIe x8 LP	3x PCIe x8 FHHL	None	None	TPM 1.2	XClarity Advanced	1x 550W Platinum	None	3-year	07/17
7X04A04GJP	JAPAN	1x Xeon Bronze 3106 8C/1.7GHz/11MB/85W/DDR4-2133	1x 8GB RDIMM DDR4-2666 (1Rx8)	1x 930-8i 2GB Flash	16x 2.5"	8x 2.5" SATA/SAS HS	Open	None	2x GbE RJ-45, 1x Mgmt	None	1x LOM, 1x PCIe x8 LP	3x PCIe x8 FHHL	None	None	TPM 1.2	XClarity Advanced	1x 550W Platinum	None	3-year	07/17
7X04A04HJP	JAPAN	1x Xeon Bronze 3104 6C/1.7GHz/8.25MB/85W/DDR4-2133	1x 8GB RDIMM DDR4-2666 (1Rx8)	1x 930-8i 2GB Flash	12x 3.5"	8x 3.5" SATA/SAS HS	Open	None	2x GbE RJ-45, 1x Mgmt	None	1x LOM, 1x PCIe x8 LP	3x PCIe x8 FHHL	None	None	TPM 1.2	XClarity Advanced	1x 550W Platinum	None	3-year	07/17
7X04A04JJP	JAPAN	1x Xeon Bronze 3104 6C/1.7GHz/8.25MB/85W/DDR4-2133	1x 8GB RDIMM DDR4-2666 (1Rx8)	1x 930-8i 2GB Flash	16x 2.5"	8x 2.5" SATA/SAS HS	Open	None	2x GbE RJ-45, 1x Mgmt	None	1x LOM, 1x PCIe x8 LP	3x PCIe x8 FHHL	None	None	TPM 1.2	XClarity Advanced	1x 550W Platinum	None	3-year	07/17

Model	Region	Processor	Memory	Storage Controller	Chassis	Disk Bays	Disks	M.2 Drives	Onboard Networking Ports	Additional Networking (LOM/ML2/PCIe)	Standard Extension Slots	Available Extension Slots via Riser Cards	Front VGA	Optical	TPM	System Management	Power Supply	Preload	Warranty	Ann Date (mm/yy)
7X04A05DLA	LA	1x Xeon Bronze 3106 8C/1.7GHz/11MB/85W/DDR4-2133	1x 8GB RDIMM DDR4-2666 (1Rx8)	1x 530-8i	12x 3.5"	8x 3.5"	SATA/SAS HS	Open	None	2x GbE RJ-45, 1x Mgmt	None	1x LOM, 1x3x PCIe x8 LP	x8 Front FHHL VGA	None	TPM 1.2	XClarity Standard	1x 750W Platinum	None	3-year	07/17
7X04A05FLA	LA	1x Xeon Bronze 3104 6C/1.7GHz/8.25MB/85W/DDR4-2133	1x 8GB RDIMM DDR4-2666 (1Rx8)	1x 530-8i	12x 3.5"	8x 3.5"	SATA/SAS HS	Open	None	2x GbE RJ-45, 1x Mgmt	None	1x LOM, 1x3x PCIe x8 LP	x8 Front FHHL VGA	None	TPM 1.2	XClarity Standard	1x 750W Platinum	None	3-year	07/17
7X04A050LA	LA	1x Xeon Bronze 3104 6C/1.7GHz/8.25MB/85W/DDR4-2133	1x 8GB RDIMM DDR4-2666 (1Rx8)	1x 530-8i	16x 2.5"	8x 2.5"	SATA/SAS HS	Open	None	2x GbE RJ-45, 1x Mgmt	None	1x LOM, 1x3x PCIe x8 LP	x8 Front FHHL VGA	None	TPM 1.2	XClarity Standard	1x 750W Platinum	None	3-year	07/17
7X04A052LA	LA	1x Xeon Bronze 3106 8C/1.7GHz/11MB/85W/DDR4-2133	1x 8GB RDIMM DDR4-2666 (1Rx8)	1x 530-8i	16x 2.5"	8x 2.5"	SATA/SAS HS	Open	None	2x GbE RJ-45, 1x Mgmt	None	1x LOM, 1x3x PCIe x8 LP	x8 Front FHHL VGA	None	TPM 1.2	XClarity Standard	1x 750W Platinum	None	3-year	07/17

Model	Region	Processor	Memory	Storage Controller	Chassis	Disk Bays	Disks	M.2 Drives	Onboard Networking Ports	Additional Networking (LOM/ML2/PCIe)	Standard Extension Slots	Available Extension Slots via Riser Cards	Front VGA	Optical	TPM	System Management	Power Supply	Preload	Warranty	Ann Date (mm/yy)
7X04A059LA	LA (except Brazil)	1x Xeon Silver 4110 8C/2.1GHz/11MB/85W/DDR4-2400	1x 16GB RDIMM DDR4-2666 (1Rx4)	1x 530-8i	12x 3.5"	8x 3.5" SATA/SAS HS	2x 600GB HDD 15K 3.5" SAS12Gbps	None	2x GbE RJ-45, 1x Mgmt	None	1x LOM, 1x PCIe x8 LP	3x PCIe x8 FHHL	x8 Front VGA	None	TPM 1.2	XClarity Advanced	2x 750W Platinum	None	3-year	07/17
7X04A04LLA	LA (except Brazil)	1x Xeon Silver 4110 8C/2.1GHz/11MB/85W/DDR4-2400	2x 16GB RDIMM DDR4-2666 (1Rx4)	1x 530-8i	12x 3.5"	8x 3.5" SATA/SAS HS	3x 4TB HDD 7.2K 3.5" SAS12Gbps	None	2x GbE RJ-45, 1x Mgmt	None	1x LOM, 1x PCIe x8 LP	3x PCIe x8 FHHL	x8 Front VGA	None	TPM 1.2	XClarity Advanced	2x 750W Platinum	None	3-year	07/17
7X04A04MLA	LA (except Brazil)	1x Xeon Silver 4108 8C/1.8GHz/11MB/85W/DDR4-2400	2x 16GB RDIMM DDR4-2666 (1Rx4)	1x 530-8i	12x 3.5"	8x 3.5" SATA/SAS HS	3x 600GB HDD 15K 3.5" SAS12Gbps	None	2x GbE RJ-45, 1x Mgmt	None	1x LOM, 1x PCIe x8 LP	3x PCIe x8 FHHL	x8 Front VGA	None	TPM 1.2	XClarity Advanced	2x 750W Platinum	None	3-year	07/17
7X04A04QLA	LA (except Brazil)	1x Xeon Silver 4108 8C/1.8GHz/11MB/85W/DDR4-2400	2x 16GB RDIMM DDR4-2666 (1Rx4)	1x 530-8i	12x 3.5"	8x 3.5" SATA/SAS HS	3x 4TB HDD 7.2K 3.5" SAS12Gbps	None	2x GbE RJ-45, 1x Mgmt	None	1x LOM, 1x PCIe x8 LP	3x PCIe x8 FHHL	x8 Front VGA	None	TPM 1.2	XClarity Advanced	2x 750W Platinum	None	3-year	07/17
7X04A04XLA	LA (except Brazil)	1x Xeon Silver 4110 8C/2.1GHz/11MB/85W/DDR4-2400	1x 16GB RDIMM DDR4-2666 (1Rx4)	1x 530-8i	12x 3.5"	8x 3.5" SATA/SAS HS	2x 2TB HDD 7.2K 3.5" SAS12Gbps	None	2x GbE RJ-45, 1x Mgmt	None	1x LOM, 1x PCIe x8 LP	3x PCIe x8 FHHL	x8 Front VGA	None	TPM 1.2	XClarity Advanced	2x 750W Platinum	None	3-year	07/17

Model	Region	Processor	Memory	Storage Controller	Chassis	Disk Bays	Disks	M.2 Drives	Onboard Networking Ports	Additional Networking (LOM/ML2/PCIe)	Standard Extension Slots	Available Extension Slots via Riser Cards	Front VGA	Optical	TPM	System Management	Power Supply	Preload	Warranty	Ann Date (mm/yy)
7X041009LA	LA (except Chile)	1x Xeon Silver 4110	1x 16GB RDIMM DDR4-2666 (1Rx4)	1x 530-8i	12x 3.5"	8x 3.5" SATA/SAS HS	Open	None	2x GbE RJ-45, 1x Mgmt	2x GbE RJ-45 LOM	1x LOM, 1x PCIe x8 LP	3x PCIe x8 FHHL	x8 Front VGA	None	TPM 2.0	XClarity Standard	1x 750W Platinum	None	3-year	09/17
7X04100ALA	LA (except Chile)	1x Xeon Silver 4110	1x 16GB RDIMM DDR4-2666 (1Rx4)	1x 930-16i 4GB Flash	12x 3.5"	12x 3.5" SATA/SAS HS	Open	None	2x GbE RJ-45, 1x Mgmt	2x GbE RJ-45 LOM	1x LOM, 1x PCIe x8 LP	3x PCIe x8 FHHL	x8 Front VGA	None	TPM 2.0	XClarity Standard	2x 750W Platinum	None	3-year	09/17

Model	Region	Processor	Memory	Storage Controller	Chassis	Disk Bays	Disks	M.2 Drives	Onboard Networking Ports	Additional Networking (LOM/ML2/PCIe)	Standard Extension Slots	Available Extension Slots via Riser Cards	Front VGA	Optical	TPM	System Management	Power Supply	Preload Warranty	Warranty	Ann Date (mm/yy)
7X04A02TNA	NA	1x Xeon Silver 4116 12C/2.1GHz/16.5MB/85W/DDR4-2400	1x 32GB RDIMM DDR4-2666 (2Rx4)	1x 930-16i 4GB Flash	12x 3.5"	8x 3.5"	SATA/SAS HS	Open	None	2x GbE RJ-45, 1x Mgmt	None	1x LOM, 1x PCIe x8 LP	None	None	TPM 1.2	XClarity Enterprise	1x 750W Platinum	None	3-year	07/17
7X04A02QNA	NA	1x Xeon Bronze 3106 8C/1.7GHz/11MB/85W/DDR4-2133	1x 16GB RDIMM DDR4-2666 (1Rx4)	1x 530-8i	12x 3.5"	8x 3.5"	SATA/SAS HS	Open	None	2x GbE RJ-45, 1x Mgmt	None	1x LOM, 1x PCIe x8 LP	None	None	TPM 1.2	XClarity Enterprise	1x 750W Platinum	None	3-year	07/17
7X04A02KNA	NA	1x Xeon Silver 4110 8C/2.1GHz/11MB/85W/DDR4-2400	1x 16GB RDIMM DDR4-2666 (1Rx4)	1x 930-8i 2GB Flash	12x 3.5"	8x 3.5"	SATA/SAS HS	Open	None	2x GbE RJ-45, 1x Mgmt	None	1x LOM, 1x PCIe x8 LP	None	None	TPM 1.2	XClarity Enterprise	1x 750W Platinum	None	3-year	07/17

Model	Region	Processor	Memory	Storage Controller	Chassis	Disk Bays	Disks	M.2 Drives	Onboard Networking Ports	Additional Networking (LOM/ML2/PCIe)	Standard Extension Slots	Available Extension Slots via Riser Cards	Front VGA	Optical	TPM	System Management	Power Supply	Preload	Warranty	Ann Date (mm/yy)
7X04A029AU	ANZ	1x Xeon Gold 6138 20C/2.0GHz/27.5MB/125W/DDR4-2666	1x 32GB RDIMM DDR4-2666 (2Rx4)	1x 930-8i 2GB Flash	16x 2.5"	8x 2.5" SATA/SAS HS	Open	None	2x GbE RJ-45, 1x Mgmt	None	1x LOM, 1x PCIe x8 LP	3x PCIe x8 FHHL	8x Front VGA	None	TPM 1.2	XClarity Standard	1x 750W Platinum	None	3-year	07/17
7X04A02HAU	ANZ	1x Xeon Silver 4116 12C/2.1GHz/16.5MB/85W/DDR4-2400	1x 16GB RDIMM DDR4-2666 (1Rx4)	1x 930-8i 2GB Flash	16x 2.5"	8x 2.5" SATA/SAS HS	Open	None	2x GbE RJ-45, 1x Mgmt	None	1x LOM, 1x PCIe x8 LP	None	None	None	TPM 1.2	XClarity Standard	1x 750W Platinum	None	3-year	07/17
7X04A02SAU	ANZ	1x Xeon Silver 4110 8C/2.1GHz/11MB/85W/DDR4-2400	1x 16GB RDIMM DDR4-2666 (1Rx4)	1x 930-8i 2GB Flash	16x 2.5"	8x 2.5" SATA/SAS HS	Open	None	2x GbE RJ-45, 1x Mgmt	None	1x LOM, 1x PCIe x8 LP	None	None	None	TPM 1.2	XClarity Standard	1x 750W Platinum	None	3-year	07/17
7X04A02XAU	ANZ	1x Xeon Gold 6130 16C/2.1GHz/22MB/125W/DDR4-2666	1x 32GB RDIMM DDR4-2666 (2Rx4)	1x 930-8i 2GB Flash	16x 2.5"	8x 2.5" SATA/SAS HS	Open	None	2x GbE RJ-45, 1x Mgmt	None	1x LOM, 1x PCIe x8 LP	3x PCIe x8 FHHL	8x Front VGA	None	TPM 1.2	XClarity Standard	1x 750W Platinum	None	3-year	07/17
7X04A033AU	ANZ	1x Xeon Silver 4108 8C/1.8GHz/11MB/85W/DDR4-2400	1x 16GB RDIMM DDR4-2666 (1Rx4)	1x 930-8i 2GB Flash	16x 2.5"	8x 2.5" SATA/SAS HS	Open	None	2x GbE RJ-45, 1x Mgmt	None	1x LOM, 1x PCIe x8 LP	None	None	None	TPM 1.2	XClarity Standard	1x 750W Platinum	None	3-year	07/17
7X04A031AU	ANZ	1x Xeon Gold 5118 12C/2.3GHz/16.5MB/105W/DDR4-2400	1x 16GB RDIMM DDR4-2666 (1Rx4)	1x 930-8i 2GB Flash	16x 2.5"	8x 2.5" SATA/SAS HS	Open	None	2x GbE RJ-45, 1x Mgmt	None	1x LOM, 1x PCIe x8 LP	3x PCIe x8 FHHL	8x Front VGA	None	TPM 1.2	XClarity Standard	1x 750W Platinum	None	3-year	07/17
7X04A037AU	ANZ	1x Xeon Gold 5120 14C/2.2GHz/19.25MB/105W/DDR4-2400	1x 16GB RDIMM DDR4-2666 (1Rx4)	1x 930-8i 2GB Flash	16x 2.5"	8x 2.5" SATA/SAS HS	Open	None	2x GbE RJ-45, 1x Mgmt	None	1x LOM, 1x PCIe x8 LP	3x PCIe x8 FHHL	8x Front VGA	None	TPM 1.2	XClarity Standard	1x 750W Platinum	None	3-year	07/17
7X04A03AAU	ANZ	1x Xeon Bronze 3104 6C/1.7GHz/8.25MB/85W/DDR4-2133	1x 16GB RDIMM DDR4-2666 (1Rx4)	1x 530-8i	16x 2.5"	8x 2.5" SATA/SAS HS	Open	None	2x GbE RJ-45, 1x Mgmt	None	1x LOM, 1x PCIe x8 LP	None	None	None	TPM 1.2	XClarity Standard	1x 750W Platinum	None	3-year	07/17
7X04A03CAU	ANZ	1x Xeon Silver 4108 8C/1.8GHz/11MB/85W/DDR4-2400	1x 16GB RDIMM DDR4-2666 (1Rx4)	1x 530-8i	16x 2.5"	8x 2.5" SATA/SAS HS	Open	None	2x GbE RJ-45, 1x Mgmt	None	1x LOM, 1x PCIe x8 LP	None	None	None	TPM 1.2	XClarity Standard	1x 750W Platinum	None	3-year	07/17
7X04A03GAU	ANZ	1x Xeon Silver 4114 10C/2.2GHz/13.75MB/85W/DDR4-2400	1x 16GB RDIMM DDR4-2666 (1Rx4)	1x 930-8i 2GB Flash	16x 2.5"	8x 2.5" SATA/SAS HS	Open	None	2x GbE RJ-45, 1x Mgmt	None	1x LOM, 1x PCIe x8 LP	None	None	None	TPM 1.2	XClarity Standard	1x 750W Platinum	None	3-year	07/17

Model	Region	Processor	Memory	Storage Controller	Chassis	Disk Bays	Disks	M.2 Drives	Onboard Networking Ports	Additional Networking (LOM/ML2/PCIe)	Standard Extension Slots	Available Extension Slots via Riser Cards	Front VGA	Optical	TPM	System Management	Power Supply	Preload	Warranty	Ann Date (mm/yy)
7X04A03HAU	ANZ	1x Xeon Gold 6126 12C/2.6GHz/19.25MB/125W/DDR4-2666	1x 32GB RDIMM DDR4-2666 (2Rx4)	1x 930-8i 2GB Flash	16x 2.5"	8x 2.5"	SATA/SAS Open	None	2x GbE RJ-45, 1x Mgmt	None	1x LOM, 1x PCIe x8 LP	3x PCIe x8 FHHL	8x Front VGA	None	TPM 1.2	XClarity Standard	1x 750W Platinum	None	3-year	07/17
7X04A03QAU	ANZ	1x Xeon Silver 4110 8C/2.1GHz/11MB/85W/DDR4-2400	1x 16GB RDIMM DDR4-2666 (1Rx4)	1x 530-8i	16x 2.5"	8x 2.5"	SATA/SAS Open	None	2x GbE RJ-45, 1x Mgmt	None	1x LOM, 1x PCIe x8 LP	None	None	None	TPM 1.2	XClarity Standard	1x 750W Platinum	None	3-year	07/17
7X04A03RAU	ANZ	1x Xeon Silver 4114 10C/2.2GHz/13.75MB/85W/DDR4-2400	1x 16GB RDIMM DDR4-2666 (1Rx4)	1x 930-16i 4GB Flash	12x 3.5"	12x 3.5"	SATA/SAS Open	None	2x GbE RJ-45, 1x Mgmt	None	1x LOM, 1x PCIe x8 LP	None	None	None	TPM 1.2	XClarity Standard	1x 750W Platinum	None	3-year	07/17
7X04A041AU	ANZ	1x Xeon Gold 6130 16C/2.1GHz/22MB/125W/DDR4-2666	1x 32GB RDIMM DDR4-2666 (2Rx4)	1x 930-8i 2GB Flash	16x 2.5"	8x 2.5"	SATA/SAS Open	None	2x GbE RJ-45, 1x Mgmt	None	1x LOM, 1x PCIe x8 LP	3x PCIe x8 FHHL	None	None	TPM 1.2	XClarity Standard	1x 750W Platinum	None	3-year	07/17
7X04A042AU	ANZ	1x Xeon Gold 6138 20C/2.0GHz/27.5MB/125W/DDR4-2666	1x 32GB RDIMM DDR4-2666 (2Rx4)	1x 930-8i 2GB Flash	16x 2.5"	8x 2.5"	SATA/SAS Open	None	2x GbE RJ-45, 1x Mgmt	None	1x LOM, 1x PCIe x8 LP	3x PCIe x8 FHHL	None	None	TPM 1.2	XClarity Standard	1x 750W Platinum	None	3-year	07/17
7X04A043AU	ANZ	1x Xeon Gold 5120 14C/2.2GHz/19.25MB/105W/DDR4-2400	1x 16GB RDIMM DDR4-2666 (1Rx4)	1x 930-8i 2GB Flash	16x 2.5"	8x 2.5"	SATA/SAS Open	None	2x GbE RJ-45, 1x Mgmt	None	1x LOM, 1x PCIe x8 LP	3x PCIe x8 FHHL	None	None	TPM 1.2	XClarity Standard	1x 750W Platinum	None	3-year	07/17
7X04A044AU	ANZ	1x Xeon Gold 5118 12C/2.3GHz/16.5MB/105W/DDR4-2400	1x 16GB RDIMM DDR4-2666 (1Rx4)	1x 930-8i 2GB Flash	16x 2.5"	8x 2.5"	SATA/SAS Open	None	2x GbE RJ-45, 1x Mgmt	None	1x LOM, 1x PCIe x8 LP	3x PCIe x8 FHHL	None	None	TPM 1.2	XClarity Standard	1x 750W Platinum	None	3-year	07/17
7X04A049AU	ANZ	1x Xeon Gold 6126T 12C/2.6GHz/19.25MB/125W/DDR4-2666	1x 32GB RDIMM DDR4-2666 (2Rx4)	1x 930-8i 2GB Flash	16x 2.5"	8x 2.5"	SATA/SAS Open	None	2x GbE RJ-45, 1x Mgmt	None	1x LOM, 1x PCIe x8 LP	3x PCIe x8 FHHL	None	None	TPM 1.2	XClarity Standard	1x 750W Platinum	None	3-year	07/17
7X04A04KAU	ANZ	1x Xeon Gold 6138 20C/2.0GHz/27.5MB/125W/DDR4-2666	1x 32GB RDIMM DDR4-2666 (2Rx4)	1x 930-8i 2GB Flash	16x 2.5"	8x 2.5"	SATA/SAS Open	None	2x GbE RJ-45, 1x Mgmt	None	1x LOM, 1x PCIe x8 LP	3x PCIe x8 FHHL	8x Front VGA	None	TPM 1.2	XClarity Standard	1x 750W Platinum	None	3-year	07/17

Model	Region	Processor	Memory	Storage Controller	Chassis	Disk Bays	Disks	M.2 Drives	Onboard Networking Ports	Additional Networking (LOM/ML2/PCIe)	Standard Extension Slots	Available Extension Slots via Riser Cards	Front VGA	Optical	TPM	System Management	Power Supply	Preload	Warranty	Ann Date (mm/yy)
7X04A04TSG	ASEAN	1x Xeon Gold 5118 12C/2.3GHz/16.5MB/105W/DDR4-2400	1x 8GB RDIMM DDR4-2666 (1Rx8)	1x 530-8i	16x 2.5"	8x 2.5" SATA/SAS HS	Open	None	2x GbE RJ-45, 1x Mgmt	[1]Sheet5!AA213	1x LOM, 1x PCIe x8 LP	None	None	None	TPM 1.2	XClarity Standard	1x 750W Platinum	None	3-year	07/17
7X04A006SG	ASEAN	1x Xeon Silver 4112 4C/2.6GHz/8.25MB/85W/DDR4-2400	1x 8GB RDIMM DDR4-2666 (1Rx8)	1x 930-16i 4GB Flash	12x 3.5"	8x 2.5" SATA/SAS HS	Open	None	2x GbE RJ-45, 1x Mgmt	None	1x LOM, 1x PCIe x8 LP	None	None	None	TPM 1.2	XClarity Standard	1x 750W Platinum	None	3-year	07/17
7X04A00BSG	ASEAN	1x Xeon Silver 4116 12C/2.1GHz/16.5MB/85W/DDR4-2400	1x 8GB RDIMM DDR4-2666 (1Rx8)	1x 530-8i	16x 2.5"	8x 2.5" SATA/SAS HS	Open	None	2x GbE RJ-45, 1x Mgmt	None	1x LOM, 1x PCIe x8 LP	None	None	None	TPM 1.2	XClarity Standard	1x 750W Platinum	None	3-year	07/17
7X04A008SG	ASEAN	1x Xeon Silver 4114 10C/2.2GHz/13.75MB/85W/DDR4-2400	1x 8GB RDIMM DDR4-2666 (1Rx8)	1x 530-8i	16x 2.5"	8x 2.5" SATA/SAS HS	Open	None	2x GbE RJ-45, 1x Mgmt	None	1x LOM, 1x PCIe x8 LP	None	None	None	TPM 1.2	XClarity Standard	1x 750W Platinum	None	3-year	07/17
7X04A00GSG	ASEAN	1x Xeon Silver 4110 8C/2.1GHz/11MB/85W/DDR4-2400	1x 8GB RDIMM DDR4-2666 (1Rx8)	1x 530-8i	16x 2.5"	8x 2.5" SATA/SAS HS	Open	None	2x GbE RJ-45, 1x Mgmt	None	1x LOM, 1x PCIe x8 LP	None	None	None	TPM 1.2	XClarity Standard	1x 750W Platinum	None	3-year	07/17
7X04A00KSG	ASEAN	1x Xeon Silver 4112 4C/2.6GHz/8.25MB/85W/DDR4-2400	1x 8GB RDIMM DDR4-2666 (1Rx8)	1x 530-8i	16x 2.5"	8x 2.5" SATA/SAS HS	Open	None	2x GbE RJ-45, 1x Mgmt	None	1x LOM, 1x PCIe x8 LP	None	None	None	TPM 1.2	XClarity Standard	1x 750W Platinum	None	3-year	07/17
7X04A00RSG	ASEAN	1x Xeon Bronze 3104 6C/1.7GHz/8.25MB/85W/DDR4-2133	1x 8GB RDIMM DDR4-2666 (1Rx8)	1x 530-8i	16x 2.5"	8x 2.5" SATA/SAS HS	Open	None	2x GbE RJ-45, 1x Mgmt	None	1x LOM, 1x PCIe x8 LP	None	None	None	TPM 1.2	XClarity Standard	1x 750W Platinum	None	3-year	07/17
7X04A00SSG	ASEAN	1x Xeon Bronze 3106 8C/1.7GHz/11MB/85W/DDR4-2133	1x 8GB RDIMM DDR4-2666 (1Rx8)	1x 530-8i	16x 2.5"	8x 2.5" SATA/SAS HS	Open	None	2x GbE RJ-45, 1x Mgmt	None	1x LOM, 1x PCIe x8 LP	None	None	None	TPM 1.2	XClarity Standard	1x 750W Platinum	None	3-year	07/17
7X04A00XSG	ASEAN	1x Xeon Gold 5122 4C/3.6GHz/16.5MB/105W/DDR4-2666	1x 8GB RDIMM DDR4-2666 (1Rx8)	1x 930-16i 4GB Flash	12x 3.5"	8x 2.5" SATA/SAS HS	Open	None	2x GbE RJ-45, 1x Mgmt	2x GbE RJ-45 LOM	1x LOM, 1x PCIe x8 LP	None	None	None	TPM 1.2	XClarity Standard	1x 750W Platinum	None	3-year	07/17
7X04A00VSG	ASEAN	1x Xeon Gold 5122 4C/3.6GHz/16.5MB/105W/DDR4-2666	1x 8GB RDIMM DDR4-2666 (1Rx8)	1x 530-8i	16x 2.5"	8x 2.5" SATA/SAS HS	Open	None	2x GbE RJ-45, 1x Mgmt	2x GbE RJ-45 LOM	1x LOM, 1x PCIe x8 LP	None	None	None	TPM 1.2	XClarity Standard	1x 750W Platinum	None	3-year	07/17

Model	Region	Processor	Memory	Storage Controller	Chassis	Disk Bays	Disks	M.2 Drives	Onboard Networking Ports	Additional Networking (LOM/ML2/PCIe)	Standard Extension Slots	Available Extension Slots via Riser Cards	Front VGA	Optical	TPM	System Management	Power Supply	Preload	Warranty	Ann Date (mm/yy)
7X04A017SG	ASEAN	1x Xeon Gold 5120 14C/2.2GHz/19.25MB/105W/DDR4-2400	1x 8GB RDIMM DDR4-2666 (1Rx8)	1x 530-8i	16x 2.5"	8x 2.5" SATA/SAS HS	Open	None	2x GbE RJ-45, 1x Mgmt	2x GbE RJ-45 LOM	1x LOM, 1x PCIe x8 LP	None	None	None	TPM 1.2	XClarity Standard	1x 750W Platinum	None	3-year	07/17
7X04A01ASG	ASEAN	1x Xeon Gold 6130 16C/2.1GHz/22MB/125W/DDR4-2666	1x 8GB RDIMM DDR4-2666 (1Rx8)	1x 530-8i	16x 2.5"	8x 2.5" SATA/SAS HS	Open	None	2x GbE RJ-45, 1x Mgmt	2x GbE RJ-45 LOM	1x LOM, 1x PCIe x8 LP	None	None	None	TPM 1.2	XClarity Standard	1x 750W Platinum	None	3-year	07/17
7X04A01ESG	ASEAN	1x Xeon Gold 5118 12C/2.3GHz/16.5MB/105W/DDR4-2400	1x 8GB RDIMM DDR4-2666 (1Rx8)	1x 530-8i	16x 2.5"	8x 2.5" SATA/SAS HS	Open	None	2x GbE RJ-45, 1x Mgmt	2x GbE RJ-45 LOM	1x LOM, 1x PCIe x8 LP	None	None	None	TPM 1.2	XClarity Standard	1x 750W Platinum	None	3-year	07/17
7X04A01XSG	ASEAN	1x Xeon Gold 6138 20C/2.0GHz/27.5MB/125W/DDR4-2666	1x 8GB RDIMM DDR4-2666 (1Rx8)	1x 530-8i	16x 2.5"	8x 2.5" SATA/SAS HS	Open	None	2x GbE RJ-45, 1x Mgmt	2x GbE RJ-45 LOM	1x LOM, 1x PCIe x8 LP	None	None	None	TPM 1.2	XClarity Standard	1x 750W Platinum	None	3-year	07/17

Model	Region	Processor	Memory	Storage Controller	Chassis	Disk Bays	Disks	M.2 Drives	Onboard Networking Ports	Additional Networking (LOM/ML2/PCIe)	Standard Extension Slots	Available Extension Slots via Riser Cards	Front VGA	Optical	TPM	System Management	Power Supply	Preload	Warranty	Ann Date (mm/yy)
7X04A063BR	Brazil	1x Xeon Gold 5118 12C/2.3GHz/16.5MB/105W/DDR4-2400	1x 16GB RDIMM DDR4-2666 (1Rx4)	1x 530-8i	16x 2.5"	8x 2.5" SATA/SAS HS	Open	None	2x GbE RJ-45, 1x Mgmt	None	1x LOM, 1x PCIe x8 LP	3x PCIe x8 FHHL	x8 Front VGA	None	TPM 1.2	XClarity Standard	1x 750W Platinum	None	3-year	07/17
7X04A064BR	Brazil	1x Xeon Gold 5120 14C/2.2GHz/19.25MB/105W/DDR4-2400	1x 16GB RDIMM DDR4-2666 (1Rx4)	1x 530-8i	16x 2.5"	8x 2.5" SATA/SAS HS	Open	None	2x GbE RJ-45, 1x Mgmt	None	1x LOM, 1x PCIe x8 LP	3x PCIe x8 FHHL	x8 Front VGA	None	TPM 1.2	XClarity Standard	1x 750W Platinum	None	3-year	07/17
7X04A065BR	Brazil	1x Xeon Gold 6130 16C/2.1GHz/22MB/125W/DDR4-2666	1x 16GB RDIMM DDR4-2666 (1Rx4)	1x 530-8i	16x 2.5"	8x 2.5" SATA/SAS HS	Open	None	2x GbE RJ-45, 1x Mgmt	None	1x LOM, 1x PCIe x8 LP	3x PCIe x8 FHHL	x8 Front VGA	None	TPM 1.2	XClarity Standard	1x 750W Platinum	None	3-year	07/17
7X04A066BR	Brazil	1x Xeon Gold 5118 12C/2.3GHz/16.5MB/105W/DDR4-2400	1x 16GB RDIMM DDR4-2666 (1Rx4)	1x 530-8i	16x 2.5"	8x 2.5" SATA/SAS HS	Open	None	2x GbE RJ-45, 1x Mgmt	None	1x LOM, 1x PCIe x8 LP	3x PCIe x8 FHHL	x8 Front VGA	None	TPM 1.2	XClarity Standard	1x 750W Platinum	None	3-year	07/17
7X04A067BR	Brazil	1x Xeon Gold 5120 14C/2.2GHz/19.25MB/105W/DDR4-2400	1x 16GB RDIMM DDR4-2666 (1Rx4)	1x 530-8i	16x 2.5"	8x 2.5" SATA/SAS HS	Open	None	2x GbE RJ-45, 1x Mgmt	None	1x LOM, 1x PCIe x8 LP	3x PCIe x8 FHHL	x8 Front VGA	None	TPM 1.2	XClarity Standard	1x 750W Platinum	None	3-year	07/17
7X04A068BR	Brazil	1x Xeon Gold 6130 16C/2.1GHz/22MB/125W/DDR4-2666	1x 16GB RDIMM DDR4-2666 (1Rx4)	1x 530-8i	16x 2.5"	8x 2.5" SATA/SAS HS	Open	None	2x GbE RJ-45, 1x Mgmt	None	1x LOM, 1x PCIe x8 LP	3x PCIe x8 FHHL	x8 Front VGA	None	TPM 1.2	XClarity Standard	1x 750W Platinum	None	3-year	07/17
7X04A069BR	Brazil	1x Xeon Gold 5118 12C/2.3GHz/16.5MB/105W/DDR4-2400	1x 16GB RDIMM DDR4-2666 (1Rx4)	1x 530-8i	12x 3.5"	8x 3.5" SATA/SAS HS	Open	None	2x GbE RJ-45, 1x Mgmt	None	1x LOM, 1x PCIe x8 LP	3x PCIe x8 FHHL	x8 Front VGA	None	TPM 1.2	XClarity Standard	1x 750W Platinum	None	3-year	07/17
7X04A06ABR	Brazil	1x Xeon Gold 5120 14C/2.2GHz/19.25MB/105W/DDR4-2400	1x 16GB RDIMM DDR4-2666 (1Rx4)	1x 530-8i	12x 3.5"	8x 3.5" SATA/SAS HS	Open	None	2x GbE RJ-45, 1x Mgmt	None	1x LOM, 1x PCIe x8 LP	3x PCIe x8 FHHL	x8 Front VGA	None	TPM 1.2	XClarity Standard	1x 750W Platinum	None	3-year	07/17
7X04A06BBR	Brazil	1x Xeon Gold 6130 16C/2.1GHz/22MB/125W/DDR4-2666	1x 16GB RDIMM DDR4-2666 (1Rx4)	1x 530-8i	12x 3.5"	8x 3.5" SATA/SAS HS	Open	None	2x GbE RJ-45, 1x Mgmt	None	1x LOM, 1x PCIe x8 LP	3x PCIe x8 FHHL	x8 Front VGA	None	TPM 1.2	XClarity Standard	1x 750W Platinum	None	3-year	07/17
7X04A06CBR	Brazil	1x Xeon Gold 5118 12C/2.3GHz/16.5MB/105W/DDR4-2400	1x 32GB RDIMM DDR4-2666 (2Rx4)	1x 530-8i	12x 3.5"	8x 3.5" SATA/SAS HS	Open	None	2x GbE RJ-45, 1x Mgmt	None	1x LOM, 1x PCIe x8 LP	3x PCIe x8 FHHL	x8 Front VGA	None	TPM 1.2	XClarity Standard	1x 750W Platinum	None	3-year	07/17

Model	Region	Processor	Memory	Storage Controller	Chassis	Disk Bays	Disks	M.2 Drives	Onboard Networking Ports	Additional Networking (LOM/ML2/PCIe)	Standard Extension Slots	Available Extension Slots via Riser Cards	Front VGA	Optical	TPM	System Management	Power Supply	Preload	Warranty	Ann Date (mm/yy)
7X04A06DBR	Brazil	1x Xeon Gold 5120 14C/2.2GHz/19.25MB/105W/DDR4-2400	1x 32GB RDIMM DDR4-2666 (2Rx4)	1x 530-8i	12x 3.5"	8x 3.5" SATA/SAS HS	Open	None	2x GbE RJ-45, 1x Mgmt	None	1x LOM, 1x PCIe x8 LP	3x PCIe x8 FHHL	8 Front VGA	None	TPM 1.2	XClarity Standard	1x 750W Platinum	None	3-year	07/17
7X04A06EBR	Brazil	1x Xeon Gold 6130 16C/2.1GHz/22MB/125W/DDR4-2666	1x 32GB RDIMM DDR4-2666 (2Rx4)	1x 530-8i	12x 3.5"	8x 3.5" SATA/SAS HS	Open	None	2x GbE RJ-45, 1x Mgmt	None	1x LOM, 1x PCIe x8 LP	3x PCIe x8 FHHL	8 Front VGA	None	TPM 1.2	XClarity Standard	1x 750W Platinum	None	3-year	07/17

Model	Region	Processor	Memory	Storage Controller	Chassis	Disk Bays	Disks	M.2 Drives	Onboard Networking Ports	Additional Networking (LOM/ML2/PCIe)	Standard Extension Slots	Available Extension Slots via Riser Cards	Front VGA	Optical	TPM	System Management	Power Supply	Preload	Warranty	Ann Date (mm/yy)
7X04A001EA	EMEA	1x Xeon Silver 4110 8C/2.1GHz/11MB/85W/DDR4-2400	1x 16GB RDIMM DDR4-2666 (1Rx4)	1x 930-8i 2GB Flash	16x 2.5"	8x 2.5" SATA/SAS HS	Open	None	2x GbE RJ-45, 1x Mgmt	None	1x LOM, 1x PCIe x8 LP	None	None	None	TPM 1.2	XClarity Standard	1x 750W Platinum	None	3-year	07/17
7X04A004EA	EMEA	1x Xeon Silver 4108 8C/1.8GHz/11MB/85W/DDR4-2400	1x 16GB RDIMM DDR4-2666 (1Rx4)	1x 930-8i 2GB Flash	16x 2.5"	8x 2.5" SATA/SAS HS	Open	None	2x GbE RJ-45, 1x Mgmt	None	1x LOM, 1x PCIe x8 LP	None	None	None	TPM 1.2	XClarity Standard	1x 750W Platinum	None	3-year	07/17
7X04A00LEA	EMEA	1x Xeon Silver 4116 12C/2.1GHz/16.5MB/85W/DDR4-2400	1x 16GB RDIMM DDR4-2666 (1Rx4)	1x 930-8i 2GB Flash	16x 2.5"	8x 2.5" SATA/SAS HS	Open	None	2x GbE RJ-45, 1x Mgmt	None	1x LOM, 1x PCIe x8 LP	None	None	None	TPM 1.2	XClarity Standard	1x 750W Platinum	None	3-year	07/17
7X04A00PEA	EMEA	1x Xeon Bronze 3104 6C/1.7GHz/8.25MB/85W/DDR4-2133	1x 16GB RDIMM DDR4-2666 (1Rx4)	1x 530-8i	16x 2.5"	8x 2.5" SATA/SAS HS	Open	None	2x GbE RJ-45, 1x Mgmt	None	1x LOM, 1x PCIe x8 LP	None	None	None	TPM 1.2	XClarity Standard	1x 750W Platinum	None	3-year	07/17
7X04A00JEA	EMEA	1x Xeon Silver 4114 10C/2.2GHz/13.75MB/85W/DDR4-2400	1x 16GB RDIMM DDR4-2666 (1Rx4)	1x 930-16i 4GB Flash	12x 3.5"	12x 3.5" SATA/SAS HS	Open	None	2x GbE RJ-45, 1x Mgmt	None	1x LOM, 1x PCIe x8 LP	None	None	None	TPM 1.2	XClarity Standard	1x 750W Platinum	None	3-year	07/17
7X04A009EA	EMEA	1x Xeon Silver 4110 8C/2.1GHz/11MB/85W/DDR4-2400	1x 16GB RDIMM DDR4-2666 (1Rx4)	1x 530-8i	16x 2.5"	8x 2.5" SATA/SAS HS	Open	None	2x GbE RJ-45, 1x Mgmt	None	1x LOM, 1x PCIe x8 LP	None	None	None	TPM 1.2	XClarity Standard	1x 750W Platinum	None	3-year	07/17
7X04A00EEA	EMEA	1x Xeon Silver 4114 10C/2.2GHz/13.75MB/85W/DDR4-2400	1x 16GB RDIMM DDR4-2666 (1Rx4)	1x 930-8i 2GB Flash	16x 2.5"	8x 2.5" SATA/SAS HS	Open	None	2x GbE RJ-45, 1x Mgmt	None	1x LOM, 1x PCIe x8 LP	None	None	None	TPM 1.2	XClarity Standard	1x 750W Platinum	None	3-year	07/17
7X04A021EA	EMEA	1x Xeon Gold 5120 14C/2.2GHz/19.25MB/105W/DDR4-2400	1x 16GB RDIMM DDR4-2666 (1Rx4)	1x 930-8i 2GB Flash	16x 2.5"	8x 2.5" SATA/SAS HS	Open	None	2x GbE RJ-45, 1x Mgmt	None	1x LOM, 1x PCIe x8 LP	None	None	None	TPM 1.2	XClarity Standard	1x 750W Platinum	None	3-year	07/17
7X04A022EA	EMEA	1x Xeon Gold 6138 20C/2.0GHz/27.5MB/125W/DDR4-2666	1x 32GB RDIMM DDR4-2666 (2Rx4)	1x 930-8i 2GB Flash	16x 2.5"	8x 2.5" SATA/SAS HS	Open	None	2x GbE RJ-45, 1x Mgmt	None	1x LOM, 1x PCIe x8 LP	None	None	None	TPM 1.2	XClarity Standard	1x 750W Platinum	None	3-year	07/17
7X04A025EA	EMEA	1x Xeon Gold 5118 12C/2.3GHz/16.5MB/105W/DDR4-2400	1x 16GB RDIMM DDR4-2666 (1Rx4)	1x 930-8i 2GB Flash	16x 2.5"	8x 2.5" SATA/SAS HS	Open	None	2x GbE RJ-45, 1x Mgmt	None	1x LOM, 1x PCIe x8 LP	None	None	None	TPM 1.2	XClarity Standard	1x 750W Platinum	None	3-year	07/17

Model	Region	Processor	Memory	Storage Controller	Chassis	Disk Bays	Disks	M.2 Drives	Onboard Networking Ports	Additional Networking (LOM/ML2/PCIe)	Standard Extension Slots	Available Extension Slots via Riser Cards	Front VGA	Optical	TPM	System Management	Power Supply	Preload	Warranty	Ann Date (mm/yy)
7X04A026EA	EMEA	1x Xeon Gold 6126 12C/2.6GHz/19.25MB/125W/DDR4-2666	1x 32GB RDIMM DDR4-2666 (2Rx4)	1x 930-8i 2GB Flash	16x 2.5"	8x 2.5" SATA/SAS HS	Open	None	2x GbE RJ-45, 1x Mgmt	None	1x LOM, 1x PCIe x8 LP	None	None	None	TPM 1.2	XClarity Standard	1x 750W Platinum	None	3-year	07/17
7X04A027EA	EMEA	1x Xeon Gold 6130 16C/2.1GHz/22MB/125W/DDR4-2666	1x 32GB RDIMM DDR4-2666 (2Rx4)	1x 930-8i 2GB Flash	16x 2.5"	8x 2.5" SATA/SAS HS	Open	None	2x GbE RJ-45, 1x Mgmt	None	1x LOM, 1x PCIe x8 LP	None	None	None	TPM 1.2	XClarity Standard	1x 750W Platinum	None	3-year	07/17
7X04A04AEA	EMEA	1x Xeon Gold 5115 10C/2.4GHz/13.75MB/85W/DDR4-2400	1x 16GB RDIMM DDR4-2666 (1Rx4)	1x 930-8i 2GB Flash	16x 2.5"	8x 2.5" SATA/SAS HS	Open	None	2x GbE RJ-45, 1x Mgmt	None	1x LOM, 1x PCIe x8 LP	None	None	None	TPM 1.2	XClarity Standard	1x 750W Platinum	None	3-year	07/17

Model	Region	Processor	Memory	Storage Controller	Chassis	Disk Bays	Disks	M.2 Drives	Onboard Networking Ports	Additional Networking (LOM/ML2/PCIe)	Standard Extension Slots	Available Extension Slots via Riser Cards	Front VGA	Optical	TPM	System Management	Power Supply	Preload	Warranty	Ann Date (mm/yy)
7X04A03UCN	HTK	1x Xeon Silver 4116 12C/2.1GHz/16.5MB/85W/DDR4-2400	1x 16GB RDIMM DDR4-2666 (1Rx4)	1x 930-8i 2GB Flash	16x 2.5"	8x 2.5" SATA/SAS HS	Open	None	2x GbE RJ-45, 1x Mgmt	2x GbE RJ-45 LOM	1x LOM, 1x PCIe x8 LP	3x PCIe x8 FHHL	None	None	TPM 1.2	XClarity Standard	1x 750W Platinum	None	3-year	07/17
7X04A03JCN	HTK	1x Xeon Silver 4108 8C/1.8GHz/11MB/85W/DDR4-2400	1x 16GB RDIMM DDR4-2666 (1Rx4)	1x 930-8i 2GB Flash	16x 2.5"	8x 2.5" SATA/SAS HS	Open	None	2x GbE RJ-45, 1x Mgmt	2x GbE RJ-45 LOM	1x LOM, 1x PCIe x8 LP	3x PCIe x8 FHHL	None	None	TPM 1.2	XClarity Standard	1x 750W Platinum	None	3-year	07/17
7X04A03FCN	HTK	1x Xeon Bronze 3106 8C/1.7GHz/11MB/85W/DDR4-2133	1x 16GB RDIMM DDR4-2666 (1Rx4)	1x 930-8i 2GB Flash	16x 2.5"	8x 2.5" SATA/SAS HS	Open	None	2x GbE RJ-45, 1x Mgmt	2x GbE RJ-45 LOM	1x LOM, 1x PCIe x8 LP	3x PCIe x8 FHHL	None	None	TPM 1.2	XClarity Standard	1x 750W Platinum	None	3-year	07/17
7X04A03DCN	HTK	1x Xeon Silver 4112 4C/2.6GHz/8.25MB/85W/DDR4-2400	1x 16GB RDIMM DDR4-2666 (1Rx4)	1x 930-8i 2GB Flash	16x 2.5"	8x 2.5" SATA/SAS HS	Open	None	2x GbE RJ-45, 1x Mgmt	2x GbE RJ-45 LOM	1x LOM, 1x PCIe x8 LP	3x PCIe x8 FHHL	None	None	TPM 1.2	XClarity Standard	1x 750W Platinum	None	3-year	07/17
7X04A03BCN	HTK	1x Xeon Bronze 3104 6C/1.7GHz/8.25MB/85W/DDR4-2133	1x 16GB RDIMM DDR4-2666 (1Rx4)	1x 930-8i 2GB Flash	16x 2.5"	8x 2.5" SATA/SAS HS	Open	None	2x GbE RJ-45, 1x Mgmt	2x GbE RJ-45 LOM	1x LOM, 1x PCIe x8 LP	3x PCIe x8 FHHL	None	None	TPM 1.2	XClarity Standard	1x 750W Platinum	None	3-year	07/17
7X04A038CN	HTK	1x Xeon Gold 5115 10C/2.4GHz/13.75MB/85W/DDR4-2400	1x 16GB RDIMM DDR4-2666 (1Rx4)	1x 930-8i 2GB Flash	16x 2.5"	8x 2.5" SATA/SAS HS	Open	None	2x GbE RJ-45, 1x Mgmt	2x GbE RJ-45 LOM	1x LOM, 1x PCIe x8 LP	3x PCIe x8 FHHL	None	None	TPM 1.2	XClarity Standard	1x 750W Platinum	None	3-year	07/17
7X04A032CN	HTK	1x Xeon Silver 4108 8C/1.8GHz/11MB/85W/DDR4-2400	1x 16GB RDIMM DDR4-2666 (1Rx4)	1x 930-16i 4GB Flash	12x 3.5"	12x 3.5" SATA/SAS HS	Open	None	2x GbE RJ-45, 1x Mgmt	2x GbE RJ-45 LOM	1x LOM, 1x PCIe x8 LP	3x PCIe x8 FHHL	None	None	TPM 1.2	XClarity Standard	1x 750W Platinum	None	3-year	07/17
7X04A02ZCN	HTK	1x Xeon Silver 4114 10C/2.2GHz/13.75MB/85W/DDR4-2400	1x 16GB RDIMM DDR4-2666 (1Rx4)	1x 930-8i 2GB Flash	16x 2.5"	8x 2.5" SATA/SAS HS	Open	None	2x GbE RJ-45, 1x Mgmt	2x GbE RJ-45 LOM	1x LOM, 1x PCIe x8 LP	3x PCIe x8 FHHL	None	None	TPM 1.2	XClarity Standard	1x 750W Platinum	None	3-year	07/17
7X04A030CN	HTK	1x Xeon Gold 5115 10C/2.4GHz/13.75MB/85W/DDR4-2400	1x 16GB RDIMM DDR4-2666 (1Rx4)	1x 930-16i 4GB Flash	12x 3.5"	12x 3.5" SATA/SAS HS	Open	None	2x GbE RJ-45, 1x Mgmt	2x GbE RJ-45 LOM	1x LOM, 1x PCIe x8 LP	3x PCIe x8 FHHL	None	None	TPM 1.2	XClarity Standard	1x 750W Platinum	None	3-year	07/17
7X04A02UCN	HTK	1x Xeon Bronze 3106 8C/1.7GHz/11MB/85W/DDR4-2133	1x 16GB RDIMM DDR4-2666 (1Rx4)	1x 930-16i 4GB Flash	12x 3.5"	12x 3.5" SATA/SAS HS	Open	None	2x GbE RJ-45, 1x Mgmt	2x GbE RJ-45 LOM	1x LOM, 1x PCIe x8 LP	3x PCIe x8 FHHL	None	None	TPM 1.2	XClarity Standard	1x 750W Platinum	None	3-year	07/17

Model	Region	Processor	Memory	Storage Controller	Chassis	Disk Bays	Disks	M.2 Drives	Onboard Networking Ports	Additional Networking (LOM/ML2/PCIe)	Standard Extension Slots	Available Extension Slots via Riser Cards	Front VGA	Optical	TPM	System Management	Power Supply	Preload	Warranty	Ann Date (mm/yy)
7X04A02MCN	HTK	1x Xeon Silver 4112 4C/2.6GHz/8.25MB/85W/DDR4-2400	1x 16GB RDIMM DDR4-2666 (1Rx4)	1x 930-16i 4GB Flash	12x 3.5"	12x 3.5"	SATA/SAS Open	None	2x GbE RJ-45, 1x Mgmt	2x GbE RJ-45 LOM	1x LOM, 1x PCIe x8 LP	3x PCIe x8 FHHL	None	None	TPM 1.2	XClarity Standard	1x 750W Platinum	None	3-year	07/17
7X04A02NCN	HTK	1x Xeon Silver 4114 10C/2.2GHz/13.75MB/85W/DDR4-2400	1x 16GB RDIMM DDR4-2666 (1Rx4)	1x 930-16i 4GB Flash	12x 3.5"	12x 3.5"	SATA/SAS Open	None	2x GbE RJ-45, 1x Mgmt	2x GbE RJ-45 LOM	1x LOM, 1x PCIe x8 LP	3x PCIe x8 FHHL	None	None	TPM 1.2	XClarity Standard	1x 750W Platinum	None	3-year	07/17
7X04A01MCN	HTK	1x Xeon Gold 5120 14C/2.2GHz/19.25MB/105W/DDR4-2400	1x 16GB RDIMM DDR4-2666 (1Rx4)	1x 930-16i 4GB Flash	12x 3.5"	12x 3.5"	SATA/SAS Open	None	2x GbE RJ-45, 1x Mgmt	2x GbE RJ-45 LOM	1x LOM, 1x PCIe x8 LP	3x PCIe x8 FHHL	None	None	TPM 1.2	XClarity Standard	1x 750W Platinum	None	3-year	07/17
7X04A02DCN	HTK	1x Xeon Bronze 3104 6C/1.7GHz/8.25MB/85W/DDR4-2133	1x 16GB RDIMM DDR4-2666 (1Rx4)	1x 930-16i 4GB Flash	12x 3.5"	12x 3.5"	SATA/SAS Open	None	2x GbE RJ-45, 1x Mgmt	2x GbE RJ-45 LOM	1x LOM, 1x PCIe x8 LP	3x PCIe x8 FHHL	None	None	TPM 1.2	XClarity Standard	1x 750W Platinum	None	3-year	07/17
7X04A02ECN	HTK	1x Xeon Silver 4110 8C/2.1GHz/11MB/85W/DDR4-2400	1x 16GB RDIMM DDR4-2666 (1Rx4)	1x 930-8i 2GB Flash	16x 2.5"	8x 2.5"	SATA/SAS Open	None	2x GbE RJ-45, 1x Mgmt	2x GbE RJ-45 LOM	1x LOM, 1x PCIe x8 LP	3x PCIe x8 FHHL	None	None	TPM 1.2	XClarity Standard	1x 750W Platinum	None	3-year	07/17
7X04A02FCN	HTK	1x Xeon Silver 4110 8C/2.1GHz/11MB/85W/DDR4-2400	1x 16GB RDIMM DDR4-2666 (1Rx4)	1x 930-16i 4GB Flash	12x 3.5"	12x 3.5"	SATA/SAS Open	None	2x GbE RJ-45, 1x Mgmt	2x GbE RJ-45 LOM	1x LOM, 1x PCIe x8 LP	3x PCIe x8 FHHL	None	None	TPM 1.2	XClarity Standard	1x 750W Platinum	None	3-year	07/17
7X04A01FCN	HTK	1x Xeon Gold 6138 20C/2.0GHz/27.5MB/125W/DDR4-2666	1x 16GB RDIMM DDR4-2666 (1Rx4)	1x 930-16i 4GB Flash	12x 3.5"	12x 3.5"	SATA/SAS Open	None	2x GbE RJ-45, 1x Mgmt	2x GbE RJ-45 LOM	1x LOM, 1x PCIe x8 LP	3x PCIe x8 FHHL	None	None	TPM 1.2	XClarity Standard	1x 750W Platinum	None	3-year	07/17
7X04A01GCN	HTK	1x Xeon Gold 6130 16C/2.1GHz/22MB/125W/DDR4-2666	1x 16GB RDIMM DDR4-2666 (1Rx4)	1x 930-16i 4GB Flash	12x 3.5"	12x 3.5"	SATA/SAS Open	None	2x GbE RJ-45, 1x Mgmt	2x GbE RJ-45 LOM	1x LOM, 1x PCIe x8 LP	3x PCIe x8 FHHL	None	None	TPM 1.2	XClarity Standard	1x 750W Platinum	None	3-year	07/17
7X04A01JCN	HTK	1x Xeon Gold 5122 4C/3.6GHz/16.5MB/105W/DDR4-2666	1x 16GB RDIMM DDR4-2666 (1Rx4)	1x 930-16i 4GB Flash	12x 3.5"	12x 3.5"	SATA/SAS Open	None	2x GbE RJ-45, 1x Mgmt	2x GbE RJ-45 LOM	1x LOM, 1x PCIe x8 LP	3x PCIe x8 FHHL	None	None	TPM 1.2	XClarity Standard	1x 750W Platinum	None	3-year	07/17
7X04A01PCN	HTK	1x Xeon Gold 5118 12C/2.3GHz/16.5MB/105W/DDR4-2400	1x 16GB RDIMM DDR4-2666 (1Rx4)	1x 930-16i 4GB Flash	12x 3.5"	12x 3.5"	SATA/SAS Open	None	2x GbE RJ-45, 1x Mgmt	2x GbE RJ-45 LOM	1x LOM, 1x PCIe x8 LP	3x PCIe x8 FHHL	None	None	TPM 1.2	XClarity Standard	1x 750W Platinum	None	3-year	07/17

Model	Region	Processor	Memory	Storage Controller	Chassis	Disk Bays	Disks	M.2 Drives	Onboard Networking Ports	Additional Networking (LOM/ML2/PCle)	Standard Extension Slots	Available Extension Slots via Riser Cards	Front VGA	Optical	TPM	System Management	Power Supply	Preload	Warranty	Ann Date (mm/yy)	
7X04A01CCN	HTK	1x Xeon Gold 6130 16C/2.1GHz/22MB/125W/DDR4-2666	1x 16GB RDIMM DDR4-2666	1x 930-8i 2GB Flash	16x 2.5"	8x 2.5"	SATA/SAS HS	Open	None	2x GbE RJ-45, 1x Mgmt	2x GbE RJ-45 LOM	1x LOM, 1x PCIe x8 LP	3x PCIe x8 FHHL	None	None	TPM 1.2	XClarity Standard	1x 750W Platinum	None	3-year	07/17
7X04A01DCN	HTK	1x Xeon Gold 5122 4C/3.6GHz/16.5MB/105W/DDR4-2666	1x 16GB RDIMM DDR4-2666	1x 930-8i 2GB Flash	16x 2.5"	8x 2.5"	SATA/SAS HS	Open	None	2x GbE RJ-45, 1x Mgmt	2x GbE RJ-45 LOM	1x LOM, 1x PCIe x8 LP	3x PCIe x8 FHHL	None	None	TPM 1.2	XClarity Standard	1x 750W Platinum	None	3-year	07/17
7X04A00WCN	HTK	1x Xeon Gold 5118 12C/2.3GHz/16.5MB/105W/DDR4-2400	1x 16GB RDIMM DDR4-2666	1x 930-8i 2GB Flash	16x 2.5"	8x 2.5"	SATA/SAS HS	Open	None	2x GbE RJ-45, 1x Mgmt	2x GbE RJ-45 LOM	1x LOM, 1x PCIe x8 LP	3x PCIe x8 FHHL	None	None	TPM 1.2	XClarity Standard	1x 750W Platinum	None	3-year	07/17
7X04A016CN	HTK	1x Xeon Gold 6138 20C/2.0GHz/27.5MB/125W/DDR4-2666	1x 16GB RDIMM DDR4-2666	1x 930-8i 2GB Flash	16x 2.5"	8x 2.5"	SATA/SAS HS	Open	None	2x GbE RJ-45, 1x Mgmt	2x GbE RJ-45 LOM	1x LOM, 1x PCIe x8 LP	3x PCIe x8 FHHL	None	None	TPM 1.2	XClarity Standard	1x 750W Platinum	None	3-year	07/17
7X04A00TCN	HTK	1x Xeon Gold 5120 14C/2.2GHz/19.25MB/105W/DDR4-2400	1x 16GB RDIMM DDR4-2666	1x 930-8i 2GB Flash	16x 2.5"	8x 2.5"	SATA/SAS HS	Open	None	2x GbE RJ-45, 1x Mgmt	2x GbE RJ-45 LOM	1x LOM, 1x PCIe x8 LP	3x PCIe x8 FHHL	None	None	TPM 1.2	XClarity Standard	1x 750W Platinum	None	3-year	07/17
7X04A03PCN	HTK	1x Xeon Silver 4116 12C/2.1GHz/16.5MB/85W/DDR4-2400	1x 16GB RDIMM DDR4-2666	1x 930-16i 4GB Flash	12x 3.5"	12x 3.5"	SATA/SAS HS	Open	None	2x GbE RJ-45, 1x Mgmt	2x GbE RJ-45 LOM	1x LOM, 1x PCIe x8 LP	3x PCIe x8 FHHL	None	None	TPM 1.2	XClarity Standard	1x 750W Platinum	None	3-year	07/17

Model	Region	Processor	Memory	Storage Controller	Chassis	Disk Bays	Disks	M.2 Drives	Onboard Networking Ports	Additional Networking (LOM/ML2/PCIe)	Standard Extension Slots	Available Extension Slots via Riser Cards	Front VGA	Optical	TPM	System Management	Power Supply	Preload	Warranty	Ann Date (mm/yy)
7X04A00USG	INDIA	1x Xeon Gold 5118 12C/2.3GHz/16.5MB/105W/DDR4-2400	1x 8GB RDIMM DDR4-2666 (1Rx8)	Onboard Intel RSTe	12x 3.5"	8x 3.5" SATA SS	Open	None	2x GbE RJ-45, 1x Mgmt	2x GbE RJ-45 LOM	1x LOM, 1x PCIe x8 LP	None	None	None	TPM 1.2	XClarity Standard	1x 550W Platinum	None	3-year	07/17
7X041000SG	INDIA	1x Xeon Bronze 3106 8C/1.7GHz/11MB/85W/DDR4-2133	1x 16GB RDIMM DDR4-2666 (1Rx4)	1x 530-8i	16x 2.5"	8x 2.5" SATA/SAS HS	Open	None	2x GbE RJ-45, 1x Mgmt	2x GbE RJ-45 LOM	1x LOM, 1x PCIe x8 LP	None	None	None	TPM 1.2	XClarity Standard	1x 750W Platinum	None	3-year	09/17
7X04A00YSG	INDIA	1x Xeon Gold 5118 12C/2.3GHz/16.5MB/105W/DDR4-2400	1x 8GB RDIMM DDR4-2666 (1Rx8)	1x 530-8i	16x 2.5"	8x 2.5" SATA/SAS HS	Open	None	2x GbE RJ-45, 1x Mgmt	2x GbE RJ-45 LOM	1x LOM, 1x PCIe x8 LP	None	None	None	TPM 1.2	XClarity Standard	1x 550W Platinum	None	3-year	07/17
7X04A00ZSG	INDIA	1x Xeon Gold 6130 16C/2.1GHz/22MB/125W/DDR4-2666	1x 16GB RDIMM DDR4-2666 (1Rx4)	1x 930-8i 2GB Flash	16x 2.5"	8x 2.5" SATA/SAS HS	Open	None	2x GbE RJ-45, 1x Mgmt	2x GbE RJ-45 LOM	1x LOM, 1x PCIe x8 LP	None	None	None	TPM 1.2	XClarity Standard	1x 750W Platinum	None	3-year	07/17
7X04A010SG	INDIA	1x Xeon Gold 5118 12C/2.3GHz/16.5MB/105W/DDR4-2400	1x 16GB RDIMM DDR4-2666 (1Rx4)	1x 530-8i	12x 3.5"	8x 3.5" SATA/SAS HS	Open	None	2x GbE RJ-45, 1x Mgmt	2x GbE RJ-45 LOM	1x LOM, 1x PCIe x8 LP	None	None	None	TPM 1.2	XClarity Standard	1x 550W Platinum	None	3-year	07/17
7X04A011SG	INDIA	1x Xeon Gold 5118 12C/2.3GHz/16.5MB/105W/DDR4-2400	1x 8GB RDIMM DDR4-2666 (1Rx8)	1x 530-8i	12x 3.5"	8x 3.5" SATA/SAS HS	Open	None	2x GbE RJ-45, 1x Mgmt	2x GbE RJ-45 LOM	1x LOM, 1x PCIe x8 LP	None	None	None	TPM 1.2	XClarity Standard	1x 550W Platinum	None	3-year	07/17
7X04A012SG	INDIA	1x Xeon Gold 5118 12C/2.3GHz/16.5MB/105W/DDR4-2400	1x 8GB RDIMM DDR4-2666 (1Rx8)	1x 930-8i 2GB Flash	12x 3.5"	8x 3.5" SATA/SAS HS	Open	None	2x GbE RJ-45, 1x Mgmt	2x GbE RJ-45 LOM	1x LOM, 1x PCIe x8 LP	None	None	None	TPM 1.2	XClarity Standard	1x 550W Platinum	None	3-year	07/17
7X04A013SG	INDIA	1x Xeon Gold 5120 14C/2.2GHz/19.25MB/105W/DDR4-2400	1x 16GB RDIMM DDR4-2666 (1Rx4)	1x 530-8i	16x 2.5"	8x 2.5" SATA/SAS HS	Open	None	2x GbE RJ-45, 1x Mgmt	2x GbE RJ-45 LOM	1x LOM, 1x PCIe x8 LP	None	None	None	TPM 1.2	XClarity Standard	1x 550W Platinum	None	3-year	07/17
7X04A014SG	INDIA	1x Xeon Gold 5118 12C/2.3GHz/16.5MB/105W/DDR4-2400	1x 8GB RDIMM DDR4-2666 (1Rx8)	1x 930-16i 4GB Flash	12x 3.5"	12x 3.5" SATA/SAS HS	Open	None	2x GbE RJ-45, 1x Mgmt	2x GbE RJ-45 LOM	1x LOM, 1x PCIe x8 LP	None	None	None	TPM 1.2	XClarity Standard	1x 550W Platinum	None	3-year	07/17
7X04A015SG	INDIA	1x Xeon Gold 6138 20C/2.0GHz/27.5MB/125W/DDR4-2666	1x 16GB RDIMM DDR4-2666 (1Rx4)	1x 930-8i 2GB Flash	16x 2.5"	8x 2.5" SATA/SAS HS	Open	None	2x GbE RJ-45, 1x Mgmt	2x GbE RJ-45 LOM	1x LOM, 1x PCIe x8 LP	None	None	None	TPM 1.2	XClarity Standard	1x 750W Platinum	None	3-year	07/17

Model	Region	Processor	Memory	Storage Controller	Chassis	Disk Bays	Disks	M.2 Drives	Onboard Networking Ports	Additional Networking (LOM/ML2/PCIe)	Standard Extension Slots	Available Extension Slots via Riser Cards	Front VGA	Optical	TPM	System Management	Power Supply	Preload	Warranty	Ann Date (mm/yy)
7X04A01QSG	INDIA	1x Xeon Gold 5120 14C/2.2GHz/19.25MB/105W/DDR4-2400	1x 16GB RDIMM DDR4-2666 (1Rx4)	1x 930-8i 2GB Flash	16x 2.5"	8x 2.5" SATA/SAS HS	Open	None	2x GbE RJ-45, 1x Mgmt	2x GbE RJ-45 LOM	1x LOM, 1x PCIe x8 LP	None	None	None	TPM 1.2	XClarity Standard	1x 750W Platinum	None	3-year	07/17
7X04A01RSG	INDIA	1x Xeon Gold 6126 12C/2.6GHz/19.25MB/125W/DDR4-2666	1x 16GB RDIMM DDR4-2666 (1Rx4)	1x 930-8i 2GB Flash	16x 2.5"	8x 2.5" SATA/SAS HS	Open	None	2x GbE RJ-45, 1x Mgmt	2x GbE RJ-45 LOM	1x LOM, 1x PCIe x8 LP	None	None	None	TPM 1.2	XClarity Standard	1x 750W Platinum	None	3-year	07/17
7X04A01SSG	INDIA	1x Xeon Gold 5120 14C/2.2GHz/19.25MB/105W/DDR4-2400	1x 16GB RDIMM DDR4-2666 (1Rx4)	1x 930-8i 2GB Flash	16x 2.5"	8x 2.5" SATA/SAS HS	Open	None	2x GbE RJ-45, 1x Mgmt	2x GbE RJ-45 LOM	1x LOM, 1x PCIe x8 LP	None	None	None	TPM 1.2	XClarity Standard	1x 550W Platinum	None	3-year	07/17
7X04A01TSG	INDIA	1x Xeon Gold 5122 4C/3.6GHz/16.5MB/105W/DDR4-2666	1x 16GB RDIMM DDR4-2666 (1Rx4)	1x 930-8i 2GB Flash	16x 2.5"	8x 2.5" SATA/SAS HS	Open	None	2x GbE RJ-45, 1x Mgmt	2x GbE RJ-45 LOM	1x LOM, 1x PCIe x8 LP	None	None	None	TPM 1.2	XClarity Standard	1x 550W Platinum	None	3-year	07/17
7X04A01USG	INDIA	1x Xeon Gold 6126 12C/2.6GHz/19.25MB/125W/DDR4-2666	1x 16GB RDIMM DDR4-2666 (1Rx4)	1x 930-8i 2GB Flash	16x 2.5"	8x 2.5" SATA/SAS HS	Open	None	2x GbE RJ-45, 1x Mgmt	2x GbE RJ-45 LOM	1x LOM, 1x PCIe x8 LP	None	None	None	TPM 1.2	XClarity Standard	1x 550W Platinum	None	3-year	07/17
7X04A01VSG	INDIA	1x Xeon Gold 6130 16C/2.1GHz/22MB/125W/DDR4-2666	1x 16GB RDIMM DDR4-2666 (1Rx4)	1x 930-8i 2GB Flash	16x 2.5"	8x 2.5" SATA/SAS HS	Open	None	2x GbE RJ-45, 1x Mgmt	2x GbE RJ-45 LOM	1x LOM, 1x PCIe x8 LP	None	None	None	TPM 1.2	XClarity Standard	1x 550W Platinum	None	3-year	07/17
7X04A01KSG	INDIA	1x Xeon Gold 6138 20C/2.0GHz/27.5MB/125W/DDR4-2666	1x 16GB RDIMM DDR4-2666 (1Rx4)	1x 930-8i 2GB Flash	16x 2.5"	8x 2.5" SATA/SAS HS	Open	None	2x GbE RJ-45, 1x Mgmt	2x GbE RJ-45 LOM	1x LOM, 1x PCIe x8 LP	None	None	None	TPM 1.2	XClarity Standard	1x 550W Platinum	None	3-year	07/17
7X04A01NSG	INDIA	1x Xeon Gold 5122 4C/3.6GHz/16.5MB/105W/DDR4-2666	1x 16GB RDIMM DDR4-2666 (1Rx4)	1x 930-8i 2GB Flash	16x 2.5"	8x 2.5" SATA/SAS HS	Open	None	2x GbE RJ-45, 1x Mgmt	2x GbE RJ-45 LOM	1x LOM, 1x PCIe x8 LP	None	None	None	TPM 1.2	XClarity Standard	1x 750W Platinum	None	3-year	07/17

Model	Region	Processor	Memory	Storage Controller	Chassis	Disk Bays	Disks	M.2 Drives	Onboard Networking Ports	Additional Networking (LOM/ML2/PCIe)	Standard Extension Slots	Available Extension Slots via Riser Cards	Front VGA	Optical	TPM	System Management	Power Supply	Preload	Warranty	Ann Date (mm/yy)
7X04A04CJP	JAPAN	1x Xeon Gold 5122 4C/3.6GHz/16.5MB/105W/DDR4-2666	1x 8GB RDIMM DDR4-2666 (1Rx8)	1x 930-8i 2GB Flash	16x 2.5"	8x 2.5" SATA/SAS HS	Open	None	2x GbE RJ-45, 1x Mgmt	None	1x LOM, 1x PCIe x8 LP	3x PCIe x8 FHHL	None	None	TPM 1.2	XClarity Advanced	1x 750W Platinum	None	3-year	07/17
7X04A04DJP	JAPAN	1x Xeon Gold 6138 20C/2.0GHz/27.5MB/125W/DDR4-2666	1x 8GB RDIMM DDR4-2666 (1Rx8)	1x 930-8i 2GB Flash	16x 2.5"	8x 2.5" SATA/SAS HS	Open	None	2x GbE RJ-45, 1x Mgmt	None	1x LOM, 1x PCIe x8 LP	3x PCIe x8 FHHL	None	None	TPM 1.2	XClarity Advanced	1x 750W Platinum	None	3-year	07/17
7X04A06GJP	JAPAN	1x Xeon Silver 4108 8C/1.8GHz/11MB/85W/DDR4-2400	1x 16GB RDIMM DDR4-2666 (1Rx4)	1x 930-8i 2GB Flash	16x 2.5"	8x 2.5" SATA/SAS HS	Open	None	2x GbE RJ-45, 1x Mgmt	None	1x LOM, 1x PCIe x8 LP	3x PCIe x8 FHHL	None	None	TPM 1.2	XClarity Advanced	1x 550W Platinum	None	3-year	08/17
7X04A06HJP	JAPAN	1x Xeon Silver 4110 8C/2.1GHz/11MB/85W/DDR4-2400	1x 16GB RDIMM DDR4-2666 (1Rx4)	1x 930-16i 4GB Flash	12x 3.5"	12x 3.5" SATA/SAS HS	Open	None	2x GbE RJ-45, 1x Mgmt	None	1x LOM, 1x PCIe x8 LP	3x PCIe x8 FHHL	None	None	TPM 1.2	XClarity Advanced	1x 750W Platinum	None	3-year	08/17
7X04A06KJP	JAPAN	1x Xeon Gold 6130 16C/2.1GHz/22MB/125W/DDR4-2666	1x 16GB RDIMM DDR4-2666 (1Rx4)	1x 930-8i 2GB Flash	16x 2.5"	8x 2.5" SATA/SAS HS	Open	None	2x GbE RJ-45, 1x Mgmt	None	1x LOM, 1x PCIe x8 LP	3x PCIe x8 FHHL	None	None	TPM 1.2	XClarity Advanced	1x 750W Platinum	None	3-year	11/17
7X04A06LJP	JAPAN	1x Xeon Gold 5118 12C/2.3GHz/16.5MB/105W/DDR4-2400	1x 16GB RDIMM DDR4-2666 (1Rx4)	1x 930-8i 2GB Flash	16x 2.5"	8x 2.5" SATA/SAS HS	Open	None	2x GbE RJ-45, 1x Mgmt	None	1x LOM, 1x PCIe x8 LP	3x PCIe x8 FHHL	None	None	TPM 1.2	XClarity Advanced	1x 750W Platinum	None	3-year	11/17
7X04A06MJP	JAPAN	1x Xeon Silver 4114 10C/2.2GHz/13.75MB/85W/DDR4-2400	1x 16GB RDIMM DDR4-2666 (1Rx4)	1x 930-8i 2GB Flash	16x 2.5"	8x 2.5" SATA/SAS HS	Open	None	2x GbE RJ-45, 1x Mgmt	None	1x LOM, 1x PCIe x8 LP	3x PCIe x8 FHHL	None	None	TPM 1.2	XClarity Advanced	1x 750W Platinum	None	3-year	11/17

Model	Region	Processor	Memory	Storage Controller	Chassis	Disk Bays	Disks	M.2 Drives	Onboard Networking Ports	Additional Networking (LOM/ML2/PCIe)	Standard Extension Slots	Available Extension Slots via Riser Cards	Front VGA	Optical	TPM	System Management	Power Supply	Preload	Warranty	Ann Date (mm/yy)
7X04A03XLA	LA	1x Xeon Gold 5120 14C/2.2GHz/19.25MB/105W/DDR4-2400	1x 8GB RDIMM DDR4-2666 (1Rx8)	1x 530-8i	16x 2.5"	8x 2.5" SATA/SAS HS	Open	None	2x GbE RJ-45, 1x Mgmt	None	1x LOM, 1x PCIe x8 LP	3x PCIe x8 FHHL	x8 Front VGA	None	TPM 1.2	XClarity Standard	1x 750W Platinum	None	3-year	07/17
7X04A03YLA	LA	1x Xeon Gold 5120 14C/2.2GHz/19.25MB/105W/DDR4-2400	1x 8GB RDIMM DDR4-2666 (1Rx8)	1x 930-8i 2GB Flash	12x 3.5"	8x 3.5" SATA/SAS HS	Open	None	2x GbE RJ-45, 1x Mgmt	None	1x LOM, 1x PCIe x8 LP	3x PCIe x8 FHHL	x8 Front VGA	None	TPM 1.2	XClarity Standard	1x 750W Platinum	None	3-year	07/17
7X04A05CLA	LA	1x Xeon Silver 4116 12C/2.1GHz/16.5MB/85W/DDR4-2400	1x 8GB RDIMM DDR4-2666 (1Rx8)	1x 930-8i 2GB Flash	16x 2.5"	8x 2.5" SATA/SAS HS	Open	None	2x GbE RJ-45, 1x Mgmt	None	1x LOM, 1x PCIe x8 LP	3x PCIe x8 FHHL	x8 Front VGA	None	TPM 1.2	XClarity Standard	1x 750W Platinum	None	3-year	07/17
7X04A05ELA	LA	1x Xeon Gold 5115 10C/2.4GHz/13.75MB/85W/DDR4-2400	1x 8GB RDIMM DDR4-2666 (1Rx8)	1x 930-8i 2GB Flash	16x 2.5"	8x 2.5" SATA/SAS HS	Open	None	2x GbE RJ-45, 1x Mgmt	None	1x LOM, 1x PCIe x8 LP	3x PCIe x8 FHHL	x8 Front VGA	None	TPM 1.2	XClarity Standard	1x 750W Platinum	None	3-year	07/17
7X04A05GLA	LA	1x Xeon Silver 4110 8C/2.1GHz/11MB/85W/DDR4-2400	1x 8GB RDIMM DDR4-2666 (1Rx8)	1x 930-8i 2GB Flash	16x 2.5"	8x 2.5" SATA/SAS HS	Open	None	2x GbE RJ-45, 1x Mgmt	None	1x LOM, 1x PCIe x8 LP	3x PCIe x8 FHHL	x8 Front VGA	None	TPM 1.2	XClarity Standard	1x 750W Platinum	None	3-year	07/17
7X04A05HLA	LA	1x Xeon Silver 4114 10C/2.2GHz/13.75MB/85W/DDR4-2400	1x 8GB RDIMM DDR4-2666 (1Rx8)	1x 930-8i 2GB Flash	16x 2.5"	8x 2.5" SATA/SAS HS	Open	None	2x GbE RJ-45, 1x Mgmt	None	1x LOM, 1x PCIe x8 LP	3x PCIe x8 FHHL	x8 Front VGA	None	TPM 1.2	XClarity Standard	1x 750W Platinum	None	3-year	07/17
7X04A054LA	LA	1x Xeon Silver 4108 8C/1.8GHz/11MB/85W/DDR4-2400	1x 8GB RDIMM DDR4-2666 (1Rx8)	1x 930-8i 2GB Flash	16x 2.5"	8x 2.5" SATA/SAS HS	Open	None	2x GbE RJ-45, 1x Mgmt	None	1x LOM, 1x PCIe x8 LP	3x PCIe x8 FHHL	x8 Front VGA	None	TPM 1.2	XClarity Standard	1x 750W Platinum	None	3-year	07/17
7X04A03LLA	LA	1x Xeon Gold 6130 16C/2.1GHz/22MB/125W/DDR4-2666	1x 8GB RDIMM DDR4-2666 (1Rx8)	1x 530-8i	16x 2.5"	8x 2.5" SATA/SAS HS	Open	None	2x GbE RJ-45, 1x Mgmt	None	1x LOM, 1x PCIe x8 LP	3x PCIe x8 FHHL	x8 Front VGA	None	TPM 1.2	XClarity Standard	1x 750W Platinum	None	3-year	07/17
7X04A03MLA	LA	1x Xeon Gold 5118 12C/2.3GHz/16.5MB/105W/DDR4-2400	1x 8GB RDIMM DDR4-2666 (1Rx8)	1x 930-8i 2GB Flash	12x 3.5"	8x 3.5" SATA/SAS HS	Open	None	2x GbE RJ-45, 1x Mgmt	None	1x LOM, 1x PCIe x8 LP	3x PCIe x8 FHHL	x8 Front VGA	None	TPM 1.2	XClarity Standard	1x 750W Platinum	None	3-year	07/17
7X04A03NLA	LA	1x Xeon Gold 5120 14C/2.2GHz/19.25MB/105W/DDR4-2400	1x 8GB RDIMM DDR4-2666 (1Rx8)	1x 930-8i 2GB Flash	16x 2.5"	8x 2.5" SATA/SAS HS	Open	None	2x GbE RJ-45, 1x Mgmt	None	1x LOM, 1x PCIe x8 LP	3x PCIe x8 FHHL	x8 Front VGA	None	TPM 1.2	XClarity Standard	1x 750W Platinum	None	3-year	07/17

Model	Region	Processor	Memory	Storage Controller	Chassis	Disk Bays	Disks	M.2 Drives	Onboard Networking Ports	Additional Networking (LOM/ML2/PCIe)	Standard Extension Slots	Available Extension Slots via Riser Cards	Front VGA	Optical	TPM	System Management	Power Supply	Preload	Warranty	Ann Date (mm/yy)
7X04A02CLA	LA	1x Xeon Gold 5118 12C/2.3GHz/16.5MB/105W/DDR4-2400	1x 8GB RDIMM DDR4-2666 (1Rx8)	1x 930-8i 2GB Flash	16x 2.5"	8x 2.5" SATA/SAS HS	Open	None	2x GbE RJ-45, 1x Mgmt	None	1x LOM, 1x PCIe x8 LP	3x PCIe x8 FHHL	x8 Front VGA	None	TPM 1.2	XClarity Standard	1x 750W Platinum	None	3-year	07/17
7X04A02PLA	LA	1x Xeon Gold 5118 12C/2.3GHz/16.5MB/105W/DDR4-2400	1x 8GB RDIMM DDR4-2666 (1Rx8)	1x 530-8i	16x 2.5"	8x 2.5" SATA/SAS HS	Open	None	2x GbE RJ-45, 1x Mgmt	None	1x LOM, 1x PCIe x8 LP	3x PCIe x8 FHHL	x8 Front VGA	None	TPM 1.2	XClarity Standard	1x 750W Platinum	None	3-year	07/17
7X04A02LLA	LA	1x Xeon Gold 6130 16C/2.1GHz/22MB/125W/DDR4-2666	1x 8GB RDIMM DDR4-2666 (1Rx8)	1x 930-8i 2GB Flash	12x 3.5"	8x 3.5" SATA/SAS HS	Open	None	2x GbE RJ-45, 1x Mgmt	None	1x LOM, 1x PCIe x8 LP	3x PCIe x8 FHHL	x8 Front VGA	None	TPM 1.2	XClarity Standard	1x 750W Platinum	None	3-year	07/17
7X04A036LA	LA	1x Xeon Gold 6130 16C/2.1GHz/22MB/125W/DDR4-2666	1x 8GB RDIMM DDR4-2666 (1Rx8)	1x 930-8i 2GB Flash	16x 2.5"	8x 2.5" SATA/SAS HS	Open	None	2x GbE RJ-45, 1x Mgmt	None	1x LOM, 1x PCIe x8 LP	3x PCIe x8 FHHL	x8 Front VGA	None	TPM 1.2	XClarity Standard	1x 750W Platinum	None	3-year	07/17

ThinkSystem SR550 - Non TopSeller - LA (except Chile)

Product Specifications Reference (PSREF)

Model	Region	Processor	Memory	Storage Controller	Chassis	Disk Bays	Disks	M.2 Drives	Onboard Networking Ports	Additional Networking (LOM/ML2/PCIe)	Standard Extension Slots	Available Extension Slots via Riser Cards	Front VGA	Optical	TPM	System Management	Power Supply	Preload	Warranty	Ann Date (mm/yy)
7X04100FLA	LA (except Chile)	1x Xeon Silver 4110	1x 16GB RDIMM DDR4-2666 (1Rx4)	1x 530-8i	12x 3.5"	8x 3.5" SATA/SAS HS	2x 600GB HDD 15K 3.5" SAS12Gbps	None	2x GbE RJ-45, 1x Mgmt	2x GbE RJ-45 LOM	1x LOM, 1x PCIe x8 LP	3x PCIe x8 FHHL	8 Front VGA	None	TPM 2.0	XClarity Advanced	2x 750W Platinum	None	3-year	04/18

Model	Region	Processor	Memory	Storage Controller	Chassis	Disk Bays	Disks	M.2 Drives	Onboard Networking Ports	Additional Networking (LOM/ML2/PCIe)	Standard Extension Slots	Available Extension Slots via Riser Cards	Front VGA	Optical	TPM	System Management	Power Supply	Preload	Warranty	Ann Date (mm/yy)
7X04A04YNA	NA	1x Xeon Silver 4110 8C/2.1GHz/11MB/85W/DDR4-2400	1x 16GB RDIMM DDR4-2666 (1Rx4)	1x 530-8i	16x 2.5"	8x 2.5" SATA/SAS HS	Open	None	2x GbE RJ-45, 1x Mgmt	None	1x LOM, 1x PCIe x8 LP	None	None	None	TPM 1.2	XClarity Standard	1x 750W Platinum	None	3-year	07/17
7X04A04ZNA	NA	1x Xeon Silver 4108 8C/1.8GHz/11MB/85W/DDR4-2400	1x 16GB RDIMM DDR4-2666 (1Rx4)	1x 530-8i	16x 2.5"	8x 2.5" SATA/SAS HS	Open	None	2x GbE RJ-45, 1x Mgmt	None	1x LOM, 1x PCIe x8 LP	None	None	None	TPM 1.2	XClarity Standard	1x 750W Platinum	None	3-year	07/17
7X04A04UNA	NA	1x Xeon Gold 6130 16C/2.1GHz/22MB/125W/DDR4-2666	1x 32GB RDIMM DDR4-2666 (2Rx4)	1x 930-8i 2GB Flash	16x 2.5"	8x 2.5" SATA/SAS HS	Open	None	2x GbE RJ-45, 1x Mgmt	None	1x LOM, 1x PCIe x8 LP	3x PCIe x8 FHHL	Front VGA	None	TPM 1.2	XClarity Standard	1x 750W Platinum	None	3-year	07/17
7X04A04VNA	NA	1x Xeon Gold 5120 14C/2.2GHz/19.25MB/105W/DDR4-2400	1x 16GB RDIMM DDR4-2666 (1Rx4)	1x 930-8i 2GB Flash	16x 2.5"	8x 2.5" SATA/SAS HS	Open	None	2x GbE RJ-45, 1x Mgmt	None	1x LOM, 1x PCIe x8 LP	3x PCIe x8 FHHL	Front VGA	None	TPM 1.2	XClarity Standard	1x 750W Platinum	None	3-year	07/17
7X04A04NNA	NA	1x Xeon Gold 6138 20C/2.0GHz/27.5MB/125W/DDR4-2666	1x 32GB RDIMM DDR4-2666 (2Rx4)	1x 930-8i 2GB Flash	16x 2.5"	8x 2.5" SATA/SAS HS	Open	None	2x GbE RJ-45, 1x Mgmt	None	1x LOM, 1x PCIe x8 LP	3x PCIe x8 FHHL	Front VGA	None	TPM 1.2	XClarity Standard	1x 750W Platinum	None	3-year	07/17
7X04A04PNA	NA	1x Xeon Gold 6126 12C/2.6GHz/19.25MB/125W/DDR4-2666	1x 32GB RDIMM DDR4-2666 (2Rx4)	1x 930-8i 2GB Flash	16x 2.5"	8x 2.5" SATA/SAS HS	Open	None	2x GbE RJ-45, 1x Mgmt	None	1x LOM, 1x PCIe x8 LP	3x PCIe x8 FHHL	Front VGA	None	TPM 1.2	XClarity Standard	1x 750W Platinum	None	3-year	07/17
7X04A05ANA	NA	1x Xeon Silver 4114 10C/2.2GHz/13.75MB/85W/DDR4-2400	1x 16GB RDIMM DDR4-2666 (1Rx4)	1x 930-16i 4GB Flash	12x 3.5"	12x 3.5" SATA/SAS HS	Open	None	2x GbE RJ-45, 1x Mgmt	None	1x LOM, 1x PCIe x8 LP	None	None	None	TPM 1.2	XClarity Standard	1x 750W Platinum	None	3-year	07/17
7X04A05BNA	NA	1x Xeon Gold 5115 10C/2.4GHz/13.75MB/85W/DDR4-2400	1x 16GB RDIMM DDR4-2666 (1Rx4)	1x 930-8i 2GB Flash	16x 2.5"	8x 2.5" SATA/SAS HS	Open	None	2x GbE RJ-45, 1x Mgmt	None	1x LOM, 1x PCIe x8 LP	None	None	None	TPM 1.2	XClarity Standard	1x 750W Platinum	None	3-year	07/17
7X04A05JNA	NA	1x Xeon Gold 5118 12C/2.3GHz/16.5MB/105W/DDR4-2400	1x 16GB RDIMM DDR4-2666 (1Rx4)	1x 930-8i 2GB Flash	16x 2.5"	8x 2.5" SATA/SAS HS	Open	None	2x GbE RJ-45, 1x Mgmt	None	1x LOM, 1x PCIe x8 LP	3x PCIe x8 FHHL	Front VGA	None	TPM 1.2	XClarity Standard	1x 750W Platinum	None	3-year	07/17
7X04A055NA	NA	1x Xeon Silver 4116 12C/2.1GHz/16.5MB/85W/DDR4-2400	1x 16GB RDIMM DDR4-2666 (1Rx4)	1x 930-8i 2GB Flash	16x 2.5"	8x 2.5" SATA/SAS HS	Open	None	2x GbE RJ-45, 1x Mgmt	None	1x LOM, 1x PCIe x8 LP	None	None	None	TPM 1.2	XClarity Standard	1x 750W Platinum	None	3-year	07/17

Model	Region	Processor	Memory	Storage Controller	Chassis	Disk Bays	Disks	M.2 Drives	Onboard Networking Ports	Additional Networking (LOM/ML2/PCIe)	Standard Extension Slots	Available Extension Slots via Riser Cards	Front VGA	Optical	TPM	System Management	Power Supply	Preload	Warranty	Ann Date (mm/yy)
7X04A056NA	NA	1x Xeon Silver 4108 8C/1.8GHz/11MB/85W/DDR4-2400	1x 16GB RDIMM DDR4-2666 (1Rx4)	1x 930-8i 2GB Flash	16x 2.5"	8x 2.5" SATA/SAS HS	Open	None	2x GbE RJ-45, 1x Mgmt	None	1x LOM, 1x PCIe x8 LP	None	None	None	TPM 1.2	XClarity Standard	1x 750W Platinum	None	3-year	07/17
7X04A057NA	NA	1x Xeon Silver 4110 8C/2.1GHz/11MB/85W/DDR4-2400	1x 16GB RDIMM DDR4-2666 (1Rx4)	1x 930-8i 2GB Flash	16x 2.5"	8x 2.5" SATA/SAS HS	Open	None	2x GbE RJ-45, 1x Mgmt	None	1x LOM, 1x PCIe x8 LP	None	None	None	TPM 1.2	XClarity Standard	1x 750W Platinum	None	3-year	07/17
7X04A053NA	NA	1x Xeon Silver 4114 10C/2.2GHz/13.75MB/85W/DDR4-2400	1x 16GB RDIMM DDR4-2666 (1Rx4)	1x 930-8i 2GB Flash	16x 2.5"	8x 2.5" SATA/SAS HS	Open	None	2x GbE RJ-45, 1x Mgmt	None	1x LOM, 1x PCIe x8 LP	None	None	None	TPM 1.2	XClarity Standard	1x 750W Platinum	None	3-year	07/17
7X04A051NA	NA	1x Xeon Bronze 3104 6C/1.7GHz/8.25MB/85W/DDR4-2133	1x 16GB RDIMM DDR4-2666 (1Rx4)	1x 530-8i	16x 2.5"	8x 2.5" SATA/SAS HS	Open	None	2x GbE RJ-45, 1x Mgmt	None	1x LOM, 1x PCIe x8 LP	None	None	None	TPM 1.2	XClarity Standard	1x 750W Platinum	None	3-year	07/17



ThinkSystem SR570 Platform Specifications

Product Specifications Reference (PSREF)

Components	Specification																																																																																											
Form factor	1U rack																																																																																											
Dimensions	Height: 43 mm (1.7 in). Width: 482 mm (19.0 in) with rack latches. Depth: 778.3 mm (30.64 in)																																																																																											
Weight	Maximum configuration: 35.27 lb (16 kg)																																																																																											
Processor	Up to two 150W Intel Xeon Scalable family processors, Bronze, Silver, Gold, or Platinum. Up to 26 cores at 2.0GHz, up to 3.6GHz with 4 cores. Two processors are connected with two UPI (Ultra Path Interconnect) links up to 10.4GT/s each																																																																																											
Chipset	Intel C622 Platform Controller Hub																																																																																											
Memory	Up to 16 DIMM sockets. Each processor supports up to 8 DIMM sockets with 6 channels. DDR4-2666. RDIMMs and LRDIMMs are supported, but memory types cannot be intermixed																																																																																											
Memory capacity	With RDIMMs: Up to 512GB with 16 x 32 GB RDIMMs and two processors With LRDIMMs: Up to 1TB with 16 x 64 GB LRDIMMs and two processors																																																																																											
Memory protection	ECC, memory mirroring, and memory sparing																																																																																											
Storage controllers	Supports the following RAID/HBA adapters:																																																																																											
	<table border="1"> <thead> <tr> <th>RAID adapter</th> <th>Interface</th> <th>Drive type</th> <th>RAID levels</th> <th>JBOD</th> <th>Cache</th> <th>Cache protection</th> <th>FastPath</th> <th>Max qty</th> </tr> </thead> <tbody> <tr> <td>For SS bays</td> <td>Onboard SATA</td> <td>6Gb SATA</td> <td>SATA</td> <td>0/1/10/5</td> <td>Yes</td> <td>None</td> <td>No</td> <td>-</td> </tr> <tr> <td rowspan="8">For HS bays</td> <td>530-8i</td> <td>12Gbs SAS</td> <td>SATA/SAS</td> <td>0/1/10/5/50</td> <td>Yes</td> <td>None</td> <td>Yes</td> <td>1</td> </tr> <tr> <td>730-8i</td> <td>12Gbs SAS</td> <td>SATA/SAS</td> <td>0/1/10/5/50</td> <td>Yes</td> <td>1GB</td> <td>No</td> <td>1</td> </tr> <tr> <td>930-8i</td> <td>12Gbs SAS</td> <td>SATA/SAS</td> <td>0/1/10/5/50/6/60</td> <td>Yes</td> <td>2GB</td> <td>Flash backup</td> <td>1</td> </tr> <tr> <td>930-16i</td> <td>12Gbs SAS</td> <td>SATA/SAS</td> <td>0/1/10/5/50/6/60</td> <td>Yes</td> <td>4GB</td> <td>Flash backup</td> <td>1</td> </tr> <tr> <td>430-8i</td> <td>12Gbs SAS</td> <td>SATA/SAS</td> <td>-</td> <td>Yes</td> <td>None</td> <td>-</td> <td>1</td> </tr> <tr> <td>430-16i</td> <td>12Gbs SAS</td> <td>SATA/SAS</td> <td>-</td> <td>Yes</td> <td>None</td> <td>-</td> <td>1</td> </tr> <tr> <td>430-8e</td> <td>12Gbs SAS</td> <td>SATA/SAS</td> <td>-</td> <td>Yes</td> <td>None</td> <td>-</td> <td>3</td> </tr> <tr> <td>430-16e</td> <td>12Gbs SAS</td> <td>SATA/SAS</td> <td>-</td> <td>Yes</td> <td>None</td> <td>-</td> <td>3</td> </tr> <tr> <td>930-8e</td> <td>12Gbs SAS</td> <td>SATA/SAS</td> <td>0/1/10/5/50/6/60</td> <td>Yes</td> <td>4GB</td> <td>Flash backup</td> <td>2</td> </tr> </tbody> </table>	RAID adapter	Interface	Drive type	RAID levels	JBOD	Cache	Cache protection	FastPath	Max qty	For SS bays	Onboard SATA	6Gb SATA	SATA	0/1/10/5	Yes	None	No	-	For HS bays	530-8i	12Gbs SAS	SATA/SAS	0/1/10/5/50	Yes	None	Yes	1	730-8i	12Gbs SAS	SATA/SAS	0/1/10/5/50	Yes	1GB	No	1	930-8i	12Gbs SAS	SATA/SAS	0/1/10/5/50/6/60	Yes	2GB	Flash backup	1	930-16i	12Gbs SAS	SATA/SAS	0/1/10/5/50/6/60	Yes	4GB	Flash backup	1	430-8i	12Gbs SAS	SATA/SAS	-	Yes	None	-	1	430-16i	12Gbs SAS	SATA/SAS	-	Yes	None	-	1	430-8e	12Gbs SAS	SATA/SAS	-	Yes	None	-	3	430-16e	12Gbs SAS	SATA/SAS	-	Yes	None	-	3	930-8e	12Gbs SAS	SATA/SAS	0/1/10/5/50/6/60	Yes	4GB	Flash backup	2
	RAID adapter	Interface	Drive type	RAID levels	JBOD	Cache	Cache protection	FastPath	Max qty																																																																																			
	For SS bays	Onboard SATA	6Gb SATA	SATA	0/1/10/5	Yes	None	No	-																																																																																			
	For HS bays	530-8i	12Gbs SAS	SATA/SAS	0/1/10/5/50	Yes	None	Yes	1																																																																																			
		730-8i	12Gbs SAS	SATA/SAS	0/1/10/5/50	Yes	1GB	No	1																																																																																			
		930-8i	12Gbs SAS	SATA/SAS	0/1/10/5/50/6/60	Yes	2GB	Flash backup	1																																																																																			
		930-16i	12Gbs SAS	SATA/SAS	0/1/10/5/50/6/60	Yes	4GB	Flash backup	1																																																																																			
		430-8i	12Gbs SAS	SATA/SAS	-	Yes	None	-	1																																																																																			
		430-16i	12Gbs SAS	SATA/SAS	-	Yes	None	-	1																																																																																			
430-8e		12Gbs SAS	SATA/SAS	-	Yes	None	-	3																																																																																				
430-16e		12Gbs SAS	SATA/SAS	-	Yes	None	-	3																																																																																				
930-8e	12Gbs SAS	SATA/SAS	0/1/10/5/50/6/60	Yes	4GB	Flash backup	2																																																																																					
<i>Note: 730-8i is available in China only</i>																																																																																												
Disk drive bays	Support 4 front 3.5" SATA simple-swap bays, or 4 front 3.5" SATA/SAS HS bays, or 8 front 2.5" SATA/SAS HS bays, or 10 front 2.5" SATA/SAS HS bays with 4 AnyBay. Optional one or two internal M.2 SSD for boot, dual M.2 SSD supports mirroring																																																																																											
Internal storage	For 3.5" SS bay	3.5" HDD, SATA6Gbs, 7.2K 3.5" HDD, SATA6Gbs, 7.2K	1TB/2TB/4TB/6TB/8TB 1TB/2TB/4TB/6TB/8TB/10TB																																																																																									
	For 3.5" bay (3.5" disks or 2.5" disks with 3.5" tray)	3.5" HDD, SAS12Gbs, 7.2K	1TB/2TB/4TB/6TB/10TB																																																																																									
		3.5" HDD, SAS12Gbs, 15K	300GB/600GB/900GB																																																																																									
		2.5" SSD, SATA6Gbs	240GB/480GB																																																																																									
		2.5" NVMe SSD, AnyBay	960GB/1.92TB/3.84TB																																																																																									
	For 2.5" bay	2.5" HDD, SATA6Gbs, 7.2K	1TB/2TB																																																																																									
		2.5" HDD, SAS12Gbs, 7.2K	1TB/2TB																																																																																									
		2.5" HDD, SAS12Gbs, 10K	300GB/600GB/900GB/1.2TB/1.8TB																																																																																									
		2.5" HDD, SAS12Gbs, 10K, SED	300GB/600GB																																																																																									
		2.5" HDD, SAS12Gbs, 15K	300GB/600GB/900GB																																																																																									
2.5" SSD, SAS12Gbs		400GB/800GB/3.84TB																																																																																										
M.2 boot drive	2.5" SSD, SATA6Gbs	240GB/480GB																																																																																										
	2.5" NVMe SSD, AnyBay	960GB/1.6TB/1.92TB/3.84TB																																																																																										
M.2 boot drive	M.2 SATA SSD	32GB/128GB																																																																																										
Optical	No internal optical bay. Optional USB DVD±RW optical drive																																																																																											
Network interfaces	Integrated one dedicated management port plus two GbE ports. One LOM slot for customized LOM with two RJ-45 or SFP+ ports, up to 10GbE. Optional ML2 or PCIe adapters are supported. ML2 adapter requires riser card with ML2 slot. Up to two ports supports Wake-on-LAN and NC-SI (see right)																																																																																											
Security features	Power-on and admin password. Trusted Platform Module, TCG 1.2 compliant, upgrade to 2.0 via UEFI setting. Optional TCM in China only. Optional lockable security bezel																																																																																											
Operating systems supported	Microsoft Windows Server 2016/2012 R2. Red Hat Enterprise Linux 7.3/6.9. SUSE Linux Enterprise Server 12 SP2/11 SP4. VMware ESXi 6.5/6.0 U3																																																																																											
Systems management	XClarity Controller Standard, optional upgrades to Advanced or Enterprise are available. Energy Manager. XClarity Administrator. Lenovo Capacity Planner. Provisioning Manager. Essentials. Light Path Diagnostics																																																																																											
GPU support	None																																																																																											

Components	Specification	
Base warranty	MT 7Y02: 1-year limited onsite service with 9x5/NBD MT 7Y03: 3-year limited onsite service with 9x5/NBD	
Power supply	Up to two redundant hot-swap 550W and 750W 80 PLUS Platinum qualified AC power supplies. Or up to two redundant hot-swap 750W Titanium qualified AC power supplies. 750W Titanium is 200V - 240V, others are 100V - 240V	
Video	Integrated Matrox G200 in XClarity Controller	
Cooling	4x 3.5" or 8x 2.5" models: four fans for single processor model, six fans for dual processor model, all fans are 4028 10x 2.5" models: six fans for both single and dual processor models, all fans are 4056	
Front ports	One XClarity Controller USB, one USB 3.0, one optional VGA	
Rear ports	One VGA, two USB 3.0, two ethernet (RJ-45), one XClarity Controller connector. Optional COM port	
Environmental specification	Supports ASHRAE A4 with limitations.	
	Temperature - operating	A4: 5°C to 45°C (41°F to 113°F) A3: 5°C to 40°C (41°F to 104°F) A2: 10°C to 35°C (50°F to 95°F)
	Temperature - non operating (no package)	-10°C to 60°C (14°F to 140°F)
	Temperature - non operating (with package)	-40°C to 70°C (-40°F to 158°F)
	Altitude - operating	(Unpressurized): 0-10000ft (0-3048m)
	Humidity - operating, non-condensing	A4: 8%-90%. A3: 8%-85%. A2: 8%-80%
	Humidity - storage (with package), non-condensing	8%-90%
	<i>Models should meet the following requirements to support A3 and A4:</i>	
	<ul style="list-style-type: none"> • Redundant power supplies required • No system fan fails • No NVMe drive • No rear two HS bays • Processor TDP is less than or equal to 140 watts, and no Intel Xeon 6140 or 6152 processor is installed • On 12x 3.5" models, no M.2 drives 	
	Environmental certification	Energy Star Server 2.1 certified. More environmental information please see: www.lenovo.com/social_responsibility/us/en/environment/

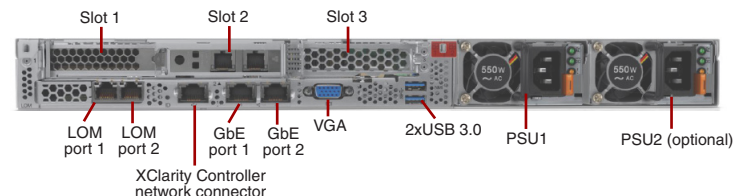

Note: GbE port 1 and LOM port 1 support Wake-on-LAN and NC-SI. Riser cards, expansion cards, and LOM adapters are optional.

Expansion slots	Supports one of the following for riser card 1:
Slot 1-2 (riser card 1)	Option 1: PCIe 3.0 x8/x16 (slot 1-2). Low profile for x8, low profile or full height half length for x16 Option 2: PCIe 3.0 x8/x8 ML2 (slot 1-2). Low profile
Slot 3 (riser card 2)	Option 1: PCIe 3.0 x 8, low profile, for single processor model Option 2: PCIe 3.0 x 16, low profile, for dual processor model When slot 2 is full height, slot 3 cannot be used

System unique options	Part Number	Description
7XH7A05892	ThinkSystem SR530/SR570 x8/x8ML2 PCIe LP+LP Riser 1 Kit	
7XH7A02682	ThinkSystem SR530/SR570/SR630 x8/x16 PCIe LP+LP Riser 1 Kit	
7XH7A05893	ThinkSystem SR530/SR570/SR630 x8/x16 PCIe LP+FH Riser 1 Kit	
7XH7A05891	ThinkSystem SR530/SR570 x8 PCIe LP Riser 2 Kit	
7XH7A02685	ThinkSystem SR530/SR570/SR630 x16 PCIe LP Riser 2 Kit	
7Z17A02579	ThinkSystem SR530/SR570/SR630 Front VGA Connector Upgrade Kit	
7Z17A02581	ThinkSystem 1U Security Bezel	
7Z17A02577	ThinkSystem COM Port Upgrade Kit	
4XH7A08762	ThinkSystem SR570 2.5" SATA/SAS 8-Bay Backplane Kit	

Model	Product	Region	Processor	Memory	Storage Controller	Chassis	Disk Bays	Disks	M.2 Drives	Onboard Networking Ports	Additional Networking (LOM/ML2/PCIe)	Standard Extension Slots	Available Extension Slots via Riser Cards	Front VGA	Optical	TPM	System Management	Power Supply	Preload	Warranty	Ann Date (mm/yy)	
7Y03A02LAU	ThinkSystem SR570	ANZ	1x Xeon Silver 4110 8C/2.1GHz/11MB/85W/DDR4-2400	1x 16GB RDIMM DDR4-2666	1x 930-8i 2GB Flash (2Rx8)	4x 3.5"	4x 3.5"	SATA/SAS HS	None	None	2x GbE RJ-45, 1x Mgmt	None	1x LOM	1x PCIe x8 LP, 1x PCIe x16 LP	None	None	TPM 1.2	XClarity Enterprise	1x 750W Platinum	None	3-year	11/17
7Y03A02MAU	ThinkSystem SR570	ANZ	1x Xeon Bronze 3104 6C/1.7GHz/8.25MB/85W/DDR4-2133	1x 16GB RDIMM DDR4-2666	1x 930-8i 2GB Flash (2Rx8)	4x 3.5"	4x 3.5"	SATA/SAS HS	None	None	2x GbE RJ-45, 1x Mgmt	None	1x LOM	1x PCIe x8 LP, 1x PCIe x16 LP	None	None	TPM 1.2	XClarity Enterprise	1x 750W Platinum	None	3-year	11/17
7Y03A02NAU	ThinkSystem SR570	ANZ	1x Xeon Bronze 3106 8C/1.7GHz/11MB/85W/DDR4-2133	1x 16GB RDIMM DDR4-2666	1x 930-8i 2GB Flash (2Rx8)	8x 2.5"	8x 2.5"	SATA/SAS HS	None	None	2x GbE RJ-45, 1x Mgmt	None	1x LOM	1x PCIe x8 LP, 1x PCIe x16 LP	None	None	TPM 1.2	XClarity Enterprise	1x 750W Platinum	None	3-year	11/17
7Y03A02PAU	ThinkSystem SR570	ANZ	1x Xeon Silver 4116 12C/2.1GHz/16.5MB/85W/DDR4-2400	1x 16GB RDIMM DDR4-2666	1x 930-8i 2GB Flash (2Rx8)	8x 2.5"	8x 2.5"	SATA/SAS HS	None	None	2x GbE RJ-45, 1x Mgmt	None	1x LOM	1x PCIe x8 LP, 1x PCIe x16 LP	None	None	TPM 1.2	XClarity Enterprise	1x 750W Platinum	None	3-year	11/17
7Y03A02QAU	ThinkSystem SR570	ANZ	1x Xeon Bronze 3106 8C/1.7GHz/11MB/85W/DDR4-2133	1x 16GB RDIMM DDR4-2666	1x 930-8i 2GB Flash (2Rx8)	4x 3.5"	4x 3.5"	SATA/SAS HS	None	None	2x GbE RJ-45, 1x Mgmt	None	1x LOM	1x PCIe x8 LP, 1x PCIe x16 LP	None	None	TPM 1.2	XClarity Enterprise	1x 750W Platinum	None	3-year	11/17
7Y03A02RAU	ThinkSystem SR570	ANZ	1x Xeon Silver 4116 12C/2.1GHz/16.5MB/85W/DDR4-2400	1x 16GB RDIMM DDR4-2666	1x 930-8i 2GB Flash (2Rx8)	4x 3.5"	4x 3.5"	SATA/SAS HS	None	None	2x GbE RJ-45, 1x Mgmt	None	1x LOM	1x PCIe x8 LP, 1x PCIe x16 LP	None	None	TPM 1.2	XClarity Enterprise	1x 750W Platinum	None	3-year	11/17
7Y03A02SAU	ThinkSystem SR570	ANZ	1x Xeon Bronze 3104 6C/1.7GHz/8.25MB/85W/DDR4-2133	1x 16GB RDIMM DDR4-2666	1x 930-8i 2GB Flash (2Rx8)	8x 2.5"	8x 2.5"	SATA/SAS HS	None	None	2x GbE RJ-45, 1x Mgmt	None	1x LOM	1x PCIe x8 LP, 1x PCIe x16 LP	None	None	TPM 1.2	XClarity Enterprise	1x 750W Platinum	None	3-year	11/17
7Y03A02TAU	ThinkSystem SR570	ANZ	1x Xeon Silver 4110 8C/2.1GHz/11MB/85W/DDR4-2400	1x 16GB RDIMM DDR4-2666	1x 930-8i 2GB Flash (2Rx8)	8x 2.5"	8x 2.5"	SATA/SAS HS	None	None	2x GbE RJ-45, 1x Mgmt	None	1x LOM	1x PCIe x8 LP, 1x PCIe x16 LP	None	None	TPM 1.2	XClarity Enterprise	1x 750W Platinum	None	3-year	11/17

Model	Product	Region	Processor	Memory	Storage Controller	Chassis	Disk Bays	Disks	M.2 Drives	Onboard Networking Ports	Additional Networking (LOM/ML2/PCIe)	Standard Extension Slots	Available Extension Slots via Riser Cards	Front VGA	Optical	ITPM	System Management	Power Supply	Preload	Warranty	Ann Date (mm/yy)
7Y03A027EA	ThinkSystem SR570	EMEA	1x Xeon Silver 4114 10C/2.2GHz/13.75MB/85W/DDR4-2400	1x 32GB RDIMM 1x 930-8i DDR4-2666 (2Rx4)	1x 930-8i 2GB Flash	8x 2.5"	SATA/SAS HS	None	None	2x GbE RJ-45, 1x Mgmt	None	1x LOM	1x PCIe x8 LP, 1x PCIe x16 LP	None	None	TPM 1.2	XClarity Advanced	2x 750W Platinum	None	3-year	11/17
7Y03A02AEA	ThinkSystem SR570	EMEA	1x Xeon Silver 4110 8C/2.1GHz/11MB/85W/DDR4-2400	1x 16GB RDIMM 1x 930-8i DDR4-2666 (2Rx8)	1x 930-8i 2GB Flash	8x 2.5"	SATA/SAS HS	None	None	2x GbE RJ-45, 1x Mgmt	None	1x LOM	1x PCIe x8 LP, 1x PCIe x16 LP	None	None	TPM 1.2	XClarity Advanced	1x 750W Platinum	None	3-year	11/17
7Y03A02HEA	ThinkSystem SR570	EMEA	1x Xeon Silver 4110 8C/2.1GHz/11MB/85W/DDR4-2400	1x 16GB RDIMM 1x 930-8i DDR4-2666 (2Rx8)	1x 930-8i 2GB Flash	4x 3.5"	SATA/SAS HS	None	None	2x GbE RJ-45, 1x Mgmt	None	1x LOM	1x PCIe x8 LP, 1x PCIe x16 LP	None	None	TPM 1.2	XClarity Advanced	1x 750W Platinum	None	3-year	11/17

Model	Product	Region	Processor	Memory	Storage Controller	Chassis	Disk Bays	Disk Drives	M.2 Drives	Onboard Networking Ports	Additional Networking (LOM/ML2/PCIe)	Standard Extension Slots	Available Extension Slots via Riser Cards	Front VGA	Optical	TPM	System Management	Power Supply	Preload	Warranty	Ann Date (mm/yy)
7Y03A02BNA	ThinkSystem SR570	NA	1x Xeon Silver 4110 8C/2.1GHz/11MB/85W/DDR4-2400	1x 16GB RDIMM DDR4-2666 (2Rx8)	1x 530-8i	4x 3.5"	4x 3.5" SATA/SAS HS	None	None	2x GbE RJ-45, 1x Mgmt	None	1x LOM	1x PCIe x8 LP, 1x PCIe x16 LP	Front VGA	None	TPM 1.2	XClarity Enterprise	1x 750W Platinum	None	3-year	11/17
7Y03A02FNA	ThinkSystem SR570	NA	1x Xeon Silver 4116 12C/2.1GHz/16.5MB/85W/DDR4-2400	1x 32GB RDIMM DDR4-2666 (2Rx4)	1x 530-8i	4x 3.5"	4x 3.5" SATA/SAS HS	None	None	2x GbE RJ-45, 1x Mgmt	None	1x LOM	1x PCIe x8 LP, 1x PCIe x16 LP	Front VGA	None	TPM 1.2	XClarity Enterprise	1x 750W Platinum	None	3-year	11/17
7Y03A02JNA	ThinkSystem SR570	NA	1x Xeon Bronze 3106 8C/1.7GHz/11MB/85W/DDR4-2133	1x 16GB RDIMM DDR4-2666 (2Rx8)	1x 530-8i	4x 3.5"	4x 3.5" SATA/SAS HS	None	None	2x GbE RJ-45, 1x Mgmt	None	1x LOM	1x PCIe x8 LP, 1x PCIe x16 LP	Front VGA	None	TPM 1.2	XClarity Enterprise	1x 750W Platinum	None	3-year	11/17

Model	Product	Region	Processor	Memory	Storage Controller	Chassis	Disk Bays	Disk s	M.2 Drives	Onboard Networking Ports	Additional Networking (LOM/ML2/PCIe)	Standard Extension Slots	Available Extension Slots via Riser Cards	Front VGA	Optical	TPM	System Management	Power Supply	Preload	Warranty	Ann Date (mm/yy)
7Y03A00GAU	ThinkSystem SR570	ANZ	2x Xeon Silver 4114 10C/2.2GHz/13.75MB/85W/DDR4-2400	2x 32GB RDIMM DDR4-2666 (2Rx4)	1x 430-16i	10x 2.5" SATA/SAS AnyBay)	6	None	None	2x GbE RJ-45, 1x Mgmt	None	1x LOM	1x PCIe x8 LP, 2x PCIe x16 LP	None	None	TPM 1.2	XClarity Enterprise	2x 750W Platinum	None	3-year	11/17
7Y03A00HAU	ThinkSystem SR570	ANZ	2x Xeon Gold 5118 12C/2.3GHz/16.5MB/105W/DDR4-2400	2x 32GB RDIMM DDR4-2666 (2Rx4)	1x 430-16i	10x 2.5" SATA/SAS AnyBay)	6	None	None	2x GbE RJ-45, 1x Mgmt	None	1x LOM	1x PCIe x8 LP, 2x PCIe x16 LP	None	None	TPM 1.2	XClarity Enterprise	2x 750W Platinum	None	3-year	11/17
7Y03A00MAU	ThinkSystem SR570	ANZ	1x Xeon Silver 4108 8C/1.8GHz/11MB/85W/DDR4-2400	1x 16GB RDIMM DDR4-2666 (2Rx8)	1x 930-8i 2GB Flash	8x 2.5" SATA/SAS HS	8	None	None	2x GbE RJ-45, 1x Mgmt	None	1x LOM	1x PCIe x8 LP, 1x PCIe x16 LP	None	None	TPM 1.2	XClarity Standard	1x 750W Platinum	None	3-year	11/17
7Y03A00NAU	ThinkSystem SR570	ANZ	1x Xeon Silver 4114 10C/2.2GHz/13.75MB/85W/DDR4-2400	1x 16GB RDIMM DDR4-2666 (2Rx8)	1x 530-8i	8x 2.5" SATA/SAS HS	8	None	None	2x GbE RJ-45, 1x Mgmt	None	1x LOM	1x PCIe x8 LP, 1x PCIe x16 LP	None	None	TPM 1.2	XClarity Standard	1x 750W Platinum	None	3-year	11/17
7Y03A00QAU	ThinkSystem SR570	ANZ	1x Xeon Gold 5120 14C/2.2GHz/19.25MB/105W/DDR4-2400	1x 16GB RDIMM DDR4-2666 (2Rx8)	1x 930-8i 2GB Flash	8x 2.5" SATA/SAS HS	8	None	None	2x GbE RJ-45, 1x Mgmt	None	1x LOM	1x PCIe x8 LP, 1x PCIe x16 LP	None	None	TPM 1.2	XClarity Standard	1x 750W Platinum	None	3-year	11/17
7Y03A00SAU	ThinkSystem SR570	ANZ	1x Xeon Bronze 3104 6C/1.7GHz/8.25MB/85W/DDR4-2133	1x 16GB RDIMM DDR4-2666 (2Rx8)	1x 930-8i 2GB Flash	8x 2.5" SATA/SAS HS	8	None	None	2x GbE RJ-45, 1x Mgmt	None	1x LOM	1x PCIe x8 LP, 1x PCIe x16 LP	None	None	TPM 1.2	XClarity Standard	1x 750W Platinum	None	3-year	11/17
7Y03A00TAU	ThinkSystem SR570	ANZ	1x Xeon Gold 6130 16C/2.1GHz/22MB/125W/DDR4-2666	1x 32GB RDIMM DDR4-2666 (2Rx4)	1x 930-8i 2GB Flash	8x 2.5" SATA/SAS HS	8	None	None	2x GbE RJ-45, 1x Mgmt	None	1x LOM	1x PCIe x8 LP, 1x PCIe x16 LP	None	None	TPM 1.2	XClarity Standard	1x 750W Platinum	None	3-year	11/17
7Y03A00UAU	ThinkSystem SR570	ANZ	1x Xeon Silver 4110 8C/2.1GHz/11MB/85W/DDR4-2400	1x 16GB RDIMM DDR4-2666 (2Rx8)	1x 530-8i	8x 2.5" SATA/SAS HS	8	None	None	2x GbE RJ-45, 1x Mgmt	None	1x LOM	1x PCIe x8 LP, 1x PCIe x16 LP	None	None	TPM 1.2	XClarity Standard	1x 750W Platinum	None	3-year	11/17
7Y03A00WAU	ThinkSystem SR570	ANZ	1x Xeon Gold 6142 16C/2.6GHz/22MB/150W/DDR4-2666	1x 32GB RDIMM DDR4-2666 (2Rx4)	1x 930-8i 2GB Flash	8x 2.5" SATA/SAS HS	8	None	None	2x GbE RJ-45, 1x Mgmt	None	1x LOM	1x PCIe x8 LP, 1x PCIe x16 LP	None	None	TPM 1.2	XClarity Standard	1x 750W Platinum	None	3-year	11/17
7Y03A00XAU	ThinkSystem SR570	ANZ	1x Xeon Bronze 3106 8C/1.7GHz/11MB/85W/DDR4-2133	1x 16GB RDIMM DDR4-2666 (2Rx8)	Onboard Intel RSTe	4x 3.5" SATA SS	4	None	None	2x GbE RJ-45, 1x Mgmt	None	1x LOM	None	None	None	TPM 1.2	XClarity Standard	1x 750W Platinum	None	3-year	11/17

Model	Product	Region	Processor	Memory	Storage Controller	Chassis	Disk Bays	Disks	M.2 Drives	Onboard Networking Ports	Additional Networking (LOM/ML2/PCle)	Standard Extension Slots	Available Extension Slots via Riser Cards	Front VGA	Optical	TPM	System Management	Power Supply	Preload	Warranty	Ann Date (mm/yy)
7Y03A011AU	ThinkSystem SR570	ANZ	1x Xeon Silver 4116 12C/2.1GHz/16.5MB/85W/DDR4-2400	1x 16GB RDIMM DDR4-2666 (2Rx8)	1x 930-8i 2GB Flash	8x 2.5"	8x 2.5"	SATA/SAS None	None	2x GbE RJ-45, 1x Mgmt	None	1x LOM	1x PCIe x8 LP, 1x PCIe x16 LP	None	None	TPM 1.2	XClarity Standard	1x 750W Platinum	None	3-year	11/17
7Y03A012AU	ThinkSystem SR570	ANZ	1x Xeon Silver 4108 8C/1.8GHz/11MB/85W/DDR4-2400	1x 16GB RDIMM DDR4-2666 (2Rx8)	1x 530-8i	8x 2.5"	8x 2.5"	SATA/SAS None	None	2x GbE RJ-45, 1x Mgmt	None	1x LOM	1x PCIe x8 LP, 1x PCIe x16 LP	None	None	TPM 1.2	XClarity Standard	1x 750W Platinum	None	3-year	11/17
7Y03A015AU	ThinkSystem SR570	ANZ	1x Xeon Gold 5118 12C/2.3GHz/16.5MB/105W/DDR4-2400	1x 16GB RDIMM DDR4-2666 (2Rx8)	1x 930-8i 2GB Flash	8x 2.5"	8x 2.5"	SATA/SAS None	None	2x GbE RJ-45, 1x Mgmt	None	1x LOM	1x PCIe x8 LP, 1x PCIe x16 LP	None	None	TPM 1.2	XClarity Standard	1x 750W Platinum	None	3-year	11/17
7Y03A016AU	ThinkSystem SR570	ANZ	1x Xeon Bronze 3104 6C/1.7GHz/8.25MB/85W/DDR4-2133	1x 16GB RDIMM DDR4-2666 (2Rx8)	1x 530-8i	8x 2.5"	8x 2.5"	SATA/SAS None	None	2x GbE RJ-45, 1x Mgmt	None	1x LOM	1x PCIe x8 LP, 1x PCIe x16 LP	None	None	TPM 1.2	XClarity Standard	1x 750W Platinum	None	3-year	11/17
7Y03A01KAU	ThinkSystem SR570	ANZ	1x Xeon Silver 4114 10C/2.2GHz/13.75MB/85W/DDR4-2400	1x 16GB RDIMM DDR4-2666 (2Rx8)	1x 930-8i 2GB Flash	8x 2.5"	8x 2.5"	SATA/SAS None	None	2x GbE RJ-45, 1x Mgmt	None	1x LOM	1x PCIe x8 LP, 1x PCIe x16 LP	None	None	TPM 1.2	XClarity Standard	1x 750W Platinum	None	3-year	11/17
7Y03A01SAU	ThinkSystem SR570	ANZ	1x Xeon Gold 5118 12C/2.3GHz/16.5MB/105W/DDR4-2400	1x 16GB RDIMM DDR4-2666 (2Rx8)	1x 530-8i	4x 3.5"	4x 3.5"	SATA/SAS None	None	2x GbE RJ-45, 1x Mgmt	None	1x LOM	1x PCIe x8 LP, 1x PCIe x16 LP	None	None	TPM 1.2	XClarity Standard	1x 750W Platinum	None	3-year	11/17
7Y03A01UAU	ThinkSystem SR570	ANZ	1x Xeon Silver 4110 8C/2.1GHz/11MB/85W/DDR4-2400	1x 16GB RDIMM DDR4-2666 (2Rx8)	1x 930-8i 2GB Flash	8x 2.5"	8x 2.5"	SATA/SAS None	None	2x GbE RJ-45, 1x Mgmt	None	1x LOM	1x PCIe x8 LP, 1x PCIe x16 LP	None	None	TPM 1.2	XClarity Standard	1x 750W Platinum	None	3-year	11/17
7Y03A01VAU	ThinkSystem SR570	ANZ	1x Xeon Gold 5118 12C/2.3GHz/16.5MB/105W/DDR4-2400	1x 16GB RDIMM DDR4-2666 (2Rx8)	1x 930-8i 2GB Flash	4x 3.5"	4x 3.5"	SATA/SAS None	None	2x GbE RJ-45, 1x Mgmt	None	1x LOM	1x PCIe x8 LP, 1x PCIe x16 LP	None	None	TPM 1.2	XClarity Standard	1x 750W Platinum	None	3-year	11/17
7Y03A01WAU	ThinkSystem SR570	ANZ	1x Xeon Silver 4110 8C/2.1GHz/11MB/85W/DDR4-2400	1x 16GB RDIMM DDR4-2666 (2Rx8)	1x 930-8i 2GB Flash	4x 3.5"	4x 3.5"	SATA/SAS None	None	2x GbE RJ-45, 1x Mgmt	None	1x LOM	1x PCIe x8 LP, 1x PCIe x16 LP	None	None	TPM 1.2	XClarity Standard	1x 750W Platinum	None	3-year	11/17
7Y03A01XAU	ThinkSystem SR570	ANZ	1x Xeon Silver 4110 8C/2.1GHz/11MB/85W/DDR4-2400	1x 16GB RDIMM DDR4-2666 (2Rx8)	1x 530-8i	4x 3.5"	4x 3.5"	SATA/SAS None	None	2x GbE RJ-45, 1x Mgmt	None	1x LOM	1x PCIe x8 LP, 1x PCIe x16 LP	None	None	TPM 1.2	XClarity Standard	1x 750W Platinum	None	3-year	11/17

Model	Product	Region	Processor	Memory	Storage Controller	Chassis	Disk Bays	Disk S	M.2 Drives	Onboard Networking Ports	Additional Networking (LOM/ML2/PCIe)	Standard Extension Slots	Available Extensions via Riser Cards	Front VGA	Optical	TPM	System Management	Power Supply	Preload	Warranty	Ann Date (mm/yy)
7Y02A00JSG	ThinkSystem SR570	ASEAN	1x Xeon Gold 6136 12C/3.0GHz/24.75MB/150W/DDR4-2666	1x 16GB RDIMM DDR4-2666 (1Rx4)	1x 530-8i	8x 2.5"	8x 2.5" SATA/SA S HS	None	None	2x GbE RJ-45, 1x Mgmt	None	1x LOM	1x PCIe x8 LP, 1x PCIe x16 LP	None	None	TPM 2.0	XClarity Enterprise	1x 750W Platinum	None	1-year	11/17
7Y02A00KSG	ThinkSystem SR570	ASEAN	1x Xeon Silver 4114 10C/2.2GHz/13.75MB/85W/DDR4-2400	1x 16GB RDIMM DDR4-2666 (1Rx4)	1x 530-8i	8x 2.5"	8x 2.5" SATA/SA S HS	None	None	2x GbE RJ-45, 1x Mgmt	None	1x LOM	1x PCIe x8 LP, 1x PCIe x16 LP	None	None	TPM 2.0	XClarity Enterprise	1x 750W Platinum	None	1-year	11/17
7Y02A00LSG	ThinkSystem SR570	ASEAN	1x Xeon Gold 6140 18C/2.3GHz/24.75MB/140W/DDR4-2666	1x 16GB RDIMM DDR4-2666 (1Rx4)	1x 530-8i	8x 2.5"	8x 2.5" SATA/SA S HS	None	None	2x GbE RJ-45, 1x Mgmt	None	1x LOM	1x PCIe x8 LP, 1x PCIe x16 LP	None	None	TPM 2.0	XClarity Enterprise	1x 750W Platinum	None	1-year	11/17
7Y02A00MSG	ThinkSystem SR570	ASEAN	1x Xeon Silver 4116 12C/2.1GHz/16.5MB/85W/DDR4-2400	1x 16GB RDIMM DDR4-2666 (1Rx4)	1x 530-8i	8x 2.5"	8x 2.5" SATA/SA S HS	None	None	2x GbE RJ-45, 1x Mgmt	None	1x LOM	1x PCIe x8 LP, 1x PCIe x16 LP	None	None	TPM 2.0	XClarity Enterprise	1x 750W Platinum	None	1-year	11/17
7Y02A00NSG	ThinkSystem SR570	ASEAN	1x Xeon Gold 6142 16C/2.6GHz/22MB/150W/DDR4-2666	1x 16GB RDIMM DDR4-2666 (1Rx4)	1x 530-8i	8x 2.5"	8x 2.5" SATA/SA S HS	None	None	2x GbE RJ-45, 1x Mgmt	None	1x LOM	1x PCIe x8 LP, 1x PCIe x16 LP	None	None	TPM 2.0	XClarity Enterprise	1x 750W Platinum	None	1-year	11/17
7Y02A00PSG	ThinkSystem SR570	ASEAN	1x Xeon Silver 4110 8C/2.1GHz/11MB/85W/DDR4-2400	1x 16GB RDIMM DDR4-2666 (1Rx4)	1x 530-8i	8x 2.5"	8x 2.5" SATA/SA S HS	None	None	2x GbE RJ-45, 1x Mgmt	None	1x LOM	1x PCIe x8 LP, 1x PCIe x16 LP	None	None	TPM 2.0	XClarity Enterprise	1x 750W Platinum	None	1-year	11/17
7Y02A00QSG	ThinkSystem SR570	ASEAN	1x Xeon Silver 4112 4C/2.6GHz/8.25MB/85W/DDR4-2400	1x 16GB RDIMM DDR4-2666 (1Rx4)	1x 530-8i	8x 2.5"	8x 2.5" SATA/SA S HS	None	None	2x GbE RJ-45, 1x Mgmt	None	1x LOM	1x PCIe x8 LP, 1x PCIe x16 LP	None	None	TPM 2.0	XClarity Enterprise	1x 750W Platinum	None	1-year	11/17
7Y02A00RSG	ThinkSystem SR570	ASEAN	1x Xeon Gold 6148 20C/2.4GHz/27.5MB/150W/DDR4-2666	1x 16GB RDIMM DDR4-2666 (1Rx4)	1x 530-8i	8x 2.5"	8x 2.5" SATA/SA S HS	None	None	2x GbE RJ-45, 1x Mgmt	None	1x LOM	1x PCIe x8 LP, 1x PCIe x16 LP	None	None	TPM 2.0	XClarity Enterprise	1x 750W Platinum	None	1-year	11/17
7Y02A00SSG	ThinkSystem SR570	ASEAN	1x Xeon Silver 4108 8C/1.8GHz/11MB/85W/DDR4-2400	1x 16GB RDIMM DDR4-2666 (1Rx4)	1x 530-8i	8x 2.5"	8x 2.5" SATA/SA S HS	None	None	2x GbE RJ-45, 1x Mgmt	None	1x LOM	1x PCIe x8 LP, 1x PCIe x16 LP	None	None	TPM 2.0	XClarity Enterprise	1x 750W Platinum	None	1-year	11/17
7Y02A00TSG	ThinkSystem SR570	ASEAN	1x Xeon Gold 6130 16C/2.1GHz/22MB/125W/DDR4-2666	1x 16GB RDIMM DDR4-2666 (1Rx4)	1x 530-8i	8x 2.5"	8x 2.5" SATA/SA S HS	None	None	2x GbE RJ-45, 1x Mgmt	None	1x LOM	1x PCIe x8 LP, 1x PCIe x16 LP	None	None	TPM 2.0	XClarity Enterprise	1x 750W Platinum	None	1-year	11/17

Model	Product	Region	Processor	Memory	Storage Controller	Chassis	Disk Bays	Disk S	M.2 Drives	Onboard Networking Ports	Additional Networking (LOM/ML2/PCIe)	Standard Extension Slots	Available Extension Slots via Riser Cards	Front VGA	Optical	TPM	System Management	Power Supply	Preload	Warranty	Ann Date (mm/yy)
7Y02A00USG	ThinkSystem SR570	ASEAN	1x Xeon Gold 6132 14C/2.6GHz/19.25MB/140W/DDR4-2666	1x 16GB RDIMM DDR4-2666 (1Rx4)	1x 530-8i	8x 2.5"	8x 2.5" SATA/SAS HS	None	None	2x GbE RJ-45, 1x Mgmt	None	1x LOM	1x PCIe x8 LP, 1x PCIe x16 LP	None	None	TPM 2.0	XClarity Enterprise	1x 750W Platinum	None	1-year	11/17
7Y02A00VSG	ThinkSystem SR570	ASEAN	1x Xeon Gold 6134 8C/3.2GHz/24.75MB/130W/DDR4-2666	1x 16GB RDIMM DDR4-2666 (1Rx4)	1x 530-8i	8x 2.5"	8x 2.5" SATA/SAS HS	None	None	2x GbE RJ-45, 1x Mgmt	None	1x LOM	1x PCIe x8 LP, 1x PCIe x16 LP	None	None	TPM 2.0	XClarity Enterprise	1x 750W Platinum	None	1-year	11/17
7Y02A00WSG	ThinkSystem SR570	ASEAN	1x Xeon Gold 6152 22C/2.1GHz/30.25MB/140W/DDR4-2666	1x 16GB RDIMM DDR4-2666 (1Rx4)	1x 530-8i	8x 2.5"	8x 2.5" SATA/SAS HS	None	None	2x GbE RJ-45, 1x Mgmt	None	1x LOM	1x PCIe x8 LP, 1x PCIe x16 LP	None	None	TPM 2.0	XClarity Enterprise	1x 750W Platinum	None	1-year	11/17
7Y02A00XSG	ThinkSystem SR570	ASEAN	1x Xeon Gold 5115 10C/2.4GHz/13.75MB/85W/DDR4-2400	1x 16GB RDIMM DDR4-2666 (1Rx4)	1x 530-8i	8x 2.5"	8x 2.5" SATA/SAS HS	None	None	2x GbE RJ-45, 1x Mgmt	None	1x LOM	1x PCIe x8 LP, 1x PCIe x16 LP	None	None	TPM 2.0	XClarity Enterprise	1x 750W Platinum	None	1-year	11/17
7Y02A00YSG	ThinkSystem SR570	ASEAN	1x Xeon Gold 5117 14C/2.0GHz/19.25MB/105W/DDR4-2400	1x 16GB RDIMM DDR4-2666 (1Rx4)	1x 530-8i	8x 2.5"	8x 2.5" SATA/SAS HS	None	None	2x GbE RJ-45, 1x Mgmt	None	1x LOM	1x PCIe x8 LP, 1x PCIe x16 LP	None	None	TPM 2.0	XClarity Enterprise	1x 750W Platinum	None	1-year	11/17
7Y02A00ZSG	ThinkSystem SR570	ASEAN	1x Xeon Gold 5122 4C/3.6GHz/16.5MB/105W/DDR4-2666	1x 16GB RDIMM DDR4-2666 (1Rx4)	1x 530-8i	8x 2.5"	8x 2.5" SATA/SAS HS	None	None	2x GbE RJ-45, 1x Mgmt	None	1x LOM	1x PCIe x8 LP, 1x PCIe x16 LP	None	None	TPM 2.0	XClarity Enterprise	1x 750W Platinum	None	1-year	11/17
7Y02A010SG	ThinkSystem SR570	ASEAN	1x Xeon Bronze 3104 6C/1.7GHz/8.25MB/85W/DDR4-2133	1x 16GB RDIMM DDR4-2666 (1Rx4)	1x 530-8i	8x 2.5"	8x 2.5" SATA/SAS HS	None	None	2x GbE RJ-45, 1x Mgmt	None	1x LOM	1x PCIe x8 LP, 1x PCIe x16 LP	None	None	TPM 2.0	XClarity Enterprise	1x 750W Platinum	None	1-year	11/17
7Y02A011SG	ThinkSystem SR570	ASEAN	1x Xeon Gold 5118 12C/2.3GHz/16.5MB/105W/DDR4-2400	1x 16GB RDIMM DDR4-2666 (1Rx4)	1x 530-8i	8x 2.5"	8x 2.5" SATA/SAS HS	None	None	2x GbE RJ-45, 1x Mgmt	None	1x LOM	1x PCIe x8 LP, 1x PCIe x16 LP	None	None	TPM 2.0	XClarity Enterprise	1x 750W Platinum	None	1-year	11/17
7Y02A012SG	ThinkSystem SR570	ASEAN	1x Xeon Gold 5120 14C/2.2GHz/19.25MB/105W/DDR4-2400	1x 16GB RDIMM DDR4-2666 (1Rx4)	1x 530-8i	8x 2.5"	8x 2.5" SATA/SAS HS	None	None	2x GbE RJ-45, 1x Mgmt	None	1x LOM	1x PCIe x8 LP, 1x PCIe x16 LP	None	None	TPM 2.0	XClarity Enterprise	1x 750W Platinum	None	1-year	11/17
7Y02A013SG	ThinkSystem SR570	ASEAN	1x Xeon Gold 6126 12C/2.6GHz/19.25MB/125W/DDR4-2666	1x 16GB RDIMM DDR4-2666 (1Rx4)	1x 530-8i	8x 2.5"	8x 2.5" SATA/SAS HS	None	None	2x GbE RJ-45, 1x Mgmt	None	1x LOM	1x PCIe x8 LP, 1x PCIe x16 LP	None	None	TPM 2.0	XClarity Enterprise	1x 750W Platinum	None	1-year	11/17

Model	Product	Region	Processor	Memory	Storage Controller	Chassis	Disk Bays	Disks	M.2 Drives	Onboard Networking Ports	Additional Networking (LOM/ML2/PCIe)	Standard Extension Slots	Available Extension Slots via Riser Cards	Front VGA	Optical	TPM	System Management	Power Supply	Preload	Warranty	Ann Date (mm/yy)
7Y02A014SG	ThinkSystem SR570	ASEAN	1x Xeon Bronze 3106 8C/1.7GHz/11MB/85W/DDR4-2133	1x 16GB RDIMM DDR4-2666 (1Rx4)	1x 530-8i	8x 2.5"	SATA/SAS HS	None	None	2x GbE RJ-45, 1x Mgmt	None	1x LOM	1x PCIe x8 LP, 1x PCIe x16 LP	None	None	TPM 2.0	XClarity Enterprise	1x 750W Platinum	None	1-year	11/17
7Y02A015SG	ThinkSystem SR570	ASEAN	1x Xeon Gold 6128 6C/3.4GHz/19.25MB/115W/DDR4-2666	1x 16GB RDIMM DDR4-2666 (1Rx4)	1x 530-8i	8x 2.5"	SATA/SAS HS	None	None	2x GbE RJ-45, 1x Mgmt	None	1x LOM	1x PCIe x8 LP, 1x PCIe x16 LP	None	None	TPM 2.0	XClarity Enterprise	1x 750W Platinum	None	1-year	11/17

Model	Product	Region	Processor	Memory	Storage Controller	Chassis	Disk Bays	Disk S	M.2 Drives	Onboard Networking Ports	Additional Networking (LOM/ML2/PCIe)	Standard Extension Slots	Available Extension Slots via Riser Cards	Front VGA	Optical	TPM	System Management	Power Supply	Preload	Warranty	Ann Date (mm/yy)
7Y03A00ZEA	ThinkSystem SR570	EMEA	1x Xeon Gold 5118 12C/2.3GHz/16.5MB/105W/DDR4-2400	1x 16GB RDIMM DDR4-2666 (2Rx8)	1x 930-8i 2GB Flash	8x 2.5"	8x 2.5" SATA/SAS HS	None	None	2x GbE RJ-45, 1x Mgmt	None	1x LOM	1x PCIe x8 LP, 1x PCIe x16 LP	None	None	TPM 1.2	XClarity Standard	1x 750W Platinum	None	3-year	11/17
7Y03A00REA	ThinkSystem SR570	EMEA	1x Xeon Gold 5120 14C/2.2GHz/19.25MB/105W/DDR4-2400	1x 16GB RDIMM DDR4-2666 (2Rx8)	1x 930-8i 2GB Flash	8x 2.5"	8x 2.5" SATA/SAS HS	None	None	2x GbE RJ-45, 1x Mgmt	None	1x LOM	1x PCIe x8 LP, 1x PCIe x16 LP	None	None	TPM 1.2	XClarity Standard	1x 750W Platinum	None	3-year	11/17
7Y03A00VEA	ThinkSystem SR570	EMEA	1x Xeon Gold 6130 16C/2.1GHz/22MB/125W/DDR4-2666	1x 32GB RDIMM DDR4-2666 (2Rx4)	1x 930-8i 2GB Flash	8x 2.5"	8x 2.5" SATA/SAS HS	None	None	2x GbE RJ-45, 1x Mgmt	None	1x LOM	1x PCIe x8 LP, 1x PCIe x16 LP	None	None	TPM 1.2	XClarity Standard	1x 750W Platinum	None	3-year	11/17
7Y03A00KEA	ThinkSystem SR570	EMEA	2x Xeon Gold 5118 12C/2.3GHz/16.5MB/105W/DDR4-2400	2x 32GB RDIMM DDR4-2666 (2Rx4)	1x 430-16i	10x 2.5"	10x 2.5" SATA/SAS , 4 AnyBay)	None	None	2x GbE RJ-45, 1x Mgmt	None	1x LOM	1x PCIe x8 LP, 2x PCIe x16 LP	None	None	TPM 1.2	XClarity Enterprise	2x 750W Platinum	None	3-year	11/17
7Y03A01REA	ThinkSystem SR570	EMEA	2x Xeon Silver 4114 10C/2.2GHz/13.75MB/85W/DDR4-2400	2x 32GB RDIMM DDR4-2666 (2Rx4)	1x 430-16i	10x 2.5"	10x 2.5" SATA/SAS , 4 AnyBay)	None	None	2x GbE RJ-45, 1x Mgmt	None	1x LOM	1x PCIe x8 LP, 2x PCIe x16 LP	None	None	TPM 1.2	XClarity Enterprise	2x 750W Platinum	None	3-year	11/17
7Y03A020EA	ThinkSystem SR570	EMEA	1x Xeon Gold 5118 12C/2.3GHz/16.5MB/105W/DDR4-2400	1x 16GB RDIMM DDR4-2666 (2Rx8)	1x 530-8i	4x 3.5"	4x 3.5" SATA/SAS HS	None	None	2x GbE RJ-45, 1x Mgmt	None	1x LOM	1x PCIe x8 LP, 1x PCIe x16 LP	None	None	TPM 1.2	XClarity Standard	1x 750W Platinum	None	3-year	11/17
7Y03A021EA	ThinkSystem SR570	EMEA	1x Xeon Silver 4110 8C/2.1GHz/11MB/85W/DDR4-2400	1x 16GB RDIMM DDR4-2666 (2Rx8)	1x 530-8i	4x 3.5"	4x 3.5" SATA/SAS HS	None	None	2x GbE RJ-45, 1x Mgmt	None	1x LOM	1x PCIe x8 LP, 1x PCIe x16 LP	None	None	TPM 1.2	XClarity Standard	1x 750W Platinum	None	3-year	11/17
7Y03A022EA	ThinkSystem SR570	EMEA	1x Xeon Bronze 3104 6C/1.7GHz/8.25MB/85W/DDR4-2133	1x 16GB RDIMM DDR4-2666 (2Rx8)	1x 930-8i 2GB Flash	8x 2.5"	8x 2.5" SATA/SAS HS	None	None	2x GbE RJ-45, 1x Mgmt	None	1x LOM	1x PCIe x8 LP, 1x PCIe x16 LP	None	None	TPM 1.2	XClarity Standard	1x 750W Platinum	None	3-year	11/17
7Y03A025EA	ThinkSystem SR570	EMEA	1x Xeon Gold 6142 16C/2.6GHz/22MB/150W/DDR4-2666	1x 32GB RDIMM DDR4-2666 (2Rx4)	1x 930-8i 2GB Flash	8x 2.5"	8x 2.5" SATA/SAS HS	None	None	2x GbE RJ-45, 1x Mgmt	None	1x LOM	1x PCIe x8 LP, 1x PCIe x16 LP	None	None	TPM 1.2	XClarity Standard	1x 750W Platinum	None	3-year	11/17
7Y03A01TEA	ThinkSystem SR570	EMEA	1x Xeon Bronze 3106 8C/1.7GHz/11MB/85W/DDR4-2133	1x 16GB RDIMM DDR4-2666 (2Rx8)	Onboard Intel RSTe	4x 3.5"	4x 3.5" SATA SS	None	None	2x GbE RJ-45, 1x Mgmt	None	1x LOM	None	None	None	TPM 1.2	XClarity Standard	1x 750W Platinum	None	3-year	11/17

Model	Product	Region	Processor	Memory	Storage Controller	Chassis	Disk Bays	Disks	M.2 Drives	Onboard Networking Ports	Additional Networking (LOM/ML2/PCle)	Standard Extension Slots	Available Extension Slots via Riser Cards	Front VGA	Optical	TPM	System Management	Power Supply	Preload	Warranty	Ann Date (mm/yy)
7Y03A014EA	ThinkSystem SR570	EMEA	1x Xeon Silver 4110 8C/2.1GHz/11MB/85W/DDR4-2400	1x 16GB RDIMM DDR4-2666 (2Rx8)	1x 530-8i	8x 2.5"	8x 2.5"	SATA/SAS None HS	None	2x GbE RJ-45, 1x Mgmt	None	1x LOM	1x PCIe x8 LP, 1x PCIe x16 LP	None	None	TPM 1.2	XClarity Standard	1x 750W Platinum	None	3-year	11/17
7Y03A01PEA	ThinkSystem SR570	EMEA	1x Xeon Silver 4108 8C/1.8GHz/11MB/85W/DDR4-2400	1x 16GB RDIMM DDR4-2666 (2Rx8)	1x 930-8i	8x 2.5"	8x 2.5"	SATA/SAS None HS	None	2x GbE RJ-45, 1x Mgmt	None	1x LOM	1x PCIe x8 LP, 1x PCIe x16 LP	None	None	TPM 1.2	XClarity Standard	1x 750W Platinum	None	3-year	11/17
7Y03A01LEA	ThinkSystem SR570	EMEA	1x Xeon Silver 4110 8C/2.1GHz/11MB/85W/DDR4-2400	1x 16GB RDIMM DDR4-2666 (2Rx8)	1x 930-8i	8x 2.5"	8x 2.5"	SATA/SAS None HS	None	2x GbE RJ-45, 1x Mgmt	None	1x LOM	1x PCIe x8 LP, 1x PCIe x16 LP	None	None	TPM 1.2	XClarity Standard	1x 750W Platinum	None	3-year	11/17
7Y03A01EEA	ThinkSystem SR570	EMEA	1x Xeon Silver 4114 10C/2.2GHz/13.75MB/85W/DDR4-2400	1x 16GB RDIMM DDR4-2666 (2Rx8)	1x 930-8i	8x 2.5"	8x 2.5"	SATA/SAS None HS	None	2x GbE RJ-45, 1x Mgmt	None	1x LOM	1x PCIe x8 LP, 1x PCIe x16 LP	None	None	TPM 1.2	XClarity Standard	1x 750W Platinum	None	3-year	11/17
7Y03A01FEA	ThinkSystem SR570	EMEA	1x Xeon Silver 4116 12C/2.1GHz/16.5MB/85W/DDR4-2400	1x 16GB RDIMM DDR4-2666 (2Rx8)	1x 930-8i	8x 2.5"	8x 2.5"	SATA/SAS None HS	None	2x GbE RJ-45, 1x Mgmt	None	1x LOM	1x PCIe x8 LP, 1x PCIe x16 LP	None	None	TPM 1.2	XClarity Standard	1x 750W Platinum	None	3-year	11/17
7Y03A01GEA	ThinkSystem SR570	EMEA	1x Xeon Gold 5118 12C/2.3GHz/16.5MB/105W/DDR4-2400	1x 16GB RDIMM DDR4-2666 (2Rx8)	1x 930-8i	4x 3.5"	4x 3.5"	SATA/SAS None HS	None	2x GbE RJ-45, 1x Mgmt	None	1x LOM	1x PCIe x8 LP, 1x PCIe x16 LP	None	None	TPM 1.2	XClarity Standard	1x 750W Platinum	None	3-year	11/17
7Y03A01HEA	ThinkSystem SR570	EMEA	1x Xeon Bronze 3104 6C/1.7GHz/8.25MB/85W/DDR4-2133	1x 16GB RDIMM DDR4-2666 (2Rx8)	1x 530-8i	8x 2.5"	8x 2.5"	SATA/SAS None HS	None	2x GbE RJ-45, 1x Mgmt	None	1x LOM	1x PCIe x8 LP, 1x PCIe x16 LP	None	None	TPM 1.2	XClarity Standard	1x 750W Platinum	None	3-year	11/17
7Y03A017EA	ThinkSystem SR570	EMEA	1x Xeon Silver 4110 8C/2.1GHz/11MB/85W/DDR4-2400	1x 16GB RDIMM DDR4-2666 (2Rx8)	1x 930-8i	4x 3.5"	4x 3.5"	SATA/SAS None HS	None	2x GbE RJ-45, 1x Mgmt	None	1x LOM	1x PCIe x8 LP, 1x PCIe x16 LP	None	None	TPM 1.2	XClarity Standard	1x 750W Platinum	None	3-year	11/17
7Y03A018EA	ThinkSystem SR570	EMEA	1x Xeon Silver 4114 10C/2.2GHz/13.75MB/85W/DDR4-2400	1x 16GB RDIMM DDR4-2666 (2Rx8)	1x 530-8i	8x 2.5"	8x 2.5"	SATA/SAS None HS	None	2x GbE RJ-45, 1x Mgmt	None	1x LOM	1x PCIe x8 LP, 1x PCIe x16 LP	None	None	TPM 1.2	XClarity Standard	1x 750W Platinum	None	3-year	11/17
7Y03A01AEA	ThinkSystem SR570	EMEA	1x Xeon Silver 4108 8C/1.8GHz/11MB/85W/DDR4-2400	1x 16GB RDIMM DDR4-2666 (2Rx8)	1x 530-8i	8x 2.5"	8x 2.5"	SATA/SAS None HS	None	2x GbE RJ-45, 1x Mgmt	None	1x LOM	1x PCIe x8 LP, 1x PCIe x16 LP	None	None	TPM 1.2	XClarity Standard	1x 750W Platinum	None	3-year	11/17

Model	Product	Region	Processor	Memory	Storage Controller	Chassis	Disk Bays	Disk S	M.2 Drives	Onboard Networking Ports	Additional Networking (LOM/ML2/PCIe)	Standard Extension Slots	Available Extension Slots via Riser Cards	Front VGA	Optical	TPM	System Management	Power Supply	Preload	Warranty	Ann Date (mm/yy)
7Y03A01BCN	ThinkSystem SR570	HTK	1x Xeon Gold 5117 14C/2.0GHz/19.25MB/105W/DDR4-2400	1x 16GB RDIMM DDR4-2666 (2Rx8)	1x 930-8i 2GB Flash	4x 3.5"	4x 3.5" SATA/SAS HS	None	None	2x GbE RJ-45, 1x Mgmt	2x GbE RJ-45 LOM	1x LOM	1x PCIe x8 LP, 1x PCIe x16 LP	None	None	TPM 1.2	XClarity Standard	1x 750W Platinum	None	3-year	11/17
7Y03A01MCN	ThinkSystem SR570	HTK	1x Xeon Gold 5115 10C/2.4GHz/13.75MB/85W/DDR4-2400	1x 16GB RDIMM DDR4-2666 (2Rx8)	1x 930-8i 2GB Flash	4x 3.5"	4x 3.5" SATA/SAS HS	None	None	2x GbE RJ-45, 1x Mgmt	2x GbE RJ-45 LOM	1x LOM	1x PCIe x8 LP, 1x PCIe x16 LP	None	None	TPM 1.2	XClarity Standard	1x 750W Platinum	None	3-year	11/17
7Y03A01QCN	ThinkSystem SR570	HTK	1x Xeon Bronze 3104 6C/1.7GHz/8.25MB/85W/DDR4-2133	1x 16GB RDIMM DDR4-2666 (2Rx8)	1x 530-8i	8x 2.5"	8x 2.5" SATA/SAS HS	None	None	2x GbE RJ-45, 1x Mgmt	2x GbE RJ-45 LOM	1x LOM	1x PCIe x8 LP, 1x PCIe x16 LP	None	None	TPM 1.2	XClarity Standard	1x 750W Platinum	None	3-year	11/17
7Y03A026CN	ThinkSystem SR570	HTK	1x Xeon Gold 5122 4C/3.6GHz/16.5MB/105W/DDR4-2666	1x 16GB RDIMM DDR4-2666 (2Rx8)	1x 930-8i 2GB Flash	8x 2.5"	8x 2.5" SATA/SAS HS	None	None	2x GbE RJ-45, 1x Mgmt	2x GbE RJ-45 LOM	1x LOM	1x PCIe x8 LP, 1x PCIe x16 LP	None	None	TPM 1.2	XClarity Standard	1x 750W Platinum	None	3-year	11/17
7Y03A01YCN	ThinkSystem SR570	HTK	1x Xeon Gold 5120T 14C/2.2GHz/19.25MB/105W/DDR4-2400	1x 16GB RDIMM DDR4-2666 (2Rx8)	1x 930-8i 2GB Flash	4x 3.5"	4x 3.5" SATA/SAS HS	None	None	2x GbE RJ-45, 1x Mgmt	2x GbE RJ-45 LOM	1x LOM	1x PCIe x8 LP, 1x PCIe x16 LP	None	None	TPM 1.2	XClarity Standard	1x 750W Platinum	None	3-year	11/17
7Y03A01ZCN	ThinkSystem SR570	HTK	1x Xeon Gold 5120T 14C/2.2GHz/19.25MB/105W/DDR4-2400	1x 16GB RDIMM DDR4-2666 (2Rx8)	1x 930-8i 2GB Flash	8x 2.5"	8x 2.5" SATA/SAS HS	None	None	2x GbE RJ-45, 1x Mgmt	2x GbE RJ-45 LOM	1x LOM	1x PCIe x8 LP, 1x PCIe x16 LP	None	None	TPM 1.2	XClarity Standard	1x 750W Platinum	None	3-year	11/17
7Y03A023CN	ThinkSystem SR570	HTK	1x Xeon Gold 5122 4C/3.6GHz/16.5MB/105W/DDR4-2666	1x 16GB RDIMM DDR4-2666 (2Rx8)	1x 930-8i 2GB Flash	4x 3.5"	4x 3.5" SATA/SAS HS	None	None	2x GbE RJ-45, 1x Mgmt	2x GbE RJ-45 LOM	1x LOM	1x PCIe x8 LP, 1x PCIe x16 LP	None	None	TPM 1.2	XClarity Standard	1x 750W Platinum	None	3-year	11/17
7Y03A024CN	ThinkSystem SR570	HTK	1x Xeon Gold 6130 16C/2.1GHz/22MB/125W/DDR4-2666	1x 16GB RDIMM DDR4-2666 (2Rx8)	1x 930-16i 4GB Flash	10x 2.5"	10x 2.5" SATA/SAS HS (6 AnyBay)	None	None	2x GbE RJ-45, 1x Mgmt	2x GbE RJ-45 LOM	1x LOM	1x PCIe x8 LP, 1x PCIe x16 LP	None	None	TPM 1.2	XClarity Standard	1x 750W Platinum	None	3-year	11/17
7Y03A00LCN	ThinkSystem SR570	HTK	1x Xeon Gold 5120 14C/2.2GHz/19.25MB/105W/DDR4-2400	1x 16GB RDIMM DDR4-2666 (2Rx8)	1x 930-8i 2GB Flash	4x 3.5"	4x 3.5" SATA/SAS HS	None	None	2x GbE RJ-45, 1x Mgmt	2x GbE RJ-45 LOM	1x LOM	1x PCIe x8 LP, 1x PCIe x16 LP	None	None	TPM 1.2	XClarity Standard	1x 750W Platinum	None	3-year	11/17
7Y03A00JCN	ThinkSystem SR570	HTK	1x Xeon Gold 5115 10C/2.4GHz/13.75MB/85W/DDR4-2400	1x 16GB RDIMM DDR4-2666 (2Rx8)	1x 930-8i 2GB Flash	8x 2.5"	8x 2.5" SATA/SAS HS	None	None	2x GbE RJ-45, 1x Mgmt	2x GbE RJ-45 LOM	1x LOM	1x PCIe x8 LP, 1x PCIe x16 LP	None	None	TPM 1.2	XClarity Standard	1x 750W Platinum	None	3-year	11/17

Model	Product	Region	Processor	Memory	Storage Controller	Chassis	Disk Bays	Disk Drives	M.2 Drives	Onboard Networking Ports	Additional Networking (LOM/ML2/PCIe)	Standard Extension Slots	Available Extension Slots via Riser Cards	Front VGA	Optical	TPM	System Management	Power Supply	Preload	Warranty	Ann Date (mm/yy)	
7Y03A00PCN	ThinkSystem SR570	HTK	1x Xeon Gold 5120 14C/2.2GHz/19.25MB/105W/DDR4-2400	1x 16GB RDIMM (2Rx8)	1x 930-8i 2GB Flash	8x 2.5"	8x 2.5"	SATA/SAS HS	None	None	2x GbE RJ-45, 1x Mgmt	2x GbE RJ-45 LOM	1x LOM	1x PCIe x8 LP, 1x PCIe x16 LP	None	None	TPM 1.2	XClarity Standard	1x 750W Platinum	None	3-year	11/17
7Y03A00YCN	ThinkSystem SR570	HTK	1x Xeon Gold 5117 14C/2.0GHz/19.25MB/105W/DDR4-2400	1x 16GB RDIMM (2Rx8)	1x 930-8i 2GB Flash	8x 2.5"	8x 2.5"	SATA/SAS HS	None	None	2x GbE RJ-45, 1x Mgmt	2x GbE RJ-45 LOM	1x LOM	1x PCIe x8 LP, 1x PCIe x16 LP	None	None	TPM 1.2	XClarity Standard	1x 750W Platinum	None	3-year	11/17
7Y03A000CN	ThinkSystem SR570	HTK	1x Xeon Silver 4108 8C/1.8GHz/11MB/85W/DDR4-2400	1x 16GB RDIMM (2Rx8)	1x 930-8i 2GB Flash	4x 3.5"	4x 3.5"	SATA/SAS HS	None	None	2x GbE RJ-45, 1x Mgmt	2x GbE RJ-45 LOM	1x LOM	1x PCIe x8 LP, 1x PCIe x16 LP	None	None	TPM 1.2	XClarity Standard	1x 750W Platinum	None	3-year	11/17
7Y03A001CN	ThinkSystem SR570	HTK	1x Xeon Silver 4110 8C/2.1GHz/11MB/85W/DDR4-2400	1x 16GB RDIMM (2Rx8)	1x 930-8i 2GB Flash	8x 2.5"	8x 2.5"	SATA/SAS HS	None	None	2x GbE RJ-45, 1x Mgmt	2x GbE RJ-45 LOM	1x LOM	1x PCIe x8 LP, 1x PCIe x16 LP	None	None	TPM 1.2	XClarity Standard	1x 750W Platinum	None	3-year	11/17
7Y03A002CN	ThinkSystem SR570	HTK	1x Xeon Silver 4110 8C/2.1GHz/11MB/85W/DDR4-2400	1x 16GB RDIMM (2Rx8)	1x 930-8i 2GB Flash	4x 3.5"	4x 3.5"	SATA/SAS HS	None	None	2x GbE RJ-45, 1x Mgmt	2x GbE RJ-45 LOM	1x LOM	1x PCIe x8 LP, 1x PCIe x16 LP	None	None	TPM 1.2	XClarity Standard	1x 750W Platinum	None	3-year	11/17
7Y03A003CN	ThinkSystem SR570	HTK	1x Xeon Silver 4112 4C/2.6GHz/8.25MB/85W/DDR4-2400	1x 16GB RDIMM (2Rx8)	1x 930-8i 2GB Flash	8x 2.5"	8x 2.5"	SATA/SAS HS	None	None	2x GbE RJ-45, 1x Mgmt	2x GbE RJ-45 LOM	1x LOM	1x PCIe x8 LP, 1x PCIe x16 LP	None	None	TPM 1.2	XClarity Standard	1x 750W Platinum	None	3-year	11/17
7Y03A004CN	ThinkSystem SR570	HTK	1x Xeon Bronze 3106 8C/1.7GHz/11MB/85W/DDR4-2133	1x 16GB RDIMM (2Rx8)	1x 930-8i 2GB Flash	8x 2.5"	8x 2.5"	SATA/SAS HS	None	None	2x GbE RJ-45, 1x Mgmt	2x GbE RJ-45 LOM	1x LOM	1x PCIe x8 LP, 1x PCIe x16 LP	None	None	TPM 1.2	XClarity Standard	1x 750W Platinum	None	3-year	11/17
7Y03A005CN	ThinkSystem SR570	HTK	1x Xeon Bronze 3106 8C/1.7GHz/11MB/85W/DDR4-2133	1x 16GB RDIMM (2Rx8)	1x 930-8i 2GB Flash	4x 3.5"	4x 3.5"	SATA/SAS HS	None	None	2x GbE RJ-45, 1x Mgmt	2x GbE RJ-45 LOM	1x LOM	1x PCIe x8 LP, 1x PCIe x16 LP	None	None	TPM 1.2	XClarity Standard	1x 750W Platinum	None	3-year	11/17
7Y03A006CN	ThinkSystem SR570	HTK	1x Xeon Silver 4108 8C/1.8GHz/11MB/85W/DDR4-2400	1x 16GB RDIMM (2Rx8)	1x 930-8i 2GB Flash	8x 2.5"	8x 2.5"	SATA/SAS HS	None	None	2x GbE RJ-45, 1x Mgmt	2x GbE RJ-45 LOM	1x LOM	1x PCIe x8 LP, 1x PCIe x16 LP	None	None	TPM 1.2	XClarity Standard	1x 750W Platinum	None	3-year	11/17
7Y03A007CN	ThinkSystem SR570	HTK	1x Xeon Gold 5118 12C/2.3GHz/16.5MB/105W/DDR4-2400	1x 16GB RDIMM (2Rx8)	1x 930-8i 2GB Flash	4x 3.5"	4x 3.5"	SATA/SAS HS	None	None	2x GbE RJ-45, 1x Mgmt	2x GbE RJ-45 LOM	1x LOM	1x PCIe x8 LP, 1x PCIe x16 LP	None	None	TPM 1.2	XClarity Standard	1x 750W Platinum	None	3-year	11/17

Model	Product	Region	Processor	Memory	Storage Controller	Chassis	Disk Bays	Disks	M.2 Drives	Onboard Networking Ports	Additional Networking (LOM/ML2/PCle)	Standard Extension Slots	Available Extension Slots via Riser Cards	Front VGA	Optical	TPM	System Management	Power Supply	Preload	Warranty	Ann Date (mm/yy)	
7Y03A008CN	ThinkSystem SR570	HTK	1x Xeon Gold 5118 12C/2.3GHz/16.5MB/105W/DDR4-2400	1x 16GB RDIMM	1x 930-8i 2GB Flash (2Rx8)	8x 2.5"	8x 2.5"	SATA/SAS HS	None	None	2x GbE RJ-45, 1x Mgmt	2x GbE RJ-45 LOM	1x LOM	1x PCIe x8 LP, 1x PCIe x16 LP	None	None	TPM 1.2	XClarity Standard	1x 750W Platinum	None	3-year	11/17
7Y03A009CN	ThinkSystem SR570	HTK	1x Xeon Silver 4116 12C/2.1GHz/16.5MB/85W/DDR4-2400	1x 16GB RDIMM	1x 930-8i 2GB Flash (2Rx8)	4x 3.5"	4x 3.5"	SATA/SAS HS	None	None	2x GbE RJ-45, 1x Mgmt	2x GbE RJ-45 LOM	1x LOM	1x PCIe x8 LP, 1x PCIe x16 LP	None	None	TPM 1.2	XClarity Standard	1x 750W Platinum	None	3-year	11/17
7Y03A00ACN	ThinkSystem SR570	HTK	1x Xeon Silver 4114 10C/2.2GHz/13.75MB/85W/DDR4-2400	1x 16GB RDIMM	1x 930-8i 2GB Flash (2Rx8)	4x 3.5"	4x 3.5"	SATA/SAS HS	None	None	2x GbE RJ-45, 1x Mgmt	2x GbE RJ-45 LOM	1x LOM	1x PCIe x8 LP, 1x PCIe x16 LP	None	None	TPM 1.2	XClarity Standard	1x 750W Platinum	None	3-year	11/17
7Y03A00BCN	ThinkSystem SR570	HTK	1x Xeon Bronze 3104 6C/1.7GHz/8.25MB/85W/DDR4-2133	1x 16GB RDIMM	1x 930-8i 2GB Flash (2Rx8)	4x 3.5"	4x 3.5"	SATA/SAS HS	None	None	2x GbE RJ-45, 1x Mgmt	2x GbE RJ-45 LOM	1x LOM	1x PCIe x8 LP, 1x PCIe x16 LP	None	None	TPM 1.2	XClarity Standard	1x 750W Platinum	None	3-year	11/17
7Y03A00CCN	ThinkSystem SR570	HTK	1x Xeon Bronze 3104 6C/1.7GHz/8.25MB/85W/DDR4-2133	1x 16GB RDIMM	1x 930-8i 2GB Flash (2Rx8)	8x 2.5"	8x 2.5"	SATA/SAS HS	None	None	2x GbE RJ-45, 1x Mgmt	2x GbE RJ-45 LOM	1x LOM	1x PCIe x8 LP, 1x PCIe x16 LP	None	None	TPM 1.2	XClarity Standard	1x 750W Platinum	None	3-year	11/17
7Y03A00DCN	ThinkSystem SR570	HTK	1x Xeon Silver 4112 4C/2.6GHz/8.25MB/85W/DDR4-2400	1x 16GB RDIMM	1x 930-8i 2GB Flash (2Rx8)	4x 3.5"	4x 3.5"	SATA/SAS HS	None	None	2x GbE RJ-45, 1x Mgmt	2x GbE RJ-45 LOM	1x LOM	1x PCIe x8 LP, 1x PCIe x16 LP	None	None	TPM 1.2	XClarity Standard	1x 750W Platinum	None	3-year	11/17
7Y03A00ECN	ThinkSystem SR570	HTK	1x Xeon Silver 4114 10C/2.2GHz/13.75MB/85W/DDR4-2400	1x 16GB RDIMM	1x 930-8i 2GB Flash (2Rx8)	8x 2.5"	8x 2.5"	SATA/SAS HS	None	None	2x GbE RJ-45, 1x Mgmt	2x GbE RJ-45 LOM	1x LOM	1x PCIe x8 LP, 1x PCIe x16 LP	None	None	TPM 1.2	XClarity Standard	1x 750W Platinum	None	3-year	11/17
7Y03A00FCN	ThinkSystem SR570	HTK	1x Xeon Silver 4116 12C/2.1GHz/16.5MB/85W/DDR4-2400	1x 16GB RDIMM	1x 930-8i 2GB Flash (2Rx8)	8x 2.5"	8x 2.5"	SATA/SAS HS	None	None	2x GbE RJ-45, 1x Mgmt	2x GbE RJ-45 LOM	1x LOM	1x PCIe x8 LP, 1x PCIe x16 LP	None	None	TPM 1.2	XClarity Standard	1x 750W Platinum	None	3-year	11/17

Model	Product	Region	Processor	Memory	Storage Controller	Chassis	Disk Bays	Disk S	M.2 Drives	Onboard Networking Ports	Additional Networking (LOM/ML2/PCIe)	Standard Extension Slots	Available Extension Slots via Riser Cards	Front VGA	Optical	TPM	System Management	Power Supply	Preload	Warranty	Ann Date (mm/yy)
7Y03A010SG	ThinkSystem SR570	INDIA	1x Xeon Silver 4108 8C/1.8GHz/11MB/85W/DDR4-2400	1x 8GB RDIMM DDR4-2666 (1Rx8)	1x 530-8i	4x 3.5"	4x 3.5" SATA/SS HS	None	None	2x GbE RJ-45, 1x Mgmt	2x GbE RJ-45 LOM	1x LOM	1x PCIe x8 LP, 1x PCIe x16 LP	1x Front VGA	USB DVD±RW	TPM 1.2	XClarity Standard	1x 750W Platinum	None	3-year	01/18
7Y03A013SG	ThinkSystem SR570	INDIA	1x Xeon Gold 5115 10C/2.4GHz/13.75MB/85W/DDR4-2400	1x 16GB RDIMM DDR4-2666 (1Rx4)	1x 530-8i	8x 2.5"	8x 2.5" SATA/SS HS	None	None	2x GbE RJ-45, 1x Mgmt	2x GbE RJ-45 LOM	1x LOM	1x PCIe x8 LP, 1x PCIe x16 LP	1x Front VGA	USB DVD±RW	TPM 1.2	XClarity Standard	1x 750W Platinum	None	3-year	01/18
7Y03A01NSG	ThinkSystem SR570	INDIA	1x Xeon Silver 4108 8C/1.8GHz/11MB/85W/DDR4-2400	1x 8GB RDIMM DDR4-2666 (1Rx8)	1x 530-8i	8x 2.5"	8x 2.5" SATA/SS HS	None	None	2x GbE RJ-45, 1x Mgmt	2x GbE RJ-45 LOM	1x LOM	1x PCIe x8 LP, 1x PCIe x16 LP	1x Front VGA	USB DVD±RW	TPM 1.2	XClarity Standard	1x 750W Platinum	None	3-year	01/18
7Y03A01CSG	ThinkSystem SR570	INDIA	1x Xeon Gold 5117 14C/2.0GHz/19.25MB/105W/DDR4-2400	1x 16GB RDIMM DDR4-2666 (1Rx4)	1x 930-8i 2GB Flash	8x 2.5"	8x 2.5" SATA/SS HS	None	None	2x GbE RJ-45, 1x Mgmt	2x GbE RJ-45 LOM	1x LOM	1x PCIe x8 LP, 1x PCIe x16 LP	1x Front VGA	USB DVD±RW	TPM 1.2	XClarity Standard	1x 750W Platinum	None	3-year	01/18
7Y03A019SG	ThinkSystem SR570	INDIA	1x Xeon Gold 5115 10C/2.4GHz/13.75MB/85W/DDR4-2400	1x 16GB RDIMM DDR4-2666 (1Rx4)	1x 930-8i 2GB Flash	8x 2.5"	8x 2.5" SATA/SS HS	None	None	2x GbE RJ-45, 1x Mgmt	2x GbE RJ-45 LOM	1x LOM	1x PCIe x8 LP, 1x PCIe x16 LP	1x Front VGA	USB DVD±RW	TPM 1.2	XClarity Standard	1x 750W Platinum	None	3-year	01/18
7Y03A01JSG	ThinkSystem SR570	INDIA	1x Xeon Silver 4108 8C/1.8GHz/11MB/85W/DDR4-2400	1x 8GB RDIMM DDR4-2666 (1Rx8)	Onboard Intel RSTe	4x 3.5"	4x 3.5" SATA SS	None	None	2x GbE RJ-45, 1x Mgmt	2x GbE RJ-45 LOM	1x LOM	1x PCIe x8 LP, 1x PCIe x16 LP	1x Front VGA	USB DVD±RW	TPM 1.2	XClarity Standard	1x 750W Platinum	None	3-year	01/18

Model	Product	Region	Processor	Memory	Storage Controller	Chassis	Disk Bays	Disk S	M.2 Drives	Onboard Networking Ports	Additional Networking (LOM/ML2/PCIe)	Standard Extension Slots	Available Extension Slots via Riser Cards	Front VGA	Optical	TPM	System Management	Power Supply	Preload	Warranty	Ann Date (mm/yy)
7Y03A01DJP	ThinkSystem SR570	JAPAN	1x Xeon Gold 6134 8C/3.2GHz/24.75MB/130W/DDR4-2666	1x 16GB RDIMM DDR4-2666 (2Rx8)	1x 930-8i 2GB Flash	8x 2.5"	8x 2.5" SATA/SAS HS	None	None	2x GbE RJ-45, 1x Mgmt	None	1x LOM	1x PCIe x8 LP, 1x PCIe x16 LP	None	None	TPM 1.2	XClarity Advanced	1x 750W Platinum	None	3-year	11/17
7Y03A02DJP	ThinkSystem SR570	JAPAN	1x Xeon Platinum 8160 24C/2.1GHz/33MB/150W/DDR4-2666	1x 16GB RDIMM DDR4-2666 (2Rx8)	1x 930-8i 2GB Flash	8x 2.5"	8x 2.5" SATA/SAS HS	None	None	2x GbE RJ-45, 1x Mgmt	None	1x LOM	1x PCIe x8 LP, 1x PCIe x16 LP	None	None	TPM 1.2	XClarity Advanced	1x 750W Platinum	None	3-year	11/17
7Y03A02EJP	ThinkSystem SR570	JAPAN	1x Xeon Gold 6136 12C/3.0GHz/24.75MB/150W/DDR4-2666	1x 16GB RDIMM DDR4-2666 (2Rx8)	1x 930-8i 2GB Flash	8x 2.5"	8x 2.5" SATA/SAS HS	None	None	2x GbE RJ-45, 1x Mgmt	None	1x LOM	1x PCIe x8 LP, 1x PCIe x16 LP	None	None	TPM 1.2	XClarity Advanced	1x 750W Platinum	None	3-year	11/17
7Y03A028JP	ThinkSystem SR570	JAPAN	1x Xeon Gold 6130 16C/2.1GHz/22MB/125W/DDR4-2666	1x 16GB RDIMM DDR4-2666 (2Rx8)	1x 930-16i 4GB Flash	10x 2.5"	10x 2.5" SATA/SAS , 4 AnyBay)	None	None	2x GbE RJ-45, 1x Mgmt	None	1x LOM	1x PCIe x8 LP, 1x PCIe x16 LP	None	None	TPM 1.2	XClarity Advanced	1x 750W Platinum	None	3-year	11/17
7Y03A02VJP	ThinkSystem SR570	JAPAN	1x Xeon Bronze 3104 6C/1.7GHz/8.25MB/85W/DDR4-2133	1x 16GB RDIMM DDR4-2666 (2Rx8)	1x 930-8i 2GB Flash	8x 2.5"	8x 2.5" SATA/SAS HS	None	None	2x GbE RJ-45, 1x Mgmt	None	1x LOM	1x PCIe x8 LP, 1x PCIe x16 LP	None	None	TPM 1.2	XClarity Advanced	1x 550W Platinum	None	3-year	11/17
7Y03A02WJP	ThinkSystem SR570	JAPAN	1x Xeon Silver 4112 4C/2.6GHz/8.25MB/85W/DDR4-2400	1x 16GB RDIMM DDR4-2666 (2Rx8)	1x 930-8i 2GB Flash	8x 2.5"	8x 2.5" SATA/SAS HS	None	None	2x GbE RJ-45, 1x Mgmt	None	1x LOM	1x PCIe x8 LP, 1x PCIe x16 LP	None	None	TPM 1.2	XClarity Advanced	1x 550W Platinum	None	3-year	11/17
7Y03A02XJP	ThinkSystem SR570	JAPAN	1x Xeon Silver 4110 8C/2.1GHz/11MB/85W/DDR4-2400	1x 16GB RDIMM DDR4-2666 (2Rx8)	1x 930-8i 2GB Flash	8x 2.5"	8x 2.5" SATA/SAS HS	None	None	2x GbE RJ-45, 1x Mgmt	None	1x LOM	1x PCIe x8 LP, 1x PCIe x16 LP	None	None	TPM 1.2	XClarity Advanced	1x 550W Platinum	None	3-year	11/17
7Y03A02YJP	ThinkSystem SR570	JAPAN	1x Xeon Bronze 3106 8C/1.7GHz/11MB/85W/DDR4-2133	1x 16GB RDIMM DDR4-2666 (2Rx8)	1x 930-8i 2GB Flash	8x 2.5"	8x 2.5" SATA/SAS HS	None	None	2x GbE RJ-45, 1x Mgmt	None	1x LOM	1x PCIe x8 LP, 1x PCIe x16 LP	None	None	TPM 1.2	XClarity Advanced	1x 550W Platinum	None	3-year	11/17
7Y03A02ZJP	ThinkSystem SR570	JAPAN	1x Xeon Silver 4114 10C/2.2GHz/13.75MB/85W/DDR4-2400	1x 16GB RDIMM DDR4-2666 (2Rx8)	1x 930-8i 2GB Flash	8x 2.5"	8x 2.5" SATA/SAS HS	None	None	2x GbE RJ-45, 1x Mgmt	None	1x LOM	1x PCIe x8 LP, 1x PCIe x16 LP	None	None	TPM 1.2	XClarity Advanced	1x 550W Platinum	None	3-year	11/17
7Y03A030JP	ThinkSystem SR570	JAPAN	1x Xeon Silver 4108 8C/1.8GHz/11MB/85W/DDR4-2400	1x 16GB RDIMM DDR4-2666 (2Rx8)	1x 930-8i 2GB Flash	8x 2.5"	8x 2.5" SATA/SAS HS	None	None	2x GbE RJ-45, 1x Mgmt	None	1x LOM	1x PCIe x8 LP, 1x PCIe x16 LP	None	None	TPM 1.2	XClarity Advanced	1x 550W Platinum	None	3-year	11/17

Model	Product	Region	Processor	Memory	Storage Controller	Chassis	Disk Bays	Disks	M.2 Drives	Onboard Networking Ports	Additional Networking (LOM/ML2/PCle)	Standard Extension Slots	Available Extension Slots via Riser Cards	Front VGA	Optical	TPM	System Management	Power Supply	Preload	Warranty	Ann Date (mm/yy)	
7Y03A016NA	ThinkSystem SR570	NA	1x Xeon Bronze 3104 6C/1.7GHz/8.25MB/85W/DDR4-2133	1x 16GB RDIMM DDR4-2666 (2Rx8)	1x 530-8i	8x 2.5"	8x 2.5"	SATA/SAS None HS	None	None	2x GbE RJ-45, 1x Mgmt	None	1x LOM	1x PCIe x8 LP, 1x PCIe x16 LP	None	None	TPM 1.2	XClarity Standard	1x 750W Platinum	None	3-year	11/17
7Y03A01LNA	ThinkSystem SR570	NA	1x Xeon Silver 4110 8C/2.1GHz/11MB/85W/DDR4-2400	1x 16GB RDIMM DDR4-2666 (2Rx8)	1x 930-8i	8x 2.5"	8x 2.5"	SATA/SAS None HS	None	None	2x GbE RJ-45, 1x Mgmt	None	1x LOM	1x PCIe x8 LP, 1x PCIe x16 LP	None	None	TPM 1.2	XClarity Standard	1x 750W Platinum	None	3-year	11/17
7Y03A01KNA	ThinkSystem SR570	NA	1x Xeon Silver 4114 10C/2.2GHz/13.75MB/85W/DDR4-2400	1x 16GB RDIMM DDR4-2666 (2Rx8)	1x 930-8i	8x 2.5"	8x 2.5"	SATA/SAS None HS	None	None	2x GbE RJ-45, 1x Mgmt	None	1x LOM	1x PCIe x8 LP, 1x PCIe x16 LP	None	None	TPM 1.2	XClarity Standard	1x 750W Platinum	None	3-year	11/17
7Y03A01PNA	ThinkSystem SR570	NA	1x Xeon Silver 4108 8C/1.8GHz/11MB/85W/DDR4-2400	1x 16GB RDIMM DDR4-2666 (2Rx8)	1x 930-8i	8x 2.5"	8x 2.5"	SATA/SAS None HS	None	None	2x GbE RJ-45, 1x Mgmt	None	1x LOM	1x PCIe x8 LP, 1x PCIe x16 LP	None	None	TPM 1.2	XClarity Standard	1x 750W Platinum	None	3-year	11/17
7Y03A01SNA	ThinkSystem SR570	NA	1x Xeon Gold 5118 12C/2.3GHz/16.5MB/105W/DDR4-2400	1x 16GB RDIMM DDR4-2666 (2Rx8)	1x 530-8i	4x 3.5"	4x 3.5"	SATA/SAS None HS	None	None	2x GbE RJ-45, 1x Mgmt	None	1x LOM	1x PCIe x8 LP, 1x PCIe x16 LP	None	None	TPM 1.2	XClarity Standard	1x 750W Platinum	None	3-year	11/17
7Y03A01TNA	ThinkSystem SR570	NA	1x Xeon Bronze 3106 8C/1.7GHz/11MB/85W/DDR4-2133	1x 16GB RDIMM DDR4-2666 (2Rx8)	Onboard Intel RSTe	4x 3.5"	4x 3.5"	SATA SS	None	None	2x GbE RJ-45, 1x Mgmt	None	1x LOM	None	None	None	TPM 1.2	XClarity Standard	1x 750W Platinum	None	3-year	11/17
7Y03A01VNA	ThinkSystem SR570	NA	1x Xeon Gold 5118 12C/2.3GHz/16.5MB/105W/DDR4-2400	1x 16GB RDIMM DDR4-2666 (2Rx8)	1x 930-8i	4x 3.5"	4x 3.5"	SATA/SAS None HS	None	None	2x GbE RJ-45, 1x Mgmt	None	1x LOM	1x PCIe x8 LP, 1x PCIe x16 LP	None	None	TPM 1.2	XClarity Standard	1x 750W Platinum	None	3-year	11/17
7Y03A01XNA	ThinkSystem SR570	NA	1x Xeon Silver 4110 8C/2.1GHz/11MB/85W/DDR4-2400	1x 16GB RDIMM DDR4-2666 (2Rx8)	1x 530-8i	4x 3.5"	4x 3.5"	SATA/SAS None HS	None	None	2x GbE RJ-45, 1x Mgmt	None	1x LOM	1x PCIe x8 LP, 1x PCIe x16 LP	None	None	TPM 1.2	XClarity Standard	1x 750W Platinum	None	3-year	11/17
7Y03A01WNA	ThinkSystem SR570	NA	1x Xeon Silver 4110 8C/2.1GHz/11MB/85W/DDR4-2400	1x 16GB RDIMM DDR4-2666 (2Rx8)	1x 930-8i	4x 3.5"	4x 3.5"	SATA/SAS None HS	None	None	2x GbE RJ-45, 1x Mgmt	None	1x LOM	1x PCIe x8 LP, 1x PCIe x16 LP	None	None	TPM 1.2	XClarity Standard	1x 750W Platinum	None	3-year	11/17
7Y03A012NA	ThinkSystem SR570	NA	1x Xeon Silver 4108 8C/1.8GHz/11MB/85W/DDR4-2400	1x 16GB RDIMM DDR4-2666 (2Rx8)	1x 530-8i	8x 2.5"	8x 2.5"	SATA/SAS None HS	None	None	2x GbE RJ-45, 1x Mgmt	None	1x LOM	1x PCIe x8 LP, 1x PCIe x16 LP	None	None	TPM 1.2	XClarity Standard	1x 750W Platinum	None	3-year	11/17

Model	Product	Region	Processor	Memory	Storage Controller	Chassis	Disk Bays	Disk S	M.2 Drives	Onboard Networking Ports	Additional Networking (LOM/ML2/PCIe)	Standard Extension Slots	Available Extension Slots via Riser Cards	Front VGA	Optical	TPM	System Management	Power Supply	Preload	Warranty	Ann Date (mm/yy)
7Y03A00ZNA	ThinkSystem SR570	NA	1x Xeon Gold 5118 12C/2.3GHz/16.5MB/105W/DDR4-2400	1x 16GB RDIMM DDR4-2666 (2Rx8)	1x 930-8i 2GB Flash	8x 2.5"	8x 2.5" SATA/SAS HS	None	None	2x GbE RJ-45, 1x Mgmt	None	1x LOM	1x PCIe x8 LP, 1x PCIe x16 LP	None	None	TPM 1.2	XClarity Standard	1x 750W Platinum	None	3-year	11/17
7Y03A011NA	ThinkSystem SR570	NA	1x Xeon Silver 4116 12C/2.1GHz/16.5MB/85W/DDR4-2400	1x 16GB RDIMM DDR4-2666 (2Rx8)	1x 930-8i 2GB Flash	8x 2.5"	8x 2.5" SATA/SAS HS	None	None	2x GbE RJ-45, 1x Mgmt	None	1x LOM	1x PCIe x8 LP, 1x PCIe x16 LP	None	None	TPM 1.2	XClarity Standard	1x 750W Platinum	None	3-year	11/17
7Y03A00WNA	ThinkSystem SR570	NA	1x Xeon Gold 6142 16C/2.6GHz/22MB/150W/DDR4-2666	1x 32GB RDIMM DDR4-2666 (2Rx4)	1x 930-8i 2GB Flash	8x 2.5"	8x 2.5" SATA/SAS HS	None	None	2x GbE RJ-45, 1x Mgmt	None	1x LOM	1x PCIe x8 LP, 1x PCIe x16 LP	None	None	TPM 1.2	XClarity Standard	1x 750W Platinum	None	3-year	11/17
7Y03A00UNA	ThinkSystem SR570	NA	1x Xeon Silver 4110 8C/2.1GHz/11MB/85W/DDR4-2400	1x 16GB RDIMM DDR4-2666 (2Rx8)	1x 530-8i	8x 2.5"	8x 2.5" SATA/SAS HS	None	None	2x GbE RJ-45, 1x Mgmt	None	1x LOM	1x PCIe x8 LP, 1x PCIe x16 LP	None	None	TPM 1.2	XClarity Standard	1x 750W Platinum	None	3-year	11/17
7Y03A00QNA	ThinkSystem SR570	NA	1x Xeon Gold 5120 14C/2.2GHz/19.25MB/105W/DDR4-2400	1x 16GB RDIMM DDR4-2666 (2Rx8)	1x 930-8i 2GB Flash	8x 2.5"	8x 2.5" SATA/SAS HS	None	None	2x GbE RJ-45, 1x Mgmt	None	1x LOM	1x PCIe x8 LP, 1x PCIe x16 LP	None	None	TPM 1.2	XClarity Standard	1x 750W Platinum	None	3-year	11/17
7Y03A00TNA	ThinkSystem SR570	NA	1x Xeon Gold 6130 16C/2.1GHz/22MB/125W/DDR4-2666	1x 32GB RDIMM DDR4-2666 (2Rx4)	1x 930-8i 2GB Flash	8x 2.5"	8x 2.5" SATA/SAS HS	None	None	2x GbE RJ-45, 1x Mgmt	None	1x LOM	1x PCIe x8 LP, 1x PCIe x16 LP	None	None	TPM 1.2	XClarity Standard	1x 750W Platinum	None	3-year	11/17
7Y03A00SNA	ThinkSystem SR570	NA	1x Xeon Bronze 3104 6C/1.7GHz/8.25MB/85W/DDR4-2133	1x 16GB RDIMM DDR4-2666 (2Rx8)	1x 930-8i 2GB Flash	8x 2.5"	8x 2.5" SATA/SAS HS	None	None	2x GbE RJ-45, 1x Mgmt	None	1x LOM	1x PCIe x8 LP, 1x PCIe x16 LP	None	None	TPM 1.2	XClarity Standard	1x 750W Platinum	None	3-year	11/17
7Y03A00NNA	ThinkSystem SR570	NA	1x Xeon Silver 4114 10C/2.2GHz/13.75MB/85W/DDR4-2400	1x 16GB RDIMM DDR4-2666 (2Rx8)	1x 530-8i	8x 2.5"	8x 2.5" SATA/SAS HS	None	None	2x GbE RJ-45, 1x Mgmt	None	1x LOM	1x PCIe x8 LP, 1x PCIe x16 LP	None	None	TPM 1.2	XClarity Standard	1x 750W Platinum	None	3-year	11/17
7Y03A00HNA	ThinkSystem SR570	NA	2x Xeon Gold 5118 12C/2.3GHz/16.5MB/105W/DDR4-2400	2x 32GB RDIMM DDR4-2666 (2Rx4)	1x 430-16i	10x 2.5"	10x 2.5" SATA/SAS , 4 AnyBay)	None	None	2x GbE RJ-45, 1x Mgmt	None	1x LOM	1x PCIe x8 LP, 2x PCIe x16 LP	None	None	TPM 1.2	XClarity Enterprise	2x 750W Platinum	None	3-year	11/17
7Y03A00GNA	ThinkSystem SR570	NA	2x Xeon Silver 4114 10C/2.2GHz/13.75MB/85W/DDR4-2400	2x 32GB RDIMM DDR4-2666 (2Rx4)	1x 430-16i	10x 2.5"	10x 2.5" SATA/SAS , 4 AnyBay)	None	None	2x GbE RJ-45, 1x Mgmt	None	1x LOM	1x PCIe x8 LP, 2x PCIe x16 LP	None	None	TPM 1.2	XClarity Enterprise	2x 750W Platinum	None	3-year	11/17



ThinkSystem SR590 Platform Specifications

Product Specifications Reference (PSREF)

Components	Specification																																																																																																						
Form factor	2U rack																																																																																																						
Dimensions	Height: 86.5 mm (3.4 in). Width: 482 mm (19.0 in) with rack latches. Depth: 763.7 mm (30.1 in)																																																																																																						
Weight	Maximum configuration: 61.7 lb (28 kg)																																																																																																						
Processor	Up to two 150W Intel Xeon Scalable family processors, Bronze, Silver, Gold, or Platinum. Up to 26 cores at 2.0GHz, up to 3.6GHz with 4 cores. Two processors are connected with two UPI (Ultra Path Interconnect) links up to 10.4GT/s each																																																																																																						
Chipset	Intel C622 Platform Controller Hub																																																																																																						
Memory	Up to 16 DIMM sockets. Each processor supports up to 8 DIMM sockets with 6 channels. DDR4-2666. RDIMMs and LRDIMMs are supported, but memory types cannot be intermixed																																																																																																						
Memory capacity	With RDIMMs: Up to 512GB with 16 x 32 GB RDIMMs and two processors With LRDIMMs: Up to 1TB with 16 x 64 GB LRDIMMs and two processors																																																																																																						
Memory protection	ECC, memory mirroring, and memory sparing																																																																																																						
Storage controllers	Supports the following RAID/HBA adapters:																																																																																																						
	<table border="1"> <thead> <tr> <th></th> <th>RAID adapter</th> <th>Interface</th> <th>Drive type</th> <th>RAID levels</th> <th>JBOD</th> <th>Cache</th> <th>Cache protection</th> <th>FastPath</th> <th>Max qty</th> </tr> </thead> <tbody> <tr> <td rowspan="3">For SS bays</td> <td>Onboard SATA</td> <td>6Gb SATA</td> <td>SATA</td> <td>0/1/10/5</td> <td>Yes</td> <td>None</td> <td>None</td> <td>No</td> <td>-</td> </tr> <tr> <td>530-8i</td> <td>12Gbs SAS</td> <td>SATA/SAS</td> <td>0/1/10/5/50</td> <td>Yes</td> <td>None</td> <td>None</td> <td>Yes</td> <td>2</td> </tr> <tr> <td>730-8i</td> <td>12Gbs SAS</td> <td>SATA/SAS</td> <td>0/1/10/5/50</td> <td>Yes</td> <td>1GB</td> <td>None</td> <td>No</td> <td>2</td> </tr> <tr> <td rowspan="7">For HS bays</td> <td>930-8i</td> <td>12Gbs SAS</td> <td>SATA/SAS</td> <td>0/1/10/5/50/6/60</td> <td>Yes</td> <td>2GB</td> <td>Flash backup</td> <td>Yes</td> <td>2</td> </tr> <tr> <td>930-16i</td> <td>12Gbs SAS</td> <td>SATA/SAS</td> <td>0/1/10/5/50/6/60</td> <td>Yes</td> <td>4GB</td> <td>Flash backup</td> <td>Yes</td> <td>1</td> </tr> <tr> <td>430-8i</td> <td>12Gbs SAS</td> <td>SATA/SAS</td> <td>-</td> <td>Yes</td> <td>None</td> <td>None</td> <td>-</td> <td>2</td> </tr> <tr> <td>430-16i</td> <td>12Gbs SAS</td> <td>SATA/SAS</td> <td>-</td> <td>Yes</td> <td>None</td> <td>None</td> <td>-</td> <td>1</td> </tr> <tr> <td>430-8e</td> <td>12Gbs SAS</td> <td>SATA/SAS</td> <td>-</td> <td>Yes</td> <td>None</td> <td>None</td> <td>-</td> <td>5</td> </tr> <tr> <td>430-16e</td> <td>12Gbs SAS</td> <td>SATA/SAS</td> <td>-</td> <td>Yes</td> <td>None</td> <td>None</td> <td>-</td> <td>5</td> </tr> <tr> <td>930-8e</td> <td>12Gbs SAS</td> <td>SATA/SAS</td> <td>0/1/10/5/50/6/60</td> <td>Yes</td> <td>4GB</td> <td>Flash backup</td> <td>Yes</td> <td>3</td> </tr> </tbody> </table>		RAID adapter	Interface	Drive type	RAID levels	JBOD	Cache	Cache protection	FastPath	Max qty	For SS bays	Onboard SATA	6Gb SATA	SATA	0/1/10/5	Yes	None	None	No	-	530-8i	12Gbs SAS	SATA/SAS	0/1/10/5/50	Yes	None	None	Yes	2	730-8i	12Gbs SAS	SATA/SAS	0/1/10/5/50	Yes	1GB	None	No	2	For HS bays	930-8i	12Gbs SAS	SATA/SAS	0/1/10/5/50/6/60	Yes	2GB	Flash backup	Yes	2	930-16i	12Gbs SAS	SATA/SAS	0/1/10/5/50/6/60	Yes	4GB	Flash backup	Yes	1	430-8i	12Gbs SAS	SATA/SAS	-	Yes	None	None	-	2	430-16i	12Gbs SAS	SATA/SAS	-	Yes	None	None	-	1	430-8e	12Gbs SAS	SATA/SAS	-	Yes	None	None	-	5	430-16e	12Gbs SAS	SATA/SAS	-	Yes	None	None	-	5	930-8e	12Gbs SAS	SATA/SAS	0/1/10/5/50/6/60	Yes	4GB	Flash backup	Yes	3
		RAID adapter	Interface	Drive type	RAID levels	JBOD	Cache	Cache protection	FastPath	Max qty																																																																																													
	For SS bays	Onboard SATA	6Gb SATA	SATA	0/1/10/5	Yes	None	None	No	-																																																																																													
		530-8i	12Gbs SAS	SATA/SAS	0/1/10/5/50	Yes	None	None	Yes	2																																																																																													
		730-8i	12Gbs SAS	SATA/SAS	0/1/10/5/50	Yes	1GB	None	No	2																																																																																													
	For HS bays	930-8i	12Gbs SAS	SATA/SAS	0/1/10/5/50/6/60	Yes	2GB	Flash backup	Yes	2																																																																																													
		930-16i	12Gbs SAS	SATA/SAS	0/1/10/5/50/6/60	Yes	4GB	Flash backup	Yes	1																																																																																													
		430-8i	12Gbs SAS	SATA/SAS	-	Yes	None	None	-	2																																																																																													
		430-16i	12Gbs SAS	SATA/SAS	-	Yes	None	None	-	1																																																																																													
430-8e		12Gbs SAS	SATA/SAS	-	Yes	None	None	-	5																																																																																														
430-16e		12Gbs SAS	SATA/SAS	-	Yes	None	None	-	5																																																																																														
930-8e		12Gbs SAS	SATA/SAS	0/1/10/5/50/6/60	Yes	4GB	Flash backup	Yes	3																																																																																														
<i>Note: 730-8i is available in China only</i>																																																																																																							
Disk drive bays	Supports 3.5" Simple-swap bay up to 8, or 3.5" HS bay up to 12, or 2.5" HS bay up to 12. On 12x 3.5", 8x 2.5", or 16x 2.5" bay models, 4 bays can be upgrade to AnyBay. Optional 2 rear 3.5" HS bays are supported on 12 x 3.5" model, takes place in riser card 1 location. Optional one or two internal M.2 SSD for boot, dual M.2 SSD supports mirroring																																																																																																						
Internal storage	For 3.5" SS bay	3.5" HDD, SATA6Gbs, 7.2K	1TB/2TB/4TB/6TB/8TB																																																																																																				
		3.5" HDD, SATA6Gbs, 7.2K	1TB/2TB/4TB/6TB/8TB/10TB																																																																																																				
	For 3.5" bay (3.5" disks or 2.5" disks with 3.5" tray)	3.5" HDD, SAS12Gbs, 7.2K	1TB/2TB/4TB/6TB/10TB																																																																																																				
		3.5" HDD, SAS12Gbs, 15K	300GB/600GB/900GB																																																																																																				
		2.5" SSD, SATA6Gbs	240GB/480GB																																																																																																				
		2.5" NVMe SSD, AnyBay	960GB/1.92TB/3.84TB																																																																																																				
	For 2.5" bay	2.5" HDD, SATA6Gbs, 7.2K	1TB/2TB																																																																																																				
		2.5" HDD, SAS12Gbs, 7.2K	1TB/2TB																																																																																																				
		2.5" HDD, SAS12Gbs, 10K	300GB/600GB/900GB/1.2TB/1.8TB																																																																																																				
		2.5" HDD, SAS12Gbs, 10K, SED	300GB/600GB																																																																																																				
2.5" HDD, SAS12Gbs, 15K		300GB/600GB/900GB																																																																																																					
2.5" SSD, SAS12Gbs		400GB/800GB/3.84TB																																																																																																					
2.5" SSD, SATA6Gbs		240GB/480GB																																																																																																					
	2.5" NVMe SSD, AnyBay	960GB/1.6TB/1.92TB/3.84TB																																																																																																					
M.2 boot drive	M.2 SATA SSD	32GB/128GB																																																																																																					

Components	Specification	
Power supply	Up to two redundant hot-swap 550W and 750W 80 PLUS Platinum qualified AC power supplies. Or up to two redundant hot-swap 750W Titanium qualified AC power supplies. 750W Titanium is 200V - 240V, others are 100V - 240V	
Video	Integrated Matrox G200 in XClarity Controller	
Cooling	Three fans (2+1) for single processor model, four fans (3+1) for dual processor model	
Front ports	One XClarity Controller USB, one USB 3.0, one optional VGA	
Rear ports	One VGA, two USB 3.0, two ethernet (RJ-45), one XClarity Controller connector. Optional COM port	
Environmental specification	Supports ASHRAE A4 with limitations.	
	Temperature - operating	A4: 5°C to 45°C (41°F to 113°F) A3: 5°C to 40°C (41°F to 104°F) A2: 10°C to 35°C (50°F to 95°F)
	Temperature - non operating (no package)	-10°C to 60°C (14°F to 140°F)
	Temperature - non operating (with package)	-40°C to 70°C (-40°F to 158°F)
	Altitude - operating	(Unpressurized): 0-10000ft (0-3048m)
	Humidity - operating, non-condensing	A4: 8%~90%. A3:8%~85%. A2:8%~80%
	Humidity - storage (with package), non-condensing	8%~90%
	<i>Models should meet the following requirements to support A3 and A4:</i>	
	<ul style="list-style-type: none"> • Redundant power supplies required • No system fan fails • No NVMe drive • No rear two HS bays • Processor TDP is less than or equal to 140 watts, and no Intel Xeon 6140 or 6152 processor is installed • On 12x 3.5" models, no M.2 drives 	
	Environmental certification	Energy Star Server 2.1 certified. More environmental information please see: www.lenovo.com/social_responsibility/us/en/environment/

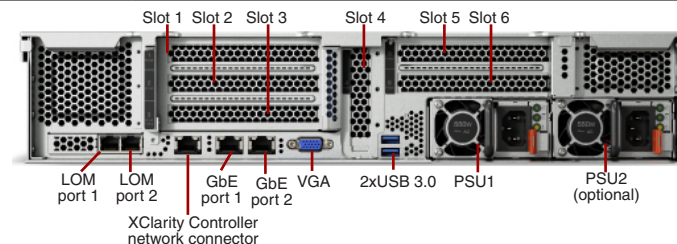

Note: GbE port 1 and LOM port 1 support Wake-on-LAN and NC-SI. Riser cards, expansion cards, and LOM adapters are optional.

Expansion slots	
Slot 1-3 (riser card 1)	Supports one of the following for riser card 1: Option 1: PCIe 3.0 x8/x8/x8 (slot 1-3). Full height, half length. Option 2: PCIe 3.0 x16/x8 (slot 1 and 3). Full height, half length Option 3: PCIe 3.0 x8/x8/x8 ML2 (slot 1-3). Full height, half length Option 4: Two rear 3.5" disk bays, 12 x 3.5" models only
Slot 4 (onboard)	PCIe 3.0 x8, low profile
Slot 5 (riser card 2)	PCIe 3.0 x16, full height, half length, requires 2nd CPU
Slot 6 (riser card 2)	PCIe 3.0 x8, full height, half length

System unique options	
7XH7A06253	ThinkSystem SR590/SR650 Rear HDD Kit
4XH7A08778	ThinkSystem SR550/SR590/SR650 x8/x8/x8 ML2 PCIe FH Riser 1 Kit
4XH7A08779	ThinkSystem SR550/SR590/SR650 x16/x8 PCIe FH Riser 1 Kit
4XH7A08777	ThinkSystem SR550/SR590/SR650 x8/x8/x8 PCIe FH Riser 1 Kit
4XH7A08780	ThinkSystem SR550/SR590/SR650 x16/x8 (or x16) PCIe FH Riser 2 Kit
7Z17A02578	ThinkSystem SR550/SR590/SR650 EIA Latch w/ VGA Upgrade Kit
7Z17A02580	ThinkSystem 2U Security Bezel
7Z17A02577	ThinkSystem COM Port Upgrade Kit
4XH7A08764	ThinkSystem SR590 2.5" Anybay 8-Bay Backplane Kit
4XH7A08763	ThinkSystem SR590 2.5" SATA/SAS 8-Bay Backplane Kit

Model	Product	Region	Processor	Memory	Storage Controller	Chassis	Disk Bays	Disks	M.2 Drives	Onboard Networking Ports	Additional Networking (LOM/ML2/PCIe)	Standard Extension Slots	Available Extension Slots via Riser Cards	Front VGA	Optical	TPM	System Management	Power Supply	Preload	Warranty	Ann Date (mm/yy)
7X99A03EAU	ThinkSystem SR590	ANZ	1x Xeon Bronze 3104 6C/1.7GHz/8.25MB/85W/DDR4-2133	1x 16GB RDIMM DDR4-2666 (2Rx8)	1x 930-8i 2GB Flash	16x 2.5"	8x 2.5"	SATA/SAS Open HS	None	2x GbE RJ-45, 1x Mgmt	None	1x LOM, 1x PCIe x8 LP	None	None	None	TPM 1.2	XClarity Enterprise	1x750W Platinum	None	3-year	11/17
7X99A03FAU	ThinkSystem SR590	ANZ	1x Xeon Silver 4110 8C/2.1GHz/11MB/85W/DDR4-2400	1x 16GB RDIMM DDR4-2666 (2Rx8)	1x 930-16i 4GB Flash	12x 3.5"	12x 3.5"	SATA/SAS Open HS	None	2x GbE RJ-45, 1x Mgmt	None	1x LOM, 1x PCIe x8 LP	None	None	None	TPM 1.2	XClarity Enterprise	1x750W Platinum	None	3-year	11/17
7X99A03GAU	ThinkSystem SR590	ANZ	1x Xeon Silver 4110 8C/2.1GHz/11MB/85W/DDR4-2400	1x 16GB RDIMM DDR4-2666 (2Rx8)	1x 930-16i 4GB Flash	16x 2.5"	16x 2.5"	SATA/SAS Open HS	None	2x GbE RJ-45, 1x Mgmt	None	1x LOM, 1x PCIe x8 LP	None	None	None	TPM 1.2	XClarity Enterprise	1x750W Platinum	None	3-year	11/17
7X99A03HAU	ThinkSystem SR590	ANZ	1x Xeon Silver 4116 12C/2.1GHz/16.5MB/85W/DDR4-2400	1x 16GB RDIMM DDR4-2666 (2Rx8)	1x 930-16i 4GB Flash	12x 3.5"	12x 3.5"	SATA/SAS Open HS	None	2x GbE RJ-45, 1x Mgmt	None	1x LOM, 1x PCIe x8 LP	None	None	None	TPM 1.2	XClarity Enterprise	1x750W Platinum	None	3-year	11/17
7X99A03JAU	ThinkSystem SR590	ANZ	1x Xeon Bronze 3104 6C/1.7GHz/8.25MB/85W/DDR4-2133	1x 16GB RDIMM DDR4-2666 (2Rx8)	1x 930-16i 4GB Flash	12x 3.5"	12x 3.5"	SATA/SAS Open HS	None	2x GbE RJ-45, 1x Mgmt	None	1x LOM, 1x PCIe x8 LP	None	None	None	TPM 1.2	XClarity Enterprise	1x750W Platinum	None	3-year	11/17
7X99A03KAU	ThinkSystem SR590	ANZ	1x Xeon Bronze 3106 8C/1.7GHz/11MB/85W/DDR4-2133	1x 16GB RDIMM DDR4-2666 (2Rx8)	1x 930-16i 4GB Flash	12x 3.5"	12x 3.5"	SATA/SAS Open HS	None	2x GbE RJ-45, 1x Mgmt	None	1x LOM, 1x PCIe x8 LP	None	None	None	TPM 1.2	XClarity Enterprise	1x750W Platinum	None	3-year	11/17
7X99A03LAU	ThinkSystem SR590	ANZ	1x Xeon Bronze 3106 8C/1.7GHz/11MB/85W/DDR4-2133	1x 16GB RDIMM DDR4-2666 (2Rx8)	1x 930-8i 2GB Flash	16x 2.5"	8x 2.5"	SATA/SAS Open HS	None	2x GbE RJ-45, 1x Mgmt	None	1x LOM, 1x PCIe x8 LP	None	None	None	TPM 1.2	XClarity Enterprise	1x750W Platinum	None	3-year	11/17
7X99A03MAU	ThinkSystem SR590	ANZ	1x Xeon Silver 4116 12C/2.1GHz/16.5MB/85W/DDR4-2400	1x 16GB RDIMM DDR4-2666 (2Rx8)	1x 930-16i 4GB Flash	16x 2.5"	16x 2.5"	SATA/SAS Open HS	None	2x GbE RJ-45, 1x Mgmt	None	1x LOM, 1x PCIe x8 LP	None	None	None	TPM 1.2	XClarity Enterprise	1x750W Platinum	None	3-year	11/17

Model	Product	Region	Processor	Memory	Storage Controller	Chassis	Disk Bays	Disks	M.2 Drives	Onboard Networking Ports	Additional Networking (LOM/ML2/PCIe)	Standard Extension Slots	Available Extension Slots via Riser Cards	Front VGA	Optical	TPM	System Management	Power Supply	Preload	Warranty	Ann Date (mm/yy)
7X99A039EA	ThinkSystem SR590	EMEA	1x Xeon Silver 4110 8C/2.1GHz/11MB/85W/DDR4-2400	1x 16GB RDIMM DDR4- 2666 (2Rx8)	1x 930-16i 4GB Flash	12x 3.5" SATA/SA S HS		Open	None	2x GbE RJ- 45, 1x Mgmt	None	1x LOM, 1x PCIe x8 LP	3x PCIe x8 FHHL	None	None	TP M 1.2	XClarity Advanced	1x750W Platinum	None	3-year	11/17
7X99A03BEA	ThinkSystem SR590	EMEA	1x Xeon Silver 4114 10C/2.2GHz/13.75MB/85W/DDR4-2400	1x 32GB RDIMM DDR4- 2666 (2Rx4)	1x 930-8i 2GB Flash	8x 2.5" SATA/SA S HS		Open	None	2x GbE RJ- 45, 1x Mgmt	None	1x LOM, 1x PCIe x8 LP	3x PCIe x8 FHHL	None	None	TP M 1.2	XClarity Advanced	2x750W Platinum	None	3-year	11/17
7X99A03CEA	ThinkSystem SR590	EMEA	1x Xeon Silver 4110 8C/2.1GHz/11MB/85W/DDR4-2400	1x 16GB RDIMM DDR4- 2666 (2Rx8)	1x 930-8i 2GB Flash	8x 2.5" SATA/SA S HS		Open	None	2x GbE RJ- 45, 1x Mgmt	None	1x LOM, 1x PCIe x8 LP	3x PCIe x8 FHHL	None	None	TP M 1.2	XClarity Advanced	1x750W Platinum	None	3-year	11/17
7X99A03PEA	ThinkSystem SR590	EMEA	1x Xeon Silver 4110 8C/2.1GHz/11MB/85W/DDR4-2400	1x 16GB RDIMM DDR4- 2666 (2Rx8)	1x 930-8i 2GB Flash	8x 2.5" SATA/SA S HS	3x600GB HDD 10K 2.5" SAS12Gbps		None	2x GbE RJ- 45, 1x Mgmt	None	1x LOM, 1x PCIe x8 LP	3x PCIe x8 FHHL	None	None	TP M 1.2	XClarity Advanced	2x750W Platinum	None	3-year	12/17

Model	Product	Region	Processor	Memory	Storage Controller	Chassis	Disk Bays	Disks	M.2 Drives	Onboard Networking Ports	Additional Networking (LOM/ML2/PCle)	Standard Extension Slots	Available Extension Slots via Riser Cards	Front VGA	Optical	TPM	System Management	Power Supply	Preload	Warranty	Ann Date (mm/yy)
7X99A004CN	ThinkSystem SR590	HTK	1x Xeon Gold 5120 14C/2.2GHz/19.25MB/105W/DDR4-2400	1x 16GB RDIMM (2Rx8)	1x 930-8i 26662GB Flash	12x 3.5"	8x 3.5"	SATA/SAS Open HS	None	2x GbE RJ-45, 1x Mgmt	2x GbE RJ-45 LOM	1x LOM, 1x PCle x8 LP	3x PCle x8 FHHL	None	None	TPM 2.0	XClarity Standard	1x750W Platinum	None	3-year	11/17
7X99A00ACN	ThinkSystem SR590	HTK	1x Xeon Silver 4112 4C/2.6GHz/8.25MB/85W/DDR4-2400	1x 16GB RDIMM (2Rx8)	1x 930-8i 26662GB Flash	16x 2.5"	8x 2.5"	SATA/SAS Open HS	None	2x GbE RJ-45, 1x Mgmt	2x GbE RJ-45 LOM	1x LOM, 1x PCle x8 LP	3x PCle x8 FHHL	None	None	TPM 2.0	XClarity Standard	1x750W Platinum	None	3-year	11/17
7X99A00BCN	ThinkSystem SR590	HTK	1x Xeon Gold 5120T 14C/2.2GHz/19.25MB/105W/DDR4-2400	1x 16GB RDIMM (2Rx8)	1x 930-8i 26662GB Flash	12x 3.5"	8x 3.5"	SATA/SAS Open HS	None	2x GbE RJ-45, 1x Mgmt	2x GbE RJ-45 LOM	1x LOM, 1x PCle x8 LP	3x PCle x8 FHHL	None	None	TPM 2.0	XClarity Standard	1x750W Platinum	None	3-year	11/17
7X99A008CN	ThinkSystem SR590	HTK	1x Xeon Gold 5122 4C/3.6GHz/16.5MB/105W/DDR4-2666	1x 16GB RDIMM (2Rx8)	1x 930-8i 26662GB Flash	12x 3.5"	8x 3.5"	SATA/SAS Open HS	None	2x GbE RJ-45, 1x Mgmt	2x GbE RJ-45 LOM	1x LOM, 1x PCle x8 LP	3x PCle x8 FHHL	None	None	TPM 2.0	XClarity Standard	1x750W Platinum	None	3-year	11/17
7X99A00FCN	ThinkSystem SR590	HTK	1x Xeon Bronze 3104 6C/1.7GHz/8.25MB/85W/DDR4-2133	1x 16GB RDIMM (2Rx8)	1x 530-8i 2666	12x 3.5"	8x 3.5"	SATA/SAS Open HS	None	2x GbE RJ-45, 1x Mgmt	2x GbE RJ-45 LOM	1x LOM, 1x PCle x8 LP	3x PCle x8 FHHL	None	None	TPM 2.0	XClarity Standard	1x750W Platinum	None	3-year	11/17
7X99A00RCN	ThinkSystem SR590	HTK	1x Xeon Bronze 3104 6C/1.7GHz/8.25MB/85W/DDR4-2133	1x 16GB RDIMM (2Rx8)	1x 530-8i 2666	16x 2.5"	8x 2.5"	SATA/SAS Open HS	None	2x GbE RJ-45, 1x Mgmt	2x GbE RJ-45 LOM	1x LOM, 1x PCle x8 LP	3x PCle x8 FHHL	None	None	TPM 2.0	XClarity Standard	1x750W Platinum	None	3-year	11/17
7X99A00KCN	ThinkSystem SR590	HTK	1x Xeon Bronze 3106 8C/1.7GHz/11MB/85W/DDR4-2133	1x 16GB RDIMM (2Rx8)	1x 530-8i 2666	12x 3.5"	8x 3.5"	SATA/SAS Open HS	None	2x GbE RJ-45, 1x Mgmt	2x GbE RJ-45 LOM	1x LOM, 1x PCle x8 LP	3x PCle x8 FHHL	None	None	TPM 2.0	XClarity Standard	1x750W Platinum	None	3-year	11/17
7X99A01CCN	ThinkSystem SR590	HTK	1x Xeon Gold 5117 14C/2.0GHz/19.25MB/105W/DDR4-2400	1x 16GB RDIMM (2Rx8)	1x 930-8i 26662GB Flash	12x 3.5"	8x 3.5"	SATA/SAS Open HS	None	2x GbE RJ-45, 1x Mgmt	2x GbE RJ-45 LOM	1x LOM, 1x PCle x8 LP	3x PCle x8 FHHL	None	None	TPM 2.0	XClarity Standard	1x750W Platinum	None	3-year	11/17
7X99A01DCN	ThinkSystem SR590	HTK	1x Xeon Silver 4114 10C/2.2GHz/13.75MB/85W/DDR4-2400	1x 16GB RDIMM (2Rx8)	1x 930-8i 26662GB Flash	16x 2.5"	8x 2.5"	SATA/SAS Open HS	None	2x GbE RJ-45, 1x Mgmt	2x GbE RJ-45 LOM	1x LOM, 1x PCle x8 LP	3x PCle x8 FHHL	None	None	TPM 2.0	XClarity Standard	1x750W Platinum	None	3-year	11/17
7X99A01ACN	ThinkSystem SR590	HTK	1x Xeon Gold 5115 10C/2.4GHz/13.75MB/85W/DDR4-2400	1x 16GB RDIMM (2Rx8)	1x 930-8i 26662GB Flash	12x 3.5"	8x 3.5"	SATA/SAS Open HS	None	2x GbE RJ-45, 1x Mgmt	2x GbE RJ-45 LOM	1x LOM, 1x PCle x8 LP	3x PCle x8 FHHL	None	None	TPM 2.0	XClarity Standard	1x750W Platinum	None	3-year	11/17

Model	Product	Region	Processor	Memory	Storage Controller	Chassis	Disk Bays	Disk S	M.2 Drives	Onboard Networking Ports	Additional Networking (LOM/ML2/PCIe)	Standard Extension Slots	Available Extension Slots via Riser Cards	Front VGA	Optical	TPM	System Management	Power Supply	Preload	Warranty	Ann Date (mm/yy)
7X99A01HCN	ThinkSystem SR590	HTK	1x Xeon Gold 5118 12C/2.3GHz/16.5MB/105W/DDR4-2400	1x 16GB RDIMM DDR4-2666 (2Rx8)	1x 930-8i 2GB Flash	12x 3.5"	8x 3.5" SATA/SA S HS	Open	None	2x GbE RJ-45, 1x Mgmt	2x GbE RJ-45 LOM	1x LOM, 1x PCIe x8 LP	3x PCIe x8 FHHL	None	None	TPM 2.0	XClarity Standard	1x750W Platinum	None	3-year	11/17
7X99A01PCN	ThinkSystem SR590	HTK	1x Xeon Gold 5115 10C/2.4GHz/13.75MB/85W/DDR4-2400	1x 16GB RDIMM DDR4-2666 (2Rx8)	1x 930-16i 4GB Flash	12x 3.5"	12x 3.5" SATA/SA S HS	Open	None	2x GbE RJ-45, 1x Mgmt	2x GbE RJ-45 LOM	1x LOM, 1x PCIe x8 LP	3x PCIe x8 FHHL	None	None	TPM 2.0	XClarity Standard	1x750W Platinum	None	3-year	11/17
7X99A01QCN	ThinkSystem SR590	HTK	1x Xeon Silver 4116 12C/2.1GHz/16.5MB/85W/DDR4-2400	1x 16GB RDIMM DDR4-2666 (2Rx8)	1x 930-8i 2GB Flash	16x 2.5"	8x 2.5" SATA/SA S HS	Open	None	2x GbE RJ-45, 1x Mgmt	2x GbE RJ-45 LOM	1x LOM, 1x PCIe x8 LP	3x PCIe x8 FHHL	None	None	TPM 2.0	XClarity Standard	1x750W Platinum	None	3-year	11/17
7X99A010CN	ThinkSystem SR590	HTK	1x Xeon Silver 4110 8C/2.1GHz/11MB/85W/DDR4-2400	1x 16GB RDIMM DDR4-2666 (2Rx8)	1x 930-8i 2GB Flash	16x 2.5"	8x 2.5" SATA/SA S HS	Open	None	2x GbE RJ-45, 1x Mgmt	2x GbE RJ-45 LOM	1x LOM, 1x PCIe x8 LP	3x PCIe x8 FHHL	None	None	TPM 2.0	XClarity Standard	1x750W Platinum	None	3-year	11/17
7X99A018CN	ThinkSystem SR590	HTK	1x Xeon Silver 4116 12C/2.1GHz/16.5MB/85W/DDR4-2400	1x 16GB RDIMM DDR4-2666 (2Rx8)	1x 930-8i 2GB Flash	12x 3.5"	8x 3.5" SATA/SA S HS	Open	None	2x GbE RJ-45, 1x Mgmt	2x GbE RJ-45 LOM	1x LOM, 1x PCIe x8 LP	3x PCIe x8 FHHL	None	None	TPM 2.0	XClarity Standard	1x750W Platinum	None	3-year	11/17
7X99A02MCN	ThinkSystem SR590	HTK	1x Xeon Gold 5122 4C/3.6GHz/16.5MB/105W/DDR4-2666	1x 16GB RDIMM DDR4-2666 (2Rx8)	1x 930-8i 2GB Flash	16x 2.5"	8x 2.5" SATA/SA S HS	Open	None	2x GbE RJ-45, 1x Mgmt	2x GbE RJ-45 LOM	1x LOM, 1x PCIe x8 LP	3x PCIe x8 FHHL	None	None	TPM 2.0	XClarity Standard	1x750W Platinum	None	3-year	11/17
7X99A02NCN	ThinkSystem SR590	HTK	1x Xeon Gold 5120T 14C/2.2GHz/19.25MB/105W/DDR4-2400	1x 16GB RDIMM DDR4-2666 (2Rx8)	1x 930-8i 2GB Flash	16x 2.5"	8x 2.5" SATA/SA S HS	Open	None	2x GbE RJ-45, 1x Mgmt	2x GbE RJ-45 LOM	1x LOM, 1x PCIe x8 LP	3x PCIe x8 FHHL	None	None	TPM 2.0	XClarity Standard	1x750W Platinum	None	3-year	11/17
7X99A02PCN	ThinkSystem SR590	HTK	1x Xeon Gold 5118 12C/2.3GHz/16.5MB/105W/DDR4-2400	1x 16GB RDIMM DDR4-2666 (2Rx8)	1x 930-8i 2GB Flash	16x 2.5"	8x 2.5" SATA/SA S HS	Open	None	2x GbE RJ-45, 1x Mgmt	2x GbE RJ-45 LOM	1x LOM, 1x PCIe x8 LP	3x PCIe x8 FHHL	None	None	TPM 2.0	XClarity Standard	1x750W Platinum	None	3-year	11/17
7X99A02FCN	ThinkSystem SR590	HTK	1x Xeon Gold 5120 14C/2.2GHz/19.25MB/105W/DDR4-2400	1x 16GB RDIMM DDR4-2666 (2Rx8)	1x 930-8i 2GB Flash	16x 2.5"	8x 2.5" SATA/SA S HS	Open	None	2x GbE RJ-45, 1x Mgmt	2x GbE RJ-45 LOM	1x LOM, 1x PCIe x8 LP	3x PCIe x8 FHHL	None	None	TPM 2.0	XClarity Standard	1x750W Platinum	None	3-year	11/17
7X99A02GCN	ThinkSystem SR590	HTK	1x Xeon Gold 5117 14C/2.0GHz/19.25MB/105W/DDR4-2400	1x 16GB RDIMM DDR4-2666 (2Rx8)	1x 930-8i 2GB Flash	16x 2.5"	8x 2.5" SATA/SA S HS	Open	None	2x GbE RJ-45, 1x Mgmt	2x GbE RJ-45 LOM	1x LOM, 1x PCIe x8 LP	3x PCIe x8 FHHL	None	None	TPM 2.0	XClarity Standard	1x750W Platinum	None	3-year	11/17

Model	Product	Region	Processor	Memory	Storage Controller	Chassis	Disk Bays	Disks	M.2 Drives	Onboard Networking Ports	Additional Networking (LOM/ML2/PCle)	Standard Extension Slots	Available Extension Slots via Riser Cards	Front VGA	Optical	TPM	System Management	Power Supply	Preload	Warranty	Ann Date (mm/yy)
7X99A026CN	ThinkSystem SR590	HTK	1x Xeon Silver 4114 10C/2.2GHz/13.75MB/85W/DDR4-2400	1x 16GB RDIMM	1x 930-8i 2GB Flash (2Rx8)	12x 3.5"	8x 3.5"	SATA/SAS Open HS	None	2x GbE RJ-45, 1x Mgmt	2x GbE RJ-45 LOM	1x LOM, 1x PCle x8 LP	3x PCle x8 FHHL	None	None	TPM 2.0	XClarity Standard	1x750W Platinum	None	3-year	11/17
7X99A01TCN	ThinkSystem SR590	HTK	1x Xeon Silver 4108 8C/1.8GHz/11MB/85W/DDR4-2400	1x 16GB RDIMM	1x 930-8i 2GB Flash (2Rx8)	12x 3.5"	8x 3.5"	SATA/SAS Open HS	None	2x GbE RJ-45, 1x Mgmt	2x GbE RJ-45 LOM	1x LOM, 1x PCle x8 LP	3x PCle x8 FHHL	None	None	TPM 2.0	XClarity Standard	1x750W Platinum	None	3-year	11/17
7X99A01UCN	ThinkSystem SR590	HTK	1x Xeon Silver 4112 4C/2.6GHz/8.25MB/85W/DDR4-2400	1x 16GB RDIMM	1x 930-8i 2GB Flash (2Rx8)	12x 3.5"	8x 3.5"	SATA/SAS Open HS	None	2x GbE RJ-45, 1x Mgmt	2x GbE RJ-45 LOM	1x LOM, 1x PCle x8 LP	3x PCle x8 FHHL	None	None	TPM 2.0	XClarity Standard	1x750W Platinum	None	3-year	11/17
7X99A01ZCN	ThinkSystem SR590	HTK	1x Xeon Silver 4110 8C/2.1GHz/11MB/85W/DDR4-2400	1x 16GB RDIMM	1x 930-8i 2GB Flash (2Rx8)	12x 3.5"	8x 3.5"	SATA/SAS Open HS	None	2x GbE RJ-45, 1x Mgmt	2x GbE RJ-45 LOM	1x LOM, 1x PCle x8 LP	3x PCle x8 FHHL	None	None	TPM 2.0	XClarity Standard	1x750W Platinum	None	3-year	11/17
7X99A02YCN	ThinkSystem SR590	HTK	1x Xeon Bronze 3106 8C/1.7GHz/11MB/85W/DDR4-2133	1x 16GB RDIMM	1x 930-8i 2GB Flash (2Rx8)	16x 2.5"	8x 2.5"	SATA/SAS Open HS	None	2x GbE RJ-45, 1x Mgmt	2x GbE RJ-45 LOM	1x LOM, 1x PCle x8 LP	3x PCle x8 FHHL	None	None	TPM 2.0	XClarity Standard	1x750W Platinum	None	3-year	11/17
7X99A034CN	ThinkSystem SR590	HTK	1x Xeon Silver 4108 8C/1.8GHz/11MB/85W/DDR4-2400	1x 16GB RDIMM	1x 930-8i 2GB Flash (2Rx8)	16x 2.5"	8x 2.5"	SATA/SAS Open HS	None	2x GbE RJ-45, 1x Mgmt	2x GbE RJ-45 LOM	1x LOM, 1x PCle x8 LP	3x PCle x8 FHHL	None	None	TPM 2.0	XClarity Standard	1x750W Platinum	None	3-year	11/17
7X99A032CN	ThinkSystem SR590	HTK	1x Xeon Gold 5115 10C/2.4GHz/13.75MB/85W/DDR4-2400	1x 16GB RDIMM	1x 930-8i 2GB Flash (2Rx8)	16x 2.5"	8x 2.5"	SATA/SAS Open HS	None	2x GbE RJ-45, 1x Mgmt	2x GbE RJ-45 LOM	1x LOM, 1x PCle x8 LP	3x PCle x8 FHHL	None	None	TPM 2.0	XClarity Standard	1x750W Platinum	None	3-year	11/17

Model	Product	Region	Processor	Memory	Storage Controller	Chassis	Disk Bays	Disks	M.2 Drives	Onboard Networking Ports	Additional Networking (LOM/ML2/PCIe)	Standard Extension Slots	Available Extension Slots via Riser Cards	Front VGA	Optical	ITPM	System Management	Power Supply	Preload	Warranty	Ann Date (mm/yy)
7X99A00YJP	ThinkSystem SR590	JAPAN	1x Xeon Gold 6136 12C/3.0GHz/24.75MB/150W/DDR4-2666	1x 16GB RDIMM	1x 930-8i 2GB Flash (2Rx8)	16x 2.5"	8x 2.5"	SATA/SAS Open HS	None	2x GbE RJ-45, 1x Mgmt	None	1x LOM, 1x PCIe x8 LP	3x PCIe x8 FHHL	None	None	TPM 1.2	XClarity Advanced	1x750W Platinum	None	3-year	11/17
7X99A02DJP	ThinkSystem SR590	JAPAN	1x Xeon Gold 6134 8C/3.2GHz/24.75MB/130W/DDR4-2666	1x 16GB RDIMM	1x 930-8i 2GB Flash (2Rx8)	16x 2.5"	8x 2.5"	SATA/SAS Open HS	None	2x GbE RJ-45, 1x Mgmt	None	1x LOM, 1x PCIe x8 LP	3x PCIe x8 FHHL	None	None	TPM 1.2	XClarity Advanced	1x750W Platinum	None	3-year	11/17

Model	Product	Region	Processor	Memory	Storage Controller	Chassis	Disk Bays	Disk Drives	M.2 Drives	Onboard Networking Ports	Additional Networking (LOM/ML2/PCIe)	Standard Extension Slots	Available Extension Slots via Riser Cards	Front VGA	Optical	TPM	System Management	Power Supply	Preload	Warranty	Ann Date (mm/yy)
7X99A038NA	ThinkSystem SR590	NA	1x Xeon Silver 4116 12C/2.1GHz/16.5MB/85W/DDR4-2400	1x 32GB RDIMM DDR4-2666 (2Rx4)	1x 930-16i 4GB Flash	12x 3.5"	SATA/SAS	Open	None	2x GbE RJ-45, 1x Mgmt	None	1x LOM, 1x PCIe x8 LP	None	None	None	TPM 1.2	XClarity Enterprise	1x750W Platinum	None	3-year	11/17
7X99A03ANA	ThinkSystem SR590	NA	1x Xeon Bronze 3106 8C/1.7GHz/11MB/85W/DDR4-2133	1x 16GB RDIMM DDR4-2666 (2Rx8)	1x 530-8i	8x 3.5"	SATA/SAS	Open	None	2x GbE RJ-45, 1x Mgmt	None	1x LOM, 1x PCIe x8 LP	None	None	None	TPM 1.2	XClarity Enterprise	1x750W Platinum	None	3-year	11/17
7X99A03DNA	ThinkSystem SR590	NA	1x Xeon Silver 4110 8C/2.1GHz/11MB/85W/DDR4-2400	1x 16GB RDIMM DDR4-2666 (2Rx8)	1x 930-8i 2GB Flash	12x 3.5"	SATA/SAS	Open	None	2x GbE RJ-45, 1x Mgmt	None	1x LOM, 1x PCIe x8 LP	None	None	None	TPM 1.2	XClarity Enterprise	1x750W Platinum	None	3-year	11/17

Model	Product	Region	Processor	Memory	Storage Controller	Chassis	Disk Bays	Disks	M.2 Drives	Onboard Networking Ports	Additional Networking (LOM/ML2/PCIe)	Standard Extension Slots	Available Extension Slots via Riser Cards	Front VGA	Optical	TPM	System Management	Power Supply	Preload	Warranty	Ann Date (mm/yy)
7X99A006AU	ThinkSystem SR590	ANZ	1x Xeon Silver 4116 12C/2.1GHz/16.5MB/85W/DDR4-2400	1x 16GB RDIMM DDR4-2666 (2Rx8)	1x 930-8i 2GB Flash	16x 2.5"	8x 2.5" SATA/SAS HS	Open	None	2x GbE RJ-45, 1x Mgmt	None	1x LOM, 1x PCIe x8 LP	3x PCIe x8 FHHL	None	None	TPM 1.2	XClarity Standard	1x750W Platinum	None	3-year	11/17
7X99A00DAU	ThinkSystem SR590	ANZ	1x Xeon Bronze 3106 8C/1.7GHz/11MB/85W/DDR4-2133	1x 16GB RDIMM DDR4-2666 (2Rx8)	Onboard Intel RSTe	12x 3.5"	8x 3.5" SATA SS	Open	None	2x GbE RJ-45, 1x Mgmt	None	1x LOM, 1x PCIe x8 LP	None	None	None	TPM 1.2	XClarity Standard	1x750W Platinum	None	3-year	11/17
7X99A00EAU	ThinkSystem SR590	ANZ	1x Xeon Silver 4108 8C/1.8GHz/11MB/85W/DDR4-2400	1x 16GB RDIMM DDR4-2666 (2Rx8)	1x 930-8i 2GB Flash	16x 2.5"	8x 2.5" SATA/SAS HS	Open	None	2x GbE RJ-45, 1x Mgmt	None	1x LOM, 1x PCIe x8 LP	3x PCIe x8 FHHL	None	None	TPM 1.2	XClarity Standard	1x750W Platinum	None	3-year	11/17
7X99A00HAU	ThinkSystem SR590	ANZ	1x Xeon Bronze 3104 6C/1.7GHz/8.25MB/85W/DDR4-2133	1x 16GB RDIMM DDR4-2666 (2Rx8)	1x 530-8i	16x 2.5"	8x 2.5" SATA/SAS HS	Open	None	2x GbE RJ-45, 1x Mgmt	None	1x LOM, 1x PCIe x8 LP	3x PCIe x8 FHHL	None	None	TPM 1.2	XClarity Standard	1x750W Platinum	None	3-year	11/17
7X99A00JAU	ThinkSystem SR590	ANZ	1x Xeon Silver 4110 8C/2.1GHz/11MB/85W/DDR4-2400	1x 16GB RDIMM DDR4-2666 (2Rx8)	1x 930-8i 2GB Flash	12x 3.5"	8x 3.5" SATA/SAS HS	Open	None	2x GbE RJ-45, 1x Mgmt	None	1x LOM, 1x PCIe x8 LP	3x PCIe x8 FHHL	None	None	TPM 1.2	XClarity Standard	1x750W Platinum	None	3-year	11/17
7X99A00XAU	ThinkSystem SR590	ANZ	1x Xeon Silver 4110 8C/2.1GHz/11MB/85W/DDR4-2400	1x 16GB RDIMM DDR4-2666 (2Rx8)	1x 530-8i	12x 3.5"	8x 3.5" SATA/SAS HS	Open	None	2x GbE RJ-45, 1x Mgmt	None	1x LOM, 1x PCIe x8 LP	3x PCIe x8 FHHL	None	None	TPM 1.2	XClarity Standard	1x750W Platinum	None	3-year	11/17
7X99A019AU	ThinkSystem SR590	ANZ	1x Xeon Silver 4108 8C/1.8GHz/11MB/85W/DDR4-2400	1x 16GB RDIMM DDR4-2666 (2Rx8)	1x 530-8i	16x 2.5"	8x 2.5" SATA/SAS HS	Open	None	2x GbE RJ-45, 1x Mgmt	None	1x LOM, 1x PCIe x8 LP	3x PCIe x8 FHHL	None	None	TPM 1.2	XClarity Standard	1x750W Platinum	None	3-year	11/17
7X99A01EAU	ThinkSystem SR590	ANZ	1x Xeon Gold 5118 12C/2.3GHz/16.5MB/105W/DDR4-2400	1x 16GB RDIMM DDR4-2666 (2Rx8)	1x 930-8i 2GB Flash	16x 2.5"	8x 2.5" SATA/SAS HS	Open	None	2x GbE RJ-45, 1x Mgmt	None	1x LOM, 1x PCIe x8 LP	3x PCIe x8 FHHL	None	None	TPM 1.2	XClarity Standard	1x750W Platinum	None	3-year	11/17
7X99A01MAU	ThinkSystem SR590	ANZ	1x Xeon Gold 5120 14C/2.2GHz/19.25MB/105W/DDR4-2400	1x 16GB RDIMM DDR4-2666 (2Rx8)	1x 930-8i 2GB Flash	16x 2.5"	8x 2.5" SATA/SAS HS	Open	None	2x GbE RJ-45, 1x Mgmt	None	1x LOM, 1x PCIe x8 LP	3x PCIe x8 FHHL	None	None	TPM 1.2	XClarity Standard	1x750W Platinum	None	3-year	11/17
7X99A020AU	ThinkSystem SR590	ANZ	1x Xeon Silver 4110 8C/2.1GHz/11MB/85W/DDR4-2400	1x 16GB RDIMM DDR4-2666 (2Rx8)	1x 530-8i	16x 2.5"	8x 2.5" SATA/SAS HS	Open	None	2x GbE RJ-45, 1x Mgmt	None	1x LOM, 1x PCIe x8 LP	3x PCIe x8 FHHL	None	None	TPM 1.2	XClarity Standard	1x750W Platinum	None	3-year	11/17

Model	Product	Region	Processor	Memory	Storage Controller	Chassis	Disk Bays	Disks	M.2 Drives	Onboard Networking Ports	Additional Networking (LOM/ML2/PCle)	Standard Extension Slots	Available Extension Slots via Riser Cards	Front VGA	Optical	TPM	System Management	Power Supply	Preload	Warranty	Ann Date (mm/yy)	
7X99A021AU	ThinkSystem SR590	ANZ	1x Xeon Silver 4110 8C/2.1GHz/11MB/85W/DDR4-2400	1x 16GB RDIMM (2Rx8)	1x 930-8i 2GB Flash	16x 2.5"	8x 2.5" HS	SATA/SAS	Open	None	2x GbE RJ-45, 1x Mgmt	None	1x LOM, 1x PCle x8 LP	3x PCle x8 FHHL	None	None	TPM 1.2	XClarity Standard	1x750W Platinum	None	3-year	11/17
7X99A023AU	ThinkSystem SR590	ANZ	2x Xeon Silver 4114 10C/2.2GHz/13.75MB/85W/DDR4-2400	2x 32GB RDIMM (2Rx4)	1x 430-16i 2GB Flash	16x 2.5"	8x 2.5" HS (4 AnyBay)	SATA/SAS	Open	None	2x GbE RJ-45, 1x Mgmt	None	1x LOM, 1x PCle x8 LP	3x PCle x8 FHHL, 2x PCle x16 FHHL	Front VGA	None	TPM 1.2	XClarity Enterprise	2x750W Platinum	None	3-year	11/17
7X99A02CAU	ThinkSystem SR590	ANZ	1x Xeon Gold 5118 12C/2.3GHz/16.5MB/105W/DDR4-2400	1x 16GB RDIMM (2Rx8)	1x 530-8i 2GB Flash	12x 3.5"	8x 3.5" HS	SATA/SAS	Open	None	2x GbE RJ-45, 1x Mgmt	None	1x LOM, 1x PCle x8 LP	3x PCle x8 FHHL	None	None	TPM 1.2	XClarity Standard	1x750W Platinum	None	3-year	11/17
7X99A02JAU	ThinkSystem SR590	ANZ	2x Xeon Gold 5118 12C/2.3GHz/16.5MB/105W/DDR4-2400	2x 32GB RDIMM (2Rx4)	1x 430-16i 2GB Flash	16x 2.5"	8x 2.5" HS (4 AnyBay)	SATA/SAS	Open	None	2x GbE RJ-45, 1x Mgmt	None	1x LOM, 1x PCle x8 LP	3x PCle x8 FHHL, 2x PCle x16 FHHL	Front VGA	None	TPM 1.2	XClarity Enterprise	2x750W Platinum	None	3-year	11/17
7X99A02KAU	ThinkSystem SR590	ANZ	1x Xeon Gold 6142 16C/2.6GHz/22MB/150W/DDR4-2666	1x 32GB RDIMM (2Rx4)	1x 930-8i 2GB Flash	16x 2.5"	8x 2.5" HS	SATA/SAS	Open	None	2x GbE RJ-45, 1x Mgmt	None	1x LOM, 1x PCle x8 LP	3x PCle x8 FHHL	None	None	TPM 1.2	XClarity Standard	1x750W Platinum	None	3-year	11/17
7X99A02UAU	ThinkSystem SR590	ANZ	1x Xeon Silver 4114 10C/2.2GHz/13.75MB/85W/DDR4-2400	1x 16GB RDIMM (2Rx8)	1x 930-8i 2GB Flash	16x 2.5"	8x 2.5" HS	SATA/SAS	Open	None	2x GbE RJ-45, 1x Mgmt	None	1x LOM, 1x PCle x8 LP	3x PCle x8 FHHL	None	None	TPM 1.2	XClarity Standard	1x750W Platinum	None	3-year	11/17
7X99A02SAU	ThinkSystem SR590	ANZ	1x Xeon Silver 4114 10C/2.2GHz/13.75MB/85W/DDR4-2400	1x 16GB RDIMM (2Rx8)	1x 530-8i 2GB Flash	16x 2.5"	8x 2.5" HS	SATA/SAS	Open	None	2x GbE RJ-45, 1x Mgmt	None	1x LOM, 1x PCle x8 LP	3x PCle x8 FHHL	None	None	TPM 1.2	XClarity Standard	1x750W Platinum	None	3-year	11/17
7X99A02ZAU	ThinkSystem SR590	ANZ	1x Xeon Gold 6130 16C/2.1GHz/22MB/125W/DDR4-2666	1x 32GB RDIMM (2Rx4)	1x 930-8i 2GB Flash	16x 2.5"	8x 2.5" HS	SATA/SAS	Open	None	2x GbE RJ-45, 1x Mgmt	None	1x LOM, 1x PCle x8 LP	3x PCle x8 FHHL	None	None	TPM 1.2	XClarity Standard	1x750W Platinum	None	3-year	11/17
7X99A030AU	ThinkSystem SR590	ANZ	1x Xeon Gold 5118 12C/2.3GHz/16.5MB/105W/DDR4-2400	1x 16GB RDIMM (2Rx8)	1x 930-16i 4GB Flash	12x 3.5"	12x 3.5" HS	SATA/SAS	Open	None	2x GbE RJ-45, 1x Mgmt	None	1x LOM, 1x PCle x8 LP	3x PCle x8 FHHL	None	None	TPM 1.2	XClarity Standard	1x750W Platinum	None	3-year	11/17
7X99A035AU	ThinkSystem SR590	ANZ	1x Xeon Bronze 3104 6C/1.7GHz/8.25MB/85W/DDR4-2133	1x 16GB RDIMM (2Rx8)	1x 930-8i 2GB Flash	16x 2.5"	8x 2.5" HS	SATA/SAS	Open	None	2x GbE RJ-45, 1x Mgmt	None	1x LOM, 1x PCle x8 LP	3x PCle x8 FHHL	None	None	TPM 1.2	XClarity Standard	1x750W Platinum	None	3-year	11/17

Model	Product	Region	Processor	Memory	Storage Controller	Chassis	Disk Bays	Disks	M.2 Drives	Onboard Networking Ports	Additional Networking (LOM/ML2/PCIe)	Standard Extension Slots	Available Extension Slots via Riser Cards	Front VGA	Optical	TPM	System Management	Power Supply	Preload	Warranty	Ann Date (mm/yy)
7X991000LA	ThinkSystem SR590	Argentina	1x Xeon Bronze 3106 8C/1.7GHz/11MB/85W/DDR4-2133	1x 16GB RDIMM DDR4-2666 (1Rx4)	1x 930-16i 4GB Flash	12x 3.5"	12x 3.5" SATA/SAS HS	6x4TB HDD 7.2K 3.5" SAS12Gbps	None	2x GbE RJ-45, 1x Mgmt	2x GbE RJ-45 LOM	1x LOM, 1x PCIe x8 LP	3x PCIe x8 FHHL	Front VGA	None	TPM 2.0	XClarity Standard	2x750W Platinum	None	3-year	02/18

Model	Product	Region	Processor	Memory	Storage Controller	Chassis	Disk Bays	Disk S	M.2 Drives	Onboard Networking Ports	Additional Networking (LOM/ML2/PCIe)	Standard Extension Slots	Available Extension Slots via Riser Cards	Front VGA	Optical	TPM	System Management	Power Supply	Preload	Warranty	Ann Date (mm/yy)
7X99A007SG	ThinkSystem SR590	ASEAN	1x Xeon Silver 4110 8C/2.1GHz/11MB/85W/DDR4-2400	1x 16GB RDIMM DDR4-2666 (1Rx4)	1x 530-8i	16x 2.5"	8x 2.5" SATA/SAS HS	Open	None	2x GbE RJ-45, 1x Mgmt	None	1x LOM, 1x PCIe x8 LP	None	None	None	TPM 2.0	XClarity Enterprise	1x750W Platinum	None	3-year	11/17
7X99A00MSG	ThinkSystem SR590	ASEAN	1x Xeon Silver 4112 4C/2.6GHz/8.25MB/85W/DDR4-2400	1x 16GB RDIMM DDR4-2666 (1Rx4)	1x 530-8i	16x 2.5"	8x 2.5" SATA/SAS HS	Open	None	2x GbE RJ-45, 1x Mgmt	None	1x LOM, 1x PCIe x8 LP	None	None	None	TPM 2.0	XClarity Enterprise	1x750W Platinum	None	3-year	11/17
7X99A00PSG	ThinkSystem SR590	ASEAN	1x Xeon Gold 5115 10C/2.4GHz/13.75MB/85W/DDR4-2400	1x 16GB RDIMM DDR4-2666 (1Rx4)	1x 530-8i	16x 2.5"	8x 2.5" SATA/SAS HS	Open	None	2x GbE RJ-45, 1x Mgmt	None	1x LOM, 1x PCIe x8 LP	None	None	None	TPM 2.0	XClarity Enterprise	1x750W Platinum	None	3-year	11/17
7X99A00QSG	ThinkSystem SR590	ASEAN	1x Xeon Gold 6148 20C/2.4GHz/27.5MB/150W/DDR4-2666	1x 16GB RDIMM DDR4-2666 (1Rx4)	1x 530-8i	16x 2.5"	8x 2.5" SATA/SAS HS	Open	None	2x GbE RJ-45, 1x Mgmt	None	1x LOM, 1x PCIe x8 LP	None	None	None	TPM 2.0	XClarity Enterprise	1x750W Platinum	None	3-year	11/17
7X99A005SG	ThinkSystem SR590	ASEAN	1x Xeon Gold 6134 8C/3.2GHz/24.75MB/130W/DDR4-2666	1x 16GB RDIMM DDR4-2666 (1Rx4)	1x 530-8i	16x 2.5"	8x 2.5" SATA/SAS HS	Open	None	2x GbE RJ-45, 1x Mgmt	None	1x LOM, 1x PCIe x8 LP	None	None	None	TPM 2.0	XClarity Enterprise	1x750W Platinum	None	3-year	11/17
7X99A00USG	ThinkSystem SR590	ASEAN	1x Xeon Silver 4114 10C/2.2GHz/13.75MB/85W/DDR4-2400	1x 16GB RDIMM DDR4-2666 (1Rx4)	1x 530-8i	16x 2.5"	8x 2.5" SATA/SAS HS	Open	None	2x GbE RJ-45, 1x Mgmt	None	1x LOM, 1x PCIe x8 LP	None	None	None	TPM 2.0	XClarity Enterprise	1x750W Platinum	None	3-year	11/17
7X99A00ZSG	ThinkSystem SR590	ASEAN	1x Xeon Gold 6126 12C/2.6GHz/19.25MB/125W/DDR4-2666	1x 16GB RDIMM DDR4-2666 (1Rx4)	1x 530-8i	16x 2.5"	8x 2.5" SATA/SAS HS	Open	None	2x GbE RJ-45, 1x Mgmt	None	1x LOM, 1x PCIe x8 LP	None	None	None	TPM 2.0	XClarity Enterprise	1x750W Platinum	None	3-year	11/17
7X99A012SG	ThinkSystem SR590	ASEAN	1x Xeon Gold 6132 14C/2.6GHz/19.25MB/140W/DDR4-2666	1x 16GB RDIMM DDR4-2666 (1Rx4)	1x 530-8i	16x 2.5"	8x 2.5" SATA/SAS HS	Open	None	2x GbE RJ-45, 1x Mgmt	None	1x LOM, 1x PCIe x8 LP	None	None	None	TPM 2.0	XClarity Enterprise	1x750W Platinum	None	3-year	11/17
7X99A013SG	ThinkSystem SR590	ASEAN	1x Xeon Gold 6138 20C/2.0GHz/27.5MB/125W/DDR4-2666	1x 16GB RDIMM DDR4-2666 (1Rx4)	1x 530-8i	16x 2.5"	8x 2.5" SATA/SAS HS	Open	None	2x GbE RJ-45, 1x Mgmt	None	1x LOM, 1x PCIe x8 LP	None	None	None	TPM 2.0	XClarity Enterprise	1x750W Platinum	None	3-year	11/17
7X99A015SG	ThinkSystem SR590	ASEAN	1x Xeon Gold 5122 4C/3.6GHz/16.5MB/105W/DDR4-2666	1x 16GB RDIMM DDR4-2666 (1Rx4)	1x 530-8i	16x 2.5"	8x 2.5" SATA/SAS HS	Open	None	2x GbE RJ-45, 1x Mgmt	None	1x LOM, 1x PCIe x8 LP	None	None	None	TPM 2.0	XClarity Enterprise	1x750W Platinum	None	3-year	11/17

Model	Product	Region	Processor	Memory	Storage Controller	Chassis	Disk Bays	Disk S	M.2 Drives	Onboard Networking Ports	Additional Networking (LOM/ML2/PCIe)	Standard Extension Slots	Available Extension Slots via Riser Cards	Front VGA	Optical	TPM	System Management	Power Supply	Preload	Warranty	Ann Date (mm/yy)
7X99A02TSG	ThinkSystem SR590	ASEAN	1x Xeon Bronze 3104 6C/1.7GHz/8.25MB/85W/DDR4-2133	1x 16GB RDIMM DDR4-2666 (1Rx4)	1x 530-8i	16x 2.5"	8x 2.5" SATA/SA S HS	Open	None	2x GbE RJ-45, 1x Mgmt	None	1x LOM, 1x PCIe x8 LP	None	None	None	TPM 2.0	XClarity Enterprise	1x750W Platinum	None	3-year	11/17
7X99A02VSG	ThinkSystem SR590	ASEAN	1x Xeon Gold 5120 14C/2.2GHz/19.25MB/105W/DDR4-2400	1x 16GB RDIMM DDR4-2666 (1Rx4)	1x 530-8i	16x 2.5"	8x 2.5" SATA/SA S HS	Open	None	2x GbE RJ-45, 1x Mgmt	None	1x LOM, 1x PCIe x8 LP	None	None	None	TPM 2.0	XClarity Enterprise	1x750W Platinum	None	3-year	11/17
7X99A02WSG	ThinkSystem SR590	ASEAN	1x Xeon Silver 4108 8C/1.8GHz/11MB/85W/DDR4-2400	1x 16GB RDIMM DDR4-2666 (1Rx4)	1x 530-8i	16x 2.5"	8x 2.5" SATA/SA S HS	Open	None	2x GbE RJ-45, 1x Mgmt	None	1x LOM, 1x PCIe x8 LP	None	None	None	TPM 2.0	XClarity Enterprise	1x750W Platinum	None	3-year	11/17
7X99A02LSG	ThinkSystem SR590	ASEAN	1x Xeon Silver 4116 12C/2.1GHz/16.5MB/85W/DDR4-2400	1x 16GB RDIMM DDR4-2666 (1Rx4)	1x 530-8i	16x 2.5"	8x 2.5" SATA/SA S HS	Open	None	2x GbE RJ-45, 1x Mgmt	None	1x LOM, 1x PCIe x8 LP	None	None	None	TPM 2.0	XClarity Enterprise	1x750W Platinum	None	3-year	11/17
7X99A025SG	ThinkSystem SR590	ASEAN	1x Xeon Gold 6140 18C/2.3GHz/24.75MB/140W/DDR4-2666	1x 16GB RDIMM DDR4-2666 (1Rx4)	1x 530-8i	16x 2.5"	8x 2.5" SATA/SA S HS	Open	None	2x GbE RJ-45, 1x Mgmt	None	1x LOM, 1x PCIe x8 LP	None	None	None	TPM 2.0	XClarity Enterprise	1x750W Platinum	None	3-year	11/17
7X99A01LSG	ThinkSystem SR590	ASEAN	1x Xeon Gold 5118 12C/2.3GHz/16.5MB/105W/DDR4-2400	1x 16GB RDIMM DDR4-2666 (1Rx4)	1x 530-8i	16x 2.5"	8x 2.5" SATA/SA S HS	Open	None	2x GbE RJ-45, 1x Mgmt	None	1x LOM, 1x PCIe x8 LP	None	None	None	TPM 2.0	XClarity Enterprise	1x750W Platinum	None	3-year	11/17
7X99A01WSG	ThinkSystem SR590	ASEAN	1x Xeon Gold 6142 16C/2.6GHz/22MB/150W/DDR4-2666	1x 16GB RDIMM DDR4-2666 (1Rx4)	1x 530-8i	16x 2.5"	8x 2.5" SATA/SA S HS	Open	None	2x GbE RJ-45, 1x Mgmt	None	1x LOM, 1x PCIe x8 LP	None	None	None	TPM 2.0	XClarity Enterprise	1x750W Platinum	None	3-year	11/17
7X99A01XSG	ThinkSystem SR590	ASEAN	1x Xeon Gold 5117 14C/2.0GHz/19.25MB/105W/DDR4-2400	1x 16GB RDIMM DDR4-2666 (1Rx4)	1x 530-8i	16x 2.5"	8x 2.5" SATA/SA S HS	Open	None	2x GbE RJ-45, 1x Mgmt	None	1x LOM, 1x PCIe x8 LP	None	None	None	TPM 2.0	XClarity Enterprise	1x750W Platinum	None	3-year	11/17
7X99A01YSG	ThinkSystem SR590	ASEAN	1x Xeon Gold 6128 6C/3.4GHz/19.25MB/115W/DDR4-2666	1x 16GB RDIMM DDR4-2666 (1Rx4)	1x 530-8i	16x 2.5"	8x 2.5" SATA/SA S HS	Open	None	2x GbE RJ-45, 1x Mgmt	None	1x LOM, 1x PCIe x8 LP	None	None	None	TPM 2.0	XClarity Enterprise	1x750W Platinum	None	3-year	11/17
7X99A036SG	ThinkSystem SR590	ASEAN	1x Xeon Gold 6130 16C/2.1GHz/22MB/125W/DDR4-2666	1x 16GB RDIMM DDR4-2666 (1Rx4)	1x 530-8i	16x 2.5"	8x 2.5" SATA/SA S HS	Open	None	2x GbE RJ-45, 1x Mgmt	None	1x LOM, 1x PCIe x8 LP	None	None	None	TPM 2.0	XClarity Enterprise	1x750W Platinum	None	3-year	11/17

Model	Product	Region	Processor	Memory	Storage Controller	Chassis	Disk Bays	Disks	M.2 Drives	Onboard Networking Ports	Additional Networking (LOM/ML2/PCle)	Standard Extension Slots	Available Extension Slots via Riser Cards	Front VGA	Optical	TPM	System Management	Power Supply	Preload	Warranty	Ann Date (mm/yy)
7X99A031SG	ThinkSystem SR590	ASEAN	1x Xeon Bronze 3106	1x 16GB RDIMM DDR4-2666 (1Rx4)	1x 530-8i	16x 2.5"	8x 2.5"	SATA/SAS Open HS	None	2x GbE RJ-45, 1x Mgmt	None	1x LOM, 1x PCIe x8 LP	None	None	None	TPM 2.0	XClarity Enterprise	1x750W Platinum	None	3-year	11/17

Model	Product	Region	Processor	Memory	Storage Controller	Chassis	Disk Bays	Disks	M.2 Drives	Onboard Networking Ports	Additional Networking (LOM/ML2/PCle)	Standard Extension Slots	Available Extension Slots via Riser Cards	Front VGA	Optical	TPM	System Management	Power Supply	Preload	Warranty	Ann Date (mm/yy)
7X99A033EA	ThinkSystem SR590	EMEA	1x Xeon Silver 4110 8C/2.1GHz/11MB/85W/DDR4-2400	1x 16GB RDIMM DDR4-2666 (2Rx8)	1x 530-8i	16x 2.5"	8x 2.5" SATA/SAS HS	Open	None	2x GbE RJ-45, 1x Mgmt	None	1x LOM, 1x PCIe x8 LP	3x PCIe x8 FHHL	None	None	TPM 1.2	XClarity Standard	1x750W Platinum	None	3-year	11/17
7X99A01VEA	ThinkSystem SR590	EMEA	1x Xeon Silver 4114 10C/2.2GHz/13.75MB/85W/DDR4-2400	1x 16GB RDIMM DDR4-2666 (2Rx8)	1x 530-8i	16x 2.5"	8x 2.5" SATA/SAS HS	Open	None	2x GbE RJ-45, 1x Mgmt	None	1x LOM, 1x PCIe x8 LP	3x PCIe x8 FHHL	None	None	TPM 1.2	XClarity Standard	1x750W Platinum	None	3-year	11/17
7X99A022EA	ThinkSystem SR590	EMEA	2x Xeon Gold 5118 12C/2.3GHz/16.5MB/105W/DDR4-2400	2x 32GB RDIMM DDR4-2666 (2Rx4)	1x 430-16i	16x 2.5"	8x 2.5" HS (4 SATA/SAS, 4 AnyBay)	Open	None	2x GbE RJ-45, 1x Mgmt	None	1x LOM, 1x PCIe x8 LP	3x PCIe x8 FHHL, 2x PCIe x16 FHHL	Front VGA	None	TPM 1.2	XClarity Enterprise	2x750W Platinum	None	3-year	11/17
7X99A02HEA	ThinkSystem SR590	EMEA	1x Xeon Gold 5118 12C/2.3GHz/16.5MB/105W/DDR4-2400	1x 16GB RDIMM DDR4-2666 (2Rx8)	1x 930-8i	16x 2.5"	8x 2.5" SATA/SAS HS	Open	None	2x GbE RJ-45, 1x Mgmt	None	1x LOM, 1x PCIe x8 LP	3x PCIe x8 FHHL	None	None	TPM 1.2	XClarity Standard	1x750W Platinum	None	3-year	11/17
7X99A016EA	ThinkSystem SR590	EMEA	1x Xeon Silver 4110 8C/2.1GHz/11MB/85W/DDR4-2400	1x 16GB RDIMM DDR4-2666 (2Rx8)	1x 930-8i	12x 3.5"	8x 3.5" SATA/SAS HS	Open	None	2x GbE RJ-45, 1x Mgmt	None	1x LOM, 1x PCIe x8 LP	3x PCIe x8 FHHL	None	None	TPM 1.2	XClarity Standard	1x750W Platinum	None	3-year	11/17
7X99A011EA	ThinkSystem SR590	EMEA	1x Xeon Gold 5118 12C/2.3GHz/16.5MB/105W/DDR4-2400	1x 16GB RDIMM DDR4-2666 (2Rx8)	1x 930-16i	12x 3.5"	12x 3.5" SATA/SAS HS	Open	None	2x GbE RJ-45, 1x Mgmt	None	1x LOM, 1x PCIe x8 LP	3x PCIe x8 FHHL	None	None	TPM 1.2	XClarity Standard	1x750W Platinum	None	3-year	11/17
7X99A014EA	ThinkSystem SR590	EMEA	1x Xeon Bronze 3104 6C/1.7GHz/8.25MB/85W/DDR4-2133	1x 16GB RDIMM DDR4-2666 (2Rx8)	1x 530-8i	16x 2.5"	8x 2.5" SATA/SAS HS	Open	None	2x GbE RJ-45, 1x Mgmt	None	1x LOM, 1x PCIe x8 LP	3x PCIe x8 FHHL	None	None	TPM 1.2	XClarity Standard	1x750W Platinum	None	3-year	11/17
7X99A00SEA	ThinkSystem SR590	EMEA	1x Xeon Silver 4116 12C/2.1GHz/16.5MB/85W/DDR4-2400	1x 16GB RDIMM DDR4-2666 (2Rx8)	1x 930-8i	16x 2.5"	8x 2.5" SATA/SAS HS	Open	None	2x GbE RJ-45, 1x Mgmt	None	1x LOM, 1x PCIe x8 LP	3x PCIe x8 FHHL	None	None	TPM 1.2	XClarity Standard	1x750W Platinum	None	3-year	11/17
7X99A00TEA	ThinkSystem SR590	EMEA	1x Xeon Silver 4108 8C/1.8GHz/11MB/85W/DDR4-2400	1x 16GB RDIMM DDR4-2666 (2Rx8)	1x 530-8i	16x 2.5"	8x 2.5" SATA/SAS HS	Open	None	2x GbE RJ-45, 1x Mgmt	None	1x LOM, 1x PCIe x8 LP	3x PCIe x8 FHHL	None	None	TPM 1.2	XClarity Standard	1x750W Platinum	None	3-year	11/17
7X99A01NEA	ThinkSystem SR590	EMEA	2x Xeon Silver 4114 10C/2.2GHz/13.75MB/85W/DDR4-2400	2x 32GB RDIMM DDR4-2666 (2Rx4)	1x 430-16i	16x 2.5"	8x 2.5" HS (4 SATA/SAS, 4 AnyBay)	Open	None	2x GbE RJ-45, 1x Mgmt	None	1x LOM, 1x PCIe x8 LP	3x PCIe x8 FHHL, 2x PCIe x16 FHHL	Front VGA	None	TPM 1.2	XClarity Enterprise	2x750W Platinum	None	3-year	11/17

Model	Product	Region	Processor	Memory	Storage Controller	Chassis	Disk Bays	Disk Drives	M.2 Drives	Onboard Networking Ports	Additional Networking (LOM/ML2/PCle)	Standard Extension Slots	Available Extension Slots via Riser Cards	Front VGA	Optical	TPM	System Management	Power Supply	Preload	Warranty	Ann Date (mm/yy)
7X99A01REA	ThinkSystem SR590	EMEA	1x Xeon Silver 4114 10C/2.2GHz/13.75MB/85W/DDR4-2400	1x 16GB RDIMM DDR4-2666 (2Rx8)	1x 930-8i 2GB Flash	16x 2.5"	8x 2.5" SATA/SAS HS	Open	None	2x GbE RJ-45, 1x Mgmt	None	1x LOM, 1x PCIe x8 LP	3x PCIe x8 FHHL	None	None	TPM 1.2	XClarity Standard	1x750W Platinum	None	3-year	11/17
7X99A01SEA	ThinkSystem SR590	EMEA	1x Xeon Silver 4110 8C/2.1GHz/11MB/85W/DDR4-2400	1x 16GB RDIMM DDR4-2666 (2Rx8)	1x 530-8i 2GB Flash	12x 3.5"	8x 3.5" SATA/SAS HS	Open	None	2x GbE RJ-45, 1x Mgmt	None	1x LOM, 1x PCIe x8 LP	3x PCIe x8 FHHL	None	None	TPM 1.2	XClarity Standard	1x750W Platinum	None	3-year	11/17
7X99A01FEA	ThinkSystem SR590	EMEA	1x Xeon Gold 6130 16C/2.1GHz/22MB/125W/DDR4-2666	1x 32GB RDIMM DDR4-2666 (2Rx4)	1x 930-8i 2GB Flash	16x 2.5"	8x 2.5" SATA/SAS HS	Open	None	2x GbE RJ-45, 1x Mgmt	None	1x LOM, 1x PCIe x8 LP	3x PCIe x8 FHHL	None	None	TPM 1.2	XClarity Standard	1x750W Platinum	None	3-year	11/17
7X99A01JEA	ThinkSystem SR590	EMEA	1x Xeon Gold 5118 12C/2.3GHz/16.5MB/105W/DDR4-2400	1x 16GB RDIMM DDR4-2666 (2Rx8)	1x 530-8i 2GB Flash	12x 3.5"	8x 3.5" SATA/SAS HS	Open	None	2x GbE RJ-45, 1x Mgmt	None	1x LOM, 1x PCIe x8 LP	3x PCIe x8 FHHL	None	None	TPM 1.2	XClarity Standard	1x750W Platinum	None	3-year	11/17
7X99A01KEA	ThinkSystem SR590	EMEA	1x Xeon Gold 5120 14C/2.2GHz/19.25MB/105W/DDR4-2400	1x 16GB RDIMM DDR4-2666 (2Rx8)	1x 930-8i 2GB Flash	16x 2.5"	8x 2.5" SATA/SAS HS	Open	None	2x GbE RJ-45, 1x Mgmt	None	1x LOM, 1x PCIe x8 LP	3x PCIe x8 FHHL	None	None	TPM 1.2	XClarity Standard	1x750W Platinum	None	3-year	11/17
7X99A01BEA	ThinkSystem SR590	EMEA	1x Xeon Gold 6142 16C/2.6GHz/22MB/150W/DDR4-2666	1x 32GB RDIMM DDR4-2666 (2Rx4)	1x 930-8i 2GB Flash	16x 2.5"	8x 2.5" SATA/SAS HS	Open	None	2x GbE RJ-45, 1x Mgmt	None	1x LOM, 1x PCIe x8 LP	3x PCIe x8 FHHL	None	None	TPM 1.2	XClarity Standard	1x750W Platinum	None	3-year	11/17
7X99A00GEA	ThinkSystem SR590	EMEA	1x Xeon Bronze 3104 6C/1.7GHz/8.25MB/85W/DDR4-2133	1x 16GB RDIMM DDR4-2666 (2Rx8)	1x 930-8i 2GB Flash	16x 2.5"	8x 2.5" SATA/SAS HS	Open	None	2x GbE RJ-45, 1x Mgmt	None	1x LOM, 1x PCIe x8 LP	3x PCIe x8 FHHL	None	None	TPM 1.2	XClarity Standard	1x750W Platinum	None	3-year	11/17
7X99A00DEA	ThinkSystem SR590	EMEA	1x Xeon Bronze 3106 8C/1.7GHz/11MB/85W/DDR4-2133	1x 16GB RDIMM DDR4-2666 (2Rx8)	Onboard Intel RSTe	12x 3.5"	8x 3.5" SATA SS	Open	None	2x GbE RJ-45, 1x Mgmt	None	1x LOM, 1x PCIe x8 LP	None	None	None	TPM 1.2	XClarity Standard	1x750W Platinum	None	3-year	11/17
7X99A009EA	ThinkSystem SR590	EMEA	1x Xeon Silver 4110 8C/2.1GHz/11MB/85W/DDR4-2400	1x 16GB RDIMM DDR4-2666 (2Rx8)	1x 930-8i 2GB Flash	16x 2.5"	8x 2.5" SATA/SAS HS	Open	None	2x GbE RJ-45, 1x Mgmt	None	1x LOM, 1x PCIe x8 LP	3x PCIe x8 FHHL	None	None	TPM 1.2	XClarity Standard	1x750W Platinum	None	3-year	11/17
7X99A003EA	ThinkSystem SR590	EMEA	1x Xeon Silver 4108 8C/1.8GHz/11MB/85W/DDR4-2400	1x 16GB RDIMM DDR4-2666 (2Rx8)	1x 930-8i 2GB Flash	16x 2.5"	8x 2.5" SATA/SAS HS	Open	None	2x GbE RJ-45, 1x Mgmt	None	1x LOM, 1x PCIe x8 LP	3x PCIe x8 FHHL	None	None	TPM 1.2	XClarity Standard	1x750W Platinum	None	3-year	11/17

Model	Product	Region	Processor	Memory	Storage Controller	Chassis	Disk Bays	Disks	M.2 Drives	Onboard Networking Ports	Additional Networking (LOM/ML2/PCle)	Standard Extension Slots	Available Extension Slots via Riser Cards	Front VGA	Optical	TPM	System Management	Power Supply	Preload	Warranty	Ann Date (mm/yy)
7X99A024SG	ThinkSystem SR590	INDIA	1x Xeon Silver 4108 8C/1.8GHz/11MB/85W/DDR4-2400	1x 8GB RDIMM DDR4-2666 (1Rx8)	1x 530-8i	16x 2.5"	8x 2.5" SATA/SAS Open HS	None	None	2x GbE RJ-45, 1x Mgmt	2x GbE RJ-45 LOM	1x LOM, 1x PCIe x8 LP	None	None	None	TPM 1.2	XClarity Standard	1x750W Platinum	None	3-year	01/18
7X99A02BSG	ThinkSystem SR590	INDIA	1x Xeon Silver 4110 8C/2.1GHz/11MB/85W/DDR4-2400	1x 8GB RDIMM DDR4-2666 (1Rx8)	1x 530-8i	16x 2.5"	8x 2.5" SATA/SAS Open HS	None	None	2x GbE RJ-45, 1x Mgmt	2x GbE RJ-45 LOM	1x LOM, 1x PCIe x8 LP	None	None	None	TPM 1.2	XClarity Standard	1x750W Platinum	None	3-year	01/18
7X99A00WSG	ThinkSystem SR590	INDIA	1x Xeon Gold 5115 10C/2.4GHz/13.75MB/85W/DDR4-2400	1x 8GB RDIMM DDR4-2666 (1Rx8)	1x 530-8i	12x 3.5"	8x 3.5" SATA/SAS Open HS	None	None	2x GbE RJ-45, 1x Mgmt	2x GbE RJ-45 LOM	1x LOM, 1x PCIe x8 LP	None	None	None	TPM 1.2	XClarity Standard	1x750W Platinum	None	3-year	01/18
7X99A00LSG	ThinkSystem SR590	INDIA	1x Xeon Silver 4110 8C/2.1GHz/11MB/85W/DDR4-2400	1x 16GB RDIMM DDR4-2666 (1Rx4)	1x 530-8i	16x 2.5"	8x 2.5" SATA/SAS Open HS	None	None	2x GbE RJ-45, 1x Mgmt	2x GbE RJ-45 LOM	1x LOM, 1x PCIe x8 LP	None	None	None	TPM 1.2	XClarity Standard	1x750W Platinum	None	3-year	01/18
7X99A00NSG	ThinkSystem SR590	INDIA	1x Xeon Silver 4110 8C/2.1GHz/11MB/85W/DDR4-2400	1x 8GB RDIMM DDR4-2666 (1Rx8)	1x 530-8i	12x 3.5"	8x 3.5" SATA/SAS Open HS	None	None	2x GbE RJ-45, 1x Mgmt	2x GbE RJ-45 LOM	1x LOM, 1x PCIe x8 LP	None	None	None	TPM 1.2	XClarity Standard	1x750W Platinum	None	3-year	01/18
7X99A00CSG	ThinkSystem SR590	INDIA	1x Xeon Gold 5118 12C/2.3GHz/16.5MB/105W/DDR4-2400	1x 16GB RDIMM DDR4-2666 (1Rx4)	1x 930-8i	16x 2.5"	8x 2.5" SATA/SAS Open HS	None	None	2x GbE RJ-45, 1x Mgmt	2x GbE RJ-45 LOM	1x LOM, 1x PCIe x8 LP	None	None	None	TPM 1.2	XClarity Standard	1x750W Platinum	None	3-year	01/18
7X99A002SG	ThinkSystem SR590	INDIA	1x Xeon Gold 5115 10C/2.4GHz/13.75MB/85W/DDR4-2400	1x 16GB RDIMM DDR4-2666 (1Rx4)	1x 530-8i	16x 2.5"	8x 2.5" SATA/SAS Open HS	None	None	2x GbE RJ-45, 1x Mgmt	2x GbE RJ-45 LOM	1x LOM, 1x PCIe x8 LP	None	None	None	TPM 1.2	XClarity Standard	1x750W Platinum	None	3-year	01/18

Model	Product	Region	Processor	Memory	Storage Controller	Chassis	Disk Bays	Disks	M.2 Drives	Onboard Networking Ports	Additional Networking (LOM/ML2/PCIe)	Standard Extension Slots	Available Extension Slots via Riser Cards	Front VGA	Optical	TPM	System Management	Power Supply	Preload	Warranty	Ann Date (mm/yy)	
7X99A02RJP	ThinkSystem SR590	JAPAN	1x Xeon Platinum 8164	1x 16GB RDIMM	1x 930-8i 16GB Flash (2Rx8)	26C/2.0GHz/35.75MB/150W/DDR4-2666	8x 2.5"	SATA/SAS HS	Open	None	2x GbE RJ-45, 1x Mgmt	None	1x LOM, 1x PCIe x8 LP	3x PCIe x8 FHHL	None	None	TPM 1.2	XClarity Advanced	1x750W Platinum	None	3-year	11/17
7X99A037JP	ThinkSystem SR590	JAPAN	1x Xeon Gold 6130	1x 16GB RDIMM	1x 930-16i 4GB Flash (2Rx8)	16C/2.1GHz/22MB/125W/DDR4-2666	8x 2.5" HS (4 AnyBay)	SATA/SAS, 4 AnyBay)	Open	None	2x GbE RJ-45, 1x Mgmt	None	1x LOM, 1x PCIe x8 LP	3x PCIe x8 FHHL	None	None	TPM 1.2	XClarity Advanced	1x750W Platinum	None	3-year	11/17

Model	Product	Region	Processor	Memory	Storage Controller	Chassis	Disk Bays	Disks	M.2 Drives	Onboard Networking Ports	Additional Networking (LOM/ML2/PCIe)	Standard Extension Slots	Available Extension Slots via Riser Cards	Front VGA	Optical	TPM	System Management	Power Supply	Preload	Warranty	Ann Date (mm/yy)
7X99A02ELA	ThinkSystem SR590	LA	1x Xeon Silver 4114 10C/2.2GHz/13.75MB/85W/DDR4-2400	1x 16GB RDIMM DDR4-2666 (1Rx4)	1x 930-8i 2GB Flash	16x 2.5"	8x 2.5" SATA/SA S HS	Open	None	2x GbE RJ-45, 1x Mgmt	2x GbE RJ-45 LOM	1x LOM, 1x PCIe x8 LP	3x PCIe x8 FHHL	Front VGA	None	TPM 2.0	XClarity Standard	1x750W Platinum	None	3-year	11/17
7X99A027LA	ThinkSystem SR590	LA	1x Xeon Silver 4114 10C/2.2GHz/13.75MB/85W/DDR4-2400	1x 16GB RDIMM DDR4-2666 (1Rx4)	1x 930-8i 2GB Flash	12x 3.5"	8x 3.5" SATA/SA S HS	Open	None	2x GbE RJ-45, 1x Mgmt	2x GbE RJ-45 LOM	1x LOM, 1x PCIe x8 LP	3x PCIe x8 FHHL	Front VGA	None	TPM 2.0	XClarity Standard	1x750W Platinum	None	3-year	11/17
7X99A029LA	ThinkSystem SR590	LA	1x Xeon Gold 6140 18C/2.3GHz/24.75MB/140W/DDR4-2666	1x 16GB RDIMM DDR4-2666 (1Rx4)	1x 930-8i 2GB Flash	12x 3.5"	8x 3.5" SATA/SA S HS	Open	None	2x GbE RJ-45, 1x Mgmt	2x GbE RJ-45 LOM	1x LOM, 1x PCIe x8 LP	3x PCIe x8 FHHL	Front VGA	None	TPM 2.0	XClarity Standard	1x750W Platinum	None	3-year	11/17
7X99A02ALA	ThinkSystem SR590	LA	1x Xeon Silver 4108 8C/1.8GHz/11MB/85W/DDR4-2400	1x 16GB RDIMM DDR4-2666 (1Rx4)	1x 930-8i 2GB Flash	12x 3.5"	8x 3.5" SATA/SA S HS	Open	None	2x GbE RJ-45, 1x Mgmt	2x GbE RJ-45 LOM	1x LOM, 1x PCIe x8 LP	3x PCIe x8 FHHL	Front VGA	None	TPM 2.0	XClarity Standard	1x750W Platinum	None	3-year	11/17
7X99A02QLA	ThinkSystem SR590	LA	1x Xeon Gold 6140 18C/2.3GHz/24.75MB/140W/DDR4-2666	1x 16GB RDIMM DDR4-2666 (1Rx4)	1x 930-8i 2GB Flash	16x 2.5"	8x 2.5" SATA/SA S HS	Open	None	2x GbE RJ-45, 1x Mgmt	2x GbE RJ-45 LOM	1x LOM, 1x PCIe x8 LP	3x PCIe x8 FHHL	Front VGA	None	TPM 2.0	XClarity Standard	1x750W Platinum	None	3-year	11/17
7X99A02XLA	ThinkSystem SR590	LA	1x Xeon Gold 5120 14C/2.2GHz/19.25MB/105W/DDR4-2400	1x 16GB RDIMM DDR4-2666 (1Rx4)	1x 930-8i 2GB Flash	16x 2.5"	8x 2.5" SATA/SA S HS	Open	None	2x GbE RJ-45, 1x Mgmt	2x GbE RJ-45 LOM	1x LOM, 1x PCIe x8 LP	3x PCIe x8 FHHL	Front VGA	None	TPM 2.0	XClarity Standard	1x750W Platinum	None	3-year	11/17
7X99A03QLA	ThinkSystem SR590	LA	1x Xeon Bronze 3106 8C/1.7GHz/11MB/85W/DDR4-2133	1x 16GB RDIMM DDR4-2666 (1Rx4)	1x 930-16i 4GB Flash	12x 3.5"	12x 3.5" SATA/SA S HS	2x 480GB SSD SATA6Gbps	2x 128GB M.2 B SSD	2x GbE RJ-45, 1x Mgmt	2x GbE RJ-45 LOM	1x LOM, 1x PCIe x8 LP, 2x M.2	3x PCIe x8 FHHL	Front VGA	None	TPM 2.0	XClarity Enterprise	2x 750W Platinum	None	3-year	04/18
7X99A03RLA	ThinkSystem SR590	LA	1x Xeon Bronze 3106 8C/1.7GHz/11MB/85W/DDR4-2133	1x 16GB RDIMM DDR4-2666 (1Rx4)	1x 930-16i 4GB Flash	12x 3.5"	12x 3.5" SATA/SA S HS	12x 8TB HDD 7.2K 3.5" SATA6Gbps	2x 128GB M.2 B SSD	2x GbE RJ-45, 1x Mgmt	2x GbE RJ-45 LOM	1x LOM, 1x PCIe x8 LP, 2x M.2	3x PCIe x8 FHHL	Front VGA	None	TPM 2.0	XClarity Enterprise	2x 750W Platinum	None	3-year	04/18
7X99A03SLA	ThinkSystem SR590	LA	1x Xeon Bronze 3106 8C/1.7GHz/11MB/85W/DDR4-2133	1x 16GB RDIMM DDR4-2666 (1Rx4)	1x 930-16i 4GB Flash	12x 3.5"	12x 3.5" SATA/SA S HS	12x 6TB HDD 7.2K 3.5" SAS12Gbps	2x 128GB M.2 B SSD	2x GbE RJ-45, 1x Mgmt	2x GbE RJ-45 LOM	1x LOM, 1x PCIe x8 LP, 2x M.2	3x PCIe x8 FHHL	Front VGA	None	TPM 2.0	XClarity Enterprise	2x 750W Platinum	None	3-year	04/18
7X99A03TLA	ThinkSystem SR590	LA	1x Xeon Bronze 3106 8C/1.7GHz/11MB/85W/DDR4-2133	1x 16GB RDIMM DDR4-2666 (1Rx4)	1x 930-16i 4GB Flash	12x 3.5"	12x 3.5" SATA/SA S HS	12x 4TB HDD 7.2K 3.5" SAS12Gbps	2x 128GB M.2 B SSD	2x GbE RJ-45, 1x Mgmt	2x GbE RJ-45 LOM	1x LOM, 1x PCIe x8 LP, 2x M.2	3x PCIe x8 FHHL	Front VGA	None	TPM 2.0	XClarity Enterprise	2x 750W Platinum	None	3-year	04/18

Model	Product	Region	Processor	Memory	Storage Controller	Chassis	Disk Bays	Disks	M.2 Drives	Onboard Networking Ports	Additional Networking (LOM/ML2/PCIe)	Standard Extension Slots	Available Extension Slots via Riser Cards	Front VGA	Optical	TPM	System Management	Power Supply	Preload	Warranty	Ann Date (mm/yy)
7X99A03ULA	ThinkSystem SR590	LA	1x Xeon Bronze 3106 8C/1.7GHz/11MB/85W/DDR4-2133	1x 16GB RDIMM DDR4-2666 (1Rx4)	1x 930-16i 4GB Flash	12x 3.5"	12x 3.5" SATA/SAS HS	8x 4TB HDD 7.2K 3.5" SAS12Gbps	2x 128GB B SSD M.2 SATA	2x GbE RJ-45, 1x Mgmt	2x GbE RJ-45 LOM	1x LOM, 1x PCIe x8 LP, 2x M.2	3x PCIe x8 FHHL	Front VGA	None	TPM 2.0	XClarity Enterprise	2x 750W Platinum	None	3-year	04/18
7X99A03VLA	ThinkSystem SR590	LA	1x Xeon Bronze 3106 8C/1.7GHz/11MB/85W/DDR4-2133	1x 16GB RDIMM DDR4-2666 (1Rx4)	1x 930-16i 4GB Flash	12x 3.5"	12x 3.5" SATA/SAS HS	6x 4TB HDD 7.2K 3.5" SAS12Gbps	2x 128GB B SSD M.2 SATA	2x GbE RJ-45, 1x Mgmt	2x GbE RJ-45 LOM	1x LOM, 1x PCIe x8 LP, 2x M.2	3x PCIe x8 FHHL	Front VGA	None	TPM 2.0	XClarity Enterprise	2x 750W Platinum	None	3-year	04/18
7X99A048LA	ThinkSystem SR590	LA	1x Xeon Bronze 3106 8C/1.7GHz/11MB/85W/DDR4-2133	1x 16GB RDIMM DDR4-2666 (1Rx4)	1x 930-16i 4GB Flash	12x 3.5"	12x 3.5" SATA/SAS HS	6x 4TB HDD 7.2K 3.5" SAS12Gbps	2x 128GB B SSD M.2 SATA	2x GbE RJ-45, 1x Mgmt	2x GbE RJ-45 LOM	1x LOM, 1x PCIe x8 LP, 2x M.2	3x PCIe x8 FHHL	Front VGA	None	TPM 2.0	XClarity Enterprise	2x 750W Platinum	None	3-year	04/18
7X99A049LA	ThinkSystem SR590	LA	1x Xeon Bronze 3106 8C/1.7GHz/11MB/85W/DDR4-2133	1x 16GB RDIMM DDR4-2666 (1Rx4)	1x 930-16i 4GB Flash	12x 3.5"	12x 3.5" SATA/SAS HS	2x 480GB SATA6Gbps	2x 128GB B SSD M.2 SATA	2x GbE RJ-45, 1x Mgmt	2x GbE RJ-45 LOM	1x LOM, 1x PCIe x8 LP, 2x M.2	3x PCIe x8 FHHL	Front VGA	None	TPM 2.0	XClarity Enterprise	2x 750W Platinum	None	3-year	04/18
7X99A044ALA	ThinkSystem SR590	LA	1x Xeon Bronze 3106 8C/1.7GHz/11MB/85W/DDR4-2133	1x 16GB RDIMM DDR4-2666 (1Rx4)	1x 930-16i 4GB Flash	12x 3.5"	12x 3.5" SATA/SAS HS	12x 4TB HDD 7.2K 3.5" SAS12Gbps	None	2x GbE RJ-45, 1x Mgmt	2x GbE RJ-45 LOM	1x LOM, 1x PCIe x8 LP	1x 3x FHHL1x x8/x8/x8	1x Front VGA	None	TPM 2.0	XClarity Enterprise	2x 750W Platinum	None	3-year	04/18
7X99A04BLA	ThinkSystem SR590	LA	1x Xeon Bronze 3106 8C/1.7GHz/11MB/85W/DDR4-2133	1x 16GB RDIMM DDR4-2666 (1Rx4)	1x 930-16i 4GB Flash	12x 3.5"	12x 3.5" SATA/SAS HS	8x 4TB HDD 7.2K 3.5" SAS12Gbps	None	2x GbE RJ-45, 1x Mgmt	2x GbE RJ-45 LOM	1x LOM, 1x PCIe x8 LP	1x 3x FHHL1x x8/x8/x8	1x Front VGA	None	TPM 2.0	XClarity Enterprise	2x 750W Platinum	None	3-year	04/18
7X99A04CLA	ThinkSystem SR590	LA	1x Xeon Bronze 3106 8C/1.7GHz/11MB/85W/DDR4-2133	1x 16GB RDIMM DDR4-2666 (1Rx4)	1x 930-16i 4GB Flash	12x 3.5"	12x 3.5" SATA/SAS HS	12x 8TB HDD 7.2K 3.5" SATA6Gbps	2x 128GB B SSD M.2 SATA	2x GbE RJ-45, 1x Mgmt	2x GbE RJ-45 LOM	1x LOM, 1x PCIe x8 LP, 2x M.2	3x PCIe x8 FHHL	Front VGA	None	TPM 2.0	XClarity Enterprise	2x 750W Platinum	None	3-year	04/18
7X99A04DLA	ThinkSystem SR590	LA	1x Xeon Bronze 3106 8C/1.7GHz/11MB/85W/DDR4-2133	1x 16GB RDIMM DDR4-2666 (1Rx4)	1x 930-16i 4GB Flash	12x 3.5"	12x 3.5" SATA/SAS HS	12x 6TB HDD 7.2K 3.5" SAS12Gbps	2x 128GB B SSD M.2 SATA	2x GbE RJ-45, 1x Mgmt	2x GbE RJ-45 LOM	1x LOM, 1x PCIe x8 LP, 2x M.2	3x PCIe x8 FHHL	Front VGA	None	TPM 2.0	XClarity Enterprise	2x 750W Platinum	None	3-year	04/18
7X99A04ELA	ThinkSystem SR590	LA	1x Xeon Bronze 3106 8C/1.7GHz/11MB/85W/DDR4-2133	1x 16GB RDIMM DDR4-2666 (1Rx4)	1x 930-16i 4GB Flash	12x 3.5"	12x 3.5" SATA/SAS HS	12x 8TB HDD 7.2K 3.5" SATA6Gbps	None	2x GbE RJ-45, 1x Mgmt	2x GbE RJ-45 LOM	1x LOM, 1x PCIe x8 LP	1x 3x FHHL1x x8/x8/x8	1x Front VGA	None	TPM 2.0	XClarity Enterprise	2x 750W Platinum	None	3-year	04/18
7X99A04FLA	ThinkSystem SR590	LA	1x Xeon Bronze 3106 8C/1.7GHz/11MB/85W/DDR4-2133	1x 16GB RDIMM DDR4-2666 (1Rx4)	1x 930-16i 4GB Flash	12x 3.5"	12x 3.5" SATA/SAS HS	12x 6TB HDD 7.2K 3.5" SAS12Gbps	None	2x GbE RJ-45, 1x Mgmt	2x GbE RJ-45 LOM	1x LOM, 1x PCIe x8 LP	1x 3x FHHL1x x8/x8/x8	1x Front VGA	None	TPM 2.0	XClarity Enterprise	2x 750W Platinum	None	3-year	04/18

Model	Product	Region	Processor	Memory	Storage Controller	Chassis	Disk Bays	Disks	M.2 Drives	Onboard Networking Ports	Additional Networking (LOM/ML2/PCIe)	Standard Extension Slots	Available Extension Slots via Riser Cards	Front VGA	Optical	TPM	System Management	Power Supply	Preload	Warranty	Ann Date (mm/yy)
7X99A04GLA	ThinkSystem SR590	LA	1x Xeon Bronze 3106 8C/1.7GHz/11MB/85W/DDR4-2133	1x 16GB RDIMM DDR4-2666 (1Rx4)	1x 930-16i 4GB Flash	12x 3.5"	12x 3.5" SATA/SA S HS	6x 4TB HDD 7.2K 3.5" SAS12Gbps	None	2x GbE RJ-45, 1x Mgmt	2x GbE RJ-45 LOM	1x LOM, 1x PCIe x8 LP	1x 3x FHHL1x x8/x8/x8	1x Front VGA	None	TPM 2.0	XClarity Enterprise	2x 750W Platinum	None	3-year	04/18
7X99A04HLA	ThinkSystem SR590	LA	1x Xeon Bronze 3106 8C/1.7GHz/11MB/85W/DDR4-2133	1x 16GB RDIMM DDR4-2666 (1Rx4)	1x 930-16i 4GB Flash	12x 3.5"	12x 3.5" SATA/SA S HS	8x 4TB HDD 7.2K 3.5" SAS12Gbps	2x B SSD M.2 SATA	2x GbE RJ-45, 1x Mgmt	2x GbE RJ-45 LOM	1x LOM, 1x PCIe x8 LP, 2x M.2	3x PCIe x8 FHHL	1x Front VGA	None	TPM 2.0	XClarity Enterprise	2x 750W Platinum	None	3-year	04/18
7X99A04JLA	ThinkSystem SR590	LA	1x Xeon Bronze 3106 8C/1.7GHz/11MB/85W/DDR4-2133	1x 16GB RDIMM DDR4-2666 (1Rx4)	1x 930-16i 4GB Flash	12x 3.5"	12x 3.5" SATA/SA S HS	12x 4TB HDD 7.2K 3.5" SAS12Gbps	2x B SSD M.2 SATA	2x GbE RJ-45, 1x Mgmt	2x GbE RJ-45 LOM	1x LOM, 1x PCIe x8 LP, 2x M.2	3x PCIe x8 FHHL	1x Front VGA	None	TPM 2.0	XClarity Enterprise	2x 750W Platinum	None	3-year	04/18
7X99A04KLA	ThinkSystem SR590	LA	1x Xeon Bronze 3106 8C/1.7GHz/11MB/85W/DDR4-2133	1x 16GB RDIMM DDR4-2666 (1Rx4)	1x 930-16i 4GB Flash	12x 3.5"	12x 3.5" SATA/SA S HS	2x 480GB SSD SATA6Gbps	None	2x GbE RJ-45, 1x Mgmt	2x GbE RJ-45 LOM	1x LOM, 1x PCIe x8 LP	1x 3x FHHL1x x8/x8/x8	1x Front VGA	None	TPM 2.0	XClarity Enterprise	2x 750W Platinum	None	3-year	04/18
7X99A00VLA	ThinkSystem SR590	LA	1x Xeon Gold 5120 14C/2.2GHz/19.25MB/105W/DDR4-2400	1x 16GB RDIMM DDR4-2666 (1Rx4)	1x 930-8i 2GB Flash	12x 3.5"	8x 3.5" SATA/SA S HS	Open	None	2x GbE RJ-45, 1x Mgmt	2x GbE RJ-45 LOM	1x LOM, 1x PCIe x8 LP	3x PCIe x8 FHHL	1x Front VGA	None	TPM 2.0	XClarity Standard	1x750W Platinum	None	3-year	11/17
7X99A017LA	ThinkSystem SR590	LA	1x Xeon Silver 4108 8C/1.8GHz/11MB/85W/DDR4-2400	1x 16GB RDIMM DDR4-2666 (1Rx4)	1x 930-8i 2GB Flash	16x 2.5"	8x 2.5" SATA/SA S HS	Open	None	2x GbE RJ-45, 1x Mgmt	2x GbE RJ-45 LOM	1x LOM, 1x PCIe x8 LP	3x PCIe x8 FHHL	1x Front VGA	None	TPM 2.0	XClarity Standard	1x750W Platinum	None	3-year	11/17
7X991001LA	ThinkSystem SR590	LA	1x Xeon Bronze 3106 8C/1.7GHz/11MB/85W/DDR4-2133	1x 16GB RDIMM DDR4-2666 (1Rx4)	1x 930-16i 4GB Flash	12x 3.5"	12x 3.5" SATA/SA S HS	6x4TB HDD 7.2K 3.5" SAS12Gbps	None	2x GbE RJ-45, 1x Mgmt	2x GbE RJ-45 LOM	1x LOM, 1x PCIe x8 LP	3x PCIe x8 FHHL	1x Front VGA	None	TPM 2.0	XClarity Enterprise	2x750W Platinum	None	3-year	02/18
7X991002LA	ThinkSystem SR590	LA	1x Xeon Bronze 3106 8C/1.7GHz/11MB/85W/DDR4-2133	1x 16GB RDIMM DDR4-2666 (1Rx4)	1x 930-16i 4GB Flash	12x 3.5"	12x 3.5" SATA/SA S HS	8x4TB HDD 7.2K 3.5" SAS12Gbps	None	2x GbE RJ-45, 1x Mgmt	2x GbE RJ-45 LOM	1x LOM, 1x PCIe x8 LP	3x PCIe x8 FHHL	1x Front VGA	None	TPM 2.0	XClarity Enterprise	2x750W Platinum	None	3-year	02/18
7X991003LA	ThinkSystem SR590	LA	1x Xeon Bronze 3106 8C/1.7GHz/11MB/85W/DDR4-2133	1x 16GB RDIMM DDR4-2666 (1Rx4)	1x 930-16i 4GB Flash	12x 3.5"	12x 3.5" SATA/SA S HS	12x4TB HDD 7.2K 3.5" SAS12Gbps	None	2x GbE RJ-45, 1x Mgmt	2x GbE RJ-45 LOM	1x LOM, 1x PCIe x8 LP	3x PCIe x8 FHHL	1x Front VGA	None	TPM 2.0	XClarity Enterprise	2x750W Platinum	None	3-year	02/18
7X991004LA	ThinkSystem SR590	LA	1x Xeon Bronze 3106 8C/1.7GHz/11MB/85W/DDR4-2133	1x 16GB RDIMM DDR4-2666 (1Rx4)	1x 930-16i 4GB Flash	12x 3.5"	12x 3.5" SATA/SA S HS	12x6TB HDD 7.2K 3.5" SAS12Gbps	None	2x GbE RJ-45, 1x Mgmt	2x GbE RJ-45 LOM	1x LOM, 1x PCIe x8 LP	3x PCIe x8 FHHL	1x Front VGA	None	TPM 2.0	XClarity Enterprise	2x750W Platinum	None	3-year	02/18

Model	Product	Region	Processor	Memory	Storage Controller	Chassis	Disk Bays	Disks	M.2 Drives	Onboard Networking Ports	Additional Networking (LOM/ML2/PCle)	Standard Extension Slots	Available Extension Slots via Riser Cards	Front VGA	Optical	TPM	System Management	Power Supply	Preload	Warranty	Ann Date (mm/yy)
7X991005LA	ThinkSystem SR590	LA	1x Xeon Bronze 3106 8C/1.7GHz/11MB/85W/DDR4-2133	1x 16GB RDIMM DDR4-2666	1x 930-16i 4GB Flash	12x 3.5"	SATA/SAS HS	12x8TB HDD 7.2K 3.5"	None	2x GbE RJ-45, 1x Mgmt	2x GbE RJ-45 LOM	1x LOM, 1x PCle x8 LP	3x PCle x8 FHHL	Front VGA	None	TPM 2.0	XClarity Enterprise	2x750W Platinum	None	3-year	02/18
7X991006LA	ThinkSystem SR590	LA	1x Xeon Bronze 3106 8C/1.7GHz/11MB/85W/DDR4-2133	1x 16GB RDIMM DDR4-2666	1x 930-8i 2GB Flash	8x 3.5"	SATA/SAS HS	2x480GB SSD SATA6Gbps	None	2x GbE RJ-45, 1x Mgmt	2x GbE RJ-45 LOM	1x LOM, 1x PCle x8 LP	3x PCle x8 FHHL	Front VGA	None	TPM 2.0	XClarity Enterprise	2x750W Platinum	None	3-year	02/18

Model	Product	Region	Processor	Memory	Storage Controller	Chassis	Disk Bays	Disks	M.2 Drives	Onboard Networking Ports	Additional Networking (LOM/ML2/PCle)	Standard Extension Slots	Available Extension Slots via Riser Cards	Front VGA	Optical	TPM	System Management	Power Supply	Preload	Warranty	Ann Date (mm/yy)
7X99A003NA	ThinkSystem SR590	NA	1x Xeon Silver 4108 8C/1.8GHz/11MB/85W/DDR4-2400	1x 16GB RDIMM DDR4-2666	1x 930-8i 2GB Flash (2Rx8)	16x 2.5"	8x 2.5"	SATA/SAS Open HS	None	2x GbE RJ-45, 1x Mgmt	None	1x LOM, 1x PCIe x8 LP	3x PCIe x8 FHHL	None	None	TPM 1.2	XClarity Standard	1x750W Platinum	None	3-year	11/17
7X99A009NA	ThinkSystem SR590	NA	1x Xeon Silver 4110 8C/2.1GHz/11MB/85W/DDR4-2400	1x 16GB RDIMM DDR4-2666	1x 930-8i 2GB Flash (2Rx8)	16x 2.5"	8x 2.5"	SATA/SAS Open HS	None	2x GbE RJ-45, 1x Mgmt	None	1x LOM, 1x PCIe x8 LP	3x PCIe x8 FHHL	None	None	TPM 1.2	XClarity Standard	1x750W Platinum	None	3-year	11/17
7X99A006NA	ThinkSystem SR590	NA	1x Xeon Silver 4116 12C/2.1GHz/16.5MB/85W/DDR4-2400	1x 16GB RDIMM DDR4-2666	1x 930-8i 2GB Flash (2Rx8)	16x 2.5"	8x 2.5"	SATA/SAS Open HS	None	2x GbE RJ-45, 1x Mgmt	None	1x LOM, 1x PCIe x8 LP	3x PCIe x8 FHHL	None	None	TPM 1.2	XClarity Standard	1x750W Platinum	None	3-year	11/17
7X99A00JNA	ThinkSystem SR590	NA	1x Xeon Silver 4110 8C/2.1GHz/11MB/85W/DDR4-2400	1x 16GB RDIMM DDR4-2666	1x 930-8i 2GB Flash (2Rx8)	12x 3.5"	8x 3.5"	SATA/SAS Open HS	None	2x GbE RJ-45, 1x Mgmt	None	1x LOM, 1x PCIe x8 LP	3x PCIe x8 FHHL	None	None	TPM 1.2	XClarity Standard	1x750W Platinum	None	3-year	11/17
7X99A00GNA	ThinkSystem SR590	NA	1x Xeon Bronze 3104 6C/1.7GHz/8.25MB/85W/DDR4-2133	1x 16GB RDIMM DDR4-2666	1x 930-8i 2GB Flash (2Rx8)	16x 2.5"	8x 2.5"	SATA/SAS Open HS	None	2x GbE RJ-45, 1x Mgmt	None	1x LOM, 1x PCIe x8 LP	3x PCIe x8 FHHL	None	None	TPM 1.2	XClarity Standard	1x750W Platinum	None	3-year	11/17
7X99A00HNA	ThinkSystem SR590	NA	1x Xeon Bronze 3104 6C/1.7GHz/8.25MB/85W/DDR4-2133	1x 16GB RDIMM DDR4-2666	1x 530-8i (2Rx8)	16x 2.5"	8x 2.5"	SATA/SAS Open HS	None	2x GbE RJ-45, 1x Mgmt	None	1x LOM, 1x PCIe x8 LP	3x PCIe x8 FHHL	None	None	TPM 1.2	XClarity Standard	1x750W Platinum	None	3-year	11/17
7X99A00TNA	ThinkSystem SR590	NA	1x Xeon Silver 4108 8C/1.8GHz/11MB/85W/DDR4-2400	1x 16GB RDIMM DDR4-2666	1x 530-8i (2Rx8)	16x 2.5"	8x 2.5"	SATA/SAS Open HS	None	2x GbE RJ-45, 1x Mgmt	None	1x LOM, 1x PCIe x8 LP	3x PCIe x8 FHHL	None	None	TPM 1.2	XClarity Standard	1x750W Platinum	None	3-year	11/17
7X99A01MNA	ThinkSystem SR590	NA	1x Xeon Gold 5120 14C/2.2GHz/19.25MB/105W/DDR4-2400	1x 16GB RDIMM DDR4-2666	1x 930-8i 2GB Flash (2Rx8)	16x 2.5"	8x 2.5"	SATA/SAS Open HS	None	2x GbE RJ-45, 1x Mgmt	None	1x LOM, 1x PCIe x8 LP	3x PCIe x8 FHHL	None	None	TPM 1.2	XClarity Standard	1x750W Platinum	None	3-year	11/17
7X99A01SNA	ThinkSystem SR590	NA	1x Xeon Silver 4110 8C/2.1GHz/11MB/85W/DDR4-2400	1x 16GB RDIMM DDR4-2666	1x 530-8i (2Rx8)	12x 3.5"	8x 3.5"	SATA/SAS Open HS	None	2x GbE RJ-45, 1x Mgmt	None	1x LOM, 1x PCIe x8 LP	3x PCIe x8 FHHL	None	None	TPM 1.2	XClarity Standard	1x750W Platinum	None	3-year	11/17
7X99A01RNA	ThinkSystem SR590	NA	1x Xeon Silver 4114 10C/2.2GHz/13.75MB/85W/DDR4-2400	1x 16GB RDIMM DDR4-2666	1x 930-8i 2GB Flash (2Rx8)	16x 2.5"	8x 2.5"	SATA/SAS Open HS	None	2x GbE RJ-45, 1x Mgmt	None	1x LOM, 1x PCIe x8 LP	3x PCIe x8 FHHL	None	None	TPM 1.2	XClarity Standard	1x750W Platinum	None	3-year	11/17

Model	Product	Region	Processor	Memory	Storage Controller	Chassis	Disk Bays	Disks	M.2 Drives	Onboard Networking Ports	Additional Networking (LOM/ML2/PCle)	Standard Extension Slots	Available Extension Slots via Riser Cards	Front VGA	Optical	TPM	System Management	Power Supply	Preload	Warranty	Ann Date (mm/yy)
7X99A02ZNA	ThinkSystem SR590	NA	1x Xeon Gold 6130 16C/2.1GHz/22MB/125W/DDR4-2666	1x 32GB RDIMM DDR4-2666	1x 930-8i 2GB Flash (2Rx4)	16x 2.5"	8x 2.5" SATA/SAS HS	Open	None	2x GbE RJ-45, 1x Mgmt	None	1x LOM, 1x PCle x8 LP	3x PCle x8 FHHL	None	None	TPM 1.2	XClarity Standard	1x750W Platinum	None	3-year	11/17
7X99A02KNA	ThinkSystem SR590	NA	1x Xeon Gold 6142 16C/2.6GHz/22MB/150W/DDR4-2666	1x 32GB RDIMM DDR4-2666	1x 930-8i 2GB Flash (2Rx4)	16x 2.5"	8x 2.5" SATA/SAS HS	Open	None	2x GbE RJ-45, 1x Mgmt	None	1x LOM, 1x PCle x8 LP	3x PCle x8 FHHL	None	None	TPM 1.2	XClarity Standard	1x750W Platinum	None	3-year	11/17
7X99A02CNA	ThinkSystem SR590	NA	1x Xeon Gold 5118 12C/2.3GHz/16.5MB/105W/DDR4-2400	1x 16GB RDIMM DDR4-2666	1x 530-8i (2Rx8)	12x 3.5"	8x 3.5" SATA/SAS HS	Open	None	2x GbE RJ-45, 1x Mgmt	None	1x LOM, 1x PCle x8 LP	3x PCle x8 FHHL	None	None	TPM 1.2	XClarity Standard	1x750W Platinum	None	3-year	11/17
7X99A028NA	ThinkSystem SR590	NA	1x Xeon Bronze 3106 8C/1.7GHz/11MB/85W/DDR4-2133	1x 16GB RDIMM DDR4-2666	Onboard Intel RSTe (2Rx8)	12x 3.5"	8x 3.5" SATA SS	Open	None	2x GbE RJ-45, 1x Mgmt	None	1x LOM, 1x PCle x8 LP	None	None	None	TPM 1.2	XClarity Standard	1x550W Platinum	None	3-year	11/17
7X99A02HNA	ThinkSystem SR590	NA	1x Xeon Gold 5118 12C/2.3GHz/16.5MB/105W/DDR4-2400	1x 16GB RDIMM DDR4-2666	1x 930-8i 2GB Flash (2Rx8)	16x 2.5"	8x 2.5" SATA/SAS HS	Open	None	2x GbE RJ-45, 1x Mgmt	None	1x LOM, 1x PCle x8 LP	3x PCle x8 FHHL	None	None	TPM 1.2	XClarity Standard	1x750W Platinum	None	3-year	11/17
7X99A02JNA	ThinkSystem SR590	NA	2x Xeon Gold 5118 12C/2.3GHz/16.5MB/105W/DDR4-2400	2x 32GB RDIMM DDR4-2666	1x 430-16i (2Rx4)	16x 2.5"	8x 2.5" HS (4 SATA/SAS, 4 AnyBay)	Open	None	2x GbE RJ-45, 1x Mgmt	None	1x LOM, 1x PCle x8 LP	3x PCle x8 FHHL, 2x PCle x16 FHHL	Front VGA	None	TPM 1.2	XClarity Enterprise	2x750W Platinum	None	3-year	11/17
7X99A023NA	ThinkSystem SR590	NA	2x Xeon Silver 4114 10C/2.2GHz/13.75MB/85W/DDR4-2400	2x 32GB RDIMM DDR4-2666	1x 430-16i (2Rx4)	16x 2.5"	8x 2.5" HS (4 SATA/SAS, 4 AnyBay)	Open	None	2x GbE RJ-45, 1x Mgmt	None	1x LOM, 1x PCle x8 LP	3x PCle x8 FHHL, 2x PCle x16 FHHL	Front VGA	None	TPM 1.2	XClarity Enterprise	2x750W Platinum	None	3-year	11/17
7X99A020NA	ThinkSystem SR590	NA	1x Xeon Silver 4110 8C/2.1GHz/11MB/85W/DDR4-2400	1x 16GB RDIMM DDR4-2666	1x 530-8i (2Rx8)	16x 2.5"	8x 2.5" SATA/SAS HS	Open	None	2x GbE RJ-45, 1x Mgmt	None	1x LOM, 1x PCle x8 LP	3x PCle x8 FHHL	None	None	TPM 1.2	XClarity Standard	1x750W Platinum	None	3-year	11/17
7X99A01VNA	ThinkSystem SR590	NA	1x Xeon Silver 4114 10C/2.2GHz/13.75MB/85W/DDR4-2400	1x 16GB RDIMM DDR4-2666	1x 530-8i (2Rx8)	16x 2.5"	8x 2.5" SATA/SAS HS	Open	None	2x GbE RJ-45, 1x Mgmt	None	1x LOM, 1x PCle x8 LP	3x PCle x8 FHHL	None	None	TPM 1.2	XClarity Standard	1x750W Platinum	None	3-year	11/17
7X99A030NA	ThinkSystem SR590	NA	1x Xeon Gold 5118 12C/2.3GHz/16.5MB/105W/DDR4-2400	1x 16GB RDIMM DDR4-2666	1x 930-16i 4GB Flash (2Rx8)	12x 3.5"	12x 3.5" SATA/SAS HS	Open	None	2x GbE RJ-45, 1x Mgmt	None	1x LOM, 1x PCle x8 LP	3x PCle x8 FHHL	None	None	TPM 1.2	XClarity Standard	1x750W Platinum	None	3-year	11/17



ThinkSystem SR630 Platform Specifications

Product Specifications Reference (PSREF)

Components	Specification																																																																																										
Form factor	1U rack																																																																																										
Dimensions	Height: 43 mm (1.7 in). Width: 482 mm (19.0 in) with rack latches. Depth: 778.3 mm (30.64 in)																																																																																										
Weight	Maximum configuration: 41.9 lb (19 kg)																																																																																										
Processor	Up to two 205W Intel Xeon Scalable family processors, Bronze, Silver, Gold, or Platinum. Up to 28 cores at 2.5GHz, up to 3.6GHz with 4 cores. Two processors are connected with two UPI (Ultra Path Interconnect) links up to 10.4GT/s																																																																																										
Chipset	Intel C624 Platform Controller Hub																																																																																										
Memory	Up to 24 DIMM sockets. Each processor supports up to 12 DIMM sockets with 6 channels. DDR4-2666. RDIMMs, LRDIMMs, 3DS RDIMMs are supported, but memory types cannot be intermixed																																																																																										
Memory capacity	Up to 768GB with 24 x 32 GB RDIMMs and two processors. Or up to 1.5TB with 24 x 64 GB LRDIMMs and two processors. Or up to 3TB with 24 x 128 GB 3DS LRDIMMs and two -M suffix processors. -M suffix processor supports 1.5TB memory per socket, non -M suffix processor supports 768GB memory per socket																																																																																										
Memory protection	ECC, memory mirroring, and memory sparing																																																																																										
Storage controllers	One dedicated internal RAID slot for most RAID/HBA adapters. Supports the following RAID/HBA adapters:																																																																																										
	<table border="1"> <thead> <tr> <th>Feature</th> <th>Interface</th> <th>Drive type</th> <th>RAID levels</th> <th>JBOD</th> <th>Cache</th> <th>Cache protection</th> <th>FastPath</th> <th>Max qty</th> </tr> </thead> <tbody> <tr> <td>530-8i</td> <td>12Gbps SAS</td> <td>SATA/SAS</td> <td>0/1/10/5/50</td> <td>Yes</td> <td>None</td> <td>None</td> <td>Yes</td> <td>1</td> </tr> <tr> <td>730-8i</td> <td>12Gbps SAS</td> <td>SATA/SAS</td> <td>0/1/10/5/50</td> <td>Yes</td> <td>1GB</td> <td>None</td> <td>No</td> <td>1</td> </tr> <tr> <td>930-8i</td> <td>12Gbps SAS</td> <td>SATA/SAS</td> <td>0/1/10/5/50/6/60</td> <td>Yes</td> <td>2GB</td> <td>Flash backup</td> <td>Yes</td> <td>1</td> </tr> <tr> <td>930-16i</td> <td>12Gbps SAS</td> <td>SATA/SAS</td> <td>0/1/10/5/50/6/60</td> <td>Yes</td> <td>4GB</td> <td>Flash backup</td> <td>Yes</td> <td>1</td> </tr> <tr> <td>430-8i</td> <td>12Gbps SAS</td> <td>SATA/SAS</td> <td>-</td> <td>Yes</td> <td>None</td> <td>None</td> <td>-</td> <td>1</td> </tr> <tr> <td>430-16i</td> <td>12Gbps SAS</td> <td>SATA/SAS</td> <td>-</td> <td>Yes</td> <td>None</td> <td>None</td> <td>-</td> <td>1</td> </tr> <tr> <td>930-8e</td> <td>12Gbps SAS</td> <td>SATA/SAS</td> <td>0/1/10/5/50/6/60</td> <td>Yes</td> <td>4GB</td> <td>Flash backup</td> <td>Yes</td> <td>2</td> </tr> <tr> <td>430-8e</td> <td>12Gbps SAS</td> <td>SATA/SAS</td> <td>-</td> <td>Yes</td> <td>None</td> <td>None</td> <td>-</td> <td>2</td> </tr> <tr> <td>430-16e</td> <td>12Gbps SAS</td> <td>SATA/SAS</td> <td>-</td> <td>Yes</td> <td>None</td> <td>None</td> <td>-</td> <td>2</td> </tr> </tbody> </table>	Feature	Interface	Drive type	RAID levels	JBOD	Cache	Cache protection	FastPath	Max qty	530-8i	12Gbps SAS	SATA/SAS	0/1/10/5/50	Yes	None	None	Yes	1	730-8i	12Gbps SAS	SATA/SAS	0/1/10/5/50	Yes	1GB	None	No	1	930-8i	12Gbps SAS	SATA/SAS	0/1/10/5/50/6/60	Yes	2GB	Flash backup	Yes	1	930-16i	12Gbps SAS	SATA/SAS	0/1/10/5/50/6/60	Yes	4GB	Flash backup	Yes	1	430-8i	12Gbps SAS	SATA/SAS	-	Yes	None	None	-	1	430-16i	12Gbps SAS	SATA/SAS	-	Yes	None	None	-	1	930-8e	12Gbps SAS	SATA/SAS	0/1/10/5/50/6/60	Yes	4GB	Flash backup	Yes	2	430-8e	12Gbps SAS	SATA/SAS	-	Yes	None	None	-	2	430-16e	12Gbps SAS	SATA/SAS	-	Yes	None	None	-	2
	Feature	Interface	Drive type	RAID levels	JBOD	Cache	Cache protection	FastPath	Max qty																																																																																		
	530-8i	12Gbps SAS	SATA/SAS	0/1/10/5/50	Yes	None	None	Yes	1																																																																																		
	730-8i	12Gbps SAS	SATA/SAS	0/1/10/5/50	Yes	1GB	None	No	1																																																																																		
	930-8i	12Gbps SAS	SATA/SAS	0/1/10/5/50/6/60	Yes	2GB	Flash backup	Yes	1																																																																																		
	930-16i	12Gbps SAS	SATA/SAS	0/1/10/5/50/6/60	Yes	4GB	Flash backup	Yes	1																																																																																		
	430-8i	12Gbps SAS	SATA/SAS	-	Yes	None	None	-	1																																																																																		
	430-16i	12Gbps SAS	SATA/SAS	-	Yes	None	None	-	1																																																																																		
	930-8e	12Gbps SAS	SATA/SAS	0/1/10/5/50/6/60	Yes	4GB	Flash backup	Yes	2																																																																																		
430-8e	12Gbps SAS	SATA/SAS	-	Yes	None	None	-	2																																																																																			
430-16e	12Gbps SAS	SATA/SAS	-	Yes	None	None	-	2																																																																																			
<i>Note: 730-8i is available in China only. 930-8e, 430-8e, and 430-16e will be placed in slot 2 firstly.</i>																																																																																											
Disk drive bays	Supports 4 front 3.5" SATA/SAS HS bays, or 8 front 2.5" SATA/SAS HS bays, or 10 front 2.5" SATA/SAS HS bays with 4 AnyBay support, or 10 front 2.5" AnyBay Optional 2 rear 2.5" HS bays are supported on 10 x 2.5" model, takes place in riser card 1 location. Optional one or two internal M.2 SSD for boot, dual M.2 SSD supports mirroring																																																																																										
Internal storage	For 3.5" bay (3.5" disks or 2.5" disks with 3.5" tray)																																																																																										
	3.5" HDD, SATA6Gbps, 7.2K	1TB/2TB/4TB/6TB/8TB/10TB																																																																																									
	3.5" HDD, SAS12Gbps, 7.2K	1TB/2TB/4TB/6TB SED FIPS/6TB/10TB																																																																																									
	2.5" HDD, SAS12Gbps, 15K	300GB/600GB																																																																																									
	2.5" SSD, SATA6Gbps	240GB/480GB																																																																																									
	2.5" HDD, SATA6Gbps, 7.2K	1TB/2TB																																																																																									
	2.5" HDD, SAS12Gbps, 7.2K	1TB/2TB																																																																																									
For 2.5" bay	2.5" HDD, SAS12Gbps, 10K	300GB/300GB SED/600GB/600GB SED/900GB/1.2TB/1.8TB																																																																																									
	2.5" HDD, SAS12Gbps, 15K	300GB/600GB/900GB																																																																																									
	2.5" SSD, SAS12Gbps	400GB/800GB/3.84TB/7.68TB																																																																																									
	2.5" SSD, SATA6Gbps	240GB/480GB																																																																																									
	2.5" NVMe SSD, AnyBay	800GB/960GB/1.6TB/1.92TB/3.84TB																																																																																									
PCIe 3.0 x4, HHHL adapter	NVMe SSD	1.6TB/1.92TB/3.2TB/3.84TB																																																																																									
M.2 boot drive	M.2 SATA SSD	32GB/128GB/480GB																																																																																									
Optical	No internal optical bay. Optional USB DVD±RW optical drive																																																																																										
Network interfaces	One dedicated management port. One LOM slot for customized LOM with up to four RJ-45 or SFP+ ports, up to 10GbE. Wake-on-LAN and NC-SI are available on Port 0 of LOM. Optional ML2 or PCIe adapters are supported. ML2 adapter requires riser card with ML2 slot.																																																																																										
Security features	Power-on and admin password. Trusted Platform Module, TCG 1.2 compliant, upgrade to 2.0 via UEFI setting. Optional TCM in China only. Optional lockable security bezel																																																																																										
Operating systems supported	Microsoft Windows Server 2016/2012 R2. Red Hat Enterprise Linux 7.4/7.3/6.9. SUSE Linux Enterprise Server 12 SP3/12 SP2/11 SP4. VMware ESXi 6.5U1/6.5/6.0 U3																																																																																										
Systems management	XClarity Controller Standard, optional upgrades to Advanced or Enterprise are available. Energy Manager. XClarity Administrator. Lenovo Capacity Planner. Provisioning Manager. Essentials. Light Path Diagnostics																																																																																										

Components	Specification	
GPU support	Up to one optional GPU, requires riser card with PCIe x16 full height slot. Supports NVIDIA Quadro P2000	
Base warranty	MT 7X01: 1-year limited onsite service with 9x5/NBD MT 7X02: 3-year limited onsite service with 9x5/NBD	
Power supply	Up to two redundant hot-swap 550W/750W/1100W 80 PLUS Platinum qualified power supplies. Or up to two redundant hot-swap 750W Titanium qualified power supplies. 750W Titanium is 200V - 240V, others are 100V - 240V	
Video	Integrated Matrox G200 in XClarity Controller	
Cooling	Five fans (4+1) for single processor model, seven fans (6+1) for dual processor model	
Front ports	One XClarity Controller USB connector, one USB 3.0, one optional VGA	
Rear ports	One VGA, two USB 3.0, one XClarity Controller network connector. Optional COM port	
Environmental specification	Supports ASHRAE A4 with limitations.	
	Temperature - operating	A4: 5°C to 45°C (41°F to 113°F) A3: 5°C to 40°C (41°F to 104°F) A2: 10°C to 35°C (50°F to 95°F)
	Temperature - non operating (no package)	-10°C to 60°C (14°F to 140°F)
	Temperature - non operating (with package)	-40°C to 70°C (-40°F to 158°F)
	Altitude - operating	(Unpressurized): 0-10000ft (0-3048m)
	Humidity - operating, non-condensing	A4: 8%-90%. A3: 8%-85%. A2: 8%-80%
	Humidity - storage (with package), non-condensing	8%-90%
	<i>Models should meet the following requirements to support A3 and A4:</i>	
	<ul style="list-style-type: none"> Processors with TDP higher than or equal to 150-Watt and Xeon 4112, 5122, 6126, 6128, 6132, 6134, 6134M, and 8156 processors not installed Both NVMe 2.5" SSD and NVMe PCIe adapter not installed GPU not installed Must have redundant PSU RAID super capacitor module cannot be installed on the bottom of the air baffle, but only can be installed on the chassis. 	
	Environmental certification	Energy Star Server 2.1 certified. More environmental information please see: www.lenovo.com/social_responsibility/us/en/environment/

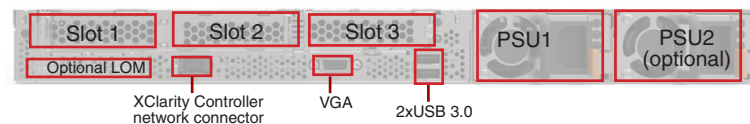

Expansion slots	Specification
Slot 1-2 (riser card 1)	Supports one of the following for riser card 1: Option 1: PCIe 3.0 x8/x16 (slot 1-2). Low profile for x8, low profile or full height half length for x16 Option 2: PCIe 3.0 x8 ML2/x16 (slot 1-2). Low profile for x8 ML2, low profile or full height half length for x16 Option 3: PCIe 3.0 x16 ML2/x8 (slot 1-2). Low profile for x16 ML2, low profile or full height half length for x8 Option 4: 2x 2.5" drive bay, for 10 x 2.5" model only
Slot 3 (riser card 2)	PCIe 3.0 x 16, low profile, requires 2nd CPU. When slot 2 is full height, slot 3 cannot be used

System unique options	Specification
7XH7A05896	Lenovo SR530/SR570/SR630 2.5" SATA/SAS 8-Bay Backplane Kit
7XH7A05893	Lenovo SR530/SR570/SR630 x8/x16 PCIe LP+FH Riser 1 Kit
7XH7A05895	Lenovo SR630 x16ML2/x8 PCIe LP+FH Riser 1 Kit
7XH7A05894	Lenovo SR630 x8ML2/x16 PCIe LP+FH Riser 1 Kit
7XH7A02682	Lenovo SR530/SR570/SR630 x8/x16 PCIe LP+LP Riser 1 Kit
7XH7A02683	Lenovo SR630 x8ML2/x16 PCIe LP+LP Riser 1 Kit
7XH7A02684	Lenovo SR630 x16ML2/x8 PCIe LP+LP Riser 1 Kit
7XH7A02685	Lenovo SR530/SR570/SR630 x16 PCIe LP Riser 2 Kit
7XH7A06252	Lenovo SR630 Rear HDD Kit
7Z17A02577	Lenovo COM Port Upgrade Kit
7Z17A02579	Lenovo SR530/SR570/SR630 Front VGA Connector Upgrade Kit
7Z17A02581	Lenovo 1U Security Bezel

Model	Region	Processor	Memory	Storage Controller	Chassis	Disk Bays	Disk S	M.2 Drives	PCIe Flash Adapter	GPU	Onboard Networking Ports	Additional Networking (LOM/ML2/PCIe)	Fibre Channel I/O	Standard Extension Slots	Available Extension Slots via Riser Cards	Front VGA	Optical	TPM	System Management	Power Supply	Preload	Warranty	Ann Date (mm/yy)
7X021006AU	ANZ	1x Xeon Bronze 3106 8C/1.7GHz/11MB/85W/DDR4-2133	1x 16GB RDIMM DDR4- 2666 (2Rx8)	1x 930-8i 2GB Flash	8x 2.5"	8x 2.5" SATA/SA S HS	Open	None	None	None	1x Mgmt	None	None	1x LOM, 1x RAID	None	Front VGA	None	TP M 1.2	XClarity Advanced	1x 750W Platinum	None	3-year	12/17
7X021007AU	ANZ	1x Xeon Bronze 3106 8C/1.7GHz/11MB/85W/DDR4-2133	1x 32GB RDIMM DDR4- 2666 (2Rx4)	1x 530-8i	8x 2.5"	8x 2.5" SATA/SA S HS	Open	None	None	None	1x Mgmt	None	None	1x LOM, 1x RAID	None	Front VGA	None	TP M 1.2	XClarity Advanced	1x 750W Platinum	None	3-year	09/17
7X021008AU	ANZ	1x Xeon Silver 4110 8C/2.1GHz/11MB/85W/DDR4-2400	1x 16GB RDIMM DDR4- 2666 (2Rx8)	1x 530-8i	8x 2.5"	8x 2.5" SATA/SA S HS	Open	None	None	None	1x Mgmt	None	None	1x LOM, 1x RAID	None	Front VGA	None	TP M 1.2	XClarity Advanced	1x 750W Platinum	None	3-year	09/17
7X021009AU	ANZ	1x Xeon Silver 4114 10C/2.2GHz/13.75MB/85W/DDR4-2400	1x 16GB RDIMM DDR4- 2666 (2Rx8)	1x 530-8i	8x 2.5"	8x 2.5" SATA/SA S HS	Open	None	None	None	1x Mgmt	None	None	1x LOM, 1x RAID	None	Front VGA	None	TP M 1.2	XClarity Advanced	1x 750W Platinum	None	3-year	09/17
7X02100AAU	ANZ	1x Xeon Silver 4116 12C/2.1GHz/16.5MB/85W/DDR4-2400	1x 16GB RDIMM DDR4- 2666 (2Rx8)	1x 530-8i	8x 2.5"	8x 2.5" SATA/SA S HS	Open	None	None	None	1x Mgmt	None	None	1x LOM, 1x RAID	None	Front VGA	None	TP M 1.2	XClarity Advanced	1x 750W Platinum	None	3-year	09/17
7X02100BAU	ANZ	1x Xeon Gold 5118 12C/2.3GHz/16.5MB/105W/DDR4-2400	1x 16GB RDIMM DDR4- 2666 (2Rx8)	1x 530-8i	8x 2.5"	8x 2.5" SATA/SA S HS	Open	None	None	None	1x Mgmt	None	None	1x LOM, 1x RAID	None	Front VGA	None	TP M 1.2	XClarity Advanced	1x 1100W Platinum	None	3-year	09/17
7X02100CAU	ANZ	1x Xeon Gold 6130 16C/2.1GHz/22MB/125W/DDR4-2666	1x 32GB RDIMM DDR4- 2666 (2Rx4)	1x 530-8i	8x 2.5"	8x 2.5" SATA/SA S HS	Open	None	None	None	1x Mgmt	None	None	1x LOM, 1x RAID	None	Front VGA	None	TP M 1.2	XClarity Advanced	1x 1100W Platinum	None	3-year	09/17
7X02100DAU	ANZ	1x Xeon Bronze 3106 8C/1.7GHz/11MB/85W/DDR4-2133	1x 16GB RDIMM DDR4- 2666 (2Rx8)	1x 530-8i	8x 2.5"	8x 2.5" SATA/SA S HS	Open	None	None	None	1x Mgmt	None	None	1x LOM, 1x RAID	None	Front VGA	None	TP M 1.2	XClarity Advanced	1x 750W Platinum	None	3-year	09/17
7X02100EAU	ANZ	1x Xeon Silver 4108 8C/1.8GHz/11MB/85W/DDR4-2400	1x 16GB RDIMM DDR4- 2666 (2Rx8)	1x 530-8i	8x 2.5"	8x 2.5" SATA/SA S HS	Open	None	None	None	1x Mgmt	None	None	1x LOM, 1x RAID	None	Front VGA	None	TP M 1.2	XClarity Advanced	1x 750W Platinum	None	3-year	09/17
7X02100FAU	ANZ	1x Xeon Silver 4110 8C/2.1GHz/11MB/85W/DDR4-2400	1x 16GB RDIMM DDR4- 2666 (2Rx8)	1x 930-8i 2GB Flash	8x 2.5"	8x 2.5" SATA/SA S HS	Open	None	None	None	1x Mgmt	None	None	1x LOM, 1x RAID	None	Front VGA	None	TP M 1.2	XClarity Advanced	1x 750W Platinum	None	3-year	09/17

Model	Region	Processor	Memory	Storage Controller	Chassis	Disk Bays	Disk S	M.2 Drives	PCIe Flash Adapter	GPU	Onboard Networking Ports	Additional Networking (LOM/ML2/PCIe)	Fibre Channel I/O	Standard Extension Slots	Available Extension Slots via Riser Cards	Front VGA	Optical	TPM	System Management	Power Supply	Preload	Warranty	Ann Date (mm/yy)
7X02100GAU	ANZ	1x Xeon Silver 4114 10C/2.2GHz/13.75MB/85W/DDR4-2400	1x 16GB RDIMM DDR4-2666 (2Rx8)	1x 930-8i 2GB Flash	8x 2.5"	8x 2.5" SATA/SAS HS	Open	None	None	None	1x Mgmt	None	None	1x LOM, 1x RAID	None	Front VGA	None	TPM 1.2	XClarity Advanced	1x 750W Platinum	None	3-year	09/17
7X02100HAU	ANZ	1x Xeon Silver 4116 12C/2.1GHz/16.5MB/85W/DDR4-2400	1x 16GB RDIMM DDR4-2666 (2Rx8)	1x 930-8i 2GB Flash	8x 2.5"	8x 2.5" SATA/SAS HS	Open	None	None	None	1x Mgmt	None	None	1x LOM, 1x RAID	None	Front VGA	None	TPM 1.2	XClarity Advanced	1x 750W Platinum	None	3-year	09/17
7X02100JAU	ANZ	1x Xeon Gold 5118 12C/2.3GHz/16.5MB/105W/DDR4-2400	1x 16GB RDIMM DDR4-2666 (2Rx8)	1x 930-8i 2GB Flash	8x 2.5"	8x 2.5" SATA/SAS HS	Open	None	None	None	1x Mgmt	None	None	1x LOM, 1x RAID	None	Front VGA	None	TPM 1.2	XClarity Advanced	1x 1100W Platinum	None	3-year	09/17
7X02100KAU	ANZ	1x Xeon Gold 6130 16C/2.1GHz/22MB/125W/DDR4-2666	1x 32GB RDIMM DDR4-2666 (2Rx4)	1x 930-8i 2GB Flash	8x 2.5"	8x 2.5" SATA/SAS HS	Open	None	None	None	1x Mgmt	None	None	1x LOM, 1x RAID	None	Front VGA	None	TPM 1.2	XClarity Advanced	1x 1100W Platinum	None	3-year	09/17
7X02100LAU	ANZ	2x Xeon Silver 4110 8C/2.1GHz/11MB/85W/DDR4-2400	4x 16GB RDIMM DDR4-2666 (2Rx8)	1x 930-8i 2GB Flash	8x 2.5"	8x 2.5" SATA/SAS HS	Open	None	None	None	1x Mgmt	4x GbE RJ-45 LOM	None	1x LOM, 1x RAID	1x PCIe x8 LP, 1x Front PCIe x16 FHHL	1x Front VGA	USB DVD±RW	TPM 1.2	XClarity Advanced	2x 750W Titanium	None	3-year	09/17

Model	Region	Processor	Memory	Storage Controller	Chassis	Disk Bays	Disk S	M.2 Drives	PCIe Flash Adapter	GPU	Onboard Networking Ports	Additional Networking (LOM/ML2/PCIe)	Fibre Channel I/O	Standard Extension Slots	Available Extension Slots via Riser Cards	Front VGA	Optical	System Management	Power Supply	Preload	Warranty	Ann Date (mm/yy)
7X02100SBR	Brazil	1x Xeon Silver 4110 8C/2.1GHz/11MB/85W/DDR4-2400	1x 32GB RDIMM DDR4- 2666 (2Rx4)	1x 930-8i 2GB Flash	8x 2.5"	8x 2.5" SATA/SA S HS	None	None	None	None	1x Mgmt	4x GbE RJ-45 LOM	None	1x LOM, 1x RAID	1x PCIe x8 LP, 1x Front PCIe x16 VGA LP	None	None	XClarity Enterprise	2x 550W Platinum	None	3-year	04/18
7X02100TBR	Brazil	2x Xeon Silver 4116 12C/2.1GHz/16.5MB/85W/DDR4-2400	2x 32GB RDIMM DDR4- 2666 (2Rx4)	1x 930-8i 2GB Flash	8x 2.5"	8x 2.5" SATA/SA S HS	None	None	None	None	1x Mgmt	4x GbE RJ-45 LOM	None	1x LOM, 1x RAID	1x PCIe x8 LP, 1x Front PCIe x16 VGA LP	None	None	XClarity Enterprise	2x 550W Platinum	None	3-year	04/18

Model	Region	Processor	Memory	Storage Controller	Chassis	Disk Bays	Disk s	M.2 Drives	PCIe Flash Adapter	GPU	Onboard Networking Ports	Additional Networking (LOM/ML2/PCIe)	Fibre Channel I/O	Standard Extension Slots	Available Extension Slots via Riser Cards	Front VGA	Optical	TPM	System Management	Power Supply	Preload	Warranty	Ann Date (mm/yy)
7X021002LA	Chile	1x Xeon Silver 4114 10C/2.2GHz/13.75MB/85W/DDR4-2400	1x 16GB RDIMM DDR4-2666 (1Rx4)	1x 930-8i 2GB Flash	8x 2.5"	8x 2.5" SATA/SAS HS	Open	None	None	None	1x Mgmt	4x GbE RJ-45 LOM	None	1x LOM, 1x RAID	1x PCIe x8 LP, 1x Front PCIe x16 VGA FHHL	None	TPM 2.0	XClarity Enterprise	2x 750W Platinum	None	3-year	09/17	
7X021003LA	Chile	1x Xeon Bronze 3104 6C/1.7GHz/8.25MB/85W/DDR4-2133	1x 16GB RDIMM DDR4-2666 (1Rx4)	1x 930-8i 2GB Flash	8x 2.5"	8x 2.5" SATA/SAS HS	Open	None	None	None	1x Mgmt	4x GbE RJ-45 LOM	None	1x LOM, 1x RAID	1x PCIe x8 LP, 1x Front PCIe x16 VGA FHHL	None	TPM 2.0	XClarity Enterprise	2x 550W Platinum	None	3-year	09/17	
7X021004LA	Chile	1x Xeon Silver 4110 8C/2.1GHz/11MB/85W/DDR4-2400	1x 16GB RDIMM DDR4-2666 (1Rx4)	1x 930-8i 2GB Flash	8x 2.5"	8x 2.5" SATA/SAS HS	Open	None	None	None	1x Mgmt	4x GbE RJ-45 LOM	None	1x LOM, 1x RAID	1x PCIe x8 LP, 1x Front PCIe x16 VGA FHHL	None	TPM 2.0	XClarity Enterprise	2x 750W Platinum	None	3-year	09/17	

Model	Region	Processor	Memory	Storage Controller	Chassis	Disk Bays	Disk S	M.2 Drives	PCIe Flash Adapter	GPU	Onboard Networking Ports	Additional Networking (LOM/ML2/PCIe)	Fibre Channel I/O	Standard Extension Slots	Available Extension Slots via Riser Cards	Front VGA	Optical	TPM	System Management	Power Supply	Preload	Warranty	Ann Date (mm/yy)
7X02100PLA	Colombia	1x Xeon Silver 4114 10C/2.2GHz/13.75MB/85W/DDR4-2400	1x 16GB RDIMM DDR4-2666 (1Rx4)	1x 930-8i 2GB Flash	8x 2.5"	8x 2.5" SATA/SAS HS	Open	None	None	None	1x Mgmt	4x GbE RJ-45 LOM	None	1x LOM, 1x RAID	1x PCIe x8 LP, 1x Front PCIe x16 VGA LP	None	TPM 2.0	XClarity Enterprise	1x 550W Platinum	None	3-year	01/18	
7X02100QLA	Colombia	2x Xeon Gold 5118 12C/2.3GHz/16.5MB/105W/DDR4-2400	2x 16GB RDIMM DDR4-2666 (1Rx4)	1x 930-8i 2GB Flash	8x 2.5"	8x 2.5" SATA/SAS HS	Open	None	None	None	1x Mgmt	4x GbE RJ-45 LOM	None	1x LOM, 1x RAID	1x PCIe x8 LP, 1x Front PCIe x16 VGA LP	None	TPM 2.0	XClarity Enterprise	2x 750W Platinum	None	3-year	01/18	

Model	Region	Processor	Memory	Storage Controller	Chassis	Disk Bays	Disks	M.2 Drives	PCIe Flash Adapter	GPU	Onboard Networking Ports	Additional Networking (LOM/ML2/PCIe)	Fibre Channel I/O	Standard Extension Slots	Available Extension Slots via Riser VGA Cards	Optical	TPM	System Management	Power Supply	Preload	Warranty	Ann Date (mm/yy)
7X02A006EA	EMEA	1x Xeon Gold 6130 16C/2.1GHz/22MB/125W/DDR4-2666	1x 32GB RDIMM DDR4-2666 (2Rx4)	1x 930-8i 2GB Flash	8x 2.5"	8x 2.5" SATA/SAS HS	Open	None	None	None	1x Mgmt	None	None	1x LOM, 1x RAID	1x PCIe x8 LP, 1x Front PCIe x16 VGA LP	None	TPM 1.2	XClarity Enterprise	1x 750W Platinum	None	3-year	07/17
7X02A008EA	EMEA	1x Xeon Gold 5118 12C/2.3GHz/16.5MB/105W/DDR4-2400	1x 16GB RDIMM DDR4-2666 (2Rx8)	1x 930-8i 2GB Flash	8x 2.5"	8x 2.5" SATA/SAS HS	Open	None	None	None	1x Mgmt	None	None	1x LOM, 1x RAID	1x PCIe x8 LP, 1x Front PCIe x16 VGA LP	None	TPM 1.2	XClarity Enterprise	1x 750W Platinum	None	3-year	07/17
7X02A00QEA	EMEA	1x Xeon Gold 5118 12C/2.3GHz/16.5MB/105W/DDR4-2400	1x 16GB RDIMM DDR4-2666 (2Rx8)	1x 930-16i 4GB Flash	10x 2.5"	10x 2.5" SATA/SAS HS (6 SATA/SAS, 4 AnyBay)	Open	None	None	None	1x Mgmt	None	None	1x LOM, 1x RAID	1x PCIe x8 LP, 1x Front PCIe x16 VGA LP	None	TPM 1.2	XClarity Enterprise	1x 750W Platinum	None	3-year	07/17
7X02A00HEA	EMEA	1x Xeon Gold 5115 10C/2.4GHz/13.75MB/85W/DDR4-2400	1x 16GB RDIMM DDR4-2666 (2Rx8)	1x 930-8i 2GB Flash	8x 2.5"	8x 2.5" SATA/SAS HS	Open	None	None	None	1x Mgmt	None	None	1x LOM, 1x RAID	1x PCIe x8 LP, 1x Front PCIe x16 VGA LP	None	TPM 1.2	XClarity Enterprise	1x 750W Platinum	None	3-year	07/17
7X02A01QEA	EMEA	2x Xeon Gold 5118 12C/2.3GHz/16.5MB/105W/DDR4-2400	4x 32GB RDIMM DDR4-2666 (2Rx4)	1x 930-8i 2GB Flash	8x 2.5"	8x 2.5" SATA/SAS HS	Open	2x 32GB SSD M.2 SATA	None	None	1x Mgmt	None	None	1x LOM, 1x RAID, 2x M.2	1x PCIe x8 LP, 2x Front PCIe x16 VGA LP	None	TPM 1.2	XClarity Enterprise	2x 750W Platinum	None	3-year	07/17
7X02A03TEA	EMEA	1x Xeon Silver 4114 10C/2.2GHz/13.75MB/85W/DDR4-2400	1x 16GB RDIMM DDR4-2666 (2Rx8)	1x 930-8i 2GB Flash	8x 2.5"	8x 2.5" SATA/SAS HS	3x 300GB HDD 10K 2.5" SAS12Gbps	None	None	None	1x Mgmt	None	None	1x LOM, 1x RAID	1x PCIe x8 LP, 1x Front PCIe x16 VGA LP	None	TPM 1.2	XClarity Enterprise	2x 750W Platinum	None	3-year	07/17
7X02A02VEA	EMEA	2x Xeon Gold 5118 12C/2.3GHz/16.5MB/105W/DDR4-2400	4x 32GB RDIMM DDR4-2666 (2Rx4)	1x 930-8i 2GB Flash	8x 2.5"	8x 2.5" SATA/SAS HS	Open	2x 32GB SSD M.2 SATA	None	None	1x Mgmt	None	None	1x LOM, 1x RAID, 2x M.2	1x PCIe x8 LP, 2x Front PCIe x16 VGA LP	None	TPM 1.2	XClarity Enterprise	2x 750W Platinum	None	3-year	07/17
7X02A05AEA	EMEA	1x Xeon Silver 4110 8C/2.1GHz/11MB/85W/DDR4-2400	4x 32GB RDIMM DDR4-2666 (2Rx4)	1x 930-8i 2GB Flash	8x 2.5"	8x 2.5" SATA/SAS HS	3x 1.2TB HDD 10K 2.5" SAS12Gbps	None	None	None	1x Mgmt	None	None	1x LOM, 1x RAID	1x PCIe x8 LP, 1x Front PCIe x16 VGA LP	None	TPM 1.2	XClarity Enterprise	2x 750W Platinum	None	3-year	07/17
7X02A056EA	EMEA	1x Xeon Silver 4114 10C/2.2GHz/13.75MB/85W/DDR4-2400	1x 16GB RDIMM DDR4-2666 (2Rx8)	1x 930-8i 2GB Flash	8x 2.5"	8x 2.5" SATA/SAS HS	Open	None	None	None	1x Mgmt	None	None	1x LOM, 1x RAID	1x PCIe x8 LP, 1x Front PCIe x16 VGA LP	None	TPM 1.2	XClarity Enterprise	1x 750W Platinum	None	3-year	07/17
7X02A054EA	EMEA	1x Xeon Silver 4114 10C/2.2GHz/13.75MB/85W/DDR4-2400	1x 16GB RDIMM DDR4-2666 (2Rx8)	1x 930-8i 2GB Flash	8x 2.5"	8x 2.5" SATA/SAS HS	2x 300GB HDD 10K 2.5" SAS12Gbps	None	None	None	1x Mgmt	None	None	1x LOM, 1x RAID	1x PCIe x8 LP, 1x Front PCIe x16 VGA LP	None	TPM 1.2	XClarity Enterprise	2x 750W Platinum	None	3-year	07/17

Model	Region	Processor	Memory	Storage Controller	Chassis	Disk Bays	Disk S	M.2 Drives	PCIe Flash Adapter	GPU	Onboard Networking Ports	Additional Networking (LOM/ML2/PCIe)	Fibre Channel I/O	Standard Extension Slots	Available Extension Slots via Riser Cards	Front VGA	Optical	TPM	System Management	Power Supply	Preload	Warranty	Ann Date (mm/yy)
7X02A051EA	EMEA	1x Xeon Gold 5118 12C/2.3GHz/16.5MB/105W/DDR4-2400	4x 32GB RDIMM DDR4-2666 (2Rx4)	1x 930-8i 2GB Flash	8x 2.5"	8x 2.5" SATA/SAS HS	Open	2x 32GB SSD M.2 SATA	None	None	1x Mgmt	None	None	1x LOM, 1x RAID, 2x M.2	1x PCIe x8 LP, 1x Front PCIe x16 VGA LP	None	None	TPM 1.2	XClarity Enterprise	2x 750W Platinum	None	3-year	07/17
7X02A04WEA	EMEA	1x Xeon Silver 4110 8C/2.1GHz/11MB/85W/DDR4-2400	1x 16GB RDIMM DDR4-2666 (2Rx8)	1x 930-8i 2GB Flash	8x 2.5"	8x 2.5" SATA/SAS HS	Open	None	None	None	1x Mgmt	None	None	1x LOM, 1x RAID	1x PCIe x8 LP, 1x Front PCIe x16 VGA LP	None	None	TPM 1.2	XClarity Enterprise	1x 750W Platinum	None	3-year	07/17
7X02A04KEA	EMEA	1x Xeon Silver 4108 8C/1.8GHz/11MB/85W/DDR4-2400	1x 16GB RDIMM DDR4-2666 (2Rx8)	1x 930-8i 2GB Flash	8x 2.5"	8x 2.5" SATA/SAS HS	Open	None	None	None	1x Mgmt	None	None	1x LOM, 1x RAID	1x PCIe x8 LP, 1x Front PCIe x16 VGA LP	None	None	TPM 1.2	XClarity Enterprise	1x 750W Platinum	None	3-year	07/17
7X02A04GEA	EMEA	1x Xeon Silver 4116 12C/2.1GHz/16.5MB/85W/DDR4-2400	1x 16GB RDIMM DDR4-2666 (2Rx8)	1x 930-8i 2GB Flash	8x 2.5"	8x 2.5" SATA/SAS HS	Open	None	None	None	1x Mgmt	None	None	1x LOM, 1x RAID	1x PCIe x8 LP, 1x Front PCIe x16 VGA LP	None	None	TPM 1.2	XClarity Enterprise	1x 750W Platinum	None	3-year	07/17
7X02A04DEA	EMEA	1x Xeon Bronze 3104 6C/1.7GHz/8.25MB/85W/DDR4-2133	1x 8GB RDIMM DDR4-2666 (1Rx8)	1x 930-8i 2GB Flash	8x 2.5"	8x 2.5" SATA/SAS HS	Open	None	None	None	1x Mgmt	None	None	1x LOM, 1x RAID	1x PCIe x8 LP, 1x Front PCIe x16 VGA LP	None	None	TPM 1.2	XClarity Enterprise	1x 750W Platinum	None	3-year	07/17
7X02A049EA	EMEA	1x Xeon Silver 4110 8C/2.1GHz/11MB/85W/DDR4-2400	1x 32GB RDIMM DDR4-2666 (2Rx4)	1x 930-8i 2GB Flash	8x 2.5"	8x 2.5" SATA/SAS HS	Open	None	None	None	1x Mgmt	None	None	1x LOM, 1x RAID	1x PCIe x8 LP, 1x Front PCIe x16 VGA LP	None	None	TPM 1.2	XClarity Enterprise	2x 750W Platinum	None	3-year	07/17
7X02A048EA	EMEA	1x Xeon Silver 4114 10C/2.2GHz/13.75MB/85W/DDR4-2400	1x 32GB RDIMM DDR4-2666 (2Rx4)	1x 930-8i 2GB Flash	8x 2.5"	8x 2.5" SATA/SAS HS	Open	None	None	None	1x Mgmt	None	None	1x LOM, 1x RAID	None	Front VGA	None	TPM 1.2	XClarity Enterprise	2x 750W Platinum	None	3-year	07/17
7X02A03VEA	EMEA	1x Xeon Silver 4108 8C/1.8GHz/11MB/85W/DDR4-2400	1x 16GB RDIMM DDR4-2666 (2Rx8)	1x 930-8i 2GB Flash	8x 2.5"	8x 2.5" SATA/SAS HS	Open	None	None	None	1x Mgmt	None	None	1x LOM, 1x RAID	1x PCIe x8 LP, 1x Front PCIe x16 VGA LP	None	None	TPM 1.2	XClarity Enterprise	1x 750W Platinum	None	3-year	07/17
7X02A042EA	EMEA	1x Xeon Silver 4110 8C/2.1GHz/11MB/85W/DDR4-2400	1x 16GB RDIMM DDR4-2666 (2Rx8)	1x 930-8i 2GB Flash	8x 2.5"	8x 2.5" SATA/SAS HS	Open	None	None	None	1x Mgmt	None	None	1x LOM, 1x RAID	1x PCIe x8 LP, 1x Front PCIe x16 VGA LP	None	None	TPM 1.2	XClarity Enterprise	1x 750W Platinum	None	3-year	07/17
7X02A066EA	EMEA	1x Xeon Gold 6136 12C/3.0GHz/24.75MB/150W/DDR4-2666	1x 16GB RDIMM DDR4-2666 (2Rx8)	1x 930-8i 2GB Flash	8x 2.5"	8x 2.5" SATA/SAS HS	Open	None	None	None	1x Mgmt	None	None	1x LOM, 1x RAID	1x PCIe x8 LP, 1x Front PCIe x16 VGA LP	None	None	TPM 1.2	XClarity Enterprise	1x 750W Platinum	None	3-year	09/17

Model	Region	Processor	Memory	Storage Controller	Chassis	Disk Bays	Disk S	M.2 Drives	PCIe Flash Adapter	GPU	Onboard Networking Ports	Additional Networking (LOM/ML2/PCIe)	Fibre Channel I/O	Standard Extension Slots	Available Extension Slots via Riser Cards	Front VGA	Optical	TPM	System Management	Power Supply	Preload	Warranty	Ann Date (mm/yy)
7X02A067EA	EMEA	1x Xeon Gold 6150 18C/2.7GHz/24.75MB/165W/DDR4-2666	1x 16GB RDIMM DDR4-2666 (2Rx8)	1x 530-8i	8x 2.5"	8x 2.5" SATA/SAS/HS	Open	None	None	None	1x Mgmt	None	None	1x LOM, 1x RAID	1x PCIe x8 LP, 1x Front PCIe x16 LP	1x Front VGA	None	TPM 1.2	XClarity Enterprise	1x 750W Platinum	None	3-year	09/17
7X02A057EA	EMEA	1x Xeon Silver 4110 8C/2.1GHz/11MB/85W/DDR4-2400	1x 16GB RDIMM DDR4-2666 (2Rx8)	1x 930-16i 4GB Flash	10x 2.5"	10x 2.5" SATA/SAS/AnyBay)	Open	None	None	None	1x Mgmt	None	None	1x LOM, 1x RAID	1x PCIe x8 LP, 1x Front PCIe x16 LP	1x Front VGA	None	TPM 1.2	XClarity Enterprise	1x 750W Platinum	None	3-year	07/17
7X02A06PEA	EMEA	1x Xeon Gold 6132 14C/2.6GHz/19.25MB/140W/DDR4-2666	1x 16GB RDIMM DDR4-2666 (2Rx8)	1x 530-8i	8x 2.5"	8x 2.5" SATA/SAS/HS	Open	None	None	None	1x Mgmt	None	None	1x LOM, 1x RAID	None	1x Front VGA	None	TPM 1.2	XClarity Enterprise	1x 1100W Platinum	None	3-year	12/17
7X02A06QEA	EMEA	1x Xeon Gold 6142 16C/2.6GHz/22MB/150W/DDR4-2666	1x 16GB RDIMM DDR4-2666 (2Rx8)	1x 530-8i	8x 2.5"	8x 2.5" SATA/SAS/HS	Open	None	None	None	1x Mgmt	None	None	1x LOM, 1x RAID	None	1x Front VGA	None	TPM 1.2	XClarity Enterprise	1x 1100W Platinum	None	3-year	12/17
7X02A06REA	EMEA	1x Xeon Gold 6128 6C/3.4GHz/19.25MB/115W/DDR4-2666	1x 16GB RDIMM DDR4-2666 (2Rx8)	1x 530-8i	8x 2.5"	8x 2.5" SATA/SAS/HS	Open	None	None	None	1x Mgmt	None	None	1x LOM, 1x RAID	None	1x Front VGA	None	TPM 1.2	XClarity Enterprise	1x 1100W Platinum	None	3-year	12/17
7X02A06SEA	EMEA	1x Xeon Gold 6126 12C/2.6GHz/19.25MB/125W/DDR4-2666	1x 16GB RDIMM DDR4-2666 (2Rx8)	1x 530-8i	8x 2.5"	8x 2.5" SATA/SAS/HS	Open	None	None	None	1x Mgmt	None	None	1x LOM, 1x RAID	None	1x Front VGA	None	TPM 1.2	XClarity Enterprise	1x 1100W Platinum	None	3-year	12/17
7X02A06TEA	EMEA	1x Xeon Gold 6130 16C/2.1GHz/22MB/125W/DDR4-2666	1x 16GB RDIMM DDR4-2666 (2Rx8)	1x 530-8i	8x 2.5"	8x 2.5" SATA/SAS/HS	Open	None	None	None	1x Mgmt	None	None	1x LOM, 1x RAID	None	1x Front VGA	None	TPM 1.2	XClarity Enterprise	1x 1100W Platinum	None	3-year	12/17
7X02A06UEA	EMEA	1x Xeon Gold 6150 18C/2.7GHz/24.75MB/165W/DDR4-2666	1x 16GB RDIMM DDR4-2666 (2Rx8)	1x 530-8i	8x 2.5"	8x 2.5" SATA/SAS/HS	Open	None	None	None	1x Mgmt	None	None	1x LOM, 1x RAID	None	1x Front VGA	None	TPM 1.2	XClarity Enterprise	1x 1100W Platinum	None	3-year	12/17
7X02A06VEA	EMEA	1x Xeon Gold 6134 8C/3.2GHz/24.75MB/130W/DDR4-2666	1x 16GB RDIMM DDR4-2666 (2Rx8)	1x 530-8i	8x 2.5"	8x 2.5" SATA/SAS/HS	Open	None	None	None	1x Mgmt	None	None	1x LOM, 1x RAID	None	1x Front VGA	None	TPM 1.2	XClarity Enterprise	1x 1100W Platinum	None	3-year	12/17
7X02A06WEA	EMEA	1x Xeon Gold 5120 14C/2.2GHz/19.25MB/105W/DDR4-2400	1x 16GB RDIMM DDR4-2666 (2Rx8)	1x 530-8i	8x 2.5"	8x 2.5" SATA/SAS/HS	Open	None	None	None	1x Mgmt	None	None	1x LOM, 1x RAID	None	1x Front VGA	None	TPM 1.2	XClarity Enterprise	1x 1100W Platinum	None	3-year	12/17

Model	Region	Processor	Memory	Storage Controller	Chassis	Disk Bays	Disk S	M.2 Drives	PCIe Flash Adapter	GPU	Onboard Networking Ports	Additional Networking (LOM/ML2/PCIe)	Fibre Channel I/O	Standard Extension Slots	Available Extension Slots via Riser Cards	Front VGA	Optical	TPM	System Management	Power Supply	Preload	Warranty	Ann Date (mm/yy)
7X02A06XEA	EMEA	1x Xeon Gold 6136 12C/3.0GHz/24.75MB/150W/DDR4-2666	1x 16GB RDIMM DDR4-2666 (2Rx8)	1x 530-8i	8x 2.5"	8x 2.5" SATA/SAS HS	Open	None	None	None	1x Mgmt	None	None	1x LOM, 1x RAID	None	Front VGA	None	TPM 1.2	XClarity Enterprise	1x 1100W Platinum	None	3-year	12/17

Model	Region	Processor	Memory	Storage Controller	Chassis	Disk Bays	Disk s	M.2 Drives	PCIe Flash Adapter	GPU	Onboard Networking Ports	Additional Networking (LOM/ML2/PCIe)	Fibre Channel I/O	Standard Extension Slots	Available Extension Slots via Riser Cards	Front VGA	Optical	TPM	System Management	Power Supply	Preload	Warranty	Ann Date (mm/yy)	
7X02A06ECN	HTK	1x Xeon Silver 4110 8C/2.1GHz/11MB/85W/DDR4-2400	1x 16GB RDIMM DDR4-2666 (2Rx8)	1x 930-8i 2GB Flash	8x 2.5"	8x 2.5"	SATA/SAS HS	Open	None	None	None	1x Mgmt	4x GbE RJ-45 LOM	None	1x LOM, 1x RAID	1x ML2 x16 LP, 1x PCIe x8 FHHL	None	None	TPM 1.2	XClarity Standard	1x 750W Platinum	None	3-year	10/17

Model	Region	Processor	Memory	Storage Controller	Chassis	Disk Bays	Disk S	M.2 Drives	PCIe Flash Adapter	GPU	Onboard Networking Ports	Additional Networking (LOM/ML2/PCIe)	Fibre Channel I/O	Standard Extension Slots	Available Extension Slots via Riser Cards	Front VGA	Optical	TPM	System Management	Power Supply	Preload	Warranty	Ann Date (mm/yy)
7X02A02CJP	JAPAN	1x Xeon Bronze 3104 6C/1.7GHz/8.25MB/85W/DDR4-2133	1x 16GB RDIMM DDR4-2666 (1Rx4)	1x 930-8i 2GB Flash	8x 2.5"	8x 2.5" SATA/SA S HS	Open	None	None	None	1x Mgmt	4x GbE RJ-45 LOM	None	1x LOM, 1x RAID	1x PCIe x8 LP, 1x PCIe x16 LP	None	None	TPM 1.2	XClarity Advanced	1x 550W Platinum	None	3-year	07/17
7X02A01WJP	JAPAN	1x Xeon Bronze 3104 6C/1.7GHz/8.25MB/85W/DDR4-2133	1x 16GB RDIMM DDR4-2666 (1Rx4)	1x 530-8i	4x 3.5"	4x 3.5" SATA/SA S HS	Open	None	None	None	1x Mgmt	4x GbE RJ-45 LOM	None	1x LOM, 1x RAID	1x PCIe x8 LP, 1x PCIe x16 LP	None	None	TPM 1.2	XClarity Advanced	1x 550W Platinum	None	3-year	07/17
7X02A02RJP	JAPAN	1x Xeon Bronze 3106 8C/1.7GHz/11MB/85W/DDR4-2133	1x 16GB RDIMM DDR4-2666 (1Rx4)	1x 930-8i 2GB Flash	8x 2.5"	8x 2.5" SATA/SA S HS	Open	None	None	None	1x Mgmt	4x GbE RJ-45 LOM	None	1x LOM, 1x RAID	1x PCIe x8 LP, 1x PCIe x16 LP	None	None	TPM 1.2	XClarity Advanced	1x 550W Platinum	None	3-year	07/17
7X02A02SJP	JAPAN	1x Xeon Silver 4110 8C/2.1GHz/11MB/85W/DDR4-2400	1x 16GB RDIMM DDR4-2666 (1Rx4)	1x 930-8i 2GB Flash	8x 2.5"	8x 2.5" SATA/SA S HS	Open	None	None	None	1x Mgmt	4x GbE RJ-45 LOM	None	1x LOM, 1x RAID	1x PCIe x8 LP, 1x PCIe x16 LP	None	None	TPM 1.2	XClarity Advanced	1x 550W Platinum	None	3-year	07/17
7X02A02TJP	JAPAN	1x Xeon Silver 4112 4C/2.6GHz/8.25MB/85W/DDR4-2400	1x 16GB RDIMM DDR4-2666 (1Rx4)	1x 930-8i 2GB Flash	8x 2.5"	8x 2.5" SATA/SA S HS	Open	None	None	None	1x Mgmt	4x GbE RJ-45 LOM	None	1x LOM, 1x RAID	1x PCIe x8 LP, 1x PCIe x16 LP	None	None	TPM 1.2	XClarity Advanced	1x 550W Platinum	None	3-year	07/17

Model	Region	Processor	Memory	Storage Controller	Chassis	Disk Bays	Disk S	M.2 Drives	PCIe Flash Adapter	GPU	Onboard Networking Ports	Additional Networking (LOM/ML2/PCIe)	Fibre Channel I/O	Standard Extension Slots	Available Extension Slots via Riser Cards	Front VGA	Optical	TPM	System Management	Power Supply	Preload	Warranty	Ann Date (mm/yy)
7X02100RLA	LA	1x Xeon Gold 5118 12C/2.3GHz/16.5MB/105W/DDR4-2400	1x 16GB RDIMM DDR4-2666 (2Rx8)	1x 530-8i	8x 2.5"	8x 2.5" SATA/SAS HS	Open	None	None	None	1x Mgmt	2x GbE RJ-45 LOM	None	1x LOM, 1x RAID	1x PCIe x8 LP, 1x Front PCIe x16 VGA LP	None	None	TPM 1.2	XClarity Standard	1x750W Platinum	None	3-year	03/18
7X02A038LA	LA	1x Xeon Gold 5115 10C/2.4GHz/13.75MB/85W/DDR4-2400	1x 16GB RDIMM DDR4-2666 (2Rx8)	1x 930-8i 2GB Flash	8x 2.5"	8x 2.5" SATA/SAS HS	Open	None	None	None	1x Mgmt	None	None	1x LOM, 1x RAID	1x PCIe x8 LP, 1x Front PCIe x16 VGA LP	None	None	TPM 1.2	XClarity Standard	1x 750W Platinum	None	3-year	07/17
7X02A02LLA	LA	1x Xeon Gold 5118 12C/2.3GHz/16.5MB/105W/DDR4-2400	1x 16GB RDIMM DDR4-2666 (2Rx8)	1x 930-8i 2GB Flash	8x 2.5"	8x 2.5" SATA/SAS HS	Open	None	None	None	1x Mgmt	None	None	1x LOM, 1x RAID	1x PCIe x8 LP, 1x Front PCIe x16 VGA LP	None	None	TPM 1.2	XClarity Standard	1x 750W Platinum	None	3-year	07/17

Model	Region	Processor	Memory	Storage Controller	Chassis	Disk Bays	Disk S	M.2 Drives	PCIe Flash Adapter	GPU	Onboard Networking Ports	Additional Networking (LOM/ML2/PCIe)	Fibre Channel I/O	Standard Extension Slots	Available Extension Slots via Riser Cards	Front VGA	Optical	TPM	System Management	Power Supply	Preload	Warranty	Ann Date (mm/yy)
7X02A03UNA	NA	1x Xeon Silver 4110 8C/2.1GHz/11MB/85W/DDR4-2400	1x 16GB RDIMM DDR4- 2666 (1Rx4)	None	8x 2.5"	None	None	None	None	None	1x Mgmt	None	None	1x LOM, 1x RAID	None	Front VGA	None	TPM 1.2	XClarity Enterprise	1x 750W Platinum	None	3-year	07/17
7X02A04YNA	NA	1x Xeon Gold 5118 12C/2.3GHz/16.5MB/105W/DDR4-2400	1x 32GB RDIMM DDR4- 2666 (2Rx4)	None	8x 2.5"	None	None	None	None	None	1x Mgmt	None	None	1x LOM, 1x RAID	None	Front VGA	None	TPM 1.2	XClarity Enterprise	1x 750W Platinum	None	3-year	07/17
7X02A04JNA	NA	1x Xeon Silver 4116 12C/2.1GHz/16.5MB/85W/DDR4-2400	1x 32GB RDIMM DDR4- 2666 (2Rx4)	None	8x 2.5"	None	None	None	None	None	1x Mgmt	None	None	1x LOM, 1x RAID	None	Front VGA	None	TPM 1.2	XClarity Enterprise	1x 750W Platinum	None	3-year	07/17

Model	Region	Processor	Memory	Storage Controller	Chassis	Disk Bays	Disk S	M.2 Drives	PCIe Flash Adapter	GPU	Onboard Networking Ports	Additional Networking (LOM/ML2/PCIe)	Fibre Channel I/O	Standard Extension Slots	Available Extensions via Riser Cards	Front VGA	Optical	TPM	System Management	Power Supply	Preload	Warranty	Ann Date (mm/yy)
7X02A00ZAU	ANZ	1x Xeon Gold 5115 10C/2.4GHz/13.75MB/85W/DDR4-2400	1x 8GB RDIMM DDR4-2666 (1Rx8)	1x 530-8i	8x 2.5"	8x 2.5" SATA/SAS	Open	None	None	None	1x Mgmt	4x GbE RJ-45 LOM	None	1x LOM, 1x RAID	1x PCIe x8 LP, 1x Front PCIe x16 VGA LP	None	None	TPM 1.2	XClarity Standard	1x 550W Platinum	None	3-year	07/17
7X02A01SAU	ANZ	1x Xeon Gold 5118 12C/2.3GHz/16.5MB/105W/DDR4-2400	1x 16GB RDIMM DDR4-2666 (2Rx8)	1x 930-8i 2GB Flash	8x 2.5"	8x 2.5" SATA/SAS	Open	None	None	None	1x Mgmt	None	None	1x LOM, 1x RAID	1x PCIe x8 LP, 1x Front PCIe x16 VGA LP	None	None	TPM 1.2	XClarity Standard	1x 750W Platinum	None	3-year	07/17
7X02A01UAU	ANZ	1x Xeon Gold 6130 16C/2.1GHz/22MB/125W/DDR4-2666	1x 32GB RDIMM DDR4-2666 (2Rx4)	1x 930-8i 2GB Flash	8x 2.5"	8x 2.5" SATA/SAS	Open	None	None	None	1x Mgmt	None	None	1x LOM, 1x RAID	1x PCIe x8 LP, 1x Front PCIe x16 VGA LP	None	None	TPM 1.2	XClarity Standard	1x 750W Platinum	None	3-year	07/17
7X02A020AU	ANZ	1x Xeon Gold 5120 14C/2.2GHz/19.25MB/105W/DDR4-2400	1x 16GB RDIMM DDR4-2666 (1Rx4)	1x 530-8i	8x 2.5"	8x 2.5" SATA/SAS	Open	None	None	None	1x Mgmt	4x GbE RJ-45 LOM	None	1x LOM, 1x RAID	1x PCIe x8 LP, 1x Front PCIe x16 VGA LP	None	None	TPM 1.2	XClarity Standard	1x 550W Platinum	None	3-year	07/17
7X02A022AU	ANZ	1x Xeon Gold 5122 4C/3.6GHz/16.5MB/105W/DDR4-2666	1x 16GB RDIMM DDR4-2666 (1Rx4)	1x 930-8i 2GB Flash	8x 2.5"	8x 2.5" SATA/SAS	Open	None	None	None	1x Mgmt	4x GbE RJ-45 LOM	None	1x LOM, 1x RAID	1x PCIe x8 LP, 1x Front PCIe x16 VGA LP	None	None	TPM 1.2	XClarity Standard	1x 550W Platinum	None	3-year	07/17
7X02A023AU	ANZ	1x Xeon Gold 5118 12C/2.3GHz/16.5MB/105W/DDR4-2400	1x 16GB RDIMM DDR4-2666 (2Rx8)	1x 930-16i 4GB Flash	10x 2.5"	10x 2.5" SATA/SAS	Open	None	None	None	1x Mgmt	None	None	1x LOM, 1x RAID	1x PCIe x8 LP, 1x Front PCIe x16 VGA LP	None	None	TPM 1.2	XClarity Standard	1x 750W Platinum	None	3-year	07/17
7X02A01XAU	ANZ	1x Xeon Gold 6130 16C/2.1GHz/22MB/125W/DDR4-2666	1x 16GB RDIMM DDR4-2666 (1Rx4)	1x 930-8i 2GB Flash	8x 2.5"	8x 2.5" SATA/SAS	Open	None	None	None	1x Mgmt	4x GbE RJ-45 LOM	None	1x LOM, 1x RAID	1x PCIe x8 LP, 1x Front PCIe x16 VGA LP	None	None	TPM 1.2	XClarity Standard	1x 550W Platinum	None	3-year	07/17
7X02A026AU	ANZ	1x Xeon Gold 5115 10C/2.4GHz/13.75MB/85W/DDR4-2400	1x 8GB RDIMM DDR4-2666 (1Rx8)	1x 530-8i	4x 3.5"	4x 3.5" SATA/SAS	Open	None	None	None	1x Mgmt	4x GbE RJ-45 LOM	None	1x LOM, 1x RAID	1x PCIe x8 LP, 1x Front PCIe x16 VGA LP	None	None	TPM 1.2	XClarity Standard	1x 550W Platinum	None	3-year	07/17
7X02A02MAU	ANZ	1x Xeon Gold 6126 12C/2.6GHz/19.25MB/125W/DDR4-2666	1x 16GB RDIMM DDR4-2666 (1Rx4)	1x 930-8i 2GB Flash	8x 2.5"	8x 2.5" SATA/SAS	Open	None	None	None	1x Mgmt	4x GbE RJ-45 LOM	None	1x LOM, 1x RAID	1x PCIe x8 LP, 1x Front PCIe x16 VGA LP	None	None	TPM 1.2	XClarity Standard	1x 550W Platinum	None	3-year	07/17
7X02A02PAU	ANZ	1x Xeon Gold 5118 12C/2.3GHz/16.5MB/105W/DDR4-2400	1x 16GB RDIMM DDR4-2666 (1Rx4)	1x 930-8i 2GB Flash	8x 2.5"	8x 2.5" SATA/SAS	Open	None	None	None	1x Mgmt	4x GbE RJ-45 LOM	None	1x LOM, 1x RAID	1x PCIe x8 LP, 1x Front PCIe x16 VGA LP	None	None	TPM 1.2	XClarity Standard	1x 550W Platinum	None	3-year	07/17

Model	Region	Processor	Memory	Storage Controller	Chassis	Disk Bays	Disk S	M.2 Drives	PCIe Flash Adapter	GPU	Onboard Networking Ports	Additional Networking (LOM/ML2/PCIe)	Fibre Channel I/O	Standard Extension Slots	Available Extensions via Riser Cards	Front VGA	Optical	TPM	System Management	Power Supply	Preload	Warranty	Ann Date (mm/yy)
7X02A030AU	ANZ	1x Xeon Gold 5118 12C/2.3GHz/16.5MB/105W/DDR4-2400	1x 16GB RDIMM DDR4-2666 (1Rx4)	1x 530-8i	8x 2.5"	SATA/SAS HS	Open	None	None	None	1x Mgmt	4x GbE RJ-45 LOM	None	1x LOM, 1x RAID	1x PCIe x8 LP, 1x Front PCIe x16 VGA LP	None	TPM 1.2	XClarity Standard	1x 550W Platinum	None	3-year	07/17	
7X02A032AU	ANZ	1x Xeon Gold 5118 12C/2.3GHz/16.5MB/105W/DDR4-2400	1x 8GB RDIMM DDR4-2666 (1Rx8)	1x 530-8i	8x 2.5"	SATA/SAS HS	Open	None	None	None	1x Mgmt	4x GbE RJ-45 LOM	None	1x LOM, 1x RAID	1x PCIe x8 LP, 1x Front PCIe x16 VGA LP	None	TPM 1.2	XClarity Standard	1x 550W Platinum	None	3-year	07/17	
7X02A033AU	ANZ	1x Xeon Gold 6142 16C/2.6GHz/22MB/150W/DDR4-2666	1x 16GB RDIMM DDR4-2666 (1Rx4)	1x 930-8i 2GB Flash	8x 2.5"	SATA/SAS HS	Open	None	None	None	1x Mgmt	4x GbE RJ-45 LOM	None	1x LOM, 1x RAID	1x PCIe x8 LP, 1x Front PCIe x16 VGA LP	None	TPM 1.2	XClarity Standard	1x 550W Platinum	None	3-year	07/17	
7X02A034AU	ANZ	1x Xeon Gold 5120 14C/2.2GHz/19.25MB/105W/DDR4-2400	1x 16GB RDIMM DDR4-2666 (1Rx4)	1x 930-8i 2GB Flash	8x 2.5"	SATA/SAS HS	Open	None	None	None	1x Mgmt	4x GbE RJ-45 LOM	None	1x LOM, 1x RAID	1x PCIe x8 LP, 1x Front PCIe x16 VGA LP	None	TPM 1.2	XClarity Standard	1x 550W Platinum	None	3-year	07/17	
7X02A035AU	ANZ	1x Xeon Gold 5115 10C/2.4GHz/13.75MB/85W/DDR4-2400	1x 16GB RDIMM DDR4-2666 (2Rx8)	1x 930-8i 2GB Flash	8x 2.5"	SATA/SAS HS	Open	None	None	None	1x Mgmt	None	None	1x LOM, 1x RAID	1x PCIe x8 LP, 1x Front PCIe x16 VGA LP	None	TPM 1.2	XClarity Standard	1x 750W Platinum	None	3-year	07/17	
7X02A03DAU	ANZ	2x Xeon Gold 6154 18C/3.0GHz/24.75MB/200W/DDR4-2666	2x 16GB RDIMM DDR4-2666 (1Rx4)	1x 930-16i 4GB Flash	10x 2.5"	SATA/SAS HS (6 AnyBay)	Open	None	None	None	1x Mgmt	4x GbE RJ-45 LOM	None	1x LOM, 1x RAID	1x PCIe x8 LP, 1x Front PCIe x16 VGA LP	None	TPM 1.2	XClarity Standard	1x 1100W Platinum	None	3-year	07/17	
7X02A03EAU	ANZ	1x Xeon Gold 6148 20C/2.4GHz/27.5MB/150W/DDR4-2666	1x 32GB RDIMM DDR4-2666 (2Rx4)	1x 930-8i 2GB Flash	8x 2.5"	SATA/SAS HS	Open	None	None	None	1x Mgmt	None	None	1x LOM, 1x RAID	1x PCIe x8 LP, 1x Front PCIe x16 VGA LP	None	TPM 1.2	XClarity Standard	1x 750W Platinum	None	3-year	07/17	
7X02A03FAU	ANZ	1x Xeon Gold 6140 18C/2.3GHz/24.75MB/140W/DDR4-2666	1x 32GB RDIMM DDR4-2666 (2Rx4)	1x 930-8i 2GB Flash	8x 2.5"	SATA/SAS HS	Open	None	None	None	1x Mgmt	None	None	1x LOM, 1x RAID	1x PCIe x8 LP, 1x Front PCIe x16 VGA LP	None	TPM 1.2	XClarity Standard	1x 750W Platinum	None	3-year	07/17	
7X02A03GAU	ANZ	1x Xeon Gold 6152 22C/2.1GHz/30.25MB/140W/DDR4-2666	1x 32GB RDIMM DDR4-2666 (2Rx4)	1x 930-8i 2GB Flash	8x 2.5"	SATA/SAS HS	Open	None	None	None	1x Mgmt	None	None	1x LOM, 1x RAID	1x PCIe x8 LP, 1x Front PCIe x16 VGA LP	None	TPM 1.2	XClarity Standard	1x 750W Platinum	None	3-year	07/17	
7X02A03HAU	ANZ	1x Xeon Gold 6134 8C/3.2GHz/24.75MB/130W/DDR4-2666	1x 32GB RDIMM DDR4-2666 (2Rx4)	1x 930-8i 2GB Flash	8x 2.5"	SATA/SAS HS	Open	None	None	None	1x Mgmt	None	None	1x LOM, 1x RAID	1x PCIe x8 LP, 1x Front PCIe x16 VGA LP	None	TPM 1.2	XClarity Standard	1x 750W Platinum	None	3-year	07/17	

Model	Region	Processor	Memory	Storage Controller	Chassis	Disk Bays	Disks	M.2 Drives	PCIe Flash Adapter	GPU	Onboard Networking Ports	Additional Networking (LOM/ML2/PCIe)	Fibre Channel I/O	Standard Extension Slots	Available Extension Slots via Riser	Front VGA Cards	Optical	TPM	System Management	Power Supply	Preload	Warranty	Ann Date (mm/yy)
7X02A03JA U	ANZ	1x Xeon Platinum 8160 24C/2.1GHz/33MB/150W/DDR4-2666	1x 32GB RDIMM DDR4-2666 (2Rx4)	1x 930-8i 2GB Flash	8x 2.5"	8x 2.5" SATA/SAS HS	Open	None	None	None	1x Mgmt	None	None	1x LOM, 1x RAID	1x PCIe x8 LP, 1x Front PCIe x16 VGA LP	None	None	TPM 1.2	XClarity Standard	1x 750W Platinum	None	3-year	07/17
7X02A03KA U	ANZ	2x Xeon Gold 5118 12C/2.3GHz/16.5MB/105W/DDR4-2400	2x 32GB RDIMM DDR4-2666 (2Rx4)	1x 430-16i	10x 2.5"	10x 2.5" SATA/SAS, 4 AnyBay)	Open	None	None	None	1x Mgmt	None	None	1x LOM, 1x RAID	1x PCIe x8 LP, 2x Front PCIe x16 VGA LP	None	None	TPM 1.2	XClarity Standard	1x 750W Platinum	None	3-year	07/17
7X02A03LA U	ANZ	1x Xeon Gold 6142 16C/2.6GHz/22MB/150W/DDR4-2666	1x 32GB RDIMM DDR4-2666 (2Rx4)	1x 930-8i 2GB Flash	8x 2.5"	8x 2.5" SATA/SAS HS	Open	None	None	None	1x Mgmt	None	None	1x LOM, 1x RAID	1x PCIe x8 LP, 1x Front PCIe x16 VGA LP	None	None	TPM 1.2	XClarity Standard	1x 750W Platinum	None	3-year	07/17
7X02A03MA U	ANZ	1x Xeon Gold 5120 14C/2.2GHz/19.25MB/105W/DDR4-2400	1x 16GB RDIMM DDR4-2666 (2Rx8)	1x 930-8i 2GB Flash	8x 2.5"	8x 2.5" SATA/SAS HS	Open	None	None	None	1x Mgmt	None	None	1x LOM, 1x RAID	1x PCIe x8 LP, 1x Front PCIe x16 VGA LP	None	None	TPM 1.2	XClarity Standard	1x 750W Platinum	None	3-year	07/17
7X02A03NA U	ANZ	1x Xeon Gold 6126T 12C/2.6GHz/19.25MB/125W/DDR4-2666	1x 32GB RDIMM DDR4-2666 (2Rx4)	1x 930-8i 2GB Flash	8x 2.5"	8x 2.5" SATA/SAS HS	Open	None	None	None	1x Mgmt	None	None	1x LOM, 1x RAID	1x PCIe x8 LP, 1x Front PCIe x16 VGA LP	None	None	TPM 1.2	XClarity Standard	1x 750W Platinum	None	3-year	07/17
7X02A03PA U	ANZ	1x Xeon Gold 6150 18C/2.7GHz/24.75MB/165W/DDR4-2666	1x 32GB RDIMM DDR4-2666 (2Rx4)	1x 930-8i 2GB Flash	8x 2.5"	8x 2.5" SATA/SAS HS	Open	None	None	None	1x Mgmt	None	None	1x LOM, 1x RAID	1x PCIe x8 LP, 1x Front PCIe x16 VGA LP	None	None	TPM 1.2	XClarity Standard	1x 750W Platinum	None	3-year	07/17
7X02A03SA U	ANZ	1x Xeon Silver 4114 10C/2.2GHz/13.75MB/85W/DDR4-2400	1x 16GB RDIMM DDR4-2666 (2Rx8)	1x 930-8i 2GB Flash	8x 2.5"	8x 2.5" SATA/SAS HS	Open	None	None	None	1x Mgmt	None	None	1x LOM, 1x RAID	1x PCIe x8 LP, 1x Front PCIe x16 LP	None	None	TPM 1.2	XClarity Standard	1x 750W Platinum	None	3-year	07/17
7X02A03TA U	ANZ	1x Xeon Silver 4114 10C/2.2GHz/13.75MB/85W/DDR4-2400	1x 16GB RDIMM DDR4-2666 (2Rx8)	1x 930-8i 2GB Flash	8x 2.5"	8x 2.5" SATA/SAS HS	3x 300GB HDD 10K 2.5" SAS12Gbps	None	None	None	1x Mgmt	None	None	1x LOM, 1x RAID	1x PCIe x8 LP, 1x Front PCIe x16 VGA LP	None	None	TPM 1.2	XClarity Enterprise	2x 750W Platinum	None	3-year	08/17
7X02A040A U	ANZ	2x Xeon Silver 4110 8C/2.1GHz/11MB/85W/DDR4-2400	2x 32GB RDIMM DDR4-2666 (2Rx4)	1x 430-16i	10x 2.5"	10x 2.5" SATA/SAS, 4 AnyBay)	Open	None	None	None	1x Mgmt	None	None	1x LOM, 1x RAID	1x PCIe x8 LP, 1x Front PCIe x16 LP	None	None	TPM 1.2	XClarity Standard	1x 750W Platinum	None	3-year	07/17
7X02A041A U	ANZ	1x Xeon Gold 6130 16C/2.1GHz/22MB/125W/DDR4-2666	1x 32GB RDIMM DDR4-2666 (2Rx4)	1x 930-8i 2GB Flash	8x 2.5"	8x 2.5" SATA/SAS HS	Open	None	None	None	1x Mgmt	None	None	1x LOM, 1x RAID	1x PCIe x8 LP, 1x Front PCIe x16 VGA LP	None	None	TPM 1.2	XClarity Enterprise	1x 750W Platinum	None	3-year	08/17

Model	Region	Processor	Memory	Storage Controller	Chassis	Disk Bays	Disk s	M.2 Drives	PCIe Flash Adapter	GPU	Onboard Networking Ports	Additional Networking (LOM/ML2/PCIe)	Fibre Channel I/O	Standard Extension Slots	Available Extension Slots via Riser Cards	Front VGA	Optical	TPM	System Management	Power Supply	Preload	Warranty	Ann Date (mm/yy)
7X02A042AU	ANZ	1x Xeon Silver 4110 8C/2.1GHz/11MB/85W/DDR4-2400	1x 16GB RDIMM DDR4-2666 (2Rx8)	1x 930-8i 2GB Flash	8x 2.5"	8x 2.5"	SATA/SAS Open	None	None	None	1x Mgmt	None	None	1x LOM, 1x RAID	1x PCIe x8 LP, 1x PCIe x16 LP, 1x Front VGA	None	None	TPM 1.2	XClarity Enterprise	1x 750W Platinum	None	3-year	08/17
7X02A03VAU	ANZ	1x Xeon Silver 4108 8C/1.8GHz/11MB/85W/DDR4-2400	1x 16GB RDIMM DDR4-2666 (2Rx8)	1x 530-8i	8x 2.5"	8x 2.5"	SATA/SAS Open	None	None	None	1x Mgmt	None	None	1x LOM, 1x RAID	1x PCIe x8 LP, 1x PCIe x16 LP, 1x Front VGA	None	None	TPM 1.2	XClarity Enterprise	1x 750W Platinum	None	3-year	08/17
7X02A048AU	ANZ	1x Xeon Silver 4114 10C/2.2GHz/13.75MB/85W/DDR4-2400	1x 32GB RDIMM DDR4-2666 (2Rx4)	1x 930-8i 2GB Flash	8x 2.5"	8x 2.5"	SATA/SAS Open	None	None	None	1x Mgmt	None	None	1x LOM, 1x RAID	None	Front VGA	None	TPM 1.2	XClarity Enterprise	2x 750W Platinum	None	3-year	08/17
7X02A049AU	ANZ	1x Xeon Silver 4110 8C/2.1GHz/11MB/85W/DDR4-2400	1x 32GB RDIMM DDR4-2666 (2Rx4)	1x 930-8i 2GB Flash	8x 2.5"	8x 2.5"	SATA/SAS Open	None	None	None	1x Mgmt	None	None	1x LOM, 1x RAID	None	Front VGA	None	TPM 1.2	XClarity Enterprise	2x 750W Platinum	None	3-year	08/17
7X02A04AAU	ANZ	1x Xeon Silver 4110 8C/2.1GHz/11MB/85W/DDR4-2400	1x 16GB RDIMM DDR4-2666 (2Rx8)	1x 930-8i 2GB Flash	8x 2.5"	8x 2.5"	SATA/SAS Open	None	None	None	1x Mgmt	None	None	1x LOM, 1x RAID	1x PCIe x8 LP, 1x PCIe x16 LP, 1x Front VGA	None	None	TPM 1.2	XClarity Standard	1x 750W Platinum	None	3-year	07/17
7X02A04DAU	ANZ	1x Xeon Bronze 3104 6C/1.7GHz/8.25MB/85W/DDR4-2133	1x 8GB RDIMM DDR4-2666 (1Rx8)	1x 530-8i	8x 2.5"	8x 2.5"	SATA/SAS Open	None	None	None	1x Mgmt	None	None	1x LOM, 1x RAID	1x PCIe x8 LP, 1x PCIe x16 LP, 1x Front VGA	None	None	TPM 1.2	XClarity Enterprise	1x 750W Platinum	None	3-year	08/17
7X02A04FAU	ANZ	1x Xeon Silver 4108 8C/1.8GHz/11MB/85W/DDR4-2400	1x 16GB RDIMM DDR4-2666 (2Rx8)	1x 530-8i	8x 2.5"	8x 2.5"	SATA/SAS Open	None	None	None	1x Mgmt	None	None	1x LOM, 1x RAID	1x PCIe x8 LP, 1x PCIe x16 LP, 1x Front VGA	None	None	TPM 1.2	XClarity Standard	1x 750W Platinum	None	3-year	07/17
7X02A04GAU	ANZ	1x Xeon Silver 4116 12C/2.1GHz/16.5MB/85W/DDR4-2400	1x 16GB RDIMM DDR4-2666 (2Rx8)	1x 930-8i 2GB Flash	8x 2.5"	8x 2.5"	SATA/SAS Open	None	None	None	1x Mgmt	None	None	1x LOM, 1x RAID	1x PCIe x8 LP, 1x PCIe x16 LP, 1x Front VGA	None	None	TPM 1.2	XClarity Enterprise	1x 750W Platinum	None	3-year	08/17
7X02A04HAU	ANZ	1x Xeon Silver 4110 8C/2.1GHz/11MB/85W/DDR4-2400	1x 16GB RDIMM DDR4-2666 (2Rx8)	1x 930-16i 4GB Flash	10x 2.5"	10x 2.5"	SATA/SAS Open	None	None	None	1x Mgmt	None	None	1x LOM, 1x RAID	1x PCIe x8 LP, 1x PCIe x16 LP, 1x Front VGA	None	None	TPM 1.2	XClarity Standard	1x 750W Platinum	None	3-year	07/17
7X02A04LAU	ANZ	1x Xeon Bronze 3106 8C/1.7GHz/11MB/85W/DDR4-2133	1x 8GB RDIMM DDR4-2666 (1Rx8)	1x 530-8i	8x 2.5"	8x 2.5"	SATA/SAS Open	None	None	None	1x Mgmt	None	None	1x LOM, 1x RAID	1x PCIe x8 LP, 1x PCIe x16 LP, 1x Front VGA	None	None	TPM 1.2	XClarity Standard	1x 750W Platinum	None	3-year	07/17

Model	Region	Processor	Memory	Storage Controller	Chassis	Disk Bays	Disks	M.2 Drives	PCIe Flash Adapter	GPU	Onboard Networking Ports	Additional Networking (LOM/ML2/PCIe)	Fibre Channel I/O	Standard Extension Slots	Available Extension Slots via Riser VGA Cards	Front Panel	Optical	TPM	System Management	Power Supply	Preload	Warranty	Ann Date (mm/yy)
7X02A04KAU	ANZ	1x Xeon Silver 4108 8C/1.8GHz/11MB/85W/DDR4-2400	1x 16GB RDIMM DDR4-2666 (2Rx8)	1x 930-8i 2GB Flash	8x 2.5"	8x 2.5" SATA/SAS HS	Open	None	None	None	1x Mgmt	None	None	1x LOM, 1x RAID	1x PCIe x8 LP, 1x Front Panel x16 VGA LP	None	None	TPM 1.2	XClarity Enterprise	1x 750W Platinum	None	3-year	08/17
7X02A04RAU	ANZ	1x Xeon Gold 5115 10C/2.4GHz/13.75MB/85W/DDR4-2400	1x 16GB RDIMM DDR4-2666 (2Rx8)	1x 930-8i 2GB Flash	8x 2.5"	8x 2.5" SATA/SAS HS	Open	None	None	None	1x Mgmt	None	None	1x LOM, 1x RAID	1x PCIe x8 LP, 1x Front Panel x16 VGA LP	None	None	TPM 1.2	XClarity Enterprise	1x 750W Platinum	None	3-year	08/17
7X02A04UAU	ANZ	1x Xeon Silver 4108 8C/1.8GHz/11MB/85W/DDR4-2400	1x 16GB RDIMM DDR4-2666 (2Rx8)	1x 530-8i	4x 3.5"	4x 3.5" SATA/SAS HS	Open	None	None	None	1x Mgmt	None	None	1x LOM, 1x RAID	1x PCIe x8 LP, 1x Front Panel x16 VGA LP	None	None	TPM 1.2	XClarity Standard	1x 750W Platinum	None	3-year	07/17
7X02A04WAU	ANZ	1x Xeon Silver 4110 8C/2.1GHz/11MB/85W/DDR4-2400	1x 16GB RDIMM DDR4-2666 (2Rx8)	1x 530-8i	8x 2.5"	8x 2.5" SATA/SAS HS	Open	None	None	None	1x Mgmt	None	None	1x LOM, 1x RAID	1x PCIe x8 LP, 1x Front Panel x16 VGA LP	None	None	TPM 1.2	XClarity Enterprise	1x 750W Platinum	None	3-year	08/17
7X02A04XAU	ANZ	1x Xeon Silver 4110 8C/2.1GHz/11MB/85W/DDR4-2400	1x 16GB RDIMM DDR4-2666 (2Rx8)	1x 530-8i	8x 2.5"	8x 2.5" SATA/SAS HS	Open	None	None	None	1x Mgmt	None	None	1x LOM, 1x RAID	1x PCIe x8 LP, 1x Front Panel x16 VGA LP	None	None	TPM 1.2	XClarity Standard	1x 750W Platinum	None	3-year	07/17
7X02A050AU	ANZ	1x Xeon Silver 4116 12C/2.1GHz/16.5MB/85W/DDR4-2400	1x 16GB RDIMM DDR4-2666 (2Rx8)	1x 930-8i 2GB Flash	8x 2.5"	8x 2.5" SATA/SAS HS	Open	None	None	None	1x Mgmt	None	None	1x LOM, 1x RAID	1x PCIe x8 LP, 1x Front Panel x16 VGA LP	None	None	TPM 1.2	XClarity Standard	1x 750W Platinum	None	3-year	07/17
7X02A051AU	ANZ	1x Xeon Gold 5118 12C/2.3GHz/16.5MB/105W/DDR4-2400	4x 32GB RDIMM DDR4-2666 (2Rx4)	1x 930-8i 2GB Flash	8x 2.5"	8x 2.5" SATA/SAS HS	Open	2x 32GB SSD M.2 SATA	None	None	1x Mgmt	None	None	1x LOM, 1x RAID, 2x M.2	1x PCIe x8 LP, 1x Front Panel x16 VGA LP	None	None	TPM 1.2	XClarity Enterprise	2x 750W Platinum	None	3-year	08/17
7X02A054AU	ANZ	1x Xeon Silver 4114 10C/2.2GHz/13.75MB/85W/DDR4-2400	1x 16GB RDIMM DDR4-2666 (2Rx8)	1x 930-8i 2GB Flash	8x 2.5"	8x 2.5" SATA/SAS HS	Open	None	None	None	1x Mgmt	None	None	1x LOM, 1x RAID	1x PCIe x8 LP, 1x Front Panel x16 VGA LP	None	None	TPM 1.2	XClarity Enterprise	2x 750W Platinum	None	3-year	08/17
7X02A055AU	ANZ	1x Xeon Gold 5118 12C/2.3GHz/16.5MB/105W/DDR4-2400	1x 16GB RDIMM DDR4-2666 (2Rx8)	1x 930-16i 4GB Flash	10x 2.5"	10x 2.5" SATA/SAS, 4 AnyBay)	Open	None	None	None	1x Mgmt	None	None	1x LOM, 1x RAID	1x PCIe x8 LP, 1x Front Panel x16 VGA LP	None	None	TPM 1.2	XClarity Enterprise	1x 750W Platinum	None	3-year	08/17
7X02A056AU	ANZ	1x Xeon Silver 4114 10C/2.2GHz/13.75MB/85W/DDR4-2400	1x 16GB RDIMM DDR4-2666 (2Rx8)	1x 930-8i 2GB Flash	8x 2.5"	8x 2.5" SATA/SAS HS	Open	None	None	None	1x Mgmt	None	None	1x LOM, 1x RAID	1x PCIe x8 LP, 1x Front Panel x16 VGA LP	None	None	TPM 1.2	XClarity Enterprise	1x 750W Platinum	None	3-year	08/17

Model	Region	Processor	Memory	Storage Controller	Chassis	Disk Bays	Disk S	M.2 Drives	PCIe Flash Adapter	GPU	Onboard Networking Ports	Additional Networking (LOM/ML2/PCIe)	Fibre Channel I/O	Standard Extension Slots	Available Extension Slots via Riser Cards	Front VGA	Optical	TPM	System Management	Power Supply	Preload	Warranty	Ann Date (mm/yy)
7X02A058AU	ANZ	1x Xeon Bronze 3104 6C/1.7GHz/8.25MB/85W/DDR4-2133	1x 8GB RDIMM DDR4-2666 (1Rx8)	1x 530-8i	8x 2.5"	8x 2.5"	SATA/SAS HS	Open	None	None	1x Mgmt	None	None	1x LOM, 1x RAID	1x PCIe x8 LP, 1x PCIe x16 LP	None	None	TPM 1.2	XClarity Standard	1x 750W Platinum	None	3-year	07/17
7X02A059AU	ANZ	1x Xeon Gold 5118 12C/2.3GHz/16.5MB/105W/DDR4-2400	1x 16GB RDIMM DDR4-2666 (2Rx8)	1x 930-8i 2GB Flash	8x 2.5"	8x 2.5"	SATA/SAS HS	Open	None	None	1x Mgmt	None	None	1x LOM, 1x RAID	1x PCIe x8 LP, 1x Front PCIe x16 LP	1x Front VGA	None	TPM 1.2	XClarity Enterprise	1x 750W Platinum	None	3-year	08/17
7X02A057AU	ANZ	1x Xeon Silver 4110 8C/2.1GHz/11MB/85W/DDR4-2400	1x 16GB RDIMM DDR4-2666 (2Rx8)	1x 930-16i 4GB Flash	10x 2.5"	10x 2.5"	SATA/SAS HS (6 , 4 AnyBay)	Open	None	None	1x Mgmt	None	None	1x LOM, 1x RAID	1x PCIe x8 LP, 1x Front PCIe x16 LP	1x Front VGA	None	TPM 1.2	XClarity Enterprise	1x 750W Platinum	None	3-year	08/17

Model	Region	Processor	Memory	Storage Controller	Chassis	Disk Bays	Disk S	M.2 Drives	PCIe Flash Adapter	GPU	Onboard Networking Ports	Additional Networking (LOM/ML2/PCIe)	Fibre Channel I/O	Standard Extension Slots	Available Extension Slots via Riser Cards	Front VGA	Optical	TPM	System Management	Power Supply	Preload	Warranty	Ann Date (mm/yy)
7X02A00FSG	ASEAN	1x Xeon Gold 5120 14C/2.2GHz/19.25MB/105W/DDR4-2400	1x 16GB RDIMM DDR4-2666 (2Rx8)	1x 930-8i 2GB Flash	8x 2.5"	8x 2.5" SATA/SAS HS	Open	None	None	None	1x Mgmt	4x 10GbE RJ-45 LOM	None	1x LOM, 1x RAID	1x PCIe x8 LP, 1x Front PCIe x16 VGA LP	None	None	TPM 1.2	XClarity Standard	1x 750W Platinum	None	3-year	07/17
7X02A00KSG	ASEAN	1x Xeon Gold 5118 12C/2.3GHz/16.5MB/105W/DDR4-2400	1x 16GB RDIMM DDR4-2666 (2Rx8)	1x 930-8i 2GB Flash	8x 2.5"	8x 2.5" SATA/SAS HS	Open	None	None	None	1x Mgmt	4x 10GbE RJ-45 LOM	None	1x LOM, 1x RAID	1x PCIe x8 LP, 1x Front PCIe x16 VGA LP	None	None	TPM 1.2	XClarity Standard	1x 750W Platinum	None	3-year	07/17
7X02A00LSG	ASEAN	1x Xeon Gold 5115 10C/2.4GHz/13.75MB/85W/DDR4-2400	1x 16GB RDIMM DDR4-2666 (2Rx8)	1x 930-8i 2GB Flash	4x 3.5"	4x 3.5" SATA/SAS HS	Open	None	None	None	1x Mgmt	4x 10GbE RJ-45 LOM	None	1x LOM, 1x RAID	1x PCIe x8 LP, 1x Front PCIe x16 VGA LP	None	None	TPM 1.2	XClarity Standard	1x 1100W Platinum	None	3-year	07/17
7X02A00MSG	ASEAN	1x Xeon Gold 6152 22C/2.1GHz/30.25MB/140W/DDR4-2666	1x 32GB RDIMM DDR4-2666 (2Rx4)	1x 930-8i 2GB Flash	8x 2.5"	8x 2.5" SATA/SAS HS	Open	None	None	None	1x Mgmt	4x 10GbE RJ-45 LOM	None	1x LOM, 1x RAID	1x PCIe x8 LP, 1x Front PCIe x16 VGA LP	None	None	TPM 1.2	XClarity Standard	1x 1100W Platinum	None	3-year	07/17
7X02A00NSG	ASEAN	1x Xeon Gold 6148 20C/2.4GHz/27.5MB/150W/DDR4-2666	1x 32GB RDIMM DDR4-2666 (2Rx4)	1x 930-8i 2GB Flash	8x 2.5"	8x 2.5" SATA/SAS HS	Open	None	None	None	1x Mgmt	4x 10GbE RJ-45 LOM	None	1x LOM, 1x RAID	1x PCIe x8 LP, 1x Front PCIe x16 VGA LP	None	None	TPM 1.2	XClarity Standard	1x 1100W Platinum	None	3-year	07/17
7X02A00SSG	ASEAN	1x Xeon Gold 6140 18C/2.3GHz/24.75MB/140W/DDR4-2666	1x 16GB RDIMM DDR4-2666 (2Rx8)	1x 930-8i 2GB Flash	8x 2.5"	8x 2.5" SATA/SAS HS	Open	None	None	None	1x Mgmt	4x 10GbE RJ-45 LOM	None	1x LOM, 1x RAID	1x PCIe x8 LP, 1x Front PCIe x16 VGA LP	None	None	TPM 1.2	XClarity Standard	1x 1100W Platinum	None	3-year	07/17
7X02A001SG	ASEAN	1x Xeon Gold 5115 10C/2.4GHz/13.75MB/85W/DDR4-2400	1x 16GB RDIMM DDR4-2666 (2Rx8)	1x 930-8i 2GB Flash	8x 2.5"	8x 2.5" SATA/SAS HS	Open	None	None	None	1x Mgmt	4x 10GbE RJ-45 LOM	None	1x LOM, 1x RAID	1x PCIe x8 LP, 1x Front PCIe x16 VGA LP	None	None	TPM 1.2	XClarity Standard	1x 750W Platinum	None	3-year	07/17
7X02A00BSG	ASEAN	1x Xeon Gold 6130 16C/2.1GHz/22MB/125W/DDR4-2666	1x 16GB RDIMM DDR4-2666 (2Rx8)	1x 930-8i 2GB Flash	8x 2.5"	8x 2.5" SATA/SAS HS	Open	None	None	None	1x Mgmt	4x 10GbE RJ-45 LOM	None	1x LOM, 1x RAID	1x PCIe x8 LP, 1x Front PCIe x16 VGA LP	None	None	TPM 1.2	XClarity Standard	1x 1100W Platinum	None	3-year	07/17
7X02A00DSG	ASEAN	1x Xeon Gold 6134 8C/3.2GHz/24.75MB/130W/DDR4-2666	1x 16GB RDIMM DDR4-2666 (2Rx8)	1x 930-8i 2GB Flash	8x 2.5"	8x 2.5" SATA/SAS HS	Open	None	None	None	1x Mgmt	4x 10GbE RJ-45 LOM	None	1x LOM, 1x RAID	1x PCIe x8 LP, 1x Front PCIe x16 VGA LP	None	None	TPM 1.2	XClarity Standard	1x 1100W Platinum	None	3-year	07/17

Model	Region	Processor	Memory	Storage Controller	Chassis	Disk Bays	Disks	M.2 Drives	PCIe Flash Adapter	GPU	Onboard Networking Ports	Additional Networking (LOM/ML2/PCIe)	Fibre Channel I/O	Standard Extension Slots	Available Extension Slots via Riser Cards	Front VGA	Optical	TPM	System Management	Power Supply	Preload	Warranty	Ann Date (mm/yy)
7X020001CN	CHINA	2x Xeon Gold 5120 14C/2.2GHz/19.25MB/105W/DDR4-2400	2x 32GB RDIMM DDR4-2666 (2Rx4), Memory Sparing	1x 930-16i 4GB Flash	8x 2.5"	8x 2.5" SATA/SAS HS	8x 600GB HDD 15K 2.5" SAS12Gbps	2x 480GB B SSD M.2 SATA	None	None	1x Mgmt	None	None	1x LOM, 1x RAID, 2x M.2	1x PCIe x16 LP	None	None	None	XClarity Standard	1x 1100W Platinum	None	3-year	11/17
7X02A061CN	CHINA	2x Xeon Gold 5120 14C/2.2GHz/19.25MB/105W/DDR4-2400	2x 128GB 3DS RDIMM DDR4-2666 (8Rx4), Memory Sparing	1x 730-8i 1GB	8x 2.5"	8x 2.5" SATA/SAS HS	6x 600GB HDD 15K 2.5" SAS12Gbps	2x 480GB B SSD M.2 SATA	None	None	1x Mgmt	None	1x 32Gb SFP+	1x LOM, 1x RAID, 2x M.2	1x PCIe x16 LP	None	None	None	XClarity Standard	1x 1100W Platinum	None	3-year	11/17
7X02A068CN	CHINA	1x Xeon Gold 5120T 14C/2.2GHz/19.25MB/105W/DDR4-2400	2x 16GB RDIMM DDR4-2666 (2Rx8), Memory Sparing	1x 530-8i	8x 2.5"	8x 2.5" SATA/SAS HS	2x 300GB HDD 10K 2.5" SAS12Gbps	None	None	None	1x Mgmt	None	1x 32Gb SFP+	1x LOM, 1x RAID	1x PCIe x16 LP, 1x PCIe x16 LP	None	None	None	XClarity Standard	1x 1100W Platinum	None	3-year	11/17

Model	Region	Processor	Memory	Storage Controller	Chassis	Disk Bays	Disk S	M.2 Drives	PCIe Flash Adapter	GPU	Onboard Networking Ports	Additional Networking (LOM/ML2/PCIe)	Fibre Channel I/O	Standard Extension Slots	Available Extension Slots via Riser Cards	Front VGA	Optical	TPM	System Management	Power Supply	Preload	Warranty	Ann Date (mm/yy)
7X02A00EEA	EMEA	1x Xeon Gold 5120 14C/2.2GHz/19.25MB/105W/DDR4-2400	1x 16GB RDIMM DDR4-2666 (2Rx8)	1x 930-8i 2GB Flash	8x 2.5"	8x 2.5" SATA/SAS HS	Open	None	None	None	1x Mgmt	None	None	1x LOM, 1x RAID	1x PCIe x8 LP, 1x PCIe x16 LP	None	None	TPM 1.2	XClarity Standard	1x 750W Platinum	None	3-year	07/17
7X02A00CEA	EMEA	1x Xeon Gold 6134 8C/3.2GHz/24.75MB/130W/DDR4-2666	1x 32GB RDIMM DDR4-2666 (2Rx4)	1x 930-8i 2GB Flash	8x 2.5"	8x 2.5" SATA/SAS HS	Open	None	None	None	1x Mgmt	None	None	1x LOM, 1x RAID	1x PCIe x8 LP, 1x PCIe x16 LP	None	None	TPM 1.2	XClarity Standard	1x 750W Platinum	None	3-year	07/17
7X02A002EA	EMEA	1x Xeon Gold 5118 12C/2.3GHz/16.5MB/105W/DDR4-2400	1x 16GB RDIMM DDR4-2666 (2Rx8)	1x 930-16i 4GB Flash	10x 2.5"	10x 2.5" SATA/SAS HS (6, 4 AnyBay)	Open	None	None	None	1x Mgmt	None	None	1x LOM, 1x RAID	1x PCIe x8 LP, 1x PCIe x16 LP	None	None	TPM 1.2	XClarity Standard	1x 750W Platinum	None	3-year	07/17
7X02A003EA	EMEA	1x Xeon Gold 5118 12C/2.3GHz/16.5MB/105W/DDR4-2400	1x 16GB RDIMM DDR4-2666 (2Rx8)	1x 930-8i 2GB Flash	8x 2.5"	8x 2.5" SATA/SAS HS	Open	None	None	None	1x Mgmt	None	None	1x LOM, 1x RAID	1x PCIe x8 LP, 1x PCIe x16 LP	None	None	TPM 1.2	XClarity Standard	1x 750W Platinum	None	3-year	07/17
7X02A004EA	EMEA	1x Xeon Gold 5115 10C/2.4GHz/13.75MB/85W/DDR4-2400	1x 16GB RDIMM DDR4-2666 (2Rx8)	1x 930-8i 2GB Flash	8x 2.5"	8x 2.5" SATA/SAS HS	Open	None	None	None	1x Mgmt	None	None	1x LOM, 1x RAID	1x PCIe x8 LP, 1x PCIe x16 LP	None	None	TPM 1.2	XClarity Standard	1x 750W Platinum	None	3-year	07/17
7X02A005EA	EMEA	1x Xeon Platinum 8160 24C/2.1GHz/33MB/150W/DDR4-2666	1x 32GB RDIMM DDR4-2666 (2Rx4)	1x 930-8i 2GB Flash	8x 2.5"	8x 2.5" SATA/SAS HS	Open	None	None	None	1x Mgmt	None	None	1x LOM, 1x RAID	1x PCIe x8 LP, 1x PCIe x16 LP	Front VGA	None	TPM 1.2	XClarity Standard	1x 750W Platinum	None	3-year	07/17
7X02A007EA	EMEA	1x Xeon Gold 6152 22C/2.1GHz/30.25MB/140W/DDR4-2666	1x 32GB RDIMM DDR4-2666 (2Rx4)	1x 930-8i 2GB Flash	8x 2.5"	8x 2.5" SATA/SAS HS	Open	None	None	None	1x Mgmt	None	None	1x LOM, 1x RAID	1x PCIe x8 LP, 1x PCIe x16 LP	None	None	TPM 1.2	XClarity Standard	1x 750W Platinum	None	3-year	07/17
7X02A009EA	EMEA	1x Xeon Gold 6150 18C/2.7GHz/24.75MB/165W/DDR4-2666	1x 32GB RDIMM DDR4-2666 (2Rx4)	1x 930-8i 2GB Flash	8x 2.5"	8x 2.5" SATA/SAS HS	Open	None	None	None	1x Mgmt	None	None	1x LOM, 1x RAID	1x PCIe x8 LP, 1x PCIe x16 LP	None	None	TPM 1.2	XClarity Standard	1x 750W Platinum	None	3-year	07/17
7X02A00AEA	EMEA	2x Xeon Gold 5118 12C/2.3GHz/16.5MB/105W/DDR4-2400	2x 32GB RDIMM DDR4-2666 (2Rx4)	1x 430-16i	10x 2.5"	10x 2.5" SATA/SAS HS (6, 4 AnyBay)	Open	None	None	None	1x Mgmt	None	None	1x LOM, 1x RAID	1x PCIe x8 LP, 2x PCIe x16 LP	None	None	TPM 1.2	XClarity Standard	1x 750W Platinum	None	3-year	07/17
7X02A00PEA	EMEA	1x Xeon Gold 6142 16C/2.6GHz/22MB/150W/DDR4-2666	1x 32GB RDIMM DDR4-2666 (2Rx4)	1x 930-8i 2GB Flash	8x 2.5"	8x 2.5" SATA/SAS HS	Open	None	None	None	1x Mgmt	None	None	1x LOM, 1x RAID	1x PCIe x8 LP, 1x PCIe x16 LP	None	None	TPM 1.2	XClarity Standard	1x 750W Platinum	None	3-year	07/17

Model	Region	Processor	Memory	Storage Controller	Chassis	Disk Bays	Disk S	M.2 Drives	PCIe Flash Adapter	GPU	Onboard Networking Ports	Additional Networking (LOM/ML2/PCIe)	Fibre Channel I/O	Standard Extension Slots	Available Extension Slots via Riser Cards	Front VGA	Optical	TPM	System Management	Power Supply	Preload	Warranty	Ann Date (mm/yy)
7X02A00REA	EMEA	1x Xeon Gold 6140 18C/2.3GHz/24.75MB/140W/DDR4-2666	1x 32GB RDIMM DDR4-2666 (2Rx4)	1x 930-8i 2GB Flash	8x 2.5"	8x 2.5" SATA/SAS HS	Open	None	None	None	1x Mgmt	None	None	1x LOM, 1x RAID	1x PCIe x8 LP, 1x PCIe x16 LP	None	None	TPM 1.2	XClarity Standard	1x 750W Platinum	None	3-year	07/17
7X02A00GEA	EMEA	1x Xeon Gold 6148 20C/2.4GHz/27.5MB/150W/DDR4-2666	1x 32GB RDIMM DDR4-2666 (2Rx4)	1x 930-8i 2GB Flash	8x 2.5"	8x 2.5" SATA/SAS HS	Open	None	None	None	1x Mgmt	None	None	1x LOM, 1x RAID	1x PCIe x8 LP, 1x PCIe x16 LP	None	None	TPM 1.2	XClarity Standard	1x 750W Platinum	None	3-year	07/17
7X02A00JEA	EMEA	1x Xeon Gold 6126 12C/2.6GHz/19.25MB/125W/DDR4-2666	1x 32GB RDIMM DDR4-2666 (2Rx4)	1x 930-8i 2GB Flash	8x 2.5"	8x 2.5" SATA/SAS HS	Open	None	None	None	1x Mgmt	None	None	1x LOM, 1x RAID	1x PCIe x8 LP, 1x PCIe x16 LP	None	None	TPM 1.2	XClarity Standard	1x 750W Platinum	None	3-year	07/17
7X02A06AEA	EMEA	1x Xeon Gold 6132 14C/2.6GHz/19.25MB/140W/DDR4-2666	1x 32GB RDIMM DDR4-2666 (2Rx4)	1x 930-8i 2GB Flash	8x 2.5"	8x 2.5" SATA/SAS HS	Open	None	None	None	1x Mgmt	None	None	1x LOM, 1x RAID	1x PCIe x8 LP, 1x PCIe x16 LP	None	None	TPM 1.2	XClarity Standard	1x 750W Platinum	None	3-year	11/17
7X02A06CEA	EMEA	1x Xeon Gold 6128 6C/3.4GHz/19.25MB/115W/DDR4-2666	1x 32GB RDIMM DDR4-2666 (2Rx4)	1x 930-8i 2GB Flash	8x 2.5"	8x 2.5" SATA/SAS HS	Open	None	None	None	1x Mgmt	None	None	1x LOM, 1x RAID	1x PCIe x8 LP, 1x PCIe x16 LP	None	None	TPM 1.2	XClarity Standard	1x 750W Platinum	None	3-year	11/17
7X02A052EA	EMEA	1x Xeon Silver 4116 12C/2.1GHz/16.5MB/85W/DDR4-2400	1x 16GB RDIMM DDR4-2666 (2Rx8)	1x 930-8i 2GB Flash	8x 2.5"	8x 2.5" SATA/SAS HS	Open	None	None	None	1x Mgmt	None	None	1x LOM, 1x RAID	1x PCIe x8 LP, 1x PCIe x16 LP	None	None	TPM 1.2	XClarity Standard	1x 750W Platinum	None	3-year	07/17
7X02A04VEA	EMEA	1x Xeon Silver 4110 8C/2.1GHz/11MB/85W/DDR4-2400	1x 16GB RDIMM DDR4-2666 (2Rx8)	1x 530-8i	8x 2.5"	8x 2.5" SATA/SAS HS	Open	None	None	None	1x Mgmt	None	None	1x LOM, 1x RAID	1x PCIe x8 LP, 1x PCIe x16 LP	None	None	TPM 1.2	XClarity Standard	1x 750W Platinum	None	3-year	07/17
7X02A03ZEA	EMEA	1x Xeon Bronze 3106 8C/1.7GHz/11MB/85W/DDR4-2133	1x 8GB RDIMM DDR4-2666 (1Rx8)	1x 530-8i	8x 2.5"	8x 2.5" SATA/SAS HS	Open	None	None	None	1x Mgmt	None	None	1x LOM, 1x RAID	1x PCIe x8 LP, 1x PCIe x16 LP	None	None	TPM 1.2	XClarity Standard	1x 750W Platinum	None	3-year	07/17
7X02A04TEA	EMEA	1x Xeon Silver 4110 8C/2.1GHz/11MB/85W/DDR4-2400	1x 16GB RDIMM DDR4-2666 (2Rx8)	1x 930-8i 2GB Flash	8x 2.5"	8x 2.5" SATA/SAS HS	Open	None	None	None	1x Mgmt	None	None	1x LOM, 1x RAID	1x PCIe x8 LP, 1x PCIe x16 LP	None	None	TPM 1.2	XClarity Standard	1x 750W Platinum	None	3-year	07/17
7X02A04BEA	EMEA	1x Xeon Silver 4110 8C/2.1GHz/11MB/85W/DDR4-2400	1x 16GB RDIMM DDR4-2666 (2Rx8)	1x 930-16i 4GB Flash	10x 2.5"	10x 2.5" SATA/SAS HS (6 AnyBay)	Open	None	None	None	1x Mgmt	None	None	1x LOM, 1x RAID	1x PCIe x8 LP, 1x PCIe x16 LP	None	None	TPM 1.2	XClarity Standard	1x 750W Platinum	None	3-year	07/17

Model	Region	Processor	Memory	Storage Controller	Chassis	Disk Bays	Disk S	M.2 Drives	PCIe Flash Adapter	GPU	Onboard Networking Ports	Additional Networking (LOM/ML2/PCIe)	Fibre Channel I/O	Standard Extension Slots	Available Extension Slots via Riser Cards	Front VGA	Optical	TPM	System Management	Power Supply	Preload	Warranty	Ann Date (mm/yy)
7X02A03WEA	EMEA	1x Xeon Silver 4108 8C/1.8GHz/11MB/85W/DDR4-2400	1x 16GB RDIMM DDR4-2666 (2Rx8)	1x 530-8i	4x 3.5"	4x 3.5" SATA/SAS HS	Open	None	None	None	1x Mgmt	None	None	1x LOM, 1x RAID	1x PCIe x8 LP, 1x PCIe x16 LP	None	None	TPM 1.2	XClarity Standard	1x 750W Platinum	None	3-year	07/17
7X02A043EA	EMEA	2x Xeon Silver 4110 8C/2.1GHz/11MB/85W/DDR4-2400	2x 32GB RDIMM DDR4-2666 (2Rx4)	1x 430-16i	10x 2.5"	10x 2.5" SATA/SAS HS (6 AnyBay)	Open	None	None	None	1x Mgmt	None	None	1x LOM, 1x RAID	1x PCIe x8 LP, 1x PCIe x16 LP	None	None	TPM 1.2	XClarity Standard	1x 750W Platinum	None	3-year	07/17
7X02A044EA	EMEA	1x Xeon Bronze 3104 6C/1.7GHz/8.25MB/85W/DDR4-2133	1x 8GB RDIMM DDR4-2666 (1Rx8)	1x 530-8i	8x 2.5"	8x 2.5" SATA/SAS HS	Open	None	None	None	1x Mgmt	None	None	1x LOM, 1x RAID	1x PCIe x8 LP, 1x PCIe x16 LP	None	None	TPM 1.2	XClarity Standard	1x 750W Platinum	None	3-year	07/17
7X02A045EA	EMEA	1x Xeon Silver 4108 8C/1.8GHz/11MB/85W/DDR4-2400	1x 16GB RDIMM DDR4-2666 (2Rx8)	1x 530-8i	8x 2.5"	8x 2.5" SATA/SAS HS	Open	None	None	None	1x Mgmt	None	None	1x LOM, 1x RAID	1x PCIe x8 LP, 1x PCIe x16 LP	None	None	TPM 1.2	XClarity Standard	1x 750W Platinum	None	3-year	07/17
7X02A046EA	EMEA	1x Xeon Silver 4114 10C/2.2GHz/13.75MB/85W/DDR4-2400	1x 16GB RDIMM DDR4-2666 (2Rx8)	1x 930-8i 2GB Flash	8x 2.5"	8x 2.5" SATA/SAS HS	Open	None	None	None	1x Mgmt	None	None	1x LOM, 1x RAID	1x PCIe x8 LP, 1x PCIe x16 LP	None	None	TPM 1.2	XClarity Standard	1x 750W Platinum	None	3-year	07/17

Model	Region	Processor	Memory	Storage Controller	Chassis	Disk Bays	Disk s	M.2 Drives	PCIe Flash Adapter	GPU	Onboard Networking Ports	Additional Networking (LOM/ML2/PCIe)	Fibre Channel I/O	Standard Extension Slots	Available Extension Slots via Riser Cards	Front VGA	Optical	TPM	System Management	Power Supply	Preload	Warranty	Ann Date (mm/yy)	
7X02A02KC N	Hong Kong	1x Xeon Silver 4110 8C/2.1GHz/11MB/85W/DDR4-2400	1x 16GB RDIMM DDR4-2666 (2Rx8)	1x 930-8i 2GB Flash	8x 2.5"	8x 2.5"	SATA/SAS HS	Open	None	None	None	1x Mgmt	4x GbE RJ-45 LOM	None	1x LOM, 1x RAID	1x PCIe x8 LP, 1x PCIe x16 LP	None	None	TPM 1.2	XClarity Standard	1x 750W Platinum	None	3-year	07/17

Model	Region	Processor	Memory	Storage Controller	Chassis	Disk Bays	Disk S	M.2 Drives	PCIe Flash Adapter	GPU	Onboard Networking Ports	Additional Networking (LOM/ML2/PCIe)	Fibre Channel I/O	Standard Extension Slots	Available Extension Slots via Riser Cards	Front VGA	Optical	TPM	System Management	Power Supply	Preload	Warranty	Ann Date (mm/yy)
7X02A028CN	HTK	1x Xeon Gold 5120 14C/2.2GHz/19.25MB/105W/DDR4-2400	1x 16GB RDIMM DDR4-2666 (2Rx8)	1x 930-8i 2GB Flash	4x 3.5"	4x 3.5" SATA/SA S HS	Open	None	None	None	1x Mgmt	4x GbE RJ-45 LOM	None	1x LOM, 1x RAID	1x PCIe x8 LP, 1x PCIe x16 LP	None	None	TPM 1.2	XClarity Standard	1x 750W Platinum	None	3-year	07/17
7X02A01YCN	HTK	1x Xeon Gold 5122 4C/3.6GHz/16.5MB/105W/DDR4-2666	1x 16GB RDIMM DDR4-2666 (2Rx8)	1x 930-8i 2GB Flash	4x 3.5"	4x 3.5" SATA/SA S HS	Open	None	None	None	1x Mgmt	4x GbE RJ-45 LOM	None	1x LOM, 1x RAID	1x PCIe x8 LP, 1x PCIe x16 LP	None	None	TPM 1.2	XClarity Standard	1x 750W Platinum	None	3-year	07/17
7X02A02ACN	HTK	1x Xeon Gold 5118 12C/2.3GHz/16.5MB/105W/DDR4-2400	1x 16GB RDIMM DDR4-2666 (2Rx8)	1x 930-8i 2GB Flash	8x 2.5"	8x 2.5" SATA/SA S HS	Open	None	None	1x NVIDIA Quadro 2000 5GB	1x Mgmt	4x GbE RJ-45 LOM	None	1x LOM, 1x RAID	1x PCIe x8 LP, 1x PCIe x16 FHHL	None	None	TPM 1.2	XClarity Standard	1x 750W Platinum	None	3-year	07/17
7X02A02BCN	HTK	1x Xeon Gold 5115 10C/2.4GHz/13.75MB/85W/DDR4-2400	1x 16GB RDIMM DDR4-2666 (2Rx8)	1x 930-8i 2GB Flash	8x 2.5"	8x 2.5" SATA/SA S HS	Open	None	None	1x NVIDIA Quadro 2000 5GB	1x Mgmt	4x GbE RJ-45 LOM	None	1x LOM, 1x RAID	1x PCIe x8 LP, 1x PCIe x16 FHHL	None	None	TPM 1.2	XClarity Standard	1x 750W Platinum	None	3-year	07/17
7X02A01RCN	HTK	1x Xeon Gold 6130 16C/2.1GHz/22MB/125W/DDR4-2666	1x 16GB RDIMM DDR4-2666 (2Rx8)	1x 930-8i 2GB Flash	4x 3.5"	4x 3.5" SATA/SA S HS	Open	None	None	None	1x Mgmt	4x GbE RJ-45 LOM	None	1x LOM, 1x RAID	1x PCIe x8 LP, 1x PCIe x16 LP	None	None	TPM 1.2	XClarity Standard	1x 750W Platinum	None	3-year	07/17
7X02A01TCN	HTK	1x Xeon Gold 6134 8C/3.2GHz/24.75MB/130W/DDR4-2666	1x 16GB RDIMM DDR4-2666 (2Rx8)	1x 930-8i 2GB Flash	4x 3.5"	4x 3.5" SATA/SA S HS	Open	None	None	None	1x Mgmt	4x GbE RJ-45 LOM	None	1x LOM, 1x RAID	1x PCIe x8 LP, 1x PCIe x16 LP	None	None	TPM 1.2	XClarity Standard	1x 750W Platinum	None	3-year	07/17
7X02A019CN	HTK	1x Xeon Gold 6134 8C/3.2GHz/24.75MB/130W/DDR4-2666	1x 16GB RDIMM DDR4-2666 (2Rx8)	1x 930-8i 2GB Flash	8x 2.5"	8x 2.5" SATA/SA S HS	Open	None	None	1x NVIDIA Quadro 2000 5GB	1x Mgmt	4x GbE RJ-45 LOM	None	1x LOM, 1x RAID	1x PCIe x8 LP, 1x PCIe x16 FHHL	None	None	TPM 1.2	XClarity Standard	1x 750W Platinum	None	3-year	07/17
7X02A036CN	HTK	1x Xeon Gold 6130 16C/2.1GHz/22MB/125W/DDR4-2666	1x 16GB RDIMM DDR4-2666 (2Rx8)	1x 930-8i 2GB Flash	8x 2.5"	8x 2.5" SATA/SA S HS	Open	None	None	1x NVIDIA Quadro 2000 5GB	1x Mgmt	4x GbE RJ-45 LOM	None	1x LOM, 1x RAID	1x PCIe x8 LP, 1x PCIe x16 FHHL	None	None	TPM 1.2	XClarity Standard	1x 750W Platinum	None	3-year	07/17
7X02A037CN	HTK	1x Xeon Gold 5120 14C/2.2GHz/19.25MB/105W/DDR4-2400	1x 16GB RDIMM DDR4-2666 (2Rx8)	1x 930-8i 2GB Flash	8x 2.5"	8x 2.5" SATA/SA S HS	Open	None	None	1x NVIDIA Quadro 2000 5GB	1x Mgmt	4x GbE RJ-45 LOM	None	1x LOM, 1x RAID	1x PCIe x8 LP, 1x PCIe x16 FHHL	None	None	TPM 1.2	XClarity Standard	1x 750W Platinum	None	3-year	07/17
7X02A03ACN	HTK	1x Xeon Gold 5122 4C/3.6GHz/16.5MB/105W/DDR4-2666	1x 16GB RDIMM DDR4-2666 (2Rx8)	1x 930-8i 2GB Flash	8x 2.5"	8x 2.5" SATA/SA S HS	Open	None	None	1x NVIDIA Quadro 2000 5GB	1x Mgmt	4x GbE RJ-45 LOM	None	1x LOM, 1x RAID	1x PCIe x8 LP, 1x PCIe x16 FHHL	None	None	TPM 1.2	XClarity Standard	1x 750W Platinum	None	3-year	07/17

Model	Region	Processor	Memory	Storage Controller	Chassis	Disk Bays	Disk S	M.2 Drives	PCIe Flash Adapter	GPU	Onboard Networking Ports	Additional Networking (LOM/ML2/PCIe)	Fibre Channel I/O	Standard Extension Slots	Available Extension Slots via Riser Cards	Front VGA	Optical	TPM	System Management	Power Supply	Preload	Warranty	Ann Date (mm/yy)
7X02A03QC N	HTK	1x Xeon Silver 4112 4C/2.6GHz/8.25MB/85W/DDR4-2400	1x 16GB RDIMM DDR4-2666 (2Rx8)	1x 930-8i 2GB Flash	4x 3.5"	4x 3.5" SATA/SA S HS	Open	None	None	None	1x Mgmt	4x GbE RJ-45 LOM	None	1x LOM, 1x RAID	1x PCIe x8 LP, 1x PCIe x16 LP	None	None	TPM 1.2	XClarity Standard	1x 750W Platinum	None	3-year	07/17
7X02A03RC N	HTK	1x Xeon Silver 4114 10C/2.2GHz/13.75MB/85W/DDR4-2400	1x 16GB RDIMM DDR4-2666 (2Rx8)	1x 930-8i 2GB Flash	4x 3.5"	4x 3.5" SATA/SA S HS	Open	None	None	None	1x Mgmt	4x GbE RJ-45 LOM	None	1x LOM, 1x RAID	1x PCIe x8 LP, 1x PCIe x16 LP	None	None	TPM 1.2	XClarity Standard	1x 750W Platinum	None	3-year	07/17
7X02A010C N	HTK	1x Xeon Gold 5115 10C/2.4GHz/13.75MB/85W/DDR4-2400	1x 16GB RDIMM DDR4-2666 (2Rx8)	1x 930-8i 2GB Flash	4x 3.5"	4x 3.5" SATA/SA S HS	Open	None	None	None	1x Mgmt	4x GbE RJ-45 LOM	None	1x LOM, 1x RAID	1x PCIe x8 LP, 1x PCIe x16 LP	None	None	TPM 1.2	XClarity Standard	1x 750W Platinum	None	3-year	07/17
7X02A011C N	HTK	1x Xeon Gold 5118 12C/2.3GHz/16.5MB/105W/DDR4-2400	1x 16GB RDIMM DDR4-2666 (2Rx8)	1x 930-8i 2GB Flash	4x 3.5"	4x 3.5" SATA/SA S HS	Open	None	None	None	1x Mgmt	4x GbE RJ-45 LOM	None	1x LOM, 1x RAID	1x PCIe x8 LP, 1x PCIe x16 LP	None	None	TPM 1.2	XClarity Standard	1x 750W Platinum	None	3-year	07/17
7X02A04ZC N	HTK	1x Xeon Bronze 3106 8C/1.7GHz/11MB/85W/DDR4-2133	1x 16GB RDIMM DDR4-2666 (2Rx8)	1x 930-8i 2GB Flash	4x 3.5"	4x 3.5" SATA/SA S HS	Open	None	None	None	1x Mgmt	4x GbE RJ-45 LOM	None	1x LOM, 1x RAID	1x PCIe x8 LP, 1x PCIe x16 LP	None	None	TPM 1.2	XClarity Standard	1x 750W Platinum	None	3-year	07/17
7X02A047C N	HTK	1x Xeon Silver 4116 12C/2.1GHz/16.5MB/85W/DDR4-2400	1x 16GB RDIMM DDR4-2666 (2Rx8)	1x 930-8i 2GB Flash	4x 3.5"	4x 3.5" SATA/SA S HS	Open	None	None	None	1x Mgmt	4x GbE RJ-45 LOM	None	1x LOM, 1x RAID	1x PCIe x8 LP, 1x PCIe x16 LP	None	None	TPM 1.2	XClarity Standard	1x 750W Platinum	None	3-year	07/17
7X02A03XC N	HTK	1x Xeon Silver 4110 8C/2.1GHz/11MB/85W/DDR4-2400	1x 16GB RDIMM DDR4-2666 (2Rx8)	1x 930-8i 2GB Flash	4x 3.5"	4x 3.5" SATA/SA S HS	Open	None	None	None	1x Mgmt	4x GbE RJ-45 LOM	None	1x LOM, 1x RAID	1x PCIe x8 LP, 1x PCIe x16 LP	None	None	TPM 1.2	XClarity Standard	1x 750W Platinum	None	3-year	07/17
7X02A03YC N	HTK	1x Xeon Silver 4108 8C/1.8GHz/11MB/85W/DDR4-2400	1x 16GB RDIMM DDR4-2666 (2Rx8)	1x 930-8i 2GB Flash	4x 3.5"	4x 3.5" SATA/SA S HS	Open	None	None	None	1x Mgmt	4x GbE RJ-45 LOM	None	1x LOM, 1x RAID	1x PCIe x8 LP, 1x PCIe x16 LP	None	None	TPM 1.2	XClarity Standard	1x 750W Platinum	None	3-year	07/17
7X02A04CC N	HTK	1x Xeon Silver 4114 10C/2.2GHz/13.75MB/85W/DDR4-2400	1x 16GB RDIMM DDR4-2666 (2Rx8)	1x 930-8i 2GB Flash	8x 2.5"	8x 2.5" SATA/SA S HS	Open	None	None	None	1x Mgmt	4x GbE RJ-45 LOM	None	1x LOM, 1x RAID	1x PCIe x8 LP, 1x PCIe x16 LP	None	None	TPM 1.2	XClarity Standard	1x 750W Platinum	None	3-year	07/17
7X02A04EC N	HTK	1x Xeon Silver 4112 4C/2.6GHz/8.25MB/85W/DDR4-2400	1x 16GB RDIMM DDR4-2666 (2Rx8)	1x 930-8i 2GB Flash	8x 2.5"	8x 2.5" SATA/SA S HS	Open	None	None	None	1x Mgmt	4x GbE RJ-45 LOM	None	1x LOM, 1x RAID	1x PCIe x8 LP, 1x PCIe x16 LP	None	None	TPM 1.2	XClarity Standard	1x 750W Platinum	None	3-year	07/17

Model	Region	Processor	Memory	Storage Controller	Chassis	Disk Bays	Disk	M.2 Drives	PCIe Flash Adapter	GPU	Onboard Networking Ports	Additional Networking (LOM/ML2/PCIe)	Fibre Channel I/O	Standard Extension Slots	Available Extension Slots via Riser Cards	Front VGA	Optical	TPM	System Management	Power Supply	Preload	Warranty	Ann Date (mm/yy)
7X02A04SCN	HTK	1x Xeon Bronze 3104 6C/1.7GHz/8.25MB/85W/DDR4-2133	1x 16GB RDIMM DDR4- 2666 (2Rx8)	1x 930-8i 2GB Flash	4x 3.5"	4x 3.5"	SATA/SA S HS	Open None	None	None	1x Mgmt	4x GbE RJ-45 LOM	None	1x LOM, 1x RAID	1x PCIe x8 LP, 1x PCIe x16 LP	None	None	TPM 1.2	XClarity Standard	1x 750W Platinum	None	3-year	07/17
7X02A04MCN	HTK	1x Xeon Silver 4108 8C/1.8GHz/11MB/85W/DDR4-2400	1x 16GB RDIMM DDR4- 2666 (2Rx8)	1x 930-8i 2GB Flash	8x 2.5"	8x 2.5"	SATA/SA S HS	Open None	None	None	1x Mgmt	4x GbE RJ-45 LOM	None	1x LOM, 1x RAID	1x PCIe x8 LP, 1x PCIe x16 LP	None	None	TPM 1.2	XClarity Standard	1x 750W Platinum	None	3-year	07/17
7X02A04NCN	HTK	1x Xeon Bronze 3104 6C/1.7GHz/8.25MB/85W/DDR4-2133	1x 16GB RDIMM DDR4- 2666 (2Rx8)	1x 930-8i 2GB Flash	8x 2.5"	8x 2.5"	SATA/SA S HS	Open None	None	None	1x Mgmt	4x GbE RJ-45 LOM	None	1x LOM, 1x RAID	1x PCIe x8 LP, 1x PCIe x16 LP	None	None	TPM 1.2	XClarity Standard	1x 750W Platinum	None	3-year	07/17
7X02A04PCN	HTK	1x Xeon Bronze 3106 8C/1.7GHz/11MB/85W/DDR4-2133	1x 16GB RDIMM DDR4- 2666 (2Rx8)	1x 930-8i 2GB Flash	8x 2.5"	8x 2.5"	SATA/SA S HS	Open None	None	None	1x Mgmt	4x GbE RJ-45 LOM	None	1x LOM, 1x RAID	1x PCIe x8 LP, 1x PCIe x16 LP	None	None	TPM 1.2	XClarity Standard	1x 750W Platinum	None	3-year	07/17
7X02A04QCN	HTK	1x Xeon Silver 4116 12C/2.1GHz/16.5MB/85W/DDR4-2400	1x 16GB RDIMM DDR4- 2666 (2Rx8)	1x 930-8i 2GB Flash	8x 2.5"	8x 2.5"	SATA/SA S HS	Open None	None	None	1x Mgmt	4x GbE RJ-45 LOM	None	1x LOM, 1x RAID	1x PCIe x8 LP, 1x PCIe x16 LP	None	None	TPM 1.2	XClarity Standard	1x 750W Platinum	None	3-year	07/17
7X02A053CN	HTK	1x Xeon Gold 5115 10C/2.4GHz/13.75MB/85W/DDR4-2400	1x 16GB RDIMM DDR4- 2666 (2Rx8)	1x 930-8i 2GB Flash	8x 2.5"	8x 2.5"	SATA/SA S HS	Open None	None	None	1x Mgmt	4x GbE RJ-45 LOM	None	1x LOM, 1x RAID	1x PCIe x8 LP, 1x PCIe x16 LP	None	None	TPM 1.2	XClarity Standard	1x 750W Platinum	None	3-year	07/17

Model	Region	Processor	Memory	Storage Controller	Chassis	Disk Bays	Disk S	M.2 Drives	PCIe Flash Adapter	GPU	Onboard Networking Ports	Additional Networking (LOM/ML2/PCIe)	Fibre Channel I/O	Standard Extension Slots	Available Extension Slots via Riser Cards	Front VGA	Optical	TPM	System Management	Power Supply	Preload	Warranty	Ann Date (mm/yy)
7X02A00USG	INDIA	1x Xeon Gold 5118 12C/2.3GHz/16.5MB/105W/DDR4-2400	1x 16GB RDIMM DDR4-2666 (1Rx4)	1x 930-8i 2GB Flash	8x 2.5"	SATA/SAS HS	Open	None	None	None	1x Mgmt	4x GbE RJ-45 LOM	None	1x LOM, 1x RAID	None	Front VGA	None	TPM 1.2	XClarity Standard	1x 550W Platinum	None	3-year	07/17
7X02A00WSG	INDIA	1x Xeon Gold 5118 12C/2.3GHz/16.5MB/105W/DDR4-2400	1x 16GB RDIMM DDR4-2666 (1Rx4)	1x 930-8i 2GB Flash	8x 2.5"	SATA/SAS HS	Open	None	None	None	1x Mgmt	4x GbE RJ-45 LOM	None	1x LOM, 1x RAID	None	Front VGA	None	TPM 1.2	XClarity Standard	1x 550W Platinum	None	3-year	07/17
7X02A017SG	INDIA	1x Xeon Gold 5115 10C/2.4GHz/13.75MB/85W/DDR4-2400	1x 8GB RDIMM DDR4-2666 (1Rx8)	1x 930-8i 2GB Flash	4x 3.5"	SATA/SAS HS	Open	None	None	None	1x Mgmt	4x GbE RJ-45 LOM	None	1x LOM, 1x RAID	None	Front VGA	None	TPM 1.2	XClarity Standard	1x 550W Platinum	None	3-year	07/17
7X02A01FSG	INDIA	1x Xeon Gold 5120 14C/2.2GHz/19.25MB/105W/DDR4-2400	1x 16GB RDIMM DDR4-2666 (1Rx4)	1x 930-8i 2GB Flash	8x 2.5"	SATA/SAS HS	Open	None	None	None	1x Mgmt	4x GbE RJ-45 LOM	None	1x LOM, 1x RAID	None	Front VGA	None	TPM 1.2	XClarity Standard	1x 550W Platinum	None	3-year	07/17
7X02A01GSG	INDIA	1x Xeon Gold 5122 4C/3.6GHz/16.5MB/105W/DDR4-2666	1x 16GB RDIMM DDR4-2666 (1Rx4)	1x 930-8i 2GB Flash	8x 2.5"	SATA/SAS HS	Open	None	None	None	1x Mgmt	4x GbE RJ-45 LOM	None	1x LOM, 1x RAID	None	Front VGA	None	TPM 1.2	XClarity Standard	1x 550W Platinum	None	3-year	07/17
7X02A01HSG	INDIA	1x Xeon Gold 5120 14C/2.2GHz/19.25MB/105W/DDR4-2400	1x 16GB RDIMM DDR4-2666 (1Rx4)	1x 930-8i 2GB Flash	8x 2.5"	SATA/SAS HS	Open	None	None	None	1x Mgmt	4x GbE RJ-45 LOM	None	1x LOM, 1x RAID	None	Front VGA	None	TPM 1.2	XClarity Standard	1x 550W Platinum	None	3-year	07/17
7X02A01JSG	INDIA	1x Xeon Gold 6126 12C/2.6GHz/19.25MB/125W/DDR4-2666	1x 16GB RDIMM DDR4-2666 (1Rx4)	1x 930-8i 2GB Flash	8x 2.5"	SATA/SAS HS	Open	None	None	None	1x Mgmt	4x GbE RJ-45 LOM	None	1x LOM, 1x RAID	None	Front VGA	None	TPM 1.2	XClarity Standard	1x 550W Platinum	None	3-year	07/17
7X02A02ZSG	INDIA	1x Xeon Gold 6130 16C/2.1GHz/22MB/125W/DDR4-2666	1x 16GB RDIMM DDR4-2666 (1Rx4)	1x 930-8i 2GB Flash	8x 2.5"	SATA/SAS HS	Open	None	None	None	1x Mgmt	4x GbE RJ-45 LOM	None	1x LOM, 1x RAID	None	Front VGA	None	TPM 1.2	XClarity Standard	1x 550W Platinum	None	3-year	07/17
7X02A02WSG	INDIA	1x Xeon Gold 6142 16C/2.6GHz/22MB/150W/DDR4-2666	1x 16GB RDIMM DDR4-2666 (1Rx4)	1x 930-8i 2GB Flash	8x 2.5"	SATA/SAS HS	Open	None	None	None	1x Mgmt	4x GbE RJ-45 LOM	None	1x LOM, 1x RAID	None	Front VGA	None	TPM 1.2	XClarity Standard	1x 550W Platinum	None	3-year	07/17
7X02A01CSG	INDIA	1x Xeon Gold 5118 12C/2.3GHz/16.5MB/105W/DDR4-2400	1x 8GB RDIMM DDR4-2666 (1Rx8)	1x 930-8i 2GB Flash	8x 2.5"	SATA/SAS HS	Open	None	None	None	1x Mgmt	4x GbE RJ-45 LOM	None	1x LOM, 1x RAID	None	Front VGA	None	TPM 1.2	XClarity Standard	1x 550W Platinum	None	3-year	07/17

Model	Region	Processor	Memory	Storage Controller	Chassis	Disk Bays	Disk S	M.2 Drives	PCIe Flash Adapter	GPU	Onboard Networking Ports	Additional Networking (LOM/ML2/PCIe)	Fibre Channel I/O	Standard Extension Slots	Available Extension Slots via Riser Cards	Front VGA	Optical	TPM	System Management	Power Supply	Preload	Warranty	Ann Date (mm/yy)
7X02A027SG	INDIA	1x Xeon Gold 5115 10C/2.4GHz/13.75MB/85W/DDR4-2400	1x 8GB RDIMM DDR4-2666 (1Rx8)	1x 530-8i	8x 2.5"	8x 2.5" SATA/SAS HS	Open	None	None	None	1x Mgmt	4x GbE RJ-45 LOM	None	1x LOM, 1x RAID	None	Front VGA	None	TPM 1.2	XClarity Standard	1x 550W Platinum	None	3-year	07/17

Model	Region	Processor	Memory	Storage Controller	Chassis	Disk Bays	Disk S	M.2 Drives	PCIe Flash Adapter	GPU	Onboard Networking Ports	Additional Networking (LOM/ML2/PCIe)	Fibre Channel I/O	Standard Extension Slots	Available Extension Slots via Riser Cards	Front VGA	Optical	TPM	System Management	Power Supply	Preload	Warranty	Ann Date (mm/yy)
7X02A024JP	JAPAN	1x Xeon Platinum 8160 24C/2.1GHz/33MB/150W/DDR4-2666	1x 16GB RDIMM DDR4-2666 (1Rx4)	1x 930-16i 4GB Flash	10x 2.5"	6 SATA/SAS, 4 Open AnyBay)	None	None	None	None	1x Mgmt	4x 10GbE RJ-45 LOM	None	1x LOM, 1x RAID	1x PCIe x8 LP, 1x PCIe x16 LP	1x Front VGA	None	TPM 1.2	XClarity Advanced	1x 1100W Platinum	None	3-year	07/17
7X02A025JP	JAPAN	1x Xeon Platinum 8176M 28C/2.1GHz/38.5MB/165W/DDR4-2666	1x 16GB RDIMM DDR4-2666 (1Rx4)	1x 930-16i 4GB Flash	10x 2.5"	6 SATA/SAS, 4 Open AnyBay)	None	None	None	None	1x Mgmt	4x 10GbE RJ-45 LOM	None	1x LOM, 1x RAID	1x PCIe x8 LP, 1x PCIe x16 LP	1x Front VGA	None	TPM 1.2	XClarity Standard	1x 1100W Platinum	None	3-year	07/17
7X02A02NP	JAPAN	1x Xeon Gold 5122 4C/3.6GHz/16.5MB/105W/DDR4-2666	1x 16GB RDIMM DDR4-2666 (1Rx4)	1x 930-8i 2GB Flash	8x 2.5"	8 SATA/SAS, HS Open	None	None	None	None	1x Mgmt	4x 10GbE RJ-45 LOM	None	1x LOM, 1x RAID	1x PCIe x8 LP, 1x PCIe x16 LP	None	None	TPM 1.2	XClarity Advanced	1x 750W Platinum	None	3-year	07/17
7X02A012JP	JAPAN	1x Xeon Gold 6134 8C/3.2GHz/24.75MB/130W/DDR4-2666	1x 16GB RDIMM DDR4-2666 (1Rx4)	1x 930-8i 2GB Flash	8x 2.5"	8 SATA/SAS, HS Open	None	None	None	None	1x Mgmt	4x 10GbE RJ-45 LOM	None	1x LOM, 1x RAID	1x PCIe x8 LP, 1x PCIe x16 LP	None	None	TPM 1.2	XClarity Advanced	1x 750W Platinum	None	3-year	07/17
7X02A06JJP	JAPAN	1x Xeon Gold 6130 16C/2.1GHz/22MB/125W/DDR4-2666	1x 16GB RDIMM DDR4-2666 (2Rx8)	1x 930-8i 2GB Flash	8x 2.5"	8 SATA/SAS, HS Open	None	None	None	None	1x Mgmt	4x GbE RJ-45 LOM	None	1x LOM, 1x RAID	1x PCIe x8 LP, 1x PCIe x16 LP	None	None	TPM 1.2	XClarity Advanced	1x 750W Platinum	None	3-year	11/17
7X02A06KJP	JAPAN	1x Xeon Gold 5118 12C/2.3GHz/16.5MB/105W/DDR4-2400	1x 16GB RDIMM DDR4-2666 (2Rx8)	1x 930-8i 2GB Flash	8x 2.5"	8 SATA/SAS, HS Open	None	None	None	None	1x Mgmt	4x GbE RJ-45 LOM	None	1x LOM, 1x RAID	1x PCIe x8 LP, 1x PCIe x16 LP	None	None	TPM 1.2	XClarity Advanced	1x 550W Platinum	None	3-year	11/17
7X02A06LJP	JAPAN	1x Xeon Gold 6136 12C/3.0GHz/24.75MB/150W/DDR4-2666	1x 16GB RDIMM DDR4-2666 (2Rx8)	1x 930-8i 2GB Flash	8x 2.5"	8 SATA/SAS, HS Open	None	None	None	None	1x Mgmt	4x GbE RJ-45 LOM	None	1x LOM, 1x RAID	1x PCIe x8 LP, 1x PCIe x16 LP	None	None	TPM 1.2	XClarity Advanced	1x 750W Platinum	None	3-year	11/17
7X02A06MJP	JAPAN	1x Xeon Silver 4108 8C/1.8GHz/11MB/85W/DDR4-2400	1x 16GB RDIMM DDR4-2666 (2Rx8)	1x 930-8i 2GB Flash	8x 2.5"	8 SATA/SAS, HS Open	None	None	None	None	1x Mgmt	4x GbE RJ-45 LOM	None	1x LOM, 1x RAID	1x PCIe x8 LP, 1x PCIe x16 LP	None	None	TPM 1.2	XClarity Advanced	1x 550W Platinum	None	3-year	11/17
7X02A06NJP	JAPAN	1x Xeon Gold 6142 16C/2.6GHz/22MB/150W/DDR4-2666	1x 16GB RDIMM DDR4-2666 (2Rx8)	1x 930-8i 2GB Flash	8x 2.5"	8 SATA/SAS, HS Open	None	None	None	None	1x Mgmt	4x GbE RJ-45 LOM	None	1x LOM, 1x RAID	1x PCIe x8 LP, 1x PCIe x16 LP	None	None	TPM 1.2	XClarity Advanced	1x 750W Platinum	None	3-year	11/17
7X02A05DJP	JAPAN	2x Xeon Gold 6150 18C/2.7GHz/24.75MB/165W/DDR4-2666	2x 16GB RDIMM DDR4-2666 (2Rx8)	None	8x 2.5"	None	None	None	None	None	1x Mgmt	4x GbE RJ-45 LOM	None	1x LOM, 1x RAID	1x PCIe x8 LP, 1x PCIe x16 LP	None	None	TPM 1.2	XClarity Standard	1x 750W Platinum	None	3-year	07/17

Model	Region	Processor	Memory	Storage Controller	Chassis	Disk Bays	Disk S	M.2 Drives	PCIe Flash Adapter	GPU	Onboard Networking Ports	Additional Networking (LOM/ML2/PCIe)	Fibre Channel I/O	Standard Extension Slots	Available Extension Slots via Riser Cards	Front VGA	Optical	TPM	System Management	Power Supply	Preload	Warranty	Ann Date (mm/yy)
7X02A05EJP	JAPAN	1x Xeon Platinum 8160 24C/2.1GHz/33MB/150W/DDR4-2666	1x 16GB RDIMM DDR4-2666 (2Rx8)	None	8x 2.5"	None	None	None	None	None	1x Mgmt	4x GbE RJ-45 LOM	None	1x LOM, 1x RAID	1x PCIe x8 LP, 1x PCIe x16 LP	None	None	TPM 1.2	XClarity Standard	1x 750W Platinum	None	3-year	07/17
7X02A05KJP	JAPAN	1x Xeon Gold 6148 20C/2.4GHz/27.5MB/150W/DDR4-2666	1x 16GB RDIMM DDR4-2666 (2Rx8)	None	8x 2.5"	None	None	None	None	None	1x Mgmt	4x GbE RJ-45 LOM	None	1x LOM, 1x RAID	1x PCIe x8 LP, 1x PCIe x16 LP	None	None	TPM 1.2	XClarity Standard	1x 750W Platinum	None	3-year	07/17
7X02A05ZJP	JAPAN	1x Xeon Silver 4114 10C/2.2GHz/13.75MB/85W/DDR4-2400	1x 16GB RDIMM DDR4-2666 (1Rx4)	1x 930-8i 2GB Flash	8x 2.5"	8x 2.5" SATA/SAS HS	Open	None	None	None	1x Mgmt	4x GbE RJ-45 LOM	None	1x LOM, 1x RAID	1x PCIe x8 LP, 1x PCIe x16 LP	None	None	TPM 1.2	XClarity Advanced	1x 550W Platinum	None	3-year	08/17

Model	Region	Processor	Memory	Storage Controller	Chassis	Disk Bays	Disks	M.2 Drives	PCIe Flash Adapter	GPU	Onboard Networking Ports	Additional Networking (LOM/ML2/PCIe)	Fibre Channel I/O	Standard Extension Slots	Available Extension Slots via Riser VGA Cards	Optical	TPM	System Management	Power Supply	Preload	Warranty	Ann Date (mm/yy)
7X02A078LA	LA	2x Xeon Gold 5120 14C/2.2GHz/19.25MB/105W/DDR4-2400	12x 16GB RDIMM DDR4-2666 (2Rx8)	1x 930-16i 4GB Flash	10x 2.5"	10x 2.5" HS (6 SATA/SAS, 4 AnyBay)	3x 800GB SSD SAS12Gbps	None	None	None	1x Mgmt	4x GbE RJ-45 PCIe, 2x 10GbE RJ-45 LOM	None	1x LOM, 1x RAID	1x PCIe x8 LP, 2x Front PCIe x16 VGA LP	None	TPM 2.0	XClarity Enterprise	2x 750W Platinum	None	3-year	04/18
7X02A079LA	LA	2x Xeon Gold 5120 14C/2.2GHz/19.25MB/105W/DDR4-2400	12x 16GB RDIMM DDR4-2666 (2Rx8)	1x 930-16i 4GB Flash	10x 2.5"	10x 2.5" HS (6 SATA/SAS, 4 AnyBay)	3x 400GB SSD SAS12Gbps	None	None	None	1x Mgmt	4x GbE RJ-45 PCIe, 2x 10GbE RJ-45 LOM	None	1x LOM, 1x RAID	1x PCIe x8 LP, 2x Front PCIe x16 VGA LP	None	TPM 2.0	XClarity Enterprise	2x 750W Platinum	None	3-year	04/18
7X02A077LA	LA	2x Xeon Gold 5120 14C/2.2GHz/19.25MB/105W/DDR4-2400	12x 32GB RDIMM DDR4-2666 (2Rx4)	1x 930-16i 4GB Flash	10x 2.5"	10x 2.5" HS (6 SATA/SAS, 4 AnyBay)	4x 800GB SSD SAS12Gbps	None	None	None	1x Mgmt	4x GbE RJ-45 PCIe, 2x 10GbE RJ-45 LOM	None	1x LOM, 1x RAID	1x PCIe x8 LP, 2x Front PCIe x16 VGA LP	None	TPM 2.0	XClarity Enterprise	2x 750W Platinum	None	3-year	04/18
7X02A07BLA	LA	2x Xeon Platinum 8176 28C/2.1GHz/38.5MB/165W/DDR4-2666	24x 64GB LRDIMM DDR4-2666 (4Rx4)	1x 930-16i 4GB Flash	10x 2.5"	10x 2.5" HS (6 SATA/SAS, 4 AnyBay)	10x 800GB SSD SAS12Gbps	None	None	None	1x Mgmt	4x GbE RJ-45 PCIe, 2x 10GbE RJ-45 LOM	None	1x LOM, 1x RAID	1x PCIe x8 LP, 2x Front PCIe x16 VGA LP	None	TPM 2.0	XClarity Enterprise	2x 1100W Platinum	None	3-year	04/18
7X02A07CLA	LA	2x Xeon Gold 5120 14C/2.2GHz/19.25MB/105W/DDR4-2400	12x 32GB RDIMM DDR4-2666 (2Rx4)	1x 930-16i 4GB Flash	10x 2.5"	10x 2.5" HS (6 SATA/SAS, 4 AnyBay)	4x 400GB SSD SAS12Gbps	None	None	None	1x Mgmt	4x GbE RJ-45 PCIe, 2x 10GbE RJ-45 LOM	None	1x LOM, 1x RAID	1x PCIe x8 LP, 2x Front PCIe x16 VGA LP	None	TPM 2.0	XClarity Enterprise	2x 750W Platinum	None	3-year	04/18
7X02A07DLA	LA	2x Xeon Gold 5120 14C/2.2GHz/19.25MB/105W/DDR4-2400	24x 64GB LRDIMM DDR4-2666 (4Rx4)	1x 930-16i 4GB Flash	10x 2.5"	10x 2.5" HS (6 SATA/SAS, 4 AnyBay)	10x 400GB SSD SAS12Gbps	None	None	None	1x Mgmt	4x GbE RJ-45 PCIe, 2x 10GbE RJ-45 LOM	None	1x LOM, 1x RAID	1x PCIe x8 LP, 2x Front PCIe x16 VGA LP	None	TPM 2.0	XClarity Enterprise	2x 1100W Platinum	None	3-year	04/18
7X02A07ELA	LA	2x Xeon Gold 6152 22C/2.1GHz/30.25MB/140W/DDR4-2666	12x 64GB LRDIMM DDR4-2666 (4Rx4)	1x 930-16i 4GB Flash	10x 2.5"	10x 2.5" HS (6 SATA/SAS, 4 AnyBay)	6x 800GB SSD SAS12Gbps	None	None	None	1x Mgmt	4x GbE RJ-45 PCIe, 2x 10GbE RJ-45 LOM	None	1x LOM, 1x RAID	1x PCIe x8 LP, 2x Front PCIe x16 VGA LP	None	TPM 2.0	XClarity Enterprise	2x 750W Platinum	None	3-year	04/18
7X02A07FLA	LA	2x Xeon Gold 5120 14C/2.2GHz/19.25MB/105W/DDR4-2400	12x 64GB LRDIMM DDR4-2666 (4Rx4)	1x 930-16i 4GB Flash	10x 2.5"	10x 2.5" HS (6 SATA/SAS, 4 AnyBay)	7x 400GB SSD SAS12Gbps	None	None	None	1x Mgmt	4x GbE RJ-45 PCIe, 2x 10GbE RJ-45 LOM	None	1x LOM, 1x RAID	1x PCIe x8 LP, 2x Front PCIe x16 VGA LP	None	TPM 2.0	XClarity Enterprise	2x 750W Platinum	None	3-year	04/18
7X02A07GLA	LA	2x Xeon Gold 6152 22C/2.1GHz/30.25MB/140W/DDR4-2666	12x 16GB RDIMM DDR4-2666 (2Rx8), 12x 32GB RDIMM DDR4-2666 (2Rx4)	1x 930-16i 4GB Flash	10x 2.5"	10x 2.5" HS (6 SATA/SAS, 4 AnyBay)	5x 800GB SSD SAS12Gbps	None	None	None	1x Mgmt	4x GbE RJ-45 PCIe, 2x 10GbE RJ-45 LOM	None	1x LOM, 1x RAID	1x PCIe x8 LP, 2x Front PCIe x16 VGA LP	None	TPM 2.0	XClarity Enterprise	2x 750W Platinum	None	3-year	04/18
7X02A07HLA	LA	2x Xeon Gold 5120 14C/2.2GHz/19.25MB/105W/DDR4-2400	12x 16GB RDIMM DDR4-2666 (2Rx8), 12x 32GB RDIMM DDR4-2666 (2Rx4)	1x 930-16i 4GB Flash	10x 2.5"	10x 2.5" HS (6 SATA/SAS, 4 AnyBay)	6x 400GB SSD SAS12Gbps	None	None	None	1x Mgmt	4x GbE RJ-45 PCIe, 2x 10GbE RJ-45 LOM	None	1x LOM, 1x RAID	1x PCIe x8 LP, 2x Front PCIe x16 VGA LP	None	TPM 2.0	XClarity Enterprise	2x 750W Platinum	None	3-year	04/18

Model	Region	Processor	Memory	Storage Controller	Chassis	Disk Bays	Disk S	M.2 Drives	PCIe Flash Adapter	GPU	Onboard Networking Ports	Additional Networking (LOM/ML2/PCIe)	Fibre Channel I/O	Standard Extension Slots	Available Extension Slots via Riser Cards	Front VGA	Optical	TPM	System Management	Power Supply	Preload	Warranty	Ann Date (mm/yy)
7X02A05MLA	LA	1x Xeon Silver 4110 8C/2.1GHz/11MB/85W/DDR4-2400	1x 16GB RDIMM DDR4-2666 (2Rx8)	1x 930-8i 2GB Flash	8x 2.5"	8x 2.5" SATA/SA S HS	Open	None	None	None	1x Mgmt	None	None	1x LOM, 1x RAID	1x PCIe x8 LP, 1x Front PCIe x16 VGA LP	None	None	TPM 1.2	XClarity Standard	1x 750W Platinum	None	3-year	07/17
7X02A05CLA	LA	1x Xeon Silver 4116 12C/2.1GHz/16.5MB/85W/DDR4-2400	1x 16GB RDIMM DDR4-2666 (2Rx8)	1x 930-8i 2GB Flash	8x 2.5"	8x 2.5" SATA/SA S HS	Open	None	None	None	1x Mgmt	None	None	1x LOM, 1x RAID	1x PCIe x8 LP, 1x Front PCIe x16 VGA LP	None	None	TPM 1.2	XClarity Standard	1x 750W Platinum	None	3-year	07/17
7X02A01KLA	LA	1x Xeon Platinum 8160 24C/2.1GHz/33MB/150W/DDR4-2666	1x 16GB RDIMM DDR4-2666 (2Rx8)	1x 930-8i 2GB Flash	8x 2.5"	8x 2.5" SATA/SA S HS	Open	None	None	None	1x Mgmt	None	None	1x LOM, 1x RAID	1x PCIe x8 LP, 1x Front PCIe x16 VGA LP	None	None	TPM 1.2	XClarity Standard	1x 1100W Platinum	None	3-year	07/17
7X02A02JLA	LA	1x Xeon Gold 5120 14C/2.2GHz/19.25MB/105W/DDR4-2400	1x 16GB RDIMM DDR4-2666 (2Rx8)	1x 930-8i 2GB Flash	8x 2.5"	8x 2.5" SATA/SA S HS	Open	None	None	None	1x Mgmt	None	None	1x LOM, 1x RAID	1x PCIe x8 LP, 1x Front PCIe x16 VGA LP	None	None	TPM 1.2	XClarity Standard	1x 1100W Platinum	None	3-year	07/17
7X02A02ELA	LA	1x Xeon Gold 6148 20C/2.4GHz/27.5MB/150W/DDR4-2666	1x 16GB RDIMM DDR4-2666 (2Rx8)	1x 930-8i 2GB Flash	8x 2.5"	8x 2.5" SATA/SA S HS	Open	None	None	None	1x Mgmt	None	None	1x LOM, 1x RAID	1x PCIe x8 LP, 1x Front PCIe x16 VGA LP	None	None	TPM 1.2	XClarity Standard	1x 1100W Platinum	None	3-year	07/17
7X02A02FLA	LA	1x Xeon Gold 6140 18C/2.3GHz/24.75MB/140W/DDR4-2666	1x 16GB RDIMM DDR4-2666 (2Rx8)	1x 930-8i 2GB Flash	8x 2.5"	8x 2.5" SATA/SA S HS	Open	None	None	None	1x Mgmt	None	None	1x LOM, 1x RAID	1x PCIe x8 LP, 1x Front PCIe x16 VGA LP	None	None	TPM 1.2	XClarity Standard	1x 1100W Platinum	None	3-year	07/17
7X02A02GLA	LA	1x Xeon Gold 6130 16C/2.1GHz/22MB/125W/DDR4-2666	1x 32GB RDIMM DDR4-2666 (2Rx4)	1x 930-8i 2GB Flash	8x 2.5"	8x 2.5" SATA/SA S HS	Open	None	None	None	1x Mgmt	None	None	1x LOM, 1x RAID	1x PCIe x8 LP, 1x Front PCIe x16 VGA LP	None	None	TPM 1.2	XClarity Standard	1x 1100W Platinum	None	3-year	07/17

Model	Region	Processor	Memory	Storage Controller	Chassis	Disk Bays	Disk S	M.2 Drives	PCIe Flash Adapter	GPU	Onboard Networking Ports	Additional Networking (LOM/ML2/PCIe)	Fibre Channel I/O	Standard Extension Slots	Available Extensions via Riser Cards	Front VGA	Optical	TPM	System Management	Power Supply	Preload	Warranty	Ann Date (mm/yy)
7X02A02HNA	NA	1x Xeon Gold 5120 14C/2.2GHz/19.25MB/105W/DDR4-2400	1x 16GB RDIMM DDR4-2666 (2Rx8)	1x 930-8i 2GB Flash	8x 2.5"	8x 2.5" SATA/SAS HS	Open	None	None	None	1x Mgmt	None	None	1x LOM, 1x RAID	1x PCIe x8 LP, 1x Front PCIe x16 VGA LP	None	None	TPM 1.2	XClarity Standard	1x 750W Platinum	None	3-year	07/17
7X02A029NA	NA	2x Xeon Gold 5118 12C/2.3GHz/16.5MB/105W/DDR4-2400	2x 32GB RDIMM DDR4-2666 (2Rx4)	1x 430-16i	10x 2.5"	10x 2.5" SATA/SAS , 4 AnyBay)	Open	None	None	None	1x Mgmt	None	None	1x LOM, 1x RAID	1x PCIe x8 LP, 2x Front PCIe x16 VGA LP	None	None	TPM 1.2	XClarity Standard	1x 750W Platinum	None	3-year	07/17
7X02A02DNA	NA	1x Xeon Gold 6126T 12C/2.6GHz/19.25MB/125W/DDR4-2666	1x 32GB RDIMM DDR4-2666 (2Rx4)	1x 930-8i 2GB Flash	8x 2.5"	8x 2.5" SATA/SAS HS	Open	None	None	None	1x Mgmt	None	None	1x LOM, 1x RAID	1x PCIe x8 LP, 1x Front PCIe x16 VGA LP	None	None	TPM 1.2	XClarity Standard	1x 750W Platinum	None	3-year	07/17
7X02A01ZNA	NA	1x Xeon Gold 6142 16C/2.6GHz/22MB/150W/DDR4-2666	1x 32GB RDIMM DDR4-2666 (2Rx4)	1x 930-8i 2GB Flash	8x 2.5"	8x 2.5" SATA/SAS HS	Open	None	None	None	1x Mgmt	None	None	1x LOM, 1x RAID	1x PCIe x8 LP, 1x Front PCIe x16 VGA LP	None	None	TPM 1.2	XClarity Standard	1x 750W Platinum	None	3-year	07/17
7X02A01VNA	NA	1x Xeon Gold 6148 20C/2.4GHz/27.5MB/150W/DDR4-2666	1x 32GB RDIMM DDR4-2666 (2Rx4)	1x 930-8i 2GB Flash	8x 2.5"	8x 2.5" SATA/SAS HS	Open	None	None	None	1x Mgmt	None	None	1x LOM, 1x RAID	1x PCIe x8 LP, 1x Front PCIe x16 VGA LP	None	None	TPM 1.2	XClarity Standard	1x 750W Platinum	None	3-year	07/17
7X02A01ANA	NA	1x Xeon Gold 6140 18C/2.3GHz/24.75MB/140W/DDR4-2666	1x 32GB RDIMM DDR4-2666 (2Rx4)	1x 930-8i 2GB Flash	8x 2.5"	8x 2.5" SATA/SAS HS	Open	None	None	None	1x Mgmt	None	None	1x LOM, 1x RAID	1x PCIe x8 LP, 1x Front PCIe x16 VGA LP	None	None	TPM 1.2	XClarity Standard	1x 750W Platinum	None	3-year	07/17
7X02A03BNA	NA	1x Xeon Platinum 8160 24C/2.1GHz/33MB/150W/DDR4-2666	1x 32GB RDIMM DDR4-2666 (2Rx4)	1x 930-8i 2GB Flash	8x 2.5"	8x 2.5" SATA/SAS HS	Open	None	None	None	1x Mgmt	None	None	1x LOM, 1x RAID	1x PCIe x8 LP, 1x Front PCIe x16 VGA LP	None	None	TPM 1.2	XClarity Standard	1x 750W Platinum	None	3-year	07/17
7X02A03CNA	NA	1x Xeon Gold 6134 8C/3.2GHz/24.75MB/130W/DDR4-2666	1x 32GB RDIMM DDR4-2666 (2Rx4)	1x 930-8i 2GB Flash	8x 2.5"	8x 2.5" SATA/SAS HS	Open	None	None	None	1x Mgmt	None	None	1x LOM, 1x RAID	1x PCIe x8 LP, 1x Front PCIe x16 VGA LP	None	None	TPM 1.2	XClarity Standard	1x 750W Platinum	None	3-year	07/17
7X02A039NA	NA	1x Xeon Gold 6152 22C/2.1GHz/30.25MB/140W/DDR4-2666	1x 32GB RDIMM DDR4-2666 (2Rx4)	1x 930-8i 2GB Flash	8x 2.5"	8x 2.5" SATA/SAS HS	Open	None	None	None	1x Mgmt	None	None	1x LOM, 1x RAID	1x PCIe x8 LP, 1x Front PCIe x16 VGA LP	None	None	TPM 1.2	XClarity Standard	1x 750W Platinum	None	3-year	07/17
7X02A02XNA	NA	1x Xeon Gold 6150 18C/2.7GHz/24.75MB/165W/DDR4-2666	1x 32GB RDIMM DDR4-2666 (2Rx4)	1x 930-8i 2GB Flash	8x 2.5"	8x 2.5" SATA/SAS HS	Open	None	None	None	1x Mgmt	None	None	1x LOM, 1x RAID	1x PCIe x8 LP, 1x Front PCIe x16 VGA LP	None	None	TPM 1.2	XClarity Standard	1x 750W Platinum	None	3-year	07/17

Model	Region	Processor	Memory	Storage Controller	Chassis	Disk Bays	Disks	M.2 Drives	PCIe Flash Adapter	GPU	Onboard Networking Ports	Additional Networking (LOM/ML2/PCIe)	Fibre Channel I/O	Standard Extension Slots	Available Extension Slots via Riser Cards	Front Panel VGA	Optical	TPM	System Management	Power Supply	Preload	Warranty	Ann Date (mm/yy)
7X02A01LNA	NA	1x Xeon Gold 5115 10C/2.4GHz/13.75MB/85W/DDR4-2400	1x 16GB RDIMM DDR4-2666 (2Rx8)	1x 930-8i 2GB Flash	8x 2.5"	8x 2.5" SATA/SAS HS	Open	None	None	None	1x Mgmt	None	None	1x LOM, 1x RAID	1x PCIe x8 LP, 1x Front Panel x16 VGA LP	None	None	TPM 1.2	XClarity Standard	1x 750W Platinum	None	3-year	07/17
7X02A01MNA	NA	1x Xeon Gold 5118 12C/2.3GHz/16.5MB/105W/DDR4-2400	1x 16GB RDIMM DDR4-2666 (2Rx8)	1x 930-8i 2GB Flash	8x 2.5"	8x 2.5" SATA/SAS HS	Open	None	None	None	1x Mgmt	None	None	1x LOM, 1x RAID	1x PCIe x8 LP, 1x Front Panel x16 VGA LP	None	None	TPM 1.2	XClarity Standard	1x 750W Platinum	None	3-year	07/17
7X02A01PNA	NA	1x Xeon Gold 5118 12C/2.3GHz/16.5MB/105W/DDR4-2400	1x 16GB RDIMM DDR4-2666 (2Rx8)	1x 930-16i 4GB Flash	10x 2.5"	10x 2.5" SATA/SAS, 4 AnyBay)	Open	None	None	None	1x Mgmt	None	None	1x LOM, 1x RAID	1x PCIe x8 LP, 1x Front Panel x16 VGA LP	None	None	TPM 1.2	XClarity Standard	1x 750W Platinum	None	3-year	07/17
7X02A072NA	NA	1x Xeon Gold 6142 16C/2.6GHz/22MB/150W/DDR4-2666	12x 16GB RDIMM DDR4-2666 (1Rx4)	1x 930-16i 4GB Flash	10x 2.5"	10x 2.5" SATA/SAS, 4 AnyBay)	8x 480GB SSD 2x 800GB SSD SAS12Gbps	2x 128GB SSD M.2 SATA	None	None	1x Mgmt	None	None	1x LOM, 1x RAID, 2x M.2	None	None	None	TPM 2.0	XClarity Standard	2x 750W Platinum	Windows Server 2016 Standard, SQL Server 2016 Standard	3-year	02/18
7X02A073NA	NA	2x Xeon Gold 6136 12C/3.0GHz/24.75MB/150W/DDR4-2666	12x 16GB RDIMM DDR4-2666 (1Rx4)	1x 930-16i 4GB Flash	10x 2.5"	10x 2.5" SATA/SAS, 4 AnyBay)	2x 300GB HDD 10K 2.5" SAS12Gbps, 4x 480GB SSD SATA6Gbps 4x 1.92TB SSD U.2	2x 128GB SSD M.2 SATA	None	None	1x Mgmt	None	None	1x LOM, 1x RAID, 2x M.2	None	None	None	TPM 1.2	XClarity Standard	2x 750W Platinum	None	3-year	02/18
7X02A074NA	NA	2x Xeon Gold 6136 12C/3.0GHz/24.75MB/150W/DDR4-2666	12x 16GB RDIMM DDR4-2666 (1Rx4)	1x 930-16i 4GB Flash	10x 2.5"	10x 2.5" SATA/SAS, 4 AnyBay)	4x 1.92TB SSD U.2, 2x 300GB HDD 10K 2.5" SAS12Gbps, 4x 480GB SSD SATA6Gbps	2x 128GB SSD M.2 SATA	None	None	1x Mgmt	None	None	1x LOM, 1x RAID, 2x M.2	None	None	None	TPM 1.2	XClarity Standard	2x 750W Platinum	Windows Server 2016 Standard, SQL Server 2016 Standard	3-year	04/18
7X02A075NA	NA	1x Xeon Gold 6142 16C/2.6GHz/22MB/150W/DDR4-2666	12x 16GB RDIMM DDR4-2666 (1Rx4)	1x 930-16i 4GB Flash	10x 2.5"	10x 2.5" SATA/SAS, 4 AnyBay)	2x 800GB SSD SAS12Gbps, 8x 480GB SSD SATA6Gbps	2x 128GB SSD M.2 SATA	None	None	1x Mgmt	None	None	1x LOM, 1x RAID, 2x M.2	None	None	None	TPM 2.0	XClarity Standard	2x 750W Platinum	None	3-year	04/18

Model	Region	Processor	Memory	Storage Controller	Chassis	Disk Bays	Disk S	M.2 Drives	PCIe Flash Adapter	GPU	Onboard Networking Ports	Additional Networking (LOM/ML2/PCIe)	Fibre Channel I/O	Standard Extension Slots	Available Extension Slots via Riser Cards	Front VGA	Optical	TPM	System Management	Power Supply	Preload	Warranty	Ann Date (mm/yy)
7X02A018CN	Taiwan	1x Xeon Gold 6140M 18C/2.3GHz/24.75MB/140W/DDR4-2666	1x 16GB RDIMM DDR4-2666 (2Rx8)	1x 930-8i 2GB Flash	8x 2.5"	8x 2.5" SATA/SA S HS	Open	None	None	1x NVIDIA A Quadro 2000 5GB	1x Mgmt	4x GbE RJ-45 LOM	None	1x LOM, 1x RAID	1x PCIe x8 LP, 1x Front PCIe x16 VGA FHHL	None	TPM 1.2	XClarity Standard	1x 750W Platinum	None	3-year	07/17	
7X02A00XCN	Taiwan	1x Xeon Gold 6140 18C/2.3GHz/24.75MB/140W/DDR4-2666	1x 16GB RDIMM DDR4-2666 (2Rx8)	1x 930-8i 2GB Flash	8x 2.5"	8x 2.5" SATA/SA S HS	Open	None	None	1x NVIDIA A Quadro 2000 5GB	1x Mgmt	4x GbE RJ-45 LOM	None	1x LOM, 1x RAID	1x PCIe x8 LP, 1x Front PCIe x16 VGA FHHL	None	TPM 1.2	XClarity Standard	1x 750W Platinum	None	3-year	07/17	
7X02A00YCN	Taiwan	1x Xeon Platinum 8156 4C/3.6GHz/16.5MB/105W/DDR4-2666	1x 16GB RDIMM DDR4-2666 (2Rx8)	1x 930-8i 2GB Flash	8x 2.5"	8x 2.5" SATA/SA S HS	Open	None	None	1x NVIDIA A Quadro 2000 5GB	1x Mgmt	4x GbE RJ-45 LOM	None	1x LOM, 1x RAID	1x PCIe x8 LP, 1x Front PCIe x16 VGA FHHL	None	TPM 1.2	XClarity Standard	1x 750W Platinum	None	3-year	07/17	
7X02A00VCN	Taiwan	1x Xeon Gold 5118 12C/2.3GHz/16.5MB/105W/DDR4-2400	1x 16GB RDIMM DDR4-2666 (2Rx8)	None	8x 2.5"	None	None	None	None	None	1x Mgmt	4x GbE RJ-45 LOM	None	1x LOM, 1x RAID	1x PCIe x8 LP, 1x Front PCIe x16 VGA LP	None	TPM 1.2	XClarity Standard	1x 750W Platinum	None	3-year	07/17	
7X02A00TCN	Taiwan	1x Xeon Gold 6132 14C/2.6GHz/19.25MB/140W/DDR4-2666	1x 16GB RDIMM DDR4-2666 (2Rx8)	1x 930-8i 2GB Flash	8x 2.5"	8x 2.5" SATA/SA S HS	Open	None	None	1x NVIDIA A Quadro 2000 5GB	1x Mgmt	4x GbE RJ-45 LOM	None	1x LOM, 1x RAID	1x PCIe x8 LP, 1x Front PCIe x16 VGA FHHL	None	TPM 1.2	XClarity Standard	1x 750W Platinum	None	3-year	07/17	
7X02A013CN	Taiwan	1x Xeon Gold 5115 10C/2.4GHz/13.75MB/85W/DDR4-2400	1x 16GB RDIMM DDR4-2666 (2Rx8)	1x 930-8i 2GB Flash	8x 2.5"	8x 2.5" SATA/SA S HS	Open	None	None	1x NVIDIA A Quadro 2000 5GB	1x Mgmt	4x GbE RJ-45 LOM	None	1x LOM, 1x RAID	1x PCIe x8 LP, 1x Front PCIe x16 VGA FHHL	None	TPM 1.2	XClarity Standard	1x 750W Platinum	None	3-year	07/17	
7X02A014CN	Taiwan	1x Xeon Gold 6126 12C/2.6GHz/19.25MB/125W/DDR4-2666	1x 16GB RDIMM DDR4-2666 (2Rx8)	1x 930-8i 2GB Flash	8x 2.5"	8x 2.5" SATA/SA S HS	Open	None	None	1x NVIDIA A Quadro 2000 5GB	1x Mgmt	4x GbE RJ-45 LOM	None	1x LOM, 1x RAID	1x PCIe x8 LP, 1x Front PCIe x16 VGA FHHL	None	TPM 1.2	XClarity Standard	1x 750W Platinum	None	3-year	07/17	
7X02A015CN	Taiwan	1x Xeon Gold 5120 14C/2.2GHz/19.25MB/105W/DDR4-2400	1x 16GB RDIMM DDR4-2666 (2Rx8)	1x 930-8i 2GB Flash	8x 2.5"	8x 2.5" SATA/SA S HS	Open	None	None	1x NVIDIA A Quadro 2000 5GB	1x Mgmt	4x GbE RJ-45 LOM	None	1x LOM, 1x RAID	1x PCIe x8 LP, 1x Front PCIe x16 VGA FHHL	None	TPM 1.2	XClarity Standard	1x 750W Platinum	None	3-year	07/17	
7X02A016CN	Taiwan	1x Xeon Gold 5122 4C/3.6GHz/16.5MB/105W/DDR4-2666	1x 16GB RDIMM DDR4-2666 (2Rx8)	1x 930-8i 2GB Flash	8x 2.5"	8x 2.5" SATA/SA S HS	Open	None	None	1x NVIDIA A Quadro 2000 5GB	1x Mgmt	4x GbE RJ-45 LOM	None	1x LOM, 1x RAID	1x PCIe x8 LP, 1x Front PCIe x16 VGA FHHL	None	TPM 1.2	XClarity Standard	1x 750W Platinum	None	3-year	07/17	
7X02A02QCN	Taiwan	1x Xeon Gold 6152 22C/2.1GHz/30.25MB/140W/DDR4-2666	1x 16GB RDIMM DDR4-2666 (2Rx8)	1x 930-8i 2GB Flash	8x 2.5"	8x 2.5" SATA/SA S HS	Open	None	None	1x NVIDIA A Quadro 2000 5GB	1x Mgmt	4x GbE RJ-45 LOM	None	1x LOM, 1x RAID	1x PCIe x8 LP, 1x Front PCIe x16 VGA FHHL	None	TPM 1.2	XClarity Standard	1x 750W Platinum	None	3-year	07/17	

Model	Region	Processor	Memory	Storage Controller	Chassis	Disk Bays	Disk S	M.2 Drives	PCIe Flash Adapter	GPU	Onboard Networking Ports	Additional Networking (LOM/ML2/PCIe)	Fibre Channel I/O	Standard Extension Slots	Available Extension Slots via Riser Cards	Front VGA	Optical	TPM	System Management	Power Supply	Preload	Warranty	Ann Date (mm/yy)
7X02A01BCN	Taiwan	1x Xeon Gold 6138T 20C/2.0GHz/27.5MB/125W/DDR4-2666	1x 16GB RDIMM DDR4-2666 (2Rx8)	1x 930-8i 2GB Flash	8x 2.5"	8x 2.5" SATA/SAS HS	Open	None	None	1x NVIDIA Quadro 2000 5GB	1x Mgmt	4x GbE RJ-45 LOM	None	1x LOM, 1x RAID	1x PCIe x8 LP, 1x PCIe x16 FHHL	1x Front VGA	None	TPM 1.2	XClarity Standard	1x 750W Platinum	None	3-year	07/17
7X02A01DCN	Taiwan	1x Xeon Gold 6130 16C/2.1GHz/22MB/125W/DDR4-2666	1x 16GB RDIMM DDR4-2666 (2Rx8)	1x 930-8i 2GB Flash	8x 2.5"	8x 2.5" SATA/SAS HS	Open	None	None	1x NVIDIA Quadro 2000 5GB	1x Mgmt	4x GbE RJ-45 LOM	None	1x LOM, 1x RAID	1x PCIe x8 LP, 1x PCIe x16 FHHL	1x Front VGA	None	TPM 1.2	XClarity Standard	1x 750W Platinum	None	3-year	07/17
7X02A01ECN	Taiwan	1x Xeon Gold 6134 8C/3.2GHz/24.75MB/130W/DDR4-2666	1x 16GB RDIMM DDR4-2666 (2Rx8)	1x 930-8i 2GB Flash	8x 2.5"	8x 2.5" SATA/SAS HS	Open	None	None	1x NVIDIA Quadro 2000 5GB	1x Mgmt	4x GbE RJ-45 LOM	None	1x LOM, 1x RAID	1x PCIe x8 LP, 1x PCIe x16 FHHL	1x Front VGA	None	TPM 1.2	XClarity Standard	1x 750W Platinum	None	3-year	07/17

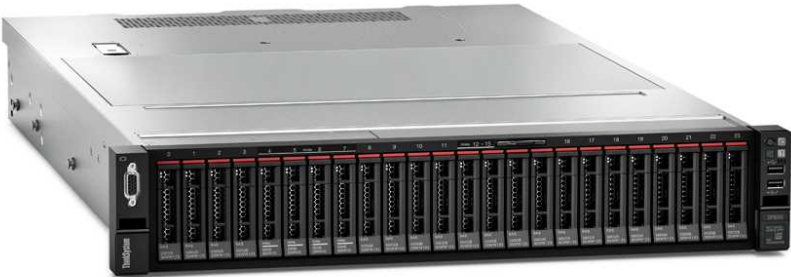

ThinkSystem SR650 Platform Specifications

Product Specifications Reference (PSREF)

Components	Specification																																																																																																			
Form factor	2U rack																																																																																																			
Dimensions	Height: 86.5 mm (3.4 in). Width: 482 mm (19.0 in) with rack latches. Depth: 763.7 mm (30.1 in)																																																																																																			
Weight	Maximum configuration: 70.54 lb (32 kg)																																																																																																			
Processor	Up to two 205W Intel Xeon Scalable family processors, Bronze, Silver, Gold, or Platinum. Up to 28 cores at 2.5GHz, up to 3.6GHz with 4 cores. Two processors are connected with two UPI (Ultra Path Interconnect) links up to 10.4GT/s																																																																																																			
Chipset	Intel C624 Platform Controller Hub																																																																																																			
Memory	Up to 24 DIMM sockets. Each processor supports up to 12 DIMM sockets with 6 channels. DDR4-2666. RDIMMs, LRDIMMs, 3DS RDIMMs are supported, but memory types cannot be intermixed																																																																																																			
Memory capacity	Up to 768GB with 24 x 32 GB RDIMMs and two processors. Or up to 1.5TB with 24 x 64 GB LRDIMMs and two processors. Or up to 3TB with 24 x 128 GB 3DS LRDIMMs and two -M suffix processors. -M suffix processor supports 1.5TB memory per socket, non -M suffix processor supports 768GB memory per socket																																																																																																			
Memory protection	ECC, memory mirroring, and memory sparing																																																																																																			
Storage controllers	One dedicated internal RAID slot for most RAID/HBA adapters.																																																																																																			
	<table border="1"> <thead> <tr> <th>Feature</th> <th>Interface</th> <th>Drive type</th> <th>RAID levels</th> <th>JBOD</th> <th>Cache</th> <th>Cache protection</th> <th>FastPath</th> <th>Max qty</th> </tr> </thead> <tbody> <tr> <td>530-8i</td> <td>12Gbps SAS</td> <td>SATA/SAS</td> <td>0/1/10/5/50</td> <td>Yes</td> <td>None</td> <td>None</td> <td>Yes</td> <td>2</td> </tr> <tr> <td>730-8i</td> <td>12Gbps SAS</td> <td>SATA/SAS</td> <td>0/1/10/5/50</td> <td>Yes</td> <td>1GB</td> <td>None</td> <td>No</td> <td>3</td> </tr> <tr> <td>930-8i</td> <td>12Gbps SAS</td> <td>SATA/SAS</td> <td>0/1/10/5/50/6/60</td> <td>Yes</td> <td>2GB</td> <td>Flash backup</td> <td>Yes</td> <td>3</td> </tr> <tr> <td>930-16i</td> <td>12Gbps SAS</td> <td>SATA/SAS</td> <td>0/1/10/5/50/6/60</td> <td>Yes</td> <td>4GB</td> <td>Flash backup</td> <td>Yes</td> <td>1</td> </tr> <tr> <td>930-24i</td> <td>12Gbps SAS</td> <td>SATA/SAS</td> <td>0/1/10/5/50/6/60</td> <td>Yes</td> <td>4GB</td> <td>Flash backup</td> <td>Yes</td> <td>1</td> </tr> <tr> <td>430-8i</td> <td>12Gbps SAS</td> <td>SATA/SAS</td> <td>-</td> <td>Yes</td> <td>None</td> <td>None</td> <td>-</td> <td>3</td> </tr> <tr> <td>430-16i</td> <td>12Gbps SAS</td> <td>SATA/SAS</td> <td>-</td> <td>Yes</td> <td>None</td> <td>None</td> <td>-</td> <td>1</td> </tr> <tr> <td>930-8e</td> <td>12Gbps SAS</td> <td>SATA/SAS</td> <td>0/1/10/5/50/6/60</td> <td>Yes</td> <td>4GB</td> <td>Flash backup</td> <td>Yes</td> <td>5</td> </tr> <tr> <td>430-8e</td> <td>12Gbps SAS</td> <td>SATA/SAS</td> <td>-</td> <td>Yes</td> <td>None</td> <td>None</td> <td>-</td> <td>5</td> </tr> <tr> <td>430-16e</td> <td>12Gbps SAS</td> <td>SATA/SAS</td> <td>-</td> <td>Yes</td> <td>None</td> <td>None</td> <td>-</td> <td>5</td> </tr> </tbody> </table>	Feature	Interface	Drive type	RAID levels	JBOD	Cache	Cache protection	FastPath	Max qty	530-8i	12Gbps SAS	SATA/SAS	0/1/10/5/50	Yes	None	None	Yes	2	730-8i	12Gbps SAS	SATA/SAS	0/1/10/5/50	Yes	1GB	None	No	3	930-8i	12Gbps SAS	SATA/SAS	0/1/10/5/50/6/60	Yes	2GB	Flash backup	Yes	3	930-16i	12Gbps SAS	SATA/SAS	0/1/10/5/50/6/60	Yes	4GB	Flash backup	Yes	1	930-24i	12Gbps SAS	SATA/SAS	0/1/10/5/50/6/60	Yes	4GB	Flash backup	Yes	1	430-8i	12Gbps SAS	SATA/SAS	-	Yes	None	None	-	3	430-16i	12Gbps SAS	SATA/SAS	-	Yes	None	None	-	1	930-8e	12Gbps SAS	SATA/SAS	0/1/10/5/50/6/60	Yes	4GB	Flash backup	Yes	5	430-8e	12Gbps SAS	SATA/SAS	-	Yes	None	None	-	5	430-16e	12Gbps SAS	SATA/SAS	-	Yes	None	None	-	5
	Feature	Interface	Drive type	RAID levels	JBOD	Cache	Cache protection	FastPath	Max qty																																																																																											
	530-8i	12Gbps SAS	SATA/SAS	0/1/10/5/50	Yes	None	None	Yes	2																																																																																											
	730-8i	12Gbps SAS	SATA/SAS	0/1/10/5/50	Yes	1GB	None	No	3																																																																																											
	930-8i	12Gbps SAS	SATA/SAS	0/1/10/5/50/6/60	Yes	2GB	Flash backup	Yes	3																																																																																											
	930-16i	12Gbps SAS	SATA/SAS	0/1/10/5/50/6/60	Yes	4GB	Flash backup	Yes	1																																																																																											
	930-24i	12Gbps SAS	SATA/SAS	0/1/10/5/50/6/60	Yes	4GB	Flash backup	Yes	1																																																																																											
	430-8i	12Gbps SAS	SATA/SAS	-	Yes	None	None	-	3																																																																																											
	430-16i	12Gbps SAS	SATA/SAS	-	Yes	None	None	-	1																																																																																											
930-8e	12Gbps SAS	SATA/SAS	0/1/10/5/50/6/60	Yes	4GB	Flash backup	Yes	5																																																																																												
430-8e	12Gbps SAS	SATA/SAS	-	Yes	None	None	-	5																																																																																												
430-16e	12Gbps SAS	SATA/SAS	-	Yes	None	None	-	5																																																																																												
<i>Note: 730-8i is available in China only. 930-8e, 430-8e, and 430-16e will be placed in slot 4 firstly. 930-24i will be placed in slot 1 firstly.</i>																																																																																																				
Disk drive bays	Supports 8 front 3.5" SATA/SAS HS bays, or 12 front 3.5" SATA/SAS HS bays with maximum 4 AnyBay, or 8 front 2.5" SATA/SAS HS bays with maximum 4 AnyBay, or 16 front 2.5" SATA/SAS HS bays with maximum 8 AnyBay, or 24 front 2.5" SATA/SAS HS bays with maximum 4 AnyBay. Optional 2 rear 3.5" HS bays are supported on 12 x 3.5" model, takes place in riser card 1 location. Optional one or two internal M.2 SSD for boot, dual M.2 SSD supports mirroring																																																																																																			
Internal storage	For 3.5" bay	3.5" HDD, SATA6Gbps, 7.2K 1TB/2TB/4TB/6TB/8TB/10TB																																																																																																		
	(3.5" disks or 2.5" disks with 3.5" tray)	3.5" HDD, SAS12Gbps, 7.2K 1TB/2TB/4TB/6TB SED FIPS/6TB/10TB																																																																																																		
		2.5" HDD, SAS12Gbps, 15K 300GB/600GB																																																																																																		
	For 2.5" bay	2.5" SSD, SATA6Gbps 240GB/480GB																																																																																																		
		2.5" NVMe SSD, AnyBay 960GB/1.92TB/3.84TB																																																																																																		
2.5" HDD, SATA6Gbps, 7.2K 1TB/2TB																																																																																																				
2.5" HDD, SAS12Gbps, 7.2K 1TB/2TB																																																																																																				
2.5" HDD, SAS12Gbps, 10K 300GB/300GB SED/600GB/600GB SED/900GB/1.2TB/1.8TB																																																																																																				
2.5" HDD, SAS12Gbps, 15K 300GB/600GB/900GB																																																																																																				
2.5" SSD, SAS12Gbps 400GB/800GB/3.84TB/7.68TB																																																																																																				
2.5" SSD, SATA6Gbps 240GB/480GB																																																																																																				
2.5" NVMe SSD, AnyBay 800GB/960GB/1.6TB/1.92TB/3.84TB																																																																																																				
PCIe 3.0 x4, HHL adapter	NVMe SSD 1.6TB/1.92TB/3.2TB/3.84TB																																																																																																			
M.2 boot drive	M.2 SATA SSD 32GB/128GB/480GB																																																																																																			
Optical	No internal optical bay. Optional USB DVD±RW optical drive																																																																																																			
Network interfaces	One dedicated management port. One LOM slot for customized LOM with up to four RJ-45 or SFP+ ports, up to 10GbE. Wake-on-LAN and NC-SI are available on Port 0 of LOM. Optional ML2 or PCIe adapters are supported. ML2 adapter requires riser card with ML2 slot.																																																																																																			
Security features	Power-on and admin password. Trusted Platform Module, TCG 1.2 compliant, upgrade to 2.0 via UEFI setting. Optional TCM in China only. Optional lockable security bezel																																																																																																			
Operating systems supported	Microsoft Windows Server 2016/2012 R2. Red Hat Enterprise Linux 7.4/7.3/6.9. SUSE Linux Enterprise Server 12 SP3/12 SP2/11 SP4. VMware ESXi 6.5U1/6.5/6.0 U3																																																																																																			
Systems management	XClarity Controller Standard, optional upgrades to Advanced or Enterprise are available. Energy Manager. XClarity Administrator. Lenovo Capacity Planner. Provisioning Manager. Essentials. Light Path Diagnostics																																																																																																			
GPU support	Up to two optional GPU, requires riser card with PCIe x16 slot. 2nd GPU requires 2nd CPU. Supports Intel Xeon Phi 7240P, NVIDIA Quadro M60, or Quadro P100																																																																																																			

Components	Specification												
Base warranty	MT 7X05: 1-year limited onsite service with 9x5/NBD MT 7X06: 3-year limited onsite service with 9x5/NBD												
Power supply	Up to two redundant hot-swap 550W/750W/1100W/1600W 80 PLUS Platinum qualified AC power supplies. Or up to two redundant hot-swap 750W Titanium qualified AC power supplies. 750W Titanium and 1600W Platinum are 200V - 240V, others are 100V - 240V												
Video	Integrated Matrox G200 in XClarity Controller												
Cooling	Five fans (4+1) for single processor model, six fans (5+1) for dual processor model												
Front ports	One XClarity Controller USB connector, one USB 3.0, one optional VGA												
Rear ports	One VGA, two USB 3.0, one XClarity Controller network connector. Optional COM port												
Environmental specification	Supports ASHRAE A4 with limitations.												
	<table border="1"> <tbody> <tr> <td>Temperature - operating</td> <td>A4: 5°C to 45°C (41°F to 113°F) A3: 5°C to 40°C (41°F to 104°F) A2: 10°C to 35°C (50°F to 95°F)</td> </tr> <tr> <td>Temperature - non operating (no package)</td> <td>-10°C to 60°C (14°F to 140°F)</td> </tr> <tr> <td>Temperature - non operating (with package)</td> <td>-40°C to 70°C (-40°F to 158°F)</td> </tr> <tr> <td>Altitude - operating</td> <td>(Unpressurized): 0-10000ft (0-3048m)</td> </tr> <tr> <td>Humidity - operating, non-condensing</td> <td>A4: 8%-90%. A3:8%-85%. A2:8%-80%</td> </tr> <tr> <td>Humidity - storage (with package), non-condensing</td> <td>8%-90%</td> </tr> </tbody> </table>	Temperature - operating	A4: 5°C to 45°C (41°F to 113°F) A3: 5°C to 40°C (41°F to 104°F) A2: 10°C to 35°C (50°F to 95°F)	Temperature - non operating (no package)	-10°C to 60°C (14°F to 140°F)	Temperature - non operating (with package)	-40°C to 70°C (-40°F to 158°F)	Altitude - operating	(Unpressurized): 0-10000ft (0-3048m)	Humidity - operating, non-condensing	A4: 8%-90%. A3:8%-85%. A2:8%-80%	Humidity - storage (with package), non-condensing	8%-90%
	Temperature - operating	A4: 5°C to 45°C (41°F to 113°F) A3: 5°C to 40°C (41°F to 104°F) A2: 10°C to 35°C (50°F to 95°F)											
	Temperature - non operating (no package)	-10°C to 60°C (14°F to 140°F)											
	Temperature - non operating (with package)	-40°C to 70°C (-40°F to 158°F)											
	Altitude - operating	(Unpressurized): 0-10000ft (0-3048m)											
	Humidity - operating, non-condensing	A4: 8%-90%. A3:8%-85%. A2:8%-80%											
	Humidity - storage (with package), non-condensing	8%-90%											
	<i>Models should meet the following requirements to support A3 and A4:</i>												
	<ul style="list-style-type: none"> NVMe drives not installed PCIe flash adapter not installed Graphic processing unit (GPU) not installed Must have redundant PSU Certain processors not installed: <ul style="list-style-type: none"> Processors with TDP more than or equal to 150-watt not installed On 16 x 2.5", 24 x 2.5", and 12 x 3.5" models, the following processors not installed: Intel Xeon 4112, 5122, 6126, 6128*, 6132*, 6134, 6134M*, and 8156 processors (Processors marked with * will be available later) 												
Environmental certification	Energy Star Server 2.1 certified. More environmental information please see: www.lenovo.com/social_responsibility/us/en/environment/												

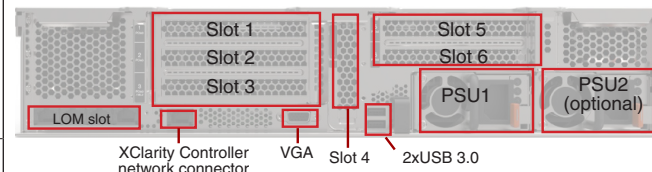

Expansion slots	Specification
Slot 1-3 (riser card 1)	Supports one of the following for riser card 1: Option 1: PCIe 3.0 x8/x8/x8 (slot 1-3). Full height, half length. Option 2: PCIe 3.0 x16/x8 (slot 1 and 3). Full height, full length for x16. Full height, half length for x8 Option 3: PCIe 3.0 x8/x8/x8 ML2 (slot 1-3). Full height, half length Option 4: PCIe 3.0 x8/x16 ML2 (slot 1 and 3). Full height, half length Option 5: Two rear 3.5" disk bays, 12 x 3.5" models only
Slot 4 (onboard)	PCIe 3.0 x8, low profile
Slot 5 (riser card 2)	PCIe 3.0 x16, full height, full length, requires 2nd CPU
Slot 6 (riser card 2)	PCIe 3.0 x16, full height, half length, requires 2nd CPU

System unique options	Specification
7XH7A06253	ThinkSystem SR590/SR650 Rear HDD Kit
7XH7A02681	ThinkSystem SR650 x8/x16ML2 PCIe FH Riser 1 Kit
7XH7A02680	ThinkSystem SR550/SR590/SR650 x8/x8x8ML2 PCIe FH Riser 1 Kit
7XH7A02678	ThinkSystem SR550/SR590/SR650 x16/x8 PCIe FH Riser 1 Kit
7XH7A02677	ThinkSystem SR550/SR590/SR650 x8/x8/x8 PCIe FH Riser 1 Kit
7XH7A02679	ThinkSystem SR550/SR590/SR650 x16/x8(or x16) PCIe FH Riser 2 Kit
7XH7A06251	ThinkSystem SR650 2.5" AnyBay 8-Bay Backplane Kit
7XH7A06254	ThinkSystem SR550/SR650 2.5" SATA/SAS 8-Bay Backplane Kit
7Z17A02578	ThinkSystem SR550/SR590/SR650 EIA Latch w/ VGA Upgrade Kit
7Z17A02580	ThinkSystem 2U Security Bezel
7Z17A02577	ThinkSystem COM Port Upgrade Kit
7XH7A05899	ThinkSystem SR650 2nd GPU Upgrade Kit
7XH7A05897	ThinkSystem SR650 GPU Thermal Kit
7XH7A05898	ThinkSystem SR650(GPU) 1U Heatsink Option Kit

Model	Region	Processor	Memory	Storage Controller	Chassis	Disk Bays	Disk S	M.2 Drives	PCIe Flash Adapter	GPU	Onboard Networking Ports	Additional Networking (LOM/ML2/PCIe)	Fibre Channel I/O	Standard Extension Slots	Available Extension Slots via Riser Cards	Front VGA	Optical	TPM	System Management	Power Supply	Preload	Warranty	Ann Date (mm/yy)
7X061001AU	ANZ	1x Xeon Bronze 3106 8C/1.7GHz/11MB/85W/DDR4-2133	1x 16GB RDIMM DDR4-2666 (2Rx8)	1x 530-8i	24x 2.5"	8x 2.5" SATA/SAS HS	Open	None	None	None	1x Mgmt	None	None	1x LOM, 1x RAID slot, 1x PCIe x8 LP	None	Front VGA	None	TPM 1.2	XClarity Advanced	1x750W Platinum	None	3-year	09/17
7X061002AU	ANZ	1x Xeon Silver 4108 8C/1.8GHz/11MB/85W/DDR4-2400	1x 16GB RDIMM DDR4-2666 (2Rx8)	1x 530-8i	24x 2.5"	8x 2.5" SATA/SAS HS	Open	None	None	None	1x Mgmt	None	None	1x LOM, 1x RAID slot, 1x PCIe x8 LP	None	Front VGA	None	TPM 1.2	XClarity Advanced	1x750W Platinum	None	3-year	09/17
7X061003AU	ANZ	1x Xeon Silver 4110 8C/2.1GHz/11MB/85W/DDR4-2400	1x 16GB RDIMM DDR4-2666 (2Rx8)	1x 530-8i	24x 2.5"	8x 2.5" SATA/SAS HS	Open	None	None	None	1x Mgmt	None	None	1x LOM, 1x RAID slot, 1x PCIe x8 LP	None	Front VGA	None	TPM 1.2	XClarity Advanced	1x750W Platinum	None	3-year	09/17
7X061004AU	ANZ	1x Xeon Silver 4114 10C/2.2GHz/13.75MB/85W/DDR4-2400	1x 16GB RDIMM DDR4-2666 (2Rx8)	1x 530-8i	24x 2.5"	8x 2.5" SATA/SAS HS	Open	None	None	None	1x Mgmt	None	None	1x LOM, 1x RAID slot, 1x PCIe x8 LP	None	Front VGA	None	TPM 1.2	XClarity Advanced	1x750W Platinum	None	3-year	09/17
7X061005AU	ANZ	1x Xeon Silver 4116 12C/2.1GHz/16.5MB/85W/DDR4-2400	1x 16GB RDIMM DDR4-2666 (2Rx8)	1x 530-8i	24x 2.5"	8x 2.5" SATA/SAS HS	Open	None	None	None	1x Mgmt	None	None	1x LOM, 1x RAID slot, 1x PCIe x8 LP	None	Front VGA	None	TPM 1.2	XClarity Advanced	1x1100W Platinum	None	3-year	09/17
7X061006AU	ANZ	1x Xeon Gold 5118 12C/2.3GHz/16.5MB/105W/DDR4-2400	1x 32GB RDIMM DDR4-2666 (2Rx4)	1x 530-8i	24x 2.5"	8x 2.5" SATA/SAS HS	Open	None	None	None	1x Mgmt	None	None	1x LOM, 1x RAID slot, 1x PCIe x8 LP	None	Front VGA	None	TPM 1.2	XClarity Advanced	1x1100W Platinum	None	3-year	09/17
7X061007AU	ANZ	1x Xeon Gold 6130 16C/2.1GHz/22MB/125W/DDR4-2666	1x 32GB RDIMM DDR4-2666 (2Rx4)	1x 530-8i	24x 2.5"	8x 2.5" SATA/SAS HS	Open	None	None	None	1x Mgmt	None	None	1x LOM, 1x RAID slot, 1x PCIe x8 LP	None	Front VGA	None	TPM 1.2	XClarity Advanced	1x1100W Platinum	None	3-year	09/17
7X061008AU	ANZ	1x Xeon Bronze 3106 8C/1.7GHz/11MB/85W/DDR4-2133	1x 16GB RDIMM DDR4-2666 (2Rx8)	1x 530-8i	24x 2.5"	8x 2.5" SATA/SAS HS	Open	None	None	None	1x Mgmt	None	None	1x LOM, 1x RAID slot, 1x PCIe x8 LP	None	Front VGA	None	TPM 1.2	XClarity Advanced	1x750W Platinum	None	3-year	09/17
7X061009AU	ANZ	1x Xeon Silver 4108 8C/1.8GHz/11MB/85W/DDR4-2400	1x 16GB RDIMM DDR4-2666 (2Rx8)	1x 930-8i 2GB Flash	24x 2.5"	8x 2.5" SATA/SAS HS	Open	None	None	None	1x Mgmt	None	None	1x LOM, 1x RAID slot, 1x PCIe x8 LP	None	Front VGA	None	TPM 1.2	XClarity Advanced	1x750W Platinum	None	3-year	09/17
7X06100AAU	ANZ	1x Xeon Silver 4110 8C/2.1GHz/11MB/85W/DDR4-2400	1x 16GB RDIMM DDR4-2666 (2Rx8)	1x 930-8i 2GB Flash	24x 2.5"	8x 2.5" SATA/SAS HS	Open	None	None	None	1x Mgmt	None	None	1x LOM, 1x RAID slot, 1x PCIe x8 LP	None	Front VGA	None	TPM 1.2	XClarity Advanced	1x750W Platinum	None	3-year	09/17

Model	Region	Processor	Memory	Storage Controller	Chassis	Disk Bays	Disk S	M.2 Drives	PCIe Flash Adapter	GPU	Onboard Networking Ports	Additional Networking (LOM/ML2/PCIe)	Fibre Channel I/O	Standard Extension Slots	Available Extension Slots via Riser Cards	Front VGA	Optical	TPM	System Management	Power Supply	Preload	Warranty	Ann Date (mm/yy)
7X06100BAU	ANZ	1x Xeon Silver 4114 10C/2.2GHz/13.75MB/85W/DDR4-2400	1x 16GB RDIMM DDR4-2666 (2Rx8)	1x 930-8i 2GB Flash	24x 2.5"	8x 2.5" SATA/SA S HS	Open	None	None	None	1x Mgmt	None	None	1x LOM, 1x RAID slot, 1x PCIe x8 LP	None	Front VGA	None	TPM 1.2	XClarity Advanced	1x750W Platinum	None	3-year	09/17
7X06100CAU	ANZ	1x Xeon Silver 4116 12C/2.1GHz/16.5MB/85W/DDR4-2400	1x 16GB RDIMM DDR4-2666 (2Rx8)	1x 930-24i 4GB Flash	24x 2.5"	24x 2.5" SATA/SA S HS	Open	None	None	None	1x Mgmt	None	None	1x LOM, 1x RAID slot, 1x PCIe x8 LP	1x PCIe x16 FHFL, 1x PCIe x8 FHHH	Front VGA	None	TPM 1.2	XClarity Advanced	1x1100W Platinum	None	3-year	09/17
7X06100DAU	ANZ	1x Xeon Gold 5118 12C/2.3GHz/16.5MB/105W/DDR4-2400	1x 16GB RDIMM DDR4-2666 (2Rx8)	1x 930-24i 4GB Flash	24x 2.5"	24x 2.5" SATA/SA S HS	Open	None	None	None	1x Mgmt	None	None	1x LOM, 1x RAID slot, 1x PCIe x8 LP	1x PCIe x16 FHFL, 1x PCIe x8 FHHH	Front VGA	None	TPM 1.2	XClarity Advanced	1x1100W Platinum	None	3-year	09/17
7X06100EAU	ANZ	1x Xeon Gold 6130 16C/2.1GHz/22MB/125W/DDR4-2666	1x 32GB RDIMM DDR4-2666 (2Rx4)	1x 930-24i 4GB Flash	24x 2.5"	24x 2.5" SATA/SA S HS	Open	None	None	None	1x Mgmt	None	None	1x LOM, 1x RAID slot, 1x PCIe x8 LP	1x PCIe x16 FHFL, 1x PCIe x8 FHHH	Front VGA	None	TPM 1.2	XClarity Advanced	1x1100W Platinum	None	3-year	09/17
7X06100FAU	ANZ	2x Xeon Silver 4110 8C/2.1GHz/11MB/85W/DDR4-2400	4x 16GB RDIMM DDR4-2666 (2Rx8)	1x 930-8i 2GB Flash	24x 2.5"	8x 2.5" SATA/SA S HS	Open	None	None	None	1x Mgmt	4x GbE RJ-45 LOM	None	1x LOM, 1x RAID slot, 1x PCIe x8 LP	None	Front VGA	USB DVD±RW	TPM 1.2	XClarity Advanced	2x1100W Platinum	None	3-year	09/17
7X06A05ZAU	ANZ	1x Xeon Gold 6130 16C/2.1GHz/22MB/125W/DDR4-2666	1x 32GB RDIMM DDR4-2666 (2Rx4)	1x 930-8i 2GB Flash	24x 2.5"	8x 2.5" SATA/SA S HS	Open	None	None	None	1x Mgmt	None	None	1x LOM, 1x RAID slot, 1x PCIe x8 LP	None	Front VGA	None	TPM 1.2	XClarity Enterprise	1x1100W Platinum	None	3-year	07/17
7X06A060AU	ANZ	1x Xeon Gold 5118 12C/2.3GHz/16.5MB/105W/DDR4-2400	1x 16GB RDIMM DDR4-2666 (2Rx8)	1x 930-8i 2GB Flash	24x 2.5"	8x 2.5" SATA/SA S HS	Open	None	None	None	1x Mgmt	None	None	1x LOM, 1x RAID slot, 1x PCIe x8 LP	None	Front VGA	None	TPM 1.2	XClarity Enterprise	1x1100W Platinum	None	3-year	07/17
7X06A061AU	ANZ	1x Xeon Gold 5120 14C/2.2GHz/19.25MB/105W/DDR4-2400	1x 16GB RDIMM DDR4-2666 (2Rx8)	1x 930-8i 2GB Flash	24x 2.5"	8x 2.5" SATA/SA S HS	Open	None	None	None	1x Mgmt	None	None	1x LOM, 1x RAID slot, 1x PCIe x8 LP	None	Front VGA	None	TPM 1.2	XClarity Enterprise	1x1100W Platinum	None	3-year	07/17
7X06A062AU	ANZ	1x Xeon Gold 6126 12C/2.6GHz/19.25MB/125W/DDR4-2666	1x 32GB RDIMM DDR4-2666 (2Rx4)	1x 930-8i 2GB Flash	24x 2.5"	8x 2.5" SATA/SA S HS	Open	None	None	None	1x Mgmt	None	None	1x LOM, 1x RAID slot, 1x PCIe x8 LP	None	Front VGA	None	TPM 1.2	XClarity Enterprise	1x750W Platinum	None	3-year	07/17
7X06A063AU	ANZ	1x Xeon Gold 5118 12C/2.3GHz/16.5MB/105W/DDR4-2400	1x 16GB RDIMM DDR4-2666 (2Rx8)	1x 930-8i 2GB Flash	24x 2.5"	8x 2.5" SATA/SA S HS	Open	None	None	None	1x Mgmt	None	None	1x LOM, 1x RAID slot, 1x PCIe x8 LP	None	Front VGA	None	TPM 1.2	XClarity Enterprise	1x750W Platinum	None	3-year	07/17

Model	Region	Processor	Memory	Storage Controller	Chassis	Disk Bays	Disk S	M.2 Drives	PCIe Flash Adapter	GPU	Onboard Networking Ports	Additional Networking (LOM/ML2/PCIe)	Fibre Channel I/O	Standard Extension Slots	Available Extension Slots via Riser Cards	Front VGA	Optical	TPM	System Management	Power Supply	Preload	Warranty	Ann Date (mm/yy)
7X06A064AU	ANZ	1x Xeon Gold 6140 18C/2.3GHz/24.75MB/140W/DDR4-2666	1x 32GB RDIMM DDR4-2666 (2Rx4)	1x 930-8i 2GB Flash	24x 2.5"	8x 2.5" SATA/SA S HS	Open	None	None	None	1x Mgmt	None	None	1x LOM, 1x RAID slot, 1x PCIe x8 LP	None	Front VGA	None	TPM 1.2	XClarity Enterprise	1x1100W Platinum	None	3-year	07/17
7X06A065AU	ANZ	1x Xeon Gold 5115 10C/2.4GHz/13.75MB/85W/DDR4-2400	1x 16GB RDIMM DDR4-2666 (2Rx8)	1x 930-8i 2GB Flash	24x 2.5"	8x 2.5" SATA/SA S HS	Open	None	None	None	1x Mgmt	None	None	1x LOM, 1x RAID slot, 1x PCIe x8 LP	None	Front VGA	None	TPM 1.2	XClarity Enterprise	1x1100W Platinum	None	3-year	07/17
7X06A066AU	ANZ	1x Xeon Gold 5122 4C/3.6GHz/16.5MB/105W/DDR4-2666	1x 32GB RDIMM DDR4-2666 (2Rx4)	1x 930-8i 2GB Flash	24x 2.5"	8x 2.5" SATA/SA S HS	Open	None	None	None	1x Mgmt	None	None	1x LOM, 1x RAID slot, 1x PCIe x8 LP	None	Front VGA	None	TPM 1.2	XClarity Enterprise	1x1600W Platinum	None	3-year	07/17
7X06A067AU	ANZ	1x Xeon Gold 5120 14C/2.2GHz/19.25MB/105W/DDR4-2400	1x 16GB RDIMM DDR4-2666 (2Rx8)	1x 930-8i 2GB Flash	24x 2.5"	8x 2.5" SATA/SA S HS	Open	None	None	None	1x Mgmt	None	None	1x LOM, 1x RAID slot, 1x PCIe x8 LP	None	Front VGA	None	TPM 1.2	XClarity Enterprise	1x750W Platinum	None	3-year	07/17
7X06A069AU	ANZ	1x Xeon Platinum 8160 24C/2.1GHz/33MB/150W/DDR4-2666	1x 32GB RDIMM DDR4-2666 (2Rx4)	1x 930-8i 2GB Flash	24x 2.5"	8x 2.5" SATA/SA S HS	Open	None	None	None	1x Mgmt	None	None	1x LOM, 1x RAID slot, 1x PCIe x8 LP	None	Front VGA	None	TPM 1.2	XClarity Enterprise	1x1100W Platinum	None	3-year	07/17
7X06A06AAU	ANZ	1x Xeon Gold 6152 22C/2.1GHz/30.25MB/140W/DDR4-2666	1x 32GB RDIMM DDR4-2666 (2Rx4)	1x 930-8i 2GB Flash	24x 2.5"	8x 2.5" SATA/SA S HS	Open	None	None	None	1x Mgmt	None	None	1x LOM, 1x RAID slot, 1x PCIe x8 LP	None	Front VGA	None	TPM 1.2	XClarity Enterprise	1x1100W Platinum	None	3-year	07/17
7X06A06BAU	ANZ	1x Xeon Gold 6130 16C/2.1GHz/22MB/125W/DDR4-2666	1x 32GB RDIMM DDR4-2666 (2Rx4)	1x 930-8i 2GB Flash	24x 2.5"	8x 2.5" SATA/SA S HS	Open	None	None	None	1x Mgmt	None	None	1x LOM, 1x RAID slot, 1x PCIe x8 LP	None	Front VGA	None	TPM 1.2	XClarity Enterprise	1x750W Platinum	None	3-year	07/17
7X06A06CAU	ANZ	1x Xeon Gold 6126 12C/2.6GHz/19.25MB/125W/DDR4-2666	1x 32GB RDIMM DDR4-2666 (2Rx4)	1x 930-8i 2GB Flash	24x 2.5"	8x 2.5" SATA/SA S HS	Open	None	None	None	1x Mgmt	None	None	1x LOM, 1x RAID slot, 1x PCIe x8 LP	None	Front VGA	None	TPM 1.2	XClarity Enterprise	1x1100W Platinum	None	3-year	07/17
7X06A06DAU	ANZ	1x Xeon Gold 5115 10C/2.4GHz/13.75MB/85W/DDR4-2400	1x 16GB RDIMM DDR4-2666 (2Rx8)	1x 930-8i 2GB Flash	24x 2.5"	8x 2.5" SATA/SA S HS	Open	None	None	None	1x Mgmt	None	None	1x LOM, 1x RAID slot, 1x PCIe x8 LP	None	Front VGA	None	TPM 1.2	XClarity Enterprise	1x750W Platinum	None	3-year	07/17
7X06A08JAU	ANZ	1x Xeon Silver 4108 8C/1.8GHz/11MB/85W/DDR4-2400	1x 16GB RDIMM DDR4-2666 (2Rx8)	1x 930-16i 4GB Flash	24x 2.5"	16x 2.5" SATA/SA S HS	Open	None	None	None	1x Mgmt	None	None	1x LOM, 1x RAID slot, 1x PCIe x8 LP	None	Front VGA	None	TPM 1.2	XClarity Enterprise	1x750W Platinum	None	3-year	10/17

Model	Region	Processor	Memory	Storage Controller	Chassis	Disk Bays	Disk S	M.2 Drives	PCIe Flash Adapter	GPU	Onboard Networking Ports	Additional Networking (LOM/ML2/PCIe)	Fibre Channel I/O	Standard Extension Slots	Available Extension Slots via Riser Cards	Front VGA	Optical	TPM	System Management	Power Supply	Preload	Warranty	Ann Date (mm/yy)
7X06A08KAU	ANZ	1x Xeon Silver 4110 8C/2.1GHz/11MB/85W/DDR4-2400	1x 16GB RDIMM DDR4-2666 (2Rx8)	1x 930-16i 4GB Flash	24x 2.5"	16x 2.5" SATA/SA S HS	Open	None	None	None	1x Mgmt	None	None	1x LOM, 1x RAID slot, 1x PCIe x8 LP	None	Front VGA	None	TPM 1.2	XClarity Enterprise	1x750W Platinum	None	3-year	10/17
7X06A08LAU	ANZ	1x Xeon Bronze 3106 8C/1.7GHz/11MB/85W/DDR4-2133	1x 16GB RDIMM DDR4-2666 (2Rx8)	1x 930-16i 4GB Flash	24x 2.5"	16x 2.5" SATA/SA S HS	Open	None	None	None	1x Mgmt	None	None	1x LOM, 1x RAID slot, 1x PCIe x8 LP	None	Front VGA	None	TPM 1.2	XClarity Enterprise	1x750W Platinum	None	3-year	10/17
7X06A08MAU	ANZ	1x Xeon Silver 4116 12C/2.1GHz/16.5MB/85W/DDR4-2400	1x 16GB RDIMM DDR4-2666 (2Rx8)	1x 930-16i 4GB Flash	24x 2.5"	16x 2.5" SATA/SA S HS	Open	None	None	None	1x Mgmt	None	None	1x LOM, 1x RAID slot, 1x PCIe x8 LP	None	Front VGA	None	TPM 1.2	XClarity Enterprise	1x750W Platinum	None	3-year	10/17
7X06A08NAU	ANZ	1x Xeon Gold 5118 12C/2.3GHz/16.5MB/105W/DDR4-2400	1x 16GB RDIMM DDR4-2666 (2Rx8)	1x 930-16i 4GB Flash	24x 2.5"	16x 2.5" SATA/SA S HS	Open	None	None	None	1x Mgmt	None	None	1x LOM, 1x RAID slot, 1x PCIe x8 LP	None	Front VGA	None	TPM 1.2	XClarity Enterprise	1x1100W Platinum	None	3-year	10/17
7X06A08QAU	ANZ	1x Xeon Silver 4114 10C/2.2GHz/13.75MB/85W/DDR4-2400	1x 16GB RDIMM DDR4-2666 (2Rx8)	1x 930-16i 4GB Flash	24x 2.5"	16x 2.5" SATA/SA S HS	Open	None	None	None	1x Mgmt	None	None	1x LOM, 1x RAID slot, 1x PCIe x8 LP	None	Front VGA	None	TPM 1.2	XClarity Enterprise	1x750W Platinum	None	3-year	10/17
7X06A08GAU	ANZ	1x Xeon Gold 6130 16C/2.1GHz/22MB/125W/DDR4-2666	1x 16GB RDIMM DDR4-2666 (2Rx8)	1x 930-16i 4GB Flash	24x 2.5"	16x 2.5" SATA/SA S HS	Open	None	None	None	1x Mgmt	None	None	1x LOM, 1x RAID slot, 1x PCIe x8 LP	None	Front VGA	None	TPM 1.2	XClarity Enterprise	1x1100W Platinum	None	3-year	10/17

Model	Region	Processor	Memory	Storage Controller	Chassis	Disk Bays	Disk S	M.2 Drives	PCIe Flash Adapter	GPU	Onboard Networking Ports	Additional Networking (LOM/ML2/PCIe)	Fibre Channel I/O	Standard Extension Slots	Available Extension Slots via Riser Cards	Front VGA	Optical	TPM	System Management	Power Supply	Preload	Warranty	Ann Date (mm/yy)
7X06100NBR	Brazil	1x Xeon Silver 4114 10C/2.2GHz/13.75MB/85W/DDR4-2400	1x 32GB RDIMM DDR4-2666 (2Rx4)	1x 930-8i 2GB Flash	16x 2.5"	8x 2.5" SATA/SAS HS	Open	None	None	None	1x Mgmt	4x GbE RJ-45 LOM	None	1x LOM, 1x RAID slot, 1x PCIe x8 LP	3x PCIe x8 FHHL	None	None	TPM 1.2	XClarity Enterprise	2x550W Platinum	None	3-year	04/18
7X06100PBR	Brazil	2x Xeon Gold 5118 12C/2.3GHz/16.5MB/105W/DDR4-2400	2x 32GB RDIMM DDR4-2666 (2Rx4)	1x 930-8i 2GB Flash	16x 2.5"	8x 2.5" SATA/SAS HS	Open	None	None	None	1x Mgmt	4x GbE RJ-45 LOM	None	1x LOM, 1x RAID slot, 1x PCIe x8 LP	3x PCIe x8 FHHL	None	None	TPM 1.2	XClarity Enterprise	2x750W Platinum	None	3-year	04/18

Model	Region	Processor	Memory	Storage Controller	Chassis	Disk Bays	Disk S	M.2 Drives	PCIe Flash Adapter	GPU	Onboard Networking Ports	Additional Networking (LOM/ML2/PCIe)	Fibre Channel I/O	Standard Extension Slots	Available Extension Slots via Riser Cards	Front VGA	Optical	TPM	System Management	Power Supply	Preload	Warranty	Ann Date (mm/yy)
7X06100GLA	Chile	1x Xeon Silver 4110 8C/2.1GHz/11MB/85W/DDR4-2400	1x 16GB RDIMM DDR4- 2666 (1Rx4)	1x 930- 16i 4GB Flash	16x 2.5"	16x 2.5" SATA/SA S HS	Open	None	None	None	1x Mgmt	4x GbE RJ-45 LOM	None	1x LOM, 1x RAID slot, 1x PCIe x8 LP	1x PCIe x16 FHFL, 1x PCIe x8 FHHL	Front VGA	None	TP M 2.0	XClarity Enterprise	2x750W Platinum	None	3-year	09/17
7X06100HLA	Chile	1x Xeon Silver 4114 10C/2.2GHz/13.75MB/85W/DDR4-2400	1x 16GB RDIMM DDR4- 2666 (1Rx4)	1x 930- 16i 4GB Flash	16x 2.5"	16x 2.5" SATA/SA S HS	Open	None	None	None	1x Mgmt	4x GbE RJ-45 LOM	None	1x LOM, 1x RAID slot, 1x PCIe x8 LP	1x PCIe x16 FHFL, 1x PCIe x8 FHHL	Front VGA	None	TP M 2.0	XClarity Enterprise	2x750W Platinum	None	3-year	09/17
7X06100JLA	Chile	1x Xeon Silver 4110 8C/2.1GHz/11MB/85W/DDR4-2400	1x 16GB RDIMM DDR4- 2666 (1Rx4)	1x 930- 16i 4GB Flash	12x 3.5"	12x 3.5" SATA/SA S HS	Open	None	None	None	1x Mgmt	4x GbE RJ-45 LOM	None	1x LOM, 1x RAID slot, 1x PCIe x8 LP	1x PCIe x16 FHFL, 1x PCIe x8 FHHL	Front VGA	None	TP M 2.0	XClarity Standard	2x 750W Platinum	None	3-year	09/17

Model	Region	Processor	Memory	Storage Controller	Chassis	Disk Bays	Disk s	M.2 Drives	PCIe Flash Adapter	GPU	Onboard Networking Ports	Additional Networking (LOM/ML2/PCIe)	Fibre Channel I/O	Standard Extension Slots	Available Extension Slots via Riser Cards	Front VGA	Optical	TPM	System Management	Power Supply	Preload	Warranty	Ann Date (mm/yy)
7X06100LLA	Colombia	1x Xeon Silver 4116 12C/2.1GHz/16.5MB/85W/DDR4-2400	1x 16GB RDIMM DDR4-2666 (1Rx4)	1x 930-16i 4GB Flash	24x 2.5"	16x 2.5" SATA/SA S HS	Open	None	None	None	1x Mgmt	4x GbE RJ-45 LOM	None	1x LOM, 1x RAID slot, 1x PCIe x8 LP	1x PCIe x16 FHFL, 1x PCIe x8 FHHL	Front VGA	None	TPM 2.0	XClarity Standard	1x 550W Platinum	None	3-year	01/18
7X06100MLA	Colombia	2x Xeon Gold 5120 14C/2.2GHz/19.25MB/105W/DDR4-2400	2x 16GB RDIMM DDR4-2666 (1Rx4)	1x 930-16i 4GB Flash	24x 2.5"	16x 2.5" SATA/SA S HS	Open	None	None	None	1x Mgmt	2x 10GbE RJ-45 PCIe, 4x GbE RJ-45 LOM	None	1x LOM, 1x RAID slot, 1x PCIe x8 LP	1x PCIe x16 FHFL, 1x PCIe x8 FHHL	Front VGA	None	TPM 2.0	XClarity Standard	2x 1100W Platinum	None	3-year	01/18

Model	Region	Processor	Memory	Storage Controller	Chassis	Disk Bays	Disk s	M.2 Drives	PCIe Flash Adapter	GPU	Onboard Networking Ports	Additional Networking (LOM/ML2/PCIe)	Fibre Channel I/O	Standard Extension Slots	Available Extension Slots via Riser Cards	Front VGA	Optical	TPM	System Management	Power Supply	Preload	Warranty	Ann Date (mm/yy)
7X06A00KEA	EMEA	1x Xeon Gold 5118 12C/2.3GHz/16.5MB/105W/DDR4-2400	1x 16GB RDIMM DDR4-2666 (2Rx8)	1x 930-8i 2GB Flash	24x 2.5"	8x 2.5" SATA/SA S HS	Open	None	None	None	1x Mgmt	None	None	1x LOM, 1x RAID slot, 1x PCIe x8 LP	None	Front VGA	None	TPM 1.2	XClarity Enterprise	1x750W Platinum	None	3-year	07/17
7X06A00LEA	EMEA	1x Xeon Gold 5115 10C/2.4GHz/13.75MB/85W/DDR4-2400	1x 16GB RDIMM DDR4-2666 (2Rx8)	1x 930-8i 2GB Flash	24x 2.5"	8x 2.5" SATA/SA S HS	Open	None	None	None	1x Mgmt	None	None	1x LOM, 1x RAID slot, 1x PCIe x8 LP	None	Front VGA	None	TPM 1.2	XClarity Enterprise	1x750W Platinum	None	3-year	07/17
7X06A00NEA	EMEA	1x Xeon Gold 6140 18C/2.3GHz/24.75MB/140W/DDR4-2666	1x 32GB RDIMM DDR4-2666 (2Rx4)	1x 930-8i 2GB Flash	24x 2.5"	8x 2.5" SATA/SA S HS	Open	None	None	None	1x Mgmt	None	None	1x LOM, 1x RAID slot, 1x PCIe x8 LP	None	Front VGA	None	TPM 1.2	XClarity Enterprise	1x1100W Platinum	None	3-year	07/17
7X06A00PEA	EMEA	1x Xeon Gold 6130 16C/2.1GHz/22MB/125W/DDR4-2666	1x 32GB RDIMM DDR4-2666 (2Rx4)	1x 930-8i 2GB Flash	24x 2.5"	8x 2.5" SATA/SA S HS	Open	None	None	None	1x Mgmt	None	None	1x LOM, 1x RAID slot, 1x PCIe x8 LP	None	Front VGA	None	TPM 1.2	XClarity Enterprise	1x1100W Platinum	None	3-year	07/17
7X06A010EA	EMEA	1x Xeon Gold 6152 22C/2.1GHz/30.25MB/140W/DDR4-2666	1x 32GB RDIMM DDR4-2666 (2Rx4)	1x 930-8i 2GB Flash	24x 2.5"	8x 2.5" SATA/SA S HS	Open	None	None	None	1x Mgmt	None	None	1x LOM, 1x RAID slot, 1x PCIe x8 LP	None	Front VGA	None	TPM 1.2	XClarity Enterprise	1x1100W Platinum	None	3-year	07/17
7X06A011EA	EMEA	1x Xeon Gold 5115 10C/2.4GHz/13.75MB/85W/DDR4-2400	1x 16GB RDIMM DDR4-2666 (2Rx8)	1x 930-8i 2GB Flash	24x 2.5"	8x 2.5" SATA/SA S HS	Open	None	None	None	1x Mgmt	None	None	1x LOM, 1x RAID slot, 1x PCIe x8 LP	None	Front VGA	None	TPM 1.2	XClarity Enterprise	1x1100W Platinum	None	3-year	07/17
7X06A013EA	EMEA	1x Xeon Platinum 8160 24C/2.1GHz/33MB/150W/DDR4-2666	1x 32GB RDIMM DDR4-2666 (2Rx4)	1x 930-8i 2GB Flash	24x 2.5"	8x 2.5" SATA/SA S HS	Open	None	None	None	1x Mgmt	None	None	1x LOM, 1x RAID slot, 1x PCIe x8 LP	None	Front VGA	None	TPM 1.2	XClarity Enterprise	1x1100W Platinum	None	3-year	07/17
7X06A014EA	EMEA	1x Xeon Gold 5120 14C/2.2GHz/19.25MB/105W/DDR4-2400	1x 16GB RDIMM DDR4-2666 (2Rx8)	1x 930-8i 2GB Flash	24x 2.5"	8x 2.5" SATA/SA S HS	Open	None	None	None	1x Mgmt	None	None	1x LOM, 1x RAID slot, 1x PCIe x8 LP	None	Front VGA	None	TPM 1.2	XClarity Enterprise	1x1100W Platinum	None	3-year	07/17
7X06A01AEA	EMEA	1x Xeon Gold 6140 18C/2.3GHz/24.75MB/140W/DDR4-2666	1x 32GB RDIMM DDR4-2666 (2Rx4)	1x 930-8i 2GB Flash	24x 2.5"	8x 2.5" SATA/SA S HS	Open	None	None	None	1x Mgmt	None	None	1x LOM, 1x RAID slot, 1x PCIe x8 LP	None	Front VGA	None	TPM 1.2	XClarity Enterprise	1x1100W Platinum	None	3-year	07/17
7X06A01BEA	EMEA	1x Xeon Gold 5122 4C/3.6GHz/16.5MB/105W/DDR4-2666	1x 32GB RDIMM DDR4-2666 (2Rx4)	1x 930-8i 2GB Flash	24x 2.5"	8x 2.5" SATA/SA S HS	Open	None	None	None	1x Mgmt	None	None	1x LOM, 1x RAID slot, 1x PCIe x8 LP	None	Front VGA	None	TPM 1.2	XClarity Enterprise	1x1600W Platinum	None	3-year	07/17

Model	Region	Processor	Memory	Storage Controller	Chassis	Disk Bays	Disks	M.2 Drives	PCIe Flash Adapter	GPU	Onboard Networking Ports	Additional Networking (LOM/ML2/PCIe)	Fibre Channel I/O	Standard Extension Slots	Available Extension Slots via Riser Cards	Front VGA	Optical	TPM	System Management	Power Supply	Preload	Warranty	Ann Date (mm/yy)
7X06A01HEA	EMEA	1x Xeon Gold 5118 12C/2.3GHz/16.5MB/105W/DDR4-2400	1x 16GB RDIMM DDR4-2666 (2Rx8)	1x 930-8i 2GB Flash	24x 2.5"	8x 2.5" SATA/SAS HS	Open	None	None	None	1x Mgmt	None	None	1x LOM, 1x RAID slot, 1x PCIe x8 LP	None	Front VGA	None	TPM 1.2	XClarity Enterprise	1x1100W Platinum	None	3-year	07/17
7X06A01NEA	EMEA	1x Xeon Gold 6130 16C/2.1GHz/22MB/125W/DDR4-2666	1x 32GB RDIMM DDR4-2666 (2Rx4)	1x 930-8i 2GB Flash	24x 2.5"	8x 2.5" SATA/SAS HS	Open	None	None	None	1x Mgmt	None	None	1x LOM, 1x RAID slot, 1x PCIe x8 LP	None	Front VGA	None	TPM 1.2	XClarity Enterprise	1x750W Platinum	None	3-year	07/17
7X06A01REA	EMEA	1x Xeon Gold 6126 12C/2.6GHz/19.25MB/125W/DDR4-2666	1x 32GB RDIMM DDR4-2666 (2Rx4)	1x 930-8i 2GB Flash	24x 2.5"	8x 2.5" SATA/SAS HS	Open	None	None	None	1x Mgmt	None	None	1x LOM, 1x RAID slot, 1x PCIe x8 LP	None	Front VGA	None	TPM 1.2	XClarity Enterprise	1x750W Platinum	None	3-year	07/17
7X06A01SEA	EMEA	1x Xeon Gold 5120 14C/2.2GHz/19.25MB/105W/DDR4-2400	1x 16GB RDIMM DDR4-2666 (2Rx8)	1x 930-8i 2GB Flash	24x 2.5"	8x 2.5" SATA/SAS HS	Open	None	None	None	1x Mgmt	None	None	1x LOM, 1x RAID slot, 1x PCIe x8 LP	None	Front VGA	None	TPM 1.2	XClarity Enterprise	1x750W Platinum	None	3-year	07/17
7X06A047EA	EMEA	1x Xeon Silver 4108 8C/1.8GHz/11MB/85W/DDR4-2400	1x 16GB RDIMM DDR4-2666 (2Rx8)	1x 930-8i 2GB Flash	24x 2.5"	8x 2.5" SATA/SAS HS	2x 300GB HDD 10K SAS12Gbps	None	None	None	1x Mgmt	None	None	1x LOM, 1x RAID slot, 1x PCIe x8 LP	None	Front VGA	None	TPM 1.2	XClarity Enterprise	2x750W Platinum	None	3-year	07/17
7X06A048EA	EMEA	1x Xeon Silver 4114 10C/2.2GHz/13.75MB/85W/DDR4-2400	1x 16GB RDIMM DDR4-2666 (2Rx8)	1x 930-16i 4GB Flash	24x 2.5"	16x 2.5" SATA/SAS HS	Open	None	None	None	1x Mgmt	None	None	1x LOM, 1x RAID slot, 1x PCIe x8 LP	None	Front VGA	None	TPM 1.2	XClarity Enterprise	2x750W Platinum	None	3-year	07/17
7X06A049EA	EMEA	1x Xeon Silver 4110 8C/2.1GHz/11MB/85W/DDR4-2400	1x 32GB RDIMM DDR4-2666 (2Rx4)	1x 930-8i 2GB Flash	24x 2.5"	8x 2.5" SATA/SAS HS	3x 300GB HDD 10K SAS12Gbps	None	None	None	1x Mgmt	None	None	1x LOM, 1x RAID slot, 1x PCIe x8 LP	None	Front VGA	None	TPM 1.2	XClarity Enterprise	2x750W Platinum	None	3-year	07/17
7X06A04AEA	EMEA	1x Xeon Silver 4114 10C/2.2GHz/13.75MB/85W/DDR4-2400	1x 32GB RDIMM DDR4-2666 (2Rx4)	1x 930-8i 2GB Flash	24x 2.5"	8x 2.5" SATA/SAS HS	3x 300GB HDD 10K SAS12Gbps	None	None	None	1x Mgmt	None	None	1x LOM, 1x RAID slot, 1x PCIe x8 LP	None	Front VGA	None	TPM 1.2	XClarity Enterprise	2x750W Platinum	None	3-year	07/17
7X06A04BEA	EMEA	1x Xeon Silver 4110 8C/2.1GHz/11MB/85W/DDR4-2400	1x 16GB RDIMM DDR4-2666 (2Rx8)	1x 930-8i 2GB Flash	24x 2.5"	8x 2.5" SATA/SAS HS	3x 300GB HDD 10K SAS12Gbps	None	None	None	1x Mgmt	None	None	1x LOM, 1x RAID slot, 1x PCIe x8 LP	None	Front VGA	None	TPM 1.2	XClarity Enterprise	2x750W Platinum	None	3-year	07/17
7X06A04CEA	EMEA	1x Xeon Silver 4108 8C/1.8GHz/11MB/85W/DDR4-2400	1x 16GB RDIMM DDR4-2666 (2Rx8)	1x 930-8i 2GB Flash	24x 2.5"	8x 2.5" SATA/SAS HS	Open	None	None	None	1x Mgmt	None	None	1x LOM, 1x RAID slot, 1x PCIe x8 LP	None	Front VGA	None	TPM 1.2	XClarity Enterprise	1x750W Platinum	None	3-year	07/17

Model	Region	Processor	Memory	Storage Controller	Chassis	Disk Bays	Disks	M.2 Drives	PCIe Flash Adapter	GPU	Onboard Networking Ports	Additional Networking (LOM/ML2/PCIe)	Fibre Channel I/O	Standard Extension Slots	Available Extension Slots via Riser Cards	Front VGA	Optical	TPM	System Management	Power Supply	Preload	Warranty	Ann Date (mm/yy)
7X06A04DEA	EMEA	1x Xeon Silver 4116 12C/2.1GHz/16.5MB/85W/DDR4-2400	1x 16GB RDIMM DDR4-2666 (2Rx8)	1x 930-8i 2GB Flash	24x 2.5"	8x 2.5" SATA/SAS HS	Open	None	None	None	1x Mgmt	None	None	1x LOM, 1x RAID slot, 1x PCIe x8 LP	None	Front VGA	None	TPM 1.2	XClarity Enterprise	1x750W Platinum	None	3-year	07/17
7X06A04EEA	EMEA	1x Xeon Silver 4110 8C/2.1GHz/11MB/85W/DDR4-2400	1x 16GB RDIMM DDR4-2666 (2Rx8)	1x 930-8i 2GB Flash	24x 2.5"	8x 2.5" SATA/SAS HS	Open	None	None	None	1x Mgmt	None	None	1x LOM, 1x RAID slot, 1x PCIe x8 LP	None	Front VGA	None	TPM 1.2	XClarity Enterprise	1x1100 W Platinum	None	3-year	07/17
7X06A04FEA	EMEA	1x Xeon Bronze 3106 8C/1.7GHz/11MB/85W/DDR4-2133	1x 8GB RDIMM DDR4-2666 (1Rx8)	1x 530-8i	24x 2.5"	8x 2.5" SATA/SAS HS	Open	None	None	None	1x Mgmt	None	None	1x LOM, 1x RAID slot, 1x PCIe x8 LP	None	Front VGA	None	TPM 1.2	XClarity Enterprise	1x750W Platinum	None	3-year	07/17
7X06A04GEA	EMEA	1x Xeon Silver 4110 8C/2.1GHz/11MB/85W/DDR4-2400	1x 16GB RDIMM DDR4-2666 (2Rx8)	1x 930-8i 2GB Flash	24x 2.5"	8x 2.5" SATA/SAS HS	2x 300GB HDD 10K 2.5" SAS12Gbps	None	None	None	1x Mgmt	None	None	1x LOM, 1x RAID slot, 1x PCIe x8 LP	None	Front VGA	None	TPM 1.2	XClarity Enterprise	2x750W Platinum	None	3-year	07/17
7X06A04HEA	EMEA	1x Xeon Silver 4110 8C/2.1GHz/11MB/85W/DDR4-2400	1x 8GB RDIMM DDR4-2666 (1Rx8)	1x 930-8i 2GB Flash	12x 3.5"	None	None	None	None	None	1x Mgmt	None	None	1x LOM, 1x RAID slot, 1x PCIe x8 LP	None	Front VGA	None	TPM 1.2	XClarity Enterprise	1x750W Platinum	None	3-year	07/17
7X06A04JEA	EMEA	1x Xeon Bronze 3104 6C/1.7GHz/8.25MB/85W/DDR4-2133	1x 8GB RDIMM DDR4-2666 (1Rx8)	1x 530-8i	24x 2.5"	8x 2.5" SATA/SAS HS	Open	None	None	None	1x Mgmt	None	None	1x LOM, 1x RAID slot, 1x PCIe x8 LP	None	Front VGA	None	TPM 1.2	XClarity Enterprise	1x750W Platinum	None	3-year	07/17
7X06A04KEA	EMEA	1x Xeon Silver 4108 8C/1.8GHz/11MB/85W/DDR4-2400	1x 16GB RDIMM DDR4-2666 (2Rx8)	1x 930-8i 2GB Flash	24x 2.5"	8x 2.5" SATA/SAS HS	Open	None	None	None	1x Mgmt	None	None	1x LOM, 1x RAID slot, 1x PCIe x8 LP	None	Front VGA	None	TPM 1.2	XClarity Enterprise	1x1100 W Platinum	None	3-year	07/17
7X06A04LEA	EMEA	1x Xeon Silver 4110 8C/2.1GHz/11MB/85W/DDR4-2400	1x 16GB RDIMM DDR4-2666 (2Rx8)	1x 930-8i 2GB Flash	24x 2.5"	8x 2.5" SATA/SAS HS	Open	None	None	None	1x Mgmt	None	None	1x LOM, 1x RAID slot, 1x PCIe x8 LP	None	Front VGA	None	TPM 1.2	XClarity Enterprise	1x750W Platinum	None	3-year	07/17
7X06A04MEA	EMEA	1x Xeon Silver 4110 8C/2.1GHz/11MB/85W/DDR4-2400	1x 16GB RDIMM DDR4-2666 (2Rx8)	1x 530-8i	24x 2.5"	8x 2.5" SATA/SAS HS	Open	None	None	None	1x Mgmt	None	None	1x LOM, 1x RAID slot, 1x PCIe x8 LP	None	Front VGA	None	TPM 1.2	XClarity Enterprise	1x750W Platinum	None	3-year	07/17
7X06A04NEA	EMEA	1x Xeon Silver 4108 8C/1.8GHz/11MB/85W/DDR4-2400	1x 16GB RDIMM DDR4-2666 (2Rx8)	1x 930-8i 2GB Flash	24x 2.5"	8x 2.5" SATA/SAS HS	3x 300GB HDD 10K 2.5" SAS12Gbps	None	None	None	1x Mgmt	None	None	1x LOM, 1x RAID slot, 1x PCIe x8 LP	None	Front VGA	None	TPM 1.2	XClarity Enterprise	2x750W Platinum	None	3-year	07/17

Model	Region	Processor	Memory	Storage Controller	Chassis	Disk Bays	Disk S	M.2 Drives	PCIe Flash Adapter	GPU	Onboard Networking Ports	Additional Networking (LOM/ML2/PCIe)	Fibre Channel I/O	Standard Extension Slots	Available Extension Slots via Riser Cards	Front VGA	Optical	TPM	System Management	Power Supply	Preload	Warranty	Ann Date (mm/yy)
7X06A04PEA	EMEA	1x Xeon Silver 4110 8C/2.1GHz/11MB/85W/DDR4-2400	1x 16GB RDIMM DDR4-2666 (2Rx8)	1x 930-8i 2GB Flash	24x 2.5"	8x 2.5" SATA/SA S HS	Open	None	None	None	1x Mgmt	None	None	1x LOM, 1x RAID slot, 1x PCIe x8 LP	None	Front VGA	None	TPM 1.2	XClarity Enterprise	1x750W Platinum	None	3-year	07/17
7X06A04QEA	EMEA	1x Xeon Silver 4114 10C/2.2GHz/13.75MB/85W/DDR4-2400	1x 16GB RDIMM DDR4-2666 (2Rx8)	1x 930-8i 2GB Flash	24x 2.5"	8x 2.5" SATA/SA S HS	Open	None	None	None	1x Mgmt	None	None	1x LOM, 1x RAID slot, 1x PCIe x8 LP	None	Front VGA	None	TPM 1.2	XClarity Enterprise	1x750W Platinum	None	3-year	07/17
7X06A04REA	EMEA	1x Xeon Silver 4114 10C/2.2GHz/13.75MB/85W/DDR4-2400	1x 16GB RDIMM DDR4-2666 (2Rx8)	1x 930-8i 2GB Flash	24x 2.5"	8x 2.5" SATA/SA S HS	Open	None	None	None	1x Mgmt	None	None	1x LOM, 1x RAID slot, 1x PCIe x8 LP	None	Front VGA	None	TPM 1.2	XClarity Enterprise	1x1100W Platinum	None	3-year	07/17
7X06A04SEA	EMEA	1x Xeon Silver 4116 12C/2.1GHz/16.5MB/85W/DDR4-2400	1x 16GB RDIMM DDR4-2666 (2Rx8)	1x 930-8i 2GB Flash	24x 2.5"	8x 2.5" SATA/SA S HS	Open	None	None	None	1x Mgmt	None	None	1x LOM, 1x RAID slot, 1x PCIe x8 LP	None	Front VGA	None	TPM 1.2	XClarity Enterprise	1x1100W Platinum	None	3-year	07/17
7X06A04TEA	EMEA	1x Xeon Silver 4108 8C/1.8GHz/11MB/85W/DDR4-2400	1x 16GB RDIMM DDR4-2666 (2Rx8)	1x 930-8i 2GB Flash	24x 2.5"	8x 2.5" SATA/SA S HS	Open	None	None	None	1x Mgmt	None	None	1x LOM, 1x RAID slot, 1x PCIe x8 LP	None	Front VGA	None	TPM 1.2	XClarity Enterprise	1x750W Platinum	None	3-year	07/17
7X06A04UEA	EMEA	1x Xeon Silver 4108 8C/1.8GHz/11MB/85W/DDR4-2400	1x 8GB RDIMM DDR4-2666 (1Rx8)	1x 930-8i 2GB Flash	12x 3.5"	None	None	None	None	None	1x Mgmt	None	None	1x LOM, 1x RAID slot, 1x PCIe x8 LP	None	Front VGA	None	TPM 1.2	XClarity Enterprise	1x750W Platinum	None	3-year	07/17
7X06A08HEA	EMEA	1x Xeon Silver 4110 8C/2.1GHz/11MB/85W/DDR4-2400	1x 16GB RDIMM DDR4-2666 (2Rx8)	None	24x 2.5"	None	None	None	None	None	1x Mgmt	None	None	1x LOM, 1x RAID slot, 1x PCIe x8 LP	None	None	None	TPM 1.2	XClarity Enterprise	1x750W Platinum	None	3-year	10/17
7X06A08YEA	EMEA	1x Xeon Gold 6126 12C/2.6GHz/19.25MB/125W/DDR4-2666	1x 16GB RDIMM DDR4-2666 (2Rx8)	None	24x 2.5"	None	None	None	None	None	1x Mgmt	None	None	1x LOM, 1x RAID slot, 1x PCIe x8 LP	None	None	None	TPM 1.2	XClarity Enterprise	1x1100W Platinum	None	3-year	12/17
7X06A08ZEA	EMEA	1x Xeon Silver 4114 10C/2.2GHz/13.75MB/85W/DDR4-2400	1x 32GB RDIMM DDR4-2666 (2Rx4)	None	24x 2.5"	None	None	None	None	None	1x Mgmt	None	None	1x LOM, 1x RAID slot, 1x PCIe x8 LP	None	None	None	TPM 1.2	XClarity Enterprise	1x750W Platinum	None	3-year	12/17
7X06A090EA	EMEA	1x Xeon Gold 6130 16C/2.1GHz/22MB/125W/DDR4-2666	1x 16GB RDIMM DDR4-2666 (2Rx8)	None	24x 2.5"	None	None	None	None	None	1x Mgmt	None	None	1x LOM, 1x RAID slot, 1x PCIe x8 LP	None	None	None	TPM 1.2	XClarity Enterprise	1x1100W Platinum	None	3-year	12/17

Model	Region	Processor	Memory	Storage Controller	Chassis	Disk Bays	Disk S	M.2 Drives	PCIe Flash Adapter	GPU	Onboard Networking Ports	Additional Networking (LOM/ML2/PCIe)	Fibre Channel I/O	Standard Extension Slots	Available Extension Slots via Riser Cards	Front VGA	Optical	TPM	System Management	Power Supply	Preload	Warranty	Ann Date (mm/yy)
7X06A091EA	EMEA	2x Xeon Gold 6154 18C/3.0GHz/24.75MB/200W/DDR4-2666	2x 32GB RDIMM DDR4-2666 (2Rx4)	None	24x 2.5"	None	None	None	None	None	1x Mgmt	None	None	1x LOM, 1x RAID slot, 1x PCIe x8 LP	None	None	None	TPM 1.2	XClarity Enterprise	1x1100W Platinum	None	3-year	12/17
7X06A092EA	EMEA	1x Xeon Gold 5120 14C/2.2GHz/19.25MB/105W/DDR4-2400	1x 16GB RDIMM DDR4-2666 (2Rx8)	None	24x 2.5"	None	None	None	None	None	1x Mgmt	None	None	1x LOM, 1x RAID slot, 1x PCIe x8 LP	None	None	None	TPM 1.2	XClarity Enterprise	1x1100W Platinum	None	3-year	12/17
7X06A093EA	EMEA	1x Xeon Gold 6128 6C/3.4GHz/19.25MB/115W/DDR4-2666	1x 16GB RDIMM DDR4-2666 (2Rx8)	None	24x 2.5"	None	None	None	None	None	1x Mgmt	None	None	1x LOM, 1x RAID slot, 1x PCIe x8 LP	None	None	None	TPM 1.2	XClarity Enterprise	1x1100W Platinum	None	3-year	12/17
7X06A094EA	EMEA	1x Xeon Gold 6142 16C/2.6GHz/22MB/150W/DDR4-2666	1x 16GB RDIMM DDR4-2666 (2Rx8)	None	24x 2.5"	None	None	None	None	None	1x Mgmt	None	None	1x LOM, 1x RAID slot, 1x PCIe x8 LP	None	None	None	TPM 1.2	XClarity Enterprise	1x1100W Platinum	None	3-year	12/17
7X06A095EA	EMEA	1x Xeon Gold 6134 8C/3.2GHz/24.75MB/130W/DDR4-2666	1x 16GB RDIMM DDR4-2666 (2Rx8)	None	24x 2.5"	None	None	None	None	None	1x Mgmt	None	None	1x LOM, 1x RAID slot, 1x PCIe x8 LP	None	None	None	TPM 1.2	XClarity Enterprise	1x1100W Platinum	None	3-year	12/17
7X06A096EA	EMEA	1x Xeon Gold 6136 12C/3.0GHz/24.75MB/150W/DDR4-2666	1x 16GB RDIMM DDR4-2666 (2Rx8)	None	24x 2.5"	None	None	None	None	None	1x Mgmt	None	None	1x LOM, 1x RAID slot, 1x PCIe x8 LP	None	None	None	TPM 1.2	XClarity Enterprise	1x1100W Platinum	None	3-year	12/17
7X06A097EA	EMEA	1x Xeon Gold 6150 18C/2.7GHz/24.75MB/165W/DDR4-2666	1x 16GB RDIMM DDR4-2666 (2Rx8)	None	24x 2.5"	None	None	None	None	None	1x Mgmt	None	None	1x LOM, 1x RAID slot, 1x PCIe x8 LP	None	None	None	TPM 1.2	XClarity Enterprise	1x1100W Platinum	None	3-year	12/17
7X06A098EA	EMEA	1x Xeon Gold 6132 14C/2.6GHz/19.25MB/140W/DDR4-2666	1x 16GB RDIMM DDR4-2666 (2Rx8)	None	24x 2.5"	None	None	None	None	None	1x Mgmt	None	None	1x LOM, 1x RAID slot, 1x PCIe x8 LP	None	None	None	TPM 1.2	XClarity Enterprise	1x1100W Platinum	None	3-year	12/17
7X06A08PEA	EMEA	1x Xeon Silver 4110 8C/2.1GHz/11MB/85W/DDR4-2400	1x 16GB RDIMM DDR4-2666 (2Rx8)	1x 930-16i 4GB Flash	24x 2.5"	16x 2.5" SATA/SAS HS	Open	None	None	None	1x Mgmt	None	None	1x LOM, 1x RAID slot, 1x PCIe x8 LP	None	None	None	TPM 1.2	XClarity Enterprise	1x750W Platinum	None	3-year	10/17
7X06A07YEA	EMEA	1x Xeon Silver 4114 10C/2.2GHz/13.75MB/85W/DDR4-2400	1x 32GB RDIMM DDR4-2666 (2Rx4)	1x 930-8i 2GB Flash	24x 2.5"	8x 2.5" SATA/SAS HS	Open	None	None	None	1x Mgmt	None	None	1x LOM, 1x RAID slot, 1x PCIe x8 LP	None	Front VGA	None	TPM 1.2	XClarity Enterprise	2x750W Platinum	None	3-year	09/17

Model	Region	Processor	Memory	Storage Controller	Chassis	Disk Bays	Disk S	M.2 Drives	PCIe Flash Adapter	GPU	Onboard Networking Ports	Additional Networking (LOM/ML2/PCIe)	Fibre Channel I/O	Standard Extension Slots	Available Extension Slots via Riser Cards	Front VGA	Optical	TPM	System Management	Power Supply	Preload	Warranty	Ann Date (mm/yy)
7X06A07ZE A	EMEA	1x Xeon Gold 6136 12C/3.0GHz/24.75MB/150W/DDR4-2666	1x 16GB RDIMM DDR4-2666 (2Rx8)	1x 530-8i	24x 2.5"	8x 2.5" SATA/SA S HS	Open	None	None	None	1x Mgmt	None	None	1x LOM, 1x RAID slot, 1x PCIe x8 LP	None	Front VGA	None	TPM 1.2	XClarity Enterprise	1x750W Platinum	None	3-year	09/17
7X06A080E A	EMEA	1x Xeon Gold 6154 18C/3.0GHz/24.75MB/200W/DDR4-2666	1x 16GB RDIMM DDR4-2666 (2Rx8)	1x 530-8i	24x 2.5"	8x 2.5" SATA/SA S HS	Open	None	None	None	1x Mgmt	None	None	1x LOM, 1x RAID slot, 1x PCIe x8 LP	None	Front VGA	None	TPM 1.2	XClarity Enterprise	1x750W Platinum	None	3-year	09/17
7X06A081E A	EMEA	1x Xeon Gold 6134 8C/3.2GHz/24.75MB/130W/DDR4-2666	1x 32GB RDIMM DDR4-2666 (2Rx4)	1x 930-8i 2GB Flash	24x 2.5"	8x 2.5" SATA/SA S HS	Open	None	None	None	1x Mgmt	None	None	1x LOM, 1x RAID slot, 1x PCIe x8 LP	None	Front VGA	None	TPM 1.2	XClarity Enterprise	1x750W Platinum	None	3-year	09/17

Model	Region	Processor	Memory	Storage Controller	Chassis	Disk Bays	Disk S	M.2 Drives	PCIe Flash Adapter	GPU	Onboard Networking Ports	Additional Networking (LOM/ML2/PCIe)	Fibre Channel I/O	Standard Extension Slots	Available Extension Slots via Riser Cards	Front VGA	Optical	TPM	System Management	Power Supply	Preload	Warranty	Ann Date (mm/yy)
7X06A01MP	JAPAN	1x Xeon Bronze 3104 6C/1.7GHz/8.25MB/85W/DDR4-2133	1x 16GB RDIMM DDR4-2666 (1Rx4)	1x 930-8i 2GB Flash	12x 3.5"	None	None	None	None	None	1x Mgmt	4x GbE RJ-45 LOM	None	1x LOM, 1x RAID slot, 1x PCIe x8 LP	3x PCIe x8 FHHL	None	None	TPM 1.2	XClarity Advanced	1x550W Platinum	None	3-year	07/17
7X06A02BJP	JAPAN	1x Xeon Silver 4112 4C/2.6GHz/8.25MB/85W/DDR4-2400	1x 16GB RDIMM DDR4-2666 (1Rx4)	1x 930-8i 2GB Flash	24x 2.5"	SATA/SAS HS	Open	None	None	None	1x Mgmt	4x GbE RJ-45 LOM	None	1x LOM, 1x RAID slot, 1x PCIe x8 LP	3x PCIe x8 FHHL	None	None	TPM 1.2	XClarity Advanced	1x550W Platinum	None	3-year	07/17
7X06A05AJP	JAPAN	1x Xeon Bronze 3106 8C/1.7GHz/11MB/85W/DDR4-2133	1x 16GB RDIMM DDR4-2666 (1Rx4)	1x 930-8i 2GB Flash	24x 2.5"	SATA/SAS HS	Open	None	None	None	1x Mgmt	4x GbE RJ-45 LOM	None	1x LOM, 1x RAID slot, 1x PCIe x8 LP	3x PCIe x8 FHHL	None	None	TPM 1.2	XClarity Advanced	1x550W Platinum	None	3-year	07/17
7X06A05BJP	JAPAN	1x Xeon Silver 4110 8C/2.1GHz/11MB/85W/DDR4-2400	1x 16GB RDIMM DDR4-2666 (1Rx4)	1x 930-8i 2GB Flash	24x 2.5"	SATA/SAS HS	Open	None	None	None	1x Mgmt	4x GbE RJ-45 LOM	None	1x LOM, 1x RAID slot, 1x PCIe x8 LP	3x PCIe x8 FHHL	None	None	TPM 1.2	XClarity Advanced	1x550W Platinum	None	3-year	07/17

Model	Region	Processor	Memory	Storage Controller	Chassis	Disk Bays	Disk s	M.2 Drives	PCIe Flash Adapter	GPU	Onboard Networking Ports	Additional Networking (LOM/ML2/PCIe)	Fibre Channel I/O	Standard Extension Slots	Available Extension Slots via Riser Cards	Front VGA	Optical	TPM	System Management	Power Supply	Preload	Warranty	Ann Date (mm/yy)
7X06100KLA	LA (except Chile)	1x Xeon Gold 5118 12C/2.3GHz/16.5MB/105W/DDR4-2400	1x 16GB RDIMM DDR4-2666 (1Rx4)	1x 930-16i 4GB Flash	24x 2.5"	16x 2.5" SATA/SAS HS	Open	None	None	None	1x Mgmt	4x GbE RJ-45 LOM	None	1x LOM, 1x RAID slot, 1x PCIe x8 LP	1x PCIe x16 FHFL, 1x PCIe x8 FHHL	Front VGA	None	TPM 2.0	XClarity Standard	2x 750W Platinum	None	3-year	09/17

Model	Region	Processor	Memory	Storage Controller	Chassis	Disk Bays	Disk	M.2 Drives	PCIe Flash Adapter	GPU	Onboard Networking Ports	Additional Networking (LOM/ML2/PCIe)	Fibre Channel I/O	Standard Extension Slots	Available Extension Slots via Riser Cards	Front VGA	Optical	TPM	System Management	Power Supply	Preload	Warranty	Ann Date (mm/yy)
7X06A04ZNA	NA	1x Xeon Silver 4116 12C/2.1GHz/16.5MB/85W/DDR4-2400	1x 32GB RDIMM DDR4-2666 (2Rx4)	None	24x 2.5"	None	None	None	None	None	1x Mgmt	None	None	1x LOM, 1x RAID slot, 1x PCIe x8 LP	None	Front VGA	None	TPM 1.2	XClarity Enterprise	1x750W Platinum	None	3-year	07/17
7X06A057NA	NA	1x Xeon Silver 4110 8C/2.1GHz/11MB/85W/DDR4-2400	1x 16GB RDIMM DDR4-2666 (2Rx8)	None	24x 2.5"	None	None	None	None	None	1x Mgmt	None	None	1x LOM, 1x RAID slot, 1x PCIe x8 LP	None	Front VGA	None	TPM 1.2	XClarity Enterprise	1x750W Platinum	None	3-year	07/17
7X06A05XNA	NA	1x Xeon Gold 5118 12C/2.3GHz/16.5MB/105W/DDR4-2400	1x 32GB RDIMM DDR4-2666 (2Rx4)	None	24x 2.5"	None	None	None	None	None	1x Mgmt	None	None	1x LOM, 1x RAID slot, 1x PCIe x8 LP	None	Front VGA	None	TPM 1.2	XClarity Enterprise	1x750W Platinum	None	3-year	07/17

Model	Region	Processor	Memory	Storage Controller	Chassis	Disk Bays	Disk S	M.2 Drives	PCIe Flash Adapter	GPU	Onboard Networking Ports	Additional Networking (LOM/ML2/PCIe)	Fibre Channel I/O	Standard Extension Slots	Available Extension Slots via Riser Cards	Front VGA	Optical	TPM	System Management	Power Supply	Preload	Warranty	Ann Date (mm/yy)
7X06A009CN	Taiwan	1x Xeon Gold 5120 14C/2.2GHz/19.25MB/105W/DDR4-2400	1x 16GB RDIMM DDR4-2666 (2Rx8)	1x 930-16i 4GB Flash	16x 2.5"	16x 2.5" SATA/SA S HS	Open	None	None	None	1x Mgmt	4x GbE RJ-45 LOM	None	1x LOM, 1x RAID slot, 1x PCIe x8 LP	3x PCIe x8 FHHL	None	None	TPM 1.2	XClarity Standard	1x 750W Platinum	None	3-year	07/17
7X06A01DCN	Taiwan	1x Xeon Gold 5120T 14C/2.2GHz/19.25MB/105W/DDR4-2400	1x 16GB RDIMM DDR4-2666 (2Rx8)	1x 930-16i 4GB Flash	16x 2.5"	16x 2.5" SATA/SA S HS	Open	None	None	None	1x Mgmt	4x GbE RJ-45 LOM	None	1x LOM, 1x RAID slot, 1x PCIe x8 LP	3x PCIe x8 FHHL	None	None	TPM 1.2	XClarity Standard	1x 750W Platinum	None	3-year	07/17
7X06A027CN	Taiwan	1x Xeon Gold 5115 10C/2.4GHz/13.75MB/85W/DDR4-2400	1x 16GB RDIMM DDR4-2666 (2Rx8)	1x 930-16i 4GB Flash	16x 2.5"	16x 2.5" SATA/SA S HS	Open	None	None	None	1x Mgmt	4x GbE RJ-45 LOM	None	1x LOM, 1x RAID slot, 1x PCIe x8 LP	3x PCIe x8 FHHL	None	None	TPM 1.2	XClarity Standard	1x 750W Platinum	None	3-year	07/17
7X06A01KCN	Taiwan	1x Xeon Gold 5122 4C/3.6GHz/16.5MB/105W/DDR4-2666	1x 16GB RDIMM DDR4-2666 (2Rx8)	1x 930-16i 4GB Flash	16x 2.5"	16x 2.5" SATA/SA S HS	Open	None	None	None	1x Mgmt	4x GbE RJ-45 LOM	None	1x LOM, 1x RAID slot, 1x PCIe x8 LP	3x PCIe x8 FHHL	None	None	TPM 1.2	XClarity Standard	1x 750W Platinum	None	3-year	07/17
7X06A01LCN	Taiwan	1x Xeon Gold 5118 12C/2.3GHz/16.5MB/105W/DDR4-2400	1x 16GB RDIMM DDR4-2666 (2Rx8)	1x 930-16i 4GB Flash	16x 2.5"	16x 2.5" SATA/SA S HS	Open	None	None	None	1x Mgmt	4x GbE RJ-45 LOM	None	1x LOM, 1x RAID slot, 1x PCIe x8 LP	3x PCIe x8 FHHL	None	None	TPM 1.2	XClarity Standard	1x 750W Platinum	None	3-year	07/17

Model	Region	Processor	Memory	Storage Controller	Chassis	Disk Bays	Disk S	M.2 Drives	PCIe Flash Adapter	GPU	Onboard Networking Ports	Additional Networking (LOM/ML2/PCIe)	Fibre Channel I/O	Standard Extension Slots	Available Extension Slots via Riser Cards	Front VGA	Optical	TPM	System Management	Power Supply	Preload	Warranty	Ann Date (mm/yy)	
7X06A04WAU	ANZ	1x Xeon Gold 5115 10C/2.4GHz/13.75MB/85W/DDR4-2400	1x 16GB RDIMM DDR4-2666 (2Rx8)	1x 930-8i 2GB Flash	24x 2.5"	8x 2.5" SATA/SAS HS	Open	None	None	None	1x Mgmt	None	None	1x LOM, 1x RAID slot, 1x PCIe x8 LP	None	None	None	TPM 1.2	XClarity Advanced	1x750W Platinum	None	3-year	07/17	
7X06A050AU	ANZ	1x Xeon Gold 6148 20C/2.4GHz/27.5MB/150W/DDR4-2666	1x 32GB RDIMM DDR4-2666 (2Rx4)	1x 930-8i 2GB Flash	24x 2.5"	8x 2.5" SATA/SAS HS	Open	None	None	None	1x Mgmt	None	None	1x LOM, 1x RAID slot, 1x PCIe x8 LP	None	None	None	TPM 1.2	XClarity Standard	1x 1100W Platinum	None	3-year	07/17	
7X06A051AU	ANZ	1x Xeon Gold 6152 22C/2.1GHz/30.25MB/140W/DDR4-2666	1x 32GB RDIMM DDR4-2666 (2Rx4)	1x 930-8i 2GB Flash	24x 2.5"	8x 2.5" SATA/SAS HS	Open	None	None	None	1x Mgmt	None	None	1x LOM, 1x RAID slot, 1x PCIe x8 LP	None	None	None	TPM 1.2	XClarity Standard	1x 1100W Platinum	None	3-year	07/17	
7X06A052AU	ANZ	1x Xeon Gold 6140 18C/2.3GHz/24.75MB/140W/DDR4-2666	1x 32GB RDIMM DDR4-2666 (2Rx4)	1x 930-8i 2GB Flash	24x 2.5"	8x 2.5" SATA/SAS HS	Open	None	None	None	1x Mgmt	None	None	1x LOM, 1x RAID slot, 1x PCIe x8 LP	None	None	None	TPM 1.2	XClarity Standard	1x 1100W Platinum	None	3-year	07/17	
7X06A054AU	ANZ	1x Xeon Gold 6130 16C/2.1GHz/22MB/125W/DDR4-2666	1x 32GB RDIMM DDR4-2666 (2Rx4)	1x 930-8i 2GB Flash	24x 2.5"	8x 2.5" SATA/SAS HS	Open	None	None	None	1x Mgmt	None	None	1x LOM, 1x RAID slot, 1x PCIe x8 LP	None	None	None	TPM 1.2	XClarity Standard	1x 750W Platinum	None	3-year	07/17	
7X06A04YA U	ANZ	1x Xeon Platinum 8160 24C/2.1GHz/33MB/150W/DDR4-2666	1x 32GB RDIMM DDR4-2666 (2Rx4)	1x 930-8i 2GB Flash	24x 2.5"	8x 2.5" SATA/SAS HS	Open	None	None	None	1x Mgmt	None	None	1x LOM, 1x RAID slot, 1x PCIe x8 LP	None	None	None	TPM 1.2	XClarity Standard	1x 1100W Platinum	None	3-year	07/17	
7X06A059AU	ANZ	1x Xeon Platinum 8164 26C/2.0GHz/35.75MB/150W/DDR4-2666	1x 32GB RDIMM DDR4-2666 (2Rx4)	1x 930-8i 2GB Flash	24x 2.5"	8x 2.5" SATA/SAS HS	Open	None	None	None	1x Mgmt	None	None	1x LOM, 1x RAID slot, 1x PCIe x8 LP	None	None	None	TPM 1.2	XClarity Standard	1x 1100W Platinum	None	3-year	07/17	
7X06A05CAU	ANZ	2x Xeon Gold 5120 14C/2.2GHz/19.25MB/105W/DDR4-2400	2x 32GB RDIMM DDR4-2666 (2Rx4)	1x 430-16i	24x 2.5"	8x 2.5" HS (4 SATA/SAS AnyBay) 4x 2.5" SATA/SAS HS	Open	None	None	None	1x Mgmt	None	None	1x LOM, 1x RAID slot, 1x PCIe x8 LP	3x PCIe x8 FHHL, 1x PCIe x16 FHFL, 1x PCIe x16 FHHL	None	None	None	TPM 1.2	XClarity Enterprise	1x1100W Platinum	None	3-year	07/17
7X06A05DAU	ANZ	1x Xeon Gold 5120 14C/2.2GHz/19.25MB/105W/DDR4-2400	1x 16GB RDIMM DDR4-2666 (2Rx8)	1x 930-8i 2GB Flash	24x 2.5"	8x 2.5" SATA/SAS HS	Open	None	None	None	1x Mgmt	None	None	1x LOM, 1x RAID slot, 1x PCIe x8 LP	None	None	None	TPM 1.2	XClarity Standard	1x 750W Platinum	None	3-year	07/17	
7X06A05GAU	ANZ	1x Xeon Gold 6150 18C/2.7GHz/24.75MB/165W/DDR4-2666	1x 32GB RDIMM DDR4-2666 (2Rx4)	1x 930-8i 2GB Flash	24x 2.5"	8x 2.5" SATA/SAS HS	Open	None	None	None	1x Mgmt	None	None	1x LOM, 1x RAID slot, 1x PCIe x8 LP	None	None	None	TPM 1.2	XClarity Standard	1x 1100W Platinum	None	3-year	07/17	

Model	Region	Processor	Memory	Storage Controller	Chassis	Disk Bays	Disk S	M.2 Drives	PCIe Flash Adapter	GPU	Onboard Networking Ports	Additional Networking (LOM/ML2/PCIe)	Fibre Channel I/O	Standard Extension Slots	Available Extension Slots via Riser Cards	Front VGA	Optical	TPM	System Management	Power Supply	Preload	Warranty	Ann Date (mm/yy)
7X06A05HAU	ANZ	1x Xeon Gold 6126 12C/2.6GHz/19.25MB/125W/DDR4-2666	1x 32GB RDIMM DDR4-2666 (2Rx4)	1x 930-8i 2GB Flash	24x 2.5"	8x 2.5" SATA/SA S HS	Open	None	None	None	1x Mgmt	None	None	1x LOM, 1x RAID slot, 1x PCIe x8 LP	None	None	None	TPM 1.2	XClarity Standard	1x 750W Platinum	None	3-year	07/17
7X06A05RAU	ANZ	1x Xeon Gold 6142 16C/2.6GHz/22MB/150W/DDR4-2666	1x 32GB RDIMM DDR4-2666 (2Rx4)	1x 930-8i 2GB Flash	24x 2.5"	8x 2.5" SATA/SA S HS	Open	None	None	None	1x Mgmt	None	None	1x LOM, 1x RAID slot, 1x PCIe x8 LP	None	None	None	TPM 1.2	XClarity Standard	1x 1100W Platinum	None	3-year	07/17
7X06A05SAU	ANZ	1x Xeon Gold 6134 8C/3.2GHz/24.75MB/130W/DDR4-2666	1x 32GB RDIMM DDR4-2666 (2Rx4)	1x 930-8i 2GB Flash	24x 2.5"	8x 2.5" SATA/SA S HS	Open	None	None	None	1x Mgmt	None	None	1x LOM, 1x RAID slot, 1x PCIe x8 LP	None	None	None	TPM 1.2	XClarity Standard	1x 750W Platinum	None	3-year	07/17
7X06A05NAU	ANZ	1x Xeon Gold 5118 12C/2.3GHz/16.5MB/105W/DDR4-2400	1x 16GB RDIMM DDR4-2666 (2Rx8)	1x 930-8i 2GB Flash	24x 2.5"	8x 2.5" SATA/SA S HS	Open	None	None	None	1x Mgmt	None	None	1x LOM, 1x RAID slot, 1x PCIe x8 LP	None	None	None	TPM 1.2	XClarity Standard	1x 750W Platinum	None	3-year	07/17
7X06A05PAU	ANZ	1x Xeon Gold 6134 8C/3.2GHz/24.75MB/130W/DDR4-2666	1x 32GB RDIMM DDR4-2666 (2Rx4)	1x 930-8i 2GB Flash	24x 2.5"	8x 2.5" SATA/SA S HS	Open	None	None	None	1x Mgmt	None	None	1x LOM, 1x RAID slot, 1x PCIe x8 LP	None	None	None	TPM 1.2	XClarity Standard	1x 1100W Platinum	None	3-year	07/17
7X06A068AU	ANZ	1x Xeon Gold 6126T 12C/2.6GHz/19.25MB/125W/DDR4-2666	1x 32GB RDIMM DDR4-2666 (2Rx4)	1x 930-8i 2GB Flash	24x 2.5"	8x 2.5" SATA/SA S HS	Open	None	None	None	1x Mgmt	None	None	1x LOM, 1x RAID slot, 1x PCIe x8 LP	None	None	None	TPM 1.2	XClarity Standard	1x 750W Platinum	None	3-year	07/17
7X06A06FAU	ANZ	1x Xeon Gold 6152 22C/2.1GHz/30.25MB/140W/DDR4-2666	1x 32GB RDIMM DDR4-2666 (2Rx4)	1x 930-8i 2GB Flash	24x 2.5"	8x 2.5" SATA/SA S HS	Open	None	None	None	1x Mgmt	None	None	1x LOM, 1x RAID slot, 1x PCIe x8 LP	None	None	None	TPM 1.2	XClarity Standard	1x 1100W Platinum	None	3-year	07/17
7X06A06GAU	ANZ	1x Xeon Gold 6134 8C/3.2GHz/24.75MB/130W/DDR4-2666	1x 32GB RDIMM DDR4-2666 (2Rx4)	1x 930-8i 2GB Flash	24x 2.5"	8x 2.5" SATA/SA S HS	Open	None	None	None	1x Mgmt	None	None	1x LOM, 1x RAID slot, 1x PCIe x8 LP	None	None	None	TPM 1.2	XClarity Standard	1x 1100W Platinum	None	3-year	07/17
7X06A06HAU	ANZ	1x Xeon Gold 6140 18C/2.3GHz/24.75MB/140W/DDR4-2666	1x 16GB RDIMM DDR4-2666 (2Rx8)	1x 930-8i 2GB Flash	16x 2.5"	8x 2.5" SATA/SA S HS	Open	None	None	None	1x Mgmt	4x GbE RJ-45 LOM	None	1x LOM, 1x RAID slot, 1x PCIe x8 LP	None	None	None	TPM 1.2	XClarity Standard	1x 1100W Platinum	None	3-year	07/17
7X06A06JAU	ANZ	1x Xeon Gold 5115 10C/2.4GHz/13.75MB/85W/DDR4-2400	1x 16GB RDIMM DDR4-2666 (2Rx8)	1x 530-8i	16x 2.5"	8x 2.5" SATA/SA S HS	Open	None	None	None	1x Mgmt	4x GbE RJ-45 LOM	None	1x LOM, 1x RAID slot, 1x PCIe x8 LP	None	None	None	TPM 1.2	XClarity Standard	1x 550W Platinum	None	3-year	07/17

Model	Region	Processor	Memory	Storage Controller	Chassis	Disk Bays	Disk S	M.2 Drives	PCIe Flash Adapter	GPU	Onboard Networking Ports	Additional Networking (LOM/ML2/PCIe)	Fibre Channel I/O	Standard Extension Slots	Available Extension Slots via Riser Cards	Front VGA	Optical	TPM	System Management	Power Supply	Preload	Warranty	Ann Date (mm/yy)
7X06A06KAU	ANZ	1x Xeon Gold 6148 20C/2.4GHz/27.5MB/150W/DDR4-2666	1x 32GB RDIMM DDR4-2666 (2Rx4)	1x 930-8i 2GB Flash	24x 2.5"	8x 2.5" SATA/SA S HS	Open	None	None	None	1x Mgmt	None	None	1x LOM, 1x RAID slot, 1x PCIe x8 LP	None	None	None	TPM 1.2	XClarity Standard	1x 1100W Platinum	None	3-year	07/17
7X06A06LAU	ANZ	1x Xeon Gold 6140 18C/2.3GHz/24.75MB/140W/DDR4-2666	1x 32GB RDIMM DDR4-2666 (2Rx4)	1x 930-8i 2GB Flash	24x 2.5"	8x 2.5" SATA/SA S HS	Open	None	None	None	1x Mgmt	None	None	1x LOM, 1x RAID slot, 1x PCIe x8 LP	None	None	None	TPM 1.2	XClarity Standard	1x 1100W Platinum	None	3-year	07/17
7X06A06MAU	ANZ	1x Xeon Platinum 8160 24C/2.1GHz/33MB/150W/DDR4-2666	1x 32GB RDIMM DDR4-2666 (2Rx4)	1x 930-8i 2GB Flash	24x 2.5"	8x 2.5" SATA/SA S HS	Open	None	None	None	1x Mgmt	None	None	1x LOM, 1x RAID slot, 1x PCIe x8 LP	None	None	None	TPM 1.2	XClarity Standard	1x 1100W Platinum	None	3-year	07/17
7X06A06PAU	ANZ	1x Xeon Gold 5115 10C/2.4GHz/13.75MB/85W/DDR4-2400	1x 8GB RDIMM DDR4-2666 (1Rx8)	1x 930-8i 2GB Flash	16x 2.5"	8x 2.5" SATA/SA S HS	Open	None	None	None	1x Mgmt	4x GbE RJ-45 LOM	None	1x LOM, 1x RAID slot, 1x PCIe x8 LP	None	None	None	TPM 1.2	XClarity Standard	1x 550W Platinum	None	3-year	07/17
7X06A06QAU	ANZ	1x Xeon Gold 5118 12C/2.3GHz/16.5MB/105W/DDR4-2400	1x 16GB RDIMM DDR4-2666 (2Rx8)	1x 930-8i 2GB Flash	16x 2.5"	8x 2.5" SATA/SA S HS	Open	None	None	None	1x Mgmt	4x GbE RJ-45 LOM	None	1x LOM, 1x RAID slot, 1x PCIe x8 LP	None	None	None	TPM 1.2	XClarity Standard	1x 750W Platinum	None	3-year	07/17
7X06A06RAU	ANZ	1x Xeon Gold 6150 18C/2.7GHz/24.75MB/165W/DDR4-2666	1x 32GB RDIMM DDR4-2666 (2Rx4)	1x 930-8i 2GB Flash	24x 2.5"	8x 2.5" SATA/SA S HS	Open	None	None	None	1x Mgmt	None	None	1x LOM, 1x RAID slot, 1x PCIe x8 LP	None	None	None	TPM 1.2	XClarity Standard	1x 1100W Platinum	None	3-year	07/17
7X06A06SAU	ANZ	1x Xeon Gold 5120 14C/2.2GHz/19.25MB/105W/DDR4-2400	1x 16GB RDIMM DDR4-2666 (2Rx8)	1x 930-8i 2GB Flash	16x 2.5"	8x 2.5" SATA/SA S HS	Open	None	None	None	1x Mgmt	4x GbE RJ-45 LOM	None	1x LOM, 1x RAID slot, 1x PCIe x8 LP	None	None	None	TPM 1.2	XClarity Standard	1x 750W Platinum	None	3-year	07/17
7X06A06TAU	ANZ	1x Xeon Gold 5118 12C/2.3GHz/16.5MB/105W/DDR4-2400	1x 16GB RDIMM DDR4-2666 (2Rx8)	1x 930-16i 4GB Flash	12x 3.5"	12x 3.5" SATA/SA S HS	Open	None	None	None	1x Mgmt	4x GbE RJ-45 LOM	None	1x LOM, 1x RAID slot, 1x PCIe x8 LP	None	None	None	TPM 1.2	XClarity Standard	1x 750W Platinum	None	3-year	07/17
7X06A06UAU	ANZ	1x Xeon Gold 6142 16C/2.6GHz/22MB/150W/DDR4-2666	1x 32GB RDIMM DDR4-2666 (2Rx4)	1x 930-8i 2GB Flash	24x 2.5"	8x 2.5" SATA/SA S HS	Open	None	None	None	1x Mgmt	None	None	1x LOM, 1x RAID slot, 1x PCIe x8 LP	None	None	None	TPM 1.2	XClarity Standard	1x 1100W Platinum	None	3-year	07/17
7X06A06VAU	ANZ	1x Xeon Gold 5120 14C/2.2GHz/19.25MB/105W/DDR4-2400	1x 16GB RDIMM DDR4-2666 (2Rx8)	1x 930-16i 4GB Flash	16x 2.5"	16x 2.5" SATA/SA S HS	Open	None	None	None	1x Mgmt	4x GbE RJ-45 LOM	None	1x LOM, 1x RAID slot, 1x PCIe x8 LP	None	None	None	TPM 1.2	XClarity Standard	1x 750W Platinum	None	3-year	07/17

Model	Region	Processor	Memory	Storage Controller	Chassis	Disk Bays	Disk S	M.2 Drives	PCIe Flash Adapter	GPU	Onboard Networking Ports	Additional Networking (LOM/ML2/PCIe)	Fibre Channel I/O	Standard Extension Slots	Available Extension Slots via Riser Cards	Front VGA	Optical	TPM	System Management	Power Supply	Preload	Warranty	Ann Date (mm/yy)
7X06A06WAU	ANZ	1x Xeon Gold 5118 12C/2.3GHz/16.5MB/105W/DDR4-2400	1x 16GB RDIMM DDR4-2666 (2Rx8)	1x 930-8i 2GB Flash	12x 3.5"	None	None	None	None	None	1x Mgmt	4x GbE RJ-45 LOM	None	1x LOM, 1x RAID slot, 1x PCIe x8 LP	None	None	None	TPM 1.2	XClarity Standard	1x 750W Platinum	None	3-year	07/17
7X06A06XAU	ANZ	1x Xeon Platinum 8164 26C/2.0GHz/35.75MB/150W/DDR4-2666	1x 32GB RDIMM DDR4-2666 (2Rx4)	1x 930-8i 2GB Flash	24x 2.5"	SATA/SAS HS	Open	None	None	None	1x Mgmt	None	None	1x LOM, 1x RAID slot, 1x PCIe x8 LP	None	None	None	TPM 1.2	XClarity Standard	1x 1100W Platinum	None	3-year	07/17
7X06A06YAU	ANZ	1x Xeon Platinum 8160 24C/2.1GHz/33MB/150W/DDR4-2666	1x 16GB RDIMM DDR4-2666 (2Rx8)	1x 930-16i 4GB Flash	16x 2.5"	SATA/SAS HS	Open	None	None	None	1x Mgmt	4x GbE RJ-45 LOM	None	1x LOM, 1x RAID slot, 1x PCIe x8 LP	None	None	None	TPM 1.2	XClarity Standard	1x 1100W Platinum	None	3-year	07/17
7X06A06ZAU	ANZ	1x Xeon Gold 6130 16C/2.1GHz/22MB/125W/DDR4-2666	1x 16GB RDIMM DDR4-2666 (2Rx8)	1x 930-8i 2GB Flash	16x 2.5"	SATA/SAS HS	Open	None	None	None	1x Mgmt	4x GbE RJ-45 LOM	None	1x LOM, 1x RAID slot, 1x PCIe x8 LP	None	None	None	TPM 1.2	XClarity Standard	1x 750W Platinum	None	3-year	07/17

Model	Region	Processor	Memory	Storage Controller	Chassis	Disk Bays	Disk S	M.2 Drives	PCIe Flash Adapter	GPU	Onboard Networking Ports	Additional Networking (LOM/ML2/PCIe)	Fibre Channel I/O	Standard Extension Slots	Available Extension Slots via Riser Cards	Front VGA	Optical	TPM	System Management	Power Supply	Preload	Warranty	Ann Date (mm/yy)
7X06A034SG	ASEAN	1x Xeon Gold 5120 14C/2.2GHz/19.25MB/105W/DDR4-2400	1x 16GB RDIMM DDR4-2666 (2Rx8)	1x 530-8i 24x 2.5"	24x 2.5"	8x 2.5" SATA/SA S HS	Open	None	None	None	1x Mgmt	4x 10GbE RJ-45 LOM	None	1x LOM, 1x RAID slot, 1x PCIe x8 LP	None	None	None	TPM 1.2	XClarity Advanced	1x750W Platinum	None	3-year	07/17
7X06A03FSG	ASEAN	1x Xeon Gold 5115 10C/2.4GHz/13.75MB/85W/DDR4-2400	1x 16GB RDIMM DDR4-2666 (2Rx8)	1x 530-8i 24x 2.5"	24x 2.5"	8x 2.5" SATA/SA S HS	Open	None	None	None	1x Mgmt	4x 10GbE RJ-45 LOM	None	1x LOM, 1x RAID slot, 1x PCIe x8 LP	None	None	None	TPM 1.2	XClarity Advanced	1x750W Platinum	None	3-year	07/17
7X06A03JSG	ASEAN	1x Xeon Gold 5118 12C/2.3GHz/16.5MB/105W/DDR4-2400	1x 16GB RDIMM DDR4-2666 (2Rx8)	1x 530-8i 24x 2.5"	24x 2.5"	8x 2.5" SATA/SA S HS	Open	None	None	None	1x Mgmt	4x 10GbE RJ-45 LOM	None	1x LOM, 1x RAID slot, 1x PCIe x8 LP	None	None	None	TPM 1.2	XClarity Advanced	1x750W Platinum	None	3-year	07/17
7X06A03TSG	ASEAN	1x Xeon Gold 6148 20C/2.4GHz/27.5MB/150W/DDR4-2666	1x 32GB RDIMM DDR4-2666 (2Rx4)	1x 530-8i 24x 2.5"	24x 2.5"	8x 2.5" SATA/SA S HS	Open	None	None	None	1x Mgmt	4x 10GbE RJ-45 LOM	None	1x LOM, 1x RAID slot, 1x PCIe x8 LP	None	None	None	TPM 1.2	XClarity Advanced	1x1100W Platinum	None	3-year	07/17
7X06A03USG	ASEAN	1x Xeon Gold 6140 18C/2.3GHz/24.75MB/140W/DDR4-2666	1x 16GB RDIMM DDR4-2666 (2Rx8)	1x 530-8i 24x 2.5"	24x 2.5"	8x 2.5" SATA/SA S HS	Open	None	None	None	1x Mgmt	4x 10GbE RJ-45 LOM	None	1x LOM, 1x RAID slot, 1x PCIe x8 LP	None	None	None	TPM 1.2	XClarity Advanced	1x1100W Platinum	None	3-year	07/17
7X06A03VSG	ASEAN	1x Xeon Gold 6152 22C/2.1GHz/30.25MB/140W/DDR4-2666	1x 32GB RDIMM DDR4-2666 (2Rx4)	1x 530-8i 24x 2.5"	24x 2.5"	8x 2.5" SATA/SA S HS	Open	None	None	None	1x Mgmt	4x 10GbE RJ-45 LOM	None	1x LOM, 1x RAID slot, 1x PCIe x8 LP	None	None	None	TPM 1.2	XClarity Advanced	1x1100W Platinum	None	3-year	07/17
7X06A03RSG	ASEAN	1x Xeon Gold 5115 10C/2.4GHz/13.75MB/85W/DDR4-2400	1x 16GB RDIMM DDR4-2666 (2Rx8)	1x 930-16i 4GB Flash	12x 3.5"	12x 3.5" SATA/SA S HS	Open	None	None	None	1x Mgmt	4x 10GbE RJ-45 LOM	None	1x LOM, 1x RAID slot, 1x PCIe x8 LP	None	None	None	TPM 1.2	XClarity Advanced	1x1100W Platinum	None	3-year	07/17
7X06A03XSG	ASEAN	1x Xeon Gold 6130 16C/2.1GHz/22MB/125W/DDR4-2666	1x 16GB RDIMM DDR4-2666 (2Rx8)	1x 530-8i 24x 2.5"	24x 2.5"	8x 2.5" SATA/SA S HS	Open	None	None	None	1x Mgmt	4x 10GbE RJ-45 LOM	None	1x LOM, 1x RAID slot, 1x PCIe x8 LP	None	None	None	TPM 1.2	XClarity Advanced	1x1100W Platinum	None	3-year	07/17
7X06A042SG	ASEAN	1x Xeon Gold 6134 8C/3.2GHz/24.75MB/130W/DDR4-2666	1x 16GB RDIMM DDR4-2666 (2Rx8)	1x 530-8i 24x 2.5"	24x 2.5"	8x 2.5" SATA/SA S HS	Open	None	None	None	1x Mgmt	4x 10GbE RJ-45 LOM	None	1x LOM, 1x RAID slot, 1x PCIe x8 LP	None	None	None	TPM 1.2	XClarity Advanced	1x1100W Platinum	None	3-year	07/17

Model	Region	Processor	Memory	Storage Controller	Chassis	Disk Bays	Disk S	M.2 Drives	PCIe Flash Adapter	GPU	Onboard Networking Ports	Additional Networking (LOM/ML2/PCIe)	Fibre Channel I/O	Standard Extension Slots	Available Extension Slots via Riser Cards	Front VGA	Optical	TPM	System Management	Power Supply	Preload	Warranty	Ann Date (mm/yy)	
7X06A03HEA	EMEA	1x Xeon Gold 6148 20C/2.4GHz/27.5MB/150W/DDR4-2666	1x 32GB RDIMM DDR4-2666 (2Rx4)	1x 930-8i 2GB Flash	24x 2.5"	8x 2.5" SATA/SAS HS	Open	None	None	None	1x Mgmt	None	None	1x LOM, 1x RAID slot, 1x PCIe x8 LP	None	None	None	TPM 1.2	XClarity Standard	1x 1100W Platinum	None	3-year	07/17	
7X06A041EA	EMEA	1x Xeon Gold 5120 14C/2.2GHz/19.25MB/105W/DDR4-2400	1x 16GB RDIMM DDR4-2666 (2Rx8)	1x 930-8i 2GB Flash	24x 2.5"	8x 2.5" SATA/SAS HS	Open	None	None	None	1x Mgmt	None	None	1x LOM, 1x RAID slot, 1x PCIe x8 LP	None	None	None	TPM 1.2	XClarity Standard	1x 750W Platinum	None	3-year	07/17	
7X06A03SEA	EMEA	1x Xeon Silver 4108 8C/1.8GHz/11MB/85W/DDR4-2400	1x 16GB RDIMM DDR4-2666 (2Rx8)	1x 930-8i 2GB Flash	24x 2.5"	8x 2.5" SATA/SAS HS	Open	None	None	None	1x Mgmt	None	None	1x LOM, 1x RAID slot, 1x PCIe x8 LP	None	None	None	TPM 1.2	XClarity Standard	1x 750W Platinum	None	3-year	07/17	
7X06A03WEA	EMEA	1x Xeon Silver 4114 10C/2.2GHz/13.75MB/85W/DDR4-2400	1x 16GB RDIMM DDR4-2666 (2Rx8)	1x 930-16i 4GB Flash	12x 3.5"	12x 3.5" SATA/SAS HS	Open	None	None	None	1x Mgmt	None	None	1x LOM, 1x RAID slot, 1x PCIe x8 LP	None	None	None	TPM 1.2	XClarity Standard	1x 750W Platinum	None	3-year	07/17	
7X06A03LEA	EMEA	1x Xeon Platinum 8160 24C/2.1GHz/33MB/150W/DDR4-2666	1x 32GB RDIMM DDR4-2666 (2Rx4)	1x 930-8i 2GB Flash	24x 2.5"	8x 2.5" SATA/SAS HS	Open	None	None	None	1x Mgmt	None	None	1x LOM, 1x RAID slot, 1x PCIe x8 LP	None	None	None	TPM 1.2	XClarity Standard	1x 1100W Platinum	None	3-year	07/17	
7X06A03MEA	EMEA	1x Xeon Platinum 8164 26C/2.0GHz/35.75MB/150W/DDR4-2666	1x 32GB RDIMM DDR4-2666 (2Rx4)	1x 930-8i 2GB Flash	24x 2.5"	8x 2.5" SATA/SAS HS	Open	None	None	None	1x Mgmt	None	None	1x LOM, 1x RAID slot, 1x PCIe x8 LP	None	None	None	TPM 1.2	XClarity Standard	1x 1100W Platinum	None	3-year	07/17	
7X06A03NEA	EMEA	1x Xeon Gold 6152 22C/2.1GHz/30.25MB/140W/DDR4-2666	1x 32GB RDIMM DDR4-2666 (2Rx4)	1x 930-8i 2GB Flash	24x 2.5"	8x 2.5" SATA/SAS HS	Open	None	None	None	1x Mgmt	None	None	1x LOM, 1x RAID slot, 1x PCIe x8 LP	None	None	None	TPM 1.2	XClarity Standard	1x 1100W Platinum	None	3-year	07/17	
7X06A03PEA	EMEA	1x Xeon Gold 6130 16C/2.1GHz/22MB/125W/DDR4-2666	1x 32GB RDIMM DDR4-2666 (2Rx4)	1x 930-8i 2GB Flash	24x 2.5"	8x 2.5" SATA/SAS HS	Open	None	None	None	1x Mgmt	None	None	1x LOM, 1x RAID slot, 1x PCIe x8 LP	None	None	None	TPM 1.2	XClarity Standard	1x 750W Platinum	None	3-year	07/17	
7X06A03QEA	EMEA	1x Xeon Gold 6150 18C/2.7GHz/24.75MB/165W/DDR4-2666	1x 32GB RDIMM DDR4-2666 (2Rx4)	1x 930-8i 2GB Flash	24x 2.5"	8x 2.5" SATA/SAS HS	Open	None	None	None	1x Mgmt	None	None	1x LOM, 1x RAID slot, 1x PCIe x8 LP	None	None	None	TPM 1.2	XClarity Standard	1x 1100W Platinum	None	3-year	07/17	
7X06A033EA	EMEA	2x Xeon Gold 5120 14C/2.2GHz/19.25MB/105W/DDR4-2400	2x 32GB RDIMM DDR4-2666 (2Rx4)	1x 430-16i	24x 2.5"	8x 2.5" HS (4 SATA/SAS AnyBay) 8x 2.5" SATA/SAS HS	Open	None	None	None	1x Mgmt	None	None	1x LOM, 1x RAID slot, 1x PCIe x8 LP	1x PCIe x16 FHFL, 1x PCIe x16 FHHL	None	None	None	TPM 1.2	XClarity Enterprise	1x 1100W Platinum	None	3-year	07/17

Model	Region	Processor	Memory	Storage Controller	Chassis	Disk Bays	Disk S	M.2 Drives	PCIe Flash Adapter	GPU	Onboard Networking Ports	Additional Networking (LOM/ML2/PCIe)	Fibre Channel I/O	Standard Extension Slots	Available Extension Slots via Riser Cards	Front VGA	Optical	TPM	System Management	Power Supply	Preload	Warranty	Ann Date (mm/yy)
7X06A03EEA	EMEA	1x Xeon Gold 6142 16C/2.6GHz/22MB/150W/DDR4-2666	1x 32GB RDIMM DDR4-2666 (2Rx4)	1x 930-8i 2GB Flash	24x 2.5"	8x 2.5" SATA/SAS HS	Open	None	None	None	1x Mgmt	None	None	1x LOM, 1x RAID slot, 1x PCIe x8 LP	None	None	None	TPM 1.2	XClarity Standard	1x 1100W Platinum	None	3-year	07/17
7X06A035EA	EMEA	1x Xeon Bronze 3104 6C/1.7GHz/8.25MB/85W/DDR4-2133	1x 8GB RDIMM DDR4-2666 (1Rx8)	1x 530-8i	24x 2.5"	8x 2.5" SATA/SAS HS	Open	None	None	None	1x Mgmt	None	None	1x LOM, 1x RAID slot, 1x PCIe x8 LP	None	None	None	TPM 1.2	XClarity Standard	1x 550W Platinum	None	3-year	07/17
7X06A036EA	EMEA	1x Xeon Gold 5118 12C/2.3GHz/16.5MB/105W/DDR4-2400	1x 16GB RDIMM DDR4-2666 (2Rx8)	1x 930-8i 2GB Flash	24x 2.5"	8x 2.5" SATA/SAS HS	Open	None	None	None	1x Mgmt	None	None	1x LOM, 1x RAID slot, 1x PCIe x8 LP	None	None	None	TPM 1.2	XClarity Standard	1x 750W Platinum	None	3-year	07/17
7X06A037EA	EMEA	1x Xeon Silver 4108 8C/1.8GHz/11MB/85W/DDR4-2400	1x 16GB RDIMM DDR4-2666 (2Rx8)	1x 530-8i	24x 2.5"	8x 2.5" SATA/SAS HS	Open	None	None	None	1x Mgmt	None	None	1x LOM, 1x RAID slot, 1x PCIe x8 LP	None	None	None	TPM 1.2	XClarity Standard	1x 750W Platinum	None	3-year	07/17
7X06A038EA	EMEA	2x Xeon Silver 4110 8C/2.1GHz/11MB/85W/DDR4-2400	2x 32GB RDIMM DDR4-2666 (2Rx4)	1x 430-16i	24x 2.5"	8x 2.5" HS (4 SATA/SAS AnyBay) 8x 2.5" SATA/SAS HS	Open	None	None	None	1x Mgmt	None	None	1x LOM, 1x RAID slot, 1x PCIe x8 LP	None	None	None	TPM 1.2	XClarity Enterprise	1x1100 W Platinum	None	3-year	07/17
7X06A03AEA	EMEA	1x Xeon Gold 5115 10C/2.4GHz/13.75MB/85W/DDR4-2400	1x 16GB RDIMM DDR4-2666 (2Rx8)	1x 930-8i 2GB Flash	24x 2.5"	8x 2.5" SATA/SAS HS	Open	None	None	None	1x Mgmt	None	None	1x LOM, 1x RAID slot, 1x PCIe x8 LP	None	None	None	TPM 1.2	XClarity Standard	1x 750W Platinum	None	3-year	07/17
7X06A03BEA	EMEA	1x Xeon Silver 4116 12C/2.1GHz/16.5MB/85W/DDR4-2400	1x 16GB RDIMM DDR4-2666 (2Rx8)	1x 930-8i 2GB Flash	24x 2.5"	8x 2.5" SATA/SAS HS	Open	None	None	None	1x Mgmt	None	None	1x LOM, 1x RAID slot, 1x PCIe x8 LP	None	None	None	TPM 1.2	XClarity Standard	1x 750W Platinum	None	3-year	07/17
7X06A03CEA	EMEA	1x Xeon Silver 4110 8C/2.1GHz/11MB/85W/DDR4-2400	1x 16GB RDIMM DDR4-2666 (2Rx8)	1x 930-8i 2GB Flash	24x 2.5"	8x 2.5" SATA/SAS HS	Open	None	None	None	1x Mgmt	None	None	1x LOM, 1x RAID slot, 1x PCIe x8 LP	None	None	None	TPM 1.2	XClarity Standard	1x 750W Platinum	None	3-year	07/17
7X06A02SEA	EMEA	1x Xeon Gold 6134 8C/3.2GHz/24.75MB/130W/DDR4-2666	1x 32GB RDIMM DDR4-2666 (2Rx4)	1x 930-8i 2GB Flash	24x 2.5"	8x 2.5" SATA/SAS HS	Open	None	None	None	1x Mgmt	None	None	1x LOM, 1x RAID slot, 1x PCIe x8 LP	None	None	None	TPM 1.2	XClarity Standard	1x 1100W Platinum	None	3-year	07/17
7X06A02WEA	EMEA	1x Xeon Silver 4114 10C/2.2GHz/13.75MB/85W/DDR4-2400	1x 16GB RDIMM DDR4-2666 (2Rx8)	1x 930-8i 2GB Flash	24x 2.5"	8x 2.5" SATA/SAS HS	Open	None	None	None	1x Mgmt	None	None	1x LOM, 1x RAID slot, 1x PCIe x8 LP	None	None	None	TPM 1.2	XClarity Standard	1x 750W Platinum	None	3-year	07/17

Model	Region	Processor	Memory	Storage Controller	Chassis	Disk Bays	Disk S	M.2 Drives	PCIe Flash Adapter	GPU	Onboard Networking Ports	Additional Networking (LOM/ML2/PCIe)	Fibre Channel I/O	Standard Extension Slots	Available Extension Slots via Riser Cards	Front VGA	Optical	TPM	System Management	Power Supply	Preload	Warranty	Ann Date (mm/yy)
7X06A02XE A	EMEA	1x Xeon Gold 6134 8C/3.2GHz/24.75MB/130W/DDR4-2666	1x 32GB RDIMM DDR4-2666 (2Rx4)	1x 930-8i 2GB Flash	24x 2.5"	8x 2.5" SATA/SA S HS	Open	None	None	None	1x Mgmt	None	None	1x LOM, 1x RAID slot, 1x PCIe x8 LP	None	None	None	TPM 1.2	XClarity Standard	1x 750W Platinum	None	3-year	07/17
7X06A02YE A	EMEA	1x Xeon Gold 6140 18C/2.3GHz/24.75MB/140W/DDR4-2666	1x 32GB RDIMM DDR4-2666 (2Rx4)	1x 930-8i 2GB Flash	24x 2.5"	8x 2.5" SATA/SA S HS	Open	None	None	None	1x Mgmt	None	None	1x LOM, 1x RAID slot, 1x PCIe x8 LP	None	None	None	TPM 1.2	XClarity Standard	1x 1100W Platinum	None	3-year	07/17
7X06A08AE A	EMEA	1x Xeon Gold 6144 8C/3.5GHz/24.75MB/150W/DDR4-2666	1x 32GB RDIMM DDR4-2666 (2Rx4)	1x 930-8i 2GB Flash	24x 2.5"	8x 2.5" SATA/SA S HS	Open	None	None	None	1x Mgmt	None	None	1x LOM, 1x RAID slot, 1x PCIe x8 LP	None	None	None	TPM 1.2	XClarity Standard	1x 1100W Platinum	None	3-year	11/17
7X06A08BE A	EMEA	1x Xeon Gold 6132 14C/2.6GHz/19.25MB/140W/DDR4-2666	1x 32GB RDIMM DDR4-2666 (2Rx4)	1x 930-8i 2GB Flash	24x 2.5"	8x 2.5" SATA/SA S HS	Open	None	None	None	1x Mgmt	None	None	1x LOM, 1x RAID slot, 1x PCIe x8 LP	None	None	None	TPM 1.2	XClarity Standard	1x 1100W Platinum	None	3-year	11/17
7X06A08CE A	EMEA	1x Xeon Gold 6146 12C/3.2GHz/24.75MB/165W/DDR4-2666	1x 32GB RDIMM DDR4-2666 (2Rx4)	1x 930-8i 2GB Flash	24x 2.5"	8x 2.5" SATA/SA S HS	Open	None	None	None	1x Mgmt	None	None	1x LOM, 1x RAID slot, 1x PCIe x8 LP	None	None	None	TPM 1.2	XClarity Standard	1x 1100W Platinum	None	3-year	11/17
7X06A08DE A	EMEA	1x Xeon Gold 6128 6C/3.4GHz/19.25MB/115W/DDR4-2666	1x 32GB RDIMM DDR4-2666 (2Rx4)	1x 930-8i 2GB Flash	24x 2.5"	8x 2.5" SATA/SA S HS	Open	None	None	None	1x Mgmt	None	None	1x LOM, 1x RAID slot, 1x PCIe x8 LP	None	None	None	TPM 1.2	XClarity Standard	1x 750W Platinum	None	3-year	11/17
7X06A044E A	EMEA	1x Xeon Gold 6126 12C/2.6GHz/19.25MB/125W/DDR4-2666	1x 32GB RDIMM DDR4-2666 (2Rx4)	1x 930-8i 2GB Flash	24x 2.5"	8x 2.5" SATA/SA S HS	Open	None	None	None	1x Mgmt	None	None	1x LOM, 1x RAID slot, 1x PCIe x8 LP	None	None	None	TPM 1.2	XClarity Standard	1x 750W Platinum	None	3-year	07/17
7X06A045E A	EMEA	1x Xeon Silver 4110 8C/2.1GHz/11MB/85W/DDR4-2400	1x 16GB RDIMM DDR4-2666 (2Rx8)	1x 530-8i	24x 2.5"	8x 2.5" SATA/SA S HS	Open	None	None	None	1x Mgmt	None	None	1x LOM, 1x RAID slot, 1x PCIe x8 LP	None	None	None	TPM 1.2	XClarity Standard	1x 750W Platinum	None	3-year	07/17

Model	Region	Processor	Memory	Storage Controller	Chassis	Disk Bays	Disk S	M.2 Drives	PCIe Flash Adapter	GPU	Onboard Networking Ports	Additional Networking (LOM/ML2/PCIe)	Fibre Channel I/O	Standard Extension Slots	Available Extension Slots via Riser Cards	Front VGA	Optical	TPM	System Management	Power Supply	Preload	Warranty	Ann Date (mm/yy)
7X06A083CN	Hong Kong	1x Xeon Silver 4114 10C/2.2GHz/13.75MB/85W/DDR4-2400	1x 16GB RDIMM DDR4-2666 (2Rx8)	1x 930-16i 4GB Flash	12x 3.5"	12x 3.5" SATA/SA S HS	Open	None	None	None	1x Mgmt	4x GbE RJ-45 LOM	None	1x LOM, 1x RAID slot, 1x PCIe x8 LP	3x PCIe x8 FHHL	None	None	TPM 1.2	XClarity Standard	1x 1100W Platinum	None	3-year	09/17
7X06A084CN	Hong Kong	1x Xeon Gold 5122 4C/3.6GHz/16.5MB/105W/DDR4-2666	1x 16GB RDIMM DDR4-2666 (2Rx8)	1x 930-24i 4GB Flash	24x 2.5"	24x 2.5" SATA/SA S HS	Open	None	None	None	1x Mgmt	4x GbE RJ-45 LOM	None	1x LOM, 1x RAID slot, 1x PCIe x8 LP	3x PCIe x8 FHHL	None	None	TPM 1.2	XClarity Standard	1x 1100W Platinum	None	3-year	09/17
7X06A085CN	Hong Kong	1x Xeon Silver 4112 4C/2.6GHz/8.25MB/85W/DDR4-2400	1x 16GB RDIMM DDR4-2666 (2Rx8)	1x 930-16i 4GB Flash	12x 3.5"	12x 3.5" SATA/SA S HS	Open	None	None	None	1x Mgmt	4x GbE RJ-45 LOM	None	1x LOM, 1x RAID slot, 1x PCIe x8 LP	3x PCIe x8 FHHL	None	None	TPM 1.2	XClarity Standard	1x 1100W Platinum	None	3-year	09/17
7X06A086CN	Hong Kong	1x Xeon Gold 5122 4C/3.6GHz/16.5MB/105W/DDR4-2666	1x 16GB RDIMM DDR4-2666 (2Rx8)	1x 930-16i 4GB Flash	12x 3.5"	12x 3.5" SATA/SA S HS	Open	None	None	None	1x Mgmt	4x GbE RJ-45 LOM	None	1x LOM, 1x RAID slot, 1x PCIe x8 LP	3x PCIe x8 FHHL	None	None	TPM 1.2	XClarity Standard	1x 1100W Platinum	None	3-year	09/17
7X06A087CN	Hong Kong	1x Xeon Silver 4114 10C/2.2GHz/13.75MB/85W/DDR4-2400	1x 16GB RDIMM DDR4-2666 (2Rx8)	1x 930-24i 4GB Flash	24x 2.5"	24x 2.5" SATA/SA S HS	Open	None	None	None	1x Mgmt	4x GbE RJ-45 LOM	None	1x LOM, 1x RAID slot, 1x PCIe x8 LP	3x PCIe x8 FHHL	None	None	TPM 1.2	XClarity Standard	1x 1100W Platinum	None	3-year	09/17
7X06A088CN	Hong Kong	1x Xeon Silver 4112 4C/2.6GHz/8.25MB/85W/DDR4-2400	1x 16GB RDIMM DDR4-2666 (2Rx8)	1x 930-24i 4GB Flash	24x 2.5"	24x 2.5" SATA/SA S HS	Open	None	None	None	1x Mgmt	4x GbE RJ-45 LOM	None	1x LOM, 1x RAID slot, 1x PCIe x8 LP	3x PCIe x8 FHHL	None	None	TPM 1.2	XClarity Standard	1x 1100W Platinum	None	3-year	09/17

Model	Region	Processor	Memory	Storage Controller	Chassis	Disk Bays	Disk s	M.2 Drives	PCIe Flash Adapter	GPU	Onboard Networking Ports	Additional Networking (LOM/ML2/PCIe)	Fibre Channel I/O	Standard Extension Slots	Available Extension Slots via Riser Cards	Front VGA	Optical	TPM	System Management	Power Supply	Preload	Warranty	Ann Date (mm/yy)
7X06A04XCN	HTK	1x Xeon Silver 4110 8C/2.1GHz/11MB/85W/DDR4-2400	1x 16GB RDIMM DDR4-2666 (2Rx8)	1x 930-8i 2GB Flash	16x 2.5"	8x 2.5" SATA/SA S HS	Open	None	None	None	1x Mgmt	4x GbE RJ-45 LOM	None	1x LOM, 1x RAID slot, 1x PCIe x8 LP	3x PCIe x8 FHHL	None	None	TPM 1.2	XClarity Standard	1x 750W Platinum	None	3-year	07/17
7X06A053CN	HTK	1x Xeon Bronze 3106 8C/1.7GHz/11MB/85W/DDR4-2133	1x 16GB RDIMM DDR4-2666 (2Rx8)	1x 930-16i 4GB Flash	12x 3.5"	12x 3.5" SATA/SA S HS	Open	None	None	None	1x Mgmt	4x GbE RJ-45 LOM	None	1x LOM, 1x RAID slot, 1x PCIe x8 LP	3x PCIe x8 FHHL	None	None	TPM 1.2	XClarity Standard	1x 750W Platinum	None	3-year	07/17
7X06A055CN	HTK	1x Xeon Silver 4114 10C/2.2GHz/13.75MB/85W/DDR4-2400	1x 16GB RDIMM DDR4-2666 (2Rx8)	1x 930-8i 2GB Flash	16x 2.5"	8x 2.5" SATA/SA S HS	Open	None	None	None	1x Mgmt	4x GbE RJ-45 LOM	None	1x LOM, 1x RAID slot, 1x PCIe x8 LP	3x PCIe x8 FHHL	None	None	TPM 1.2	XClarity Standard	1x 750W Platinum	None	3-year	07/17
7X06A05QC N	HTK	1x Xeon Silver 4110 8C/2.1GHz/11MB/85W/DDR4-2400	1x 16GB RDIMM DDR4-2666 (2Rx8)	1x 930-16i 4GB Flash	12x 3.5"	12x 3.5" SATA/SA S HS	Open	None	None	None	1x Mgmt	4x GbE RJ-45 LOM	None	1x LOM, 1x RAID slot, 1x PCIe x8 LP	3x PCIe x8 FHHL	None	None	TPM 1.2	XClarity Standard	1x 750W Platinum	None	3-year	07/17
7X06A05TCN	HTK	1x Xeon Silver 4116 12C/2.1GHz/16.5MB/85W/DDR4-2400	1x 16GB RDIMM DDR4-2666 (2Rx8)	1x 930-16i 4GB Flash	12x 3.5"	12x 3.5" SATA/SA S HS	Open	None	None	None	1x Mgmt	4x GbE RJ-45 LOM	None	1x LOM, 1x RAID slot, 1x PCIe x8 LP	3x PCIe x8 FHHL	None	None	TPM 1.2	XClarity Standard	1x 750W Platinum	None	3-year	07/17
7X06A05UC N	HTK	1x Xeon Silver 4116 12C/2.1GHz/16.5MB/85W/DDR4-2400	1x 16GB RDIMM DDR4-2666 (2Rx8)	1x 930-8i 2GB Flash	16x 2.5"	8x 2.5" SATA/SA S HS	Open	None	None	None	1x Mgmt	4x GbE RJ-45 LOM	None	1x LOM, 1x RAID slot, 1x PCIe x8 LP	3x PCIe x8 FHHL	None	None	TPM 1.2	XClarity Standard	1x 750W Platinum	None	3-year	07/17
7X06A05VCN	HTK	1x Xeon Silver 4114 10C/2.2GHz/13.75MB/85W/DDR4-2400	1x 16GB RDIMM DDR4-2666 (2Rx8)	1x 930-16i 4GB Flash	12x 3.5"	12x 3.5" SATA/SA S HS	Open	None	None	None	1x Mgmt	4x GbE RJ-45 LOM	None	1x LOM, 1x RAID slot, 1x PCIe x8 LP	3x PCIe x8 FHHL	None	None	TPM 1.2	XClarity Standard	1x 750W Platinum	None	3-year	07/17
7X06A05WC N	HTK	1x Xeon Bronze 3106 8C/1.7GHz/11MB/85W/DDR4-2133	1x 16GB RDIMM DDR4-2666 (2Rx8)	1x 930-8i 2GB Flash	16x 2.5"	8x 2.5" SATA/SA S HS	Open	None	None	None	1x Mgmt	4x GbE RJ-45 LOM	None	1x LOM, 1x RAID slot, 1x PCIe x8 LP	3x PCIe x8 FHHL	None	None	TPM 1.2	XClarity Standard	1x 750W Platinum	None	3-year	07/17
7X06A05KCN	HTK	1x Xeon Silver 4112 4C/2.6GHz/8.25MB/85W/DDR4-2400	1x 16GB RDIMM DDR4-2666 (2Rx8)	1x 930-16i 4GB Flash	12x 3.5"	12x 3.5" SATA/SA S HS	Open	None	None	None	1x Mgmt	4x GbE RJ-45 LOM	None	1x LOM, 1x RAID slot, 1x PCIe x8 LP	3x PCIe x8 FHHL	None	None	TPM 1.2	XClarity Standard	1x 750W Platinum	None	3-year	07/17
7X06A05LCN	HTK	1x Xeon Silver 4108 8C/1.8GHz/11MB/85W/DDR4-2400	1x 16GB RDIMM DDR4-2666 (2Rx8)	1x 930-8i 2GB Flash	16x 2.5"	8x 2.5" SATA/SA S HS	Open	None	None	None	1x Mgmt	4x GbE RJ-45 LOM	None	1x LOM, 1x RAID slot, 1x PCIe x8 LP	3x PCIe x8 FHHL	None	None	TPM 1.2	XClarity Standard	1x 750W Platinum	None	3-year	07/17

Model	Region	Processor	Memory	Storage Controller	Chassis	Disk Bays	Disk S	M.2 Drives	PCIe Flash Adapter	GPU	Onboard Networking Ports	Additional Networking (LOM/ML2/PCIe)	Fibre Channel I/O	Standard Extension Slots	Available Extension Slots via Riser Cards	Front VGA	Optical	TPM	System Management	Power Supply	Preload	Warranty	Ann Date (mm/yy)
7X06A05MCN	HTK	1x Xeon Bronze 3104 6C/1.7GHz/8.25MB/85W/DDR4-2133	1x 16GB RDIMM DDR4-2666 (2Rx8)	1x 930-16i 4GB Flash	12x 3.5"	12x 3.5" SATA/SA S HS	Open	None	None	None	1x Mgmt	4x GbE RJ-45 LOM	None	1x LOM, 1x RAID slot, 1x PCIe x8 LP	3x PCIe x8 FHHL	None	None	TPM 1.2	XClarity Standard	1x 750W Platinum	None	3-year	07/17
7X06A05ECN	HTK	1x Xeon Bronze 3104 6C/1.7GHz/8.25MB/85W/DDR4-2133	1x 16GB RDIMM DDR4-2666 (2Rx8)	1x 930-8i 2GB Flash	16x 2.5"	8x 2.5" SATA/SA S HS	Open	None	None	None	1x Mgmt	4x GbE RJ-45 LOM	None	1x LOM, 1x RAID slot, 1x PCIe x8 LP	3x PCIe x8 FHHL	None	None	TPM 1.2	XClarity Standard	1x 750W Platinum	None	3-year	07/17
7X06A05FCN	HTK	1x Xeon Silver 4108 8C/1.8GHz/11MB/85W/DDR4-2400	1x 16GB RDIMM DDR4-2666 (2Rx8)	1x 930-16i 4GB Flash	12x 3.5"	12x 3.5" SATA/SA S HS	Open	None	None	None	1x Mgmt	4x GbE RJ-45 LOM	None	1x LOM, 1x RAID slot, 1x PCIe x8 LP	3x PCIe x8 FHHL	None	None	TPM 1.2	XClarity Standard	1x 750W Platinum	None	3-year	07/17
7X06A02FCN	HTK	1x Xeon Gold 6152 22C/2.1GHz/30.25MB/140W/DDR4-2666	1x 16GB RDIMM DDR4-2666 (2Rx8)	1x 930-8i 2GB Flash	16x 2.5"	8x 2.5" SATA/SA S HS	Open	None	None	None	1x Mgmt	4x GbE RJ-45 LOM	None	1x LOM, 1x RAID slot, 1x PCIe x8 LP	3x PCIe x8 FHHL	None	None	TPM 1.2	XClarity Standard	1x 750W Platinum	None	3-year	07/17
7X06A02JCN	HTK	1x Xeon Gold 5115 10C/2.4GHz/13.75MB/85W/DDR4-2400	1x 16GB RDIMM DDR4-2666 (2Rx8)	1x 930-16i 4GB Flash	12x 3.5"	12x 3.5" SATA/SA S HS	Open	None	None	None	1x Mgmt	4x GbE RJ-45 LOM	None	1x LOM, 1x RAID slot, 1x PCIe x8 LP	3x PCIe x8 FHHL	None	None	TPM 1.2	XClarity Standard	1x 750W Platinum	None	3-year	07/17
7X06A02KCN	HTK	1x Xeon Gold 6140 18C/2.3GHz/24.75MB/140W/DDR4-2666	1x 16GB RDIMM DDR4-2666 (2Rx8)	1x 930-16i 4GB Flash	12x 3.5"	12x 3.5" SATA/SA S HS	Open	None	None	None	1x Mgmt	4x GbE RJ-45 LOM	None	1x LOM, 1x RAID slot, 1x PCIe x8 LP	3x PCIe x8 FHHL	None	None	TPM 1.2	XClarity Standard	1x 750W Platinum	None	3-year	07/17
7X06A02LCN	HTK	1x Xeon Gold 6148 20C/2.4GHz/27.5MB/150W/DDR4-2666	1x 16GB RDIMM DDR4-2666 (2Rx8)	1x 930-16i 4GB Flash	12x 3.5"	12x 3.5" SATA/SA S HS	Open	None	None	None	1x Mgmt	4x GbE RJ-45 LOM	None	1x LOM, 1x RAID slot, 1x PCIe x8 LP	3x PCIe x8 FHHL	None	None	TPM 1.2	XClarity Standard	1x 750W Platinum	None	3-year	07/17
7X06A02QCN	HTK	1x Xeon Gold 6152 22C/2.1GHz/30.25MB/140W/DDR4-2666	1x 16GB RDIMM DDR4-2666 (2Rx8)	1x 930-16i 4GB Flash	12x 3.5"	12x 3.5" SATA/SA S HS	Open	None	None	None	1x Mgmt	4x GbE RJ-45 LOM	None	1x LOM, 1x RAID slot, 1x PCIe x8 LP	3x PCIe x8 FHHL	None	None	TPM 1.2	XClarity Standard	1x 750W Platinum	None	3-year	07/17
7X06A04VCN	HTK	1x Xeon Silver 4112 4C/2.6GHz/8.25MB/85W/DDR4-2400	1x 16GB RDIMM DDR4-2666 (2Rx8)	1x 930-8i 2GB Flash	16x 2.5"	8x 2.5" SATA/SA S HS	Open	None	None	None	1x Mgmt	4x GbE RJ-45 LOM	None	1x LOM, 1x RAID slot, 1x PCIe x8 LP	3x PCIe x8 FHHL	None	None	TPM 1.2	XClarity Standard	1x 750W Platinum	None	3-year	07/17
7X06A01TCN	HTK	1x Xeon Gold 6136 12C/3.0GHz/24.75MB/150W/DDR4-2666	1x 16GB RDIMM DDR4-2666 (2Rx8)	1x 930-16i 4GB Flash	12x 3.5"	12x 3.5" SATA/SA S HS	Open	None	None	None	1x Mgmt	4x GbE RJ-45 LOM	None	1x LOM, 1x RAID slot, 1x PCIe x8 LP	3x PCIe x8 FHHL	None	None	TPM 1.2	XClarity Standard	1x 750W Platinum	None	3-year	07/17

Model	Region	Processor	Memory	Storage Controller	Chassis	Disk Bays	Disk S	M.2 Drives	PCIe Flash Adapter	GPU	Onboard Networking Ports	Additional Networking (LOM/ML2/PCIe)	Fibre Channel I/O	Standard Extension Slots	Available Extension Slots via Riser Cards	Front VGA	Optical	TPM	System Management	Power Supply	Preloaded	Warranty	Ann Date (mm/yy)
7X06A01UCN	HTK	1x Xeon Gold 5118 12C/2.3GHz/16.5MB/105W/DDR4-2400	1x 16GB RDIMM DDR4-2666 (2Rx8)	1x 930-16i 4GB Flash	12x 3.5"	12x 3.5" SATA/SAS HS	Open	None	None	None	1x Mgmt	4x GbE RJ-45 LOM	None	1x LOM, 1x RAID slot, 1x PCIe x8 LP	3x PCIe x8 FHHL	None	None	TPM 1.2	XClarity Standard	1x 750W Platinum	None	3-year	07/17
7X06A01VCN	HTK	1x Xeon Gold 5120 14C/2.2GHz/19.25MB/105W/DDR4-2400	1x 16GB RDIMM DDR4-2666 (2Rx8)	1x 930-16i 4GB Flash	12x 3.5"	12x 3.5" SATA/SAS HS	Open	None	None	None	1x Mgmt	4x GbE RJ-45 LOM	None	1x LOM, 1x RAID slot, 1x PCIe x8 LP	3x PCIe x8 FHHL	None	None	TPM 1.2	XClarity Standard	1x 750W Platinum	None	3-year	07/17
7X06A01YCN	HTK	1x Xeon Gold 5122 4C/3.6GHz/16.5MB/105W/DDR4-2666	1x 16GB RDIMM DDR4-2666 (2Rx8)	1x 930-16i 4GB Flash	12x 3.5"	12x 3.5" SATA/SAS HS	Open	None	None	None	1x Mgmt	4x GbE RJ-45 LOM	None	1x LOM, 1x RAID slot, 1x PCIe x8 LP	3x PCIe x8 FHHL	None	None	TPM 1.2	XClarity Standard	1x 750W Platinum	None	3-year	07/17
7X06A020CN	HTK	1x Xeon Gold 6130 16C/2.1GHz/22MB/125W/DDR4-2666	1x 16GB RDIMM DDR4-2666 (2Rx8)	1x 930-16i 4GB Flash	12x 3.5"	12x 3.5" SATA/SAS HS	Open	None	None	None	1x Mgmt	4x GbE RJ-45 LOM	None	1x LOM, 1x RAID slot, 1x PCIe x8 LP	3x PCIe x8 FHHL	None	None	TPM 1.2	XClarity Standard	1x 750W Platinum	None	3-year	07/17
7X06A021CN	HTK	1x Xeon Silver 4114 10C/2.2GHz/13.75MB/85W/DDR4-2400	1x 16GB RDIMM DDR4-2666 (2Rx8)	1x 930-8i 2GB Flash	16x 2.5"	8x 2.5" SATA/SAS HS	Open	None	None	None	1x Mgmt	4x GbE RJ-45 LOM	None	1x LOM, 1x RAID slot, 1x PCIe x8 LP	3x PCIe x8 FHHL	None	None	TPM 1.2	XClarity Standard	1x 750W Platinum	None	3-year	07/17
7X06A01QCN	HTK	1x Xeon Gold 6134 8C/3.2GHz/24.75MB/130W/DDR4-2666	1x 16GB RDIMM DDR4-2666 (2Rx8)	1x 930-16i 4GB Flash	12x 3.5"	12x 3.5" SATA/SAS HS	Open	None	None	None	1x Mgmt	4x GbE RJ-45 LOM	None	1x LOM, 1x RAID slot, 1x PCIe x8 LP	3x PCIe x8 FHHL	None	None	TPM 1.2	XClarity Standard	1x 750W Platinum	None	3-year	07/17
7X06A00ZCN	HTK	1x Xeon Gold 6136 12C/3.0GHz/24.75MB/150W/DDR4-2666	1x 16GB RDIMM DDR4-2666 (2Rx8)	1x 930-8i 2GB Flash	16x 2.5"	8x 2.5" SATA/SAS HS	Open	None	None	None	1x Mgmt	4x GbE RJ-45 LOM	None	1x LOM, 1x RAID slot, 1x PCIe x8 LP	3x PCIe x8 FHHL	None	None	TPM 1.2	XClarity Standard	1x 750W Platinum	None	3-year	07/17
7X06A00QCN	HTK	1x Xeon Gold 6140 18C/2.3GHz/24.75MB/140W/DDR4-2666	1x 16GB RDIMM DDR4-2666 (2Rx8)	1x 930-8i 2GB Flash	16x 2.5"	8x 2.5" SATA/SAS HS	Open	None	None	None	1x Mgmt	4x GbE RJ-45 LOM	None	1x LOM, 1x RAID slot, 1x PCIe x8 LP	3x PCIe x8 FHHL	None	None	TPM 1.2	XClarity Standard	1x 750W Platinum	None	3-year	07/17
7X06A00UCN	HTK	1x Xeon Gold 6148 20C/2.4GHz/27.5MB/150W/DDR4-2666	1x 16GB RDIMM DDR4-2666 (2Rx8)	1x 930-8i 2GB Flash	16x 2.5"	8x 2.5" SATA/SAS HS	Open	None	None	None	1x Mgmt	4x GbE RJ-45 LOM	None	1x LOM, 1x RAID slot, 1x PCIe x8 LP	3x PCIe x8 FHHL	None	None	TPM 1.2	XClarity Standard	1x 750W Platinum	None	3-year	07/17
7X06A00MCN	HTK	1x Xeon Gold 6130 16C/2.1GHz/22MB/125W/DDR4-2666	1x 16GB RDIMM DDR4-2666 (2Rx8)	1x 930-8i 2GB Flash	16x 2.5"	8x 2.5" SATA/SAS HS	Open	None	None	None	1x Mgmt	4x GbE RJ-45 LOM	None	1x LOM, 1x RAID slot, 1x PCIe x8 LP	3x PCIe x8 FHHL	None	None	TPM 1.2	XClarity Standard	1x 750W Platinum	None	3-year	07/17

Model	Region	Processor	Memory	Storage Controller	Chassis	Disk Bays	Disk S	M.2 Drives	PCIe Flash Adapter	GPU	Onboard Networking Ports	Additional Networking (LOM/ML2/PCIe)	Fibre Channel I/O	Standard Extension Slots	Available Extension Slots via Riser Cards	Front VGA	Optical	TPM	System Management	Power Supply	Preload	Warranty	Ann Date (mm/yy)
7X06A00GCN	HTK	1x Xeon Gold 6134 8C/3.2GHz/24.75MB/130W/DDR4-2666	1x 16GB RDIMM DDR4-2666 (2Rx8)	1x 930-8i 2GB Flash	16x 2.5"	8x 2.5" SATA/SA S HS	Open	None	None	None	1x Mgmt	4x GbE RJ-45 LOM	None	1x LOM, 1x RAID slot, 1x PCIe x8 LP	3x PCIe x8 FHHL	None	None	TPM 1.2	XClarity Standard	1x 750W Platinum	None	3-year	07/17
7X06A00ECN	HTK	1x Xeon Gold 5115 10C/2.4GHz/13.75MB/85W/DDR4-2400	1x 16GB RDIMM DDR4-2666 (2Rx8)	1x 930-8i 2GB Flash	16x 2.5"	8x 2.5" SATA/SA S HS	Open	None	None	None	1x Mgmt	4x GbE RJ-45 LOM	None	1x LOM, 1x RAID slot, 1x PCIe x8 LP	3x PCIe x8 FHHL	None	None	TPM 1.2	XClarity Standard	1x 750W Platinum	None	3-year	07/17
7X06A007CN	HTK	1x Xeon Gold 5122 4C/3.6GHz/16.5MB/105W/DDR4-2666	1x 16GB RDIMM DDR4-2666 (2Rx8)	1x 930-8i 2GB Flash	16x 2.5"	8x 2.5" SATA/SA S HS	Open	None	None	None	1x Mgmt	4x GbE RJ-45 LOM	None	1x LOM, 1x RAID slot, 1x PCIe x8 LP	3x PCIe x8 FHHL	None	None	TPM 1.2	XClarity Standard	1x 750W Platinum	None	3-year	07/17
7X06A003CN	HTK	1x Xeon Gold 5118 12C/2.3GHz/16.5MB/105W/DDR4-2400	1x 16GB RDIMM DDR4-2666 (2Rx8)	1x 930-8i 2GB Flash	16x 2.5"	8x 2.5" SATA/SA S HS	Open	None	None	None	1x Mgmt	4x GbE RJ-45 LOM	None	1x LOM, 1x RAID slot, 1x PCIe x8 LP	3x PCIe x8 FHHL	None	None	TPM 1.2	XClarity Standard	1x 750W Platinum	None	3-year	07/17
7X06A005CN	HTK	1x Xeon Gold 5120 14C/2.2GHz/19.25MB/105W/DDR4-2400	1x 16GB RDIMM DDR4-2666 (2Rx8)	1x 930-8i 2GB Flash	16x 2.5"	8x 2.5" SATA/SA S HS	Open	None	None	None	1x Mgmt	4x GbE RJ-45 LOM	None	1x LOM, 1x RAID slot, 1x PCIe x8 LP	3x PCIe x8 FHHL	None	None	TPM 1.2	XClarity Standard	1x 750W Platinum	None	3-year	07/17

Model	Region	Processor	Memory	Storage Controller	Chassis	Disk Bays	Disk S	M.2 Drives	PCIe Flash Adapter	GPU	Onboard Networking Ports	Additional Networking (LOM/ML2/PCIe)	Fibre Channel I/O	Standard Extension Slots	Available Extension Slots via Riser Cards	Front VGA	Optical	TPM	System Management	Power Supply	Preload	Warranty	Ann Date (mm/yy)
7X06A00FSG	INDIA	1x Xeon Gold 5115 10C/2.4GHz/13.75MB/85W/DDR4-2400	1x 16GB RDIMM DDR4-2666 (2Rx8)	1x 530-8i	16x 2.5"	8x 2.5" SATA/SAS HS	Open	None	None	None	1x Mgmt	4x GbE RJ-45 LOM	None	1x LOM, 1x RAID slot, 1x PCIe x8 LP	None	None	None	TPM 1.2	XClarity Standard	1x 550W Platinum	None	3-year	07/17
7X06A00ASG	INDIA	1x Xeon Gold 5118 12C/2.3GHz/16.5MB/105W/DDR4-2400	1x 16GB RDIMM DDR4-2666 (2Rx8)	1x 930-8i 2GB Flash	16x 2.5"	8x 2.5" SATA/SAS HS	Open	None	None	None	1x Mgmt	4x GbE RJ-45 LOM	None	1x LOM, 1x RAID slot, 1x PCIe x8 LP	None	None	None	TPM 1.2	XClarity Standard	1x 750W Platinum	None	3-year	07/17
7X06A00CSG	INDIA	1x Xeon Gold 5118 12C/2.3GHz/16.5MB/105W/DDR4-2400	1x 16GB RDIMM DDR4-2666 (2Rx8)	1x 930-8i 2GB Flash	12x 3.5"	None	None	None	None	None	1x Mgmt	4x GbE RJ-45 LOM	None	1x LOM, 1x RAID slot, 1x PCIe x8 LP	None	None	None	TPM 1.2	XClarity Standard	1x 750W Platinum	None	3-year	07/17
7X06A00JSG	INDIA	1x Xeon Gold 5115 10C/2.4GHz/13.75MB/85W/DDR4-2400	1x 8GB RDIMM DDR4-2666 (1Rx8)	1x 530-8i	16x 2.5"	8x 2.5" SATA/SAS HS	Open	None	None	None	1x Mgmt	4x GbE RJ-45 LOM	None	1x LOM, 1x RAID slot, 1x PCIe x8 LP	None	None	None	TPM 1.2	XClarity Standard	1x 550W Platinum	None	3-year	07/17
7X06A00WSG	INDIA	1x Xeon Platinum 8160 24C/2.1GHz/33MB/150W/DDR4-2666	1x 16GB RDIMM DDR4-2666 (2Rx8)	1x 930-16i 4GB Flash	16x 2.5"	16x 2.5" SATA/SAS HS	Open	None	None	None	1x Mgmt	4x GbE RJ-45 LOM	None	1x LOM, 1x RAID slot, 1x PCIe x8 LP	None	None	None	TPM 1.2	XClarity Standard	1x 1100W Platinum	None	3-year	07/17
7X06A00XSG	INDIA	1x Xeon Gold 6140 18C/2.3GHz/24.75MB/140W/DDR4-2666	1x 16GB RDIMM DDR4-2666 (2Rx8)	1x 930-8i 2GB Flash	16x 2.5"	8x 2.5" SATA/SAS HS	Open	None	None	None	1x Mgmt	4x GbE RJ-45 LOM	None	1x LOM, 1x RAID slot, 1x PCIe x8 LP	None	None	None	TPM 1.2	XClarity Standard	1x 1100W Platinum	None	3-year	07/17
7X06A00YSG	INDIA	1x Xeon Gold 6130 16C/2.1GHz/22MB/125W/DDR4-2666	1x 16GB RDIMM DDR4-2666 (2Rx8)	1x 930-8i 2GB Flash	16x 2.5"	8x 2.5" SATA/SAS HS	Open	None	None	None	1x Mgmt	4x GbE RJ-45 LOM	None	1x LOM, 1x RAID slot, 1x PCIe x8 LP	None	None	None	TPM 1.2	XClarity Standard	1x 750W Platinum	None	3-year	07/17
7X06A00RSG	INDIA	1x Xeon Gold 5120 14C/2.2GHz/19.25MB/105W/DDR4-2400	1x 16GB RDIMM DDR4-2666 (2Rx8)	1x 930-16i 4GB Flash	16x 2.5"	16x 2.5" SATA/SAS HS	Open	None	None	None	1x Mgmt	4x GbE RJ-45 LOM	None	1x LOM, 1x RAID slot, 1x PCIe x8 LP	None	None	None	TPM 1.2	XClarity Standard	1x 750W Platinum	None	3-year	07/17
7X06A00SSG	INDIA	1x Xeon Gold 5120 14C/2.2GHz/19.25MB/105W/DDR4-2400	1x 16GB RDIMM DDR4-2666 (2Rx8)	1x 930-8i 2GB Flash	16x 2.5"	8x 2.5" SATA/SAS HS	Open	None	None	None	1x Mgmt	4x GbE RJ-45 LOM	None	1x LOM, 1x RAID slot, 1x PCIe x8 LP	None	None	None	TPM 1.2	XClarity Standard	1x 750W Platinum	None	3-year	07/17
7X06A00TSG	INDIA	1x Xeon Gold 5118 12C/2.3GHz/16.5MB/105W/DDR4-2400	1x 16GB RDIMM DDR4-2666 (2Rx8)	1x 930-16i 4GB Flash	12x 3.5"	12x 3.5" SATA/SAS HS	Open	None	None	None	1x Mgmt	4x GbE RJ-45 LOM	None	1x LOM, 1x RAID slot, 1x PCIe x8 LP	None	None	None	TPM 1.2	XClarity Standard	1x 750W Platinum	None	3-year	07/17

Model	Region	Processor	Memory	Storage Controller	Chassis	Disk Bays	Disk S	M.2 Drives	PCIe Flash Adapter	GPU	Onboard Networking Ports	Additional Networking (LOM/ML2/PCIe)	Fibre Channel I/O	Standard Extension Slots	Available Extension Slots via Riser Cards	Front VGA	Optical	TPM	System Management	Power Supply	Preload	Warranty	Ann Date (mm/yy)
7X06A01JJP	JAPAN	1x Xeon Bronze 3104 6C/1.7GHz/8.25MB/85W/DDR4-2133	1x 16GB RDIMM DDR4-2666 (1Rx4)	1x 930-8i 2GB Flash	24x 2.5"	8x 2.5" SATA/SAS HS	Open	None	None	None	1x Mgmt	4x GbE RJ-45 LOM	None	1x LOM, 1x RAID slot, 1x PCIe x8 LP	3x PCIe x8 FHHL	None	None	TPM 1.2	XClarity Advanced	1x550W Platinum	None	3-year	07/17
7X06A05JJP	JAPAN	1x Xeon Platinum 8160 24C/2.1GHz/33MB/150W/DDR4-2666	1x 16GB RDIMM DDR4-2666 (1Rx4)	1x 930-24i 4GB Flash	24x 2.5"	8x 2.5" HS (4 SATA/SAS, 4 AnyBay) 2x8 x 2.5" SATA/SAS HS	Open	None	None	None	1x Mgmt	4x 10GbE RJ-45 LOM	None	1x LOM, 1x RAID slot, 1x PCIe x8 LP	3x PCIe x8 FHHL	Front VGA	None	TPM 1.2	XClarity Advanced	1x1600W Platinum	None	3-year	07/17
7X06A058JP	JAPAN	1x Xeon Gold 5122 4C/3.6GHz/16.5MB/105W/DDR4-2666	1x 16GB RDIMM DDR4-2666 (1Rx4)	1x 930-8i 2GB Flash	24x 2.5"	8x 2.5" SATA/SAS HS	Open	None	None	None	1x Mgmt	4x 10GbE RJ-45 LOM	None	1x LOM, 1x RAID slot, 1x PCIe x8 LP	3x PCIe x8 FHHL	Front VGA	None	TPM 1.2	XClarity Advanced	1x750W Platinum	None	3-year	07/17
7X06A05YJP	JAPAN	1x Xeon Platinum 8180 28C/2.5GHz/38.5MB/205W/DDR4-2666	1x 16GB RDIMM DDR4-2666 (1Rx4)	1x 930-8i 2GB Flash	24x 2.5"	8x 2.5" SATA/SAS HS	Open	None	None	None	1x Mgmt	4x 10GbE RJ-45 LOM	None	1x LOM, 1x RAID slot, 1x PCIe x8 LP	3x PCIe x8 FHHL	Front VGA	None	TPM 1.2	XClarity Advanced	1x1100W Platinum	None	3-year	07/17
7X06A056JP	JAPAN	1x Xeon Gold 6134 8C/3.2GHz/24.75MB/130W/DDR4-2666	1x 16GB RDIMM DDR4-2666 (1Rx4)	1x 930-24i 4GB Flash	24x 2.5"	8x 2.5" HS (4 SATA/SAS, 4 AnyBay) 2x8 x 2.5" SATA/SAS HS	Open	None	None	None	1x Mgmt	4x 10GbE RJ-45 LOM	None	1x LOM, 1x RAID slot, 1x PCIe x8 LP	3x PCIe x8 FHHL	Front VGA	None	TPM 1.2	XClarity Advanced	1x1100W Platinum	None	3-year	07/17
7X06A07TJP	JAPAN	1x Xeon Silver 4108 8C/1.8GHz/11MB/85W/DDR4-2400	1x 16GB RDIMM DDR4-2666 (1Rx4)	1x 930-8i 2GB Flash	24x 2.5"	8x 2.5" SATA/SAS HS	Open	None	None	None	1x Mgmt	4x GbE RJ-45 LOM	None	1x LOM, 1x RAID slot, 1x PCIe x8 LP	3x PCIe x8 FHHL	None	None	TPM 1.2	XClarity Advanced	1x550W Platinum	None	3-year	08/17
7X06A07UJP	JAPAN	1x Xeon Silver 4110 8C/2.1GHz/11MB/85W/DDR4-2400	1x 16GB RDIMM DDR4-2666 (1Rx4)	1x 930-16i 4GB Flash	12x 3.5"	12x 3.5" SATA/SAS HS	Open	None	None	None	1x Mgmt	4x GbE RJ-45 LOM	None	1x LOM, 1x RAID slot, 1x PCIe x8 LP	3x PCIe x8 FHHL	None	None	TPM 1.2	XClarity Advanced	1x750W Platinum	None	3-year	08/17
7X06A09LJP	JAPAN	2x Xeon Gold 6136 12C/3.0GHz/24.75MB/150W/DDR4-2666	2x 16GB RDIMM DDR4-2666 (2Rx8)	1x 930-8i 2GB Flash	16x 2.5"	8x 2.5" SATA/SAS HS	Open	None	None	None	1x Mgmt	4x 10GbE RJ-45 LOM	None	1x LOM, 1x RAID slot, 1x PCIe x8 LP	2x PCIe x16 FHFL, 1x PCIe x16 FHHL, 1x PCIe x8 FHHL	None	None	TPM 1.2	XClarity Advanced	2x1600W Platinum	None	3-year	02/18
7X06A09MJP	JAPAN	2x Xeon Gold 6134 8C/3.2GHz/24.75MB/130W/DDR4-2666	2x 16GB RDIMM DDR4-2666 (2Rx8)	1x 930-8i 2GB Flash	16x 2.5"	8x 2.5" SATA/SAS HS	Open	None	None	None	1x Mgmt	4x 10GbE RJ-45 LOM	None	1x LOM, 1x RAID slot, 1x PCIe x8 LP	2x PCIe x16 FHFL, 1x PCIe x16 FHHL, 1x PCIe x8 FHHL	None	None	TPM 1.2	XClarity Advanced	2x1600W Platinum	None	3-year	02/18
7X06A08RJP	JAPAN	1x Xeon Gold 6136 12C/3.0GHz/24.75MB/150W/DDR4-2666	1x 16GB RDIMM DDR4-2666 (2Rx8)	1x 930-8i 2GB Flash	24x 2.5"	8x 2.5" SATA/SAS HS	Open	None	None	None	1x Mgmt	4x GbE RJ-45 LOM	None	1x LOM, 1x RAID slot, 1x PCIe x8 LP	3x PCIe x8 FHHL	None	None	TPM 1.2	XClarity Advanced	1x1100W Platinum	None	3-year	11/17

Model	Region	Processor	Memory	Storage Controller	Chassis	Disk Bays	Disk S	M.2 Drives	PCIe Flash Adapter	GPU	Onboard Networking Ports	Additional Networking (LOM/ML2/PCIe)	Fibre Channel I/O	Standard Extension Slots	Available Extension Slots via Riser Cards	Front VGA	Optical	TPM	System Management	Power Supply	Preload	Warranty	Ann Date (mm/yy)
7X06A08SJP	JAPAN	1x Xeon Silver 4114 10C/2.2GHz/13.75MB/85W/DDR4-2400	1x 16GB RDIMM DDR4-2666 (2Rx8)	1x 930-8i 2GB Flash	24x 2.5"	8x 2.5" SATA/SA S HS	Open	None	None	None	1x Mgmt	4x GbE RJ-45 LOM	None	1x LOM, 1x RAID slot, 1x PCIe x8 LP	3x PCIe x8 FHHL	None	None	TPM 1.2	XClarity Advanced	1x750W Platinum	None	3-year	11/17
7X06A08TJP	JAPAN	1x Xeon Gold 5118 12C/2.3GHz/16.5MB/105W/DDR4-2400	1x 16GB RDIMM DDR4-2666 (2Rx8)	1x 930-8i 2GB Flash	24x 2.5"	8x 2.5" SATA/SA S HS	Open	None	None	None	1x Mgmt	4x GbE RJ-45 LOM	None	1x LOM, 1x RAID slot, 1x PCIe x8 LP	3x PCIe x8 FHHL	None	None	TPM 1.2	XClarity Advanced	1x750W Platinum	None	3-year	11/17
7X06A08UJP	JAPAN	1x Xeon Gold 6142 16C/2.6GHz/22MB/150W/DDR4-2666	1x 16GB RDIMM DDR4-2666 (2Rx8)	1x 930-8i 2GB Flash	24x 2.5"	8x 2.5" SATA/SA S HS	Open	None	None	None	1x Mgmt	4x GbE RJ-45 LOM	None	1x LOM, 1x RAID slot, 1x PCIe x8 LP	3x PCIe x8 FHHL	None	None	TPM 1.2	XClarity Advanced	1x1100W Platinum	None	3-year	11/17
7X06A08VJP	JAPAN	1x Xeon Gold 6154 18C/3.0GHz/24.75MB/200W/DDR4-2666	1x 16GB RDIMM DDR4-2666 (2Rx8)	1x 930-8i 2GB Flash	24x 2.5"	8x 2.5" SATA/SA S HS	Open	None	None	None	1x Mgmt	4x GbE RJ-45 LOM	None	1x LOM, 1x RAID slot, 1x PCIe x8 LP	3x PCIe x8 FHHL	None	None	TPM 1.2	XClarity Advanced	1x1100W Platinum	None	3-year	11/17
7X06A08WJP	JAPAN	1x Xeon Gold 6130 16C/2.1GHz/22MB/125W/DDR4-2666	1x 16GB RDIMM DDR4-2666 (2Rx8)	1x 930-8i 2GB Flash	24x 2.5"	8x 2.5" SATA/SA S HS	Open	None	None	None	1x Mgmt	4x GbE RJ-45 LOM	None	1x LOM, 1x RAID slot, 1x PCIe x8 LP	3x PCIe x8 FHHL	None	None	TPM 1.2	XClarity Advanced	1x750W Platinum	None	3-year	11/17

Model	Region	Processor	Memory	Storage Controller	Chassis	Disk Bays	Disk S	M.2 Drives	PCIe Flash Adapter	GPU	Onboard Networking Ports	Additional Networking (LOM/ML2/PCIe)	Fibre Channel I/O	Standard Extension Slots	Available Extension Slots via Riser Cards	Front VGA	Optical	TPM	System Management	Power Supply	Preload	Warranty	Ann Date (mm/yy)
7X06A02NLA	LA	1x Xeon Gold 6130 16C/2.1GHz/22MB/125W/DDR4-2666	1x 16GB RDIMM DDR4-2666 (2Rx8)	1x 930-8i 2GB Flash	16x 2.5"	8x 2.5" SATA/SA S HS	Open	None	None	None	1x Mgmt	None	None	1x LOM, 1x RAID slot, 1x PCIe x8 LP	3x PCIe x8 FHHL	Front VGA	None	TPM 1.2	XClarity Standard	1x 1100W Platinum	None	3-year	07/17
7X06A02ALA	LA	1x Xeon Gold 5120 14C/2.2GHz/19.25MB/105W/DDR4-2400	1x 16GB RDIMM DDR4-2666 (2Rx8)	1x 930-8i 2GB Flash	16x 2.5"	8x 2.5" SATA/SA S HS	Open	None	None	None	1x Mgmt	None	None	1x LOM, 1x RAID slot, 1x PCIe x8 LP	3x PCIe x8 FHHL	Front VGA	None	TPM 1.2	XClarity Standard	1x 750W Platinum	None	3-year	07/17
7X06A023LA	LA	1x Xeon Gold 6130 16C/2.1GHz/22MB/125W/DDR4-2666	1x 16GB RDIMM DDR4-2666 (2Rx8)	1x 930-8i 2GB Flash	16x 2.5"	8x 2.5" SATA/SA S HS	Open	None	None	None	1x Mgmt	None	None	1x LOM, 1x RAID slot, 1x PCIe x8 LP	3x PCIe x8 FHHL	Front VGA	None	TPM 1.2	XClarity Standard	1x 1100W Platinum	None	3-year	07/17
7X06A026LA	LA	1x Xeon Gold 6148 20C/2.4GHz/27.5MB/150W/DDR4-2666	1x 16GB RDIMM DDR4-2666 (2Rx8)	1x 930-8i 2GB Flash	16x 2.5"	8x 2.5" SATA/SA S HS	Open	None	None	None	1x Mgmt	None	None	1x LOM, 1x RAID slot, 1x PCIe x8 LP	3x PCIe x8 FHHL	Front VGA	None	TPM 1.2	XClarity Standard	1x 1100W Platinum	None	3-year	07/17
7X06A01WLA	LA	1x Xeon Platinum 8160 24C/2.1GHz/33MB/150W/DDR4-2666	1x 16GB RDIMM DDR4-2666 (2Rx8)	1x 930-8i 2GB Flash	16x 2.5"	8x 2.5" SATA/SA S HS	Open	None	None	None	1x Mgmt	None	None	1x LOM, 1x RAID slot, 1x PCIe x8 LP	3x PCIe x8 FHHL	Front VGA	None	TPM 1.2	XClarity Standard	1x 1100W Platinum	None	3-year	07/17
7X06A00VLA	LA	1x Xeon Gold 6140 18C/2.3GHz/24.75MB/140W/DDR4-2666	1x 16GB RDIMM DDR4-2666 (2Rx8)	1x 930-8i 2GB Flash	16x 2.5"	8x 2.5" SATA/SA S HS	Open	None	None	None	1x Mgmt	None	None	1x LOM, 1x RAID slot, 1x PCIe x8 LP	3x PCIe x8 FHHL	Front VGA	None	TPM 1.2	XClarity Standard	1x 1100W Platinum	None	3-year	07/17
7X06A01CLA	LA	1x Xeon Gold 6148 20C/2.4GHz/27.5MB/150W/DDR4-2666	1x 16GB RDIMM DDR4-2666 (2Rx8)	1x 930-8i 2GB Flash	16x 2.5"	8x 2.5" SATA/SA S HS	Open	None	None	None	1x Mgmt	None	None	1x LOM, 1x RAID slot, 1x PCIe x8 LP	3x PCIe x8 FHHL	Front VGA	None	TPM 1.2	XClarity Standard	1x 1100W Platinum	None	3-year	07/17
7X06A016LA	LA	1x Xeon Platinum 8160 24C/2.1GHz/33MB/150W/DDR4-2666	1x 16GB RDIMM DDR4-2666 (2Rx8)	1x 930-8i 2GB Flash	16x 2.5"	8x 2.5" SATA/SA S HS	Open	None	None	None	1x Mgmt	None	None	1x LOM, 1x RAID slot, 1x PCIe x8 LP	3x PCIe x8 FHHL	Front VGA	None	TPM 1.2	XClarity Standard	1x 1100W Platinum	None	3-year	07/17
7X06A006LA	LA	1x Xeon Gold 5120 14C/2.2GHz/19.25MB/105W/DDR4-2400	1x 16GB RDIMM DDR4-2666 (2Rx8)	1x 930-8i 2GB Flash	16x 2.5"	8x 2.5" SATA/SA S HS	Open	None	None	None	1x Mgmt	None	None	1x LOM, 1x RAID slot, 1x PCIe x8 LP	3x PCIe x8 FHHL	Front VGA	None	TPM 1.2	XClarity Standard	1x 750W Platinum	None	3-year	07/17
7X06A008LA	LA	1x Xeon Gold 6140 18C/2.3GHz/24.75MB/140W/DDR4-2666	1x 16GB RDIMM DDR4-2666 (2Rx8)	1x 930-8i 2GB Flash	16x 2.5"	8x 2.5" SATA/SA S HS	Open	None	None	None	1x Mgmt	None	None	1x LOM, 1x RAID slot, 1x PCIe x8 LP	3x PCIe x8 FHHL	Front VGA	None	TPM 1.2	XClarity Standard	1x 1100W Platinum	None	3-year	07/17

Model	Region	Processor	Memory	Storage Controller	Chassis	Disk Bays	Disk S	M.2 Drives	PCIe Flash Adapter	GPU	Onboard Networking Ports	Additional Networking (LOM/ML2/PCIe)	Fibre Channel I/O	Standard Extension Slots	Available Extension Slots via Riser Cards	Front VGA	Optical	TPM	System Management	Power Supply	Preload	Warranty	Ann Date (mm/yy)
7X06A03KNA	NA	1x Xeon Gold 6148 20C/2.4GHz/27.5MB/150W/DDR4-2666	1x 32GB RDIMM DDR4-2666 (2Rx4)	1x 930-8i 2GB Flash	24x 2.5"	8x 2.5" SATA/SA S HS	Open	None	None	None	1x Mgmt	None	None	1x LOM, 1x RAID slot, 1x PCIe x8 LP	None	None	None	TPM 1.2	XClarity Standard	1x 1100W Platinum	None	3-year	07/17
7X06A03GNA	NA	1x Xeon Gold 5115 10C/2.4GHz/13.75MB/85W/DDR4-2400	1x 16GB RDIMM DDR4-2666 (2Rx8)	1x 930-8i 2GB Flash	24x 2.5"	8x 2.5" SATA/SA S HS	Open	None	None	None	1x Mgmt	None	None	1x LOM, 1x RAID slot, 1x PCIe x8 LP	None	None	None	TPM 1.2	XClarity Standard	1x 750W Platinum	None	3-year	07/17
7X06A03DNA	NA	1x Xeon Platinum 8164 26C/2.0GHz/35.75MB/150W/DDR4-2666	1x 32GB RDIMM DDR4-2666 (2Rx4)	1x 930-8i 2GB Flash	24x 2.5"	8x 2.5" SATA/SA S HS	Open	None	None	None	1x Mgmt	None	None	1x LOM, 1x RAID slot, 1x PCIe x8 LP	None	None	None	TPM 1.2	XClarity Standard	1x 1100W Platinum	None	3-year	07/17
7X06A039NA	NA	1x Xeon Gold 6130 16C/2.1GHz/22MB/125W/DDR4-2666	1x 32GB RDIMM DDR4-2666 (2Rx4)	1x 930-8i 2GB Flash	24x 2.5"	8x 2.5" SATA/SA S HS	Open	None	None	None	1x Mgmt	None	None	1x LOM, 1x RAID slot, 1x PCIe x8 LP	None	None	None	TPM 1.2	XClarity Standard	1x 750W Platinum	None	3-year	07/17
7X06A02CNA	NA	1x Xeon Gold 6126 12C/2.6GHz/19.25MB/125W/DDR4-2666	1x 32GB RDIMM DDR4-2666 (2Rx4)	None	24x 2.5"	None	None	None	None	None	1x Mgmt	None	None	1x LOM, 1x RAID slot, 1x PCIe x8 LP	None	Front VGA	None	TPM 1.2	XClarity Standard	1x 750W Platinum	None	3-year	07/17
7X06A02ZNA	NA	1x Xeon Gold 6152 22C/2.1GHz/30.25MB/140W/DDR4-2666	1x 32GB RDIMM DDR4-2666 (2Rx4)	1x 930-8i 2GB Flash	24x 2.5"	8x 2.5" SATA/SA S HS	Open	None	None	None	1x Mgmt	None	None	1x LOM, 1x RAID slot, 1x PCIe x8 LP	None	None	None	TPM 1.2	XClarity Standard	1x 1100W Platinum	None	3-year	07/17
7X06A030NA	NA	1x Xeon Gold 5120 14C/2.2GHz/19.25MB/105W/DDR4-2400	1x 16GB RDIMM DDR4-2666 (2Rx8)	1x 930-8i 2GB Flash	24x 2.5"	8x 2.5" SATA/SA S HS	Open	None	None	None	1x Mgmt	None	None	1x LOM, 1x RAID slot, 1x PCIe x8 LP	None	None	None	TPM 1.2	XClarity Standard	1x 750W Platinum	None	3-year	07/17
7X06A031NA	NA	1x Xeon Platinum 8160 24C/2.1GHz/33MB/150W/DDR4-2666	1x 32GB RDIMM DDR4-2666 (2Rx4)	1x 930-8i 2GB Flash	24x 2.5"	8x 2.5" SATA/SA S HS	Open	None	None	None	1x Mgmt	None	None	1x LOM, 1x RAID slot, 1x PCIe x8 LP	None	None	None	TPM 1.2	XClarity Standard	1x 1100W Platinum	None	3-year	07/17
7X06A032NA	NA	1x Xeon Gold 6142 16C/2.6GHz/22MB/150W/DDR4-2666	1x 32GB RDIMM DDR4-2666 (2Rx4)	1x 930-8i 2GB Flash	24x 2.5"	8x 2.5" SATA/SA S HS	Open	None	None	None	1x Mgmt	None	None	1x LOM, 1x RAID slot, 1x PCIe x8 LP	None	None	None	TPM 1.2	XClarity Standard	1x 1100W Platinum	None	3-year	07/17
7X06A02TNA	NA	1x Xeon Gold 6134 8C/3.2GHz/24.75MB/130W/DDR4-2666	1x 32GB RDIMM DDR4-2666 (2Rx4)	1x 930-8i 2GB Flash	24x 2.5"	8x 2.5" SATA/SA S HS	Open	None	None	None	1x Mgmt	None	None	1x LOM, 1x RAID slot, 1x PCIe x8 LP	None	None	None	TPM 1.2	XClarity Standard	1x 750W Platinum	None	3-year	07/17

Model	Region	Processor	Memory	Storage Controller	Chassis	Disk Bays	Disks	M.2 Drives	PCIe Flash Adapter	GPU	Onboard Networking Ports	Additional Networking (LOM/ML2/PCIe)	Fibre Channel I/O	Standard Extension Slots	Available Extension Slots via Riser Cards	Front VGA	Optical	TPM	System Management	Power Supply	Preloaded	Warranty	Ann Date (mm/yy)
7X06A02UNA	NA	1x Xeon Gold 6150 18C/2.7GHz/24.75MB/165W/DDR4-2666	1x 32GB RDIMM DDR4-2666 (2Rx4)	1x 930-8i 2GB Flash	24x 2.5"	8x 2.5" SATA/SAS HS	Open	None	None	None	1x Mgmt	None	None	1x LOM, 1x RAID slot, 1x PCIe x8 LP	None	None	None	TPM 1.2	XClarity Standard	1x 1100W Platinum	None	3-year	07/17
7X06A02VNA	NA	1x Xeon Gold 6140 18C/2.3GHz/24.75MB/140W/DDR4-2666	1x 32GB RDIMM DDR4-2666 (2Rx4)	1x 930-8i 2GB Flash	24x 2.5"	8x 2.5" SATA/SAS HS	Open	None	None	None	1x Mgmt	None	None	1x LOM, 1x RAID slot, 1x PCIe x8 LP	None	None	None	TPM 1.2	XClarity Standard	1x 1100W Platinum	None	3-year	07/17
7X06A03ZNA	NA	1x Xeon Gold 5118 12C/2.3GHz/16.5MB/105W/DDR4-2400	1x 16GB RDIMM DDR4-2666 (2Rx8)	1x 930-8i 2GB Flash	24x 2.5"	8x 2.5" SATA/SAS HS	Open	None	None	None	1x Mgmt	None	None	1x LOM, 1x RAID slot, 1x PCIe x8 LP	None	None	None	TPM 1.2	XClarity Standard	1x 750W Platinum	None	3-year	07/17
7X06A040NA	NA	1x Xeon Gold 6134 8C/3.2GHz/24.75MB/130W/DDR4-2666	1x 32GB RDIMM DDR4-2666 (2Rx4)	1x 930-8i 2GB Flash	24x 2.5"	8x 2.5" SATA/SAS HS	Open	None	None	None	1x Mgmt	None	None	1x LOM, 1x RAID slot, 1x PCIe x8 LP	None	None	None	TPM 1.2	XClarity Standard	1x 1100W Platinum	None	3-year	07/17
7X06A043NA	NA	2x Xeon Gold 5120 14C/2.2GHz/19.25MB/105W/DDR4-2400	2x 32GB RDIMM DDR4-2666 (2Rx4)	1x 430-16i	24x 2.5"	8x 2.5" HS (4 SATA/SAS, 4 AnyBay) x 2.5" SATA/SAS HS	Open	None	None	None	1x Mgmt	None	None	1x LOM, 1x RAID slot, 1x PCIe x8 LP	3x PCIe x8 FHHL, 1x PCIe x16 FHFL, 1x PCIe x16 FHHL	None	None	TPM 1.2	XClarity Enterprise	2x 1100W Platinum	None	3-year	07/17
7X06A09NNA	NA	2x Xeon Platinum 8176 28C/2.1GHz/38.5MB/165W/DDR4-2666	24x 32GB RDIMM DDR4-2666 (2Rx4)	1x 930-8i 2GB Flash	16x 2.5"	8x 2.5" HS (4 SATA/SAS, 4 AnyBay)	4x 800GB SSD SAS12Gbps, 2x 480GB SSD SATA6Gbps	None	4x 3.84TB PCIe 3.0 x4 HHHH	None	1x Mgmt	None	None	1x LOM, 1x RAID slot, 1x PCIe x8 LP	2x PCIe x8 FHHL, 1x ML2 x8 FHHL, 1x PCIe x16 FHFL, 1x PCIe x16 FHHL	None	None	TPM 1.2	XClarity Standard	2x 1100W Platinum	None	3-year	04/18
7X06A09FNA	NA	2x Xeon Platinum 8176 28C/2.1GHz/38.5MB/165W/DDR4-2666	24x 32GB RDIMM DDR4-2666 (2Rx4)	1x 930-8i 2GB Flash	16x 2.5"	8x 2.5" HS (4 SATA/SAS, 4 AnyBay)	4x 800GB SSD SAS12Gbps, 2x 480GB SSD SATA6Gbps	None	4x 3.84TB PCIe 3.0 x4 HHHH	None	1x Mgmt	None	None	1x LOM, 1x RAID slot, 1x PCIe x8 LP	2x PCIe x8 FHHL, 1x ML2 x8 FHHL, 1x PCIe x16 FHFL, 1x PCIe x16 FHHL	None	None	TPM 1.2	XClarity Standard	2x 1100W Platinum	None	3-year	02/18
7X06A09GNA	NA	2x Xeon Platinum 8160 24C/2.1GHz/33MB/150W/DDR4-2666	24x 16GB RDIMM DDR4-2666 (1Rx4)	1x 930-8i 2GB Flash	16x 2.5"	8x 2.5" HS (4 SATA/SAS, 4 AnyBay)	2x 300GB HDD 10K 2.5" SAS12Gbps, 6x 800GB SSD SAS12Gbps	None	4x 3.84TB PCIe 3.0 x4 HHHH	None	1x Mgmt	None	None	1x LOM, 1x RAID slot, 1x PCIe x8 LP	2x PCIe x8 FHHL, 1x ML2 x8 FHHL, 1x PCIe x16 FHFL, 1x PCIe x16 FHHL	None	None	TPM 1.2	XClarity Standard	2x 1100W Platinum	None	3-year	02/18
7X06A046NA	NA	1x Xeon Gold 6126 12C/2.6GHz/19.25MB/125W/DDR4-2666	1x 32GB RDIMM DDR4-2666 (2Rx4)	1x 930-8i 2GB Flash	24x 2.5"	8x 2.5" SATA/SAS HS	Open	None	None	None	1x Mgmt	None	None	1x LOM, 1x RAID slot, 1x PCIe x8 LP	None	None	None	TPM 1.2	XClarity Standard	1x 750W Platinum	None	3-year	07/17

Model	Region	Processor	Memory	Storage Controller	Chassis	Disk Bays	Disk S	M.2 Drives	PCIe Flash Adapter	GPU	Onboard Networking Ports	Additional Networking (LOM/ML2/PCIe)	Fibre Channel I/O	Standard Extension Slots	Available Extension Slots via Riser Cards	Front VGA	Optical	TPM	System Management	Power Supply	Preload	Warranty	Ann Date (mm/yy)
7X06A02HC N	Taiwan	1x Xeon Gold 5115 10C/2.4GHz/13.75MB/85W/DDR4-2400	1x 16GB RDIMM DDR4-2666 (2Rx8)	1x 930-16i 4GB Flash	16x 2.5"	16x 2.5" SATA/SAS HS	Open	None	None	None	1x Mgmt	4x GbE RJ-45 LOM	None	1x LOM, 1x RAID slot, 1x PCIe x8 LP	3x PCIe x8 FHHL	None	None	TPM 1.2	XClarity Standard	1x 750W Platinum	None	3-year	07/17



ThinkSystem ST550 Platform Specifications

Product Specifications Reference (PSREF)

Components	Specification	
Form factor	Tower or 4U rack	
Dimensions	Without foot stands and security door: Height: 425.5 mm (16.8 in). Width: 175.8 mm (6.92 in). Depth: 666.4 mm (26.24 in)	
Weight	Maximum configuration: 81.35 lb (36.9 kg)	
Processor	Up to two 125W Intel Xeon Scalable family processors, Bronze, Silver, Gold, or Platinum. Up to 20 cores at 2.0GHz, up to 3.6GHz with 4 cores. Two processors are connected with two UPI (Ultra Path Interconnect) links up to 10.4GT/s	
Chipset	Intel C621 Platform Controller Hub	
Memory	Up to 12 DIMM sockets. Each processor supports up to 6 DIMM sockets with 6 channels. DDR4-2666. RDIMMs and LRDIMMs are supported, but memory types cannot be intermixed	
Memory capacity	With RDIMMs: Up to 384GB with 12 x 32 GB RDIMMs and two processors With LRDIMMs: Up to 768GB with 12 x 64 GB LRDIMMs and two processors	
Memory protection	ECC, memory mirroring, and memory sparing	
Storage controllers	Supports the following RAID/HBA adapters:	
Note: 730-8i is available in China only. All RAID/HBA adapters should be placed in slot 1 firstly.		
Disk drive bays	Supports 4 or 8 front 3.5" SATA simple-swap bays. Or 4 or 8 front 3.5" SATA/SAS HS bays. Or 8 or 16 front 2.5" SATA/SAS HS bays with maximum 4 AnyBay. Optional 4 front 2.5" HS bays are supported on hot-swap models, takes place in two 5.25" bays location Optional one or two internal M.2 SSD for boot, dual M.2 SSD supports mirroring	
Internal storage	For 3.5" SS bay	
	For 3.5" bay	
	(3.5" disks or 2.5" disks with 3.5" tray)	
	For 2.5" bay	
Optical	Two 5.25" bays for optical and tape drive. Supports DVD-ROM or DVD±RW drives, half-height. Supports LTO-6 SAS, LTO-7 SAS, and RDX USB 3.0 tape drives	
Network interfaces	Integrated one dedicated management port plus two GbE ports. Optional PCIe adapters are supported. NC-SI and Wake-on-LAN are available on GbE port 1 (See right)	
Security features	Power-on and admin password. Trusted Platform Module, TCG 1.2 compliant, upgrade to 2.0 via UEFI setting. Optional TCM in China only. Optional lockable security bezel. Optional chassis intrusion switch	
Operating systems supported	Microsoft Windows Server 2016/2012 R2. Red Hat Enterprise Linux 7.3/6.9. SUSE Linux Enterprise Server 12 SP2/11 SP4. VMware vSphere (ESXi) 6.5/6.0 U3	
Systems management	XClarity Controller Standard, optional upgrades to Advanced or Enterprise are available. Energy Manager. XClarity Administrator. Provisioning Manager. Essentials. LEDs on front panel show the status of power, ID, network, simple-swap disks, and system error	
GPU support	Up to two optional NVIDIA Quadro P2000 or Quadro P6000	

Components	Specification
Base warranty	MT 7X09: 1-year limited onsite service with 9x5/NBD MT 7X10: 3-year limited onsite service with 9x5/NBD
Power supply	Supports one fixed 450W 80 PLUS Gold qualified AC power supply, non-hot-swap, no redundant. Or up to two redundant hot-swap 550W/750W/1100W 80 PLUS Platinum qualified AC power supplies. Or up to two redundant hot-swap 750W Titanium qualified AC power supplies. 750W Titanium is 200V - 240V, others are 100V - 240V
Video	Integrated Matrox G200 in XClarity Controller
Cooling	Up to four fans with one for redundant. Two fans for single processor, three fans for dual processor or single processor with 4 x 2.5" HS bay installed. 4th fan is N + 1 redundant or GPU installed
Front ports	One XClarity Controller USB connector, one USB 3.0
Rear ports	One VGA, two USB 3.0, four USB 2.0, two ethernet (RJ-45), one XClarity Controller network connector. Optional COM port
Environmental specification	Supports ASHRAE A4 with limitations.
Environmental certification	Energy Star Server 2.1 certified. More environmental information please see: www.lenovo.com/social_responsibility/us/en/environment/

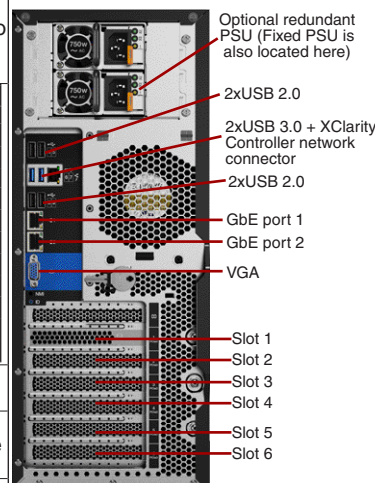

Expansion slots	
Slot 1 (CPU1)	PCIe 3.0 x8, full height, half length
Slot 2 (CPU1)	PCIe 3.0 x16, full height, half length
Slot 3 (CPU1)	PCIe 3.0 x16, full height, full length, double-width
Slot 4 (CPU2)	PCIe 3.0 x16 (x8 elec), full height, full length
Slot 5 (CPU2)	PCIe 3.0 x16, full height, full length, double-width
Slot 6 (CPU1)	PCIe 3.0 x8 (x4 elec), full height, full length

Note: All expansion cards and redundant PSU are optional.

System unique options

7X77A03475	ThinkSystem ST550 2.5" SATA/SAS 4-Bay Backplane Kit
7X77A03476	ThinkSystem ST550 2.5" Anybay 8-Bay Backplane Kit
7TP7A04369	ThinkSystem ST550 2.5" 8-Bay Backplane Kit
7TP7A04370	ThinkSystem ST550 3.5" SATA/SAS 4-Bay Backplane kit
7X77A03481	ThinkSystem ST550 3.5" Simple Swap Bracket Plate
7X77A03484	ThinkSystem ST550 4U Security Bezel
7X77A03485	ThinkSystem ST550 CMA kit
7X77A03488	ThinkSystem ST550 4U Tower to Rack Conversion Kit
7Z17A02577	ThinkSystem ST550 COM Port Upgrade Kit
7XH7A06781	ThinkSystem ST550 Front Mid FAN Module for 4x2.5" ODD conversion
7TP7A04371	ThinkSystem ST550 Rear FAN Module for RDN FAN

Model	Region	Processor	Memory	Storage Controller	Chassis	Disk Bays	Disks	M.2 Drives	GPU	Networking Ports	Onboard Networking	Additional Networking (LOM/ML2/PCle)	Standard Extension Slots	TPM	Intrusion Switch	Security Door	Optical	Optional Ports	Keyboard	System Management	Power Supply	Preload	Warranty	Ann Date (mm/yy)	
7X101000AU	ANZ	1x Xeon Bronze 3106 8C/1.7GHz/11MB/85W/DDR4-2133	1x 16GB RDIMM DDR4-2666 (1Rx4)	1x 930-8i 2GB Flash	16x 2.5"	8x 2.5"	SATA/SAS Open HS	None	None	1x Mgmt, 2x GbE	None	None	1x PCIe x8 FHHL, 1x PCIe x8 FHFL, 1x PCIe x16 FHFL, 1x PCIe x16 FHHL	TPM 1.2	Intrusion Switch	Security door	None	None	None	XClarity Enterprise	1x 750W Platinum	None	3-year	09/17	
7X101001AU	ANZ	1x Xeon Silver 4108 8C/1.8GHz/11MB/85W/DDR4-2400	1x 16GB RDIMM DDR4-2666 (1Rx4)	1x 930-8i 2GB Flash	16x 2.5"	8x 2.5"	SATA/SAS Open HS	None	None	1x Mgmt, 2x GbE	None	None	1x PCIe x8 FHHL, 1x PCIe x8 FHFL, 1x PCIe x16 FHFL, 1x PCIe x16 FHHL	TPM 1.2	Intrusion Switch	Security door	None	None	None	XClarity Enterprise	1x 750W Platinum	None	3-year	09/17	
7X101002AU	ANZ	1x Xeon Silver 4110 8C/2.1GHz/11MB/85W/DDR4-2400	1x 16GB RDIMM DDR4-2666 (1Rx4)	1x 930-8i 2GB Flash	16x 2.5"	8x 2.5"	SATA/SAS Open HS	None	None	1x Mgmt, 2x GbE	None	None	1x PCIe x8 FHHL, 1x PCIe x8 FHFL, 1x PCIe x16 FHFL, 1x PCIe x16 FHHL	TPM 1.2	Intrusion Switch	Security door	None	None	None	XClarity Enterprise	1x 750W Platinum	None	3-year	09/17	
7X101003AU	ANZ	1x Xeon Silver 4116 12C/2.1GHz/16.5MB/85W/DDR4-2400	1x 16GB RDIMM DDR4-2666 (1Rx4)	1x 930-8i 2GB Flash	16x 2.5"	8x 2.5"	SATA/SAS Open HS	None	None	1x Mgmt, 2x GbE	None	None	1x PCIe x8 FHHL, 1x PCIe x8 FHFL, 1x PCIe x16 FHFL, 1x PCIe x16 FHHL	TPM 1.2	Intrusion Switch	Security door	None	None	None	XClarity Enterprise	1x 750W Platinum	None	3-year	09/17	
7X101004AU	ANZ	1x Xeon Gold 5118 12C/2.3GHz/16.5MB/105W/DDR4-2400	1x 16GB RDIMM DDR4-2666 (1Rx4)	1x 930-8i 2GB Flash	16x 2.5"	8x 2.5"	SATA/SAS Open HS	None	None	1x Mgmt, 2x GbE	None	None	1x PCIe x8 FHHL, 1x PCIe x8 FHFL, 1x PCIe x16 FHFL, 1x PCIe x16 FHHL	TPM 1.2	Intrusion Switch	Security door	None	None	None	XClarity Enterprise	1x 1100W Platinum	None	3-year	09/17	
7X101005AU	ANZ	1x Xeon Gold 6130 16C/2.1GHz/22MB/125W/DDR4-2666	1x 32GB RDIMM DDR4-2666 (2Rx4)	1x 930-16i 4GB Flash	16x 2.5"	16x 2.5"	SATA/SAS Open HS	None	None	1x Mgmt, 2x GbE	None	None	1x PCIe x8 FHHL, 1x PCIe x8 FHFL, 1x PCIe x16 FHFL, 1x PCIe x16 FHHL	TPM 1.2	Intrusion Switch	Security door	None	None	None	XClarity Enterprise	1x 1100W Platinum	None	3-year	09/17	
7X101007AU	ANZ	1x Xeon Silver 4110 8C/2.1GHz/11MB/85W/DDR4-2400	2x 16GB RDIMM DDR4-2666 (1Rx4)	1x 930-8i 2GB Flash	16x 2.5"	8x 2.5"	SATA/SAS Open HS	None	None	1x Mgmt, 2x GbE	None	None	1x PCIe x8 FHHL, 1x PCIe x8 FHFL, 1x PCIe x16 FHFL, 1x PCIe x16 FHHL	TPM 1.2	Intrusion Switch	Security door	1x USB DVD±RW	None	None	None	XClarity Enterprise	2x 750W Titanium	None	3-year	09/17
7X101008AU	ANZ	1x Xeon Silver 4110 8C/2.1GHz/11MB/85W/DDR4-2400	1x 16GB RDIMM DDR4-2666 (1Rx4)	1x 930-16i 4GB Flash	16x 2.5"	16x 2.5"	SATA/SAS Open HS	None	None	1x Mgmt, 2x GbE	None	None	1x PCIe x8 FHHL, 1x PCIe x8 FHFL, 1x PCIe x16 FHFL, 1x PCIe x16 FHHL	TPM 1.2	Intrusion Switch	Security door	None	None	None	XClarity Enterprise	1x 1100W Platinum	None	3-year	09/17	

Model	Region	Processor	Memory	Storage Controller	Chassis	Disk Bays	Disks	M.2 Drives	GPU	Networking Ports	Onboard Networking (LOM/ML2/PCIe)	Standard Extension Slots	TPM	Intrusion Switch	Security Door	Optical	Optional Ports	Keyboard	System Management	Power Supply	Preload	Warranty	Ann Date (mm/yy)	
7X101009AU	ANZ	1x Xeon Silver 4108 8C/1.8GHz/11MB/85W/DDR4-2400	1x 16GB RDIMM DDR4-2666 (1Rx4)	1x 930-16i 4GB Flash	16x 2.5"	16x 2.5"	SATA/SAS HS	Open	None	None	1x Mgmt, 2x GbE	None	1x PCIe x8 FHHL, 1x PCIe x8 FHFL, 1x PCIe x16	TPM 1.2	Intrusion Switch	Security door	None	None	None	XClarity Enterprise	1x 1100W Platinum	None	3-year	09/17
7X10100AAU	ANZ	1x Xeon Silver 4110 8C/2.1GHz/11MB/85W/DDR4-2400	1x 16GB RDIMM DDR4-2666 (1Rx4)	1x 530-8i	16x 2.5"	8x 2.5"	SATA/SAS HS	Open	None	None	1x Mgmt, 2x GbE	None	1x PCIe x8 FHHL, 1x PCIe x8 FHFL, 1x PCIe x16	TPM 1.2	Intrusion Switch	Security door	1x USB DVD±RW	None	None	XClarity Enterprise	1x 750W Platinum	None	3-year	09/17
7X10100BAU	ANZ	1x Xeon Bronze 3106 8C/1.7GHz/11MB/85W/DDR4-2133	1x 16GB RDIMM DDR4-2666 (1Rx4)	1x 530-8i	16x 2.5"	8x 2.5"	SATA/SAS HS	Open	None	None	1x Mgmt, 2x GbE	None	1x PCIe x8 FHHL, 1x PCIe x8 FHFL, 1x PCIe x16	TPM 1.2	Intrusion Switch	Security door	1x USB DVD±RW	None	None	XClarity Enterprise	1x 750W Platinum	None	3-year	09/17
7X10100CAU	ANZ	1x Xeon Silver 4110 8C/2.1GHz/11MB/85W/DDR4-2400	1x 16GB RDIMM DDR4-2666 (1Rx4)	1x 530-8i	16x 2.5"	8x 2.5"	SATA/SAS HS	Open	None	None	1x Mgmt, 2x GbE	None	1x PCIe x8 FHHL, 1x PCIe x8 FHFL, 1x PCIe x16	TPM 1.2	Intrusion Switch	Security door	None	None	None	XClarity Enterprise	1x 750W Platinum	None	3-year	09/17
7X10100DAU	ANZ	1x Xeon Bronze 3104 6C/1.7GHz/8.25MB/85W/DDR4-2133	1x 16GB RDIMM DDR4-2666 (1Rx4)	1x 530-8i	16x 2.5"	8x 2.5"	SATA/SAS HS	Open	None	None	1x Mgmt, 2x GbE	None	1x PCIe x8 FHHL, 1x PCIe x8 FHFL, 1x PCIe x16	TPM 1.2	Intrusion Switch	Security door	None	None	None	XClarity Enterprise	1x 750W Platinum	None	3-year	09/17
7X10100EAU	ANZ	1x Xeon Silver 4108 8C/1.8GHz/11MB/85W/DDR4-2400	1x 16GB RDIMM DDR4-2666 (1Rx4)	1x 530-8i	16x 2.5"	8x 2.5"	SATA/SAS HS	Open	None	None	1x Mgmt, 2x GbE	None	1x PCIe x8 FHHL, 1x PCIe x8 FHFL, 1x PCIe x16	TPM 1.2	Intrusion Switch	Security door	None	None	None	XClarity Enterprise	1x 750W Platinum	None	3-year	09/17
7X10100FAU	ANZ	1x Xeon Silver 4114 10C/2.2GHz/13.75MB/85W/DDR4-2400	1x 16GB RDIMM DDR4-2666 (1Rx4)	1x 530-8i	16x 2.5"	8x 2.5"	SATA/SAS HS	Open	None	None	1x Mgmt, 2x GbE	None	1x PCIe x8 FHHL, 1x PCIe x8 FHFL, 1x PCIe x16	TPM 1.2	Intrusion Switch	Security door	None	None	None	XClarity Enterprise	1x 750W Platinum	None	3-year	09/17
7X10100GAU	ANZ	1x Xeon Silver 4116 12C/2.1GHz/16.5MB/85W/DDR4-2400	1x 16GB RDIMM DDR4-2666 (1Rx4)	1x 530-8i	16x 2.5"	8x 2.5"	SATA/SAS HS	Open	None	None	1x Mgmt, 2x GbE	None	1x PCIe x8 FHHL, 1x PCIe x8 FHFL, 1x PCIe x16	TPM 1.2	Intrusion Switch	Security door	None	None	None	XClarity Enterprise	1x 1100W Platinum	None	3-year	09/17

Model	Region	Processor	Memory	Storage Controller	Chassis	Disk Bays	Disks	M.2 Drives	GPU	Onboard Networking Ports	Additional Networking (LOM/ML2/PCIe)	Standard Extension Slots	TPM	Intrusion Switch	Security Door	Optical	Optional Ports	Keyboard	System Management	Power Supply	Preload	Warranty	Ann Date (mm/yy)	
7X10100HAU	ANZ	1x Xeon Gold 5118 12C/2.3GHz/16.5MB/105W/DDR4-2400	1x 16GB RDIMM DDR4-2666 (1Rx4)	1x 530-8i	16x 2.5"	8x 2.5"	SATA/SAS HS	Open	None	None	1x Mgmt, 2x GbE	None	1x PCIe x8 FHHL, 1x PCIe x8 FHFL, 1x PCIe x16 FHFL, 1x PCIe x16 FHHL	TPM 1.2	Intrusion Switch	Security door	None	None	None	XClarity Enterprise	1x 1100W Platinum	None	3-year	09/17
7X10100JAU	ANZ	1x Xeon Gold 6130 16C/2.1GHz/22MB/125W/DDR4-2666	1x 16GB RDIMM DDR4-2666 (1Rx4)	1x 530-8i	16x 2.5"	8x 2.5"	SATA/SAS HS	Open	None	None	1x Mgmt, 2x GbE	None	1x PCIe x8 FHHL, 1x PCIe x8 FHFL, 1x PCIe x16 FHFL, 1x PCIe x16 FHHL	TPM 1.2	Intrusion Switch	Security door	None	None	None	XClarity Enterprise	1x 1100W Platinum	None	3-year	09/17

Model	Region	Processor	Memory	Storage Controller	Chassis	Disk Bays	Disks	M.2 Drives	GPU	Networking	Onboard Networking Ports	Additional Networking (LOM/ML2/PCle)	Standard Extension Slots	TPM	Intrusion Switch	Security Door	Optical	Optional Ports	Keyboard	System Management	Power Supply	Preload	Warranty	Ann Date (mm/yy)
7X10A04ELA	Argentina	1x Xeon Silver 4110 8C/2.1GHz/11MB/85W/DDR4-2400	1x 8GB RDIMM DDR4-2666 (1Rx8)	1x 530-8i	8x 3.5"	4x 3.5" SATA/SAS HS	Open	None	None	1x Mgmt, 2x GbE	None	None	1x PCIe x8 FHHL, 1x PCIe x8 FHFL, 1x PCIe x16 FHHH, 1x PCIe x16 FHHH	1.2	None	None	1x HH DVD±RW	None	None	XClarity Standard	1x 750W Platinum	None	3-year	07/17
7X10A04JLA	Argentina	1x Xeon Silver 4108 8C/1.8GHz/11MB/85W/DDR4-2400	1x 16GB RDIMM DDR4-2666 (1Rx4)	1x 930-8i 2GB Flash	8x 3.5"	8x 3.5" SATA/SAS HS	2x600GB HDD 15K 3.5" SAS12Gbps	None	None	1x Mgmt, 2x GbE	None	None	1x PCIe x8 FHHL, 1x PCIe x8 FHFL, 1x PCIe x16 FHHH, 1x PCIe x16 FHHH	1.2	None	None	1x HH DVD±RW	None	None	XClarity Advanced	2x 750W Platinum	None	3-year	07/17
7X10A04SLA	Argentina	1x Xeon Bronze 3106 8C/1.7GHz/11MB/85W/DDR4-2133	1x 8GB RDIMM DDR4-2666 (1Rx8)	1x 530-8i	8x 3.5"	4x 3.5" SATA/SAS HS	Open	None	None	1x Mgmt, 2x GbE	None	None	1x PCIe x8 FHHL, 1x PCIe x8 FHFL, 1x PCIe x16 FHHH, 1x PCIe x16 FHHH	1.2	None	None	1x HH DVD±RW	None	None	XClarity Standard	1x 750W Platinum	None	3-year	07/17
7X10A04WLA	Argentina	1x Xeon Silver 4108 8C/1.8GHz/11MB/85W/DDR4-2400	1x 8GB RDIMM DDR4-2666 (1Rx8)	1x 530-8i	8x 3.5"	4x 3.5" SATA/SAS HS	Open	None	None	1x Mgmt, 2x GbE	None	None	1x PCIe x8 FHHL, 1x PCIe x8 FHFL, 1x PCIe x16 FHHH, 1x PCIe x16 FHHH	1.2	None	None	1x HH DVD±RW	None	None	XClarity Standard	1x 750W Platinum	None	3-year	07/17
7X10A052LA	Argentina	1x Xeon Silver 4108 8C/1.8GHz/11MB/85W/DDR4-2400	1x 8GB RDIMM DDR4-2666 (1Rx8)	1x 530-8i	16x 2.5"	8x 2.5" SATA/SAS HS	Open	None	None	1x Mgmt, 2x GbE	None	None	1x PCIe x8 FHHL, 1x PCIe x8 FHFL, 1x PCIe x16 FHHH, 1x PCIe x16 FHHH	1.2	None	None	1x HH DVD±RW	None	None	XClarity Standard	1x 750W Platinum	None	3-year	07/17
7X10A055LA	Argentina	1x Xeon Bronze 3106 8C/1.7GHz/11MB/85W/DDR4-2133	1x 8GB RDIMM DDR4-2666 (1Rx8)	1x 530-8i	16x 2.5"	8x 2.5" SATA/SAS HS	Open	None	None	1x Mgmt, 2x GbE	None	None	1x PCIe x8 FHHL, 1x PCIe x8 FHFL, 1x PCIe x16 FHHH, 1x PCIe x16 FHHH	1.2	None	None	1x HH DVD±RW	None	None	XClarity Standard	1x 750W Platinum	None	3-year	07/17
7X10A057LA	Argentina	1x Xeon Bronze 3104 6C/1.7GHz/8.25MB/85W/DDR4-2133	1x 8GB RDIMM DDR4-2666 (1Rx8)	1x 530-8i	8x 3.5"	4x 3.5" SATA/SAS HS	Open	None	None	1x Mgmt, 2x GbE	None	None	1x PCIe x8 FHHL, 1x PCIe x8 FHFL, 1x PCIe x16 FHHH, 1x PCIe x16 FHHH	1.2	None	None	1x HH DVD±RW	None	None	XClarity Standard	1x 750W Platinum	None	3-year	07/17
7X10A05CLA	Argentina	1x Xeon Bronze 3104 6C/1.7GHz/8.25MB/85W/DDR4-2133	1x 8GB RDIMM DDR4-2666 (1Rx8)	1x 530-8i	16x 2.5"	8x 2.5" SATA/SAS HS	Open	None	None	1x Mgmt, 2x GbE	None	None	1x PCIe x8 FHHL, 1x PCIe x8 FHFL, 1x PCIe x16 FHHH, 1x PCIe x16 FHHH	1.2	None	None	1x HH DVD±RW	None	None	XClarity Standard	1x 750W Platinum	None	3-year	07/17

Model	Region	Processor	Memory	Storage Controller	Chassis	Disk Bays	Disks	M.2 Drives	GPU	Onboard Networking Ports	Additional Networking (LOM/ML2/PCle)	Standard Extension Slots	TPM	Intrusion Switch	Security Door	Optical	Optional Ports	Keyboard	System Management	Power Supply	Preload	Warranty	Ann Date (mm/yy)
7X10A05JLA	Argentina	1x Xeon Silver 4110 8C/2.1GHz/11MB/85W/DDR4-2400	1x 8GB RDIMM DDR4-2666 (1Rx8)	1x 530-8i	16x 2.5"	8x 2.5" SATA/SAS HS	Open	None	None	1x Mgmt, 2x GbE	None	1x PCIe x8 FHHL, 1x PCIe x8 FHFL, 1x PCIe x16	1.2	None	None	1x HH DVD±RW	None	None	XClarity Standard	1x 750W Platinum	None	3-year	07/17
7X10A06KAR	Argentina	1x Xeon Silver 4110 8C/2.1GHz/11MB/85W/DDR4-2400	2x 16GB RDIMM DDR4-2666 (1Rx4)	1x 930-8i 2GB Flash	16x 2.5"	8x 2.5" SATA/SAS HS	3x900GB HDD 10K 2.5" SAS12Gbps	None	None	1x Mgmt, 2x GbE	None	1x PCIe x8 FHHL, 1x PCIe x8 FHFL, 1x PCIe x16	2.0	None	None	1x HH DVD±RW	None	None	XClarity Standard	2x 750W Platinum	None	3-year	12/17
7X10A06LAR	Argentina	1x Xeon Bronze 3106 8C/1.7GHz/11MB/85W/DDR4-2133	1x 16GB RDIMM DDR4-2666 (1Rx4)	1x 530-8i	8x 3.5"	8x 3.5" SATA/SAS HS	Open	None	None	1x Mgmt, 2x GbE	None	1x PCIe x8 FHHL, 1x PCIe x8 FHFL, 1x PCIe x16	2.0	None	None	1x HH DVD±RW	None	None	XClarity Standard	2x 750W Platinum	None	3-year	12/17

Model	Region	Processor	Memory	Storage Controller	Chassis	Disk Bays	Disks	M.2 Drives	GPU	Onboard Networking Ports	Additional Networking (LOM/ML2/PCIE)	Standard Extension Slots	TPM	Intrusion Switch	Security Door	Optical	Optional Ports	Keyboard	System Management	Power Supply	Preload	Warranty	Ann Date (mm/yy)
7X10A05DLA	Chile	1x Xeon Silver 4114 10C/2.2GHz/13.75MB/85W/DDR4-2400	2x 16GB RDIMM DDR4-2666 (1Rx4)	1x 930-8i 2GB Flash	8x 3.5"	8x 3.5" SATA/SAS HS	3x600GB HDD 15K 3.5" SAS12Gbps	None	None	1x Mgmt, 2x GbE	None	1x PCIe x8 FHHL, 1x PCIe x8 FHFL, 1x PCIe x16 FHH, 1x PCIe x16 FHH	1.2	None	None	1x HH DVD±RW	None	None	XClarity Advanced	2x 750W Platinum	None	3-year	07/17
7X10A051LA	Chile	1x Xeon Silver 4108 8C/1.8GHz/11MB/85W/DDR4-2400	1x 16GB RDIMM DDR4-2666 (1Rx4)	1x 930-8i 2GB Flash	8x 3.5"	8x 3.5" SATA/SAS HS	2x2TB HDD 7.2K 3.5" SAS12Gbps	None	None	1x Mgmt, 2x GbE	None	1x PCIe x8 FHHL, 1x PCIe x8 FHFL, 1x PCIe x16 FHH, 1x PCIe x16 FHH	1.2	None	None	1x HH DVD±RW	None	None	XClarity Advanced	2x 750W Platinum	None	3-year	07/17
7X10A06HCL	Chile	1x Xeon Bronze 3106 8C/1.7GHz/11MB/85W/DDR4-2133	1x 16GB RDIMM DDR4-2666 (1Rx4)	1x 530-8i	16x 2.5"	8x 2.5" SATA/SAS HS	Open	None	None	1x Mgmt, 2x GbE	None	1x PCIe x8 FHHL, 1x PCIe x8 FHFL, 1x PCIe x16 FHH, 1x PCIe x16 FHH	2.0	None	None	1x HH DVD±RW	None	None	XClarity Standard	1x 750W Platinum	None	3-year	12/17
7X10A06JCL	Chile	1x Xeon Silver 4114 10C/2.2GHz/13.75MB/85W/DDR4-2400	1x 16GB RDIMM DDR4-2666 (1Rx4)	1x 530-8i	16x 2.5"	8x 2.5" SATA/SAS HS	Open	None	None	1x Mgmt, 2x GbE	None	1x PCIe x8 FHHL, 1x PCIe x8 FHFL, 1x PCIe x16 FHH, 1x PCIe x16 FHH	2.0	None	None	1x HH DVD±RW	None	None	XClarity Standard	1x 750W Platinum	None	3-year	12/17

Model	Region	Processor	Memory	Storage Controller	Chassis	Disk Bays	Disks	M.2 Drives	GPU	Onboard Networking Ports	Additional Networking (LOM/ML2/PCIe)	Standard Extension Slots	TPM	Intrusion Switch	Security Door	Optical	Optional Ports	Keyboard	System Management	Power Supply	Preload	Warranty	Ann Date (mm/yy)
7X10A06MLA	Colombia	1x Xeon Bronze 3106 8C/1.7GHz/11MB/85W/DDR4-2133	1x 16GB RDIMM DDR4-2666 (1Rx4)	1x 530-8i	8x 3.5"	4x 3.5"	SATA/SAS Open HS	None	None	1x Mgmt, 2x GbE	None	1x PCIe x8 FHHL, 1x PCIe x8 FHFL, 1x PCIe x16 FHFL, 1x PCIe x16 FHHL	2.0	None	None	1x HH DVD±RW	None	None	XClarity Standard	1x 550W Platinum	None	3-year	12/17
7X10A06NLA	Colombia	1x Xeon Silver 4114 10C/2.2GHz/13.75MB/85W/DDR4-2400	1x 16GB RDIMM DDR4-2666 (1Rx4)	1x 930-8i 2GB Flash	16x 2.5"	8x 2.5"	SATA/SAS Open HS	None	None	1x Mgmt, 2x GbE	None	1x PCIe x8 FHHL, 1x PCIe x8 FHFL, 1x PCIe x16 FHFL, 1x PCIe x16 FHHL	2.0	None	None	1x HH DVD±RW	None	None	XClarity Standard	1x 550W Platinum	None	3-year	12/17

Model	Region	Processor	Memory	Storage Controller	Chassis	Disk Bays	Disks	M.2 Drives	GPU	Networking Ports	Onboard Networking	Additional Networking (LOM/ML/PCIe)	Standard Extension Slots	TPM	Intrusion Switch	Security Door	Optical	Optional Ports	Keyboard	System Management	Power Supply	Preload	Warranty	Ann Date (mm/yy)
7X10A06PEA	EMEA	1x Xeon Gold 6128 6C/3.4GHz/19.25MB/115W/DDR4-2666	1x 32GB RDIMM DDR4-2666 (2Rx4)	1x 930-8i 2GB Flash	8x 3.5"	8x 3.5" SATA/SAS HS	Open	None	None	1x Mgmt, 2x GbE	None	None	1x PCIe x8 FHHL, 1x PCIe x8 FHL, 1x PCIe x16 FHL, 1x PCIe x16 FHL	1.2	None	None	1x HH DVD±RW	None	None	XClarity Standard	1x 750W Platinum	None	3-year	12/17
7X10A06QEA	EMEA	1x Xeon Gold 6128 6C/3.4GHz/19.25MB/115W/DDR4-2666	1x 32GB RDIMM DDR4-2666 (2Rx4)	1x 930-8i 2GB Flash	16x 2.5"	8x 2.5" SATA/SAS HS	Open	None	None	1x Mgmt, 2x GbE	None	None	1x PCIe x8 FHHL, 1x PCIe x8 FHL, 1x PCIe x16 FHL, 1x PCIe x16 FHL	1.2	None	None	1x HH DVD±RW	None	None	XClarity Standard	1x 750W Platinum	None	3-year	12/17
7X10A03ZEA	EMEA	1x Xeon Silver 4110 8C/2.1GHz/11MB/85W/DDR4-2400	4x 32GB RDIMM DDR4-2666 (2Rx4)	1x 930-8i 2GB Flash	16x 2.5"	8x 2.5" SATA/SAS HS	3x900GB HDD 10K 2.5" SAS12Gbps	None	None	1x Mgmt, 2x GbE	None	None	1x PCIe x8 FHHL, 1x PCIe x8 FHL, 1x TPM Intrusion Switch, 1x PCIe x16 FHL, 1x PCIe x16 FHL	1.2	Intrusion Switch	Security door	1x HH DVD±RW	None	None	XClarity Standard	2x 750W Platinum	None	3-year	07/17
7X10A03VEA	EMEA	1x Xeon Silver 4110 8C/2.1GHz/11MB/85W/DDR4-2400	1x 16GB RDIMM DDR4-2666 (1Rx4)	1x 930-8i 2GB Flash	16x 2.5"	8x 2.5" SATA/SAS HS	2x300GB HDD 10K 2.5" SAS12Gbps	None	None	1x Mgmt, 2x GbE	None	None	1x PCIe x8 FHHL, 1x PCIe x8 FHL, 1x TPM Intrusion Switch, 1x PCIe x16 FHL, 1x PCIe x16 FHL	1.2	Intrusion Switch	Security door	1x HH DVD±RW	None	None	XClarity Standard	2x 550W Platinum	None	3-year	07/17
7X10A03KEA	EMEA	1x Xeon Bronze 3106 8C/1.7GHz/11MB/85W/DDR4-2133	1x 16GB RDIMM DDR4-2666 (1Rx4)	1x 530-8i	8x 3.5"	4x 3.5" SATA/SAS HS	Open	None	None	1x Mgmt, 2x GbE	None	None	1x PCIe x8 FHHL, 1x PCIe x8 FHL, 1x TPM Intrusion Switch, 1x PCIe x16 FHL, 1x PCIe x16 FHL	1.2	Intrusion Switch	Security door	1x HH DVD±RW	None	None	XClarity Standard	1x 550W Platinum	None	3-year	07/17
7X10A039EA	EMEA	1x Xeon Bronze 3106 8C/1.7GHz/11MB/85W/DDR4-2133	1x 16GB RDIMM DDR4-2666 (1Rx4)	1x 530-8i	8x 3.5"	8x 3.5" SATA/SAS HS	2x1TB HDD 7.2K 3.5" SATA6Gbps	None	None	1x Mgmt, 2x GbE	None	None	1x PCIe x8 FHHL, 1x PCIe x8 FHL, 1x TPM Intrusion Switch, 1x PCIe x16 FHL, 1x PCIe x16 FHL	1.2	Intrusion Switch	Security door	None	None	None	XClarity Standard	1x 550W Platinum	None	3-year	07/17
7X10A02HEA	EMEA	1x Xeon Gold 5118 12C/2.3GHz/16.5MB/105W/DDR4-2400	1x 16GB RDIMM DDR4-2666 (1Rx4)	1x 930-8i 2GB Flash	16x 2.5"	8x 2.5" SATA/SAS HS	Open	None	None	1x Mgmt, 2x GbE	None	None	1x PCIe x8 FHHL, 1x PCIe x8 FHL, 1x TPM Intrusion Switch, 1x PCIe x16 FHL, 1x PCIe x16 FHL	1.2	Intrusion Switch	Security door	None	None	None	XClarity Standard	1x 750W Platinum	None	3-year	07/17
7X10A02YEA	EMEA	1x Xeon Silver 4110 8C/2.1GHz/11MB/85W/DDR4-2400	1x 16GB RDIMM DDR4-2666 (1Rx4)	1x 930-8i 2GB Flash	16x 2.5"	8x 2.5" SATA/SAS HS	Open	None	None	1x Mgmt, 2x GbE	None	None	1x PCIe x8 FHHL, 1x PCIe x8 FHL, 1x TPM Intrusion Switch, 1x PCIe x16 FHL, 1x PCIe x16 FHL	1.2	Intrusion Switch	Security door	1x HH DVD±RW	None	None	XClarity Standard	1x 550W Platinum	None	3-year	07/17

Model	Region	Processor	Memory	Storage Controller	Chassis	Disk Bays	Disks	M.2 Drives	GPU	Networking Ports	Onboard Networking	Additional Networking (LOM/ML2/PCle)	Standard Extension Slots	TPM	Intrusion Switch	Security Door	Optical	Optional Ports	Keyboard	System Management	Power Supply	Preload	Warranty	Ann Date (mm/yy)
7X10A006EA	EMEA	1x Xeon Gold 5122 4C/3.6GHz/16.5MB/105W/DDR4-2666	1x 16GB RDIMM DDR4-2666 (1Rx4)	1x 930-8i 2GB Flash	16x 2.5"	8x 2.5" SATA/SAS HS	Open	None	None	1x Mgmt, 2x GbE	None	None	1x PCIe x8 FHHL, 1x PCIe x8 FHFL, 1x PCIe x16	1.2	TPM Switch	Intrusion door	Security 1x HH DVD±RW	None	None	XClarity Standard	1x 750W Platinum	None	3-year	07/17
7X10A00HEA	EMEA	1x Xeon Gold 5115 10C/2.4GHz/13.75MB/85W/DDR4-2400	1x 16GB RDIMM DDR4-2666 (1Rx4)	1x 930-8i 2GB Flash	16x 2.5"	8x 2.5" SATA/SAS HS	Open	None	None	1x Mgmt, 2x GbE	None	None	1x PCIe x8 FHHL, 1x PCIe x8 FHFL, 1x PCIe x16	1.2	TPM Switch	Intrusion door	Security 1x HH DVD±RW	None	None	XClarity Standard	2x 750W Platinum	None	3-year	07/17
7X10A013EA	EMEA	1x Xeon Gold 5115 10C/2.4GHz/13.75MB/85W/DDR4-2400	1x 16GB RDIMM DDR4-2666 (1Rx4)	1x 930-8i 2GB Flash	16x 2.5"	8x 2.5" SATA/SAS HS	Open	None	None	1x Mgmt, 2x GbE	None	None	1x PCIe x8 FHHL, 1x PCIe x8 FHFL, 1x PCIe x16	1.2	TPM Switch	Intrusion door	Security None	None	None	XClarity Standard	1x 750W Platinum	None	3-year	07/17
7X10A017EA	EMEA	1x Xeon Silver 4110 8C/2.1GHz/11MB/85W/DDR4-2400	1x 16GB RDIMM DDR4-2666 (1Rx4)	1x 930-8i 2GB Flash	16x 2.5"	8x 2.5" SATA/SAS HS	Open	None	None	1x Mgmt, 2x GbE	None	None	1x PCIe x8 FHHL, 1x PCIe x8 FHFL, 1x PCIe x16	1.2	TPM Switch	Intrusion door	Security 1x HH DVD±RW	None	None	XClarity Standard	1x 750W Platinum	None	3-year	07/17
7X10A018EA	EMEA	1x Xeon Silver 4108 8C/1.8GHz/11MB/85W/DDR4-2400	1x 16GB RDIMM DDR4-2666 (1Rx4)	1x 930-8i 2GB Flash	16x 2.5"	8x 2.5" SATA/SAS HS	Open	None	None	1x Mgmt, 2x GbE	None	None	1x PCIe x8 FHHL, 1x PCIe x8 FHFL, 1x PCIe x16	1.2	TPM Switch	Intrusion door	Security 1x HH DVD±RW	None	None	XClarity Standard	1x 750W Platinum	None	3-year	07/17
7X10A019EA	EMEA	1x Xeon Silver 4108 8C/1.8GHz/11MB/85W/DDR4-2400	1x 16GB RDIMM DDR4-2666 (1Rx4)	1x 930-8i 2GB Flash	16x 2.5"	8x 2.5" SATA/SAS HS	3x300GB HDD 10K 2.5" SAS12Gbps	None	None	1x Mgmt, 2x GbE	None	None	1x PCIe x8 FHHL, 1x PCIe x8 FHFL, 1x PCIe x16	1.2	TPM Switch	Intrusion door	Security 1x HH DVD±RW	None	None	XClarity Standard	2x 750W Platinum	None	3-year	07/17
7X10A01AEA	EMEA	1x Xeon Silver 4110 8C/2.1GHz/11MB/85W/DDR4-2400	1x 16GB RDIMM DDR4-2666 (1Rx4)	1x 930-8i 2GB Flash	16x 2.5"	8x 2.5" SATA/SAS HS	3x300GB HDD 10K 2.5" SAS12Gbps	None	None	1x Mgmt, 2x GbE	None	None	1x PCIe x8 FHHL, 1x PCIe x8 FHFL, 1x PCIe x16	1.2	TPM Switch	Intrusion door	Security 1x HH DVD±RW	None	None	XClarity Standard	2x 750W Platinum	None	3-year	07/17
7X10A01BEA	EMEA	1x Xeon Silver 4116 12C/2.1GHz/16.5MB/85W/DDR4-2400	1x 16GB RDIMM DDR4-2666 (1Rx4)	1x 930-8i 2GB Flash	16x 2.5"	8x 2.5" SATA/SAS HS	Open	None	None	1x Mgmt, 2x GbE	None	None	1x PCIe x8 FHHL, 1x PCIe x8 FHFL, 1x PCIe x16	1.2	TPM Switch	Intrusion door	Security None	None	None	XClarity Standard	1x 750W Platinum	None	3-year	07/17

Model	Region	Processor	Memory	Storage Controller	Chassis	Disk Bays	Disks	M.2 Drives	GPU	Onboard Networking Ports	Additional Networking (LOM/ML2/PCle)	Standard Extension Slots	TPM	Intrusion Switch	Security Door	Optical	Optional Ports	Keyboard	System Management	Power Supply	Preload	Warranty	Ann Date (mm/yy)
7X10A01CEA	EMEA	1x Xeon Silver 4108 8C/1.8GHz/11MB/85W/DDR4-2400	1x 16GB RDIMM DDR4-2666 (1Rx4)	1x 930-8i 2GB Flash	16x 2.5"	8x 2.5" SATA/SAS HS	Open	None	None	1x Mgmt, 2x GbE	None	1x PCIe x8 FHHL, 1x PCIe x8 FHFL, 1x PCIe x16	1.2	TPM Switch	Intrusion door	Security 1x HH DVD±RW	None	None	XClarity Standard	2x 750W Platinum	None	3-year	07/17
7X10A01DEA	EMEA	1x Xeon Bronze 3106 8C/1.7GHz/11MB/85W/DDR4-2133	1x 16GB RDIMM DDR4-2666 (1Rx4)	1x 930-8i	16x 2.5"	8x 2.5" SATA/SAS HS	Open	None	None	1x Mgmt, 2x GbE	None	1x PCIe x8 FHHL, 1x PCIe x8 FHFL, 1x PCIe x16	1.2	TPM Switch	Intrusion door	Security 1x HH DVD±RW	None	None	XClarity Standard	1x 750W Platinum	None	3-year	07/17
7X10A01EEA	EMEA	1x Xeon Silver 4110 8C/2.1GHz/11MB/85W/DDR4-2400	1x 16GB RDIMM DDR4-2666 (1Rx4)	1x 930-8i 2GB Flash	16x 2.5"	8x 2.5" SATA/SAS HS	Open	None	None	1x Mgmt, 2x GbE	None	1x PCIe x8 FHHL, 1x PCIe x8 FHFL, 1x PCIe x16	1.2	TPM Switch	Intrusion door	Security	None	None	XClarity Standard	1x 750W Platinum	None	3-year	07/17
7X10A01FEA	EMEA	1x Xeon Bronze 3106 8C/1.7GHz/11MB/85W/DDR4-2133	1x 16GB RDIMM DDR4-2666 (1Rx4)	1x 930-8i	8x 3.5"	8x 3.5" SATA/SAS HS	Open	None	None	1x Mgmt, 2x GbE	None	1x PCIe x8 FHHL, 1x PCIe x8 FHFL, 1x PCIe x16	1.2	TPM Switch	Intrusion door	Security 1x HH DVD±RW	None	None	XClarity Standard	1x 750W Platinum	None	3-year	07/17
7X10A01GEA	EMEA	1x Xeon Silver 4116 12C/2.1GHz/16.5MB/85W/DDR4-2400	1x 16GB RDIMM DDR4-2666 (1Rx4)	1x 930-8i 2GB Flash	16x 2.5"	8x 2.5" SATA/SAS HS	Open	None	None	1x Mgmt, 2x GbE	None	1x PCIe x8 FHHL, 1x PCIe x8 FHFL, 1x PCIe x16	1.2	TPM Switch	Intrusion door	Security 1x HH DVD±RW	None	None	XClarity Standard	1x 750W Platinum	None	3-year	07/17
7X10A01HEA	EMEA	1x Xeon Bronze 3104 6C/1.7GHz/8.25MB/85W/DDR4-2133	1x 16GB RDIMM DDR4-2666 (1Rx4)	1x 930-8i	8x 3.5"	8x 3.5" SATA/SAS HS	Open	None	None	1x Mgmt, 2x GbE	None	1x PCIe x8 FHHL, 1x PCIe x8 FHFL, 1x PCIe x16	1.2	TPM Switch	Intrusion door	Security 1x HH DVD±RW	None	None	XClarity Standard	1x 750W Platinum	None	3-year	07/17
7X10A01JEA	EMEA	1x Xeon Silver 4110 8C/2.1GHz/11MB/85W/DDR4-2400	1x 16GB RDIMM DDR4-2666 (1Rx4)	1x 930-8i 2GB Flash	8x 3.5"	8x 3.5" SATA/SAS HS	Open	None	None	1x Mgmt, 2x GbE	None	1x PCIe x8 FHHL, 1x PCIe x8 FHFL, 1x PCIe x16	1.2	TPM Switch	Intrusion door	Security	None	None	XClarity Standard	1x 750W Platinum	None	3-year	07/17
7X10A01KEA	EMEA	1x Xeon Silver 4110 8C/2.1GHz/11MB/85W/DDR4-2400	4x 16GB RDIMM DDR4-2666 (1Rx4)	1x 930-8i 2GB Flash	16x 2.5"	8x 2.5" SATA/SAS HS				1x Mgmt, 2x GbE	None	1x PCIe x8 FHHL, 1x PCIe x8 FHFL, 1x PCIe x16	1.2	TPM Switch	Intrusion door	Security 1x HH DVD±RW	None	None	XClarity Standard	2x 750W Platinum	None	3-year	07/17

Model	Region	Processor	Memory	Storage Controller	Chassis	Disk Bays	Disks	M.2 Drives	GPU	Onboard Networking Ports	Additional Networking (LOM/ML2/PCIe)	Standard Extension Slots	TPM	Intrusion Switch	Security Door	Optical	Optional Ports	Keyboard	System Management	Power Supply	Preload	Warranty	Ann Date (mm/yy)
7X10A01LEA	EMEA	1x Xeon Silver 4108 8C/1.8GHz/11MB/85W/DDR4-2400	1x 16GB RDIMM DDR4-2666 (1Rx4)	1x 930-8i 2GB Flash	16x 2.5"	8x 2.5"	SATA/SAS Open HS	None	None	1x Mgmt, 2x GbE	None	1x PCIe x8 FHHL, 1x PCIe x8 FHFL, 1x PCIe x16 FHFL, 1x PCIe x16 FHHL	TPM 1.2	Intrusion Switch	Security door	None	None	None	XClarity Standard	1x 750W Platinum	None	3-year	07/17
7X10A01MEA	EMEA	1x Xeon Silver 4114 10C/2.2GHz/13.75MB/85W/DDR4-2400	1x 16GB RDIMM DDR4-2666 (1Rx4)	1x 930-8i 2GB Flash	8x 3.5"	8x 3.5"	SATA/SAS Open HS	None	None	1x Mgmt, 2x GbE	None	1x PCIe x8 FHHL, 1x PCIe x8 FHFL, 1x PCIe x16 FHFL, 1x PCIe x16 FHHL	TPM 1.2	Intrusion Switch	Security door	None	None	None	XClarity Standard	1x 750W Platinum	None	3-year	07/17
7X10A01NEA	EMEA	1x Xeon Bronze 3104 6C/1.7GHz/8.25MB/85W/DDR4-2133	1x 16GB RDIMM DDR4-2666 (1Rx4)	1x 530-8i	16x 2.5"	8x 2.5"	SATA/SAS Open HS	None	None	1x Mgmt, 2x GbE	None	1x PCIe x8 FHHL, 1x PCIe x8 FHFL, 1x PCIe x16 FHFL, 1x PCIe x16 FHHL	TPM 1.2	Intrusion Switch	Security door	1x HH DVD±RW	None	None	XClarity Standard	1x 750W Platinum	None	3-year	07/17
7X10A01PEA	EMEA	1x Xeon Silver 4114 10C/2.2GHz/13.75MB/85W/DDR4-2400	1x 16GB RDIMM DDR4-2666 (1Rx4)	1x 930-8i 2GB Flash	16x 2.5"	8x 2.5"	SATA/SAS Open HS	None	None	1x Mgmt, 2x GbE	None	1x PCIe x8 FHHL, 1x PCIe x8 FHFL, 1x PCIe x16 FHFL, 1x PCIe x16 FHHL	TPM 1.2	Intrusion Switch	Security door	None	None	None	XClarity Standard	1x 750W Platinum	None	3-year	07/17
7X10A01QEA	EMEA	1x Xeon Bronze 3104 6C/1.7GHz/8.25MB/85W/DDR4-2133	1x 16GB RDIMM DDR4-2666 (1Rx4)	1x 930-8i 2GB Flash	16x 2.5"	8x 2.5"	SATA/SAS Open HS	None	None	1x Mgmt, 2x GbE	None	1x PCIe x8 FHHL, 1x PCIe x8 FHFL, 1x PCIe x16 FHFL, 1x PCIe x16 FHHL	TPM 1.2	Intrusion Switch	Security door	None	None	None	XClarity Standard	1x 750W Platinum	None	3-year	07/17

Model	Region	Processor	Memory	Storage Controller	Chassis	Disk Bays	Disks	M.2 Drives	GPU	Networking Ports	Additional Networking (LOM/ML2/PCIe)	Standard Extension Slots	TPM	Intrusion Switch	Security Door	Optical	Optional Ports	Keyboard	System Management	Power Supply	Preload	Warranty	Ann Date (mm/yy)	
7X10A063CN	HTK	1x Xeon Silver 4110 8C/2.1GHz/11MB/85W/DDR4-2400	1x 16GB RDIMM DDR4-2666 (1Rx4)	1x 930-8i 2GB Flash	16x 2.5"	8x 2.5"	SATA/SAS HS	Open	None	None	1x Mgmt, 2x GbE	2x GbE RJ-45 PCIe	1x PCIe x8 FHHL, 1x PCIe x8 FFL, 1x PCIe x16 FFL, 1x PCIe x16 FHHL	TPM 2.0	None	None	None	None	None	XClarity Standard	1x 750W Platinum	None	3-year	10/17
7X10A064CN	HTK	1x Xeon Silver 4114 10C/2.2GHz/13.75MB/85W/DDR4-2400	1x 16GB RDIMM DDR4-2666 (1Rx4)	1x 930-8i 2GB Flash	16x 2.5"	8x 2.5"	SATA/SAS HS	Open	None	None	1x Mgmt, 2x GbE	2x GbE RJ-45 PCIe	1x PCIe x8 FHHL, 1x PCIe x8 FFL, 1x PCIe x16 FFL, 1x PCIe x16 FHHL	TPM 2.0	None	None	None	None	None	XClarity Standard	1x 750W Platinum	None	3-year	10/17
7X10A065CN	HTK	1x Xeon Silver 4116 12C/2.1GHz/16.5MB/85W/DDR4-2400	1x 16GB RDIMM DDR4-2666 (1Rx4)	1x 930-8i 2GB Flash	16x 2.5"	8x 2.5"	SATA/SAS HS	Open	None	None	1x Mgmt, 2x GbE	2x GbE RJ-45 PCIe	1x PCIe x8 FHHL, 1x PCIe x8 FFL, 1x PCIe x16 FFL, 1x PCIe x16 FHHL	TPM 2.0	None	None	None	None	None	XClarity Standard	1x 750W Platinum	None	3-year	10/17
7X10A066CN	HTK	1x Xeon Silver 4112 4C/2.6GHz/8.25MB/85W/DDR4-2400	1x 16GB RDIMM DDR4-2666 (1Rx4)	1x 930-8i 2GB Flash	16x 2.5"	8x 2.5"	SATA/SAS HS	Open	None	None	1x Mgmt, 2x GbE	2x GbE RJ-45 PCIe	1x PCIe x8 FHHL, 1x PCIe x8 FFL, 1x PCIe x16 FFL, 1x PCIe x16 FHHL	TPM 2.0	None	None	None	None	None	XClarity Standard	1x 750W Platinum	None	3-year	10/17
7X10A067CN	HTK	1x Xeon Silver 4110 8C/2.1GHz/11MB/85W/DDR4-2400	1x 16GB RDIMM DDR4-2666 (1Rx4)	1x 930-8i 2GB Flash	8x 3.5"	8x 3.5"	SATA/SAS HS	Open	None	None	1x Mgmt, 2x GbE	2x GbE RJ-45 PCIe	1x PCIe x8 FHHL, 1x PCIe x8 FFL, 1x PCIe x16 FFL, 1x PCIe x16 FHHL	TPM 1.2	None	None	None	1x Serial	None	XClarity Standard	1x 750W Platinum	None	3-year	10/17
7X10A068CN	HTK	1x Xeon Silver 4114 10C/2.2GHz/13.75MB/85W/DDR4-2400	1x 16GB RDIMM DDR4-2666 (1Rx4)	1x 930-8i 2GB Flash	8x 3.5"	8x 3.5"	SATA/SAS HS	Open	None	None	1x Mgmt, 2x GbE	2x GbE RJ-45 PCIe	1x PCIe x8 FHHL, 1x PCIe x8 FFL, 1x PCIe x16 FFL, 1x PCIe x16 FHHL	TPM 1.2	None	None	None	1x Serial	None	XClarity Standard	1x 750W Platinum	None	3-year	10/17
7X10A069CN	HTK	1x Xeon Silver 4116 12C/2.1GHz/16.5MB/85W/DDR4-2400	1x 16GB RDIMM DDR4-2666 (1Rx4)	1x 930-8i 2GB Flash	8x 3.5"	8x 3.5"	SATA/SAS HS	Open	None	None	1x Mgmt, 2x GbE	2x GbE RJ-45 PCIe	1x PCIe x8 FHHL, 1x PCIe x8 FFL, 1x PCIe x16 FFL, 1x PCIe x16 FHHL	TPM 1.2	None	None	None	1x Serial	None	XClarity Standard	1x 750W Platinum	None	3-year	10/17
7X10A06ACN	HTK	1x Xeon Silver 4112 4C/2.6GHz/8.25MB/85W/DDR4-2400	1x 16GB RDIMM DDR4-2666 (1Rx4)	1x 930-8i 2GB Flash	8x 3.5"	4x 3.5"	SATA/SAS HS	Open	None	None	1x Mgmt, 2x GbE	2x GbE RJ-45 PCIe	1x PCIe x8 FHHL, 1x PCIe x8 FFL, 1x PCIe x16 FFL, 1x PCIe x16 FHHL	TPM 1.2	None	None	None	1x Serial	None	XClarity Standard	1x 750W Platinum	None	3-year	10/17

Model	Region	Processor	Memory	Storage Controller	Chassis	Disk Bays	Disks	M.2 Drives	GPU	Onboard Networking Ports	Additional Networking (LOM/ML2/PCIe)	Standard Extension Slots	TPM	Intrusion Switch	Security Door	Optical	Optional Ports	Keyboard	System Management	Power Supply	Preload	Warranty	Ann Date (mm/yy)	
7X10A06BCN	HTK	1x Xeon Bronze 3104 6C/1.7GHz/8.25MB/85W/DDR4-2133	1x 16GB RDIMM DDR4-2666 (1Rx4)	1x 930-8i 2GB Flash	16x 2.5"	8x 2.5"	SATA/SAS HS	Open	None	None	1x Mgmt, 2x GbE	2x GbE RJ-45 PCIe	1x PCIe x8 FHHL, 1x PCIe x8 FHFL, 1x PCIe x16 FHFL, 1x PCIe x16 FHHL	TPM 1.2	None	None	None	1x Serial	None	XClarity Standard	1x 750W Platinum	None	3-year	10/17
7X10A06CCN	HTK	1x Xeon Bronze 3106 8C/1.7GHz/11MB/85W/DDR4-2133	1x 16GB RDIMM DDR4-2666 (1Rx4)	1x 930-8i 2GB Flash	16x 2.5"	8x 2.5"	SATA/SAS HS	Open	None	None	1x Mgmt, 2x GbE	2x GbE RJ-45 PCIe	1x PCIe x8 FHHL, 1x PCIe x8 FHFL, 1x PCIe x16 FHFL, 1x PCIe x16 FHHL	TPM 1.2	None	None	None	1x Serial	None	XClarity Standard	1x 750W Platinum	None	3-year	10/17
7X10A06DCN	HTK	1x Xeon Bronze 3104 6C/1.7GHz/8.25MB/85W/DDR4-2133	1x 16GB RDIMM DDR4-2666 (1Rx4)	1x 930-8i 2GB Flash	8x 3.5"	8x 3.5"	SATA/SAS HS	Open	None	None	1x Mgmt, 2x GbE	2x GbE RJ-45 PCIe	1x PCIe x8 FHHL, 1x PCIe x8 FHFL, 1x PCIe x16 FHFL, 1x PCIe x16 FHHL	TPM 1.2	None	None	None	1x Serial	None	XClarity Standard	1x 750W Platinum	None	3-year	10/17
7X10A06ECN	HTK	1x Xeon Bronze 3106 8C/1.7GHz/11MB/85W/DDR4-2133	1x 16GB RDIMM DDR4-2666 (1Rx4)	1x 930-8i 2GB Flash	8x 3.5"	8x 3.5"	SATA/SAS HS	Open	None	None	1x Mgmt, 2x GbE	2x GbE RJ-45 PCIe	1x PCIe x8 FHHL, 1x PCIe x8 FHFL, 1x PCIe x16 FHFL, 1x PCIe x16 FHHL	TPM 1.2	None	None	None	1x Serial	None	XClarity Standard	1x 750W Platinum	None	3-year	10/17

Model	Region	Processor	Memory	Storage Controller	Chassis	Disk Bays	Disks	M.2 Drives	GPU	Onboard Networking Ports	Additional Networking (LOM/ML2/PCle)	Standard Extension Slots	TPM	Intrusion Switch	Security Door	Optical	Optional Ports	Keyboard	System Management	Power Supply	Preload	Warranty	Ann Date (mm/yy)	
7X10A043JP	JAPAN	1x Xeon Silver 4110 8C/2.1GHz/11MB/85W/DDR4-2400	2x 16GB RDIMM DDR4-2666 (1Rx4)	1x 930-16i 4GB Flash	16x 2.5"	16x 2.5"	SATA/SAS HS	Open	None	None	1x Mgmt, 2x GbE	None	1x PCIe x8 FHHL, 1x PCIe x8 FHFL, 1x PCIe x16 FHFL, 1x PCIe x16 FHHL	TPM 1.2	Intrusion Switch	Security door	1x HH DVD	None	USB, with pointing device	XClarity Advanced	1x 1100W Platinum	None	3-year	07/17
7X10A044JP	JAPAN	1x Xeon Bronze 3104 6C/1.7GHz/8.25MB/85W/DDR4-2133	2x 16GB RDIMM DDR4-2666 (1Rx4)	1x 930-8i 2GB Flash	8x 3.5"	8x 3.5"	SATA/SAS HS	Open	None	None	1x Mgmt, 2x GbE	None	1x PCIe x8 FHHL, 1x PCIe x8 FHFL, 1x PCIe x16 FHFL, 1x PCIe x16 FHHL	TPM 1.2	Intrusion Switch	Security door	1x HH DVD	None	USB, with pointing device	XClarity Advanced	1x 550W Platinum	None	3-year	07/17
7X10A045JP	JAPAN	1x Xeon Bronze 3106 8C/1.7GHz/11MB/85W/DDR4-2133	2x 16GB RDIMM DDR4-2666 (1Rx4)	1x 930-16i 4GB Flash	16x 2.5"	16x 2.5"	SATA/SAS HS	Open	None	None	1x Mgmt, 2x GbE	None	1x PCIe x8 FHHL, 1x PCIe x8 FHFL, 1x PCIe x16 FHFL, 1x PCIe x16 FHHL	TPM 1.2	Intrusion Switch	Security door	1x HH DVD	None	USB, with pointing device	XClarity Advanced	1x 750W Platinum	None	3-year	07/17
7X10A046JP	JAPAN	1x Xeon Silver 4110 8C/2.1GHz/11MB/85W/DDR4-2400	2x 16GB RDIMM DDR4-2666 (1Rx4)	1x 930-8i 2GB Flash	8x 3.5"	8x 3.5"	SATA/SAS HS	Open	None	None	1x Mgmt, 2x GbE	None	1x PCIe x8 FHHL, 1x PCIe x8 FHFL, 1x PCIe x16 FHFL, 1x PCIe x16 FHHL	TPM 1.2	Intrusion Switch	Security door	1x HH DVD	None	USB, with pointing device	XClarity Advanced	1x 1100W Platinum	None	3-year	07/17
7X10A047JP	JAPAN	1x Xeon Silver 4114 10C/2.2GHz/13.75MB/85W/DDR4-2400	2x 16GB RDIMM DDR4-2666 (1Rx4)	1x 930-8i 2GB Flash	8x 3.5"	8x 3.5"	SATA/SAS HS	Open	None	None	1x Mgmt, 2x GbE	None	1x PCIe x8 FHHL, 1x PCIe x8 FHFL, 1x PCIe x16 FHFL, 1x PCIe x16 FHHL	TPM 1.2	Intrusion Switch	Security door	1x HH DVD	None	USB, with pointing device	XClarity Advanced	1x 750W Platinum	None	3-year	07/17
7X10A048JP	JAPAN	1x Xeon Gold 6130 16C/2.1GHz/22MB/125W/DDR4-2666	2x 16GB RDIMM DDR4-2666 (1Rx4)	1x 930-24i 4GB Flash	16x 2.5"	4x 2.5"	SATA/SAS HS	Open	None	None	1x Mgmt, 2x GbE	None	1x PCIe x8 FHHL, 1x PCIe x8 FHFL, 1x PCIe x16 FHFL, 1x PCIe x16 FHHL	TPM 1.2	Intrusion Switch	Security door	None	None	USB, with pointing device	XClarity Advanced	1x 1100W Platinum	None	3-year	07/17
7X10A049JP	JAPAN	1x Xeon Gold 6130 16C/2.1GHz/22MB/125W/DDR4-2666	2x 16GB RDIMM DDR4-2666 (1Rx4)	1x 930-16i 4GB Flash	16x 2.5"	16x 2.5"	SATA/SAS HS	Open	None	None	1x Mgmt, 2x GbE	None	1x PCIe x8 FHHL, 1x PCIe x8 FHFL, 1x PCIe x16 FHFL, 1x PCIe x16 FHHL	TPM 1.2	Intrusion Switch	Security door	1x HH DVD	None	USB, with pointing device	XClarity Advanced	1x 1100W Platinum	None	3-year	07/17

Model	Region	Processor	Memory	Storage Controller	Chassis	Disk Bays	Disks	M.2 Drives	GPU	Onboard Networking Ports	Additional Networking (LOM/ML2/PCIe)	Standard Extension Slots	TPM	Intrusion Switch	Security Door	Optical	Optional Ports	Keyboard	System Management	Power Supply	Preload	Warranty	Ann Date (mm/yy)
7X10A04GLA	LA (except Brazil)	1x Xeon Silver 4108 8C/1.8GHz/11MB/85W/DDR4-2400	1x 16GB RDIMM DDR4-2666 (1Rx4)	1x 930-8i 2GB Flash	8x 3.5"	8x 3.5"	2x2TB HDD 7.2K 3.5" SAS12Gbps	None	None	1x Mgmt, 2x GbE	None	1x PCIe x8 FHHL, 1x PCIe x8 FHF, 1x PCIe x16 FHF, 1x PCIe x16 FHHL	TPM 1.2	None	None	1x HH DVD±RW	None	None	XClarity Advanced	2x 750W Platinum	None	3-year	07/17
7X10A04LLA	LA (except Brazil)	1x Xeon Silver 4110 8C/2.1GHz/11MB/85W/DDR4-2400	1x 16GB RDIMM DDR4-2666 (1Rx4)	1x 930-8i 2GB Flash	16x 2.5"	8x 2.5" SATA/SAS HS	2x900GB HDD 10K 2.5" SAS12Gbps	None	None	1x Mgmt, 2x GbE	None	1x PCIe x8 FHHL, 1x PCIe x8 FHF, 1x PCIe x16 FHF, 1x PCIe x16 FHHL	TPM 1.2	None	None	1x HH DVD±RW	None	None	XClarity Advanced	2x 750W Platinum	None	3-year	07/17
7X10A04QLA	LA (except Brazil)	1x Xeon Silver 4110 8C/2.1GHz/11MB/85W/DDR4-2400	1x 16GB RDIMM DDR4-2666 (1Rx4)	1x 930-8i 2GB Flash	8x 3.5"	8x 3.5" SATA/SAS HS	2x2TB HDD 7.2K 3.5" SAS12Gbps	None	None	1x Mgmt, 2x GbE	None	1x PCIe x8 FHHL, 1x PCIe x8 FHF, 1x PCIe x16 FHF, 1x PCIe x16 FHHL	TPM 1.2	None	None	1x HH DVD±RW	None	None	XClarity Advanced	2x 750W Platinum	None	3-year	07/17
7X10A053LA	LA (except Brazil)	1x Xeon Silver 4108 8C/1.8GHz/11MB/85W/DDR4-2400	1x 16GB RDIMM DDR4-2666 (1Rx4)	1x 930-8i 2GB Flash	8x 3.5"	8x 3.5" SATA/SAS HS	2x600GB HDD 15K 3.5" SAS12Gbps	None	None	1x Mgmt, 2x GbE	None	1x PCIe x8 FHHL, 1x PCIe x8 FHF, 1x PCIe x16 FHF, 1x PCIe x16 FHHL	TPM 1.2	None	None	1x HH DVD±RW	None	None	XClarity Advanced	2x 750W Platinum	None	3-year	07/17
7X10A05ELA	LA (except Brazil)	1x Xeon Silver 4110 8C/2.1GHz/11MB/85W/DDR4-2400	2x 16GB RDIMM DDR4-2666 (1Rx4)	1x 930-8i 2GB Flash	16x 2.5"	8x 2.5" SATA/SAS HS	3x900GB HDD 10K 2.5" SAS12Gbps	None	None	1x Mgmt, 2x GbE	None	1x PCIe x8 FHHL, 1x PCIe x8 FHF, 1x PCIe x16 FHF, 1x PCIe x16 FHHL	TPM 1.2	None	None	1x HH DVD±RW	None	None	XClarity Advanced	2x 750W Platinum	None	3-year	07/17
7X10A05BLA	LA (except Brazil)	1x Xeon Silver 4108 8C/1.8GHz/11MB/85W/DDR4-2400	1x 16GB RDIMM DDR4-2666 (1Rx4)	1x 930-8i 2GB Flash	8x 3.5"	8x 3.5" SATA/SAS HS	2x4TB HDD 7.2K 3.5" SAS12Gbps	None	None	1x Mgmt, 2x GbE	None	1x PCIe x8 FHHL, 1x PCIe x8 FHF, 1x PCIe x16 FHF, 1x PCIe x16 FHHL	TPM 1.2	None	None	1x HH DVD±RW	None	None	XClarity Advanced	2x 750W Platinum	None	3-year	07/17
7X10A058LA	LA (except Brazil)	1x Xeon Silver 4110 8C/2.1GHz/11MB/85W/DDR4-2400	2x 16GB RDIMM DDR4-2666 (1Rx4)	1x 930-8i 2GB Flash	8x 3.5"	8x 3.5" SATA/SAS HS	3x4TB HDD 7.2K 3.5" SAS12Gbps	None	None	1x Mgmt, 2x GbE	None	1x PCIe x8 FHHL, 1x PCIe x8 FHF, 1x PCIe x16 FHF, 1x PCIe x16 FHHL	TPM 1.2	None	None	1x HH DVD±RW	None	None	XClarity Advanced	2x 750W Platinum	None	3-year	07/17

ThinkSystem ST550 - TopSeller - LA (except Chile)

Product Specifications Reference (PSREF)

Model	Region	Processor	Memory	Storage Controller	Chassis	Disk Bays	Disks	M.2 Drives	GPU	Onboard Networking Ports	Additional Networking (LOM/ML2/PCIe)	Standard Extension Slots	TPM	Intrusion Switch	Security Door	Optical	Optional Ports	Keyboard	System Management	Power Supply	Preload	Warranty	Ann Date (mm/yy)
7X10100KLA	LA (except Chile)	1x Xeon Silver 4110 8C/2.1GHz/11MB/85W/DDR4-2400	1x 16GB RDIMM DDR4-2666 (1Rx4)	1x 530-8i	16x 2.5"	8x 2.5"	SATA/SAS Open HS	None	None	1x Mgmt, 2x GbE	None	1x PCIe x8 FHHL, 1x PCIe x8 FHFL, 1x PCIe x16 FHFL, 1x PCIe x16 FHHL	TPM 2.0	None	None	1x HH DVD±RW	None	USB	XClarity Standard	1x 750W Platinum	None	3-year	09/17
7X10100LLA	LA (except Chile)	1x Xeon Silver 4110 8C/2.1GHz/11MB/85W/DDR4-2400	1x 16GB RDIMM DDR4-2666 (1Rx4)	1x 930-16i 4GB Flash	16x 2.5"	16x 2.5"	SATA/SAS Open HS	None	None	1x Mgmt, 2x GbE	None	1x PCIe x8 FHHL, 1x PCIe x8 FHFL, 1x PCIe x16 FHFL, 1x PCIe x16 FHHL	TPM 2.0	None	None	1x HH DVD±RW	None	USB	XClarity Standard	2x 750W Platinum	None	3-year	09/17

Model	Region	Processor	Memory	Storage Controller	Chassis	Disk Bays	Disks	M.2 Drives	GPU	Onboard Networking Ports	Additional Networking (LOM/ML2/PCIe)	Standard Extension Slots	TPM	Intrusion Switch	Security Door	Optical	Optional Ports	Keyboard	System Management	Power Supply	Preload	Warranty	Ann Date (mm/yy)
7X10100NNA	NA	1x Xeon Silver 4110 8C/2.1GHz/11MB/85W/DDR4-2400	1x 16GB RDIMM DDR4-2666 (1Rx4)	1x 930-8i 2GB Flash	16x 2.5"	8x 2.5"	SATA/SAS Open HS	None	None	1x Mgmt, 2x GbE	None	1x PCIe x8 FHHL, 1x PCIe x8 FFFL, 1x PCIe x16 FFFL, 1x PCIe x16 FHHL	TPM 1.2	None	None	None	None	None	XClarity Enterprise	1x 750W Platinum	None	3-year	03/18
7X10100PNA	NA	1x Xeon Silver 4116 12C/2.1GHz/16.5MB/85W/DDR4-2400	1x 16GB RDIMM DDR4-2666 (1Rx4)	1x 930-8i 2GB Flash	16x 2.5"	8x 2.5"	SATA/SAS Open HS	None	None	1x Mgmt, 2x GbE	None	1x PCIe x8 FHHL, 1x PCIe x8 FFFL, 1x PCIe x16 FFFL, 1x PCIe x16 FHHL	TPM 1.2	None	None	None	None	None	XClarity Enterprise	1x 750W Platinum	None	3-year	03/18
7X10100QNA	NA	1x Xeon Gold 5118 12C/2.3GHz/16.5MB/105W/DDR4-2400	1x 32GB RDIMM DDR4-2666 (2Rx4)	1x 930-16i 4GB Flash	16x 2.5"	16x 2.5"	SATA/SAS Open HS	None	None	1x Mgmt, 2x GbE	None	1x PCIe x8 FHHL, 1x PCIe x8 FFFL, 1x PCIe x16 FFFL, 1x PCIe x16 FHHL	TPM 1.2	None	None	None	None	None	XClarity Enterprise	1x 750W Platinum	None	3-year	03/18
7X10A03PNA	NA	1x Xeon Bronze 3106 8C/1.7GHz/11MB/85W/DDR4-2133	1x 16GB RDIMM DDR4-2666 (1Rx4)	1x 530-8i	8x 3.5"	4x 3.5"	SATA/SAS Open HS	None	None	1x Mgmt, 2x GbE	None	1x PCIe x8 FHHL, 1x PCIe x8 FFFL, 1x PCIe x16 FFFL, 1x PCIe x16 FHHL	TPM 1.2	None	None	None	None	None	XClarity Enterprise	1x 750W Platinum	None	3-year	07/17
7X10A028NA	NA	1x Xeon Silver 4110 8C/2.1GHz/11MB/85W/DDR4-2400	1x 16GB RDIMM DDR4-2666 (1Rx4)	1x 530-8i	8x 3.5"	8x 3.5"	SATA/SAS Open HS	None	None	1x Mgmt, 2x GbE	None	1x PCIe x8 FHHL, 1x PCIe x8 FFFL, 1x PCIe x16 FFFL, 1x PCIe x16 FHHL	TPM 1.2	None	None	None	None	None	XClarity Enterprise	1x 750W Platinum	None	3-year	07/17
7X10A02PNA	NA	1x Xeon Silver 4116 12C/2.1GHz/16.5MB/85W/DDR4-2400	1x 32GB RDIMM DDR4-2666 (2Rx4)	1x 930-8i 2GB Flash	8x 3.5"	8x 3.5"	SATA/SAS Open HS	None	None	1x Mgmt, 2x GbE	None	1x PCIe x8 FHHL, 1x PCIe x8 FFFL, 1x PCIe x16 FFFL, 1x PCIe x16 FHHL	TPM 1.2	None	None	None	None	None	XClarity Enterprise	1x 750W Platinum	None	3-year	07/17

Model	Region	Processor	Memory	Storage Controller	Chassis	Disk Bays	Disks	M.2 Drives	GPU	Networking Ports	Onboard Networking	Additional Networking (LOM/ML2/PCle)	Standard Extension Slots	TPM	Intrusion Switch	Security Door	Optical	Optional Ports	Keyboard	System Management	Power Supply	Preload	Warranty	Ann Date (mm/yy)
7X10A005AU	ANZ	1x Xeon Gold 5115 10C/2.4GHz/13.75MB/85W/DDR4-2400	1x 16GB RDIMM DDR4-2666 (1Rx4)	1x Onboard Intel RSTe	8x 3.5"	4x 3.5"	SATA SS	Open	None	None	1x Mgmt, 2x GbE	None	1x PCIe x8 FHHL, 1x PCIe x8 FHFL, 1x PCIe x16 FHFL, 1x PCIe x16 FHHL	1.2	Intrusion Switch	Security door	None	None	None	XClarity Standard	1x 550W Platinum	None	3-year	07/17
7X10A00AAU	ANZ	1x Xeon Gold 5115 10C/2.4GHz/13.75MB/85W/DDR4-2400	1x 16GB RDIMM DDR4-2666 (1Rx4)	1x 930-8i 2GB Flash	16x 2.5"	8x 2.5"	SATA/SAS HS	Open	None	None	1x Mgmt, 2x GbE	None	1x PCIe x8 FHHL, 1x PCIe x8 FHFL, 1x PCIe x16 FHFL, 1x PCIe x16 FHHL	1.2	Intrusion Switch	Security door	None	None	None	XClarity Standard	2x 750W Platinum	None	3-year	07/17
7X10A00KAU	ANZ	1x Xeon Gold 5120 14C/2.2GHz/19.25MB/105W/DDR4-2400	1x 16GB RDIMM DDR4-2666 (1Rx4)	1x 930-8i 2GB Flash	16x 2.5"	8x 2.5"	SATA/SAS HS	Open	None	None	1x Mgmt, 2x GbE	None	1x PCIe x8 FHHL, 1x PCIe x8 FHFL, 1x PCIe x16 FHFL, 1x PCIe x16 FHHL	1.2	Intrusion Switch	Security door	None	None	None	XClarity Standard	1x 750W Platinum	None	3-year	07/17
7X10A00MAU	ANZ	1x Xeon Gold 6126T 12C/2.6GHz/19.25MB/125W/DDR4-2666	1x 32GB RDIMM DDR4-2666 (2Rx4)	1x 930-8i 2GB Flash	16x 2.5"	8x 2.5"	SATA/SAS HS	Open	None	None	1x Mgmt, 2x GbE	None	1x PCIe x8 FHHL, 1x PCIe x8 FHFL, 1x PCIe x16 FHFL, 1x PCIe x16 FHHL	1.2	Intrusion Switch	Security door	None	None	None	XClarity Standard	1x 750W Platinum	None	3-year	07/17
7X10A00TAU	ANZ	1x Xeon Gold 5115 10C/2.4GHz/13.75MB/85W/DDR4-2400	1x 16GB RDIMM DDR4-2666 (1Rx4)	1x 530-8i	8x 3.5"	4x 3.5"	SATA/SAS HS	Open	None	None	1x Mgmt, 2x GbE	None	1x PCIe x8 FHHL, 1x PCIe x8 FHFL, 1x PCIe x16 FHFL, 1x PCIe x16 FHHL	1.2	Intrusion Switch	Security door	None	None	None	XClarity Standard	1x 550W Platinum	None	3-year	07/17
7X10A029AU	ANZ	1x Xeon Bronze 3106 8C/1.7GHz/11MB/85W/DDR4-2133	1x 16GB RDIMM DDR4-2666 (1Rx4)	1x 530-8i	16x 2.5"	8x 2.5"	SATA/SAS HS	Open	None	None	1x Mgmt, 2x GbE	None	1x PCIe x8 FHHL, 1x PCIe x8 FHFL, 1x PCIe x16 FHFL, 1x PCIe x16 FHHL	1.2	Intrusion Switch	Security door	1x HH DVD±RW	None	None	XClarity Standard	1x 750W Platinum	None	3-year	07/17
7X10A02AAU	ANZ	1x Xeon Bronze 3104 6C/1.7GHz/8.25MB/85W/DDR4-2133	1x 16GB RDIMM DDR4-2666 (1Rx4)	1x Onboard Intel RSTe	8x 3.5"	8x 3.5"	SATA SS	Open	None	None	1x Mgmt, 2x GbE	None	1x PCIe x8 FHHL, 1x PCIe x8 FHFL, 1x PCIe x16 FHFL, 1x PCIe x16 FHHL	1.2	Intrusion Switch	Security door	1x HH DVD±RW	None	None	XClarity Standard	1x 750W Platinum	None	3-year	07/17
7X10A02BAU	ANZ	1x Xeon Gold 5115 10C/2.4GHz/13.75MB/85W/DDR4-2400	1x 16GB RDIMM DDR4-2666 (1Rx4)	1x 930-8i 2GB Flash	16x 2.5"	8x 2.5"	SATA/SAS HS	Open	None	None	1x Mgmt, 2x GbE	None	1x PCIe x8 FHHL, 1x PCIe x8 FHFL, 1x PCIe x16 FHFL, 1x PCIe x16 FHHL	1.2	Intrusion Switch	Security door	1x HH DVD±RW	None	None	XClarity Standard	2x 750W Platinum	None	3-year	07/17

Model	Region	Processor	Memory	Storage Controller	Chassis	Disk Bays	Disks	M.2 Drives	GPU	Onboard Networking Ports	Additional Networking (LOM/ML2/PCIe)	Standard Extension Slots	TPM	Intrusion Switch	Security Door	Optical	Optional Ports	Keyboard	System Management	Power Supply	Preload	Warranty	Ann Date (mm/yy)	
7X10A02DAU	ANZ	1x Xeon Silver 4110 8C/2.1GHz/11MB/85W/DDR4-2400	4x 16GB RDIMM DDR4-2666 (1Rx4)	1x 930-8i 2GB Flash	16x 2.5"	8x 2.5" SATA/SAS HS	2x600GB HDD 10K 2.5" SAS12Gbps	None	None	1x Mgmt, 2x GbE	None	1x PCIe x8 FHHL, 1x PCIe x8 FHFL, 1x PCIe x16 FHFL, 1x PCIe x16 FHHL	1.2	TPM Switch	Intrusion door	Security DVD±RW	1x HH None	None	None	XClarity Standard	2x 750W Platinum	None	3-year	07/17
7X10A02EAU	ANZ	1x Xeon Silver 4114 10C/2.2GHz/13.75MB/85W/DDR4-2400	1x 16GB RDIMM DDR4-2666 (1Rx4)	1x 930-8i 2GB Flash	8x 3.5"	8x 3.5" SATA/SAS HS	Open	None	None	1x Mgmt, 2x GbE	None	1x PCIe x8 FHHL, 1x PCIe x8 FHFL, 1x PCIe x16 FHFL, 1x PCIe x16 FHHL	1.2	TPM Switch	Intrusion door	Security None	None	None	XClarity Standard	1x 750W Platinum	None	3-year	07/17	
7X10A02FAU	ANZ	1x Xeon Bronze 3104 6C/1.7GHz/8.25MB/85W/DDR4-2133	1x 16GB RDIMM DDR4-2666 (1Rx4)	1x 530-8i	16x 2.5"	8x 2.5" SATA/SAS HS	Open	None	None	1x Mgmt, 2x GbE	None	1x PCIe x8 FHHL, 1x PCIe x8 FHFL, 1x PCIe x16 FHFL, 1x PCIe x16 FHHL	1.2	TPM Switch	Intrusion door	Security DVD	1x HH None	None	None	XClarity Standard	1x 750W Platinum	None	3-year	07/17
7X10A02GAU	ANZ	1x Xeon Silver 4110 8C/2.1GHz/11MB/85W/DDR4-2400	1x 16GB RDIMM DDR4-2666 (1Rx4)	1x 930-8i 2GB Flash	16x 2.5"	8x 2.5" SATA/SAS HS	3x300GB HDD 10K 2.5" SAS12Gbps	None	None	1x Mgmt, 2x GbE	None	1x PCIe x8 FHHL, 1x PCIe x8 FHFL, 1x PCIe x16 FHFL, 1x PCIe x16 FHHL	1.2	TPM Switch	Intrusion door	Security DVD±RW	1x HH None	None	None	XClarity Standard	2x 750W Platinum	None	3-year	07/17
7X10A011AU	ANZ	1x Xeon Gold 6130T 16C/2.1GHz/22MB/125W/DDR4-2666	1x 32GB RDIMM DDR4-2666 (2Rx4)	1x 930-8i 2GB Flash	16x 2.5"	8x 2.5" SATA/SAS HS	Open	None	None	1x Mgmt, 2x GbE	None	1x PCIe x8 FHHL, 1x PCIe x8 FHFL, 1x PCIe x16 FHFL, 1x PCIe x16 FHHL	1.2	TPM Switch	Intrusion door	Security None	None	None	XClarity Standard	1x 750W Platinum	None	3-year	07/17	
7X10A02JAU	ANZ	1x Xeon Silver 4114 10C/2.2GHz/13.75MB/85W/DDR4-2400	1x 16GB RDIMM DDR4-2666 (1Rx4)	1x 930-8i 2GB Flash	16x 2.5"	8x 2.5" SATA/SAS HS	Open	None	None	1x Mgmt, 2x GbE	None	1x PCIe x8 FHHL, 1x PCIe x8 FHFL, 1x PCIe x16 FHFL, 1x PCIe x16 FHHL	1.2	TPM Switch	Intrusion door	Security None	None	None	XClarity Standard	1x 750W Platinum	None	3-year	07/17	
7X10A02LAU	ANZ	1x Xeon Silver 4110 8C/2.1GHz/11MB/85W/DDR4-2400	1x 16GB RDIMM DDR4-2666 (1Rx4)	1x 530-8i	16x 2.5"	8x 2.5" SATA/SAS HS	Open	None	None	1x Mgmt, 2x GbE	None	1x PCIe x8 FHHL, 1x PCIe x8 FHFL, 1x PCIe x16 FHFL, 1x PCIe x16 FHHL	1.2	TPM Switch	Intrusion door	Security DVD	1x HH None	None	None	XClarity Standard	1x 750W Platinum	None	3-year	07/17
7X10A02MAU	ANZ	1x Xeon Bronze 3106 8C/1.7GHz/11MB/85W/DDR4-2133	1x 16GB RDIMM DDR4-2666 (1Rx4)	1x 530-8i	16x 2.5"	8x 2.5" SATA/SAS HS	Open	None	None	1x Mgmt, 2x GbE	None	1x PCIe x8 FHHL, 1x PCIe x8 FHFL, 1x PCIe x16 FHFL, 1x PCIe x16 FHHL	1.2	TPM Switch	Intrusion door	Security DVD	1x HH None	None	None	XClarity Standard	1x 750W Platinum	None	3-year	07/17

Model	Region	Processor	Memory	Storage Controller	Chassis	Disk Bays	Disks	M.2 Drives	GPU	Networking Ports	Onboard Networking	Additional Networking (LOM/ML2/PCle)	Standard Extension Slots	TPM	Intrusion Switch	Security Door	Optical	Optional Ports	Keyboard	System Management	Power Supply	Preload	Warranty	Ann Date (mm/yy)
7X10A02NAU	ANZ	1x Xeon Silver 4108 8C/1.8GHz/11MB/85W/DDR4-2400	1x 16GB RDIMM DDR4-2666 (1Rx4)	1x 530-8i	16x 2.5"	8x 2.5" SATA/SAS HS	Open	None	None	1x Mgmt, 2x GbE	None	None	1x PCIe x8 FHHL, 1x PCIe x8 FHFL, 1x PCIe x16 FHFL, 1x PCIe x16 FHHH	1.2	TPM Switch	Intrusion door	1x HH DVD	None	None	XClarity Standard	1x 750W Platinum	None	3-year	07/17
7X10A02RAU	ANZ	1x Xeon Gold 5118 12C/2.3GHz/16.5MB/105W/DDR4-2400	1x 16GB RDIMM DDR4-2666 (1Rx4)	1x 930-8i	16x 2.5"	8x 2.5" SATA/SAS HS	Open	None	None	1x Mgmt, 2x GbE	None	None	1x PCIe x8 FHHL, 1x PCIe x8 FHFL, 1x PCIe x16 FHFL, 1x PCIe x16 FHHH	1.2	TPM Switch	Intrusion door	1x HH DVD	None	None	XClarity Standard	1x 750W Platinum	None	3-year	07/17
7X10A02TAU	ANZ	1x Xeon Bronze 3104 6C/1.7GHz/8.25MB/85W/DDR4-2133	1x 16GB RDIMM DDR4-2666 (1Rx4)	1x 530-8i	16x 2.5"	8x 2.5" SATA/SAS HS	Open	None	None	1x Mgmt, 2x GbE	None	None	1x PCIe x8 FHHL, 1x PCIe x8 FHFL, 1x PCIe x16 FHFL, 1x PCIe x16 FHHH	1.2	TPM Switch	Intrusion door	1x HH DVD±RW	None	None	XClarity Standard	1x 750W Platinum	None	3-year	07/17
7X10A02VAU	ANZ	1x Xeon Silver 4108 8C/1.8GHz/11MB/85W/DDR4-2400	1x 16GB RDIMM DDR4-2666 (1Rx4)	1x 930-8i	16x 2.5"	8x 2.5" SATA/SAS HS	Open	None	None	1x Mgmt, 2x GbE	None	None	1x PCIe x8 FHHL, 1x PCIe x8 FHFL, 1x PCIe x16 FHFL, 1x PCIe x16 FHHH	1.2	TPM Switch	Intrusion door	1x HH DVD±RW	None	None	XClarity Standard	1x 750W Platinum	None	3-year	07/17
7X10A02ZAU	ANZ	1x Xeon Silver 4116 12C/2.1GHz/16.5MB/85W/DDR4-2400	1x 16GB RDIMM DDR4-2666 (1Rx4)	1x 530-8i	16x 2.5"	8x 2.5" SATA/SAS HS	Open	None	None	1x Mgmt, 2x GbE	None	None	1x PCIe x8 FHHL, 1x PCIe x8 FHFL, 1x PCIe x16 FHFL, 1x PCIe x16 FHHH	1.2	TPM Switch	Intrusion door	1x HH DVD	None	None	XClarity Standard	1x 750W Platinum	None	3-year	07/17
7X10A032AU	ANZ	1x Xeon Silver 4108 8C/1.8GHz/11MB/85W/DDR4-2400	1x 16GB RDIMM DDR4-2666 (1Rx4)	1x 930-8i	16x 2.5"	8x 2.5" SATA/SAS HS	Open	None	None	1x Mgmt, 2x GbE	None	None	1x PCIe x8 FHHL, 1x PCIe x8 FHFL, 1x PCIe x16 FHFL, 1x PCIe x16 FHHH	1.2	TPM Switch	Intrusion door	1x HH DVD±RW	None	None	XClarity Standard	2x 750W Platinum	None	3-year	07/17
7X10A036AU	ANZ	1x Xeon Silver 4110 8C/2.1GHz/11MB/85W/DDR4-2400	1x 16GB RDIMM DDR4-2666 (1Rx4)	1x 930-8i	16x 2.5"	8x 2.5" SATA/SAS HS	Open	None	None	1x Mgmt, 2x GbE	None	None	1x PCIe x8 FHHL, 1x PCIe x8 FHFL, 1x PCIe x16 FHFL, 1x PCIe x16 FHHH	1.2	TPM Switch	Intrusion door	None	None	None	XClarity Standard	1x 750W Platinum	None	3-year	07/17
7X10A038AU	ANZ	1x Xeon Silver 4116 12C/2.1GHz/16.5MB/85W/DDR4-2400	1x 16GB RDIMM DDR4-2666 (1Rx4)	1x 930-8i	16x 2.5"	8x 2.5" SATA/SAS HS	Open	None	None	1x Mgmt, 2x GbE	None	None	1x PCIe x8 FHHL, 1x PCIe x8 FHFL, 1x PCIe x16 FHFL, 1x PCIe x16 FHHH	1.2	TPM Switch	Intrusion door	None	None	None	XClarity Standard	1x 750W Platinum	None	3-year	07/17

Model	Region	Processor	Memory	Storage Controller	Chassis	Disk Bays	Disks	M.2 Drives	GPU	Networking Ports	Onboard Networking	Additional Networking (LOM/ML2/PCle)	Standard Extension Slots	TPM	Intrusion Switch	Security Door	Optical	Optional Ports	Keyboard	System Management	Power Supply	Preload	Warranty	Ann Date (mm/yy)
7X10A03DAU	ANZ	1x Xeon Silver 4108 8C/1.8GHz/11MB/85W/DDR4-2400	1x 16GB RDIMM DDR4-2666 (1Rx4)	1x Onboard Intel RSTe	8x 3.5"	8x 3.5"	SATA SS	Open	None	None	1x Mgmt, 2x GbE	None	1x PCIe x8 FHHL, 1x PCIe x8 FHL, 1x PCIe x16 FHL, 1x PCIe x16 FHHL	TPM 1.2	Intrusion Switch	Security door	1x HH DVD±RW	None	None	XClarity Standard	1x 750W Platinum	None	3-year	07/17
7X10A03EAU	ANZ	1x Xeon Bronze 3104 6C/1.7GHz/8.25MB/85W/DDR4-2133	1x 16GB RDIMM DDR4-2666 (1Rx4)	1x 530-8i	8x 3.5"	8x 3.5"	SATA/SAS HS	Open	None	None	1x Mgmt, 2x GbE	None	1x PCIe x8 FHHL, 1x PCIe x8 FHL, 1x PCIe x16 FHL, 1x PCIe x16 FHHL	TPM 1.2	Intrusion Switch	Security door	1x HH DVD±RW	None	None	XClarity Standard	1x 750W Platinum	None	3-year	07/17
7X10A03FAU	ANZ	1x Xeon Silver 4110 8C/2.1GHz/11MB/85W/DDR4-2400	1x 16GB RDIMM DDR4-2666 (1Rx4)	1x 930-8i 2GB Flash	8x 3.5"	8x 3.5"	SATA/SAS HS	Open	None	None	1x Mgmt, 2x GbE	None	1x PCIe x8 FHHL, 1x PCIe x8 FHL, 1x PCIe x16 FHL, 1x PCIe x16 FHHL	TPM 1.2	Intrusion Switch	Security door	None	None	None	XClarity Standard	1x 750W Platinum	None	3-year	07/17
7X10A03GAU	ANZ	1x Xeon Bronze 3106 8C/1.7GHz/11MB/85W/DDR4-2133	1x 16GB RDIMM DDR4-2666 (1Rx4)	1x 530-8i	8x 3.5"	8x 3.5"	SATA/SAS HS	Open	None	None	1x Mgmt, 2x GbE	None	1x PCIe x8 FHHL, 1x PCIe x8 FHL, 1x PCIe x16 FHL, 1x PCIe x16 FHHL	TPM 1.2	Intrusion Switch	Security door	1x HH DVD±RW	None	None	XClarity Standard	1x 750W Platinum	None	3-year	07/17
7X10A03HAU	ANZ	1x Xeon Silver 4108 8C/1.8GHz/11MB/85W/DDR4-2400	1x 16GB RDIMM DDR4-2666 (1Rx4)	1x 930-8i 2GB Flash	16x 2.5"	8x 2.5"	SATA/SAS HS	Open	None	None	1x Mgmt, 2x GbE	None	1x PCIe x8 FHHL, 1x PCIe x8 FHL, 1x PCIe x16 FHL, 1x PCIe x16 FHHL	TPM 1.2	Intrusion Switch	Security door	None	None	None	XClarity Standard	1x 750W Platinum	None	3-year	07/17
7X10A03LAU	ANZ	1x Xeon Gold 5120 14C/2.2GHz/19.25MB/105W/DDR4-2400	1x 16GB RDIMM DDR4-2666 (1Rx4)	1x 930-8i 2GB Flash	16x 2.5"	8x 2.5"	SATA/SAS HS	Open	None	None	1x Mgmt, 2x GbE	None	1x PCIe x8 FHHL, 1x PCIe x8 FHL, 1x PCIe x16 FHL, 1x PCIe x16 FHHL	TPM 1.2	Intrusion Switch	Security door	1x HH DVD	None	None	XClarity Standard	1x 750W Platinum	None	3-year	07/17
7X10A03MAU	ANZ	1x Xeon Bronze 3104 6C/1.7GHz/8.25MB/85W/DDR4-2133	1x 16GB RDIMM DDR4-2666 (1Rx4)	1x 930-8i 2GB Flash	16x 2.5"	8x 2.5"	SATA/SAS HS	Open	None	None	1x Mgmt, 2x GbE	None	1x PCIe x8 FHHL, 1x PCIe x8 FHL, 1x PCIe x16 FHL, 1x PCIe x16 FHHL	TPM 1.2	Intrusion Switch	Security door	None	None	None	XClarity Standard	1x 750W Platinum	None	3-year	07/17
7X10A03NAU	ANZ	1x Xeon Silver 4108 8C/1.8GHz/11MB/85W/DDR4-2400	1x 16GB RDIMM DDR4-2666 (1Rx4)	1x 930-8i 2GB Flash	16x 2.5"	8x 2.5"	SATA/SAS HS	Open	None	None	1x Mgmt, 2x GbE	None	1x PCIe x8 FHHL, 1x PCIe x8 FHL, 1x PCIe x16 FHL, 1x PCIe x16 FHHL	TPM 1.2	Intrusion Switch	Security door	1x HH DVD±RW	None	None	XClarity Standard	2x 750W Platinum	None	3-year	07/17

Model	Region	Processor	Memory	Storage Controller	Chassis	Disk Bays	Disks	M.2 Drives	GPU	Onboard Networking Ports	Additional Networking (LOM/ML2/PCIe)	Standard Extension Slots	TPM	Intrusion Switch	Security Door	Optical	Optional Ports	Keyboard	System Management	Power Supply	Preload	Warranty	Ann Date (mm/yy)
7X10A03QAU	ANZ	1x Xeon Silver 4110 8C/2.1GHz/11MB/85W/DDR4-2400	1x 16GB RDIMM DDR4-2666 (1Rx4)	1x 930-8i 2GB Flash	16x 2.5"	8x 2.5"	SATA/SAS Open HS	None	None	1x Mgmt, 2x GbE	None	1x PCIe x8 FHHL, 1x PCIe x8 FHFL, 1x PCIe x16 FHFL, 1x PCIe x16 FHHL	TPM 1.2	Intrusion Switch	Security door	1x HH DVD±RW	None	None	XClarity Standard	1x 750W Platinum	None	3-year	07/17
7X10A03RAU	ANZ	1x Xeon Silver 4114 10C/2.2GHz/13.75MB/85W/DDR4-2400	1x 16GB RDIMM DDR4-2666 (1Rx4)	1x 930-8i 2GB Flash	16x 2.5"	8x 2.5"	SATA/SAS Open HS	None	None	1x Mgmt, 2x GbE	None	1x PCIe x8 FHHL, 1x PCIe x8 FHFL, 1x PCIe x16 FHFL, 1x PCIe x16 FHHL	TPM 1.2	Intrusion Switch	Security door	1x HH DVD	None	None	XClarity Standard	1x 750W Platinum	None	3-year	07/17
7X10A03UUAU	ANZ	1x Xeon Gold 5118 12C/2.3GHz/16.5MB/105W/DDR4-2400	1x 16GB RDIMM DDR4-2666 (1Rx4)	1x 930-8i 2GB Flash	16x 2.5"	8x 2.5"	SATA/SAS Open HS	None	None	1x Mgmt, 2x GbE	None	1x PCIe x8 FHHL, 1x PCIe x8 FHFL, 1x PCIe x16 FHFL, 1x PCIe x16 FHHL	TPM 1.2	Intrusion Switch	Security door	None	None	None	XClarity Standard	1x 750W Platinum	None	3-year	07/17
7X10A03AAU	ANZ	1x Xeon Silver 4116 12C/2.1GHz/16.5MB/85W/DDR4-2400	1x 16GB RDIMM DDR4-2666 (1Rx4)	1x 930-8i 2GB Flash	16x 2.5"	8x 2.5"	SATA/SAS Open HS	None	None	1x Mgmt, 2x GbE	None	1x PCIe x8 FHHL, 1x PCIe x8 FHFL, 1x PCIe x16 FHFL, 1x PCIe x16 FHHL	TPM 1.2	Intrusion Switch	Security door	1x HH DVD±RW	None	None	XClarity Standard	1x 750W Platinum	None	3-year	07/17

Model	Region	Processor	Memory	Storage Controller	Chassis	Disk Bays	Disks	M.2 Drives	GPU	Networking Ports	Onboard Networking	Additional Networking (LOM/ML2/PCle)	Standard Extension Slots	TPM	Intrusion Switch	Security Door	Optical	Optional Ports	Keyboard	System Management	Power Supply	Preload	Warranty	Ann Date (mm/yy)
7X10A04KLA	Argentina	1x Xeon Gold 6130 16C/2.1GHz/22MB/125W/DDR4-2666	1x 16GB RDIMM DDR4-2666 (1Rx4)	1x 930-8i 2GB Flash	8x 3.5"	4x 3.5"	SATA/SAS Open HS	None	None	1x Mgmt, 2x GbE	None	None	1x PCIe x8 FHHL, 1x PCle x8 FHFL, 1x PCle x16 FHFL, 1x PCle x16 FHHL	TPM 1.2	None	None	1x HH DVD±RW	None	None	XClarity Standard	1x 750W Platinum	None	3-year	07/17
7X10A04RLA	Argentina	1x Xeon Gold 5115 10C/2.4GHz/13.75MB/85W/DDR4-2400	1x 16GB RDIMM DDR4-2666 (1Rx4)	1x 930-8i 2GB Flash	8x 3.5"	4x 3.5"	SATA/SAS Open HS	None	None	1x Mgmt, 2x GbE	None	None	1x PCIe x8 FHHL, 1x PCle x8 FHFL, 1x PCle x16 FHFL, 1x PCle x16 FHHL	TPM 1.2	None	None	1x HH DVD±RW	None	None	XClarity Standard	1x 750W Platinum	None	3-year	07/17
7X10A04XLA	Argentina	1x Xeon Gold 5118 12C/2.3GHz/16.5MB/105W/DDR4-2400	1x 16GB RDIMM DDR4-2666 (1Rx4)	1x 930-8i 2GB Flash	8x 3.5"	4x 3.5"	SATA/SAS Open HS	None	None	1x Mgmt, 2x GbE	None	None	1x PCIe x8 FHHL, 1x PCle x8 FHFL, 1x PCle x16 FHFL, 1x PCle x16 FHHL	TPM 1.2	None	None	1x HH DVD±RW	None	None	XClarity Standard	1x 750W Platinum	None	3-year	07/17
7X10A054LA	Argentina	1x Xeon Gold 6138 20C/2.0GHz/27.5MB/125W/DDR4-2666	1x 16GB RDIMM DDR4-2666 (1Rx4)	1x 930-8i 2GB Flash	16x 2.5"	8x 2.5"	SATA/SAS Open HS	None	None	1x Mgmt, 2x GbE	None	None	1x PCIe x8 FHHL, 1x PCle x8 FHFL, 1x PCle x16 FHFL, 1x PCle x16 FHHL	TPM 1.2	None	None	1x HH DVD±RW	None	None	XClarity Standard	1x 750W Platinum	None	3-year	07/17
7X10A056LA	Argentina	1x Xeon Gold 6130 16C/2.1GHz/22MB/125W/DDR4-2666	1x 16GB RDIMM DDR4-2666 (1Rx4)	1x 930-8i 2GB Flash	16x 2.5"	8x 2.5"	SATA/SAS Open HS	None	None	1x Mgmt, 2x GbE	None	None	1x PCIe x8 FHHL, 1x PCle x8 FHFL, 1x PCle x16 FHFL, 1x PCle x16 FHHL	TPM 1.2	None	None	1x HH DVD±RW	None	None	XClarity Standard	1x 750W Platinum	None	3-year	07/17
7X10A059LA	Argentina	1x Xeon Gold 6138 20C/2.0GHz/27.5MB/125W/DDR4-2666	1x 16GB RDIMM DDR4-2666 (1Rx4)	1x 930-8i 2GB Flash	8x 3.5"	4x 3.5"	SATA/SAS Open HS	None	None	1x Mgmt, 2x GbE	None	None	1x PCIe x8 FHHL, 1x PCle x8 FHFL, 1x PCle x16 FHFL, 1x PCle x16 FHHL	TPM 1.2	None	None	1x HH DVD±RW	None	None	XClarity Standard	1x 750W Platinum	None	3-year	07/17
7X10A05ALA	Argentina	1x Xeon Gold 5118 12C/2.3GHz/16.5MB/105W/DDR4-2400	1x 16GB RDIMM DDR4-2666 (1Rx4)	1x 930-8i 2GB Flash	16x 2.5"	8x 2.5"	SATA/SAS Open HS	None	None	1x Mgmt, 2x GbE	None	None	1x PCIe x8 FHHL, 1x PCle x8 FHFL, 1x PCle x16 FHFL, 1x PCle x16 FHHL	TPM 1.2	None	None	1x HH DVD±RW	None	None	XClarity Standard	1x 750W Platinum	None	3-year	07/17
7X10A05FLA	Argentina	1x Xeon Gold 5115 10C/2.4GHz/13.75MB/85W/DDR4-2400	1x 16GB RDIMM DDR4-2666 (1Rx4)	1x 930-8i 2GB Flash	16x 2.5"	8x 2.5"	SATA/SAS Open HS	None	None	1x Mgmt, 2x GbE	None	None	1x PCIe x8 FHHL, 1x PCle x8 FHFL, 1x PCle x16 FHFL, 1x PCle x16 FHHL	TPM 1.2	None	None	1x HH DVD±RW	None	None	XClarity Standard	1x 750W Platinum	None	3-year	07/17

Model	Region	Processor	Memory	Storage Controller	Chassis	Disk Bays	Disks	M.2 Drives	GPU	Networking Ports	Onboard Networking	Additional Networking (LOM/ML2/PCle)	Standard Extension Slots	TPM	Intrusion Switch	Security Door	Optical	Optional Ports	Keyboard	System Management	Power Supply	Preload	Warranty	Ann Date (mm/yy)
7X10A05GLA	Argentina	1x Xeon Gold 5120 14C/2.2GHz/19.25MB/105W/DDR4-2400	1x 16GB RDIMM DDR4-2666 (1Rx4)	1x 930-8i 2GB Flash	8x 3.5"	4x 3.5"	SATA/SAS HS	Open	None	None	1x Mgmt, 2x GbE	None	1x PCIe x8 FHHL, 1x PCIe x8 FHFL, 1x PCIe x16 FHFL, 1x PCIe x16 FHHL	TPM 1.2	None	None	1x HH DVD±RW	None	None	XClarity Standard	1x 750W Platinum	None	3-year	07/17
7X10A05HLA	Argentina	1x Xeon Silver 4114 10C/2.2GHz/13.75MB/85W/DDR4-2400	1x 8GB RDIMM DDR4-2666 (1Rx8)	1x 530-8i	16x 2.5"	8x 2.5"	SATA/SAS HS	Open	None	None	1x Mgmt, 2x GbE	None	1x PCIe x8 FHHL, 1x PCIe x8 FHFL, 1x PCIe x16 FHFL, 1x PCIe x16 FHHL	TPM 1.2	None	None	1x HH DVD±RW	None	None	XClarity Standard	1x 750W Platinum	None	3-year	07/17
7X10A05KLA	Argentina	1x Xeon Gold 5120 14C/2.2GHz/19.25MB/105W/DDR4-2400	1x 16GB RDIMM DDR4-2666 (1Rx4)	1x 930-8i 2GB Flash	16x 2.5"	8x 2.5"	SATA/SAS HS	Open	None	None	1x Mgmt, 2x GbE	None	1x PCIe x8 FHHL, 1x PCIe x8 FHFL, 1x PCIe x16 FHFL, 1x PCIe x16 FHHL	TPM 1.2	None	None	1x HH DVD±RW	None	None	XClarity Standard	1x 750W Platinum	None	3-year	07/17
7X10A05LLA	Argentina	1x Xeon Silver 4114 10C/2.2GHz/13.75MB/85W/DDR4-2400	1x 8GB RDIMM DDR4-2666 (1Rx8)	1x 530-8i	8x 3.5"	4x 3.5"	SATA/SAS HS	Open	None	None	1x Mgmt, 2x GbE	None	1x PCIe x8 FHHL, 1x PCIe x8 FHFL, 1x PCIe x16 FHFL, 1x PCIe x16 FHHL	TPM 1.2	None	None	1x HH DVD±RW	None	None	XClarity Standard	1x 750W Platinum	None	3-year	07/17

Model	Region	Processor	Memory	Storage Controller	Chassis	Disk Bays	Disks	M.2 Drives	GPU	Networking Ports	Additional Networking (LOM/ML2/PCle)	Standard Extension Slots	TPM	Intrusion Switch	Security Door	Optical	Optional Ports	Keyboard	System Management	Power Supply	Preload	Warranty	Ann Date (mm/yy)
7X10A01ZSG	ASEAN	1x Xeon Bronze 3104 6C/1.7GHz/8.25MB/85W/DDR4-2133	1x 8GB RDIMM DDR4-2666 (1Rx8)	1x 530-8i	8x 3.5"	4x 3.5"	SATA/SAS Open	None	None	1x Mgmt, 2x GbE	None	1x PCIe x8 FHHL, 1x PCIe x8 FHFL, 1x PCIe x16 FHFL, 1x PCIe x16 FHHL	TPM 1.2	None	None	None	None	None	XClarity Standard	1x 550W Platinum	None	3-year	07/17
7X10A020SG	ASEAN	1x Xeon Silver 4110 8C/2.1GHz/11MB/85W/DDR4-2400	1x 8GB RDIMM DDR4-2666 (1Rx8)	1x 530-8i	8x 3.5"	4x 3.5"	SATA/SAS Open	None	None	1x Mgmt, 2x GbE	None	1x PCIe x8 FHHL, 1x PCIe x8 FHFL, 1x PCIe x16 FHFL, 1x PCIe x16 FHHL	TPM 1.2	None	None	None	None	None	XClarity Standard	1x 550W Platinum	None	3-year	07/17
7X10A021SG	ASEAN	1x Xeon Bronze 3106 8C/1.7GHz/11MB/85W/DDR4-2133	1x 8GB RDIMM DDR4-2666 (1Rx8)	1x 530-8i	8x 3.5"	4x 3.5"	SATA/SAS Open	None	None	1x Mgmt, 2x GbE	None	1x PCIe x8 FHHL, 1x PCIe x8 FHFL, 1x PCIe x16 FHFL, 1x PCIe x16 FHHL	TPM 1.2	None	None	None	None	None	XClarity Standard	1x 550W Platinum	None	3-year	07/17
7X10A022SG	ASEAN	1x Xeon Silver 4114 10C/2.2GHz/13.75MB/85W/DDR4-2400	1x 8GB RDIMM DDR4-2666 (1Rx8)	1x 530-8i	8x 3.5"	4x 3.5"	SATA/SAS Open	None	None	1x Mgmt, 2x GbE	None	1x PCIe x8 FHHL, 1x PCIe x8 FHFL, 1x PCIe x16 FHFL, 1x PCIe x16 FHHL	TPM 1.2	None	None	None	None	None	XClarity Standard	1x 550W Platinum	None	3-year	07/17
7X10A023SG	ASEAN	1x Xeon Silver 4114 10C/2.2GHz/13.75MB/85W/DDR4-2400	1x 8GB RDIMM DDR4-2666 (1Rx8)	1x 530-8i	16x 2.5"	8x 2.5"	SATA/SAS Open	None	None	1x Mgmt, 2x GbE	None	1x PCIe x8 FHHL, 1x PCIe x8 FHFL, 1x PCIe x16 FHFL, 1x PCIe x16 FHHL	TPM 1.2	None	None	None	None	None	XClarity Standard	1x 750W Platinum	None	3-year	07/17
7X10A024SG	ASEAN	1x Xeon Silver 4116 12C/2.1GHz/16.5MB/85W/DDR4-2400	1x 8GB RDIMM DDR4-2666 (1Rx8)	1x 530-8i	16x 2.5"	8x 2.5"	SATA/SAS Open	None	None	1x Mgmt, 2x GbE	None	1x PCIe x8 FHHL, 1x PCIe x8 FHFL, 1x PCIe x16 FHFL, 1x PCIe x16 FHHL	TPM 1.2	None	None	None	None	None	XClarity Standard	1x 750W Platinum	None	3-year	07/17
7X10A025SG	ASEAN	1x Xeon Silver 4116 12C/2.1GHz/16.5MB/85W/DDR4-2400	1x 8GB RDIMM DDR4-2666 (1Rx8)	1x 530-8i	8x 3.5"	4x 3.5"	SATA/SAS Open	None	None	1x Mgmt, 2x GbE	None	1x PCIe x8 FHHL, 1x PCIe x8 FHFL, 1x PCIe x16 FHFL, 1x PCIe x16 FHHL	TPM 1.2	None	None	None	None	None	XClarity Standard	1x 550W Platinum	None	3-year	07/17
7X10A026SG	ASEAN	1x Xeon Silver 4112 4C/2.6GHz/8.25MB/85W/DDR4-2400	1x 8GB RDIMM DDR4-2666 (1Rx8)	1x 530-8i	8x 3.5"	4x 3.5"	SATA/SAS Open	None	None	1x Mgmt, 2x GbE	None	1x PCIe x8 FHHL, 1x PCIe x8 FHFL, 1x PCIe x16 FHFL, 1x PCIe x16 FHHL	TPM 1.2	None	None	None	None	None	XClarity Standard	1x 550W Platinum	None	3-year	07/17

Model	Region	Processor	Memory	Storage Controller	Chassis	Disk Bays	Disks	M.2 Drives	GPU	Networking	Onboard Networking Ports	Additional Networking (LOM/ML2/PCIe)	Standard Extension Slots	TPM	Intrusion Switch	Security Door	Optical	Optional Ports	Keyboard	System Management	Power Supply	Preload	Warranty	Ann Date (mm/yy)
7X10A00GSG	ASEAN	1x Xeon Gold 5122 4C/3.6GHz/16.5MB/105W/DDR4-2666	1x 8GB RDIMM DDR4-2666 (1Rx8)	1x 530-8i	8x 3.5"	4x 3.5"	SATA/SAS Open HS	None	None	1x Mgmt, 2x GbE	None	None	1x PCIe x8 FHHL, 1x PCIe x8 FHFL, 1x PCIe x16 FHFL, 1x PCIe x16 FHHL	TPM 1.2	None	None	None	None	None	XClarity Standard	1x 750W Platinum	None	3-year	07/17
7X10A00BSG	ASEAN	1x Xeon Gold 6130 16C/2.1GHz/22MB/125W/DDR4-2666	1x 8GB RDIMM DDR4-2666 (1Rx8)	1x 530-8i	16x 2.5"	8x 2.5"	SATA/SAS Open HS	None	None	1x Mgmt, 2x GbE	None	None	1x PCIe x8 FHHL, 1x PCIe x8 FHFL, 1x PCIe x16 FHFL, 1x PCIe x16 FHHL	TPM 1.2	None	None	None	None	None	XClarity Standard	1x 750W Platinum	None	3-year	07/17
7X10A00DSG	ASEAN	1x Xeon Gold 5120 14C/2.2GHz/19.25MB/105W/DDR4-2400	1x 8GB RDIMM DDR4-2666 (1Rx8)	1x 530-8i	16x 2.5"	8x 2.5"	SATA/SAS Open HS	None	None	1x Mgmt, 2x GbE	None	None	1x PCIe x8 FHHL, 1x PCIe x8 FHFL, 1x PCIe x16 FHFL, 1x PCIe x16 FHHL	TPM 1.2	None	None	None	None	None	XClarity Standard	1x 750W Platinum	None	3-year	07/17
7X10A00ESG	ASEAN	1x Xeon Gold 5118 12C/2.3GHz/16.5MB/105W/DDR4-2400	1x 8GB RDIMM DDR4-2666 (1Rx8)	1x 530-8i	16x 2.5"	8x 2.5"	SATA/SAS Open HS	None	None	1x Mgmt, 2x GbE	None	None	1x PCIe x8 FHHL, 1x PCIe x8 FHFL, 1x PCIe x16 FHFL, 1x PCIe x16 FHHL	TPM 1.2	None	None	None	None	None	XClarity Standard	1x 750W Platinum	None	3-year	07/17
7X10A003SG	ASEAN	1x Xeon Gold 5115 10C/2.4GHz/13.75MB/85W/DDR4-2400	1x 8GB RDIMM DDR4-2666 (1Rx8)	1x 530-8i	8x 3.5"	4x 3.5"	SATA/SAS Open HS	None	None	1x Mgmt, 2x GbE	None	None	1x PCIe x8 FHHL, 1x PCIe x8 FHFL, 1x PCIe x16 FHFL, 1x PCIe x16 FHHL	TPM 1.2	None	None	None	None	None	XClarity Standard	1x 750W Platinum	None	3-year	07/17
7X10A004SG	ASEAN	1x Xeon Gold 5118 12C/2.3GHz/16.5MB/105W/DDR4-2400	1x 8GB RDIMM DDR4-2666 (1Rx8)	1x 530-8i	8x 3.5"	4x 3.5"	SATA/SAS Open HS	None	None	1x Mgmt, 2x GbE	None	None	1x PCIe x8 FHHL, 1x PCIe x8 FHFL, 1x PCIe x16 FHFL, 1x PCIe x16 FHHL	TPM 1.2	None	None	None	None	None	XClarity Standard	1x 750W Platinum	None	3-year	07/17

Model	Region	Processor	Memory	Storage Controller	Chassis	Disk Bays	Disks	M.2 Drives	GPU	Onboard Networking Ports	Additional Networking (LOM/ML2/PCle)	Standard Extension Slots	TPM	Intrusion Switch	Security Door	Optical	Optional Ports	Keyboard	System Management	Power Supply	Preload	Warranty	Ann Date (mm/yy)
7X10A040BR	Brazil	1x Xeon Gold 5115 10C/2.4GHz/13.75MB/85W/DDR4-2400	1x 16GB RDIMM DDR4-2666 (1Rx4)	1x 930-8i 2GB Flash	16x 2.5"	8x 2.5" SATA/SAS HS	Open	None	None	1x Mgmt, 2x GbE	None	1x PCIe x8 FHHL, 1x PCIe x8 FHFL, 1x PCIe x16 FHFL, 1x PCIe x16 FHHL	1.2	Intrusion Switch	Security door	1x HH DVD±RW	None	None	XClarity Standard	2x 750W Platinum	None	3-year	07/17
7X10A041BR	Brazil	1x Xeon Gold 5118 12C/2.3GHz/16.5MB/105W/DDR4-2400	1x 16GB RDIMM DDR4-2666 (1Rx4)	1x 930-8i 2GB Flash	16x 2.5"	8x 2.5" SATA/SAS HS	Open	None	None	1x Mgmt, 2x GbE	None	1x PCIe x8 FHHL, 1x PCIe x8 FHFL, 1x PCIe x16 FHFL, 1x PCIe x16 FHHL	1.2	Intrusion Switch	Security door	None	None	None	XClarity Standard	1x 750W Platinum	None	3-year	07/17
7X10A042BR	Brazil	1x Xeon Gold 5118 12C/2.3GHz/16.5MB/105W/DDR4-2400	1x 16GB RDIMM DDR4-2666 (1Rx4)	1x 930-8i 2GB Flash	16x 2.5"	8x 2.5" SATA/SAS HS	Open	None	None	1x Mgmt, 2x GbE	None	1x PCIe x8 FHHL, 1x PCIe x8 FHFL, 1x PCIe x16 FHFL, 1x PCIe x16 FHHL	1.2	Intrusion Switch	Security door	1x HH DVD	None	None	XClarity Standard	1x 750W Platinum	None	3-year	07/17
7X10A03YBR	Brazil	1x Xeon Gold 5120 14C/2.2GHz/19.25MB/105W/DDR4-2400	1x 16GB RDIMM DDR4-2666 (1Rx4)	1x 930-8i 2GB Flash	16x 2.5"	8x 2.5" SATA/SAS HS	Open	None	None	1x Mgmt, 2x GbE	None	1x PCIe x8 FHHL, 1x PCIe x8 FHFL, 1x PCIe x16 FHFL, 1x PCIe x16 FHHL	1.2	Intrusion Switch	Security door	1x HH DVD	None	None	XClarity Standard	1x 750W Platinum	None	3-year	07/17

Model	Region	Processor	Memory	Storage Controller	Chassis	Disk Bays	Disks	M.2 Drives	GPU	Networking Ports	Onboard Networking	Additional Networking (LOM/ML2/PCIe)	Standard Extension Slots	TPM	Intrusion Switch	Security Door	Optical	Optional Ports	Keyboard	System Management	Power Supply	Preload	Warranty	Ann Date (mm/yy)	
7X10A02UEA	EMEA	1x Xeon Gold 5118 12C/2.3GHz/16.5MB/105W/DDR4-2400	1x 16GB RDIMM DDR4-2666 (1Rx4)	1x 930-8i 2GB Flash	16x 2.5"	8x 2.5"	SATA/SAS Open HS	None	None	1x Mgmt, 2x GbE	None	1x PCIe x8 FHHL, 1x PCIe x8 FHFL, 1x PCIe x16 FHFL, 1x PCIe x16 FHHL	1.2	TPM Switch	Intrusion Switch	Security door	1x HH DVD	None	None	XClarity Standard	1x 750W Platinum	None	3-year	07/17	
7X10A00VEA	EMEA	1x Xeon Gold 5120 14C/2.2GHz/19.25MB/105W/DDR4-2400	1x 16GB RDIMM DDR4-2666 (1Rx4)	1x 930-8i 2GB Flash	16x 2.5"	8x 2.5"	SATA/SAS Open HS	None	None	1x Mgmt, 2x GbE	None	1x PCIe x8 FHHL, 1x PCIe x8 FHFL, 1x PCIe x16 FHFL, 1x PCIe x16 FHHL	1.2	TPM Switch	Intrusion Switch	Security door	1x HH DVD	None	None	XClarity Standard	1x 750W Platinum	None	3-year	07/17	
7X10A01REA	EMEA	1x Xeon Bronze 3106 8C/1.7GHz/11MB/85W/DDR4-2133	1x 16GB RDIMM DDR4-2666 (1Rx4)	1x 530-8i	16x 2.5"	8x 2.5"	SATA/SAS Open HS	None	None	1x Mgmt, 2x GbE	None	1x PCIe x8 FHHL, 1x PCIe x8 FHFL, 1x PCIe x16 FHFL, 1x PCIe x16 FHHL	1.2	TPM Switch	Intrusion Switch	Security door	1x HH DVD	None	None	XClarity Standard	1x 750W Platinum	None	3-year	07/17	
7X10A01SEA	EMEA	1x Xeon Silver 4116 12C/2.1GHz/16.5MB/85W/DDR4-2400	1x 16GB RDIMM DDR4-2666 (1Rx4)	1x 530-8i	16x 2.5"	8x 2.5"	SATA/SAS Open HS	None	None	1x Mgmt, 2x GbE	None	1x PCIe x8 FHHL, 1x PCIe x8 FHFL, 1x PCIe x16 FHFL, 1x PCIe x16 FHHL	1.2	TPM Switch	Intrusion Switch	Security door	1x HH DVD	None	None	XClarity Standard	1x 750W Platinum	None	3-year	07/17	
7X10A01TEA	EMEA	1x Xeon Silver 4108 8C/1.8GHz/11MB/85W/DDR4-2400	1x 16GB RDIMM DDR4-2666 (1Rx4)	1x Onboard Intel RSTe	8x 3.5"	8x 3.5"	SATA SS	Open	None	None	1x Mgmt, 2x GbE	None	1x PCIe x8 FHHL, 1x PCIe x8 FHFL, 1x PCIe x16 FHFL, 1x PCIe x16 FHHL	1.2	TPM Switch	Intrusion Switch	Security door	1x HH DVD±RW	None	None	XClarity Standard	1x 750W Platinum	None	3-year	07/17
7X10A01UEA	EMEA	1x Xeon Bronze 3104 6C/1.7GHz/8.25MB/85W/DDR4-2133	1x 16GB RDIMM DDR4-2666 (1Rx4)	1x Onboard Intel RSTe	8x 3.5"	8x 3.5"	SATA SS	Open	None	None	1x Mgmt, 2x GbE	None	1x PCIe x8 FHHL, 1x PCIe x8 FHFL, 1x PCIe x16 FHFL, 1x PCIe x16 FHHL	1.2	TPM Switch	Intrusion Switch	Security door	1x HH DVD±RW	None	None	XClarity Standard	1x 750W Platinum	None	3-year	07/17
7X10A01VEA	EMEA	1x Xeon Silver 4108 8C/1.8GHz/11MB/85W/DDR4-2400	1x 16GB RDIMM DDR4-2666 (1Rx4)	1x 530-8i	16x 2.5"	8x 2.5"	SATA/SAS Open HS	None	None	1x Mgmt, 2x GbE	None	1x PCIe x8 FHHL, 1x PCIe x8 FHFL, 1x PCIe x16 FHFL, 1x PCIe x16 FHHL	1.2	TPM Switch	Intrusion Switch	Security door	1x HH DVD	None	None	XClarity Standard	1x 750W Platinum	None	3-year	07/17	
7X10A01WEA	EMEA	1x Xeon Silver 4114 10C/2.2GHz/13.75MB/85W/DDR4-2400	1x 16GB RDIMM DDR4-2666 (1Rx4)	1x 530-8i	16x 2.5"	8x 2.5"	SATA/SAS Open HS	None	None	1x Mgmt, 2x GbE	None	1x PCIe x8 FHHL, 1x PCIe x8 FHFL, 1x PCIe x16 FHFL, 1x PCIe x16 FHHL	1.2	TPM Switch	Intrusion Switch	Security door	1x HH DVD	None	None	XClarity Standard	1x 750W Platinum	None	3-year	07/17	

Model	Region	Processor	Memory	Storage Controller	Chassis	Disk Bays	Disks	M.2 Drives	GPU	Onboard Networking Ports	Additional Networking (LOM/ML2/PCIe)	Standard Extension Slots	TPM	Intrusion Switch	Security Door	Optical	Optional Ports	Keyboard	System Management	Power Supply	Preload	Warranty	Ann Date (mm/yy)
7X10A01XEA	EMEA	1x Xeon Bronze 3104 6C/1.7GHz/8.25MB/85W/DDR4-2133	1x 16GB RDIMM DDR4-2666 (1Rx4)	1x 530-8i	16x 2.5"	8x 2.5"	SATA/SAS Open HS	None	None	1x Mgmt, 2x GbE	None	1x PCIe x8 FHHL, 1x PCIe x8 FHFL, 1x PCIe x16 FHFL, 1x PCIe x16 FHHL	1.2	Intrusion Switch	Security door	1x HH DVD	None	None	XClarity Standard	1x 750W Platinum	None	3-year	07/17
7X10A01YEA	EMEA	1x Xeon Silver 4110 8C/2.1GHz/11MB/85W/DDR4-2400	1x 16GB RDIMM DDR4-2666 (1Rx4)	1x 530-8i	16x 2.5"	8x 2.5"	SATA/SAS Open HS	None	None	1x Mgmt, 2x GbE	None	1x PCIe x8 FHHL, 1x PCIe x8 FHFL, 1x PCIe x16 FHFL, 1x PCIe x16 FHHL	1.2	Intrusion Switch	Security door	1x HH DVD	None	None	XClarity Standard	1x 750W Platinum	None	3-year	07/17

Model	Region	Processor	Memory	Storage Controller	Chassis	Disk	Bays	Disks	M.2 Drives	GPU	Networking	Onboard Networking Ports	Additional Networking (LOM/ML2/PCle)	Standard Extension Slots	TPM	Intrusion Switch	Security Door	Optical	Optional Ports	Keyboard	System Management	Power Supply	Preload	Warranty	Ann Date (mm/yy)
7X10A014CN	HTK	1x Xeon Gold 5122 4C/3.6GHz/16.5MB/105W/DDR4-2666	1x 16GB RDIMM DDR4-2666 (1Rx4)	1x 930-8i 2GB Flash	16x 2.5"	8x 2.5" SATA/SAS HS	Open	None	None	None	1x Mgmt, 2x GbE	None	1x PCIe x8 FHHL, 1x PCIe x8 FHFL, 1x PCIe x16 FHFL, 1x PCIe x16 FHHL	TPM 1.2	None	None	None	None	None	XClarity Standard	1x 750W Platinum	None	3-year	07/17	
7X10A00WCN	HTK	1x Xeon Gold 5120 14C/2.2GHz/19.25MB/105W/DDR4-2400	1x 16GB RDIMM DDR4-2666 (1Rx4)	1x 930-8i 2GB Flash	16x 2.5"	8x 2.5" SATA/SAS HS	Open	None	None	None	1x Mgmt, 2x GbE	None	1x PCIe x8 FHHL, 1x PCIe x8 FHFL, 1x PCIe x16 FHFL, 1x PCIe x16 FHHL	TPM 1.2	None	None	None	None	None	XClarity Standard	1x 750W Platinum	None	3-year	07/17	
7X10A00XCN	HTK	1x Xeon Gold 6130 16C/2.1GHz/22MB/125W/DDR4-2666	1x 16GB RDIMM DDR4-2666 (1Rx4)	1x 930-8i 2GB Flash	16x 2.5"	8x 2.5" SATA/SAS HS	Open	None	None	None	1x Mgmt, 2x GbE	None	1x PCIe x8 FHHL, 1x PCIe x8 FHFL, 1x PCIe x16 FHFL, 1x PCIe x16 FHHL	TPM 1.2	None	None	None	None	None	XClarity Standard	1x 750W Platinum	None	3-year	07/17	
7X10A00YCN	HTK	1x Xeon Gold 5118 12C/2.3GHz/16.5MB/105W/DDR4-2400	1x 16GB RDIMM DDR4-2666 (1Rx4)	1x 930-8i 2GB Flash	16x 2.5"	8x 2.5" SATA/SAS HS	Open	None	None	None	1x Mgmt, 2x GbE	None	1x PCIe x8 FHHL, 1x PCIe x8 FHFL, 1x PCIe x16 FHFL, 1x PCIe x16 FHHL	TPM 1.2	None	None	None	None	None	XClarity Standard	1x 750W Platinum	None	3-year	07/17	
7X10A00ZCN	HTK	1x Xeon Gold 6126 12C/2.6GHz/19.25MB/125W/DDR4-2666	1x 16GB RDIMM DDR4-2666 (1Rx4)	1x 930-8i 2GB Flash	16x 2.5"	8x 2.5" SATA/SAS HS	Open	None	None	None	1x Mgmt, 2x GbE	None	1x PCIe x8 FHHL, 1x PCIe x8 FHFL, 1x PCIe x16 FHFL, 1x PCIe x16 FHHL	TPM 1.2	None	None	None	None	None	XClarity Standard	1x 750W Platinum	None	3-year	07/17	
7X10A010CN	HTK	1x Xeon Gold 5115 10C/2.4GHz/13.75MB/85W/DDR4-2400	1x 16GB RDIMM DDR4-2666 (1Rx4)	1x 930-8i 2GB Flash	16x 2.5"	8x 2.5" SATA/SAS HS	Open	None	None	None	1x Mgmt, 2x GbE	None	1x PCIe x8 FHHL, 1x PCIe x8 FHFL, 1x PCIe x16 FHFL, 1x PCIe x16 FHHL	TPM 1.2	None	None	None	None	None	XClarity Standard	1x 750W Platinum	None	3-year	07/17	
7X10A00PCN	HTK	1x Xeon Gold 6130 16C/2.1GHz/22MB/125W/DDR4-2666	1x 16GB RDIMM DDR4-2666 (1Rx4)	1x 930-8i 2GB Flash	8x 3.5"	4x 3.5" SATA/SAS HS	Open	None	None	None	1x Mgmt, 2x GbE	None	1x PCIe x8 FHHL, 1x PCIe x8 FHFL, 1x PCIe x16 FHFL, 1x PCIe x16 FHHL	TPM 1.2	None	None	None	None	None	XClarity Standard	1x 750W Platinum	None	3-year	07/17	
7X10A00QCNC	HTK	1x Xeon Gold 6126 12C/2.6GHz/19.25MB/125W/DDR4-2666	1x 16GB RDIMM DDR4-2666 (1Rx4)	1x 930-8i 2GB Flash	8x 3.5"	4x 3.5" SATA/SAS HS	Open	None	None	None	1x Mgmt, 2x GbE	None	1x PCIe x8 FHHL, 1x PCIe x8 FHFL, 1x PCIe x16 FHFL, 1x PCIe x16 FHHL	TPM 1.2	None	None	None	None	None	XClarity Standard	1x 750W Platinum	None	3-year	07/17	

Model	Region	Processor	Memory	Storage Controller	Chassis	Disk Bays	Disks	M.2 Drives	GPU	Onboard Networking Ports	Additional Networking (LOM/ML2/PCIe)	Standard Extension Slots	TPM	Intrusion Switch	Security Door	Optical	Optional Ports	Keyboard	System Management	Power Supply	Preload	Warranty	Ann Date (mm/yy)
7X10A00RCN	HTK	1x Xeon Gold 5120 14C/2.2GHz/19.25MB/105W/DDR4-2400	1x 16GB RDIMM DDR4-2666 (1Rx4)	1x 930-8i 2GB Flash	8x 3.5"	4x 3.5"	SATA/SAS Open HS	None	None	1x Mgmt, 2x GbE	None	1x PCIe x8 FHHL, 1x PCIe x8 FHFL, 1x PCIe x16 FHFL, 1x PCIe x16 FHHL	TPM 1.2	None	None	None	None	None	XClarity Standard	1x 750W Platinum	None	3-year	07/17
7X10A00SCN	HTK	1x Xeon Gold 5122 4C/3.6GHz/16.5MB/105W/DDR4-2666	1x 16GB RDIMM DDR4-2666 (1Rx4)	1x 930-8i 2GB Flash	8x 3.5"	4x 3.5"	SATA/SAS Open HS	None	None	1x Mgmt, 2x GbE	None	1x PCIe x8 FHHL, 1x PCIe x8 FHFL, 1x PCIe x16 FHFL, 1x PCIe x16 FHHL	TPM 1.2	None	None	None	None	None	XClarity Standard	1x 750W Platinum	None	3-year	07/17
7X10A012CN	HTK	1x Xeon Gold 6126 12C/2.6GHz/19.25MB/125W/DDR4-2666	1x 8GB RDIMM DDR4-2666 (1Rx8)	1x 530-8i	8x 3.5"	4x 3.5"	SATA/SAS Open HS	None	None	1x Mgmt, 2x GbE	None	1x PCIe x8 FHHL, 1x PCIe x8 FHFL, 1x PCIe x16 FHFL, 1x PCIe x16 FHHL	TPM 1.2	None	None	None	None	None	XClarity Standard	1x 750W Platinum	None	3-year	07/17

Model	Region	Processor	Memory	Storage Controller	Chassis	Disk Bays	Disks	M.2 Drives	GPU	Onboard Networking Ports	Additional Networking (LOM/ML2/PCle)	Standard Extension Slots	TPM	Intrusion Switch	Security Door	Optical	Optional Ports	Keyboard	System Management	Power Supply	Preload	Warranty	Ann Date (mm/yy)
7X10A03BSG	INDIA	1x Xeon Bronze 3106 8C/1.7GHz/11MB/85W/DDR4-2133	1x 16GB RDIMM DDR4-2666 (1Rx4)	1x 530-8i	8x 3.5"	4x 3.5" SATA/SAS HS	Open	None	None	1x Mgmt, 2x GbE	None	1x PCIe x8 FHHL, 1x PCIe x8 FHFL, 1x PCIe x16 FHFL, 1x PCIe x16 FHHL	1.2	None	None	1x HH DVD±RW	None	None	XClarity Standard	1x 550W Platinum	None	3-year	07/17
7X10A03CSG	INDIA	1x Xeon Silver 4114 10C/2.2GHz/13.75MB/85W/DDR4-2400	1x 16GB RDIMM DDR4-2666 (1Rx4)	1x 930-8i 2GB Flash	16x 2.5"	8x 2.5" SATA/SAS HS	Open	None	None	1x Mgmt, 2x GbE	None	1x PCIe x8 FHHL, 1x PCIe x8 FHFL, 1x PCIe x16 FHFL, 1x PCIe x16 FHHL	1.2	None	None	1x HH DVD±RW	None	None	XClarity Standard	1x 550W Platinum	None	3-year	07/17
7X10A02KSG	INDIA	1x Xeon Silver 4116 12C/2.1GHz/16.5MB/85W/DDR4-2400	1x 16GB RDIMM DDR4-2666 (1Rx4)	1x 930-16i 4GB Flash	16x 2.5"	16x 2.5" SATA/SAS HS	Open	None	None	1x Mgmt, 2x GbE	None	1x PCIe x8 FHHL, 1x PCIe x8 FHFL, 1x PCIe x16 FHFL, 1x PCIe x16 FHHL	1.2	None	None	1x HH DVD±RW	None	None	XClarity Standard	1x 750W Platinum	None	3-year	07/17
7X10A02SSG	INDIA	1x Xeon Bronze 3106 8C/1.7GHz/11MB/85W/DDR4-2133	1x 8GB RDIMM DDR4-2666 (1Rx8)	1x Onboard Intel RSTe	8x 3.5"	4x 3.5" SATA SS	Open	None	None	1x Mgmt, 2x GbE	None	1x PCIe x8 FHHL, 1x PCIe x8 FHFL, 1x PCIe x16 FHFL, 1x PCIe x16 FHHL	1.2	None	None	1x HH DVD±RW	None	None	XClarity Standard	1x 550W Platinum	None	3-year	07/17
7X10A02QSG	INDIA	1x Xeon Silver 4114 10C/2.2GHz/13.75MB/85W/DDR4-2400	1x 16GB RDIMM DDR4-2666 (1Rx4)	1x 530-8i	16x 2.5"	8x 2.5" SATA/SAS HS	Open	None	None	1x Mgmt, 2x GbE	None	1x PCIe x8 FHHL, 1x PCIe x8 FHFL, 1x PCIe x16 FHFL, 1x PCIe x16 FHHL	1.2	None	None	1x HH DVD±RW	None	None	XClarity Standard	1x 550W Platinum	None	3-year	07/17
7X10A02WSG	INDIA	1x Xeon Silver 4114 10C/2.2GHz/13.75MB/85W/DDR4-2400	1x 16GB RDIMM DDR4-2666 (1Rx4)	1x 530-8i	8x 3.5"	4x 3.5" SATA/SAS HS	Open	None	None	1x Mgmt, 2x GbE	None	1x PCIe x8 FHHL, 1x PCIe x8 FHFL, 1x PCIe x16 FHFL, 1x PCIe x16 FHHL	1.2	None	None	1x HH DVD±RW	None	None	XClarity Standard	1x 550W Platinum	None	3-year	07/17
7X10A02XSG	INDIA	1x Xeon Silver 4116 12C/2.1GHz/16.5MB/85W/DDR4-2400	1x 8GB RDIMM DDR4-2666 (1Rx8)	1x 530-8i	16x 2.5"	8x 2.5" SATA/SAS HS	Open	None	None	1x Mgmt, 2x GbE	None	1x PCIe x8 FHHL, 1x PCIe x8 FHFL, 1x PCIe x16 FHFL, 1x PCIe x16 FHHL	1.2	None	None	1x HH DVD±RW	None	None	XClarity Standard	1x 550W Platinum	None	3-year	07/17
7X10A02CSG	INDIA	1x Xeon Bronze 3106 8C/1.7GHz/11MB/85W/DDR4-2133	1x 8GB RDIMM DDR4-2666 (1Rx8)	1x 530-8i	16x 2.5"	8x 2.5" SATA/SAS HS	Open	None	None	1x Mgmt, 2x GbE	None	1x PCIe x8 FHHL, 1x PCIe x8 FHFL, 1x PCIe x16 FHFL, 1x PCIe x16 FHHL	1.2	None	None	1x HH DVD±RW	None	None	XClarity Standard	1x 550W Platinum	None	3-year	07/17

Model	Region	Processor	Memory	Storage Controller	Chassis	Disk Bays	Disks	M.2 Drives	GPU	Networking Ports	Onboard Networking	Additional Networking (LOM/ML2/PCIe)	Standard Extension Slots	TPM	Intrusion Switch	Security Door	Optical	Optional Ports	Keyboard	System Management	Power Supply	Preload	Warranty	Ann Date (mm/yy)
7X10A027SG	INDIA	1x Xeon Silver 4108 8C/1.8GHz/11MB/85W/DDR4-2400	1x 16GB RDIMM DDR4-2666 (1Rx4)	1x 530-8i	16x 2.5"	8x 2.5"	SATA/SAS HS	Open	None	None	1x Mgmt, 2x GbE	None	1x PCIe x8 FHHL, 1x PCIe x8 FHFL, 1x PCIe x16 FHFL, 1x PCIe x16 FHHL	TPM 1.2	None	None	1x HH DVD±RW	None	None	XClarity Standard	1x 550W Platinum	None	3-year	07/17
7X10A037SG	INDIA	1x Xeon Silver 4110 8C/2.1GHz/11MB/85W/DDR4-2400	1x 8GB RDIMM DDR4-2666 (1Rx8)	1x 530-8i	8x 3.5"	4x 3.5"	SATA/SAS HS	Open	None	None	1x Mgmt, 2x GbE	None	1x PCIe x8 FHHL, 1x PCIe x8 FHFL, 1x PCIe x16 FHFL, 1x PCIe x16 FHHL	TPM 1.2	None	None	1x HH DVD±RW	None	None	XClarity Standard	1x 550W Platinum	None	3-year	07/17
7X10A033SG	INDIA	1x Xeon Bronze 3106 8C/1.7GHz/11MB/85W/DDR4-2133	1x 8GB RDIMM DDR4-2666 (1Rx8)	1x 530-8i	8x 3.5"	4x 3.5"	SATA/SAS HS	Open	None	None	1x Mgmt, 2x GbE	None	1x PCIe x8 FHHL, 1x PCIe x8 FHFL, 1x PCIe x16 FHFL, 1x PCIe x16 FHHL	TPM 1.2	None	None	1x HH DVD±RW	None	None	XClarity Standard	1x 550W Platinum	None	3-year	07/17
7X10A034SG	INDIA	1x Xeon Silver 4108 8C/1.8GHz/11MB/85W/DDR4-2400	1x 8GB RDIMM DDR4-2666 (1Rx8)	1x 530-8i	8x 3.5"	4x 3.5"	SATA/SAS HS	Open	None	None	1x Mgmt, 2x GbE	None	1x PCIe x8 FHHL, 1x PCIe x8 FHFL, 1x PCIe x16 FHFL, 1x PCIe x16 FHHL	TPM 1.2	None	None	1x HH DVD±RW	None	None	XClarity Standard	1x 550W Platinum	None	3-year	07/17
7X10A030SG	INDIA	1x Xeon Silver 4116 12C/2.1GHz/16.5MB/85W/DDR4-2400	1x 16GB RDIMM DDR4-2666 (1Rx4)	1x 930-8i 2GB Flash	16x 2.5"	8x 2.5"	SATA/SAS HS	Open	None	None	1x Mgmt, 2x GbE	None	1x PCIe x8 FHHL, 1x PCIe x8 FHFL, 1x PCIe x16 FHFL, 1x PCIe x16 FHHL	TPM 1.2	None	None	1x HH DVD±RW	None	None	XClarity Standard	1x 550W Platinum	None	3-year	07/17
7X10A03WSG	INDIA	1x Xeon Silver 4108 8C/1.8GHz/11MB/85W/DDR4-2400	1x 16GB RDIMM DDR4-2666 (1Rx4)	1x 930-8i 2GB Flash	16x 2.5"	8x 2.5"	SATA/SAS HS	Open	None	None	1x Mgmt, 2x GbE	None	1x PCIe x8 FHHL, 1x PCIe x8 FHFL, 1x PCIe x16 FHFL, 1x PCIe x16 FHHL	TPM 1.2	None	None	1x HH DVD±RW	None	None	XClarity Standard	1x 550W Platinum	None	3-year	07/17
7X10A03XSG	INDIA	1x Xeon Silver 4116 12C/2.1GHz/16.5MB/85W/DDR4-2400	1x 16GB RDIMM DDR4-2666 (1Rx4)	1x 530-8i	8x 3.5"	4x 3.5"	SATA/SAS HS	Open	None	None	1x Mgmt, 2x GbE	None	1x PCIe x8 FHHL, 1x PCIe x8 FHFL, 1x PCIe x16 FHFL, 1x PCIe x16 FHHL	TPM 1.2	None	None	1x HH DVD±RW	None	None	XClarity Standard	1x 550W Platinum	None	3-year	07/17
7X10A03SSG	INDIA	1x Xeon Bronze 3104 6C/1.7GHz/8.25MB/85W/DDR4-2133	1x 8GB RDIMM DDR4-2666 (1Rx8)	1x Onboard Intel RSTe	8x 3.5"	4x 3.5"	SATA SS	Open	None	None	1x Mgmt, 2x GbE	None	1x PCIe x8 FHHL, 1x PCIe x8 FHFL, 1x PCIe x16 FHFL, 1x PCIe x16 FHHL	TPM 1.2	None	None	1x HH DVD±RW	None	None	XClarity Standard	1x 550W Platinum	None	3-year	07/17

Model	Region	Processor	Memory	Storage Controller	Chassis	Disk Bays	Disks	M.2 Drives	GPU	Networking Ports	Onboard Networking	Additional Networking (LOM/ML2/PCIe)	Standard Extension Slots	TPM	Intrusion Switch	Security Door	Optical	Optional Ports	Keyboard	System Management	Power Supply	Preload	Warranty	Ann Date (mm/yy)
7X10A03TSG	INDIA	1x Xeon Bronze 3106 8C/1.7GHz/11MB/85W/DDR4-2133	1x 16GB RDIMM DDR4-2666 (1Rx4)	1x 930-8i 2GB Flash	16x 2.5"	8x 2.5"	SATA/SAS HS	Open	None	None	1x Mgmt, 2x GbE	None	1x PCIe x8 FHHL, 1x PCIe x8 FHFL, 1x PCIe x16 FHFL, 1x PCIe x16 FHHL	TPM 1.2	None	None	1x HH DVD±RW	None	None	XClarity Standard	1x 550W Platinum	None	3-year	07/17
7X10A00USG	INDIA	1x Xeon Gold 5120 14C/2.2GHz/19.25MB/105W/DDR4-2400	1x 16GB RDIMM DDR4-2666 (1Rx4)	1x 930-8i 2GB Flash	16x 2.5"	8x 2.5"	SATA/SAS HS	Open	None	None	1x Mgmt, 2x GbE	None	1x PCIe x8 FHHL, 1x PCIe x8 FHFL, 1x PCIe x16 FHFL, 1x PCIe x16 FHHL	TPM 1.2	None	None	1x HH DVD±RW	None	None	XClarity Standard	1x 750W Platinum	None	3-year	07/17
7X10A00NSG	INDIA	1x Xeon Gold 6130 16C/2.1GHz/22MB/125W/DDR4-2666	1x 16GB RDIMM DDR4-2666 (1Rx4)	1x 930-8i 2GB Flash	16x 2.5"	8x 2.5"	SATA/SAS HS	Open	None	None	1x Mgmt, 2x GbE	None	1x PCIe x8 FHHL, 1x PCIe x8 FHFL, 1x PCIe x16 FHFL, 1x PCIe x16 FHHL	TPM 1.2	None	None	1x HH DVD±RW	None	None	XClarity Standard	1x 750W Platinum	None	3-year	07/17
7X10A015SG	INDIA	1x Xeon Gold 5115 10C/2.4GHz/13.75MB/85W/DDR4-2400	1x 16GB RDIMM DDR4-2666 (1Rx4)	1x 530-8i	8x 3.5"	4x 3.5"	SATA/SAS HS	Open	None	None	1x Mgmt, 2x GbE	None	1x PCIe x8 FHHL, 1x PCIe x8 FHFL, 1x PCIe x16 FHFL, 1x PCIe x16 FHHL	TPM 1.2	None	None	1x HH DVD±RW	None	None	XClarity Standard	1x 550W Platinum	None	3-year	07/17
7X10A016SG	INDIA	1x Xeon Gold 5115 10C/2.4GHz/13.75MB/85W/DDR4-2400	1x 16GB RDIMM DDR4-2666 (1Rx4)	1x 530-8i	16x 2.5"	8x 2.5"	SATA/SAS HS	Open	None	None	1x Mgmt, 2x GbE	None	1x PCIe x8 FHHL, 1x PCIe x8 FHFL, 1x PCIe x16 FHFL, 1x PCIe x16 FHHL	TPM 1.2	None	None	1x HH DVD±RW	None	None	XClarity Standard	1x 550W Platinum	None	3-year	07/17
7X10A00LSG	INDIA	1x Xeon Gold 5118 12C/2.3GHz/16.5MB/105W/DDR4-2400	1x 16GB RDIMM DDR4-2666 (1Rx4)	1x 530-8i	16x 2.5"	8x 2.5"	SATA/SAS HS	Open	None	None	1x Mgmt, 2x GbE	None	1x PCIe x8 FHHL, 1x PCIe x8 FHFL, 1x PCIe x16 FHFL, 1x PCIe x16 FHHL	TPM 1.2	None	None	1x HH DVD±RW	None	None	XClarity Standard	1x 550W Platinum	None	3-year	07/17
7X10A00FSG	INDIA	1x Xeon Gold 5115 10C/2.4GHz/13.75MB/85W/DDR4-2400	1x 8GB RDIMM DDR4-2666 (1Rx8)	1x Onboard Intel RSTe	8x 3.5"	4x 3.5"	SATA SS	Open	None	None	1x Mgmt, 2x GbE	None	1x PCIe x8 FHHL, 1x PCIe x8 FHFL, 1x PCIe x16 FHFL, 1x PCIe x16 FHHL	TPM 1.2	None	None	1x HH DVD±RW	None	None	XClarity Standard	1x 550W Platinum	None	3-year	07/17
7X10A007SG	INDIA	1x Xeon Gold 6126 12C/2.6GHz/19.25MB/125W/DDR4-2666	1x 16GB RDIMM DDR4-2666 (1Rx4)	1x 930-16i 4GB Flash	16x 2.5"	16x 2.5"	SATA/SAS HS	Open	None	None	1x Mgmt, 2x GbE	None	1x PCIe x8 FHHL, 1x PCIe x8 FHFL, 1x PCIe x16 FHFL, 1x PCIe x16 FHHL	TPM 1.2	None	None	1x HH DVD±RW	None	None	XClarity Standard	1x 750W Platinum	None	3-year	07/17

Model	Region	Processor	Memory	Storage Controller	Chassis	Disk Bays	Disks	M.2 Drives	GPU	Onboard Networking Ports	Additional Networking (LOM/ML2/PCle)	Standard Extension Slots	TPM	Intrusion Switch	Security Door	Optical	Optional Ports	Keyboard	System Management	Power Supply	Preload	Warranty	Ann Date (mm/yy)
7X10A008SG	INDIA	1x Xeon Gold 5120 14C/2.2GHz/19.25MB/105W/DDR4-2400	1x 16GB RDIMM DDR4-2666 (1Rx4)	1x 530-8i	16x 2.5"	8x 2.5" SATA/SAS HS	Open	None	None	1x Mgmt, 2x GbE	None	1x PCIe x8 FHHL, 1x PCIe x8 FHFL, 1x PCIe x16 FHFL, 1x PCIe x16 FHHL	TPM 1.2	None	None	1x HH DVD±RW	None	None	XClarity Standard	1x 550W Platinum	None	3-year	07/17
7X10A001SG	INDIA	1x Xeon Gold 5115 10C/2.4GHz/13.75MB/85W/DDR4-2400	1x 8GB RDIMM DDR4-2666 (1Rx8)	1x 530-8i	8x 3.5"	4x 3.5" SATA/SAS HS	Open	None	None	1x Mgmt, 2x GbE	None	1x PCIe x8 FHHL, 1x PCIe x8 FHFL, 1x PCIe x16 FHFL, 1x PCIe x16 FHHL	TPM 1.2	None	None	1x HH DVD±RW	None	None	XClarity Standard	1x 550W Platinum	None	3-year	07/17
7X10A002SG	INDIA	1x Xeon Gold 6130 16C/2.1GHz/22MB/125W/DDR4-2666	1x 16GB RDIMM DDR4-2666 (1Rx4)	1x 930-16i 4GB Flash	16x 2.5"	16x 2.5" SATA/SAS HS	Open	None	None	1x Mgmt, 2x GbE	None	1x PCIe x8 FHHL, 1x PCIe x8 FHFL, 1x PCIe x16 FHFL, 1x PCIe x16 FHHL	TPM 1.2	None	None	1x HH DVD±RW	None	None	XClarity Standard	1x 750W Platinum	None	3-year	07/17

ThinkSystem ST550 - Non TopSeller - JAPAN

Product Specifications Reference (PSREF)

Model	Region	Processor	Memory	Storage Controller	Chassis	Disk Bays	Disks	M.2 Drives	GPU	Onboard Networking Ports	Additional Networking (LOM/ML2/PCIe)	Standard Extension Slots	TPM	Intrusion Switch	Security Door	Optical	Optional Ports	Keyboard	System Management	Power Supply	Preload	Warranty	Ann Date (mm/yy)
7X10A009JP	JAPAN	1x Xeon Gold 6130 16C/2.1GHz/22MB/125W/DDR4-2666	2x 16GB RDIMM DDR4-2666 (1Rx4)	1x 930-16i 4GB Flash	16x 2.5"	16x 2.5"	SATA/SAS Open HS	None	None	1x Mgmt, 2x GbE	None	1x PCIe x8 FHHL, 1x PCIe x8 FHFL, 1x PCIe x16 1.2 FHFL, 1x PCIe x16 FHHL	TPM	Intrusion Switch	Security door	1x HH DVD	None	None	XClarity Advanced	1x 1100W Platinum	None	3-year	07/17

Model	Region	Processor	Memory	Storage Controller	Chassis	Disk Bays	Disks	M.2 Drives	GPU	Networking Ports	Onboard Networking	Additional Networking (LOM/ML2/PCle)	Standard Extension Slots	TPM	Intrusion Switch	Security Door	Optical	Optional Ports	Keyboard	System Management	Power Supply	Preload	Warranty	Ann Date (mm/yy)
7X10A04DNA	NA	1x Xeon Silver 4108 8C/1.8GHz/11MB/85W/DDR4-2400	1x 16GB RDIMM DDR4-2666 (1Rx4)	1x 530-8i	16x 2.5"	8x 2.5"	SATA/SAS HS	Open	None	None	1x Mgmt, 2x GbE	None	1x PCIe x8 FHHL, 1x PCIe x8 FHFL, 1x PCIe x16 FHFL, 1x PCIe x16 FHHL	1.2	Intrusion Switch	Security door	1x HH DVD	None	None	XClarity Standard	1x 750W Platinum	None	3-year	07/17
7X10A04YNA	NA	1x Xeon Gold 5118 12C/2.3GHz/16.5MB/105W/DDR4-2400	1x 16GB RDIMM DDR4-2666 (1Rx4)	1x 930-8i 2GB Flash	16x 2.5"	8x 2.5"	SATA/SAS HS	Open	None	None	1x Mgmt, 2x GbE	None	1x PCIe x8 FHHL, 1x PCIe x8 FHFL, 1x PCIe x16 FHFL, 1x PCIe x16 FHHL	1.2	Intrusion Switch	Security door	1x HH DVD	None	None	XClarity Standard	1x 750W Platinum	None	3-year	07/17
7X10A04ZNA	NA	1x Xeon Gold 5120 14C/2.2GHz/19.25MB/105W/DDR4-2400	1x 16GB RDIMM DDR4-2666 (1Rx4)	1x 930-8i 2GB Flash	16x 2.5"	8x 2.5"	SATA/SAS HS	Open	None	None	1x Mgmt, 2x GbE	None	1x PCIe x8 FHHL, 1x PCIe x8 FHFL, 1x PCIe x16 FHFL, 1x PCIe x16 FHHL	1.2	Intrusion Switch	Security door	1x HH DVD	None	None	XClarity Standard	1x 750W Platinum	None	3-year	07/17
7X10A04NNA	NA	1x Xeon Bronze 3104 6C/1.7GHz/8.25MB/85W/DDR4-2133	1x 16GB RDIMM DDR4-2666 (1Rx4)	1x 530-8i	16x 2.5"	8x 2.5"	SATA/SAS HS	Open	None	None	1x Mgmt, 2x GbE	None	1x PCIe x8 FHHL, 1x PCIe x8 FHFL, 1x PCIe x16 FHFL, 1x PCIe x16 FHHL	1.2	Intrusion Switch	Security door	1x HH DVD	None	None	XClarity Standard	1x 750W Platinum	None	3-year	07/17
7X10A04PNA	NA	1x Xeon Bronze 3106 8C/1.7GHz/11MB/85W/DDR4-2133	1x 16GB RDIMM DDR4-2666 (1Rx4)	1x 530-8i	16x 2.5"	8x 2.5"	SATA/SAS HS	Open	None	None	1x Mgmt, 2x GbE	None	1x PCIe x8 FHHL, 1x PCIe x8 FHFL, 1x PCIe x16 FHFL, 1x PCIe x16 FHHL	1.2	Intrusion Switch	Security door	1x HH DVD	None	None	XClarity Standard	1x 750W Platinum	None	3-year	07/17
7X10A04TNA	NA	1x Xeon Silver 4116 12C/2.1GHz/16.5MB/85W/DDR4-2400	1x 16GB RDIMM DDR4-2666 (1Rx4)	1x 530-8i	16x 2.5"	8x 2.5"	SATA/SAS HS	Open	None	None	1x Mgmt, 2x GbE	None	1x PCIe x8 FHHL, 1x PCIe x8 FHFL, 1x PCIe x16 FHFL, 1x PCIe x16 FHHL	1.2	Intrusion Switch	Security door	1x HH DVD	None	None	XClarity Standard	1x 750W Platinum	None	3-year	07/17
7X10A04UNA	NA	1x Xeon Bronze 3104 6C/1.7GHz/8.25MB/85W/DDR4-2133	1x 16GB RDIMM DDR4-2666 (1Rx4)	1x Onboard Intel RSTe	8x 3.5"	8x 3.5"	SATA SS	Open	None	None	1x Mgmt, 2x GbE	None	1x PCIe x8 FHHL, 1x PCIe x8 FHFL, 1x PCIe x16 FHFL, 1x PCIe x16 FHHL	1.2	Intrusion Switch	Security door	1x HH DVD±RW	None	None	XClarity Standard	1x 750W Platinum	None	3-year	07/17
7X10A04VNA	NA	1x Xeon Silver 4108 8C/1.8GHz/11MB/85W/DDR4-2400	1x 16GB RDIMM DDR4-2666 (1Rx4)	1x Onboard Intel RSTe	8x 3.5"	8x 3.5"	SATA SS	Open	None	None	1x Mgmt, 2x GbE	None	1x PCIe x8 FHHL, 1x PCIe x8 FHFL, 1x PCIe x16 FHFL, 1x PCIe x16 FHHL	1.2	Intrusion Switch	Security door	1x HH DVD±RW	None	None	XClarity Standard	1x 750W Platinum	None	3-year	07/17

Model	Region	Processor	Memory	Storage Controller	Chassis	Disk Bays	Disks	M.2 Drives	GPU	Onboard Networking Ports	Additional Networking (LOM/ML2/PCIe)	Standard Extension Slots	TPM	Intrusion Switch	Security Door	Optical	Optional Ports	Keyboard	System Management	Power Supply	Preload	Warranty	Ann Date (mm/yy)
7X10A04HNA	NA	1x Xeon Silver 4114 10C/2.2GHz/13.75MB/85W/DDR4-2400	1x 16GB RDIMM DDR4-2666 (1Rx4)	1x 530-8i	16x 2.5"	8x 2.5" SATA/SAS HS	Open	None	None	1x Mgmt, 2x GbE	None	1x PCIe x8 FHHL, 1x PCIe x8 FHFL, 1x PCIe x16 FHFL, 1x PCIe x16 FHHL	1.2	Intrusion Switch	Security door	1x HH DVD	None	None	XClarity Standard	1x 750W Platinum	None	3-year	07/17
7X10A04FNA	NA	1x Xeon Silver 4110 8C/2.1GHz/11MB/85W/DDR4-2400	1x 16GB RDIMM DDR4-2666 (1Rx4)	1x 530-8i	16x 2.5"	8x 2.5" SATA/SAS HS	Open	None	None	1x Mgmt, 2x GbE	None	1x PCIe x8 FHHL, 1x PCIe x8 FHFL, 1x PCIe x16 FHFL, 1x PCIe x16 FHHL	1.2	Intrusion Switch	Security door	1x HH DVD	None	None	XClarity Standard	1x 750W Platinum	None	3-year	07/17

This publication was developed for products and services offered in the United States and E.M.E.A countries. Lenovo may not offer the products, services or features discussed in this document in other countries. Lenovo may withdraw an offering at any time. Information is subject to change without notice. Consult your local representative for information on offerings available in your area.

Lenovo reserves the right to change specifications or other product information without notice. Lenovo is not responsible for photographic or typographical errors.

LENOVO PROVIDES THIS PUBLICATION "AS IS," WITHOUT WARRANTY OF ANY KIND, EITHER EXPRESS OR IMPLIED, INCLUDING THE IMPLIED WARRANTIES OF MERCHANTABILITY OR FITNESS FOR A PARTICULAR PURPOSE.

Some jurisdictions do not allow disclaimer of express or implied warranties in certain transactions, therefore this disclaimer may not apply to you.

Availability: All offers subject to availability. Lenovo reserves the right to alter product offerings and specifications at any time, without notice. Lenovo is not responsible for photographic or typographic errors.

General: Review key information provided by Microsoft that may apply to your system purchase, including details on Windows 10, Windows 8, Windows 7, and potential upgrades/downgrades. Lenovo makes no representation or warranty regarding third-party products or services.

Trademarks: Lenovo, ThinkPad, ThinkCentre, ThinkStation and the Lenovo logo are trademarks of Lenovo. Microsoft, Windows, Windows NT, and the Windows logo are trademarks of Microsoft Corporation. Ultrabook, Celeron, Celeron Inside, Core Inside, Intel, Intel Logo, Intel Atom, Intel Atom Inside, Intel Core, Intel Inside, Intel Inside Logo, Intel vPro, Itanium, Itanium Inside, Pentium, Pentium Inside, vPro Inside, Xeon, Xeon Phi, and Xeon Inside are trademarks of Intel Corporation in the U.S. and/or other countries. Other company, product or service names may be trademarks or service marks of others.

Warranty: For a copy of applicable warranties, write to: Lenovo Warranty Information, 1009 Think Place, Morrisville, NC, 27560. Lenovo makes no representation or warranty regarding third party products or services. The Lenovo Limited Warranty applies only to Lenovo hardware products purchased for your own use, and does not transfer upon resale.

Limited warranty: Support unrelated to a warranty issue may be subject to additional charges.

Lenovo Services:

Carry-in or Mail-in Service: Parts and labor repair coverage where the customer is responsible for shipping (including packaging) or delivery to authorized warranty provider or repair center.

Depot or Courier Service: Parts and labor repair coverage where shipping (including packaging) or delivery to the repair center is paid for by Lenovo.

Expedited Depot: Parts and labor coverage with expedited turnaround. Shipping (including packaging) or delivery to the repair center is paid for by Lenovo.

Onsite / In-home Service: Parts and labor repair coverage where labor is provided onsite at your place of business.

If Lenovo determines your product problem is covered by the product warranty and cannot be resolved over the telephone, a technician will be dispatched to arrive onsite, typically the next day.

International Warranty Service (IWS): PC repair coverage for customers who require a critical warranty repair while travelling internationally. Visit www.lenovo.com/internationalwarranty for details. Visit www.lenovo.com/warranty for Lenovo Warranty Services terms and conditions for complete details and restrictions.

Included software: may differ from its retail version (if available), and may not include user manuals or all program functionality. Software license agreements may apply.

Battery life: Battery life (and recharge times) will vary based on many factors including screen brightness, applications, features, power management, battery conditioning, and other customer preferences.

Visit <http://psref.lenovo.com/> for the latest version of Product Specifications Reference.

© Lenovo, 2018. All rights reserved.
Lenovo 1009 Think Place Morrisville, NC 27560 U.S.A.

LenovoTM

ThinkVision

PSREF



Product Specifications Reference

Version 520, February 2018

U.S.

Visit <http://psref.lenovo.com> for the latest version

Contents

Cover		
Contents		
Summary Of Change		
17 Inch - 20 Inch		
ThinkVision E1922s		
ThinkVision E1922s Platform Specifications		
ThinkVision E2054		
ThinkVision E2054 Platform Specifications		
ThinkVision LT1913p Square		
ThinkVision LT1913p Square Platform Specifications		
ThinkVision T1714		
ThinkVision T1714 Platform Specifications		
ThinkVision T1714p		
ThinkVision T1714p Platform Specifications		
ThinkVision T2054p		
ThinkVision T2054p Platform Specifications		
21 Inch - 24 Inch		
ThinkVision E21		
ThinkVision E21 Platform Specifications		
ThinkVision E24		
ThinkVision E24 Platform Specifications		
ThinkVision LT2423		
ThinkVision LT2423 Platform Specifications		
ThinkVision P24h		
ThinkVision P24h Platform Specifications		
ThinkVision P24q		
ThinkVision P24q Platform Specifications		
ThinkVision T2224d		
ThinkVision T2224d Platform Specifications		
ThinkVision T2224z		
ThinkVision T2224z Platform Specifications		
ThinkVision T2254p		
ThinkVision T2254p Platform Specifications		
ThinkVision T22i		
ThinkVision T22i Platform Specifications		
1 ThinkVision T22v		35
2 ThinkVision T22v Platform Specifications		36
4 ThinkVision T2324d		37
5 ThinkVision T2324d Platform Specifications		38
5 ThinkVision T2364t		39
6 ThinkVision T2364t Platform Specifications		40
7 ThinkVision T23i		41
8 ThinkVision T23i Platform Specifications		42
9 ThinkVision T2424z		43
10 ThinkVision T2424z Platform Specifications		44
11 ThinkVision T2454p		45
12 ThinkVision T2454p Platform Specifications		46
13 ThinkVision T24d		47
14 ThinkVision T24d Platform Specifications		48
15 ThinkVision T24i		49
16 ThinkVision T24i Platform Specifications		50
17 ThinkVision T24m		51
17 ThinkVision T24m Platform Specifications		52
18 ThinkVision T24v		53
19 ThinkVision T24v Platform Specifications		54
20 ThinkVision X24 Pro		55
21 ThinkVision X24 Pro Platform Specifications		56
22 ThinkVision X24-20		57
23 ThinkVision X24-20 Platform Specifications		58
24 Above 25 Inch		59
25 ThinkVision P27		59
26 ThinkVision P27 Platform Specifications		60
27 ThinkVision P27h		61
28 ThinkVision P27h Platform Specifications		62
29 ThinkVision P27u		63
30 ThinkVision P27u Platform Specifications		64
31 ThinkVision Pro2820		65
32 ThinkVision Pro2820 Platform Specifications		66
33 ThinkVision X1		67
34 ThinkVision X1 Platform Specifications		68

Contents

Legal Information

69

Summary of Changes

This section describes the technical changes made in this edition.

This edition might also include minor corrections and editorial changes which are not identified.

February 13, 2018 - Version 520

Additions in this update

▶ **New product(s)**

ThinkVision X24-20 new product announced February 2018

▶ **New model(s)**

None

▶ **Others**

None

Changes in this update

None

Withdrawals in this update

None



<p>Name E1922s Wide Flat Panel Monitor Case color Black Type-model 60G2AAR6US / 60G2AAT6EU Panel TFT-LCD, twisted nematic (TN), White LED backlight Viewable image size 18.5" (470mm) diagonal Max view area (W x H) 16.1" x 9.1" / 409.8mm x 230.4mm Native resolution 1366x768 Aspect ratio 16:9 Pixel pitch (mm) 0.3mm Dot/Pixel per Inch 85 dpi Brightness 200 nits or cd/m² (typical) Contrast ratio 600:1 (typical) Pixel response time 5ms (typical) Color gamut 72% Viewing angle at 10:1 CR 180° (+/- 90°) horizontal, 100° (+/- 50°) vertical Stand Tilt adjustable stand Bezel width Sides: 0.73" (18.5mm) Dimensions (HxWxD) 13.44" H x 17.65" W x 6.58" D; 341.5mm H x 448.4mm W x 167.2mm D Power supply 13.7 watts typical, 17 watts maximum, <0.5 watts standby/suspend, universal, integrated (no external brick-like power supply) Weight 6.03 lb; 2.74 kg Limited warranty⁴ 3 year (includes backlight) Available date March 2014</p>	<p style="text-align: center;">Features</p> <ul style="list-style-type: none"> • Widescreen 18.5-inch monitor • Supports HD 1366x768 resolution • Supports VESA mount (100mm) • Mercury free panel and arsenic free glass • Kensington lock slot ready for enhanced security • Support Lenovo Tiny PC via VESA mount • Supports optional soundbar • Microsoft® Windows® 7 certified • Microsoft Windows 8 / Windows 8.1 certified 				
<p>VESA-compliant² VESA DPMS-compliant Power management ENERGY STAR® 7.0 Ergonomics ISO 9241-307 Emission standards FCC Class B Environmental TCO (TCO Displays 7.0), WEEE, RoHS, EPEAT™ Gold rating</p>	<div style="text-align: center;">  <p>ThinkVision E1922s Wide Monitor</p> </div>				
<p>Preset resolutions VGA: 640x350, 640x480, 720x400 SVGA: 800x600, 832x624 XGA: 1024x768, 1152x864 SXGA: 1280x1024 WXGA: 1366x768</p> <p>Presets / user settings Standard presets: 15 user settings: 16</p>					
<p>Viewing adjustments Tilt: 20° backward, -5° forward Rotating screen None On screen display On screen display with digital user controls (8 languages) Control features Direct access (control buttons on front) for automatic image setup and adjustment for brightness Multiple input None Monitor connectors VGA 15-pin D-shell, analog, blue Signal cables detachable, VGA 15-pin D-shell at each end, analog, 1.8 meter Mounting features Wall or desk mounting using the Extend Arm or third-party accessories meeting the VESA FPMPI® (100mm mount) Security Security keyhole for attachment of optional cable lock (Kensington® lock-compatible)</p>					
<p>Ship group Monitor with stand, 1.8 meter analog signal cable, 1.8 meter black power cord</p>					
<p style="text-align: center;">Limited Warranty</p> <p>See details at http://support.lenovo.com/en_US/guides-and-manuals/detail.page?DocID=UM008281</p>	<p style="text-align: center;">Accessories</p> <table border="0"> <tr> <td>Kensington MicroSaver Cable Lock</td> <td style="text-align: right;">73P2582</td> </tr> <tr> <td>Kensington Twin Head Cable Lock</td> <td style="text-align: right;">45K1620</td> </tr> </table> <p>See details at www.lenovo.com/support/monitoraccessories</p> <p>See all monitors at www.lenovo.com/thinkvision</p>	Kensington MicroSaver Cable Lock	73P2582	Kensington Twin Head Cable Lock	45K1620
Kensington MicroSaver Cable Lock	73P2582				
Kensington Twin Head Cable Lock	45K1620				



<p>Name E2054 Wide Flat Panel Monitor Case color Raven black Type-model 60DFAAR1US / 60DFAAT1EU Panel TFT-LCD, In-Plane Switching (IPS), LED backlight Viewable image size 19.5" (494mm) diagonal Max view area (W x H) 16.48" x 10.33" / 418.6mm x 262.4mm Native resolution 1440x900 Aspect ratio 16:10 Pixel pitch (mm) 0.097mm x 0.292mm Dot/Pixel per Inch 87 dpi Brightness 250 nits or cd/m² (typical) Contrast ratio 1000:1 (typical) Pixel response time 7ms (typical) Color gamut 72% Viewing angle at 10:1 CR 178° (+/- 89°) horizontal, 178° (+/- 89°) vertical Stand Tilt adjustable stand Bezel width Top: 0.71" (18.0mm) Bottom: 0.70" (17.9mm) Sides: 1.02" (26.0mm) Dimensions (HxWxD) 14.65" H x 17.95" W x 7.41" D; 372.0mm H x 456.0mm W x 188.3mm D Power supply 16 watts typical, 20 watts maximum, <0.5 watts standby/suspend, universal, integrated (no external brick-like power supply) Weight 6.17 lb; 2.8 kg Limited warranty 3 year (includes backlight) Available date November 2015</p>	<p style="text-align: center;">Features</p> <ul style="list-style-type: none"> • Widescreen 19.5-inch monitor • Supports HD 1440x900 resolution • Supports VESA mount (100mm) • Mercury free panel and arsenic free glass • Kensington lock slot ready for enhanced security • Support Lenovo Tiny PC via VESA mount • Microsoft® Windows® 7 certified • Microsoft Windows 8 / Windows 8.1 certified • Microsoft Windows 10 certified
<p>VESA-compliant VESA DPMS-compliant Power management ENERGY STAR® 6.0 Ergonomics ISO 9241-307 Emission standards FCC Class B Environmental TCO (TCO Displays 6.0), WEEE, RoHS, EPEAT™ Silver rating</p>	<div style="text-align: center;">  <p>ThinkVision E2054 Wide Monitor</p> </div>
<p>Preset resolutions VGA: 640x480, 720x400 SVGA: 800x600 XGA: 1024x768 SXGA: 1280x768, 1280x1024 WXGA: 1366x768 WXGA+: 1440x900</p> <p>Presets / user settings Standard presets: 18 user settings: 10</p>	
<p>Viewing adjustments Tilt: 22° backward, -5° forward Rotating screen None On screen display On screen display with digital user controls (8 languages) Control features Direct access (control buttons on front) for automatic image setup and adjustment for brightness Multiple input None Monitor connectors VGA 15-pin D-shell, analog, blue Signal cables detachable, VGA 15-pin D-shell at each end, analog, 1.8 meter Mounting features Wall or desk mounting using the Extend Arm or third-party accessories meeting the VESA FPMPI® (100mm mount) Security Security keyhole for attachment of optional cable lock (Kensington® lock-compatible)</p>	
<p>Ship group Monitor with stand, 1.8 meter analog signal cable, 1.8 meter black power cord</p>	

<p style="text-align: center;">Limited Warranty</p> <p>See details at http://support.lenovo.com/en_US/guides-and-manuals/detail.page?DocID=UM008281</p>	<p style="text-align: center;">Accessories</p> <table border="0"> <tr> <td>Kensington MicroSaver Cable Lock</td> <td style="text-align: right;">73P2582</td> </tr> <tr> <td>Kensington Twin Head Cable Lock</td> <td style="text-align: right;">45K1620</td> </tr> </table> <p>See details at www.lenovo.com/support/monitoraccessories</p> <p>See all monitors at www.lenovo.com/thinkvision</p>	Kensington MicroSaver Cable Lock	73P2582	Kensington Twin Head Cable Lock	45K1620
Kensington MicroSaver Cable Lock	73P2582				
Kensington Twin Head Cable Lock	45K1620				



<p>Name LT1913p Square Flat Panel Monitor Case color Black Type-model 60FBHAR1US / 60FBHAT1EU Panel TFT-LCD, In-Plane Switching (IPS), White LED backlight Viewable image size 19.0" (480.0mm) diagonal Max view area (W x H) 14.76" x 11.80" (374.7mm x 299.8mm) Optimum resolution 1280x1024 Max pixel rate 205MHz (VGA), 165MHz (DVI) Aspect ratio 5:4 Pixel pitch (mm) 0.0976 (H) x 0.2928 (V) mm Dot/Pixel per Inch 86.8 dpi Brightness 250 nits or cd/m² (typical) Contrast ratio 1000:1 (typical) Pixel response time 7ms (typical) Color gamut 72% Viewing angle at 10:1 CR 178° horizontal, 178° vertical Stand Tilt, swivel, pivot, and height adjustable stand Bezel width Sides: 0.68" (17.4mm); top: 0.68" (17.4mm); bottom: 0.68" (17.4mm) Dimensions (HxWxD) 14.63" H x 16.18" W x 10.40" D; 371.5mm H x 411.0mm W x 264.2mm D Power supply 24 watts typical, 27 watts maximum, <0.5 watts standby/suspend, universal, integrated (no external brick-like power supply) Weight 10.69 lb; 4.85kg Limited warranty⁴ 3 year (includes backlight) Available date April 2015</p>	<p>Features</p> <ul style="list-style-type: none"> • 19-inch Square IPS LED backlit panel • Supports 1280x1024 resolution • Supports ThinkCentre Tiny Clamp Bracket • Mercury and arsenic free glass • Low Halogen • Recycled content in plastic material • Supports optional soundbar • Microsoft® Windows® 7 certified • Microsoft Windows 8 / Windows 8.1 certified • Microsoft Windows 10 certified 								
<p>VESA-compliant² VESA DDC2B/C1, EDID 1.3 Power management ENERGY STAR® 7.0 Ergonomics ISO 9241-307 Emission standards FCC Class B Environmental TCO Displays 7.0, TCO Certified Edge 1.1, WEEE, RoHS, EPEAT™ Gold rating, ULE Gold</p> <p>Preset resolutions VGA: 640x350, 640x480, 720x400 SVGA: 800x600, 823x624 XGA: 1024x768, 1152x864, 1152x900 SXGA: 1280x1024</p> <p>Presets / user settings Standard presets: 20; user settings: 20</p>	 <p>ThinkVision LT1913p Square Monitor</p>								
<p>Viewing adjustments Tilt: 30° back, -5° forward; lift: 4.3" (110mm); swivel: +/- 45° Rotating screen Screen pivots 90 degrees from landscape to portrait On screen display On screen display with digital user controls (8 languages) Control features Direct access (buttons on front) for automatic image setup, input switch, and brightness Multiple input Dual input (two different PCs attach to two different connectors; one PC shows image; select via button) Monitor connectors (1) VGA 15-pin D-shell, analog, blue (2) Digital Visual Interface (DVI-D), digital, white, HDCP-compliant Signal cables (1) detachable, VGA 15-pin D-shell at each end, analog, 1.8 meter (2) detachable, DVI-D at each end, digital, 1.8 meter Mounting features Wall or desk mounting using the Extend Arm or third-party accessories meeting the VESA FPMPI® (100mm mount) Security Security keyhole for attachment of optional cable lock (Kensington® lock-compatible)</p> <p>Ship group Monitor, attached stand, Setup poster, Safety and Warranty Information, 1.8 meter analog signal cable, 1.8 meter DVI-D cable, 1.8 meter black power cord</p>									
<p>Limited Warranty</p> <p>See details at http://support.lenovo.com/en_US/guides-and-manuals/detail.page?DocID=UM008281</p>	<p>Accessories</p> <table border="0"> <tr> <td>Kensington MicroSaver Cable Lock</td> <td>73P2582</td> </tr> <tr> <td>Kensington Twin Head Cable Lock</td> <td>45K1620</td> </tr> <tr> <td>Lenovo Security Cable Lock</td> <td>57Y4303</td> </tr> <tr> <td>Lenovo Easy Reach Monitor Stand</td> <td>55Y9258</td> </tr> </table> <p>See details at www.lenovo.com/support/monitoraccessories</p> <p>See all monitors at www.lenovo.com/thinkvision</p>	Kensington MicroSaver Cable Lock	73P2582	Kensington Twin Head Cable Lock	45K1620	Lenovo Security Cable Lock	57Y4303	Lenovo Easy Reach Monitor Stand	55Y9258
Kensington MicroSaver Cable Lock	73P2582								
Kensington Twin Head Cable Lock	45K1620								
Lenovo Security Cable Lock	57Y4303								
Lenovo Easy Reach Monitor Stand	55Y9258								



<p>Name T1714 Square Flat Panel Monitor Case color Black Type-model 60FDHAR1US / 60FDHAT1EU Panel TFT-LCD, twisted nematic (TN), White LED backlight Viewable image size 17.0" (432mm) diagonal Max view area (W x H) 13.3" x 10.6" (337.9mm x 270.3mm) Optimum resolution 1280x1024 Aspect ratio 5:4 Pixel pitch (mm) 0.264mm Dot/Pixel per Inch 96 dpi Brightness 250 nits or cd/m² (typical) Contrast ratio 1000:1 (typical) Pixel response time 5ms (typical) Color gamut 72% Viewing angle at 10:1 CR 170° (+/- 85°) horizontal, 160° (+/- 80°) vertical Stand Tilt stand Bezel width Sides: 0.69" (17.5mm) Dimensions 14.72" H x 14.74" W x 7.87" D; (HxWxD, including stand) 373.9mm H x 374.5mm W x 200mm D Power supply 14.0 watts typical, 18.0 watts maximum, <0.5 watts standby/suspend, universal, integrated (no external brick-like power supply) Weight 5.75 lb; 2.61kg Limited warranty 3 year (includes backlight) Available date September 2015</p>	<p>Features</p> <ul style="list-style-type: none"> • 17-inch Square LCD monitor • Supports SXGA 1280x1024 resolution • Includes dual input connection for attachment to two systems concurrently (analog and digital) • Mercury Arsenic free glass • Supports optional soundbar • Microsoft® Windows® 7 certified • Microsoft Windows 8 certified • Microsoft Windows 8.1 certified • Microsoft Windows 10 certified 						
<p>VESA-compliant VESA DDC2B/CI Power management ENERGY STAR® 7.0 Ergonomics ISO 9241-307 Emission standards FCC Class B Environmental TCO Displays 7.0, TCO Certified Edge 2.0, WEEE, RoHS, EPEAT™ Gold rating</p>	<div style="text-align: center;">  <p>ThinkVision T1714 Monitor</p> </div>						
<p>Preset resolutions VGA: 640x350, 640x480, 720x400 SVGA: 800x600 XGA: 1024x768, 1152x864, SXGA: 1280x800, 1280x1024</p> <p>Presets / user settings Standard presets: 17; user settings: 17</p>							
<p>Viewing adjustments Tilt: 22° back, -5° forward Rotating screen None On screen display On screen display with digital user controls (8 languages) Control features Direct access (buttons on front) for automatic image setup and brightness Multiple input Dual input (two different PCs attach to two different connectors; one PC shows image; select via button) Monitor connectors (1) VGA 15-pin D-shell, analog, blue (2) Digital Visual Interface (DVI-D), digital, white, HDCP-compliant Signal cables (1) detachable, VGA 15-pin D-shell at each end, analog, 1.8 meter (2) detachable, DVI-D at each end, digital, 1.8 meter Mounting features Wall or desk mounting using the Extend Arm or third-party accessories meeting the VESA FPMPI® (100mm mount) Security Security keyhole for attachment of optional cable lock (Kensington® lock-compatible)</p>							
<p>Ship group Monitor and stand, Setup poster, Safety and Warranty Information, 1.8 meter analog signal cable, 1.8 meter DVI-D cable, 1.8 meter black power cord</p>	<p>Limited Warranty</p> <p>See details at http://support.lenovo.com/en_US/guides-and-manuals/detail.page?DocID=UM008281</p> <p>Accessories</p> <table border="0"> <tr> <td>Kensington MicroSaver Cable Lock</td> <td>73P2582</td> </tr> <tr> <td>Kensington Twin Head Cable Lock</td> <td>45K1620</td> </tr> <tr> <td>Lenovo Easy Reach Monitor Stand</td> <td>55Y9258</td> </tr> </table> <p>See details at www.lenovo.com/support/monitoraccessories</p> <p>See all monitors at www.lenovo.com/thinkvision</p>	Kensington MicroSaver Cable Lock	73P2582	Kensington Twin Head Cable Lock	45K1620	Lenovo Easy Reach Monitor Stand	55Y9258
Kensington MicroSaver Cable Lock	73P2582						
Kensington Twin Head Cable Lock	45K1620						
Lenovo Easy Reach Monitor Stand	55Y9258						



<p>Name T1714p Square Flat Panel Monitor Case color Black Type-model 60FELAR1US / 60FELAT1EU Panel TFT-LCD, twisted nematic (TN), White LED backlight Viewable image size 17.0" (432mm) diagonal Max view area (W x H) 13.3" x 10.6" (337.9mm x 270.3mm) Optimum resolution 1280x1024 Aspect ratio 5:4 Pixel pitch (mm) 0.264mm Dot/Pixel per Inch 96 dpi Brightness 250 nits or cd/m² (typical) Contrast ratio 1000:1 (typical) Pixel response time 5ms (typical) Color gamut 72% Viewing angle at 10:1 CR 170° (+/- 85°) horizontal, 160° (+/- 80°) vertical Stand Tilt height adjustable stand Bezel width Sides: 0.69" (17.5mm) Dimensions (HxWxD, including stand) 17.63" H x 14.74" W x 9.61" D; 447.9mm H x 374.5mm W x 244.2mm D Power supply 14.0 watts typical, 18.0 watts maximum, <0.5 watts standby/suspend, universal, integrated (no external brick-like power supply) Weight 8.71 lb; 3.95kg Limited warranty 3 year (includes backlight) Available date September 2015</p>	<p>Features</p> <ul style="list-style-type: none"> • 17-inch Square LCD monitor • Supports SXGA 1280x1024 resolution • Includes dual input connection for attachment to two systems concurrently (analog and digital) • Mercury Arsenic free glass • Supports Lenovo Tiny PC and 3rd party thin client via optional Lenovo bracket • Supports optional soundbar • Microsoft® Windows® 7 certified • Microsoft Windows 8 certified • Microsoft Windows 8.1 certified • Microsoft Windows 10 certified 						
<p>VESA-compliant VESA DDC2B/CI Power management ENERGY STAR® 7.0 Ergonomics ISO 9241-307 Emission standards FCC Class B Environmental TCO Displays 7.0, TCO Certified Edge 2.0, WEEE, RoHS, EPEAT™ Gold rating</p>	<div style="text-align: center;">  <p>ThinkVision T1714p Monitor</p> </div>						
<p>Preset resolutions VGA: 640x350, 640x480, 720x400 SVGA: 800x600 XGA: 1024x768, 1152x864, SXGA: 1280x800, 1280x1024 Presets / user settings Standard presets: 22; user settings: 22</p>							
<p>Viewing adjustments Tilt: 22° back, -5° forward; lift: 4.3" (110mm) Rotating screen None On screen display On screen display with digital user controls (8 languages) Control features Direct access (buttons on front) for automatic image setup and brightness Multiple input Dual input (two different PCs attach to two different connectors; one PC shows image; select via button) Monitor connectors (1) VGA 15-pin D-shell, analog, blue (2) Digital Visual Interface (DVI-D), digital, white, HDCP-compliant (3) DisplayPort, digital, black, HDCP-compliant Signal cables (1) detachable, VGA 15-pin D-shell at each end, analog, 1.8 meter (2) detachable, DVI-D at each end, digital, 1.8 meter Mounting features Wall or desk mounting using the Extend Arm or third-party accessories meeting the VESA FPMPI® (100mm mount) Security Security keyhole for attachment of optional cable lock (Kensington® lock-compatible)</p>							
<p>Ship group Monitor and stand, Setup poster, Safety and Warranty Information, 1.8 meter analog signal cable, 1.8 meter DVI-D cable, 1.8 meter black power cord</p>							
<p style="text-align: center;">Limited Warranty</p> <p>See details at http://support.lenovo.com/en_US/guides-and-manuals/detail.page?DocID=UM008281</p>	<p style="text-align: center;">Accessories</p> <table border="0"> <tr> <td>Kensington MicroSaver Cable Lock</td> <td style="text-align: right;">73P2582</td> </tr> <tr> <td>Kensington Twin Head Cable Lock</td> <td style="text-align: right;">45K1620</td> </tr> <tr> <td>Lenovo Easy Reach Monitor Stand</td> <td style="text-align: right;">55Y9258</td> </tr> </table> <p>See details at www.lenovo.com/support/monitoraccessories</p> <p>See all monitors at www.lenovo.com/thinkvision</p>	Kensington MicroSaver Cable Lock	73P2582	Kensington Twin Head Cable Lock	45K1620	Lenovo Easy Reach Monitor Stand	55Y9258
Kensington MicroSaver Cable Lock	73P2582						
Kensington Twin Head Cable Lock	45K1620						
Lenovo Easy Reach Monitor Stand	55Y9258						



<p>Name T2054p Wide Flat Panel Monitor Bezel color Raven black Type-model 60G1MAR2US / 60G1MAT2EU Panel TFT-LCD, In-Plane Switching (IPS), White LED backlight</p> <p>Viewable image size 19.5" (495mm) diagonal Max view area (W x H) 16.48" x 10.33" (418.6mm x 262.4mm) Native resolution 1440x900 Aspect ratio 16:10 Pixel pitch (mm) 0.2915 x 0.2915 mm Dot/Pixel per Inch 87 dpi Brightness 250 nits or cd/m² (typical) Contrast ratio 1000:1 (typical) Pixel response time 7ms (typical) Color gamut 72% Viewing angle at 10:1 CR 178° (+/- 89°) horizontal, 178° (+/- 89°) vertical Stand Tilt, swivel, and height adjustable Bezel width Sides: 0.67" (17.0mm) Dimensions (HxWxD) 13.62" H x 17.88" W x 9.55" D; 345.9mm H x 454.2mm W x 242.6mm D</p> <p>Power supply 14.5 watts typical, 21 watts maximum, <0.3 watts standby/suspend, universal, integrated (no external brick-like power supply)</p> <p>Weight 8.16 lb; 3.70 kg Limited warranty⁴ 3 year (includes backlight) Available date September 2015</p>	<p style="text-align: center;">Features</p> <ul style="list-style-type: none"> • Widescreen 19.5-inch monitor • Supports 1440x900 resolution • Supports ThinkCentre Tiny Clamp Bracket • Includes dual input connection for attachment to two systems concurrently (analog and digital) • EPEAT Gold certified • Supports optional soundbar • Microsoft® Windows® 7 certified • Microsoft Windows 8 / Windows 8.1 certified • Microsoft Windows 10 certified 				
<p>VESA-compliant² VESA DDC2B/CI Power management ENERGY STAR® qualified Ergonomics ISO 9241-307 Emission standards FCC Class B Environmental TCO Displays 7.0, TCO Certified Edge 2.0, WEEE, RoHS, EPEAT™ Gold rating</p>	<div style="text-align: center;">  <p>ThinkVision T2054p Wide Monitor</p> </div>				
<p>Preset resolutions VGA: 640x480, 720x400, 720x576 SVGA: 800x600 XGA: 1024x768, 1152x864 SXGA: 1280x800, 1280x1024 WXGA: 1366x768 WXGA+: 1440x900</p> <p>Presets / user settings Standard presets: 22 user settings: 16</p>					
<p>Viewing adjustments Tilt: 22° backward, -5° forward; lift: 4.3" (110mm); swivel: +/-45°; detachable stand Rotating screen None On screen display On screen display with digital user controls (8 languages) Control features Direct access (buttons on front) for automatic image setup, dual input and brightness Multiple input Dual input (two different PCs attach to two different connectors; one PC shows image; select via button) Monitor connectors (1) VGA 15-pin D-shell, analog, blue (2) HDMI (1.4), digital, HDCP-compliant (3) DisplayPort, digital, black, HDCP-compliant</p> <p>Signal cables (1) detachable, VGA 15-pin D-shell at each end, analog, 1.8 meter (2) detachable, DisplayPort at each end, digital, 1.8 meter</p> <p>Mounting features Wall or desk mounting using the Extend Arm or third-party accessories, 100mm x 100mm mount Security Security keyhole for attachment of optional cable lock (Kensington® lock-compatible)</p> <p>Ship group Monitor with stand, Safety and Warranty Information, 1.8 meter analog signal cable, 1.8 meter DP signal cable, 1.8 meter black power cord</p>					
<p style="text-align: center;">Limited Warranty</p> <p>See details at http://support.lenovo.com/en_US/guides-and-manuals/detail.page?DocID=UM008281</p>	<p style="text-align: center;">Accessories</p> <table border="0"> <tr> <td>Kensington MicroSaver Cable Lock</td> <td style="text-align: right;">73P2582</td> </tr> <tr> <td>Kensington Twin Head Cable Lock</td> <td style="text-align: right;">45K1620</td> </tr> </table> <p>See details at www.lenovo.com/support/monitoraccessories</p> <p>See all monitors at www.lenovo.com/thinkvision</p>	Kensington MicroSaver Cable Lock	73P2582	Kensington Twin Head Cable Lock	45K1620
Kensington MicroSaver Cable Lock	73P2582				
Kensington Twin Head Cable Lock	45K1620				



<p>Name E21 Wide Flat Panel Monitor Bezel color Black Type-model 61B9JAR1US / 61B9JAT1EU Panel TFT-LCD, twisted nematic (TN), White LED backlight Viewable image size 20.7" (525.78mm) diagonal Max view area (W x H) 18.03" x 10.14" (457.92mm x 257.58mm) Native resolution 1920x1080 Aspect ratio 16:9 Pixel pitch (mm) 0.2385 x 0.2385 mm Dot/Pixel per Inch 106 dpi Brightness 250 nits or cd/m² (typical) Contrast ratio 1000:1 (typical) Pixel response time 5ms (typical) Color gamut 72% Viewing angle at 10:1 CR 170° (+/- 85°) horizontal, 160° (+/- 80°) vertical Stand Tilt adjustable stand Bezel width Sides: 0.6" (15.3mm) Dimensions (HxWxD) 14.6" H x 19.31" W x 8.07" D; 370.9mm H x 490.5mm W x 204.9mm D Power supply 18 watts typical, 23 watts maximum, <0.3 watts standby/suspend, universal, integrated (no external brick-like power supply) Weight 5.82 lb; 2.64 kg Limited warranty 3 year (includes backlight) Available date August 2017</p>	<p style="text-align: center;">Features</p> <ul style="list-style-type: none"> • Widescreen 20.7-inch monitor • Supports 1920x1080 resolution • Supports ThinkCentre Tiny Clamp Bracket • Supports optional soundbar • EPEAT Gold certified • Low Blue Light certification • Microsoft® Windows® 7 certified • Microsoft Windows 10 certified 				
<p>VESA-compliant VESA DDC2B/CI Power management ENERGY STAR® qualified Ergonomics ISO 9241-307 Emission standards FCC Class B Environmental TCO Displays 7.0, TCO Certified Edge 2.0, WEEE, RoHS, EPEAT™ Gold rating</p>	<div style="text-align: center;">  <p>ThinkVision E21 Wide Monitor</p> </div>				
<p>Preset resolutions VGA: 640x350, 640x480, 720x400 SVGA: 800x600, 832x624 XGA: 1024x768, 1152x864 SXGA: 1280x1024 WXGA+: 1440x900 WSXGA+: 1680x1050 Full HD: 1920x1080</p> <p>Presets display modes Standard presets: 22</p>					
<p>Viewing adjustments Tilt: 22° back, -5° forward Rotating screen None On screen display On screen display with digital user controls (8 languages) Control features Direct access (buttons on front) for power, menu, input source select and brightness USB hub None Multiple input Dual input (two different PCs attach to two different connectors; one PC shows image; select via button) Monitor connectors (1) VGA 15-pin D-shell, analog, blue (2) DisplayPort (1.2), digital, black, HDCP-compliant Signal cables (1) detachable, VGA 15-pin D-shell at each end, analog, 1.8 meter Mounting features Wall or desk mounting using the Extend Arm or third-party accessories, 100mm x 100mm mount Security Security keyhole for attachment of optional cable lock (Kensington® lock-compatible)</p>					
<p>Ship group Monitor with stand, Safety and Warranty Information, 1.8 meter analog signal cable, 1.8 meter black power cord</p>	<p style="text-align: center;">Accessories</p> <table border="0"> <tr> <td>Kensington MicroSaver Cable Lock</td> <td style="text-align: right;">73P2582</td> </tr> <tr> <td>Kensington Twin Head Cable Lock</td> <td style="text-align: right;">45K1620</td> </tr> </table> <p>See details at www.lenovo.com/support/monitoraccessories</p> <p>See all monitors at www.lenovo.com/thinkvision</p>	Kensington MicroSaver Cable Lock	73P2582	Kensington Twin Head Cable Lock	45K1620
Kensington MicroSaver Cable Lock	73P2582				
Kensington Twin Head Cable Lock	45K1620				



<p>Name E24 Wide Flat Panel Monitor Bezel color Black Type-model 61B7JAR6US / 61B7JAT6EU Panel TFT-LCD, In-Plane Switching (IPS), White LED backlight Viewable image size 23.8" (604.7mm) diagonal Max view area (W x H) 20.75" x 11.67" (527.04mm x 296.46mm) Native resolution 1920x1080 Aspect ratio 16:9 Pixel pitch (mm) 0.2745 x 0.2745 mm Dot/Pixel per Inch 92.5 dpi Brightness 250 nits or cd/m² (typical) Contrast ratio 1000:1 (typical) Pixel response time 6ms (typical) Color gamut 72% Viewing angle at 10:1 CR 178° (+/- 89°) horizontal, 178° (+/- 89°) vertical Stand Tilt adjustable stand Bezel width <i>Sides:</i> 0.51" (13mm) Dimensions (HxWxD) 15.9" H x 21.81" W x 8.07" D; 403.8mm H x 554mm W x 204.9mm D Power supply 18 watts typical, 23 watts maximum, <0.3 watts standby/suspend, universal, integrated (no external brick-like power supply) Weight 8.2 lb; 3.7 kg Limited warranty 3 year (includes backlight) Available date August 2017</p>	<p style="text-align: center;">Features</p> <ul style="list-style-type: none"> • Widescreen 23.8-inch monitor • Supports 1920x1080 resolution • Supports ThinkCentre Tiny Clamp Bracket • Supports optional soundbar • Includes dual input connection for attachment to two systems concurrently • EPEAT Gold certified • Microsoft® Windows® 7 certified • Microsoft Windows 10 certified 				
<p>VESA-compliant VESA DDC2B/CI Power management ENERGY STAR® qualified Ergonomics ISO 9241-307 Emission standards FCC Class B Environmental TCO Displays 7.0, TCO Certified Edge 2.0, WEEE, RoHS, EPEAT™ Gold rating</p>	<div style="text-align: center;">  <p>ThinkVision E24 Wide Monitor</p> </div>				
<p>Preset resolutions VGA: 640x350, 640x480, 720x400 SVGA: 800x600, 832x624 XGA: 1024x768, 1152x864 SXGA: 1280x1024 WXGA: 1366x768 WXGA+: 1440x900, 1600x900 WSXGA+: 1680x1050 Full HD: 1920x1080</p> <p>Presets display modes Standard presets: 24; user settings: 20</p>					
<p>Viewing adjustments <i>Tilt:</i> 22° back, -5° forward Rotating screen None On screen display On screen display with digital user controls (8 languages) Control features Direct access (buttons on front) for power, menu, input source select and brightness USB hub None Multiple input Dual input (two different PCs attach to two different connectors; one PC shows image; select via button) Monitor connectors (1) VGA 15-pin D-shell, analog, blue (2) DisplayPort, digital, black, HDCP-compliant Signal cables (1) detachable, VGA 15-pin D-shell at each end, analog, 1.8 meter (2) detachable, DisplayPort at each end, digital, 1.8 meter Mounting features Wall or desk mounting using the Extend Arm or third-party accessories, 100mm x 100mm mount Security Security keyhole for attachment of optional cable lock (Kensington® lock-compatible)</p>					
<p>Ship group Monitor with stand, Safety and Warranty Information, 1.8 meter analog signal cable, 1.8 meter DP signal cable, 1.8 meter black power cord</p>	<p style="text-align: center;">Accessories</p> <table border="0" style="width: 100%;"> <tr> <td>Kensington MicroSaver Cable Lock</td> <td style="text-align: right;">73P2582</td> </tr> <tr> <td>Kensington Twin Head Cable Lock</td> <td style="text-align: right;">45K1620</td> </tr> </table> <p>See details at www.lenovo.com/support/monitoraccessories</p> <p>See all monitors at www.lenovo.com/thinkvision</p>	Kensington MicroSaver Cable Lock	73P2582	Kensington Twin Head Cable Lock	45K1620
Kensington MicroSaver Cable Lock	73P2582				
Kensington Twin Head Cable Lock	45K1620				
<p style="text-align: center;">Limited Warranty</p> <p>See details at http://support.lenovo.com/en_US/guides-and-manuals/detail.page?DocID=UM008281</p>					



<p>Name LT2423 Wide Flat Panel Monitor Case color Business black Type-model 60A8KAR2US / 60A8KAT2EU Panel TFT-LCD, twisted nematic (TN), White LED backlight Viewable image size 24" (610mm) diagonal Max view area (W x H) 20.9" x 11.8" (531.4mm x 298.9mm) Optimum resolution 1920x1080 Max pixel rate 205MHz Aspect ratio 16:9 Pixel pitch (mm) 0.278mm Dot/Pixel per Inch 92 dpi Brightness 250 nits or cd/m² (typical) Contrast ratio 1000:1 (typical) Contrast ratio 2000000:1 Pixel response time 5ms Color gamut 72% Viewing angle at 10:1 CR 170° horizontal, 160° vertical Stand Tilt stand Bezel width Sides: 0.67" (17.0mm); top: 0.67" (17.0mm); bottom: 1.02" (26.0mm)</p> <p>Dimensions (HxWxD, excluding stand) 13.53" H x 22.33" W x 1.97" D; Dimensions (HxWxD, including stand) 343.7mm H x 567.1mm W x 50.0mm D Dimensions (HxWxD, including stand) 16.30" H x 22.33" W x 8.50" D; Dimensions (HxWxD, including stand) 414.3mm H x 567.1mm W x 216.7mm D Power supply 21 watts typical, 31 watts maximum, <0.5 watts standby/suspend, universal, integrated (no external brick-like power supply)</p> <p>Weight 8.30 lb; 3.76kg Limited warranty⁴ 3 year (includes backlight) Available date July 2013</p>	<p>Features</p> <ul style="list-style-type: none"> • Widescreen 24-inch monitor • Supports 1920x1080 resolution • Two 3W stereo speakers • Audio in (3.5mm) • Supports VGA and HDMI 1.4 interfaces • Supports optional soundbar • Support Lenovo Tiny PC and 3rd party thin client via optional Lenovo bracket • Microsoft® Windows® 8 certified • Arsenic/Lead/Mercury free 										
<p>VESA-compliant² VESA DDC2B/CI Power management ENERGY STAR® 6.0 Ergonomics ISO 9241-307 Emission standards MPR-2, FCC Class B Environmental TCO Displays 6.0, TCO Certified Edge 1.2, WEEE, RoHS, EPEAT™ Gold rating, ULE Gold</p> <p>Preset resolutions VGA: 640x350, 640x480, 720x400 SVGA: 800x600, 832x624 XGA: 1024x768, 1152x864 SXGA: 1280x1024 WXGA: 1366x768 WXGA+: 1440x900, 1600x900 WSXGA+: 1680x1050 Full HD: 1920x1080</p> <p>Presets / user settings Standard presets: 24; User settings: 20</p>	 <p>ThinkVision LT2423 Wide Monitor</p>										
<p>Viewing adjustments Tilt: 22° back, -5° forward Rotating screen None On screen display On screen display with digital user controls (8 languages) Control features Direct access (buttons on front) for automatic image setup, input switch, and brightness Multimedia Integrated stereo speakers (3 watts x 2) Multiple input Dual input (two different PCs attach to two different connectors; one PC shows image; select via button) Monitor connectors (1) VGA 15-pin D-shell, analog, blue (2) HDMI (1.4), digital, HDCP-compliant Signal cables (1) detachable, VGA 15-pin D-shell at each end, analog, 1.8 meter Mounting features Wall or desk mounting using the Extend Arm or third-party accessories meeting the VESA FPMPI® (100mm mount) Security Security keyhole for attachment of optional cable lock (Kensington® lock-compatible)</p>											
<p>Ship group Monitor, attached stand, Setup poster, Safety and Warranty Information, 1.8 meter analog signal cable, 1.8 meter Audio cable, 1.8 meter black power cord</p>											
<p>Limited Warranty</p> <p>See details at http://support.lenovo.com/en_US/guides-and-manuals/detail.page?DocID=UM008281</p>	<p>Accessories</p> <table border="0"> <tr> <td>Kensington MicroSaver Cable Lock</td> <td>73P2582</td> </tr> <tr> <td>Kensington Twin Head Cable Lock</td> <td>45K1620</td> </tr> <tr> <td>Lenovo Security Cable Lock</td> <td>57Y4303</td> </tr> <tr> <td>ThinkCentre Extend Arm</td> <td>57Y4352</td> </tr> <tr> <td>Lenovo Easy Reach Monitor Stand</td> <td>55Y9258</td> </tr> </table> <p>See details at www.lenovo.com/support/monitoraccessories</p> <p>See all monitors at www.lenovo.com/thinkvision</p>	Kensington MicroSaver Cable Lock	73P2582	Kensington Twin Head Cable Lock	45K1620	Lenovo Security Cable Lock	57Y4303	ThinkCentre Extend Arm	57Y4352	Lenovo Easy Reach Monitor Stand	55Y9258
Kensington MicroSaver Cable Lock	73P2582										
Kensington Twin Head Cable Lock	45K1620										
Lenovo Security Cable Lock	57Y4303										
ThinkCentre Extend Arm	57Y4352										
Lenovo Easy Reach Monitor Stand	55Y9258										



<p>Name P24h Wide Flat Panel Monitor Bezel color Black Type-model 61AEGAR3US / 61AEGAT3EU Panel TFT-LCD, In-Plane Switching (IPS), White LED backlight Viewable image size 23.8" (604.7mm) diagonal Max view area (W x H) 20.74" x 11.67" (526.9mm x 296.4mm) Native resolution 2560x1440 Aspect ratio 16:9 Pixel pitch (mm) 0.2058x 0.2058 mm Dot/Pixel per Inch 124 dpi Brightness 300 nits or cd/m² (typical) Contrast ratio 1000:1 (typical) Pixel response time 4ms (extreme) / 6ms (typical) Color gamut 99% sRGB Viewing angle at 10:1 CR 178° (+/- 89°) horizontal, 178° (+/- 89°) vertical Stand Tilt, swivel, pivot, and height adjustable stand Bezel width <i>Sides:</i> 0.08" (2.0mm) Dimensions (HxWxD) 14.7" H x 21.26" W x 10.3" D; 373.4mm H x 540.2mm W x 261.75mm D Power supply 24 watts typical, 120 watts maximum (with USB 3.0 hub), <0.5 watts standby/suspend, universal, integrated (no external brick-like power supply) Weight 12.54 lb; 5.69 kg Limited warranty 3 year (includes backlight) Available date April 2017</p>	<p style="text-align: center;">Features</p> <ul style="list-style-type: none"> • Widescreen 23.8-inch monitor • Supports 2560x1440 resolution • Supports optional soundbar • Supports ThinkCentre Tiny Clamp Bracket • Includes dual input connection for attachment to two systems concurrently • EPEAT Gold certified • Microsoft® Windows® 7 certified • Microsoft Windows 10 certified 				
<p>VESA-compliant VESA DDC2B/CI Power management ENERGY STAR® qualified Ergonomics ISO 9241-307 Emission standards FCC Class B Environmental TCO Displays 7.0, TCO Certified Edge 2.0, WEEE, RoHS, EPEAT™ Gold rating</p>	<div style="text-align: center;">  <p>ThinkVision P24h Wide Monitor</p> </div>				
<p>Preset resolutions VGA: 640x480, 720x400 SVGA: 800x600 XGA: 1024x768 SXGA: 1280x1024 WXGA: 1366x768 WXGA+: 1440x900, 1680x900 WSXGA+: 1680x1050 Full HD: 1920x1080, 1920x1200 QHD: 2560x1440 Presets display modes HDMI: 22; DP: 14</p>					
<p>Viewing adjustments <i>Tilt:</i> 30° back, -5° forward; <i>lift:</i> 4.3" (110mm); <i>swivel:</i> +/-45°; detachable stand Rotating screen Screen pivots 90 degrees from landscape to portrait On screen display On screen display with digital user controls (8 languages) Control features Direct access (buttons on front) for power, menu, input source select and brightness USB hub USB Hub: one USB 3.1 Type-C upstream port, four USB 3.0 Type-A downstream ports Multimedia Audio-out, optional sound bar supported Camera None Multiple input Support HDMI, DisplayPort, USB 3.1 Type-C, DisplayPort-out Monitor connectors (1) 2*HDMI (1.4), digital, HDCP-compliant (2) DisplayPort (1.2), digital, HDCP-compliant (3) DisplayPort-out, digital (4) USB 3.1 Type-C Signal cables (1) USB 3.1 Type-C cable, 1.8 meter Mounting features Wall or desk mounting using the Extend Arm or third-party accessories, 100mm x 100mm mount Security Security keyhole for attachment of optional cable lock (Kensington® lock-compatible)</p>					
<p>Ship group Monitor with stand, Safety and Warranty Information, 1.8 meter USB 3.1 Type-C cable, 1.8 meter black power cord</p>	<p style="text-align: center;">Accessories</p> <table border="0" style="width: 100%;"> <tr> <td>Kensington MicroSaver Cable Lock</td> <td style="text-align: right;">73P2582</td> </tr> <tr> <td>Kensington Twin Head Cable Lock</td> <td style="text-align: right;">45K1620</td> </tr> </table> <p>See details at www.lenovo.com/support/monitoraccessories</p> <p>See all monitors at www.lenovo.com/thinkvision</p>	Kensington MicroSaver Cable Lock	73P2582	Kensington Twin Head Cable Lock	45K1620
Kensington MicroSaver Cable Lock	73P2582				
Kensington Twin Head Cable Lock	45K1620				
<p style="text-align: center;">Limited Warranty</p> <p>See details at http://support.lenovo.com/en_US/guides-and-manuals/detail.page?DocID=UM008281</p>					



<p>Name P24q Wide Flat Panel Monitor Case color Black Type-model 61A5GAR3US / 61A5GAT3EU Panel TFT-LCD, IPS (In-Plane Switching), White LED backlight Viewable image size 23.8" (604.5mm) diagonal Max view area (W x H) 20.74" x 11.67" (526.85mm x 296.35mm) Optimum resolution 2560x1440 Max pixel rate 300MHz Aspect ratio 16:9 Pixel pitch (mm) 0.2058 x 0.2058mm Dot/Pixel per Inch 123 dpi Brightness 300 nits or cd/m² (typical) Contrast ratio 1000:1 (typical) Pixel response time 4ms Color gamut 99% sRGB Viewing angle at 10:1 CR 178° horizontal, 178° vertical Stand Tilt, swivel, pivot, and height adjustable stand Bezel width <i>Sides:</i> 0.08" (2mm) Dimensions 14.7" H x 21.26" W x 10.3" D; (HxWxD, including stand) 373.4mm H x 540.2mm W x 261.75mm D Power supply 24 watts typical, 67 watts maximum (with USB), <0.5 watts sleep/off; <0.5 watts switch off integrated (no external brick-like power supply) Weight 12.35 lb; 5.6kg (including stand) Limited warranty 3 year Available date January 2017</p>	<p>Features</p> <ul style="list-style-type: none"> • 23.8-inch IPS LED backlight monitor • Supports 2560x1440 resolution • 5-Ports USB hub, support USB 3.0 • Support ThinkCentre Tiny • Supports optional soundbar • Microsoft® Windows® 7 certified • Microsoft Windows 10 certified 						
<p>VESA-compliant VESA DDC2B/CI Power management ENERGY STAR® 7.0 Ergonomics ISO 9241-307 Emission standards FCC Class B Environmental TCO Displays 7.0, RoHS, EPEAT™ Gold rating, ULE Gold</p>	 <p>ThinkVision P24q Monitor</p>						
<p>Preset resolutions VGA: 640x480, 720x400 SVGA: 800x600 XGA: 1024x768 SXGA: 1280x1024 WXGA: 1366x768 WXGA+: 1440x900, 1600x900 WSXGA+: 1680x1050 Full HD: 1920x1080, 1920x1200 QHD: 2560x1440</p> <p>Presets / user settings Standard presets: 20; user settings: 24</p>							
<p>Viewing adjustments <i>Tilt:</i> 30° back, -5° forward; <i>lift:</i> 4.33" (110mm); <i>swivel:</i> +/-45° Rotating screen Screen pivots 90 degrees from landscape to portrait On screen display On screen display with digital user controls (8 languages) Control features Direct access for menu, source switch, and brightness USB hub USB Hub: one USB 3.0 upstream port, four USB 3.0 downstream ports Multimedia Audio-out, optional sound bar supported Camera None Multiple input Support HDMI, DisplayPort, mini DisplayPort, DisplayPort-out Monitor connectors (1) 2*HDMI (1.4), digital, HDCP-compliant (2) DisplayPort (1.2), digital, HDCP-compliant (3) Mini DisplayPort, digital, HDCP-compliant Signal cables (1) detachable, mini DisplayPort to DisplayPort, digital, 1.8 meter Mounting features Wall or desk mounting using the Extend Arm or third-party accessories meeting the VESA FPMPI® (100mm mount) Security Security keyhole for attachment of optional cable lock (Kensington® lock-compatible)</p>							
<p>Ship group Monitor, detachable stand, Quick start and safety poster, 1.8 meter USB 3.0 cable, 1.8 meter mini DP to DP cable, 1.8 meter black power cord</p>	<p>Limited Warranty</p> <p>See details at http://support.lenovo.com/en_US/guides-and-manuals/detail.page?DocID=UM008281</p> <p>Accessories</p> <table border="0"> <tr> <td>Kensington MicroSaver Cable Lock</td> <td>73P2582</td> </tr> <tr> <td>Kensington Twin Head Cable Lock</td> <td>45K1620</td> </tr> <tr> <td>Lenovo Security Cable Lock</td> <td>57Y4303</td> </tr> </table> <p>See details at www.lenovo.com/support/monitoraccessories</p> <p>See all monitors at www.lenovo.com/thinkvision</p>	Kensington MicroSaver Cable Lock	73P2582	Kensington Twin Head Cable Lock	45K1620	Lenovo Security Cable Lock	57Y4303
Kensington MicroSaver Cable Lock	73P2582						
Kensington Twin Head Cable Lock	45K1620						
Lenovo Security Cable Lock	57Y4303						



<p>Name T2224d Wide Flat Panel Monitor Bezel color Black Type-model 61B1JAR1US / 61B1JAT1EU Panel TFT-LCD, In-Plane Switching (IPS), White LED backlight Viewable image size 21.5" (546mm) diagonal Max view area (W x H) 18.74" x 10.54" (476.1mm x 267.8mm) Native resolution 1920x1080 Aspect ratio 16:9 Pixel pitch (mm) 0.248 x 0.248 mm Dot/Pixel per Inch 102 dpi Brightness 250 nits or cd/m² (typical) Contrast ratio 1000:1 (typical) Pixel response time 7ms (typical); 4ms (extreme mode) Color gamut 72% Viewing angle at 10:1 CR 178° (+/- 89°) horizontal, 178° (+/- 89°) vertical Stand Tilt stand Bezel width <i>Sides:</i> 0.69" (17.6mm) Dimensions (HxWxD) 15.02" H x 20.19" W x 8.06" D; 381.4mm H x 512.9mm W x 204.9mm D Power supply 20 watts typical, 25 watts maximum <0.5 watts standby/suspend, universal, integrated (no external brick-like power supply) Weight 6.48 lb; 2.94 kg Limited warranty 3 year (includes backlight) Available date March 2017</p>	<p style="text-align: center;">Features</p> <ul style="list-style-type: none"> • Widescreen 21.5-inch monitor • Supports 1920x1080 resolution • Supports optional soundbar • Supports ThinkCentre Tiny via VESA back mount • Includes dual input connection for attachment to two systems concurrently (analog and digital) • EPEAT Gold certified • Microsoft® Windows® 7 certified • Microsoft Windows 10 certified 				
<p>VESA-compliant VESA DDC2B/CI Power management ENERGY STAR® qualified Ergonomics ISO 9241-307 Emission standards FCC Class B Environmental TCO Displays 7.0, TCO Certified Edge 2.0, WEEE, RoHS, EPEAT™ Gold rating</p>	<div style="text-align: center;">  <p>ThinkVision T2224d Wide Monitor</p> </div>				
<p>Preset resolutions VGA: 640x350, 640x480, 720x400 SVGA: 800x600 XGA: 1024x768, 1152x864 SXGA: 1280x1024 WXGA: 1280x768, 1280x800, 1366x768 WXGA+: 1440x900 WSXGA+: 1680x1050 Full HD: 1920x1080 Presets / user settings Standard presets: 22; user settings: 22</p>					
<p>Viewing adjustments <i>Tilt:</i> 22° back, -5° forward Rotating screen None On screen display On screen display with digital user controls (8 languages) Control features Direct access (buttons on front) for automatic image setup, dual input and brightness USB hub None Multiple input Dual input (two different PCs attach to two different connectors; one PC shows image; select via button) Monitor connectors (1) VGA 15-pin D-shell, analog, blue (2) DisplayPort, digital, black, HDCP-compliant Signal cables (1) detachable, VGA 15-pin D-shell at each end, analog, 1.8 meter (2) detachable, DisplayPort at each end, digital, 1.8 meter Mounting features Wall or desk mounting using the Extend Arm or third-party accessories, 100mm x 100mm mount Security Security keyhole for attachment of optional cable lock (Kensington® lock-compatible)</p>					
<p>Ship group Monitor with stand, Safety and Warranty Information, 1.8 meter analog signal cable, 1.8 meter DP signal cable, 1.8 meter black power cord</p>	<p style="text-align: center;">Accessories</p> <table border="0" style="width: 100%;"> <tr> <td>Kensington MicroSaver Cable Lock</td> <td style="text-align: right;">73P2582</td> </tr> <tr> <td>Kensington Twin Head Cable Lock</td> <td style="text-align: right;">45K1620</td> </tr> </table> <p>See details at www.lenovo.com/support/monitoraccessories</p> <p>See all monitors at www.lenovo.com/thinkvision</p>	Kensington MicroSaver Cable Lock	73P2582	Kensington Twin Head Cable Lock	45K1620
Kensington MicroSaver Cable Lock	73P2582				
Kensington Twin Head Cable Lock	45K1620				
<p style="text-align: center;">Limited Warranty</p> <p>See details at http://support.lenovo.com/en_US/guides-and-manuals/detail.page?DocID=UM008281</p>					



<p>Name T2224z Wide Flat Panel Monitor Bezel color Raven black Type-model 60F5MARG6US / 60F5MAT6EU Panel TFT-LCD, In-Plane Switching (IPS), White LED backlight</p> <p>Viewable image size 21.5" (546mm) diagonal Max view area (W x H) 18.74" x 10.54" (476.1mm x 267.8mm) Native resolution 1920x1080 Aspect ratio 16:9 Pixel pitch (mm) 0.248 x 0.248 mm Dot/Pixel per Inch 102 dpi Brightness 250 nits or cd/m² (typical) Contrast ratio 1000:1 (typical) Pixel response time 7ms (typical) Color gamut 72% Viewing angle at 10:1 CR 178° (+/- 89°) horizontal, 178° (+/- 89°) vertical Stand Tilt, swivel, pivot, and height adjustable stand Bezel width <i>Sides:</i> 0.69" (17.6mm) Dimensions (HxWxD) 14.08" H x 20.19" W x 9.55" D; 357.8mm H x 512.9mm W x 242.7mm D</p> <p>Power supply 21 watts typical, 25 watts maximum (without USB 3.0 hub), 45 watts maximum (with USB 3.0 hub), <0.5 watts standby/suspend, universal, integrated (no external brick-like power supply)</p> <p>Weight 10.63 lb; 4.83 kg Limited warranty 3 year (includes backlight) Available date March 2015</p>	<p style="text-align: center;">Features</p> <ul style="list-style-type: none"> • Widescreen 21.5-inch monitor • Supports 1920x1080 resolution • Supports ThinkCentre Tiny Clamp Bracket • Supports optional soundbar • Includes dual input connection for attachment to two systems concurrently (analog and digital) • EPEAT Gold certified • Microsoft® Windows® 7 certified • Microsoft Windows 8 / Windows 8.1 certified • Microsoft Windows 10 certified 				
<p>VESA-compliant VESA DDC2B/CI Power management ENERGY STAR® qualified Ergonomics ISO 9241-307 Emission standards FCC Class B Environmental TCO Displays 7.0, TCO Certified Edge 2.0, WEEE, RoHS, EPEAT™ Gold rating</p> <p>Preset resolutions VGA: 640x350, 640x480, 720x400 SVGA: 800x600 XGA: 1024x768, 1152x864 SXGA: 1280x1024 WXGA: 1280x768, 1280x800, 1366x768 WXGA+: 1440x900 WSXGA+: 1680x1050 Full HD: 1920x1080</p> <p>Presets / user settings Standard presets: 27; user settings: 20</p>	 <p style="text-align: center;">ThinkVision T2224z Wide Monitor</p>				
<p>Viewing adjustments <i>Tilt:</i> 30° back, -5° forward; <i>lift:</i> 4.3" (110mm); <i>swivel:</i> +/-45°; detachable stand Rotating screen Screen pivots 90 degrees from landscape to portrait On screen display On screen display with digital user controls (8 languages) Control features Direct access (buttons on front) for automatic image setup, dual input and brightness USB hub USB 3.0 Hub: 1 port into PC (USB 3.0); 2 ports for accessories (2 USB 3.0) Multimedia Integrated digital speakers (3 watts x 2) Camera Integrated camera (Full HD) and digital dual array microphone Multiple input Dual input (two different PCs attach to two different connectors; one PC shows image; select via button) Monitor connectors (1) VGA 15-pin D-shell, analog, blue (2) HDMI (1.4), digital, HDCP-compliant (3) DisplayPort, digital, black, HDCP-compliant</p> <p>Signal cables (1) detachable, VGA 15-pin D-shell at each end, analog, 1.8 meter (2) detachable, DisplayPort at each end, digital, 1.8 meter</p> <p>Mounting features Wall or desk mounting using the Extend Arm or third-party accessories, 100mm x 100mm mount Security Security keyhole for attachment of optional cable lock (Kensington® lock-compatible)</p>	<p>Ship group Monitor with stand, Safety and Warranty Information, 1.8 meter analog signal cable, 1.8 meter DP signal cable, 1.8 meter USB signal cable, 1.8 meter black power cord</p>				
<p style="text-align: center;">Limited Warranty</p> <p>See details at http://support.lenovo.com/en_US/guides-and-manuals/detail.page?DocID=UM008281</p>	<p style="text-align: center;">Accessories</p> <table border="0"> <tr> <td>Kensington MicroSaver Cable Lock</td> <td style="text-align: right;">73P2582</td> </tr> <tr> <td>Kensington Twin Head Cable Lock</td> <td style="text-align: right;">45K1620</td> </tr> </table> <p>See details at www.lenovo.com/support/monitoraccessories</p> <p>See all monitors at www.lenovo.com/thinkvision</p>	Kensington MicroSaver Cable Lock	73P2582	Kensington Twin Head Cable Lock	45K1620
Kensington MicroSaver Cable Lock	73P2582				
Kensington Twin Head Cable Lock	45K1620				



<p>Name T2254p Wide Flat Panel Monitor Bezel color Raven black Type-model 61BAMAR2US / 60E1MAR2US / 60CCMAR2US / 60CCMAT2EU / 61BAMAT2EU Panel TFT-LCD, twisted nematic (TN), White LED backlight Viewable image size 22.0" (559mm) diagonal Max view area (W x H) 18.70" x 11.70" (473.8mm x 296.1mm) Native resolution 1680x1050 Aspect ratio 16:10 Pixel pitch (mm) 0.282 x 0.282 mm Dot/Pixel per Inch 90 dpi Brightness 250 nits or cd/m² (typical) Contrast ratio 1000:1 (typical) Pixel response time 5ms (typical) Color gamut 72% Viewing angle at 10:1 CR 170° (+/- 85°) horizontal, 160° (+/- 80°) vertical Stand Tilt, swivel, pivot, and height adjustable Bezel width Sides: 0.67" (17.1mm) Dimensions (HxWxD) 14.63" H x 20.01" W x 9.55" D; 371.7mm H x 509.3mm W x 242.7mm D Power supply 20 watts typical, 25 watts maximum, <0.5 watts standby/suspend, universal, integrated (no external brick-like power supply) Weight 10.14 lb; 4.60 kg Limited warranty 3 year (includes backlight) Available date March 2015</p>	<p style="text-align: center;">Features</p> <ul style="list-style-type: none"> • Widescreen 22.0-inch monitor • Supports 1680x1050 resolution • Supports ThinkCentre Tiny Clamp Bracket • Supports optional soundbar • Includes dual input connection for attachment to two systems concurrently (analog and digital) • EPEAT Gold certified • Microsoft® Windows® 7 certified • Microsoft Windows 8 / Windows 8.1 certified • Microsoft Windows 10 certified 				
<p>VESA-compliant VESA DDC2B/CI Power management ENERGY STAR® qualified Ergonomics ISO 9241-307 Emission standards FCC Class B Environmental TCO Displays 7.0, TCO Certified Edge 2.0, WEEE, RoHS, EPEAT™ Gold rating</p>	<div style="text-align: center;">  <p>ThinkVision T2254p Wide Monitor</p> </div>				
<p>Preset resolutions VGA: 640x350, 640x480, 720x400 SVGA: 800x600 XGA: 1024x768, 1152x864 SXGA: 1280x1024 WXGA: 1280x768, 1280x800, 1366x768 WXGA+: 1440x900 WSXGA+: 1600x900, 1680x1050 Presets / user settings Standard presets: 28; user settings: 20</p>					
<p>Viewing adjustments Tilt: 30° back, -5° forward; lift: 4.3" (110mm); swivel: +/-45°; detachable stand Rotating screen Screen pivots 90 degrees from landscape to portrait On screen display On screen display with digital user controls (8 languages) Control features Direct access (buttons on front) for automatic image setup, dual input and brightness USB hub None Multiple input Dual input (two different PCs attach to two different connectors; one PC shows image; select via button) Monitor connectors (1) VGA 15-pin D-shell, analog, blue (2) HDMI (1.4), digital, HDCP-compliant (3) DisplayPort, digital, black, HDCP-compliant Signal cables (1) detachable, VGA 15-pin D-shell at each end, analog, 1.8 meter (2) detachable, DisplayPort at each end, digital, 1.8 meter Mounting features Wall or desk mounting using the Extend Arm or third-party accessories, 100mm x 100mm mount Security Security keyhole for attachment of optional cable lock (Kensington® lock-compatible)</p>					
<p>Ship group Monitor with stand, Safety and Warranty Information, 1.8 meter analog signal cable, 1.8 meter DP signal cable, 1.8 meter black power cord</p>					
<p style="text-align: center;">Limited Warranty</p> <p>See details at http://support.lenovo.com/en_US/guides-and-manuals/detail.page?DocID=UM008281</p>	<p style="text-align: center;">Accessories</p> <table border="0"> <tr> <td>Kensington MicroSaver Cable Lock</td> <td style="text-align: right;">73P2582</td> </tr> <tr> <td>Kensington Twin Head Cable Lock</td> <td style="text-align: right;">45K1620</td> </tr> </table> <p>See details at www.lenovo.com/support/monitoraccessories</p> <p>See all monitors at www.lenovo.com/thinkvision</p>	Kensington MicroSaver Cable Lock	73P2582	Kensington Twin Head Cable Lock	45K1620
Kensington MicroSaver Cable Lock	73P2582				
Kensington Twin Head Cable Lock	45K1620				





<p>Name T22i Wide Flat Panel Monitor Bezel color Black Type-model 61A9MAR1US / 61A9MAT1EU Panel TFT-LCD, In-Plane Switching (IPS), White LED backlight Viewable image size 21.5" (546mm) diagonal Max view area (W x H) 18.74" x 10.54" (476.1mm x 267.8mm) Native resolution 1920x1080 Aspect ratio 16:9 Pixel pitch (mm) 0.248 x 0.248 mm Dot/Pixel per Inch 102 dpi Brightness 250 nits or cd/m² (typical) Contrast ratio 1000:1 (typical) Pixel response time 6ms (typical); 4ms (extreme mode) Color gamut 72% Viewing angle at 10:1 CR 178° (+/- 89°) horizontal, 178° (+/- 89°) vertical Stand Tilt, swivel, pivot, and height adjustable stand Bezel width <i>Sides:</i> 0.08" (2.0mm) Dimensions (HxWxD) 14.08" H x 19.28" W x 9.92" D; 357.6mm H x 489.7mm W x 251.9mm D Power supply 16.5 watts typical, 55 watts maximum (with USB 3.0 hub), <0.5 watts standby/suspend, universal, integrated (no external brick-like power supply) Weight 10.85 lb; 4.92 kg Limited warranty 3 year (includes backlight) Available date April 2017</p>	<p style="text-align: center;">Features</p> <ul style="list-style-type: none"> • Widescreen 21.5-inch monitor • Supports 1920x1080 resolution • Supports optional soundbar • Supports ThinkCentre Tiny via VESA back mount • Includes dual input connection for attachment to two systems concurrently • EPEAT Gold certified • Microsoft® Windows® 7 certified • Microsoft Windows 10 certified 				
<p>VESA-compliant VESA DDC2B/CI Power management ENERGY STAR® qualified Ergonomics ISO 9241-307 Emission standards FCC Class B Environmental TCO Displays 7.0, TCO Certified Edge 2.0, WEEE, RoHS, EPEAT™ Gold rating</p>	<div style="text-align: center;">  <p>ThinkVision T22i Wide Monitor</p> </div>				
<p>Preset resolutions VGA: 640x350, 640x480, 720x400 SVGA: 800x600 XGA: 1024x768, 1152x864 SXGA: 1280x1024 WXGA: 1280x768, 1366x768 WXGA+: 1440x900, 1680x900 WSXGA+: 1680x1050 Full HD: 1920x1080 Presets display modes HDMI: 17; DP: 17</p>					
<p>Viewing adjustments <i>Tilt:</i> 30° back, -5° forward; <i>lift:</i> 4.3" (110mm); <i>swivel:</i> +/-45°; detachable stand Rotating screen Screen pivots 90 degrees from landscape to portrait On screen display On screen display with digital user controls (8 languages) Control features Direct access (buttons on front) for power, menu, input source select and brightness USB hub USB 3.0 Hub: 1 port into PC (USB 3.0); 4 ports for accessories (4 USB 3.0) Multiple input Dual input (two different PCs attach to two different connectors; one PC shows image; select via button) Monitor connectors (1) VGA 15-pin D-shell, analog, blue (2) HDMI (1.4), digital, HDCP-compliant (3) DisplayPort, digital, black, HDCP-compliant Signal cables (1) detachable, VGA 15-pin D-shell at each end, analog, 1.8 meter (2) detachable, DisplayPort at each end, digital, 1.8 meter Mounting features Wall or desk mounting using the Extend Arm or third-party accessories, 100mm x 100mm mount Security Security keyhole for attachment of optional cable lock (Kensington® lock-compatible)</p>					
<p>Ship group Monitor with stand, Safety and Warranty Information, 1.8 meter analog signal cable, 1.8 meter DP signal cable, 1.8 meter USB signal cable, 1.8 meter black power cord</p>					
<p style="text-align: center;">Limited Warranty</p> <p>See details at http://support.lenovo.com/en_US/guides-and-manuals/detail.page?DocID=UM008281</p>	<p style="text-align: center;">Accessories</p> <table border="0"> <tr> <td>Kensington MicroSaver Cable Lock</td> <td style="text-align: right;">73P2582</td> </tr> <tr> <td>Kensington Twin Head Cable Lock</td> <td style="text-align: right;">45K1620</td> </tr> </table> <p>See details at www.lenovo.com/support/monitoraccessories</p> <p>See all monitors at www.lenovo.com/thinkvision</p>	Kensington MicroSaver Cable Lock	73P2582	Kensington Twin Head Cable Lock	45K1620
Kensington MicroSaver Cable Lock	73P2582				
Kensington Twin Head Cable Lock	45K1620				



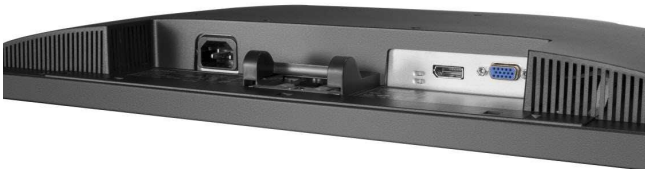

<p>Name T22v Wide Flat Panel Monitor Bezel color Black Type-model 61BBMAR6US / 61BBMAT6EU Panel TFT-LCD, In-Plane Switching (IPS), White LED backlight Viewable image size 21.5" (546mm) diagonal Max view area (W x H) 18.74" x 10.54" (476.1mm x 267.8mm) Native resolution 1920x1080 Aspect ratio 16:9 Pixel pitch (mm) 0.248 x 0.248 mm Dot/Pixel per Inch 102 dpi Brightness 250 nits or cd/m² (typical) Contrast ratio 1000:1 (typical) Pixel response time 6ms (typical); 4ms (extreme mode) Color gamut 72% Viewing angle at 10:1 CR 178° (+/- 89°) horizontal, 178° (+/- 89°) vertical Stand Tilt, swivel, pivot, and height adjustable stand Bezel width <i>Sides:</i> 0.08" (2.0mm) Dimensions (HxWxD) 19.14" H x 19.28" W x 9.92" D; 485.8mm H x 489.7mm W x 251.9mm D Power supply 18 watts typical, 43 watts maximum (with USB 3.0 hub), <0.5 watts standby/suspend, universal, integrated (no external brick-like power supply) Weight 10.16 lb; 4.61 kg Limited warranty 3 year (includes backlight) Available date October 2017</p>	<p style="text-align: center;">Features</p> <ul style="list-style-type: none"> • Widescreen 21.5-inch monitor • Supports 1920x1080 resolution • Supports optional soundbar • Supports ThinkCentre Tiny via VESA back mount • EPEAT Gold certified • Microsoft® Windows® 7 certified • Microsoft Windows 10 certified
<p>VESA-compliant VESA DDC2B/CI Power management ENERGY STAR® qualified Ergonomics ISO 9241-307 Emission standards FCC Class B Environmental TCO Displays 7.0, TCO Certified Edge 2.0, WEEE, RoHS, EPEAT™ Gold rating</p>	<div style="text-align: center;">  <p>ThinkVision T22v Wide Monitor</p> </div>
<p>Preset resolutions VGA: 640x480, 720x400 SVGA: 800x600, 832x624 XGA: 1024x768, 1152x864 SXGA: 1280x1024 WXGA+: 1440x900, 1600x900 WSXGA+: 1680x1050 Full HD: 1920x1080 Presets display modes Presets: 24; user modes: 20</p>	
<p>Viewing adjustments <i>Tilt:</i> 30° back, -5° forward; <i>lift:</i> 4.3" (110mm); <i>swivel:</i> +/-45°; detachable stand Rotating screen Screen pivots 90 degrees from landscape to portrait On screen display On screen display with digital user controls (8 languages) Control features Direct access for power, menu, input source select, volume up / down, speaker mute and microphone mute USB hub USB 3.0 Hub: 1 port into PC (USB 3.0); 2 ports for accessories (2 USB 3.0) Multimedia Integrated speakers, dual-array microphone, audio-in and Audio-out, optional sound bar supported Camera Integrated FHD camera with IR Multiple input Support HDMI, DisplayPort, VGA Monitor connectors (1) VGA 15-pin D-shell, analog, blue (2) HDMI (1.4), digital, HDCP-compliant (3) DisplayPort, digital, black, HDCP-compliant Signal cables (1) detachable, VGA 15-pin D-shell at each end, analog, 1.8 meter (2) detachable, DisplayPort at each end, digital, 1.8 meter Mounting features Wall or desk mounting using the Extend Arm or third-party accessories, 100mm x 100mm mount Security Security keyhole for attachment of optional cable lock (Kensington® lock-compatible)</p>	
<p>Ship group Monitor with stand, Safety and Warranty Information, 1.8 meter analog signal cable, 1.8 meter DP signal cable, 1.8 meter USB signal cable, 1.8 meter black power cord, 1.8 meter HDMI signal cable (Row)</p>	

<p style="text-align: center;">Limited Warranty</p> <p>See details at http://support.lenovo.com/en_US/guides-and-manuals/detail.page?DocID=UM008281</p>	<p style="text-align: center;">Accessories</p> <table border="0"> <tr> <td>Kensington MicroSaver Cable Lock</td> <td style="text-align: right;">73P2582</td> </tr> <tr> <td>Kensington Twin Head Cable Lock</td> <td style="text-align: right;">45K1620</td> </tr> </table> <p>See details at www.lenovo.com/support/monitoraccessories</p> <p>See all monitors at www.lenovo.com/thinkvision</p>	Kensington MicroSaver Cable Lock	73P2582	Kensington Twin Head Cable Lock	45K1620
Kensington MicroSaver Cable Lock	73P2582				
Kensington Twin Head Cable Lock	45K1620				



<p>Name T2324d Wide Flat Panel Monitor Bezel color Black Type-model 60F3JAR2US / 60F3JAT2EU Panel TFT-LCD, twisted nematic (TN), White LED backlight Viewable image size 23.0" (584mm) diagonal Max view area (W x H) 20.07" x 11.29" (509.8mm x 286.7mm) Native resolution 1920x1080 Aspect ratio 16:9 Pixel pitch (mm) 0.2655 x 0.2655 mm Dot/Pixel per Inch 96 dpi Brightness 250 nits or cd/m² (typical) Contrast ratio 1000:1 (typical) Pixel response time 5ms (typical) Color gamut 72% Viewing angle at 10:1 CR 170° (+/- 85°) horizontal, 160° (+/- 80°) vertical Stand Tilt stand Bezel width Sides: 0.68" (17.3mm) Dimensions (HxWxD) 15.75" H x 21.48" W x 8.06" D; 400.3mm H x 545.8mm W x 204.9mm D Power supply 20 watts typical, 27 watts maximum <0.3 watts standby/suspend, universal, integrated (no external brick-like power supply) Weight 7.06 lb; 3.20 kg Limited warranty 3 year (includes backlight) Available date June 2016</p>	<p style="text-align: center;">Features</p> <ul style="list-style-type: none"> • Widescreen 23.0-inch monitor • Supports 1920x1080 resolution • Supports optional soundbar • Supports ThinkCentre Tiny via VESA back mount • Includes dual input connection for attachment to two systems concurrently (analog and digital) • EPEAT Gold certified • Microsoft® Windows® 7 certified • Microsoft Windows 10 certified 				
<p>VESA-compliant VESA DDC2B/CI Power management ENERGY STAR® qualified Ergonomics ISO 9241-307 Emission standards FCC Class B Environmental TCO Displays 7.0, TCO Certified Edge 2.0, WEEE, RoHS, EPEAT™ Gold rating</p>	<div style="text-align: center;">  <p>ThinkVision T2324d Wide Monitor</p> </div>				
<p>Preset resolutions VGA: 640x350, 640x480, 720x400 SVGA: 800x600 XGA: 1024x768, 1152x864 SXGA: 1280x1024 WXGA: 1280x768, 1280x800, 1366x768 WXGA+: 1440x900 WSXGA+: 1680x1050 Full HD: 1920x1080</p> <p>Presets / user settings Standard presets: 26; user settings: 16</p>					
<p>Viewing adjustments Tilt: 22° back, -5° Rotating screen None On screen display On screen display with digital user controls (8 languages) Control features Direct access (buttons on front) for automatic image setup, dual input and brightness USB hub None Multiple input Dual input (two different PCs attach to two different connectors; one PC shows image; select via button) Monitor connectors (1) VGA 15-pin D-shell, analog, blue (2) DisplayPort, digital, black, HDCP-compliant Signal cables (1) detachable, VGA 15-pin D-shell at each end, analog, 1.8 meter (2) detachable, DisplayPort at each end, digital, 1.8 meter Mounting features Wall or desk mounting using the Extend Arm or third-party accessories, 100mm x 100mm mount Security Security keyhole for attachment of optional cable lock (Kensington® lock-compatible)</p>					
<p>Ship group Monitor with stand, Safety and Warranty Information, 1.8 meter analog signal cable, 1.8 meter DP signal cable, 1.8 meter black power cord</p>	<p style="text-align: center;">Limited Warranty</p> <p>See details at http://support.lenovo.com/en_US/guides-and-manuals/detail.page?DocID=UM008281</p> <p style="text-align: center;">Accessories</p> <table border="0" style="width: 100%;"> <tr> <td>Kensington MicroSaver Cable Lock</td> <td style="text-align: right;">73P2582</td> </tr> <tr> <td>Kensington Twin Head Cable Lock</td> <td style="text-align: right;">45K1620</td> </tr> </table> <p>See details at www.lenovo.com/support/monitoraccessories</p> <p>See all monitors at www.lenovo.com/thinkvision</p>	Kensington MicroSaver Cable Lock	73P2582	Kensington Twin Head Cable Lock	45K1620
Kensington MicroSaver Cable Lock	73P2582				
Kensington Twin Head Cable Lock	45K1620				



<p>Name T2364t Wide Flat Panel Monitor Bezel color Black Type-model 60E9MAR1US / 60E9MAT1EU Panel TFT-LCD, In-Plane Switching (IPS), White LED backlight</p> <p>Viewable image size 23.0" (584mm) diagonal Max view area (W x H) 20.05" x 11.28" (509.2mm x 286.4mm) Native resolution 1920x1080 Touch Supports 10-point touch</p> <p>Aspect ratio 16:9 Pixel pitch (mm) 0.2652 x 0.2652 mm Dot/Pixel per Inch 95 dpi Brightness 250 nits or cd/m² (typical) Contrast ratio 1000:1 (typical) Pixel response time 7ms (typical) Color gamut 72% Viewing angle at 10:1 CR 178° (+/- 89°) horizontal, 178° (+/- 89°) vertical</p> <p>Stand Tilt adjustable stand Bezel width <i>Sides:</i> 0.079" (2.0mm) Dimensions (HxWxD) 12.53" H x 20.56" W x 2.86" D; 318.2mm H x 522.2mm W x 72.7mm D</p> <p>Power supply 22 watts typical, 45 watts maximum, <0.5 watts standby/suspend, universal, integrated (no external brick-like power supply)</p> <p>Weight 9.24 lb; 4.32 kg Limited warranty 3 year (includes backlight) Available date June 2015</p>	<p style="text-align: center;">Features</p> <ul style="list-style-type: none"> • Widescreen 23.0-inch monitor • Supports 1920x1080 resolution • Includes dual input connection for attachment to two systems concurrently • EPEAT Gold certified • 10-point touch screen • Microsoft® Windows® 7 certified • Microsoft Windows 10 certified
<p>VESA-compliant VESA DDC2B/CI Power management ENERGY STAR® qualified Ergonomics ISO 9241-307 Emission standards FCC Class B Environmental TCO Displays 7.0, TCO Certified Edge 2.0, WEEE, RoHS, EPEAT™ Gold rating</p>	<div style="text-align: center;">   </div> <p style="text-align: center;">ThinkVision T2364t</p>
<p>Preset resolutions VGA: 640x350, 640x480, 720x400, 700x570 SVGA: 800x600, 832x624 XGA: 1024x768, 1152x864 SXGA: 1280x1024 WXGA: 1366x768 WXGA+: 1440x900, 1600x900 WSXGA+: 1680x1050 Full HD: 1920x1080</p> <p>Presets / user settings User settings: 20</p>	<p>Viewing adjustments <i>Tilt:</i> 10° - 70° degrees; detachable stand Rotating screen None On screen display On screen display with digital user controls (8 languages) Control features Direct access (buttons on front) for automatic image setup, dual input and brightness USB hub USB 3.0 Hub: 1 port into PC (USB 3.0); 3 ports for accessories (3 USB 3.0) Multiple input Dual input (two different PCs attach to two different connectors; one PC shows image; select via button) Monitor connectors (1) VGA 15-pin D-shell, analog, blue (2) HDMI (1.4), digital, HDCP-compliant (3) DisplayPort, digital, black, HDCP-compliant</p> <p>Signal cables (1) detachable, VGA 15-pin D-shell at each end, analog, 1.8 meter (2) detachable, HDMI at each end, digital, 1.8 meter (3) detachable, DisplayPort at each end, digital, 1.8 meter</p> <p>Mounting features Wall or desk mounting using the Extend Arm or third-party accessories, 100mm x 100mm mount Security Security keyhole for attachment of optional cable lock (Kensington® lock-compatible)</p> <p>Ship group Monitor with stand, Safety and Warranty Information, 1.8 meter analog signal cable, 1.8 meter HDMI cable, 1.8 meter DisplayPort cable, 1.8 meter USB signal cable, 1.8 meter black power cord</p>

<p style="text-align: center;">Limited Warranty</p> <p>See details at http://support.lenovo.com/en_US/guides-and-manuals/detail.page?DocID=UM008281</p>	<p style="text-align: center;">Accessories</p> <table border="0" style="width: 100%;"> <tr> <td>Kensington MicroSaver Cable Lock</td> <td style="text-align: right;">73P2582</td> </tr> <tr> <td>Kensington Twin Head Cable Lock</td> <td style="text-align: right;">45K1620</td> </tr> </table> <p>See details at www.lenovo.com/support/monitoraccessories</p> <p>See all monitors at www.lenovo.com/thinkvision</p>	Kensington MicroSaver Cable Lock	73P2582	Kensington Twin Head Cable Lock	45K1620
Kensington MicroSaver Cable Lock	73P2582				
Kensington Twin Head Cable Lock	45K1620				



<p>Name T23i Wide Flat Panel Monitor Bezel color Black Type-model 61ABMAR1US / 61ABMAT1EU Panel TFT-LCD, In-Plane Switching (IPS), White LED backlight Viewable image size 23" (584.2mm) diagonal Max view area (W x H) 20.36" x 11.92" (517.2mm x 302.8mm) Native resolution 1920x1080 Aspect ratio 16:9 Pixel pitch (mm) 0.2652 x 0.2652 mm Dot/Pixel per Inch 95.8 dpi Brightness 250 nits or cd/m² (typical) Contrast ratio 1000:1 (typical) Pixel response time 6ms (typical) Color gamut 72% Viewing angle at 10:1 CR 178° (+/- 89°) horizontal, 178° (+/- 89°) vertical Stand Tilt, swivel, pivot, and height adjustable stand Bezel width Sides: 0.08" (2.0mm) Dimensions (HxWxD) 13.3" H x 20.56" W x 10.4" D; 337.7mm H x 522.2mm W x 264.2mm D Power supply 16 watts typical, 45 watts maximum (with USB 3.0 hub), <0.5 watts standby/suspend, universal, integrated (no external brick-like power supply) Weight 10.85 lb; 4.92 kg Limited warranty 3 year (includes backlight) Available date April 2017</p>	<p style="text-align: center;">Features</p> <ul style="list-style-type: none"> • Widescreen 23-inch monitor • Supports 1920x1080 resolution • Supports ThinkCentre Tiny Clamp Bracket • Includes dual input connection for attachment to two systems concurrently • EPEAT Gold certified • Microsoft® Windows® 7 certified • Microsoft Windows 10 certified 				
<p>VESA-compliant VESA DDC2B/CI Power management ENERGY STAR® qualified Ergonomics ISO 9241-307 Emission standards FCC Class B Environmental TCO Displays 7.0, TCO Certified Edge 2.0, WEEE, RoHS, EPEAT™ Gold rating</p>	<div style="text-align: center;">  <p>ThinkVision T23i Wide Monitor</p> </div>				
<p>Preset resolutions VGA: 640x480, 720x400; SVGA: 800x600; XGA: 1024x768, 1152x864; SXGA: 1280x1024; WXGA+: 1440x900; WSXGA+: 1680x1050; Full HD: 1920x1080</p> <p>Presets display modes HDMI: 18; DP: 18</p>					
<p>Viewing adjustments Tilt: 30° back, -5° forward; lift: 4.3" (110mm); swivel: +/-45°; detachable stand Rotating screen Screen pivots 90 degrees from landscape to portrait On screen display On screen display with digital user controls (8 languages) Control features Direct access (buttons on front) for power, menu, input source select and brightness and automatic image setup USB hub USB 3.0 Hub: 1 port into PC (USB 3.0); 4 ports for accessories (4 USB 3.0) Multiple input Dual input (two different PCs attach to two different connectors; one PC shows image; select via button) Monitor connectors (1) VGA 15-pin D-shell, analog, blue; (2) HDMI (1.4), digital, HDCP-compliant; (3) DisplayPort, digital, black, HDCP-compliant Signal cables (1) detachable, VGA 15-pin D-shell at each end, analog, 1.8 meter; (2) detachable, DisplayPort at each end, digital, 1.8 meter Mounting features Wall or desk mounting using the Extend Arm or third-party accessories, 100mm x 100mm mount Security Security keyhole for attachment of optional cable lock (Kensington® lock-compatible)</p>					
<p>Ship group Monitor with stand, Safety and Warranty Information, 1.8 meter analog signal cable, 1.8 meter DP signal cable, 1.8 meter USB signal cable, 1.8 meter black power cord</p>					
<p style="text-align: center;">Limited Warranty</p> <p>See details at http://support.lenovo.com/en_US/guides-and-manuals/detail.page?DocID=UM008281</p>	<p style="text-align: center;">Accessories</p> <table border="0"> <tr> <td>Kensington MicroSaver Cable Lock</td> <td style="text-align: right;">73P2582</td> </tr> <tr> <td>Kensington Twin Head Cable Lock</td> <td style="text-align: right;">45K1620</td> </tr> </table> <p>See details at www.lenovo.com/support/monitoraccessories</p> <p>See all monitors at www.lenovo.com/thinkvision</p>	Kensington MicroSaver Cable Lock	73P2582	Kensington Twin Head Cable Lock	45K1620
Kensington MicroSaver Cable Lock	73P2582				
Kensington Twin Head Cable Lock	45K1620				



<p>Name T2424z Wide Flat Panel Monitor Bezel color Raven black Type-model 60F8MAR1US / 60F8MAT1EU Panel TFT-LCD, In-Plane Switching (IPS), White LED backlight</p> <p>Viewable image size 23.8" (604.7mm) diagonal Max view area (W x H) 20.75" x 11.67" (527.0mm x 296.5mm) Native resolution 1920x1080 Aspect ratio 16:9 Pixel pitch (mm) 0.2745 x 0.2745 mm Dot/Pixel per Inch 92 dpi Brightness 250 nits or cd/m² (typical) Contrast ratio 1000:1 (typical) Pixel response time 7ms (typical) Color gamut 72% Viewing angle at 10:1 CR 178° (+/- 89°) horizontal, 178° (+/- 89°) vertical Stand Tilt, swivel, pivot, and height adjustable stand Bezel width Sides: 0.69" (17.5mm) Dimensions (HxWxD) 19.53" H x 22.19" W x 10.39" D; 496.0mm H x 563.6mm W x 264.2mm D</p> <p>Power supply 22 watts typical, 40 watts maximum (without USB 3.0 hub), <0.5 watts standby/suspend, universal, integrated (no external brick-like power supply)</p> <p>Weight 12.90 lb; 5.85 kg Limited warranty 3 year (includes backlight) Available date June 2016</p>	<p style="text-align: center;">Features</p> <ul style="list-style-type: none"> • Widescreen 23.8-inch monitor • Supports 1920x1080 resolution • Supports ThinkCentre Tiny Clamp Bracket • Includes dual input connection for attachment to two systems concurrently (analog and digital) • EPEAT Gold certified • Microsoft® Windows® 7 certified • Microsoft Windows 8 / Windows 8.1 certified • Microsoft Windows 10 certified 				
<p>VESA-compliant VESA DDC2B/CI Power management ENERGY STAR® qualified Ergonomics ISO 9241-307 Emission standards FCC Class B Environmental TCO Displays 7.0, TCO Certified Edge 2.0, WEEE, RoHS, EPEAT™ Gold rating</p>	<div style="text-align: center;">  <p>ThinkVision T2424z Wide Monitor</p> </div>				
<p>Preset resolutions VGA: 640x350, 640x480, 720x400 SVGA: 800x600 XGA: 1024x768, 1152x864 SXGA: 1280x1024 WXGA+: 1440x900, 1600x900 WSXGA+: 1680x1050 Full HD: 1920x1080</p> <p>Presets / user settings Standard presets: 31; user settings: 20</p>					
<p>Viewing adjustments <i>Tilt:</i> 30° back, -5° forward; <i>lift:</i> 4.3" (110mm); <i>swivel:</i> +/-45°; detachable stand Rotating screen Screen pivots 90 degrees from landscape to portrait On screen display On screen display with digital user controls (8 languages) Control features Direct access (buttons on front) for automatic image setup, dual input and brightness USB hub USB 3.0 Hub: 1 port into PC (USB 3.0); 2 ports for accessories (2 USB 3.0) Multimedia Integrated digital speakers (3 watts x 2) Camera Integrated camera (Full HD) and digital dual array microphone Multiple input Dual input (two different PCs attach to two different connectors; one PC shows image; select via button) Monitor connectors (1) VGA 15-pin D-shell, analog, blue (2) HDMI (1.4), digital, HDCP-compliant (3) DisplayPort, digital, black, HDCP-compliant</p> <p>Signal cables (1) detachable, VGA 15-pin D-shell at each end, analog, 1.8 meter (2) detachable, DisplayPort at each end, digital, 1.8 meter</p> <p>Mounting features Wall or desk mounting using the Extend Arm or third-party accessories, 100mm x 100mm mount Security Security keyhole for attachment of optional cable lock (Kensington® lock-compatible)</p>					
<p>Ship group Monitor with stand, Safety and Warranty Information, 1.8 meter analog signal cable, 1.8 meter DP signal cable, 1.8 meter USB signal cable, 1.8 meter black power cord</p>	<p style="text-align: center;">Accessories</p> <table border="0"> <tr> <td>Kensington MicroSaver Cable Lock</td> <td style="text-align: right;">73P2582</td> </tr> <tr> <td>Kensington Twin Head Cable Lock</td> <td style="text-align: right;">45K1620</td> </tr> </table> <p>See details at www.lenovo.com/support/monitoraccessories</p> <p>See all monitors at www.lenovo.com/thinkvision</p>	Kensington MicroSaver Cable Lock	73P2582	Kensington Twin Head Cable Lock	45K1620
Kensington MicroSaver Cable Lock	73P2582				
Kensington Twin Head Cable Lock	45K1620				
<p style="text-align: center;">Limited Warranty</p> <p>See details at http://support.lenovo.com/en_US/guides-and-manuals/detail.page?DocID=UM008281</p>					

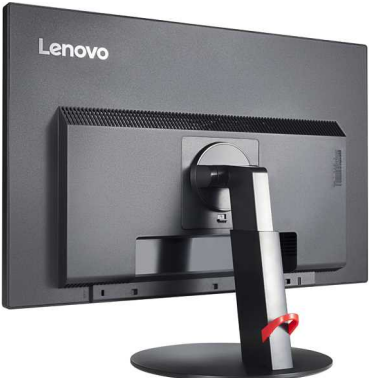

<p>Name T2454p Wide Flat Panel Monitor Bezel color Raven black Type-model 60F9MAR1US / 60F9MAT1EU Panel TFT-LCD, In-Plane Switching (IPS), White LED backlight</p> <p>Viewable image size 24.0" (609.6mm) diagonal Max view area (W x H) 20.41" x 12.76" (518.4mm x 324.0mm) Native resolution 1920x1200 Aspect ratio 16:10 Pixel pitch (mm) 0.270 x 0.270 mm Dot/Pixel per Inch 94 dpi Brightness 300 nits or cd/m² (typical) Contrast ratio 1000:1 (typical) Pixel response time 7ms (typical) Color gamut 77.4% Viewing angle at 10:1 CR 178° (+/- 89°) horizontal, 178° (+/- 89°) vertical Stand Tilt, swivel, pivot, and height adjustable stand Bezel width Sides: 0.74" (18.8mm) Dimensions (HxWxD) 15.85" H x 21.94" W x 10.39" D; 402.5mm H x 557.4mm W x 264.2mm D</p> <p>Power supply 24 watts typical, 27 watts maximum (without USB 3.0 hub), 54 watts maximum (with USB 3.0 hub), <0.5 watts standby/suspend, universal, integrated (no external brick-like power supply) Weight 13.60 lb; 6.15 kg Limited warranty 3 year (includes backlight) Available date March 2015</p>	<p style="text-align: center;">Features</p> <ul style="list-style-type: none"> • Widescreen 24.0-inch monitor • Supports 1920x1200 resolution • Supports ThinkCentre Tiny Clamp Bracket • Supports optional soundbar • Includes dual input connection for attachment to two systems concurrently (analog and digital) • EPEAT Gold certified • Microsoft® Windows® 7 certified • Microsoft Windows 8 / Windows 8.1 certified • Microsoft Windows 10 certified 				
<p>VESA-compliant VESA DDC2B/CI Power management ENERGY STAR® qualified Ergonomics ISO 9241-307 Emission standards FCC Class B Environmental TCO Displays 7.0, TCO Certified Edge 2.0, WEEE, RoHS, EPEAT™ Gold rating</p> <p>Preset resolutions VGA: 640x350, 640x480, 720x400 SVGA: 800x600 XGA: 1024x768 SXGA: 1280x1024 WXGA: 1280x720, 1280x768, 1280x800 WXGA+: 1440x900 WSXGA+: 1680x1050, 1600x1200 Full HD: 1920x1080, 1920x1200</p> <p>Presets / user settings Standard presets: 21; user settings: 20</p>	<div style="text-align: center;">  <p>ThinkVision T2454p Wide Monitor</p> </div>				
<p>Viewing adjustments <i>Tilt: 30° back, -5° forward; lift: 4.3" (110mm); swivel: +/-45°; detachable stand</i> Rotating screen Screen pivots 90 degrees from landscape to portrait On screen display On screen display with digital user controls (8 languages) Control features Direct access (buttons on front) for automatic image setup, dual input and brightness USB hub USB 3.0 Hub: 1 port into PC (USB 3.0); 4 ports for accessories (4 USB 3.0) Multiple input Dual input (two different PCs attach to two different connectors; one PC shows image; select via button) Monitor connectors (1) VGA 15-pin D-shell, analog, blue (2) HDMI (1.4), digital, HDCP-compliant (3) DisplayPort, digital, black, HDCP-compliant</p> <p>Signal cables (1) detachable, VGA 15-pin D-shell at each end, analog, 1.8 meter (2) detachable, DisplayPort at each end, digital, 1.8 meter</p> <p>Mounting features Wall or desk mounting using the Extend Arm or third-party accessories, 100mm x 100mm mount Security Security keyhole for attachment of optional cable lock (Kensington® lock-compatible)</p>					
<p>Ship group Monitor with stand, Safety and Warranty Information, 1.8 meter analog signal cable, 1.8 meter DisplayPort cable, 1.8 meter USB signal cable, 1.8 meter black power cord</p>					
<p style="text-align: center;">Limited Warranty</p> <p>See details at http://support.lenovo.com/en_US/guides-and-manuals/detail.page?DocID=UM008281</p>	<p style="text-align: center;">Accessories</p> <table border="0" style="width: 100%;"> <tr> <td>Kensington MicroSaver Cable Lock</td> <td style="text-align: right;">73P2582</td> </tr> <tr> <td>Kensington Twin Head Cable Lock</td> <td style="text-align: right;">45K1620</td> </tr> </table> <p>See details at www.lenovo.com/support/monitoraccessories</p> <p>See all monitors at www.lenovo.com/thinkvision</p>	Kensington MicroSaver Cable Lock	73P2582	Kensington Twin Head Cable Lock	45K1620
Kensington MicroSaver Cable Lock	73P2582				
Kensington Twin Head Cable Lock	45K1620				



<p>Name T24d Wide Flat Panel Monitor Bezel color Black Type-model 61B4MAR1US / 61B4MAT1EU Panel TFT-LCD, In-Plane Switching (IPS), White LED backlight Viewable image size 24" (609.6mm) diagonal Max view area (W x H) 20.41" x 12.75" (518.4mm x 324mm) Native resolution 1920x1200 Aspect ratio 16:10 Pixel pitch (mm) 0.27 x 0.27 mm Dot/Pixel per Inch 94 dpi Brightness 300 nits or cd/m² (typical) Contrast ratio 1000:1 (typical) Pixel response time 7ms (typical) Color gamut 99% Viewing angle at 10:1 CR 178° (+/- 89°) horizontal, 178° (+/- 89°) vertical Stand Tilt, swivel, pivot, and height adjustable stand Bezel width Sides: 0.08" (2.0mm) Dimensions (HxWxD) 19.58" H x 20.99" W x 10.25" D; 497.4mm H x 533.2mm W x 260.4mm D Power supply 22 watts typical, 64 watts maximum (with USB 3.0 hub), <0.3 watts standby/suspend, universal, integrated (no external brick-like power supply) Weight 12.41 lb; 5.63 kg Limited warranty 3 year (includes backlight) Available date June 2017</p>	<p style="text-align: center;">Features</p> <ul style="list-style-type: none"> • Widescreen 24-inch monitor • Supports 1920x1200 resolution • Supports ThinkCentre Tiny Clamp Bracket • Supports optional soundbar • Includes dual input connection for attachment to two systems concurrently • EPEAT Gold certified • Microsoft® Windows® 7 certified • Microsoft Windows 10 certified 																		
<p>VESA-compliant VESA DDC2B/CI Power management ENERGY STAR® qualified Ergonomics ISO 9241-307 Emission standards FCC Class B Environmental TCO Displays 7.0, TCO Certified Edge 2.0, WEEE, RoHS, EPEAT™ Gold rating</p> <p>Preset resolutions</p> <table border="0"> <tr><td>VGA:</td><td>640x480, 720x400</td></tr> <tr><td>SVGA:</td><td>800x600</td></tr> <tr><td>XGA:</td><td>1024x768</td></tr> <tr><td>SXGA:</td><td>1280x1024</td></tr> <tr><td>WXGA:</td><td>1366x768</td></tr> <tr><td>WXGA+:</td><td>1440x900</td></tr> <tr><td>WSXGA+:</td><td>1680x1050</td></tr> <tr><td>Full HD:</td><td>1920x1080</td></tr> <tr><td>WUXGA:</td><td>1920x1200</td></tr> </table> <p>Presets display modes Standard presets: 22; user settings: 20</p>	VGA:	640x480, 720x400	SVGA:	800x600	XGA:	1024x768	SXGA:	1280x1024	WXGA:	1366x768	WXGA+:	1440x900	WSXGA+:	1680x1050	Full HD:	1920x1080	WUXGA:	1920x1200	<div style="text-align: center;">  <p>ThinkVision T24d Wide Monitor</p> </div>
VGA:	640x480, 720x400																		
SVGA:	800x600																		
XGA:	1024x768																		
SXGA:	1280x1024																		
WXGA:	1366x768																		
WXGA+:	1440x900																		
WSXGA+:	1680x1050																		
Full HD:	1920x1080																		
WUXGA:	1920x1200																		
<p>Viewing adjustments <i>Tilt: 30° back, -5° forward; lift: 4.3" (110mm); swivel: +/-45°; detachable stand</i> Rotating screen <i>Screen pivots 90 degrees from landscape to portrait</i> On screen display <i>On screen display with digital user controls (8 languages)</i> Control features <i>Direct access (buttons on front) for power, menu, input source select and brightness</i> USB hub <i>USB 3.0 Hub: 1 port into PC (USB 3.0); 4 ports for accessories (4 USB 3.0)</i> Multiple input <i>Dual input (two different PCs attach to two different connectors; one PC shows image; select via button)</i> Monitor connectors <i>(1) VGA 15-pin D-shell, analog, blue (2) HDMI (1.4), digital, HDCP-compliant (3) DisplayPort, digital, black, HDCP-compliant</i> Signal cables <i>(1) detachable, VGA 15-pin D-shell at each end, analog, 1.8 meter (2) detachable, DisplayPort at each end, digital, 1.8 meter</i> Mounting features <i>Wall or desk mounting using the Extend Arm or third-party accessories, 100mm x 100mm mount</i> Security <i>Security keyhole for attachment of optional cable lock (Kensington® lock-compatible)</i></p>	<p>Ship group <i>Monitor with stand, Safety and Warranty Information, 1.8 meter analog signal cable, 1.8 meter DP signal cable, 1.8 meter USB signal cable, 1.8 meter black power cord, 1.8 meter HDMI signal cable (NA only)</i></p>																		
<p style="text-align: center;">Limited Warranty</p> <p>See details at http://support.lenovo.com/en_US/guides-and-manuals/detail.page?DocID=UM008281</p>	<p style="text-align: center;">Accessories</p> <table border="0"> <tr> <td>Kensington MicroSaver Cable Lock</td> <td style="text-align: right;">73P2582</td> </tr> <tr> <td>Kensington Twin Head Cable Lock</td> <td style="text-align: right;">45K1620</td> </tr> </table> <p>See details at www.lenovo.com/support/monitoraccessories</p> <p>See all monitors at www.lenovo.com/thinkvision</p>	Kensington MicroSaver Cable Lock	73P2582	Kensington Twin Head Cable Lock	45K1620														
Kensington MicroSaver Cable Lock	73P2582																		
Kensington Twin Head Cable Lock	45K1620																		



<p>Name T24i Wide Flat Panel Monitor Bezel color Black Type-model 61A6MAR3US / 61A6MAT3EU Panel TFT-LCD, In-Plane Switching (IPS), White LED backlight Viewable image size 23.8" (604.7mm) diagonal Max view area (W x H) 20.75" x 11.67" (527.04mm x 296.5mm) Native resolution 1920x1080 Aspect ratio 16:9 Pixel pitch (mm) 0.2745 x 0.2745 mm Dot/Pixel per Inch 93 dpi Brightness 250 nits or cd/m² (typical) Contrast ratio 1000:1 (typical) Pixel response time 6ms (typical) Color gamut 72% Viewing angle at 10:1 CR 178° (+/- 89°) horizontal, 178° (+/- 89°) vertical Stand Tilt, swivel, pivot, and height adjustable stand Bezel width <i>Sides:</i> 0.08" (2.0mm) Dimensions (HxWxD) 14.7" H x 21.26" W x 10.3" D; 373.4mm H x 540.2mm W x 261.75mm D Power supply 16.5 watts typical, 55 watts maximum (with USB 3.0 hub), <0.5 watts standby/suspend, universal, integrated (no external brick-like power supply) Weight 11.57 lb; 5.25 kg Limited warranty 3 year (includes backlight) Available date April 2017</p>	<p style="text-align: center;">Features</p> <ul style="list-style-type: none"> • Widescreen 23.8-inch monitor • Supports 1920x1080 resolution • Supports ThinkCentre Tiny Clamp Bracket • Supports optional soundbar • Includes dual input connection for attachment to two systems concurrently • EPEAT Gold certified • Microsoft® Windows® 7 certified • Microsoft Windows 10 certified 				
<p>VESA-compliant VESA DDC2B/CI Power management ENERGY STAR® qualified Ergonomics ISO 9241-307 Emission standards FCC Class B Environmental TCO Displays 7.0, TCO Certified Edge 2.0, WEEE, RoHS, EPEAT™ Gold rating</p>	<div style="text-align: center;">  <p>ThinkVision T24i Wide Monitor</p> </div>				
<p>Preset resolutions VGA: 640x480, 720x400 SVGA: 800x600 XGA: 1024x768 SXGA: 1280x1024 WXGA: 1366x768 WXGA+: 1440x900, 1680x900 WSXGA+: 1680x1050 Full HD: 1920x1080 Presets display modes HDMI: 17; DP: 17</p>					
<p>Viewing adjustments <i>Tilt:</i> 30° back, -5° forward; <i>lift:</i> 4.3" (110mm); <i>swivel:</i> +/-45°; detachable stand Rotating screen Screen pivots 90 degrees from landscape to portrait On screen display On screen display with digital user controls (8 languages) Control features Direct access (buttons on front) for power, menu, input source select and brightness and automatic image setup USB hub USB 3.0 Hub: 1 port into PC (USB 3.0); 4 ports for accessories (4 USB 3.0) Multiple input Dual input (two different PCs attach to two different connectors; one PC shows image; select via button) Monitor connectors (1) VGA 15-pin D-shell, analog, blue (2) HDMI (1.4), digital, HDCP-compliant (3) DisplayPort, digital, black, HDCP-compliant Signal cables (1) detachable, VGA 15-pin D-shell at each end, analog, 1.8 meter (2) detachable, DisplayPort at each end, digital, 1.8 meter Mounting features Wall or desk mounting using the Extend Arm or third-party accessories, 100mm x 100mm mount Security Security keyhole for attachment of optional cable lock (Kensington® lock-compatible)</p>	<p>Ship group Monitor with stand, Safety and Warranty Information, 1.8 meter analog signal cable, 1.8 meter DP signal cable, 1.8 meter USB signal cable, 1.8 meter black power cord</p>				
<p style="text-align: center;">Limited Warranty</p> <p>See details at http://support.lenovo.com/en_US/guides-and-manuals/detail.page?DocID=UM008281</p>	<p style="text-align: center;">Accessories</p> <table border="0"> <tr> <td>Kensington MicroSaver Cable Lock</td> <td style="text-align: right;">73P2582</td> </tr> <tr> <td>Kensington Twin Head Cable Lock</td> <td style="text-align: right;">45K1620</td> </tr> </table> <p>See details at www.lenovo.com/support/monitoraccessories</p> <p>See all monitors at www.lenovo.com/thinkvision</p>	Kensington MicroSaver Cable Lock	73P2582	Kensington Twin Head Cable Lock	45K1620
Kensington MicroSaver Cable Lock	73P2582				
Kensington Twin Head Cable Lock	45K1620				

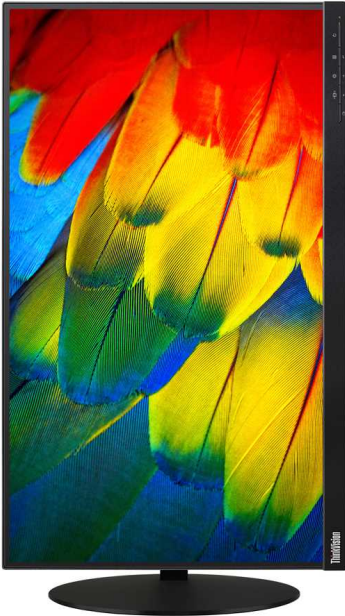

<p>Name T24m Wide Flat Panel Monitor Bezel color Black Type-model 61B8RAR3US / 61B8RAT3EU Panel TFT-LCD, In-Plane Switching (IPS), White LED backlight Viewable image size 23.8" (604.7mm) diagonal Max view area (W x H) 20.75" x 11.67" (527.04mm x 296.46mm) Native resolution 1920x1080 Aspect ratio 16:9 Pixel pitch (mm) 0.2745 x 0.2745 mm Dot/Pixel per Inch 92 dpi Brightness 250 nits or cd/m² (typical) Contrast ratio 1000:1 (typical) Pixel response time 6ms (typical) Color gamut 99% sRGB Viewing angle at 10:1 CR 170° (+/- 85°) horizontal, 178° (+/- 89°) vertical Stand Tilt, swivel, pivot, and height adjustable Bezel width <i>Sides:</i> 0.08" (2.0mm) Dimensions (HxWxD) 19.03" H x 21.26" W x 10.3" D; 483.4mm H x 540.2mm W x 261.75mm D Power supply 17 watts typical, 110 watts maximum (with USB 3.0 hub), <0.5 watts standby/suspend, universal, integrated (no external brick-like power supply) Weight 12.34 lb; 5.6 kg Limited warranty 3 year (includes backlight) Available date August 2017</p>	<p style="text-align: center;">Features</p> <ul style="list-style-type: none"> • Widescreen 23.8-inch monitor • Supports 1920x1080 resolution • Supports ThinkCentre Tiny Clamp Bracket • Supports optional soundbar • EPEAT Gold certified • Microsoft® Windows® 7 certified • Microsoft Windows 10 certified 				
<p>VESA-compliant VESA DDC2B/CI Power management ENERGY STAR® qualified Ergonomics ISO 9241-307 Emission standards FCC Class B Environmental TCO Displays 7.0, TCO Certified Edge 2.0, WEEE, RoHS, EPEAT™ Gold rating</p>	<div style="text-align: center;">  <p>ThinkVision T24m Wide Monitor</p> </div>				
<p>Preset resolutions VGA: 640x480 SVGA: 800x600 XGA: 1024x768 SXGA: 1280x1024 WXGA: 1366x768 WXGA+: 1440x900, 1600x900 WSXGA+: 1680x1050 Full HD: 1920x1080, 1920x1200 HDMI: 19; DP: 11</p>					
<p>Viewing adjustments <i>Tilt:</i> 30° back, -5° forward; <i>lift:</i> 4.3" (110mm); <i>swivel:</i> +/-45°; detachable stand Rotating screen Screen pivots 90 degrees from landscape to portrait On screen display On screen display with digital user controls (8 languages) Control features Direct access (buttons on front) for power, menu, input source select and brightness USB hub USB 3.0 Hub: 1 port into PC (USB 3.0); 4 ports for accessories (4 USB 3.0) Multimedia Audio-out, optional sound bar supported Multiple input Support HDMI, DisplayPort, USB 3.1 Type-C Monitor connectors (1) HDMI (1.4), digital, HDCP-compliant (2) DisplayPort (1.2), digital, HDCP-compliant (3) USB 3.1 Type-C Signal cables (1) 1.8 meter USB Type-C to USB Type-C cable Mounting features Wall or desk mounting using the Extend Arm or third-party accessories, 100mm x 100mm mount Security Security keyhole for attachment of optional cable lock (Kensington® lock-compatible)</p>	<p>Viewing adjustments <i>Tilt:</i> 30° back, -5° forward; <i>lift:</i> 4.3" (110mm); <i>swivel:</i> +/-45°; detachable stand Rotating screen Screen pivots 90 degrees from landscape to portrait On screen display On screen display with digital user controls (8 languages) Control features Direct access (buttons on front) for power, menu, input source select and brightness USB hub USB 3.0 Hub: 1 port into PC (USB 3.0); 4 ports for accessories (4 USB 3.0) Multimedia Audio-out, optional sound bar supported Multiple input Support HDMI, DisplayPort, USB 3.1 Type-C Monitor connectors (1) HDMI (1.4), digital, HDCP-compliant (2) DisplayPort (1.2), digital, HDCP-compliant (3) USB 3.1 Type-C Signal cables (1) 1.8 meter USB Type-C to USB Type-C cable Mounting features Wall or desk mounting using the Extend Arm or third-party accessories, 100mm x 100mm mount Security Security keyhole for attachment of optional cable lock (Kensington® lock-compatible)</p>				
<p>Ship group Monitor with stand, Safety and Warranty Information, 1.8 meter USB Type-C to USB Type-C cable, 1.8 meter black power cord</p>	<p>Ship group Monitor with stand, Safety and Warranty Information, 1.8 meter USB Type-C to USB Type-C cable, 1.8 meter black power cord</p>				
<p style="text-align: center;">Limited Warranty</p> <p>See details at http://support.lenovo.com/en_US/guides-and-manuals/detail.page?DocID=UM008281</p>	<p style="text-align: center;">Accessories</p> <table border="0"> <tr> <td>Kensington MicroSaver Cable Lock</td> <td style="text-align: right;">73P2582</td> </tr> <tr> <td>Kensington Twin Head Cable Lock</td> <td style="text-align: right;">45K1620</td> </tr> </table> <p>See details at www.lenovo.com/support/monitoraccessories</p> <p>See all monitors at www.lenovo.com/thinkvision</p>	Kensington MicroSaver Cable Lock	73P2582	Kensington Twin Head Cable Lock	45K1620
Kensington MicroSaver Cable Lock	73P2582				
Kensington Twin Head Cable Lock	45K1620				



<p>Name T24v Wide Flat Panel Monitor Bezel color Black Type-model 61BCMAR6US / 61BCMAT6EU Panel TFT-LCD, In-Plane Switching (IPS), White LED backlight Viewable image size 23.8" (604.5mm) diagonal Max view area (W x H) 20.75" x 11.67" (527.04mm x 296.46mm) Native resolution 1920x1080 Aspect ratio 16:9 Pixel pitch (mm) 0.2745 x 0.2745 mm Dot/Pixel per Inch 92 dpi Brightness 250 nits or cd/m² (typical) Contrast ratio 1000:1 (typical) Pixel response time 6ms (typical); 4ms (extreme mode) Color gamut 72% Viewing angle at 10:1 CR 178° (+/- 89°) horizontal, 178° (+/- 89°) vertical Stand Tilt, swivel, pivot, and height adjustable stand Bezel width <i>Sides:</i> 0.08" (2.0mm) Dimensions (HxWxD) 19.72" H x 21.28" W x 10.32" D; 500.5mm H x 540.2mm W x 261.9mm D Power supply 20 watts typical, 45 watts maximum (with USB 3.0 hub), <0.5 watts standby/suspend, universal, integrated (no external brick-like power supply) Weight 11.18 lb; 5.07 kg Limited warranty 3 year (includes backlight) Available date October 2017</p>	<p style="text-align: center;">Features</p> <ul style="list-style-type: none"> • Widescreen 23.8-inch monitor • Supports 1920x1080 resolution • Supports ThinkCentre Tiny Clamp Bracket • Supports optional soundbar • EPEAT Gold certified • Microsoft® Windows® 7 certified • Microsoft Windows 10 certified 				
<p>VESA-compliant VESA DDC2B/C1 Power management ENERGY STAR® qualified Ergonomics ISO 9241-307 Emission standards FCC Class B Environmental TCO Displays 7.0, TCO Certified Edge 2.0, WEEE, RoHS, EPEAT™ Gold rating</p> <p>Preset resolutions VGA: 640x480, 720x400 SVGA: 800x600, 832x624 XGA: 1024x768, 1152x864 SXGA: 1280x1024 WXGA+: 1440x900, 1600x900 WSXGA+: 1680x1050 Full HD: 1920x1080</p> <p>Presets display modes Presets: 24; user modes: 20</p>	 <p style="text-align: center;">ThinkVision T24v Wide Monitor</p>				
<p>Viewing adjustments <i>Tilt:</i> 30° back, -5° forward; <i>lift:</i> 4.3" (110mm); <i>swivel:</i> +/-45°; detachable stand Rotating screen Screen pivots 90 degrees from landscape to portrait On screen display On screen display with digital user controls (8 languages) Control features Direct access for power, menu, input source select, volume up / down, speaker mute and microphone mute USB hub USB 3.0 Hub: 1 port into PC (USB 3.0); 2 ports for accessories (2 USB 3.0) Multimedia Integrated speakers, dual-array microphone, audio-in and Audio-out, optional sound bar supported Camera Integrated FHD camera with IR Multiple input Support HDMI, DisplayPort, VGA Monitor connectors (1) VGA 15-pin D-shell, analog, blue (2) HDMI (1.4), digital, HDCP-compliant (3) DisplayPort, digital, black, HDCP-compliant Signal cables (1) detachable, VGA 15-pin D-shell at each end, analog, 1.8 meter (2) detachable, HDMI at each end, digital, 1.8 meter Mounting features Wall or desk mounting using the Extend Arm or third-party accessories, 100mm x 100mm mount Security Security keyhole for attachment of optional cable lock (Kensington® lock-compatible)</p>	<p>Viewing adjustments <i>Tilt:</i> 30° back, -5° forward; <i>lift:</i> 4.3" (110mm); <i>swivel:</i> +/-45°; detachable stand Rotating screen Screen pivots 90 degrees from landscape to portrait On screen display On screen display with digital user controls (8 languages) Control features Direct access for power, menu, input source select, volume up / down, speaker mute and microphone mute USB hub USB 3.0 Hub: 1 port into PC (USB 3.0); 2 ports for accessories (2 USB 3.0) Multimedia Integrated speakers, dual-array microphone, audio-in and Audio-out, optional sound bar supported Camera Integrated FHD camera with IR Multiple input Support HDMI, DisplayPort, VGA Monitor connectors (1) VGA 15-pin D-shell, analog, blue (2) HDMI (1.4), digital, HDCP-compliant (3) DisplayPort, digital, black, HDCP-compliant Signal cables (1) detachable, VGA 15-pin D-shell at each end, analog, 1.8 meter (2) detachable, HDMI at each end, digital, 1.8 meter Mounting features Wall or desk mounting using the Extend Arm or third-party accessories, 100mm x 100mm mount Security Security keyhole for attachment of optional cable lock (Kensington® lock-compatible)</p>				
<p>Ship group Monitor with stand, Safety and Warranty Information, 1.8 meter analog signal cable, 1.8 meter DP signal cable, 1.8 meter USB signal cable, 1.8 meter black power cord, 1.8 meter HDMI signal cable (Row)</p>					
<p style="text-align: center;">Limited Warranty</p> <p>See details at http://support.lenovo.com/en_US/guides-and-manuals/detail.page?DocID=UM008281</p>	<p style="text-align: center;">Accessories</p> <table border="0"> <tr> <td>Kensington MicroSaver Cable Lock</td> <td style="text-align: right;">73P2582</td> </tr> <tr> <td>Kensington Twin Head Cable Lock</td> <td style="text-align: right;">45K1620</td> </tr> </table> <p>See details at www.lenovo.com/support/monitoraccessories</p> <p>See all monitors at www.lenovo.com/thinkvision</p>	Kensington MicroSaver Cable Lock	73P2582	Kensington Twin Head Cable Lock	45K1620
Kensington MicroSaver Cable Lock	73P2582				
Kensington Twin Head Cable Lock	45K1620				



<p>Name X24 Pro Wide Flat Panel Monitor Bezel color Black Type-model 60E4ECR1US / 60E4ECT1US / 60E4ECT1EU Panel TFT-LCD, AH-IPS (In-Plane Switching), White LED backlight Viewable image size 23.8" (604.5mm) diagonal Max view area (W x H) 20.75" x 11.67" (527.0mm x 296.5mm) Native resolution 1920x1080 Aspect ratio 16:9 Pixel pitch (mm) 0.2745 x 0.2745 mm Dot/Pixel per Inch 92 dpi Brightness 250 nits or cd/m² (typical) Contrast ratio 1000:1 (typical) Pixel response time 7ms (typical) Color gamut 72% Viewing angle at 10:1 CR 178° (+/- 89°) horizontal, 178° (+/- 89°) vertical Stand Tilt stand Bezel width <i>Sides:</i> 0.09" (2.3mm) Dimensions (HxWxD) 17.61" H x 21.30" W x 9.39" D; 447.4mm H x 540.9mm W x 238.4mm D Power supply 20 watts typical, 90 watts maximum, <0.5 watts standby/suspend, universal, external power supply Weight 9.26 lb; 4.20 kg Limited warranty 1 year (includes backlight) Available date July 2016</p>	<p style="text-align: center;">Features</p> <ul style="list-style-type: none"> • Widescreen 23.8-inch monitor • Supports 1920x1080 resolution • Includes dual input connection for attachment to two systems concurrently • EPEAT Silver certified • Intel RealSense 3D camera • Stereo speakers 3 watts x 2 • One cable docking through USB 3.1 Type C with power delivery • Windows Hello certified • Microsoft® Windows® 10 certified 				
<p>Power management ENERGY STAR® qualified Ergonomics ISO 9241-307 Emission standards FCC Class B Environmental TCO Displays 6.0, WEEE, RoHS, EPEAT™ Silver rating</p> <p>Preset resolutions VGA: 640x350, 640x480, 720x400 SVGA: 800x600 XGA: 1024x768 SXGA: 1280x1024 WXGA: 1366x768 WXGA+: 1440x900, 1600x900 WSXGA+: 1680x1050 Full HD: 1920x1080</p> <p>Presets / user settings Standard presets: 16; user settings: 20</p>	<div style="text-align: center;">  <p>ThinkVision X24 Pro Wide Monitor</p> </div>				
<p>Viewing adjustments <i>Tilt:</i> 22° back, -5° forward Rotating screen None On screen display On screen display with digital user controls Control features Direct access (buttons on side bezel) for dual input and brightness USB hub USB Hub: two USB 3.1 Type-C and one micro USB 3.0 ports Multimedia Integrated stereo speakers (3 watts x 2), built-in microphone Camera RealSense 3D camera SR300 Multiple input Dual input (two different PCs attach to two different connectors; one PC shows image; select via button) Monitor connectors (1) mDP, Mini DisplayPort, digital, HDCP-compliant (2) USB Type-C, digital Signal cables (1) detachable, mDP to DP, digital, 2.0 meter (2) DP to mDP adapter (3) Micro USB 3.0 cable Mounting features None Security Security keyhole for attachment of optional cable lock (Kensington® lock-compatible)</p>					
<p>Ship group Monitor with stand, Safety and Warranty Information, ThinkPad 90W Square tip power adaptor, 2.0 meter Mini DisplayPort to DisplayPort signal cable (with DP to mDP adapter), Micro USB 3.0 cable (for using camera)</p>					
<p style="text-align: center;">Limited Warranty</p> <p>See details at http://support.lenovo.com/en_US/guides-and-manuals/detail.page?DocID=UM008281</p>	<p style="text-align: center;">Accessories</p> <table border="0"> <tr> <td>Kensington MicroSaver Cable Lock</td> <td style="text-align: right;">73P2582</td> </tr> <tr> <td>Kensington Twin Head Cable Lock</td> <td style="text-align: right;">45K1620</td> </tr> </table> <p>See details at www.lenovo.com/support/monitoraccessories</p> <p>See all monitors at www.lenovo.com/thinkvision</p>	Kensington MicroSaver Cable Lock	73P2582	Kensington Twin Head Cable Lock	45K1620
Kensington MicroSaver Cable Lock	73P2582				
Kensington Twin Head Cable Lock	45K1620				

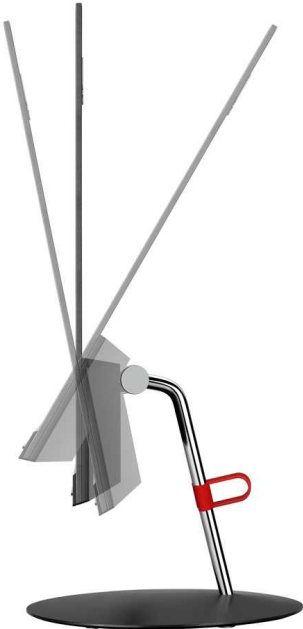

<p>Name X24-20 Flat Panel Monitor Bezel color Raven black Type-model 61BDGAR3US / 61BDGAT3EU Panel TFT-LCD, IPS (In-Plane Switching), White LED backlight Viewable image size 23.8" (604.5mm) diagonal Max view area (W x H) 20.75" x 11.67" (527.0mm x 296.5mm) Native resolution 1920x1080 Aspect ratio 16:9 Pixel pitch (mm) 0.2745 x 0.2745 mm Dot/Pixel per Inch 92 dpi Brightness 250 nits or cd/m² (typical) Contrast ratio 1000:1 (typical) Pixel response time 6ms (typical) Color gamut 72% (NTSC) Viewing angle at 10:1 CR 178° (+/- 89°) horizontal, 178° (+/- 89°) vertical Stand Tilt stand Bezel width <i>Sides:</i> 0.04" (1.1mm) Dimensions (HxWxD) 12.85" H x 21.16" W x 8.66" D; 326.4mm H x 537.4mm W x 220mm D Power supply 20 watts typical, 25 watts maximum, <0.5 watts standby/suspend, universal, external power supply Weight 7.3 lb; 3.3 kg Limited warranty 3 year (includes backlight) Available date December 2017</p>	<p style="text-align: center;">Features</p> <ul style="list-style-type: none"> • Widescreen 23.8-inch monitor • Supports 1920x1080 resolution • Includes dual input connection for attachment to two systems concurrently • EPEAT Silver certified • Microsoft® Windows® 7 certified • Microsoft Windows 10 certified 				
<p>Power management ENERGY STAR® qualified Ergonomics ISO 9241-307 Emission standards FCC Class B Environmental TCO Displays 7.0, TCO Certified Edge 2.0, WEEE, RoHS, EPEAT™ Silver rating</p>	<div style="text-align: center;">  <p>ThinkVision X24-20 Monitor</p> </div>				
<p>Preset resolutions VGA: 640x350, 640x480, 720x400 SVGA: 800x600 XGA: 1024x768 SXGA: 1280x1024 WXGA: 1366x768 WXGA+: 1440x900, 1600x900 WSXGA+: 1680x1050 Full HD: 1920x1080 Presets / user settings Standard presets: 18; user settings: 0</p>					
<p>Viewing adjustments <i>Tilt:</i> 30° back, -5° forward Rotating screen None On screen display On screen display with digital user controls (8 languages) Control features Direct access (buttons on side bezel) for power, dual input and brightness USB hub None Multiple input Dual input (two different PCs attach to two different connectors; one PC shows image; select via button) Monitor connectors (1) HDMI (1.4a), digital, HDCP-compliant (2) DisplayPort, digital, black, HDCP-compliant Signal cables (1) detachable, HDMI at each end, digital, 1.8 meter Mounting features None Security Security keyhole for attachment of optional cable lock (Kensington® lock-compatible)</p>					
<p>Ship group Monitor with stand, Safety and Warranty Information, 1.8 meter HDMI signal cable, 1.8 meter black power cord</p>	<div style="text-align: center;"> <p>Limited Warranty</p> <p>See details at http://support.lenovo.com/en_US/guides-and-manuals/detail.page?DocID=UM008281</p> </div> <div style="text-align: center;"> <p>Accessories</p> <table border="0"> <tr> <td>Kensington MicroSaver Cable Lock</td> <td style="text-align: right;">73P2582</td> </tr> <tr> <td>Kensington Twin Head Cable Lock</td> <td style="text-align: right;">45K1620</td> </tr> </table> <p>See details at www.lenovo.com/support/monitoraccessories</p> <p>See all monitors at www.lenovo.com/thinkvision</p> </div>	Kensington MicroSaver Cable Lock	73P2582	Kensington Twin Head Cable Lock	45K1620
Kensington MicroSaver Cable Lock	73P2582				
Kensington Twin Head Cable Lock	45K1620				



<p>Name P27 Wide Flat Panel Monitor Case color Black Type-model 60E3GAR1US / 60E3GAT1EU Panel TFT-LCD, IPS (In-Plane Switching), White LED backlight Viewable image size 27" (684.7mm) diagonal Max view area (W x H) 23.49" x 13.21" (596.7mm x 335.7mm) Optimum resolution 3840x2160 Max pixel rate 600MHz Aspect ratio 16:9 Pixel pitch (mm) 0.16 x 0.16mm Dot/Pixel per Inch 163 dpi Brightness 300 nits or cd/m² (typical) Contrast ratio 1300:1 (typical) Pixel response time 6ms Color gamut 99% Viewing angle at 10:1 CR 178° horizontal, 178° vertical Stand Tilt, swivel, pivot, and height adjustable stand Bezel width Sides: 0.088" (2.23mm) Dimensions (HxWxD, including stand) 18.59" H x 24.19" W x 11.81" D; 472.3mm H x 614.5mm W x 299.9mm D Power supply 40 watts typical, 70 watts maximum (with USB), <0.5 watts sleep/off; <0.5 watts switch off Weight 15.12 lb; 6.86kg (including stand) Limited warranty⁴ 3 year Available date March 2016</p>	<p style="text-align: center;">Features</p> <ul style="list-style-type: none"> • 27-inch IPS LED backlight monitor with speaker • Supports 3840x2160 resolution • 5-Ports USB hub, support USB 3.0 • 3watts x 2 stereo speakers • Microsoft® Windows® 7 certified • Microsoft Windows 10 certified 					
<p>VESA-compliant² VESA DDC2B/CI Power management ENERGY STAR® 7.0 Ergonomics ISO 9241-307 Emission standards FCC Class B Environmental TCO Displays 7.0, RoHS, EPEAT™ Gold rating, ULE Gold</p>	<div style="text-align: center;">  <p>ThinkVision P27 Monitor</p> </div>					
<p>Preset resolutions VGA: 640x350, 640x480, 720x400 SVGA: 800x600 XGA: 1024x768, 1152x864 SXGA: 1280x1024 WXGA: 1280x720, 1280x768, 1280x800, 1360x768 WXGA+: 1440x900, 1600x900 WSXGA+: 1680x1050 Full HD: 1920x1080, 1920x1200 UHD: 3840x2160</p> <p>Presets / user settings Standard presets: 20; user settings: 20</p>						
<p>Viewing adjustments <i>Tilt: 30° back, -5° forward; lift: 3.15" (80mm); swivel: +/-45°</i> Rotating screen Screen pivots 90 degrees from landscape to portrait On screen display On screen display with digital user controls (8 languages) Control features Direct access (touch buttons on front) for menu, mute, volume up/down, and brightness USB hub USB Hub: one USB 3.0 upstream port, four USB 3.0 downstream ports Multimedia Integrated stereo speakers (3 watts x 2) Camera None Multiple input Support HDMI, DisplayPort Monitor connectors (1) HDMI (2.0), digital, HDCP-compliant (2) DisplayPort (1.2), digital, HDCP-compliant Signal cables (1) detachable, DisplayPort at each end, digital, 1.8 meter Mounting features Wall or desk mounting using the Extend Arm or third-party accessories meeting the VESA FPMPI® (100mm mount) Security Security keyhole for attachment of optional cable lock (Kensington® lock-compatible)</p>						
<p>Ship group Monitor, detachable stand, Quick start and safety poster, 1.8 meter DisplayPort cable, 1.8 meter USB 3.0 cable, 1.8 meter black power cord, mini DP to DP adapter, power adapter (90W)</p>	<p style="text-align: center;">Limited Warranty</p> <p>See details at http://support.lenovo.com/en_US/guides-and-manuals/detail.page?DocID=UM008281</p>					
<p style="text-align: center;">Accessories</p> <table border="0"> <tr> <td>Kensington MicroSaver Cable Lock</td> <td style="text-align: right;">73P2582</td> </tr> <tr> <td>Kensington Twin Head Cable Lock</td> <td style="text-align: right;">45K1620</td> </tr> <tr> <td>Lenovo Security Cable Lock</td> <td style="text-align: right;">57Y4303</td> </tr> </table> <p>See details at www.lenovo.com/support/monitoraccessories</p> <p>See all monitors at www.lenovo.com/thinkvision</p>	Kensington MicroSaver Cable Lock	73P2582	Kensington Twin Head Cable Lock	45K1620	Lenovo Security Cable Lock	57Y4303
Kensington MicroSaver Cable Lock	73P2582					
Kensington Twin Head Cable Lock	45K1620					
Lenovo Security Cable Lock	57Y4303					



<p>Name P27h Wide Flat Panel Monitor Case color Black Type-model 61AFGAR1US / 61AFGAT1EU Panel TFT-LCD, IPS (In-Plane Switching), White LED backlight Viewable image size 27" (685.8mm) diagonal Max view area (W x H) 23.49" x 13.21" (596.7mm x 335.7mm) Optimum resolution 2560x1440 Max pixel rate 300MHz Aspect ratio 16:9 Pixel pitch (mm) 0.2331 x 0.2331mm Dot/Pixel per Inch 109 dpi Brightness 350 nits or cd/m² (typical) Contrast ratio 1000:1 (typical) Pixel response time 4ms (extreme) / 6ms (typical) Color gamut 99% sRGB Viewing angle at 10:1 CR 178° horizontal, 178° vertical Stand Tilt, swivel, pivot, and height adjustable stand Bezel width <i>Sides:</i> 0.08" (2mm) Dimensions 20.21" H x 24.08" W x 10.62" D; (HxWxD, including stand) 513mm H x 611.6mm W x 269.8mm D Power supply 38 watts typical, 140 watts maximum (with USB), <0.5 watts sleep/off; <0.5 watts switch off integrated (no external brick-like power supply) Weight 15.43 lb; 7.0kg (including stand) Limited warranty 3 year Available date April 2017</p>	<p style="text-align: center;">Features</p> <ul style="list-style-type: none"> • 27-inch IPS LED backlit monitor • Supports 2560x1440 resolution • 5-Ports USB hub, support USB 3.0 • Supports optional soundbar • Support ThinkCentre Tiny • Microsoft® Windows® 7 certified • Microsoft Windows 10 certified 						
<p>VESA-compliant VESA DDC2B/CI Power management ENERGY STAR® 7.0 Ergonomics ISO 9241-307 Emission standards FCC Class B Environmental TCO Displays 7.0, RoHS, EPEAT™ Gold rating, ULE Gold</p>	<div style="text-align: center;">  <p>ThinkVision P27h Monitor</p> </div>						
<p>Preset resolutions VGA: 640x480, 720x400 SVGA: 800x600 XGA: 1024x768 SXGA: 1280x1024 WXGA: 1366x768 WXGA+: 1440x900, 1680x900 WSXGA+: 1680x1050 Full HD: 1920x1080, 1920x1200 QHD: 2560x1440</p> <p>Presets display modes HDMI: 22; DP: 14</p>							
<p>Viewing adjustments <i>Tilt:</i> 30° back, -5° forward; <i>lift:</i> 4.33" (110mm); <i>swivel:</i> +/-45° Rotating screen Screen pivots 90 degrees from landscape to portrait On screen display On screen display with digital user controls (8 languages) Control features Direct access (buttons on front) for power, menu, input source select and brightness USB hub USB Hub: one USB 3.1 Type-C upstream port, four USB 3.0 Type-A downstream ports Multimedia Audio-out, optional sound bar supported Camera None Multiple input Support HDMI, DisplayPort, USB 3.1 Type-C, DisplayPort-out Monitor connectors (1) 2*HDMI (1.4), digital, HDCP-compliant (2) DisplayPort (1.2), digital, HDCP-compliant (3) DisplayPort-out, digital (4) USB 3.1 Type-C Signal cables (1) USB 3.1 Type-C cable, 1.8 meter Mounting features Wall or desk mounting using the Extend Arm or third-party accessories meeting the VESA FPMPI® (100mm mount) Security Security keyhole for attachment of optional cable lock (Kensington® lock-compatible)</p>							
<p>Ship group Monitor, detachable stand, Quick start and safety poster, 1.8 meter USB 3.1 Type-C cable, 1.8 meter black power cord</p>	<p style="text-align: center;">Limited Warranty</p> <p>See details at http://support.lenovo.com/en_US/guides-and-manuals/detail.page?DocID=UM008281</p> <p style="text-align: center;">Accessories</p> <table border="0"> <tr> <td>Kensington MicroSaver Cable Lock</td> <td style="text-align: right;">73P2582</td> </tr> <tr> <td>Kensington Twin Head Cable Lock</td> <td style="text-align: right;">45K1620</td> </tr> <tr> <td>Lenovo Security Cable Lock</td> <td style="text-align: right;">57Y4303</td> </tr> </table> <p>See details at www.lenovo.com/support/monitoraccessories</p> <p>See all monitors at www.lenovo.com/thinkvision</p>	Kensington MicroSaver Cable Lock	73P2582	Kensington Twin Head Cable Lock	45K1620	Lenovo Security Cable Lock	57Y4303
Kensington MicroSaver Cable Lock	73P2582						
Kensington Twin Head Cable Lock	45K1620						
Lenovo Security Cable Lock	57Y4303						



<p>Name P27u Wide Flat Panel Monitor Case color Black Type-model 61CBGAR1US / 61CBGAT1EU / 61CBGAR1EU / 61B0GAR1US / 61B0GAT1EU Panel TFT-LCD, IPS (In-Plane Switching), White LED backlight Viewable image size 27" (684.7mm) diagonal Max view area (W x H) 23.49" x 13.21" (596.74mm x 335.66mm) Optimum resolution 3840x2160 Max pixel rate 600MHz Aspect ratio 16:9 Pixel pitch (mm) 0.1554 x 0.1554mm Dot/Pixel per Inch 163 dpi Brightness 350 nits or cd/m² (typical) Contrast ratio 1000:1 (typical) Pixel response time 6ms (typical) Color gamut 1.457 sRGB Viewing angle at 10:1 CR 178° horizontal, 178° vertical Stand Tilt, swivel, pivot, and height adjustable stand Bezel width Sides: 0.08" (2mm) Dimensions (HxWxD, including stand) 20.21" H x 24.08" W x 10.62" D; 513.3mm H x 611.6mm W x 269.8mm D Power supply 50 watts typical, 160 watts maximum (with USB), <0.5 watts sleep/off; <0.3 watts switch off integrated (no external brick-like power supply) Weight 15.32 lb; 6.95kg (including stand) Limited warranty 3 year Available date August 2017</p>	<p>Features</p> <ul style="list-style-type: none"> • 27-inch IPS LED backlight monitor • Supports 3840x2160 resolution • 5-Ports USB hub, support USB 3.0 • Support ThinkCentre Tiny • Supports optional soundbar • Microsoft® Windows® 7 certified • Microsoft Windows 10 certified 						
<p>VESA-compliant VESA DDC2B/CI Power management ENERGY STAR® 7.0 Ergonomics ISO 9241-307 Emission standards FCC Class B Environmental TCO Displays 7.0, TCO Certified Edge 2.0, WEEE, RoHS, EPEAT™ Gold rating, ULE Gold</p>	 <p>ThinkVision P27u Monitor</p>						
<p>Preset resolutions VGA: 640x480, 720x400, 720x480, 720x576 SVGA: 800x600 XGA: 1024x768 SXGA: 1280x720, 1280x800, 1280x1024 WXGA+: 1440x900, 1600x900 WSXGA+: 1680x1050 Full HD: 1920x1080, 1920x1200 QHD: 2560x1440 UHD: 3840x2160</p> <p>Presets / user settings Standard presets: 27; user settings: 20</p>							
<p>Viewing adjustments Tilt: 30° back, -5° forward; lift: 4.33" (110mm); swivel: +/-45° Rotating screen Screen pivots 90 degrees from landscape to portrait On screen display On screen display with digital user controls (8 languages) Control features Direct access (buttons on front) for power, menu, input source select and brightness USB hub USB Hub: one USB 3.1 Type-C port, four USB 3.0 Type-A downstream ports Multimedia Audio-out, optional sound bar supported Camera None Multiple input Support HDMI, DisplayPort, USB 3.1 Type-C Monitor connectors (1) 2*HDMI (2.0), digital, HDCP-compliant (2) DisplayPort (1.2), digital, HDCP-compliant (3) USB 3.1 Type-C Signal cables (1) detachable, DisplayPort to DisplayPort, digital, 1.8 meter Mounting features Wall or desk mounting using the Extend Arm or third-party accessories meeting the VESA FPMPI® (100mm mount) Security Security keyhole for attachment of optional cable lock (Kensington® lock-compatible)</p>							
<p>Ship group Monitor, detachable stand, Quick start and safety poster, 1.8 meter USB Type-C to USB Type-C cable, 1.8 meter DP to DP cable, 1.8 meter HDMI to HDMI cable (NA only), 1.8 meter black power cord, 1.8 meter USB Type-C to USB Type-A cable</p>							
<p>Limited Warranty</p> <p>See details at http://support.lenovo.com/en_US/guides-and-manuals/detail.page?DocID=UM008281</p>	<p>Accessories</p> <table border="0"> <tr> <td>Kensington MicroSaver Cable Lock</td> <td>73P2582</td> </tr> <tr> <td>Kensington Twin Head Cable Lock</td> <td>45K1620</td> </tr> <tr> <td>Lenovo Security Cable Lock</td> <td>57Y4303</td> </tr> </table> <p>See details at www.lenovo.com/support/monitoraccessories</p> <p>See all monitors at www.lenovo.com/thinkvision</p>	Kensington MicroSaver Cable Lock	73P2582	Kensington Twin Head Cable Lock	45K1620	Lenovo Security Cable Lock	57Y4303
Kensington MicroSaver Cable Lock	73P2582						
Kensington Twin Head Cable Lock	45K1620						
Lenovo Security Cable Lock	57Y4303						



<p>Name Pro2820 Wide Flat Panel Monitor Case color Black Type-model 60FCRAR6US / 60FCRAT6EU Panel TFT-LCD, with wide viewing angle (WVA) technology, White LED backlight Viewable image size 28" (711mm) diagonal Max view area (W x H) 24.44" x 13.44" (620.9mm x 341.3mm) Optimum resolution 1920x1080 Max pixel rate 205MHz (VGA); 165MHz(DP/ HDMI); 149MHz (MHL) Frequency Supports 1920 x 10800 @ 60Hz Aspect ratio 16:9 Pixel pitch (mm) 0.32 x 0.32mm Dot/Pixel per Inch 79 dpi Brightness 300 nits or cd/m² (typical) Contrast ratio 3000:1 (typical) Pixel response time 6.5ms Color gamut 72% Viewing angle at 10:1 CR 178° horizontal, 178° vertical Stand Tilt, swivel, and height adjustable stand Bezel width Sides: 0.86" (21.85mm) Dimensions (HxWxD, excluding stand) 17.45" H x 26.21" W x 2.30" D; Dimensions (HxWxD, including stand) 443.3mm H x 665.9mm W x 58.2mm D Power supply 60 watts typical, 90 watts typical (with USB), 65 watts maximum, 95 watts maximum (with USB), <1.2 watts sleep/off; <0.5 watts switch off integrated (no external brick-like power supply) Weight 17.84 lb; 8.11kg (including stand) Limited warranty⁴ 3 year (includes backlight) Available date September 2014</p>	<p>Features</p> <ul style="list-style-type: none"> • 28-inch MVA (Multi-domain Vertical Alignment) panel LED backlit monitor • Supports 1920x1080 resolution • 5-Ports USB hub, support USB 3.0 • Arsenic/Mercury free • Microsoft® Windows® 7 • Windows 8/ Windows 8.1 certified 						
<p>VESA-compliant² VESA DDC2B/CI Power management ENERGY STAR® 6.0 Ergonomics ISO 9241-307 Emission standards FCC Class B Environmental TCO Displays 6.0, TCO Certified Edge 1.2, RoHS, EPEAT™ Gold rating, ULE Gold</p> <p>Preset resolutions VGA: 640x480, 720x400 SVGA: 800x600 XGA: 1024x768, 1024x760 SXGA: 1280x1024 WXGA: 1280x720, 1280x800, 1366x768 WXGA+: 1440x900, 1600x900 WSXGA+: 1680x1050 Full HD: 1920x1080 Others: 1152x864</p> <p>Presets / user settings Standard presets: 17; user settings: 17</p>	 <p>ThinkVision Pro2820 Monitor</p>						
<p>Viewing adjustments <i>Tilt: 25° back, -5° forward; lift: 4.3" (110mm); swivel: +/-45°</i> Rotating screen Screen pivots 90 degrees from landscape to portrait On screen display On screen display with digital user controls (8 languages) Control features Direct access (touch buttons on front) for automatic image setup, input switch, and brightness USB hub USB Hub: one USB 3.0 upstream port, four USB 3.0 downstream ports Multimedia None Camera None Multiple input Support VGA, HDMI, DisplayPort, MHL connections (Mobile High-definition Link) Monitor connectors (1) VGA 15-pin D-shell, analog (2) HDMI (1.4), digital, HDCP-compliant (3) DisplayPort (1.2), digital, HDCP-compliant</p> <p>Signal cables (1) detachable, VGA 15-pin D-shell at each end, analog, 1.8 meter (2) detachable, DisplayPort at each end, digital, 1.8 meter</p> <p>Mounting features Wall or desk mounting using the Extend Arm or third-party accessories meeting the VESA FPMPI® (100mm mount) Security Security keyhole for attachment of optional cable lock (Kensington® lock-compatible)</p>							
<p>Ship group Monitor, detachable stand, Quick start and safety poster, 1.8 meter DisplayPort cable, 1.8 meter VGA cable, 1.8 meter USB 3.0 cable, 1.8 meter black power cord</p>							
<p>Limited Warranty</p> <p>See details at http://support.lenovo.com/en_US/guides-and-manuals/detail.page?DocID=UM008281</p>	<p>Accessories</p> <table border="0"> <tr> <td>Kensington MicroSaver Cable Lock</td> <td>73P2582</td> </tr> <tr> <td>Kensington Twin Head Cable Lock</td> <td>45K1620</td> </tr> <tr> <td>Lenovo Security Cable Lock</td> <td>57Y4303</td> </tr> </table> <p>See details at www.lenovo.com/support/monitoraccessories</p> <p>See all monitors at www.lenovo.com/thinkvision</p>	Kensington MicroSaver Cable Lock	73P2582	Kensington Twin Head Cable Lock	45K1620	Lenovo Security Cable Lock	57Y4303
Kensington MicroSaver Cable Lock	73P2582						
Kensington Twin Head Cable Lock	45K1620						
Lenovo Security Cable Lock	57Y4303						



<p>Name X1 Wide Flat Panel Monitor Case color Black Type-model 60E2GAR1US / 60E2GAT1US / 60E2GAT1EU Panel TFT-LCD, IPS (In-Plane Switching), White LED backlight Viewable image size 27" (684.7mm) diagonal Max view area (W x H) 23.49" x 13.21" (596.7mm x 335.7mm) Optimum resolution 3840x2160 Max pixel rate 600MHz Aspect ratio 16:9 Pixel pitch (mm) 0.16 x 0.16mm Dot/Pixel per Inch 163 dpi Brightness 300 nits or cd/m² (typical) Contrast ratio 1300:1 (typical) Pixel response time 6ms Color gamut 99% Viewing angle at 10:1 CR 178° horizontal, 178° vertical Stand Tilt stand Bezel width Sides: 0.088" (2.23mm) Dimensions (HxWxD, including stand) 19.35" H x 24.19" W x 10.63" D; 491.4mm H x 614.5mm W x 270.0mm D Power supply 40 watts typical, 130 watts maximum (with USB), <0.5 watts sleep/off; <0.5 watts switch off Weight 14.11 lb; 6.40kg (including stand) Limited warranty⁴ 3 year Available date March 2016</p>	<p>Features</p> <ul style="list-style-type: none"> • 27-inch IPS LED backlight monitor with speaker • Supports 3840x2160 resolution • 5-Ports USB hub, support USB Type-C • 3watts x 2 stereo speakers • Microsoft® Windows® 7 certified • Microsoft Windows 10 certified 						
<p>VESA-compliant² VESA DDC2B/CI Power management ENERGY STAR® 7.0 Ergonomics ISO 9241-307 Emission standards FCC Class B Environmental TCO Displays 7.0, RoHS, EPEAT™ Silver rating, ULE Gold</p>	 <p style="text-align: center;">ThinkVision X1 Monitor</p>						
<p>Preset resolutions VGA: 640x350, 640x480, 720x400 SVGA: 800x600 XGA: 1024x768, 1152x864 SXGA: 1280x1024 WXGA: 1280x720, 1280x768, 1280x800, 1360x768 WXGA+: 1440x900, 1600x900 WSXGA+: 1680x1050 Full HD: 1920x1080, 1920x1200 UHD: 3840x2160</p> <p>Presets / user settings Standard presets: 20; user settings: 20</p>							
<p>Viewing adjustments <i>Tilt: 22° back, -5° forward;</i> Rotating screen None On screen display On screen display with digital user controls (8 languages) Control features Direct access (touch buttons on front) for menu, mute, volume up/down, and brightness USB hub USB Hub: one USB 3.1 Type-C upstream port, four USB 3.0 Type-A downstream ports Multimedia Integrated stereo speakers (3 watts x 2), built-in microphone Camera Full HD camera with LED light Multiple input Support HDMI, DisplayPort Monitor connectors (1) HDMI (1.4), digital, HDCP-compliant (2) DisplayPort (1.2), digital, HDCP-compliant Signal cables (1) detachable, HDMI at each end, digital, 1.8 meter (2) detachable, DisplayPort at each end, digital, 1.8 meter Mounting features Wall or desk mounting using the Extend Arm or third-party accessories meeting the VESA FPMPI® (100mm mount) Security Security keyhole for attachment of optional cable lock (Kensington® lock-compatible)</p>							
<p>Ship group Monitor, detachable stand, Quick start and safety poster, 1.8 meter DisplayPort cable, 1.8 meter HDMI cable, 1.8 meter USB Type-C cable, 1.8 meter USB Type-C to Type-A cable, 1.8 meter black power cord, mini DP to DP adapter, power adapter (135W)</p>	<p style="text-align: center;">Limited Warranty</p> <p>See details at http://support.lenovo.com/en_US/guides-and-manuals/detail.page?DocID=UM008281</p> <p style="text-align: center;">Accessories</p> <table border="0"> <tr> <td>Kensington MicroSaver Cable Lock</td> <td style="text-align: right;">73P2582</td> </tr> <tr> <td>Kensington Twin Head Cable Lock</td> <td style="text-align: right;">45K1620</td> </tr> <tr> <td>Lenovo Security Cable Lock</td> <td style="text-align: right;">57Y4303</td> </tr> </table> <p>See details at www.lenovo.com/support/monitoraccessories</p> <p>See all monitors at www.lenovo.com/thinkvision</p>	Kensington MicroSaver Cable Lock	73P2582	Kensington Twin Head Cable Lock	45K1620	Lenovo Security Cable Lock	57Y4303
Kensington MicroSaver Cable Lock	73P2582						
Kensington Twin Head Cable Lock	45K1620						
Lenovo Security Cable Lock	57Y4303						

See footnotes for important warranty information

This publication was developed for products and services offered in the United States and E.M.E.A countries. Lenovo may not offer the products, services or features discussed in this document in other countries. Lenovo may withdraw an offering at any time. Information is subject to change without notice. Consult your local representative for information on offerings available in your area.

Lenovo reserves the right to change specifications or other product information without notice. Lenovo is not responsible for photographic or typographical errors.

LENOVO PROVIDES THIS PUBLICATION "AS IS," WITHOUT WARRANTY OF ANY KIND, EITHER EXPRESS OR IMPLIED, INCLUDING THE IMPLIED WARRANTIES OF MERCHANTABILITY OR FITNESS FOR A PARTICULAR PURPOSE.

Some jurisdictions do not allow disclaimer of express or implied warranties in certain transactions, therefore this disclaimer may not apply to you.

Availability: All offers subject to availability. Lenovo reserves the right to alter product offerings and specifications at any time, without notice. Lenovo is not responsible for photographic or typographic errors.

General: Review key information provided by Microsoft that may apply to your system purchase, including details on Windows 10, Windows 8, Windows 7, and potential upgrades/downgrades. Lenovo makes no representation or warranty regarding third-party products or services.

Trademarks: Lenovo, ThinkPad, ThinkCentre, ThinkStation and the Lenovo logo are trademarks of Lenovo. Microsoft, Windows, Windows NT, and the Windows logo are trademarks of Microsoft Corporation. Ultrabook, Celeron, Celeron Inside, Core Inside, Intel, Intel Logo, Intel Atom, Intel Atom Inside, Intel Core, Intel Inside, Intel Inside Logo, Intel vPro, Itanium, Itanium Inside, Pentium, Pentium Inside, vPro Inside, Xeon, Xeon Phi, and Xeon Inside are trademarks of Intel Corporation in the U.S. and/or other countries. Other company, product or service names may be trademarks or service marks of others.

Warranty: For a copy of applicable warranties, write to: Lenovo Warranty Information, 1009 Think Place, Morrisville, NC, 27560. Lenovo makes no representation or warranty regarding third party products or services. The Lenovo Limited Warranty applies only to Lenovo hardware products purchased for your own use, and does not transfer upon resale.

Limited warranty: Support unrelated to a warranty issue may be subject to additional charges.

Lenovo Services:

Carry-in or Mail-in Service: Parts and labor repair coverage where the customer is responsible for shipping (including packaging) or delivery to authorized warranty provider or repair center.

Depot or Courier Service: Parts and labor repair coverage where shipping (including packaging) or delivery to the repair center is paid for by Lenovo.

Expedited Depot: Parts and labor coverage with expedited turnaround. Shipping (including packaging) or delivery to the repair center is paid for by Lenovo.

Onsite / In-home Service: Parts and labor repair coverage where labor is provided onsite at your place of business.

If Lenovo determines your product problem is covered by the product warranty and cannot be resolved over the telephone, a technician will be dispatched to arrive onsite, typically the next day.

International Warranty Service (IWS): PC repair coverage for customers who require a critical warranty repair while travelling internationally. Visit www.lenovo.com/internationalwarranty for details. Visit www.lenovo.com/warranty for Lenovo Warranty Services terms and conditions for complete details and restrictions.

Included software: may differ from its retail version (if available), and may not include user manuals or all program functionality. Software license agreements may apply.

Battery life: Battery life (and recharge times) will vary based on many factors including screen brightness, applications, features, power management, battery conditioning, and other customer preferences.

Visit <http://psref.lenovo.com/> for the latest version of Product Specifications Reference.

© Lenovo, 2018. All rights reserved.
Lenovo 1009 Think Place Morrisville, NC 27560 U.S.A.