



Product Specifications Reference

ThinkCentre Desktops



Version 629

April 25th, 2024



Contents

Cover	1
Contents	2
Summary Of Change	4
All-In-One	5
ThinkCentre M70a Gen 2	5
ThinkCentre M70a Gen 3	14
ThinkCentre M90a Gen 2	23
ThinkCentre M90a Gen 3	33
ThinkCentre M90a Gen 5	43
ThinkCentre M90a Pro Gen 3	53
ThinkCentre M90a Pro Gen 4	63
ThinkCentre neo 30a 22	72
ThinkCentre neo 30a 22 Gen 4	80
ThinkCentre neo 30a 24	87
ThinkCentre neo 30a 24 Gen 4	95
ThinkCentre neo 30a 27	102
ThinkCentre neo 30a 27 Gen 4	110
ThinkCentre neo 50a 24	117
ThinkCentre neo 50a 24 Gen 4	125
ThinkCentre neo 50a 24 Gen 5	133
ThinkCentre neo 50a 27 Gen 5	140
Nano Desktops	147
ThinkCentre M75n	147
ThinkCentre M75n IoT	155
ThinkCentre M75n Thin Client	163
ThinkCentre M90n-1 Nano	170
ThinkCentre M90n-1 Nano IoT	178
SFF Desktops	186
ThinkCentre M70s Gen 3	186
ThinkCentre M70s Gen 4	195
ThinkCentre M75s Gen 2	204
ThinkCentre M80s Gen 3	214
ThinkCentre M90s Gen 3	223
ThinkCentre M90s Gen 4	233
ThinkCentre M90s Gen 5	242
ThinkCentre neo 50s	250
ThinkCentre neo 50s Gen 4	259
Tiny Desktops	267
ThinkCentre M60q Chromebox	267
ThinkCentre M60q Chromebox Enterprise	274
ThinkCentre M70q Gen 3	281
ThinkCentre M70q Gen 4	290
ThinkCentre M75q Gen 2	299
ThinkCentre M80q Gen 3	308
ThinkCentre M80q Gen 4	317
ThinkCentre M90q Gen 3	326
ThinkCentre M90q Gen 4	336
ThinkCentre neo 50q Gen 4	345
ThinkCentre neo 50q Gen 4 Thin Client	353
Tiny-In-One	360
ThinkCentre Tiny-In-One 22 Gen 4	360

Contents

ThinkCentre Tiny-In-One 22 Gen 5	366
ThinkCentre Tiny-In-One 24 Gen 4	372
ThinkCentre Tiny-In-One 24 Gen 5	378
ThinkCentre Tiny-In-One 27	384
ThinkCentre TIO Flex 22i	390
ThinkCentre TIO Flex 24i	396
ThinkCentre TIO Flex 27i	402
Tower Desktops	408
ThinkCentre M70t Gen 3	408
ThinkCentre M70t Gen 4	417
ThinkCentre M75t Gen 2	426
ThinkCentre M80t Gen 3	435
ThinkCentre M90t Gen 3	445
ThinkCentre M90t Gen 4	455
ThinkCentre M90t Gen 5	464
ThinkCentre neo 50t	473
ThinkCentre neo 50t Gen 4	482
ThinkCentre neo 70t	491
Legal Information	500

Summary of Changes

This section describes the technical changes made in this edition.

This edition might also include minor corrections and editorial changes which are not identified.

April 2024 - Version 629

Additions in this update

▶ **New product(s)**

ThinkCentre M90t Gen 5

ThinkCentre M90s Gen 5

▶ **New model(s)**

None

▶ **Others**

None

Withdrawals in this update

▶ **Withdrawn product(s)**

None

▶ **Withdrawn model(s)**

None

OVERVIEW

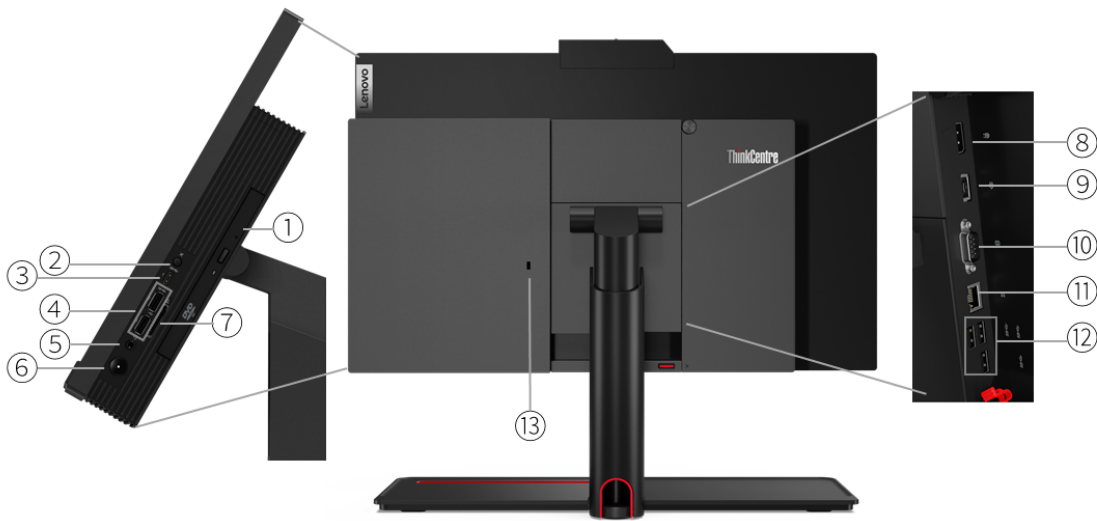

1. Optical drive *	8. DisplayPort
2. Microphone mute button	9. Power connector
3. USB-C 3.2 Gen 2	10. Serial or HDMI *
4. 1x USB 3.2 Gen 2 + 1x USB 3.2 Gen 1	11. Ethernet (RJ-45)
5. Headphone / microphone combo jack (3.5mm)	12. 3x USB 3.2 Gen 1
6. Power button	13. Kensington Security Slot
7. Card reader *	

Notes:

- Items with * are only available on selected models

PERFORMANCE

Processor

Processor Family

Intel® Celeron®, Intel® Pentium®, 10th Generation Intel® Core™ i3, or 11th Generation Intel® Core™ i5 / i7 / i9 Processor

Processor**

Processor Name	Cores	Threads	Base Frequency	Max Frequency	Cache	Memory Support	Processor Graphics
Celeron® G5905	2	2	3.5GHz	-	4MB	DDR4-2666	Intel® UHD Graphics 610
Celeron® G5925	2	2	3.6GHz	-	4MB	DDR4-2666	Intel® UHD Graphics 610
Pentium® Gold G6405	2	4	4.1GHz	-	4MB	DDR4-2666	Intel® UHD Graphics 610
Pentium® Gold G6505	2	4	4.2GHz	-	4MB	DDR4-2666	Intel® UHD Graphics 630
Pentium® Gold G6605	2	4	4.3GHz	-	4MB	DDR4-2666	Intel® UHD Graphics 630
Core™ i3-10105	4	8	3.7GHz	4.4GHz ^[1]	6MB	DDR4-2666	Intel® UHD Graphics 630
Core™ i3-10305	4	8	3.8GHz	4.5GHz ^[2]	8MB	DDR4-2666	Intel® UHD Graphics 630
Core™ i3-10325	4	8	3.9GHz	4.7GHz ^[3]	8MB	DDR4-2666	Intel® UHD Graphics 630
Core™ i5-11400	6	12	2.6GHz	4.4GHz ^[4]	12MB	DDR4-3200	Intel® UHD Graphics 730
Core™ i5-11500	6	12	2.7GHz	4.6GHz ^[5]	12MB	DDR4-3200	Intel® UHD Graphics 750
Core™ i5-11600	6	12	2.8GHz	4.8GHz ^[6]	12MB	DDR4-3200	Intel® UHD Graphics 750
Core™ i7-11700	8	16	2.5GHz	4.9GHz ^[7]	16MB	DDR4-3200	Intel® UHD Graphics 750
Core™ i9-11900	8	16	2.5GHz	5.2GHz ^[8]	16MB	DDR4-3200	Intel® UHD Graphics 750

Notes:

[1], [2], [3], [4], [5], [6], [7], [8] Intel® Max Turbo frequency will vary depending on application workload and the hardware and software configurations, see <http://www.intel.com/technology/turboboost/> for more information.

Operating System

Operating System**

- Windows® 11 Pro
- Windows® 11 Home
- Windows® 11 Home Single Language
- Windows® 11 DG Windows® 10 Pro 64
- Windows® 10 Pro 64
- Windows® 10 Home 64
- Windows® 10 Home 64 Single Language
- Windows® 10 IoT Enterprise
- Ubuntu Linux^[1]
- No preload operating system

Notes:

[1] Some features may not be supported on the system with Linux preload, including but not limited to Intel® RST RAID, Human Presence Detection, etc.

Graphics

Graphics**

Graphics	Type	Memory	Connector	Max Resolution	Key Features
Intel® UHD graphics 610	Integrated	Shared	1x DP 1.4b, 1x optional HDMI® 2.1	4096x2304@60Hz(DP), 4096x2160@60Hz(HDMI®)	DirectX® 12
Intel® UHD graphics 630	Integrated	Shared	1x DP 1.4b, 1x optional HDMI® 2.1	4096x2304@60Hz(DP), 4096x2160@60Hz(HDMI®)	DirectX® 12
Intel® UHD graphics 730	Integrated	Shared	1x DP 1.4b, 1x optional HDMI® 2.1	4096x2304@60Hz(DP), 4096x2160@60Hz(HDMI®)	DirectX® 12
Intel® UHD graphics 750	Integrated	Shared	1x DP 1.4b, 1x optional HDMI® 2.1	4096x2304@60Hz(DP), 4096x2160@60Hz(HDMI®)	DirectX® 12

Monitor Support

Monitor Support

Supports up to 3 independent displays via native display and 2 external monitor; supports external monitors via DisplayPort™ and optional HDMI®

Chipset

Chipset

Intel® B560 chipset

Memory

Max Memory^[1]

Up to 64GB DDR4-3200

Memory Slots

Two DDR4 SO-DIMM slots, dual-channel capable

Memory Type**^[2]

- DDR4-2666
- DDR4-3200

Notes:

[1] The max memory is based on the test results with current Lenovo® memory offerings.

[2] Installed memory is actually 3200MHz, but may run at 2666MHz, 2933 MHz or 3200MHz depending on the memory support capability of processor.

Storage

Storage Support^[1]

Up to two drives, 1x 2.5" HDD + 1x M.2 SSD

- 2.5" HDD up to 2TB
- M.2 SSD up to 1TB

Storage Type***

Disk Type	Interface	RPM	Security
2.5" SATA HDD	SATA 6Gb/s	5.4K	-
2.5" SATA HDD	SATA 6Gb/s	7.2K	-
M.2 2280 SSD	PCIe® NVMe®, PCIe® 3.0 x4	-	Opal
M.2 2242 SSD	PCIe® NVMe®, PCIe® 3.0 x4	-	-

RAID

No support

Notes:

[1] The max capacity of each disk type is based on the test results with current Lenovo® storage offerings.

Removable Storage

Optical**

- DVD-ROM, SATA 1.5Gb/s, slim (9.0mm)
- DVD burner (DVD±RW), SATA 1.5Gb/s, slim (9.0mm)
- None

Card Reader

- 3-in-1 card reader
- No card reader

Multi-Media

Audio Chip

High Definition (HD) Audio, Realtek® ALC233 codec

Speakers

Stereo speakers, 2W x2, Dolby® Atmos®

Microphone

- Dual-microphone array
- No microphone

Camera**

- FHD 1080p + IR, with ThinkShutter (physical switch on/off), Windows® Hello support
- FHD 1080p, with ThinkShutter (physical switch on/off)
- No camera

Power Supply

Power Supply**

Power	Type	Efficiency	Key Features
135W	Adapter	89%	Autosensing
170W	Adapter	89%	Autosensing

DESIGN

Display

Display**^[1]

Size	Resolution	Touch	Type	Brightness	Surface	Aspect Ratio	Contrast Ratio	Color Gamut	Refresh Rate	Viewing Angle (L/R/U/D)	Key Features
21.5"	FHD (1920x1080)	None	IPS	250nits	Anti-glare	16:9	1000:1	72% NTSC	60Hz	89°/89°/89°/89°	Borderless design (88% screen to body ratio), support low blue light mode
21.5"	FHD (1920x1080)	Multi-touch	IPS	250nits	Anti-glare	16:9	1000:1	72% NTSC	60Hz	89°/89°/89°/89°	Borderless design (88% screen to body ratio), support low blue light mode

Touchscreen

- Advanced In-cell Touch (AIT), supports 10-point touch
- Non-touch

Notes:

[1] IPS (in-plane switching) technology may refer to IPS, PLS, ADS, AHVA, AAS.

Input Device

Keyboard**

- Lenovo® Calliope Keyboard (USB connector), black
- Lenovo® Calliope Wireless Keyboard (2.4GHz via USB receiver), black
- Lenovo® Traditional Keyboard (USB connector), black
- No keyboard

Mouse**

- Lenovo® Calliope Mouse (USB connector), black
- Lenovo® Calliope Wireless Mouse (2.4GHz via USB receiver), black
- Lenovo® Fingerprint Mouse (USB connector), Windows® Hello support, black (EOL on Jan, 2023)
- No mouse

Mechanical

Buttons

- Microphone mute button
- Power button

Form Factor

AIO (21.5 inches)

Dimensions (WxDxH)^[1]

490.1 x 55.6 x 312.3 mm (19.3 x 2.2 x 12.3 inches), no stand, with ODD, with camera

Weight^[2]

8.1 kg (17.9 lbs) at maximum configuration

Case Color

Black

Bays

- 1x 2.5" disk bay
- 1x slim ODD bay

Expansion Slots

Two M.2 slots (one for WLAN, one for SSD)

EOU

Toolless cover and stand assembly / removal

Stand**

- UltraFlex IV stand, supports -5° to +70° tilt, up to 164mm lift (flat mode) / up to 115mm lift (vertical mode)
- Full function monitor stand, supports -5° to +30° tilt, up to 80mm lift
- No stand

Mounting

Supports VESA mount 100mm

Others

Supports Smart Power On

Notes:

[1] The system dimensions may vary depending on configurations.

[2] The system weight is approximate and based on results in Lenovo® lab, which varies depending on the source of component, variance of the distribution of each component, and manufacturing process. It may not be the exact weight for each specific model.

CONNECTIVITY

Network

Onboard Ethernet

Gigabit Ethernet, Realtek® RTL8111K, 1x RJ-45, supports Wake-on-LAN

Optional Ethernet

No optional Ethernet

WLAN + Bluetooth®**

- Realtek® RTL8822CE, 802.11ac Dual Band 2x2 Wi-Fi® + Bluetooth® 5.0, M.2 card
- Intel® Wireless-AC 9560, 802.11ac Dual Band 2x2 Wi-Fi® + Bluetooth® 5.1, M.2 card
- Intel® Wi-Fi® 6 AX201, 802.11ax 2x2 Wi-Fi® + Bluetooth® 5.1, M.2 Card^[1]
- No WLAN and Bluetooth®

Notes:

[1] Bluetooth® 5.2 is hardware ready but may run at a lower version due to OS limitations.

Ports^[1]**Rear Ports**

- 3x USB 3.2 Gen 1
- 1x DisplayPort™
- 1x Ethernet (RJ-45)

Optional Rear Ports**

- 1x HDMI®
- 1x serial

Right Ports

- 1x USB-C® 3.2 Gen 2 (support data transfer and 5V@3A charging)
- 1x USB 3.2 Gen 1
- 1x USB 3.2 Gen 2
- 1x headphone / microphone combo jack (3.5mm)

Optional Right Ports

1x card reader

Notes:

[1] The transfer speed of following ports will vary and, depending on many factors, such as the processing speed of the host device, file attributes and other factors related to system configuration and your operating environment, will be slower than theoretical speed.

USB 2.0: 480 Mbit/s;

USB 3.2 Gen 1 (SuperSpeed USB 5Gbps, formerly USB 3.0 / USB 3.1 Gen 1): 5 Gbit/s;

USB 3.2 Gen 2 (SuperSpeed USB 10Gbps, formerly USB 3.1 Gen 2): 10 Gbit/s;

USB4® 20Gbps / USB 3.2 Gen 2x2 (SuperSpeed USB 20Gbps): 20 Gbit/s;

USB4® 40Gbps (USB 40Gbps): 40 Gbit/s;

Thunderbolt™ 3/4: 40 Gbit/s.

Monitor Cable**Monitor Cable*****

- DP to VGA dongle
- DP to dual DP dongle
- DP to DVI-D dongle
- DP to HDMI® dongle
- No monitor cable

SECURITY & PRIVACY**Security****Security Chip**

Discrete TPM 2.0, TCG certified

Physical Locks

Kensington® Security Slot™, 3 x 7 mm

Chassis Intrusion Switch

- Chassis intrusion switch
- No chassis intrusion switch

Fingerprint Reader

- Touch style fingerprint reader on mouse (EOL on Jan, 2023)
- No fingerprint reader

Other Security

(Optional) ThinkShutter camera cover

BIOS Security

- Administrator password
- Power-on password
- Hard disk password
- Boot sequence control
- Boot without keyboard and mouse
- Self-healing BIOS
- Smart USB protection (allows keyboard / mouse only, blocks all storage devices)
- Individual USB port disablement

MANAGEABILITY**System Management****System Management**

Non-vPro®

SERVICE**Warranty^[1]****Base Warranty****

- 1-year courier or carry-in service
- 1-year limited onsite service
- 3-year limited onsite service
- No base warranty

Notes:

[1] The warranty upgrades may be bundled with some models, please check the "Included upgrade" column in the specific model's configurations. For more service extensions, please go to <https://smartfind.lenovo.com/>. To learn more details of warranty policy, please access <https://pcsupport.lenovo.com/warranty>.

ENVIRONMENTAL**Operating Environment****Temperature**

- Operating: 5°C (41°F) to 35°C (95°F)
- Storage: -20°C (-4°F) to 60°C (140°F)

Relative Humidity

Operating: 20% to 80%

Altitude

- Operating: 0 m (0 ft) to 3048 m (10,000 ft)
- Storage: 0 m (0 ft) to 12192 m (40,000 ft)

CERTIFICATIONS**Green Certifications^[1]****Green Certifications**

- ENERGY STAR® 8.0
- EPEAT™ Silver Registered
- ErP Lot 3
- RoHS compliant
- TCO Certified 8.0
- TCO edge

Notes:

[1] The items listed under the "Green Certifications" section may not only refer to certification but also registration or self-declaration.

Other Certifications

Other Certifications

- (Optional) TÜV Rheinland® Ultra Low Noise
- TÜV Rheinland® Eye Comfort Certification
- TÜV Rheinland® Low Blue Light

Mil-Spec Test

MIL-STD-810H military test passed (Low Pressure [Altitude], High Temperature, Low Temperature, Temperature Shock, Humidity, Sand and Dust, Vibration, Shock, Fungus, Solar Radiation)

- Feature with ** means that only one offering listed under the feature is configured on selected models.
- Feature with *** means that one or more offerings listed under the feature could be configured on selected models.
- Lenovo reserves the right to change specifications or other product information without notice. Lenovo is not responsible for photographic or typographical errors. LENOVO PROVIDES THIS PUBLICATION "AS IS," WITHOUT WARRANTY OF ANY KIND, EITHER EXPRESS OR IMPLIED, INCLUDING THE IMPLIED WARRANTIES OF MERCHANTABILITY OR FITNESS FOR A PARTICULAR PURPOSE. Some jurisdictions do not allow disclaimer of express or implied warranties in certain transactions, therefore this disclaimer may not apply to you.
- The specifications on this page may not be available in all regions, and may be changed or updated without notice.



OVERVIEW

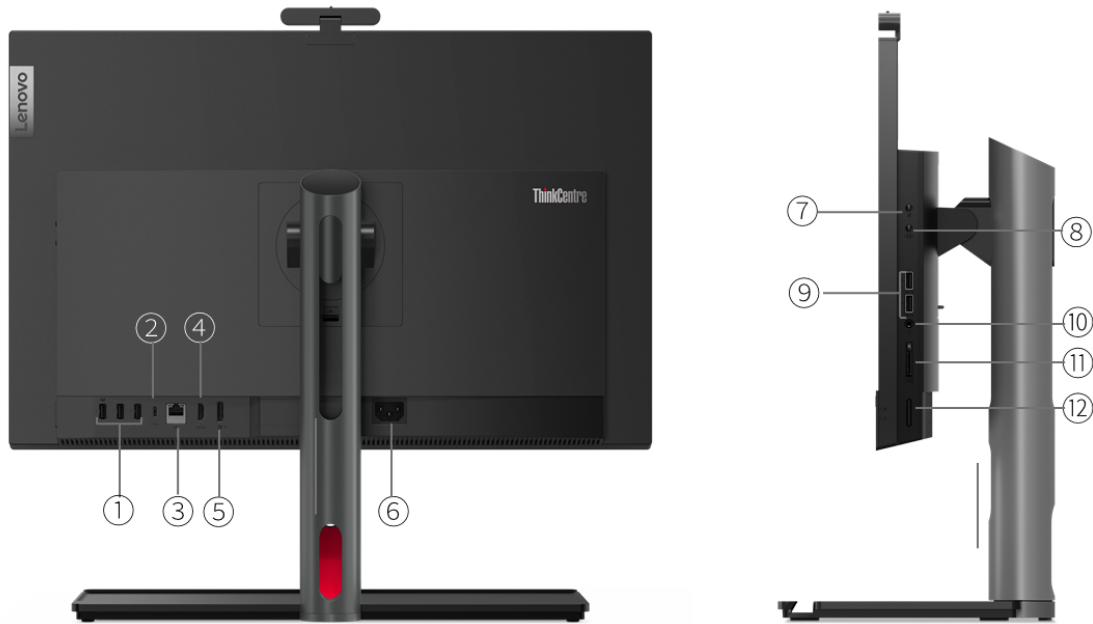

1. 3x USB 3.2 Gen 1	7. Microphone mute button
2. USB-C 3.2 Gen 2 (data transfer, 15W charging)	8. PC / monitor mode switch
3. Ethernet (RJ-45)	9. 2x USB 3.2 Gen 2
4. HDMI (HDMI in / HDMI out combo port)	10. Headphone / microphone combo jack (3.5mm)
5. DisplayPort 1.4	11. Card reader *
6. Power connector	12. Power button

Notes:

- Items with * are only available on selected models

PERFORMANCE

Processor

Processor Family

Intel® Celeron®, Intel® Pentium®, or 12th Generation Intel® Core™ i3 / i5 / i7 / i9 Processor

Processor**

Processor Name	Cores	Threads	Base Frequency	Max Frequency	Cache	Memory Support	Processor Graphics
Celeron® G6900	2	2	3.4GHz	-	4MB	DDR4-3200	Intel® UHD Graphics 710
Pentium® Gold G7400	2	4	3.7GHz	-	6MB	DDR4-3200	Intel® UHD Graphics 710
Core™ i3-12100	4 (4 P-core + 0 E-core)	8	P-core 3.3GHz	P-core 4.3GHz ^[1]	12MB	DDR4-3200	Intel® UHD Graphics 730
Core™ i3-12300	4 (4 P-core + 0 E-core)	8	P-core 3.5GHz	P-core 4.4GHz ^[2]	12MB	DDR4-3200	Intel® UHD Graphics 730
Core™ i5-12400	6 (6 P-core + 0 E-core)	12	P-core 2.5GHz	P-core 4.4GHz ^[3]	18MB	DDR4-3200	Intel® UHD Graphics 730
Core™ i5-12500	6 (6 P-core + 0 E-core)	12	P-core 3.0GHz	P-core 4.6GHz ^[4]	18MB	DDR4-3200	Intel® UHD Graphics 770
Core™ i5-12600	6 (6 P-core + 0 E-core)	12	P-core 3.3GHz	P-core 4.8GHz ^[5]	18MB	DDR4-3200	Intel® UHD Graphics 770
Core™ i7-12700	12 (8 P-core + 4 E-core)	20	P-core 2.1GHz / E-core 1.6GHz	Max Turbo up to 4.9GHz / P-core 4.8GHz / E-core 3.6GHz ^[6]	25MB	DDR5-4800	Intel® UHD Graphics 770
Core™ i9-12900	16 (8 P-core + 8 E-core)	24	P-core 2.4GHz / E-core 1.8GHz	Max Turbo up to 5.1GHz / P-core 5.0GHz / E-core 3.8GHz ^[7]	30MB	DDR5-4800	Intel® UHD Graphics 770

Notes:

[1], [2], [3], [4], [5], [6], [7] Intel® Max Turbo frequency will vary depending on application workload and the hardware and software configurations, see <http://www.intel.com/technology/turboboost/> for more information.

Operating System

Operating System**

- Windows® 11 Pro
- Windows® 11 Home
- Windows® 11 Home Single Language
- Windows® 11 DG Windows® 10 Pro 64
- No preload operating system

Graphics

Graphics**

Graphics	Type	Memory	Connector	Max Resolution	Key Features
Intel® UHD graphics 710	Integrated	Shared	1x HDMI® 2.1 TMDS, 1x DP 1.4	4096x2160@60Hz(HDMI®), 5120x2160@60Hz(DP)	DirectX® 12
Intel® UHD graphics 730	Integrated	Shared	1x HDMI® 2.1 TMDS, 1x DP 1.4	4096x2160@60Hz(HDMI®), 5120x2160@60Hz(DP)	DirectX® 12
Intel® UHD graphics 770	Integrated	Shared	1x HDMI® 2.1 TMDS, 1x DP 1.4	4096x2160@60Hz(HDMI®), 5120x2160@60Hz(DP)	DirectX® 12

Monitor Support

Monitor Support

Supports up to 3 independent displays via native display and 2 external monitor; supports external monitors via DisplayPort™ and HDMI®; work as standalone monitor via HDMI® (HDMI® in / out combo)

Chipset**Chipset**

Intel® Q670 chipset

Memory**Max Memory^[1]**

Up to 64GB DDR4-3200

Memory Slots

Two DDR4 SO-DIMM slots, dual-channel capable

Memory Type

DDR4-3200

Notes:

[1] The max memory is based on the test results with current Lenovo® memory offerings.

Storage**Storage Support^{[1][2]}**

Up to three drives, 2x 2.5" HDD + 1x M.2 SSD

- 2.5" HDD up to 2TB each
- M.2 SSD up to 1TB

Technical support up to 2 HDDs + 1 SSD, but Lenovo® only offers the models with up to 2 HDDs or 1 SSD + 1 HDD

Storage Type

Disk Type	Interface	RPM	Security
2.5" SATA HDD	SATA 6Gb/s	5.4K	-
2.5" SATA HDD	SATA 6Gb/s	7.2K	-
M.2 2280 SSD	PCIe® NVMe®, PCIe® 3.0 x4	-	Opal 2.0
M.2 2280 SSD	PCIe® NVMe®, PCIe® 4.0 x4 Performance	-	Opal 2.0
M.2 2280 SSD	PCIe® NVMe®, PCIe® 4.0 x4 Value	-	Opal 2.0

RAID^[3]

RAID 0/1 support for HDDs

Notes:

[1] The max capacity of each disk type is based on the test results with current Lenovo® storage offerings.

[2] 2nd 2.5" HDD occupies ODD bay, and needs ODD to HDD bracket kit (optional, come with 2nd 2.5" HDD).

[3] RAID is not preset by default, user can config RAID 0/1 according to the demand.

Removable Storage**Optical****

- DVD-ROM, SATA connector, slim (9.0mm)
- DVD burner (DVD±RW), SATA connector, slim (9.0mm)
- None

Card Reader

- 3-in-1 card reader (SD, SDHC, SDXC)
- No card reader

Multi-Media**Audio Chip**

High Definition (HD) Audio, Realtek® ALC256-NL codec

Speakers

ThinkCentre M70a Gen 3

Stereo speakers, 2W x2, Dolby® Atmos®

Microphone

- Dual-microphone array
- No microphone

Camera**

- 5.0-megapixel, IR + RGB hybrid, with ThinkShutter (physical switch on/off), ±20° view angle adjustable, Windows® Hello support
- 5.0-megapixel, with ThinkShutter (physical switch on/off), ±20° view angle adjustable
- No camera

Power Supply

Power Supply

Power	Type	Efficiency	Key Features
180W	Fixed	90%	100V - 240V, 50-60Hz

DESIGN

Display

Display**[1]

Size	Resolution	Touch	Type	Brightness	Surface	Aspect Ratio	Contrast Ratio	Color Gamut	Refresh Rate	Viewing Angle (L/R/U/D)	Key Features
21.5"	FHD (1920x1080)	None	IPS	250nits	Anti-glare	16:9	1000:1	72% NTSC	60Hz	89°/89°/89°/89°	14ms response Time, borderless design, low blue light, flicker free
21.5"	FHD (1920x1080)	Multi-touch	IPS	250nits	Anti-glare	16:9	1000:1	72% NTSC	60Hz	89°/89°/89°/89°	14ms response Time, borderless design, low blue light, flicker free

Touchscreen

- Advanced In-cell Touch (AIT), supports 10-point touch
- Non-touch

Notes:

[1] IPS (in-plane switching) technology may refer to IPS, PLS, ADS, AHVA, AAS.

Input Device

Keyboard**

- Lenovo® Calliope Keyboard (USB connector), black
- Lenovo® Calliope Wireless Keyboard (2.4GHz via USB receiver), black
- Lenovo® Traditional Keyboard (USB connector), black
- No keyboard

Mouse**

- Lenovo® Calliope Mouse (USB connector), black
- Lenovo® Calliope Wireless Mouse (2.4GHz via USB receiver), black
- Lenovo® Fingerprint Mouse (USB connector), Windows® Hello support, black (EOL on Jan, 2023)
- No mouse

Mechanical

Buttons

- Microphone mute button
- Monitor / PC mode switch button
- Power button

Form Factor

AIO (21.5 inches)

Dimensions (WxDxH)^[1]

Models	Dimensions
Models (with UltraFlex V stand, with camera)	Lowest in vertical mode: 489 x 216.32 x 358.82 mm (19.25 x 8.52 x 14.13 inches) Highest in vertical mode: 489 x 216.32 x 443.31 mm (19.25 x 8.52 x 17.45 inches)
Models (with UltraFlex V stand, without camera)	Lowest in vertical mode: 489 x 216.32 x 338.32 mm (19.25 x 8.52 x 13.32 inches) Highest in vertical mode: 489 x 216.32 x 422.81 mm (19.25 x 8.52 x 16.65 inches)
Models (with full function monitor stand, with camera)	Lowest in vertical mode: 489 x 217.31 x 365.96 mm (19.52 x 8.56 x 14.41 inches) Highest in vertical mode: 489 x 217.31 x 474.97 mm (19.52 x 8.56 x 18.7 inches)
Models (with full function monitor stand, without camera)	Lowest in vertical mode: 489 x 217.31 x 345.46 mm (19.52 x 8.56 x 13.6 inches) Highest in vertical mode: 489 x 217.31 x 454.47 mm (19.52 x 8.56 x 17.89 inches)

Packaging Dimensions (WxDxH)

- With Full Function Monitor Stand: 605 x 235 x 550 mm (23.82 x 9.35 x 21.65 inches)
- With UltraFlex V Stand: 605 x 248 x 545 mm (23.82 x 9.76 x 23.46 inches)

Weight^[2]

Models	Weight
Models (with UltraFlex V stand, with ODD, with camera)	Around 7.985 kg (17.6 lbs)
Models (with full function monitor stand, with ODD, with camera)	Around 7.678 kg (16.92 lbs)

Packaging Weight

- With Full Function Monitor Stand: 1.867 kg (4.12 lbs), packaging only
- With UltraFlex V Stand: 1.983 kg (4.37 lbs), packaging only

Case Color

Black

Bays^[3]

- 2x 2.5" disk bay (2nd 2.5" HDD occupies ODD bay)
- 1x slim ODD bay

Expansion Slots

Two M.2 slots (one for WLAN, one for SSD)

EOU

Toolless cover, stand, motherboard shielding, HDD, and memory assembly / removal

Stand**

- UltraFlex V stand, supports -5° to +70° tilt, up to 70°±2° lift (up to 179.96mm lift in flat mode / up to 84.37mm lift in vertical mode)
- Full function monitor stand, supports -5° to +20° tilt, left & right 45° swivel, 90° pivot, up to 110mm lift
- No stand

Mounting

Supports VESA mount 100mm

Others

- (Optional) Conference Call Base, 3W x4 Harman speakers, 4 digital microphones array with AI noise suppression, Physical button for Teams, USB-C® connector
- Supports Smart Power On

Notes:

[1] The system dimensions may vary depending on configurations.

[2] The system weight is approximate and based on results in Lenovo® lab, which varies depending on the source of component, variance of the distribution of each component, and manufacturing process. It may not be the exact weight for each specific model.

[3] 2nd 2.5" HDD needs ODD to HDD bracket kit (optional, come with 2nd 2.5" HDD).

CONNECTIVITY

Network

Onboard Ethernet

Gigabit Ethernet, Realtek® RTL8111K, 1x RJ-45, supports Wake-on-LAN

Optional Ethernet

No optional Ethernet

WLAN + Bluetooth®**

- Realtek® RTL8822CE, 802.11ac Dual Band 2x2 Wi-Fi® + Bluetooth® 5.0, M.2 card
- Intel® Wireless-AC 9560, 802.11ac Dual Band 2x2 Wi-Fi® + Bluetooth® 5.1, M.2 card
- MediaTek Wi-Fi® 6 MT7921, 802.11ax 2x2 Wi-Fi® + Bluetooth® 5.3, M.2 Card^[1]
- Realtek® Wi-Fi® 6 RTL8852AE, 802.11ax Dual Band 2x2 Wi-Fi® + Bluetooth® 5.3, M.2 card^[2]
- Realtek® Wi-Fi® 6 RTL8852BE, 802.11ax Dual Band 2x2 Wi-Fi® + Bluetooth® 5.3, M.2 card^[3]
- Intel® Wi-Fi® 6 AX201, 802.11ax 2x2 Wi-Fi® + Bluetooth® 5.2, M.2 Card^[4]
- No WLAN and Bluetooth®

Notes:

[1], [2], [3] Bluetooth® 5.3 requires Windows® 11.

[4] Bluetooth® 5.2 requires Windows® 11.

Ports^[1]

Rear Ports

- 1x USB-C® 3.2 Gen 2 (support data transfer and 15W charging)
- 3x USB 3.2 Gen 1
- 1x HDMI® (HDMI® in 1.4 / HDMI® out 2.1 TMDS combo port)
- 1x DisplayPort™ 1.4
- 1x Ethernet (RJ-45)

Optional Rear Ports

1x serial

Right Ports

- 2x USB 3.2 Gen 2
- 1x headphone / microphone combo jack (3.5mm)

Optional Right Ports

1x card reader

Notes:

[1] The transfer speed of following ports will vary and, depending on many factors, such as the processing speed of the host device, file attributes and other factors related to system configuration and your operating environment, will be slower than theoretical speed.

USB 2.0: 480 Mbit/s;

USB 3.2 Gen 1 (SuperSpeed USB 5Gbps, formerly USB 3.0 / USB 3.1 Gen 1): 5 Gbit/s;

USB 3.2 Gen 2 (SuperSpeed USB 10Gbps, formerly USB 3.1 Gen 2): 10 Gbit/s;

USB4® 20Gbps / USB 3.2 Gen 2x2 (SuperSpeed USB 20Gbps): 20 Gbit/s;

USB4® 40Gbps (USB 40Gbps): 40 Gbit/s;

Thunderbolt™ 3/4: 40 Gbit/s.

Monitor Cable

Monitor Cable**

- HDMI® to DVI dongle
- HDMI® to VGA dongle

- DP to VGA dongle
- DP to dual DP dongle
- DP to DVI-D dongle
- DP to HDMI® dongle
- No monitor cable

SECURITY & PRIVACY

Security

Security Chip

Discrete TPM 2.0, TCG certified

Physical Locks

Kensington® Security Slot™, 3 x 7 mm

Chassis Intrusion Switch

- Chassis intrusion switch
- No chassis intrusion switch

Fingerprint Reader

- Touch style fingerprint reader on mouse (EOL on Jan, 2023)
- No fingerprint reader

Other Security

(Optional) ThinkShutter camera cover

BIOS Security

- Administrator password
- Power-on password
- Hard disk password
- Boot sequence control
- Boot without keyboard and mouse
- Self-healing BIOS
- Smart USB protection (allows keyboard / mouse only, blocks all storage devices)
- Individual USB port disablement

MANAGEABILITY

System Management

System Management

Non-vPro®

SERVICE

Warranty^[1]

Base Warranty

- 1-year courier or carry-in service
- 1-year limited onsite service
- 3-year limited onsite service
- No base warranty

Notes:

[1] The warranty upgrades may be bundled with some models, please check the "Included upgrade" column in the specific model's configurations. For more service extensions, please go to <https://smartfind.lenovo.com/>. To learn more details of warranty policy, please access <https://pcsupport.lenovo.com/warranty>.

ENVIRONMENTAL

Operating Environment

Temperature

- Operating: 5°C (41°F) to 35°C (95°F)
- Storage: -20°C (-4°F) to 60°C (140°F)

Relative Humidity

Operating: 20% to 80%

Altitude

- Operating: 0 m (0 ft) to 3048 m (10,000 ft)
- Storage: 0 m (0 ft) to 12192 m (40,000 ft)

CERTIFICATIONS

Green Certifications^[1]

Green Certifications

- (Optional) ENERGY STAR® 8.0
- (Optional) EPEAT™ Gold Registered^[2]
- ErP Lot 3
- RoHS compliant
- TCO Certified 9.0
- TCO edge

Notes:

[1] The items listed under the "Green Certifications" section may not only refer to certification but also registration or self-declaration.

[2] EPEAT™ is registered where applicable, please see epeat.net for registration status by country.

Other Certifications

Other Certifications

- (Optional) TÜV Rheinland® Ultra Low Noise
- TÜV Rheinland® Flicker Free
- TÜV Rheinland® Low Blue Light
- UL Anti-dust

Mil-Spec Test

MIL-STD-810H military test passed (Low Pressure [Altitude], High Temperature, Low Temperature, Temperature Shock, Humidity, Sand and Dust, Vibration, Shock, Fungus, Solar Radiation, Contamination by Fluids, Salt Fog)

- Feature with ** means that only one offering listed under the feature is configured on selected models.
- Lenovo reserves the right to change specifications or other product information without notice. Lenovo is not responsible for photographic or typographical errors. LENOVO PROVIDES THIS PUBLICATION "AS IS," WITHOUT WARRANTY OF ANY KIND, EITHER EXPRESS OR IMPLIED, INCLUDING THE IMPLIED WARRANTIES OF MERCHANTABILITY OR FITNESS FOR A PARTICULAR PURPOSE. Some jurisdictions do not allow disclaimer of express or implied warranties in certain transactions, therefore this disclaimer may not apply to you.
- The specifications on this page may not be available in all regions, and may be changed or updated without notice.



intel



intel



intel



intel



intel



OVERVIEW

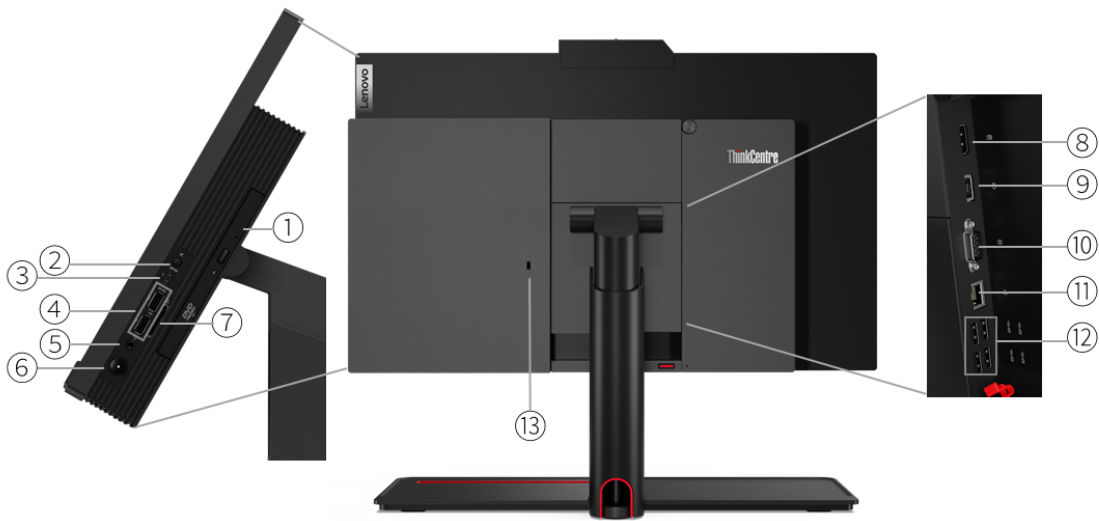

1. Optical drive *	8. DisplayPort (DP in/out combo port)
2. Microphone mute button	9. Power connector
3. USB-C 3.2 Gen 2	10. Serial or HDMI *
4. 2x USB 3.2 Gen 2	11. Ethernet (RJ-45)
5. Headphone / microphone combo jack (3.5mm)	12. 4x USB 3.2 Gen 1
6. Power button	13. Kensington Security Slot
7. Card reader *	

Notes:

- Items with * are only available on selected models

PERFORMANCE

Processor

Processor Family

Intel® Celeron®, Intel® Pentium®, 10th Generation Intel® Core™ i3, or 11th Generation Intel® Core™ i5 / i7 / i9 Processor

Processor**

Processor Name	Cores	Threads	Base Frequency	Max Frequency	Cache	Memory Support	Processor Graphics
Celeron® G5905	2	2	3.5GHz	-	4MB	DDR4-2666	Intel® UHD Graphics 610
Celeron® G5925	2	2	3.6GHz	-	4MB	DDR4-2666	Intel® UHD Graphics 610
Pentium® Gold G6405	2	4	4.1GHz	-	4MB	DDR4-2666	Intel® UHD Graphics 610
Pentium® Gold G6505	2	4	4.2GHz	-	4MB	DDR4-2666	Intel® UHD Graphics 630
Pentium® Gold G6605	2	4	4.3GHz	-	4MB	DDR4-2666	Intel® UHD Graphics 630
Core™ i3-10105	4	8	3.7GHz	4.4GHz ^[1]	6MB	DDR4-2666	Intel® UHD Graphics 630
Core™ i3-10305	4	8	3.8GHz	4.5GHz ^[2]	8MB	DDR4-2666	Intel® UHD Graphics 630
Core™ i3-10325	4	8	3.9GHz	4.7GHz ^[3]	8MB	DDR4-2666	Intel® UHD Graphics 630
Core™ i5-11400	6	12	2.6GHz	4.4GHz ^[4]	12MB	DDR4-3200	Intel® UHD Graphics 730
Core™ i5-11500	6	12	2.7GHz	4.6GHz ^[5]	12MB	DDR4-3200	Intel® UHD Graphics 750
Core™ i5-11600	6	12	2.8GHz	4.8GHz ^[6]	12MB	DDR4-3200	Intel® UHD Graphics 750
Core™ i7-11700	8	16	2.5GHz	4.9GHz ^[7]	16MB	DDR4-3200	Intel® UHD Graphics 750
Core™ i9-11900	8	16	2.5GHz	5.2GHz ^[8]	16MB	DDR4-3200	Intel® UHD Graphics 750

Notes:

[1], [2], [3], [4], [5], [6], [7], [8] Intel® Max Turbo frequency will vary depending on application workload and the hardware and software configurations, see <http://www.intel.com/technology/turboboost/> for more information.

Operating System

Operating System**

- Windows® 11 Pro
- Windows® 11 Home
- Windows® 11 Home Single Language
- Windows® 11 DG Windows® 10 Pro 64
- Windows® 10 Pro 64
- Windows® 10 Home 64
- Windows® 10 Home 64 Single Language
- Windows® 10 IoT Enterprise
- Ubuntu Linux^[1]
- No preload operating system

Notes:

[1] Some features may not be supported on the system with Linux preload, including but not limited to Intel® RST RAID, Human Presence Detection, etc.

Graphics

Graphics**

Graphics	Type	Memory	Connector	Max Resolution	Key Features
Intel® UHD graphics 610	Integrated	Shared	1x DP 1.4b, 1x optional HDMI® 2.1	4096x2304@60Hz(DP), 4096x2160@60Hz(HDMI®)	DirectX® 12
Intel® UHD graphics 630	Integrated	Shared	1x DP 1.4b, 1x optional HDMI® 2.1	4096x2304@60Hz(DP), 4096x2160@60Hz(HDMI®)	DirectX® 12
Intel® UHD graphics 730	Integrated	Shared	1x DP 1.4b, 1x optional HDMI® 2.1	4096x2304@60Hz(DP), 4096x2160@60Hz(HDMI®)	DirectX® 12
Intel® UHD graphics 750	Integrated	Shared	1x DP 1.4b, 1x optional HDMI® 2.1	4096x2304@60Hz(DP), 4096x2160@60Hz(HDMI®)	DirectX® 12
AMD Radeon™ 630	Discrete	2GB GDDR5	1x DP 1.4b, 1x optional HDMI® 2.1	4096x2304@60Hz(DP), 4096x2160@60Hz(HDMI®)	DirectX® 12

Monitor Support

Monitor Support

Supports up to 3 displays via native display and 2 external monitor; supports external monitors via DisplayPort™ and optional HDMI®; work as standalone monitor via DisplayPort™ (DP in / out combo)

Chipset

Chipset

Intel® Q570 chipset

Memory

Max Memory^[1]

Up to 64GB DDR4-3200

Memory Slots

Two DDR4 SO-DIMM slots, dual-channel capable

Memory Type**^[2]

- DDR4-2666
- DDR4-3200

Notes:

[1] The max memory is based on the test results with current Lenovo® memory offerings.

[2] Installed memory is actually 3200MHz, but may run at 2666MHz or 3200MHz depending on the memory support capability of processor.

Storage

Storage Support^{[1][2]}

Up to three drives, 2x 2.5" HDD + 1x M.2 SSD

- 2.5" HDD up to 2TB each
- M.2 SSD up to 1TB

Technical support up to 2 HDDs + 1 SSD, but Lenovo® only offers the models with up to 2 HDDs or 1 SSD + 1 HDD

Storage Type***

Disk Type	Interface	RPM	Security
2.5" SATA HDD	SATA 6Gb/s	5.4K	-
2.5" SATA HDD	SATA 6Gb/s	7.2K	-
M.2 2280 SSD	PCIe® NVMe®, PCIe® 3.0 x4	-	Opal
M.2 2280 SSD	PCIe® NVMe®, PCIe® 4.0 x4	-	Opal
M.2 2242 SSD	PCIe® NVMe®, PCIe® 3.0 x2	-	-
M.2 2242 SSD	PCIe® NVMe®, PCIe® 3.0 x4	-	-

RAID^[3]

RAID 0/1 support for HDDs

Notes:

- [1] The max capacity of each disk type is based on the test results with current Lenovo® storage offerings.
- [2] 2nd 2.5" HDD occupies ODD bay, and needs ODD to HDD bracket kit (optional, come with 2nd 2.5" HDD).
- [3] RAID is not preset by default, user can config RAID 0/1 according to the demand.

Removable Storage**Optical****

- DVD-ROM, SATA 1.5Gb/s, slim (9.0mm)
- DVD burner (DVD±RW), SATA 1.5Gb/s, slim (9.0mm)
- None

Card Reader

- 3-in-1 card reader
- No card reader

Multi-Media**Audio Chip**

High Definition (HD) Audio, Realtek® ALC233 codec

Speakers

Stereo speakers, 3W x2, Dolby® Atmos®

Microphone

- Dual-microphone array
- No microphone

Camera**

- 5.0-megapixel, IR + RGB hybrid, with ThinkShutter (physical switch on/off), Windows® Hello support
- 5.0-megapixel, with ThinkShutter (physical switch on/off)
- No camera

Power Supply**Power Supply****

Power	Type	Efficiency	Key Features
150W	Adapter	89%	Autosensing
170W	Adapter	89%	Autosensing

DESIGN**Display****Display****^[1]

Size	Resolution	Touch	Type	Brightness	Surface	Aspect Ratio	Contrast Ratio	Color Gamut	Refresh Rate	Viewing Angle (L/R/U/D)	Key Features
23.8"	FHD (1920x1080)	None	IPS	250nits	Anti-glare	16:9	1000:1	72% NTSC	60Hz	89°/89°/89°/89°	Borderless design, low blue light
23.8"	FHD (1920x1080)	None	IPS	350nits	Anti-glare	16:9	1000:1	72% NTSC	60Hz	89°/89°/89°/89°	Borderless design, low blue light, PrivacyGuard
23.8"	FHD (1920x1080)	Multi-touch	IPS	250nits	Anti-glare	16:9	1000:1	72% NTSC	60Hz	89°/89°/89°/89°	Borderless design, low blue light

Touchscreen

ThinkCentre M90a Gen 2

- Advanced In-cell Touch (AIT), supports 10-point touch
- Non-touch

Notes:

[1] IPS (in-plane switching) technology may refer to IPS, PLS, ADS, AHVA, AAS.

Input Device

Keyboard**

- Lenovo® Calliope Keyboard (USB connector), black
- Lenovo® Calliope Wireless Keyboard (2.4GHz via USB receiver), black
- Lenovo® Traditional Keyboard (USB connector), black
- No keyboard

Mouse**

- Lenovo® Calliope Mouse (USB connector), black
- Lenovo® Calliope Wireless Mouse (2.4GHz via USB receiver), black
- Lenovo® Fingerprint Mouse (USB connector), Windows® Hello support, black (EOL on Jan, 2023)
- No mouse

Mechanical

Buttons

- Microphone mute button
- Power button
- PrivacyGuard on/off button (PrivacyGuard models only)

Form Factor

AIO (23.8 inches)

Dimensions (WxDxH)^[1]

Models	Dimensions
Models (with UltraFlex IV stand, with ODD, without PrivacyGuard, with camera)	Lowest in flat mode: 541 x 312.8 x 227.4 mm (21.3 x 12.3 x 9.0 inches) Highest in vertical mode: 541 x 232.7 x 467.7 mm (21.3 x 9.2 x 18.4 inches)
Models (with UltraFlex IV stand, without ODD, without PrivacyGuard, with camera)	Lowest in flat mode: 541 x 312.8 x 227.4 mm (21.3 x 12.3 x 9.0 inches) Highest in vertical mode: 541 x 232.7 x 467.7 mm (21.3 x 9.2 x 18.4 inches)
Models (with full function monitor stand, with ODD, with PrivacyGuard, with camera)	541 x 200 x 414.2-494.2 mm (21.3 x 7.9 x 16.3-19.5 inches)
Models (with full function monitor stand, with ODD, without PrivacyGuard, with camera)	541 x 200 x 414.2-494.2 mm (21.3 x 7.9 x 16.3-19.5 inches)
Models (with full function monitor stand, without ODD, with PrivacyGuard, with camera)	541 x 200 x 414.2-494.2 mm (21.3 x 7.9 x 16.3-19.5 inches)
Models (with full function monitor stand, without ODD, without PrivacyGuard, with camera)	541 x 200 x 414.2-494.2 mm (21.3 x 7.9 x 16.3-19.5 inches)
Models (without stand, with ODD, with PrivacyGuard, with camera)	541 x 61.3 x 340.5 mm (21.3 x 2.4 x 13.4 inches)
Models (without stand, with ODD, without PrivacyGuard, with camera)	541 x 57.8 x 340.5 mm (21.3 x 2.3 x 13.4 inches)
Models (without stand, without ODD, with PrivacyGuard, with camera)	541 x 49.5 x 340.5 mm (21.3 x 1.9 x 13.4 inches)
Models (without stand, without ODD, without PrivacyGuard, with camera)	541 x 46 x 340.5 mm (21.3 x 1.8 x 13.4 inches)

Weight^[2]

Models	Weight
Models (with UltraFlex IV stand, with ODD, without PrivacyGuard, with camera)	Around 8.58 kg (18.9 lbs)
Models (with UltraFlex IV stand, without ODD, without PrivacyGuard, with camera)	Around 8.26 kg (18.2 lbs)

Models (with full function monitor stand, with ODD, with PrivacyGuard, with camera)	Around 8.71 kg (19.2 lbs)
Models (with full function monitor stand, with ODD, without PrivacyGuard, with camera)	Around 7.84 kg (17.3 lbs)
Models (with full function monitor stand, without ODD, with PrivacyGuard, with camera)	Around 8.39 kg (18.5 lbs)
Models (with full function monitor stand, without ODD, without PrivacyGuard, with camera)	Around 7.51 kg (16.6 lbs)
Models (without stand, with ODD, with PrivacyGuard, with camera)	Around 6.45 kg (14.2 lbs)
Models (without stand, with ODD, without PrivacyGuard, with camera)	Around 5.57 kg (12.3 lbs)
Models (without stand, without ODD, with PrivacyGuard, with camera)	Around 6.13 kg (13.5 lbs)
Models (without stand, without ODD, without PrivacyGuard, with camera)	Around 5.25 kg (11.6 lbs)

Case Color

Black

Bays^[3]

- 2x 2.5" disk bay (2nd 2.5" HDD occupies ODD bay)
- 1x slim ODD bay

Expansion Slots

Two M.2 slots (one for WLAN, one for SSD)

EOU

Toolless cover and stand assembly / removal

Stand**

- UltraFlex IV stand, supports -5° to +70° tilt, up to 164mm lift (flat mode) / up to 115mm lift (vertical mode)
- Full function monitor stand, supports -5° to +30° tilt, up to 80mm lift
- No stand

Mounting

Supports VESA mount 100mm

Others

Supports Smart Power On

Notes:[\[1\]](#) The system dimensions may vary depending on configurations.[\[2\]](#) The system weight is approximate and based on results in Lenovo® lab, which varies depending on the source of component, variance of the distribution of each component, and manufacturing process. It may not be the exact weight for each specific model.[\[3\]](#) 2nd 2.5" HDD needs ODD to HDD bracket kit (optional, come with 2nd 2.5" HDD).**CONNECTIVITY****Network**^[1]**Onboard Ethernet**

Gigabit Ethernet, Intel® Ethernet Connection I219-LM, 1x RJ-45, supports Wake-on-LAN

Optional Ethernet

No optional Ethernet

WLAN + Bluetooth**

- Realtek® RTL8822CE, 802.11ac Dual Band 2x2 Wi-Fi® + Bluetooth® 5.0, M.2 card
- Intel® Wireless-AC 9560, 802.11ac Dual Band 2x2 Wi-Fi® + Bluetooth® 5.1, Intel® vPro® technology support, M.2 card
- Intel® Wireless-AC 9560, 802.11ac Dual Band 2x2 Wi-Fi® + Bluetooth® 5.1, M.2 card
- Intel® Wi-Fi® 6 AX201, 802.11ax 2x2 Wi-Fi® + Bluetooth® 5.1, Intel® vPro® technology support, M.2 Card^[2]
- Intel® Wi-Fi® 6 AX201, 802.11ax 2x2 Wi-Fi® + Bluetooth® 5.1, M.2 Card^[3]
- No WLAN and Bluetooth®

Notes:[\[1\]](#) This system does not support Power Over Ethernet (PoE). If the system is used in a PoE environment, then a Network Isolator is required to prevent possible damage to the system, PoE equipment, or both.[\[2\]](#), [\[3\]](#) Bluetooth® 5.2 is hardware ready but may run at a lower version due to OS limitations.

Ports^[1]

Rear Ports

- 4x USB 3.2 Gen 1
- 1x DisplayPort™
- 1x Ethernet (RJ-45)

Optional Rear Ports**

- 1x HDMI®
- 1x serial

Right Ports

- 1x USB-C® 3.2 Gen 2 (support data transfer and 5V@3A charging)
- 2x USB 3.2 Gen 2
- 1x headphone / microphone combo jack (3.5mm)

Optional Right Ports

1x card reader

Notes:

[1] The transfer speed of following ports will vary and, depending on many factors, such as the processing speed of the host device, file attributes and other factors related to system configuration and your operating environment, will be slower than theoretical speed.

USB 2.0: 480 Mbit/s;

USB 3.2 Gen 1 (SuperSpeed USB 5Gbps, formerly USB 3.0 / USB 3.1 Gen 1): 5 Gbit/s;

USB 3.2 Gen 2 (SuperSpeed USB 10Gbps, formerly USB 3.1 Gen 2): 10 Gbit/s;

USB4® 20Gbps / USB 3.2 Gen 2x2 (SuperSpeed USB 20Gbps): 20 Gbit/s;

USB4® 40Gbps (USB 40Gbps): 40 Gbit/s;

Thunderbolt™ 3/4: 40 Gbit/s.

Monitor Cable

Monitor Cable***

- DP to VGA dongle
- DP to dual DP dongle
- DP to DVI-D dongle
- DP to HDMI® dongle
- No monitor cable

SECURITY & PRIVACY

Security

Security Chip

Discrete TPM 2.0, TCG certified

Physical Locks

Kensington® Security Slot™, 3 x 7 mm

Chassis Intrusion Switch

- Chassis intrusion switch
- No chassis intrusion switch

Fingerprint Reader

- Touch style fingerprint reader on mouse (EOL on Jan, 2023)
- No fingerprint reader

Other Security

(Optional) ThinkShutter camera cover

BIOS Security

- Administrator password
- Power-on password
- Hard disk password
- Boot sequence control
- Boot without keyboard and mouse
- Self-healing BIOS

- Smart USB protection (allows keyboard / mouse only, blocks all storage devices)
- Individual USB port disablement

MANAGEABILITY

System Management

System Management

- Intel® vPro®^[1]
- Non-vPro®

Notes:

[1] Intel® vPro® offers a superset of DASH's defined capabilities.

SERVICE

Warranty^[1]

Base Warranty**

- 1-year limited onsite service
- 3-year limited onsite service
- No base warranty

Notes:

[1] The warranty upgrades may be bundled with some models, please check the "Included upgrade" column in the specific model's configurations. For more service extensions, please go to <https://smartfind.lenovo.com/>. To learn more details of warranty policy, please access <https://pcsupport.lenovo.com/warranty>.

ENVIRONMENTAL

Operating Environment

Temperature

- Operating: 5°C (41°F) to 35°C (95°F)
- Storage: -20°C (-4°F) to 60°C (140°F)

Relative Humidity

Operating: 20% to 80%

Altitude

- Operating: 0 m (0 ft) to 3048 m (10,000 ft)
- Storage: 0 m (0 ft) to 12192 m (40,000 ft)

CERTIFICATIONS

Green Certifications^[1]

Green Certifications

- ENERGY STAR® 8.0
- EPEAT™ Silver Registered
- ErP Lot 3
- RoHS compliant
- TCO Certified 8.0
- TCO edge

Notes:

[1] The items listed under the "Green Certifications" section may not only refer to certification but also registration or self-declaration.

Other Certifications

Other Certifications

- (Optional) TÜV Rheinland® Eye Comfort Certification
- (Optional) TÜV Rheinland® Ultra Low Noise
- TÜV Rheinland® Low Blue Light

Mil-Spec Test

MIL-STD-810H military test passed (Low Pressure [Altitude], High Temperature, Low Temperature, Temperature Shock, Humidity, Sand and Dust, Vibration, Shock, Fungus, Solar Radiation)

- Feature with ** means that only one offering listed under the feature is configured on selected models.
- Feature with *** means that one or more offerings listed under the feature could be configured on selected models.
- Lenovo reserves the right to change specifications or other product information without notice. Lenovo is not responsible for photographic or typographical errors. LENOVO PROVIDES THIS PUBLICATION “AS IS,” WITHOUT WARRANTY OF ANY KIND, EITHER EXPRESS OR IMPLIED, INCLUDING THE IMPLIED WARRANTIES OF MERCHANTABILITY OR FITNESS FOR A PARTICULAR PURPOSE. Some jurisdictions do not allow disclaimer of express or implied warranties in certain transactions, therefore this disclaimer may not apply to you.
- The specifications on this page may not be available in all regions, and may be changed or updated without notice.



intel



intel



intel

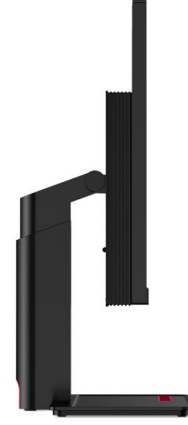

intel



intel



intel
inside

OVERVIEW

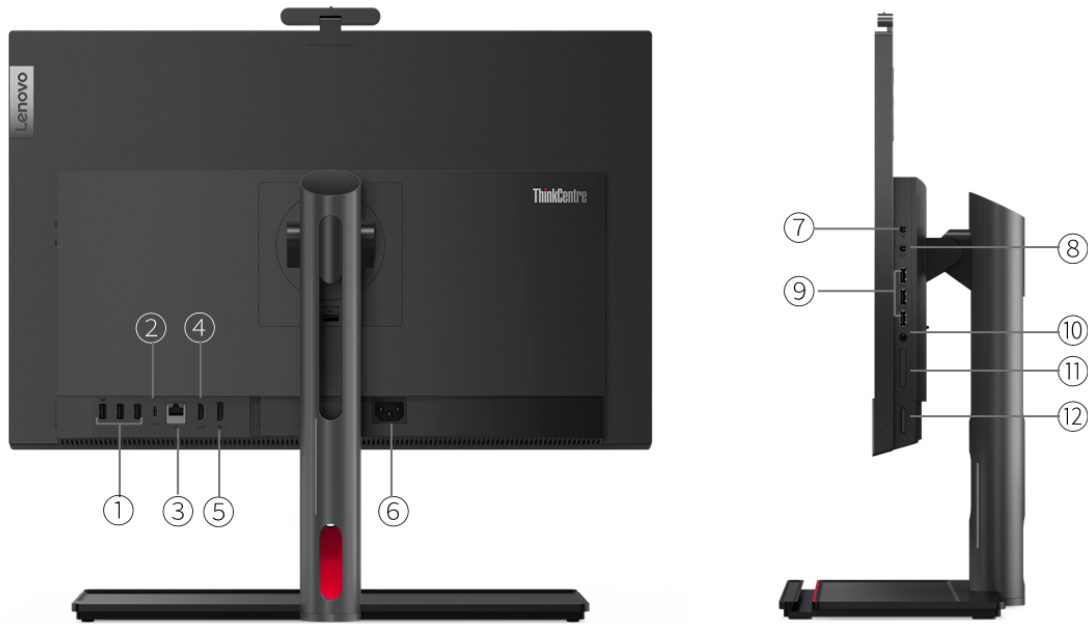

1. 3x USB 3.2 Gen 1	7. Microphone mute button
2. USB-C 3.2 Gen 2 (support data transfer and 15W charging)	8. PC / monitor mode switch
3. Ethernet (RJ-45)	9. 3x USB 3.2 Gen 2
4. HDMI (HDMI in 1.4 / HDMI out 2.1 TMDS combo port)	10. Headphone / microphone combo jack (3.5mm)
5. DisplayPort 1.4	11. Card reader *
6. Power connector	12. Power button

Notes:

- Items with * are only available on selected models

PERFORMANCE

Processor

Processor Family

Intel® Celeron®, Intel® Pentium®, or 12th Generation Intel® Core™ i3 / i5 / i7 / i9 Processor

Processor**

Processor Name	Cores	Threads	Base Frequency	Max Frequency	Cache	Memory Support	Processor Graphics
Celeron® G6900	2	2	3.4GHz	-	4MB	DDR4-3200	Intel® UHD Graphics 710
Pentium® Gold G7400	2	4	3.7GHz	-	6MB	DDR4-3200	Intel® UHD Graphics 710
Core™ i3-12100	4 (4 P-core + 0 E-core)	8	P-core 3.3GHz	P-core 4.3GHz ^[1]	12MB	DDR4-3200	Intel® UHD Graphics 730
Core™ i3-12300	4 (4 P-core + 0 E-core)	8	P-core 3.5GHz	P-core 4.4GHz ^[2]	12MB	DDR4-3200	Intel® UHD Graphics 730
Core™ i5-12400	6 (6 P-core + 0 E-core)	12	P-core 2.5GHz	P-core 4.4GHz ^[3]	18MB	DDR4-3200	Intel® UHD Graphics 730
Core™ i5-12500	6 (6 P-core + 0 E-core)	12	P-core 3.0GHz	P-core 4.6GHz ^[4]	18MB	DDR4-3200	Intel® UHD Graphics 770
Core™ i5-12600	6 (6 P-core + 0 E-core)	12	P-core 3.3GHz	P-core 4.8GHz ^[5]	18MB	DDR4-3200	Intel® UHD Graphics 770
Core™ i7-12700	12 (8 P-core + 4 E-core)	20	P-core 2.1GHz / E-core 1.6GHz	Max Turbo up to 4.9GHz / P-core 4.8GHz / E-core 3.6GHz ^[6]	25MB	DDR4-3200	Intel® UHD Graphics 770
Core™ i9-12900	16 (8 P-core + 8 E-core)	24	P-core 2.4GHz / E-core 1.8GHz	Max Turbo up to 5.1GHz / P-core 5.0GHz / E-core 3.8GHz ^[7]	30MB	DDR4-3200	Intel® UHD Graphics 770

Notes:

[1], [2], [3], [4], [5], [6], [7] Intel® Max Turbo frequency will vary depending on application workload and the hardware and software configurations, see <http://www.intel.com/technology/turboboost/> for more information.

Operating System

Operating System**

- Windows® 11 Pro
- Windows® 11 Home
- Windows® 11 Home Single Language
- Windows® 11 DG Windows® 10 Pro 64
- No preload operating system

Graphics

Graphics***

Graphics	Type	Memory	Connector	Max Resolution	Key Features
Intel® UHD graphics 710	Integrated	Shared	1x HDMI® 2.1 TMDS, 1x DP 1.4	4096x2160@60Hz(HDMI®), 5120x2160@60Hz(DP)	DirectX® 12
Intel® UHD graphics 730	Integrated	Shared	1x HDMI® 2.1 TMDS, 1x DP 1.4	4096x2160@60Hz(HDMI®), 5120x2160@60Hz(DP)	DirectX® 12
Intel® UHD graphics 770	Integrated	Shared	1x HDMI® 2.1 TMDS, 1x DP 1.4	4096x2160@60Hz(HDMI®), 5120x2160@60Hz(DP)	DirectX® 12
NVIDIA® GeForce MX550	Discrete	2GB GDDR6	1x HDMI® 2.1 TMDS, 1x DP 1.4	4096x2160@60Hz(HDMI®), 5120x2160@60Hz(DP)	DirectX® 12

Monitor Support

Monitor Support

Supports up to 3 independent displays via native display and 2 external monitor; supports external monitors via DisplayPort™ and HDMI®; work as standalone monitor via HDMI® (HDMI® in / out combo)

Chipset

Chipset

Intel® Q670 chipset

Memory

Max Memory^[1]

Up to 64GB DDR4-3200

Memory Slots

Two DDR4 SO-DIMM slots, dual-channel capable

Memory Type

DDR4-3200

Notes:

[1] The max memory is based on the test results with current Lenovo® memory offerings.

Storage

Storage Support^{[1][2]}

Up to three drives, 2x 2.5" HDD + 1x M.2 SSD

- 2.5" HDD up to 2TB each
- M.2 SSD up to 1TB

Technical support up to 2 HDDs + 1 SSD, but Lenovo® only offers the models with up to 2 HDDs or 1 SSD + 1 HDD

Storage Type^{***}

Disk Type	Interface	RPM	Security
2.5" SATA HDD	SATA 6Gb/s	5.4K	-
2.5" SATA HDD	SATA 6Gb/s	7.2K	-
M.2 2280 SSD	PCIe® NVMe®, PCIe® 3.0 x4	-	Opal 2.0
M.2 2280 SSD	PCIe® NVMe®, PCIe® 4.0 x4 Performance	-	Opal 2.0
M.2 2280 SSD	PCIe® NVMe®, PCIe® 4.0 x4 Value	-	Opal 2.0

RAID^[3]

RAID 0/1 support for HDDs

Notes:

[1] The max capacity of each disk type is based on the test results with current Lenovo® storage offerings.

[2] 2nd 2.5" HDD occupies ODD bay, and needs ODD to HDD bracket kit (optional, come with 2nd 2.5" HDD).

[3] RAID is not preset by default, user can config RAID 0/1 according to the demand.

Removable Storage

Optical^{**}

- DVD-ROM, SATA connector, slim (9.0mm)
- DVD burner (DVD±RW), SATA connector, slim (9.0mm)
- None

Card Reader

- 3-in-1 card reader (SD, SDHC, SDXC)
- No card reader

Multi-Media

Audio Chip

High Definition (HD) Audio, Realtek® ALC256-NL codec

Speakers

Stereo speakers, 3W x2, Dolby® Atmos®

Microphone

- Dual-microphone array
- No microphone

Camera**

- 5.0-megapixel, IR + RGB hybrid, with ThinkShutter (physical switch on/off), ±20° view angle adjustable, Windows® Hello support
- 5.0-megapixel, with ThinkShutter (physical switch on/off), ±20° view angle adjustable
- No camera

Power Supply

Power Supply**

Power	Type	Efficiency	Key Features
180W	Fixed	90%	100V - 240V, 50-60Hz
230W	Fixed	92%	100V - 240V, 50-60Hz

DESIGN

Display

Display[1]**

Size	Resolution	Touch	Type	Brightness	Surface	Aspect Ratio	Contrast Ratio	Color Gamut	Refresh Rate	Viewing Angle (L/R/U/D)	Key Features
23.8"	FHD (1920x1080)	None	IPS	250nits	Anti-glare	16:9	1000:1	72% NTSC	60Hz	89°/89°/89°/89°	14ms response Time, borderless design, low blue light, flicker free
23.8"	FHD (1920x1080)	Multi-touch	IPS	250nits	Anti-glare	16:9	1000:1	72% NTSC	60Hz	89°/89°/89°/89°	14ms response Time, borderless design, low blue light, flicker free

Touchscreen

- Advanced In-cell Touch (AIT), supports 10-point touch
- Non-touch

Notes:

[1] IPS (in-plane switching) technology may refer to IPS, PLS, ADS, AHVA, AAS.

Input Device

Keyboard**

- Lenovo® Calliope Keyboard (USB connector), black
- Lenovo® Calliope Wireless Keyboard (2.4GHz via USB receiver), black
- Lenovo® Traditional Keyboard (USB connector), black
- No keyboard

Mouse**

- Lenovo® Calliope Mouse (USB connector), black
- Lenovo® Calliope Wireless Mouse (2.4GHz via USB receiver), black
- Lenovo® Fingerprint Mouse (USB connector), Windows® Hello support, black (EOL on Jan, 2023)
- No mouse

Mechanical

Buttons

- Microphone mute button
- Monitor / PC mode switch button
- Power button

Form Factor

AIO (23.8 inches)

Dimensions (WxDxH)^[1]

Models	Dimensions
Models (with UltraFlex V stand, with camera)	Lowest in vertical mode: 539.6 x 216.32 x 387.63 mm (21.24 x 8.52 x 15.26 inches) Highest in vertical mode: 539.6 x 216.32 x 472 mm (21.24 x 8.52 x 18.58 inches)
Models (with UltraFlex V stand, without camera)	Lowest in vertical mode: 539.6 x 216.32 x 367.13 mm (21.24 x 8.52 x 14.45 inches) Highest in vertical mode: 539.6 x 216.32 x 451.5 mm (21.24 x 8.52 x 17.78 inches)
Models (with full function monitor stand, with camera)	Lowest in vertical mode: 539.6 x 217.31 x 394.65 mm (21.24 x 8.56 x 15.54 inches) Highest in vertical mode: 539.6 x 217.31 x 503.66 mm (21.24 x 8.56 x 19.83 inches)
Models (with full function monitor stand, without camera)	Lowest in vertical mode: 539.6 x 217.31 x 374.15 mm (21.24 x 8.56 x 14.73 inches) Highest in vertical mode: 539.6 x 217.31 x 483.16 mm (21.24 x 8.56 x 19.02 inches)

Packaging Dimensions (WxDxH)

- With UltraFlex V Stand: 660 x 238 x 545 mm (25.98 x 9.37 x 21.46 inches)
- With Full Function Monitor Stand: 660 x 238 x 575 mm (25.98 x 9.37 x 22.64 inches)

Weight^[2]

Models	Weight
Models (with UltraFlex V stand, with ODD, with camera)	Around 8.742 kg (19.27 lbs)
Models (with full function monitor stand, with ODD, with camera)	Around 8.235 kg (18.15 lbs)

Packaging Weight

- With Full Function Monitor Stand: 2.084 kg (4.59 lbs), packaging only
- With UltraFlex V Stand: 2.0658 kg (4.55 lbs), packaging only

Case Color

Black

Bays^[3]

- 2x 2.5" disk bay (2nd 2.5" HDD occupies ODD bay)
- 1x slim ODD bay

Expansion Slots

Two M.2 slots (one for WLAN, one for SSD)

EOU

Toolless cover, stand, motherboard shielding, HDD, and memory assembly / removal

Stand**

- UltraFlex V stand, supports -5° to +70° tilt, up to 70°±2° lift (up to 174.02mm lift in flat mode / up to 84.37mm lift in vertical mode)
- Full function monitor stand, supports -5° to +20° tilt, left & right 45° swivel, 90° pivot, up to 110mm lift
- No stand

Mounting

Supports VESA mount 100mm

Others

ThinkCentre M90a Gen 3

- (Optional) Conference Call Base, 3W x4 Harman speakers, 4 digital microphones array with AI noise suppression, Physical button for Teams, USB-C® connector
- (Optional) Smart Human Presence Detection based on Radar Sensor
- Supports Smart Power On

Notes:

[1] The system dimensions may vary depending on configurations.

[2] The system weight is approximate and based on results in Lenovo® lab, which varies depending on the source of component, variance of the distribution of each component, and manufacturing process. It may not be the exact weight for each specific model.

[3] 2nd 2.5" HDD needs ODD to HDD bracket kit (optional, come with 2nd 2.5" HDD).

CONNECTIVITY

Network

Onboard Ethernet

Gigabit Ethernet, Intel® Ethernet Connection I219-LM, 1x RJ-45, supports Wake-on-LAN

Optional Ethernet

No optional Ethernet

WLAN + Bluetooth®**

- MediaTek Wi-Fi® 6 MT7921, 802.11ax 2x2 Wi-Fi® + Bluetooth® 5.3, M.2 Card^[1]
- Realtek® Wi-Fi® 6 RTL8852AE, 802.11ax Dual Band 2x2 Wi-Fi® + Bluetooth® 5.3, M.2 card^[2]
- Intel® Wi-Fi® 6 AX201, 802.11ax 2x2 Wi-Fi® + Bluetooth® 5.2, M.2 Card^[3]
- AMD Wi-Fi® 6E RZ616, 802.11ax 2x2 Wi-Fi® + Bluetooth® 5.1, M.2 Card
- Intel® Wi-Fi® 6E AX211, 802.11ax 2x2 Wi-Fi® + Bluetooth® 5.3, Intel® vPro® technology support, M.2 Card^[4]
- No WLAN and Bluetooth®

Notes:

[1], [2], [4] Bluetooth® 5.3 requires Windows® 11.

[3] Bluetooth® 5.2 requires Windows® 11.

Ports^[1]

Rear Ports

- 1x USB-C® 3.2 Gen 2 (support data transfer and 15W charging)
- 3x USB 3.2 Gen 1
- 1x HDMI® (HDMI® in 1.4 / HDMI® out 2.1 TMDS combo port)
- 1x DisplayPort™ 1.4
- 1x Ethernet (RJ-45)

Optional Rear Ports

1x serial

Right Ports

- 3x USB 3.2 Gen 2
- 1x headphone / microphone combo jack (3.5mm)

Optional Right Ports

1x card reader

Notes:

[1] The transfer speed of following ports will vary and, depending on many factors, such as the processing speed of the host device, file attributes and other factors related to system configuration and your operating environment, will be slower than theoretical speed.

USB 2.0: 480 Mbit/s;

USB 3.2 Gen 1 (SuperSpeed USB 5Gbps, formerly USB 3.0 / USB 3.1 Gen 1): 5 Gbit/s;

USB 3.2 Gen 2 (SuperSpeed USB 10Gbps, formerly USB 3.1 Gen 2): 10 Gbit/s;

USB4® 20Gbps / USB 3.2 Gen 2x2 (SuperSpeed USB 20Gbps): 20 Gbit/s;

USB4® 40Gbps (USB 40Gbps): 40 Gbit/s;

Thunderbolt™ 3/4: 40 Gbit/s.

Monitor Cable

Monitor Cable**

- HDMI® to DVI dongle
- HDMI® to VGA dongle
- DP to VGA dongle
- DP to dual DP dongle
- DP to DVI-D dongle
- DP to HDMI® dongle
- No monitor cable

SECURITY & PRIVACY**Security****Security Chip**

Discrete TPM 2.0, TCG certified

Physical Locks

Kensington® Security Slot™, 3 x 7 mm

Chassis Intrusion Switch

- Chassis intrusion switch
- No chassis intrusion switch

Fingerprint Reader

- Touch style fingerprint reader on mouse (EOL on Jan, 2023)
- No fingerprint reader

Other Security

(Optional) ThinkShutter camera cover

BIOS Security

- Administrator password
- Power-on password
- Hard disk password
- Boot sequence control
- Boot without keyboard and mouse
- Self-healing BIOS
- Smart USB protection (allows keyboard / mouse only, blocks all storage devices)
- Individual USB port disablement

MANAGEABILITY**System Management****System Management**

- Intel® vPro® Enterprise^[1]
- Non-vPro®

Notes:

[1] Intel® vPro® offers a superset of DASH's defined capabilities.

SERVICE**Warranty^[1]****Base Warranty**

- 1-year limited onsite service
- 3-year limited onsite service
- No base warranty

Notes:

[1] The warranty upgrades may be bundled with some models, please check the "Included upgrade" column in the specific model's configurations. For more service extensions, please go to <https://smartfind.lenovo.com/>. To learn more details of

warranty policy, please access <https://pcsupport.lenovo.com/warranty>.

ENVIRONMENTAL

Operating Environment

Temperature

- Operating: 5°C (41°F) to 35°C (95°F)
- Storage: -20°C (-4°F) to 60°C (140°F)

Relative Humidity

Operating: 20% to 80%

Altitude

- Operating: 0 m (0 ft) to 3048 m (10,000 ft)
- Storage: 0 m (0 ft) to 12192 m (40,000 ft)

CERTIFICATIONS

Green Certifications^[1]

Green Certifications

- (Optional) ENERGY STAR® 8.0
- (Optional) EPEAT™ Gold Registered^[2]
- ErP Lot 3
- RoHS compliant
- TCO Certified 9.0
- TCO edge

Notes:

[1] The items listed under the "Green Certifications" section may not only refer to certification but also registration or self-declaration.

[2] EPEAT™ is registered where applicable, please see epeat.net for registration status by country.

Other Certifications

Other Certifications

- (Optional) TÜV Rheinland® Ultra Low Noise
- TÜV Rheinland® Flicker Free
- TÜV Rheinland® Low Blue Light
- UL Anti-dust

Mil-Spec Test

MIL-STD-810H military test passed (Low Pressure [Altitude], High Temperature, Low Temperature, Temperature Shock, Humidity, Sand and Dust, Vibration, Shock, Fungus, Solar Radiation, Contamination by Fluids, Salt Fog)

- Feature with ** means that only one offering listed under the feature is configured on selected models.
- Feature with *** means that one or more offerings listed under the feature could be configured on selected models.
- Lenovo reserves the right to change specifications or other product information without notice. Lenovo is not responsible for photographic or typographical errors. LENOVO PROVIDES THIS PUBLICATION "AS IS," WITHOUT WARRANTY OF ANY KIND, EITHER EXPRESS OR IMPLIED, INCLUDING THE IMPLIED WARRANTIES OF MERCHANTABILITY OR FITNESS FOR A PARTICULAR PURPOSE. Some jurisdictions do not allow disclaimer of express or implied warranties in certain transactions, therefore this disclaimer may not apply to you.
- The specifications on this page may not be available in all regions, and may be changed or updated without notice.





OVERVIEW

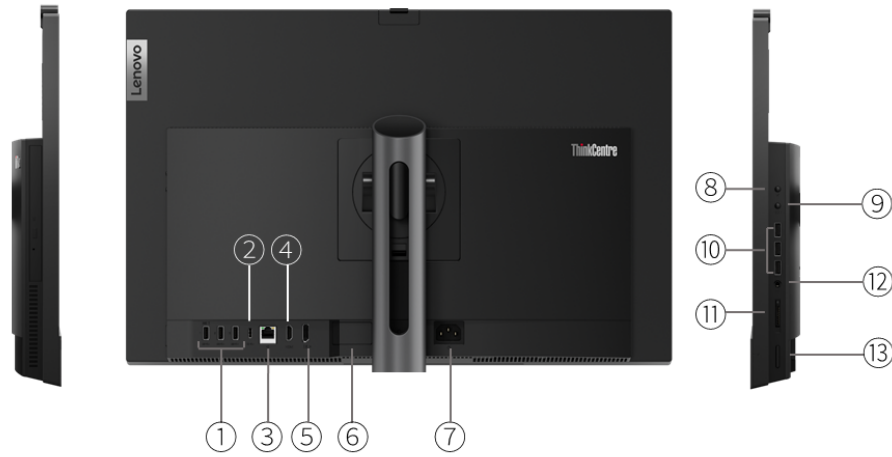

1. 3x USB-A (USB 5Gbps)	8. Microphone mute button
2. USB-C (USB 10Gbps), with 15W charging	9. PC / monitor mode switch
3. Ethernet (RJ-45)	10. 3x USB-A (USB 10Gbps)
4. HDMI (HDMI in 1.4 / HDMI out 2.1 TMDS combo)	11. Headphone / microphone combo jack (3.5mm)
5. DisplayPort 1.4	12. Card reader *
6. Serial *	13. Power button
7. Power connector	

Notes:

- Items with * are only available on selected models

PERFORMANCE

Processor

Processor Family

13th / 14th Generation Intel® Core™ i3 / i5 / i7 Processor

Processor**

Processor Name	Cores	Threads	Base Frequency	Max Frequency	Cache	Processor Graphics
Core™ i3-13100	4 (4 P-core + 0 E-core)	8	P-core 3.4GHz	P-core 4.5GHz	12MB	Intel® UHD Graphics 730
Core™ i5-13400	10 (6 P-core + 4 E-core)	16	P-core 2.5GHz / E-core 1.8GHz	P-core 4.6GHz / E-core 3.3GHz	20MB	Intel® UHD Graphics 730
Core™ i5-13500	14 (6 P-core + 8 E-core)	20	P-core 2.5GHz / E-core 1.8GHz	P-core 4.8GHz / E-core 3.5GHz	24MB	Intel® UHD Graphics 770
Core™ i7-13700	16 (8 P-core + 8 E-core)	24	P-core 2.1GHz / E-core 1.5GHz	Max Turbo up to 5.2GHz / P-core 5.1GHz / E-core 4.1GHz	30MB	Intel® UHD Graphics 770
Core™ i3-14100	4 (4 P-core + 0 E-core)	8	P-core 3.5GHz	P-core 4.7GHz	12MB	Intel® UHD Graphics 730
Core™ i5-14400	10 (6 P-core + 4 E-core)	16	P-core 2.5GHz / E-core 1.8GHz	P-core 4.7GHz / E-core 3.5GHz	20MB	Intel® UHD Graphics 730
Core™ i5-14500	14 (6 P-core + 8 E-core)	20	P-core 2.6GHz / E-core 1.9GHz	P-core 5.0GHz / E-core 3.7GHz	24MB	Intel® UHD Graphics 770
Core™ i7-14700	20 (8 P-core + 12 E-core)	28	P-core 2.1GHz / E-core 1.5GHz	Max Turbo up to 5.4GHz / P-core 5.3GHz / E-core 4.2GHz	33MB	Intel® UHD Graphics 770

Operating System

Operating System**

- Windows® 11 Pro
- Windows® 11 Home
- Windows® 11 Home Single Language
- Windows® 11 DG Windows® 10 Pro 64
- No preload operating system

Graphics

Graphics**

Graphics	Type	Memory	Connector	Max Resolution	Key Features
Intel® UHD graphics 730	Integrated	Shared	1x HDMI® 2.1 TMDS, 1x DP 1.4	4096x2160@60Hz(HDMI®), 4096x2160@60Hz(DP)	DirectX® 12
Intel® UHD graphics 770	Integrated	Shared	1x HDMI® 2.1 TMDS, 1x DP 1.4	4096x2160@60Hz(HDMI®), 4096x2160@60Hz(DP)	DirectX® 12
NVIDIA® GeForce MX570A	Discrete	4GB GDDR6	1x HDMI® 2.1 TMDS, 1x DP 1.4	4096x2160@60Hz(HDMI®), 4096x2160@60Hz(DP)	DirectX® 12

Monitor Support

Monitor Support

Supports up to 3 independent displays via native display and 2 external monitor; supports external monitors via DisplayPort™ and HDMI®; work as standalone monitor via HDMI® (HDMI® in / out combo)

Chipset

Chipset

Intel® Q670 chipset

Memory

ThinkCentre M90a Gen 5

Max Memory^[1]

- Models with Core™ i3/i5: Up to 64GB DDR5-4800
- Models with Core™ i7: Up to 64GB DDR5-5200

Memory Slots

Two DDR5 SO-DIMM slots, dual-channel capable

Memory Type^{**[2]}

- DDR5-4800
- DDR5-5200
- DDR5-5600

Memory Protection

Non-ECC

Notes:

[1] The max memory is based on the test results with current Lenovo® memory offerings.

[2] Installed memory is actually 5600MHz, but may run at 4800MHz, 5200MHz, or 5600MHz depending on the memory support capability of processor.

Storage

Storage Support^[1]

- Models with Intel® UHD graphics:
Up to two drives, 2x M.2 SSD
 - M.2 SSD up to 2TB each
- Models with NVIDIA® GeForce MX570A:
Up to one drives, 1x M.2 SSD
 - M.2 SSD up to 2TB each

Storage Type

Disk Type	Interface	Security
M.2 2280 SSD	PCIe® NVMe®, PCIe® 4.0 x4	Opal 2.0

RAID^[2]

- RAID 0/1 support for SSDs
- No support

Notes:

[1] The max capacity of each disk type is based on the test results with current Lenovo® storage offerings.

[2] Only available for models with integrated graphics

Removable Storage

Optical^{**}

- DVD-ROM, SATA connector, slim (9.0mm)
- DVD burner (DVD±RW), SATA connector, slim (9.0mm)
- None

Card Reader

- 3-in-1 card reader (SD, SDHC, SDXC)
- No card reader

Multi-Media

Audio Chip

High Definition (HD) Audio, Realtek® ALC233NL-VB2-CG codec

Speakers

Stereo speakers, 3W x2, Dolby® Atmos®

Microphone

- Dual-microphone array
- No microphone

Camera^{**}

ThinkCentre M90a Gen 5

- 5.0-megapixel, IR + RGB hybrid, with ThinkShutter (physical switch on/off) and Human Presence Detection (Radar Sensor), ±20° view angle adjustable, Windows® Hello support
- 5.0-megapixel, IR + RGB hybrid, with ThinkShutter (physical switch on/off), ±20° view angle adjustable, Windows® Hello support
- 5.0-megapixel, with ThinkShutter (physical switch on/off)
- No camera

Power Supply

Power Supply**

Power	Type	Efficiency	Key Features
180W	Fixed	90%	100V - 240V, 50-60Hz
230W	Fixed	92%	100V - 240V, 50-60Hz

DESIGN

Display

Display**[1]

Size	Resolution	Touch	Type	Brightness	Surface	Aspect Ratio	Contrast Ratio	Color Gamut	Refresh Rate	Viewing Angle (L/R/U/D)	Key Features
23.8"	FHD (1920x1080)	None	IPS	250nits	Anti-glare	16:9	1300:1	99% sRGB	60Hz	89°/89°/89°/89°	14ms response Time, borderless design, TÜV Rheinland® Low Blue Light (Hardware Solution), TÜV Rheinland® Flicker Free, Eyesafe® Certified 2.0
23.8"	FHD (1920x1080)	Multi-touch	IPS	250nits	Anti-glare	16:9	1000:1	72% NTSC	60Hz	89°/89°/89°/89°	14ms response Time, borderless design, TÜV Rheinland® Low Blue Light (Software Solution), TÜV Rheinland® Flicker Free

Touchscreen

- Advanced In-cell Touch (AIT), supports 10-point touch
- Non-touch

Notes:

[1] IPS (in-plane switching) technology may refer to IPS, PLS, ADS, AHVA, AAS.

Input Device

Keyboard**

- EOS Wireless Keyboard, black
- Lenovo® Calliope Keyboard (USB connector), black

- Lenovo® Traditional Keyboard (USB connector), black
- No keyboard

Mouse**

- Lenovo® Calliope Mouse (USB connector), black
- EOS Wireless Mouse, Black
- No mouse

Mechanical

Buttons

- Microphone mute button
- Monitor / PC mode switch button
- Power button

Form Factor

AIO (23.8 inches)

Dimensions (WxDxH)^[1]

Models	Dimensions
Models (with UltraFlex V stand, with camera)	Lowest in flat mode: 539.6 x 344.19 x 227.54 mm (21.24 x 13.55 x 8.96 inches) Highest in vertical mode: 539.6 x 252.60 x 472.00 mm (21.24 x 9.94 x 18.58 inches)
Models (with UltraFlex V stand, without camera)	Lowest in flat mode: 539.6 x 341.42 x 219.50 mm (21.24 x 13.44 x 8.64 inches) Highest in vertical mode: 539.6 x 252.60 x 451.51 mm (21.24 x 9.94 x 17.78 inches)
Models (with full function monitor stand, with camera)	539.6 x 217.31 x 393.66-501.85 mm (21.24 x 8.56 x 15.50-19.76 inches)
Models (with full function monitor stand, without camera)	539.6 x 217.31 x 374.15-483.16 mm (21.24 x 8.56 x 14.73-19.02 inches)
Models (with tilt only stand, with camera)	539.6 x 213.38 x 453.39 mm (21.24 x 8.40 x 17.85 inches)
Models (with tilt only stand, without camera)	539.6 x 213.38 x 434.39 mm (21.24 x 8.40 x 17.10 inches)
Models (without stand, with camera)	539.6 x 49.6 x 371 mm (21.24 x 1.95 x 14.61 inches)
Models (without stand, without camera)	539.6 x 49.6 x 352 mm (21.24 x 1.95 x 13.86 inches)

Packaging Dimensions (WxDxH)**

- Models (with UltraFlex V stand): 690 x 545 x 238 mm (27.17 x 21.46 x 9.37 inches)
- Models (with full function monitor stand): 660 x 575 x 228 mm (25.98 x 22.64 x 8.98 inches)
- Models (with tilt only stand): 660 x 550 x 216 mm (25.98 x 21.65 x 8.50 inches)

Weight^[2]

Models	Weight
Models (with UltraFlex V stand)	Around 7.83 kg (17.3 lbs)
Models (with full function monitor stand)	Around 8.13 kg (17.9 lbs)
Models (with tilt only stand)	Around 7.61 kg (16.8 lbs)
Models (without stand)	Around 5.53 kg (12.2 lbs)

Packaging Weight

- Models (with UltraFlex V stand): 2.94 kg (6.5 lbs), packaging only
- Models (with full function monitor stand): 2.96 kg (6.5 lbs), packaging only
- Models (with tilt only stand): 2.73 kg (6.0 lbs), packaging only

Case Color

Black

Bays

- 1x 2.5" disk bay (optional, only available via special bid)
- 1x slim ODD bay

Expansion Slots

- Models with NVIDIA® GeForce MX570A: Two M.2 slots (one for WLAN, one for SSD)
- Models with Intel® UHD graphics: Three M.2 slots (one for WLAN, two for SSD)

EOU

Toolless cover, stand, motherboard shielding, and memory assembly / removal

Stand**

- UltraFlex V stand, supports -5° to +70° tilt, up to 70°±2° lift (up to 179.96mm lift in flat mode / up to 84.37mm lift in vertical mode)
- Full function monitor stand, supports -5° to +20° tilt, left & right 45° swivel, 90° pivot, up to 110mm lift
- Tilt only stand, supports -5° to +20° tilt.
- No stand

Mounting

Supports VESA mount 100mm

Others

Supports Smart Power On

Notes:

[1] The system dimensions may vary depending on configurations.

[2] The system weight is approximate and based on results in Lenovo® lab, which varies depending on the source of component, variance of the distribution of each component, and manufacturing process. It may not be the exact weight for each specific model.

CONNECTIVITY

Network

Onboard Ethernet

Gigabit Ethernet, Intel® Ethernet Connection I219-LM, 1x RJ-45, supports Wake-on-LAN

Optional Ethernet

No optional Ethernet

WLAN + Bluetooth®**

- Realtek® Wi-Fi® 6 RTL8852BE, 802.11ax Dual Band 2x2 Wi-Fi® + Bluetooth® 5.3, M.2 card^[1]
- Intel® Wi-Fi® 6 AX201, 802.11ax 2x2 Wi-Fi® + Bluetooth® 5.2, M.2 Card^[2]
- Intel® Wi-Fi® 6E AX211, 802.11ax 2x2 Wi-Fi® + Bluetooth® 5.3, Intel® vPro® technology support, M.2 Card^[3]
- No WLAN and Bluetooth®

Notes:

[1], [3] Bluetooth® 5.3 requires Windows® 11.

[2] Bluetooth® 5.2 requires Windows® 11.

Ports^[1]

Rear Ports

- 1x USB-C® (USB 10Gbps / USB 3.2 Gen 2), with data transfer and 15W charging
- 3x USB-A (USB 5Gbps / USB 3.2 Gen 1)
- 1x HDMI® (HDMI® in 1.4 / HDMI® out 2.1 TMDS combo port)
- 1x DisplayPort™ 1.4
- 1x Ethernet (RJ-45)

Optional Rear Ports

1x serial

Right Ports

- 3x USB-A (USB 10Gbps / USB 3.2 Gen 2)
- 1x headphone / microphone combo jack (3.5mm)

Optional Right Ports

1x card reader

Notes:

[1] The transfer speed of following ports will vary and, depending on many factors, such as the processing speed of the

host device, file attributes and other factors related to system configuration and your operating environment, will be slower than theoretical speed.

USB 2.0: 480 Mbit/s;

USB 3.2 Gen 1 (SuperSpeed USB 5Gbps, formerly USB 3.0 / USB 3.1 Gen 1): 5 Gbit/s;

USB 3.2 Gen 2 (SuperSpeed USB 10Gbps, formerly USB 3.1 Gen 2): 10 Gbit/s;

USB4® 20Gbps / USB 3.2 Gen 2x2 (SuperSpeed USB 20Gbps): 20 Gbit/s;

USB4® 40Gbps (USB 40Gbps): 40 Gbit/s;

Thunderbolt™ 3/4: 40 Gbit/s.

Monitor Cable

Monitor Cable**

- HDMI® to DVI dongle
- HDMI® to VGA dongle
- DP to VGA dongle
- DP to dual DP dongle
- DP to DVI-D dongle
- DP to HDMI® dongle
- No monitor cable

SECURITY & PRIVACY

Security

Security Chip

Discrete TPM 2.0, TCG certified, FIPS 140-2 certified

Physical Locks

Kensington® Security Slot™, 3 x 7 mm

Chassis Intrusion Switch

- Chassis intrusion switch
- No chassis intrusion switch

Fingerprint Reader

No fingerprint reader

Other Security

- (Optional) Smart Human Presence Detection (Camera with Radar Sensor)
- (Optional) ThinkShutter camera cover

BIOS Security

- Administrator password
- Power-on password
- Hard disk password
- Boot sequence control
- Boot without keyboard and mouse
- Self-healing BIOS
- Smart USB protection (allows keyboard / mouse only, blocks all storage devices)
- Individual USB port disablement

MANAGEABILITY

System Management

System Management^[1]

- Intel® vPro® Enterprise
- Non-vPro®

Notes:

[1] Intel® vPro® offers a superset of DASH's defined capabilities.

SERVICE

Warranty^[1]

Base Warranty**

- 1-year limited onsite service
- 3-year limited onsite service
- No base warranty

Notes:

[1] The warranty upgrades may be bundled with some models, please check the "Included upgrade" column in the specific model's configurations. For more service extensions, please go to <https://smartfind.lenovo.com/>. To learn more details of warranty policy, please access <https://pcsupport.lenovo.com/warranty>.

ENVIRONMENTAL

Operating Environment

Temperature

- Operating: 5°C (41°F) to 35°C (95°F)
- Storage: -20°C (-4°F) to 60°C (140°F)

Relative Humidity

Operating: 20% to 80%

Altitude

- Operating: 0 m (0 ft) to 3048 m (10,000 ft)
- Storage: 0 m (0 ft) to 12192 m (40,000 ft)

CERTIFICATIONS

Green Certifications^[1]

Green Certifications

- (Optional) ENERGY STAR® 8.0
- (Optional) EPEAT™ Gold Registered
- ErP Lot 3
- GREENGUARD®
- RoHS compliant
- TCO Certified 9.0
- TCO edge

Notes:

[1] The items listed under the "Green Certifications" section may not only refer to certification but also registration or self-declaration.

Other Certifications

Other Certifications

- (Optional) TÜV Rheinland® Low Blue Light (Hardware Solution)
- (Optional) TÜV Rheinland® Low Blue Light (Software Solution)
- (Optional) TÜV Rheinland® Ultra Low Noise
- Eyesafe® Certified 2.0
- TÜV Rheinland® Flicker Free
- UL Anti-dust

Mil-Spec Test

MIL-STD-810H military test passed (Low Pressure [Altitude], High Temperature, Low Temperature, Temperature Shock, Humidity, Sand and Dust, Vibration, Shock, Fungus, Solar Radiation, Contamination by Fluids, Salt Fog)

- Feature with ** means that only one offering listed under the feature is configured on selected models.
- Lenovo reserves the right to change specifications or other product information without notice. Lenovo is not

responsible for photographic or typographical errors. LENOVO PROVIDES THIS PUBLICATION “AS IS,” WITHOUT WARRANTY OF ANY KIND, EITHER EXPRESS OR IMPLIED, INCLUDING THE IMPLIED WARRANTIES OF MERCHANTABILITY OR FITNESS FOR A PARTICULAR PURPOSE. Some jurisdictions do not allow disclaimer of express or implied warranties in certain transactions, therefore this disclaimer may not apply to you.

- The specifications on this page may not be available in all regions, and may be changed or updated without notice.



OVERVIEW

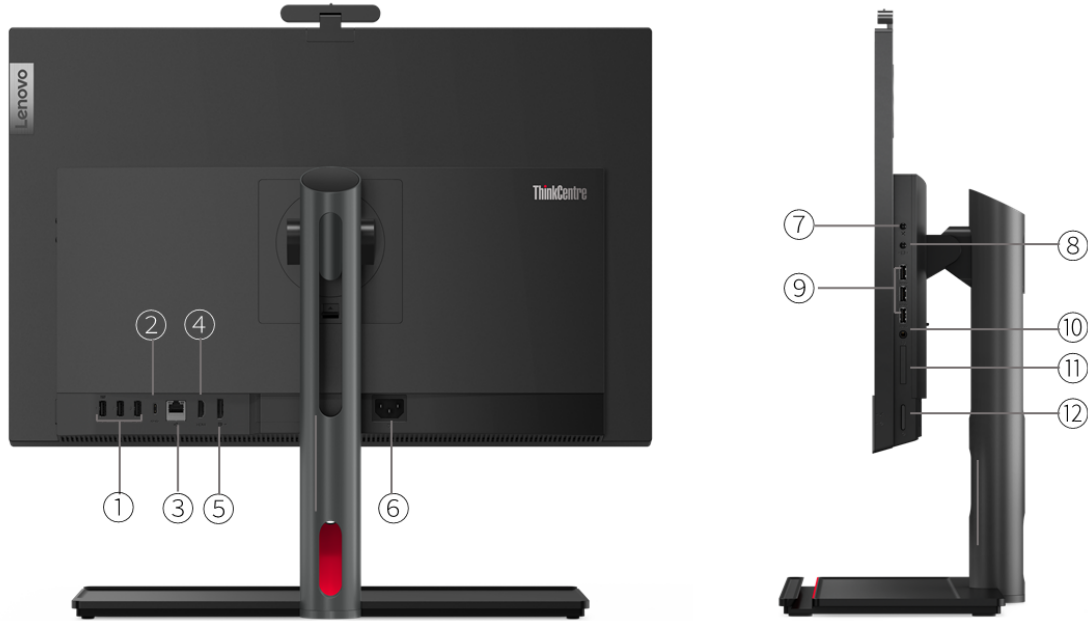

1. 3x USB 3.2 Gen 1	7. Microphone mute button
2. USB-C 3.2 Gen 2 (data transfer, 15W charging)	8. PC / monitor mode switch
3. Ethernet (RJ-45)	9. 3x USB 3.2 Gen 2
4. HDMI in/out combo port	10. Headphone / microphone combo jack (3.5mm)
5. DisplayPort 1.4	11. Card reader *
6. Power connector	12. Power button

Notes:

- Items with * are only available on selected models

PERFORMANCE

Processor

Processor Family

Intel® Celeron®, Intel® Pentium®, or 12th Generation Intel® Core™ i3 / i5 / i7 / i9 Processor

Processor**

Processor Name	Cores	Threads	Base Frequency	Max Frequency	Cache	Memory Support	Processor Graphics
Celeron® G6900	2	2	3.4GHz	-	4MB	DDR5-4800	Intel® UHD Graphics 710
Pentium® Gold G7400	2	4	3.7GHz	-	6MB	DDR5-4800	Intel® UHD Graphics 710
Core™ i3-12100	4 (4 P-core + 0 E-core)	8	P-core 3.3GHz	P-core 4.3GHz ^[1]	12MB	DDR5-4800	Intel® UHD Graphics 730
Core™ i3-12300	4 (4 P-core + 0 E-core)	8	P-core 3.5GHz	P-core 4.4GHz ^[2]	12MB	DDR5-4800	Intel® UHD Graphics 730
Core™ i5-12400	6 (6 P-core + 0 E-core)	12	P-core 2.5GHz	P-core 4.4GHz ^[3]	18MB	DDR5-4800	Intel® UHD Graphics 730
Core™ i5-12500	6 (6 P-core + 0 E-core)	12	P-core 3.0GHz	P-core 4.6GHz ^[4]	18MB	DDR5-4800	Intel® UHD Graphics 770
Core™ i5-12600	6 (6 P-core + 0 E-core)	12	P-core 3.3GHz	P-core 4.8GHz ^[5]	18MB	DDR5-4800	Intel® UHD Graphics 770
Core™ i7-12700	12 (8 P-core + 4 E-core)	20	P-core 2.1GHz / E-core 1.6GHz	Max Turbo up to 4.9GHz / P-core 4.8GHz / E-core 3.6GHz ^[6]	25MB	DDR5-4800	Intel® UHD Graphics 770
Core™ i9-12900	16 (8 P-core + 8 E-core)	24	P-core 2.4GHz / E-core 1.8GHz	Max Turbo up to 5.1GHz / P-core 5.0GHz / E-core 3.8GHz ^[7]	30MB	DDR5-4800	Intel® UHD Graphics 770

Notes:

[1], [2], [3], [4], [5], [6], [7] Intel® Max Turbo frequency will vary depending on application workload and the hardware and software configurations, see <http://www.intel.com/technology/turboboost/> for more information.

Operating System

Operating System**

- Windows® 11 Pro
- Windows® 11 Home
- Windows® 11 Home Single Language
- Windows® 11 DG Windows® 10 Pro 64
- No preload operating system

Graphics

Graphics

Graphics	Type	Memory	Connector	Max Resolution	Key Features
Intel® UHD graphics 710	Integrated	Shared	1x HDMI® 2.1 TMDS, 1x DP 1.4	4096x2160@60Hz(HDMI®), 5120x2160@60Hz(DP)	DirectX® 12
Intel® UHD graphics 730	Integrated	Shared	1x HDMI® 2.1 TMDS, 1x DP 1.4	4096x2160@60Hz(HDMI®), 5120x2160@60Hz(DP)	DirectX® 12
Intel® UHD graphics 770	Integrated	Shared	1x HDMI® 2.1 TMDS, 1x DP 1.4	4096x2160@60Hz(HDMI®), 5120x2160@60Hz(DP)	DirectX® 12
NVIDIA® GeForce MX550	Discrete	2GB GDDR6	1x HDMI® 2.1 TMDS, 1x DP 1.4	4096x2160@60Hz(HDMI®), 5120x2160@60Hz(DP)	DirectX® 12

Monitor Support

Monitor Support

Supports up to 3 independent displays via native display and 2 external monitor; supports external monitors via DisplayPort™ and HDMI®; work as standalone monitor via HDMI® (HDMI® in / out combo)

Chipset

Chipset

Intel® Q670 chipset

Memory

Max Memory^[1]

Up to 64GB DDR5-4800

Memory Slots

Two DDR5 SO-DIMM slots, dual-channel capable

Memory Type

DDR5-4800

Notes:

[1] The max memory is based on the test results with current Lenovo® memory offerings.

Storage

Storage Support^{[1][2]}

Up to three drives, 2x 2.5" HDD + 1x M.2 SSD

- 2.5" HDD up to 2TB each
- M.2 SSD up to 1TB

Technical support up to 2 HDDs + 1 SSD, but Lenovo® only offers the models with up to 2 HDDs or 1 SSD + 1 HDD

Storage Type^{***}

Disk Type	Interface	RPM	Security
2.5" SATA HDD	SATA 6Gb/s	5.4K	-
2.5" SATA HDD	SATA 6Gb/s	7.2K	-
M.2 2280 SSD	PCIe® NVMe®, PCIe® 3.0 x4	-	Opal 2.0
M.2 2280 SSD	PCIe® NVMe®, PCIe® 4.0 x4 Performance	-	Opal 2.0
M.2 2280 SSD	PCIe® NVMe®, PCIe® 4.0 x4 Value	-	Opal 2.0

RAID^[3]

RAID 0/1 support for HDDs

Notes:

[1] The max capacity of each disk type is based on the test results with current Lenovo® storage offerings.

[2] 2nd 2.5" HDD occupies ODD bay, and needs ODD to HDD bracket kit (optional, come with 2nd 2.5" HDD).

[3] RAID is not preset by default, user can config RAID 0/1 according to the demand.

Removable Storage

Optical^{**}

- DVD-ROM, SATA connector, slim (9.0mm)
- DVD burner (DVD±RW), SATA connector, slim (9.0mm)
- None

Card Reader

- 3-in-1 card reader (SD, SDHC, SDXC)
- No card reader

Multi-Media

Audio Chip

High Definition (HD) Audio, Realtek® ALC256-NL codec

ThinkCentre M90a Pro Gen 3

Speakers

Stereo speakers, 3W x2, Dolby® Atmos®

Microphone

- Dual-microphone array
- No microphone

Camera**

- 5.0-megapixel, IR + RGB hybrid, with ThinkShutter (physical switch on/off), ±20° view angle adjustable, Windows® Hello support
- 5.0-megapixel, with ThinkShutter (physical switch on/off), ±20° view angle adjustable
- No camera

Power Supply

Power Supply**

Power	Type	Efficiency	Key Features
180W	Fixed	90%	100V - 240V, 50-60Hz
230W	Fixed	92%	100V - 240V, 50-60Hz

DESIGN

Display

Display^[1]

Size	Resolution	Touch	Type	Brightness	Surface	Aspect Ratio	Contrast Ratio	Color Gamut	Refresh Rate	Viewing Angle (L/R/U/D)	Key Features
23.8"	QHD (2560x1440)	None	IPS	300nits	Anti-glare	16:9	1000:1	99% sRGB	60Hz	89°/89°/89°/89°	14ms response Time, borderless design, low blue light (Hardware Solution), flicker free, Eye Safe

Touchscreen

Non-touch

Notes:

[1] IPS (in-plane switching) technology may refer to IPS, PLS, ADS, AHVA, AAS.

Input Device

Keyboard**

- Lenovo® Calliope Keyboard (USB connector), black
- Lenovo® Calliope Wireless Keyboard (2.4GHz via USB receiver), black
- Lenovo® Traditional Keyboard (USB connector), black
- No keyboard

Mouse**

- Lenovo® Calliope Mouse (USB connector), black
- Lenovo® Calliope Wireless Mouse (2.4GHz via USB receiver), black
- Lenovo® Fingerprint Mouse (USB connector), Windows® Hello support, black (EOL on Jan, 2023)
- No mouse

Mechanical

Buttons

- Microphone mute button
- Monitor / PC mode switch button

- Power button

Form Factor

AIO (23.8 inches)

Dimensions (WxDxH)^[1]

Models	Dimensions
Models (with UltraFlex V stand, with camera)	Lowest in vertical mode: 539.6 x 216.32 x 387.63 mm (21.24 x 8.52 x 15.26 inches) Highest in vertical mode: 539.6 x 216.32 x 472 mm (21.24 x 8.52 x 18.58 inches)
Models (with UltraFlex V stand, without camera)	Lowest in vertical mode: 539.6 x 216.32 x 367.13 mm (21.24 x 8.52 x 14.45 inches) Highest in vertical mode: 539.6 x 216.32 x 451.5 mm (21.24 x 8.52 x 17.78 inches)
Models (with full function monitor stand, with camera)	Lowest in vertical mode: 539.6 x 217.31 x 394.65 mm (21.24 x 8.56 x 15.54 inches) Highest in vertical mode: 539.6 x 217.31 x 503.66 mm (21.24 x 8.56 x 19.83 inches)
Models (with full function monitor stand, without camera)	Lowest in vertical mode: 539.6 x 217.31 x 374.15 mm (21.24 x 8.56 x 14.73 inches) Highest in vertical mode: 539.6 x 217.31 x 483.16 mm (21.24 x 8.56 x 19.02 inches)

Packaging Dimensions (WxDxH)

- With UltraFlex V Stand: 660 x 238 x 545 mm (25.98 x 9.37 x 21.46 inches)
- With Full Function Monitor Stand: 660 x 238 x 575 mm (25.98 x 9.37 x 22.64 inches)

Weight^[2]

Models	Weight
Models (with UltraFlex V stand, with ODD, with camera)	Around 8.742 kg (19.27 lbs)
Models (with full function monitor stand, with ODD, with camera)	Around 8.235 kg (18.15 lbs)

Packaging Weight

- With Full Function Monitor Stand: 2.084 kg (4.59 lbs), packaging only
- With UltraFlex V Stand: 2.0658 kg (4.55 lbs), packaging only

Case Color

Black

Bays^[3]

- 2x 2.5" disk bay (2nd 2.5" HDD occupies ODD bay)
- 1x slim ODD bay

Expansion Slots

Two M.2 slots (one for WLAN, one for SSD)

EOU

Toolless cover, stand, motherboard shielding, HDD, and memory assembly / removal

Stand**

- UltraFlex V stand, supports -5° to +70° tilt, up to 70°±2° lift (up to 174.02mm lift in flat mode / up to 84.37mm lift in vertical mode)
- Full function monitor stand, supports -5° to +20° tilt, left & right 45° swivel, 90° pivot, up to 110mm lift
- No stand

Mounting

Supports VESA mount 100mm

Others

- (Optional) Conference Call Base, 3W x4 Harman speakers, 4 digital microphones array with AI noise suppression, Physical button for Teams, USB-C® connector
- (Optional) Smart Human Presence Detection based on Radar Sensor
- Supports Smart Power On

Notes:

[1] The system dimensions may vary depending on configurations.

[2] The system weight is approximate and based on results in Lenovo® lab, which varies depending on the source of component, variance of the distribution of each component, and manufacturing process. It may not be the exact weight for each specific model.

[3] 2nd 2.5" HDD needs ODD to HDD bracket kit (optional, come with 2nd 2.5" HDD).

CONNECTIVITY

Network

Onboard Ethernet

Gigabit Ethernet, Intel® Ethernet Connection I219-LM, 1x RJ-45, supports Wake-on-LAN

Optional Ethernet

No optional Ethernet

WLAN + Bluetooth®**

- MediaTek Wi-Fi® 6 MT7921, 802.11ax 2x2 Wi-Fi® + Bluetooth® 5.3, M.2 Card^[1]
- Realtek® Wi-Fi® 6 RTL8852AE, 802.11ax Dual Band 2x2 Wi-Fi® + Bluetooth® 5.3, M.2 card^[2]
- Intel® Wi-Fi® 6 AX201, 802.11ax 2x2 Wi-Fi® + Bluetooth® 5.2, M.2 Card^[3]
- AMD Wi-Fi® 6E RZ616, 802.11ax 2x2 Wi-Fi® + Bluetooth® 5.1, M.2 Card^[4]
- Intel® Wi-Fi® 6E AX211, 802.11ax 2x2 Wi-Fi® + Bluetooth® 5.3, Intel® vPro® technology support, M.2 Card^[5]
- No WLAN and Bluetooth®

Notes:

[1], [2], [5] Bluetooth® 5.3 requires Windows® 11.

[3] Bluetooth® 5.2 requires Windows® 11.

[4] Bluetooth® 5.2 is hardware ready but may run at a lower version due to OS limitations.

Ports^[1]

Rear Ports

- 1x USB-C® 3.2 Gen 2 (support data transfer and 15W charging)
- 3x USB 3.2 Gen 1
- 1x HDMI® (HDMI® in 1.4 / HDMI® out 2.1 TMDS combo port)
- 1x DisplayPort™ 1.4
- 1x Ethernet (RJ-45)

Optional Rear Ports

1x serial

Right Ports

- 3x USB 3.2 Gen 2
- 1x headphone / microphone combo jack (3.5mm)

Optional Right Ports

1x card reader

Notes:

[1] The transfer speed of following ports will vary and, depending on many factors, such as the processing speed of the host device, file attributes and other factors related to system configuration and your operating environment, will be slower than theoretical speed.

USB 2.0: 480 Mbit/s;

USB 3.2 Gen 1 (SuperSpeed USB 5Gbps, formerly USB 3.0 / USB 3.1 Gen 1): 5 Gbit/s;

USB 3.2 Gen 2 (SuperSpeed USB 10Gbps, formerly USB 3.1 Gen 2): 10 Gbit/s;

USB4® 20Gbps / USB 3.2 Gen 2x2 (SuperSpeed USB 20Gbps): 20 Gbit/s;

USB4® 40Gbps (USB 40Gbps): 40 Gbit/s;

Thunderbolt™ 3/4: 40 Gbit/s.

Monitor Cable

Monitor Cable**

- HDMI® to DVI dongle
- HDMI® to VGA dongle
- DP to VGA dongle

- DP to dual DP dongle
- DP to DVI-D dongle
- DP to HDMI® dongle
- No monitor cable

SECURITY & PRIVACY

Security

Security Chip

Discrete TPM 2.0, TCG certified

Physical Locks

Kensington® Security Slot™, 3 x 7 mm

Chassis Intrusion Switch

- Chassis intrusion switch
- No chassis intrusion switch

Fingerprint Reader

- Touch style fingerprint reader on mouse (EOL on Jan, 2023)
- No fingerprint reader

Other Security

(Optional) ThinkShutter camera cover

BIOS Security

- Administrator password
- Power-on password
- Hard disk password
- Boot sequence control
- Boot without keyboard and mouse
- Self-healing BIOS
- Smart USB protection (allows keyboard / mouse only, blocks all storage devices)
- Individual USB port disablement

MANAGEABILITY

System Management

System Management

- Intel® vPro® Enterprise^[1]
- Non-vPro®

Notes:

[1] Intel® vPro® offers a superset of DASH's defined capabilities.

SERVICE

Warranty^[1]

Base Warranty**

- 1-year limited onsite service
- 3-year limited onsite service
- No base warranty

Notes:

[1] The warranty upgrades may be bundled with some models, please check the "Included upgrade" column in the specific model's configurations. For more service extensions, please go to <https://smartfind.lenovo.com/>. To learn more details of warranty policy, please access <https://pcsupport.lenovo.com/warranty>.

ENVIRONMENTAL

Operating Environment

Temperature

- Operating: 5°C (41°F) to 35°C (95°F)
- Storage: -20°C (-4°F) to 60°C (140°F)

Relative Humidity

Operating: 20% to 80%

Altitude

- Operating: 0 m (0 ft) to 3048 m (10,000 ft)
- Storage: 0 m (0 ft) to 12192 m (40,000 ft)

CERTIFICATIONS

Green Certifications^[1]

Green Certifications

- (Optional) ENERGY STAR® 8.0
- (Optional) EPEAT™ Gold Registered^[2]
- ErP Lot 3
- RoHS compliant
- TCO Certified 9.0
- TCO edge
- VOC Report

Notes:

[1] The items listed under the "Green Certifications" section may not only refer to certification but also registration or self-declaration.

[2] EPEAT™ is registered where applicable, please see epeat.net for registration status by country.

Other Certifications

Other Certifications

- (Optional) TÜV Rheinland® Ultra Low Noise
- Eyesafe® Certified
- TÜV Rheinland® Flicker Free
- TÜV Rheinland® Low Blue Light (Hardware Solution)
- UL Anti-dust

Mil-Spec Test

MIL-STD-810H military test passed (Low Pressure [Altitude], High Temperature, Low Temperature, Temperature Shock, Humidity, Sand and Dust, Vibration, Shock, Fungus, Solar Radiation, Contamination by Fluids, Salt Fog)

- Feature with ** means that only one offering listed under the feature is configured on selected models.
- Feature with *** means that one or more offerings listed under the feature could be configured on selected models.
- Lenovo reserves the right to change specifications or other product information without notice. Lenovo is not responsible for photographic or typographical errors. **LENOVO PROVIDES THIS PUBLICATION "AS IS," WITHOUT WARRANTY OF ANY KIND, EITHER EXPRESS OR IMPLIED, INCLUDING THE IMPLIED WARRANTIES OF MERCHANTABILITY OR FITNESS FOR A PARTICULAR PURPOSE.** Some jurisdictions do not allow disclaimer of express or implied warranties in certain transactions, therefore this disclaimer may not apply to you.
- The specifications on this page may not be available in all regions, and may be changed or updated without notice.





OVERVIEW



1. OSD joystick	8. Microphone mute button
2. 3x USB 3.2 Gen 1	9. Thunderbolt 4
3. USB-C 3.2 Gen 2 (data transfer, 15W charging)	10. 2x USB 3.2 Gen 2
4. Ethernet (RJ-45)	11. Thunderbolt 3 (for display and file sharing) *
5. HDMI in 1.4 / out 2.1 TMDS combo port	12. Headphone / microphone combo jack (3.5mm)
6. DisplayPort 1.4	13. Card reader *
7. Power connector	14. Power button

Notes:

- Items with * are only available on selected models
- Please note the optional Thunderbolt 3 is not a Thunderbolt host port. For the details, please refer to the Ports section of specifications.

PERFORMANCE

Processor

Processor Family

13th Generation Intel® Core™ i5 / i7 / i9 Processor

Processor**^[1]

Processor Name	Cores	Threads	Base Frequency	Max Frequency	Cache	Processor Graphics
Core™ i5-13400	10 (6 P-core + 4 E-core)	16	P-core 2.5GHz / E-core 1.8GHz	P-core 4.6GHz / E-core 3.3GHz	20MB	Intel® UHD Graphics 730
Core™ i5-13500	14 (6 P-core + 8 E-core)	20	P-core 2.5GHz / E-core 1.8GHz	P-core 4.8GHz / E-core 3.5GHz	24MB	Intel® UHD Graphics 770
Core™ i5-13600 ^[2]	14 (6 P-core + 8 E-core)	20	P-core 2.7GHz / E-core 2.0GHz	P-core 5.0GHz / E-core 3.7GHz	24MB	Intel® UHD Graphics 770
Core™ i7-13700	16 (8 P-core + 8 E-core)	24	P-core 2.1GHz / E-core 1.5GHz	Max Turbo up to 5.2GHz / P-core 5.1GHz / E-core 4.1GHz	30MB	Intel® UHD Graphics 770
Core™ i9-13900	24 (8 P-core + 16 E-core)	32	P-core 2.0GHz / E-core 1.5GHz	Max Turbo up to 5.6GHz / P-core 5.2GHz / E-core 4.2GHz	36MB	Intel® UHD Graphics 770

Notes:

[1] Intel® Max Turbo frequency will vary depending on application workload and the hardware and software configurations, see <http://www.intel.com/technology/turboboost/> for more information.

[2] Special bid only.

Operating System

Operating System**^[1]

- Windows® 11 Pro
- Windows® 11 Home
- Windows® 11 Home Single Language
- Windows® 11 DG Windows® 10 Pro 64
- No preload operating system

Notes:

[1] Windows® 10 drivers support Windows® 10 21H1, 21H2 and 22H2, and Windows® 11 drivers support Windows® 11 21H2, 22H2 and MayCI

Graphics

Graphics**

Graphics	Type	Memory	Connector	Max Resolution	Key Features
Intel® UHD graphics 730	Integrated	Shared	1x HDMI® 2.1 TMDS, 1x DP 1.4, 1x Thunderbolt™ 4	4096x2160@60Hz(HDMI®), 4096x2304@60Hz - 36 bpp / 5120x3200@60Hz - 24 bpp (DP), 7680x4320@60Hz - 30 bpp (Thunderbolt™ 4)	DirectX® 12, OpenGL 4.6
Intel® UHD graphics 770	Integrated	Shared	1x HDMI® 2.1 TMDS, 1x DP 1.4, 1x Thunderbolt™ 4	4096x2160@60Hz(HDMI®), 4096x2304@60Hz - 36 bpp / 5120x3200@60Hz - 24 bpp (DP), 7680x4320@60Hz - 30 bpp (Thunderbolt™ 4)	DirectX® 12, OpenGL 4.6
NVIDIA® GeForce RTX™ 4050	Discrete	6GB GDDR6	1x HDMI® 2.1a TMDS, 1x DP 1.4, 1x Thunderbolt™ 4	4096x2160@60Hz(HDMI®), 4096x2304@60Hz - 36 bpp / 5120x3200@60Hz - 24 bpp (DP), 7680x4320@60Hz - 30 bpp (Thunderbolt™ 4)	DirectX® 12, OpenGL 4.6

Monitor Support

Monitor Support

Supports up to 4 independent displays via native display and 3 external monitors; supports external monitors via DisplayPort™, HDMI® and Thunderbolt™ 4; work as standalone monitor via HDMI® (HDMI® in / out combo) or optional Thunderbolt™ 3 port

Chipset

Chipset

Intel® Q670 chipset

Memory

Max Memory^{[1][2]}

- Models with Core™ i5: Up to 64GB DDR5-4800
- Models with Core™ i7/i9: Up to 64GB DDR5-5200

Memory Slots

Two DDR5 SO-DIMM slots, dual-channel capable

Memory Type^{**[3]}

- DDR5-4800
- DDR5-5200
- DDR5-5600

Memory Protection

Non-ECC

Notes:

[1] The max memory is based on the test results with current Lenovo® memory offerings.

[2], [3] Installed memory is actually 5600MHz, but may run at 4800MHz or 5200MHz depending on the memory support capability of processor.

Storage

Storage Support^[1]

Up to three drives, 1x 2.5" HDD + 2x M.2 SSD

- 2.5" HDD up to 1TB
- M.2 SSD up to 1TB each

Storage Type^{***}

Disk Type	Interface	RPM	Security
2.5" SATA HDD	SATA 6Gb/s	7.2K	-
M.2 2280 SSD	PCIe® NVMe®, PCIe® 4.0 x4	-	Opal 2.0

RAID^[2]

RAID 0/1 support for SSDs

Notes:

[1] The max capacity of each disk type is based on the test results with current Lenovo® storage offerings.

[2] RAID is not preset by default, user can config RAID 0/1 according to the demand.

Removable Storage

Optical

- DVD burner (DVD±RW), SATA connector, slim (9.0mm)
- None

Card Reader

- 3-in-1 card reader (SD, SDHC, SDXC)
- No card reader

Multi-Media

Audio Chip

High Definition (HD) Audio, Realtek® ALC256-NL codec

Speakers

Stereo speakers, 5W x2, Dolby® Atmos®

Microphone

Dual-microphone array

ThinkCentre M90a Pro Gen 4

Camera**

- 5.0-megapixel, IR + RGB hybrid, with ThinkShutter (physical switch on/off) and Human Presence Detection (Radar Sensor), ±20° view angle adjustable, Windows® Hello support
- 5.0-megapixel, IR + RGB hybrid, with ThinkShutter (physical switch on/off), ±20° view angle adjustable, Windows® Hello support
- 5.0-megapixel, with ThinkShutter (physical switch on/off), ±20° view angle adjustable

Power Supply

Power Supply

Power	Type	Efficiency	Key Features
230W	Fixed	92%	100V - 240V, 50-60Hz

DESIGN

Display

Display^[1]

Size	Resolution	Touch	Type	Brightness	Surface	Aspect Ratio	Contrast Ratio	Color Gamut	Refresh Rate	Viewing Angle (L/R/U/D)	Key Features
27"	QHD (2560x1440)	None	IPS	350nits	Anti-glare	16:9	1000:1	99% sRGB	60Hz	89°/89°/89°/89°	14ms response Time, 16.7 million color support, borderless design, TÜV Rheinland® Low Blue Light (Hardware Solution), TÜV Rheinland® Flicker Free, Eyesafe® Certified 2.0

Touchscreen

Non-touch

Notes:

[1] IPS (in-plane switching) technology may refer to IPS, PLS, ADS, AHVA, AAS.

Input Device

Keyboard**

- Lenovo® Calliope Keyboard (USB connector), black
- Lenovo® Calliope Wireless Keyboard (2.4GHz via USB receiver), black
- Lenovo® Traditional Keyboard (USB connector), black
- No keyboard

Mouse**

- Lenovo® Calliope Mouse (USB connector), black
- Lenovo® Calliope Wireless Mouse (2.4GHz via USB receiver), black
- No mouse

Mechanical

Buttons

- Microphone mute button
- OSD joystick
- Power button

Form Factor

AIO (27 inches)

Dimensions (WxDxH)^[1]

Models	Dimensions
Models without stand and camera	613.6 x 54.5 x 383.4 mm (24.2 x 2.1 x 15.1 inches)
Models (with UltraFlex V stand, with camera)	Lowest in flat mode: 613.6 x 364.54 x 227.11 mm (24.2 x 14.4 x 8.9 inches) Highest in vertical mode: 613.6 x 252.59 x 461.37 mm (24.2 x 9.9 x 18.2 inches)
Models (with full function monitor stand, with camera)	Lowest in vertical mode: 613.6 x 219.81 x 411.04 mm (24.2 x 8.7 x 16.2 inches) Highest in vertical mode: 613.6 x 219.81 x 521.81 mm (24.2 x 8.7 x 20.5 inches)

Packaging Dimensions (WxDxH)

764 x 235 x 545 mm (30.1 x 9.3 x 21.5 inches)

Weight^[2]

11.2 kg (24.8 lbs, maximum configuration)

Packaging Weight

2.4 kg (5.28 lbs), packaging only

Case Color

Black

Bays

- 1x 2.5" disk bay
- 1x slim ODD bay

Expansion Slots

Three M.2 slots (one for WLAN, two for SSD)

EOU

Toolless cover, stand, motherboard shielding, HDD, and memory assembly / removal

Stand**

- UltraFlex V stand, supports -5° to +70° tilt, up to 70°±2° lift (up to 166.3mm lift in flat mode / up to 63mm lift in vertical mode)
- Full function monitor stand, supports -5° to +20° tilt, left & right 45° swivel, 90° pivot, up to 110mm lift
- No stand

Mounting

Supports VESA mount 100mm

Others

- (Optional) Conference Call Base, 3W x4 Harman speakers, 4 digital microphones array with AI noise suppression, Physical button for Teams, USB-C® connector
- Supports Smart Power On

Notes:

^[1] The system dimensions may vary depending on configurations.^[2] The system weight is approximate and based on results in Lenovo® lab, which varies depending on the source of component, variance of the distribution of each component, and manufacturing process. It may not be the exact weight for each specific model.

CONNECTIVITY

Network

Onboard Ethernet

Gigabit Ethernet, Intel® Ethernet Connection I219-LM, 1x RJ-45, supports Wake-on-LAN

WLAN + Bluetooth®**

- Realtek® Wi-Fi® 6 RTL8852BE, 802.11ax Dual Band 2x2 Wi-Fi® + Bluetooth® 5.3, M.2 card^[1]
- Intel® Wi-Fi® 6E AX211, 802.11ax 2x2 Wi-Fi® + Bluetooth® 5.3, Intel® vPro® technology support, M.2 Card^[2]

ThinkCentre M90a Pro Gen 4

- No WLAN and Bluetooth®

Notes:

[1], [2] Bluetooth® 5.3 requires Windows® 11.

Ports^[1]

Rear Ports

- 1x USB-C® 3.2 Gen 2 (support data transfer and 15W charging)
- 3x USB 3.2 Gen 1
- 1x HDMI® (HDMI® in 1.4 / HDMI® out 2.1 TMDS combo port)
- 1x DisplayPort™ 1.4
- 1x Ethernet (RJ-45)

Optional Rear Ports

None

Right Ports

- 1x Thunderbolt™ 4 / USB4® 40Gbps (support data transfer, 15W charging and DisplayPort™ 1.4)
- 2x USB 3.2 Gen 2
- 1x headphone / microphone combo jack (3.5mm)

Optional Right Ports

- 1x ThunderBolt 3^[2]
- 1x card reader

Notes:

[1] The transfer speed of following ports will vary and, depending on many factors, such as the processing speed of the host device, file attributes and other factors related to system configuration and your operating environment, will be slower than theoretical speed.

USB 2.0: 480 Mbit/s;

USB 3.2 Gen 1 (SuperSpeed USB 5Gbps, formerly USB 3.0 / USB 3.1 Gen 1): 5 Gbit/s;

USB 3.2 Gen 2 (SuperSpeed USB 10Gbps, formerly USB 3.1 Gen 2): 10 Gbit/s;

USB4® 20Gbps / USB 3.2 Gen 2x2 (SuperSpeed USB 20Gbps): 20 Gbit/s;

USB4® 40Gbps (USB 40Gbps): 40 Gbit/s;

Thunderbolt™ 3/4: 40 Gbit/s.

[2] This Thunderbolt™ 3 port is not a Thunderbolt™ host port. By connecting it to a laptop or desktop Thunderbolt™ port with the included Type-C cable, customers can share M90a Pro Gen 4 as a Thunderbolt™ monitor and share the files saved on the 2nd SSD of M90a Pro Gen 4. A Type-C cable is bouncluded with the models with Thunderbolt™ 3 port.

SECURITY & PRIVACY

Security

Security Chip

Discrete TPM 2.0, TCG certified

Physical Locks

Kensington® Security Slot™, 3 x 7 mm

Chassis Intrusion Switch

- Chassis intrusion switch
- No chassis intrusion switch

Fingerprint Reader

No fingerprint reader

Other Security

- (Optional) Smart Human Presence Detection (Camera with Radar Sensor)
- ThinkShutter camera cover

BIOS Security

- Administrator password
- Power-on password
- Hard disk password
- Boot sequence control
- Boot without keyboard and mouse

- Self-healing BIOS
- Smart USB protection (allows keyboard / mouse only, blocks all storage devices)
- Individual USB port disablement

MANAGEABILITY

System Management

System Management^[1]

- Intel® vPro® Enterprise
- Non-vPro®

Notes:

[1] Intel® vPro® offers a superset of DASH's defined capabilities.

SERVICE

Warranty^[1]

Base Warranty**

- 1-year limited onsite service
- 3-year limited onsite service
- No base warranty

Notes:

[1] The warranty upgrades may be bundled with some models, please check the "Included upgrade" column in the specific model's configurations. For more service extensions, please go to <https://smartfind.lenovo.com/>. To learn more details of warranty policy, please access <https://pcsupport.lenovo.com/warranty>.

ENVIRONMENTAL

Operating Environment

Temperature

- Operating: 5°C (41°F) to 35°C (95°F)
- Storage: -20°C (-4°F) to 60°C (140°F)

Relative Humidity

Operating: 20% to 80%

Altitude

- Operating: 0 m (0 ft) to 3048 m (10,000 ft)
- Storage: 0 m (0 ft) to 12192 m (40,000 ft)

ACCESSORIES

Bundled Accessories

Bundled Accessories

- DP to dual DP dongle
- HDMI® to DVI dongle
- DP to DVI dongle
- DP to VGA dongle
- DP to HDMI® dongle
- HDMI® to VGA dongle
- None

CERTIFICATIONS

Green Certifications^[1]

Green Certifications

- (Optional) ENERGY STAR® 8.0
- (Optional) EPEAT™ Gold Registered
- ErP Lot 3
- RoHS compliant
- TCO Certified 9.0
- TCO edge
- VOC Report

Notes:

[1] The items listed under the "Green Certifications" section may not only refer to certification but also registration or self-declaration.

Other Certifications

Other Certifications

- (Optional) TÜV Rheinland® Ultra Low Noise
- Eyesafe® Certified 2.0
- TÜV Rheinland® Flicker Free
- TÜV Rheinland® Low Blue Light (Hardware Solution)
- UL Anti-dust

Mil-Spec Test

MIL-STD-810H military test passed (Low Pressure [Altitude], High Temperature, Low Temperature, Temperature Shock, Humidity, Sand and Dust, Vibration, Shock, Fungus, Solar Radiation, Contamination by Fluids, Salt Fog)

- Feature with ** means that only one offering listed under the feature is configured on selected models.
- Feature with *** means that one or more offerings listed under the feature could be configured on selected models.
- Lenovo reserves the right to change specifications or other product information without notice. Lenovo is not responsible for photographic or typographical errors. LENOVO PROVIDES THIS PUBLICATION "AS IS," WITHOUT WARRANTY OF ANY KIND, EITHER EXPRESS OR IMPLIED, INCLUDING THE IMPLIED WARRANTIES OF MERCHANTABILITY OR FITNESS FOR A PARTICULAR PURPOSE. Some jurisdictions do not allow disclaimer of express or implied warranties in certain transactions, therefore this disclaimer may not apply to you.
- The specifications on this page may not be available in all regions, and may be changed or updated without notice.



OVERVIEW



1. Power button	5. 2x USB 3.2 Gen 2
2. Combo audio jack (on bottom)	6. Ethernet (RJ-45)
3. Power connector	7. 2x USB 2.0
4. HDMI-out	8. Optical drive *

Notes:

- Items with * are only available on selected models

PERFORMANCE

Processor

Processor Family

Intel® Celeron®, Intel® Pentium®, 12th Gen Intel® U or P Series Core™ i3 / i5, or 12th Gen Intel® H Series Core™ i5 Processor

Processor**^[1]

Processor Name	Cores	Threads	Base Frequency	Max Frequency	Cache	Processor Graphics
Celeron® 7305	5 (1 P-core + 4 E-core)	6	P-core 1.1GHz / E-core 0.9GHz	-	8MB	Intel® UHD Graphics
Pentium® Gold 8505	5 (1 P-core + 4 E-core)	6	P-core 1.2GHz / E-core 0.9GHz	P-core 4.4GHz / E-core 3.3GHz ^[2]	8MB	Intel® UHD Graphics
Core™ i3-1215U	6 (2 P-core + 4 E-core)	8	P-core 1.2GHz / E-core 0.9GHz	P-core 4.4GHz / E-core 3.3GHz ^[3]	10MB	Intel® UHD Graphics
Core™ i3-1220P	10 (2 P-core + 8 E-core)	12	P-core 1.5GHz / E-core 1.1GHz	P-core 4.4GHz / E-core 3.3GHz ^[4]	12MB	Intel® UHD Graphics
Core™ i5-1235U	10 (2 P-core + 8 E-core)	12	P-core 1.3GHz / E-core 0.9GHz	P-core 4.4GHz / E-core 3.3GHz ^[5]	12MB	Intel® Iris® Xe Graphics
Core™ i5-1240P	12 (4 P-core + 8 E-core)	16	P-core 1.7GHz / E-core 1.2GHz	P-core 4.4GHz / E-core 3.3GHz ^[6]	12MB	Intel® Iris® Xe Graphics
Core™ i5-12450H	8 (4 P-core + 4 E-core)	12	P-core 2.0GHz / E-core 1.5GHz	P-core 4.4GHz / E-core 3.3GHz ^[7]	12MB	Intel® UHD Graphics

Notes:

[1] Intel® Iris® Xe Graphics capability requires system to be configured with dual-channel memory. On the system with single-channel memory, Intel® Iris® Xe Graphics will function as Intel® UHD Graphics.

[2], [3], [4], [5], [6], [7] Intel® Max Turbo frequency will vary depending on application workload and the hardware and software configurations, see <http://www.intel.com/technology/turboboost/> for more information.

Operating System

Operating System**

- Windows® 11 Pro
- Windows® 11 Home
- Windows® 11 Home Single Language
- Windows® 11 DG Windows® 10 Pro 64
- No preload operating system

Graphics

Graphics**

Graphics	Type	Memory	Connector	Max Resolution	Key Features
Intel® UHD Graphics	Integrated	Shared	1x HDMI® 1.4	1920x1080@60Hz	DirectX® 12.1
Intel® Iris® Xe Graphics ^[1]	Integrated	Shared	1x HDMI® 1.4	1920x1080@60Hz	DirectX® 12.1

Notes:

[1] Intel® Iris® Xe Graphics capability requires system to be configured with dual-channel memory. On the system with single-channel memory, Intel® Iris® Xe Graphics will function as Intel® UHD Graphics.

Monitor Support

Monitor Support

Supports up to 2 independent displays via native display and 1 external monitor; supports external monitor via HDMI®

Chipset

Chipset

ThinkCentre neo 30a 22

Intel® SoC (System on Chip) platform

Memory

Max Memory^[1]

Up to 16GB DDR4-3200

Memory Slots

Two DDR4 SO-DIMM slots, dual-channel capable

Memory Type

DDR4-3200

Notes:

[1] The max memory is based on the test results with current Lenovo® memory offerings.

Storage

Storage Support^[1]

- Up to two drives, 1x 2.5" HDD + 1x M.2 SSD
 - 2.5" HDD up to 1TB
 - M.2 SSD up to 512GB
- For installing HDD storage, assembly kits are needed. The kits only come with HDD models.

Storage Type**

Disk Type	Interface	RPM
2.5" SATA HDD	SATA 6Gb/s	5.4K
M.2 2280 SSD	PCIe® NVMe®, PCIe® 3.0 x4	-
M.2 2280 SSD	PCIe® NVMe®, PCIe® 4.0 x4	-
M.2 2280 SSD	PCIe® NVMe®, PCIe® 4.0 x4	-
M.2 2242 SSD	PCIe® NVMe®, PCIe® 3.0 x4	-

RAID

No support

Notes:

[1] The max capacity of each disk type is based on the test results with current Lenovo® storage offerings.

Removable Storage

Optical

- DVD burner (DVD±RW), SATA 1.5Gb/s, slim (9.0mm)
- None

Card Reader

No card reader

Multi-Media

Audio Chip

High Definition (HD) Audio, Realtek® ALC256 codec

Speakers

Stereo speakers, 3W x2, Audio by HARMAN

Microphone**

- Single microphone
- Dual-microphone array
- No microphone

Camera

- HD 720p 0° Pre-angle pull up camera, LED indicator
- No camera

Power Supply

Power Supply

Power	Type	Efficiency	Key Features
90W	Adapter	89%	Autosensing

DESIGN**Display****Display^[1]**

Size	Resolution	Touch	Type	Brightness	Surface	Aspect Ratio	Contrast Ratio	Color Gamut	Refresh Rate	Viewing Angle (L/R/U/D)	Key Features
21.5"	FHD (1920x1080)	None	IPS	250nits	Anti-glare	16:9	1000:1	72% NTSC	60Hz	89°/89°/89°/89°	14ms response Time, 16.7 million color depth, borderless design

Touchscreen

Non-touch

Notes:

[1] IPS (in-plane switching) technology may refer to IPS, PLS, ADS, AHVA, AAS.

Input Device**Keyboard****

- Lenovo® Calliope Keyboard (USB connector), black
- Lenovo® Calliope Wireless Keyboard, black
- No keyboard

Mouse**

- Lenovo® Calliope Mouse (USB connector), black
- Lenovo® Calliope Wireless Mouse (2.4GHz via USB receiver), black
- No mouse

Mechanical**Form Factor**

AIO (21.5 inches)

Dimensions (WxDxH)^[1]

490.3 x 207.5 x 405.39 mm (19.3 x 8.71 x 15.96 inches)

Packaging Dimensions (WxDxH)

591 x 231 x 522 mm (23.27 x 9.09 x 20.55 inches)

Weight^[2]

Around 5.7 kg (12.6 lbs)

Packaging Weight

Around 9.3 kg (20.5 lbs)

Case Color

Raven black

Bays

- 1x 2.5" disk bay
- For installing HDD storage, assembly kits are needed. The kits only come with HDD models.

Expansion Slots

Two M.2 slots (one for WLAN, one for SSD)

EOU

No support

Stand

Monitor stand, supports -5° to +25° tilt, left & right 45° swivel

Mounting

None

Notes:

[1] The system dimensions may vary depending on configurations.

[2] The system weight is approximate and based on results in Lenovo® lab, which varies depending on the source of component, variance of the distribution of each component, and manufacturing process. It may not be the exact weight for each specific model.

CONNECTIVITY**Network****Onboard Ethernet**

Gigabit Ethernet, Realtek® RTL8111H, 1x RJ-45

WLAN + Bluetooth®**

- Realtek® RTL8822CE, 802.11ac Dual Band 2x2 Wi-Fi® + Bluetooth® 5.0, M.2 card
- Intel® Wireless-AC 9560, 802.11ac Dual Band 2x2 Wi-Fi® + Bluetooth® 5.0, Intel® vPro® technology support, M.2 card
- Realtek® Wi-Fi® 6 RTL8852BE, 802.11ax Dual Band 2x2 Wi-Fi® + Bluetooth® 5.1, M.2 card^[1]
- Intel® Wi-Fi® 6 AX201, 802.11ax 2x2 Wi-Fi® + Bluetooth® 5.1, M.2 Card^[2]

Notes:

[1], [2] Bluetooth® 5.2 is hardware ready but may run at a lower version due to OS limitations.

Ports^[1]**Rear Ports**

- 2x USB 2.0
- 2x USB 3.2 Gen 2
- 1x HDMI®-out
- 1x Ethernet (RJ-45)
- 1x power connector

Bottom Ports

1x headphone / microphone combo jack (3.5mm)

Left Ports

None

Optional Left Ports

None

Right Ports

None

Optional Right Ports

None

Notes:

[1] The transfer speed of following ports will vary and, depending on many factors, such as the processing speed of the host device, file attributes and other factors related to system configuration and your operating environment, will be slower than theoretical speed.

USB 2.0: 480 Mbit/s;

USB 3.2 Gen 1 (SuperSpeed USB 5Gbps, formerly USB 3.0 / USB 3.1 Gen 1): 5 Gbit/s;

USB 3.2 Gen 2 (SuperSpeed USB 10Gbps, formerly USB 3.1 Gen 2): 10 Gbit/s;

USB4® 20Gbps / USB 3.2 Gen 2x2 (SuperSpeed USB 20Gbps): 20 Gbit/s;

USB4® 40Gbps (USB 40Gbps): 40 Gbit/s;

Thunderbolt™ 3/4: 40 Gbit/s.

SECURITY & PRIVACY

Security

Security Chip

Firmware TPM 2.0 integrated in SoC

BIOS Security

- Administrator password
- Power-on password
- Hard disk password
- Cover presence switch
- Intel® BIOS guard

SERVICE

Warranty^[1]

Base Warranty**

- 1-year courier or carry-in service
- 1-year limited onsite service

Notes:

[1] The warranty upgrades may be bundled with some models, please check the "Included upgrade" column in the specific model's configurations. For more service extensions, please go to <https://smartfind.lenovo.com/>. To learn more details of warranty policy, please access <https://pcsupport.lenovo.com/warranty>.

ENVIRONMENTAL

Operating Environment

Temperature

- Operating: 5°C (41°F) to 35°C (95°F)
- Storage: -20°C (-4°F) to 60°C (140°F)

Relative Humidity

- Operating: 20% to 80%
- Storage: 10% to 90%

Altitude

- Operating: 0 m (0 ft) to 3048 m (10,000 ft)
- Storage: 0 m (0 ft) to 12192 m (40,000 ft)

CERTIFICATIONS

Green Certifications^[1]

Green Certifications

- (Optional) ENERGY STAR® 8.0
- (Optional) EPEAT™ Silver Registered^[2]
- ErP Lot 3 and Lot 7

Notes:

[1] The items listed under the "Green Certifications" section may not only refer to certification but also registration or self-declaration.

[2] EPEAT™ is registered where applicable, please see epeat.net for registration status by country.

Other Certifications

Other Certifications

- TÜV Rheinland® Flicker Free
- TÜV Rheinland® Low Blue Light
- TÜV Rheinland® Low Noise

- Feature with ** means that only one offering listed under the feature is configured on selected models.
- Lenovo reserves the right to change specifications or other product information without notice. Lenovo is not responsible for photographic or typographical errors. LENOVO PROVIDES THIS PUBLICATION “AS IS,” WITHOUT WARRANTY OF ANY KIND, EITHER EXPRESS OR IMPLIED, INCLUDING THE IMPLIED WARRANTIES OF MERCHANTABILITY OR FITNESS FOR A PARTICULAR PURPOSE. Some jurisdictions do not allow disclaimer of express or implied warranties in certain transactions, therefore this disclaimer may not apply to you.
- The specifications on this page may not be available in all regions, and may be changed or updated without notice.



intel



intel



intel



intel



intel



intel

OVERVIEW



1. Power button	5. 2x USB 3.2 Gen 2
2. Combo audio jack (on bottom)	6. Ethernet (RJ-45)
3. Power connector	7. 2x USB 2.0
4. HDMI-out	8. Optical drive *

Notes:

- Items with * are only available on selected models

PERFORMANCE

Processor

Processor Family

13th Generation Intel® H Series Core™ i5 Processor

Processor

Processor Name	Cores	Threads	Base Frequency	Max Frequency	Cache	Processor Graphics
Core™ i5-13420H	8 (4 P-core + 4 E-core)	12	P-core 2.1GHz / E-core 1.5GHz	P-core 4.6GHz / E-core 3.4GHz ^[1]	12MB	Intel® UHD Graphics

Notes:

[1] Intel® Max Turbo frequency will vary depending on application workload and the hardware and software configurations, see <http://www.intel.com/technology/turboboost/> for more information.

Operating System

Operating System**

- Windows® 11 Pro
- Windows® 11 Home
- Windows® 11 Home Single Language
- No preload operating system

Graphics

Graphics

Graphics	Type	Memory	Connector	Max Resolution	Key Features
Intel® UHD Graphics	Integrated	Shared	1x HDMI® 1.4	1920x1080@60Hz	DirectX® 12.1

Monitor Support

Monitor Support

Supports up to 2 independent displays via native display and 1 external monitor; supports external monitor via HDMI®

Chipset

Chipset

Intel® SoC (System on Chip) platform

Memory

Max Memory^[1]

Up to 8GB DDR4-3200

Memory Slots

Two DDR4 SO-DIMM slots, dual-channel capable

Memory Type

DDR4-3200

Notes:

[1] The max memory is based on the test results with current Lenovo® memory offerings.

Storage

Storage Support^[1]

- Up to two drives, 1x 2.5" HDD + 1x M.2 SSD
 - 2.5" HDD up to 1TB
 - M.2 SSD up to 512GB
- For installing HDD storage, assembly kits are needed. The kits only come with HDD models.

Storage Type**

ThinkCentre neo 30a 22 Gen 4

Disk Type	Interface	RPM	Security
2.5" SATA HDD	SATA 6Gb/s	5.4K	-
M.2 2280 SSD	PCIe® NVMe®, PCIe® 4.0 x4	-	-
M.2 2280 SSD	PCIe® NVMe®, PCIe® 4.0 x4	-	Opal 2.0

RAID

No support

Notes:

[1] The max capacity of each disk type is based on the test results with current Lenovo® storage offerings.

Removable Storage

Optical

- DVD burner (DVD±RW), SATA 1.5Gb/s, slim (9.0mm)
- None

Card Reader

No card reader

Multi-Media

Audio Chip

High Definition (HD) Audio, Realtek® ALC256 codec

Speakers

Stereo speakers, 3W x2, Audio by HARMAN

Microphone

- Dual-microphone array
- No microphone

Camera

- HD 720p 0° Pre-angle pull up camera, LED indicator
- No camera

Power Supply

Power Supply

Power	Type	Efficiency	Key Features
90W	Adapter	89%	Autosensing

DESIGN

Display

Display^[1]

Size	Resolution	Touch	Type	Brightness	Surface	Aspect Ratio	Contrast Ratio	Color Gamut	Refresh Rate	Viewing Angle (L/R/U/D)	Key Features
21.5"	FHD (1920x1080)	None	IPS	250nits	Anti-glare	16:9	1000:1	72% NTSC	60Hz	89°/89°/89°/89°	14ms response Time, 16.7 million color depth, borderless design

Touchscreen

Non-touch

Notes:

[1] IPS (in-plane switching) technology may refer to IPS, PLS, ADS, AHVA, AAS.

Input Device

Keyboard**

- Lenovo® Calliope Keyboard (USB connector), black
- Lenovo® Calliope Wireless Keyboard, black
- No keyboard

Mouse**

- Lenovo® Calliope Mouse (USB connector), black
- Lenovo® Calliope Wireless Mouse (2.4GHz via USB receiver), black
- No mouse

Mechanical

Form Factor

AIO (21.5 inches)

Dimensions (WxDxH)^[1]

490.3 x 207.5 x 405.39 mm (19.3 x 8.17 x 15.96 inches)

Packaging Dimensions (WxDxH)

591 x 231 x 522 mm (23.27 x 9.09 x 20.55 inches)

Weight^[2]

Around 5.7 kg (12.6 lbs)

Packaging Weight

Around 9.3 kg (20.5 lbs)

Case Color

Raven black

Bays

- 1x 2.5" disk bay
- For installing HDD storage, assembly kits are needed. The kits only come with HDD models.

Expansion Slots

Two M.2 slots (one for WLAN, one for SSD)

EOU

No support

Stand

Monitor stand, supports -5° to +25° tilt, left & right 45° swivel

Mounting

None

Notes:

[1] The system dimensions may vary depending on configurations.

[2] The system weight is approximate and based on results in Lenovo® lab, which varies depending on the source of component, variance of the distribution of each component, and manufacturing process. It may not be the exact weight for each specific model.

CONNECTIVITY

Network

Onboard Ethernet

Gigabit Ethernet, Realtek® RTL8111H, 1x RJ-45

WLAN + Bluetooth®**

- Realtek® Wi-Fi® 6 RTL8852BE, 802.11ax Dual Band 2x2 Wi-Fi® + Bluetooth® 5.3, M.2 card^[1]
- Intel® Wi-Fi® 6 AX201, 802.11ax 2x2 Wi-Fi® + Bluetooth® 5.2, M.2 Card^[2]

Notes:

[1] Bluetooth® 5.3 requires Windows® 11.

[2] Bluetooth® 5.2 requires Windows® 11.

Ports^[1]

Rear Ports

- 2x USB 2.0
- 2x USB 3.2 Gen 2
- 1x HDMI®-out
- 1x Ethernet (RJ-45)
- 1x power connector

Bottom Ports

1x headphone / microphone combo jack (3.5mm)

Notes:

[1] The transfer speed of following ports will vary and, depending on many factors, such as the processing speed of the host device, file attributes and other factors related to system configuration and your operating environment, will be slower than theoretical speed.

USB 2.0: 480 Mbit/s;

USB 3.2 Gen 1 (SuperSpeed USB 5Gbps, formerly USB 3.0 / USB 3.1 Gen 1): 5 Gbit/s;

USB 3.2 Gen 2 (SuperSpeed USB 10Gbps, formerly USB 3.1 Gen 2): 10 Gbit/s;

USB4® 20Gbps / USB 3.2 Gen 2x2 (SuperSpeed USB 20Gbps): 20 Gbit/s;

USB4® 40Gbps (USB 40Gbps): 40 Gbit/s;

Thunderbolt™ 3/4: 40 Gbit/s.

SECURITY & PRIVACY

Security

Security Chip

Firmware TPM 2.0 integrated in SoC

BIOS Security

- Administrator password
- Power-on password
- Intel® BIOS guard

SERVICE

Warranty^[1]

Base Warranty**

- 1-year courier or carry-in service
- 1-year limited onsite service

Notes:

[1] The warranty upgrades may be bundled with some models, please check the "Included upgrade" column in the specific model's configurations. For more service extensions, please go to <https://smartfind.lenovo.com/>. To learn more details of warranty policy, please access <https://pcsupport.lenovo.com/warranty>.

ENVIRONMENTAL

Operating Environment

Temperature

- Operating: 5°C (41°F) to 35°C (95°F)
- Storage: -20°C (-4°F) to 60°C (140°F)

Relative Humidity

- Operating: 20% to 80%
- Storage: 10% to 90%

Altitude

- Operating: 0 m (0 ft) to 3048 m (10,000 ft)

- Storage: 0 m (0 ft) to 12192 m (40,000 ft)

CERTIFICATIONS

Green Certifications^[1]

Green Certifications

- (Optional) ENERGY STAR® 8.0
- (Optional) EPEAT™ Silver Registered^[2]

Notes:

[1] The items listed under the "Green Certifications" section may not only refer to certification but also registration or self-declaration.

[2] EPEAT™ is registered where applicable, please see [epeat.net](https://www.epeat.net) for registration status by country.

Other Certifications

Other Certifications

- TÜV Rheinland® Flicker Free
- TÜV Rheinland® Low Blue Light
- TÜV Rheinland® Low Noise

- Feature with ** means that only one offering listed under the feature is configured on selected models.
- Lenovo reserves the right to change specifications or other product information without notice. Lenovo is not responsible for photographic or typographical errors. LENOVO PROVIDES THIS PUBLICATION "AS IS," WITHOUT WARRANTY OF ANY KIND, EITHER EXPRESS OR IMPLIED, INCLUDING THE IMPLIED WARRANTIES OF MERCHANTABILITY OR FITNESS FOR A PARTICULAR PURPOSE. Some jurisdictions do not allow disclaimer of express or implied warranties in certain transactions, therefore this disclaimer may not apply to you.
- The specifications on this page may not be available in all regions, and may be changed or updated without notice.



intel



intel



intel



intel



intel



intel

OVERVIEW



1. Power button	5. 2x USB 3.2 Gen 2
2. Combo audio jack (on bottom)	6. Ethernet (RJ-45)
3. Power connector	7. 2x USB 2.0
4. HDMI-out	8. Optical drive *

Notes:

- Items with * are only available on selected models

PERFORMANCE

Processor

Processor Family

Intel® Celeron®, Intel® Pentium®, 12th Gen Intel® U Series Core™ i3 / i5, 12th Gen Intel® P Series Core™ i3 / i5 / i7, or 12th Gen Intel® H Series Core™ i5 Processor

Processor**^[1]

Processor Name	Cores	Threads	Base Frequency	Max Frequency	Cache	Processor Graphics
Celeron® 7305	5 (1 P-core + 4 E-core)	6	P-core 1.1GHz / E-core 0.9GHz	-	8MB	Intel® UHD Graphics
Pentium® Gold 8505	5 (1 P-core + 4 E-core)	6	P-core 1.2GHz / E-core 0.9GHz	P-core 4.4GHz / E-core 3.3GHz ^[2]	8MB	Intel® UHD Graphics
Core™ i3-1215U	6 (2 P-core + 4 E-core)	8	P-core 1.2GHz / E-core 0.9GHz	P-core 4.4GHz / E-core 3.3GHz ^[3]	10MB	Intel® UHD Graphics
Core™ i3-1220P	10 (2 P-core + 8 E-core)	12	P-core 1.5GHz / E-core 1.1GHz	P-core 4.4GHz / E-core 3.3GHz ^[4]	12MB	Intel® UHD Graphics
Core™ i5-1235U	10 (2 P-core + 8 E-core)	12	P-core 1.3GHz / E-core 0.9GHz	P-core 4.4GHz / E-core 3.3GHz ^[5]	12MB	Intel® Iris® Xe Graphics
Core™ i5-1240P	12 (4 P-core + 8 E-core)	16	P-core 1.7GHz / E-core 1.2GHz	P-core 4.4GHz / E-core 3.3GHz ^[6]	12MB	Intel® Iris® Xe Graphics
Core™ i5-12450H	8 (4 P-core + 4 E-core)	12	P-core 2.0GHz / E-core 1.5GHz	P-core 4.4GHz / E-core 3.3GHz ^[7]	12MB	Intel® UHD Graphics
Core™ i7-1260P	12 (4 P-core + 8 E-core)	16	P-core 2.1GHz / E-core 1.5GHz	P-core 4.7GHz / E-core 3.4GHz ^[8]	18MB	Intel® Iris® Xe Graphics

Notes:

[1] Intel® Iris® Xe Graphics capability requires system to be configured with dual-channel memory. On the system with single-channel memory, Intel® Iris® Xe Graphics will function as Intel® UHD Graphics.

[2], [3], [4], [5], [6], [7], [8] Intel® Max Turbo frequency will vary depending on application workload and the hardware and software configurations, see <http://www.intel.com/technology/turboboost/> for more information.

Operating System

Operating System**

- Windows® 11 Pro
- Windows® 11 Home
- Windows® 11 Home Single Language
- Windows® 11 DG Windows® 10 Pro 64
- Ubuntu Linux
- No preload operating system

Graphics

Graphics**

Graphics	Type	Memory	Connector	Max Resolution	Key Features
Intel® UHD Graphics	Integrated	Shared	1x HDMI® 1.4	1920x1080@60Hz	DirectX® 12.1
Intel® Iris® Xe Graphics ^[1]	Integrated	Shared	1x HDMI® 1.4	1920x1080@60Hz	DirectX® 12.1

Notes:

[1] Intel® Iris® Xe Graphics capability requires system to be configured with dual-channel memory. On the system with single-channel memory, Intel® Iris® Xe Graphics will function as Intel® UHD Graphics.

Monitor Support

Monitor Support

Supports up to 2 independent displays via native display and 1 external monitor; supports external monitor via HDMI®

Chipset

Chipset

Intel® SoC (System on Chip) platform

Memory

Max Memory^[1]

Up to 16GB DDR4-3200

Memory Slots

Two DDR4 SO-DIMM slots, dual-channel capable

Memory Type

DDR4-3200

Notes:

[1] The max memory is based on the test results with current Lenovo® memory offerings.

Storage

Storage Support^[1]

- Up to two drives, 1x 2.5" HDD + 1x M.2 SSD
 - 2.5" HDD up to 1TB
 - M.2 SSD up to 1TB
- For installing HDD storage, assembly kits are needed. The kits only come with HDD models.

Storage Type^{***}

Disk Type	Interface	RPM
2.5" SATA HDD	SATA 6Gb/s	5.4K
M.2 2280 SSD	PCIe® NVMe®, PCIe® 3.0 x4	-
M.2 2280 SSD	PCIe® NVMe®, PCIe® 4.0 x4	-
M.2 2280 SSD	PCIe® NVMe®, PCIe® 4.0 x4	-
M.2 2242 SSD	PCIe® NVMe®, PCIe® 3.0 x4	-

RAID

No support

Notes:

[1] The max capacity of each disk type is based on the test results with current Lenovo® storage offerings.

Removable Storage

Optical

- DVD burner (DVD±RW), SATA 1.5Gb/s, slim (9.0mm)
- None

Card Reader

No card reader

Multi-Media

Audio Chip

High Definition (HD) Audio, Realtek® ALC256 codec

Speakers

Stereo speakers, 3W x2, Audio by HARMAN

Microphone

- Dual-microphone array
- No microphone

Camera^{**}

- 5.0-megapixel IR camera, 0° Pre-angle pull up camera, LED indicator

ThinkCentre neo 30a 24

- HD 720p 0° Pre-angle pull up camera, LED indicator
- No camera

Power Supply

Power Supply

Power	Type	Efficiency	Key Features
90W	Adapter	89%	Autosensing

DESIGN

Display

Display^[1]

Size	Resolution	Touch	Type	Brightness	Surface	Aspect Ratio	Contrast Ratio	Color Gamut	Refresh Rate	Viewing Angle (L/R/U/D)	Key Features
23.8"	FHD (1920x1080)	None	IPS	250nits	Anti-glare	16:9	1000:1	72% NTSC	60Hz	89°/89°/89°/89°	14ms response Time, 16.7 million color depth, borderless design

Touchscreen

Non-touch

Notes:

[1] IPS (in-plane switching) technology may refer to IPS, PLS, ADS, AHVA, AAS.

Input Device

Keyboard**

- Lenovo® Calliope Keyboard (USB connector), black
- Lenovo® Calliope Wireless Keyboard, black
- No keyboard

Mouse**

- Lenovo® Calliope Mouse (USB connector), black
- Lenovo® Calliope Wireless Mouse (2.4GHz via USB receiver), black
- No mouse

Mechanical

Form Factor

AIO (23.8 inches)

Dimensions (WxDxH)^[1]

Models	Dimensions
Models with monitor stand	541 x 207.5 x 433.8 mm (21.3 x 8.17 x 17.1 inches)
Models with liftable monitor stand	541 x 220 x 380.5-480.5 mm (21.3 x 8.66 x 14.98-18.92 inches)

Packaging Dimensions (WxDxH)

662 x 231 x 551 mm (26.06 x 9.09 x 21.69 inches)

Weight^[2]

Models	Weight
Models with liftable monitor stand	Around 6.6 kg (14.6 lbs)
Models with monitor stand	Around 6.7 kg (14.8 lbs)

Packaging Weight

Around 10.74 kg (23.08 lbs)

Case Color

Raven black

Bays

- 1x 2.5" disk bay
- For installing HDD storage, assembly kits are needed. The kits only come with HDD models.

Expansion Slots

Two M.2 slots (one for WLAN, one for SSD)

EOU

No support

Stand**

- Monitor stand, supports -5° to +25° tilt, left & right 45° swivel
- Liftable monitor stand, supports -5° to +16° tilt, left & right 45° swivel, up to 100mm lift

Mounting

None

Notes:

[1] The system dimensions may vary depending on configurations.

[2] The system weight is approximate and based on results in Lenovo® lab, which varies depending on the source of component, variance of the distribution of each component, and manufacturing process. It may not be the exact weight for each specific model.

CONNECTIVITY

Network

Onboard Ethernet

Gigabit Ethernet, Realtek® RTL8111H, 1x RJ-45

WLAN + Bluetooth®**

- Realtek® RTL8822CE, 802.11ac Dual Band 2x2 Wi-Fi® + Bluetooth® 5.0, M.2 card
- Intel® Wireless-AC 9560, 802.11ac Dual Band 2x2 Wi-Fi® + Bluetooth® 5.0, Intel® vPro® technology support, M.2 card
- Realtek® Wi-Fi® 6 RTL8852BE, 802.11ax Dual Band 2x2 Wi-Fi® + Bluetooth® 5.1, M.2 card^[1]
- Intel® Wi-Fi® 6 AX201, 802.11ax 2x2 Wi-Fi® + Bluetooth® 5.1, M.2 Card^[2]

Notes:

[1], [2] Bluetooth® 5.2 is hardware ready but may run at a lower version due to OS limitations.

Ports^[1]

Rear Ports

- 2x USB 2.0
- 2x USB 3.2 Gen 2
- 1x HDMI®-out
- 1x Ethernet (RJ-45)
- 1x power connector

Bottom Ports

1x headphone / microphone combo jack (3.5mm)

Left Ports

None

Optional Left Ports

None

Right Ports

None

Optional Right Ports

None

Notes:

[1] The transfer speed of following ports will vary and, depending on many factors, such as the processing speed of the host device, file attributes and other factors related to system configuration and your operating environment, will be slower than theoretical speed.

USB 2.0: 480 Mbit/s;

USB 3.2 Gen 1 (SuperSpeed USB 5Gbps, formerly USB 3.0 / USB 3.1 Gen 1): 5 Gbit/s;

USB 3.2 Gen 2 (SuperSpeed USB 10Gbps, formerly USB 3.1 Gen 2): 10 Gbit/s;

USB4® 20Gbps / USB 3.2 Gen 2x2 (SuperSpeed USB 20Gbps): 20 Gbit/s;

USB4® 40Gbps (USB 40Gbps): 40 Gbit/s;

Thunderbolt™ 3/4: 40 Gbit/s.

SECURITY & PRIVACY

Security

Security Chip

Firmware TPM 2.0 integrated in SoC

BIOS Security

- Administrator password
- Power-on password
- Hard disk password
- Cover presence switch
- Intel® BIOS guard

SERVICE

Warranty^[1]

Base Warranty**

- 1-year courier or carry-in service
- 1-year limited onsite service

Notes:

[1] The warranty upgrades may be bundled with some models, please check the "Included upgrade" column in the specific model's configurations. For more service extensions, please go to <https://smartfind.lenovo.com/>. To learn more details of warranty policy, please access <https://pcsupport.lenovo.com/warranty>.

ENVIRONMENTAL

Operating Environment

Temperature

- Operating: 5°C (41°F) to 35°C (95°F)
- Storage: -20°C (-4°F) to 60°C (140°F)

Relative Humidity

- Operating: 20% to 80%
- Storage: 10% to 90%

Altitude

- Operating: 0 m (0 ft) to 3048 m (10,000 ft)
- Storage: 0 m (0 ft) to 12192 m (40,000 ft)

CERTIFICATIONS

Green Certifications^[1]

Green Certifications

- (Optional) ENERGY STAR® 8.0
- (Optional) EPEAT™ Silver Registered^[2]
- ErP Lot 3 and Lot 7
- RoHS / WEEE / REACH

Notes:

[1] The items listed under the "Green Certifications" section may not only refer to certification but also registration or self-declaration.

[2] EPEAT™ is registered where applicable, please see [epeat.net](https://www.epeat.net) for registration status by country.

Other Certifications

Other Certifications

- TÜV Rheinland® Flicker Free
- TÜV Rheinland® Low Blue Light
- TÜV Rheinland® Low Noise

- Feature with ** means that only one offering listed under the feature is configured on selected models.
- Feature with *** means that one or more offerings listed under the feature could be configured on selected models.
- Lenovo reserves the right to change specifications or other product information without notice. Lenovo is not responsible for photographic or typographical errors. LENOVO PROVIDES THIS PUBLICATION "AS IS," WITHOUT WARRANTY OF ANY KIND, EITHER EXPRESS OR IMPLIED, INCLUDING THE IMPLIED WARRANTIES OF MERCHANTABILITY OR FITNESS FOR A PARTICULAR PURPOSE. Some jurisdictions do not allow disclaimer of express or implied warranties in certain transactions, therefore this disclaimer may not apply to you.
- The specifications on this page may not be available in all regions, and may be changed or updated without notice.



intel



intel



intel



intel



intel



intel

OVERVIEW



1. Power button	5. 2x USB 3.2 Gen 2
2. Combo audio jack (on bottom)	6. Ethernet (RJ-45)
3. Power connector	7. 2x USB 2.0
4. HDMI-out	8. Optical drive *

Notes:

- Items with * are only available on selected models

PERFORMANCE

Processor

Processor Family

13th Generation Intel® H Series Core™ i5 / i7 Processor

Processor**

Processor Name	Cores	Threads	Base Frequency	Max Frequency	Cache	Processor Graphics
Core™ i5-13420H	8 (4 P-core + 4 E-core)	12	P-core 2.1GHz / E-core 1.5GHz	P-core 4.6GHz / E-core 3.4GHz ^[1]	12MB	Intel® UHD Graphics
Core™ i7-13620H	10 (6 P-core + 4 E-core)	16	P-core 2.4GHz / E-core 1.8GHz	P-core 4.9GHz / E-core 3.6GHz ^[2]	24MB	Intel® UHD Graphics

Notes:

[1], [2] Intel® Max Turbo frequency will vary depending on application workload and the hardware and software configurations, see <http://www.intel.com/technology/turboboost/> for more information.

Operating System

Operating System**

- Windows® 11 Pro
- Windows® 11 Home
- Windows® 11 Home Single Language
- No preload operating system

Graphics

Graphics

Graphics	Type	Memory	Connector	Max Resolution	Key Features
Intel® UHD Graphics	Integrated	Shared	1x HDMI® 1.4	1920x1080@60Hz	DirectX® 12.1

Monitor Support

Monitor Support

Supports up to 2 independent displays via native display and 1 external monitor; supports external monitor via HDMI®

Chipset

Chipset

Intel® SoC (System on Chip) platform

Memory

Max Memory^[1]

Up to 16GB DDR4-3200

Memory Slots

Two DDR4 SO-DIMM slots, dual-channel capable

Memory Type

DDR4-3200

Notes:

[1] The max memory is based on the test results with current Lenovo® memory offerings.

Storage

Storage Support^[1]

- Up to two drives, 1x 2.5" HDD + 1x M.2 SSD
 - 2.5" HDD up to 1TB
 - M.2 SSD up to 1TB
- For installing HDD storage, assembly kits are needed. The kits only come with HDD models.

Storage Type***

Disk Type	Interface	RPM	Security
2.5" SATA HDD	SATA 6Gb/s	5.4K	-
M.2 2280 SSD	PCIe® NVMe®, PCIe® 4.0 x4	-	-
M.2 2280 SSD	PCIe® NVMe®, PCIe® 4.0 x4	-	Opal 2.0

Notes:
 [1] The max capacity of each disk type is based on the test results with current Lenovo® storage offerings.

Removable Storage

Optical

- DVD burner (DVD±RW), SATA connector, slim (9.0mm)
- None

Card Reader

No card reader

Multi-Media

Audio Chip

High Definition (HD) Audio, Realtek® ALC256 codec

Speakers

Stereo speakers, 3W x2, Audio by HARMAN

Microphone

- Dual-microphone array
- No microphone

Camera**

- 5.0-megapixel IR camera, 0° Pre-angle pull up camera, LED indicator
- HD 720p 0° Pre-angle pull up camera, LED indicator
- No camera

Power Supply

Power Supply

Power	Type	Efficiency	Key Features
90W	Adapter	89%	Autosensing

DESIGN

Display

Display^[1]

Size	Resolution	Touch	Type	Brightness	Surface	Aspect Ratio	Contrast Ratio	Color Gamut	Refresh Rate	Viewing Angle (L/R/U/D)	Key Features
23.8"	FHD (1920x1080)	None	IPS	250nits	Anti-glare	16:9	1000:1	72% NTSC	60Hz	89°/89°/89°/89°	14ms response Time, 16.7 million color depth, borderless design

Touchscreen

Non-touch

Notes:
 [1] IPS (in-plane switching) technology may refer to IPS, PLS, ADS, AHVA, AAS.

Input Device

Keyboard**

- Lenovo® Calliope Keyboard (USB connector), black
- Lenovo® Calliope Wireless Keyboard, black
- No keyboard

Mouse**

- Lenovo® Calliope Mouse (USB connector), black
- Lenovo® Calliope Wireless Mouse (2.4GHz via USB receiver), black
- No mouse

Mechanical

Form Factor

AIO (23.8 inches)

Dimensions (WxDxH)^[1]

Models	Dimensions
Models with monitor stand	541 x 207.5 x 433.8 mm (21.3 x 8.17 x 17.1 inches)
Models with liftable monitor stand	541 x 220 x 380.5-480.5 mm (21.3 x 8.66 x 14.98-18.92 inches)

Packaging Dimensions (WxDxH)

- Models with liftable monitor stand: 658 x 264 x 570 mm (25.91 x 10.39 x 22.44 inches)
- Models with monitor stand: 659 x 206 x 554 mm (25.94 x 8.11 x 21.81 inches)

Weight^[2]

Models	Weight
Models with liftable monitor stand	Around 6.6 kg (14.6 lbs)
Models with monitor stand	Around 6.7 kg (14.8 lbs)

Packaging Weight

Around 10.74 kg (23.08 lbs)

Case Color

Raven black

Bays

- 1x 2.5" disk bay
- For installing HDD storage, assembly kits are needed. The kits only come with HDD models.

Expansion Slots

Two M.2 slots (one for WLAN, one for SSD)

Stand**

- Monitor stand, supports -5° to +25° tilt, left & right 45° swivel
- Liftable monitor stand, supports -5° to +16° tilt, left & right 45° swivel, up to 100mm lift

Mounting

None

Notes:

[1] The system dimensions may vary depending on configurations.

[2] The system weight is approximate and based on results in Lenovo® lab, which varies depending on the source of component, variance of the distribution of each component, and manufacturing process. It may not be the exact weight for each specific model.

CONNECTIVITY

Network

Onboard Ethernet

Gigabit Ethernet, Realtek® RTL8111H, 1x RJ-45

WLAN + Bluetooth®**

ThinkCentre neo 30a 24 Gen 4

- Realtek® Wi-Fi® 6 RTL8852BE, 802.11ax Dual Band 2x2 Wi-Fi® + Bluetooth® 5.3, M.2 card^[1]
- Intel® Wi-Fi® 6 AX201, 802.11ax 2x2 Wi-Fi® + Bluetooth® 5.2, M.2 Card^[2]

Notes:

[1] Bluetooth® 5.3 requires Windows® 11.

[2] Bluetooth® 5.2 requires Windows® 11.

Ports^[1]

Rear Ports

- 2x USB 2.0
- 2x USB 3.2 Gen 2
- 1x HDMI®-out
- 1x Ethernet (RJ-45)
- 1x power connector

Bottom Ports

1x headphone / microphone combo jack (3.5mm)

Left Ports

None

Notes:

[1] The transfer speed of following ports will vary and, depending on many factors, such as the processing speed of the host device, file attributes and other factors related to system configuration and your operating environment, will be slower than theoretical speed.

USB 2.0: 480 Mbit/s;

USB 3.2 Gen 1 (SuperSpeed USB 5Gbps, formerly USB 3.0 / USB 3.1 Gen 1): 5 Gbit/s;

USB 3.2 Gen 2 (SuperSpeed USB 10Gbps, formerly USB 3.1 Gen 2): 10 Gbit/s;

USB4® 20Gbps / USB 3.2 Gen 2x2 (SuperSpeed USB 20Gbps): 20 Gbit/s;

USB4® 40Gbps (USB 40Gbps): 40 Gbit/s;

Thunderbolt™ 3/4: 40 Gbit/s.

SECURITY & PRIVACY

Security

Security Chip

Firmware TPM 2.0 integrated in SoC

BIOS Security

- Administrator password
- Power-on password
- Intel® BIOS guard

SERVICE

Warranty^[1]

Base Warranty**

- 1-year courier or carry-in service
- 1-year limited onsite service

Notes:

[1] The warranty upgrades may be bundled with some models, please check the "Included upgrade" column in the specific model's configurations. For more service extensions, please go to <https://smartfind.lenovo.com/>. To learn more details of warranty policy, please access <https://pcsupport.lenovo.com/warranty>.

ENVIRONMENTAL

Operating Environment

Temperature

- Operating: 5°C (41°F) to 35°C (95°F)
- Storage: -20°C (-4°F) to 60°C (140°F)

Relative Humidity

- Operating: 20% to 80%
- Storage: 10% to 90%

Altitude

- Operating: 0 m (0 ft) to 3048 m (10,000 ft)
- Storage: 0 m (0 ft) to 12192 m (40,000 ft)

CERTIFICATIONS

Green Certifications^[1]

Green Certifications

- (Optional) ENERGY STAR® 8.0
- (Optional) EPEAT™ Silver Registered^[2]

Notes:

[1] The items listed under the "Green Certifications" section may not only refer to certification but also registration or self-declaration.

[2] EPEAT™ is registered where applicable, please see epeat.net for registration status by country.

Other Certifications

Other Certifications

- TÜV Rheinland® Flicker Free
- TÜV Rheinland® Low Blue Light
- TÜV Rheinland® Low Noise

- Feature with ** means that only one offering listed under the feature is configured on selected models.
- Feature with *** means that one or more offerings listed under the feature could be configured on selected models.
- Lenovo reserves the right to change specifications or other product information without notice. Lenovo is not responsible for photographic or typographical errors. LENOVO PROVIDES THIS PUBLICATION "AS IS," WITHOUT WARRANTY OF ANY KIND, EITHER EXPRESS OR IMPLIED, INCLUDING THE IMPLIED WARRANTIES OF MERCHANTABILITY OR FITNESS FOR A PARTICULAR PURPOSE. Some jurisdictions do not allow disclaimer of express or implied warranties in certain transactions, therefore this disclaimer may not apply to you.
- The specifications on this page may not be available in all regions, and may be changed or updated without notice.



intel



intel



intel



intel



intel



intel

OVERVIEW



1. Power button	5. 2x USB 3.2 Gen 2
2. Combo audio jack (on bottom)	6. Ethernet (RJ-45)
3. Power connector	7. 2x USB 2.0
4. HDMI-out	8. Optical drive *

Notes:

- Items with * are only available on selected models

PERFORMANCE

Processor

Processor Family

12th Gen Intel® U Series Core™ i3 / i5, 12th Gen Intel® P Series Core™ i3 / i5 / i7, or 12th Gen Intel® H Series Core™ i5 Processor

Processor**[1]

Processor Name	Cores	Threads	Base Frequency	Max Frequency	Cache	Processor Graphics
Core™ i3-1215U	6 (2 P-core + 4 E-core)	8	P-core 1.2GHz / E-core 0.9GHz	P-core 4.4GHz / E-core 3.3GHz ^[2]	10MB	Intel® UHD Graphics
Core™ i3-1220P	10 (2 P-core + 8 E-core)	12	P-core 1.5GHz / E-core 1.1GHz	P-core 4.4GHz / E-core 3.3GHz ^[3]	12MB	Intel® UHD Graphics
Core™ i5-1235U	10 (2 P-core + 8 E-core)	12	P-core 1.3GHz / E-core 0.9GHz	P-core 4.4GHz / E-core 3.3GHz ^[4]	12MB	Intel® Iris® Xe Graphics
Core™ i5-1240P	12 (4 P-core + 8 E-core)	16	P-core 1.7GHz / E-core 1.2GHz	P-core 4.4GHz / E-core 3.3GHz ^[5]	12MB	Intel® Iris® Xe Graphics
Core™ i5-12450H	8 (4 P-core + 4 E-core)	12	P-core 2.0GHz / E-core 1.5GHz	P-core 4.4GHz / E-core 3.3GHz ^[6]	12MB	Intel® UHD Graphics
Core™ i7-1260P	12 (4 P-core + 8 E-core)	16	P-core 2.1GHz / E-core 1.5GHz	P-core 4.7GHz / E-core 3.4GHz ^[7]	18MB	Intel® Iris® Xe Graphics

Notes:

[1] Intel® Iris® Xe Graphics capability requires system to be configured with dual-channel memory. On the system with single-channel memory, Intel® Iris® Xe Graphics will function as Intel® UHD Graphics.

[2], [3], [4], [5], [6], [7] Intel® Max Turbo frequency will vary depending on application workload and the hardware and software configurations, see <http://www.intel.com/technology/turboboost/> for more information.

Operating System

Operating System**

- Windows® 11 Pro
- Windows® 11 Home
- Windows® 11 Home Single Language
- Windows® 11 DG Windows® 10 Pro 64
- No preload operating system

Graphics

Graphics**

Graphics	Type	Memory	Connector	Max Resolution	Key Features
Intel® UHD Graphics	Integrated	Shared	1x HDMI® 1.4	1920x1080@60Hz	DirectX® 12.1
Intel® Iris® Xe Graphics ^[1]	Integrated	Shared	1x HDMI® 1.4	1920x1080@60Hz	DirectX® 12.1

Notes:

[1] Intel® Iris® Xe Graphics capability requires system to be configured with dual-channel memory. On the system with single-channel memory, Intel® Iris® Xe Graphics will function as Intel® UHD Graphics.

Monitor Support

Monitor Support

Supports up to 2 independent displays via native display and 1 external monitor; supports external monitor via HDMI®

Chipset

Chipset

Intel® SoC (System on Chip) platform

Memory

Max Memory^[1]

Up to 16GB DDR4-3200

Memory Slots

Two DDR4 SO-DIMM slots, dual-channel capable

Memory Type

DDR4-3200

Notes:

[1] The max memory is based on the test results with current Lenovo® memory offerings.

Storage

Storage Support^[1]

- Up to two drives, 1x 2.5" HDD + 1x M.2 SSD
 - 2.5" HDD up to 1TB
 - M.2 SSD up to 1TB
- For installing HDD storage, assembly kits are needed. The kits only come with HDD models.

Storage Type^{***}

Disk Type	Interface	RPM	Security
2.5" SATA HDD	SATA 6Gb/s	5.4K	-
M.2 2280 SSD	PCIe® NVMe®, PCIe® 3.0 x4	-	-
M.2 2280 SSD	PCIe® NVMe®, PCIe® 4.0 x4	-	Opal 2.0

RAID

No support

Notes:

[1] The max capacity of each disk type is based on the test results with current Lenovo® storage offerings.

Removable Storage

Optical

- DVD burner (DVD±RW), SATA 1.5Gb/s, slim (9.0mm)
- None

Card Reader

No card reader

Multi-Media

Audio Chip

High Definition (HD) Audio, Realtek® ALC256 codec

Speakers

Stereo speakers, 3W x2

Microphone

- Dual-microphone array
- No microphone

Camera^{**}

- 5.0-megapixel IR camera, fixed focus
- 5.0-megapixel, fixed focus
- No camera

Power Supply

Power Supply

Power	Type	Efficiency	Key Features
90W	Adapter	89%	Autosensing

DESIGN

Display

Display^[1]

Size	Resolution	Touch	Type	Brightness	Surface	Aspect Ratio	Contrast Ratio	Color Gamut	Refresh Rate	Viewing Angle (L/R/U/D)	Key Features
27"	FHD (1920x1080)	None	IPS	250nits	Anti-glare	16:9	1000:1	72% NTSC	60Hz	89°/89°/89°/89°	14ms response Time, 16.7 million color depth, borderless design

Touchscreen

Non-touch

Notes:

[1] IPS (in-plane switching) technology may refer to IPS, PLS, ADS, AHVA, AAS.

Input Device

Keyboard**

- Lenovo® Calliope Keyboard (USB connector), black
- Lenovo® Calliope Wireless Keyboard, black
- No keyboard

Mouse**

- Lenovo® Calliope Mouse (USB connector), black
- Lenovo® Calliope Wireless Mouse (2.4GHz via USB receiver), black
- No mouse

Mechanical

Form Factor

AIO (27 inches)

Dimensions (WxDxH)^[1]

474.12 x 207.52 x 613.1 mm (18.67 x 8.17 x 24.14 inches)

Packaging Dimensions (WxDxH)

570 x 233 x 763 mm (22.44 x 9.17 x 30.03 inches)

Weight^[2]

Around 8.11 kg (17.88 lbs)

Packaging Weight

Around 12.38 kg (27.29 lbs)

Case Color

Raven black

Bays

- 1x 2.5" disk bay
- For installing HDD storage, assembly kits are needed. The kits only come with HDD models.

Expansion Slots

Two M.2 slots (one for WLAN, one for SSD)

EOU

No support

Stand

Monitor stand, supports -5° to +25° tilt, left & right 45° swivel

Mounting

None

Notes:

[1] The system dimensions may vary depending on configurations.

[2] The system weight is approximate and based on results in Lenovo® lab, which varies depending on the source of component, variance of the distribution of each component, and manufacturing process. It may not be the exact weight for each specific model.

CONNECTIVITY

Network

Onboard Ethernet

Gigabit Ethernet, Realtek® RTL8111H, 1x RJ-45

WLAN + Bluetooth®**

- Realtek® RTL8822CE, 802.11ac Dual Band 2x2 Wi-Fi® + Bluetooth® 5.0, M.2 card
- Intel® Wireless-AC 9560, 802.11ac Dual Band 2x2 Wi-Fi® + Bluetooth® 5.0, Intel® vPro® technology support, M.2 card
- Realtek® Wi-Fi® 6 RTL8852BE, 802.11ax Dual Band 2x2 Wi-Fi® + Bluetooth® 5.3, M.2 card^[1]
- Intel® Wi-Fi® 6 AX201, 802.11ax 2x2 Wi-Fi® + Bluetooth® 5.2, M.2 Card^[2]

Notes:

[1] Bluetooth® 5.3 requires Windows® 11.

[2] Bluetooth® 5.2 requires Windows® 11.

Ports^[1]

Rear Ports

- 2x USB 2.0
- 2x USB 3.2 Gen 2
- 1x HDMI®-out
- 1x Ethernet (RJ-45)
- 1x power connector

Bottom Ports

1x headphone / microphone combo jack (3.5mm)

Left Ports

None

Optional Left Ports

None

Right Ports

None

Optional Right Ports

None

Notes:

[1] The transfer speed of following ports will vary and, depending on many factors, such as the processing speed of the host device, file attributes and other factors related to system configuration and your operating environment, will be slower than theoretical speed.

USB 2.0: 480 Mbit/s;

USB 3.2 Gen 1 (SuperSpeed USB 5Gbps, formerly USB 3.0 / USB 3.1 Gen 1): 5 Gbit/s;

USB 3.2 Gen 2 (SuperSpeed USB 10Gbps, formerly USB 3.1 Gen 2): 10 Gbit/s;

USB4® 20Gbps / USB 3.2 Gen 2x2 (SuperSpeed USB 20Gbps): 20 Gbit/s;

USB4® 40Gbps (USB 40Gbps): 40 Gbit/s;

Thunderbolt™ 3/4: 40 Gbit/s.

SECURITY & PRIVACY

Security

Security Chip

Firmware TPM 2.0 integrated in SoC

BIOS Security

- Administrator password
- Power-on password
- Hard disk password
- Cover presence switch
- Intel® BIOS guard

SERVICE

Warranty^[1]

Base Warranty**

- 1-year courier or carry-in service
- 1-year limited onsite service

Notes:

[1] The warranty upgrades may be bundled with some models, please check the "Included upgrade" column in the specific model's configurations. For more service extensions, please go to <https://smartfind.lenovo.com/>. To learn more details of warranty policy, please access <https://pcsupport.lenovo.com/warranty>.

ENVIRONMENTAL

Operating Environment

Temperature

- Operating: 5°C (41°F) to 35°C (95°F)
- Storage: -20°C (-4°F) to 60°C (140°F)

Relative Humidity

- Operating: 20% to 80%
- Storage: 10% to 90%

Altitude

- Operating: 0 m (0 ft) to 3048 m (10,000 ft)
- Storage: 0 m (0 ft) to 12192 m (40,000 ft)

CERTIFICATIONS

Green Certifications^[1]

Green Certifications

- (Optional) ENERGY STAR® 8.0
- (Optional) EPEAT™ Silver Registered^[2]
- ErP Lot 3 and Lot 7
- RoHS / WEEE / REACH

Notes:

[1] The items listed under the "Green Certifications" section may not only refer to certification but also registration or self-declaration.

[2] EPEAT™ is registered where applicable, please see epeat.net for registration status by country.

Other Certifications

Other Certifications

- TÜV Rheinland® Flicker Free
- TÜV Rheinland® Low Blue Light
- TÜV Rheinland® Low Noise

- Feature with ** means that only one offering listed under the feature is configured on selected models.

- Feature with *** means that one or more offerings listed under the feature could be configured on selected models.
- Lenovo reserves the right to change specifications or other product information without notice. Lenovo is not responsible for photographic or typographical errors. LENOVO PROVIDES THIS PUBLICATION “AS IS,” WITHOUT WARRANTY OF ANY KIND, EITHER EXPRESS OR IMPLIED, INCLUDING THE IMPLIED WARRANTIES OF MERCHANTABILITY OR FITNESS FOR A PARTICULAR PURPOSE. Some jurisdictions do not allow disclaimer of express or implied warranties in certain transactions, therefore this disclaimer may not apply to you.
- The specifications on this page may not be available in all regions, and may be changed or updated without notice.



OVERVIEW



1. Power button	5. 2x USB 3.2 Gen 2
2. Combo audio jack (on bottom)	6. Ethernet (RJ-45)
3. Power connector	7. 2x USB 2.0
4. HDMI-out	8. Optical drive *

Notes:

- Items with * are only available on selected models

PERFORMANCE

Processor

Processor Family

13th Generation Intel® H Series Core™ i5 / i7 Processor

Processor**

Processor Name	Cores	Threads	Base Frequency	Max Frequency	Cache	Processor Graphics
Core™ i5-13420H	8 (4 P-core + 4 E-core)	12 ^[1]	P-core 2.1GHz / E-core 1.5GHz	P-core 4.6GHz / E-core 3.4GHz	12MB	Intel® UHD Graphics
Core™ i7-13620H	10 (6 P-core + 4 E-core)	16	P-core 2.4GHz / E-core 1.8GHz	P-core 4.9GHz / E-core 3.6GHz ^[2]	24MB	Intel® UHD Graphics

Notes:

[1], [2] Intel® Max Turbo frequency will vary depending on application workload and the hardware and software configurations, see <http://www.intel.com/technology/turboboost/> for more information.

Operating System

Operating System**

- Windows® 11 Pro
- Windows® 11 Home
- Windows® 11 Home Single Language
- No preload operating system

Graphics

Graphics

Graphics	Type	Memory	Connector	Max Resolution	Key Features
Intel® UHD Graphics	Integrated	Shared	1x HDMI® 1.4	1920x1080@60Hz	DirectX® 12.1

Monitor Support

Monitor Support

Supports up to 2 independent displays via native display and 1 external monitor; supports external monitor via HDMI®

Chipset

Chipset

Intel® SoC (System on Chip) platform

Memory

Max Memory^[1]

Up to 16GB DDR4-3200

Memory Slots

Two DDR4 SO-DIMM slots, dual-channel capable

Memory Type

DDR4-3200

Notes:

[1] The max memory is based on the test results with current Lenovo® memory offerings.

Storage

Storage Support^[1]

- Up to two drives, 1x 2.5" HDD + 1x M.2 SSD
 - 2.5" HDD up to 1TB
 - M.2 SSD up to 1TB
- For installing HDD storage, assembly kits are needed. The kits only come with HDD models.

Storage Type***

Disk Type	Interface	RPM	Security
2.5" SATA HDD	SATA 6Gb/s	5.4K	-
M.2 2280 SSD	PCIe® NVMe®, PCIe® 4.0 x4	-	-
M.2 2280 SSD	PCIe® NVMe®, PCIe® 4.0 x4	-	Opal 2.0

RAID

No support

Notes:

[1] The max capacity of each disk type is based on the test results with current Lenovo® storage offerings.

Removable Storage**Optical**

- DVD burner (DVD±RW), SATA 1.5Gb/s, slim (9.0mm)
- None

Card Reader

No card reader

Multi-Media**Audio Chip**

High Definition (HD) Audio, Realtek® ALC256 codec

Speakers

Stereo speakers, 3W x2

Microphone

- Dual-microphone array
- No microphone

Camera**

- 5.0-megapixel IR camera, 0° Pre-angle pull up camera, LED indicator
- 5.0-megapixel camera, 0° Pre-angle pull up camera, LED indicator
- No camera

Power Supply**Power Supply**

Power	Type	Efficiency	Key Features
90W	Adapter	89%	Autosensing

DESIGN**Display****Display^[1]**

Size	Resolution	Touch	Type	Brightness	Surface	Aspect Ratio	Contrast Ratio	Color Gamut	Refresh Rate	Viewing Angle (L/R/U/D)	Key Features
27"	FHD (1920x1080)	None	IPS	250nits	Anti-glare	16:9	1000:1	72% NTSC	60Hz	89°/89°/89°/89°	14ms response Time, 16.7 million color depth, borderless design

Touchscreen

Non-touch

Notes:

[1] IPS (in-plane switching) technology may refer to IPS, PLS, ADS, AHVA, AAS.

Input Device

Keyboard**

- Lenovo® Calliope Keyboard (USB connector), black
- Lenovo® Calliope Wireless Keyboard, black
- No keyboard

Mouse**

- Lenovo® Calliope Mouse (USB connector), black
- Lenovo® Calliope Wireless Mouse (2.4GHz via USB receiver), black
- No mouse

Mechanical

Form Factor

AIO (27 inches)

Dimensions (WxDxH)^[1]

474.1 x 207.5 x 613.1 mm (18.67 x 8.17 x 24.14 inches)

Packaging Dimensions (WxDxH)

570 x 233 x 763 mm (22.44 x 9.17 x 30.03 inches)

Weight^[2]

Around 8.11 kg (17.88 lbs)

Packaging Weight

Around 12.38 kg (27.29 lbs)

Case Color

Raven black

Bays

- 1x 2.5" disk bay
- For installing HDD storage, assembly kits are needed. The kits only come with HDD models.

Expansion Slots

Two M.2 slots (one for WLAN, one for SSD)

EOU

No support

Stand

Monitor stand, supports -5° to +25° tilt, left & right 45° swivel

Mounting

None

Notes:

[1] The system dimensions may vary depending on configurations.

[2] The system weight is approximate and based on results in Lenovo® lab, which varies depending on the source of component, variance of the distribution of each component, and manufacturing process. It may not be the exact weight for each specific model.

CONNECTIVITY

Network

Onboard Ethernet

Gigabit Ethernet, Realtek® RTL8111H, 1x RJ-45

WLAN + Bluetooth®**

- Realtek® Wi-Fi® 6 RTL8852BE, 802.11ax Dual Band 2x2 Wi-Fi® + Bluetooth® 5.3, M.2 card^[1]
- Intel® Wi-Fi® 6 AX201, 802.11ax 2x2 Wi-Fi® + Bluetooth® 5.2, M.2 Card^[2]

ThinkCentre neo 30a 27 Gen 4

Notes:

[1] Bluetooth® 5.3 requires Windows® 11.

[2] Bluetooth® 5.2 requires Windows® 11.

Ports^[1]

Rear Ports

- 2x USB 2.0
- 2x USB 3.2 Gen 2
- 1x HDMI®-out
- 1x Ethernet (RJ-45)
- 1x power connector

Bottom Ports

1x headphone / microphone combo jack (3.5mm)

Notes:

[1] The transfer speed of following ports will vary and, depending on many factors, such as the processing speed of the host device, file attributes and other factors related to system configuration and your operating environment, will be slower than theoretical speed.

USB 2.0: 480 Mbit/s;

USB 3.2 Gen 1 (SuperSpeed USB 5Gbps, formerly USB 3.0 / USB 3.1 Gen 1): 5 Gbit/s;

USB 3.2 Gen 2 (SuperSpeed USB 10Gbps, formerly USB 3.1 Gen 2): 10 Gbit/s;

USB4® 20Gbps / USB 3.2 Gen 2x2 (SuperSpeed USB 20Gbps): 20 Gbit/s;

USB4® 40Gbps (USB 40Gbps): 40 Gbit/s;

Thunderbolt™ 3/4: 40 Gbit/s.

SECURITY & PRIVACY

Security

Security Chip

Firmware TPM 2.0 integrated in SoC

BIOS Security

- Administrator password
- Power-on password
- Intel® BIOS guard

SERVICE

Warranty^[1]

Base Warranty**

- 1-year courier or carry-in service
- 1-year limited onsite service

Notes:

[1] The warranty upgrades may be bundled with some models, please check the "Included upgrade" column in the specific model's configurations. For more service extensions, please go to <https://smartfind.lenovo.com/>. To learn more details of warranty policy, please access <https://pcsupport.lenovo.com/warranty>.

ENVIRONMENTAL

Operating Environment

Temperature

- Operating: 5°C (41°F) to 35°C (95°F)
- Storage: -20°C (-4°F) to 60°C (140°F)

Relative Humidity

- Operating: 20% to 80%
- Storage: 10% to 90%

Altitude

- Operating: 0 m (0 ft) to 3048 m (10,000 ft)
- Storage: 0 m (0 ft) to 12192 m (40,000 ft)

CERTIFICATIONS**Green Certifications^[1]****Green Certifications**

- (Optional) ENERGY STAR® 8.0
- (Optional) EPEAT™ Silver Registered^[2]

Notes:

[1] The items listed under the "Green Certifications" section may not only refer to certification but also registration or self-declaration.

[2] EPEAT™ is registered where applicable, please see [epeat.net](https://www.epeat.net) for registration status by country.

Other Certifications**Other Certifications**

- TÜV Rheinland® Flicker Free
- TÜV Rheinland® Low Blue Light
- TÜV Rheinland® Low Noise

- Feature with ** means that only one offering listed under the feature is configured on selected models.
- Feature with *** means that one or more offerings listed under the feature could be configured on selected models.
- Lenovo reserves the right to change specifications or other product information without notice. Lenovo is not responsible for photographic or typographical errors. LENOVO PROVIDES THIS PUBLICATION "AS IS," WITHOUT WARRANTY OF ANY KIND, EITHER EXPRESS OR IMPLIED, INCLUDING THE IMPLIED WARRANTIES OF MERCHANTABILITY OR FITNESS FOR A PARTICULAR PURPOSE. Some jurisdictions do not allow disclaimer of express or implied warranties in certain transactions, therefore this disclaimer may not apply to you.
- The specifications on this page may not be available in all regions, and may be changed or updated without notice.



OVERVIEW

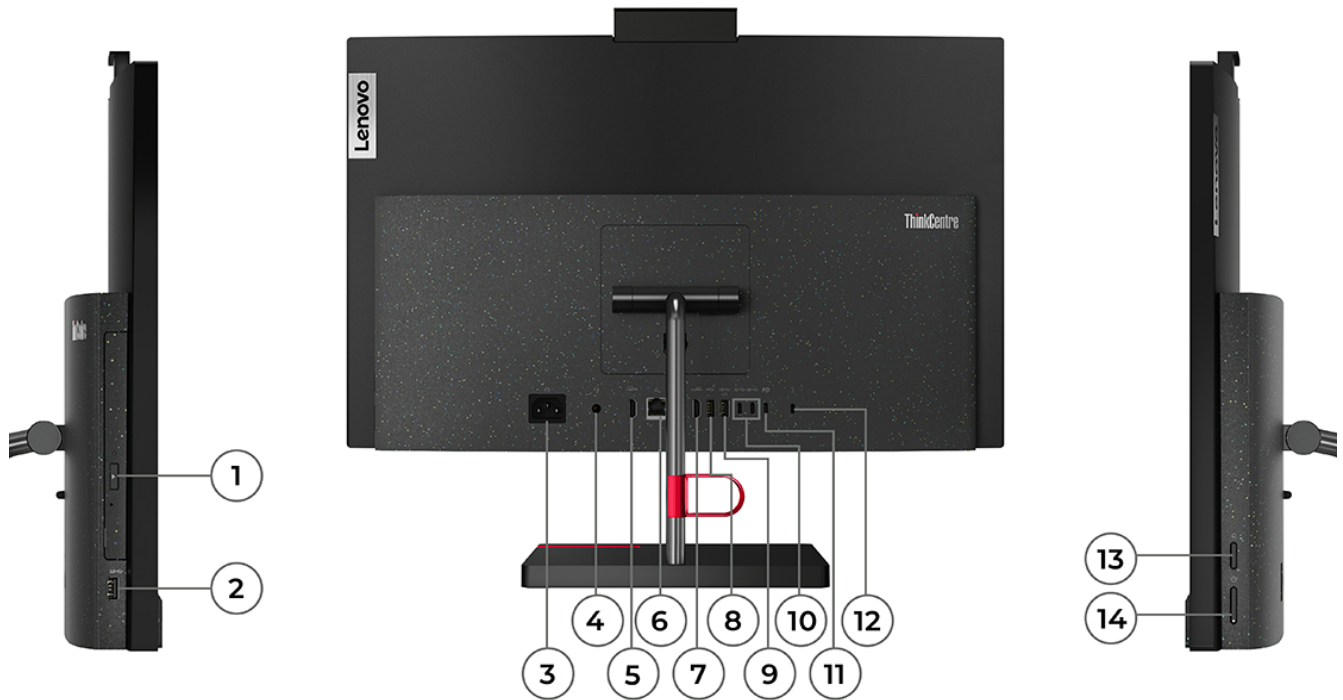

1. Optical drive eject button *	8. USB 2.0
2. USB 3.2 Gen 1	9. USB 3.2 Gen 2
3. Power connector	10. 2x USB-C 3.2 Gen 2
4. Headphone / microphone combo jack (3.5mm)	11. USB-C 2.0 (support data transfer, PD 3.0)
5. HDMI-in 1.4	12. Kensington Security Slot
6. Ethernet (RJ-45)	13. HDMI Switch Key
7. HDMI-out 2.1 TMDS	14. Power button

Notes:

- Items with * are only available on selected models

PERFORMANCE

Processor

Processor Family

12th Generation Intel® Core™ i3 P-Series and i5 / i7 H-Series Processor

Processor**^[1]

Processor Name	Cores	Threads	Base Frequency	Max Frequency	Cache	Processor Graphics
Core™ i3-1220P	10 (2 P-core + 8 E-core)	12	P-core 1.5GHz / E-core 1.1GHz	P-core 4.4GHz / E-core 3.3GHz ^[2]	12MB	Intel® UHD Graphics
Core™ i5-12450H	8 (4 P-core + 4 E-core)	12	P-core 2.0GHz / E-core 1.5GHz	P-core 4.4GHz / E-core 3.3GHz ^[3]	12MB	Intel® UHD Graphics
Core™ i5-12500H	12 (4 P-core + 8 E-core)	16	P-core 2.5GHz / E-core 1.8GHz	P-core 4.5GHz / E-core 3.3GHz ^[4]	18MB	Intel® Iris® Xe Graphics
Core™ i7-12700H	14 (6 P-core + 8 E-core)	20	P-core 2.3GHz / E-core 1.7GHz	P-core 4.7GHz / E-core 3.5GHz ^[5]	24MB	Intel® Iris® Xe Graphics

Notes:

^[1] Intel® Iris® Xe Graphics capability requires system to be configured with dual-channel memory. On the system with single-channel memory, Intel® Iris® Xe Graphics will function as Intel® UHD Graphics.

^[2], ^[3], ^[4], ^[5] Intel® Max Turbo frequency will vary depending on application workload and the hardware and software configurations, see

<http://www.intel.com/technology/turboboost/> for more information.

Operating System

Operating System**

- Windows® 11 Pro
- Windows® 11 Home
- Windows® 11 Home Single Language
- Windows® 11 DG Windows® 10 Pro 64
- Ubuntu Linux^[1]
- No preload operating system

Notes:

^[1] Some features may not be supported on the system with Linux preload, including but not limited to Intel® RST RAID, Human Presence Detection, etc.

Graphics

Graphics**

Graphics	Type	Memory	Connector	Max Resolution	Key Features
Intel® UHD Graphics	Integrated	Shared	1x HDMI® 2.1 TMDS	3840x2160@60Hz(HDMI®)	DirectX® 12.1
Intel® Iris® Xe Graphics ^[1]	Integrated	Shared	1x HDMI® 2.1 TMDS	3840x2160@60Hz(HDMI®)	DirectX® 12.1
Intel® Arc™ A370M Graphics	Discrete	4GB GDDR6	1x HDMI® 2.1 TMDS	3840x2160@60Hz(HDMI®)	DirectX® 12 Ultimate

Notes:

^[1] Intel® Iris® Xe Graphics capability requires system to be configured with dual-channel memory. On the system with single-channel memory, Intel® Iris® Xe Graphics will function as Intel® UHD Graphics.

Monitor Support

Monitor Support

Supports up to 2 independent displays via native display and 1 external monitor; supports external monitor via HDMI®

Chipset

Chipset

Intel® SoC (System on Chip) platform

Memory

Max Memory^[1]

Up to 16GB DDR5-4800

Memory Slots

Two DDR5 SO-DIMM slots, dual-channel capable

Memory Type

DDR5-4800

Notes:

[1] The max memory is based on the test results with current Lenovo® memory offerings.

Storage

Storage Support^[1]

- Up to two drives, 1x 2.5" HDD + 1x M.2 SSD
 - 2.5" HDD up to 2TB
 - M.2 SSD up to 1TB
- For installing HDD storage, assembly kits are needed. The kits only come with HDD models.

Storage Type**

Disk Type	Interface	RPM	Security
2.5" SATA HDD	SATA 6Gb/s	5.4K	-
M.2 2280 SSD	PCIe® NVMe®, PCIe® 3.0 x4	-	-
M.2 2280 SSD	PCIe® NVMe®, PCIe® 4.0 x4	-	Opal 2.0
M.2 2280 SSD	PCIe® NVMe®, PCIe® 4.0 x4 Value	-	Opal 2.0

RAID

No support

Notes:

[1] The max capacity of each disk type is based on the test results with current Lenovo® storage offerings.

Removable Storage

Optical

- DVD burner (DVD±RW), SATA connector, slim (9.0mm)
- None

Card Reader

No card reader

Multi-Media

Audio Chip

High Definition (HD) Audio, Realtek® ALC274-CG codec

Speakers

Stereo speakers, 3W x2

Microphone

Dual-microphone array

Camera**

- 5.0-megapixel IR camera, fixed focus
- 5.0-megapixel IR camera, fixed focus, with AI chip
- 5.0-megapixel, fixed focus
- No camera

Power Supply

Power Supply

Power	Type	Efficiency	Key Features
180W	Fixed	90%	100V - 240V, 50-60Hz

DESIGN

Display

Display**^[1]

Size	Resolution	Touch	Type	Brightness	Surface	Aspect Ratio	Contrast Ratio	Color Gamut	Refresh Rate	Viewing Angle (L/R/U/D)	Key Features
23.8"	FHD (1920x1080)	None	IPS	250nits	Anti-glare	16:9	1000:1	72% NTSC	60Hz	89°/89°/89°/89°	14ms response Time, borderless design, low blue light, flicker free
23.8"	FHD (1920x1080)	Multi-touch	IPS	250nits	Anti-glare	16:9	1000:1	72% NTSC	60Hz	89°/89°/89°/89°	14ms response Time, borderless design, low blue light, flicker free

Touchscreen

- Advanced In-cell Touch (AIT), supports 10-point touch
- Non-touch

Notes:

^[1] IPS (in-plane switching) technology may refer to IPS, PLS, ADS, AHVA, AAS.

Input Device

Keyboard**

- Lenovo® Calliope Keyboard (USB connector), black
- Lenovo® Calliope Wireless Keyboard, black
- No keyboard

Mouse**

- Lenovo® Calliope Mouse (USB connector), black
- Lenovo® Calliope Wireless Mouse (2.4GHz via USB receiver), black
- Euterpe Wireless Mouse, grey
- No mouse

Mechanical

Form Factor

AIO (23.8 inches)

Dimensions (WxDxH)^[1]

Models	Dimensions
Models with monitor stand	541 x 209.9 x 433.7 mm (21.3 x 8.3 x 17.1 inches)
Models with liftable monitor stand	541 x 220 x 482 mm (21.3 x 8.7 x 19 inches)

Packaging Dimensions (WxDxH)

- Models with liftable monitor stand: 658 x 264 x 567 mm (25.9 x 10.4 x 22.3 inches)
- Models with monitor stand: 695 x 196 x 569 mm (27.4 x 7.7 x 22.4 inches)

Weight^[2]

Models	Weight
--------	--------

Models with monitor stand	Around 7.43 kg (16.4 lbs)
Models with liftable monitor stand	Around 7.65 kg (16.9 lbs)

Packaging Weight

- Models with liftable monitor stand: 10.3 kg (22.7 lbs)
- Models with monitor stand: 9.69 kg (21.4 lbs)

Case Color

Raven black

Bays

- 1x 2.5" disk bay
- 1x slim ODD bay
- For installing HDD storage, assembly kits are needed. The kits only come with HDD models.

Expansion Slots

Two M.2 slots (one for WLAN, one for SSD)

Stand**

- Monitor stand, supports -5° to +25° tilt, left & right 45° swivel
- Liftable monitor stand, supports -5° to +18° tilt, left & right 45° swivel, up to 100mm lift

Mounting

Supports VESA mount 100mm

Others

Supports Smart Power On

Notes:

[1] The system dimensions may vary depending on configurations.

[2] The system weight is approximate and based on results in Lenovo® lab, which varies depending on the source of component, variance of the distribution of each component, and manufacturing process. It may not be the exact weight for each specific model.

CONNECTIVITY

Network

Onboard Ethernet

Gigabit Ethernet, Realtek® RTL8111K, 1x RJ-45, supports Wake-on-LAN

WLAN + Bluetooth®**

- Realtek® RTL8822CE, 802.11ac Dual Band 2x2 Wi-Fi® + Bluetooth® 5.0, M.2 card
- Intel® Wireless-AC 9560, 802.11ac Dual Band 2x2 Wi-Fi® + Bluetooth® 5.0, Intel® vPro® technology support, M.2 card
- Realtek® Wi-Fi® 6 RTL8852BE, 802.11ax Dual Band 2x2 Wi-Fi® + Bluetooth® 5.1, M.2 card^[1]
- Intel® Wi-Fi® 6 AX201, 802.11ax 2x2 Wi-Fi® + Bluetooth® 5.1, M.2 Card^[2]

Notes:

[1], [2] Bluetooth® 5.2 is hardware ready but may run at a lower version due to OS limitations.

Ports^[1]

Rear Ports

- 1x USB-C® 2.0 (Supports data transfer, Power Delivery 3.0)
- 2x USB-C® 3.2 Gen 2
- 1x USB 2.0
- 1x USB 3.2 Gen 2 (Supports smart power-on)
- 1x HDMI®-in 1.4
- 1x HDMI®-out 2.1 TMDS
- 1x Ethernet (RJ-45)
- 1x headphone / microphone combo jack (3.5mm)

Left Ports

1x USB 3.2 Gen 1

Notes:

[1] The transfer speed of following ports will vary and, depending on many factors, such as the processing speed of the host device, file attributes and other factors related to system configuration and your operating environment, will be slower than theoretical speed.

USB 2.0: 480 Mbit/s;

USB 3.2 Gen 1 (SuperSpeed USB 5Gbps, formerly USB 3.0 / USB 3.1 Gen 1): 5 Gbit/s;

USB 3.2 Gen 2 (SuperSpeed USB 10Gbps, formerly USB 3.1 Gen 2): 10 Gbit/s;

USB4® 20Gbps / USB 3.2 Gen 2x2 (SuperSpeed USB 20Gbps): 20 Gbit/s;

USB4® 40Gbps (USB 40Gbps): 40 Gbit/s;

Thunderbolt™ 3/4: 40 Gbit/s.

SECURITY & PRIVACY

Security

Security Chip

Firmware TPM 2.0 integrated in SoC

Physical Locks

Kensington® Security Slot™, 3 x 7 mm

BIOS Security

- Administrator password
- Power-on password
- Hard disk password
- Cover presence switch
- Intel® BIOS guard

SERVICE

Warranty^[1]

Base Warranty**

- 1-year courier or carry-in service
- 1-year limited onsite service

Notes:

[1] The warranty upgrades may be bundled with some models, please check the "Included upgrade" column in the specific model's configurations. For more service extensions, please go to <https://smartfind.lenovo.com/>. To learn more details of warranty policy, please access <https://pcsupport.lenovo.com/warranty>.

ENVIRONMENTAL

Operating Environment

Temperature

- Operating: 5°C (41°F) to 35°C (95°F)
- Storage: -20°C (-4°F) to 60°C (140°F)

Relative Humidity

- Operating: 20% to 80%
- Storage: 10% to 90%

Altitude

- Operating: 0 m (0 ft) to 3048 m (10,000 ft)
- Storage: 0 m (0 ft) to 12192 m (40,000 ft)

ACCESSORIES

Bundled Accessories

Bundled Accessories

- USB-C® to USB-A dongle
- None

CERTIFICATIONS

Green Certifications^[1]

Green Certifications

- (Optional) ENERGY STAR® 8.0
- (Optional) EPEAT™ Silver Registered^[2]

Notes:

[1] The items listed under the "Green Certifications" section may not only refer to certification but also registration or self-declaration.

[2] EPEAT™ is registered where applicable, please see [epeat.net](https://www.epeat.net) for registration status by country.

Other Certifications

Other Certifications

- TÜV Rheinland® Flicker Free
- TÜV Rheinland® Low Blue Light
- TÜV Rheinland® Ultra Low Noise

Mil-Spec Test

None

- Feature with ** means that only one offering listed under the feature is configured on selected models.
- Lenovo reserves the right to change specifications or other product information without notice. Lenovo is not responsible for photographic or typographical errors. LENOVO PROVIDES THIS PUBLICATION "AS IS," WITHOUT WARRANTY OF ANY KIND, EITHER EXPRESS OR IMPLIED, INCLUDING THE IMPLIED WARRANTIES OF MERCHANTABILITY OR FITNESS FOR A PARTICULAR PURPOSE. Some jurisdictions do not allow disclaimer of express or implied warranties in certain transactions, therefore this disclaimer may not apply to you.
- The specifications on this page may not be available in all regions, and may be changed or updated without notice.



intel



intel



intel



intel



intel



intel

OVERVIEW

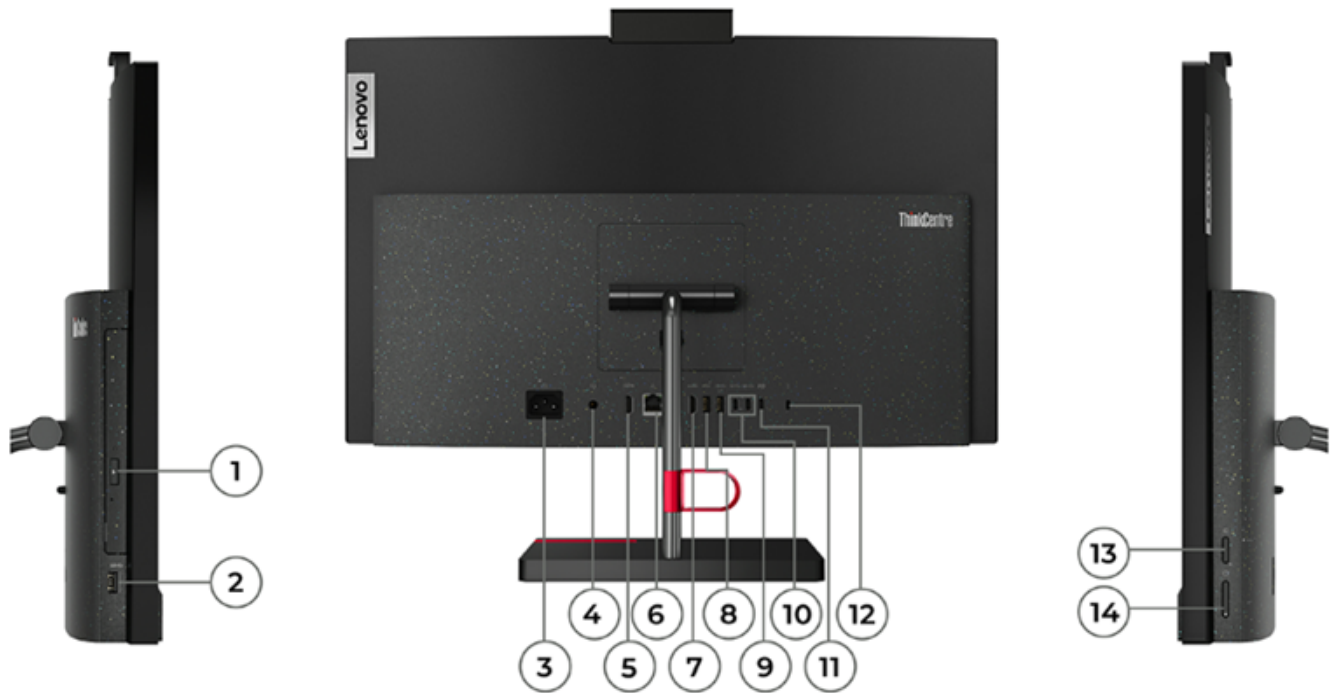

1. Optical drive eject button *	8. USB 2.0
2. USB 3.2 Gen 1	9. USB 3.2 Gen 2
3. Power connector	10. 2x USB-C 3.2 Gen 2
4. Headphone / microphone combo jack (3.5mm)	11. USB-C 2.0 (support data transfer, PD 3.0)
5. HDMI-in 1.4	12. Kensington Security Slot
6. Ethernet (RJ-45)	13. HDMI Switch Key
7. HDMI-out 2.1 TMDS	14. Power button

Notes:

- Items with * are only available on selected models

PERFORMANCE

Processor

Processor Family

13th Generation Intel® Core™ i5 / i7 Processor

Processor**^[1]

Processor Name	Cores	Threads	Base Frequency	Max Frequency	Cache	Processor Graphics
Core™ i5-13500H	12 (4 P-core + 8 E-core)	16	P-core 2.6GHz / E-core 1.9GHz	P-core 4.7GHz / E-core 3.5GHz ^[2]	18MB	Intel® Iris® Xe Graphics
Core™ i7-13700H	14 (6 P-core + 8 E-core)	20	P-core 2.4GHz / E-core 1.8GHz	P-core 5.0GHz / E-core 3.7GHz ^[3]	24MB	Intel® Iris® Xe Graphics

Notes:

^[1] Intel® Iris® Xe Graphics capability requires system to be configured with dual-channel memory. On the system with single-channel memory, Intel® Iris® Xe Graphics will function as Intel® UHD Graphics.

^[2], ^[3] Intel® Max Turbo frequency will vary depending on application workload and the hardware and software configurations, see <http://www.intel.com/technology/turboboost/> for more information.

Operating System

Operating System

- Windows® 11 Pro
- Windows® 11 Home
- Windows® 11 Home Single Language
- Ubuntu Linux^[1]
- No preload operating system

Notes:

^[1] Some features may not be supported on the system with Linux preload, including but not limited to Intel® RST RAID, Human Presence Detection, etc.

Graphics

Graphics**

Graphics	Type	Memory	Connector	Max Resolution	Key Features
Intel® Iris® Xe Graphics ^[1]	Integrated	Shared	1x HDMI® 2.1 TMDS	4096x2306@60Hz(HDMI®)	DirectX® 12.1
Intel® Arc™ A370M Graphics	Discrete	4GB GDDR6	1x HDMI® 2.1 TMDS	3840x2160@60Hz(HDMI®)	DirectX® 12 Ultimate

Notes:

^[1] Intel® Iris® Xe Graphics capability requires system to be configured with dual-channel memory. On the system with single-channel memory, Intel® Iris® Xe Graphics will function as Intel® UHD Graphics.

Monitor Support

Monitor Support

Supports up to 2 independent displays via native display and 1 external monitor; supports external monitor via HDMI®

Chipset

Chipset

Intel® SoC (System on Chip) platform

Memory

Max Memory^[1]

Up to 16GB DDR5-5200

Memory Slots

Two DDR5 SO-DIMM slots, dual-channel capable

ThinkCentre neo 50a 24 Gen 4

Memory Type

DDR5-5200

Notes:

[1] The max memory is based on the test results with current Lenovo® memory offerings.

Storage

Storage Support^[1]

- Up to two drives, 1x 2.5" HDD + 1x M.2 SSD
 - 2.5" HDD up to 2TB
 - M.2 SSD up to 1TB
- For installing HDD storage, assembly kits are needed. The kits only come with HDD models.

Storage Type

Disk Type	Interface	Security
M.2 2280 SSD	PCIe® NVMe®, PCIe® 4.0 x4	Opal 2.0

RAID

No support

Notes:

[1] The max capacity of each disk type is based on the test results with current Lenovo® storage offerings.

Removable Storage

Optical

- DVD burner (DVD±RW), SATA connector, slim (9.0mm)
- None

Card Reader

No card reader

Multi-Media

Audio Chip

High Definition (HD) Audio

Speakers

Stereo speakers, 3W x2, Audio by HARMAN

Microphone

Dual-microphone array

Camera**

- 5.0-megapixel IR camera, fixed focus
- 5.0-megapixel IR camera, fixed focus, with AI chip
- 5.0-megapixel, fixed focus
- No camera

Power Supply

Power Supply

Power	Type	Efficiency	Key Features
180W	Fixed	90%	100V - 240V, 50-60Hz

DESIGN

Display

Display**^[1]

Size	Resolution	Touch	Type	Brightness	Surface	Aspect Ratio	Contrast Ratio	Color Gamut	Refresh Rate	Viewing Angle (L/R/U/D)	Key Features

ThinkCentre neo 50a 24 Gen 4

23.8"	FHD (1920x1080)	None	IPS	250nits	Anti-glare	16:9	1000:1	72% NTSC	60Hz	89°/89°/89°/89°	14ms response Time, borderless design, low blue light, flicker free
23.8"	FHD (1920x1080)	Multi-touch	IPS	250nits	Anti-glare	16:9	1000:1	72% NTSC	60Hz	89°/89°/89°/89°	14ms response Time, borderless design, low blue light, flicker free

Touchscreen

- Advanced In-cell Touch (AIT), supports 10-point touch
- Non-touch

Notes:

[1] IPS (in-plane switching) technology may refer to IPS, PLS, ADS, AHVA, AAS.

Input Device

Keyboard**

- Lenovo® Calliope Keyboard (USB connector), black
- Lenovo® Calliope Wireless Keyboard, black
- No keyboard

Mouse**

- Lenovo® Calliope Mouse (USB connector), black
- Lenovo® Calliope Wireless Mouse (2.4GHz via USB receiver), black
- No mouse

Mechanical

Form Factor

AIO (23.8 inches)

Dimensions (WxDxH)^[1]

Models	Dimensions
Models with monitor stand	541 x 209.9 x 433.7 mm (21.3 x 8.3 x 17.1 inches)
Models with liftable monitor stand	541 x 220 x 482 mm (21.3 x 8.7 x 19 inches)

Packaging Dimensions (WxDxH)

- Models with liftable monitor stand: 658 x 264 x 570 mm (25.9 x 10.4 x 22.44 inches)
- Models with monitor stand: 695 x 196 x 554 mm (27.4 x 7.7 x 21.81 inches)

Weight^[2]

Models	Weight
Models with monitor stand	Around 7.42 kg (16.36 lbs)
Models with liftable monitor stand	Around 7.64 kg (16.84 lbs)

Packaging Weight

- Models with liftable monitor stand: 11.88 kg (26.19 lbs)
- Models with monitor stand: 11.04 kg (24.34 lbs)

Case Color

Raven black

Bays

- 1x 2.5" disk bay
- 1x slim ODD bay
- For installing HDD storage, assembly kits are needed. The kits only come with HDD models.

ThinkCentre neo 50a 24 Gen 4

Expansion Slots

Two M.2 slots (one for WLAN, one for SSD)

Stand**

- Monitor stand, supports -5° to +25° tilt, left & right 45° swivel
- Lifiable monitor stand, supports -5° to +18° tilt, left & right 45° swivel, up to 100mm lift

Mounting

Supports VESA mount 100mm

Others

Supports Smart Power On

Notes:

[1] The system dimensions may vary depending on configurations.

[2] The system weight is approximate and based on results in Lenovo® lab, which varies depending on the source of component, variance of the distribution of each component, and manufacturing process. It may not be the exact weight for each specific model.

CONNECTIVITY

Network

Onboard Ethernet

Gigabit Ethernet, Realtek® RTL8111K-CG, 1x RJ-45

WLAN + Bluetooth®**

- Realtek® Wi-Fi® 6 RTL8852BE, 802.11ax Dual Band 2x2 Wi-Fi® + Bluetooth® 5.3, M.2 card^[1]
- Intel® Wi-Fi® 6 AX201, 802.11ax 2x2 Wi-Fi® + Bluetooth® 5.2, M.2 Card^[2]

Notes:

[1] Bluetooth® 5.3 requires Windows® 11.

[2] Bluetooth® 5.2 requires Windows® 11.

Ports^[1]

Rear Ports

- 1x USB-C® 2.0 (Supports data transfer, Power Delivery 3.0)
- 2x USB-C® 3.2 Gen 2
- 1x USB 2.0
- 1x USB 3.2 Gen 2 (Supports smart power-on)
- 1x HDMI®-in 1.4
- 1x HDMI®-out 2.1 TMDS
- 1x Ethernet (RJ-45)
- 1x headphone / microphone combo jack (3.5mm)

Left Ports

1x USB 3.2 Gen 1

Notes:

[1] The transfer speed of following ports will vary and, depending on many factors, such as the processing speed of the host device, file attributes and other factors related to system configuration and your operating environment, will be slower than theoretical speed.

USB 2.0: 480 Mbit/s;

USB 3.2 Gen 1 (SuperSpeed USB 5Gbps, formerly USB 3.0 / USB 3.1 Gen 1): 5 Gbit/s;

USB 3.2 Gen 2 (SuperSpeed USB 10Gbps, formerly USB 3.1 Gen 2): 10 Gbit/s;

USB4® 20Gbps / USB 3.2 Gen 2x2 (SuperSpeed USB 20Gbps): 20 Gbit/s;

USB4® 40Gbps (USB 40Gbps): 40 Gbit/s;

Thunderbolt™ 3/4: 40 Gbit/s.

SECURITY & PRIVACY

Security

Security Chip

Firmware TPM 2.0 integrated in SoC

Physical Locks

Kensington® Security Slot™, 3 x 7 mm

BIOS Security

- Administrator password
- Power-on password
- Hard disk password
- Cover presence switch
- Intel® BIOS guard

SERVICE

Warranty^[1]

Base Warranty

- 1-year courier or carry-in service
- 1-year limited onsite service

Notes:

[1] The warranty upgrades may be bundled with some models, please check the "Included upgrade" column in the specific model's configurations. For more service extensions, please go to <https://smartfind.lenovo.com/>. To learn more details of warranty policy, please access <https://pcsupport.lenovo.com/warranty>.

ENVIRONMENTAL

Operating Environment

Temperature

- Operating: 5°C (41°F) to 35°C (95°F)
- Storage: -20°C (-4°F) to 60°C (140°F)

Relative Humidity

- Operating: 20% to 80%
- Storage: 10% to 90%

Altitude

- Operating: 0 m (0 ft) to 3048 m (10,000 ft)
- Storage: 0 m (0 ft) to 12192 m (40,000 ft)

ACCESSORIES

Bundled Accessories

Bundled Accessories

- USB-C® to USB-A dongle
- None

CERTIFICATIONS

Green Certifications^[1]

Green Certifications

- (Optional) ENERGY STAR® 8.0
- (Optional) EPEAT™ Silver Registered^[2]

Notes:

[1] The items listed under the "Green Certifications" section may not only refer to certification but also registration or self-declaration.

[2] EPEAT™ is registered where applicable, please see [epeat.net](https://peat.net) for registration status by country.

Other Certifications

Other Certifications

- TÜV Rheinland® Flicker Free
- TÜV Rheinland® Low Blue Light
- TÜV Rheinland® Ultra Low Noise

Mil-Spec Test

None

- Feature with ** means that only one offering listed under the feature is configured on selected models.
- Lenovo reserves the right to change specifications or other product information without notice. Lenovo is not responsible for photographic or typographical errors. LENOVO PROVIDES THIS PUBLICATION “AS IS,” WITHOUT WARRANTY OF ANY KIND, EITHER EXPRESS OR IMPLIED, INCLUDING THE IMPLIED WARRANTIES OF MERCHANTABILITY OR FITNESS FOR A PARTICULAR PURPOSE. Some jurisdictions do not allow disclaimer of express or implied warranties in certain transactions, therefore this disclaimer may not apply to you.
- The specifications on this page may not be available in all regions, and may be changed or updated without notice.



intel



intel



intel



intel



intel



intel

OVERVIEW



1. USB-C (USB 10Gbps), data transfer only	7. USB-A (Hi-Speed USB)
2. Headphone / microphone combo jack (3.5mm)	8. USB-A (USB 10Gbps)
3. HDMI-in 1.4	9. HDMI-out 2.1 TMDS
4. Power-in	10. Power button
5. USB-A (Hi-Speed USB)	11. Camera shutter latch
6. Ethernet (RJ-45)	

PERFORMANCE

Processor

Processor Family

Intel® U-series or 13th Generation Intel® Core™ i3 / i5 / i7 Processor

Processor**

Processor Name	Cores	Threads	Base Frequency	Max Frequency	Cache	Processor Graphics
U300	5 (1 P-core + 4 E-core)	6	P-core 1.2GHz / E-core 0.9GHz	P-core 4.4GHz / E-core 3.3GHz	8MB	Intel® UHD Graphics
Core™ i3-1315U	6 (2 P-core + 4 E-core)	8	P-core 1.2GHz / E-core 0.9GHz	P-core 4.5GHz / E-core 3.3GHz	10MB	Intel® UHD Graphics
Core™ i5-13420H	8 (4 P-core + 4 E-core)	12	P-core 2.1GHz / E-core 1.5GHz	P-core 4.6GHz / E-core 3.4GHz	12MB	Intel® UHD Graphics
Core™ i7-13620H	10 (6 P-core + 4 E-core)	16	P-core 2.4GHz / E-core 1.8GHz	P-core 4.9GHz / E-core 3.6GHz	24MB	Intel® UHD Graphics

Operating System

Operating System**

- Windows® 11 Pro
- Windows® 11 Home
- Windows® 11 Home Single Language
- Ubuntu Linux
- No preload operating system

Graphics

Graphics^[1]

Graphics	Type	Memory	Connector	Max Resolution	Key Features
Intel® UHD Graphics	Integrated	Shared	1x HDMI® 2.1 TMDs	4096x2160@60Hz(HDMI®)	DirectX® 12.1

Notes:

[1] The information of integrated graphics are not applicable for the models with processor which has no integrated graphics inside (for the details, please refer to processor section).

Monitor Support

Monitor Support

Supports up to 2 independent displays via native display and 1 external monitor; supports external monitor via HDMI®

Chipset

Chipset

Intel® SoC (System on Chip) platform

Memory

Max Memory^[1]

Up to 32GB DDR5-5200

Memory Slots

Two DDR5 SO-DIMM slots, dual-channel capable

Memory Type

DDR5-5200

Notes:

[1] The max memory is based on the test results with current Lenovo® memory offerings.

Storage

ThinkCentre neo 50a 24 Gen 5

Storage Support^[1]

One drive, up to 1TB M.2 2280 SSD

Storage Type**

Disk Type	Interface	Security
M.2 2280 SSD	PCIe® NVMe®, PCIe® 4.0 x4	-
M.2 2280 SSD	PCIe® NVMe®, PCIe® 4.0 x4	Opal 2.0

Notes:

[1] The max capacity of each disk type is based on the test results with current Lenovo® storage offerings.

Removable Storage

Optical

None

Card Reader

No card reader

Multi-Media

Audio Chip

High Definition (HD) Audio, Realtek® ALC233-CG codec

Speakers

Stereo speakers, 3W x2, Audio by HARMAN

Microphone

Dual-microphone array

Camera**

- 5.0-megapixel
- 5.0-megapixel IR camera

Power Supply

Power Supply**

Power	Type	Efficiency	Key Features
90W	Adapter	89%	Autosensing
135W	Adapter	90%	Autosensing

DESIGN

Display

Display**^[1]

Size	Resolution	Touch	Type	Brightness	Surface	Aspect Ratio	Contrast Ratio	Color Gamut	Refresh Rate	Viewing Angle (L/R/U/D)	Key Features
23.8"	FHD (1920x1080)	None	IPS	250nits	Anti-glare	16:9	1300:1	99% sRGB	100Hz	89°/89°/89°/89°	Borderless design, low blue light, flicker free
23.8"	FHD (1920x1080)	Multi-touch	IPS	250nits	Anti-glare	16:9	1300:1	99% sRGB	100Hz	89°/89°/89°/89°	Borderless design, low blue light, flicker free

Touchscreen

- (Optional) 10-point multi-touch
- Non-touch

Notes:

[1] IPS (in-plane switching) technology may refer to IPS, PLS, ADS, AHVA, AAS.

Input Device

Keyboard**

- EOS Wireless Keyboard, black
- Lenovo® Calliope Keyboard (USB connector), black
- No keyboard

Mouse**

- Lenovo® Calliope Mouse (USB connector), black
- EOS Wireless Mouse, Black
- No mouse

Mechanical

Buttons

- Camera Shutter Latch
- Power button

Form Factor

AIO (23.8 inches)

Dimensions (WxDxH)^[1]

540 x 192 x 431 mm (21.25 x 7.56 x 16.97 inches)

Packaging Dimensions (WxDxH)

670 x 229 x 553 mm (26.38 x 9.02 x 21.77 inches)

Weight^[2]

Around 6.0 kg (13.23 lbs)

Packaging Weight

Around 9.55 kg (21.05 lbs)

Case Color

Luna grey

Bays

No bays

Expansion Slots

Two M.2 slots (one for WLAN, one for SSD)

Stand

Monitor stand, supports -5° to +15° tilt.

Mounting

None

Others

(Optional) Wireless charger 15W

Notes:

[1] The system dimensions may vary depending on configurations.

[2] The system weight is approximate and based on results in Lenovo® lab, which varies depending on the source of component, variance of the distribution of each component, and manufacturing process. It may not be the exact weight for each specific model.

CONNECTIVITY

Network

Onboard Ethernet

Gigabit Ethernet, Realtek® RTL8111H, 1x RJ-45

WLAN + Bluetooth®**

- Realtek® Wi-Fi® 6 RTL8852BE, 802.11ax Dual Band 2x2 Wi-Fi® + Bluetooth® 5.3, M.2 card^[1]
- Intel® Wi-Fi® 6 AX201, 802.11ax 2x2 Wi-Fi® + Bluetooth® 5.2, M.2 Card^[2]

- No WLAN and Bluetooth®

Notes:

- [1] Bluetooth® 5.3 requires Windows® 11.
- [2] Bluetooth® 5.2 requires Windows® 11.

Ports^[1]

Rear Ports

- 1x USB-A (USB 10Gbps / USB 3.2 Gen 2)
- 2x USB-A (Hi-Speed USB / USB 2.0)
- 1x HDMI®-in 1.4
- 1x HDMI®-out 2.1 TMDS
- 1x Ethernet (RJ-45)
- 1x power connector

Left Ports

- 1x USB-C® (USB 10Gbps / USB 3.2 Gen 2), data transfer only
- 1x headphone / microphone combo jack (3.5mm)

Notes:

- [1] The transfer speed of following ports will vary and, depending on many factors, such as the processing speed of the host device, file attributes and other factors related to system configuration and your operating environment, will be slower than theoretical speed.

USB 2.0: 480 Mbit/s;

USB 3.2 Gen 1 (SuperSpeed USB 5Gbps, formerly USB 3.0 / USB 3.1 Gen 1): 5 Gbit/s;

USB 3.2 Gen 2 (SuperSpeed USB 10Gbps, formerly USB 3.1 Gen 2): 10 Gbit/s;

USB4® 20Gbps / USB 3.2 Gen 2x2 (SuperSpeed USB 20Gbps): 20 Gbit/s;

USB4® 40Gbps (USB 40Gbps): 40 Gbit/s;

Thunderbolt™ 3/4: 40 Gbit/s.

SECURITY & PRIVACY

Security

Security Chip

Firmware TPM 2.0 integrated in SoC

Physical Locks

No physical locks

Chassis Intrusion Switch

No chassis intrusion switch

BIOS Security

- Administrator password
- Power-on password

MANAGEABILITY

System Management

System Management

None

SERVICE

Warranty^[1]

Base Warranty**

- 1-year courier or carry-in service
- 1-year limited onsite service

Notes:

[1] The warranty upgrades may be bundled with some models, please check the "Included upgrade" column in the specific model's configurations. For more service extensions, please go to <https://smartfind.lenovo.com/>. To learn more details of warranty policy, please access <https://pcsupport.lenovo.com/warranty>.

ENVIRONMENTAL

Operating Environment

Temperature

- Operating: 5°C (41°F) to 35°C (95°F)
- Storage: -20°C (-4°F) to 60°C (140°F)

Relative Humidity

- Operating: 20% to 80%
- Storage: 10% to 90%

Altitude

- Operating: 0 m (0 ft) to 3048 m (10,000 ft)
- Storage: 0 m (0 ft) to 12192 m (40,000 ft)

CERTIFICATIONS

Green Certifications^[1]

Green Certifications

- (Optional) ENERGY STAR® 8.0
- (Optional) EPEAT™ Silver Registered
- ErP Lot 3 and Lot 7
- GREENGUARD®
- RoHS / WEEE / REACH

Notes:

[1] The items listed under the "Green Certifications" section may not only refer to certification but also registration or self-declaration.

Other Certifications

Other Certifications

- TÜV Rheinland® Flicker Free
- TÜV Rheinland® Low Blue Light
- TÜV Rheinland® Ultra Low Noise

- Feature with ** means that only one offering listed under the feature is configured on selected models.
- Lenovo reserves the right to change specifications or other product information without notice. Lenovo is not responsible for photographic or typographical errors. **LENOVO PROVIDES THIS PUBLICATION "AS IS," WITHOUT WARRANTY OF ANY KIND, EITHER EXPRESS OR IMPLIED, INCLUDING THE IMPLIED WARRANTIES OF MERCHANTABILITY OR FITNESS FOR A PARTICULAR PURPOSE.** Some jurisdictions do not allow disclaimer of express or implied warranties in certain transactions, therefore this disclaimer may not apply to you.
- The specifications on this page may not be available in all regions, and may be changed or updated without notice.



OVERVIEW



1. USB-C (USB 10Gbps), data transfer only	7. USB-A (Hi-Speed USB)
2. Headphone / microphone combo jack (3.5mm)	8. USB-A (USB 10Gbps)
3. HDMI-in 1.4	9. HDMI-out 2.1 TMDS
4. Power-in	10. Power button
5. USB-A (Hi-Speed USB)	11. Camera shutter latch
6. Ethernet (RJ-45)	

PERFORMANCE

Processor

Processor Family

13th Generation Intel® Core™ i3 / i5 / i7 Processor

Processor**

Processor Name	Cores	Threads	Base Frequency	Max Frequency	Cache	Processor Graphics
Core™ i3-1315U	6 (2 P-core + 4 E-core)	8	P-core 1.2GHz / E-core 0.9GHz	P-core 4.5GHz / E-core 3.3GHz	10MB	Intel® UHD Graphics
Core™ i5-13420H	8 (4 P-core + 4 E-core)	12	P-core 2.1GHz / E-core 1.5GHz	P-core 4.6GHz / E-core 3.4GHz	12MB	Intel® UHD Graphics
Core™ i7-13620H	10 (6 P-core + 4 E-core)	16	P-core 2.4GHz / E-core 1.8GHz	P-core 4.9GHz / E-core 3.6GHz	24MB	Intel® UHD Graphics

Operating System

Operating System**

- Windows® 11 Pro
- Windows® 11 Home
- No preload operating system

Graphics

Graphics^[1]

Graphics	Type	Memory	Connector	Max Resolution	Key Features
Intel® UHD Graphics	Integrated	Shared	1x HDMI® 2.1 TMDS	4096x2160@60Hz(HDMI®)	DirectX® 12.1

Notes:

[1] The information of integrated graphics are not applicable for the models with processor which has no integrated graphics inside (for the details, please refer to processor section).

Monitor Support

Monitor Support

Supports up to 2 independent displays via native display and 1 external monitor; supports external monitor via HDMI®

Chipset

Chipset

Intel® SoC (System on Chip) platform

Memory

Max Memory^[1]

Up to 32GB DDR5-5200

Memory Slots

Two DDR5 SO-DIMM slots, dual-channel capable

Memory Type

DDR5-5200

Notes:

[1] The max memory is based on the test results with current Lenovo® memory offerings.

Storage

Storage Support^[1]

One drive, up to 1TB M.2 2280 SSD

Storage Type**

ThinkCentre neo 50a 27 Gen 5

Disk Type	Interface	Security
M.2 2280 SSD	PCIe® NVMe®, PCIe® 4.0 x4	-
M.2 2280 SSD	PCIe® NVMe®, PCIe® 4.0 x4	Opal 2.0

Notes:
 [1] The max capacity of each disk type is based on the test results with current Lenovo® storage offerings.

Removable Storage

Optical

None

Card Reader

No card reader

Multi-Media

Audio Chip

High Definition (HD) Audio, Realtek® ALC233-CG codec

Speakers

Stereo speakers, 3W x2, Audio by HARMAN

Microphone

Dual-microphone array

Camera**

- 5.0-megapixel
- 5.0-megapixel IR camera

Power Supply

Power Supply**

Power	Type	Efficiency	Key Features
90W	Adapter	89%	Autosensing
135W	Adapter	90%	Autosensing

DESIGN

Display

Display**[1]

Size	Resolution	Touch	Type	Brightness	Surface	Aspect Ratio	Contrast Ratio	Color Gamut	Refresh Rate	Viewing Angle (L/R/U/D)	Key Features
27"	FHD (1920x1080)	None	IPS	300nits	Anti-glare	16:9	1300:1	99% sRGB	100Hz	89°/89°/89°/89°	Borderless design, low blue light, flicker free
27"	FHD (1920x1080)	Multi-touch	IPS	300nits	Anti-glare	16:9	1300:1	99% sRGB	100Hz	89°/89°/89°/89°	Borderless design, low blue light, flicker free

Touchscreen

- (Optional) 10-point multi-touch
- Non-touch

Notes:
 [1] IPS (in-plane switching) technology may refer to IPS, PLS, ADS, AHVA, AAS.

Input Device

Keyboard**

- EOS Wireless Keyboard, black
- Lenovo® Calliope Keyboard (USB connector), black
- No keyboard

Mouse**

- Lenovo® Calliope Mouse (USB connector), black
- EOS Wireless Mouse, Black

Mechanical**Buttons**

- Camera Shutter Latch
- Power button

Form Factor

AIO (27 inches)

Dimensions (WxDxH)^[1]

611.72 x 192 x 473.16 mm (24.08 x 7.55 x 18.62 inches)

Packaging Dimensions (WxDxH)

766 x 229 x 570 mm (30.16 x 9.02 x 22.44 inches)

Weight^[2]

Around 7.1 kg (15.65 lbs)

Packaging Weight

Around 10.9 kg (24.03 lbs)

Case Color

Luna grey

Bays

No bays

Expansion Slots

Two M.2 slots (one for WLAN, one for SSD)

Stand

Monitor stand, supports -5° to +15° tilt.

Mounting

None

Others

(Optional) Wireless charger 15W

Notes:

[1] The system dimensions may vary depending on configurations.

[2] The system weight is approximate and based on results in Lenovo® lab, which varies depending on the source of component, variance of the distribution of each component, and manufacturing process. It may not be the exact weight for each specific model.

CONNECTIVITY**Network****Onboard Ethernet**

Gigabit Ethernet, Realtek® RTL8111H, 1x RJ-45

WLAN + Bluetooth®**

- Realtek® Wi-Fi® 6 RTL8852BE, 802.11ax Dual Band 2x2 Wi-Fi® + Bluetooth® 5.3, M.2 card^[1]
- Intel® Wi-Fi® 6 AX201, 802.11ax 2x2 Wi-Fi® + Bluetooth® 5.2, M.2 Card^[2]
- No WLAN and Bluetooth®

Notes:

[1] Bluetooth® 5.3 requires Windows® 11.

[2] Bluetooth® 5.2 requires Windows® 11.

Ports^[1]

Rear Ports

- 1x USB-A (USB 10Gbps / USB 3.2 Gen 2)
- 2x USB-A (Hi-Speed USB / USB 2.0)
- 1x HDMI®-in 1.4
- 1x HDMI®-out 2.1 TMDS
- 1x Ethernet (RJ-45)
- 1x power connector

Left Ports

- 1x USB-C® (USB 10Gbps / USB 3.2 Gen 2), data transfer only
- 1x headphone / microphone combo jack (3.5mm)

Notes:

[1] The transfer speed of following ports will vary and, depending on many factors, such as the processing speed of the host device, file attributes and other factors related to system configuration and your operating environment, will be slower than theoretical speed.

USB 2.0: 480 Mbit/s;

USB 3.2 Gen 1 (SuperSpeed USB 5Gbps, formerly USB 3.0 / USB 3.1 Gen 1): 5 Gbit/s;

USB 3.2 Gen 2 (SuperSpeed USB 10Gbps, formerly USB 3.1 Gen 2): 10 Gbit/s;

USB4® 20Gbps / USB 3.2 Gen 2x2 (SuperSpeed USB 20Gbps): 20 Gbit/s;

USB4® 40Gbps (USB 40Gbps): 40 Gbit/s;

Thunderbolt™ 3/4: 40 Gbit/s.

SECURITY & PRIVACY

Security

Security Chip

Firmware TPM 2.0 integrated in SoC

Physical Locks

No physical locks

Chassis Intrusion Switch

No chassis intrusion switch

BIOS Security

- Administrator password
- Power-on password

MANAGEABILITY

System Management

System Management

None

SERVICE

Warranty^[1]

Base Warranty**

- 1-year courier or carry-in service
- 1-year limited onsite service

Notes:

[1] The warranty upgrades may be bundled with some models, please check the "Included upgrade" column in the specific model's configurations. For more service extensions, please go to <https://smartfind.lenovo.com/>. To learn more details of

warranty policy, please access <https://pcsupport.lenovo.com/warranty>.

ENVIRONMENTAL

Operating Environment

Temperature

- Operating: 5°C (41°F) to 35°C (95°F)
- Storage: -20°C (-4°F) to 60°C (140°F)

Relative Humidity

- Operating: 20% to 80%
- Storage: 10% to 90%

Altitude

- Operating: 0 m (0 ft) to 3048 m (10,000 ft)
- Storage: 0 m (0 ft) to 12192 m (40,000 ft)

CERTIFICATIONS

Green Certifications^[1]

Green Certifications

- (Optional) ENERGY STAR® 8.0
- (Optional) EPEAT™ Silver Registered
- ErP Lot 3 and Lot 7
- GREENGUARD®
- RoHS / WEEE / REACH

Notes:

[1] The items listed under the "Green Certifications" section may not only refer to certification but also registration or self-declaration.

Other Certifications

Other Certifications

- TÜV Rheinland® Flicker Free
- TÜV Rheinland® Low Blue Light
- TÜV Rheinland® Ultra Low Noise

- Feature with ** means that only one offering listed under the feature is configured on selected models.
- Lenovo reserves the right to change specifications or other product information without notice. Lenovo is not responsible for photographic or typographical errors. LENOVO PROVIDES THIS PUBLICATION "AS IS," WITHOUT WARRANTY OF ANY KIND, EITHER EXPRESS OR IMPLIED, INCLUDING THE IMPLIED WARRANTIES OF MERCHANTABILITY OR FITNESS FOR A PARTICULAR PURPOSE. Some jurisdictions do not allow disclaimer of express or implied warranties in certain transactions, therefore this disclaimer may not apply to you.
- The specifications on this page may not be available in all regions, and may be changed or updated without notice.



OVERVIEW

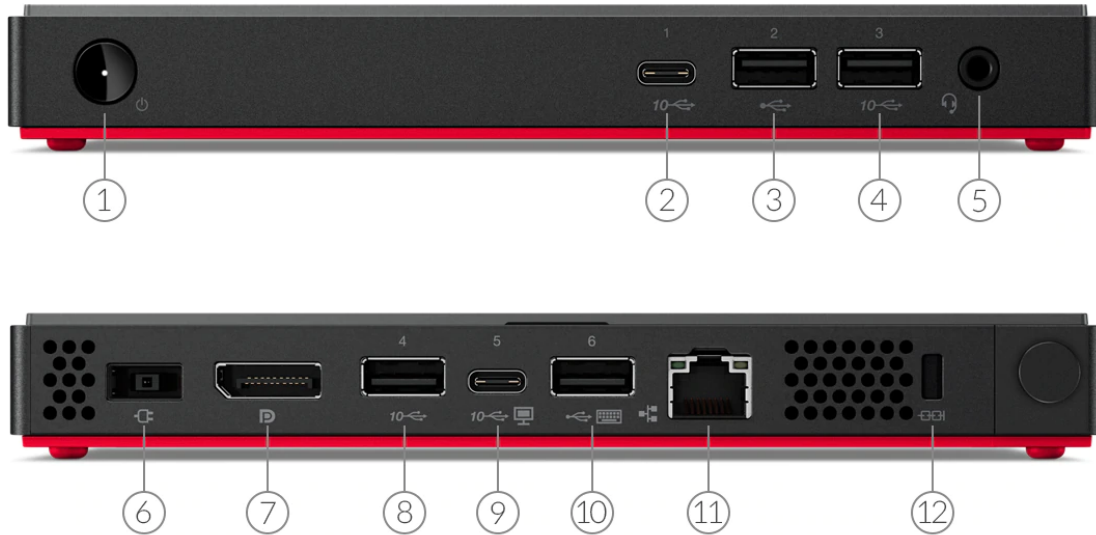

1. Power button	7. DisplayPort
2. USB-C 3.2 Gen 2	8. USB 3.2 Gen 2
3. USB 2.0	9. USB-C 3.2 Gen 2 (display and power-in)
4. USB 3.2 Gen 2	10. USB 2.0
5. Headphone / microphone combo jack (3.5mm)	11. Ethernet (RJ-45)
6. Power connector	

PERFORMANCE

Processor

Processor Family

AMD Ryzen™ 3 / 5 Processor

Processor**

Processor Name	Cores	Threads	Base Frequency	Max Frequency	Cache	Memory Support	Processor Graphics
AMD Ryzen™ 3 PRO 3300U	4	4	2.1GHz	3.5GHz	2MB L2 / 4MB L3	DDR4-2400	AMD Radeon™ Vega 6 Graphics
AMD Ryzen™ 5 PRO 3500U	4	8	2.1GHz	3.7GHz	2MB L2 / 4MB L3	DDR4-2400	AMD Radeon™ Vega 8 Graphics

Operating System

Operating System**

- Windows® 10 Pro 64
- Windows® 10 Home 64
- Windows® 10 Home 64 Single Language
- Windows® 10 IoT Enterprise LTSC 2019
- Ubuntu Linux^[1]
- No preload operating system

Notes:

[1] Some features may not be supported on the system with Linux preload, including but not limited to Intel® RST RAID, Human Presence Detection, etc.

Graphics

Graphics**

Graphics	Type	Memory	Connector	Max Resolution	Key Features
AMD Radeon™ Vega 6 Graphics	Integrated	Shared	1x DisplayPort™, 1x USB-C®	3840x2160@60Hz(DP), 3840x2160@60Hz(USB-C®)	DirectX® 12
AMD Radeon™ Vega 8 Graphics	Integrated	Shared	1x DisplayPort™, 1x USB-C®	3840x2160@60Hz(DP), 3840x2160@60Hz(USB-C®)	DirectX® 12

Monitor Support

Monitor Support

Supports up to 2 independent displays via onboard ports (DisplayPort™ and USB-C®)

Chipset

Chipset

AMD SoC (System on Chip) platform

Memory

Max Memory^[1]

8GB soldered memory, not upgradable

Memory Slots

Memory soldered to systemboard, no slots, dual-channel

Memory Type

DDR4-2400

Notes:

[1] The max memory is based on the test results with current Lenovo® memory offerings.

Storage

Storage Support^[1]

Up to two drives, 2x M.2 SSD

- M.2 SSD up to 1TB each

Storage Type^{***}

Disk Type	Interface	Security
M.2 2280 SSD	PCIe [®] NVMe [®] , PCIe [®] 3.0 x4	Opal
M.2 2242 SSD	PCIe [®] NVMe [®] , PCIe [®] 3.0 x2	-
M.2 2242 SSD	PCIe [®] NVMe [®] , PCIe [®] 3.0 x4	-

RAID

No support

Notes:

[1] The max capacity of each disk type is based on the test results with current Lenovo[®] storage offerings.

Removable Storage

Optical

None

Card Reader

No card reader

Multi-Media

Audio Chip

High Definition (HD) Audio, Realtek[®] ALC233 codec

Speakers

Single speaker, 1W x1

Power Supply

Power Supply

Power	Type	Efficiency	Key Features
65W	Adapter	89%	Autosensing
No power supply	-	-	-

DESIGN

Input Device

Keyboard^{**}

- Lenovo[®] Calliope Keyboard (USB connector), black
- Lenovo[®] Calliope Wireless Keyboard (2.4GHz via USB receiver), black
- Lenovo[®] Traditional Keyboard (USB connector), black
- No keyboard

Mouse^{**}

- Lenovo[®] Calliope Mouse (USB connector), black
- Lenovo[®] Calliope Wireless Mouse (2.4GHz via USB receiver), black
- Lenovo[®] Fingerprint Mouse (USB connector), Windows[®] Hello support, black (EOL on Jan, 2023)
- No mouse

Mechanical

Form Factor

Nano (0.35L)

Dimensions (WxDxH)^[1]

ThinkCentre M75n

179 x 88 x 22 mm (7.05 x 3.46 x 0.87 inches)

Packaging Dimensions (WxDxH)

490 x 125 x 255 mm (19.29 x 4.92 x 10.04 inches)

Weight^[2]

Around 0.505 kg (1.11 lbs)

Packaging Weight

0.83 kg (1.83 lbs)

Case Color

Iron grey (top cover), black (mid bezel), red (bottom cover)

Bays

No bays

Expansion Slots

- Two M.2 slots (for SSD, one supports up to PCIe® 3.0 x4, one supports up to PCIe® 3.0 x2)
- One M.2 slot (for WLAN)

Stand

No stand

IO Box

No IO box

Mounting**

- VESA mount bracket kit with adapter holder, supports VESA mount 75mm and 100mm
- VESA mount bracket kit, supports VESA mount 75mm and 100mm
- DIN rail mount bracket kit
- None

Notes:

[1] The system dimensions may vary depending on configurations.

[2] The system weight is approximate and based on results in Lenovo® lab, which varies depending on the source of component, variance of the distribution of each component, and manufacturing process. It may not be the exact weight for each specific model.

CONNECTIVITY

Network

Onboard Ethernet

Gigabit Ethernet, Realtek® RTL8111FP-CG, 1x RJ-45, supports Wake-on-LAN

Optional Ethernet

No optional Ethernet

WLAN + Bluetooth®**

- Realtek® RTL8822CE, 802.11ac Dual Band 2x2 Wi-Fi® + Bluetooth® 5.0, M.2 card
- Qualcomm® QCA6174A, 802.11ac Dual Band 2x2 Wi-Fi® + Bluetooth® 4.2, M.2 card
- Intel® Wireless-AC 9260, 802.11ac Dual Band 2x2 Wi-Fi® + Bluetooth® 5.0, M.2 card
- Realtek® Wi-Fi® 6 RTL8852AE, 802.11ax Dual Band 2x2 Wi-Fi® + Bluetooth® 5.1, M.2 card^[1]
- No WLAN and Bluetooth®

Notes:

[1] Bluetooth® 5.2 is hardware ready but may run at a lower version due to OS limitations.

Ports^[1]

Front Ports

- 1x USB-C® 3.2 Gen 2
- 1x USB 2.0
- 1x USB 3.2 Gen 2
- 1x headphone / microphone combo jack (3.5mm)

Rear Ports

- 1x USB-C® 3.2 Gen 2 (support display function and power-in [20V and >45W])
- 1x USB 2.0
- 1x USB 3.2 Gen 2
- 1x DisplayPort™
- 1x Ethernet (RJ-45)

Notes:

[1] The transfer speed of following ports will vary and, depending on many factors, such as the processing speed of the host device, file attributes and other factors related to system configuration and your operating environment, will be slower than theoretical speed.

USB 2.0: 480 Mbit/s;

USB 3.2 Gen 1 (SuperSpeed USB 5Gbps, formerly USB 3.0 / USB 3.1 Gen 1): 5 Gbit/s;

USB 3.2 Gen 2 (SuperSpeed USB 10Gbps, formerly USB 3.1 Gen 2): 10 Gbit/s;

USB4® 20Gbps / USB 3.2 Gen 2x2 (SuperSpeed USB 20Gbps): 20 Gbit/s;

USB4® 40Gbps (USB 40Gbps): 40 Gbit/s;

Thunderbolt™ 3/4: 40 Gbit/s.

Monitor Cable

Monitor Cable***

- USB-C® to DP dongle
- USB-C® to HDMI® dongle
- USB-C® to VGA dongle
- DP to VGA dongle
- DP to HDMI® dongle
- No monitor cable

SECURITY & PRIVACY

Security

Security Chip

Discrete TPM 2.0, TCG certified

Physical Locks

Kensington® Security Slot™, 3 x 7 mm

Chassis Intrusion Switch

Chassis intrusion switch

Fingerprint Reader

- Touch style fingerprint reader on mouse (EOL on Jan, 2023)
- No fingerprint reader

BIOS Security

- Administrator password
- Power-on password
- Hard disk password
- Boot sequence control
- Boot without keyboard and mouse
- Smart USB protection (allows keyboard / mouse only, blocks all storage devices)
- Individual USB port disablement

MANAGEABILITY

System Management

System Management

DASH 1.1 / 1.2

SERVICE

Warranty^[1]

Base Warranty**

- 1-year courier or carry-in service
- 1-year limited onsite service
- 3-year limited onsite service
- No base warranty

Notes:

[1] The warranty upgrades may be bundled with some models, please check the "Included upgrade" column in the specific model's configurations. For more service extensions, please go to <https://smartfind.lenovo.com/>. To learn more details of warranty policy, please access <https://pcsupport.lenovo.com/warranty>.

ENVIRONMENTAL

Operating Environment

Temperature

- Operating: 5°C (41°F) to 35°C (95°F)
- Storage: -40°C (-40°F) to 60°C (140°F)

Relative Humidity

- Operating: 20% to 80%
- Storage: 10% to 90%

Altitude

- Operating: 0 m (0 ft) to 3048 m (10,000 ft)
- Storage: 0 m (0 ft) to 12192 m (40,000 ft)

CERTIFICATIONS

Green Certifications^[1]

Green Certifications

- ENERGY STAR® 8.0
- EPEAT™ Silver Registered^[2]
- ErP Lot 3
- REACH
- RoHS compliant
- TCO Certified 8.0
- WEEE

Notes:

[1] The items listed under the "Green Certifications" section may not only refer to certification but also registration or self-declaration.

[2] EPEAT™ is registered where applicable, please see epeat.net for registration status by country.

Other Certifications

Other Certifications

TÜV Rheinland® Ultra Low Noise

Mil-Spec Test

MIL-STD-810H military test passed (Low Pressure [Altitude], High Temperature, Low Temperature, Temperature Shock, Humidity, Sand and Dust, Vibration, Shock, Fungus, Solar Radiation)

- Feature with ** means that only one offering listed under the feature is configured on selected models.
- Feature with *** means that one or more offerings listed under the feature could be configured on selected models.
- Lenovo reserves the right to change specifications or other product information without notice. Lenovo is not responsible for photographic or typographical errors. **LENOVO PROVIDES THIS PUBLICATION "AS IS," WITHOUT WARRANTY OF ANY KIND, EITHER EXPRESS OR IMPLIED, INCLUDING THE IMPLIED WARRANTIES**

OF MERCHANTABILITY OR FITNESS FOR A PARTICULAR PURPOSE. Some jurisdictions do not allow disclaimer of express or implied warranties in certain transactions, therefore this disclaimer may not apply to you.

- The specifications on this page may not be available in all regions, and may be changed or updated without notice.



AMD



AMD



AMD



AMD



AMD



AMD

OVERVIEW

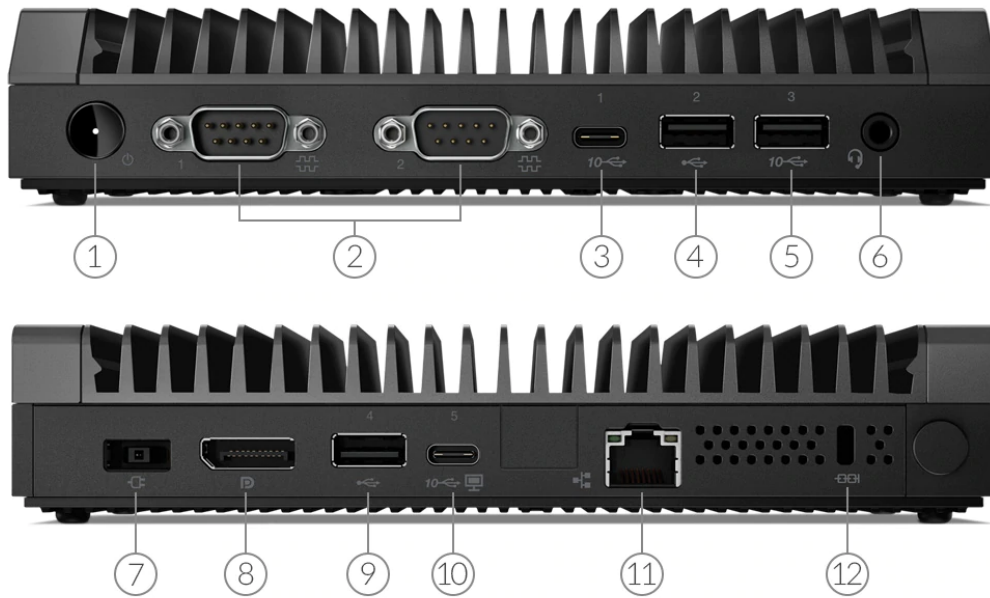

1. Power button	7. Power connector
2. 2x Serial (RS232)	8. DisplayPort
3. USB-C 3.2 Gen 2	9. USB 3.2 Gen 2
4. USB 2.0	10. USB-C 3.2 Gen 2 (display and power-in)
5. USB 3.2 Gen 2	11. Ethernet (RJ-45)
6. Headphone / microphone combo jack (3.5mm)	12. Kensington Security Slot

PERFORMANCE

Processor

Processor Family

AMD Athlon™ Processor

Processor

Processor Name	Cores	Threads	Base Frequency	Max Frequency	Cache	Memory Support	Processor Graphics
AMD Athlon™ Silver 3050e	2	4	1.4GHz	2.8GHz	1MB L2 / 4MB L3	DDR4-2400	AMD Radeon™ Graphics

Operating System

Operating System**^[1]

- Windows® 10 Pro 64
- Windows® 10 Home 64
- Windows® 10 Home 64 Single Language
- Windows® 10 IoT Enterprise LTSC 2019
- Windows® 10 IoT Enterprise LTSC 2019 (Thin Client)
- LeTOS™ V2 (Lenovo® Terminal Operating System, Linux-based)
- Ubuntu Linux^[2]
- No preload operating system

Notes:

^[1] Windows® 10 IoT Enterprise (Thin Client) and LeTOS™ V2 are for Thin Client models.

^[2] Some features may not be supported on the system with Linux preload, including but not limited to Intel® RST RAID, Human Presence Detection, etc.

Graphics

Graphics

Graphics	Type	Memory	Connector	Max Resolution	Key Features
AMD Radeon™ Graphics	Integrated	Shared	1x DisplayPort™, 1x USB-C®	3840x2160@60Hz(DP), 3840x2160@60Hz(USB-C®)	DirectX® 12

Monitor Support

Monitor Support

Supports up to 2 independent displays via onboard ports (DisplayPort™ and USB-C®)

Chipset

Chipset

AMD SoC (System on Chip) platform

Memory

Max Memory^[1]

4GB soldered memory, not upgradable

Memory Slots

Memory soldered to systemboard, no slots

Memory Type

DDR4-2400

Notes:

^[1] The max memory is based on the test results with current Lenovo® memory offerings.

Storage

Storage Support^[1]

One drive, up to 1TB M.2 2280 SSD

Storage Type***

Disk Type	Interface	Security
M.2 2280 SSD	SATA 6Gb/s	Opal
M.2 2280 SSD	PCIe® NVMe®, PCIe® 3.0 x4	Opal
M.2 2242 SSD	PCIe® NVMe®, PCIe® 3.0 x2	-
M.2 2242 SSD	PCIe® NVMe®, PCIe® 3.0 x4	-

RAID

No support

Notes:

[1] The max capacity of each disk type is based on the test results with current Lenovo® storage offerings.

Removable Storage**Optical**

None

Card Reader

No card reader

Multi-Media**Audio Chip**

High Definition (HD) Audio, Realtek® ALC233 codec

Speakers

Single speaker, 1W x1

Power Supply**Power Supply****

Power	Type	Efficiency	Key Features	Dimensions
65W	Adapter	89%	100-240 VAC	108 x 46 x 29 mm, 1800 mm cable
65W	Adapter	88%	100-240 VAC, wide temperature	129 x 53 x 30 mm, 1800 mm cable
No power supply	-	-	-	-

DESIGN**Input Device****Keyboard****

- Lenovo® Calliope Keyboard (USB connector), black
- Lenovo® Calliope Wireless Keyboard (2.4GHz via USB receiver), black
- Lenovo® Traditional Keyboard (USB connector), black
- No keyboard

Mouse**

- Lenovo® Calliope Mouse (USB connector), black
- Lenovo® Calliope Wireless Mouse (2.4GHz via USB receiver), black
- Lenovo® Fingerprint Mouse (USB connector), Windows® Hello support, black (EOL on Jan, 2023)
- No mouse

Mechanical**Form Factor**

Nano (0.55L)

Dimensions (WxDxH)^[1]

Models	Dimensions
Nano only	179 x 88 x 34.5 mm (7.05 x 3.46 x 1.36 inches)

Nano with IO box	179 x 88 x 61.3 mm (7.05 x 3.46 x 2.41 inches)
------------------	--

Packaging Dimensions (WxDxH)

490 x 125 x 255 mm (19.29 x 4.92 x 10.04 inches)

Weight^[2]

Models	Weight
Nano only	Around 0.72 kg (1.58 lbs)
Nano with IO box	Around 1.2 kg (2.65 lbs)

Packaging Weight

0.83 kg (1.83 lbs)

Case Color

Iron grey (top cover), black (mid bezel), black (bottom cover)

Bays

No bays

Expansion Slots

Two M.2 slots (one for WLAN, one for SSD)

Stand

No stand

IO Box

- IO box: 2x serial (RS232 / RS422 / RS485, SDK selectable) and 2x Ethernet (RJ-45, Realtek® RTL8153B, gigabit Ethernet) on front, 1x DIO (4DI / 4DO), 1x USB-C® (connect to Nano) and 1x DC-in connector (9V - 36V) on rear
- No IO box

Mounting**

- VESA mount bracket kit with adapter holder, supports VESA mount 75mm and 100mm
- VESA mount bracket kit, supports VESA mount 75mm and 100mm
- DIN rail mount bracket kit
- None

Notes:

[1] The system dimensions may vary depending on configurations.

[2] The system weight is approximate and based on results in Lenovo® lab, which varies depending on the source of component, variance of the distribution of each component, and manufacturing process. It may not be the exact weight for each specific model.

CONNECTIVITY

Network

Onboard Ethernet

Gigabit Ethernet, Realtek® RTL8111FP-CG, 1x RJ-45, supports Wake-on-LAN

Optional Ethernet

No optional Ethernet

WLAN + Bluetooth®**

- Realtek® RTL8822CE, 802.11ac Dual Band 2x2 Wi-Fi® + Bluetooth® 5.0, M.2 card
- Qualcomm® QCA6174A, 802.11ac Dual Band 2x2 Wi-Fi® + Bluetooth® 4.2, M.2 card
- Intel® Wireless-AC 9260, 802.11ac Dual Band 2x2 Wi-Fi® + Bluetooth® 5.0, M.2 card
- Realtek® Wi-Fi® 6 RTL8852AE, 802.11ax Dual Band 2x2 Wi-Fi® + Bluetooth® 5.1, M.2 card^[1]
- No WLAN and Bluetooth®

Notes:

[1] Bluetooth® 5.2 is hardware ready but may run at a lower version due to OS limitations.

Ports^[1]

Front Ports

ThinkCentre M75n IoT

- 1x USB-C® 3.2 Gen 2
- 1x USB 2.0
- 1x USB 3.2 Gen 2
- 1x headphone / microphone combo jack (3.5mm)
- 2x serial (RS-232)

Optional Front Ports

- 2x gigabit Ethernet (RJ-45) on SE30 IO box
- 2x serial (RS232 / RS422 / RS485, SDK selectable) on SE30 IO box

Rear Ports

- 1x USB-C® 3.2 Gen 2 (support display function and power-in [20V and >45W])
- 1x USB 3.2 Gen 2
- 1x DisplayPort™
- 1x Ethernet (RJ-45)

Optional Rear Ports

- 1x DC-in 3pin Phoenix connector on SE30 IO box
- 1x DIO (4DI / 4DO) on SE30 IO box

Notes:

[1] The transfer speed of following ports will vary and, depending on many factors, such as the processing speed of the host device, file attributes and other factors related to system configuration and your operating environment, will be slower than theoretical speed.

USB 2.0: 480 Mbit/s;

USB 3.2 Gen 1 (SuperSpeed USB 5Gbps, formerly USB 3.0 / USB 3.1 Gen 1): 5 Gbit/s;

USB 3.2 Gen 2 (SuperSpeed USB 10Gbps, formerly USB 3.1 Gen 2): 10 Gbit/s;

USB4® 20Gbps / USB 3.2 Gen 2x2 (SuperSpeed USB 20Gbps): 20 Gbit/s;

USB4® 40Gbps (USB 40Gbps): 40 Gbit/s;

Thunderbolt™ 3/4: 40 Gbit/s.

Monitor Cable

Monitor Cable***

- USB-C® to DP dongle
- USB-C® to HDMI® dongle
- USB-C® to VGA dongle
- DP to VGA dongle
- DP to HDMI® dongle
- No monitor cable

SECURITY & PRIVACY

Security

Security Chip

Discrete TPM 2.0, TCG certified

Physical Locks

Kensington® Security Slot™, 3 x 7 mm

Chassis Intrusion Switch

Chassis intrusion switch

Fingerprint Reader

- Touch style fingerprint reader on mouse (EOL on Jan, 2023)
- No fingerprint reader

BIOS Security

- Administrator password
- Power-on password
- Hard disk password
- Boot sequence control
- Boot without keyboard and mouse
- Smart USB protection (allows keyboard / mouse only, blocks all storage devices)
- Individual USB port disablement

MANAGEABILITY

System Management

System Management

DASH 1.1 / 1.2

SERVICE

Warranty^[1]

Base Warranty**

- 1-year courier or carry-in service
- 1-year limited onsite service
- 3-year limited onsite service
- No base warranty

Notes:

[1] The warranty upgrades may be bundled with some models, please check the "Included upgrade" column in the specific model's configurations. For more service extensions, please go to <https://smartfind.lenovo.com/>. To learn more details of warranty policy, please access <https://pcsupport.lenovo.com/warranty>.

ENVIRONMENTAL

Operating Environment

Temperature

- Operating:
 - From 10°C (50°F) to 50°C (122°F): for the machine types of 11GW and 11GX
 - From 10°C (50°F) to 35°C (95°F): for the machine types of 11BW and 11BX
- Storage: -40°C (-40°F) to 60°C (140°F)

Relative Humidity

- Operating: 20% to 80%
- Storage: 10% to 90%

Altitude

- Operating: 0 m (0 ft) to 3048 m (10,000 ft)
- Storage: 0 m (0 ft) to 12192 m (40,000 ft)

CERTIFICATIONS

Green Certifications^[1]

Green Certifications^[2]

- ENERGY STAR® 8.0
- EPEAT™ Silver Registered
- ErP Lot 3
- REACH
- RoHS compliant
- TCO Certified 8.0
- WEEE

Notes:

[1] The items listed under the "Green Certifications" section may not only refer to certification but also registration or self-declaration.

[2] ENERGY STAR® 8.0 and EPEAT™ are not available for the models with I/O box.

Other Certifications

Other Certifications

TÜV Rheinland® Ultra Low Noise

Mil-Spec Test

- MIL-STD-810H military test passed (Low Pressure [Altitude], High Temperature, Low Temperature, Temperature Shock, Humidity, Sand and Dust, Vibration, Shock, Fungus, Solar Radiation)
 - None
-
- Feature with ** means that only one offering listed under the feature is configured on selected models.
 - Feature with *** means that one or more offerings listed under the feature could be configured on selected models.
 - Lenovo reserves the right to change specifications or other product information without notice. Lenovo is not responsible for photographic or typographical errors. LENOVO PROVIDES THIS PUBLICATION “AS IS,” WITHOUT WARRANTY OF ANY KIND, EITHER EXPRESS OR IMPLIED, INCLUDING THE IMPLIED WARRANTIES OF MERCHANTABILITY OR FITNESS FOR A PARTICULAR PURPOSE. Some jurisdictions do not allow disclaimer of express or implied warranties in certain transactions, therefore this disclaimer may not apply to you.
 - The specifications on this page may not be available in all regions, and may be changed or updated without notice.



AMD



AMD



AMD



AMD



AMD



AMD

OVERVIEW

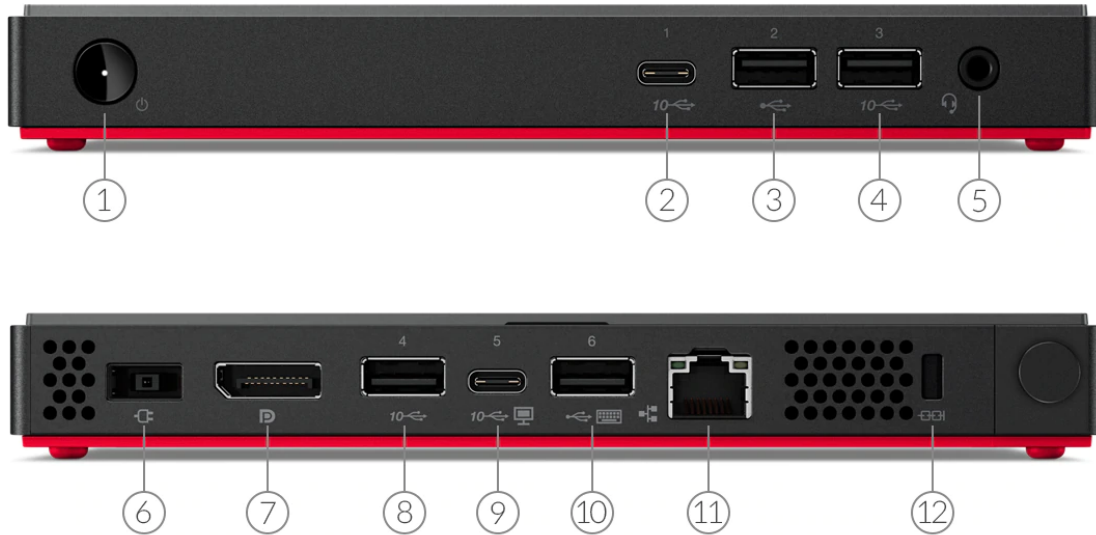

1. Power button	7. DisplayPort
2. USB-C 3.2 Gen 2	8. USB 3.2 Gen 2
3. USB 2.0	9. USB-C 3.2 Gen 2 (display and power-in)
4. USB 3.2 Gen 2	10. USB 2.0
5. Headphone / microphone combo jack (3.5mm)	11. Ethernet (RJ-45)
6. Power connector	

PERFORMANCE

Processor

Processor Family

AMD Ryzen™ 3 Processor

Processor

Processor Name	Cores	Threads	Base Frequency	Max Frequency	Cache	Memory Support	Processor Graphics
AMD Ryzen™ 3 PRO 3300U	4	4	2.1GHz	3.5GHz	2MB L2 / 4MB L3	DDR4-2400	AMD Radeon™ Vega 6 Graphics

Operating System

Operating System**

- Windows® 10 IoT Enterprise LTSC 2019 (Thin Client)
- LeTOS™ V2 (Lenovo® Terminal Operating System, Linux-based)
- Ubuntu Linux
- No preload operating system

Graphics

Graphics

Graphics	Type	Memory	Connector	Max Resolution	Key Features
AMD Radeon™ Vega 6 Graphics	Integrated	Shared	1x DisplayPort™, 1x USB-C®	3840x2160@60Hz(DP), 3840x2160@60Hz(USB-C®)	DirectX® 12

Monitor Support

Monitor Support

Supports up to 2 independent displays via onboard ports (DisplayPort™ and USB-C®)

Chipset

Chipset

AMD SoC (System on Chip) platform

Memory

Max Memory^[1]

8GB soldered memory, not upgradable

Memory Slots

Memory soldered to systemboard, no slots, dual-channel

Memory Type

DDR4-2400

Notes:

[1] The max memory is based on the test results with current Lenovo® memory offerings.

Storage

Storage Support^[1]

Up to two drives, 2x M.2 SSD

- M.2 SSD up to 256GB each

Storage Type***

Disk Type	Interface	Security
M.2 2280 SSD	SATA 6Gb/s	Opal
M.2 2280 SSD	PCIe® NVMe®, PCIe® 3.0 x4	Opal

ThinkCentre M75n Thin Client

M.2 2242 SSD	PCIe® NVMe®, PCIe® 3.0 x2	-
M.2 2242 SSD	PCIe® NVMe®, PCIe® 3.0 x4	-

RAID

No support

Notes:

[1] The max capacity of each disk type is based on the test results with current Lenovo® storage offerings.

Removable Storage

Optical

None

Card Reader

No card reader

Multi-Media

Audio Chip

High Definition (HD) Audio, Realtek® ALC233 codec

Speakers

Single speaker, 1W x1

Power Supply

Power Supply

Power	Type	Efficiency	Key Features
65W	Adapter	89%	Autosensing
No power supply	-	-	-

DESIGN

Input Device

Keyboard**

- Lenovo® Calliope Keyboard (USB connector), black
- Lenovo® Calliope Wireless Keyboard (2.4GHz via USB receiver), black
- Lenovo® Traditional Keyboard (USB connector), black
- No keyboard

Mouse**

- Lenovo® Calliope Mouse (USB connector), black
- Lenovo® Calliope Wireless Mouse (2.4GHz via USB receiver), black
- No mouse

Mechanical

Form Factor

Nano (0.35L)

Dimensions (WxDxH)^[1]

179 x 88 x 22 mm (7.05 x 3.46 x 0.87 inches)

Packaging Dimensions (WxDxH)

490 x 125 x 255 mm (19.29 x 4.92 x 10.04 inches)

Weight^[2]

Around 0.505 kg (1.11 lbs)

Packaging Weight

0.83 kg (1.83 lbs)

Case Color

Iron grey (top cover), black (mid bezel), red (bottom cover)

ThinkCentre M75n Thin Client

Bays

No bays

Expansion Slots

- Two M.2 slots (for SSD, one supports up to PCIe® 3.0 x4, one supports up to PCIe® 3.0 x2 or SATA interface)
- One M.2 slot (for WLAN)

Stand

No stand

IO Box

No IO box

Mounting**

- VESA mount bracket kit with adapter holder, supports VESA mount 75mm and 100mm
- VESA mount bracket kit, supports VESA mount 75mm and 100mm
- DIN rail mount bracket kit
- None

Notes:

[1] The system dimensions may vary depending on configurations.

[2] The system weight is approximate and based on results in Lenovo® lab, which varies depending on the source of component, variance of the distribution of each component, and manufacturing process. It may not be the exact weight for each specific model.

CONNECTIVITY

Network

Onboard Ethernet

Gigabit Ethernet, Realtek® RTL8111FP-CG, 1x RJ-45, supports Wake-on-LAN

Optional Ethernet

No optional Ethernet

WLAN + Bluetooth®**

- Realtek® RTL8822CE, 802.11ac Dual Band 2x2 Wi-Fi® + Bluetooth® 5.0, M.2 card
- Intel® Wireless-AC 9260, 802.11ac Dual Band 2x2 Wi-Fi® + Bluetooth® 5.0, M.2 card
- Realtek® Wi-Fi® 6 RTL8852AE, 802.11ax Dual Band 2x2 Wi-Fi® + Bluetooth® 5.1, M.2 card^[1]
- No WLAN and Bluetooth®

Notes:

[1] Bluetooth® 5.2 is hardware ready but may run at a lower version due to OS limitations.

Ports^[1]

Front Ports

- 1x USB-C® 3.2 Gen 2
- 1x USB 2.0
- 1x USB 3.2 Gen 2
- 1x headphone / microphone combo jack (3.5mm)

Rear Ports

- 1x USB-C® 3.2 Gen 2 (support display function and power-in [20V and >45W])
- 1x USB 2.0
- 1x USB 3.2 Gen 2
- 1x DisplayPort™
- 1x Ethernet (RJ-45)

Notes:

[1] The transfer speed of following ports will vary and, depending on many factors, such as the processing speed of the host device, file attributes and other factors related to system configuration and your operating environment, will be slower than theoretical speed.

USB 2.0: 480 Mbit/s;

USB 3.2 Gen 1 (SuperSpeed USB 5Gbps, formerly USB 3.0 / USB 3.1 Gen 1): 5 Gbit/s;

USB 3.2 Gen 2 (SuperSpeed USB 10Gbps, formerly USB 3.1 Gen 2): 10 Gbit/s;
USB4® 20Gbps / USB 3.2 Gen 2x2 (SuperSpeed USB 20Gbps): 20 Gbit/s;
USB4® 40Gbps (USB 40Gbps): 40 Gbit/s;
Thunderbolt™ 3/4: 40 Gbit/s.

Monitor Cable

Monitor Cable***

- USB-C® to DP dongle
- USB-C® to HDMI® dongle
- USB-C® to VGA dongle
- DP to VGA dongle
- DP to HDMI® dongle
- No monitor cable

SECURITY & PRIVACY

Security

Security Chip

Discrete TPM 2.0, TCG certified

Physical Locks

Kensington® Security Slot™, 3 x 7 mm

Chassis Intrusion Switch

Chassis intrusion switch

BIOS Security

- Administrator password
- Power-on password
- Hard disk password
- Boot sequence control
- Boot without keyboard and mouse
- Smart USB protection (allows keyboard / mouse only, blocks all storage devices)
- Individual USB port disablement

MANAGEABILITY

System Management

System Management

DASH 1.1 / 1.2

SERVICE

Warranty^[1]

Base Warranty**

- 1-year courier or carry-in service
- 1-year limited onsite service
- 3-year limited onsite service
- No base warranty

Notes:

[1] The warranty upgrades may be bundled with some models, please check the "Included upgrade" column in the specific model's configurations. For more service extensions, please go to <https://smartfind.lenovo.com/>. To learn more details of warranty policy, please access <https://pcsupport.lenovo.com/warranty>.

ENVIRONMENTAL

Operating Environment

Temperature

- Operating: 5°C (41°F) to 35°C (95°F)
- Storage: -40°C (-40°F) to 60°C (140°F)

Relative Humidity

- Operating: 20% to 80%
- Storage: 10% to 90%

Altitude

- Operating: 0 m (0 ft) to 3048 m (10,000 ft)
- Storage: 0 m (0 ft) to 12192 m (40,000 ft)

CERTIFICATIONS

Green Certifications^[1]

Green Certifications

- ENERGY STAR® 8.0
- EPEAT™ Silver Registered
- ErP Lot 3
- REACH
- RoHS compliant
- TCO Certified 8.0
- WEEE

Notes:

[1] The items listed under the "Green Certifications" section may not only refer to certification but also registration or self-declaration.

Other Certifications

Other Certifications

TÜV Rheinland® Ultra Low Noise

Mil-Spec Test

MIL-STD-810H military test passed (Low Pressure [Altitude], High Temperature, Low Temperature, Temperature Shock, Humidity, Sand and Dust, Vibration, Shock, Fungus, Solar Radiation)

- Feature with ** means that only one offering listed under the feature is configured on selected models.
- Feature with *** means that one or more offerings listed under the feature could be configured on selected models.
- Lenovo reserves the right to change specifications or other product information without notice. Lenovo is not responsible for photographic or typographical errors. LENOVO PROVIDES THIS PUBLICATION "AS IS," WITHOUT WARRANTY OF ANY KIND, EITHER EXPRESS OR IMPLIED, INCLUDING THE IMPLIED WARRANTIES OF MERCHANTABILITY OR FITNESS FOR A PARTICULAR PURPOSE. Some jurisdictions do not allow disclaimer of express or implied warranties in certain transactions, therefore this disclaimer may not apply to you.
- The specifications on this page may not be available in all regions, and may be changed or updated without notice.



AMD



AMD



AMD



AMD



AMD



AMD

OVERVIEW

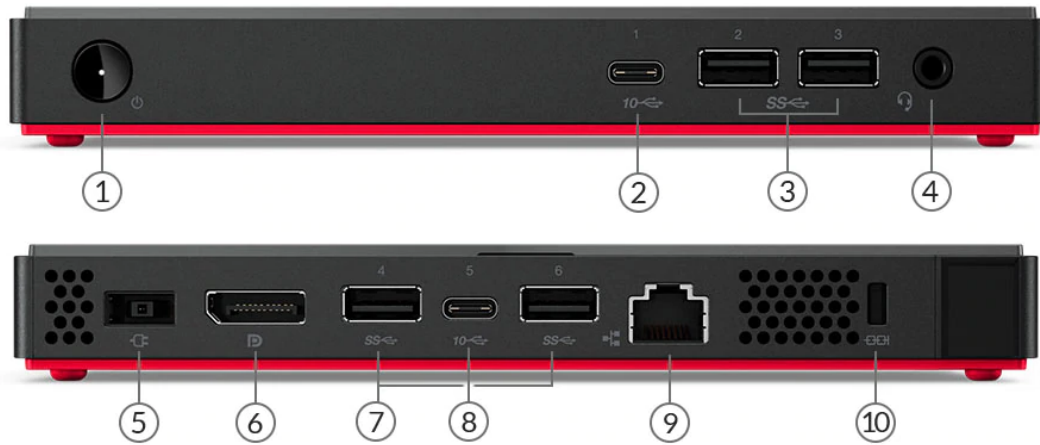

1. Power button	6. DisplayPort
2. USB-C 3.2 Gen 2	7. 2x USB 3.2 Gen 2
3. 2x USB 3.2 Gen 2	8. USB-C 3.2 Gen 2 (display and power-in)
4. Headphone / microphone combo jack (3.5mm)	9. Ethernet (RJ-45)
5. Power connector	10. Kensington Security Slot

PERFORMANCE

Processor

Processor Family

8th Generation Intel® Core™ i3 / i5 / i7 Processor

Processor**^[1]

Processor Name	Cores	Threads	Base Frequency	Max Frequency	Cache	Memory Support	Processor Graphics
Core™ i3-8145U	2	4	2.1GHz	3.9GHz	4MB	DDR4-2400	Intel® UHD Graphics
Core™ i5-8265U	4	8	1.6GHz	3.9GHz	6MB	DDR4-2400	Intel® UHD Graphics
Core™ i5-8365U	4	8	1.6GHz	4.1GHz	6MB	DDR4-2400	Intel® UHD Graphics
Core™ i7-8665U	4	8	1.9GHz	4.8GHz	8MB	DDR4-2400	Intel® UHD Graphics

Notes:

^[1] Intel® Max Turbo frequency will vary depending on application workload and the hardware and software configurations, see <http://www.intel.com/technology/turboboost/> for more information.

Operating System

Operating System**

- Windows® 10 Pro 64
- Windows® 10 Home 64
- Windows® 10 Home 64 Single Language
- Windows® 10 IoT Enterprise LTSC 2019
- Ubuntu Linux^[1]
- No preload operating system

Notes:

^[1] Some features may not be supported on the system with Linux preload, including but not limited to Intel® RST RAID, Human Presence Detection, etc.

Graphics

Graphics

Graphics	Type	Memory	Connector	Max Resolution	Key Features
Intel® UHD Graphics 620	Integrated	Shared	1x DP, 1 USB-C®	4096x2304@60Hz(DP); 4096x2304@60Hz(USB-C®)	DirectX® 12

Monitor Support

Monitor Support

Supports up to 2 independent displays via onboard ports (DisplayPort™ and USB-C®)

Chipset

Chipset

Intel® SoC (System on Chip) platform

Memory

Max Memory^[1]

- 4GB soldered memory, not upgradable
- 8GB soldered memory, not upgradable
- 16GB soldered memory, not upgradable

Memory Slots

Memory soldered to systemboard, no slots

Memory Type^[2]

DDR4-2666

Notes:

- [1] The max memory is based on the test results with current Lenovo® memory offerings.
- [2] Installed memory is actually 2666MHz, but runs at 2400MHz due to the memory support capability of processor.

Storage

Storage Support^[1]

Up to two drives, 2x M.2 SSD

- M.2 SSD up to 1TB each
- Optional Intel® Optane™ Memory Integrated with SSD, M.2

Storage Type^{**}

Disk Type	Interface	Security
M.2 2280 SSD	PCIe® NVMe®, PCIe® 3.0 x4	Opal
M.2 2242 SSD	PCIe® NVMe®, PCIe® 3.0 x2	-
Intel® Optane™ Memory with Solid State Storage, M.2 2280	PCIe® NVMe®, PCIe® 3.0 x4	-

RAID

RAID 0/1 support for M.2 SSDs (RAID preset only available via special bid models)

Notes:

- [1] The max capacity of each disk type is based on the test results with current Lenovo® storage offerings.

Removable Storage

Optical

None

Card Reader

No card reader

Multi-Media

Audio Chip

High Definition (HD) Audio, Realtek® ALC233VB codec

Speakers

Single speaker, 1W x1

Power Supply

Power Supply

Power	Type	Efficiency
65W	Adapter	88%
No power supply	-	-

DESIGN

Input Device

Keyboard^{**}

- Lenovo® Calliope Keyboard (USB connector), black
- Lenovo® Calliope Wireless Keyboard (2.4GHz via USB receiver), black
- Lenovo® Traditional Keyboard (USB connector), black
- No keyboard

Mouse^{**}

- Lenovo® Calliope Mouse (USB connector), black
- Lenovo® Calliope Wireless Mouse (2.4GHz via USB receiver), black
- Lenovo® Fingerprint Mouse (USB connector), Windows® Hello support, black (EOL on Jan, 2023)
- No mouse

Mechanical

Form Factor

Nano (0.35L)

Dimensions (WxDxH)^[1]

179 x 88 x 22 mm (7.05 x 3.46 x 0.87 inches)

Packaging Dimensions (WxDxH)

490 x 125 x 255 mm (19.29 x 4.92 x 10.04 inches)

Weight^[2]

Around 0.505 kg (1.11 lbs)

Packaging Weight

0.83 kg (1.83 lbs)

Case Color

Iron grey (top cover), black (mid bezel), red (bottom cover)

Bays

No bays

Expansion Slots

Three M.2 slots (one for WLAN, two for SSD)

Stand

No stand

IO Box

No IO box

Mounting^{}**

- VESA mount bracket kit with adapter holder, supports VESA mount 75mm and 100mm
- VESA mount bracket kit, supports VESA mount 75mm and 100mm
- DIN rail mount bracket kit
- None

Notes:

[1] The system dimensions may vary depending on configurations.

[2] The system weight is approximate and based on results in Lenovo® lab, which varies depending on the source of component, variance of the distribution of each component, and manufacturing process. It may not be the exact weight for each specific model.

CONNECTIVITY

Network

Onboard Ethernet^{}**

- Gigabit Ethernet, Intel® Ethernet Connection I219-LM, 1x RJ-45, supports Wake-on-LAN
- Gigabit Ethernet, Intel® Ethernet Connection I219-V, 1x RJ-45, supports Wake-on-LAN

Optional Ethernet

No optional Ethernet

WLAN + Bluetooth^{}**

- 802.11ac 1x1 Wi-Fi® + Bluetooth® 5.0, M.2 card
- Realtek® RTL8822CE, 802.11ac Dual Band 2x2 Wi-Fi® + Bluetooth® 5.0, M.2 card
- Intel® Wireless-AC 9462, 802.11ac Dual Band 1x1 Wi-Fi® + Bluetooth® 5.0, M.2 card
- Intel® Wireless-AC 9560, 802.11ac Dual Band 2x2 Wi-Fi® + Bluetooth® 5.1, Intel® vPro® technology support, M.2 card
- Intel® Wireless-AC 9560, 802.11ac Dual Band 2x2 Wi-Fi® + Bluetooth® 5.1, M.2 card
- No WLAN and Bluetooth®

Ports^[1]

Front Ports

- 1x USB-C® 3.2 Gen 2
- 2x USB 3.2 Gen 2
- 1x headphone / microphone combo jack (3.5mm)

Rear Ports

ThinkCentre M90n-1 Nano

- 1x USB-C® 3.2 Gen 2 (support display function and power-in [20V and >45W])
- 2x USB 3.2 Gen 2
- 1x DisplayPort™
- 1x Ethernet (RJ-45)

Notes:

[1] The transfer speed of following ports will vary and, depending on many factors, such as the processing speed of the host device, file attributes and other factors related to system configuration and your operating environment, will be slower than theoretical speed.

USB 2.0: 480 Mbit/s;

USB 3.2 Gen 1 (SuperSpeed USB 5Gbps, formerly USB 3.0 / USB 3.1 Gen 1): 5 Gbit/s;

USB 3.2 Gen 2 (SuperSpeed USB 10Gbps, formerly USB 3.1 Gen 2): 10 Gbit/s;

USB4® 20Gbps / USB 3.2 Gen 2x2 (SuperSpeed USB 20Gbps): 20 Gbit/s;

USB4® 40Gbps (USB 40Gbps): 40 Gbit/s;

Thunderbolt™ 3/4: 40 Gbit/s.

Monitor Cable

Monitor Cable***

- USB-C® to DP dongle
- USB-C® to HDMI® dongle
- USB-C® to VGA dongle
- DP to VGA dongle
- DP to HDMI® dongle
- No monitor cable

SECURITY & PRIVACY

Security

Security Chip

Discrete TPM 2.0, TCG certified

Physical Locks

Kensington® Security Slot™, 3 x 7 mm

Chassis Intrusion Switch

Chassis intrusion switch

Fingerprint Reader

- Touch style fingerprint reader on mouse (EOL on Jan, 2023)
- No fingerprint reader

BIOS Security

- Administrator password
- Power-on password
- Hard disk password
- Boot sequence control
- Boot without keyboard and mouse
- Smart USB protection (allows keyboard / mouse only, blocks all storage devices)
- Individual USB port disablement

MANAGEABILITY

System Management

System Management

- Intel® vPro®^[1]
- Non-vPro®

Notes:

[1] Intel® vPro® offers a superset of DASH's defined capabilities.

SERVICE

Warranty^[1]

Base Warranty**

- 1-year limited onsite service
- 3-year limited onsite service
- No base warranty

Notes:

[1] The warranty upgrades may be bundled with some models, please check the "Included upgrade" column in the specific model's configurations. For more service extensions, please go to <https://smartfind.lenovo.com/>. To learn more details of warranty policy, please access <https://pcsupport.lenovo.com/warranty>.

ENVIRONMENTAL

Operating Environment

Temperature

- Operating: 5°C (41°F) to 35°C (95°F)
- Storage: -40°C (-40°F) to 60°C (140°F)

Relative Humidity

- Operating: 20% to 80%
- Storage: 10% to 90%

Altitude

- Operating: 0 m (0 ft) to 3048 m (10,000 ft)
- Storage: 0 m (0 ft) to 12192 m (40,000 ft)

CERTIFICATIONS

Green Certifications^[1]

Green Certifications

- ENERGY STAR® 8.0
- EPEAT™ Silver Registered^[2]
- ErP Lot 3
- REACH
- RoHS compliant
- TCO Certified 8.0
- WEEE

Notes:

[1] The items listed under the "Green Certifications" section may not only refer to certification but also registration or self-declaration.

[2] EPEAT™ is registered where applicable, please see epeat.net for registration status by country.

Other Certifications

Other Certifications

- (Optional) TÜV Rheinland® Low Noise
- (Optional) TÜV Rheinland® Ultra Low Noise

Mil-Spec Test

MIL-STD-810H military test passed (Low Pressure [Altitude], High Temperature, Low Temperature, Temperature Shock, Humidity, Sand and Dust, Vibration, Shock, Fungus, Solar Radiation)

- Feature with ** means that only one offering listed under the feature is configured on selected models.
- Feature with *** means that one or more offerings listed under the feature could be configured on selected models.

- Lenovo reserves the right to change specifications or other product information without notice. Lenovo is not responsible for photographic or typographical errors. LENOVO PROVIDES THIS PUBLICATION “AS IS,” WITHOUT WARRANTY OF ANY KIND, EITHER EXPRESS OR IMPLIED, INCLUDING THE IMPLIED WARRANTIES OF MERCHANTABILITY OR FITNESS FOR A PARTICULAR PURPOSE. Some jurisdictions do not allow disclaimer of express or implied warranties in certain transactions, therefore this disclaimer may not apply to you.
- The specifications on this page may not be available in all regions, and may be changed or updated without notice.

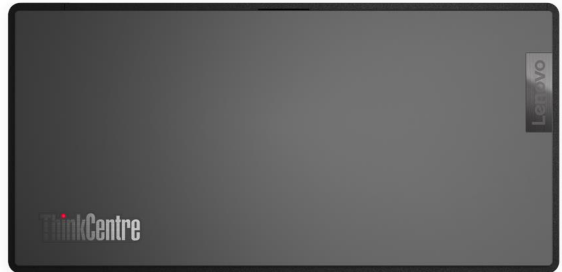

OVERVIEW

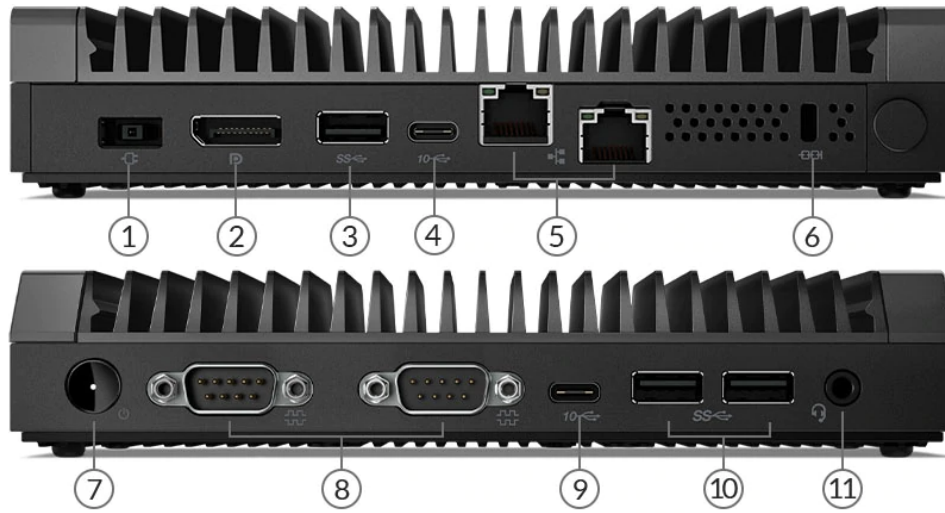

1. Power connector	7. Power button
2. HDMI (for 8145UE models) / DP (for others)	8. 2x Serial (RS232)
3. USB 3.2 Gen 2 (USB 2.0 for Celeron models)	9. USB-C 3.2 Gen 2
4. USB-C 3.2 Gen 2 (display and power-in)	10. 2x USB 3.2 Gen 2
5. 2x Ethernet (1x Ethernet for Celeron)	11. Headphone / microphone combo jack (3.5mm)
6. Kensington Security Slot	

PERFORMANCE

Processor

Processor Family

Intel® Celeron® or 8th Generation Intel® Core™ i3 / i5 Processor

Processor**^[1]

Processor Name	Cores	Threads	Base Frequency	Max Frequency	Cache	Memory Support	Processor Graphics
Celeron® 4205U	2	2	1.8GHz	-	2MB	DDR4-2133	Intel® UHD Graphics
Celeron® 4305UE	2	2	2.0GHz	-	2MB	DDR4-2133	Intel® UHD Graphics 610
Core™ i3-8145U	2	4	2.1GHz	3.9GHz ^[2]	4MB	DDR4-2400	Intel® UHD Graphics
Core™ i3-8145UE	2	4	2.2GHz	3.9GHz ^[3]	4MB	DDR4-2400	Intel® UHD Graphics 620
Core™ i5-8365U	4	8	1.6GHz	4.1GHz ^[4]	6MB	DDR4-2400	Intel® UHD Graphics

Notes:

^[1] Celeron® 4205U, Core™ i3-8145U and Core™ i5-8365U have been already end of life and not available any more.

^[2], ^[3], ^[4] Intel® Max Turbo frequency will vary depending on application workload and the hardware and software configurations, see

<http://www.intel.com/technology/turboboost/> for more information.

Operating System

Operating System**

- Windows® 10 Pro 64
- Windows® 10 Home 64
- Windows® 10 Home 64 Single Language
- Windows® 10 IoT Enterprise LTSC 2019
- FreeDOS
- Ubuntu Linux^[1]
- No preload operating system

Notes:

^[1] Some features may not be supported on the system with Linux preload, including but not limited to Intel® RST RAID, Human Presence Detection, etc.

Graphics

Graphics**^[1]

Graphics	Type	Memory	Connector	Max Resolution	Key Features
Intel® UHD Graphics 610	Integrated	Shared	1x DP, 1 USB-C®	4096x2304@60Hz(DP); 4096x2304@60Hz(USB-C®)	DirectX® 12
Intel® UHD Graphics 620	Integrated	Shared	1x HDMI®, 1 USB-C®	4096x2304@60Hz(USB-C®)	DirectX® 12
Intel® UHD graphics	Integrated	Shared	1x DP, 1x USB-C®	4096x2304@60Hz(DP), 4096x2304@60Hz(USB-C®)	DirectX® 12

Notes:

^[1] The Intel® UHD Graphics which is integrated in Celeron® 4205U, Core™ i3-8145U, or Core™ i5-8365U is not available any more, because those CPUs have been already end of life.

Monitor Support

Monitor Support

Supports up to 2 independent displays via onboard ports (DisplayPort™ and USB-C®, 8145UE models support HDMI® and USB-C®)

Chipset

ThinkCentre M90n-1 Nano IoT

Chipset

Intel® SoC (System on Chip) platform

Memory

Max Memory^[1]

- 4GB soldered memory, not upgradable
- 8GB soldered memory, not upgradable

Memory Slots

Memory soldered to systemboard, no slots

Memory Type^[2]

DDR4-2666

Notes:

[1] The max memory is based on the test results with current Lenovo® memory offerings.

[2] Installed memory is actually 2666MHz, but runs at 2133MHz or 2400MHz depending on the memory support capability of processor.

Storage

Storage Support^[1]

Up to two drives, 2x M.2 SSD

- M.2 SSD up to 1TB each
- Optional Intel® Optane™ Memory Integrated with SSD, M.2

Storage Type^{***}

Disk Type	Interface	Security
M.2 2280 SSD	PCIe® NVMe®, PCIe® 3.0 x4	Opal
M.2 2242 SSD	PCIe® NVMe®, PCIe® 3.0 x2	-
Intel® Optane™ Memory with Solid State Storage, M.2 2280	PCIe® NVMe®, PCIe® 3.0 x4	-

RAID

RAID 0/1 support for M.2 SSDs (RAID preset only available via special bid models)

Notes:

[1] The max capacity of each disk type is based on the test results with current Lenovo® storage offerings.

Removable Storage

Optical

None

Card Reader

No card reader

Multi-Media

Audio Chip

High Definition (HD) Audio, Realtek® ALC233VB codec

Speakers

Single speaker, 1W x1

Power Supply

Power Supply^{**}

Power	Type	Efficiency	Key Features	Dimensions
65W	Adapter	88%	100-240 VAC, wide temperature	129 x 53 x 30 mm, 1800 mm cable
65W	Adapter	88%	-	-
No power supply	-	-	-	-

DESIGN

Input Device

Keyboard**

- Lenovo® Calliope Keyboard (USB connector), black
- Lenovo® Calliope Wireless Keyboard (2.4GHz via USB receiver), black
- Lenovo® Traditional Keyboard (USB connector), black
- No keyboard

Mouse**

- Lenovo® Calliope Mouse (USB connector), black
- Lenovo® Calliope Wireless Mouse (2.4GHz via USB receiver), black
- Lenovo® Fingerprint Mouse (USB connector), Windows® Hello support, black (EOL on Jan, 2023)
- No mouse

Mechanical

Form Factor

Nano (0.55L)

Dimensions (WxDxH)^[1]

Models	Dimensions
Nano only	179 x 88 x 34.5 mm (7.05 x 3.46 x 1.36 inches)
Nano with IO box	179 x 88 x 61.3 mm (7.05 x 3.46 x 2.41 inches)

Packaging Dimensions (WxDxH)

490 x 125 x 255 mm (19.29 x 4.92 x 10.04 inches)

Weight^[2]

Models	Weight
Nano only	Around 0.72 kg (1.58 lbs)
Nano with IO box	Around 1.2 kg (2.65 lbs)

Packaging Weight

0.83 kg (1.83 lbs)

Case Color

Iron grey (top cover), black (mid bezel), black (bottom cover)

Bays

No bays

Expansion Slots

Three M.2 slots (one for WLAN, two for SSD)

Stand

No stand

IO Box

- IO box: 2x serial (RS232 / RS422 / RS485, SDK selectable) and 2x Ethernet (RJ-45, Realtek® RTL8153B, gigabit Ethernet) on front, 1x DIO (4DI / 4DO), 1x USB-C® (connect to Nano) and 1x DC-in connector (9V - 36V) on rear
- No IO box

Mounting**

- VESA mount bracket kit with adapter holder, supports VESA mount 75mm and 100mm
- VESA mount bracket kit, supports VESA mount 75mm and 100mm
- DIN rail mount bracket kit
- None

Notes:

[1] The system dimensions may vary depending on configurations.

[2] The system weight is approximate and based on results in Lenovo® lab, which varies depending on the source of component, variance of the distribution of each component, and manufacturing process. It may not be the exact weight for each specific model.

CONNECTIVITY

Network

Onboard Ethernet**

- Gigabit Ethernet, Realtek® RTL8111K, 1x RJ-45, supports Wake-on-LAN
- Two Gigabit Ethernet, Intel® Ethernet Connection I219-LM and Realtek® RTL8111H, 2x RJ-45, supports Wake-on-LAN
- Two Gigabit Ethernet, Realtek® RTL8111K and RTL8111H, 2x RJ-45, supports Wake-on-LAN

Optional Ethernet

No optional Ethernet

WLAN + Bluetooth®**

- 802.11ac 1x1 Wi-Fi® + Bluetooth® 5.0, M.2 card
- Realtek® RTL8822CE, 802.11ac Dual Band 2x2 Wi-Fi® + Bluetooth® 5.0, M.2 card
- Intel® Wireless-AC 9462, 802.11ac Dual Band 1x1 Wi-Fi® + Bluetooth® 5.0, M.2 card
- Intel® Wireless-AC 9560, 802.11ac Dual Band 2x2 Wi-Fi® + Bluetooth® 5.1, Intel® vPro® technology support, M.2 card
- Intel® Wireless-AC 9560, 802.11ac Dual Band 2x2 Wi-Fi® + Bluetooth® 5.1, M.2 card
- No WLAN and Bluetooth®

WWAN

- Intel® XMM 7360, 4G CAT9, M.2 Card
- No support

Ports^[1]

Front Ports

- 1x USB-C® 3.2 Gen 2
- 2x USB 3.2 Gen 2
- 1x headphone / microphone combo jack (3.5mm)
- 2x serial (RS-232)

Optional Front Ports

- 2x gigabit Ethernet (RJ-45) on SE30 IO box
- 2x serial (RS232 / RS422 / RS485, SDK selectable) on SE30 IO box

Rear Ports

- 1x USB-C® 3.2 Gen 2 (support display function and power-in [20V and >45W])
- 1x USB 2.0 (for Celeron® models)
- 1x USB 3.2 Gen 2 (for i3 / i5 models only)
- 1x HDMI® (for 8145UE models)
- 1x DisplayPort™ (for 4205U / 4305UE / 8145U / 8365U models)
- 1x Ethernet (RJ-45, for Celeron® models)
- 2x Ethernet (RJ-45, for i3 / i5 models)

Optional Rear Ports

- 1x DC-in 3pin Phoenix connector on SE30 IO box
- 1x DIO (4DI / 4DO) on SE30 IO box

Notes:

[1] The transfer speed of following ports will vary and, depending on many factors, such as the processing speed of the host device, file attributes and other factors related to system configuration and your operating environment, will be slower than theoretical speed.

USB 2.0: 480 Mbit/s;

USB 3.2 Gen 1 (SuperSpeed USB 5Gbps, formerly USB 3.0 / USB 3.1 Gen 1): 5 Gbit/s;

USB 3.2 Gen 2 (SuperSpeed USB 10Gbps, formerly USB 3.1 Gen 2): 10 Gbit/s;

USB4® 20Gbps / USB 3.2 Gen 2x2 (SuperSpeed USB 20Gbps): 20 Gbit/s;

USB4® 40Gbps (USB 40Gbps): 40 Gbit/s;

Thunderbolt™ 3/4: 40 Gbit/s.

Monitor Cable

Monitor Cable***

- USB-C® to DP dongle
- USB-C® to HDMI® dongle
- USB-C® to VGA dongle
- DP to VGA dongle
- DP to HDMI® dongle
- No monitor cable

SECURITY & PRIVACY

Security

Security Chip

Discrete TPM 2.0, TCG certified

Physical Locks

Kensington® Security Slot™, 3 x 7 mm

Chassis Intrusion Switch

Chassis intrusion switch

Fingerprint Reader

- Touch style fingerprint reader on mouse (EOL on Jan, 2023)
- No fingerprint reader

BIOS Security

- Administrator password
- Power-on password
- Hard disk password
- Boot sequence control
- Boot without keyboard and mouse
- Individual USB port disablement

MANAGEABILITY

System Management

System Management

- Intel® vPro®^[1]
- Non-vPro®

Notes:

[1] Intel® vPro® offers a superset of DASH's defined capabilities.

SERVICE

Warranty^[1]

Base Warranty**

- 1-year limited onsite service
- 3-year limited onsite service
- No base warranty

Notes:

[1] The warranty upgrades may be bundled with some models, please check the "Included upgrade" column in the specific model's configurations. For more service extensions, please go to <https://smartfind.lenovo.com/>. To learn more details of warranty policy, please access <https://pcsupport.lenovo.com/warranty>.

ENVIRONMENTAL

Operating Environment

Temperature

- Operating:
 - From 0°C (32°F) to 50°C (122°F): for the machine types of 11AK, 11AL, 11AM, 11AS, 11J3, 11J4, 11J7, and 11J8
 - From 0°C (32°F) to 35°C (95°F): for the machine types of 11AH and 11AJ
- Storage: -40°C (-40°F) to 60°C (140°F)

Relative Humidity

- Operating: 20% to 80%
- Storage: 10% to 90%

Altitude

- Operating: 0 m (0 ft) to 3048 m (10,000 ft)
- Storage: 0 m (0 ft) to 12192 m (40,000 ft)

CERTIFICATIONS

Green Certifications^[1]

Green Certifications^[2]

- ENERGY STAR® 8.0
- EPEAT™ Silver Registered^[3]
- ErP Lot 3
- REACH
- RoHS compliant
- TCO Certified 8.0
- WEEE

Notes:

[1] The items listed under the "Green Certifications" section may not only refer to certification but also registration or self-declaration.

[2] Energy Star 8.0 and EPEAT™ are not available for the models with I/O box, No OS, or Free DOS.

[3] EPEAT™ is registered where applicable, please see epeat.net for registration status by country.

Other Certifications

Other Certifications

- (Optional) TÜV Rheinland® Low Noise
- (Optional) TÜV Rheinland® Ultra Low Noise

Mil-Spec Test^[1]

- MIL-STD-810H military test passed (Low Pressure [Altitude], High Temperature, Low Temperature, Temperature Shock, Humidity, Sand and Dust, Vibration, Shock, Fungus, Solar Radiation)
- None

Notes:

[1] Not for the models with I/O box.

- Feature with ** means that only one offering listed under the feature is configured on selected models.
- Feature with *** means that one or more offerings listed under the feature could be configured on selected models.
- Lenovo reserves the right to change specifications or other product information without notice. Lenovo is not responsible for photographic or typographical errors. **LENOVO PROVIDES THIS PUBLICATION "AS IS," WITHOUT WARRANTY OF ANY KIND, EITHER EXPRESS OR IMPLIED, INCLUDING THE IMPLIED WARRANTIES OF MERCHANTABILITY OR FITNESS FOR A PARTICULAR PURPOSE.** Some jurisdictions do not allow disclaimer of express or implied warranties in certain transactions, therefore this disclaimer may not apply to you.
- The specifications on this page may not be available in all regions, and may be changed or updated without notice.



OVERVIEW

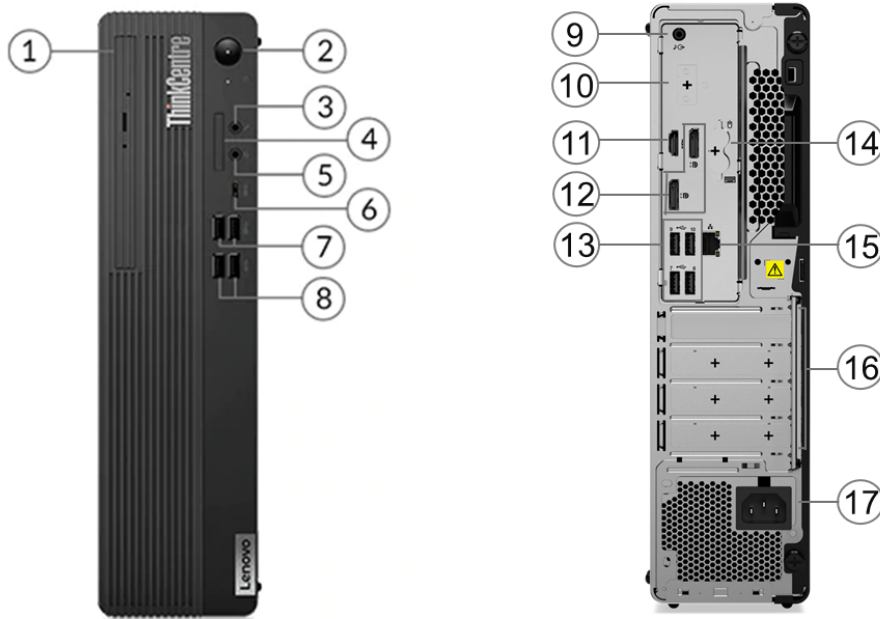

1. Optical drive *	10. Flex IO *
2. Power button	11. HDMI 2.1 TMDS
3. Microphone (3.5mm)	12. 2x DisplayPort 1.4
4. Card reader *	13. 4x USB 2.0
5. Headphone / microphone combo jack (3.5mm)	14. 2x PS/2 ports (keyboard / mouse) *
6. USB-C 3.2 Gen 1	15. Ethernet (RJ-45)
7. 2x USB 3.2 Gen 1	16. Optional ports on expansion cards *
8. 2x USB 3.2 Gen 2	17. Power connector
9. Line-out (3.5mm)	

Notes:

- Items with * are only available on selected models
- More ports are available through the optional expansion cards (not shown on the sample product above)

PERFORMANCE

Processor

Processor Family

Intel® Pentium® or 12th Generation Intel® Core™ i3 / i5 / i7 / i9 Processor

Processor**

Processor Name	Cores	Threads	Base Frequency	Max Frequency	Cache	Processor Graphics
Pentium® Gold G7400	2	4	3.7GHz	-	6MB	Intel® UHD Graphics 710
Core™ i3-12100	4 (4 P-core + 0 E-core)	8	P-core 3.3GHz	P-core 4.3GHz ^[1]	12MB	Intel® UHD Graphics 730
Core™ i3-12300	4 (4 P-core + 0 E-core)	8	P-core 3.5GHz	P-core 4.4GHz ^[2]	12MB	Intel® UHD Graphics 730
Core™ i5-12400	6 (6 P-core + 0 E-core)	12	P-core 2.5GHz	P-core 4.4GHz ^[3]	18MB	Intel® UHD Graphics 730
Core™ i5-12400F	6 (6 P-core + 0 E-core)	12	P-core 2.5GHz	P-core 4.4GHz ^[4]	18MB	-
Core™ i5-12500	6 (6 P-core + 0 E-core)	12	P-core 3.0GHz	P-core 4.6GHz ^[5]	18MB	Intel® UHD Graphics 770
Core™ i5-12600	6 (6 P-core + 0 E-core)	12	P-core 3.3GHz	P-core 4.8GHz ^[6]	18MB	Intel® UHD Graphics 770
Core™ i7-12700	12 (8 P-core + 4 E-core)	20	P-core 2.1GHz / E-core 1.6GHz	Max Turbo up to 4.9GHz / P-core 4.8GHz / E-core 3.6GHz ^[7]	25MB	Intel® UHD Graphics 770
Core™ i7-12700F	12 (8 P-core + 4 E-core)	20	P-core 2.1GHz / E-core 1.6GHz	Max Turbo up to 4.9GHz / P-core 4.8GHz / E-core 3.6GHz ^[8]	25MB	-
Core™ i9-12900	16 (8 P-core + 8 E-core)	24	P-core 2.4GHz / E-core 1.8GHz	Max Turbo up to 5.1GHz / P-core 5.0GHz / E-core 3.8GHz ^[9]	30MB	Intel® UHD Graphics 770
Core™ i9-12900F	16 (8 P-core + 8 E-core)	24	P-core 2.4GHz / E-core 1.8GHz	Max Turbo up to 5.1GHz / P-core 5.0GHz / E-core 3.8GHz ^[10]	30MB	-

Notes:

[1], [2], [3], [4], [5], [6], [7], [8], [9], [10] Intel® Max Turbo frequency will vary depending on application workload and the hardware and software configurations, see <http://www.intel.com/technology/turboboost/> for more information.

Operating System

Operating System**

- Windows® 11 Pro
- Windows® 11 Home
- Windows® 11 Home Single Language
- Windows® 11 DG Windows® 10 Pro 64
- Windows® 10 IoT Enterprise LTSC 2021
- Ubuntu Linux^[1]
- No preload operating system

Notes:

[1] Some features may not be supported on the system with Linux preload, including but not limited to Intel® RST RAID, Human Presence Detection, etc.

Graphics

Graphics***[1]

Graphics	Type	Memory	Connector	Max Resolution	Key Features

ThinkCentre M70s Gen 3

Intel® UHD graphics 710	Integrated	Shared	2x DP 1.4 HBR2, 1x HDMI® 2.1 TMDS, 1x Flex IO (VGA / DP 1.2 / HDMI® 2.1 TMDS / USB-C®)	4096x2304@60Hz(DP), 4096x2160@60Hz[HDMI® / Flex IO(HDMI®) / Flex IO(DP)], 3840x2160@60Hz[Flex IO(USB-C®)], 2048x1536@50Hz[Flex IO(VGA)]	DirectX® 12
Intel® UHD graphics 730	Integrated	Shared	2x DP 1.4 HBR2, 1x HDMI® 2.1 TMDS, 1x Flex IO (VGA / DP 1.2 / HDMI® 2.1 TMDS / USB-C®)	4096x2304@60Hz(DP), 4096x2160@60Hz[HDMI® / Flex IO(HDMI®) / Flex IO(DP)], 3840x2160@60Hz[Flex IO(USB-C®)], 2048x1536@50Hz[Flex IO(VGA)]	DirectX® 12
Intel® UHD graphics 770	Integrated	Shared	2x DP 1.4 HBR2, 1x HDMI® 2.1 TMDS, 1x Flex IO (VGA / DP 1.2 / HDMI® 2.1 TMDS / USB-C®)	4096x2304@60Hz(DP), 4096x2160@60Hz[HDMI® / Flex IO(HDMI®) / Flex IO(DP)], 3840x2160@60Hz[Flex IO(USB-C®)], 2048x1536@50Hz[Flex IO(VGA)]	DirectX® 12
Intel® Iris® Xe MAX 100	Discrete	2GB LPDDR4X	2x DP 1.4	3840x2160@60Hz(DP)	DirectX® 12, OpenGL 4.6

Notes:

[1] The information of integrated graphics are not applicable for the models with processor which has no integrated graphics inside (for the details, please refer to processor section).

Monitor Support

Monitor Support^[1]

Supports up to 4 independent displays via onboard ports (2x DP, 1x HDMI®, and 1x optional Flex IO), more displays support via discrete graphics

Notes:

[1] Onboard video ports are only available for the models with integrated graphics.

Chipset

Chipset

Intel® Q670 chipset

Memory

Max Memory^[1]

Up to 128GB DDR4-3200

Memory Slots

Four DDR4 DIMM slots, dual-channel capable

Memory Type

DDR4-3200

Notes:

[1] The max memory is based on the test results with current Lenovo® memory offerings.

Storage

Storage Support^{[1][2]}

Up to three drives, 1x 2.5"/3.5" HDD + 1x 2.5" HDD + 1x M.2 SSD

- 2.5" HDD up to 1TB each
- 3.5" HDD up to 2TB
- M.2 SSD up to 2TB

Storage Type^{***}

Disk Type	Interface	RPM	Security
2.5" SATA HDD	SATA 6Gb/s	7.2K	-
3.5" SATA HDD	SATA 6Gb/s	7.2K	-

M.2 2280 SSD	PCIe® NVMe®, PCIe® 3.0 x4	-	Opal
M.2 2280 SSD	PCIe® NVMe®, PCIe® 4.0 x4 Performance	-	Opal 2.0
M.2 2280 SSD	PCIe® NVMe®, PCIe® 4.0 x4 Value	-	Opal 2.0
M.2 2242 SSD	PCIe® NVMe®, PCIe® 3.0 x4	-	-

RAID

RAID 0/1 support for HDDs (RAID preset only available via special bid models)

Notes:

- [1] The max capacity of each disk type is based on the test results with current Lenovo® storage offerings.
 [2] The max capacity of SSD/HDD is based on the test results with current Lenovo® SSD/HDD offerings.

Removable Storage

Optical**

- DVD-ROM, SATA connector, slim (9.0mm)
- DVD burner (DVD±RW), SATA connector, slim (9.0mm)
- None

Card Reader

- 3-in-1 card reader (SD, SDHC, SDXC)
- No card reader

Multi-Media

Audio Chip

High Definition (HD) Audio, Realtek® ALC897Q-CG codec

Speakers

Single speaker, 1W x1

Power Supply

Power Supply**

Power	Type	Efficiency	Key Features
180W	Fixed	85%	100-240V, 50-60Hz
260W	Fixed	90%	100-240V, 50-60Hz
310W	Fixed	92%	100-240V, 50-60Hz
380W	Fixed	92%	100-240V, 50-60Hz

DESIGN

Input Device

Keyboard**

- Lenovo® Calliope Keyboard (USB connector), black
- Lenovo® Calliope Wireless Keyboard (2.4GHz via USB receiver), black
- Lenovo® Traditional Keyboard (USB connector), black
- No keyboard

Mouse**

- Lenovo® Calliope Mouse (USB connector), black
- Lenovo® Calliope Wireless Mouse (2.4GHz via USB receiver), black
- Lenovo® Mouse (PS/2 connector), black (only available via special bid)
- Lenovo® Fingerprint Mouse (USB connector), Windows® Hello support, black (EOL on Jan, 2023)
- No mouse

Mechanical

Form Factor

SFF (8.2L)

Dimensions (WxDxH)^[1]

ThinkCentre M70s Gen 3

92.5 x 297.7 x 339.5 mm (3.6 x 11.7 x 13.4 inches)

Weight^[2]

Around 5.3 kg (11.7 lbs)

Case Color

Black

Bays^[3]

- 1x 2.5" disk bay
- 1x 3.5" disk bay
- 1x slim ODD bay

Expansion Slots

- One PCIe® 4.0 x16, low-profile, length ≤ 155mm, height ≤ 70mm
- Two PCIe® 3.0 x1, low-profile, length ≤ 155mm, height ≤ 70mm
- Two M.2 slots (one for WLAN, one for SSD)

EOU

Toolless cover, disk, optical, extension card assembly / removal

Stand

- Vertical stand
- No stand

Others

- (Optional) Dust filter
- (Optional) Smart Cable (USB-A to USB-C®)
- Supports Smart Power On

Notes:

[1] The system dimensions may vary depending on configurations.

[2] The system weight is approximate and based on results in Lenovo® lab, which varies depending on the source of component, variance of the distribution of each component, and manufacturing process. It may not be the exact weight for each specific model.

[3] 2.5" HDD tray is optional, or comes with 2.5 HDD. 3.5" bay supports 2.5" / 3.5" HDD, 3.5" to 2.5 converter comes with 2nd 2.5" HDD.

CONNECTIVITY

Network

Onboard Ethernet

Gigabit Ethernet, Intel® Ethernet Connection I219-LM, 1x RJ-45, supports Wake-on-LAN

Optional Ethernet^{***}

- Gigabit Ethernet, Bitland BN8E88, 1x RJ-45, PCIe® x1
- Gigabit Ethernet, Bitland RTL8168H, 1x RJ-45, PCIe® x1
- 2.5 Gigabit Ethernet, Realtek® RTL8125BGS, 1x RJ-45, PCIe® x1
- No optional Ethernet

WLAN + Bluetooth^{**}

- Realtek® RTL8822CE, 802.11ac Dual Band 2x2 Wi-Fi® + Bluetooth® 5.0, M.2 card
- Intel® Wireless-AC 9560, 802.11ac Dual Band 2x2 Wi-Fi® + Bluetooth® 5.1, M.2 card
- Realtek® Wi-Fi® 6 RTL8852BE, 802.11ax Dual Band 2x2 Wi-Fi® + Bluetooth® 5.3, M.2 card^[1]
- Intel® Wi-Fi® 6 AX201, 802.11ax 2x2 Wi-Fi® + Bluetooth® 5.2, M.2 Card^[2]
- Intel® Wi-Fi® 6E AX211, 802.11ax 2x2 Wi-Fi® + Bluetooth® 5.3, Intel® vPro® technology support, M.2 Card^[3]
- No WLAN and Bluetooth®

Notes:

[1], [3] Bluetooth® 5.3 requires Windows® 11.

[2] Bluetooth® 5.2 requires Windows® 11.

Ports^[1]

Front Ports

- 1x USB-C® 3.2 Gen 1 (15W charging)

ThinkCentre M70s Gen 3

- 2x USB 3.2 Gen 1
- 2x USB 3.2 Gen 2
- 1x headphone / microphone combo jack (3.5mm)
- 1x microphone (3.5mm)

Optional Front Ports

1x card reader

Rear Ports^[2]

- 4x USB 2.0
- 1x HDMI[®] 2.1 TMDS
- 2x DisplayPort[™] 1.4a (HBR2, DSC)
- 1x Ethernet (RJ-45)
- 1x line-out (3.5mm)

Optional Rear Ports^{***}

- 1x USB-C[®] 3.2 Gen 1 with DisplayPort[™] function and 5V@3A charging (Flex IO)
- 1x HDMI[®] 2.1 TMDS (Flex IO)
- 1x DP 1.2 (Flex IO)
- 1x VGA (Flex IO)
- 2x USB 3.2 Gen 1 (via 2-port USB expansion card, PCIe[®] x1)
- 1x parallel
- 1x serial
- 1x 2nd serial
- 4x serial (via 4-port serial expansion card, PCIe[®] x1)
- 2x PS/2

Notes:

[1] The transfer speed of following ports will vary and, depending on many factors, such as the processing speed of the host device, file attributes and other factors related to system configuration and your operating environment, will be slower than theoretical speed.

USB 2.0: 480 Mbit/s;

USB 3.2 Gen 1 (SuperSpeed USB 5Gbps, formerly USB 3.0 / USB 3.1 Gen 1): 5 Gbit/s;

USB 3.2 Gen 2 (SuperSpeed USB 10Gbps, formerly USB 3.1 Gen 2): 10 Gbit/s;

USB4[®] 20Gbps / USB 3.2 Gen 2x2 (SuperSpeed USB 20Gbps): 20 Gbit/s;

USB4[®] 40Gbps (USB 40Gbps): 40 Gbit/s;

Thunderbolt[™] 3/4: 40 Gbit/s.

[2] For video ports on discrete graphics, please see graphics section.

Monitor Cable

Monitor Cable^{***}

- HDMI[®] to HDMI[®] cable (1.5m)
- HDMI[®] to VGA dongle
- DP to VGA dongle
- DP to dual DP dongle
- DP to DVI-D dongle
- DP to HDMI[®] dongle
- No monitor cable

SECURITY & PRIVACY

Security

Security Chip

Discrete TPM 2.0, TCG certified

Physical Locks

- (Optional) E-lock
- (Optional) Smart Cable Clip
- Kensington[®] Security Slot[™], 3 x 7 mm
- Padlock Loop

Chassis Intrusion Switch

- Chassis intrusion switch
- No chassis intrusion switch

Fingerprint Reader

- Touch style fingerprint reader on mouse (EOL on Jan, 2023)
- No fingerprint reader

BIOS Security

- Administrator password
- Power-on password
- Hard disk password
- Boot sequence control
- Boot without keyboard and mouse
- Self-healing BIOS (Level 2)
- Smart USB protection (allows keyboard / mouse only, blocks all storage devices)
- Individual USB port disablement

MANAGEABILITY**System Management****System Management****

- Intel® vPro® Enterprise^[1]
- Intel® vPro® Essentials^[2]
- Non-vPro®

Notes:

[1], [2] Intel® vPro® offers a superset of DASH's defined capabilities.

SERVICE**Warranty^[1]****Base Warranty****

- 1-year courier or carry-in service
- 1-year limited onsite service
- 3-year limited onsite service
- No base warranty

Notes:

[1] The warranty upgrades may be bundled with some models, please check the "Included upgrade" column in the specific model's configurations. For more service extensions, please go to <https://smartfind.lenovo.com/>. To learn more details of warranty policy, please access <https://pcsupport.lenovo.com/warranty>.

ENVIRONMENTAL**Operating Environment****Temperature**

- Operating: 5°C (41°F) to 35°C (95°F)
- Storage: -40°C (-40°F) to 60°C (140°F)

Relative Humidity

- Operating: 20% to 80%
- Storage: 10% to 90%

Altitude

- Operating: 0 m (0 ft) to 3048 m (10,000 ft)
- Storage: 0 m (0 ft) to 12192 m (40,000 ft)

CERTIFICATIONS**Green Certifications^[1]****Green Certifications**

- (Optional) ENERGY STAR® 8.0
- (Optional) EPEAT™ Silver Registered^[2]
- (Optional) EPEAT™ Gold Registered^[3]
- ErP Lot 3
- RoHS compliant
- TCO Certified 9.0

Notes:

[1] The items listed under the "Green Certifications" section may not only refer to certification but also registration or self-declaration.

[2], [3] EPEAT™ is registered where applicable, please see epeat.net for registration status by country.

Other Certifications

Other Certifications

- (Optional) TÜV Rheinland® Low Noise
- (Optional) TÜV Rheinland® Ultra Low Noise

Mil-Spec Test

MIL-STD-810H military test passed (Low Pressure [Altitude], High Temperature, Low Temperature, Temperature Shock, Humidity, Sand and Dust, Vibration, Shock, Fungus, Solar Radiation, Contamination by Fluids, Salt Fog)

- Feature with ** means that only one offering listed under the feature is configured on selected models.
- Feature with *** means that one or more offerings listed under the feature could be configured on selected models.
- Lenovo reserves the right to change specifications or other product information without notice. Lenovo is not responsible for photographic or typographical errors. LENOVO PROVIDES THIS PUBLICATION "AS IS," WITHOUT WARRANTY OF ANY KIND, EITHER EXPRESS OR IMPLIED, INCLUDING THE IMPLIED WARRANTIES OF MERCHANTABILITY OR FITNESS FOR A PARTICULAR PURPOSE. Some jurisdictions do not allow disclaimer of express or implied warranties in certain transactions, therefore this disclaimer may not apply to you.
- The specifications on this page may not be available in all regions, and may be changed or updated without notice.



intel



intel



intel



intel

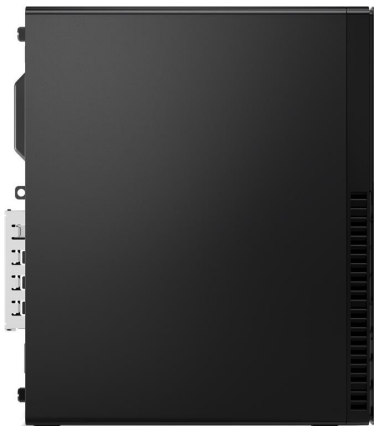

intel



intel

OVERVIEW

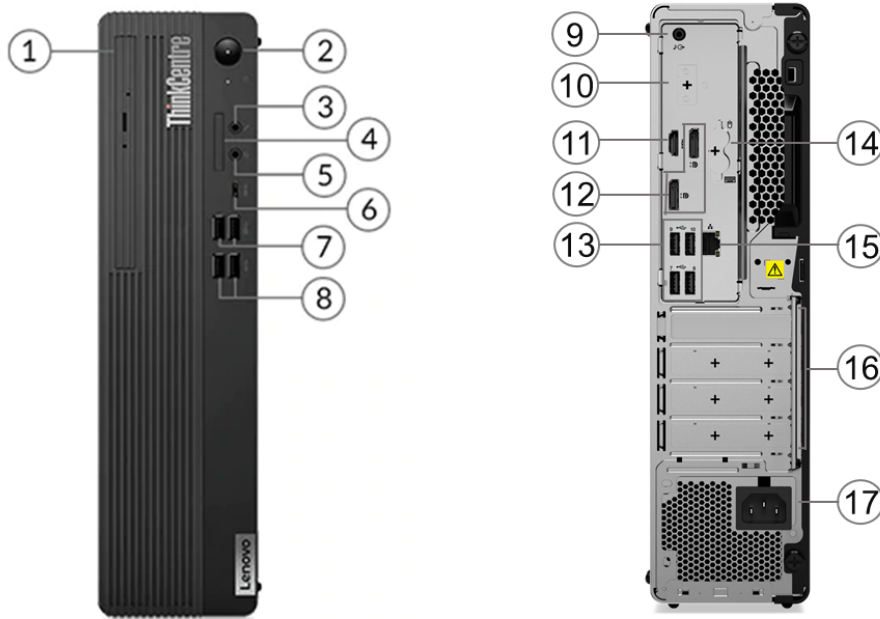

1. Optical drive *	10. Flex IO *
2. Power button	11. HDMI 2.1 TMDS
3. Microphone (3.5mm)	12. 2x DisplayPort 1.4a
4. Card reader *	13. 4x USB 2.0
5. Headphone / microphone combo jack (3.5mm)	14. 2x PS/2 ports (keyboard / mouse) *
6. USB-C 3.2 Gen 1	15. Ethernet (RJ-45)
7. 2x USB 3.2 Gen 1	16. Optional ports on expansion cards *
8. 2x USB 3.2 Gen 2	17. Power connector
9. Line-out (3.5mm)	

Notes:

- Items with * are only available on selected models
- More ports are available through the optional expansion cards (not shown on the sample product above)

PERFORMANCE

Processor

Processor Family

13th Generation Intel® Core™ i3 / i5 / i7 Processor

Processor**^[1]

Processor Name	Cores	Threads	Base Frequency	Max Frequency	Cache	Processor Graphics
Core™ i3-13100	4 (4 P-core + 0 E-core)	8	P-core 3.4GHz	P-core 4.5GHz	12MB	Intel® UHD Graphics 730
Core™ i5-13400	10 (6 P-core + 4 E-core)	16	P-core 2.5GHz / E-core 1.8GHz	P-core 4.6GHz / E-core 3.3GHz	20MB	Intel® UHD Graphics 730
Core™ i5-13500	14 (6 P-core + 8 E-core)	20	P-core 2.5GHz / E-core 1.8GHz	P-core 4.8GHz / E-core 3.5GHz	24MB	Intel® UHD Graphics 770
Core™ i5-13600	14 (6 P-core + 8 E-core)	20	P-core 2.7GHz / E-core 2.0GHz	P-core 5.0GHz / E-core 3.7GHz	24MB	Intel® UHD Graphics 770
Core™ i7-13700	16 (8 P-core + 8 E-core)	24	P-core 2.1GHz / E-core 1.5GHz	Max Turbo up to 5.2GHz / P-core 5.1GHz / E-core 4.1GHz	30MB	Intel® UHD Graphics 770

Notes:

^[1] Intel® Max Turbo frequency will vary depending on application workload and the hardware and software configurations, see <http://www.intel.com/technology/turboboost/> for more information.

Operating System

Operating System**

- Windows® 11 Pro
- Windows® 11 Home
- Windows® 11 Home Single Language
- Windows® 11 DG Windows® 10 Pro 64
- Windows® 10 IoT Enterprise LTSC 2021^[1]
- Ubuntu Linux^[2]
- No preload operating system

Notes:

^[1] Windows® 10 IoT Enterprise LTSC 2021 is special bid only.

^[2] Some features may not be supported on the system with Linux preload, including but not limited to Intel® RST RAID, Human Presence Detection, etc.

Graphics

Graphics**

Graphics	Type	Memory	Connector	Max Resolution	Key Features
Intel® UHD graphics 730	Integrated	Shared	2x DP 1.4a (HBR2, DSC), 1x HDMI® 2.1 TMDS, 1x Flex IO (VGA / DP 1.2 / HDMI® 2.1 TMDS / USB-C®)	4096x2304@60Hz(DP), 4096x2160@60Hz[HDMI® / Flex IO(HDMI) / Flex IO(DP)], 3840x2160@60Hz[Flex IO(USB-C®)], 2048x1536@50Hz[Flex IO(VGA)]	DirectX® 12
Intel® UHD graphics 770	Integrated	Shared	2x DP 1.4a (HBR2, DSC), 1x HDMI® 2.1 TMDS, 1x Flex IO (VGA / DP 1.2 / HDMI® 2.1 TMDS / USB-C®)	4096x2304@60Hz(DP), 4096x2160@60Hz[HDMI® / Flex IO(HDMI) / Flex IO(DP)], 3840x2160@60Hz[Flex IO(USB-C®)], 2048x1536@50Hz[Flex IO(VGA)]	DirectX® 12

Monitor Support

Monitor Support

Supports up to 4 independent displays via onboard ports (2x DP, 1x HDMI®, and 1x optional Flex IO)

Chipset

ThinkCentre M70s Gen 4

Chipset

Intel® Q670 chipset

Memory

Max Memory^[1]

Up to 128GB DDR4-3200

Memory Slots

Four DDR4 DIMM slots, dual-channel capable

Memory Type

DDR4-3200

Memory Protection

Non-ECC

Notes:

[1] The max memory is based on the test results with current Lenovo® memory offerings.

Storage

Storage Support^{[1][2]}

Up to three drives, 1x 2.5"/3.5" HDD + 1x 2.5" HDD + 1x M.2 SSD

- 2.5" HDD up to 1TB each
- 3.5" HDD up to 2TB
- M.2 SSD up to 2TB

Storage Type^{***}

Disk Type	Interface	RPM	Security
2.5" SATA HDD	SATA 6Gb/s	7.2K	-
3.5" SATA HDD	SATA 6Gb/s	7.2K	-
M.2 2280 SSD	PCIe® NVMe®, PCIe® 4.0 x4 Performance	-	Opal 2.0
M.2 2280 SSD	PCIe® NVMe®, PCIe® 4.0 x4 Value	-	Opal 2.0

RAID

RAID 0/1 support for HDDs (RAID preset only available via special bid models)

Notes:

[1] The max capacity of each disk type is based on the test results with current Lenovo® storage offerings.

[2] 2TB SSD is special bid only.

Removable Storage

Optical**

- DVD-ROM, SATA connector, slim (9.0mm)
- DVD burner (DVD±RW), SATA connector, slim (9.0mm)
- None

Card Reader

- 3-in-1 card reader (SD, SDHC, SDXC)
- No card reader

Multi-Media

Audio Chip

High Definition (HD) Audio, Realtek® ALC897Q-CG codec

Speakers

Single speaker, 1W x1

Power Supply

Power Supply**

Power	Type	Efficiency	Key Features
-------	------	------------	--------------

ThinkCentre M70s Gen 4

180W	Fixed	85%	100-240V, 50-60Hz
260W	Fixed	90%	100-240V, 50-60Hz
310W	Fixed	92%	100-240V, 50-60Hz
380W	Fixed	92%	100-240V, 50-60Hz

DESIGN

Input Device

Keyboard**

- Lenovo® Calliope Keyboard (USB connector), black
- Lenovo® Calliope Wireless Keyboard, black
- Lenovo® Traditional Keyboard (USB connector), black
- No keyboard

Mouse**

- Lenovo® Calliope Mouse (USB connector), black
- Lenovo® Calliope Wireless Mouse (2.4GHz via USB receiver), black
- No mouse

Mechanical

Form Factor

SFF (8.2L)

Dimensions (WxDxH)^[1]

92.5 x 297.7 x 339.5 mm (3.6 x 11.7 x 13.4 inches)

Packaging Dimensions (WxDxH)

195 x 395 x 530 mm (7.68 x 15.55 x 20.87 inches)

Weight^[2]

Around 5.3 kg (11.7 lbs)

Packaging Weight

Around 7.6 kg (16.76 lbs)

Case Color

Black

Bays

- 1x 2.5" disk bay^[3]
- 1x 3.5" disk bay^[4]
- 1x slim ODD bay

Expansion Slots

- One PCIe® 4.0 x16, low-profile, length ≤ 155mm, height ≤ 70mm
- Two PCIe® 3.0 x1, low-profile, length ≤ 155mm, height ≤ 70mm
- Two M.2 slots (one for WLAN, one for SSD)

EOU

Toolless cover, disk, optical, extension card assembly / removal

Stand

- Vertical stand
- No stand

Others

- (Optional) Dust filter
- (Optional) Smart Cable (USB-A to USB-C®)
- Supports Smart Power On

Notes:

[1] The system dimensions may vary depending on configurations.

[2] The system weight is approximate and based on results in Lenovo® lab, which varies depending on the source of component, variance of the distribution of each component, and manufacturing process. It may not be the exact weight

for each specific model.

[3] 2.5" HDD tray is optional, or comes with 2.5 HDD.

[4] 3.5" bay supports 2.5" / 3.5" HDD, 3.5" to 2.5 converter comes with 2nd 2.5" HDD.

CONNECTIVITY

Network

Onboard Ethernet

Gigabit Ethernet, Intel® Ethernet Connection I219-LM, 1x RJ-45, supports Wake-on-LAN

Optional Ethernet

- 2.5 Gigabit Ethernet, Realtek® RTL8125BGS, 1x RJ-45, PCIe® x1
- No optional Ethernet

WLAN + Bluetooth®**

- Realtek® Wi-Fi® 6 RTL8852BE, 802.11ax Dual Band 2x2 Wi-Fi® + Bluetooth® 5.1, M.2 card^[1]
- Intel® Wi-Fi® 6 AX201, 802.11ax 2x2 Wi-Fi® + Bluetooth® 5.1, M.2 Card^[2]
- Intel® Wi-Fi® 6E AX211, 802.11ax 2x2 Wi-Fi® + Bluetooth® 5.1, Intel® vPro® technology support, M.2 Card^[3]
- No WLAN and Bluetooth®

Notes:

[1], [2], [3] Bluetooth® 5.2 is hardware ready but may run at a lower version due to OS limitations.

Ports^[1]

Front Ports

- 1x USB-C® 3.2 Gen 1 (15W charging)
- 2x USB 3.2 Gen 1
- 2x USB 3.2 Gen 2
- 1x headphone / microphone combo jack (3.5mm)
- 1x microphone (3.5mm)

Optional Front Ports

1x card reader

Rear Ports^[2]

- 4x USB 2.0
- 1x HDMI® 2.1 TMDS
- 2x DisplayPort™ 1.4a (HBR2, DSC)
- 1x Ethernet (RJ-45)
- 1x line-out (3.5mm)

Optional Rear Ports^{***}

- 1x USB-C® 3.2 Gen 1 with DisplayPort™ function and 5V@3A charging (Flex IO)
- 1x HDMI® 2.1 TMDS (Flex IO)
- 1x DP 1.2 (Flex IO)
- 1x VGA (Flex IO)
- 2x USB 3.2 Gen 1 (via 2-port USB expansion card, PCIe® x1)
- 1x parallel
- 1x serial
- 1x 2nd serial
- 4x serial (via 4-port serial expansion card, PCIe® x1)
- 2x PS/2
- None

Notes:

[1] The transfer speed of following ports will vary and, depending on many factors, such as the processing speed of the host device, file attributes and other factors related to system configuration and your operating environment, will be slower than theoretical speed.

USB 2.0: 480 Mbit/s;

USB 3.2 Gen 1 (SuperSpeed USB 5Gbps, formerly USB 3.0 / USB 3.1 Gen 1): 5 Gbit/s;

USB 3.2 Gen 2 (SuperSpeed USB 10Gbps, formerly USB 3.1 Gen 2): 10 Gbit/s;

USB4® 20Gbps / USB 3.2 Gen 2x2 (SuperSpeed USB 20Gbps): 20 Gbit/s;

USB4® 40Gbps (USB 40Gbps): 40 Gbit/s;

Thunderbolt™ 3/4: 40 Gbit/s.

[2] For video ports on discrete graphics, please see graphics section.

Monitor Cable

Monitor Cable***

- HDMI® to HDMI® cable (1.5m)
- HDMI® to VGA dongle
- DP to VGA dongle
- DP to DVI-D dongle
- DP to HDMI® dongle
- No monitor cable

SECURITY & PRIVACY

Security

Security Chip

Discrete TPM 2.0, TCG certified

Physical Locks

- (Optional) E-lock
- (Optional) Smart Cable Clip
- Kensington® Security Slot™, 3 x 7 mm
- Padlock Loop

Chassis Intrusion Switch

- Chassis intrusion switch
- No chassis intrusion switch

Fingerprint Reader

No fingerprint reader

BIOS Security

- Administrator password
- Power-on password
- Hard disk password
- Boot sequence control
- Boot without keyboard and mouse
- Self-healing BIOS (Level 2)
- Smart USB protection (allows keyboard / mouse only, blocks all storage devices)
- Individual USB port disablement

MANAGEABILITY

System Management

System Management

- Intel® vPro® Enterprise^[1]
- Non-vPro®

Notes:

[1] Intel® vPro® offers a superset of DASH's defined capabilities.

SERVICE

Warranty^[1]

Base Warranty**

- 1-year courier or carry-in service
- 1-year limited onsite service
- 3-year limited onsite service
- No base warranty

Notes:

[1] The warranty upgrades may be bundled with some models, please check the "Included upgrade" column in the specific model's configurations. For more service extensions, please go to <https://smartfind.lenovo.com/>. To learn more details of warranty policy, please access <https://pcsupport.lenovo.com/warranty>.

ENVIRONMENTAL

Operating Environment

Temperature

- Operating: 5°C (41°F) to 35°C (95°F)
- Storage: -40°C (-40°F) to 60°C (140°F)

Relative Humidity

- Operating: 20% to 80%
- Storage: 10% to 90%

Altitude

- Operating: 0 m (0 ft) to 3048 m (10,000 ft)
- Storage: 0 m (0 ft) to 12192 m (40,000 ft)

CERTIFICATIONS

Green Certifications^[1]

Green Certifications

- (Optional) ENERGY STAR® 8.0
- (Optional) EPEAT™ Silver Registered^[2]
- (Optional) EPEAT™ Gold Registered^[3]
- ErP Lot 3
- RoHS compliant
- TCO Certified 9.0

Notes:

[1] The items listed under the "Green Certifications" section may not only refer to certification but also registration or self-declaration.

[2], [3] EPEAT™ is registered where applicable, please see epeat.net for registration status by country.

Other Certifications

Other Certifications

- (Optional) TÜV Rheinland® Low Noise
- (Optional) TÜV Rheinland® Ultra Low Noise

Mil-Spec Test

MIL-STD-810H military test passed (Low Pressure [Altitude], High Temperature, Low Temperature, Temperature Shock, Humidity, Sand and Dust, Vibration, Shock, Fungus, Solar Radiation, Contamination by Fluids, Salt Fog)

- Feature with ** means that only one offering listed under the feature is configured on selected models.
- Feature with *** means that one or more offerings listed under the feature could be configured on selected models.
- Lenovo reserves the right to change specifications or other product information without notice. Lenovo is not responsible for photographic or typographical errors. LENOVO PROVIDES THIS PUBLICATION "AS IS," WITHOUT WARRANTY OF ANY KIND, EITHER EXPRESS OR IMPLIED, INCLUDING THE IMPLIED WARRANTIES OF MERCHANTABILITY OR FITNESS FOR A PARTICULAR PURPOSE. Some jurisdictions do not allow disclaimer of express or implied warranties in certain transactions, therefore this disclaimer may not apply to you.

- The specifications on this page may not be available in all regions, and may be changed or updated without notice.



intel



intel



intel



intel

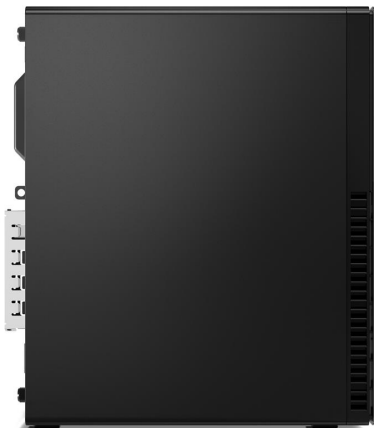

intel



intel

OVERVIEW

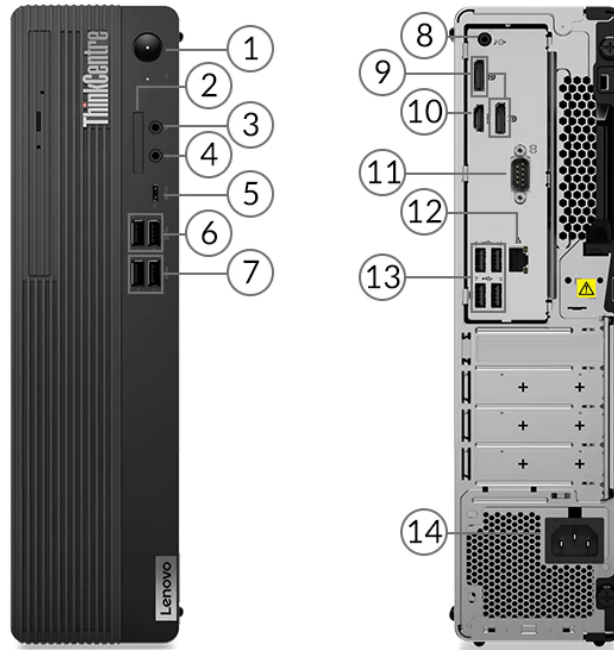

1. Power button	8. Line-out (3.5mm)
2. Card reader	9. 2x DisplayPort 1.4
3. Microphone (3.5mm)	10. HDMI 1.4b
4. Headphone / microphone combo jack (3.5mm)	11. Serial
5. USB-C 3.2 Gen 1	12. Ethernet (RJ-45)
6. 2x USB 3.2 Gen 1	13. 4x USB 2.0 (Note 1)
7. 2x USB 3.2 Gen 2	14. Power connector

Notes:

- 4 rear USB ports are USB 3.2 Gen 1 for selected Brazil models only
- More ports are available through the optional expansion cards (not shown on the sample product above)

PERFORMANCE

Processor

Processor Family

AMD Athlon™ or AMD Ryzen™ 3 / 5 / 7 / 9 Processor

Processor**

Processor Name	Cores	Threads	Base Frequency	Max Frequency	Cache	Memory Support	Processor Graphics
AMD Athlon™ Gold PRO 3150G ^[1]	4	4	3.5GHz	3.9GHz	2MB L2 / 4MB L3	DDR4-2933	AMD Radeon™ Graphics
AMD Athlon™ Silver 3050GE ^[2]	2	4	3.4GHz	3.4GHz	1MB L2 / 4MB L3	DDR4-2666	AMD Radeon™ Graphics
AMD Ryzen™ 3 3200G ^[3]	4	4	3.6GHz	4.0GHz	2MB L2 / 4MB L3	DDR4-2933	AMD Radeon™ Vega 8 Graphics
AMD Ryzen™ 3 4300G ^[4]	4	8	3.8GHz	4.0GHz	2MB L2 / 4MB L3	DDR4-3200	AMD Radeon™ Graphics
AMD Ryzen™ 3 5300G	4	8	4.0GHz	4.2GHz	2MB L2 / 8MB L3	DDR4-3200	AMD Radeon™ Graphics
AMD Ryzen™ 3 PRO 4350G ^[5]	4	8	3.8GHz	4.0GHz	2MB L2 / 4MB L3	DDR4-3200	AMD Radeon™ Graphics
AMD Ryzen™ 3 PRO 5350G	4	8	4.0GHz	4.2GHz	2MB L2 / 8MB L3	DDR4-3200	AMD Radeon™ Graphics
AMD Ryzen™ 5 4600G ^[6]	6	12	3.7GHz	4.2GHz	3MB L2 / 8MB L3	DDR4-3200	AMD Radeon™ Graphics
AMD Ryzen™ 5 5600G	6	12	3.9GHz	4.4GHz	3MB L2 / 16MB L3	DDR4-3200	AMD Radeon™ Graphics
AMD Ryzen™ 5 PRO 3350G ^[7]	4	8	3.6GHz	4.0GHz	2MB L2 / 4MB L3	DDR4-2933	AMD Radeon™ Vega 11 Graphics
AMD Ryzen™ 5 PRO 3400G ^[8]	4	8	3.7GHz	4.2GHz	2MB L2 / 4MB L3	DDR4-2933	AMD Radeon™ Vega 11 Graphics
AMD Ryzen™ 5 PRO 3600 ^[9]	6	12	3.6GHz	4.2GHz	3MB L2 / 32MB L3	DDR4-3200	-
AMD Ryzen™ 5 PRO 4650G ^[10]	6	12	3.7GHz	4.2GHz	3MB L2 / 8MB L3	DDR4-3200	AMD Radeon™ Graphics
AMD Ryzen™ 5 PRO 5650G	6	12	3.9GHz	4.4GHz	3MB L2 / 16MB L3	DDR4-3200	AMD Radeon™ Graphics
AMD Ryzen™ 7 4700G ^[11]	8	16	3.6GHz	4.4GHz	4MB L2 / 8MB L3	DDR4-3200	AMD Radeon™ Graphics
AMD Ryzen™ 7 5700G	8	16	3.8GHz	4.6GHz	4MB L2 / 16MB L3	DDR4-3200	AMD Radeon™ Graphics
AMD Ryzen™ 7 PRO 3700 ^[12]	8	16	3.6GHz	4.4GHz	4MB L2 / 32MB L3	DDR4-3200	-
AMD Ryzen™ 7 PRO 4750G ^[13]	8	16	3.6GHz	4.4GHz	4MB L2 / 8MB L3	DDR4-3200	AMD Radeon™ Graphics
AMD Ryzen™ 7 PRO 5750G	8	16	3.8GHz	4.6GHz	4MB L2 / 16MB L3	DDR4 3200	AMD Radeon™ Graphics
AMD Ryzen™ 9 PRO 3900 ^[14]	12	24	3.1GHz	4.3GHz	6MB L2 / 64MB L3	DDR4-3200	-

Notes:

^[1], ^[2], ^[3], ^[4], ^[5], ^[6], ^[7], ^[8], ^[9], ^[10], ^[11], ^[12], ^[13], ^[14] End of life and not available any more.

Operating System

Operating System**

- Windows® 11 Pro
- Windows® 11 Home
- Windows® 11 Home Single Language
- Windows® 11 DG Windows® 10 Pro 64
- Windows® 10 Pro 64
- Windows® 10 Home 64
- Windows® 10 Home 64 Single Language
- Windows® 10 IoT Enterprise
- Ubuntu Linux^[1]
- No preload operating system

Notes:

[1] Some features may not be supported on the system with Linux preload, including but not limited to Intel® RST RAID, Human Presence Detection, etc.

Graphics**Graphics**^{[1][2]}**

Graphics	Type	Memory	Connector	Max Resolution	Key Features
AMD Radeon™ Graphics	Integrated	Shared	2x DisplayPort™ 1.4, 1x HDMI® 1.4	4096x2160@60Hz(DP), 4096x2160@24Hz(HDMI®)	DirectX® 12
AMD Radeon™ Vega 11 Graphics	Integrated	Shared	2x DisplayPort™ 1.4, 1x HDMI® 1.4	4096x2160@60Hz(DP), 4096x2160@24Hz(HDMI®)	DirectX® 12
AMD Radeon™ Vega 8 Graphics	Integrated	Shared	2x DisplayPort™ 1.4, 1x HDMI® 1.4	4096x2160@60Hz(DP), 4096x2160@24Hz(HDMI®)	DirectX® 12
AMD Radeon™ 520	Discrete	2GB GDDR5	2x DP 1.2	4096x2160@60Hz(DP)	DirectX® 12
AMD Radeon™ RX 550X	Discrete	4GB GDDR5	1x HDMI® 2.0, 1x DP 1.4	4096x2160@60Hz(HDMI®), 3840x2160@60Hz(DP)	DirectX® 12, OpenGL 4.5
AMD Radeon™ RX 6400	Discrete	4GB GDDR6	1x HDMI® 2.1 FRL, 1x DP 1.4a	7680x4320@60Hz(HDMI®), 7680x4320@60Hz(DP)	DirectX® 12, OpenGL 4.6

Notes:

[1] The information of integrated graphics are not applicable for the models with processor which has no integrated graphics inside (for the details, please refer to processor section).

[2] AMD Radeon™ 520 is not available for MT 11R7 / 11R8 / 11R9 / 11RA.

Monitor Support**Monitor Support**

Supports up to 3 independent displays via onboard ports (HDMI® and 2x DisplayPort™), more displays support via discrete graphics

Chipset**Chipset**

AMD PRO 565 chipset

Memory^[1]**Max Memory^[2]**

Up to 128GB DDR4-3200

Memory Slots

Four DDR4 DIMM slots, dual-channel capable

Memory Type^[3]**

- DDR4-1866
- DDR4-2133
- DDR4-2400
- DDR4-2666

ThinkCentre M75s Gen 2

- DDR4-3200

Notes:

[1] Recommend to choose the models with more than 4GB for better performance and experience.

[2] The max memory is based on the test results with current Lenovo® memory offerings.

[3] Installed memory is actually DDR4-3200, but may run as DDR4-1866, DDR4-2133, DDR4-2400 or DDR4-2666 depending on the memory support capability of processor.

Storage

Storage Support^[1]

Up to three drives, 1x 2.5"/3.5" HDD + 1x 2.5" HDD + 1x M.2 SSD

- 2.5" HDD up to 1TB each
- 3.5" HDD up to 2TB
- M.2 SSD up to 2TB

Storage Type^{***}

Disk Type	Interface	RPM	Security
2.5" SATA HDD	SATA 6Gb/s	7.2K	-
3.5" SATA HDD	SATA 6Gb/s	7.2K	-
M.2 2280 SSD	PCIe® NVMe®, PCIe® 3.0 x4	-	Opal
M.2 2280 SSD	PCIe® NVMe®, PCIe® 4.0 x4 Value ^[2]	-	Opal 2.0
M.2 2280 SSD ^[3]	PCIe® NVMe®, PCIe® x4	-	Opal 2.0
M.2 2242 SSD	PCIe® NVMe®, PCIe® 3.0 x2	-	-
M.2 2242 SSD	PCIe® NVMe®, PCIe® 3.0 x4	-	-

RAID

RAID 0/1 support for HDDs (RAID preset only available via special bid models)

Notes:

[1] The max capacity of each disk type is based on the test results with current Lenovo® storage offerings.

[2] M.2 PCIe® Gen 4 SSD in the M.2 PCIe® Gen 3 slot is downgraded to PCIe® Gen 3 performance.

[3] PCIe® x4 SSD may be PCIe® 3.0 x4 or PCIe® 4.0 x4 as substitution. M.2 PCIe® Gen 4 SSD in the M.2 PCIe® Gen 3 slot is downgraded to PCIe® Gen 3 performance.

Removable Storage

Optical^{**}

- DVD-ROM, SATA 1.5Gb/s, slim (9.0mm)
- DVD burner (DVD±RW), SATA 1.5Gb/s, slim (9.0mm)
- None

Card Reader

- 3-in-1 card reader (SD, SDHC, SDXC)
- No card reader

Multi-Media

Audio Chip

High Definition (HD) Audio, Realtek® ALC623-CG codec

Speakers

- No speakers
- Single speaker, 1W x1

Power Supply

Power Supply^{**}

Power	Type	Efficiency	Key Features
180W	Fixed	85%	-
260W	Fixed	85%	100-240V, 50-60Hz

310W	Fixed	92%	100-240V, 50-60Hz
------	-------	-----	-------------------

DESIGN

Input Device

Keyboard**

- Lenovo® Calliope Keyboard (USB connector), black
- Lenovo® Calliope Wireless Keyboard (2.4GHz via USB receiver), black
- Lenovo® Traditional Keyboard (USB connector), black
- No keyboard

Mouse**

- Lenovo® Calliope Mouse (USB connector), black
- Lenovo® Calliope Wireless Mouse (2.4GHz via USB receiver), black
- Lenovo® Fingerprint Mouse (USB connector), Windows® Hello support, black (EOL on Jan, 2023)
- No mouse

Mechanical

Form Factor

SFF (8.2L)

Dimensions (WxDxH)^[1]

92.5 x 297.7 x 339.5 mm (3.6 x 11.7 x 13.4 inches)

Weight^[2]

Around 5.3 kg (11.7 lbs)

Case Color

Black

Bays

- 1x 2.5" disk bay (bay comes with disk)
- 1x 3.5" disk bay
- 1x slim ODD bay

Expansion Slots

- One PCIe® 3.0 x16, low-profile (length < 155mm, height < 68mm)
- One PCIe® 3.0 x1, low-profile (length < 155mm, height < 68mm)
- Two M.2 slots (one for WLAN, one for SSD)
- Two dummy slots, only brackets for optional port extension

EOU

EOU design for chassis open, M.2 SSD, HDD, ODD, memory, and PCIe® extension card

Stand

- Vertical stand
- No stand

Others

- (Optional) Dust filter
- Supports Smart Power On

Notes:

[1] The system dimensions may vary depending on configurations.

[2] The system weight is approximate and based on results in Lenovo® lab, which varies depending on the source of component, variance of the distribution of each component, and manufacturing process. It may not be the exact weight for each specific model.

CONNECTIVITY

Network^[1]

Onboard Ethernet**

- Gigabit Ethernet, Realtek® RTL8111EPV, 1x RJ-45, supports Wake-on-LAN

- Gigabit Ethernet, Realtek® RTL8111HN, 1x RJ-45, supports Wake-on-LAN

Optional Ethernet[2]**

- Gigabit Ethernet, Bitland BN8E88, 1x RJ-45, PCIe® x1
- Gigabit Ethernet, Bitland RTL8111FP, 1x RJ-45, PCIe® x1
- No optional Ethernet

WLAN + Bluetooth®**

- Realtek® RTL8822CE, 802.11ac Dual Band 2x2 Wi-Fi® + Bluetooth® 5.0, M.2 card
- Intel® Wireless-AC 9260, 802.11ac Dual Band 2x2 Wi-Fi® + Bluetooth® 5.0, M.2 card
- MediaTek Wi-Fi® 6 MT7921, 802.11ax 2x2 Wi-Fi® + Bluetooth® 5.3, M.2 Card^[3]
- Realtek® Wi-Fi® 6 RTL8852AE, 802.11ax Dual Band 2x2 Wi-Fi® + Bluetooth® 5.3, M.2 card^[4]
- Intel® Wi-Fi® 6 AX200, 802.11ax 2x2 Wi-Fi® + Bluetooth® 5.1, M.2 card^[5]
- No WLAN and Bluetooth®

Notes:

[1] This system does not support Power Over Ethernet (PoE). If the system is used in a PoE environment, then a Network Isolator is required to prevent possible damage to the system, PoE equipment, or both.

[2] RTL8111FP is not available for AP countries.

[3], [4] Bluetooth® 5.3 requires Windows® 11.

[5] Bluetooth® 5.2 is hardware ready but may run at a lower version due to OS limitations.

Ports^[1]**Front Ports**

- 1x USB-C® 3.2 Gen 1
- 2x USB 3.2 Gen 1
- 2x USB 3.2 Gen 2
- 1x headphone / microphone combo jack (3.5mm)
- 1x microphone (3.5mm)

Optional Front Ports

- 1x card reader
- None

Rear Ports^[2]

- 4x USB 2.0
- 1x HDMI® 1.4b
- 2x DisplayPort™ 1.4
- 1x Ethernet (RJ-45)
- 1x line-out (3.5mm)
- 1x serial (9-pin)

Optional Rear Ports***

- 2x USB-C® 3.2 Gen 2 (support data transfer, via 2-port USB-C® expansion card, PCIe® x4)
- 2x USB 3.2 Gen 1 (via 2-port USB expansion card, PCIe® x1)
- 2x USB 2.0 (via 2-port adapter)
- 1x parallel
- 1x serial
- 4x serial (via 4-port serial expansion card, PCIe® x1)

Notes:

[1] The transfer speed of following ports will vary and, depending on many factors, such as the processing speed of the host device, file attributes and other factors related to system configuration and your operating environment, will be slower than theoretical speed.

USB 2.0: 480 Mbit/s;

USB 3.2 Gen 1 (SuperSpeed USB 5Gbps, formerly USB 3.0 / USB 3.1 Gen 1): 5 Gbit/s;

USB 3.2 Gen 2 (SuperSpeed USB 10Gbps, formerly USB 3.1 Gen 2): 10 Gbit/s;

USB4® 20Gbps / USB 3.2 Gen 2x2 (SuperSpeed USB 20Gbps): 20 Gbit/s;

USB4® 40Gbps (USB 40Gbps): 40 Gbit/s;

Thunderbolt™ 3/4: 40 Gbit/s.

[2] For video ports on discrete graphics, please see graphics section.

Monitor Cable**Monitor Cable*****

- HDMI® to HDMI® cable (1.5m)
- HDMI® to VGA dongle
- DP to VGA dongle
- DP to VGA cable (1.5M)
- DP to dual DP dongle
- DP to DVI-D dongle
- DP to HDMI® dongle
- No monitor cable

SECURITY & PRIVACY

Security

Security Chip

Discrete TPM 2.0, TCG certified

Physical Locks

- (Optional) E-lock
- (Optional) Smart Cable Clip
- Kensington® Security Slot™, 3 x 7 mm
- Padlock Loop

Chassis Intrusion Switch

- Chassis intrusion switch
- No chassis intrusion switch

Fingerprint Reader

- Touch style fingerprint reader on mouse (EOL on Jan, 2023)
- No fingerprint reader

BIOS Security

- Administrator password
- Power-on password
- Hard disk password
- Boot sequence control
- Boot without keyboard and mouse
- Smart USB protection (allows keyboard / mouse only, blocks all storage devices)
- Individual USB port disablement

MANAGEABILITY

System Management

System Management^[1]

- DASH 1.2
- Non-DASH

Notes:

[1] DASH 1.2 is an optional feature for the selected MTs, MT 11W1 / 11W2 / 11W3 / 11W4 do not support DASH.

SERVICE

Warranty^[1]

Base Warranty**

- 1-year courier or carry-in service
- 1-year limited onsite service
- 3-year limited onsite service
- No base warranty

Notes:

[1] The warranty upgrades may be bundled with some models, please check the "Included upgrade" column in the specific model's configurations. For more service extensions, please go to <https://smartfind.lenovo.com/>. To learn more details of warranty policy, please access <https://pcsupport.lenovo.com/warranty>.

ENVIRONMENTAL

Operating Environment

Temperature

- Operating: 5°C (41°F) to 35°C (95°F)
- Storage: -40°C (-40°F) to 60°C (140°F)

Relative Humidity

- Operating: 20% to 80%
- Storage: 10% to 90%

Altitude

- Operating: 0 m (0 ft) to 3048 m (10,000 ft)
- Storage: 0 m (0 ft) to 12192 m (40,000 ft)

CERTIFICATIONS

Green Certifications^[1]

Green Certifications^[2]

- (Optional) ENERGY STAR® 8.0
- (Optional) EPEAT™ Silver Registered^[3]
- (Optional) EPEAT™ Gold Registered^[4]
- ErP Lot 3
- RoHS compliant
- TCO Certified 8.0

Notes:

[1] The items listed under the "Green Certifications" section may not only refer to certification but also registration or self-declaration.

[2] ENERGY STAR® 8.0 and EPEAT™ are only available for selected MTs.

[3], [4] EPEAT™ is registered where applicable, please see [epeat.net](https://www.epeat.net) for registration status by country.

Other Certifications

Other Certifications

- (Optional) TÜV Rheinland® Low Noise
- (Optional) TÜV Rheinland® Ultra Low Noise

Mil-Spec Test

MIL-STD-810H military test passed (Low Pressure [Altitude], High Temperature, Low Temperature, Temperature Shock, Humidity, Sand and Dust, Vibration, Shock, Fungus, Solar Radiation)

- Feature with ** means that only one offering listed under the feature is configured on selected models.
- Feature with *** means that one or more offerings listed under the feature could be configured on selected models.
- Lenovo reserves the right to change specifications or other product information without notice. Lenovo is not responsible for photographic or typographical errors. **LENOVO PROVIDES THIS PUBLICATION "AS IS," WITHOUT WARRANTY OF ANY KIND, EITHER EXPRESS OR IMPLIED, INCLUDING THE IMPLIED WARRANTIES OF MERCHANTABILITY OR FITNESS FOR A PARTICULAR PURPOSE.** Some jurisdictions do not allow disclaimer of express or implied warranties in certain transactions, therefore this disclaimer may not apply to you.
- The specifications on this page may not be available in all regions, and may be changed or updated without notice.





AMD



AMD



AMD



AMD



AMD



AMD

OVERVIEW

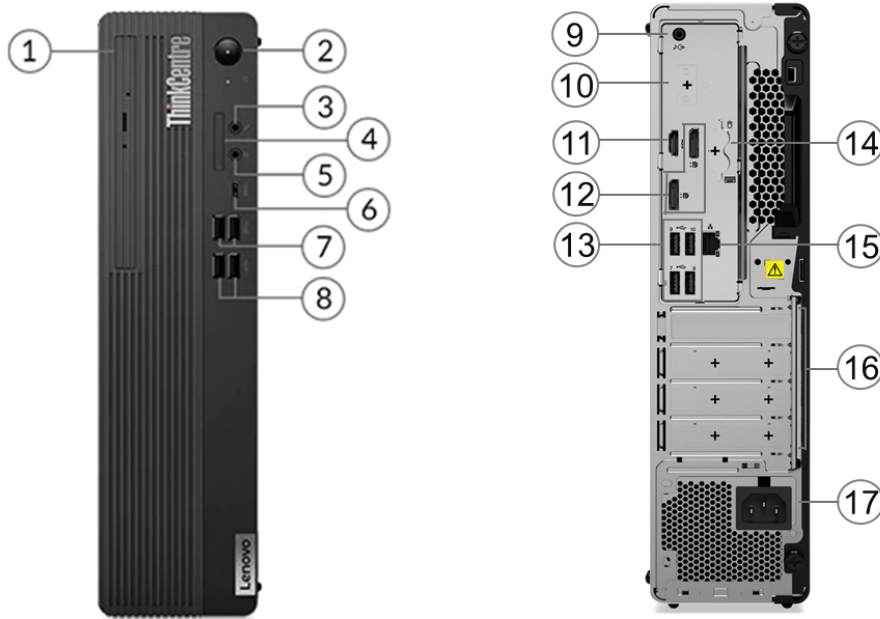

1. Optical drive *	10. Flex IO *
2. Power button	11. HDMI 2.1 TMDS
3. Microphone (3.5mm)	12. 2x DisplayPort 1.4
4. Card reader *	13. 4x USB 3.2 Gen 1
5. Headphone / microphone combo jack (3.5mm)	14. 2x PS/2 ports (keyboard / mouse) *
6. USB-C 3.2 Gen 2	15. Ethernet (RJ-45)
7. 2x USB 3.2 Gen 1	16. Optional ports on expansion cards *
8. 2x USB 3.2 Gen 2	17. Power connector
9. Line-out (3.5mm)	

Notes:

- Items with * are only available on selected models
- More ports are available through the optional expansion cards (not shown on the sample product above)

PERFORMANCE

Processor

Processor Family

Intel® Pentium® or 12th Generation Intel® Core™ i3 / i5 / i7 / i9 Processor

Processor**

Processor Name	Cores	Threads	Base Frequency	Max Frequency	Cache	Processor Graphics
Pentium® Gold G7400	2	4	3.7GHz	-	6MB	Intel® UHD Graphics 710
Core™ i3-12100	4 (4 P-core + 0 E-core)	8	P-core 3.3GHz	P-core 4.3GHz ^[1]	12MB	Intel® UHD Graphics 730
Core™ i3-12300	4 (4 P-core + 0 E-core)	8	P-core 3.5GHz	P-core 4.4GHz ^[2]	12MB	Intel® UHD Graphics 730
Core™ i5-12400	6 (6 P-core + 0 E-core)	12	P-core 2.5GHz	P-core 4.4GHz ^[3]	18MB	Intel® UHD Graphics 730
Core™ i5-12500	6 (6 P-core + 0 E-core)	12	P-core 3.0GHz	P-core 4.6GHz ^[4]	18MB	Intel® UHD Graphics 770
Core™ i5-12600	6 (6 P-core + 0 E-core)	12	P-core 3.3GHz	P-core 4.8GHz ^[5]	18MB	Intel® UHD Graphics 770
Core™ i7-12700	12 (8 P-core + 4 E-core)	20	P-core 2.1GHz / E-core 1.6GHz	Max Turbo up to 4.9GHz / P-core 4.8GHz / E-core 3.6GHz ^[6]	25MB	Intel® UHD Graphics 770
Core™ i9-12900	16 (8 P-core + 8 E-core)	24	P-core 2.4GHz / E-core 1.8GHz	Max Turbo up to 5.1GHz / P-core 5.0GHz / E-core 3.8GHz ^[7]	30MB	Intel® UHD Graphics 770
Core™ i9-12900F	16 (8 P-core + 8 E-core)	24	P-core 2.4GHz / E-core 1.8GHz	Max Turbo up to 5.1GHz / P-core 5.0GHz / E-core 3.8GHz ^[8]	30MB	-

Notes:

[1], [2], [3], [4], [5], [6], [7], [8] Intel® Max Turbo frequency will vary depending on application workload and the hardware and software configurations, see <http://www.intel.com/technology/turboboost/> for more information.

Operating System

Operating System**

- Windows® 11 Pro
- Windows® 11 Home
- Windows® 11 Home Single Language
- Windows® 11 DG Windows® 10 Pro 64
- Windows® 10 IoT Enterprise LTSC 2021
- Ubuntu Linux^[1]
- No preload operating system

Notes:

[1] Some features may not be supported on the system with Linux preload, including but not limited to Intel® RST RAID, Human Presence Detection, etc.

Graphics

Graphics***[1]

Graphics	Type	Memory	Connector	Max Resolution	Key Features
Intel® UHD graphics 710	Integrated	Shared	2x DP 1.4 HBR2, 1x HDMI® 2.1 TMDS, 1x Flex IO (VGA / DP 1.2 / HDMI® 2.1 TMDS / USB-C®)	4096x2304@60Hz(DP), 4096x2160@60Hz[HDMI® / Flex IO(HDMI®) / Flex IO(DP)], 3840x2160@60Hz[Flex IO(USB-C®)], 2048x1536@50Hz[Flex IO(VGA)]	DirectX® 12

Intel® UHD graphics 730	Integrated	Shared	2x DP 1.4 HBR2, 1x HDMI® 2.1 TMDS, 1x Flex IO (VGA / DP 1.2 / HDMI® 2.1 TMDS / USB-C®)	4096x2304@60Hz(DP), 4096x2160@60Hz[HDMI® / Flex IO(HDMI) / Flex IO(DP)], 3840x2160@60Hz[Flex IO(USB-C®)], 2048x1536@50Hz[Flex IO(VGA)]	DirectX® 12
Intel® UHD graphics 770	Integrated	Shared	2x DP 1.4 HBR2, 1x HDMI® 2.1 TMDS, 1x Flex IO (VGA / DP 1.2 / HDMI® 2.1 TMDS / USB-C®)	4096x2304@60Hz(DP), 4096x2160@60Hz[HDMI® / Flex IO(HDMI) / Flex IO(DP)], 3840x2160@60Hz[Flex IO(USB-C®)], 2048x1536@50Hz[Flex IO(VGA)]	DirectX® 12
AMD Radeon™ RX 6400	Discrete	4GB GDDR6	1x HDMI® 2.1 FRL, 1x DP 1.4a	7680x4320@60Hz(HDMI®), 7680x4320@60Hz(DP)	DirectX® 12, OpenGL 4.6
Intel® Iris® Xe MAX 100	Discrete	2GB LPDDR4X	2x DP 1.4	3840x2160@60Hz(DP)	DirectX® 12, OpenGL 4.6

Notes:

[1] The information of integrated graphics are not applicable for the models with processor which has no integrated graphics inside (for the details, please refer to processor section).

Monitor Support

Monitor Support^[1]

Supports up to 4 independent displays via onboard ports (2x DP, 1x HDMI®, and 1x optional Flex IO), more displays support via discrete graphics

Notes:

[1] Onboard video ports are only available for the models with integrated graphics.

Chipset

Chipset

Intel® Q670 chipset

Memory

Max Memory^[1]

Up to 128GB DDR5

Memory Slots

Four DDR5 UDIMM slots, dual-channel capable

Memory Type^[2]

- DDR5-3600
- DDR5-4000
- DDR5-4400

Notes:

[1] The max memory is based on the test results with current Lenovo® memory offerings.

[2] Installed memory is actually 4800MHz, but may run at 3600MHz, 4000MHz, or 4400MHz depending on the memory support capability of processor.

Storage

Storage Support^{[1][2]}

Up to four drives, 1x 2.5"/3.5" HDD + 1x 2.5" HDD + 2x M.2 SSD

- 2.5" HDD up to 1TB
- 3.5" HDD up to 2TB
- M.2 SSD up to 2TB each

Storage Type

Disk Type	Interface	RPM	Security
2.5" SATA HDD	SATA 6Gb/s	7.2K	-
3.5" SATA HDD	SATA 6Gb/s	7.2K	-
M.2 2280 SSD	PCIe® NVMe®, PCIe® 3.0 x4	-	Opal 2.0
M.2 2280 SSD	PCIe® NVMe®, PCIe® 4.0 x4 Performance	-	Opal 2.0
M.2 2280 SSD	PCIe® NVMe®, PCIe® 4.0 x4 Value	-	Opal 2.0
M.2 2242 SSD	PCIe® NVMe®, PCIe® 3.0 x4	-	-

RAID

RAID 0/1 support (RAID preset only available via special bid models)

Notes:

- [1] The max capacity of each disk type is based on the test results with current Lenovo® storage offerings.
 [2] The max capacity of SSD/HDD is based on the test results with current Lenovo® SSD/HDD offerings.

Removable Storage**Optical****

- DVD-ROM, SATA connector, slim (9.0mm)
- DVD burner (DVD±RW), SATA connector, slim (9.0mm)
- None

Card Reader

- 3-in-1 card reader (SD, SDHC, SDXC)
- No card reader

Multi-Media**Audio Chip**

High Definition (HD) Audio, Realtek® ALC897Q-CG codec

Speakers

Single speaker, 1W x1

Power Supply**Power Supply****

Power	Type	Efficiency	Key Features
180W	Fixed	85%	100-240V, 50-60Hz
260W	Fixed	90%	100-240V, 50-60Hz
310W	Fixed	92%	100-240V, 50-60Hz
380W	Fixed	92%	100-240V, 50-60Hz

DESIGN**Input Device****Keyboard****

- Lenovo® Calliope Keyboard (USB connector), black
- Lenovo® Calliope Wireless Keyboard (2.4GHz via USB receiver), black
- Lenovo® Keyboard (PS/2 connector), black
- Lenovo® Traditional Keyboard (USB connector), black
- No keyboard

Mouse**

- Lenovo® Calliope Mouse (USB connector), black
- Lenovo® Calliope Wireless Mouse (2.4GHz via USB receiver), black
- Lenovo® Mouse (PS/2 connector), black (only available via special bid)
- Lenovo® Fingerprint Mouse (USB connector), Windows® Hello support, black (EOL on Jan, 2023)
- No mouse

Mechanical

Form Factor

SFF (8.2L)

Dimensions (WxDxH)^[1]

92.5 x 297.7 x 339.5 mm (3.6 x 11.7 x 13.4 inches)

Packaging Dimensions (WxDxH)

195 x 395 x 530 mm (7.68 x 15.55 x 20.87 inches)

Weight^[2]

Starting at 3.824 kg (8.43 lbs)

Packaging Weight

7.6 kg (16.76 lbs)

Case Color

Black

Bays^[3]

- 1x 2.5" disk bay
- 1x 3.5" disk bay
- 1x slim ODD bay

Expansion Slots

- One PCIe[®] 4.0 x16 (x4 signal), low-profile, length ≤ 155mm, height ≤ 70mm
- One PCIe[®] 4.0 x16, low-profile, length ≤ 155mm, height ≤ 70mm
- One PCIe[®] 3.0 x1, low-profile, length ≤ 155mm, height ≤ 70mm
- Three M.2 slots (one for WLAN, two for SSD)

EOU

Toolless cover, disk, optical, extension card assembly / removal

Stand

- Vertical stand
- No stand

Others

- (Optional) Dust filter
- (Optional) Smart Cable (USB-A to USB-C[®])
- Supports Smart Power On

Notes:

[1] The system dimensions may vary depending on configurations.

[2] The system weight is approximate and based on results in Lenovo[®] lab, which varies depending on the source of component, variance of the distribution of each component, and manufacturing process. It may not be the exact weight for each specific model.

[3] 2.5" HDD tray is optional, or comes with 2.5 HDD. 3.5" bay supports 2.5" / 3.5" HDD, 3.5" to 2.5 converter comes with 2nd 2.5" HDD.

CONNECTIVITY

Network

Onboard Ethernet

Gigabit Ethernet, Intel[®] Ethernet Connection I219-LM, 1x RJ-45, supports Wake-on-LAN

Optional Ethernet^{**}

- Gigabit Ethernet, Bitland BN8E88, 1x RJ-45, PCIe[®] x1
- Gigabit Ethernet, Intel[®] Ethernet Server Adapter I350-T4, 4x RJ-45, PCIe[®] x4^[1]
- 2.5 Gigabit Ethernet, Realtek[®] RTL8125BGS, 1x RJ-45, PCIe[®] x1
- No optional Ethernet

WLAN + Bluetooth^{**}

- Realtek[®] RTL8822CE, 802.11ac Dual Band 2x2 Wi-Fi[®] + Bluetooth[®] 5.0, M.2 card
- Intel[®] Wireless-AC 9560, 802.11ac Dual Band 2x2 Wi-Fi[®] + Bluetooth[®] 5.1, M.2 card

ThinkCentre M80s Gen 3

- Realtek® Wi-Fi® 6 RTL8852BE, 802.11ax Dual Band 2x2 Wi-Fi® + Bluetooth® 5.3, M.2 card^[2]
- Intel® Wi-Fi® 6 AX201, 802.11ax 2x2 Wi-Fi® + Bluetooth® 5.2, M.2 Card^[3]
- AMD Wi-Fi® 6E RZ616, 802.11ax 2x2 Wi-Fi® + Bluetooth® 5.1, M.2 Card^[4]
- Intel® Wi-Fi® 6E AX211, 802.11ax 2x2 Wi-Fi® + Bluetooth® 5.3, Intel® vPro® technology support, M.2 Card^[5]
- No WLAN and Bluetooth®

Notes:

[1] Intel® Ethernet Server Adapter I350-T4 is not available in EMEA.

[2], [5] Bluetooth® 5.3 requires Windows® 11.

[3] Bluetooth® 5.2 requires Windows® 11.

[4] Bluetooth® 5.2 is hardware ready but may run at a lower version due to OS limitations.

Ports^[1]

Front Ports

- 1x USB-C® 3.2 Gen 2 (support data transfer and 15W charging)
- 2x USB 3.2 Gen 1
- 2x USB 3.2 Gen 2
- 1x headphone / microphone combo jack (3.5mm)
- 1x microphone (3.5mm)

Optional Front Ports

1x card reader

Rear Ports^[2]

- 4x USB 3.2 Gen 1
- 1x HDMI® 2.1 TMDS
- 2x DisplayPort™ 1.4
- 1x Ethernet (RJ-45)
- 1x line-out (3.5mm)

Optional Rear Ports^{***}

- 1x USB-C® 3.2 Gen 1 with DisplayPort™ function and 5V@3A charging (Flex IO)
- 1x HDMI® 2.1 TMDS (Flex IO)
- 1x DP 1.2 (Flex IO)
- 1x VGA (Flex IO)
- 1x USB-C® 3.2 Gen 2x2 (support data transfer, via USB-C® expansion card, PCIe® x4)
- 2x USB-C® 3.2 Gen 2 (support data transfer, via 2-port USB-C® expansion card, PCIe® x4)
- 2x USB 3.2 Gen 1 (via 2-port USB expansion card, PCIe® x1)
- 2x USB 2.0 (via 2-port adapter)
- 1x parallel
- 1x serial
- 1x 2nd serial
- 4x serial (via 4-port serial expansion card, PCIe® x1)
- 2x PS/2

Notes:

[1] The transfer speed of following ports will vary and, depending on many factors, such as the processing speed of the host device, file attributes and other factors related to system configuration and your operating environment, will be slower than theoretical speed.

USB 2.0: 480 Mbit/s;

USB 3.2 Gen 1 (SuperSpeed USB 5Gbps, formerly USB 3.0 / USB 3.1 Gen 1): 5 Gbit/s;

USB 3.2 Gen 2 (SuperSpeed USB 10Gbps, formerly USB 3.1 Gen 2): 10 Gbit/s;

USB4® 20Gbps / USB 3.2 Gen 2x2 (SuperSpeed USB 20Gbps): 20 Gbit/s;

USB4® 40Gbps (USB 40Gbps): 40 Gbit/s;

Thunderbolt™ 3/4: 40 Gbit/s.

[2] For video ports on discrete graphics, please see graphics section.

Monitor Cable

Monitor Cable^{***}

- HDMI® to HDMI® cable (1.5m)
- HDMI® to VGA dongle
- DP to VGA dongle
- DP to dual DP dongle

- DP to DVI-D dongle
- DP to HDMI® dongle
- No monitor cable

SECURITY & PRIVACY

Security

Security Chip

Discrete TPM 2.0, TCG certified

Physical Locks

- (Optional) E-lock
- (Optional) Smart Cable Clip
- Kensington® Security Slot™, 3 x 7 mm
- Padlock Loop

Chassis Intrusion Switch

- Chassis intrusion switch
- No chassis intrusion switch

Fingerprint Reader

- Touch style fingerprint reader on mouse (EOL on Jan, 2023)
- No fingerprint reader

BIOS Security

- Administrator password
- Power-on password
- Hard disk password
- Boot sequence control
- Boot without keyboard and mouse
- Self-healing BIOS (Level 2)
- Smart USB protection (allows keyboard / mouse only, blocks all storage devices)
- Individual USB port disablement

MANAGEABILITY

System Management

System Management**

- Intel® vPro® Enterprise^[1]
- Intel® vPro® Essentials^[2]
- Non-vPro®

Notes:

[1], [2] Intel® vPro® offers a superset of DASH's defined capabilities.

SERVICE

Warranty^[1]

Base Warranty

- 1-year courier or carry-in service
- 1-year limited onsite service
- 3-year limited onsite service
- No base warranty

Notes:

[1] The warranty upgrades may be bundled with some models, please check the "Included upgrade" column in the specific model's configurations. For more service extensions, please go to <https://smartfind.lenovo.com/>. To learn more details of warranty policy, please access <https://pcsupport.lenovo.com/warranty>.

ENVIRONMENTAL

Operating Environment

Temperature

- Operating: 5°C (41°F) to 35°C (95°F)
- Storage: -40°C (-40°F) to 60°C (140°F)

Relative Humidity

- Operating: 20% to 80%
- Storage: 10% to 90%

Altitude

- Operating: 0 m (0 ft) to 3048 m (10,000 ft)
- Storage: 0 m (0 ft) to 12192 m (40,000 ft)

CERTIFICATIONS

Green Certifications^[1]

Green Certifications

- (Optional) ENERGY STAR® 8.0
- (Optional) EPEAT™ Silver Registered^[2]
- (Optional) EPEAT™ Gold Registered^[3]
- ErP Lot 3
- RoHS compliant
- TCO Certified 9.0

Notes:

[1] The items listed under the "Green Certifications" section may not only refer to certification but also registration or self-declaration.

[2], [3] EPEAT™ is registered where applicable, please see epeat.net for registration status by country.

Other Certifications

Other Certifications

- (Optional) TÜV Rheinland® Low Noise
- (Optional) TÜV Rheinland® Ultra Low Noise

Mil-Spec Test

MIL-STD-810H military test passed (Low Pressure [Altitude], High Temperature, Low Temperature, Temperature Shock, Humidity, Sand and Dust, Vibration, Shock, Fungus, Solar Radiation, Contamination by Fluids, Salt Fog)

- Feature with ** means that only one offering listed under the feature is configured on selected models.
- Feature with *** means that one or more offerings listed under the feature could be configured on selected models.
- Lenovo reserves the right to change specifications or other product information without notice. Lenovo is not responsible for photographic or typographical errors. LENOVO PROVIDES THIS PUBLICATION "AS IS," WITHOUT WARRANTY OF ANY KIND, EITHER EXPRESS OR IMPLIED, INCLUDING THE IMPLIED WARRANTIES OF MERCHANTABILITY OR FITNESS FOR A PARTICULAR PURPOSE. Some jurisdictions do not allow disclaimer of express or implied warranties in certain transactions, therefore this disclaimer may not apply to you.
- The specifications on this page may not be available in all regions, and may be changed or updated without notice.



intel



intel



intel



intel

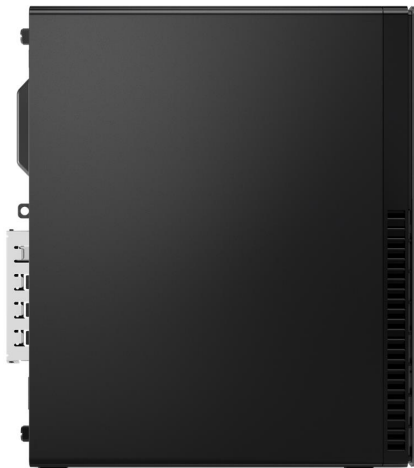

intel



intel

OVERVIEW

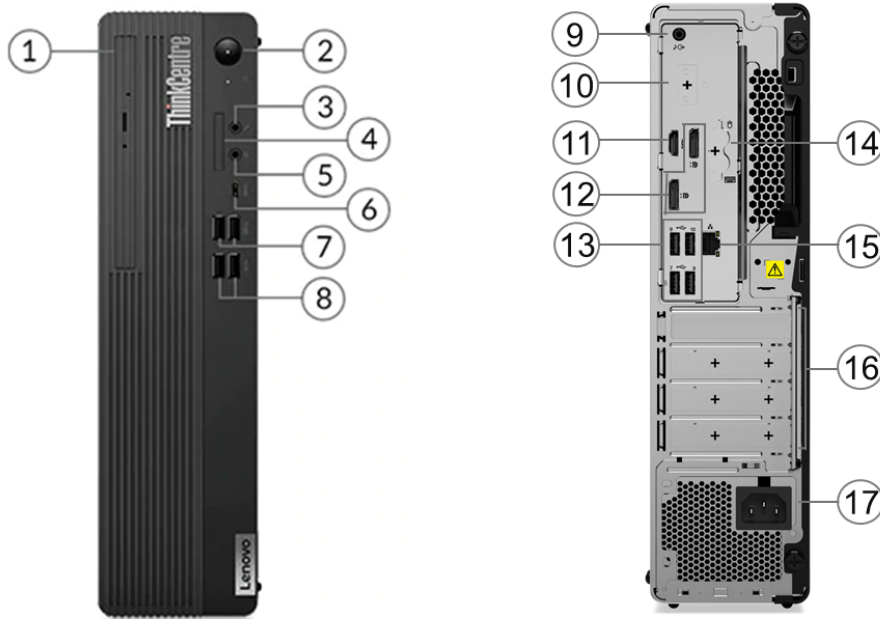

1. Optical drive *	10. Flex IO *
2. Power button	11. HDMI 2.1 TMDS
3. Microphone (3.5mm)	12. 2x DisplayPort 1.4
4. Card reader *	13. 4x USB 3.2 Gen 1
5. Headphone / microphone combo jack (3.5mm)	14. 2x PS/2 ports (keyboard / mouse) *
6. USB-C 3.2 Gen 2	15. Ethernet (RJ-45)
7. 2x USB 3.2 Gen 1	16. Optional ports on expansion cards *
8. 2x USB 3.2 Gen 2	17. Power connector
9. Line-out (3.5mm)	

Notes:

- Items with * are only available on selected models
- More ports are available through the optional expansion cards (not shown on the sample product above)

PERFORMANCE

Processor

Processor Family

Intel® Pentium® or 12th Generation Intel® Core™ i3 / i5 / i7 / i9 Processor

Processor**

Processor Name	Cores	Threads	Base Frequency	Max Frequency	Cache	Processor Graphics
Pentium® Gold G7400	2	4	3.7GHz	-	6MB	Intel® UHD Graphics 710
Core™ i3-12100	4 (4 P-core + 0 E-core)	8	P-core 3.3GHz	P-core 4.3GHz ^[1]	12MB	Intel® UHD Graphics 730
Core™ i3-12300	4 (4 P-core + 0 E-core)	8	P-core 3.5GHz	P-core 4.4GHz ^[2]	12MB	Intel® UHD Graphics 730
Core™ i5-12400	6 (6 P-core + 0 E-core)	12	P-core 2.5GHz	P-core 4.4GHz ^[3]	18MB	Intel® UHD Graphics 730
Core™ i5-12400F	6 (6 P-core + 0 E-core)	12	P-core 2.5GHz	P-core 4.4GHz ^[4]	18MB	-
Core™ i5-12500	6 (6 P-core + 0 E-core)	12	P-core 3.0GHz	P-core 4.6GHz ^[5]	18MB	Intel® UHD Graphics 770
Core™ i5-12600	6 (6 P-core + 0 E-core)	12	P-core 3.3GHz	P-core 4.8GHz ^[6]	18MB	Intel® UHD Graphics 770
Core™ i5-12600K	10 (6 P-core + 4 E-core)	16	P-core 3.7GHz / E-core 2.8GHz	P-core 4.9GHz / E-core 3.6GHz ^[7]	20MB	Intel® UHD Graphics 770
Core™ i7-12700	12 (8 P-core + 4 E-core)	20	P-core 2.1GHz / E-core 1.6GHz	Max Turbo up to 4.9GHz / P-core 4.8GHz / E-core 3.6GHz ^[8]	25MB	Intel® UHD Graphics 770
Core™ i7-12700F	12 (8 P-core + 4 E-core)	20	P-core 2.1GHz / E-core 1.6GHz	Max Turbo up to 4.9GHz / P-core 4.8GHz / E-core 3.6GHz ^[9]	25MB	-
Core™ i7-12700K	12 (8 P-core + 4 E-core)	20	P-core 3.6GHz / E-core 2.7GHz	Max Turbo up to 5.0GHz / P-core 4.9GHz / E-core 3.8GHz ^[10]	25MB	Intel® UHD Graphics 770
Core™ i9-12900	16 (8 P-core + 8 E-core)	24	P-core 2.4GHz / E-core 1.8GHz	Max Turbo up to 5.1GHz / P-core 5.0GHz / E-core 3.8GHz ^[11]	30MB	Intel® UHD Graphics 770
Core™ i9-12900F	16 (8 P-core + 8 E-core)	24	P-core 2.4GHz / E-core 1.8GHz	Max Turbo up to 5.1GHz / P-core 5.0GHz / E-core 3.8GHz ^[12]	30MB	-
Core™ i9-12900K	16 (8 P-core + 8 E-core)	24	P-core 3.2GHz / E-core 2.4GHz	Max Turbo up to 5.2GHz / P-core 5.1GHz / E-core 3.9GHz ^[13]	30MB	Intel® UHD Graphics 770

Notes:

[1], [2], [3], [4], [5], [6], [7], [8], [9], [10], [11], [12], [13] Intel® Max Turbo frequency will vary depending on application workload and the hardware and software configurations, see <http://www.intel.com/technology/turboboost/> for more information.

Operating System

Operating System**

- Windows® 11 Pro
- Windows® 11 Home
- Windows® 11 Home Single Language
- Windows® 11 DG Windows® 10 Pro 64
- Windows® 10 IoT Enterprise LTSC 2021
- Ubuntu Linux^[1]
- No preload operating system

Notes:

[1] Some features may not be supported on the system with Linux preload, including but not limited to Intel® RST RAID,

Human Presence Detection, etc.

Graphics

Graphics^{***[1]}

Graphics	Type	Memory	Connector	Max Resolution	Key Features
Intel® UHD graphics 710	Integrated	Shared	2x DP 1.4 HBR2, 1x HDMI® 2.1 TMDS, 1x Flex IO (VGA / DP 1.2 / HDMI® 2.1 TMDS / USB-C®)	4096x2304@60Hz(DP), 4096x2160@60Hz[HDMI® / Flex IO(HDMI®) / Flex IO(DP)], 3840x2160@60Hz[Flex IO(USB-C®)], 2048x1536@50Hz[Flex IO(VGA)]	DirectX® 12
Intel® UHD graphics 730	Integrated	Shared	2x DP 1.4 HBR2, 1x HDMI® 2.1 TMDS, 1x Flex IO (VGA / DP 1.2 / HDMI® 2.1 TMDS / USB-C®)	4096x2304@60Hz(DP), 4096x2160@60Hz[HDMI® / Flex IO(HDMI) / Flex IO(DP)], 3840x2160@60Hz[Flex IO(USB-C®)], 2048x1536@50Hz[Flex IO(VGA)]	DirectX® 12
Intel® UHD graphics 770	Integrated	Shared	2x DP 1.4 HBR2, 1x HDMI® 2.1 TMDS, 1x Flex IO (VGA / DP 1.2 / HDMI® 2.1 TMDS / USB-C®)	4096x2304@60Hz(DP), 4096x2160@60Hz[HDMI® / Flex IO(HDMI) / Flex IO(DP)], 3840x2160@60Hz[Flex IO(USB-C®)], 2048x1536@50Hz[Flex IO(VGA)]	DirectX® 12
AMD Radeon™ RX 6400	Discrete	4GB GDDR6	1x HDMI® 2.1 FRL, 1x DP 1.4a	7680x4320@60Hz(HDMI®), 7680x4320@60Hz(DP)	DirectX® 12, OpenGL 4.6
Intel® Iris® Xe MAX 100	Discrete	2GB LPDDR4X	2x DP 1.4	3840x2160@60Hz(DP)	DirectX® 12, OpenGL 4.6

Notes:

[1] The information of integrated graphics are not applicable for the models with processor which has no integrated graphics inside (for the details, please refer to processor section).

Monitor Support

Monitor Support^[1]

Supports up to 4 independent displays via onboard ports (2x DP, 1x HDMI®, and 1x optional Flex IO), more displays support via discrete graphics

Notes:

[1] Onboard video ports are only available for the models with integrated graphics.

Chipset

Chipset

Intel® Q670 chipset

Memory

Max Memory^[1]

Up to 128GB DDR5

Memory Slots

Four DDR5 UDIMM slots, dual-channel capable

Memory Type^[2]

- DDR5-3600
- DDR5-4000
- DDR5-4400

Notes:

ThinkCentre M90s Gen 3

[1] The max memory is based on the test results with current Lenovo® memory offerings.

[2] Installed memory is actually DDR5-4800, but may run as DDR5-3600, DDR5-4000, or DDR5-4400 depending on the memory support capability of processor.

Storage

Storage Support^{[1][2]}

Up to four drives, 1x 2.5"/3.5" HDD + 1x 2.5" HDD + 2x M.2 SSD

- 2.5" HDD up to 1TB
- 3.5" HDD up to 2TB
- M.2 SSD up to 2TB each

Storage Type^{***}

Disk Type	Interface	RPM	Security
2.5" SATA HDD	SATA 6Gb/s	7.2K	-
3.5" SATA HDD	SATA 6Gb/s	7.2K	-
M.2 2280 SSD	PCIe® NVMe®, PCIe® 3.0 x4	-	Opal 2.0
M.2 2280 SSD	PCIe® NVMe®, PCIe® 4.0 x4 Performance	-	Opal 2.0
M.2 2280 SSD	PCIe® NVMe®, PCIe® 4.0 x4 Value	-	Opal 2.0
M.2 2242 SSD	PCIe® NVMe®, PCIe® 3.0 x4	-	-

RAID

RAID 0/1 support (RAID preset only available via special bid models)

Notes:

[1] The max capacity of each disk type is based on the test results with current Lenovo® storage offerings.

[2] The max capacity of SSD/HDD is based on the test results with current Lenovo® SSD/HDD offerings.

Removable Storage

Optical^{**}

- DVD-ROM, SATA connector, slim (9.0mm)
- DVD burner (DVD±RW), SATA connector, slim (9.0mm)
- None

Card Reader

- 3-in-1 card reader (SD, SDHC, SDXC)
- No card reader

Multi-Media

Audio Chip

High Definition (HD) Audio, Realtek® ALC897Q-CG codec

Speakers

Single speaker, 1W x1

Power Supply

Power Supply^{**}

Power	Type	Efficiency	Key Features
260W	Fixed	90%	100-240V, 50-60Hz
310W	Fixed	92%	100-240V, 50-60Hz
380W	Fixed	92%	100-240V, 50-60Hz

DESIGN

Input Device

Keyboard^{**}

- Lenovo® Calliope Keyboard (USB connector), black

- Lenovo® Calliope Wireless Keyboard (2.4GHz via USB receiver), black
- Lenovo® Keyboard (PS/2 connector), black
- Lenovo® Traditional Keyboard (USB connector), black
- No keyboard

Mouse**

- Lenovo® Calliope Mouse (USB connector), black
- Lenovo® Calliope Wireless Mouse (2.4GHz via USB receiver), black
- Lenovo® Mouse (PS/2 connector), black (only available via special bid)
- Lenovo® Fingerprint Mouse (USB connector), Windows® Hello support, black (EOL on Jan, 2023)
- No mouse

Mechanical**Form Factor**

SFF (8.2L)

Dimensions (WxDxH)^[1]

92.5 x 297.7 x 339.5 mm (3.6 x 11.7 x 13.4 inches)

Packaging Dimensions (WxDxH)

195 x 395 x 530 mm (7.68 x 15.55 x 20.87 inches)

Weight^[2]

Around 5.3 kg (11.7 lbs)

Packaging Weight

7.6 kg (16.76 lbs)

Case Color

Black

Bays^[3]

- 1x 2.5" disk bay
- 1x 3.5" disk bay
- 1x slim ODD bay

Expansion Slots

- One PCIe® 4.0 x16 (x4 signal), low-profile, length ≤ 155mm, height ≤ 70mm
- One PCIe® 4.0 x16, low-profile, length ≤ 155mm, height ≤ 70mm
- Two PCIe® 3.0 x1, low-profile, length ≤ 155mm, height ≤ 70mm
- Three M.2 slots (one for WLAN, two for SSD)

EOU

Toolless cover, disk, optical, extension card assembly / removal

Stand

- Vertical stand
- No stand

Others

- (Optional) Dust filter
- (Optional) Smart Cable (USB-A to USB-C®)
- Supports Smart Power On

Notes:

[1] The system dimensions may vary depending on configurations.

[2] The system weight is approximate and based on results in Lenovo® lab, which varies depending on the source of component, variance of the distribution of each component, and manufacturing process. It may not be the exact weight for each specific model.

[3] 2.5" HDD tray is optional, or comes with 2.5 HDD. 3.5" bay supports 2.5" / 3.5" HDD, 3.5" to 2.5 converter comes with 2nd 2.5" HDD.

CONNECTIVITY**Network****Onboard Ethernet**

Gigabit Ethernet, Intel® Ethernet Connection I219-LM, 1x RJ-45, supports Wake-on-LAN

Optional Ethernet***

- Gigabit Ethernet, Bitland BN8E88, 1x RJ-45, PCIe® x1
- Gigabit Ethernet, Bitland RTL8168H, 1x RJ-45, PCIe® x1
- Gigabit Ethernet, Intel® Ethernet Server Adapter I350-T4, 4x RJ-45, PCIe® x4^[1]
- No optional Ethernet

WLAN + Bluetooth**

- Realtek® Wi-Fi® 6 RTL8852BE, 802.11ax Dual Band 2x2 Wi-Fi® + Bluetooth® 5.3, M.2 card^[2]
- Intel® Wi-Fi® 6 AX201, 802.11ax 2x2 Wi-Fi® + Bluetooth® 5.2, M.2 Card^[3]
- AMD Wi-Fi® 6E RZ616, 802.11ax 2x2 Wi-Fi® + Bluetooth® 5.1, M.2 Card^[4]
- Intel® Wi-Fi® 6E AX211, 802.11ax 2x2 Wi-Fi® + Bluetooth® 5.3, Intel® vPro® technology support, M.2 Card^[5]
- No WLAN and Bluetooth®

Notes:

[1] Intel® Ethernet Server Adapter I350-T4 is not available in EMEA.

[2], [5] Bluetooth® 5.3 requires Windows® 11.

[3] Bluetooth® 5.2 requires Windows® 11.

[4] Bluetooth® 5.2 is hardware ready but may run at a lower version due to OS limitations.

Ports^[1]

Front Ports

- 1x USB-C® 3.2 Gen 2 (support data transfer and 15W charging)
- 2x USB 3.2 Gen 1
- 2x USB 3.2 Gen 2
- 1x headphone / microphone combo jack (3.5mm)
- 1x microphone (3.5mm)

Optional Front Ports

1x card reader

Rear Ports^[2]

- 4x USB 3.2 Gen 1
- 1x HDMI® 2.1 TMDS
- 2x DisplayPort™ 1.4
- 1x Ethernet (RJ-45)
- 1x line-out (3.5mm)

Optional Rear Ports***

- 1x USB-C® 3.2 Gen 1 with DisplayPort™ function and 5V@3A charging (Flex IO)
- 1x HDMI® 2.1 TMDS (Flex IO)
- 1x DP 1.2 (Flex IO)
- 1x VGA (Flex IO)
- 1x USB-C® 3.2 Gen 2x2 (support data transfer, via USB-C® expansion card, PCIe® x4)
- 2x USB-C® 3.2 Gen 2 (support data transfer, via 2-port USB-C® expansion card, PCIe® x4)
- 2x USB 3.2 Gen 1 (via 2-port USB expansion card, PCIe® x1)
- 2x USB 2.0 (via 2-port adapter)
- 1x parallel
- 1x serial
- 1x 2nd serial
- 4x serial (via 4-port serial expansion card, PCIe® x1)
- 2x PS/2
- None

Notes:

[1] The transfer speed of following ports will vary and, depending on many factors, such as the processing speed of the host device, file attributes and other factors related to system configuration and your operating environment, will be slower than theoretical speed.

USB 2.0: 480 Mbit/s;

USB 3.2 Gen 1 (SuperSpeed USB 5Gbps, formerly USB 3.0 / USB 3.1 Gen 1): 5 Gbit/s;

USB 3.2 Gen 2 (SuperSpeed USB 10Gbps, formerly USB 3.1 Gen 2): 10 Gbit/s;

USB4® 20Gbps / USB 3.2 Gen 2x2 (SuperSpeed USB 20Gbps): 20 Gbit/s;

USB4® 40Gbps (USB 40Gbps): 40 Gbit/s;

Thunderbolt™ 3/4: 40 Gbit/s.

[2] For video ports on discrete graphics, please see graphics section.

Monitor Cable

Monitor Cable***

- HDMI® to HDMI® cable (1.5m)
- HDMI® to VGA dongle
- DP to VGA dongle
- DP to dual DP dongle
- DP to DVI-D dongle
- DP to HDMI® dongle
- No monitor cable

SECURITY & PRIVACY

Security

Security Chip

Discrete TPM 2.0, TCG certified

Physical Locks

- (Optional) E-lock
- (Optional) Smart Cable Clip
- Kensington® Security Slot™, 3 x 7 mm
- Padlock Loop

Chassis Intrusion Switch

- Chassis intrusion switch
- No chassis intrusion switch

Fingerprint Reader

- Touch style fingerprint reader on mouse (EOL on Jan, 2023)
- No fingerprint reader

BIOS Security

- Administrator password
- Power-on password
- Hard disk password
- Boot sequence control
- Boot without keyboard and mouse
- Self-healing BIOS (Level 2)
- Smart USB protection (allows keyboard / mouse only, blocks all storage devices)
- Individual USB port disablement

MANAGEABILITY

System Management

System Management

- Intel® vPro® Enterprise^[1]
- Non-vPro®

Notes:

[1] Intel® vPro® offers a superset of DASH's defined capabilities.

SERVICE

Warranty^[1]

Base Warranty**

- 1-year limited onsite service
- 3-year limited onsite service
- No base warranty

Notes:

[1] The warranty upgrades may be bundled with some models, please check the "Included upgrade" column in the specific model's configurations. For more service extensions, please go to <https://smartfind.lenovo.com/>. To learn more details of warranty policy, please access <https://pcsupport.lenovo.com/warranty>.

ENVIRONMENTAL

Operating Environment

Temperature

- Operating: 5°C (41°F) to 35°C (95°F)
- Storage: -40°C (-40°F) to 60°C (140°F)

Relative Humidity

- Operating: 20% to 80%
- Storage: 10% to 90%

Altitude

- Operating: 0 m (0 ft) to 3048 m (10,000 ft)
- Storage: 0 m (0 ft) to 12192 m (40,000 ft)

CERTIFICATIONS

Green Certifications^[1]

Green Certifications

- (Optional) ENERGY STAR® 8.0
- (Optional) EPEAT™ Silver Registered^[2]
- (Optional) EPEAT™ Gold Registered^[3]
- ErP Lot 3
- RoHS compliant
- TCO Certified 9.0

Notes:

[1] The items listed under the "Green Certifications" section may not only refer to certification but also registration or self-declaration.

[2], [3] EPEAT™ is registered where applicable, please see epeat.net for registration status by country.

Other Certifications

Other Certifications

(Optional) TÜV Rheinland® Ultra Low Noise

Mil-Spec Test

MIL-STD-810H military test passed (Low Pressure [Altitude], High Temperature, Low Temperature, Temperature Shock, Humidity, Sand and Dust, Vibration, Shock, Fungus, Solar Radiation, Contamination by Fluids, Salt Fog)

- Feature with ** means that only one offering listed under the feature is configured on selected models.
- Feature with *** means that one or more offerings listed under the feature could be configured on selected models.
- Lenovo reserves the right to change specifications or other product information without notice. Lenovo is not responsible for photographic or typographical errors. LENOVO PROVIDES THIS PUBLICATION "AS IS," WITHOUT WARRANTY OF ANY KIND, EITHER EXPRESS OR IMPLIED, INCLUDING THE IMPLIED WARRANTIES OF MERCHANTABILITY OR FITNESS FOR A PARTICULAR PURPOSE. Some jurisdictions do not allow disclaimer of express or implied warranties in certain transactions, therefore this disclaimer may not apply to you.
- The specifications on this page may not be available in all regions, and may be changed or updated without

notice.



intel



intel



intel



intel



intel



intel

OVERVIEW

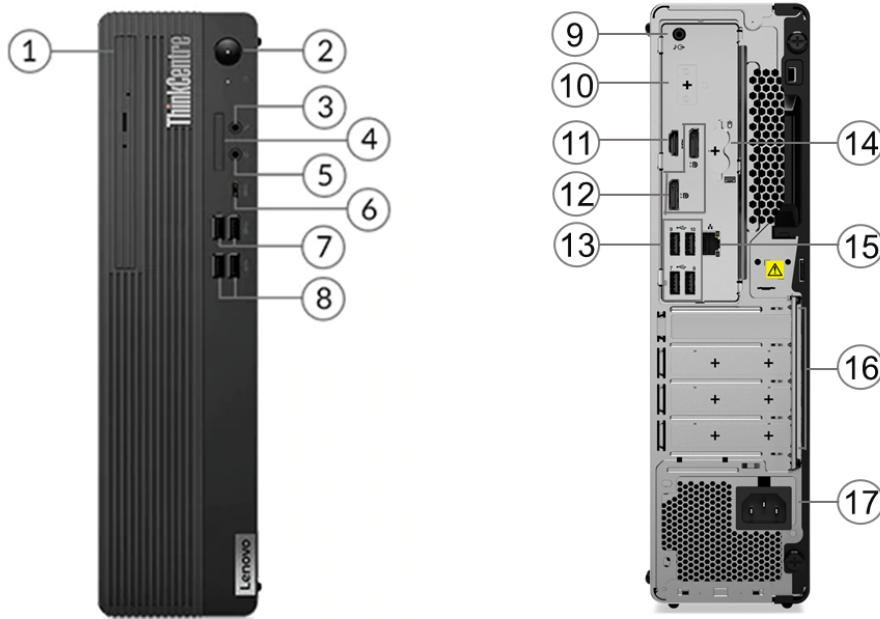

1. Optical drive *	10. Flex IO *
2. Power button	11. HDMI 2.1 TMDS
3. Microphone (3.5mm)	12. 2x DisplayPort 1.4a
4. Card reader *	13. 4x USB 3.2 Gen 1
5. Headphone / microphone combo jack (3.5mm)	14. 2x PS/2 ports (keyboard / mouse) *
6. USB-C 3.2 Gen 2	15. Ethernet (RJ-45)
7. 2x USB 3.2 Gen 1	16. Optional ports on expansion cards *
8. 2x USB 3.2 Gen 2	17. Power connector
9. Line-out (3.5mm)	

Notes:

- Items with * are only available on selected models
- More ports are available through the optional expansion cards (not shown on the sample product above)

PERFORMANCE

Processor

Processor Family

13th Generation Intel® Core™ i3 / i5 / i7 / i9 Processor

Processor**^[1]

Processor Name	Cores	Threads	Base Frequency	Max Frequency	Cache	Processor Graphics
Core™ i3-13100	4 (4 P-core + 0 E-core)	8	P-core 3.4GHz	P-core 4.5GHz	12MB	Intel® UHD Graphics 730
Core™ i5-13400	10 (6 P-core + 4 E-core)	16	P-core 2.5GHz / E-core 1.8GHz	P-core 4.6GHz / E-core 3.3GHz	20MB	Intel® UHD Graphics 730
Core™ i5-13400F	10 (6 P-core + 4 E-core)	16	P-core 2.5GHz / E-core 1.8GHz	P-core 4.6GHz / E-core 3.3GHz	20MB	-
Core™ i5-13500	14 (6 P-core + 8 E-core)	20	P-core 2.5GHz / E-core 1.8GHz	P-core 4.8GHz / E-core 3.5GHz	24MB	Intel® UHD Graphics 770
Core™ i5-13600	14 (6 P-core + 8 E-core)	20	P-core 2.7GHz / E-core 2.0GHz	P-core 5.0GHz / E-core 3.7GHz	24MB	Intel® UHD Graphics 770
Core™ i7-13700	16 (8 P-core + 8 E-core)	24	P-core 2.1GHz / E-core 1.5GHz	Max Turbo up to 5.2GHz / P-core 5.1GHz / E-core 4.1GHz	30MB	Intel® UHD Graphics 770
Core™ i7-13700F	16 (8 P-core + 8 E-core)	24	P-core 2.1GHz / E-core 1.5GHz	Max Turbo up to 5.2GHz / P-core 5.1GHz / E-core 4.1GHz	30MB	-
Core™ i9-13900	24 (8 P-core + 16 E-core)	32	P-core 2.0GHz / E-core 1.5GHz	Max Turbo up to 5.6GHz / P-core 5.2GHz / E-core 4.2GHz	36MB	Intel® UHD Graphics 770
Core™ i9-13900F	24 (8 P-core + 16 E-core)	32	P-core 2.0GHz / E-core 1.5GHz	Max Turbo up to 5.6GHz / P-core 5.2GHz / E-core 4.2GHz	36MB	-

Notes:

[1] Intel® Max Turbo frequency will vary depending on application workload and the hardware and software configurations, see <http://www.intel.com/technology/turboboost/> for more information.

Operating System

Operating System**

- Windows® 11 Pro
- Windows® 11 Home
- Windows® 11 Home Single Language
- Windows® 11 DG Windows® 10 Pro 64
- Windows® 10 IoT Enterprise LTSC 2021
- Ubuntu Linux^[1]
- No preload operating system

Notes:

[1] Some features may not be supported on the system with Linux preload, including but not limited to Intel® RST RAID, Human Presence Detection, etc.

Graphics

Graphics***^[1]

Graphics	Type	Memory	Connector	Max Resolution	Key Features
Intel® UHD graphics 730	Integrated	Shared	2x DP 1.4a (HBR2, DSC), 1x HDMI® 2.1 TMDS, 1x Flex IO (VGA / DP 1.2 / HDMI® 2.1 TMDS / USB-C®)	4096x2304@60Hz(DP), 4096x2160@60Hz[HDMI® / Flex IO(HD MI) / Flex IO(DP)], 3840x2160@60Hz[Flex IO(USB-C®)], 2048x1536@50Hz[Flex IO(VGA)]	DirectX® 12

Intel® UHD graphics 770	Integrated	Shared	2x DP 1.4a (HBR2, DSC), 1x HDMI® 2.1 TMDS, 1x Flex IO (VGA / DP 1.2 / HDMI® 2.1 TMDS / USB-C®)	4096x2304@60Hz(DP), 4096x2160@60Hz[HDMI® / Flex IO(HDMI) / Flex IO(DP)], 3840x2160@60Hz[Flex IO(USB-C®)], 2048x1536@50Hz[Flex IO(VGA)]	DirectX® 12
AMD Radeon™ RX 6400	Discrete	4GB GDDR6	1x HDMI® 2.1 FRL, 1x DP 1.4a	7680x4320@60Hz(HDMI®), 7680x4320@60Hz(DP)	DirectX® 12, OpenGL 4.6

Notes:

[1] The information of integrated graphics are not applicable for the models with processor which has no integrated graphics inside (for the details, please refer to processor section).

Monitor Support

Monitor Support^[1]

Supports up to 4 independent displays via onboard ports (2x DP, 1x HDMI®, and 1x optional Flex IO), more displays support via discrete graphics

Notes:

[1] Onboard video ports are only available for the models with integrated graphics.

Chipset

Chipset

Intel® Q670 chipset

Memory

Max Memory^[1]

Up to 128GB DDR5

Memory Slots

Four DDR5 UDIMM slots, dual-channel capable

Memory Type^[2]

- DDR5-3600
- DDR5-4000
- DDR5-4400

Notes:

[1] The max memory is based on the test results with current Lenovo® memory offerings.

[2] Installed memory is actually DDR5-5600, but may run as DDR5-3600, DDR5-4000, or DDR5-4400 depending on the memory support capability of processor.

Storage

Storage Support^[1]

Up to four drives, 1x 2.5"/3.5" HDD + 1x 2.5" HDD + 2x M.2 SSD

- 2.5" HDD up to 1TB
- 3.5" HDD up to 2TB
- M.2 SSD up to 2TB each

Storage Type^{***}

Disk Type	Interface	RPM	Security
2.5" SATA HDD	SATA 6Gb/s	7.2K	-
3.5" SATA HDD	SATA 6Gb/s	7.2K	-
M.2 2280 SSD	PCIe® NVMe®, PCIe® 4.0 x4 Performance	-	Opal 2.0
M.2 2280 SSD	PCIe® NVMe®, PCIe® 4.0 x4 Value	-	Opal 2.0

RAID

RAID 0/1 support (RAID preset only available via special bid models)

ThinkCentre M90s Gen 4

Notes:
^[1] The max capacity of each disk type is based on the test results with current Lenovo® storage offerings.

Removable Storage

Optical**

- DVD-ROM, SATA connector, slim (9.0mm)
- DVD burner (DVD±RW), SATA connector, slim (9.0mm)
- None

Card Reader

- 3-in-1 card reader (SD, SDHC, SDXC)
- No card reader

Multi-Media

Audio Chip

High Definition (HD) Audio, Realtek® ALC897Q-CG codec

Speakers

Single speaker, 1W x1

Power Supply

Power Supply**

Power	Type	Efficiency	Key Features
260W	Fixed	90%	100-240V, 50-60Hz
310W	Fixed	92%	100-240V, 50-60Hz
380W	Fixed	92%	100-240V, 50-60Hz

DESIGN

Input Device

Keyboard**

- Lenovo® Calliope Keyboard (USB connector), black
- Lenovo® Calliope Wireless Keyboard (2.4GHz via USB receiver), black
- Lenovo® Traditional Keyboard (USB connector), black
- No keyboard

Mouse**

- Lenovo® Calliope Mouse (USB connector), black
- Lenovo® Calliope Wireless Mouse (2.4GHz via USB receiver), black
- No mouse

Mechanical

Form Factor

SFF (8.2L)

Dimensions (WxDxH)^[1]

92.5 x 297.7 x 339.5 mm (3.6 x 11.7 x 13.4 inches)

Packaging Dimensions (WxDxH)

195 x 395 x 530 mm (7.68 x 15.55 x 20.87 inches)

Weight^[2]

Around 5.3 kg (11.7 lbs)

Packaging Weight

7.6 kg (16.76 lbs)

Case Color

Black

Bays^[3]

- 1x 2.5" disk bay

- 1x 3.5" disk bay
- 1x slim ODD bay

Expansion Slots

- One PCIe® 4.0 x16 (x4 signal), low-profile, length ≤ 155mm, height ≤ 70mm
- One PCIe® 4.0 x16, low-profile, length ≤ 155mm, height ≤ 70mm
- One PCIe® 3.0 x1, low-profile, length ≤ 155mm, height ≤ 70mm
- Three M.2 slots (one for WLAN, two for SSD)

EOU

Toolless cover, disk, optical, extension card assembly / removal

Stand

- Vertical stand
- No stand

Others

- (Optional) Dust filter
- (Optional) Smart Cable (USB-A to USB-C®)
- Supports Smart Power On

Notes:

[1] The system dimensions may vary depending on configurations.

[2] The system weight is approximate and based on results in Lenovo® lab, which varies depending on the source of component, variance of the distribution of each component, and manufacturing process. It may not be the exact weight for each specific model.

[3] 2.5" HDD tray is optional, or comes with 2.5 HDD. 3.5" bay supports 2.5" / 3.5" HDD, 3.5" to 2.5 converter comes with 2nd 2.5" HDD.

CONNECTIVITY

Network

Onboard Ethernet

Gigabit Ethernet, Intel® Ethernet Connection I219-LM, 1x RJ-45, supports Wake-on-LAN

Optional Ethernet

- 2.5 Gigabit Ethernet, Realtek® RTL8125BGS, 1x RJ-45, PCIe® x1
- No optional Ethernet

WLAN + Bluetooth®**

- Realtek® Wi-Fi® 6 RTL8852BE, 802.11ax Dual Band 2x2 Wi-Fi® + Bluetooth® 5.1, M.2 card^[1]
- Intel® Wi-Fi® 6 AX201, 802.11ax 2x2 Wi-Fi® + Bluetooth® 5.1, M.2 Card^[2]
- Intel® Wi-Fi® 6E AX211, 802.11ax 2x2 Wi-Fi® + Bluetooth® 5.1, Intel® vPro® technology support, M.2 Card^[3]
- No WLAN and Bluetooth®

Notes:

[1], [2], [3] Bluetooth® 5.2 is hardware ready but may run at a lower version due to OS limitations.

Ports^[1]

Front Ports

- 1x USB-C® 3.2 Gen 2 (support data transfer and 15W charging)
- 2x USB 3.2 Gen 1
- 2x USB 3.2 Gen 2
- 1x headphone / microphone combo jack (3.5mm)
- 1x microphone (3.5mm)

Optional Front Ports

1x card reader

Rear Ports^[2]

- 4x USB 3.2 Gen 1
- 1x HDMI® 2.1 TMDS
- 2x DisplayPort™ 1.4a (HBR2, DSC)
- 1x Ethernet (RJ-45)
- 1x line-out (3.5mm)

Optional Rear Ports***

- 1x USB-C® 3.2 Gen 1 with DisplayPort™ function and 5V@3A charging (Flex IO)
- 1x HDMI® 2.1 TMDS (Flex IO)
- 1x DP 1.2 (Flex IO)
- 1x VGA (Flex IO)
- 1x USB-C® 3.2 Gen 2x2 (support data transfer, via USB-C® expansion card, PCIe® x4)
- 2x USB-C® 3.2 Gen 2 (support data transfer, via 2-port USB-C® expansion card, PCIe® x4)
- 2x USB 3.2 Gen 1 (via 2-port USB expansion card, PCIe® x1)
- 2x USB 2.0 (via 2-port adapter)
- 1x parallel
- 1x serial
- 1x 2nd serial

Notes:

[1] The transfer speed of following ports will vary and, depending on many factors, such as the processing speed of the host device, file attributes and other factors related to system configuration and your operating environment, will be slower than theoretical speed.

USB 2.0: 480 Mbit/s;

USB 3.2 Gen 1 (SuperSpeed USB 5Gbps, formerly USB 3.0 / USB 3.1 Gen 1): 5 Gbit/s;

USB 3.2 Gen 2 (SuperSpeed USB 10Gbps, formerly USB 3.1 Gen 2): 10 Gbit/s;

USB4® 20Gbps / USB 3.2 Gen 2x2 (SuperSpeed USB 20Gbps): 20 Gbit/s;

USB4® 40Gbps (USB 40Gbps): 40 Gbit/s;

Thunderbolt™ 3/4: 40 Gbit/s.

[2] For video ports on discrete graphics, please see graphics section.

Monitor Cable**Monitor Cable*****

- HDMI® to VGA dongle
- DP to VGA dongle
- DP to DVI-D dongle
- DP to HDMI® dongle
- No monitor cable

SECURITY & PRIVACY**Security****Security Chip**

Discrete TPM 2.0, TCG certified, FIPS 140-2 certified

Physical Locks

- (Optional) E-lock
- (Optional) Smart Cable Clip
- Kensington® Security Slot™, 3 x 7 mm
- Padlock Loop

Chassis Intrusion Switch

- Chassis intrusion switch
- No chassis intrusion switch

Fingerprint Reader

No fingerprint reader

BIOS Security

- Administrator password
- Power-on password
- Hard disk password
- Boot sequence control
- Boot without keyboard and mouse
- Self-healing BIOS (Level 2)
- Smart USB protection (allows keyboard / mouse only, blocks all storage devices)
- Individual USB port disablement

MANAGEABILITY

System Management

System Management^[1]

- Intel® vPro® Enterprise^[2]
- Non-vPro®

Notes:

[1], [2] Intel® vPro® offers a superset of DASH's defined capabilities.

SERVICE

Warranty^[1]

Base Warranty**

- 1-year limited onsite service
- 3-year limited onsite service
- No base warranty

Notes:

[1] The warranty upgrades may be bundled with some models, please check the "Included upgrade" column in the specific model's configurations. For more service extensions, please go to <https://smartfind.lenovo.com/>. To learn more details of warranty policy, please access <https://pcsupport.lenovo.com/warranty>.

ENVIRONMENTAL

Operating Environment

Temperature

- Operating: 5°C (41°F) to 35°C (95°F)
- Storage: -40°C (-40°F) to 60°C (140°F)

Relative Humidity

- Operating: 20% to 80%
- Storage: 10% to 90%

Altitude

- Operating: 0 m (0 ft) to 3048 m (10,000 ft)
- Storage: 0 m (0 ft) to 12192 m (40,000 ft)

CERTIFICATIONS

Green Certifications^[1]

Green Certifications

- (Optional) ENERGY STAR® 8.0
- (Optional) EPEAT™ Silver Registered^[2]
- (Optional) EPEAT™ Gold Registered^[3]
- ErP Lot 3
- RoHS compliant
- TCO Certified 9.0

Notes:

[1] The items listed under the "Green Certifications" section may not only refer to certification but also registration or self-declaration.

[2], [3] EPEAT™ is registered where applicable, please see epeat.net for registration status by country.

Other Certifications

Other Certifications

(Optional) TÜV Rheinland® Ultra Low Noise

Mil-Spec Test

MIL-STD-810H military test passed (Low Pressure [Altitude], High Temperature, Low Temperature, Temperature Shock, Humidity, Sand and Dust, Vibration, Shock, Fungus, Solar Radiation, Contamination by Fluids, Salt Fog)

- Feature with ** means that only one offering listed under the feature is configured on selected models.
- Feature with *** means that one or more offerings listed under the feature could be configured on selected models.
- Lenovo reserves the right to change specifications or other product information without notice. Lenovo is not responsible for photographic or typographical errors. LENOVO PROVIDES THIS PUBLICATION “AS IS,” WITHOUT WARRANTY OF ANY KIND, EITHER EXPRESS OR IMPLIED, INCLUDING THE IMPLIED WARRANTIES OF MERCHANTABILITY OR FITNESS FOR A PARTICULAR PURPOSE. Some jurisdictions do not allow disclaimer of express or implied warranties in certain transactions, therefore this disclaimer may not apply to you.
- The specifications on this page may not be available in all regions, and may be changed or updated without notice.



intel



intel



intel



intel



intel



intel

OVERVIEW

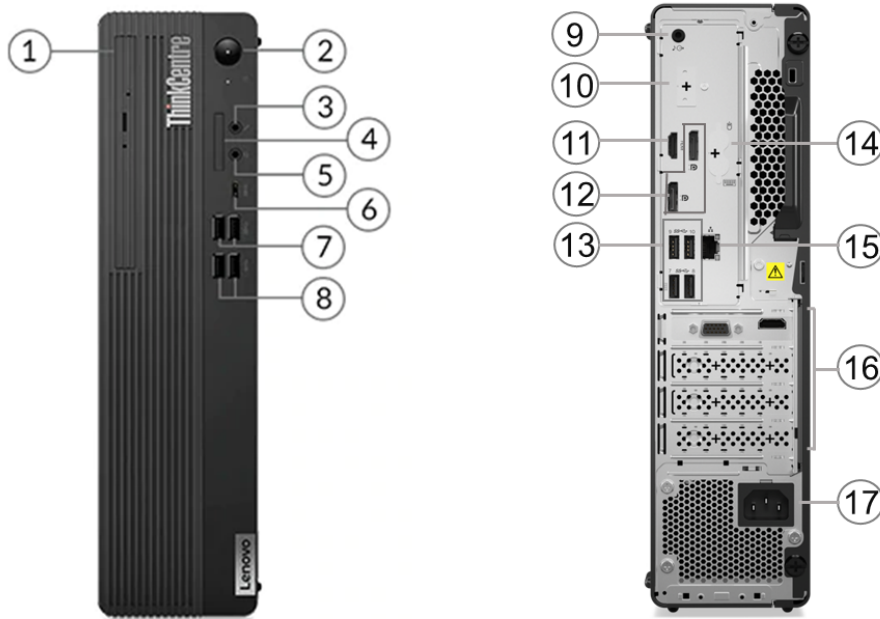

1. Optical drive *	10. Flex IO *
2. Power button	11. HDMI 2.1 TMDS
3. Microphone (3.5mm)	12. 2x DisplayPort 1.4a
4. Card reader *	13. 4x USB-A (USB 5Gbps)
5. Headphone / microphone combo jack (3.5mm)	14. 2x PS/2 ports (keyboard / mouse) *
6. USB-C (USB 10Gbps), data transfer only	15. Ethernet (RJ-45)
7. 2x USB-A (USB 5Gbps)	16. Optional ports on expansion cards *
8. 2x USB-A (USB 10Gbps)	17. Power connector
9. Line-out (3.5mm)	

Notes:

- Items with * are only available on selected models
- More ports are available through the optional expansion cards (not shown on the sample product above)

PERFORMANCE

Processor

Processor Family

13th Generation Intel® Core™ i5 / i7 or 14th Generation Intel® Core™ i5 / i7 / i9 Processor

Processor**

Processor Name	Cores	Threads	Base Frequency	Max Frequency	Cache	Processor Graphics
Core™ i5-13500	14 (6 P-core + 8 E-core)	20	P-core 2.5GHz / E-core 1.8GHz	P-core 4.8GHz / E-core 3.5GHz	24MB	Intel® UHD Graphics 770
Core™ i7-13700	16 (8 P-core + 8 E-core)	24	P-core 2.1GHz / E-core 1.5GHz	Max Turbo up to 5.2GHz / P-core 5.1GHz / E-core 4.1GHz	30MB	Intel® UHD Graphics 770
Core™ i5-14400	10 (6 P-core + 4 E-core)	16	P-core 2.5GHz / E-core 1.8GHz	P-core 4.7GHz / E-core 3.5GHz	20MB	Intel® UHD Graphics 730
Core™ i5-14500	14 (6 P-core + 8 E-core)	20	P-core 2.6GHz / E-core 1.9GHz	P-core 5.0GHz / E-core 3.7GHz	24MB	Intel® UHD Graphics 770
Core™ i5-14600	14 (6 P-core + 8 E-core)	20	P-core 2.7GHz / E-core 2.0GHz	P-core 5.2GHz / E-core 3.9GHz	24MB	Intel® UHD Graphics 770
Core™ i7-14700	20 (8 P-core + 12 E-core)	28	P-core 2.1GHz / E-core 1.5GHz	Max Turbo up to 5.4GHz / P-core 5.3GHz / E-core 4.2GHz	33MB	Intel® UHD Graphics 770
Core™ i9-14900	24 (8 P-core + 16 E-core)	32	P-core 2.0GHz / E-core 1.5GHz	Max Turbo up to 5.8GHz / P-core 5.4GHz / E-core 4.3GHz	36MB	Intel® UHD Graphics 770

Operating System

Operating System**

- Windows® 11 Pro
- Windows® 11 Home
- Windows® 11 Home Single Language
- Windows® 11 DG Windows® 10 Pro 64
- Ubuntu Linux
- No preload operating system

Graphics

Graphics***[1]

Graphics	Type	Memory	Connector	Max Resolution	Key Features
Intel® UHD graphics 730	Integrated	Shared	2x DP 1.4a (HBR2, DSC), 1x HDMI® 2.1 TMDs, 1x Flex IO (VGA / DP 1.2 / HDMI® 2.1 TMDs / USB-C®)	4096x2304@60Hz(DP), 4096x2160@60Hz[HDMI® / Flex IO(HDMI) / Flex IO(DP)], 3840x2160@60Hz[Flex IO(USB-C®)], 2048x1536@50Hz[Flex IO(VGA)]	DirectX® 12
Intel® UHD graphics 770	Integrated	Shared	2x DP 1.4a (HBR2, DSC), 1x HDMI® 2.1 TMDs, 1x Flex IO (VGA / DP 1.2 / HDMI® 2.1 TMDs / USB-C®)	4096x2304@60Hz(DP), 4096x2160@60Hz[HDMI® / Flex IO(HDMI) / Flex IO(DP)], 3840x2160@60Hz[Flex IO(USB-C®)], 2048x1536@50Hz[Flex IO(VGA)]	DirectX® 12

Notes:

[1] The information of integrated graphics are not applicable for the models with processor which has no integrated graphics inside (for the details, please refer to processor section).

Monitor Support

Monitor Support

Supports up to 4 independent displays via onboard ports (2x DP, 1x HDMI®, and 1x optional Flex IO), more displays support via discrete graphics

Chipset

ThinkCentre M90s Gen 5

Chipset

Intel® Q670 chipset

Memory

Max Memory^[1]

Up to 128GB DDR5

Memory Slots

Four DDR5 UDIMM slots, dual-channel capable

Memory Type^{**[2]}

- DDR5-3600
- DDR5-4000
- DDR5-4400

Notes:

[1] The max memory is based on the test results with current Lenovo® memory offerings.

[2] Installed memory is actually DDR5-5600, but runs at DDR5-3600, DDR5-4000, DDR5-4400 due to the memory support capability of processor.

Storage

Storage Support^[1]

Up to four drives, 1x 3.5" HDD + 1x 2.5" HDD + 2x M.2 SSD

- 3.5" HDD up to 2TB
- 2.5" HDD bay is only for customer self upgrade
- M.2 SSD up to 2TB each^[2]

Storage Type^{***}

Disk Type	Interface	RPM	Security
3.5" SATA HDD	SATA 6Gb/s	7.2K	-
M.2 2280 SSD	PCIe® NVMe®, PCIe® 4.0 x4	-	Opal 2.0

RAID

RAID 0/1 support (RAID preset only available via special bid models)

Notes:

[1] The max capacity of each disk type is based on the test results with current Lenovo® storage offerings.

[2] 2.5" HDD bay is optional part, only for customer self upgrade purpose and the hard drive is sold separately.

Removable Storage

Optical^{**}

- DVD-ROM, SATA connector, slim (9.0mm)
- DVD burner (DVD±RW), SATA connector, slim (9.0mm)
- None

Card Reader

- 3-in-1 card reader (SD, SDHC, SDXC)
- No card reader

Multi-Media

Audio Chip

High Definition (HD) Audio, Realtek® ALC897Q-CG codec

Speakers

Single speaker, 1W x1

Power Supply

Power Supply^{**}

Power	Type	Efficiency	Key Features

260W	Fixed	90%	100-240V, 50-60Hz
310W	Fixed	92%	100-240V, 50-60Hz

DESIGN

Input Device

Keyboard**

- EOS Wireless Keyboard, black
- Lenovo® Calliope Keyboard (USB connector), black
- Lenovo® Traditional Keyboard (USB connector), black
- No keyboard

Mouse**

- Lenovo® Calliope Mouse (USB connector), black
- EOS Wireless Mouse, Black
- No mouse

Mechanical

Form Factor

SFF (8.2L)

Dimensions (WxDxH)^[1]

92.5 x 297.7 x 339.5 mm (3.6 x 11.7 x 13.4 inches)

Packaging Dimensions (WxDxH)

195 x 395 x 530 mm (7.7 x 15.6 x 20.9 inches)

Weight^[2]

Around 5.3 kg (11.7 lbs)

Packaging Weight

7.6 kg (16.76 lbs)

Case Color

Black

Bays

- 1x 2.5" disk bay (optional)^[3]
- 1x 3.5" disk bay
- 1x slim ODD bay

Expansion Slots

- One PCIe® 4.0 x16 (x4 signal), low-profile, length ≤ 155mm, height ≤ 70mm
- One PCIe® 4.0 x16, low-profile, length ≤ 155mm, height ≤ 70mm
- One PCIe® 3.0 x1, low-profile, length ≤ 155mm, height ≤ 70mm
- Three M.2 slots (one for WLAN, two for SSD)

EOU

Toolless cover, disk, optical, extension card assembly / removal

Stand

- Vertical stand
- No stand

Others

- (Optional) Dust filter
- Supports Smart Power On

Notes:

[1] The system dimensions may vary depending on configurations.

[2] The system weight is approximate and based on results in Lenovo® lab, which varies depending on the source of component, variance of the distribution of each component, and manufacturing process. It may not be the exact weight for each specific model.

[3] 2.5" HDD bay is optional part

CONNECTIVITY

Network

Onboard Ethernet

Gigabit Ethernet, Intel® Ethernet Connection I219-LM, 1x RJ-45, supports Wake-on-LAN

Optional Ethernet

- 2.5 Gigabit Ethernet, Realtek® RTL8125BGS, 1x RJ-45, PCIe® x1
- No optional Ethernet

WLAN + Bluetooth®**

- Realtek® Wi-Fi® 6 RTL8852BE, 802.11ax Dual Band 2x2 Wi-Fi® + Bluetooth® 5.3, M.2 card
- Intel® Wi-Fi® 6 AX201, 802.11ax 2x2 Wi-Fi® + Bluetooth® 5.2, M.2 Card
- Intel® Wi-Fi® 6E AX211, 802.11ax 2x2 Wi-Fi® + Bluetooth® 5.3, Intel® vPro® technology support, M.2 Card
- No WLAN and Bluetooth®

Ports^[1]

Front Ports

- 1x USB-C® (USB 10Gbps / USB 3.2 Gen 2), with 15W charging
- 2x USB-A (USB 5Gbps / USB 3.2 Gen 1)
- 2x USB-A (USB 10Gbps / USB 3.2 Gen 2)
- 1x headphone / microphone combo jack (3.5mm)
- 1x microphone (3.5mm)

Optional Front Ports

1x card reader

Rear Ports^[2]

- 4x USB-A (USB 5Gbps / USB 3.2 Gen 1)
- 1x HDMI® 2.1 TMDS
- 2x DisplayPort™ 1.4a (HBR2, DSC)
- 1x Ethernet (RJ-45)
- 1x line-out (3.5mm)

Optional Rear Ports^{***}

- 1x USB-C® (USB 5Gbps / USB 3.2 Gen 1), with DisplayPort™ function and 5V@3A charging (Flex IO)
- 1x HDMI® 2.1 TMDS (Flex IO)
- 1x DP 1.2 (Flex IO)
- 1x VGA (Flex IO)
- 2x USB-A (Hi-Speed USB / USB 2.0), via 2-port adapter
- 2x USB-A (USB 5Gbps / USB 3.2 Gen 1), via 2-port USB expansion card, PCIe® x1
- 1x parallel
- 1x serial
- 1x 2nd serial

Notes:

[1] The transfer speed of following ports will vary and, depending on many factors, such as the processing speed of the host device, file attributes and other factors related to system configuration and your operating environment, will be slower than theoretical speed.

USB 2.0: 480 Mbit/s;

USB 3.2 Gen 1 (SuperSpeed USB 5Gbps, formerly USB 3.0 / USB 3.1 Gen 1): 5 Gbit/s;

USB 3.2 Gen 2 (SuperSpeed USB 10Gbps, formerly USB 3.1 Gen 2): 10 Gbit/s;

USB4® 20Gbps / USB 3.2 Gen 2x2 (SuperSpeed USB 20Gbps): 20 Gbit/s;

USB4® 40Gbps (USB 40Gbps): 40 Gbit/s;

Thunderbolt™ 3/4: 40 Gbit/s.

[2] For video ports on discrete graphics, please see graphics section.

SECURITY & PRIVACY

Security

Security Chip

Discrete TPM 2.0, TCG certified, FIPS 140-2 certified

Physical Locks

- (Optional) E-lock
- (Optional) Smart Cable Clip
- Kensington® Security Slot™, 3 x 7 mm
- Padlock Loop

Chassis Intrusion Switch

- Chassis intrusion switch
- No chassis intrusion switch

Fingerprint Reader

No fingerprint reader

BIOS Security

- Administrator password
- Power-on password
- Hard disk password
- Boot sequence control
- Boot without keyboard and mouse
- Self-healing BIOS (Level 2)
- Smart USB protection (allows keyboard / mouse only, blocks all storage devices)
- Individual USB port disablement

MANAGEABILITY

System Management

System Management^[1]

- Intel® vPro® Enterprise
- Non-vPro®

Notes:

[1] Intel® vPro® offers a superset of DASH's defined capabilities.

SERVICE

Warranty^[1]

Base Warranty**

- 1-year limited onsite service
- 3-year limited onsite service
- No base warranty

Notes:

[1] The warranty upgrades may be bundled with some models, please check the "Included upgrade" column in the specific model's configurations. For more service extensions, please go to <https://smartfind.lenovo.com/>. To learn more details of warranty policy, please access <https://pcsupport.lenovo.com/warranty>.

ENVIRONMENTAL

Operating Environment

Temperature

- Operating: 5°C (41°F) to 35°C (95°F)
- Storage: -40°C (-40°F) to 60°C (140°F)

Relative Humidity

- Operating: 20% to 80%
- Storage: 10% to 90%

Altitude

- Operating: 0 m (0 ft) to 3048 m (10,000 ft)
- Storage: 0 m (0 ft) to 12192 m (40,000 ft)

ACCESSORIES

Bundled Accessories

Bundled Accessories***

- DP to DVI dongle
- DP to HDMI® dongle
- HDMI® to VGA dongle
- Smart Cable (USB-A to USB-C®)
- None

CERTIFICATIONS

Green Certifications^[1]

Green Certifications

- (Optional) ENERGY STAR® 8.0
- (Optional) EPEAT™ Gold Registered^[2]
- ErP Lot 3
- GREENGUARD®
- RoHS compliant
- TCO Certified 9.0

Notes:

[1] The items listed under the "Green Certifications" section may not only refer to certification but also registration or self-declaration.

[2] EPEAT™ is registered where applicable, please see [epeat.net](https://www.epeat.net) for registration status by country.

Other Certifications

Other Certifications

(Optional) TÜV Rheinland® Ultra Low Noise

Mil-Spec Test

MIL-STD-810H military test passed (Low Pressure [Altitude], High Temperature, Low Temperature, Temperature Shock, Humidity, Sand and Dust, Vibration, Shock, Fungus, Solar Radiation, Contamination by Fluids, Salt Fog)

- Feature with ** means that only one offering listed under the feature is configured on selected models.
- Feature with *** means that one or more offerings listed under the feature could be configured on selected models.
- Lenovo reserves the right to change specifications or other product information without notice. Lenovo is not responsible for photographic or typographical errors. LENOVO PROVIDES THIS PUBLICATION "AS IS," WITHOUT WARRANTY OF ANY KIND, EITHER EXPRESS OR IMPLIED, INCLUDING THE IMPLIED WARRANTIES OF MERCHANTABILITY OR FITNESS FOR A PARTICULAR PURPOSE. Some jurisdictions do not allow disclaimer of express or implied warranties in certain transactions, therefore this disclaimer may not apply to you.
- The specifications on this page may not be available in all regions, and may be changed or updated without notice.



OVERVIEW

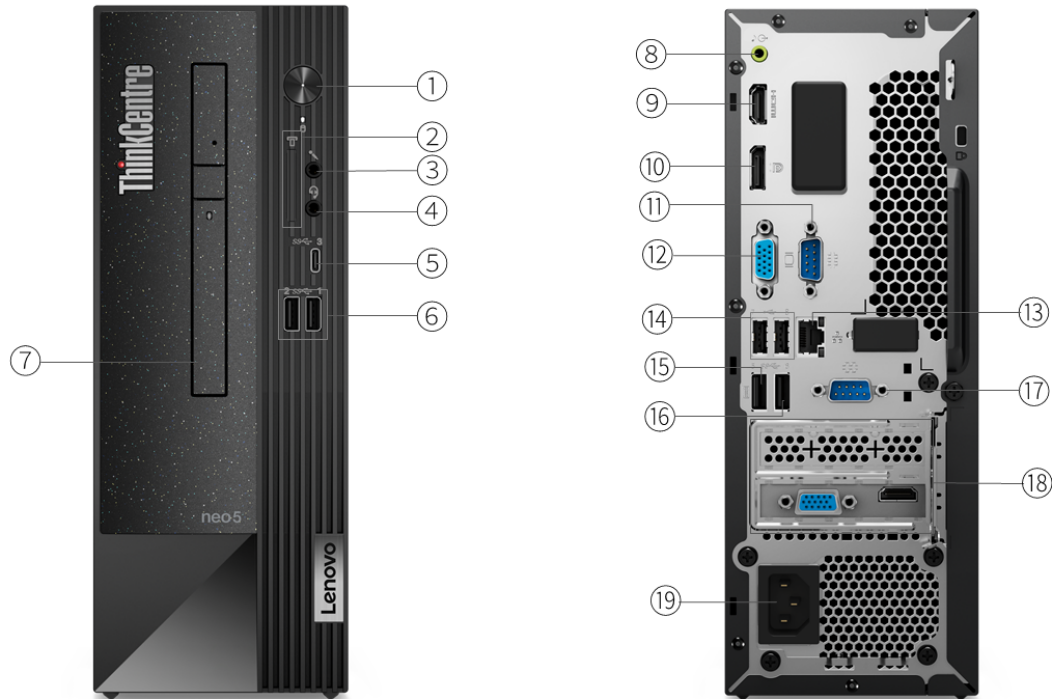

1. Power button	11. Serial *
2. Card reader *	12. VGA
3. Microphone (3.5mm)	13. Ethernet (RJ-45)
4. Headphone / microphone combo jack (3.5mm)	14. 2x USB 2.0
5. USB-C 3.2 Gen 1 (support data transfer and 5V@3A charging)	15. USB 3.2 Gen 1 (with Smart Power On feature)
6. 2x USB 3.2 Gen 1	16. USB 3.2 Gen 1
7. Optical drive *	17. Serial *
8. Line-out (3.5mm)	18. Optional ports on expansion cards *
9. HDMI	19. Power connector
10. DisplayPort 1.4	

Notes:

- Items with * are only available on selected models
- Onboard video ports are only available for the models with integrated graphics

PERFORMANCE

Processor

Processor Family

Intel® Celeron®, Intel® Pentium®, or 12th Generation Intel® Core™ i3 / i5 / i7 / i9 Processor

Processor**

Processor Name	Cores	Threads	Base Frequency	Max Frequency	Cache	Processor Graphics
Celeron® G6900	2	2	3.4GHz	-	4MB	Intel® UHD Graphics 710
Pentium® Gold G7400	2	4	3.7GHz	-	6MB	Intel® UHD Graphics 710
Core™ i3-12100	4 (4 P-core + 0 E-core)	8	P-core 3.3GHz	P-core 4.3GHz ^[1]	12MB	Intel® UHD Graphics 730
Core™ i3-12300	4 (4 P-core + 0 E-core)	8	P-core 3.5GHz	P-core 4.4GHz ^[2]	12MB	Intel® UHD Graphics 730
Core™ i5-12400	6 (6 P-core + 0 E-core)	12	P-core 2.5GHz	P-core 4.4GHz ^[3]	18MB	Intel® UHD Graphics 730
Core™ i5-12400F	6 (6 P-core + 0 E-core)	12	P-core 2.5GHz	P-core 4.4GHz ^[4]	18MB	-
Core™ i5-12500	6 (6 P-core + 0 E-core)	12	P-core 3.0GHz	P-core 4.6GHz ^[5]	18MB	Intel® UHD Graphics 770
Core™ i5-12600	6 (6 P-core + 0 E-core)	12	P-core 3.3GHz	P-core 4.8GHz ^[6]	18MB	Intel® UHD Graphics 770
Core™ i7-12700	12 (8 P-core + 4 E-core)	20	P-core 2.1GHz / E-core 1.6GHz	Max Turbo up to 4.9GHz / P-core 4.8GHz / E-core 3.6GHz ^[7]	25MB	Intel® UHD Graphics 770
Core™ i7-12700F	12 (8 P-core + 4 E-core)	20	P-core 2.1GHz / E-core 1.6GHz	Max Turbo up to 4.9GHz / P-core 4.8GHz / E-core 3.6GHz ^[8]	25MB	-
Core™ i9-12900	16 (8 P-core + 8 E-core)	24	P-core 2.4GHz / E-core 1.8GHz	Max Turbo up to 5.1GHz / P-core 5.0GHz / E-core 3.8GHz ^[9]	30MB	Intel® UHD Graphics 770
Core™ i9-12900F	16 (8 P-core + 8 E-core)	24	P-core 2.4GHz / E-core 1.8GHz	Max Turbo up to 5.1GHz / P-core 5.0GHz / E-core 3.8GHz ^[10]	30MB	-

Notes:

[1], [2], [3], [4], [5], [6], [7], [8], [9], [10] Intel® Max Turbo frequency will vary depending on application workload and the hardware and software configurations, see <http://www.intel.com/technology/turboboost/> for more information.

Operating System

Operating System**

- Windows® 11 Pro
- Windows® 11 Home
- Windows® 11 Home Single Language
- Windows® 11 DG Windows® 10 Pro 64
- Ubuntu Linux^[1]
- No preload operating system

Notes:

[1] Some features may not be supported on the system with Linux preload, including but not limited to Intel® RST RAID, Human Presence Detection, etc.

Graphics

Graphics***^[1]

Graphics	Type	Memory	Connector	Max Resolution	Key Features
----------	------	--------	-----------	----------------	--------------

Intel® UHD graphics 710	Integrated	Shared	1x HDMI® 2.1 TMDS, 1x VGA, 1x DP 1.4 HBR2	3840×2160@60Hz(HDMI®), 1920x1200@60Hz(VGA), 4096x2304@60Hz(DP)	DirectX® 12
Intel® UHD graphics 730	Integrated	Shared	1x HDMI® 2.1 TMDS, 1x VGA, 1x DP 1.4 HBR2	3840×2160@60Hz(HDMI®), 1920x1200@60Hz(VGA), 4096x2304@60Hz(DP)	DirectX® 12
Intel® UHD graphics 770	Integrated	Shared	1x HDMI® 2.1 TMDS, 1x VGA, 1x DP 1.4 HBR2	3840×2160@60Hz(HDMI®), 1920x1200@60Hz(VGA), 4096x2304@60Hz(DP)	DirectX® 12
Intel® Iris® Xe MAX 100 Graphics ^[2]	Discrete	2GB LPDDR4X	1x VGA, 1x HDMI® 1.4	3840x2160@30Hz(HDMI®), 1920x1080@60Hz(VGA)	DirectX® 12, OpenGL 4.6

Notes:

[1] The information of integrated graphics are not applicable for the models with processor which has no integrated graphics inside (for the details, please refer to processor section).

[2] Onboard video ports are only available for the models with integrated graphics.

Monitor Support

Monitor Support

Supports up to 3 independent displays via (HDMI®, DP and VGA), more displays support via discrete graphics

Chipset

Chipset

Intel® B660 chipset

Memory

Max Memory^[1]

Up to 64GB DDR4-3200

Memory Slots

Two DDR4 UDIMM slots, dual-channel capable

Memory Type

DDR4-3200

Notes:

[1] The max memory is based on the test results with current Lenovo® memory offerings.

Storage

Storage Support^[1]

Up to two drives, 1x 2.5"/3.5" HDD + 1x M.2 SSD

- 2.5" HDD up to 1TB
- 3.5" HDD up to 2TB
- M.2 SSD up to 1TB

Storage Type^{***}

Disk Type	Interface	RPM	Security
2.5" SATA HDD	SATA 6Gb/s	7.2K	-
3.5" SATA HDD	SATA 6Gb/s	7.2K	-
M.2 2280 SSD	PCIe® NVMe®, PCIe® 3.0 x4	-	Opal 2.0
M.2 2280 SSD	PCIe® NVMe®, PCIe® 4.0 x4	-	Opal 2.0
M.2 2242 SSD	PCIe® NVMe®, PCIe® 3.0 x4	-	-

RAID

No support

Notes:

[1] The max capacity of each disk type is based on the test results with current Lenovo® storage offerings.

Removable Storage

Optical**

- DVD-ROM, SATA 1.5Gb/s, slim (9.0mm)
- DVD burner (DVD±RW), SATA 1.5Gb/s, slim (9.0mm)
- None

Card Reader

- 7-in-1 card reader (SD, SDHC, SDXC, MMC, MS, MS-Pro, XD)
- No card reader

Multi-Media

Audio Chip

High Definition (HD) Audio, Realtek® ALC623-CG codec

Speakers

- No speakers
- Single speaker, 1W x1

Power Supply

Power Supply**

Power	Type	Efficiency	Key Features
180W	Fixed	85%	Autosensing
260W	Fixed	90%	Autosensing

DESIGN

Input Device

Keyboard**

- Lenovo® Calliope Keyboard (USB connector), black
- Lenovo® Calliope Wireless Keyboard, black
- Lenovo® Traditional Keyboard (USB connector), black
- No keyboard

Mouse**

- Lenovo® Calliope Mouse (USB connector), black
- Lenovo® Calliope Wireless Mouse (2.4GHz via USB receiver), black
- No mouse

Mechanical

Form Factor

SFF (7.4L)

Dimensions (WxDxH)^[1]

100 x 308 x 274.8 mm (3.9 x 12.1 x 10.8 inches)

Packaging Dimensions (WxDxH)

195 x 390 x 500 mm (7.67 x 15.35 x 19.69 inches)

Weight^[2]

Around 4.5 kg (9.9 lbs)

Packaging Weight

Around 6.35 kg (14 lbs)

Case Color

Raven black

Bays

- 1x 2.5"/3.5" disk bay
- 1x slim ODD bay

Expansion Slots

- One PCIe® 4.0 x16, low-profile (length < 167.65mm, height < 68.90mm)
- One PCIe® 3.0 x1, low-profile (length < 167.65mm, height < 68.90mm)
- Two M.2 slots (one for WLAN, one for SSD)

EOU

No support

Stand

- Vertical stand
- No stand

Notes:

[1] The system dimensions may vary depending on configurations.

[2] The system weight is approximate and based on results in Lenovo® lab, which varies depending on the source of component, variance of the distribution of each component, and manufacturing process. It may not be the exact weight for each specific model.

CONNECTIVITY

Network

Onboard Ethernet

Gigabit Ethernet, Realtek® RTL8111HN, 1x RJ-45, supports Wake-on-LAN

WLAN + Bluetooth®**

- Realtek® RTL8822CE, 802.11ac Dual Band 2x2 Wi-Fi® + Bluetooth® 5.0, M.2 card
- Intel® Wireless-AC 9560, 802.11ac Dual Band 2x2 Wi-Fi® + Bluetooth® 5.0, Intel® vPro® technology support, M.2 card
- Realtek® Wi-Fi® 6 RTL8852AE, 802.11ax Dual Band 2x2 Wi-Fi® + Bluetooth® 5.1, M.2 card^[1]
- Intel® Wi-Fi® 6 AX201, 802.11ax 2x2 Wi-Fi® + Bluetooth® 5.1, M.2 Card^[2]
- No WLAN and Bluetooth®

Notes:

[1], [2] Bluetooth® 5.2 is hardware ready but may run at a lower version due to OS limitations.

Ports^[1]

Front Ports

- 1x USB-C® 3.2 Gen 1 (support data transfer and 5V@3A charging)
- 2x USB 3.2 Gen 1
- 1x headphone / microphone combo jack (3.5mm)
- 1x microphone (3.5mm)

Optional Front Ports

1x card reader

Rear Ports^{[2][3]}

- 2x USB 2.0
- 2x USB 3.2 Gen 1 (one supports Smart Power On)
- 1x HDMI® 2.1 TMDS
- 1x DisplayPort™ 1.4
- 1x VGA
- 1x Ethernet (RJ-45)
- 1x line-out (3.5mm)

Optional Rear Ports**

- 2x USB 2.0 (via 2-port adapter)
- 1x parallel
- 1x serial
- 1x 2nd serial
- None

Notes:

[1] The transfer speed of following ports will vary and, depending on many factors, such as the processing speed of the host device, file attributes and other factors related to system configuration and your operating environment, will be

slower than theoretical speed.

USB 2.0: 480 Mbit/s;

USB 3.2 Gen 1 (SuperSpeed USB 5Gbps, formerly USB 3.0 / USB 3.1 Gen 1): 5 Gbit/s;

USB 3.2 Gen 2 (SuperSpeed USB 10Gbps, formerly USB 3.1 Gen 2): 10 Gbit/s;

USB4® 20Gbps / USB 3.2 Gen 2x2 (SuperSpeed USB 20Gbps): 20 Gbit/s;

USB4® 40Gbps (USB 40Gbps): 40 Gbit/s;

Thunderbolt™ 3/4: 40 Gbit/s.

[2] For video ports on discrete graphics, please see graphics section.

[3] Onboard video ports are only available for the models with integrated graphics.

SECURITY & PRIVACY

Security

Security Chip

Discrete TPM 2.0, TCG certified

Physical Locks

- (Optional) Smart Cable Clip
- Kensington® Security Slot™, 3 x 7 mm
- Padlock Loop

Chassis Intrusion Switch

- Chassis intrusion switch
- No chassis intrusion switch

Fingerprint Reader

No fingerprint reader

BIOS Security

- Secure Wipe
- Power-on password
- Supervisor password
- Hard disk password
- Cover presence switch
- Smart USB protection (allows keyboard / mouse only, blocks all storage devices)
- Intel® BIOS guard

MANAGEABILITY

System Management

System Management

Non-vPro®

SERVICE

Warranty^[1]

Base Warranty**

- 1-year courier or carry-in service
- 1-year limited onsite service
- No base warranty

Notes:

[1] The warranty upgrades may be bundled with some models, please check the "Included upgrade" column in the specific model's configurations. For more service extensions, please go to <https://smartfind.lenovo.com/>. To learn more details of warranty policy, please access <https://pcsupport.lenovo.com/warranty>.

ENVIRONMENTAL

Operating Environment

Temperature

- Operating: 5°C (41°F) to 35°C (95°F)
- Storage: -40°C (-40°F) to 60°C (140°F)

Relative Humidity

- Operating: 20% to 80%
- Storage: 10% to 90%

Altitude

- Operating: 0 m (0 ft) to 3048 m (10,000 ft)
- Storage: 0 m (0 ft) to 12192 m (40,000 ft)

ACCESSORIES

Bundled Accessories

Bundled Accessories

- DP to DVI dongle
- DP to Dual DP dongle
- HDMI® to HDMI® dongle
- HDMI® to VGA dongle
- Smart Cable (USB-A to USB-C®)
- None
- DP to HDMI® dongle
- DP to VGA dongle

CERTIFICATIONS

Green Certifications^[1]

Green Certifications

- (Optional) ENERGY STAR® 8.0
- (Optional) EPEAT™ Silver Registered^[2]
- (Optional) EPEAT™ Gold Registered^[3]
- ErP Lot 3
- RoHS compliant
- TCO Certified

Notes:

[1] The items listed under the "Green Certifications" section may not only refer to certification but also registration or self-declaration.

[2], [3] EPEAT™ is registered where applicable, please see [epeat.net](https://www.epeat.net) for registration status by country.

Other Certifications

Other Certifications

- (Optional) TÜV Rheinland® Low Noise
- (Optional) TÜV Rheinland® Ultra Low Noise

- Feature with ** means that only one offering listed under the feature is configured on selected models.
- Feature with *** means that one or more offerings listed under the feature could be configured on selected models.
- Lenovo reserves the right to change specifications or other product information without notice. Lenovo is not responsible for photographic or typographical errors. LENOVO PROVIDES THIS PUBLICATION "AS IS," WITHOUT WARRANTY OF ANY KIND, EITHER EXPRESS OR IMPLIED, INCLUDING THE IMPLIED WARRANTIES OF MERCHANTABILITY OR FITNESS FOR A PARTICULAR PURPOSE. Some jurisdictions do not allow disclaimer of express or implied warranties in certain transactions, therefore this disclaimer may not apply to

you.

- The specifications on this page may not be available in all regions, and may be changed or updated without notice.



intel



intel



intel

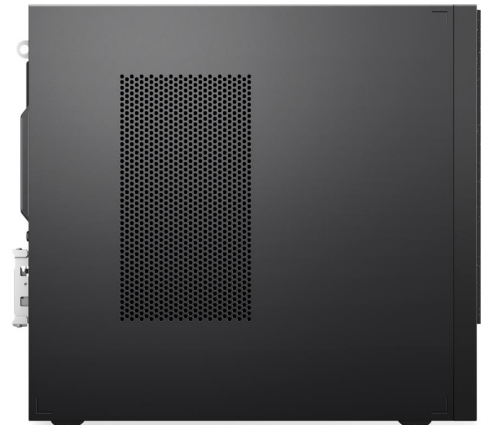

intel

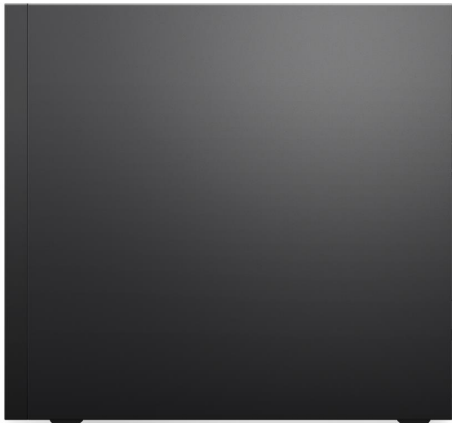

intel



intel

OVERVIEW

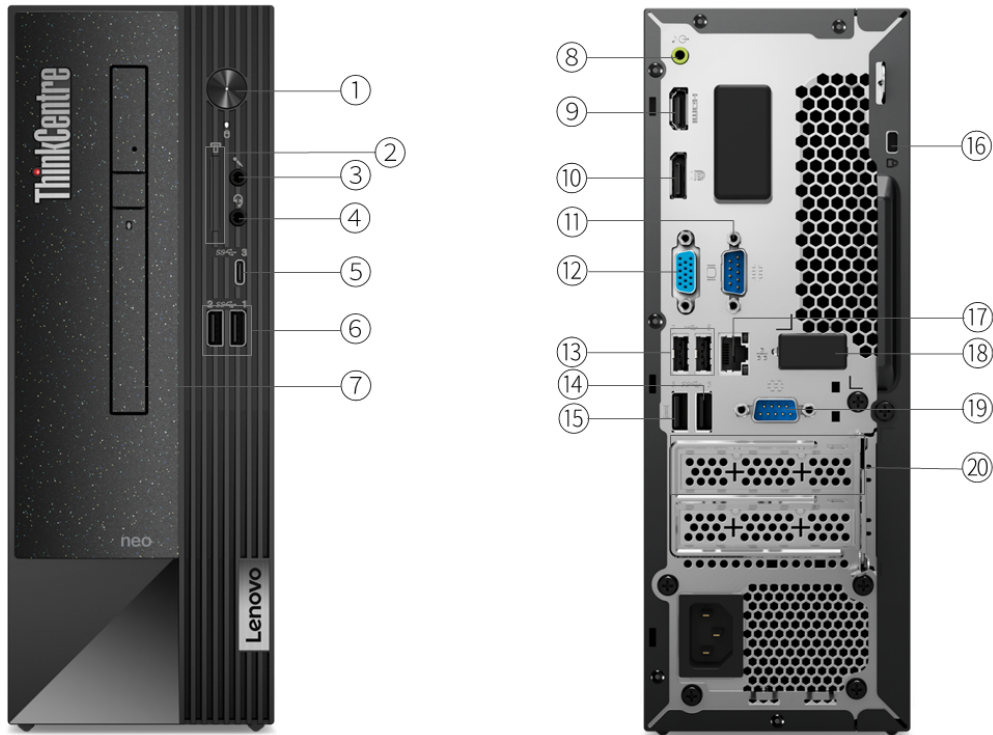

1. Power button	11. Serial *
2. Card reader *	12. VGA
3. Microphone (3.5mm)	13. 2x USB 2.0
4. Headphone / microphone combo jack (3.5mm)	14. 1x USB 3.2 Gen 1
5. USB-C 3.2 Gen 1 (data transfer, 15W charging)	15. 1x USB 3.2 Gen 1 (smart power on)
6. 2x USB 3.2 Gen 1	16. Kensington Security Slot
7. Optical drive *	17. Ethernet (RJ-45)
8. Audio line-out (3.5mm)	18. Smart cable clip slots *
9. HDMI 2.1 TMDS	19. Serial *
10. DP 1.4	20. Optional ports *

Notes:

- Items with * are only available on selected models

PERFORMANCE

Processor

Processor Family

Intel® Celeron®, Intel® Pentium®, or 12th / 13th Generation Intel® Core™ i3 / i5 / i7 Processor

Processor**

Processor Name	Cores	Threads	Base Frequency	Max Frequency	Cache	Processor Graphics
Celeron® G6900	2	2	3.4GHz	-	4MB	Intel® UHD Graphics 710
Pentium® Gold G7400	2	4	3.7GHz	-	6MB	Intel® UHD Graphics 710
Core™ i3-12100	4 (4 P-core + 0 E-core)	8	P-core 3.3GHz	P-core 4.3GHz ^[1]	12MB	Intel® UHD Graphics 730
Core™ i3-12300	4 (4 P-core + 0 E-core)	8	P-core 3.5GHz	P-core 4.4GHz ^[2]	12MB	Intel® UHD Graphics 730
Core™ i5-12400	6 (6 P-core + 0 E-core)	12	P-core 2.5GHz	P-core 4.4GHz ^[3]	18MB	Intel® UHD Graphics 730
Core™ i5-12500	6 (6 P-core + 0 E-core)	12	P-core 3.0GHz	P-core 4.6GHz ^[4]	18MB	Intel® UHD Graphics 770
Core™ i5-12600	6 (6 P-core + 0 E-core)	12	P-core 3.3GHz	P-core 4.8GHz ^[5]	18MB	Intel® UHD Graphics 770
Core™ i7-12700	12 (8 P-core + 4 E-core)	20	P-core 2.1GHz / E-core 1.6GHz	Max Turbo up to 4.9GHz / P-core 4.8GHz / E-core 3.6GHz ^[6]	25MB	Intel® UHD Graphics 770
Core™ i3-13100	4 (4 P-core + 0 E-core)	8	P-core 3.4GHz	P-core 4.5GHz ^[7]	12MB	Intel® UHD Graphics 730
Core™ i5-13400	10 (6 P-core + 4 E-core)	16	P-core 2.5GHz / E-core 1.8GHz	P-core 4.6GHz / E-core 3.3GHz ^[8]	20MB	Intel® UHD Graphics 730
Core™ i5-13500	14 (6 P-core + 8 E-core)	20	P-core 2.5GHz / E-core 1.8GHz	P-core 4.8GHz / E-core 3.5GHz ^[9]	24MB	Intel® UHD Graphics 770
Core™ i5-13600	14 (6 P-core + 8 E-core)	20	P-core 2.7GHz / E-core 2.0GHz	P-core 5.0GHz / E-core 3.7GHz ^[10]	24MB	Intel® UHD Graphics 770
Core™ i7-13700	16 (8 P-core + 8 E-core)	24	P-core 2.1GHz / E-core 1.5GHz	Max Turbo up to 5.2GHz / P-core 5.1GHz / E-core 4.1GHz ^[11]	30MB	Intel® UHD Graphics 770

Notes:

[1], [2], [3], [4], [5], [6], [7], [8], [9], [10], [11] Intel® Max Turbo frequency will vary depending on application workload and the hardware and software configurations, see <http://www.intel.com/technology/turboboost/> for more information.

Operating System

Operating System**

- Windows® 11 Pro
- Windows® 11 Home
- Windows® 11 Home Single Language
- Windows® 11 DG Windows® 10 Pro 64
- Ubuntu Linux^[1]
- No preload operating system

Notes:

[1] Some features may not be supported on the system with Linux preload, including but not limited to Intel® RST RAID, Human Presence Detection, etc.

Graphics

Graphics

**[1]

Graphics	Type	Memory	Connector	Max Resolution	Key Features
Intel® UHD graphics 710	Integrated	Shared	1x HDMI® 2.1 TMDS, 1x VGA, 1x DP 1.4 HBR2	3840×2160@60Hz(HDMI®), 1920×1200@60Hz(VGA), 4096×2304@60Hz(DP)	DirectX® 12
Intel® UHD graphics 730	Integrated	Shared	1x HDMI® 2.1 TMDS, 1x VGA, 1x DP 1.4 HBR2	3840×2160@60Hz(HDMI®), 1920×1200@60Hz(VGA), 4096×2304@60Hz(DP)	DirectX® 12
Intel® UHD graphics 770	Integrated	Shared	1x HDMI® 2.1 TMDS, 1x VGA, 1x DP 1.4 HBR2	3840×2160@60Hz(HDMI®), 1920×1200@60Hz(VGA), 4096×2304@60Hz(DP)	DirectX® 12

Notes:

[1] The information of integrated graphics are not applicable for the models with processor which has no integrated graphics inside (for the details, please refer to processor section).

Monitor Support

Monitor Support

Supports up to 3 independent displays via (HDMI®, DP and VGA)

Chipset

Chipset

Intel® B660 chipset

Memory

Max Memory^[1]

Up to 64GB DDR4-3200

Memory Slots

Two DDR4 UDIMM slots, dual-channel capable

Memory Type

DDR4-3200

Notes:

[1] The max memory is based on the test results with current Lenovo® memory offerings.

Storage

Storage Support^[1]

Up to two drives, 1x 3.5" HDD + 1x M.2 SSD

- 3.5" HDD up to 2TB
- M.2 SSD up to 1TB

Storage Type^{***}

Disk Type	Interface	RPM	Security
3.5" SATA HDD	SATA 6Gb/s	7.2K	-
M.2 2280 SSD	PCIe® NVMe®, PCIe® 4.0 x4	-	Opal
M.2 2280 SSD	PCIe® NVMe®, PCIe® 4.0 x4	-	Opal 2.0

Notes:

[1] The max capacity of each disk type is based on the test results with current Lenovo® storage offerings.

Removable Storage

Optical^{**}

- DVD-ROM, SATA 1.5Gb/s, slim (9.0mm)
- DVD burner (DVD±RW), SATA connector, slim (9.0mm)

ThinkCentre neo 50s Gen 4

- None

Card Reader

- 7-in-1 card reader (SD, SDHC, SDXC, MMC, MS, MS-Pro, XD)
- No card reader

Multi-Media

Audio Chip

High Definition (HD) Audio, Realtek® ALC623-CG codec

Speakers

- No speakers
- Single speaker, 1W x1

Power Supply

Power Supply**

Power	Type	Efficiency	Key Features
260W	Fixed	90%	Autosensing, 80 PLUS Gold qualified
180W	Fixed	85%	Autosensing

DESIGN

Input Device

Keyboard**

- Lenovo® Calliope Keyboard (USB connector), black
- Lenovo® Traditional Keyboard (USB connector), black
- No keyboard

Mouse

- Lenovo® Calliope Mouse (USB connector), black
- No mouse

Mechanical

Form Factor

SFF (7.4L)

Dimensions (WxDxH)^[1]

100 x 308 x 274.8 mm (3.9 x 12.1 x 10.8 inches)

Packaging Dimensions (WxDxH)

195 x 390 x 500 mm (7.7 x 15.4 x 19.7 inches)

Weight^[2]

Around 4.5 kg (9.9 lbs)

Packaging Weight

Around 6.35 kg (14 lbs)

Case Color

Raven black

Bays

- 1x 2.5"/3.5" disk bay
- 1x slim ODD bay

Expansion Slots

- One PCIe® 4.0 x16, low-profile (length < 167.65mm, height < 68.90mm)
- One PCIe® 3.0 x1, low-profile (length < 167.65mm, height < 68.90mm)
- Two M.2 slots (one for WLAN, one for SSD)

Stand

- Vertical stand
- No stand

Others

(Optional) Smart Cable (USB-A to USB-C®)

Notes:

[1] The system dimensions may vary depending on configurations.

[2] The system weight is approximate and based on results in Lenovo® lab, which varies depending on the source of component, variance of the distribution of each component, and manufacturing process. It may not be the exact weight for each specific model.

CONNECTIVITY

Network

Onboard Ethernet

Gigabit Ethernet, Realtek® RTL8111HN, 1x RJ-45, supports Wake-on-LAN

WLAN + Bluetooth®**

- Realtek® Wi-Fi® 6 RTL8852BE, 802.11ax Dual Band 2x2 Wi-Fi® + Bluetooth® 5.1, M.2 card
- Intel® Wi-Fi® 6 AX201, 802.11ax 2x2 Wi-Fi® + Bluetooth® 5.1 (Bluetooth® 5.2 hardware ready), M.2 Card^[1]
- Intel® Wi-Fi® 6E AX211, 802.11ax 2x2 Wi-Fi® + Bluetooth® 5.1 (Bluetooth® 5.3 hardware ready), M.2 Card^[2]
- No WLAN and Bluetooth®

Notes:

[1] Bluetooth® 5.2 is hardware ready but may run at a lower version due to OS limitations.

[2] Bluetooth® 5.3 is hardware ready but may run at a lower version due to OS limitations.

Ports^[1]

Front Ports

- 1x USB-C® 3.2 Gen 1 (support data transfer and 5V@3A charging)
- 2x USB 3.2 Gen 1
- 1x headphone / microphone combo jack (3.5mm)
- 1x microphone (3.5mm)

Optional Front Ports

1x card reader

Rear Ports

- 2x USB 2.0
- 2x USB 3.2 Gen 1 (one supports Smart Power On)
- 1x HDMI® 2.1 TMDS
- 1x DisplayPort™ 1.4
- 1x VGA
- 1x Ethernet (RJ-45)
- 1x line-out (3.5mm)

Optional Rear Ports***

- 2x USB 2.0
- 1x parallel
- 1x serial
- 1x 2nd serial
- None

Notes:

[1] The transfer speed of following ports will vary and, depending on many factors, such as the processing speed of the host device, file attributes and other factors related to system configuration and your operating environment, will be slower than theoretical speed.

USB 2.0: 480 Mbit/s;

USB 3.2 Gen 1 (SuperSpeed USB 5Gbps, formerly USB 3.0 / USB 3.1 Gen 1): 5 Gbit/s;

USB 3.2 Gen 2 (SuperSpeed USB 10Gbps, formerly USB 3.1 Gen 2): 10 Gbit/s;

USB4® 20Gbps / USB 3.2 Gen 2x2 (SuperSpeed USB 20Gbps): 20 Gbit/s;

USB4® 40Gbps (USB 40Gbps): 40 Gbit/s;

Thunderbolt™ 3/4: 40 Gbit/s.

SECURITY & PRIVACY

Security

Security Chip

Discrete TPM 2.0, TCG certified

Physical Locks

- (Optional) Smart Cable Clip
- Kensington® Security Slot™, 3 x 7 mm
- Padlock Loop

Chassis Intrusion Switch

- Chassis intrusion switch
- No chassis intrusion switch

Fingerprint Reader

No fingerprint reader

BIOS Security

- Secure Wipe
- Power-on password
- Supervisor password
- Hard disk password
- Certificate based BIOS authentication
- Certificate based BIOS management
- Cover presence switch
- Self-healing BIOS
- Smart USB protection (allows keyboard / mouse only, blocks all storage devices)
- Individual USB port disablement
- Intel® BIOS guard

MANAGEABILITY

System Management

System Management

Non-vPro®

SERVICE

Warranty^[1]

Base Warranty**

- 1-year courier or carry-in service
- 1-year limited onsite service
- No base warranty

Notes:

[1] The warranty upgrades may be bundled with some models, please check the "Included upgrade" column in the specific model's configurations. For more service extensions, please go to <https://smartfind.lenovo.com/>. To learn more details of warranty policy, please access <https://pcsupport.lenovo.com/warranty>.

ENVIRONMENTAL

Operating Environment

Temperature

- Operating: 5°C (41°F) to 35°C (95°F)
- Storage: -40°C (-40°F) to 60°C (140°F)

Relative Humidity

- Operating: 20% to 80%
- Storage: 10% to 90%

Altitude

- Operating: 0 m (0 ft) to 3048 m (10,000 ft)
- Storage: 0 m (0 ft) to 12192 m (40,000 ft)

ACCESSORIES

Bundled Accessories

Bundled Accessories

- DP to DVI dongle
- DP to Dual DP dongle
- HDMI® to HDMI® dongle
- HDMI® to VGA dongle
- None
- DP to HDMI® dongle
- DP to VGA dongle

CERTIFICATIONS

Green Certifications^[1]

Green Certifications

- (Optional) ENERGY STAR® 8.0
- (Optional) EPEAT™ Silver Registered^[2]
- (Optional) EPEAT™ Gold Registered^[3]
- ErP Lot 3
- RoHS compliant
- TCO Certified

Notes:

[1] The items listed under the "Green Certifications" section may not only refer to certification but also registration or self-declaration.

[2], [3] EPEAT™ is registered where applicable, please see [epeat.net](https://www.epeat.net) for registration status by country.

Other Certifications

Other Certifications

- (Optional) TÜV Rheinland® Low Noise
- (Optional) TÜV Rheinland® Ultra Low Noise

- Feature with ** means that only one offering listed under the feature is configured on selected models.
- Feature with *** means that one or more offerings listed under the feature could be configured on selected models.
- Lenovo reserves the right to change specifications or other product information without notice. Lenovo is not responsible for photographic or typographical errors. LENOVO PROVIDES THIS PUBLICATION "AS IS," WITHOUT WARRANTY OF ANY KIND, EITHER EXPRESS OR IMPLIED, INCLUDING THE IMPLIED WARRANTIES OF MERCHANTABILITY OR FITNESS FOR A PARTICULAR PURPOSE. Some jurisdictions do not allow disclaimer of express or implied warranties in certain transactions, therefore this disclaimer may not apply to you.
- The specifications on this page may not be available in all regions, and may be changed or updated without notice.



intel



intel

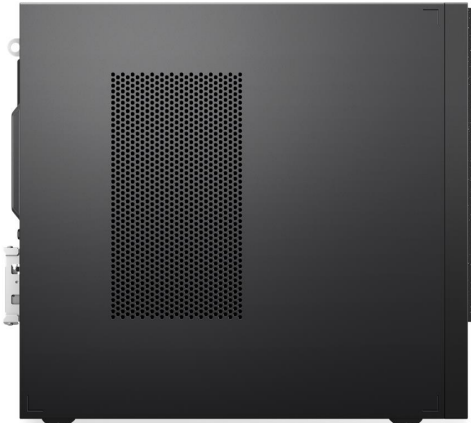

intel

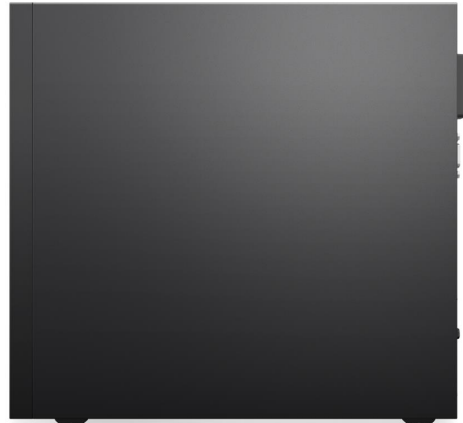

intel



intel

OVERVIEW

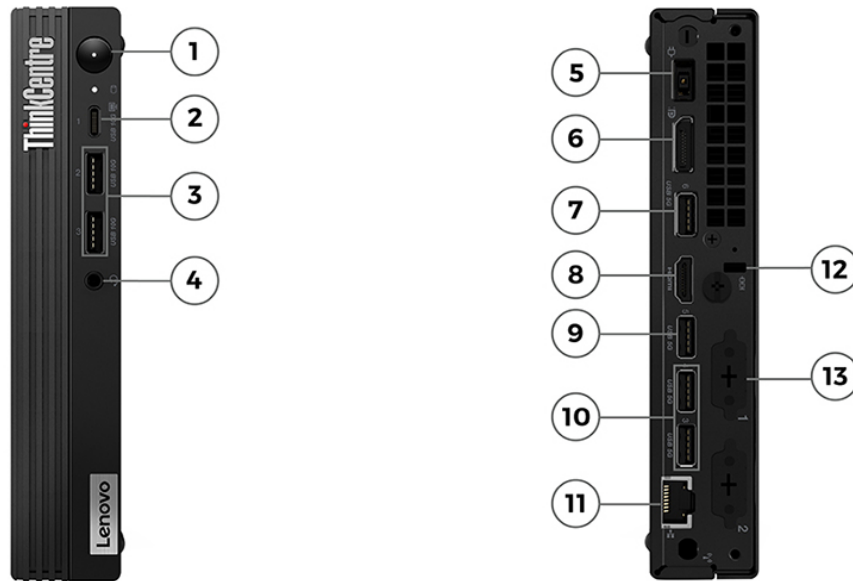

1. Power button	8. HDMI 2.1 TMDs
2. USB-C 3.2 Gen 2 (with DP 1.4)	9. USB 3.2 Gen 1
3. 2x USB 3.2 Gen 2	10. 2x USB 3.2 Gen 1
4. Headphone / microphone combo jack (3.5mm)	11. Ethernet (RJ-45)
5. Power connector	12. Kensington Security Slot
6. DisplayPort 1.4	13. Flex IO *
7. USB 3.2 Gen 1	

Notes:

- Items with * are only available on selected models

PERFORMANCE

Processor

Processor Family

Intel® Celeron® or 12th Generation Intel® U Series Core™ i3 / i5 Processor

Processor**^[1]

Processor Name	Cores	Threads	Base Frequency	Max Frequency	Cache	Memory Support	Processor Graphics
Celeron® 7305	5 (1 P-core + 4 E-core)	6	P-core 1.1GHz / E-core 0.9GHz	-	8MB	DDR4-3200	Intel® UHD Graphics
Core™ i3-1215U	6 (2 P-core + 4 E-core)	8	P-core 1.2GHz / E-core 0.9GHz	P-core 4.4GHz / E-core 3.3GHz ^[2]	10MB	DDR4-3200	Intel® UHD Graphics
Core™ i5-1235U	10 (2 P-core + 8 E-core)	12	P-core 1.3GHz / E-core 0.9GHz	P-core 4.4GHz / E-core 3.3GHz ^[3]	12MB	DDR4-3200	Intel® Iris® Xe Graphics

Notes:

[1] Intel® Iris® Xe Graphics capability requires system to be configured with dual-channel memory. On the system with single-channel memory, Intel® Iris® Xe Graphics will function as Intel® UHD Graphics.

[2], [3], [4] Intel® Max Turbo frequency will vary depending on application workload and the hardware and software configurations, see <http://www.intel.com/technology/turboboost/> for more information.

Operating System

Operating System

ChromeOS

Graphics

Graphics**

Graphics	Type	Memory	Connector	Max Resolution	Key Features
Intel® UHD Graphics	Integrated	Shared	1x DP 1.4 HBR2, 1x USB-C® with DP 1.4 function, 1x HDMI® 2.1 TMDS, 1x punch out port (1x HDMI® 2.1 TMDS or 1x DP 1.4)	4096x2304@60Hz(DP), 4096x2304@60Hz(USB-C® with DP function), 4096x2304@60Hz(HDMI®)	DirectX® 12.1
Intel® Iris® Xe Graphics ^[1]	Integrated	Shared	1x DP 1.4 HBR2, 1x USB-C® with DP 1.4 function, 1x HDMI® 2.1 TMDS, 1x punch out port (1x HDMI® 2.1 TMDS or 1x DP 1.4)	4096x2304@60Hz(DP), 4096x2304@60Hz(USB-C® with DP function), 4096x2304@60Hz(HDMI®)	DirectX® 12

Notes:

[1] Intel® Iris® Xe Graphics capability requires system to be configured with dual-channel memory. On the system with single-channel memory, Intel® Iris® Xe Graphics will function as Intel® UHD Graphics.

Monitor Support

Monitor Support

Supports up to 4 independent displays via (onboard USB-C®, onboard DP, onboard HDMI®, and one optional port [2nd DP / 2nd HDMI®])

Chipset

Chipset

Intel® SoC (System on Chip) platform

Memory

Max Memory^[1]

Up to 32GB DDR4-3200

ThinkCentre M60q Chromebox

Memory Slots

Two DDR4 SO-DIMM slots, dual-channel capable

Memory Type

DDR4-3200

Notes:

[1] The max memory is based on the test results with current Lenovo® memory offerings.

Storage

Storage Support^[1]

One drive, up to 256GB M.2 2280 SSD or 64GB eMMC 5.1 on systemboard

Storage Type^{***}

Disk Type	Interface
M.2 2280 SSD	PCIe® NVMe®, PCIe® 4.0 x4
Flash Memory ^[2]	eMMC 5.1
M.2 2242 SSD	PCIe® NVMe®, PCIe® 3.0 x4

RAID

No support

Notes:

[1] The max capacity of each disk type is based on the test results with current Lenovo® storage offerings.

[2] EMMC is pre-configured, not upgradable.

Removable Storage

Optical

None

Card Reader

No card reader

Multi-Media

Audio Chip

High Definition (HD) Audio, Realtek® ALC5682I codec

Speakers

No speakers

Microphone

No microphone

Camera

No camera

Power Supply

Power Supply^{**}

Power	Type	Efficiency	Key Features
65W	Adapter	89%	Autosensing
90W	Adapter	89%	Autosensing

DESIGN

Input Device

Keyboard

- Chrome USB Keyboard, black
- No keyboard

Mouse

- USB Calliope Mouse, black
- No mouse

Mechanical

Form Factor

Tiny (1L)

Dimensions (WxDxH)^[1]

178 x 182 x 34 mm (7 x 7.16 x 1.33 inches)

Packaging Dimensions (WxDxH)

140 x 485 x 270 (5.51 x 19.1x 10.6 inches)

Weight^[2]

Around 1.07 kg (2.35 lbs)

Packaging Weight

Around 2.95 kg (6.5 lbs)

Case Color

Raven black

Bays

No bays

Expansion Slots

- One M.2 slot (for WLAN, models with Celeron® processor)
- Two M.2 slots (one for WLAN, one for SSD)

EOU

(Optional) Toolless cover and stand assembly / removal

Stand

- Vertical stand
- No stand

Mounting

- Supports VESA mount 100mm
- None

Others

(Optional) Power adapter cage

Notes:

[1] The system dimensions may vary depending on configurations.

[2] The system weight is approximate and based on results in Lenovo® lab, which varies depending on the source of component, variance of the distribution of each component, and manufacturing process. It may not be the exact weight for each specific model.

CONNECTIVITY

Network

Onboard Ethernet

Gigabit Ethernet, Realtek® RTL8111K-CG, 1x RJ-45

WLAN + Bluetooth®

Intel® Wi-Fi® 6E AX211, 802.11ax 2x2 Wi-Fi® + Bluetooth® 5.3, M.2 Card

Ports^[1]

Front Ports

- 1x USB-C® 3.2 Gen 2 (with DP 1.4)
- 2x USB 3.2 Gen 2
- 1x headphone / microphone combo jack (3.5mm)

Rear Ports

- 4x USB 3.2 Gen 1
- 1x HDMI®-out 2.1 TMDS
- 1x DisplayPort™ 1.4
- 1x Ethernet (GbE RJ-45)

Optional Rear Ports**

- 1x HDMI® 2.1 TMDS (Flex IO)
- 1x DP 1.4 (Flex IO)
- None

Notes:

[1] The transfer speed of following ports will vary and, depending on many factors, such as the processing speed of the host device, file attributes and other factors related to system configuration and your operating environment, will be slower than theoretical speed.

USB 2.0: 480 Mbit/s;

USB 3.2 Gen 1 (SuperSpeed USB 5Gbps, formerly USB 3.0 / USB 3.1 Gen 1): 5 Gbit/s;

USB 3.2 Gen 2 (SuperSpeed USB 10Gbps, formerly USB 3.1 Gen 2): 10 Gbit/s;

USB4® 20Gbps / USB 3.2 Gen 2x2 (SuperSpeed USB 20Gbps): 20 Gbit/s;

USB4® 40Gbps (USB 40Gbps): 40 Gbit/s;

Thunderbolt™ 3/4: 40 Gbit/s.

SECURITY & PRIVACY

Security

Security Chip

Google Security Chip H1

Physical Locks

Kensington® Security Slot™

BIOS Security

No support

MANAGEABILITY

System Management

System Management

Non-vPro®

SERVICE

Warranty^[1]

Base Warranty

- 1-year courier or carry-in service
- 1-year limited onsite service
- No base warranty

Notes:

[1] The warranty upgrades may be bundled with some models, please check the "Included upgrade" column in the specific model's configurations. For more service extensions, please go to <https://smartfind.lenovo.com/>. To learn more details of warranty policy, please access <https://pcsupport.lenovo.com/warranty>.

ENVIRONMENTAL

Operating Environment

Temperature

- Operating: 5°C (41°F) to 35°C (95°F)
- Storage: -40°C (-40°F) to 60°C (140°F)

Relative Humidity

- Operating: 20% to 80%
- Storage: 10% to 90%

Altitude

- Operating: -15.2 m (-50 ft) to 3048 m (10,000 ft)
- Storage: -15.2 m (-50 ft) to 10668 m (35,000 ft)

ACCESSORIES

Bundled Accessories

Bundled Accessories

- DP to DVI dongle
- None
- DP to HDMI® dongle

CERTIFICATIONS

Green Certifications^[1]

Green Certifications

- (Optional) ENERGY STAR® 8.0
- (Optional) EPEAT™ Gold Registered^[2]

Notes:

[1] The items listed under the "Green Certifications" section may not only refer to certification but also registration or self-declaration.

[2] EPEAT™ is registered where applicable, please see epeat.net for registration status by country.

Other Certifications

Mil-Spec Test

MIL-STD-810H military test passed (Low Pressure [Altitude], High Temperature, Low Temperature, Temperature Shock, Humidity, Sand and Dust, Vibration, Shock, Fungus, Solar Radiation, Contamination by Fluids, Salt Fog)

- Feature with ** means that only one offering listed under the feature is configured on selected models.
- Feature with *** means that one or more offerings listed under the feature could be configured on selected models.
- Lenovo reserves the right to change specifications or other product information without notice. Lenovo is not responsible for photographic or typographical errors. LENOVO PROVIDES THIS PUBLICATION "AS IS," WITHOUT WARRANTY OF ANY KIND, EITHER EXPRESS OR IMPLIED, INCLUDING THE IMPLIED WARRANTIES OF MERCHANTABILITY OR FITNESS FOR A PARTICULAR PURPOSE. Some jurisdictions do not allow disclaimer of express or implied warranties in certain transactions, therefore this disclaimer may not apply to you.
- The specifications on this page may not be available in all regions, and may be changed or updated without notice.



OVERVIEW

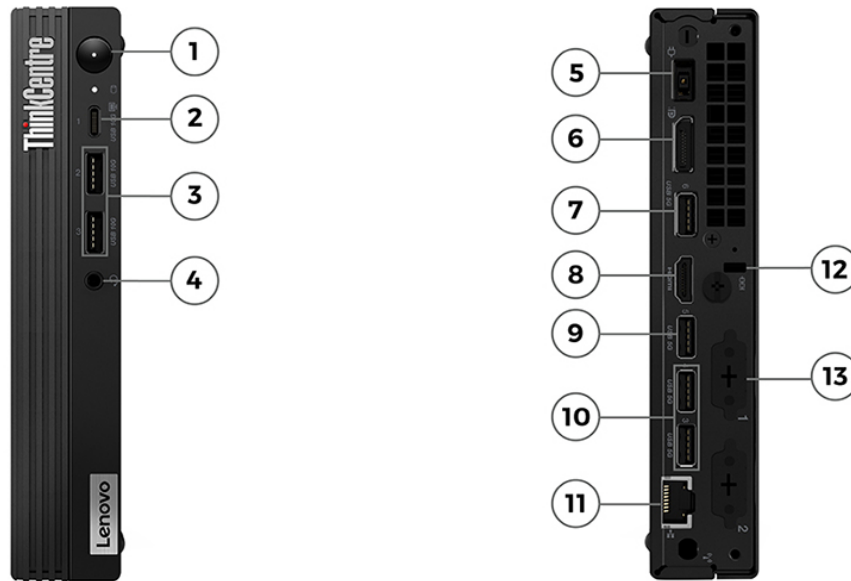

1. Power button	8. HDMI 2.1 TMDs
2. USB-C 3.2 Gen 2 (with DP 1.4)	9. USB 3.2 Gen 1
3. 2x USB 3.2 Gen 2	10. 2x USB 3.2 Gen 1
4. Headphone / microphone combo jack (3.5mm)	11. Ethernet (RJ-45)
5. Power connector	12. Kensington Security Slot
6. DisplayPort 1.4	13. Flex IO *
7. USB 3.2 Gen 1	

Notes:

- Items with * are only available on selected models

PERFORMANCE

Processor

Processor Family

Intel® Celeron® or 12th Generation Intel® U Series Core™ i3 / i5 Processor

Processor**^[1]

Processor Name	Cores	Threads	Base Frequency	Max Frequency	Cache	Memory Support	Processor Graphics
Celeron® 7305	5 (1 P-core + 4 E-core)	6	P-core 1.1GHz / E-core 0.9GHz	-	8MB	DDR4-3200	Intel® UHD Graphics
Core™ i3-1215U	6 (2 P-core + 4 E-core)	8	P-core 1.2GHz / E-core 0.9GHz	P-core 4.4GHz / E-core 3.3GHz ^[2]	10MB	DDR4-3200	Intel® UHD Graphics
Core™ i5-1235U	10 (2 P-core + 8 E-core)	12	P-core 1.3GHz / E-core 0.9GHz	P-core 4.4GHz / E-core 3.3GHz ^[3]	12MB	DDR4-3200	Intel® Iris® Xe Graphics

Notes:

[1] Intel® Iris® Xe Graphics capability requires system to be configured with dual-channel memory. On the system with single-channel memory, Intel® Iris® Xe Graphics will function as Intel® UHD Graphics.

[2], [3], [4] Intel® Max Turbo frequency will vary depending on application workload and the hardware and software configurations, see <http://www.intel.com/technology/turboboost/> for more information.

Operating System

Operating System

ChromeOS

Graphics

Graphics**

Graphics	Type	Memory	Connector	Max Resolution	Key Features
Intel® UHD Graphics	Integrated	Shared	1x DP 1.4 HBR2, 1x USB-C® with DP 1.4 function, 1x HDMI® 2.1 TMDS, 1x punch out port (1x HDMI® 2.1 TMDS or 1x DP 1.4)	4096x2304@60Hz(DP), 4096x2304@60Hz(USB-C® with DP function), 4096x2304@60Hz(HDMI®)	DirectX® 12
Intel® Iris® Xe Graphics ^[1]	Integrated	Shared	1x DP 1.4 HBR2, 1x USB-C® with DP 1.4 function, 1x HDMI® 2.1 TMDS, 1x punch out port (1x HDMI® 2.1 TMDS or 1x DP 1.4)	4096x2304@60Hz(DP), 4096x2304@60Hz(USB-C® with DP function), 4096x2304@60Hz(HDMI®)	DirectX® 12

Notes:

[1] Intel® Iris® Xe Graphics capability requires system to be configured with dual-channel memory. On the system with single-channel memory, Intel® Iris® Xe Graphics will function as Intel® UHD Graphics.

Monitor Support

Monitor Support

Supports up to 4 independent displays via (onboard USB-C®, onboard DP, onboard HDMI®, and one optional port [2nd DP / 2nd HDMI®])

Chipset

Chipset

Intel® SoC (System on Chip) platform

Memory

Max Memory^[1]

Up to 32GB DDR4-3200

Memory Slots

Two DDR4 SO-DIMM slots, dual-channel capable

Memory Type

DDR4-3200

Notes:

[1] The max memory is based on the test results with current Lenovo® memory offerings.

Storage

Storage Support^[1]

One drive, up to 256GB M.2 2280 SSD or 64GB eMMC 5.1 on systemboard

Storage Type^{***}

Disk Type	Interface
M.2 2280 SSD	PCIe® NVMe®, PCIe® 4.0 x4
Flash Memory ^[2]	eMMC 5.1
M.2 2242 SSD	PCIe® NVMe®, PCIe® 3.0 x4

RAID

No support

Notes:

[1] The max capacity of each disk type is based on the test results with current Lenovo® storage offerings.

[2] EMMC is pre-configured, not upgradable.

Removable Storage

Optical

None

Card Reader

No card reader

Multi-Media

Audio Chip

High Definition (HD) Audio, Realtek® ALC5682I codec

Speakers

No speakers

Microphone

No microphone

Camera

No camera

Power Supply

Power Supply^{**}

Power	Type	Efficiency	Key Features
65W	Adapter	89%	Autosensing
90W	Adapter	89%	Autosensing

DESIGN

Input Device

Keyboard

- Chrome USB Keyboard, black
- No keyboard

Mouse

- USB Calliope Mouse, black
- No mouse

Mechanical

Form Factor

Tiny (1L)

Dimensions (WxDxH)^[1]

178 x 182 x 34 mm (7 x 7.16 x 1.33 inches)

Packaging Dimensions (WxDxH)

140 x 485 x 270 (5.51 x 19.1x 10.6 inches)

Weight^[2]

Around 1.07 kg (2.35 lbs)

Packaging Weight

Around 2.95 kg (6.5 lbs)

Case Color

Raven black

Bays

No bays

Expansion Slots

- One M.2 slot (for WLAN, models with Celeron® processor)
- Two M.2 slots (one for WLAN, one for SSD)

EOU

(Optional) Toolless cover and stand assembly / removal

Stand

- Vertical stand
- No stand

Mounting

- Supports VESA mount 100mm
- None

Others

(Optional) Power adapter cage

Notes:

[1] The system dimensions may vary depending on configurations.

[2] The system weight is approximate and based on results in Lenovo® lab, which varies depending on the source of component, variance of the distribution of each component, and manufacturing process. It may not be the exact weight for each specific model.

CONNECTIVITY

Network

Onboard Ethernet

Gigabit Ethernet, Realtek® RTL8111K-CG, 1x RJ-45

WLAN + Bluetooth®

Intel® Wi-Fi® 6E AX211, 802.11ax 2x2 Wi-Fi® + Bluetooth® 5.3, M.2 Card

Ports^[1]

Front Ports

- 1x USB-C® 3.2 Gen 2 (with DP 1.4)
- 2x USB 3.2 Gen 2
- 1x headphone / microphone combo jack (3.5mm)

Rear Ports

- 4x USB 3.2 Gen 1
- 1x HDMI® 2.1 TMDS
- 1x DisplayPort™ 1.4
- 1x Ethernet (GbE RJ-45)

Optional Rear Ports**

- 1x HDMI® 2.1 TMDS (Flex IO)
- 1x DP 1.4 (Flex IO)
- None

Notes:

[1] The transfer speed of following ports will vary and, depending on many factors, such as the processing speed of the host device, file attributes and other factors related to system configuration and your operating environment, will be slower than theoretical speed.

USB 2.0: 480 Mbit/s;

USB 3.2 Gen 1 (SuperSpeed USB 5Gbps, formerly USB 3.0 / USB 3.1 Gen 1): 5 Gbit/s;

USB 3.2 Gen 2 (SuperSpeed USB 10Gbps, formerly USB 3.1 Gen 2): 10 Gbit/s;

USB4® 20Gbps / USB 3.2 Gen 2x2 (SuperSpeed USB 20Gbps): 20 Gbit/s;

USB4® 40Gbps (USB 40Gbps): 40 Gbit/s;

Thunderbolt™ 3/4: 40 Gbit/s.

SECURITY & PRIVACY

Security

Security Chip

Google Security Chip H1

Physical Locks

Kensington® Security Slot™

BIOS Security

No support

MANAGEABILITY

System Management

System Management

Non-vPro®

SERVICE

Warranty^[1]

Base Warranty

- 1-year courier or carry-in service
- 1-year limited onsite service
- No base warranty

Notes:

[1] The warranty upgrades may be bundled with some models, please check the "Included upgrade" column in the specific model's configurations. For more service extensions, please go to <https://smartfind.lenovo.com/>. To learn more details of warranty policy, please access <https://pcsupport.lenovo.com/warranty>.

ENVIRONMENTAL

Operating Environment

Temperature

- Operating: 5°C (41°F) to 35°C (95°F)
- Storage: -40°C (-40°F) to 60°C (140°F)

Relative Humidity

- Operating: 20% to 80%
- Storage: 10% to 90%

Altitude

- Operating: -15.2 m (-50 ft) to 3048 m (10,000 ft)
- Storage: -15.2 m (-50 ft) to 10668 m (35,000 ft)

ACCESSORIES

Bundled Accessories

Bundled Accessories

- DP to DVI dongle
- None
- DP to HDMI® dongle

CERTIFICATIONS

Green Certifications^[1]

Green Certifications

- (Optional) ENERGY STAR® 8.0
- (Optional) EPEAT™ Gold Registered^[2]

Notes:

[1] The items listed under the "Green Certifications" section may not only refer to certification but also registration or self-declaration.

[2] EPEAT™ is registered where applicable, please see epeat.net for registration status by country.

Other Certifications

Mil-Spec Test

MIL-STD-810H military test passed (Low Pressure [Altitude], High Temperature, Low Temperature, Temperature Shock, Humidity, Sand and Dust, Vibration, Shock, Fungus, Solar Radiation, Contamination by Fluids, Salt Fog)

- Feature with ** means that only one offering listed under the feature is configured on selected models.
- Feature with *** means that one or more offerings listed under the feature could be configured on selected models.
- Lenovo reserves the right to change specifications or other product information without notice. Lenovo is not responsible for photographic or typographical errors. LENOVO PROVIDES THIS PUBLICATION "AS IS," WITHOUT WARRANTY OF ANY KIND, EITHER EXPRESS OR IMPLIED, INCLUDING THE IMPLIED WARRANTIES OF MERCHANTABILITY OR FITNESS FOR A PARTICULAR PURPOSE. Some jurisdictions do not allow disclaimer of express or implied warranties in certain transactions, therefore this disclaimer may not apply to you.
- The specifications on this page may not be available in all regions, and may be changed or updated without notice.

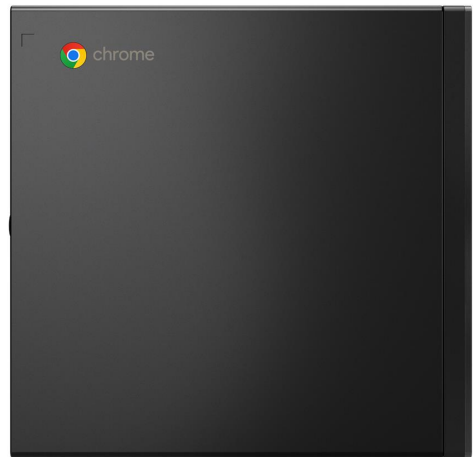

OVERVIEW

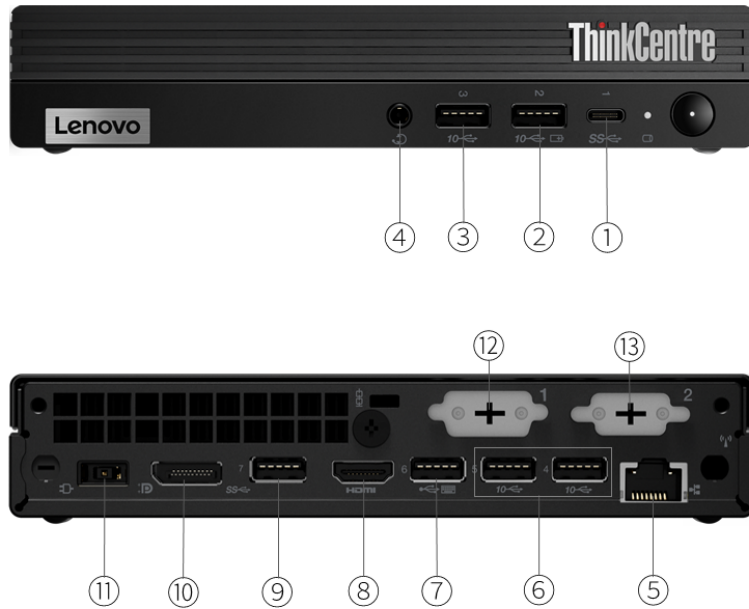

1. USB-C 3.2 Gen 1	8. HDMI 2.1 TMDS
2. USB 3.2 Gen 2 (Always On and fast charge)	9. USB 3.2 Gen 1
3. USB 3.2 Gen 2	10. DisplayPort 1.4
4. Headphone / microphone combo jack (3.5mm)	11. Power connector
5. Ethernet (RJ-45)	12. Punch out port 1 *
6. 2x USB 3.2 Gen 2	13. Punch out port 2 *
7. 1x USB 2.0 (with smart power-on feature)	

Notes:

- Items with * are only available on selected models

PERFORMANCE

Processor

Processor Family

Intel® Celeron®, Intel® Pentium®, or 12th Generation Intel® Core™ i3 / i5 / i7 / i9 Processor

Processor**

Processor Name	Cores	Threads	Base Frequency	Max Frequency	Cache	Processor Graphics
Celeron® G6900T	2	2	2.8GHz	-	4MB	Intel® UHD Graphics 710
Pentium® Gold G7400T	2	4	3.1GHz	-	6MB	Intel® UHD Graphics 710
Core™ i3-12100T	4 (4 P-core + 0 E-core)	8	P-core 2.2GHz	P-core 4.1GHz ^[1]	12MB	Intel® UHD Graphics 730
Core™ i3-12300T	4 (4 P-core + 0 E-core)	8	P-core 2.3GHz	P-core 4.2GHz ^[2]	12MB	Intel® UHD Graphics 730
Core™ i5-12400T	6 (6 P-core + 0 E-core)	12	P-core 1.8GHz	P-core 4.2GHz ^[3]	18MB	Intel® UHD Graphics 730
Core™ i5-12500T	6 (6 P-core + 0 E-core)	12	P-core 2.0GHz	P-core 4.4GHz ^[4]	18MB	Intel® UHD Graphics 770
Core™ i5-12600T	6 (6 P-core + 0 E-core)	12	P-core 2.1GHz	P-core 4.6GHz ^[5]	18MB	Intel® UHD Graphics 770
Core™ i7-12700T	12 (8 P-core + 4 E-core)	20	P-core 1.4GHz / E-core 1.0GHz	Max Turbo up to 4.7GHz / P-core 4.6GHz / E-core 3.4GHz ^[6]	25MB	Intel® UHD Graphics 770
Core™ i9-12900T	16 (8 P-core + 8 E-core)	24	P-core 1.4GHz / E-core 1.0GHz	Max Turbo up to 4.9GHz / P-core 4.8GHz / E-core 3.6GHz ^[7]	30MB	Intel® UHD Graphics 770

Notes:

[1], [2], [3], [4], [5], [6], [7] Intel® Max Turbo frequency will vary depending on application workload and the hardware and software configurations, see <http://www.intel.com/technology/turboboost/> for more information.

Operating System

Operating System**

- Windows® 11 Pro
- Windows® 11 Home
- Windows® 11 Home Single Language
- Windows® 11 DG Windows® 10 Pro 64
- Windows® 10 IoT Enterprise LTSC 2021
- Ubuntu Linux^[1]
- No preload operating system

Notes:

[1] Some features may not be supported on the system with Linux preload, including but not limited to Intel® RST RAID, Human Presence Detection, etc.

Graphics

Graphics**

Graphics	Type	Memory	Connector	Max Resolution	Key Features
Intel® UHD graphics 710	Integrated	Shared	1x HDMI® 2.1 TMDs, 1x DP 1.4, 2x punch out ports([2x HDMI®/VGA/DP] or [USB-C® with DP function, HDMI®/VGA/DP])	4096x2160@60Hz(HDMI®), 1920x1200@60Hz(VGA), 4096x2160@60Hz(DP), 4096x2160@60Hz(USB-C® with DP function)	DirectX® 12

ThinkCentre M70q Gen 3

Intel® UHD graphics 730	Integrated	Shared	1x HDMI® 2.1 TMDS, 1x DP 1.4, 2x punch out ports([2x HDMI®/VGA/DP] or [USB-C® with DP function, HDMI®/VGA/DP])	4096x2304@60Hz(HDMI®), 1920x1200@60Hz(VGA), 4096x2304@60Hz(DP), 4096x2304@60Hz(USB-C® with DP function)	DirectX® 12
Intel® UHD graphics 770	Integrated	Shared	1x HDMI® 2.1 TMDS, 1x DP 1.4, 2x punch out ports([2x HDMI®/VGA/DP] or [USB-C® with DP function, HDMI®/VGA/DP])	4096x2304@60Hz(HDMI®), 1920x1200@60Hz(VGA), 4096x2304@60Hz(DP), 4096x2304@60Hz(USB-C® with DP function)	DirectX® 12

Monitor Support

Monitor Support

Supports up to 4 independent displays via (onboard DP, onboard HDMI®, punch out port 1 [VGA / HDMI® / DP / USB-C®], and punch out port 2 [VGA / HDMI® / DP])

Chipset

Chipset

Intel® Q670 chipset

Memory

Max Memory^[1]

Up to 64GB DDR4-3200

Memory Slots

Two DDR4 SO-DIMM slots, dual-channel capable

Memory Type

DDR4-3200

Notes:

[1] The max memory is based on the test results with current Lenovo® memory offerings.

Storage

Storage Support^[1]

Up to two drives, 1x 2.5" HDD + 1x M.2 SSD

- 2.5" HDD up to 1TB
- M.2 SSD up to 2TB

Storage Type^{***}

Disk Type	Interface	RPM	Security
2.5" SATA HDD	SATA 6Gb/s	7.2K	-
M.2 2280 SSD	PCIe® NVMe®, PCIe® 4.0 x4	-	-
M.2 2280 SSD	PCIe® NVMe®, PCIe® 4.0 x4	-	Opal 2.0
M.2 2242 SSD	PCIe® NVMe®, PCIe® 3.0 x2	-	-

RAID

No support

Notes:

[1] The max capacity of each disk type is based on the test results with current Lenovo® storage offerings.

Removable Storage

Optical^{**}

- DVD-ROM, slim (9.0mm), via USB external ODD box
- DVD burner (DVD±RW), slim (9.0mm), via USB external ODD box
- None

Card Reader

No card reader

Multi-Media

Audio Chip

High Definition (HD) Audio, Realtek® ALC256VB codec

Speakers**

- Premium single speaker, 2W x1
- Single speaker, 2W x1

Power Supply

Power Supply**^[1]

Power	Type	Efficiency	Key Features
65W	Adapter	89%	Autosensing
90W	Adapter	89%	Autosensing
135W	Adapter	89%	Autosensing
No power supply	-	-	-

Notes:

^[1] The optional 90w adapter may increase performance scores when 12500T/12400T CPUs are installed.

DESIGN

Input Device

Keyboard**

- Lenovo® Calliope Keyboard (USB connector), black
- Lenovo® Calliope Wireless Keyboard, black
- Lenovo® Traditional Keyboard (USB connector), black
- No keyboard

Mouse**

- Lenovo® Calliope Mouse (USB connector), black
- Lenovo® Calliope Wireless Mouse (2.4GHz via USB receiver), black
- Lenovo® Fingerprint Mouse (USB connector), black (EOL on Jan, 2023)
- No mouse

Mechanical

Form Factor

Tiny (1L)

Dimensions (WxDxH)^[1]

Models	Dimensions
Tiny only	179 x 182.9 x 36.5 mm with rubber feet (7.05 x 7.2 x 1.44 inches with rubber feet)
Tiny & ODD	204.2 x 186.6 x 64 mm with rubber feet (8.04 x 7.35 x 2.52 inches with rubber feet)

Packaging Dimensions (WxDxH)**^[2]

- Tiny only: 490 x 250 x 130 mm (19.29 x 9.84 x 5.12 inches)
- Tiny & ODD: 490 x 268 x 166 mm (19.29 x 10.55 x 6.54 inches)

Weight^[3]

Models	Weight
Tiny only	Around 1.25 kg (2.76 lbs)
With VESA mount & ODD box	Around 1.74 kg (3.84 lbs)

Packaging Weight**^[4]

- Tiny only: Around 3.2 kg (7.05 lbs)
- Tiny & ODD: Around 3.9 kg (8.6 lbs)

Case Color

Raven black

Bays

1x 2.5" disk bay

Expansion Slots

Two M.2 slots (one for WLAN, one for SSD)

EOU

(Optional) Toolless cover (toolless chassis screw required), stand, optional 2.5" HDD bracket assembly / removal

Stand

- Vertical stand
- No stand

IO Box

No IO box

Mounting

- VESA mount bracket kit, supports VESA mount 75mm and 100mm
- None

Others

- (Optional) Dust filter
- (Optional) Power adapter cage
- Supports Smart Power On

Notes:

[1] The system dimensions may vary depending on configurations.

[2] The new packages take effect from September 2023. The old packages are:

Tiny only: 500 x 150 x 280 mm (19.69 x 5.91 x 11.02 inches)

Tiny & ODD: 500 x 175 x 280 mm (19.69 x 6.89 x 11.02 inches)

[3] The system weight is approximate and based on results in Lenovo® lab, which varies depending on the source of component, variance of the distribution of each component, and manufacturing process. It may not be the exact weight for each specific model.

[4] The new packages take effect from September 2023. The old package are:

Tiny only: 2.85 kg (6.28 lbs)

Tiny & ODD: 3.58 kg (7.89 lbs)

CONNECTIVITY

Network

Onboard Ethernet

Gigabit Ethernet, Intel® Ethernet Connection I219-LM, 1x RJ-45, supports Wake-on-LAN

Optional Ethernet^[1]

- 2.5 Gigabit Ethernet, Realtek® RTL8125BGS, 1x RJ-45, supports Wake-on-LAN
- No optional Ethernet

WLAN + Bluetooth®**

- Realtek® RTL8822CE, 802.11ac Dual Band 2x2 Wi-Fi® + Bluetooth® 5.0, M.2 card
- Intel® Wireless-AC 9560, 802.11ac Dual Band 2x2 Wi-Fi® + Bluetooth® 5.1, M.2 card
- Realtek® Wi-Fi® 6 RTL8852BE, 802.11ax Dual Band 2x2 Wi-Fi® + Bluetooth® 5.3, M.2 card^[2]
- Intel® Wi-Fi® 6 AX201, 802.11ax 2x2 Wi-Fi® + Bluetooth® 5.2, Intel® vPro® technology support, M.2 Card^[3]
- Intel® Wi-Fi® 6 AX201, 802.11ax 2x2 Wi-Fi® + Bluetooth® 5.2, M.2 Card^[4]
- Intel® Wi-Fi® 6E AX211, 802.11ax 2x2 Wi-Fi® + Bluetooth® 5.3, Intel® vPro® technology support, M.2 Card^[5]
- No WLAN and Bluetooth®

Notes:

[1] Optional Ethernet card occupied puch out port 2.

[2], [5] Bluetooth® 5.3 requires Windows® 11.

[3], [4] Bluetooth® 5.2 requires Windows® 11.

Ports^[1]

Front Ports

- 1x USB-C® 3.2 Gen 1 (support data transfer and 5V@0.9A charging)
- 1x USB 3.2 Gen 2 (Always On and 5V@2.1A charging)
- 1x USB 3.2 Gen 2
- 1x headphone / microphone combo jack (3.5mm)

Optional Front Ports

None

Rear Ports

- 1x USB 2.0
- 1x USB 3.2 Gen 1
- 2x USB 3.2 Gen 2
- 1x HDMI® 2.1 TMDS
- 1x DisplayPort™ 1.4
- 1x Ethernet (RJ-45)

Optional Rear Ports**

- Punch out port 1 (one of VGA / DisplayPort™ / HDMI® / serial / USB-C® 2.0 with DisplayPort™ function)
- Punch out port 2 (one of VGA / DisplayPort™ / HDMI® / serial / RJ-45)

Notes:

[1] The transfer speed of following ports will vary and, depending on many factors, such as the processing speed of the host device, file attributes and other factors related to system configuration and your operating environment, will be slower than theoretical speed.

USB 2.0: 480 Mbit/s;

USB 3.2 Gen 1 (SuperSpeed USB 5Gbps, formerly USB 3.0 / USB 3.1 Gen 1): 5 Gbit/s;

USB 3.2 Gen 2 (SuperSpeed USB 10Gbps, formerly USB 3.1 Gen 2): 10 Gbit/s;

USB4® 20Gbps / USB 3.2 Gen 2x2 (SuperSpeed USB 20Gbps): 20 Gbit/s;

USB4® 40Gbps (USB 40Gbps): 40 Gbit/s;

Thunderbolt™ 3/4: 40 Gbit/s.

SECURITY & PRIVACY

Security

Security Chip

Discrete TPM 2.0, TCG certified

Physical Locks

Kensington® Security Slot™, 3 x 7 mm

Chassis Intrusion Switch

Chassis intrusion switch

Fingerprint Reader

- Touch style fingerprint reader on mouse (EOL on Jan, 2023)
- No fingerprint reader

BIOS Security

- Administrator password
- Power-on password
- Hard disk password
- Boot sequence control
- Boot without keyboard and mouse
- Certificate based BIOS management
- Cover presence switch
- Self-healing BIOS
- Smart USB protection (allows keyboard / mouse only, blocks all storage devices)
- Individual USB port disablement

MANAGEABILITY

System Management

System Management

- Intel® vPro® Enterprise^[1]
- Non-vPro®

Notes:

[1] Intel® vPro® offers a superset of DASH's defined capabilities.

SERVICE

Warranty^[1]

Base Warranty**

- 1-year courier or carry-in service
- 1-year limited onsite service
- 3-year limited onsite service
- No base warranty

Notes:

[1] The warranty upgrades may be bundled with some models, please check the "Included upgrade" column in the specific model's configurations. For more service extensions, please go to <https://smartfind.lenovo.com/>. To learn more details of warranty policy, please access <https://pcsupport.lenovo.com/warranty>.

ENVIRONMENTAL

Sustainability

Material^[1]

85% PCC recycled plastic used in product chassis.

95% PCC recycled plastic used in USB keyboard/mouse.

90% PIC recycled plastic EPE cushion or 90% PCC recycled plastic thermal shell with 30% OBP material.

30% OBP used in bag.

FSC certified paper in packaging.

Notes:

[1] PCC: Post Consumer Content, recycled materials from customers.

PIC: Post Industry Content, recycled materials from internal factories.

EPE: Expanded Polyethylene.

OBP: Ocean Bound Plastic, reducing plastic spill into the sea.

FSC: Forest Stewardship Council.

Operating Environment

Temperature

- Operating: 5°C (41°F) to 35°C (95°F)
- Storage: -40°C (-40°F) to 60°C (140°F)

Relative Humidity

- Operating: 20% to 80%
- Storage: 10% to 90%

Altitude

- Operating: 0 m (0 ft) to 3048 m (10,000 ft)
- Storage: 0 m (0 ft) to 12192 m (40,000 ft)

ACCESSORIES

Bundled Accessories

Bundled Accessories

- DP to DVI dongle
- DP to Dual DP dongle
- HDMI® to HDMI® dongle
- HDMI® to VGA dongle
- None

- DP to HDMI® dongle
- DP to VGA dongle

CERTIFICATIONS

Green Certifications^[1]

Green Certifications

- (Optional) EPEAT™ Gold Registered^[2]
- ENERGY STAR® 8.0
- ErP Lot 3 and Lot 7
- RoHS compliant
- TCO Certified 9.0

Notes:

[1] The items listed under the "Green Certifications" section may not only refer to certification but also registration or self-declaration.

[2] EPEAT™ is registered where applicable, please see [epeat.net](https://www.epeat.net) for registration status by country.

Other Certifications

Other Certifications

- (Optional) TÜV Rheinland® Low Noise
- (Optional) TÜV Rheinland® Ultra Low Noise

Mil-Spec Test

MIL-STD-810H military test passed (Low Pressure [Altitude], High Temperature, Low Temperature, Temperature Shock, Humidity, Sand and Dust, Vibration, Shock, Fungus, Solar Radiation)

- Feature with ** means that only one offering listed under the feature is configured on selected models.
- Feature with *** means that one or more offerings listed under the feature could be configured on selected models.
- Lenovo reserves the right to change specifications or other product information without notice. Lenovo is not responsible for photographic or typographical errors. LENOVO PROVIDES THIS PUBLICATION "AS IS," WITHOUT WARRANTY OF ANY KIND, EITHER EXPRESS OR IMPLIED, INCLUDING THE IMPLIED WARRANTIES OF MERCHANTABILITY OR FITNESS FOR A PARTICULAR PURPOSE. Some jurisdictions do not allow disclaimer of express or implied warranties in certain transactions, therefore this disclaimer may not apply to you.
- The specifications on this page may not be available in all regions, and may be changed or updated without notice.

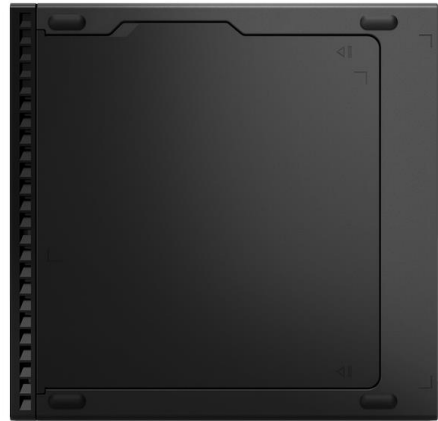

OVERVIEW

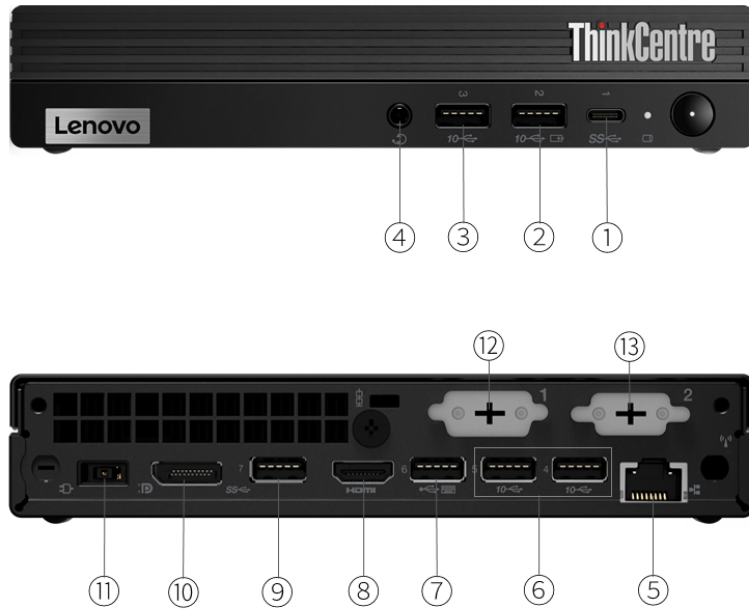

1. USB-C 3.2 Gen 1	8. HDMI 2.1 TMDS
2. USB 3.2 Gen 2 (Always On and fast charge)	9. USB 3.2 Gen 1
3. USB 3.2 Gen 2	10. DisplayPort 1.4a
4. Headphone / microphone combo jack (3.5mm)	11. Power connector
5. Ethernet (RJ-45)	12. Punch out port 1 *
6. 2x USB 3.2 Gen 2	13. Punch out port 2 *
7. 1x USB 2.0 (with smart power-on feature)	

Notes:

- Items with * are only available on selected models

PERFORMANCE

Processor

Processor Family

13th Generation Intel® Core™ i3 / i5 / i7 Processor

Processor**

Processor Name	Cores	Threads	Base Frequency	Max Frequency	Cache	Processor Graphics
Core™ i3-13100T	4 (4 P-core + 0 E-core)	8	P-core 2.5GHz	P-core 4.2GHz ^[1]	12MB	Intel® UHD Graphics 730
Core™ i5-13400T	10 (6 P-core + 4 E-core)	16	P-core 1.3GHz / E-core 1.0GHz	P-core 4.4GHz / E-core 3.0GHz ^[2]	20MB	Intel® UHD Graphics 730
Core™ i5-13500T	14 (6 P-core + 8 E-core)	20	P-core 1.6GHz / E-core 1.2GHz	P-core 4.6GHz / E-core 3.2GHz ^[3]	24MB	Intel® UHD Graphics 770
Core™ i5-13600T	14 (6 P-core + 8 E-core)	20	P-core 1.8GHz / E-core 1.3GHz	P-core 4.8GHz / E-core 3.4GHz ^[4]	24MB	Intel® UHD Graphics 770
Core™ i7-13700T	16 (8 P-core + 8 E-core)	24	P-core 1.4GHz / E-core 1.0GHz	Max Turbo up to 4.9GHz / P-core 4.8GHz / E-core 3.6GHz ^[5]	30MB	Intel® UHD Graphics 770

Notes:

[1], [2], [3], [4], [5] Intel® Max Turbo frequency will vary depending on application workload and the hardware and software configurations, see

<http://www.intel.com/technology/turboboost/> for more information.

Operating System

Operating System**

- Windows® 11 Pro
- Windows® 11 Home
- Windows® 11 DG Windows® 10 Pro 64
- Windows® 10 IoT Enterprise LTSC 2021
- Ubuntu Linux^[1]
- No preload operating system

Notes:

[1] Some features may not be supported on the system with Linux preload, including but not limited to Intel® RST RAID, Human Presence Detection, etc.

Graphics

Graphics**

Graphics	Type	Memory	Connector	Max Resolution	Key Features
Intel® UHD graphics 730	Integrated	Shared	1x HDMI® 2.1 TMDS, 1x DP 1.4a (HBR2, DSC), 2x punch out ports ([2x HDMI®/VGA/DP] or [USB-C® with DP function, HDMI®/VGA/DP])	4096x2304@60Hz(HDMI®), 1920x1200@60Hz(VGA), 4096x2304@60Hz(DP), 4096x2304@60Hz(USB-C® with DP function)	DirectX® 12
Intel® UHD graphics 770	Integrated	Shared	1x HDMI® 2.1 TMDS, 1x DP 1.4a (HBR2, DSC), 2x punch out ports ([2x HDMI®/VGA/DP] or [USB-C® with DP function, HDMI®/VGA/DP])	4096x2304@60Hz(HDMI®), 1920x1200@60Hz(VGA), 4096x2304@60Hz(DP), 4096x2304@60Hz(USB-C® with DP function)	DirectX® 12

Monitor Support

Monitor Support

Supports up to 4 independent displays via (onboard DP, onboard HDMI®, punch out port 1 [VGA / HDMI® / DP / USB-C®], and punch out port 2 [VGA / HDMI® / DP])

Chipset

Chipset

Intel® Q670 chipset

Memory

Max Memory^[1]

Up to 64GB DDR4-3200

Memory Slots

Two DDR4 SO-DIMM slots, dual-channel capable

Memory Type

DDR4-3200

Notes:

[1] The max memory is based on the test results with current Lenovo® memory offerings.

Storage

Storage Support^[1]

Up to two drives, 1x 2.5" HDD + 1x M.2 SSD

- 2.5" HDD up to 1TB
- M.2 SSD up to 2TB

Storage Type^{***}

Disk Type	Interface	RPM	Security
2.5" SATA HDD	SATA 6Gb/s	7.2K	-
M.2 2280 SSD	PCIe® NVMe®, PCIe® 4.0 x4	-	Opal 2.0
M.2 2242 SSD	PCIe® NVMe®, PCIe® 3.0 x4	-	-

RAID

No support

Notes:

[1] The max capacity of each disk type is based on the test results with current Lenovo® storage offerings.

Removable Storage

Optical

None

Card Reader

No card reader

Multi-Media

Audio Chip

High Definition (HD) Audio, Realtek® ALC256VB codec

Speakers^{**}

- Premium single speaker, 2W x1
- Single speaker, 2W x1

Power Supply

Power Supply^{**[1]}

Power	Type	Efficiency	Key Features
65W	Adapter	89%	Autosensing
90W	Adapter	89%	Autosensing
135W	Adapter	90%	Autosensing

Notes:

[1] When work with TIO monitor, an appropriate power adapter is needed. Customer may need to:

- Order a Tiny for TIO MT (12E5, 12E6 or 12E8) models
- Or for Intel® Core™ i5/i7 models order an additional 135W power adapter, for Intel® Core™ i3 models order an additional 90W power adapter. If original power adapter is less than 135W (i5/i7 models) or 90W (i3 models).

DESIGN

Input Device

Keyboard**

- Lenovo® Calliope Keyboard (USB connector), black
- Lenovo® Calliope Wireless Keyboard, black
- Lenovo® Traditional Keyboard (USB connector), black
- No keyboard

Mouse**

- Lenovo® Calliope Mouse (USB connector), black
- Lenovo® Calliope Wireless Mouse (2.4GHz via USB receiver), black
- No mouse

Mechanical

Form Factor

Tiny (1L)

Dimensions (WxDxH)^[1]

Models	Dimensions
Tiny only	179 x 182.9 x 36.5 mm with rubber feet (7.05 x 7.2 x 1.44 inches with rubber feet)
Tiny & ODD	204.2 x 186.6 x 64 mm with rubber feet (8.04 x 7.35 x 2.52 inches with rubber feet)

Packaging Dimensions (WxDxH)**^[2]

- Tiny only: 490 x 250 x 130 mm (19.29 x 9.84 x 5.12 inches)
- Tiny & ODD: 490 x 268 x 166 mm (19.29 x 10.55 x 6.54 inches)

Weight^[3]

Models	Weight
Tiny only	Around 1.25 kg (2.76 lbs)
With VESA mount & ODD box	Around 1.74 kg (3.84 lbs)

Packaging Weight**^[4]

- Tiny only: Around 3.2 kg (7.05 lbs)
- Tiny & ODD: Around 3.9 kg (8.6 lbs)

Case Color

Raven black

Bays

- 1x 2.5" disk bay (optional, or bay comes with disk)
- No bays

Expansion Slots

Two M.2 slots (one for WLAN, one for SSD)

EOU

(Optional) toolless chassis open (toolless chassis screw required) and toolless M.2 SSD, HDD, memory assembly / removal

Stand

- Vertical stand
- No stand

IO Box

No IO box

Mounting

- VESA mount bracket kit, supports VESA mount 75mm and 100mm

- None

Others

- (Optional) Dust filter
- (Optional) Power adapter cage

Notes:

[1] The system dimensions may vary depending on configurations.

[2] The new packages take effect from September 2023. The old packages are:

Tiny only : 490 x 268 x 141 mm (19.29 x 10.55 x 5.55 inches)

Tiny & ODD : 490 x 268 x 166 mm (19.29 x 10.55 x 6.54 inches)

[3] The system weight is approximate and based on results in Lenovo® lab, which varies depending on the source of component, variance of the distribution of each component, and manufacturing process. It may not be the exact weight for each specific model.

[4] The new packages take effect from September 2023. The old package are:

Tiny only: 2.85 kg (6.28 lbs)

Tiny & ODD: 3.58 kg (7.89 lbs)

CONNECTIVITY

Network

Onboard Ethernet

Gigabit Ethernet, Intel® Ethernet Connection I219-LM, 1x RJ-45, supports Wake-on-LAN

Optional Ethernet

- 2.5 Gigabit Ethernet, Realtek® RTL8125BGS, 1x RJ-45, supports Wake-on-LAN^[1]
- No optional Ethernet

WLAN + Bluetooth^{}**

- Realtek® Wi-Fi® 6 RTL8852BE, 802.11ax Dual Band 2x2 Wi-Fi® + Bluetooth® 5.3, M.2 card^[2]
- Intel® Wi-Fi® 6 AX201, 802.11ax 2x2 Wi-Fi® + Bluetooth® 5.2, M.2 Card^[3]
- Intel® Wi-Fi® 6E AX211, 802.11ax 2x2 Wi-Fi® + Bluetooth® 5.3, Intel® vPro® technology support, M.2 Card^[4]
- No WLAN and Bluetooth®

Notes:

[1] Optional Ethernet card occupied punch out port 2.

[2], [4] Bluetooth® 5.3 requires Windows® 11.

[3] Bluetooth® 5.2 requires Windows® 11.

Ports^[1]

Front Ports

- 1x USB-C® 3.2 Gen 1 (support data transfer and 5V@0.9A charging)
- 1x USB 3.2 Gen 2 (Always On and 5V@2.1A charging)
- 1x USB 3.2 Gen 2
- 1x headphone / microphone combo jack (3.5mm)

Optional Front Ports

None

Rear Ports

- 1x USB 2.0
- 1x USB 3.2 Gen 1
- 2x USB 3.2 Gen 2
- 1x HDMI® 2.1 TMDS
- 1x DisplayPort™ 1.4a (HBR2, DSC)
- 1x Ethernet (RJ-45)

Optional Rear Ports^{*}**

- Punch out port 1 (one of VGA / DisplayPort™ / HDMI® / serial / USB-C® 2.0 with DisplayPort™ function)
- Punch out port 2 (one of VGA / DisplayPort™ / HDMI® / serial / RJ-45)

Notes:

[1] The transfer speed of following ports will vary and, depending on many factors, such as the processing speed of the

host device, file attributes and other factors related to system configuration and your operating environment, will be slower than theoretical speed.

USB 2.0: 480 Mbit/s;

USB 3.2 Gen 1 (SuperSpeed USB 5Gbps, formerly USB 3.0 / USB 3.1 Gen 1): 5 Gbit/s;

USB 3.2 Gen 2 (SuperSpeed USB 10Gbps, formerly USB 3.1 Gen 2): 10 Gbit/s;

USB4® 20Gbps / USB 3.2 Gen 2x2 (SuperSpeed USB 20Gbps): 20 Gbit/s;

USB4® 40Gbps (USB 40Gbps): 40 Gbit/s;

Thunderbolt™ 3/4: 40 Gbit/s.

SECURITY & PRIVACY

Security

Security Chip

Discrete TPM 2.0, TCG certified

Physical Locks

Kensington® Security Slot™, 3 x 7 mm

Chassis Intrusion Switch

Chassis intrusion switch

Fingerprint Reader

No fingerprint reader

BIOS Security

- Administrator password
- Power-on password
- Hard disk password
- Boot sequence control
- Boot without keyboard and mouse
- Certificate based BIOS management
- Cover presence switch
- Self-healing BIOS
- Smart USB protection (allows keyboard / mouse only, blocks all storage devices)
- Individual USB port disablement

MANAGEABILITY

System Management

System Management

- Intel® vPro® Enterprise^[1]
- Non-vPro®

Notes:

[1] Intel® vPro® offers a superset of DASH's defined capabilities.

SERVICE

Warranty^[1]

Base Warranty

- 1-year courier or carry-in service
- 1-year limited onsite service
- 3-year limited onsite service
- No base warranty

Notes:

[1] The warranty upgrades may be bundled with some models, please check the "Included upgrade" column in the specific model's configurations. For more service extensions, please go to <https://smartfind.lenovo.com/>. To learn more details of warranty policy, please access <https://pcsupport.lenovo.com/warranty>.

ENVIRONMENTAL

Sustainability

Material^[1]

- 85% PCC recycled plastic used in product chassis.
- 95% PCC recycled plastic used in USB keyboard/mouse.
- 90% PIC recycled plastic EPE cushion or 90% PCC recycled plastic thermal shell with 30% OBP material.
- 30% OBP used in bag.
- FSC certified paper in packaging.

Notes:

- [1] PCC: Post Consumer Content, recycled materials from customers.
- PIC: Post Industry Content, recycled materials from internal factories.
- EPE: Expanded Polyethylene.
- OBP: Ocean Bound Plastic, reducing plastic spill into the sea.
- FSC: Forest Stewardship Council.

Operating Environment

Temperature

- Operating: 5°C (41°F) to 35°C (95°F)
- Storage: -40°C (-40°F) to 60°C (140°F)

Relative Humidity

- Operating: 20% to 80%
- Storage: 10% to 90%

Altitude

- Operating: 0 m (0 ft) to 3048 m (10,000 ft)
- Storage: 0 m (0 ft) to 12192 m (40,000 ft)

ACCESSORIES

Bundled Accessories

Bundled Accessories

- DP to DVI dongle
- DP to Dual DP dongle
- HDMI® to HDMI® dongle
- HDMI® to VGA dongle
- None
- DP to HDMI® dongle
- DP to VGA dongle

CERTIFICATIONS

Green Certifications^[1]

Green Certifications

- (Optional) EPEAT™ Silver Registered^[2]
- (Optional) EPEAT™ Gold Registered^[3]
- ENERGY STAR® 8.0
- ErP Lot 3 and Lot 7
- RoHS compliant
- TCO Certified

Notes:

- [1] The items listed under the "Green Certifications" section may not only refer to certification but also registration or self-declaration.
- [2], [3] EPEAT™ is registered where applicable, please see [epeat.net](https://www.epeat.net) for registration status by country.

Other Certifications

Other Certifications

- (Optional) TÜV Rheinland® Low Noise

- (Optional) TÜV Rheinland® Ultra Low Noise

Mil-Spec Test

MIL-STD-810H military test passed (Low Pressure [Altitude], High Temperature, Low Temperature, Humidity, Sand and Dust, Vibration, Shock, Solar Radiation, Contamination by Fluids, Salt Fog, Temperature Shock)

- Feature with ** means that only one offering listed under the feature is configured on selected models.
- Feature with *** means that one or more offerings listed under the feature could be configured on selected models.
- Lenovo reserves the right to change specifications or other product information without notice. Lenovo is not responsible for photographic or typographical errors. LENOVO PROVIDES THIS PUBLICATION “AS IS,” WITHOUT WARRANTY OF ANY KIND, EITHER EXPRESS OR IMPLIED, INCLUDING THE IMPLIED WARRANTIES OF MERCHANTABILITY OR FITNESS FOR A PARTICULAR PURPOSE. Some jurisdictions do not allow disclaimer of express or implied warranties in certain transactions, therefore this disclaimer may not apply to you.
- The specifications on this page may not be available in all regions, and may be changed or updated without notice.



intel



intel



intel

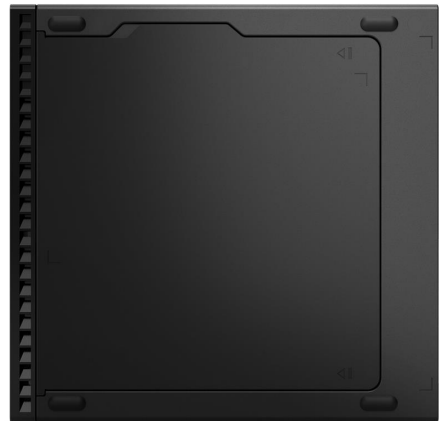

intel

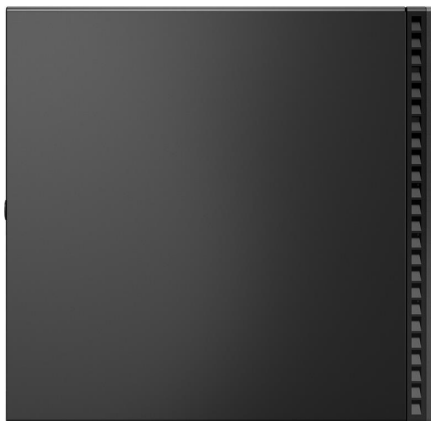

intel



intel

OVERVIEW

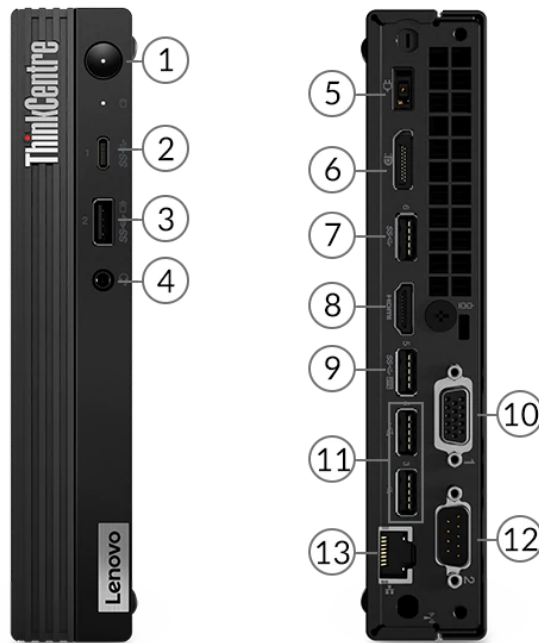

1. Power button	8. HDMI 1.4b
2. USB-C 3.2 Gen 1	9. USB 3.2 Gen 1
3. USB 3.2 Gen 2	10. Optional port 1 (VGA is shown)
4. Headphone / microphone combo jack (3.5mm)	11. 2x USB 2.0
5. Power connector	12. Optional port 2 (serial is shown)
6. DisplayPort 1.4	13. Ethernet (RJ-45)
7. USB 3.2 Gen 1	

PERFORMANCE

Processor

Processor Family

AMD Athlon™ or AMD Ryzen™ 3 / 5 / 7 Processor

Processor**

Processor Name	Cores	Threads	Base Frequency	Max Frequency	Cache	Memory Support	Processor Graphics
AMD Athlon™ Gold PRO 3150GE	4	4	3.3GHz	3.8GHz	2MB L2 / 4MB L3	DDR4-2933	AMD Radeon™ Graphics
AMD Athlon™ Silver 3050GE	2	4	3.4GHz	3.4GHz	1MB L2 / 4MB L3	DDR4-2666	AMD Radeon™ Graphics
AMD Athlon™ Silver PRO 3125GE	2	4	3.4GHz	3.4GHz	1MB L2 / 4MB L3	DDR4-2666	AMD Radeon™ Graphics
AMD Ryzen™ 3 3200GE	4	4	3.3GHz	3.8GHz	2MB L2 / 4MB L3	DDR4-2933	AMD Radeon™ Vega 8 Graphics
AMD Ryzen™ 3 4300GE	4	8	3.5GHz	4.0GHz	2MB L2 / 4MB L3	DDR4-3200	AMD Radeon™ Graphics
AMD Ryzen™ 3 5300GE	4	8	3.6GHz	4.2GHz	2MB L2 / 8MB L3	DDR4-3200	AMD Radeon™ Graphics
AMD Ryzen™ 3 PRO 4350GE	4	8	3.5GHz	4.0GHz	2MB L2 / 4MB L3	DDR4-3200	AMD Radeon™ Graphics
AMD Ryzen™ 3 PRO 5350GE	4	8	3.6GHz	4.2GHz	2MB L2 / 8MB L3	DDR4-3200	AMD Radeon™ Graphics
AMD Ryzen™ 5 4600GE	6	12	3.3GHz	4.2GHz	3MB L2 / 8MB L3	DDR4-3200	AMD Radeon™ Graphics
AMD Ryzen™ 5 5600GE	6	12	3.4GHz	4.4GHz	3MB L2 / 16MB L3	DDR4-3200	AMD Radeon™ Graphics
AMD Ryzen™ 5 PRO 3350GE	4	8	3.3GHz	3.9GHz	2MB L2 / 4MB L3	DDR4-2933	AMD Radeon™ Vega 11 Graphics
AMD Ryzen™ 5 PRO 4650GE	6	12	3.3GHz	4.2GHz	3MB L2 / 8MB L3	DDR4-3200	AMD Radeon™ Graphics
AMD Ryzen™ 5 PRO 5650GE	6	12	3.4GHz	4.4GHz	3MB L2 / 16MB L3	DDR4-3200	AMD Radeon™ Graphics
AMD Ryzen™ 7 4700GE	8	16	3.1GHz	4.3GHz	4MB L2 / 8MB L3	DDR4-3200	AMD Radeon™ Graphics
AMD Ryzen™ 7 5700GE	8	16	3.2GHz	4.6GHz	4MB L2 / 16MB L3	DDR4-3200	AMD Radeon™ Graphics
AMD Ryzen™ 7 PRO 4750GE	8	16	3.1GHz	4.3GHz	4MB L2 / 8MB L3	DDR4-3200	AMD Radeon™ Graphics
AMD Ryzen™ 7 PRO 5750GE	8	16	3.2GHz	4.6GHz	4MB L2 / 16MB L3	DDR4-3200	AMD Radeon™ Graphics

Operating System

Operating System**

- Windows® 11 Pro
- Windows® 11 Home
- Windows® 11 Home Single Language
- Windows® 11 DG Windows® 10 Pro 64
- Windows® 10 Pro 64
- Windows® 10 Home 64
- Windows® 10 Home 64 Single Language
- Windows® 10 IoT Enterprise
- Windows® 10 IoT Enterprise LTSC 2021

ThinkCentre M75q Gen 2

- IGEL Linux^[1]
- Ubuntu Linux
- No preload operating system

Notes:

[1] The device is preload with a free evaluation license. The evaluation license will be valid for a period of 90 days.

Graphics

Graphics**^[1]

Graphics	Type	Memory	Connector	Max Resolution	Key Features
AMD Radeon™ Graphics	Integrated	Shared	1x HDMI®, 1x DisplayPort™ 1.4, 1x optional port (VGA / 2nd DP / USB-C® / 2nd HDMI® / dual DP)	3840x2160@30Hz or 2560x1440@60Hz(HDMI®), 1920x1200@60Hz(VGA), 3840x2160(DP)@60Hz	DirectX® 12
AMD Radeon™ Vega 11 Graphics	Integrated	Shared	1x HDMI®, 1x DisplayPort™ 1.4, 1x optional port (VGA / 2nd DP / USB-C® / 2nd HDMI® / dual DP)	3840x2160@30Hz or 2560x1440@60Hz(HDMI®), 1920x1200@60Hz(VGA), 3840x2160(DP)@60Hz	DirectX® 12
AMD Radeon™ Vega 8 Graphics	Integrated	Shared	1x HDMI®, 1x DisplayPort™ 1.4, 1x optional port (VGA / 2nd DP / USB-C® / 2nd HDMI® / dual DP)	3840x2160@30Hz or 2560x1440@60Hz(HDMI®), 1920x1200@60Hz(VGA), 3840x2160(DP)@60Hz	DirectX® 12

Notes:

[1] The information of integrated graphics are not applicable for the models with processor which has no integrated graphics inside (for the details, please refer to processor section).

Monitor Support

Monitor Support

Supports up to 3 independent displays via onboard ports (DisplayPort™ + HDMI®) and optional ports (VGA / 2nd DP / 2nd HDMI® / USB-C® / 2x DP)

Chipset

Chipset

AMD PRO 500 chipset

Memory

Max Memory^[1]

Up to 64GB DDR4-3200

Memory Slots

Two DDR4 SO-DIMM slots, dual-channel capable

Memory Type^[2]

DDR4-3200

Notes:

[1] The max memory is based on the test results with current Lenovo® memory offerings.

[2] Installed memory is actually 3200MHz, but may run as 2666MHz, 2933MHz or 3200MHz depending on the memory support capability of processor.

Storage

Storage Support^[1]

Up to two drives, 1x 2.5" HDD + 1x M.2 SSD

- 2.5" HDD up to 1TB
- M.2 SSD up to 1TB

Storage Type***

ThinkCentre M75q Gen 2

Disk Type	Interface	RPM	Security
2.5" SATA HDD	SATA 6Gb/s	5.4K	-
2.5" SATA HDD	SATA 6Gb/s	7.2K	-
M.2 2280 SSD	PCIe® NVMe®, PCIe® 3.0 x4	-	Opal
M.2 2280 SSD	PCIe® NVMe®, PCIe® 4.0 x4	-	Opal 2.0
M.2 2242 SSD	PCIe® NVMe®, PCIe® 3.0 x2	-	-

Notes:
[1] The max capacity of each disk type is based on the test results with current Lenovo® storage offerings.

Removable Storage

Optical**

- DVD-ROM, slim (9.0mm), via USB external ODD box
- DVD burner (DVD±RW), slim (9.0mm), via USB external ODD box
- None

Multi-Media

Audio Chip

High Definition (HD) Audio, Realtek® ALC222 codec

Speakers

Single speaker, 1.5W x1

Power Supply

Power Supply**

Power	Type	Efficiency	Key Features
65W	Adapter	89%	Autosensing
90W	Adapter	89%	Autosensing

DESIGN

Input Device

Keyboard**

- Lenovo® Calliope Keyboard (USB connector), black
- Lenovo® Calliope Wireless Keyboard, black
- Lenovo® Traditional Keyboard (USB connector), black
- No keyboard

Mouse**

- Lenovo® Calliope Mouse (USB connector), black
- Lenovo® Calliope Wireless Mouse (2.4GHz via USB receiver), black
- Lenovo® Fingerprint Mouse (USB connector), Windows® Hello support, black (EOL on Jan, 2023)
- No mouse

Mechanical

Form Factor

Tiny (1L)

Dimensions (WxDxH)^[1]

Models	Dimensions
Tiny only	179 x 183 x 34.5 / 37 mm with rubber feet (7.05 x 7.2 x 1.36 / 1.5 inches with rubber feet)

Packaging Dimensions (WxDxH)^[2]

- Tiny only: 490 x 250 x 130 mm (19.29 x 9.84 x 5.12 inches)
- Tiny & ODD: 490 x 268 x 166 mm (19.29 x 10.55 x 6.54 inches)

Weight^[3]

Models	Weight
Tiny only	1.25 kg (2.76 lbs)

Packaging Weight^[4]

- Tiny only: Around 3.2 kg (7.05 lbs)
- Tiny & ODD: Around 3.9 kg (8.6 lbs)

Case Color

Black

Bays

1x 2.5" disk bay

Expansion Slots

- One M.2 slot (for SSD)
- One M.2 slot (for WLAN)

EOU

(Optional) toolless chassis open (toolless chassis screw required) and toolless M.2 SSD, HDD, memory assembly / removal

Stand

- Vertical stand
- No stand

Mounting

- VESA mount bracket kit, supports VESA mount 75mm and 100mm
- None

Notes:

[1] The system dimensions may vary depending on configurations.

[2] The new packages take effect from September 2023. The old packages are:

Tiny only: 500 x 150 x 280 mm (19.69 x 5.91 x 11.02 inches)

Tiny & ODD: 500 x 175 x 280 mm (19.69 x 6.89 x 11.02 inches)

[3] The system weight is approximate and based on results in Lenovo® lab, which varies depending on the source of component, variance of the distribution of each component, and manufacturing process. It may not be the exact weight for each specific model.

[4] The new packages take effect from September 2023. The old package are:

Tiny only: 2.85 kg (6.28 lbs)

Tiny & ODD: 3.58 kg (7.89 lbs)

CONNECTIVITY

Network

Onboard Ethernet

- Gigabit Ethernet, Realtek® RTL8111FP, 1x RJ-45, supports DASH and Wake-on-LAN
- Gigabit Ethernet, Realtek® RTL8111HN, 1x RJ-45, supports Wake-on-LAN

WLAN + Bluetooth®**

- Realtek® RTL8822CE, 802.11ac Dual Band 2x2 Wi-Fi® + Bluetooth® 5.0, M.2 card
- Intel® Wireless-AC 9260, 802.11ac Dual Band 2x2 Wi-Fi® + Bluetooth® 5.1, M.2 card
- Realtek® Wi-Fi® 6 RTL8852AE, 802.11ax Dual Band 2x2 Wi-Fi® + Bluetooth® 5.3, M.2 card^[1]
- Realtek® Wi-Fi® 6 RTL8852BE, 802.11ax Dual Band 2x2 Wi-Fi® + Bluetooth® 5.3, M.2 card^[2]
- Intel® Wi-Fi® 6 AX200, 802.11ax 2x2 Wi-Fi® + Bluetooth® 5.1, M.2 card
- No WLAN and Bluetooth®

Notes:

[1], [2] Bluetooth® 5.3 requires Windows® 11.

Ports^[1]

Front Ports

- 1x USB-C® 3.2 Gen 1 (support data transfer)
- 1x USB 3.2 Gen 2 (Always On and fast charge)
- 1x headphone / microphone combo jack (3.5mm)

Rear Ports^[2]

- 2x USB 2.0
- 2x USB 3.2 Gen 1
- 1x HDMI® 1.4b
- 1x DisplayPort™ 1.4
- 1x Ethernet (RJ-45)

Optional Rear Ports^{***}

- Optional port 1 (one of VGA / 2nd DisplayPort™ / 2nd HDMI® / serial / USB-C® 3.2 Gen 1 with DisplayPort™ function)
- Optional port 2 (serial)
- 2x USB 3.2 Gen 1 (occupies port 1 and 2)
- 4x USB 3.2 Gen 1 (share one USB 3.2 Gen 1 bandwidth, occupy port 1 and 2)
- 2x DisplayPort™ (occupies port 1 and 2)
- 1x parallel

Notes:

[1] The transfer speed of following ports will vary and, depending on many factors, such as the processing speed of the host device, file attributes and other factors related to system configuration and your operating environment, will be slower than theoretical speed.

USB 2.0: 480 Mbit/s;

USB 3.2 Gen 1 (SuperSpeed USB 5Gbps, formerly USB 3.0 / USB 3.1 Gen 1): 5 Gbit/s;

USB 3.2 Gen 2 (SuperSpeed USB 10Gbps, formerly USB 3.1 Gen 2): 10 Gbit/s;

USB4® 20Gbps / USB 3.2 Gen 2x2 (SuperSpeed USB 20Gbps): 20 Gbit/s;

USB4® 40Gbps (USB 40Gbps): 40 Gbit/s;

Thunderbolt™ 3/4: 40 Gbit/s.

[2] For video ports on discrete graphics, please see graphics section.

Monitor Cable**Monitor Cable**^{***}

- VGA Cable Tiny
- HDMI® to HDMI® cable (1.5m)
- HDMI® to VGA dongle
- DP to VGA dongle
- DP to VGA cable (1.5M)
- DP to dual DP dongle
- DP to DVI-D dongle
- DP to HDMI® dongle
- No monitor cable

SECURITY & PRIVACY**Security****Security Chip**

Discrete TPM 2.0, TCG certified, FIPS 140-2 certified

Physical Locks

Kensington® Security Slot™, 3 x 7 mm

Chassis Intrusion Switch

Chassis intrusion switch

BIOS Security

- Administrator password
- Power-on password
- Hard disk password
- Boot sequence control
- Boot without keyboard and mouse
- Individual USB port disablement

MANAGEABILITY**System Management**

System Management

- DASH 1.2
- Non-DASH

SERVICE**Warranty**^[1]**Base Warranty**^{**}

- 1-year courier or carry-in service
- 1-year limited onsite service
- 3-year limited onsite service
- No base warranty

Notes:

[1] The warranty upgrades may be bundled with some models, please check the "Included upgrade" column in the specific model's configurations. For more service extensions, please go to <https://smartfind.lenovo.com/>. To learn more details of warranty policy, please access <https://pcsupport.lenovo.com/warranty>.

ENVIRONMENTAL**Operating Environment****Temperature**

- Operating: 5°C (41°F) to 35°C (95°F)
- Storage: -40°C (-40°F) to 60°C (140°F)

Relative Humidity

- Operating: 20% to 80%
- Storage: 10% to 90%

Altitude

- Operating: 0 m (0 ft) to 3048 m (10,000 ft)
- Storage: 0 m (0 ft) to 12192 m (40,000 ft)

CERTIFICATIONS**Green Certifications**^[1]**Green Certifications**

- (Optional) ENERGY STAR® 8.0
- (Optional) EPEAT™ Silver Registered^[2]
- (Optional) EPEAT™ Gold Registered^[3]
- ErP Lot 3
- RoHS compliant
- TCO Certified 9.0

Notes:

[1] The items listed under the "Green Certifications" section may not only refer to certification but also registration or self-declaration.

[2], [3] EPEAT™ is registered where applicable, please see epeat.net for registration status by country.

Other Certifications**Mil-Spec Test**

MIL-STD-810H military test passed

- Feature with ** means that only one offering listed under the feature is configured on selected models.
- Feature with *** means that one or more offerings listed under the feature could be configured on selected

models.

- Lenovo reserves the right to change specifications or other product information without notice. Lenovo is not responsible for photographic or typographical errors. LENOVO PROVIDES THIS PUBLICATION “AS IS,” WITHOUT WARRANTY OF ANY KIND, EITHER EXPRESS OR IMPLIED, INCLUDING THE IMPLIED WARRANTIES OF MERCHANTABILITY OR FITNESS FOR A PARTICULAR PURPOSE. Some jurisdictions do not allow disclaimer of express or implied warranties in certain transactions, therefore this disclaimer may not apply to you.
- The specifications on this page may not be available in all regions, and may be changed or updated without notice.



AMD



AMD



AMD

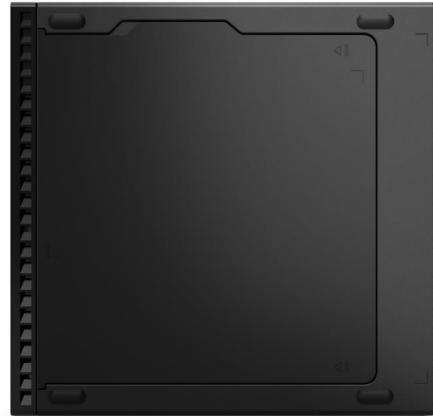

AMD

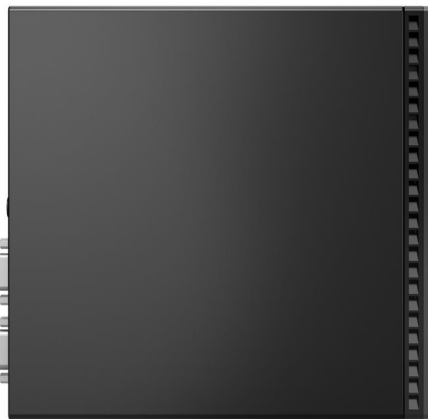

AMD



AMD

OVERVIEW

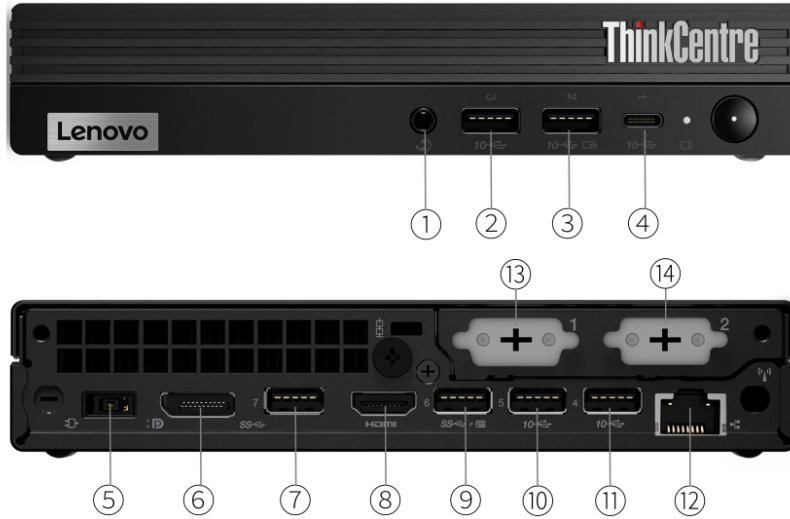

1. Headphone / microphone combo jack (3.5mm)	8. HDMI
2. USB 3.2 Gen 2	9. USB 3.2 Gen 1 (with Smart Power On feature)
3. USB 3.2 Gen 2 (Always On and fast charge)	10. USB 3.2 Gen 2
4. USB-C 3.2 Gen 2	11. USB 3.2 Gen 2
5. Power connector	12. Ethernet (RJ-45)
6. DisplayPort 1.4	13. Punch out port 1 *
7. USB 3.2 Gen 1	14. Punch out port 2 *

Notes:

- Items with * are only available on selected models

PERFORMANCE

Processor

Processor Family

Intel® Celeron®, Intel® Pentium®, or 12th Generation Intel® Core™ i3 / i5 / i7 / i9 Processor

Processor**

Processor Name	Cores	Threads	Base Frequency	Max Frequency	Cache	Memory Support	Processor Graphics
Celeron® G6900T	2	2	2.8GHz	-	4MB	DDR5-4800	Intel® UHD Graphics 710
Pentium® Gold G7400T	2	4	3.1GHz	-	6MB	DDR5-4800	Intel® UHD Graphics 710
Core™ i3-12100T	4 (4 P-core + 0 E-core)	8	P-core 2.2GHz	P-core 4.1GHz ^[1]	12MB	DDR5-4800	Intel® UHD Graphics 730
Core™ i3-12300T	4 (4 P-core + 0 E-core)	8	P-core 2.3GHz	P-core 4.2GHz ^[2]	12MB	DDR5-4800	Intel® UHD Graphics 730
Core™ i5-12400T	6 (6 P-core + 0 E-core)	12	P-core 1.8GHz	P-core 4.2GHz ^[3]	18MB	DDR5-4800	Intel® UHD Graphics 730
Core™ i5-12500T	6 (6 P-core + 0 E-core)	12	P-core 2.0GHz	P-core 4.4GHz ^[4]	18MB	DDR5-4800	Intel® UHD Graphics 770
Core™ i5-12600T	6 (6 P-core + 0 E-core)	12	P-core 2.1GHz	P-core 4.6GHz ^[5]	18MB	DDR5-4800	Intel® UHD Graphics 770
Core™ i7-12700T	12 (8 P-core + 4 E-core)	20	P-core 1.4GHz / E-core 1.0GHz	Max Turbo up to 4.7GHz / P-core 4.6GHz / E-core 3.4GHz ^[6]	25MB	DDR5-4800	Intel® UHD Graphics 770
Core™ i9-12900T	16 (8 P-core + 8 E-core)	24	P-core 1.4GHz / E-core 1.0GHz	Max Turbo up to 4.9GHz / P-core 4.8GHz / E-core 3.6GHz ^[7]	30MB	DDR5-4800	Intel® UHD Graphics 770

Notes:

[1], [2], [3], [4], [5], [6], [7] Intel® Max Turbo frequency will vary depending on application workload and the hardware and software configurations, see <http://www.intel.com/technology/turboboost/> for more information.

Operating System

Operating System**^[1]

- Windows® 11 Pro
- Windows® 11 Home
- Windows® 11 Home Single Language
- Windows® 11 DG Windows® 10 Pro 64
- Windows® 10 IoT Enterprise LTSC 2021
- Red Hat Enterprise Linux 8.6 (certified only, for detailed and latest information, please visit [Red Hat Certified Hardware](#))
- Ubuntu Linux
- No preload operating system

Notes:

[1] Windows® 10 IoT Enterprise LTSC 2021 is for special bid only.

Graphics

Graphics**

Graphics	Type	Memory	Connector	Max Resolution	Key Features
Intel® UHD graphics	Integrated	Shared	1x HDMI® 2.1 TMDS, 1x DP 1.4, 2x punch out ports([2x	4096x2160@60Hz(HDMI®), 1920x1200@60Hz(VGA),	DirectX® 12

710			HDMI®/VGA/DP] or [USB-C® with DP function, HDMI®/VGA/DP])	4096x2160@60Hz(DP), 4096x2160@60Hz(USB-C® with DP function)	
Intel® UHD graphics 730	Integrated	Shared	1x HDMI® 2.1 TMDS, 1x DP 1.4, 2x punch out ports([2x HDMI®/VGA/DP] or [USB-C® with DP function, HDMI®/VGA/DP])	4096x2304@60Hz(HDMI®), 1920x1200@60Hz(VGA), 4096x2304@60Hz(DP), 4096x2304@60Hz(USB-C® with DP function)	DirectX® 12
Intel® UHD graphics 770	Integrated	Shared	1x HDMI® 2.1 TMDS, 1x DP 1.4, 2x punch out ports([2x HDMI®/VGA/DP] or [USB-C® with DP function, HDMI®/VGA/DP])	4096x2304@60Hz(HDMI®), 1920x1200@60Hz(VGA), 4096x2304@60Hz(DP), 4096x2304@60Hz(USB-C® with DP function)	DirectX® 12

Monitor Support

Monitor Support

Supports up to 4 independent displays via (onboard DP, onboard HDMI®, punch out port 1 [VGA / HDMI® / DP / USB-C®], and punch out port 2 [VGA / HDMI® / DP])

Chipset

Chipset

Intel® Q670 chipset

Memory

Max Memory^[1]

Up to 64GB DDR5-4800

Memory Slots

Two DDR5 SO-DIMM slots, dual-channel capable

Memory Type

DDR5-4800

Notes:

[1] The max memory is based on the test results with current Lenovo® memory offerings.

Storage

Storage Support^[1]

Up to three drives, 1x 2.5" HDD + 2x M.2 SSD

- 2.5" HDD up to 1TB
- M.2 SSD up to 2TB each

Storage Type^{***}

Disk Type	Interface	RPM	Offering	Security
2.5" SATA HDD	SATA 6Gb/s	7.2K	500GB / 1TB	-
M.2 2280 SSD	PCIe® NVMe®, PCIe® 4.0 x4	-	256GB / 512GB / 1TB	Opal 2.0
M.2 2280 SSD	PCIe® NVMe®, PCIe® 4.0 x4 Performance	-	512GB / 1TB / 2TB	Opal 2.0
M.2 2242 SSD	PCIe® NVMe®, PCIe® 3.0 x2	-	128GB	-

RAID

RAID 0/1 support for M.2 SSDs (RAID preset only available via special bid models)

Notes:

[1] The max capacity of each disk type is based on the test results with current Lenovo® storage offerings.

Removable Storage

Optical^{**}

- DVD-ROM, slim (9.0mm), via USB external ODD box

ThinkCentre M80q Gen 3

- DVD burner (DVD±RW), slim (9.0mm), via USB external ODD box
- None

Card Reader

No card reader

Multi-Media

Audio Chip

High Definition (HD) Audio, Realtek® ALC256VB codec

Speakers**

- Premium single speaker, 2W x1
- Single speaker, 2W x1

Microphone

No microphone

Power Supply

Power Supply**

Power	Type	Efficiency	Key Features
65W	Adapter	89%	Autosensing
90W	Adapter	89%	Autosensing
135W	Adapter	89%	Autosensing
No power supply	-	-	-

DESIGN

Input Device

Keyboard**

- Lenovo® Calliope Keyboard (USB connector), black
- Lenovo® Calliope Wireless Keyboard, black
- Lenovo® Traditional Keyboard (USB connector), black
- No keyboard

Mouse**

- Lenovo® Calliope Mouse (USB connector), black
- Lenovo® Calliope Wireless Mouse (2.4GHz via USB receiver), black
- Lenovo® Fingerprint Mouse (USB connector), black (EOL on Jan, 2023)
- No mouse

Mechanical

Form Factor

Tiny (1L)

Dimensions (WxDxH)^[1]

Models	Dimensions
Tiny only	179 x 182.9 x 36.5 mm with rubber feet (7.05 x 7.2 x 1.44 inches with rubber feet)
Tiny & ODD	204.2 x 186.6 x 64 mm with rubber feet (8.04 x 7.35 x 2.52 inches with rubber feet)

Packaging Dimensions (WxDxH)^[2]

- Tiny only: 490 x 250 x 130 mm (19.29 x 9.84 x 5.12 inches)
- Tiny & ODD: 490 x 268 x 166 mm (19.29 x 10.55 x 6.54 inches)

Weight^[3]

Models	Weight
Tiny only	1.25 kg (2.76 lbs)
With VESA mount & ODD box	1.74 kg (3.84 lbs)

Packaging Weight^[4]

- Tiny only: Around 3.2 kg (7.05 lbs)
- Tiny & ODD: Around 3.9 kg (8.6 lbs)

Case Color

Black

Bays

1x 2.5" disk bay

Expansion Slots

- Two M.2 PCIe® Gen 4x4 slots (for SSD)
- One M.2 slot (for WLAN)

EOU

- (Optional) toolless chassis open (toolless chassis screw required) and toolless M.2 SSD, HDD, memory assembly / removal
- No support

Stand

- Vertical stand
- No stand

IO Box

No IO box

Mounting

- VESA mount bracket kit, supports VESA mount 75mm and 100mm
- None

Others

- (Optional) Dust filter
- (Optional) Power adapter cage

Notes:

[1] The system dimensions may vary depending on configurations.

[2] The new packages take effect from September 2023. The old packages are:

Tiny only: 500 x 150 x 280 mm (19.69 x 5.91 x 11.02 inches)

Tiny & ODD: 500 x 175 x 280 mm (19.69 x 6.89 x 11.02 inches)

[3] The system weight is approximate and based on results in Lenovo® lab, which varies depending on the source of component, variance of the distribution of each component, and manufacturing process. It may not be the exact weight for each specific model.

[4] The new packages take effect from September 2023. The old package are:

Tiny only: 2.85 kg (6.28 lbs)

Tiny & ODD: 3.58 kg (7.89 lbs)

CONNECTIVITY

Network

Onboard Ethernet

Gigabit Ethernet, Intel® Ethernet Connection I219-LM, 1x RJ-45, supports Wake-on-LAN

Optional Ethernet

- 2.5 Gigabit Ethernet, Realtek® RTL8125BGS, 1x RJ-45, supports Wake-on-LAN
- No optional Ethernet

WLAN + Bluetooth®**

- Realtek® Wi-Fi® 6 RTL8852BE, 802.11ax Dual Band 2x2 Wi-Fi® + Bluetooth® 5.3, M.2 card^[1]
- Intel® Wi-Fi® 6 AX201, 802.11ax 2x2 Wi-Fi® + Bluetooth® 5.2, M.2 Card^[2]
- AMD Wi-Fi® 6E RZ616, 802.11ax 2x2 Wi-Fi® + Bluetooth® 5.3, M.2 Card^[3]
- Intel® Wi-Fi® 6E AX211, 802.11ax 2x2 Wi-Fi® + Bluetooth® 5.3, Intel® vPro® technology support, M.2 Card^[4]
- No WLAN and Bluetooth®

Notes:

[1], [3], [4] Bluetooth® 5.3 requires Windows® 11.

[2] Bluetooth® 5.2 requires Windows® 11.

Ports^[1]

Front Ports

- 1x USB-C® 3.2 Gen 2 (support data transfer)
- 1x USB 3.2 Gen 2 (Always On and 5V@2.1A charging)
- 1x USB 3.2 Gen 2
- 1x headphone / microphone combo jack (3.5mm)

Optional Front Ports

None

Rear Ports

- 2x USB 3.2 Gen 1 (one supports Smart Power On)
- 2x USB 3.2 Gen 2
- 1x HDMI® 2.1 TMDS
- 1x DisplayPort™ 1.4
- 1x Ethernet (RJ-45)

Optional Rear Ports

- Punch out port 1 (one of VGA / DisplayPort™ / HDMI® / serial / USB-C® 3.2 Gen 1 with DisplayPort™ functions)
- Punch out port 2 (one of VGA / DisplayPort™ / HDMI® / serial / RJ-45)
- 2x USB 3.2 Gen 1 (share one USB 3.2 Gen 1 bandwidth, occupies port 1 and 2)
- 4x USB 3.2 Gen 1 (share one USB 3.2 Gen 1 bandwidth, occupy port 1 and 2)
- 1x 2.5GbE RJ-45, via RTL8125BGS

Notes:

[1] The transfer speed of following ports will vary and, depending on many factors, such as the processing speed of the host device, file attributes and other factors related to system configuration and your operating environment, will be slower than theoretical speed.

USB 2.0: 480 Mbit/s;

USB 3.2 Gen 1 (SuperSpeed USB 5Gbps, formerly USB 3.0 / USB 3.1 Gen 1): 5 Gbit/s;

USB 3.2 Gen 2 (SuperSpeed USB 10Gbps, formerly USB 3.1 Gen 2): 10 Gbit/s;

USB4® 20Gbps / USB 3.2 Gen 2x2 (SuperSpeed USB 20Gbps): 20 Gbit/s;

USB4® 40Gbps (USB 40Gbps): 40 Gbit/s;

Thunderbolt™ 3/4: 40 Gbit/s.

Monitor Cable

Monitor Cable

- HDMI® to HDMI® cable (1.5m)
- HDMI® to VGA dongle
- DP to VGA dongle
- DP to DVI dongle
- DP to dual DP dongle
- DP to DVI-D dongle
- DP to HDMI® dongle
- No monitor cable

SECURITY & PRIVACY

Security

Security Chip

Discrete TPM 2.0, TCG certified, FIPS 140-2 certified

Physical Locks

Kensington® Security Slot™, 3 x 7 mm

Chassis Intrusion Switch

Chassis intrusion switch

Fingerprint Reader

- Touch style fingerprint reader on mouse (EOL on Jan, 2023)
- No fingerprint reader

BIOS Security

- Administrator password

- Power-on password
- Hard disk password
- Boot sequence control
- Boot without keyboard and mouse
- Certificate based BIOS management
- Cover presence switch
- Self-healing BIOS
- Smart USB protection (allows keyboard / mouse only, blocks all storage devices)
- Individual USB port disablement

MANAGEABILITY

System Management

System Management**

- Intel® vPro® Enterprise^[1]
- Intel® vPro® Essentials^[2]
- Non-vPro®

Notes:

[1], [2] Intel® vPro® offers a superset of DASH's defined capabilities.

SERVICE

Warranty^[1]

Base Warranty**

- 1-year courier or carry-in service
- 1-year limited onsite service
- 3-year limited onsite service
- No base warranty

Notes:

[1] The warranty upgrades may be bundled with some models, please check the "Included upgrade" column in the specific model's configurations. For more service extensions, please go to <https://smartfind.lenovo.com/>. To learn more details of warranty policy, please access <https://pcsupport.lenovo.com/warranty>.

ENVIRONMENTAL

Sustainability

Material^[1]

85% PCC recycled plastic used in product chassis.

95% PCC recycled plastic used in USB keyboard/mouse.

90% PIC recycled plastic EPE cushion or 90% PCC recycled plastic thermal shell with 30% OBP material.

30% OBP used in bag.

FSC certified paper in packaging.

Notes:

[1] PCC: Post Consumer Content, recycled materials from customers.

PIC: Post Industry Content, recycled materials from internal factories.

EPE: Expanded Polyethylene.

OBP: Ocean Bound Plastic, reducing plastic spill into the sea.

FSC: Forest Stewardship Council.

Operating Environment

Temperature

- Operating: 5°C (41°F) to 35°C (95°F)
- Storage: -40°C (-40°F) to 60°C (140°F)

Relative Humidity

- Operating: 20% to 80%
- Storage: 10% to 90%

Altitude

- Operating: 0 m (0 ft) to 3048 m (10,000 ft)
- Storage: 0 m (0 ft) to 12192 m (40,000 ft)

CERTIFICATIONS

Green Certifications^[1]

Green Certifications

- (Optional) ENERGY STAR® 8.0
- (Optional) EPEAT™ Silver Registered^[2]
- ErP Lot 3
- RoHS compliant
- TCO Certified 9.0

Notes:

[1] The items listed under the "Green Certifications" section may not only refer to certification but also registration or self-declaration.

[2] EPEAT™ is registered where applicable, please see [epeat.net](https://www.epeat.net) for registration status by country.

Other Certifications

Other Certifications

(Optional) TÜV Rheinland® Ultra Low Noise

Mil-Spec Test

MIL-STD-810H military test passed

- Feature with ** means that only one offering listed under the feature is configured on selected models.
- Feature with *** means that one or more offerings listed under the feature could be configured on selected models.
- Lenovo reserves the right to change specifications or other product information without notice. Lenovo is not responsible for photographic or typographical errors. LENOVO PROVIDES THIS PUBLICATION "AS IS," WITHOUT WARRANTY OF ANY KIND, EITHER EXPRESS OR IMPLIED, INCLUDING THE IMPLIED WARRANTIES OF MERCHANTABILITY OR FITNESS FOR A PARTICULAR PURPOSE. Some jurisdictions do not allow disclaimer of express or implied warranties in certain transactions, therefore this disclaimer may not apply to you.
- The specifications on this page may not be available in all regions, and may be changed or updated without notice.



intel



intel



intel

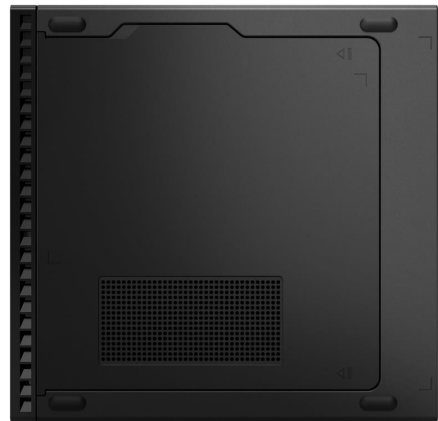

intel



intel



intel

OVERVIEW

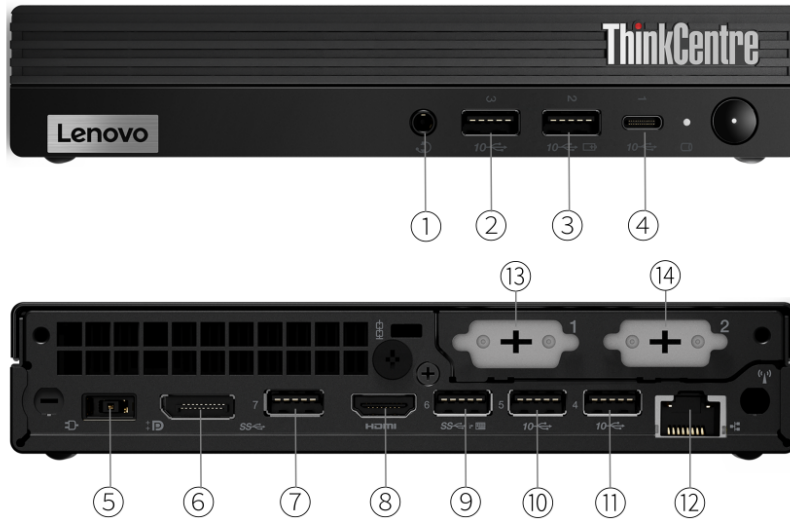

1. Headphone / microphone combo jack (3.5mm)	8. HDMI
2. USB 3.2 Gen 2	9. USB 3.2 Gen 1 (with Smart Power On feature)
3. USB 3.2 Gen 2 (Always On and fast charge)	10. USB 3.2 Gen 2
4. USB-C 3.2 Gen 2	11. USB 3.2 Gen 2
5. Power connector	12. Ethernet (RJ-45)
6. DisplayPort 1.4a	13. Punch out port 1 *
7. USB 3.2 Gen 1	14. Punch out port 2 *

Notes:

- Items with * are only available on selected models

PERFORMANCE

Processor

Processor Family

13th Generation Intel® Core™ i3 / i5 / i7 / i9 Processor, 35W

Processor**^[1]

Processor Name	Cores	Threads	Base Frequency	Max Frequency	Cache	Memory Support	Processor Graphics
Core™ i3-13100T	4 (4 P-core + 0 E-core)	8	P-core 2.5GHz	P-core 4.2GHz	12MB	DDR5-4800	Intel® UHD Graphics 730
Core™ i5-13400T	10 (6 P-core + 4 E-core)	16	P-core 1.3GHz / E-core 1.0GHz	P-core 4.4GHz / E-core 3.0GHz	20MB	DDR5-4800	Intel® UHD Graphics 730
Core™ i5-13500T	14 (6 P-core + 8 E-core)	20	P-core 1.6GHz / E-core 1.2GHz	P-core 4.6GHz / E-core 3.2GHz	24MB	DDR5-4800	Intel® UHD Graphics 770
Core™ i5-13600T	14 (6 P-core + 8 E-core)	20	P-core 1.8GHz / E-core 1.3GHz	P-core 4.8GHz / E-core 3.4GHz	24MB	DDR5-4800	Intel® UHD Graphics 770
Core™ i7-13700T	16 (8 P-core + 8 E-core)	24	P-core 1.4GHz / E-core 1.0GHz	Max Turbo up to 4.9GHz / P-core 4.8GHz / E-core 3.6GHz	30MB	DDR5-5600	Intel® UHD Graphics 770
Core™ i9-13900T	24 (8 P-core + 16 E-core)	32	P-core 1.1GHz / E-core 0.8GHz	Max Turbo up to 5.3GHz / P-core 5.1GHz / E-core 3.9GHz	36MB	DDR5-5600	Intel® UHD Graphics 770

Notes:

[1] Intel® Max Turbo frequency will vary depending on application workload and the hardware and software configurations, see <http://www.intel.com/technology/turboboost/> for more information.

Operating System

Operating System**

- Windows® 11 Pro
- Windows® 11 Home
- Windows® 11 Home Single Language
- Windows® 11 DG Windows® 10 Pro 64
- Windows® 10 IoT Enterprise LTSC 2021
- Ubuntu Linux^[1]
- No preload operating system

Notes:

[1] Some features may not be supported on the system with Linux preload, including but not limited to Intel® RST RAID, Human Presence Detection, etc.

Graphics

Graphics**

Graphics	Type	Memory	Connector	Max Resolution	Key Features
Intel® UHD graphics 730	Integrated	Shared	1x HDMI® 2.1 TMDS, 1x DP 1.4a (HBR2, DSC), 2x punch out ports ([2x HDMI®/VGA/DP] or [USB-C® with DP function, HDMI®/VGA/DP])	4096x2304@60Hz(HDMI®), 1920x1200@60Hz(VGA), 4096x2304@60Hz(DP), 4096x2304@60Hz(USB-C® with DP function)	DirectX® 12
Intel® UHD graphics 770	Integrated	Shared	1x HDMI® 2.1 TMDS, 1x DP 1.4a (HBR2, DSC), 2x punch out ports ([2x HDMI®/VGA/DP] or [USB-C® with DP function, HDMI®/VGA/DP])	4096x2304@60Hz(HDMI®), 1920x1200@60Hz(VGA), 4096x2304@60Hz(DP), 4096x2304@60Hz(USB-C® with DP function)	DirectX® 12

Monitor Support

Monitor Support

Supports up to 4 independent displays via (onboard DP, onboard HDMI®, punch out port 1 [VGA / HDMI® / DP / USB-C®], and punch out port 2 [VGA / HDMI® / DP])

Chipset**Chipset**

Intel® Q670 chipset

Memory**Max Memory^[1]**

Up to 64GB (2x 32GB DDR5 SO-DIMM)

Memory Slots

Two DDR5 SO-DIMM slots, dual-channel capable

Memory Type^{[2]}**

- DDR5-4800
- DDR5-5200
- DDR5-5600

Notes:

[1] The max memory is based on the test results with current Lenovo® memory offerings.

[2] Installed memory is actually DDR5-5600, but may run as DDR5-4800, DDR5-5200, or DDR5-5600 depending on the memory support capability of processor.

Storage**Storage Support^[1]**

Up to three drives, 1x 2.5" HDD + 2x M.2 SSD

- 2.5" HDD up to 1TB
- M.2 SSD up to 2TB each

Storage Type^{*}**

Disk Type	Interface	RPM	Offering	Security
2.5" SATA HDD	SATA 6Gb/s	7.2K	1TB	-
M.2 2280 SSD	PCIe® NVMe®, PCIe® 4.0 x4	-	256GB / 512GB / 1TB	Opal 2.0
M.2 2280 SSD	PCIe® NVMe®, PCIe® 4.0 x4 Performance	-	512GB / 1TB / 2TB	Opal 2.0

RAID

None

Notes:

[1] The max capacity of each disk type is based on the test results with current Lenovo® storage offerings.

Removable Storage**Optical**

None

Card Reader

No card reader

Multi-Media**Audio Chip**

High Definition (HD) Audio, Realtek® ALC256VB codec

Speakers^{}**

- Premium single speaker, 2W x1
- Single speaker, 2W x1

Microphone

No microphone

Power Supply

Power Supply**

Power	Type	Efficiency	Key Features
65W	Adapter	89%	Autosensing
90W	Adapter	89%	Autosensing
135W	Adapter	90%	Autosensing
No power supply	-	-	-

DESIGN

Input Device

Keyboard**

- Lenovo® Calliope Keyboard (USB connector), black
- Lenovo® Calliope Wireless Keyboard, black
- Lenovo® Traditional Keyboard (USB connector), black
- No keyboard

Mouse**

- Lenovo® Calliope Mouse (USB connector), black
- Lenovo® Calliope Wireless Mouse (2.4GHz via USB receiver), black
- No mouse

Mechanical

Form Factor

Tiny (1L)

Dimensions (WxDxH)^[1]

Models	Dimensions
Tiny only	179 x 182.9 x 36.5 mm with rubber feet (7.05 x 7.2 x 1.44 inches with rubber feet)
Tiny & ODD	204.2 x 186.6 x 64 mm with rubber feet (8.04 x 7.35 x 2.52 inches with rubber feet)

Packaging Dimensions (WxDxH)^[2]

- Tiny only: 490 x 250 x 130 mm (19.29 x 9.84 x 5.12 inches)
- Tiny & ODD: 490 x 268 x 166 mm (19.29 x 10.55 x 6.54 inches)

Weight^[3]

Models	Weight
Tiny only	1.25 kg (2.76 lbs)
With VESA mount & ODD box	1.74 kg (3.84 lbs)

Packaging Weight^[4]

- Tiny only: Around 3.2 kg (7.05 lbs)
- Tiny & ODD: Around 3.9 kg (8.6 lbs)

Case Color

Black

Bays

- 1x 2.5" disk bay (optional, or bay comes with disk)
- No bays

Expansion Slots

- Two M.2 PCIe® Gen 4x4 slots (for SSD)
- One M.2 slot (for WLAN)

EOU

- (Optional) toolless chassis open (toolless chassis screw required) and toolless M.2 SSD, HDD, memory assembly / removal
- No support

Stand

- Vertical stand
- No stand

IO Box

No IO box

Mounting

- VESA mount bracket kit, supports VESA mount 75mm and 100mm
- None

Others

- (Optional) Dust filter
- (Optional) Power adapter cage

Notes:

[1] The system dimensions may vary depending on configurations.

[2] The new packages take effect from September 2023. The old packages are:

Tiny only: 500 x 150 x 280 mm (19.69 x 5.91 x 11.02 inches)

Tiny & ODD: 500 x 175 x 280 mm (19.69 x 6.89 x 11.02 inches)

[3] The system weight is approximate and based on results in Lenovo® lab, which varies depending on the source of component, variance of the distribution of each component, and manufacturing process. It may not be the exact weight for each specific model.

[4] The new packages take effect from September 2023. The old package are:

Tiny only: 2.85 kg (6.28 lbs)

Tiny & ODD: 3.58 kg (7.89 lbs)

CONNECTIVITY

Network

Onboard Ethernet

Gigabit Ethernet, Intel® Ethernet Connection I219-LM, 1x RJ-45, supports Wake-on-LAN

Optional Ethernet

- 2.5 Gigabit Ethernet, Realtek® RTL8125BGS, 1x RJ-45
- No optional Ethernet

WLAN + Bluetooth®**

- Realtek® Wi-Fi® 6 RTL8852BE, 802.11ax Dual Band 2x2 Wi-Fi® + Bluetooth® 5.3, M.2 card^[1]
- Intel® Wi-Fi® 6 AX201, 802.11ax 2x2 Wi-Fi® + Bluetooth® 5.2, M.2 Card^[2]
- Intel® Wi-Fi® 6E AX211, 802.11ax 2x2 Wi-Fi® + Bluetooth® 5.3, Intel® vPro® technology support, M.2 Card^[3]
- No WLAN and Bluetooth®

Notes:

[1], [3] Bluetooth® 5.3 requires Windows® 11.

[2] Bluetooth® 5.2 requires Windows® 11.

Ports^[1]

Front Ports

- 1x USB-C® 3.2 Gen 2 (support data transfer)
- 1x USB 3.2 Gen 2 (Always On and 5V@2.1A charging)
- 1x USB 3.2 Gen 2
- 1x headphone / microphone combo jack (3.5mm)

Optional Front Ports

None

Rear Ports

- 2x USB 3.2 Gen 1 (one supports Smart Power On)
- 2x USB 3.2 Gen 2
- 1x HDMI® 2.1 TMDS
- 1x DisplayPort™ 1.4a (HBR2, DSC)
- 1x Ethernet (RJ-45)

Optional Rear Ports

- Punch out port 1 (one of VGA / DisplayPort™ / HDMI® / serial / USB-C® 3.2 Gen 1 with DisplayPort™ functions)
- Punch out port 2 (one of VGA / DisplayPort™ / HDMI® / serial / RJ-45)
- 2x USB 3.2 Gen 1 (share one USB 3.2 Gen 1 bandwidth, occupies port 1 and 2)
- 4x USB 3.2 Gen 1 (share one USB 3.2 Gen 1 bandwidth, occupy port 1 and 2)

Notes:

[1] The transfer speed of following ports will vary and, depending on many factors, such as the processing speed of the host device, file attributes and other factors related to system configuration and your operating environment, will be slower than theoretical speed.

USB 2.0: 480 Mbit/s;

USB 3.2 Gen 1 (SuperSpeed USB 5Gbps, formerly USB 3.0 / USB 3.1 Gen 1): 5 Gbit/s;

USB 3.2 Gen 2 (SuperSpeed USB 10Gbps, formerly USB 3.1 Gen 2): 10 Gbit/s;

USB4® 20Gbps / USB 3.2 Gen 2x2 (SuperSpeed USB 20Gbps): 20 Gbit/s;

USB4® 40Gbps (USB 40Gbps): 40 Gbit/s;

Thunderbolt™ 3/4: 40 Gbit/s.

Monitor Cable

Monitor Cable

- HDMI® to VGA dongle
- DP to VGA dongle
- DP to DVI dongle
- DP to dual DP dongle
- DP to DVI-D dongle
- DP to HDMI® dongle
- No monitor cable

SECURITY & PRIVACY

Security

Security Chip

Discrete TPM 2.0, TCG certified, FIPS 140-2 certified

Physical Locks

Kensington® Security Slot™, 3 x 7 mm

Chassis Intrusion Switch

Chassis intrusion switch

Fingerprint Reader

No fingerprint reader

BIOS Security

- Administrator password
- Power-on password
- Hard disk password
- Boot sequence control
- Boot without keyboard and mouse
- Certificate based BIOS management
- Cover presence switch
- Self-healing BIOS
- Smart USB protection (allows keyboard / mouse only, blocks all storage devices)
- Individual USB port disablement

MANAGEABILITY

System Management

System Management

- Intel® vPro® Enterprise with Intel® AMT 16^[1]
- Non-vPro®

Notes:

[1] Intel® vPro® offers a superset of DASH's defined capabilities.

SERVICE

Warranty^[1]

Base Warranty**

- 1-year courier or carry-in service
- 1-year limited onsite service
- 3-year limited onsite service
- No base warranty

Notes:

[1] The warranty upgrades may be bundled with some models, please check the "Included upgrade" column in the specific model's configurations. For more service extensions, please go to <https://smartfind.lenovo.com/>. To learn more details of warranty policy, please access <https://pcsupport.lenovo.com/warranty>.

ENVIRONMENTAL

Sustainability

Material^[1]

85% PCC recycled plastic used in product chassis.
95% PCC recycled plastic used in USB keyboard/mouse.
90% PIC recycled plastic EPE cushion or 90% PCC recycled plastic thermal shell with 30% OBP material.
30% OBP used in bag.
FSC certified paper in packaging.

Notes:

[1] PCC: Post Consumer Content, recycled materials from customers.
PIC: Post Industry Content, recycled materials from internal factories.
EPE: Expanded Polyethylene.
OBP: Ocean Bound Plastic, reducing plastic spill into the sea.
FSC: Forest Stewardship Council.

Operating Environment

Temperature

- Operating: 5°C (41°F) to 35°C (95°F)
- Storage: -40°C (-40°F) to 60°C (140°F)

Relative Humidity

- Operating: 20% to 80%
- Storage: 10% to 90%

Altitude

- Operating: 0 m (0 ft) to 3048 m (10,000 ft)
- Storage: 0 m (0 ft) to 12192 m (40,000 ft)

CERTIFICATIONS

Green Certifications^[1]

Green Certifications

- (Optional) ENERGY STAR® 8.0
- (Optional) EPEAT™ Silver Registered^[2]
- (Optional) EPEAT™ Gold Registered^[3]
- ErP Lot 3
- RoHS compliant
- TCO Certified 9.0

Notes:

[1] The items listed under the "Green Certifications" section may not only refer to certification but also registration or self-declaration.

[2], [3] EPEAT™ is registered where applicable, please see [epeat.net](https://www.epeat.net) for registration status by country.

Other Certifications

Other Certifications

(Optional) TÜV Rheinland® Ultra Low Noise

Mil-Spec Test

MIL-STD-810H military test passed

- Feature with ** means that only one offering listed under the feature is configured on selected models.
- Feature with *** means that one or more offerings listed under the feature could be configured on selected models.
- Lenovo reserves the right to change specifications or other product information without notice. Lenovo is not responsible for photographic or typographical errors. LENOVO PROVIDES THIS PUBLICATION "AS IS," WITHOUT WARRANTY OF ANY KIND, EITHER EXPRESS OR IMPLIED, INCLUDING THE IMPLIED WARRANTIES OF MERCHANTABILITY OR FITNESS FOR A PARTICULAR PURPOSE. Some jurisdictions do not allow disclaimer of express or implied warranties in certain transactions, therefore this disclaimer may not apply to you.
- The specifications on this page may not be available in all regions, and may be changed or updated without notice.



intel



intel



intel



intel

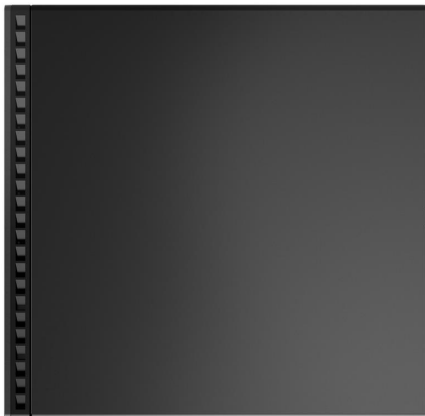

intel



intel

OVERVIEW

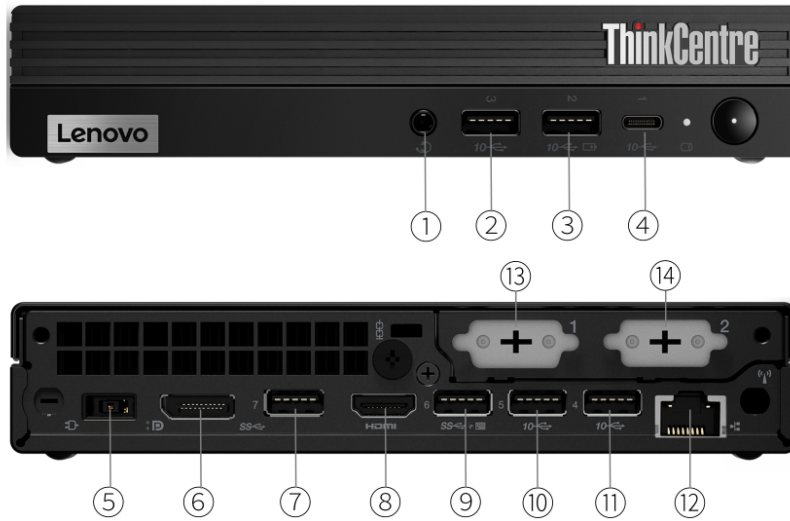

1. Headphone / microphone combo jack (3.5mm)	8. HDMI
2. USB 3.2 Gen 2	9. USB 3.2 Gen 1 (with Smart Power On feature)
3. USB 3.2 Gen 2 (Always On and fast charge)	10. USB 3.2 Gen 2
4. USB-C 3.2 Gen 2	11. USB 3.2 Gen 2
5. Power connector	12. Ethernet (RJ-45)
6. DisplayPort 1.4	13. Punch out port 1 *
7. USB 3.2 Gen 1	14. Punch out port 2 *

Notes:

- Items with * are only available on selected models

PERFORMANCE

Processor

Processor Family

Intel® Celeron®, Intel® Pentium®, or 12th Generation Intel® Core™ i3 / i5 / i7 / i9 Processor

Processor**

Processor Name	Cores	Threads	Base Frequency	Max Frequency	Cache	Memory Support	Processor Graphics
Celeron® G6900	2	2	3.4GHz	-	4MB	DDR5-4800	Intel® UHD Graphics 710
Celeron® G6900T	2	2	2.8GHz	-	4MB	DDR5-4800	Intel® UHD Graphics 710
Pentium® Gold G7400	2	4	3.7GHz	-	6MB	DDR5-4800	Intel® UHD Graphics 710
Pentium® Gold G7400T	2	4	3.1GHz	-	6MB	DDR5-4800	Intel® UHD Graphics 710
Core™ i3-12100	4 (4 P-core + 0 E-core)	8	P-core 3.3GHz	P-core 4.3GHz ^[1]	12MB	DDR5-4800	Intel® UHD Graphics 730
Core™ i3-12100T	4 (4 P-core + 0 E-core)	8	P-core 2.2GHz	P-core 4.1GHz ^[2]	12MB	DDR5-4800	Intel® UHD Graphics 730
Core™ i3-12300	4 (4 P-core + 0 E-core)	8	P-core 3.5GHz	P-core 4.4GHz ^[3]	12MB	DDR5-4800	Intel® UHD Graphics 730
Core™ i3-12300T	4 (4 P-core + 0 E-core)	8	P-core 2.3GHz	P-core 4.2GHz ^[4]	12MB	DDR5-4800	Intel® UHD Graphics 730
Core™ i5-12400	6 (6 P-core + 0 E-core)	12	P-core 2.5GHz	P-core 4.4GHz ^[5]	18MB	DDR4-3200	Intel® UHD Graphics 730
Core™ i5-12400T	6 (6 P-core + 0 E-core)	12	P-core 1.8GHz	P-core 4.2GHz ^[6]	18MB	DDR5-4800	Intel® UHD Graphics 730
Core™ i5-12500	6 (6 P-core + 0 E-core)	12	P-core 3.0GHz	P-core 4.6GHz ^[7]	18MB	DDR5-4800	Intel® UHD Graphics 770
Core™ i5-12500T	6 (6 P-core + 0 E-core)	12	P-core 2.0GHz	P-core 4.4GHz ^[8]	18MB	DDR5-4800	Intel® UHD Graphics 770
Core™ i5-12600	6 (6 P-core + 0 E-core)	12	P-core 3.3GHz	P-core 4.8GHz ^[9]	18MB	DDR5-4800	Intel® UHD Graphics 770
Core™ i5-12600T	6 (6 P-core + 0 E-core)	12	P-core 2.1GHz	P-core 4.6GHz ^[10]	18MB	DDR5-4800	Intel® UHD Graphics 770
Core™ i7-12700	12 (8 P-core + 4 E-core)	20	P-core 2.1GHz / E-core 1.6GHz	Max Turbo up to 4.9GHz / P-core 4.8GHz / E-core 3.6GHz ^[11]	25MB	DDR5-4800	Intel® UHD Graphics 770
Core™ i7-12700T	12 (8 P-core + 4 E-core)	20	P-core 1.4GHz / E-core 1.0GHz	Max Turbo up to 4.7GHz / P-core 4.6GHz / E-core 3.4GHz ^[12]	25MB	DDR5-4800	Intel® UHD Graphics 770
Core™ i9-12900	16 (8 P-core + 8 E-core)	24	P-core 2.4GHz / E-core 1.8GHz	Max Turbo up to 5.1GHz / P-core 5.0GHz / E-core 3.8GHz ^[13]	30MB	DDR5-4800	Intel® UHD Graphics 770
Core™ i9-12900T	16 (8 P-core + 8 E-core)	24	P-core 1.4GHz / E-core 1.0GHz	Max Turbo up to 4.9GHz / P-core 4.8GHz / E-core 3.6GHz ^[14]	30MB	DDR5-4800	Intel® UHD Graphics 770

Notes:

[1], [2], [3], [4], [5], [6], [7], [8], [9], [10], [11], [12], [13], [14] Intel® Max Turbo frequency will vary depending on application workload and the hardware and software configurations, see <http://www.intel.com/technology/turboboost/> for more information.

Operating System

Operating System**^[1]

- Windows® 11 Pro
- Windows® 11 Home
- Windows® 11 Home Single Language
- Windows® 11 DG Windows® 10 Pro 64
- Windows® 10 IoT Enterprise LTSC 2021
- Red Hat Enterprise Linux 8.6 (certified only, for detailed and latest information, please visit [Red Hat Certified Hardware](#))
- Ubuntu Linux
- No preload operating system

Notes:

^[1] Windows® 10 IoT Enterprise LTSC 2021 is for special bid only.

Graphics

Graphics**

Graphics	Type	Memory	Connector	Max Resolution	Key Features
Intel® UHD graphics 710	Integrated	Shared	1x HDMI® 2.1 TMDS, 1x DP 1.4, 2x punch out ports ([2x HDMI®/VGA/DP] or [USB-C® with DP function, HDMI®/VGA/DP])	4096x2160@60Hz(HDMI®), 1920x1200@60Hz(VGA), 4096x2160@60Hz(DP), 4096x2160@60Hz(USB-C® with DP function)	DirectX® 12
Intel® UHD graphics 730	Integrated	Shared	1x HDMI® 2.1 TMDS, 1x DP 1.4, 2x punch out ports ([2x HDMI®/VGA/DP] or [USB-C® with DP function, HDMI®/VGA/DP])	4096x2304@60Hz(HDMI®), 1920x1200@60Hz(VGA), 4096x2304@60Hz(DP), 4096x2304@60Hz(USB-C® with DP function)	DirectX® 12
Intel® UHD graphics 770	Integrated	Shared	1x HDMI® 2.1 TMDS, 1x DP 1.4, 2x punch out ports ([2x HDMI®/VGA/DP] or [USB-C® with DP function, HDMI®/VGA/DP])	4096x2304@60Hz(HDMI®), 1920x1200@60Hz(VGA), 4096x2304@60Hz(DP), 4096x2304@60Hz(USB-C® with DP function)	DirectX® 12
Intel® Iris® Xe MAX 100	Discrete	2GB LPDDR4X	2x DP 1.4	3840x2160@60Hz(DP)	DirectX® 12, OpenGL 4.6

Monitor Support

Monitor Support

Supports up to 4 independent displays via (onboard DP, onboard HDMI®, punch out port 1 [VGA / HDMI® / DP / USB-C®], and punch out port 2 [VGA / HDMI® / DP])

Chipset

Chipset

Intel® Q670 chipset

Memory

Max Memory^[1]

Up to 64GB DDR5-4800

Memory Slots

Two DDR5 SO-DIMM slots, dual-channel capable

Memory Type

DDR5-4800

Notes:

[1] The max memory is based on the test results with current Lenovo® memory offerings.

Storage

Storage Support^[1]

Up to three drives, 1x 2.5" HDD + 2x M.2 SSD

- 2.5" HDD up to 1TB
- M.2 SSD up to 2TB each

Storage Type^{**}

Disk Type	Interface	RPM	Offering	Security
2.5" SATA HDD	SATA 6Gb/s	7.2K	500GB / 1TB	-
M.2 2280 SSD	PCIe® NVMe®, PCIe® 4.0 x4	-	256GB / 512GB / 1TB	Opal 2.0
M.2 2280 SSD	PCIe® NVMe®, PCIe® 4.0 x4 Performance	-	512GB / 1TB / 2TB	Opal 2.0
M.2 2242 SSD	PCIe® NVMe®, PCIe® 3.0 x2	-	128GB	-

RAID

RAID 0/1 support for M.2 SSDs (RAID preset only available via special bid models)

Notes:

[1] The max capacity of each disk type is based on the test results with current Lenovo® storage offerings.

Removable Storage

Optical^{**}

- DVD-ROM, slim (9.0mm), via USB external ODD box
- DVD burner (DVD±RW), slim (9.0mm), via USB external ODD box
- None

Card Reader

No card reader

Multi-Media

Audio Chip

High Definition (HD) Audio, Realtek® ALC256VB codec

Speakers^{**}

- Premium single speaker, 2W x1
- Single speaker, 2W x1

Power Supply

Power Supply^{**}

Power	Type	Efficiency	Key Features
65W	Adapter	89%	Autosensing
90W	Adapter	89%	Autosensing
135W	Adapter	89%	Autosensing
230W	Adapter	89%	Autosensing
No power supply	-	-	-

DESIGN

Input Device

Keyboard^{**}

- Lenovo® Calliope Keyboard (USB connector), black
- Lenovo® Calliope Wireless Keyboard, black
- Lenovo® Traditional Keyboard (USB connector), black
- No keyboard

Mouse**

- Lenovo® Calliope Mouse (USB connector), black
- Lenovo® Calliope Wireless Mouse (2.4GHz via USB receiver), black
- Lenovo® Fingerprint Mouse (USB connector), black (EOL on Jan, 2023)
- No mouse

Mechanical**Form Factor**

Tiny (1L)

Dimensions (WxDxH)^[1]

Models	Dimensions
Tiny only	179 x 182.9 x 36.5 mm with rubber feet (7.05 x 7.2 x 1.44 inches with rubber feet)
Tiny & ODD	204.2 x 186.6 x 64 mm with rubber feet (8.04 x 7.35 x 2.52 inches with rubber feet)

Packaging Dimensions (WxDxH)^[2]

- Tiny only: 490 x 250 x 130 mm (19.29 x 9.84 x 5.12 inches)
- Tiny & ODD: 490 x 268 x 166 mm (19.29 x 10.55 x 6.54 inches)

Weight^[3]

Models	Weight
Tiny only	1.25 kg (2.76 lbs)
With VESA mount & ODD box	1.74 kg (3.84 lbs)

Packaging Weight^[4]

- Tiny only: Around 3.2 kg (7.05 lbs)
- Tiny & ODD: Around 3.9 kg (8.6 lbs)

Case Color

Black

Bays

1x 2.5" disk bay

Expansion Slots

- One PCIe® 4.0 x8, low-profile
- Two M.2 PCIe® Gen 4x4 slots (for SSD)
- One M.2 slot (for WLAN)

EOU

- (Optional) toolless chassis open (toolless chassis screw required) and toolless M.2 SSD, HDD, memory assembly / removal
- No support

Stand

- Vertical stand
- No stand

IO Box

No IO box

Mounting

- VESA mount bracket kit, supports VESA mount 75mm and 100mm
- None

Others

- (Optional) Dust filter
- (Optional) Power adapter cage

Notes:

[1] The system dimensions may vary depending on configurations.

[2] The new packages take effect from September 2023. The old packages are:

Tiny only: 500 x 150 x 280 mm (19.69 x 5.91 x 11.02 inches)

Tiny & ODD: 500 x 175 x 280 mm (19.69 x 6.89 x 11.02 inches)

[3] The system weight is approximate and based on results in Lenovo® lab, which varies depending on the source of

component, variance of the distribution of each component, and manufacturing process. It may not be the exact weight for each specific model.

[4] The new packages take effect from September 2023. The old package are:

Tiny only: 2.85 kg (6.28 lbs)

Tiny & ODD: 3.58 kg (7.89 lbs)

CONNECTIVITY

Network

Onboard Ethernet

Gigabit Ethernet, Intel® Ethernet Connection I219-LM, 1x RJ-45, supports Wake-on-LAN

Optional Ethernet

- Gigabit Ethernet, Intel® Ethernet Server Adapter I350-T4, 4x RJ-45, PCIe® x4^[1]
- 2.5 Gigabit Ethernet, Realtek® RTL8125BGS, 1x RJ-45, supports Wake-on-LAN
- No optional Ethernet

WLAN + Bluetooth®**

- Realtek® Wi-Fi® 6 RTL8852AE, 802.11ax Dual Band 2x2 Wi-Fi® + Bluetooth® 5.3, M.2 card^[2]
- Realtek® Wi-Fi® 6 RTL8852BE, 802.11ax Dual Band 2x2 Wi-Fi® + Bluetooth® 5.3, M.2 card^[3]
- Intel® Wi-Fi® 6 AX201, 802.11ax 2x2 Wi-Fi® + Bluetooth® 5.2, Intel® vPro® technology support, M.2 Card^[4]
- Intel® Wi-Fi® 6 AX201, 802.11ax 2x2 Wi-Fi® + Bluetooth® 5.2, M.2 Card^[5]
- Realtek® Wi-Fi® 6E RTL8852CE, 802.11ax Dual Band 2x2 Wi-Fi® + Bluetooth® 5.3, M.2 card^[6]
- AMD Wi-Fi® 6E RZ616, 802.11ax 2x2 Wi-Fi® + Bluetooth® 5.3, M.2 Card^[7]
- Intel® Wi-Fi® 6E AX211, 802.11ax 2x2 Wi-Fi® + Bluetooth® 5.3, Intel® vPro® technology support, M.2 Card^[8]
- No WLAN and Bluetooth®

Notes:

[1] Intel® Ethernet Server Adapter I350-T4 is not available in EMEA.

[2], [3], [6], [7], [8] Bluetooth® 5.3 requires Windows® 11.

[4], [5] Bluetooth® 5.2 requires Windows® 11.

Ports^[1]

Front Ports

- 1x USB-C® 3.2 Gen 2 (support data transfer)
- 1x USB 3.2 Gen 2 (Always On and 5V@2.1A charging)
- 1x USB 3.2 Gen 2
- 1x headphone / microphone combo jack (3.5mm)

Optional Front Ports

None

Rear Ports

- 2x USB 3.2 Gen 1 (one supports Smart Power On)
- 2x USB 3.2 Gen 2
- 1x HDMI® 2.1 TMDS
- 1x DisplayPort™ 1.4
- 1x Ethernet (RJ-45)

Optional Rear Ports

- Punch out port 1 (one of VGA / DisplayPort™ / HDMI® / serial / USB-C® 3.2 Gen 1 with DisplayPort™ functions)
- Punch out port 2 (one of VGA / DisplayPort™ / HDMI® / serial / RJ-45)
- 2x USB 3.2 Gen 1 (share one USB 3.2 Gen 1 bandwidth, occupies port 1 and 2)
- 4x USB 3.2 Gen 1 (share one USB 3.2 Gen 1 bandwidth, occupy port 1 and 2)
- 1x 2.5GbE RJ-45, via RTL8125BGS
- 4x GbE RJ-45, via additional PCIe® adapter

Notes:

[1] The transfer speed of following ports will vary and, depending on many factors, such as the processing speed of the host device, file attributes and other factors related to system configuration and your operating environment, will be slower than theoretical speed.

USB 2.0: 480 Mbit/s;

USB 3.2 Gen 1 (SuperSpeed USB 5Gbps, formerly USB 3.0 / USB 3.1 Gen 1): 5 Gbit/s;

USB 3.2 Gen 2 (SuperSpeed USB 10Gbps, formerly USB 3.1 Gen 2): 10 Gbit/s;
USB4® 20Gbps / USB 3.2 Gen 2x2 (SuperSpeed USB 20Gbps): 20 Gbit/s;
USB4® 40Gbps (USB 40Gbps): 40 Gbit/s;
Thunderbolt™ 3/4: 40 Gbit/s.

Monitor Cable

Monitor Cable

- HDMI® to HDMI® cable (1.5m)
- HDMI® to VGA dongle
- DP to VGA dongle
- DP to DVI dongle
- DP to dual DP dongle
- DP to HDMI® dongle
- No monitor cable

SECURITY & PRIVACY

Security

Security Chip

Discrete TPM 2.0, TCG certified, FIPS 140-2 certified

Physical Locks

Kensington® Security Slot™, 3 x 7 mm

Chassis Intrusion Switch

Chassis intrusion switch

Fingerprint Reader

- Touch style fingerprint reader on mouse (EOL on Jan, 2023)
- No fingerprint reader

BIOS Security

- Administrator password
- Power-on password
- Hard disk password
- Boot sequence control
- Boot without keyboard and mouse
- Certificate based BIOS management
- Cover presence switch
- Self-healing BIOS
- Smart USB protection (allows keyboard / mouse only, blocks all storage devices)
- Individual USB port disablement

MANAGEABILITY

System Management

System Management

- Intel® vPro® Enterprise^[1]
- Non-vPro®

Notes:

[1] Intel® vPro® offers a superset of DASH's defined capabilities.

SERVICE

Warranty^[1]

Base Warranty**

- 1-year limited onsite service
- 3-year limited onsite service
- No base warranty

Notes:

[1] The warranty upgrades may be bundled with some models, please check the "Included upgrade" column in the specific model's configurations. For more service extensions, please go to <https://smartfind.lenovo.com/>. To learn more details of warranty policy, please access <https://pcsupport.lenovo.com/warranty>.

ENVIRONMENTAL

Sustainability

Material^[1]

85% PCC recycled plastic used in product chassis.

95% PCC recycled plastic used in USB keyboard/mouse.

90% PIC recycled plastic EPE cushion or 90% PCC recycled plastic thermal shell with 30% OBP material.

30% OBP used in bag.

FSC certified paper in packaging.

Notes:

[1] PCC: Post Consumer Content, recycled materials from customers.

PIC: Post Industry Content, recycled materials from internal factories.

EPE: Expanded Polyethylene.

OBP: Ocean Bound Plastic, reducing plastic spill into the sea.

FSC: Forest Stewardship Council.

Operating Environment

Temperature

- Operating: 5°C (41°F) to 35°C (95°F)
- Storage: -40°C (-40°F) to 60°C (140°F)

Relative Humidity

- Operating: 20% to 80%
- Storage: 10% to 90%

Altitude

- Operating: 0 m (0 ft) to 3048 m (10,000 ft)
- Storage: 0 m (0 ft) to 12192 m (40,000 ft)

CERTIFICATIONS

Green Certifications^[1]

Green Certifications

- (Optional) ENERGY STAR® 8.0
- (Optional) EPEAT™ Silver Registered^[2]
- (Optional) EPEAT™ Gold Registered^[3]
- ErP Lot 3
- RoHS compliant
- TCO Certified 9.0

Notes:

[1] The items listed under the "Green Certifications" section may not only refer to certification but also registration or self-declaration.

[2], [3] EPEAT™ is registered where applicable, please see epeat.net for registration status by country.

Other Certifications

Other Certifications

(Optional) TÜV Rheinland® Ultra Low Noise

Mil-Spec Test

MIL-STD-810H military test passed

- Feature with ** means that only one offering listed under the feature is configured on selected models.
- Feature with *** means that one or more offerings listed under the feature could be configured on selected models.
- Lenovo reserves the right to change specifications or other product information without notice. Lenovo is not responsible for photographic or typographical errors. LENOVO PROVIDES THIS PUBLICATION “AS IS,” WITHOUT WARRANTY OF ANY KIND, EITHER EXPRESS OR IMPLIED, INCLUDING THE IMPLIED WARRANTIES OF MERCHANTABILITY OR FITNESS FOR A PARTICULAR PURPOSE. Some jurisdictions do not allow disclaimer of express or implied warranties in certain transactions, therefore this disclaimer may not apply to you.
- The specifications on this page may not be available in all regions, and may be changed or updated without notice.



intel



intel



intel

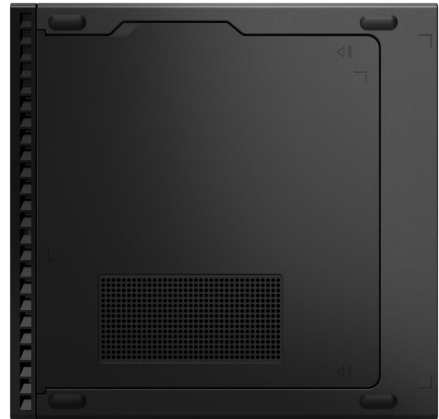

intel



intel



intel

OVERVIEW

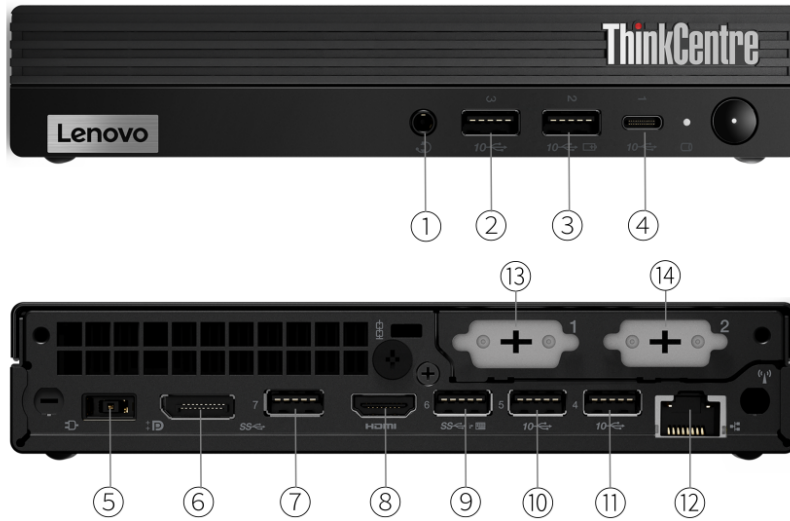

1. Headphone / microphone combo jack (3.5mm)	8. HDMI
2. USB 3.2 Gen 2	9. USB 3.2 Gen 1 (with Smart Power On feature)
3. USB 3.2 Gen 2 (Always On and fast charge)	10. USB 3.2 Gen 2
4. USB-C 3.2 Gen 2	11. USB 3.2 Gen 2
5. Power connector	12. Ethernet (RJ-45)
6. DisplayPort 1.4a	13. Punch out port 1 *
7. USB 3.2 Gen 1	14. Punch out port 2 *

Notes:

- Items with * are only available on selected models

PERFORMANCE

Processor

Processor Family

13th Generation Intel® Core™ i3 / i5 / i7 / i9 Processor, 35W or 65W

Processor**^[1]

Processor Name	Cores	Threads	Base Frequency	Max Frequency	Cache	Memory Support	Processor Graphics
Core™ i3-13100	4 (4 P-core + 0 E-core)	8	P-core 3.4GHz	P-core 4.5GHz	12MB	DDR5-4800	Intel® UHD Graphics 730
Core™ i3-13100T	4 (4 P-core + 0 E-core)	8	P-core 2.5GHz	P-core 4.2GHz	12MB	DDR5-4800	Intel® UHD Graphics 730
Core™ i5-13400	10 (6 P-core + 4 E-core)	16	P-core 2.5GHz / E-core 1.8GHz	P-core 4.6GHz / E-core 3.3GHz	20MB	DDR5-4800	Intel® UHD Graphics 730
Core™ i5-13400T	10 (6 P-core + 4 E-core)	16	P-core 1.3GHz / E-core 1.0GHz	P-core 4.4GHz / E-core 3.0GHz	20MB	DDR5-4800	Intel® UHD Graphics 730
Core™ i5-13500	14 (6 P-core + 8 E-core)	20	P-core 2.5GHz / E-core 1.8GHz	P-core 4.8GHz / E-core 3.5GHz	24MB	DDR5-4800	Intel® UHD Graphics 770
Core™ i5-13500T	14 (6 P-core + 8 E-core)	20	P-core 1.6GHz / E-core 1.2GHz	P-core 4.6GHz / E-core 3.2GHz	24MB	DDR5-4800	Intel® UHD Graphics 770
Core™ i5-13600	14 (6 P-core + 8 E-core)	20	P-core 2.7GHz / E-core 2.0GHz	P-core 5.0GHz / E-core 3.7GHz	24MB	DDR5-4800	Intel® UHD Graphics 770
Core™ i5-13600T	14 (6 P-core + 8 E-core)	20	P-core 1.8GHz / E-core 1.3GHz	P-core 4.8GHz / E-core 3.4GHz	24MB	DDR5-4800	Intel® UHD Graphics 770
Core™ i7-13700	16 (8 P-core + 8 E-core)	24	P-core 2.1GHz / E-core 1.5GHz	Max Turbo up to 5.2GHz / P-core 5.1GHz / E-core 4.1GHz	30MB	DDR5-5600	Intel® UHD Graphics 770
Core™ i7-13700T	16 (8 P-core + 8 E-core)	24	P-core 1.4GHz / E-core 1.0GHz	Max Turbo up to 4.9GHz / P-core 4.8GHz / E-core 3.6GHz	30MB	DDR5-5600	Intel® UHD Graphics 770
Core™ i9-13900	24 (8 P-core + 16 E-core)	32	P-core 2.0GHz / E-core 1.5GHz	Max Turbo up to 5.6GHz / P-core 5.2GHz / E-core 4.2GHz	36MB	DDR5-5600	Intel® UHD Graphics 770
Core™ i9-13900T	24 (8 P-core + 16 E-core)	32	P-core 1.1GHz / E-core 0.8GHz	Max Turbo up to 5.3GHz / P-core 5.1GHz / E-core 3.9GHz	36MB	DDR5-5600	Intel® UHD Graphics 770

Notes:

^[1] Intel® Max Turbo frequency will vary depending on application workload and the hardware and software configurations, see <http://www.intel.com/technology/turboboost/> for more information.

Operating System

Operating System**

- Windows® 11 Pro
- Windows® 11 Home
- Windows® 11 Home Single Language
- Windows® 11 DG Windows® 10 Pro 64
- Windows® 10 IoT Enterprise LTSC 2021
- Ubuntu Linux^[1]
- No preload operating system

Notes:

^[1] Some features may not be supported on the system with Linux preload, including but not limited to Intel® RST RAID, Human Presence Detection, etc.

Graphics

Graphics**

Graphics	Type	Memory	Connector	Max Resolution	Key Features
Intel® UHD graphics 730	Integrated	Shared	1x HDMI® 2.1 TMDS, 1x DP 1.4a (HBR2, DSC), 2x punch out ports ([2x HDMI®/VGA/DP] or [USB-C® with DP function, HDMI®/VGA/DP])	4096x2304@60Hz(HDMI®), 1920x1200@60Hz(VGA), 4096x2304@60Hz(DP), 4096x2304@60Hz(USB-C® with DP function)	DirectX® 12
Intel® UHD graphics 770	Integrated	Shared	1x HDMI® 2.1 TMDS, 1x DP 1.4a (HBR2, DSC), 2x punch out ports ([2x HDMI®/VGA/DP] or [USB-C® with DP function, HDMI®/VGA/DP])	4096x2304@60Hz(HDMI®), 1920x1200@60Hz(VGA), 4096x2304@60Hz(DP), 4096x2304@60Hz(USB-C® with DP function)	DirectX® 12

Monitor Support

Monitor Support

Supports up to 4 independent displays via (onboard DP, onboard HDMI®, punch out port 1 [VGA / HDMI® / DP / USB-C®], and punch out port 2 [VGA / HDMI® / DP])

Chipset

Chipset

Intel® Q670 chipset

Memory

Max Memory^[1]

Up to 64GB (2x 32GB DDR5 SO-DIMM)

Memory Slots

Two DDR5 SO-DIMM slots, dual-channel capable

Memory Type**^[2]

- DDR5-4800
- DDR5-5200
- DDR5-5600

Notes:

[1] The max memory is based on the test results with current Lenovo® memory offerings.

[2] Installed memory is actually DDR5-5600, but may run as DDR5-4800, DDR5-5200, or DDR5-5600 depending on the memory support capability of processor.

Storage

Storage Support^[1]

Up to three drives, 1x 2.5" HDD + 2x M.2 SSD

- 2.5" HDD up to 1TB
- M.2 SSD up to 2TB each

Storage Type***

Disk Type	Interface	RPM	Offering	Security
2.5" SATA HDD	SATA 6Gb/s	7.2K	1TB	-
M.2 2280 SSD	PCIe® NVMe®, PCIe® 4.0 x4	-	256GB / 512GB / 1TB	Opal 2.0
M.2 2280 SSD	PCIe® NVMe®, PCIe® 4.0 x4 Performance	-	512GB / 1TB / 2TB	Opal 2.0

RAID

None

Notes:

[1] The max capacity of each disk type is based on the test results with current Lenovo® storage offerings.

ThinkCentre M90q Gen 4

Removable Storage

Optical

None

Card Reader

No card reader

Multi-Media

Audio Chip

High Definition (HD) Audio, Realtek® ALC256VB codec

Speakers**

- Premium single speaker, 2W x1
- Single speaker, 2W x1

Power Supply

Power Supply**

Power	Type	Efficiency	Key Features
65W	Adapter	89%	Autosensing
90W	Adapter	89%	Autosensing
135W	Adapter	90%	Autosensing
230W	Adapter	89%	Autosensing
No power supply	-	-	-

DESIGN

Input Device

Keyboard**

- Lenovo® Calliope Keyboard (USB connector), black
- Lenovo® Calliope Wireless Keyboard, black
- Lenovo® Traditional Keyboard (USB connector), black
- No keyboard

Mouse**

- Lenovo® Calliope Mouse (USB connector), black
- Lenovo® Calliope Wireless Mouse (2.4GHz via USB receiver), black
- No mouse

Mechanical

Form Factor

Tiny (1L)

Dimensions (WxDxH)^[1]

Models	Dimensions
Tiny only	179 x 182.9 x 36.5 mm with rubber feet (7.05 x 7.2 x 1.44 inches with rubber feet)
Tiny & ODD	204.2 x 186.6 x 64 mm with rubber feet (8.04 x 7.35 x 2.52 inches with rubber feet)

Packaging Dimensions (WxDxH)^[2]

- Tiny only: 490 x 250 x 130 mm (19.29 x 9.84 x 5.12 inches)
- Tiny & ODD: 490 x 268 x 166 mm (19.29 x 10.55 x 6.54 inches)

Weight^[3]

Models	Weight
Tiny only	1.25 kg (2.76 lbs)
With VESA mount & ODD box	1.74 kg (3.84 lbs)

Packaging Weight^[4]

- Tiny only: Around 3.2 kg (7.05 lbs)
- Tiny & ODD: Around 3.9 kg (8.6 lbs)

Case Color

Black

Bays

- 1x 2.5" disk bay (optional, or bay comes with disk)
- No bays

Expansion Slots

- One PCIe® 4.0 x8, low-profile
- Two M.2 PCIe® Gen 4x4 slots (for SSD)
- One M.2 slot (for WLAN)

EOU

- (Optional) toolless chassis open (toolless chassis screw required) and toolless M.2 SSD, HDD, memory assembly / removal
- No support

Stand

- Vertical stand
- No stand

IO Box

No IO box

Mounting

- VESA mount bracket kit, supports VESA mount 75mm and 100mm
- None

Others

- (Optional) Dust filter
- (Optional) Power adapter cage

Notes:

[1] The system dimensions may vary depending on configurations.

[2] The new packages take effect from September 2023. The old packages are:

Tiny only: 500 x 150 x 280 mm (19.69 x 5.91 x 11.02 inches)

Tiny & ODD: 500 x 175 x 280 mm (19.69 x 6.89 x 11.02 inches)

[3] The system weight is approximate and based on results in Lenovo® lab, which varies depending on the source of component, variance of the distribution of each component, and manufacturing process. It may not be the exact weight for each specific model.

[4] The new packages take effect from September 2023. The old package are:

Tiny only: 2.85 kg (6.28 lbs)

Tiny & ODD: 3.58 kg (7.89 lbs)

CONNECTIVITY

Network

Onboard Ethernet

Gigabit Ethernet, Intel® Ethernet Connection I219-LM, 1x RJ-45, supports Wake-on-LAN

Optional Ethernet**

- 2.5 Gigabit Ethernet, Realtek® RTL8125BGS, 1x RJ-45
- Gigabit Ethernet, Intel® Ethernet Server Adapter I350-T4, 4x RJ-45, PCIe® x4
- No optional Ethernet

WLAN + Bluetooth®**

- Realtek® Wi-Fi® 6 RTL8852BE, 802.11ax Dual Band 2x2 Wi-Fi® + Bluetooth® 5.3, M.2 card^[1]
- Intel® Wi-Fi® 6 AX201, 802.11ax 2x2 Wi-Fi® + Bluetooth® 5.2, M.2 Card^[2]
- Intel® Wi-Fi® 6E AX211, 802.11ax 2x2 Wi-Fi® + Bluetooth® 5.3, Intel® vPro® technology support, M.2 Card^[3]
- No WLAN and Bluetooth®

Notes:

[1], [3] Bluetooth® 5.3 requires Windows® 11.

[2] Bluetooth® 5.2 requires Windows® 11.

Ports^[1]

Front Ports

- 1x USB-C® 3.2 Gen 2 (support data transfer)
- 1x USB 3.2 Gen 2 (Always On and 5V@2.1A charging)
- 1x USB 3.2 Gen 2
- 1x headphone / microphone combo jack (3.5mm)

Optional Front Ports

None

Rear Ports

- 2x USB 3.2 Gen 1 (one supports Smart Power On)
- 2x USB 3.2 Gen 2
- 1x HDMI® 2.1 TMDS
- 1x DisplayPort™ 1.4a (HBR2, DSC)
- 1x Ethernet (RJ-45)

Optional Rear Ports

- Punch out port 1 (one of VGA / DisplayPort™ / HDMI® / serial / USB-C® 3.2 Gen 1 with DisplayPort™ functions)
- Punch out port 2 (one of VGA / DisplayPort™ / HDMI® / serial / RJ-45)
- 1x Thunderbolt™ 4 (supports data transfer, Power Delivery 3.0 and DisplayPort™ 1.4, via Thunderbolt™ expansion card, PCIe® x4)
- 2x USB 3.2 Gen 1 (share one USB 3.2 Gen 1 bandwidth, occupies port 1 and 2)
- 4x USB 3.2 Gen 1 (share one USB 3.2 Gen 1 bandwidth, occupy port 1 and 2)
- 4x GbE RJ-45, via additional PCIe® adapter
- 4x serial (via 4-port serial expansion card, PCIe® x1)

Notes:

[1] The transfer speed of following ports will vary and, depending on many factors, such as the processing speed of the host device, file attributes and other factors related to system configuration and your operating environment, will be slower than theoretical speed.

USB 2.0: 480 Mbit/s;

USB 3.2 Gen 1 (SuperSpeed USB 5Gbps, formerly USB 3.0 / USB 3.1 Gen 1): 5 Gbit/s;

USB 3.2 Gen 2 (SuperSpeed USB 10Gbps, formerly USB 3.1 Gen 2): 10 Gbit/s;

USB4® 20Gbps / USB 3.2 Gen 2x2 (SuperSpeed USB 20Gbps): 20 Gbit/s;

USB4® 40Gbps (USB 40Gbps): 40 Gbit/s;

Thunderbolt™ 3/4: 40 Gbit/s.

Monitor Cable

Monitor Cable

- HDMI® to HDMI® cable (1.5m)
- HDMI® to VGA dongle
- DP to VGA dongle
- DP to DVI dongle
- DP to dual DP dongle
- DP to HDMI® dongle
- No monitor cable

SECURITY & PRIVACY

Security

Security Chip

Discrete TPM 2.0, TCG certified, FIPS 140-2 certified

Physical Locks

Kensington® Security Slot™, 3 x 7 mm

Chassis Intrusion Switch

Chassis intrusion switch

Fingerprint Reader

No fingerprint reader

BIOS Security

- Administrator password
- Power-on password
- Hard disk password
- Boot sequence control
- Boot without keyboard and mouse
- Certificate based BIOS management
- Cover presence switch
- Self-healing BIOS
- Smart USB protection (allows keyboard / mouse only, blocks all storage devices)
- Individual USB port disablement

MANAGEABILITY

System Management

System Management

- Intel® vPro® Enterprise^[1]
- Non-vPro®

Notes:

[1] Intel® vPro® offers a superset of DASH's defined capabilities.

SERVICE

Warranty^[1]

Base Warranty**

- 1-year limited onsite service
- 3-year limited onsite service
- No base warranty

Notes:

[1] The warranty upgrades may be bundled with some models, please check the "Included upgrade" column in the specific model's configurations. For more service extensions, please go to <https://smartfind.lenovo.com/>. To learn more details of warranty policy, please access <https://pcsupport.lenovo.com/warranty>.

ENVIRONMENTAL

Sustainability

Material^[1]

85% PCC recycled plastic used in product chassis.

95% PCC recycled plastic used in USB keyboard/mouse.

90% PIC recycled plastic EPE cushion or 90% PCC recycled plastic thermal shell with 30% OBP material.

30% OBP used in bag.

FSC certified paper in packaging.

Notes:

[1] PCC: Post Consumer Content, recycled materials from customers.

PIC: Post Industry Content, recycled materials from internal factories.

EPE: Expanded Polyethylene.

OBP: Ocean Bound Plastic, reducing plastic spill into the sea.

FSC: Forest Stewardship Council.

Operating Environment

Temperature

- Operating: 5°C (41°F) to 35°C (95°F)
- Storage: -40°C (-40°F) to 60°C (140°F)

Relative Humidity

- Operating: 20% to 80%
- Storage: 10% to 90%

Altitude

- Operating: 0 m (0 ft) to 3048 m (10,000 ft)
- Storage: 0 m (0 ft) to 12192 m (40,000 ft)

CERTIFICATIONS

Green Certifications^[1]

Green Certifications

- (Optional) ENERGY STAR® 8.0
- (Optional) EPEAT™ Silver Registered^[2]
- (Optional) EPEAT™ Gold Registered^[3]
- ErP Lot 3
- RoHS compliant
- TCO Certified 9.0

Notes:

[1] The items listed under the "Green Certifications" section may not only refer to certification but also registration or self-declaration.

[2], [3] EPEAT™ is registered where applicable, please see [epeat.net](https://www.epeat.net) for registration status by country.

Other Certifications

Mil-Spec Test

MIL-STD-810H military test passed

- Feature with ** means that only one offering listed under the feature is configured on selected models.
- Feature with *** means that one or more offerings listed under the feature could be configured on selected models.
- Lenovo reserves the right to change specifications or other product information without notice. Lenovo is not responsible for photographic or typographical errors. LENOVO PROVIDES THIS PUBLICATION "AS IS," WITHOUT WARRANTY OF ANY KIND, EITHER EXPRESS OR IMPLIED, INCLUDING THE IMPLIED WARRANTIES OF MERCHANTABILITY OR FITNESS FOR A PARTICULAR PURPOSE. Some jurisdictions do not allow disclaimer of express or implied warranties in certain transactions, therefore this disclaimer may not apply to you.
- The specifications on this page may not be available in all regions, and may be changed or updated without notice.



intel



intel



intel



intel



intel



intel

OVERVIEW

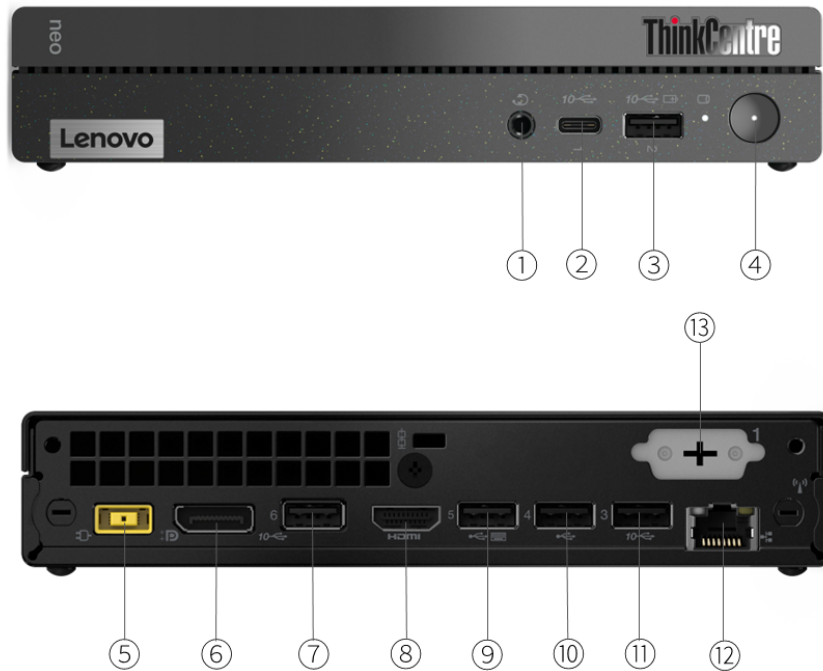

1. Headphone / microphone combo jack (3.5mm)	8. HDMI 2.1 TMDS
2. USB-C 3.2 Gen 2 (support data transfer and 5V@0.9A charging)	9. USB 2.0
3. USB 3.2 Gen 2 (Always On and 5V@2.1A charging)	10. USB 2.0
4. Power button	11. USB 3.2 Gen 2
5. Power-in	12. Ethernet (RJ-45)
6. DisplayPort 1.4	13. Punch out port *
7. USB 3.2 Gen 2	

Notes:

- Items with * are only available on selected models

PERFORMANCE

Processor

Processor Family

12th Generation Intel® Core™ i3, or 13th Generation Intel® Core™ i5 Processor

Processor**

Processor Name	Cores	Threads	Base Frequency	Max Frequency	Cache	Processor Graphics
Core™ i3-1215U	6 (2 P-core + 4 E-core)	8	P-core 1.2GHz / E-core 0.9GHz	P-core 4.4GHz / E-core 3.3GHz ^[1]	10MB	Intel® UHD Graphics
Core™ i5-13420H	8 (4 P-core + 4 E-core)	12	P-core 2.1GHz / E-core 1.5GHz	P-core 4.6GHz / E-core 3.4GHz ^[2]	12MB	Intel® UHD Graphics

Notes:

[1], [2] Intel® Max Turbo frequency will vary depending on application workload and the hardware and software configurations, see <http://www.intel.com/technology/turboboost/> for more information.

Operating System

Operating System**

- Windows® 11 Pro
- Windows® 11 Home
- Windows® 11 Home Single Language
- Windows® 11 DG Windows® 10 Pro 64
- Ubuntu Linux^[1]
- No preload operating system

Notes:

[1] The pre-installed IGEL OS version is 11.08.240
The device is preload with a free evaluation license. The evaluation license will be valid for a period of 90 days.

Graphics

Graphics

Graphics	Type	Memory	Connector	Max Resolution	Key Features
Intel® UHD Graphics	Integrated	Shared	1x DP 1.4, 1x HDMI® 2.1 TMDS, 1x punch out port (1x VGA or 1x DP 1.4)	4096x2160@60Hz(DP), 4096x2160@60Hz(HDMI®), 1920x1200@60Hz(VGA)	DirectX® 12.1

Monitor Support

Monitor Support

Supports up to 3 independent displays via (onboard DP, onboard HDMI®, punch out port 1 [VGA / DP])

Chipset

Chipset

Intel® SoC (System on Chip) platform

Memory

Max Memory^[1]

Up to 32GB DDR4-3200

Memory Slots

Two DDR4 SO-DIMM slots, dual-channel capable

Memory Type

DDR4-3200

ThinkCentre neo 50q Gen 4

Notes:

[1] The max memory is based on the test results with current Lenovo® memory offerings.

Storage

Storage Support^{[1][2]}

Up to two drives, 1x 2.5" HDD + 1x M.2 SSD

- 2.5" HDD up to 1TB
- M.2 SSD up to 1TB

Storage Type^{***}

Disk Type	Interface	RPM	Security
2.5" SATA HDD	SATA 6Gb/s	7.2K	-
M.2 2280 SSD	PCIe® NVMe®, PCIe® 4.0 x4	-	Opal 2.0
M.2 2242 SSD	PCIe® NVMe®, PCIe® 3.0 x4	-	-

Notes:

[1] The max capacity of each disk type is based on the test results with current Lenovo® storage offerings.

[2] 2.5" HDD bracket kit only comes with pre-configured HDD models.

Removable Storage

Optical

None

Card Reader

No card reader

Multi-Media

Audio Chip

High Definition (HD) Audio, Realtek® ALC256 codec

Speakers

Single speaker, 2W x1

Microphone

No microphone

Power Supply

Power Supply^{**[1]}

Power	Type	Efficiency	Key Features
65W	Adapter	89%	Autosensing
90W	Adapter	89%	Autosensing
135W	Adapter	89%	Autosensing
No power supply	-	-	-

Notes:

[1] The optional 90w adapter may increase performance scores when i5-13420H CPUs are installed.

When work with TIO monitor, an appropriate power adapter is needed. Customer may need to:

- Order a Tiny for TIO MT (12LQ, 12LR) models
- Or for Intel® Core™ i5 models order an additional 135W power adapter, for Intel® Core™ i3 models order an additional 90W power adapter. If original power adapter is less than 135W (i5 models) or 90W (i3 models).

DESIGN

Input Device

Keyboard

ThinkCentre neo 50q Gen 4

- Lenovo® Calliope Keyboard (USB connector), black
- No keyboard

Mouse

- Lenovo® Calliope Mouse (USB connector), black
- No mouse

Mechanical

Form Factor

Tiny (1L)

Dimensions (WxDxH)^[1]

179 x 182.9 x 36.5 mm (7.05 x 7.2 x 1.44 inches)

Packaging Dimensions (WxDxH)^[2]

494 x 250 x 130 mm (19.45 x 9.84 x 5.12 inches)

Weight^[3]

Around 1.11 kg (2.45 lbs)

Packaging Weight^[4]

Around 3.2 kg (7.05 lbs)

Case Color

Black

Bays

1x 2.5" disk bay (optional, or bay comes with disk)

Expansion Slots

Two M.2 slots (one for WLAN, one for SSD)

EOU

(Optional) Toolless cover (toolless chassis screw required), stand, optional 2.5" HDD bracket assembly / removal

Stand

- Vertical stand
- No stand

Mounting

- Supports VESA mount 100mm
- None

Others

(Optional) Power adapter cage

Notes:

[1] The system dimensions may vary depending on configurations.

[2] The new package takes effect from November 2023. The old package is:
140 x 262 x 500 mm (5.51 x 10.31 x 19.69 inches)

[3] The system weight is approximate and based on results in Lenovo® lab, which varies depending on the source of component, variance of the distribution of each component, and manufacturing process. It may not be the exact weight for each specific model.

[4] The new package takes effect from November 2023. The old package is:
Around 5.18 kg (11.42 lbs)

CONNECTIVITY

Network

Onboard Ethernet

Gigabit Ethernet, Realtek® RTL8111K-CG, 1x RJ-45

WLAN + Bluetooth[®]**

- Realtek® Wi-Fi® 6 RTL8852BE, 802.11ax Dual Band 2x2 Wi-Fi® + Bluetooth® 5.3, M.2 card^[1]
- Intel® Wi-Fi® 6 AX201, 802.11ax 2x2 Wi-Fi® + Bluetooth® 5.2, M.2 Card^[2]
- No WLAN and Bluetooth®

ThinkCentre neo 50q Gen 4

Notes:

[1] Bluetooth® 5.3 requires Windows® 11.

[2] Bluetooth® 5.2 requires Windows® 11.

Ports^[1]

Front Ports

- 1x USB-C® 3.2 Gen 2 (support data transfer and 5V@0.9A charging)
- 1x USB 3.2 Gen 2 (Always On and 5V@2.1A charging)
- 1x headphone / microphone combo jack (3.5mm)

Optional Front Ports

None

Rear Ports

- 2x USB 2.0
- 2x USB 3.2 Gen 2
- 1x HDMI® 2.1 TMDS
- 1x DisplayPort™ 1.4
- 1x Ethernet (RJ-45)

Optional Rear Ports

Punch out port (one of VGA / DisplayPort™ 1.4 / serial)

Notes:

[1] The transfer speed of following ports will vary and, depending on many factors, such as the processing speed of the host device, file attributes and other factors related to system configuration and your operating environment, will be slower than theoretical speed.

USB 2.0: 480 Mbit/s;

USB 3.2 Gen 1 (SuperSpeed USB 5Gbps, formerly USB 3.0 / USB 3.1 Gen 1): 5 Gbit/s;

USB 3.2 Gen 2 (SuperSpeed USB 10Gbps, formerly USB 3.1 Gen 2): 10 Gbit/s;

USB4® 20Gbps / USB 3.2 Gen 2x2 (SuperSpeed USB 20Gbps): 20 Gbit/s;

USB4® 40Gbps (USB 40Gbps): 40 Gbit/s;

Thunderbolt™ 3/4: 40 Gbit/s.

SECURITY & PRIVACY

Security

Security Chip

Firmware TPM 2.0 integrated in SoC

Physical Locks

Kensington® Security Slot™, 3 x 7 mm

Chassis Intrusion Switch

Chassis intrusion switch

BIOS Security

- Administrator password
- Supervisor password
- Hard disk password
- Boot sequence control
- Cover presence switch
- Self-healing BIOS
- Smart USB protection (allows keyboard / mouse only, blocks all storage devices)
- Individual USB port disablement
- Intel® BIOS guard

MANAGEABILITY

System Management

System Management

None

SERVICE

Warranty^[1]

Base Warranty**

- 1-year courier or carry-in service
- 1-year limited onsite service
- No base warranty

Notes:

[1] The warranty upgrades may be bundled with some models, please check the "Included upgrade" column in the specific model's configurations. For more service extensions, please go to <https://smartfind.lenovo.com/>. To learn more details of warranty policy, please access <https://pcsupport.lenovo.com/warranty>.

ENVIRONMENTAL

Operating Environment

Temperature

- Operating: 10°C (50°F) to 35°C (95°F)
- Storage: -40°C (-40°F) to 60°C (140°F)

Relative Humidity

- Operating: 20% to 80%
- Storage: 20% to 90%

Altitude

- Operating: -15.2 m (-50 ft) to 3048 m (10,000 ft)
- Storage: -15.2 m (-50 ft) to 10668 m (35,000 ft)

ACCESSORIES

Bundled Accessories

Bundled Accessories

- DP to DVI dongle
- DP to VGA dongle

CERTIFICATIONS

Green Certifications^[1]

Green Certifications

- (Optional) ENERGY STAR® 8.0
- (Optional) EPEAT™ Gold Registered^[2]
- ErP Lot 3 and Lot 7
- RoHS compliant
- TCO Certified 9.0

Notes:

[1] The items listed under the "Green Certifications" section may not only refer to certification but also registration or self-declaration.

[2] EPEAT™ is registered where applicable, please see epeat.net for registration status by country.

Other Certifications

Other Certifications

(Optional) TÜV Rheinland® Ultra Low Noise

- Feature with ** means that only one offering listed under the feature is configured on selected models.

- Feature with *** means that one or more offerings listed under the feature could be configured on selected models.
- Lenovo reserves the right to change specifications or other product information without notice. Lenovo is not responsible for photographic or typographical errors. LENOVO PROVIDES THIS PUBLICATION “AS IS,” WITHOUT WARRANTY OF ANY KIND, EITHER EXPRESS OR IMPLIED, INCLUDING THE IMPLIED WARRANTIES OF MERCHANTABILITY OR FITNESS FOR A PARTICULAR PURPOSE. Some jurisdictions do not allow disclaimer of express or implied warranties in certain transactions, therefore this disclaimer may not apply to you.
- The specifications on this page may not be available in all regions, and may be changed or updated without notice.



OVERVIEW

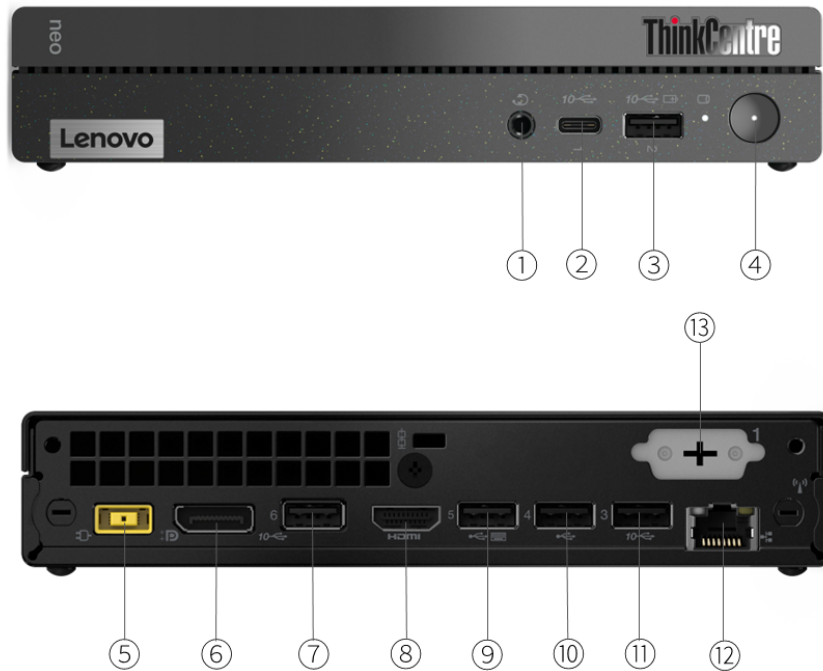

1. Headphone / microphone combo jack (3.5mm)	8. HDMI 2.1 TMDs
2. USB-C 3.2 Gen 2 (support data transfer and 5V@0.9A charging)	9. USB 2.0
3. USB 3.2 Gen 2 (Always On and 5V@2.1A charging)	10. USB 2.0
4. Power button	11. USB 3.2 Gen 2
5. Power-in	12. Ethernet (RJ-45)
6. DisplayPort 1.4	13. Punch out port *
7. USB 3.2 Gen 2	

Notes:

- Items with * are only available on selected models

PERFORMANCE

Processor

Processor Family

Intel® Celeron® or 12th Generation Intel® Core™ i3 Processor

Processor**

Processor Name	Cores	Threads	Base Frequency	Max Frequency	Cache	Processor Graphics
Celeron® 7305	5 (1 P-core + 4 E-core)	6	P-core 1.1GHz / E-core 0.9GHz	P-core 1.1GHz / E-core 0.9GHz ^[1]	8MB	Intel® UHD Graphics
Core™ i3-1215U	6 (2 P-core + 4 E-core)	8	P-core 1.2GHz / E-core 0.9GHz	P-core 4.4GHz / E-core 3.3GHz ^[2]	10MB	Intel® UHD Graphics

Notes:

[1], [2] Intel® Max Turbo frequency will vary depending on application workload and the hardware and software configurations, see <http://www.intel.com/technology/turboboost/> for more information.

Operating System

Operating System**

- Windows® 10 IoT Enterprise (Thin Client)
- IGEL Linux^[1]
- LeTOS™ V2 (Lenovo® Terminal Operating System, Linux-based)
- No preload operating system

Notes:

[1] The pre-installed IGEL OS version is 11.08.240
The device is preload with a free evaluation license. The evaluation license will be valid for a period of 90 days.

Graphics

Graphics

Graphics	Type	Memory	Connector	Max Resolution	Key Features
Intel® UHD Graphics	Integrated	Shared	1x DP 1.4, 1x HDMI® 2.1 TMDS, 1x punch out port (1x VGA or 1x DP 1.4)	4096x2160@60Hz(DP), 4096x2160@60Hz(HDMI®), 1920x1200@60Hz(VGA)	DirectX® 12.1

Monitor Support

Monitor Support

Supports up to 3 independent displays via (onboard DP, onboard HDMI®, punch out port 1 [VGA / DP])

Chipset

Chipset

Intel® SoC (System on Chip) platform

Memory

Max Memory^[1]

- Models with Intel® Celeron® processor: Up to 16GB DDR4-3200
- Models with Intel® Core™ processor: Up to 32GB DDR4-3200

Memory Slots

- Models with Intel® Core™ processor: Two DDR4 SO-DIMM slots, dual-channel capable
- Models with Intel® Celeron® processor: One DDR4 SO-DIMM slot, dual-channel capable

Memory Type

DDR4-3200

ThinkCentre neo 50q Gen 4 Thin Client

Notes:

[1] The max memory is based on the test results with current Lenovo® memory offerings.

Storage

Storage Support^[1]

One drive, 256GB M.2 2280 SSD

Storage Type

Disk Type	Interface	Security
M.2 2280 SSD	PCIe® NVMe®, PCIe® 4.0 x4	Opal 2.0

Notes:

[1] The max capacity of each disk type is based on the test results with current Lenovo® storage offerings.

Removable Storage

Optical

None

Card Reader

No card reader

Multi-Media

Audio Chip

High Definition (HD) Audio, Realtek® ALC256 codec

Speakers

Single speaker, 2W x1

Microphone

No microphone

Power Supply

Power Supply^{**[1]}

Power	Type	Efficiency	Key Features
65W	Adapter	89%	Autosensing
90W	Adapter	89%	Autosensing
No power supply	-	-	-

Notes:

[1] When work with TIO monitor, an appropriate power adapter is needed. Customer may need to:

- Order a Tiny for TIO MT (12LK, 12LK, 12M3, 12M4) models
- Or order an additional 90W power adapter. If original power adapter is less than 90W.

DESIGN

Input Device

Keyboard

- Lenovo® Calliope Keyboard (USB connector), black
- No keyboard

Mouse

- Lenovo® Calliope Mouse (USB connector), black
- No mouse

Mechanical

Form Factor

Tiny (1L)

Dimensions (WxDxH)^[1]

179 x 182.9 x 36.5 mm (7.05 x 7.2 x 1.44 inches)

Packaging Dimensions (WxDxH)^[2]

494 x 250 x 130 mm (19.45 x 9.84 x 5.12 inches)

Weight^[3]

Around 1.11 kg (2.45 lbs)

Packaging Weight^[4]

Around 3.2 kg (7.05 lbs)

Case Color

Black

Bays

No bays

Expansion Slots

Two M.2 slots (one for WLAN, one for SSD)

EOU

- No support
- (Optional) Toolless cover (toolless chassis screw required), stand, optional 2.5" HDD bracket assembly / removal

Stand

- Vertical stand
- No stand

Mounting

- Supports VESA mount 100mm
- None

Others

(Optional) Power adapter cage

Notes:

[1] The system dimensions may vary depending on configurations.

[2] The new package takes effect from November 2023. The old package is:
140 x 262 x 500 mm (5.51 x 10.31 x 19.69 inches)

[3] The system weight is approximate and based on results in Lenovo® lab, which varies depending on the source of component, variance of the distribution of each component, and manufacturing process. It may not be the exact weight for each specific model.

[4] The new package takes effect from November 2023. The old package is:
Around 5.18 kg (11.42 lbs)

CONNECTIVITY

Network

Onboard Ethernet

Gigabit Ethernet, Realtek® RTL8111K-CG, 1x RJ-45

WLAN + Bluetooth[®]**

- Realtek® Wi-Fi® 6 RTL8852BE, 802.11ax Dual Band 2x2 Wi-Fi® + Bluetooth® 5.1, M.2 card^[1]
- Intel® Wi-Fi® 6 AX201, 802.11ax 2x2 Wi-Fi® + Bluetooth® 5.1, M.2 Card^[2]
- No WLAN and Bluetooth®

Notes:

[1], [2] Bluetooth® 5.2 is hardware ready but may run at a lower version due to OS limitations.

Ports^[1]

Front Ports

- 1x USB-C® 3.2 Gen 2 (support data transfer and 5V@0.9A charging)
- 1x USB 3.2 Gen 2 (Always On and 5V@2.1A charging)
- 1x headphone / microphone combo jack (3.5mm)

Optional Front Ports

None

Rear Ports

- 2x USB 2.0
- 2x USB 3.2 Gen 2
- 1x HDMI® 2.1 TMDS
- 1x DisplayPort™ 1.4
- 1x Ethernet (RJ-45)

Optional Rear Ports^[2]

Punch out port (one of VGA / DisplayPort™ 1.4 / serial)

Notes:

[1] The transfer speed of following ports will vary and, depending on many factors, such as the processing speed of the host device, file attributes and other factors related to system configuration and your operating environment, will be slower than theoretical speed.

USB 2.0: 480 Mbit/s;

USB 3.2 Gen 1 (SuperSpeed USB 5Gbps, formerly USB 3.0 / USB 3.1 Gen 1): 5 Gbit/s;

USB 3.2 Gen 2 (SuperSpeed USB 10Gbps, formerly USB 3.1 Gen 2): 10 Gbit/s;

USB4® 20Gbps / USB 3.2 Gen 2x2 (SuperSpeed USB 20Gbps): 20 Gbit/s;

USB4® 40Gbps (USB 40Gbps): 40 Gbit/s;

Thunderbolt™ 3/4: 40 Gbit/s.

[2] Punch out ports only available on i3 models.

SECURITY & PRIVACY

Security

Security Chip

Firmware TPM 2.0 integrated in SoC

Physical Locks

Kensington® Security Slot™, 3 x 7 mm

Chassis Intrusion Switch

Chassis intrusion switch

BIOS Security

- Administrator password
- Supervisor password
- Hard disk password
- Boot sequence control
- Cover presence switch
- Self-healing BIOS
- Smart USB protection (allows keyboard / mouse only, blocks all storage devices)
- Individual USB port disablement
- Intel® BIOS guard

MANAGEABILITY

System Management

System Management

None

SERVICE

Warranty^[1]

Base Warranty**

- 1-year courier or carry-in service
- 1-year limited onsite service
- No base warranty

Notes:

[1] The warranty upgrades may be bundled with some models, please check the "Included upgrade" column in the specific model's configurations. For more service extensions, please go to <https://smartfind.lenovo.com/>. To learn more details of warranty policy, please access <https://pcsupport.lenovo.com/warranty>.

ENVIRONMENTAL

Operating Environment

Temperature

- Operating: 10°C (50°F) to 35°C (95°F)
- Storage: -40°C (-40°F) to 60°C (140°F)

Relative Humidity

- Operating: 20% to 80%
- Storage: 10% to 90%

Altitude

- Operating: -15.2 m (-50 ft) to 3048 m (10,000 ft)
- Storage: -15.2 m (-50 ft) to 10668 m (35,000 ft)

CERTIFICATIONS

Green Certifications^[1]

Green Certifications

- (Optional) ENERGY STAR® 8.0
- ErP Lot 3 and Lot 7
- RoHS compliant
- TCO Certified 9.0

Notes:

[1] The items listed under the "Green Certifications" section may not only refer to certification but also registration or self-declaration.

Other Certifications

Other Certifications

(Optional) TÜV Rheinland® Ultra Low Noise

- Feature with ** means that only one offering listed under the feature is configured on selected models.
- Lenovo reserves the right to change specifications or other product information without notice. Lenovo is not responsible for photographic or typographical errors. LENOVO PROVIDES THIS PUBLICATION "AS IS," WITHOUT WARRANTY OF ANY KIND, EITHER EXPRESS OR IMPLIED, INCLUDING THE IMPLIED WARRANTIES OF MERCHANTABILITY OR FITNESS FOR A PARTICULAR PURPOSE. Some jurisdictions do not allow disclaimer of express or implied warranties in certain transactions, therefore this disclaimer may not apply to you.
- The specifications on this page may not be available in all regions, and may be changed or updated without notice.



OVERVIEW



1. Power connector	3. USB-B 3.1 Gen 1
2. DisplayPort	4. USB 3.1 Gen 1

Notes:

- USB 3.1 Gen 1(only available when a Tiny is installed or a PC is connected)

PERFORMANCE

Panel

Panel

In-Plane Switching (IPS)

Backlight

WLED

Display Size

21.5 inches

Max View Area

WxH: 476.1 x 267.8 mm

Resolution

1920 x 1080

Aspect Ratio

16:9

Pixel Pitch

0.24795 x 0.24795 mm

Dot / Pixel Per Inch

102 dpi

Brightness

250 cd/m²

Contrast Ratio

- Contrast Ratio: 1000:1
- Dynamic Contrast Ratio: 3M™:1

View Angle (H / V)

Horizontal: 178°, Vertical: 178°

Response Time

- Extreme Mode: 4 ms
- Normal Mode: 6 ms
- Off Mode: 14 ms

Refresh Rate

60Hz

Color Gamut

72% NTSC

Color Support

16.7 Million

Color Depth

8-bit

Screen Surface Treatment

Anti-glare

Operating System

Operating System

- Windows® 7 Support
- Windows® 10 Support

Multi-Media

Camera

HD 720p, with dual microphone and ThinkShutter

Microphone

Dual-microphone array

Speakers

ThinkCentre Tiny-In-One 22 Gen 4

Stereo speakers, 2W x2

Power Supply

Power Consumption

Typical / Max: 14W / 25W

Voltage Required

AC 100 to 240 V (40-60Hz)

DESIGN

Display

Touchscreen

- (Optional) Advanced In-cell Touch (AIT), supports 10-point touch (for models 11GTPAT1 and 11GTPAR1 only)
- Non-touch

Mechanical

ThinkCentre® M Series Support

P340 / P330 / P320 / P350 / P360 / M90q / M80q / M70q / M75q / M920(x) / M720 / M910(x) / M710 / M715 / M900(x) / M700 / M630e / M625 / M600 Tiny / M90n / M75n Nano (with TIO kit)

Bezel Width

- Bottom: 22.1mm
- Top / side: 2mm

Buttons

- Brightness button
- Exit button
- Menu button
- Mode-switching button
- Power button

Cable Management

Support

Case Color

Black

Dimensions (WxDxH)^[1]

Models	Dimensions
Models with full function monitor stand	489 x 220.4 x 568.2 mm (19.26 x 8.68 x 22.37 inches)
Models without stand	489 x 65.3 x 339 mm (19.26 x 2.57 x 13.35 inches)

Weight^[2]

Models	Weight
Models without stand	Around 3.41 kg (7.52 lbs)
Models with full function monitor stand	Around 6.58 kg (14.51 lbs)

Mounting

Supports VESA mount 100mm

Stand

Full function monitor stand, supports -5° to +30° tilt, left & right 45° swivel, up to 150mm lift, 90° pivot

In the Box

- 1x Power adapter
- Power cable
- Detachable stand
- Quick Setup Guide
- TIO (monitor)

Notes:

[1] The system dimensions may vary depending on configurations.

[2] The system weight is approximate and based on results in Lenovo® lab, which varies depending on the source of component, variance of the distribution of each component, and manufacturing process. It may not be the exact weight for each specific model.

CONNECTIVITY

Ports^[1]

Rear Ports

- 1x USB-B 3.1 Gen 1, USB upstream
- 1x DisplayPort™
- 1x power connector

Left Ports^[2]

- 1x USB 3.1 Gen 1 (on TIO)
The availability and version depends on the Tiny installed or the PC connected via USB upstream port (USB-B 3.1 Gen 1)
- Side ports offered by installed Tiny (on Tiny)

Notes:

[1] The transfer speed of following ports will vary and, depending on many factors, such as the processing speed of the host device, file attributes and other factors related to system configuration and your operating environment, will be slower than theoretical speed.

USB 2.0: 480 Mbit/s;

USB 3.2 Gen 1 (SuperSpeed USB 5Gbps, formerly USB 3.0 / USB 3.1 Gen 1): 5 Gbit/s;

USB 3.2 Gen 2 (SuperSpeed USB 10Gbps, formerly USB 3.1 Gen 2): 10 Gbit/s;

USB4® 20Gbps / USB 3.2 Gen 2x2 (SuperSpeed USB 20Gbps): 20 Gbit/s;

USB4® 40Gbps (USB 40Gbps): 40 Gbit/s;

Thunderbolt™ 3/4: 40 Gbit/s.

[2] The availability and version depends on the Tiny installed or the PC connected via USB upstream port.

SECURITY & PRIVACY

Security

Physical Locks

Kensington® Security Slot™, 3 x 7 mm

SERVICE

Warranty

Base Warranty

3-year limited warranty

CERTIFICATIONS

Green Certifications^[1]

Green Certifications

- ENERGY STAR® 8.0
- EPEAT™ Silver Registered^[2]
- ErP Lot 5
- GREENGUARD®
- RoHS compliant
- TCO Certified 8.0
- TCO edge 2.0
- WEEE

Notes:

[1] The items listed under the "Green Certifications" section may not only refer to certification but also registration or self-declaration.

[2] EPEAT™ is registered where applicable, please see [epeat.net](https://www.epeat.net) for registration status by country.

Other Certifications

Other Certifications

- TÜV Rheinland® Eye Comfort Certification
- TÜV Rheinland® Flicker Free
- TÜV Rheinland® Low Blue Light

- Lenovo reserves the right to change specifications or other product information without notice. Lenovo is not responsible for photographic or typographical errors. LENOVO PROVIDES THIS PUBLICATION “AS IS,” WITHOUT WARRANTY OF ANY KIND, EITHER EXPRESS OR IMPLIED, INCLUDING THE IMPLIED WARRANTIES OF MERCHANTABILITY OR FITNESS FOR A PARTICULAR PURPOSE. Some jurisdictions do not allow disclaimer of express or implied warranties in certain transactions, therefore this disclaimer may not apply to you.
- The specifications on this page may not be available in all regions, and may be changed or updated without notice.



OVERVIEW



1. Kensington Security Slot	4. DP 1.2
2. Power-in	5. USB-B 3.2 Gen 1
3. HDMI 1.4	6. USB 3.2 Gen 1

PERFORMANCE

Panel

Panel

In-Plane Switching (IPS)

Backlight

WLED

Display Size

21.5 inches

Max View Area

WxH: 476.1 x 267.8 mm (18.74 x 10.54 inches)

Resolution

1920 x 1080

Aspect Ratio

16:9

Pixel Pitch

0.248 x 0.248 mm

Dot / Pixel Per Inch

102 dpi

Brightness

250 cd/m²

Contrast Ratio

- Contrast Ratio: 1000:1
- Dynamic Contrast Ratio: 3M:1

View Angle (H / V)

Horizontal: 178°, Vertical: 178°

Response Time

- Extreme Mode: 4 ms
- Normal Mode: 6 ms

Refresh Rate

60Hz

Color Gamut

99% sRGB

Color Support

16.7 Million

Color Depth

8-bit (6-bit+FRC)

Screen Surface Treatment

Anti-glare

Curvature

Flat Panel

Operating System

Operating System

- Windows® 11 Support
- Windows® 10 Support

Multi-Media

Camera

FHD 1080p

Microphone

Integrated microphone

Speakers

Stereo speakers, 3W x2

Power Supply**Power Consumption**

- Typical / Max: 13.4W / 33W
- Sleep / Off mode: <0.5W
- Switch-off Mode: <0.3W
- Energy Star Power On: 10W
- Energy Star TEC: 32.3kWh
- External Power Supply

Voltage Required

AC 100 to 240 V (50-60Hz)

Special Features**Special Features**

- KVM Switch
- Natural Low Blue Light
- Lenovo® ThinkColour (Lenovo® Display Accessories and Display Manager) Support
Lenovo® ThinkColour supports Windows® 10 & 11, Mac OS, and Windows® On Arm (functions vary across systems).
Lenovo® Display Accessories and Display Manager is formerly Lenovo® Display Control Center.

DESIGN**Display****Touchscreen**

- Capacitive-type multi-touch, supports 10-point touch (for MT 12N9 only)
- Non-touch

Mechanical**ThinkCentre® M Series Support**

ThinkCentre® Tiny, ThinkStation® Tiny from 4th Generation

Bezel Width

- Side: 2mm
- Top / Bottom: 2mm / 46mm

Case Color

Raven black

Dimensions (WxDxH)^[1]

Models	Dimensions
Lowest Position	489.3 x 207.6 x 357.3 mm (19.26 x 8.17 x 14.07 inches)
Highest Position	489.3 x 207.6 x 512.3 mm (19.26 x 8.17 x 20.17 inches)
Head Only	489.3 x 72.8 x 339.1 mm (19.26 x 2.87 x 13.3 inches)

Packaging Dimensions (WxDxH)

568 x 176 x 422 mm (22.36 x 6.93 x 16.61 inches)

Weight^[2]

Models	Weight
Monitor With Stand	5.5 kg (12.1 lbs)
Monitor Head Only	3.2 kg (7.1 lbs)

Packaging Weight

8.1 kg (17.86 lbs)

Mounting

Supports VESA mount 100mm

Stand

ThinkCentre Tiny-In-One 22 Gen 5

Supports -5° to +23.5° tilt, left & right 45 swivel, -5° to +90° pivot, up to 155mm lift

In the Box

- Monitor with Stand
- Power Adapter (90W)
- Power cable (1.0 m)
- Quick Setup Guide

Notes:

[1] The system dimensions may vary depending on configurations.

[2] The system weight is approximate and based on results in Lenovo® lab, which varies depending on the source of component, variance of the distribution of each component, and manufacturing process. It may not be the exact weight for each specific model.

CONNECTIVITY

Ports^[1]

Rear Ports

- 1x USB 3.2 Gen 1
- 1x USB-B 3.2 Gen 1, USB upstream
- 1x HDMI® 1.4
- 1x DisplayPort™ 1.2

Notes:

[1] The transfer speed of following ports will vary and, depending on many factors, such as the processing speed of the host device, file attributes and other factors related to system configuration and your operating environment, will be slower than theoretical speed.

USB 2.0: 480 Mbit/s;

USB 3.2 Gen 1 (SuperSpeed USB 5Gbps, formerly USB 3.0 / USB 3.1 Gen 1): 5 Gbit/s;

USB 3.2 Gen 2 (SuperSpeed USB 10Gbps, formerly USB 3.1 Gen 2): 10 Gbit/s;

USB4® 20Gbps / USB 3.2 Gen 2x2 (SuperSpeed USB 20Gbps): 20 Gbit/s;

USB4® 40Gbps (USB 40Gbps): 40 Gbit/s;

Thunderbolt™ 3/4: 40 Gbit/s.

SECURITY & PRIVACY

Security

Physical Locks

Kensington® Security Slot™, 3 x 7 mm and 2.5 x 6 mm

SERVICE

Warranty

Base Warranty

3-year limited warranty

CERTIFICATIONS

Green Certifications^[1]

Green Certifications

- ENERGY STAR® Certified
- EPEAT™ Gold Registered
- EU Energy Label (D-class)
- RoHS compliant
- TCO Certified 9.0
- TCO edge 2.0
- Volatile Organic Compound Certification

Notes:

[1] The items listed under the "Green Certifications" section may not only refer to certification but also registration or self-declaration.

Other Certifications

Other Certifications

- Eyesafe® Certified 2.0
- TÜV Rheinland® Eye Comfort Certification
- TÜV Rheinland® Low Blue Light (Hardware Solution)

- Lenovo reserves the right to change specifications or other product information without notice. Lenovo is not responsible for photographic or typographical errors. LENOVO PROVIDES THIS PUBLICATION "AS IS," WITHOUT WARRANTY OF ANY KIND, EITHER EXPRESS OR IMPLIED, INCLUDING THE IMPLIED WARRANTIES OF MERCHANTABILITY OR FITNESS FOR A PARTICULAR PURPOSE. Some jurisdictions do not allow disclaimer of express or implied warranties in certain transactions, therefore this disclaimer may not apply to you.
- The specifications on this page may not be available in all regions, and may be changed or updated without notice.



OVERVIEW



1. Power connector	3. USB-B 3.1 Gen 1
2. DisplayPort	4. USB 3.1 Gen 1

Notes:

- USB 3.1 Gen 1(only available when a Tiny is installed or a PC is connected)

PERFORMANCE

Panel

Panel

In-Plane Switching (IPS)

Backlight

WLED

Display Size

23.8 inches

Max View Area

WxH: 527 x 296.5 mm

Resolution

1920 x 1080

Aspect Ratio

16:9

Pixel Pitch

0.2745 x 0.2745 mm

Dot / Pixel Per Inch

92.6 dpi

Brightness

250 cd/m²

Contrast Ratio

- Contrast Ratio: 1000:1
- Dynamic Contrast Ratio: 3M™:1

View Angle (H / V)

Horizontal: 178°, Vertical: 178°

Response Time

- Extreme Mode: 4 ms
- Normal Mode: 6 ms
- Off Mode: 14 ms

Refresh Rate

60Hz

Color Gamut

72% NTSC

Color Support

16.7 Million

Color Depth

8-bit

Screen Surface Treatment

Anti-glare

Operating System

Operating System

- Windows® 7 Support
- Windows® 10 Support

Multi-Media

Camera

- FHD 1080p, with dual microphone and Think Shutter
- IR + RGB camera, with dual microphone and ThinkShutter

Microphone

Dual-microphone array

Speakers

Stereo speakers, 2W x2

Power Supply

Power Consumption

Typical / Max: 15W / 27W

Voltage Required

AC 100 to 240 V (40-60Hz)

DESIGN

Display

Touchscreen

- (Optional) Advanced In-cell Touch (AIT), supports 10-point touch (for models 11GCPAT1 and 11GCPAR1 only)
- Non-touch

Mechanical

ThinkCentre® M Series Support

P340 / P330 / P320 / P350 / P360 / M90q / M80q / M70q / M75q / M920(x) / M720 / M910(x) / M710 / M715 / M900(x) / M700 / M630e / M625 / M600 Tiny / M90n / M75n Nano (with TIO kit)

Bezel Width

- Bottom: 22.1mm
- Top / side: 2mm

Buttons

- Brightness button
- Exit button
- Menu button
- Mode-switching button
- Power button
- Volume button

Cable Management

Support

Case Color

Black

Dimensions (WxDxH)^[1]

Models	Dimensions
Models with full function monitor stand	539.8 x 230.4 x 596.9 mm (21.25 x 9.07 x 23.5 inches)
Models without stand	539.8 x 65.3 x 367.6 mm (21.25 x 2.57 x 14.47 inches)

Packaging Dimensions (WxDxH)

602 x 160 x 422 mm (23.70 x 6.3 x 16.61 inches)

Weight^[2]

Models	Weight
Models without stand	Around 3.61 kg (7.96 lbs)
Models with full function monitor stand	Around 6.66 kg (14.68 lbs)

Packaging Weight

7.6 kg (16.8 lbs)

Mounting

Supports VESA mount 100mm

Stand

Full function monitor stand, supports -5° to +30° tilt, left & right 45° swivel, up to 150mm lift, 90° pivot

In the Box

ThinkCentre Tiny-In-One 24 Gen 4

- 1x Power adapter
- Power cable
- Detachable stand
- Quick Setup Guide
- TIO (monitor)

Notes:

[1] The system dimensions may vary depending on configurations.

[2] The system weight is approximate and based on results in Lenovo® lab, which varies depending on the source of component, variance of the distribution of each component, and manufacturing process. It may not be the exact weight for each specific model.

CONNECTIVITY

Ports^[1]

Rear Ports

- 1x USB-B 3.1 Gen 1, USB upstream
- 1x DisplayPort™
- 1x power connector

Left Ports^[2]

- 1x USB 3.1 Gen 1 (on TIO)
The availability and version depends on the Tiny installed or the PC connected via USB upstream port (USB-B 3.1 Gen 1)
- Side ports offered by installed Tiny (on Tiny)

Notes:

[1] The transfer speed of following ports will vary and, depending on many factors, such as the processing speed of the host device, file attributes and other factors related to system configuration and your operating environment, will be slower than theoretical speed.

USB 2.0: 480 Mbit/s;

USB 3.2 Gen 1 (SuperSpeed USB 5Gbps, formerly USB 3.0 / USB 3.1 Gen 1): 5 Gbit/s;

USB 3.2 Gen 2 (SuperSpeed USB 10Gbps, formerly USB 3.1 Gen 2): 10 Gbit/s;

USB4® 20Gbps / USB 3.2 Gen 2x2 (SuperSpeed USB 20Gbps): 20 Gbit/s;

USB4® 40Gbps (USB 40Gbps): 40 Gbit/s;

Thunderbolt™ 3/4: 40 Gbit/s.

[2] The availability and version depends on the Tiny installed or the PC connected via USB upstream port.

SECURITY & PRIVACY

Security

Physical Locks

Kensington® Security Slot™, 3 x 7 mm

SERVICE

Warranty

Base Warranty

3-year limited warranty

CERTIFICATIONS

Green Certifications^[1]

Green Certifications

- ENERGY STAR® 8.0
- EPEAT™ Silver Registered^[2]
- ErP Lot 5
- GREENGUARD®
- RoHS compliant

- TCO edge 2.0
- WEEE

Notes:

[1] The items listed under the "Green Certifications" section may not only refer to certification but also registration or self-declaration.

[2] EPEAT™ is registered where applicable, please see [epeat.net](https://www.epeat.net) for registration status by country.

Other Certifications

Other Certifications

- TÜV Rheinland® Eye Comfort Certification
- TÜV Rheinland® Flicker Free
- TÜV Rheinland® Low Blue Light

- Lenovo reserves the right to change specifications or other product information without notice. Lenovo is not responsible for photographic or typographical errors. LENOVO PROVIDES THIS PUBLICATION "AS IS," WITHOUT WARRANTY OF ANY KIND, EITHER EXPRESS OR IMPLIED, INCLUDING THE IMPLIED WARRANTIES OF MERCHANTABILITY OR FITNESS FOR A PARTICULAR PURPOSE. Some jurisdictions do not allow disclaimer of express or implied warranties in certain transactions, therefore this disclaimer may not apply to you.
- The specifications on this page may not be available in all regions, and may be changed or updated without notice.



OVERVIEW



1. Kensington Security Slot	4. DP 1.2
2. Power-in	5. USB-B 3.2 Gen 1
3. HDMI 1.4	6. USB 3.2 Gen 1

PERFORMANCE

Panel

Panel

In-Plane Switching (IPS)

Backlight

WLED

Display Size

23.8 inches

Max View Area

WxH: 527.0 x 296.4 mm (20.75 x 11.67 inches)

Resolution

1920 x 1080

Aspect Ratio

16:9

Pixel Pitch

0.275 x 0.275 mm

Dot / Pixel Per Inch

93 dpi

Brightness

250 cd/m²

Contrast Ratio

- Contrast Ratio: 1000:1
- Dynamic Contrast Ratio: 3M:1

View Angle (H / V)

Horizontal: 178°, Vertical: 178°

Response Time

- Extreme Mode: 4 ms
- Normal Mode: 6 ms

Refresh Rate

60Hz

Color Gamut

99% sRGB

Color Support

16.7 Million

Color Depth

8-bit (6-bit+FRC)

Screen Surface Treatment

Anti-glare

Curvature

Flat Panel

Operating System

Operating System

- Windows® 11 Support
- Windows® 10 Support

Multi-Media

Camera

FHD 1080p

Microphone

Integrated microphone

Speakers

Stereo speakers, 3W x2

Power Supply

Power Consumption

- Typical / Max: 14W / 34W
- Sleep / Off mode: <0.5W
- Switch-off Mode: <0.3W
- Energy Star Power On: 11.9W
- Energy Star TEC: 37.9kWh
- External Power Supply

Voltage Required

AC 100 to 240 V (50-60Hz)

Special Features

Special Features

- KVM Switch
- Natural Low Blue Light
- Lenovo® ThinkColour (Lenovo® Display Accessories and Display Manager) Support
Lenovo® ThinkColour supports Windows® 10 & 11, Mac OS, and Windows® On Arm (functions vary across systems).
Lenovo® Display Accessories and Display Manager is formerly Lenovo® Display Control Center.

DESIGN

Display

Touchscreen

- Capacitive-type multi-touch, supports 10-point touch (for MT 12NB only)
- Non-touch

Mechanical

ThinkCentre® M Series Support

ThinkCentre® Tiny, ThinkStation® Tiny from 4th Generation

Bezel Width

- Side: 2mm
- Top / Bottom: 2mm / 46mm

Case Color

Raven black

Dimensions (WxDxH)^[1]

Models	Dimensions
Lowest Position	539.8 x 207.6 x 384.6 mm (21.25 x 8.17 x 15.14 inches)
Highest Position	539.8 x 207.6 x 539.6 mm (21.25 x 8.17 x 21.24 inches)
Head Only	539.8 x 72.8 x 367.6 mm (21.25 x 2.87 x 14.47 inches)

Packaging Dimensions (WxDxH)

620 x 187 x 420 mm (24.41 x 7.36 x 16.54 inches)

Weight^[2]

Models	Weight
Monitor With Stand	6.0 kg (13.2 lbs)
Monitor Head Only	3.7 kg (8.2 lbs)

Packaging Weight

9.5 kg (20.9 lbs)

Mounting

Supports VESA mount 100mm

Stand

ThinkCentre Tiny-In-One 24 Gen 5

Supports -5° to +23.5° tilt, left & right 45 swivel, -5° to +90° pivot, up to 155mm lift

In the Box

- Monitor with Stand
- Power Adapter (90W)
- Power cable (1.0 m)
- Quick Setup Guide

Notes:

[1] The system dimensions may vary depending on configurations.

[2] The system weight is approximate and based on results in Lenovo® lab, which varies depending on the source of component, variance of the distribution of each component, and manufacturing process. It may not be the exact weight for each specific model.

CONNECTIVITY

Ports^[1]

Rear Ports

- 1x USB 3.2 Gen 1
- 1x USB-B 3.2 Gen 1, USB upstream
- 1x HDMI® 1.4
- 1x DisplayPort™ 1.2

Notes:

[1] The transfer speed of following ports will vary and, depending on many factors, such as the processing speed of the host device, file attributes and other factors related to system configuration and your operating environment, will be slower than theoretical speed.

USB 2.0: 480 Mbit/s;

USB 3.2 Gen 1 (SuperSpeed USB 5Gbps, formerly USB 3.0 / USB 3.1 Gen 1): 5 Gbit/s;

USB 3.2 Gen 2 (SuperSpeed USB 10Gbps, formerly USB 3.1 Gen 2): 10 Gbit/s;

USB4® 20Gbps / USB 3.2 Gen 2x2 (SuperSpeed USB 20Gbps): 20 Gbit/s;

USB4® 40Gbps (USB 40Gbps): 40 Gbit/s;

Thunderbolt™ 3/4: 40 Gbit/s.

SECURITY & PRIVACY

Security

Physical Locks

Kensington® Security Slot™, 3 x 7 mm and 2.5 x 6 mm

SERVICE

Warranty

Base Warranty

3-year limited warranty

CERTIFICATIONS

Green Certifications^[1]

Green Certifications

- ENERGY STAR® Certified
- EPEAT™ Gold Registered
- EU Energy Label (D-class)
- RoHS compliant
- TCO Certified 9.0
- TCO edge 2.0
- Volatile Organic Compound Certification

Notes:

[1] The items listed under the "Green Certifications" section may not only refer to certification but also registration or self-declaration.

Other Certifications

Other Certifications

- Eyesafe® Certified 2.0
- TÜV Rheinland® Eye Comfort Certification
- TÜV Rheinland® Low Blue Light (Hardware Solution)

- Lenovo reserves the right to change specifications or other product information without notice. Lenovo is not responsible for photographic or typographical errors. LENOVO PROVIDES THIS PUBLICATION "AS IS," WITHOUT WARRANTY OF ANY KIND, EITHER EXPRESS OR IMPLIED, INCLUDING THE IMPLIED WARRANTIES OF MERCHANTABILITY OR FITNESS FOR A PARTICULAR PURPOSE. Some jurisdictions do not allow disclaimer of express or implied warranties in certain transactions, therefore this disclaimer may not apply to you.
- The specifications on this page may not be available in all regions, and may be changed or updated without notice.



OVERVIEW



1. 2x USB 3.1 Gen 1	4. Power connector
2. Headphone / microphone combo jack (3.5mm)	5. DisplayPort
3. HDMI 1.4	6. USB-B 3.1 Gen 1

Notes:

- USB 3.1 Gen 1 (only available when a Tiny is installed or a PC is connected)

PERFORMANCE

Panel

Panel

In-Plane Switching (IPS)

Backlight

WLED

Display Size

27 inches

Max View Area

WxH: 596.7 x 335.7 mm

Resolution

2560 x 1440

Aspect Ratio

16:9

Pixel Pitch

0.2331 x 0.2331 mm

Dot / Pixel Per Inch

109 dpi

Brightness

350 cd/m²

Contrast Ratio

- Contrast Ratio: 1000:1
- Dynamic Contrast Ratio: 3M™:1

View Angle (H / V)

Horizontal: 178°, Vertical: 178°

Response Time

- Extreme Mode: 4 ms
- Normal Mode: 6 ms
- Off Mode: 14 ms

Refresh Rate

60Hz

Color Gamut

99% sRGB

Color Support

16.7 Million

Screen Surface Treatment

Anti-glare

Operating System

Operating System

- Windows® 7 Support
- Windows® 10 Support

Multi-Media

Camera

IR + RGB camera, with dual microphone, ThinkShutter, and LED indicator. Supports Window Hello and Facial Recognition

Microphone

Dual-microphone array

Speakers

Stereo speakers, 2W x2

Power Supply

Power Consumption

Typical / Max: 37W / 57W

DESIGN

Display

Touchscreen

Non-touch

Mechanical

ThinkCentre® M Series Support

ThinkCentre® Tiny, ThinkCentre® Nano, and ThinkStation Tiny

Bezel Width

- Bottom: 23.3mm
- Top / side: 2mm

Buttons

- Brightness button
- Exit button
- Menu button
- Mode-switching button
- Power button
- Volume button

Cable Management

Support

Case Color

Black

Dimensions (WxDxH)^[1]

Models	Dimensions
Models with full function monitor stand	614 x 329 x 554.25 mm (24.17 x 12.95 x 21.82 inches)
Models without stand	614 x 73.89 x 413.1 mm (24.17 x 2.91 x 16.26 inches)

Packaging Dimensions (WxDxH)

782 x 172 x 469 mm (30.79 x 77.00 x 18.46 inches)

Weight^[2]

Models	Weight
Models without stand	Around 4.90 kg (10.82 lbs)
Models with full function monitor stand	Around 7.95 kg (17.53 lbs)

Packaging Weight

9.75 kg (21.5 lbs)

Mounting

Supports VESA mount 100mm

Stand

Full function monitor stand, supports -5° to +30° tilt, left & right 45° swivel, up to 110mm lift, +90° pivot

In the Box

- 1x Power adapter
- Power cable
- Detachable stand
- TIO (monitor)

Notes:

[1] The system dimensions may vary depending on configurations.

[2] The system weight is approximate and based on results in Lenovo® lab, which varies depending on the source of component, variance of the distribution of each component, and manufacturing process. It may not be the exact weight for each specific model.

CONNECTIVITY

Ports^[1]

Rear Ports

- 1x USB-B 3.1 Gen 1, USB upstream
- 1x HDMI® 1.4
- 1x DisplayPort™ 1.2
- 1x power connector

Left Ports^[2]

- 2x USB 3.1 Gen 1 (on TIO)
The availability and version depends on the Tiny installed or the PC connected via USB upstream port (USB-B 3.1 Gen 1)
- 1x headphone / microphone combo jack (on TIO)
- Side ports offered by installed Tiny (on Tiny)

Notes:

[1] The transfer speed of following ports will vary and, depending on many factors, such as the processing speed of the host device, file attributes and other factors related to system configuration and your operating environment, will be slower than theoretical speed.

USB 2.0: 480 Mbit/s;

USB 3.2 Gen 1 (SuperSpeed USB 5Gbps, formerly USB 3.0 / USB 3.1 Gen 1): 5 Gbit/s;

USB 3.2 Gen 2 (SuperSpeed USB 10Gbps, formerly USB 3.1 Gen 2): 10 Gbit/s;

USB4® 20Gbps / USB 3.2 Gen 2x2 (SuperSpeed USB 20Gbps): 20 Gbit/s;

USB4® 40Gbps (USB 40Gbps): 40 Gbit/s;

Thunderbolt™ 3/4: 40 Gbit/s.

[2] The USB ports are enabled by installing a Tiny or connecting USB upstream port; the audio port is enabled by installing a Tiny or connecting USB upstream, DisplayPort™(in), or HDMI®(in) port.

SECURITY & PRIVACY

Security

Physical Locks

Kensington® Security Slot™, 3 x 7 mm

SERVICE

Warranty

Base Warranty

3-year limited warranty

CERTIFICATIONS

Green Certifications^[1]

Green Certifications

- ENERGY STAR® 8.0
- EPEAT™ Silver Registered^[2]
- RoHS compliant
- TCO edge 2.0
- ULE Gold
- WEEE

Notes:

[1] The items listed under the "Green Certifications" section may not only refer to certification but also registration or self-

declaration.

[2] EPEAT™ is registered where applicable, please see epeat.net for registration status by country.

Other Certifications

Other Certifications

- ISO 9241-307
- TÜV Rheinland® Eye Comfort Certification
- TÜV Rheinland® Flicker Free
- TÜV Rheinland® Low Blue Light

- Lenovo reserves the right to change specifications or other product information without notice. Lenovo is not responsible for photographic or typographical errors. LENOVO PROVIDES THIS PUBLICATION “AS IS,” WITHOUT WARRANTY OF ANY KIND, EITHER EXPRESS OR IMPLIED, INCLUDING THE IMPLIED WARRANTIES OF MERCHANTABILITY OR FITNESS FOR A PARTICULAR PURPOSE. Some jurisdictions do not allow disclaimer of express or implied warranties in certain transactions, therefore this disclaimer may not apply to you.
- The specifications on this page may not be available in all regions, and may be changed or updated without notice.



OVERVIEW



1. Power connector	6. USB 3.0
2. DP 1.2	7. USB 3.0
3. HDMI 1.4	8. Audio line-out (3.5mm)
4. VGA	9. USB 3.0
5. USB-B 3.0	10. USB 3.0

PERFORMANCE

Panel

Panel

In-Plane Switching (IPS)

Backlight

WLED

Display Size

21.5 inches

Max View Area

WxH: 476.1 x 267.8 mm

Resolution

1920 x 1080

Aspect Ratio

16:9

Pixel Pitch

0.2479 x 0.2579 mm

Dot / Pixel Per Inch

102 dpi

Brightness

250 cd/m²

Contrast Ratio

Contrast Ratio: 1000:1

View Angle (H / V)

Horizontal: 178°, Vertical: 178°

Response Time

- Extreme Mode: 4 ms
- Normal Mode: 6 ms
- Off Mode: 14 ms

Refresh Rate

60Hz

Color Gamut

99% sRGB

Color Support

16.7 Million

Color Depth

8-bit

Screen Surface Treatment

Anti-glare

Operating System

Operating System

- Windows® 11 Support
- Windows® 10 Support

Power Supply

Power Consumption

Typical / Max: 15W / 48W

Voltage Required

AC 100 to 240 V (50-60Hz)

Special Features

Special Features

Lenovo® ThinkColour (Lenovo® Display Accessories and Display Manager) Support
 Lenovo® ThinkColour supports Windows® 10 & 11, Mac OS, and Windows® On Arm (functions vary across systems).
 Lenovo® Display Accessories and Display Manager is formerly Lenovo® Display Control Center.

DESIGN

Mechanical

ThinkCentre® M Series Support

ThinkCentre® Tiny, ThinkStation® Tiny

Bezel Width

Side: 2mm

Buttons

- Input Source Switch button
- Menu stick
- Power button

Cable Management

Support

Case Color

Raven black

Dimensions (WxDxH)^[1]

Models	Dimensions
Lowest Position	489 x 223 x 369 mm (19.25 x 8.78 x 14.53 inches)
Highest Position	489 x 223 x 494 mm (19.25 x 8.78 x 19.45 inches)
Head Only	489.3 x 46.4 x 292.7 mm (19.3 x 1.8 x 11.5 inches)

Packaging Dimensions (WxDxH)

577 x 187 x 442 mm (22.72 x 7.36 x 17.40 inches)

Weight^[2]

Models	Weight
Monitor With Stand	6.05 kg (13.34 lbs)

Packaging Weight

7.58 kg (16.71 lbs)

Mounting

Supports VESA mount 100mm

Stand

- TIO Flex stand, supports -5° to +23° tilt, up to 125mm lift
- Build in DisplayPort™ cable for monitor
- Build in DisplayPort™ connector for Tiny
- Build in USB-A connector for Tiny
- Build in USB-B cable for monitor

In the Box

- Monitor Head
- Power cable
- TIO Flex stand
- User's guide

Notes:

[1] The system dimensions may vary depending on configurations.

[2] The system weight is approximate and based on results in Lenovo® lab, which varies depending on the source of component, variance of the distribution of each component, and manufacturing process. It may not be the exact weight for each specific model.

CONNECTIVITY

Ports^[1]

Rear Ports

- 1x USB-B 3.0, USB upstream
- 4x USB 3.0, USB downstream
- 1x HDMI® 1.4
- 1x DisplayPort™ 1.2
- 1x VGA
- 1x audio-out (3.5mm)

Notes:

[1] The transfer speed of following ports will vary and, depending on many factors, such as the processing speed of the host device, file attributes and other factors related to system configuration and your operating environment, will be slower than theoretical speed.

USB 2.0: 480 Mbit/s;

USB 3.2 Gen 1 (SuperSpeed USB 5Gbps, formerly USB 3.0 / USB 3.1 Gen 1): 5 Gbit/s;

USB 3.2 Gen 2 (SuperSpeed USB 10Gbps, formerly USB 3.1 Gen 2): 10 Gbit/s;

USB4® 20Gbps / USB 3.2 Gen 2x2 (SuperSpeed USB 20Gbps): 20 Gbit/s;

USB4® 40Gbps (USB 40Gbps): 40 Gbit/s;

Thunderbolt™ 3/4: 40 Gbit/s.

SECURITY & PRIVACY

Security

Physical Locks

Kensington® Security Slot™, 3 x 7 mm

SERVICE

Warranty

Base Warranty

- TIO Flex stand: 1-year CRU warranty
- Monitor: 3 years limited warranty

CERTIFICATIONS

Green Certifications^[1]

Green Certifications

- ENERGY STAR® 8.0
- EPEAT™ Gold Registered^[2]
- RoHS compliant
- TCO Certified
- TCO edge

Notes:

[1] The items listed under the "Green Certifications" section may not only refer to certification but also registration or self-declaration.

[2] EPEAT™ is registered where applicable, please see [epeat.net](https://www.epeat.net) for registration status by country.

Other Certifications

Other Certifications

- Eyesafe® Certified
- TÜV Rheinland® Eye Comfort Certification
- TÜV Rheinland® Low Blue Light (Hardware Solution)

• Lenovo reserves the right to change specifications or other product information without notice. Lenovo is not

responsible for photographic or typographical errors. LENOVO PROVIDES THIS PUBLICATION “AS IS,” WITHOUT WARRANTY OF ANY KIND, EITHER EXPRESS OR IMPLIED, INCLUDING THE IMPLIED WARRANTIES OF MERCHANTABILITY OR FITNESS FOR A PARTICULAR PURPOSE. Some jurisdictions do not allow disclaimer of express or implied warranties in certain transactions, therefore this disclaimer may not apply to you.

- The specifications on this page may not be available in all regions, and may be changed or updated without notice.



intel



intel



intel



intel



intel



intel

OVERVIEW



1. DisplayPort 1.2	6. USB 3.0
2. HDMI 1.4	7. Audio-out (3.5mm)
3. VGA	8. USB 3.0
4. USB-B 3.0	9. USB 3.0
5. USB 3.0	

PERFORMANCE

Panel

Panel

In-Plane Switching (IPS)

Backlight

WLED

Display Size

23.8 inches

Max View Area

WxH: 527 x 296.5 mm

Resolution

1920 x 1080

Aspect Ratio

16:9

Pixel Pitch

0.275 x 0.275 mm

Dot / Pixel Per Inch

93 dpi

Brightness

250 cd/m²

Contrast Ratio

Contrast Ratio: 1000:1

View Angle (H / V)

Horizontal: 178°, Vertical: 178°

Response Time

- Extreme Mode: 4 ms
- Normal Mode: 6 ms

Refresh Rate

60Hz

Color Gamut

99% sRGB

Color Support

16.7 Million

Color Depth

8-bit

Screen Surface Treatment

Anti-glare

Operating System

Operating System

- Windows® 11 Support
- Windows® 10 Support

Power Supply

Power Consumption

Typical / Max: 14W / 56W

Voltage Required

AC 100 to 240 V (47-63Hz)

Special Features

Special Features

ThinkCentre TIO Flex 24i

Lenovo® ThinkColour (Lenovo® Display Accessories and Display Manager) Support
 Lenovo® ThinkColour supports Windows® 10 & 11, Mac OS, and Windows® On Arm (functions vary across systems).
 Lenovo® Display Accessories and Display Manager is formerly Lenovo® Display Control Center.

DESIGN

Mechanical

ThinkCentre® M Series Support

ThinkCentre® Tiny, ThinkStation® Tiny

Bezel Width

- Side: 2mm
- Top / Bottom: 2mm / 17.3mm

Buttons

- Input Source Switch button
- Menu stick
- Power button

Cable Management

Support

Case Color

Raven black

Dimensions (WxDxH)^[1]

Models	Dimensions
Lowest Position	539.8 x 223 x 386.78 mm (21.25 x 8.78 x 15.23 inches)
Highest Position	539.8 x 223 x 511.78 mm (21.25 x 8.78 x 20.15 inches)
Head Only	539.80 x 49.00 x 321.40 mm (21.25 x 1.93 x 12.65 inches)

Packaging Dimensions (WxDxH)

619 x 187 x 421 mm (24.37 x 7.36 x 16.57 inches)

Weight^[2]

Models	Weight
Monitor With Stand	6.3 kg (13.89 lbs)
Monitor Head Only	3.1 kg (6.83 lbs)

Packaging Weight

8.61 kg (18.98 lbs)

Mounting

Supports VESA mount 100mm

Stand

- TIO Flex stand, supports -5° to +23° tilt, up to 125mm lift
- Build in DisplayPort™ cable for monitor
- Build in DisplayPort™ connector for Tiny
- Build in USB-A connector for Tiny
- Build in USB-B cable for monitor

In the Box

- Monitor Head
- Power cable
- TIO Flex stand
- User's guide

Notes:

[1] The system dimensions may vary depending on configurations.

[2] The system weight is approximate and based on results in Lenovo® lab, which varies depending on the source of component, variance of the distribution of each component, and manufacturing process. It may not be the exact weight for each specific model.

CONNECTIVITY

Ports^[1]

Rear Ports

- 1x USB-B 3.0, USB upstream
- 4x USB 3.0, USB downstream
- 1x HDMI® 1.4
- 1x DisplayPort™ 1.2
- 1x VGA
- 1x audio-out (3.5mm)

Notes:

[1] The transfer speed of following ports will vary and, depending on many factors, such as the processing speed of the host device, file attributes and other factors related to system configuration and your operating environment, will be slower than theoretical speed.

USB 2.0: 480 Mbit/s;

USB 3.2 Gen 1 (SuperSpeed USB 5Gbps, formerly USB 3.0 / USB 3.1 Gen 1): 5 Gbit/s;

USB 3.2 Gen 2 (SuperSpeed USB 10Gbps, formerly USB 3.1 Gen 2): 10 Gbit/s;

USB4® 20Gbps / USB 3.2 Gen 2x2 (SuperSpeed USB 20Gbps): 20 Gbit/s;

USB4® 40Gbps (USB 40Gbps): 40 Gbit/s;

Thunderbolt™ 3/4: 40 Gbit/s.

SECURITY & PRIVACY

Security

Physical Locks

Kensington® Security Slot™, 3 x 7 mm

SERVICE

Warranty

Base Warranty

- TIO Flex stand: 1-year CRU warranty
- Monitor: 3 years limited warranty

CERTIFICATIONS

Green Certifications^[1]

Green Certifications

- ENERGY STAR® 8.0
- EPEAT™ Silver Registered^[2]
- RoHS compliant
- TCO Certified
- TCO edge

Notes:

[1] The items listed under the "Green Certifications" section may not only refer to certification but also registration or self-declaration.

[2] EPEAT™ is registered where applicable, please see [epeat.net](https://www.epeat.net) for registration status by country.

Other Certifications

Other Certifications

- Eyesafe® Certified
- TÜV Rheinland® Eye Comfort Certification
- TÜV Rheinland® Low Blue Light (Hardware Solution)

- Lenovo reserves the right to change specifications or other product information without notice. Lenovo is not responsible for photographic or typographical errors. LENOVO PROVIDES THIS PUBLICATION “AS IS,” WITHOUT WARRANTY OF ANY KIND, EITHER EXPRESS OR IMPLIED, INCLUDING THE IMPLIED WARRANTIES OF MERCHANTABILITY OR FITNESS FOR A PARTICULAR PURPOSE. Some jurisdictions do not allow disclaimer of express or implied warranties in certain transactions, therefore this disclaimer may not apply to you.
- The specifications on this page may not be available in all regions, and may be changed or updated without notice.



intel



intel



intel



intel



intel



intel

OVERVIEW



1. Joystick	7. USB-B 3.2 Gen 1
2. Source Key	8. USB 3.2 Gen 1
3. Power connector	9. Audio-out (3.5mm)
4. HDMI 1.4	10. USB 3.2 Gen 1
5. DP 1.2	11. USB 3.2 Gen 1
6. VGA	12. USB 3.2 Gen 1

PERFORMANCE

Panel

Panel

In-Plane Switching (IPS)

Backlight

WLED

Display Size

27 inches

Max View Area

WxH: 596.7 x 335.3 mm

Resolution

1920 x 1080

Aspect Ratio

16:9

Pixel Pitch

0.3114 x 0.3114 mm

Dot / Pixel Per Inch

82 dpi

Brightness

300 cd/m²

Contrast Ratio

- Contrast Ratio: 1000:1
- Dynamic Contrast Ratio: 3M™:1

View Angle (H / V)

Horizontal: 178°, Vertical: 178°

Response Time

- Extreme Mode: 4 ms
- Normal Mode: 6 ms
- Off Mode: 14 ms

Refresh Rate

60Hz

Color Gamut

99% sRGB

Color Support

16.7 Million

Operating System

Operating System

- Windows® 11 Support
- Windows® 10 Support

Power Supply

Power Consumption

Typical / Max: 24W / 65W

Voltage Required

AC 100 to 240 V (47-63Hz)

Special Features

Special Features

Lenovo® ThinkColour (Lenovo® Display Accessories and Display Manager) Support

Lenovo® ThinkColour supports Windows® 10 & 11, Mac OS, and Windows® On Arm (functions vary across systems).

Lenovo® Display Accessories and Display Manager is formerly Lenovo® Display Control Center.

DESIGN

Mechanical

ThinkCentre® M Series Support

ThinkCentre® Tiny, ThinkStation® Tiny

Bezel Width

- Side: 2mm
- Top / Bottom: 2mm / 17.6mm

Buttons

- Input Source Switch button
- Menu stick
- Power button

Case Color

Raven black

Dimensions (WxDxH)^[1]

Models	Dimensions
Lowest Position	611x 223 x 426 mm (24.09 x 8.78 x 16.78 inches)
Highest Position	611 x 223 x 551 mm (24.09 x 8.78 x 21.7 inches)
Head Only	611.9 x 50.0 x 362.5 mm (24.09 x 1.97 x 14.27 inches)

Packaging Dimensions (WxDxH)

715 x 160 x 527 mm (28.15 x 6.30 x 20.75 inches)

Weight^[2]

Models	Weight
Monitor With Stand	7.90 kg (17.42 lbs)
Monitor Head Only	4.9 kg (10.8 lbs)

Packaging Weight

10.24 kg (22.58 lbs)

Mounting

Supports VESA mount 100mm

Stand

- TIO Flex stand, supports -5° to +23° tilt, up to 125mm lift
- Build in DisplayPort™ cable for monitor
- Build in DisplayPort™ connector for Tiny
- Build in USB-A connector for Tiny
- Build in USB-B cable for monitor

In the Box

- Monitor Head
- Power cable
- TIO Flex stand
- User's guide

Notes:

[1] The system dimensions may vary depending on configurations.

[2] The system weight is approximate and based on results in Lenovo® lab, which varies depending on the source of component, variance of the distribution of each component, and manufacturing process. It may not be the exact weight for each specific model.

CONNECTIVITY

Ports^[1]

Rear Ports

- 1x USB-B 3.2 Gen 1, USB upstream

- 4x USB 3.1 Gen 1 (1x BC), USB downstream
- 1x HDMI® 1.4
- 1x DisplayPort™ 1.2
- 1x VGA
- 1x audio-out (3.5mm)
- 1x power connector

Notes:

[1] The transfer speed of following ports will vary and, depending on many factors, such as the processing speed of the host device, file attributes and other factors related to system configuration and your operating environment, will be slower than theoretical speed.

USB 2.0: 480 Mbit/s;

USB 3.2 Gen 1 (SuperSpeed USB 5Gbps, formerly USB 3.0 / USB 3.1 Gen 1): 5 Gbit/s;

USB 3.2 Gen 2 (SuperSpeed USB 10Gbps, formerly USB 3.1 Gen 2): 10 Gbit/s;

USB4® 20Gbps / USB 3.2 Gen 2x2 (SuperSpeed USB 20Gbps): 20 Gbit/s;

USB4® 40Gbps (USB 40Gbps): 40 Gbit/s;

Thunderbolt™ 3/4: 40 Gbit/s.

SECURITY & PRIVACY

Security

Physical Locks

Kensington® Security Slot™, 3 x 7 mm

SERVICE

Warranty

Base Warranty

- TIO Flex stand: 1-year CRU warranty
- Monitor: 3 years limited warranty

CERTIFICATIONS

Green Certifications^[1]

Green Certifications

- ENERGY STAR® Certified
- EPEAT™ Silver Registered^[2]
- RoHS compliant
- TCO Certified
- TCO edge

Notes:

[1] The items listed under the "Green Certifications" section may not only refer to certification but also registration or self-declaration.

[2] EPEAT™ is registered where applicable, please see [epeat.net](https://www.epeat.net) for registration status by country.

Other Certifications

Other Certifications

- Eyesafe® Certified
- TÜV Rheinland® Eye Comfort Certification
- TÜV Rheinland® Low Blue Light (Hardware Solution)

- Lenovo reserves the right to change specifications or other product information without notice. Lenovo is not responsible for photographic or typographical errors. **LENOVO PROVIDES THIS PUBLICATION "AS IS," WITHOUT WARRANTY OF ANY KIND, EITHER EXPRESS OR IMPLIED, INCLUDING THE IMPLIED WARRANTIES**

OF MERCHANTABILITY OR FITNESS FOR A PARTICULAR PURPOSE. Some jurisdictions do not allow disclaimer of express or implied warranties in certain transactions, therefore this disclaimer may not apply to you.

- The specifications on this page may not be available in all regions, and may be changed or updated without notice.



OVERVIEW

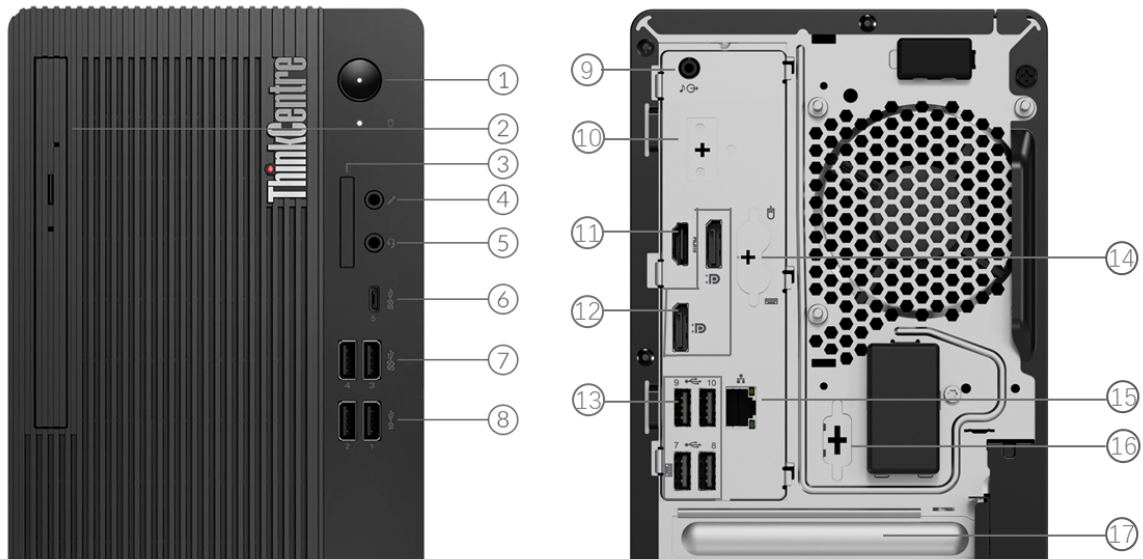

1. Power button	10. Flex IO *
2. Optical drive *	11. HDMI 2.1 TMDS
3. Card reader *	12. 2x DisplayPort 1.4
4. Microphone (3.5mm)	13. 4x USB 2.0
5. Headphone / microphone combo jack (3.5mm)	14. 2x PS/2 ports (keyboard / mouse) *
6. USB-C 3.2 Gen 1	15. Ethernet (RJ-45)
7. 2x USB 3.2 Gen 1	16. Serial *
8. 2x USB 3.2 Gen 2	17. Optional ports on expansion cards *
9. Line-out (3.5mm)	

Notes:

- Items with * are only available on selected models
- More ports are available through the optional expansion cards (not shown on the sample product above)

PERFORMANCE

Processor

Processor Family

Intel® Pentium® or 12th Generation Intel® Core™ i3 / i5 / i7 / i9 Processor

Processor**

Processor Name	Cores	Threads	Base Frequency	Max Frequency	Cache	Processor Graphics
Pentium® Gold G7400	2	4	3.7GHz	-	6MB	Intel® UHD Graphics 710
Core™ i3-12100	4 (4 P-core + 0 E-core)	8	P-core 3.3GHz	P-core 4.3GHz ^[1]	12MB	Intel® UHD Graphics 730
Core™ i3-12300	4 (4 P-core + 0 E-core)	8	P-core 3.5GHz	P-core 4.4GHz ^[2]	12MB	Intel® UHD Graphics 730
Core™ i5-12400	6 (6 P-core + 0 E-core)	12	P-core 2.5GHz	P-core 4.4GHz ^[3]	18MB	Intel® UHD Graphics 730
Core™ i5-12400F	6 (6 P-core + 0 E-core)	12	P-core 2.5GHz	P-core 4.4GHz ^[4]	18MB	-
Core™ i5-12500	6 (6 P-core + 0 E-core)	12	P-core 3.0GHz	P-core 4.6GHz ^[5]	18MB	Intel® UHD Graphics 770
Core™ i5-12600	6 (6 P-core + 0 E-core)	12	P-core 3.3GHz	P-core 4.8GHz ^[6]	18MB	Intel® UHD Graphics 770
Core™ i7-12700	12 (8 P-core + 4 E-core)	20	P-core 2.1GHz / E-core 1.6GHz	Max Turbo up to 4.9GHz / P-core 4.8GHz / E-core 3.6GHz ^[7]	25MB	Intel® UHD Graphics 770
Core™ i7-12700F	12 (8 P-core + 4 E-core)	20	P-core 2.1GHz / E-core 1.6GHz	Max Turbo up to 4.9GHz / P-core 4.8GHz / E-core 3.6GHz ^[8]	25MB	-
Core™ i9-12900	16 (8 P-core + 8 E-core)	24	P-core 2.4GHz / E-core 1.8GHz	Max Turbo up to 5.1GHz / P-core 5.0GHz / E-core 3.8GHz ^[9]	30MB	Intel® UHD Graphics 770
Core™ i9-12900F	16 (8 P-core + 8 E-core)	24	P-core 2.4GHz / E-core 1.8GHz	Max Turbo up to 5.1GHz / P-core 5.0GHz / E-core 3.8GHz ^[10]	30MB	-

Notes:

[1], [2], [3], [4], [5], [6], [7], [8], [9], [10] Intel® Max Turbo frequency will vary depending on application workload and the hardware and software configurations, see <http://www.intel.com/technology/turboboost/> for more information.

Operating System

Operating System**

- Windows® 11 Pro
- Windows® 11 Home
- Windows® 11 Home Single Language
- Windows® 11 DG Windows® 10 Pro 64
- Windows® 10 IoT Enterprise LTSC 2021
- Ubuntu Linux^[1]
- No preload operating system

Notes:

[1] Some features may not be supported on the system with Linux preload, including but not limited to Intel® RST RAID, Human Presence Detection, etc.

Graphics

Graphics***[1]

Graphics	Type	Memory	Connector	Max Resolution	Key Features

ThinkCentre M70t Gen 3

Intel® UHD graphics 710	Integrated	Shared	2x DP 1.4 HBR2, 1x HDMI® 2.1 TMDS, 1x Flex IO (VGA / DP 1.2 / HDMI® 2.1 TMDS / USB-C®)	4096x2304@60Hz(DP), 4096x2160@60Hz[HDMI® / Flex IO(HDMI®) / Flex IO(DP)], 3840x2160@60Hz[Flex IO(USB-C®)], 2048x1536@50Hz[Flex IO(VGA)]	DirectX® 12
Intel® UHD graphics 730	Integrated	Shared	2x DP 1.4 HBR2, 1x HDMI® 2.1 TMDS, 1x Flex IO (VGA / DP 1.2 / HDMI® 2.1 TMDS / USB-C®)	4096x2304@60Hz(DP), 4096x2160@60Hz[HDMI® / Flex IO(HDMI®) / Flex IO(DP)], 3840x2160@60Hz[Flex IO(USB-C®)], 2048x1536@50Hz[Flex IO(VGA)]	DirectX® 12
Intel® UHD graphics 770	Integrated	Shared	2x DP 1.4 HBR2, 1x HDMI® 2.1 TMDS, 1x Flex IO (VGA / DP 1.2 / HDMI® 2.1 TMDS / USB-C®)	4096x2304@60Hz(DP), 4096x2160@60Hz[HDMI® / Flex IO(HDMI®) / Flex IO(DP)], 3840x2160@60Hz[Flex IO(USB-C®)], 2048x1536@50Hz[Flex IO(VGA)]	DirectX® 12
AMD Radeon™ RX 6400	Discrete	4GB GDDR6	1x HDMI® 2.1 FRL, 1x DP 1.4a	7680x4320@60Hz(HDMI®), 7680x4320@60Hz(DP)	DirectX® 12, OpenGL 4.6
AMD Radeon™ RX 6500XT	Discrete	4GB GDDR6	1x HDMI® 2.1, 1x DP 1.4	7680x4320@60Hz(HDMI®), 7680x4320@60Hz(DP)	DirectX® 12, OpenGL 4.6
Intel® Iris® Xe MAX 100	Discrete	2GB LPDDR4X	2x DP 1.4	3840x2160@60Hz(DP)	DirectX® 12, OpenGL 4.6
NVIDIA® GeForce RTX™ 3050	Discrete	8GB GDDR6	1x HDMI® 2.1 FRL, 3x DP 1.4a	7680x4320@60Hz(HDMI®), 7680x4320@120Hz(DP) ^[2]	DirectX® 12, OpenGL 4.6

Notes:

[1] The information of integrated graphics are not applicable for the models with processor which has no integrated graphics inside (for the details, please refer to processor section).

[2] Requires two DisplayPort™ 1.4a links and DSC compression.

Monitor Support

Monitor Support^[1]

Supports up to 4 independent displays via onboard ports (2x DP, 1x HDMI®, and 1x optional Flex IO), more displays support via discrete graphics

Notes:

[1] Onboard video ports are only available for the models with integrated graphics.

Chipset

Chipset

Intel® Q670 chipset

Memory

Max Memory^[1]

Up to 128GB DDR4-3200

Memory Slots

Four DDR4 DIMM slots, dual-channel capable

Memory Type

DDR4-3200

Notes:

[1] The max memory is based on the test results with current Lenovo® memory offerings.

Storage

Storage Support^{[1][2]}

Up to three drives, 1x 2.5"/3.5" HDD + 1x 2.5" HDD + 1x M.2 SSD

- 2.5" HDD up to 1TB each
- 3.5" HDD up to 2TB
- M.2 SSD up to 2TB

Storage Type^{***}

Disk Type	Interface	RPM	Security
2.5" SATA HDD	SATA 6Gb/s	7.2K	-
3.5" SATA HDD	SATA 6Gb/s	7.2K	-
M.2 2280 SSD	PCIe® NVMe®, PCIe® 3.0 x4	-	Opal
M.2 2280 SSD	PCIe® NVMe®, PCIe® 4.0 x4 Performance	-	Opal 2.0
M.2 2280 SSD	PCIe® NVMe®, PCIe® 4.0 x4 Value	-	Opal 2.0
M.2 2242 SSD	PCIe® NVMe®, PCIe® 3.0 x4	-	-

RAID

RAID 0/1 support for HDDs (RAID preset only available via special bid models)

Notes:

[1] The max capacity of each disk type is based on the test results with current Lenovo® storage offerings.

[2] The max capacity of SSD/HDD is based on the test results with current Lenovo® SSD/HDD offerings.

Removable Storage

Optical^{**}

- DVD-ROM, SATA connector, slim (9.0mm)
- DVD burner (DVD±RW), SATA connector, slim (9.0mm)
- None

Card Reader

- 3-in-1 card reader (SD, SDHC, SDXC)
- No card reader

Multi-Media

Audio Chip

High Definition (HD) Audio, Realtek® ALC897Q-CG codec

Speakers

Single speaker, 2W x1

Power Supply

Power Supply^{**}

Power	Type	Efficiency	Key Features
180W	Fixed	85%	100-240V, 50-60Hz
260W	Fixed	90%	100-240V, 50-60Hz
310W	Fixed	92%	100-240V, 50-60Hz
380W	Fixed	92%	100-240V, 50-60Hz

DESIGN

Input Device

Keyboard^{**}

- Lenovo® Calliope Keyboard (USB connector), black

ThinkCentre M70t Gen 3

- Lenovo® Calliope Wireless Keyboard (2.4GHz via USB receiver), black
- Lenovo® Traditional Keyboard (USB connector), black
- No keyboard

Mouse**

- Lenovo® Calliope Mouse (USB connector), black
- Lenovo® Calliope Wireless Mouse (2.4GHz via USB receiver), black
- Lenovo® Mouse (PS/2 connector), black (only available via special bid)
- Lenovo® Fingerprint Mouse (USB connector), Windows® Hello support, black (EOL on Jan, 2023)
- No mouse

Mechanical

Form Factor

Tower (13.6L)

Dimensions (WxDxH)^[1]

145 x 296 x 346 mm (5.7 x 11.7 x 13.6 inches)

Weight^[2]

Around 5.9 kg (13.0 lbs)

Case Color

Black

Bays^[3]

- 1x 2.5" disk bay
- 1x 3.5" disk bay
- 1x slim ODD bay

Expansion Slots

- One PCIe® 4.0 x16, full-height, length ≤ 209mm, height ≤ 117.5mm
- Two PCIe® 3.0 x1, full-height, (length ≤ 185mm, height ≤ 100mm) or (length ≤ 118mm, height ≤ 110mm)
- Two M.2 slots (one for WLAN, one for SSD)

EOU

Toolless cover, disk, optical, extension card assembly / removal

Stand

No stand

Others

- (Optional) Dust filter
- (Optional) Smart Cable (USB-A to USB-C®)
- Supports Smart Power On

Notes:

[1] The system dimensions may vary depending on configurations.

[2] The system weight is approximate and based on results in Lenovo® lab, which varies depending on the source of component, variance of the distribution of each component, and manufacturing process. It may not be the exact weight for each specific model.

[3] 2.5" HDD tray is optional, or comes with 2.5 HDD. 3.5" bay supports 2.5" / 3.5" HDD, 3.5" to 2.5 converter comes with 2nd 2.5" HDD.

CONNECTIVITY

Network

Onboard Ethernet

Gigabit Ethernet, Intel® Ethernet Connection I219-LM, 1x RJ-45, supports Wake-on-LAN

Optional Ethernet***

- Gigabit Ethernet, Bitland BN8E88, 1x RJ-45, PCIe® x1
- Gigabit Ethernet, Bitland RTL8168H, 1x RJ-45, PCIe® x1
- 2.5 Gigabit Ethernet, Realtek® RTL8125BGS, 1x RJ-45, PCIe® x1
- No optional Ethernet

WLAN + Bluetooth®**

ThinkCentre M70t Gen 3

- Realtek® RTL8822CE, 802.11ac Dual Band 2x2 Wi-Fi® + Bluetooth® 5.0, M.2 card
- Intel® Wireless-AC 9560, 802.11ac Dual Band 2x2 Wi-Fi® + Bluetooth® 5.1, M.2 card
- Realtek® Wi-Fi® 6 RTL8852BE, 802.11ax Dual Band 2x2 Wi-Fi® + Bluetooth® 5.3, M.2 card^[1]
- Intel® Wi-Fi® 6 AX201, 802.11ax 2x2 Wi-Fi® + Bluetooth® 5.2, M.2 Card^[2]
- Intel® Wi-Fi® 6E AX211, 802.11ax 2x2 Wi-Fi® + Bluetooth® 5.3, Intel® vPro® technology support, M.2 Card^[3]
- No WLAN and Bluetooth®

Notes:

[1], [3] Bluetooth® 5.3 requires Windows® 11.

[2] Bluetooth® 5.2 requires Windows® 11.

Ports^[1]

Front Ports

- 1x USB-C® 3.2 Gen 1 (15W charging)
- 2x USB 3.2 Gen 1
- 2x USB 3.2 Gen 2
- 1x headphone / microphone combo jack (3.5mm)
- 1x microphone (3.5mm)

Optional Front Ports

1x card reader

Rear Ports^[2]

- 4x USB 2.0
- 1x HDMI® 2.1 TMDS
- 2x DisplayPort™ 1.4
- 1x Ethernet (RJ-45)
- 1x line-out (3.5mm)

Optional Rear Ports^{***}

- 1x USB-C® 3.2 Gen 1 with DisplayPort™ function and 5V@3A charging (Flex IO)
- 1x HDMI® 2.1 TMDS (Flex IO)
- 1x DP 1.2 (Flex IO)
- 1x VGA (Flex IO)
- 2x USB 3.2 Gen 1 (via 2-port USB expansion card, PCIe® x1)
- 1x parallel
- 1x serial
- 1x 2nd serial
- 4x serial (via 4-port serial expansion card, PCIe® x1)
- 2x PS/2

Notes:

[1] The transfer speed of following ports will vary and, depending on many factors, such as the processing speed of the host device, file attributes and other factors related to system configuration and your operating environment, will be slower than theoretical speed.

USB 2.0: 480 Mbit/s;

USB 3.2 Gen 1 (SuperSpeed USB 5Gbps, formerly USB 3.0 / USB 3.1 Gen 1): 5 Gbit/s;

USB 3.2 Gen 2 (SuperSpeed USB 10Gbps, formerly USB 3.1 Gen 2): 10 Gbit/s;

USB4® 20Gbps / USB 3.2 Gen 2x2 (SuperSpeed USB 20Gbps): 20 Gbit/s;

USB4® 40Gbps (USB 40Gbps): 40 Gbit/s;

Thunderbolt™ 3/4: 40 Gbit/s.

[2] For video ports on discrete graphics, please see graphics section.

Monitor Cable

Monitor Cable^{***}

- HDMI® to HDMI® cable (1.5m)
- HDMI® to VGA dongle
- DP to VGA dongle
- DP to dual DP dongle
- DP to DVI-D dongle
- DP to HDMI® dongle
- No monitor cable

SECURITY & PRIVACY

Security

Security Chip

Discrete TPM 2.0, TCG certified

Physical Locks

- (Optional) E-lock
- (Optional) Smart Cable Clip
- Kensington® Security Slot™, 3 x 7 mm
- Padlock Loop

Chassis Intrusion Switch

- Chassis intrusion switch
- No chassis intrusion switch

Fingerprint Reader

- Touch style fingerprint reader on mouse (EOL on Jan, 2023)
- No fingerprint reader

BIOS Security

- Administrator password
- Power-on password
- Hard disk password
- Boot sequence control
- Boot without keyboard and mouse
- Self-healing BIOS (Level 2)
- Smart USB protection (allows keyboard / mouse only, blocks all storage devices)
- Individual USB port disablement

MANAGEABILITY

System Management

System Management**

- Intel® vPro® Enterprise^[1]
- Intel® vPro® Essentials^[2]
- Non-vPro®

Notes:

[1], [2] Intel® vPro® offers a superset of DASH's defined capabilities.

SERVICE

Warranty^[1]

Base Warranty**

- 1-year courier or carry-in service
- 1-year limited onsite service
- 3-year limited onsite service
- No base warranty

Notes:

[1] The warranty upgrades may be bundled with some models, please check the "Included upgrade" column in the specific model's configurations. For more service extensions, please go to <https://smartfind.lenovo.com/>. To learn more details of warranty policy, please access <https://pcsupport.lenovo.com/warranty>.

ENVIRONMENTAL

Operating Environment

Temperature

- Operating: 5°C (41°F) to 35°C (95°F)
- Storage: -40°C (-40°F) to 60°C (140°F)

Relative Humidity

- Operating: 20% to 80%
- Storage: 10% to 90%

Altitude

- Operating: 0 m (0 ft) to 3048 m (10,000 ft)
- Storage: 0 m (0 ft) to 12192 m (40,000 ft)

CERTIFICATIONS

Green Certifications^[1]

Green Certifications

- (Optional) ENERGY STAR® 8.0
- (Optional) EPEAT™ Silver Registered^[2]
- (Optional) EPEAT™ Gold Registered^[3]
- ErP Lot 3
- RoHS compliant
- TCO Certified 9.0

Notes:

[1] The items listed under the "Green Certifications" section may not only refer to certification but also registration or self-declaration.

[2], [3] EPEAT™ is registered where applicable, please see [epeat.net](https://www.epeat.net) for registration status by country.

Other Certifications

Other Certifications

- (Optional) TÜV Rheinland® Low Noise
- (Optional) TÜV Rheinland® Ultra Low Noise

Mil-Spec Test

MIL-STD-810H military test passed (Low Pressure [Altitude], High Temperature, Low Temperature, Temperature Shock, Humidity, Sand and Dust, Vibration, Shock, Fungus, Solar Radiation, Contamination by Fluids, Salt Fog)

- Feature with ** means that only one offering listed under the feature is configured on selected models.
- Feature with *** means that one or more offerings listed under the feature could be configured on selected models.
- Lenovo reserves the right to change specifications or other product information without notice. Lenovo is not responsible for photographic or typographical errors. LENOVO PROVIDES THIS PUBLICATION "AS IS," WITHOUT WARRANTY OF ANY KIND, EITHER EXPRESS OR IMPLIED, INCLUDING THE IMPLIED WARRANTIES OF MERCHANTABILITY OR FITNESS FOR A PARTICULAR PURPOSE. Some jurisdictions do not allow disclaimer of express or implied warranties in certain transactions, therefore this disclaimer may not apply to you.
- The specifications on this page may not be available in all regions, and may be changed or updated without notice.



intel



intel

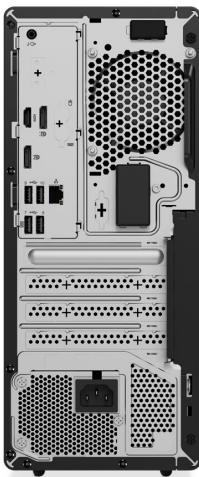

intel

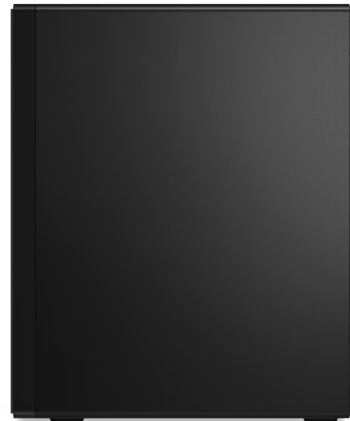

intel

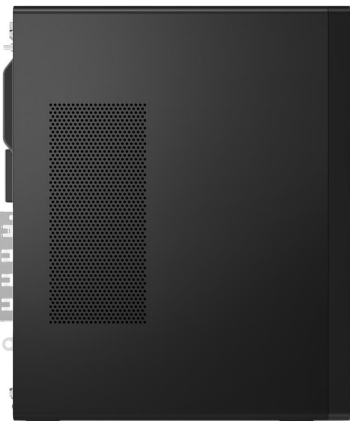

intel



intel

OVERVIEW

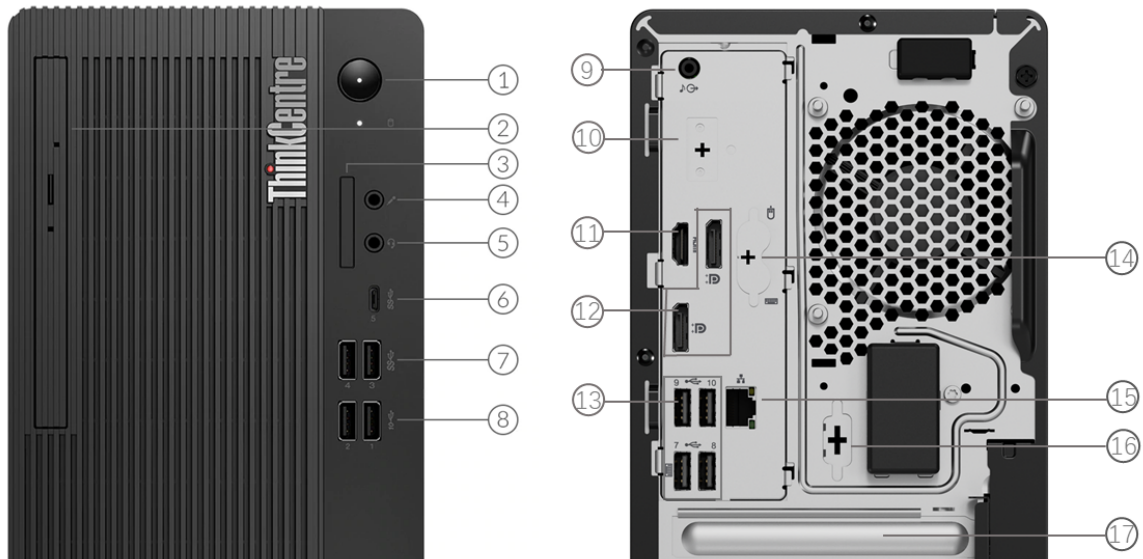

1. Power button	10. Flex IO *
2. Optical drive *	11. HDMI 2.1 TMDs
3. Card reader *	12. 2x DisplayPort 1.4a
4. Microphone (3.5mm)	13. 4x USB 2.0
5. Headphone / microphone combo jack (3.5mm)	14. 2x PS/2 ports (keyboard / mouse) *
6. USB-C 3.2 Gen 1	15. Ethernet (RJ-45)
7. 2x USB 3.2 Gen 1	16. Serial *
8. 2x USB 3.2 Gen 2	17. Optional ports on expansion cards *
9. Line-out (3.5mm)	

Notes:

- Items with * are only available on selected models
- More ports are available through the optional expansion cards (not shown on the sample product above)

PERFORMANCE

Processor

Processor Family

13th Generation Intel® Core™ i3 / i5 / i7 Processor

Processor**^[1]

Processor Name	Cores	Threads	Base Frequency	Max Frequency	Cache	Processor Graphics
Core™ i3-13100	4 (4 P-core + 0 E-core)	8	P-core 3.4GHz	P-core 4.5GHz	12MB	Intel® UHD Graphics 730
Core™ i5-13400	10 (6 P-core + 4 E-core)	16	P-core 2.5GHz / E-core 1.8GHz	P-core 4.6GHz / E-core 3.3GHz	20MB	Intel® UHD Graphics 730
Core™ i5-13400F ^[2]	10 (6 P-core + 4 E-core)	16	P-core 2.5GHz / E-core 1.8GHz	P-core 4.6GHz / E-core 3.3GHz	20MB	-
Core™ i5-13500	14 (6 P-core + 8 E-core)	20	P-core 2.5GHz / E-core 1.8GHz	P-core 4.8GHz / E-core 3.5GHz	24MB	Intel® UHD Graphics 770
Core™ i5-13600	14 (6 P-core + 8 E-core)	20	P-core 2.7GHz / E-core 2.0GHz	P-core 5.0GHz / E-core 3.7GHz	24MB	Intel® UHD Graphics 770
Core™ i7-13700	16 (8 P-core + 8 E-core)	24	P-core 2.1GHz / E-core 1.5GHz	Max Turbo up to 5.2GHz / P-core 5.1GHz / E-core 4.1GHz	30MB	Intel® UHD Graphics 770
Core™ i7-13700F ^[3]	16 (8 P-core + 8 E-core)	24	P-core 2.1GHz / E-core 1.5GHz	Max Turbo up to 5.2GHz / P-core 5.1GHz / E-core 4.1GHz	30MB	-

Notes:

[1] Intel® Max Turbo frequency will vary depending on application workload and the hardware and software configurations, see <http://www.intel.com/technology/turboboost/> for more information.

[2], [3] Special bid only.

Operating System

Operating System**

- Windows® 11 Pro
- Windows® 11 Home
- Windows® 11 Home Single Language
- Windows® 11 DG Windows® 10 Pro 64
- Windows® 10 IoT Enterprise LTSC 2021^[1]
- Ubuntu Linux^[2]
- No preload operating system

Notes:

[1] Special bid only.

[2] Some features may not be supported on the system with Linux preload, including but not limited to Intel® RST RAID, Human Presence Detection, etc.

Graphics

Graphics***^[1]

Graphics	Type	Memory	Connector	Max Resolution	Key Features
Intel® UHD graphics 730	Integrated	Shared	2x DP 1.4a (HBR2, DSC), 1x HDMI® 2.1 TMDS, 1x Flex IO (VGA / DP 1.2 / HDMI® 2.1 TMDS / USB-C®)	4096x2304@60Hz(DP), 4096x2160@60Hz[HDMI® / Flex IO(HDMI) / Flex IO(DP)], 3840x2160@60Hz[Flex IO(USB-C®)], 2048x1536@50Hz[Flex IO(VGA)]	DirectX® 12
Intel® UHD graphics 770	Integrated	Shared	2x DP 1.4a (HBR2, DSC), 1x HDMI® 2.1 TMDS, 1x Flex IO (VGA / DP 1.2 /	4096x2304@60Hz(DP), 4096x2160@60Hz[HDMI® / Flex IO(HDMI) / Flex IO(DP)], 3840x2160@60Hz[Flex IO(USB-	DirectX® 12

			HDMI® 2.1 TMDS / USB-C®)	C®)], 2048x1536@50Hz[Flex IO(VGA)]	
AMD Radeon™ RX 6400	Discrete	4GB GDDR6	1x HDMI® 2.1 FRL, 1x DP 1.4a	7680x4320@60Hz(HDMI®), 7680x4320@60Hz(DP)	DirectX® 12, OpenGL 4.6
NVIDIA® GeForce RTX™ 3050	Discrete	8GB GDDR6	1x HDMI® 2.1 FRL, 3x DP 1.4a	7680x4320@60Hz(HDMI®), 7680x4320@120Hz(DP) ^[2]	DirectX® 12, OpenGL 4.6

Notes:

- [1] The information of integrated graphics are not applicable for the models with processor which has no integrated graphics inside (for the details, please refer to processor section).
- [2] Requires two DisplayPort™ 1.4a links and DSC compression.

Monitor Support

Monitor Support^[1]

Supports up to 4 independent displays via onboard ports (2x DP, 1x HDMI®, and 1x optional Flex IO), more displays support via discrete graphics

Notes:

- [1] Onboard video ports are only available for the models with integrated graphics.

Chipset

Chipset

Intel® Q670 chipset

Memory

Max Memory^[1]

Up to 128GB DDR4-3200

Memory Slots

Four DDR4 DIMM slots, dual-channel capable

Memory Type

DDR4-3200

Notes:

- [1] The max memory is based on the test results with current Lenovo® memory offerings.

Storage

Storage Support^{[1][2]}

Up to three drives, 1x 2.5"/3.5" HDD + 1x 2.5" HDD + 1x M.2 SSD

- 2.5" HDD up to 1TB each
- 3.5" HDD up to 2TB
- M.2 SSD up to 2TB

Storage Type^{***}

Disk Type	Interface	RPM	Security
2.5" SATA HDD	SATA 6Gb/s	7.2K	-
3.5" SATA HDD	SATA 6Gb/s	7.2K	-
M.2 2280 SSD	PCIe® NVMe®, PCIe® 4.0 x4 Performance	-	Opal 2.0
M.2 2280 SSD	PCIe® NVMe®, PCIe® 4.0 x4 Value	-	Opal 2.0

RAID

RAID 0/1 support for HDDs (RAID preset only available via special bid models)

ThinkCentre M70t Gen 4

Notes:

- [1] The max capacity of each disk type is based on the test results with current Lenovo® storage offerings.
- [2] 2TB SSD is special bid only.

Removable Storage

Optical**

- DVD-ROM, SATA connector, slim (9.0mm)
- DVD burner (DVD±RW), SATA connector, slim (9.0mm)
- None

Card Reader

- 3-in-1 card reader (SD, SDHC, SDXC)
- No card reader

Multi-Media

Audio Chip

High Definition (HD) Audio, Realtek® ALC897Q-CG codec

Speakers

Single speaker, 2W x1

Power Supply

Power Supply**

Power	Type	Efficiency	Key Features
180W	Fixed	85%	100-240V, 50-60Hz
260W	Fixed	90%	100-240V, 50-60Hz
310W	Fixed	92%	100-240V, 50-60Hz
380W	Fixed	92%	100-240V, 50-60Hz

DESIGN

Input Device

Keyboard**

- Lenovo® Calliope Keyboard (USB connector), black
- Lenovo® Calliope Wireless Keyboard, black
- Lenovo® Traditional Keyboard (USB connector), black
- No keyboard

Mouse**

- Lenovo® Calliope Mouse (USB connector), black
- Lenovo® Calliope Wireless Mouse (2.4GHz via USB receiver), black
- No mouse

Mechanical

Form Factor

Tower (13.6L)

Dimensions (WxDxH)^[1]

145 x 296 x 346 mm (5.7 x 11.7 x 13.6 inches)

Packaging Dimensions (WxDxH)

245 x 395 x 530 mm (9.65 x 15.55 x 20.87 inches)

Weight^[2]

Around 5.9 kg (13.0 lbs)

Packaging Weight

8.3 kg (18.29 lbs)

Case Color

Black

Bays

- 1x 2.5" disk bay^[3]
- 1x 3.5" disk bay^[4]
- 1x slim ODD bay

Expansion Slots

- One PCIe® 4.0 x16, full-height, length ≤ 209mm, height ≤ 117.5mm
- Two PCIe® 3.0 x1, full-height, (length ≤ 185mm, height ≤ 100mm) or (length ≤ 118mm, height ≤ 110mm)
- Two M.2 slots (one for WLAN, one for SSD)

EOU

Toolless cover, disk, optical, extension card assembly / removal

Others

- (Optional) Dust filter
- (Optional) Smart Cable (USB-A to USB-C®)
- Supports Smart Power On

Notes:

[1] The system dimensions may vary depending on configurations.

[2] The system weight is approximate and based on results in Lenovo® lab, which varies depending on the source of component, variance of the distribution of each component, and manufacturing process. It may not be the exact weight for each specific model.

[3] 2.5" HDD tray is optional, or comes with 2.5 HDD.

[4] 3.5" bay supports 2.5" / 3.5" HDD, 3.5" to 2.5 converter comes with 2nd 2.5" HDD.

CONNECTIVITY

Network

Onboard Ethernet

Gigabit Ethernet, Intel® Ethernet Connection I219-LM, 1x RJ-45, supports Wake-on-LAN

Optional Ethernet

- 2.5 Gigabit Ethernet, Realtek® RTL8125BGS, 1x RJ-45, PCIe® x1
- No optional Ethernet

WLAN + Bluetooth®**

- Realtek® Wi-Fi® 6 RTL8852BE, 802.11ax Dual Band 2x2 Wi-Fi® + Bluetooth® 5.1, M.2 card^[1]
- Intel® Wi-Fi® 6 AX201, 802.11ax 2x2 Wi-Fi® + Bluetooth® 5.1, M.2 Card^[2]
- Intel® Wi-Fi® 6E AX211, 802.11ax 2x2 Wi-Fi® + Bluetooth® 5.1, Intel® vPro® technology support, M.2 Card^[3]
- No WLAN and Bluetooth®

Notes:

[1], [2], [3] Bluetooth® 5.2 is hardware ready but may run at a lower version due to OS limitations.

Ports^[1]

Front Ports

- 1x USB-C® 3.2 Gen 1 (15W charging)
- 2x USB 3.2 Gen 1
- 2x USB 3.2 Gen 2
- 1x headphone / microphone combo jack (3.5mm)
- 1x microphone (3.5mm)

Optional Front Ports

1x card reader

Rear Ports^[2]

- 4x USB 2.0
- 1x HDMI® 2.1 TMDS
- 2x DisplayPort™ 1.4a (HBR2, DSC)
- 1x Ethernet (RJ-45)
- 1x line-out (3.5mm)

Optional Rear Ports***

ThinkCentre M70t Gen 4

- 1x USB-C® 3.2 Gen 1 with DisplayPort™ function and 5V@3A charging (Flex IO)
- 1x HDMI® 2.1 TMDS (Flex IO)
- 1x DP 1.2 (Flex IO)
- 1x VGA (Flex IO)
- 2x USB 3.2 Gen 1 (via 2-port USB expansion card, PCIe® x1)
- 1x parallel
- 1x serial
- 1x 2nd serial
- 4x serial (via 4-port serial expansion card, PCIe® x1)
- 2x PS/2

Notes:

[1] The transfer speed of following ports will vary and, depending on many factors, such as the processing speed of the host device, file attributes and other factors related to system configuration and your operating environment, will be slower than theoretical speed.

USB 2.0: 480 Mbit/s;

USB 3.2 Gen 1 (SuperSpeed USB 5Gbps, formerly USB 3.0 / USB 3.1 Gen 1): 5 Gbit/s;

USB 3.2 Gen 2 (SuperSpeed USB 10Gbps, formerly USB 3.1 Gen 2): 10 Gbit/s;

USB4® 20Gbps / USB 3.2 Gen 2x2 (SuperSpeed USB 20Gbps): 20 Gbit/s;

USB4® 40Gbps (USB 40Gbps): 40 Gbit/s;

Thunderbolt™ 3/4: 40 Gbit/s.

[2] For video ports on discrete graphics, please see graphics section.

Monitor Cable

Monitor Cable***

- HDMI® to HDMI® cable (1.5m)
- HDMI® to VGA dongle
- DP to VGA dongle
- DP to DVI-D dongle
- DP to HDMI® dongle
- No monitor cable

SECURITY & PRIVACY

Security

Security Chip

Discrete TPM 2.0, TCG certified

Physical Locks

- (Optional) E-lock
- (Optional) Smart Cable Clip
- Kensington® Security Slot™, 3 x 7 mm
- Padlock Loop

Chassis Intrusion Switch

- Chassis intrusion switch
- No chassis intrusion switch

Fingerprint Reader

No fingerprint reader

BIOS Security

- Administrator password
- Power-on password
- Hard disk password
- Boot sequence control
- Boot without keyboard and mouse
- Self-healing BIOS (Level 2)
- Smart USB protection (allows keyboard / mouse only, blocks all storage devices)
- Individual USB port disablement

MANAGEABILITY

System Management

System Management

- Intel® vPro® Enterprise^[1]
- Non-vPro®

Notes:

[1] Intel® vPro® offers a superset of DASH's defined capabilities.

SERVICE

Warranty^[1]

Base Warranty**

- 1-year courier or carry-in service
- 1-year limited onsite service
- 3-year limited onsite service
- No base warranty

Notes:

[1] The warranty upgrades may be bundled with some models, please check the "Included upgrade" column in the specific model's configurations. For more service extensions, please go to <https://smartfind.lenovo.com/>. To learn more details of warranty policy, please access <https://pcsupport.lenovo.com/warranty>.

ENVIRONMENTAL

Operating Environment

Temperature

- Operating: 5°C (41°F) to 35°C (95°F)
- Storage: -40°C (-40°F) to 60°C (140°F)

Relative Humidity

- Operating: 20% to 80%
- Storage: 10% to 90%

Altitude

- Operating: 0 m (0 ft) to 3048 m (10,000 ft)
- Storage: 0 m (0 ft) to 12192 m (40,000 ft)

CERTIFICATIONS

Green Certifications^[1]

Green Certifications

- (Optional) ENERGY STAR® 8.0
- (Optional) EPEAT™ Silver Registered^[2]
- (Optional) EPEAT™ Gold Registered^[3]
- ErP Lot 3
- RoHS compliant
- TCO Certified 9.0

Notes:

[1] The items listed under the "Green Certifications" section may not only refer to certification but also registration or self-declaration.

[2], [3] EPEAT™ is registered where applicable, please see epeat.net for registration status by country.

Other Certifications

Other Certifications

- (Optional) TÜV Rheinland® Low Noise
- (Optional) TÜV Rheinland® Ultra Low Noise

Mil-Spec Test

MIL-STD-810H military test passed (Low Pressure [Altitude], High Temperature, Low Temperature, Temperature Shock, Humidity, Sand and Dust, Vibration, Shock, Fungus, Solar Radiation, Contamination by Fluids, Salt Fog)

- Feature with ** means that only one offering listed under the feature is configured on selected models.
- Feature with *** means that one or more offerings listed under the feature could be configured on selected models.
- Lenovo reserves the right to change specifications or other product information without notice. Lenovo is not responsible for photographic or typographical errors. LENOVO PROVIDES THIS PUBLICATION “AS IS,” WITHOUT WARRANTY OF ANY KIND, EITHER EXPRESS OR IMPLIED, INCLUDING THE IMPLIED WARRANTIES OF MERCHANTABILITY OR FITNESS FOR A PARTICULAR PURPOSE. Some jurisdictions do not allow disclaimer of express or implied warranties in certain transactions, therefore this disclaimer may not apply to you.
- The specifications on this page may not be available in all regions, and may be changed or updated without notice.



intel



intel

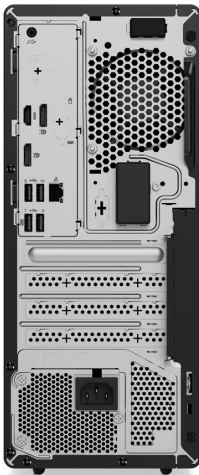

intel

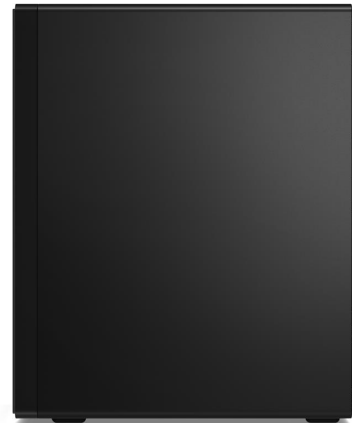

intel

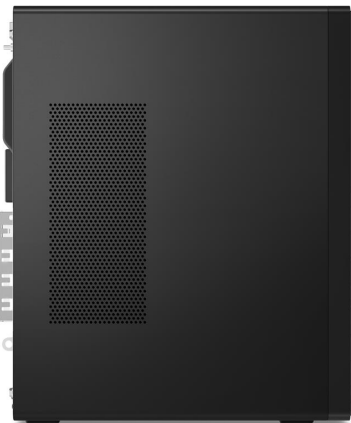

intel



intel

OVERVIEW

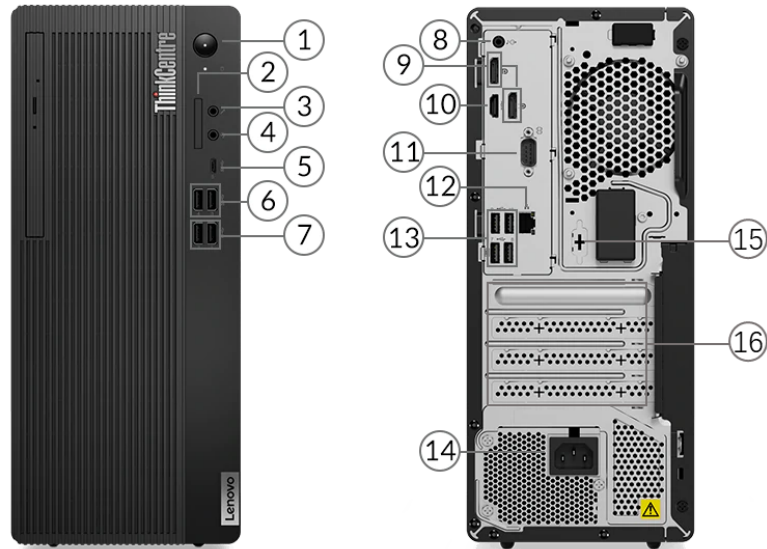

1. Power button	9. 2x DisplayPort 1.4
2. Card reader *	10. HDMI 1.4b
3. Microphone (3.5mm)	11. Serial
4. Headphone / microphone combo jack (3.5mm)	12. Ethernet (RJ-45)
5. USB-C 3.2 Gen 1	13. 4x USB 2.0
6. 2x USB 3.2 Gen 1	14. Power connector
7. 2x USB 3.2 Gen 2	15. Serial *
8. Line-out (3.5mm)	16. Optional ports on expansion cards *

Notes:

- Items with * are only available on selected models

PERFORMANCE

Processor

Processor Family

AMD Athlon™ or AMD Ryzen™ 3 / 5 / 7 / 9 Processor

Processor**

Processor Name	Cores	Threads	Base Frequency	Max Frequency	Cache	Memory Support	Processor Graphics
AMD Athlon™ Gold PRO 3150G ^[1]	4	4	3.5GHz	3.9GHz	2MB L2 / 4MB L3	DDR4-2933	AMD Radeon™ Graphics
AMD Athlon™ Silver 3050GE ^[2]	2	4	3.4GHz	3.4GHz	1MB L2 / 4MB L3	DDR4-2666	AMD Radeon™ Graphics
AMD Ryzen™ 3 3200G ^[3]	4	4	3.6GHz	4.0GHz	2MB L2 / 4MB L3	DDR4-2933	AMD Radeon™ Vega 8 Graphics
AMD Ryzen™ 3 4300G ^[4]	4	8	3.8GHz	4.0GHz	2MB L2 / 4MB L3	DDR4-3200	AMD Radeon™ Graphics
AMD Ryzen™ 3 5300G	4	8	4.0GHz	4.2GHz	2MB L2 / 8MB L3	DDR4-3200	AMD Radeon™ Graphics
AMD Ryzen™ 3 PRO 4350G ^[5]	4	8	3.8GHz	4.0GHz	2MB L2 / 4MB L3	DDR4-3200	AMD Radeon™ Graphics
AMD Ryzen™ 3 PRO 5350G	4	8	4.0GHz	4.2GHz	2MB L2 / 8MB L3	DDR4-3200	AMD Radeon™ Graphics
AMD Ryzen™ 5 4600G ^[6]	6	12	3.7GHz	4.2GHz	3MB L2 / 8MB L3	DDR4-3200	AMD Radeon™ Graphics
AMD Ryzen™ 5 5600G	6	12	3.9GHz	4.4GHz	3MB L2 / 16MB L3	DDR4-3200	AMD Radeon™ Graphics
AMD Ryzen™ 5 PRO 3350G ^[7]	4	8	3.6GHz	4.0GHz	2MB L2 / 4MB L3	DDR4-2933	AMD Radeon™ Vega 11 Graphics
AMD Ryzen™ 5 PRO 3400G ^[8]	4	8	3.7GHz	4.2GHz	2MB L2 / 4MB L3	DDR4-2933	AMD Radeon™ Vega 11 Graphics
AMD Ryzen™ 5 PRO 3600 ^[9]	6	12	3.6GHz	4.2GHz	3MB L2 / 32MB L3	DDR4-3200	-
AMD Ryzen™ 5 PRO 4650G ^[10]	6	12	3.7GHz	4.2GHz	3MB L2 / 8MB L3	DDR4-3200	AMD Radeon™ Graphics
AMD Ryzen™ 5 PRO 5650G	6	12	3.9GHz	4.4GHz	3MB L2 / 16MB L3	DDR4-3200	AMD Radeon™ Graphics
AMD Ryzen™ 7 4700G ^[11]	8	16	3.6GHz	4.4GHz	4MB L2 / 8MB L3	DDR4-3200	AMD Radeon™ Graphics
AMD Ryzen™ 7 5700G	8	16	3.8GHz	4.6GHz	4MB L2 / 16MB L3	DDR4-3200	AMD Radeon™ Graphics
AMD Ryzen™ 7 PRO 3700 ^[12]	8	16	3.6GHz	4.4GHz	4MB L2 / 32MB L3	DDR4-3200	-
AMD Ryzen™ 7 PRO 4750G ^[13]	8	16	3.6GHz	4.4GHz	4MB L2 / 8MB L3	DDR4-3200	AMD Radeon™ Graphics
AMD Ryzen™ 7 PRO 5750G	8	16	3.8GHz	4.6GHz	4MB L2 / 16MB L3	DDR4 3200	AMD Radeon™ Graphics
AMD Ryzen™ 9 PRO 3900 ^[14]	12	24	3.1GHz	4.3GHz	6MB L2 / 64MB L3	DDR4-3200	-

Notes:

[1], [2], [3], [4], [5], [6], [7], [8], [9], [10], [11], [12], [13], [14] End of life and not available any more.

Operating System

Operating System**

- Windows® 11 Pro
- Windows® 11 Home
- Windows® 11 Home Single Language
- Windows® 11 DG Windows® 10 Pro 64
- Windows® 10 Pro 64
- Windows® 10 Home 64
- Windows® 10 Home 64 Single Language
- Windows® 10 IoT Enterprise
- Ubuntu Linux^[1]
- No preload operating system

Notes:

[1] Some features may not be supported on the system with Linux preload, including but not limited to Intel® RST RAID, Human Presence Detection, etc.

Graphics

Graphics**^{[1][2]}

Graphics	Type	Memory	Connector	Max Resolution	Key Features
AMD Radeon™ Graphics	Integrated	Shared	2x DisplayPort™ 1.4, 1x HDMI® 1.4	4096x2160@60Hz(DP), 4096x2160@24Hz(HDMI®)	DirectX® 12
AMD Radeon™ Vega 11 Graphics	Integrated	Shared	2x DisplayPort™ 1.4, 1x HDMI® 1.4	4096x2160@60Hz(DP), 4096x2160@24Hz(HDMI®)	DirectX® 12
AMD Radeon™ Vega 8 Graphics	Integrated	Shared	2x DisplayPort™ 1.4, 1x HDMI® 1.4	4096x2160@60Hz(DP), 4096x2160@24Hz(HDMI®)	DirectX® 12
AMD Radeon™ 520	Discrete	2GB GDDR5	2x DP 1.2	4096x2160@60Hz(DP)	DirectX® 12
AMD Radeon™ RX 550X	Discrete	4GB GDDR5	1x HDMI® 2.0, 1x VGA, 1x DP 1.4	4096x2160@60Hz(HDMI®), 2048x1536@85Hz(VGA), 3840x2160@60Hz(DP)	DirectX® 12
AMD Radeon™ RX 6400	Discrete	4GB GDDR6	1x HDMI® 2.1 FRL, 1x DP 1.4a	7680x4320@60Hz(HDMI®), 7680x4320@60Hz(DP)	DirectX® 12, OpenGL 4.6

Notes:

[1] The information of integrated graphics are not applicable for the models with processor which has no integrated graphics inside (for the details, please refer to processor section).

[2] AMD Radeon™ 520 is not available for MT 11RB / 11RC / 11RD / 11RE.

Monitor Support

Monitor Support

Supports up to 3 independent displays via onboard ports (HDMI® and 2x DisplayPort™), more displays support via discrete graphics

Chipset

Chipset

AMD PRO 565 chipset

Memory^[1]

Max Memory^[2]

Up to 128GB DDR4-3200

Memory Slots

Four DDR4 DIMM slots, dual-channel capable

Memory Type**^[3]

- DDR4-1866
- DDR4-2133
- DDR4-2400

ThinkCentre M75t Gen 2

- DDR4-2666
- DDR4-3200

Notes:

- [1] Recommend to choose the models with more than 4GB for better performance and experience.
- [2] The max memory is based on the test results with current Lenovo® memory offerings.
- [3] Installed memory is actually DDR4-3200, but may run as DDR4-1866, DDR4-2133, DDR4-2400 or DDR4-2666 depending on the memory support capability of processor.

Storage

Storage Support^[1]

Up to three drives, 1x 2.5"/3.5" HDD + 1x 2.5" HDD + 1x M.2 SSD

- 2.5" HDD up to 1TB each
- 3.5" HDD up to 2TB
- M.2 SSD up to 2TB

Storage Type^{***}

Disk Type	Interface	RPM	Security
2.5" SATA HDD	SATA 6Gb/s	7.2K	-
3.5" SATA HDD	SATA 6Gb/s	7.2K	-
M.2 2280 SSD	PCIe® NVMe®, PCIe® 3.0 x4	-	Opal
M.2 2280 SSD	PCIe® NVMe®, PCIe® 4.0 x4 Value	-	Opal
M.2 2242 SSD	PCIe® NVMe®, PCIe® 3.0 x2	-	-
M.2 2242 SSD	PCIe® NVMe®, PCIe® 3.0 x4	-	-

RAID

RAID 0/1 support for HDDs (RAID preset only available via special bid models)

Notes:

- [1] The max capacity of each disk type is based on the test results with current Lenovo® storage offerings.

Removable Storage

Optical^{**}

- DVD-ROM, SATA 1.5Gb/s, slim (9.0mm)
- DVD burner (DVD±RW), SATA 1.5Gb/s, slim (9.0mm)
- None

Card Reader

- 3-in-1 card reader (SD, SDHC, SDXC)
- No card reader

Multi-Media

Audio Chip

High Definition (HD) Audio, Realtek® ALC623-CG codec

Speakers

- No speakers
- Single speaker, 2W x1

Power Supply

Power Supply^{**}

Power	Type	Efficiency	Key Features
180W	Fixed	85%	-
260W	Fixed	85%	100-240V, 50-60Hz
310W	Fixed	92%	100-240V, 50-60Hz

DESIGN

Input Device

Keyboard**

- Lenovo® Calliope Keyboard (USB connector), black
- Lenovo® Calliope Wireless Keyboard (2.4GHz via USB receiver), black
- Lenovo® Traditional Keyboard (USB connector), black
- No keyboard

Mouse**

- Lenovo® Calliope Mouse (USB connector), black
- Lenovo® Calliope Wireless Mouse (2.4GHz via USB receiver), black
- Lenovo® Fingerprint Mouse (USB connector), Windows® Hello support, black (EOL on Jan, 2023)
- No mouse

Mechanical

Form Factor

Tower (13.6L)

Dimensions (WxDxH)^[1]

145 x 296 x 346 mm (5.7 x 11.7 x 13.6 inches)

Weight^[2]

Around 5.9 kg (13 lbs)

Case Color

Black

Bays

- 1x 2.5" disk bay (bay comes with disk)
- 1x 3.5" disk bay
- 1x slim ODD bay

Expansion Slots

- One PCIe® 3.0 x16, full-height (length < 215mm)
- One PCIe® 3.0 x1, full-height (length < 215mm)
- Two M.2 slots (one for WLAN, one for SSD)
- Two dummy slots, only brackets for optional port extension

EOU

EOU design for chassis open, M.2 SSD, ODD, memory, and PCIe® extension card

Others

- (Optional) Dust filter
- Supports Smart Power On

Notes:

[1] The system dimensions may vary depending on configurations.

[2] The system weight is approximate and based on results in Lenovo® lab, which varies depending on the source of component, variance of the distribution of each component, and manufacturing process. It may not be the exact weight for each specific model.

CONNECTIVITY

Network^[1]

Onboard Ethernet**

- Gigabit Ethernet, Realtek® RTL8111EPV, 1x RJ-45, supports Wake-on-LAN
- Gigabit Ethernet, Realtek® RTL8111HN, 1x RJ-45, supports Wake-on-LAN

Optional Ethernet**^[2]

- Gigabit Ethernet, Bitland BN8E88, 1x RJ-45, PCIe® x1
- Gigabit Ethernet, Bitland RTL8111FP, 1x RJ-45, PCIe® x1
- No optional Ethernet

WLAN + Bluetooth®**

- Realtek® RTL8822CE, 802.11ac Dual Band 2x2 Wi-Fi® + Bluetooth® 5.0, M.2 card

- Intel® Wireless-AC 9260, 802.11ac Dual Band 2x2 Wi-Fi® + Bluetooth® 5.0, M.2 card
- MediaTek Wi-Fi® 6 MT7921, 802.11ax 2x2 Wi-Fi® + Bluetooth® 5.1, M.2 Card^[3]
- Realtek® Wi-Fi® 6 RTL8852AE, 802.11ax Dual Band 2x2 Wi-Fi® + Bluetooth® 5.1, M.2 card^[4]
- Intel® Wi-Fi® 6 AX200, 802.11ax 2x2 Wi-Fi® + Bluetooth® 5.1, M.2 card^[5]
- No WLAN and Bluetooth®

Notes:

[1] This system does not support Power Over Ethernet (PoE). If the system is used in a PoE environment, then a Network Isolator is required to prevent possible damage to the system, PoE equipment, or both.

[2] RTL8111FP is not available for AP countries.

[3], [4], [5] Bluetooth® 5.2 is hardware ready but may run at a lower version due to OS limitations.

Ports^[1]

Front Ports

- 1x USB-C® 3.2 Gen 1
- 2x USB 3.2 Gen 1
- 2x USB 3.2 Gen 2
- 1x headphone / microphone combo jack (3.5mm)
- 1x microphone (3.5mm)

Optional Front Ports

- 1x card reader
- None

Rear Ports^[2]

- 4x USB 2.0
- 1x HDMI® 1.4b
- 2x DisplayPort™ 1.4
- 1x Ethernet (RJ-45)
- 1x line-out (3.5mm)
- 1x serial (9-pin)

Optional Rear Ports^{***}

- 2x USB-C® 3.2 Gen 2 (support data transfer, via 2-port USB-C® expansion card, PCIe® x4)
- 2x USB 3.2 Gen 1 (via 2-port USB expansion card, PCIe® x1)
- 2x USB 2.0 (via 2-port adapter)
- 1x parallel
- 1x serial
- None

Notes:

[1] The transfer speed of following ports will vary and, depending on many factors, such as the processing speed of the host device, file attributes and other factors related to system configuration and your operating environment, will be slower than theoretical speed.

USB 2.0: 480 Mbit/s;

USB 3.2 Gen 1 (SuperSpeed USB 5Gbps, formerly USB 3.0 / USB 3.1 Gen 1): 5 Gbit/s;

USB 3.2 Gen 2 (SuperSpeed USB 10Gbps, formerly USB 3.1 Gen 2): 10 Gbit/s;

USB4® 20Gbps / USB 3.2 Gen 2x2 (SuperSpeed USB 20Gbps): 20 Gbit/s;

USB4® 40Gbps (USB 40Gbps): 40 Gbit/s;

Thunderbolt™ 3/4: 40 Gbit/s.

[2] For video ports on discrete graphics, please see graphics section.

Monitor Cable

Monitor Cable^{***}

- HDMI® to DVI dongle
- HDMI® to HDMI® cable (1.5m)
- HDMI® to VGA dongle
- DP to VGA dongle
- DP to VGA cable (1.5M)
- DP to dual DP dongle
- DP to DVI-D dongle
- DP to HDMI® dongle
- No monitor cable

SECURITY & PRIVACY

Security

Security Chip

Discrete TPM 2.0, TCG certified

Physical Locks

- (Optional) E-lock
- (Optional) Smart Cable Clip
- Kensington® Security Slot™, 3 x 7 mm
- Padlock Loop

Chassis Intrusion Switch

- Chassis intrusion switch
- No chassis intrusion switch

Fingerprint Reader

- Touch style fingerprint reader on mouse (EOL on Jan, 2023)
- No fingerprint reader

BIOS Security

- Administrator password
- Power-on password
- Hard disk password
- Boot sequence control
- Boot without keyboard and mouse
- Smart USB protection (allows keyboard / mouse only, blocks all storage devices)
- Individual USB port disablement

MANAGEABILITY

System Management

System Management^[1]

- DASH 1.2
- Non-DASH

Notes:

[1] DASH 1.2 is an optional feature for the selected MTs, MT 11W5/11W6/11W7/11W8 do not support DASH.

SERVICE

Warranty^[1]

Base Warranty**

- 1-year courier or carry-in service
- 1-year limited onsite service
- 3-year limited onsite service
- No base warranty

Notes:

[1] The warranty upgrades may be bundled with some models, please check the "Included upgrade" column in the specific model's configurations. For more service extensions, please go to <https://smartfind.lenovo.com/>. To learn more details of warranty policy, please access <https://pcsupport.lenovo.com/warranty>.

ENVIRONMENTAL

Operating Environment

Temperature

- Operating: 5°C (41°F) to 35°C (95°F)
- Storage: -40°C (-40°F) to 60°C (140°F)

Relative Humidity

- Operating: 20% to 80%
- Storage: 10% to 90%

Altitude

- Operating: 0 m (0 ft) to 3048 m (10,000 ft)
- Storage: 0 m (0 ft) to 12192 m (40,000 ft)

CERTIFICATIONS

Green Certifications^[1]

Green Certifications^[2]

- (Optional) ENERGY STAR® 8.0
- (Optional) EPEAT™ Silver Registered^[3]
- (Optional) EPEAT™ Gold Registered^[4]
- ErP Lot 3
- RoHS compliant
- TCO Certified 8.0

Notes:

[1] The items listed under the "Green Certifications" section may not only refer to certification but also registration or self-declaration.

[2] ENERGY STAR® 8.0 and EPEAT™ are only available for MT 11KB/11KC.

[3], [4] EPEAT™ is registered where applicable, please see [epeat.net](https://www.epeat.net) for registration status by country.

Other Certifications

Other Certifications

- (Optional) TÜV Rheinland® Low Noise
- (Optional) TÜV Rheinland® Ultra Low Noise

Mil-Spec Test

MIL-STD-810H military test passed (Low Pressure [Altitude], High Temperature, Low Temperature, Temperature Shock, Humidity, Sand and Dust, Vibration, Shock, Fungus, Solar Radiation)

- Feature with ** means that only one offering listed under the feature is configured on selected models.
- Feature with *** means that one or more offerings listed under the feature could be configured on selected models.
- Lenovo reserves the right to change specifications or other product information without notice. Lenovo is not responsible for photographic or typographical errors. LENOVO PROVIDES THIS PUBLICATION "AS IS," WITHOUT WARRANTY OF ANY KIND, EITHER EXPRESS OR IMPLIED, INCLUDING THE IMPLIED WARRANTIES OF MERCHANTABILITY OR FITNESS FOR A PARTICULAR PURPOSE. Some jurisdictions do not allow disclaimer of express or implied warranties in certain transactions, therefore this disclaimer may not apply to you.
- The specifications on this page may not be available in all regions, and may be changed or updated without notice.



AMD



AMD



AMD

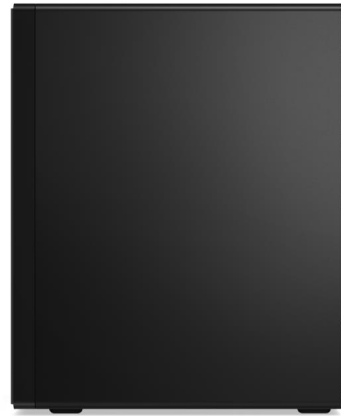

AMD



AMD



AMD

OVERVIEW

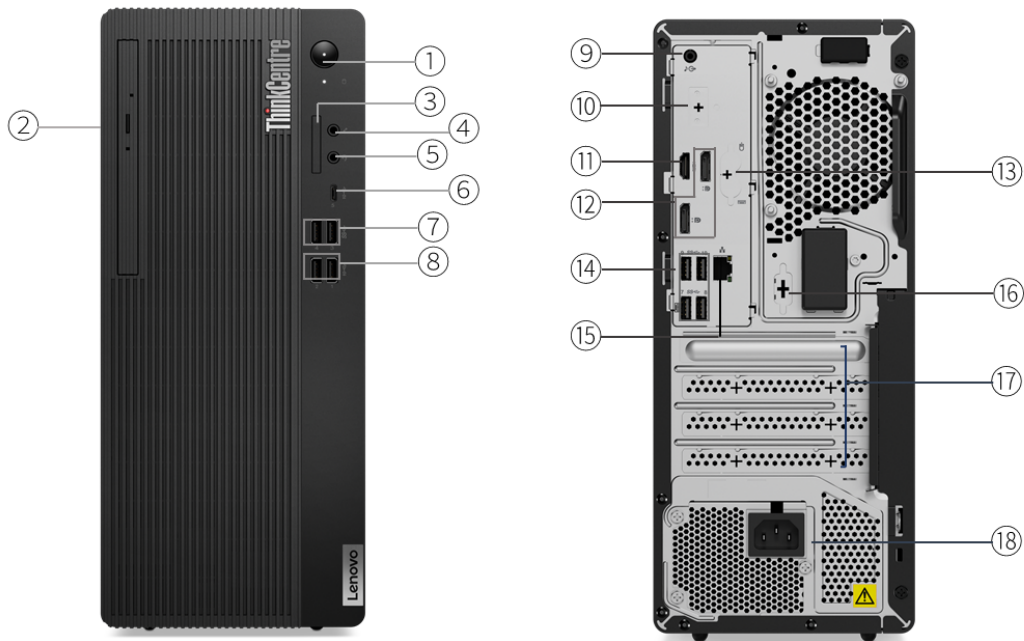

1. Power button	10. Flex IO *
2. Optical drive *	11. HDMI 2.1 TMDS
3. Card reader *	12. 2x DisplayPort 1.4
4. Microphone (3.5mm)	13. 2x PS/2 ports (keyboard / mouse) *
5. Headphone / microphone combo jack (3.5mm)	14. 4x USB 3.2 Gen 1
6. USB-C 3.2 Gen 2	15. Ethernet (RJ-45)
7. 2x USB 3.2 Gen 1	16. Serial *
8. 2x USB 3.2 Gen 2	17. Optional ports on expansion cards *
9. Line-out (3.5mm)	18. Power connector

Notes:

- Items with * are only available on selected models
- More ports are available through the optional expansion cards (not shown on the sample product above)

PERFORMANCE

Processor

Processor Family

Intel® Pentium® or 12th Generation Intel® Core™ i3 / i5 / i7 / i9 Processor

Processor**

Processor Name	Cores	Threads	Base Frequency	Max Frequency	Cache	Memory Support	Processor Graphics
Pentium® Gold G7400	2	4	3.7GHz	-	6MB	DDR5-4800	Intel® UHD Graphics 710
Core™ i3-12100	4 (4 P-core + 0 E-core)	8	P-core 3.3GHz	P-core 4.3GHz ^[1]	12MB	DDR5-4800	Intel® UHD Graphics 730
Core™ i3-12300	4 (4 P-core + 0 E-core)	8	P-core 3.5GHz	P-core 4.4GHz ^[2]	12MB	DDR5-4800	Intel® UHD Graphics 730
Core™ i5-12400	6 (6 P-core + 0 E-core)	12	P-core 2.5GHz	P-core 4.4GHz ^[3]	18MB	DDR5-4800	Intel® UHD Graphics 730
Core™ i5-12500	6 (6 P-core + 0 E-core)	12	P-core 3.0GHz	P-core 4.6GHz ^[4]	18MB	DDR5-4800	Intel® UHD Graphics 770
Core™ i5-12600	6 (6 P-core + 0 E-core)	12	P-core 3.3GHz	P-core 4.8GHz ^[5]	18MB	DDR5-4800	Intel® UHD Graphics 770
Core™ i7-12700	12 (8 P-core + 4 E-core)	20	P-core 2.1GHz / E-core 1.6GHz	Max Turbo up to 4.9GHz / P-core 4.8GHz / E-core 3.6GHz ^[6]	25MB	DDR5-4800	Intel® UHD Graphics 770
Core™ i9-12900	16 (8 P-core + 8 E-core)	24	P-core 2.4GHz / E-core 1.8GHz	Max Turbo up to 5.1GHz / P-core 5.0GHz / E-core 3.8GHz ^[7]	30MB	DDR5-4800	Intel® UHD Graphics 770
Core™ i9-12900F	16 (8 P-core + 8 E-core)	24	P-core 2.4GHz / E-core 1.8GHz	Max Turbo up to 5.1GHz / P-core 5.0GHz / E-core 3.8GHz ^[8]	30MB	DDR5-4800	-

Notes:

[1], [2], [3], [4], [5], [6], [7], [8] Intel® Max Turbo frequency will vary depending on application workload and the hardware and software configurations, see <http://www.intel.com/technology/turboboost/> for more information.

Operating System

Operating System**

- Windows® 11 Pro
- Windows® 11 Home
- Windows® 11 Home Single Language
- Windows® 11 DG Windows® 10 Pro 64
- Windows® 10 IoT Enterprise LTSC 2021
- Ubuntu Linux^[1]
- No preload operating system

Notes:

[1] Some features may not be supported on the system with Linux preload, including but not limited to Intel® RST RAID, Human Presence Detection, etc.

Graphics

Graphics***^[1]

Graphics	Type	Memory	Connector	Max Resolution	Key Features
Intel® UHD graphics	Integrated	Shared	2x DP 1.4 HBR2, 1x HDMI® 2.1 TMDS, 1x	4096x2304@60Hz(DP), 4096x2160@60Hz[HDMI® / Flex IO(HDMI®) /	DirectX® 12

710			Flex IO (VGA / DP 1.2 / HDMI® 2.1 TMDS / USB-C®)	Flex IO(DP)], 3840x2160@60Hz[Flex IO(USB-C®)], 2048x1536@50Hz[Flex IO(VGA)]	
Intel® UHD graphics 730	Integrated	Shared	2x DP 1.4 HBR2, 1x HDMI® 2.1 TMDS, 1x Flex IO (VGA / DP 1.2 / HDMI® 2.1 TMDS / USB-C®)	4096x2304@60Hz(DP), 4096x2160@60Hz[HDMI® / Flex IO(HDMI) / Flex IO(DP)], 3840x2160@60Hz[Flex IO(USB-C®)], 2048x1536@50Hz[Flex IO(VGA)]	DirectX® 12
Intel® UHD graphics 770	Integrated	Shared	2x DP 1.4 HBR2, 1x HDMI® 2.1 TMDS, 1x Flex IO (VGA / DP 1.2 / HDMI® 2.1 TMDS / USB-C®)	4096x2304@60Hz(DP), 4096x2160@60Hz[HDMI® / Flex IO(HDMI) / Flex IO(DP)], 3840x2160@60Hz[Flex IO(USB-C®)], 2048x1536@50Hz[Flex IO(VGA)]	DirectX® 12
AMD Radeon™ RX 6400	Discrete	4GB GDDR6	1x HDMI® 2.1 FRL, 1x DP 1.4a	7680x4320@60Hz(HDMI®), 7680x4320@60Hz(DP)	DirectX® 12, OpenGL 4.6
AMD Radeon™ RX 6500XT	Discrete	4GB GDDR6	1x HDMI® 2.1, 1x DP 1.4	7680x4320@60Hz(HDMI®), 7680x4320@60Hz(DP)	DirectX® 12, OpenGL 4.6
Intel® Iris® Xe MAX 100	Discrete	2GB LPDDR4X	2x DP 1.4	3840x2160@60Hz(DP)	DirectX® 12, OpenGL 4.6
NVIDIA® GeForce RTX™ 3050	Discrete	8GB GDDR6	1x HDMI® 2.1 FRL, 3x DP 1.4a	7680x4320@60Hz(HDMI®), 7680x4320@120Hz(DP) ^[2]	DirectX® 12, OpenGL 4.6

Notes:

[1] The information of integrated graphics are not applicable for the models with processor which has no integrated graphics inside (for the details, please refer to processor section).

[2] Requires two DisplayPort™ 1.4a links and DSC compression.

Monitor Support

Monitor Support^[1]

Supports up to 4 independent displays via onboard ports (2x DP, 1x HDMI®, and 1x optional Flex IO), more displays support via discrete graphics

Notes:

[1] Onboard video ports are only available for the models with integrated graphics.

Chipset

Chipset

Intel® Q670 chipset

Memory

Max Memory^[1]

Up to 128GB DDR5

Memory Slots

Four DDR5 UDIMM slots, dual-channel capable

Memory Type^[2]

- DDR5-3600
- DDR5-4000
- DDR5-4400

Notes:

[1] The max memory is based on the test results with current Lenovo® memory offerings.

[2] Installed memory is actually DDR5-4800, but may run as DDR5-3600, DDR5-4000, or DDR5-4400 depending on the memory support capability of processor.

Storage

Storage Support^{[1][2]}

Up to four drives, 1x 2.5"/3.5" HDD + 1x 2.5" HDD + 2x M.2 SSD

- 2.5" HDD up to 1TB
- 3.5" HDD up to 2TB
- M.2 SSD up to 2TB each

Storage Type^{***}

Disk Type	Interface	RPM	Security
2.5" SATA HDD	SATA 6Gb/s	7.2K	-
3.5" SATA HDD	SATA 6Gb/s	7.2K	-
M.2 2280 SSD	PCIe® NVMe®, PCIe® 3.0 x4	-	Opal 2.0
M.2 2280 SSD	PCIe® NVMe®, PCIe® 4.0 x4 Performance	-	Opal 2.0
M.2 2280 SSD	PCIe® NVMe®, PCIe® 4.0 x4 Value	-	Opal 2.0
M.2 2242 SSD	PCIe® NVMe®, PCIe® 3.0 x4	-	-

RAID

RAID 0/1 support (RAID preset only available via special bid models)

Notes:

[1] The max capacity of each disk type is based on the test results with current Lenovo® storage offerings.

[2] The max capacity of SSD/HDD is based on the test results with current Lenovo® SSD/HDD offerings.

Removable Storage

Optical^{**}

- DVD-ROM, SATA connector, slim (9.0mm)
- DVD burner (DVD±RW), SATA connector, slim (9.0mm)
- None

Card Reader

- 3-in-1 card reader (SD, SDHC, SDXC)
- No card reader

Multi-Media

Audio Chip

High Definition (HD) Audio, Realtek® ALC897Q-CG codec

Speakers

Single speaker, 2W x1

Power Supply

Power Supply^{**}

Power	Type	Efficiency	Key Features
180W	Fixed	85%	100-240V, 50-60Hz
260W	Fixed	90%	100-240V, 50-60Hz
310W	Fixed	92%	100-240V, 50-60Hz
380W	Fixed	92%	100-240V, 50-60Hz

DESIGN

Input Device

Keyboard

**

- Lenovo® Calliope Keyboard (USB connector), black
- Lenovo® Calliope Wireless Keyboard (2.4GHz via USB receiver), black
- Lenovo® Traditional Keyboard (USB connector), black
- No keyboard

Mouse**

- Lenovo® Calliope Mouse (USB connector), black
- Lenovo® Calliope Wireless Mouse (2.4GHz via USB receiver), black
- Lenovo® Mouse (PS/2 connector), black (only available via special bid)
- Lenovo® Fingerprint Mouse (USB connector), Windows® Hello support, black (EOL on Jan, 2023)
- No mouse

Mechanical**Form Factor**

Tower (13.6L)

Dimensions (WxDxH)^[1]

145 x 296 x 346 mm (5.7 x 11.7 x 13.6 inches)

Packaging Dimensions (WxDxH)

245 x 395 x 530 mm (9.65 x 15.55 x 20.87 inches)

Weight^[2]

Around 5.9 kg (13.0 lbs)

Packaging Weight

8.3 kg (18.29 lbs)

Case Color

Black

Bays^[3]

- 1x 2.5" disk bay
- 1x 3.5" disk bay
- 1x slim ODD bay

Expansion Slots

- One PCIe® 4.0 x16 (x4 signal), full-height, (length ≤ 185mm, height ≤ 100mm) or (length ≤ 118mm, height ≤ 110mm)
- One PCIe® 4.0 x16, full-height, length ≤ 209mm, height ≤ 117.5mm
- One PCIe® 3.0 x1, full-height, (length ≤ 185mm, height ≤ 100mm) or (length ≤ 118mm, height ≤ 110mm)
- Three M.2 slots (one for WLAN, two for SSD)

EOU

Toolless cover, disk, optical, extension card assembly / removal

Stand

No stand

Others

- (Optional) Dust filter
- (Optional) Smart Cable (USB-A to USB-C®)
- Supports Smart Power On

Notes:

[1] The system dimensions may vary depending on configurations.

[2] The system weight is approximate and based on results in Lenovo® lab, which varies depending on the source of component, variance of the distribution of each component, and manufacturing process. It may not be the exact weight for each specific model.

[3] 2.5" HDD tray is optional, or comes with 2.5 HDD. 3.5" bay supports 2.5" / 3.5" HDD, 3.5" to 2.5 converter comes with 2nd 2.5" HDD.

CONNECTIVITY**Network****Onboard Ethernet**

Gigabit Ethernet, Intel® Ethernet Connection I219-LM, 1x RJ-45, supports Wake-on-LAN

Optional Ethernet***

- Gigabit Ethernet, Bitland BN8E88, 1x RJ-45, PCIe® x1
- Gigabit Ethernet, Intel® Ethernet Server Adapter I350-T4, 4x RJ-45, PCIe® x4^[1]
- 2.5 Gigabit Ethernet, Realtek® RTL8125BGS, 1x RJ-45, PCIe® x1
- No optional Ethernet

WLAN + Bluetooth®**

- Realtek® RTL8822CE, 802.11ac Dual Band 2x2 Wi-Fi® + Bluetooth® 5.0, M.2 card
- Intel® Wireless-AC 9560, 802.11ac Dual Band 2x2 Wi-Fi® + Bluetooth® 5.1, M.2 card
- Realtek® Wi-Fi® 6 RTL8852BE, 802.11ax Dual Band 2x2 Wi-Fi® + Bluetooth® 5.3, M.2 card^[2]
- Intel® Wi-Fi® 6 AX201, 802.11ax 2x2 Wi-Fi® + Bluetooth® 5.2, M.2 Card^[3]
- AMD Wi-Fi® 6E RZ616, 802.11ax 2x2 Wi-Fi® + Bluetooth® 5.1, M.2 Card^[4]
- Intel® Wi-Fi® 6E AX211, 802.11ax 2x2 Wi-Fi® + Bluetooth® 5.3, Intel® vPro® technology support, M.2 Card^[5]
- No WLAN and Bluetooth®

Notes:

[1] Intel® Ethernet Server Adapter I350-T4 is not available in EMEA.

[2], [5] Bluetooth® 5.3 requires Windows® 11.

[3] Bluetooth® 5.2 requires Windows® 11.

[4] Bluetooth® 5.2 is hardware ready but may run at a lower version due to OS limitations.

Ports^[1]

Front Ports

- 1x USB-C® 3.2 Gen 2 (support data transfer and 15W charging)
- 2x USB 3.2 Gen 1
- 2x USB 3.2 Gen 2
- 1x headphone / microphone combo jack (3.5mm)
- 1x microphone (3.5mm)

Optional Front Ports

1x card reader

Rear Ports^[2]

- 4x USB 3.2 Gen 1
- 1x HDMI® 2.1 TMDS
- 2x DisplayPort™ 1.4
- 1x Ethernet (RJ-45)
- 1x line-out (3.5mm)

Optional Rear Ports***

- 1x USB-C® 3.2 Gen 1 with DisplayPort™ function and 5V@3A charging (Flex IO)
- 1x HDMI® 2.1 TMDS (Flex IO)
- 1x DP 1.2 (Flex IO)
- 1x VGA (Flex IO)
- 1x USB-C® 3.2 Gen 2x2 (support data transfer, via USB-C® expansion card, PCIe® x4)
- 2x USB-C® 3.2 Gen 2 (support data transfer, via 2-port USB-C® expansion card, PCIe® x4)
- 2x USB 3.2 Gen 1 (via 2-port USB expansion card, PCIe® x1)
- 2x USB 2.0 (via 2-port adapter)
- 1x parallel
- 1x serial
- 1x 2nd serial
- 4x serial (via 4-port serial expansion card, PCIe® x1)
- 2x PS/2

Notes:

[1] The transfer speed of following ports will vary and, depending on many factors, such as the processing speed of the host device, file attributes and other factors related to system configuration and your operating environment, will be slower than theoretical speed.

USB 2.0: 480 Mbit/s;

USB 3.2 Gen 1 (SuperSpeed USB 5Gbps, formerly USB 3.0 / USB 3.1 Gen 1): 5 Gbit/s;

USB 3.2 Gen 2 (SuperSpeed USB 10Gbps, formerly USB 3.1 Gen 2): 10 Gbit/s;

USB4® 20Gbps / USB 3.2 Gen 2x2 (SuperSpeed USB 20Gbps): 20 Gbit/s;

USB4® 40Gbps (USB 40Gbps): 40 Gbit/s;

Thunderbolt™ 3/4: 40 Gbit/s.

[2] For video ports on discrete graphics, please see graphics section.

Monitor Cable

Monitor Cable***

- HDMI® to HDMI® cable (1.5m)
- HDMI® to VGA dongle
- DP to VGA dongle
- DP to dual DP dongle
- DP to DVI-D dongle
- DP to HDMI® dongle
- No monitor cable

SECURITY & PRIVACY

Security

Security Chip

Discrete TPM 2.0, TCG certified

Physical Locks

- (Optional) E-lock
- (Optional) Smart Cable Clip
- Kensington® Security Slot™, 3 x 7 mm
- Padlock Loop

Chassis Intrusion Switch

- Chassis intrusion switch
- No chassis intrusion switch

Fingerprint Reader

- Touch style fingerprint reader on mouse (EOL on Jan, 2023)
- No fingerprint reader

BIOS Security

- Administrator password
- Power-on password
- Hard disk password
- Boot sequence control
- Boot without keyboard and mouse
- Self-healing BIOS (Level 2)
- Smart USB protection (allows keyboard / mouse only, blocks all storage devices)
- Individual USB port disablement

MANAGEABILITY

System Management

System Management**

- Intel® vPro® Enterprise^[1]
- Intel® vPro® Essentials^[2]
- Non-vPro®

Notes:

[1], [2] Intel® vPro® offers a superset of DASH's defined capabilities.

SERVICE

Warranty^[1]

Base Warranty**

- 1-year courier or carry-in service
- 1-year limited onsite service

- 3-year limited onsite service
- No base warranty

Notes:

[1] The warranty upgrades may be bundled with some models, please check the "Included upgrade" column in the specific model's configurations. For more service extensions, please go to <https://smartfind.lenovo.com/>. To learn more details of warranty policy, please access <https://pcsupport.lenovo.com/warranty>.

ENVIRONMENTAL

Operating Environment

Temperature

- Operating: 5°C (41°F) to 35°C (95°F)
- Storage: -40°C (-40°F) to 60°C (140°F)

Relative Humidity

- Operating: 20% to 80%
- Storage: 10% to 90%

Altitude

- Operating: 0 m (0 ft) to 3048 m (10,000 ft)
- Storage: 0 m (0 ft) to 12192 m (40,000 ft)

CERTIFICATIONS

Green Certifications^[1]

Green Certifications

- (Optional) ENERGY STAR® 8.0
- (Optional) EPEAT™ Silver Registered^[2]
- (Optional) EPEAT™ Gold Registered^[3]
- ErP Lot 3
- RoHS compliant
- TCO Certified 9.0

Notes:

[1] The items listed under the "Green Certifications" section may not only refer to certification but also registration or self-declaration.

[2], [3] EPEAT™ is registered where applicable, please see epeat.net for registration status by country.

Other Certifications

Other Certifications

(Optional) TÜV Rheinland® Ultra Low Noise

Mil-Spec Test

MIL-STD-810H military test passed (Low Pressure [Altitude], High Temperature, Low Temperature, Temperature Shock, Humidity, Sand and Dust, Vibration, Shock, Fungus, Solar Radiation, Contamination by Fluids, Salt Fog)

- Feature with ** means that only one offering listed under the feature is configured on selected models.
- Feature with *** means that one or more offerings listed under the feature could be configured on selected models.
- Lenovo reserves the right to change specifications or other product information without notice. Lenovo is not responsible for photographic or typographical errors. **LENOVO PROVIDES THIS PUBLICATION "AS IS," WITHOUT WARRANTY OF ANY KIND, EITHER EXPRESS OR IMPLIED, INCLUDING THE IMPLIED WARRANTIES OF MERCHANTABILITY OR FITNESS FOR A PARTICULAR PURPOSE.** Some jurisdictions do not allow disclaimer of express or implied warranties in certain transactions, therefore this disclaimer may not apply to

you.

- The specifications on this page may not be available in all regions, and may be changed or updated without notice.



intel



intel

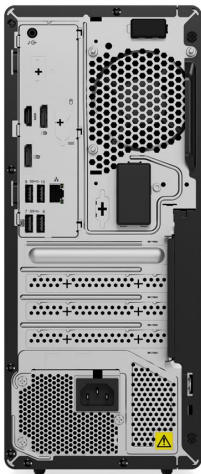

intel

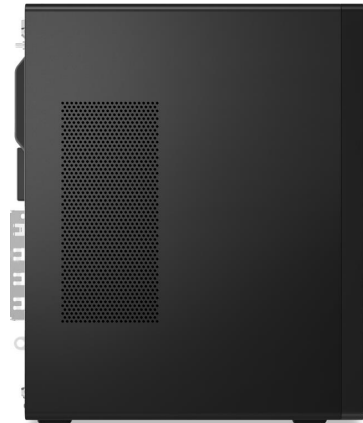

intel

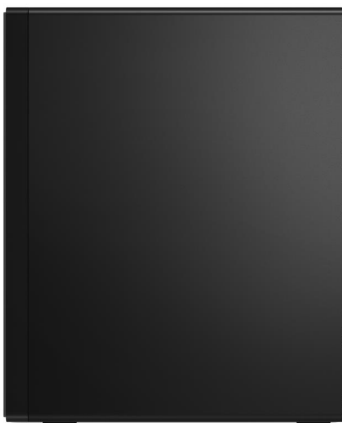

intel



intel

OVERVIEW

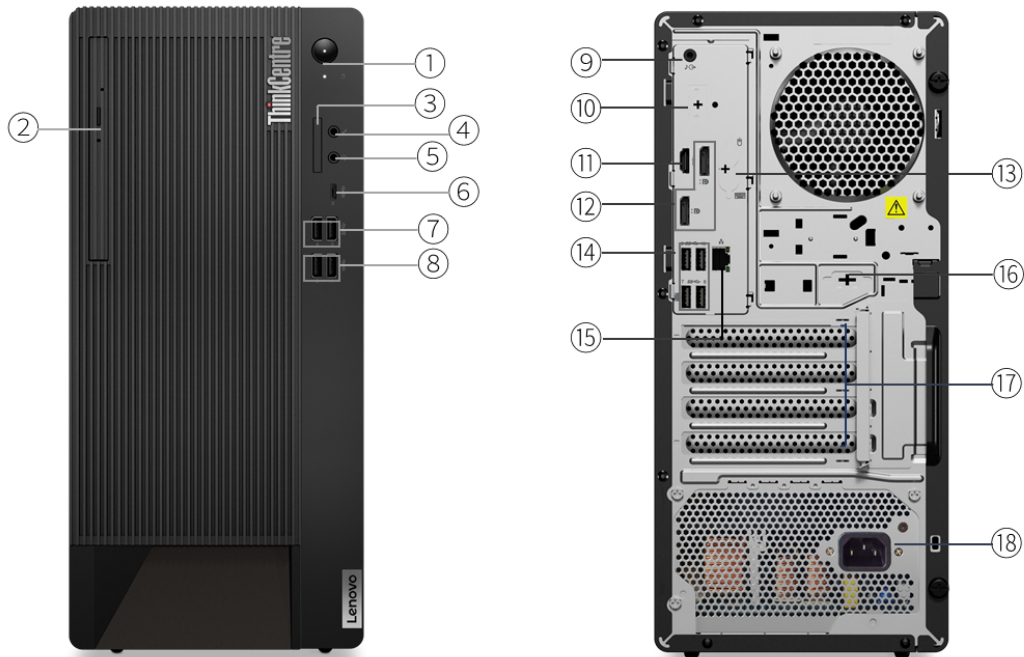

1. Power button	10. Flex IO *
2. Optical drive *	11. HDMI 2.1 TMDS
3. Card reader *	12. 2x DisplayPort 1.4
4. Microphone (3.5mm)	13. 2x PS/2 ports (keyboard / mouse) *
5. Headphone / microphone combo jack (3.5mm)	14. 4x USB 3.2 Gen 1
6. USB-C 3.2 Gen 2	15. Ethernet (RJ-45)
7. 2x USB 3.2 Gen 1	16. Serial *
8. 2x USB 3.2 Gen 2	17. Optional ports on expansion cards *
9. Line-out (3.5mm)	18. Power connector

Notes:

- Items with * are only available on selected models
- More ports are available through the optional expansion cards (not shown on the sample product above)

PERFORMANCE

Processor

Processor Family

Intel® Pentium® or 12th Generation Intel® Core™ i3 / i5 / i7 / i9 Processor

Processor**

Processor Name	Cores	Threads	Base Frequency	Max Frequency	Cache	Processor Graphics
Pentium® Gold G7400	2	4	3.7GHz	-	6MB	Intel® UHD Graphics 710
Core™ i3-12100	4 (4 P-core + 0 E-core)	8	P-core 3.3GHz	P-core 4.3GHz ^[1]	12MB	Intel® UHD Graphics 730
Core™ i3-12300	4 (4 P-core + 0 E-core)	8	P-core 3.5GHz	P-core 4.4GHz ^[2]	12MB	Intel® UHD Graphics 730
Core™ i5-12400	6 (6 P-core + 0 E-core)	12	P-core 2.5GHz	P-core 4.4GHz ^[3]	18MB	Intel® UHD Graphics 730
Core™ i5-12400F	6 (6 P-core + 0 E-core)	12	P-core 2.5GHz	P-core 4.4GHz ^[4]	18MB	-
Core™ i5-12500	6 (6 P-core + 0 E-core)	12	P-core 3.0GHz	P-core 4.6GHz ^[5]	18MB	Intel® UHD Graphics 770
Core™ i5-12600	6 (6 P-core + 0 E-core)	12	P-core 3.3GHz	P-core 4.8GHz ^[6]	18MB	Intel® UHD Graphics 770
Core™ i5-12600K	10 (6 P-core + 4 E-core)	16	P-core 3.7GHz / E-core 2.8GHz	P-core 4.9GHz / E-core 3.6GHz ^[7]	20MB	Intel® UHD Graphics 770
Core™ i7-12700	12 (8 P-core + 4 E-core)	20	P-core 2.1GHz / E-core 1.6GHz	Max Turbo up to 4.9GHz / P-core 4.8GHz / E-core 3.6GHz ^[8]	25MB	Intel® UHD Graphics 770
Core™ i7-12700F	12 (8 P-core + 4 E-core)	20	P-core 2.1GHz / E-core 1.6GHz	Max Turbo up to 4.9GHz / P-core 4.8GHz / E-core 3.6GHz ^[9]	25MB	-
Core™ i7-12700K	12 (8 P-core + 4 E-core)	20	P-core 3.6GHz / E-core 2.7GHz	Max Turbo up to 5.0GHz / P-core 4.9GHz / E-core 3.8GHz ^[10]	25MB	Intel® UHD Graphics 770
Core™ i9-12900	16 (8 P-core + 8 E-core)	24	P-core 2.4GHz / E-core 1.8GHz	Max Turbo up to 5.1GHz / P-core 5.0GHz / E-core 3.8GHz ^[11]	30MB	Intel® UHD Graphics 770
Core™ i9-12900F	16 (8 P-core + 8 E-core)	24	P-core 2.4GHz / E-core 1.8GHz	Max Turbo up to 5.1GHz / P-core 5.0GHz / E-core 3.8GHz ^[12]	30MB	-
Core™ i9-12900K	16 (8 P-core + 8 E-core)	24	P-core 3.2GHz / E-core 2.4GHz	Max Turbo up to 5.2GHz / P-core 5.1GHz / E-core 3.9GHz ^[13]	30MB	Intel® UHD Graphics 770

Notes:

[1], [2], [3], [4], [5], [6], [7], [8], [9], [10], [11], [12], [13] Intel® Max Turbo frequency will vary depending on application workload and the hardware and software configurations, see <http://www.intel.com/technology/turboboost/> for more information.

Operating System

Operating System**

- Windows® 11 Pro
- Windows® 11 Home
- Windows® 11 Home Single Language
- Windows® 11 DG Windows® 10 Pro 64
- Windows® 10 IoT Enterprise LTSC 2021
- Ubuntu Linux^[1]
- No preload operating system

Notes:

[1] Some features may not be supported on the system with Linux preload, including but not limited to Intel® RST RAID,

Human Presence Detection, etc.

Graphics

Graphics**^{[1][2]}

Graphics	Type	Memory	Connector	Max Resolution	Key Features	Remark
Intel® UHD graphics 710	Integrated	Shared	2x DP 1.4 HBR2, 1x HDMI® 2.1 TMDs, 1x Flex IO (VGA / DP 1.2 / HDMI® 2.1 TMDs / USB-C®)	4096x2304@60Hz(DP), 4096x2160@60Hz[HDMI® / Flex IO(HDMI®) / Flex IO(DP)], 3840x2160@60Hz[Flex IO(USB-C®)], 2048x1536@50Hz[Flex IO(VGA)]	DirectX® 12	-
Intel® UHD graphics 730	Integrated	Shared	2x DP 1.4 HBR2, 1x HDMI® 2.1 TMDs, 1x Flex IO (VGA / DP 1.2 / HDMI® 2.1 TMDs / USB-C®)	4096x2304@60Hz(DP), 4096x2160@60Hz[HDMI® / Flex IO(HDMI) / Flex IO(DP)], 3840x2160@60Hz[Flex IO(USB-C®)], 2048x1536@50Hz[Flex IO(VGA)]	DirectX® 12	-
Intel® UHD graphics 770	Integrated	Shared	2x DP 1.4 HBR2, 1x HDMI® 2.1 TMDs, 1x Flex IO (VGA / DP 1.2 / HDMI® 2.1 TMDs / USB-C®)	4096x2304@60Hz(DP), 4096x2160@60Hz[HDMI® / Flex IO(HDMI) / Flex IO(DP)], 3840x2160@60Hz[Flex IO(USB-C®)], 2048x1536@50Hz[Flex IO(VGA)]	DirectX® 12	-
Intel® Iris® Xe MAX 100	Discrete	2GB LPDDR4X	2x DP 1.4	3840x2160@60Hz(DP)	DirectX® 12, OpenGL 4.6	-
AMD Radeon™ RX 6400	Discrete	4GB GDDR6	1x HDMI® 2.1 FRL, 1x DP 1.4a	7680x4320@60Hz(HDMI®), 7680x4320@60Hz(DP)	DirectX® 12, OpenGL 4.6	-
AMD Radeon™ RX 6500XT	Discrete	4GB GDDR6	1x HDMI® 2.1, 1x DP 1.4	7680x4320@60Hz(HDMI®), 7680x4320@60Hz(DP)	DirectX® 12, OpenGL 4.6	-
NVIDIA® GeForce GTX 1660 SUPER	Discrete	6GB GDDR6	1x HDMI® 2.0, 1x DP 1.4, 1x DVI-D	4096x2160@60Hz(HDMI®), 5120x3200@60Hz (DP), 2560x1600@60Hz(DVI-D)	DirectX® 12	-
NVIDIA® GeForce RTX™ 3050	Discrete	8GB GDDR6	1x HDMI® 2.1 FRL, 3x DP 1.4a	7680x4320@60Hz(HDMI®), 7680x4320@120Hz(DP) ^[3]	DirectX® 12, OpenGL 4.6	-
NVIDIA® GeForce RTX™ 3060	Discrete	12G GDDR6	1x HDMI® 2.1, 3x DP 1.4	7680x4320@60Hz(HDMI®), 7680x4320@120Hz(DP) ^[4]	DirectX® 12	-
NVIDIA® GeForce RTX™ 3070 Ti	Discrete	8G GDDR6X	3x DP 1.4, 1x HDMI® 2.1	7680x4320@60Hz(HDMI®); 5120x2880@60Hz(DP)	DirectX® 12	EOL

Notes:

^[1] The information of integrated graphics are not applicable for the models with processor which has no integrated graphics inside (for the details, please refer to processor section).

^[2] NVIDIA® GeForce RTX™ 3070 Ti is EOL.

^{[3], [4]} Requires two DisplayPort™ 1.4a links and DSC compression.

Monitor Support

Monitor Support^[1]

Supports up to 4 independent displays via onboard ports (2x DP, 1x HDMI®, and 1x optional Flex IO), more displays support

ThinkCentre M90t Gen 3

via discrete graphics

Notes:

[1] Onboard video ports are only available for the models with integrated graphics.

Chipset

Chipset

Intel® Q670 chipset

Memory

Max Memory^[1]

Up to 128GB DDR5

Memory Slots

Four DDR5 UDIMM slots, dual-channel capable

Memory Type^[2]

- DDR5-3600
- DDR5-4000
- DDR5-4400

Notes:

[1] The max memory is based on the test results with current Lenovo® memory offerings.

[2] Installed memory is actually 4800MHz, but may run at 3600MHz, 4000MHz, or 4400MHz depending on the memory support capability of processor.

Storage

Storage Support^{[1][2]}

Up to five drives, 2x 2.5"/3.5" HDD + 1x 2.5" HDD + 2x M.2 SSD

- 2.5" HDD up to 1TB each
- 3.5" HDD up to 2TB
- M.2 SSD up to 2TB each

Storage Type^{***}

Disk Type	Interface	RPM	Security
2.5" SATA HDD	SATA 6Gb/s	7.2K	-
3.5" SATA HDD	SATA 6Gb/s	7.2K	-
M.2 2280 SSD	PCIe® NVMe®, PCIe® 3.0 x4	-	Opal 2.0
M.2 2280 SSD	PCIe® NVMe®, PCIe® 4.0 x4 Performance	-	Opal 2.0
M.2 2280 SSD	PCIe® NVMe®, PCIe® 4.0 x4 Value	-	Opal 2.0
M.2 2242 SSD	PCIe® NVMe®, PCIe® 3.0 x4	-	-

RAID

RAID 0/1 support (RAID preset only available via special bid models)

Notes:

[1] The max capacity of each disk type is based on the test results with current Lenovo® storage offerings.

[2] The max capacity of SSD/HDD is based on the test results with current Lenovo® SSD/HDD offerings.

Removable Storage

Optical**

- DVD-ROM, SATA connector, slim (9.0mm)
- DVD burner (DVD±RW), SATA connector, slim (9.0mm)
- None

Card Reader

- 3-in-1 card reader (SD, SDHC, SDXC)
- No card reader

Multi-Media

Audio Chip

High Definition (HD) Audio, Realtek® ALC897Q-CG codec

Speakers

Single speaker, 2W x1

Power Supply

Power Supply**

Power	Type	Efficiency	Key Features
300W	Fixed	90%	100-240V, 50-60Hz
500W	Fixed	92%	100-240V, 50-60Hz
750W	Fixed	92%	100-240V, 50-60Hz

DESIGN

Input Device

Keyboard**

- Lenovo® Calliope Keyboard (USB connector), black
- Lenovo® Calliope Wireless Keyboard (2.4GHz via USB receiver), black
- Lenovo® Keyboard (PS/2 connector), black
- Lenovo® Traditional Keyboard (USB connector), black
- No keyboard

Mouse**

- Lenovo® Calliope Mouse (USB connector), black
- Lenovo® Calliope Wireless Mouse (2.4GHz via USB receiver), black
- Lenovo® Mouse (PS/2 connector), black (only available via special bid)
- Lenovo® Fingerprint Mouse (USB connector), Windows® Hello support, black (EOL on Jan, 2023)
- No mouse

Mechanical

Form Factor

Tower (17L)

Dimensions (WxDxH)^[1]

170 x 298 x 376 mm (6.7 x 11.7 x 14.8 inches)

Packaging Dimensions (WxDxH)

275 x 395 x 540 mm (10.8 x 15.6 x 21.4 inches)

Weight^[2]

Around 6.5 kg (14.3 lbs)

Packaging Weight

9.8 kg (21.61 lbs)

Case Color

Black

Bays

- 1x 2.5" disk bay (bay comes with disk)
- 1x 3.5" disk bay
- 1x 3.5" disk bay (optional, or bay comes with disk)
- 1x slim ODD bay

Expansion Slots

- One PCIe® 4.0 x16 (x4 signal), full-height, length ≤ 205mm, height ≤ 114.55mm
- One PCIe® 4.0 x16, full-height, length ≤ 268.5mm, height ≤ 114.55mm
- Two PCIe® 3.0 x1, full-height, length ≤ 205mm, height ≤ 114.55mm
- Three M.2 slots (one for WLAN, two for SSD)

EOU

ThinkCentre M90t Gen 3

Toolless cover, disk, optical, extension card assembly / removal

Stand

No stand

Others

- (Optional) Dust filter
- (Optional) Smart Cable (USB-A to USB-C®)
- Supports Smart Power On

Notes:

[1] The system dimensions may vary depending on configurations.

[2] The system weight is approximate and based on results in Lenovo® lab, which varies depending on the source of component, variance of the distribution of each component, and manufacturing process. It may not be the exact weight for each specific model.

CONNECTIVITY

Network

Onboard Ethernet

Gigabit Ethernet, Intel® Ethernet Connection I219-LM, 1x RJ-45, supports Wake-on-LAN

Optional Ethernet***

- Gigabit Ethernet, Bitland BN8E88, 1x RJ-45, PCIe® x1
- Gigabit Ethernet, Bitland RTL8168H, 1x RJ-45, PCIe® x1
- Gigabit Ethernet, Intel® Ethernet Server Adapter I350-T4, 4x RJ-45, PCIe® x4^[1]
- 2.5 Gigabit Ethernet, Realtek® RTL8125BGS, 1x RJ-45, PCIe® x1
- No optional Ethernet

WLAN + Bluetooth®**

- Realtek® Wi-Fi® 6 RTL8852BE, 802.11ax Dual Band 2x2 Wi-Fi® + Bluetooth® 5.3, M.2 card^[2]
- Intel® Wi-Fi® 6 AX201, 802.11ax 2x2 Wi-Fi® + Bluetooth® 5.2, M.2 Card^[3]
- AMD Wi-Fi® 6E RZ616, 802.11ax 2x2 Wi-Fi® + Bluetooth® 5.1, M.2 Card^[4]
- Intel® Wi-Fi® 6E AX211, 802.11ax 2x2 Wi-Fi® + Bluetooth® 5.3, Intel® vPro® technology support, M.2 Card^[5]
- No WLAN and Bluetooth®

Notes:

[1] Intel® Ethernet Server Adapter I350-T4 is not available in EMEA.

[2], [5] Bluetooth® 5.3 requires Windows® 11.

[3] Bluetooth® 5.2 requires Windows® 11.

[4] Bluetooth® 5.2 is hardware ready but may run at a lower version due to OS limitations.

Ports^[1]

Front Ports

- 1x USB-C® 3.2 Gen 2 (support data transfer and 15W charging)
- 2x USB 3.2 Gen 1
- 2x USB 3.2 Gen 2
- 1x headphone / microphone combo jack (3.5mm)
- 1x microphone (3.5mm)

Optional Front Ports

1x card reader

Rear Ports^[2]

- 4x USB 3.2 Gen 1
- 1x HDMI® 2.1 TMDS
- 2x DisplayPort™ 1.4
- 1x Ethernet (RJ-45)
- 1x line-out (3.5mm)

Optional Rear Ports***

- 1x USB-C® 3.2 Gen 1 with DisplayPort™ function and 5V@3A charging (Flex IO)
- 1x HDMI® 2.1 TMDS (Flex IO)
- 1x DP 1.2 (Flex IO)

- 1x VGA (Flex IO)
- 1x USB-C® 3.2 Gen 2x2 (support data transfer, via USB-C® expansion card, PCIe® x4)
- 2x USB-C® 3.2 Gen 2 (support data transfer, via 2-port USB-C® expansion card, PCIe® x4)
- 2x USB 3.2 Gen 1 (via 2-port USB expansion card, PCIe® x1)
- 2x USB 2.0 (via 2-port adapter)
- 1x parallel
- 1x serial
- 1x 2nd serial
- 4x serial (via 4-port serial expansion card, PCIe® x1)
- 2x PS/2

Notes:

[1] The transfer speed of following ports will vary and, depending on many factors, such as the processing speed of the host device, file attributes and other factors related to system configuration and your operating environment, will be slower than theoretical speed.

USB 2.0: 480 Mbit/s;

USB 3.2 Gen 1 (SuperSpeed USB 5Gbps, formerly USB 3.0 / USB 3.1 Gen 1): 5 Gbit/s;

USB 3.2 Gen 2 (SuperSpeed USB 10Gbps, formerly USB 3.1 Gen 2): 10 Gbit/s;

USB4® 20Gbps / USB 3.2 Gen 2x2 (SuperSpeed USB 20Gbps): 20 Gbit/s;

USB4® 40Gbps (USB 40Gbps): 40 Gbit/s;

Thunderbolt™ 3/4: 40 Gbit/s.

[2] For video ports on discrete graphics, please see graphics section.

Monitor Cable

Monitor Cable***

- HDMI® to HDMI® cable (1.5m)
- HDMI® to VGA dongle
- DP to VGA dongle
- DP to DVI dongle
- DP to dual DP dongle
- DP to HDMI® dongle
- No monitor cable

SECURITY & PRIVACY

Security

Security Chip

Discrete TPM 2.0, TCG certified

Physical Locks

- (Optional) E-lock
- (Optional) Smart Cable Clip
- Kensington® Security Slot™, 3 x 7 mm
- Padlock Loop

Chassis Intrusion Switch

- Chassis intrusion switch
- No chassis intrusion switch

Fingerprint Reader

- Touch style fingerprint reader on mouse (EOL on Jan, 2023)
- No fingerprint reader

BIOS Security

- Administrator password
- Power-on password
- Hard disk password
- Boot sequence control
- Boot without keyboard and mouse
- Self-healing BIOS (Level 2)
- Smart USB protection (allows keyboard / mouse only, blocks all storage devices)
- Individual USB port disablement

MANAGEABILITY

System Management

System Management

- Intel® vPro® Enterprise^[1]
- Non-vPro®

Notes:

[1] Intel® vPro® offers a superset of DASH's defined capabilities.

SERVICE

Warranty^[1]

Base Warranty**

- 1-year limited onsite service
- 3-year limited onsite service
- No base warranty

Notes:

[1] The warranty upgrades may be bundled with some models, please check the "Included upgrade" column in the specific model's configurations. For more service extensions, please go to <https://smartfind.lenovo.com/>. To learn more details of warranty policy, please access <https://pcsupport.lenovo.com/warranty>.

ENVIRONMENTAL

Operating Environment

Temperature

- Operating: 5°C (41°F) to 35°C (95°F)
- Storage: -40°C (-40°F) to 60°C (140°F)

Relative Humidity

- Operating: 20% to 80%
- Storage: 10% to 90%

Altitude

- Operating: 0 m (0 ft) to 3048 m (10,000 ft)
- Storage: 0 m (0 ft) to 12192 m (40,000 ft)

CERTIFICATIONS

Green Certifications^[1]

Green Certifications

- (Optional) ENERGY STAR® 8.0
- (Optional) EPEAT™ Silver Registered^[2]
- (Optional) EPEAT™ Gold Registered^[3]
- ErP Lot 3
- RoHS compliant
- TCO Certified 9.0

Notes:

[1] The items listed under the "Green Certifications" section may not only refer to certification but also registration or self-declaration.

[2], [3] EPEAT™ is registered where applicable, please see epeat.net for registration status by country.

Other Certifications

Other Certifications

- (Optional) TÜV Rheinland® Low Noise
- (Optional) TÜV Rheinland® Ultra Low Noise

Mil-Spec Test

MIL-STD-810H military test passed (Low Pressure [Altitude], High Temperature, Low Temperature, Temperature Shock, Humidity, Sand and Dust, Vibration, Shock, Fungus, Solar Radiation, Contamination by Fluids, Salt Fog)

- Feature with ** means that only one offering listed under the feature is configured on selected models.
- Feature with *** means that one or more offerings listed under the feature could be configured on selected models.
- Lenovo reserves the right to change specifications or other product information without notice. Lenovo is not responsible for photographic or typographical errors. LENOVO PROVIDES THIS PUBLICATION “AS IS,” WITHOUT WARRANTY OF ANY KIND, EITHER EXPRESS OR IMPLIED, INCLUDING THE IMPLIED WARRANTIES OF MERCHANTABILITY OR FITNESS FOR A PARTICULAR PURPOSE. Some jurisdictions do not allow disclaimer of express or implied warranties in certain transactions, therefore this disclaimer may not apply to you.
- The specifications on this page may not be available in all regions, and may be changed or updated without notice.



intel



intel

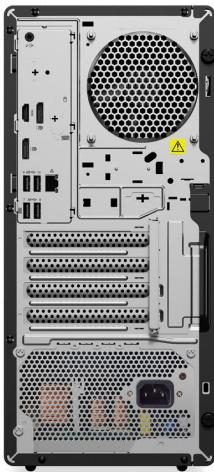

intel



intel



intel



intel

OVERVIEW

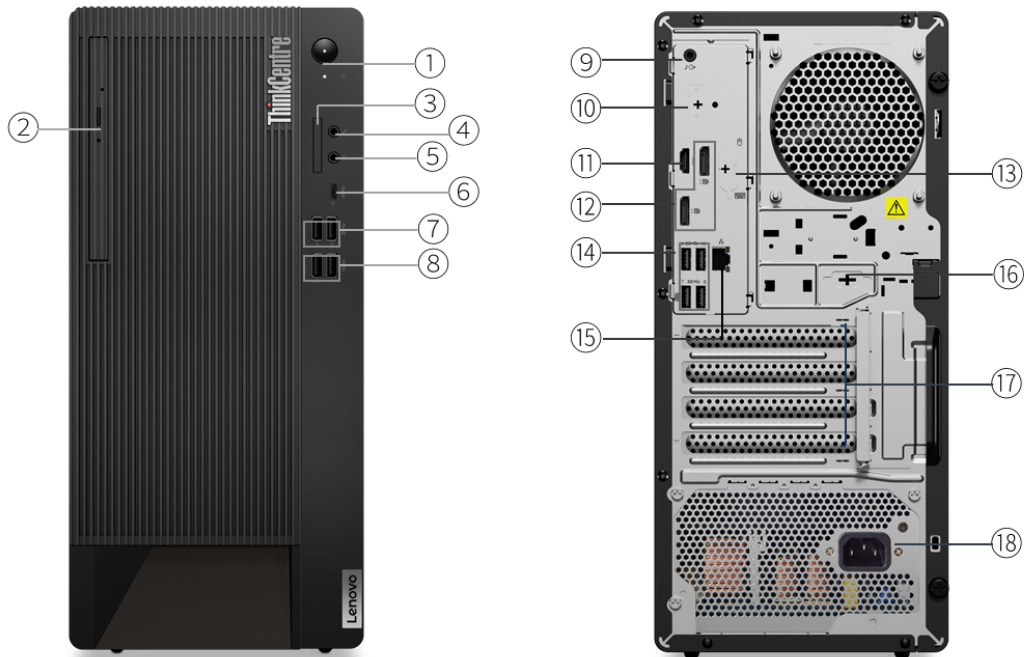

1. Power button	10. Flex IO *
2. Optical drive *	11. HDMI 2.1 TMDS
3. Card reader *	12. 2x DisplayPort 1.4a
4. Microphone (3.5mm)	13. 2x PS/2 ports (keyboard / mouse) *
5. Headphone / microphone combo jack (3.5mm)	14. 4x USB 3.2 Gen 1
6. USB-C 3.2 Gen 2	15. Ethernet (RJ-45)
7. 2x USB 3.2 Gen 1	16. Serial *
8. 2x USB 3.2 Gen 2	17. Optional ports on expansion cards *
9. Line-out (3.5mm)	18. Power connector

Notes:

- Items with * are only available on selected models
- More ports are available through the optional expansion cards (not shown on the sample product above)

PERFORMANCE

Processor

Processor Family

13th Generation Intel® Core™ i3 / i5 / i7 / i9 Processor

Processor**^[1]

Processor Name	Cores	Threads	Base Frequency	Max Frequency	Cache	Processor Graphics
Core™ i3-13100	4 (4 P-core + 0 E-core)	8	P-core 3.4GHz	P-core 4.5GHz	12MB	Intel® UHD Graphics 730
Core™ i5-13400	10 (6 P-core + 4 E-core)	16	P-core 2.5GHz / E-core 1.8GHz	P-core 4.6GHz / E-core 3.3GHz	20MB	Intel® UHD Graphics 730
Core™ i5-13400F	10 (6 P-core + 4 E-core)	16	P-core 2.5GHz / E-core 1.8GHz	P-core 4.6GHz / E-core 3.3GHz	20MB	-
Core™ i5-13500	14 (6 P-core + 8 E-core)	20	P-core 2.5GHz / E-core 1.8GHz	P-core 4.8GHz / E-core 3.5GHz	24MB	Intel® UHD Graphics 770
Core™ i5-13600	14 (6 P-core + 8 E-core)	20	P-core 2.7GHz / E-core 2.0GHz	P-core 5.0GHz / E-core 3.7GHz	24MB	Intel® UHD Graphics 770
Core™ i7-13700	16 (8 P-core + 8 E-core)	24	P-core 2.1GHz / E-core 1.5GHz	Max Turbo up to 5.2GHz / P-core 5.1GHz / E-core 4.1GHz	30MB	Intel® UHD Graphics 770
Core™ i7-13700F	16 (8 P-core + 8 E-core)	24	P-core 2.1GHz / E-core 1.5GHz	Max Turbo up to 5.2GHz / P-core 5.1GHz / E-core 4.1GHz	30MB	-
Core™ i9-13900	24 (8 P-core + 16 E-core)	32	P-core 2.0GHz / E-core 1.5GHz	Max Turbo up to 5.6GHz / P-core 5.2GHz / E-core 4.2GHz	36MB	Intel® UHD Graphics 770
Core™ i9-13900F	24 (8 P-core + 16 E-core)	32	P-core 2.0GHz / E-core 1.5GHz	Max Turbo up to 5.6GHz / P-core 5.2GHz / E-core 4.2GHz	36MB	-

Notes:

[1] Intel® Max Turbo frequency will vary depending on application workload and the hardware and software configurations, see <http://www.intel.com/technology/turboboost/> for more information.

Operating System

Operating System**

- Windows® 11 Pro
- Windows® 11 Home
- Windows® 11 Home Single Language
- Windows® 11 DG Windows® 10 Pro 64
- Windows® 10 IoT Enterprise LTSC 2021
- Ubuntu Linux^[1]
- No preload operating system

Notes:

[1] Some features may not be supported on the system with Linux preload, including but not limited to Intel® RST RAID, Human Presence Detection, etc.

Graphics

Graphics***^[1]

Graphics	Type	Memory	Connector	Max Resolution	Key Features
Intel® UHD graphics 730	Integrated	Shared	2x DP 1.4a (HBR2, DSC), 1x HDMI® 2.1 TMDS, 1x Flex IO (VGA / DP 1.2 / HDMI® 2.1 TMDS / USB-C®)	4096x2304@60Hz(DP), 4096x2160@60Hz[HDMI® / Flex IO(HDMI) / Flex IO(DP)], 3840x2160@60Hz[Flex IO(USB-C®)], 2048x1536@50Hz[Flex IO(VGA)]	DirectX® 12

Intel® UHD graphics 770	Integrated	Shared	2x DP 1.4a (HBR2, DSC), 1x HDMI® 2.1 TMDS, 1x Flex IO (VGA / DP 1.2 / HDMI® 2.1 TMDS / USB-C®)	4096x2304@60Hz(DP), 4096x2160@60Hz[HDMI® / Flex IO(HDMI) / Flex IO(DP)], 3840x2160@60Hz[Flex IO(USB-C®)], 2048x1536@50Hz[Flex IO(VGA)]	DirectX® 12
AMD Radeon™ RX 6400	Discrete	4GB GDDR6	1x HDMI® 2.1 FRL, 1x DP 1.4a	7680x4320@60Hz(HDMI®), 7680x4320@60Hz(DP)	DirectX® 12, OpenGL 4.6
NVIDIA® GeForce RTX™ 3050	Discrete	8GB GDDR6	1x HDMI® 2.1 FRL, 3x DP 1.4a	7680x4320@60Hz(HDMI®), 7680x4320@120Hz(DP) ^[2]	DirectX® 12, OpenGL 4.6
NVIDIA® GeForce RTX™ 4060	Discrete	8G GDDR6	1x HDMI® 2.1a FRL, 3x DP 1.4a	7680x4320@60Hz(HDMI®), 7680x4320@60Hz(DP)	DirectX® 12, OpenGL 4.6

Notes:

[1] The information of integrated graphics are not applicable for the models with processor which has no integrated graphics inside (for the details, please refer to processor section).

[2] Requires two DisplayPort™ 1.4a links and DSC compression.

Monitor Support

Monitor Support^[1]

Supports up to 4 independent displays via onboard ports (2x DP, 1x HDMI®, and 1x optional Flex IO), more displays support via discrete graphics

Notes:

[1] Onboard video ports are only available for the models with integrated graphics.

Chipset

Chipset

Intel® Q670 chipset

Memory

Max Memory^[1]

Up to 128GB DDR5

Memory Slots

Four DDR5 UDIMM slots, dual-channel capable

Memory Type^[2]

- DDR5-3600
- DDR5-4000
- DDR5-4400

Notes:

[1] The max memory is based on the test results with current Lenovo® memory offerings.

[2] Installed memory is actually DDR5-5600, but may run as DDR5-3600, DDR5-4000, or DDR5-4400 depending on the memory support capability of processor.

Storage

Storage Support^[1]

Up to five drives, 2x 2.5"/3.5" HDD + 1x 2.5" HDD + 2x M.2 SSD

- 2.5" HDD up to 1TB each
- 3.5" HDD up to 2TB
- M.2 SSD up to 2TB each

Storage Type^{***}

Disk Type	Interface	RPM	Security
2.5" SATA HDD	SATA 6Gb/s	7.2K	-
3.5" SATA HDD	SATA 6Gb/s	7.2K	-
M.2 2280 SSD	PCIe® NVMe®, PCIe® 4.0 x4 Performance	-	Opal 2.0
M.2 2280 SSD	PCIe® NVMe®, PCIe® 4.0 x4 Value	-	Opal 2.0

RAID

RAID 0/1 support (RAID preset only available via special bid models)

Notes:

[1] The max capacity of each disk type is based on the test results with current Lenovo® storage offerings.

Removable Storage**Optical****

- DVD-ROM, SATA connector, slim (9.0mm)
- DVD burner (DVD±RW), SATA connector, slim (9.0mm)
- None

Card Reader

- 3-in-1 card reader (SD, SDHC, SDXC)
- No card reader

Multi-Media**Audio Chip**

High Definition (HD) Audio, Realtek® ALC897Q-CG codec

Speakers

Single speaker, 2W x1

Power Supply**Power Supply****

Power	Type	Efficiency	Key Features
260W	Fixed	90%	100-240V, 50-60Hz
300W	Fixed	90%	100-240V, 50-60Hz
500W	Fixed	92%	100-240V, 50-60Hz

DESIGN**Input Device****Keyboard****

- Lenovo® Calliope Keyboard (USB connector), black
- Lenovo® Calliope Wireless Keyboard (2.4GHz via USB receiver), black
- Lenovo® Traditional Keyboard (USB connector), black
- No keyboard

Mouse**

- Lenovo® Calliope Mouse (USB connector), black
- Lenovo® Calliope Wireless Mouse (2.4GHz via USB receiver), black
- No mouse

Mechanical**Form Factor**

Tower (17L)

Dimensions (WxDxH)^[1]

170 x 298 x 376 mm (6.7 x 11.7 x 14.8 inches)

Packaging Dimensions (WxDxH)

275 x 395 x 540 mm (10.8 x 15.6 x 21.4 inches)

Weight^[2]

Around 6.5 kg (14.3 lbs)

Packaging Weight

9.8 kg (21.61 lbs)

Case Color

Black

Bays

- 1x 2.5" disk bay (bay comes with disk)
- 1x 3.5" disk bay
- 1x 3.5" disk bay (optional, or bay comes with disk)
- 1x slim ODD bay

Expansion Slots

- One PCIe[®] 4.0 x16 (x4 signal), full-height, length ≤ 205mm, height ≤ 114.55mm
- One PCIe[®] 4.0 x16, full-height, length ≤ 268.5mm, height ≤ 114.55mm
- One PCIe[®] 3.0 x1, full-height, length ≤ 205mm, height ≤ 114.55mm
- Three M.2 slots (one for WLAN, two for SSD)

EOU

Toolless cover, disk, optical, extension card assembly / removal

Stand

No stand

Others

- (Optional) Dust filter
- (Optional) Smart Cable (USB-A to USB-C[®])
- Supports Smart Power On

Notes:

[1] The system dimensions may vary depending on configurations.

[2] The system weight is approximate and based on results in Lenovo[®] lab, which varies depending on the source of component, variance of the distribution of each component, and manufacturing process. It may not be the exact weight for each specific model.

CONNECTIVITY

Network

Onboard Ethernet

Gigabit Ethernet, Intel[®] Ethernet Connection I219-LM, 1x RJ-45, supports Wake-on-LAN

Optional Ethernet

- 2.5 Gigabit Ethernet, Realtek[®] RTL8125BGS, 1x RJ-45, PCIe[®] x1
- No optional Ethernet

WLAN + Bluetooth[®]**

- Realtek[®] Wi-Fi[®] 6 RTL8852BE, 802.11ax Dual Band 2x2 Wi-Fi[®] + Bluetooth[®] 5.1, M.2 card^[1]
- Intel[®] Wi-Fi[®] 6 AX201, 802.11ax 2x2 Wi-Fi[®] + Bluetooth[®] 5.1, M.2 Card^[2]
- Intel[®] Wi-Fi[®] 6E AX211, 802.11ax 2x2 Wi-Fi[®] + Bluetooth[®] 5.1, Intel[®] vPro[®] technology support, M.2 Card^[3]
- No WLAN and Bluetooth[®]

Notes:

[1], [2], [3] Bluetooth[®] 5.2 is hardware ready but may run at a lower version due to OS limitations.

Ports^[1]

Front Ports

- 1x USB-C[®] 3.2 Gen 2 (support data transfer and 15W charging)
- 2x USB 3.2 Gen 1
- 2x USB 3.2 Gen 2
- 1x headphone / microphone combo jack (3.5mm)

- 1x microphone (3.5mm)

Optional Front Ports

1x card reader

Rear Ports^[2]

- 4x USB 3.2 Gen 1
- 1x HDMI® 2.1 TMDS
- 2x DisplayPort™ 1.4a (HBR2, DSC)
- 1x Ethernet (RJ-45)
- 1x line-out (3.5mm)

Optional Rear Ports^{***}

- 1x USB-C® 3.2 Gen 1 with DisplayPort™ function and 5V@3A charging (Flex IO)
- 1x HDMI® 2.1 TMDS (Flex IO)
- 1x DP 1.2 (Flex IO)
- 1x VGA (Flex IO)
- 1x USB-C® 3.2 Gen 2x2 (support data transfer, via USB-C® expansion card, PCIe® x4)
- 2x USB-C® 3.2 Gen 2 (support data transfer, via 2-port USB-C® expansion card, PCIe® x4)
- 2x USB 3.2 Gen 1 (via 2-port USB expansion card, PCIe® x1)
- 2x USB 2.0 (via 2-port adapter)
- 1x parallel
- 1x serial
- 1x 2nd serial

Notes:

[1] The transfer speed of following ports will vary and, depending on many factors, such as the processing speed of the host device, file attributes and other factors related to system configuration and your operating environment, will be slower than theoretical speed.

USB 2.0: 480 Mbit/s;

USB 3.2 Gen 1 (SuperSpeed USB 5Gbps, formerly USB 3.0 / USB 3.1 Gen 1): 5 Gbit/s;

USB 3.2 Gen 2 (SuperSpeed USB 10Gbps, formerly USB 3.1 Gen 2): 10 Gbit/s;

USB4® 20Gbps / USB 3.2 Gen 2x2 (SuperSpeed USB 20Gbps): 20 Gbit/s;

USB4® 40Gbps (USB 40Gbps): 40 Gbit/s;

Thunderbolt™ 3/4: 40 Gbit/s.

[2] For video ports on discrete graphics, please see graphics section.

Monitor Cable**Monitor Cable**^{***}

- HDMI® to VGA dongle
- DP to VGA dongle
- DP to DVI dongle
- DP to HDMI® dongle
- No monitor cable

SECURITY & PRIVACY**Security****Security Chip**

Discrete TPM 2.0, TCG certified, FIPS 140-2 certified

Physical Locks

- (Optional) E-lock
- (Optional) Smart Cable Clip
- Kensington® Security Slot™, 3 x 7 mm
- Padlock Loop

Chassis Intrusion Switch

- Chassis intrusion switch
- No chassis intrusion switch

Fingerprint Reader

No fingerprint reader

BIOS Security

- Administrator password
- Power-on password
- Hard disk password
- Boot sequence control
- Boot without keyboard and mouse
- Self-healing BIOS (Level 2)
- Smart USB protection (allows keyboard / mouse only, blocks all storage devices)
- Individual USB port disablement

MANAGEABILITY

System Management

System Management

- Intel® vPro® Enterprise^[1]
- Non-vPro®

Notes:

[1] Intel® vPro® offers a superset of DASH's defined capabilities.

SERVICE

Warranty^[1]

Base Warranty**

- 1-year limited onsite service
- 3-year limited onsite service
- No base warranty

Notes:

[1] The warranty upgrades may be bundled with some models, please check the "Included upgrade" column in the specific model's configurations. For more service extensions, please go to <https://smartfind.lenovo.com/>. To learn more details of warranty policy, please access <https://pcsupport.lenovo.com/warranty>.

ENVIRONMENTAL

Operating Environment

Temperature

- Operating: 5°C (41°F) to 35°C (95°F)
- Storage: -40°C (-40°F) to 60°C (140°F)

Relative Humidity

- Operating: 20% to 80%
- Storage: 10% to 90%

Altitude

- Operating: 0 m (0 ft) to 3048 m (10,000 ft)
- Storage: 0 m (0 ft) to 12192 m (40,000 ft)

CERTIFICATIONS

Green Certifications^[1]

Green Certifications

- (Optional) ENERGY STAR® 8.0
- (Optional) EPEAT™ Silver Registered^[2]
- (Optional) EPEAT™ Gold Registered^[3]
- ErP Lot 3
- RoHS compliant
- TCO Certified 9.0

Notes:

[1] The items listed under the "Green Certifications" section may not only refer to certification but also registration or self-declaration.

[2], [3] EPEAT™ is registered where applicable, please see [epeat.net](https://www.epeat.net) for registration status by country.

Other Certifications

Other Certifications

- (Optional) TÜV Rheinland® Low Noise
- (Optional) TÜV Rheinland® Ultra Low Noise

Mil-Spec Test

MIL-STD-810H military test passed (Low Pressure [Altitude], High Temperature, Low Temperature, Temperature Shock, Humidity, Sand and Dust, Vibration, Shock, Fungus, Solar Radiation, Contamination by Fluids, Salt Fog)

- Feature with ** means that only one offering listed under the feature is configured on selected models.
- Feature with *** means that one or more offerings listed under the feature could be configured on selected models.
- Lenovo reserves the right to change specifications or other product information without notice. Lenovo is not responsible for photographic or typographical errors. LENOVO PROVIDES THIS PUBLICATION "AS IS," WITHOUT WARRANTY OF ANY KIND, EITHER EXPRESS OR IMPLIED, INCLUDING THE IMPLIED WARRANTIES OF MERCHANTABILITY OR FITNESS FOR A PARTICULAR PURPOSE. Some jurisdictions do not allow disclaimer of express or implied warranties in certain transactions, therefore this disclaimer may not apply to you.
- The specifications on this page may not be available in all regions, and may be changed or updated without notice.



intel



intel

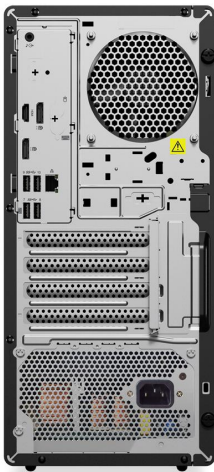

intel



intel



intel



intel

OVERVIEW

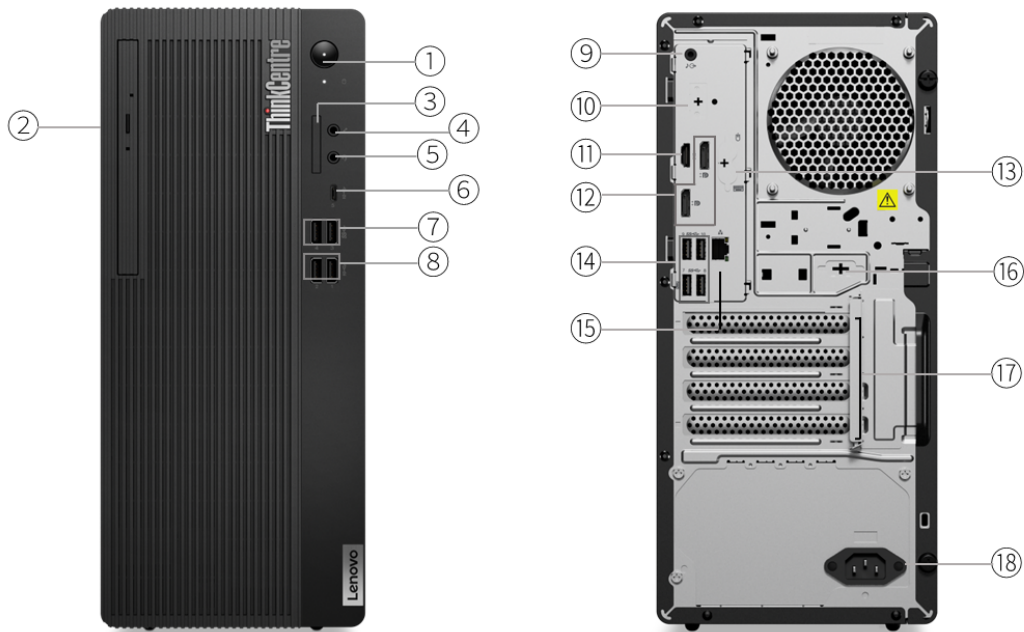

1. Power button	10. Flex IO *
2. Optical drive *	11. HDMI 2.1 TMDS
3. Card reader *	12. 2x DisplayPort 1.4a
4. Microphone (3.5mm)	13. 2x PS/2 ports (keyboard / mouse) *
5. Headphone / microphone combo jack (3.5mm)	14. 4x USB-A (USB 5Gbps)
6. USB-C (USB 10Gbps), data transfer only	15. Ethernet (RJ-45)
7. 2x USB-A (USB 5Gbps)	16. Serial *
8. 2x USB-A (USB 10Gbps)	17. Optional ports on expansion cards *
9. Line-out (3.5mm)	18. Power connector

Notes:

- Items with * are only available on selected models
- More ports are available through the optional expansion cards (not shown on the sample product above)

PERFORMANCE

Processor

Processor Family

13th Generation Intel® Core™ i5 / i7 or 14th Generation Intel® Core™ i5 / i7 / i9 Processor

Processor**

Processor Name	Cores	Threads	Base Frequency	Max Frequency	Cache	Processor Graphics
Core™ i5-13500	14 (6 P-core + 8 E-core)	20	P-core 2.5GHz / E-core 1.8GHz	P-core 4.8GHz / E-core 3.5GHz	24MB	Intel® UHD Graphics 770
Core™ i7-13700	16 (8 P-core + 8 E-core)	24	P-core 2.1GHz / E-core 1.5GHz	Max Turbo up to 5.2GHz / P-core 5.1GHz / E-core 4.1GHz	30MB	Intel® UHD Graphics 770
Core™ i5-14400	10 (6 P-core + 4 E-core)	16	P-core 2.5GHz / E-core 1.8GHz	P-core 4.7GHz / E-core 3.5GHz	20MB	Intel® UHD Graphics 730
Core™ i5-14500	14 (6 P-core + 8 E-core)	20	P-core 2.6GHz / E-core 1.9GHz	P-core 5.0GHz / E-core 3.7GHz	24MB	Intel® UHD Graphics 770
Core™ i5-14600	14 (6 P-core + 8 E-core)	20	P-core 2.7GHz / E-core 2.0GHz	P-core 5.2GHz / E-core 3.9GHz	24MB	Intel® UHD Graphics 770
Core™ i7-14700	20 (8 P-core + 12 E-core)	28	P-core 2.1GHz / E-core 1.5GHz	Max Turbo up to 5.4GHz / P-core 5.3GHz / E-core 4.2GHz	33MB	Intel® UHD Graphics 770
Core™ i9-14900	24 (8 P-core + 16 E-core)	32	P-core 2.0GHz / E-core 1.5GHz	Max Turbo up to 5.8GHz / P-core 5.4GHz / E-core 4.3GHz	36MB	Intel® UHD Graphics 770

Operating System

Operating System**

- Windows® 11 Pro
- Windows® 11 Home
- Windows® 11 Home Single Language
- Windows® 11 DG Windows® 10 Pro 64
- Ubuntu Linux
- No preload operating system

Graphics

Graphics***[1]

Graphics	Type	Memory	Connector	Max Resolution	Key Features
Intel® UHD graphics 730	Integrated	Shared	2x DP 1.4a (HBR2, DSC), 1x HDMI® 2.1 TMDS, 1x Flex IO (VGA / DP 1.2 / HDMI® 2.1 TMDS / USB-C®)	4096x2304@60Hz(DP), 4096x2160@60Hz[HDMI® / Flex IO(HDMI) / Flex IO(DP)], 3840x2160@60Hz[Flex IO(USB-C®)], 2048x1536@50Hz[Flex IO(VGA)]	DirectX® 12
Intel® UHD graphics 770	Integrated	Shared	2x DP 1.4a (HBR2, DSC), 1x HDMI® 2.1 TMDS, 1x Flex IO (VGA / DP 1.2 / HDMI® 2.1 TMDS / USB-C®)	4096x2304@60Hz(DP), 4096x2160@60Hz[HDMI® / Flex IO(HDMI) / Flex IO(DP)], 3840x2160@60Hz[Flex IO(USB-C®)], 2048x1536@50Hz[Flex IO(VGA)]	DirectX® 12
NVIDIA® GeForce RTX™ 4060	Discrete	8G GDDR6	1x HDMI® 2.1a FRL, 3x DP 1.4a	7680x4320@60Hz(HDMI®), 7680x4320@60Hz(DP)	DirectX® 12, OpenGL 4.6

Notes:

[1] The information of integrated graphics are not applicable for the models with processor which has no integrated graphics inside (for the details, please refer to processor section).

Monitor Support

Monitor Support

Supports up to 4 independent displays via onboard ports (2x DP, 1x HDMI®, and 1x optional Flex IO), more displays support via discrete graphics

Chipset**Chipset**

Intel® Q670 chipset

Memory**Max Memory^[1]**

Up to 128GB DDR5

Memory Slots

Four DDR5 UDIMM slots, dual-channel capable

Memory Type^{[2]}**

- DDR5-3600
- DDR5-4000
- DDR5-4400

Notes:

[1] The max memory is based on the test results with current Lenovo® memory offerings.

[2] Installed memory is actually DDR5-5600, but runs at DDR5-3600, DDR5-4000, DDR5-4400 due to the memory support capability of processor.

Storage**Storage Support^[1]**

Up to five drives, 2x 3.5" HDD + 1x 2.5" HDD + 2x M.2 SSD

- 3.5" HDD up to 2TB
- 2.5" HDD bay is only for customer self upgrade
- M.2 SSD up to 2TB each^[2]

Storage Type^{*}**

Disk Type	Interface	RPM	Security
3.5" SATA HDD	SATA 6Gb/s	7.2K	-
M.2 2280 SSD	PCIe® NVMe®, PCIe® 4.0 x4	-	Opal 2.0

RAID

RAID 0/1 support (RAID preset only available via special bid models)

Notes:

[1] The max capacity of each disk type is based on the test results with current Lenovo® storage offerings.

[2] 2.5" HDD bay and 2nd 3.5" bay are optional parts, and 2.5" HDD bay is only for customer self upgrade purpose and the hard drive is sold separately.

Removable Storage**Optical^{**}**

- DVD-ROM, SATA connector, slim (9.0mm)
- DVD burner (DVD±RW), SATA connector, slim (9.0mm)
- None

Card Reader

- 3-in-1 card reader (SD, SDHC, SDXC)
- No card reader

Multi-Media**Audio Chip**

High Definition (HD) Audio, Realtek® ALC897Q-CG codec

Speakers

Single speaker, 2W x1

Power Supply

Power Supply**

Power	Type	Efficiency	Key Features
260W	Fixed	90%	100-240V, 50-60Hz
300W	Fixed	90%	100-240V, 50-60Hz
500W	Fixed	92%	100-240V, 50-60Hz

DESIGN

Input Device

Keyboard**

- EOS Wireless Keyboard, black
- Lenovo® Calliope Keyboard (USB connector), black
- Lenovo® Traditional Keyboard (USB connector), black
- No keyboard

Mouse**

- Lenovo® Calliope Mouse (USB connector), black
- EOS Wireless Mouse, Black
- No mouse

Mechanical

Form Factor

Tower (17L)

Dimensions (WxDxH)^[1]

170 x 298 x 376 mm (6.7 x 11.7 x 14.8 inches)

Packaging Dimensions (WxDxH)

275 x 395 x 540 mm (10.8 x 15.6 x 21.4 inches)

Weight^[2]

Around 6.5 kg (14.3 lbs)

Packaging Weight

9.8 kg (21.61 lbs)

Case Color

Black

Bays

- 1x 2.5" disk bay (optional)^[3]
- 1x 3.5" disk bay
- 1x 3.5" disk bay (optional, or bay comes with disk)^[4]
- 1x slim ODD bay

Expansion Slots

- One PCIe® 4.0 x16 (x4 signal), full-height, length ≤ 205mm, height ≤ 114.55mm
- One PCIe® 4.0 x16, full-height, length ≤ 268.5mm, height ≤ 114.55mm
- One PCIe® 3.0 x1, full-height, length ≤ 205mm, height ≤ 114.55mm
- Three M.2 slots (one for WLAN, two for SSD)

EOU

Toolless cover, disk, optical, extension card assembly / removal

Stand

No stand

Others

- (Optional) Dust filter
- Supports Smart Power On

Notes:

[1] The system dimensions may vary depending on configurations.

[2] The system weight is approximate and based on results in Lenovo® lab, which varies depending on the source of component, variance of the distribution of each component, and manufacturing process. It may not be the exact weight for each specific model.

[3] 2.5" HDD bay is optional part

[4] 2nd 3.5" bay is optional part

CONNECTIVITY

Network

Onboard Ethernet

Gigabit Ethernet, Intel® Ethernet Connection I219-LM, 1x RJ-45, supports Wake-on-LAN

Optional Ethernet

- 2.5 Gigabit Ethernet, Realtek® RTL8125BGS, 1x RJ-45, PCIe® x1
- No optional Ethernet

WLAN + Bluetooth®**

- Realtek® Wi-Fi® 6 RTL8852BE, 802.11ax Dual Band 2x2 Wi-Fi® + Bluetooth® 5.3, M.2 card
- Intel® Wi-Fi® 6 AX201, 802.11ax 2x2 Wi-Fi® + Bluetooth® 5.2, M.2 Card
- Intel® Wi-Fi® 6E AX211, 802.11ax 2x2 Wi-Fi® + Bluetooth® 5.3, Intel® vPro® technology support, M.2 Card
- No WLAN and Bluetooth®

Ports^[1]

Front Ports

- 1x USB-C® (USB 10Gbps / USB 3.2 Gen 2), with 15W charging
- 2x USB-A (USB 5Gbps / USB 3.2 Gen 1)
- 2x USB-A (USB 10Gbps / USB 3.2 Gen 2)
- 1x headphone / microphone combo jack (3.5mm)
- 1x microphone (3.5mm)

Optional Front Ports

1x card reader

Rear Ports^[2]

- 4x USB-A (USB 5Gbps / USB 3.2 Gen 1)
- 1x HDMI® 2.1 TMDS
- 2x DisplayPort™ 1.4a (HBR2, DSC)
- 1x Ethernet (RJ-45)
- 1x line-out (3.5mm)

Optional Rear Ports***

- 1x USB-C® (USB 5Gbps / USB 3.2 Gen 1), with DisplayPort™ function and 5V@3A charging (Flex IO)
- 1x HDMI® 2.1 TMDS (Flex IO)
- 1x DP 1.2 (Flex IO)
- 1x VGA (Flex IO)
- 2x USB-A (Hi-Speed USB / USB 2.0), via 2-port adapter
- 2x USB-A (USB 5Gbps / USB 3.2 Gen 1), via 2-port USB expansion card, PCIe® x1
- 1x parallel
- 1x serial
- 1x 2nd serial

Notes:

[1] The transfer speed of following ports will vary and, depending on many factors, such as the processing speed of the host device, file attributes and other factors related to system configuration and your operating environment, will be slower than theoretical speed.

USB 2.0: 480 Mbit/s;

USB 3.2 Gen 1 (SuperSpeed USB 5Gbps, formerly USB 3.0 / USB 3.1 Gen 1): 5 Gbit/s;

USB 3.2 Gen 2 (SuperSpeed USB 10Gbps, formerly USB 3.1 Gen 2): 10 Gbit/s;

USB4® 20Gbps / USB 3.2 Gen 2x2 (SuperSpeed USB 20Gbps): 20 Gbit/s;

USB4® 40Gbps (USB 40Gbps): 40 Gbit/s;

Thunderbolt™ 3/4: 40 Gbit/s.

[2] For video ports on discrete graphics, please see graphics section.

SECURITY & PRIVACY

Security

Security Chip

Discrete TPM 2.0, TCG certified, FIPS 140-2 certified

Physical Locks

- (Optional) E-lock
- (Optional) Smart Cable Clip
- Kensington® Security Slot™, 3 x 7 mm
- Padlock Loop

Chassis Intrusion Switch

- Chassis intrusion switch
- No chassis intrusion switch

Fingerprint Reader

No fingerprint reader

BIOS Security

- Administrator password
- Power-on password
- Hard disk password
- Boot sequence control
- Boot without keyboard and mouse
- Self-healing BIOS (Level 2)
- Smart USB protection (allows keyboard / mouse only, blocks all storage devices)
- Individual USB port disablement

MANAGEABILITY

System Management

System Management^[1]

- Intel® vPro® Enterprise
- Non-vPro®

Notes:

[1] Intel® vPro® offers a superset of DASH's defined capabilities.

SERVICE

Warranty^[1]

Base Warranty**

- 1-year limited onsite service
- 3-year limited onsite service
- No base warranty

Notes:

[1] The warranty upgrades may be bundled with some models, please check the "Included upgrade" column in the specific model's configurations. For more service extensions, please go to <https://smartfind.lenovo.com/>. To learn more details of warranty policy, please access <https://pcsupport.lenovo.com/warranty>.

ENVIRONMENTAL

Operating Environment

Temperature

- Operating: 5°C (41°F) to 35°C (95°F)
- Storage: -40°C (-40°F) to 60°C (140°F)

Relative Humidity

- Operating: 20% to 80%
- Storage: 10% to 90%

Altitude

- Operating: 0 m (0 ft) to 3048 m (10,000 ft)
- Storage: 0 m (0 ft) to 12192 m (40,000 ft)

ACCESSORIES

Bundled Accessories

Bundled Accessories***

- DP to DVI dongle
- DP to HDMI® dongle
- HDMI® to VGA dongle
- Smart Cable (USB-A to USB-C®)
- None

CERTIFICATIONS

Green Certifications^[1]

Green Certifications

- (Optional) ENERGY STAR® 8.0
- (Optional) EPEAT™ Gold Registered^[2]
- ErP Lot 3
- GREENGUARD®
- RoHS compliant
- TCO Certified 9.0

Notes:

[1] The items listed under the "Green Certifications" section may not only refer to certification but also registration or self-declaration.

[2] EPEAT™ is registered where applicable, please see [epeat.net](https://www.epeat.net) for registration status by country.

Other Certifications

Other Certifications

- (Optional) TÜV Rheinland® Low Noise
- (Optional) TÜV Rheinland® Ultra Low Noise

Mil-Spec Test

MIL-STD-810H military test passed (Low Pressure [Altitude], High Temperature, Low Temperature, Temperature Shock, Humidity, Sand and Dust, Vibration, Shock, Fungus, Solar Radiation, Contamination by Fluids, Salt Fog)

- Feature with ** means that only one offering listed under the feature is configured on selected models.
- Feature with *** means that one or more offerings listed under the feature could be configured on selected models.
- Lenovo reserves the right to change specifications or other product information without notice. Lenovo is not responsible for photographic or typographical errors. LENOVO PROVIDES THIS PUBLICATION "AS IS," WITHOUT WARRANTY OF ANY KIND, EITHER EXPRESS OR IMPLIED, INCLUDING THE IMPLIED WARRANTIES OF MERCHANTABILITY OR FITNESS FOR A PARTICULAR PURPOSE. Some jurisdictions do not allow disclaimer of express or implied warranties in certain transactions, therefore this disclaimer may not apply to you.
- The specifications on this page may not be available in all regions, and may be changed or updated without notice.



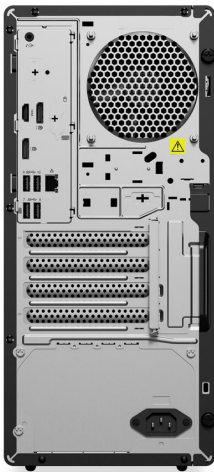

OVERVIEW

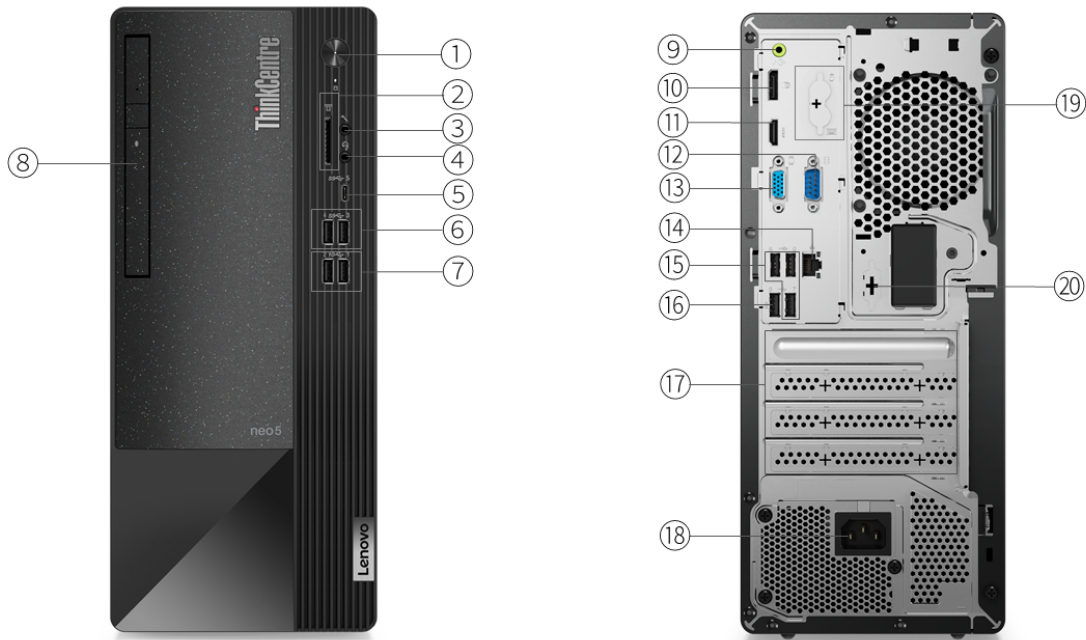

1. Power button	11. HDMI 1.4b
2. Card reader *	12. Serial
3. Microphone (3.5mm)	13. VGA
4. Headphone / microphone combo jack (3.5mm)	14. Ethernet (RJ-45)
5. 1x USB-C 3.2 Gen 1	15. 3x USB 2.0
6. 2x USB 3.2 Gen 1	16. 1x USB 2.0 (with smart power-on feature)
7. 2x USB 3.2 Gen 2	17. Optional ports on expansion cards *
8. Optical drive *	18. Power connector
9. Headphone (3.5mm)	19. 2x PS/2 ports (keyboard / mouse) *
10. DisplayPort 1.4	20. Serial *

Notes:

- Items with * are only available on selected models
- Onboard video ports are only available for the models with integrated graphics

PERFORMANCE

Processor

Processor Family

Intel® Celeron®, Intel® Pentium®, or 12th Generation Intel® Core™ i3 / i5 / i7 / i9 Processor

Processor**

Processor Name	Cores	Threads	Base Frequency	Max Frequency	Cache	Processor Graphics
Celeron® G6900	2	2	3.4GHz	-	4MB	Intel® UHD Graphics 710
Pentium® Gold G7400	2	4	3.7GHz	-	6MB	Intel® UHD Graphics 710
Core™ i3-12100	4 (4 P-core + 0 E-core)	8	P-core 3.3GHz	P-core 4.3GHz ^[1]	12MB	Intel® UHD Graphics 730
Core™ i5-12400	6 (6 P-core + 0 E-core)	12	P-core 2.5GHz	P-core 4.4GHz ^[2]	18MB	Intel® UHD Graphics 730
Core™ i5-12400F	6 (6 P-core + 0 E-core)	12	P-core 2.5GHz	P-core 4.4GHz ^[3]	18MB	-
Core™ i5-12500	6 (6 P-core + 0 E-core)	12	P-core 3.0GHz	P-core 4.6GHz ^[4]	18MB	Intel® UHD Graphics 770
Core™ i7-12700	12 (8 P-core + 4 E-core)	20	P-core 2.1GHz / E-core 1.6GHz	Max Turbo up to 4.9GHz / P-core 4.8GHz / E-core 3.6GHz ^[5]	25MB	Intel® UHD Graphics 770
Core™ i9-12900	16 (8 P-core + 8 E-core)	24	P-core 2.4GHz / E-core 1.8GHz	Max Turbo up to 5.1GHz / P-core 5.0GHz / E-core 3.8GHz ^[6]	30MB	Intel® UHD Graphics 770

Notes:

[1], [2], [3], [4], [5], [6] Intel® Max Turbo frequency will vary depending on application workload and the hardware and software configurations, see <http://www.intel.com/technology/turboboost/> for more information.

Operating System

Operating System**

- Windows® 11 Pro
- Windows® 11 Home
- Windows® 11 Home Single Language
- Windows® 11 DG Windows® 10 Pro 64
- Ubuntu Linux^[1]
- No preload operating system

Notes:

[1] Some features may not be supported on the system with Linux preload, including but not limited to Intel® RST RAID, Human Presence Detection, etc.

Graphics

Graphics***^[1]

Graphics	Type	Memory	Connector	Max Resolution	Key Features
Intel® UHD graphics 710	Integrated	Shared	1x HDMI® 1.4b, 1x VGA, 1x DP 1.4	3840x2160@24Hz(HDMI®), 1920x1200@60Hz(VGA), 4096x2304@60Hz(DP)	DirectX® 12
Intel® UHD graphics 730	Integrated	Shared	1x HDMI® 1.4b, 1x VGA, 1x DP 1.4	3840x2160@24Hz(HDMI®), 1920x1200@60Hz(VGA), 4096x2304@60Hz(DP)	DirectX® 12
Intel® UHD graphics 770	Integrated	Shared	1x HDMI® 1.4b, 1x VGA, 1x DP 1.4	3840x2160@24Hz(HDMI®), 1920x1200@60Hz(VGA),	DirectX® 12

				4096x2304@60Hz(DP)	
AMD Radeon™ RX 6400 ^[2]	Discrete	4GB GDDR6	1x HDMI® 2.1 FRL, 1x DP 1.4a	7680x4320@60Hz(HDMI®), 7680x4320@60Hz(DP)	DirectX® 12, OpenGL 4.6
AMD Radeon™ RX 6500XT ^[3]	Discrete	4GB GDDR6	1x HDMI® 2.1, 1x DP 1.4	7680x4320@60Hz(HDMI®), 7680x4320@60Hz(DP)	DirectX® 12, OpenGL 4.6
Intel® Iris® Xe MAX 100 Graphics ^[4]	Discrete	2GB LPDDR4X	1x VGA, 1x HDMI® 1.4	3840x2160@30Hz(HDMI®), 1920x1080@60Hz(VGA)	DirectX® 12, OpenGL 4.6
NVIDIA® GeForce RTX™ 3050 ^[5]	Discrete	8GB GDDR6	1x HDMI® 2.1 FRL, 3x DP 1.4a	7680x4320@60Hz(HDMI®), 7680x4320@120Hz(DP)	DirectX® 12, OpenGL 4.6

Notes:

[1] The information of integrated graphics are not applicable for the models with processor which has no integrated graphics inside (for the details, please refer to processor section).

[2], [3], [4] The onboard video ports VGA, HDMI® and DisplayPort™ are disabled on the models with discrete graphics.

[5] The onboard video ports VGA, HDMI® and DisplayPort™ are disabled on the models with discrete graphics. 7680x4320@120Hz(DP) requires two DisplayPort™ 1.4a links and DSC compression.

Monitor Support

Monitor Support

Supports up to 3 independent displays via (HDMI®, DP and VGA)

Chipset

Chipset

Intel® B660 chipset

Memory

Max Memory^[1]

Up to 64GB DDR4-3200

Memory Slots

Two DDR4 UDIMM slots, dual-channel capable

Memory Type

DDR4-3200

Notes:

[1] The max memory is based on the test results with current Lenovo® memory offerings.

Storage

Storage Support^[1]

Up to two drives, 1x 3.5" HDD + 1x M.2 SSD

- 3.5" HDD up to 2TB
- M.2 SSD up to 1TB

Storage Type^{***}

Disk Type	Interface	RPM	Security
3.5" SATA HDD	SATA 6Gb/s	7.2K	-
M.2 2280 SSD	PCIe® NVMe®, PCIe® 3.0 x4	-	-
M.2 2280 SSD	PCIe® NVMe®, PCIe® 3.0 x4	-	Opal 2.0
M.2 2280 SSD	PCIe® NVMe®, PCIe® 4.0 x4	-	Opal 2.0
M.2 2242 SSD	PCIe® NVMe®, PCIe® 3.0 x4	-	-

RAID

No support

Notes:

[1] The max capacity of each disk type is based on the test results with current Lenovo® storage offerings.

Removable Storage

Optical**

- DVD-ROM, SATA 1.5Gb/s, slim (9.0mm)
- DVD burner (DVD±RW), SATA 1.5Gb/s, slim (9.0mm)
- None

Card Reader

- 3-in-1 card reader (SD, SDHC, SDXC)
- No card reader

Multi-Media

Audio Chip

High Definition (HD) Audio, Realtek® ALC222-CG codec

Speakers

- No speakers
- Single speaker, 2W x1

Power Supply

Power Supply**

Power	Type	Efficiency
180W	Fixed	85%
260W	Fixed	90%
310W	Fixed	92%
380W	Fixed	92%

DESIGN

Input Device

Keyboard**

- Euterpe Wireless Keyboard, grey
- Lenovo® Calliope Keyboard (USB connector), black
- Lenovo® Traditional Keyboard (USB connector), black
- No keyboard

Mouse**

- Lenovo® Calliope Mouse (USB connector), black
- Euterpe Wireless Mouse, grey
- No mouse

Mechanical

Form Factor

Tower (13.6L)

Dimensions (WxDxH)^[1]

145 x 294 x 340 mm (5.71 x 11.57 x 13.39 inches)

Packaging Dimensions (WxDxH)

245 x 395 x 530 mm (9.65 x 15.55 x 20.87 inches)

Weight^[2]

Around 5.5 kg (12.1 lbs)

Packaging Weight

Around 7.5 kg (16.53 lbs)

Case Color

Black (chassis), grey (bezel)

Bays

ThinkCentre neo 50t

- 1x 3.5" disk bay
- 1x slim ODD bay

Expansion Slots

- One PCIe® 4.0 x16, full-height, half-length
- Two PCIe® 3.0 x1, full-height, half-length
- (Optional) M.2 Bracket. For installing M.2 devices, M.2 bracket kit is needed. The kit is optional, or comes with pre-configured M.2 SSD or M.2 Wifi models
- Two M.2 slots (one for WLAN, one for SSD)

EOU

- (Optional) toolless chassis open (toolless chassis screw required) and toolless M.2 SSD, HDD, memory assembly / removal
- No support

Cooling System (Fan & Cooler)***

- (Optional) 1x rear fan
- (Optional) 1x front system fan
- (Optional) 1x Photocatalyst System Fan

Others

(Optional) Smart Cable (USB-A to USB-C®)

Notes:

[1] The system dimensions may vary depending on configurations.

[2] The system weight is approximate and based on results in Lenovo® lab, which varies depending on the source of component, variance of the distribution of each component, and manufacturing process. It may not be the exact weight for each specific model.

CONNECTIVITY

Network

Onboard Ethernet

Gigabit Ethernet, Intel® Ethernet Connection I219-V, 1x RJ-45, supports Wake-on-LAN

Optional Ethernet

No optional Ethernet

WLAN + Bluetooth®**

- Realtek® RTL8822CE, 802.11ac Dual Band 2x2 Wi-Fi® + Bluetooth® 5.0, M.2 card
- Intel® Wireless-AC 9560, 802.11ac Dual Band 2x2 Wi-Fi® + Bluetooth® 5.0, Intel® vPro® technology support, M.2 card
- Realtek® Wi-Fi® 6 RTL8852BE, 802.11ax Dual Band 2x2 Wi-Fi® + Bluetooth® 5.1, M.2 card^[1]
- Intel® Wi-Fi® 6 AX201, 802.11ax 2x2 Wi-Fi® + Bluetooth® 5.1, M.2 Card^[2]
- No WLAN and Bluetooth®

Notes:

[1], [2] Bluetooth® 5.2 is hardware ready but may run at a lower version due to OS limitations.

Ports^[1]

Front Ports

- 1x USB-C® 3.2 Gen 1 (support data transfer and 5V@3A charging)
- 2x USB 3.2 Gen 1
- 2x USB 3.2 Gen 2
- 1x headphone / microphone combo jack (3.5mm)
- 1x microphone (3.5mm)

Optional Front Ports

1x card reader

Rear Ports^{[2][3]}

- 4x USB 2.0
- 1x HDMI® 1.4b
- 1x DisplayPort™ 1.4
- 1x VGA
- 1x Ethernet (RJ-45)

- 1x headphone (3.5mm)
- 1x serial (9-pin)

Optional Rear Ports***

- 1x parallel
- 1x serial
- 2x PS/2
- None

Notes:

[1] The transfer speed of following ports will vary and, depending on many factors, such as the processing speed of the host device, file attributes and other factors related to system configuration and your operating environment, will be slower than theoretical speed.

USB 2.0: 480 Mbit/s;

USB 3.2 Gen 1 (SuperSpeed USB 5Gbps, formerly USB 3.0 / USB 3.1 Gen 1): 5 Gbit/s;

USB 3.2 Gen 2 (SuperSpeed USB 10Gbps, formerly USB 3.1 Gen 2): 10 Gbit/s;

USB4® 20Gbps / USB 3.2 Gen 2x2 (SuperSpeed USB 20Gbps): 20 Gbit/s;

USB4® 40Gbps (USB 40Gbps): 40 Gbit/s;

Thunderbolt™ 3/4: 40 Gbit/s.

[2] For video ports on discrete graphics, please see graphics section.

[3] The onboard video ports VGA, HDMI® and DisplayPort™ are disabled on the models with discrete graphics.

SECURITY & PRIVACY

Security

Security Chip

Discrete TPM 2.0, TCG certified

Physical Locks

- (Optional) Smart Cable Clip
- Kensington® Security Slot™, 3 x 7 mm
- Padlock Loop

Chassis Intrusion Switch

- Chassis intrusion switch
- No chassis intrusion switch

Fingerprint Reader

No fingerprint reader

BIOS Security

- Administrator password
- Power-on password
- Hard disk password
- Cover presence switch
- Smart USB protection (allows keyboard / mouse only, blocks all storage devices)
- Individual USB port disablement

MANAGEABILITY

System Management

System Management

Non-vPro®

SERVICE

Warranty^[1]

Base Warranty**

- 1-year courier or carry-in service
- 1-year limited onsite service

Notes:

[1] The warranty upgrades may be bundled with some models, please check the "Included upgrade" column in the specific model's configurations. For more service extensions, please go to <https://smartfind.lenovo.com/>. To learn more details of warranty policy, please access <https://pcsupport.lenovo.com/warranty>.

ENVIRONMENTAL

Operating Environment

Temperature

- Operating: 5°C (41°F) to 35°C (95°F)
- Storage: -40°C (-40°F) to 60°C (140°F)

Relative Humidity

- Operating: 20% to 80%
- Storage: 10% to 90%

Altitude

- Operating: 0 m (0 ft) to 3048 m (10,000 ft)
- Storage: 0 m (0 ft) to 12192 m (40,000 ft)

ACCESSORIES

Bundled Accessories

Bundled Accessories

- DP to DVI dongle
- HDMI® to DVI dongle

CERTIFICATIONS

Green Certifications^[1]

Green Certifications

- (Optional) ENERGY STAR® 8.0
- (Optional) EPEAT™ Silver Registered^[2]
- (Optional) EPEAT™ Gold Registered^[3]
- REACH
- RoHS compliant
- TCO Certified
- WEEE

Notes:

[1] The items listed under the "Green Certifications" section may not only refer to certification but also registration or self-declaration.

[2], [3] EPEAT™ is registered where applicable, please see epeat.net for registration status by country.

Other Certifications

Other Certifications

TÜV Rheinland® Ultra Low Noise

- Feature with ** means that only one offering listed under the feature is configured on selected models.
- Feature with *** means that one or more offerings listed under the feature could be configured on selected models.
- Lenovo reserves the right to change specifications or other product information without notice. Lenovo is not responsible for photographic or typographical errors. **LENOVO PROVIDES THIS PUBLICATION "AS IS," WITHOUT WARRANTY OF ANY KIND, EITHER EXPRESS OR IMPLIED, INCLUDING THE IMPLIED WARRANTIES**

OF MERCHANTABILITY OR FITNESS FOR A PARTICULAR PURPOSE. Some jurisdictions do not allow disclaimer of express or implied warranties in certain transactions, therefore this disclaimer may not apply to you.

- The specifications on this page may not be available in all regions, and may be changed or updated without notice.



OVERVIEW

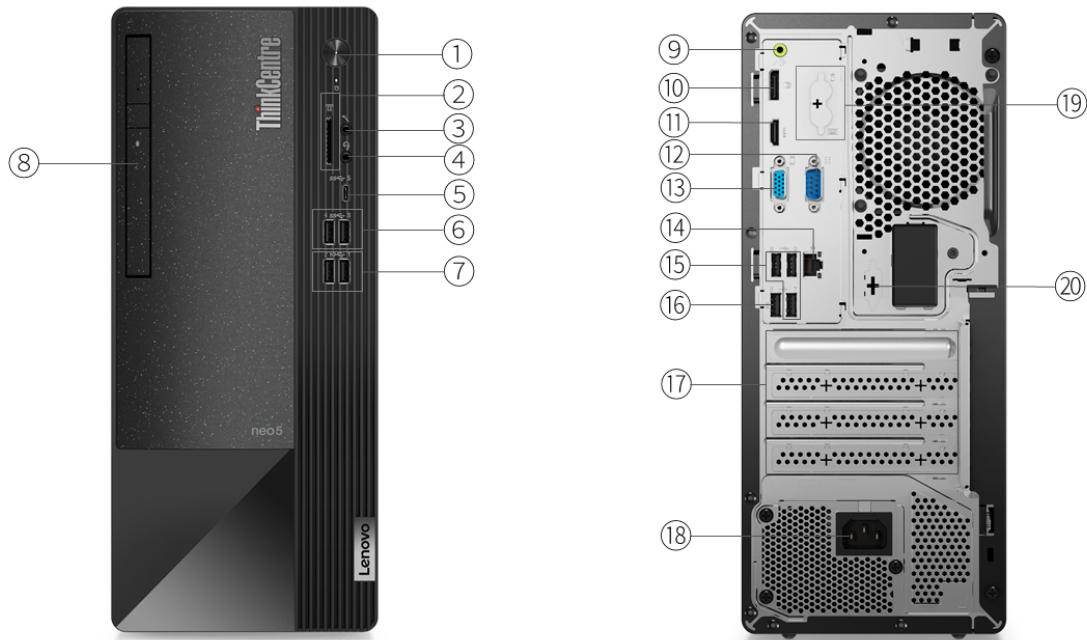

1. Power button	11. HDMI 1.4b
2. Card reader *	12. Serial
3. Microphone (3.5mm)	13. VGA
4. Headphone / microphone combo jack (3.5mm)	14. Ethernet (RJ-45)
5. 1x USB-C 3.2 Gen 1	15. 3x USB 2.0
6. 2x USB 3.2 Gen 1	16. 1x USB 2.0 (with smart power-on feature)
7. 2x USB 3.2 Gen 2	17. Optional ports on expansion cards *
8. Optical drive *	18. Power connector
9. Headphone (3.5mm)	19. 2x PS/2 ports (keyboard / mouse) *
10. DisplayPort 1.4	20. Serial *

Notes:

- Items with * are only available on selected models
- Onboard video ports are only available for the models with integrated graphics

PERFORMANCE

Processor

Processor Family

Intel® Celeron®, Intel® Pentium®, or 12th / 13th Generation Intel® Core™ i3 / i5 / i7 / i9 Processor

Processor**

Processor Name	Cores	Threads	Base Frequency	Max Frequency	Cache	Processor Graphics
Celeron® G6900	2	2	3.4GHz	-	4MB	Intel® UHD Graphics 710
Pentium® Gold G7400	2	4	3.7GHz	-	6MB	Intel® UHD Graphics 710
Core™ i3-12100	4 (4 P-core + 0 E-core)	8	P-core 3.3GHz	P-core 4.3GHz ^[1]	12MB	Intel® UHD Graphics 730
Core™ i5-12400	6 (6 P-core + 0 E-core)	12	P-core 2.5GHz	P-core 4.4GHz ^[2]	18MB	Intel® UHD Graphics 730
Core™ i5-12400F	6 (6 P-core + 0 E-core)	12	P-core 2.5GHz	P-core 4.4GHz ^[3]	18MB	-
Core™ i5-12500	6 (6 P-core + 0 E-core)	12	P-core 3.0GHz	P-core 4.6GHz ^[4]	18MB	Intel® UHD Graphics 770
Core™ i7-12700	12 (8 P-core + 4 E-core)	20	P-core 2.1GHz / E-core 1.6GHz	Max Turbo up to 4.9GHz / P-core 4.8GHz / E-core 3.6GHz ^[5]	25MB	Intel® UHD Graphics 770
Core™ i9-12900	16 (8 P-core + 8 E-core)	24	P-core 2.4GHz / E-core 1.8GHz	Max Turbo up to 5.1GHz / P-core 5.0GHz / E-core 3.8GHz ^[6]	30MB	Intel® UHD Graphics 770
Core™ i3-13100	4 (4 P-core + 0 E-core)	8	P-core 3.4GHz	P-core 4.5GHz ^[7]	12MB	Intel® UHD Graphics 730
Core™ i5-13400	10 (6 P-core + 4 E-core)	16	P-core 2.5GHz / E-core 1.8GHz	P-core 4.6GHz / E-core 3.3GHz ^[8]	20MB	Intel® UHD Graphics 730
Core™ i5-13400F	10 (6 P-core + 4 E-core)	16	P-core 2.5GHz / E-core 1.8GHz	P-core 4.6GHz / E-core 3.3GHz ^[9]	20MB	-
Core™ i5-13500	14 (6 P-core + 8 E-core)	20	P-core 2.5GHz / E-core 1.8GHz	P-core 4.8GHz / E-core 3.5GHz ^[10]	24MB	Intel® UHD Graphics 770
Core™ i7-13700	16 (8 P-core + 8 E-core)	24	P-core 2.1GHz / E-core 1.5GHz	Max Turbo up to 5.2GHz / P-core 5.1GHz / E-core 4.1GHz ^[11]	30MB	Intel® UHD Graphics 770
Core™ i9-13900	24 (8 P-core + 16 E-core)	32	P-core 2.0GHz / E-core 1.5GHz	Max Turbo up to 5.6GHz / P-core 5.2GHz / E-core 4.2GHz ^[12]	36MB	Intel® UHD Graphics 770

Notes:

[1], [2], [3], [4], [5], [6], [7], [8], [9], [10], [11], [12] Intel® Max Turbo frequency will vary depending on application workload and the hardware and software configurations, see <http://www.intel.com/technology/turboboost/> for more information.

Operating System

Operating System**

- Windows® 11 Pro
- Windows® 11 Home
- Windows® 11 Home Single Language
- Windows® 11 DG Windows® 10 Pro 64
- Ubuntu Linux^[1]
- No preload operating system

Notes:

[1] Some features may not be supported on the system with Linux preload, including but not limited to Intel® RST RAID, Human Presence Detection, etc.

Graphics

Graphics***^[1]

Graphics	Type	Memory	Connector	Max Resolution	Key Features
Intel® UHD graphics 710	Integrated	Shared	1x HDMI® 1.4b, 1x VGA, 1x DP 1.4	1920x1080@60Hz(HDMI®), 2048x1536@60HZ(VGA), 4096x2304@60Hz(DP)	DirectX® 12
Intel® UHD graphics 730	Integrated	Shared	1x HDMI® 1.4b, 1x VGA, 1x DP 1.4	1920x1080@60Hz(HDMI®), 2048x1536@60HZ(VGA), 4096x2304@60Hz(DP)	DirectX® 12
Intel® UHD graphics 770	Integrated	Shared	1x HDMI® 1.4b, 1x VGA, 1x DP 1.4	1920x1080@60Hz(HDMI®), 2048x1536@60HZ(VGA), 4096x2304@60Hz(DP)	DirectX® 12
AMD Radeon™ RX 6400 ^[2]	Discrete	4GB GDDR6	1x HDMI® 2.1 FRL, 1x DP 1.4a	7680x4320@60Hz(HDMI®), 7680x4320@60Hz(DP)	DirectX® 12, OpenGL 4.6

Notes:

[1] The information of integrated graphics are not applicable for the models with processor which has no integrated graphics inside (for the details, please refer to processor section).

[2] The onboard video ports VGA, HDMI® and DisplayPort™ are disabled on the models with discrete graphics.

Monitor Support

Monitor Support

Supports up to 3 independent displays via (HDMI®, DP and VGA)

Chipset

Chipset

Intel® B760 chipset

Memory

Max Memory^[1]

Up to 64GB DDR4-3200

Memory Slots

Two DDR4 UDIMM slots, dual-channel capable

Memory Type

DDR4-3200

Notes:

[1] The max memory is based on the test results with current Lenovo® memory offerings.

Storage

Storage Support^[1]

Up to two drives, 1x 3.5" HDD + 1x M.2 SSD

- 3.5" HDD up to 2TB
- M.2 SSD up to 1TB

Storage Type***

Disk Type	Interface	RPM	Security
3.5" SATA HDD	SATA 6Gb/s	7.2K	-
M.2 2280 SSD	PCIe® NVMe®, PCIe® 4.0 x4	-	-
M.2 2280 SSD	PCIe® NVMe®, PCIe® 4.0 x4	-	Opal 2.0

RAID

No support

Notes:

[1] The max capacity of each disk type is based on the test results with current Lenovo® storage offerings.

Removable Storage

Optical**

- DVD-ROM, SATA 1.5Gb/s, slim (9.0mm)
- DVD burner (DVD±RW), SATA 1.5Gb/s, slim (9.0mm)
- None

Card Reader

- 3-in-1 card reader (SD, SDHC, SDXC)
- No card reader

Multi-Media

Audio Chip

High Definition (HD) Audio, Realtek® ALC222-CG codec

Speakers

- No speakers
- Single speaker, 2W x1

Power Supply

Power Supply**

Power	Type	Efficiency	Key Features
180W	Fixed	85%	100-240V, 50-60Hz
260W	Fixed	90%	100-240V, 50-60Hz
310W	Fixed	92%	100-240V, 50-60Hz
380W	Fixed	92%	100-240V, 50-60Hz

DESIGN

Input Device

Keyboard**

- Euterpe Wireless Keyboard, grey
- Lenovo® Calliope Keyboard (USB connector), black
- Lenovo® Traditional Keyboard (USB connector), black
- No keyboard

Mouse**

- Lenovo® Calliope Mouse (USB connector), black
- Euterpe Wireless Mouse, grey
- No mouse

Mechanical

Form Factor

Tower (13.6L)

Dimensions (WxDxH)^[1]

145 x 294 x 340 mm (5.71 x 11.57 x 13.39 inches)

Packaging Dimensions (WxDxH)

245 x 395 x 530 mm (9.65 x 15.55 x 20.87 inches)

Weight^[2]

Around 5.5 kg (12.1 lbs)

Packaging Weight

Around 7.5 kg (16.53 lbs)

Case Color

Black

Bays

ThinkCentre neo 50t Gen 4

- 1x 3.5" disk bay
- 1x slim ODD bay

Expansion Slots

- One PCIe® 4.0 x16, full-height, half-length
- Two PCIe® 3.0 x1, full-height, half-length
- (Optional) M.2 Bracket. For installing M.2 devices, M.2 bracket kit is needed. The kit is optional, or comes with pre-configured M.2 SSD or M.2 Wifi models
- Two M.2 slots (one for WLAN, one for SSD)

Cooling System (Fan & Cooler)^{***}

- (Optional) 1x rear system fan
- (Optional) 1x front system fan
- (Optional) 1x Photocatalyst System fan

Others

(Optional) Smart Cable (USB-A to USB-C®)

Notes:

[1] The system dimensions may vary depending on configurations.

[2] The system weight is approximate and based on results in Lenovo® lab, which varies depending on the source of component, variance of the distribution of each component, and manufacturing process. It may not be the exact weight for each specific model.

CONNECTIVITY

Network

Onboard Ethernet

Gigabit Ethernet, Intel® Ethernet Connection I219-V, 1x RJ-45, supports Wake-on-LAN

Optional Ethernet

No optional Ethernet

WLAN + Bluetooth[®]**

- Realtek® Wi-Fi® 6 RTL8852BE, 802.11ax Dual Band 2x2 Wi-Fi® + Bluetooth® 5.3, M.2 card^[1]
- Intel® Wi-Fi® 6 AX201, 802.11ax 2x2 Wi-Fi® + Bluetooth® 5.2, M.2 Card^[2]
- No WLAN and Bluetooth®

Notes:

[1] Bluetooth® 5.3 requires Windows® 11.

[2] Bluetooth® 5.2 requires Windows® 11.

Ports^[1]

Front Ports

- 1x USB-C® 3.2 Gen 1 (support data transfer and 5V@3A charging)
- 2x USB 3.2 Gen 1
- 2x USB 3.2 Gen 2
- 1x headphone / microphone combo jack (3.5mm)
- 1x microphone (3.5mm)

Optional Front Ports

1x card reader

Rear Ports^{[2][3]}

- 4x USB 2.0 (one supports Smart Power On)
- 1x HDMI® 1.4b
- 1x DisplayPort™ 1.4
- 1x VGA
- 1x Ethernet (RJ-45)
- 1x headphone (3.5mm)
- 1x serial (9-pin)

Optional Rear Ports^{***}

- 1x parallel

ThinkCentre neo 50t Gen 4

- 1x 2nd serial
- 2x PS/2
- None

Notes:

[1] The transfer speed of following ports will vary and, depending on many factors, such as the processing speed of the host device, file attributes and other factors related to system configuration and your operating environment, will be slower than theoretical speed.

USB 2.0: 480 Mbit/s;

USB 3.2 Gen 1 (SuperSpeed USB 5Gbps, formerly USB 3.0 / USB 3.1 Gen 1): 5 Gbit/s;

USB 3.2 Gen 2 (SuperSpeed USB 10Gbps, formerly USB 3.1 Gen 2): 10 Gbit/s;

USB4® 20Gbps / USB 3.2 Gen 2x2 (SuperSpeed USB 20Gbps): 20 Gbit/s;

USB4® 40Gbps (USB 40Gbps): 40 Gbit/s;

Thunderbolt™ 3/4: 40 Gbit/s.

[2] For video ports on discrete graphics, please see graphics section.

[3] The onboard video ports VGA, HDMI® and DisplayPort™ are disabled on the models with discrete graphics.

SECURITY & PRIVACY

Security

Security Chip

Discrete TPM 2.0, TCG certified

Physical Locks

- (Optional) Smart Cable Clip
- Kensington® Security Slot™, 3 x 7 mm
- Padlock Loop

Chassis Intrusion Switch

- Chassis intrusion switch
- No chassis intrusion switch

Fingerprint Reader

No fingerprint reader

BIOS Security

- Administrator password
- Power-on password
- Hard disk password
- Certificate based BIOS authentication
- Certificate based BIOS management
- Cover presence switch
- Self-healing BIOS
- Smart USB protection (allows keyboard / mouse only, blocks all storage devices)
- Individual USB port disablement

MANAGEABILITY

System Management

System Management

Non-vPro®

SERVICE

Warranty^[1]

Base Warranty**

- 1-year courier or carry-in service
- 1-year limited onsite service

Notes:

[1] The warranty upgrades may be bundled with some models, please check the "Included upgrade" column in the specific model's configurations. For more service extensions, please go to <https://smartfind.lenovo.com/>. To learn more details of warranty policy, please access <https://pcsupport.lenovo.com/warranty>.

ENVIRONMENTAL

Operating Environment

Temperature

- Operating: 5°C (41°F) to 35°C (95°F)
- Storage: -40°C (-40°F) to 60°C (140°F)

Relative Humidity

- Operating: 20% to 80%
- Storage: 10% to 90%

Altitude

- Operating: 0 m (0 ft) to 3048 m (10,000 ft)
- Storage: 0 m (0 ft) to 12192 m (40,000 ft)

ACCESSORIES

Bundled Accessories

Bundled Accessories

- DP to DVI dongle
- HDMI® to DVI dongle

CERTIFICATIONS

Green Certifications^[1]

Green Certifications

- (Optional) ENERGY STAR® 8.0
- (Optional) EPEAT™ Silver Registered^[2]
- (Optional) EPEAT™ Gold Registered^[3]
- REACH
- RoHS compliant
- TCO Certified
- WEEE

Notes:

[1] The items listed under the "Green Certifications" section may not only refer to certification but also registration or self-declaration.

[2], [3] EPEAT™ is registered where applicable, please see epeat.net for registration status by country.

Other Certifications

Other Certifications

(Optional) TÜV Rheinland® Ultra Low Noise

- Feature with ** means that only one offering listed under the feature is configured on selected models.
- Feature with *** means that one or more offerings listed under the feature could be configured on selected models.
- Lenovo reserves the right to change specifications or other product information without notice. Lenovo is not responsible for photographic or typographical errors. **LENOVO PROVIDES THIS PUBLICATION "AS IS," WITHOUT WARRANTY OF ANY KIND, EITHER EXPRESS OR IMPLIED, INCLUDING THE IMPLIED WARRANTIES OF MERCHANTABILITY OR FITNESS FOR A PARTICULAR PURPOSE.** Some jurisdictions do not allow

disclaimer of express or implied warranties in certain transactions, therefore this disclaimer may not apply to you.

- The specifications on this page may not be available in all regions, and may be changed or updated without notice.



intel



OVERVIEW

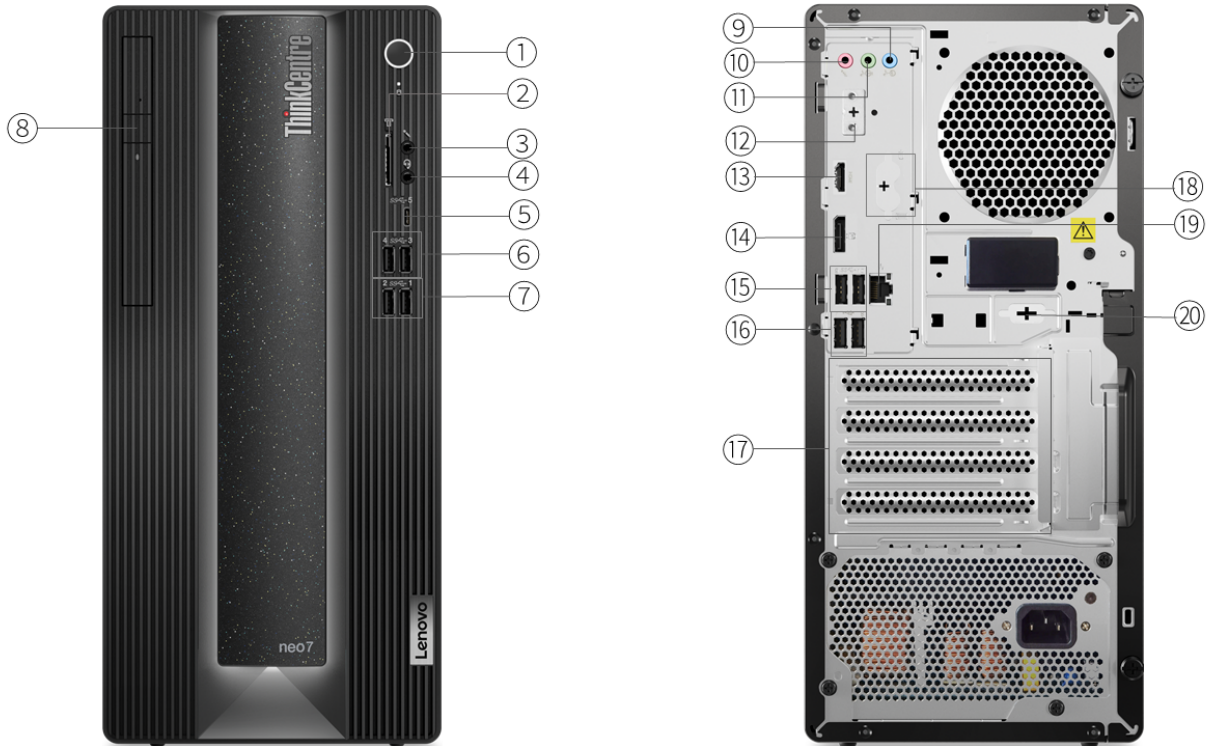

1. Power button	11. Line-out (3.5mm)
2. Card reader *	12. Flex IO *
3. Microphone (3.5mm)	13. HDMI 2.1 TMDS
4. Headphone / microphone combo jack (3.5mm)	14. DisplayPort 1.4
5. 1x USB-C 3.2 Gen 2	15. 2x USB 3.1 Gen 1
6. 2x USB 3.2 Gen 1	16. 2x USB 2.0 (one with smart power-on feature)
7. 2x USB 3.2 Gen 2	17. Expansion card *
8. Optical drive *	18. 2x PS/2 ports (keyboard / mouse) *
9. Line-in (3.5mm)	19. Ethernet (RJ-45)
10. Microphone (3.5mm)	20. Serial *

Notes:

- Items with * are only available on selected models
- Onboard video ports are only available for the models with integrated graphics

PERFORMANCE

Processor

Processor Family

12th Generation Intel® Core™ i3 / i5 / i7 / i9 Processor

Processor**

Processor Name	Cores	Threads	Base Frequency	Max Frequency	Cache	Processor Graphics
Core™ i3-12100	4 (4 P-core + 0 E-core)	8	P-core 3.3GHz	P-core 4.3GHz ^[1]	12MB	Intel® UHD Graphics 730
Core™ i5-12400	6 (6 P-core + 0 E-core)	12	P-core 2.5GHz	P-core 4.4GHz ^[2]	18MB	Intel® UHD Graphics 730
Core™ i5-12400F	6 (6 P-core + 0 E-core)	12	P-core 2.5GHz	P-core 4.4GHz ^[3]	18MB	-
Core™ i5-12500	6 (6 P-core + 0 E-core)	12	P-core 3.0GHz	P-core 4.6GHz ^[4]	18MB	Intel® UHD Graphics 770
Core™ i7-12700	12 (8 P-core + 4 E-core)	20	P-core 2.1GHz / E-core 1.6GHz	Max Turbo up to 4.9GHz / P-core 4.8GHz / E-core 3.6GHz ^[5]	25MB	Intel® UHD Graphics 770
Core™ i7-12700KF	12 (8 P-core + 4 E-core)	20	P-core 3.6GHz / E-core 2.7GHz	Max Turbo up to 5.0GHz / P-core 4.9GHz / E-core 3.8GHz ^[6]	25MB	-
Core™ i9-12900	16 (8 P-core + 8 E-core)	24	P-core 2.4GHz / E-core 1.8GHz	Max Turbo up to 5.1GHz / P-core 5.0GHz / E-core 3.8GHz ^[7]	30MB	Intel® UHD Graphics 770
Core™ i9-12900KF	16 (8 P-core + 8 E-core)	24	P-core 3.2GHz / E-core 2.4GHz	Max Turbo up to 5.2GHz / P-core 5.1GHz / E-core 3.9GHz ^[8]	30MB	-

Notes:

[1], [2], [3], [4], [5], [6], [7], [8] Intel® Max Turbo frequency will vary depending on application workload and the hardware and software configurations, see <http://www.intel.com/technology/turboboost/> for more information.

Operating System

Operating System**

- Windows® 11 Pro
- Windows® 11 DG Windows® 10 Pro 64
- No preload operating system

Graphics

Graphics***[1]

Graphics	Type	Memory	Connector	Max Resolution	Key Features
Intel® UHD graphics 730	Integrated	Shared	1x HDMI® 2.1 TMDS, 1x DP 1.4	4096x2160@60Hz(HDMI®), 4096x2304@60Hz(DP)	DirectX® 12
Intel® UHD graphics 770	Integrated	Shared	1x HDMI® 2.1 TMDS, 1x DP 1.4	4096x2304@60Hz(HDMI®), 4096x2304@60Hz(DP)	DirectX® 12
AMD Radeon™ RX 6500XT ^[2]	Discrete	4GB GDDR6	1x HDMI® 2.1, 1x DP 1.4	7680x4320@60Hz(HDMI®), 7680x4320@60Hz(DP)	DirectX® 12
NVIDIA® GeForce RTX™ 3050 ^[3]	Discrete	8GB GDDR6	1x HDMI® 2.1 FRL, 3x DP 1.4a	7680x4320@60Hz(HDMI®), 7680x4320@120Hz(DP)	DirectX® 12, OpenGL 4.6
NVIDIA® GeForce RTX™ 3060 Ti ^[4]	Discrete	8G GDDR6	1x HDMI® 2.1, 3x DP 1.4	7680x4320@60Hz(HDMI®), 7680x4320@120Hz(DP)	DirectX® 12

Notes:

[1] The information of integrated graphics are not applicable for the models with processor which has no integrated graphics inside (for the details, please refer to processor section).

[2], [4] The onboard video ports HDMI® and DisplayPort™ are disabled on the models with discrete graphics.

[3] The onboard video ports HDMI® and DisplayPort™ are disabled on the models with discrete graphics. 7680x4320@120Hz(DP) requires two DisplayPort™ 1.4a links and DSC compression.

Monitor Support

Monitor Support

Supports up to 3 independent displays via onboard ports (HDMI®, DisplayPort™, and 1x optional Flex IO), more displays support via discrete graphics

Chipset

Chipset

Intel® Q670 chipset

Memory

Max Memory^[1]

Up to 128GB DDR5

Memory Slots

Four DDR5 UDIMM slots, dual-channel capable

Memory Type^[2]

- DDR5-3600
- DDR5-4000
- DDR5-4400

Memory Protection

Non-ECC

Notes:

[1] The max memory is based on the test results with current Lenovo® memory offerings.

[2] Installed memory is actually DDR5-4800, but may run at DDR5-3600, DDR5-4000, or DDR5-4400 depending on the memory support capability of processor.

Storage

Storage Support^[1]

Up to four drives, 2x 3.5" HDD + 2x M.2 SSD

- 3.5" HDD up to 2TB each
- M.2 SSD up to 1TB each

Storage Type^{***}

Disk Type	Interface	RPM	Security
3.5" SATA HDD	SATA 6Gb/s	7.2K	-
M.2 2280 SSD	PCIe® NVMe®, PCIe® 3.0 x4	-	Opal 2.0
M.2 2280 SSD	PCIe® NVMe®, PCIe® 4.0 x4	-	Opal 2.0

RAID

RAID 0/1 support

Notes:

[1] The max capacity of each disk type is based on the test results with current Lenovo® storage offerings.

Removable Storage

Optical^{**}

- DVD-ROM, SATA 1.5Gb/s, slim (9.0mm)
- DVD burner (DVD±RW), SATA 1.5Gb/s, slim (9.0mm)
- None

Card Reader

- 3-in-1 card reader (SD, SDHC, SDXC)
- No card reader

Multi-Media

Audio Chip

High Definition (HD) Audio, Realtek® ALC623-CG codec

Speakers

- No speakers
- Single speaker, 2W x1

Power Supply

Power Supply

Power	Type	Efficiency	Key Features
750W	Fixed	92%	100-240V, autosensing

DESIGN

Input Device

Keyboard**

- Euterpe Wireless Keyboard, grey
- Lenovo® Calliope Keyboard (USB connector), black
- No keyboard

Mouse**

- Lenovo® Calliope Mouse (USB connector), black
- Euterpe Wireless Mouse, grey
- No mouse

Mechanical

Form Factor

Tower (17L)

Dimensions (WxDxH)^[1]

376 x 170 x 297.85 mm (14.8x 6.7 x 11.73 inches)

Packaging Dimensions (WxDxH)

395 x 275 x 540 mm (21.4 x 10.8 x 15.6 inches)

Weight^[2]

Around 7.5 kg (16.53 lbs)

Packaging Weight

Around 10.5 kg (23.15 lbs)

Case Color

Raven black

Bays

- 1x 3.5" disk bay (optional)
- 1x 3.5" disk bay
- 1x slim ODD bay

Expansion Slots

- One PCIe® 4.0 x16 (x4 signal)
- One PCIe® 4.0 x16, full-height, length<249mm
- One PCIe® 3.0 x1
- Three M.2 slots (one for WLAN, two for SSD)

Cooling System (Fan & Cooler)**

- (Optional) 1x front system fan, 1x rear system fan
- (Optional) 1x rear system fan
- (Optional) 1x front system fan

Notes:

[1] The system dimensions may vary depending on configurations.

[2] The system weight is approximate and based on results in Lenovo® lab, which varies depending on the source of component, variance of the distribution of each component, and manufacturing process. It may not be the exact weight for each specific model.

CONNECTIVITY

Network

Onboard Ethernet

Gigabit Ethernet, Intel® Ethernet Connection I219-V, 1x RJ-45, supports Wake-on-LAN

Optional Ethernet

- Gigabit Ethernet, Bitland BN8E88, 1x RJ-45, supports Wake-on-LAN
- No optional Ethernet

WLAN + Bluetooth®**

- Realtek® RTL8822CE, 802.11ac Dual Band 2x2 Wi-Fi® + Bluetooth® 5.0, M.2 card
- Intel® Wireless-AC 9560, 802.11ac Dual Band 2x2 Wi-Fi® + Bluetooth® 5.0, Intel® vPro® technology support, M.2 card
- Realtek® Wi-Fi® 6 RTL8852BE, 802.11ax Dual Band 2x2 Wi-Fi® + Bluetooth® 5.1, M.2 card^[1]
- Intel® Wi-Fi® 6 AX201, 802.11ax 2x2 Wi-Fi® + Bluetooth® 5.1, M.2 Card^[2]
- AMD Wi-Fi® 6E RZ616, 802.11ax 2x2 Wi-Fi® + Bluetooth® 5.1, M.2 Card^[3]
- Intel® Wi-Fi® 6E AX211, 802.11ax 2x2 Wi-Fi® + Bluetooth® 5.1, M.2 Card^[4]
- No WLAN and Bluetooth®

Notes:

[1], [2], [3], [4] Bluetooth® 5.2 is hardware ready but may run at a lower version due to OS limitations.

Ports^[1]

Front Ports

- 1x USB-C® 3.2 Gen 2
- 2x USB 3.2 Gen 1
- 2x USB 3.2 Gen 2
- 1x headphone / microphone combo jack (3.5mm)
- 1x microphone (3.5mm)

Optional Front Ports

1x card reader

Rear Ports^{[2][3]}

- 2x USB 2.0 (one with smart power-on feature)
- 2x USB 3.2 Gen 1
- 1x HDMI® 2.1 TMDS
- 1x DisplayPort™ 1.4
- 1x Ethernet (RJ-45)
- 1x line-in (3.5mm)
- 1x line-out (3.5mm)
- 1x microphone (3.5mm)

Optional Rear Ports***

- 1x USB-C® 3.2 Gen 1 (Flex IO)
- 1x HDMI® 2.1 TMDS (Flex IO)
- 1x DP 1.4 (Flex IO)
- 1x VGA (Flex IO)
- 1x USB-C® 3.2 Gen 2x2 (support data transfer, via USB-C® expansion card, PCIe® x4)
- 2x USB-C® 3.2 Gen 2 (support data transfer, via 2-port USB-C® expansion card, PCIe® x4)
- 2x USB 3.2 Gen 1 (via 2-port USB expansion card, PCIe® x1)
- 1x 1GbE RJ-45, via BN8E88
- 1x 1GbE RJ-45, via RGL8168H
- 1x 2.5GbE RJ-45, via RTL8125BGS
- 1x parallel
- 1x serial
- 4x serial (via 4-port serial expansion card, PCIe® x1)
- 2x PS/2
- None

Notes:

[1] The transfer speed of following ports will vary and, depending on many factors, such as the processing speed of the host device, file attributes and other factors related to system configuration and your operating environment, will be slower than theoretical speed.

USB 2.0: 480 Mbit/s;

USB 3.2 Gen 1 (SuperSpeed USB 5Gbps, formerly USB 3.0 / USB 3.1 Gen 1): 5 Gbit/s;

USB 3.2 Gen 2 (SuperSpeed USB 10Gbps, formerly USB 3.1 Gen 2): 10 Gbit/s;

USB4® 20Gbps / USB 3.2 Gen 2x2 (SuperSpeed USB 20Gbps): 20 Gbit/s;

USB4® 40Gbps (USB 40Gbps): 40 Gbit/s;

Thunderbolt™ 3/4: 40 Gbit/s.

[2] For video ports on discrete graphics, please see graphics section.

[3] Onboard video ports are only available for the models with integrated graphics.

SECURITY & PRIVACY

Security

Security Chip

Discrete TPM 2.0, TCG certified

Physical Locks

(Optional) Smart Cable Clip

Chassis Intrusion Switch

- Chassis intrusion switch
- No chassis intrusion switch

Fingerprint Reader

- Touch style fingerprint reader integrated in power button
- No fingerprint reader

BIOS Security

- Administrator password
- Secure Wipe
- Power-on password
- Hard disk password
- Cover presence switch
- Smart USB protection (allows keyboard / mouse only, blocks all storage devices)

MANAGEABILITY

System Management

System Management

- Intel® vPro® Essentials^[1]
- Non-vPro®

Notes:

[1] Intel® vPro® offers a superset of DASH's defined capabilities.

SERVICE

Warranty^[1]

Base Warranty**

- 1-year courier or carry-in service
- 1-year limited onsite service

Notes:

[1] The warranty upgrades may be bundled with some models, please check the "Included upgrade" column in the specific model's configurations. For more service extensions, please go to <https://smartfind.lenovo.com/>. To learn more details of warranty policy, please access <https://pcsupport.lenovo.com/warranty>.

ENVIRONMENTAL

Operating Environment

Temperature

- Operating: 10°C (50°F) to 35°C (95°F)
- Storage: -40°C (-40°F) to 60°C (140°F)

Relative Humidity

- Operating: 20% to 80%
- Storage: 20% to 90%

Altitude

- Operating: -15.2 m (-50 ft) to 3048 m (10,000 ft)
- Storage: -15.2 m (-50 ft) to 10668 m (35,000 ft)

ACCESSORIES

Bundled Accessories

Bundled Accessories

- DP to DVI dongle
- DP to VGA dongle
- DP to HDMI® dongle
- DP to Dual DP dongle
- HDMI® to HDMI® dongle
- HDMI® to VGA dongle
- Smart Cable (USB-A to USB-C®)
- None

CERTIFICATIONS

Green Certifications^[1]

Green Certifications

- (Optional) ENERGY STAR® 8.0
- (Optional) EPEAT™ Silver Registered^[2]
- ErP Lot 3
- RoHS / WEEE / REACH

Notes:

[1] The items listed under the "Green Certifications" section may not only refer to certification but also registration or self-declaration.

[2] EPEAT™ is registered where applicable, please see [epeat.net](https://www.epeat.net) for registration status by country.

Other Certifications

Other Certifications

- (Optional) TÜV Rheinland® Low Noise
- (Optional) TÜV Rheinland® Ultra Low Noise

- Feature with ** means that only one offering listed under the feature is configured on selected models.
- Feature with *** means that one or more offerings listed under the feature could be configured on selected models.
- Lenovo reserves the right to change specifications or other product information without notice. Lenovo is not responsible for photographic or typographical errors. LENOVO PROVIDES THIS PUBLICATION "AS IS," WITHOUT WARRANTY OF ANY KIND, EITHER EXPRESS OR IMPLIED, INCLUDING THE IMPLIED WARRANTIES OF MERCHANTABILITY OR FITNESS FOR A PARTICULAR PURPOSE. Some jurisdictions do not allow

disclaimer of express or implied warranties in certain transactions, therefore this disclaimer may not apply to you.

- The specifications on this page may not be available in all regions, and may be changed or updated without notice.



intel



intel



intel



intel

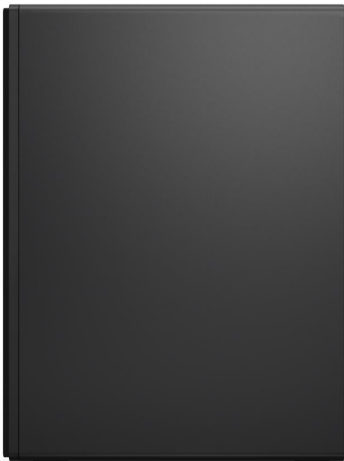

intel



intel

This publication was developed for products and services offered in the North America, E.M.E.A and Asia & Pacific countries. Lenovo may not offer the products, services or features discussed in this document in other countries. Lenovo may withdraw an offering at any time. Information is subject to change without notice. Consult your local representative for information on offerings available in your area.

Lenovo reserves the right to change specifications or other product information without notice. Lenovo is not responsible for photographic or typographical errors.

LENOVO PROVIDES THIS PUBLICATION "AS IS," WITHOUT WARRANTY OF ANY KIND, EITHER EXPRESS OR IMPLIED, INCLUDING THE IMPLIED WARRANTIES OF MERCHANTABILITY OR FITNESS FOR A PARTICULAR PURPOSE.

Some jurisdictions do not allow disclaimer of express or implied warranties in certain transactions, therefore this disclaimer may not apply to you.

Iteration Cycle: PSREF books iterate about every 3 weeks, the information in PSREF books may not be as updated as online platform specifications. If there is spec inconsistency between these two sources, please always refer to the online platform specifications.

Availability: All offers subject to availability. Lenovo reserves the right to alter product offerings and specifications at any time, without notice. Lenovo is not responsible for photographic or typographic errors.

General: Review key information provided by Microsoft that may apply to your system purchase, including details on Windows 10, Windows 8, Windows 7, and potential upgrades/downgrades. Lenovo makes no representation or warranty regarding third-party products or services.

Trademarks: Lenovo, ThinkPad, ThinkBook, ThinkCentre, ThinkStation, ThinkVision and the Lenovo logo are trademarks of Lenovo. Microsoft, Windows, Windows NT, and the Windows logo are trademarks of Microsoft Corporation. Ultrabook, Celeron, Celeron Inside, Core Inside, Intel, Intel Logo, Intel Atom, Intel Atom Inside, Intel Core, Intel Inside, Intel Inside Logo, Intel vPro, Itanium, Itanium Inside, Pentium, Pentium Inside, vPro Inside, Xeon, Xeon Phi, and Xeon Inside are trademarks of Intel Corporation in the U.S. and/or other countries. Other company, product or service names may be trademarks or service marks of others.

Warranty: For a copy of applicable warranties, write to: Lenovo Warranty Information, 1009 Think Place, Morrisville, NC, 27560. Lenovo makes no representation or warranty regarding third party products or services. The Lenovo Limited Warranty applies only to Lenovo hardware products purchased for your own use, and does not transfer upon resale.

Limited warranty: Support unrelated to a warranty issue may be subject to additional charges.

Lenovo Services:

Carry-in or Mail-in Service: Parts and labor repair coverage where the customer is responsible for shipping (including packaging) or delivery to authorized warranty provider or repair center.

Depot or Courier Service: Parts and labor repair coverage where shipping (including packaging) or delivery to the repair center is paid for by Lenovo.

Expedited Depot: Parts and labor coverage with expedited turnaround. Shipping (including packaging) or delivery to the repair center is paid for by Lenovo.

Onsite / In-home Service: Parts and labor repair coverage where labor is provided onsite at your place of business.

If Lenovo determines your product problem is covered by the product warranty and cannot be resolved over the telephone, a technician will be dispatched to arrive onsite, typically the next day.

International Warranty Service (IWS): PC repair coverage for customers who require a critical warranty repair while travelling internationally. Visit www.lenovo.com/internationalwarranty for details.

Visit www.lenovo.com/warranty for Lenovo Warranty Services terms and conditions for complete details and restrictions.

Included software: may differ from its retail version (if available), and may not include user manuals or all program functionality. Software license agreements may apply.

Battery life: Battery life (and recharge times) will vary based on many factors including screen brightness, applications, features, power management, battery conditioning, and other customer preferences.

Visit <http://psref.lenovo.com/> for the latest version of Product Specifications Reference.

© Lenovo, 2023. All rights reserved.

Lenovo 1009 Think Place Morrisville, NC 27560 U.S.A.