

**COMMONWEALTH OF KENTUCKY  
BEFORE THE PUBLIC SERVICE COMMISSION**

In the matter of:

THE APPLICATION OF EAST KENTUCKY NETWORK )  
LIMITED LIABILITY COMPANY FOR THE ISSUANCE )  
OF A CERTIFICATE OF PUBLIC CONVENIENCE AND ) CASE NO. 2020-00325  
NECESSITY TO CONSTRUCT A TOWER IN FLOYD )  
COUNTY, KENTUCKY. )

East Kentucky Network, LLC d/b/a Appalachian Wireless, was granted authorization to provide cellular service in the KY-9 Cellular Market Area (CMA451) by the Federal Communications Commission (FCC). FCC license is included as Exhibit 1. East Kentucky Network, LLC merger documents were filed with the Commission on February 2, 2001 in Case No. 2001-022. East Kentucky Network, LLC is a Kentucky Limited Liability Company that was organized on June 16, 1998. East Kentucky Network, LLC is in good standing with the state of Kentucky.

In an effort to improve service in Floyd County, pursuant to KRS 278.020 Subsection 1 and 807 KAR 5:001, East Kentucky Network, LLC is seeking the Commission's approval to construct a 300-foot self-supporting tower on a tract of land located near 316 Spurlock Fork Road, Dana, Floyd County, Kentucky (37°33'13.76"N 82°41'45.00"W). A map and detailed directions to the site can be found in Exhibit 7.

Construction of the proposed tower is required by public convenience and necessity. Due to increasing demand for telecommunications service, the proposed tower is necessary to provide adequate coverage. The proposed tower will improve service in Floyd County by providing an interconnection between East Kentucky Network, LLC's other sites thereby forming a cohesive network.

Exhibit 2 is a list of all Property owners according to the Property Valuation Administrator's record who own property within 500 feet of the proposed tower and all property owners who own property contiguous to the property upon which construction is proposed in accordance with the Property Valuation Administrator's record.

Pursuant to 807 KAR 5:063 Section 1(1)(l), Section 1(1)(m), and Section 2, all affected property owners according to the Property Valuation Administrator's record who own property within 500 feet of the proposed Tower or contiguous to the property upon which construction is proposed were notified by certified mail return receipt requested of East Kentucky Network, LLC's proposed construction and informed of their right to intervene. They were given the docket number under which this application is filed. Enclosed in Exhibit 2 is a copy of that notification.

Floyd County has no formal local planning unit. In absence of this unit, the Floyd County Judge Executive's office was notified by certified mail, return receipt requested of East Kentucky Network, LLC's proposal and informed of their right to intervene. The Floyd County Judge Executive's Office was also given the docket number under which this application is filed. Enclosed in Exhibit 3 is a copy of that notification.

Notice of the location of the proposed construction was published in the The Floyd County Chronicle & Times, October 7, 2020, edition. Enclosed in Exhibit 3 is a copy of that notice. The Floyd County Chronicle & Times is the newspaper with the largest circulation in Floyd County.

A geologist was employed to determine soil and rock types and to ascertain the distance to solid bedrock. The geotechnical report is enclosed as Exhibit 4.

A copy of the tower design information is enclosed as Exhibit 5. The proposed tower has been designed by engineers at Allstate Tower, Inc. and will be constructed under their



supervision. Their qualifications are evidenced in Exhibit 5 by the seal and signature of the registered professional engineer responsible for this project.

The tower will be erected by S & S Tower Services of St. Albans, West Virginia. S & S Tower Services has vast experience in the erection of communications towers. Their qualifications are described in Exhibit 13.

FAA and Kentucky Airport Zoning Commission approvals are included as Exhibit 6.

No Federal Communications Commission approval is required prior to construction of this facility. Once service is established from this tower we must immediately notify the Federal Communications Commission of its operation. Prior approval is needed only if the proposed facility increases the size of the cellular geographic service area. This cell site will not expand the cellular geographic service area.

Two notice signs meeting the requirements prescribed by 807 KAR 5:063, Section 1(2), measuring at least two (2) feet in height and four (4) feet in width and containing all required language in letters of required height, have been posted, one at a visible location on the proposed site and one on the nearest public road. The two signs were posted on October 4, 2020 and will remain posted for at least two weeks after filing of this application as specified.

Enclosed in Exhibit 8 is a copy of East Kentucky Network, LLC's Memorandum of Lease Agreement for the site location along with a lot description.

The proposed construction site is on a very rugged mountaintop some feet from the nearest structure. Prior to construction, the site was wooded.

East Kentucky Network, LLC's operation will not affect the use of nearby land nor its value. No more suitable site exists in the area. A copy of the search area map is enclosed in Exhibit 7. No other tower capable of supporting East Kentucky Network, LLC's load exists in

the general area; therefore, there is no opportunity for co-location of our facilities with anyone else.

Enclosed, and filed as Exhibit 9 is a survey of the proposed tower site signed by a Kentucky registered professional engineer.

Exhibit 10 is a map in one (1) inch equals 200 feet scale identifying every structure and every owner of real estate within 500 feet of the proposed tower and all property owners who own contiguous property to the property upon which construction is proposed.

Exhibit 11 contains a vertical sketch of the tower supplied by James W. Caudill, Kentucky registered professional engineer.

Enclosed as Exhibit 12 is a list of utilities, corporations, or persons with whom the tower is likely to compete.

**[THE REMAINDER OF THIS PAGE INTENTIONALLY LEFT BLANK.]**

**WHEREFORE**, Applicant, having met the requirements of KRS 278.020(1), 278.650, 278.665, and all applicable rules and regulations of the PSC, respectfully requests that the PSC accept the foregoing Application for filing and grant a Certificate of Public Convenience and Necessity to construct and operate the proposed tower.

The foregoing document was prepared by Cindy McCarty, attorney for East Kentucky Network, LLC d/b/a Appalachian Wireless. All related questions or correspondence concerning this filing should be mailed to East Kentucky Network, LLC d/b/a/ Appalachian Wireless, 101 Technology Trail, Ivel, KY 41642.

SUBMITTED BY: Lynn Haney DATE: 10/7/2020  
Lynn Haney, Regulatory Compliance Director

APPROVED BY: W.A. Gillum DATE: 10/7/2020  
W.A. Gillum, General Manager

ATTORNEY: Cindy McCarty DATE: 10/7/2020  
Hon. Krystal Branham, Attorney  
Hon. Cindy McCarty, Attorney

**CONTACT INFORMATION:**

**W.A. Gillum, General Manager**  
Phone: (606) 477-2355, Ext. 111  
Email: wagillum@ekn.com

**Krystal Branham, Attorney**  
Phone: (606) 477-2355, Ext. 1009  
Email: kbranham@ekn.com

**Lynn Haney, Regulatory Compliance Director**  
Phone: (606) 477-2355, Ext. 1007  
Email: lhaney@ekn.com

**Cindy McCarty, Attorney**  
Phone: (606) 477-2355, Ext. 1006  
Email: cmccarty@ekn.com

**Mailing Address:**

**East Kentucky Network, LLC  
d/b/a Appalachian Wireless  
101 Technology Trail  
Ivel, KY 41642**

1	FCC License
2	Copies of Cell Site Notice to Land Owners
3	Notifications of County Judge Executive and Newspaper
4	Universal Soil Bearing Analysis
5	Tower Design
6	FAA and KAZC Determination
7	Driving Directions from County Court House and Map to SUItable Scale
8	Memorandum of Lease for Proposed Site with Legal Description
9	Survey of Site Signed/Sealed by Professional Engineer Registered in State of Kentucky
10	Site Survey Map with Property Owners Identified in Accordance with PVA of County
11	Vertical Profile Sketch of Proposed Tower
12	List of Competitors
13	Qualifications
14	
15	

# Exhibit 1

ULS License

## Cellular License - KNKN880 - East Kentucky Network, LLC d/b/a Appalachian Wireless

Call Sign	KNKN880	Radio Service	CL - Cellular
Status	Active	Auth Type	Regular

**Market**

Market	CMA451 - Kentucky 9 - Elliott	Channel Block	B
Submarket	0	Phase	2

**Dates**

Grant	08/30/2011	Expiration	10/01/2021
Effective	09/04/2014	Cancellation	

**Five Year Buildout Date**

10/23/1996

**Control Points**

**1** U.S. 23, HAROLD, KY

**Licensee**

FRN	0001786607	Type	Limited Liability Company
-----	------------	------	---------------------------

**Licensee**

East Kentucky Network, LLC d/b/a Appalachian Wireless  
 101 Technology Trail  
 Ivel, KY 41642  
 ATTN W.A. Gillum, General Manager / CEO  
 P:(606)477-2355

**Contact**

Lukas, Nace, Gutierrez & Sachs, LLP	P:(703)584-8665
Pamela L Gist Esq	F:(703)584-8696
8300 Greensboro Drive	E:pgist@fcclaw.com
McLean, VA 22102	

**Ownership and Qualifications**

Radio Service Type	Mobile
Regulatory Status	Common Carrier Interconnected Yes

**Alien Ownership**

The Applicant answered "No" to each of the Alien Ownership questions.

**Basic Qualifications**

The Applicant answered "No" to each of the Basic Qualification questions.



**Demographics**

Race

Ethnicity

Gender





# Exhibit 2

## **EXHIBIT 2 - LIST OF PROPERTY OWNERS**

### **Statement Pursuant to Section 1 (1) (I) 807 KAR 5:063**

**Section 1 (1)(I) 1.** The following is a list of every property owner who according to property valuation administrator's records, owns property within 500 feet of the proposed tower and each have been: notified by certified mail, return receipt requested, of the proposed construction,

**Section 1 (1)(I) 2.** Every person listed below who, according to the property valuation administrator's records, owns property within 500 feet of the proposed tower has been: Given the Commission docket number under which the application will be processed: and

**Section 1 (1)(I) 3.** Every person listed below who, according to property valuation administrator's records owns property within 500 feet of the proposed tower has been: Informed of his right to request intervention.

**Section 2.** If the construction is proposed for an area outside the incorporated boundaries of a city, the application shall state that public notices required by Section 1(1)(L) have been sent to every person who, according to the property valuation administrator, owns property contiguous to the property upon which the construction is proposed

#### LIST OF PROPERTY OWNERS

Lee Akers Estate  
C/O Pauline Akers  
3623 KY RT 1426  
Dana, KY 41615

Sabrina Michele Lequire  
P.O. Box 4088  
Pikeville, KY 41502

Don and Lucille Wallen  
21 Spurlock Fork  
Dana, KY 41615

Teddy and Lorene Cordial  
3834 KY RT 1426  
Banner, KY 41603

Arlie and Emogene Boyd Estate  
C/O Carol Dillion and Arlene Mitchell  
30 Tom Dillion Drive  
Banner, KY 41603

Adam and Heather Akers  
316 Spurlock Fork  
Dana, KY 41615

William G. and Magalene Conn  
3928 KY RT 1426  
Dana, KY 41615

Donnie and Monica Akers  
316 Spurlock Fork  
Dana, KY 41615

John E. and Cathryn J. Rehmeyer  
739 Akers Branch  
Banner, KY 41605

Ellis and Lasher Akers  
244 Spurlock Fork  
Dana, KY 41615

Conn Cemetery

Adam and Heather Akers  
220 Spurlock Fork Road  
Dana, KY 41615



VIA: U.S. CERTIFIED MAIL

PUBLIC NOTICE

October 7, 2020

Lee Akers Estate  
C/O Pauline Akers  
3623 KY RT 1426  
Dana, KY 41615

RE: Public Notice-Public Service Commission of Kentucky (Case No. 2020-00325)

East Kentucky Network, LLC d/b/a Appalachian Wireless has applied to the Public Service Commission of Kentucky for a Certificate of Public Convenience and Necessity to construct and operate a new facility to provide cellular telecommunications service in Floyd County. The facility will include a 300-foot self-supporting tower with attached antennas extending upwards, and an equipment shelter located on a tract of land near 316 Spurlock Fork, Floyd County, Dana. A map showing the location of the proposed new facility is enclosed. This notice is being sent to you because you may own property within a 500' radius of the proposed tower or own property contiguous to the property upon which construction is proposed.

The Commission invites your comments regarding the proposed construction. You also have the right to intervene in this matter. The Commission must receive your initial communication within 20 days of the date of this letter as shown above.

Your comments and request for intervention should be addressed to: Executive Director's Office, Public Service Commission of Kentucky, P.O. Box 615, Frankfort, KY 40602. Please refer to Case No. 2020-00325 in your correspondence.

If you have any questions for East Kentucky Network, LLC, please direct them to my attention at the following address: East Kentucky Network, LLC, 101 Technology Trail, Ivel, KY 41642 or call me at 606-477-2355, Ext. 1007.

Sincerely,

A handwritten signature in blue ink that reads "Lynn Haney".

Lynn Haney, CPA  
Regulatory Compliance Director  
Enclosure 1



VIA: U.S. CERTIFIED MAIL

PUBLIC NOTICE

October 7, 2020

Sabrina Michele Lequire  
P.O. Box 4088  
Pikeville, KY 41502

RE: Public Notice-Public Service Commission of Kentucky (Case No. 2020-00325)

East Kentucky Network, LLC d/b/a Appalachian Wireless has applied to the Public Service Commission of Kentucky for a Certificate of Public Convenience and Necessity to construct and operate a new facility to provide cellular telecommunications service in Floyd County. The facility will include a 300-foot self-supporting tower with attached antennas extending upwards, and an equipment shelter located on a tract of land near 316 Spurlock Fork, Floyd County, Dana. A map showing the location of the proposed new facility is enclosed. This notice is being sent to you because you may own property within a 500' radius of the proposed tower or own property contiguous to the property upon which construction is proposed.

The Commission invites your comments regarding the proposed construction. You also have the right to intervene in this matter. The Commission must receive your initial communication within 20 days of the date of this letter as shown above.

Your comments and request for intervention should be addressed to: Executive Director's Office, Public Service Commission of Kentucky, P.O. Box 615, Frankfort, KY 40602. Please refer to Case No. 2020-00325 in your correspondence.

If you have any questions for East Kentucky Network, LLC, please direct them to my attention at the following address: East Kentucky Network, LLC, 101 Technology Trail, Ivel, KY 41642 or call me at 606-477-2355, Ext. 1007.

Sincerely,

A handwritten signature in blue ink that reads "Lynn Haney".

Lynn Haney, CPA  
Regulatory Compliance Director  
Enclosure 1





VIA: U.S. CERTIFIED MAIL

PUBLIC NOTICE

October 7, 2020

Don and Lucille Wallen  
21 Spurlock Fork  
Dana, KY 41615

RE: Public Notice-Public Service Commission of Kentucky (Case No. 2020-00325)

East Kentucky Network, LLC d/b/a Appalachian Wireless has applied to the Public Service Commission of Kentucky for a Certificate of Public Convenience and Necessity to construct and operate a new facility to provide cellular telecommunications service in Floyd County. The facility will include a 300-foot self-supporting tower with attached antennas extending upwards, and an equipment shelter located on a tract of land near 316 Spurlock Fork, Floyd County, Dana. A map showing the location of the proposed new facility is enclosed. This notice is being sent to you because you may own property within a 500' radius of the proposed tower or own property contiguous to the property upon which construction is proposed.

The Commission invites your comments regarding the proposed construction. You also have the right to intervene in this matter. The Commission must receive your initial communication within 20 days of the date of this letter as shown above.

Your comments and request for intervention should be addressed to: Executive Director's Office, Public Service Commission of Kentucky, P.O. Box 615, Frankfort, KY 40602. Please refer to Case No. 2020-00325 in your correspondence.

If you have any questions for East Kentucky Network, LLC, please direct them to my attention at the following address: East Kentucky Network, LLC, 101 Technology Trail, Ivel, KY 41642 or call me at 606-477-2355, Ext. 1007.

Sincerely,

A handwritten signature in blue ink that reads "Lynn Haney".

Lynn Haney, CPA  
Regulatory Compliance Director  
Enclosure 1

VIA: U.S. CERTIFIED MAIL

PUBLIC NOTICE

October 7, 2020

Teddy and Lorene Cordial  
3834 KY RT 1426  
Banner, KY 41603

RE: Public Notice-Public Service Commission of Kentucky (Case No. 2020-00325)

East Kentucky Network, LLC d/b/a Appalachian Wireless has applied to the Public Service Commission of Kentucky for a Certificate of Public Convenience and Necessity to construct and operate a new facility to provide cellular telecommunications service in Floyd County. The facility will include a 300-foot self-supporting tower with attached antennas extending upwards, and an equipment shelter located on a tract of land near 316 Spurlock Fork, Floyd County, Dana. A map showing the location of the proposed new facility is enclosed. This notice is being sent to you because you may own property within a 500' radius of the proposed tower or own property contiguous to the property upon which construction is proposed.

The Commission invites your comments regarding the proposed construction. You also have the right to intervene in this matter. The Commission must receive your initial communication within 20 days of the date of this letter as shown above.

Your comments and request for intervention should be addressed to: Executive Director's Office, Public Service Commission of Kentucky, P.O. Box 615, Frankfort, KY 40602. Please refer to Case No. 2020-00325 in your correspondence.

If you have any questions for East Kentucky Network, LLC, please direct them to my attention at the following address: East Kentucky Network, LLC, 101 Technology Trail, Ivel, KY 41642 or call me at 606-477-2355, Ext. 1007.

Sincerely,



Lynn Haney, CPA  
Regulatory Compliance Director  
Enclosure 1





VIA: U.S. CERTIFIED MAIL

PUBLIC NOTICE

October 7, 2020

Arlie and Emogene Boyd Estate  
C/O Carol Dillion and Arlene Mitchell  
30 Tom Dillion Drive  
Banner, KY 41603

RE: Public Notice-Public Service Commission of Kentucky (Case No. 2020-00325)

East Kentucky Network, LLC d/b/a Appalachian Wireless has applied to the Public Service Commission of Kentucky for a Certificate of Public Convenience and Necessity to construct and operate a new facility to provide cellular telecommunications service in Floyd County. The facility will include a 300-foot self-supporting tower with attached antennas extending upwards, and an equipment shelter located on a tract of land near 316 Spurlock Fork, Floyd County, Dana. A map showing the location of the proposed new facility is enclosed. This notice is being sent to you because you may own property within a 500' radius of the proposed tower or own property contiguous to the property upon which construction is proposed.

The Commission invites your comments regarding the proposed construction. You also have the right to intervene in this matter. The Commission must receive your initial communication within 20 days of the date of this letter as shown above.

Your comments and request for intervention should be addressed to: Executive Director's Office, Public Service Commission of Kentucky, P.O. Box 615, Frankfort, KY 40602. Please refer to Case No. 2020-00325 in your correspondence.

If you have any questions for East Kentucky Network, LLC, please direct them to my attention at the following address: East Kentucky Network, LLC, 101 Technology Trail, Ivel, KY 41642 or call me at 606-477-2355, Ext. 1007.

Sincerely,

Lynn Haney, CPA  
Regulatory Compliance Director  
Enclosure 1



VIA: U.S. CERTIFIED MAIL

PUBLIC NOTICE

October 7, 2020

Adam and Heather Akers  
316 Spurlock Fork  
Dana, KY 41615

RE: Public Notice-Public Service Commission of Kentucky (Case No. 2020-00325)

East Kentucky Network, LLC d/b/a Appalachian Wireless has applied to the Public Service Commission of Kentucky for a Certificate of Public Convenience and Necessity to construct and operate a new facility to provide cellular telecommunications service in Floyd County. The facility will include a 300-foot self-supporting tower with attached antennas extending upwards, and an equipment shelter located on a tract of land near 316 Spurlock Fork, Floyd County, Dana. A map showing the location of the proposed new facility is enclosed. This notice is being sent to you because you may own property within a 500' radius of the proposed tower or own property contiguous to the property upon which construction is proposed.

The Commission invites your comments regarding the proposed construction. You also have the right to intervene in this matter. The Commission must receive your initial communication within 20 days of the date of this letter as shown above.

Your comments and request for intervention should be addressed to: Executive Director's Office, Public Service Commission of Kentucky, P.O. Box 615, Frankfort, KY 40602. Please refer to Case No. 2020-00325 in your correspondence.

If you have any questions for East Kentucky Network, LLC, please direct them to my attention at the following address: East Kentucky Network, LLC, 101 Technology Trail, Ivel, KY 41642 or call me at 606-477-2355, Ext. 1007.

Sincerely,



Lynn Haney, CPA  
Regulatory Compliance Director  
Enclosure 1



VIA: U.S. CERTIFIED MAIL

PUBLIC NOTICE

October 7, 2020

William G. and Magalene Conn  
3928 KY RT 1426  
Dana, KY 41615

RE: Public Notice-Public Service Commission of Kentucky (Case No. 2020-00325)

East Kentucky Network, LLC d/b/a Appalachian Wireless has applied to the Public Service Commission of Kentucky for a Certificate of Public Convenience and Necessity to construct and operate a new facility to provide cellular telecommunications service in Floyd County. The facility will include a 300-foot self-supporting tower with attached antennas extending upwards, and an equipment shelter located on a tract of land near 316 Spurlock Fork, Floyd County, Dana. A map showing the location of the proposed new facility is enclosed. This notice is being sent to you because you may own property within a 500' radius of the proposed tower or own property contiguous to the property upon which construction is proposed.

The Commission invites your comments regarding the proposed construction. You also have the right to intervene in this matter. The Commission must receive your initial communication within 20 days of the date of this letter as shown above.

Your comments and request for intervention should be addressed to: Executive Director's Office, Public Service Commission of Kentucky, P.O. Box 615, Frankfort, KY 40602. Please refer to Case No. 2020-00325 in your correspondence.

If you have any questions for East Kentucky Network, LLC, please direct them to my attention at the following address: East Kentucky Network, LLC, 101 Technology Trail, Ivel, KY 41642 or call me at 606-477-2355, Ext. 1007.

Sincerely,

A handwritten signature in blue ink that reads "Lynn Haney".

Lynn Haney, CPA  
Regulatory Compliance Director  
Enclosure 1





VIA: U.S. CERTIFIED MAIL

PUBLIC NOTICE

October 7, 2020

Donnie and Monica Akers  
316 Spurlock Fork  
Dana, KY 41615

RE: Public Notice-Public Service Commission of Kentucky (Case No. 2020-00325)

East Kentucky Network, LLC d/b/a Appalachian Wireless has applied to the Public Service Commission of Kentucky for a Certificate of Public Convenience and Necessity to construct and operate a new facility to provide cellular telecommunications service in Floyd County. The facility will include a 300-foot self-supporting tower with attached antennas extending upwards, and an equipment shelter located on a tract of land near 316 Spurlock Fork, Floyd County, Dana. A map showing the location of the proposed new facility is enclosed. This notice is being sent to you because you may own property within a 500' radius of the proposed tower or own property contiguous to the property upon which construction is proposed.

The Commission invites your comments regarding the proposed construction. You also have the right to intervene in this matter. The Commission must receive your initial communication within 20 days of the date of this letter as shown above.

Your comments and request for intervention should be addressed to: Executive Director's Office, Public Service Commission of Kentucky, P.O. Box 615, Frankfort, KY 40602. Please refer to Case No. 2020-00325 in your correspondence.

If you have any questions for East Kentucky Network, LLC, please direct them to my attention at the following address: East Kentucky Network, LLC, 101 Technology Trail, Ivel, KY 41642 or call me at 606-477-2355, Ext. 1007.

Sincerely,

Lynn Haney, CPA  
Regulatory Compliance Director  
Enclosure 1

VIA: U.S. CERTIFIED MAIL

PUBLIC NOTICE

October 7, 2020

John E. and Cathryn J. Rehmeier  
739 Akers Branch  
Banner, KY 41605

RE: Public Notice-Public Service Commission of Kentucky (Case No. 2020-00325)

East Kentucky Network, LLC d/b/a Appalachian Wireless has applied to the Public Service Commission of Kentucky for a Certificate of Public Convenience and Necessity to construct and operate a new facility to provide cellular telecommunications service in Floyd County. The facility will include a 300-foot self-supporting tower with attached antennas extending upwards, and an equipment shelter located on a tract of land near 316 Spurlock Fork, Floyd County, Dana. A map showing the location of the proposed new facility is enclosed. This notice is being sent to you because you may own property within a 500' radius of the proposed tower or own property contiguous to the property upon which construction is proposed.

The Commission invites your comments regarding the proposed construction. You also have the right to intervene in this matter. The Commission must receive your initial communication within 20 days of the date of this letter as shown above.

Your comments and request for intervention should be addressed to: Executive Director's Office, Public Service Commission of Kentucky, P.O. Box 615, Frankfort, KY 40602. Please refer to Case No. 2020-00325 in your correspondence.

If you have any questions for East Kentucky Network, LLC, please direct them to my attention at the following address: East Kentucky Network, LLC, 101 Technology Trail, Ivel, KY 41642 or call me at 606-477-2355, Ext. 1007.

Sincerely,



Lynn Haney, CPA  
Regulatory Compliance Director  
Enclosure 1





VIA: U.S. CERTIFIED MAIL

PUBLIC NOTICE

October 7, 2020

Ellis and Lasheri Akers  
244 Spurlock Fork  
Dana, KY 41615

RE: Public Notice-Public Service Commission of Kentucky (Case No. 2020-00325)

East Kentucky Network, LLC d/b/a Appalachian Wireless has applied to the Public Service Commission of Kentucky for a Certificate of Public Convenience and Necessity to construct and operate a new facility to provide cellular telecommunications service in Floyd County. The facility will include a 300-foot self-supporting tower with attached antennas extending upwards, and an equipment shelter located on a tract of land near 316 Spurlock Fork, Floyd County, Dana. A map showing the location of the proposed new facility is enclosed. This notice is being sent to you because you may own property within a 500' radius of the proposed tower or own property contiguous to the property upon which construction is proposed.

The Commission invites your comments regarding the proposed construction. You also have the right to intervene in this matter. The Commission must receive your initial communication within 20 days of the date of this letter as shown above.

Your comments and request for intervention should be addressed to: Executive Director's Office, Public Service Commission of Kentucky, P.O. Box 615, Frankfort, KY 40602. Please refer to Case No. 2020-00325 in your correspondence.

If you have any questions for East Kentucky Network, LLC, please direct them to my attention at the following address: East Kentucky Network, LLC, 101 Technology Trail, Ivel, KY 41642 or call me at 606-477-2355, Ext. 1007.

Sincerely,

A handwritten signature in blue ink that reads "Lynn Haney".

Lynn Haney, CPA  
Regulatory Compliance Director  
Enclosure 1

VIA: U.S. CERTIFIED MAIL

PUBLIC NOTICE

October 7, 2020

Conn Cemetery

RE: Public Notice-Public Service Commission of Kentucky (Case No. 2020-00325)

East Kentucky Network, LLC d/b/a Appalachian Wireless has applied to the Public Service Commission of Kentucky for a Certificate of Public Convenience and Necessity to construct and operate a new facility to provide cellular telecommunications service in Floyd County. The facility will include a 300-foot self-supporting tower with attached antennas extending upwards, and an equipment shelter located on a tract of land near 316 Spurlock Fork, Floyd County, Dana. A map showing the location of the proposed new facility is enclosed. This notice is being sent to you because you may own property within a 500' radius of the proposed tower or own property contiguous to the property upon which construction is proposed.

The Commission invites your comments regarding the proposed construction. You also have the right to intervene in this matter. The Commission must receive your initial communication within 20 days of the date of this letter as shown above.

Your comments and request for intervention should be addressed to: Executive Director's Office, Public Service Commission of Kentucky, P.O. Box 615, Frankfort, KY 40602. Please refer to Case No. 2020-00325 in your correspondence.

If you have any questions for East Kentucky Network, LLC, please direct them to my attention at the following address: East Kentucky Network, LLC, 101 Technology Trail, Ivel, KY 41642 or call me at 606-477-2355, Ext. 1007.

Sincerely,



Lynn Haney, CPA  
Regulatory Compliance Director  
Enclosure 1





VIA: U.S. CERTIFIED MAIL

PUBLIC NOTICE

October 7, 2020

Adam and Heather Akers  
220 Spurlock Fork Road  
Dana, KY 41615

RE: Public Notice-Public Service Commission of Kentucky (Case No. 2020-00325)

East Kentucky Network, LLC d/b/a Appalachian Wireless has applied to the Public Service Commission of Kentucky for a Certificate of Public Convenience and Necessity to construct and operate a new facility to provide cellular telecommunications service in Floyd County. The facility will include a 300-foot self-supporting tower with attached antennas extending upwards, and an equipment shelter located on a tract of land near 316 Spurlock Fork, Floyd County, Dana. A map showing the location of the proposed new facility is enclosed. This notice is being sent to you because you may own property within a 500' radius of the proposed tower or own property contiguous to the property upon which construction is proposed.

The Commission invites your comments regarding the proposed construction. You also have the right to intervene in this matter. The Commission must receive your initial communication within 20 days of the date of this letter as shown above.

Your comments and request for intervention should be addressed to: Executive Director's Office, Public Service Commission of Kentucky, P.O. Box 615, Frankfort, KY 40602. Please refer to Case No. 2020-00325 in your correspondence.

If you have any questions for East Kentucky Network, LLC, please direct them to my attention at the following address: East Kentucky Network, LLC, 101 Technology Trail, Ivel, KY 41642 or call me at 606-477-2355, Ext. 1007.

Sincerely,

A handwritten signature in blue ink that reads "Lynn Haney".

Lynn Haney, CPA  
Regulatory Compliance Director  
Enclosure 1



# Dana

Location:

316 Spurlock Fork  
Dana, KY 41615

Coordinates:

37 33' 13.76"N  
82 41' 45.00"W

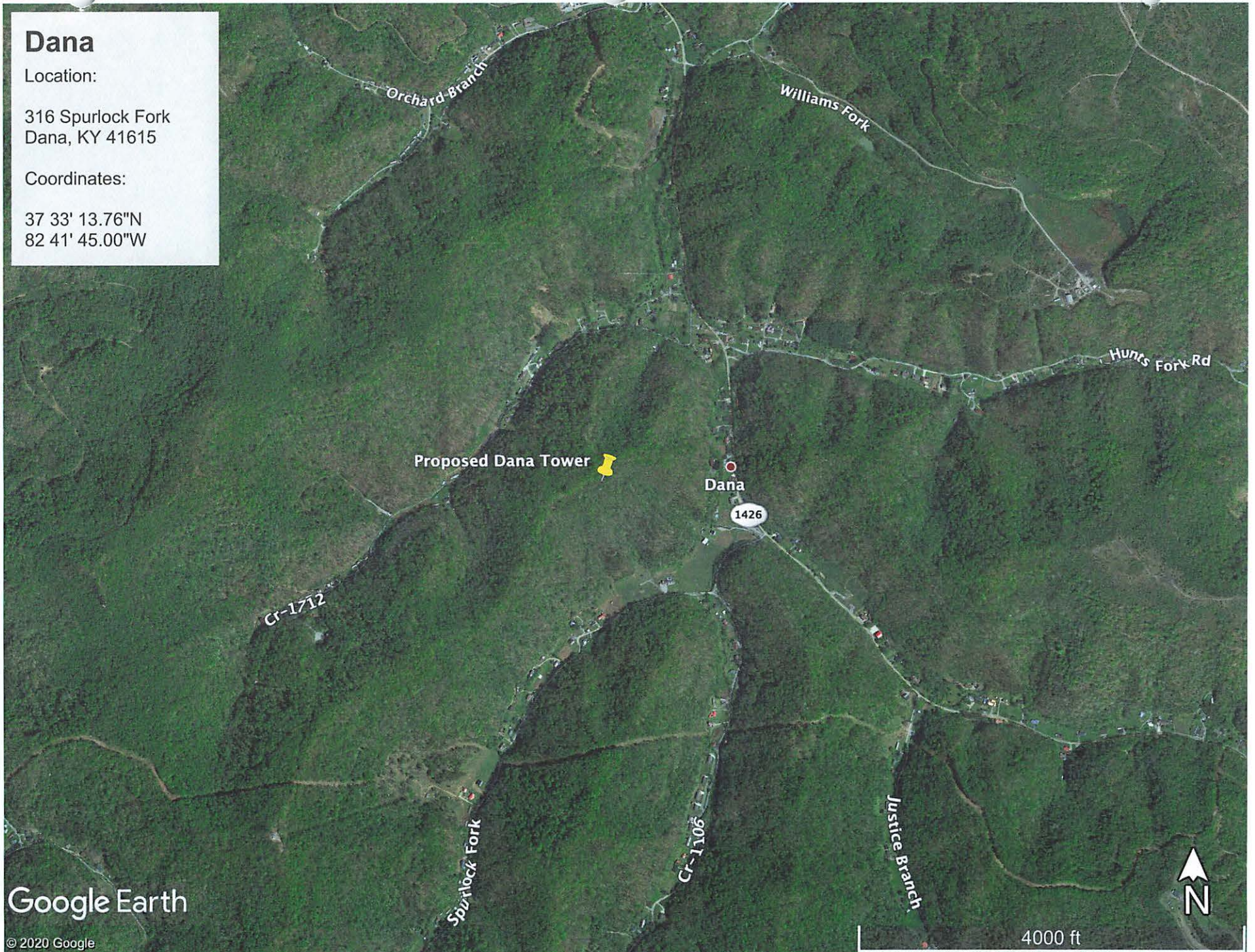

Google Earth

© 2020 Google

4000 ft



**Exhibit 3**

dba Appalachian Wireless  
101 Technology Trail  
Ivel, KY 41642  
Phone: 606-477-2355  
Fax: 606-791-2225

EAST KENTUCKY  
NETWORK



**To:** The Floyd County Chronicle and Times    **From:** Raina Helton  
Attn: Classifieds    Regulatory Compliance Assistant

---

**Email:** classads@news-expressky.com    **Date:** October 5, 2020

---

**Re:** PUBLIC NOTICE ADVERTISEMENT    **Pages:** 1

---

**Please place the following Public Notice Advertisement in The Floyd County Chronicle Times to be ran on October 7, 2020.**

PUBLIC NOTICE:

RE: Public Service Commission of Kentucky (CASE NO. 2020-00325)

Public Notice is hereby given that East Kentucky Network, LLC, dba Appalachian Wireless has applied to the Kentucky Public Service Commission to construct a cellular telecommunications tower on a tract of land located near 316 Spurlock Fork, Dana, Floyd County, Kentucky. The proposed tower will be a 300 foot self-supporting tower with attached antennas. If you would like to respond to this notice, please contact the Executive Director, Public Service Commission, 211 Sower Boulevard, PO Box 615, Frankfort, Kentucky 40602. Please refer to Case No. 2020-00325.

If you have any questions about the placement of the above mentioned notice, please call me at 606-477-2375, ext. 1005.

Thank you,

Raina Helton  
Regulatory Compliance Assistant

The message above and the information contained in the documents transmitted are confidential and intended only for the person(s) named above. Dissemination, distribution or copying of this communication by anyone other than the person(s) named above is prohibited. If you have received this communication in error, please notify us immediately by telephone and return the original message to us at the address listed above via regular mail. Thank you.

VIA: U.S. CERTIFIED MAIL

October 8, 2020

Robert Williams, Judge Executive  
149 S Central Ave.  
Prestonsburg, KY 41653

RE: Public Notice-Public Service Commission of Kentucky (Case No. 2020-00325)

East Kentucky Network, LLC d/b/a Appalachian Wireless has applied to the Public Service Commission of Kentucky for a Certificate of Public Convenience and Necessity to construct and operate a new facility to provide cellular telecommunications service in Floyd County. The facility will include a 300-foot self-supporting tower with attached antennas extending upwards, and an equipment shelter located on a tract of land near 316 Spurlock Fork, Dana, Floyd County, Kentucky. A map showing the location of the proposed new facility is enclosed. This notice is being sent to you because you are the County Judge Executive of Floyd County.

The Commission invites your comments regarding the proposed construction. You also have the right to intervene in this matter. The Commission must receive your initial communication within 20 days of the date of this letter as shown above.

Your comments and request for intervention should be addressed to: Executive Director's Office, Public Service Commission of Kentucky, P.O. Box 615, Frankfort, KY 40602. Please refer to Case No. 2020-00325 in your correspondence.

If you have any questions for East Kentucky Network, LLC, please direct them to my attention at the following address: East Kentucky Network, LLC, 101 Technology Trail, Ivel, KY 41642 or call me at 606-477-2355, Ext. 1007.

Sincerely,



Lynn Haney  
Regulatory Compliance Director  
Enclosure



# Dana

Location:

316 Spurlock Fork  
Dana, KY 41615

Coordinates:

37 33' 13.76"N  
82 41' 45.00"W



Proposed Dana Tower

Dana

1426

CR-1712

Spurlock Fork

CR-1106

Justice Branch

Hunts Fork Rd

Orchard Branch

Williams Fork

Google Earth

© 2020 Google



4000 ft



# Exhibit 4



230 Swartz Drive • Hazard • Kentucky • 41701  
Phone (606) 551-1050

---

**EAST KENTUCKY ENGINEERING, LLC.**

**APPALACHIAN WIRELESS  
Geotechnical Investigation on the  
Dana Tower Site  
Floyd County, Kentucky  
EKYENG Project No. 165-000-0112**

PREPARED FOR:

Appalachian Wireless.  
101 Technology Trail  
Ivel, Kentucky 41642

PREPARED BY:

Richard Dirk Smith PE, PLS  
President  
**East Kentucky Engineering**  
230 Swartz Drive  
Hazard, Kentucky 41701



\_\_\_\_\_, 20215, August 14<sup>th</sup>, 2020



# EAST KENTUCKY ENGINEERING, LLC.

---

## **EXECUTIVE SUMMARY**

### **1.0 INTRODUCTION**

### **2.0 PROJECT DESCRIPTION**

### **3.0 SITE DESCRIPTION & HISTORICAL MINING**

3.1 GENERAL INFORMATION

3.2 SURFACE MINING

3.3 UNDERGROUND MINING

3.4 FLOOD HAZARD

### **4.0 FIELD EXPLORATION**

4.1 SITE INFORMATION

4.2 TRENCHING

4.3 GROUNDWATER

4.4 SEISMIC SITE CLASSIFICATION

### **5.0 DISCUSSION AND RECOMMENDATIONS**

5.1 GENERAL

5.2 SHALLOW MAT FOUNDATIONS RECOMMENDATIONS

5.3 BURIED UTILITIES

### **6.0 WARRANTY**

6.1 SUBSURFACE EXPLORATION

6.2 LABORATORY AND FIELD TEST

6.3 ANALYSIS AND RECOMMENDATIONS

6.4 CONSTRUCTION MONITORING

6.5 GENERAL

## **SPECIFICATIONS**

**I – GENERAL**

**II – ENGINEERED FILL BENEATH STRUCTURES CLEARING AND GRADING SPECIFICATIONS**

**III – GUIDELINES FOR EXCAVATIONS AND TRENCHING**

**IV – GENERAL CONCRETE SPECIFICATIONS**

**APPENDIX A – PHOTOGRAPHS**

**APPENDIX B – BORING LOGS**

**APPENDIX C – SEISMIC DATA**

**APPENDIX D – MAPS**



## EAST KENTUCKY ENGINEERING, LLC.

### EXECUTIVE SUMMARY

A geotechnical investigation has been performed on the Dana Tower Site, located in Floyd County, Kentucky. This site is not readily accessible. A location map is shown in Figure 1 of this report. Field inspections were completed by trenching with an excavator. Access to this site with drilling equipment is limited. The following geotechnical considerations were identified:

- Trenching utilized for this study encountered soils, shale, and sandstone.
- Elevations were taken from aerial DEM mapping available at ArcGIS Kentucky Elevation Data, and Static GPS Surveying.
- The maximum estimated base elevation of the tower mat foundation is 1,130 ft.
- This site is on a forested slope.
- **The allowable bearing capacities are estimated at 4 TSF for the sandstone rock foundations, with a tower pad elevation of 1136.0. There are 13 ft of soils present at the center of the tower location.**
- The 2018 Kentucky Building Code seismic site classification for this site is "A."
- If during the foundation design it becomes necessary to lower or raise the footer, alternate design recommendations can be provided by EKYENG.
- Close monitoring of the construction operations discussed herein will be critical in achieving the design subgrade support. We, therefore, recommend that EKYENG is retained to monitor this portion of the work.

This executive summary is included to provide a general overview of the project and should not be relied upon except for the purpose it was prepared. Please rely on the complete report for the information on the findings, recommendations, and all other concerns.





# EAST KENTUCKY ENGINEERING, LLC.

## 1. INTRODUCTION

East Kentucky Engineering (EKYENG) was retained by Mr. Stanton Neece of Appalachian Wireless to prepare a geotechnical engineering report for the proposed tower site located on the Dana Property, in Floyd County, Kentucky. A site location map is shown in Figure No. 1.

Pits were opened by trenching. The purpose of these services is to provide information and geotechnical engineering recommendations about subsurface conditions, earthwork, seismic considerations, groundwater conditions, and foundation design.

## 2.0 PROJECT DESCRIPTION

The proposed communication facility will consist of a self-supporting tower of undetermined height and ancillary support areas. The footing area is estimated to be 43.5 ft. X 43.5 ft. with an estimated base of the tower footer elevation at 1,130.0 ft. Based on the information provided, we estimate the structural loads will be like the following conditions.

CONDITION	LOAD
Total Shear	40 Kips
Axial Load	50 Kips

We anticipate that overturning will govern the structural design. If the loading is significantly different than these expected values, EKYENG should be notified to re-evaluate the recommendations provided in this report.



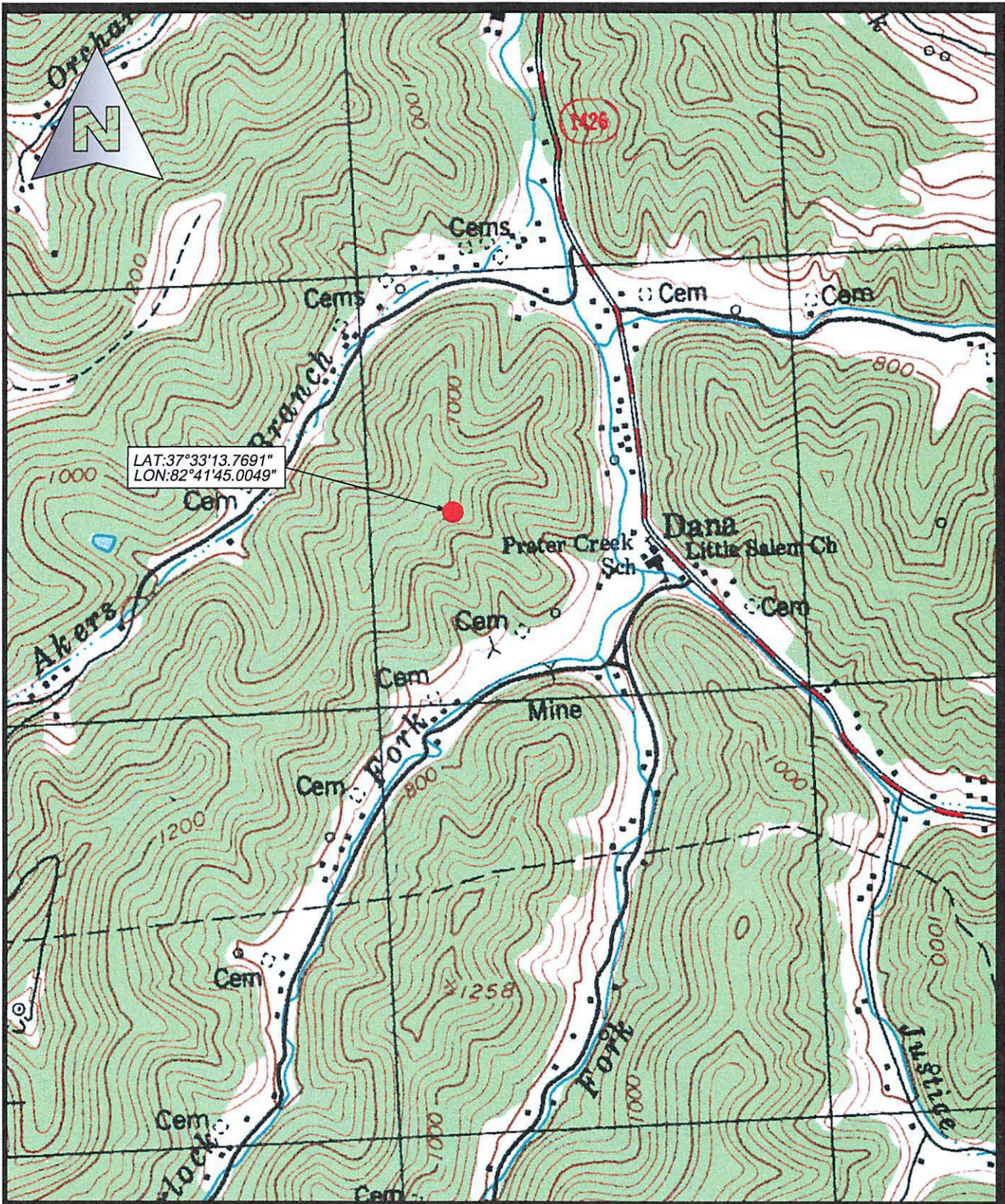

LAT: 37°33'13.7691"  
 LON: 82°41'45.0049"

Drawn: RDS	8/12/2020
Job: 165-112	Scale: 1"=1000

**APPALACHIAN WIRELESS**  
 EXCERPT FROM USGS QUAD  
 LOCATION MAP  
 DANA TOWER SITE  
 FIGURE NO 1

**East Kentucky Engineering, LLC.**  
 230 Swartz Drive  
 Hazard, KY 41701  
 (606) 551-1050





## EAST KENTUCKY ENGINEERING, LLC.

### 3.0 SITE DESCRIPTION & HISTORICAL MINING

#### 3.1 GENERAL INFORMATION

The site location is on a forested slope, in Floyd County, Kentucky. The current surface elevation is approximately 1,145 ft. Research on the historical mining was conducted by obtaining previous mine license maps from the "Kentucky Mine Mapping Information System" (KMMIS).

#### 3.2 SURFACE MINING

No surface mining or auger mining was found during our research that would influence this site. No adverse issues from surface mining activities are expected at this site location.

#### 3.3 UNDERGROUND MINING

Two underground mines were found that were under or adjacent to this site during our research.

Mining was conducted in the Elkhorn No. 2 Seam in the Spurlock No. 11 Mine. Room and pillar mining was conducted west of the proposed tower site approximately 465 ft lower than the proposed tower elevation. Based upon the locations of the mine works found on the map, the mine openings are outside of the area of influence of subsidence.

Redhawk mining has an active mine that has sealed workings that are below the proposed tower site in the Elkhorn No. 3 Seam. The mine openings under the proposed site are in an area that is sealed off from the active workings and there is little possibility of reactivating the sealed workings in the future.

#### 3.4 FLOOD HAZARD

A flood determination was conducted by EKYENG. For this determination, the FEMA Flood Map Service was reviewed for this location. The flood map for the



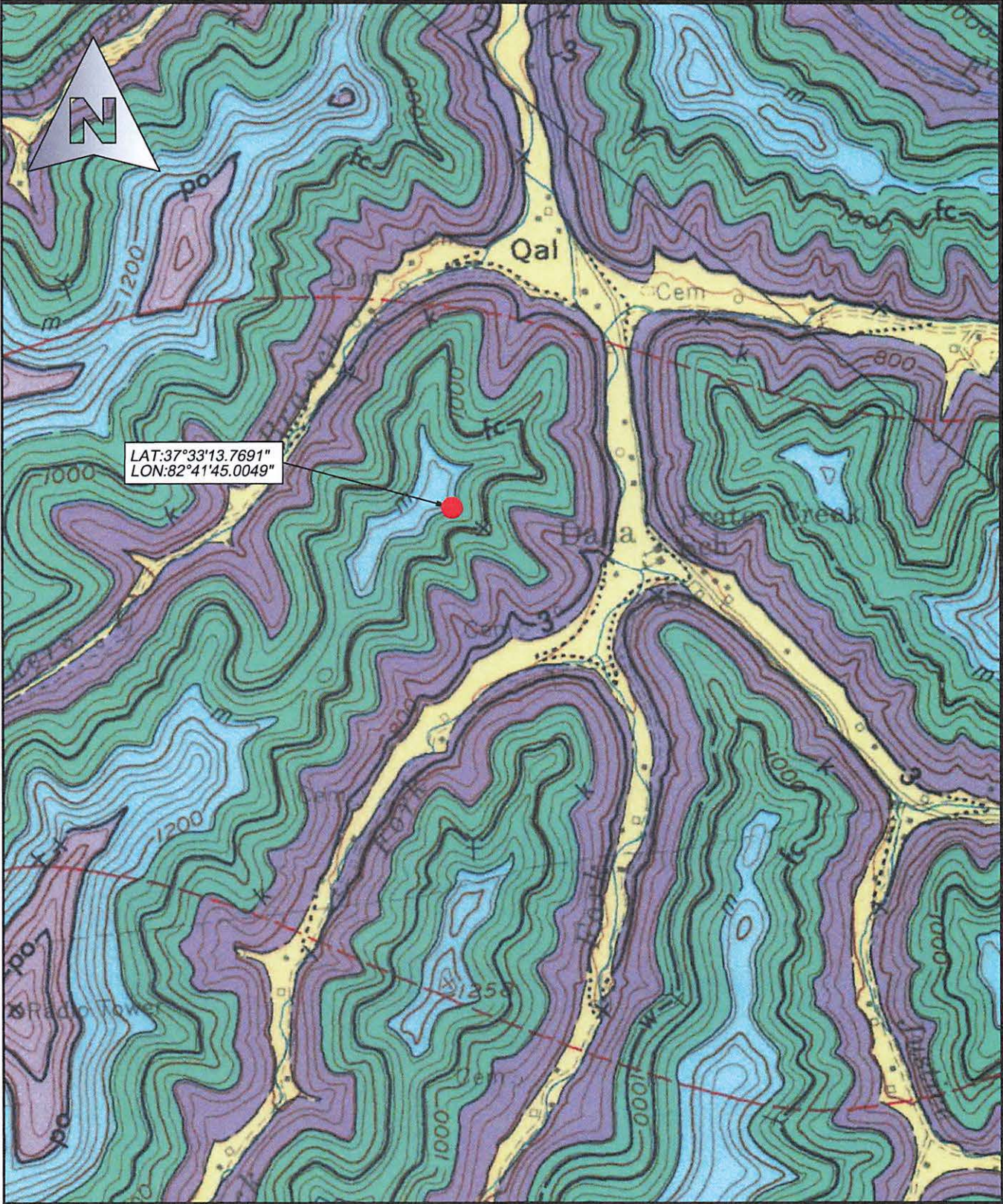

Drawn: RDS	Date: 8/12/2020
Job: 165-112	Scale: 1"=1000'

**APPALACHIAN WIRELESS**  
**EXCERPT FROM GEOLOGIC QUAD**  
**LOCATION MAP**  
**DANA TOWER SITE**  
**FIGURE NO 2**

**East Kentucky Engineering, LLC.**  
 230 Swartz Drive  
 Hazard, KY 41701  
 (606) 551-1050





## EAST KENTUCKY ENGINEERING, LLC.

selected area is number **21071C0215E-210069**. The flood zone for this area is Zone X and is an area of minimal flood Hazard. A FIRMette map is included in Appendix C of this report.

### 4.0 FIELD EXPLORATION

#### 4.1 SITE INFORMATION

The proposed site is located on a forested slope in Floyd County, Kentucky. The site lies within the Harold Quadrangle. The site is not readily accessible by conventional exploratory equipment. An estimated pad location was determined based on the information provided. Foundation dimensions were estimated to be a 43.5 ft X 43.5 ft footer for this report.

#### 4.2 TRENCHING

This investigation was conducted by trenching with an excavator to determine subsurface information. The combinations of trenching and visual inspections were used to evaluate the site lithology and type of materials immediately below the proposed tower site. The following soils and rock properties were found.

TABLE 2

Test Pit	DEPTH INCREMENT, (FT.) TO REFUSAL	SOILS TYPE
TR	0.0 / 13.0	Soils / Clays
TR	13.0 / 31.0	Sandstone / Shales

*Note: A cross-section of this information is in Appendix D of this report*



## EAST KENTUCKY ENGINEERING, LLC.

---

### 4.3 GROUNDWATER

Groundwater in Eastern Kentucky is characterized by water flowing through a system of internal fractures that lead to an alluvial aquifer near the bottom of valley floors. Large, defined aquifers other than the alluvium is not common, especially in higher elevations such as where this tower site is proposed. Therefore, groundwater should not be a concern in this area. During field test activities, no groundwater resources were observed.

### 4.4 SEISMIC SITE CLASSIFICATION

Based on the encountered soil conditions at the project site, the site classification was determined to be "Site Class A" per the 2018 Kentucky Building Code. In addition, an  $S_{DS}$  coefficient of 0.100 g was calculated, and an  $S_{D1}$  coefficient of 0.045 g was also calculated for design based on the aforementioned building code.

## 5.0 DISCUSSION AND RECOMMENDATIONS

### 5.1 GENERAL

The structure will be a self-supporting free-standing tri-pole tower with a mat foundation. Due to wind loading, lattice tower foundations can experience both vertical loads and horizontal loads. The vertical loads act in both an upward and downward direction as the tower attempts to overturn and can act in any directions.

### 5.2 SHALLOW MAT FOUNDATIONS RECOMMENDATIONS

We are recommending shallow foundations. It should be noted that the material type and bearing capacity can vary significantly due to the inconsistency of the underlying material. Based on the laboratory and field testing, visual inspection of the materials, and practical experience we have estimated that the **allowable bearing capacity of the weathered interbedded shale and sandstone at this site will be 4 TSF at the estimated mat base elevation of 1,130.0 ft.** The



## EAST KENTUCKY ENGINEERING, LLC.

---

interbedded shale and sandstone unit is present from the range of 1132.0 ft to 1127.0 ft and will provide the necessary cut width to support the proposed mat without overhanging outside the rock outcrop line. Below and above are two coal seams that need to be avoided for the direct placement of the mat foundation. We recommend a minimum of 3 feet of solid bedrock between the base of the mat and the top of the coal seam.

It is furthermore recommended that the slabs-on-grade be supported on a 4 to 6-inch layer of relatively clean granular material such as sand and gravel or crushed stone. This is to help distribute concentrated loads and equalize moisture conditions beneath the slab. Proper drainage must be incorporated into this granular layer to preclude future wet areas in the finished slab-on-grade. However, all topsoil and/or other deleterious materials encountered during site preparation must be removed and replaced with 4000 psi concrete below the foundation base. Provided that a minimum of 4 inches of granular material is placed below the new slab-on-grade, a modulus of subgrade reaction ( $k_{30}$ ) of 100 lbs/cu in can be used for the design of the slabs.

The support structure for this tower can be placed as needed. It is recommended that test pits are examined to ensure that any of these structures are on the competent materials. If pockets of soft, loose, or otherwise unsuitable material are encountered in the footing excavations, and it is inconvenient to lower the footings, the proposed footing elevations may be re-established by backfilling after the undesirable material has been removed. The undercut excavation beneath each footing should extend to suitable bearing soils, and the dimensions of the excavation base should be determined by imaginary planes extending outward and down on a 1 (vertical) to 1 (horizontal) slope from the base perimeter of the footing. The entire excavation should then be refilled with a well-compacted engineered fill, or lean concrete (Please note that the width of the lean concrete zone should be equal or wider than the width of the overlying footing element). Special care should be exercised to remove any sloughed, loose or soft materials





## EAST KENTUCKY ENGINEERING, LLC.

near the base of the excavation slopes. In addition, special care should be taken to "tie-in" the compacted fill with the excavation slopes, with benches as necessary, to ensure that no pockets of loose or soft materials will be left in place along the excavation slopes below the foundation bearing level. All Federal, State, and Local regulations should be strictly adhered to relative to excavation side-slope geometry.

### 5.3 BURIED UTILITIES

Excavations for buried utility pipelines should follow the guidelines outlined in this report. Depending on the pipeline material, a minimum thickness of at least 0.5 feet of select fine-grained granular bedding material should be used beneath all below-grade pipes, with a minimum cover thickness of at least 3 feet to afford an "arching" effect and reduce stresses on the pipe. The cover thickness may be reduced if the external loading condition on the pipe is relatively light or if the pipe is designed to withstand the external loading condition. It is not recommended that "pea-gravel" or other "open-work" aggregates be used for trench backfill since these materials are nearly impossible to compact and tend to pond water within their interstices.

## 6.0 WARRANTY

Our professional services have been performed, our findings obtained, and our recommendations prepared in accordance with generally accepted geotechnical engineering principles and practices. No other warranty, express or implied, is made.

While the services of EKYENG are a valuable and integral part of the design and construction teams, we do not warrant, guarantee, or ensure the quality or completeness of services provided by other members of those teams, the quality, completeness, or satisfactory performance of construction plans and



## **EAST KENTUCKY ENGINEERING, LLC.**

---

specifications which we have not prepared, nor the ultimate performance of building site materials.

### **6.1 SUBSURFACE EXPLORATION**

Subsurface exploration is normally accomplished by test borings, although test pits are sometimes employed. The location and elevation of the test locations should be considered accurate only to the degree inherent with the method used.

The boring log includes sampling information, description of the materials recovered, approximate depth of boundaries between soil and rock strata, and groundwater data. The boring log represents conditions specifically at the location and time the testing was conducted. The boundaries between different soil strata are indicated at specific depths; however, these depths are in fact approximate and are somewhat dependent upon the frequency of sampling (The transition between soil strata is often gradual). Free groundwater level readings are made at the times and under conditions stated on the boring logs (Groundwater levels change with time and season). The trenches and pits do not always remain open sufficiently long enough for the measured water level to coincide with the groundwater table.

### **6.2 LABORATORY AND FIELD TESTS**

Laboratory and field tests are performed by specific ASTM standards unless otherwise indicated. All determinations included in each ASTM standard are not always required and performed. Each test report indicates the measurements and determinations made.

### **6.3 ANALYSIS AND RECOMMENDATIONS**

The geotechnical report is prepared primarily to aid in the engineering design of site work and structural foundations. Although the information in the report is expected to be sufficient for these purposes, it is not intended to determine the cost of construction or to stand alone as a construction specification.





## EAST KENTUCKY ENGINEERING, LLC.

---

Our engineering report recommendations are based primarily on data from test borings or other methods made at the locations shown on the attached drawings. Soil variations may exist between test sites, and these variations may not become evident until construction. If significant variations are then noted, the geotechnical engineer should be contacted so that field conditions can be examined and recommendations revised if necessary.

The geotechnical engineering report states our understanding as to the location, dimensions and structural features proposed for the site. Any significant changes in the nature, design, or location of the site improvements **MUST** be communicated to the geotechnical engineer such that the geotechnical analysis, conclusions, and recommendations can be appropriately adjusted. The geotechnical engineer should be given the opportunity to review all drawings that have been prepared based on their recommendations.

### **6.4 CONSTRUCTION MONITORING**

Construction monitoring is a vital element of complete geotechnical services. The field engineer/inspector is the owner's "representative" observing the work of the contractor, performing tests as required in the specifications, and reporting data developed from such tests and observations. The field engineer or inspector does not direct the contractor's construction means, methods, operations or personnel. The field inspector/engineer does not interfere with the relationship between the owner and the contractor and, except as an observer, does not become a substitute owner on site. The field inspector/engineer is responsible for his own safety but has no responsibility for the safety of other personnel at the site. The field inspector/engineer is an important member of a team whose responsibility is to watch and test the work being done and report to the owner whether that work is being carried out in general conformance with the plans and specifications.





## EAST KENTUCKY ENGINEERING, LLC.

---

### 6.5 GENERAL

The scope of our services did not include an environmental assessment for the presence or absence of hazardous or toxic materials in the soil, surface water, groundwater or air, on, within or beyond the site studied. Any statements in the report or on the boring logs regarding odors, staining of soils or other unusual items or conditions observed are strictly for the information of our client.

To evaluate the site for possible environmental liabilities, we recommend an environmental assessment, consisting of a detailed site reconnaissance, a record review, and report of findings. Additional subsurface drilling and samplings, including groundwater sampling, may be required.

This report has been prepared for the exclusive use of Appalachian Wireless, for specific application to the proposed cellular tower located on the Dana Property located in Floyd County, Kentucky. Specific design and construction recommendations have been provided in the various sections of the report. The report shall, therefore, be used in its entirety. This report is not a bidding document and shall not be used for that purpose. Anyone reviewing this report must interpret and draw their conclusions regarding the specific construction techniques and methods that were chosen. EKYENG is not responsible for the independent conclusions, opinions or recommendations made by others based on the field exploratory and laboratory test data presented in this report.



## **SPECIFICATIONS**

### **I – GENERAL**

#### **1.0 STANDARDS AND DEFINITIONS**

**1.1 STANDARDS** - All standards refer to latest edition unless otherwise noted.

**1.1.1** ASTM D-698-70 (Method C) "Standard Test Methods for Moisture, Density Relations of Soils and Soil-Aggregate Mixtures Using 5.5-lb (2.5 kg.) Rammer and 12-inch (305-mm) Drop".

**1.1.2** ASTM D-2922 "Standard Test Method for Density of Soil and Soil-Aggregate in Place by Nuclear Methods (Shallow Depth)."

**1.1.3** ASTM D-1556 "Standard Test Method for Density of Soil in place by the Sand-Cone Method."

#### **1.2 DEFINITIONS**

**1.2.1** Owner - In these specifications, the word "Owner" shall mean Appalachian Wireless.

**1.2.2** Engineer - In these specifications, the word "Engineer" shall mean the Owner designated engineer.

**1.2.3** Design Engineer - In these specifications, the words "Design Engineer" shall mean the Owner designated design engineer.

**1.2.4** Contractor - In these specifications, the word "Contractor" shall mean the firm or corporation undertaking the execution of any work under the terms of these specifications.

**1.2.5** Approved - In these specifications the word "approved" shall refer to the approval of the Engineer or his designated representative.

**1.2.6** As Directed - In these specifications the words "as directed" shall refer to the directions to the Contractor from the Owner or his designated representative.



## EAST KENTUCKY ENGINEERING, LLC.

---

### II - ENGINEERED FILL BENEATH STRUCTURES CLEARING AND GRADING SPECIFICATIONS

#### 1.0 GENERAL CONDITIONS

The Contractor shall furnish all labor, materials, and equipment, and perform all work and services necessary to complete in a satisfactory manner the site preparation, excavation, filling, compaction and grading as shown on the plans and as described therein.

This work shall consist of all clearing and grading, removal of existing structures unless otherwise stated, preparation of the land to be filled, filling of the land, spreading and compaction of the fill, and all subsidiary work necessary to complete the grading of the cut and fill areas to conform with the lines, grades, slopes, and specifications.

This work is to be accomplished under the constant and continuous supervision of the Owner or his designated representative.

In these specifications, the terms "approved" and "as directed" shall refer to directions to the Contractor from the Owner or his designated representative.

#### 2.0 SUBSURFACE CONDITIONS

Prior to bidding the work, the Contractor shall examine, investigate and inspect the construction site as to the nature and location of the work, and the general and local conditions at the construction site, including without limitation, the character of surface or subsurface conditions and obstacles to be encountered on and around the construction site; and shall make such additional investigation as he may deem necessary for the planning and proper execution of the work. Borings and/or soil investigations shall have been made. Results of these borings and studies will be made available by the Owner to the Contractor upon his request, but the Owner is not responsible for any interpretations or conclusions with respect thereto made by the Contractor based on such information, and the





**2.0 GENERAL CONDITIONS**

- 2.1** The Contractor shall furnish all labor, material, and equipment and perform all work and services except those set-out and furnished by the Owner, necessary to complete in a satisfactory manner the site preparation, excavation, filling, compaction, grading as shown on the plans and as described therein.

This work shall consist of all mobilization clearing and grading, grubbing, stripping, removal of existing material unless otherwise stated, preparation of the land to be filled, filling of the land, spreading and compaction of the fill, and all subsidiary work necessary to complete the grading of the cut and fill areas to conform with the lines, grades, slopes, and specifications.

This work is to be accomplished under the observation of the Owner or his designated representative.

- 2.2** Prior to bidding the work, the Contractor shall examine, investigate and inspect the construction site as to the nature and location of the work, and the general and local conditions at the construction site, including, without limitation, the character of surface or subsurface conditions and obstacles to be encountered on and around the construction site; and shall make such additional investigation as he may deem necessary for the planning and proper execution of the work.

If conditions other than those indicated are discovered by the Contractor, the Owner should be notified immediately. The material which the Contractor believes to be a changed condition should not be disturbed so that the owner can investigate the condition.

- 2.3** The construction shall be performed under the direction of an experienced engineer who is familiar with the design plan.



## EAST KENTUCKY ENGINEERING, LLC.

---

Owner further has no responsibility for the accuracy of the borings and the soil investigations.

If conditions other than those indicated are discovered by the Contractor, the Owner should be notified immediately. The material which the Contractor believes to be a changed condition should not be disturbed so that the Owner can investigate the condition.

### **3.0 SITE PREPARATION**

Within the specified areas, all trees, brush, stumps, logs, tree roots, and structures scheduled for demolition shall be removed and disposed of.

All cut, and fill areas shall be properly stripped. Topsoil will be removed to its full depth and stockpiled for use in finish grading. Any rubbish, organic and other objectionable soils, and other deleterious material shall be disposed of off the site, or as directed by the Owner or his designated representative if on-site disposal is provided. In no case shall such objectionable material be allowed in or under the fill unless specifically authorized in writing.

Prior to the addition of fill, the original ground shall be compacted to job specifications as outlined below. Special notice shall be given to the proposed fill area now. If wet spots, spongy conditions, or groundwater seepage is found, corrective measures must be taken before the placement of fill.

### **4.0 FORMATION OF FILL AREAS**

Fills shall be formed of satisfactory materials placed in successive horizontal layers of not more than eight (8) inches in loose depth for the full width of the cross-section. The depth of lift may be increased if the Contractor can demonstrate the ability to compact a larger lift. If compaction is accomplished using hand-tamping equipment, lifts will be limited to 4-inch loose lifts. Engineered fill placed below the structure bearing elevation shall be compacted to at least 95% of the maximum dry unit weight with a moisture content within 2% of the optimum moisture content as determined by the modified Proctor test. The top size of the material placed shall not exceed 4 inches.





## EAST KENTUCKY ENGINEERING, LLC.

---

All material entering the fill shall be free of organic matter such as leaves, grass, roots, and other objectionable material.

The operations on earthwork shall be suspended at any time when satisfactory results cannot be obtained because of rain, freezing weather, or other unsatisfactory conditions. The Contractor shall keep the work areas graded to provide the drainage always.

The fill material shall be of the proper moisture content before compaction efforts are started. Wetting or drying of the material and manipulation to secure a uniform moisture content throughout the layer shall be required. Should the material be too wet to permit proper compaction or rolling, all work thus affected shall be delayed until the material has dried to the required moisture content. The moisture content of the fill material should be no more than two (2) percentage points higher or lower than optimum unless otherwise authorized. Sprinkling shall be done with equipment that will satisfactorily distribute the water over the disced area. Any areas inaccessible to a roller shall be consolidated and compacted by mechanical tampers. The equipment shall be operated in such a manner that hardpan, cemented gravel, clay or other chunky soil material will be broken up into small particles and become incorporated with the other material in the layer.

In the construction of filled areas, starting layers shall be placed in the deepest portion of the fill, and as placement progresses, additional layers shall be constructed in horizontal planes. Original slopes shall be continuous, vertically benched to provide horizontal fill planes. The size of the benches shall be formed so that the base of the bench is horizontal, and the back of the bench is vertical. As many benches as are necessary to bring the site to final grade shall be constructed. Filling operations shall begin on the lowest bench, with the fill being placed in horizontal eight (8) inch thick loose lifts unless otherwise authorized. The filling shall progress in this manner until the entire first bench has been filled, before any fill is placed on the succeeding benches. Proper drainage shall always be maintained during benching and filling of the benches, to ensure that all water is drained away from the fill area.





## EAST KENTUCKY ENGINEERING, LLC.

---

Frozen material shall not be placed in the fill nor shall the fill be placed upon frozen material.

The Contractor shall be responsible for the stability of all fills made under the contract and shall replace any portion, which in the opinion of the Owner or his designated representative, has become displaced due to carelessness or negligence on the part of the Contractor. Fill damaged by inclement weather shall be repaired at the Contractor's expense.

### **5.0 SLOPE RATIO AND STORM WATER RUN-OFF**

Slopes shall not be greater than 2 (horizontal) to 1 (vertical) in both cut and fill, or as illustrated on the construction drawings. Excavations shall be constructed in accordance with all Federal, State and local codes relative to slope geometry.

### **6.0 GRADING**

The Contractor shall furnish, operate, and maintain such equipment as is necessary to construct uniform layers and control smoothness of grade for maximum compaction and drainage.

### **7.0 COMPACTING**

The compaction equipment shall be approved equipment of such design, weight, and quantity to obtain the required density in accordance with these specifications.

### **8.0 TESTING AND INSPECTION SERVICES**

Testing and inspection services will be provided by the Owner.



## GUIDELINES FOR EXCAVATIONS AND TRENCHES

The following represents some general guidelines relative to the design and construction of excavations and trenches. It must be emphasized that these guidelines are not intended to represent a "safety plan," but rather are presented herein to provide general guidance regarding the design characteristics and safety measures for excavations and trenches.

1. Check with the following utilities prior to breaking ground:
  - Sewer
  - Telephone
  - Fuel
  - Electric
  - Water
  - Gas
  - Cable

When utility companies or owners do not respond to your request within 48 hours, the contractor may only then proceed provided the contractor does so with caution by using detection equipment or other acceptable means to locate utility installations.

Once the excavation is open, the contractor should protect and support the exposed underground utilities or remove installations to safeguard workers and prevent damage to exposed utilities.

2. Access and egress ramps must be designed by a "competent person" and structural ramps used for equipment must be designed by a "competent person" with qualified knowledge in structural design. In addition:
  - Ramps must be secured to prevent displacement;
  - Ramps used in lieu of steps must have cleats to prevent slipping; and



## EAST KENTUCKY ENGINEERING, LLC.

---

- Trenching excavations four feet or greater in depth must have a stairway, ladder, ramps or other safe means to egress with lateral travel no more than 25 feet.
3. Workers must be provided with reflector garments, such as warning orange or red vests, when exposed to vehicular traffic.
  4. Contractors must not allow workers to work under or near equipment when there is danger of falling debris, spillage or equipment-related injuries.
  5. Mobile equipment, operating adjacent to an open excavation or approaching the edge of an excavation, must have one of the following when the operator's view is obstructed:
    - Warning System
    - Mechanical Signals
    - Barricades
    - Stop Logs
    - Hand Signals
  6. The contractor must check the atmosphere for hazardous gases and oxygen deficiencies when excavating four feet or greater around landfills, or when hazardous substances are stored nearby, and when the contractor expects there could be any exposure to the workers.
  7. When hazardous atmospheric conditions exist, or when conditions could change, the contractor must make emergency rescue equipment readily available including breathing apparatus, safety harnesses with lifelines and a basket stretcher.
  8. When workers enter bell-bottom pier holes or other deep and confined excavations, the worker must wear (always while performing work in the confined space) a separate lifeline attached to a harness. The line must be





## EAST KENTUCKY ENGINEERING, LLC.

---

attended by someone above while work is being performed. The worker must check for hazardous atmospheric conditions prior to entry.

9. The contractor must ensure that water does not accumulate in open excavations and must inspect the excavation prior to allowing workers to re-enter after heavy rains.
10. Adjacent structures (buildings, walls, etc.) must be supported or secured to prevent worker exposure to unsafe conditions and damage to existing structures.
11. A registered professional engineer must approve operations when a contractor underpins existing structures to ensure worker safety and prevent damage to existing structures.
12. Workers must not be exposed to loose soil and rock or materials in and around excavations. Materials, such as removed soil and rock, must not be stored closer than two feet from the edge of the excavation.
13. Daily inspections of the excavation, the adjacent areas, and protective systems must be made by a "competent person" for evidence of possible cave-ins, indications of failure of protective systems, hazardous atmospheres or other hazardous conditions. The "competent person" must stop work immediately and remove workers from the excavation when conditions change and pose a threat to their safety.
14. Workers must not be exposed to fall hazards associated with excavations. Protective walkways or bridges with standard guardrails must be provided.
15. All wells, pits, shafts etc. must be barricaded or covered. After completion of work, all wells, pits, shafts etc. must be backfilled.



## IV - GENERAL CONCRETE SPECIFICATIONS

### 1.0 GENERAL

It is the intent of this specification to secure, for every part of the work, concrete of homogenous structure which, when hardened, will have the required strength and resistance to weathering. To this end, the limiting values of concrete and the requirements hereinafter specified must be met. Standard tests of the cement, aggregates, concrete and reinforcement will be made by the Owner as it sees fit. The Contractor shall furnish the material for all required samples plus such labor as required to obtain samples. The Contractor shall provide to authorized representatives of the Owner, convenient access to all parts of the work of all concreting operations for sampling and inspection.

### 2.0 SCOPE

Contractor shall furnish all materials, labor, services, transportation, tools, equipment, and related items required to complete work indicated on the drawings and/or specified.

Unless otherwise noted or as modified by more stringent requirements specified herein, all plain and reinforced concrete work shall be performed in full compliance with applicable requirements of the Building Code Requirements for Reinforced Concrete ACI 318.

Contractor shall obtain Owner's approval of all subgrades, footing bottoms, forms, and reinforcement just prior to placing concrete.

Contractor shall coordinate the work specified in this section with that specified in other sections so that all anchors, pipes and other embedded items are properly installed before concrete is placed.

Contractor shall clean all exposed concrete surfaces and obtain approval of Owner for method of cleaning.



## EAST KENTUCKY ENGINEERING, LLC.

---

### 3.0 MATERIALS

All materials shall be of the respective quality specified herein, delivered, stored, and handled as to prevent inclusion of foreign matter and damage by dampness or breakage. Packaged material shall be stored in original container until ready for use. Materials showing evidence of dampness or other damage may be rejected.

- A. Fine and Coarse Aggregates: Coarse and fine aggregates shall conform to ASTM Specification C33. The maximum size of aggregate shall not be larger than one-fifth (1/5) of the narrowest dimensions between forms, or larger than three fourths (3/4) of the minimum clear spacing between reinforcement.
1. Fine Aggregate: Sand shall be composed essentially of clean, hard, strong, durable grains free of structurally weak grains, organic matter, loam, clay, silt, salt, mica or other fine materials that may affect bonding of the cement paste.
  2. Coarse Aggregate: Cement concrete shall consist of crushed rock or screened gravel and shall be composed essentially of clean, hard, strong and impermeable particles, resistant to wear and frost and free from deleterious amounts of organic matter, loam, clay, salts, mica, and soft, thin, elongated, laminated or disintegrated stone, and shall be inert to water and cement.
- B. Portland Cement: Portland cement shall conform to ASTM Specification C150. Type I or Type II Portland Cement shall be used if they are not intermixed during any one batch. Type II Portland Cement shall not be used unless indicated on the plans.
- C. Water: Water for mixing and curing shall be clean, fresh, and free from deleterious materials.
- D. Metal Reinforcement: Rebar shall be Grade 60 and with deformations conforming to ASTM Specification A305. Welded wire mesh shall conform to W4 x W4 size and be of Grade 60 steel.





## EAST KENTUCKY ENGINEERING, LLC.

---

- E. Admixtures: Except as herein noted, admixtures shall not be used.
1. Under adverse weather conditions only retarding or accelerating agents containing no chloride may be used.
  2. Air-Entraining Agent shall be used for all concrete will give an entrained air range of not less than 4 percent but no greater than 8 percent in the finished product. Under no circumstances shall the air-entraining be interground with cement.
  3. Approval in writing shall be required from Owner prior to the use of any admixture.

### 4.0 FORM

Forms shall be constructed with proper shoring and cross-bracing, safeguarding the total structure and specifically lateral stability and sufficiently strong to stand vibrations of concrete and to carry, without appreciable deflection or displacement, all dead and live loads to which they may be subjected.

### 5.0 INSERTS, ETC.

Anchors, bolts, dowels, conduit, water stops, vent pipes and other similar built-in or concreted-in items shall be properly located, accurately positioned and secured. The Contractor shall cooperate in placing of such items with other contractors who require a fastening device for their work and he shall maintain them in proper location during the progress of his work.

### 6.0 REINFORCEMENT

Reinforcement at the time concrete is placed shall be free from rust, scale or other coatings that will destroy or reduce the bond.



## EAST KENTUCKY ENGINEERING, LLC.

---

Reinforcement shall be accurately placed and securely tied at intersections and shall be securely held in position during the placing of concrete by pacers, chairs, or other approved supports.

The reinforcement of foundations, footings and other principal structural members in which the concrete is deposited against the ground shall not have less than three (3) inches of concrete between it and the ground contact surface. If concrete surfaces after removal of the forms are to be exposed to the weather or to be in contact with the ground or rock, reinforcement shall be protected with not less than two (2) inches of concrete,

### **7.0 CONCRETE**

Concrete for the various parts of the work shall be of 4000 pounds per square inch compressive strength with a minimum 28-day cure. Contractor is responsible to provide a mix of not less than 6 bags of cement per yard of concrete and not more than 7 gallons of water per bag of cement, producing a minimum slump of 2-1/2 inches and a maximum slump of 4-1/2 inches. Concrete that exceeds the above range of maximum or minimum slump requirements may be rejected by the Owner. All concrete shall be air-entrained. Contractors are required to furnish the name or names of the company(s) that will be providing the mix. The Owner reserves the right to disapprove any concrete supplier that has been known to supply an undesirable material to the Owner on previous occasions.

### **8.0 DEPOSITING CONCRETE**

4.1. Preparation for Placing Concrete: Before depositing concrete, the Contractor shall:

1. Remove from space to be occupied by concrete all debris, including snow, ice, and water unless otherwise permitted by Owner.
2. Provide diversion, satisfactory to Owner, of any flow of water to an excavation to avoid washing the freshly deposited concrete.



## EAST KENTUCKY ENGINEERING, LLC.

---

3. Coat the forms prior to placing of reinforcing steel as required in form work.
  4. Secure firmly in correct position, all reinforcement and other items to be encased and remove therefrom all coating including ice and frost.
- B. Transportation of Concrete from Batch Plant: The concrete shall be delivered to the site of the work and discharge shall be completed within 90 minutes after addition of the cement and water to the aggregates. Each batch of concrete delivered at the job site shall be accompanied by a time slip issued at the batching plant, bearing the time of charging of the mixer drum with the cement and aggregates.
- C. Transporting of Concrete from Mixer to Place of Final Deposit: Transportation shall be done as rapidly as practical by means which shall prevent the separation or loss of the ingredients. If chutes are used, they shall be at a slope not flatter than one vertical to two horizontal. Buggies or carts shall be equipped with pneumatic rubber tires or surfaces of runways shall be sufficiently smooth or both so as not to cause separation or segregation of concrete ingredients. Concrete shall not be allowed to drop freely more than 4 feet. Where greater drops are required, canvas "elephant trunks" or galvanized iron chutes equipped with suitable hopper heads shall be employed and a sufficient number placed to ensure that the concrete may be effectively compacted into horizontal layers not exceeding 12 inches in thickness with minimum lateral movements.
- D. Depositing of Concrete: Depositing of concrete shall:





## EAST KENTUCKY ENGINEERING, LLC.

---

1. Proceed continuously after once starting until reaching the end of a section of construction joint location shown on the drawings, or as approved by the Owner. The operations shall be conducted so that no concrete is deposited on concrete sufficiently hardened to cause formation of seams, and planes of weakness.
  2. Be as near as practical to its final position in the forms.
  3. Proceed to maintain constantly a top surface which is approximately level.
  4. Be placed before initial set has occurred, and in no event after it has contained its water content for more than 90 minutes.
  5. Be thoroughly worked and compacted by means of suitable tools to provide impermeability, durability and strength and shall be thoroughly worked around reinforcements and embedded items and into corners of forms and to be free from voids, pockets or honeycombing. Care shall be taken to provide impermeability.
- E. Vibration Equipment: Vibration equipment shall be of the appropriate type and shall, always, be adequate in number of units and power of each unit to properly consolidate all concrete.
- F. Monolithic Pours: Proper delivery of concrete shall be the Contractor's responsibility to make a mono-lithic pour without delays and changes of cold joints.



## EAST KENTUCKY ENGINEERING, LLC.

---

### 9.0 CURING

All concrete work shall be protected from injurious action by the sun, rain, flowing water, frost and other injury and shall be covered with plastic after application of curing compound for three (3) days on pours located above ground.

Contractor shall not remove any formwork for a minimum period of 24 hours after a concrete pour without written approval of the Owner.

### 10.0 CONCRETE FINISHES

Finishes of all exposed concrete shall be free of defects which impair its durability or adversely affect its appearance. All such surfaces when stripped, shall be uniform in appearance and any surfaces displaying any deviations from adjacent uniform surfaces shall be rejected and subject to removal.

Finished work shall be level and plumb, true to lines, and dimensions. Finished plane surfaces shall be smooth, and as nearly perfect as practical; however, deviations from a true plane shall not exceed 1/8 inch when measured from a 6-foot straight edge placed against the surface to any point on the surface and under the straight edge.

All exposed surfaces shall have defects corrected, protrusions removed, and holes filled.





# EAST KENTUCKY ENGINEERING, LLC.

## APPENDIX A PHOTOGRAPHS



Trench Photographs



Trench Photograph





**EAST KENTUCKY ENGINEERING, LLC.**

---

**APPENDIX B BORING LOG**

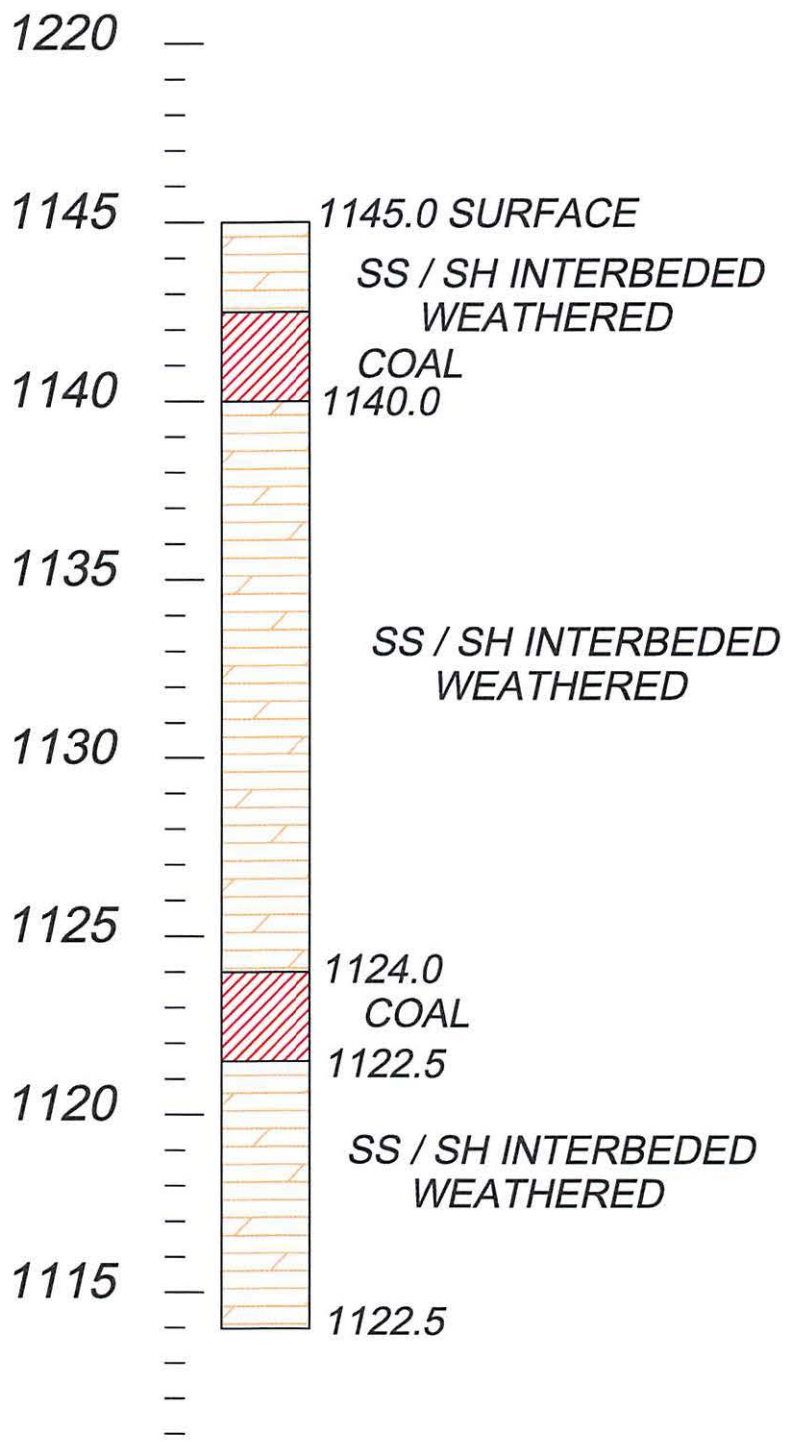

Drawn:	Date: 8/14/20
Job:	Scale: 1" = 5'
Drawing:	
Tool Palette EKYENG	

APPALACHIAN WIRELESS  
 BORING LOG  
 DANA TOWER SITE  
 FLOYD COUNTY KENTUCKY



East Kentucky Engineering, LLC  
 230 Swartz Drive  
 Hazard, KY 41701  
 (606) 551-1050



**EAST KENTUCKY ENGINEERING, LLC.**

---

**APPENDIX C SEISMIC**





# Dana Tower Site

Latitude, Longitude: 37.5538, -82.6958



Map data ©2020

<b>Date</b>	8/14/2020, 4:36:04 PM
<b>Design Code Reference Document</b>	IBC-2015
<b>Risk Category</b>	IV
<b>Site Class</b>	A - Hard Rock

Type	Value	Description
S <sub>s</sub>	0.188	MCE <sub>R</sub> ground motion. (for 0.2 second period)
S <sub>1</sub>	0.084	MCE <sub>R</sub> ground motion. (for 1.0s period)
S <sub>MS</sub>	0.15	Site-modified spectral acceleration value
S <sub>M1</sub>	0.067	Site-modified spectral acceleration value
S <sub>DS</sub>	0.1	Numeric seismic design value at 0.2 second SA
S <sub>D1</sub>	0.045	Numeric seismic design value at 1.0 second SA

Type	Value	Description
SDC	A	Seismic design category
F <sub>a</sub>	0.8	Site amplification factor at 0.2 second
F <sub>v</sub>	0.8	Site amplification factor at 1.0 second
PGA	0.09	MCE <sub>G</sub> peak ground acceleration
F <sub>PGA</sub>	0.8	Site amplification factor at PGA
PGA <sub>M</sub>	0.072	Site modified peak ground acceleration
T <sub>L</sub>	12	Long-period transition period in seconds
S <sub>sRT</sub>	0.188	Probabilistic risk-targeted ground motion. (0.2 second)
S <sub>sUH</sub>	0.205	Factored uniform-hazard (2% probability of exceedance in 50 years) spectral acceleration
S <sub>sD</sub>	1.5	Factored deterministic acceleration value. (0.2 second)
S <sub>1RT</sub>	0.084	Probabilistic risk-targeted ground motion. (1.0 second)
S <sub>1UH</sub>	0.092	Factored uniform-hazard (2% probability of exceedance in 50 years) spectral acceleration.
S <sub>1D</sub>	0.6	Factored deterministic acceleration value. (1.0 second)
PGA <sub>d</sub>	0.6	Factored deterministic acceleration value. (Peak Ground Acceleration)
C <sub>RS</sub>	0.917	Mapped value of the risk coefficient at short periods
C <sub>R1</sub>	0.907	Mapped value of the risk coefficient at a period of 1 s

DISCLAIMER

While the information presented on this website is believed to be correct, SEAOC / OSHPD and its sponsors and contributors assume no responsibility or liability for its accuracy. The material presented in this web application should not be used or relied upon for any specific application without competent examination and verification of its accuracy, suitability and applicability by engineers or other licensed professionals. SEAOC / OSHPD do not intend that the use of this information replace the sound judgment of such competent professionals, having experience and knowledge in the field of practice, nor to substitute for the standard of care required of such professionals in interpreting and applying the results of the seismic data provided by this website. Users of the information from this website assume all liability arising from such use. Use of the output of this website does not imply approval by the governing building code bodies responsible for building code approval and interpretation for the building site described by latitude/longitude location in the search results of this website.



**EAST KENTUCKY ENGINEERING, LLC.**

---

**APPENDIX D    MAPS**



# National Flood Hazard Layer FIRMette



82°42'4"W 37°33'28"N

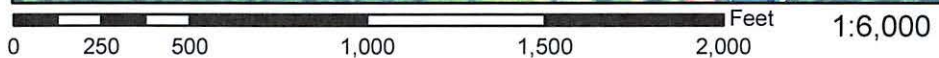

## Legend

SEE FIS REPORT FOR DETAILED LEGEND AND INDEX MAP FOR FIRM PANEL LAYOUT

- |   |   |
|---|---|
| <p><b>SPECIAL FLOOD HAZARD AREAS</b></p>  | <ul style="list-style-type: none"> <li> Without Base Flood Elevation (BFE)<br/><i>Zone A, V, A99</i></li> <li> With BFE or Depth <i>Zone AE, AO, AH, VE, AR</i></li> <li> Regulatory Floodway</li> </ul>  |
| <p><b>OTHER AREAS OF FLOOD HAZARD</b></p> | <ul style="list-style-type: none"> <li> 0.2% Annual Chance Flood Hazard, Areas of 1% annual chance flood with average depth less than one foot or with drainage areas of less than one square mile <i>Zone X</i></li> <li> Future Conditions 1% Annual Chance Flood Hazard <i>Zone X</i></li> <li> Area with Reduced Flood Risk due to Levee. See Notes. <i>Zone X</i></li> <li> Area with Flood Risk due to Levee <i>Zone D</i></li> </ul> |
| <p><b>OTHER AREAS</b></p>                 | <ul style="list-style-type: none"> <li> NO SCREEN Area of Minimal Flood Hazard <i>Zone X</i></li> <li> Effective LOMRs</li> <li> Area of Undetermined Flood Hazard <i>Zone D</i></li> </ul>   |
| <p><b>GENERAL STRUCTURES</b></p>          | <ul style="list-style-type: none"> <li> Channel, Culvert, or Storm Sewer</li> <li> Levee, Dike, or Floodwall</li> </ul>   |
| <p><b>OTHER FEATURES</b></p>              | <ul style="list-style-type: none"> <li> Cross Sections with 1% Annual Chance Water Surface Elevation</li> <li> Coastal Transect</li> <li> Base Flood Elevation Line (BFE)</li> <li> Limit of Study</li> <li> Jurisdiction Boundary</li> <li> Coastal Transect Baseline</li> <li> Profile Baseline</li> <li> Hydrographic Feature</li> </ul>   |
| <p><b>MAP PANELS</b></p>                  | <ul style="list-style-type: none"> <li> Digital Data Available</li> <li> No Digital Data Available</li> <li> Unmapped</li> </ul>  |
- N
- The pin displayed on the map is an approximate point selected by the user and does not represent an authoritative property location.

This map complies with FEMA's standards for the use of digital flood maps if it is not void as described below. The basemap shown complies with FEMA's basemap accuracy standards

The flood hazard information is derived directly from the authoritative NFHL web services provided by FEMA. This map was exported on **8/17/2020 at 11:22 AM** and does not reflect changes or amendments subsequent to this date and time. The NFHL and effective information may change or become superseded by new data over time.

This map image is void if the one or more of the following map elements do not appear: basemap imagery, flood zone labels, legend, scale bar, map creation date, community identifiers, FIRM panel number, and FIRM effective date. Map images for unmapped and unmodernized areas cannot be used for regulatory purposes.



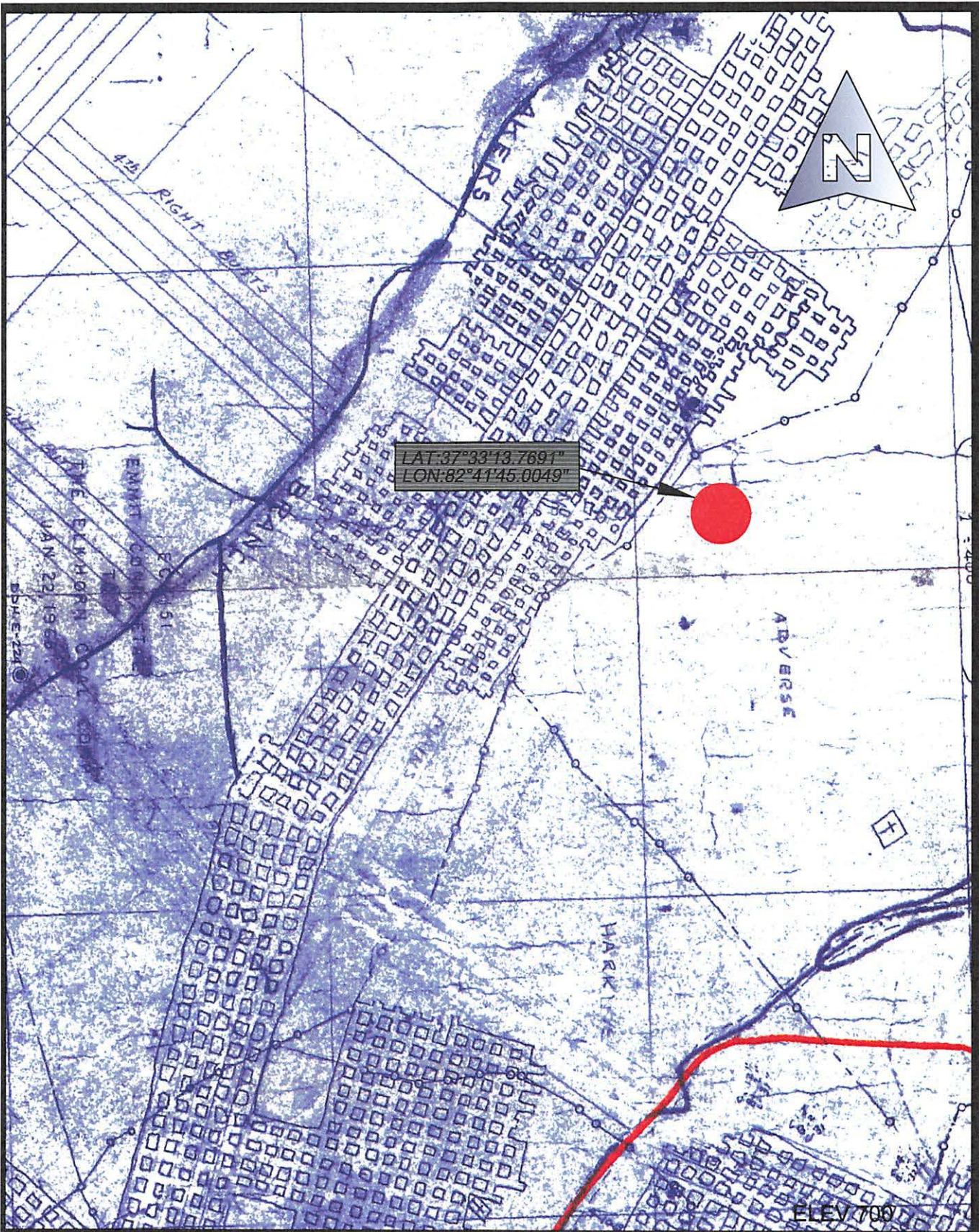

LAT: 37°33'13.7691"  
 LON: 82°41'45.0049"

Drawn: RDS Date: 8/10/20  
 Job: 165-0112 Scale: 1" = 400'  
 Drawing:  
 Tool Palette EKYENG

**SPURLOCK MINE NO 11  
 ELKHORN NO 2 SEAM  
 EXCERPT FINAL MAP**



East Kentucky Engineering, LLC  
 230 Swartz Drive  
 Hazard, KY 41701  
 (606) 551-1050



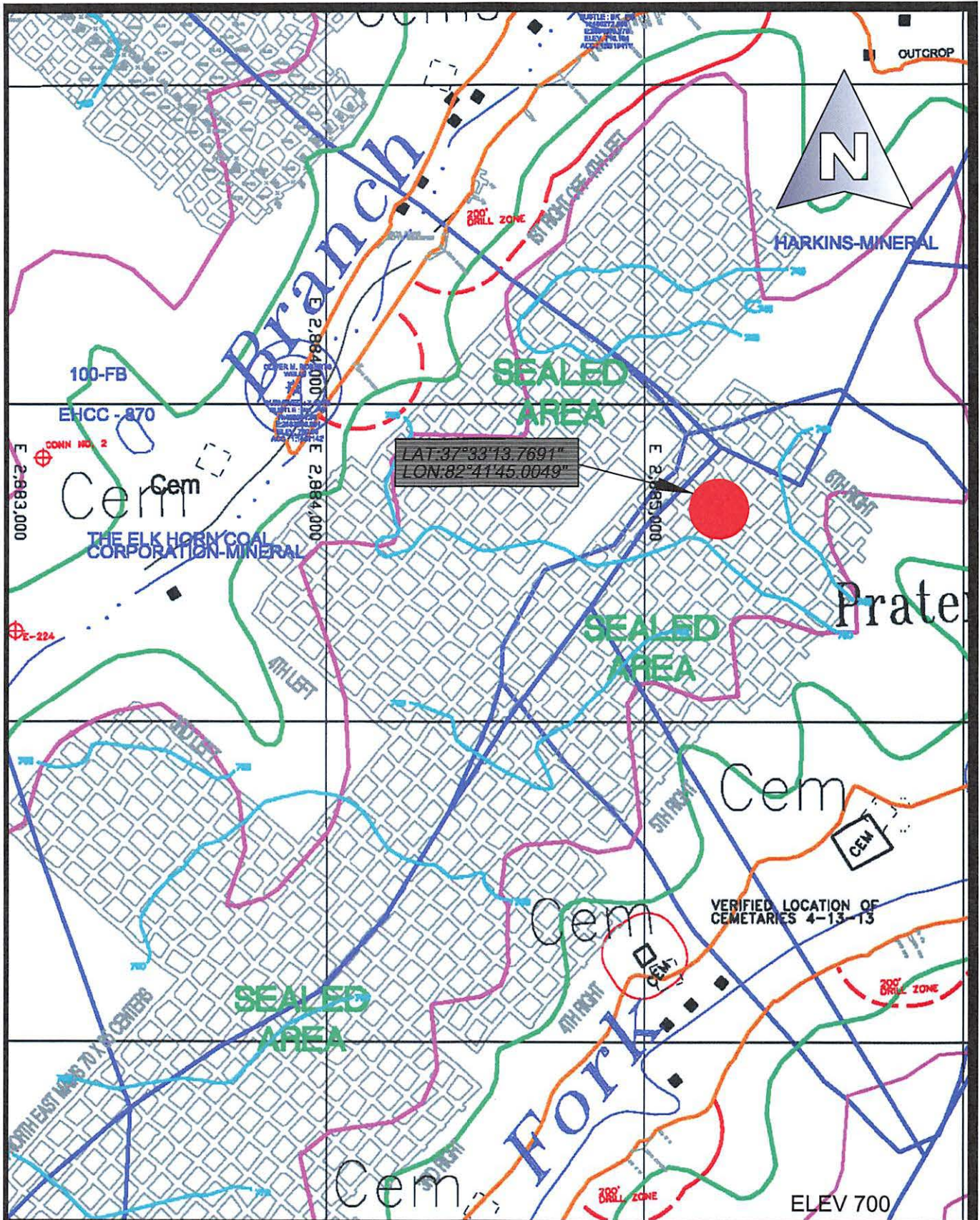

Drawn:RDS Date: 8/10/20  
 Job:165-0112 Scale:1"= 400'  
 Drawing:  
 Tool Palette EKYENG

**REDHAWK MINING LLC  
 ELKHORN NO 3 SEAM  
 EXCERPT LICENCES MAP**



**East Kentucky Engineering, LLC**  
 230 Swartz Drive  
 Hazard, KY 41701  
 (606) 551-1050



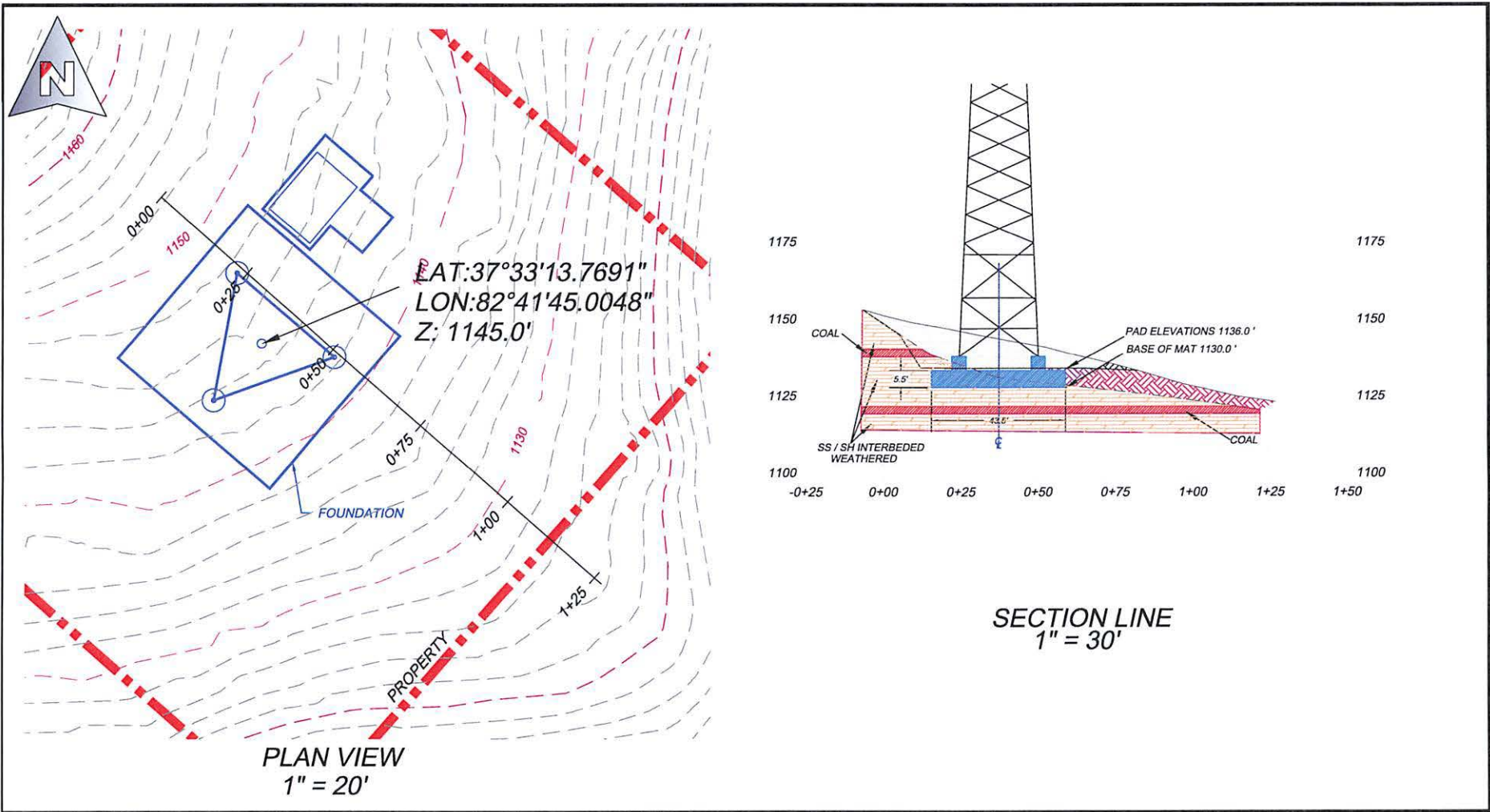

East Kentucky Engineering, LLC

230 Swartz  
 Hazard, KY 41701  
 (606) 551-1050  
 Email: ekyeng@ekyeng.net

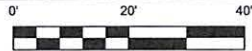

Drawn by: RDS	8/14/2020
Job #: 165-000-0112	Scale: 1" = AS NOTED
File Location:	

APPALACHIAN WIRELESS  
 PROPOSED DANA TOWER LOCATION  
 FLOYD COUNTY  
 KENTUCKY

# Exhibit 5





CENTER OF TOWER AND FOUNDATION  
REINFORCEMENT BAR MAT

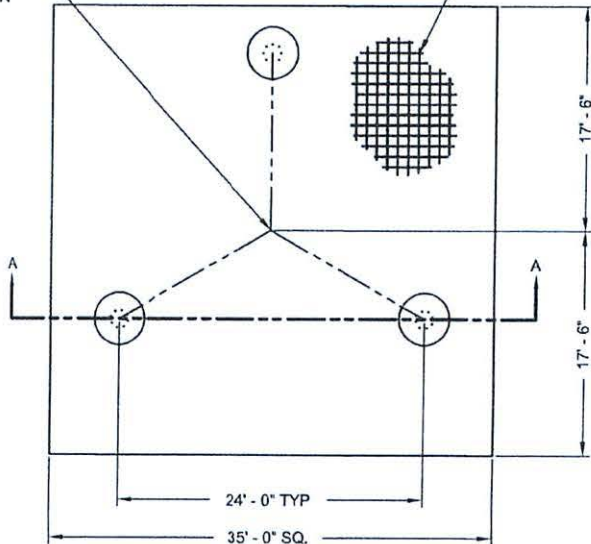

PLAN VIEW

TOTAL VOLUME OF CONCRETE = 95.0 CY

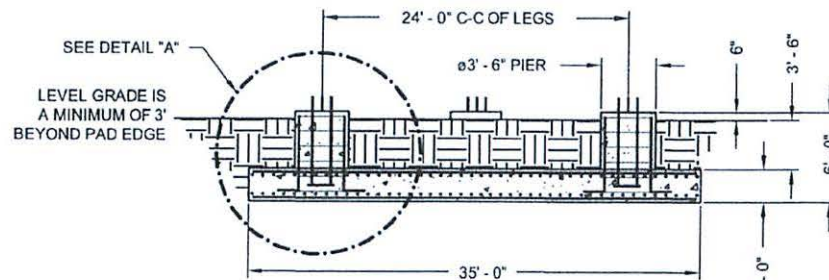

SECTION A-A

(6)  $\phi 2" \times 6'-0"$  OVERALL LENGTH ANCHOR BOLTS (F1554-GR105) W/ 1" THK BEARING PLATE AT THE BOTTOM OF THE ANCHOR BOLT CLUSTER (5'-0" MIN. ANCHOR BOLT EMBEDMENT)

(35) #6 HORIZONTAL BARS  $\times 34' - 6"$  LONG EQUALLY SPACED EACH WAY AT TOP OF MAT (TOTAL = 70)

USE EPOXY BONDING AGENT WHEN POURED SEPARATELY

(10) #10 VERTICAL BARS W/ #5 TIES AT 16" ON CENTER

(42) #10 HORIZONTAL BARS  $\times 34' - 6"$  LONG EQUALLY SPACED EACH WAY AT BOTTOM OF MAT (TOTAL = 84)

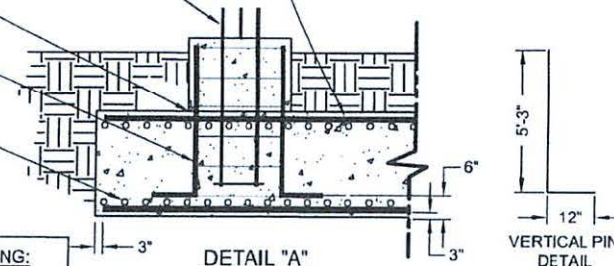

DETAIL "A"

VERTICAL PIN DETAIL

**FOUNDATION INSTALLATION/DESIGN NOTES:**

1. THIS FOUNDATION IS DESIGNED TO MEET ALL STANDARDS SET FORTH BY ACI 318: AMERICAN CONCRETE INSTITUTE, BUILDING CODE REQUIREMENTS FOR STRUCTURAL CONCRETE, ANSI/TIA/EIA 222-G: STRUCTURAL STANDARDS FOR STEEL ANTENNA TOWERS AND ANTENNA SUPPORTING STRUCTURES.
2. THIS FOUNDATION IS DESIGNED UTILIZING THE GEOTECHNICAL REPORT PREPARED BY EAST KENTUCKY ENGINEERING, LLC, NO. 165-000-0112, DATED 8-14-2020. THE FOUNDATION CONTRACTOR SHALL INSTALL THE FOUNDATIONS IN ACCORDANCE WITH THE RECOMMENDATIONS OF THE GEOTECHNICAL REPORT.
3. ALL WORK PERFORMED FROM THESE DRAWINGS SHOULD BE BY QUALIFIED CONTRACTORS EXPERIENCED IN TOWER FOUNDATION CONSTRUCTION.
4. ALL FOOTING EXCAVATIONS SHALL BE MANUALLY CLEANED PRIOR TO PLACING CONCRETE. COMPACT THE EXPOSED SOIL SURFACE AND ANY GRANULAR FILL UNDER THE FOUNDATION TO 90% OF THE MODIFIED PROCTOR DENSITY.
5. ALL CONCRETE SHALL HAVE A MINIMUM COMPRESSIVE STRENGTH OF 4000 PSI AFTER 28 DAYS. COPIES OF THE CONCRETE CYLINDER TEST REPORTS SHALL BE SENT TO THE RESIDENT ENGINEER / INSPECTOR.
6. CONCRETE COVER FOR REINFORCING BARS SHALL BE 2" UNLESS OTHERWISE NOTED. ALL REINFORCING BARS SHALL BE GRADE 60 REBAR (MIN YIELD = 60KSI).
7. FIELD BENDING OR WELDING OF REINFORCEMENT BARS IS NOT PERMITTED.
8. PROVIDE CHAMFERS AT ALL EXPOSED CORNERS OF CONCRETE.
9. BACKFILL NEAR AND AROUND THE FOUNDATIONS SHALL BE A WELL GRADED FILL MATERIAL PLACED IN 8" THICK LAYERS THAT HAS BEEN COMPACTED TO 90% OF THE MODIFIED PROCTOR DENSITY PER ASTM D1557.
10. SOME DETAIL HAS BEEN PURPOSELY OMITTED TO CLARIFY ILLUSTRATION.

**REINFORCEMENT BAR SPlicing:**

1. ALL LAP SPLICES SHALL CONFORM TO ACI 318 REQUIREMENTS.
2. REFER TO CHART BELOW WHEN REINFORCEMENT BAR SPlicing IS NECESSARY.

REINFORCING BAR SIZE	LAP SPLICE LENGTH
3	15"
4	19"
5	24"
6	28"
7	41"
8	47"
9	53"
10	60"
11	66"



*Keith M. Eaton*  
9-23-2020

**ALLSTATE TOWER**

ALL STATE TOWER INC.  
P.O. BOX 25  
HENDERSON, KY 42410  
PHONE: (770) 833-8512  
FAX: (770) 833-8475  
WWW.PTTG.COM

PROPRIETARY STATEMENT: THIS DRAWING IS THE PROPERTY OF ALLSTATE TOWER INC. IT IS NOT TO BE REPRODUCED OR COPIED IN ANY WAY WITHOUT PRIOR WRITTEN CONSENT OF ALLSTATE TOWER INC.

REV #	DESCRIPTION	DATE	BY	UNLESS OTHERWISE NOTED DIMENSIONS ARE IN: INCHES	DESCRIPTION:
				TOLERANCE BANDS: X +3/32" / -0 ANGLES $\pm 2'$ XX +3/32" / -0 XXX +1/16" / -0 HOLES $\pm 0.1/16" / 0$	PAD & PIER FOUNDATION DESIGN APPALACHIAN WIRELESS 300' SELF SUPPORT TOWER "DANA" FLOYD CO., KY
SCALE: NTS				DRAWN BY: KE / T.LONG/JJT	FILE NAME: FT-089813 - B
DATE: 9/17/2020				DESIGN: FT-089813	SHEET: B

# Exhibit 6



**KENTUCKY AIRPORT ZONING COMMISSION**

ANDY BESHEAR  
Governor

Office of Audits, 200 Mero Street, 4th floor  
Frankfort, KY 40622  
[www.transportation.ky.gov](http://www.transportation.ky.gov)  
502-782-4043

**APPROVAL OF APPLICATION**

August 13, 2020

**APPLICANT**

East Kentucky Network, LLC  
Cindy McCarty  
101 Technology Trail  
Ivel, KY 41642

SUBJECT: AS-FLOYD-PBX-2020-065

STRUCTURE: Antenna Tower  
LOCATION: Dana, KY  
COORDINATES: 37° 33' 13.77" N / 82° 41' 45" W  
HEIGHT: 310' AGL/1455' AMSL

The Kentucky Airport Zoning Commission has approved your application for a permit to construct 310' AGL/1455' AMSL Antenna Tower near Dana, KY 37° 33' 13.77" N / 82° 41' 45" W.

This permit is valid for a period of 18 Month(s) from its date of issuance. If construction is not completed within said 18-Month period, this permit shall lapse and be void, and no work shall be performed without the issuance of a new permit.

Medium Intensity White Obstruction Lighting Required

***Randall S. Royer***

Randall S. Royer, Executive Director  
Office of Audits  
Acting Administrator  
[Randall.Royer@ky.gov](mailto:Randall.Royer@ky.gov)  
[Jason.Salazar-Munoz@ky.gov](mailto:Jason.Salazar-Munoz@ky.gov)



An Equal Opportunity Employer M/F/D





Mail Processing Center  
 Federal Aviation Administration  
 Southwest Regional Office  
 Obstruction Evaluation Group  
 10101 Hillwood Parkway  
 Fort Worth, TX 76177

Aeronautical Study No.  
 2020-ASO-16402-OE

Issued Date: 06/11/2020

Cindy D. McCarty  
 East Kentucky Network, LLC  
 101 Technology Trail  
 Ivel, KY 41642

**\*\* DETERMINATION OF NO HAZARD TO AIR NAVIGATION \*\***

The Federal Aviation Administration has conducted an aeronautical study under the provisions of 49 U.S.C., Section 44718 and if applicable Title 14 of the Code of Federal Regulations, part 77, concerning:

Structure:	Antenna Tower Dana
Location:	Dana, KY
Latitude:	37-33-13.77N NAD 83
Longitude:	82-41-45.00W
Heights:	1145 feet site elevation (SE)
	310 feet above ground level (AGL)
	1455 feet above mean sea level (AMSL)

This aeronautical study revealed that the structure does not exceed obstruction standards and would not be a hazard to air navigation provided the following condition(s), if any, is(are) met:

As a condition to this Determination, the structure is to be marked/lighted in accordance with FAA Advisory circular 70/7460-1 L Change 2, Obstruction Marking and Lighting, 24-hr med-strobes - Chapters 4,6(MIWOL),&12.

Any failure or malfunction that lasts more than thirty (30) minutes and affects a top light or flashing obstruction light, regardless of its position, should be reported immediately to (877) 487-6867 so a Notice to Airmen (NOTAM) can be issued. As soon as the normal operation is restored, notify the same number.

It is required that FAA Form 7460-2, Notice of Actual Construction or Alteration, be e-filed any time the project is abandoned or:

- At least 10 days prior to start of construction (7460-2, Part 1)
- Within 5 days after the construction reaches its greatest height (7460-2, Part 2)

**See attachment for additional condition(s) or information.**

While the structure does not constitute a hazard to air navigation, it would be located within or near a military training area and/or route.

This determination expires on 12/11/2021 unless:

- (a) the construction is started (not necessarily completed) and FAA Form 7460-2, Notice of Actual Construction or Alteration, is received by this office.
- (b) extended, revised, or terminated by the issuing office.
- (c) the construction is subject to the licensing authority of the Federal Communications Commission (FCC) and an application for a construction permit has been filed, as required by the FCC, within 6 months of the date of this determination. In such case, the determination expires on the date prescribed by the FCC for completion of construction, or the date the FCC denies the application.

NOTE: REQUEST FOR EXTENSION OF THE EFFECTIVE PERIOD OF THIS DETERMINATION MUST BE E-FILED AT LEAST 15 DAYS PRIOR TO THE EXPIRATION DATE. AFTER RE-EVALUATION OF CURRENT OPERATIONS IN THE AREA OF THE STRUCTURE TO DETERMINE THAT NO SIGNIFICANT AERONAUTICAL CHANGES HAVE OCCURRED, YOUR DETERMINATION MAY BE ELIGIBLE FOR ONE EXTENSION OF THE EFFECTIVE PERIOD.

This determination is based, in part, on the foregoing description which includes specific coordinates, heights, frequency(ies) and power. Any changes in coordinates, heights, and frequencies or use of greater power, except those frequencies specified in the Colo Void Clause Coalition; Antenna System Co-Location; Voluntary Best Practices, effective 21 Nov 2007, will void this determination. Any future construction or alteration, including increase to heights, power, or the addition of other transmitters, requires separate notice to the FAA. This determination includes all previously filed frequencies and power for this structure.

If construction or alteration is dismantled or destroyed, you must submit notice to the FAA within 5 days after the construction or alteration is dismantled or destroyed.

This determination does include temporary construction equipment such as cranes, derricks, etc., which may be used during actual construction of the structure. However, this equipment shall not exceed the overall heights as indicated above. Equipment which has a height greater than the studied structure requires separate notice to the FAA.

This determination concerns the effect of this structure on the safe and efficient use of navigable airspace by aircraft and does not relieve the sponsor of compliance responsibilities relating to any law, ordinance, or regulation of any Federal, State, or local government body.

A copy of this determination will be forwarded to the Federal Communications Commission (FCC) because the structure is subject to their licensing authority.

If we can be of further assistance, please contact our office at (817) 222-5928, or [chris.smith@faa.gov](mailto:chris.smith@faa.gov). On any future correspondence concerning this matter, please refer to Aeronautical Study Number 2020-ASO-16402-OE.

**Signature Control No: 441865157-442630884**

( DNE )

Chris Smith  
Specialist

Attachment(s)  
Additional Information  
Frequency Data

Map(s)

cc: FCC



**Additional information for ASN 2020-ASO-16402-OE**

The tower is within the confines of VR-093, request NVG compatible lighting

Frequency Data for ASN 2020-ASO-16402-OE

LOW FREQUENCY	HIGH FREQUENCY	FREQUENCY UNIT	ERP	ERP UNIT
6	7	GHz	55	dBW
6	7	GHz	42	dBW
10	11.7	GHz	55	dBW
10	11.7	GHz	42	dBW
17.7	19.7	GHz	55	dBW
17.7	19.7	GHz	42	dBW
21.2	23.6	GHz	55	dBW
21.2	23.6	GHz	42	dBW
614	698	MHz	1000	W
614	698	MHz	2000	W
698	806	MHz	1000	W
806	901	MHz	500	W
806	824	MHz	500	W
824	849	MHz	500	W
851	866	MHz	500	W
869	894	MHz	500	W
896	901	MHz	500	W
901	902	MHz	7	W
929	932	MHz	3500	W
930	931	MHz	3500	W
931	932	MHz	3500	W
932	932.5	MHz	17	dBW
935	940	MHz	1000	W
940	941	MHz	3500	W
1670	1675	MHz	500	W
1710	1755	MHz	500	W
1850	1910	MHz	1640	W
1850	1990	MHz	1640	W
1930	1990	MHz	1640	W
1990	2025	MHz	500	W
2110	2200	MHz	500	W
2305	2360	MHz	2000	W
2305	2310	MHz	2000	W
2345	2360	MHz	2000	W
2496	2690	MHz	500	W

TOPO Map for ASN 2020-ASO-16402-OE

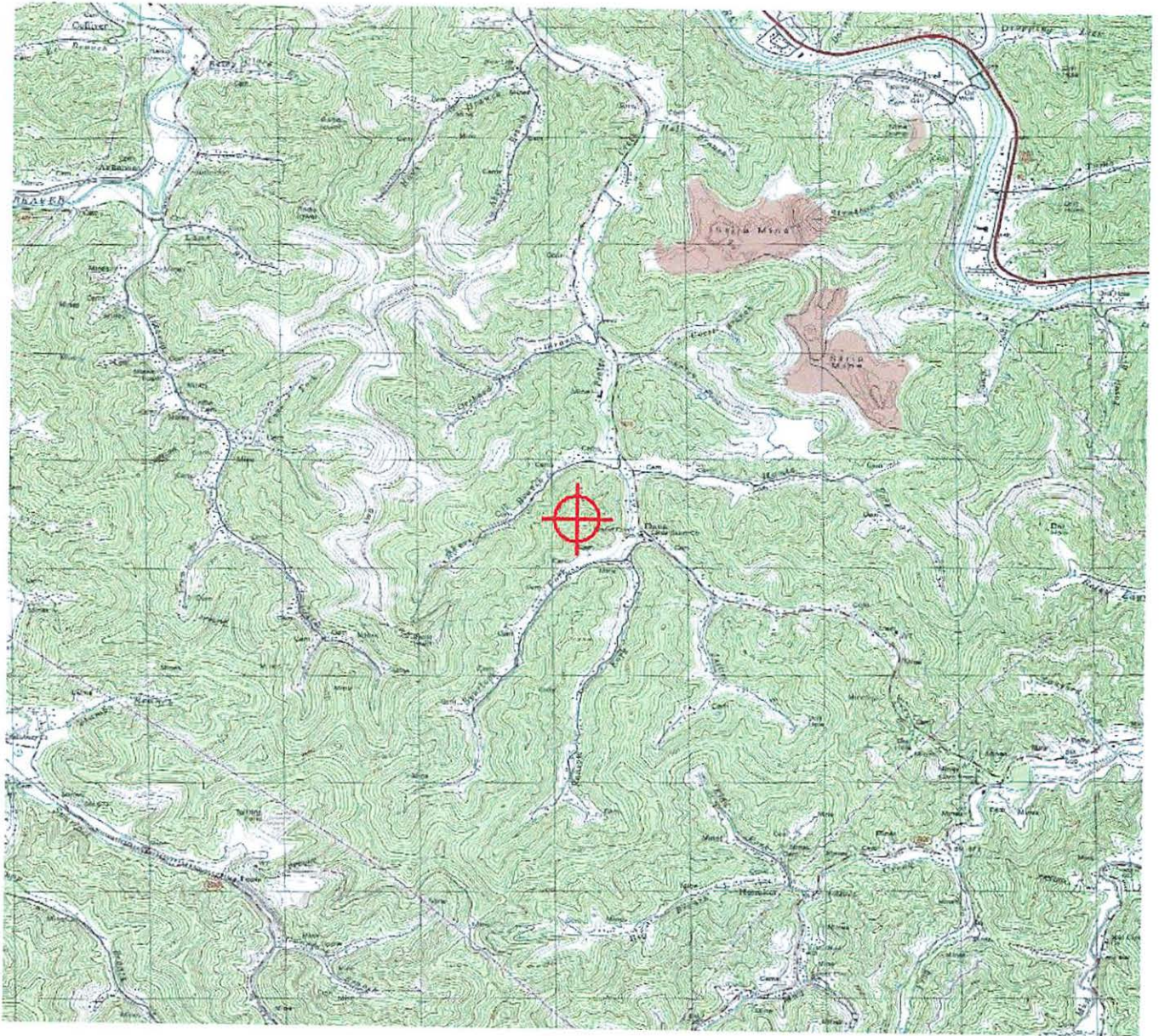



Sectional Map for ASN 2020-ASO-16402-OE

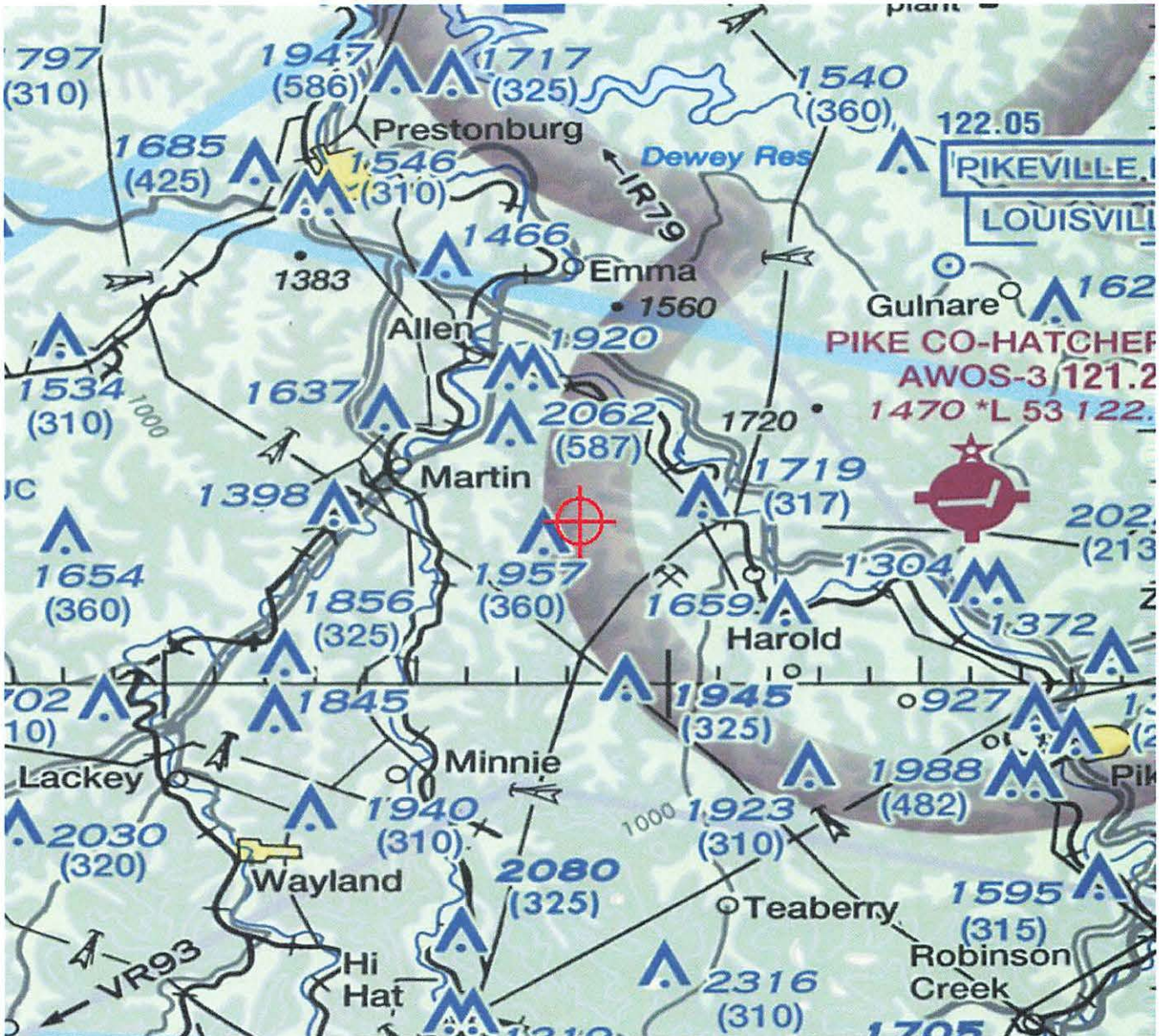

# Exhibit 7

### Driving Directions for Dana

1. Beginning at 127 S Lake Drive, Prestonsburg, KY head southwest on S Lake Drive toward Gray Ct.
2. Travel approximately 0.6 miles and turn right onto KY-302 S/Water Gap Rd.
3. Travel 2.6 miles and turn left to merge onto KY-80 E/US-23 S/US-460 E toward Pikeville.
4. Drive approximately 3.8 miles and turn right onto KY-1426 S.
5. Drive 4.0 miles to Scholl House Hollow, then turn right onto Cr-1106 and drive approximately 0.2 miles.
6. Take a slight right onto Spurlock Fork Rd.
7. Drive approximately 0.3 miles (sign posted).
8. Walk 3100' up the hill following the flags to the tower site (sign posted).

Prepared By:  
Daryl Bartley  
Appalachian Wireless  
606-477-2355



# Dana

Location:

316 Spurlock Fork  
Dana, KY 41615

Coordinates:

37 33' 13.76"N  
82 41' 45.00"W

## Legend

 1/2 Mile Search Area

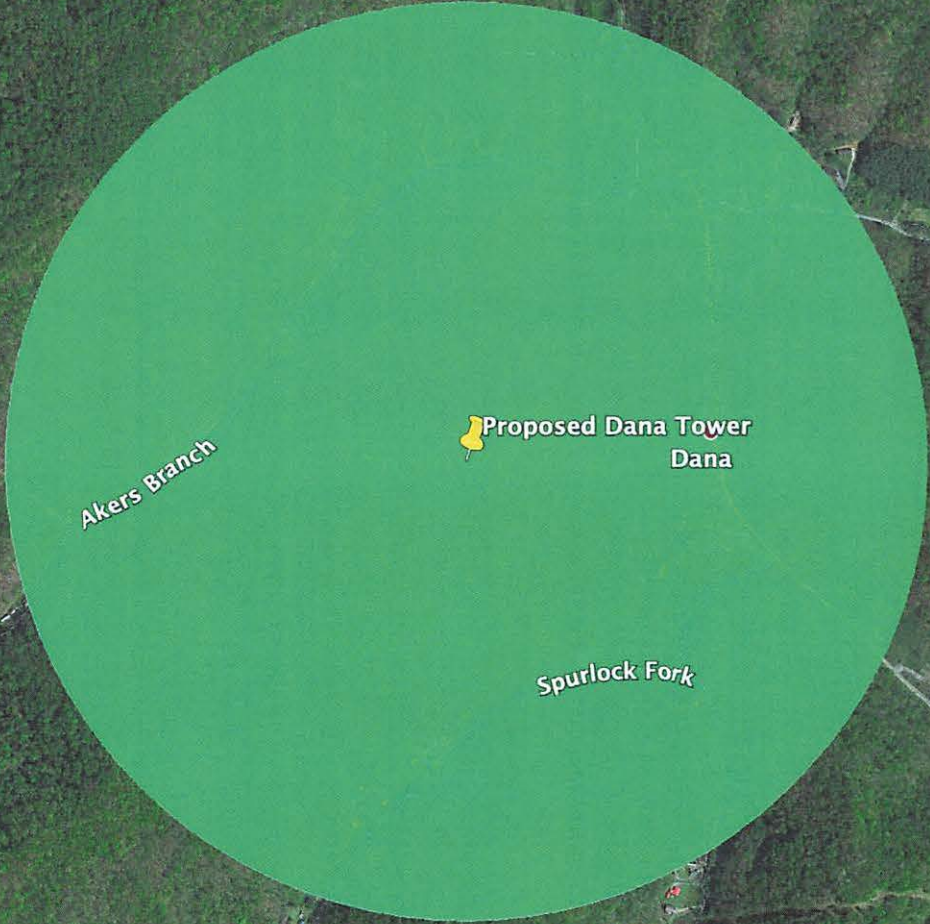

Google Earth

© 2020 Google



3000 ft

**Exhibit 8**



**MEMORANDUM OF LEASE**

THIS MEMORANDUM OF LEASE is made and entered into on this 02<sup>nd</sup> day of May, 2020, with a commencement date of June 1, 2020 (the "Commencement Date"), by and between **DONNIE AKERS** and **MONICA AKERS**, a married couple, with an address of 316 Spurlock Fork, Dana, Kentucky 41615, hereinafter referred to as "Lessors", and **EAST KENTUCKY NETWORK, LLC D/B/A APPALACHIAN WIRELESS**, a Kentucky limited liability company, with a mailing address of 101 Technology Trail, Ivel, Kentucky, 41642, hereinafter referred to as "Lessee."

**WITNESSETH**

1. **Demised Premises.** For good and valuable consideration, Lessors leased to Lessee, and Lessee has leased from Lessors that certain tract of real estate located in Floyd County, Kentucky, and being a portion of the same land conveyed to Lessors by Deed dated August 19, 2011, and recorded on August 30, 2011, in Deed Book 581, Page 440, in the Floyd County Clerk's Office. Said property is more particularly described in the description **attached** hereto and made a part hereof as **Exhibit A** and the plat **attached** hereto and made a part hereof as **Exhibit B**, prepared by James W. Caudill, Licensed Professional Land Surveyor (hereinafter referred to as the "Premises"). The Lessors have also granted unto Lessee full and complete rights of ingress, egress and regress to and from the Premises over any property owned by Lessors and other associated rights for installation of utilities, maintenance, and other purposes. Lessee has the absolute right to assign, sublease, sublicense or otherwise transfer, in whole or in part, the Leased Premises and the easements and rights-of-way.



2. **Term.** The initial term of the Lease is for a period of five (5) years from the Commencement Date set forth above.

3. **Renewals.** The Lease shall automatically renew for an additional seven (7) terms of five (5) years each, unless Lessee provides sixty (60) days written notice prior to the end of the current term that it does not wish to renew.

4. **Binding Effect.** All of the terms, conditions, and covenants hereof shall be binding and inure to the benefit of the parties and their respective heirs, representatives, successors, and assigns.

5. **Purpose.** This Memorandum of Lease is prepared solely for the purpose of recordation, and is not intended to, nor shall it be deemed to, modify any of the terms and conditions set forth in the Lease, nor to construe any of the rights, duties or responsibilities of Lessors and Lessee. In the event of any conflict between the terms and conditions of this Memorandum and the terms and conditions of the Lease, the terms and conditions of the Lease shall supersede and control.

**[THE REMAINDER OF THIS PAGE INTENTIONALLY LEFT BLANK.]**

IN WITNESS WHEREOF, Lessors and Lessee have caused their names to be signed hereto, as of the date(s) indicated below.

LESSORS:

Donnie Akers

DONNIE AKERS

Monica Akers

MONICA AKERS

COMMONWEALTH OF KENTUCKY,  
COUNTY OF Floyd, TO WIT:

The foregoing instrument was acknowledged before me on this 18 day of May, 2020, by Donnie Akers and Monica Akers, Lessors.

Mary F. Bush

Notary Public

Commission No.: 630053

My Commission Expires 10/19/2023

LESSEE:

EAST KENTUCKY NETWORK, LLC D/B/A  
APPALACHIAN WIRELESS

W.A. Gillum

By: W.A. Gillum

Its: CEO/ General Manager

COMMONWEALTH OF KENTUCKY  
COUNTY OF Floyd

The foregoing instrument was acknowledged before me on this 22nd day of May, 2020, by W.A. Gillum, CEO/General Manager of East Kentucky Network, LLC d/b/a Appalachian Wireless, Lessee.

Raina La'Nell Helton

Notary Public

Commission No.: KYNP375

My Commission Expires 2-6-2024

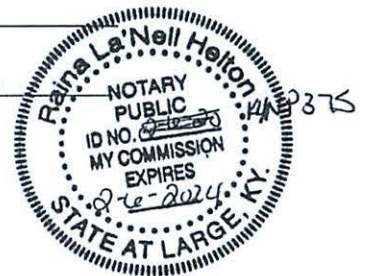

This instrument was prepared by:

*Krystal Branham*

---

Krystal Branham, Attorney  
101 Technology Trail  
Ivel, Kentucky 41642  
(606) 477-2355



**LOT DESCRIPTION**

Property of  
Donnie Akers and  
Monica Akers  
316 Spurlock Fork  
Dana, Kentucky 41615  
Off of Highway 1426  
Near the Community of Dana  
in Floyd County, Kentucky  
March 06, 2020

A certain tract or parcel of land lying in Floyd County, Kentucky, and being a portion of the same tract of land conveyed to Donnie Akers and Monica Akers, husband and wife, by Deed of Conveyance, dated August 19, 2011, from Geraldine Jarrell, and of record in Deed Book 581 Page 440 of the records of the Floyd County Court Clerk's Office. The tract is more particularly bounded and described as follows:

Lot 1A

Beginning at a set iron pin with cap marked LS#2259 on hillside at the bottom of a slope of a knob (said point having Latitude: 37 deg 33 min 13.7435 sec and Longitude: 82 deg 41 min 46.3131 sec); thence a straight line along the bottom of previously mentioned slope North 41 deg 20 min 13 sec East, a distance of 150.00 feet to a set iron pin with cap marked LS#2259 on hillside at bottom of a slope of a knob; thence down the hillside South 48 deg 39 min 47 sec East, a distance of 150.00 feet to a set iron pin with cap marked LS#2259 on hillside; thence around the hillside South 41 deg 20 min 13 sec West, a distance of 150.00 feet to a set iron pin with cap marked LS#2259 on hillside; thence back up the hillside North 48 deg 39 min 47 sec West, a distance of 150.00 feet to the point of the beginning. Containing a calculated area of 22500 Sq. Feet, or 0.52 Acres.

Also to be included is an access road from the public road to Lot 1A. Also to be included is a right to install fiber and utility lines in or along said access road and/or such other location to be agreed upon by the parties.

Unless stated otherwise, any monument referred to herein as "set iron pin with cap" is a set 1/2" diameter rebar, at least eighteen (18") in length, with a plastic cap stamped "LS-2259". All bearings stated herein are referred to NAD83, KY single zone of the Kentucky state plane system.

This survey was performed on March 06, 2020 by James W. Caudill, a Kentucky Licensed Professional Land Surveyor No. 2259.

  
James W. Caudill





APPALACHIAN WIRELESS  
101 TECHNOLOGY TRAIL  
IVEL, KY. 41642  
PROPOSED TOWER SITE  
OFF HWY 1426 NEAR DANA  
IN FLOYD COUNTY, KY.

MAP 64 PARCEL 44  
SABRINA MICHELE LEQUIRE  
P.O. BOX 4088  
PIKEVILLE, KY 41502  
DEED BOOK 575, PAGE 466

MAP 64 PARCEL 43  
DON AND  
LUCILLE WARREN  
21 SPURLOCK FORK  
DANA, KY 41615  
DB 306 PG328

**Legend**

-  1/2" re-bar set with a plastic cap  
Stamped J.W. Caudill, PLS #2259  
Unless otherwise noted.
-  Monument - Found - Type Noted
-  Property Line

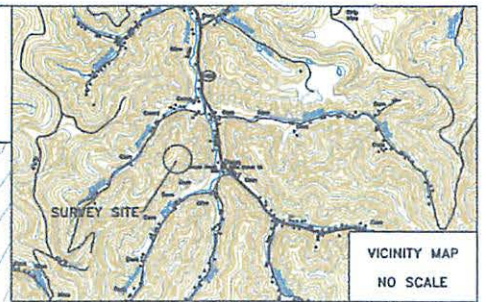

MAP 64 PARCEL 71  
DONNIE AND MONICA AKERS  
316 SPURLOCK FORK  
DANA, KY 41615  
DEED BOOK 581 PAGE 440

Beginning on a set iron pin with cap marked #LS2259 on hillside at bottom of a slope;  
Thence a straight line with bottom of slope N 41° 20' 13" E, a distance of 150.00 feet to a set iron pin with cap marked #LS2259;  
Thence down the hill S 48° 39' 47" E, a distance of 150.00 feet to a set iron pin with cap marked #LS2259;  
Thence a straight line with hillside S 41° 20' 13" W, a distance of 150.00 feet to a set iron pin with cap marked LS#2259;  
Thence back up the hillside N 48° 39' 47" W, a distance of 150.00 feet to the point of the beginning.  
Containing a calculated area of 22500 Sq. Ft. or 0.52 Acres.



BEG - SET IPC  
LAT:37°33'13.7435"  
LON:82°41'46.3131"

Lot 1A  
22500 Sq. Ft  
0.52 Acres

Proposed New Access Road  
3100' Long @ 15% Grade

**SURVEYOR'S STATEMENTS**

The survey shown hereon was conducted under my direct supervision. The method used was random traverse with sideshots. The mathematical error of closure was 1:12,000. The bearings and distances were not adjusted for closure. The basis for the bearings Grid North, NAD83 KY Single Zone. This is a "Rural" survey. This plat of survey represents a Boundary Survey and complies with 201 KAR 18:150

STATE OF KENTUCKY  
JAMES W. CAUDILL  
2259  
LICENSED PROFESSIONAL LAND SURVEYOR

NAD83 KY Single Zone

James W. Caudill      2259      03/06/2020      Date  
PLS No. 2259

PLAT OF SURVEY		
DRAWN JWC	DATE 03/06/2020	Subdivision of the Property of Donnie and Monica Akers D.B. 581 Pg. 440
APPROVED JWC	DATE 03/06/2020	
SCALE 1" = 50'	SHEET 1 of 1	SURVEYED BY JAMES W. CAUDILL LS2259 2999 PERKINS/MADDEN ROAD AMBURGEY, KY 41773 PHONE 606-642-3217

# Exhibit 9

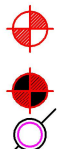

APPALACHIAN WIRELESS  
 101 TECHNOLOGY TRAIL  
 IVEL, KY. 41642  
 PROPOSED TOWER SITE  
 OFF HWY 1426 NEAR DANA  
 IN FLOYD COUNTY, KY.

**Legend**  
  
 1/2" re-bar set with a plastic cap  
 Stamped J.W. Caudill, PLS #2259  
 Unless otherwise noted.  
 Monument - Found - Type Noted  
 Utility Pole

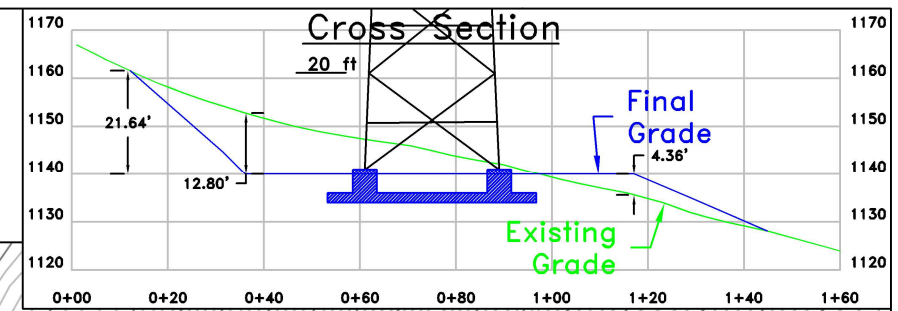

MAP 64 PARCEL 44  
 SABRINA MICHELE LEQUIRE  
 P.O. BOX 4088  
 PIKEVILLE, KY 41502  
 DEED BOOK 575 PAGE 466

MAP 64 PARCEL 43  
 DON AND  
 LUCILLE WARREN  
 21 SPURLOCK FORK  
 DANA, KY 41615  
 DB 306 PG328

MAP 64 PARCEL 71  
 DONNIE AND MONICA AKERS  
 316 SPURLOCK FORK  
 DANA, KY 41615  
 DEED BOOK 581 PAGE 440

Lot 1A  
 22500 Sq. Ft  
 0.52 Acres

Center of Proposed Tower  
 LAT:37°33'13.7691"  
 LON:82°41'45.0048"  
 N:3739719.49  
 E:5806426.66  
 Ground El: 1145'

"I certify that the latitude 37°33'13.7691"N and longitude 82°41'45.0048"W are within +/- 50 feet horizontally; and the site elevation 1141.0 ft. MSL, is within +/- 20 feet vertically. With a structure height of 300 ft AGL, the overall height is 1441.0 ft, AMSL. The horizontal datum (coordinates) is in terms of the North American Datum of 1983 (NAD 83). The vertical datum heights are in terms of the North American Vertical Datum of 1988, and are determined to the nearest foot."

- THE PROPOSED TOWER HAS BEEN LOCATED USING DUAL FREQUENCY GPS UNIT PROCESSED BY "OPUS"
- STATE PLANE COORDINATES NAD 83 KY SINGLE ZONE N:3739719.49, E:5806426.66, EL 1145.0' EXISTING GRD TOP OF PROPOSED FOUNDATION EL1141'-TOP TOWER EL1441'
- PRECISION: HORIZONTAL=0.30' VERTICAL=0.50'
- THIS SURVEY MEETS OBSTACLE ACCURACY CODE 2C.
- PROPERTY LINE INFORMATION TAKEN FROM DEEDS

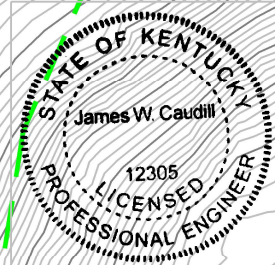

Proposed New Access Road  
 3100' Long @ 15% Grade

LINE	BEARING	DISTANCE
L1	S 18°01'04" E	64.71'
L2	S 04°41'34" E	77.75'
L3	S 03°17'22" E	106.76'
L4	S 02°18'34" E	76.74'
L5	S 12°55'47" W	112.59'
L6	N 70°46'28" W	87.14'
L7	N 75°45'43" W	80.51'
L8	N 81°47'08" W	85.42'
L9	N 82°25'06" W	96.90'
L10	S 85°35'38" W	76.71'
L11	S 69°36'35" W	111.77'

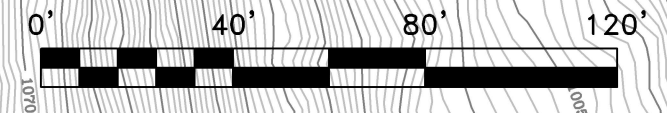

NAD83 KY Single Zone

East Kentucky Network d/b/a Appalachian Wireless 101 Technology Trail, Ivel, KY 41642		
DRAWN JWC	DATE 09/23/2020	Dana Tower Site Proposed Tower and Layout Located off HWY 1426 Floyd County, Kentucky
APPROVED JWC	DATE 09/23/2020	
SCALE 1" = 40'	SHEET 2 of 3	PROJECT NO. Dana/dana2c40

SIGNED: *James W. Caudill* 12305/2259 09/23/2020  
 PRINTED: JAMES W. CAUDILL PE #12305 & LS #2259 DATE



# Exhibit 10



APPALACHIAN WIRELESS  
 101 TECHNOLOGY TRAIL  
 IVEL, KY. 41642  
 PROPOSED TOWER SITE  
 OFF HWY 1426 NEAR DANA  
 IN FLOYD COUNTY, KY.

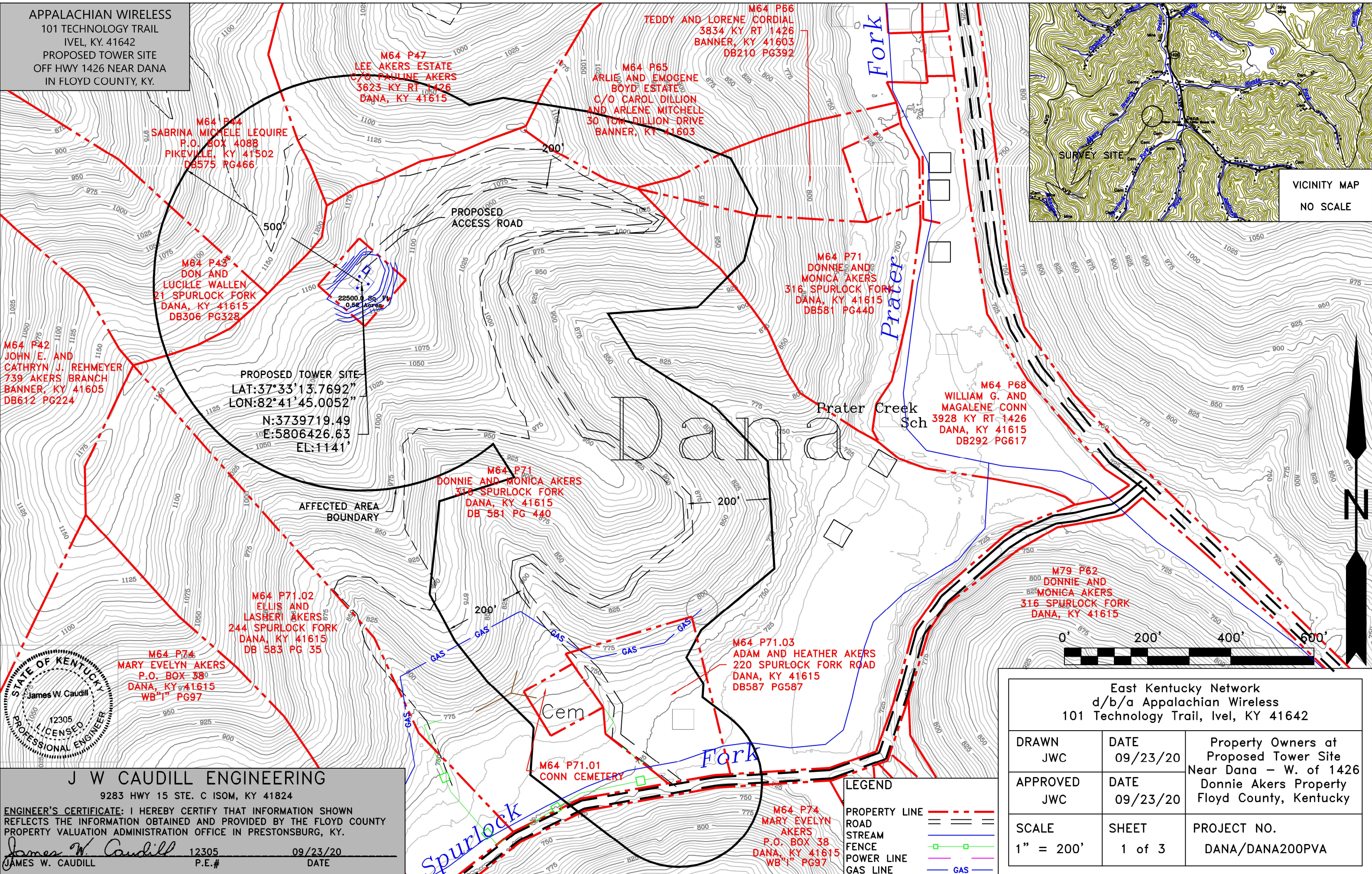

M64 P42  
 JOHN E. AND  
 CATHRYN J. REHMEYER  
 739 AKERS BRANCH  
 BANNER, KY 41605  
 DB612 PG224

M64 P44  
 SABRINA MICHELE LEQUIRE  
 P.O. BOX 4088  
 PIKEVILLE, KY 41502  
 DB575 PG466

M64 P43  
 DON AND  
 LUCILLE WALLEN  
 21 SPURLOCK FORK  
 DANA, KY 41615  
 DB306 PG328

PROPOSED TOWER SITE  
 LAT:37°33'13.7692"  
 LON:82°41'45.0052"  
 N:3739719.49  
 E:5806426.63  
 EL:1141'

AFFECTED AREA  
 BOUNDARY

M64 P71.02  
 ELLIS AND  
 LASHER AKERS  
 244 SPURLOCK FORK  
 DANA, KY 41615  
 DB 583 PG 35

M64 P74  
 MARY EVELYN AKERS  
 P.O. BOX 38  
 DANA, KY 41615  
 WB "I" PG97

M64 P47  
 LEE AKERS ESTATE  
 C/O PAULINE AKERS  
 3623 KY RT 1426  
 DANA, KY 41615

M64 P65  
 ARLIE AND EMOGENE  
 BOYD ESTATE  
 C/O CAROL DILLION  
 AND ARLENE MITCHELL  
 30 TOM DILLION DRIVE  
 BANNER, KY 41603

M64 P66  
 TEDDY AND LORENE CORDIAL  
 3834 KY RT 1426  
 BANNER, KY 41603  
 DB210 PG392

M64 P71  
 DONNIE AND  
 MONICA AKERS  
 316 SPURLOCK FORK  
 DANA, KY 41615  
 DB581 PG440

M64 P68  
 WILLIAM G. AND  
 MAGALENE CONN  
 3928 KY RT 1426  
 DANA, KY 41615  
 DB292 PG617

M64 P71  
 DONNIE AND MONICA AKERS  
 316 SPURLOCK FORK  
 DANA, KY 41615  
 DB 581 PG 440

M64 P71.03  
 ADAM AND HEATHER AKERS  
 220 SPURLOCK FORK ROAD  
 DANA, KY 41615  
 DB587 PG587

M79 P62  
 DONNIE AND  
 MONICA AKERS  
 316 SPURLOCK FORK  
 DANA, KY 41615

M64 P71.01  
 CONN CEMETERY

M64 P74  
 MARY EVELYN  
 AKERS  
 P.O. BOX 38  
 DANA, KY 41615  
 WB "I" PG97

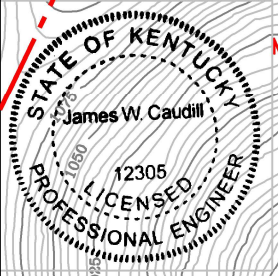
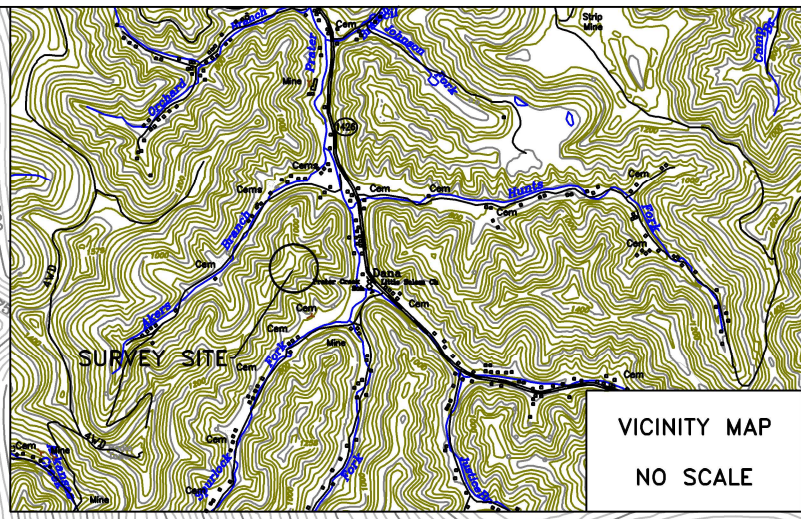

**J W CAUDILL ENGINEERING**  
 9283 HWY 15 STE. C ISOM, KY 41824  
 ENGINEER'S CERTIFICATE: I HEREBY CERTIFY THAT INFORMATION SHOWN  
 REFLECTS THE INFORMATION OBTAINED AND PROVIDED BY THE FLOYD COUNTY  
 PROPERTY VALUATION ADMINISTRATION OFFICE IN PRESTONSBURG, KY.  
 James W. Caudill 12305 09/23/20  
 JAMES W. CAUDILL P.E.# DATE

LEGEND

PROPERTY LINE	---
ROAD	==
STREAM	—
FENCE	□
POWER LINE	—
GAS LINE	— GAS



East Kentucky Network d/b/a Appalachian Wireless 101 Technology Trail, Ivel, KY 41642		
DRAWN JWC	DATE 09/23/20	Property Owners at Proposed Tower Site Near Dana – W. of 1426 Donnie Akers Property Floyd County, Kentucky
APPROVED JWC	DATE 09/23/20	
SCALE 1" = 200'	SHEET 1 of 3	PROJECT NO. DANA/DANA200PVA



# Exhibit 11

# PROFILE WITH TOWER

THIS IS A VERTICAL PROFILE SKETCH OF THE TOWER INDICATING THE PROPOSED ANTENNA AND DISH ELEVATIONS. NO DESIGN CRITERIA WAS CONSIDERED IN THE PREPARATION OF THIS DRAWING.

*James W. Caudill* 12305 09/23/2020  
 JAMES W. CAUDILL PE #. DATE

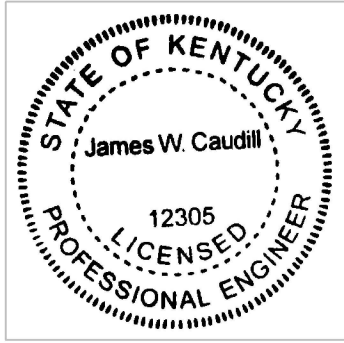

NOTE: SEE FOUNDATION DRAWINGS FOR DETAILS

09/23/2020  
 SCALE 1" = 20'



East Kentucky Network d/b/a Appalachian Wireless 101 Technology Trail, Ivel, KY 41642		
DRAWN JWC	DATE 09/23/2020	Dana Tower Site Proposed Tower and Layout Located off HWY 1426 Floyd County, Kentucky
APPROVED JWC	DATE 09/23/2020	
SCALE 1" = 20'	SHEET 3 of 3	PROJECT NO. Dana/danapro20

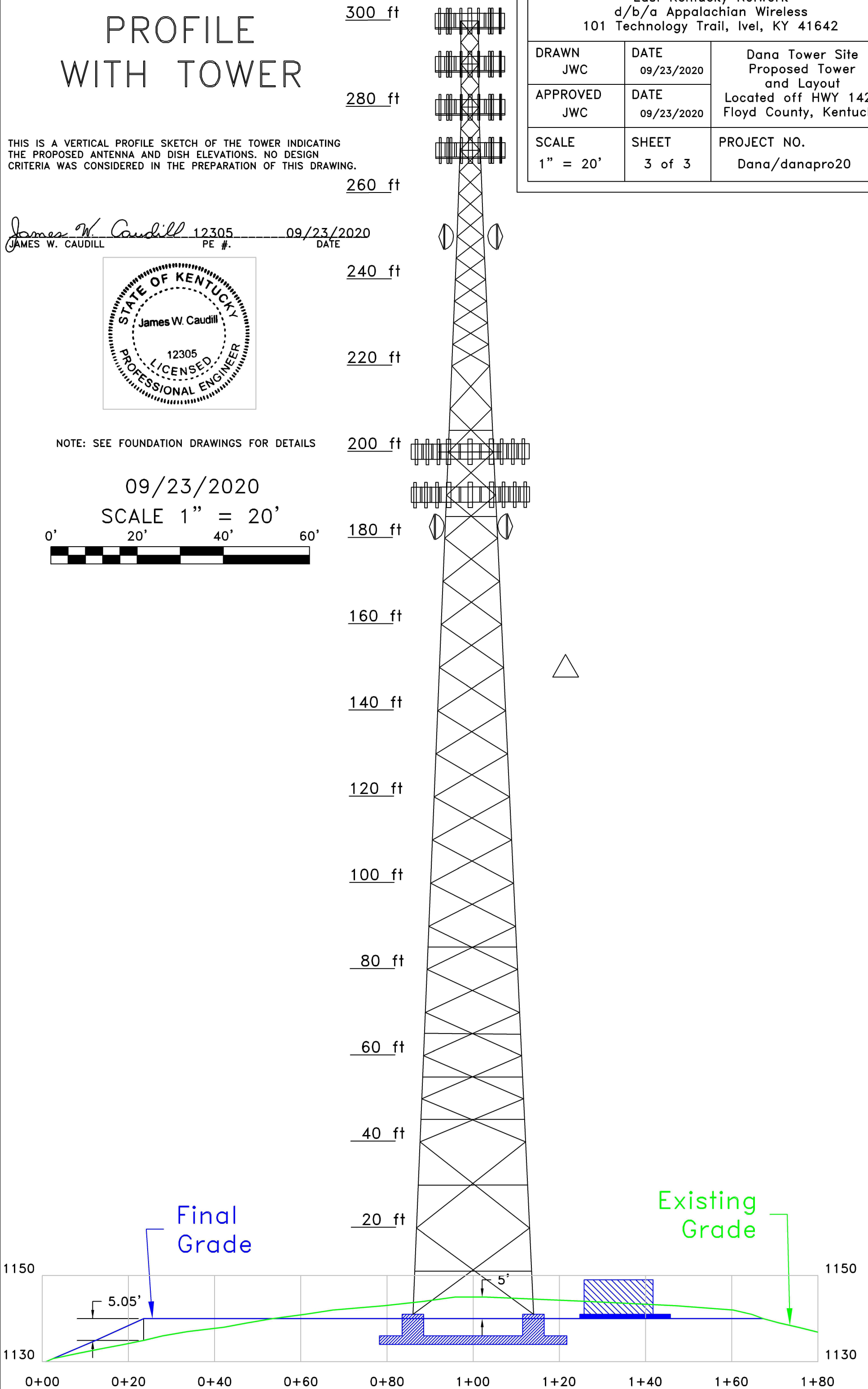

# Exhibit 12



Utility ID	Utility Name	Utility Type	Class	City	State
4107900	365 Wireless, LLC	Cellular	D	Atlanta	GA
4109300	Access Point, Inc.	Cellular	D	Cary	NC
4108300	Air Voice Wireless, LLC	Cellular	A	Bloomfield Hill	MI
4110650	Alliant Technologies of KY, L.L.C.	Cellular	C	Morristown	NJ
44451184	Alltel Communications, LLC	Cellular	A	Basking Ridge	NJ
4110850	AltaWorx, LLC	Cellular	C	Fairhope	AL
4107800	American Broadband and Telecommunications Company	Cellular	C	Toledo	OH
4108650	AmeriMex Communications Corp.	Cellular	D	Dunedin	FL
4105100	AmeriVision Communications, Inc. d/b/a Affinity 4	Cellular	D	Virginia Beach	VA
4110700	Andrew David Balholm dba Norcell	Cellular	C	Clayton	WA
4108600	BCN Telecom, Inc.	Cellular	D	Morristown	NJ
4110550	Blue Casa Mobile, LLC	Cellular	D	Santa Barbara	CA
4108750	Blue Jay Wireless, LLC	Cellular	C	Carrollton	TX
4111050	BlueBird Communications, LLC	Cellular	C	New York	NY
4202300	Bluegrass Wireless, LLC	Cellular	A	Elizabethtown	KY
4107600	Boomerang Wireless, LLC	Cellular	B	Hiawatha	IA
4105500	BullsEye Telecom, Inc.	Cellular	D	Southfield	MI
4110050	CampusSims, Inc.	Cellular	D	Boston	MA
4100700	Cellco Partnership dba Verizon Wireless	Cellular	A	Basking Ridge	NJ
4106600	Cintex Wireless, LLC	Cellular	D	Rockville	MD
4111000	ComApp Technologies LLC	Cellular	C	Melrose	MA
4101900	Consumer Cellular, Incorporated	Cellular	A	Portland	OR
4106400	Credo Mobile, Inc.	Cellular	A	San Francisco	CA
4108850	Cricket Wireless, LLC	Cellular	A	San Antonio	TX
4001900	CTC Communications Corp. d/b/a EarthLink Business I	Cellular	D	Grand Rapids	MI
10640	Cumberland Cellular Partnership	Cellular	A	Elizabethtown	KY
4101000	East Kentucky Network, LLC dba Appalachian Wireless	Cellular	A	Ivel	KY
4002300	Easy Telephone Service Company dba Easy Wireless	Cellular	D	Ocala	FL
4109500	Enhanced Communications Group, LLC	Cellular	D	Bartlesville	OK
4110450	Excellus Communications, LLC	Cellular	D	Chattanooga	TN
4105900	Flash Wireless, LLC	Cellular	C	Concord	NC
4104800	France Telecom Corporate Solutions L.L.C.	Cellular	D	Oak Hill	VA
4109350	Global Connection Inc. of America	Cellular	D	Norcross	GA
4102200	Globalstar USA, LLC	Cellular	B	Covington	LA
4109600	Google North America Inc.	Cellular	A	Mountain View	CA
33350363	Granite Telecommunications, LLC	Cellular	D	Quincy	MA
4106000	GreatCall, Inc. d/b/a Jitterbug	Cellular	A	San Diego	CA
10630	GTE Wireless of the Midwest dba Verizon Wireless	Cellular	A	Basking Ridge	NJ
4110600	Horizon River Technologies, LLC	Cellular	C	Atlanta	GA
4103100	i-Wireless, LLC	Cellular	A	Newport	KY
4109800	IM Telecom, LLC d/b/a Infiniti Mobile	Cellular	D	Tulsa	OK
22215360	KDDI America, Inc.	Cellular	D	New York	NY
10872	Kentucky RSA #1 Partnership	Cellular	A	Basking Ridge	NJ
10680	Kentucky RSA #3 Cellular General	Cellular	A	Elizabethtown	KY
10681	Kentucky RSA #4 Cellular General	Cellular	A	Elizabethtown	KY
4109750	Konatel, Inc. dba telecom.mobi	Cellular	D	Johnstown	PA
4110900	Lunar Labs, Inc.	Cellular	C	Detroit	MI
4107300	Lycamobile USA, Inc.	Cellular	D	Newark	NJ
4108800	MetroPCS Michigan, LLC	Cellular	A	Bellevue	WA
4109650	Mitel Cloud Services, Inc.	Cellular	D	Mesa	AZ
4202400	New Cingular Wireless PCS, LLC dba AT&T Mobility, PCS	Cellular	A	San Antonio	TX
10900	New Par dba Verizon Wireless	Cellular	A	Basking Ridge	NJ
4000800	Nextel West Corporation	Cellular	D	Overland Park	KS
4001300	NPCR, Inc. dba Nextel Partners	Cellular	D	Overland Park	KS

4001800	OnStar, LLC	Cellular	A	Detroit	MI
4110750	Onvoy Spectrum, LLC	Cellular	C	Plymouth	MN
4109050	Patriot Mobile LLC	Cellular	D	Southlake	TX
4110250	Plintron Technologies USA LLC	Cellular	D	Bellevue	WA
33351182	PNG Telecommunications, Inc. dba PowerNet Global Communications	Cellular	D	Cincinnati	OH
4202100	Powertel/Memphis, Inc. dba T-Mobile	Cellular	A	Bellevue	WA
4107700	Puretalk Holdings, LLC	Cellular	A	Covington	GA
4106700	Q Link Wireless, LLC	Cellular	A	Dania	FL
4108700	Ready Wireless, LLC	Cellular	B	Hiawatha	IA
4110500	Republic Wireless, Inc.	Cellular	D	Raleigh	NC
4111100	ROK Mobile, Inc.	Cellular	C	Culver City	CA
4106200	Rural Cellular Corporation	Cellular	A	Basking Ridge	NJ
4108550	Sage Telecom Communications, LLC dba TruConnect	Cellular	D	Los Angeles	CA
4109150	SelecTel, Inc. d/b/a SelecTel Wireless	Cellular	D	Freemont	NE
4106300	SI Wireless, LLC	Cellular	A	Carbondale	IL
4110150	Spectrotel, Inc. d/b/a Touch Base Communications	Cellular	D	Neptune	NJ
4200100	Sprint Spectrum, L.P.	Cellular	A	Atlanta	GA
4200500	SprintCom, Inc.	Cellular	A	Atlanta	GA
4109550	Stream Communications, LLC	Cellular	D	Dallas	TX
4110200	T C Telephone LLC d/b/a Horizon Cellular	Cellular	D	Red Bluff	CA
4202200	T-Mobile Central, LLC dba T-Mobile	Cellular	A	Bellevue	WA
4002500	TAG Mobile, LLC	Cellular	D	Carrollton	TX
4109700	Telecom Management, Inc. dba Pioneer Telephone	Cellular	D	South Portland	ME
4107200	Telefonica USA, Inc.	Cellular	D	Miami	FL
4108900	Telrite Corporation dba Life Wireless	Cellular	D	Covington	GA
4108450	Tempo Telecom, LLC	Cellular	D	Kansas City	MO
4109950	The People's Operator USA, LLC	Cellular	D	New York	NY
4109000	Ting, Inc.	Cellular	A	Toronto	ON
4110400	Torch Wireless Corp.	Cellular	D	Jacksonville	FL
4103300	Touchtone Communications, Inc.	Cellular	D	Whippany	NJ
4104200	TracFone Wireless, Inc.	Cellular	D	Miami	FL
4002000	Truphone, Inc.	Cellular	D	Durham	NC
4110300	UVNV, Inc.	Cellular	D	Costa Mesa	CA
4105700	Virgin Mobile USA, L.P.	Cellular	A	Atlanta	GA
4110800	Visible Service LLC	Cellular	C	Lone Tree	CO
4106500	WiMacTel, Inc.	Cellular	D	Palo Alto	CA
4110950	Wing Tel Inc.	Cellular	C	New York	NY
4109900	Wireless Telecom Cooperative, Inc. dba theWirelessFreeway	Cellular	D	Louisville	KY

# Exhibit 13



S & S Tower Services  
120 Branden Dr.  
Mousie, KY 41839

Kentucky Public Service Commission  
211 Sower Blvd.  
P.O. Box 615  
Frankfort, KY 40602-0615

Dear Commissioners:

The Construction Manager for the proposed communications facility will be Dave Strausbaugh. His contact information is (606) 497-6730 or [dstrausbaugh010@gmail.com](mailto:dstrausbaugh010@gmail.com).

Dave has been in the industry completing civil construction and constructing towers since 1991. He has worked for S&S Tower Services since 2015 as Construction Manager overseeing the construction of telecommunications towers and sites.

Thank you,

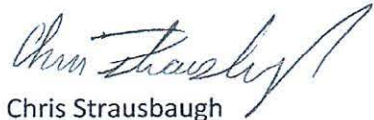

Chris Strausbaugh  
Owner  
S&S Tower Services  
(606) 497-5798