



YOUR RELIABLE SEALING SOLUTION PARTNER

# WONYOUNG SEAL CORPORATION

RELIABLE

PROFESSIONAL

MODERATE

[www.wys-seals.com](http://www.wys-seals.com)



WONYOUNG SEAL CORPORATION

## Our Mission

Our company is leading seal maker specially for Hydraulic and Pneumatic seal product.

Our product range is

- \* Whole hydraulic seal for construction machinery and industrial used.
- \* Repair seal kit(for Doosan, Hyundai, Volvo, Komatsu, Hitach, Kobelco, Cat...etc)
- \* Hydraulic Breaker seal
- \* Hydraulic Breaker seal kit
- \* Floating seal
- \* Machined seal(made by CNC for Special size by Special material) etc.

WYS Sealing solution characterized by to provide Heat resistance/Cold resistance /Reducing oil pollution. This is main stream of needs of Cylinder maker and we are providing verified OEM quality seal. Recently WYS seals made a remarkable growth of quality and quality control, the quality already have reached or surpassed the Global Major leading seal maker quality with very reasonable cost.

Our motto is to provide to our costumer Most reliable, Most superior, Most reasonable sealing solution to satisfy customer requirement.





WONYOUNG SEAL CORPORATION

## Index

1.	Hydraulic seal -----	4~127 PAGE
2.	Hydraulic seal kit -----	128~207 PAGE
3.	Hydraulic Breaker seal -----	208~218 PAGE
4.	Hydraulic Breaker seal kit -----	219-224 PAGE
5.	Pneumatic seal -----	225 PAGE
6.	Floating seal -----	226~227 PAGE
7.	Custom oil seal -----	228~229 PAGE
8.	Machined seal -----	230~234 PAGE
9.	Contact -----	235 PAGE



## 1. Hydraulic seal

### PISTON SEAL

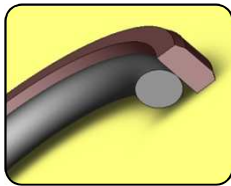

Style : **GRBW(D-SEAL/GR)**  
Material : PTFE+NBR

Page:  
17

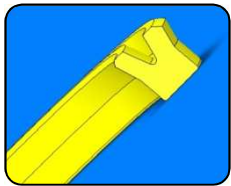

Style : **ODW/OSW(OSI/ODI)**  
Material : PU

Page:  
19



Style : **OHM**  
Material : NBR+P/A

Page:  
21

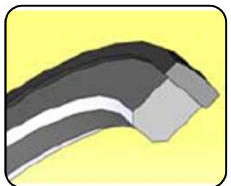

Style : **OK**  
Material : NBR+P/A

Page:  
22

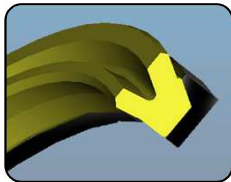

Style : **OUYH(OUY)**  
Material : PU+P/A

Page:  
23

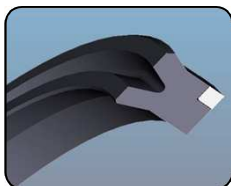

Style : **OUYK(OUY)**  
Material : NBR+P/A

Page:  
24

## 1. Hydraulic seal

### PISTON SEAL



Style : **SPGA**  
Material : NBR+P/A

Page:  
25

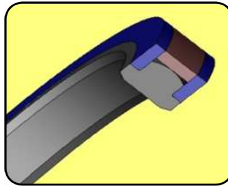

Style : **SPGWB(SPGW)**  
Material : NBR+P/A+PTFE

Page:  
26

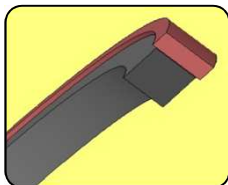

Style : **SPW(SPG)**  
Material : NBR+PTFE

Page:  
28



Style : **UKH**  
Material : NBR+P/A

Page:  
30

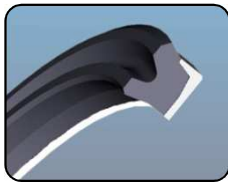

Style : **OUY**  
Material : NBR+P/A

Page:  
31

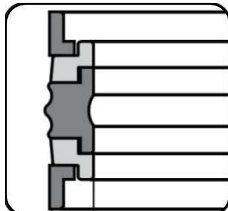

Style : **DAS**  
Material :  
NBR+TPE+,POM Glass Filler

Page:  
32

## 1. Hydraulic seal

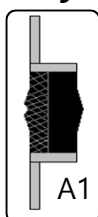
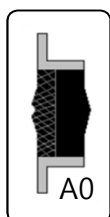

Style : NCF A0, NCF A1  
 Material : A1 : FABRIC NBR+TPE+POM  
 A0 : FABRIC NBR+POM

Page:  
34-35

## WEAR RING



Style : **WRW(WR)**  
 Material : PHENOL+COTTON

Page:  
36-45



Style : **GWR(WR)**  
 Material : PHENOL+COTTON+GRAPHITE

Page:  
36-45



Style : **AWR(WR)**  
 Material : PHENOL+ARAMID+GRAPHITE

Page:  
36-45

## DUST RING

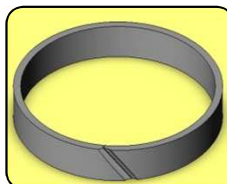

Style : **KZW(KZT)**  
 Material : PTFE(Bonze or Moly filled)

Page:  
46-48



Style : **DZW(DR/DZT)**  
 Material : PTFE(Glass filled)

Page:  
46-48

## 1. Hydraulic seal

### WEAR BAND

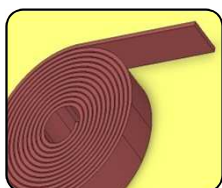

Style : **RYW(RYT)**  
Material : PTFE(Bronze/Moly filled)

Page:  
49-50

### BUFFER SEAL

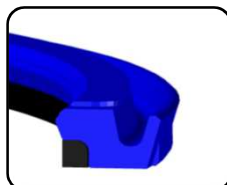

Style : **HBHW(HBY)**  
Material : High performance PU+P/A

Page:  
51-52

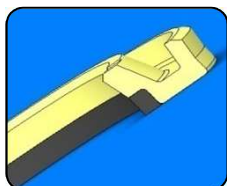

Style : **HBW(HBY)**  
Material : PU+P/A

Page:  
51-52



Style : **HBYW(HBTY)**  
Material : NBR+PTFE

Page:  
53

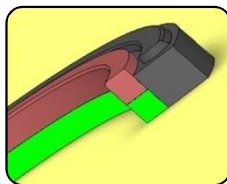

Style : **HBZW(HBTZ)**  
Material : NBR+P/A +PTFE

Page:  
54

## 1. Hydraulic seal

### BUFFER SEAL

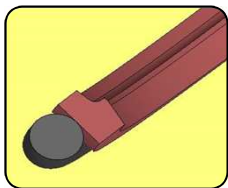

Style : **SSW(SK/E-RING)**  
Material : PTFE+NBR

Page:  
55

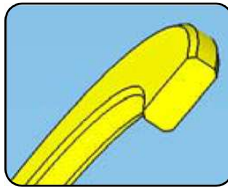

Style : **HBI**  
Material : PU

Page:  
57

### ROD SEAL

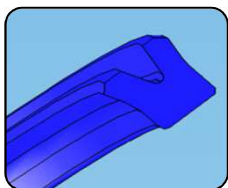

Style : **IDKW(IDI/ISI;NOK PUU641equivalent)**  
Material : High performance PU

Page:  
58-69

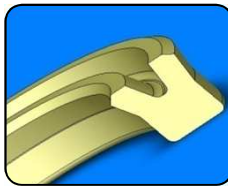

Style : **IDW/ISW(IDI/ISI)**  
Material : PU

Page:  
58-69



Style : **UPRH**  
Material : NBR+PU

Page:  
58-69



## 1. Hydraulic seal

### ROD SEAL



Style : **IUW(IUH old type)**  
Material : NBR

Page:  
58-69



Style : **IUW2(IUH new type)**  
Material : NBR

Page:  
58-69

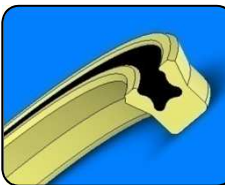

Style : **UPRM**  
Material : PU+NBR

Page:  
58-69

### ROD & PISTON SEAL

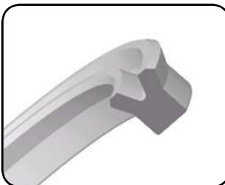

Style : **UPNW(UPH/USH)**  
Material : NBR

Page:  
70



Style : **UPW(UPI)**  
Material : PU

Page:  
72-73

## 1. Hydraulic seal

### O-RING BACK UP RING



Style : **T3G**  
Material : PTFE(White)

Page:  
74-75



Style : **T3P**  
Material : PTFE(White)

Page:  
76-77

### PACKING BACK UP RING



Style : **BRDW(BRN)**  
Material : P/A + Special material

Page:  
78-79

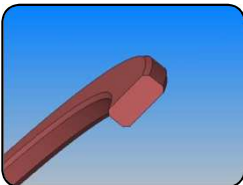

Style : **BRBW/BRWW/BRGW(BRT)**  
Material : PTFE(Bronze/White/Glass filled)

Page:  
80-82

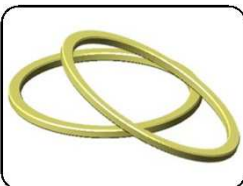

Style : **N4W**  
Material : P/A(Glass filled)

Page:  
83

## 1. Hydraulic seal

### DUST SEAL

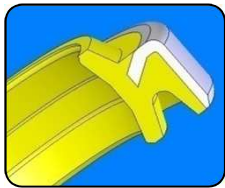

Style : **DKBW(DKBI)**  
Material : PU+SPCC

Page:  
**84-85**

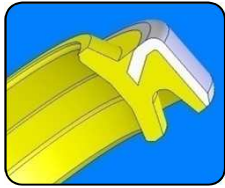

Style : **DKBIN**(KAYABA TYPE DKBI)  
Material : PU+SPCC

Page:  
**86**



Style : **DKNW(DKB)**  
Material : NBR+SPCC

Page:  
**87-88**

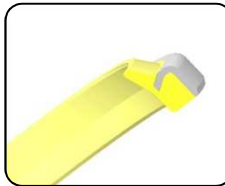

Style : **DKW(DKI)**  
Material : PU+SPCC

Page:  
**89-90**

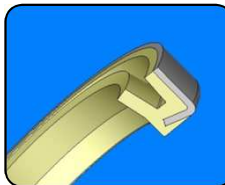

Style :  
**DWW(DWI;MM)/DWIN(DKIY;INCHI)**  
Material : PU+SPCC

Page:  
**91-92**

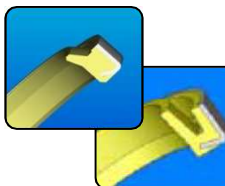

Style : **DWIW(DWIR)**  
Material : PU+SPCC

Page:  
**93-94**

## 1. Hydraulic seal

## DUST SEAL



Style : **SA**  
Material : NBR+SPCC

Page:  
95-96

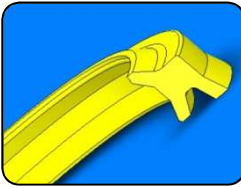

Style : **LBW(LBI)**  
Material : PU

Page:  
97

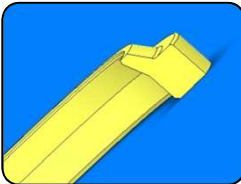

Style : **DSW(DSI)**  
Material : PU

Page:  
98

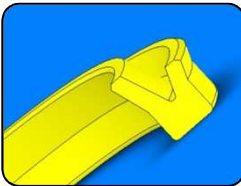

Style : **LPIY**  
Material : PU

Page:  
99



Style : **LBNW(LBH)**  
Material : NBR/FKM

Page:  
100

## 1. Hydraulic seal

### PIN DUST SEAL

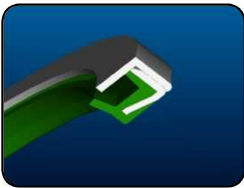

Style : **VAW(PPY,DKIY,VAY)**  
Material : PU+SPCC

Page:  
101-  
102

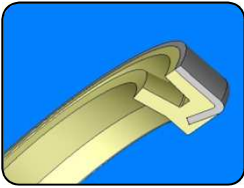

Style : **DLW(DLI)**  
Material : PU+SPCC

Page:  
103-  
104



Style : **VB**  
Material : NBR+SPCC

Page:  
105

### CUSHION SEAL

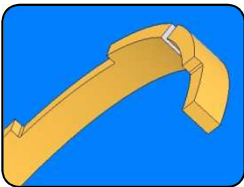

Style : **N4B**  
Material : P/A(Glass filled)

Page:  
106

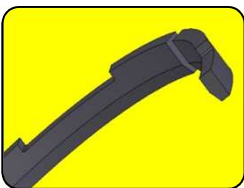

Style : **N4BN(N4B new type)**  
Material : P/A(Glass filled)

Page:  
107

## 1. Hydraulic seal

### CENTER JOINT SEAL



Style : **CSI / ROI**  
Material : PU/High performance PU

Page:  
**108**

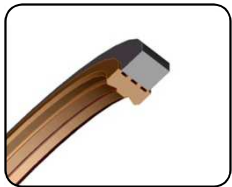

Style : **MSJA**  
Material : PTFE+NBR

Page:  
**109**



Style : **SPN**  
Material : PTFE+NBR

Page:  
**110**

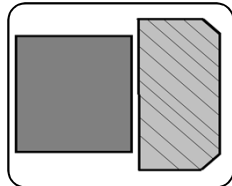

Style : **WSJG(LFT)**  
Material : LFT+NBR

Page:  
**111**

### PU O-RING/D-RING

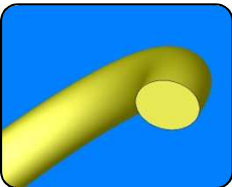

Style : **ORI**  
Material : PU

Page:  
**112**

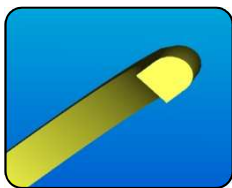

Style : **DRI**  
Material : PU

Page:  
**113**

## 1. Hydraulic seal

### OIL SEAL



Style : **TCV**  
Material : NBR/FKM+SPCC

Page:  
**114**

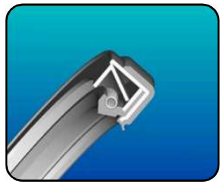

Style : **TCN**  
Material : NBR/FKM+SPCC

Page:  
**116**

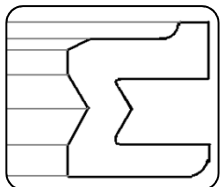

Style : **LINK SEAL**  
Material : PU

Page:  
**117**

### O-RING BOX



Style : **MM BOX**  
Material : NBR

Page:  
**118**



Style : **INCH BOX**  
Material : NBR

Page:  
**118**

## 1. Hydraulic seal

### DU BUSH



Style : **DU**  
Material : SPCC+PTFE PAINTED

Page:  
119

### PTFE SEAL RING

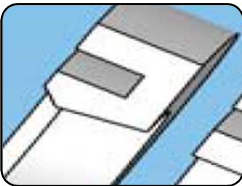

Style : **IUT**  
Material : PTFE(Glass filled)

Page:  
121

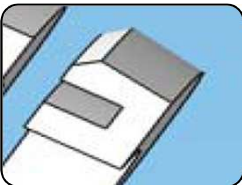

Style : **OUT**  
Material : PTFE(Glass filled)

Page:  
122

### HUB SEAL & OIL SEAL & ENGINE LINER O-RING



HUB SEAL/SHAFT SEAL

Page:  
124

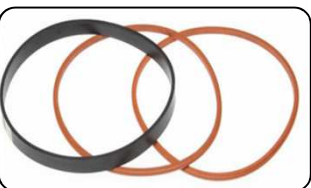

LINER -RING  
Material : NBR/VMQ

Page:  
126



## 1. Hydraulic seal

### PISTON SEAL – STYLE : **GRBW(D-SEAL/GR)**

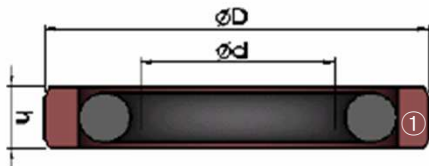

Material & working condition	Main function	Feature
<b>PTFE PISTON SEAL</b> <b>70A NITRILE ENERGIZER</b> <b>Working Temperature :</b> -30~100℃ <b>Working Pressure :</b> 35Mpa <b>Speed :</b> 0.05~1.5 m/s.	Retention of oil pressure	A PTFE seal ring ① with excellent friction and abrasion characteristics is used. It has the oil pressure introduction slit②, the oil pressure enter the installation groove(pressure side) beginning at the early stage of pressure application, smoothing movement of the packing to the side opposite the pressure side..

#### SEAL INFORMATION

PART  
NUMBER

(Prefix)-D\*d\*h

PART NUMBER		PART NUMBER		PART NUMBER		PART NUMBER	
GRBW	40*29.3*4.2	GRBW	63*52.3*4.2	GRBW	75*59.9*6.3	GRBW	105*89.9*6.3
GRBW	42*31.3*4.2	GRBW	65*54.3*4.2	GRBW	80*64.9*6.3	GRBW	110*94.9*6.3
GRBW	45*34.4*4.2	GRBW	70*59.3*4.2	GRBW	85*69.9*6.3	GRBW	115*99.9*6.3
GRBW	50*39.3*4.2	GRBW	60*44.9*6.3	GRBW	90*74.9*6.3	GRBW	120*104.9*6.3
GRBW	55*44.3*4.2	GRBW	65*49.9*6.3	GRBW	95*79.9*6.3	GRBW	125*109.9*6.3
GRBW	60*49.3*4.2	GRBW	70*54.9*6.3	GRBW	100*84.9*6.3	GRBW	130*114.9*6.3



WONYOUNG SEAL CORPORATION

## 1. Hydraulic seal

# PISTON SEAL – STYLE : **GRBW(D-SEAL/GR)**

PART NUMBER	
GRBW	80*59.5*8.1
GRBW	85*64.5*8.1
GRBW	90*69.5*8.1
GRBW	95*74.5*8.1
GRBW	100*79.5*8.1
GRBW	105*84.5*8.1

PART NUMBER	
GRBW	110*89.5*8.1
GRBW	115*94.5*8.1
GRBW	120*99.5*8.1
GRBW	125*104.5*8.1
GRBW	130*109.5*8.1
GRBW	135*114.5*8.1

PART NUMBER	
GRBW	140*119.5*8.1
GRBW	145*124.5*8.1
GRBW	150*129.5*8.1
GRBW	160*139.5*8.1
GRBW	165*144.5*8.1
GRBW	170*149.5*8.1

PART NUMBER	
GRBW	175*154.5*8.1
GRBW	180*159.5*8.1
GRBW	185*164.5*8.1
GRBW	190*169.5*8.1
GRBW	195*174.5*8.1
GRBW	200*179.5*8.1
GRBW	205*184.5*8.1

## 1. Hydraulic seal

### PISTON SEAL – STYLE : ODW/OSW(OSI/ODI)

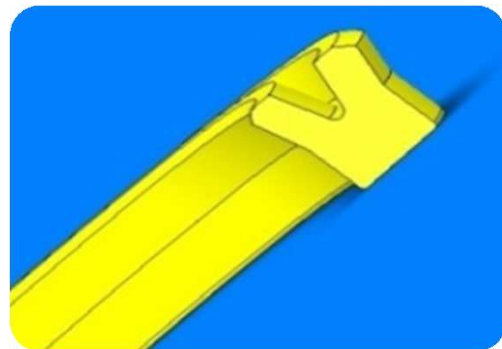
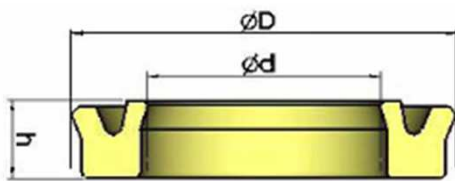

Material & working condition	Main function	Feature
<b>Polyurethane</b> <b>Working Temperature</b> : -35~100℃ <b>Working Pressure</b> : 0~35(70with nylon back up)Mpa <b>Speed</b> : 0.03~1 m/s.	Retention of oil pressure	ODW : Designed for large section, applicable for wide pressure range. OSW : Designed for smaller section, and able to be fitted into integrated groove.

#### SEAL INFORMATION

PART NUMBER

(Prefix)-D\*d\*h

PART NUMBER		PART NUMBER		PART NUMBER		PART NUMBER	
OSW	40*30*6	OSW	65*55*6	OSW	100*85*9	OSW	125*110*9
OSW	45*35*6	OSW	70*60*6	OSW	105*90*9	OSW	125*112*9
OSW	50*40*6	OSW	75*65*6	OSW	110*95*9	OSW	130*115*9
OSW	55*45*6	OSW	80*70*6	OSW	115*100*9	OSW	140*125*9
OSW	60*50*6	OSW	85*75*6	OSW	120*105*9	OSW	150*135*9
OSW	63*53*6	OSW	90*80*6	OSW	120*106*8.5	OSW	150*136*8.5



WONYOUNG SEAL CORPORATION

# 1. Hydraulic seal

## PISTON SEAL – STYLE : ODW/OSW(OSI/ODI)

PART NUMBER	
OSW	155*140*9
OSW	160*145*9
OSW	170*155*9
OSW	180*165*9
OSW	190*175*9
OSW	200*180*12
OSW	210*190*12

PART NUMBER	
ODW	35*25*6
ODW	45*30*6
ODW	45*30*9
ODW	45*30*10
ODW	50*35*9
ODW	50*35*10
ODW	50*40*10
ODW	55*40*10
ODW	60*45*9
ODW	60*45*10
ODW	63*48*9
ODW	60*50*9
ODW	65*50*9

PART NUMBER	
ODW	65*50*10
ODW	70*55*9
ODW	70*55*10
ODW	75*60*9
ODW	75*60*10
ODW	80*60*12
ODW	80*65*9
ODW	80*65*10
ODW	85*65*12
ODW	85*70*10
ODW	90*75*9
ODW	90*75*10
ODW	95*80*10

PART NUMBER	
ODW	100*80*15
ODW	105*85*12
ODW	105*85*15
ODW	110*90*12
ODW	115*95*12
ODW	115*95*15
ODW	120*100*12
ODW	120*100*15
ODW	125*105*12
ODW	125*105*15
ODW	125*105*16
ODW	130*110*12
ODW	130*110*15

PART NUMBER	
ODW	130*110*16
ODW	132*112*15
ODW	135*115*12
ODW	140*120*12
ODW	140*120*16
ODW	150*130*12
ODW	150*130*14
ODW	150*130*16
ODW	160*140*10
ODW	160*140*12
ODW	160*140*16
ODW	170*150*16
ODW	180*160*12
ODW	180*160*16
ODW	225*200*16

## 1. Hydraulic seal

### PISTON SEAL – STYLE : OHM

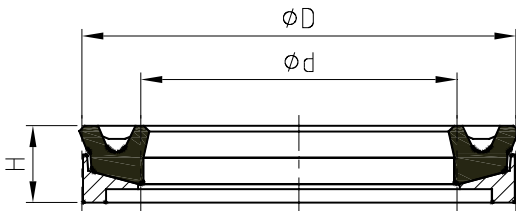

Material & working condition	Main function	Feature
<b>70A NITRILE</b> <b>NYLON BACK-UP</b> <b>Working Temperature</b> : -30~100 °C <b>Working Pressure</b> : 0~21 Mpa <b>Speed</b> : 0.008~1 m/s.	Retention of oil pressure	Molded from 70A nitrile for high seal ability they employ a hard nylon anti-extrusion ring as a companion piece.

#### SEAL INFORMATION

PART NUMBER

(Prefix)-D\*d\*H

PART NUMBER		PART NUMBER		PART NUMBER		PART NUMBER	
OHM	45*27*12.1	OHM	80*58*14.5	OHM	120*98*14.5	OHM	150*128*14.5
OHM	50*32*12.1	OHM	85*67*14.5	OHM	125*103*14.5	OHM	160*138*14.5
OHM	55*37*12.1	OHM	90*68*14.5	OHM	130*108*14.5	OHM	170*148*14.5
OHM	60*42*12.1	OHM	100*78*14.5	OHM	135*113*14.5	OHM	180*158*14.5
OHM	65*47*12.1	OHM	110*88*14.5	OHM	140*118*14.5	OHM	190*168*14.5
OHM	70*48*14.5	OHM	115*93*14.5	OHM	145*123*14.5	OHM	200*178*14.5

## 1. Hydraulic seal

### PISTON SEAL – STYLE : OK

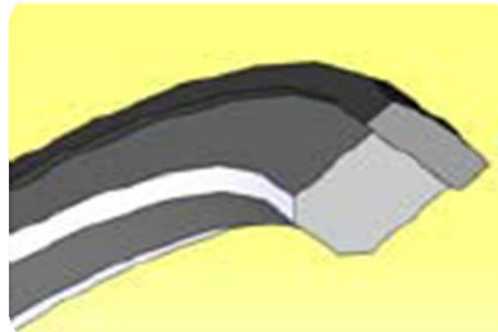
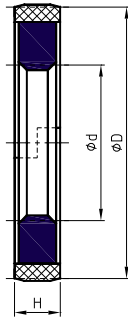
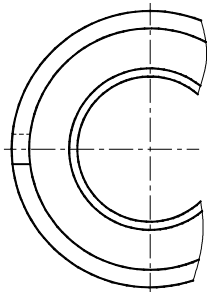

Material & working condition	Main function	Feature
<b>NYLON SEAL WITH NITRILE ENERGIZER</b> <b>Working Temperature :</b> -30~110 °C <b>Working Pressure :</b> 0~50 Mpa <b>Speed :</b> 0.005~1 m/s.	Retention of oil pressure	The <b>OK</b> type double action piston seal is designed for heavy duty hydraulic applications. The small profile is resistant to shock loads and has high abrasion and extrusion resistance. Its split design allows simple installation on a solid piston..

#### SEAL INFORMATION

PART NUMBER

(Prefix)-D\*d\*H

PART NUMBER	
OK	95*74*8
OK	100*79*8
OK	105*84*8
OK	110*89*8

PART NUMBER	
OK	115*94*8
OK	120*99*8
OK	125*104*8
OK	130*109*8

PART NUMBER	
OK	135*114*8
OK	140*119*8
OK	145*124*8
OK	150*129*8

PART NUMBER	
OK	160*139*8
OK	165*144*8
OK	170*149*8
OK	175*154*8
OK	180*159*8
OK	190*169*8

## 1. Hydraulic seal

### PISTON SEAL – STYLE : OUYH(OUY)

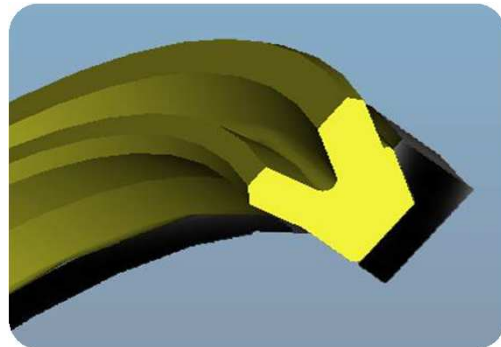
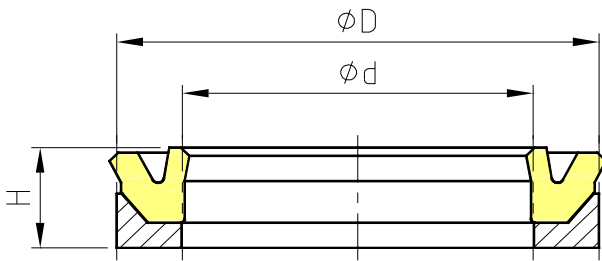

Material & working condition	Main function	Feature
<b>Polyurethane SEAL</b> <b>NYLON BACK-UP</b> <b>Working Temperature :</b> -50~110 °C <b>Working Pressure :</b> 0~78.5 Mpa <b>Speed :</b> 0.03~1 m/s.	Retention of oil pressure	Molded from 95A PU for high sealability and pressure resistance. they employ a hard nylon anti-extrusion ring as a companion piece

#### SEAL INFORMATION

PART NUMBER

(Prefix)-D\*d\*H

PART NUMBER	
OUYH	40*25*12
OUYH	45*30*12
OUYH	50*35*12

PART NUMBER	
OUYH	55*40*12
OUYH	60*45*12
OUYH	65*50*12

PART NUMBER	
OUYH	70*55*12
OUYH	75*60*12
OUYH	80*65*12

PART NUMBER	
OUYH	85*70*12
OUYH	95*80*12

## 1. Hydraulic seal

### PISTON SEAL – STYLE : OUYK(OUY)

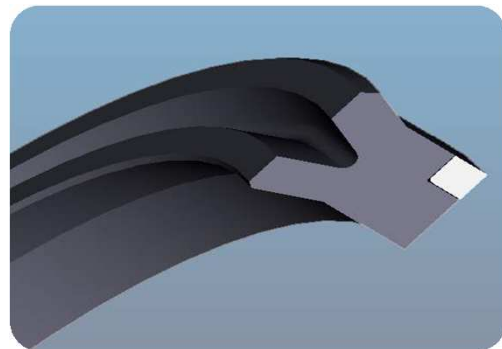
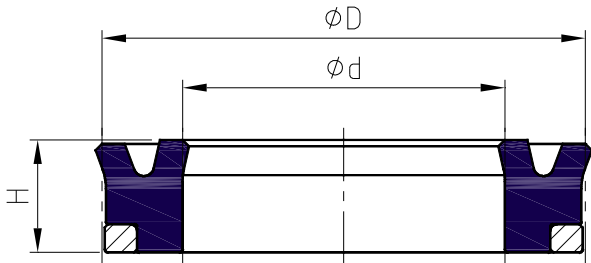

Material & working condition	Main function	Feature
<b>70A NITRILE</b> <b>ACETAL BACK-UP</b> <b>Working Temperature</b> : -30~110℃ <b>Working Pressure</b> : 0~27 Mpa <b>Speed</b> : 0.008~1 m/s.	Retention of oil pressure	Molded from 70A nitrile for high seal ability they employ a hard nylon anti-extrusion ring as a companion piece.

#### SEAL INFORMATION

PART NUMBER

(Prefix)-D\*d\*H

PART NUMBER	
OUYK	40*25*12
OUYK	50*35*12
OUYK	56*30*15.5

PART NUMBER	
OUYK	60*35*15.5
OUYK	60*45*15.5
OUYK	70*45*15.5

PART NUMBER	
OUYK	80*55*18
OUYK	90*65*18
OUYK	100*75*18

PART NUMBER	
OUYK	70*55*10.5



## 1. Hydraulic seal

### PISTON SEAL – STYLE : SPGA

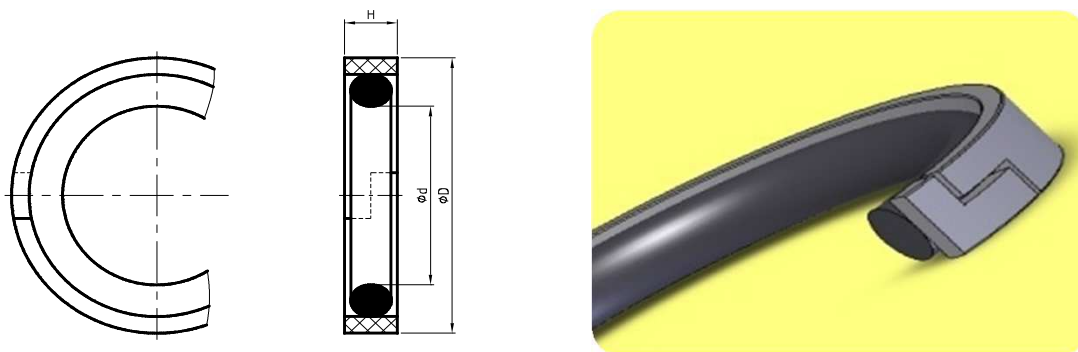

Material & working condition	Main function	Feature
<b>NYLON SEAL 70A NITRINE ENERGIZER</b> <b>Working Temperature :</b> -30~110 °C <b>Working Pressure :</b> 0~27 Mpa <b>Speed :</b> 0.008~1 m/s.	Retention of oil pressure	This seal is use for Caterpillar equipment The Nylon seal good for durability and extrusion and It's easy to fix on the piston for the step cut. And the o-ring is characterized the shape like oval energizer o-ring

SEAL INFORMATION	
PART NUMBER	(Prefix)-D*d*H

PART NUMBER		MANUFACTURE NO.
SPGA	100*85.75*6.9	9X-7298
SPGA	110*95.75*6.9	9X-7301
SPGA	120*105.75*6.9	9X-3592

PART NUMBER		MANUFACTURE NO.
SPGA	127*112.75*6.9	
SPGA	130*115.75*6.9	9X-3595
SPGA	150*130.63*9.4	9X-3601

PART NUMBER		MANUFACTURE NO.
SPGA	160*140.63*9.4	9X-3604
SPGA	170*150.63*9.4	9X-3605, 9X-3607
SPGA	190*170.63*9.4	

## 1. Hydraulic seal

# PISTON SEAL – STYLE : SPGWB(SPGW)

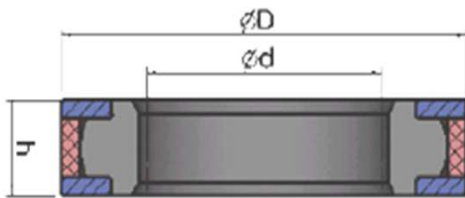

Material & working condition	Main function	Feature
<b>PTFE PISTON SEAL</b> <b>NYLON BACK-UP</b> <b>NITRILE ENERGIZER</b> <b>Working Temperature :</b> - 30~120 °C <b>Working Pressure :</b> 0~50 Mpa <b>Speed :</b> 0.005~1.5 m/s.	Retention of oil pressure	They consist of a filled PTFE cap energized by a T-shaped nitrile energizer and backed by two split nylon back-up rings. These seals offer low friction, high pressure operating conditions.

### SEAL INFORMATION

PART  
NUMBER

(Prefix)-D\*d\*h

PART NUMBER		PART NUMBER		PART NUMBER		PART NUMBER	
SPGWB	45*31*8.5	SPGWB	70*55*10.5	SPGWB	100*85*12	SPGWB	130*107*15.5
SPGWB	50*36*8.5	SPGWB	75*60*10.5	SPGWB	105*90*12	SPGWB	135*112*15.5
SPGWB	55*41*8.5	SPGWB	80*65*10.5	SPGWB	110*95*12	SPGWB	140*117*15.5
SPGWB	60*46*8.5	SPGWB	85*70*10.5	SPGWB	115*100*12	SPGWB	145*122*15.5
SPGWB	63*48*10.5	SPGWB	90*75*10.5	SPGWB	120*105*12	SPGWB	150*127*15.5
SPGWB	65*50*10.5	SPGWB	95*80*10.5	SPGWB	125*102*15.5	SPGWB	155*132*15.5



WONYOUNG SEAL CORPORATION

## 1. Hydraulic seal

# PISTON SEAL – STYLE : **SPGWB(SPGW)**

PART NUMBER	
SPGWB	160*137*15.5
SPGWB	165*142*15.5
SPGWB	170*147*15.5
SPGWB	175*152*15.5
SPGWB	180*157*15.5

PART NUMBER	
SPGWB	185*162*15.5
SPGWB	190*167*15.5
SPGWB	195*172*15.5
SPGWB	200*177*15.5
SPGWB	210*187*15.5

PART NUMBER	
SPGWB	220*197*15.5
SPGWB	225*202*15.5
SPGWB	230*207*15.5
SPGWB	240*217*15.5
SPGWB	250*222*17

PART NUMBER	
SPGWB	260*232*17
SPGWB	270*242*17
SPGWB	280*252*17
SPGWB	290*262*17
SPGWB	300*272*17

## 1. Hydraulic seal

### PISTON SEAL – STYLE : SPW(SPG)

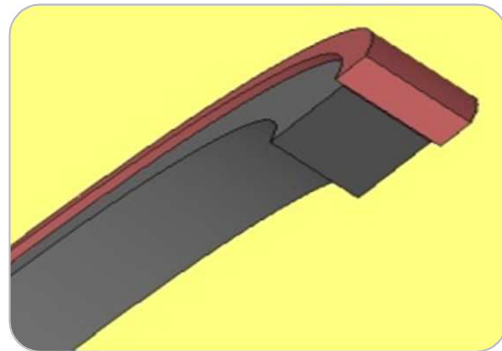
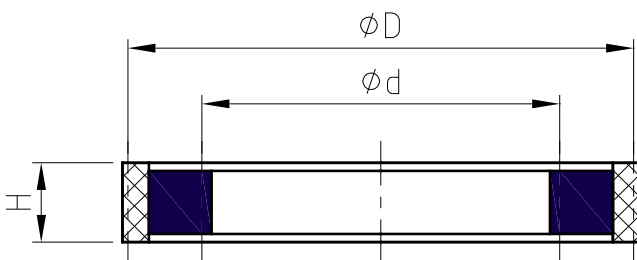

Material & working condition	Main function	Feature
<b>PTFE PISTON SEAL</b> <b>NITRILE ENERGIZER</b> <b>Working Temperature :</b> -30~100 °C <b>Working Pressure :</b> 0~35 Mpa <b>Speed :</b> 0.005~1.5 m/s.	Retention of oil pressure	This is a standard type of combination seal for wide range of application.

#### SEAL INFORMATION

PART NUMBER

(Prefix)-D\*d\*h

PART NUMBER		PART NUMBER		PART NUMBER		PART NUMBER	
SPW	30*20.5*4.3	SPW	45*35*4.3	SPW	60*50*4.3	SPW	65*54*4.9
SPW	31.5*22*4.3	SPW	50*40*4.3	SPW	60*49*4.9	SPW	65*50*7.3
SPW	32*22.5*4.3	SPW	50*39*4.9	SPW	60*49*5.9	SPW	69*54*7.3
SPW	35*25.5*4.3	SPW	55*45*3.8	SPW	60*45*4.9	SPW	70*60*4.8
SPW	35.5*26*4.3	SPW	55*45*4.3	SPW	60*45*6	SPW	70*59*4.9
SPW	40*30*4.3	SPW	56*46*4.3	SPW	63*48*7.3	SPW	70*59*5.9



## 1. Hydraulic seal

# PISTON SEAL – STYLE : SPW(SPQ)

PART NUMBER	
SPW	70*56*6
SPW	70*55*6
SPW	70*55*7.3
SPW	71*56*7.3
SPW	75*60*7.3
SPW	80*69*4.9
SPW	80*65*6
SPW	80*65*7.3
SPW	85*70*7.3
SPW	90*80*5
SPW	90*79*5.9
SPW	90*75*5.9
SPW	90*75*7.3
SPW	95*80*7.3
SPW	100*86*5.9
SPW	100*85*7.3
SPW	105*89*7.3
SPW	108*92*7.3
SPW	110*95*5.9
SPW	110*95*7.3

PART NUMBER	
SPW	110*94*5.9
SPW	110*94*7.3
SPW	112*96*7.3
SPW	115*99*5.9
SPW	115*99*7.3
SPW	120*104*7.3
SPW	125*109*7.3
SPW	130*114*7.3
SPW	135*114*7.3
SPW	140*128*5.3
SPW	140*124*7.3
SPW	140*122*7.9
SPW	145*129*7.3
SPW	150*134*7.3
SPW	150*132*7.9
SPW	155*139*7.3
SPW	160*144*7.3
SPW	160*138*10.8
SPW	170*148*10.8
SPW	175*153*10.8

PART NUMBER	
SPW	180*158*10.8
SPW	185*163*10.8
SPW	190*168*10.8
SPW	195*173*10.8
SPW	200*178*10.8
SPW	204*182*10.8
SPW	210*188*10.8
SPW	215*203*4.8
SPW	220*198*10.8
SPW	224*202*10.8
SPW	225*203*10.8
SPW	230*208*10.8
SPW	240*218*10.8
SPW	250*236*10.8
SPW	260*236*11.7
SPW	270*246*11.7
SPW	280*256*11.7
SPW	290*266*11.7
SPW	300*276*11.7
SPW	310*286*11.7

PART NUMBER	
SPW	320*296*11.7
SPW	330*308*9.85
SPW	63.5*53.98*4.7
SPW	69.85*60.33*4.7
SPW	76.2*62.48*4.7
SPW	82.55*68.83*4.7
SPW	88.9*75.18*4.7
SPW	101.6*84.71*6.3
SPW	107.95*91.06*6.3
SPW	114.3*97.41*6.3
SPW	120.65*103.76*6.3
SPW	127*107.32*9.5
SPW	139.7*120.02*9.5
SPW	152.4*129.41*9.5
SPW	158.75*135.76*9.5
SPW	165.1*142.11*9.5
SPW	177.8*154.81*9.5
SPW	184.15*161.16*9.5
SPW	209.55*184.28*9.5

## 1. Hydraulic seal

### PISTON SEAL – STYLE : UKH

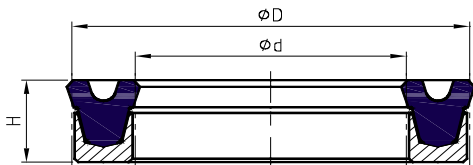

Material & working condition	Main function	Feature
<b>NITRILE PACKING</b> <b>NYLON BACK-UP</b> <b>Working Temperature</b> : -30~100 °C <b>Working Pressure</b> : 0~21 Mpa <b>Speed</b> : 0.008~1 m/s.	Retention of oil pressure	Molded from 70A nitrile for high seal ability they employ a hard nylon anti-extrusion ring as a companion piece.

#### SEAL INFORMATION

PART NUMBER

(Prefix)-D\*d\*h

PART NUMBER	
UKH	45*30*9
UKH	50*35*9
UKH	55*40*9
UKH	60*45*9

PART NUMBER	
UKH	65*50*9
UKH	70*55*9
UKH	75*60*12
UKH	80*65*12

PART NUMBER	
UKH	85*70*12
UKH	90*70*12
UKH	95*75*12
UKH	110*90*12

PART NUMBER	
UKH	120*100*13
UKH	150*130*13
UKH	160*140*13
UKH	180*160*15

## 1. Hydraulic seal

### PISTON SEAL – STYLE : OUY

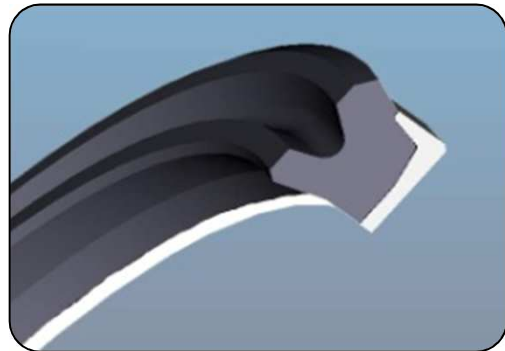
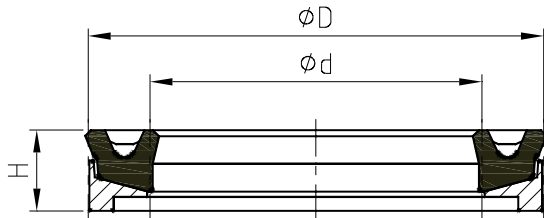

Material & working condition	Main function	Feature
<b>NITRILE PACKING</b> <b>NYLON BACK-UP</b> <b>Working Temperature :</b> -30~100 °C <b>Working Pressure :</b> 0~21 Mpa <b>Speed :</b> 0.008~1 m/s.	Retention of oil pressure	Molded from 70A nitrile for high seal ability they employ a hard nylon anti-extrusion ring as a companion piece.

#### SEAL INFORMATION

PART NUMBER

(Prefix)-D\*d\*h

PART NUMBER	
OUY	70*55*8
OUY	90*70*12
OUY	95*75*12
OUY	100*80*12

PART NUMBER	
OUY	110*90*13
OUY	130*110*13
OUY	140*120*13

## 1. Hydraulic seal

### PISTON SEAL – STYLE : DAS

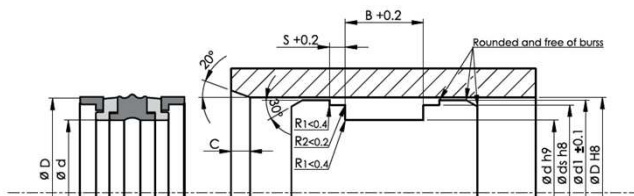

Material & working condition	Main function	Feature
<b>NBR+TPE+,POM Glass Filler</b> <b>Working Temperature :</b> - 30~105 °C <b>Working Pressure :</b> 0~40 Mpa <b>Speed :</b> 0.005~1.5 m/s.	Retention of oil pressure	DAS Compact seals which have a widespread use are used as double acting sealing elements in hydraulic cylinders' piston applications. They can be easily assembled thanks to their 5-piece design.

#### SEAL INFORMATION

PART NUMBER

(Prefix)-D\*d\*B\*S

PART NUMBER	
DAS	20*11*13.5*2.1
DAS	25*15*16.4
DAS	25*15*12.5*4
DAS	25*16*13.5*2.1
DAS	25*17*10*4
DAS	25*17*13.5*3.2

PART NUMBER	
DAS	30*17*15.4
DAS	30*21*13.5
DAS	32*22*16.4
DAS	32*22*15.5
DAS	32*22*12.5
DAS	32*24*15.5

PART NUMBER	
DAS	32*24*10*4
DAS	35*25*16.4
DAS	38.1*25.4*15.87
DAS	40*24*18.4
DAS	40*26*15.5
DAS	40*30*16.4

PART NUMBER	
DAS	40*30*12.5
DAS	40*30*12.3
DAS	40*32*15.5
DAS	40*32*10*4
DAS	44.45*28.57*19.05
DAS	45*29*18.4





WONYOUNG SEAL CORPORATION

## 1. Hydraulic seal

# PISTON SEAL – STYLE : DAS

PART NUMBER		PART NUMBER		PART NUMBER		PART NUMBER	
DAS	45*31*15.5	DAS	75*55*22.4	DAS	110*92*22.5	DAS	160*135*25.4
DAS	45*35*16.4	DAS	75*59*20.5	DAS	110*95*20	DAS	160*135*45
DAS	50.8*34.92*19.05	DAS	76.2*57.15*23.80	DAS	110*96*22.4	DAS	160*138*26.5/5.1
DAS	50*34*20.5	DAS	80*60*22.4	DAS	115*90*22.4	DAS	160*143*26.5
DAS	50*34*18.4	DAS	80*60*25	DAS	115*97*22.4	DAS	165*140*25.4
DAS	50*35*20	DAS	80*62*22.4	DAS	115*101*22.4	DAS	170*145*25.4
DAS	50*38*20.5	DAS	80*65*20	DAS	120*95*22.4	DAS	170*148*26.5
DAS	50*40*12.5	DAS	80*66*22.4	DAS	120*100*35	DAS	180*150*35.4
DAS	55*39*20.5	DAS	82*55*63.5*23.80	DAS	120*106*22.4	DAS	180*155*25.4
DAS	55*39*18.4	DAS	85*65*22.4	DAS	125*100*25.4	DAS	180*158*26.5
DAS	55*45*11	DAS	85*65*21.4	DAS	125*100*45	DAS	180*163*26.5
DAS	55*45*12.5	DAS	88.9*69.85*30.15	DAS	125*103*26.5	DAS	185*160*25.4*12.7
DAS	56*40*20.5	DAS	88.9*69.85*24.81*6.35	DAS	125*105*25.4	DAS	190*165*25.4*12.7
DAS	57.15*41.27*19.05	DAS	90*70*22.4	DAS	125*105*25*6.35	DAS	195*170*25.4*12.7
DAS	60*44*20.5	DAS	90*72*22.5	DAS	125*108*26.5	DAS	200*170*35.4
DAS	60*44*18.4	DAS	90*75*20	DAS	127*101.6*31.75	DAS	200*175*31.5
DAS	60*48*20.5	DAS	90*76*22.4	DAS	130*105*25.4	DAS	200*175*25.4
DAS	63.5*47.62*19.05	DAS	95*75*22.4	DAS	130*105*25.4/9.52	DAS	200*180*31.5
DAS	63.5*53.97*11.1	DAS	95*81*22.4	DAS	130*105*25.4/9.2	DAS	210*185*25.4
DAS	63*47*20.5	DAS	100*75*22.4	DAS	135*110*25.4*9.52	DAS	220*190*35.4
DAS	63*47*18.4	DAS	100*80*25.4	DAS	140*115*25.4	DAS	220*195*25.4*12.7
DAS	63*47*19.4	DAS	100*80*25	DAS	140*115*25.4*9.52	DAS	220*200*31.5
DAS	63*48*20	DAS	100*80*35	DAS	140*118*26.5	DAS	230*205*25.4
DAS	63*51*20.5	DAS	100*82*22.4	DAS	140*120*25*6.35	DAS	240*215*25.4*12.7
DAS	63*53*12.5	DAS	100*85*20	DAS	140*123*26.5	DAS	250*220*35.4
DAS	65*49*20.5	DAS	100*86*22.4	DAS	145*120*25.4*9.52	DAS	250*225*25.4
DAS	65*50*18.4	DAS	101.6*82.55*23.81	DAS	150*125*25.4*9.5	DAS	250*230*31.5
DAS	66.67*50.80*19.50	DAS	105*80*22.4	DAS	150*125*25.4*6.35	DAS	280*250*36.4
DAS	70*50*22.4	DAS	110*85*22.4	DAS	150*128*26.5	DAS	280*250*35.4*9.52
DAS	70*54*20.5	DAS	110*85*25.4	DAS	152.4*127*31.75		
DAS	70*55*20*5	DAS	110*90*35	DAS	160*130*25.4		
DAS	70*58*20.5	DAS	110*90*25.3*9.52	DAS	160*130*25.4*9.52		

## 1. Hydraulic seal

### PISTON SEAL – STYLE : NCF A1

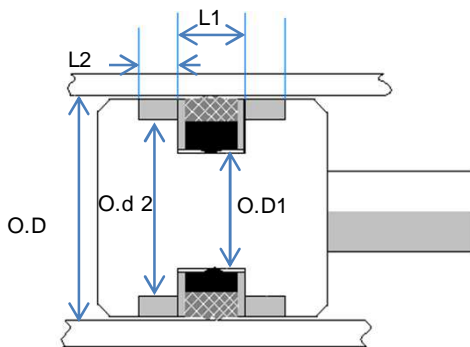

Material & working condition	Main function	Feature
<b>FABRIC NBR + POM (Glass filler)</b> <b>+ TPE</b> <b>Working Temperature : - 25~105 °C</b> <b>Working Pressure : 0~350Mpa</b> <b>Speed : 0.5 m/sn.</b>	Retention of oil pressure	NCF A0 Compact seals which have a widespread use are used as double acting sealing elements in hydraulic cylinders' piston applications. They can be easily assembled thanks to their 5-piece design.

#### SEAL INFORMATION

PART NUMBER

(Prefix)-OD

Part Number	OD	OD1	Od2	L1	L2
NCF A1-70	70	56	61.5	22	7.95
NCF A1-80	80	66	71.5	22	7.95
NCF A1-90	90	76	81.5	22	7.95
NCF A1-100	100	86	91.5	22	9.95
NCF A1-110	110	96	101.5	22	9.95
NCF A1-120	120	106	111.5	22	9.95

## 1. Hydraulic seal

### PISTON SEAL – STYLE : NCF A0

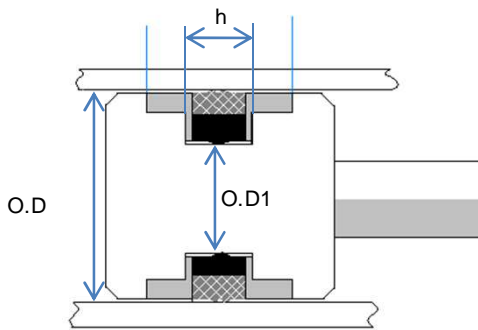

Material & working condition	Main function	Feature
<b>FABRIC NBR+,POM</b> <b>Working Temperature :</b> -30~105℃ <b>Working Pressure :</b> 0~350Mpa <b>Speed :</b> 0.5 m/sn.	Retention of oil pressure	NCF A0 Compact seals which have a widespread use are used as double acting sealing elements in hydraulic cylinders' piston applications. They can be easily assembled thanks to their 5-piece design.

#### SEAL INFORMATION

PART NUMBER	(Prefix)-O.D*O.D1*h
-------------	---------------------

Part number	
NCF A0	30*22*13.5
NCF A0	40*32*15.5
NCF A0	63*51*20.5
NCF A0	70*58*20.5
NCF A0	80*66*22.5

Part number	
NCF A0	90*76*22.5
NCF A0	100*86*22.5
NCF A0	120*106*22.5
NCF A0	140*123*26.5
NCF A0	150*133*26.5

## 1. Hydraulic seal

### WEAR RING- STYLE : **WRW/GWR/AWR (WR)**



Material & working condition	Main function	Feature
①WRW: HRM 100, C/Strength 250Mpa (Temperature range: -40~120) ②GWR : HRM 105, C/Strength 280Mpa (Temperature range: -40~130) ③AWR : HRM 115, C/Strength 344Mpa (Temperature range: -40~200)	Bearing	Stick slip is prevented by using PTFE's excellent friction characteristics. Fabric phenol resin with high elasticity is used for applications requiring large lateral load. GWR : filled graphite compound for improving lubricant AWR : it is made of Aramid fabric which has very special compressive strength(344Mpa) and cold proof and high heat resistance. ※ When the O/D is over 100 Φ, Thickness is under 2.5 mm , Height is under 15 mm, we suggest to use <b>AWR</b> or at least use <b>GWR</b> to assure the compressive strength.

SEAL INFORMATION	
PART NUMBER	(Prefix)-D*d*H

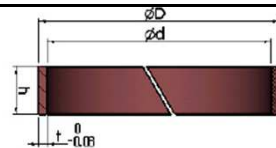

PART NUMBER		PART NUMBER		PART NUMBER		PART NUMBER	
Prefix	20*16*8	Prefix	26*22*8	Prefix	29*25*25	Prefix	30*25*15
Prefix	22*18*8	Prefix	28*24*8	Prefix	29*25*8	Prefix	30*25*20
Prefix	24*20*8	Prefix	29*22*20	Prefix	30*22*15	Prefix	30*25*8
Prefix	25*20*9.5	Prefix	29*22*25	Prefix	30*22*20	Prefix	30*25*9.5
Prefix	25*21*8	Prefix	29*22*8	Prefix	30*22*8	Prefix	30*26*8
Prefix	26*22*15	Prefix	29*25*20	Prefix	30*25*10	Prefix	31*22*16



WONYOUNG SEAL CORPORATION

## 1. Hydraulic seal

### WEAR RING- STYLE : **WRW/GWR/AWR (WR)**

PART NUMBER		PART NUMBER		PART NUMBER		PART NUMBER	
Prefix	31*22*8	Prefix	39*35*10	Prefix	45*40*30	Prefix	50*46*12
Prefix	31*25*16	Prefix	39*35*25	Prefix	45*40*50	Prefix	50*46*15
Prefix	31*28*16	Prefix	40*30*5	Prefix	45*40*8	Prefix	50*46*20
Prefix	31.8*27.7*15.5	Prefix	40*35*10	Prefix	45*40*9.5	Prefix	50*46*35
Prefix	32*22*20	Prefix	40*35*15	Prefix	45*41*12	Prefix	50*46*8
Prefix	32*22*8	Prefix	40*35*20	Prefix	45*41*20	Prefix	51*45*12.5
Prefix	32*25*20	Prefix	40*35*5.5	Prefix	46*40*20	Prefix	51*45*50
Prefix	32*25*8	Prefix	40*35*8	Prefix	50*44*16	Prefix	51*45*6
Prefix	32*28*20	Prefix	40*35*9.5	Prefix	50*44*20	Prefix	52*49*8
Prefix	32*28*8	Prefix	40*36*10	Prefix	50*44*8	Prefix	53*50*12
Prefix	33*22*20	Prefix	40*36*20	Prefix	50*45*10	Prefix	53*50*8
Prefix	33*25*20	Prefix	40*36*5	Prefix	50*45*12	Prefix	53.8*50.8*24.7
Prefix	33*28*20	Prefix	40*36*8	Prefix	50*45*15	Prefix	55*49*15
Prefix	34*30*10	Prefix	40*36*9.7	Prefix	50*45*20	Prefix	55*49*16
Prefix	34*30*20	Prefix	41*36*9.7	Prefix	50*45*25	Prefix	55*49*20
Prefix	34*30*25	Prefix	42*39*16	Prefix	50*45*30	Prefix	55*49*6
Prefix	35*30*10	Prefix	45*39*14	Prefix	50*45*35	Prefix	55*50*10
Prefix	35*30*20	Prefix	45*39*15	Prefix	50*45*5	Prefix	55*50*15
Prefix	35*30*25	Prefix	45*39*20	Prefix	50*45*5.6	Prefix	55*50*20
Prefix	35*30*30	Prefix	45*40*10	Prefix	50*45*7	Prefix	55*50*25
Prefix	35*31*10	Prefix	45*40*12	Prefix	50*45*8	Prefix	55*50*30
Prefix	36*31*6	Prefix	45*40*15	Prefix	50*45*8.7	Prefix	55*50*8
Prefix	36*32*10	Prefix	45*40*20	Prefix	50*45*9.5	Prefix	55*50*9.5
Prefix	38*32*6	Prefix	45*40*25	Prefix	50*46*10	Prefix	55*51*10



WONYOUNG SEAL CORPORATION

## 1. Hydraulic seal

### WEAR RING– STYLE : **WRW/GWR/AWR (WR)**

PART NUMBER		PART NUMBER		PART NUMBER		PART NUMBER	
Prefix	55*51*10	Prefix	63*58*10	Prefix	66*60*50	Prefix	73.03*60.2*45.5
Prefix	56*50*10	Prefix	63*58*12	Prefix	66*61*20	Prefix	73.03*66.68*22.0
Prefix	56*50*15	Prefix	63*58*15	Prefix	68*63*9.4	Prefix	75*64*15
Prefix	56*50*16	Prefix	63*58*20	Prefix	69*63*15	Prefix	75*69*12
Prefix	56*50*30	Prefix	63*58*25	Prefix	69*64*10	Prefix	75*69*12.5
Prefix	56*50*9.5	Prefix	63*58*6	Prefix	69*64*20	Prefix	75*69*15
Prefix	56*51*10	Prefix	63*58*8	Prefix	70*60*15	Prefix	75*69*20
Prefix	56*51*15	Prefix	63*58*9.5	Prefix	70*63.7*15.2	Prefix	75*69*25
Prefix	57.15*50.8*22.0	Prefix	63*59*10	Prefix	70*64*15	Prefix	75*70*10
Prefix	60*54*15	Prefix	63*59*4	Prefix	70*64*16	Prefix	75*70*12
Prefix	60*54*20	Prefix	63*59*8	Prefix	70*64*20	Prefix	75*70*15
Prefix	60*54*25	Prefix	65*55*10	Prefix	70*64.3*14.5	Prefix	75*70*20
Prefix	60*54*8	Prefix	65*57*12	Prefix	70*65*10	Prefix	75*70*25
Prefix	60*55*10	Prefix	65*59*10	Prefix	70*65*12	Prefix	75*70*30
Prefix	60*55*12	Prefix	65*59*15	Prefix	70*65*15	Prefix	75*70*40
Prefix	60*55*15	Prefix	65*59*16	Prefix	70*65*20	Prefix	75*70*50
Prefix	60*55*20	Prefix	65*59*20	Prefix	70*65*25	Prefix	75*70*9.5
Prefix	60*55*25	Prefix	65*60*10	Prefix	70*65*5.3	Prefix	76*70*10
Prefix	60*55*30	Prefix	65*60*15	Prefix	70*65*9.5	Prefix	76*70*20
Prefix	60*55*7	Prefix	65*60*20	Prefix	71*65*20	Prefix	76*71*20
Prefix	60*55*8	Prefix	65*60*25	Prefix	71*65*30	Prefix	76.2*69.85*12.7
Prefix	60*55*9.5	Prefix	65*60*30	Prefix	71*66*10	Prefix	80*73*10
Prefix	61*56*15	Prefix	65*60*9.5	Prefix	71*66*20	Prefix	80*74*10
Prefix	63*57*16	Prefix	66*60*10	Prefix	71*66*6	Prefix	80*74*12



# 1. Hydraulic seal

## WEAR RING– STYLE : **WRW/GWR/AWR (WR)**

PART NUMBER		PART NUMBER		PART NUMBER		PART NUMBER	
Prefix	73.03*60.2*45.5	Prefix	80*74*15	Prefix	85*75*10	Prefix	90*84*15
Prefix	73.03*66.68*22.0	Prefix	80*74*16.5	Prefix	85*79*10	Prefix	90*84*20
Prefix	75*64*15	Prefix	80*74*17	Prefix	85*79*12.5	Prefix	90*84*25
Prefix	75*69*12	Prefix	80*74*20	Prefix	85*79*14.5	Prefix	90*84*30
Prefix	75*69*12.5	Prefix	80*74*25	Prefix	85*79*15	Prefix	90*84*35
Prefix	75*69*15	Prefix	80*74*30	Prefix	85*79*20	Prefix	90*85*10
Prefix	75*69*20	Prefix	80*74*6	Prefix	85*79*25	Prefix	90*85*12.5
Prefix	75*69*25	Prefix	80*74*8	Prefix	85*80*10	Prefix	90*85*15
Prefix	75*70*10	Prefix	80*75*10	Prefix	85*80*12	Prefix	90*85*20
Prefix	75*70*12	Prefix	80*75*12	Prefix	85*80*15	Prefix	90*85*25
Prefix	75*70*15	Prefix	80*75*15	Prefix	85*80*20	Prefix	90*85*35
Prefix	75*70*20	Prefix	80*75*20	Prefix	85*80*25	Prefix	90*85*40
Prefix	75*70*25	Prefix	80*75*25	Prefix	85*80*35	Prefix	90*85*6
Prefix	75*70*30	Prefix	80*75*30	Prefix	85*80*9.5	Prefix	90*85*9.5
Prefix	75*70*40	Prefix	80*75*6	Prefix	86*80*25	Prefix	90*86*20
Prefix	75*70*50	Prefix	80*75*9.5	Prefix	88*81.7*37.5	Prefix	91*81*13
Prefix	75*70*9.5	Prefix	80*76*10	Prefix	88.9*82.5*9.5	Prefix	93*84*12
Prefix	76*70*10	Prefix	80*76*15	Prefix	88.9*82.55*12.7	Prefix	95*85*15
Prefix	76*70*20	Prefix	80*76*30	Prefix	89*82*10	Prefix	95*86*12
Prefix	76*71*20	Prefix	80*76*5	Prefix	90*80*19.5	Prefix	95*86*12.5
Prefix	76.2*69.85*12.7	Prefix	80*76*8	Prefix	90*81*12.5	Prefix	95*87*6
Prefix	80*73*10	Prefix	82*72*12	Prefix	90*82*15	Prefix	95*89*10
Prefix	80*74*10	Prefix	83*75*6	Prefix	90*84*10	Prefix	95*89*12.5
Prefix	80*74*12	Prefix	84*78*15	Prefix	90*84*12.5	Prefix	95*89*15



WONYOUNG SEAL CORPORATION

## 1. Hydraulic seal

### WEAR RING– STYLE : **WRW/GWR/AWR (WR)**

PART NUMBER		PART NUMBER		PART NUMBER		PART NUMBER	
Prefix	95*89*20	Prefix	100*95*10	Prefix	105*100*25	Prefix	110*103*35
Prefix	95*89*25	Prefix	100*95*12.5	Prefix	105*100*6	Prefix	110*104*12
Prefix	95*90*10	Prefix	100*95*15	Prefix	105*100*8	Prefix	110*104*12.5
Prefix	95*90*12.5	Prefix	100*95*20	Prefix	105*100*9.5	Prefix	110*104*13
Prefix	95*90*15	Prefix	100*95*25	Prefix	105*101*20	Prefix	110*104*14
Prefix	95*90*25	Prefix	100*95*30	Prefix	105*96*12.5	Prefix	110*104*15
Prefix	95*90*50	Prefix	100*95*5	Prefix	105*99*10	Prefix	110*104*20
Prefix	95*90*6	Prefix	100*95*6	Prefix	105*99*12.5	Prefix	110*104*25
Prefix	95*90*9.5	Prefix	100*95*8	Prefix	105*99*15	Prefix	110*104*30
Prefix	100*91*10	Prefix	100*95*9.5	Prefix	105*99*20	Prefix	110*104*35
Prefix	100*91*12.1	Prefix	100*96*10	Prefix	105*99*25	Prefix	110*104*40
Prefix	100*91*12.5	Prefix	100*96*15	Prefix	105*99*30	Prefix	110*105*10
Prefix	100*92*10	Prefix	100*96*5	Prefix	106*100*15	Prefix	110*105*12.5
Prefix	100*92*15	Prefix	100*96*6	Prefix	106*100*20	Prefix	110*105*15
Prefix	100*92*30	Prefix	100*96*8	Prefix	106*99*25	Prefix	110*105*20
Prefix	100*92*5.9	Prefix	101*95.6*10	Prefix	108*102*15	Prefix	110*105*25
Prefix	100*92*9.5	Prefix	101*95.6*12.5	Prefix	110*101*10	Prefix	110*105*30
Prefix	100*94*10	Prefix	101.0*95.25*12.7	Prefix	110*101*12.1	Prefix	110*105*40
Prefix	100*94*12.5	Prefix	102*96*8	Prefix	110*101*12.5	Prefix	110*105*6
Prefix	100*94*14	Prefix	103*94*12	Prefix	110*101*15	Prefix	110*105*8
Prefix	100*94*15	Prefix	105*100*10	Prefix	110*101*9.8	Prefix	110*105*9.5
Prefix	100*94*20	Prefix	105*100*12.5	Prefix	110*102*15	Prefix	110*106*15
Prefix	100*94*25	Prefix	105*100*15	Prefix	110*102*25	Prefix	112*106*10
Prefix	100*94*30	Prefix	105*100*20	Prefix	110*102*8	Prefix	112*106*15





WONYOUNG SEAL CORPORATION

## 1. Hydraulic seal

### WEAR RING- STYLE : **WRW/GWR/AWR (WR)**

PART NUMBER		PART NUMBER		PART NUMBER		PART NUMBER	
Prefix	112*106*20	Prefix	120*111*15	Prefix	124*114*15	Prefix	125*120*40
Prefix	112*106*30	Prefix	120*112*15	Prefix	125*114*15	Prefix	125*120*50
Prefix	115*105*15	Prefix	120*112*6	Prefix	125*115*15	Prefix	125*120*6
Prefix	115*105*20	Prefix	120*112*8	Prefix	125*115*20	Prefix	125*120*8
Prefix	115*106*15	Prefix	120*112*9.5	Prefix	125*117*8	Prefix	125*120*9.5
Prefix	115*107*15	Prefix	120*113*20	Prefix	125*118*10	Prefix	125*121*10
Prefix	115*107*8	Prefix	120*113*30	Prefix	125*118*15	Prefix	126*120*10
Prefix	115*109*10	Prefix	120*114*10	Prefix	125*118*20	Prefix	126*120*30
Prefix	115*109*15	Prefix	120*114*12	Prefix	125*118*30	Prefix	127*121*15
Prefix	115*109*30	Prefix	120*114*15	Prefix	125*118*50	Prefix	129*119*30
Prefix	115*110*10	Prefix	120*114*20	Prefix	125*119*10	Prefix	130*118*7.5
Prefix	115*110*12.5	Prefix	120*114*25	Prefix	125*119*15	Prefix	130*120*15
Prefix	115*110*15	Prefix	120*114*30	Prefix	125*119*20	Prefix	130*120*16
Prefix	115*110*20	Prefix	120*114*35	Prefix	125*119*25	Prefix	130*120*20
Prefix	115*110*25	Prefix	120*115*10	Prefix	125*119*30	Prefix	130*120*30
Prefix	115*110*30	Prefix	120*115*12.5	Prefix	125*119*35	Prefix	130*121*15
Prefix	115*110*35	Prefix	120*115*15	Prefix	125*119*8	Prefix	130*122*8
Prefix	115*110*6	Prefix	120*115*20	Prefix	125*119*9.5	Prefix	130*122*9.5
Prefix	115*110*8	Prefix	120*115*25	Prefix	125*120*10	Prefix	130*123*10
Prefix	115*110*9.5	Prefix	120*115*30	Prefix	125*120*12.5	Prefix	130*123*15
Prefix	116*110*30	Prefix	120*115*35	Prefix	125*120*15	Prefix	130*123*20
Prefix	118*108*15	Prefix	120*115*8	Prefix	125*120*20	Prefix	130*123*25
Prefix	120*110*16	Prefix	120*115*9.5	Prefix	125*120*25	Prefix	130*123*30
Prefix	120*110*9.5	Prefix	122*117*15	Prefix	125*120*30	Prefix	130*123*35



WONYOUNG SEAL CORPORATION

# 1. Hydraulic seal

## WEAR RING- STYLE : **WRW/GWR/AWR (WR)**

PART NUMBER		PART NUMBER		PART NUMBER		PART NUMBER	
Prefix	130*123*40	Prefix	135*128*25	Prefix	139.4*133.6*31.7	Prefix	140*135*10
Prefix	130*124*15	Prefix	135*128*35	Prefix	140*117*15	Prefix	140*135*12
Prefix	130*124*30	Prefix	135*128*50	Prefix	140*128*12	Prefix	140*135*12.5
Prefix	130*124*9.8	Prefix	135*128*9.5	Prefix	140*128*17	Prefix	140*135*15
Prefix	130*125*10	Prefix	135*129*14	Prefix	140*128*17.5	Prefix	140*135*20
Prefix	130*125*12.5	Prefix	135*129*15	Prefix	140*128*20	Prefix	140*135*25
Prefix	130*125*15	Prefix	135*129*20	Prefix	140*130*30	Prefix	140*135*30
Prefix	130*125*20	Prefix	135*129*25	Prefix	140*132*8	Prefix	140*135*35
Prefix	130*125*25	Prefix	135*129*30	Prefix	140*132*9.5	Prefix	140*135*50
Prefix	130*125*30	Prefix	135*129*35	Prefix	140*133*10	Prefix	140*135*8
Prefix	130*125*8	Prefix	135*129*8	Prefix	140*133*15	Prefix	140*135*9.5
Prefix	130*125*9.5	Prefix	135*130*10	Prefix	140*133*17	Prefix	142*135*15
Prefix	131*127*22	Prefix	135*130*12.5	Prefix	140*133*17.5	Prefix	145*130*40
Prefix	132*125*35	Prefix	135*130*15	Prefix	140*133*20	Prefix	145*133*17.5
Prefix	135*125*15	Prefix	135*130*8	Prefix	140*133*25	Prefix	145*135*15
Prefix	135*125*7.6	Prefix	135*130*9.5	Prefix	140*133*30	Prefix	145*137*10
Prefix	135*126*15	Prefix	136*130*10	Prefix	140*133*35	Prefix	145*138*10
Prefix	135*127*10	Prefix	137*127*17	Prefix	140*133*40	Prefix	145*138*15
Prefix	135*127*15	Prefix	137*130*30	Prefix	140*133*45	Prefix	145*138*17
Prefix	135*127*25	Prefix	137.4*133.6*31.7	Prefix	140*133*50	Prefix	145*138*20
Prefix	135*127*8	Prefix	138*130*15	Prefix	140*134*25	Prefix	145*138*25
Prefix	135*128*10	Prefix	138*132*20	Prefix	140*134*30	Prefix	145*138*30
Prefix	135*128*15	Prefix	139*127*17.2	Prefix	140*134*40	Prefix	145*138*35
Prefix	135*128*20	Prefix	139*132.7*31	Prefix	140*134*50	Prefix	145*138*50



WONYOUNG SEAL CORPORATION

## 1. Hydraulic seal

### WEAR RING– STYLE : **WRW/GWR/AWR (WR)**

PART NUMBER		PART NUMBER		PART NUMBER		PART NUMBER	
Prefix	145*138*9.5	Prefix	150*143*30	Prefix	155*150*10	Prefix	160*153*45
Prefix	145*140*10	Prefix	150*143*35	Prefix	155*150*15	Prefix	160*154*15
Prefix	145*140*12.5	Prefix	150*143*40	Prefix	155*150*20	Prefix	160*154*40
Prefix	145*140*15	Prefix	150*143*45	Prefix	155*150*25	Prefix	160*154*50
Prefix	145*140*20	Prefix	150*143*50	Prefix	155*150*30	Prefix	160*155*10
Prefix	145*140*25	Prefix	150*144*35	Prefix	155*150*8	Prefix	160*155*12.5
Prefix	145*140*50	Prefix	150*144*40	Prefix	156*150*35	Prefix	160*155*15
Prefix	145*140*8	Prefix	150*144*50	Prefix	157*150*40	Prefix	160*155*20
Prefix	145*140*9.5	Prefix	150*145*10	Prefix	157*152*25	Prefix	160*155*25
Prefix	147*140*30	Prefix	150*145*12.5	Prefix	158*150*60	Prefix	160*155*40
Prefix	147*140*40	Prefix	150*145*15	Prefix	159*147*20	Prefix	160*155*50
Prefix	150*127*15	Prefix	150*145*20	Prefix	160*148*10	Prefix	160*155*8
Prefix	150*138*17.5	Prefix	150*145*25	Prefix	160*148*20	Prefix	160*155*9.5
Prefix	150*140*35	Prefix	150*145*35	Prefix	160*148*22	Prefix	165*157*10
Prefix	150*140*9.5	Prefix	150*145*40	Prefix	160*150*20	Prefix	165*157*15
Prefix	150*142*15	Prefix	150*145*50	Prefix	160*150*23	Prefix	165*157*20
Prefix	150*142*17	Prefix	150*145*8	Prefix	160*152*35	Prefix	165*157*25
Prefix	150*142*20	Prefix	150*145*9.5	Prefix	160*153*10	Prefix	165*157*30
Prefix	150*142*8	Prefix	150*145*9.7	Prefix	160*153*15	Prefix	165*157*35
Prefix	150*143*10	Prefix	151*145*50	Prefix	160*153*20	Prefix	165*157*45
Prefix	150*143*15	Prefix	152*147*13	Prefix	160*153*25	Prefix	165*157*50
Prefix	150*143*17.5	Prefix	152*147*15	Prefix	160*153*30	Prefix	165*157*9.5
Prefix	150*143*20	Prefix	155*148*15	Prefix	160*153*35	Prefix	165*158*15
Prefix	150*143*25	Prefix	155*148*35	Prefix	160*153*40	Prefix	165*158*50



WONYOUNG SEAL CORPORATION

## 1. Hydraulic seal

### WEAR RING– STYLE : **WRW/GWR/AWR (WR)**

PART NUMBER		PART NUMBER		PART NUMBER		PART NUMBER	
Prefix	165*159*30	Prefix	170*164*9.5	Prefix	180*172*22.5	Prefix	180*175*35
Prefix	165*160*10	Prefix	170*165*10	Prefix	180*172*25	Prefix	180*175*40
Prefix	165*160*15	Prefix	170*165*15	Prefix	180*172*30	Prefix	180*175*45
Prefix	165*160*20	Prefix	170*165*20	Prefix	180*172*35	Prefix	180*175*50
Prefix	165*160*25	Prefix	170*165*25	Prefix	180*172*40	Prefix	180*175*8
Prefix	165*160*30	Prefix	170*165*30	Prefix	180*172*45	Prefix	180*175*9.5
Prefix	165*160*35	Prefix	170*165*35	Prefix	180*172*50	Prefix	184.5*178.2*25.4
Prefix	165*160*40	Prefix	170*165*50	Prefix	180*172*55	Prefix	185*173*20
Prefix	165*160*50	Prefix	170*165*8	Prefix	180*173*14.8	Prefix	185*173*22.5
Prefix	170*158*20	Prefix	170*165*9.5	Prefix	180*173*25	Prefix	185*173*25
Prefix	170*162*10	Prefix	175*165*15	Prefix	180*173*45	Prefix	185*177*15
Prefix	170*162*15	Prefix	175*168*15	Prefix	180*173*50	Prefix	185*177*45
Prefix	170*162*20	Prefix	175*169*50	Prefix	180*174*10	Prefix	185*180*10
Prefix	170*162*25	Prefix	175*170*10	Prefix	180*174*20	Prefix	185*180*14.8
Prefix	170*162*30	Prefix	175*170*25	Prefix	180*174*35	Prefix	185*180*25
Prefix	170*162*35	Prefix	180*168*22.5	Prefix	180*174*40	Prefix	185*180*50
Prefix	170*162*4.5	Prefix	180*170*25	Prefix	180*174*50	Prefix	186*180*20
Prefix	170*162*40	Prefix	180*170*8	Prefix	180*175*10	Prefix	190*178*22
Prefix	170*162*45	Prefix	180*172*10	Prefix	180*175*12	Prefix	190*182*10
Prefix	170*162*50	Prefix	180*172*12	Prefix	180*175*12.5	Prefix	190*182*15
Prefix	170*163*40	Prefix	180*172*12.5	Prefix	180*175*15	Prefix	190*182*20
Prefix	170*164*20	Prefix	180*172*15	Prefix	180*175*20	Prefix	190*182*22.5
Prefix	170*164*35	Prefix	180*172*20	Prefix	180*175*25	Prefix	190*182*25
Prefix	170*164*50	Prefix	180*172*22	Prefix	180*175*30	Prefix	190*182*30



WONYOUNG SEAL CORPORATION

## 1. Hydraulic seal

### WEAR RING– STYLE : **WRW/GWR/AWR (WR)**

PART NUMBER	
Prefix	190*182*35
Prefix	190*182*45
Prefix	190*182*50
Prefix	190*184*50
Prefix	190*185*10
Prefix	190*185*15
Prefix	190*185*30
Prefix	190*185*8
Prefix	190*185*9.5
Prefix	195*190*10
Prefix	195*190*15
Prefix	195*190*20
Prefix	195*190*25
Prefix	195*190*30
Prefix	200*188*22.5
Prefix	200*191*25
Prefix	200*192*10

PART NUMBER	
Prefix	200*192*15
Prefix	200*192*20
Prefix	200*192*22.5
Prefix	200*192*25
Prefix	200*192*30
Prefix	200*192*40
Prefix	200*192*45
Prefix	200*192*50
Prefix	200*194*10
Prefix	200*194*15
Prefix	200*194*20
Prefix	200*194*25
Prefix	200*194*30
Prefix	200*194*35
Prefix	200*194*40
Prefix	200*194*50
Prefix	200*195*10

PART NUMBER	
Prefix	200*195*15
Prefix	200*195*20
Prefix	200*195*8
Prefix	200*195*9.5
Prefix	200*196*25
Prefix	204*196*25
Prefix	205*197*50
Prefix	205*200*70
Prefix	210*202*14
Prefix	210*202*25
Prefix	210*202*45
Prefix	210*202*50
Prefix	210*204*50
Prefix	215*207*50
Prefix	215*210*15
Prefix	215*210*20
Prefix	215*210*35

PART NUMBER	
Prefix	218*211*12
Prefix	220*212*20
Prefix	220*212*40
Prefix	220*212*45
Prefix	220*212*50
Prefix	220*214*60
Prefix	224*215*50
Prefix	224*216*25
Prefix	224*216*26
Prefix	224*218*60
Prefix	225*213*22.5
Prefix	225*217*25
Prefix	225*217*45
Prefix	225*217*50
Prefix	230*222*30
Prefix	270*262*35
Prefix	280*268*30

If you looking for other size please contact us!  
We are adding new size everyday!

## 1. Hydraulic seal

### DUST RING- STYLE : DZW(DR,DZT)/KZW(KZT)

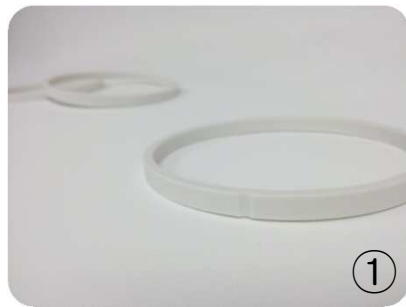

Material & working condition	Main function	Feature
①DZW : Teflon(Glass filled) ②KZW : Teflon(Moly filled) <b>Working Temperature</b> : -55~220℃ <b>Working Pressure</b> : - Mpa <b>Speed</b> : 0.005~1.5 m/s.	Elimination of foreign objects in oil	Intrusion of foreign objects into the piston packing is inhibited by burying and capturing the foreign objects not only by scraping off foreign objects in the oil but also using PTFE's plastic deformability.

SEAL INFORMATION	
PART NUMBER	(Prefix)-D*d*h

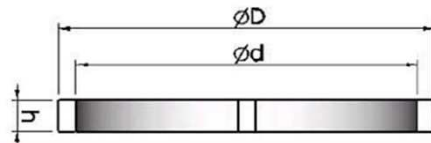

PART NUMBER		PART NUMBER		PART NUMBER		PART NUMBER	
Prefix	20*16*3.5	Prefix	50*42*14.8	Prefix	60*52*4	Prefix	60*55*6
Prefix	35*30*3	Prefix	55*47*4	Prefix	60*52*6	Prefix	60*55*8
Prefix	50*42*4	Prefix	55*47*5	Prefix	60*52*8	Prefix	60*55*9.5
Prefix	50*42*6	Prefix	55*47*9.5	Prefix	60*52*9.5	Prefix	63*55*4
Prefix	50*42*8	Prefix	55*50*4	Prefix	60*52*14.8	Prefix	63*55*8
Prefix	50*42*9.5	Prefix	58*50*9.5	Prefix	60*54*12	Prefix	63*55*9.5



WONYOUNG SEAL CORPORATION

## 1. Hydraulic seal

### DUST RING- STYLE : DZW(DR,DZT)/KZW(KZT)

PART NUMBER		PART NUMBER		PART NUMBER		PART NUMBER	
Prefix	65*57*4	Prefix	80*72*14.8	Prefix	95*87*9.5	Prefix	111*105*29.6
Prefix	65*57*8	Prefix	80*75*6	Prefix	95*87*14.8	Prefix	115*107*6
Prefix	65*57*9.5	Prefix	80*75*9.5	Prefix	95*90*8	Prefix	115*107*8
Prefix	65*60*9.5	Prefix	85*77*4	Prefix	95*90*9.5	Prefix	115*107*9.5
Prefix	69*65*3.6	Prefix	85*77*6	Prefix	95*90*14.8	Prefix	115*107*14.8
Prefix	70*62*4	Prefix	85*77*8	Prefix	100*92*6	Prefix	115*110*6
Prefix	70*62*6	Prefix	85*77*9.5	Prefix	100*92*8	Prefix	118*108*5.3
Prefix	70*62*8	Prefix	85*77*10	Prefix	100*92*9.5	Prefix	120*112*6
Prefix	70*62*9.5	Prefix	85*77*14.8	Prefix	100*92*14.8	Prefix	120*112*8
Prefix	70*62*12	Prefix	85*80*6	Prefix	100*95*6	Prefix	120*112*9.5
Prefix	70*62*14.8	Prefix	85*80*8	Prefix	100*95*9.5	Prefix	120*112*14.8
Prefix	70*65*9.5	Prefix	85*80*9.5	Prefix	100*95*20	Prefix	120*115*8
Prefix	75*67*4	Prefix	85*80*20	Prefix	105*97*6	Prefix	120*115*9.5
Prefix	75*67*6	Prefix	90*82*4	Prefix	105*97*8	Prefix	120*115*10
Prefix	75*67*8	Prefix	90*82*6	Prefix	105*97*9.5	Prefix	125*117*6
Prefix	75*67*9.5	Prefix	90*82*8	Prefix	105*97*14.8	Prefix	125*117*8
Prefix	75*67*12	Prefix	90*82*9.5	Prefix	105*100*6	Prefix	125*117*9.5
Prefix	75*67*14.8	Prefix	90*82*14.8	Prefix	105*100*9.5	Prefix	125*117*14.8
Prefix	75*70*9.5	Prefix	90*85*6	Prefix	108*100*9.5	Prefix	125*119*13.6
Prefix	80*72*4	Prefix	90*85*8	Prefix	110*102*6	Prefix	130*122*6
Prefix	80*72*6	Prefix	90*85*9.5	Prefix	110*102*8	Prefix	130*122*8
Prefix	80*72*8	Prefix	90*85*20	Prefix	110*102*9.5	Prefix	130*122*9.5
Prefix	80*72*9.5	Prefix	95*87*6	Prefix	110*102*14.8	Prefix	130*122*14.8
Prefix	80*72*12	Prefix	95*87*8	Prefix	110*105*10	Prefix	130*125*9.5



## 1. Hydraulic seal

### DUST RING- STYLE : DZW(DR,DZT)/KZW(KZT)

PART NUMBER	
Prefix	135*127*6
Prefix	135*127*8
Prefix	135*127*9.5
Prefix	135*127*14.8
Prefix	135*128*6
Prefix	135*129*14
Prefix	140*132*6
Prefix	140*132*8
Prefix	140*132*9.5
Prefix	140*132*14.8
Prefix	140*134*22.5
Prefix	140*135*8
Prefix	140*135*9.5
Prefix	145*137*6
Prefix	145*137*8
Prefix	145*137*9.5
Prefix	145*137*14.8
Prefix	145*140*9.5

PART NUMBER	
Prefix	150*142*6
Prefix	150*142*8
Prefix	150*142*9.5
Prefix	150*142*14.8
Prefix	155*147*6
Prefix	155*147*8
Prefix	155*147*9.5
Prefix	155*147*14.8
Prefix	160*152*6
Prefix	160*152*8
Prefix	160*152*9.5
Prefix	160*152*14.8
Prefix	165*157*6
Prefix	165*157*8
Prefix	165*157*9.5
Prefix	165*157*14.8
Prefix	168*160*9.5
Prefix	170*162*6

PART NUMBER	
Prefix	170*162*8
Prefix	170*162*9.5
Prefix	170*162*14.8
Prefix	170*163*9.5
Prefix	170*165*9.5
Prefix	175*167*6
Prefix	175*167*8
Prefix	175*167*9.5
Prefix	175*167*14.8
Prefix	180*170*9.5
Prefix	180*172*6
Prefix	180*172*8
Prefix	180*172*9.5
Prefix	180*172*14.8
Prefix	185*177*6
Prefix	185*177*8
Prefix	185*177*9.5
Prefix	185*177*14.8

PART NUMBER	
Prefix	190*182*6
Prefix	190*182*8
Prefix	190*182*9.5
Prefix	190*182*14.8
Prefix	195*187*6
Prefix	195*187*8
Prefix	195*187*9.5
Prefix	195*187*14.8
Prefix	200*192*6
Prefix	200*192*8
Prefix	200*192*9.5
Prefix	200*192*14.8
Prefix	205*197*8
Prefix	205*197*9.5
Prefix	210*202*8
Prefix	210*202*9.5
Prefix	215*207*8
Prefix	215*207*9.5



## 1. Hydraulic seal

### WEAR BAND- STYLE : RYW(RYT)

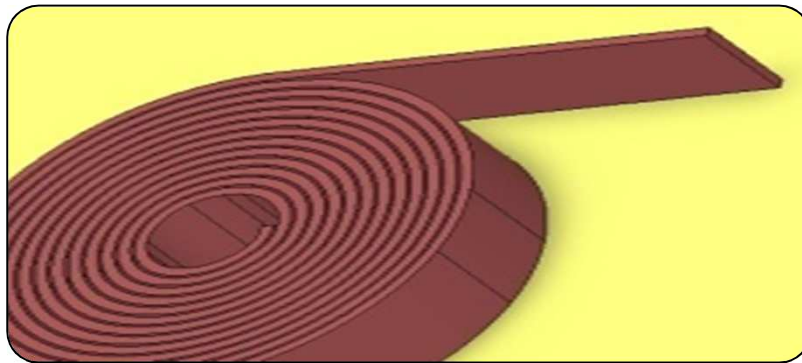

Material & working condition	Main function	Feature
Teflon : Bronze / Moly filled <b>Working Temperature</b> : -55~220℃ <b>Working Pressure</b> : - Mpa <b>Speed</b> : 0.005~1.5 m/s.	Elimination of foreign objects in oil	Intrusion of foreign objects into the piston packing is inhibited by burying and capturing the foreign objects not only by scraping off foreign objects in the oil but also using PTFE's plastic deformability.

#### SEAL INFORMATION

PART NUMBER

(Prefix)-h\*t\*l(m)

PART NUMBER	
Prefix	5*2*13m
Prefix	6*2*13m
Prefix	6*2.5*10m
Prefix	6*3*8m
Prefix	6*4*6m
Prefix	8*2*13m

PART NUMBER	
Prefix	8*2.5*10m
Prefix	8*3*8m
Prefix	8*4*6m
Prefix	9*2.5*10m
Prefix	9.5*2.5*10m
Prefix	9.5*3*8m

PART NUMBER	
Prefix	9.5*4*6m
Prefix	10*2*13m
Prefix	10*2.5*10m
Prefix	10*3*8m
Prefix	10*4*6m
Prefix	14.5*2.5*10m

PART NUMBER	
Prefix	14.5*3*8m
Prefix	14.5*4*6m
Prefix	15*2*13m
Prefix	15*2.5*10m
Prefix	15*3*8m
Prefix	15*3.5*7m



WONYOUNG SEAL CORPORATION

## 1. Hydraulic seal

### WEAR BAND- STYLE : **RYW(RYT)**

PART NUMBER	
Prefix	15*4*6m
Prefix	20*2*13m
Prefix	20*2.5*10m
Prefix	20*3*8m
Prefix	20*4*6m
Prefix	25*2*13m

PART NUMBER	
Prefix	25*2.5*10m
Prefix	25*3*8m
Prefix	25*4*6m
Prefix	30*2*13m
Prefix	30*2.5*10m
Prefix	30*3*8m

PART NUMBER	
Prefix	30*4*6m
Prefix	35*2.5*10m
Prefix	40*2.5*10m
Prefix	40*3*8m
Prefix	40*4*6m
Prefix	50*2.5*10m

PART NUMBER	
Prefix	50*3*8m
Prefix	50*4*6m
Prefix	60*3*8m
Prefix	70*3*8m

## 1. Hydraulic seal

### BUFFER SEAL – STYLE : HBW/HBHW(HBY)



Material	Main function	Feature
①TPU : HS A 94 - Pressure: 0~45Mpa - Temperature range: -30~100 ②TPU : HS A 93 - Pressure: 0~50Mpa - Temperature range: -40~130 ③PA : Polyamide HS D 80	Buffering of impact pressure applied to rod packing	Since there are high pressure, TPU sealing ①② is used in combination with PA backup ring ③ , to use TPU with a combination of strength and flexibility so that the pressure resistance is supplemented. For your reference, since most sealing rod cover sealing performed by buffer seal. So the selection of proper buffer seal is very important than rod seal.

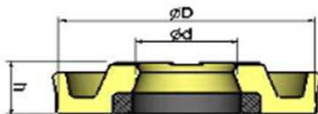

SEAL INFORMATION	
PART NUMBER	(Prefix)-d*D*h

PART NUMBER	
Prefix	40*55.5*6
Prefix	45*60.5*6
Prefix	50*65.5*6
Prefix	55*70.5*6
Prefix	60*75.5*6
Prefix	65*80.5*6

PART NUMBER	
Prefix	70*85.5*6
Prefix	75*90.5*6
Prefix	80*95.5*6
Prefix	85*100.5*6
Prefix	90*105.5*6
Prefix	95*110.5*6

PART NUMBER	
Prefix	100*115.5*6
Prefix	105*120.5*6
Prefix	110*125.5*6
Prefix	115*130.5*6
Prefix	120*135.5*6
Prefix	125*140.5*6

PART NUMBER	
Prefix	130*145.5*6
Prefix	135*150.5*6
Prefix	140*155.5*6
Prefix	150*165.5*6
Prefix	155*170.5*6
Prefix	160*175.5*6



WONYOUNG SEAL CORPORATION

## 1. Hydraulic seal

### **BUFFER SEAL – STYLE : HBW/HBHW(HBY)**

PART NUMBER	
Prefix	165*180.5*6
Prefix	170*185.5*6
Prefix	190*205.5*6

## 1. Hydraulic seal

### BUFFER SEAL – STYLE : HBYW(HBTY)

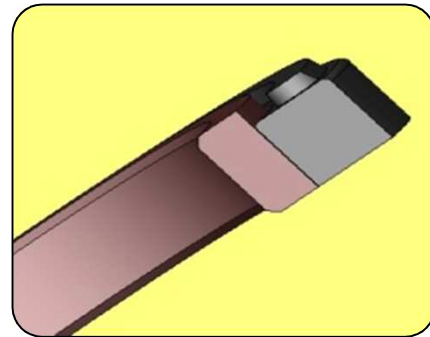
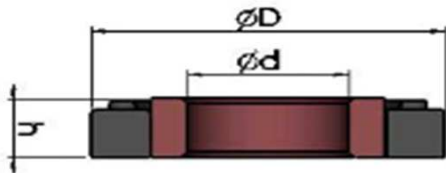

Material & working condition	Main function	Feature
Bronze filled Teflon Rubber energizer <b>Working Temperature</b> : -30~100 °C <b>Working Pressure</b> : 0~35 Mpa <b>Speed</b> : 0.005~1.5 m/s.	Buffering of impact pressure applied to rod packing	Teflon is used for sliding material . This packing has low friction resistance eliminating stick slip and assuring high wear resistance.

SEAL INFORMATION	
PART NUMBER	(Prefix)-d*D*H(Groove height)

PART NUMBER	
HBYW	40*55.5*6.3
HBYW	45*60.5*6.3
HBYW	50*65.5*6.3
HBYW	55*70.5*6.3
HBYW	60*75.5*6.3
HBYW	65*80.5*6.3

PART NUMBER	
HBYW	70*85.5*6.3
HBYW	75*90.5*6.3
HBYW	80*95.5*6.3
HBYW	85*100.5*6.3
HBYW	90*105.5*6.3
HBYW	95*110.5*6.3

PART NUMBER	
HBYW	100*115.5*6.3
HBYW	105*120.5*6.3
HBYW	110*125.5*6.3
HBYW	115*130.5*6.3
HBYW	120*135.5*6.3
HBYW	125*140.5*6.3

PART NUMBER	
HBYW	130*145.5*6.3
HBYW	135*150.5*6.3
HBYW	140*155.5*6.3
HBYW	145*160.5*6.3
HBYW	150*165.5*6.3
HBYW	155*170.5*6.3
HBYW	165*180.5*6.3

## 1. Hydraulic seal

# BUFFER SEAL – STYLE : HBZW(HBTZ)

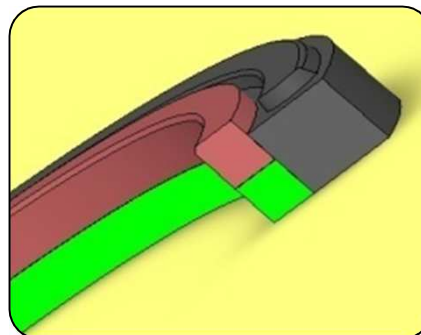
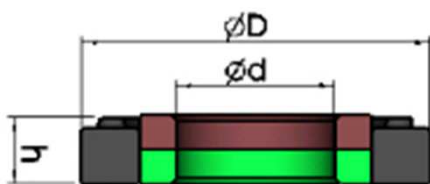

Material & working condition	Main function	Feature
Bronze filled Teflon Rubber energizer Nylon back up ring <b>Working Temperature</b> : -30~100 °C <b>Working Pressure</b> : 0~35 Mpa <b>Speed</b> : 0.005~1.5 m/s.	Buffering of impact pressure applied to rod packing	Teflon is used for sliding material . This packing has low friction resistance eliminating stick slip and assuring high wear resistance. The polyamide back up ring improve extrusion resistance.

### SEAL INFORMATION

PART NUMBER

(Prefix)-d\*D\*H(Groove height)

PART NUMBER		PART NUMBER		PART NUMBER		PART NUMBER	
HBZW	40*55.5*6.3	HBZW	70*85.5*6.3	HBZW	100*115.5*6.3	HBZW	130*145.5*6.3
HBZW	45*60.5*6.3	HBZW	75*90.5*6.3	HBZW	105*120.5*6.3	HBZW	135*150.5*6.3
HBZW	50*65.5*6.3	HBZW	80*95.5*6.3	HBZW	110*125.5*6.3	HBZW	140*155.5*6.3
HBZW	55*70.5*6.3	HBZW	85*100.5*6.3	HBZW	115*130.5*6.3	HBZW	145*160.5*6.3
HBZW	60*75.5*6.3	HBZW	90*105.5*6.3	HBZW	120*135.5*6.3	HBZW	150*165.5*6.3
HBZW	65*80.5*6.3	HBZW	95*110.5*6.3	HBZW	125*140.5*6.3	HBZW	155*170.5*6.3
						HBZW	165*180.5*6.3

## 1. Hydraulic seal

# BUFFER SEAL – STYLE : SSW(SK/E-RING)

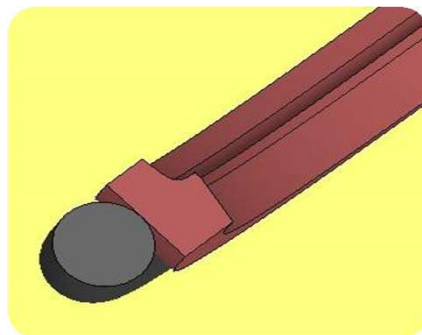
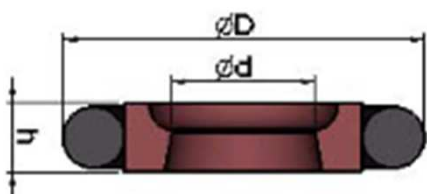

Material & working condition	Main function	Feature
Bronze filled Teflon Rubber energizer <b>Working Temperature</b> : -30~100 °C <b>Working Pressure</b> : 0~35 Mpa <b>Speed</b> : 0.005~1.5 m/s.	Buffering of impact pressure applied to rod packing	Teflon is used for sliding material . This packing has low friction resistance eliminating stick slip and assuring high wear resistance. Compared to HBYW/HBZW the product is excellent in the sealing performance.

### SEAL INFORMATION

PART NUMBER	(Prefix)-d*D*H(Groove height)
-------------	-------------------------------

PART NUMBER		PART NUMBER		PART NUMBER		PART NUMBER	
SSW	35*45.7*4.2	SSW	55*65.7*4.2	SSW	55*70.5*6.3	SSW	75*90.5*6.3
SSW	36*46.7*4.2	SSW	60*70.7*4.2	SSW	60*75.5*6.3	SSW	80*95.5*6.3
SSW	38*48.7*4.2	SSW	90*100.7*4.2	SSW	63*78.5*6.3	SSW	85*100.5*6.3
SSW	40*50.7*4.2	SSW	40*55.5*6.3	SSW	65*80.5*6.3	SSW	90*105.5*6.3
SSW	45*55.7*4.2	SSW	45*60.5*6.3	SSW	68*83.5*6.3	SSW	95*110.5*6.3
SSW	50*60.7*4.2	SSW	50*65.5*6.3	SSW	70*85.5*6.3	SSW	98*113.5*6.3



WONYOUNG SEAL CORPORATION

## 1. Hydraulic seal

# BUFFER SEAL – STYLE : **SSW(SK/E-RING)**

PART NUMBER	
SSW	100*115.5*6.3
SSW	105*120.5*6.3
SSW	110*125.5*6.3
SSW	115*130.5*6.3
SSW	120*135.5*6.3
SSW	125*140.5*6.3

PART NUMBER	
SSW	130*145.5*6.3
SSW	135*150.5*6.3
SSW	136*151.5*6.3
SSW	137*152.5*6.3
SSW	138*153.5*6.3
SSW	140*155.5*6.3

PART NUMBER	
SSW	145*160.5*6.3
SSW	147*162.5*6.3
SSW	147.6*163.1*6.3
SSW	150*165.5*6.3
SSW	152*167.5*6.3
SSW	155*170.5*6.3

PART NUMBER	
SSW	157*172.5*6.3
SSW	160*175.5*6.3
SSW	165*180.5*6.3
SSW	170*185.5*6.3
SSW	177*192.5*6.3



## 1. Hydraulic seal

### BUFFER SEAL – STYLE : HBI

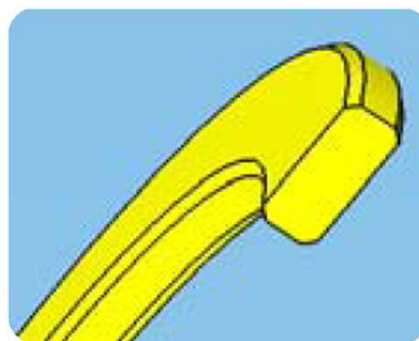

Material & working condition	Main function	Feature
Polyurethane <b>Working Temperature</b> : -35~110℃ <b>Working Pressure</b> : 0~35 Mpa <b>Speed</b> : 0.03~1.0 m/s.	Buffering of impact pressure applied to rod packing	Molded in polyurethane this buffer is a simple flat, washer-like profile

#### SEAL INFORMATION

PART NUMBER	(Prefix)-d*D*H(Groove height)
-------------	-------------------------------

PART NUMBER	
HBI	37.12*52.14*2.92
HBI	44.07*58.49*2.92
HBI	50.8*63.35*2.92
HBI	50.42*64.84*2.92

PART NUMBER	
HBI	53.19*68.07*2.92
HBI	57.15*72.6*4.78
HBI	56.77*74.05*4.78
HBI	59.94*77.22*4.78

PART NUMBER	
HBI	63.5*79.375*4.78
HBI	63.5*80.6*4.75
HBI	69.47*86.75*4.78
HBI	75.82*93.48*4.78

PART NUMBER	
HBI	69.47*96.75*4.78
HBI	82.17*99.45*4.78
HBI	88.9*106.48*4.78

## 1. Hydraulic seal

### ROD SEAL – STYLE : IDKW/ISW(ISI)/IDW(IDI)/UPRH/IUW(IUH)/IUW2(IUH new type)

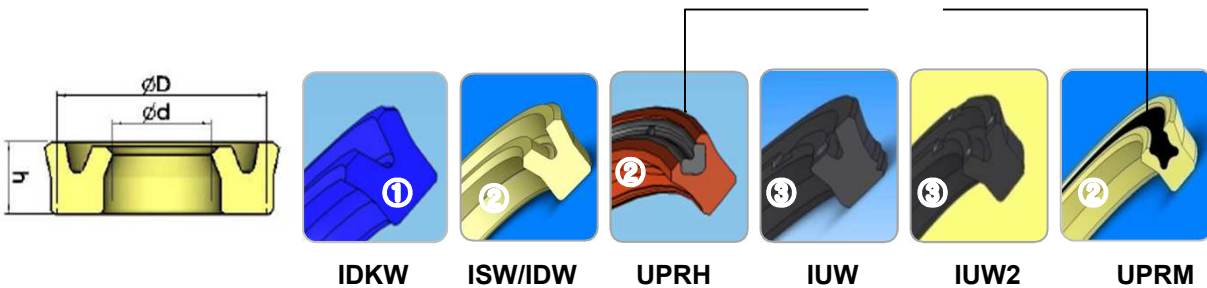

Material & working condition	Main function	Feature
① PU: Heat resistance application (-35~130℃) ② PU: General temperature used (-30~100℃) ③ Nitrile rubber (-25~100℃) ④ Nitrile rubber for energizer. * Speed : ①/② : 0.03~1.0 m/s ③ : 0.008~1.0 m/s	Prevention of external oil leakage	<b>IDKW</b> : it's excellent use for high heat working condition. <b>IDW/ISW</b> : It has excellent wear resistance and sealing ability and can be apply very wide range. <b>IUW</b> : Improvement is made to prevent damages by back pressure. <b>IUW2</b> : more improved to prevent the damage through outer sealing lip also. Also has low temperature resistance. <b>UPRH/UPRM</b> : Is good for use for old machine for more wide sealing lip size and rubber energizer.

SEAL INFORMATION	
PART NUMBER	(Prefix)-d*D*h

PART NUMBER							SIZE
Prefix							
IDKW	IDW	ISW	IUW	IUW2	UPRH	UPRM	
	○						14*22*5.9
	○						14*24*5
	○						15*25*5



WONYOUNG SEAL CORPORATION

# 1. Hydraulic seal

## ROD SEAL – STYLE

**IDKW/ISW(ISI)/IDW(IDI)/UPRH/IUW(IUH)/IUW2(IUH new type)**

PART NUMBER							SIZE
Prefix						SIZE	
IDKW	IDW	ISW	IUW	IUW2	UPRH		UPRM
		○					16*24*5
	○						18*28*8
	○						19*26*5
	○						19*27*6
		○					20*28*5
	○						20*30*6
		○					22*30*5
○		○			○		25*33*5
		○					25*35*5
	○						25*35*6
	○						25*35*8
	○						25*38*10
	○						25*40*10
○		○					28*35.5*5
	○						28*38*6
	○						28*43*10
	○						30*37*6
○		○			○		30*40*6
○	○						30*40*7
○	○						30*40*8
	○						30*45*9
		○					31.5*41.5*6
	○						31.8*44.45*9.5



WONYOUNG SEAL CORPORATION

# 1. Hydraulic seal

## ROD SEAL – STYLE

**IDKW/ISW(ISI)/IDW(IDI)/UPRH/IUW(IUH)/IUW2(IUH new type)**

PART NUMBER							SIZE
Prefix						SIZE	
IDKW	IDW	ISW	IUW	IUW2	UPRH		UPRM
	○						32*42*6
	○						34*50*12
○		○			○		35*45*6
○	○				○		35*45*7
	○						35*45*8
	○						35*45*10
○	○				○		35*50*9
○	○				○		35*50*10
	○						35*50*12
	○						35*51*10
	○						36*46*7.3
	○						36*51*9.5
○	○						38*48*6
	○						40*48*5
	○						40*48*8
○		○			○		40*50*6
○	○		○		○		40*50*7
○	○				○		40*50*8
	○						40*52*9
	○						40*55*6
	○						40*55*7
○	○						40*55*9



WONYOUNG SEAL CORPORATION

# 1. Hydraulic seal

## ROD SEAL – STYLE : IDKW/ISW(ISI)/IDW(IDI)/UPRH/IUW(IUH)/IUW2(IUH new type)

PART NUMBER							SIZE
Prefix						SIZE	
IDKW	IDW	ISW	IUW	IUW2	UPRH		UPRM
○	○				○		40*55*10
	○						40*56*12
	○						40*60*12
	○						40*62*12
	○						44.45*54.03*6.35
	○						45*53*8
○		○			○		45*55*6
○					○		45*55*7
			○				45*55*7.3
○	○						45*55*8
○					○		45*55*10
○	○				○		45*60*9
			○	○			45*60*9.5
	○						45*60*10
○					○		45*60*12
○	○						45*65*12
	○						50*58*8
○		○	○		○		50*60*6
	○						50*60*6.2
	○						50*60*7.3
	○						50*60*8
	○						50*63*8



WONYOUNG SEAL CORPORATION

# 1. Hydraulic seal

## ROD SEAL – STYLE : IDKW/ISW(ISI)/IDW(IDI)/UPRH/IUW(IUH)/IUW2(IUH new type)

PART NUMBER							SIZE
Prefix						SIZE	
IDKW	IDW	ISW	IUW	IUW2	UPRH		UPRM
○	○		○	○	○		50*63*10
○	○				○		50*65*9
○	○				○		50*65*10
○	○				○		50*70*12
	○						50.8*63.5*9.53
					○		50.8*63.5*9.7
	○						50.8*66.68*9
	○						53*63*10
○		○			○		55*65*6
	○						55*65*12
○	○		○	○	○		55*68*10
○	○			○	○		55*70*9
○	○				○	○	55*70*10
○	○				○	○	55*70*12
	○						55*71*12
○	○				○		55*75*12
		○					56*66*6
	○						56*71*9
	○						57.1*69.9*9.7
					○		57.15*69.85*9.7
○		○	○		○		60*70*6
○					○		60*70*7



WONYOUNG SEAL CORPORATION

# 1. Hydraulic seal

## ROD SEAL – STYLE : IDKW/ISW(ISI)/IDW(IDI)/UPRH/IUW(IUH)/IUW2(IUH new type)

PART NUMBER							SIZE
Prefix						SIZE	
IDKW	IDW	ISW	IUW	IUW2	UPRH		UPRM
○	○				○		60*70*8
○							60*70*10
	○						60*70*12
	○						60*72*8
○	○		○	○	○		60*73*10
○	○			○	○		60*75*9
○	○				○	○	60*75*10
○					○	○	60*75*12
	○						60*76*10
○	○				○		60*80*12
	○						60*82*8
	○						60.325*73.025*9.525
	○						63*78*10
	○						63*83*12
					○		63.5*76.2*9.7
	○						63.5*76.25*9.7
○		○	○		○		65*75*6
○	○				○		65*75*8
○	○		○	○	○		65*78*10
	○						65*78*12
○	○			○	○		65*80*9
○	○				○	○	65*80*10



WONYOUNG SEAL CORPORATION

# 1. Hydraulic seal

## ROD SEAL – STYLE : IDKW/ISW(ISI)/IDW(IDI)/UPRH/IUW(IUH)/IUW2(IUH new type)

PART NUMBER							SIZE
Prefix						SIZE	
IDKW	IDW	ISW	IUW	IUW2	UPRH		UPRM
○	○				○	○	65*80*12
○	○				○		65*85*12
	○						69.85*82.55*9.525
○		○			○		70*80*6
○	○				○		70*80*8
	○						70*83*9
○	○		○	○	○		70*83*10
○	○			○	○		70*85*9
○	○				○	○	70*85*10
○					○	○	70*85*12
○					○		70*90*10
○	○				○		70*90*12
		○					71*81*6
○		○			○		75*85*6
○	○				○		75*85*8
○					○		75*85*10
○	○		○	○	○		75*88*10
○	○			○	○		75*90*9
○	○				○	○	75*90*10
○					○	○	75*90*12
○	○				○		75*95*12
	○						76.2*88.9*9.53





WONYOUNG SEAL CORPORATION

# 1. Hydraulic seal

## ROD SEAL – STYLE : IDKW/ISW(ISI)/IDW(IDI)/UPRH/IUW(IUH)/IUW2(IUH new type)

PART NUMBER							SIZE
Prefix						SIZE	
IDKW	IDW	ISW	IUW	IUW2	UPRH		UPRM
					○		76.2*88.9*9.7
○		○			○		80*90*6
○	○				○		80*90*8
	○						80*92*8
○	○		○	○	○		80*93*10
○	○			○	○	○	80*95*9
○	○		○	○	○	○	80*95*10
○	○				○	○	80*95*12
○							80*100*9
					○		80*100*10
○	○				○		80*100*12
	○						82.55*95.25*9.525
○							85*95*9
	○						85*98*10
	○						85*100*8
○		○		○	○	○	85*100*9
○	○		○	○	○	○	85*100*10
○					○	○	85*100*12
	○						85*100*15
○	○			○	○		85*105*12
	○						88.9*101.6*9.53
○	○				○		90*100*6



WONYOUNG SEAL CORPORATION

# 1. Hydraulic seal

## ROD SEAL – STYLE : IDKW/ISW(ISI)/IDW(IDI)/UPRH/IUW(IUH)/IUW2(IUH new type)

PART NUMBER							SIZE
Prefix						SIZE	
IDKW	IDW	ISW	IUW	IUW2	UPRH		UPRM
○		○	○	○	○	○	90*105*9
○	○		○	○	○	○	90*105*10
○	○				○	○	90*105*12
○	○			○	○		90*110*12
○	○						90*110*15
○							95*105*9
○					○		95*105*10
○		○		○	○	○	95*110*9
○	○		○	○	○	○	95*110*10
○	○				○		95*110*12
	○						95*110.5*9
○	○			○	○	○	95*115*12
	○						95.25*107.95*9.525
		○					98*112*8
	○						98*115*12
	○						100*110*6
	○						100*112*8.5
○		○		○	○		100*115*9
○	○		○	○	○		100*115*10
○					○		100*115*12
			○	○	○		100*120*10
○	○			○	○	○	100*120*12



WONYOUNG SEAL CORPORATION

# 1. Hydraulic seal

## ROD SEAL – STYLE : IDKW/ISW(ISI)/IDW(IDI)/UPRH/IUW(IUH)/IUW2(IUH new type)

PART NUMBER							SIZE
Prefix							
IDKW	IDW	ISW	IUW	IUW2	UPRH		
○							100*120*15
	○						100*125*9
	○						101.6*117.5*9.5
○		○	○	○	○		105*120*9
○	○		○	○	○		105*120*10
○	○			○	○		105*125*12
○	○			○	○		105*125*15
○							110*120*12
○		○	○	○	○		110*125*9
○	○		○	○	○		110*125*10
○	○		○	○	○		110*130*10
○	○				○		110*130*12
○					○		110*130*13
○	○			○	○		110*130*15
○	○				○		110*130*16
		○					112*125*9
			○				115*130*8.5
○	○		○	○	○		115*130*9
			○				115*130*9.5
○	○			○	○		115*130*10
○	○			○	○		115*135*12
	○						115*135*15



WONYOUNG SEAL CORPORATION

# 1. Hydraulic seal

## ROD SEAL – STYLE : IDKW/ISW(ISI)/IDW(IDI)/UPRH/IUW(IUH)/IUW2(IUH new type)

PART NUMBER							SIZE
Prefix							
IDKW	IDW	ISW	IUW	IUW2	UPRH		
○	○			○	○		115*135*16
○		○			○		118*133*9
○		○	○		○		120*135*9
○	○						120*135*10
○	○		○	○	○		120*140*10
○	○				○		120*140*12
○				○	○		120*140*15
	○						120*140*16
○		○					125*140*9
○	○				○		125*145*12
	○						125*145*16
○		○			○		130*145*9
○							130*145*10
○	○		○	○	○		130*150*12
○				○	○		130*150*16
	○						135*145*10
		○					135*150*9
	○						135*155*15
		○					136*150*8.5
	○						140*150*6
	○						140*150*7
		○					140*155*9



WONYOUNG SEAL CORPORATION

# 1. Hydraulic seal

## ROD SEAL – STYLE : IDKW/ISW(ISI)/IDW(IDI)/UPRH/IUW(IUH)/IUW2(IUH new type)

PART NUMBER							SIZE
Prefix						SIZE	
IDKW	IDW	ISW	IUW	IUW2	UPRH		UPRM
○							140*160*10
○	○				○		140*160*12
	○						140*160*15
	○						140*160*16
		○					145*160*9
		○					150*165*9
	○						150*170*12
	○						150*170*16
	○						155*165*6.3
		○					155*170*9
		○					160*175*9
○	○				○		160*180*12
	○						160*180*16
	○						160*185*16
		○					170*185*9
	○						170*190*12
	○						170*195*15
	○						170*195*16
		○					175*190*9
		○					180*200*12
	○						180*205*16
	○						190*215*16
	○						210*235*19

## 1. Hydraulic seal

### ROD&PISTON SEAL – STYLE : UPNW(UPH/USH)

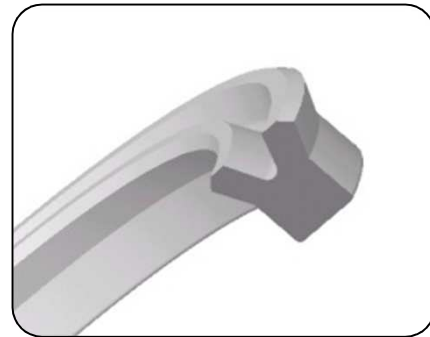
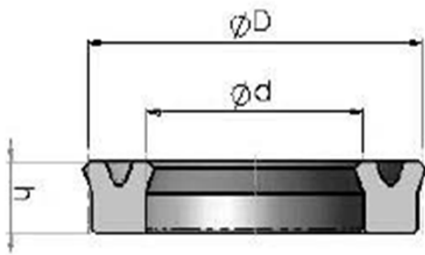

Material & working condition	Main function	Feature
Nitrile rubber Working temperature : -25~100℃ Speed : 0.008~1.0 m/s Working pressure : 0~15Mpa(w/o B.U.R), 0~32(w/ B.U.R)	Prevention of external oil leakage or Retention of oil pressure	This can be used for piston and rod seal. Nitrile rubber and fluoro rubber are available for material to assure wide range of operating temperature. Wide variation of size is available.

#### SEAL INFORMATION

PART NUMBER	(Prefix)-d*D*h
-------------	----------------

PART NUMBER		PART NUMBER		PART NUMBER		PART NUMBER	
UPNW	10*14*2.2	UPNW	15*19*2.8	UPNW	19*25*3.5	UPNW	25*31*3.5
UPNW	10*14*3	UPNW	15*23*5.5	UPNW	19*27*6	UPNW	25*33*5
UPNW	10*17*5	UPNW	16*20*2.5	UPNW	22*32*6	UPNW	25*35*6
UPNW	10*18*6	UPNW	18*25*3	UPNW	22.4*30.4*5	UPNW	25*35*8
UPNW	11.2*21.2*7.5	UPNW	18*26*5	UPNW	22.4*32.4*6	UPNW	25*38*8
UPNW	14*16*3	UPNW	18*26*5.5	UPNW	24.9*31.3*4.2	UPNW	27*32*4



WONYOUNG SEAL CORPORATION

## 1. Hydraulic seal

### ROD&PISTON SEAL – STYLE : UPNW(UPH/USH)

PART NUMBER		PART NUMBER		PART NUMBER		PART NUMBER	
UPNW	28.01*34.3*4.75	UPNW	49*65*8.5	UPNW	75*90*10	UPNW	120*140*12
UPNW	30*40*6	UPNW	50*60*6	UPNW	80*90*6	UPNW	120*140*15
UPNW	30*40*7.8	UPNW	50*60*9	UPNW	80*100*12	UPNW	125*140*9
UPNW	31.21*37.6*4.25	UPNW	50*65*9	UPNW	85*100*9	UPNW	125*150*13
UPNW	35*45*6	UPNW	50*65*10	UPNW	85*100*12	UPNW	130*140*6
UPNW	35*46*7	UPNW	53*63*6	UPNW	90*100*6	UPNW	130*145*9
UPNW	35*50*9	UPNW	54*70*12	UPNW	90*105*9	UPNW	130*150*15
UPNW	35*50*10	UPNW	55*70*10	UPNW	90*105*12	UPNW	135*150*9
UPNW	38*55*10	UPNW	55*75*12	UPNW	95*110*9	UPNW	140*155*9
UPNW	38*55*11	UPNW	60*70*5	UPNW	100*110*6	UPNW	145*160*9
UPNW	40*50*6	UPNW	60*70*6	UPNW	100*115*9	UPNW	150*165*9
UPNW	40*55*10	UPNW	60*80*12	UPNW	100*120*11	UPNW	155*170*9
UPNW	40*65*10	UPNW	63*73*6	UPNW	100*120*12	UPNW	155*180*15
UPNW	44*60*12	UPNW	64*80*12	UPNW	105*120*9	UPNW	165*180*9
UPNW	45*55*6	UPNW	65*75*6	UPNW	110*120*6	UPNW	170*180*6
UPNW	45*55*7	UPNW	65*80*12	UPNW	110*130*15	UPNW	175*190*9
UPNW	45*55*8	UPNW	65*85*12	UPNW	112*125*9	UPNW	180*200*12
UPNW	45*60*9	UPNW	70*80*6	UPNW	120*130*6		
UPNW	45*60*11	UPNW	75*85*6	UPNW	120*140*9		

## 1. Hydraulic seal

# ROD&PISTON SEAL – STYLE : UPW(UPI)

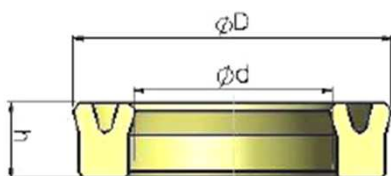

Material & working condition	Main function	Feature
Polyurethane Working temperature : -35~100℃ Speed : 0.03~1.0 m/s Working pressure : 0~35Mpa	Prevention of external oil leakage or Retention of oil pressure	The Polyurethane material has excellent wear resistance and sealing ability. This packing can be used for wide range of operation.

### SEAL INFORMATION

PART NUMBER	(Prefix)-d*D*h
-------------	----------------

PART NUMBER		PART NUMBER		PART NUMBER		PART NUMBER	
UPW	30*40*6	UPW	38.08*57.15*12.7	UPW	44.45*61.917*9.52	UPW	55*75*12
UPW	31.8*44.5*9.5	UPW	38.1*47.625*6.35	UPW	45*55*6	UPW	57.15*69.85*9.52
UPW	32*45*8	UPW	40*50*9	UPW	45*70*15.5	UPW	60*70*6
UPW	35*45*6	UPW	40*50*10	UPW	47*80*16	UPW	60*70*10
UPW	36*51*9.5	UPW	40*60*11	UPW	47.57*73.13*15.7	UPW	60*74*8
UPW	38*52*10	UPW	44.45*53.97*6.35	UPW	50*60*6	UPW	60*80*12





WONYOUNG SEAL CORPORATION

## 1. Hydraulic seal

# ROD&PISTON SEAL – STYLE : UPW(UPI)

PART NUMBER	
UPW	61*71*6
UPW	65*85*12
UPW	70*80*8
UPW	70*90*12
UPW	70*92*12
UPW	75*90*10
UPW	75*95*12
UPW	76.2*101.6*16.66

PART NUMBER	
UPW	80*94*8
UPW	80*100*12
UPW	80*100*15
UPW	85*105*12
UPW	90*110*12
UPW	95*115*12
UPW	100*120*12
UPW	106*120*8.5

PART NUMBER	
UPW	110*130*12
UPW	110*130*15
UPW	120*140*12
UPW	120*140*15
UPW	130*150*15
UPW	132*152*15
UPW	139.7*152.11*14.3
UPW	140*160*15

PART NUMBER	
UPW	150*170*15
UPW	170*195*15
UPW	180*205*15
UPW	185*210*15
UPW	210*230*12
UPW	210*235*18
UPW	220*245*19
UPW	230*255*18

## 1. Hydraulic seal

# O-RING BACK UP RING – STYLE : T1/2/3 G

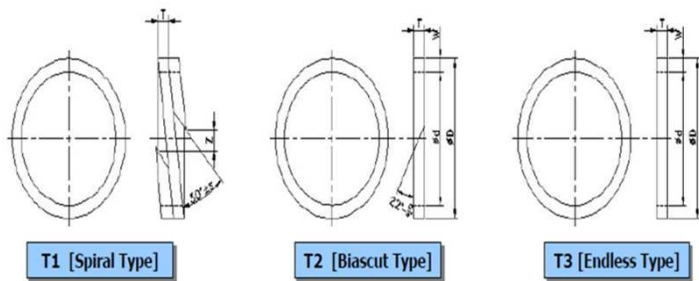

Material & working condition	Main function	Feature
Teflon Working temperature : -55~220℃ Speed : - m/s Working pressure : - Mpa	Prevent o - ring extrusion	This is used to prevent extrusion o - ring and to improve the pressure resistance of the o - rings. Standard cutting type is Endless type. But once need bias cut type can be supply by Bias cut type. Spiral type also available.

SEAL INFORMATION	
PART NUMBER	(Prefix)-d(d*D*h)

PART NUMBER		PART NUMBER		PART NUMBER		PART NUMBER	
G	25(25*30*1.25)	G	50(50*55*1.25)	G	60(60*65*1.25)	G	76(76*81*1.25)
G	30(30*35*1.25)	G	52(52*57*1.25)	G	62(62*67*1.25)	G	80(80*85*1.25)
G	34(34*39*1.25)	G	53(53*58*1.25)	G	65(65*70*1.25)	G	81(81*86*1.25)
G	35(35*40*1.25)	G	55(55*60*1.25)	G	67(67*72*1.25)	G	85(85*90*1.25)
G	40(40*45*1.25)	G	57(57*62*1.25)	G	70(70*75*1.25)	G	90(90*95*1.25)
G	45(45*50*1.25)	G	58(58*63*1.25)	G	75(75*80*1.25)	G	95(95*100*1.25)



WONYOUNG SEAL CORPORATION

## 1. Hydraulic seal

# O-RING BACK UP RING – STYLE : T1/2/3 G

PART NUMBER	
G	95(95*100*1.25)
G	100(100*105*1.25)
G	105(105*110*1.25)
G	106(106*111*1.25)
G	108(108*113*1.25)
G	110(110*115*1.25)
G	115(115*120*1.25)
G	116(116*121*1.25)
G	120(120*125*1.25)
G	125(125*130*1.25)
G	126(126*131*1.25)

PART NUMBER	
G	128(128*133*1.25)
G	130(130*135*1.25)
G	135(135*140*1.25)
G	136(136*141*1.25)
G	140(140*145*1.25)
G	145(145*150*1.25)
G	146(146*151*1.25)
G	150(150*160*1.9)
G	152(152*162*1.9)
G	155(155*165*1.9)
G	160(160*170*1.9)

PART NUMBER	
G	165(165*175*1.9)
G	170(170*180*1.9)
G	175(175*185*1.9)
G	180(180*190*1.9)
G	185(185*195*1.9)
G	190(190*200*1.9)
G	192(192*202*1.9)
G	195(195*205*1.9)
G	200(200*210*1.9)
G	205(205*215*1.9)
G	210(210*220*1.9)

PART NUMBER	
G	215(215*225*1.9)
G	220(220*230*1.9)
G	225(225*235*1.9)
G	230(230*240*1.9)
G	235(235*245*1.9)
G	240(240*250*1.9)
G	245(245*255*1.9)
G	250(250*260*1.9)

# 1. Hydraulic seal

## O-RING BACK UP RING – STYLE : T1/2/3 P

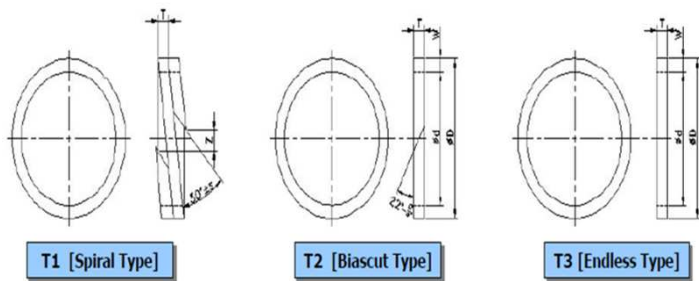

Material & working condition	Main function	Feature
Teflon Working temperature : -55~220℃ Speed : - m/s Working pressure : - Mpa	Prevent o - ring extrusion	This is used to prevent extrusion o - ring and to improve the pressure resistance of the o - rings. Standard cutting type is Endless type. But once need bias cut type can be supply by Bias cut type. Spiral type also available.

SEAL INFORMATION	
PART NUMBER	(Prefix)-d(d*D*h)

PART NUMBER		PART NUMBER		PART NUMBER		PART NUMBER	
P	41(41*47*1.25)	P	49(49*55*1.25)	P	55(55*65*1.9)	P	67(67*77*1.9)
P	42(42*48*1.25)	P	50(50*56*1.25)	P	58(58*68*1.9)	P	70(70*80*1.9)
P	44(44*50*1.25)	P	48A(48A*58*1.9)	P	60(60*70*1.9)	P	71(71*81*1.9)
P	45(45*51*1.25)	P	50A(50A*60*1.9)	P	62(62*72*1.9)	P	75(75*85*1.9)
P	46(46*52*1.25)	P	52(52*62*1.9)	P	63(63*73*1.9)	P	80(80*90*1.9)
P	48(48*54*1.25)	P	53(53*63*1.9)	P	65(65*75*1.9)	P	85(85*95*1.9)



WONYOUNG SEAL CORPORATION

## 1. Hydraulic seal

# O-RING BACK UP RING – STYLE : T1/2/3 P

PART NUMBER	
P	90(90*100*1.9)
P	91(91*96*1.9)
P	95(95*105*1.9)
P	100(100*110*1.9)
P	102(102*112*1.9)
P	105(105*115*1.9)
P	110(110*120*1.9)
P	112(112*122*1.9)
P	115(115*125*1.9)
P	120(120*130*1.9)
P	125(125*135*1.9)
P	126(126*136*1.9)
P	130(130*140*1.9)

PART NUMBER	
P	132(132*142*1.9)
P	135(135*145*1.9)
P	140(140*150*1.9)
P	145(145*155*1.9)
P	150(150*160*1.9)
P	150A(150A*165*2.75)
P	155(155*170*2.75)
P	160(160*175*2.75)
P	165(165*180*2.75)
P	170(170*185*2.75)
P	175(175*190*2.75)
P	180(180*195*2.75)
P	185(185*200*2.75)

PART NUMBER	
P	190(190*205*2.75)
P	195(195*210*2.75)
P	200(200*215*2.75)
P	205(205*220*2.75)
P	209(209*224*2.75)
P	210(210*225*2.75)
P	215(215*230*2.75)
P	220(220*235*2.75)
P	225(225*240*2.75)
P	230(230*245*2.75)
P	235(235*250*2.75)
P	240(240*255*2.75)
P	245(245*260*2.75)

PART NUMBER	
P	250(250*265*2.75)
P	255(255*270*2.75)
P	260(260*275*2.75)
P	265(265*280*2.75)
P	270(270*285*2.75)
P	275(275*290*2.75)
P	280(280*295*2.75)
P	285(285*300*2.75)
P	290(290*305*2.75)
P	295(295*310*2.75)
P	300(300*315*2.75)

## 1. Hydraulic seal

### PACKING BACK UP RING – STYLE : **BRDW(BRN)**

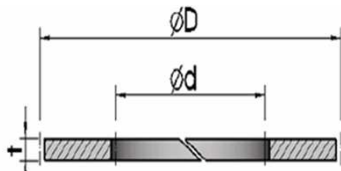

Material & working condition	Main function	Feature
Special nylon material Working temperature : -55~120℃ Speed : - m/s Working pressure : - Mpa	Prevent packing extrusion	Material : Polyamide + Special Material Shock proof material inside. Low friction Material inside. ; It can be replaced also instead PTFE B/U ring to prevent the oil pollution and cost down.

SEAL INFORMATION	
PART NUMBER	(Prefix)- d*D*t

PART NUMBER	
BRDW	40*50*3
BRDW	50*60*3
BRDW	50*63*3
BRDW	50*65*3
BRDW	55*65*3
BRDW	55*68*3

PART NUMBER	
BRDW	55*70*3
BRDW	55*71*3
BRDW	60*70*3
BRDW	60*73*3
BRDW	60*75*3
BRDW	60*76*3

PART NUMBER	
BRDW	60*80*3
BRDW	65*75*3
BRDW	65*78*3
BRDW	65*80*3
BRDW	65*85*3
BRDW	70*80*3

PART NUMBER	
BRDW	70*85*3
BRDW	70*85*4
BRDW	70*90*3
BRDW	70*93*3
BRDW	75*85*3
BRDW	75*88*3



## 1. Hydraulic seal

### PACKING BACK UP RING – STYLE : BRDW(BRN)

PART NUMBER	
BRDW	75*90*3
BRDW	75*90*4
BRDW	75*95*3
BRDW	80*90*3
BRDW	80*93*3
BRDW	80*95*3
BRDW	80*95*4
BRDW	80*100*3
BRDW	85*100*1.9

PART NUMBER	
BRDW	85*100*3
BRDW	85*100*4
BRDW	85*105*3
BRDW	90*105*3
BRDW	90*105*4
BRDW	90*110*3
BRDW	95*110*3
BRDW	95*110*4
BRDW	95*115*3

PART NUMBER	
BRDW	100*115*3
BRDW	100*115*4
BRDW	100*120*3
BRDW	105*120*3
BRDW	105*125*3
BRDW	110*125*3
BRDW	110*130*3
BRDW	115*130*3
BRDW	115*135*3

PART NUMBER	
BRDW	120*135*3
BRDW	120*140*3
BRDW	120*140*4
BRDW	125*145*3
BRDW	130*150*3
BRDW	140*160*3
BRDW	145*165*4
BRDW	150*170*3
BRDW	150*170*4
BRDW	160*160*3
BRDW	160*180*4

## 1. Hydraulic seal

### PACKING BACK UP RING – STYLE : BRBW/BRWW/BRGW (BRT)

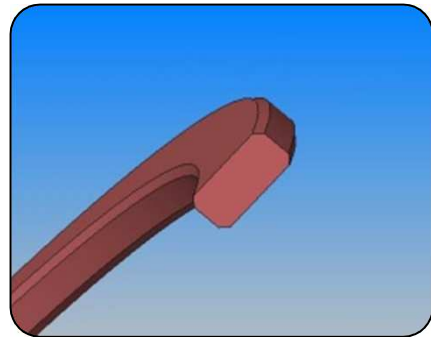
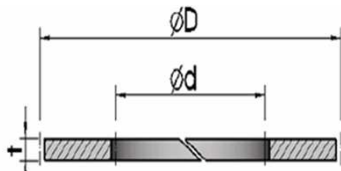

Material & working condition	Main function	Feature
Teflon (B:Bronze,W:white,G:glass) filled. Working temperature : -55~120℃ Speed : - m/s Working pressure : - Mpa	Prevent packing extrusion	This is used to prevent extrusion packing and to improve the pressure resistance of the packing. Standard cutting type is Endless type. But once need bias cut type can be supply by Bias cut type.

SEAL INFORMATION	
PART NUMBER	(Prefix)- d*D*t

PART NUMBER		PART NUMBER		PART NUMBER		PART NUMBER	
Prefix	16*24*2	Prefix	20*30*2	Prefix	22.4*33*2	Prefix	25*35*3
Prefix	16*26*2	Prefix	20*33*2	Prefix	23.5*31.5*2	Prefix	25*38*2
Prefix	18*26*2	Prefix	22*30*2	Prefix	24*32*2	Prefix	25.5*35.5*2
Prefix	18*31*2	Prefix	22*33*2	Prefix	25*33*2	Prefix	27*40*3
Prefix	20*25*2	Prefix	22*35*2	Prefix	25*33*3	Prefix	28*35*3
Prefix	20*28*2	Prefix	22.4*30*2	Prefix	25*35*2	Prefix	28*36*3





1. Hydraulic seal

**PACKING BACK UP RING – STYLE :  
BRBW/BRWW/BRGW (BRT)**

PART NUMBER		PART NUMBER		PART NUMBER		PART NUMBER	
Prefix	28*40*3	Prefix	45*60*3	Prefix	64*80*3	Prefix	90*105*3
Prefix	28*41*3	Prefix	47*61*3	Prefix	65*75*3	Prefix	90*110*3
Prefix	30*40*2	Prefix	47*63*3	Prefix	65*78*3	Prefix	95*105*3
Prefix	30*40*3	Prefix	48*63*3	Prefix	65*80*3	Prefix	95*105*3.5
Prefix	30*45*3	Prefix	50*60*3	Prefix	65*85*3	Prefix	95*110*3
Prefix	31.5*41.5*3	Prefix	50*63*3	Prefix	67*77*3	Prefix	95*110*3.5
Prefix	31.5*44.5*3	Prefix	50*65*3	Prefix	70*80*3	Prefix	95*115*3
Prefix	32*38*2	Prefix	50*70*3	Prefix	70*83*3	Prefix	100*115*3
Prefix	32*38*3	Prefix	53*63*3	Prefix	70*85*3	Prefix	100*115*4
Prefix	32*42*3	Prefix	54*60*3	Prefix	70*90*3	Prefix	100*120*3
Prefix	32*48*3	Prefix	54*70*3	Prefix	71*80*3	Prefix	100*125*3
Prefix	34*50*3	Prefix	55*65*3	Prefix	71*81*3	Prefix	105*120*3
Prefix	35*45*2	Prefix	55*68*3	Prefix	75*85*3	Prefix	105*125*3
Prefix	35*45*3	Prefix	55*70*3	Prefix	75*88*3	Prefix	106*120*3
Prefix	35*50*3	Prefix	55*71*3	Prefix	75*90*3	Prefix	106*123*3
Prefix	35.5*45*3	Prefix	55*75*3	Prefix	75*95*3	Prefix	106*126*3
Prefix	35.5*51.5*3	Prefix	60*70*3	Prefix	80*90*3	Prefix	110*125*3
Prefix	36*46*3	Prefix	60*71*3	Prefix	80*93*3	Prefix	110*125*4
Prefix	40*50*2	Prefix	60*73*3	Prefix	80*95*3	Prefix	110*130*3
Prefix	40*50*3	Prefix	60*75*3	Prefix	80*100*3	Prefix	112*125*3
Prefix	40*55*3	Prefix	60*76*3	Prefix	85*95*3	Prefix	115*130*3
Prefix	40*56*3	Prefix	60*80*3	Prefix	85*100*2	Prefix	115*135*3
Prefix	45*55*3	Prefix	61*71*3	Prefix	85*100*3	Prefix	120*135*3
Prefix	45*56*3	Prefix	63*73*3	Prefix	85*105*3	Prefix	120*140*3



WONYOUNG SEAL CORPORATION

## 1. Hydraulic seal

### **PACKING BACK UP RING – STYLE : BRBW/BRWW/BRGW (BRT)**

PART NUMBER	
Prefix	125*140*3
Prefix	125*150*3
Prefix	130*145*3
Prefix	130*150*3
Prefix	135*150*3
Prefix	135*160*3
Prefix	136*150*3
Prefix	140*155*3
Prefix	140*160*3
Prefix	140*165*3
Prefix	145*160*3
Prefix	145*165*3
Prefix	145*170*3
Prefix	150*165*3

PART NUMBER	
Prefix	150*170*3
Prefix	155*170*4
Prefix	155*180*4
Prefix	160*175*4
Prefix	160*180*4
Prefix	160*185*4
Prefix	165*180*4
Prefix	170*180*4
Prefix	170*190*4
Prefix	170*200*4
Prefix	175*190*4
Prefix	175*200*4
Prefix	180*200*4
Prefix	180*205*4

PART NUMBER	
Prefix	190*200*4
Prefix	190*210*3
Prefix	190*210*4
Prefix	200*220*4
Prefix	200*225*4
Prefix	204*224*4
Prefix	205*220*4
Prefix	205*225*4
Prefix	210*230*4
Prefix	220*240*4
Prefix	225*245*4
Prefix	225*250*4
Prefix	230*250*4
Prefix	240*260*4

PART NUMBER	
Prefix	250*270*4
Prefix	250*275*4
Prefix	255*280*4
Prefix	260*285*4
Prefix	265*290*4
Prefix	265*297*4
Prefix	270*295*4
Prefix	270*300*4
Prefix	275*300*4
Prefix	280*305*4
Prefix	280*312*4
Prefix	290*315*4
Prefix	300*325*4
Prefix	300*332*4

## 1. Hydraulic seal

### SLIPPER SEAL BACK UP RING – STYLE : N4W

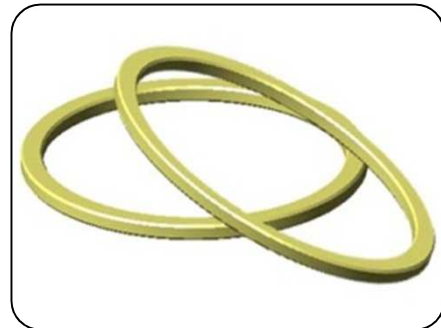
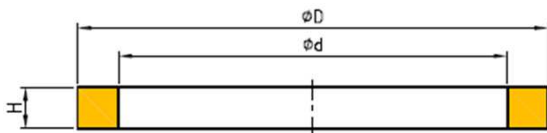

Material & working condition	Main function	Feature
Nylon glass filled Working temperature : -55~120℃ Speed : - m/s Working pressure : - Mpa	Prevent packing extrusion	It's special back ring for combination with slipper seal.

#### SEAL INFORMATION

PART NUMBER	(Prefix)- d*D*H
-------------	-----------------

PART NAME		PART NAME		PART NAME		PART NAME	
N4W	75*70*2.5	N4W	90*85*2.5	N4W	115*109*3	N4W	130*120*3
N4W	80*75*2.5	N4W	95*90*2.5	N4W	120*114*3	N4W	135*129*3
N4W	85*80*2.5	N4W	110*104*3	N4W	125*119*3	N4W	140*134*3
						N4W	150*144*3
						N4W	170*164*3

## 1. Hydraulic seal

### DUST SEAL(Steel cover) – STYLE : DKBW(DKBI)

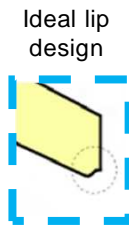
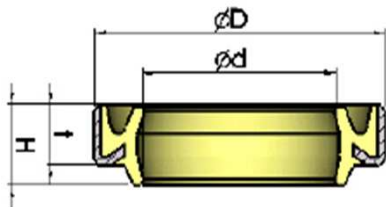

Material & working condition	Main function	Feature
① TPU : - Pressure: - Mpa - Temperature range: -55~100  ② SPCC	Prevent of intrusion of foreign objects	To cope with the harsh external contaminant conditions, high strength TPU is used to resist plastic deformation. Since the SPCC phosphate process, the bonding with TPU is very strong. Since the ideal design of the dust sealing lip, it can be done ideal dust wiping for good dust resistance and good oil film making.

SEAL INFORMATION	
PART NUMBER	(Prefix)- d*D*t/H

PART NUMBER	
DKBW	19*31*6/9
DKBW	20*31*6/9
DKBW	20*32*6/9
DKBW	22*34*6/9
DKBW	25*37*6/9
DKBW	30*42*6/9

PART NUMBER	
DKBW	32*52*8/11
DKBW	35*45*7/10
DKBW	35*47*7/10
DKBW	40*50*7/10
DKBW	40*52*7/10
DKBW	44.5*53.82*5/7

PART NUMBER	
DKBW	45*57*7/10
DKBW	50*62*7/10
DKBW	55*69*8/11
DKBW	60*74*8/11
DKBW	65*79*8/11
DKBW	70*82*7/10

PART NUMBER	
DKBW	70*84*8/11
DKBW	75*87*7/10
DKBW	75*89*8/11
DKBW	80*94*8/11
DKBW	85*99*8/11
DKBW	90*104*8/11



WONYOUNG SEAL CORPORATION

## 1. Hydraulic seal

### DUST SEAL(Steel cover) – STYLE : **DKBW**(DKBI)

PART NUMBER	
DKBW	95*109*8/11
DKBW	100*114*8/11
DKBW	105*121*9/12
DKBW	110*126*9/12
DKBW	115*131*9/12
DKBW	120*136*9/12

PART NUMBER	
DKBW	125*141*9/12
DKBW	130*146*9/12
DKBW	135*155*10/14
DKBW	140*160*10/14
DKBW	145*165*10/14
DKBW	150*170*10/14

PART NUMBER	
DKBW	155*175*10/14
DKBW	160*180*10/14
DKBW	165*185*10/14
DKBW	170*190*10/14
DKBW	175*195*10/14
DKBW	180*200*10/14

PART NUMBER	
DKBW	180*205*12/17
DKBW	190*205*9/12
DKBW	200*216*10/14

## 1. Hydraulic seal

### DUST SEAL(Steel cover) – STYLE : DKBIN(KAYABA TYPE DKBI)

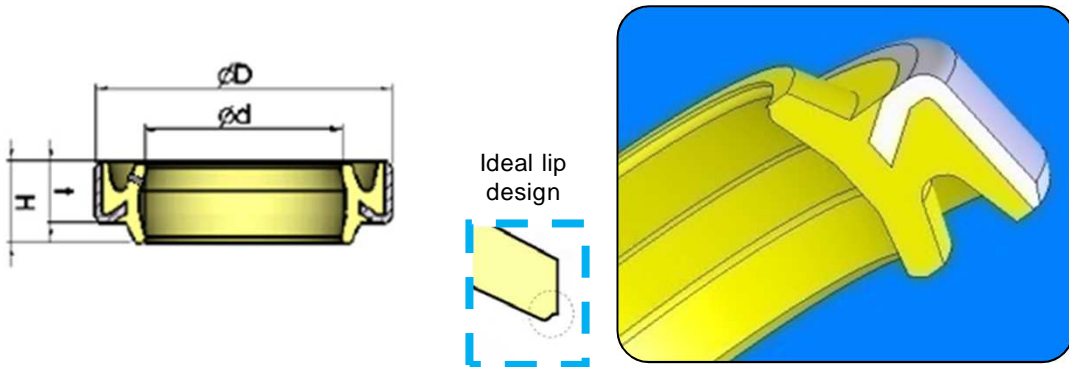

Material & working condition	Main function	Feature
①TPU : - Pressure: - Mpa - Temperature range: -55~100  ②SPCC	Prevent of intrusion of foreign objects	To cope with the harsh external contaminant conditions, high strength TPU is used to resist plastic deformation. The more longer dust lip than DKBW improve dust resistance. Small one point hole in oil lip allows build to escape and prevents loss or damage to the dust seal.

SEAL INFORMATION	
PART NUMBER	(Prefix)- d*D*t/H

PART NUMBER	
DKBIN	45*57*7/11
DKBIN	50*62*7/11
DKBIN	55*69*8/13
DKBIN	60*74*8/13
DKBIN	65*79*8/13

PART NUMBER	
DKBIN	70*84*8/13
DKBIN	75*89*8/13
DKBIN	80*94*8/13
DKBIN	85*99*8/13
DKBIN	90*104*8/13

PART NUMBER	
DKBIN	95*109*8/13
DKBIN	100*114*9/14
DKBIN	105*121*9/14
DKBIN	110*126*9/14
DKBIN	115*131*9/14

PART NUMBER	
DKBIN	120*136*9/14
DKBIN	130*146*9/14

## 1. Hydraulic seal

### DUST SEAL(Steel cover) – STYLE : DKNW(DKB)

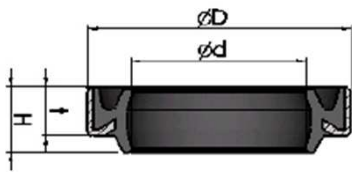

Material & working condition	Main function	Feature
① Nitrile rubber : - Pressure: - Mpa - Temperature range: -20~100  ② SPCC	Prevent of intrusion of foreign objects	Employing nitrile rubber as material . This is a double lip dust seal to prevent oil scraping off.

SEAL INFORMATION	
PART NUMBER	(Prefix)- d*D*t/H

PART NUMBER		PART NUMBER		PART NUMBER		PART NUMBER	
DKNW	13*19*4/5.4	DKNW	20*32*6/9	DKNW	40*52*7/10	DKNW	70*84*8/11
DKNW	14*25*5/7	DKNW	22*34*6/9	DKNW	45*57*7/10	DKNW	75*89*8/11
DKNW	14.5*22*4/5.5	DKNW	30*42*6/9	DKNW	50*62*7/10	DKNW	80*94*8/11
DKNW	18*26*6.6/12.4	DKNW	32*52*8/11	DKNW	55*69*8/11	DKNW	85*99*8/11
DKNW	18*30*6/9	DKNW	35*47*7/10	DKNW	60*74*8/11	DKNW	90*104*8/11
DKNW	20*26*6/9	DKNW	35*48*6/9	DKNW	65*79*8/11	DKNW	95*105*8/11



WONYOUNG SEAL CORPORATION

## 1. Hydraulic seal

### DUST SEAL(Steel cover) – STYLE : DKNW(DKB)

PART NUMBER	
DKNW	95*109*8/11
DKNW	100*114*8/11
DKNW	105*121*9/12

PART NUMBER	
DKNW	110*126*9/12
DKNW	115*131*9/12
DKNW	120*136*9/12

PART NUMBER	
DKNW	130*146*9/12
DKNW	140*160*10/14
DKNW	145*165*10/14

PART NUMBER	
DKNW	160*180*10/14
DKNW	170*190*10/14



## 1. Hydraulic seal

# DUST SEAL(Steel cover) – STYLE : DKW(DKI)

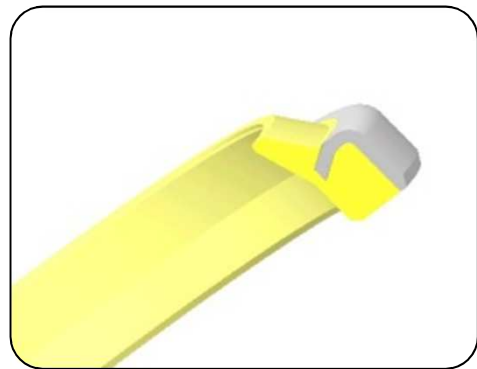
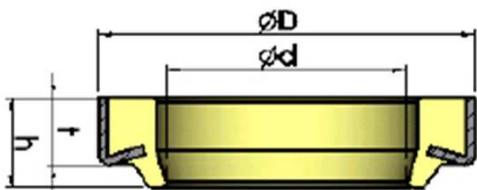

Material & working condition	Main function	Feature
①TPU : - Pressure: - Mpa - Temperature range: -55~100  ②SPCC	Prevent of intrusion of foreign objects	This is a standard type of dust seal of Polyurethane with high dust proof performance.

SEAL INFORMATION	
PART NUMBER	(Prefix)- d*D*t/h

PART NUMBER		PART NUMBER		PART NUMBER		PART NUMBER	
DKW	25*37*6/9	DKW	35*47*7/10	DKW	55*69*8/11	DKW	85*99*8/11
DKW	28*40*6/9	DKW	38*50*7/10	DKW	60*74*8/11	DKW	90*104*8/11
DKW	30*42*6/9	DKW	40*52*7/10	DKW	65*79*8/11	DKW	95*109*8/11
DKW	30*45*7/10	DKW	45*57*7/10	DKW	70*84*8/11	DKW	100*114*8/11
DKW	32*44*7/10	DKW	50*60*7/10	DKW	75*89*8/11	DKW	105*121*9/12
DKW	32*52*8/11	DKW	50*62*7/10	DKW	80*94*8/11	DKW	110*126*9/12



WONYOUNG SEAL CORPORATION

## 1. Hydraulic seal

### DUST SEAL(Steel cover) – STYLE : DKW(DKI)

PART NUMBER	
DKW	115*131*9/12
DKW	120*136*9/12

PART NUMBER	
DKW	130*146*9/12
DKW	140*160*10/14

PART NUMBER	
DKW	150*170*10/14
DKW	160*180*10/14

PART NUMBER	
DKW	180*205*12/17
DKW	190*215*12/17

## 1. Hydraulic seal

### DUST SEAL(Steel cover) – STYLE : DWW(DWI;MM)

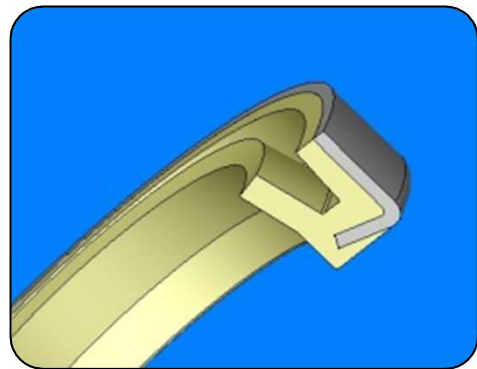
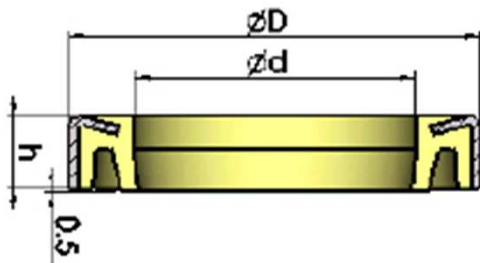

Material & working condition	Main function	Feature
①TPU : - Pressure: - Mpa - Temperature range: -55~100  ②SPCC	Prevent of intrusion of foreign objects	Employing polyurethane as material, this seal serves under severe dust conditions such as construction equipment.

#### SEAL INFORMATION

PART NUMBER	(Prefix)- d*D*t/H
-------------	-------------------

PART NUMBER		PART NUMBER		PART NUMBER		PART NUMBER	
DWW	25*37*6	DWW	50*60*7	DWW	70*84*8	DWW	100*114*8
DWW	35*45*7	DWW	50*62*7	DWW	75*89*8	DWW	105*121*9
DWW	35*47*7	DWW	50*65*7	DWW	80*94*8	DWW	110*126*9
DWW	36*46*7	DWW	55*69*8	DWW	85*99*8	DWW	115*131*9
DWW	40*52*7	DWW	60*74*8	DWW	90*104*8	DWW	120*136*9
DWW	45*57*7	DWW	65*79*8	DWW	95*109*8	DWW	125*141*9



WONYOUNG SEAL CORPORATION

# 1. Hydraulic seal

## DUST SEAL(Steel cover) – STYLE : DWW(DWI;MM)

PART NUMBER	
DWW	130*146*9
DWW	140*160*10
DWW	150*170*10

## DUST SEAL(Steel cover) – STYLE : DWIN(DKIY;INCH)

PART NO.	WYS PART NAME
7K-9201	DWIN 38.1*50.8*6.35
4J-8979	DWIN 38.1*57.15*9.52
7K-9202	DWIN 44.45*57.15*6.35
7K-9203	DWIN 50.8*63.5*6.35

PART NO.	WYS PART NAME
1K-6981	DWIN 50.8*68.33*9.5
7K-9204	DWIN 57.15*69.85*6.35
4J-3515	DWIN 57.15*76.2*9.525
6J-3892	DWIN 60.32*79.48*9.5

PART NO.	WYS PART NAME
7K-9205	DWIN 63.5*76.2*7.94
1K-6982, 7K-9027,8C-3840	DWIN 63.5*82.55*9.525
7K-9208	DWIN 69.85*82.55*7.92
1J-3540	DWIN 69.85*95.25*12.7

PART NO.	WYS PART NAME
2J-1411	DWIN 76.2*101.8*12.7
7K-9209	DWIN 76.2*88.9*7.925
6J-4169	DWIN 82.55*108.08*12.7
7K-9210	DWIN 82.55*95.25*7.92
5P-5343, 7K-9212	DWIN 88.9*104.78*7.92
4J-8981	DWIN 88.9*114.45*12.7

## 1. Hydraulic seal

### DUST SEAL(Steel cover) – STYLE : DWIW(DWIR)

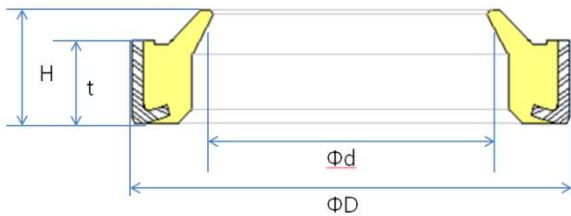

Material & working condition	Main function	Feature
① TPU : - Pressure: - Mpa - Temperature range: -55~100  ② SPCC	Prevent of intrusion of foreign objects	Employing polyurethane material as material, this is same performance as DWW, excellent in preventing of oil scraping off and follow ability to the eccentricity.

SEAL INFORMATION	
PART NUMBER	(Prefix)- d*D*t/H

PART NUMBER		PART NUMBER		PART NUMBER		PART NUMBER	
DWIW	20*30*5/7	DWIW	50*60*5/7	DWIW	35*45*7/10	DWIW	50*60*7/10
DWIW	25*35*5/7	DWIW	20*30*7/10	DWIW	35*47*7/10	DWIW	50*62*7/10
DWIW	30*40*5/7	DWIW	22*32*7/10	DWIW	40*50*7/10	DWIW	55*65*7/10
DWIW	35*45*5/7	DWIW	25*35*7/10	DWIW	40*52*7/10	DWIW	60*70*7/10
DWIW	40*50*5/7	DWIW	28*38*7/10	DWIW	45*55*7/10	DWIW	65*75*7/10
DWIW	45*55*5/7	DWIW	30*40*7/10	DWIW	45*57*7/10	DWIW	70*80*7/10

## 1. Hydraulic seal

### DUST SEAL(Steel cover) – STYLE : DWIW(DWIR)

PART NUMBER	
DWIW	75*85*7/10
DWIW	80*90*7/10
DWIW	85*95*7/10

PART NUMBER	
DWIW	90*100*7/10
DWIW	90*105*7/10
DWIW	95*105*7/10

PART NUMBER	
DWIW	100*110*7/10
DWIW	110*120*7/10
DWIW	120*130*7/10

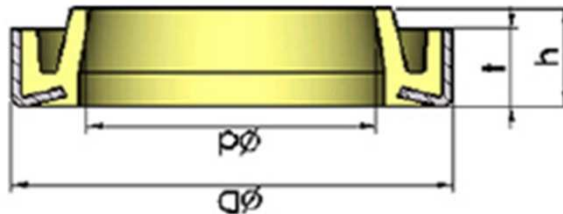

SEAL INFORMATION	
PART NUMBER	(Prefix)- d*D*t/h

PART NUMBER	
DWIW	55*69*8/13
DWIW	60*74*8/13
DWIW	65*79*8/13
DWIW	70*84*8/13
DWIW	75*89*8/13

PART NUMBER	
DWIW	80*94*8/13
DWIW	85*99*8/13
DWIW	90*104*8/13
DWIW	95*109*8/13
DWIW	100*114*9/14

PART NUMBER	
DWIW	105*121*9/14
DWIW	110*126*9/14
DWIW	115*131*9/14
DWIW	120*136*9/14
DWIW	130*146*9/14
DWIW	140*160*10/15

## 1. Hydraulic seal

### DUST SEAL(Steel cover) – STYLE : SA

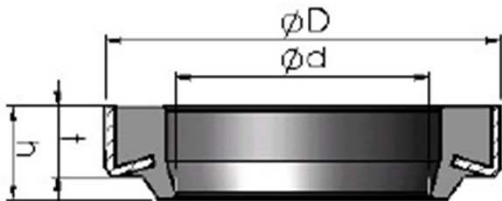

Material & working condition	Main function	Feature
①Nitrile rubber : - Pressure: - Mpa - Temperature range: -20~100  ②SPCC	Prevent of intrusion of foreign objects	Employing nitrile rubber as material . This is a single lip dust seal.

#### SEAL INFORMATION

PART NUMBER	(Prefix)- d*D*t/h
-------------	-------------------

PART NUMBER		PART NUMBER		PART NUMBER		PART NUMBER	
SA	25*35*7/10	SA	55*63*7/10	SA	80*90*7/10	SA	105*115*7/10
SA	30*40*7/10	SA	55*65*7/10	SA	80*88*7/10	SA	110*120*7/10
SA	35*45*7/10	SA	60*70*7/10	SA	85*95*7/10	SA	110*122*7/10
SA	40*50*7/10	SA	65*75*7/10	SA	90*100*7/10	SA	115*125*7/10
SA	45*55*7/10	SA	70*80*7/10	SA	95*105*7/10	SA	120*130*7/10
SA	50*60*7/10	SA	75*85*7/10	SA	100*110*7/10	SA	170*185*9/12

## 1. Hydraulic seal

### DUST SEAL – STYLE : **LBW(LBI)**

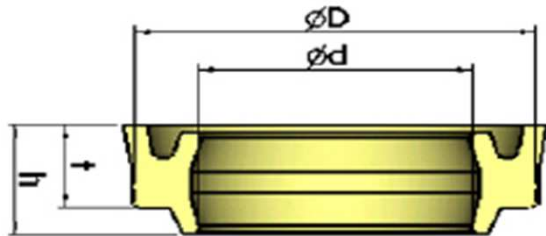

Material & working condition	Main function	Feature
①TPU : - Pressure: - Mpa - Temperature range: -55~100	Prevent of intrusion of foreign objects	This product uses the polyurethane as material, and is a double lip rubber only dust seal aiming at preventing scrape out of oil.

SEAL INFORMATION	
PART NUMBER	(Prefix)- d*D*t/h

PART NUMBER	
LBW	16*24*4.5/6
LBW	18*26*4.5/6
LBW	20*25*4.5/6
LBW	20*28*4.5/6
LBW	20*28*5/6.5
LBW	22*30*4.5/6

PART NUMBER	
LBW	22.4*30.4*4.5/6
LBW	25*33*4.5/6
LBW	26*34*4.5/6
LBW	28*36*4.5/6
LBW	30*38*5/6.5
LBW	31.5*39.5*5/6.5

PART NUMBER	
LBW	32*40*5/6.5
LBW	35*43*5/6.5
LBW	35.5*43.5*5/6.5
LBW	36*44*5/6.5
LBW	38*46*5/6.5
LBW	40*48*5/6.5

PART NUMBER	
LBW	40*50*5/6.5
LBW	45*53*5/6.5
LBW	45*55*5/6.5
LBW	50*58*5/6.5
LBW	50*60*5/6.5
LBW	53*61*5/6.5





WONYOUNG SEAL CORPORATION

## 1. Hydraulic seal

### DUST SEAL – STYLE : **LBW(LBI)**

PART NUMBER	
LBW	55*63*5/6.5
LBW	56*64*5/6.5
LBW	60*68*5/6.5
LBW	63*71*5/6.5
LBW	65*73*5/6.5
LBW	67*75*5/6.5

PART NUMBER	
LBW	70*80*6/8
LBW	71*81*6/8
LBW	75*85*6/8
LBW	80*90*6/8
LBW	85*95*6/8
LBW	90*100*6/8

PART NUMBER	
LBW	95*105*6/8
LBW	100*110*6/8
LBW	105*115*6/8
LBW	110*120*6/8
LBW	112*122*6/8
LBW	115*125*6/8

PART NUMBER	
LBW	118*128*6/8
LBW	118*130*6/8
LBW	120*130*6/8
LBW	125*138*7/9.5
LBW	130*143*7/9.5

## 1. Hydraulic seal

### DUST SEAL – STYLE : DSW(DSI)

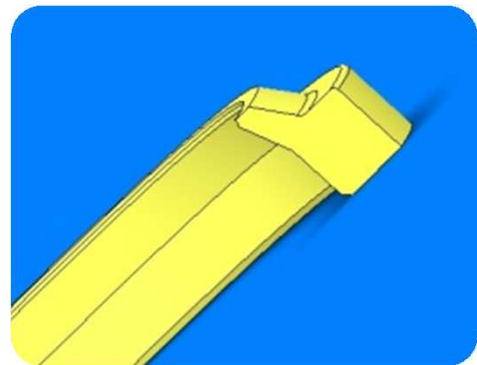
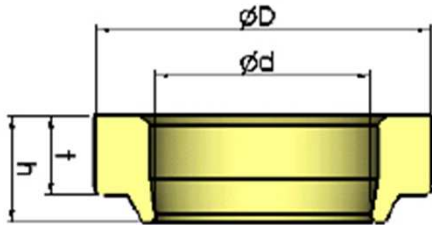

Material & working condition	Main function	Feature
①TPU : - Pressure: - Mpa - Temperature range: -55~100	Prevent of intrusion of foreign objects	Employing polyurethane as material . This is single lip all rubber dust seal.

#### SEAL INFORMATION

PART NUMBER	(Prefix)- d*D*t/H
-------------	-------------------

PART NUMBER	
DSW	25*33*4.5/6
DSW	30*38*5/6.5
DSW	35*43*5/6.5
DSW	40*48*5/6.5
DSW	40*50*6/8
DSW	45*53*5/6.5

PART NUMBER	
DSW	50*58*5/6.5
DSW	50*60*6/8
DSW	55*63*5/6.5
DSW	55*65*6/8.5
DSW	63.5*76.2*6.35/9.525
DSW	65*73*5/6.5

PART NUMBER	
DSW	70*80*6/8
DSW	75*85*6/8
DSW	80*90*6/8
DSW	85*95*6/8
DSW	90*100*6/8
DSW	95*105*6/8

PART NUMBER	
DSW	100*110*6/8
DSW	105*115*6/8
DSW	106*116*6/8
DSW	110*120*6/8
DSW	112*122*6/8
DSW	118*128*6/8
DSW	120*130*6/8

## 1. Hydraulic seal

### DUST SEAL – STYLE : LPIY

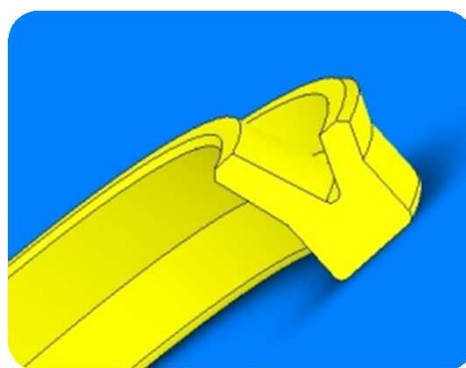
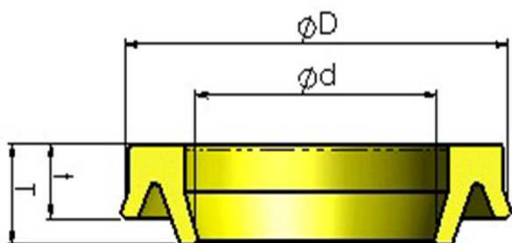

Material & working condition	Main function	Feature
①TPU : - Pressure: - Mpa - Temperature range: -55~100	Prevent of intrusion of foreign objects	Employing polyurethane as material . This is single lip all rubber dust seal. excellent in preventing of oil scraping off and follow ability to the eccentricity

SEAL INFORMATION	
PART NUMBER	(Prefix)- d*D*t/H

PART NUMBER	
LPIY	45*55*6/8
LPIY	60*73*7/9.5
LPIY	65*78*7/9.5
LPIY	70*83*7/9.5

PART NUMBER	
LPIY	75*88*7/9.5
LPIY	80*93*7/9.5
LPIY	85*98*7/9.5
LPIY	90*103*7/9.5

PART NUMBER	
LPIY	95*108*7/9.5
LPIY	100*113*7/9.5
LPIY	110*123*7/9.5
LPIY	125*138*7/9.5

PART NUMBER	
LPIY	130*143*7/9.5
LPIY	140*153*7.9.5
LPIY	145*158*7/9.5

## 1. Hydraulic seal

### DUST SEAL – STYLE : LBNW(LBH)

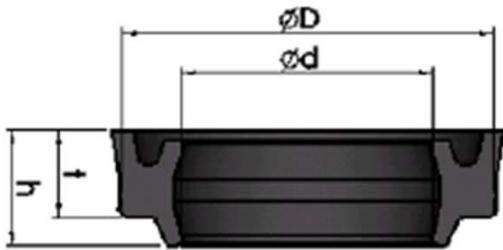

Material & working condition	Main function	Feature
①Nitrile rubber : - Pressure: - Mpa - Temperature range: -25~100	Prevent of intrusion of foreign objects	This is a double lip all rubber dust seal to prevent oil scraping off. Nitrile rubber and fluoro rubber are available as material for wide rage of operation temperature.

#### SEAL INFORMATION

PART NUMBER	(Prefix)- d*D*t/H
-------------	-------------------

PART NUMBER		PART NUMBER		PART NUMBER		PART NUMBER	
LBNW	12.5*20.5*4.5/6	LBNW	30*38*5/6.5	LBNW	55*63*5/6.5	LBNW	90*100*6/8
LBNW	12.7*20*5/6.5	LBNW	31.5*39.5*5/6.5	LBNW	60*68*5/6.5	LBNW	95*105*6/8
LBNW	13*20*5/6.5	LBNW	35*43*5/6.5	LBNW	65*73*5/6.5	LBNW	100*110*6/8
LBNW	20*28*4.5/6	LBNW	40*48*5/6.5	LBNW	70*80*6/8	LBNW	105*115*6/8
LBNW	22*30*4.5/6	LBNW	45*53*5/6.5	LBNW	80*90*6/8	LBNW	132*145*7/9.5
LBNW	25*33*4.5/6	LBNW	50*58*5/6.5	LBNW	85*95*6/8		

## 1. Hydraulic seal

### PIN DUST SEAL – STYLE : VAW(PPY,DKIY,VAY)

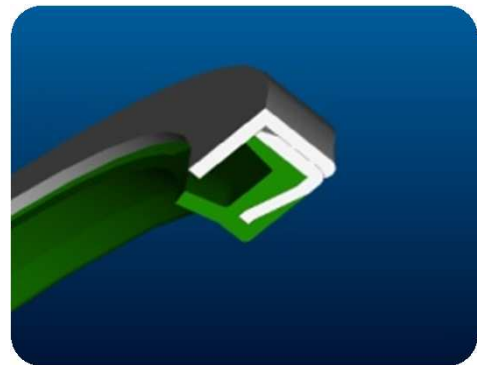
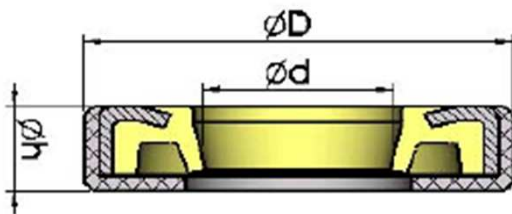

Material & working condition	Main function	Feature
①TPU : - Pressure: - Mpa - Temperature range: -35~100  ②SPCC	This is a dust seal for oscillating and rotating movement for hinge pin and bush.	This can be used under severe dust conditions to improve the durability of the equipment . Relief effect makes easy to drain used grease when filling up new grease. The metallic protection plate reduce the lip wear and prevent the seal lip from harsh impact like stone from out side.

#### SEAL INFORMATION

PART NUMBER	(Prefix)- d*D*t/H
-------------	-------------------

PART NUMBER		PART NUMBER		PART NUMBER		PART NUMBER	
VAW	25*35*4	VAW	45*55*6	VAW	55*65*4	VAW	60*75*5
VAW	30*40*4	VAW	50*60*4	VAW	55*68*4	VAW	60*75*6
VAW	35*45*4	VAW	50*60*5	VAW	55*70*4	VAW	60*75*8
VAW	40*50*4	VAW	50*60*6	VAW	55*70*6	VAW	65*75*4
VAW	40*50*6	VAW	50*65*6	VAW	55*75*6	VAW	65*79*6
VAW	45*55*4	VAW	50*65*7.5	VAW	60*75*4	VAW	65*80*4



## 1. Hydraulic seal

### PIN DUST SEAL – STYLE : **VAW(PPY,DKIY,VAY)**

PART NUMBER		PART NUMBER		PART NUMBER		PART NUMBER	
VAW	65*80*5	VAW	75*90*5	VAW	90*100*4.5	VAW	100*120*8
VAW	65*80*6	VAW	75*90*8	VAW	90*105*4	VAW	100*120*10
VAW	65*80*7	VAW	75*95*7	VAW	90*105*4.3	VAW	110*125*4
VAW	65*80*8	VAW	80*90*4	VAW	90*105*6	VAW	110*125*8
VAW	65*85*5	VAW	80*90*5	VAW	90*105*7.5	VAW	110*125*9
VAW	65*85*6	VAW	80*95*4	VAW	90*105*8	VAW	110*130*4
VAW	68*94*4	VAW	80*95*5	VAW	90*105*11	VAW	110*130*8
VAW	70*80*4	VAW	80*95*6	VAW	90*105*13	VAW	110*135*8
VAW	70*80*6	VAW	80*95*7	VAW	90*110*6	VAW	115*130*8
VAW	70*85*4	VAW	80*95*8	VAW	90*110*8	VAW	120*130*8
VAW	70*85*5	VAW	80*95*10	VAW	90*110*10	VAW	120*135*4
VAW	70*85*6	VAW	80*95*11	VAW	95*110*4	VAW	120*140*4
VAW	70*85*7	VAW	80*100*6	VAW	95*110*8	VAW	120*140*8
VAW	70*85*8	VAW	85*95*5	VAW	100*115*4	VAW	125*140*4
VAW	75*89*6	VAW	85*100*4	VAW	100*115*8	VAW	140*155*4
VAW	75*90*4	VAW	85*100*8	VAW	100*115*11	VAW	140*155*8
VAW	75*90*5	VAW	90*100*4	VAW	100*120*4		

## 1. Hydraulic seal

### PIN DUST SEAL – STYLE : DLW(DLI)

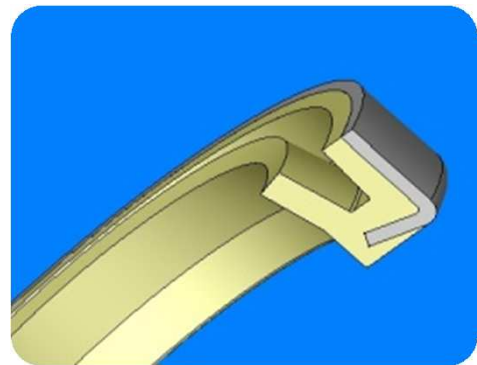
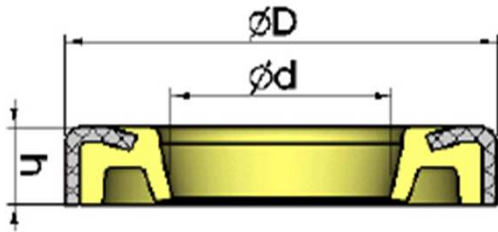

Material & working condition	Main function	Feature
①TPU : - Pressure: - Mpa - Temperature range: -35~100  ②SPCC	This is a dust seal for oscillating and rotating movement for hinge pin and bush.	This can be used under severe dust conditions to improve the durability of the equipment . Relief effect makes easy to drain used grease when filling up new grease. This is a standard type of hinge pin seal excellent in dust resistance.

#### SEAL INFORMATION

PART NUMBER	(Prefix)- d*D*t/H
-------------	-------------------

PART NUMBER		PART NUMBER		PART NUMBER		PART NUMBER	
DLW	25*35*4	DLW	35*45*5	DLW	45*55*4	DLW	50*60*4
DLW	30*40*3.2	DLW	40*50*3.2	DLW	45*55*4.2	DLW	50*60*4.2
DLW	30*40*4	DLW	40*50*4	DLW	45*55*5	DLW	50*60*4.5
DLW	30*40*5	DLW	40*50*5	DLW	45*55*6	DLW	50*60*5
DLW	35*45*3.2	DLW	42*52*5	DLW	45*60*5	DLW	50*63*8
DLW	35*45*4	DLW	45*55*3.2	DLW	45*62*5	DLW	50*65*5



## 1. Hydraulic seal

# PIN DUST SEAL – STYLE : DLW(DLI)

PART NUMBER		PART NUMBER		PART NUMBER		PART NUMBER	
DLW	50*65*7.5	DLW	65*80*8	DLW	85*100*8	DLW	110*125*5
DLW	55*65*3.2	DLW	70*80*5	DLW	90*105*5	DLW	110*125*8
DLW	55*65*4	DLW	70*83*8	DLW	90*105*6	DLW	110*125*9
DLW	55*65*4.2	DLW	70*85*5	DLW	90*105*8	DLW	110*125*9.5
DLW	55*65*5	DLW	70*85*8	DLW	90*108*5	DLW	110*130*8
DLW	55*68*4	DLW	70*90*5	DLW	90*110*5	DLW	110*130*9
DLW	55*68*6	DLW	71*85*6	DLW	90*110*9.5	DLW	110*130*10
DLW	55*70*5	DLW	71*86*5	DLW	90*110*10	DLW	110*160*16
DLW	55*70*6	DLW	75*87*8	DLW	90*115*8	DLW	120*135*5
DLW	55*70*7.5	DLW	75*90*5	DLW	90*130*13	DLW	120*135*8
DLW	60*70*4	DLW	75*90*6	DLW	95*110*6	DLW	120*140*8
DLW	60*70*5	DLW	75*90*8	DLW	95*110*8	DLW	120*140*10
DLW	60*73*8	DLW	80*90*4.5	DLW	100*115*6	DLW	120*147*10
DLW	60*75*4	DLW	80*93*5	DLW	100*115*7	DLW	125*140*8
DLW	60*75*5	DLW	80*93*8	DLW	100*115*7.5	DLW	125*140*8
DLW	60*75*6	DLW	80*95*5	DLW	100*118*5	DLW	125*145*10
DLW	60*75*8	DLW	80*95*6	DLW	100*120*7	DLW	140*155*8
DLW	60*85*5	DLW	80*95*8	DLW	100*120*8	DLW	140*160*10
DLW	63*75*8	DLW	80*100*5	DLW	100*120*10	DLW	145*160*8
DLW	63*77*8	DLW	80*100*6	DLW	100*125*4	DLW	190*210*10
DLW	63*80*5	DLW	80*100*10	DLW	105*120*8		
DLW	65*75*5	DLW	85*95*5	DLW	105*125*10		
DLW	65*80*5	DLW	85*100*6	DLW	110*125*4		



## 1. Hydraulic seal

### PIN DUST SEAL – STYLE : VB

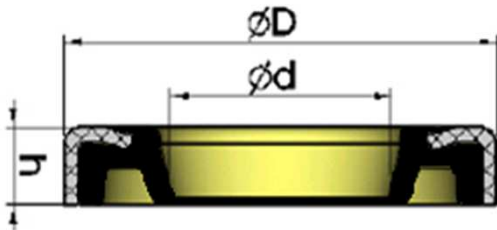

Material & working condition	Main function	Feature
①Nitrile rubber : - Pressure: - Mpa - Temperature range: -20~100  ②SPCC	This is a dust seal for oscillating and rotating movement for hinge pin and bush.	This can be used under severe dust conditions to improve the durability of the equipment . Relief effect makes easy to drain used grease when filling up new grease. This is a standard type of hinge pin seal excellent in dust resistance. And the rubber material is good for low temperature resistance. And reduce the torque.

#### SEAL INFORMATION

PART NUMBER	(Prefix)- d*D*t/H
-------------	-------------------

PART NUMBER	
VB	45*55*4.2
VB	55*70*5
VB	60*75*5

PART NUMBER	
VB	65*80*4
VB	65*80*5
VB	71*86*5

PART NUMBER	
VB	80*90*5
VB	80*95*5
VB	85*95*5

PART NUMBER	
VB	90*105*6
VB	100*115*7
VB	115*135*6
VB	125*140*7
VB	155*170*7

## 1. Hydraulic seal

### CUSHION SEAL – STYLE : N4B

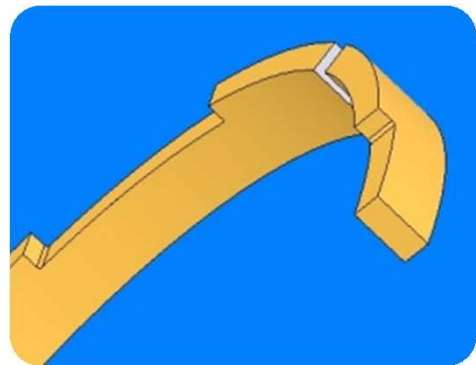
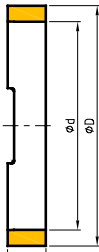
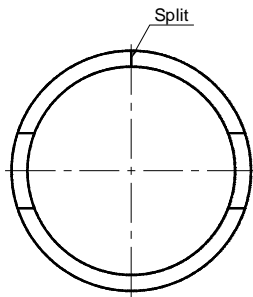

Material & working condition	Main function	Feature
Nylon glass filled Working temperature : -20~110℃	Cushion at the end of the stroke in a hydraulic cylinder.	This is a standard type of cushion seal.

SEAL INFORMATION	
PART NUMBER	(Prefix)- D*d*t

PART NUMBER	
N4B	30*26*5
N4B	30*25*5
N4B	38*33*6
N4B	39*32.8*6
N4B	40*35*6
N4B	46*41*6

PART NUMBER	
N4B	55*50*6
N4B	60*55*6
N4B	65*60*6
N4B	67.5*62.5*6
N4B	70*65*6
N4B	75*70*6

PART NUMBER	
N4B	80*75*6
N4B	82.5*77.5*6
N4B	85*80*6
N4B	90*85*6
N4B	92.5*87.5*6
N4B	95*90*6

PART NUMBER	
N4B	100*95*6
N4B	105*100*6
N4B	110*105*6
N4B	115*110*6
N4B	120*115*6

## 1. Hydraulic seal

### CUSHION SEAL – STYLE : N4BN(N4B NEW TYPE)

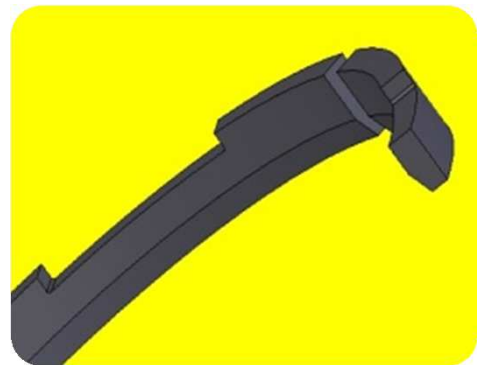
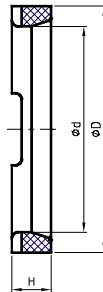
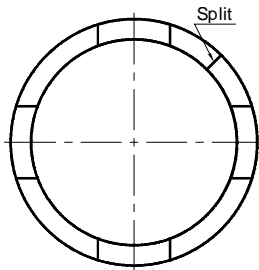

Material & working condition	Main function	Feature
Nylon glass filled Black color Working temperature : -20~110℃	Cushion at the end of the stroke in a hydraulic cylinder.	This is a standard type of cushion seal. Seal inside has damper.

#### SEAL INFORMATION

PART NUMBER	(Prefix)- D*d*H
-------------	-----------------

PART NUMBER	
N4BN	30*25*5
N4BN	38*32*6
N4BN	40*34*6

PART NUMBER	
N4BN	65*59*6
N4BN	70*64*6
N4BN	75*69*6

PART NUMBER	
N4BN	80*74*6
N4BN	90*84*6
N4BN	95*89*6

## 1. Hydraulic seal

### CENTER JOINT SEAL – STYLE : **ROI/CSI**

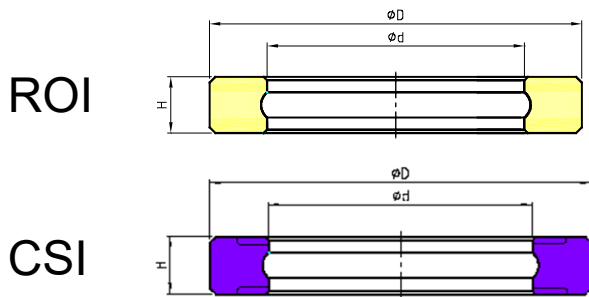

Material & working condition	Main function	Feature
Polyurethane Working temperature : -20~100℃ Working pressure : 0~35Mpa	Retention of oil pressure	This is a special seal for center swivel with excellent wear resistance and extrusion proof ability. Since the perfect sealing cannot be expected, please provide a drain at end and use oil seal for rotating pressure with it.

SEAL INFORMATION	
PART NUMBER	(Prefix)- d*D*H

PART NUMBER	
Prefix	70.5*81*4.9
Prefix	80*91*4.9
Prefix	85*96*4.9

PART NUMBER	
Prefix	90*101*4.9
Prefix	95*106*4.9
Prefix	100*111*4.9

PART NUMBER	
Prefix	105*116*4.9
Prefix	115*126*4.9
Prefix	120*131*4.9

PART NUMBER	
Prefix	125*136*4.9
Prefix	130*141*4.9
Prefix	150*161*4.9

## 1. Hydraulic seal

### CENTER JOINT SEAL – STYLE : MSJA

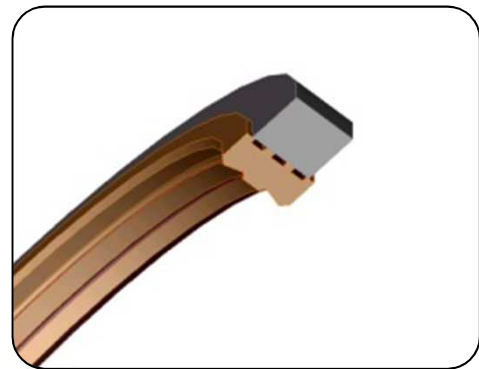
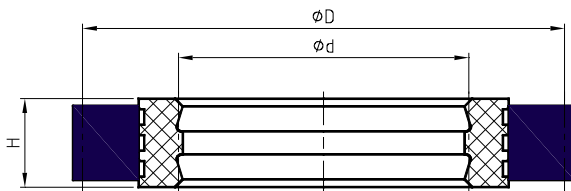

Material & working condition	Main function	Feature
PTFE and energizer nitrile rubber Working temperature : -20~100℃ Working pressure : 0~35Mpa	Retention of oil pressure	The special PTFE seal designed optimize the sealing ability without friction.

#### SEAL INFORMATION

PART NUMBER	(Prefix)- d*D*t/H
-------------	-------------------

PART NUMBER	
MSJA	50
MSJA	60

PART NUMBER	
MSJA	80
MSJA	90

PART NUMBER	
MSJA	95
MSJA	100

PART NUMBER	
MSJA	110
MSJA	120

## 1. Hydraulic seal

### CENTER JOINT SEAL – STYLE : **SPN**

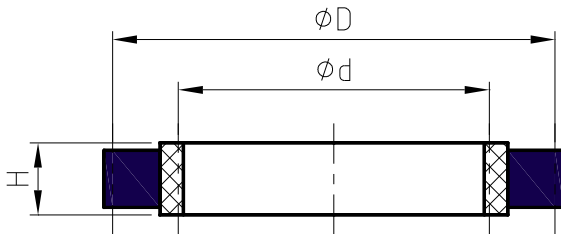

Material & working condition	Main function	Feature
PTFE and energizer nitrile rubber Working temperature : -20~100 °C Working pressure : 0~35Mpa	Retention of oil pressure	This is a standard PTFE swivel joint seal.

#### SEAL INFORMATION

PART NUMBER	(Prefix)- d*D*H
-------------	-----------------

PART NUMBER	
SPN	75*85.6*4.8
SPN	80*90.6*4.8

PART NUMBER	
SPN	90*100.6*4.8
SPN	95*105*4.8

PART NUMBER	
SPN	120*130.6*4.8
SPN	130*140.6*4.8

## 1. Hydraulic seal

# CENTER JOINT SEAL – STYLE : WSJG(LFT)

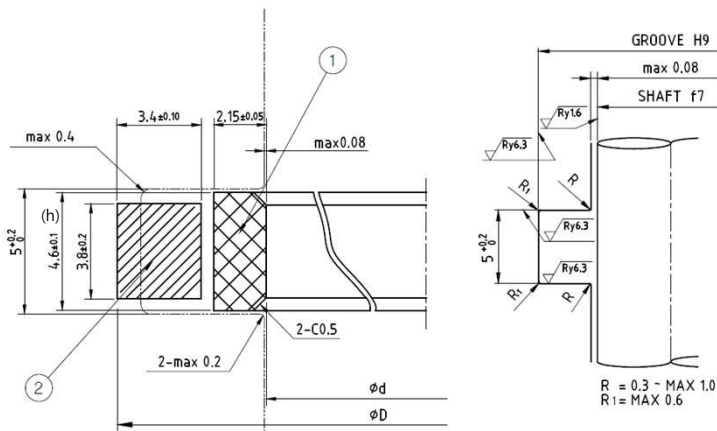

Material & working condition	Main function	Feature
Engineering plastic(GUR) and Energizer nitrile rubber(NBR) Working temperature : -20~100℃ Working pressure : 0~35Mpa	Retention of oil pressure	NBR: wear resistance, oil resistance, heat resistance up. GUR: Life time up(3time longer than PTFE type), low torque, Prevent broken at low temperature resistance up. Reducing oil pollution.

### SEAL INFORMATION

PART NUMBER	(Prefix)- d*D*h
-------------	-----------------

PART NUMBER	Φd	ΦD	Shaft	Groove
WSJG 50*60.4*4.6	50	60.4	50	60
WSJG 60*70.4*4.6	60	70.4	60	70
WSJG 70*80.4*4.6	70	80.4	70	80
WSJG 80*90.6*4.6	80	90.6	80	90
WSJG 90*100.8*4.6	90	100.8	90	100
WSJG 95*105.8*4.6	95	105.8	95	105
WSJG 100*111.2*4.6	100	111.2	100	110
WSJG 110*121.2*4.6	110	121.2	110	120
WSJG 120*131.2*4.6	120	131.2	120	130
WSJG 125*136.2*4.6	125	136.2	125	135

## 1. Hydraulic seal

### PU O-RING – STYLE : ORI

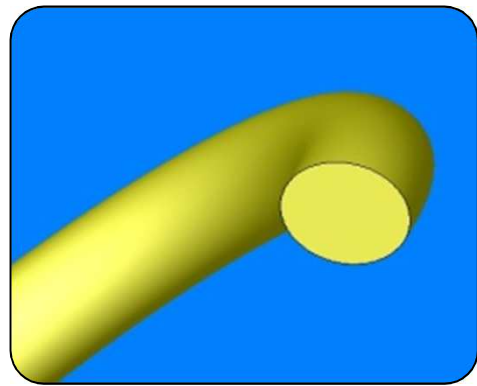
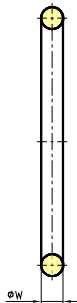
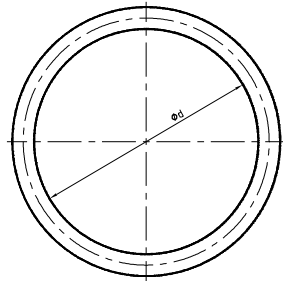

Material & working condition	Main function	Feature
Polyurethane Working Temperature : -30~100℃ Working pressure : 35Mpa	Retention of oil pressure	Use for oil pump.

#### SEAL INFORMATION

PART NUMBER	(Prefix)- d*D*t/H
-------------	-------------------

PART NUMBER		PART NUMBER		PART NUMBER		PART NUMBER	
ORI P 15.6	15.6*2.4	ORI	60*5	ORI P 110	109.6*5.7	ORI P 135	134.6*5.7
ORI P 18	17.8*2.4	ORI P 70	69.6*5.7	ORI P 115	114.6*5.7	ORI G 140	139.4*3.1
ORI P 19	18.77*2.4	ORI P 80	79.6*5.7	ORI G 120	119.4*3.1	ORI P 140	139.6*5.7
ORI P 25	24.7*3.5	ORI P 85	84.6*5.7	ORI P 120	119.6*5.7	ORI P 150	149.6*5.7
ORI P 30	29.7*3.5	ORI P 90	89.6*5.7	ORI G 125	124.4*3.1	ORI ARP 260	164.9*3.53
ORI P 32	31.7*3.5	ORI P 100	99.6*5.7	ORI P 125	124.6*5.7		
ORI	53.8*3.8	ORI ARP 345	100.96*5.33	ORI P 130	129.6*5.7		



## 1. Hydraulic seal

### PU D-RING – STYLE : DRI

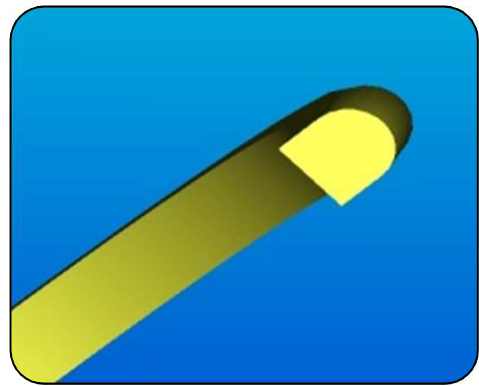
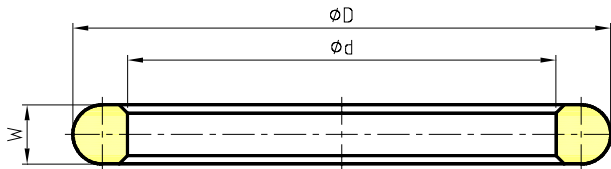

Material & working condition	Main function	Feature
Polyurethane Working Temperature : -30~100℃ Working pressure : 35Mpa	Retention of oil pressure	Use for oil pump.

#### SEAL INFORMATION

PART NUMBER	(Prefix)- d*D*t/H
-------------	-------------------

PART NUMBER	
DRI P 70	69.6*5.7
DRI P 90	89.6*5.7
DRI P 100	99.6*5.7

PART NUMBER	
DRI P 110	109.6*5.7
DRI P 120	119.6*5.7
DRI P 125	124.6*5.7

PART NUMBER	
DRI P 148	147.6*5.7
DRI P 150	149.6*5.7
DRI P 155	154.5*5.7

PART NUMBER	
DRI	187.6*3.4

## 1. Hydraulic seal

### OIL SEAL – STYLE : TCV

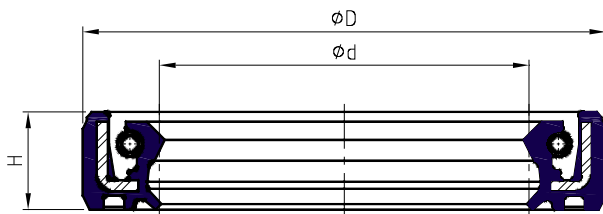

Material & working condition	Main function	Feature
NBR/FKM+SPCC	Prevention of external oil leakage Prevent the internal of foreign object to in side.	This is used for relatively small diameter and medium pressure operation.

#### SEAL INFORMATION

PART NUMBER

(Prefix)- d\*D\*H

PART NUMBER		PART NUMBER		PART NUMBER		PART NUMBER	
TCV	20*30*6	TCV	18*35*8	TCV	28*48*11	TCV	48*62*9
TCV	22*34*7	TCV	28*40*6	TCV	30*50*11	TCV	45*62*7
TCV	25*35*6	TCV	30*42*7	TCV	28.58*50.75*6.4	TCV	45*62*7
TCV	25*35*7	TCV	25*45*11	TCV	35*52*6	TCV	42*62*7
TCV	20*35*7	TCV	25*47*6	TCV	35*55*11	TCV	42*62*7
TCV	19*35*8	TCV	38*48*11	TCV	38*58*11	TCV	40*62*6



WONYOUNG SEAL CORPORATION

## 1. Hydraulic seal

# OIL SEAL – STYLE : TCV

PART NUMBER	
TCV	40*62*6
TCV	40*62*11
TCV	55*65*7
TCV	45*68*12
TCV	52*72*7

PART NUMBER	
TCV	50*72*7
TCV	50*72*12
TCV	55*75*7
TCV	55*78*8
TCV	55*78*12

PART NUMBER	
TCV	60*80*7
TCV	62*85*7
TCV	70*90*6.5
TCV	70*90*7
TCV	90*100*10

PART NUMBER	
TCV	80*100*10
TCV	90*110*10
TCV	80*110*12

## 1. Hydraulic seal

### OIL SEAL – STYLE : TCN

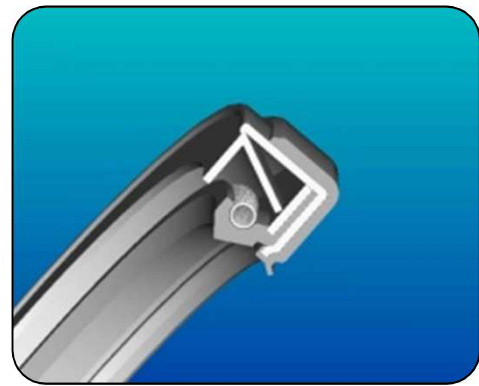
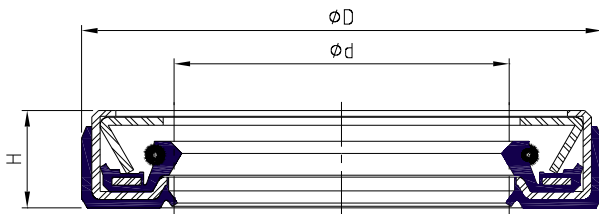

Material & working condition	Main function	Feature
NBR/FKM+SPCC	Prevention of external oil leakage Prevent the internal of foreign object to in side.	This is used for relatively high pressure operation.

#### SEAL INFORMATION

PART NUMBER

(Prefix)- d\*D\*H

PART NUMBER	
TCN	17.46*30.16*8
TCN	25*45*12
TCN	25*45*11
TCN	28*48*11
TCN	30*50*11
TCN	32*52*11

PART NUMBER	
TCN	35*55*11
TCN	38*58*11
TCN	40*62*11
TCN	42*65*12
TCN	45*68*12
TCN	48*70*12

PART NUMBER	
TCN	50*72*12
TCN	52*75*12
TCN	55*78*12
TCN	60*82*12
TCN	65*90*13
TCN	70*95*13

PART NUMBER	
TCN	80*105*13
TCN	100*125*13
TCN	105*135*14
TCN	110*140*13
TCN	110*140*14
TCN	125*155*14
TCN	130*160*14

## 1. Hydraulic seal LINK SEAL

V type

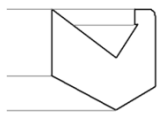

W type

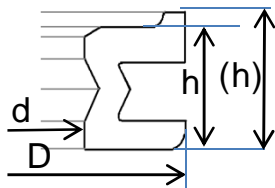

W2 type

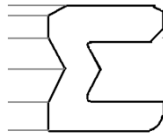

W3 type

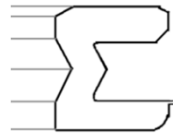

J type

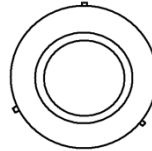
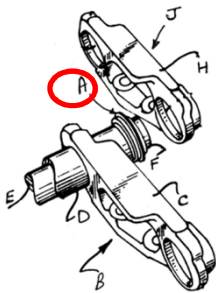
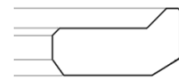

SEAL INFORMATION	
PART NUMBER	d*D*h(h)

Material & working condition	Main function	Feature
TPU	Prevent the foreign object entry to track link shaft	Link seal is used for oscillating application in order to retain lubricant oil Prevent entry of dust. The sealing characteristics are good for excellent abrasion resistance, even under the severe condition like mud, earth and sand, etc. exist.

WYS SIZE	USING MODEL	TYPE
22.8*35*3.5	TDL135	J type
24.0*41.7*9.6	PC60	V type
24.5*41.4*9.3(10.3)	PC60-7, SY75, P154, R80C-7	W3 type
24.5*42.2*10.4	PC60-3/5	V type
28.4*46.7*10.8(12.0)	TDL154	W type
30.4*46.5*10.7(11.9)	PC100-5/6, P175	W3 type
30.4*47.0*9.4(10.4)	PC120-1	W type
32.8*48.6*10.8(12.0)	TDL175	W type
34.0*52.0*10.4	EX120, CAT312	W type
34.0*52*10.7	PC120, EX120-5, EX100	W type
34.2*54.2*11.5(13.0)	TDL171	W type
37.3*58.8*13.0(14.5)	CAT320, SY205, LDM1908, SH200, SP190, DCF TREK 225-5	W/W2/3 type
38.8*59.7*13.0(14.5)	PC200, EC210, R210-5	W type
47.8*71.4*13.6(15.1)	TDL216	W type

## 1. Hydraulic seal

### O-RING BOX – STYLE : MM/INCH BOX



Material & working condition	Main function	Feature
Nitrile rubber	Construction equipment repairing	Metric size o-rings for Japan and Korea machines. Inch size o-rings for American machined.

SEAL INFORMATION	
PART NUMBER	MM/INCH BOX

## 1. Hydraulic seal

### DU BUSH – STYLE : DU

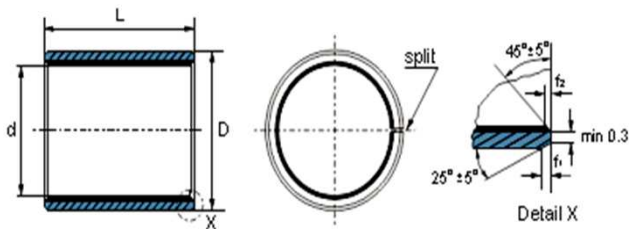

Material & working condition	Main function	Feature
SPCC+Teflon compose	Bearing for cylinder rod.	It characterized dry lubrication by teflon compose.

SEAL INFORMATION	
PART NUMBER	(Prefix)- d*L

PART NUMBER		PART NUMBER		PART NUMBER		PART NUMBER	
DU	6*10	DU	14*20	DU	17*25	DU	19*15
DU	10*20	DU	14*25	DU	18*15	DU	19*25
DU	12*10	DU	16*15	DU	18*20	DU	20*10
DU	12*15	DU	16*20	DU	18*25	DU	20*20
DU	12*20	DU	16*25	DU	18*30	DU	20*25
DU	12*25	DU	17*20	DU	19*10	DU	20*30



# 1. Hydraulic seal

## DU BUSH – STYLE : DU

PART NUMBER		PART NUMBER		PART NUMBER		PART NUMBER	
DU	70*15	DU	85*50	DU	100*45	DU	120*20
DU	70*25	DU	85*60	DU	100*50	DU	120*30
DU	70*30	DU	85*70	DU	100*60	DU	120*35
DU	70*35	DU	85*80	DU	100*70	DU	120*40
DU	70*40	DU	90*20	DU	100*90	DU	120*50
DU	70*50	DU	90*30	DU	100*95	DU	120*60
DU	70*60	DU	90*35	DU	105*30	DU	120*95
DU	75*15	DU	90*40	DU	105*35	DU	125*50
DU	75*30	DU	90*40	DU	105*40	DU	125*60
DU	75*35	DU	90*45	DU	105*45	DU	130*35
DU	75*40	DU	90*50	DU	105*50	DU	130*50
DU	75*60	DU	90*60	DU	105*60	DU	130*60
DU	80*15	DU	90*75	DU	110*30	DU	130*80
DU	80*30	DU	95*30	DU	110*35	DU	135*50
DU	80*30	DU	95*35	DU	110*40	DU	135*60
DU	80*35	DU	95*40	DU	110*45	DU	140*35
DU	80*40	DU	95*45	DU	110*50	DU	140*50
DU	80*40	DU	95*50	DU	110*55	DU	140*60
DU	80*50	DU	95*60	DU	110*60	DU	140*65
DU	80*60	DU	100*20	DU	115*35	DU	140*70
DU	80*80	DU	100*30	DU	115*40	DU	140*100
DU	85*30	DU	100*35	DU	115*45	DU	145*60
DU	85*35	DU	100*35	DU	115*50	DU	150*95
DU	85*40	DU	100*40	DU	115*60	DU	150*100
DU	160*80	DU	160*100	DU	200*70	DU	240*70
DU	160*95	DU	170*50	DU	205*70		
DU	160*96	DU	180*120	DU	210*70		



## 1. Hydraulic seal

# PTFE SEAL RING – STYLE : IUT

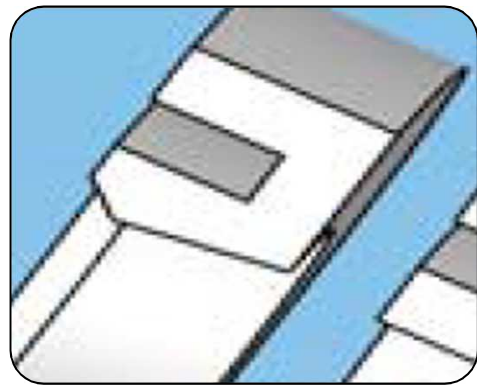
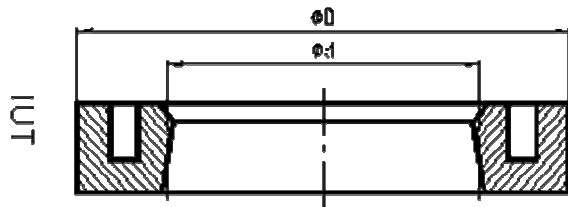

Material & working condition	Main function	Feature
PTFE Glass filled	Sealing at engine	It employing PTFE glass filled as material. It characterized low friction. Inner sealing

SEAL INFORMATION	
PART NUMBER	(Prefix)- d*D*H

PART NUMBER	
IUT	80*86*2.8
IUT	85*92*2.8
IUT	92*85*2.8
IUT	104*96*2.8

PART NUMBER	
IUT	116*110*2.8
IUT	141*135*2.8
IUT	155*161*2.8
IUT	175*181*2.8

PART NUMBER	
IUT	186*180*2.8
IUT	200*194*2.8
IUT	201*195*2.8
IUT	215*221*2.8

PART NUMBER	
IUT	221*215*2.8
IUT	235*241*2.8

## 1. Hydraulic seal

### PTFE SEAL RING – STYLE : OUT

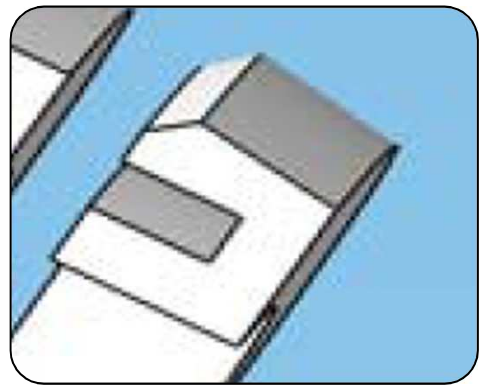
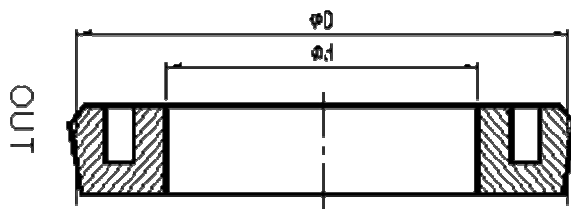

Material & working condition	Main function	Feature
PTFE Glass filled	Sealing at engine	It employing PTFE glass filled as material. It characterized low friction. outer sealing

#### SEAL INFORMATION

PART NUMBER	(Prefix)- d*D*t/H
-------------	-------------------

PART NUMBER	
OUT	113*107*2.8
OUT	130*123.6*2.8
OUT	135*129*2.8
OUT	140*134*2.8
OUT	145*139*2.8
OUT	160*153*2.8

PART NUMBER	
OUT	160*154*2.8
OUT	164*158*2.8
OUT	170*164*2.8
OUT	175*169*2.8
OUT	180*174*2.8
OUT	184.5*178*2.8

PART NUMBER	
OUT	186*180*2.8
OUT	188.6*182.2*2.8
OUT	196*190*2.8
OUT	198*192*2.8
OUT	198.8*192.4*2.8
OUT	200*194*2.8

PART NUMBER	
OUT	205*199*2.8
OUT	210*203*2.8
OUT	214*208*2.8
OUT	215*209*2.8
OUT	216*210*2.8
OUT	220*214*2.8



WONYOUNG SEAL CORPORATION

## 1. Hydraulic seal

# PTFE SEAL RING – STYLE : OUT

PART NUMBER	
OUT	221*215*2.8
OUT	230*224*2.8
OUT	235*229*2.8
OUT	240*234*2.8
OUT	245*239*2.8
OUT	250*244*2.8
OUT	259.5*253*2.8
OUT	270*264*2.8

PART NUMBER	
OUT	275*269*2.8
OUT	280*274*2.8
OUT	285*278*3.3
OUT	285*279*2.8
OUT	290*284*2.8
OUT	300*294*2.8
OUT	305*299*2.8
OUT	313.4*307*2.8

PART NUMBER	
OUT	315*309*2.8
OUT	320*314*2.8
OUT	325*318*3.3
OUT	325*319*2.8
OUT	335*328*3.3
OUT	335*329*2.8
OUT	340*334*2.8
OUT	350*344*2.8

PART NUMBER	
OUT	360*353*3.3
OUT	360*354*2.8
OUT	397.8*391.4*2.8
OUT	400*392*3.8
OUT	400*394*2.8
OUT	425*417*3.8
OUT	455*447*3.8

## 1. Hydraulic seal

### STYLE : HUB SEAL

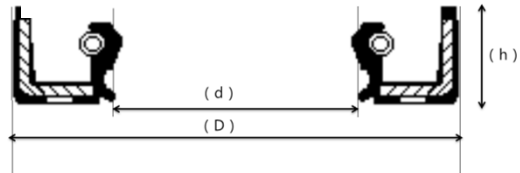
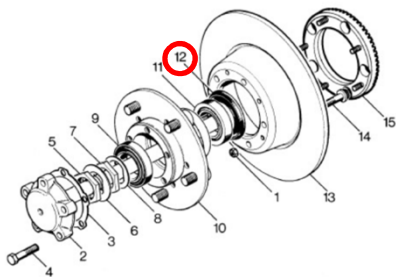

<b>Main function</b>
Prevention of external oil leakage / Prevent the internal of foreign

SEAL INFORMATION	
PART NUMBER	(Prefix)- d*D*h

PART NAME	SIZE	REMARKS
OIL SEAL(0750 110 134)	DSS 46*65*16	
SHAFT SEAL(0750 110 135J)	DSS 56*75*15.5	DX210W
OIL SEAL(0750 110 138)	DSS 56*75*22.5	
OIL SEAL(ZF 0734 309 430)	COMBI 46*65*21(K9001482)	DX140W(NEW TYPE)
OIL SEAL(ZTAM-00062)	COMBI 50*65*18	HX1400W-7
OIL SEAL(ZTAM-00046)발포	COMBI 55*80*11	HX1400W-7
OIL SEAL(ZTAM-00118)	COMBI 55*90*10	
OIL SEAL(ZF 0734 309 262)	COMBI 56*75*16	
OIL SEAL(ZF 0734 309 763)	COMBI 56*75*22.5	K9004138 DX210W
0734 319 697 (2HL-290)	COMBI 80*110*10.3/19	
OIL SEAL(0734 319 557)	COMBI 80*110*12/16	
0734 319 718(2HL-290)	COMBI 80*110*11/17	
SHAFT SEAL(K9001471)	TC3 60*90*10/14.5	DX140W
SHAFT SEAL(ZGAQ-02303)	TC3 65*105*10/14.5	8220-10010 TRAVLE MORTOR&MISSION SEAL



WONYOUNG SEAL CORPORATION

125

## 1. Hydraulic seal

# STYLE : HUB SEAL

PART NAME	SIZE	REMARKS
HUB SEAL(001.21.1393K)	CASSETTE 110*140*14.5 / 16	EW55,MX-3W-R
HUB SEAL(7114-12431)	QLFY 120*150*14-OLD	MX132W
HUB SEAL(7114-12431)	QLFY 120*150*14-NEW	MX132W
HUB SEAL(CFW TYPE)	CASSETTE 120*150*14/15.5	
HUB SEAL(A033565)	CASSETTE 121.8*150*13	D50S / FX50D
HUB SEAL(200W)발포	COMBI 136*165.5*15	
HUB SEAL(0750 110 156)	CASSETTE 136.8*165*13	
HUB SEAL(212.06.055.01N)	CASSETTE 145*175*14.5 / 15.5	R1400W-7
HUB SEAL(278.06.032.01N)	CASSETTE 148*170*14	MX-3W-F)(275.06.008.01L)
HUB SEAL(0750 110 155)	CASSETTE 150.15*178*13/16	DX140W,R140W(K9001529)(ZGAQ-02912)
HUB SEAL(7124-42400)	CASSETTE 155*190*19	S170W-3
HUB SEAL(A233367)	CASSETTE 167.5*203*15	
HUB SEAL(0734 309 281)401	CASSETTE 167.8*198*16	MX8
HUB SEAL(0734 319 425)	CASSETTE 190*230*17	DX210W,R2000(2115-00485)
HUB SEAL(0734 300 225)	COMBI 235*280*15/22.5	
HUB SEAL(2180-1235)	STEFA 120*160*14/17	
HUB SEAL(7124-52550)	STEFA 190*230*14/17	MEGA 400(FRONT)
HUB SEAL(7114-22410)	STEFA 140*170*14/17	
HUB SEAL(7124-22530)	STEFA 178*205*14/19	

PART NAME	SIZE	REMARKS
1-09625-350-0	TA2Y 118*174*16/28_A037006	
43090-90000	OCY 124*170*14.5_A037010	
43090-90003	OC 140*185*15_A037008	
9828-01120	TB3 140*160*14_OIL SEAL(A037009)	
A23-30	TC 140*160*14_OIL SEAL(NBR)_A037001	
A23-32	TC 185*210*15_OIL SEAL(NBR)_A037002	
A23-32-철	TB2 185*210*15_OIL SEAL(NBR)_A037007	
BPW13501567080N	SCY 135*156.7*8/10_OIL SEAL(NBR)_A037012	
DI14015514	TC 140*155*14_OIL SEAL(NBR)_A037004	
DI14015575	TC 140*155*7.5_OIL SEAL(NBR)_A037005	
DI15518015	TC 155*180*15_OIL SEAL(NBR)_A037003	
OS124174145	OCY 124*174*14.5_A037011	

## 1. Hydraulic seal

### STYLE : LINER O-RING AND RING FOR ENGINE

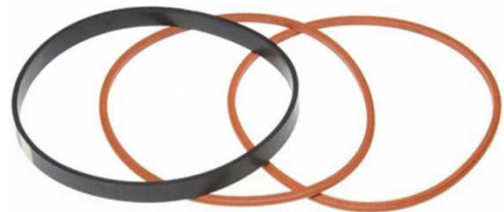
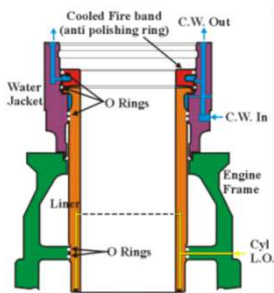

Material & working condition	Main function
VMQ : -60~+225, HNBR : -25~+140 NBR : -40~+125	Prevention the external of cooling water to out side Prevent the internal of foreign object to in side

SEAL INFORMATION	
PART NUMBER	(Prefix)- d / d*h / d*D*h

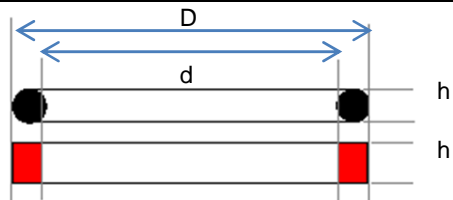

PART NAME	SIZE	REMARKS
1-09623-270-0	OR 128.7*4.2_O-RING(VMQ70)10PA0_B037001	
1-09623-271-0	OR 129.7*2.4_O-RING(VMQ70)10PA-1_B037002	
1-09623-319-0	OR 131.7*2.4_O-RING(VMQ70)10PC-1_B037014	
1-09623-410-0	OR 132.2*4.2_O-RING(VMQ70)10PC-1_B037013	
1-09623-432-0	Y 130.6*135*7_PACKING(NBR70)_B037003	
11018-01T01	Y 104*108.4*8_PACKING(NBR70)_B037020	
11026-T9000	Y 104*110*8_PACKING(NBR70)_B037019	
30907-22300	Y 138.8*145.2*9_PACKING(NBR70)_B037009	
31107-02401	1AG 140_O-RING(VMQ70)6D22_B037008	
31207-62302	1AG 145_O-RING(VMQ70)8DC-8_B037011	
31207-62400	Y 145*151.4*12_PACKING_8DC-8_B037012	
6127-21-2221	OR 162.5*5.33_O-RING(NBR75)_B037023	



WONYOUNG SEAL CORPORATION

127

## 1. Hydraulic seal

### STYLE : LINER O-RING AND RING FOR ENGINE

PART NAME	SIZE	REMARKS
6127-21-2241z	OR 162.5*5.33_O-RING(VMQ70)_B037024	
6127-21-2252	Y 165.5*173.5*14_PACKING(NBR70)B037025	
8M20ME161592	OR 157*166.6*4.8_O-RING(S7504)_B037021	
8M20ME165230	Y 159.8*166*12_PACKING(HNBR)_B037022	
9-11267-010-0	OR 112.5*4.2_O-RING(NBR75)_B037015	
ME031601	Y 119*123.4*9_PACKING_6D15_B037006	
ME031605	OR 122.2*3.53_O-RING(VMQ70)6D14_B037004	
ME031610	1AG 120_O-RING(VMQ70)6D15_B037005	
ME071066	Y 117*120.4*7.8_PACKING(NBR70)_B037007	
ME151039(ME051375)	1S 140_O-RING(VMQ70)6D22_B037010	
MH035606	OR 152.3*158.5*3.1_(VMQ)B037017	
MH035614	OR 154.0*158.8*2.4_(VMQ)B037018	

## 2. Hydraulic seal repair kit



**Superior seal**

Korea Masterpiece



**WYS providing special concept of high quality service kit.**

We are the exclusive authorized genuine seal kit supplier for **Doosan infracore** and **Hyundai heavy industries** whom the biggest construction machinery in Korea

We are supplying **new concept hydraulic seal kit** with them named **'Superior seal'** hydraulic seal repair kit' .

**'Superior seal'** hydraulic seal repair kit is the seal kit for the repair but the seal configuration of seal kit is replaced by more **superior** and **evolved seals** instead the **initial seal configuration of maker** for more **superior sealing performance**.

All consisted seals are already verified and proved the sealing performance by WYS bench testing and OEM field testing.

**'Superior seal'** hydraulic seal repair kit aim to improve **'Heat resistance'** , **'cold proof'** , **'Reducing oil pollution'** to achieve **extension of cylinder life**.

**And this is the main stream of all top class cylinder maker aiming.**





**Superior seal**

Korea Masterpiece

## 2. Hydraulic seal repair kit

### Main seals feature and advantages

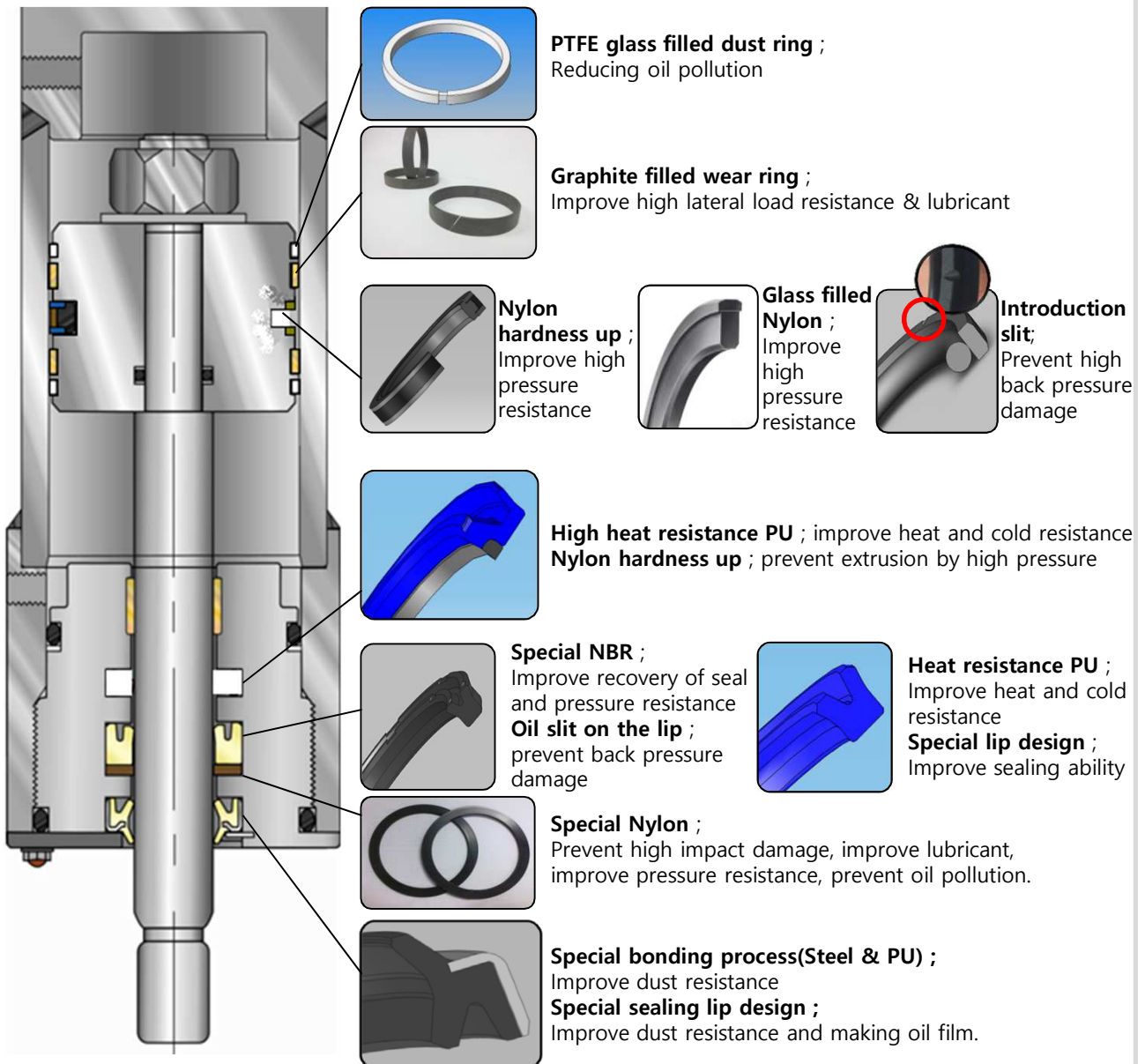



WONYOUNG SEAL CORPORATION

## 2. Hydraulic seal repair kit



**Superior seal**

Korea Masterpiece

# MAKER : CATERPILAR

MAKER	MODEL	SEAL KIT	REMARKS
CATAPILAR	E120B ARM_SEAL KIT		OD:GR 120, ID : 80*95*10
CATAPILAR	E120B ARM_SEAL KIT		OD:SPGW 120, ID: 80*93*10
CATAPILAR	E120B BOOM_SEAL KIT		OD:GR 110, ID : 75*90*10
CATAPILAR	E120B BOOM_SEAL KIT		OD:SPGW 110, ID : 75*88*10
CATAPILAR	E120B BUCKET_SEAL KIT		OD:GR 110, ID : 70*85*10
CATAPILAR	E120B BUCKET_SEAL KIT		OD:SPGW 100, ID : 65*78*10
CATAPILAR	E200B ADJUST_SEAL KIT		
CATAPILAR	E200B ARM_SEAL KIT(NEW)	965606	OD:GR140, ID: 100*120*12
CATAPILAR	E200B ARM_SEAL KIT(OLD)	E85300041	OD:GR130, ID: 95*115*12
CATAPILAR	E200B BOOM_SEAL KIT(NEW)	096-4395	OD:GR120, ID: 85*100*9
CATAPILAR	E200B BOOM_SEAL KIT(OLD)	E85300011	OD:GR120, ID: 85*100*9
CATAPILAR	E200B BUCKET_SEAL KIT(NEW)		OD:GR115, ID:75*90*9
CATAPILAR	E200B BUCKET_SEAL KIT(OLD)		OD:GR115, ID:75*90*9
CATAPILAR	E200B T/JOINT_SEAL KIT		
CATAPILAR	E200E ARM_SEAL KIT	E85300041	
CATAPILAR	E200E BUCKET_SEAL KIT		
CATAPILAR	E200E-1 BOOM_SEAL KIT	E85300011	
CATAPILAR	E240 ARM_SEAL KIT		
CATAPILAR	E240 BOOM_SEAL KIT		
CATAPILAR	E240 BUCKET_SEAL KIT		
CATAPILAR	E240B ADJUST_SEAL KIT		
CATAPILAR	E240B ARM_SEAL KIT	094-2697	
CATAPILAR	E240B BOOM_SEAL KIT		
CATAPILAR	E240B BUCKET_SEAL KIT		
CATAPILAR	E240B T/JOINT_SEAL KIT		
CATAPILAR	E300-1 ADJUST_SEAL KIT		
CATAPILAR	E300B ADJUST_SEAL KIT		
CATAPILAR	E300B ARM_SEAL KIT	FA5300022	
CATAPILAR	E300B BOOM_SEAL KIT	FA5300041	
CATAPILAR	E300B BUCKET_SEAL KIT	FA5300030	
CATAPILAR	E300B PILOT VALVE_SEAL KIT		
CATAPILAR	E300E ARM_SEAL KIT	FA5300022	
CATAPILAR	E320 ADJUST_SEAL KIT		
CATAPILAR	E320 ARM_SEAL KIT		
CATAPILAR	E320 T/JOINT_SEAL KIT		



WONYOUNG SEAL CORPORATION

## 2. Hydraulic seal repair kit



**Superior seal**

Korea Masterpiece

### MAKER : CATERPILAR

MAKER	MODEL	SEAL KIT	REMARKS
CATAPILAR	E320(LC) ARM_SEAL KIT		
CATAPILAR	E320/E320B BUCKET_SEAL KIT		
CATAPILAR	E320B ARM_SEAL KIT		
CATAPILAR	E320B BOOM_SEAL KIT		
CATAPILAR	E320B BUCKET_SEAL KIT		
CATAPILAR	E320C ARM_SEAL KIT	127-0630	
CATAPILAR	E320C BOOM / BUCKET_SEAL KIT	4I3665	
CATAPILAR	E325 ARM_SEAL KIT	7Y4698	
CATAPILAR	E325 BOOM_SEAL KIT	7Y 5147	
CATAPILAR	E325 BUCKET_SEAL KIT	7Y 5145	
CATAPILAR	E330 ARM_SEAL KIT	7Y 4970	
CATAPILAR	E330 BOOM_SEAL KIT	7Y 4698(116-3612)	
CATAPILAR	E330 BUCKET_SEAL KIT	7Y 5145	
CATAPILAR	E450 ARM_SEAL KIT		



WONYOUNG SEAL CORPORATION

## 2. Hydraulic seal repair kit



**Superior seal**

Korea Masterpiece

# MAKER : DOOSAN INFRACORE

MAKER	MODEL	SEAL KIT	REMARKS
DOOSAN	FD75 LIFT SEAL KIT	401107-00505	
DOOSAN	LIFT SEAL KIT	401107-00500	
DOOSAN	LIFT SEAL KIT	401107-00501A	
DOOSAN	LIFT SEAL KIT	401107-00502	
DOOSAN	LIFT SEAL KIT	401107-00865	
DOOSAN	LIFT SEAL KIT	401107-00866	
DOOSAN	LIFT SEAL KIT	D510601KT	
DOOSAN	LIFT SEAL KIT	D510612	
DOOSAN	130W SEAL KIT;BUCKET CYL	2440-9127K	
DOOSAN	ARM SEAL KIT	2440-6049K	
DOOSAN	ARM SEAL KIT	2440-6093KT	
DOOSAN	ARM SEAL KIT	2440-6126AK	
DOOSAN	ARM SEAL KIT	2440-9079K	
DOOSAN	ARM SEAL KIT	2440-9115CKT	
DOOSAN	ARM SEAL KIT	2440-9124KT	
DOOSAN	ARM SEAL KIT	2440-9138KM	
DOOSAN	ARM SEAL KIT	2440-9210KT	
DOOSAN	ARM SEAL KIT	2440-9240KM	
DOOSAN	ARM SEAL KIT	2440-9280CKT	
DOOSAN	ARM SEAL KIT	401107-00679	
DOOSAN	ARM SEAL KIT	401107-00915	
DOOSAN	ARM SEAL KIT	401107-01050	
DOOSAN	ARM SEAL KIT	K1001986KT	
DOOSAN	ARM SEAL KIT	K9002067	
DOOSAN	ARM SEAL KIT	K9002308	
DOOSAN	ARM SEAL KIT	K9005266	
DOOSAN	ARM SEAL KIT	K9005879	
DOOSAN	B20X SEAL KIT	D870350	
DOOSAN	BOOM SEAL KIT	4440-6268K	
DOOSAN	BOOM/BUCKET SEAL KIT	401107-00678	
DOOSAN	BOOM SEAL KIT	2440-6046K	
DOOSAN	BOOM SEAL KIT	2440-6066K2	
DOOSAN	BOOM SEAL KIT	2440-6095K	
DOOSAN	BOOM SEAL KIT	2440-6099K	
DOOSAN	BOOM SEAL KIT	2440-9078K	



WONYOUNG SEAL CORPORATION

## 2. Hydraulic seal repair kit



**Superior seal**

Korea Masterpiece

# MAKER : DOOSAN INFRACORE

MAKER	MODEL	SEAL KIT	REMARKS
DOOSAN	BOOM_SEAL KIT	2440-9230KM	
DOOSAN	BOOM_SEAL KIT	401107-00270A	
DOOSAN	BOOM_SEAL KIT	401107-00477	
DOOSAN	BOOM_SEAL KIT	401107-00909	
DOOSAN	BOOM_SEAL KIT	401107-00912	
DOOSAN	BOOM_SEAL KIT	401107-00914	
DOOSAN	BOOM_SEAL KIT	401107-01046	
DOOSAN	BOOM_SEAL KIT	440-00311KT	
DOOSAN	BOOM_SEAL KIT	440-00355AKT	
DOOSAN	BOOM_SEAL KIT	D501522	
DOOSAN	BOOM_SEAL KIT	K9002066	
DOOSAN	BOOM_SEAL KIT	K9005862	
DOOSAN	BR10/18 LIFT_SEAL KIT	401107-00855	
DOOSAN	BR10/18 LIFT_SEAL KIT	D510082	
DOOSAN	BR10/18 REACH_SEAL KIT	401107-00849	
DOOSAN	BR10/18 REACH_SEAL KIT	D501212	
DOOSAN	BR10/18(J) TILT_SEAL KIT	401107-00848	
DOOSAN	BR10/18(J) TILT_SEAL KIT	D501211A	
DOOSAN	BR13S2_SEAL KIT	401107-00889	
DOOSAN	BR13S2_SEAL KIT	D511900	
DOOSAN	BR20 REACH_SEAL KIT	D510242	
DOOSAN	BR20/25S LIFT_SEAL KIT	911701KT	
DOOSAN	BR20S_SEAL KIT	401107-00868	
DOOSAN	BR20S_SEAL KIT	D510661KT	
DOOSAN	BUCKET_SEAL KIT( -90.1)	401107-00926	
DOOSAN	BUCKET_SEAL KIT( -90.1)	D504601K	
DOOSAN	BUCKET_SEAL KIT(DL450)	K9007301	
DOOSAN	BUCKET_SEAL KIT(DX55W)	K9006361	
DOOSAN	BUCKET_SEAL KIT(DX85R-3)	401107-01343	
DOOSAN	BUCKET_SEAL KIT	2440-6068K2	
DOOSAN	BUCKET_SEAL KIT	2440-9080K	
DOOSAN	BUCKET_SEAL KIT	2440-9116BKM	
DOOSAN	BUCKET_SEAL KIT	2440-9241KM	
DOOSAN	BUCKET_SEAL KIT	2440-9282GKT	
DOOSAN	BUCKET_SEAL KIT	401107-00680	



WONYOUNG SEAL CORPORATION

## 2. Hydraulic seal repair kit



**Superior seal**

Korea Masterpiece

# MAKER : DOOSAN INFRACORE

MAKER	MODEL	SEAL KIT	REMARKS
DOOSAN	BUCKET_SEAL KIT	401107-00916	
DOOSAN	BUCKET_SEAL KIT	401107-00922	
DOOSAN	BUCKET_SEAL KIT	401107-00924	
DOOSAN	BUCKET_SEAL KIT	401107-01047	
DOOSAN	BUCKET_SEAL KIT	401107-01188	
DOOSAN	BUCKET_SEAL KIT	401107-01313	
DOOSAN	BUCKET_SEAL KIT	440-00081AKT	
DOOSAN	BUCKET_SEAL KIT	440-00135BKT	
DOOSAN	BUCKET_SEAL KIT	D501523	
DOOSAN	BUCKET_SEAL KIT	D501618	
DOOSAN	BUCKET_SEAL KIT	K9005880	
DOOSAN	BUK_SEAL KIT	K9002068	
DOOSAN	CENTER JOINT_SEAL KIT	2181-6032K	
DOOSAN	CENTER JOINT_SEAL KIT	401107-00808	
DOOSAN	CENTER JOINT_SEAL KIT	401107-00809B	
DOOSAN	CENTER JOINT_SEAL KIT	401107-00918	
DOOSAN	CHOKING_SEAL KIT	401107-00352B	
DOOSAN	CHOKING_SEAL KIT	401107-01027	
DOOSAN	D(G)25S/B(G)25S_SEAL KIT	401106-00283	
DOOSAN	D(G)35/55C-5_SEAL KIT	401106-00185	
DOOSAN	D10 TILT_SEAL KIT	401107-00851	
DOOSAN	D10 TILT_SEAL KIT	D501233	
DOOSAN	D10/12 LIFT_SEAL KIT	401107-00862	
DOOSAN	D10/12 LIFT_SEAL KIT	D510365KT	
DOOSAN	D10/12 POWER STEERING_SEAL KIT	401107-00861	
DOOSAN	D10/12 POWER STEERING_SEAL KIT	D510337KT	
DOOSAN	D10/12 TILT_SEAL KIT	D512046	
DOOSAN	D10/12_SEAL KIT	401107-00891	
DOOSAN	D10/12_SEAL KIT	D511990	
DOOSAN	D100 POWER STEERING_SEAL KIT	401107-00873	
DOOSAN	D100 POWER STEERING_SEAL KIT	D511349KT	
DOOSAN	D100/120 LIFT_SEAL KIT	401107-00893	
DOOSAN	D100/120 LIFT_SEAL KIT	D512173	
DOOSAN	D100/150 TILT_SEAL KIT	401107-00860	
DOOSAN	D100/150 TILT_SEAL KIT	D510322KT	



WONYOUNG SEAL CORPORATION

## 2. Hydraulic seal repair kit



**Superior seal**

Korea Masterpiece

# MAKER : DOOSAN INFRACORE

MAKER	MODEL	SEAL KIT	REMARKS
DOOSAN	D100/D150_SEAL KIT	401106-00067	
DOOSAN	D100_SEAL KIT	401107-00892	
DOOSAN	D100_SEAL KIT	D512042	
DOOSAN	D15/18S POWER STEERING_SEAL KIT	D510025	
DOOSAN	D15/18S TILT_SEAL KIT	D510023	
DOOSAN	D150 LIFT_SEAL KIT	401107-00894	
DOOSAN	D150 LIFT_SEAL KIT	D512177	
DOOSAN	D160S-5_SEAL KIT	401107-00902	
DOOSAN	D160S-5_SEAL KIT	D513431	
DOOSAN	D180S-7_SEAL KIT	400314-00012	
DOOSAN	D180S-7_SEAL KIT	400321-00163	
DOOSAN	D180S-7_SEAL KIT	400321-00173	
DOOSAN	D180S-7_SEAL KIT	400321-00185	
DOOSAN	D180S-7_SEAL KIT	400334-00092	
DOOSAN	D180S-7_SEAL KIT	401107-01154	
DOOSAN	D18S FFEL SEC_SEAL KIT	401107-00877	
DOOSAN	D18S FFEL SEC_SEAL KIT	D511503	
DOOSAN	D20A-3_SEAL KIT	D511927	
DOOSAN	D20S3 POWER STEERING_SEAL KIT	401107-00875	
DOOSAN	D20S3 POWER STEERING_SEAL KIT	401107-00885	
DOOSAN	D20S3 POWER STEERING_SEAL KIT	D511419	
DOOSAN	D20S3 POWER STEERING_SEAL KIT	D511817	
DOOSAN	D20S3_SEAL KIT	401107-00886	
DOOSAN	D20S3_SEAL KIT	D511848	
DOOSAN	D35/45S-2 POWER STEERING_SEAL KIT	401107-00863	
DOOSAN	D35/45S-2 POWER STEERING_SEAL KIT	D510545	
DOOSAN	D35/45S-2_SEAL KIT	401107-00907	
DOOSAN	D35/45S-2_SEAL KIT	401107-00908	
DOOSAN	D35/45S-2_SEAL KIT	D870951	
DOOSAN	D35/45S-2_SEAL KIT	D870952	
DOOSAN	D35S TILT_SEAL KIT	D510235	
DOOSAN	D35SM2 LIFT_SEAL KIT	D510120	
DOOSAN	D35SM2 LIFT_SEAL KIT	401107-00890	
DOOSAN	D35SM2 LIFT_SEAL KIT	D511917	
DOOSAN	D50/70S_SEAL KIT	D511571	



WONYOUNG SEAL CORPORATION

## 2. Hydraulic seal repair kit



**Superior seal**

Korea Masterpiece

# MAKER : DOOSAN INFRACORE

MAKER	MODEL	SEAL KIT	REMARKS
DOOSAN	D50S POWER STEERING_SEAL KIT	401107-00867	
DOOSAN	D50S POWER STEERING_SEAL KIT	D510649	
DOOSAN	D50S PRI_SEAL KIT	401107-00884	
DOOSAN	D50S PRI_SEAL KIT	D511759	
DOOSAN	D50S_SEAL KIT	401107-00881	
DOOSAN	D50S_SEAL KIT	D511605	
DOOSAN	D50S2 POWER STEERING_SEAL KIT	401107-00878	
DOOSAN	D50S2 POWER STEERING_SEAL KIT	401107-00883	
DOOSAN	D50S2 POWER STEERING_SEAL KIT	401107-00887	
DOOSAN	D50S2 POWER STEERING_SEAL KIT	401107-00888	
DOOSAN	D50S2 POWER STEERING_SEAL KIT	D511508	
DOOSAN	D50S2 POWER STEERING_SEAL KIT	D511726	
DOOSAN	D50S2 POWER STEERING_SEAL KIT	D511862	
DOOSAN	D50S2 POWER STEERING_SEAL KIT	D511886	
DOOSAN	D50S2_SEAL KIT	401107-00882	
DOOSAN	D50S2_SEAL KIT	401107-00897	
DOOSAN	D50S2_SEAL KIT	D511479	
DOOSAN	D50S2_SEAL KIT	D511677	
DOOSAN	D50S2_SEAL KIT	D512326	
DOOSAN	D70S LIFT_SEAL KIT	D510635	
DOOSAN	D80/90S-5 LIFY_SEAL KIT	D513883	
DOOSAN	DD80_BLADE_SEAL KIT	401107-00287A	
DOOSAN	DD80_SEAL KIT	401107-00126A	
DOOSAN	DD80L ANGLE(=5440-6248AKT)	5440-9153AKT	
DOOSAN	DD80L DOZER_SEAL KIT	5440-9152BKT	
DOOSAN	DD80L DOZER_SEAL KIT	5440-9152CKT	
DOOSAN	DD80L_SEAL KIT	401107-00125A	
DOOSAN	D-G10/18 POWER STEERING_SEAL KIT	D501251	
DOOSAN	DH02 BOOM_SEAL KIT	401107-00216A	
DOOSAN	DH02 BUCKET_SEAL KIT	401107-00288A	
DOOSAN	DH028 BOOM_SEAL KIT	2440-6125K	
DOOSAN	DH028 BOOM_SEAL KIT	401107-00117A	
DOOSAN	DH028 BUCKET_SEAL KIT	401107-00118A	
DOOSAN	DH04S BOOM_SEAL KIT	401107-00231A	
DOOSAN	DH07W BUCKET_SEAL KIT	401107-00301A	





WONYOUNG SEAL CORPORATION

## 2. Hydraulic seal repair kit



**Superior seal**

Korea Masterpiece

# MAKER : DOOSAN INFRACORE

MAKER	MODEL	SEAL KIT	REMARKS
DOOSAN	DH07W OUTRIGGER_SEAL KIT	401107-00403A	
DOOSAN	DH08 BOOM_SEAL KIT	401107-00215A	
DOOSAN	DH08 BUCKET_SEAL KIT	401107-00300A	
DOOSAN	DH130 ARM_SEAL KIT	401107-00172A	
DOOSAN	DH130 BOOM_SEAL KIT	401107-00219A	
DOOSAN	DH130 BUCKET_SEAL KIT	401107-00303A	
DOOSAN	DH130-2 ARM_SEAL KIT	2440-6227K	
DOOSAN	DH130W BUCKET_SEAL KIT	401107-00302A	
DOOSAN	DH180L ARM_SEAL KIT	2440-9018KT	
DOOSAN	DH180L ARM_SEAL KIT	401107-00665	
DOOSAN	DH180L BUCKET_SEAL KIT	2440-9019KT	
DOOSAN	DH180LC BOOM_SEAL KIT	401107-00232A	
DOOSAN	DH180LC BUCKET_SEAL KIT	401107-00351	
DOOSAN	DH200W ARM_SEAL KIT	401107-00161A	
DOOSAN	DH220-3 ARM_SEAL KIT	2440-9146KT	
DOOSAN	DH220-3 BOOM_SEAL KIT	2440-9144KT	
DOOSAN	DH220-3 BUCKET_SEAL KIT	2440-9147KT	
DOOSAN	DH220-5 BUCKET_SEAL KIT	2440-9237KM	
DOOSAN	DH220-5 BUCKET_SEAL KIT	2440-9237KT	
DOOSAN	DH220LC ARM_SEAL KIT	401107-00173	
DOOSAN	DH220LC BOOM_SEAL KIT	401107-00233	
DOOSAN	DH280 ARM_SEAL KIT	401107-00162	
DOOSAN	DH280-3 ARM_SEAL KIT	2440-9138KT	
DOOSAN	DH280-3 BOOM_SEAL KIT	2440-9136KT	
DOOSAN	DH280-3 BUCKET_SEAL KIT	2440-9139KT	
DOOSAN	DH300-5 ARM_SEAL KIT	2440-9240KT	
DOOSAN	DH330-3 BUCKET_SEAL KIT	2440-9415AKT	
DOOSAN	DH50 ARM_SEAL KIT	401107-00163	
DOOSAN	DH50 ARM_SEAL KIT	401107-00164A	
DOOSAN	DH50 BOOM_SEAL KIT	401107-00220	
DOOSAN	DH50 BOOM_SEAL KIT	401107-00221A	
DOOSAN	DH80-VII ARM_SEAL KIT	401107-00170	
DOOSAN	DH80W BOOM_SEAL KIT	401107-00218A	
DOOSAN	DL200 BUCKET_SEAL KIT	401107-00299A	
DOOSAN	DL200 LIFT CYLINDER_SEAL KIT	401107-00392A	



WONYOUNG SEAL CORPORATION

## 2. Hydraulic seal repair kit



**Superior seal**

Korea Masterpiece

# MAKER : DOOSAN INFRACORE

MAKER	MODEL	SEAL KIT	REMARKS
DOOSAN	DL200A/-3 BUCKET_SEAL KIT	401107-01229	
DOOSAN	DL200A/-3 OPTION LIFT_SEAL KIT	401107-01231	
DOOSAN	DL200A/-3_LIFT_SEAL KIT	401107-01230	
DOOSAN	DL250-3 ARM_SEAL KIT	401107-01279	
DOOSAN	DL250-3 BUCKET_SEAL KIT	401107-01280	
DOOSAN	DL250-3 STEERING_SEAL KIT	401107-01281	
DOOSAN	DL250A BUCKET_SEAL KIT	401107-01232	
DOOSAN	DL250TC-3 BUCKET_SEAL KIT	401107-01347	
DOOSAN	DL300_SEAL KIT	401107-00008	
DOOSAN	DL300_SEAL KIT	401107-00140A	
DOOSAN	DL300_SEAL KIT	401107-00141A	
DOOSAN	DL300-3_LIFT_SEAL KIT	401107-01219	
DOOSAN	DL350-3 BUCKET_SEAL KIT	401107-01193	
DOOSAN	DL350-3_LIFT_SEAL KIT	401107-01194	
DOOSAN	DL400_SEAL KIT	401107-00135A	
DOOSAN	DL400_SEAL KIT	401107-00136A	
DOOSAN	DL400_SEAL KIT	401107-00137A	
DOOSAN	DL420-3_LIFT_SEAL KIT	401107-01181	
DOOSAN	DL450-3 BUCKET_SEAL KIT	401107-01117	
DOOSAN	DL450-3_LIFT_SEAL KIT	401107-01118	
DOOSAN	DL500_SEAL KIT	401107-00142A	
DOOSAN	DL500_SEAL KIT	401107-00143A	
DOOSAN	DL500_SEAL KIT	401107-00144A	
DOOSAN	DL550-3 BUCKET_SEAL KIT	401107-01210	
DOOSAN	DL550-3 TRACK SPRING_SEAL KIT	401107-00965	
DOOSAN	DL550-3_LIFT_SEAL KIT	401107-01208	
DOOSAN	DLS702_SEAL KIT	401107-00937	
DOOSAN	DLS702_SEAL KIT	D511769	
DOOSAN	DLS702_SEAL KIT	K1022600	
DOOSAN	DOZER_SEAL KIT	401107-00542	
DOOSAN	DSL 702_SEAL KIT	401107-00939	
DOOSAN	DSL 702_SEAL KIT	D512208	
DOOSAN	DSL 702_SEAL KIT	K1022637	
DOOSAN	DSL601 BOOM_SEAL KIT	401107-00936	
DOOSAN	DSL601 BOOM_SEAL KIT	K1022569	



WONYOUNG SEAL CORPORATION

## 2. Hydraulic seal repair kit



**Superior seal**

Korea Masterpiece

# MAKER : DOOSAN INFRACORE

MAKER	MODEL	SEAL KIT	REMARKS
DOOSAN	DSL702 BOOM_SEAL KIT	K1022606	
DOOSAN	DSL702 BUCKET_SEAL KIT	401107-00938	
DOOSAN	DSL702 BUCKET_SEAL KIT	D512203	
DOOSAN	DSL702 BUCKET_SEAL KIT	K1022632	
DOOSAN	DSL702_SEAL KIT	401107-00930	
DOOSAN	DSL702_SEAL KIT	D511807	
DOOSAN	DSL800 BOOM_SEAL KIT	401107-00910	
DOOSAN	DSL800 BOOM_SEAL KIT	D501553	
DOOSAN	DSL800 BUCKET_SEAL KIT	401107-00923	
DOOSAN	DSL800 BUCKET_SEAL KIT	401107-00927	
DOOSAN	DSL800 BUCKET_SEAL KIT	D501552	
DOOSAN	DSL800 BUCKET_SEAL KIT	D510155K	
DOOSAN	DSL802 BOOM_SEAL KIT	D511455	
DOOSAN	DSL802 BOOM_SEAL KIT	K1022590	
DOOSAN	DSL802 BUCKET_SEAL KIT	D511454	
DOOSAN	DSL802_SEAL KIT	D511432	
DOOSAN	DX140 TRACK SPRING_SEAL KIT	401107-00934	
DOOSAN	DX140 TRACK SPRING_SEAL KIT	K9005356	
DOOSAN	DX140LC BUCKET_SEAL KIT	401107-00350A	
DOOSAN	DX140LC T/JOINT_SEAL KIT	K9005490	
DOOSAN	DX140W BOOM_SEAL KIT	K9002306	
DOOSAN	DX140W_SEAL KIT	401107-00138A	
DOOSAN	DX140W_SEAL KIT	401107-00139A	
DOOSAN	DX140W_SEAL KIT	401107-00151A	
DOOSAN	DX140W_SEAL KIT	401107-00155A	
DOOSAN	DX140W_SEAL KIT	401107-00157A	
DOOSAN	DX140W_SEAL KIT	K9002309	
DOOSAN	DX140W-3 BOOM_SEAL KIT	401107-01178	
DOOSAN	DX180LC ARTI BOOM_SEAL KIT	401107-00210	
DOOSAN	DX180LC_SEAL KIT	401107-00146A	
DOOSAN	DX180LC_SEAL KIT	K9004402	
DOOSAN	DX180LC_SEAL KIT	K9004440	
DOOSAN	DX190W-3 DOZER_SEAL KIT	401107-01239	
DOOSAN	DX210W ARM_SEAL KIT	401107-00208A	
DOOSAN	DX210W BOOM_SEAL KIT	401107-00259A	



WONYOUNG SEAL CORPORATION

## 2. Hydraulic seal repair kit



**Superior seal**

Korea Masterpiece

# MAKER : DOOSAN INFRACORE

MAKER	MODEL	SEAL KIT	REMARKS
DOOSAN	DX210W DOZER SEAL KIT	401107-00370A	
DOOSAN	DX210W SEAL KIT	401107-00145	
DOOSAN	DX220 ARM SEAL KIT	K9002289	
DOOSAN	DX220 ARM SEAL KIT	K9002290	
DOOSAN	DX220LC ARM SEAL KIT SEAL KIT	K9001901	
DOOSAN	DX220LC ARM SEAL KIT	401107-00171A	
DOOSAN	DX220LC BOOM SEAL KIT SEAL KIT	K9001878	
DOOSAN	DX220LC BOOM SEAL KIT	401107-00229A	
DOOSAN	DX220LC BUCKET SEAL KIT	401107-00298A	
DOOSAN	DX220LC SEAL KIT;BUK SEAL KIT	K9001892	
DOOSAN	DX220LC SEAL KIT;T/R SEAL KIT	K9001853	
DOOSAN	DX235NLC BOOM SEAL KIT	401107-00697	
DOOSAN	DX235NLC BUCKET SEAL KIT	401107-00698	
DOOSAN	DX255LC SEAL KIT	401107-00147A	
DOOSAN	DX255LC-3 ARM SEAL KIT	401107-01202	
DOOSAN	DX255LC-3 BOOM SEAL KIT	401107-01221	
DOOSAN	DX255LC-3 BUCKET SEAL KIT	401107-01220	
DOOSAN	DX27Z ARM SEAL KIT	401107-00204A	
DOOSAN	DX27Z BOOM/SWING SEAL KIT	401107-00283A	
DOOSAN	DX27Z BOOM SEAL KIT	401107-00275A	
DOOSAN	DX27Z BUCKET SEAL KIT	401107-00341A	
DOOSAN	DX27Z DOZER SEAL KIT	401107-00366A	
DOOSAN	DX30 ARM SEAL KIT	K9006258	
DOOSAN	DX30 BUCKET SEAL KIT	K9006259	
DOOSAN	DX300 SEAL KIT	K9001752	
DOOSAN	DX300LC ARM SEAL KIT	401107-00203A	
DOOSAN	DX300LC BOOM SEAL KIT	401107-00274A	
DOOSAN	DX300LC BUCKET SEAL KIT	401107-00339A	
DOOSAN	DX300LC BUCKET SEAL KIT	401107-00340A	
DOOSAN	DX300LC TRACK SEAL KIT	K9006412	
DOOSAN	DX30Z(K1027108B) BOOM SEAL KIT	K9006257	
DOOSAN	DX340LC ARM SEAL KIT	401107-00192A	
DOOSAN	DX340LC ARM SEAL KIT	401107-00757	
DOOSAN	DX340LC BOOM SEAL KIT	401107-00214A	
DOOSAN	DX35Z SEAL KIT	401107-00148A	



WONYOUNG SEAL CORPORATION

## 2. Hydraulic seal repair kit



**Superior seal**

Korea Masterpiece

# MAKER : DOOSAN INFRACORE

MAKER	MODEL	SEAL KIT	REMARKS
DOOSAN	DX35Z_SEAL KIT	401107-00149A	
DOOSAN	DX35Z_SEAL KIT	401107-00150A	
DOOSAN	DX380LC_ARM_SEAL KIT	401107-00578	
DOOSAN	DX380LC_BOOM_SEAL KIT	K9002933	
DOOSAN	DX380LCA_BOOM_SEAL KIT	401107-00583	
DOOSAN	DX380LCA_BUCKET_SEAL KIT	401107-00584	
DOOSAN	DX420_BUCKET_SEAL KIT[29]	K9002068A	
DOOSAN	DX420LC_ARM_SEAL KIT	401107-00191A	
DOOSAN	DX420LC_ARM_SEAL KIT	401107-00579	
DOOSAN	DX420LC_BOOM_SEAL KIT	401107-00258	
DOOSAN	DX420LC_BUCKET_SEAL KIT	401107-00324A	
DOOSAN	DX420LC-3_BUCKET_SEAL KIT	401107-01236	
DOOSAN	DX420LC-3_BUCKET_SEAL KIT	401107-01348	
DOOSAN	DX480LC_ARM_SEAL KIT_SEAL KIT	K9002002	
DOOSAN	DX480LC_ARM_SEAL KIT	401107-00190A	
DOOSAN	DX480LC_BOOM_SEAL KIT&BUK_SEAL KIT	K9002003	
DOOSAN	DX480LC_BUCKET_SEAL KIT	401107-00323A	
DOOSAN	DX55_BOOM_SEAL KIT	401107-00260A	
DOOSAN	DX55_BUCKET_SEAL KIT	401107-00325A	
DOOSAN	DX55_SEAL KIT	401107-00080A	
DOOSAN	DX55ACE_DOZER_SEAL KIT	401107-01275	
DOOSAN	DX55W_BOOM/SWING_SEAL KIT	K9006359	
DOOSAN	DX55W_BOOM_SEAL KIT	401107-00663	
DOOSAN	DX55W_BOOM_SEAL KIT	K9006362	
DOOSAN	DX55W_DOZER_CYL_SEAL KIT	401107-00667	
DOOSAN	DX55W_DOZER_CYL_SEAL KIT	K9006360	
DOOSAN	DX55W_DOZER_SEAL KIT	401107-01274	
DOOSAN	DX80R_ARM_SEAL KIT	401107-00666	
DOOSAN	DX80R_ARM_SEAL KIT	K9006616	
DOOSAN	FD 20_LS_SEAL KIT	401107-00847	
DOOSAN	FD 20_LS_SEAL KIT	D330142K	
DOOSAN	FD10/15_POWER_STEERING_SEAL KIT	1440-2013K	
DOOSAN	FD10/15_POWER_STEERING_SEAL KIT	401107-00831	
DOOSAN	FD150_LIFT_SEAL KIT	1400-2041K	
DOOSAN	FD150_LIFT_SEAL KIT	1400-2042K	



WONYOUNG SEAL CORPORATION

## 2. Hydraulic seal repair kit



**Superior seal**

Korea Masterpiece

# MAKER : DOOSAN INFRACORE

MAKER	MODEL	SEAL KIT	REMARKS
DOOSAN	FD150 LIFT_SEAL KIT	401107-00503	
DOOSAN	FD150 LIFT_SEAL KIT	401107-00504	
DOOSAN	FD25 POWER STEERING_SEAL KIT	1400-2024KT	
DOOSAN	FD25 POWER STEERING_SEAL KIT	401107-00829	
DOOSAN	FD25FVM LIFT_SEAL KIT	1440-2026KT	
DOOSAN	FD35/45 OPTION LIFT_SEAL KIT	1400-2038KT	
DOOSAN	FD35/45 POWER STEERING_SEAL KIT	1400-2025KT	
DOOSAN	FD35/45 POWER STEERING_SEAL KIT	401107-00830	
DOOSAN	FD35/45 TILT_SEAL KIT	1400-2019KT	
DOOSAN	FD35/45 TILT_SEAL KIT	401107-00828	
DOOSAN	FD50 LIFT(-85.4)_SEAL KIT	1400-2021K	
DOOSAN	FD50 LIFT(-86.2)_SEAL KIT	1400-2020K	
DOOSAN	FD75M LIFT_SEAL KIT	1400A2022F30P	
DOOSAN	FVM LIFT_SEAL KIT(-89.9)	1440-2027K	
DOOSAN	FVM LIFT_SEAL KIT	1440-2010D3KT	
DOOSAN	FVM LIFT_SEAL KIT	401107-00497A	
DOOSAN	FVM LIFT_SEAL KIT	401107-00498A	
DOOSAN	FVM LIFT_SEAL KIT	401107-00499A	
DOOSAN	G25S3 LIFT_SEAL KIT	A215034KT	
DOOSAN	G25S3 LIFT_SEAL KIT	D511213KT	
DOOSAN	G25S3 PRI LIFT_SEAL KIT	D511211KT	
DOOSAN	GC15C TILT-GP_SEAL KIT	401107-00876	
DOOSAN	GC15C TILT-GP_SEAL KIT	D511447	
DOOSAN	HINGED FORK_SEAL KIT	D330636K	
DOOSAN	K1011296A BOOM_SEAL KIT	K9004947	
DOOSAN	K1011296A_SEAL KIT	K9004928	
DOOSAN	K1012363B BUCKET_SEAL KIT	K9004959	
DOOSAN	LBCALL SET LIFT_SEAL KIT	401107-00857	
DOOSAN	LBCALL SET LIFT_SEAL KIT	401107-00928	
DOOSAN	LBCALL SET LIFT_SEAL KIT	401107-00929	
DOOSAN	LBCALL SET LIFT_SEAL KIT	D510171	
DOOSAN	LBCALL SET LIFT_SEAL KIT	D510171K	
DOOSAN	LBCALL SET LIFT_SEAL KIT	D510176	
DOOSAN	LD20 POWER STEERING_SEAL KIT	401107-00853	
DOOSAN	LD20 POWER STEERING_SEAL KIT	D501670KT	



WONYOUNG SEAL CORPORATION

## 2. Hydraulic seal repair kit



**Superior seal**

Korea Masterpiece

# MAKER : DOOSAN INFRACORE

MAKER	MODEL	SEAL KIT	REMARKS
DOOSAN	LD20 TILT_SEAL KIT	401107-00833	
DOOSAN	LD20 TILT_SEAL KIT	911158KT	
DOOSAN	LD20/30 LIFT_SEAL KIT	401107-00935	
DOOSAN	LD20/30 LIFT_SEAL KIT	911700KT	
DOOSAN	LD20/30S LIFT_SEAL KIT	401107-00835	
DOOSAN	LD20/30S LIFT_SEAL KIT	911407KT	
DOOSAN	LD25 POWER STEERING_SEAL KIT	401107-00838	
DOOSAN	LD25 POWER STEERING_SEAL KIT	D144355	
DOOSAN	LD35 POWER STEERING_SEAL KIT	401107-00839	
DOOSAN	LD35 POWER STEERING_SEAL KIT	D164050KT	
DOOSAN	LD35 PRI LIFT_SEAL KIT	D164935KT	
DOOSAN	LD35 STD/SEC LIFT_SEAL KIT	401107-00841	
DOOSAN	LD35 STD/SEC LIFT_SEAL KIT	D164932KT	
DOOSAN	LD35 TILT_SEAL KIT	401107-00840	
DOOSAN	LD35 TILT_SEAL KIT	D164101KT	
DOOSAN	LD50 LIFT(UNDER)_SEAL KIT	401107-00846	
DOOSAN	LD50 LIFT(UNDER)_SEAL KIT	D184900KTA	
DOOSAN	LD50 TILT_SEAL KIT	401107-00845	
DOOSAN	LD50 TILT_SEAL KIT	D184900KT	
DOOSAN	LD50/70 LIFT_SEAL KIT	D510062	
DOOSAN	LD50/70 TILT_SEAL KIT	401107-00874	
DOOSAN	LD50/70 TILT_SEAL KIT	D511411	
DOOSAN	LIFT CYL SEAL KIT	401107-00664	
DOOSAN	LIFT CYL SEAL KIT	4440-6266K	
DOOSAN	LIFT_SEAL KIT(45MM: -89.10)	1440-2087K	
DOOSAN	LIFT_SEAL KIT(50MM:-89.10)	1440-2046K	
DOOSAN	LIFT_SEAL KIT	401107-00834	
DOOSAN	LIFT_SEAL KIT	401107-00895	
DOOSAN	LIFT_SEAL KIT	911400K	
DOOSAN	LIFT_SEAL KIT	920666KT	
DOOSAN	LIFT_SEAL KIT	D512303	
DOOSAN	M160TC LIFT CYLINDER_SEAL KIT	401107-00384A	
DOOSAN	M160TC LIFT_SEAL KIT	4440-6476BKT	
DOOSAN	M160TC LIFT_SEAL KIT	4440-6476CKT	
DOOSAN	M160TC STEER_SEAL KIT	4440-6480KT	



WONYOUNG SEAL CORPORATION

## 2. Hydraulic seal repair kit



**Superior seal**

Korea Masterpiece

# MAKER : DOOSAN INFRACORE

MAKER	MODEL	SEAL KIT	REMARKS
DOOSAN	M160TC STEERING_SEAL KIT	401107-00420	
DOOSAN	M160TC-E BUCKET_SEAL KIT	401107-00328A	
DOOSAN	M160TC-E LIFT CYLINDER_SEAL KIT	401107-00391A	
DOOSAN	M200-V BUCKET_SEAL KIT	401107-00347A	
DOOSAN	M200-V LIFT CYLINDER_SEAL KIT	401107-00389A	
DOOSAN	M250-3 BKT_SEAL KIT	4440-6398KT	
DOOSAN	M250-3 LIFT_SEAL KIT	4440-6399KT	
DOOSAN	M250-5 LIFT_SEAL KIT	440-00248KT	
DOOSAN	M250-5 LIFT_SEAL KIT	440-00250KT	
DOOSAN	M250-III BUCKET_SEAL KIT	401107-00338A	
DOOSAN	M250-III LIFT CYLINDER_SEAL KIT	401107-00386A	
DOOSAN	M250-V BUCKET_SEAL KIT	401107-00348A	
DOOSAN	M250-V LIFT CYLINDER_SEAL KIT	401107-00390A	
DOOSAN	M300-3 LIFT_SEAL KIT	4440-6359KT	
DOOSAN	M300-III LIFT CYLINDER_SEAL KIT	401107-00385A	
DOOSAN	M300-V BUCKET_SEAL KIT	401107-00295B	
DOOSAN	M300-VFL STEERING_SEAL KIT	401107-00418A	
DOOSAN	M400-5 LIFT_SEAL KIT	440-00136BKT	
DOOSAN	M400-V BUCKET_SEAL KIT	401107-00346A	
DOOSAN	M400-V LIFT CYLINDER_SEAL KIT	401107-00388A	
DOOSAN	M400-V STEERING_SEAL KIT	401107-00416A	
DOOSAN	M500-V BUCKET_SEAL KIT	401107-00321A	
DOOSAN	MEG200 P/S_SEAL KIT	4440-6265K	
DOOSAN	MEG300 BUCKET_SEAL KIT	4440-6219K	
DOOSAN	MEG300 P/S_SEAL KIT	4440-6221K	
DOOSAN	MEG400 LIFT_SEAL KIT	4440-6207K	
DOOSAN	MEG400_BKT_SEAL KIT	4440-6209K	
DOOSAN	MEGA160 BUCKET_SEAL KIT	401107-00349	
DOOSAN	MEGA200 STEERING_SEAL KIT	401107-00419	
DOOSAN	MEGA300 BUCKET_SEAL KIT	401107-00322A	
DOOSAN	MEGA400 BUCKET_SEAL KIT	401107-00297A	
DOOSAN	MEGA400 LIFT CYLINDER_SEAL KIT	401107-00383A	
DOOSAN	MEGA400 STEERING_SEAL KIT	401107-00417A	
DOOSAN	OIL,REACH CYLINDER_SEAL KIT	401106-00195	
DOOSAN	OIL,SIDE SHIFT CYLINDER_SEAL KIT	401106-00201	



## 2. Hydraulic seal repair kit



**Superior seal**

Korea Masterpiece

# MAKER : DOOSAN INFRACORE

MAKER	MODEL	SEAL KIT	REMARKS
DOOSAN	OPTION LIFT_SEAL KIT	1400-2037KT	
DOOSAN	OPTION LIFT_SEAL KIT	401107-00506A	
DOOSAN	OPTION LIFT_SEAL KIT	401107-00507	
DOOSAN	P/S CYL_SEAL KIT	401107-00879	
DOOSAN	P/S CYL_SEAL KIT	D511526	
DOOSAN	P/S CYL_SEAL KIT(D35S)	401107-00856	
DOOSAN	P/S CYL_SEAL KIT(D35S)	D510112	
DOOSAN	P/S SEAL KIT	4440-6211K	
DOOSAN	PC15MR-1 ARM_SEAL KIT	401107-00175	
DOOSAN	PC15MR-1 BLADE_SEAL KIT	401107-00212	
DOOSAN	PC15MR-1 BOOM/SWING_SEAL KIT	401107-00281	
DOOSAN	PC15MR-1 BUCKET_SEAL KIT	401107-00306	
DOOSAN	PC20MR BLADE_SEAL KIT	401107-00213	
DOOSAN	PC20MR BOOM_SEAL KIT	401107-00236	
DOOSAN	PC30MR ARM_SEAL KIT	401107-00174	
DOOSAN	PC30MR BLADE_SEAL KIT	401107-00211	
DOOSAN	PC30MR BOOM_SEAL KIT	401107-00235	
DOOSAN	POWER STEERING_SEAL KIT	1440-2001K	
DOOSAN	POWER STEERING_SEAL KIT	401107-00843	
DOOSAN	POWER STEERING_SEAL KIT	D184050KT	
DOOSAN	RAM CYL_SEAL KIT	2440-9406CKT	
DOOSAN	RAM_SEAL KIT	2440-9011K	
DOOSAN	RAM_SEAL KIT	401107-00913	
DOOSAN	REPACKING GP PRI FF	D510236	
DOOSAN	REPACKING GP_SEAL KIT	401107-00859	
DOOSAN	REPACKING GP_SEAL KIT	D510304	
DOOSAN	REPACKING SEAL KIT	401107-00836	
DOOSAN	REPACKING SEAL KIT	911725KT	
DOOSAN	ROD SEMI_SEAL KIT	D512436	
DOOSAN	S/SHAFT_SEAL KIT	401107-00864	
DOOSAN	S/SHAFT_SEAL KIT	D510565	
DOOSAN	S007 ARM_SEAL KIT	2440-9173KT	
DOOSAN	S007 ARM_SEAL KIT	401107-00206A	
DOOSAN	S007 BOOM_SEAL KIT	2440-9172KT	
DOOSAN	S007 BOOM_SEAL KIT	401107-00223A	



WONYOUNG SEAL CORPORATION

## 2. Hydraulic seal repair kit



**Superior seal**

Korea Masterpiece

# MAKER : DOOSAN INFRACORE

MAKER	MODEL	SEAL KIT	REMARKS
DOOSAN	S007 BUCKET_SEAL KIT	2440-9174KT	
DOOSAN	S007 BUCKET_SEAL KIT	401107-00344A	
DOOSAN	S015 ARM&BKT_SEAL KIT	2440-9263KT	
DOOSAN	S015 ARM/BUCKET_SEAL KIT	2440-6516KT	
DOOSAN	S015 ARM/BUCKET_SEAL KIT	401107-00176A	
DOOSAN	S015 ARM_SEAL KIT	401107-00167	
DOOSAN	S015 BOOM_SEAL KIT	2440-9262KT	
DOOSAN	S015 BOOM/SWING_SEAL KIT	2440-6518KT	
DOOSAN	S015 BOOM/SWING_SEAL KIT	2440-6518KT	
DOOSAN	S015 BOOM/SWING_SEAL KIT	401107-00278A	
DOOSAN	S015 BOOM_SEAL KIT	2440-6515KT	
DOOSAN	S015 BOOM_SEAL KIT	401107-00234A	
DOOSAN	S015 BOOM_SEAL KIT	401107-00248	
DOOSAN	S015 DOZER_SEAL KIT	2440-6519KT	
DOOSAN	S015 DOZER_SEAL KIT	401107-00369A	
DOOSAN	S015 T/SPRING_SEAL KIT	2440-9266AKT	
DOOSAN	S030 BOOM&ARM_SEAL KIT	2440-9214KT	
DOOSAN	S030 BOOM/ARM_SEAL KIT	2440-9214AKT	
DOOSAN	S030 BOOM_SEAL KIT	401107-00266A	
DOOSAN	S030 BOOM_SEAL KIT	401107-00267A	
DOOSAN	S030 BUCKET_SEAL KIT	2440-9216AKT	
DOOSAN	S030 BUCKET_SEAL KIT	2440-9216KT	
DOOSAN	S030 BUCKET_SEAL KIT	401107-00332A	
DOOSAN	S030 BUCKET_SEAL KIT	401107-00342A	
DOOSAN	S030 DOZER_SEAL KIT(1~368)	401107-00368A	
DOOSAN	S030 DOZER_SEAL KIT	2440-9218AKT	
DOOSAN	S030 DOZER_SEAL KIT	401107-00365A	
DOOSAN	S030 SWING CYL_SEAL KIT	401107-00422A	
DOOSAN	S030 SWING CYL_SEAL KIT	401107-00423A	
DOOSAN	S030 SWING CYL_SEAL KIT	401107-00424A	
DOOSAN	S035 ARM_SEAL KIT	401107-00184A	
DOOSAN	S035 BOOM KIT	2440-9204KT	
DOOSAN	S035 BOOM/SWING SEAL KIT	401107-00282A	
DOOSAN	S035 BOOM SEAL KIT	401107-00254A	
DOOSAN	S035 BUCKET SEAL KIT	2440-9206KT	



WONYOUNG SEAL CORPORATION

## 2. Hydraulic seal repair kit



**Superior seal**

Korea Masterpiece

# MAKER : DOOSAN INFRACORE

MAKER	MODEL	SEAL KIT	REMARKS
DOOSAN	S035 BUCKET_SEAL KIT	401107-00318A	
DOOSAN	S035 CENTER JOINT SEAL KIT	07309-0KT	
DOOSAN	S035 DOZER_SEAL KIT	2440-9207KT	
DOOSAN	S035 DOZER_SEAL KIT	401107-00363A	
DOOSAN	S035 SWING_SEAL KIT	2440-9208KT	
DOOSAN	S10 C/J_SEAL KIT	2181-9085K	
DOOSAN	S120W BOOM_SEAL KIT	401107-00230A	
DOOSAN	S120W CENTER JOINT SEAL KIT	2480-9401K	
DOOSAN	S130 BOOM_SEAL KIT	2440-9034K	
DOOSAN	S130 BUCKET SEAL KIT	2440-9037K	
DOOSAN	S130-2 BOOM_SEAL KIT	401107-00249A	
DOOSAN	S130-2 BUCKET_SEAL KIT	2440-6228K	
DOOSAN	S130-5 ARM_SEAL KIT	2440-9242KT	
DOOSAN	S130-5 ARM_SEAL KIT	401107-00199A	
DOOSAN	S130-5 BOOM_SEAL KIT	401107-00268A	
DOOSAN	S130-III TRACK SPRING_SEAL KIT	401107-00119	
DOOSAN	S130LC-5 BUCKET_SEAL KIT	2440-9233KM	
DOOSAN	S130LC-V BOOM_SEAL KIT	401107-00276	
DOOSAN	S130LC-V BUCKET_SEAL KIT	401107-00313	
DOOSAN	S130-V BOOM/ARM_SEAL KIT	401107-00285A	
DOOSAN	S130-V BUCKET_SEAL KIT	401107-00333A	
DOOSAN	S130W3 ARM_SEAL KIT	2440-6227AKT	
DOOSAN	S130W-3 ARM_SEAL KIT	2440-9126K	
DOOSAN	S130W3 ARM_SEAL KIT	2440-9126KM	
DOOSAN	S130W3 BOOM_SEAL KIT	2440-9128AKM	
DOOSAN	S130W-3 BOOM_SEAL KIT	2440-9128AKT	
DOOSAN	S130W3 C/JOINT_SEAL KIT	2480-9004AKT	
DOOSAN	S130W-3 C/JOINT_SEAL KIT	2480-9004K	
DOOSAN	S130W3 CHOCK_SEAL KIT	2440-9403BK	
DOOSAN	S130W-3 DOZER_SEAL KIT	2440-9164K	
DOOSAN	S130W5 ARM_SEAL KIT	2440-9242KM	
DOOSAN	S130W5 CENTER JOINT SEAL KIT	2480-9023KT	
DOOSAN	S130W-III ARM_SEAL KIT	401107-00180A	
DOOSAN	S130W-III ARM_SEAL KIT	401107-00181	
DOOSAN	S130W-III ARM_SEAL KIT	401107-00193A	

## 2. Hydraulic seal repair kit



**Superior seal**

Korea Masterpiece

# MAKER : DOOSAN INFRACORE

MAKER	MODEL	SEAL KIT	REMARKS
DOOSAN	S130W-III BOOM SEAL KIT	401107-00222	
DOOSAN	S130W-III BOOM SEAL KIT	401107-00265A	
DOOSAN	S130W-III BUCKET SEAL KIT	401107-00310A	
DOOSAN	S130W-III CHOCKING SEAL KIT	401107-00354	
DOOSAN	S130W-III DOZER SEAL KIT	401107-00364A	
DOOSAN	S130W-V ARM SEAL KIT	401107-00178	
DOOSAN	S130W-V BOOM SEAL KIT	401107-00245	
DOOSAN	S130W-V BOOM SEAL KIT	401107-00263A	
DOOSAN	S130W-V OUT CYL SEAL KIT	401107-00404A	
DOOSAN	S130W-V,S170W-V,S200W-V CENTER JOINT SEAL KIT	401107-00811	
DOOSAN	S140-5 TRACK SPRING SEAL KIT	K9000480	
DOOSAN	S140-V TRACK SPRING SEAL KIT	401107-00432	
DOOSAN	S140W-V ARTI BOOM SEAL KIT	401107-00209A	
DOOSAN	S170 ARM SEAL KIT	401107-00196A	
DOOSAN	S170 BKT SEAL KIT	2440-9125KT	
DOOSAN	S170 BOOM SEAL KIT	2440-9122KT	
DOOSAN	S170 BOOM SEAL KIT	401107-00264A	
DOOSAN	S170 BUCKET SEAL KIT	401107-00331A	
DOOSAN	S170-V ARM SEAL KIT	401107-00124A	
DOOSAN	S170W3 DOZER SEAL KIT	2440-6085K	
DOOSAN	S170W-III DOZER SEAL KIT	401107-00367A	
DOOSAN	S200LC,DH07S BOOM SEAL KIT	2440-6091KT	
DOOSAN	S200W CENTER JOINT SEAL KIT	2480-9022KT	
DOOSAN	S200W5 SERVICE KIT;C/J[29]	K9001746	
DOOSAN	S200W-V DOZER,OUT CYLINDER SEAL KIT	401107-00371A	
DOOSAN	S220-5 ARM(OVER SIZE) SEAL KIT	2440-9236KM	
DOOSAN	S220-5 BOOM SEAL KIT(OVER SIZE)	2440-9234KM	
DOOSAN	S220-5 BOOM SEAL KIT	2440-9234KT	
DOOSAN	S220-5 BUCKET SEAL KIT	401107-00293A	
DOOSAN	S220L3 ARM SEAL KIT	401107-00183A	
DOOSAN	S220L3 SHORT ARM SEAL KIT	2440-9163KT	
DOOSAN	S220LC ARM SEAL KIT	2440-9089KT	
DOOSAN	S220LC ARM SEAL KIT	2440-9146KM	
DOOSAN	S220LC ARM SEAL KIT	401107-00123A	
DOOSAN	S220LC BOOM SEAL KIT	2440-9087KM	



WONYOUNG SEAL CORPORATION

## 2. Hydraulic seal repair kit



**Superior seal**

Korea Masterpiece

# MAKER : DOOSAN INFRACORE

MAKER	MODEL	SEAL KIT	REMARKS
DOOSAN	S220LC BOOM_SEAL KIT	2440-9087KT	
DOOSAN	S220LC BOOM_SEAL KIT	401107-00078	
DOOSAN	S220LC BOOM_SEAL KIT	401107-00078A	
DOOSAN	S220LC BUCKET_SEAL KIT	2440-9090KT	
DOOSAN	S220LC BUCKET_SEAL KIT	401107-00329A	
DOOSAN	S220LC-3 BOOM(OVER SIZE)_SEAL KIT	2440-9144KM	
DOOSAN	S220LC3 BUCKET_SEAL KIT	2440-9147KM	
DOOSAN	S220LC-III ARM_SEAL KIT	401107-00194A	
DOOSAN	S220LC-III ARM_SEAL KIT	401107-00195	
DOOSAN	S220LC-III BOOM_SEAL KIT	401107-00252	
DOOSAN	S220LC-III BOOM_SEAL KIT	401107-00253A	
DOOSAN	S220LC-III BUCKET_SEAL KIT 22M	401107-00311A	
DOOSAN	S220LC-III BUCKET_SEAL KIT	401107-00327	
DOOSAN	S220LC-III BUCKET_SEAL KIT	401107-00345A	
DOOSAN	S220LC-V ARM_SEAL KIT	401107-00165	
DOOSAN	S220LC-V ARM_SEAL KIT	401107-00197A	
DOOSAN	S220LC-V BOOM_SEAL KIT	401107-00224	
DOOSAN	S220LC-V BOOM_SEAL KIT	401107-00269A	
DOOSAN	S220LC-V BUCKET_SEAL KIT	401107-00305	
DOOSAN	S220LL STICK CYLINDER_SEAL KIT	401107-00421A	
DOOSAN	S220N-5 BUCKET_SEAL KIT	2440-9339KT	
DOOSAN	S220NLC-V BUCKET_SEAL KIT	401107-00294A	
DOOSAN	S225LC-5/7 BOOM_SEAL KIT	401107-00519	
DOOSAN	S225LC-V BOOM_SEAL KIT	401107-00277A	
DOOSAN	S225LL HEEL CYLINDER_SEAL KIT	401107-00377A	
DOOSAN	S250LC-V ARM_SEAL KIT	401107-00201A	
DOOSAN	S250LC-V BOOM/BUCKET_SEAL KIT	401107-00243A	
DOOSAN	S255-V CENTER JOINT_SEAL KIT	401107-00810	
DOOSAN	S280 ARM_SEAL KIT	2440-6122KM	
DOOSAN	S280 ARM_SEAL KIT	2440-6122KT	
DOOSAN	S280 ARM_SEAL KIT	401107-00121	
DOOSAN	S280 BOOM_SEAL KIT	2440-6120KM	
DOOSAN	S280 BOOM_SEAL KIT	2440-6120KT	
DOOSAN	S280 BOOM_SEAL KIT	401107-00120	
DOOSAN	S280 TRACK SPRING_SEAL KIT	401107-00431	



WONYOUNG SEAL CORPORATION

## 2. Hydraulic seal repair kit



**Superior seal**

Korea Masterpiece

# MAKER : DOOSAN INFRACORE

MAKER	MODEL	SEAL KIT	REMARKS
DOOSAN	S280-3 ARM_SEAL KIT	401107-00207	
DOOSAN	S280-3 BOOM_SEAL KIT	2440-9136KM	
DOOSAN	S280-3 BOOM_SEAL KIT	401107-00251A	
DOOSAN	S280-3 BUCKET_SEAL KIT	2440-6228AKT	
DOOSAN	S280-3 BUCKET_SEAL KIT	2440-9139KM	
DOOSAN	S280-3 BUCKET_SEAL KIT	401107-00317	
DOOSAN	S280-3 C/J_SEAL KIT[65]	2480-6060KT	
DOOSAN	S280-3 CENTER JOINT_SEAL KIT	401107-00919	
DOOSAN	S280LC-III ARM_SEAL KIT	401107-00182	
DOOSAN	S280LC-III BOOM_SEAL KIT	401107-00250	
DOOSAN	S280LC-III BUCKET_SEAL KIT	401107-00289A	
DOOSAN	S280LC-III BUCKET_SEAL KIT	401107-00316	
DOOSAN	S290-5 BOOM_SEAL KIT	2440-9238KM	
DOOSAN	S290LC-V ARM_SEAL KIT	401107-00177	
DOOSAN	S290LC-V ARM_SEAL KIT	401107-00198A	
DOOSAN	S290LC-V BOOM_SEAL KIT	401107-00246	
DOOSAN	S290LC-V BUCKET_SEAL KIT	401107-00314	
DOOSAN	S290LC-V BUCKET_SEAL KIT	401107-00335A	
DOOSAN	S30 DOZER_SEAL KIT	401107-00917	
DOOSAN	S300-5 BUCKET_SEAL KIT	2440-9241KT	
DOOSAN	S300LC-V ARM_SEAL KIT	401107-00202A	
DOOSAN	S300LC-V BOOM_SEAL KIT	401107-00273A	
DOOSAN	S300LC-V BUCKET_SEAL KIT	401107-00334A	
DOOSAN	S320 ARM_SEAL KIT	401107-00186A	
DOOSAN	S320 ARM_SEAL KIT	707-99-69900K	
DOOSAN	S320 BOOM_SEAL KIT	401107-00255A	
DOOSAN	S320 BOOM_SEAL KIT	707-99-66200K	
DOOSAN	S320 BUCKET_SEAL KIT	401107-00319A	
DOOSAN	S320,330-3 ARM_SEAL KIT	2440-9416AKT	
DOOSAN	S330-3 BOOM_SEAL KIT	2440-9413AKT	
DOOSAN	S330-5 ARM_SEAL KIT	440-00257AKT	
DOOSAN	S330-5 BOOM_SEAL KIT	440-00416AKT	
DOOSAN	S330-5 BUCKET_SEAL KIT	2440-9241HKT	
DOOSAN	S330LC-5 BOOM_SEAL KIT	2440-9279BKT	
DOOSAN	S330LC-5 BUCKET_SEAL KIT	2440-9281AKT	



WONYOUNG SEAL CORPORATION

## 2. Hydraulic seal repair kit



**Superior seal**

Korea Masterpiece

# MAKER : DOOSAN INFRACORE

MAKER	MODEL	SEAL KIT	REMARKS
DOOSAN	S330LC-V ARM_SEAL KIT	401107-00200A	
DOOSAN	S35 ARM_SEAL KIT	2440-9205KT	
DOOSAN	S360-5 CENTER JOINT_SEAL KIT	2480-9405BKT	
DOOSAN	S360LC-V BOOM_SEAL KIT	401107-00271A	
DOOSAN	S360LC-V BUCKET_SEAL KIT	401107-00336A	
DOOSAN	S370LC-V BOOM_SEAL KIT	401107-00227A	
DOOSAN	S400-5 ARM_SEAL KIT	2440-9293KT	
DOOSAN	S400-5 BKT_SEAL KIT	2440-9294KT	
DOOSAN	S400-5 SEAL KIT	2440-9295KT	
DOOSAN	S400L3 BKT_SEAL KIT	2440-9441KT	
DOOSAN	S400L3 BOOM_SEAL KIT	2440-9438KT	
DOOSAN	S400L3 TRACK_SEAL KIT	2274-6014AKT	
DOOSAN	S400L3 TRACK_SEAL KIT	401107-00911	
DOOSAN	S400LC-3 ARM_SEAL KIT	2440-9440KT	
DOOSAN	S400LC-III ARM_SEAL KIT	401107-00188A	
DOOSAN	S400LC-V ARM_SEAL KIT	401107-00205A	
DOOSAN	S400LC-V BOOM_SEAL KIT	401107-00272A	
DOOSAN	S400LC-V BUCKET_SEAL KIT	401107-00337A	
DOOSAN	S450 ARM_SEAL KIT	401107-00187A	
DOOSAN	S450 BOOM/BUCKET_SEAL KIT	401107-00284A	
DOOSAN	S450LC-V ARM_SEAL KIT	401107-00168A	
DOOSAN	S450LC-V BOOM/BUCKET_SEAL KIT	401107-00242A	
DOOSAN	S50 BOOM_SEAL KIT	2440-9114CKM	
DOOSAN	S50 BOOM_SEAL KIT	2440-9114CKT	
DOOSAN	S50 C/JOINT_SEAL KIT	2480-9001K	
DOOSAN	S50 DOZER_SEAL KIT	401107-00362A	
DOOSAN	S50 SERVICE KIT;C/J	K9001743	
DOOSAN	S50_SEAL KIT	401107-00082A	
DOOSAN	S50-3 BUCKET_SEAL KIT	2440-6127K	
DOOSAN	S50W ARM_SEAL KIT	2440-9115CKM	
DOOSAN	S50W CHOCKING_SEAL KIT	401107-00353A	
DOOSAN	S50W3 BUCKET_SEAL KIT	2440-6127AK	
DOOSAN	S50W-III BUCKET_SEAL KIT	401107-00330A	
DOOSAN	S50W-III SEAL KIT	401107-00122	
DOOSAN	S55-5 ARM(OVER SIZE) SEAL KIT	2440-9253KM	



WONYOUNG SEAL CORPORATION

## 2. Hydraulic seal repair kit



**Superior seal**

Korea Masterpiece

# MAKER : DOOSAN INFRACORE

MAKER	MODEL	SEAL KIT	REMARKS
DOOSAN	S55-5 ARM_SEAL KIT	2440-9253KT	
DOOSAN	S55-5 ARM_SEAL KIT	401107-00166A	
DOOSAN	S55-5 BOOM/SWING_SEAL KIT	401107-00279A	
DOOSAN	S55-5 BOOM_SEAL KIT	2440-9252KM	
DOOSAN	S55-5 BOOM_SEAL KIT	2440-9252KT	
DOOSAN	S55-5 BOOM_SEAL KIT	401107-00225A	
DOOSAN	S55-5 BUCKET_SEAL KIT	401107-00291A	
DOOSAN	S55-5 C/J_SEAL KIT[65]	2480-9018KT	
DOOSAN	S55-5 DOZER_SEAL KIT	401107-00357A	
DOOSAN	S55-5 GREASE CYLINDER_SEAL KIT	401107-00376	
DOOSAN	S55-5 GREASE_SEAL KIT	2460-9058KT	
DOOSAN	S55-5 TRACK_SEAL KIT (00543통합)	2274-1029KT	
DOOSAN	S55-V ARM_SEAL KIT	401107-00179	
DOOSAN	S55-V BOOM_SEAL KIT	401107-00247	
DOOSAN	S55-V BUCKET_SEAL KIT	401107-00290	
DOOSAN	S55-V GOLD ARM_SEAL KIT	401107-00189A	
DOOSAN	S55-V GOLD BOOM_SEAL KIT	401107-00257A	
DOOSAN	S55W C/JOINT_SEAL KIT	2480-9028KT	
DOOSAN	S55W-V BOOM_SEAL KIT	401107-00226A	
DOOSAN	S55W-V DOZER_SEAL KIT	401107-00360A	
DOOSAN	S70-3 BUCKET_SEAL KIT	2440-9211K	
DOOSAN	S70-3 DOZER_SEAL KIT	2440-9180K	
DOOSAN	S70-III ARM_SEAL KIT	401107-00185A	
DOOSAN	S70-III BUCKET_SEAL KIT	401107-00292A	
DOOSAN	S70-III TRACK SPRING_SEAL KIT	401107-00430A	
DOOSAN	S75-5 ARM_SEAL KIT	440-00348KT	
DOOSAN	S75-5 BOOM_SEAL KIT	440-00347KT	
DOOSAN	S75-5 BUCKET_SEAL KIT	440-00349KT	
DOOSAN	S75-5 DOZER_SEAL KIT	440-00393KT	
DOOSAN	S75-V ARM_SEAL KIT	401107-00169A	
DOOSAN	S75-V BOOM/SWING_SEAL KIT	401107-00280A	
DOOSAN	S75-V BOOM_SEAL KIT	401107-00228A	
DOOSAN	S75-V BUCKET_SEAL KIT	401107-00296A	
DOOSAN	S75-V DOZER_SEAL KIT	401107-00358A	
DOOSAN	S80W BOOM_SEAL KIT	2440-9031K	





WONYOUNG SEAL CORPORATION

## 2. Hydraulic seal repair kit



**Superior seal**

Korea Masterpiece

# MAKER : DOOSAN INFRACORE

MAKER	MODEL	SEAL KIT	REMARKS
DOOSAN	SEAL KIT;OPT ARM	2440-9232KT	
DOOSAN	SEAL KIT C/JOINT_SEAL KIT	2480-9022 AIR	
DOOSAN	SEAL KIT C/JOINT_SEAL KIT	2480-9022 HYD	
DOOSAN	SEAL KIT(DL200TC LIFT CYL)	K9005963	
DOOSAN	SEAL KIT(FFL-PRI BSC)	D511109	
DOOSAN	SEAL KIT(SEC)_SEAL KIT	D501224	
DOOSAN	SEAL KIT, FORK MOVER(D50/90S-5)	D513938	
DOOSAN	SEAL KIT,BOOM	2440-9209K	
DOOSAN	SEAL KIT: BUCKET CYL	2440-9233KT	
DOOSAN	SEAL KIT: DOZER CYL	2440-9201KT	
DOOSAN	SEAL KIT:BOOM CYL (DX60R)	K9006671	
DOOSAN	SEAL KIT:BOOM SWING	K9005270	
DOOSAN	SEAL KIT:BOOM SEAL KIT	2440-9230KT	
DOOSAN	SEAL KIT:BOOM SEAL KIT	2440-9238KT	
DOOSAN	SEAL KIT:BOOM	K9005267	
DOOSAN	SEAL KIT:BUCKET	K9005268	
DOOSAN	SEAL KIT:BUCKET	K9005434	
DOOSAN	SEAL KIT:CENTER JOINT(DX60R)	K9006617	
DOOSAN	SEAL KIT:CENTER JOINT	480-00002KT	
DOOSAN	SEAL KIT:CENTER JOINT	K9001748	
DOOSAN	SEAL KIT:DOZER CYL	2440-9120KT	
DOOSAN	SEAL KIT:DOZER CYL	2440-9270KT	
DOOSAN	SEAL KIT:DOZER	K9005269	
DOOSAN	SEAL KIT:LIFT CYL(STD)	D511159	
DOOSAN	SEAL KIT:LIFT	D511208	
DOOSAN	SEAL KIT:SWING CYL(369호기~,S30)	2440-9217AKT	
DOOSAN	SEAL KIT; RAM CYL	2440-9426K	
DOOSAN	SEAL KIT;( -90.1)	401107-00925	
DOOSAN	SEAL KIT;( -90.1)	D504501K	
DOOSAN	SEAL KIT;ARM(450,450-3)	2440-9430K	
DOOSAN	SEAL KIT;ARM	2440-6097K	
DOOSAN	SEAL KIT;ARM	2440-9236KT	
DOOSAN	SEAL KIT;ARTI BOOM	2440-9132KT	
DOOSAN	SEAL KIT;ARTIC CYL(S130W)	2440-9097K	
DOOSAN	SEAL KIT;ARW	K9009768	



WONYOUNG SEAL CORPORATION

## 2. Hydraulic seal repair kit



**Superior seal**

Korea Masterpiece

# MAKER : DOOSAN INFRACORE

MAKER	MODEL	SEAL KIT	REMARKS
DOOSAN	SEAL KIT;BOOM & BUCKET	2440-9428K	
DOOSAN	SEAL KIT;BOOM CYL	2440-6225K	
DOOSAN	SEAL KIT;BOOM SWING	2440-9213KT	
DOOSAN	SEAL KIT;BOOM	2440-6062K	
DOOSAN	SEAL KIT;BUCKET CLY	4440-6475AKT	
DOOSAN	SEAL KIT;BUCKET CYLINDER	440-00245KT	
DOOSAN	SEAL KIT;BUCKET	2440-6098K	
DOOSAN	SEAL KIT;BUCKET	2440-9116BKT	
DOOSAN	SEAL KIT;C/J CYL	2480-9407K	
DOOSAN	SEAL KIT;C/J(NOK)[65]	2480-1013EKT	
DOOSAN	SEAL KIT;C/J(NOK)S130	2480-1013KT	
DOOSAN	SEAL KIT;C/JOINT[65]	2480-6043KT	
DOOSAN	SEAL KIT;C/JOINT	2480-9026KT	
DOOSAN	SEAL KIT;CENTER JOINT	K9005861	
DOOSAN	SEAL KIT;CHOCKING CYL(DX55W)	K9006400	
DOOSAN	SEAL KIT;DOZER CYL(DX80R)	K9006618	
DOOSAN	SEAL KIT;DOZER(DX30Z(K1028460))	K9006260	
DOOSAN	SEAL KIT;DOZER	2440-9182K	
DOOSAN	SEAL KIT;DOZER	2440-9276KT	
DOOSAN	SEAL KIT;J/C(DX225LC)	K1038790KT	
DOOSAN	SEAL KIT;O/R	2440-6087K	
DOOSAN	SEAL KIT;SPOOL-SECTION	D513104KT	
DOOSAN	SEAL KIT_ARM CYL	K9003935	
DOOSAN	SEAL KIT_BOOM	K9003969	
DOOSAN	SEAL KIT_BUCKET	D511441	
DOOSAN	SEAL KIT_BUCKET	K9004589	
DOOSAN	SEAL KIT_CENTER JOINT	480-00018KT	
DOOSAN	SEAL KIT_CENTER JOINT	K9004009	
DOOSAN	SEAL KIT_D160 LIFT(D518072)	D513715	
DOOSAN	SEAL KIT_DOZER	K9003936	
DOOSAN	SEAL KIT_DX140W[29]	K9001443	
DOOSAN	SEAL KIT_SEAL KIT	K9002307	
DOOSAN	SEAL KIT	07389-05000	
DOOSAN	SEAL KIT	2274-6013KT	
DOOSAN	SEAL KIT	2440-6094KT	



WONYOUNG SEAL CORPORATION

## 2. Hydraulic seal repair kit



**Superior seal**

Korea Masterpiece

# MAKER : DOOSAN INFRACORE

MAKER	MODEL	SEAL KIT	REMARKS
DOOSAN	SEAL KIT	2440-6123KT	
DOOSAN	SEAL KIT	2440-6126K	
DOOSAN	SEAL KIT	2440-6176K	
DOOSAN	SEAL KIT	2440-6184K	
DOOSAN	SEAL KIT	2440-6490BKT	
DOOSAN	SEAL KIT	2440-6491BKT	
DOOSAN	SEAL KIT	2440-9113K	
DOOSAN	SEAL KIT	2440-9114AKT	
DOOSAN	SEAL KIT	2440-9114K	
DOOSAN	SEAL KIT	2440-9115AKT	
DOOSAN	SEAL KIT	2440-9115BK	
DOOSAN	SEAL KIT	2440-9115K	
DOOSAN	SEAL KIT	2440-9116AKT	
DOOSAN	SEAL KIT	2440-9116K	
DOOSAN	SEAL KIT	2440-9117BKT	
DOOSAN	SEAL KIT	2440-9128K	
DOOSAN	SEAL KIT	2440-9155K	
DOOSAN	SEAL KIT	2440-9156K	
DOOSAN	SEAL KIT	2440-9157K	
DOOSAN	SEAL KIT	2440-9175BKT	
DOOSAN	SEAL KIT	2440-9185KT	
DOOSAN	SEAL KIT	2440-9186AKT	
DOOSAN	SEAL KIT	2440-9217KT	
DOOSAN	SEAL KIT	2440-9218KT	
DOOSAN	SEAL KIT	2440-9239KT	
DOOSAN	SEAL KIT	2440-9253BKT	
DOOSAN	SEAL KIT	2440-9256K	
DOOSAN	SEAL KIT	2440-9260KT	
DOOSAN	SEAL KIT	2440-9261KT	
DOOSAN	SEAL KIT	2440-9304AKT	
DOOSAN	SEAL KIT	2440-9339BKT	
DOOSAN	SEAL KIT	2440-9404K	
DOOSAN	SEAL KIT	2440-9434BKT	
DOOSAN	SEAL KIT	2480-1014K	
DOOSAN	SEAL KIT	2480-9004 AIR	



WONYOUNG SEAL CORPORATION

156

## 2. Hydraulic seal repair kit



**Superior seal**

Korea Masterpiece

### MAKER : DOOSAN INFRACORE

MAKER	MODEL	SEAL KIT	REMARKS
DOOSAN	SEAL KIT	2480-9004 HYD	
DOOSAN	SEAL KIT	2480-9007AK	
DOOSAN	SEAL KIT	2480-9405K	
DOOSAN	SEAL KIT	2480-9405KT	
DOOSAN	SEAL KIT	401107-00837	
DOOSAN	SEAL KIT	401107-00871	
DOOSAN	SEAL KIT	401107-00898	
DOOSAN	SEAL KIT	401107-00899	
DOOSAN	SEAL KIT	401107-00900	
DOOSAN	SEAL KIT	440-00013AKT	
DOOSAN	SEAL KIT	440-00015AKT	
DOOSAN	SEAL KIT	440-00020AKT	
DOOSAN	SEAL KIT	440-00042BKT	
DOOSAN	SEAL KIT	440-00044AKT	
DOOSAN	SEAL KIT	440-00077KT	
DOOSAN	SEAL KIT	440-00081KT	
DOOSAN	SEAL KIT	440-00138AKT	
DOOSAN	SEAL KIT	440-00162KT	
DOOSAN	SEAL KIT	440-00184KT	
DOOSAN	SEAL KIT	440-00196KT	
DOOSAN	SEAL KIT	440-00214BKT	
DOOSAN	SEAL KIT	440-00222BKT	
DOOSAN	SEAL KIT	440-00243AKT	
DOOSAN	SEAL KIT	4440-6217K	
DOOSAN	SEAL KIT	4440-6395KT	
DOOSAN	SEAL KIT	5440-9154AKT	
DOOSAN	SEAL KIT	A215281	
DOOSAN	SEAL KIT	D510535	
DOOSAN	SEAL KIT	D511150	
DOOSAN	SEAL KIT	D511700	
DOOSAN	SEAL KIT	D512602	
DOOSAN	SEAL KIT	D512666	
DOOSAN	SEAL KIT	D512692	
DOOSAN	SEAL KIT	D512805	
DOOSAN	SEAL KIT	D513349	

## 2. Hydraulic seal repair kit



**Superior seal**

Korea Masterpiece

# MAKER : DOOSAN INFRACORE

MAKER	MODEL	SEAL KIT	REMARKS
DOOSAN	SEAL KIT	D513935	
DOOSAN	SEAL KIT-LIFT	D511480	
DOOSAN	SEAL-KIT	LX-SEAL-KIT	
DOOSAN	SEMI SEAL KIT	D512475	
DOOSAN	SL600 SEAL KIT	D510159	
DOOSAN	STEERING SEAL KIT	440-00139KT	
DOOSAN	STICK CYLINDER SEAL KIT	440-00146AKT	
DOOSAN	SWING CYL D SEAL KIT	2440-9117K	
DOOSAN	T/JOINT CYL SEAL KIT (T14)	401107-01321	
DOOSAN	T/JOINT CYL SEAL KIT	401107-01330	
DOOSAN	T30 ARM SEAL KIT	K9001008	
DOOSAN	T30 BOOM SEAL KIT	K9001007	
DOOSAN	T30 BUCKET SEAL KIT	K9001009	
DOOSAN	T30 CENTER JOINT SEAL KIT[29]	K9001025	
DOOSAN	TILT CYL D SEAL KIT	401107-00869	
DOOSAN	TILT CYL D SEAL KIT	401107-00870	
DOOSAN	TILT CYL D SEAL KIT	D510680KT	
DOOSAN	TILT CYL D SEAL KIT	D510840KT	
DOOSAN	TILT CYLINDER SEAL KIT	401107-00832	
DOOSAN	TILT SEAL KIT( -85.5)	1400-2027K	
DOOSAN	TILT SEAL KIT(86.7- )	1400-2023K	
DOOSAN	TILT SEAL KIT(A135270)	401107-00896	
DOOSAN	TILT SEAL KIT(A135270)	D512322	
DOOSAN	TILT SEAL KIT	1400-2018KT	
DOOSAN	TILT SEAL KIT	1440-2014K	
DOOSAN	TILT SEAL KIT	401107-00508	
DOOSAN	TILT SEAL KIT	401107-00509	
DOOSAN	TILT SEAL KIT	401107-00510A	
DOOSAN	TILT SEAL KIT	401107-00827	
DOOSAN	TILT SEAL KIT	401107-00844	
DOOSAN	TILT SEAL KIT	401107-00850	
DOOSAN	TILT SEAL KIT	401107-00854	
DOOSAN	TILT SEAL KIT	D184100KT	
DOOSAN	TILT SEAL KIT	D501232	
DOOSAN	TILT SEAL KIT	D510035	



WONYOUNG SEAL CORPORATION

158

## 2. Hydraulic seal repair kit



**Superior seal**

Korea Masterpiece

# MAKER : DOOSAN INFRACORE

MAKER	MODEL	SEAL KIT	REMARKS
DOOSAN	TRACK ADJUST_SEAL KIT	2274-1008BKT	
DOOSAN	TRACK ADJUST_SEAL KIT	2274-1014AKT	
DOOSAN	TRACK ADJUST_SEAL KIT	2274-9401BKT	
DOOSAN	TRACK CYLINDER_SEAL KIT	2460-1004KT	
DOOSAN	TRACK SPRING_SEAL KIT	2129-6013BKT	
DOOSAN	TRACK SPRING_SEAL KIT	2440-9316AKT	
DOOSAN	TRACK SPRING_SEAL KIT	274-00004BKT	
DOOSAN	TRACK SPRING_SEAL KIT	274-00009KT	
DOOSAN	TRACK SPRING_SEAL KIT	401107-00543	
DOOSAN	TRACK SPRING_SEAL KIT	401107-00677	
DOOSAN	TRACK SPRING_SEAL KIT	401107-00920	
DOOSAN	TRACK_SEAL KIT	401107-00921	
DOOSAN	U34_TRACK_SEAL KIT	401107-01023	
DOOSAN	U34_TRACK_SEAL KIT	401107-01273	
DOOSAN	U48_SEAL KIT	401107-01085	
DOOSAN	WHEEL CY D PISTON_SEAL KIT	D160776	



WONYOUNG SEAL CORPORATION

## 2. Hydraulic seal repair kit



**Superior seal**

Korea Masterpiece

### MAKER : HITACHI

MAKER	MODEL	SEAL KIT	REMARKS
HITACHI	EX100 ARM(WIPRO) SEAL KIT	TD 00751/38	OD:SPGW105, ID: 75*85*12
HITACHI	EX100 ARM/EX120 BOOM_KIT	4206343	OD:GR105, ID: 75*90*9
HITACHI	EX100 BOOM (WIPRO) SEAL KIT	TD 00749/46	OD:GR95, ID: 70*85*11.4
HITACHI	EX100 BOOM SEAL KIT	4206340	OD:GR95, ID: 70*85*9
HITACHI	EX100 BUCKET(WIPRO) SEAL KIT	TD 00752/40	OD:GR95, ID: 65*80*12
HITACHI	EX100 T/ADJUST SEAL KIT	9074447K	
HITACHI	EX100/EX120 BUCKET SEAL KIT	4206345	OD:GR95, ID: 65*80*9
HITACHI	EX100-1 T/ADJUST SEAL KIT		
HITACHI	EX100-2 ARM SEAL KIT	4286770	
HITACHI	EX100-2 BOOM SEAL KIT	4286743	
HITACHI	EX100-2 BUCKET SEAL KIT	4286739	
HITACHI	EX100-2 T/ADJUST SEAL KIT		
HITACHI	EX100-3 ARM SEAL KIT	4320997	
HITACHI	EX100-3 BOOM SEAL KIT	4320996	
HITACHI	EX100-3 BUCKET SEAL KIT	4320994	
HITACHI	EX100-5 ARM SEAL KIT	4379261	
HITACHI	EX100-5 BOOM SEAL KIT	4379260	
HITACHI	EX100-5 BUCKET SEAL KIT	4364914	
HITACHI	EX100W C/JOINT C/JOINT SEAL KIT		
HITACHI	EX120 ARM SEAL KIT	4206344	
HITACHI	EX120 BOOM SEAL KIT	4206343	
HITACHI	EX120 BUCKET SEAL KIT	4206345	
HITACHI	EX120-1 T/ADJUST SEAL KIT		
HITACHI	EX120-1T/JOINT SEAL KIT		
HITACHI	EX120-2 ARM SEAL KIT	4286463	
HITACHI	EX120-2 BOOM SEAL KIT	4286459	
HITACHI	EX120-2 BUCKET SEAL KIT	4286739	
HITACHI	EX120-2/3/5 ARM SEAL KIT	4206344	OD:GR115, ID: 80*95*9
HITACHI	EX120-2/3/5 ARM SEAL KIT	4286463	OD:GR110, ID: 80*95*9
HITACHI	EX120-2/3/5 BOOM SEAL KIT	4286459	
HITACHI	EX120-2/3/5 BUCKET SEAL KIT	4286739	
HITACHI	EX120-2T/JOINT SEAL KIT		
HITACHI	EX120-3 (NEW) BOOM SEAL KIT	4369772	OD:GR105, ID: 70*85*9
HITACHI	EX120-3 (NEW) BUCKET SEAL KIT	4369766	OD:GR95, ID: 65*80*9
HITACHI	EX120-3 (NEW) ARM CYL SEAL KIT	4369892	OD:GR110, ID: 80*95*9



WONYOUNG SEAL CORPORATION

## 2. Hydraulic seal repair kit



**Superior seal**

Korea Masterpiece

### MAKER : HITACHI

MAKER	MODEL	SEAL KIT	REMARKS
HITACHI	EX120-3 (OLD) ARM_SEAL KIT	4320993	OD:GR110, ID: 80*95*9
HITACHI	EX120-3 (OLD) BOOM_SEAL KIT	4320990	OD:GR105, ID: 70*85*9
HITACHI	EX120-3 (OLD) BUCKET_SEAL KIT	4320994	OD:GR95, ID: 65*80*9
HITACHI	EX120-3T/JOINT_SEAL KIT		
HITACHI	EX120-5 ARM_SEAL KIT	4364913	
HITACHI	EX120-5 BOOM_SEAL KIT	4364912	
HITACHI	EX120-5 BUCKET_SEAL KIT	4364914	
HITACHI	EX120WD-1 ARM_SEAL KIT		
HITACHI	EX120WD-1 BOOM_SEAL KIT		
HITACHI	EX120WD-1 BUCKET_SEAL KIT		
HITACHI	EX150 ARM_SEAL KIT	4216264	
HITACHI	EX150 BOOM_SEAL KIT	4216263	
HITACHI	EX150 BUCKET_SEAL KIT	4216263	
HITACHI	EX150-5 ARM_SEAL KIT	4389720	
HITACHI	EX150-5 BOOM_SEAL KIT	4389719	
HITACHI	EX150-5 BUCKET_SEAL KIT	4389721	
HITACHI	EX200 ARM(WIPRO) SEAL KIT	TD 00718/40	OD:SPGW135, ID: 95*115*12
HITACHI	EX200 ARM(WIPRO) NEW_SEAL KIT	TD 20604/40	OD:SPGW135, ID: 95*110*9
HITACHI	EX200 ARM_SEAL KIT	4206019	OD:GR135, ID: 95*115*12
HITACHI	EX200 BOOM(WIPRO) SEAL KIT	TD 00716/49	OD:GR125, ID: 85*100*12
HITACHI	EX200 BOOM(WIPRO) NEW_SEAL KIT	TD 20605/43	OD:SPGW125, ID: 85*100*9
HITACHI	EX200 BUCKET(WIPRO) SEAL KIT	TD 00719/41	OD:GR120, ID: 80*95*9
HITACHI	EX200 BUCKET(WIPRO) NEW_SEAL KIT	TD 20607/43	OD:SPGW115, ID: 85*100*9
HITACHI	EX200 BUCKET_SEAL KIT	4206020	OD:GR120, ID: 80*95*9
HITACHI	EX200 C/JOINT_SEAL KIT		
HITACHI	EX200 T/ADJUST_SEAL KIT	9074450K	
HITACHI	EX200 T/JOINT_SEAL KIT		
HITACHI	EX200-1 ARM_SEAL KIT	4206019	OD:GR135, ID: 95*115*12
HITACHI	EX200-1 BOOM_SEAL KIT	4206018	OD:GR125, ID: 85*100*9
HITACHI	EX200-1 BUCKET_SEAL KIT	4206020	OD:GR120, ID: 80*95*9
HITACHI	EX200-2 ARM_SEAL KIT	4286780	OD:GR130, ID: 95*115*12
HITACHI	EX200-2 BOOM_SEAL KIT	4286774	OD:GR120, ID: 85*100*9
HITACHI	EX200-2 BUCKET_SEAL KIT	4286784	OD:GR110, ID: 75*90*9
HITACHI	EX200-2 T/ADJUST_SEAL KIT		
HITACHI	EX200-2/3 ARM_SEAL KIT	4286780	





WONYOUNG SEAL CORPORATION

## 2. Hydraulic seal repair kit



**Superior seal**

Korea Masterpiece

### MAKER : HITACHI

MAKER	MODEL	SEAL KIT	REMARKS
HITACHI	EX200-2_BOOM_SEAL KIT	4286774	
HITACHI	EX200-2_T/JOINT_SEAL KIT		
HITACHI	EX200-5_ARM_SEAL KIT	4364916	
HITACHI	EX200-5_BUCKET_SEAL KIT	4364917	
HITACHI	EX200-5_C/JOINT_SEAL KIT		
HITACHI	EX200-5_BOOM_SEAL KIT	4364915	
HITACHI	EX200T/ADJUST_SEAL KIT		
HITACHI	EX210LC_ARM(WIPRO)_SEAL KIT	TC 00794/38	OD:SPGW130, ID: 95*110*10
HITACHI	EX210LC_BOOM(WIPRO)_SEAL KIT	TC 00792/35	OD:SPGW120, ID: 85*100*10
HITACHI	EX210LC_BUCKET(WIPRO)_SEAL KIT	TC 00795/37	OD:SPGW110, ID: 75*90*9
HITACHI	EX220-1_ARM_SEAL KIT	4203831	
HITACHI	EX220-1_BOOM_SEAL KIT	4203830	
HITACHI	EX220-1_BUCKET_SEAL KIT	4203830	
HITACHI	EX220-2_ARM_SEAL KIT	9103843	
HITACHI	EX220-2_BOOM_SEAL KIT	9103842	
HITACHI	EX220-2_BUCKET_SEAL KIT	9103844	
HITACHI	EX220-5_ARM_SEAL KIT	9156441	
HITACHI	EX220-5_BOOM_SEAL KIT	9178283	OD:SPGW125, ID: 90*105*9
HITACHI	EX220-5_BOOM_SEAL KIT	9178284	OD:SPGW135, ID: 100*115*9
HITACHI	EX220-5_BOOM_SEAL KIT	9144507	
HITACHI	EX220-5_BUCKET_SEAL KIT	9144508	
HITACHI	EX270_ARM_SEAL KIT	9078844	
HITACHI	EX270_BOOM_SEAL KIT	9078843	
HITACHI	EX270_BUCKET_SEAL KIT	9078843	
HITACHI	EX270-5_ARM_SEAL KIT	9161918	
HITACHI	EX270-5_BOOM_SEAL KIT	9161917	
HITACHI	EX270-5_BUCKET_SEAL KIT	9161919	
HITACHI	EX300_C/JOINT_SEAL KIT		
HITACHI	EX300-1_ARM_SEAL KIT	9078846	
HITACHI	EX300-1_BOOM_SEAL KIT	9078845	
HITACHI	EX300-1_BUCKET_SEAL KIT	9078843	
HITACHI	EX300-1_T/ADJUST_SEAL KIT	EX300-1-T/A	
HITACHI	EX300-2_ARM_SEAL KIT	9123264	
HITACHI	EX300-2_BUCKET_SEAL KIT	9123265	
HITACHI	EX300-2_BOOM_CYL' SEALK KIT	9123263	



WONYOUNG SEAL CORPORATION

## 2. Hydraulic seal repair kit



**Superior seal**

Korea Masterpiece

### MAKER : HITACHI

MAKER	MODEL	SEAL KIT	REMARKS
HITACHI	EX300-3 ARM_SEAL KIT	9123264	
HITACHI	EX300-3 BOOM_SEAL KIT	9078845	
HITACHI	EX300-3 BUCKET_SEAL KIT	9123265	
HITACHI	EX300-5/ZAXIS 330 ARM_KIT	9173711	
HITACHI	EX300-5/ZAXIS 330 BOOM_KIT	9173710	OD:SPGW150, ID:105*120*9
HITACHI	EX300-5/ZAXIS 330 BUCKET_KIT	9154896	
HITACHI	EX300-5-ZX370 BOOM_SEAL KIT	9180581	OD:SPGW150, ID:105*120*9
HITACHI	EX400 ARM_SEAL KIT	4236058	
HITACHI	EX400 BOOM / BUCKET_SEAL KIT	4236057	
HITACHI	EX400 BUCKET_SEAL KIT	4236057	
HITACHI	EX400 C/JOINT_SEAL KIT		
HITACHI	EX400-3/5 BOOM / BUCKET_SEAL KIT	4340620	
HITACHI	EX40U ARM_SEAL KIT		OD:GR60, ID: 50*65*9
HITACHI	EX40U BUCKET_SEAL KIT		OD:GR70, ID: 40*55*9
HITACHI	EX40U S/NO.(WITH S/R) BOOM_SEAL KIT		OD:GR90, ID: 55*70*9
HITACHI	EX60 ARM(WIPRO)_SEAL KIT	TC00600/35	OD:GR95, ID: 60*73*10
HITACHI	EX60 ARM_SEAL KIT	4217003	OD:GR100, ID: 60*75*9
HITACHI	EX60 BLADE(WIPRO)_SEAL KIT	TC00602/22	
HITACHI	EX60 BOOM(WIPRO)_SEAL KIT	TC00599/36	
HITACHI	EX60 BOOM_SEAL KIT	4217002	
HITACHI	EX60 BUCKET(WIPRO)_SEAL KIT	TC00601/36	OD:GR85, ID: 55*68*10
HITACHI	EX60 BUCKET_SEAL KIT	4217004	OD:GR90, ID: 55*70*9
HITACHI	EX60 C/JOINT_SEAL KIT		ROI80
HITACHI	EX60W C/JOINT_SEAL KIT		ROI110
HITACHI	UH0083-1 BOOM_SEAL KIT	4169353	
HITACHI	UH02 T/ADJUST_SEAL KIT		
HITACHI	UH025 T/ADJUST_SEAL KIT		
HITACHI	UH04-3 ARM_SEAL KIT	4089552	OD:OHM120, ID: 80*100*12
HITACHI	UH04-3 ARM_SEAL KIT	4101986	OD:OHM120, ID: 70*90*12
HITACHI	UH04-3 BOOM_SEAL KIT	4089551	
HITACHI	UH04-3 BUCKET_SEAL KIT	4089553	
HITACHI	UH04-5 ARM_SEAL KIT(NEW)	4101986	OD:OHM120, ID: 70*90*12
HITACHI	UH04-5 ARM_SEAL KIT(OLD)	4089552	OD:OHM120, ID: 80*100*12
HITACHI	UH04-5 BOOM_SEAL KIT	4089551	
HITACHI	UH04-5 BUCKET_SEAL KIT	4089553	



WONYOUNG SEAL CORPORATION

## 2. Hydraulic seal repair kit



**Superior seal**

Korea Masterpiece

### MAKER : HITACHI

MAKER	MODEL	SEAL KIT	REMARKS
HITACHI	UH045-5 T/ADJUST_SEAL KIT		
HITACHI	UH04M-2 ARM_SEAL KIT		
HITACHI	UH04M-2 BOOM_SEAL KIT		
HITACHI	UH04M-2 BUCKET_SEAL KIT		
HITACHI	UH053M T/ADJUST_SEAL KIT		
HITACHI	UH063 ARM_SEAL KIT	4149828	
HITACHI	UH063 BOOM_SEAL KIT	4149826	
HITACHI	UH063 BUCKET_SEAL KIT	4149827	
HITACHI	UH063 T/ADJUST_SEAL KIT		
HITACHI	UH07-3 ARM_SEAL KIT	4071693	OD:OHM125, ID: 85*105*12
HITACHI	UH07-3 ARM_SEAL KIT (LONG ARM)	4094458	OD:OHM125, ID: 85*105*12
HITACHI	UH07-3 BOOM_SEAL KIT	4071692	OD:OHM125, ID: 85*105*12
HITACHI	UH07-3 BOOM_SEAL KIT (LONG BOOM)	4094457	OD:OHM125, ID: 85*105*12
HITACHI	UH07-3 BUCKET_SEAL KIT	4071694	
HITACHI	UH07-5 ARM_SEAL KIT		
HITACHI	UH07-5 BOOM_SEAL KIT		
HITACHI	UH07-5 BUCKET_SEAL KIT		
HITACHI	UH07-5 T/ADJUST_SEAL KIT		
HITACHI	UH07-7 BOOM_SEAL KIT	4169353 (NO.22317UP)	
HITACHI	UH07-7 C/JOINT_SEAL KIT		
HITACHI	UH07-7 / UH083 ARM_SEAL KIT	4153205 (NO.20001~22316)	
HITACHI	UH07-7 / UH083 BOOM_SEAL KIT	4153203 (NO.20001~22316)	
HITACHI	UH07-7 / UH083 BUCKET_SEAL KIT	4153207 (NO.20001~22316)	
HITACHI	UH07-7 ARM_SEAL KIT	4153211 (NO.22317UP)	
HITACHI	UH07-7 BUCKET_SEAL KIT	4153213 (NO.22317UP)	
HITACHI	UH083-1 ARM_SEAL KIT	4153211	
HITACHI	UH083-1 BUCKET_SEAL KIT	4153213	
HITACHI	UH09-7 T/ADJUST_SEAL KIT		
HITACHI	UH10-7 T/ADJUST_SEAL KIT		
HITACHI	UH121 T/ADJUST_SEAL KIT		
HITACHI	UH16 T/ADJUST_SEAL KIT		
HITACHI	ZAX SEAL KIT	4662066	
HITACHI	ZAX110M/200 T/ADJUST_SEAL KIT	9188207K	
HITACHI	ZAX120 T/ADJUST_SEAL KIT	ZAX120ADJUSTKT	
HITACHI	ZAX200 ARM_SEAL KIT	4448399	INDIA(OD:GR135, ID: 95*110*9)



WONYOUNG SEAL CORPORATION

164

## 2. Hydraulic seal repair kit



**Superior seal**

Korea Masterpiece

### MAKER : HITACHI

MAKER	MODEL	SEAL KIT	REMARKS
HITACHI	ZAX200 ARM_SEAL KIT	4448399	OD:GR135, ID: 95*110*9
HITACHI	ZAX200 ARM_SEAL KIT	4654422	OD:GR135, ID: 95*110*9
HITACHI	ZAX200 BOOM_SEAL KIT	4448398	OD:GR120, ID: 85*100*9
HITACHI	ZAX200 BUCKET_SEAL KIT	1102306	OD:GR115, ID: 80*95*9
HITACHI	ZAX200 BUCKET_SEAL KIT	4448400	OD:GR115, ID: 80*95*9
HITACHI	ZAX200-3 BOOM_SEAL KIT	4661485	OD:GR120, ID: 85*100*9
HITACHI	ZAX200-3 BUCKET_SEAL KIT	1102306	
HITACHI	ZAX200-ZAX210-3 ARM_SEAL KIT	4654422	OD:GR135, ID: 95*110*9
HITACHI	ZAX225-1 BUCKET_SEA; KIT	4654423	
HITACHI	ZAX230/240 ARM_SEAL KIT	9207058	
HITACHI	ZAX230/240 ARM_SEAL KIT	9207059	
HITACHI	ZAX230/240 BOOM_SEAL KIT	ZAX230BOOM	
HITACHI	ZAX230/240 BUCKET_SEAL KIT	ZAX230BUCKET	
HITACHI	ZAX240-ZAX250-3 ARM_SEAL KIT	4649050	
HITACHI	ZAX330 ARM_SEAL KIT	9180582	
HITACHI	ZAX330 BOOM_SEAL KIT	9180581	
HITACHI	ZAX330 BUCKET_SEAL KIT	9175564	
HITACHI	ZAX330-3-ZAX360-3 BOOM_SEAL KIT	4649049	
HITACHI	ZAX330-ZAX360-3 ARM_SEAL KIT	4649051	
HITACHI	ZAX330-ZAX360-3 BUCKET_SEAL KIT	4649053	



WONYOUNG SEAL CORPORATION

## 2. Hydraulic seal repair kit



**Superior seal**

Korea Masterpiece

### MAKER : HYUNDAI

MAKER	MODEL	SEAL KIT	REMARKS
HYUNDAI	39FG-70011_SEAL KIT	31Y3-19770	
HYUNDAI	BUCKET_SEAL KIT	XKCC-00631	
HYUNDAI	DX60_SEAL KIT	31Y1-15690	
HYUNDAI	F12620300	31Y5-00150	
HYUNDAI	HBF20-2_LIFT_SEAL KIT	F12620300	
HYUNDAI	HDF20/25-5_LIFT_SEAL KIT	31Y3-18530	
HYUNDAI	HDF20-2_SEAL KIT	6060-DF-3000	
HYUNDAI	HDF20-5_LIFT_SEAL KIT	31Y3-18750	
HYUNDAI	HDF20-5_LIFT_SEAL KIT	31Y3-18760	
HYUNDAI	HDF20-5_TILT_SEAL KIT	31Y3-18960	
HYUNDAI	HDF30-5_LIFT_SEAL KIT	31Y3-18740	
HYUNDAI	HDF30-5_SEAL KIT	31Y3-18901	
HYUNDAI	HDF35_TILT_SEAL KIT	31Y3-15671	
HYUNDAI	HDF35-3_LIFT_SEAL KIT	31Y3-15650	
HYUNDAI	HDF35-3_TILT_SEAL KIT	31Y3-15670	
HYUNDAI	HDF35-3_SEAL KIT	31Y1-16540	
HYUNDAI	HDF50-3_LIFT_SEAL KIT	31Y3-14490	
HYUNDAI	HDF50-3_TILT_SEAL KIT	31Y3-13810	
HYUNDAI	HDF70-3_SEAL KIT	31Y3-16660	
HYUNDAI	HL17C_STEERING_SEAL KIT	31Y2-00900	
HYUNDAI	HL180SM_BUCKET_SEAL KIT	31Y2-04750	
HYUNDAI	HL600S-3_BOOM_SEAL KIT	31Y2-00480	
HYUNDAI	HL600S-3_TILT_SEAL KIT	31Y2-00510	
HYUNDAI	HL730_STEERING_SEAL KIT	31Y2-05311	
HYUNDAI	HL740-7_SEAL KIT	31Y2-08080	
HYUNDAI	HL757-7_BUCKET_SEAL KIT	31Y2-07430	
HYUNDAI	HL757-7_STEERING_SEAL KIT	31Y2-07590	
HYUNDAI	HL760-7_STEERING_SEAL KIT	31Y2-07860	
HYUNDAI	HL760-7_SEAL KIT	31Y2-07660	
HYUNDAI	HL760-7_SEAL KIT	31Y2-07770	
HYUNDAI	HL770-7_STEERING_SEAL KIT	31Y2-08270	
HYUNDAI	HL810SM_BOOM_SEAL KIT	31Y2-04640	
HYUNDAI	HLF20-2_TILT_SEAL KIT	31Y3-16760	
HYUNDAI	HR25D_HOIST_SEAL KIT	31Y3-00490	
HYUNDAI	HR35D_LIFT_SEAL KIT	31Y3-01030	



WONYOUNG SEAL CORPORATION

## 2. Hydraulic seal repair kit



**Superior seal**

Korea Masterpiece

### MAKER : HYUNDAI

MAKER	MODEL	SEAL KIT	REMARKS
HYUNDAI	HR35D SEAL KIT	31Y3-00750	
HYUNDAI	HSL600 BOOM_SEAL KIT	31Y2-00480	
HYUNDAI	HSL600-7 LIFT_SEAL KIT	31Y2-10030	
HYUNDAI	HSL600-7 TLT_SEAL KIT	31Y2-10130	
HYUNDAI	LG230 ARM_SEAL KIT	31YR-09120	
HYUNDAI	LG230_BOOM_SEAL KIT	31YR-09280	
HYUNDAI	OUT RIGGER (R200W-2)	31Y1-05950	
HYUNDAI	R1300LC ARM_SEAL KIT	91E6-2712	
HYUNDAI	R1300LC BOOM_SEAL KIT	91E6-2711	
HYUNDAI	R1300LC BUCKET_SEAL KIT	91E6-2713	
HYUNDAI	R1300LC3 ARM_SEAL KIT	31Y1-03710	
HYUNDAI	R1300LC3 ARM_SEAL KIT	31Y1-03712	
HYUNDAI	R1300LC3 BOOM_SEAL KIT	31Y1-03560	
HYUNDAI	R1300LC3 BOOM_SEAL KIT	31Y1-03562	
HYUNDAI	R1300LC3 BUCKET_SEAL KIT	31Y1-03861	
HYUNDAI	R1300W ARM_SEAL KIT	707-99-38610	
HYUNDAI	R1300W BOOM_SEAL KIT	707-99-36230	
HYUNDAI	R1300W BUCKET_SEAL KIT	707-99-36250	
HYUNDAI	R1300WM T/JOINT_SEAL KIT	91E6-27150	
HYUNDAI	R130C7 BUCKET_SEAL KIT	31Y1-18210	
HYUNDAI	R130LC BKT_SEAL KIT	31Y1-03860	
HYUNDAI	R130LC BKT_SEAL KIT	31Y1-03862	
HYUNDAI	R130LC3 S/LOCK_SEAL KIT	31Y1-15980	
HYUNDAI	R170W-3 SEAL KIT	31Y1-04912	
HYUNDAI	R1800LC3 T/JOINT_SEAL KIT	91E6-2718	
HYUNDAI	R2000W2 ARM_SEAL KIT	91E1-2707	
HYUNDAI	R2000W2 BOOM_SEAL KIT	91E1-2706	
HYUNDAI	R2000W2 DOZER_SEAL KIT	91E4-2019	
HYUNDAI	R200LC ARM_SEAL KIT	91E1-2718	
HYUNDAI	R200W2 BUCKET_SEAL KIT	91E1-2708	
HYUNDAI	R210C7 ARM_SEAL KIT	31Y1-18240	
HYUNDAI	R210C7_BOOM_SEAL KIT	31Y1-15880	
HYUNDAI	R210LC-3 ARM_SEAL KIT	31Y1-06731	
HYUNDAI	R210LC-3 BOOM_SEAL KIT	31Y1-06561	
HYUNDAI	R210LC-3 BUCKET_SEAL KIT	31Y1-06841	



WONYOUNG SEAL CORPORATION

## 2. Hydraulic seal repair kit



**Superior seal**

Korea Masterpiece

### MAKER : HYUNDAI

MAKER	MODEL	SEAL KIT	REMARKS
HYUNDAI	R210LC3 HOIST_SEAL KIT	31Y6-00110	
HYUNDAI	R210LC-3 SA/LOCK_SEAL KIT	31Y1-15930	
HYUNDAI	R210LC3_SEAL KIT	31Y1-12630	
HYUNDAI	R210LC7_ARM_SEAL KIT	31Y1-15230	
HYUNDAI	R210NLC7_SEAL KIT	31Y1-16180	
HYUNDAI	R215-7 BUCKET_SEAL KIT	31Y1-05612	
HYUNDAI	R215-7_SEAL KIT	31Y1-05261	
HYUNDAI	R2200LC7 BOOM_SEAL KIT	31Y1-05800	
HYUNDAI	R2200LC7 BUCKET_SEAL KIT	31Y1-15700	
HYUNDAI	R2900LC3 T/JOINT_SEAL KIT	91E1-2705	
HYUNDAI	R290LC-3 S/LOCK SEAL KIT	31Y1-15950	
HYUNDAI	R290LC-3_SEAL KIT	31Y1-16050	
HYUNDAI	R320C-7 SEAL KIT	31Y1-21100	
HYUNDAI	R320LC7_SEAL KIT	31Y1-19550	
HYUNDAI	R360C7_ARM_SEAL KIT	31Y1-18480	
HYUNDAI	R360C7 BKT_SEAL KIT	31Y1-18490	
HYUNDAI	R360C7 BOOM_SEAL KIT	31Y1-20910	
HYUNDAI	R360C7_SEAL KIT	31Y1-20920	
HYUNDAI	R4500C7 BOOM SEAL KIT	31Y1-18411	
HYUNDAI	R4500LC3 CENTER JOINT SEAL KIT	91E6-27110	
HYUNDAI	R450LC3 SEAL KIT	31Y1-16100	
HYUNDAI	R450LC3_SEAL KIT	31Y1-16110	
HYUNDAI	R550W-3 SEAL KIT	31Y1-12072	
HYUNDAI	R555C7 BUCKET_SEAL KIT	31Y1-24370	
HYUNDAI	R555C7 BOOM SWING SEAL KIT	31Y1-24420	
HYUNDAI	R55-7A ARM SEAL KIT	31Y1-24350	
HYUNDAI	R55-7A BOOM_SEAL KIT	31Y1-24310	
HYUNDAI	R630LC7_SEAL KIT	31YN-40950	
HYUNDAI	SEAL KIT	31Y6-00180	
HYUNDAI	SEAL KIT	3EB6405070	
HYUNDAI	SEAL KIT	3EB6405080	
HYUNDAI	SEAL KIT	91E6-2705	
HYUNDAI	STEERING SEAL KIT	31Y3-16840	
HYUNDAI	TURNING JOINT SEAL KIT	91E6-27111	
HYUNDAI	100D-7 STEERING SEAL KIT	31Y3-25450	



WONYOUNG SEAL CORPORATION

## 2. Hydraulic seal repair kit



**Superior seal**

Korea Masterpiece

### MAKER : HYUNDAI

MAKER	MODEL	SEAL KIT	REMARKS
HYUNDAI	33HD-07110/35B,40B,45B LIFT_SEAL KIT	31Y3-30370	
HYUNDAI	33HD-07110/50BA LIFT_SEAL KIT	31Y3-30340	
HYUNDAI	33HD-07513/50BA_FREE LIFT_SEAL KIT	31Y3-30350	
HYUNDAI	33HD-07601/35B,40B,45B_FREE_SEAL KIT	31Y3-30360	
HYUNDAI	39FG-70011_SEAL KIT	31Y3-19770	
HYUNDAI	BUCKET_SEAL KIT	31Y1-11450	
HYUNDAI	BUCKET_SEAL KIT	31Y1-14270	
HYUNDAI	F01 STEERING_SEAL KIT	31YN-04300	
HYUNDAI	HBR14-2 TITL_SEAL KIT	5109005200(9)	
HYUNDAI	HBR14-2_SEAL KIT	5102005300	
HYUNDAI	HBR14-2_SEAL KIT	5109005200	
HYUNDAI	HBR14-2_SEAL KIT	5109005400	
HYUNDAI	HC25 HOR_SEAL KIT	31Y5-00150	
HYUNDAI	HC25 HOR_SEAL KIT	31Y5-00520	
HYUNDAI	HC25 JAK_SEAL KIT	31Y5-00380	
HYUNDAI	HC25 VERTICAL_SEAL KIT	31Y5-00250	
HYUNDAI	HC25 VERTICAL_SEAL KIT	31Y5-01400	
HYUNDAI	HC25 HOIST_SEAL KIT	31Y5-01070	
HYUNDAI	HC25 TELESCOPE_SEAL KIT	31Y5-01090	
HYUNDAI	HC50 JAK_SEAL KIT	31Y5-00810	
HYUNDAI	HC50 TELESCOPE_SEAL KIT	31Y5-01090	
HYUNDAI	HC50 VERTICAL_SEAL KIT	31Y5-00700	
HYUNDAI	HC50_SEAL KIT	31Y5-01090	
HYUNDAI	HC50 HOIST_SEAL KIT	31Y5-01150	
HYUNDAI	HC50 HOR_SEAL KIT	31Y5-00520	
HYUNDAI	HD75D TILT_SEAL KIT	31Y3-11280	
HYUNDAI	HDF135/165-7 LIFT_SEAL KIT	31Y3-25110	
HYUNDAI	HDF15-3 TILT_SEAL KIT	6600391200	
HYUNDAI	HDF35-3_SEAL KIT	31FE-09000	
HYUNDAI	HDF50A TILT_SEAL KIT	6025-DF7-1000	
HYUNDAI	HL17 BUCKET_SEAL KIT	91L3-2713	
HYUNDAI	HL720 BOOM_SEAL KIT	31Y2-04930	
HYUNDAI	HL720 STEERING CYL_SEAL KIT	31Y2-05311	
HYUNDAI	HL720-3 ARM_SEAL KIT	31Y2-05070	
HYUNDAI	HL730 BOOM_SEAL KIT	31Y2-04281	





WONYOUNG SEAL CORPORATION

## 2. Hydraulic seal repair kit



**Superior seal**

Korea Masterpiece

### MAKER : HYUNDAI

MAKER	MODEL	SEAL KIT	REMARKS
HYUNDAI	HL730 BUCKET_SEAL KIT	31Y2-03751	
HYUNDAI	HL730 STEERING CYL SEAL KIT	31Y2-05311	
HYUNDAI	HL730TM3 BUCKET_SEAL KIT	31Y2-06520	
HYUNDAI	HL740 BOOM_SEAL KIT	31Y2-03751	
HYUNDAI	HL740 BUCKET_SEAL KIT	31Y2-03921	
HYUNDAI	HL740 STEERING CYL SEAL KIT	31Y2-04062	
HYUNDAI	HL740TM3 BOOM_SEAL KIT	31Y2-03751	
HYUNDAI	HL740TM3 BUCKET_SEAL KIT	31Y2-05790	
HYUNDAI	HL750 BOOM SEAL KIT	31Y2-01990	
HYUNDAI	HL750 BUCKET SEAL KIT	31Y2-02180	
HYUNDAI	HL750 STEERING CYL SEAL KIT	31Y2-04062	
HYUNDAI	HL750TM3 BOOM SEAL KIT	31Y2-06260	
HYUNDAI	HL750TM3 BUCKET SEAL KIT	31Y2-06251	
HYUNDAI	HL760 BOOM_SEAL KIT	31Y2-02490	
HYUNDAI	HL760 BUCKET_SEAL KIT	31Y2-02600	
HYUNDAI	HL760 STEERING CYL SEAL KIT	31Y2-02690	
HYUNDAI	HL770 BOOM_SEAL KIT	31Y2-02860	
HYUNDAI	HL770 BUCKET_SEAL KIT	31Y2-02970	
HYUNDAI	HL770 STEERING CYL SEAL KIT	31Y2-03030	
HYUNDAI	HL780 BOOM_SEAL KIT	31Y2-03180	
HYUNDAI	HL780 BUCKET SEAL KIT	31Y2-03400	
HYUNDAI	HL780 STEERING CYL SEAL KIT	31Y2-03580	
HYUNDAI	HL780 3A BUCKET SEAL KIT	31Y2-03400	
HYUNDAI	HSL810 BOOM SEAL KIT	31Y2-04640	
HYUNDAI	LG230 ARM SEAL KIT	31YR - 08400(31YR-09120)	
HYUNDAI	LG230 BOOM SEAL KIT	31YR - 08400(31YR-09280)	
HYUNDAI	LG230 BUCKET SEAL KIT	31YR - 08400(31YR- 09420)	
HYUNDAI	LL634 2 HEEL RACH CYL SEAL KIT	31Y6-00290	
HYUNDAI	R120LC7 ARM SEAL KIT	31Y1-15235	
HYUNDAI	R120LC7 ARM SEAL KIT	31Y1-15236	
HYUNDAI	R120LC7 ARM SEAL KIT	31Y1-15236	INDIA
HYUNDAI	R120LC7 BOOM SEAL KIT	31Y1-15885N	
HYUNDAI	R120LC7 BOOM SEAL KIT	31Y1-15885N	INDIA
HYUNDAI	R120LC7 BUCKET SEAL KIT	31Y1-15705N	
HYUNDAI	R120LC7 BUCKET SEAL KIT	31Y1-15705N	INDIA



WONYOUNG SEAL CORPORATION

## 2. Hydraulic seal repair kit



**Superior seal**

Korea Masterpiece

### MAKER : HYUNDAI

MAKER	MODEL	SEAL KIT	REMARKS
HYUNDAI	R1300LC BOOM_SEAL KIT	31Y1-03560	
HYUNDAI	R1300LC BOOM_SEAL KIT	91E6-2711	
HYUNDAI	R1300LC BUCKET_SEAL KIT	91E6-2713	
HYUNDAI	R1300LC ARM_SEAL KIT	91E6-2712	
HYUNDAI	R1300LC-3 BOOM_SEAL KIT	31Y1-03561	
HYUNDAI	R1300LC-3 BOOM_SEAL KIT	31Y1-03562	
HYUNDAI	R1300LC-3 BUCKET_SEAL KIT	31Y1-03861	
HYUNDAI	R1300LC-3 ARM_SEAL KIT	31Y1-03711	
HYUNDAI	R1300LC-3 ARM_SEAL KIT	31Y1-03712	
HYUNDAI	R1300W BLADE_SEAL KIT	31Y1-02970	
HYUNDAI	R1300W BUCKET_SEAL KIT	707-99-36250	
HYUNDAI	R1300W ARM_SEAL KIT	31Y1-02740	
HYUNDAI	R1300W BOOM_SEAL KIT	31Y1-02570	
HYUNDAI	R1300W BOOM_SEAL KIT	31Y1-02570	
HYUNDAI	R1300W BUCKET_SEAL KIT	31Y1-02870	
HYUNDAI	R1300W DOZER_SEAL KIT	31Y1-17660	
HYUNDAI	R1300W DOZER_SEAL KIT	31Y1-17930	
HYUNDAI	R1300W OSCILLATING_SEAL KIT	31E3-00211N	
HYUNDAI	R1300W3 DOZER_SEAL KIT	31Y1-02970	
HYUNDAI	R130C7 BOOM_SEAL KIT	31Y1-18170	
HYUNDAI	R130C7 ARM_SEAL KIT	31Y1-18110	
HYUNDAI	R130C7 ARM_SEAL KIT	31Y1-18110	
HYUNDAI	R130C7 BUCKET_SEAL KIT	31Y1-18210	
HYUNDAI	R130C7 SEAL KIT	31Y1-18580	
HYUNDAI	R130LC BUCKET_SEAL KIT	31Y1-03860	
HYUNDAI	R130LC ARM_SEAL KIT	31Y1-03710	
HYUNDAI	R130LC3 BUCKET_SEAL KIT	31Y1-03862	
HYUNDAI	R130W ARM_SEAL KIT	31Y1-02740	
HYUNDAI	R130W SEAL KIT	31Y1-03350	
HYUNDAI	R130W-3 ARM_SEAL KIT	31Y1-15890	
HYUNDAI	R1400LC BOOM_SEAL KIT	31Y1-18170	
HYUNDAI	R1400W7 OSCILLATING_SEAL KIT	31EM-00545N	
HYUNDAI	R140W7 SEAL KIT	31Y1-23860	
HYUNDAI	R140W7 OSCILLATING SEAL KIT	31EM-00540N	
HYUNDAI	R1700W-3 BOOM_SEAL KIT	31Y1-04190	



WONYOUNG SEAL CORPORATION

## 2. Hydraulic seal repair kit



**Superior seal**

Korea Masterpiece

### MAKER : HYUNDAI

MAKER	MODEL	SEAL KIT	REMARKS
HYUNDAI	R1700W-3 BOOM_SEAL KIT	31Y1-04191	
HYUNDAI	R1700W-3 BUCKET_SEAL KIT	31Y1-04460	
HYUNDAI	R1700W-3 BUCKET_SEAL KIT	31Y1-04461	
HYUNDAI	R1700W-3 ARM_SEAL KIT	31Y1-04360	
HYUNDAI	R1700W-3 ARM_SEAL KIT	31Y1-04361	
HYUNDAI	R1700W-3 ARM_SEAL KIT	31Y1-04362	
HYUNDAI	R1700W-3 BOOM_SEAL KIT	31Y1-04192	
HYUNDAI	R1700W3 BOOM_SEAL KIT	31Y1-04192	
HYUNDAI	R1700W7 ARM_SEAL KIT	31Y1-20450	
HYUNDAI	R1700W7 BOOM_SEAL KIT	31Y1-20430	
HYUNDAI	R1700W7 BUCKET_SEAL KIT	31Y1-20340	
HYUNDAI	R170W3 BUCKET_SEAL KIT	31Y1-04462	
HYUNDAI	R170W7 ADJUST_SEAL KIT	31Y1-24090	
HYUNDAI	R170WS/LOCK_SEAL KIT	31Y1-15910	
HYUNDAI	R1800LC3 ARM_SEAL KIT	31Y1-04362	
HYUNDAI	R1800LC3 BUCKET_SEAL KIT	31Y1-04462	
HYUNDAI	R1800LC3 DOZER_SEAL KIT	31Y1-13010	
HYUNDAI	R1800LC3 S/LOCK_SEAL KIT	31Y1-16010	
HYUNDAI	R2000LC BUCKET_SEAL KIT	91E1-2708	
HYUNDAI	R2000LC ARM_SEAL KIT	91E1-2707	
HYUNDAI	R2000LC BOOM_SEAL KIT	91E1-2706	
HYUNDAI	R2000LC BOOM_SEAL KIT	31Y1-05260	
HYUNDAI	R2000LC BOOM_SEAL KIT	31Y1-05260	
HYUNDAI	R2000LC BUCKET_SEAL KIT	31Y1-05610	
HYUNDAI	R2000W OUT RIGGER_SEAL KIT	707-98-45710	
HYUNDAI	R2000W3,R200W2 T/ADJUST_SEAL KIT	31Y1-06400	
HYUNDAI	R2000W7 BOOM_SEAL KIT	31Y1-18061	
HYUNDAI	R2000W7 DOZER_SEAL KIT	31Y1-14360	
HYUNDAI	R200LC ARM_SEAL KIT	31Y1-05440	
HYUNDAI	R200LC BUCKET_SEAL KIT	31Y1-05610	
HYUNDAI	R200LC BUCKET_SEAL KIT	31Y1-05611	
HYUNDAI	R200W2 ARM_SEAL KIT	31Y1-05440	
HYUNDAI	R200W2 ARM_SEAL KIT	31Y1-05441	
HYUNDAI	R200W-2 OUTRIGGER_SEAL KIT	31Y1-05950	
HYUNDAI	R200W-7 ARM_SEAL KIT	31Y1-18240	



WONYOUNG SEAL CORPORATION

## 2. Hydraulic seal repair kit



**Superior seal**

Korea Masterpiece

### MAKER : HYUNDAI

MAKER	MODEL	SEAL KIT	REMARKS
HYUNDAI	R210C7 BOOM_SEAL KIT	31Y1-15880	
HYUNDAI	R210C7 ARM_SEAL KIT	31Y1-15230	
HYUNDAI	R210C7 BUCKET_SEAL KIT	31Y1-15700	
HYUNDAI	R210C7 LAM CYL SEAL KIT	31Y1-06731	
HYUNDAI	R210F3 HEEL RACH CYL SEAL KIT	31Y1-17340	
HYUNDAI	R210F3 HOIST_SEAL KIT	31Y1-17190	
HYUNDAI	R210F3 STICK CYL SEAL KIT	31Y1-17030	
HYUNDAI	R210LC3LL STICK CYL SEAL KIT	31Y6-00180	
HYUNDAI	R210LC-7 BUCKET_SEAL KIT	31Y1-13800	
HYUNDAI	R210LC-7_SEAL KIT	31Y1-18060	
HYUNDAI	R2200LC-3 ARM_SEAL KIT	31Y1-06731	
HYUNDAI	R2200LC-3 ARM_SEAL KIT	31Y1-06730	
HYUNDAI	R220LC-3 BOOM_SEAL KIT	31Y1-06561	
HYUNDAI	R220LC-3 BUCKET_SEAL KIT	31Y1-06840	
HYUNDAI	R220LC-3 BUCKET_SEAL KIT	31Y1-06841	
HYUNDAI	R220LC-3 BOOM_SEAL KIT	31Y1-06560	
HYUNDAI	R2500LC3 BUCKET_SEAL KIT	31Y1-10160	
HYUNDAI	R2500LC3 ARM_SEAL KIT	31Y1-09860	
HYUNDAI	R2500LC-3 BOOM_SEAL KIT	31Y1-09990	
HYUNDAI	R250LC3 ARM SAFETY LOCK SYS(#0260-,2 P CS BOOM) SEAL KIT	31Y1-15940	
HYUNDAI	R250LC-7 (105/145) ARM_SEAL KIT	31Y1-18250	
HYUNDAI	R250LC-7_SEAL KIT	31Y1-20000	
HYUNDAI	R250LC7A BOOM CYL / SAFETY LOCK_SEAL KIT	31Y1-20000	
HYUNDAI	R2800K ARM_SEAL KIT	91E9-2708	
HYUNDAI	R2800K BUCKET_SEAL KIT	91E9-2709	
HYUNDAI	R2800K BOOM_SEAL KIT	91E9-2707	
HYUNDAI	R2800KLC BOOM_SEAL KIT	31Y1-07600	
HYUNDAI	R2800KLC BUCKET_SEAL KIT	31Y1-07910	
HYUNDAI	R2800LC BUCKET_SEAL KIT	31Y1-07350	
HYUNDAI	R2800LC BUCKET_SEAL KIT	91E2-2709	
HYUNDAI	R2800LC ARM_SEAL KIT	31Y1-07190	
HYUNDAI	R2800LC BOOM_SEAL KIT	31Y1-06990	
HYUNDAI	R2800LC ARM_SEAL KIT	91E2-2708	
HYUNDAI	R2800LC BOOM_SEAL KIT	91E2-2707	
HYUNDAI	R2900LC-3 ARM_SEAL KIT	31Y1-07751	



WONYOUNG SEAL CORPORATION

## 2. Hydraulic seal repair kit



**Superior seal**

Korea Masterpiece

### MAKER : HYUNDAI

MAKER	MODEL	SEAL KIT	REMARKS
HYUNDAI	R2900LC-3 ARM_SEAL KIT	31Y1-07750	
HYUNDAI	R2900LC-3 BOOM_SEAL KIT	31Y1-07601	
HYUNDAI	R2900LC-3 BOOM_SEAL KIT	31Y1-07602	
HYUNDAI	R2900LC-3 BUCKET_SEAL KIT	31Y1-07911	
HYUNDAI	R2900LC-3 ARM_SEAL KIT	31Y1-07751	
HYUNDAI	R2900LC3 BUCKET_SEAL KIT	31Y1-02870	
HYUNDAI	R2900LC7 BUCKET_SEAL KIT	31Y1-13800	
HYUNDAI	R2900LC7 BUCKET_SEAL KIT	31Y1-15540	
HYUNDAI	R2900LC7 T/JOINT_SEAL KIT	31N3-40950	
HYUNDAI	R2900LC7 T/JOINT_SEAL KIT	31N3-40951	
HYUNDAI	R290C7 BOOM_SEAL KIT	31Y1-15390	
HYUNDAI	R290C7 ARM_SEAL KIT	31Y1-15040	
HYUNDAI	R290C7 ARM_SEAL KIT	31Y1-15046	
HYUNDAI	R290C7 SEAL KIT	31Y1-18070	
HYUNDAI	R290C7 SEAL KIT	31Y1-18071	
HYUNDAI	R290F3 HEEL RACH CYL_SEAL KIT	31Y1-16900	
HYUNDAI	R290F3 HOIST_SEAL KIT	31Y1-16760	
HYUNDAI	R290F3 STICK CYL_SEAL KIT	31Y1-16600	
HYUNDAI	R3200LC BUCKET_SEAL KIT	91E8-2709	
HYUNDAI	R3200LC BOOM_SEAL KIT	91E8-2707	
HYUNDAI	R3200LC ARM_SEAL KIT	91E8-2708	
HYUNDAI	R3200LC-3 ARM_SEAL KIT	31Y1-08241	
HYUNDAI	R3200LC-3 BOOM_SEAL KIT	31Y1-08070	
HYUNDAI	R3200LC-3 BUCKET_SEAL KIT	31Y1-08370	
HYUNDAI	R3200LC-3 ARM_SEAL KIT	31Y1-08240	
HYUNDAI	R3200LC-3 ARM_SEAL KIT	31Y1-08242	
HYUNDAI	R3200LC-3 BOOM_SEAL KIT	31Y1-08071	
HYUNDAI	R3200LC-3 BUCKET_SEAL KIT	31Y1-08371	
HYUNDAI	R3200LC-3 ARM_SEAL KIT	31Y1-08243	
HYUNDAI	R320C7 BOOM_SEAL KIT	31Y1-19070	
HYUNDAI	R320C7 ARM_SEAL KIT	31Y1-19080	
HYUNDAI	R320C7 BUCKET_SEAL KIT	31Y1-19090	
HYUNDAI	R3600LC-3 BUCKET SEAL KIT	31Y1-08830	
HYUNDAI	R3600LC-3 BUCKET SEAL KIT	31Y1-08831	
HYUNDAI	R3600LC-3 ARM SEAL KIT	31Y1-08691	



WONYOUNG SEAL CORPORATION

## 2. Hydraulic seal repair kit



**Superior seal**

Korea Masterpiece

### MAKER : HYUNDAI

MAKER	MODEL	SEAL KIT	REMARKS
HYUNDAI	R3600LC-3 ARM_SEAL KIT	31Y1-08692	
HYUNDAI	R3600LC-3 BOOM_SEAL KIT	31Y1-08540	
HYUNDAI	R3600LC-3 ARM_SEAL KIT	31Y1-08690	
HYUNDAI	R3600LC-3 BOOM_SEAL KIT	31Y1-08541	
HYUNDAI	R3600LC7 T/JOINT_SEAL KIT	31N6-40950	
HYUNDAI	R3600LC7 T/JOINT_SEAL KIT	31N6-40951	
HYUNDAI	R360C7 BOOM_SEAL KIT	31Y1-18470	
HYUNDAI	R360C7 ARM_SEAL KIT	31Y1-18480	
HYUNDAI	R360C7 BUCKET_SEAL KIT	31Y1-18490	
HYUNDAI	R4500LC ARM_SEAL KIT	31E7-2712	
HYUNDAI	R4500LC BOOM_SEAL KIT	31E7-2711	
HYUNDAI	R4500LC BUCKET_SEAL KIT	31E7-2713	
HYUNDAI	R4500LC3 ARM_SEAL KIT	31Y1-09271	
HYUNDAI	R4500LC3 A1090 BUCKET_SEAL KIT	31Y1-09410	
HYUNDAI	R4500LC3 ARM_SEAL KIT	31Y1-09270	
HYUNDAI	R4500LC3 BOOM_SEAL KIT	31Y1-09060	
HYUNDAI	R4500LC7 ARM_SEAL KIT	31Y1-18420	
HYUNDAI	R4500LC7 BUCKET_SEAL KIT	31Y1-18430	
HYUNDAI	R450C7 BOOM_SEAL KIT	31Y1-18410	
HYUNDAI	R450C7 ARM_SEAL KIT	31Y1-18420	
HYUNDAI	R450C7 BUCKET_SEAL KIT	31Y1-18430	
HYUNDAI	R480LC-9 BUCKET_SEAL KIT	31Y1-35840	
HYUNDAI	R500C9 ARM_SEAL KIT	31Y1-35450	
HYUNDAI	R500C9 BOOM_SEAL KIT	31Y1-35590	
HYUNDAI	R520LC-9 BUCKET_SEAL KIT	31Y1-35710	
HYUNDAI	R520LC9S ARM SAFETY LOCK SYSTEM SEAL KIT	31Y1-35930	
HYUNDAI	R520LC9S BOOM SAFETY LOCK SEAL KIT	31Y1-35940	
HYUNDAI	R55 3 BOOM_SEAL KIT	31Y1-01320	
HYUNDAI	R550 3 BUCKET_SEAL KIT	31Y1-01550	
HYUNDAI	R550 3 SWING SEAL KIT	31Y1-01650	
HYUNDAI	R550-3 ARM SEAL KIT	31Y1-12071	
HYUNDAI	R550W-3 BLADE SEAL KIT	31Y1-01980	
HYUNDAI	R550W-3 BOOM SEAL KIT	31Y1-01820	
HYUNDAI	R550W-3 SEAL KIT	31Y1-01890	
HYUNDAI	R550W-3 SEAL KIT	31Y1-12072	



WONYOUNG SEAL CORPORATION

175

## 2. Hydraulic seal repair kit



**Superior seal**

Korea Masterpiece

### MAKER : HYUNDAI

MAKER	MODEL	SEAL KIT	REMARKS
HYUNDAI	R550W-3 SEAL KIT	31Y1-19610	
HYUNDAI	R555C7 BLADE SEAL KIT	31Y1-24500	
HYUNDAI	R555M BOOM SEAL KIT	31Y1-14670	
HYUNDAI	R555M ARM SEAL KIT	31Y1-16430	
HYUNDAI	R555M ARM SEAL KIT	31Y1-16431	
HYUNDAI	R555M ARM SEAL KIT	31Y1-17790	
HYUNDAI	R555M BLADE SEAL KIT	31Y1-01780	
HYUNDAI	R555M BUCKET SEAL KIT	31Y1-16280	
HYUNDAI	R557-7 BLADE SEAL KIT	31Y1-25260	
HYUNDAI	R755 3 BOOM SEAL KIT	31Y1-13500	
HYUNDAI	R755 3 ARM SEAL KIT	31Y1-13250	
HYUNDAI	R755 3 BUCKET SEAL KIT	31Y1-13670	
HYUNDAI	R95W- DOZER SEAL KIT	31Y1-17650	
HYUNDAI	R95W3 BOOM SEAL KIT	31Y1-10360	
HYUNDAI	R95W3 AJV SEAL KIT	31Y1-17870	
HYUNDAI	R95W3 ARM SEAL KIT	31Y1-10510	
HYUNDAI	R95W3 ARM SEAL KIT	31Y1-17860	
HYUNDAI	R95W-3 ARM SEAL KIT	31Y1-10510	
HYUNDAI	R95W3 BLADE SEAL KIT	31Y1-17650	
HYUNDAI	R95W3 BUCKET SEAL KIT	31Y1-10630	
HYUNDAI	R95W3 BUCKET SEAL KIT	31Y1-10630	
HYUNDAI	R95W3 SEAL KIT	31Y1-17850	
HYUNDAI	R95W3 SWING CYL SEAL KIT	31Y1-10780	
HYUNDAI	R95W3 SWING SEAL KIT	31Y1-10780	
HYUNDAI	R95W3 T/ADJUST SEAL KIT	31Y1-11030	
HYUNDAI	SEAL KIT	31Y1-15990	
HYUNDAI	SEAL KIT	31Y1-16111	
HYUNDAI	SEAL KIT	31Y2-00630	
HYUNDAI	SEAL KIT	31Y3-00750	
HYUNDAI	SEAL KIT	31Y3-20401	
HYUNDAI	SEAL KIT	31Y3-20401(HDF STEERING)	
HYUNDAI	SEAL KIT	5109002000	
HYUNDAI	SEAL KIT, ARM CYL	31Y1-15237	INDIA
HYUNDAI	SEAL KIT, BUCJET CYL	31Y1-15706	INDIA
HYUNDAI	SEAL KIT SEAL KIT	31Y1-26410N	



WONYOUNG SEAL CORPORATION

176

## 2. Hydraulic seal repair kit



**Superior seal**

Korea Masterpiece

### MAKER : HYUNDAI

MAKER	MODEL	SEAL KIT	REMARKS
HYUNDAI	T//JOINT_SEAL KIT	31M8-51530	
HYUNDAI	TILT_SEAL KIT	31Y3-19640	
HYUNDAI	TILT_SEAL KIT	31Y3-24320	
HYUNDAI	TLT_SEAL KIT	31Y3-26990	





WONYOUNG SEAL CORPORATION

177

## 2. Hydraulic seal repair kit



**Superior seal**

Korea Masterpiece

### MAKER : KATO

MAKER	MODEL	SEAL KIT	REMARKS
KATO	HD1023 ARM_SEAL KIT		
KATO	HD1023 BOOM_SEAL KIT		
KATO	HD1023 BUCKET_SEAL KIT		
KATO	HD1200G ARM_SEAL KIT		
KATO	HD1200G BOOM_SEAL KIT		
KATO	HD1200G BUCKET_SEAL KIT		
KATO	HD1200G T/ADJUST_SEAL KIT		
KATO	HD1200G T/JOINT_SEAL KIT		
KATO	HD1220SE ARM_SEAL KIT		
KATO	HD1220SE BOOM_SEAL KIT		
KATO	HD1220SE BUCKET_SEAL KIT		
KATO	HD1220SE T/ADJUST_SEAL KIT		
KATO	HD1220SE T/JOINT_SEAL KIT		
KATO	HD1220SEII ARM_SEAL KIT		
KATO	HD1220SEII BOOM_SEAL KIT		
KATO	HD1220SEII BUCKET_SEAL KIT		
KATO	HD1220SEII T/ADJUST_SEAL KIT		
KATO	HD1220SEII T/JOINT_SEAL KIT		
KATO	HD1250SEV ARM_SEAL KIT		
KATO	HD1250SEV BOOM_SEAL KIT		
KATO	HD1250SEV BUCKET_SEAL KIT		
KATO	HD1250SEV T/ADJUST_SEAL KIT		
KATO	HD1250SEV T/JOINT_SEAL KIT		
KATO	HD1250VII ARM_SEAL KIT		
KATO	HD1250VII BOOM_SEAL KIT		
KATO	HD1250VII BUCKET_SEAL KIT		
KATO	HD1800G ARM_SEAL KIT		
KATO	HD1800G BOOM_SEAL KIT		
KATO	HD1800G BUCKET_SEAL KIT		
KATO	HD1800G T/JOINT_SEAL KIT		
KATO	HD1800SE T/JOINT_SEAL KIT		
KATO	HD1800SEII T/JOINT_SEAL KIT		
KATO	HD180G T/ADJUST_SEAL KIT		
KATO	HD1880SE ARM_SEAL KIT		
KATO	HD1880SE BOOM_SEAL KIT		



WONYOUNG SEAL CORPORATION

## 2. Hydraulic seal repair kit



**Superior seal**

Korea Masterpiece

### MAKER : KATO

MAKER	MODEL	SEAL KIT	REMARKS
KATO	HD1880SE BUCKET_SEAL KIT		
KATO	HD1880SE T/ADJUST_SEAL KIT		
KATO	HD1880SEII ARM_SEAL KIT		
KATO	HD1880SEII BOOM_SEAL KIT		
KATO	HD1880SEII BUCKET_SEAL KIT		
KATO	HD1880SEII T/ADJUST_SEAL KIT		
KATO	HD1880SEIII ARM_SEAL KIT		
KATO	HD1880SEIII BOOM_SEAL KIT		
KATO	HD1880SEIII BUCKET_SEAL KIT		
KATO	HD1880SEIII T/ADJUST_SEAL KIT		
KATO	HD1880VII ARM_SEAL KIT		
KATO	HD1880VII BOOM_SEAL KIT		
KATO	HD1880VII BUCKET_SEAL KIT		
KATO	HD1880VII T/ADJUST_SEAL KIT		
KATO	HD230GS T/ADJUST_SEAL KIT		
KATO	HD2500SE ARM_SEAL KIT		
KATO	HD2500SE BOOM_SEAL KIT		
KATO	HD2500SE BUCKET_SEAL KIT		
KATO	HD250SE ARM_SEAL KIT		OD:GR110, ID: 70*85*9
KATO	HD250SE BOOM_SEAL KIT		OD:GR120, ID: 75*90*9
KATO	HD250SE BUCKET_SEAL KIT		
KATO	HD250SE T/ADJUST_SEAL KIT		
KATO	HD250SE(ROD SEMI) ARM_SEAL KIT		OD:X, ID: 65*80*9
KATO	HD250SE(ROD SEMI) BOOM_SEAL KIT		OD:X, ID: 70*85*9
KATO	HD250VII ARM_SEAL KIT		
KATO	HD250VII BOOM_SEAL KIT		
KATO	HD250VII BUCKET_SEAL KIT		
KATO	HD250VII-6 T/JOINT_SEAL KIT		
KATO	HD250VII-8 T/JOINT_SEAL KIT		
KATO	HD400G ARM_SEAL KIT		
KATO	HD400G BOOM_SEAL KIT		
KATO	HD400G BUCKET_SEAL KIT		
KATO	HD400GS ARM_SEAL KIT		
KATO	HD400GS BOOM_SEAL KIT		
KATO	HD400GS BUCKET_SEAL KIT		



WONYOUNG SEAL CORPORATION

## 2. Hydraulic seal repair kit



**Superior seal**

Korea Masterpiece

### MAKER : KATO

MAKER	MODEL	SEAL KIT	REMARKS
KATO	HD400GS T/ADJUST_SEAL KIT		
KATO	HD400GS T/JOINT_SEAL KIT		
KATO	HD400SE ARM_SEAL KIT		
KATO	HD400SE BOOM_SEAL KIT		
KATO	HD400SE BUCKET_SEAL KIT		
KATO	HD400SE T/ADJUST_SEAL KIT		
KATO	HD400SE T/JOINT_SEAL KIT		
KATO	HD400SEII ARM_SEAL KIT		
KATO	HD400SEII BOOM_SEAL KIT		
KATO	HD400SEII BUCKET_SEAL KIT		
KATO	HD400SEII T/ADJUST_SEAL KIT		
KATO	HD400SEM T/JOINT_SEAL KIT		
KATO	HD400SEMII ARM_SEAL KIT		
KATO	HD400SEMII BOOM_SEAL KIT		
KATO	HD400SEMII BUCKET_SEAL KIT		
KATO	HD400SEMII T/JOINT_SEAL KIT		
KATO	HD400SEMIV T/JOINT_SEAL KIT		
KATO	HD400SEMV T/ADJUST_SEAL KIT		
KATO	HD400SEV T/ADJUST_SEAL KIT		
KATO	HD400SEV T/JOINT_SEAL KIT		
KATO	HD400SEV/VII ARM_SEAL KIT		
KATO	HD400SEV/VII BOOM_SEAL KIT		
KATO	HD400SEV/VII BUCKET_SEAL KIT		
KATO	HD450SE ARM_SEAL KIT		
KATO	HD450SE BOOM_SEAL KIT		
KATO	HD450SE BUCKET_SEAL KIT		
KATO	HD450SE T/ADJUST_SEAL KIT		
KATO	HD450SE T/JOINT_SEAL KIT		
KATO	HD450SEV ARM_SEAL KIT		
KATO	HD450SEV BOOM_SEAL KIT		
KATO	HD450SEV BUCKET_SEAL KIT		
KATO	HD450SEV T/ADJUST_SEAL KIT		
KATO	HD450SEV T/JOINT_SEAL KIT		
KATO	HD450VII T/ADJUST_SEAL KIT		
KATO	HD510 ARM_SEAL KIT		

## 2. Hydraulic seal repair kit



**Superior seal**

Korea Masterpiece

### MAKER : KATO

MAKER	MODEL	SEAL KIT	REMARKS
KATO	HD510 BOOM_SEAL KIT		
KATO	HD510 BUCKET_SEAL KIT		
KATO	HD512 ARM_SEAL KIT		
KATO	HD512 BOOM_SEAL KIT		
KATO	HD512 BUCKET_SEAL KIT		
KATO	HD550G ARM_SEAL KIT		
KATO	HD550G BOOM_SEAL KIT		
KATO	HD550G BUCKET_SEAL KIT		
KATO	HD550G T/ADJUST_SEAL KIT		
KATO	HD550G T/JOINT_SEAL KIT		
KATO	HD550GS ARM_SEAL KIT		
KATO	HD550GS BOOM_SEAL KIT		
KATO	HD550GS BUCKET_SEAL KIT		
KATO	HD550GS T/ADJUST_SEAL KIT		
KATO	HD550GS T/JOINT_SEAL KIT		
KATO	HD550SE ARM_SEAL KIT		
KATO	HD550SE BOOM_SEAL KIT		
KATO	HD550SE BUCKET_SEAL KIT		
KATO	HD550SE T/ADJUST_SEAL KIT		
KATO	HD550SE T/JOINT_SEAL KIT		
KATO	HD550SEII ARM_SEAL KIT		
KATO	HD550SEII BOOM_SEAL KIT		
KATO	HD550SEII BUCKET_SEAL KIT		
KATO	HD550SEII T/ADJUST_SEAL KIT		
KATO	HD550SEII T/JOINT_SEAL KIT		
KATO	HD550SEV ARM_SEAL KIT		
KATO	HD550SEV BOOM_SEAL KIT		
KATO	HD550SEV BUCKET_SEAL KIT		
KATO	HD550SEV T/ADJUST_SEAL KIT		
KATO	HD550SEV T/JOINT_SEAL KIT		
KATO	HD550VII ARM_SEAL KIT		
KATO	HD550VII BOOM_SEAL KIT		
KATO	HD550VII T/ADJUST_SEAL KIT		
KATO	HD650SE ARM_SEAL KIT		
KATO	HD650SE BOOM_SEAL KIT		



WONYOUNG SEAL CORPORATION

## 2. Hydraulic seal repair kit



**Superior seal**

Korea Masterpiece

### MAKER : KATO

MAKER	MODEL	SEAL KIT	REMARKS
KATO	HD650SE BUCKET_SEAL KIT		
KATO	HD700G ARM_SEAL KIT		
KATO	HD700G BOOM_SEAL KIT		
KATO	HD700G BUCKET_SEAL KIT		
KATO	HD700G T/ADJUST_SEAL KIT		
KATO	HD700G T/JOINT_SEAL KIT		
KATO	HD700SE ARM_SEAL KIT		
KATO	HD700SE BOOM_SEAL KIT		
KATO	HD700SE BUCKET_SEAL KIT		
KATO	HD700SE T/ADJUST_SEAL KIT		
KATO	HD700SE T/JOINT_SEAL KIT		
KATO	HD700SEII ARM_SEAL KIT		
KATO	HD700SEII BOOM_SEAL KIT		
KATO	HD700SEII BUCKET_SEAL KIT		
KATO	HD700SEII T/ADJUST_SEAL KIT		
KATO	HD700SEII T/JOINT_SEAL KIT		
KATO	HD700SEV T/ADJUST_SEAL KIT		
KATO	HD700SEV T/JOINT_SEAL KIT		
KATO	HD700SEV/VII ARM_SEAL KIT		
KATO	HD700SEV/VII BOOM_SEAL KIT		
KATO	HD700SEV/VII BUCKET_SEAL KIT		
KATO	HD700VII T/ADJUST_SEAL KIT		
KATO	HD700VII T/JOINT_SEAL KIT		
KATO	HD750G T/ADJUST_SEAL KIT		
KATO	HD750G T/JOINT_SEAL KIT		
KATO	HD770SE ARM_SEAL KIT		
KATO	HD770SE BOOM_SEAL KIT		
KATO	HD770SE BUCKET_SEAL KIT		
KATO	HD770SE T/ADJUST_SEAL KIT		
KATO	HD770SE T/JOINT_SEAL KIT		
KATO	HD770SEII ARM_SEAL KIT		
KATO	HD770SEII BOOM_SEAL KIT		
KATO	HD770SEII BUCKET_SEAL KIT		
KATO	HD770SEII T/ADJUST_SEAL KIT		
KATO	HD770SEII T/JOINT_SEAL KIT		



WONYOUNG SEAL CORPORATION

## 2. Hydraulic seal repair kit



**Superior seal**

Korea Masterpiece

### MAKER : KATO

MAKER	MODEL	SEAL KIT	REMARKS
KATO	HD800SEV T/ADJUST_SEAL KIT		
KATO	HD800SEV T/JOINT_SEAL KIT		
KATO	HD800SEV/VII ARM_SEAL KIT		
KATO	HD800SEV/VII BOOM_SEAL KIT		
KATO	HD800SEV/VII BUCKET_SEAL KIT		
KATO	HD800VII T/ADJUST_SEAL KIT		
KATO	HD800VII T/JOINT_SEAL KIT		
KATO	HD820 ARM_SEAL KIT		
KATO	HD820 BOOM_SEAL KIT		
KATO	HD820 BUCKET_SEAL KIT		
KATO	HD850G ARM_SEAL KIT		
KATO	HD850G BOOM_SEAL KIT		
KATO	HD850G BUCKET_SEAL KIT		
KATO	HD850G T/ADJUST_SEAL KIT		
KATO	HD850G T/JOINT_SEAL KIT		
KATO	HD850GS T/ADJUST_SEAL KIT		
KATO	HD880SE-1 ARM_SEAL KIT		
KATO	HD880SE-1 BOOM_SEAL KIT		
KATO	HD880SE-1 BUCKET_EAL KIT		
KATO	HD880SE-2 BUCKET_EAL KIT		
KATO	HD880SE-ADJ-SK T/ADJUST_SEAL KIT		
KATO	HD880SE-ARM-SK ARM_SEAL KIT		
KATO	HD880SE-BO-SK BOOM_SEAL KIT		
KATO	HD880SE-BU-SK BUCKET_SEAL KIT		
KATO	HD880SEII-ADJ-SK T/ADJUST_SEAL KIT		
KATO	HD880SEII-ARM-SK ARM_SEAL KIT		
KATO	HD880SEII-BO-SK BOOM_SEAL KIT		
KATO	HD880SEII-T/J-SK T/JOINT_SEAL KIT		
KATO	HD880SE-T/J-SK T/JOINT_SEAL KIT		
KATO	HD900SEV-ADJ-SK T/ADJUST_SEAL KIT		
KATO	HD900SEV-ARM-SK ARM_SEAL KIT		
KATO	HD900SEV-BO-SK BOOM_SEAL KIT		
KATO	HD900SEV-BU-SK BUCKET_SEAL KIT		
KATO	HD900SEV-T/J-SK T/JOINT_SEAL KIT		
KATO	HD900VII-ADJ-SK T/ADJUST_SEAL KIT		



WONYOUNG SEAL CORPORATION

183

## 2. Hydraulic seal repair kit



**Superior seal**

Korea Masterpiece

### MAKER : **KATO**

MAKER	MODEL	SEAL KIT	REMARKS
KATO	HD900VII-ARM-SK ARM SEAL KIT		
KATO	HD900VII-BO-SK BOOM SEAL KIT		
KATO	HD900VII-BU-SK BUCKET SEAL KIT		
KATO	HD900VII-T/J-SK T/JOINT SEAL KIT		



WONYOUNG SEAL CORPORATION

## 2. Hydraulic seal repair kit



**Superior seal**

Korea Masterpiece

# MAKER : KOBELCO

MAKER	MODEL	SEAL KIT	REMARKS
KOBELCO	K904C T/ADJUST SEAL KIT		
KOBELCO	K907B T/ADJUST SEAL KIT		
KOBELCO	K909 T/ADJUST SEAL KIT		
KOBELCO	SK035 T/ADJUST SEAL KIT		
KOBELCO	SK04 T/ADJUST SEAL KIT		
KOBELCO	SK04-2 ARM SEAL KIT		
KOBELCO	SK04-2 BOOM SEAL KIT		
KOBELCO	SK04-2 T/ADJUST SEAL KIT		
KOBELCO	SK05-1 ARM SEAL KIT		
KOBELCO	SK05-1 BUCKET SEAL KIT		
KOBELCO	SK07-1 ARM SEAL KIT		
KOBELCO	SK07-1 BOOM SEAL KIT		
KOBELCO	SK07-1 BUCKET SEAL KIT		
KOBELCO	SK07-1 T/ADJUST SEAL KIT		
KOBELCO	SK07-N2 (K907-2) SEAL KIT	2438U741R300	
KOBELCO	SK07-N2 (K907-2) SEAL KIT	2438U995R300	
KOBELCO	SK07-N2 (K907-2) SEAL KIT	2438U996R300	
KOBELCO	SK07-N2 ARM SEAL KIT	2438U941R300	
KOBELCO	SK07-N2 BOOM SEAL KIT	2438U996R300	
KOBELCO	SK07-N2 BUCKET SEAL KIT	2438U995R300	
KOBELCO	SK07-N2 T/ADJUST SEAL KIT		
KOBELCO	SK100-1 ARM SEAL KIT		
KOBELCO	SK100-1 BOOM SEAL KIT		
KOBELCO	SK100-1 BUCKET SEAL KIT		
KOBELCO	SK120-1 ARM SEAL KIT		
KOBELCO	SK120-1 BOOM SEAL KIT		
KOBELCO	SK120-1 BUCKET SEAL KIT		
KOBELCO	SK200 (KAYABA) ARM SEAL KIT(KAYABA)	2438U1104R300	OD:GR145, ID: 100*120*12
KOBELCO	SK200 (KAYABA) BOOM SEAL KIT	2438U1102R300	OD:GR125, ID: 85*100*9
KOBELCO	SK200 (KAYABA) BUCKET SEAL KIT(KAYABA)	2438U1105R300	OD:GR120, ID: 80*95*9
KOBELCO	SK200/SK200-3 (NABUCO) ARM SEAL KIT(NABUCO)	2438U1108R300	OD:SPGW145, ID: 100*115*9
KOBELCO	SK200/SK200-3 (NABUCO) BOOM SEAL KIT	2438U1106R300	OD:GR125, ID: 85*100*9
KOBELCO	SK200/SK200-3 (NABUCO) BUCKET SEAL KIT(NABUCO)	2438U1109R300	OD:GR120, ID: 80*95*9
KOBELCO	SK200-1-ADJ-SK T/ADJUST SEAL KIT SEAL KIT		
KOBELCO	SK200-2 ARM SEAL KIT		OD:SPGW135, ID: 95*110*9





WONYOUNG SEAL CORPORATION

## 2. Hydraulic seal repair kit



**Superior seal**

Korea Masterpiece

### MAKER : KOBELCO

MAKER	MODEL	SEAL KIT	REMARKS
KOBELCO	SK200-2 BOOM SEAL KIT		OD:SPGW120, ID: 80*95*9
KOBELCO	SK200-2 BUCKET SEAL KIT		OD:SPGW115, ID:75*90*9
KOBELCO	SK200-2/3/5- T/JOINT SEAL KIT		
KOBELCO	SK200-3 ARM SEAL KIT(NEW)	2438U1108R300	OD:SPGW145, ID: 100*115*9
KOBELCO	SK200-3 ARM SEAL KIT		OD:GR145, ID: 100*120*12
KOBELCO	SK200-3 BOOM SEAL KIT	2438U1106R300	OD:GR125, ID: 85*100*9
KOBELCO	SK200-3 BUCKET SEAL KIT	2438U1109R300	OD:GR120, ID: 80*95*9
KOBELCO	SK200-5 ARM SEAL KIT	YN01V00003R300	
KOBELCO	SK200-5 BOOM SEAL KIT	YN01V00001R300	
KOBELCO	SK200-5 BUCKET SEAL KIT	YN01V00004R300	
KOBELCO	SK200-6 (SUPER) BUCKET SEAL KIT	YN01V00112R300	OD:GR120, ID: 80*95*9
KOBELCO	SK200-6 ARM SEAL KIT	YN01V00039R300	OD:SPGW135, ID: 95*110*9
KOBELCO	SK200-6 BOOM SEAL KIT	YN01V00052R300	OD:SPGW125, ID: 85*100*9
KOBELCO	SK200-6 BUCKET SEAL KIT	YN01V00068R300	OD:SPGW115, ID: 115*100*12
KOBELCO	SK200-6(SUPER) ARM SEAL KIT(SUPER)	YN01V00105R300	OD:GR135, ID: 95*110*9
KOBELCO	SK200-6(SUPER) BOOM SEAL KIT	YN01V00103R300	OD:GR125, ID: 85*100*9
KOBELCO	SK200-6S ARM SEAL KIT(KAYABA)	YN01V00105R900-R	OD:GR135, ID: 95*110*9
KOBELCO	SK200-6S ARM SEAL KIT(WIPRO)	YN01V00128R300-R	OD:SPGW135, ID: 95*110*9
KOBELCO	SK200-6S BOOM SEAL KIT(KAYABA)	YN01V00103R900-R	OD:GR125, ID: 85*100*9
KOBELCO	SK200-6S BOOM SEAL KIT(WIPRO)	YN01V00126R300-R	OD:SPGW125, ID: 85*100*9
KOBELCO	SK200-6S BUCKET SEAL KIT(WIPRO)	YN01V00129R300-R	OD:SPGW115, ID: 80*95*9
KOBELCO	SK200-6S BUCKETCYL SEAL KIT(KAYABA)	YN01V00112R900-R	OD:GR120, ID: 80*95*9
KOBELCO	SK200-8 ARM SEAL KIT(KAYABA)	YN01V00175R300-R	OD:GR135, ID: 95*110*9
KOBELCO	SK200-8 ARM SEAL KIT	YN01V00175R300	OD:GR135, ID: 95*110*9
KOBELCO	SK200-8 BOOM SEAL KIT(KAYABA)	YN01V00151R300-R	OD:GR120, ID: 85*100*9
KOBELCO	SK200-8 BOOM SEAL KIT	YN01V00151R300	OD:GR120, ID: 85*100*9
KOBELCO	SK200-8 BUCKET SEAL KIT(KAYABA)	YN01V00153R300-R	OD:GR120, ID: 80*95*9
KOBELCO	SK200-8 BUCKET SEAL KIT	YN01V00153R300	OD:GR120, ID: 80*95*9
KOBELCO	SK220-1/2 ARM SEAL KIT		
KOBELCO	SK220-1/2 BOOM SEAL KIT		
KOBELCO	SK220-1/2 BUCKET SEAL KIT		
KOBELCO	SK220-3 ARM SEAL KIT		
KOBELCO	SK220-3 BOOM SEAL KIT		
KOBELCO	SK220-3 BUCKET SEAL KIT		
KOBELCO	SK220-5 ARM SEAL KIT		



WONYOUNG SEAL CORPORATION

## 2. Hydraulic seal repair kit



**Superior seal**

Korea Masterpiece

### MAKER : **KOBELCO**

MAKER	MODEL	SEAL KIT	REMARKS
KOBELCO	SK220-5 BOOM_SEAL KIT		
KOBELCO	SK220-5 BUCKET_SEAL KIT		
KOBELCO	SK300-1 ARM_SEAL KIT(NEW)		OD:GR170, ID: 120*140*12
KOBELCO	SK300-1 ARM_SEAL KIT		OD:GR160, ID: 110*130*12
KOBELCO	SK300-1 BOOM_SEAL KIT		
KOBELCO	SK300-1 BUCKET_SEAL KIT		
KOBELCO	SK300-1 T/ADJUST_SEAL KIT		
KOBELCO	SK300-1- T/JOINT_SEAL KIT		
KOBELCO	SK300-3 T/ADJUST_SEAL KIT		
KOBELCO	SK904(B.C) ARM_SEAL KIT		
KOBELCO	SK904(B.C) BOOM_SEAL KIT		
KOBELCO	SK904(B.C) BUCKET_SEAL KIT		
KOBELCO	SK904-2 ARM_SEAL KIT		
KOBELCO	SK904-2 BOOM_SEAL KIT		
KOBELCO	SK904-2 BUCKET_SEAL KIT		
KOBELCO	SK905-2 ARM_SEAL KIT		
KOBELCO	SK905-2 BOOM_SEAL KIT		
KOBELCO	SK905-2 BUCKET_SEAL KIT		
KOBELCO	SK907(D) ARM_SEAL KIT		
KOBELCO	SK907(D) BOOM_SEAL KIT		
KOBELCO	SK907-2 ARM_SEAL KIT	2438U741R300	
KOBELCO	SK907-2 BOOM_SEAL KIT	2438U996R300	
KOBELCO	SK907-2 BUCKET_SEAL KIT	2438U995R300	
KOBELCO	SK907B ARM_SEAL KIT		
KOBELCO	SK907B BOOM_SEAL KIT		
KOBELCO	SK907B BUCKET_SEAL KIT		
KOBELCO	SK909-1 ARM_SEAL KIT		
KOBELCO	SK909-1 BOOM_SEAL KIT		
KOBELCO	SK909-1 BUCKET_SEAL KIT		
KOBELCO	SK909-2 ARM_SEAL KIT		
KOBELCO	SK909-2 BOOM_SEAL KIT		
KOBELCO	SK909-2 BUCKET_SEAL KIT		
KOBELCO	SK912-2 ARM_SEAL KIT		
KOBELCO	SK912-2 BOOM_SEAL KIT		
KOBELCO	SK912-2 BUCKET_SEAL KIT		



WONYOUNG SEAL CORPORATION

## 2. Hydraulic seal repair kit



**Superior seal**

Korea Masterpiece

### MAKER : **KOBELCO**

MAKER	MODEL	SEAL KIT	REMARKS
KOMATSU	10HT-1 ARM_SEAL KIT		
KOMATSU	10HT-1 BOOM_SEAL KIT		
KOMATSU	20HT-2 ARM_SEAL KIT		
KOMATSU	20HT-2 BOOM_SEAL KIT		
KOMATSU	20HT-2 BUCKET_SEAL KIT		
KOMATSU	20HT-3 ARM_SEAL KIT		
KOMATSU	20HT-3 BOOM_SEAL KIT		
KOMATSU	20HT-3 BUCKET_SEAL KIT		
KOMATSU	20HT-3 T/ADJUST_SEAL KIT		
KOMATSU	D155A-1/2 BLADE LIFT_SEAL KIT	175-63-05140	
KOMATSU	D155A-1/2 RIPPER LIFT/TILE_SEAL KIT	707-99-71420	
KOMATSU	D155A-2 BLADE LIFT_SEAL KIT	707-98-53100	
KOMATSU	D275A-5 BLADE LIFT_SEAL KIT	707-99-45310	OD:SPGW120, ID:80*93*10
KOMATSU	D275A-5 BLADE TILT_SEAL KIT	707-99-66600	OD:SPGW180, ID:100*115*10
KOMATSU	D275AX-5 RIPPER LIFT_SEAL KIT	707-99-66610	OD:SPGW180, ID:100*115*10
KOMATSU	D275AX-5 RIPPER TILT_SEAL KIT	707-99-64200	OD:SPGW160, ID:90*105*10
KOMATSU	D355A-3 BLADE TILT_SEAL KIT	195-63-05130	OD:SPGW250, ID:90*110*12
KOMATSU	D355A-3 RIPPER LIFT_SEAL KIT	707-99-71440	OD:SPGW225, ID:90*110*12
KOMATSU	D85A-18 BLADE LIFT_SEAL KIT	707-99-43010	OD:UKH120, ID: 70*90*12
KOMATSU	D85A-18 BLADE TILT_SEAL KIT	707-99-71110	OD:SPGW200, ID: 90*110*12
KOMATSU	D85A-18 RIPPER_SEAL KIT	707-98-52410	OD:SPGW150, ID: 70*90*12
KOMATSU	DOZER CYL_SEAL KIT	707-99-36240	
KOMATSU	GD663A-1 DRAWBAR SHIFT CYL_SEAL KIT	707-98-24040	OD:SPG80, ID: 45*55*7
KOMATSU	LIFT CYL KIT LIFT_SEAL KIT	175-63-05150	OD:SPGW140, ID: 75*95*12
KOMATSU	P220-3 ARM_SEAL KIT		
KOMATSU	PC100-1 ARM_SEAL KIT		
KOMATSU	PC100-1 BOOM_SEAL KIT		
KOMATSU	PC100-1 BUCKET_SEAL KIT		
KOMATSU	PC100-2 ARM_SEAL KIT		
KOMATSU	PC100-2 BOOM_SEAL KIT		
KOMATSU	PC100-2 BUCKET_SEAL KIT		
KOMATSU	PC100-3 ARM_SEAL KIT		OD:SPGW110, ID:75*88*10
KOMATSU	PC100-3 BOOM_SEAL KIT		
KOMATSU	PC100-3 BUCKET_SEAL KIT		
KOMATSU	PC100-3 T/ADJUST_SEAL KIT		



WONYOUNG SEAL CORPORATION

## 2. Hydraulic seal repair kit



**Superior seal**

Korea Masterpiece

### MAKER : **KOBELCO**

MAKER	MODEL	SEAL KIT	REMARKS
KOMATSU	PC100-5 ARM SEAL KIT	707-99-44200(28001-)	
KOMATSU	PC100-5 BOOM SEAL KIT	707-98-36200(28001-)	
KOMATSU	PC100-5 BUCKET SEAL KIT	707-98-27600(28001-)	
KOMATSU	PC100-5 T/ADJUST SEAL KIT		
KOMATSU	PC100-5 T/JOINT SEAL KIT		
KOMATSU	PC100-6 ARM SEAL KIT	707-99-44230	OD:SPGW115, ID: 75*88*10
KOMATSU	PC100-6 BOOM SEAL KIT	707-98-36250	OD:SPGW95, ID: 65*78*10
KOMATSU	PC100-6 BOOM SEAL KIT	707-99-25840	OD:SPGW95, ID: 65*78*10
KOMATSU	PC100-6 BUCKET SEAL KIT	707-98-27620	OD:SPGW90, ID: 60*73*10
KOMATSU	PC100L-6 ARM SEAL KIT	707-99-44230	OD:SPGW115, ID: 75*88*10
KOMATSU	PC120-1 ARM SEAL KIT		
KOMATSU	PC120-1 BOOM SEAL KIT		
KOMATSU	PC120-1 BUCKET SEAL KIT		
KOMATSU	PC120-1 T/ADJUST SEAL KIT		
KOMATSU	PC120-2 ARM SEAL KIT		
KOMATSU	PC120-2 BOOM SEAL KIT		
KOMATSU	PC120-2 BUCKET SEAL KIT		
KOMATSU	PC120-3 ARM SEAL KIT		
KOMATSU	PC120-3 BOOM SEAL KIT		
KOMATSU	PC120-3 BUCKET SEAL KIT		
KOMATSU	PC120-3 T/ADJUST SEAL KIT		
KOMATSU	PC120-3 T/JOINT SEAL KIT		
KOMATSU	PC120-5 ARM SEAL KIT	707-99-44200	
KOMATSU	PC120-5 BOOM SEAL KIT	707-98-37620	
KOMATSU	PC120-5 BUCKET SEAL KIT	707-98-36210	
KOMATSU	PC120-5 T/JOINT SEAL KIT		
KOMATSU	PC120-6 ARM SEAL KIT	707-98-44220	OD:SPGW115, ID: 75*88*10
KOMATSU	PC120-6 BOOM SEAL KIT	707-98-37620	
KOMATSU	PC120-6 BUCKET SEAL KIT	707-98-36210	
KOMATSU	PC120-6 T/ADJUST SEAL KIT		
KOMATSU	PC130-7 ARM SEAL KIT	707-99-44340	INDIA(OD:SPGW115, ID: 75*88*10)
KOMATSU	PC130-7 BOOM SEAL KIT	707-99-37300	INDIA(OD:SPGW105, ID: 70*83*10)
KOMATSU	PC150-3 ARM SEAL KIT		
KOMATSU	PC150-3 BOOM SEAL KIT		
KOMATSU	PC150-3 BUCKET SEAL KIT		



WONYOUNG SEAL CORPORATION

## 2. Hydraulic seal repair kit



**Superior seal**

Korea Masterpiece

### MAKER : KOMATSU

MAKER	MODEL	SEAL KIT	REMARKS
KOMATSU	PC200 ( LC ) -3 T/ADJUST SEAL KIT		
KOMATSU	PC200 ( LC ) -5 T/ADJUST SEAL KIT		
KOMATSU	PC200-1 T/ADJUST SEAL KIT		
KOMATSU	PC200-1- T/JOINT SEAL KIT		
KOMATSU	PC200-2 ARM SEAL KIT		
KOMATSU	PC200-2 BOOM SEAL KIT		
KOMATSU	PC200-2 BUCKET SEAL KIT		
KOMATSU	PC200-2 T/ADJUST SEAL KIT		
KOMATSU	PC200-2- T/JOINT SEAL KIT		
KOMATSU	PC200-3 ARM SEAL KIT	(707-98-48600(20001-35302)	
KOMATSU	PC200-3 BOOM SEAL KIT	707-98-46200(20001-35302)	
KOMATSU	PC200-3 BUCKET SEAL KIT(OLD)	707-98-38500(20001-35302)	
KOMATSU	PC200-3 T/ADJUST SEAL KIT		
KOMATSU	PC200-3- T/JOINT SEAL KIT		
KOMATSU	PC200-5 T/ADJUST SEAL KIT		
KOMATSU	PC200-5 T/ADJUST SEAL KIT	PC200-5_ADJ-SK	
KOMATSU	PC200-5- T/JOINT SEAL KIT		
KOMATSU	PC200-5 T/JOINT SEAL KIT	PC200-5_T/J-SK	
KOMATSU	PC200-5,6 BOOM SEAL KIT	707-99-46600	OD:SPGW120, ID: 85*100*10
KOMATSU	PC200-5,6A ARM SEAL KIT	707-99-57200	OD:SPGW135, ID: 95*110*10
KOMATSU	PC200-5/6 BUCKET SEAL KIT	707-99-45220	OD:SPGW115, ID: 80*93*10
KOMATSU	PC200-6 T/ADJUST SEAL KIT	PC200-6_ADJ-SK	
KOMATSU	PC200-6- T/JOINT SEAL KIT		
KOMATSU	PC200-6 T/JOINT SEAL KIT	PC200-6_T/J-SK	
KOMATSU	PC200-6S BUCKET SEAL KIT	707-98-45250	INDIA(OD:SPGW115, ID:80*93*10)
KOMATSU	PC200-6S BOOM SEAL KIT	707-99-46270	INDIA(OD:SPGW120, ID:85*100*10)
KOMATSU	PC200-6S ARM SEAL KIT	707-99-57250	INDIA(OD:SPGW135, ID:95*110*10)
KOMATSU	PC200-6S BUCKET SEAL KIT	707-98-45250	OD:SPGW115, ID:80*93*10
KOMATSU	PC200-6S BOOM SEAL KIT	707-99-46270	OD:SPGW120, ID:85*100*10
KOMATSU	PC200-6S ARM SEAL KIT	707-99-57250	OD:SPGW135, ID:95*110*10
KOMATSU	PC200-7 ARM SEAL KIT	707-99-57160	
KOMATSU	PC200-7 ARM SEAL KIT	707-99-57160	OD:SPGW135, ID:95*110*10
KOMATSU	PC200-7 BOOM SEAL KIT	707-99-46130	
KOMATSU	PC200-7 BOOM SEAL KIT	707-99-46130	OD:SPGW120, ID:85*100*10
KOMATSU	PC200-7 BUCKET SEAL KIT	707-99-45230	



WONYOUNG SEAL CORPORATION

## 2. Hydraulic seal repair kit



**Superior seal**

Korea Masterpiece

### MAKER : KOMATSU

MAKER	MODEL	SEAL KIT	REMARKS
KOMATSU	PC200-7 BUCKET_SEAL KIT	707-99-45230	OD:SPGW115, ID:80*93*10
KOMATSU	PC200-8 ARM_SEAL KIT	707-98-48610	
KOMATSU	PC200-8 BOOM_SEAL KIT	707-98-46280	
KOMATSU	PC200-8 BUCKET_SEAL KIT	707-98-39610	
KOMATSU	PC220(LC)-3 T/ADJUST_SEAL KIT		
KOMATSU	PC220(LC)-5 T/ADJUST_SEAL KIT		
KOMATSU	PC220-1 ARM_SEAL KIT		
KOMATSU	PC220-1 BOOM_SEAL KIT		
KOMATSU	PC220-1 BUCKET_SEAL KIT		
KOMATSU	PC220-1 T/ADJUST_SEAL KIT		
KOMATSU	PC220-2 ARM_SEAL KIT		
KOMATSU	PC220-2 BOOM_SEAL KIT		
KOMATSU	PC220-2 BUCKET_SEAL KIT		
KOMATSU	PC220-2 T/ADJUST_SEAL KIT		
KOMATSU	PC220-3 ARM_SEAL KIT(NEW)		OD:SPGW140, ID: 95*110*10
KOMATSU	PC220-3 BOOM_SEAL KIT(NEW)		OD:SPGW130, ID: 90*105*10
KOMATSU	PC220-3 BOOM_SEAL KIT(OLD)	707-98-47600(20001-23737)	OD:SPGW130, ID: 90*105*10
KOMATSU	PC220-3 BUCKET_SEAL KIT(NEW)		OD:SPGW130, ID: 90*105*10
KOMATSU	PC220-3 BUCKET_SEAL KIT(OLD)	707-98-47500(20001-23737)	OD:SPGW130, ID: 90*105*10
KOMATSU	PC220-3 T/ADJUST_SEAL KIT		
KOMATSU	PC220-3 T/JOINT_SEAL KIT		
KOMATSU	PC220-5 ARM_SEAL KIT		
KOMATSU	PC220-5 BOOM_SEAL KIT		
KOMATSU	PC220-5 BUCKET_SEAL KIT		
KOMATSU	PC220-5 T/ADJUST_SEAL KIT		
KOMATSU	PC220-5 T/JOINT_SEAL KIT		
KOMATSU	PC220-6 ARM_SEAL KIT		
KOMATSU	PC220-6 BOOM_SEAL KIT		
KOMATSU	PC220-6 BUCKET_SEAL KIT		
KOMATSU	PC220-6 T/ADJUST_SEAL KIT		
KOMATSU	PC220-7 ARM_SEAL KIT	707-99-58070	
KOMATSU	PC220-7 ARM_SEAL KIT	707-99-58070	OD:SPGW140, ID:100*115*10
KOMATSU	PC220-7 BOOM_SEAL KIT	707-99-47790	
KOMATSU	PC220-7 BUCKET_SEAL KIT	707-99-47570	
KOMATSU	PC230-6 ARM_SEAL KIT		



WONYOUNG SEAL CORPORATION

## 2. Hydraulic seal repair kit



**Superior seal**

Korea Masterpiece

### MAKER : KOMATSU

MAKER	MODEL	SEAL KIT	REMARKS
KOMATSU	PC270-7 ARM_SEAL KIT	707-99-59620	
KOMATSU	PC270-7 BOOM_SEAL KIT	707-99-58050	
KOMATSU	PC300-1 ARM_SEAL KIT		
KOMATSU	PC300-1 BOOM_SEAL KIT		
KOMATSU	PC300-1 BUCKET_SEAL KIT		
KOMATSU	PC300-1 T/ADJUST_SEAL KIT		
KOMATSU	PC300-2 ARM_SEAL KIT		
KOMATSU	PC300-2 BOOM_SEAL KIT		
KOMATSU	PC300-2 BUCKET_SEAL KIT		
KOMATSU	PC300-2 T/ADJUST_SEAL KIT		
KOMATSU	PC300-3 ARM_SEAL KIT	707-98-67100	
KOMATSU	PC300-3 BOOM_SEAL KIT	707-98-58200	
KOMATSU	PC300-3 BUCKET_SEAL KIT	707-98-58210	
KOMATSU	PC300-3 T/ADJUST_SEAL KIT		
KOMATSU	PC300-5 ARM_SEAL KIT	707-99-67110	
KOMATSU	PC300-5 BOOM_SEAL KIT	707-99-58210	
KOMATSU	PC300-5 BUCKET_SEAL KIT	707-99-58110	
KOMATSU	PC300-5 T/ADJUST_SEAL KIT	PC300-5_ADJ-SK	
KOMATSU	PC300-5/6 T/ADJUST_SEAL KIT		
KOMATSU	PC300-6 ARM_SEAL KIT	707-99-67280	
KOMATSU	PC300-6 BOOM_SEAL KIT	707-99-58360	
KOMATSU	PC300-6 BUCKET_SEAL KIT	707-99-58370	
KOMATSU	PC300-6 T/ADJUST_SEAL KIT	PC300-6_ADJ-SK	
KOMATSU	PC300-7 ARM_SEAL KIT(INDONESIA)	707-99-67090	OD:SPGW160, ID: 110*130*10
KOMATSU	PC300-7 ARM_SEAL KIT(MALAYSIA)	707-13-16710	OD:SPGW160, ID: 110*130*10
KOMATSU	PC300-7 ARM_SEAL KIT	707-99-67090	INDIA(OD:SPGW160, ID: 110*130*10)
KOMATSU	PC300-7 ARM_SEAL KIT	707-99-67090	OD:SPGW160, ID: 110*130*10
KOMATSU	PC300-7 BOOM_SEAL KIT(INDONESIA)	707-99-58080	OD:SPGW140, ID: 100*115*10
KOMATSU	PC300-7 BOOM_SEAL KIT(MALAYSIA)	707-13-14580	OD:SPGW140, ID: 100*115*10
KOMATSU	PC300-7 BOOM_SEAL KIT	707-99-58080	INDIA(OD:SPGW140, ID: 100*115*10)
KOMATSU	PC300-7 BOOM_SEAL KIT	707-99-58080	OD:SPGW140, ID: 100*115*10
KOMATSU	PC300-7 BUCKET_SEAL KIT(INDONESIA)	707-99-59610	OD:SPGW150, ID: 110*130*10
KOMATSU	PC300-7 BUCKET_SEAL KIT(MALAYSIA)	707-99-58090	OD:SPGW140, ID: 100*115*10
KOMATSU	PC300-7 BUCKET_SEAL KIT	707-99-58090	INDIA(OD:SPGW140, ID: 100*115*10)
KOMATSU	PC300-7 BUCKET_SEAL KIT	707-99-58090	OD:SPGW140, ID: 100*115*10



WONYOUNG SEAL CORPORATION

## 2. Hydraulic seal repair kit



**Superior seal**

Korea Masterpiece

### MAKER : KOMATSU

MAKER	MODEL	SEAL KIT	REMARKS
KOMATSU	PC300-7 BUCKET_SEAL KIT	707-99-59610	OD:SPGW150, ID: 110*130*10
KOMATSU	PC30-5 ARM_SEAL KIT		
KOMATSU	PC30-5 BOOM_SEAL KIT		
KOMATSU	PC30-5 BUCKET_SEAL KIT		
KOMATSU	PC400-1 ARM_SEAL KIT		
KOMATSU	PC400-1 BOOM_SEAL KIT		
KOMATSU	PC400-1 BUCKET_SEAL KIT		
KOMATSU	PC400-1 T/ADJUST_SEAL KIT		
KOMATSU	PC400-3 ARM_SEAL KIT	707-98-68400	
KOMATSU	PC400-3 BOOM_SEAL KIT	707-98-67110	
KOMATSU	PC400-3 BUCKET_SEAL KIT	707-98-48510	
KOMATSU	PC400-5 ARM_SEAL KIT	707-99-68510	
KOMATSU	PC400-5 BOOM_SEAL KIT	707-99-67120	
KOMATSU	PC400-5 BUCKET_SEAL KIT	707-99-67010	
KOMATSU	PC400-5 T/ADJUST_SEAL KIT		
KOMATSU	PC400-5 T/ADJUST_SEAL KIT	PC400-5_ADJ-SK	
KOMATSU	PC400-6 ARM_SEAL KIT	707-99-68560	
KOMATSU	PC400-6 BOOM_SEAL KIT	707-99-67300	
KOMATSU	PC400-6 BUCKET_SEAL KIT	707-99-67310	
KOMATSU	PC400-7 ARM_SEAL KIT	707-99-68780	
KOMATSU	PC400-7 BOOM_SEAL KIT	707-99-67870	
KOMATSU	PC400-7 BUCKET_SEAL KIT	707-99-72240	
KOMATSU	PC400-7/PC450LC-7 BUCKET_SEAL KIT	707-99-66240	
KOMATSU	PC410-5 BUCKET_SEAL KIT		
KOMATSU	PC600-8 ARM_SEAL KIT	707-99-76300	
KOMATSU	PC60-3 T/ADJUST_SEAL KIT		
KOMATSU	PC60-3/5 ARM_SEAL KIT	707-98-27500	
KOMATSU	PC60-3/5 BOOM_SEAL KIT	707-99-36260	
KOMATSU	PC60-3/5 BUCKET_SEAL KIT	707-98-26520	
KOMATSU	PC60-5 T/ADJUST_SEAL KIT		
KOMATSU	PC60-5- T/JOINT_SEAL KIT		
KOMATSU	PC60-6 ARM_SEAL KIT		
KOMATSU	PC60-6 BOOM_SEAL KIT		
KOMATSU	PC60-6 BUCKET_SEAL KIT		
KOMATSU	PC60-6 T/ADJUST_SEAL KIT		





WONYOUNG SEAL CORPORATION

## 2. Hydraulic seal repair kit



**Superior seal**

Korea Masterpiece

### MAKER : KOMATSU

MAKER	MODEL	SEAL KIT	REMARKS
KOMATSU	PC60-6- T/JOINT_SEAL KIT		
KOMATSU	PC650-1 ARM_SEAL KIT		
KOMATSU	PC650-3 ARM_SEAL KIT	707-99-78640	
KOMATSU	PC650-3 ARM_SEAL KIT	707-99-78640 PC650-3 ARM(exc ept PPY 184X210X8 1pcs)	
KOMATSU	PC650-3 BOOM_SEAL KIT	707-99-68600	
KOMATSU	PC650-3 BOTTOM DUMP_SEAL KIT	707-99-56300	
KOMATSU	PC650-3 T/ADJUST_SEAL KIT		
KOMATSU	WA250-5 LIFT_SEAL KIT	418-62-05000	
KOMATSU	WA250-5 STEERING_SEAL KIT	707-99-14760	
KOMATSU	WA320-1 DUMP_SEAL KIT	707-99-62010	
KOMATSU	WA320-1 LIFT_SEAL KIT	707-99-54100	
KOMATSU	WA320-1 STEERING_SEAL KIT	707-99-14600	
KOMATSU	WA320-3 DUMP_SEAL KIT	707-99-62020	
KOMATSU	WA320-3 LIFT_SEAL KIT	707-99-53100	
KOMATSU	WA320-3 STEERING_SEAL KIT	707-99-14610	
KOMATSU	WA320-5 DUMP_SEAL KIT	707-99-62120	
KOMATSU	WA320-5 LIFT_SEAL KIT	707-99-53170	
KOMATSU	WA320-5 STEERING_SEAL KIT	707-99-14770	
KOMATSU	WA380-3 DUMP_SEAL KIT	707-99-64520	
KOMATSU	WA380-3 LIFT_SEAL KIT	707-99-64120	
KOMATSU	WA380-3 STEERING_SEAL KIT	707-99-24120	
KOMATSU	WA380-3 STEERING_SEAL KIT	707-99-24280	
KOMATSU	WA380-5 BUCKET_SEAL KIT	707-99-64540	
KOMATSU	WA380-5 STEERING_SEAL KIT	707-99-24630	
KOMATSU	WA380-6 DUMP_SEAL KIT	707-99-56620	
KOMATSU	WA380-6 LIFT_SEAL KIT	707-99-48620	
KOMATSU	WA380-6 STEERING_SEAL KIT	707-99-15810	
KOMATSU	WA420-1 DUMP_SEAL KIT	707-99-73010	
KOMATSU	WA420-1 LIFT_SEAL KIT	707-99-66010	
KOMATSU	WA420-1 STEERING_SEAL KIT	707-99-24500	
KOMATSU	WA420-3 DUMP_SEAL KIT	707-99-73140	
KOMATSU	WA420-3 LIFT_SEAL KIT	707-99-64130	
KOMATSU	WA420-3 STEERING_SEAL KIT	707-99-24610	
KOMATSU	WA430-5 LIFT_SEAL KIT	707-99-64080	
KOMATSU	WA430-6 LIFT_SEAL KIT	707-99-50740	



WONYOUNG SEAL CORPORATION

194

## 2. Hydraulic seal repair kit



**Superior seal**

Korea Masterpiece

### MAKER : KOMATSU

MAKER	MODEL	SEAL KIT	REMARKS
KOMATSU	WA450/470 LIFT_SEAL KIT	707-99-65400	OD:SPGW180, ID: 95*110*10
KOMATSU	WA450/470 LIFT_SEAL KIT	707-99-65410	OD:SPGW180, ID: 95*110*10
KOMATSU	WA450/470 LIFT_SEAL KIT	707-99-66400	OD:SPGW180, ID:100*115*10
KOMATSU	WA450/470 STEERING_SEAL KIT	707-99-32100	OD:SPGW100, ID:UKH50*65*9
KOMATSU	WA450/470 STEERING_SEAL KIT	707-99-32110	OD:SPGW100, ID:50*63*10
KOMATSU	WA450-1 BOOM_SEAL KIT		
KOMATSU	WA470-3 DUMP_SEAL KIT	707-99-73020	
KOMATSU	WA470-3/5,450-3 STEERING_SEAL KIT	707-99-32140	
KOMATSU	WA470-5 DUMP_SEAL KIT	707-99-73150	
KOMATSU	WA470-5 LIFT_SEAL KIT	707-99-65420	
KOMATSU	WA470-6 DUMP_SEAL KIT	707-99-66360	
KOMATSU	WA470-6,WA480-6 LIFT_SEAL KIT	707-99-57330	
KOMATSU	WA470-6,WA480-6 STEERING_SEAL KIT	707-99-25710	
KOMATSU	WA480-5 DUMP_SEAL KIT	707-99-75480	
KOMATSU	WA480-6 DUMP_SEAL KIT	707-99-67680	
KOMATSU	WA500-3 DUMP_SEAL KIT	707-99-75450	
KOMATSU	WA500-3 LIFT_SEAL KIT	707-99-74120	
KOMATSU	WA500-3 STEERING_SEAL KIT	707-99-34550	



WONYOUNG SEAL CORPORATION

195

## 2. Hydraulic seal repair kit



**Superior seal**

Korea Masterpiece

### MAKER : MITSUBUSHI

MAKER	MODEL	SEAL KIT	REMARKS
MITSUBUSHI	MS110-1 T/ADJUST SEAL KIT		
MITSUBUSHI	MS160-1 ARM_SEAL KIT		
MITSUBUSHI	MS160-1 BOOM_SEAL KIT		
MITSUBUSHI	MS160-1 BUCKET_SEAL KIT		
MITSUBUSHI	MS180-2 ARM_SEAL KIT		
MITSUBUSHI	MS180-2 BOOM_SEAL KIT		
MITSUBUSHI	MS180-2 BUCKET_SEAL KIT		
MITSUBUSHI	MS180-3 ARM_SEAL KIT	E15300024	
MITSUBUSHI	MS180-3 BOOM_SEAL KIT	E15300014	
MITSUBUSHI	MS180-3 BUCKET_SEAL KIT	E15300034	
MITSUBUSHI	MS180-8 ARM_SEAL KIT	E75300010	
MITSUBUSHI	MS180-8 BOOM_SEAL KIT	E35300040	
MITSUBUSHI	MS180-8 BUCKET_SEAL KIT	E35300041	
MITSUBUSHI	MS230-3 ARM_SEAL KIT		
MITSUBUSHI	MS230-3 BOOM_SEAL KIT		
MITSUBUSHI	MS230-3 BUCKET_SEAL KIT		
MITSUBUSHI	MS240-8 ARM_SEAL KIT		
MITSUBUSHI	MS240-8 BUCKET_SEAL KIT		
MITSUBUSHI	MS450-1 ARM_SEAL KIT		
MITSUBUSHI	MS450-1 BOOM_SEAL KIT		
MITSUBUSHI	MS450-1 BUCKET_SEAL KIT		



WONYOUNG SEAL CORPORATION

## 2. Hydraulic seal repair kit



**Superior seal**

Korea Masterpiece

# MAKER : SUMITOMO

MAKER	MODEL	SEAL KIT	REMARKS
SUMITOMO	LS2600AJ ARM_SEAL KIT		
SUMITOMO	LS2600AJ BOOM_SEAL KIT		
SUMITOMO	LS2600AJ BUCKET_SEAL KIT		
SUMITOMO	LS2600BJ ARM_SEAL KIT		
SUMITOMO	LS2600BJ BOOM_SEAL KIT		
SUMITOMO	LS2600BJ BUCKET_SEAL KIT		
SUMITOMO	LS2600F2 ARM_SEAL KIT		
SUMITOMO	LS2600F2 BOOM_SEAL KIT		
SUMITOMO	LS2600F2 BUCKET_SEAL KIT		
SUMITOMO	LS2650F2 ARM_SEAL KIT		
SUMITOMO	LS2650F2 BOOM_SEAL KIT		
SUMITOMO	LS2650F2 BUCKET_SEAL KIT		
SUMITOMO	LS2800 ARM_SEAL KIT	LQU0138R	
SUMITOMO	LS2800 BOOM_SEAL KIT	LQU10130R	
SUMITOMO	LS2800 BUCKET_SEAL KIT	LQU0142R	
SUMITOMO	LS2800BJ ARM_SEAL KIT		
SUMITOMO	LS2800BJ BOOM_SEAL KIT		
SUMITOMO	LS2800BJ BUCKET_SEAL KIT		
SUMITOMO	LS2800BS ARM_SEAL KIT		
SUMITOMO	LS2800BS BOOM_SEAL KIT		
SUMITOMO	LS2800BS BUCKET_SEAL KIT		
SUMITOMO	LS2800DJ ARM_SEAL KIT		
SUMITOMO	LS2800DJ BOOM_SEAL KIT		
SUMITOMO	LS2800DJ BUCKET_SEAL KIT		
SUMITOMO	LS2800DJ T/JOINT_SEAL KIT		
SUMITOMO	LS2800EJ ARM_SEAL KIT		
SUMITOMO	LS2800EJ BOOM_SEAL KIT		
SUMITOMO	LS2800EJ BUCKET_SEAL KIT		
SUMITOMO	LS2800EJ T/JOINT_SEAL KIT		
SUMITOMO	LS2800FA T/JOINT_SEAL KIT		
SUMITOMO	LS2800FJ ARM_SEAL KIT		
SUMITOMO	LS2800FJ BOOM_SEAL KIT		
SUMITOMO	LS2800FJ BUCKET_SEAL KIT		
SUMITOMO	LS2800FJ T/ADJUST_SEAL KIT		
SUMITOMO	LS2800FJ T/JOINT_SEAL KIT		

## 2. Hydraulic seal repair kit



**Superior seal**

Korea Masterpiece

# MAKER : SUMITOMO

MAKER	MODEL	SEAL KIT	REMARKS
SUMITOMO	LS2800FJ/F2 T/ADJUST_SEAL KIT		
SUMITOMO	LS2800FJ2 ARM_SEAL KIT		
SUMITOMO	LS2800FJ2 BOOM_SEAL KIT		
SUMITOMO	LS2800FJ2 BUCKET_SEAL KIT		
SUMITOMO	LS2800FJ2 T/ADJUST_SEAL KIT		
SUMITOMO	LS2800FJ2 T/JOINT_SEAL KIT		
SUMITOMO	LS3400AJ ARM_SEAL KIT		
SUMITOMO	LS3400AJ BOOM_SEAL KIT		
SUMITOMO	LS3400AJ BUCKET_SEAL KIT		
SUMITOMO	LS3400F2 ARM_SEAL KIT		
SUMITOMO	LS3400F2 BOOM_SEAL KIT		
SUMITOMO	LS3400F2 BUCKET_SEAL KIT		
SUMITOMO	LS4300 T/ADJUST_SEAL KIT		
SUMITOMO	LS4300FJ ARM_SEAL KIT		
SUMITOMO	LS4300FJ BOOM_SEAL KIT		
SUMITOMO	LS4300FJ BUCKET_SEAL KIT		
SUMITOMO	S580F2 ARM_SEAL KIT		
SUMITOMO	S580F2 BOOM_SEAL KIT		
SUMITOMO	S580F2 BUCKET_SEAL KIT		
SUMITOMO	SH100 ARM_SEAL KIT		
SUMITOMO	SH100 BOOM_SEAL KIT		
SUMITOMO	SH100 BUCKET_SEAL KIT		
SUMITOMO	SH120 T/ADJUST_SEAL KIT		
SUMITOMO	SH120-1 BOOM_SEAL KIT		
SUMITOMO	SH200 ARM_SEAL KIT		
SUMITOMO	SH200 BOOM_SEAL KIT		
SUMITOMO	SH200 BUCKET_SEAL KIT		
SUMITOMO	SH200 T/ADJUST_SEAL KIT		
SUMITOMO	SH200-1- PILOT VALVE_SEAL KIT		
SUMITOMO	SH200-1- T/JOINT_SEAL KIT		
SUMITOMO	SH200-2 ARM_SEAL KIT		
SUMITOMO	SH200-2 BOOM_SEAL KIT		
SUMITOMO	SH200-2 BUCKET_SEAL KIT		
SUMITOMO	SH220-1 ARM_SEAL KIT		
SUMITOMO	SH220-1 BOOM_SEAL KIT		



WONYOUNG SEAL CORPORATION

198

## 2. Hydraulic seal repair kit



**Superior seal**

Korea Masterpiece

### MAKER : **SUMITOMO**

MAKER	MODEL	SEAL KIT	REMARKS
SUMITOMO	SH220-1 BUCKET_SEAL KIT		
SUMITOMO	SH300 T/ADJUST_SEAL KIT		



WONYOUNG SEAL CORPORATION

## 2. Hydraulic seal repair kit



**Superior seal**

Korea Masterpiece

### MAKER : VOLVO

MAKER	MODEL	SEAL KIT	REMARKS
VOLVO	3040-91521S TILT_SEAL KIT	3040-91521S	
VOLVO	ARM SEAL KIT ARM SEAL KIT	8148-14021	
VOLVO	BOOM SEAL KIT BOOM SEAL KIT	8148-14011	
VOLVO	BUCKET SEAL KIT BUCKET_SEAL KIT	8148-14031	
VOLVO	DX5P AIR_C_SEAL KIT	3040-91501S	
VOLVO	DX5P LIFT_SEAL KIT	3040-91481S	
VOLVO	DX5P LIFT_SEAL KIT	3040-91511S	
VOLVO	DX5P TILT_SEAL KIT	3040-91491S	
VOLVO	DX6PL LIFT_SEAL KIT	3040-927001S	
VOLVO	DX6PL TILT_SEAL KIT	3040-04620S	
VOLVO	EC140B BOOM SEAL KIT	14516932	INDIA
VOLVO	EC140B BUCKET_SEAL KIT	14513718	
VOLVO	EC140B BUCKET_SEAL KIT	14513718	INDIA
VOLVO	EC210B ARM_SEAL KIT	14515052	
VOLVO	EC210B BOOM_SEAL KIT	14515051	
VOLVO	EC210B BUCKET_SEAL KIT	14515053	
VOLVO	EC240B 2ND BOOM_SEAL KIT	14514456	
VOLVO	EC240B ARM SEAL KIT	14514457	
VOLVO	EC240B BOOM SEAL KIT	14514455	
VOLVO	EC240B BUCKET_SEAL KIT	14514454	
VOLVO	EC290B ARM_SEAL KIT	14513715	
VOLVO	EC290B ARM_SEAL KIT	14513716	
VOLVO	EC290B BOOM / BUCKET_SEAL KIT	14513714	
VOLVO	EC330B BOOM SEAL KIT	14512968	
VOLVO	EC330B BUCKET_SEAL KIT	14512955	
VOLVO	EC360B ARM_SEAL KIT	14512950	
VOLVO	EC360B BOOM_SEAL KIT	14512948	
VOLVO	EC360B BUCKET_SEAL KIT	14512961	
VOLVO	EC360BLC, EC330CL BUCKET_SEAL KIT	14589142	한성
VOLVO	EC460B ARM_SEAL KIT	14513727	
VOLVO	EC460B BOOM / BUCKET_SEAL KIT	14513726	
VOLVO	EW130 C/JOINT_SEAL KIT		
VOLVO	EW55 C/JOINT_SEAL KIT		
VOLVO	HC085-0001S OUTR_SEAL KIT	HC085-0001S	
VOLVO	HC087-0038S 3RD BOOM_SEAL KIT	HC087-0038S	



WONYOUNG SEAL CORPORATION

## 2. Hydraulic seal repair kit



**Superior seal**

Korea Masterpiece

### MAKER : VOLVO

MAKER	MODEL	SEAL KIT	REMARKS
VOLVO	LX10 DUMP SEAL KIT	NEW:8130-00340, OLD:2046-01953S	
VOLVO	LX10 LIFT SEAL KIT	NEW:8130-00320, OLD:2046-01851S	
VOLVO	LX15 ARM SEAL KIT	NEW:8130-00220, OLD:2046-00150S	
VOLVO	LX15 DUMP CYL SEAL KIT	2046-00150S	
VOLVO	LX15 LIFT CYL SEAL KIT	2046-00010S (8048-00310)	
VOLVO	LX15 LIFT SEAL KIT	NEW:8130-00200, OLD:2046-00010S	
VOLVO	LX15 STEERING CYL SEAL KIT	2046-00250S (8048-00300)	
VOLVO	LX18 LIFT SEAL KIT	NEW:8130-00240, OLD:2046-00410S	
VOLVO	LX18 STEERING SEAL KIT	NEW:8130-00270, OLD:2046-00680S	
VOLVO	LX18(SL180-2B) DUMP CYL SEAL KIT	2046-00540S (2046-00420)	
VOLVO	LX18(SL180-2B) LIFT SEAL KIT	2046-00410S (8048-00280)	
VOLVO	LX18(SL180-2B) STEERING SEAL KIT	2046-00680S	
VOLVO	LX232 LIFT SEAL KIT	NEW:8130-00210, OLD:2046-00012S	
VOLVO	LX232 STEERING SEAL KIT	NEW:8130-00230, OLD:2046-00252S	
VOLVO	LX25 ,LX352 LIFT SEAL KIT	8048-00250	
VOLVO	LX25 DUMP SEAL KIT	8048-00260	
VOLVO	LX25 DUMP SEAL KIT	NEW:8130-00510, OLD:8048-00260	
VOLVO	LX25 LIFT SEAL KIT	NEW:8130-00500, OLD:8048-00250	
VOLVO	LX25 STEERING SEAL KIT	8048-00240S	
VOLVO	LX25 STEERING SEAL KIT	NEW:8130-00490, OLD:8048-00240	
VOLVO	LX282 DUMP SEAL KIT	NEW:8130-00370, OLD:2046-02511S	
VOLVO	LX282 LIFT SEAL KIT	NEW:8130-00250, OLD:2046-00412S	
VOLVO	LX282 STEERING SEAL KIT	NEW:8130-00280, OLD:2046-00681S	
VOLVO	LX30 DUMP SEAL KIT(NEW)	2046-01613S(NEW)	
VOLVO	LX30 DUMP SEAL KIT(NEW)	8048-00220(NEW)	
VOLVO	LX30 DUMP SEAL KIT(OLD)	8048-00220(OLD)	
VOLVO	LX30 DUMP SEAL KIT	2046-01613S	
VOLVO	LX30 DUMP SEAL KIT	8048-00220	
VOLVO	LX30 LIFT SEAL KIT(NEW)	8048-00230(NEW)	
VOLVO	LX30 LIFT SEAL KIT(OLD)	8048-00230(OLD)	
VOLVO	LX30 LIFT SEAL KIT	2046-01441S	
VOLVO	LX30 LIFT SEAL KIT	8048-00230	
VOLVO	LX30 STEERING SEAL KIT(NEW)	2046-01763S(NEW)	
VOLVO	LX30 STEERING SEAL KIT(NEW)	8048-00210S(NEW)	
VOLVO	LX30 STEERING SEAL KIT(OLD)	8048-00210S(OLD)	





WONYOUNG SEAL CORPORATION

## 2. Hydraulic seal repair kit



**Superior seal**

Korea Masterpiece

### MAKER : VOLVO

MAKER	MODEL	SEAL KIT	REMARKS
VOLVO	LX30 STEERING SEAL KIT	2046-01763S	
VOLVO	LX30 STEERING SEAL KIT	8048-00210	
VOLVO	LX352 DUMP SEAL KIT	2046-02501S	
VOLVO	LX352 DUMP SEAL KIT	NEW:8130-00350, OLD:2046-02451S	
VOLVO	LX352 DUMP SEAL KIT	NEW:8130-00360, OLD:2046-02501S	
VOLVO	LX352 DUMP SEAL KIT	NEW:8130-00510, OLD:8048-00260	
VOLVO	LX352 LIFT SEAL KIT	2046-01032S	
VOLVO	LX352 LIFT SEAL KIT	NEW:8130-00290, OLD:2046-01032S	
VOLVO	LX352 LIFT SEAL KIT	NEW:8130-00500, OLD:8048-00250	
VOLVO	LX352 STEERING SEAL KIT	2046-01203S	
VOLVO	LX352 STEERING SEAL KIT	NEW:8130-00300, OLD:2046-01203S	
VOLVO	LX352 STEERING SEAL KIT	NEW:8130-00490, OLD:8048-00240	
VOLVO	LX473 DUMP SEAL KIT	2046-03661S	
VOLVO	LX473 DUMP SEAL KIT	8148-20030	
VOLVO	LX473 LIFT SEAL KIT	2046-03511S	
VOLVO	LX473 LIFT SEAL KIT	8148-20020	
VOLVO	LX473 STEERING SEAL KIT	2046-03810S	
VOLVO	LX473 STEERING SEAL KIT	8148-20010	
VOLVO	MPC55B C/JOINT SEAL KIT	7281-10470S	
VOLVO	MPC55B REAR SEAL KIT	7281-10360S	
VOLVO	MPC55B SEAL KIT	7281-10490S	
VOLVO	MX10 ARM SEAL KIT	MXB-20S	
VOLVO	MX10 ARM SEAL KIT	NEW:8130-00620, OLD:MXB-20S	
VOLVO	MX10 BOOM / BUCKET SEAL KIT	MXB-10S	
VOLVO	MX10 BOOM SEAL KIT	NEW:8130-00610, OLD:MXB-10S	
VOLVO	MX10LC-2 BOOM / BUCKET SEAL KIT	8048-00090S	
VOLVO	MX10LC-2(SE280LC-2) ARM SEAL KIT	8048-00101S	
VOLVO	MX10LC-2(SE280LC-2) BOOM / BUCKET SEAL KIT	8048-00090S	
VOLVO	MX10LC-2(SE280LC-2) T/T SEAL KIT	8048-00010S	
VOLVO	MX132 BLADE SEAL KIT	8048-00180	
VOLVO	MX132 OUTRIGGER SEAL KIT	8048-00190	
VOLVO	MX132 STEERING SEAL KIT	NEW:8120-00040, OLD:7114-14000S1	
VOLVO	MX132W BLADE SEAL KIT	8048-00180S	
VOLVO	MX132W BOOM SEAL KIT	8048-00160S	
VOLVO	MX132W BUCKET SEAL KIT	8048-00980S	



WONYOUNG SEAL CORPORATION

## 2. Hydraulic seal repair kit



**Superior seal**

Korea Masterpiece

### MAKER : VOLVO

MAKER	MODEL	SEAL KIT	REMARKS
VOLVO	MX132W DIPPER SEAL KIT	8048-00170S	
VOLVO	MX135 ARM SEAL KIT	8148-11021	
VOLVO	MX135 BLADE SEAL KIT	8148-11041	
VOLVO	MX135 LOCKING SEAL KIT	8148-11050	
VOLVO	MX135 STEERING SEAL KIT	8148-11060	
VOLVO	MX135WS ARM SEAL KIT	8048-11020S	
VOLVO	MX135WS BLADE SEAL KIT	8048-11040S	
VOLVO	MX135WS BOOM SEAL KIT	8048-11010S	
VOLVO	MX135WS BUCKET SEAL KIT	8048-11030S	
VOLVO	MX135WS BUCKET SEAL KIT	814811031	
VOLVO	MX14-2 ARM SEAL KIT	8048-00140S	
VOLVO	MX14-2 BOOM SEAL KIT	8048-00130S, (NEW)8130-00390	
VOLVO	MX14-2 BUCKET SEAL KIT	8048-00150S	
VOLVO	MX14-2(SE350LC-2) ARM SEAL KIT	8048-00140S	
VOLVO	MX14-2(SE350LC-2) BOOM SEAL KIT	8048-00130S, (NEW)8130-00390	
VOLVO	MX14-2(SE350LC-2) BUCKET SEAL KIT	8048-00150S	
VOLVO	MX14-2(SE350LC-2) T/JOINT SEAL KIT	8028-00010S	
VOLVO	MX175 ARM SEAL KIT	8148-13021	
VOLVO	MX175 BLADE SEAL KIT	8148-13031	
VOLVO	MX175 BOOM SEAL KIT	8148-13011	
VOLVO	MX175 STABILIZER SEAL KIT	8148-13041	
VOLVO	MX202 ARM SEAL KIT	NEW:8130-00410, OLD:8048-00081	
VOLVO	MX202 STEERING SEAL KIT	NEW:8120-00050, OLD:7114-34121S	
VOLVO	MX202W ARM SEAL KIT	8048-00080S	
VOLVO	MX202W BLADE SEAL KIT	8048-01509S	
VOLVO	MX202W BOOM / BUCKET SEAL KIT	8048-00070S	
VOLVO	MX202W OUTRIGGER SEAL KIT	8048-01510S	
VOLVO	MX222 BOOM/BUCKET SEAL KIT	NEW:8130-00400, OLD:8048-00070	
VOLVO	MX222LC BOOM SEAL KIT	8048-00070S	
VOLVO	MX222LC BUCKET SEAL KIT	8048-00070S	
VOLVO	MX222LC DIPPER SEAL KIT	8048-00080S	
VOLVO	MX225 ARM SEAL KIT	8148-10051	
VOLVO	MX225 ARM SEAL KIT	8148-10061	
VOLVO	MX225 BOOM SEAL KIT	8148-10031	
VOLVO	MX225 BUCKET SEAL KIT	8148-10071	



WONYOUNG SEAL CORPORATION

## 2. Hydraulic seal repair kit



**Superior seal**

Korea Masterpiece

### MAKER : VOLVO

MAKER	MODEL	SEAL KIT	REMARKS
VOLVO	MX225 BUCKET SEAL KIT	8148-10081	
VOLVO	MX225 RMT SEAL KIT	NEW:8130-00560, OLD:8048-00940	
VOLVO	MX225LC , LH , LX , LF ARM SEAL KIT	8148-10050S	
VOLVO	MX225LC , LH , LX , LF BOOM SEAL KIT	8148-10030S	
VOLVO	MX225LC , LH , LX , LF BUCKET SEAL KIT	8148-10070S	
VOLVO	MX225LS ARM SEAL KIT	814810051	
VOLVO	MX225LS BOOM SEAL KIT	814810031	
VOLVO	MX225LS BUCKET SEAL KIT	814810071	
VOLVO	MX255 ARM SEAL KIT	8148-10121	
VOLVO	MX255 ARM SEAL KIT	8148-10130	
VOLVO	MX255 ARM SEAL KIT	8148-10131	
VOLVO	MX255 BUCKET SEAL KIT	8148-10141	
VOLVO	MX255 BUCKET SEAL KIT	8148-10151	
VOLVO	MX255LS , NLS , LH , LX ARM SEAL KIT	8148-10120S	
VOLVO	MX255LS , NLS , LH , LX BOOM SEAL KIT	8148-10100S	
VOLVO	MX255LS , NLS , LH , LX BUCKET SEAL KIT	8148-10140S	
VOLVO	MX255LS ARM SEAL KIT	814810121	
VOLVO	MX255LS BOOM SEAL KIT	814810101	
VOLVO	MX255LS BUCKET SEAL KIT	814810141	
VOLVO	MX292 ,MX292LC ARM SEAL KIT	8048-00100S	
VOLVO	MX292 ,MX292LC BOOM / BUCKET SEAL KIT	8048-00090S	
VOLVO	MX292 ARM SEAL KIT	NEW:8130-00430, OLD:8048-00101	
VOLVO	MX292 ARM SEAL KIT	NEW:8130-00430, OLD:8048-00101A	
VOLVO	MX292 BOOM/BUCKET SEAL KIT	NEW:8130-00420, OLD:8048-00090A	
VOLVO	MX292 T/T SEAL KIT	8048-00010	
VOLVO	MX295LS ARM SEAL KIT	814815020	
VOLVO	MX295LS SEAL KIT	814815010	
VOLVO	MX3 BOOM SEAL KIT	NEW:8130-00130, OLD:1046-01422S	
VOLVO	MX3, W, -2 BLADE SEAL KIT	1046-01782S	
VOLVO	MX3, W, -2 BOOM SEAL KIT	1046-01422S, (NEW)8130-00130	
VOLVO	MX3, W, -2 BUCKET SEAL KIT	1046-01592S, (NEW)8130-00150	
VOLVO	MX3, W, -2 SWING SEAL KIT	1046-01701S, (NEW)8130-00160	
VOLVO	MX350L BUCKET SEAL KIT	8048-01330	
VOLVO	MX352 ARM SEAL KIT	8048-00140	
VOLVO	MX352 ARM SEAL KIT	NEW:8130-00450, OLD:8048-00140A	



WONYOUNG SEAL CORPORATION

## 2. Hydraulic seal repair kit



**Superior seal**

Korea Masterpiece

### MAKER : VOLVO

MAKER	MODEL	SEAL KIT	REMARKS
VOLVO	MX352 BOOM SEAL KIT	NEW:8130-00440, OLD:8048-00130A	
VOLVO	MX352 BUCKET SEAL KIT	8048-00150	
VOLVO	MX352 BUCKET SEAL KIT	NEW:8130-00460, OLD:8048-00150A	
VOLVO	MX352LC ARM SEAL KIT	8048-00140S	
VOLVO	MX352LC BOOM SEAL KIT	8048-00130S	
VOLVO	MX352LC BUCKET SEAL KIT	8048-00150S	
VOLVO	MX3A BLADE SEAL KIT	NEW:8130-00170, OLD:1046-01782S	
VOLVO	MX3A,3W, ARM SEAL KIT	1046-01511S, (NEW) 8130-00140	
VOLVO	MX3W LOCKING SEAL KIT	NEW:8130-00100, OLD:1040-97000S	
VOLVO	MX3W STEEL SEAL KIT	NEW:8130-00080, OLD:1040-90931S	
VOLVO	MX3WABLSK SEAL KIT	MX3WABLSK	
VOLVO	MX452 , LC , LCHD(SE450LC T/JOINT_SEAL KIT	8048-00810	
VOLVO	MX452 ARM SEAL KIT	8048-00790S, (NEW)8130-00540	
VOLVO	MX452 ARM SEAL KIT	NEW:8130-00540, OLD:8048-00790A	
VOLVO	MX452 BOOM SEAL KIT	NEW:8130-00530, OLD:8048-00780A	
VOLVO	MX452 BUCKET SEAL KIT	NEW:8130-00550, OLD:8048-00800A	
VOLVO	MX452(SE450LC-2) ARM SEAL KIT	8048-00790S, (NEW)8130-00540	
VOLVO	MX452(SE450LC-2) BOOM SEAL KIT	8048-00780S, (NEW)8130-00530	
VOLVO	MX452(SE450LC-2) BUCKET SEAL KIT	8048-00800S, (NEW)8130-00550	
VOLVO	MX55 ARM SEAL KIT	8148-14020S	
VOLVO	MX55 BOOM SEAL KIT	8148-14010S	
VOLVO	MX55 BUCKET SEAL KIT	8148-14030S	
VOLVO	MX55 DOZER BLADE SEAL KIT	8148-14040S	
VOLVO	MX55 SWING SEAL KIT	8148-14050S	
VOLVO	MX55A ARM SEAL KIT	8148-14020S	
VOLVO	MX55A BOOM SEAL KIT	8148-14010S	
VOLVO	MX55A BUCKET SEAL KIT	8148-14030S	
VOLVO	MX6LC(SE130LC-2) ARM SEAL KIT	1046-00780S	
VOLVO	MX6LC(SE130LC-2) BOOM SEAL KIT	1046-00670S	
VOLVO	MX6LC(SE130LC-2) BUCKET SEAL KIT	8048-00120S	
VOLVO	MX6W ARM SEAL KIT	NEW:8130-00480, OLD:8048-00170A	
VOLVO	MX6W BOOM SEAL KIT	NEW:8130-00470, OLD:8048-00160A	
VOLVO	MX6W C/JOINT SEAL KIT		
VOLVO	MX6W LOCKING SEAL KIT	NEW:8230-28190, OLD:X2649622	
VOLVO	MX6W STEERING SEAL KIT	NEW:8130-00380, OLD:3144873S	



WONYOUNG SEAL CORPORATION

205

## 2. Hydraulic seal repair kit



**Superior seal**

Korea Masterpiece

### MAKER : VOLVO

MAKER	MODEL	SEAL KIT	REMARKS
VOLVO	MX6W-2 , BLADE SEAL KIT	8048-00180S	
VOLVO	MX6W-2 ,MX132W ARM SEAL KIT	8048-00170S	
VOLVO	MX6W-2 ,MX132W BOOM / BUCKET SEAL KIT	8048-00160S	
VOLVO	MX6W-2 ,MX6W BLADE SEAL KIT	MXC-50SL	
VOLVO	MX6W-2 BLADE SEAL KIT	8048-00180S	
VOLVO	MX6W-2 LOCKING SEAL KIT	8048-00201S	
VOLVO	MX6W-2 STEERING SEAL KIT	7114-14000SL, (NEW)8130-00380	
VOLVO	MX8 ARM SEAL KIT	NEW:8130-00590, OLD:MXA-20S	
VOLVO	MX8 BLADE SEAL KIT	NEW:8130-00600, OLD:MXA-40S	
VOLVO	MX8(SE210LC-3) ARM SEAL KIT	MXA-20S	
VOLVO	MX8(SE210LC-3) BLADE SEAL KIT	MXA-40S	
VOLVO	MX8(SE210LC-3) BOOM / BUCKET SEAL KIT	1046-90170S	
VOLVO	MX8LC-2 T/T SEAL KIT	8038-00010S	
VOLVO	MX8W ARM SEAL KIT	NEW:8130-00410, OLD:8048-00081A	
VOLVO	MX8W BOOM/BUCKET SEAL KIT	NEW:8130-00400, OLD:8048-00070A	
VOLVO	MX8W STEERING SEAL KIT	7114-34120S	
VOLVO	MX8W STEERING SEAL KIT	NEW:8120-00030, OLD:4472374056S1	
VOLVO	MX8W/ W-2 ARM SEAL KIT	8048-00081S	
VOLVO	MX8W/ W-2 BOOM / BUCKET SEAL KIT	8048-00070S	
VOLVO	MX8W/ W-2(SE210-2) ARM SEAL KIT	8048-00081S	
VOLVO	MX8W/ W-2(SE210-2) BOOM / BUCKET SEAL KIT	8048-00070S, 8047-00070S(공용)	
VOLVO	MXC-40S SEAL KIT	MXC-40S	
VOLVO	NEW:8230-02810,OLD:1030-202701 T/ADJUST SEAL KIT	NEW:8230-02810,OLD:1030-202701	
VOLVO	PX321 O/R HOLI SEAL KIT	8048-01280	
VOLVO	PX321 O/R REARE SEAL KIT	8048-01260	
VOLVO	PX321 O/R SWING SEAL KIT	8048-01453	
VOLVO	PX321 SWING SEAL KIT	4174-10540S	
VOLVO	PX321 SEAL KIT	4146-00010S	
VOLVO	SC50H JACK FRO SEAL KIT	8048-01482	
VOLVO	SE210 BUCKET SEAL KIT	8148-10090	
VOLVO	SE210L ARM SEAL KIT	8048-01360	
VOLVO	SE210L BOOM SEAL KIT	8048-01350	
VOLVO	SE210L BUCKET SEAL KIT	8048-01370	
VOLVO	SE210W S/M SEAL KIT	8048-01511	
VOLVO	SE22 ARM / HEAD SEAL KIT	933138-40200L	



WONYOUNG SEAL CORPORATION

## 2. Hydraulic seal repair kit



**Superior seal**

Korea Masterpiece

### MAKER : VOLVO

MAKER	MODEL	SEAL KIT	REMARKS
VOLVO	SE22 ARM / PISTON SEAL KIT	933138-75300L	
VOLVO	SE22 ARM/HEAD SEAL KIT	933138-40200L	
VOLVO	SE22 ARM/PISTON SEAL KIT	933138-75300L	
VOLVO	SE22 BOOM , HEAD SEAL KIT	933138-40100L	
VOLVO	SE22 BOOM , PISTON SEAL KIT	933138-78000L	
VOLVO	SE22 BOOM/HEAD SEAL KIT	933138-40100L	
VOLVO	SE22 BUCKET , HEAD SEAL KIT	933138-40000L	
VOLVO	SE22 BUCKET/PISTON SEAL KIT	933138-70500L	
VOLVO	SE22 SWING SEAL KIT	933138-34500L	
VOLVO	SE22 SWING SEAL KIT	933138-75400L	
VOLVO	SE22 T/ADJUST SEAL KIT SEAL KIT	172122-37820L	
VOLVO	SE22 T/JOINT SEAL KIT	172123-73880L	
VOLVO	SE25 ARM SEAL KIT	SE25-STSK	
VOLVO	SE25 ARM SEAL KIT	SE25-STSKL	
VOLVO	SE25 BLADE SEAL KIT	SE25-BLSK	
VOLVO	SE25 BOOM SEAL KIT	SE25-BOSK	
VOLVO	SE25 BOOM SEAL KIT	SE25-BOSKL	
VOLVO	SE25 BUCKET SEAL KIT	SE25-BUSK	
VOLVO	SE25 BUCKET SEAL KIT	SE25-BUSKL	
VOLVO	SE280 ARM SEAL KIT	8048-01400	
VOLVO	SE280 BOOM SEAL KIT	8048-01390	
VOLVO	SE280 BUCKET SEAL KIT	8048-01380	
VOLVO	SE350L ARM SEAL KIT	8048-01320	
VOLVO	SE350L BOOM SEAL KIT	8048-01310	
VOLVO	SE350L SEAL KIT	8048-01300	
VOLVO	SE350LC-3 SEAL KIT	814816020	
VOLVO	SE350LC-3 SEAL KIT	814816030	
VOLVO	SE350LC-3 SEAL KIT	814816040	
VOLVO	SE40W ARM SEAL KIT	1040-91420S	
VOLVO	SE40W ARM SEAL KIT	8046-91420S	
VOLVO	SE40W BOOM SEAL KIT	1040-91180S	
VOLVO	SE40W BUCKET SEAL KIT	1040-91670S	
VOLVO	SE450LC-3 SEAL KIT	814816080	
VOLVO	SE450LC-3 SEAL KIT	814816090	
VOLVO	SE450LC-3 SEAL KIT	814816100	



WONYOUNG SEAL CORPORATION

## 2. Hydraulic seal repair kit



**Superior seal**

Korea Masterpiece

### MAKER : VOLVO

MAKER	MODEL	SEAL KIT	REMARKS
VOLVO	SL10 /SL15(SL120-2B) STEERING SEAL KIT	HC024-0132S	
VOLVO	SL10 LIFT SEAL KIT	HC024-0171S	
VOLVO	SL10 STEERING SEAL KIT	HC024-00371S	
VOLVO	SL10(SL120-2B) DUMP SEAL KIT	HC024-0186S	
VOLVO	SL10(SL120-2B) LIFT SEAL KIT	HC024-0171S	
VOLVO	SL120 STEERING SEAL KIT	8048-00300	
VOLVO	SL15 DUMP SEAL KIT	HC024-0001S	
VOLVO	SL15 LIFT SEAL KIT	HC024-0020S	
VOLVO	SL20 AXLE SEAL KIT	41B-33-05010L	
VOLVO	SL20 AXLE SEAL KIT	41B-33-05020L	
VOLVO	SL20 DUMP SEAL KIT	HC024-0062S	
VOLVO	SL20 LIFT SEAL KIT	HC024-00791S	
VOLVO	SL20 LIFT SEAL KIT	HC024-00791SL	
VOLVO	SL20 PARKI SEAL KIT	421-43-05120L	
VOLVO	SL20 STEERING SEAL KIT	HC024-0094S	
VOLVO	SL5 DUMP SEAL KIT	HC024-01151S	
VOLVO	SL5 LIFT SEAL KIT	HC024-0037S	
VOLVO	SL5 LIFT SEAL KIT	HC024-01321S	
VOLVO	SL5 STEERING SEAL KIT	HC024-0147S	
VOLVO	SPF100 1ST BOOM SEAL KIT	7281-02600S	
VOLVO	SPF100 2ND BOOM SEAL KIT	HC087-0001S	
VOLVO	SPF100 2ND BOOM SEAL KIT	HC087-0019S	
VOLVO	SPF100 3RD BOOM SEAL KIT	7281-02700S	
VOLVO	SPF100 MAIN SEAL KIT	HA371500S	
VOLVO	SPF100 MAIN SEAL KIT	HC086-00011S	
VOLVO	SPF100 OUTRIGGER SEAL KIT	HC085-0024S	
VOLVO	SPF100 REAR SEAL KIT	7281-00300S	
VOLVO	SPF100 REAR SEAL KIT	7281-004101S	
VOLVO	SPF100 VALVE SEAL KIT	NEW:7281-09940S,OLD:HC084-0030S	
VOLVO	ST120 DUMP SEAL KIT	8048-01641	
VOLVO	ST120 LIFT SEAL KIT	8048-01640	
VOLVO	ST120 Q COUPL SEAL KIT	8048-01642	
VOLVO	SWING MORTOR(PL-003) SEAL KIT	14556029	
VOLVO	Y33800667S SEAL KIT	Y33800667S	

### 3. Hydraulic Breaker seal



**WYS** providing special concept of high quality Hydraulic Breaker seals.

The quality already verified by supplying OEM manufacturer like

The Korea biggest Breaker manufacture **Everdigm** etc.

The Special polyurethane material is developed by WYS

And produced by WYS also.

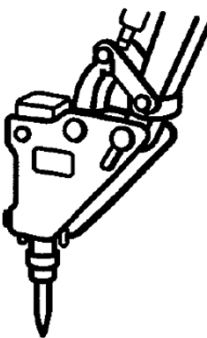
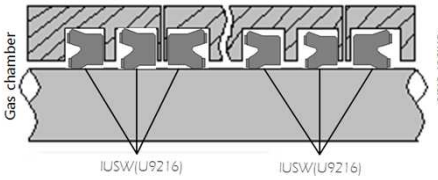
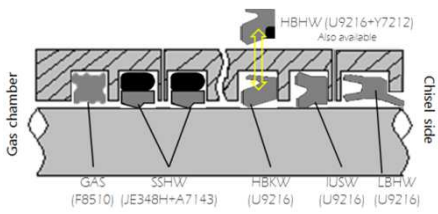

## 3. Hydraulic Breaker seal

Equipment	Operating condition	Magnified view of sealing system	Feature
 <b>Hydraulic breaker</b>	0~16.7 Mpa {0~170kgf /cm <sup>2</sup> }  - 30~100 °C		All seal using IUSW type only, because of high speed and high pressure. U9216 poly urethane material is used for severe operating condition.
	0~17.7 Mpa {0~180kgf /cm <sup>2</sup> }  - 30~100 °C		'HBKW' is used upper hydraulic seals to reduce the friction. 'SSHW' is also used to absorb impact pressure and reduce the friction. 'GAS' with high wear resistance characteristics is used for gas seals to prevent oil scrapping off from the gas chamber.

## 3. Hydraulic Breaker seal

### ROD SEAL

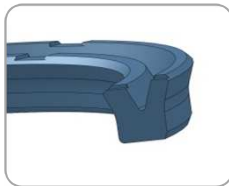

Style : **IUSW(IUSI)**  
Material : High performance PU

Page:  
211

### BUFFER SEAL

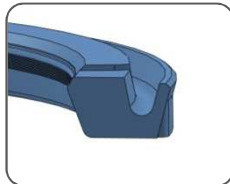
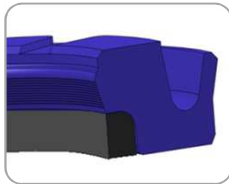

Style :  
**HBHW(HBY)/HBKW**  
Material : High performance  
PU+P/A / High performance PU

Page:  
213-  
14

### DUST SEAL

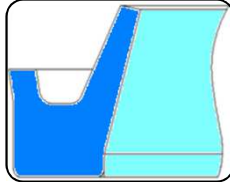
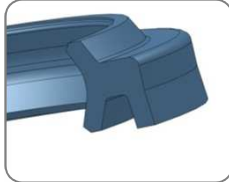

Style : **LBHW(LBI)/LPIY**  
Material : High  
performance PU

Page:  
215-  
216

### GAS SEAL

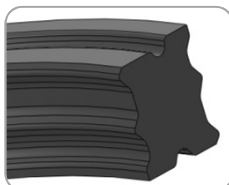

Style : **GAS**  
Material : FKM

Page:  
217

### STEP SEAL

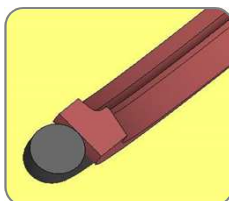

Style : **SSW(E-RING,SK)**  
Material : PTFE+NBR

Page:  
218

## 3. Hydraulic Breaker seal

### ROD SEAL- STYLE : IUSW

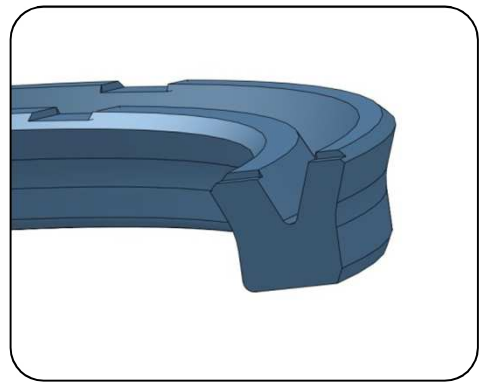
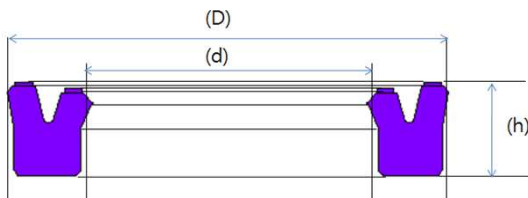

Material	Main function	Feature
Heat resistance PU - Pressure: 0~50Mpa - Temperature range: -35~130	Prevention of external oil leakage	Since the heat resistance PU material has very special heat resistance for low temperature and high temperature, it can be used at very wide temperature range. And since it has very good elasticity even under hard working condition, good for prolong the seal life time (Compression set : 25% in 80℃ 70hr)

#### SEAL INFORMATION

PART NUMBER	(Prefix)- d*D*h
-------------	-----------------

PART NUMBER		PART NUMBER		PART NUMBER		PART NUMBER	
IUSW	40*50*6	IUSW	60*70*6	IUSW	124*134*6	IUSW	150*165*9
IUSW	42*52*6	IUSW	70*80*6	IUSW	125*140*10	IUSW	155*165*6
IUSW	45*55*6	IUSW	85*100*9	IUSW	125*140*9	IUSW	155*170*9
IUSW	50*60*6	IUSW	98*112*8.5	IUSW	130*145*9	IUSW	156*171*10
IUSW	53*63*6	IUSW	100*115*9	IUSW	140*150*6	IUSW	160*175*9
IUSW	55*65*6	IUSW	120*135*9	IUSW	140*155*9	IUSW	170*180*6



WONYOUNG SEAL CORPORATION

### 3. Hydraulic Breaker seal

## ROD SEAL– STYLE : **IUSW**

PART NUMBER	
IUSW	170*185*9
IUSW	175*190*9
IUSW	180*200*12
IUSW	185*205*12
IUSW	186*206*13
IUSW	200*220*12
IUSW	210*230*12

## 3. Hydraulic Breaker seal

### ROD SEAL- STYLE : HBHW

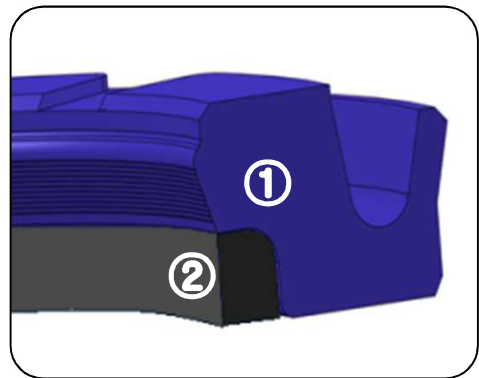
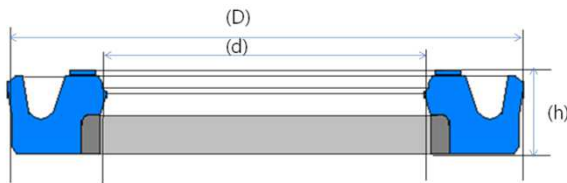

Material	Main function	Feature
① Heat resistance PU - Pressure: 0~50Mpa - Temperature range: -35~130 ② Nylon back up ring	Buffering of impact pressure applied to rod packing	Since there are high pressure & impact , TPU sealing ① is used in combination with P/A backup ring ②, to use TPU with a combination of strength and flexibility so that the pressure resistance is supplemented. Some case, the P/A back up ring can scratch the rod, without back up ring style "HBKW" also available to use.

#### SEAL INFORMATION

PART NUMBER	(Prefix)- d*D*h
-------------	-----------------

PART NAME	
HBHW	50*65.5*6
HBHW	55*70.5*6
HBHW	60*75.5*6
HBHW	65*80.5*6
HBHW	70*85.5*6
HBHW	75*90.5*6

PART NAME	
HBHW	80*95.5*6
HBHW	85*100.5*6
HBHW	90*105.5*6
HBHW	95*110.5*6
HBHW	100*115.5*6
HBHW	105*120.5*6

PART NAME	
HBHW	110*125.5*6
HBHW	115*130.5*6
HBHW	120*135.5*6
HBHW	124*139.5*6
HBHW	130*145.5*6
HBHW	132*147.5*6

PART NAME	
HBHW	140*155.5*5.8
HBHW	145*160.5*5.8
HBHW	155*170.5*5.8
HBHW	160*175.5*6
HBHW	170*185.5*6
HBHW	180*195.5*6

## 3. Hydraulic Breaker seal

### BUFFER SEAL- STYLE : HBKW

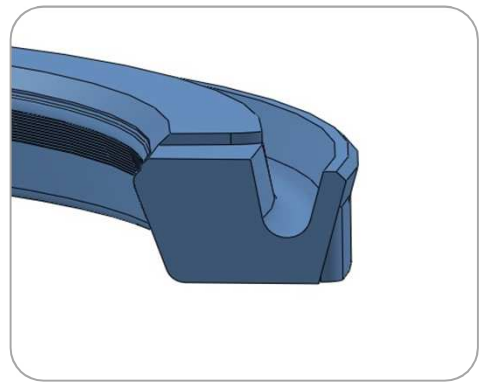
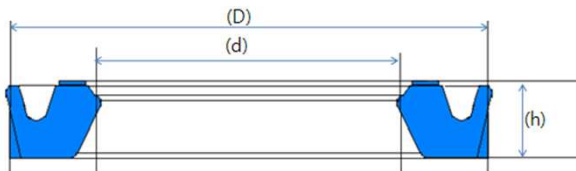

Material	Main function	Feature
① Heat resistance PU - Pressure: 0~50Mpa - Temperature range: -35~130	Buffering of impact pressure applied to rod packing	Some case, the nylon back up ring can scratch the rod, without back up ring style 'HBKW' also available to use.

SEAL INFORMATION	
PART NUMBER	(Prefix)- d*D*h

PART NAME	
HBKW	75*90.5*6
HBKW	85*100.5*6
HBKW	100*115.5*6
HBKW	124*139.5*6
HBKW	130*145.5*6
HBKW	132*147.5*6

PART NAME	
HBKW	135*150.5*6
HBKW	140*155.5*6
HBKW	150*165.5*6
HBKW	155*170.5*6
HBKW	160*175.5*6
HBKW	170*185.5*6

PART NAME	
HBKW	180*195.5*6
HBKW	185*200.5*6

## 3. Hydraulic Breaker seal

### DUST SEAL- STYLE : LBHW

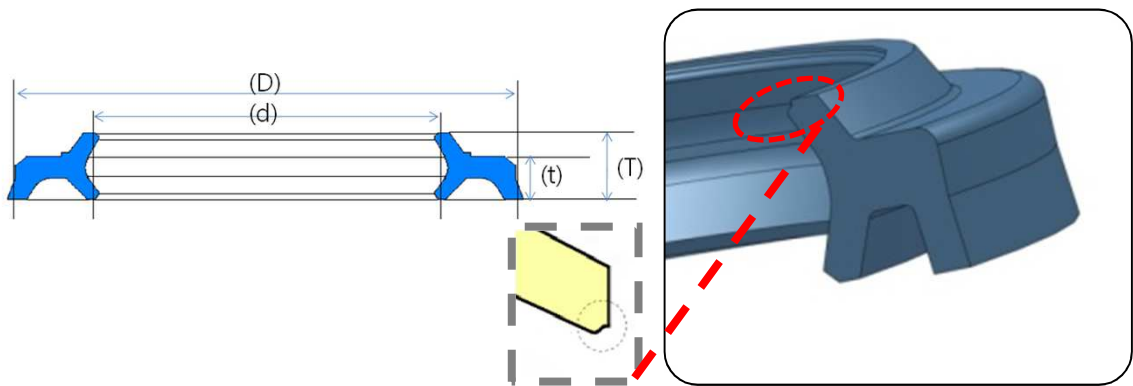

Material	Main function	Feature
Heat resistance PU - Pressure: 0~50Mpa - Temperature range: -35~130	Prevent of intrusion of foreign objects	To cope with the harsh external contaminant conditions, high strength TPU is used to resist plastic deformation. Since the ideal design of the dust sealing lip, it can be done ideal dust wiping for good dust resistance and good oil film making.

SEAL INFORMATION	
PART NUMBER	(Prefix)- d*D*t/T

PART NUMBER	
LBHW	40*48*5/6.5
LBHW	45*53*5*6.5
LBHW	53*61*5/6.5
LBHW	55*63*5/6.5
LBHW	60*68*5/6.5
LBHW	70*80*6/8

PART NUMBER	
LBHW	85*95*6/8
LBHW	100*110*6/8
LBHW	120*130*6/8
LBHW	125*138*7/9.5
LBHW	130*143*7/9.5
LBHW	140*153*7/9.5

PART NUMBER	
LBHW	150*163*7*9.5
LBHW	156*169*7/9.5
LBHW	160*173*7/9.5
LBHW	170*183*7/9.5
LBHW	175*188*7*9.5
LBHW	180*193*7/9.5

PART NUMBER	
LBHW	185*198*7/9.5
LBHW	186*201*7/9.5
LBHW	200*213*7/9.5
LBHW	210*223*7/9.5

## 3. Hydraulic Breaker seal

### DUST SEAL- STYLE : LPIY

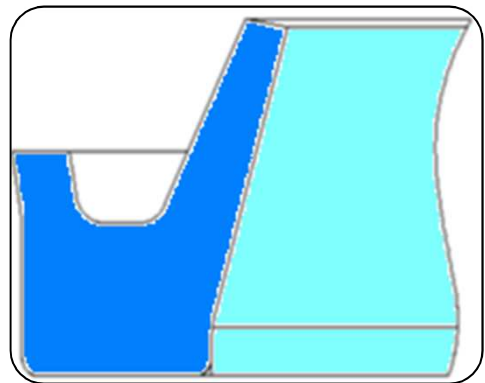
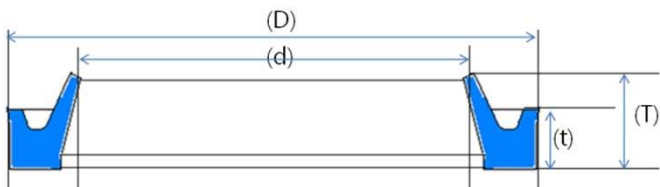

Material	Main function	Feature
Heat resistance PU - Pressure: 0~50Mpa - Temperature range: -35~130	Prevent of intrusion of foreign objects	To cope with the harsh external contaminant conditions, high strength TPU is used to resist plastic deformation. Since the ideal design of the dust sealing lip, it can be done ideal dust wiping for good dust resistance and good oil film making.

SEAL INFORMATION	
PART NUMBER	(Prefix)- d*D*t/T

PART NUMBER	
LPIY	124*139*6.5/10.3
LPIY	155*170*6.5/10.3
LPIY	140*155*6.5/10.3



## 3. Hydraulic Breaker seal

### GAS SEAL- STYLE : GAS

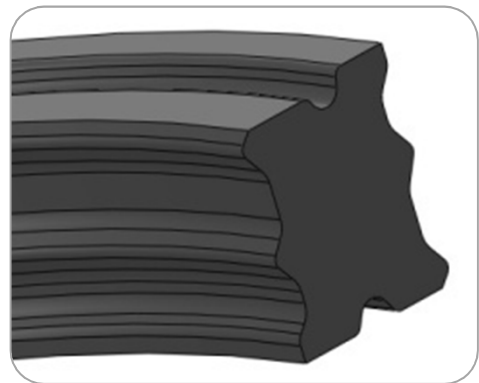
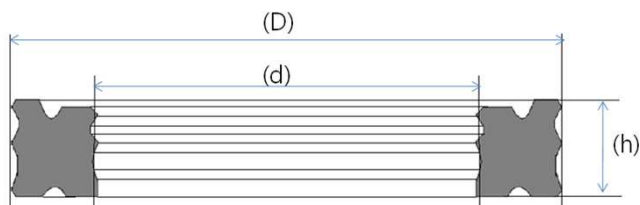

Material	Main function	Feature
FKM	Prevention of external gas leakage	'GAS' with high wear resistance characteristics is used for gas seals to prevent oil scrapping off from the gas chamber.

#### SEAL INFORMATION

PART NUMBER	(Prefix)- d*D*h(±0.2)
-------------	-----------------------

PART NAME	
GAS	68*78*5.4
GAS	83.5*93.5*7.2
GAS	98*108*7.2
GAS	120*133*9.8
GAS	128*141*9.8

PART NAME	
GAS	130*145*10.2
GAS	133*146*9.8
GAS	135*148*9.8
GAS	136*149*9.8
GAS	137*150*9.8

PART NAME	
GAS	138*151*9.8
GAS	147*160*9.8
GAS	150*163*9.8
GAS	150*163*9.8
GAS	157*170*9.8

PART NAME	
GAS	163*176*9.8
GAS	165*178*9.8
GAS	167*180*9.8
GAS	177*190*9.8
GAS	182*195*9.8

### 3. Hydraulic Breaker seal

## STEP SEAL- STYLE : SSHW

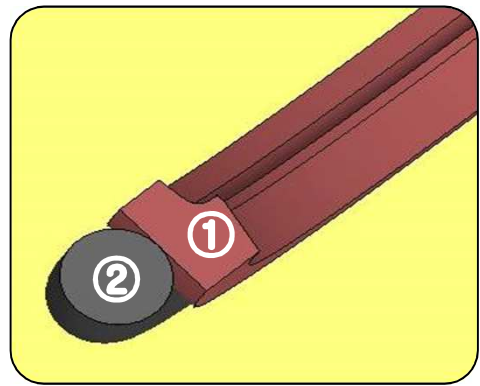
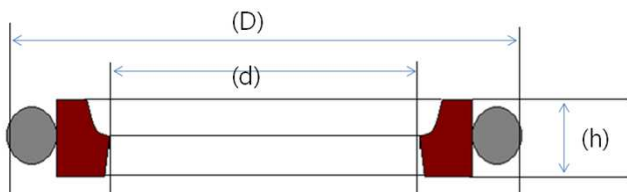

Material	Main function	Feature
① Teflon(Bronze50%filled) ② Nitrile rubber	Absorb pressure impact to Gas seal	'SSHW' is used to absorb impact pressure and reduce the friction.

#### SEAL INFORMATION

PART NUMBER	(Prefix)- d*D*h
-------------	-----------------

PART NUMBER	
SSHW	37*47.7*3.9
SSHW	42*52.7*3.9
SSHW	50*60.7*3.9
SSHW	57*72.1*5.9
SSHW	68*83.1*5.9
SSHW	83.5*98.6*5.9
SSHW	98*113.1*5.9

PART NUMBER	
SSHW	118*133.1*5.9
SSHW	120*135.1*5.9
SSHW	123.5*138.6*5.9
SSHW	128*143.1*5.9
SSHW	135*150.1*5.9
SSHW	136*151.1*5.9
SSHW	137*152.1*5.9

PART NUMBER	
SSHW	138*153.1*5.9
SSHW	147*162.1*5.9
SSHW	150*165.1*5.9
SSHW	155*170.1*5.9
SSHW	157*172.1*5.9
SSHW	165*180.1*5.9
SSHW	167*182.1*5.9

PART NUMBER	
SSHW	172*187.1*5.9
SSHW	177*192.1*5.9
SSHW	180*195.1*5.9
SSHW	195*210.5*5.9

### 3. Hydraulic Breaker seal

## FACE SEAL- STYLE : FACE



Material	Main function	Feature
① Polyurethane	Prevent oil leakage	Face seal is one piece alternative to O-ring. Mainly OD in important to use.

SEAL INFORMATION	
PART NUMBER	(Prefix)- d*D*h

PART NUMBER		PART NUMBER		PART NUMBER		PART NUMBER	
FACE	10*16*1.9	FACE	25*33*2.4	FACE	34*40*2.9	FACE	60*67*3.1
FACE	12*18*1.9	FACE	25*33*3	FACE	35*43*3.1	FACE	62*77*5.3
FACE	14*18*1.9	FACE	29.5*36*3	FACE	39.2*48*3.1	FACE	64*73*3.1
FACE	14*21*1.9	FACE	28*40*2.4	FACE	40*48*2.4	FACE	65*72.5*3
FACE	16*23*1.9	FACE	30*38*1.9	FACE	45*52.5*3.1	FACE	70*77.5*3
FACE	18*23*2.4	FACE	30*38*2.4	FACE	50*58*3.1	FACE	80*89*3.1
FACE	20*28*1.9	FACE	32*40*2.4	FACE	54.5*62.5*3.1		
FACE	23.5*26.5*1.7	FACE	32*40*3	FACE	54*63*3.1		

## 4. Hydraulic Breaker seal kit



**WYS** providing special concept of high quality seal.

We are supplying **new concept hydraulic breaker seal kit** with them named '**Evolution seal kit**'.  
**What we call Evolution seal kit?** It's the seal kit for the repair but the seal configuration of seal kit is replaced by more **superior** and **evolved seals** instead the **initial seal configuration of maker** for more **superior sealing performance**.

All consisted seals are already verified and proved the sealing performance by OEM bench testing and field testing.

Evolution seal kit aim to improve '**Heat resistance**', '**cold proof**', '**Reducing oil pollution**' to achieve **extension of cylinder life**.

**And this is the main stream of all top class cylinder maker aiming.**



## 4. Hydraulic Breaker seal kit

### MAKER : SOOSAN

PART NAME	
SOOSAN	SB20
SOOSAN	SB30
SOOSAN	SB40
SOOSAN	SB43

PART NAME	
SOOSAN	SB45
SOOSAN	SB50
SOOSAN	SB60
SOOSAN	SB70(81N)

PART NAME	
SOOSAN	SB100
SOOSAN	SB121
SOOSAN	SB130
SOOSAN	SB135

PART NAME	
SOOSAN	SB140
SOOSAN	SB151

### MAKER : KRUPP

PART NAME	
KRUPP	560/580
KRUPP	700/712/720
KRUPP	900/950/952

PART NAME	
KRUPP	960
KRUPP	960-2
KRUPP	1000

PART NAME	
KRUPP	1200
KRUPP	1300
KRUPP	1500

PART NAME	
KRUPP	1500CS
KRUPP	2000

### MAKER : DAEMO

PART NAME	
DAEMO	S-500
DAEMO	S-1300
DAEMO	S-1800

PART NAME	
DAEMO	S-2200
DAEMO	S-2200-2.3
DAEMO	S-3000

PART NAME	
DAEMO	S-3600
DAEMO	S-4400
DAEMO	S-4500

### MAKER : MSB(SAGA)

PART NAME	
MSB (SAGA)	200
MSB (SAGA)	400

PART NAME	
MSB (SAGA)	450
MSB (SAGA)	500

PART NAME	
MSB (SAGA)	550
MSB (SAGA)	600

PART NAME	
MSB (SAGA)	700
MSB (SAGA)	800
MSB (SAGA)	20G



## 4. Hydraulic Breaker seal kit

### MAKER : FURUKAWA

PART NAME	
FURUKAWA	HB 1G
FURUKAWA	HB 3G
FURUKAWA	HB 5G
FURUKAWA	HB 8G
FURUKAWA	HB 10G

PART NAME	
FURUKAWA	HB 15G
FURUKAWA	HB 20G
FURUKAWA	HB 20G-2
FURUKAWA	HB 20G-2SK5
FURUKAWA	HB 30G

PART NAME	
FURUKAWA	HB 30G-2
FURUKAWA	HB 30G-2SK5
FURUKAWA	HB 40G
FURUKAWA	HB 40G-2
FURUKAWA	HB 40G-2SK5

PART NAME	
FURUKAWA	HB 200
FURUKAWA	HB 400
FURUKAWA	HB 700
FURUKAWA	HB 1200
FURUKAWA	HB 1500

PART NAME	
FURUKAWA	F-3
FURUKAWA	F-6
FURUKAWA	F-9
FURUKAWA	F-20(A)
FURUKAWA	F-20(B)
FURUKAWA	F-20(C)
FURUKAWA	F-20(D)
FURUKAWA	F-12(A)
FURUKAWA	F-12(B)

PART NAME	
FURUKAWA	F-12(C)
FURUKAWA	F-12(D)
FURUKAWA	F-19(A)
FURUKAWA	F-19(B)
FURUKAWA	F-19(C)
FURUKAWA	F-19(D)
FURUKAWA	F-22(A)
FURUKAWA	F-22(B)
FURUKAWA	F-22(C)

PART NAME	
FURUKAWA	F-22(D)
FURUKAWA	F-27(A)
FURUKAWA	F-27(B)
FURUKAWA	F-27(C)
FURUKAWA	F-27(D)
FURUKAWA	F-35(A)
FURUKAWA	F-35(B)
FURUKAWA	F-35(C)
FURUKAWA	F-35(D)

PART NAME	
FURUKAWA	F-45(A)
FURUKAWA	F-45(B)
FURUKAWA	F-45(C)
FURUKAWA	F-45(D)
FURUKAWA	F-30(A)
FURUKAWA	F-30(B)
FURUKAWA	F-30(C)
FURUKAWA	F-30(D)

### MAKER : TOKU

PART NAME	
TOKU	TNB 2E
TOKU	TNB 6E
TOKU	TNB 7E
TOKU	TNB 7B
TOKU	TNB 14E

PART NAME	
TOKU	TNB 14B
TOKU	TNB 150LU
TOKU	TNB 151LU
TOKU	MKB 500
TOKU	MKB 800

PART NAME	
TOKU	MKB 1100
TOKU	MKB 1300
TOKU	MKB 1400
TOKU	MKB 1500
TOKU	MKB 1600

PART NAME	
TOKU	MKB 2000
TOKU	MKB 2500
TOKU	MKB 4000



## 4. Hydraulic Breaker seal kit

### MAKER : THBB

PART NAME	
THBB	THBB 101
THBB	THBB 301

PART NAME	
THBB	THBB 401
THBB	THBB 801

PART NAME	
THBB	THBB 1401
THBB	THBB 1400

PART NAME	
THBB	THBB 1600

### MAKER : RAMMER

PART NAME	
RAMMER	S-23
RAMMER	S-25

PART NAME	
RAMMER	S-26
RAMMER	S-56

PART NAME	
RAMMER	S-82
RAMMER	S-83

PART NAME	
RAMMER	G-80

### MAKER : SOOSAN

PART NAME	
SOOSAN	SB 20
SOOSAN	SB 30
SOOSAN	SB 40
SOOSAN	SB 43

PART NAME	
SOOSAN	SB 45
SOOSAN	SB 50
SOOSAN	SB 60
SOOSAN	SB 70(81N)

PART NAME	
SOOSAN	SB 81(80)
SOOSAN	SB 100
SOOSAN	SB 121(121)
SOOSAN	SB 130

PART NAME	
SOOSAN	SB 135
SOOSAN	SB 140
SOOSAN	SB 151

### MAKER : HANWOO

PART NAME	
HANWOO	RHB 301
HANWOO	RHB 302
HANWOO	RHB 303
HANWOO	RHB 305
HANWOO	RHB 305-2

PART NAME	
HANWOO	RHB 308
HANWOO	RHB 313
HANWOO	RHB 313-2
HANWOO	RHB 313V
HANWOO	RHB 320

PART NAME	
HANWOO	RHB 320
HANWOO	RHB 322/325
HANWOO	RHB 328
HANWOO	RHB 330/332
HANWOO	RHB 335

PART NAME	
HANWOO	RHB 340
HANWOO	RHB 350



WONYOUNG SEAL CORPORATION

## 4. Hydraulic Breaker seal kit

### MAKER : N.P.K

PART NAME	
N.P.K	H-1X
N.P.K	H-2X
N.P.K	H-3X
N.P.K	H-4X
N.P.K	H-5X
N.P.K	H-6X

PART NAME	
N.P.K	H-7X
N.P.K	H-8X
N.P.K	H-8XA
N.P.K	H-10X
N.P.K	H-10XE
N.P.K	H-10XB

PART NAME	
N.P.K	H-11X
N.P.K	H-12X
N.P.K	H-12XE
N.P.K	H-14X
N.P.K	H-16X
N.P.K	H-16XE

PART NAME	
N.P.K	H-25X
N.P.K	E-218
N.P.K	E-210
N.P.K	H-20X

### MAKER : KANGLIM

PART NAME	
KANGLIM	SG 400
KANGLIM	SG 800
KANGLIM	SG 1200

PART NAME	
KANGLIM	SG 1800
KANGLIM	SG 2100
KANGLIM	SG 2800

PART NAME	
KANGLIM	SG 3200
KANGLIM	SG 3300
KANGLIM	KTB 2800

PART NAME	
KANGLIM	KTB 3000

### MAKER : G.B

PART NAME	
GB	1T
GB	2T
GB	4T
GB	5T

PART NAME	
GB	6T
GB	8T/8AT
GB	11T
GB	14T

PART NAME	
GB	290E
GB	300E
GB	400E
GB	500E

PART NAME	
GB	220E

### MAKER : D/MYUNG

PART NAME	
D / MYUNG	TOPA 300
D / MYUNG	TOPA 500

PART NAME	
D / MYUNG	TOPA 900
D / MYUNG	TOPA 1400

PART NAME	
D / MYUNG	TOPA 1600
D / MYUNG	TOPA 2000

PART NAME	
D / MYUNG	TOPA 3000





## 4. Hydraulic Breaker seal kit

### MAKER : DAESIN

PART NAME	
DAESIN	TB 200
DAESIN	TB 350

PART NAME	
DAESIN	TB 450
DAESIN	TB 500

PART NAME	
DAESIN	TB 550

### MAKER : DONGNAM

PART NAME	
DONGNAM	145V
DONGNAM	146V

PART NAME	
DONGNAM	160V
DONGNAM	161V

PART NAME	
DONGNAM	170V
DONGNAM	171V

### MAKER : DONGYANG

PART NAME	
DONGYANG	DYB 300
DONGYANG	DYB 600

PART NAME	
DONGYANG	DYB 1200
DONGYANG	DYB 1300

## 5. Pneumatic seal



WYS providing high quality pneumatic seals.

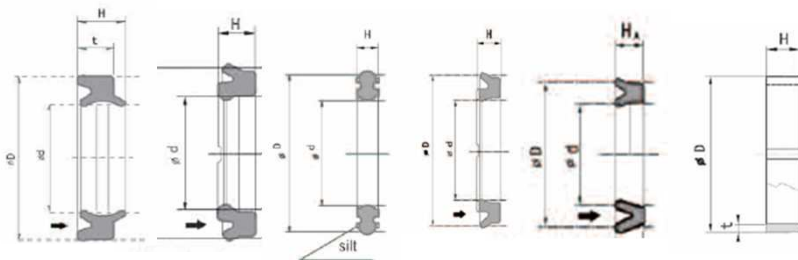

CUW

PRW

PPYW

PPW

PGW

MYW

TWR

## 6. Floating seal

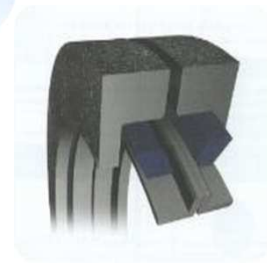
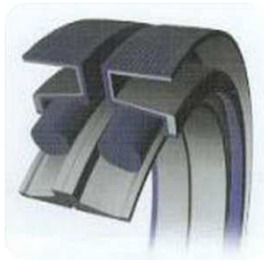

**WYS providing special high quality floating seal.**

Same seal we are providing to

**Jin sung(Caterpillar)also.**

Our production process and material is characterized as follow.

\* SHELL MOULD process is 'Hi-Cr'

\* Centrifugal casting process is 'Ni-HARD' .



WONYOUNG SEAL CORPORATION

## 6. Floating seal

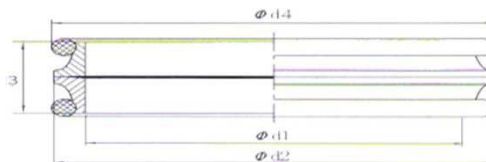

No.	PART No.	ORIGINAL PART No.	ORIGINAL PART No.	DIMENSION			
				$\phi d1$	$\phi d2$	$\phi d4$	t3
1	WY042FS	58645-01500	110-30-00045	45	58	61.6	21
2	WY045FS	760S045FS	4110358	48	62	68	25
3	WY053FS	760S053FS	4508192	56	70	76	25
4	WY055FS	140-30-00040	140-30-00040	58	75	79.4	27
5	WY060FS	2M2858	2M2858	63.5	82	86.8	31.8
6	WY061FS	4060225	4060225	64	78	84.6	25
7	WY063FS	760S063FS	760S063FS	66	85	90	28
8	WY067FS	58845-20500	58845-20500	69	84	90.6	26
9	WY068FS	141-30-00610	141-30-00610	70	90	95.5	29
10	WY070FS	1M8747	1M8747	73	92	96.2	31.8
11	WY071FS		20Y-30-00070	74	86	91	22
12	WY074FS	150-30-00035	150-30-00035	76	94	101	29
13	WY077FS	170-30-00110	170-30-00110	80	99	105	29
14	WY078FS	760S078FS	760S078FS	81	100	104	29
15	WY085FS		6S 3285	90	105	107.8	28
16	WY087FS	1M8746	1M8746	90.5	109	113.6	31.8
17	WY089FS		20Y-30-00041	92	109.3	114.6	22
18	WY091FS		20Y-30-00040	94	106.7	112	22
19	WY092FS	760S092FS	4153468	95	114	120	30
20	WY095FS		760S095FS	98.5	119	*	30
21	WY096FS	V20801	205-30-00050	98.5	119	123.5	29
22	WY097FS	1M8748	1M8748	100	118	123.2	31.8
23	WY099FS	760S099FS	4153731	102	122	127.2	32
24	WY100FS		20Y-30-00100	104	117	122.2	20
25	WY101FS		20Y-30-00101	104	122	125.8	22
26	WY106FS	760S106FS	130-27-00020	109	132	136.6	32
27	WY107FS	4508193	4508193	110	127	133	32
28	WY112FS	147-27-00015	150-27-00015	115	137	141.8	31
29	WY117FS		JB5640	120	143	149	38
30	WY121FS		207-30-00101	124	141	147	22
31	WY122FS			125	144.1	148.5	31.8
32	WY123FS	1P7249	1P7249	127	146	150.2	31.8
33	WY124FS			127	141	148	25
34	WY126FS	760S126FS	45007221	130	152	150	38
35	WY127FS	170-27-00010	170-27-00010	130	150	155.6	32
36	WY134FS			136	153	161.7	30
37	WY140FS	5K5288	5K5285	143	157	159.7	25
38	WY143FS	4K6049	4K6049	146	171.7	177	38
39	WY145FS			148	170	175.6	31
40	WY147FS	760S147FS	JB5620	150	172	179	40
41	WY149FS		760S149FS	152	176	*	32
42	WY151FS	5K1078	5K1078	154	168	171	25
43	WY156FS		180-27-00020/1	159.5	180	186.3	32
44	WY160FS	7M481	7M0481	163.3	191.2	196.4	38
45	WY175FS		4513173	178	200	210.6	38
46	WY179FS	5M1176	5M1176	182	210	215.4	38
47	WY179-1FS		9W6674	182	210	215.4	50
48	WY189FS		FL5420	192	215	220.8	33
49	WY206FS		JB5650	209	234	242.6	42
50	WY217FS		760S217FS	220	246	254.6	41
51	WY220FS	5M8647	5M8647	223	252	258	38
52	WY220-1FS		8P1252	223	248	257	48
53	WY222FS	760S222FS	760S222FS	225	252	258	37
54	WY223FS		130-27-00010	225	252	258	38
55	WY236FS	141-27-00025	141-27-00010	239	268	274.2	40
56	WY247FS	760S247FS	760S247FS	250	276	284.6	41
57	WY247-1FS		4514259	250	276	284.6	44
58	WY262FS	5M1177	5M1177	265	293	298	37
59	WY297FS	150-27-00025	150-27-00025/20	300	328	333	40
60	WY315FS		5M7294	318	343	351.6	37
61	WY337FS	170-27-0020	170-27-0020	340	368	374.8	38
62	WY363FS		4D4521	365	391	399.5	37

## 7. Custom oil seal



**WYS available** providing any type of oil seal as customer request by our design and material and molding







This oil seal can be used for Car and Heavy equipment and other industrial using  
Kindly check below profile of available oil seal and if you need any type of oil seal, please contact  
with us

Also if you can not find the type which you looking for, please try to contact with us  
we can discuss about new development also







## 7. Custom oil seal(SEAL PROFILE)

### ● OIL SEAL

STYLE	SC	TC	TB	TCK	VC	KC	TCZ
PRODUCT IMAGE							

STYLE	TCV	TCN	TC4	TCJ	SA1J	VAJ	VA3J
PRODUCT IMAGE							

STYLE	DC	OC	QLFY	VR	ZF	ZT	SBB
PRODUCT IMAGE							

STYLE	SB(BIG SIZE)	TB(BIG SIZE)	MG	WT	WTT	OKC3
PRODUCT IMAGE						

### ● OTHERS

STYLE	MECHANICAL SEAL	VALVE STEM SEAL	CHANGE LEVER SEAL
PRODUCT IMAGE			

## 8. Machined seal

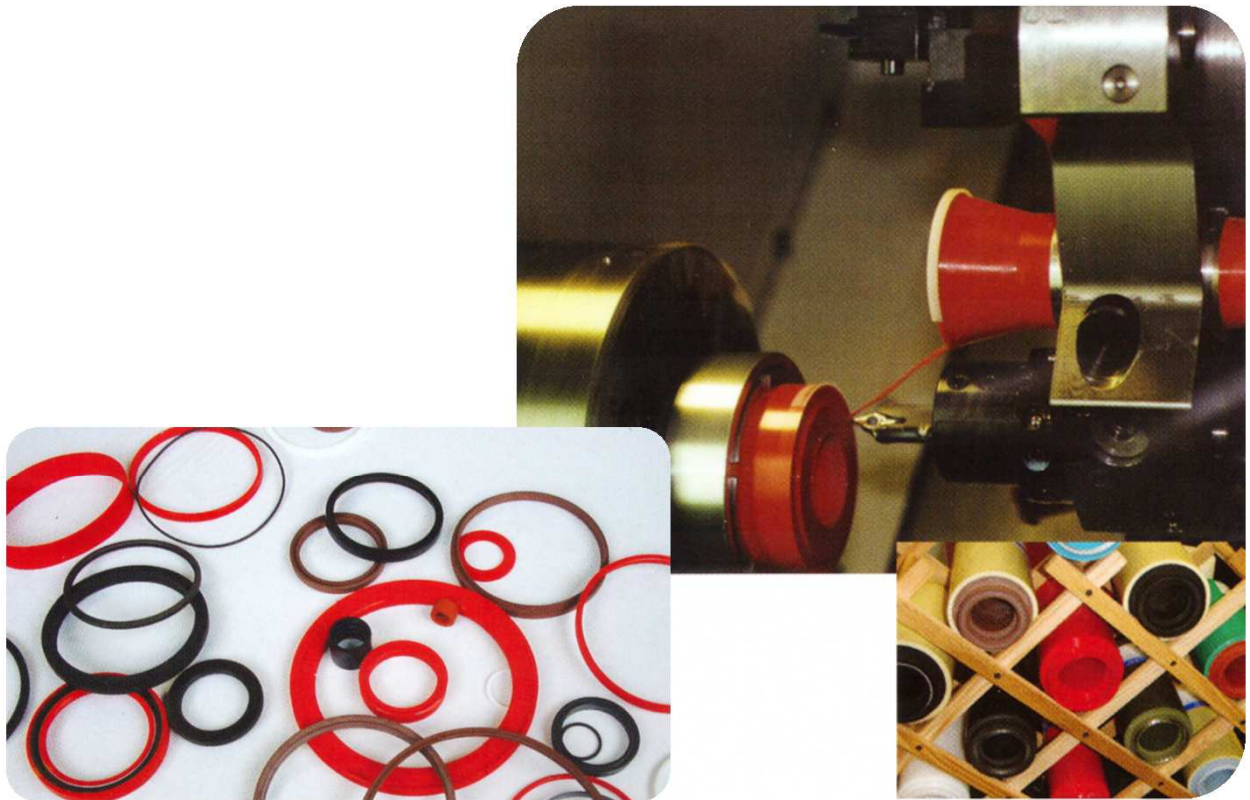

**WYS** available to provides a wide selection of custom, cost effective sealing solutions using advanced rapid-prototype technology.

The programmable CNC production cell can manufacture both hydraulic and pneumatic styles of o-rings, rod seals, piston seals, wipers, backup rings, rotary seals, swivel seals and static seals in both imperial and metric sizes for almost any fluid power application including agriculture, automotive, heavy construction, material handling, manufacturing, mining, logging, fluid handling and refuse.

**WYS** technology gives you the ability to source custom manufactured products with a short turn-around time and with no mold costs. **WYS** software offers over 100 standard profiles and can produce countless custom designs by modifying the standard dimensions. The advanced lathe technology results in exceptional sealing products with smooth corners and fillets, fine surface finishes and sharp lips. **WYS** cooperate with leading Korea factory who has a large inventory of high quality materials in numerous sizes including materials from elastomers of rubber and urethane to plastics of fluoro-polymers (PTFE) and Acetal (POM) available for your sealing application.



## 8. Machined seal(MATERIAL DATA SHEET)

Material			Polyurethane								Rubber				
Properties	Standard	Unit	HPU	C-HPU	HPU 55D	C-HPU 57D	C-HPU 72D	LT-PU	HT-PU	SL-PU	NBR	H-NBR	FPM	EPDM	MVQ
			Red	Red	Yellow	Yellow	Nature	Blue	Nature	Grey	Black	Green	VITON		SILICON
Hardness	ISO 868	Shore A	95±2	96±2				96±2	96±2	96±2	85±5	85±5	85±5	85±5	85±5
Hardness	ISO 868	Shore D	48±3	50±3	55±3	57±3	70±3	50±3	47±3	48±3					
Ball indentation hardness	DIN 53456	MPa													
Tensile strength	DIN 53504	MPa	50	45	45	45	50	60	45	45	17	20	9	12	7
Elongation at break	DIN 53504	%	350	450	340	350	150	550	500	350	150	190	200	80	120
Modulus 100%	DIN 53504	MPa	15	12	20	20	30	12	11	12	11	10	6		4
Modulus 300%	DIN 53504	MPa	28	22	35	33		22	22	22					
Rebound elasticity	DIN 53512	%									20	30	7	37	35
Tear strength	DIN ISO 34-1	kN/mm	110	80	110	110	110	80	80	80	18	15	20	10	15
Spec. gravity	ISO 1183	kg/m <sup>3</sup>	1200	1130	1210	1160	1210	1170	1170	1190	1320	1320	2530	1220	1580
Abrasion	DIN 53516	mm <sup>3</sup>	17	20	25	25		17	15	15	100	135	175	140	
Compressive strength	DIN 53455	MPa													
Thermal conductivity	DIN 52612	J <sup>-1</sup> 10 <sup>3</sup> /m <sup>2</sup> h <sup>-1</sup> k													
Coefficient of thermal expansion		K <sup>-1</sup> x 10 <sup>-5</sup>													
Coefficient of friction	DIN 52612														
Spec. gravity	DIN 53479	kg/m <sup>3</sup>													
Compression set *	ISO 815	%	27	30	30	30		27	32	30	5	12	17	7	8
Compression set **	ISO 815	%	33	35	35	35		33	35	35	6	14	10	7	9
Compression set ***	ISO 815	%									22	15			
Temperature min.		°C	-20	-37	-20	-30	-20	-50	-35	-20	-30	-20	-20	-45	-60
Temperature max.		°C	115	110	115	110	110	110	135	110	110	150	220	130	200
Temp. max. water/steam		°C	80		80							120	150	150	120
Temp. max. hot air(short)		°C										180	300	180	300
Young's modulus	DIN 53457	MPa													
FDA-approval			√	√											
Special compound with FDA approval					√							√	√	√	√

\* 24h 70°C 25% deflection \*\* 24h 100°C 25% deflection \*\*\* 24h 150°C 25% deflection

The test results are average-results measured from test specimen and cannot be transferred to seal applications.

Material			Fluoropolymer										Thermoplastic		
Properties	Standard	Unit	PTFE Virgin	PTFE D05	PTFE D08	PTFE Glass	PTFE I	PTFE II	PTFE D46	PTFE Carbon	PTFE E-Carbon	PTFE Ekonol	POM	PA	UHMW-PE
					Glass 15%	Glass 25%	Glass/MoS <sub>2</sub>	Bronze40%	Bronze46%	Carbon25%	Carbon10%	Ekonol10%			
Color			White	Turquoise	Orange	Grey	Grey	Brown	Green	Black	Black	Cream	White	Nature	Nature
Hardness	ISO 868	Shore A													
Hardness	ISO 868	Shore D	55±3	57±3	62±3	60±3	58±3	60±3	63±3	67±3	60±3	56±3	85±3	85±3	61±3
Ball indentation hardness	DIN 53456	MPa	23±5	28±5	24±5	24±5	27±5	33±5	35±5	35±5	30±5	28±5	160	153	36
Tensile strength	DIN 53504	MPa	27	31	26	17	16	22	24	12	24	20	70	80	40
Elongation at break	DIN 53504	%	250	270	300	170	185	200	170	45	250	250	40	40	50
Modulus 100%	DIN 53504	MPa													
Modulus 300%	DIN 53504	MPa													
Rebound elasticity	DIN 53512	%													
Tear strength	DIN ISO 34-1	kN/mm													
Spec. gravity	ISO 1183	kg/m <sup>3</sup>													
Abrasion	DIN 53516	mm <sup>3</sup>													
Compressive strength	DIN 53455	MPa	4	4	8	8	8	10	10			11	88	110	88
Thermal conductivity	DIN 52612	J <sup>-1</sup> 10 <sup>3</sup> /m <sup>2</sup> h <sup>-1</sup> k	0.8	0.8	1.1	1.3	1.1	4	4.2	3.5	3.5	5.4	0.25	0.29	0.41
Coefficient of thermal expansion		K <sup>-1</sup> x 10 <sup>-5</sup>	19	19	10	10.7	13	8	8.5	10.9	10.9	8.4	11	8	15
Coefficient of friction	DIN 52612		0.08	0.08	0.13	0.16	0.13	0.13	0.15	0.17	0.18	0.18	0.28	0.4	0.25
Spec. gravity	DIN 53479	kg/m <sup>3</sup>	2150	2170	2230	2210	2260	3110	3200	2060	2140	2040	1410	1130	930
Compression set *	ISO 815	%													
Compression set **	ISO 815	%													
Compression set ***	ISO 815	%													
Temperature min.		°C	-200	-200	-200	-200	-200	-200	-200	-200	-200	-200	-45	-40	-200
Temperature max.		°C	260	260	260	260	260	260	260	260	260	260	100	110	80
Temp. max. water/steam		°C													
Temp. max. hot air(short)		°C													
Young's modulus	DIN 53457	MPa	540	540			1230	1375	1420				3000	3000	680
FDA-approval			√										√		
Special compound with FDA approval															

\* 24h 70°C 25% deflection \*\* 24h 100°C 25% deflection \*\*\* 24h 150°C 25% deflection

The test results are average-results measured from test specimen and cannot be transferred to seal applications.



## 8. Machined seal(SEAL PROFILES)

### WIPER

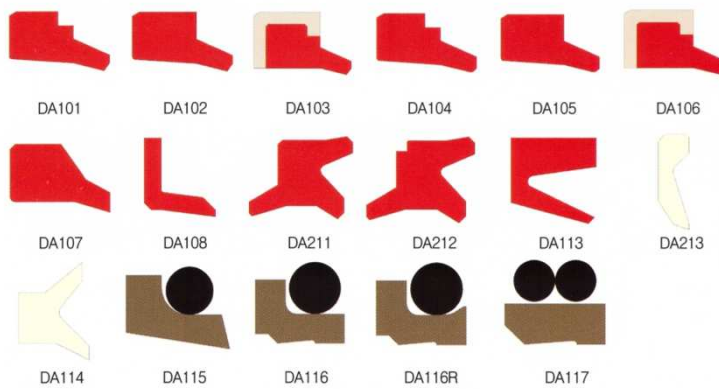

### ROD SEALS

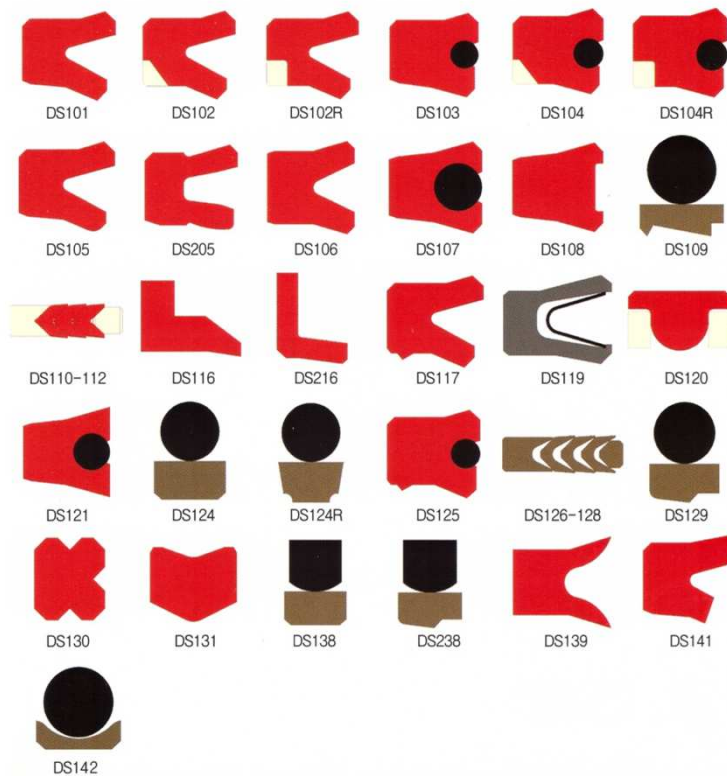

## 8. Machined seal(SEAL PROFILES)

### PISTON SEALS



DK101

DK102

DK102R



DK105

DK205

DK106

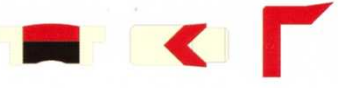

DK109

DK110-112

DK116



DK119

DK120

DK120N



DK124

DK125

DK126



DK139

DK140

DK141



DK103

DK104

DK104R



DK107

DK108

DK108R



DK216

DK117

DK118



DK122

DK222

DK123



DK127

DK138

DK238



DK142

DK151

DK152

### ROTARY SEALS



DR101

DR102

DR103



DR107

DR108

DR109



DR115

DR116

DR117



DR104

DR105

DR106



DR110

DR111

DR112



DR118

DR119

DR120

## 8. Machined seal(SEAL PROFILES)

### ROTARY SEALS

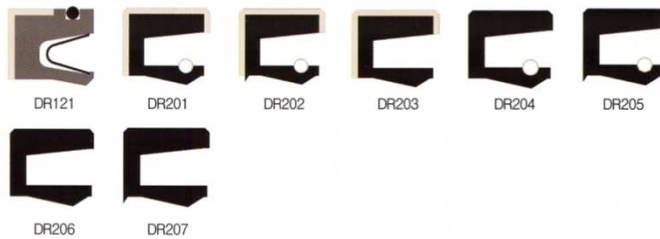

### LIP SEALS



### GUIDE RINGS



### BACKRINGS



### GASKETS





WONYOUNG SEAL CORPORATION

SEAL CATALOG Ver. 2021

**WONYOUNG SEAL CORPORATION**  
Address : 272-16, Yeomjeon-Ro,  
Michuhol-Gu, Incheon-City, Korea  
Tel : +82-32-864-3438  
Fax : +82-32-864-8273  
E-mail : [wonyoung@wonyoung.co.kr](mailto:wonyoung@wonyoung.co.kr)  
Web site : [www.wys-seals.com](http://www.wys-seals.com)