

H2W2PER3 H2W4PER3

Network WDR 2MP/4MP IR Micro Dome Camera









OPERATIONAL	
VIDEO STANDARD	NTSC/PAL
SCANNING SYSTEM	Progressive
IMAGE SENSOR	H2W2PER3: 1/2.8" 2 Megapixel progressive scan CMOS H2W4PER3: 1/3" 4 Megapixel progressive scan CMOS
NUMBER OF PIXELS (H × V)	H2W2PER3: 1920(H) × 1080(V) H2W4PER3: 2688(H) × 1520(V)
MINIMUM ILLUMINATION	H2W2PER3: 0.07lux/F2.0 (Color,30IRE) 0Lux/F2.0 (IR on) H2W4PER3: 0.3lux/F2.0 (Color,30IRE) 0Lux/F2.0 (IR On)
S/N RATIO	More than 45dB
ELECTRONIC SHUTTER SPEED	1/3(4)-1/100000s
IR DISTANCE	Up to 20m (66ft), depending on scene reflectance
IR LIGHT CONTROL	Manual/SmartIR/OFF
IR LIGHT NUMBER	10
DAY/NIGHT	Auto(ICR) / Color / B/W
BACKLIGHT COMPENSATION	BLC / HLC / WDR
WHITE BALANCE	Auto/Natural/Street Lamp/Outdoor/Manual/Customized Region
GAIN CONTROL	0~100
WIDE DYNAMIC RANGE	120dB
NOISE REDUCTION	3D DNR
PRIVACY MASKING	Off / On (4 Areas, Rectangle)
MOTION DETECTION	Off / On (4 Zones, Rectangle)
REGION OF INTEREST	Off / On (4 Zones)
FACE DETECTION	Supported
AUDIO DETECTION	Supported
LENS	2.8mm, F2.0 Fixed, Board-in
ANGLE OF VIEW	H2W2PER3: H: 110°, V:60° H2W4PER3: H: 104°, V:58°
VIDEO	
VIDEO COMPRESSION	H.265/H.264H/Smart Codec/MJPEG (Sub Stream)
RESOLUTION	H2W2PER3: 1080P(1920x1080)/1.3M(1280x960)/720P(1280x720)/D1(704x480/576)/CIF(352x240/288) H2W4PER3: 4M(2688x1520)/3M(2304x1296)/1080P(1920x1080)/1.3M(1280x960)/720P(1280x720)/D1(704x480/576)/CIF(352x240/288)
FRAME RATE	H2W2PER3: Main Stream: 1080P (1~50/60fps) Sub Stream: D1(1~50/60fps) Third Stream: 1080P(1~25/30fps) H2W4PER3: Main Stream: 4M(1~25/30fps) Sub Stream: D1(1~25/30fps) Third Stream: 720P(1~25/30fps)
BIT RATE CONTROL	CBR/VBR
BIT RATE	H2W2PER3: H.264: 24~9472Kbps H.265: 14~5632Kbps H2W4PER3: H.264: 24~10240Kbps H.265: 14~9984Kbps

AUDIO	
COMPRESSION	G.711a/G.711Mu/AAC/G.726
INTERFACE	Built-in Mic
NETWORK	
ETHERNET	RJ-45 (10/100Base-T)/M12 D-Coding
SUPPORTED WEB BROWSERS	Internet Explorer (11.0+)
SUPPORTED OS	Windows® 7 32-bit/64-bit; Windows® 10 32-bit/64-bit
PROTOCOLS*	HTTP; HTTPS; TCP; ARP; RTSP; RTP; RTCP; UDP; SMTP; DHCP; DNS; PPPoE; IPv4/v6; QoS; UPnP; NTP; Bonjour; IEEE 802.1x; Multicast; ICMP; IGMP; TLS
INTEROPERABILITY	ONVIF Profile S/G/Q
MAXIMUM USERS ACCESS	20 Users
SECURITY	User account and password protection HTTPS, IP Filter, Digest authentication, User access log, TLS1.2 only, AES-128/256, SSH/Telnet closed, sFTP by default, PCIDSS compliance
EVENT	No SD card, SD card error, Capacity warning, Network disconnection, IP conflict, Illegal access
MICRO SD	Up to 128 GB microSDHC card, Class 10 (not included)
ELECTRICAL	
POWER SUPPLY	DC12V, PoE (802.3af) (Class 0)
POWER CONSUMPTION	<4.5W
MECHANICAL	
DIMENSIONS	Ø106mm×50.3mm (4.17"×1.98")
PRODUCT WEIGHT	0.32kg (0.71lb)
PACKAGE WEIGHT	0.46kg (1.01lb)
CONSTRUCTION	Die-cast aluminum housing with powder coat
CONSTRUCTION COLOR	RAL 9003 (White)
ENVIRONMENTAL	
OPERATING TEMPERATURE	-30° C ~ +60° C (-22° F ~ +140° F)
RELATIVE HUMIDITY	Less than 95%, non-condensing
INGRESS PROTECTION	IP66
VANDAL RESISTANCE	IK10
REGULATORY	
EMISSIONS	FCC Part 15B, EN55032
IMMUNITY	EN 50130-4
SAFETY	UL 60950-1, EN 62368-1
ROHS	EN 50581

* Some development may be required in specific user cases to support some of these protocols in the field as they mature over time.

Network WDR 2MP/4MP IR Micro Dome Camera

RECOMMENDED ACCESSORIES

SYSTEM COMPATIBILITY		MOUNTS AND ACCESSORIES	
HEN*4	8/16/32/64-channel Performance Series 4K NVRs (H.264 and H.265)	HQA-PM2**	 Pole Mount Adapter
HEN*3	4/8/16/32-channel Performance Series 4K NVRs (H.264 and H.265)	HQA-PK**	 Pendant Mount Cap
HEN*2	4/8/16-channel Performance Series NVRs (H.264)	HQA-CBE**	 Ceiling Mount Extend Bracket for HQA-CB
HRHT4*	4/8/16-channel 4 MP HQA/IP/CVBS Hybrid DVRs (H.264)	HQA-CB**	 Ceiling Mount Bracket for Pendant Mount Cap
MOUNTS AND ACCESSORIES			
HQA-WK2	 Outdoor Wall Mount Bracket		
HQA-BB3**	 Junction Box		

** The HQA-BB3 must be used when installing the camera to HQA-PM2, vice versa.

The HQA-PK must be used when installing the camera to HQA-CB.

The HQA-CBE must be used with HQA-CB together.

ORDERING

H2W2PER3	Network WDR 2MP IR Micro Dome Camera, 1/2.8" CMOS, 2.8mm Fixed, 10 IR LEDs, PoE, IP66, H.265/H.264/Smart Codec
H2W4PER3	Network WDR 4MP IR Micro Dome Camera, 1/3" CMOS, 2.8mm Fixed, 10 IR LEDs, PoE, IP66, H.265/H.264/Smart Codec

DIMENSIONS

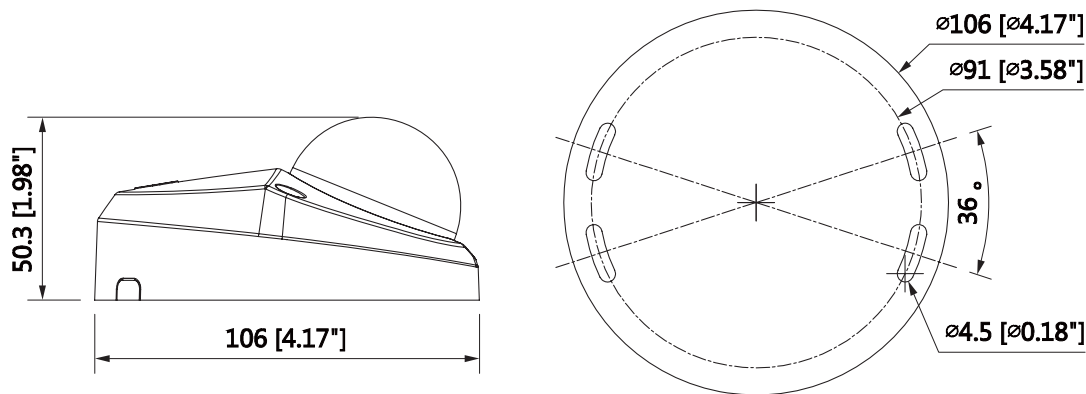

For more information

www.honeywellvideo.com

Honeywell Security Office
 Emaar Business Park, Sheikh Zayed
 Road Building No. 2, 2nd Floor, 201
 Post Office Box 232362
 Dubai, United Arab Emirates
 Tel: +971 44541704
www.honeywell.com

ONVIF and the ONVIF logo are trademarks of ONVIF Inc. Honeywell reserves the right, without notification, to make changes in product design or specifications.

HSV-H2WxPER3-01-US(1118)DS-Y
 © 2018 Honeywell International Inc.

Honeywell