

Dell EMC PowerProtect DD3300

Hardware Overview and Installation Guide

Notes, cautions, and warnings

 **NOTE:** A NOTE indicates important information that helps you make better use of your product.

 **CAUTION:** A CAUTION indicates either potential damage to hardware or loss of data and tells you how to avoid the problem.

 **WARNING:** A WARNING indicates a potential for property damage, personal injury, or death.

Figures	5
Tables	6
Revision history.....	7
Chapter 1: Planning and Site Preparation	8
Tools and supplies needed.....	8
Safety overview.....	8
Chapter 2: PowerProtect DD3300 Hardware Overview	10
DD3300 system features.....	11
DD3300 system specifications.....	11
DD3300 storage capacity.....	13
Front panel.....	13
Left control panel.....	14
Right control panel.....	16
Front disks.....	17
Information tag.....	17
Rear panel.....	18
Product serial number tag (PSNT).....	20
Rear SSD.....	20
NIC indicators.....	21
Power supply indicators.....	21
Chapter 3: Install the System in the Rack	23
Identifying the rail kit components.....	23
Install the rails.....	24
Secure the rail assemblies to the cabinet.....	25
Install the system in the cabinet.....	26
Install the front bezel.....	28
Chapter 4: Connect Cables and Power on	29
Connect data cables.....	29
Connect power cables and power on.....	30
Chapter 5: Configure System for Use	31
Enable administrative communication.....	31
Configure serial over LAN (SOL).....	32
Configure iDRAC.....	33
Run the configuration wizard.....	35
Configuring the network.....	35
Configuring additional system parameters.....	38
Configuring the system with the DD System Manager GUI interface configuration wizard.....	39
License page.....	40
Network.....	40

File System.....	41
System Settings.....	44
DD Boost protocol.....	45
CIFS protocol.....	45
NFS protocol.....	46
DD VTL protocol.....	46
Using the system.....	47
Using the CLI to configure storage for DD Cloud Tier.....	48
Using the CLI to configure storage for the SSD Cache Tier.....	50

1	Front panel.....	14
2	Left control panel.....	15
3	Right control panel.....	16
4	Disk LEDs.....	17
5	Information tag.....	18
6	Rear panel.....	18
7	2 x 10 GbE module.....	19
8	4 x 16 Gbps FC module.....	19
9	PSNT location.....	20
10	Disk LEDs.....	20
11	NIC LEDs.....	21
12	Power supply LED.....	22
13	Sliding rail assembly - 2U systems.....	23
14	Installing the rear end of the rail.....	24
15	Installing the front end of the rail.....	25
16	Installing screws.....	25
17	Pull the inner rails out of the cabinet.....	26
18	Install the system in the rails.....	27
19	Slide the system into the cabinet.....	27
20	Installing the front bezel.....	28
21	Network daughter card location.....	29
22	10 GbE module.....	30
23	16 Gbps FC module.....	30
24	iDRAC Settings > Network.....	34
25	iDRAC Settings > User Configuration.....	34

1	Document revision history.....	7
2	DD3300 system features.....	11
3	DD3300 system specifications.....	11
4	System operating environment.....	11
5	DD3300 storage capacity.....	13
6	Front disk slot numbers.....	14
7	Rear disk slot numbers.....	19
8	Network daughter card port identifiers.....	19
9	Optional 10 GbE module port identifiers.....	19
10	Optional 16 Gbps FC module port identifiers.....	20
11	NIC LED states.....	21
12	Network daughter card port identifiers.....	29
13	Optional 10 GbE module port identifiers.....	30
14	Optional 16 Gbps FC module port identifiers.....	30
15	Communications settings.....	31
16	License Configuration page values.....	40
17	General page settings.....	40
18	Interfaces page settings.....	41
19	DNS page settings.....	41
20	Addable Storage.....	42
21	Active Tier values.....	42
22	Addable Storage.....	42
23	Cloud Tier values.....	43
24	Addable Storage.....	43
25	Cloud Tier values.....	43
26	Administrator page settings.....	44
27	Email/Location page settings.....	44
28	Storage Unit page settings.....	45
29	Authentication page settings.....	45
30	Share page settings.....	46
31	Export page settings.....	46
32	Library page settings.....	46
33	Access Group page settings.....	47

Revision history

Table 1. Document revision history

Revision	Date	Software version	Description
09	August 2021	7.6	Added clarifications regarding the use of serial over LAN (SOL).
08	July 2021	7.6	Corrected the port identifiers for the FC card.
07	March 2021	7.5	Added the key mappings for console redirection to the <i>Configure iDRAC</i> section.
06	December 2020	7.4	Updated to include a list of supported and unsupported features for the underlying DDVE in the <i>Using the system</i> section.
05	September 2020	7.3	Updated for: <ul style="list-style-type: none">• Instant Access Instant Restore support for 8 TB, 16 TB, and 32 TB configurations• Updated instructions for changing the iDRAC IP address during configuration with VT100+ keyboard emulation• Clarified product serial number information.• Clarified virtual disk usage for 8 TB configurations.
04	December 2018	6.2	Updated for: <ul style="list-style-type: none">• 8 TB configuration• 4 x 10 GbE RJ-45 network daughter card• Optional FC card for VTL• Port failover• Serial over LAN through iDRAC
03	July 2018	6.1	Updated for: <ul style="list-style-type: none">• Storage overhead enhancements• SSD Cache Tier support• Product serial number tag changes
02	February 2018	6.1	Editorial revisions.
01	January 2018	6.1	Initial publication.

Planning and Site Preparation

This chapter contains the following information:

Topics:

- [Tools and supplies needed](#)
- [Safety overview](#)

Tools and supplies needed

Ensure that you have the required tools and supplies on hand for the PowerProtect system installation.

You will need:

- Antistatic wrist strap and conductive foam pad
- Screwdrivers:
 - Phillips #1
 - Phillips #2 with a 4- to 6-inch blade and a magnetic tip
 - Phillips #2 with a 12 in. or longer blade and magnetic tip
 - Flat head with a 3/16 in. blade
 - Flat head with a 1/4 in. blade
 - Torx T8
 - Torx T10
 - Torx T30 with adjustable torque setting
 - Torque
- Flashlight (free-standing for single-person installations)
- Roll of 5/8 inch Velcro cable tie material (3M Scotchmate SJ-3401 or similar)
- Null modem cable with DB-9 female connector to connect a service laptop to the PowerProtect system.
- Power adapter or a power cord for your laptop power adapter so that you can power your laptop from a rack PDU

The following additional tools and supplies might be needed when working with PowerProtect systems:

- Torque screwdriver
- Pliers
 - Needle nose
 - Regular
 - Locking
- 10 mm socket or wrench
- Diagonal wire cutters (for cutting tie wraps)
- exFAT formatted 4 GB or greater USB flash memory drive
- Tie wraps (4 in. and 8 in.)
- Labels
- Pen or marker
- Masking tape

Safety overview

CAUTION:

- **If the system is used in a manner not specified by the manufacturer, the protection provided by the equipment may be impaired.**

- **The RJ45 sockets on the motherboard, PCI cards, or I/O modules are for Ethernet connection only and must not be connected to a telecommunications network.**

Review this list of important safety recommendations.

- All plug-in modules and blank plates are part of the fire enclosure and must be removed only when a replacement can be added immediately. The system must not be run without all parts in place.
- A DD3300 system must be operated only from a power supply input voltage range of 100–240 VAC and 50–60 Hz.
- The system is intended to operate with all installed power supplies working as intended.
- Provide a suitable power source with electrical overload protection.
- A safe electrical earth connection must be provided to each power cord. Check the grounding of the power sources before applying power.
- The plug on each power supply cord is used as the main device to disconnect power from the system. Ensure that the socket outlets are located near the equipment and are easily accessible.
- Permanently unplug the unit if you think it is damaged in any way and before moving the system. A DD3300 system includes one or two power supplies. To completely remove system power, you must disconnect all power supplies.
- The power connections must always be disconnected prior to removal or replacement of a power supply module from any of the components in the system.
- A faulty power supply module should be replaced within 24 hours.
- Do not lift system components by yourself. A DD3300 system weighs up to 72.91 lbs (33.1 kg).

 **CAUTION: PowerProtect systems are heavy. Use at least two people or a mechanical lift to move any system.**

- To comply with applicable safety, emission, and thermal requirements, covers must not be removed and all bays must be fitted with plug-in modules.
- For ESD protection, Dell EMC recommends that you wear a suitable antistatic wrist or ankle strap. Observe all conventional ESD precautions when handling plug-in modules and components.

PowerProtect DD3300 Hardware Overview

This chapter contains the following information:

Topics:

- [DD3300 system features](#)
- [DD3300 system specifications](#)
- [DD3300 storage capacity](#)
- [Front panel](#)
- [Rear panel](#)

DD3300 system features

Table 2. DD3300 system features

Feature	4 TB configuration	8 TB configuration	16 TB configuration	32 TB configuration
Rack Height	2U, supported in four-post racks only			
Power	1 or 2 hot-swappable power units			
Fans	6 hot swappable fans, installed in two fan assemblies (3 fans per fan assembly)			
Rack mounting	Rack mount kit included with each system. Adjustable between 24 - 36 in. (60.9–76.2 cm).			
Processor	1 x 8-core Intel 4110 series, hyperthreaded			
Voltage	100–240 V~. Frequency: 50 Hz to 60 Hz.			
Internal 3.5" drives (front)	4 x 4 TB HDD	10 x 4 TB HDD	10 x 4 TB HDD	12 x 4 TB HDD
Internal 3.5" drives (middle)	N/A	N/A	N/A	4 x 4 TB HDD
Internal 3.5" drives (rear)	N/A	1 x 480 GB SSD for NVRAM ^a		
NIC	4 x 1 GbE or 4 x 10 GbE (always present) ^b + 2 x 10 GbE (optional)			
FC (DD VTL only)	4 x 16 Gbps (optional)			
Memory	16 GB or 24 GB ^c	48 GB	48 GB or 56 GB ^d	64 GB

- a. The SSD is for use as an NVRAM device, SSD Cache Tier storage only, and Random I/O handling (Instant Access Instant Restore). The maximum supported SSD Cache Tier capacity is one percent of the Active Tier capacity.
- b. Starting with DD OS 6.2, DD3300 systems ship with a 4 x 10 GbE RJ-45 network daughter card.
- c. 24 GB of memory is required to use the FC module for DD VTL.
- d. A 16 TB system will have 56 GB of memory if it was a 4 TB system equipped with the FC module, and was later upgraded to 16 TB.

NOTE: DD OS may report less storage and memory than indicated in this table. The unreported resources are used for internal system processes.

DD3300 system specifications

Table 3. DD3300 system specifications

Watts	BTU/hr	Weight	Width	Depth	Height
750	2891	72.91 lb/33.1 kg	17.09 in/43.4 cm	28.17 inches/71.55 cm	3.42 in/8.68 cm

Table 4. System operating environment

Operating Temperature	50° to 95° F (10° to 35° C), derate 1.1° C per 1000 feet, above 7500 feet up to 10,000 feet
Operating Humidity	20% to 80%, non-condensing
Non-operating Temperature	-40° to +149° F (-40° to +65° C)

Table 4. System operating environment (continued)

Operating Acoustic Noise	Sound power, LWAd: 7.52 bels. Sound pressure, LpAm: 56.4 dB. (Declared noise emission per ISO 9296.)
--------------------------	--

DD3300 storage capacity

The table lists the capacities of the systems. The system internal indexes and other product components use variable amounts of storage, depending on the type of data and the sizes of files. If you send different datasets to otherwise identical systems, one system may, over time, have room for more or less actual backup data than another.

Table 5. DD3300 storage capacity

Configuration	Internal disks - physical ^{ab}	Internal disks - virtual	Raw storage	Usable storage (local) ^c	Cloud storage	SSD metadata cache storage
4 TB capacity /16 GB memory	4 x 4 TB 7200 RPM NLSAS	<ul style="list-style-type: none"> 1 x 4 TB for Active Tier 1 x 1 TB for DD Cloud Tier metadata 	16 TB	4 TB	8 TB	N/A
8 TB capacity/48 GB memory	10 x 4 TB 7200 RPM NLSAS	<ul style="list-style-type: none"> 4 x 4 TB for Active Tier^d 2 x 1 TB for DD Cloud Tier metadata 	40 TB	8 TB	16 TB	160 GB
16 TB capacity/48 GB memory	10 x 4 TB 7200 RPM NLSAS	<ul style="list-style-type: none"> 4 x 4 TB for Active Tier 2 x 1 TB for DD Cloud Tier metadata 	40 TB	16 TB	32 TB	160 GB
32 TB capacity/64 GB memory	<ul style="list-style-type: none"> 12 x 4 TB 7200 RPM NLSAS (front) 4 x 4 TB 7200 RPM NLSAS (middle) 	<ul style="list-style-type: none"> 8 x 4 TB for Active Tier 4 x 1 TB for DD Cloud Tier metadata 	64 TB	32 TB	64 TB	320 GB

- The internal hard drives are configured in a RAID6 configuration. RAID6 provides the system with the ability to withstand the simultaneous failure of two hard drives, or the failure of one hard drive while another hard drive is still rebuilding after a drive replacement operation.
- After replacing a disk, it takes approximately 18 hours to complete the rebuild operation on the new disk, but may take longer depending on the amount of activity on the system.
- The system compensates for the required file system overhead, so the reported usable capacity matches the specified usable capacity.
- For 8 TB configurations, the Active Tier supports a maximum of 2 x 4 TB virtual disks.

Front panel

The DD3300 front panel consists of two control panels, which contain system LEDs and ports, twelve 3.5" disk drive bays, and the service tag. [Front panel](#) on page 14 shows the locations of the front panel components.



Figure 1. Front panel

- 1. Left control panel
- 2. 3.5" disk drive
- 3. Right control panel
- 4. Information tag.

Disk layout

The following table shows the physical location of each disk slot.

NOTE: Although the physical slots are numbered starting from 0, the software identifies the slots starting at 1.

Table 6. Front disk slot numbers

Slot 0 (SW slot 1)	Slot 3 (SW slot 4)	Slot 6 (SW slot 7)	Slot 9 (SW slot 10)
Slot 1 (SW slot 2)	Slot 4 (SW slot 5)	Slot 7 (SW slot 8)	Slot 10 (SW slot 11)
Slot 2 (SW slot 3)	Slot 5 (SW slot 6)	Slot 8 (SW slot 9)	Slot 11 (SW slot 12)

Left control panel

The left control panel contains system status LEDs. [Left control panel](#) on page 15 shows the panel.

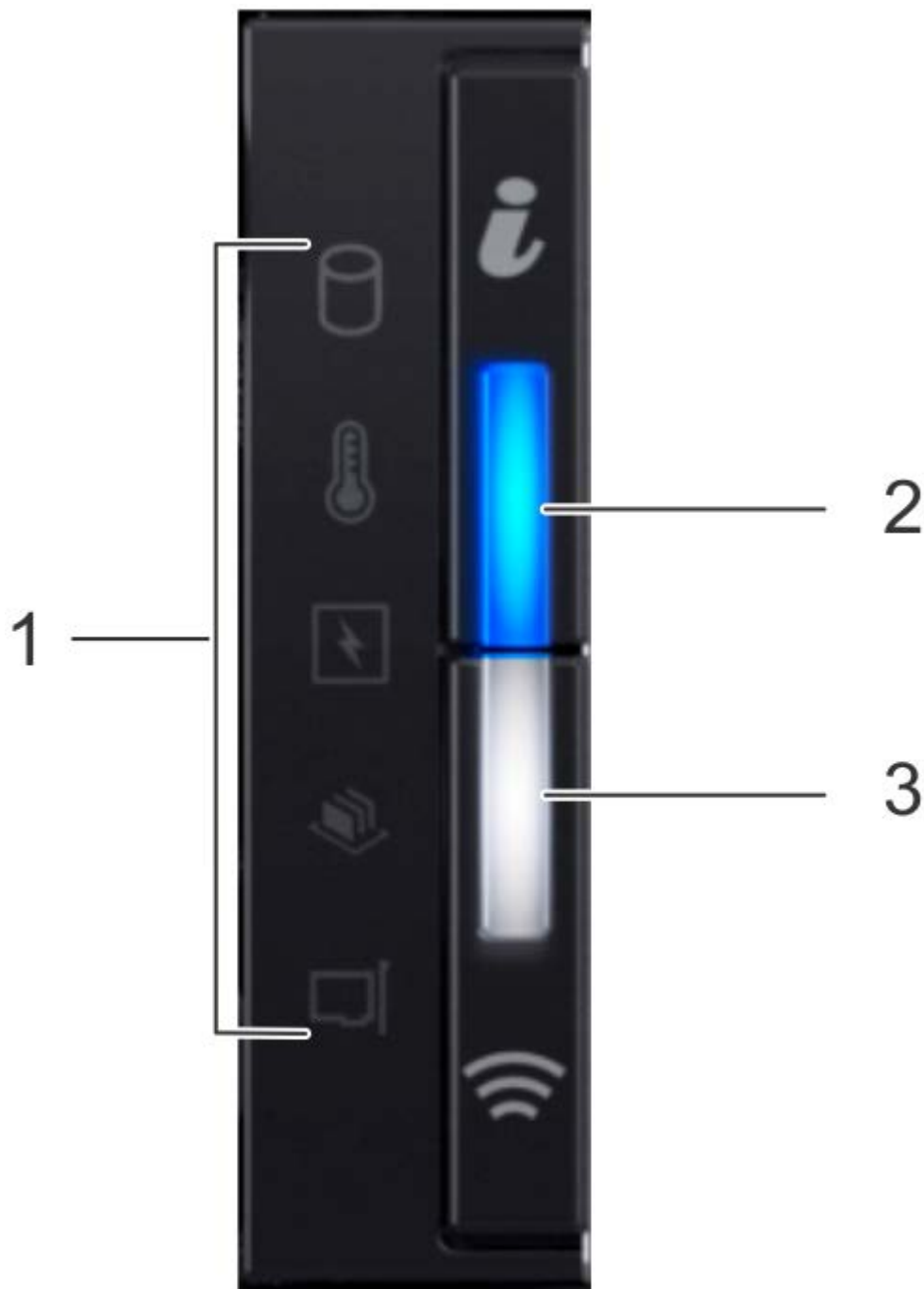

Figure 2. Left control panel

1. System status LEDs
2. System health and system ID indicator
3. iDRAC Quick Sync 2 wireless indicator (Not supported)

The system status LEDs turn solid amber if the system experiences an error in any of the following categories. Under normal operating conditions, the system status LEDs remain off. From top to bottom, the five system status LEDs are:

- Drive indicator
- Temperature indicator
- Electrical indicator
- Memory indicator
- PCIe indicator

The system health and system ID indicator has the following states:

- Solid blue: Indicator is in system health mode. System is on and healthy.
- Blinking blue: Indicator is in system ID mode.
- **NOTE:** Press the System Health and System ID button to switch the indicator between system health and system ID modes.
- Solid amber: System is in fail-safe mode.
- Blinking amber: System is experiencing a fault.

Right control panel

The right control panel contains the system power button, and system maintenance ports. [Right control panel](#) on page 16 shows the panel.

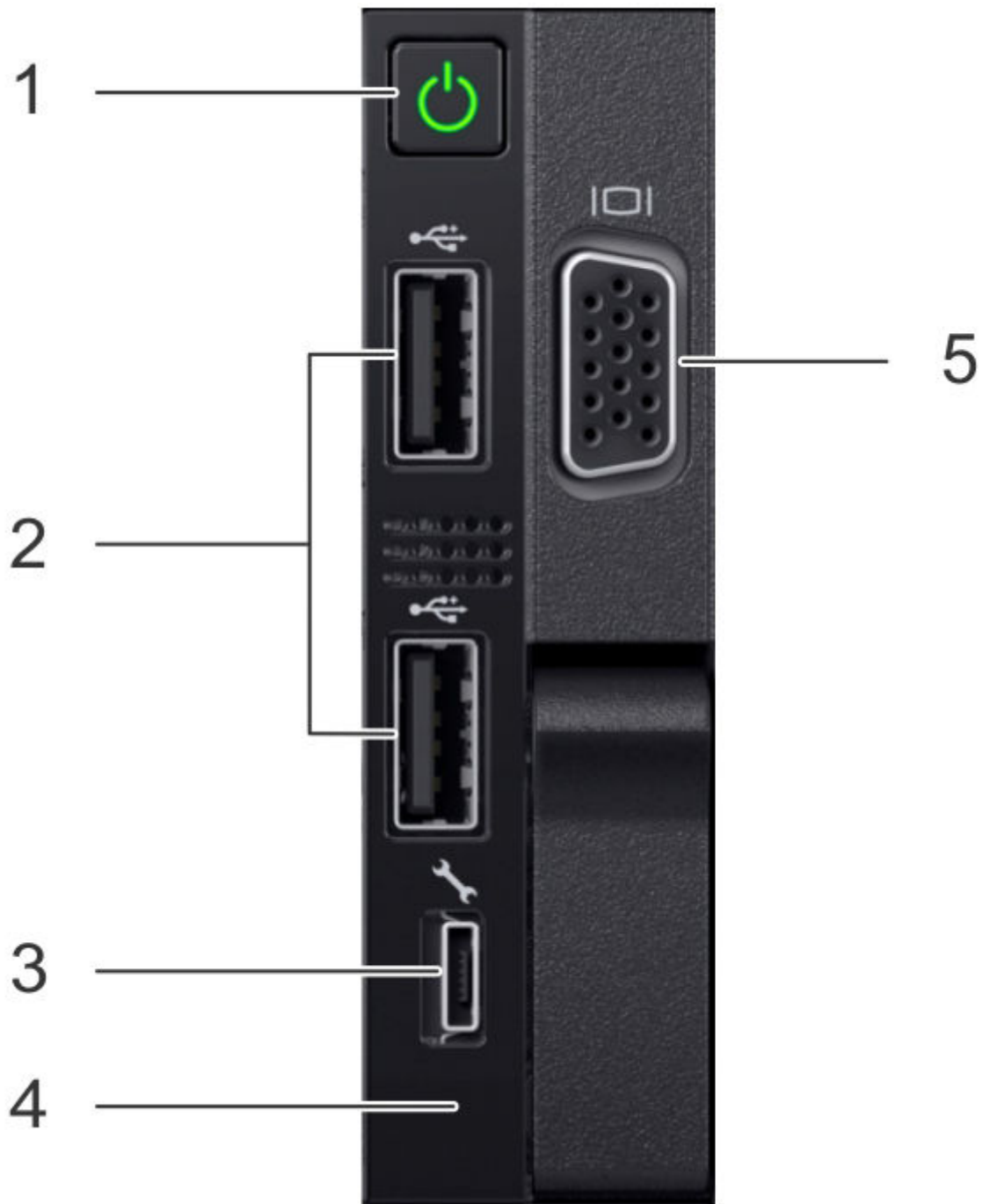

Figure 3. Right control panel

1. Power button
2. Not Supported -- 2 x USB 2.0 ports (Not supported)
3. Not Supported -- iDRAC Direct port (micro USB 2.0)
4. iDRAC Direct LED
5. Not Used -- VGA port

Front disks

The DD3300 system contains 4, 10, or 12 front-mounted 3.5" HDDs, depending on the capacity configuration. Each HDD has an activity indicator, and a status indicator. [Disk LEDs](#) on page 17 shows the HDD indicators.

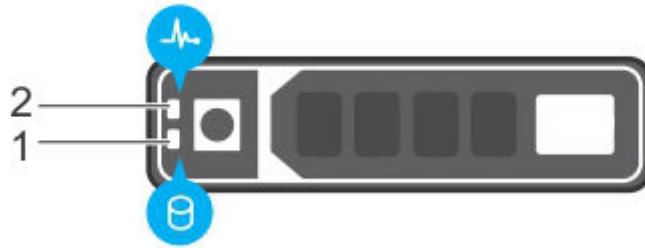

Figure 4. Disk LEDs

1. HDD activity indicator
2. HDD status indicator

The HDD activity indicator blinks during drive activity.

The HDD status indicator has the following states:

- Flashes green twice per second: Identifying drive or preparing for removal.
- Off: Drive is ready for removal.
- Flashes green, then amber, then turns off: Predicted drive failure.
- Flashes amber four times per second: Drive failed.
- Solid green: Drive online.
- Flashes green slowly: Drive rebuilding.
- Flashes green for three seconds, then amber for three seconds, then turns off: Rebuild stopped.

Information tag

The DD3300 system information tag is located at the front of the system, in the lower right-hand corner of the chassis. This tag is on all DD3300 systems, and includes the product serial number.

The product serial number, a 14-digit alphanumeric string, is the default password for serial console, system manager, and iDRAC access is located on the iDRAC MAC address and password label (#4) in the following figure.

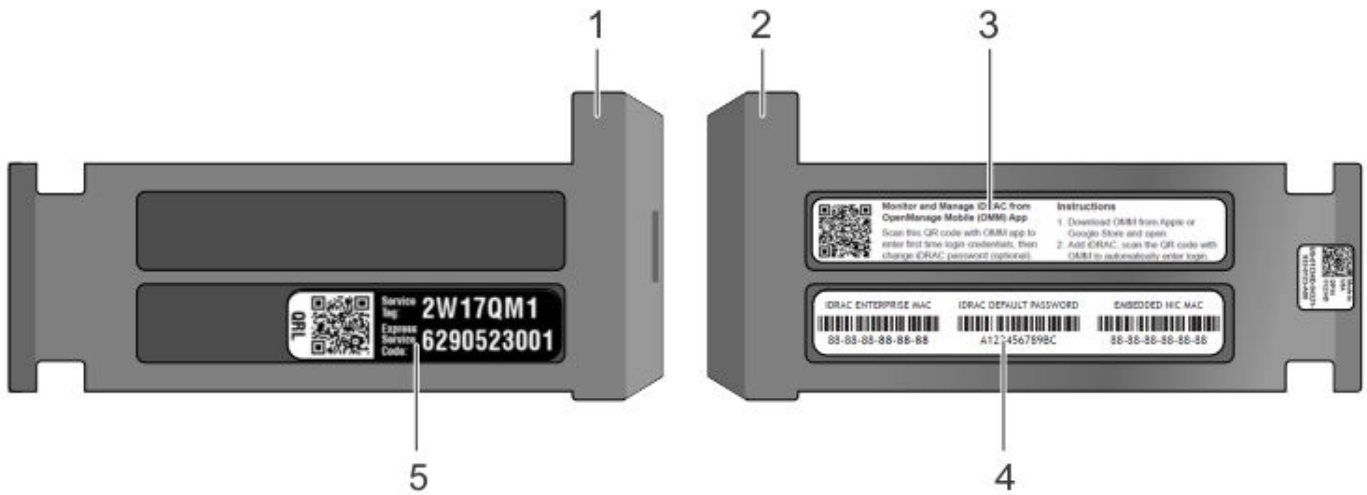

Figure 5. Information tag

1. Information tag (top view)
2. Information tag (back view)
3. OpenManage Mobile (OMM) label
4. iDRAC MAC address and password label
5. Service tag

Rear panel

The DD3300 rear panel contains the system serial port, NIC cards, power supplies, and 3.5" drive bays. shows the rear of the system.

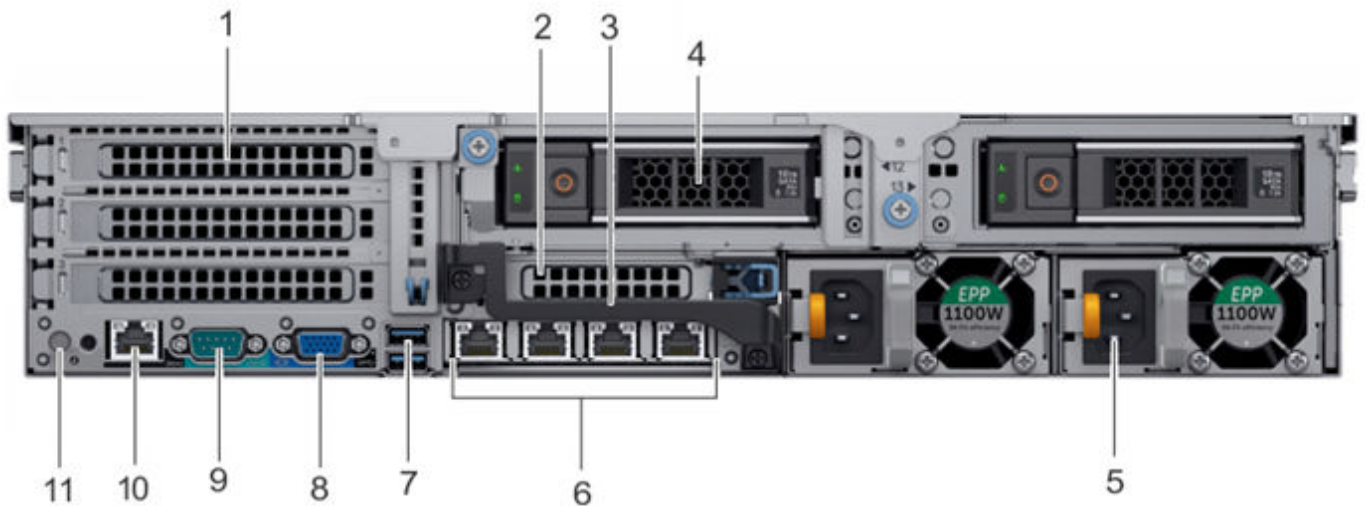

Figure 6. Rear panel

1. Full height PCIe expansion card slots
 - The top slot is for the optional 2 x 10 GbE NIC
 - The middle slot is for the optional 4 x 16 Gbps FC module
 - The bottom slot is not supported
2. Not Supported -- Half height PCIe expansion card slot
3. Rear handle
4. 3.5" drive bays (used for 1 x 480 GB SSD in the 8 TB, 16 TB, and 32 TB configurations)
5. Power supply units (1 or 2)

- 6. Network daughter card Ethernet ports
- 7. Not Supported -- USB 3.0 ports
- 8. Not Supported -- VGA port
- 9. Serial port
- 10. iDRAC9 dedicated management port
- 11. System identification button

The DD3300 system supports the use of the iDRAC9 dedicated management port to emulate a serial console.

Disk layout

8 TB, 16 TB, and 32 TB configurations use one rear slot for an SSD. 4 TB configurations do not use an SSD. The following table shows the physical location of the rear SSD slots.

NOTE: Although the physical slots are numbered starting from 0, the software identifies the slots starting at 1.

Table 7. Rear disk slot numbers

Slot 12 (SW slot 13)	Slot 13 (SW slot 14)
----------------------	----------------------

Network port layout

The DD3300 network daughter card provides 4 x 1 GbE or 4 x 10 GbE network ports for network connectivity.

NOTE: Starting with DD OS 6.2, DD3300 systems ship with a 4 x 10 GbE RJ-45 network daughter card.

The following table lists the layout of the network daughter card ports.

Table 8. Network daughter card port identifiers

ethMa	ethMb	ethMc	ethMd
-------	-------	-------	-------

An optional 2 x 10 GbE module is supported on the DD3300 system.



Figure 7. 2 x 10 GbE module

The following table lists the layout of the 10 GbE ports.

NOTE: The 10 GbE module is inserted upside down, therefore the ports are in descending order from left to right.

Table 9. Optional 10 GbE module port identifiers

eth1b	eth1a
-------	-------

FC port layout

An optional 4 x 16 Gbps FC module is supported on the DD3300 system.

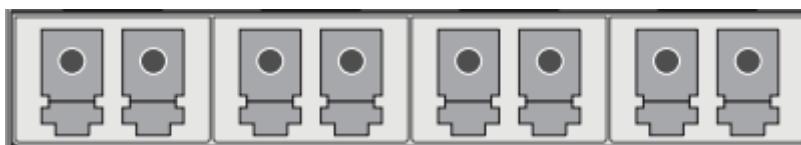

Figure 8. 4 x 16 Gbps FC module

The following table lists the layout of the FC ports.

Table 10. Optional 16 Gbps FC module port identifiers

22d	22c	22b	22a
-----	-----	-----	-----

Product serial number tag (PSNT)

Some DD3300 systems have a PSNT tag located on the rear of the system, attached to the arm in the center of the chassis. If this tag is not present, the product serial number is always available from the service tag located on the front of the system.

NOTE: Information tag on page 17 describes the front-mounted information tag.



Figure 9. PSNT location

If present, the PSNT lists the part number (PN) and serial number (PROD ID/SN) of the system. The PN is 900-555-024. The SN is the 14-digit alphanumeric string that accompanies the part number. This serial number is the default system password for serial console, system manager, and iDRAC access.

Rear SSD

The DD3300 8 TB, 16 TB, and 32 TB configurations use one rear-mounted 480 GB 2.5" SSD. The SSD has an activity indicator, and a status indicator.

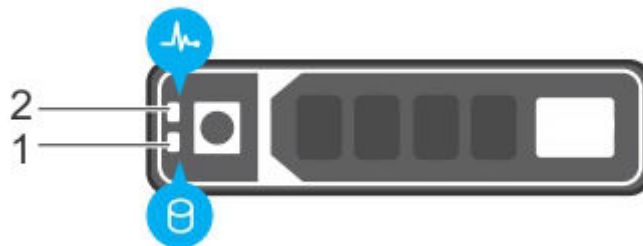

Figure 10. Disk LEDs

1. HDD activity indicator
2. HDD status indicator

The HDD activity indicator blinks during drive activity.

The HDD status indicator has the following states:

- Flashes green twice per second: Identifying drive or preparing for removal.
- Off: Drive is ready for removal.
- Flashes green, then amber, then turns off: Predicted drive failure.
- Flashes amber four times per second: Drive failed.
- Solid green: Drive online.

NIC indicators

All network ports on the DD3300 system have link and activity LED indicators.

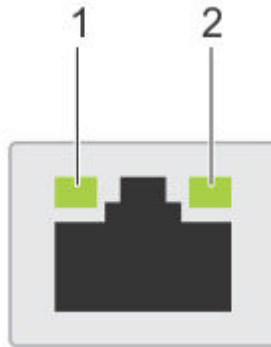

Figure 11. NIC LEDs

1. Link LED indicator
2. Activity LED indicator

The NIC LEDs have the following states:

Table 11. NIC LED states

Link indicator state	Activity indicator state	Meaning
Green	Blinking green	The NIC is connected to a valid network at its maximum port speed and data is being sent or received.
Amber	Blinking green	The NIC is connected to a valid network at less than its maximum port speed and data is being sent or received.
Green	Off	The NIC is connected to a valid network at its maximum port speed and data is not being sent or received.
Amber	Off	The NIC is connected to a valid network at less than its maximum port speed and data is not being sent or received.
Blinking green	Off	NIC identify is enabled through the NIC configuration utility.

Power supply indicators

The power supply unit has an illuminated, translucent handle that functions as a status LED.

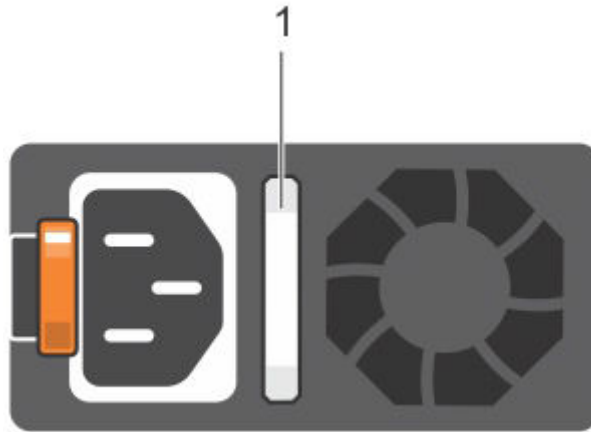

Figure 12. Power supply LED

The indicator has the following states:

- Green: Valid power source is connected, and the PSU is operational.
- Blinking amber: Indicates a problem with the PSU.
- Off: Power is not connected.
- Blinking green: Firmware update is in progress.
CAUTION: Do not disconnect the power cord or unplug the PSU when updating firmware. If firmware update is interrupted, the PSUs do not function.
- Blinking green, then off: When hot-plugging a PSU, the PSU handle blinks green five times at a rate of 4 Hz and turns off. This indicates a PSU mismatch with respect to efficiency, feature set, health status, or supported voltage.

Install the System in the Rack

This chapter contains the following information:

Topics:

- Identifying the rail kit components
- Install the rails
- Secure the rail assemblies to the cabinet
- Install the system in the cabinet
- Install the front bezel

Identifying the rail kit components

The 2U sliding rail assemblies allow the server to be secured in the cabinet, and extended from the cabinet so that the system cover can be removed to access the internal FRUs.

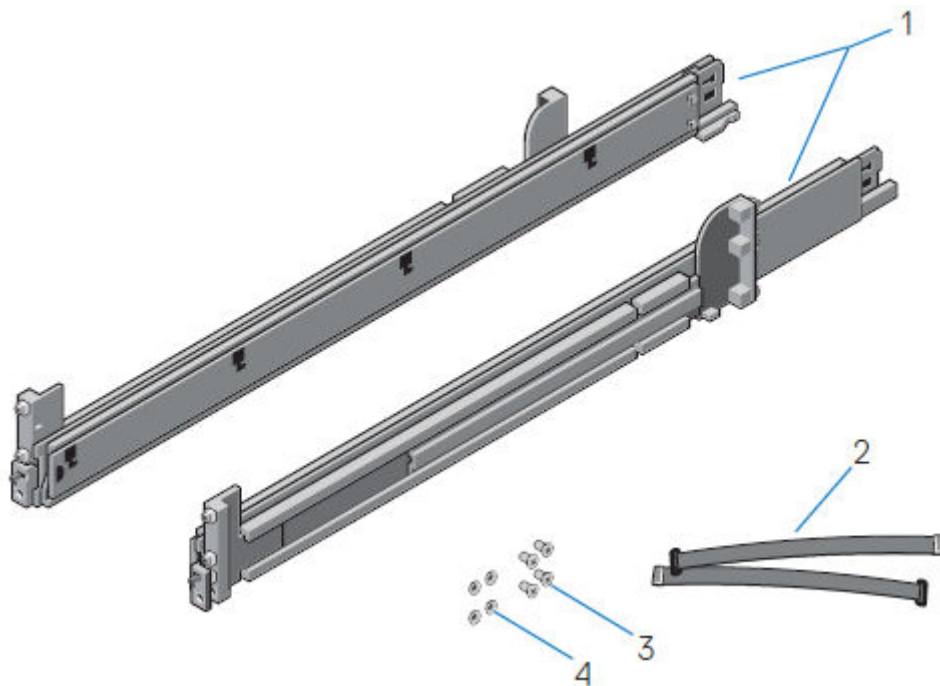

Figure 13. Sliding rail assembly - 2U systems

1. Sliding rail (2)
2. Velcro strap (2)
3. Screw (4)
4. Washer (4)

Install the rails

About this task

The rails are labeled left and right, and cannot be interchanged. The front side of each rail is labeled **Left Front** or **Right Front** when the rail faces the cabinet front.

Steps

1. Determine where to mount the system, and mark the location at the front and back of the cabinet.

NOTE: Install the left rail assembly first.

2. Fully extend the rear sliding bracket of the rail.
3. Position the rail end piece labeled **Left Front** facing inward and orient the rear end piece to align with the holes on the rear cabinet flanges.
4. Push the rail straight toward the rear of the rack until the latch locks in place.

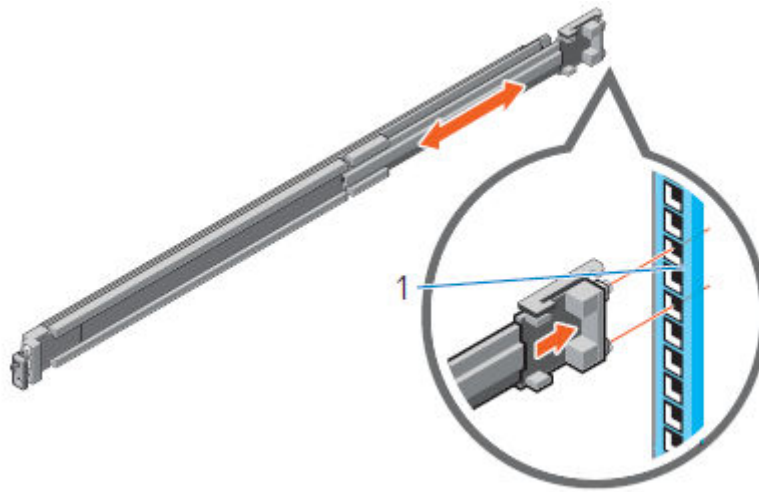

Figure 14. Installing the rear end of the rail

5. For the front end piece, rotate the latch outward and pull the rail forward until the pins slide into the flange, and release the latch to secure the rail in place.

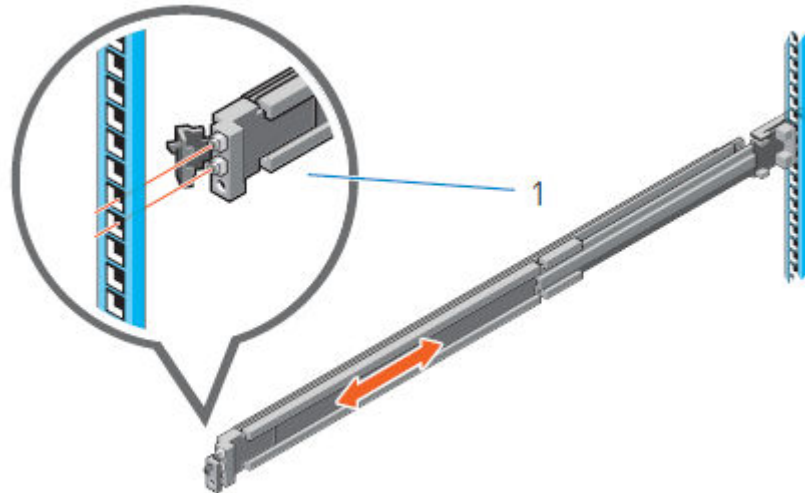

Figure 15. Installing the front end of the rail

6. Repeat the preceding steps to install the right rail assembly.

Secure the rail assemblies to the cabinet

The supplied screws and washers are used to secure the rail assemblies to the front and rear of the cabinet.

About this task

NOTE: For square hole cabinets, install the supplied conical washer before installing the screw. For unthreaded round hole cabinets, install only the screw without the conical washer.

Steps

1. Align the screws with the designated U spaces on the front and rear rack flanges.
Ensure that the screw holes on the tab of the system retention bracket are seated on the designated U spaces.
2. Insert and tighten the two screws using the Phillips #2 screwdriver.

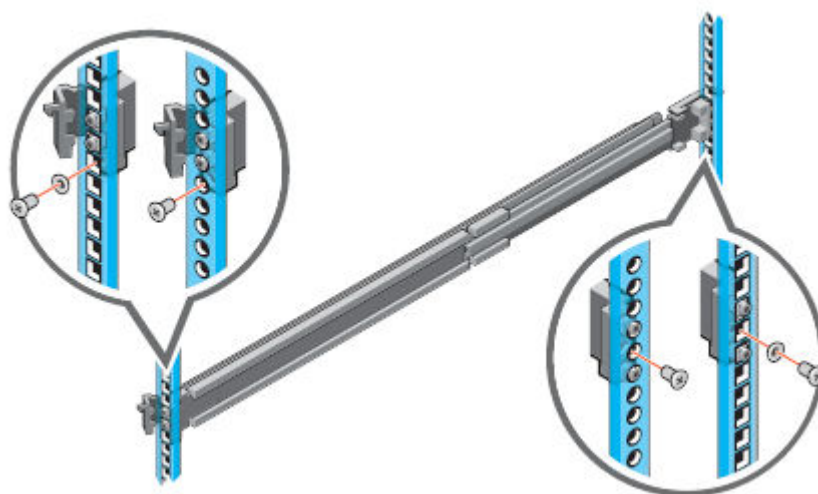

Figure 16. Installing screws

Install the system in the cabinet

This procedure is used to install the system in the cabinet.

About this task

⚠ WARNING: The system is heavy and should be installed in a cabinet by two people. To avoid personal injury and/or damage to the equipment, do not attempt to install the system in a cabinet without a mechanical lift and/or help from another person.

Steps

1. At front of the cabinet, pull the inner slide rails out of the cabinet until they lock into place.



Figure 17. Pull the inner rails out of the cabinet

2. Locate the rear rail standoff on each side of the system. Position the system above the rails and lower the rear rail standoffs into the rear J-slots on the slide assemblies.
3. Rotate the system downward until all the rail standoffs are seated in the J-slots.

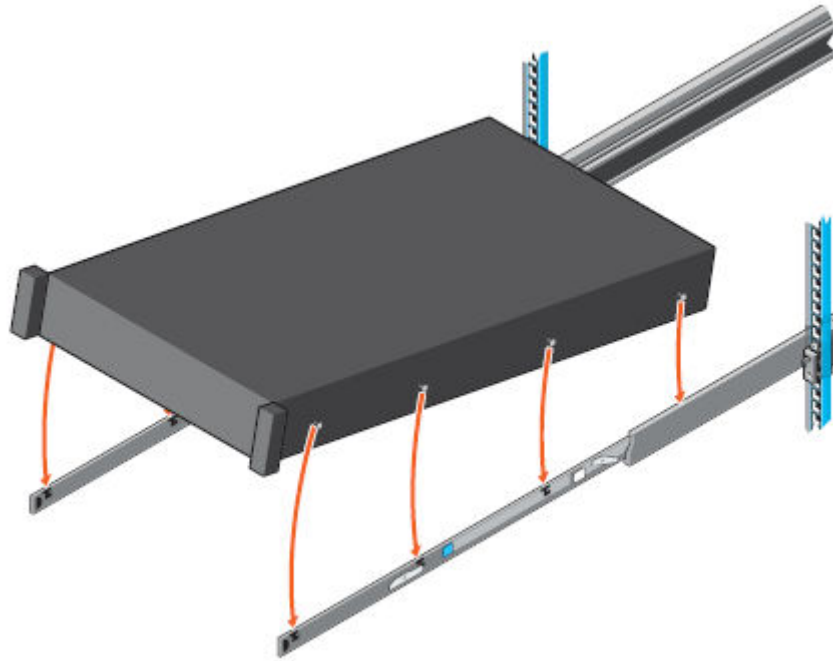

Figure 18. Install the system in the rails

4. Push the system inward until the lock levers click into place.
5. Pull the blue slide release lock tabs forward on both rails and slide the system into the cabinet. The slam latches will engage to secure the system in the cabinet.

i **NOTE:** Ensure that the inner rail slides completely into the middle rail. The middle rail locks if the inner rail is not fully engaged.

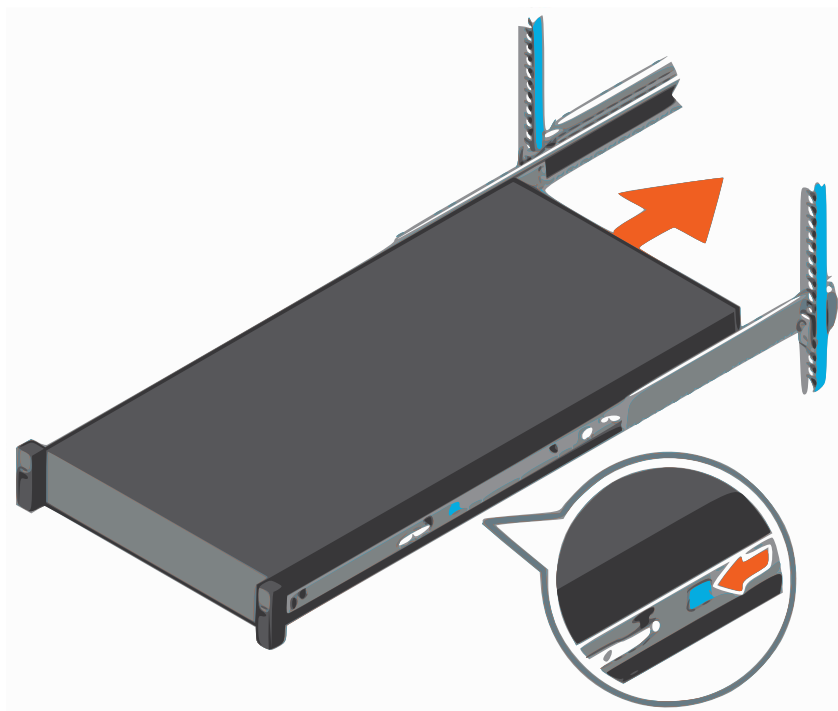

Figure 19. Slide the system into the cabinet

Install the front bezel

The procedure to install the front bezel with the LCD panel and the front bezel without the LCD panel is the same.

Steps

1. Align and insert the right end of the bezel onto the system.
2. Press the release button and fit the left end of the bezel onto the system.
3. Lock the bezel by using the key.

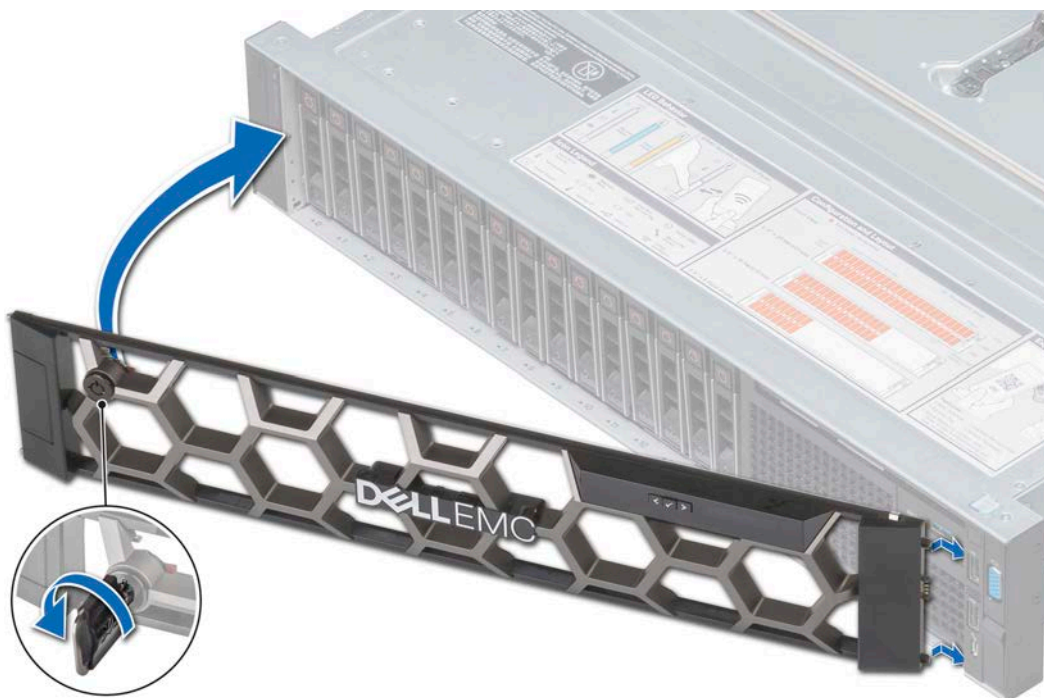

Figure 20. Installing the front bezel

Connect Cables and Power on

This chapter contains the following information:

Topics:

- [Connect data cables](#)
- [Connect power cables and power on](#)

Connect data cables

About this task

Connect the DD3300 Ethernet ports to the network.

NOTE: Do not connect data cables to the dedicated iDRAC9 management port.

[Rear panel](#) on page 18 shows the serial and LAN ports.

Steps

1. To connect the 1 GbE or 10 GbE ports, attach a Cat 5e or Cat 6 copper Ethernet cable to an RJ-45 Ethernet network port .

NOTE: Starting with DD OS 6.2, DD3300 systems ship with a 4 x 10 GbE RJ-45 network daughter card.

The network daughter card is located at the rear of the chassis, at the bottom.



Figure 21. Network daughter card location

The following table lists the layout of the network daughter card ports.

Table 12. Network daughter card port identifiers

ethMa	ethMb	ethMc	ethMd
-------	-------	-------	-------

2. To connect the optional 10 GbE ports, use one of the following cable types: a qualified SFP+ copper cable.

CAUTION: All SFP+ modules and cables used for the 10 GbE ports must be compatible with the Intel X710 10 GbE NIC.

- Fibre cables with a 10 Gb optical SFP
- Direct-attached copper cables

The 10 GbE module, if the system is equipped with one, is located at the rear of the chassis, in the top PCI slot in the upper left-hand corner of the system.



Figure 22. 10 GbE module

The following table lists the layout of the 10 GbE ports.

Table 13. Optional 10 GbE module port identifiers

eth1b	eth1a
-------	-------

- To connect the optional 16 Gbps FC ports, use a qualified FC cable.

The 16 Gbps FC module, if the system is equipped with one, is located at the rear of the chassis, in the middle PCI slot in the upper left-hand corner of the system.

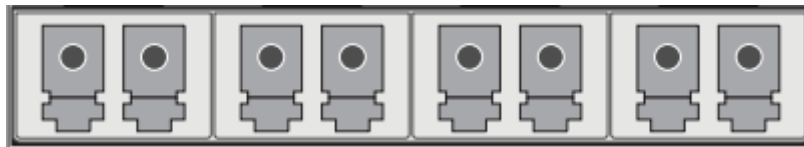

Figure 23. 16 Gbps FC module

The following table lists the layout of the FC ports.

Table 14. Optional 16 Gbps FC module port identifiers

22d	22c	22b	22a
-----	-----	-----	-----

Connect power cables and power on

Steps

- Connect the power supply units to the rack.

NOTE: For dual PSU systems, connect each PSU to a redundant AC power source. Redundant power sources allow one AC source to fail or be serviced without impacting system operation. Connect PSU 0 to one AC source, and PSU 1 to the other AC source.

The system may not power on automatically after plugging in the AC power cords. The system identification button located on the rear of the chassis, on the lower left-hand side illuminates blue when power is on.

- If the system does not power on automatically after connecting the power cables, press the power button on the right control panel at the front of the chassis to power on the system .



Configure System for Use

This chapter contains the following information:

Topics:

- [Enable administrative communication](#)
- [Configure serial over LAN \(SOL\)](#)
- [Configure iDRAC](#)
- [Run the configuration wizard](#)
- [Configuring the system with the DD System Manager GUI interface configuration wizard](#)
- [Using the system](#)

Enable administrative communication

The serial port at the rear of the system is the only supported interface for console access. Do not connect to the iDRAC9 dedicated management port on the rear of the system, or to the USB, VGA, and iDRAC direct micro-USB port on the front of the system.

1. Connect the DB-9 cable to the serial port on the back panel of the system.

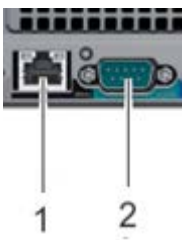

2. Launch a terminal emulation program from your computer and configure the following communication settings:

NOTE: You must have 115200 baud rate for the system to work correctly; 9600 baud rate does not work.

Table 15. Communications settings

Setting	Value
Baud rate	115200
Data bits	8
Stop bits	1
Parity	None
Flow control	None
Emulation	VT-100

3. Press `Enter` to activate the console.

NOTE:

- It can take up to 5 minutes for the system to display console messages.
- The system can take up to 15 minutes to complete the boot process. If you do not see the prompt on your terminal to log in, complete Step 4.

4. Verify the front blue power LED is on. If it is not, make sure the power cables are fully seated at both ends, and all AC sources are on.
5. Log in to the system console using the `sysadmin` username.

```
localhost.localdomain login: sysadmin
```

6. Type the default password, which is the system serial number.

i NOTE: The system serial number (SN) is always on the information tag at the front of the system, and on the PSNT attached to the rear handle of the chassis if the system has a rear-mounted PSNT. The SN is a 14-digit alphanumeric string that is located in the following places:

- On the front-mounted information tag, accompanying the iDRAC and embedded NIC MAC addresses.
- On the rear-mounted PSNT, accompanying the system part number (PN) 900-555-024.

[Information tag](#) on page 17 provides more information about the front-mounted information tag, and [Product serial number tag \(PSNT\)](#) on page 20 provides more information about the rear-mounted PSNT.

```
Password: system_serial_number
```

i NOTE: If you type an incorrect password four consecutive times, the system locks out the specified username for 120 seconds. The login count and lockout period are configurable and might be different on your system. See the *DD OS Administration Guide* and the *DD OS Command Reference Guide* for setting these values.

Configure serial over LAN (SOL)

About this task

The DD3300 system provides the ability to access the system serial console through the iDRAC interface.

Configuring SOL is optional.

⚠ CAUTION: Do not use iDRAC to change the storage configuration, system settings, or BIOS settings, as making changes will impact system functionality. Contact Support if changes are required in any of these areas.

⚠ CAUTION: Enabling SOL disables the DD3300 serial console. If SOL is enabled on the Data Domain controller and the controller subsequently requires servicing, please disable SOL and enable the serial console port. This may prevent confusion and unnecessary troubleshooting should service personnel attempt to use the serial port to access the system.

Steps

1. In a web browser, type the iDRAC IP address. The default IP address is 192.168.0.120.
2. Login with the user name root.

i NOTE: The system serial number (SN) is always on the information tag at the front of the system, and on the PSNT attached to the rear handle of the chassis if the system has a rear-mounted PSNT. The SN is a 14-digit alphanumeric string that is located in the following places:

- On the front-mounted information tag, accompanying the iDRAC and embedded NIC MAC addresses.
- On the rear-mounted PSNT, accompanying the system part number (PN) 900-555-024.

[Information tag](#) on page 17 provides more information about the front-mounted information tag, and [Product serial number tag \(PSNT\)](#) on page 20 provides more information about the rear-mounted PSNT.

3. Select **Configuration > BIOS Settings > Serial Communications**.

4. Specify the following values:

- **Serial Communication:** On with Console Redirection via COM2
- **Serial Port Address:** Serial Device1=COM1, Serial Device2=COM2
- **External Serial Connector:** Serial Device 2
- **Failsafe Baud Rate:** 115200
- **Remote Terminal Type:** VT100/VT220
- **Redirection After Boot:** Enabled

5. Click **Apply**.

6. Select **iDRAC Settings > Connectivity > Serial Over LAN**.

7. Specify the following values:

- **Enable Serial Over Lan:** Enable
- **Baud Rate:** 115.2 kbps
- **Channel Privilege Level Limit:** Administrator
- **Redirect Enable:** Enable
- **Escape Key:** ^\

8. Click **Apply**.
9. Select **iDRAC Settings > Services**.
10. Specify the following values:
 - a. Select **Enabled for SSH**.
 - b. Verify the Port Number is set to 22.
11. Click **Apply**.
12. Select **Configuration > BIOS Settings > Serial Communications**.
13. Click **Apply and Reboot**.
14. Select **Maintenance > Job Queue** and verify the `Configure: BIOS.Setup` job is complete.

 **NOTE:** Click **Refresh** to get the latest status

Configure iDRAC

About this task

The DD3300 system requires that the Integrated Dell Remote Access Controller (iDRAC) is configured for system upgrade and maintenance operations. Additionally, the system supports the use of iDRAC to change security settings, and remotely power the system on and off.

 **CAUTION:** Do not use iDRAC to change the storage configuration, system settings, or BIOS settings, as making changes will impact system functionality. Contact Support if changes are required in any of these areas.

The system uses the following key mapping for console redirection:

```
Use the <ESC><1> key sequence for <F1>
Use the <ESC><2> key sequence for <F2>
Use the <ESC><3> key sequence for <F3>
Use the <ESC><0> key sequence for <F10>
Use the <ESC><!> key sequence for <F11>
Use the <ESC><@> key sequence for <F12>
```

```
Use the <ESC><Ctrl><M> key sequence for <Ctrl><M>
Use the <ESC><Ctrl><H> key sequence for <Ctrl><H>
Use the <ESC><Ctrl><I> key sequence for <Ctrl><I>
Use the <ESC><Ctrl><J> key sequence for <Ctrl><J>
```

Use the <ESC><X><X> key sequence for <Alt><x>, where x is any letter key, and X is the upper case of that key

```
Use the <ESC><R><ESC><r><ESC><R> key sequence for <Ctrl><Alt><Del>
```

Steps

1. During the system boot process, press **F2** to access the BIOS menu.
2. Select **iDRAC Settings**.
3. Select **Network**.
4. Under **IPv4 Settings**, select **Static IP Address** and press **Enter** to specify a new static IP address.

 **NOTE:** Press **Shift + Backspace** to delete an existing IP address value over connections with VT100+ keyboard emulation.

```

iDRAC Settings

iDRAC Settings > Network

Auto Config Domain Name      <Disabled>
Static DNS Domain Name       [datadomain.com ]

IPV4 SETTINGS
Enable IPv4                   <Enabled>
Enable DHCP                   <Disabled>
Static IP Address              [10.25.129.30 ]
Static Gateway                 [10.25.128.1 ]
Static Subnet Mask             [255.255.240.0 ]
Use DHCP to obtain DNS server addresses <Disabled>
Static Preferred DNS Server    [0.0.0.0 ]
Static Alternate DNS Server    [0.0.0.0 ]

IPV6 SETTINGS
Enable IPv6                   <Disabled>

```

Figure 24. iDRAC Settings > Network

5. Press **Esc** to return to the previous menu.
6. Select **User Configuration**.
 - a. Enable the root user.
 - b. Change the root user password.

NOTE: The system serial number (SN) is always on the information tag at the front of the system, and on the PSNT attached to the rear handle of the chassis if the system has a rear-mounted PSNT. The SN is a 14-digit alphanumeric string that is located in the following places:

- On the front-mounted information tag, accompanying the iDRAC and embedded NIC MAC addresses.
- On the rear-mounted PSNT, accompanying the system part number (PN) 900-555-024.

[Information tag](#) on page 17 provides more information about the front-mounted information tag, and [Product serial number tag \(PSNT\)](#) on page 20 provides more information about the rear-mounted PSNT.

```

iDRAC Settings

iDRAC Settings > User Configuration

User ID                        2
Enable User                    <Enabled>
User Name                       [root ]
LAN User Privilege              <Administrator>
Serial Port User Privilege      <Administrator>
Change Password                 [ ]
Clear Factory Default Password <No>

```

Figure 25. iDRAC Settings > User Configuration

Next steps

The *DD OS Administration Guide* describes how to power the system on and off with iDRAC.

The *DD OS, PowerProtect DD Virtual Edition, and PowerProtect DD Management Center Security Configuration Guide* provides additional information about accessing security settings in iDRAC.

Run the configuration wizard

There are two wizards, a DD System Manager configuration wizard and a Command Line Interface (CLI) configuration wizard. The configuration wizards guide you through a simplified configuration of the system to get the system operating quickly.

Command Line Interface (CLI) configuration wizard

The CLI configuration wizard starts automatically the first time the system starts. The wizard prompts you through a series of questions that provide just enough information for initial system configuration and basic network connectivity.

You can begin the CLI configuration wizard manually by typing **config setup**.

After you complete the basic configuration with a wizard, you can use additional configuration controls in DD System Manager and the CLI to further configure the system.

DD System Manager configuration wizard

DD System Manager provides a single, consolidated management interface that allows for configuration and monitoring of many system features and system settings.

Configuring the network

Steps

1. To configure the system for network connectivity, type **yes**.

```
Do you want to configure system using GUI wizard (yes|no) [no]:  
yes
```

2. Type **yes** to configure the system for network connectivity.

```
Network Configuration  
Configure Network at this time (yes|no) [no]:  
yes
```

3. Type **yes** to configure DHCP (Dynamic Host Configuration Protocol) to obtain network parameters (such as, the hostname, domain name, and IP addresses) dynamically from a DHCP server. Or type **no** to configure the parameters manually.

```
Use DHCP  
Use DHCP for hostname, domainname, default gateway  
and DNS servers? (At least one interface needs to  
be configured using DHCP) (yes|no|?)
```

4. Type a fully qualified domain name (FQDN) for the hostname; for example, **str01.yourcompany.com**. Or accept the hostname, if the system can discover it.

```
Enter the hostname for this system  
(fully-qualified domain name) []:
```

5. Type the DNS (Domain Name System) domain name; for example, **yourcompany.com**. Or accept the domain name, if the system can discover it.

```
Domainname  
Enter your DNS domainname []:
```

6. Enable and configure each Ethernet interface. Accept or decline DHCP for each interface. If the port does not use DHCP to discover network parameters automatically, type the information manually.

 **NOTE:** Ports eth1a and eth1b only appear if the optional 2 x 10 GbE NIC is installed on the system.

```
Ethernet port ethMa
Enable Ethernet port ethMa (yes|no|?) [yes]:
yes

Use DHCP on Ethernet port ethMa (yes|no|?) [yes]: no
Enter the IP address for ethMa:
192.168.10.189
Enter the netmask for ethMa
[255.0.0.0]: 255.255.255.0
```

```
Ethernet port ethMb
Enable Ethernet port ethMb (yes|no|?) [yes]:
yes

Use DHCP on Ethernet port ethMb (yes|no|?) [yes]: no
Enter the IP address for ethMb:
192.168.10.190
Enter the netmask for ethMb
[255.0.0.0]: 255.255.255.0
```

```
Ethernet port ethMc
Enable Ethernet port ethMc (yes|no|?) [yes]:
yes

Use DHCP on Ethernet port ethMc (yes|no|?) [yes]: no
Enter the IP address for ethMc:
192.168.10.191
Enter the netmask for ethMc
[255.0.0.0]: 255.255.255.0
```

```
Ethernet port ethMd
Enable Ethernet port ethMd (yes|no|?) [yes]:
yes

Use DHCP on Ethernet port ethMd (yes|no|?) [yes]: no
Enter the IP address for ethMd:
192.168.10.192
Enter the netmask for ethMd
[255.0.0.0]: 255.255.255.0
```

```
Ethernet port eth1a
Enable Ethernet port eth1a (yes|no|?) [no]:
yes

Use DHCP on Ethernet port eth1a (yes|no|?) [yes]: no
Enter the IP address for eth1a:
192.168.10.193
Enter the netmask for eth1a
[255.0.0.0]: 255.255.255.0
```

```
Ethernet port eth1b
Enable Ethernet port eth1b (yes|no|?) [no]:
yes

Use DHCP on Ethernet port eth1b (yes|no|?) [yes]: no
Enter the IP address for eth1b:
192.168.10.194
Enter the netmask for eth1b
[255.0.0.0]: 255.255.255.0
```

7. Type the IP address of the default routing gateway. Or accept the default gateway, if the system can discover it.

```
Default Gateway
Enter the default gateway IP address:
192.168.10.1
```

8. Type the IPv6 address of the default routing gateway. Or accept the IPv6 address of the default gateway, if the system can discover it. If IPv6 is not in use, leave the field empty, and press **Enter** to continue.

```
IPv6 Default Gateway
Enter the ipv6 default gateway IP address:
```

- Type up to three DNS servers to use for resolving host names to IP addresses. Use a comma-separated or space-separated list. Type a space for no DNS servers. Or accept the IP addresses of the DNS servers, if the system can discover them.

```
DNS Servers
Enter the DNS Server list (zero, one, two or three IP addresses):
192.168.10.1
```

- A summary of the network settings is displayed. You can accept the settings (**Save**), reject the settings and exit to the CLI (**Cancel**), or return to the beginning of the current section and change the settings (**Retry**). Entering **Retry** displays the previous responses for each prompt. To accept the displayed value or type a new one, press **Return**.

```
Pending Network Settings
Hostname          ddbetal.dallasrdc.com
Domain name       dallasrdc.com
Default Gateway   192.168.10.1
DNS Server List   192.168.10.1
Port      Enabled      Cable      DHCP      IP Address      Netmask or Prefix Length
-----
ethMa     yes           yes        no         192.168.10.189  255.255.255.0
ethMb     yes           yes        no         192.168.10.190  255.255.255.0
ethMc     yes           yes        no         192.168.10.191  255.255.255.0
ethMd     yes           yes        no         192.168.10.192  255.255.255.0
eth1a     yes           yes        no         192.168.10.193  255.255.255.0
eth1b     yes           yes        no         192.168.10.194  255.255.255.0
-----
Do you want to save these settings (Save|Cancel|Retry):
```

- NOTE:** If you would like to continue the configuration using the DD System Manager GUI interface Configuration Wizard, enter **no** to the remaining options, if prompted, and exit the CLI wizard. [Configuring the system with the DD System Manager GUI interface configuration wizard](#) on page 39 describes how to configure the system with the GUI configuration wizard.

Type **yes** to configure the system licenses.

```
DD3300 Licenses Configuration
Configure DD3300 Licenses at this time (yes|no) [no]: yes
yes

eLicenses Configuration

No eLicense files found in /ddvar.

Enter the content of eLicense file and then press Control-D, or press Control-C to
cancel:

#####
# EMC License File
# Activation Date: Oct 03, 2017 01:07:38 PM
# Activated By: Robert Galli
# Type:UNSERVED
#####
INCREMENT DD_CLOUDTIER_CAPACITY EMCLM 1 permanent uncounted \

VENDOR_STRING=LOCKING_ID=FNM00173900945;CAPACITY=6;CAPACITY_UNIT=TB;SWID=ELMDDV1017SGDS;\
HOSTID=ANY dist_info="ACTIVATED TO DATA DOMAIN" ISSUER=EMC \
ISSUED=03-Oct-2017 NOTICE="ACTIVATED TO License Site Number: \
67522" SN=2961356 SIGN="004B 6CFE BBE4 C01F 3D67 DA36 330D \
E600 06F2 4AF8 0CE3 E5BC 41FC A04E 109D"
INCREMENT DD_REPLICATION EMCLM 1 permanent uncounted \
VENDOR_STRING=LOCKING_ID=FNM00173900945;SWID=ELMDDV1017SGDS;PLC=DDVE \
HOSTID=ANY dist_info="ACTIVATED TO DATA DOMAIN" ISSUER=EMC \
ISSUED=03-Oct-2017 NOTICE="ACTIVATED TO License Site Number: \
67522" SN=2961356 SIGN="00F1 F965 7DOB 77C5 6EDB 3606 ED6E \
0300 657A 9E4F 1C7C EF51 ECB7 7879 9B11"
INCREMENT DD_DDBOOST EMCLM 1.0 permanent uncounted \
VENDOR_STRING=LOCKING_ID=FNM00173900945;SWID=ELMDDV1017SGDS;PLC=DDVE \
HOSTID=ANY dist_info="ACTIVATED TO DATA DOMAIN" ISSUER=EMC \
ISSUED=03-Oct-2017 NOTICE="ACTIVATED TO License Site Number: \
67522" SN=2961356 SIGN="00F8 91C9 66CA 0550 46A1 62EB 92B8 \
EE00 2FAD 39C6 3A22 E684 E5B0 B9BF 7CE1"
INCREMENT DD_ENCRYPTION EMCLM 1 permanent uncounted \
VENDOR_STRING=LOCKING_ID=FNM00173900945;SWID=ELMDDV1017SGDS;PLC=DDVE \
```

```

HOSTID=ANY dist info="ACTIVATED TO DATA DOMAIN" ISSUER=EMC \
ISSUED=03-Oct-2017 NOTICE="ACTIVATED TO License Site Number: \
67522" SN=2961356 SIGN="0052 B7BE 4B42 B245 FFE7 72C5 5485 \
2D00 C3C7 494D 86B6 DA7A BD6A 94D9 082E"
INCREMENT DD_CAPACITY_ACTIVE EMCLM 1.0 permanent uncounted \

VENDOR_STRING=LOCKING_ID=FNMO0173900945;CAPACITY=4;CAPACITY_UNIT=TB;SHELF_MODEL=AIO;SWID\
HOSTID=ANY dist info="ACTIVATED TO DATA DOMAIN" ISSUER=EMC \
ISSUED=03-Oct-2017 NOTICE="ACTIVATED TO License Site Number: \
67522" SN=2961356 SIGN="00D7 93FE 8293 6FF5 9992 5D5C 29F3 \
A400 70A1 9E97 30B8 23C3 E412 C77A 81F0"

Pending eLicense Settings
Existing Licenses:
    No licenses found.

New Licenses:
Capacity licenses:
  ##  Feature                Shelf Model  Capacity  Mode          Expiration Date
  --  -----                -
  1   CLOUDTIER-CAPACITY      n/a         5.45 TiB  permanent     n/a
  2   CAPACITY-ACTIVE         AIO         3.63 TiB  permanent     n/a
  --  -----                -

Licensed Active Tier capacity: 3.63 TiB*
* Depending on the hardware platform, usable filesystem capacities may vary.

Feature licenses:
  ##  Feature      Count  Mode          Expiration Date
  --  -----      -
  1   REPLICATION    1     permanent     n/a
  2   DDBOOST        1     permanent     n/a
  3   ENCRYPTION     1     permanent     n/a
  --  -----      -

** New license(s) will overwrite existing license(s).
   Do you want to save these settings (Save|Cancel|Retry): Save

Successfully updated eLicenses.

```

12. Type **no** to configure the system at this time.

```

System Configuration
Configure System at this time (yes|no) [no]:
no

Configuration complete.

```

Configuring additional system parameters

About this task

Most installations would benefit from the configuration of a few additional system parameters, provided in this section for convenience.

 **NOTE:** You can also use the DD System Manager GUI interface to configure the system parameters. Open a web browser, and enter your system IP address in the browser's address text box. Log in when the DD System Manager login screen displays. Use the DD System Manager online help for more information.

Steps

1. To set up the mail server, enter:

```
# config set mailserver mail.datadomain.com
The Mail (SMTP) server is: mail.datadomain.com
```

2. To set up the system location, enter:

```
# config set location "Dallas Regional Data Center Lab,
5000 Apple Drive Suite #130, Dallas, Tx"
```

```
The System Location is: Dallas Regional Data Center Lab,  
5000 Apple Drive Suite #130, Dallas, Tx
```

3. To add one or more time servers, enter:

```
# ntp add timeserver 192.168.101.1  
Remote Time Servers: 192.168.10.1
```

4. To enable the NTP daemon, enter:

```
# ntp enable  
NTP enabled.
```

5. To change the system time zone, enter:

 **NOTE:** This requires a system reboot.

```
# config set timezone US/Central  
The Timezone name is: US/Central  
*** You made a change to the timezone setting. To fully effect this change  
*** (in currently running processes), you need to reboot the machine.
```

6. Reboot the system for the time zone change to take effect:

```
# system reboot  
  
The 'system reboot' command reboots the system. File access is interrupted during the  
reboot.  
Are you sure? (yes|no|?) [no]: yes  
  
ok, proceeding.  
The system is going down for reboot.
```

7. After the system completes the reboot, login again as **sysadmin** using the serial number as a password. Press **Ctrl-C** to get through the EULA, sysadmin password prompt, and config setup wizard.
8. Generate an autosupport sent to yourself to use as ACG input:

```
# autosupport send your.email@emc.com  
OK: Message sent.
```

Configuring the system with the DD System Manager GUI interface configuration wizard

Steps

1. Launch the DD System Manager GUI interface by specifying one of the following system details in a web browser.
 - A fully qualified domain name (for example, `http://dd01.emc.com`)
 - A hostname (`http://dd01`)
 - An IP address (`http://10.5.50.5`)

 **NOTE:** DD System Manager uses HTTP port 80 and HTTPS port 443. If the system is behind a firewall, you may need to enable port 80 if using HTTP, or port 443 if using HTTPS to reach the system. If security requirements dictate, the port numbers can be easily changed.

If you responded **Yes** to the CLI wizard prompt `Do you want to configure the system using GUI wizard`, the configuration wizard starts automatically the first time you run DD System Manager. If you responded **No**, or if the configuration wizard does not start automatically, select **Maintenance > System > Configure System** to run the wizard manually.

2. Log in as sysadmin, with the credentials you configured earlier.
3. To select which features you want to configure and to advance through the wizard, use the controls at the bottom of the configuration wizard dialog box. To display help for a feature, click the help icon (question mark) in the lower-left corner of the display.

Some features, such as **Network General** and **Network Interfaces**, were previously configured during the initial CLI configuration wizard. These settings can be modified or skipped

NOTE: Anytime you display the **File System** section when the File System has not been created, the system displays an error message. Continue with the Configuration Wizard to configure storage and create the file system.

License page

The License page displays all installed licenses. Click **Yes** to add, modify, or delete a license, or click **No** to skip license installation.

License Configuration

The **Licenses Configuration** section enables you add, modify, or delete licenses from a license file. DD OS 6.0 and later supports licensing via the Electronic License Management System (ELMS), which enables you to include multiple features in a single license file upload.

When using the Configuration Wizard on a system with no licenses configured, select the license type from the drop-down, and click the ... button. Browse to the directory where the license file resides, and select it for upload to the system.

Table 16. License Configuration page values

Item	Description
Add Licenses	Select this option to add licenses from a license file.
Replace Licenses	If licenses are already configured the Add Licenses selection changes to Replace Licenses . Select this option to replace the licenses already added.
Delete Licenses	Select this option to delete licenses already configured on the system.

Network

The **Network** section enables you to configure the network settings. Click **Yes** to configure the network settings, or click **No** to skip network configuration.

Network General page

The General page enables you to configure network settings that define how the system participates in an IP network.

To configure these network settings outside of the configuration wizard, select **Hardware > Ethernet**.

Table 17. General page settings

Item	Description
Obtain Settings using DHCP	Select this option to specify that the system collect network settings from a Dynamic Host Control Protocol (DHCP) server. When you configure the network interfaces, at least one of the interfaces should be configured to use DHCP.
Manually Configure	Select this option to use the network settings defined in the Settings area of this page.
Host Name	Specifies the network hostname for this system. NOTE: If you choose to obtain the network settings through DHCP, you can manually configure the hostname at Hardware > Ethernet > Settings or with the <code>net set hostname</code> command. You must manually configure the host name when using DHCP over IPv6.
Domain Name	Specifies the network domain to which this system belongs.
Default IPv4 Gateway	Specifies the IPv4 address of the static default gateway to which the system will forward network requests when there is no route entry for the destination system.
Default IPv6 Gateway	Specifies the IPv6 address of the static default gateway to which the system will forward network requests when there is no route entry for the destination system.

Network Interfaces page

The Interfaces page enables you to configure network settings that define how each interface participates in an IP network. To Configure these network settings outside of the configuration wizard, select **Hardware > Ethernet > Interfaces**.

Table 18. Interfaces page settings

Item	Description
Interface	Lists the interfaces available on your system.
Enabled	Shows whether each interface is enabled (checkbox selected) or disabled (not selected). Click the checkbox to toggle the interface between the enabled and disabled states.
DHCP	Shows the current Dynamic Host Control Protocol (DHCP) configuration for each interface. Select v4 for IPv4 DHCP connections, v6 for IPv6 connections, or no to disable DHCP.
IP Address	Specifies an IPv4 or IPv6 address for an interface on this system. To configure the IP address, you must set DHCP to No .
Netmask	Specifies the network mask for this system. To configure the network mask, you must configure a static IP address and set DHCP to No .
Link	Displays whether the Ethernet link is active (Yes) or not (No).

Network DNS page

The DNS page enables you to configure IP addresses for DNS servers to convert hostnames to IP addresses and vice versa. To Configure these network settings outside of the configuration wizard, select **Hardware > Ethernet > Settings**.

Table 19. DNS page settings

Item	Description
Obtain DNS using DHCP.	Select this option to specify that the system collect DNS IP addresses from a Dynamic Host Control Protocol (DHCP) server. When you configure the network interfaces, at least one of the interfaces should be configured to use DHCP.
Manually configure DNS list.	Select this option when you want to manually enter DNS server IP addresses.
Add (+) button	Click this button to display a dialog box in which you can add a DNS IP address to the DNS IP Address list. You must select Manually configure DNS list before you can add or delete DNS IP addresses.
Delete (X) button	Click this button to delete a DNS IP address from the DNS IP Address list. You must select the IP address to delete before this button is enabled. You must also select Manually configure DNS list before you can add or delete DNS IP addresses.
IP Address Checkboxes	Select a checkbox for a DNS IP address that you want to delete. Select the DNS IP Address checkbox when you want to delete all IP addresses. You must select Manually configure DNS list before you can add or delete DNS IP addresses.

File System

The **File System** section allows you to configure Active and Cloud Tier storage. Each has a separate wizard page. You can also create the File System within this section. The configuration pages cannot be accessed if the file system is already created.

Anytime you display the **File System** section when the File System has not been created, the system displays an error message. Continue with the procedure to create the file system.

Configure storage tier pages

The configure storage tier pages allow you to configure storage for each licensed tier on the system, Active Tier and DD Cloud Tier. Each tier has a separate wizard page. The storage tier configuration pages cannot be accessed if the file system is already created.

Configure Active Tier

The Configure Active Tier section allows you to configure the Active Storage Tier devices. The Active Tier is where back up data resides. To add storage to the Active Tier, select one or more devices and add them to the tier. You can add storage devices up to the capacity licenses installed.

The DD3300 system requires 4 TB devices for the Active Tier. Scroll down in the Addable Storage list until you see the 4 TB devices, and add the capacity up to your licensed amount.

 **CAUTION: Do not add 1 TB devices or SSD devices to the Active Tier, as they are not supported.**

Table 20. Addable Storage

Item	Description
Device	The disk identifier.
Size	The data storage capacity of the device. ^a
Type	SAS.

a. The PowerProtect DD convention for computing disk space defines one gibibyte as 230 bytes, giving a different disk capacity than the manufacturer's rating.

Table 21. Active Tier values

Item	Description
Device	The disk identifier.
Size	The data storage capacity of the device. ^a
Type	SAS.

a. The PowerProtect DD convention for computing disk space defines one gibibyte as 230 bytes, giving a different disk capacity than the manufacturer's rating.

Configure Cache Tier (8 TB, 16 TB, and 32 TB configurations only)

The Configure Cache Tier section allows you to configure the SSD Cache storage devices. To add storage to the Cache Tier, select one or more devices and add them to the tier. You can add SSD storage devices up to one percent of the Active Tier capacity (160 GB for 16 TB configurations, and 320 GB for 32 TB configurations).

The DD3300 system requires SSD devices for DD Cache Tier. Scroll down in the Addable Storage list until you see the SSD devices, and add the capacity up to your licensed amount.

 **CAUTION: Do not add 1 TB or 4 TB devices to the SSD Cache Tier, as they are not supported.**

Table 22. Addable Storage

Item	Description
Device	The disk identifier.
Size	The data storage capacity of the device. ^a
Type	SAS-SSD.

a. The PowerProtect DD convention for computing disk space defines one gibibyte as 230 bytes, giving a different disk capacity than the manufacturer's rating.

Table 23. Cloud Tier values

Item	Description
Device	The disk identifier.
Size	The data storage capacity of the device. ^a
Type	SAS-SSD.

a. The PowerProtect DD convention for computing disk space defines one gibibyte as 230 bytes, giving a different disk capacity than the manufacturer's rating.

Configure Cloud Tier

The Configure Cloud Tier section allows you to configure the Cloud Storage Tier devices. To add storage to the Cloud Tier, select one or more devices and add them to the tier. You can add storage devices up to the capacity licenses installed.

The DD3300 system requires 1 TB devices for DD Cloud Tier. Scroll down in the Addable Storage list until you see the 1 TB devices, and add the capacity up to your licensed amount.

 **CAUTION: Do not add 4 TB devices or SSD devices to DD Cloud Tier, as they are not supported.**

Table 24. Addable Storage

Item	Description
Device	The disk identifier.
Size	The data storage capacity of the device. ^a
Type	SAS.

a. The PowerProtect DD convention for computing disk space defines one gibibyte as 230 bytes, giving a different disk capacity than the manufacturer's rating.

Table 25. Cloud Tier values

Item	Description
Device	The disk identifier.
Size	The data storage capacity of the device. ^a
Type	SAS.

a. The PowerProtect DD convention for computing disk space defines one gibibyte as 230 bytes, giving a different disk capacity than the manufacturer's rating.

Create File System page

The Create File System page displays the allowed size of each storage tier in the file system, and provides a setting to automatically enable the file system after it is created.

System Settings

The **System Settings** section enables you to configure system passwords and email settings. Click **Yes** to configure the system settings or click **No** to skip system settings configuration.

System Settings Administrator page

The Administrator page enables you to configure the administrator password and define how the system communicates with the administrator.

Table 26. Administrator page settings

Item	Description
User Name	The default administrator name is <i>sysadmin</i> . The <i>sysadmin</i> user cannot be renamed or deleted.
Old Password	Type the old password for <i>sysadmin</i> .
New Password	Type the new password for <i>sysadmin</i> .
Verify New Password	Retype the new password for <i>sysadmin</i> .
Admin Email	Specify the email address to which DD System Manager sends alert and autosupport email messages.
Send Alert Notification Emails to this address	Check to configure DD System Manager to send alert notifications to the Admin email address as alert events occur.
Send Daily Alert Summary Emails to this address	Check to configure DD System Manager to send alert summaries to the Admin email address at the end of each day.
Send Autosupport Emails to this address	Check to configure DD System Manager to send the Admin user autosupport emails, which are daily reports that document system activity and status.

System Settings Email/Location page

The Email/Location page enables you to configure the mail server name, control what system information is sent to Dell EMC, and specify a location name to identify your system.

Table 27. Email/Location page settings

Item	Description
Mail Server	Specify the name of the mail server that manages emails to and from the system.
Credentials	Select whether or not to require credentials for the mail server.
User Name	If credentials are enabled, specify the mail server username.
Password	If credentials are enabled, specify the mail server password.
Send Alert Notification Emails to Dell EMC	Check to configure DD System Manager to send alert notification emails to Dell EMC.
Send Vendor Support Notification Emails to Dell EMC	Check to configure DD System Manager to send vendor support notification emails to Dell EMC.
Location	Use this optional attribute to record the location of your system. If you specify a location, this information is stored as the SNMP system location.

DD Boost protocol

The **DD Boost** settings section enables you to configure the DD Boost protocol settings. Click **Yes** to configure the DD Boost Protocol settings, or click **No** to skip DD Boost configuration.

DD Boost Protocol Storage Unit page

The Storage Unit page enables you to configure DD Boost storage units.

To configure these settings outside of the configuration wizard, select **Protocols > DD Boost > Storage Units > + (plus sign)** to add a storage unit, **the pencil** to modify a storage unit, or **X** to delete a storage unit.

Table 28. Storage Unit page settings

Item	Description
Storage Unit	The name of your DD Boost Storage Unit. You may optionally change this name.
User	For the default DD Boost user, either select an existing user, or select Create a new Local User, and enter their User name, Password, and Management Role. This role can be one of the following: <ul style="list-style-type: none">• <i>Admin role</i>: Lets you configure and monitor the entire protection system.• <i>User role</i>: Lets you monitor systems and change your own password.• <i>Security role</i>: In addition to user role privileges, lets you set up security-officer configurations and manage other security-officer operators.• <i>Backup-operator role</i>: In addition to user role privileges, lets you create snapshots, import and export tapes to, or move tapes within a DD VTL.• <i>None role</i>: Intended only for DD Boost authentication, so you cannot monitor or configure a system. None is also the parent role for the SMT tenant-admin and tenant-user roles. None is also the preferred user type for DD Boost storage owners. Creating a new local user here only allows that user to have the "none" role.

CIFS protocol

The **CIFS Protocol** settings section enables you to configure the CIFS protocol settings. Click **Yes** to configure the CIFS protocol settings, or click **No** to skip CIFS configuration.

The system uses the term MTree to describe directories. When you configure a directory path, DD OS creates an MTree where the data will reside.

CIFS Protocol Authentication page

The Authentication page enables you to configure Active Directory and Workgroup for your system.

To configure these settings outside of the configuration wizard, select **Administration > Access > Authentication**.

Table 29. Authentication page settings

Item	Description
Active Directory/Kerberos Authentication	Expand this panel to enable, disable, and configure Active Directory Kerberos authentication.
Workgroup Authentication	Expand this panel to configure Workgroup authentication.
LDAP Authentication	Expand this panel to configure LDAP authentication.
NIS Authentication	Expand this panel to configure NIS authentication.

CIFS Protocol Share page

The Share page enables you to configure a CIFS protocol share name and a directory path for your system.

To configure these settings outside of the configuration wizard, select **Protocols > CIFS > Shares > Create**.

Table 30. Share page settings

Item	Description
Share Name	Enter a share name for the system.
Directory Path	Enter a directory path for the system.
Add (+) button	Click + to enter a system client, user, or group.
Pencil icon	Modify a client, user, or group.
Delete (X) button	Click X to delete a selected client, user, or group.

NFS protocol

The **NFS Protocol** settings section enables you to configure the NFS protocol settings. Click **Yes** to configure the NFS protocol settings, or click **No** to skip NFS configuration.

The system uses the term MTree to describe directories. When you configure a directory path, DD OS creates an MTree where the data will reside.

NFS Protocol Export page

The Export page enables you to configure an NFS protocol export directory path, network clients, and NFSv4 referrals.

To configure these settings outside of the configuration wizard, select **Protocols > NFS > Create**.

Table 31. Export page settings

Item	Description
Directory Path	Enter a pathname for the export.
Add (+) button	Click + to enter a system client or NFSv4 referral.
Pencil icon	Modify a client or NFSv4 referral.
Delete (X) button	Click X to delete a selected client or NFSv4 referral.

DD VTL protocol

The **DD VTL Protocol** settings section enables you to configure the DD Virtual Tape Library settings. Click **Yes** to configure the DD VTL settings, or click **No** to skip DD VTL configuration.

VTL Protocol Library page

The Library page enables you to configure the DD VTL protocol settings for a library.

To configure these settings outside of the configuration wizard, select **PROTOCOLS > VTL > Virtual Tape Libraries > VTL Service > Libraries > More Tasks > Library > Create**

Table 32. Library page settings

Item	Description
Library Name	Enter a name of from 1 to 32 alphanumeric characters.
Number of Drives	Number of supported tape drives.

Table 32. Library page settings (continued)

Item	Description
Drive Model	Select the desired model from the drop-down list: <ul style="list-style-type: none"> • IBM-LTO-1 • IBM-LTO-2 • IBM-LTO-3 • IBM-LTO-4 • IBM-LTO-5 (default) • HP-LTO-3 • HP-LTO-4
Number of Slots	Enter the number of slots per library: <ul style="list-style-type: none"> • Up to 32,000 slots per library • Up to 64,000 slots per system • This should be equal to, or greater than, the number of drives.
Number of CAPs	(Optional) Enter the number of cartridge access ports (CAPs): <ul style="list-style-type: none"> • Up to 100 CAPs per library • Up to 1000 CAPs per system
Changer Model Name	Select the desired model from the drop-down list: <ul style="list-style-type: none"> • L180 (default) • RESTORER-L180 • TS3500 • I2000 • I6000 • DDVTL
Starting Barcode	Enter the desired barcode for the first tape, in the format A990000LA.
Tape Capacity	(Optional) Enter the tape capacity. If not specified, the capacity is derived from the last character of the barcode.

VTL Protocol Access Group page

The Access Group page enables you to configure DD VTL protocol settings for an access group.

To configure these settings outside of the configuration wizard, select **PROTOCOLS > VTL > Access Groups > Groups > More Tasks > Group > Create**.

Table 33. Access Group page settings

Item	Description
Group Name	Enter a unique name of from 1 - 128 characters. Duplicate access groups are not supported.
Initiators	Select one or more initiators. Optionally, replace the initiator name by entering a new one. An initiator is a backup client that connects to a system to read and write data using the Fibre Channel (FC) protocol. A specific initiator can support DD Boost over FC or DD VTL, but not both.
Devices	The devices (drives and changer) to be used are listed. These are available on all endpoints. An endpoint is the logical target on the protection system to which the initiator connects.

Using the system

The DD3300 system runs a modified version of the DD Virtual Edition (DDVE) software. The modified DDVE software and hypervisor are managed by DD OS, and cannot be managed by the user.

The following DD features and protocols are supported on the DD3300:

- CIFS

- NFS
- DD Boost (DD Boost) over IP
- DD BoostFS
- DD Boost managed file replication (MFR)
- DD VTL
- Encryption
- Secure multitenancy (SMT) with Network Isolation Support
- Cloud Tier (supported in 16 TB, 64 TB, and 96 TB configurations)
- Hadoop Application Agent
- KMIP
- More restricted IPtables settings
- Managed file replication and MTree replication
- Instant access (supported on 8 TB and larger configurations only)
- Retention Lock Governance Edition

The following DD features and protocols are not supported on the DD3300:

- DD Boost over FC
- DD High Availability (HA)
- NDMP
- Collection replication
- Directory replication
- Instant access (not supported on 4 TB configurations)
- Retention Lock Compliance Edition
- Net aggregation

The *DD OS Administration Guide* provides information and configuration information for system features.

The following sections describe additional procedures that are specific to the DD3300 system.

Using the CLI to configure storage for DD Cloud Tier

Prerequisites

The appropriate capacity license for the DD3300 system must be installed.

About this task

The procedure to configure storage for DD Cloud Tier is unique for the DD3300 because the system requires the use of 4 TB virtual disks for Active Tier storage, and 1 TB virtual disks to store the DD Cloud Tier metadata.

This procedure uses the CLI to configure DD Cloud Tier, but equivalent functionality is available in DD System Manager. The *DD OS Administration Guide* describes how to configure DD Cloud Tier through the GUI.

For DD Cloud Tier configurations with ECS, the DD3300 system requires a close time synchronization with the ECS system to configure a cloud unit. Configuring NTP on the DD3300 and ECS systems addresses this issue.

Steps

1. Ensure licenses for the features CLOUDTIER-CAPACITY and CAPACITY-ACTIVE are installed. To check the ELMS license:

```
# elicense show
```

If the license is not installed, use the `elicense update` command to install the license. Enter the command and paste the contents of the license file after this prompt. After pasting, ensure there is a carriage return, then press **Control-D** to save. You are prompted to replace licenses, and after answering yes, the licenses are applied and displayed.

```
# elicense update
```

```
Enter the content of license file and then press Control-D, or press Control-C to cancel.
```

2. Display the list of storage devices on the system:

NOTE: This example output does not include the columns for Slot (pci/idx), Manufacturer/Model, Firmware, and Serial Number that will appear in the actual system output.

```
# disk show hardware
Disk    Capacity    Type
----    -
dev1    250.00 GiB   SAS
dev2    10.00 GiB    SAS-SSD
dev3    1024.00 GiB  SAS
dev4    1024.00 GiB  SAS
dev5    4.00 TiB     SAS
dev6    4.00 TiB     SAS
dev7    4.00 TiB     SAS
dev8    4.00 TiB     SAS
----    -
8 drives present.
```

3. Add storage to the Active Tier:

 **CAUTION: Active Tier storage requires 4.00 TiB virtual disks. Do not add 1024.00 GiB virtual disks for this storage tier.**

 **NOTE:** In this example dev5-dev8 are the 4.00 TiB devices for Active Tier storage.

```
# storage add tier active dev5,dev6,dev7,dev8
Checking storage requirements...done
Adding dev5 to the active tier...done

Updating system information...done

dev5 successfully added to the active tier

Checking storage requirements...done
Adding dev6 to the active tier...done

Updating system information...done

dev6 successfully added to the active tier.

Checking storage requirements...done
Adding dev7 to the active tier...done

Updating system information...done

dev7 successfully added to the active tier.

Checking storage requirements...done
Adding dev8 to the active tier...done

Updating system information...done

dev8 successfully added to the active tier.
```

4. Add storage to the cloud tier:

 **CAUTION:**

- **DD Cloud Tier storage requires 1024.00 GiB virtual disks. Do not add 4.00 TiB virtual disks for this storage tier.**
- **If the tier cloud option is excluded, the storage will be added to the Active Tier instead of DD Cloud Tier**

 **NOTE:** In this example dev3-dev4 are the 1024.00 GiB devices for DD Cloud Tier metadata storage.

```
# storage add tier cloud dev3,dev4
Checking storage requirements...done
Adding dev3 to the cloud tier...done

Updating system information...done

dev3 successfully added to the cloud tier.

Checking storage requirements...done
Adding dev4 to the cloud tier...done
```

```
Updating system information...done
dev4 successfully added to the cloud tier.
```

Results

Use the appropriate Avamar or NetWorker documentation to configure DD Cloud Tier for use with those products. Use the *DD OS Administration Guide* to configure DD Cloud Tier with AWS, Azure, ECS, Virtustream, or a Generic S3 provider.

Using the CLI to configure storage for the SSD Cache Tier

Prerequisites

The DD3300 system must be an 8 TB, 16 TB, or 32 TB configuration running DD OS 6.1.2 or later. No license is required to configure the SSD Cache Tier on a DD3300 system.

About this task

This procedure uses the CLI to configure the SSD Cache Tier, but equivalent functionality is available in DD System Manager. The *DD OS Administration Guide* describes how to configure the SSD Cache Tier through the GUI.

Steps

1. Display the list of storage devices on the system:

NOTE: This example output does not include the columns for Slot (pci/idx), Manufacturer/Model, Firmware, and Serial Number that will appear in the actual system output.

```
# disk show hardware
Disk  Capacity  Type
----  -
dev1  250.00 GiB  SAS
dev2  10.00 GiB   SAS-SSD
dev3  1024.00 GiB SAS
dev4  1024.00 GiB SAS
dev5  160.00 GiB  SAS-SSD
dev6  4.00 TiB    SAS
dev7  4.00 TiB    SAS
dev8  4.00 TiB    SAS
dev9  4.00 TiB    SAS
-----
9 drives present.
```

2. Add storage to the SSD Cache Tier:

NOTE: In this example dev5 is the device for SSD Cache Tier storage.

```
# storage add tier cache dev5
Checking storage requirements...done
Adding dev5 to the cache tier...done

Updating system information...done
dev5 successfully added to the cache tier.
```