

# REFERENCE GUIDE 2016/2017

STAR ALLIANCE



FOR EMPLOYEES OF STAR ALLIANCE MEMBER CARRIERS



# WELCOME

## **WELCOME TO THE 2016 EDITION OF THE STAR ALLIANCE REFERENCE GUIDE**

This guide is intended to provide a single reference point for a wealth of detail about the services offered by the 28 Star Alliance member airlines. It gives an overview of each airline's policies (for example on baggage) and services (such as frequent flyer programmes and lounges) as well as information and maps for the main Star Alliance hub airports.

The aim is to help all Star Alliance member airline employees to assist customers who are travelling on any Star Alliance flight. Information changes regularly, so please continue to consult your airline's own information systems for changes and updates, as well as for operational information and procedures. We are planning a future electronic version of this guide with more frequent updates.

Please let us have your feedback and comments on the Reference Guide at **[ref.guide@staralliance.com](mailto:ref.guide@staralliance.com)**.

Thank you,

Star Alliance Internal Communications

# TABLE OF CONTENTS

## OVERVIEW

Welcome	2
Greetings from Star Alliance Headquarters	4
Vision / Mission	5
Facts & Figures	6

## GENERAL INFORMATION 10

Customer Benefits	11
Frequent Flyer Programmes	15
Reservation Call Centres	19
Reservations Special Service Items	57
Booking Class Alignment	59
Ticketing Procedures	66
Interline E-Ticket FAQ - Reservations	70
GDS Access Codes	73

## AIRPORTS INFORMATION 74

Priority Baggage Handling	75
Free Checked Baggage Allowances	76
Special Checked Baggage	81
Carry-on Baggage Policy	141
Irregular Operations Handling	142
Interline E-Ticketing FAQ - Airports	145

## LOUNGE INFORMATION 147

Lounge Access	148
Lounge Access Chart	154
Destinations with Lounges	157

## MAJOR AIRPORT MAPS 179

World Time Zones	261
------------------	-----

Star Alliance Services GmbH, Frankfurt Airport Centre, Main Lobby, D-60546 Frankfurt/Main

**Vice-President,  
Corporate Office**  
Christian Klick

**Director, Internal  
Communication**  
Janet Northcote

**Editor**  
Gary Bridgewater,  
Sherana Productions

**Layout**  
Ken Blitz & Jason Lavole  
Solid Green Inc.

**Photography**  
Ted Fahn, British Airports Authority  
and Star Alliance

## GREETINGS FROM STAR ALLIANCE HEADQUARTERS

The 28 member airlines of Star Alliance strive to give the best possible service to all of our customers. We know from surveys and other feedback that every individual employee can make a positive difference to a customer's travel experience. This Reference Guide is intended to help you serve the particular needs of the customer who is interlining across the Alliance.

Our Alliance is constantly evolving to ensure its proposition remains attractive as the industry grows and develops. We recently created the "Connecting Partner" model, offering a simplified way for carriers to associate themselves with Star Alliance without becoming a member. Shanghai-based Juneyao Airlines is set to be our first Connecting Partner from Q2 next year.

For customers, the model extends our network and offers them certain privileges whenever they travel on a connecting itinerary involving a Star Alliance flight. As we start implementing the new model we will keep you posted about what this means for you and your customers

**Mark Schwab, CEO Star Alliance**



**Mark Schwab,  
CEO  
Star Alliance**



## VISION

To be the leading global airline alliance for the high-value international traveller.

## MISSION

To contribute to the long-term profitability of its members beyond their individual capabilities.

## CUSTOMER EXPECTATIONS

Star Alliance was formed to better meet the needs of international travellers. Following extensive research with these valuable customers, we learned that they want and expect the following from the Alliance:

- a **consistent delivery** of **best quality** and comfort standards
- **trusted performance** with focus on safety and security
- an enjoyable and **relaxing travel experience**
- Frequent Flyer privileges and **status recognition**
- Convenient and hassle-free global access

Customers want us to provide them with these specific, tangible benefits every time they travel with each of the member carriers.

## STAR ALLIANCE SOCIAL MEDIA AND ONLINE

Please invite your customers to follow us on Facebook [www.facebook.com/staralliance](http://www.facebook.com/staralliance),  
Twitter [www.twitter.com/staralliance](http://www.twitter.com/staralliance), and Instagram [www.instagram.com/staralliance](http://www.instagram.com/staralliance).

Further information can be found on the Star Alliance website [www.staralliance.com](http://www.staralliance.com).

Download our smartphone apps at [www.staralliance.com/en/mobile-apps](http://www.staralliance.com/en/mobile-apps).











Employees can also visit [www.starallianceemployees.com](http://www.starallianceemployees.com) to get the latest Star Alliance news and reference information.











# FACTS & FIGURES









## THE NETWORK AS OF NOVEMBER, 2016

<b>Total revenue US\$</b>	<b>173.94 billion</b>
<b>Annual passengers</b>	<b>689.98 million</b>
<b>Daily departures</b>	<b>More than 18,450</b>
<b>Number of employees</b>	<b>446,093</b>
<b>Countries served</b>	<b>190</b>
<b>Airports served</b>	<b>1,300</b>
<b>Fleet</b>	<b>4,633</b>
<b>Lounges</b>	<b>More than 1,100</b>

Figures relate to schedule data as of November, 2016 as compiled by Star Alliance Corporate Office.

	<b>STAR ALLIANCE MEMBERS</b>	<b>FLEET SIZE</b>	<b>NUMBER OF EMPLOYEES</b>	<b>MAJOR HUB AIRPORTS</b>
	<b>Adria Airways (JP)</b>	12	388	Ljubljana
	<b>Aegean Airlines (A3)</b>	47	2,621	Athens
	<b>Air Canada (AC)</b>	365	30,000	Montreal, Vancouver, Calgary, Toronto
	<b>Air China (CA)</b>	366	27,442	Chengdu, Beijing, Shanghai
	<b>Air India (AI)</b>	106	19,285	Bangalore, Mumbai (Bombay), Calcutta, Delhi, Hyderabad, Chennai
	<b>Air New Zealand (NZ)</b>	104	11,500	Auckland, Buenos Aires, Hong Kong, Houston, Los Angeles, London, Tokyo, San Francisco, Singapore, Sydney, Vancouver, Shanghai
	<b>ANA (NH)</b>	246	13,000	Tokyo, Tokyo
	<b>Asiana Airlines (OZ)</b>	83	10,065	Seoul, Seoul
	<b>Austrian (OS)</b>	78	6,200	Vienna
	<b>Avianca (AV)</b>	170	21,000	Bogota, Lima, San Salvador

	STAR ALLIANCE MEMBERS	FLEET SIZE	NUMBER OF EMPLOYEES	MAJOR HUB AIRPORTS
	<b>Avianca in Brazil (O6)</b>	41	4,287	Brasilia
	<b>Brussels Airlines (SN)</b>	49	3,400	Brussels
	<b>Copa Airlines (CM)</b>	100	8,754	Panama City
	<b>Croatia Airlines (OU)</b>	12	902	Zagreb
	<b>EGYPTAIR (MS)</b>	63	9,000	Cairo
	<b>Ethiopian Airlines (ET)</b>	82	12,703	Addis Ababa, Lome, Liege, Lilongwe
	<b>EVA Airways (BR)</b>	74	9,200	Taipei
	<b>LOT Polish Airlines (LO)</b>	43	2,360	Warsaw
	<b>Lufthansa (LH)</b>	424	55,000	Frankfurt, Munich
	<b>Scandinavian Airlines (SK)</b>	152	11,288	Stockholm, Copenhagen, Oslo

	<b>STAR ALLIANCE MEMBERS</b>	<b>FLEET SIZE</b>	<b>NUMBER OF EMPLOYEES</b>	<b>MAJOR HUB AIRPORTS</b>
	<b>Shenzhen Airlines (ZH)</b>	165	17,049	Guangzhou, Shenzhen
	<b>Singapore Airlines (SQ)</b>	104	14,046	Singapore
	<b>South African Airways (SA)</b>	53	8,525	Johannesburg
	<b>SWISS (LX)</b>	96	8,564	Geneva, Zurich
	<b>TAP Portugal (TP)</b>	80	7,300+	Lisbon
	<b>Thai Airways International (TG)</b>	95	22,684	Bangkok (Suvamabhumi Airport and Don Mueang International Airport)
	<b>Turkish Airlines (TK)</b>	299	22,030	Ankara, Istanbul
	<b>United Airlines (UA)</b>	1,124	87,500	Denver, New York, Guam, Washington, Houston, Los Angeles Tokyo, Chicago, San Francisco



# GENERAL INFORMATION

# CUSTOMER BENEFITS

## **MILEAGE ACCRUAL AND REDEMPTION**

There is no Star Alliance frequent flyer programme. There are 21 frequent flyer programmes, all operating independently. Customers of any Star Alliance member airline's frequent flyer programme (see chart) can accrue and redeem miles, kilometres or points\* when they travel on any eligible Star Alliance member airline flight on a fare eligible for mileage accrual.

In addition, when travelling on Star Alliance member flights, miles or points count toward higher membership status in the customer's chosen frequent flyer programme.

To ensure successful membership accrual, passengers should quote the frequent flyer number on their membership card, show their card, and save passenger receipts and boarding passes in case retroactive crediting is necessary.

\*Qualifying accruals vary by frequent flyer programme and are subject to paid fares. Air New Zealand's frequent flyer currency is Airpoints Dollars.

---

## **RECOGNITION ON INFLIGHT PAPERWORK AND BOARDING PASSES**

Recognition of Star Alliance Gold and Star Alliance Silver customers can be found on inflight paperwork and boarding passes. Look for this format: XX\*G or XX\*S and read as Airline Star Alliance Gold or Airline Star Alliance Silver (XX is the two-letter airline code).

Example: TG\*S = THAI Star Alliance Silver = THAI Royal Orchid Plus Silver

---

## **STAR ALLIANCE UPGRADE AWARDS**

The Star Alliance Upgrade Awards is an electronic upgrade product. Customers can use their own FFP miles to upgrade on member airline operated flights. The upgrade must be requested and confirmed in advance and is subject to seat availability.

---

## RECOGNITION OF MEMBERSHIP CARDS

Membership cards carry the Star Alliance Gold or Star Alliance Silver badge.

---

### STAR ALLIANCE GOLD



Priority Airport Check-in  
Extra Baggage Allowance <sup>1</sup>  
Gold Track (Priority Security & Immigration)  
Airport Lounge Access <sup>2</sup>  
Priority Boarding  
Priority Baggage Handling  
Priority Reservations Waitlist  
Priority Airport Stand-by

### STAR ALLIANCE SILVER



Priority Reservations Waitlist  
Priority Airport Stand-by

- 1 Star Alliance Gold customers are entitled to one additional piece of checked baggage (piece concept) or an additional 20 kgs (weight concept) if travelling on two or more Star Alliance member airlines on a single ticket.
  - 2 See Star Alliance Lounge Access details. Star Alliance Gold Lounges are identified by the Star Alliance Gold badge at the entrance. Additional top-tier benefits for each airline's frequent flyer programme are only applicable on that particular airline.
- 

### STAR ALLIANCE GOLD BADGES

Star Alliance Gold badges have been placed at all Star Alliance Gold Lounge entrances.





# CUSTOMER BENEFITS

---

## LOUNGE RESTRICTIONS

- Different access policies may prevail for each airline's own premium customers, particularly as they pertain to guests and/or lounges operated by third parties in select cities.
  - Exceptions or restrictions are shown in the Lounge Access Chart.
- 

## STAR ALLIANCE GOLD CARDS







The following levels are Star Alliance Gold Card holders. Please refer to frequent flyer programmes of Star Alliance member carriers for more details.







Adria Airways	JP	HON Circle, Senator
Aegean Airlines	A3	Miles+Bonus Gold
Air Canada	AC	Air Canada VIP, Altitude Super Elite 100K, Altitude Elite 75K, Altitude Elite 50K
Air China	CA	PhoenixMiles Platinum, PhoenixMiles Gold
Air India	AI	The Maharajah Club, Golden Edge Club
Air New Zealand	NZ	Airpoints Elite, Airpoints Gold
ANA	NH	Diamond, Platinum, Super Flyers
Asiana Airlines	OZ	Asiana Club Platinum, Asiana Club Diamond Plus, Asiana Club Diamond
Austrian	OS	HON Circle, Senator
Avianca	AV	LifeMiles Diamond, LifeMiles Gold
Avianca in Brazil	O6	Amigo Diamond, Amigo Gold
Brussels Airlines	SN	HON Circle, Senator
Copa Airlines	CM	PreferMember Presidential Platinum, PreferMember Platinum, PreferMember Gold







Croatia Airlines	OU	HON Circle, Senator
EGYPTAIR	MS	EGYPTAIR Plus Platinum, EGYPTAIR Plus Gold
Ethiopian Airlines	ET	ShebaMiles Gold
EVA Airways	BR	Infinity MileageLands Diamond, Infinity MileageLands Gold
LOT Polish Airlines	LO	HON Circle, Senator
Lufthansa	LH	HON Circle, Senator
Scandinavian Airlines	SK	EuroBonus Pandion, EuroBonus Diamond, EuroBonus Gold
Shenzhen Airlines	ZH	PhoenixMiles Platinum, PhoenixMiles Gold
Singapore Airlines	SQ	Solitaire PPS Club Life, Solitaire PPS Club, PPS Club, KrisFlyer Elite Gold
South African Airways	SA	Lifetime Platinum, Platinum, Gold
SWISS	LX	HON Circle, Senator
TAP Portugal	TP	Victoria Gold
Thai Airways International	TG	Royal Orchid Plus Platinum, Royal Orchid Plus Gold
Turkish Airlines	TK	Elite Plus, Elite
United Airlines	UA	Global Services, Premier 1K, Premier Platinum, Premier Gold

# FREQUENT FLYER PROGRAMMES

Star Alliance Members	Frequent Flyer Programme	Star Alliance Gold	Star Alliance Silver	Programme Currency
 <b>Adria Airways (JP)</b>	Miles & More	HON Circle Senator	Frequent Traveller Miles	
 <b>Aegean Airlines (A3)</b>	Miles+Bonus	Miles+Bonus Gold	Miles+Bonus Blue Miles	
 <b>Air Canada (AC)</b>	Aeroplan	Air Canada VIP Altitude Super Elite 100K Altitude Elite 75K Altitude Elite 50K	Altitude Elite 35K Altitude Prestige 25K	Miles
 <b>Air China (CA)</b>	PhoenixMiles	PhoenixMiles Platinum PhoenixMiles Gold	PhoenixMiles Silver	Kilometres
 <b>Air India (AI)</b>	Flying Returns	The Maharaja Club Golden Edge Club	Silver Edge Club	Miles
 <b>Air New Zealand (NZ)</b>	Airpoints	Airpoints Elite Airpoints Gold	Airpoints Silver	Airpoints Dollars
 <b>ANA (NH)</b>	ANA Mileage Club	Diamond Platinum Super Flyers	Bronze	Miles

Star Alliance Members	Frequent Flyer Programme	Star Alliance Gold	Star Alliance Silver	Programme Currency
 <b>Asiana Airlines (OZ)</b>	Asiana Club	Asiana Club Platinum Asiana Club Diamond Plus Asiana Club Diamond	Asiana Club Gold	Miles
 <b>Austrian (OS)</b>	Miles & More	HON Circle Senator	Frequent Traveller Miles	
 <b>Avianca (AV)</b>	LifeMiles	LifeMiles Diamond LifeMiles Gold	LifeMiles Silver	Miles
 <b>Avianca in Brazil (O6)</b>	Amigo	Amigo Diamond Amigo Gold	Amigo Silver	Points
 <b>Brussels Airlines (SN)</b>	Miles & More	HON Circle Senator	Frequent Traveller Miles	
 <b>Copa Airlines (CM)</b>	ConnectMiles	PreferMember Presidential Platinum PreferMember Platinum PreferMemberGold	PreferMember Silver	Miles
 <b>Croatia Airlines (OU)</b>	Miles & More	HON Circle Senator	Frequent Traveller Miles	

<b>Star Alliance Members</b>	<b>Frequent Flyer Programme</b>	<b>Star Alliance Gold</b>	<b>Star Alliance Silver</b>	<b>Programme Currency</b>
 <b>EGYPTAIR (MS)</b>	EGYPTAIR Plus	EGYPTAIR Plus Platinum EGYPTAIR Plus Gold	EGYPTAIR Plus Silver	Miles
 <b>Ethiopian Airlines (ET)</b>	ShebaMiles	ShebaMiles Gold	ShebaMiles Silver	Miles
 <b>EVA Airways (BR)</b>	Infinity MileageLands	Infinity MileageLands Diamond Infinity MileageLands Gold	Infinity MileageLands Silver	Miles
 <b>LOT Polish Airlines (LO)</b>	Miles & More	HON Circle Senator	Frequent Traveller Miles	
 <b>Lufthansa (LH)</b>	Miles & More	HON Circle Senator	Frequent Traveller Miles	
 <b>Scandinavian Airlines (SK)</b>	EuroBonus	EuroBonus Pandion EuroBonus Diamond EuroBonus Gold	EuroBonus Silver	Points
 <b>Shenzhen Airlines (ZH)</b>	PhoenixMiles	PhoenixMiles Platinum PhoenixMiles Gold	PhoenixMiles Silver	Kilometres

<b>Star Alliance Members</b>	<b>Frequent Flyer Programme</b>	<b>Star Alliance Gold</b>	<b>Star Alliance Silver</b>	<b>Programme Currency</b>
 <b>Singapore Airlines (SQ)</b>	KrisFlyer	Solitaire PPS Club Life Solitaire PPS Club PPS Club KrisFlyer Elite Gold	KrisFlyer Elite Silver	Miles
 <b>South African Airways (SA)</b>	Voyager	Lifetime Platinum Platinum Gold	Silver	Miles
 <b>SWISS (LX)</b>	Miles & More	HON Circle Senator	Frequent Traveller Miles	
 <b>TAP Portugal (TP)</b>	Victoria	Victoria Gold	Victoria Silver	Miles
 <b>Thai Airways Intl. (TG)</b>	Royal Orchid Plus	Royal Orchid Plus Platinum Royal Orchid Plus Gold	Royal Orchid Plus Silver	Miles
 <b>Turkish Airlines (TK)</b>	Miles&Smiles	Elite Plus Elite	Classic Plus	Miles
 <b>United Airlines (UA)</b>	Mileage Plus	Global Services Premier 1K Premier Platinum Premier Gold	Premier Silver	Miles

# RESERVATION CALL CENTRES

 **Adria Airways (JP)** [www.adria.si](http://www.adria.si)

<b>Albania</b>	+355-4-2272-666	<b>Macedonia</b>	+389-2-3117-009
<b>Austria</b>	+43-1-879-87-05	<b>Montenegro</b>	+382-20-201-201
<b>Belgium</b>	+32-2808-47-99	<b>Netherlands</b>	+386-1-369-1010
<b>Bosnia &amp; Herzegovina</b>	+387-33-232-125/126	<b>Poland</b>	+48-22-696-85-23
<b>Czech Republic</b>	+420-234-723-295	<b>Russia</b>	+7-495-727-0885
<b>Denmark</b>	+46-42-28-47-78	<b>Serbia</b>	+381-11-2286-457/458
<b>France</b>	+386-1-369-1010	<b>Spain</b>	+34-93-246-67-77
<b>Germany</b>	+49 (69) 269-56-720/721	<b>Slovenia</b>	+386-1-369-1010
<b>Israel</b>	+972-3-52-23-161	<b>Switzerland</b>	+41 (44) 212-63-93/94
<b>Japan</b>	+81-3-5733-7108	<b>Turkey</b>	+90-212-465-55-15
<b>Korea (South)</b>	+82-2-752-2633	<b>United Kingdom</b>	+386-1-369-1010
<b>Kosovo</b>	+381-38-24-6746	<b>USA and Canada</b>	+1-855-77-ADRIA(23742)

 **Aegean Airlines (A3)** [www.aegeanair.com](http://www.aegeanair.com)

<b>HQ Call Centre</b>	+30-2106261000801-11-20000	<b>Nicosia</b>	+35722654100
<b>Barcelona</b>	+34935500550+34900802376	<b>Paris</b>	+33170031323
<b>Brussels</b>	+3227534710	<b>Rome</b>	+390697150532-33
<b>Frankfurt</b>	+49692385630	<b>Thessaloniki</b>	+302310501340
<b>London</b>	+442087593800 +448712000040 (UK only)		



**Air Canada (AC)** [www.aircanada.com](http://www.aircanada.com)

<b>Antigua &amp; Barbuda</b>	+1-268-462-1147; +1-800-744-2472 (toll free)	<b>Czech Republic</b>	+48-22-696-8521
<b>Argentina</b>	0800-444-2007 (toll free)	<b>Denmark</b>	+45-3311-4555
<b>Aruba</b>	1-800-744-2472	<b>Dominican Rep.</b>	1-888-760-0020 (toll free)
<b>Australia</b>	+61-2-8248-5757; 01-300-655-767 (toll free)	<b>Ecuador</b>	+1-800-010135 (toll free)
<b>Austria</b>	+49-69-27-115-111	<b>Egypt</b>	+20-2-2579-2980
<b>Bahamas</b>	+1-800-389-0653	<b>Estonia</b>	+45-3311-4555
<b>Bahrain</b>	973-17-828-771/4	<b>Ethiopia</b>	+254-20-2105-348/9
<b>Barbados</b>	+1-246-428-5077; +1-800-744-2472 (toll free)	<b>Finland</b>	+45-3311-4555
<b>Belgium</b>	+32-070-220-100	<b>France</b>	0825-880-881 (Indigo number, charges)
<b>Bermuda</b>	1-888-247-2262	<b>Germany</b>	+49-69-27115-111
<b>Botswana</b>	+27-11-463-1147	<b>Grand Cayman</b>	1-866-931-2021 or 1-800-744-1112
<b>Brazil</b>	5511-3254-6630 (toll free)	<b>Greece</b>	00800-39-12-91-998
<b>Canada</b>	+1-888-247-2262 (toll free)	<b>Grenada</b>	800-744-2472
<b>Chile</b>	800-400-142 (toll free)	<b>Guadeloupe</b>	+590-211-277
<b>China</b>	+86-400-811-2001 HKG +852-2-867-8111	<b>Haiti</b>	509-2810-5857
<b>Colombia</b>	1-800-952-0337	<b>Hungary</b>	+48-22-696-8521
<b>Costa Rica</b>	0-800-052-1988 (toll free)	<b>India</b>	Delhi & Haryana 91-11-4717-2900 Outside Delhi & Haryana 1-800-102-8182
<b>Cuba</b>	Mexico, Federal District 52-55-9138-0280 Local Ticketing Office 537-8363226	<b>Indonesia</b>	+62-21-522-6660



<b>Ireland</b>	1-800-709900
<b>Israel</b>	+972-3-607-2111
<b>Italy</b>	+39-06-835-14-955
<b>Jamaica</b>	800-677-2485
<b>Japan</b>	In Japan 0570-014-787 From outside Japan +81-3-4335-9300
<b>Jordan</b>	1-514-393-3333 (charges apply)
<b>Kenya</b>	(254) 20-7606011/2
<b>Korea (South)</b>	+82-2-3788-0100
<b>Latvia</b>	+45-3311-4555
<b>Lebanon</b>	+961-1-811-690/1/2/3
<b>Lesotho</b>	+27-11-463-1147
<b>Lithuania</b>	+45-3311-4555
<b>Luxembourg</b>	+32-70-220-100
<b>Malaysia</b>	+60-3-2715-2053
<b>Malta</b>	39-06-6501-1462/0991
<b>Martinique</b>	+596-21-1277
<b>Mexico</b>	01-800-719-2827 (toll free in Mexico)
<b>Namibia</b>	+27-11-463-1147
<b>Netherlands</b>	0800-022-9769
<b>New Zealand</b>	0508-747-767

<b>Norway</b>	+45-3311-4555
<b>Pakistan</b>	92-21-356-77395/77212/54933
<b>Panama</b>	00-800-052-1215 (toll free)
<b>Paraguay</b>	+595-21-448917
<b>Peru</b>	0800-52-073 (toll free)
<b>Philippines</b>	+63-2-840-4626 to 29
<b>Poland</b>	(48) 22-696-85-21
<b>Portugal</b>	1-514-393-3333 (charges apply)
<b>Puerto Rico</b>	1-877-321-0173
<b>Qatar</b>	1-514-393-3333 (charges apply)
<b>Russia</b>	Moscow +7-495-771-6471 St. Petersburg 7-812-740-3820
<b>Saudi Arabia</b>	Dharan (966) 3-8822602 Riyadh (966) 1-4772228 Jeddah (966) 2-2632996 Dammam (966) 3-8356000
<b>Singapore</b>	6567373166
<b>South Africa</b>	+27-11-463-1147
<b>Spain</b>	900935265
<b>Sri Lanka</b>	+94-11-547-4747
<b>St. Lucia</b>	+1-800-744-2472
<b>St. Maarten</b>	52-55-9138-0280
<b>Sudan</b>	+254-20-2105-348/9
<b>Swaziland</b>	+27-11-463-1147

<b>Sweden</b>	+45-3311-4555
<b>Switzerland</b>	0848-247-226
<b>Taiwan</b>	+886-2-2511-7799
<b>Tanzania</b>	+254-20-2105-348/9
<b>Thailand</b>	+66-2-718-1839
<b>Trinidad &amp; Tobago</b>	868-669-4279
<b>Turks &amp; Caicos</b>	+1-866-931-2012 (toll free)
<b>Uganda</b>	+254-20-2105-348/9

<b>Ukraine</b>	1-514-393-3333 (charges apply)
<b>United Arab Emirates</b>	971-4-2112-537
<b>United Kingdom</b>	0871-220-1111 (charges apply)
<b>United States</b>	+1-888-247-2262 (toll free)
<b>Uruguay</b>	000-405210083 (toll free)
<b>Venezuela</b>	0-800-100-4918 (toll free)
<b>Vietnam</b>	1-514-393-3333 (charges apply)



**Air China (CA)** [www.airchina.com.cn](http://www.airchina.com.cn)

<b>Americas</b>	+1-800-882-8122
<b>Australia</b>	0011-800-86-100-999 (Free) 1-800-860-999
<b>Canada</b>	+1-800-860-999
<b>China</b>	+86-10-95583

<b>Europe</b>	+800-86-100-999
<b>Hong Kong</b>	001/006-800-86-100-999
<b>Japan</b>	+800-86-100-999/ 0120-474-999
<b>Korea</b>	+800-86-100-999
<b>Philippines</b>	+800-86-100-999
<b>Singapore</b>	+800-86-100-999



<b>Australia</b>	1800-247-463
<b>Austria</b>	00-431-5872147
<b>Bahrain</b>	00-97-317223848
<b>Canada</b>	1800-625-6424
<b>Denmark</b>	00-4533-157070
<b>Egypt</b>	00-202-23922592
<b>France</b>	0033-1-76545741
<b>Germany</b>	0049-69-1200-9821
<b>India</b>	1800-180-1407
<b>Iran</b>	00-9821-88735956
<b>Italy</b>	Milan 00-3902-864-53032 Rome 00-3906-700-5206
<b>Japan</b>	Osaka 00-816-62645915 Tokyo 00-813-51575592
<b>Kuwait</b>	00-965-22409094
<b>Lebanon</b>	00-9611-342200
<b>Netherlands</b>	00-3120-6248109
<b>Oman</b>	00-968-2476-2100

<b>Qatar</b>	00-974-44426889
<b>Russia</b>	007-499-2364440
<b>Saudi Arabia</b>	Dammam 00-9663-8820834 Jeddah 00-9662-2633006 00-9662-2633006 Salalah 00-9611-23297948 Riyadh 00-96611-4774484
<b>Singapore</b>	00-65-62259411
<b>South Korea</b>	00-82-2-752-5439
<b>Spain</b>	00-3491-5419260
<b>Switzerland</b>	00-4143-8887090
<b>United Arab Emirates</b>	Abu Dhabi 00-971-26334766 Al Ain 00-971-37557696 Dubai 00-9714-2227715 Sharjah 00-9716-5970333
<b>United Kingdom</b>	0044-207-760-3290
<b>United States</b>	1800-223-7776



<b>Australia</b>	132-476 (toll-free)	<b>Italy</b>	800-876-126
<b>Austria</b>	0-800-295-838 (toll-free)	<b>Japan</b>	+81-3-5521-2770
<b>Belgium</b>	0-800-79-586 (toll-free)	<b>Korea (South)</b>	+82-2-737-4025
<b>Canada</b>	1-866-351-9528 Vancouver 1-604-606-0150	<b>Luxembourg</b>	0-800-225-27 (toll-free)
<b>China</b>	Beijing +86-10-6587-0000 Shanghai +86-21-2325-3333 Hong Kong +852-2862-8988	<b>Malaysia</b>	+603-2715-5020
<b>Cook Islands</b>	+682-26-300	<b>Mexico</b>	+52-55-5208-1216
<b>Czech Republic</b>	800-143-854 (toll-free)	<b>Netherlands</b>	0-800-022-1016 (toll-free)
<b>Denmark</b>	+800-17-055 (toll-free)	<b>New Caledonia</b>	+687-286-677
<b>Fiji</b>	+679-331-3100	<b>New Zealand</b>	+64-9-357-3000 0-800-737-000 (toll-free)
<b>Finland</b>	0-800-113-282 (toll-free)	<b>Norfolk Island</b>	+6723-22-195
<b>France</b>	0-800-907-712 (toll-free)	<b>Norway</b>	800-11-080 (toll-free)
<b>French Polynesia</b>	+689-540-740	<b>Niue</b>	+683-4317
<b>Germany</b>	0-800-183-0619 (toll-free)	<b>Philippines</b>	+632-884-8097
<b>India</b>	New Delhi +91-11-23730864 Mumbai +91-22-26817910 Chennai +91-44-28586868	<b>Portugal</b>	800-880-452 (toll-free)
<b>Ireland</b>	1-800-551-447 (toll-free)	<b>Russia</b>	+7-495-744-0490
<b>Israel</b>	+972-3-560-1616	<b>Samoa</b>	+685-20825
		<b>Singapore</b>	+65-6884-8121
		<b>Slovakia</b>	0-800-005-126 (toll-free)
		<b>South Africa</b>	+27-11-289-8036
		<b>Spain</b>	+900-99-32-41

<b>Sweden</b>	0-20-792-939 (toll-free)
<b>Switzerland</b>	0-800-557-778 (toll-free)
<b>Taiwan</b>	+886-2-2537-0146
<b>Thailand</b>	+66-2-2358-226

<b>Tonga</b>	+676-23-192
<b>United Kingdom</b>	0-800-028-4149
<b>United States</b>	+1-800-262-1234 (toll-free)
<b>Vanuatu</b>	+678-22-666

 **ANA (NH)** [www.ana.co.jp](http://www.ana.co.jp)

<b>Argentina</b>	+54-11-5274-1600
<b>Australia</b>	+61-1800-081-765
<b>Austria</b>	+43-1-7956-7360
<b>Belgium</b>	+32-702-33387
<b>Bolivia</b>	+591-2279-7068 / +591-2212-4475
<b>Brazil</b>	+55-11-2141-2121
<b>Canada</b>	+1-844-728-0647
<b>Cambodia</b>	+855-23-963-617/618
<b>China</b>	+86-10-8559-9292 Hong Kong +852-2810-7100
<b>Colombia</b>	+57-1-620-3515
<b>Costa Rica</b>	+506-2257-5745
<b>France</b>	+33-820-803-212
<b>Germany</b>	+49-69-170-776-647
<b>Guatemala</b>	+502-2-362-8018

<b>India</b>	+91-22-6147-0787/0737
<b>Indonesia</b>	+62-21-5797-4382
<b>Ireland</b>	+353-1-850-200-058
<b>Israel</b>	+972-9-9669339
<b>Italy</b>	+39-848-858140
<b>Japan</b>	+81-3-6741-6685
<b>Korea (South)</b>	+82-2-2096-5500
<b>Malaysia</b>	+60-3-2032-1331
<b>Myanmar</b>	+95-01-255-412 / 3
<b>Netherlands</b>	+31-900-666-6666
<b>Norway</b>	+49-810-00-011
<b>Panama</b>	+507-263-3033/301-0404
<b>Peru</b>	+51-1-444-4441
<b>Philippines</b>	+63-2-553-8000
<b>Russia</b>	+7-495-258-2370
<b>Singapore</b>	+65-6323-4333

<b>Spain</b>	+34-901-116-703
<b>Sweden</b>	+46-8-5877-0428
<b>Switzerland</b>	+41-844-803-545
<b>Taiwan</b>	+886-2-2521-1989
<b>Thailand</b>	+66-2-238-5121

<b>United Arab Emirates</b>	+971-4-4060-515
<b>United Kingdom</b>	+44-20-8762-8977
<b>United States</b>	+1-800-235-9262
<b>Venezuela</b>	+58-212-285-4433
<b>Vietnam</b>	+84-8-3821-9612

 **Asiana (OZ)** [www.flyasiana.com](http://www.flyasiana.com)

<b>Australia</b>	+61-1300-767-234
<b>Argentina</b>	+54-11-4393-8867
<b>Austria</b>	+43-1-585-36-31-75
<b>Bangladesh</b>	+880-2-912-9682
<b>Belgium</b>	+31-20-6547920
<b>Brazil</b>	+55-11-3337-7778
<b>Cambodia</b>	+855-23-890-441
<b>Chile</b>	+56-2-639-0889
<b>China</b>	400-650-8000 / +86-10-8451-0101
<b>Czechoslovakia</b>	+42-296-368-271
<b>Dubai</b>	+971-4-352-6000
<b>France</b>	+33-1-81-80-0940
<b>Germany</b>	+49-69-9210-190
<b>Hongkong</b>	400-650-8000 / +86-10-8451-0101

<b>Hungary</b>	+36-70-388-8267
<b>India</b>	+91-11-2331-5631/2
<b>Indonesia</b>	+62-21-5591-3104/3229
<b>Italy</b>	+39-06-6595-26972
<b>Japan</b>	0570-082-555 / +81-3-5812-6600
<b>Kazakhstan</b>	+7-727-356-32-35~7
<b>Korea(south)</b>	1588-8000 / +82-2-2669-8000
<b>Malaysia</b>	+60-88-268-677
<b>Mexico</b>	+52-55-5208-1122
<b>Nepal</b>	+977-1-426-2167/422-2086
<b>Netherlands</b>	+31-20-6547920
<b>New Zealand</b>	+64-9-308-3359
<b>Pakistan</b>	+92-21-568-0620
<b>Palau</b>	+680-587-2250

<b>Philippines</b>	+63-2-662-8000
<b>Russia</b>	+7-4242-722000/1
<b>Saipan</b>	+1-670-288-2625
<b>Singapore</b>	+65-6225-3866
<b>Spain/Portugal</b>	+34-91-562-54-9
<b>Sri Lanka</b>	+94-11-243-0380
<b>Swiss</b>	+41-44-286-99-42
<b>Taiwan</b>	+885-2-2581-4000

<b>Thailand</b>	+66-2-016-6500
<b>Turkey</b>	+90-212-256-4144
<b>United Kingdom</b>	+44-845-602-9900
<b>United States</b>	+1-213-365-4500/2000 / 800-227-4262
<b>Uzbekistan</b>	+998-71-140-0900-1
<b>Vietnam</b>	+84-4-3771-4094/5

---

 **Austrian (OS)** [www.austrian.com](http://www.austrian.com)

---

<b>Albania</b>	+355-4-2235028/9
<b>Armenia</b>	+374-10-512-201
<b>Australia</b>	1-300-655-727 (toll free)
<b>Austria</b>	+43-5-1766-1000
<b>Azerbaijan</b>	+994-12-497-18-22
<b>Belarus</b>	+375-17-2-900-900
<b>Belgium</b>	+32-2-642-25-79
<b>Bosnia &amp; Herzegovina</b>	+387-33-788-500
<b>Bulgaria</b>	+359-2-806-0001
<b>Canada</b>	+1-800-843-0002 (toll free)

<b>China</b>	+86-4008-810-770
<b>Croatia</b>	+385-1-6265-900
<b>Cyprus</b>	+357-22873330
<b>Czech Republic</b>	+420-227-231-231
<b>Denmark</b>	+45-70-11-30-00
<b>Egypt</b>	19380 (local hotline) +2-02-19380
<b>Estonia</b>	+371-6-7507700
<b>France</b>	0-820-816-816 (within France)
<b>Georgia</b>	+995-32-224-33-24
<b>Germany</b>	+49-180-3000-520

<b>Greece</b>	+30-801-11-26026
<b>Hungary</b>	+36-1-411-9940
<b>India</b>	1-800-102-5838 (toll free)
<b>Iran</b>	+98-21-833-88
<b>Iraq</b>	+964-750-302-1112/3/4
<b>Israel</b>	+1-80-937-1-937
<b>Italy</b>	+39-02-896-34-296
<b>Japan</b>	0120961786 (toll free) +81-(0)-3-4455-6407
<b>Jordan</b>	+962-5-200-180
<b>Kazakhstan</b>	+7-7172-595-8888
<b>Korea (South)</b>	+82-2-3788-140
<b>Latvia/Estonia</b>	+371-67507700
<b>Lebanon</b>	+971-4-211-25-38
<b>Libya</b>	+218-21-335-375
<b>Lithuania</b>	+370-5-210-5030
<b>Macedonia</b>	+389-2-3148372/5
<b>Moldavia</b>	+373-22-244083
<b>Montenegro</b>	+382-20-653-350

<b>Netherlands</b>	0-900-265-8920 (local hotline)
<b>Norway</b>	815-21-052 (local number)
<b>Poland</b>	0-801-40-40-40 (local hotline) +48-22-5203420
<b>Romania</b>	+40-21-204-45-60
<b>Russia</b>	+7-495-995-0-995
<b>Serbia</b>	+381-11-324-8077
<b>Slovak Republic</b>	+421 (0) 2-4940-2100
<b>Slovenia</b>	+386-1-244-30-60
<b>Spain</b>	902-551-257 (local hotline) +34-(0)-902-551-257
<b>Sweden</b>	0-770-82-73-73 (local hotline) +46-770-82-73-73
<b>Switzerland</b>	+41-44-286-8088
<b>Thailand</b>	+66-2654-6800 (press 3)
<b>Turkey</b>	+90-212-354-88-67
<b>Ukraine</b>	0-800-300049/492
<b>United Arab Emirates</b>	+971-4-211-25-38 to 42
<b>United Kingdom</b>	0-870-1-24-26-25 (local toll free)
<b>United States</b>	+1-800-843-0002 (toll free)



**Avianca (AV)** [www.avianca.com](http://www.avianca.com)

<b>Argentina</b>	810-333-8222	<b>Curacao</b>	005999-8-202020
<b>Aruba</b>	00297-588-0059	<b>Dominican Rep.</b>	809-200-8662
<b>Avianca Tours</b>	01-8000-914600	<b>Ecuador</b>	1-800-003434
<b>Bolivia, La Paz &amp; Santa Cruz</b>	800-10-8222	<b>El Salvador</b>	503-2267-8222
<b>Brazil</b>	0800-891-8668; TDD 0800-891-1684	<b>Guatemala</b>	502-2470-8222
<b>Canada</b>	1-800-722-8222	<b>Honduras</b>	San Pedro Sula 504-2570-8222; Tegucigalpa 504-2281-8222
<b>Chile</b>	800-536022	<b>Mexico</b>	01800-1233120
<b>Colombia</b>	Barranquilla 330-20-30; Bogota 401-34-34; Cali 321-34-34; Medellin 444-34-34; Rest of Colombia 01-8000-953-434; Aviancatours 01-8000-914-600; Deprisa 01-8000-519393	<b>Nicaragua</b>	505-2276-9982
<b>Costa Rica</b>	506-2299-8222	<b>Panama</b>	800-0555; 507-206-8222
		<b>Paraguay</b>	009-800-511-8222
		<b>Peru</b>	Lima 511-511-8222; Provincia 0-800-5-1111
		<b>Spain</b>	34-902-026655
		<b>Uruguay</b>	000-405-1004
		<b>Venezuela</b>	0800-2842622

**Avianca in Brazil (O6)** [www.avianca.com.br](http://www.avianca.com.br)

<b>São Paulo</b>	+5511 4004-4040	<b>Other Cities in Brazil</b>	0300-798-8160; 0800-286-6543
------------------	-----------------	-------------------------------	---------------------------------



<b>General Number</b>	+32-27-232420/30/40; Gen. Res. 0902-51600 (€0,75/min.) After sales 078-18-88-89
<b>Angola</b>	+244-222-311-447
<b>Austria</b>	+32-2-723-23-62; Base 0902-51-600; FTL +32-2-723-24-20; SEN: -30; HON:-40
<b>Belgium</b>	Gen. Res. 0902-51600 (€0,75/min.) After sales 078-18-88-89
<b>Burundi</b>	+257-2225-6281
<b>Cameroon</b>	+237-342-05-15; +237-223-47-35 (NSI)
<b>Czech Republic</b>	+42 (0) 2-34-00-82-58
<b>DR Congo</b>	+243-89-89-75-010
<b>Denmark</b>	+45-333-77-353
<b>Finland</b>	+358 (0) 203-86-300
<b>France</b>	0892-231-682
<b>Gambia</b>	+220-446-68-82/3/4

<b>Germany</b>	Base: 01805-59-59; FTL: 01803-99-33-55; SEN: -66; HON: 0800-099-33-88; +49-69-209-777-777
<b>Greece</b>	+30-210-6175-350
<b>Guinea</b>	+224-41-34-40
<b>Hungary</b>	+36-1-411-99-77
<b>Ireland</b>	+44 (0) 8-71-94-59-737
<b>Israel</b>	1-80-937-0-937; +272-14-15-35-87
<b>Italy</b>	199-400-299
<b>Ivory Coast</b>	+225-21-21-38-70
<b>Kenya</b>	+254-20-444-30-70
<b>Lithuania</b>	+370-5-230-60-31; +370-5-232-92-92
<b>Luxembourg</b>	90-07-30-15/75
<b>Malta</b>	+97-14-373-922 or +356-21-805-025
<b>Netherlands</b>	0900-1234-380
<b>Norway</b>	+47 (0) 22-83-65-69

<b>Poland</b>	+48-22-5777-222
<b>Portugal</b>	+351-707-783-783
<b>Romania</b>	+40-21-20-48-411
<b>Russia</b>	+7-495-980-999-7
<b>Rwanda</b>	+250-57-52-90
<b>Senegal</b>	+221-823-04-60
<b>Sierra Leone</b>	+232-22-23-6442
<b>Slovenia</b>	+386 (0) 40-747-440

<b>Spain</b>	+34-902-220-105
<b>Sweden</b>	+46 (0) 86-11-59-30
<b>Switzerland</b>	0900-85-0000
<b>Uganda</b>	+256-41-423-4201
<b>Ukraine</b>	+38 (0) 44-4-90-38-00
<b>United Kingdom</b>	+44-(0)871-945-9737
<b>United States</b>	1-800-581-6400



**Copa Airlines (CM)** [www.copaair.com](http://www.copaair.com)

<b>Argentina</b>	Buenos Aires 0810-222-COPA (2672) Cordoba 0810-222-COPA (2672)
<b>Aruba</b>	Oranjestad (297) 585-COPA (2672)
<b>Australia</b>	+61-2-8644-1884
<b>Austria</b>	+43-1-512-86-86
<b>Bahamas</b>	Nassau 1-800-359-COPA (2672)
<b>Belgium</b>	+31 (0) 202-410-168

<b>Bolivia</b>	Santa Cruz De La Sierra 800-10-COPA (2672)  Belo Horizonte 0-800-771-COPA (2672) Brasilia 0-800-771-COPA (2672) Manaos 0-800-771-COPA (2672)
<b>Brazil</b>	Porto Alegre 0-800-771-COPA (2672) Recife 0-800-771-COPA (2672) Rio de Janeiro 0-800-771-COPA (2672) San Paulo (5511)-3549-COPA (2672)

<b>Canada</b>	Toronto 1-800-FLY-COPA (359-2672)
<b>Chile</b>	Santiago De Chile (562) 2200-2100
<b>Colombia</b>	Barranquilla 01-8000-112600 Bogota (571) 320-9090 Bucaramanga 01-8000-112600 Cali 01-8000-112600 Cartagena 01-8000-112600 Cucuta 01-8000-112600 Leticia 01-8000-112600 Medellin 01-8000-112600 Pereira 01-8000-112600 San Andres 01-8000-112600 Santa Marta 01-8000-112600
<b>Costa Rica</b>	Liberia (506) 2223-COPA (2672) San Jose (506) 2223-COPA (2672)
<b>Cuba</b>	Havana (537) 204-1111
<b>Dominican Republic</b>	Punta Cana (809) 200-2772 Santiago De Los Caballeros (809) 200-2772 Santo Domingo (809) 472-COPA (2672) Santo Domingo 809-200-2772 (toll-free provinces)

<b>Ecuador</b>	Cuenca (593) 4230-3211 Quayaquil (593) 4230-3211 Quito (5932) 227-3082
<b>El Salvador</b>	San Salvador (503) 2209-COPA (2672)
<b>England</b>	+44-203-598-8030
<b>France</b>	+33 (0) 158-22-20-04
<b>Germany</b>	+49 611-26767-70
<b>Guatemala</b>	Guatemala (502) 2312-5410
<b>Haiti</b>	Port Au Prince 1-800-271-COPA (2672); (868) 669-5189
<b>Honduras</b>	San Pedro Sula (504) 516-COPA (2672) Tegucigalpa (504) 233-COPA (2672)
<b>India</b>	+91-22-2291-0300
<b>Italy</b>	+39-02-8721-3401
<b>Jamaica</b>	Kingston 1-800-234-COPA (2672) Montego Bay 1-800-234-COPA (2672)
<b>Japan</b>	+81-3-3597-9480
<b>Korea</b>	+82-2-771-5622

<b>Mexico</b>	Cancun 01-800-265-COPA (2672)
	Guadalajara 01-800-265-COPA (2672)
	Monterrey 01-800-265-COPA (2672)
	Mexico DF 01-800-265-COPA (2672)
	<b>Netherlands Antilles</b> Curacao 001-877-389-3606 St. Maarten 001-877-389-3606
<b>New Zealand</b> +64-21-800-623-4293	
<b>Nicaragua</b> Managua (505) 2267-0045	
<b>Panama</b>	Panama (507) 217-COPA (2672)
	David, Chiriqui (507) 217-COPA (2672)
	Zona Libre Colon (507) 217-COPA (2672)
<b>Paraguay</b> Asuncion 0098005420074 (Not avail. from cellular)	
<b>Peru</b> Lima (511) 610-0808	

<b>Puerto Rico</b>	San Juan 1-800-FLY-COPA (359-2672)
<b>Russia</b>	+7 (495) 744-0490
<b>Scandinavia</b>	+45-3325-2566
<b>Spain</b>	+34-91-547-85-88
<b>Switzerland</b>	+41-56-675-7555
<b>Taiwan</b>	+886-2-25413366
<b>Trinidad &amp; Tobago</b>	Port of Spain 1-800-271-COPA (2672)
<b>Uruguay</b>	Montevideo (598) 2707-COPA (2672)
<b>USA</b>	Chicago, Los Angeles, New York, Miami, Orlando, Washington 1-800-FLY-COPA (359-2672) (305) 371-COPA (2672)
	Caracas 0-800-826-7200; (58) 212-953-5311
<b>Venezuela</b>	Maracaibo 0-800-826-7200; (58) 212-953-5311
	Valencia 0-800-826-7200; (58) 212-953-5311

**Croatia Airlines (OU)** [www.croatiaairlines.com](http://www.croatiaairlines.com)

<b>Benelux</b>	(+32-2)753-5132
<b>Bosnia &amp; Herzegovnia</b>	(+387-33) 789-600
<b>Croatia</b>	072-500-505/ +385 (0)1-6676-555 Dubrovnik +385 (0) 20-772-255 Pula +385 (0) 52-218-909/ +385 (0) 52-218-943 Split +385 (0) 21-203-305/ +385 (0) 21-895-298 Zadar +385 (0) 23-250-101 Zagreb +385 (0) 1-6164-581

<b>France</b>	(+33-1) 48-16-40-00
<b>Germany</b>	Frankfurt (+49-69) 92-00-520
<b>Italy</b>	(+39-06) 5421-0021
<b>Macedonia</b>	(+389-2) 3148-390
<b>United Kingdom</b>	(+44-20) 8563-0022

**EGYPTAIR (MS)** [www.egyptair.com](http://www.egyptair.com)

<b>Algeria</b>	00213 (21) 644357/634008
<b>Australia</b>	0061 (02) 97674321
<b>Austria</b>	0043 (01) 587-453-216/217/218
<b>Bahrain</b>	00973 (17) 243-060/317
<b>Belgium</b>	0032 (2) 219-16-14
<b>Canada</b>	001 (514) 8755538
<b>China</b>	(CAN) 0086 (20) 8626-6969/6900/6092
<b>Cyprus</b>	+357-22-55-9200

<b>Denmark</b>	0045-72304470
<b>Egypt Land Line</b>	090070000 / Mobile 1717
<b>Eritrea</b>	0029 (11) 127510/034
<b>Ethiopia</b>	+251 911 212 338
<b>France</b>	+33 (1) 4494-8500/1 (FRA) +49 (069) 27 300335/337/338; (DUS) +49 152 20 9000 265; (MUC) +49 (089) 5458820; (BER) +49 (30) 8823319
<b>Germany</b>	

<b>Ghana</b>	00233 (302) 243537/538
<b>Greece</b>	0030 (210) 9212818/20/24/25
<b>Hong Kong</b>	00852-(02)-865-1122
<b>Hungary</b>	0036 (1 ) 266-4300; 0036 (1) 267 2484; 0036 (1) 3280148
<b>India</b>	0091 (022) 22041855/2824088
<b>Indonesia</b>	0062 (21) 5742-471/5742- 473/5704-444
<b>Italy</b>	0039 (02) 865777/72021805; 0039 (06) 4871429/4742641/42/43 (0039 (06) 4871430)
<b>Japan</b>	0081 (3) 3568-8161/68/66
<b>Jordan</b>	00962 (6) 4636011/28911
<b>Kenya</b>	00254 (20) 226821/2/3
<b>Korea (South)</b>	0082 (02) 3194555
<b>Kuwait</b>	00965-224- 39576/39620/60957/60950; +965-22460 95617
<b>Lebanon</b>	00961 3790799
<b>Libya</b>	(TIP) 00218 (021) 3335781/2/3
<b>Malaysia</b>	066 (3) 21456867
<b>Malta</b>	00356-21-342472

<b>Morocco</b>	00212 (22) 306700/315564/309225
<b>Netherlands</b>	0031 (20) 6256661
<b>Nigeria</b>	(ABV) 0023 408 95 999 080
<b>Norway</b>	004781500575
<b>Oman</b>	00968 (24) 794113/6134/6389
<b>Philippines</b>	0063 (2) 8925722
<b>Portugal</b>	00351 (218) 923-830/36/38
<b>Qatar</b>	00974-55561389
<b>Russia</b>	007 (925) 526-6384/526- 6385/258-9686  (MED) +966 555 344 958; (JED) + 966-50 66 92 094; (QCA) +966-2-5425544/41680/ 41808/41185/45767; (AHB) + 00966026645999
<b>Saudi Arabia</b>	
<b>Singapore</b>	00656278811
<b>South Africa</b>	0027 (11) 88-04126/9; 0027 (11) 880-4834
<b>Spain</b>	0034 (091) 548-8645; (93) 302-3148/7312
<b>Sudan</b>	00249 (183)780064/781428; 00249(11) 771259/092-781428
<b>Sweden</b>	0046 (86) 636558

<b>Switzerland</b>	0041 (022) 731-3936/ 7-7317151/2
<b>Syria</b>	00963 (11) 224-5843/224- 0164/223-2158
<b>Taiwan</b>	008 (86) 225682121
<b>Thailand</b>	(BKK) 0066 (2) 231- 0504/5/6/7/8
<b>Tunisia</b>	00216 (71) 860138/165/466
<b>Turkey</b>	0090 530 664 8482
<b>Uganda</b>	00256 (41)-233-960/341-276

<b>Ukraine</b>	00380 (44) 2563020
<b>United Arab Emirates</b>	(AUH) 00971-55690-8865; (SHJ) 00971-06-5735351/2
<b>United Kingdom</b>	0044 (207) 287-1728; 0044 (207) 734-2343/2395; 0044 (207) 734-2864; (LON) 08448221110
<b>United States</b>	001 (212) 581-5600; 001 (212) 586-6599 [3150 900]
<b>Yemen</b>	00967 (1) 273452/5061
<b>Zimbabwe</b>	(HRE) 00263-4732093/4/5



**Ethiopian** [www.ethiopianairlines.com](http://www.ethiopianairlines.com)

<b>Angola</b>	+244 222 310 615 +244 914 526 675 +244 912 215 683
<b>Belgium</b>	32-28948303 0032-2-712-05-86
<b>Benin</b>	+229-21310718 +229-21327161
<b>Burkina Faso</b>	22650301024/25
<b>Burundi</b>	257-2222-6820/038 257-2222-9842 (APT)
<b>Cameroon</b>	00237-33-43 (RES) 00237-33-43-37-30 (APT)

<b>Canada</b>	1-800-445-2733/ 1-877-340-8201 +1 (416) 962-0005
<b>Central Africa Republic</b>	0023 670 551 111/72251 111
<b>Chad</b>	235-2523143/3027 (CTO) 235-522599 (APT)



<b>China</b>	Hong Kong: 800905629 852-31508122 (APT) Beijing: 8610- 65050314/5/65069692 8610-64591156 (APT) Guangzhou: 8620- 87621101/0120/0836 (CTO) 8620 36067405 (APT) North China: 108007141635/86-4001589689 South China: 108001401619/86-4001-589689	
	<b>Congo</b> (Republic of the Congo)	242-22 281 0766 242-222 810 600 242-066-12-020 (CTO)
	<b>Congo</b> (Democratic Republic of Congo)	Lubumbashi: 00243 812771780/817789225
	<b>Djibouti</b>	00(253)-21-35-42-35 00(253)-21-34-12-16
	<b>Egypt</b>	0800-0000-411 202-26214935/36/37/38 (RES) 202 26966620 (APT)
	<b>Equatorial Guinea</b>	00240333090588 (CTO)
<b>Ethiopia</b>	251-11-5517000 (CTO) 251-11-6656666 (RES) 251-11-5178320 (APT)	

<b>France</b>	800901031 33-1-53-892102 0 825 826 135 (CTO) +33-1-74-37-04-80 (CDG)
<b>Gabon</b>	741315 (CTO) 241-760144/45 (APT)
<b>Germany</b>	8001818982 49-69-770673052 (CTO) 49-(0)-69-6976-9790 (APT)
<b>Ghana</b>	233 302 664856/57/58 (CTO) 233-302-775168/778993 (APT)
<b>India</b>	18001039933
<b>Israel</b>	972-3-763-1052 (CTO)
<b>Italy</b>	Rome: 39-06-42011199 39-06-45230459 (CTO) Rome: (+39)0665954126 (APT) Milan: +39-02-8056562
<b>Ivory Coast</b>	00-225-20219332 (CTO) 225-21278819 (APT)
<b>Kenya</b>	Nairobi: +254-20311507/544 +254 723786649/734 666066 (RES) 254-20-822236/311 (APT) Mombasa: +254-41-2319977/78/79 (RES) Mombasa: +254716044791 (APT) +254-41-2011199 (APT)

<b>Kuwait</b>	+965-222-70-600
<b>Lebanon</b>	961-1-752846/7 961-1-629814 (APT)
<b>Malawi</b>	00265 1772031/1771002/177130 8/1776003
<b>Malaysia</b>	+603-21412190; +60321420581/0582 (RES and CTO) +603-21422060
<b>Mali</b>	00-223-20-22-2088
<b>Mozambique</b>	258-21-31-44-21 258-845072366/823144211
<b>Nigeria</b>	Lagos: 234-1-7744711/2 234-1-7744710/7751921/3 (APT) Abuja: 234-92906844/4941 234-92903852/2761 (APT)
<b>Oman</b>	+968-24819119 (RES) +968-24817676 (CTO)
<b>Rwanda</b>	250252570440/42 (CTO) 250788751585 (CTO) 2502525100000; 250788426164 (APT)

<b>Saudi Arabia</b>	800-814-0018 Jeddah: 9662-6512365/6614/9609 Jeddah: 9662-6853064/196 (APT) Riyadh: 966-1-4782140/4789763 Dammam: 966-(3)-8984696
<b>Senegal</b>	221-33-823-5552/54 221-33-820-9396/5077 (APT)
<b>Somaliland</b>	252-2-528445 252-2-4855950-953
<b>South Africa</b>	800984023 27-11-7815950 (CTO) 27-11-3903819 (APT)
<b>South Sudan</b>	+211956212301 (CTO) +211956988408 (APT)
<b>Sudan</b>	249-1-83762063/88 2491-8790991 (APT)
<b>Sweden</b>	46-85051-3549
<b>Seychelles</b>	00248-4288907 00248-8909 (CTO) 00248-437-4326 (APT)

<b>Tanzania</b>	Dar-es-Salaam: 255-22-2117063/64/65 (RES) 255-22-2125443 (CTO) 255-22-2844243 (APT) Arusha 255-27-2506167/4231/9904 (CTO) 255-27-2554159 (APT)
<b>Thailand</b>	00-18001562069708 66(0) 26534366/7 (CTO) 66(0) 21343062/3/4 (APT)
<b>Togo</b>	228-22-21-70-74/87-38 (CTO) 228-22-26-30-39/361240 (APT)
<b>Uganda</b>	414254796/414254787 414345577/414345578/414345118
<b>United Arab Emirates</b>	8-000-3570-2401 9714-2236639 (CTO) 9714-2161807/1833/2885/2833/ 1805/1806

<b>United Kingdom</b>	44 (0)800-0163449 44-208-745-4235 (APT) 44-208-987-7000 (CTO)
<b>United States</b>	703-682-0570/1 (WASCTO/RES) 703-572-6809/8740 (IADAPT) 1-800-445-2733 (Global Call Centre- toll free) 703-682-0569 (Global Call Centre)
<b>Zambia</b>	260-211-236401/02/03; 00260955236401/ 00260979821971 (CTO) 260-211-271141 (APT) 00260955271141
<b>Zanzibar</b>	255-77441-7070 255-777667665 +255-254-2231527/28 (CTO)
<b>Zimbabwe</b>	263-4790705/6/700735



**EVA** [www.evaair.com](http://www.evaair.com)

<b>Australia</b>	+61-7-38605555
<b>Austria</b>	+43-1-700738700
<b>Cambodia</b>	+855-23-210303/219911
<b>China</b>	4008-205-893 (Mainland China only) +86-21-38613999 Hong Kong +852-28109251

<b>England</b>	+44-20-73808300
<b>France</b>	+33-1-41439111-3
<b>Indonesia</b>	Denpasar +62-361-9368405/9359773 Jakarta +62-21-5205363 Surabaya +62-31-5465123

<b>Japan</b>	0570-666-737 (Toll)(Japan Only) +81-3-5798-2811 (International or Internet only)
<b>Korea (South)</b>	+82-2-7560015
<b>Macau</b>	+853-28726866
<b>Malaysia</b>	+60-3-21622981
<b>Netherlands</b>	+31-20-5759166
<b>Philippines</b>	+63-2-8643800

<b>Singapore</b>	+65-62261533
<b>Taiwan</b>	+886-2-25011999
<b>Thailand</b>	+66-2-2696288
<b>Turkey</b>	+90-212-4016999
<b>United States &amp; Canada</b>	General +1-800-695-1188 Guam +1-671-6487226
<b>Vietnam</b>	Hanoi +84-4-39361600/602 Ho Chi Minh +84-8-38224488

**LOT** LOT Polish Airlines [www.lot.com](http://www.lot.com)

<b>Austria</b>	+43-(0)-810-810-855
<b>Belgium</b>	+32-7-818-0014
<b>Canada</b>	+1-416-236-4242
<b>China</b>	+86-8522-8690-668
<b>Denmark</b>	+45-7-010-5063
<b>Finland</b>	+358-9-6937-9036
<b>France</b>	+33-1-47-42-05-60
<b>Germany</b>	+49-69-2400-1020
<b>Italy</b>	+39-848-859-300
<b>Japan</b>	+81-120-944-179

<b>Netherlands</b>	+31-20-201-3917
<b>Poland</b>	+48-22-577-7755
<b>Russia</b>	+7-810-800-5082-5082
<b>Spain</b>	+34-901-116-713
<b>Sweden</b>	+46-08-58770447
<b>Switzerland</b>	+41-0-844-555-232
<b>Turkey</b>	+90-212-241-5749
<b>United Kingdom</b>	+44-0845-601-0767
<b>United States</b>	+1-212-789-0970



<b>Albania</b>	+355 4 450 0295	<b>China</b>	+86 4008 868 868 (Shanghai)
<b>Algeria</b>	+213-21-435767	<b>China</b>	+86 21 5352 4999 (Beijing)
<b>Angola</b>	+244 928 492 942	<b>Colombia</b>	+57 1 508 8000
<b>Argentina</b>	+54 11 5032 0162	<b>Congo</b>	+242 05 312 120 3/04
<b>Armenia</b>	+37 (410) 282443	<b>Costa Rica</b>	+506 25397339
<b>Australia</b>	+61-1300 655 727	<b>Croatia</b>	+385 72 220 220
<b>Austria</b>	+43 810 1025 8080	<b>Cyprus</b>	+35 722000834
<b>Azerbaijan</b>	+994 12 4 907050	<b>Czech Republic</b>	+420 234 008 234
<b>Bahrain</b>	1654 8922 (toll free, from within Bahrain only)	<b>Denmark</b>	+45 70 100 333
<b>Bahrain</b>	+971 4389 8100 (from abroad)	<b>Ecuador</b>	180 000 0550*
<b>Belarus</b>	+375 17 292 8999	<b>Egypt</b>	+202 25803500
<b>Belgium</b>	+32 70 35 30 30* (from within Belgium only)	<b>El Salvador</b>	+503 21368404
<b>Bolivia</b>	+591 2 2774343	<b>Equatorial Guinea</b>	+240 333 09 2827
<b>Bosnia &amp; Herzegovina</b>	+387 63 990 001	<b>Eritrea</b>	+291 1 186904
<b>Brazil</b>	+55 11 3878 8151	<b>Estonia</b>	+372 6868 800
<b>Bulgaria</b>	+ 359 2 935 8210	<b>Ethiopia</b>	+251-11-551 5666
<b>Canada</b>	+1-800-563-5954*	<b>Finland</b>	+358 20 358 358
<b>Chile</b>	+56 22 6188333	<b>France</b>	+33 892 231 690
		<b>Gabon</b>	+241 07 07 09 77
		<b>Georgia</b>	+995 32247 3990

<b>Germany</b>	+49 69 86 799 799
<b>Ghana</b>	+234 1 4480963
<b>Ghana</b>	+233 (0) 302 243 894
<b>Greece</b>	+30 210 6175200
<b>Guatemala</b>	+502 2366 6274
<b>Honduras</b>	+504 2235 7469
<b>Hong Kong</b>	+852 2868 2313
<b>Hungary</b>	+361 429 2200
<b>Iceland</b>	+354 800 7556
<b>India</b>	1800 102 5838
<b>Indonesia</b>	001 803 852 6562
<b>Iran</b>	+98 21 83388
<b>Iraq</b>	+964 750 302 1112 - 1114
<b>Ireland</b>	+353 1 8 44 55 44
<b>Israel</b>	03-9058049
<b>Italy</b>	+39 199 400 044
<b>Japan</b>	0120-051-844
<b>Jordan</b>	+962 6 5200180
<b>Kazakhstan</b>	+7 (727) 333 50 25
<b>Kenya</b>	+254 202666969
<b>Korea, Republic of</b>	+82 2 6022 4228
<b>Kuwait</b>	+965 2228 5886
<b>Latvia</b>	+371 6 785 2199
<b>Lebanon</b>	+961 1 347007

<b>Libya</b>	+216 71 966 160
<b>Lithuania</b>	+370 5 205 1183
<b>Luxembourg</b>	900 73055 (valid within Luxembourg)
<b>Macedonia</b>	+ 359 2 935 8210
<b>Malaysia</b>	+60 3 2053 1898
<b>Malta</b>	+356 21252020
<b>Mexico</b>	+52 55 50 91 31 40
<b>Moldova</b>	+373 603 65 146
<b>Montenegro</b>	+381 11 303 4944
<b>Morocco</b>	+ 216 71 966 160
<b>Namibia</b>	+27 21 415 3747
<b>Netherlands</b>	0900 – 1234 777
<b>New Zealand</b>	0800 945 220 (toll-free within New Zealand)
<b>Nicaragua</b>	+505 22 668517
<b>Nigeria</b>	09-4610657
<b>Norway</b>	+47 22 330 900
<b>Oman</b>	+971 4 389 8200
<b>Panama</b>	+507 833-9737
<b>Peru</b>	+51 1708 6759
<b>Philippines</b>	+63 2 580 6400
<b>Poland</b>	+48 22 512 3917
<b>Portugal</b>	+351 707 782 782

<b>Qatar</b>	+971 4 389 8200
<b>Romania</b>	+40 21 655 0719
<b>Russian Federation</b>	+7 495 411 8444
<b>Saudi Arabia</b>	8008447661
<b>Serbia</b>	+381 11 303 4944
<b>Singapore</b>	+65 6 2455 600
<b>Slovakia</b>	+421 250 112 125
<b>Slovenia</b>	+386 407 477 37
<b>South Africa</b>	0861 842538
<b>Spain</b>	+34 902 883 882
<b>Sudan</b>	00249 183 771322
<b>Sweden</b>	+46 770 111 010
<b>Switzerland</b>	0900 900 922

<b>Taiwan, Republic of China</b>	+886 2 2325 8861
<b>Thailand</b>	+66 2 654 6800
<b>Tunisia</b>	+216 71 966 161
<b>Turkey</b>	+90 212 354 88 88
<b>Turkmenistan</b>	+993 12 234131
<b>Ukraine</b>	+38 044 490 3800
<b>United Arab Emirates</b>	+971 4 389 8100
<b>United Kingdom</b>	+44 371 945 9747
<b>USA</b>	+1 800 - 645 38 80
<b>Uruguay</b>	000413 598 4894
<b>Venezuela</b>	+58 (212) 335 8944
<b>Vietnam</b>	+84 8 3829 8529
<b>Yemen</b>	+967 1 213400



**Scandinavian Airlines (SK)** [www.flysas.com](http://www.flysas.com)

<b>Australia</b>	+1-300-727-707	<b>Italy</b>	+39-699-748-015 or 199-259-104
<b>Austria</b>	+43-(0)-820988530	<b>Japan</b>	+81-3-5400-2331
<b>Belgium &amp; Luxembourg</b>	+32-2-643-6900	<b>Korea (South)</b>	+82-2-752-5121
<b>Canada</b>	+1-800-221-2350 or 1-201-896-3600 (International Calls)	<b>Latvia</b>	+371-678-52-191
<b>China</b>	Beijing: +86-10-8527-6100 Shanghai: + 86-21-5228-5001	<b>Lithuania</b>	+370-5-205-1109
<b>Denmark</b>	+45-70-10-20-00	<b>Norway</b>	+47-915-05400
<b>Finland</b>	+358-981710062	<b>Poland</b>	+48-22-8500-500 (From abroad)
<b>Germany</b>	01805-11-70-02	<b>Russia</b>	+7-495-782-9353
<b>Greece</b>	+302-112-111-542	<b>Spain</b>	+34-807-001-724 (From abroad) or 902-40-50-33
<b>Hong Kong</b>	+852-3184-0710	<b>Sweden</b>	+46-8-797-4000 (From abroad) or 0770-727-727
<b>Iceland</b>	+354-800-7624	<b>Taiwan</b>	+886-2-2545-5665 (From abroad)
<b>India</b>	+91-11-4351-3202 (From abroad)	<b>United Arab Emirates</b>	+971-4-316-6505 (From abroad)
<b>Ireland</b>	+353-1-844-5440	<b>United Kingdom</b>	+44-208-990-7159 (International calls)
<b>Israel</b>	+972-3-510-1181	<b>United States</b>	+1-800-221-2350 or 1-201-896-3600 (International calls)



**Shenzhen Airlines (ZH)** [global.shenzhenair.com/zh/main.jsp](http://global.shenzhenair.com/zh/main.jsp)

<b>China</b>	+86-755-95080 +86-755-88814023 (for the unavailable areas)	<b>Hong Kong</b>	+852-81795080
--------------	--	------------------	---------------





<b>Austria</b>	+43-1513-46-55
<b>Australia</b>	13-10-11
<b>Bangladesh</b>	+8802-98-51-881
<b>Belgium</b>	+31-88-1-618-618
<b>Brazil</b>	+55-11-31790888
<b>Brunei</b>	+673-244-901/2
<b>Canada</b>	+1-800-663-3046 (toll free) 604-689-1223 (within Canada)
<b>China</b>	BJS: +86-10-6505-2233 CAN: +86-20-8755-6300 SHA: +86-21-6288-7999 Hong Kong: +852-2520-2233
<b>Czech Republic</b>	+420-224-232-603
<b>Denmark</b>	+45-3-314-3456
<b>Egypt</b>	+202-3749-2879
<b>France</b>	0-821-230-380 (within France) +33-153-65-79-00 (International)
<b>Germany</b>	+49-69-719-5200
<b>Greece</b>	+302-109-942-567

<b>India</b>	AMD: +91-79-30012828 BLR: +91-80-22867870 BOM: +91-22-22022747 CCU: +91-33-23675417 DEL: +91-124-4310999 MAA: +91-44-45921921
<b>Indonesia</b>	JKT: +62-21-52-997-888 DPS: +62-361-9368388/9
<b>Italy</b>	+39-06-4785-5360
<b>Japan</b>	+81-3-3213-3431
<b>Korea (South)</b>	+82-2-755-1226
<b>Kuwait</b>	+965-2225-8230
<b>Malaysia</b>	+60-3-2618-6333
<b>Maldives</b>	+960-3310031
<b>Mauritius</b>	+230-2087695/6/7
<b>Netherlands</b>	0-900-1-618-618
<b>New Zealand</b>	0800-808-909 (within NZ) +64-9-379-3209 (International)
<b>Norway</b>	+45-33143456
<b>Philippines</b>	+63-2-756-8888
<b>Russia</b>	+7-495-775-3087

<b>Saudi Arabia</b>	+966-9200-18081
<b>Singapore</b>	+65-6223-8888
<b>South Africa</b>	JNB: +27-11-880-8560 CPT: +27-21-674-0601
<b>Spain</b>	902-380-777 (within Spain) +34-934-873-908 (International)
<b>Sri Lanka</b>	+94-11-2499699
<b>Sweden</b>	+46-86117131
<b>Switzerland</b>	0900-88-18-18 (CHF 0.50/min.)
<b>Taiwan</b>	+886-2-2551-6655

<b>Thailand</b>	+66-2-3536000
<b>Turkey</b>	+90-212-463-1800
<b>Ukraine</b>	+38-044-287-0747
<b>United Arab Emirates</b>	AUH: +971-2-622-1110 DXB: +971-4-3166888
<b>United Kingdom</b>	0844-800-2380
<b>United States</b>	+1-800-742-3333 (toll free)
<b>Vietnam</b>	HAN: +84-4-3826-8888 SGN: +84-8-38231588



**South African Airways (SA)** [www.flysaa.com](http://www.flysaa.com)

<b>Angola</b>	+244-222-320-774/544
<b>Argentina</b>	+5411-4319-0099
<b>Australia</b>	+61-1-300-435-972
<b>Austria</b>	+43-1-587-1585
<b>Bahrain</b>	+97317551714
<b>Belgium</b>	+31-(0) 206-55-11-77
<b>Benin</b>	+229-21-31-84-08/21-31-46-45
<b>Botswana</b>	+09-267-391-3202
<b>Brazil</b>	+55-11-3065-5115
<b>Burundi</b>	+251-2227-7420/21/22

<b>Canada</b>	+1-800-722-9675
<b>Cape Verde</b>	+238-241-1358/1788
<b>Chile</b>	+56-2-376-9040
<b>China</b>	+86-10-6595-0066
<b>Colombia</b>	+55-11-3065-5115
<b>Congo</b>	Pointe Noire: +242-06-626-2616 Brazzaville: +242-06-650-9192
<b>Cyprus</b>	+35-75-340-030
<b>Czech Republic</b>	+420-234-723-240

<b>Dem. Rep. Of Congo</b>	+243-81-700-5908 +243-999-934-776 +243-999-925-121 +243-817-005-018
<b>Denmark</b>	+45-3314-3031
<b>Egypt</b>	+20-2-2579-5008
<b>Ethiopia</b>	+251 (0) 11-5-537880/1
<b>Finland</b>	+45-3314-3031
<b>France</b>	0825-800-969
<b>Gabon</b>	+00-241-724-194/726-081
<b>Germany</b>	+49-69-299-803-20
<b>Ghana</b>	+233 (0) 30-278-3676/7/8
<b>Greece</b>	+30-210-9600-942/3
<b>Hong Kong</b>	+852-2877-3277
<b>Hungary</b>	+36 (1) 999-1490
<b>India</b>	Ahmedabad +91(0)79-265-65580/62174 Bangalore +91-80-2227- 3438 Chennai +91-44-2822-6150/56 Hyderabad +91-44-666-88480 New Delhi +91-11-435-13131/3354422 Mumbai +91-22-6137-8141
<b>Indonesia</b>	+62-818-785155
<b>Ireland</b>	+44-(0)-20-8576-5555
<b>Israel</b>	+972-3-795-1344

<b>Italy</b>	+39-0243458381/82
<b>Ivory Coast</b>	+225-20-30-10-20
<b>Japan</b>	+813-3470-1901
<b>Kenya</b>	+254-20-224-7342/5520/5521
<b>Korea (South)</b>	+82-2775-4697
<b>Kuwait</b>	+965-242667
<b>Lesotho</b>	+266-310662
<b>Malawi</b>	+265-1-620-617/627/629/991
<b>Malaysia</b>	+603-2141-7456/7465
<b>Mauritius</b>	+230-202-6737
<b>Mozambique</b>	+214-656-27 Cell: 00-258-84-488-9710
<b>Namibia</b>	+264-61-273340 092-6462-540-082
<b>Netherlands</b>	+31 (0) 20-6-55-11-77
<b>New Zealand</b>	+64-9-977-2237
<b>Nigeria</b>	+23412702681-5 ext. 109/110/111/112 234-177-43197
<b>Norway</b>	+45-3314-3031
<b>Oman</b>	+968-247-65029
<b>Peru</b>	+55-11-3065-5115
<b>Philippines</b>	+632-884-8129
<b>Poland</b>	+48-22-455-3824
<b>Portugal</b>	+351-21-781-74-70

<b>Russia</b>	+7-4959-375953
<b>Saudi Arabia</b>	+996-2-682-0710
<b>Senegal</b>	+221-33-869-4000
<b>Singapore</b>	+65-62277911
<b>South Africa</b>	+27-11-978-1111
<b>Spain</b>	+349-1296-0420
<b>Sri Lanka</b>	+94-4-1-430707/94
<b>Swaziland</b>	09268-518-6155
<b>Sweden</b>	+45-3314-3031
<b>Switzerland</b>	+49-69-29-98-03-20
<b>Taiwan</b>	+886-2-2503-9393
<b>Tanzania</b>	+255-22-2117044-7
<b>Thailand</b>	+662-635-1410
<b>Turkey</b>	+90-212-297-4851

<b>Uganda</b>	+256-41-4345772/3/5 +256-41-4255-501 +256-41-4258-223 256-39-2767-801 256-31-2263-355
<b>Ukraine</b>	+38-44-490-65-01
<b>United Arab Emirates</b>	Dubai +4-3970-766 OR 050-6578923 Abu Dhabi +2-6780-038
<b>United Kingdom</b>	+0844-375-9680
<b>United States</b>	+1-800-722-9675
<b>Vietnam</b>	(84-4)-3562-7362 OR (84-8)-730-61518
<b>Zambia</b>	+260-211-254-350
<b>Zimbabwe</b>	+263-4-702-702/704-704

 **SWISS (LX)** [www.swiss.com](http://www.swiss.com)

<b>Austria</b>	+43-810-810-840
<b>Belgium</b>	+32-78-15-53-19
<b>Brazil</b>	+55-11-4700-8910
<b>Canada</b>	+1-877-359-7947 (TTY users: 711)
<b>China</b>	+86-4008-820-880
<b>Czech Republic</b>	+420-234-008-229
<b>Denmark</b>	+45-70-105-064

<b>Finland</b>	+358-9-693790-34
<b>France</b>	+33-892-232-501
<b>Germany</b>	+49 (0) 69-867-98-000
<b>Greece</b>	+30-210-6175-320
<b>Hong Kong</b>	+852-300-213-30
<b>Hungary</b>	+36-1-411-99-50

<b>India</b>	+91-2267137200 1-800-209-7240 (toll-free)
<b>Ireland</b>	+353-1-890-200-515
<b>Israel</b>	1-700-700-257
<b>Italy</b>	+39-848-868-120
<b>Luxembourg</b>	+352-34-20-808-370
<b>Netherlands</b>	+31-900-20-20-232
<b>Norway</b>	+47-810-00-012
<b>Poland</b>	+48-22-520-34-56
<b>Portugal</b>	+351-808-200-487
<b>Romania</b>	+40-21-312-02-38
<b>Russia</b>	+7-495-937-77-67 +7-495-937-77-60 (First class, HON, SEN members)

<b>Serbia</b>	+381-11-3030-140
<b>Singapore</b>	+65-6-823-20-10
<b>Slovakia</b>	+421-232-223-255
<b>Slovenia</b>	+381-113030-140
<b>South Africa</b>	+27-860-04-05-06
<b>Spain</b>	+34-901-116-712
<b>Sweden</b>	+46-8-587-704-45
<b>Switzerland</b>	+41-848-700-700
<b>Thailand</b>	+66-2-654-6800
<b>Turkey</b>	+90-212-354-99-19
<b>United Kingdom</b>	+44-845-601-0956
<b>United States</b>	+1-877-359-7947

 **TAP Portugal (TP)** [www.flytap.com](http://www.flytap.com)

<b>Angola</b>	+244-222-632000
<b>Austria</b>	+43-810810807 / 0-810810807 (local number)
<b>Belgium</b>	+32-272-03077
<b>Brazil</b>	+300-210-6060 / 1121311200 (local number)
<b>Canada</b>	1-800-221-7370

<b>Cape Verde</b>	+2413129/1195-SID, 2615826-RAI, 2328050-VXE (all local numbers)
<b>Denmark</b>	+45-7010-5068
<b>Finland</b>	+358-9-6937-9728
<b>France</b>	0-820-319-320 (only available within France)

<b>Germany</b>	01806-000 341 (only available within Germany)
<b>Greece</b>	210-325-1711 (only available within Greece)
<b>Guinea-Bissau</b>	+245-5603131 / +245-3201359
<b>Ireland</b>	+353-16569162
<b>Italy</b>	+39-02-6968-2334
<b>Luxembourg</b>	+352-24647133
<b>Morocco</b>	00211-0011 / 8887041281
<b>Mozambique</b>	+258-21303927/8 / 258-21303879 / 258- 821303928/846409426
<b>Netherlands</b>	0900-263-5827 (only available within Netherlands)

<b>Norway</b>	+47-8-100-0015
<b>Portugal</b>	+351-707-205-700
<b>Sao Tomé</b>	+239-2-222307
<b>Senegal</b>	+221-33-8494737
<b>Spain</b>	+34-901-11-6718
<b>Sweden</b>	+46-8-5877-0455 / 0-858770455 (local number)
<b>Switzerland</b>	+41-44-800-9652
<b>United Kingdom</b>	+44-845-601-0932 / 0-8456010932 (local number)
<b>United States</b>	1-800-221-7370
<b>Venezuela</b>	+58-212-9515508/0511



**Thai Airways International (TG)** [www.thaiairways.com](http://www.thaiairways.com)

<b>Australia</b>	General 1300-651-960 (within Australia) +61-2-9844-0929
<b>Bangladesh</b>	88 (02)-887-9131-46
<b>Belgium</b>	+32-2-502-4744
<b>Cambodia</b>	+855-23-214-359-61

<b>China</b>	(BJS) +86-10-8515-0088 Chengdu 8666-7171/75 Guangzhou 8620-8365-2333 ext 12 Hong Kong +852-2179-7777 Kunming +86-871-6351-1515 (PEK) +86-10-8515-0088 Shanghai +86-21-3366-4111 Xiamen +86-592-226-1688
--------------	---

<b>Denmark</b>	+45-33-75-01-20
<b>France</b>	+33-1-5568-8070
<b>Germany</b>	+49-69-9287-4444
<b>India</b>	Delhi +91-11-4149-7777 Hyderabad +91-40-2333-3030 (CCU) +91-33-2283-22-8865/68 Mumbai 1800-102-1225 Chennai +91-44-420-63311 Bangalore +91-80-409 80396/97
<b>Indonesia</b>	Jakarta +62-36-1288-141 Denpasar +62-36-128-8141
<b>Italy</b>	Rome (3906)-4781-3304 Milan (3902)-8645-1710
<b>Japan</b>	0570-064-015
<b>Korea (South)</b>	+82-2-3707-0011
<b>Kuwait</b>	+965-242-1444
<b>Laos</b>	+856-21-222-527/8/9
<b>Malaysia</b>	+603-2034-6999
<b>Myanmar</b>	+959-777-918-570/573

<b>Nepal</b>	+977-1-422-4387
<b>New Zealand</b>	+64-9-377-3886
<b>Norway</b>	+47-90-15-17-49
<b>Oman</b>	+968-24-65-41-95/96
<b>Pakistan</b>	Islamabad +92-51-227-2140/4 Lahore +92-42-3630-9791/4 Karachi +92+21+3279-2294
<b>Philippines</b>	+63-2-580-8424
<b>Singapore</b>	+65-6210-5000
<b>Sri Lanka</b>	+94-11-2307100/8
<b>Sweden</b>	+46-8-5988-3600
<b>Switzerland</b>	+41-44-215-6500
<b>Taiwan</b>	+886-2-8772-5111
<b>Thailand</b>	General +662-356-1111
<b>United Arab Emirates</b>	+971-4-268-1701
<b>United Kingdom</b>	(44-20)-7491-7953
<b>Vietnam</b>	+84-4-3826-7921/2



<b>Argentina</b>	+54-(011)5984-2758
<b>Australia</b>	1-800-750849
<b>Austria</b>	+43-0810-222-849
<b>Bahrain</b>	+973-16-19-6664
<b>Belgium</b>	+32-262-008-49
<b>Brazil</b>	+55-1133-719-600
<b>China</b>	+86-40008-198-698
<b>Denmark</b>	+45-33-14-40-55
<b>Finland</b>	+358-9-8171-0-849
<b>France</b>	+33-825-800-902
<b>Germany</b>	+49-69-86-799-849
<b>Iran</b>	+98-2123546
<b>Ireland</b>	+353-1-525-18-49
<b>Israel</b>	1-809-453-174
<b>Italy</b>	800-599-111
<b>Japan</b>	+81-334-350-421
<b>Jordan</b>	0800-22347
<b>Lebanon</b>	+961-1200471
<b>Malaysia</b>	+60-320-531-899
<b>Moldova</b>	0800-22347
<b>Morocco</b>	+212-520-484-978
<b>Netherlands</b>	+31-20-405-9636

<b>Nigeria</b>	+234-1-277-1559
<b>Northern Cyprus</b>	0392-444-0-849
<b>Norway</b>	+47-800-40849
<b>Oman</b>	+968-800-77241
<b>Pakistan</b>	00-800-900-33020
<b>Portugal</b>	+351-21-0608087
<b>Qatar</b>	+974-800-100-592
<b>Romania</b>	+40-800-672-371
<b>Russia</b>	8-800-7006161
<b>Saudi Arabia</b>	+966-800-811-0478
<b>South Africa</b>	+27-0861-88-7547
<b>Spain</b>	+34-913-754-189
<b>Sweden</b>	+46-851-999849
<b>Switzerland</b>	+41-848-444-849
<b>Turkey</b>	+90-212-444-0-849
<b>Ukraine</b>	0800-501-207
<b>United Arab Emirates</b>	8000-3570-43-43
<b>United Kingdom</b>	+44-844-800-66-66 0207-471-6666
<b>United States</b>	1-800-874-8875





<b>Argentina</b>	11-4316-0777 0810-777-UNITED (toll-free)	<b>China</b>	400-883-4288 Hong Kong 852-2810-4888
<b>Aruba</b>	800-1507	<b>Colombia</b>	01-800-944-0219
<b>Australia</b>	131-777 (toll-free)	<b>Costa Rica</b>	0800-44-0005
<b>Bahamas</b>	800-UNITED-1	<b>Curacao</b>	001-UNITED-1
<b>Bahrain</b>	973-1713-1288	<b>Denmark</b>	7012-6233
<b>Bangladesh</b>	880-2-9565380 880-2-9568388	<b>Dominican Republic</b>	Santo Domingo: (809) 262-1060 Other regions: 1-200-1062 (toll-free)
<b>Barbados</b>	1-800-534-0089	<b>Ecuador</b>	1-800-222-333 (toll-free) Quito (local) (593) 2-225-0905
<b>Belgium</b>	02-2-0088-68	<b>Egypt</b>	202-578-4478 202-578-4658
<b>Belize</b>	0800-266-3822 501-822-1062	<b>El Salvador</b>	800-6153 503-2-207-2040
<b>Bermuda</b>	800-UNITED-1	<b>Finland</b>	0800-96-070 (toll-free)
<b>Bonaire</b>	0101-001-800-UNITED-1	<b>France</b>	01-71-23-03-35
<b>Brazil</b>	0800-16-2323 Sao Paulo: (11) 3145-4200 0800-047-4646 (hearing impaired within Brazil)	<b>Germany</b>	06950-985-051
<b>Canada</b>	1-800-UNITED-1 1-800-864-8331	<b>Greece</b>	00-800-441-4-3592 (Mobile/Cell users) 2111-76-8888
<b>Cayman Islands</b>	800-UNITED-1	<b>Guam</b>	1-800-UNITED-1

<b>Guatemala</b>	1-801-81-26684 502-2385-9610
<b>Honduras</b>	San Pedro Sula: 557-4141/2557-4142 Tegucigalpa: 2220-0999
<b>India</b>	New Delhi: 91-124-4315500 Chennai: 91-044-24330211/24351829 Kolkata: 91-033-22890440/1/2 Mumbai: 91-022-40908000
<b>Indonesia</b>	62-21-837-80-607/730
<b>Ireland</b>	1-890-925-252
<b>Israel</b>	03-511-67-77
<b>Italy</b>	Milan: 02-69-63-32-56 Rome: 06-66-05-30-30
<b>Jamaica</b>	800-United-1
<b>Japan</b>	(81)-3-6732-5011
<b>Jordan</b>	Amman: 962-6-554-8964/968
<b>Kenya</b>	Nairobi: (254) 20-7606-009/010/011
<b>Kosrae</b>	(691) 370-3224
<b>Kuwait</b>	965-2295-8900
<b>Luxembourg</b>	02-200-8868
<b>Malaysia</b>	603-2142-4311 603-2143-1433

<b>Marshall Islands</b>	Kwajalein: (805) 355-1013 Majuro: (692) 625-3209
<b>Mexico</b>	01-800-900-5000 (toll-free, all cities) 52-83-555-00
<b>Mongolia</b>	976-11-331390/1
<b>Nepal</b>	977-1-4-220245
<b>Netherlands</b>	02-0346-9381
<b>Netherlands Antilles</b>	800-UNITED-1
<b>New Zealand</b>	0800-747-400
<b>Nicaragua</b>	(505) 22-76-81-29
<b>Nigeria</b>	Lagos: +234 (0) 1-460-7464/5; +234 (0) 80-6564-3886/3921; (254) 20-7606-012
<b>Norway</b>	810-03-630
<b>Pakistan</b>	Islamabad 92-51-2206704/5 Karachi: 922-1-5680970 Lahore: 92-42-6312136/183
<b>Palau (Koror)</b>	(680) 488-2448/1029
<b>Panama</b>	00-800-044-0001 011-800-044-0001 (507) 265-0040
<b>Paraguay</b>	595-2161-2319 595-21-604-552
<b>Peru</b>	0800-700-30 (511) 712-9230

<b>Philippines</b>	(632) 844-8272 63-2-818-8701
<b>Pohnpei</b>	(691) 320-2424/5
<b>Portugal</b>	21-415-9102
<b>Puerto Rico</b>	800-UNITED-1
<b>Russia</b>	7-495-9800882
<b>Saudi Arabia</b>	Dhahran/Dammam (Eastern Province): 00966-3-8821518/2602 Jeddah (Western Province): 00966-2-2636171 Ext. 197 Riyadh (Central Province): 00966-1-4772228 Ext. 289/290
<b>Saipan</b>	1-800-UNITED-1
<b>Singapore</b>	+65-6-873-3533
<b>South Africa</b>	Johannesburg: (27) 11-463-1147/1170
<b>South Korea</b>	82-2-751-0300
<b>Spain</b>	900-96-1266 cell phone: 91-453-4364
<b>Sri Lanka</b>	9411-2661703/04 9411-2683230
<b>St. Thomas, St. Croix</b>	800-UNITED-1
<b>Sweden</b>	08-585-36954

<b>Switzerland</b>	English, Swiss German: 044-800-9212 Swiss French: 022-417-7280
<b>Taiwan</b>	+886-2-2325-8868
<b>Thailand</b>	+66-2-353-3939
<b>Trinidad &amp; Tobago</b>	800-461-2744
<b>Truk (Chuuk)</b>	(691) 300-2424
<b>Turkey</b>	0212-334-2920
<b>United Arab Emirates</b>	800-0-441-5492 Abu Dhabi: 971-80004415492
<b>United Kingdom</b>	0845-607-6760 0845-607-0777 (United BusinessFirst)
<b>United States</b>	1-800-United-1 +1-800-864-8331
<b>U.S. Virgin Islands</b>	800-UNITED-1
<b>Venezuela</b>	0800-100-3198
<b>Vietnam</b>	Ho Chi Minh City: +84-8-3823-4755 Hanoi: 84-4-3934-7233
<b>Yap</b>	(691) 350-2702 (691) 350-2788



# RESERVATIONS SPECIAL SERVICE ITEMS

The following special service items have been harmonised by all Star Alliance member carriers.

---

## **Wheelchairs**

Should be requested at time of reservation. Will be confirmed by the individual carrier (e.g. WCHR / WCHS / WCHC).

---

## **Passenger Contact (PCTC)**

If permitted by law, to be used in reservation messages.

---

## **Special Meals**

A minimum list of special meals will be offered by all Star Alliance member carriers. Exceptions may apply on certain routes and carriers.

---

## **Seat Requests**

All carriers can create and respond to generic and specific seat requests (if applicable for the market booked).

---

## **Checked Baggage Policy**

See the Airport Information section for details on free checked baggage allowances and carrier specific information about special checked baggage items.

---

## **Flight Information (FLIFO)**

Access to real-time movement flight information can be provided via the individual carrier's in-house reservation system.

---

## Passenger Name Records (PNRs)

Bilateral Passenger Name Records servicing exists between the Amadeus carriers, between UA, LX, SN and LH/OS (only applies to UA airport workers who use native Share to access PNR Servicing).

---

## Availability Display

A common Star Alliance availability display containing only Star Alliance member carriers' flights is available in Amadeus, Galileo, Infini, Apollo, Sabre, Abacus, Travelsky and Worldspan.



## Example for fights from London Heathrow to Bangkok:



GDS System	Entry	
AMADEUS	AN*A DDMMM LHRBKK	
APOLLO	A DDMMM LHRBKK +/*A	(please enter: "end item" instead of +)
ABACUS	1 DDMMM LHRBKK +/*A	(please enter: "Cross of Lorraine" instead of +)
GALILEO	A DDMMM LHRBKK // *A	
INFINI	1 DDMMM LHRBKK +/*A	(please enter: "Yen sign" instead of +)
SABRE	1 DDMMM LHRBKK +/*A	(please enter: "Cross of Lorraine" instead of +)
WORLDSPAN	A DDMMM LHRBKK -/*A	

\*A: Indicator to obtain Star Alliance availability







# BOOKING CLASS ALIGNMENT





Star Alliance common classes are in **bold face: First F, A, O; Business C, D, I, R; Economy Y, B, M, H, Q, X, N, V, W.** Carrier specific exceptions are in regular face.



Star Alliance Members	FIRST	FIRST CODE	BUSINESS	BUSINESS CODE	ECONOMY	ECONOMY CODE
 <b>Adria Airways (JP)</b>	No service		Business Class	J, <b>C,D</b> ,Z,I,R	Economy Class	P, <b>Y,B,M</b> ,U, <b>H,G,Q,X</b> ,E,T,N, <b>V,W</b> ,S,L,K
 <b>Aegean Airlines (A3)</b>	No service		Business Class	<b>C,D</b> ,Z,A,I,R	Economy Class	<b>Y,B,M,H,Q,V</b> ,W,O,L,K,J,E,S,T,U,P,G,N, <b>X,F</b>
 <b>Air Canada (AC)</b>						
All except Caribbean	No service		Business Class	J, <b>C,D</b> ,Z	Economy Class	P, <b>Y,B,M</b> ,U, <b>H,Q,V</b> ,N,W,G,S,T,E,L,A,K,R
Caribbean	No service		Business Class	J, <b>C,D</b> ,Z	Economy Class	<b>Y,B,M</b> ,U, <b>H,Q,V</b> ,W,K,G
Premium Economy	No service		No service		Economy Class	P,O,E,N





Star Alliance Members	FIRST	FIRST CODE	BUSINESS	BUSINESS CODE	ECONOMY	ECONOMY CODE
 <b>Air China (CA)</b>	International	First Class	<b>F,A,O</b>	Business Class	<b>J,C,D,Z,R,I</b>	Economy Class <b>Y,B,M,U,H,Q,V, W,S,T,L,X,N,K</b>
	Premium Economy	No service		No service		Premium Economy G,E
	Domestic	First Class	<b>P,F,A,O</b>	Business Class	<b>J,C,D,Z,R,I</b>	Economy Class <b>Y,B,M,U,H,Q,V, W,S,T,L,X,N,K</b>
 <b>Air India (AI)</b>	First Class	<b>F,A,P,O</b>	Business Class	<b>C,D, J, Z,I,R</b>	Economy Class	<b>Y,B,M,H,K,Q,V, W,G,L,U,T,S,E, X,N</b>
 <b>Air New Zealand (NZ)</b>	No service		Business Class	<b>C,D, Z,J</b>	Economy Class	<b>Y,B,M,H,Q,V, W,T,L,S,G,K</b>
	Premium Economy	No service	No service		Premium Economy	U,E,O,A







Star Alliance Members	FIRST	FIRST CODE	BUSINESS	BUSINESS CODE	ECONOMY	ECONOMY CODE
 <b>ANA (NH)</b>	First Class	<b>F,A</b>	Business Class	J, <b>C,D</b> , Z, P, R	Economy Class	<b>Y,E,B,M,U,H,Q,V,W,S,L,K,N</b>
Premium Economy	No service		No service		Premium Economy	Y,E
 <b>Asiana Airlines (OZ)</b>	First Class	<b>F,A</b>	Business Class	<b>C,D,Z</b>	Economy Class	<b>Y,B,M,H,E,Q,K,S,V,L,W,T,G</b>
 <b>Austrian (OS)</b>	No service		Business Class	J, <b>C,D,Z,P,I,R</b>	Economy Class	<b>Y,B,M,U,H,X,G,Q,N,V,W,S,T,E,L,K</b>
 <b>Avianca (AV)</b>	No service		Business Class	<b>C,J,D,I,R</b>	Economy Class	<b>Y,B,M,H,Q,V,A,E,K,L,O,P,Z,W,S,T,U,X,N</b>
 <b>Avianca in Brazil (O6)</b>	No service		No service		Economy	<b>Y,B,M,H,Q,V,A,E,K,L,O,P,Z,W,S,X</b>
 <b>Brussels Airlines (SN)</b>	No service		Business Class	J, <b>C,D,Z,P,I</b>	Economy Class	<b>Y,B,M,U,H,Q,V,W,S,T,E,L,K,X</b>
 <b>Copa Airlines (CM)</b>	No service		Business Class	<b>C,D,Z,I</b>	Economy Class	<b>Y,B,M,H,Q,K,V,U,S,W,E,L,T,N,X</b>

Star Alliance Members	FIRST	FIRST CODE	BUSINESS	BUSINESS CODE	ECONOMY	ECONOMY CODE
 <b>Croatia Airlines (OU)</b>	No service		Business Class	<b>C,D,Z,R,I</b>	Economy Class	<b>Y,B,M,H,X,Q,N,V,W,S,T,E,G</b>
 <b>EGYPTAIR (MS)</b>	First Class	<b>F,A,O,P</b>	Business Class	<b>C,D,J,Z,I,R</b>	Economy Class	<b>Y,B,M,H,Q,K,X,N,V,L,E,S,W,T,U</b>
 <b>Ethiopian Airlines (ET)</b>	No service		Business Class	<b>C,J,D,P,I,R</b>	Economy Class	<b>Y,G,S,B,M,K,L,V,H,U,Q,T,W,E,O,N</b>
 <b>EVA Airways (BR)</b>						
	No service		Business Class	<b>C,J,D,I,R</b>	Economy Class	<b>Y,B,M,H,Q,V,S,X,N,G</b>
Premium Economy	No service		No service		Economy Class	K,L,T
 <b>LOT Polish Airlines (LO)</b>						
	No service		Business Class	<b>C,D,Z,I</b>	Economy Class	<b>Y,B,M,E,H,K,Q,G,T,S,X,V,W,L,U,N</b>
Premium Economy	No service		No service		Economy Class	R,P,A

Star Alliance Members	FIRST	FIRST CODE	BUSINESS	BUSINESS CODE	ECONOMY	ECONOMY CODE
 <b>Lufthansa (LH)</b>	First Class	<b>F,A,O</b>	Business Class	J, <b>C,D,Z,I,R</b> ,P	Economy Class	<b>Y,B,M,U,H,X,Q,V,W</b> ,S,T,L,K
	Premium Economy	No service	No service		Economy Class	G,E,N
 <b>Scandinavian Airlines (SK)</b>	Long Haul	No service	Business Class	<b>C,D,Z,I,R</b>	Economy Class	E, <b>M,H,Q,V,W</b> ,U,K,L,T,O,G, <b>X,N</b>
	Short Haul	No service	No service		Economy Class	E, <b>M,H,Q,V,W</b> ,U,K,L,T,O,G, <b>X,N</b>
	SAS Plus (*Nordic and Europe Services)	No service	No service		Economy	<b>C*,D*,Z*,I*,J*,Y,S,B</b> ,P,A*
	Premium Economy	No service	No service		Premium Economy	<b>Y,S,B</b> ,P

Star Alliance Members	FIRST	FIRST CODE	BUSINESS	BUSINESS CODE	ECONOMY	ECONOMY CODE
 <b>Shenzhen Airlines (ZH)</b>						
International	First Class	<b>F,A,O</b>	Business Class	<b>C,D,I,R</b>	Economy Class	<b>Y,B,M,H,K,L,Q,G,S,X,N,V,U,W,T,E</b>
Domestic	First Class	<b>F,P,A,O</b>	No service		Economy Class	<b>Y,B,M,H,K,L,J,Q,Z,G,V,W,E,T,U,S,X,N</b>
 <b>Singapore Airlines (SQ)</b>						
	First Class	<b>R,F,P,A,O</b>	Business Class	<b>Z,C,J,D,I</b>	Economy Class	<b>Y,B,E,M,H,W,Q,N,V,U,G,L,K,X</b>
Premium Economy	No service		No service		Premium Economy	<b>S,T,P</b>
 <b>South African Airways (SA)</b>	No service		Business Class	<b>C,J,Z,D,E,I,R</b>	Economy Class	<b>Y,B,M,K,H,S,Q,T,V,L,W,G,X,N</b>
 <b>SWISS (LX)</b>						
Short Haul	No service		Business Class	<b>J,C,D,Z,P,I,R</b>	Economy Class	<b>Y,B,M,U,H,X,Q,N,V,W,S,T,E,L,K</b>
Long Haul	First Class	<b>F,A,O</b>	Business Class	<b>J,C,D,Z,P,I,R</b>	Economy Class	<b>Y,B,M,U,H,X,Q,N,V,W,S,T,L,K</b>

Star Alliance Members	FIRST	FIRST CODE	BUSINESS	BUSINESS CODE	ECONOMY	ECONOMY CODE
 <b>TAP Portugal (TP)</b>	No service		Business Class	<b>C,D,Z,J,P,I,R</b>	Economy Class	<b>Y,B,M,S,H,Q,V,W,A,K,L,U,X,E,T,O,G,N</b>
 <b>Thai Airways International (TG)</b>	First Class	<b>F,A,P,O</b>	Business Class	<b>C,D,J,Z,I,R</b>	Economy Class	<b>Y,B,M,H,Q,G,T,K,S,X,V,W,N</b>
Premium Economy	No service		No service		Premium Economy	U
 <b>Turkish Airlines (TK)</b>	No service		Business Class	<b>C,D,Z,K,J,I,R</b>	Economy Class	<b>Y,B,M,A,H,S,O,E,Q,T,L,V,P,W,U,X,N,G</b>
 <b>United Airlines (UA)</b>	Domestic	<b>F,C,A,D,Z,P,I</b>	No service		Economy Class	<b>Y,B,M,E,U,H,Q,V,W,S,T,L,K,G,N,X</b>
International	First Class	<b>F,A,O</b>	Business Class	J, <b>C,D,Z,P,I</b>	Economy Class	<b>Y,B,M,E,U,H,Q,V,W,S,T,L,K,G,N,X</b>

# TICKETING PROCEDURES

The following are harmonised ticketing policies and procedures.

---

## **Initial Issue**

Each carrier's policies and procedures related to the issuance of tickets will be in accordance with the IATA Ticketing Handbook.

---

## **Reissue**

Each carrier's policies and procedures related to the reissue of tickets will be in accordance with the IATA Ticketing Handbook.

---

## **Reservation Changes/Revalidation**

Each carrier's policies and procedures related to the revalidation of tickets will be in accordance with the IATA Ticketing Handbook.

---

## **Endorsement Waiver**

Each carrier will publish and honour the Star Alliance Endorsement Waiver Agreement (EWA) policy, as agreed on a multilateral basis between Star Alliance member carriers.

For electronic tickets, the endorsement, as described in the following conditions, is granted by giving airport control from the validating carrier to the Star Alliance member carrier performing the reissue/exchange.

Paper tickets: Any Star Alliance member carrier or one of its agents will be able to reissue or exchange a ticket or MCO without having to request a written or stamped endorsement, under the described conditions:

## Conditions: Voluntary

- When a customer requests a change of airline or re-routing (as described in IATA Resolution 736), the Star Alliance member carriers agree to grant airport control (thus waive the endorsement requirement between themselves) for non-restricted tickets or MCOs provided that:
  - A.** such tickets or MCOs do not bear carrier validation restrictions, which by their terms prohibit the transfer of the ticket or MCOs such as “Valid on XX only” and “Non-Endorsable”;
  - B.** such tickets or MCOs are not governed by fare rules that prohibit transfer of the ticket to the other party.
- No endorsement required for First Class, Business Class, full Economy Class and non-restricted excursion fare tickets.
- Does not apply to ID/AD tickets.

## Conditions: Involuntary

- When an airline undergoes a schedule change or encounters an irregularity in accordance with the general provisions of IATA Resolution 735D, the Star Alliance member carriers agree to grant airport control (and thereby waive the endorsement requirement) for the following:
  - A.** non-restricted tickets;
  - B.** restricted tickets;
  - C.** Frequent flyer redemption tickets. After schedule changes, rebookings are made with Star Alliance carriers according to redemption seat availability.
- No endorsement required for any fare types when an airline encounters an irregular operation (within 24 hours of departure).
- Does not apply to ID tickets.

# TICKETING PROCEDURES

## **Miscellaneous Charges Order (MCO)**

Each carrier's own MCO is handled according to the carrier's policies and procedures and in accordance with the IATA Ticketing Handbook.

## **MCOs for Star Alliance member carriers**

Each member issues MCOs for travel on other member carriers, using its own MCO stock. The MCO is issued for the purpose of service recovery, and is endorsed valid for redemption on any Star Alliance member for the following purposes:

- It can be used to pay for tickets, upgrades and excess baggage;
- It can be redeemed at all Star Alliance member carriers' sales offices or airport ticket offices but not at travel agencies;
- The MCO tendered to all member carriers must be limited to US\$750, or its equivalent in other currencies:
  - A.** if the value of the service purchased exceeds that of the MCO, payment of the outstanding sum can be made in any form accepted by the Star Alliance member carrier,
  - B.** if the value of the service purchased is less than the value of the MCO, a new MCO will be issued for the remaining amount. A new MCO will be issued under the same conditions as the original MCO.

MCOs are valid for one year from the date of issue. Extension of validity is at the discretion of the issuing member; Lost MCOs cannot be reissued.

UA does not issue MCOs but will accept them from other Star Alliance carriers.

---

## **Multi-Purpose Document (MPD)**

Each carrier's policies and procedures related to the use of an MPD will be in accordance with the IATA Ticketing Handbook.



## Transmittal of Ticket Number(s) in the PNR

Each carrier agrees, by automated or procedural means, to transmit the ticket numbers to any Star Alliance member carriers participating in the ticketed itinerary.

### NOTE: Carrier positions:

- Automated for AC, OS, SK, and TG as SSR TKT(-) element
- Automated for 06, AV, CM, ET, LO, MS, NH, SQ and UA as SSR TKN(-) element
- Automated for NZ as SSR TKNE element, the transmission of paper ticket numbers to a PNR via the TKNM SSR entry.
- Automated for TK and OZ as OSI TKNO and SSR TKNE element
- Automated for TP as SSR TKNx element (x = E or A), SSR TKNE if IET agreement exists and all segments are eligible for electronic ticket, SSR TKNA for automatic paper ticket issuance
- Automated for SN as SSR TKNE element
- Automated for JP, OU, SA, LH, LX as SSR TKNx element (x = A or M or E)
- Automated for CA, TG, ZH as SSR TKNE for ETKT numbers, while OSI TKNA, OSI TKNM, SSR TKNA or SSR TKNM for paper ticket numbers depending on specific requirements of the airlines in the ticketed itinerary.

---

## Prepaid Ticket Advice (PTA)

If carriers still use PTAs (e.g. for non-e-ticket eligible sales) these carriers' policies and procedures related to the issuance and refunding of PTAs will be in accordance with the IATA Ticketing Handbook.

**NOTE:** AC, ET, LO, LX, SK and TP do not allow PTAs.

---

## Lost Ticket Indemnity

If a paper ticket is lost, each carrier will issue a ticket against a Lost Ticket Indemnity if the original ticket was plated on its own ticket stock for travel on its own or another carrier's flight.

---

## Flight Interruption Manifest (FIM)

A FIM is a document used in place of a ticket when a passenger is involuntarily re-routed and the appropriate flight coupon(s) is (are) no longer available. IATA resolutions have been adopted with the intent of reducing the number of FIMs issued in the event of an involuntary re-route. The FIM format has been standardised allowing for a ticket-sized FIM and two coupons. For details about how to process FIMs, please consult your own carrier's procedural training manuals, or contact your training representative.

# INTERLINE E-TICKET FAQ - RESERVATIONS

## GENERAL INFORMATION

### **Q: What are the benefits of interline e-tickets to the reservation/ticketing agents?**

**A:** E-ticketing allows greater flexibility when serving Star Alliance customers. The e-ticket is available online. Interline E-ticketing has been implemented between all Star Alliance member carriers.

## ISSUING

### **Q: Is there a service fee for issuing an interline e-ticket?**

**A:** Some carriers may apply a service fee for e-ticket issuance. Please contact the individual airline for more information.

### **Q: When do I still have to issue paper tickets?**

**A:** Your system will indicate if the issuance of an e-ticket is technically not possible. In this case a paper ticket needs to be issued.

### **Q: Can I issue an interline e-ticket for groups?**

**A:** Yes, most carriers have the ability to issue e-tickets for groups. Some carriers may have restrictions.

### **Q: Can I issue an interline e-ticket for a PNR with infant?**

**A:** Yes, most carriers have the ability to issue e-tickets for infants. Some carriers may have restrictions.

**Q: Can I issue an interline e-ticket for ID-tickets?**

**A:** Some carriers have the ability to issue ID interline e-tickets.

**Q: Can I issue an interline e-ticket for a fully-open itinerary?**

**A:** Some carriers have the ability to issue interline e-tickets with open segments, including fully open e-tickets.

**Q: Can I print an interline e-ticket to paper?**

**A:** In IRROP situations, most carriers have the ability to print an e-ticket to paper using either the Direct Print or Print Exchange functionality, depending on the system's capability.

## CHANGES

**Q: How do I make changes to an existing e-ticket?**

**A:** All necessary information about the e-ticket is stored in the system and changes are made according to fare conditions, ticket validity and in accordance with the IATA Ticketing Handbook.

**Q: How do I exchange another carrier's e-ticket?**

**A:** The validating carrier will grant airport control according to endorsement agreements so that the necessary ticket information is available in your carrier's system. Exchanges are made according to fare conditions, ticket validity and in accordance with the IATA Ticketing Handbook.

# INTERLINE E-TICKET FAQ - RESERVATIONS

**Q: What do I have to do if the fare, the origin/destination or the operating carrier changes?**

**A:** The e-ticket must be reissued/exchanged.

## REFUNDS/VOIDS

**Q: How do I refund another carrier's ticket?**

**A:** Refunds of other carrier-issued e-tickets are not permitted.

**Q: Can I void an interline e-ticket?**

**A:** In accordance with individual airline policy, an interline e-ticket may be voided only by the validating carrier.

# GDS ACCESS CODES FOR FARE & DISCOUNT PRODUCTS

For Star Alliance **Round the World** fares use Fare Quote Display:

**FQD FRAFRA/VRW, FD ORDORD or FD ORDORD-RTW/A** (carrier code), **FSD SINSIN, FQ LAXLAX, 4FMIAMIArW**-(carrier code), etc.

For Star Alliance **Circle Pacific fare**, use Fare Quote Display:

**FQD AKLAKL/VCT, FDHKGHKG, or FD HKGHKG-CTF** (carrier code), **FD LAXLAX-, 4FSFOSFOct**-(carrier code), etc.

---

To access rules and fares of below Star Alliance Fare & Discount Products, use Fare Quote Display in your GDS of fictitious O&D **“QMXQMY”**

AMADEUS: **FQD QMXQMY/R,U/A(carrier code)**  
GALILEO: **FD QMXQMY/(carrier code) or FD JQMXQMY/(carrier code)**  
SABRE: **FQ QMXQMY-(carrier code)**  
SITA: **FSD QMXQMY/(carrier code)/(currency code)/P+**  
WORLDSPAN: **4FQMXQMYSR-(CARRIER CODE)**

---

## Product Codes in the fictitious O&D “QMXQMY” display:

Conventions Plus	= <b>CONVPLUS</b>	China Airpass	= <b>STARAPCN</b>
Africa Airpass	= <b>STARAPAF</b>	Europe Airpass	= <b>STARAPEU</b>
Asia Airpass	= <b>STARAPAS</b>	North America Airpass	= <b>STARAPNA</b>

# AIRPORTS



# PRIORITY BAGGAGE HANDLING

---

## **Priority Baggage Handling Policy**

Identification of priority bags is achieved by two separate and alternative methods which are used for premium customers. The Star Alliance priority tag features the Star Alliance logo and the word "PRIORITY" and it should be attached to the bag tag to make it highly visible and recognisable by all baggage handling staff. The second method is where the word "PRIORITY" is printed on the bag tag from a kiosk when customers self-tag their bags. Both of these methods are used to ensure that the bags will be placed on the arrival belts/carousels before all other baggage.

This harmonised policy will ensure that our most valued customers receive consistent baggage handling service and this policy sets the minimum standard to be applied by all airlines. Recognition of priority status at check-in and the priority handling of checked baggage is offered to the following customers:

---

### **First Class**

On all flights

**NOTE:** Some carriers do not provide First Class service.

---

### **Business Class**

On intercontinental flights including connecting flights (for this purpose intercontinental is defined as travel between Europe, Asia, North America, South America, Australia, New Zealand and Africa).

**NOTE:** Some airlines offer Priority Baggage Handling to all business class customers.

---

### **Star Alliance Gold Members**

On all flights, regardless of fare paid or class of service flown.

# FREE CHECKED BAGGAGE ALLOWANCES

**NOTE:** Free baggage allowances may change. Please check your carrier's CRS for up-to-date information.

Piece Concept	Number of Pieces	Maximum dimensions of each piece	Maximum weight of each piece
<b>1. First and Business Class</b>			
A3, AC, AI, AV, BR, CA, ET, JP, MS, OU, OZ, SA, SK, SN, SQ, TG, TK, TP, ZH	2	158 cm (62 inches)	32 kg (70 pounds)
CM, LH, LO, LX, NH, OS	F class 3, C class 2	158 cm (62 inches)	32 kg (70 pounds)
NZ	3	158 cm (62 inches)	23 kg (50 pounds)
UA	International Routes: F class-3, C class-2 Domestic routes: F/C class-2	158 cm (62 inches)	32 kg (70 pounds)  23 kg (50 pounds)

**NOTE:** Some carriers do not offer First Class. **AC, LX, NZ, SN:** No bags over 32 kg (70 lbs) accepted as checked baggage. **AC:** For travel to/from Japan, 2 free checked bags at 23 kg (50 lbs), 158 cm (62 in) and Brazil 2 free pieces at 32 kg (70 lbs). **AI:** Weight and dimensions may vary depending on destination. Please check with AI to confirm. **AV:** For international flights, 2 X 32 kg (70 lbs). For domestic flights, 2 pieces of a combined weight of 32 kg (70 lbs). **CM, LH, LX, OS, SN:** First Class, 3 bags up to 32 kg each, Business Class 2 bags up to 32 kg each. **LO:** Allows 3 pieces on long-haul flights (158 cm/62 inches/32 kg) in Business Class and 2 pieces in Premium Club Class (158 cm/62 inches/23 kg). **MS:** For travel within Egypt, 1 piece with max. 32 kg, 158 cm. **SK:** Economy Extra Class counts as Business Class. Econ. Extra allowed 2 x 23 kg, 158 cm. **TG:** The checked baggage policy by piece concept only applies to international sectors to/from USA/Canada. **TP:** Executive travel originating in OXB 2 pcs 20 kg or 1 pc 30 kg. All others 2 pcs 32 kg. **ZH:** Piece concept is only applicable to the transportation to/from Canada/USA/ US Territories.



Piece Concept	Number of Pieces	Maximum dimensions of each piece	Maximum weight of each piece
---------------	------------------	----------------------------------	------------------------------

## 1.1 Star Alliance Gold (First and Business)

All carriers	one additional piece		
--------------	----------------------	--	--

## 2. Economy

A3, AC, AI, JP, LH, LX, NZ, OS, OU, SK, SN, UA, ZH	1	158 cm (62 inches)	23kg (50pounds)
--	---	--------------------	-----------------

AV, BR, CA, CM, ET, LO, MS, NH, OZ, SA, SQ, TG, TK, TP	2	158 cm (62 inches)	23kg (50pounds)
--	---	--------------------	-----------------

**NOTE:** **AC:** Number of pieces vary by destination, please check with AC to confirm. **AI:** Weight and dimensions may vary depending on destination. Please check with AI to confirm. **AV:** For international flights, 2 X 23 kg (50 lbs). For flights between Brazil-EU and Brazil-Canada, 2 X 32 kg (70 lbs). **BR:** Premium Economy (Elite Class) is allowed 2 x 28 kg. **CA:** Max. dimension of both pieces may not exceed 273 cm. 2 pieces of a combined weight of 23 kg (50 lbs). **CM:** For travel from/to Venezuela (except for Canada, Mexico and USA), two pieces for a max. of 20 kg each. For travel to/from Canada, USA, and Mexico (except Brazil) and between Mexico and Brazil, two pieces for a max. of 23 kg each. For travel between USA/Canada and Brazil, two pieces for a max. of 32 kg each. **ET:** For travel within Latin America, two pieces for a max. combined weight of 32 kg (70 lbs). **JP:** Economy basic class: no baggage allowance. **LH:** For travel origin Brazil 2 x 32 kg (70 lbs). A higher allowance may apply for specific routings in Economy Class. Premium Economy class: 2 x 23 kg. Economy basic class: no baggage allowance. **LO:** For Economy Plus 2 X 23 kg. For Economy 1 X 23 kg. **LX:** For travel origin Brazil 2 x 32 kg (70 lbs). Travel to/from East-West-and Central Africa 2 X 23 kg (50 lbs). Travel between South Africa and US/CA/MX 2 X 23 kg (50 lbs). Economy basic class: no baggage allowance. **MS:** For travel within Egypt only one piece with max. 23 kg, 158 cm. **NZ:** Premium Economy is allowed an additional piece. No bags over 32 kg (70 lbs) accepted as checked baggage. **OS:** Specific regional exceptions with higher bag allowance might be applicable. Check with carrier with more information. Economy basic class: no baggage allowance. **SA:** For travel between South Africa, Hong Kong and Brazil, the baggage allowance is 32 kg per bag and will not accept any bag heavier than 32 kg. **SK:** Allowance to/from U.S. 1 pc with 23 kg. Business allowed 1 extra piece 32 kg and 158 cm. Economy Extra, one extra piece at 23 kg, 158 cm. Charge applies to 2nd bag to and from certain destinations. Check with carrier for more information. **SN:** For travel To/From West-East-Central Africa 2 X 23 kg maximum dimensions 158 cm **SQ:** For travel to/from Brazil, the baggage allowance is 2 x 32 kg. **TK:** For travel from Turkey to Brazil & Argentina, 2 x 23 kg. For travel from Brazil & Argentina to Turkey, 2 X 32 kg. For travel from Toronto to Iran and Iran to Toronto, 3 x 23 kg. **TG:** The checked baggage policy by piece concept only applies to international sectors to/from USA/Canada. **TP:** For travel between Europe and North America, 1 x 23 kg. For domestic flights and travel within Europe, 1 X 23 kg. For travel between Europe and Brazil, 2 X 32 kg. No other exceptions to the general 2 X 23 kg apply. **UA:** For travel to/from Brazil Y class max. bag weight is 32 kg (70 lbs). Charge applies to 1st and 2nd checked bag to/from certain destinations, exceptions apply. Check with carrier for more information. **ZH:** Piece concept is only applicable to the transportation to/from Canada/USA/US territories.

Piece Concept	Number of Pieces	Maximum dimensions of each piece	Maximum weight of each piece
<b>2.1 Star Alliance Gold (Economy)</b>			
AI, BR, CA, ET, JP, LH, LO, LX, MS, NH, NZ, OS, OU, OZ, SA, SK, SN, SQ, TG, TK, ZH	one additional piece	158 cm (62 inches)	23 kg (50 pounds)
AV, TP	one additional piece	158 cm (62 inches)	20 kg (44 pounds)
AC	3	158 cm (62 inches)	32 kg (70 pounds)
CM	3	158 cm (62 inches)	32 kg (70 pounds)
UA	2	158 cm (62 inches)	23 kg (50 pounds)

Note: **AC:** For Brazil, free baggage weight allowance is 32 kg (70 lbs). No bags over 32 kg (70 lbs) accepted as checked baggage. **AI:** Weight and dimensions may vary depending on destination. Please check with AI to confirm. **CA:** For transportation between IATA Area 2 and Area 3, or within Area 3 (except CHN-JPN routes), only one piece allowed. **LO:** 1 X 23 kg + Golf + Ski (exc. USA and Canada) **OU:** Baggage weight is according to booking class. C class is 32 kg, Y class is 23 kg. **NZ:** Premium Economy is allowed an additional piece. No bags over 32 kg (70 lbs) accepted as checked baggage. **SK:** For Star Gold travelling in economy: 3 pieces with 23 kg but to/from U.S.: 2 pieces with 23 kg. **SQ:** To and From U.S 2 pieces are allowed, with maximum dimensions of each piece 158 cm (62 inches), maximum weight of each piece 23 kg (50 lbs). To and From Brazil 2 pieces are allowed, with maximum dimensions of each piece 158 cm (62 inches), maximum weight of each piece 32 kg (70 lbs). **ZH:** Piece concept is only applicable to the transportation to/from Canada/USA/US territories.

### 3. Infants not occupying a seat

AI, AV	1 + 1 fold up, collapsible stroller	158 cm (62 inches)	10 kg (22 pounds)
A3	1 + 1 fold up, collapsible stroller	158 cm (62 inches)	32 kg (70 pounds)
BR, NH	1 + 1 fold up, collapsible stroller	158 cm (62 inches)	as per adult allowance in booked class
NZ	2 infant related items (car seat collapsible stroller or cot)	158 cm (62 inches)	23 kg (50 pounds)

LH, LX, OS, OU, OZ, SN, ZH	1 + 1 fold up, collapsible stroller	158 cm (62 inches)	23 kg (50 pounds)
CA, CM, JP, LO, SK, SQ, TG, TK, UA	1 + 1 fold up, collapsible stroller	115 cm (45 inches)	23 kg (50 pounds)
AC	1 + collapsible stroller at the gate	158 cm (62 inches)	23 kg (50 pounds)
ET, MS, SA, TP	1 + 1 fold up, collapsible stroller	115 cm (45 inches)	10 kg (22 pounds)

Note: **BR**: A fully collapsible stroller, carrying basket and car seat for infants/children may be accepted free of charge. **CM**: If travelling with a stroller and a car seat, only one of these items will be permitted free of charge in addition to regular (no charge) baggage. They will also be subject to all excess baggage fees depending on size and weight. **JP**: No bags over 32 kg (70 lbs) accepted as checked baggage. **LO**: Max. dimension of both pieces not to exceed 273 cm (107 in). **MS**: For travel to/from USA and Canada 23 kg. **NZ**: Two infant related items travel free. **SQ**: To and From Brazil free baggage allowance is 32 kg (70 lbs). TG: The checked baggage policy by piece concept only applies to international sectors to/from USA/Canada. ROP Platinum, 30 kg or 1 piece. ROP Gold and Star Silver, 20 kg or 1 piece. **UA**: If fare paid. **ZH**: Piece concept is only applicable to the transportation to/from Canada/USA/US territories.

<b>Weight Concept</b>	<b>Maximum combined weight of all pieces</b>	<b>Class of service</b>
All Carriers	40 kg (88 lbs)	First Class
All Carriers	30 kg (66 lbs)	Business Class
All Carriers	20 kg (44 lbs)	Economy Class
For TG	50 kg (110 lbs)	Royal First Class
	40 kg (88 lbs)	Royal Silk Class
	30 kg (66 lbs)	Premium Economy
	30 kg (66 lbs)	Economy
	30 kg (66 lbs)	Royal Orchid Platinum Member & ROP SilverMembers (On TG sectors only) Extra 10 kg (22 lbs)

Weight Concept	Maximum combined weight of all pieces	Class of service
For 06	23 kg (Adult, Child) 10 kg (Infant)	Domestic Economy
	32 kg (1 or 2 pieces) 10 kg (1 piece)	International (Adult, Child) International (Infant)
For SQ	50 kg (110 lbs)	First Class
	40 kg (88 lbs)	Business Class
	35 kg (77 lbs)	Premium Economy Class
	30 kg (66 lbs)	Economy Class

### Star Alliance Gold

All Carriers	Extra 20 kg (44 lbs)
--------------	----------------------

### Infants not occupying a seat

All Carriers	10 kg (22 lbs) +1 fold up, collapsible stroller
NZ	1 car seat + 1 fold up, collapsible stroller

Note: **AI**: While on international routes (and if domestic journey is part of international itinerary) allowances are as indicated in the table. For travel on purely domestic tickets: First Class 40 kgs. Executive Class 35 kgs. Economy Class (Y,B,M & H) 20 kgs. Economy Class (K,Q,V,W,G,L,U,S,T,X, N, E) 15 kgs. Infants not entitled to a seat (all economy classes) Nil. **NZ, SA**: No bags over 32 kg (70 lbs) accepted as checked baggage. **LH, LX, NH, NZ, OS, SK, SN, TP**: Do not offer the weight concept. Some carriers do not offer First Class. **SK**: Economy Extra Class counts as Business Class. **JP**: No bags over 45 kg. Max. dimensions 178 cm accepted on checked baggage. **NZ**: Car seat and stroller travel free. **TG**: Above table only applies for international sectors within TC3, between TC2 and TC3. For domestic sectors: Royal Silk Class 40 kg (88 lbs), Economy Class 30 kg (66 lbs), Royal Orchid Platinum members (on TG sectors only) extra 30 kg (66 lbs), ROP Silver & Star Alliance Gold members extra 30 kg (44 lbs), ROP Silver members (on TG sectors only) extra 10 kg (22 lbs), infants not occupying a seat 10 kg (22 lbs). **TK**: Max. weight per piece is 32 kg (70 lbs) and max. dimensions for each piece is 115 cm. If the full First Class itinerary is on TK, baggage allowance is 60 kg. If the First Class flight completely operated by TK, baggage allowance is 60 kg. If the First Class flight with TK and connecting with a Star Alliance member airline, baggage allowance is 40 kg.

# SPECIAL CHECKED BAGGAGE

The following is a general guideline, for information purposes only. For up-to-date information please consult your internal Star Alliance information pages or contact the carrier directly. "NA" means: Not Available.

## Adria Airways (JP)

ITEMS	WITHIN FREE BAGGAGE ALLOWANCE		INTERLIN-EABLE	SSR REQUIRED	SSR ITEM	PACKAGING REQUIRED
	Piece Concept	Weight Concept				
Ammunition	Yes	N/A	Yes	Yes	WEAP	Max 5 kgs ammunition, separate packaging from arms.
Archery Equipment	Yes	N/A	Yes	Yes	SPEQ	
Bike	No	N/A	Yes	Yes	BIKE	Limitations may apply on CRJ aircraft.
Bike - Tandem	No	N/A	Yes	Yes	BIKE + BULK or SPEQ	Limitations may apply on CRJ aircraft.
Bulk baggage	No	N/A	Yes	Yes	BULK/ FRAG/ XBAG	Several SSR codes can be used.
Cabin baggage in seat	No	N/A	No	Yes	CBBG	Max. 75 kg.
Firearms	Yes	N/A	Yes	Yes	WEAP	With max. 5 kgs ammunition, separate packaging from arms.
Fishing equipment	Yes	N/A	Yes	Yes	SPEQ	
Golf equipment	Yes <sup>1</sup>	N/A	Yes	Yes	SPEQ	
Hang gliders	No	N/A	Yes	Yes	SPEQ	
Kayaks	No	N/A	Yes	Yes	SPEQ	Volume limitations may apply on CRJ aircraft.
Kite	No	N/A	Yes	Yes	SPEQ	
Pets as Checked Baggage (AVIH)	No	N/A	Yes	Yes	AVIH	
Pets in Cabin	No	N/A	Yes	Yes	PETC	Cats & dogs only, limited number, 2 PETC on CRJ aircraft.



## Adria Airways (JP) - continued

ITEMS	WITHIN FREE BAGGAGE ALLOWANCE		INTERLIN-EABLE	SSR REQUIRED	SSR ITEM	PACKAGING REQUIRED
	Piece Concept	Weight Concept				
Scuba Equipment	No	N/A	Yes	Yes	SPEQ	Oxygen bottles must be empty.
Service Animals	Yes	N/A	Yes	Yes	DEAF / BLND + PETC	
Skis/Snowboard	Yes <b>2</b>	N/A	Yes	Yes	SPEQ	
Small Surfboard less than 2 m/Wakeboard	Yes <b>2</b>	N/A	Yes	Yes	SPEQ	
Surfboard/Windsurfer	No	N/A	Yes	Yes	SPEQ	Volumetric limitations may apply on CRJ aircraft. Max. 32 kg.
Wet Cell Batteries	N/A	N/A	N/A	N/A	N/A	Spillable batteries (WCBW) not accepted on JP flights.
Wheelchair non-powered	Yes	N/A	Yes	Yes	WCHx + WCMP	Volumetric limitations may apply on CRJ aircraft.
Wheelchair with Dry Cell Batteries	Yes	N/A	Yes	Yes	WCHx + WCBD	Volumetric limitations may apply on CRJ aircraft.

**NOTE: 1** One Golf bag in addition to free baggage allowance (FBA) is granted free of charge to: Senators, HON Circle members and Star Gold card holders.

**2** One set of Ski equipment/snowboard is granted free of charge in addition to FBA.

**Aegean Airlines (A3)**

ITEMS	WITHIN FREE BAGGAGE ALLOWANCE		INTERLIN-EABLE	SSR REQUIRED	SSR ITEM	PACKAGING REQUIRED
	Piece Concept	Weight Concept				
Alpinist	Yes <b>2</b>	Yes <b>2</b>	Yes	Yes	SPEQ	Yes
Ammunition	Yes <b>1</b>	No <b>1</b>	Yes	Yes	WEAP	Yes
Archery Equipment	Yes <b>2</b>	Yes <b>2</b>	Yes	Yes	SPEQ	Yes
Bike	No	No	Yes	Yes	BIKE	No
Bike - Tandem	No	No	Yes	Yes	BULK	No
Body Board	No	No	Yes	Yes	SPEQ	Yes
Bowling Equipment	Yes <b>2</b>	Yes <b>2</b>	Yes	Yes	SPEQ	Yes
Bulk baggage	No	No	Yes	Yes	BULK	No
Cabin baggage in seat	No	No	Yes	Yes	CBBG	No, but must be restrained in seat
Canoe	No	No	Yes	Yes	Bulk	No
Firearms	Yes	No	Yes	Yes	WEAP	Yes
Fishing equipment	No	No	Yes	Yes	SPEQ	Yes
Golf equipment	Yes <b>3</b>	Yes <b>3</b>	Yes	Yes	GOLF	No
Hang gliders	No	No	Yes	Yes	BULK	Yes
Javelin	Yes <b>2</b>	Yes <b>2</b>	Yes	Yes	SPEQ	Yes
Kayaks	No	No	Yes	Yes	BULK	No
Kite	No	No	Yes	Yes	BULK	No, but recommended.
Longboard exceeding 2m	Yes	Yes	Yes	Yes	BULK	Yes
Parachute	Yes	Yes	Yes	Yes	SPEQ	Yes
Pets in Cabin	No	No	Yes	Yes	PETC	Yes, in appropriate kennel

 Aegean Airlines (A3) - continued

ITEMS	WITHIN FREE BAGGAGE ALLOWANCE		INTERLIN-EABLE	SSR REQUIRED	SSR ITEM	PACKAGING REQUIRED
	Piece Concept	Weight Concept				
Pets as Checked Baggage (AVIH)	No	No	Yes	Yes	AVIH	Yes, in appropriate kennel
Scuba Equipment	Yes	Yes	Yes	Yes	SPEQ	No, but recommended.
Skateboard	Yes <b>2</b>	Yes <b>2</b>	Yes	Yes	SPEQ	Yes
Service Animals	Yes	Yes	Yes	Yes	PETC	No
Skis/Snowboard	Yes	Yes	Yes	Yes	SPEQ	Yes
Small Surfboard less than 2m/Wakeboard	No	No	Yes	Yes	SPEQ	No, but recommended.
Surfboard/Windsurfer	No	No	Yes	Yes	SPEQ/BULK	No, but recommended.
Tennis/Squash/Badminton	Yes <b>2</b>	Yes <b>2</b>	Yes	Yes	SPEQ	Yes
Vaulting Poles	No	No	Yes	Yes	SPEQ/BULK	No
Waveboard	No	No	Yes	Yes	SPEQ	Yes
Wet Cell Batteries	Not permitted	Not permitted	No	No	NIL	No
Wheelchair non-powered	Yes	Yes	Yes	Yes	WCMP	No
Wheelchair with Dry Cell Batteries	Yes	Yes	Yes	Yes	WCBD	No

**NOTE: 1** Yes for police officers, bodyguards and civilians holding gun license for personal protection.

**2** Small category: if exceeds free baggage allowance, then chargeable.

**3** Only first golf bag is free. Exception: Chargeable from first golf bag, route Kalamata-Stockholm and v.v.





## Air Canada (AC)

ITEMS	WITHIN FREE BAGGAGE ALLOWANCE		INTERLIN-EABLE	SSR REQUIRED	SSR ITEM	PACKAGING REQUIRED
	Piece Concept	Weight Concept				
Ammunition	Yes	Yes	Yes	No		Max of 5kg. Must be packaged separately from firearm. Declaration form required.
Archery Equipment	Yes	Yes	Yes	No		Recommended, but not mandatory. <b>1</b>
Bike	Yes - Handling fee applies	No	Yes	Yes	BIKE	Recommended, but not mandatory. <b>1</b>
Bike - Tandem	Yes - Handling fee applies	No	Yes	Yes	BIKE	Recommended, but not mandatory. <b>1</b>
Bulk baggage	N/A	N/A	N/A	N/A	N/A	Recommended, but not mandatory. <b>1</b>
Cabin baggage in seat	Yes	No	No	Yes	CBBG	Cabin Baggage restraint net. Not valid on codeshare, Star and OAL flights. Customer must contact operating carrier to arrange seat loaded baggage.
Firearms	Yes - Handling fee applies	Yes	Yes	Yes	WEAP or SPEQ	Firearm must be unloaded. Packaged in a locked non-see through case. Declaration form required. Ammunition must be packaged separately.
Fishing equipment	Yes	Yes	Yes	No		Recommended, but not mandatory. <b>1</b>
Golf equipment	Yes	Yes	Yes	No		Recommended, but not mandatory. <b>1</b>
Hang gliders	Not accepted	N/A	N/A	N/A		N/A
Kayaks	Not accepted	N/A	N/A	N/A		N/A
Kite	Not accepted if Kiteboard	N/A	N/A	N/A		Kiteboards are accepted except during excess baggage embargo periods.
Pets as Checked Baggage (AVIH)	Yes	No	STAR Only	Yes	AVIH	Approved kennel. Embargo and restrictions apply.
Pets in Cabin	Yes	N/A	N/A	Yes	PETC	Approved pet carrier
Scuba Equipment	Yes	Yes	Yes	No		Tank must be empty.



## Air Canada (AC) - continued

ITEMS	WITHIN FREE BAGGAGE ALLOWANCE		INTERLIN-EABLE	SSR REQUIRED	SSR ITEM	PACKAGING REQUIRED
	Piece Concept	Weight Concept				
Service Animals	Yes - Birds not accepted in cabin as service animals.	No	Yes	Yes	MEDA/CKIN/ BLND/DEAF	N/A
Skis/Snowboard	Yes	Yes	Yes	No		Recommended, but not mandatory. <b>1</b>
Small Surfboard less than 2m/Wakeboard	Yes	No	Yes	No		Recommended, but not mandatory. <b>1</b>
Surfboard/Windsurfer	Windsurfer not accepted	N/A	N/A	N/A		N/A
Wheelchair non-powered	In addition to free baggage allowance	N/A	Yes	Yes	WCMP	No
Wheelchair with Dry Cell Batteries	In addition to free baggage allowance	N/A	No	Yes	WCBD	Battery must be disconnected. If the wheelchair cannot be stowed in an upright position, battery must be removed and prevented from short circuit.
Wheelchair with Wet Cell Batteries	In addition to free baggage allowance	N/A	No	Yes	WCBW	Battery must be disconnected. If the wheelchair cannot be stowed in an upright position, battery must be removed and prevented from short circuit.

**NOTE: 1** Items must be suitably packed in rigid and/or hard shell container designed for shipping. If otherwise packaged, items may be refused for carriage. Air Canada will not be liable for damage resulting from defect/quality of baggage.

ITEMS	WITHIN FREE BAGGAGE ALLOWANCE		INTERLIN-EABLE	SSR REQUIRED	SSR ITEM	PACKAGING REQUIRED
	Piece Concept	Weight Concept				
Ammunition	No	No	No			Max of 5 kg. Must be packaged separately from firearm. Declaration form required. Handling fee will apply.
Archery Equipment	No	No	No			Packaging required.
Bike	Yes	Yes	Yes	No		Packaging required. Only 1 piece for 1 pax.
Bike - Tandem	No	No	No			Ship via cargo.
Bulk baggage	No	No	No			Packaging required.
Cabin baggage in seat	No	No	No	Yes	CBBG	Packaging required. Max. weight 75 kg, max. dimensions: 100x60x40 cm.
Edge Tool and Blunt other than Controlled Knives	Yes	Yes	No	No		Packaging required.
Firearms	No	No	No	No		Firearm must be unloaded. Packaging required. Declaration form required. Ammunition must be packaged separately. Handling fee will apply.
Fishing equipment	Yes	Yes	Yes	No		Packaging required.
Golf equipment	Yes	Yes	Yes	No		Packaging required. Handling fee will apply.
Hang gliders	No	No	No	Yes	Needs to include dimensions and total weight	Packaging required. Handling fee will apply.
Kayaks	No	No	Yes	Yes	SPEQ	Packaging required. Handling fee will apply.
Pets in Cabin	No	No	No			
Pole	No	No	No	Yes	SPEQ	
Precision Instrument and Electrical Equipment	No	No	No	No		Packaging required. Handling fee will apply.
Scuba Equipment	No	No	No			Not allowed.



## Air China (CA) - continued

ITEMS	WITHIN FREE BAGGAGE ALLOWANCE		INTERLIN-EABLE	SSR REQUIRED	SSR ITEM	PACKAGING REQUIRED
	Piece Concept	Weight Concept				
Service Animals	Yes	Yes	Yes			
Skis/Snowboard	Yes	Yes	Yes	No		Handling fee will apply.
Small Surfboard less than 2m/Wakeboard	Yes	Yes	No	Yes		Handling fee will apply.
Surfboard/Windsurfer	No	No	Yes	Yes	SPEQ	Handling fee will apply.
Vaulting Poles	Yes	Yes	Yes	No		Packaging required.
Wheelchair non-powered	Yes	Yes	Yes			No
Wheelchair with Dry Cell Batteries	Yes	Yes	Yes	No		
Wheelchair with Wet Cell Batteries	No	No	No	No		Packaging required.

ITEMS	WITHIN FREE BAGGAGE ALLOWANCE		INTERLIN-EABLE	SSR REQUIRED	SSR ITEM	PACKAGING REQUIRED
	Piece Concept	Weight Concept				
Ammunition	Yes	Yes	No	No		Handling charges are levied - For Domestic - INR5000/- plus taxes. For International - Equivalent of USD 100/- plus local taxes
Archery Equipment	Yes	Yes	Yes	No		No
Bike	Yes	Yes	Yes	No		No
Bike - Tandem	Yes	Yes	Yes	No		No
Bulk baggage	N/A	N/A	N/A	N/A		N/A
Cabin baggage in seat	N/A	N/A	N/A	N/A		N/A
Firearms	Yes	Yes	No	No		Handling charges are levied - For Domestic - INR5000/- plus taxes. For International - Equivalent of USD 100/- plus local taxes
Fishing equipment	Yes	Yes	Yes	No		No
Golf equipment	No	No	Yes	No		
Hang gliders	N/A	N/A	N/A	N/A		N/A
Kayaks	N/A	N/A	N/A	N/A		N/A
Kite	N/A	N/A	N/A	N/A		N/A
Pets as Checked Baggage (AVIH)	No	No	No	Yes	AVIH	Proper caging.
Pets in Cabin	No	No	No	Yes	PETC	Muzzled
Scuba Equipment	N/A	N/A	N/A	N/A		N/A
Service Animals	N/A	N/A	N/A	N/A		N/A
Skis/Snowboard	No	No	Yes	No		

**Air India (AI) - continued**

ITEMS	WITHIN FREE BAGGAGE ALLOWANCE		INTERLIN-EABLE	SSR REQUIRED	SSR ITEM	PACKAGING REQUIRED
	Piece Concept	Weight Concept				
Small Surfboard less than 2m/Wakeboard	N/A	N/A	N/A	N/A		N/A
Surfboard/Windsurfer	N/A	N/A	N/A	N/A		N/A
Waveboard	N/A	N/A	N/A	N/A		N/A
Wheelchair non-powered	N/A	N/A	N/A	N/A		N/A
Wheelchair with Dry Cell Batteries	N/A	N/A	N/A	N/A		N/A
Wheelchair with Wet Cell Batteries	N/A	N/A	N/A	N/A		N/A

 Air New Zealand (NZ)

ITEMS	WITHIN FREE BAGGAGE ALLOWANCE		INTERLIN-EABLE	SSR REQUIRED	SSR ITEM	PACKAGING REQUIRED
	Piece Concept	Weight Concept				
Ammunition	Yes		Yes	Yes	SSRWEAP NZNN1	Securely packaged in quantities not exceeding 5 kg (11 lbs) gross per pax.
Archery Equipment	Yes		Yes	No	Nil	Nil
Bike	Yes		Yes	Yes	SSRBIKENZNN1	Yes. Handle bars fixed sideways. Pedals removed or padded. Chain wrapped. Bike wrapped in corrugated cardboard or in purpose built bike container.
Bike - Tandem	Yes		Yes	Yes	SSRBIKENZNN1	Yes. Handle bars fixed sideways. Pedals removed or padded. Chain wrapped. Bike wrapped in corrugated cardboard or in purpose built bike container.
Bulk baggage	No		No	No	Nil	Nil
Cabin baggage in seat	Yes		No	Yes	SSRCBBGNZNN1	Nil
Firearms	No		No	Yes	SSRWEAP NZNN1	In passenger baggage or suitable container.
Fishing equipment	Yes (under 2 metres)		Yes	No	Nil	Nil
Golf equipment	Yes		Yes	No	Nil	Nil
Hang gliders	Yes (under) 2 metres <b>1,4</b>		Yes	No	Nil	Maximum length 2.5m. If booked on a 5000 or 8000 flight number max. length is 1.8m.
Kayaks	Yes (under) 2 metres <b>1,4</b>		Yes	No	Nil	Maximum length 2.5m. If booked on a 5000 or 8000 flight number max. length is 1.8m.
Kite	Yes (under) 2 metres <b>1,4</b>		Yes	No	Nil	Maximum length 2.5m. If booked on a 5000 or 8000 flight number max. length is 1.8m.
Pets as Checked Baggage (AVIH)	N/A (only permitted domestically with N.Z.) <b>2</b>		No	Yes	SSRAVIHNZNN1	Clean,/leakproof/escape proof/well ventilated container made of fibreglass, metal, rigid plastic, wickerwork, wire mesh or wood with a strong framework.
Pets in Cabin	No		No	No	N/A	N/A

**Air New Zealand (NZ) - continued**

ITEMS	WITHIN FREE BAGGAGE ALLOWANCE		INTERLIN-EABLE	SSR REQUIRED	SSR ITEM	PACKAGING REQUIRED
	Piece Concept	Weight Concept				
Scuba Equipment	Yes		Yes	No	N/A	Tanks must be de-pressurised.
Service Animals	Carried in cabin <b>3</b>		N/A	Yes	SSRPETC	N/A
Skis/Snowboard	Yes (under 2 metres)		Yes	No	No	N/A
Small Surfboard less than 2m/Wakeboard	Yes		Yes	No	No	N/A
Surfboard/Windsurfer	Yes (subject to space) <b>1,4</b>		Yes	No	No	Maximum length 2.5m (if booked on a 5000 or 8000 flight number Max. length is 1.8 m)
Wet Cell Batteries	No (for wheelchairs) <b>2</b>		Yes	No	N/A	Leaktight, impervious to battery fluid packaging, spill resistant caps, insulate battery terminals, secured upright position. Corrosive and package orientation labelling.
Wheelchair non-powered	No		Yes	No	N/A	N/A
Wheelchair with Dry Cell Batteries	No		Yes	No	N/A	Insulate battery terminals, battery securely fastened to wheelchair.

**NOTE:** **1** Subject to space

**2** For wheelchairs

**3** Service animals: See note below

**4** Charges apply to items that exceed 2 m. in length.

**NOTE:** Service animals: Applicable for NZ and AU: A) Australian regulations permit only guide dogs in the cabin. Therapy or companion animals must be consigned as freight or baggage. B) Guide dogs can be imported without need for quarantine, provided customer obtains import health permit from the Chief Veterinary Officer of the Ministry of Agriculture or equivalent governing body. C) It is the customer's responsibility to ensure he has the health permit and all necessary documentation and information from the originating country prior to departure. D) U.S. does not accept service animals to the U.K., Ireland and Barbados.



ITEMS	WITHIN FREE BAGGAGE ALLOWANCE		INTERLIN-EABLE	SSR REQUIRED	SSR ITEM	PACKAGING REQUIRED
	Piece Concept	Weight Concept				
Ammunition	Yes	N/A	Yes	Yes	WEAP	Yes, in proper package.
Archery Equipment	Yes	N/A	Yes	Yes	SPEQ	Yes, in proper package.
Bike	Yes	N/A	Yes	Yes	BIKE	Yes, in proper package.
Bike - Tandem	Yes	N/A	Yes	Yes	BIKE	Yes, in proper package.
Bulk baggage	Yes	N/A	Yes	Yes	BULK	Yes, in proper package.
Cabin baggage in seat	No	N/A	Yes	Yes	CBBG	No
Firearms	Yes	N/A	No	Yes	WEAP	Yes, in proper package.
Fishing equipment	Yes	N/A	Yes	No		Yes
Golf equipment	Yes	N/A	Yes	Yes	SPEQ	No
Hang gliders	Yes	N/A	Not permitted	Yes	SPEQ	Yes, in appropriate packaging.
Kayaks	Yes	N/A	Not permitted	Yes	SPEQ	Not permitted
Kite	Yes	N/A	Yes	No		Yes, in proper package.
Pets as Checked Baggage (AVIH)	No	N/A	No	Yes	AVIH	Yes, in proper kennel.
Pets in Cabin	Not permitted	N/A	Not permitted	Not permitted	Not permitted	Not permitted
Scuba Equipment	Yes	N/A	Yes	Yes	SPEQ	Yes, in proper package.
Service Animals	No	N/A	Yes	Yes	PETC/AVIH	Yes, in proper package.
Skis/Snowboard	Yes	N/A	Yes	Yes	SPEQ	Yes, in proper package.
Small Surfboard less than 2m/Wakeboard	Yes	N/A	Yes	Yes	SPEQ	Yes, in proper package.
Surfboard/Windsurfer	Yes	N/A	Yes	Yes	SPEQ	Yes, in proper package.

ANA  **ANA (NH)** - continued

ITEMS	WITHIN FREE BAGGAGE ALLOWANCE		INTERLIN-EABLE	SSR REQUIRED	SSR ITEM	PACKAGING REQUIRED
	Piece Concept	Weight Concept				
Wheelchair with Wet Cell Batteries	Yes, free	N/A	Yes	Yes	WCBW	Yes, in proper package.
Wheelchair non-powered	Yes, free	N/A	Yes	Yes	WCMP	Yes, in proper package.
Wheelchair with Dry Cell Batteries	Yes, free	N/A	Yes	Yes	WCBD	Yes, in proper package.

# 7 Asiana Airlines (OZ)

ITEMS	WITHIN FREE BAGGAGE ALLOWANCE		INTERLIN-EABLE	SSR REQUIRED	SSR ITEM	PACKAGING REQUIRED
	Piece Concept	Weight Concept				
Ammunition	Yes	N/A	Yes	Yes	WEAP	Yes. Accepted under condition stipulated in IATA DGR and OZ manual.
Archery Equipment	Yes	N/A	Yes	Yes	SPEQ (Recommended but not mandatory)	Yes. Packaging required.
Bike	Yes	N/A	Yes	Yes	BIKE (Recommended but not mandatory)	Yes. Packaging required.
Bike - Tandem	Yes	N/A	Yes	Yes	BIKE (Recommended but not mandatory)	Yes. Packaging required.
Bulk baggage	N/A	N/A	N/A	N/A	N/A	N/A
Cabin baggage in seat	No	No	Yes	Yes	CBBG	Yes, must be restrained in seat. Max. weight 75 kg. Max. height 155 cm for an instrument (150 cm for cello).
Firearms	Yes	N/A	Yes	Yes	WEAP	Yes. Accepted under condition stipulated in IATA DGR and OZ manual.
Fishing equipment	Yes	N/A	Yes	Yes	SPEQ (Recommended but not mandatory)	Yes. Packaging required.
Golf equipment	Yes	N/A	Yes	Yes	SPEQ (Recommended but not mandatory)	Yes. Packaging required.
Hang gliders	Not accepted	N/A	Not accepted	N/A	N/A	Only accepted as Cargo.

## 7 Asiana Airlines (OZ) - continued

ITEMS	WITHIN FREE BAGGAGE ALLOWANCE		INTERLIN-EABLE	SSR REQUIRED	SSR ITEM	PACKAGING REQUIRED
	Piece Concept	Weight Concept				
Kayaks	Not accepted	N/A	Not accepted	N/A	N/A	Only accepted as Cargo
Kite	Yes	N/A	Yes	No	N/A	Yes, in proper packaging
Pets as Checked Baggage (AVIH)	No	N/A	Yes	Yes	AVIH	Yes. Max. weight 32 kg. Max. dimensions 246 cm.
Pets in Cabin	No	N/A	Yes	Yes	PETC	Yes. Dog, Cat, Bird only. Max. weight 5 kg including cage. Hardside cage: 43cm x 30cm x 21cm (height). Softside cage: 43cm x 30cm x 25cm (height)
Scuba Equipment	Yes	N/A	Yes	Yes	SPEQ (Recommended but not mandatory)	Yes. Packaging required. Tank must be empty.
Service Animals	Free of charge	N/A	Yes	Yes	BLND	No
Skis/Snowboard	Yes	N/A	Yes	Yes	SPEQ (Recommended but not mandatory)	Yes. Packaging required.
Small Surfboard less than 2m/Wakeboard	Yes	N/A	Yes	Yes	SPEQ (Recommended but not mandatory)	Yes. Packaging required.
Surfboard/Windsurfer	Yes	N/A	Yes	Yes	SPEQ (Recommended but not mandatory)	Yes. Packaging required.
Wet Cell Batteries	Yes	N/A	Yes	Yes	WCBW	For WCBW, accepted under condition stipulated in IATA DGR and OZ manual, free of charge.
Wheelchair non-powered	Free of charge	N/A	Yes	Yes	WCHR	Accepted under condition stipulated in IATA DGR and OZ manual.
Wheelchair with Dry Cell Batteries	Free of charge	N/A	Yes	Yes	WCBD	Accepted under condition stipulated in IATA DGR and OZ manual.

 **Austrian (OS)**

ITEMS	WITHIN FREE BAGGAGE ALLOWANCE		INTERLIN-EABLE	SSR REQUIRED	SSR ITEM	PACKAGING REQUIRED
	Piece Concept	Weight Concept				
Ammunition	Yes	N/A	Yes	Yes	WEAP	Securely packed, separated from arms and in line with IATA DGR.
Archery Equipment	Yes	N/A	Yes	Yes	SPEQ	Packaging required.
Bike	Yes	N/A	Yes	Yes	BIKE	Advisable to rotate handlebar 90 degrees and tighten. Remove pedals. Pack bike in carton box or a special plastic box to protect from damage.
Bike - Tandem	No	N/A	Yes	Yes	BIKE-TANDEM	Advisable to rotate handlebar 90 degrees and tighten. Remove the pedals. Pack bike in carton box or a special plastic box to protect from damage.
Bulk baggage	No	N/A	Yes	Yes	BULK	No.
Cabin baggage in seat	No	N/A	Yes	Yes	CBBG	No, must be restrained in seat. Max 75kg. Max 155x42x-25cm from cabin floor, or 110x42x50cm from seat.
Firearms	Yes	N/A	Yes	Yes	WEAP	Strong, rigid container made of wood, metal etc.
Fishing equipment	Yes	N/A	Yes	Yes	SPEQ	Yes
Golf equipment	Yes	N/A	Yes	Yes	SPEQ-GOLF	Packaging recommended.
Hang gliders	No	N/A	Yes	Yes	SPEQ	Yes
Kayaks	No	N/A	Yes	Yes	SPEQ	No
Kite	No	N/A	Yes	Yes	SPEQ	Yes
Pets as Checked Baggage (AVIH)	No	N/A	Yes (provided the transfer time does not exceed 3 hrs)	Yes	AVIH	Kennel according IATA LAR.
Pets in Cabin	No	N/A	Yes	Yes	PETC	Leak-proof kennel. Max total weight 8kg. Max 55x40x23cm.
Scuba Equipment	Yes	N/A	Yes	Yes	SPEQ	Yes, in line with IATA DGR

 **Austrian (OS)** - continued

ITEMS	WITHIN FREE BAGGAGE ALLOWANCE		INTERLIN-EABLE	SSR REQUIRED	SSR ITEM	PACKAGING REQUIRED
	Piece Concept	Weight Concept				
Service Animals	Yes	N/A	Yes	Yes	SVAN	None
Skis/Snowboard	Yes	N/A	Yes	Yes	SPEQ-SKI	Yes
Small Surfboard less than 2m/Wakeboard	Yes	N/A	Yes	Yes	SPEQ	Yes
Surfboard/Windsurfer	Yes	N/A	Yes	Yes	SPEQ	Yes
Vaulting Poles	Yes	N/A	Yes	Yes	SPEQ	Yes, 1 set of vaulting poles in 1 container
Wheelchair non-powered	Yes	N/A	Yes	Yes	WCMP	No
Wheelchair with Wet Cell Batteries	Yes	N/A	Yes	Yes	WCBW	Yes, in line with IATA DGR
Wheelchair with Lithium Batteries	Yes	N/A	Yes	Yes	WCLB	Yes, in line with IATA DGR
Wheelchair with Dry Cell Batteries	Yes	N/A	Yes	Yes	WCBD	Yes, in line with IATA DGR



## Avianca (AV)

ITEMS	WITHIN FREE BAGGAGE ALLOWANCE		INTERLIN-EABLE	SSR REQUIRED	SSR ITEM	PACKAGING REQUIRED
	Piece Concept	Weight Concept				
Ammunition	Yes		No	No		Transport of sporting arms and/or gun collections as checked baggage in the hold of aircraft, in compliance with local regulations and agreement with the airline.
Archery Equipment	Yes		Yes	No	No	Must be packed in a special suitcase.
Bike	Yes		Yes	No	No	Correctly packed and handlebars fixed sideways, pedals removed. No fee applies if checked as part of bag allowance, otherwise fee applies and handled as standby bag.
Bike - Tandem	Yes		Yes	No	No	Correctly packed and handlebars fixed sideways, pedals removed. No fee applies if checked as part of bag allowance, otherwise fee applies and handled as standby bag.
Bulk baggage	Yes		Yes			A318, A319, A320, 321 aircraft and bin #5 (bulk), A330 aircraft. Live animals, wheelchair, fragile baggage, recommended luggage, baby cars, crew tag luggage, carryon luggage.
Cabin baggage in seat	Yes		Yes	Yes	CBBG, SSR	Contents must not compromise safety. Ticket fare to be equal to that of the client. Must be properly packaged, located in seat next to window, beside the client. Must be secured to seat with seatbelt. Not to exceed 75kg and 80 inches in overall dimensions.
Firearms	Yes		Yes			It allows the transport of sporting arms and / or gun collections as checked baggage in the hold of the aircraft, in compliance with corresponding local regulations and agreement with the airline.
Fishing equipment	Yes		Yes	No	No	Accept 1 pair of boots, 1 reel and 2 fishing rods with dimensions greater than 62" but less than 85" as part of the free baggage allowance.
Golf equipment	Yes		Yes	No	No	A golf club bag with 14 clubs, 12 balls, 1 pair of golf shoes, properly packed and insured.
Hang gliders	No		No			
Kayaks	No		No			



## Avianca (AV) - continued

ITEMS	WITHIN FREE BAGGAGE ALLOWANCE		INTERLIN-EABLE	SSR REQUIRED	SSR ITEM	PACKAGING REQUIRED
	Piece Concept	Weight Concept				
Kite	No		No			
Pets as Checked Baggage (AVIH)	Yes		Yes	Yes	AVIH	Within Colombia, only dogs, cats and birds accepted with max weight of 20kg on flights less than 2 hrs. International, only dogs and cats accepted up to 20kg on flights under 2 hrs. Must be in container, max weight 10kg.
Pets in Cabin	Yes		No	Yes	PETC	Pets are accepted in Roll-on baggage, briefcases in hard or soft containers if they can be accommodated under the passenger seat.
Scuba Equipment	Yes		Yes			An air regulator, an empty tank, two (2) rubber fins, a conventional harpoon, a mask, a snorkel, a wet suit, a weight belt and high intensity lamps underwater (diving lamps without batteries).
Service Animals	Yes		Yes	Yes	SVAN, ESAN	Accepts emotional support animals and psychiatric service animals with current documentation on the letterhead of a licensed mental health professional.
Skis/Snowboard	Yes		Yes	No	No	A pair of skis, 2 sticks, boots and shoes are allowed, Snowboards
Small Surfboard less than 2 m/Wakeboard	Yes		Yes	No	No	Applies to tables smaller than 12 feet (366 cm) and weighing less than 70lbs.
Surfboard/Windsurfer	Yes		No			Applies to tables smaller than 12 feet (366 cm) and weighing less than 70lbs. The Windsurfing equipment consists of a board, mast and "boom"
Wet Cell Batteries	Yes		Yes	Yes	WCHC/WCHR/WCHS/WCOB/WCMP	Electric wheelchairs, gel-type battery, dry or wet as checked bags. Disconnect battery. Transmit message to the destination to ensure assistance to reconnect battery.
Wheelchair non-powered	Yes		Yes	Yes	WCHC/WCHR/WCHS/WCOB/WCMP	
Wheelchair with Dry Cell Batteries	Yes		Yes	Yes	WCHC/WCHR/WCHS/WCOB/WCMP	Electric wheelchairs, gel-type battery, dry or wet as checked bags. Disconnect battery. Transmit message to destination to ensure assistance to reconnect battery.





## Avianca in Brazil (O6)

ITEMS	WITHIN FREE BAGGAGE ALLOWANCE		INTERLIN-EABLE	SSR REQUIRED	SSR ITEM	PACKAGING REQUIRED
	Piece Concept	Weight Concept				
Ammunition	Yes	Yes	Yes	Yes	WEAP	5 kg per passenger, 25 kg per aircraft. Ammunition must be securely stored in a strong, sealed box packed inside a suitcase and surrounded by other contents. The suitcase must not bear an "Explosive" label.
Archery Equipment	No	Yes	Yes	Yes	SPEQ	Bow, Arrows and maintenance equipment, all packed, securing the item. <b>1</b>
Bike	Yes	No	Yes	Yes	BIKE	O6 accepts tourism or racing bicycles, with a single seat, motorless, folded handles and detached pedals, all duly packed. O6 accepts for each flight a maximum of 5 bicycles. <b>2</b>
Bike - Tandem	No	No	No	No		
Bulk baggage	No	No	No	No		
Cabin baggage in seat	Yes	Yes	Yes	Yes	CBBG	Cabin Baggage SSR allows passengers to carry additional bags due to his/her physical condition cannot be loaded into the plane's belly, and must be taken in the cabin in a separate passenger seat. <b>3</b>
Firearms	Yes	Yes	Yes	Yes	WEAP	Firearms designed for sporting purposes, such as target pistols rifles, air guns, safari rifles, hunting rifles, etc., may be carried as checked baggage on Avianca O6 flights under conditions noted below. <b>4</b>
Fishing equipment	No	Yes	Yes	Yes	SPEQ	Accepted items: Pair of boots, fishing net and fish stick. Passenger must pack the equipment assuring its protection. Passenger assumes damage responsibility for equipment not packed properly. No limit of quantity of fishing equipment. <b>1</b>
Golf equipment	No	Yes	Yes	Yes	SPEQ	Bag and clubs should be duly protected. <b>2</b>
Hang gliders	No	No	No	No		
Kayaks	No	No	No	No		
Kite	No	No	No	No		



## Avianca in Brazil (06) - continued

ITEMS	WITHIN FREE BAGGAGE ALLOWANCE		INTERLIN-EABLE	SSR REQUIRED	SSR ITEM	PACKAGING REQUIRED
	Piece Concept	Weight Concept				
Pets as Checked Baggage (AVIH)	No	No	No	No		
Pets in Cabin	Yes	Yes	No	Yes	PETC	<b>5</b>
Scuba Equipment	No	Yes	Yes	Yes	SPEQ	<b>1, 6</b>
Service Animals	No	No	Yes	Yes	SVAN/ESAN	<b>7</b>
Skis/Snowboard	No	No	No	No	SPEQ	Accepted items: pair of skis, two bats, boots and shoes. Passenger must pack the equipment assuring its protection. Passenger assumes damage responsibility for equipment not packed properly. No limit on amount of sport equipment. <b>8</b>
Small Surfboard less than 2m/Wakeboard	Yes	No	Yes	Yes	SPEQ, SURF	06 accepts (without charge) a max. of 2 bags with 2 surfboards (packed in the same bag) with a max. length of 2 m. • Damaged or manipulation-resistant packaging not allowed • Damaged sport equipment not allowed.
Surfboard/Windsurfer	No	No	No	No		
Wet Cell Batteries	No	No	Yes	Yes	WCBW	Accepted (except MK-28) in the payload bay, vertical position, isolated poles (according to DGR). According ANAC 280 resolution, no limits since it does affect safety.
Wheelchair non-powered	No	No	Yes	Yes	WCHC, WCHR, WCHS	The SSR code will be inserted according to passenger conditions. According ANAC 280 resolution, no limits since it does affect safety.
Wheelchair with Dry Cell Batteries	No	No	Yes	Yes	WCBW	Keeping the poles isolated, with the battery attached in the wheelchair. According ANAC 280 resolution, no limits since it does affect safety.

**NOTE:** 1 Restrictions:

- Damaged or manipulation-resistant packaging will not be allowed
- Damaged sports equipment is not allowed
- Sports equipment measuring more than 230 cm (90 inches) or weighing more than 45 kg, will only be transported by cargo services, subject to policies applicable for such area.
- If the sporting equipment is registered as an additional item from the allowed baggage, excess baggage charges will apply and such items should be subject to space availability.

## CONTINUED O6

### **NOTE:** 2 Restrictions:

- Damaged or manipulation-resistant packaging will not be allowed.
- Damaged sports equipment not allowed.
- Sports equipment measuring more than 230 cm (90 inches) or weighing more than 45 kg, will only be transported by cargo services, subject to policies applicable for such area.

### 3 Conditions:

- Avianca only accepts violin/cello as CBBG.
- Baggage must be rigid, to avoid possible damages to the instrument, passengers and crew.
- At check-in, passengers must complete and sign the form F-DSA-018 "term of shipping violin/cello", containing weights and measures allowed.
- The system generates 2 tickets and boarding passes for the same passenger.
- If Avianca refuses to carry the item, the passenger must sign the form with the reasons for refusal.
- Reservations and payment must be made at the call center.
- Passenger seat will be assigned in the first line of the aircraft, providing a window seat for the instrument.
- Instrument must be secured with the safety belt.
- Ticket will be named CBBG/passenger's last name, as well as an SSR reference in the PNR.

### Restrictions:

CBBG transportation does not grant extra allowance for baggage acceptance. Dimensions should not exceed 1.60 m + 0.70 cm + 0.60 cm; maximum weight allowance, included protective cover, is 75 kg.

### 4 Firearms:

The firearm must be completely unloaded and, if possible, dismantled and packed inside a suitcase or standard gun case. The carriage of any type of firearms, ammunition and explosives, including items containing explosives, must be approved by Avianca no less than three days before the flight. Contact your nearest Avianca office to start the approval process. The maximum gross weight of the ammunition carried by any single customer is 5 kg (11 lb). Customers travelling in groups must carry ammunition in their own separate bags, with no single bag carrying more than the 5 kg (11 lb) limit.

### 5 Pets in Cabin:

Dogs (including guide dog) and cats aged at least 12 weeks, maximum 1 per passenger, 1 animal per kennel, at most 3 per aircraft, preventing the shipment of different breeds on the same flights. The weight of the animal plus kennel should not exceed 8 kg. Dimensions: 40 cm long, 25 cm high, 25 cm wide.

### 6 Scuba Equipment:

Tanks are not accepted. O6 accepts a pressure gauge, snorkel, harpoon, flippers, safety vest, weight belt, regulator and visor. High density diving lamps will be accepted only if the battery heating component has been packed separately to avoid its activation during flight. Every extracted battery must be protected against short circuits.

## CONTINUED O6

### 7 Service Animals:

The seeing-eye dog trained to assist the handicapped (SVAN) and emotional support/psychiatric assistance dog (ESAN) will be transported free of charge in the cabin, on the floor of the air craft, in a place adjacent to its owner. This seat will be determined by the airline, and the dog should travel on a leash with its owner in control. The same documentation requested for other pets (PETC) should be presented. There is no restriction on boarding a seeing-eye dog, when another dog is on the flight.

### 8 Skis/Snowboards:

If equipment is checked as an additional piece of baggage, excess baggage charges will apply and such items should be subject to space availability.

#### Restrictions:

- Damaged or manipulation-resistant packaging will not be allowed.
- Damaged sport equipment not allowed.uch items should be subject to space availability.



## Brussels Airlines (SN)

ITEMS	WITHIN FREE BAGGAGE ALLOWANCE		INTERLIN-EABLE	SSR REQUIRED	SSR ITEM	PACKAGING REQUIRED
	Piece Concept	Weight Concept				
Ammunition	Yes	No	Yes	Yes	WEAP	Ammunition packed separately from firearm, in a strong outer container made of wood, metal or fibreboard. Protected inside against shock. Quantity limitation of max. 5 kg per passenger.
Archery Equipment	N/A	N/A	N/A	N/A	N/A	1 set of bow and arrow packed in 1 durable protective container
Bike	Yes - free	No	Yes	Yes	BIKE	Recommended to rotate handlebar 90°, tighten, and remove pedals.
Bike - Tandem	Yes	No	Yes	Yes	BIKE	Recommended to rotate handlebar 90°, tighten, and remove pedals.
Bulk baggage	No	No	Yes	Yes	CBBG	An extra seat must be booked and paid, max. weight 75kg. Sum of total dimensions may not exceed 115cm (45 inches).
Cabin baggage in seat	No	No	Yes	Yes	CBBG	An extra seat must be booked and paid, max. weight 75kg. Sum of total dimensions may not exceed 115cm (45 inches).
Firearms	Yes	No	Yes	Yes	WEAP	Arms must be unloaded, packed in a strong rigid container made of wood, metal, fibre, styropor.
Fishing equipment	Yes	No	Yes	Yes	SPEQ	
Golf equipment	Yes	No <b>1</b>	Yes	Yes	SPEQ	
Hang gliders	Yes	No	Yes	Yes	SPEQ	
Kayaks	Yes	No	Yes	Yes	SPEQ	
Kite	Yes	N/A	N/A	N/A	N/A	
Pets as Checked Baggage (AVIH)	No <b>2</b>	No	Yes	Yes	AVIH	Container must be large enough for animal to stand upright, turn and lie down in a natural manner.
Pets in Cabin	No <b>2</b>	No	Yes	Yes	PETC	Leak -and smell proof, soft-sided bag that can be stowed under the seat in front with max. weight of 6kg (animal + container).
Scuba Equipment	Yes	No	Yes	Yes	SPEQ	



## Brussels Airlines (SN) - continued

ITEMS	WITHIN FREE BAGGAGE ALLOWANCE		INTERLIN-EABLE	SSR REQUIRED	SSR ITEM	PACKAGING REQUIRED
	Piece Concept	Weight Concept				
Service Animals	Yes - free	Yes - free	Yes	Yes	BLND / DEAF	The presence of a guide dog must be mentioned in the SSR BLND or SSR DEAF.
Skis/Snowboard	Yes	Free- no restrictions	Yes		SPEQ	
Small Surfboard less than 2m/Wakeboard	Yes	No	Yes	Yes	SPEQ	
Surfboard/Windsurfer	Yes	No	Yes	Yes	SPEQ	It is recommended to use a protective wrapping.
Wet Cell Batteries	Yes - free	Yes - free	Yes	Yes	WCHR/WHCS /WCHC	Battery must be disconnected, insulated and securely attached to the wheelchair.
Wheelchair non-powered	Yes - free	Yes - free	Yes	Yes	WCHR/WHCS /WCHC	
Wheelchair with Dry Cell Batteries	Yes - free	Yes - free	Yes	Yes	WCHR/WHCS /WCHC	Battery must be disconnected, insulated and securely attached to the wheelchair.

**NOTE: 1** One golf bag in addition to free bag allowance is granted free of charge, except on routes to/from/via USA/Canada, to:

- HON Circle members, except when travelling in Check@Go
- Senators, except when travelling in Check@Go
- Star Gold Card Holders, except when travelling in Check@Go
- LX Golf Club members travelling on LH/LX operated flights
- Selected SN passengers on SN operated flights in possession of vouchers (max 15 kg).

**2** The transportation of AVIH to the United Kingdom is strictly forbidden on Brussels Airlines flights. However, they can be accepted, but only under following conditions:

- On flights to LHR only,
- and ONLY as cargo

**NOTE:** Sport equipment included in the free baggage allowance (FBA) and only charged if in excess.

Any type of sports equipment is free of charge provided the number of pieces as per FBA and the max. limits in weight are not exceeded. If the FBA is exceeded, excess baggage to be charged either according to a specific rate in the list of sport equipment related to specific type of sport equipment or to standard excess baggage rates, if the sport equipment is not listed or does not correspond with the specific definition.



## Copa Airlines (CM)

ITEMS	WITHIN FREE BAGGAGE ALLOWANCE		INTERLIN-EABLE	SSR REQUIRED	SSR ITEM	PACKAGING REQUIRED
	Piece Concept	Weight Concept				
Ammunition	Yes <b>1</b>	Yes <b>2</b>	Yes	No	No	Not to exceed 5 kg per person (excl. ammunition with explosive and incendiary projectiles) and more than two per pax.
Archery Equipment	Yes <b>1</b> 1/pax	Yes <b>2</b> 1/pax	Yes	No	No	One bow box with bows, 1 arrow box with arrows, 1 maintenance kit. Items packed in suitable container.
Bike	Yes <b>1</b>	Yes <b>2</b>	Yes	Yes	Yes	Properly packed in box. Bicycles between 24 and 32 kg subject to excess fees on certain routes.
Bike - Tandem	No	No	No	N/A	N/A	Sport bikes with a single seat. Non-motorized bikes. Small items stored in plastic bags. Pedals and handlebars removed and stored aside.
Bulk baggage	Yes <b>1</b>	Yes <b>2</b>	Yes	No	No	Plastic wrapped and will be conditioned. Otherwise will not be accepted.
Cabin baggage in seat	Yes	Yes	No	N/A	N/A	Cabin baggage is treated as a passenger and is subject to pax fares per route ONLY PERMITTED ONLINE.
Canoe	No	No	No	N/A	N/A	Please refer to the Cargo Department for more information.
Firearms	Yes <b>1</b> Check destinations	Yes <b>2</b> Check destinations	No	No (Document in PNR OS)	No (Document in PNR OS)	All firearms must be properly packed and stored in containers made for firearm transport.
Fishing equipment	Yes <b>1</b> but not to USA	Yes <b>2</b>	Yes	No	No	All items must be packed in a suitable container that does not exceed 115 linear inches (292 cm) (length + width + height) Fishing equipment cannot exceed 80 inches (203 cm) in length.
Golf equipment	Yes <b>1</b>	Yes <b>2</b>	Yes	Yes	Yes	Golf equipment is accepted as part of the checked bags and must be properly packed and covered.
Hang gliders	No	No	No	No	No	CM does not accept gliders as checked baggage or as cargo due to the dimensions of these on the size of our aircraft.
Kayaks	Yes <b>1</b>	Yes <b>2</b>	Yes, but only for inflatable kayaks	No	No	Inflatable kayaks will be accepted as baggage, if deflated meet the measures in place (no more than 62") and packed as baggage.
Kite	Yes <b>1</b>	Yes <b>2</b>	Yes	No	No	Must be small, unmounted, boxed or can be fitted in a suitcase. Must meet measurement and weight restrictions.
Pets as Checked Baggage (AVIH)	No	No	No	No	N/A	Shipped only via Cargo.



## Copa Airlines (CM) - continued

ITEMS	WITHIN FREE BAGGAGE ALLOWANCE		INTERLIN-EABLE	SSR REQUIRED	SSR ITEM	PACKAGING REQUIRED
	Piece Concept	Weight Concept				
Pets in Cabin	No	Yes	No	Yes (3 TOT)	Yes (3 TOT)	Not allowed in Business Class. Less than 22 lbs or 10 kgs with permits and fitted inside the proper kennel, to fit under the pax's seat for an EMB 190 (our smallest aircraft).
Scuba Equipment	Yes <b>1</b> but with empty tank	Yes <b>2</b> but with empty tank	Yes, but without tanks	No	No	Empty tank and article bag will be charged as two separate pieces.
Service Animals	No	Yes	CO/UA and all airline complying with DOT382	Yes	Yes	Service animals accompanying disabled persons are permitted in the airplane cabin free of charge.
Skis/Snowboard	Yes <b>1</b> but only 1 per passenger	Yes <b>2</b> but only 1 per passenger	Yes	No	No	On international flights, CM will accept 1 piece of ski equipment per pax in place of 1 piece of allowed luggage. These items will charge US\$100 transport fee. Must comply with our max. dimensions.
Small Surfboard less than 2m/Wakeboard	Yes <b>1</b> but only 1 per passenger	Yes <b>2</b> but only 1 per passenger	Yes	No	No	On international flights, CM will accept 1 piece of less than 2m/ Wakeboard per pax in place of 1 piece of allowed luggage. This item will be charged US\$100 transport fee.
Surfboard/Windsurfer	Yes <b>1</b> but only 1 bag for 2 passengers	Yes <b>2</b> but only 1 bag for 2 passengers	Yes	Yes	Yes	Copa Airlines will transport a maximum of two surfboards, packed in the same bag, per passenger. Any additional boards must be checked as cargo.
Vaulting Poles	Yes <b>1</b> 1 per pax	Yes <b>2</b> 1 per pax	Yes 1 per pax	No	No	CM will accept 1 pole for transport as checked baggage. Pole vault equipment must be packed in an appropriate container.
Wet Cell Batteries	Yes	Yes	Yes	Yes	Yes	See note 3 below
Wheelchair non-powered	Yes	Yes	Yes (DOT 382 Compliance)	Yes	Yes	See note 3 below
Wheelchair with Dry Cell Batteries	Yes	Yes	Yes (DOT 382 Compliance)	Yes	Yes	Can be transported as long as they are disconnected and the edges isolated and the battery is tightly adjusted to the wheelchair.

- NOTE:**
- 1** For travel to/from U.S.
  - 2** For travel within Latin America
  - 3** Disconnect dry battery. If the battery is wet type, customer must remove and place in container that prevents spilling.





## Croatia Airlines (OU)

ITEMS	WITHIN FREE BAGGAGE ALLOWANCE		INTERLIN-EABLE	SSR REQUIRED	SSR ITEM	PACKAGING REQUIRED
	Piece Concept	Weight Concept				
Ammunition	Yes	Yes	No	Yes	WEAP	Yes
Archery Equipment	Yes	Yes	Yes	Yes	WEAP	Yes
Bike	Yes	Yes	Yes	Yes	BIKE	Although no special packing is required it is recommended to use a protective wrapping.
Bike - Tandem	Yes	Yes	Yes	Yes	BIKE	Although no special packing is required it is recommended to use a protective wrapping.
Bulk baggage	No	No	Yes	Yes	SPEQ/BULK	
Cabin baggage in seat	No	No	No	Yes	CBBG	
Firearms	Yes	Yes	No	Yes	WEAP	Yes
Fishing equipment	Yes	Yes	Yes	Yes	SPEQ/ FISH EQIP	
Golf equipment	Yes	Yes	Yes	Yes	SPEQ-GOLF	
Hang gliders	Yes	Yes	Yes	Yes	SPEQ/ HANG GLIDERS	No special packing is required but it is recommended to use a protective wrapping. (All packed in container).
Kayaks	Yes	Yes	Yes	Yes	SPEQ / KAYAK / CANOE	Although no special packing is required it is recommended to use a protective wrapping.
Kite	N/A	Yes	Yes	Yes	SPEQ/KITE	Although no special packing is required it is recommended to use a protective wrapping.
Pets as Checked Baggage (AVIH)	N/A	Yes	Yes	Yes	AVIH	Animal containers.
Pets in Cabin	No	No	Yes	Yes	PETC	Box or cage, max. 115 cm.
Scuba Equipment	Yes	Yes	Yes	Yes	SPEQ / SCUBA	
Service Animals	Yes	Yes	Yes	Yes	SVAN/ESAN	No
Skis/Snowboard	Yes	Yes	Yes	Yes	SPEQ-SKI	Ski bag required.



## Croatia Airlines (OU) - continued

ITEMS	WITHIN FREE BAGGAGE ALLOWANCE		INTERLIN-EABLE	SSR REQUIRED	SSR ITEM	PACKAGING REQUIRED
	Piece Concept	Weight Concept				
Small Surfboard less than 2m/Wakeboard	Yes	Yes	Yes	Yes	SPEQ-WIND SURFER	
Surfboard/Windsurfer	No	N/A	Yes	Yes	BULK-WINDSURFER	
Wet Cell Batteries	NOT PERMITTED					
Wheelchair non-powered	Yes	Yes	Yes	Yes	WCMP	
Wheelchair with Dry Cell Batteries	Yes	Yes	Yes	Yes	WCBD	



## EGYPTAIR (MS)

ITEMS	WITHIN FREE BAGGAGE ALLOWANCE		INTERLIN-EABLE	SSR REQUIRED	SSR ITEM	PACKAGING REQUIRED
	Piece Concept	Weight Concept				
Ammunition	Yes	N/A	Allowed from INT to INT only	Yes	AMUN	Max. 5 kg per pax. Must be packed in strong container made of wood, metal or fibreboard, protected against shocks. More than 5 kgs. must be shipped as cargo. Must be packaged separately from firearm and a declaration form is required.
Archery Equipment	Yes	N/A	Yes	Yes	AREQ	Max. 23 kgs. Adequate packing recommended.
Bike	Yes	N/A	Yes	Yes	BIKE (SPB)	Handlebar must be rotated 90 degrees and tightened. Pedals must be removed. The bike must be packed in a carton box or in a special plastic box to protect other baggage/items from being damaged. Tires partially deflated.
Bike - Tandem	Checked as Cargo	Checked as Cargo				
Bulk baggage	Checked as Cargo	Checked as Cargo				
Cabin baggage in seat	No	N/A	Yes (Intermediate station must be informed)	Yes	CBBG (SBP)	An extra seat must be booked and paid. Max. weight 75 kg. No baggage allowance for the extra seat purchased.
Canoe	Checked as Cargo	Checked as Cargo				
Emotional support animals	Yes, Free	N/A	Yes carrier restrictions apply	Yes	ESAN	Letterhead documentation from licensed physician within the past 12 months required. Exempt from any weight limitations and kennel requirements.



## EGYPTAIR (MS) - continued

ITEMS	WITHIN FREE BAGGAGE ALLOWANCE		INTERLIN-EABLE	SSR REQUIRED	SSR ITEM	PACKAGING REQUIRED
	Piece Concept	Weight Concept				
Falcons	No	N/A	Yes	Yes	PETC	Reservation, valid certificates and permits required. 1 Falcon can be carried against excess bag ticket. If more, extra seat must be purchased. Max 2 Falcons per seat. Must be hooded and restrained on perches. Max 10 on narrowbody & 15 on widebody aircraft
Film Equipment	Yes	N/A	Yes	Yes	FILM	Suitable packaging in rigid or metal boxes. Max 23kg in Y Class and 32kg in C Class.
Firearms	Yes	N/A	Allowed from INT to INT only	Yes	WEAP (FAM) (WEA)	Must be packed in strong rigid container made of wood, metal, fiber. Cartridges securely boxed in quantity not exceeding 5 kgs/ pax. Firearms must be unloaded, i.e. cartridges or bullets must be removed to render the firearms inoperative, before acceptance.
Fishing equipment	Yes	N/A	Yes	Yes	FIEQ	Max 23 kgs must be checked into the hold. Packing recommended. No live bait carried.
Golf equipment	Yes	N/A	Yes	Yes	XGOL	Golf equipment should be enclosed with a cover to prevent loss of contents. Max weight 23kg. One Golf bag: Clubs, 1 pair shoes, balls, umbrella.
Hang gliders	Checked as Cargo	Checked as Cargo				
Kayaks	Checked as Cargo	N/A				
Kite	No	N/A	Yes	Yes	KITE	Must be properly packed for transportation. Max 32kg. Max 2m.



## EGYPTAIR (MS) - continued

ITEMS	WITHIN FREE BAGGAGE ALLOWANCE		INTERLIN-EABLE	SSR REQUIRED	SSR ITEM	PACKAGING REQUIRED
	Piece Concept	Weight Concept				
Oars	Yes	N/A	Yes	Yes	OARS	Max 23kg. Max 2m. 1 Oar case contains 2 oars.
Pets as Checked Baggage (AVIH)	No	N/A	Yes (carrier restrictions apply)	Yes	AVIH (up to 23kg) AVIM (24-32kg) AVIL (33-45kg)	Clean/Leakage proof/Escape-proof/Well ventilated container according to IATA LAR. Cage must be large enough that the animal can stand upright, reservation has to be made for connecting flight. A/C E170 and A320 (SUGCL) not allowed.
Pets in Cabin	No	N/A	Yes (carrier restrictions apply)	Yes	PETC (PET)	Cats and dogs only. Weight of animal and container max. 8 Kgs (55x40x20). Reservation to be made for connecting flights. 1 container per pax. (2 cohabiting pets can be accepted in 1 cage). 2 containers per cabin class.
Scuba Equipment	Yes	N/A	Yes	Yes	SCEQ	Max 23 kgs. Oxygen bottles must be empty. Gear must be securely packed in a rigid or hard shell container.
Service Animals	Yes, free	N/A	Yes (carrier restrictions apply)	Yes	SVAN	Seeing eye dog/ hearing aid dog, SVAN. Animals should be accompanied with valid health/vaccination certificates/entry permits. Escort dog in cabin is exempted from any weight limitations and container requirements.
Skis/Snowboard	Yes	N/A	Yes	Yes	XSKI	Max 23kg. Packed in rigid or soft shell container. 1 set contains: 1 skis, boots, poles OR snowboard and boots OR waterskis OR wakeboard.
Small Surfboard less than 2m/Wakeboard	No	N/A	Yes	Yes	SSRB	When packaging a surfboard, keels and/or kedges must be removed or crated in such a manner so as to prevent damage to other baggage. The passengers must sign a limited release bag tag.



## EGYPTAIR (MS) - continued

ITEMS	WITHIN FREE BAGGAGE ALLOWANCE		INTERLIN-EABLE	SSR REQUIRED	SSR ITEM	PACKAGING REQUIRED
	Piece Concept	Weight Concept				
Surfboard/Windsurfer	Checked as Cargo	Checked as Cargo			SPEQ (SPB)	
Vaulting Poles	Checked as Cargo	Checked as Cargo				
Wheelchair with Wet Cell Batteries	Checked as Cargo	Checked as Cargo			WCBW	
Wheelchair non-powered	Yes, free	N/A	Yes	Yes	WCMP	Suitable backing or wrapping required.
Wheelchair with Dry Cell Batteries	Yes, free	N/A	Yes (carrier restrictions apply)	Yes	WCBD (RMD)	Battery must be disconnected, terminals insulated and attached to the wheelchair. Gel type and wet (sealed non spillable) battery operated are accepted. Removable battery must be insulated and securely packed in a wooden or metal box.
Wheelchair with Lithium Battery	Yes, Free	N/A	Yes	Yes	WCLB	Max 300Wh per battery. Battery terminals must be insulated. Max 1 spare battery 300Wh, or 2 160Wh (in cabin). Removable batteries must be packaged.



## Ethiopian Airlines (ET)

ITEMS	WITHIN FREE BAGGAGE ALLOWANCE		INTERLIN-EABLE	SSR REQUIRED	SSR ITEM	PACKAGING REQUIRED
	Piece Concept	Weight Concept				
Ammunition	Not defined	Not defined	Yes	Yes	WEAP	Must be packed in a strong container made of wood, metal or fiberboard. Ammunition must be secured against shock and movement. Max. of 5 kg and declaration required.
Archery Equipment	N/A	N/A	N/A	N/A	N/A	N/A
Bike	No	No	Yes	Yes	BIKE	Will be accepted if handlebars turned sideways, pedals removed, all sharp protrusions padded and boxed or in container.
Bike - Tandem	N/A	N/A	N/A	N/A	N/A	N/A
Bulk baggage	No	No	Yes	Yes	BULK	No
Cabin baggage in seat	No	No	Yes	Yes	CBBG	Must be placed forward of all seated pax in aircraft. Secured with seatbelt and seatbelt extension. Articles too large or bulky will not be accepted.
Canoe	No	No	Yes	Yes	SPEQ	No
Firearms	Yes	Yes	Yes	Yes	WEAP	Must be free from ammunition and packed in crash-proof container. Baggage containing handguns must be locked with a key or combination lock.
Fishing equipment	N/A	N/A	N/A	N/A	N/A	N/A
Golf equipment	No	No	Yes	Yes	SPEQ	Must be packed in soft or hard golf case.
Hang gliders	N/A	N/A	N/A	N/A	N/A	N/A
Kayaks	N/A	N/A	N/A	N/A	N/A	N/A
Kite	No	No	Yes	Yes	SPEQ	No
Pets as Checked Baggage (AVIH)	No	No	Yes	Yes	AVIH	The container must be ventilated on three sides and big enough to let the animal stand up and lie down in comfort.
Pets in Cabin	No	No	Yes	Yes	PETC	Total weight not exceeding 8 kgs including cage, and dimensions not more than 55x40x20 cm.
Scuba Equipment	No	No	Yes	Yes	SPEQ	Must be packed in a proper soft or hard scuba case.



## Ethiopian Airlines (ET) - continued

ITEMS	WITHIN FREE BAGGAGE ALLOWANCE		INTERLIN-EABLE	SSR REQUIRED	SSR ITEM	PACKAGING REQUIRED
	Piece Concept	Weight Concept				
Service Animals	Yes	Yes	Yes	Yes	PETC	Seeing eye dogs and hearing ear dogs must be harnessed and muzzled.
Skis/Snowboard	No	No	Yes	Yes	SPEQ	Must be packed in a proper soft or hard ski/snowboard bag.
Small Surfboard less than 2m/Wakeboard	N/A	N/A	N/A	N/A	N/A	N/A
Surfboard/Windsurfer	No	No	Yes	Yes	SPEQ	One surfboard is not required to be in a case. If more than 2 must be in a surfboard case.
Vaulting Poles	No	No	Yes	Yes	SPEQ	No
Wet Cell Batteries	Yes	Yes	Yes	Yes	WCBW	Disconnect battery. Terminals insulated to prevent short circuits and battery must be securely attached to the wheelchair.
Wheelchair non-powered	Yes	Yes	Yes	Yes	WCMP	No
Wheelchair with Dry Cell Batteries	Yes	Yes	Yes	Yes	WCBD	No





## EVA Airways (BR)

ITEMS	WITHIN FREE BAGGAGE ALLOWANCE		INTERLIN-EABLE	SSR REQUIRED	SSR ITEM	PACKAGING REQUIRED
	Piece Concept	Weight Concept				
Ammunition	Yes	Yes	Yes	Yes	WEAP	Restrictions apply/country acceptance requirements apply. Packaged separately from firearm. Declaration form required. Advise Reservation office prior to travel.
Archery Equipment	Yes	Yes	Yes	Yes	SPEQ	Yes
Bike	Yes	Yes	Yes	Yes	BIKE	Advisable to rotate handlebar 90 degrees and tighten. Pedals must be turned inside or removed.
Bike - Tandem	Yes	Yes	Yes	Yes	BIKE	Advisable to rotate handlebar 90 degrees and tighten. Pedals turned inside or removed. Advise Reservation office prior to travel.
Bulk baggage	Yes	Yes	Yes	Yes	BULK	Oversize/overweight baggage to get approval from TPERDBR prior to travel.
Cabin baggage in seat	No	No	No	Yes	CBBG	Pax to pack non-square shape CBBG into secure and strong box with handles. Advise Reservation office prior to travel.
Firearms	Yes	Yes	Yes	Yes	WEAP	Restrictions apply/country acceptance requirements apply. Firearm must be unloaded. Packaged in locked non-see-through case. Declaration form required. Ammunition packaged separately. Advise Reservation office prior to travel.
Fishing equipment	Yes	Yes	Yes	No	SPEQ	Yes
Golf equipment	Yes	Yes	Yes	No	SPEQ	Yes
Hang gliders	Yes	Yes	Yes	No	SPEQ	Yes
Kayaks	Yes	Yes	Yes	No	SPEQ	Recommended, but not mandatory. Advise Reservation office prior to travel.
Kite	Yes	Yes	Yes	No	SPEQ	Yes
Pets as Checked Baggage (AVIH)	No	No	No	Yes	AVIH	Approved Kennel. Related document required. Country acceptance required if needed. Advise Reservation office prior to travel.



## EVA Airways (BR) - continued

ITEMS	WITHIN FREE BAGGAGE ALLOWANCE		INTERLIN-EABLE	SSR REQUIRED	SSR ITEM	PACKAGING REQUIRED
	Piece Concept	Weight Concept				
Pets in Cabin	Not Accepted. Service animals only.	Not Accepted. Service animals only.	No	No	N/A	N/A
Scuba Equipment	Yes	Yes	Yes	No	SPEQ	Tank must be empty.
Service Animals	Yes. Birds not accepted in cabin as service animals	Yes. Birds not accepted in cabin as service animals	Yes	Yes	SVAN	NA. Advise Reservation office prior to travel.
Skis/Snowboard	Yes	Yes	Yes	No	SPEQ	Yes
Small Surfboard less than 2m/Wakeboard	Yes	Yes	Yes	No	SPEQ	Recommended, but not mandatory. Advise Reservation office prior to travel.
Surfboard/Windsurfer	Yes	Yes	No	No	SPEQ	Recommended, but not mandatory. Considered as normal checked baggage and extra baggage charges will be collected based on the dimensions. Advise Reservation office prior to travel.
Wheelchair with Wet Cell Batteries	Yes	Yes	Yes	Yes	WCBW	Must be loaded, stowed, secured and unloaded in an upright position. BR can accept the interline baggage containing removed spillable batteries provided that all requirements are met with IATA regulations.
Wheelchair non-powered	Free baggage at no charge	Free baggage at no charge	Yes	Yes	WCMP	For disabled passenger use only.
Wheelchair with Dry Cell Batteries	Free baggage at no charge	Free baggage at no charge	Yes	Yes	WCBDB	Battery must be disconnected. If the wheelchair cannot be stowed in an upright position, battery must be removed and prevented from short circuit. For disabled passenger use only.
Wheelchair with Lithium Battery	Free baggage at no charge	Free baggage at no charge	Yes	Yes	WCLB	For disabled passenger use only.

**LOT LOT Polish Airlines (LO)**

ITEMS	WITHIN FREE BAGGAGE ALLOWANCE		INTERLIN-EABLE	SSR REQUIRED	SSR ITEM	PACKAGING REQUIRED
	Piece Concept	Weight Concept				
Ammunition	Yes (up to 5 kg/ pax with firearms)	No	Yes	Yes	WEAP	Special boxes with proper label "Firearm(s) unloaded".
Archery Equipment	No	No	Yes	Yes	SPEQ (description & 3 dimensions)	Adequate packaging recommended.
Bike	Yes <b>1</b>	No	Yes	Yes	BIKE	Cardboard package recommended. Handlebars fixed sideways or removed, pedals fixed inside.
Bike - Tandem	No	No	Yes	Yes	BIKE	Cardboard package recommended. Handlebars fixed sideways or removed, pedals fixed inside.
Bulk baggage	No	No	Yes	Yes	SPEQ (description & 3 dimensions)	Adequate packaging recommended.
Cabin baggage in seat	No	No	Yes	Yes	CBBG	An extra seat must be booked and paid. Max. weight 75 kg.
Firearms	Yes <b>2</b>	No	Yes	Yes	WEAP	Special boxes with proper label "Firearm(s) unloaded".
Fishing equipment	Yes <b>1</b>	No	Yes	Yes	SPEQ (description & 3 dimensions)	Adequate packaging recommended.
Golf equipment	Yes	No	Yes	Yes	SPEQ-GOLF (with weight and dimensions)	Golf equipment adequate package.
Hang gliders	No	No	Yes	Yes	SPEQ (description & 3 dimensions)	Packaging recommended.
Kayaks	No	No	No	Yes	SPEQ (description & 3 dimensions)	Depending on the type of a/c and kind of kayak. Every case must be confirmed by LOT Space Control Department.
Kite	Yes <b>1</b>	No	Yes	Yes	SPEQ (description & 3 dimensions)	Packaging recommended.
Pets as Checked Baggage (AVIH)	No	No	Yes	Yes	AVIH	Cage
Pets in Cabin	No	No	Yes	Yes	PETC	Bag or cage (up to 8 kg). Dogs, cats and ferrets only.
Scuba Equipment	No	No	No	No	SPEQ (description & 3 dimensions)	Adequate packaging recommended.

**LOT** LOT Polish Airlines (LO) - continued

ITEMS	WITHIN FREE BAGGAGE ALLOWANCE		INTERLIN-EABLE	SSR REQUIRED	SSR ITEM	PACKAGING REQUIRED
	Piece Concept	Weight Concept				
Service Animals	Yes - free	Yes - free	Yes	Yes	PETC	
Skis/Snowboard	Yes <sup>1</sup>	No	Yes	Yes	SPEQ (description & 3 dimensions)	Packaging recommended.
Small Surfboard less than 2m/Wakeboard	No	No	No	No	SPEQ (description & 3 dimensions)	Adequate packaging recommended.
Surfboard/Windsurfer	No	No	No	No	SPEQ (description & 3 dimensions)	Adequate packaging recommended. Acceptance depending on the type of a/c.
Wet Cell Batteries	Yes - after in advance arrangements	Yes - after in advance arrangements	Yes - after in advance arrangements	Yes	WCBW	Fitted with spill resistant vent caps, batteries disconnected, pilot-in-command to be notified
Wheelchair non-powered	Yes - free	Yes - free	Yes	Yes	WCMP	
Wheelchair with Dry Cell Batteries	Yes - after in advance arrangements	Yes - after in advance arrangements	Yes - after in advance arrangements	Yes	WCBD	Batteries disconnected..

**NOTE:** <sup>1</sup> If in category "small" and within free pieces allowance.

<sup>2</sup> If in category small and packed in regular checked bag (including guns of security guards on duty), otherwise with additional payment.



## Lufthansa (LH)

ITEMS	WITHIN FREE BAGGAGE ALLOWANCE		INTERLIN-EABLE	SSR REQUIRED	SSR ITEM	PACKAGING REQUIRED
	Piece Concept	Weight Concept				
Ammunition	Yes	N/A	Yes	Yes	WEAP	Yes
Archery Equipment	Yes	N/A	Yes	Yes	SPEQ	Yes
Bike	Yes	N/A	Yes	Yes	BIKE	No
Bike - Tandem	Yes	N/A	Yes	Yes	BULK	No
Bulk baggage	No	N/A	Yes	Yes	BULK	No
Cabin baggage in seat	No	N/A	Yes	Yes	CBBG	No, but must be restrained in seat.
Canoe	Yes	N/A	Yes	Yes	BULK	No
Fencing	Yes	N/A	Yes	Yes	SPEQ	No
Firearms	Yes	N/A	Yes	Yes	WEAP	Yes
Fishing equipment	Yes	N/A	Yes	Yes	SPEQ	Yes
Golf equipment	Yes	N/A	Yes	Yes	SPEQ	No
Hang gliders	Yes	N/A	Yes	Yes	BULK	Yes
Kayaks	Yes	N/A	Yes	Yes	BULK	No
Kite	Yes	N/A	Yes	Yes	SPEQ	No, but recommended
Pets as Checked Baggage (AVIH)	No	N/A	Yes	Yes	AVIH	Yes, in appropriate kennel.
Pets in Cabin	No	N/A	Yes	Yes	PETC	Yes
Scuba Equipment	Yes	N/A	Yes	Yes	SPEQ	No
Service Animals	Yes	N/A	Yes	Yes	SVAN	No
Skis/Snowboard	Yes	N/A	Yes	Yes	SPEQ	Yes



## Lufthansa (LH) - continued

ITEMS	WITHIN FREE BAGGAGE ALLOWANCE		INTERLIN-EABLE	SSR REQUIRED	SSR ITEM	PACKAGING REQUIRED
	Piece Concept	Weight Concept				
Small Surfboard less than 2m/Wakeboard	Yes	N/A	Yes	Yes	SPEQ	No, but recommended
Surfboard/Windsurfer	Yes	N/A	Yes	Yes	SPEQ/BULK	No, but recommended
Vaulting Poles	Yes	N/A	Yes	Yes	BULK	No
Wheelchair non-powered	Yes	N/A	Yes	Yes	WCMP	No
Wheelchair with Dry Cell Batteries	Yes	N/A	Yes	Yes	WCBD	No
Wheelchair with Lithium Battery	Yes	N/A	Yes	Yes	WCLB	No
Wheelchair with Wet Cell Batteries	Yes	N/A	Yes	Yes	WCBW	No



## Scandinavian Airlines (SK)

ITEMS	WITHIN FREE BAGGAGE ALLOWANCE		INTERLIN-EABLE	SSR REQUIRED	SSR ITEM	PACKAGING REQUIRED
	Piece Concept	Weight Concept				
Ammunition	Yes	N/A	Yes	Yes	SR WEAP	Max 5 kg. Separate from the weapon.
Archery Equipment	Yes	N/A	Yes	No	SR*SPEQ-ARCHERY	Yes, Required.
Bike	Yes	N/A	Yes	No if packed in bike bag Yes if unpacked	SR BIKE	
Bike - Tandem	Forbidden	N/A		Must be sent as cargo	Must be sent as cargo	Yes, must be sent as cargo.
Bulk baggage	Yes	N/A	Yes	Yes	SR*KGS150 DIMS 100X40X40CM	Yes, Required
Cabin baggage in seat	No	N/A	Yes	Yes	SR*SPEQ CELLO	Musical instrument Cello only. The cello shall not exceed 150 x 35 x 50 cm.
Firearms	Yes	N/A	Yes	Yes	SR*WEAP	Sporting weapon only.
Fishing equipment	Yes	N/A	Yes	No		Suitable packaging required.
Golf equipment	Yes	N/A	Yes	No	SR*SPEQ-GOLF	Yes, Packaging required
Hang gliders	Yes	N/A	Yes	Yes	SR*SPEQ- HANG GLIDER	Suitable packaging required.
Kayaks	No, (only accepted as cargo)	N/A		Only accepted as cargo	Only accepted as cargo	Only accepted as cargo.
Kite	Yes	N/A	Yes	No		Required
Pets as Checked Baggage (AVIH)	Yes	N/A	Yes	Yes	SR AVIH	Leakage and bite proof material.
Pets in Cabin	Yes	N/A	Yes	Yes	SSR PETC	Leakage proof container 8 kg.



## Scandinavian Airlines (SK) - continued

ITEMS	WITHIN FREE BAGGAGE ALLOWANCE		INTERLIN-EABLE	SSR REQUIRED	SSR ITEM	PACKAGING REQUIRED
	Piece Concept	Weight Concept				
Scuba Equipment	Yes	N/A	Yes	No	SR*SPEQ-DIVING	Tank must be empty.
Service Animals	No	N/A	Yes	Yes	SR SVAN - SERVICE ANIMAL	No.
Skis/Snowboard	Yes	N/A	Yes	No		Yes, Total maximum combined weight of ski equipment (1 ski cover + 1 ski boot bag): 32kg in SAS Business and 23kg in Plus and Go.
Small Surfboard less than 2m/Wakeboard	Yes	N/A	Yes	No	SR*SPEQ-WAKEBOARD	No, but recommended.
Surfboard/Windsurfer	Yes	N/A	Yes	Yes	SR*SPEQ-WINDSURFER	If only board, not required. Board with sail, required.
Wet Cell Batteries	Yes	N/A	Yes	Yes	SR*WCBW-120X80X70cm /40kgs/S2/P1	Yes, packaging required.
Wheelchair non-powered	Yes	N/A	Yes	Yes	SR*WCMP 100X80X70cm/ /40kgs/S2/P1	One input per segment must be made with dimensions and weight.
Wheelchair with Dry Cell Batteries	Yes	N/A	Yes	Yes	SR*WCBD 120X80X70cm/ /80kgs/S2/P1	One input per segment must be made with dimensions and weight.

**NOTE:** Maximum dimension is only applicable to cabin baggage.





## Shenzhen Airlines (ZH)

ITEMS	WITHIN FREE BAGGAGE ALLOWANCE		INTERLIN-EABLE	SSR REQUIRED	SSR ITEM	PACKAGING REQUIRED
	Piece Concept	Weight Concept				
Ammunition	No	Yes	No	No		Securely packaged in quantities not exceeding 5 kg gross per pax.
Archery Equipment						
Bike	No	Yes	No	No		To protect other baggage/item from damage, handlebar must be turned lengthwise and pedals taken off.
Bike - Tandem						
Bulk baggage						
Cabin baggage in seat	No	No	No	Yes	CBBG	Cabin baggage in seat must be paid. Baggage must be restrained in seat, and extra paid. Max. weight 75 kg.
Firearms	No	Yes	No	No		Sporting gun and bullets only.
Fishing equipment	No	Yes	No	No		Packaging required. Equipment cannot exceed 2 rods, one reel, one dipnet, one pair of fishing boots and one tool box.
Golf equipment	No	Yes	Yes	No		Check as normal baggage.
Hang gliders						
Kayaks						
Kite						
Pets as Checked Baggage (AVIH)	No	No	No	Yes	AVIH	The permit request must be made before check in. AVIH must be paid. Waste leakage proof/escape proof. Must be large enough for the animal to stand upright.
Pets in Cabin						
Scuba Equipment						



## Shenzhen Airlines (ZH)

ITEMS	WITHIN FREE BAGGAGE ALLOWANCE		INTERLIN-EABLE	SSR REQUIRED	SSR ITEM	PACKAGING REQUIRED
	Piece Concept	Weight Concept				
Service Animals						Must apply for service while booking. Each flight accepts only one service animal.
Skis/Snowboard	No	Yes	Yes	No		Check as normal baggage.
Small Surfboard less than 2m/Wakeboard						
Surfboard/Windsurfer						
Wet Cell Batteries						
Wheelchair non-powered	No	Yes	Yes	No		Check as normal baggage.
Wheelchair with Dry Cell Batteries	No	Yes	No	No		Appliance with IATA DGR.



## Singapore Airlines (SQ)

ITEMS	WITHIN FREE BAGGAGE ALLOWANCE		INTERLIN-EABLE	SSR REQUIRED	SSR ITEM	PACKAGING REQUIRED
	Piece Concept	Weight Concept				
Ammunition	Yes	Yes	No	No	Telex has to be sent to carrier's local reservation office.	Telex to be sent. Cartridges must be secured in box and quantity should not exceed 5 kgs/person and for sporting use only. Carriage of ammunition is not allowed in cabin.
Archery Equipment	Yes	Yes	Yes	No		
Bike	Yes	Yes	Yes	No		Bike may be accepted provided pedals are taken off and handlebar is turned lengthwise.
Bike - Tandem	Yes	Yes	Yes	No		
Bulk baggage	Yes	Yes	Yes	No		
Cabin baggage in seat	No	No	Yes	Yes	CBBG - must be included in SSR element	Weight limited to 40 kgs and dimensions have to fit the seat and item must be able to be strapped.
Firearms	Yes	Yes	No	No		Telex to be sent. Carrier will only accept sporting rifles for carriage. Check with local carrier reservation office for details. Carriage of firearms in cabin is not allowed for any passenger.
Fishing equipment	Yes	Yes	Yes	No		
Golf equipment	Yes	Yes	Yes	No		
Hang gliders	Yes	Yes	No	No		
Kayaks	No	No	No	No		
Kite	Yes	Yes	Yes	No		
Pets as Checked Baggage (AVIH)	Yes	Yes	Yes	Yes	AVIH - must be included in SSR element	Telex to be sent. Carrier will only accept certain breeds of domestic dogs/cats (check with local reservation office), subject to government regulations.



## Singapore Airlines (SQ) - continued

ITEMS	WITHIN FREE BAGGAGE ALLOWANCE		INTERLIN-EABLE	SSR REQUIRED	SSR ITEM	PACKAGING REQUIRED
	Piece Concept	Weight Concept				
Pets in Cabin	No	No	No	No		We do not accept pets in cabin except seeing eye dog.
Scuba Equipment	Yes	Yes	Yes	No		Tank must be completely empty of contents.
Service Animals	Yes	Yes	Yes	Yes	PETC - must be included in SSR element	We only accept seeing eye dog in cabin.
Skis/Snowboard	Yes	Yes	Yes	No		
Small Surfboard less than 2m/Wakeboard	Yes	Yes	No	No		Contact carrier office. Subject to space availability.
Surfboard/Windsurfer	Yes	Yes	Yes	No		
Wet Cell Batteries	Yes	Yes	No	Yes	WCBW - must be included in SSR element	There is no charge for transportation.
Wheelchair non-powered	Yes	Yes	Yes	Yes	WCMP - must be included in SSR element	There is no charge for transportation.
Wheelchair with Wet Cell Batteries	Yes	Yes	No	Yes	WCBD - must be included in SSR element	There is no charge for transportation.



## South African Airways (SA)

ITEMS	WITHIN FREE BAGGAGE ALLOWANCE		INTERLIN-EABLE	SSR REQUIRED	SSR ITEM	PACKAGING REQUIRED
	Piece Concept	Weight Concept				
Ammunition	Yes	Yes	No	No		
Archery Equipment	Yes	Yes	No	No		
Athletic track & field	Yes	Yes	No	No		
Baseball / Softball / Basketball / Bowls / Soccer / Rugby / Netball	Yes	Yes	No	No		
Bike	Yes	Yes	Yes	No		
Bike - Tandem	No	No	No	No		Not accepted as checked baggage, only cargo.
Bowling Equipment	Yes	Yes	Yes	No		
Bulk baggage	No	No	No	No		
Cabin baggage in seat	No	No	No	No		
Cricket	Yes	Yes	No	No		
Firearms	Yes	Yes	No	No		
Fishing equipment	Yes	Yes	No	No		
Golf equipment	Yes	Yes	Yes	No		
Hang gliders	No	No	No	No		
Kayaks	No	No	No	No		Not accepted as checked baggage, only cargo
Kite	Yes	Yes	Yes	No		Included in free baggage allowance. Thereafter the applicable excess baggage rate is charged.
Motorcycle gear	Yes	Yes	Yes	No		Protective riding gear & helmet, motorcycle to be sent as cargo.
Parachute	Yes	Yes	Yes	No		
Pets as Checked Baggage (AVIH)	No	No	Yes	Yes		Must travel as manifested cargo on international flights.
Pets in Cabin	No	No	No	No		Not allowed on SAA aircraft.



## South African Airways (SA) - continued

ITEMS	WITHIN FREE BAGGAGE ALLOWANCE		INTERLIN-EABLE	SSR REQUIRED	SSR ITEM	PACKAGING REQUIRED
	Piece Concept	Weight Concept				
Polo Cross	Yes	Yes	Yes	No		Riding helmet, stick and balls.
Rock climbing	Yes	Yes	Yes	No		Helmets, rope bags, climbing harness & crash pads / bouldering mats if not exceeding 200 cm in length.
Sailing equipment	Yes	Yes	Yes	No		Wet/dry sailing suits, life jackets, water boots, ropes, blocks, pulleys, selected tools, water bottle (empty), sails (folded or rolled), tube may not be longer than 200 cm.
Scuba Equipment	Yes	Yes	Yes	No		Tank must be empty.
Service Animals	No	No	Yes	Yes		One dog for blind or deaf passengers in the cabin at no cost. Service Animals allowed as per DOT Part 382 regulations.
Skis/Snowboard	Yes	Yes	Yes	No		One pair of skis, poles, boots and one snowboard included in allowance.
Small Surfboard less than 2m/Wakeboard	Yes	Yes	Yes	No		Packed well and marked.
Surfboard/Windsurfer	No	No	No	No		Packed well and marked.
Tennis/Squash/Badminton	Yes	Yes	Yes	No		
Wet Cell Batteries	No	No	Yes	Yes		
Wheelchair non-powered	No	No	Yes	Yes		
Wheelchair with Dry Cell Batteries	Yes	Yes	Yes	Yes		

ITEMS	WITHIN FREE BAGGAGE ALLOWANCE		INTERLIN-EABLE	SSR REQUIRED	SSR ITEM	PACKAGING REQUIRED
	Piece Concept	Weight Concept				
Ammunition	Yes	N/A	Yes	Yes	WEAP	Packed separately from firearm in strong container made of wood/metal/fibreboard. Protected inside container against shock and secured against movement. Limit of 5 kg per pax.
Archery Equipment	Yes	N/A	Yes	No		
Bike	Yes	N/A	Yes	Yes	BIKE	Must be packed in a cardboard box or in a hardshell container.
Bike - Tandem	Yes	N/A	Yes	Yes	BIKE	Must be packed in a cardboard box or in a hardshell container.
Bulk baggage	N/A	N/A	N/A	N/A	N/A	
Cabin baggage in seat	No	N/A	Yes	Yes	CBBG	Extra seat must be booked and paid. Max. weight 75 kg.
Firearms	Yes	N/A	Yes	Yes	WEAP	Arms must be unloaded, suitably packed in a strong rigid container made of wood/metal/fibre/styropor etc. LX needs pre-advice TLX from carrier to transfer station and destination.
Fishing equipment	Yes	N/A	Yes	No		
Golf equipment	Yes	N/A	Yes	No		
Hang gliders	Yes	N/A	Yes	No		
Kayaks	Yes	N/A	Yes	No		
Kite	Yes	N/A	Yes	No		
Pets as Checked Baggage (AVIH)	No	N/A	Yes	Yes	AVIH	Animal container must be large enough that the animal can stand upright, turn and lie down in a natural manner.
Pets in Cabin	No	N/A	Yes	Yes	PETC	Container must be soft-sided with max. weight of 8 kg (animal including container). Only dogs and cats allowed.
Scuba Equipment	Yes	N/A	Yes	No		Torch in carry-on baggage only
Service Animals	Yes - free	N/A	Yes	Yes	PETC	Only dogs allowed

**SWISS (LX) - continued**

ITEMS	WITHIN FREE BAGGAGE ALLOWANCE		INTERLIN-EABLE	SSR REQUIRED	SSR ITEM	PACKAGING REQUIRED
	Piece Concept	Weight Concept				
Skis/Snowboard	Yes. Every pax may check in 1 eq. free, except when holding a Light fare with no free baggage allowance.	N/A	Yes	No		
Small Surfboard less than 2m/Wakeboard	Yes	N/A	Yes	No		
Surfboard/Windsurfer	Yes	N/A	Yes	No		
Vaulting Poles	Yes	N/A	Yes	No		Must be pre-advised.
Wet Cell Batteries	Yes - free	N/A	Yes	Yes	WCHR / WCHS / WCHC & WCBW	Only accepted in conx. with wheelchair with wet cell batteries. The battery package must be leak-tight, impervious to battery fluid and protected against spillage. IATA DGR rules apply.
Wheelchair non-powered	Yes - free	N/A	Yes	Yes	WCHR / WCHS / WCHC & WCMP	
Wheelchair with Dry Cell Batteries	Yes - free	N/A	Yes	Yes	WCHR / WCHS / WCHC & WCBW	Battery must be securely attached to the wheelchair. IATA DGR rules apply.



ITEMS	WITHIN FREE BAGGAGE ALLOWANCE		INTERLIN-EABLE	SSR REQUIRED	SSR ITEM	PACKAGING REQUIRED
	Piece Concept	Weight Concept				
Ammunition	No	No	Yes	Yes	WEAP	Special packing required. Max. 5 kgs per passenger. Service fee applicable. Accepted as extra checked baggage.
Archery Equipment	No	No	Yes	Yes	SPEQ	Special packing required. Service fee applicable. Accepted as extra checked baggage.
Bike	No	No	Yes	Yes	BIKE	Special packing required. Service fee applicable. Accepted as extra checked baggage.
Bike - Tandem	No	No	Yes	Yes	BIKE	Special packing required. Service fee applicable. Accepted as extra checked baggage.
Bulk baggage	No	Yes	Yes	Yes	BULK	Special packing required. Service fee applicable. Accepted as extra checked baggage.
Cabin baggage in seat	Not applicable	Not applicable	Yes	Yes	CBBG	Special packing required. Max. 75 kgs per seat. Service fee, extra seat applies.
Emotional support animals	Not applicable	Not applicable	Yes	Yes	ESAN	Restricted to cats and dogs, in a pet container. Accepted free of charge.
Firearms	No	No	Yes	Yes	WEAP	Special packing required. Firearms unloaded and ammunitions packed separated. Service fee applicable.
Fishing equipment	No	No	Yes	Yes	SPEQ	Special packing required. Service fee applicable.
Golf equipment	No	No	Yes	Yes	SPEQ	Special packing required. Service fee applicable.
Hang gliders	No	No	Yes	Yes	SPEQ	Special packing required. Maximum weight up to 32 kgs. Service fee applicable.
Kayaks	No	No	Yes	Yes	SPEQ	Special packing required. Service fee applicable.
Kite	No	No	Yes	Yes	SPEQ	Special packing required. Maximum weight up to 32 kgs. Service fee applicable.
Pets as Checked Baggage (AVIH)	No	No	Yes	Yes	AVIH	Pet container required. Max. weight allowed 32 kgs or 45 kgs per pet plus container. Service fee applicable.

ITEMS	WITHIN FREE BAGGAGE ALLOWANCE		INTERLIN-EABLE	SSR REQUIRED	SSR ITEM	PACKAGING REQUIRED
	Piece Concept	Weight Concept				
Pets in Cabin	Not applicable	Not applicable	Yes	Yes	PETC	Pet container required. Restricted to cats and dogs. Max. weight 8 kgs and limited dimensions apply. Service fee applicable.
Scuba Equipment	No	No	Yes	Yes	SPEQ	Special packing required. Service fee applicable. Accepted as extra checked baggage.
Service Animals	Not applicable	Not applicable	Yes	Yes	SVAN	Acceptance in cabin restricted to dogs only, with training. Pet container not required. Accepted free of charge.
Skis/Snowboard	No	No	Yes	Yes	SPEQ	Special packing required. Service fee applicable. Accepted as extra checked baggage.
Surfboard/Windsurfer	No	No	Yes	Yes	SPEQ	Special packing required. Max. weight 32 kgs. Service fee applicable. Accepted as extra checked baggage.
Wheelchair non-powered	No	No	Yes	Yes	WCMP plus WCHR/S/C service required (as applicable) shall be included	Accepted free of charge. Accepted as extra checked baggage.
Wheelchair with Dry Cell Batteries	No	No	Yes	Yes	WCBD plus WCHR/S/C service required (as applicable) shall be included	Accepted under conditions stipulated in DGR. Accepted as extra checked baggage, free of charge. According to IATA recommended practice "must be claimed and rechecked at each interline transfer point".
Wheelchair with Lithium Battery	No	No	Yes	Yes	WCLB plus WCHR/S/C service required (as applicable) shall be included	Accepted under conditions stipulated in DGR. Accepted as extra checked baggage, free of charge. According to IATA recommended practice "must be claimed and rechecked at each interline transfer point".
Wheelchair with Wet Cell Batteries	No	No	Yes	Yes	WCBW plus WCHR/S/C service required (as applicable) shall be included	Accepted under conditions stipulated in DGR. Accepted as extra checked baggage, free of charge. According to IATA recommended practice "must be claimed and rechecked at each interline transfer point".



## Thai Airways (TG)

ITEMS	WITHIN FREE BAGGAGE ALLOWANCE		INTERLIN-EABLE	SSR REQUIRED	SSR ITEM	PACKAGING REQUIRED
	Piece Concept	Weight Concept				
Ammunition	Yes	Yes	Yes	Yes	WEAP	Cartridges must be securely boxed in quantity not exceeding 5 kg per pax. Ammunition with explosive or incendiary projectiles is prohibited for carriage by air. (All are for sporting purpose).
Archery Equipment	Yes	Yes	Yes	Yes	SPEQ	
Bike	Yes	Yes	Yes	recommended but not mandatory	BIKE	To protect other baggage/items from damage, bicycle only be accepted as baggage provided handlebar is turned lengthwise and pedals are taken off.
Bike - Tandem	No	No	Yes	recommended but not mandatory	BIKE	To protect other baggage/items from damage, bicycle only be accepted as baggage provided handlebar is turned lengthwise and pedals are taken off.
Bulk baggage	Yes	Yes	Yes	Yes	BULK	Maximum 32 kg in weight
Cabin baggage in seat	No	No	Yes	Yes	CBBG	Maximum 50 kg per item per seat. Maximum 70 cm in height must be fitted in seat with seat belt.
Firearms	Yes	Yes	No	Yes	WEAP	Yes
Fishing equipment	Yes	Yes	Yes	Yes	SPEQ	Yes
Golf equipment	Yes	Yes	Yes	Yes	SPEQ	Yes
Hang gliders	Yes	Yes	Yes	Yes	SPEQ	Yes
Kayaks	Yes	Yes	No	Yes	SPEQ	
Kite	Yes	Yes	Yes	Yes	SPEQ	
Pets as Checked Baggage (AVIH)	No	No	Yes	Yes	AVIH	Yes, only dog or cat allowed.
Pets in Cabin	No	No	No	No	PETC	TG does not accept PETC since Aug. 2013, except for animals to accompany disability according to rules & regulations (Service animal/escort dog)
Scuba Equipment	Yes	Yes	Yes	Yes	SPEQ	



## Thai Airways (TG) - continued

ITEMS	WITHIN FREE BAGGAGE ALLOWANCE		INTERLIN-EABLE	SSR REQUIRED	SSR ITEM	PACKAGING REQUIRED
	Piece Concept	Weight Concept				
Service Animals	No	No	Yes	Yes	SVAN	SVAN accepted to accompany disability according to rules and regulation
Skis/Snowboard	Yes	Yes	Yes	Yes	SPEQ	
Small Surfboard less than 2m/Wakeboard	No	No	No	Yes	SPEQ	
Surfboard/Windsurfer	No	No	No	Yes	SPEQ	
Wet Cell Batteries	Yes	Yes	Yes	Yes	WCBW <sup>1</sup>	Accept under conditions stipulated in TG manual (dangerous goods chapter)
Wheelchair non-powered	Yes	Yes	Yes	Yes	WCMP	Weight / dimension required
Wheelchair with Dry Cell Batteries	Yes	Yes	Yes	Yes	WCBD	Accept under conditions stipulated in TG manual (dangerous goods chapter)

**NOTE:** <sup>1</sup> 1 Most Star Alliance carriers will not allow WCBW type on their flights. It is necessary to check, and confirmation must be received prior to acceptance.



## Turkish Airlines (TK)

ITEMS	WITHIN FREE BAGGAGE ALLOWANCE		INTERLIN-EABLE	SSR REQUIRED	SSR ITEM	PACKAGING REQUIRED
	Piece Concept	Weight Concept				
Ammunition	Yes	Yes	Yes	Yes	Must be requested.	Cartridges packed in strong container made of wood, metal or fibreboard, protected and secured against shock and movement inside container. Quantity not to exceed 5 kg per pax. (All for sporting purposes).
Archery Equipment	No	No	Yes	Yes	<b>1, 7</b>	No
Bike	No	No	Yes	Yes	Must be requested. <b>5</b>	No
Bike - Tandem	No	No	Yes	Yes	Must be requested. <b>5</b>	No
Bulk baggage	Yes	Yes	Yes	Yes	<b>1, 7</b>	No
Cabin baggage in seat	No	No	Yes	Yes	Must be requested. <b>2</b>	No. Must be restrained in seat.
Canoe	No (First piece free of charge)	No (First piece free of charge)	Yes	Yes	Must be requested. <b>1, 7</b>	No
Firearms	Yes	Yes	Yes	Yes	Must be requested. Only hunting weapons.	Yes
Fishing equipment	Yes	Yes	Yes	Yes	<b>1, 7</b>	No
Golf equipment	No (First piece free of charge)	No (First piece free of charge)	Yes	Yes	<b>1, 7</b>	No
Hang gliders	No	No	Yes	Yes	<b>1, 7</b>	No
Kayaks	No	No	Yes	Yes	<b>1, 7</b>	No
Kite	No	No	Yes	Yes	<b>1, 7</b>	No
Pets as Checked Baggage (AVIH)	No	No	Yes	Yes	Must be requested. <b>3</b>	Yes



## Turkish Airlines (TK) - continued

ITEMS	WITHIN FREE BAGGAGE ALLOWANCE		INTERLIN-EABLE	SSR REQUIRED	SSR ITEM	PACKAGING REQUIRED
	Piece Concept	Weight Concept				
Pets in Cabin	No	No	Yes	Yes	Must be requested. <b>4</b>	Yes
Scuba Equipment	No	No	Yes	Yes	<b>1, 7</b>	No. Tank must be empty.
Service Animals	Free of Charge	Free of Charge	Yes	Yes	Must be requested. <b>6</b>	No
Skis/Snowboard	No (First piece free of charge)	No (First piece free of charge)	Yes	Yes	<b>1, 7</b>	Yes
Small Surfboard less than 2m/Wakeboard	No	No	Yes	Yes	<b>1, 7</b>	No
Surfboard/Windsurfer	No	No	Yes	Yes	<b>1, 7</b>	No
Wet Cell Batteries	Not accepted.	Not accepted.	Not accepted.	Not accepted.	Not accepted.	Not accepted.
Wheelchair non-powered	Free of Charge	Free of Charge	Yes	Yes	Must be requested.	No
Wheelchair with Dry Cell Batteries	Free of Charge	Free of Charge	Yes	Yes	Must be requested.	Yes

**NOTE:** **1** Dimensions, weight and type of item must be advised. Not permitted over 32 kg. each piece.

**2** 1 piece allowed, max. size 50x59x67 cm. Max. weight 75 kgs. No size and weight restriction for musical instruments. Contrabass is not allowed in cabin.

**3** Dog and cat only. Dimensions of container, total weight and kind of animal must be advised.

**4** Dog and cat only. One species of animal per cabin class allowed on any Airbus and B777 aircraft. On other equipment, only one animal is accepted. Dimension of the box should be 45x35x23 cm. Weight of animal and cage cannot exceed 6 kgs.

**5** Dimensions, weight must be advised.

**6** Seeing-eye and Hearing-ear dogs to be requested as PETC. Service animals are accepted free of charge.

**7** Must be requested as XBAG.



## United (UA)

ITEMS	WITHIN FREE BAGGAGE ALLOWANCE		INTERLIN-EABLE	SSR REQUIRED	SSR ITEM	PACKAGING REQUIRED
	Piece Concept	Weight Concept				
Ammunition	Yes	Yes	Yes	Yes	WEAP	Yes, restrictions apply/country acceptance requirements apply.
Archery Equipment	Yes	Yes	Yes	No	N/A	Yes, in a hardsided container.
Bike	No	Yes (depending on weight)	Yes	No	BIKE	No, strongly recommended; aircraft limitations for UAX.
Bike - Tandem	No	Yes (depending on weight)	Yes	No	N/A	No, strongly recommended; aircraft limitations for UAX.
Bulk baggage	N/A	N/A	N/A	N/A	N/A	N/A
Cabin baggage in seat	No	N/A	Yes	Yes	CBBG	No, must be restrained in seat.
Firearms	Yes	Yes	Yes	Yes	WEAP	Yes, restrictions apply/country acceptance requirements apply.
Fishing equipment	Yes	Yes	Yes	No	N/A	Yes
Golf equipment	Yes	Yes	Yes	No	N/A	Yes
Hang gliders	No	No	Yes	N/A	N/A	Yes, Aircraft restrictions apply, not allowed on UAX.
Kayaks	No	No	No	N/A	N/A	Yes, Aircraft restrictions apply, not allowed on UAX.
Kite	No	No	Yes	N/A	N/A	Treated as hang glider.
Pets as Checked Baggage (AVIH)	No	No	No	Yes	AVIH	Yes. Aircraft restrictions/country acceptance requirements apply, handled through UA Cargo.
Pets in Cabin	No	No	No	Yes	PETC	Yes, restrictions apply/country acceptance requirements apply.
Scuba Equipment	Yes	Yes	Yes	No	No	Restrictions apply + TSA mandated.
Service Animals	Yes	Yes	Yes	Yes	SVAN for service animal, ESAN for emotional support animal	No, country acceptance requirements apply.



## United (UA) - continued

ITEMS	WITHIN FREE BAGGAGE ALLOWANCE		INTERLIN-EABLE	SSR REQUIRED	SSR ITEM	PACKAGING REQUIRED
	Piece Concept	Weight Concept				
Skis/Snowboard	Yes	Yes	Yes	No	N/A	Yes
Small Surfboard less than 2m/Wakeboard	Yes	Yes	Yes	No	N/A	No. Aircraft restrictions apply.
Surfboard/Windsurfer	No	No	Yes	Yes	SPEQ	No. Aircraft restrictions apply.
Wet Cell Batteries	Yes	Yes	Yes	Yes	Applicable code to identify customer	Yes
Wheelchair non-powered	Yes	Yes	Yes	Yes	Applicable code to identify customer	No
Wheelchair with Dry Cell Batteries	Yes	Yes	Yes	Yes	Applicable code to identify customer	Yes. Aircraft and other restrictions.



# CARRY-ON BAGGAGE POLICY

---

## **WEIGHT & SIZE**

Weight and Size policy has not been harmonised. Please check individual carrier restrictions.

---

## **PIECES**

### **2 / 2 POLICY:**

**2** pieces for First Class and **2** pieces for Business Class

The 2/2 policy applies to intercontinental flights, and domestic flights connecting to intercontinental flights. Intercontinental refers to travel between Europe, Asia, North America, South America, Australia, New Zealand and Africa. Some carriers may use "International", nonetheless, the policy is the same. Two pieces can be defined as one carry-on and one personal item.

**NOTE:** Certain governments limit carry-on to one piece regardless of class of travel.

# IRREGULAR OPERATIONS HANDLING

When a flight is delayed, cancelled or re-routed, special guidelines and procedures have been created for rebooking and notification to the passengers and onward Star Alliance member carriers. Special rules and exceptions apply for EU carriers and non-EU carriers operating from the EU.

---

## **COMMUNICATION TO THE CUSTOMER**

For all disrupted services, communication to customers must be provided immediately when known, and not later than scheduled departure time with updates every 30 minutes or as appropriate.

---

## **AMENITIES - CONTROLLABLE\***

In the event of a controllable delay, Star Alliance member carriers will provide amenities such as accommodation, refreshment, meals and transportation for customers as appropriate.

---

## **AMENITIES - UNCONTROLLABLE\***

In the event of an uncontrollable delay, Star Alliance member carriers will provide amenities to premium customers (First, Business and Star Alliance Gold status customers).

\*Special conditions apply for EU registered carriers and non-EU registered carriers operating from the EU.

## **REBOOKING**

The policies apply in all irregularity situations.

When a customer's travel plan is disrupted due to a flight irregularity and rebooking is required, the following procedures apply to all Star Alliance member carriers. Alternative transportation may apply when no flights are available on the same day or protection is not acceptable to the customer.

The policies apply to all customers with confirmed reservations and those who have been accepted on the flight. Contact the receiving carrier for rebooking within six hours prior to scheduled departure time of rebooked flight. If the receiving carrier confirms the booking, customers shall be treated as other confirmed customers of the receiving carrier.

---

## **ONWARD CARRIAGE**

Provide onward carriage with the least possible delay to the destination shown on the ticket(s).

---

## **SAME RATED ROUTING\***

Rebook on the same rated routing whenever possible.

\*Special conditions apply for EU registered carriers and non-EU registered carriers operating from the EU.

---

## **CARRIER ORDER**

Rebook in the following carrier order, depending on frequency of flights and the customer's best interest:

- Original receiving carrier
- Own airline
- Star Alliance member airline
- Non-Star Alliance member airline (OAL)

## **PASSPORT OR VISA**

Identify any passport or visa constraints that would affect rebooking customers via alternative routing.

---

## **SAME BOOKING CLASS**

Rebook in the same booking class whenever possible.

---

## **HIGHER CABIN CLASS**

If booking in a higher cabin class is required, preference must be given to Star Alliance Gold and full-fare customers.

Rebooking in a higher cabin class on another Star Alliance carrier or another airline is only permitted with prior approval of the new receiving carrier. Additional cost may apply.

---

## **STANDBY**

Previously inconvenienced customers that receive standby status should receive special priority.

---

## **ALTERNATIVE TRANSPORTATION**

Alternative transportation, such as taxi, train or bus will be provided on request or when no alternative flights are available

# INTERLINE E-TICKETING FAQ - AIRPORTS

## MISSING DOCUMENTS

**Q: What do I do if the present credit card indicator (fraud indicator) has been set and the passenger can't produce the credit card used to purchase the ticket? (note: Not all carriers use this indicator)**

**A:** If the passenger can't produce the credit card used to purchase the interline e-ticket, he/she is required to purchase a new ticket. Alternatively, the original issuing carrier may be contacted for authorisation.

## MISSING DATA

**Q: What do I do if I can't find the interline e-ticket coupon?**

**A:** Get as much information about the journey as you can from the passenger. Use this information to search for the e-ticket using alternative search criteria. If you still can't find it, call your help desk.

**Q: What do I do if I can find the PNR but not the ticket?**

**A:** Get as much information about the journey as you can from the passenger. Use this information to search for the e-ticket using alternative search criteria. If you still can't find it, call your help desk.

**Q: What do I do if I can find neither the PNR nor the ticket?**

**A:** Get as much information about the journey as you can from the passenger. Use this information to search for the e-ticket using alternative search criteria. If you still can't find it, call your help desk.

**Q: What do I do if I can't get control of the interline e-ticket coupon?**

**A:** Call your help desk.

## IRREGULAR OPERATIONS

**Q: How do I handle an IRROP situation when the operating flight has been cancelled?**

**A:** According to individual carrier processes.

**Q: How do I handle an IRROP situation when another operating flight has been cancelled and a passenger is coming to me?** **A:** According to individual carrier processes.

**Q: How do I handle re-routes?**

**A:** According to individual carrier processes.

## MODIFICATIONS

**Q: Is there a help desk number in case of problems?**

**A:** Most carriers have their own help desks. Airport agents are to call their own internal help desk.

**Q: What do I have to do if I have to make a name correction in the PNR?**

**A:** Contact airline ticket office or help desk.

# LOUNGES



# LOUNGE ACCESS

---

## **INTERNATIONAL FIRST CLASS CUSTOMERS**

International First Class Customers are entitled to access member airline lounges. Some member airlines offer exclusive lounges for customers travelling in International First Class. Eligible International First Class customers also have access to all other member airline lounges too. The customer needs to show a boarding pass in International First Class on a Star Alliance flight departing from the local airport and is entitled to a maximum of one guest. Exceptions are: LH HON/First Class Lounges in FRA/MUC; LX HON/First Class Lounges in ZRH/GVA; OS HON/First Class Lounges in VIE; TG Spa Lounge in BKK (subject to change).

---

## **INTERNATIONAL BUSINESS CLASS CUSTOMERS**

International Business Class Customers are entitled to access member airline Business Class Lounges. The customer will need to show a boarding pass in International Business Class on a Star Alliance member airline operated flight departing from the local airport. The customer is not entitled to bring any guests.

---

## **DOMESTIC FIRST CLASS**

Some member airlines offer lounge access if customers are travelling in Domestic First Class although restrictions apply for Domestic First Class passengers travelling with United Airlines in the USA. Customers will need to show a boarding pass in Domestic First Class for a Star Alliance member airline operated flight departing from the local airport. Customers are entitled to a maximum of one guest.



## **DOMESTIC BUSINESS CLASS**

Some member airlines offer lounge access if customers are travelling in Domestic Business Class, however restrictions apply for Domestic Business Class passengers travelling with United Airlines in the USA. Customers will need to show a boarding pass in Domestic Business Class on a Star Alliance member airline operated flight departing from the local airport. Customers are not entitled to bring any guests.

---

## **STAR ALLIANCE GOLD (SAG) CUSTOMERS TRAVELLING IN ANY CLASS**

Star Alliance Gold customers have access to any member airline lounge that displays the Star Alliance Gold logo. Customers will need to present a boarding pass for a Star Alliance flight departing from the local airport. If the boarding pass does not carry the Star Alliance Gold indicator, the customer will need also to show a valid Star Alliance Gold card. Customers are entitled to a maximum of one guest. Restrictions apply for United MileagePlus Star Alliance Gold customers wishing to access United Clubs within the U.S.

---

## **PAID LOUNGE MEMBERSHIP CUSTOMERS**

As an eligible holder of Paid Lounge Membership, customers have access to any Star Alliance member airline Business Class Lounge. Eligible paid memberships include United Club and Air Canada Maple Leaf Club – Worldwide. Customers will need to show a boarding pass for a Star Alliance flight departing from the local airport together with a valid eligible paid lounge membership card, displaying the Star Alliance Lounge Logo. Customers are entitled to a maximum of one guest except in Singapore where the Singapore Airlines Krisflyer Gold Lounge is available.

## **DEFINITION: TYPE OF LOUNGES**

**Member carriers' owned lounges:** Departure lounges owned, operated by Star Alliance member carriers  
Arrival lounges are not included.

**Contract lounges:** Lounges owned and operated by a third party and contracted for use by Star Alliance member carriers.

**Star Alliance branded lounges:** Lounges operated on behalf of a subset of Star Alliance member carriers with Star Alliance branding.

## **DEFINITION: TYPE OF ELIGIBLE CUSTOMERS**

**International First Class customers:** Customers holding a boarding pass for a Star Alliance member airline operated flight in International First Class departing from the local airport.

**International Business Class customers:** Customers holding a boarding pass for a Star Alliance member airline operated flight in International Business Class departing from the local airport.

**Domestic First Class customers:** Customers holding a boarding pass for a Star Alliance member airline operated flight in Domestic First Class departing from the local airport.

**Domestic Business Class customers:** Customers holding a boarding pass for a Star Alliance member airline operated flight in Domestic Business Class departing from the local airport.

**Star Alliance Gold (SAG) customers:** Customers holding valid proof of their Star Alliance Gold level status and a boarding pass for a Star Alliance member airline operated flight in any class departing from the local airport.

**Eligible Paid Lounge Membership Customers:** Customers holding their valid eligible Paid Lounge Membership card issued by United Club or Air Canada Maple Leaf Club –Worldwide together with a boarding pass for a Star Alliance member airline operated flight in any class departing from the local airport.

**Eligible Guests:** First Class, Star Alliance Gold and Eligible Paid Lounge Membership customers are each entitled to a maximum of one guest. The guest must enter the designated lounge with the Eligible Customer and present a boarding pass for any Star Alliance member airline operated flight departing from the local airport. For contract lounges, the guest must be flying on the same airline as the Eligible Customer. Any person over the age of two is considered a guest. Infants under the age of two travelling with an Eligible Customer may accompany them to the lounge in addition to a maximum of one guest.

#### **OTHER NOTES:**

- Boarding pass for a Star Alliance member airline operated flight: Boarding pass must display the two letter IATA code for a Star Alliance member airline operated flight departing from that airport.
- Lounge access is only permitted to revenue customers except for Paid Lounge Membership Customers who do not need to be revenue customers. All customers travelling on full or discounted fares, frequent flyer award tickets or upgrades are considered revenue customers. Airline employees flying on free or service charge tickets, or on Industry Discount (e.g., ID50, ID75, ID90) tickets are not considered revenue customers.
- Customers must be departing from the local airport the same day, or up to five hours after midnight the following calendar day, in order to access a lounge.

## **CONTRACT LOUNGES**

Star Alliance Gold customers have access to third party Contract Lounges contracted by the member airline on which they are travelling. Simply present a boarding pass for a flight departing from the local airport with a Star Alliance member airline flight that has a contract with that lounge. If the boarding pass does not carry the Star Alliance Gold indicator, the customer will need also to show a valid Star Alliance Gold card. Customers are entitled to a maximum of one guest, who must be travelling on the same airline as the customer. Paid Lounge Membership Customers are not entitled to use contract lounges.

---

## **STAR ALLIANCE BRANDED LOUNGES**

Access policy for Star Alliance branded lounges is the same as for the member carriers' owned lounges. Prerequisite for access is that the individual member carrier has signed an agreement with the assigned operator.

---

## **OTHERS**

Lounge access not explicitly addressed in the previous sections is outside the scope of the SAE 2.1 Lounge Access Standard and should be agreed upon bilaterally. Different rates and/or billing procedures may be applied.

---

## **LOUNGE NETWORK**









The Star Alliance network offers Star Alliance Gold customers access to more than 1,000 airport lounges worldwide, owned, operated or contracted by a Star Alliance member carrier.

---







## **STAR ALLIANCE GOLD SIGNS**

Star Alliance Gold signs have been placed at all Star Alliance Gold Lounge entrances.

# LOUNGE ACCESS CHART









		BOARDING PASS ACCESS				CARD ACCESS		
		Int'l First Class	Int'l Business Class	Domestic First Class	Domestic Business Class	Star Alliance Gold ✦	AC Maple Leaf Club - Worldwide	United Club
	Aegean Club Lounge	✓	✓	-	✓	✓	✓	✓
	Maple Leaf Lounge	✓	✓	-	✓	✓	✓	✓
	Air China Lounge (First Class)	✓	-	✓	-	-	-	-
	Air China Lounge (Business Class)	✓	✓	✓	✓	✓	✓	✓
	Air India First Class Lounge	✓	-	-	-	-	-	-
	Air India Business Class Lounge	✓	✓	-	✓	✓	✓	✓
	International Lounge	✓	✓	-	-	✓	✓	✓
	Koru Lounge	✓	✓	-	-	✓	✓	✓
	ANA Suite Lounge	✓	-	-	-	-	-	-
	ANA Lounge	✓	✓	✓	-	✓	✓ <sup>3</sup>	✓ <sup>3</sup>
	CLUB ANA Lounge	✓	✓	-	-	✓	✓	✓
	Asiana Lounge (First Class)	✓	-	-	-	-	-	-
	Asiana Lounge (Business Class)	✓	✓	-	-	✓	✓	✓
	Asiana Lounge (Domestic)	-	-	-	-	✓	✓	✓
	HON Circle Lounge	✓ <sup>2</sup>	-	-	-	-	-	-
	Austrian Senator Lounge	✓	-	-	-	✓	-	-
	Austrian Business Lounge	✓	✓	-	✓	✓	✓	✓
	VIP Lounge	✓	✓	-	✓	✓	✓	✓

**BOARDING PASS ACCESS**
**CARD ACCESS**

	Int'l First Class	Int'l Business Class	Domestic First Class	Domestic Business Class	Star Alliance Gold ✦	AC Maple Leaf Club - Worldwide	United Club
 Business Lounge Sunrise Lounge	✓	✓	-	-	✓	✓	✓
 Copa Club	✓	✓	-	-	✓	✓	✓
 EGYPTAIR First Class Lounge EGYPTAIR Business Class Lounge	✓	-	-	-	-	-	-
 Cloud Nine Lounge Star Alliance Gold Lounge	✓	✓	-	✓	✓	✓	✓
 EVA Air Lounge EVA Air Lounge (The Star)	✓	✓	-	-	✓	✓	✓
 LOT Business Lounge - Polonez	✓ <sup>5</sup>	✓ <sup>5</sup>	-	-	✓ <sup>5</sup>	✓ <sup>5</sup>	✓ <sup>5</sup>
 LOT Business Lounge - Polonez	✓	✓	-	✓	✓	✓	✓
 First Class Lounge Senator Lounge Business Lounge	✓ <sup>2</sup>	-	-	-	-	-	-
 Scandinavian Lounge Business Lounge	✓	-	-	-	✓	-	-
 King Lounge	✓	✓	-	✓	✓	✓	✓
 SilverKris Lounge (First Class) SilverKris Lounge (Business Class) SIA Krisflyer Gold Lounge	✓	-	-	-	-	-	-
 SilverKris Lounge (Business Class) SIA Krisflyer Gold Lounge	✓	✓	-	-	✓ <sup>4</sup>	✓ <sup>4</sup>	✓ <sup>4</sup>
 SIA Krisflyer Gold Lounge	✓	✓	-	-	✓	✓	✓

## BOARDING PASS ACCESS

## CARD ACCESS

	Int'l First Class	Int'l Business Class	Domestic First Class	Domestic Business Class	Star Alliance Gold 	AC Maple Leaf Club - Worldwide	United Club
 Baobab Premium Class Lounge	✓	✓	-	✓	✓	✓	✓
 Star Alliance Lounge (First Class)	✓	-	-	-	-	-	-
Star Alliance Lounge (Business Class)	✓	✓	-	✓	✓	✓	✓
 SWISS First Class Lounge	✓ <sup>2</sup>	-	-	-	-	-	-
Senator Lounge	✓	-	-	-	✓	-	-
SWISS Business Class Lounge	✓	✓	-	✓	✓	✓	✓
 TAP Premium Lounge	✓	✓	-	-	✓	✓	✓
Blue Lounge (Domestic Lounge)	-	-	-	✓	✓	✓	✓
 Royal First Lounge	✓ <sup>2</sup>	-	-	-	-	-	-
Royal Silk Lounge	✓	✓	-	✓	✓	✓	✓
Royal Orchid Lounge	✓	✓	-	✓	✓	✓	✓
 Business Class Lounge	✓	✓	-	✓	✓	✓	✓
 United International First Lounge	✓	-	-	-	-	-	-
United Club	✓	✓	-	-	✓ <sup>1</sup>	✓	✓

**NOTE:** 1 UA SAG customers may only access the UA United Clubs within the United States when travelling in conjunction with a Star Alliance international flight.

2 Except: HON/First Class Lounge in FRA/MUC for LH, ZRH/GVA for LX and VIE for OS; BKK TG Spa Lounge; SQ The Private Room in SIN.

3 NRT and HND International Departures Lounge only.

4 Except SIN.

5 TPE only.



## DESTINATIONS WITH LOUNGES

This section provides a quick reference to key destination information for customers. The destinations listed are where each airport has at least one of these facilities: Gold Lounge or First Class Lounge.

For each city, you will find which carrier has a Star Alliance Gold Lounge, or which carrier has a First Class lounge. The two-letter carrier code in "gold" type is the owner of a Star Alliance Gold Lounge.

<b>City</b> Country	<b>Airport Code</b> Airport Name		
<b>Hong Kong</b> China	<b>HKG</b> Hong Kong International Airport	<b>SQ, TG,</b> <b>UA</b>	SQ, TG, UA

For example, at Hong Kong International Airport:  
SQ, TG and UA operate Star Alliance Gold Lounges.  
SQ, TG and UA also operate a First Class Lounge.

Please refer to Lounge Access policies.

## DESTINATIONS WITH LOUNGES: A

<b>City</b> Country	<b>Airport Code</b> Airport Name		
<b>Adana</b> Turkey	<b>ADA</b> Adana Sakirpasa Airport	<b>TK</b>	
<b>Addis Ababa</b> Ethiopia	<b>ADD</b> Bole International Airport	<b>ET</b>	
<b>Adelaide</b> Australia	<b>ADL</b> Adelaide International Airport	<b>SQ</b>	
<b>Ankara</b> Turkey	<b>ESB</b> Esenboga International Airport	<b>TK</b>	
<b>Antalya</b> Turkey	<b>AYT</b> Antalya Airport	<b>TK</b>	
<b>Armenia</b> Colombia	<b>AXM</b> Armenia, Colombia	<b>AV</b>	
<b>Athens</b> Greece	<b>ATH</b> Eleftherios Venizelos International Airport	<b>A3, LH</b>	
<b>Atlanta</b> United States	<b>ATL</b> Hartsfield-Jackson Atlanta International Airport	<b>UA</b>	
<b>Auckland</b> New Zealand	<b>AKL</b> Auckland International Airport	<b>NZ</b>	

## DESTINATIONS WITH LOUNGES: A-B

<b>City</b> Country	<b>Airport Code</b> Airport Name		
<b>Austin</b> United States	<b>AUS</b> Austin-Bergstrom International Airport	<b>UA</b>	
<b>Bangkok</b> Thailand	<b>BKK</b> Suvarnabhumi International Airport	<b>BR, SQ, TG</b>	BR, TG
<b>Barranquilla</b> Colombia	<b>BAQ</b> Barranquilla (Ernesto Cortissoz), Colombia	<b>AV</b>	
<b>Beijing</b> China	<b>PEK</b> Beijing Capital International Airport	<b>CA</b>	CA
<b>Berlin</b> Germany	<b>TXL</b> Berlin Tegel/Otto Lilienthal Airport	<b>LH</b>	
<b>Bodrum</b> Turkey	<b>BJV</b> Milas-Bodrum Airport	<b>TK</b>	
<b>Bogota</b> Colombia	<b>BOG</b> Bogota (Eldorado), Colombia	<b>AV</b>	AV
<b>Boston</b> United States	<b>BOS</b> Logan International Airport	<b>LH, UA</b>	
<b>Bremen</b> Germany	<b>BRE</b> Bremen Airport	<b>LH</b>	



## DESTINATIONS WITH LOUNGES: B-C

<b>City</b> Country	<b>Airport Code</b> Airport Name		
<b>Brisbane</b> Australia	<b>BNE</b> Brisbane International Airport	<b>NZ, SQ</b>	
<b>Brussels</b> Belgium	<b>BRU</b> Brussels National Airport	<b>SN</b>	
<b>Bucaramanga</b> Colombia	<b>BGA</b> Bucaramanga (Palonegro), Colombia	<b>AV</b>	
<b>Buenos Aires</b> Argentina	<b>EZE</b> Ministro Pistarini International Airport		
<b>Cairo</b> Egypt	<b>CAI</b> Cairo International Airport	<b>MS</b>	
<b>Calgary</b> Canada	<b>YYC</b> Calgary International Airport	<b>AC</b>	
<b>Cali</b> Colombia	<b>CLO</b> Cali (Alfonso Bonilla Aragon), Colombia	<b>AV</b>	
<b>Cape Town</b> South Africa	<b>CPT</b> Cape Town International Airport	<b>SA</b>	

## DESTINATIONS WITH LOUNGES: C

<b>City</b> Country	<b>Airport Code</b> Airport Name		
<b>Cartagena de Indias</b> Colombia	<b>CTG</b> Cartagena de Indias (Rafael Nunez), Colombia	<b>AV</b>	
<b>Cheju</b> South Korea	<b>CJU</b> Cheju International Airport	<b>OZ</b>	
<b>Chengdu</b> China	<b>CTU</b> Chengdu Shuangliu international Airport	<b>CA</b>	CA
<b>Chiang Mai</b> Thailand	<b>CNX</b> Chiang Mai International Airport	<b>TG</b>	
<b>Chiang Rai</b> Thailand	<b>CEI</b> Chiang Rai International Airport	<b>TG</b>	
<b>Chicago</b> United States	<b>ORD</b> Chicago O'Hare International Airport	<b>LX, SK, UA</b>	LX, UA
<b>Christchurch</b> New Zealand	<b>CHC</b> Christchurch International Airport	<b>NZ</b>	
<b>Cleveland</b> United States	<b>CLE</b> Cleveland-Hopkins International Airport	<b>UA</b>	

## DESTINATIONS WITH LOUNGES: C-D

<b>City</b> Country	<b>Airport Code</b> Airport Name		
<b>Cologne</b> Germany	<b>CGN</b> Cologne-Bonn Airport	<b>LH</b>	
<b>Copenhagen</b> Denmark	<b>CPH</b> Copenhagen Kastrup Airport	<b>SK</b>	
<b>Cucuta</b> Colombia	<b>CUC</b> Cucuta (Camilo Daza), Colombia	<b>AV</b>	
<b>Dalaman</b> Turkey	<b>DLM</b> Dalaman International Airport	<b>TK</b>	
<b>Dallas</b> United States	<b>DFW</b> Dallas Fort Worth International Airport	<b>UA</b>	
<b>Delhi</b> India	<b>DEL</b> Indira Gandhi International Airport	<b>AI, LH, SQ</b>	<b>AI</b>
<b>Denver</b> United States	<b>DEN</b> Denver International Airport	<b>UA</b>	
<b>Detroit</b> United States	<b>DTW</b> Detroit Metropolitan Wayne County Airport	<b>LH</b>	
<b>Dhaka</b> Bangladesh	<b>DAC</b> Zia International Airport	<b>TG</b>	

## DESTINATIONS WITH LOUNGES: D-F

<b>City</b> Country	<b>Airport Code</b> Airport Name		
<b>Dresden</b> Germany	<b>DRS</b> Dresden Airport	<b>LH</b>	
<b>Dubai</b> United Arab Emirates	<b>DXB</b> Dubai International Airport	<b>LH</b>	
<b>Dunedin</b> New Zealand	<b>DUD</b> Dunedin International Airport	<b>NZ</b>	
<b>Durban</b> South Africa	<b>DUR</b> Durban International Airport	<b>SA</b>	
<b>Dusseldorf</b> Germany	<b>DUS</b> Dusseldorf International Airport	<b>LH</b>	
<b>East London</b> South Africa	<b>ELS</b> East London Airport	<b>SA</b>	
<b>Edmonton</b> Canada	<b>YEG</b> Edmonton International Airport	<b>AC</b>	
<b>Fort Lauderdale</b> United States	<b>FLL</b> Fort Lauderdale/Hollywood International Airport	<b>UA</b>	
<b>Frankfurt</b> Germany	<b>FRA</b> Frankfurt Main International Airport	<b>LH, AC</b>	

## DESTINATIONS WITH LOUNGES: F-H

<b>City</b> Country	<b>Airport Code</b> Airport Name		
<b>Fukuoka</b> Japan	<b>FUK</b> Fukuoka Airport	<b>NH</b>	
<b>Funchal</b> Portugal	<b>FNC</b> Funchal Madeira Airport	<b>TP</b>	
<b>Gaziantep</b> Turkey	<b>GZT</b> Gaziantep Airport	<b>TK</b>	
<b>Geneva</b> Switzerland	<b>GVA</b> Geneva International Airport	<b>LX</b>	
<b>Gothenburg</b> Sweden	<b>GOT</b> Gothenburg Landvetter Airport	<b>SK</b>	
<b>Guam</b> Guam	<b>GUM</b> Guam International Airport	<b>UA</b>	
<b>Guatemala City</b> Guatemala	<b>GUA</b> Guatemala City (La Aurora), Guatemala	<b>CM</b>	
<b>Gwangju</b> South Korea	<b>KWJ</b> Gwangju Airport	<b>OZ</b>	
<b>Halifax</b> Canada	<b>YHZ</b> Halifax International Airport	<b>AC</b>	



## DESTINATIONS WITH LOUNGES: H

<b>City</b> Country	<b>Airport Code</b> Airport Name		
<b>Hamburg</b> Germany	<b>HAM</b> Hamburg Fuhlsbuttel Airport	<b>LH</b>	
<b>Hamilton</b> New Zealand	<b>HLZ</b> Hamilton International Airport	<b>NZ</b>	
<b>Hangzhou</b> China	<b>HGH</b> Hangzhou [Jianqiao], China	<b>CA</b>	CA
<b>Hannover</b> Germany	<b>HAJ</b> Hannover Langenhagen International Airport	<b>LH</b>	
<b>Harare</b> Zimbabwe	<b>HRE</b> Harare International Airport	<b>SA</b>	
<b>Hat Yai</b> Thailand	<b>HDY</b> Hat Yai International Airport	<b>TG</b>	
<b>Hatay</b> Turkey	<b>HTY</b> Hatay Havalimani Airport	<b>TK</b>	
<b>Helsinki</b> Finland	<b>HEL</b> Helsinki Vantaa International Airport	<b>SK</b>	
<b>Hiroshima</b> Japan	<b>HIJ</b> Hiroshima International Airport	<b>NH</b>	

## DESTINATIONS WITH LOUNGES: H-K

<b>City</b> Country	<b>Airport Code</b> Airport Name		
<b>Hohhot</b> China	<b>HET</b> Hohhot Baita International Airport		CA
<b>Hong Kong</b> China	<b>HKG</b> Hong Kong International Airport	<b>SQ, TG, UA</b>	SQ, TG, UA
<b>Honolulu</b> United States	<b>HNL</b> Honolulu International Airport	<b>UA</b>	
<b>Houston</b> United States	<b>IAH</b> George Bush Intercontinental Airport	<b>UA</b>	
<b>Istanbul</b> Turkey	<b>IST</b> Istanbul Ataturk International Airport	<b>TK</b>	
<b>Istanbul</b> Turkey	<b>SAW</b> Istanbul Sabiha Gokcen International Airport	<b>TK</b>	
<b>Izmir</b> Turkey	<b>ADB</b> Izmir Adnan Menderes International Airport	<b>TK</b>	
<b>Johannesburg</b> South Africa	<b>JNB</b> OR Tambo International Airport	<b>SA</b>	
<b>Kagoshima</b> Japan	<b>KOJ</b> Kagoshima Airport	<b>NH</b>	

## DESTINATIONS WITH LOUNGES: K-L

<b>City</b> Country	<b>Airport Code</b> Airport Name		
<b>Kaohsiung</b> Taiwan	<b>KHH</b> Kaohsiung (International), Taiwan	<b>BR</b>	BR
<b>Kathmandu</b> Nepal	<b>KTM</b> Kathmandu Tribhuvan International Airport	<b>TG</b>	
<b>Kiev</b> Ukraine	<b>KBP</b> Kiev Borispol, Ukraine	<b>OS</b>	
<b>Komatsu</b> Japan	<b>KMQ</b> Komatsu Airport	<b>NH</b>	
<b>Krabi</b> Thailand	<b>KBV</b> Krabi Airport	<b>TG</b>	
<b>Kuala Lumpur</b> Malaysia	<b>KUL</b> Kuala Lumpur International Airport	<b>SQ, TG</b>	
<b>Larnaca</b> Cyprus	<b>LCA</b> Larnaca International Airport	<b>A3</b>	
<b>Las Vegas</b> United States	<b>LAS</b> McCarran International Airport	<b>UA</b>	
<b>Leipzig</b> Germany	<b>LEJ</b> Leipzig Halle Airport	<b>LH</b>	

## DESTINATIONS WITH LOUNGES: L-M

<b>City</b> Country	<b>Airport Code</b> Airport Name		
<b>London</b> United Kingdom	<b>LHR</b> London Heathrow Airport	 <b>AC, AI, LH, SQ, UA</b>	 <b>SQ, UA</b>
<b>Los Angeles</b> United States	<b>LAX</b> Los Angeles International Airport	 <b>AC, UA</b>	
<b>Lulea</b> Sweden	<b>LLA</b> Lulea [Kallax], Sweden	<b>SK</b>	
<b>Lusaka</b> Zambia	<b>LUN</b> Lusaka International Airport	<b>SA</b>	
<b>Malmo</b> Sweden	<b>MMX</b> Malmo [Sturup], Sweden	<b>SK</b>	
<b>Manila</b> Philippines	<b>MNL</b> Ninoy Aquino International Airport	<b>SQ, TG</b>	
<b>Manizales</b> Colombia	<b>MZL</b> Manizales, Colombia	<b>AV</b>	
<b>Matsuyama</b> Japan	<b>MYJ</b> Matsuyama Airport	<b>NH</b>	
<b>Medellin</b> Colombia	<b>MDE</b> Medellin (Olaya Herrera), Colombia	<b>AV, CM</b>	



## DESTINATIONS WITH LOUNGES: M-N

<b>City</b> Country	<b>Airport Code</b> Airport Name		
<b>Melbourne</b> Australia	<b>MEL</b> Tullamarine International Airport	<b>NZ, SQ</b>	SQ
<b>Mexico City</b> Mexico	<b>MEX</b> Benito Juarez International Airport	<b>AV, UA</b>	
<b>Miami</b> United States	<b>MIA</b> Miami, FL [Miami International Airport], USA	<b>AV</b>	
<b>Milan</b> Italy	<b>MLP</b> Milan Malpensa Airport	<b>LH</b>	
<b>Minneapolis/St. Paul</b> United States	<b>MSP</b> Minneapolis St. Paul International Airport	<b>UA</b>	
<b>Montreal</b> Canada	<b>YUL</b> P. E. Trudeau International Airport	<b>AC</b>	
<b>Moscow</b> Russia	<b>VKO</b> Moscow (Moskva), Moscow (Vnukovo), Russia	<b>TK</b>	
<b>Munich</b> Germany	<b>MUC</b> Munich Franz Josef Strauss	<b>LH</b>	
<b>Nadi</b> Fiji	<b>NAN</b> Nadi International Airport	<b>NZ</b>	

## DESTINATIONS WITH LOUNGES: N

<b>City</b> Country	<b>Airport Code</b> Airport Name		
<b>Nagoya</b> Japan	<b>NGO</b> Central Japan International Airport		
<b>Nanjing</b> China	<b>NKG</b> Nanjing Lukou International Airport	<b>ZH</b>	ZH
<b>Napier / Hastings</b> New Zealand	<b>NPE</b> Napier Airport	<b>NZ</b>	
<b>Nelson</b> New Zealand	<b>NSN</b> Nelson Airport	<b>NZ</b>	
<b>New Plymouth</b> New Zealand	<b>NPL</b> New Plymouth Airport	<b>NZ</b>	
<b>New York</b> United States	<b>JFK</b> John F. Kennedy International Airport	<b>AI, LH, LX,</b>	AI, LX
	<b>EWR</b> Newark Liberty International Airport	<b>LH, SK, UA</b>	
	<b>LGA</b> La Guardia Airport	<b>AC, UA</b>	
<b>Nuremberg</b> Germany	<b>NUE</b> Nuremberg Airport	<b>LH</b>	

## DESTINATIONS WITH LOUNGES: O-P

<b>City</b> Country	<b>Airport Code</b> Airport Name	 <b>NH</b>	 <b>First Class Lounge</b>
<b>Okinawa</b> Japan	<b>OKA</b> Okinawa Naha Airport	<b>NH</b>	
<b>Orlando</b> United States	<b>MCO</b> Orlando International Airport	<b>UA</b>	
<b>Osaka</b> Japan	<b>KIX</b> Osaka Kansai International Airport	<b>NH, TG</b>	
	<b>ITM</b> Osaka Itami Airport	<b>NH</b>	
<b>Oslo</b> Norway	<b>OSL</b> Oslo Gardermoen Airport	<b>SK</b>	
<b>Ottawa</b> Canada	<b>YOW</b> Macdonald-Cartier International Airport	<b>AC</b>	
<b>Palmerston North</b> New Zealand	<b>PMR</b> Palmerston North International Airport	<b>NZ</b>	
<b>Panama City</b> Panama	<b>PTY</b> Tocumen International Airport	<b>CM</b>	

## DESTINATIONS WITH LOUNGES: P

<b>City</b> Country	<b>Airport Code</b> Airport Name		
<b>Paris</b> France	<b>CDG</b> Charles de Gaulle	 <b>AC, LH, SK</b>	
<b>Pereira</b> Colombia	<b>PEI</b> Pereira (Matecana), Colombia	<b>AV</b>	
<b>Perth</b> Australia	<b>PER</b> Perth International Airport	<b>SQ</b>	
<b>Philadelphia</b> United States	<b>PHL</b> Philadelphia International Airport	<b>UA</b>	
<b>Phoenix</b> United States	<b>PHX</b> Phoenix Sky Harbor International Airport	<b>UA</b>	
<b>Phuket</b> Thailand	<b>HKT</b> Phuket International Airport	<b>TG</b>	
<b>Port Elizabeth</b> South Africa	<b>PLZ</b> Port Elizabeth Airport	<b>SA</b>	
<b>Portland</b> United States	<b>PDX</b> Portland International Airport	<b>UA</b>	



## DESTINATIONS WITH LOUNGES: P-S

City Country	Airport Code Airport Name		
<b>Pusan</b> South Korea	<b>PUS</b> Pusan Kimhae International Airport	<b>OZ</b>	
<b>Queenstown</b> New Zealand	<b>ZQN</b> Queenstown International Airport	<b>NZ</b>	
<b>Rarotonga Island</b> Cook Island	<b>RAR</b> Rarotonga International Airport	<b>NZ</b>	
<b>Regina</b> Canada	<b>YQR</b> Regina International Airport	<b>AC</b>	
<b>Salt Lake City</b> United States	<b>SLC</b> Salt Lake City, UT [Salt Lake City International Airport], USA	<b>AV</b>	
<b>San Antonio</b> United States	<b>SAT</b> San Antonio International Airport	<b>UA</b>	
<b>San Diego</b> United States	<b>SAN</b> San Diego International Airport	<b>UA</b>	
<b>San Francisco</b> United States	<b>SFO</b> San Francisco International Airport	<b>BR, SQ, UA</b>	BR, UA

## DESTINATIONS WITH LOUNGES: S

<b>City</b> Country	<b>Airport Code</b> Airport Name		
<b>San Jose</b> Costa Rica	<b>SJO</b> San Jose (Juan Santamaria International), Costa Rica	<b>AV, CM</b>	
<b>San Juan</b> Puerto Rico	<b>SJU</b> San Juan [Luis Munoz Marin International Airport], Puerto Rico	<b>AV</b>	
<b>San Salvador</b> El Salvador	<b>SAL</b> San Salvador (Internacional), El Salvador	<b>AV</b>	
<b>Santa Ana</b> United States	<b>SNA</b> John Wayne Airport	<b>UA</b>	
<b>Santa Marta</b> Columbia	<b>SMR</b> Santa Marta [Simon Bolivar], Colombia	<b>AV</b>	
<b>Santo Domingo</b> Dominican Republic	<b>SDQ</b> Santo Domingo (Aeropuerto de las Americas), Dominican Republic	<b>CM</b>	
<b>Sao Paulo</b> Brazil	<b>GRU</b> Sao Paulo Guarulhos International Airport		
<b>Sapporo</b> Japan	<b>CTS</b> New Chitose Airport	<b>NH</b>	
<b>Seattle</b> United States	<b>SEA</b> Seattle Tacoma International Airport	<b>UA</b>	

## DESTINATIONS WITH LOUNGES: S

<b>City</b> Country	<b>Airport Code</b> Airport Name		
<b>Sendai</b> Japan	<b>SDJ</b> Sendai Airport	<b>NH</b>	
<b>Seoul</b> South Korea	<b>ICN</b> Seoul Incheon International Airport	<b>OZ, SQ</b>	OZ
	<b>GMP</b> Seoul Gimpo International Airport	<b>OZ</b>	
<b>Shanghai</b> China	<b>PVG</b> Shanghai Pudong International	<b>CA</b>	CA
<b>Shenyang</b> China	<b>SHE</b> Shenyang Taoxian International Airport	<b>ZH</b>	ZH
<b>Shenzhen</b> China	<b>SZX</b> Shenzhen International Airport	<b>CA, ZH</b>	ZH
<b>Singapore</b> Singapore	<b>SIN</b> Singapore Changi International Airport	<b>SQ, TG</b>	SQ
<b>St. John's</b> Canada	<b>YYT</b> St. John's International Airport	<b>AC</b>	
<b>Stockholm</b> Sweden	<b>ARN</b> Stockholm Arlanda Airport	<b>SK</b>	

## DESTINATIONS WITH LOUNGES: S-T

<b>City</b> Country	<b>Airport Code</b> Airport Name		
<b>Stuttgart</b> Germany	<b>STR</b> Stuttgart Echterdingen Airport	<b>LH</b>	
<b>Surat Thani</b> Thailand	<b>URT</b> Surat Thani Airport	<b>TG</b>	
<b>Sydney</b> Australia	<b>SYD</b> Sydney Kingsford Smith Airport	<b>NZ, SQ</b>	SQ
<b>Taipei</b> Taiwan	<b>TPE</b> Taiwan Taoyuan International Airport	<b>BR, SQ, TG</b>	BR
<b>Thessaloniki</b> Greece	<b>SKG</b> Thessaloniki Airport	<b>A3</b>	
<b>Tianjin</b> China	<b>TSN</b> Tianjin Binhai International Airport	<b>CA</b>	
<b>Tokyo</b> Japan	<b>HND</b> Tokyo Haneda International Airport	<b>NH</b>	
	<b>NRT</b> Narita International Airport	<b>NH, UA</b>	UA
<b>Toronto</b> Canada	<b>YYZ</b> Lester B. Pearson International Airport	<b>AC</b>	

## DESTINATIONS WITH LOUNGES: T-W

City Country	Airport Code Airport Name		
<b>Trabzon</b> Turkey	<b>TZX</b> Trabzon Airport	<b>TK</b>	
<b>Tromso</b> Norway	<b>TOS</b> Tromso [Langnes], Norway	<b>SK</b>	
<b>Trondheim</b> Norway	<b>TRD</b> Trondheim [Vaernes], Norway	<b>SK</b>	
<b>Vancouver</b> Canada	<b>YVR</b> Vancouver International Airport	<b>AC</b>	
<b>Varna</b> Bulgaria	<b>VAR</b> Varna, Bulgaria	<b>TK</b>	
<b>Vienna</b> Austria	<b>VIE</b> Vienna International Airport	<b>OS</b>	
<b>Warsaw</b> Poland	<b>WAW</b> Frederic Chopin Airport	<b>LO</b>	
<b>Washington</b> United States	<b>IAD</b> Washington Dulles International Airport	<b>LH, UA</b>	UA
	<b>DCA</b> Washington National Airport	<b>UA</b>	

## DESTINATIONS WITH LOUNGES: W-Z

<b>City</b> Country	<b>Airport Code</b> Airport Name		
<b>Wellington</b> New Zealand	<b>WLG</b> Wellington International Airport	<b>NZ</b>	
<b>Winnipeg</b> Canada	<b>YWG</b> Winnipeg International Airport	<b>AC</b>	
<b>Wuxi</b> China	<b>WUX</b> Sunan Shuofang International Airport	<b>ZH</b>	ZH
<b>Xian Xianyang</b> China	<b>XIY</b> Xian Xianyang, China	<b>ZH</b>	ZH
<b>Zurich</b> Switzerland	<b>ZRH</b> Zurich Kloten Airport	<b>LX</b>	

# MAPS



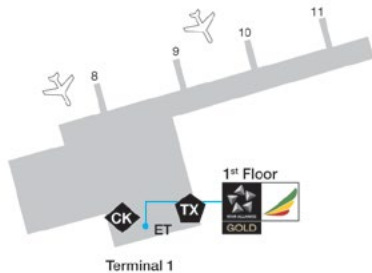

SEE LAST-PAGE FOLDOUT FOR MEMBER LOGOS AND LEGEND

Operating Carriers: ET | LH | MS | TK

ADD

Addis Ababa, Ethiopia  
 Bole International Airport  
[www.ethiopianairports.com](http://www.ethiopianairports.com)



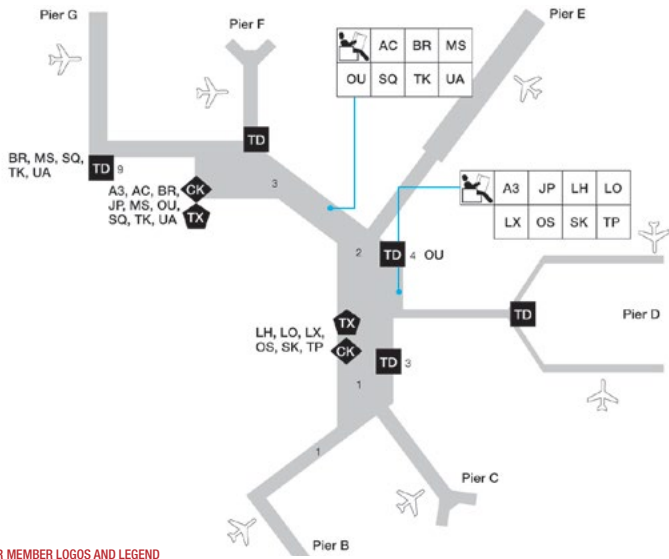

SEE LAST-PAGE FOLDOUT FOR MEMBER LOGOS AND LEGEND

Operating Carriers: A3 | AC | BR | ET | JP | LH | LO | LX | MS | OS | OU | SK | SQ | TK | TP | UA

AMS

Amsterdam, Netherlands  
 Schiphol Airport  
[www.schiphol.nl](http://www.schiphol.nl)



AKL

Auckland, New Zealand  
Auckland International Airport  
[www.aucklandairport.co.nz](http://www.aucklandairport.co.nz)

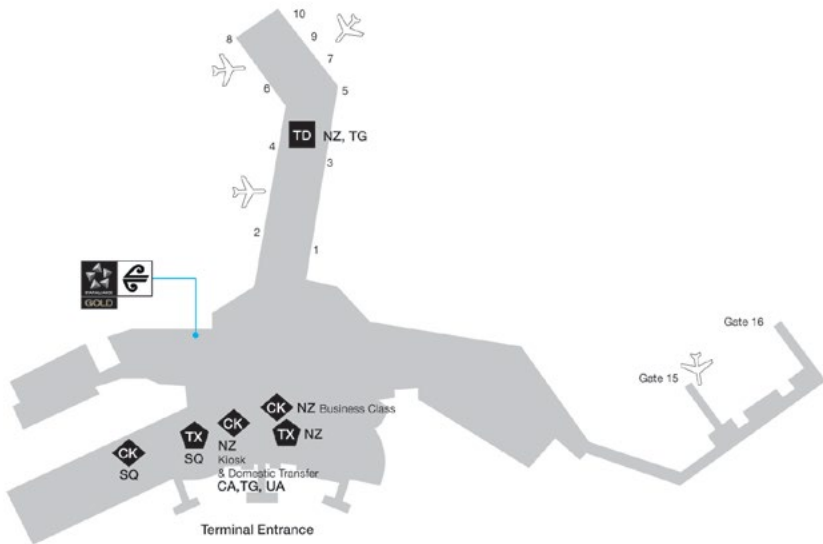

SEE LAST-PAGE FOLDOUT FOR MEMBER LOGOS AND LEGEND  
Operating Carriers: CA | NZ | SQ | TG | UA

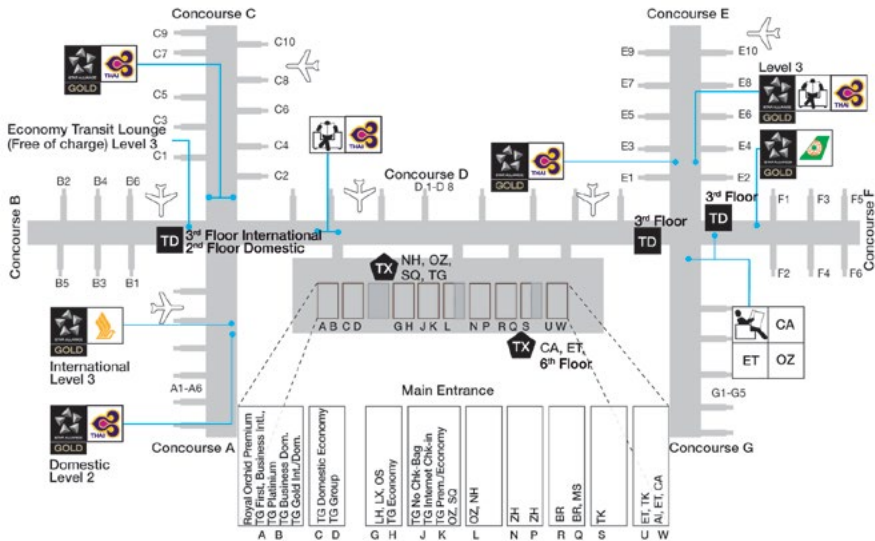

SEE LAST-PAGE FOLDOUT FOR MEMBER LOGOS AND LEGEND

Operating Carriers: AI | BR | CA | ET | LH | LX | MS | NH | OS | OZ | SQ | TG | TK | ZH

BKK

Bangkok, Thailand  
 Suvarnabhumi International Airport  
[www.airportthai.co.th](http://www.airportthai.co.th)

BCN

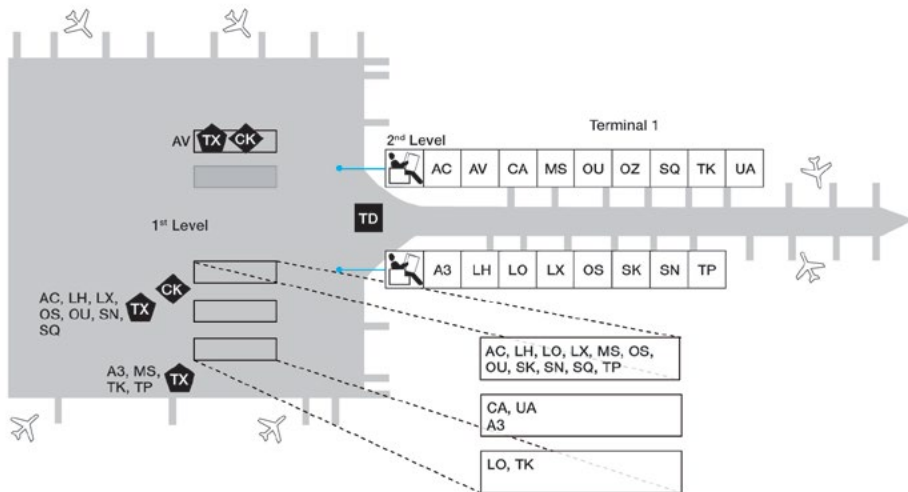

SEE LAST-PAGE FOLDOUT FOR MEMBER LOGOS AND LEGEND

Operating Carriers: A3 | AC | AV | CA | LH | LO | LX | MS | OS | OU | OZ | SK | SN | SQ | TK | TP | UA

Barcelona, Spain  
Barcelona Airport  
[www.aena.es](http://www.aena.es)

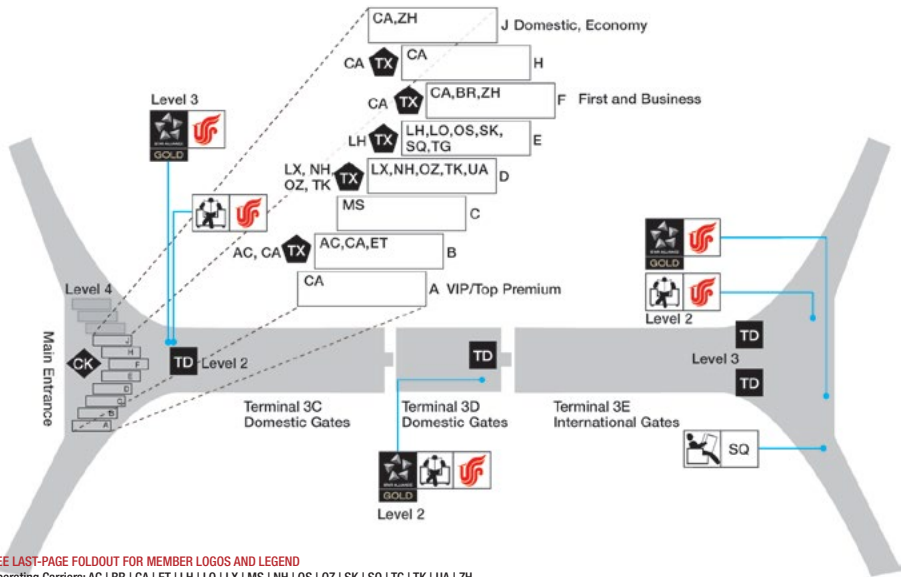

SEE LAST-PAGE FOLDOUT FOR MEMBER LOGOS AND LEGEND

Operating Carriers: AC | BR | CA | ET | LH | LO | LX | MS | NH | OS | OZ | SK | SQ | TG | TK | UA | ZH

BOG

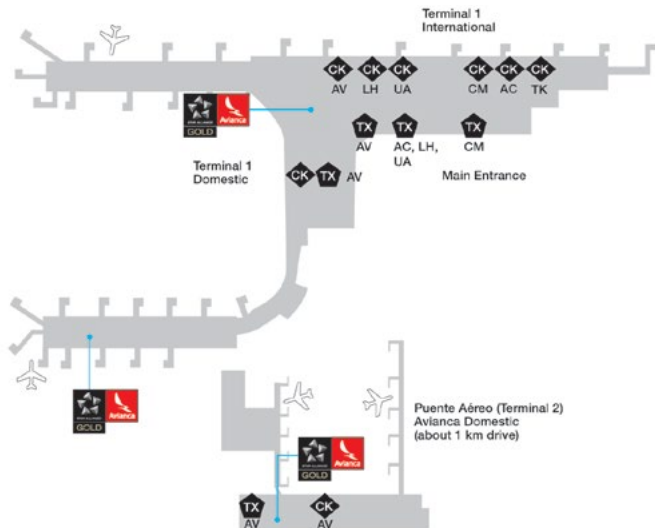

SEE LAST-PAGE FOLDOUT FOR MEMBER LOGOS AND LEGEND  
Operating Carriers: AC | AV | CM | LH | TK | UA

Bogotá, Colombia  
El Nuevo Dorado International  
[www.elnuevodorado.com](http://www.elnuevodorado.com)

BOS

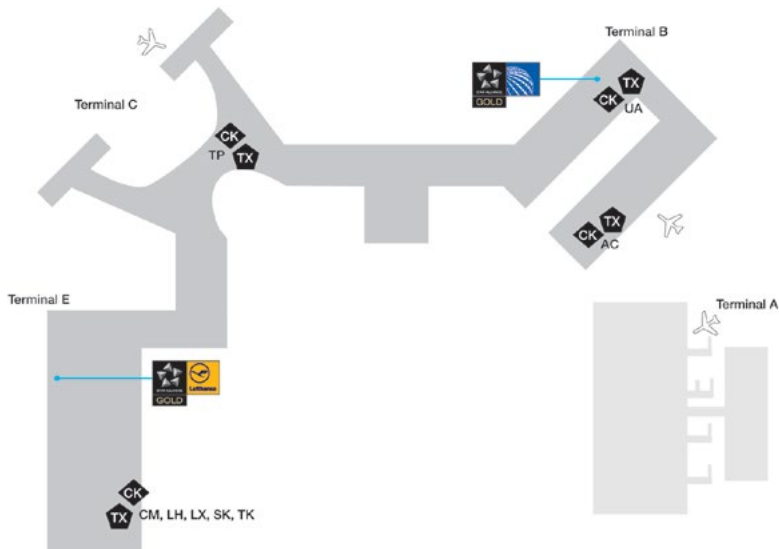

SEE LAST-PAGE FOLDOUT FOR MEMBER LOGOS AND LEGEND  
Operating Carriers: AC | CM | LH | LX | SK | TK | TP | UA

Boston, USA  
Logan International Airport  
[www.massport.com](http://www.massport.com)



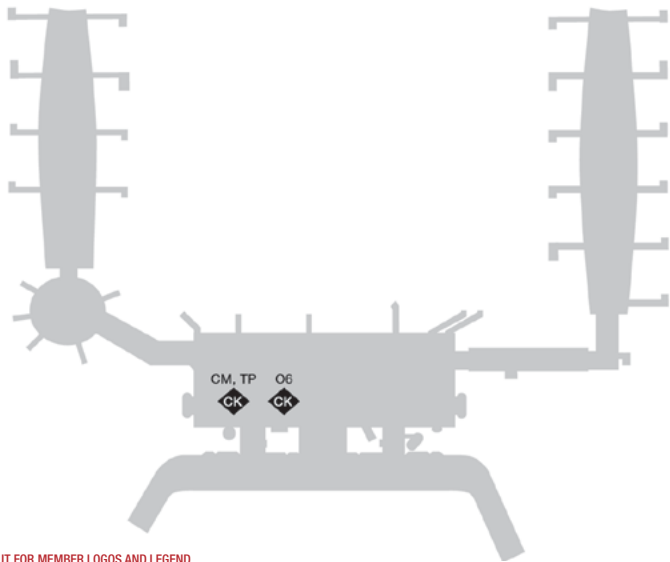

SEE LAST-PAGE FOLDOUT FOR MEMBER LOGOS AND LEGEND  
Operating Carriers: CM | O6 | TP

BSB

Brasilia, Brazil  
Brasilia International Airport  
[www.bsb.aero](http://www.bsb.aero)

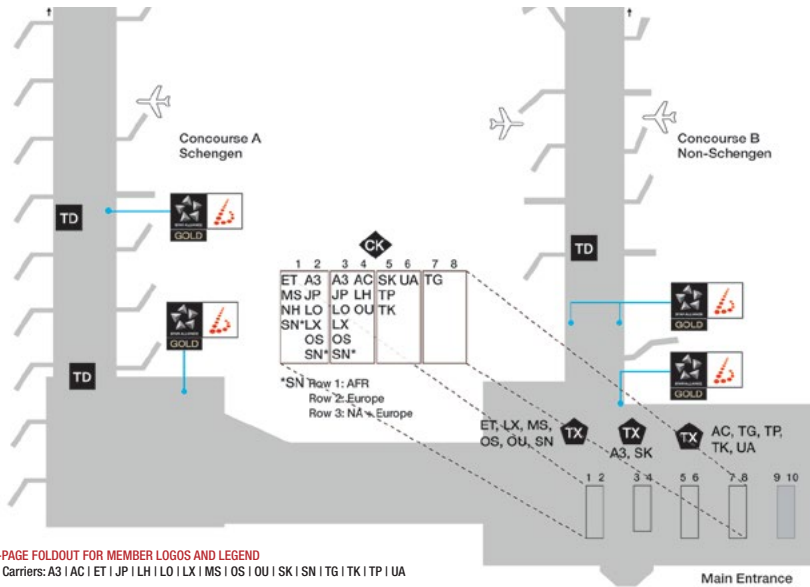

SEE LAST-PAGE FOLDOUT FOR MEMBER LOGOS AND LEGEND

Operating Carriers: A3 | AC | ET | JP | LH | LO | LX | MS | OS | OU | SK | SN | TG | TK | TP | UA

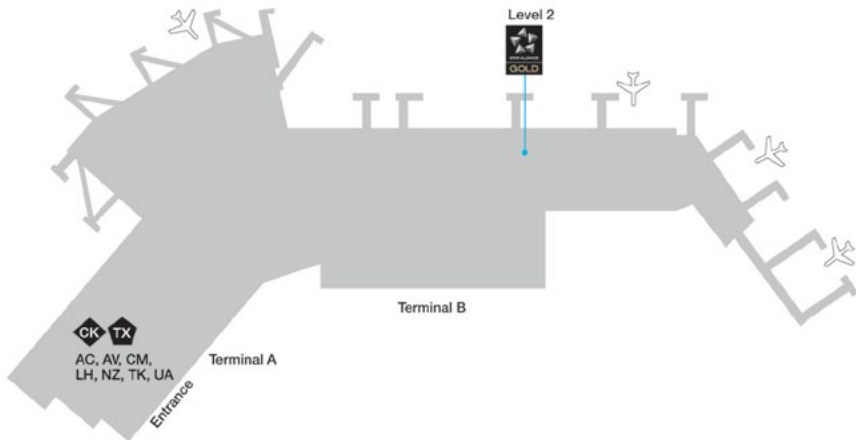

SEE LAST-PAGE FOLDOUT FOR MEMBER LOGOS AND LEGEND  
 Operating Carriers: AC | AV | CM | LH | NZ | TK | UA

EZE

Buenos Aires, Argentina  
 Ministro Pistarini International Airport  
[www.aa2000.com.ar](http://www.aa2000.com.ar)

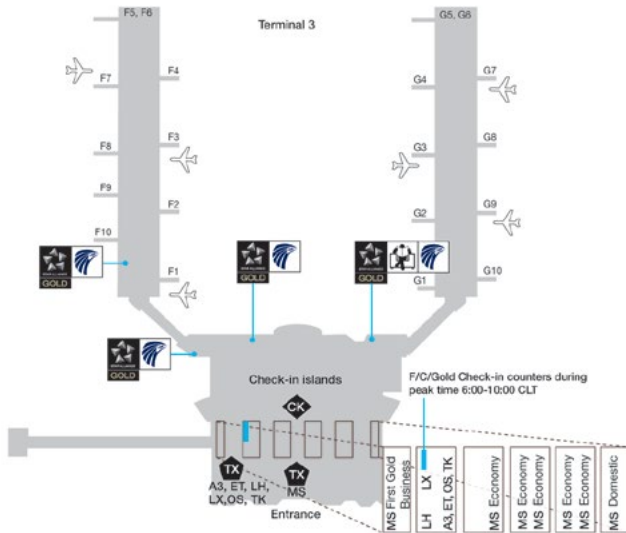

SEE LAST-PAGE FOLDOUT FOR MEMBER LOGOS AND LEGEND

Operating Carriers: A3 | ET | LH | LX | MS | OS | TK

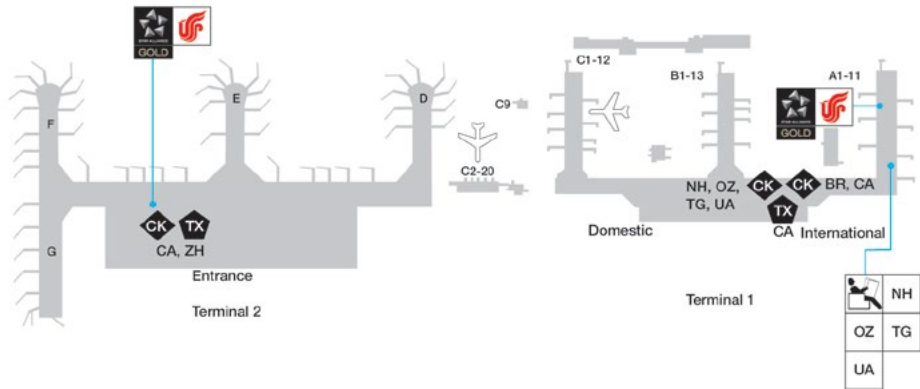

SEE LAST-PAGE FOLDOUT FOR MEMBER LOGOS AND LEGEND  
 Operating Carriers: BR | CA | NH | OZ | TG | UA | ZH

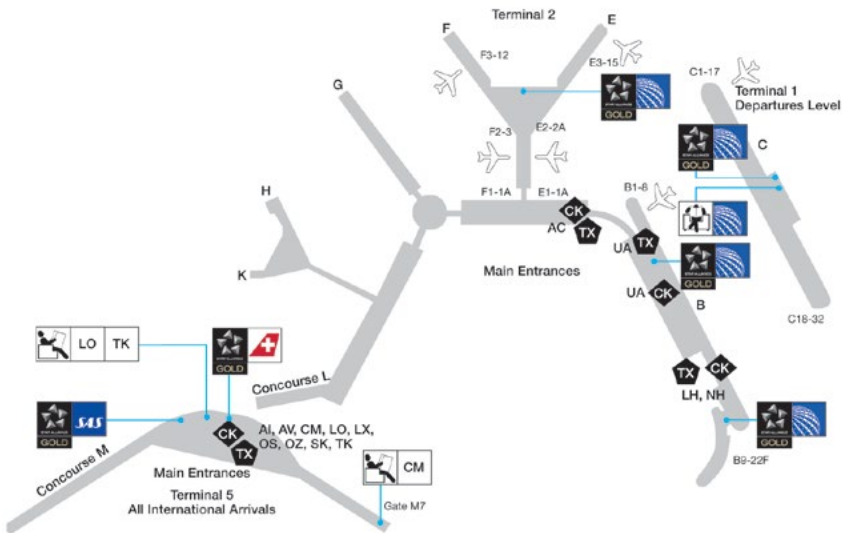

SEE LAST-PAGE FOLDOUT FOR MEMBER LOGOS AND LEGEND

Operating Carriers: AC | AI | AV | CM | LH | LO | LX | NH | OS | OZ | SK | TK | UA

Chicago, USA

Chicago O'Hare

[www.flychicago.com](http://www.flychicago.com)

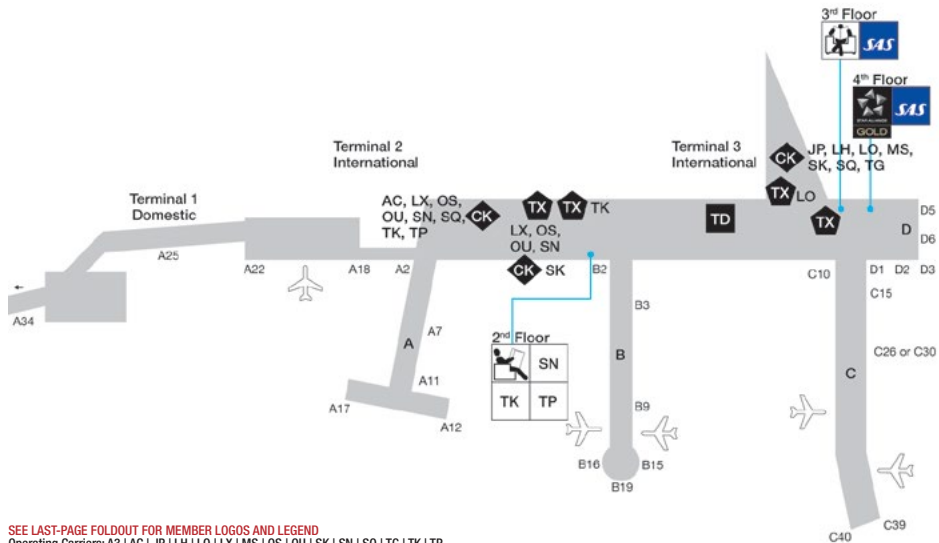

SEE LAST-PAGE FOLDOUT FOR MEMBER LOGOS AND LEGEND  
 Operating Carriers: A3 | AC | JP | LH | LO | LX | MS | OS | OU | SK | SN | SQ | TG | TK | TP

DEL

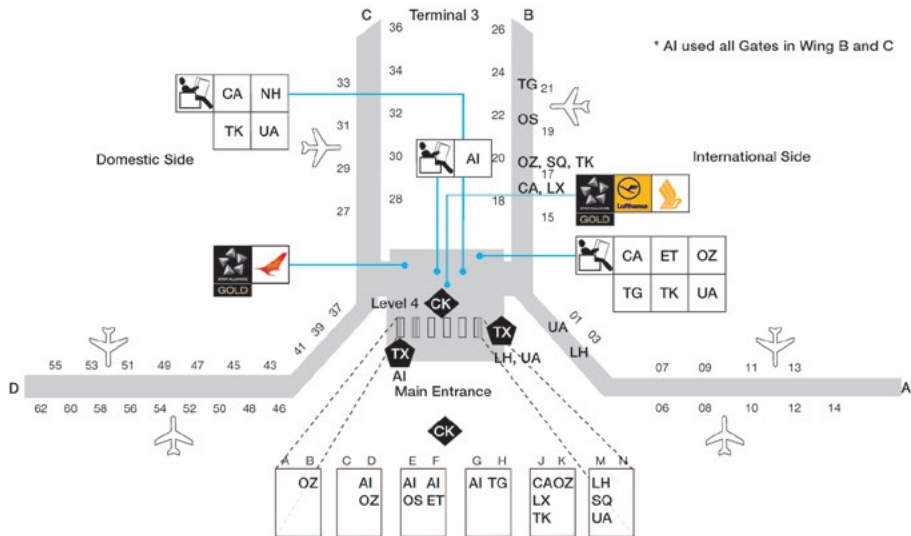

SEE LAST-PAGE FOLDOUT FOR MEMBER LOGOS AND LEGEND

Operating Carriers: AI\* | CA | ET | LH | LX | NH | OS | OZ | SQ | TG | TK | UA

Delhi, India  
Indira Gandhi International  
[www.newdelhairport.in](http://www.newdelhairport.in)



DEN

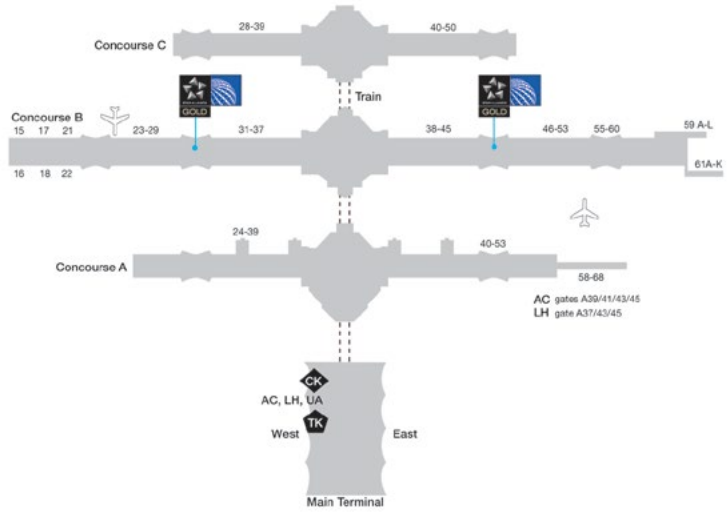

SEE LAST-PAGE FOLDOUT FOR MEMBER LOGOS AND LEGEND  
Operating Carriers: AC | LH | UA

Denver, USA  
Denver International Airport  
[www.flydenver.com](http://www.flydenver.com)

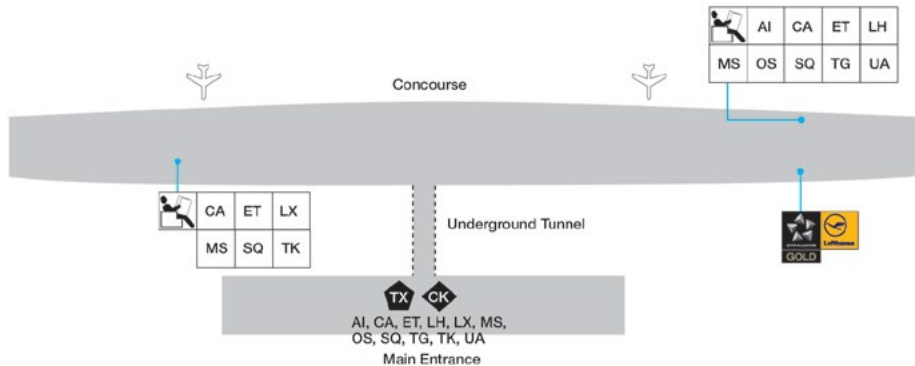

SEE LAST-PAGE FOLDOUT FOR MEMBER LOGOS AND LEGEND

Operating Carriers: AI | CA | ET | LH | LX | MS | OS | SQ | TG | TK | UA



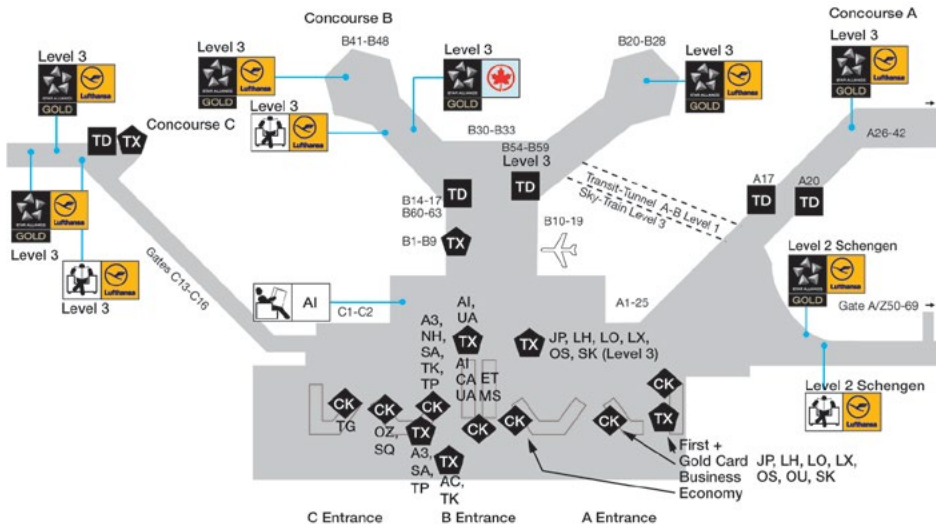

SEE LAST-PAGE FOLDOUT FOR MEMBER LOGOS AND LEGEND

Operating Carriers: A3 | AC | AI | CA | ET | JP | LH | LO | LX | MS | NH | OS | OU | OZ | SA | SK | SQ | TG | TK | TP | UA

Frankfurt, Germany  
 Frankfurt Main International Airport  
[www.frankfurt-airport.de](http://www.frankfurt-airport.de)

# FUK

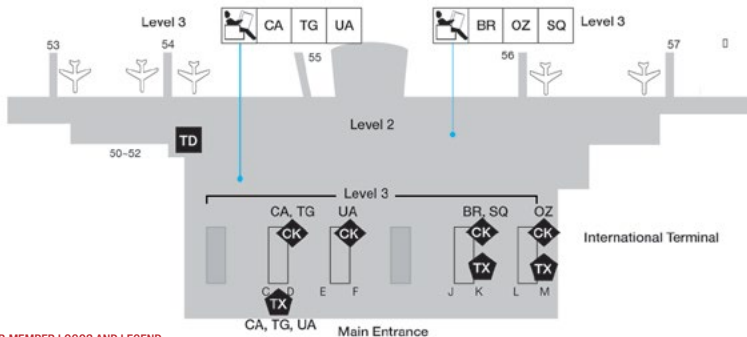

SEE LAST-PAGE FOLDOUT FOR MEMBER LOGOS AND LEGEND  
Operating Carriers: BR | CA | NH | OZ | SQ | TG | UA

Fukuoka, Japan  
Fukuoka Airport  
[www.fuk-ab.co.jp](http://www.fuk-ab.co.jp)



Note: UA does not offer TX services.  
Pax are requested to call a callcenter.

SEE LAST-PAGE FOLDOUT FOR MEMBER LOGOS AND LEGEND

Operating Carriers: A3 | AC | CA | LH | LO | LX | MS | OS | SK | SN | TK | TP | UA

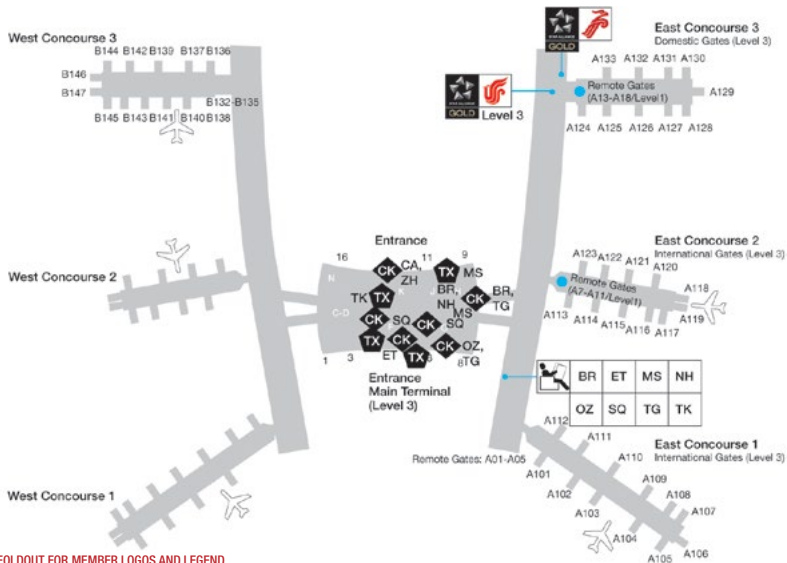

SEE LAST-PAGE FOLDOUT FOR MEMBER LOGOS AND LEGEND  
 Operating Carriers: BR | CA | ET | MS | NH | OZ | SQ | TG | TK | ZH

CAN

Guangzhou, China  
 Guangzhou Baiyun International Airport  
 www.baiyunairport.com

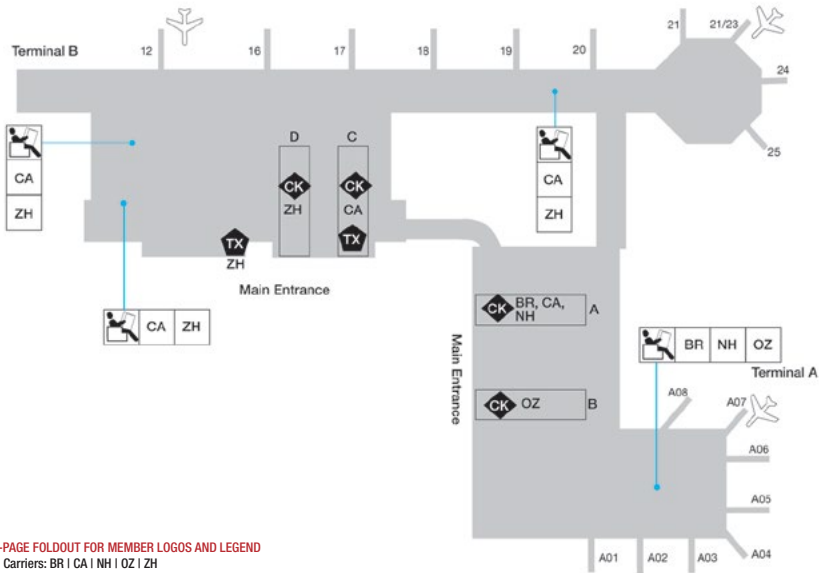

SEE LAST-PAGE FOLDOUT FOR MEMBER LOGOS AND LEGEND  
 Operating Carriers: BR | CA | NH | OZ | ZH



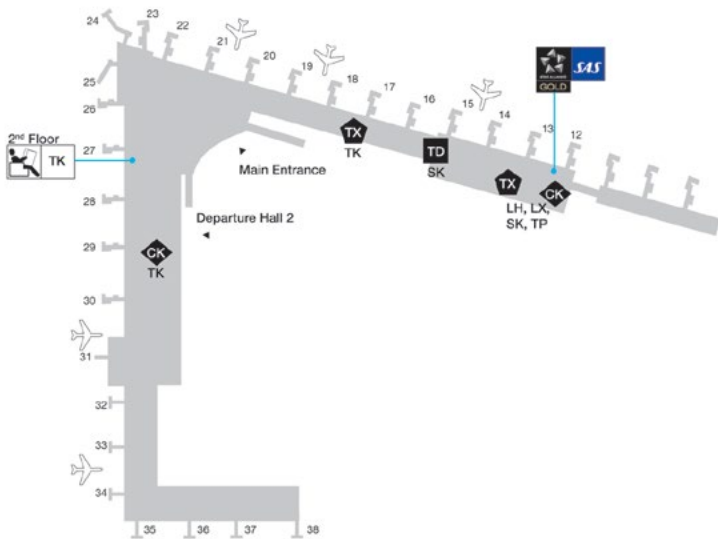

SEE LAST-PAGE FOLDOUT FOR MEMBER LOGOS AND LEGEND  
 Operating Carriers: LH | LX | SK | TK | TP

HEL

Helsinki, Finland  
 Helsinki-Vantaa International Airport  
[www.helsinki-vantaa.fi](http://www.helsinki-vantaa.fi)

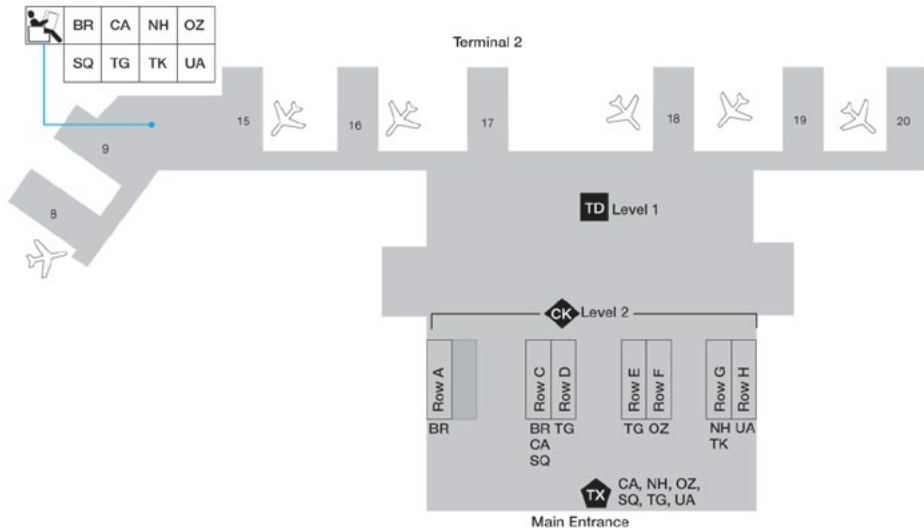

SEE LAST-PAGE FOLDOUT FOR MEMBER LOGOS AND LEGEND  
 Operating Carriers: BR | CA | NH | OZ | SQ | TG | TK | UA

Ho Chi Minh City, Vietnam  
 Tan Son Nhat Airport  
[www.hochiminhcityairport.com/](http://www.hochiminhcityairport.com/)

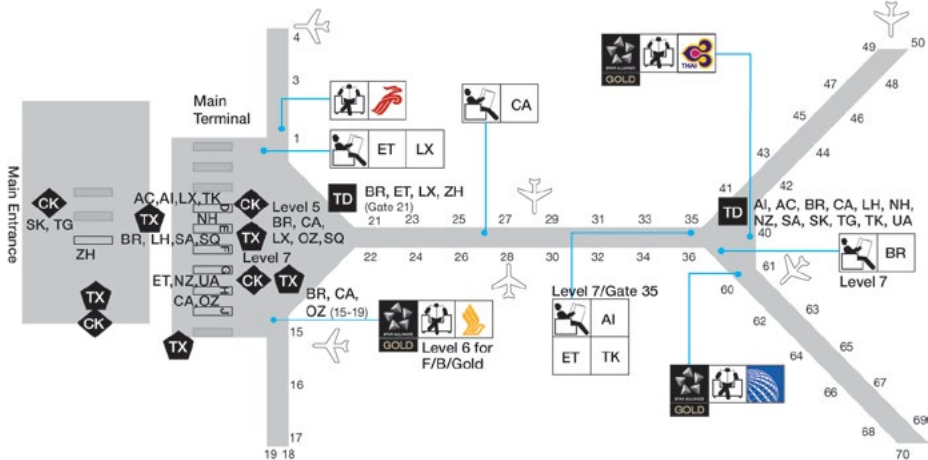

SEE LAST-PAGE FOLDOUT FOR MEMBER LOGOS AND LEGEND

Operating Carriers: AC | AI | BR | CA | ET | LH | LX | NH | NZ | OZ | SA | SQ | SK | TG | TK | UA | ZH





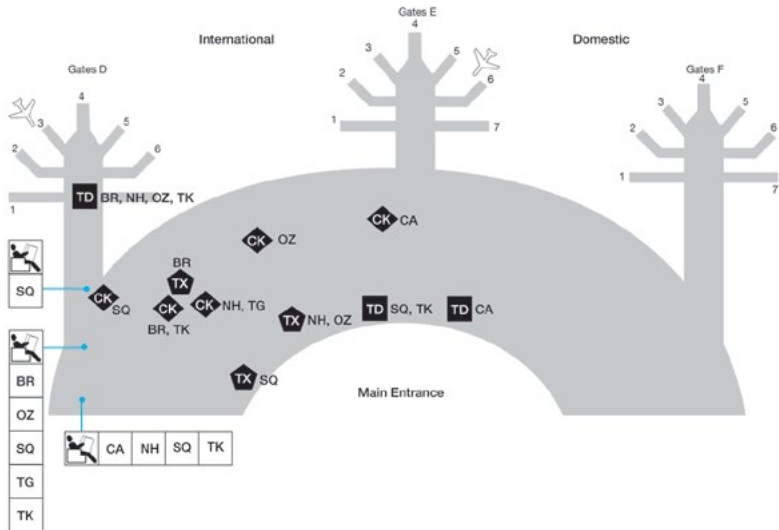

SEE LAST-PAGE FOLDOUT FOR MEMBER LOGOS AND LEGEND

Operating Carriers: BR | CA | NH | OZ | SQ | TG | TK

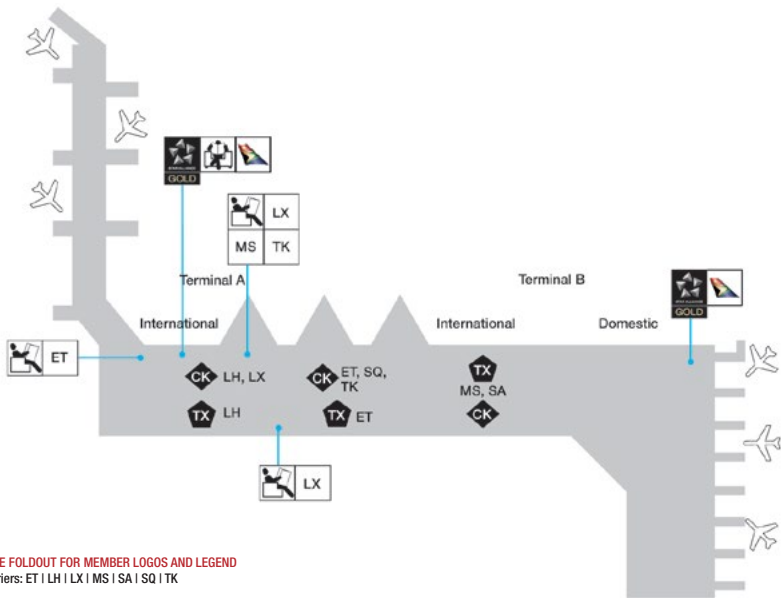

SEE LAST-PAGE FOLDOUT FOR MEMBER LOGOS AND LEGEND  
 Operating Carriers: ET | LH | LX | MS | SA | SQ | TK

JNB

Johannesburg, South Africa  
 Johannesburg International Airport  
[www.acsa.co.za](http://www.acsa.co.za)

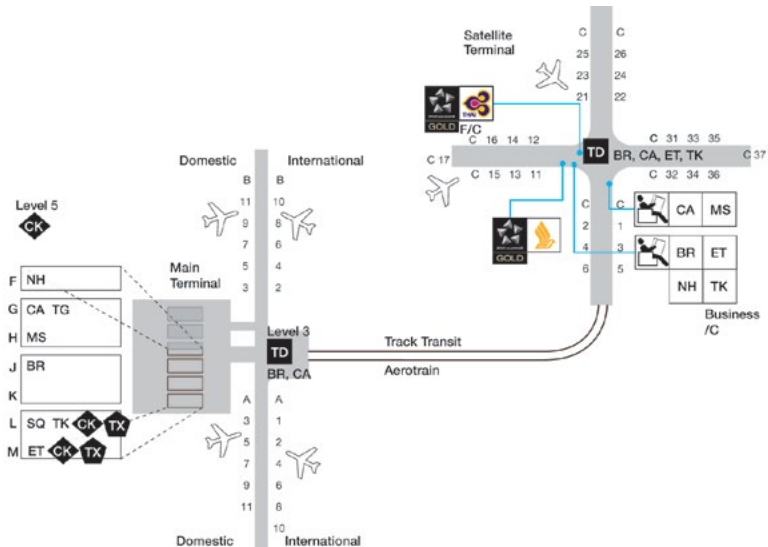

SEE LAST-PAGE FOLDOUT FOR MEMBER LOGOS AND LEGEND

Operating Carriers: BR | CA | ET | MS | NH | SQ | TG | TK

KUL

Kuala Lumpur, Malaysia  
 Kuala Lumpur International Airport  
[www.klia.com.my](http://www.klia.com.my)



LIM

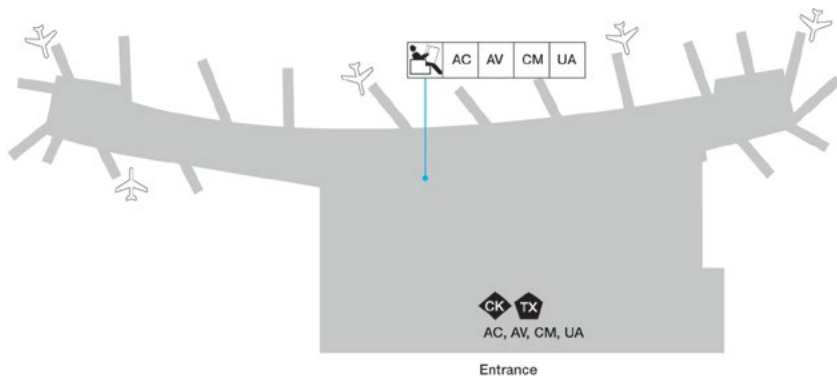

SEE LAST-PAGE FOLDOUT FOR MEMBER LOGOS AND LEGEND  
Operating Carriers: AC | AV | CM | UA

Lima, Peru  
Jorge Chávez International Airport  
[www.lap.com.pe](http://www.lap.com.pe)

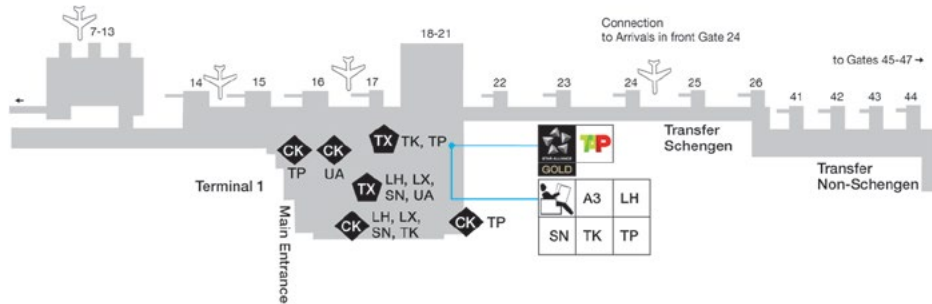

SEE LAST-PAGE FOLDOUT FOR MEMBER LOGOS AND LEGEND

Operating Carriers: A3 | LH | LX | SN | TK | TP | UA

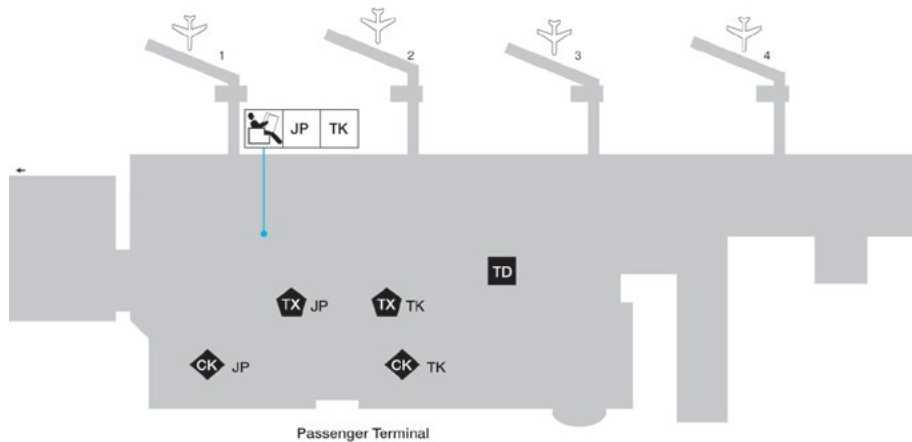

SEE LAST-PAGE FOLDOUT FOR MEMBER LOGOS AND LEGEND  
Operating Carriers: JP | TK

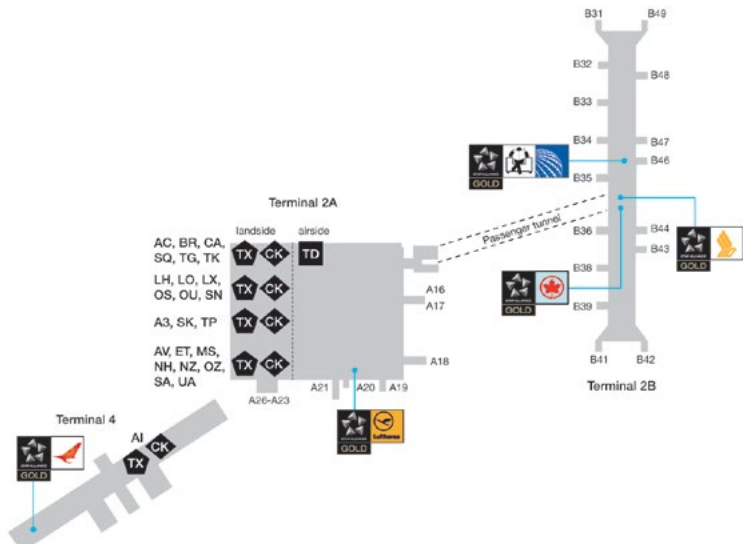

SEE LAST-PAGE FOLDOUT FOR MEMBER LOGOS AND LEGEND

Operating Carriers: A3 | AC | AI | AV | BR | CA | ET | LH | LO | LX | MS | NH | NZ | OS | OU | OZ | SA | SK | SN | SQ | TG | TK | TP | UA

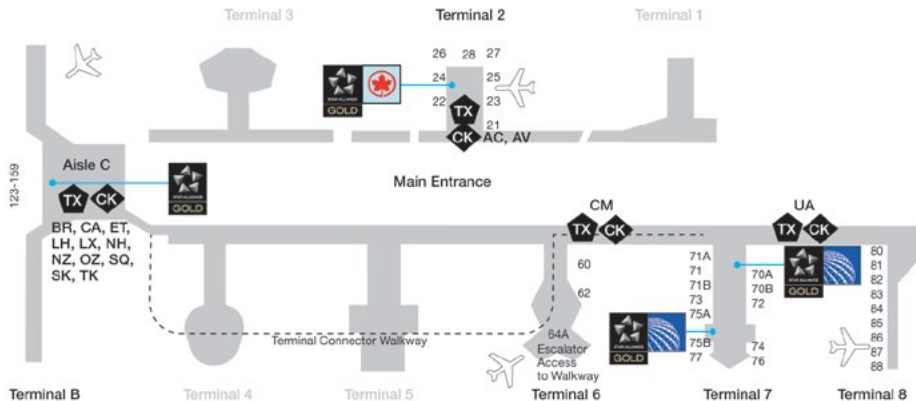

SEE LAST-PAGE FOLDOUT FOR MEMBER LOGOS AND LEGEND

Operating Carriers: AC | AV | BR | CA | CM | ET | LH | LX | NH | NZ | OZ | SQ | SK | TK | UA

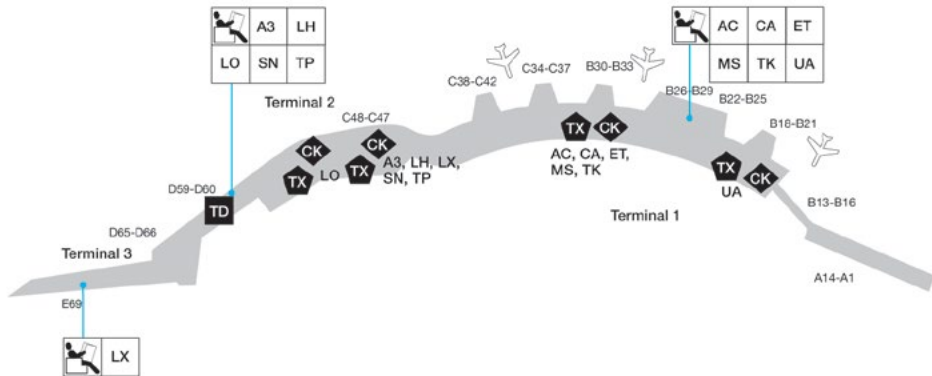

\*AV operates in Terminal 4

SEE LAST-PAGE FOLDOUT FOR MEMBER LOGOS AND LEGEND

Operating Carriers: A3 | AC | AV\* T4 | CA | ET | LH | LO | LX | MS | SN | TK | TP | UA

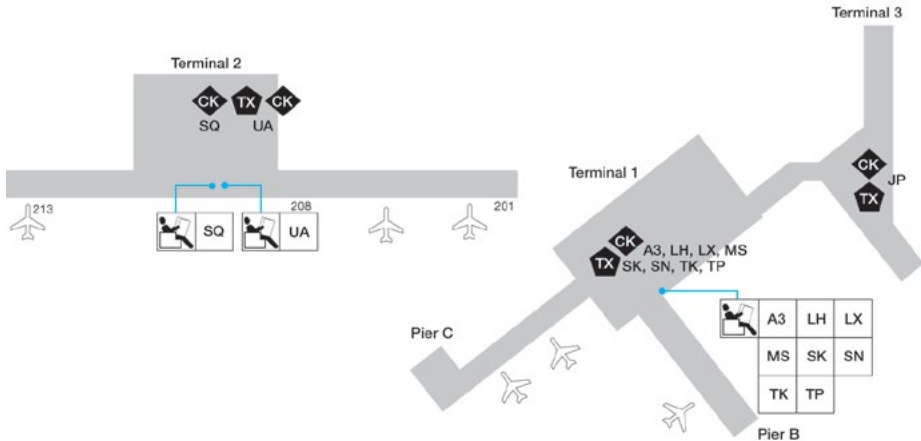

SEE LAST-PAGE FOLDOUT FOR MEMBER LOGOS AND LEGEND  
 Operating Carriers: A3 | JP | LH | LX | MS | SK | SN | SQ | TK | TP | UA

MAN

Manchester, United Kingdom  
 Manchester International  
[www.ManchesterAirport.co.uk](http://www.ManchesterAirport.co.uk)

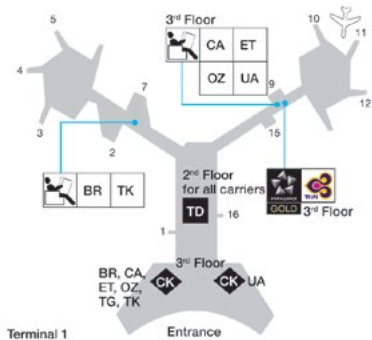

SEE LAST-PAGE FOLDOUT FOR MEMBER LOGOS AND LEGEND

Operating Carriers: BR | CA | ET | NH | OZ | SQ | TG | TK | UA

MNL

Manila, Philippines  
Ninoy Aquino International Airport  
[www.manila-airport.net](http://www.manila-airport.net)



MEL

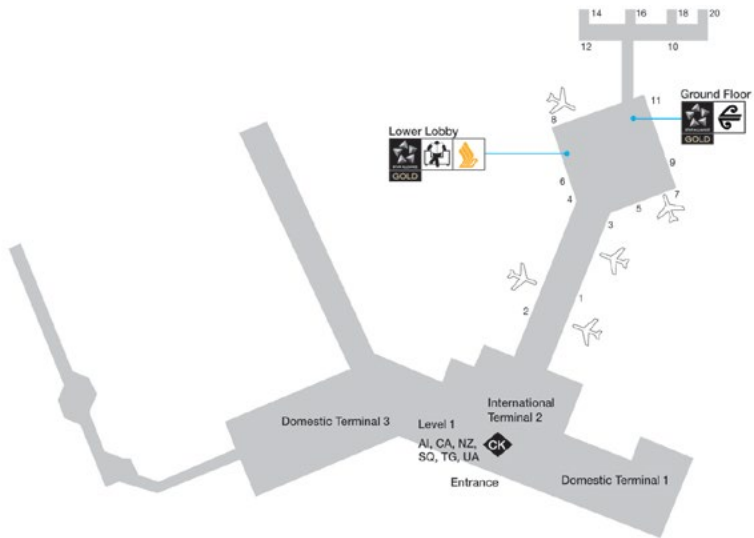

SEE LAST-PAGE FOLDOUT FOR MEMBER LOGOS AND LEGEND  
Operating Carriers: AI | CA | NZ | SQ | TG | UA

Melbourne, Australia  
Tullamarine International  
[www.melbourneairport.com.au](http://www.melbourneairport.com.au)

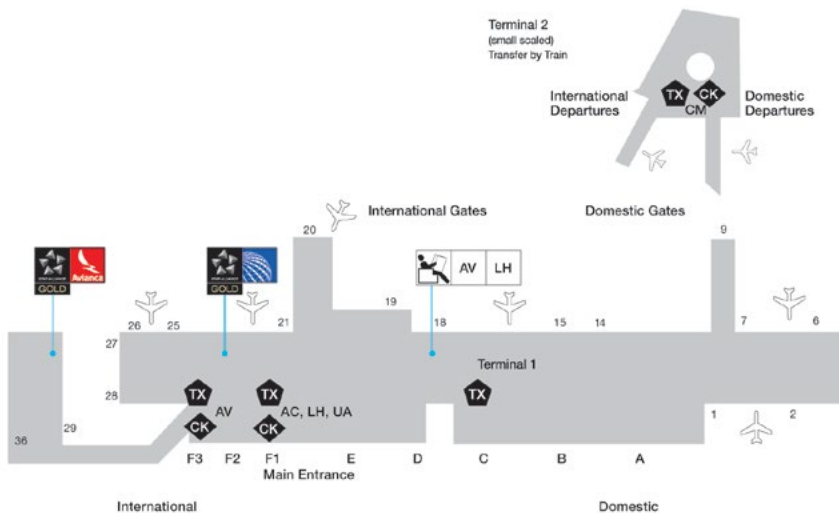

SEE LAST-PAGE FOLDOUT FOR MEMBER LOGOS AND LEGEND

Operating Carriers: AC | AV | CM | LH | UA

MIA

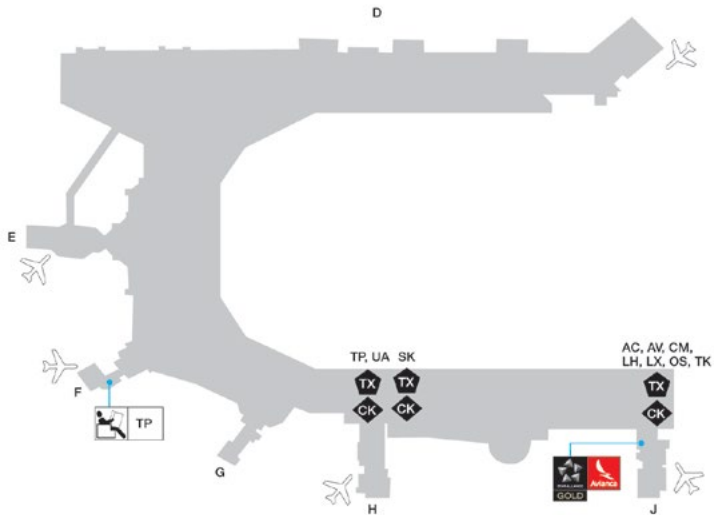

SEE LAST-PAGE FOLDOUT FOR MEMBER LOGOS AND LEGEND  
Operating Carriers: AC | AV | CM | LH | LX | OS | SK | TP | TK | UA

Miami, USA  
Miami International  
[www.miami-airport.com](http://www.miami-airport.com)

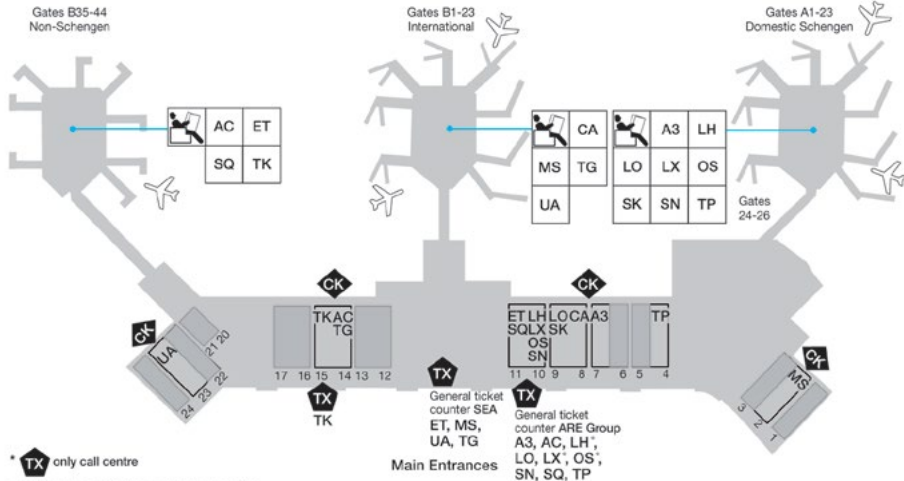

\* **TX** only call centre  
 \* only for remote ticketing encashment services

SEE LAST-PAGE FOLDOUT FOR MEMBER LOGOS AND LEGEND  
 Operating Carriers: A3 | AC | CA\* | ET | LH | LO | LX | MS | OS | SK\* | SN | SQ | TG | TK | TP | UA

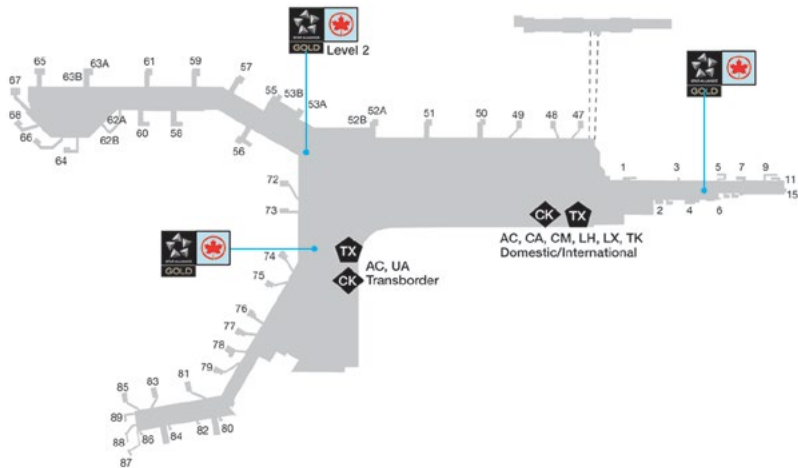

SEE LAST-PAGE FOLDOUT FOR MEMBER LOGOS AND LEGEND  
 Operating Carriers: AC | CA | CM | LH | LX | TK | UA

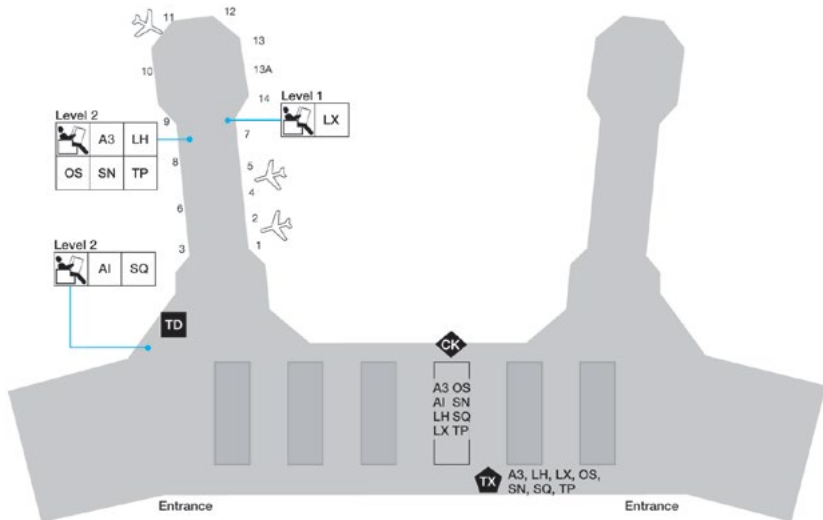

SEE LAST-PAGE FOLDOUT FOR MEMBER LOGOS AND LEGEND

Operating Carriers: A3 | AI | LH | LX | OS | SN | SQ | TP

BOM

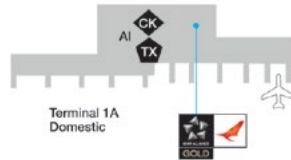
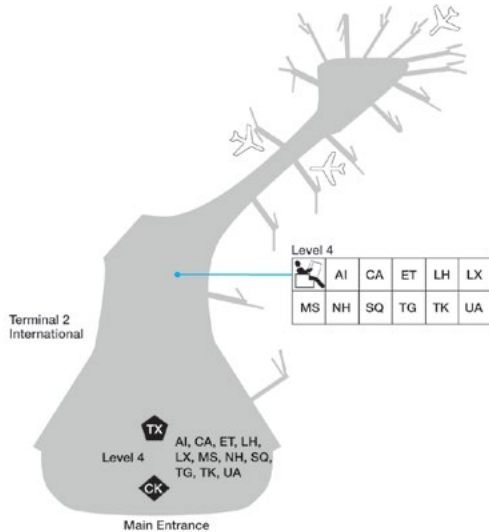

SEE LAST-PAGE FOLDOUT FOR MEMBER LOGOS AND LEGEND  
Operating Carriers: AI | CA | ET | LH | LX | MS | NH | SQ | TG | TK | UA

Mumbai, India  
Chhatrapati Shivaji International Airport  
www.csia.in

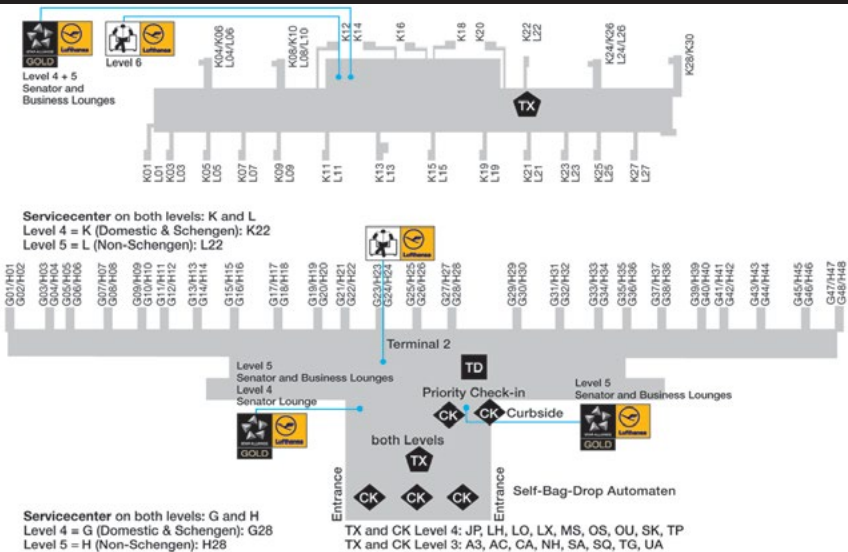

\*TK operates in Terminal 1

SEE LAST-PAGE FOLDOUT FOR MEMBER LOGOS AND LEGEND

Operating Carriers: A3 | AC | CA | JP | LH | LO | LX | MS | NH | OS | OU | SA | SK | SQ | TG | TK\* | TP | UA



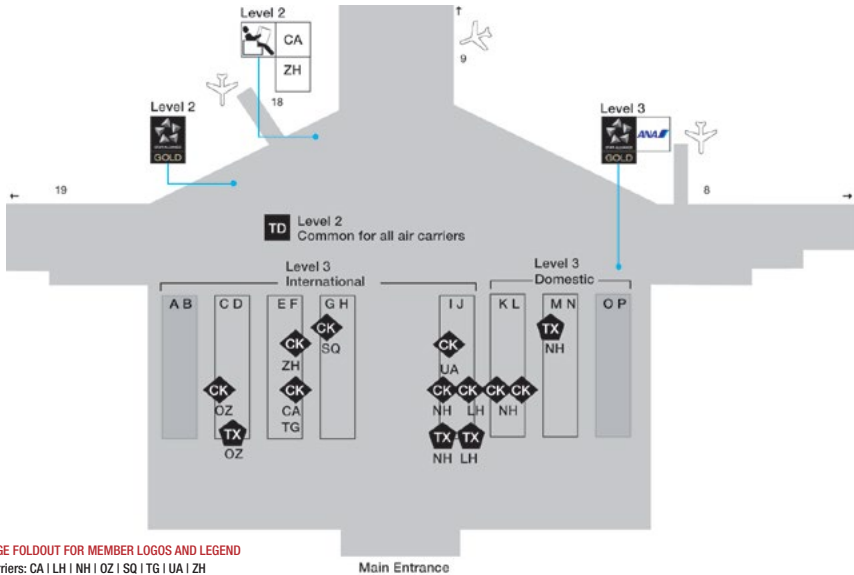

SEE LAST-PAGE FOLDOUT FOR MEMBER LOGOS AND LEGEND

Operating Carriers: CA | LH | NH | OZ | SQ | TG | UA | ZH

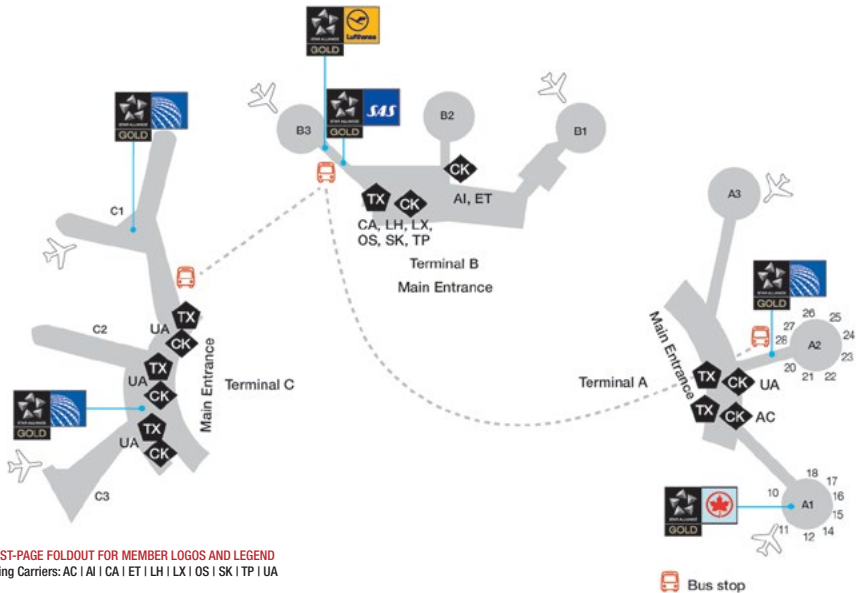

SEE LAST-PAGE FOLDOUT FOR MEMBER LOGOS AND LEGEND  
 Operating Carriers: AC | AI | CA | ET | LH | LX | OS | SK | TP | UA

New York, USA  
 Newark Liberty International Airport  
[www.panynj.gov/airports](http://www.panynj.gov/airports)



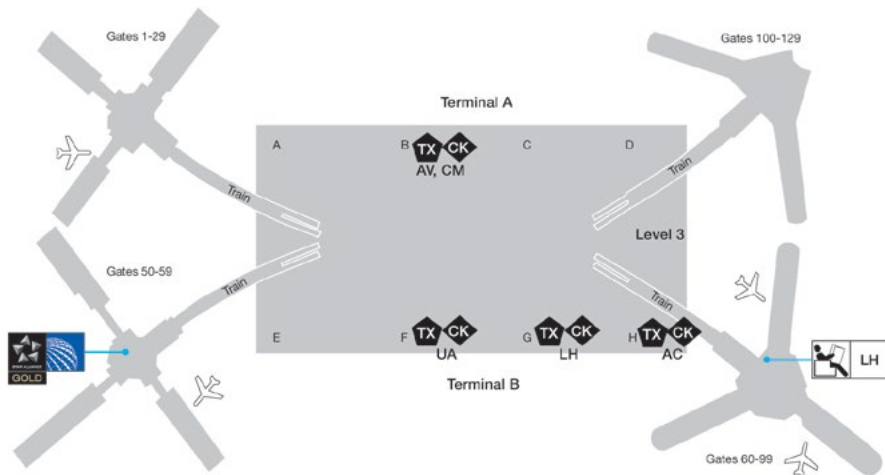

SEE LAST-PAGE FOLDOUT FOR MEMBER LOGOS AND LEGEND

Operating Carriers: AC | AV | CM | LH | UA

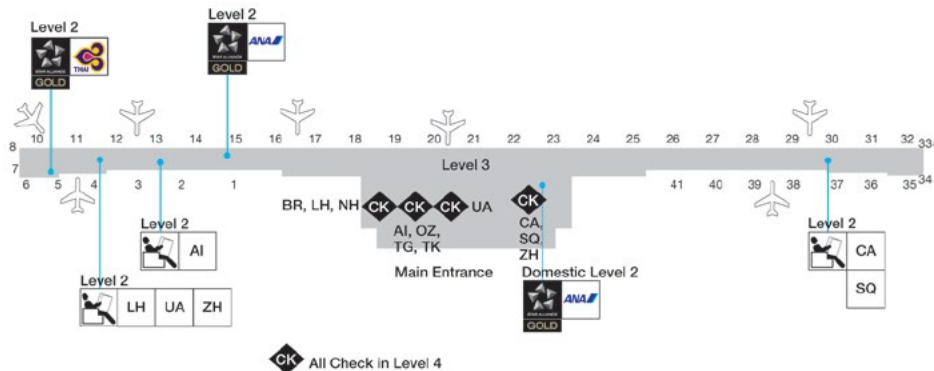

SEE LAST-PAGE FOLDOUT FOR MEMBER LOGOS AND LEGEND

Operating Carriers: AI | BR | CA | LH | NH | OZ | SQ | TG | TK | UA | ZH

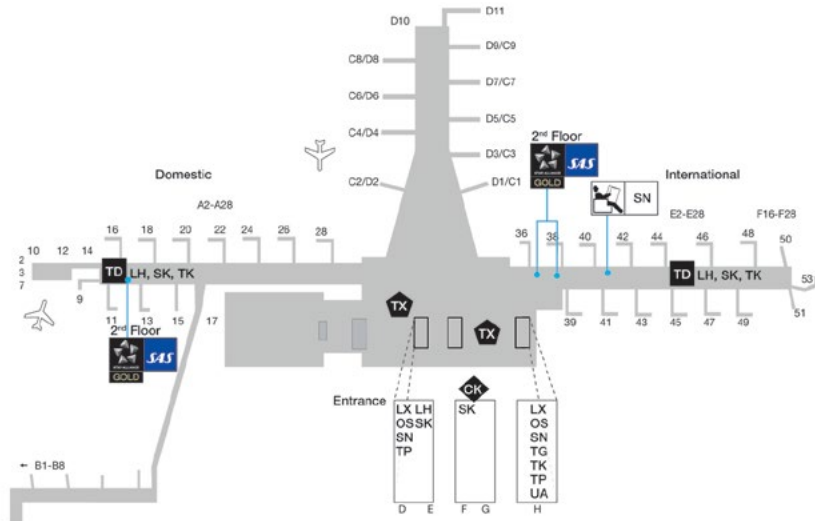

SEE LAST-PAGE FOLDOUT FOR MEMBER LOGOS AND LEGEND

Operating Carriers: A3 | LH | LX | OS | SK | SN | TG | TK | TP | UA

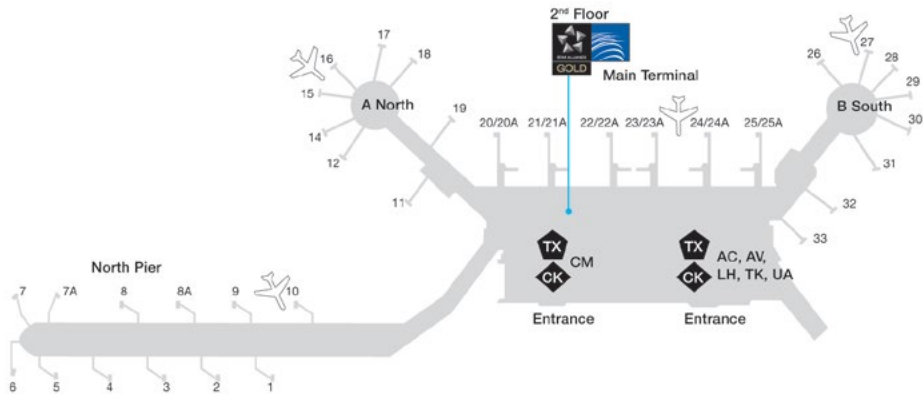

SEE LAST-PAGE FOLDOUT FOR MEMBER LOGOS AND LEGEND  
 Operating Carriers: AC | AV | CM | LH | TK | UA

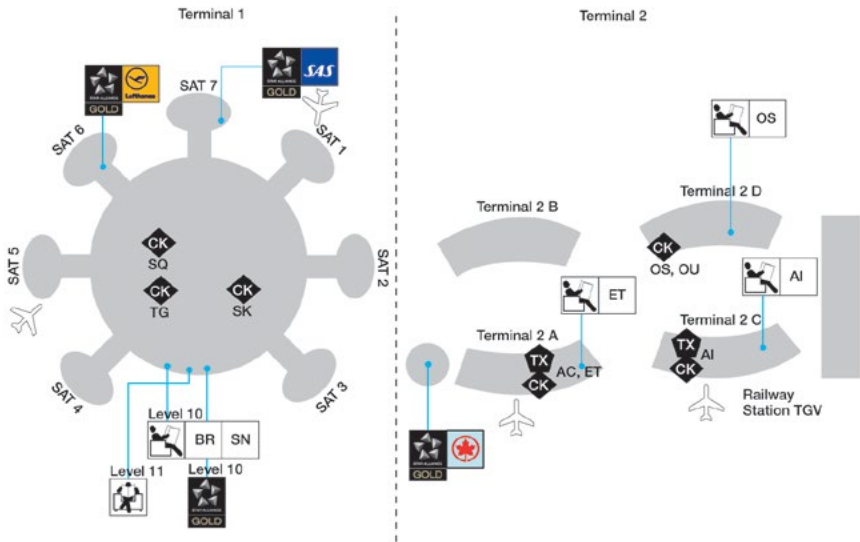

SEE LAST-PAGE FOLDOUT FOR MEMBER LOGOS AND LEGEND

Operating Carriers: A3 | AC T2A | AI T2C | BR | CA | ET T2A | JP | LH | LO | LX | MS | NH | OS T2D | OU T2D | OZ | SK | SN | SQ | TG | TK | UA



GIG

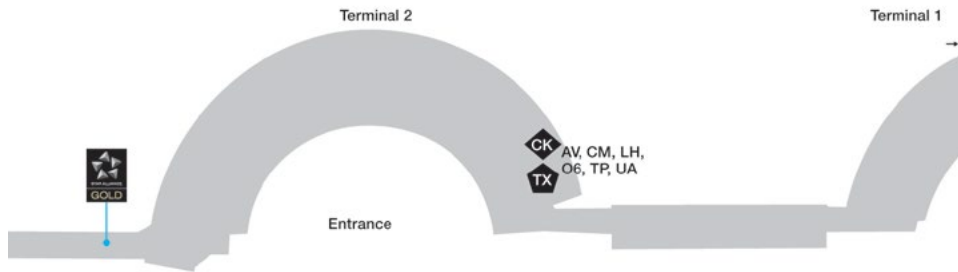

SEE LAST-PAGE FOLDOUT FOR MEMBER LOGOS AND LEGEND  
Operating Carriers: AV | CM | LH | O6 | TP | UA

Rio de Janeiro, Brazil  
Galeão International Airport  
[www.infraero.com.br](http://www.infraero.com.br)

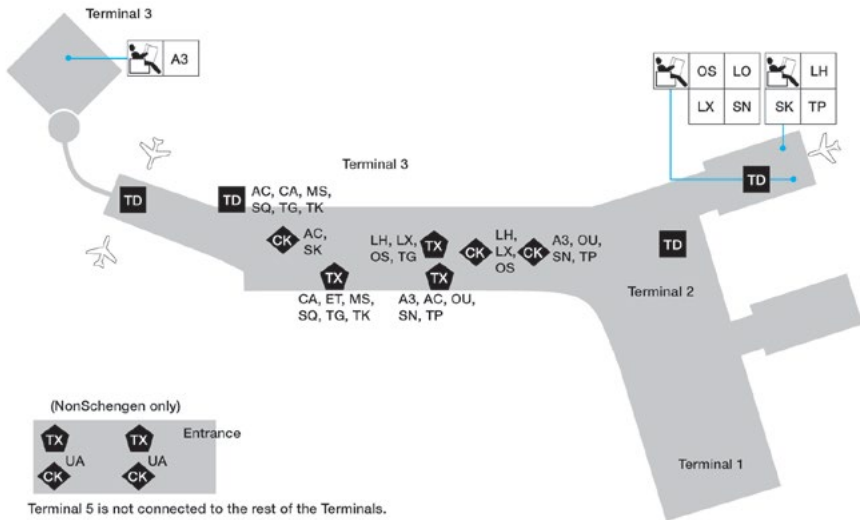

SEE LAST-PAGE FOLDOUT FOR MEMBER LOGOS AND LEGEND

Operating Carriers: A3 | AC | CA | ET | LH | LO | LX | MS | OS | OU | SK | SN | SQ | TG | TK | TP | UA

LED

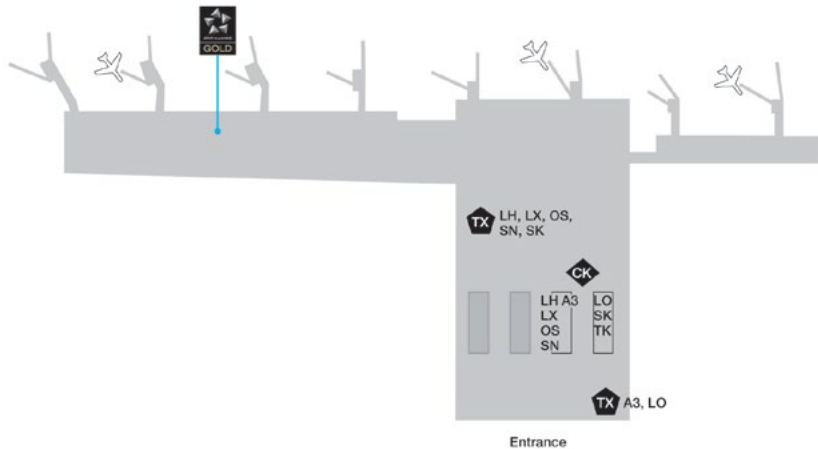

SEE LAST-PAGE FOLDOUT FOR MEMBER LOGOS AND LEGEND  
Operating Carriers: A3 | LH | LO | LX | SK | SN | TK

Saint Petersburg, Russia  
Pulkovo Airport  
[www.pulkovoairport.ru](http://www.pulkovoairport.ru)

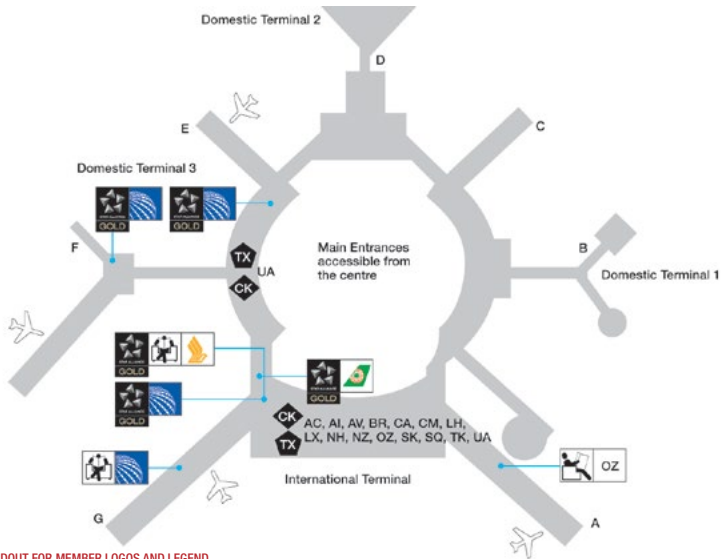

SEE LAST-PAGE FOLDOUT FOR MEMBER LOGOS AND LEGEND

Operating Carriers: AC | AI | AV | BR | CA | CM | LH | LX | NH | NZ | OZ | SK | SQ | TK | UA

GRU

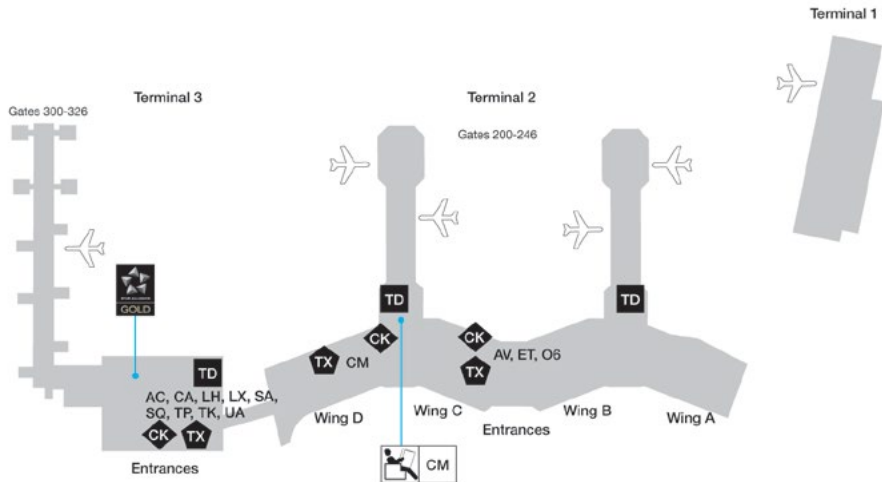

SEE LAST-PAGE FOLDOUT FOR MEMBER LOGOS AND LEGEND

Operating Carriers: AC | AV | CA | CM | ET | LH | LX | O6 | SA | SQ | TK | TP | UA

São Paulo, Brazil  
Guarulhos-São Paulo International Airport  
[www.infraero.com.br](http://www.infraero.com.br)

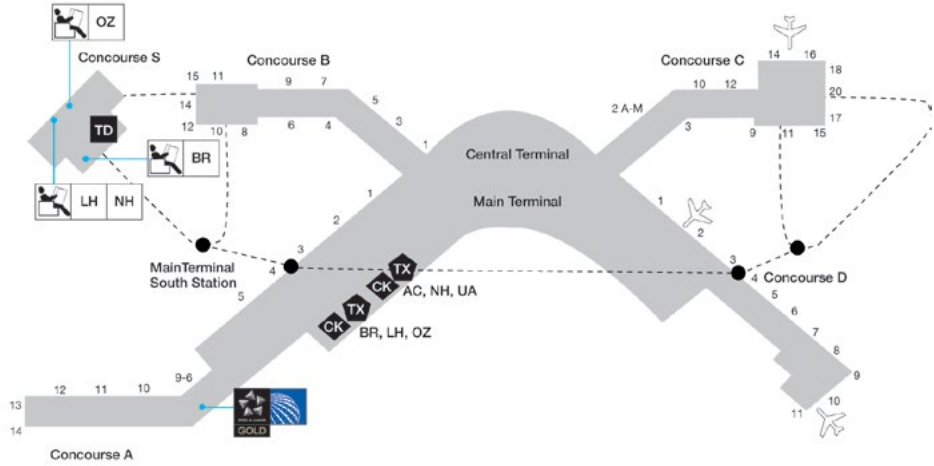

--- Transit (Underground)

SEE LAST-PAGE FOLDOUT FOR MEMBER LOGOS AND LEGEND  
Operating Carriers: AC | BR | LH | NH | OZ | UA

Seattle, USA  
Seattle Tacoma International Airport  
[www.portseattle.org/sea-tac](http://www.portseattle.org/sea-tac)

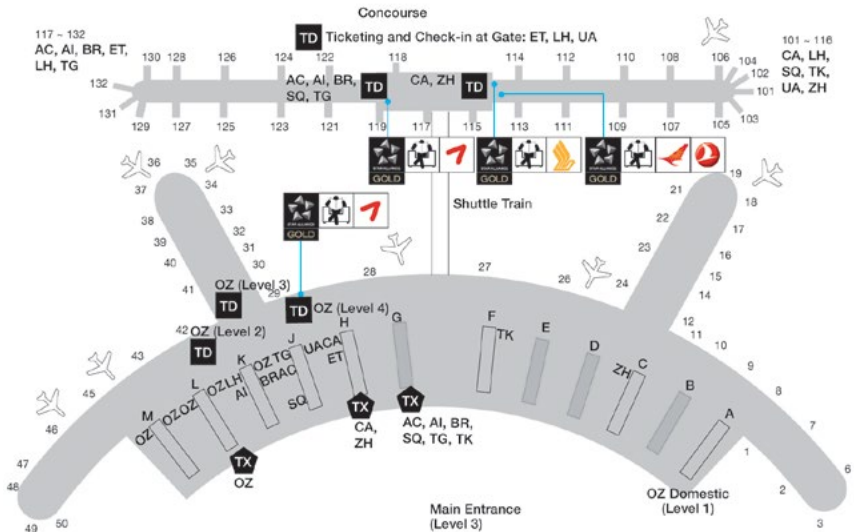

SEE LAST-PAGE FOLDOUT FOR MEMBER LOGOS AND LEGEND  
 Operating Carriers: AC | AI | BR | CA | ET | LH | OZ | SQ | TG | TK | UA | ZH

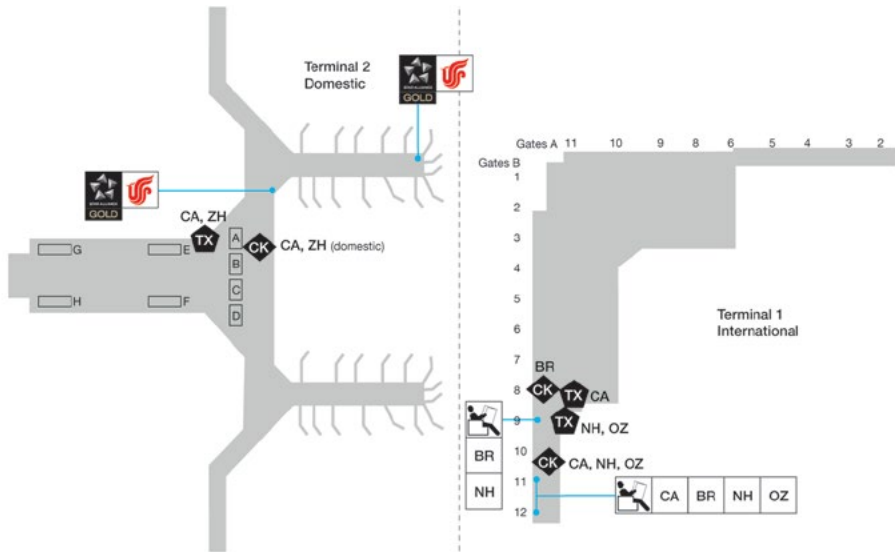

SEE LAST-PAGE FOLDOUT FOR MEMBER LOGOS AND LEGEND  
 Operating Carriers: BR | CA | NH | OZ | ZH

Shanghai, China  
 Shanghai Hongqiao International Airport  
[en.shairport.com/hongqiaoair](http://en.shairport.com/hongqiaoair)



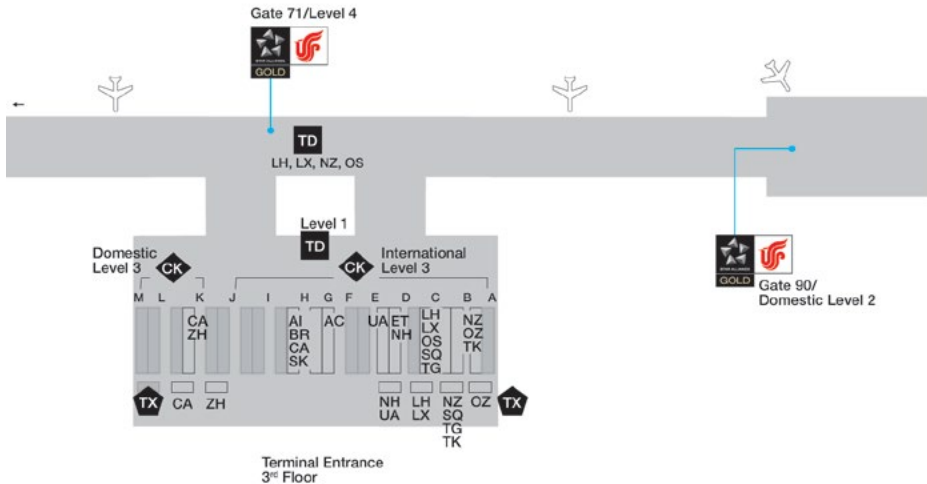

SEE LAST-PAGE FOLDOUT FOR MEMBER LOGOS AND LEGEND

Operating Carriers: AC | AI | BR | CA | ET | LH | LX | NH | NZ | OS | OZ | SK | SQ | TG | TK | UA | ZH

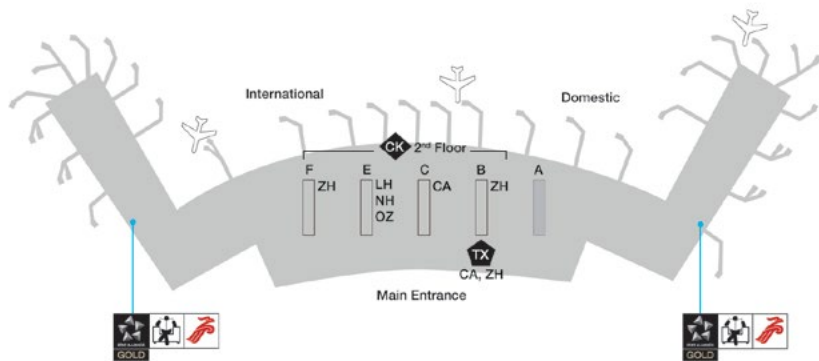

SEE LAST-PAGE FOLDOUT FOR MEMBER LOGOS AND LEGEND

Operating Carriers: CA | LH | NH | OZ | ZH

Shenyang, China  
 Shenyang Taoxian International Airport  
[tx.lnairport.com/en](http://tx.lnairport.com/en)

SZX

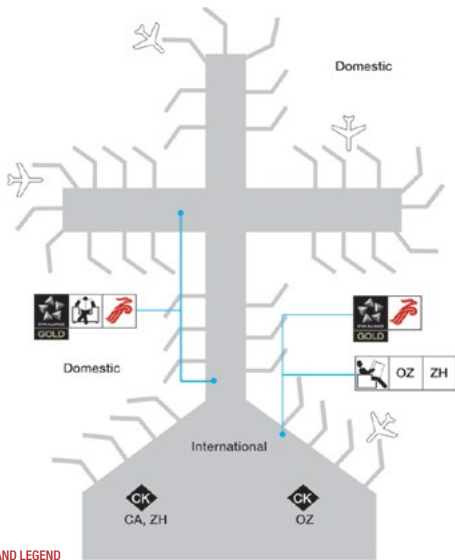

SEE LAST-PAGE FOLDOUT FOR MEMBER LOGOS AND LEGEND  
Operating Carriers: CA | OZ | ZH

Shenzhen, China  
Shenzhen Bao'an International Airport  
[www.szairport.com](http://www.szairport.com)

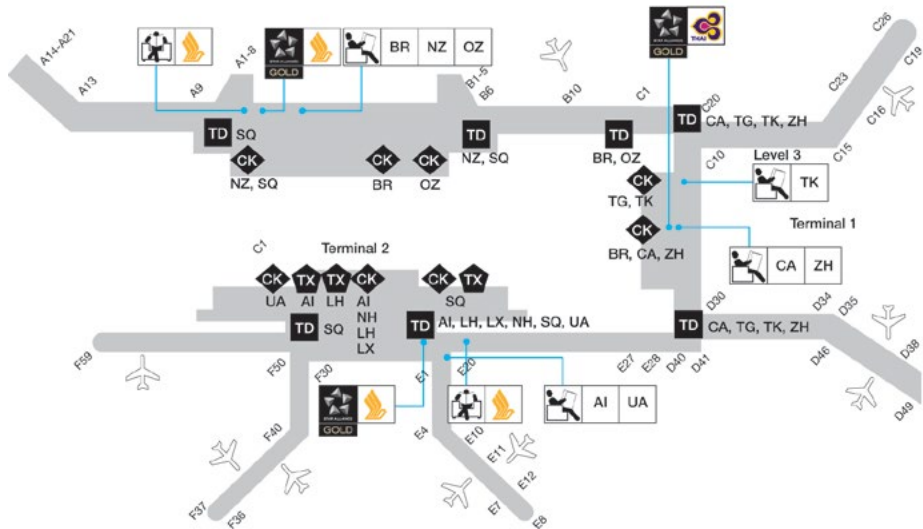

SEE LAST-PAGE FOLDOUT FOR MEMBER LOGOS AND LEGEND  
 Operating Carriers: AI | BR | CA | LH | LX | NH | NZ | OZ | SQ | TG | TK | UA | ZH

SIN

Singapore  
 Singapore Changi Airport  
[www.changiairport.com](http://www.changiairport.com)

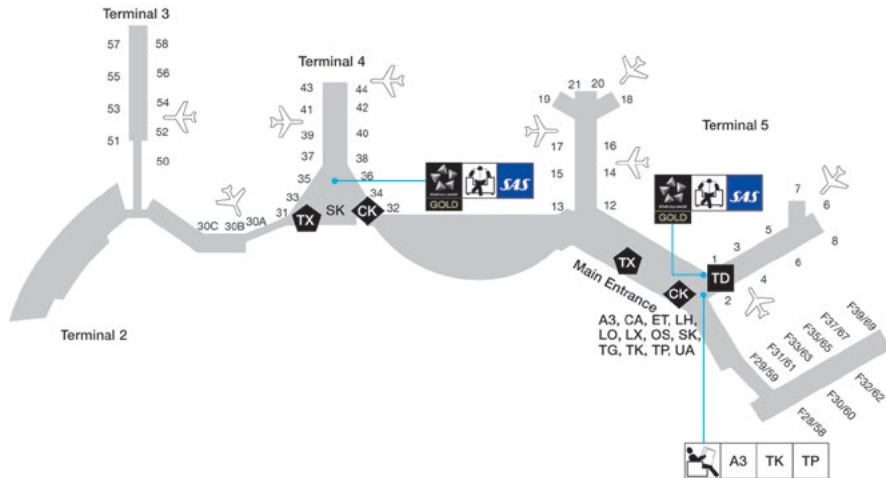

SEE LAST-PAGE FOLDOUT FOR MEMBER LOGOS AND LEGEND

Operating Carriers: A3 | CA | ET | LH | LO | LX | OS | SK | TG | TK | TP | UA

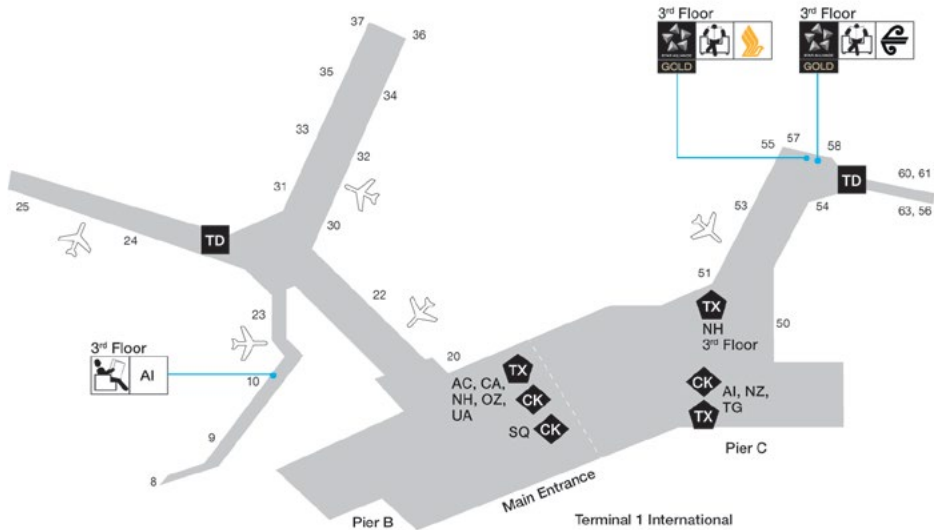

SEE LAST-PAGE FOLDOUT FOR MEMBER LOGOS AND LEGEND

Operating Carriers: AC | AI | CA | NH | NZ | OZ | SQ | TG | UA

TPE

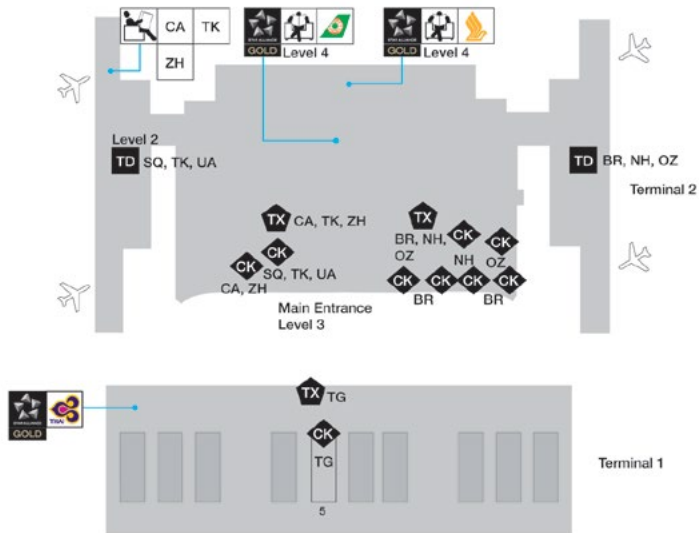

SEE LAST-PAGE FOLDOUT FOR MEMBER LOGOS AND LEGEND  
Operating Carriers: BR | CA | NH | OZ | SQ | TG | TK | UA | ZH

Taipei, Taiwan  
Taiwan Taoyuan International Airport  
[www.taoyuan-airport.com](http://www.taoyuan-airport.com)

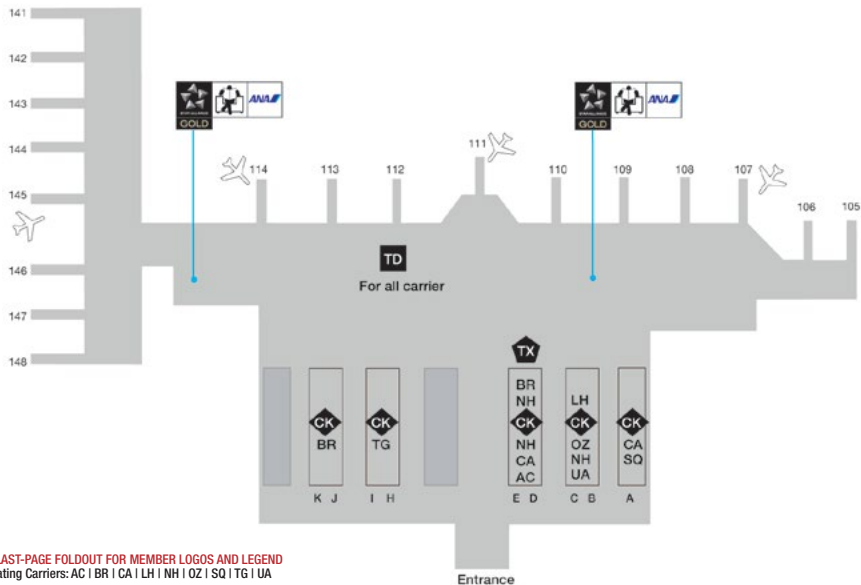

SEE LAST-PAGE FOLDOUT FOR MEMBER LOGOS AND LEGEND  
 Operating Carriers: AC | BR | CA | LH | NH | OZ | SQ | TG | UA



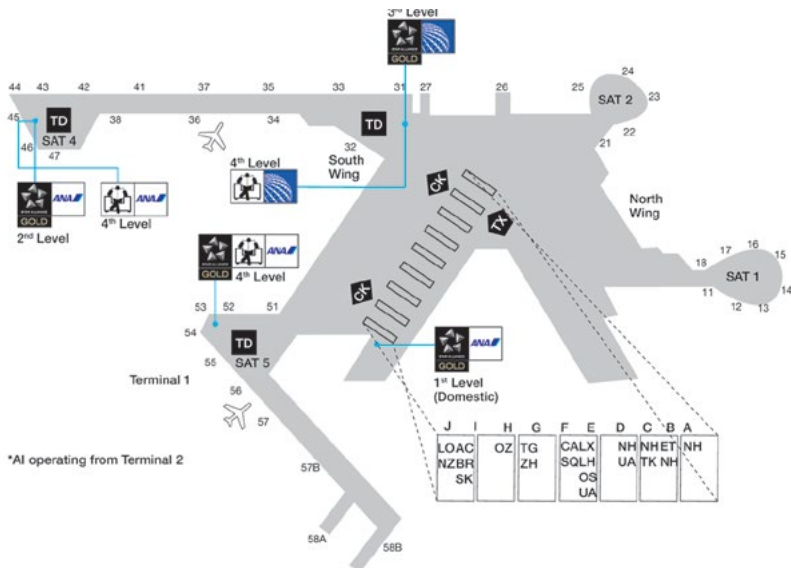

SEE LAST-PAGE FOLDOUT FOR MEMBER LOGOS AND LEGEND

Operating Carriers: AC | AI\* | BR | CA | ET | LH | LO | LX | NH | NZ | OS | OZ | SK | SQ | TG | TK | UA | ZH

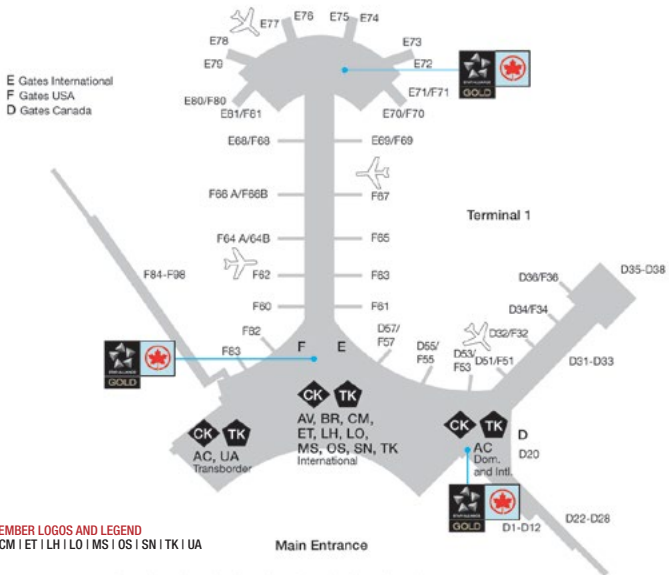

SEE LAST-PAGE FOLDOUT FOR MEMBER LOGOS AND LEGEND  
 Operating Carriers: AC | AV | BR | CM | ET | LH | LO | MS | OS | SN | TK | UA

Toronto, Canada  
 Lester B. Pearson International  
[www.torontopearson.com](http://www.torontopearson.com)

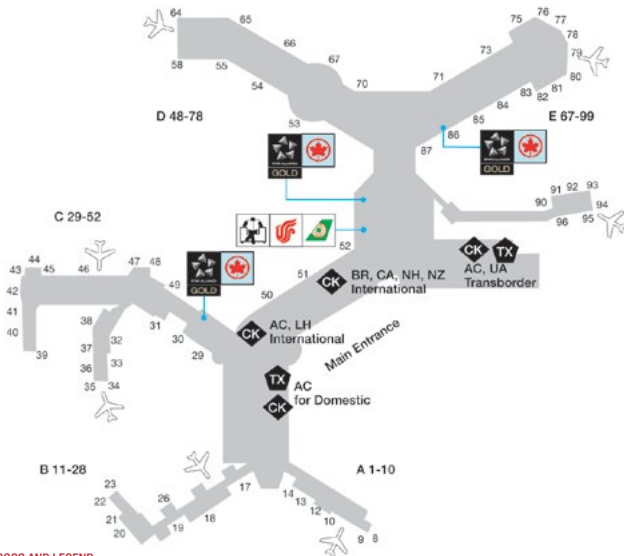

SEE LAST-PAGE FOLDOUT FOR MEMBER LOGOS AND LEGEND  
 Operating Carriers: AC | BR | CA | LH | NH | NZ | UA

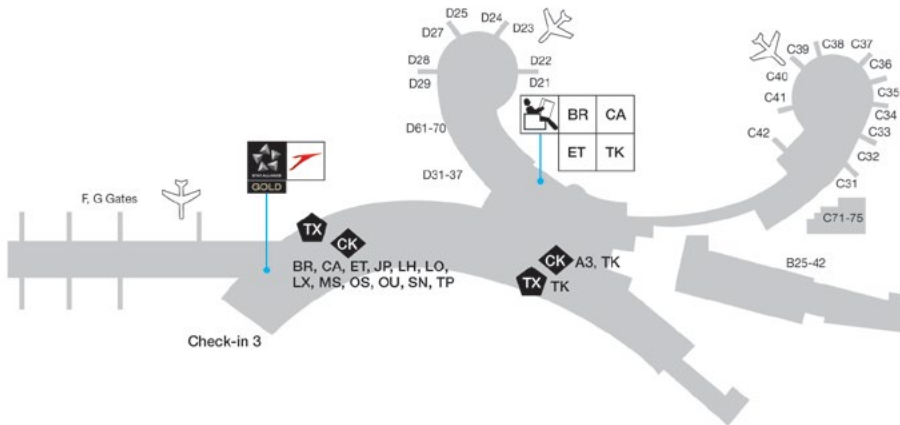

SEE LAST-PAGE FOLDOUT FOR MEMBER LOGOS AND LEGEND

Operating Carriers: A3 | BR | CA | ET | JP | LH | LO | LX | MS | OS | OU | SN | TK | TP

Vienna, Austria  
 Vienna International Airport  
[www.viennaairport.com](http://www.viennaairport.com)

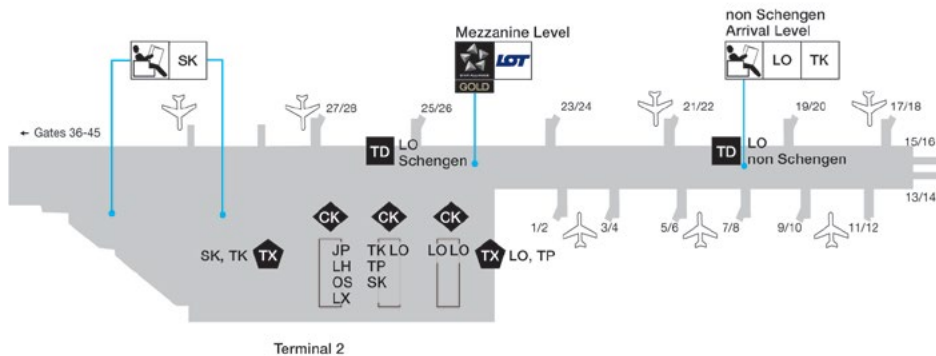

SEE LAST-PAGE FOLDOUT FOR MEMBER LOGOS AND LEGEND  
 Operating Carriers: JP | LH | LO | LX | OS | SK | TK | TP

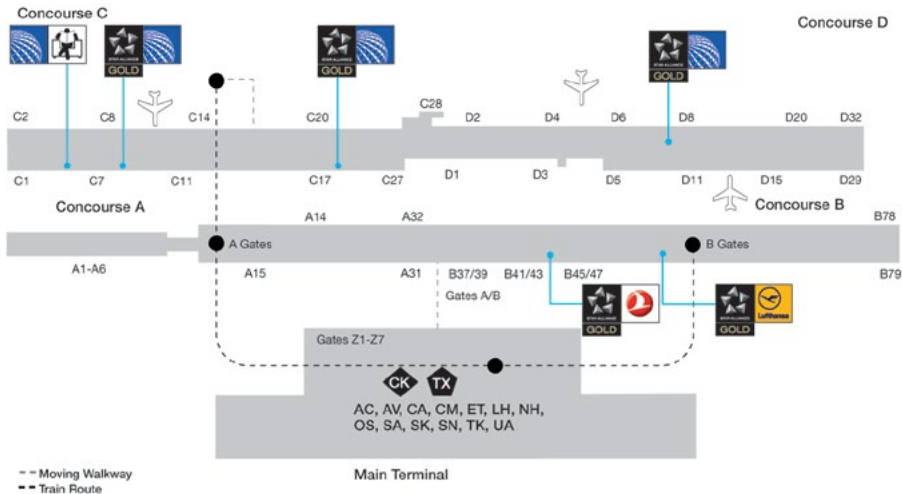

SEE LAST-PAGE FOLDOUT FOR MEMBER LOGOS AND LEGEND

Operating Carriers: AC | AV | CA | CM | ET | LH | NH | OS | SA | SK | SN | TK | UA

IAD

Washington, USA  
 Washington Dulles International Airport  
[www.metwashairports.com](http://www.metwashairports.com)

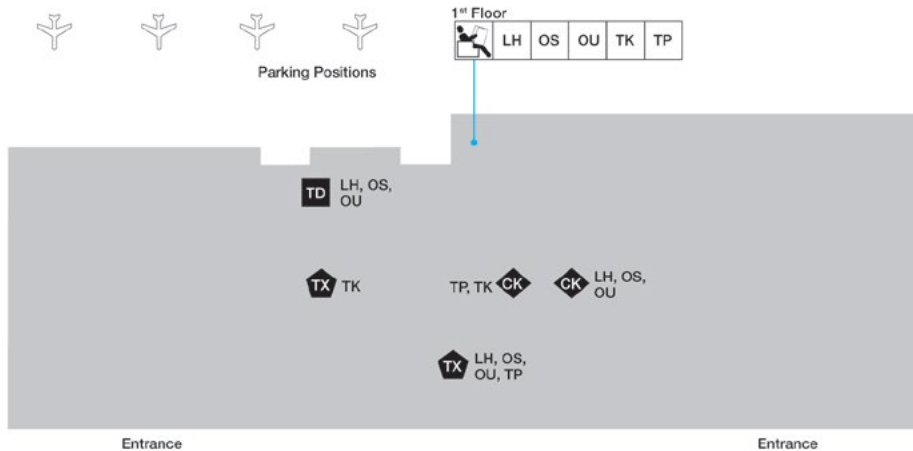

SEE LAST-PAGE FOLDOUT FOR MEMBER LOGOS AND LEGEND  
 Operating Carriers: LH | OS | OU | TK | TP

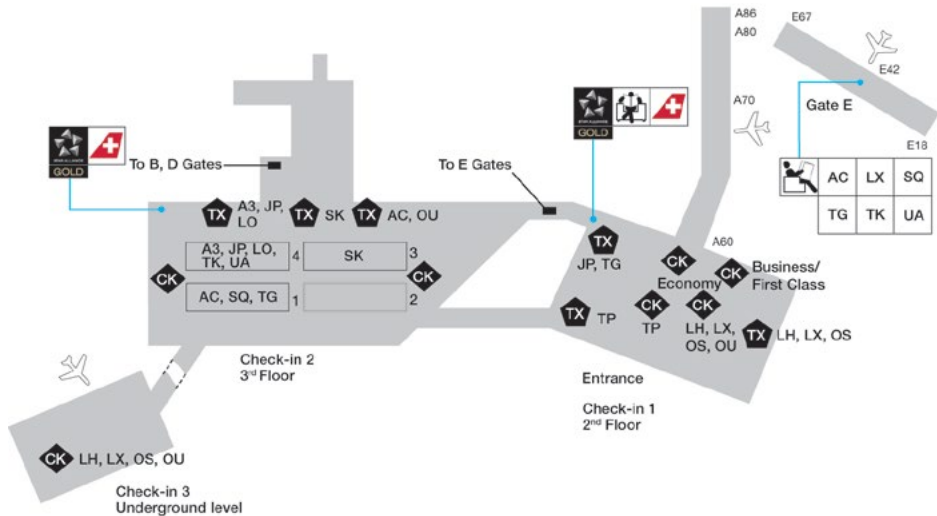

SEE LAST-PAGE FOLDOUT FOR MEMBER LOGOS AND LEGEND

Operating Carriers: A3 | AC | JP | LH | LO | LX | OS | OU | SK | SQ | TG | TK | TP | UA





STAR ALLIANCE MEMBERS - KEY TO MAP SYMBOLS

 Adria Airways <b>JP</b>	 Air India <b>AI</b>	 Austrian <b>OS</b>	 Croatia Airlines <b>OU</b>	 LOT Polish Airlines <b>LO</b>	 Singapore Airlines <b>SQ</b>	 THAI <b>TG</b>
 Aegean Airlines <b>A3</b>	 Air New Zealand <b>NZ</b>	 Avianca <b>AV</b>	 EGYPT-AIR <b>MS</b>	 Lufthansa <b>LH</b>	 South African Airways <b>SA</b>	 Turkish Airlines <b>TK</b>
 Air Canada <b>AC</b>	 ANA <b>NH</b>	 Brussels Airlines <b>SN</b>	 Ethiopian Airlines <b>ET</b>	 Scandinavian Airlines <b>SK</b>	 SWISS <b>LX</b>	 United <b>UA</b>
 Air China <b>CA</b>	 Asiana Airlines <b>OZ</b>	 Copa Airlines <b>CM</b>	 EVA Airways <b>BR</b>	 Shenzhen Airlines <b>ZH</b>	 TAP Portugal <b>TP</b>	

LOUNGES



LOCATIONS





STAR ALLIANCE



MEMBERS & LEGEND KEY