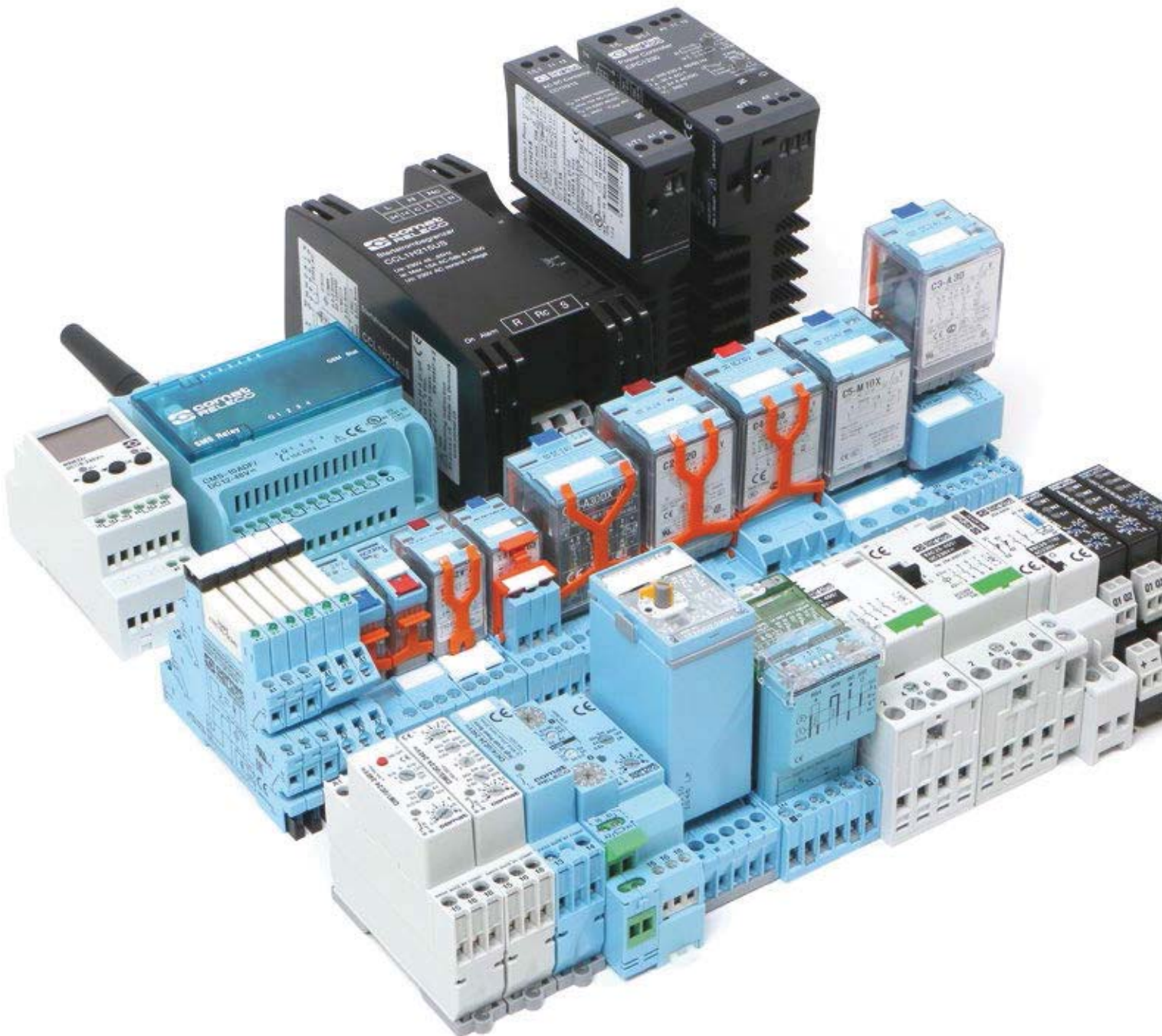
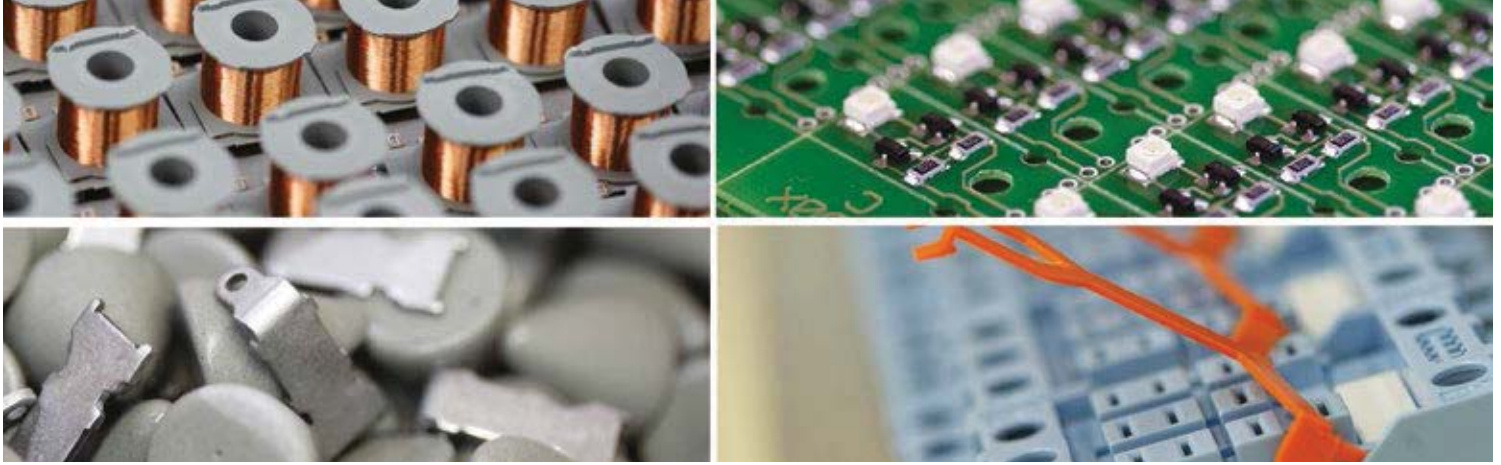


WORLD OF RELAYS

General Catalogue 2015/16





Comat Releco Group at a glance

The Comat Releco Group is a leading global supplier of high-quality components, systems and services in Industrial Automation, Electrical Installations and Railway and Transport Applications.

Our core competencies are Industrial, Time and Monitoring Relays. The product portfolio enjoys an outstanding world-wide reputation. Since 1996 our Quality Management System is certified according to ISO 9001.

Two strong brands www.comat.ch und www.releco.com

Comat and Releco are two well-established brands that have for decades enjoyed an outstanding reputation in their complementary segments of the market for Industrial, Time and Monitoring Relays.

Releco concentrates on high quality Industrial Relays and sets a focus on a high variety of features and functionalities to cover also specific customer requirements with customized solutions in low quantities.

Comat offers complete system solutions, including also software and services in the areas of Time and Monitoring Relays, SMS Relays, Miniature Contactors, Controllers as well as Power Electronics.

Customer focus and cutting-edge technology

The Group invests continuously in research and development, ensuring a sustained high rate of innovation. Due to our own qualified research and development teams, as well as the diversified production plants in Switzerland, Spain, India and China, the Group offers a complete range of standard as well as customized Industrial Automation, Electrical Installations and Railway and Transport Applications solutions.

Headquartered in Switzerland - Worldwide presence

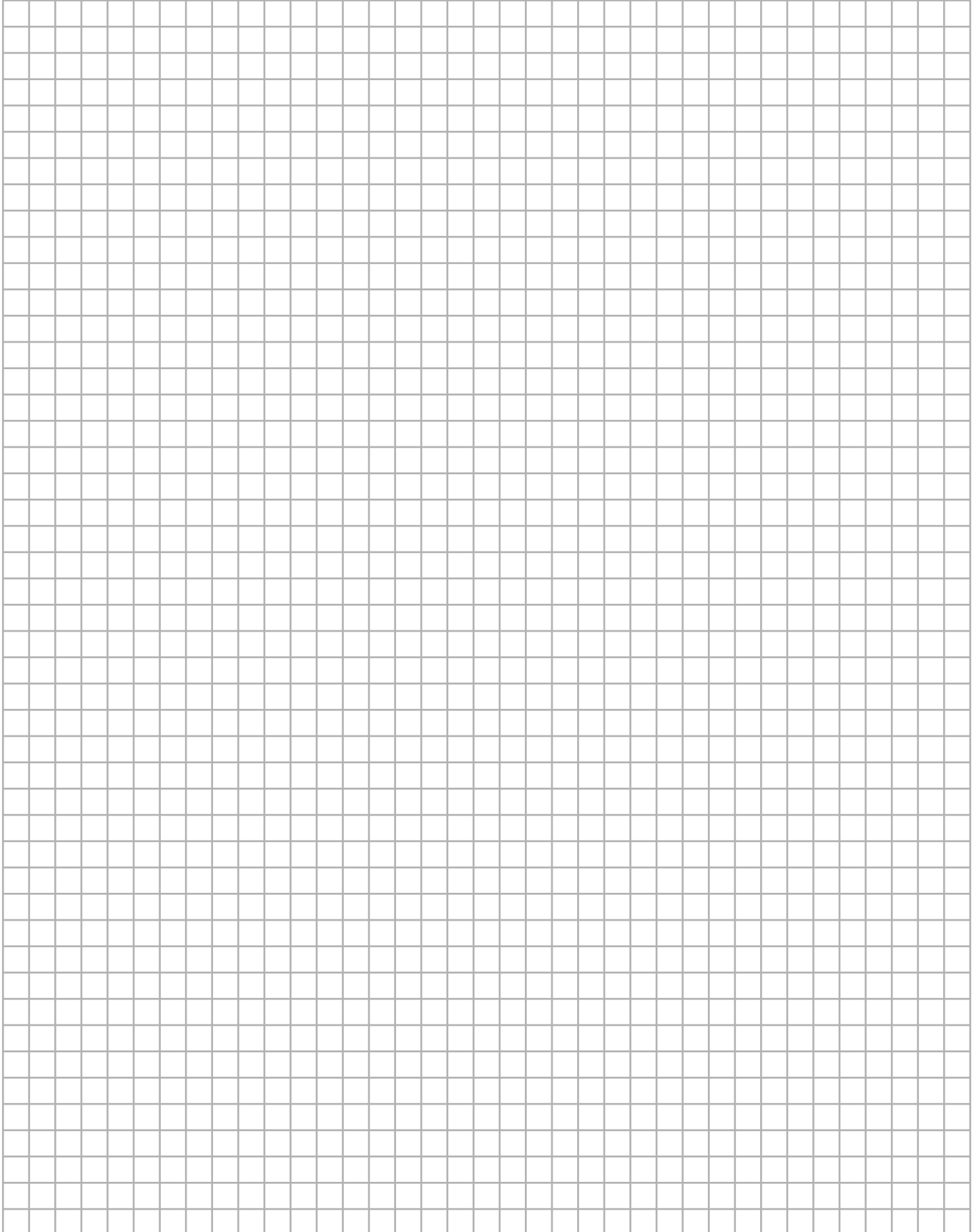
Due to our distributor network the Group is present in all world markets. We maintain our own sales subsidiaries in Germany, France and Brazil. Since 2003 the Group is owned by the management.

Index		
New in this catalogue		Page 5
1. Relays		Page 17
1.1	Interface Relays	C10, C12, CRINT 25
1.2	Miniature Industrial Relays	C7, R7, C9 39
1.3	Industrial Relays	C2, C20, C3, C30, R3, C4, C5 53
1.4	Long Life Relays	C21, C22, C31, C32 85
1.5	Solid State Relays	CSS, CRINT-C1x5, CRINT-C1x8 91
1.6	High Inrush Relays	CHI14, C7-W10, CIM14, RIC 103
1.7	Motor Control Relays	CMC1, CMC15, CMC16, KDM3 111
1.8	Contactors	RIC, RAC, RBC 117
1.9	Solid State Contactors	CC, CR, CCR, CPC 129
2. Time Relays		Page 151
2.0	Overview Time Functions	152
2.1	DIN Time Relays Monofunction	CMD 155
2.2	DIN Time Relays Multifunction	CIM, CM, CRV, CSV, CPF 161
2.3	Plug-in Time Relays	CS1, CS2, CS3 179
2.4	Time Cubes	CT2, CT3 183
2.5	Time Modules	CT30, CT32, CT33, CT36 187
3. Monitoring Relays		Page 195
3.1	Multifunction Monitoring	MRM 197
3.2	Voltage Monitoring	MRU 201
3.3	Current Monitoring	MRI, EOCR, EUCR 205
3.4	3-Phase Monitoring	SSU33L, SSU34, SSU36 209
3.5	Isolation Monitoring	ESU 213
3.6	Monitoring Modules	CT512, CT515, CT516, CT524 215
4. Sockets		Page 225
	Sockets for Interface Relays IRC	S10, S12
	Sockets for Miniature Relays QRC	S7, S9
	Sockets for Industrial Relays MRC	S2, S3, S4, S5, S20, S30
	System Sockets	C12B0
5. SMS Relay		Page 251
5.0	SMS Relay	CMS
6. Softstarters		Page 263
6.1	Starting Torque Limiter	CTC
6.2	Compressor Softstarter	CCL33
6.3	Softstarter 2 Phases Switched	CCM3
6.4	Softstarter 3 Phases Switched	CCM33
6.5	Softstarter With Dynamic Breaking	CCMB3

Relays				1		Time Relays		2	
Type	Page	Type	Page	Type	Page	Type	Page	Type	Page
C2-A20...	55	C10-A15...	26	RAC-25...	124	CIM1...	163		
C2-A28...	55	C10-A18...	26	RBC-AUX...	127	CIM2...	167		
C2-A29...	55	C10-G10...	27	RBC-20...	125	CIM3...	170		
C2-G20...	57	C10-G15...	27	RBC-32...	126	CIM12...	164		
C2-T21...	56	C10-GT12...	29	RIC-AUX...	122	CIM13...	165		
C2-T22...	56	C10-GT13...	29	RIC20...	118	CIM14...	166		
C20-A20...	58	C10-T11...	28	RIC25...	119	CIM22...	168		
C3-A30...	59	C10-T13...	28	RIC40...	120	CIM23	169		
C3-A38...	59	C12-A21...	30	RIC63...	121	CIM32...	171		
C3-A39...	59	C12-A22...	30			CIM33...	172		
C3-E24...	66	C12-G21...	31			CM3...	173		
C3-E28...	66	C12-G22...	31			CMD11.../UC12V	156		
C3-G30...	61	C21...	86			CMD11.../UC24V	157		
C3-M10...	62	C22...	87			CMD11.../AC115V	158		
C3-N34...	67	C31...	88			CMD11.../AC230V	159		
C3-N38...	67	C32...	89			CPF11...	176		
C3-R20...	64	CC1H215	131			CRV4...	174		
C3-R28...	64	CC1H230	132			CS1...	180		
C3-R29...	64	CC1H250	133			CS2...	181		
C3-S14...	65	CC1H415	134			CS3...	182		
C3-S18...	65	CC1H450	135			CSV4...	175		
C3-T31...	60	CC2H230	136			CT2-...	185		
C3-T32...	60	CC3H410	137			CT3-...	185		
C3-X10...	63	CC3H420	138			CT30...	189		
C30-A30	69	CC3H610	139			CT30.3-A30...	190		
C30-M10	71	CCR3H410	146			CT30.3-T31...	190		
C30-T30	70	CPC1230	147			CT30.3-T32...	190		
C30-X10	72	CPC1430	148			CT30.5-A30...	192		
C4-A40...	73	CPC1450	149			CT30.5-M10...	192		
C4-A48...	73	CR11H210	140			CT30.31...	191		
C4-R30...	75	CR11H430	141			CT30.32...	191		
C4-R38...	75	CR11H480	142			CT32...	189		
C4-R39...	75	CR11H4125	143			CT32.3-A30...	190		
C4-X20...	74	CR22H430	144			CT32.3-T31...	190		
C5-A20...	76	CR33H420	145			CT32.3-T32...	190		
C5-A30...	77	CHI14...	109			CT32.5-A30...	192		
C5-G30...	78	CMC1...	112			CT32.5-M10...	192		
C5-M10...	80	CMC15...	113			CT32.31...	191		
C5-M20...	81	CMC16...	114			CT32.32...	191		
C5-R20...	82	CRINT-C1x1...	33			CT33...	189		
C5-X10...	79	CRINT-C1x2...	34			CT33.3-A30...	190		
C7-A10...	40	CRINT-C1x5...	35			CT33.3-T31...	190		
C7-A20...	41	CRINT-C1x8...	36			CT33.3-T32...	190		
C7-A28...	41	CSS-I...	92			CT33.5-A30...	192		
C7-A29...	41	CSS-N...	94			CT33.5-M10...	192		
C7-G20...	43	CSS-P...	95			CT33.31...	191		
C7-H23...	45	CSS-Z...	93			CT33.32...	191		
C7-T21...	42	KDM3-24...	115			CT36...	189		
C7-T22...	42	R3-N30...	68			CT36.3-A30...	190		
C7-W10...	46	R3-N34...	68			CT36.3-T31...	190		
C7-X10...	44	R3-N38...	68			CT36.3-T32...	190		
C9-A41...	49	R7-A20...	47			CT36.5-A30...	192		
C9-A42...	49	R7-A24...	47			CT36.5-M10...	192		
C9-E21...	50	R7-A28...	47			CT36.31...	191		
C9-E22...	50	R7-T21...	48			CT36.32...	191		
C9-R21...	51	R7-T22...	48						
C10-A10...	26	RAC-20...	123						

Monitoring Relays 3		Sockets 4		SMS Relay 5		Softstarters 6	
Type	Page	Type	Page	Type	Page	Type	Page
CT512...	218	C12B0	234	App SMSrelay	259	CCL33H415US	267
CT512.3-A30...	220	S10	246	CMS-10ACDF	257	CCL33H425US	268
CT512.3-T31...	220	S10-P	247	CMS-10ADF	257	CCL33H435US	269
CT512.3-T32...	220	S12	248	CMS-10F	257	CCM3H403USi	270
CT512.5-A30...	222	S12-P	249	DR-15-24...	258	CCM3H415	271
CT512.5-M10...	222	S2-B	226	DR-30-24...	258	CCM3H425	272
CT512.31...	221	S20-B	227	KS-110...	259	CCM3H415DS	273
CT512.32...	221	S2-L	228	PS1...	259	CCM33H425US	274
CT515...	218	S2-P, S2-PO	228	RF01-U...	258	CCM33H450US	275
CT515.3-A30...	220	S3-B	229	RF01-U-D...	258	CCM33H530USi	276
CT515.3-T31...	220	S30-B	230	RTBSB-001...	258	CCM33H550USi	277
CT515.3-T32...	220	S3-L	233	WF50 ext-U...	258	CCMB3H425	278
CT515.5-A30...	222	S3-P, S3-PO	233	ZPT-10-H...	258	CTC3415	265
CT515.5-M10...	222	S3-MP	231			CTC3425	266
CT515.31...	221	S3-S	232				
CT515.32...	221	S4-J	235				
CT516...	218	S4-L	236				
CT516.3-A30...	220	S4-P, S4-PO	236				
CT516.3-T31...	220	S5-L	239				
CT516.3-T32...	220	S5-M	238				
CT516.5-A30...	222	S5-P, S5-PO	239				
CT516.5-M10...	222	S5-S	237				
CT516.31...	221	S7-16	242				
CT516.32...	221	S7-C	240				
CT524...	219	S7-I/O	241				
CT524.3-A30...	220	S7-L	243				
CT524.3-T31...	220	S7-P, S7-PO	243				
CT524.3-T32...	220	S9-L	245				
CT524.5-A30...	222	S9-M	244				
CT524.5-M10...	222	S9-P, S9-PO	245				
CT524.31...	221						
CT524.32...	221						
EOCR...	208						
ESU-D2...	214						
EUCR...	208						
MRI11...	206						
MRI32...	207						
MRM11...	198						
MRM32...	199						
MRU11...	202						
MRU32...	203						
SSU33L...	210						
SSU34...	211						
SSU36...	212						

Notes



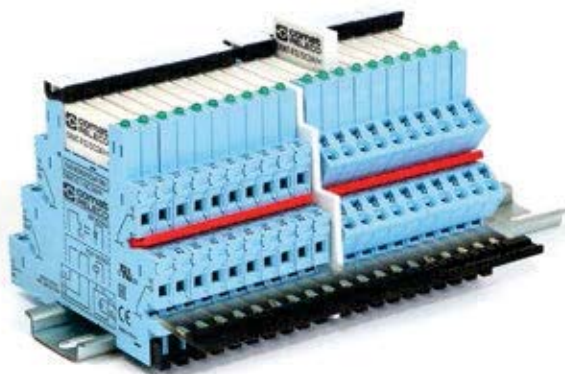
New in this catalogue



- CRINT
- CHI14
- CMD11
- Installation Contactors
- Solid State Contactors
- Softstarters

CRINT – Interface Relay

- Relay module up to 6 A 250 V, different contact materials
- Solid state modules for most loads DC and AC up to 2 A
- Coil UC = AC/DC, no protection circuit required
- LED status display
- Screw terminals or cage clamp terminals
- Jumper link
- Super small mounting: 6,2 mm



CHI14 – Power relay for high inrush currents

- For inrush currents up to 800 A: Switching of loads such as electronic control gears or switching power supplies for the latest generation of energy-saving lamps and LED
- Designed for fitting in electric switchboards due to the high nominal current of 16 A and the housing with 45 mm norm front
- Reduction of the inrush current and less wear thanks to switching while zero-crossing
- Suitable to use in living area: extremely low noise during operation



CMD11 – Mono Function Timing Relay

- 17 mm case system
- Relay contact 8 A
- On delay or off delay timing function
- 5 time ranges from 50 ms to 60 min
- Service function ON/OFF
- LED input and output status display



RAC, RBC – Installation Contactors

- Long lifetime due to double-break contacts
- Switching of different voltages with adjacent contacts
- Easily expandable by expansion module
- Hum-free operation
- Sample applications: light installations, heaters, motors, pumps, air conditioning, etc.
- With ON-OFF-AUTO-function
- With stepping function*
- With expansion module AUX



* RBC only

Solid State Contactors

- For frequent switching without contact bounce
- No wear and tear and silent operation thanks to semiconductor technology
- Non-hazardous switching of inductive loads
- Reduction of switch-on current thanks to zero voltage switching
- Clear LED status display
- Integrated overload protection
- DIN rack or screw assembly
- Space-saving: standard module width from 22.5 to 90 mm
- Integrated cooling element with optional thermal protector















Softstarters

- Reduces wear in the entire drive train through soft start-up
- Optimal starting torque through intelligent current control during start-up
- Protects the engine through integrated, adjustable motor protection with I2t-monitoring
- Minimises wiring effort and component costs: integrated bypass and motor protection
- Safe to use: comprehensive self-monitoring



Select the right relay for the right application

	Reduction of contact erosion when switching DC loads	p.10
	Contacts for high inrush current	p.10
	Safe separation of power circuits	p.11
	Reliable switching of low power signals	p.11
	Efficient switching of high voltages high currents	p.12
	Switching with a pulse	p.12
	Max. life time and highest number of switching cycles	p.13
	Blinking relays	p.13
	Impulse shaping (Extending short pulses)	p.14
	Energy saving with the same switching capacity	p.14
	Protection against aggressive environment	p.15
	Relays according to Railway standard (increased shock and vibration resistance)	p.16



Reduction of contact erosion when switching DC loads

Increased contact gaps, double make contacts, and arc blow-out magnets to reduce contact erosion (burn offs).

Compared with standard contacts, the reliability can be remarkably increased when using customized contacts for switching DC loads with breakaway sparks.

Increased contact caps, double make contacts and blow out magnets are causing a longer distance for the electric arc. Electric arcs are extinguished quickly and increase significant the lifetime of the contacts.

Suitable relays for this application

Series	Type	Base	Contacts	Gap	Extras	DC-1 rating
MRC	C2-G2x			1.7 mm		1.2 A 110 V DC
	C3-G3x			1.7 mm		1.2 A 110 V DC
	C3-M1x			2x 1.7 mm ≥ 3 mm	Double make contacts; Blow out magnet	10 A 220 V DC
	C3-X1x			2x 1.7 mm ≥ 3 mm	Double make contacts	7 A 110 V DC
	C4-X2x			2x 1.7 mm ≥ 3 mm	Double make contacts	7 A 110 V DC
	C5-G3x			1.7 mm		1.2 A 110 V DC
	C5-X1x			1.7 mm ≥ 3 mm	Double make contact	7 A 110 V DC
	C5-M1x			2x 1.7 mm ≥ 3 mm	Double make contacts; Blow out Mmagnet	10 A 220 V DC
	C5-M2x			2x 1.7 mm	Blow out magnet	7 A 110 V DC
QRC	C7-G2x			1.5 mm		0.8 A 110 V DC
	C7-X1x			2x 1.5 mm	Double make contacts	6 A 110 V DC
IRC	C10-G1x			1.0 mm		10 A 30 V DC
	C12-G2x			1.0 mm		5 A 30 V DC
DIN	CMC1	DIN 14 mm	2x		Adjustable start and breaking ramps	10 A 24 V DC



Contacts for high inrush current

Tungsten contacts have a higher melting point that help resist high power peaks and protect main contacts

High power peaks during switch-on of electrical loads, for example when switching power supplies and ballasts can lead to welding of the contacts.

Early make tungsten contacts resist high inrush currents and avoid contact welding.

Suitable relays for this application

Series	Type	Base	Contacts	Extras	AC-1 rating
QRC	C7-W1x			Tungsten early make contact; Inrush current 2.5 ms 500 A	10 A 250 V AC
DIN	CHI14	DIN 17.5 mm		W / AgSnO ₂ contact for high inrush currents up to 800 A	16 A 250 V AC
	CIM14	DIN 17.5 mm		W / AgSnO ₂ contact for high inrush currents up to 800 A	16 A 250 V AC
	RIC...	DIN			20...63 A 400 V AC
	RAC...	DIN			20...25 A 400 V AC
	RBC...	DIN			20...32 A 400 V AC



Safe separation of power circuits

Relays with increased contact distance of at least 3 mm allow safe separations in power circuits of high voltage currents and increase the protection degree from potentially lethal currents.

Suitable relays for this application

Serie	Type	Base	Contacts	Gap	Extras	AC-1 rating	
MRC	C3-M1x			2x 1.7 mm \geq 3 mm	Double make contacts; Blow out magnet	10 A	250 V AC
	C3-X1x			2x 1.7 mm \geq 3 mm	Double make contacts	10 A	250 V AC
	C4-X2x			2x 1.7 mm \geq 3 mm	Double make contacts	10 A	250 V AC
	C5-X1x			\geq 3 mm	Double make contacts	16 A	400 V AC
	C5-M1x			\geq 3 mm	Double make contacts; Blow out magnet	16 A	400 V AC
QRC	C7-X1x			2x 1.5 mm \geq 3 mm	Double make contacts	10 A	250 V AC



Reliable switching of low power signals

Twin contacts increase reliable switching by factors of 10 to 100 times. 10 μ hard gold plated contacts help to avoid contact oxidation. Together this allows reliable switching of very low level signals through the contacts.

Low level voltages in analogue circuits and signal voltages $<10V/5$ mA are not easily able to overcome contact resistances. Twin contacts increase contact reliability and gold contacts avoid contact oxidations and are especially suitable to switch low power signal loads.

Suitable relays for this application

Serie	Type	Base	Contacts	Extras	Min. rating	
MRC	C2-T22x			Twin contacts, 10 μ gold plated	1 mA	5 V DC
	C3-T32x			Twin contacts, 10 μ gold plated	1 mA	5 V DC
QRC	C7-T22x			Twin contacts, 10 μ gold plated	1 mA	5 V DC
	C7-H23			1 power & 1 signal contact 2 μ gold plated	5 mA	5 V DC
	C9-A42x			Contacts, 10 μ gold plated	5 mA	5 V DC
IRC	C10-T13x			Twin contacts, 3 μ gold plated	1 mA	5 V DC
	C10-GT13x			Twin contacts, 3 μ gold plated	1 mA	5 V DC
	C12-A22x			Contacts, 3 μ gold plated	5 mA	5 V DC
	CSS-N			NPN Solide state	1 mA	...48 V DC
	CSS-P			PNP Solide state	1 mA	...48 V DC



Efficient switching of high voltages high currents

Heavy duty relays are designed to switch high currents. Due to their relatively small dimensions and lower cost, these relays are more economical than contactors. Therefore control panels can be optimized for high power switching.

Heavy duty relays save space in the panel and cost less than contactors. They can be used for switching higher currents, for example electrical heaters up to 16 A at 400 V AC.

Suitable relays for this application

Series	Type	Base	Contacts	Gap	AC-1 rating	
MRC	C5-A2x				16 A	400 V AC
	C5-A3x				16 A	400 V AC
	C5-G3x			1.7 mm	16 A	400 V AC
	C5-X1x			> 3 mm	16 A	400 V AC
QRC	C7-A1x				16 A	250 V AC
RIC	RIC20	DIN 17.5 mm			20 A	400 V AC
	RIC25	DIN 35 mm			25 A	400 V DC
	RIC40	DIN 54.5 mm			40 A	400 V AC
	RIC63	DIN 54.5 mm			63 A	400 V AC
RAC	RAC20	DIN 17.5 mm			20 A	400 V AC
	RAC25	DIN 34 mm			25 A	400 V AC
RBC	RBC20	DIN 18 mm			20 A	400 V AC
	RBC32	DIN 35 mm			32 A	400 V AC



Switching with a pulse

Change the ON/OFF status of a latching relay (remanence relay) with a single pulse. The switching status remains stable also in the case of power failure.

The switching status of a latching relay is changed with a single input pulse although permanent connection is also possible. The contacts remain in position even after the "on" coil is de-energized. This guarantees that the relay status remains in position until such time that a control signal is applied to the "off" coil. A stepping relay provides an alternative for pulse switching and latching.

Latching relays help to save power dissipation, what is especially important when a hot environment is expected or when a high number of relays are mounted close with each other in a control cabinet.

Suitable relays for this application

Series	Type	Base	Contacts	Extras	Max. contact rating	
MRC	C3-R2x		Rem.	Remanence (Latching) relay	10 A	250 V AC
	C4-R3x		Rem.	Remanence (Latching) relay	10 A	250 V AC
	C5-R2x		Rem.	Remanence (Latching) relay	10 A	400 V AC
QRC	C9-R2x		Rem.	Remanence (Latching) relay	5 A	120 V AC
DIN	RBC20	DIN 18 mm		Bistable installation contactor	20 A	400 V AC
DIN	RBC32	DIN 35 mm		Bistable installation contactor	32 A	400 V AC



Max. life time and highest number of switching cycles

Long Life relays are relays of robust mechanical structure with 5 times longer life cycles compared to standard relays. Unlimited switching cycles are reached with solid state relays.

The Long Life Relays with a more robust design provide a 5 times longer service life. Standard relays are designed for 10 to 20 million mechanical switching cycles. For periodical switching frequencies in the second or minute range, the standard relays reach their life cycle within a few months. The long life relays are specially designed for frequent switching applications.

Suitable relays for this application

Serie	Type	Base	Contacts/Outputs	Extras	Max. contact rating	
MRC C20 C30	C21			> 10 ⁸ mechanical operations	10 A	250 V AC
	C22			> 10 ⁸ mechanical operations, twin contacts	5 A	250 V AC
	C31			> 10 ⁸ mechanical operations	10 A	250 V AC
	C31			> 10 ⁸ mechanical operations, twin contacts	5 A	250 V AC
CSS	CSS-I			Solide state AC (unlimited ops.)	3 A	250 V AC
	CSS-Z			Solide state AC (unlimited ops.)	3 A	250 V AC
	CSS-N			Solide state DC (unlimited ops.) NPN	6 A	48 V DC
	CSS-P			Solide state DC (unlimited ops.) PNP	6 A	48 V DC
CRINT	CRINT-C1x5	DIN 6.2 mm		Solide state DC (unlimited ops.)	2 A	24 V DC
	CRINT-C1x8	DIN 6.2 mm		Solide state AC (unlimited ops.)	1 A	240 V AC
DIN	CMC1	DIN 14 mm	2x	Adjustable start and breaking ramps	16 A	24 V DC
	CMC15/16	DIN 14 mm	2x	Adjustable start and breaking ramps and speed	10 A	24 V DC



Blinking relays

Blinking relays with integrated solid state outputs have a virtually unlimited life time independent from the switching cycles. Specially appropriate for blinking functions in intervals of seconds or minutes.

Blinking in second or minute intervals with permanent repetitions wear standard mechanical relays in a short time. A standard relay will reach the limit of its designed life time within weeks or months. Special blinking relays with integrated semi conductor contacts provide the alternative for such applications.

Suitable relays for this application

Series	Type	Base	Contacts/Outputs	Extras	Max. contact rating	
CIM	CIM1	DIN 17.5 mm		Time range adjustable 0.6 s - 60 h	16 A	250 V AC
	CIM2	DIN 17.5 mm		Time range adjustable 0.6 s - 60 h	16 A	250 V AC
	CIM12	DIN 17.5 mm		Time range adjustable 0.6 s - 60 h	2 A	250 V AC
	CIM22	DIN 17.5 mm		Time range adjustable 0.6 s - 60 h	2 A	250 V AC
	CIM13	DIN 17.5 mm		Time range adjustable 0.6 s - 60 h	5 A	30 V DC
	CIM23	DIN 17.5 mm		Time range adjustable 0.6 s - 60 h	5 A	30 V DC
	CIM14	DIN 17.5 mm			Time range adjustable 0.6 s - 60 h	16 A



Impulse shaping (Extending short pulses)

Pulse shaper of the series CPF extend or shorten input pulses for accurate further processing by PLC's.

PLC's or other control circuits are often not able to process fast and short pulses. The pulses are conditioned with CPF pulse formers for further processing by PLC's. Fast revolution speeds and distance measurements as well as "Namur" sensor signals are conditioned with the CPF type relays for further processing.

Suitable relays for this application

Series	Type	Base	Contacts	Trigger and Outputs times	Max. contact rating	
DIN	CPF11	DIN 17.5 mm		Input 1 - 5 ms; Output 5 - 60 ms	2 A	32 V DC
	CIM1x	DIN 17.5 mm		Input min. 20 ms; Output 50 ms - 60 h	16 A	250 V AC
	CIM2x	DIN 17.5 mm		Input min. 20 ms; Output 50 ms - 60 h	16 A	250 V AC
	CIM3x	DIN 17.5 mm		Input min. 20 ms; Output 50 ms - 60 h	16 A	250 V AC
	CM3	DIN 17.5 mm		Input min. 35 ms; Output 50 ms - 60 h	5 A	250 V AC
	CRV4	DIN 13 mm		Input min. 35 ms; Output 50 ms - 60 h	6 A	250 V AC
	CSV4	DIN 13 mm		Input min. 20 ms; Output 8 ms - 10 h	1.5 A	24 V DC
CS	CS2			Input min. 50 ms; Output 50 ms - 60 h	8 A	250 V AC
	CS3			Input min. 50 ms; Output 50 ms - 60 h	6 A	250 V AC



Energy saving with the same switching capacity

Relays with sensitive coils have considerably less power consumption than standard relays. This allows up to 90% energy saving with practically identical switching capacity

Relays with sensitive coils have improved and more effective magnetic circuits than coils of standard relays. The result is a considerably reduced coil current compared to a standard relay but with an almost identical switching capacity per contact. This means lower power consumption and therefore more economical operating and less heat. Under some circumstances, the user can provide a smaller power supply and save costs.

Suitable relays for this application

Series	Type	Base	Contacts	Sensitive coil	AC-1 contact rating	
MRC	C3-S1x			Nominal power 250 mW	6 A	250 V AC
	C3-E2x			Nominal power 500 mW	6 A	250 V AC
	C3-N3x			Nominal power 800 mW	6 A	250 V AC
QRC	C9-E2x			Nominal power 800 mW	5 A	250 V AC


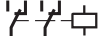



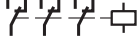





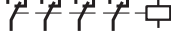

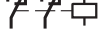

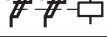

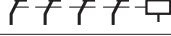







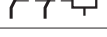




Protection against aggressive environment

A 10 μ hard gold plating of the contacts is an effective way to protect the contacts against oxidation caused by aggressive gases.

Aggressive gases may develop in sewage plants, chemical plants, or in the steel production. Conducting failures may occur on relays with standard silver nickel contacts because of contact surface oxidation. 10 μ hard gold plated contacts are especially suitable in such environments and improve the contact reliability.

Suitable relays for this application

Series	Type	Base	Contacts	Extras	AC-1 contact rating	
MRC	C2-A28			Contacts 10 μ gold plated	10 A	250 V AC
	C2-T22			Twin contacts, 10 μ gold plated	6 A	250 V AC
	C3-A38			Contacts 10 μ gold plated	10 A	250 V AC
	C3-T32			Twin contacts, 10 μ gold plated	6 A	250 V AC
	C3-S18			Contacts 10 μ gold plated	6 A	250 V AC
	C4-A48			Contacts 10 μ gold plated	10 A	250 V AC
QRC	C7-A28			Contacts 10 μ gold plated	10 A	250 V AC
	C7-T22			Twin contacts, 10 μ gold plated	6 A	250 V AC
	C9-A48			Contacts 10 μ gold plated	5 A	250 V AC
IRC	C10-A18			Contacts 3 μ gold plated	10 A	250 V AC
	C10-GT13			Twin contacts, 3 μ gold plated	6 A	250 V AC
	C10-T13			Twin contacts, 3 μ gold plated	6 A	250 V AC
	C12-A22			Contacts 3 μ gold plated	5 A	250 V AC
	C12-G22			Twin contacts, 3 μ gold plated	5 A	250 V AC



Relays according to Railway standard (increased shock and vibration resistance)

Relays as per Railway standard EN50155/EN60077/EN61373 are more suitable for applications with shock and vibration and have a higher degree of surge protection. Many of these railway relays also comply to additional fire protection standards, have lower inflammability and develop less toxic smoke and gases in case of fire.

Relays specially developed to comply with railway standards are designed for higher vibration, shock and surge values and allow higher tolerance in the voltage supply. Some of these relays additionally comply to special fire protection standards in regard to inflammability and the development of toxic smoke and gases in fire accidents.

Although specially designed for railway applications these relays are also suitable for other industrial applications where increased product safety is required.

Suitable relays for this application

Series	Type	Base	Contacts	Railway standard	Max. contact rating	
MRC	R3-N3x			EN 60077-1-2/99, EN 61373/99	6 A	250 V AC
Long Life	C31			EN 50155, Fire protection NF F16-101/102	10 A	250 V AC
	C32			EN 50155, Fire protection NF F16-101/102	6 A	250 V AC
QRC	R7-A2x			EN 60077-1-2/99, EN 61373/99	10 A	250 V AC
	R7-T2x			EN 60077-1-2/99, EN 61373/99	6 A	250 V AC
CIM	CIM1R	DIN 17.5 mm		EN 50155, Fire protection NF F16-101/102	16 A	250 V AC
	CIM12R	DIN 17.5 mm		EN 50155, Fire protection NF F16-101/102	2 A	250 V AC
	CIM13R	DIN 17.5 mm		EN 50155, Fire protection NF F16-101/102	5 A	30 V DC
	CIM2R	DIN 17.5 mm		EN 50155, Fire protection NF F16-101/102	16 A	250 V AC
	CIM22R	DIN 17.5 mm		EN 50155, Fire protection NF F16-101/102	2 A	250 V AC
	CIM23R	DIN 17.5 mm		EN 50155, Fire protection NF F16-101/102	5 A	30 V DC
	CIM3R	DIN 17.5 mm		EN 50155, Fire protection NF F16-101/102	16 A	250 V AC
	CIM32R	DIN 17.5 mm		EN 50155, Fire protection NF F16-101/102	2 A	250 V AC
	CIM33R	DIN 17.5 mm		EN 50155, Fire protection NF F16-101/102	5 A	30 V DC
RIC	RIC20	DIN 17.5 mm		EN 50155	20 A	400 V AC
	RIC25	DIN 35 mm		EN 50155	25 A	400 V AC
	RIC-AUX	DIN 8 mm		EN 50155	6 A	400 V AC

1.0 Relays



Product range

Releco offers a wide range of relay types and versions and associated sockets and accessories.

Standard (general-purpose) relay, MRC series

35 x 35 mm round plug-in relay, 8- or 11-terminals multipole connector according to IEC 67 with 2 or 3 contacts up to 10 A and different contact types and contact materials.

Standard relay 35 x 35 mm with flat blade connectors with up to 4 contacts and up to 16 A with 3 contacts.

Miniature industrial relay, QRC series

22.5 mm series with up to 4 contacts and up to 10 A with 1 or 2 contacts.

Interface relay, IRC series

Overall width 13 mm with up to 2 electro-mechanical contacts, or fully electronic switches.

Special relays, remanence relays

While "normal" relays are monostable, i.e. they return to the idle state when the excitation is switched off, remanence relays are bistable, i.e. the current switching state is retained irrespective of the excitation. Relays of this type are available in different versions.

Electronic relay, CSS

In the IRC series different electronic DC or AC relays up to 6 A are available. For AC relays a distinction is made between synchronously (zero crossing) and asynchronously switching versions. For switching transformer loads we recommended using asynchronously switching semiconductor switches. For incandescent lamp loads etc. synchronously switching switches are ideal for avoiding high switch-on currents.

Accessories

Suitable sockets are available for the different relay series for DIN rail mounting or panel mounting. In addition, retaining clips are available for the relays, some of which are included in the scope of supply. Suitable bridges for cost-saving wiring in series are also available.

* Special requirements

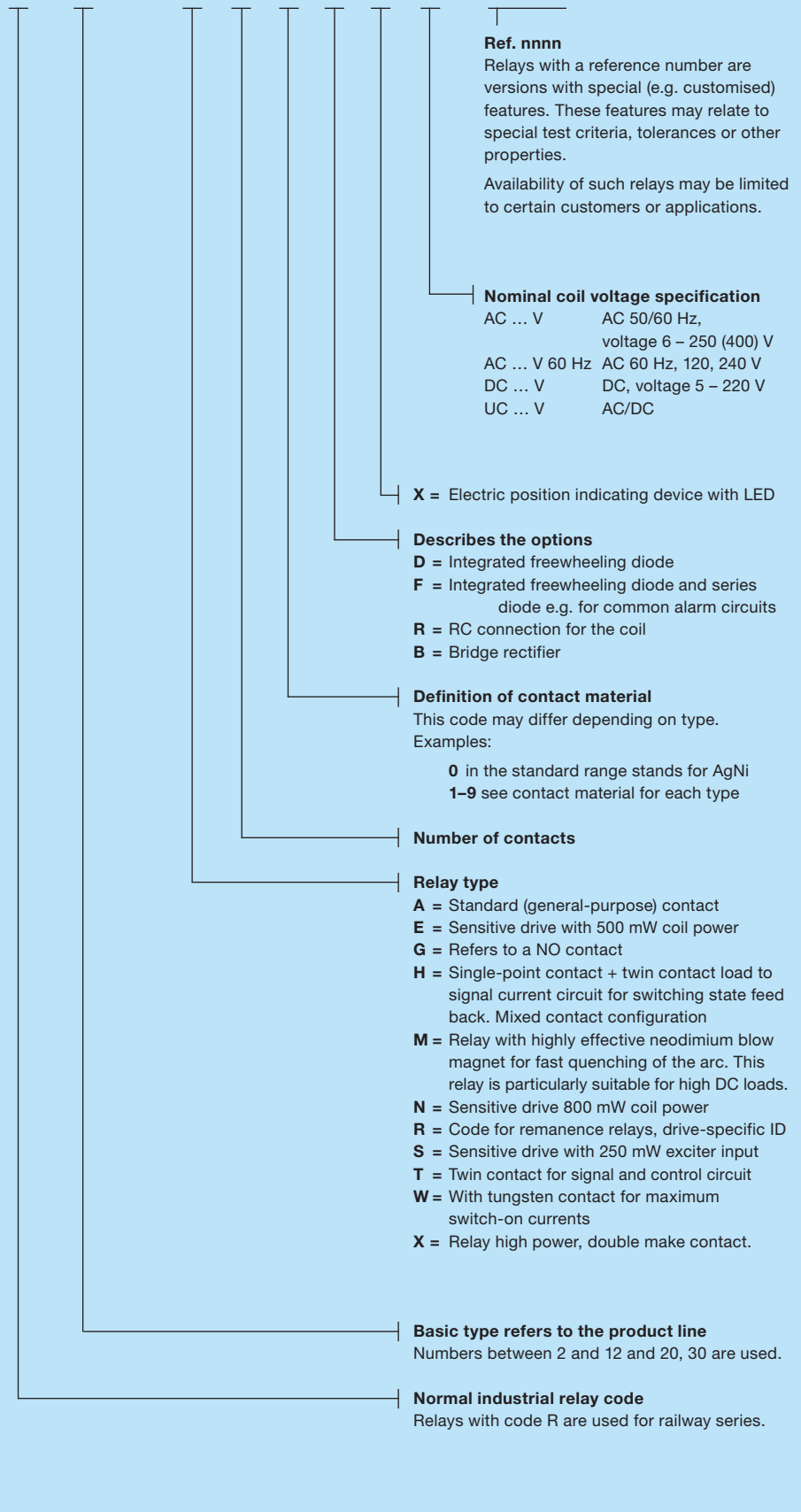
H = Orange button. No lockable function
N = Black button. No function
P = Printing board pins

E = Lap transparent cover
Z = Close transparent cover
T = Close transparent cover (lamp)
M = Close transparent cover (lamp + button)

If other requirements, please consult.

Basic identification principle (type designation code electromechanical relays)

C **n(n)** - **T** **X** **y** **z(*)z** /...**V** **RF-nnnn**



MRC – QRC

Protection against transients

When the coil is disconnected from an electro-magnet, peaks of inverse voltage appear at the terminals which can reach very high values. These pulses can be transmitted down the line associated with the coil and could possibly affect other components.

In the case of a relay being operated by such devices as transistors, triacs, etc; it may be necessary to protect against transients.

Transients carried in the line

High voltage surges can be carried in the supply line to the relay coil. These may appear in the form of peaks or bursts and are generated by the connection and disconnection of electric motors, transformers, capacitors etc. Normally a relay is unaffected by these pulses, but if a diode is connected in association with the coil, it must be capable of withstanding an inverse voltage higher than those of the incoming peaks.

Protection circuits

A protection circuit must efficiently cope with pulses generated by the coil as well as incoming line surges (surges $U_{1,2/50\mu s}$). Releco relays are available with integrated protection circuits or with modules plugged into sockets S3-MP or S3-MS.

X LED indication with rectifier.
For DC and AC relays up to 250 V
Surges of 1000 V up to 24 V
Surges of 2000 V from 25 to 60 V
Surges of 4000 V from 61 to 250 V
Note: LED connected, in series with the coil @ 220 VDC in QRC types.

D Free-wheeling diode.
DX Free-wheeling diode + LED
Dampens transients caused by the relay coil on de-energisation.
Surges of 2000 V up to 60 VDC
Surges of 4000 V from 61 to 250 VDC (*)

F Polarity + free wheeling diode.
FX Polarity + free wheeling diode + LED
A diode in series with the coil protects the relay from reverse connection.
Surges of 1000 V up to 60 VDC
Surges of 4000 V from 61 to 250 VDC (*)

B Bridge rectifier incorporated
BX Bridge rectifier + LED indication
Allows the relay to operate in both AC or DC without any polarity inconvenience. Available only in voltages up to 60 V.
Surges of 1000 V

R Resistor and capacitor.
Suppressor for AC coils. Surges of 2000 V.
Available only in **MRC** types.

(*) Surges of 2000 V in **QRC** types.

IRC

LED and protection circuit connected to coil.

- X** LED with no polarity, (standard)
Coils ≤ 12 V CC y CA
LED rectifier bridge in parallel
- X** LED with no polarity, (standard)
Coils ≥ 24 V ... CC y CA
LED rectifier bridge in series
- FX** LED with polarity **A1+** (option)
Every DC coil voltage
Polarity and Free-wheeling diodes
- BX** LED with no polarity, (option)
Only 24 V and 48 V ADC coils
Rectifier bridge for AC/DC relays
- R** LED not available (option)
RC protection against pulses on AC

Protection against pulses

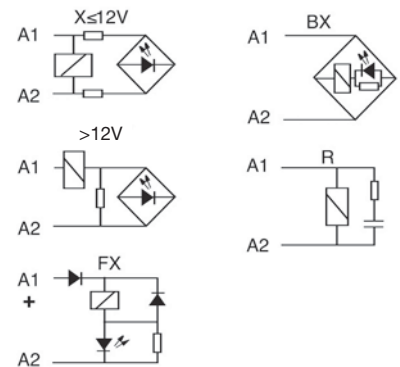
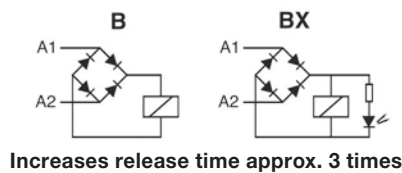
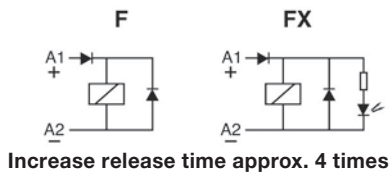
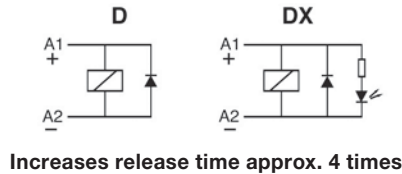
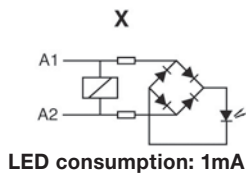
When a relay coil is disconnected, reverse voltage peaks may arise and reach very high values. Said peaks can transmit to the coil associated line and other relays or semiconductors can be affected.

If triac, transistor, etc. controls a relay, appropriate steps must be taken to avoid or decrease peaks down to a non risky level.

Both Polarity and Free-wheeling diodes (**FX**), must protect coils, to avoid malfunctions provided DC relays in battery are installed.

Making or breaking engines, transformers or contactors in an industrial environmental, may generate high voltage pulses, either isolated or burst, through the main line.

The voltage level of those pulse may be high enough to affect the isolation of the coil.



Contacts

There are different contact types. The main distinction is between single contacts and twin contacts. While single contacts are more suitable for higher loads, twin contacts are significantly more reliable at small loads, i.e. 24 V, <math>< 100\text{ mA}</math>.

Contact Material

There is no all-purpose contact! AgNi is used as standard material for a wide range of applications. AgNi contacts with hard gold plating (up to $10\text{ }\mu\text{m}$) are offered for applications in aggressive atmosphere. Relays with gold contacts are approved for relatively high currents (e.g. 6 A , 250 V), but in practice values of 200 mA , 30 V should not be exceeded for operation with intact gold plating. Relays with a tungsten pre-contact are available for very high switch-on currents (up to 500 A , 2.5 ms). For some applications AgNi contacts with gold flashing ($0.2\text{ }\mu\text{m}$) are available. The purpose is corrosion protection during storage. There is no other purpose. Tin oxide is specially appropriated for load with high-inrush current.

Minimum load

The minimum load value is a recommended value under normal conditions such as regular switching, no special ambient conditions, etc. Under these conditions reliable switching behaviour can be expected.

Contact resistance

Initial values of resistance of contact can vary with the use, load and others conditions. Typical values when the relay is new is about $50\text{ m}\Omega$.

Contact spacing

Normally all contacts have an air gap between $0,5 \dots 1,5\text{ mm}$ when they are open. They are referred to as μ contacts. According to the Low-Voltage Directive and the associated standards these contacts are not suitable for safe disconnection. For switching of DC loads large contact clearances are beneficial for quenching the arc. See special relays: series connections with a gap of 3 mm .

Switching capacity

The contact switching capacity is the product of switching voltage and switching current. For AC the permitted switching capacity is generally high enough to handle the max. continuous AC1 current over the whole voltage range. For DC the load limit curve must never be exceeded, because this would lead to a remaining switch-off arc and immediate destruction of the relay. The order of magnitude of the DC switching capacity is a few 100 W (DC 1).

Drive (coil)

The drive of a relay refers to the coil plus connections.

The coil has special characteristics, depending on the rated voltage and the type of current.

Coil design

The coil consists of a plastic former (resistant up to about $130\text{ }^\circ\text{C}$) and doubly insulated high-purity copper wire, temperature class F. The winding must withstand threshold voltages (EN 61000-4-5) of more than 2000 V . This is ensured through forced separation of the start and end of the winding.

Coil resistance and other properties

Each coil has an ohmic coil resistance that can be verified with an ohmmeter. The specified coil resistance applies to a temperature of $20\text{ }^\circ\text{C}$. The tolerance is $\pm 10\text{ }\%$.

For AC operation the coil current will not match the ohmic value, because self-inductance plays a dominant role. At 230 V this may reach more than 90 H . When a relay is switched off, self-inductance results in a self-induced voltage that may affect the switching source (destruction of transistors, EMC problems).

Drive voltages

A distinction is made between the standardised voltages according to EN 60947 as guaranteed values, and typical values that can be expected with a high degree of probability.

Pick-up voltage, Release voltage

The pick-up voltage is the voltage at which the relay engages safely. For DC the typical trip voltage is approx. $65\text{ }\%$ of U_{nom} , for AC approx. $75\text{ }\%$. The release voltage, on the other hand, is approx. $25\text{ }\%$ or $60\text{ }\%$ respectively.

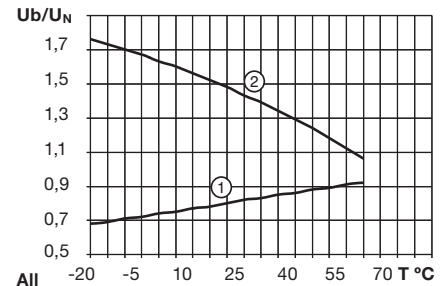
For DC these voltages are strongly temperature-dependent, according to the temperature coefficient of Cu. This is not the case for AC, where the inductive resistance is the controlling factor, which is practically constant over a wide temperature range.

With AC, in a certain undervoltage range the relay may hum, and the armature may flutter. This voltage range must be avoided.

Operating voltage range

Unless specified otherwise, the following characteristic curve applies for the operating voltage range. The upper limit of the coil voltage is determined by self-heating and the ambient temperature. Self-heating through contacts under high load must not be underestimated. It may be higher than the power dissipation in the drive.

During intermittent operation significantly higher overvoltages temporary may occur for short periods. If in doubt please consult our specialists.



General design

RELECO relays are made from high-quality, carefully selected materials.

They comply with the latest environmental regulations such as RoHS. Their meticulous design makes them particularly suitable for industrial applications and installation engineering.

They are particularly service-friendly through robust terminals, mechanical position indicating device a standard, manual operation, dynamic, permanent characteristics.

Colour coding for manual operation as a function of the coil voltage is another useful feature. Further options such as different coil connections, freewheeling diode, LED display, bridge rectifier for AC/DC drives etc., and short-term availability of special versions for practically any drive voltage up to DC 220 V / AC 400 V leave nothing to be desired.

Apart from a few special versions, the standard RELECO industrial relays feature manual operation (push/pull) and a mechanical position indicating device.

For safety reasons, manual operation may be replaced with a black button, if required.

Coil connections

Different coil connections can be integrated in the relay as an option.

For DC a cost-effective freewheeling diode is available. Please note that the stated release times are generally specified without the coil connection.

While an additional LED status indicator has practically no effect, a freewheeling diode (D) will lead to an increase in release time by a factor 2 to 5, or 10 ms to 30 ms . For AC VDRs or RC elements may be used. In this case resonance effects may have to be considered. VDRs and common RC elements may increase release times by less than 5 ms .

Standards, conformities

While CE marking of relays/sockets is controversial, since relays are sometimes regarded as components to which the marking requirement does not apply, all RELECO relays feature the CE mark to indicate that CE standards may also be applied to the relays, e.g. 2 kV surge resistance according to EN 61000-4-5.

A significant and not generally available characteristic is that the coils and in particular the connections are able to withstand the voltage spikes that may occur in practice. In addition, the relays feature various technical approvals depending on the respective relay code, and they comply with further standards and guidelines. The main technical approvals include cURus, CSA, and CCC.

The associated information is provided in the respective data sheets.

Switching classes

EN 60947 defines different switching classes that specify the suitability of contacts for different load types.

Examples:

AC1 = Ohmic AC load

AC5b = AC incandescent lamp loads

AC15 = Power contactors, solenoid valves, solenoids

DC1 = Ohmic DC load

DC6 = DC incandescent lamps

DC13 = DC contactors, solenoids

UL508 contains different technical approval criteria such as general purpose, control application etc. Switching classes are defined based on the electrical switching capacity, e.g. B600 etc.

Main technical approvals and standards

Country	Technical approval
China	 Authority: CQC Specification GB14048.5-2001 A003850
Canada	 Authority: CSA Specification C 22,2; UL 508
Russia	 Authority: KORPORATSIA STANDART Specification GOST R 50030.5.1
USA	 Authority: UL Specification C 22,2; UL 508
United Kingdom	 Authority: GB Lloyd's Register of Shipping

Utilisation categories according to

EN 60947-4-1/-5-1

Pollution category

Cat. 1

Dry, non-conductive contamination without further effect

Cat. 2

Occasional conductive contamination, short duration due to moisture condensation

Cat. 3

Dry, non-conductive and conductive contamination with moisture condensation

Cat. 4

Contamination with persistent conductivity through conductive dust, rain

Protection class IP according to DIN 40050 and other standards. Industrial relays and their sockets can be classified as follows:

Socket IP20: Contact safety

Relay IP40/IP50: not watertight, but protected against ingress of coarse contaminants.

Further information and tips

The main operational criteria for relays such as number of cycles, switching frequency, ambient conditions, reliability requirements, load type, switch-on current, load switch-off energy must be clarified in order to ensure reliable operation and long service life.

Example

If the number of cycles is expected to exceed several 100,000 operations per year (e.g. clock generators, fast running machines), an electronic solution is no doubt more appropriate, although we also offer solutions for this type of application. In AC applications crosstalk caused by long control leads is often problem and can result in constant humming of the relay or even inadvertent triggering due to interference. Here, too, we offer solutions.

Various, apparently harmless loads may lead to very high switch-on currents or switch-off energy values, resulting in an unacceptable reduction in service life.

Particularly tricky are DC loads, particularly if they are inductive.

Circuits with relays and their connections often require a level of developer skill that is frequently no longer offered during standard education and training.

Your supplier will be very happy to provide expert advice

Characteristics of various loads:

Heating circuits

No higher switch-on currents, no higher switch-off loads.

Incandescent lamps, halogen lamps

Switch-on currents during a few ms in the range 10 ... 18 x rated. Switch-off at rated load.

Low-energy lamps

Very high, but very short switch-on currents due to built-in decoupling capacitors.

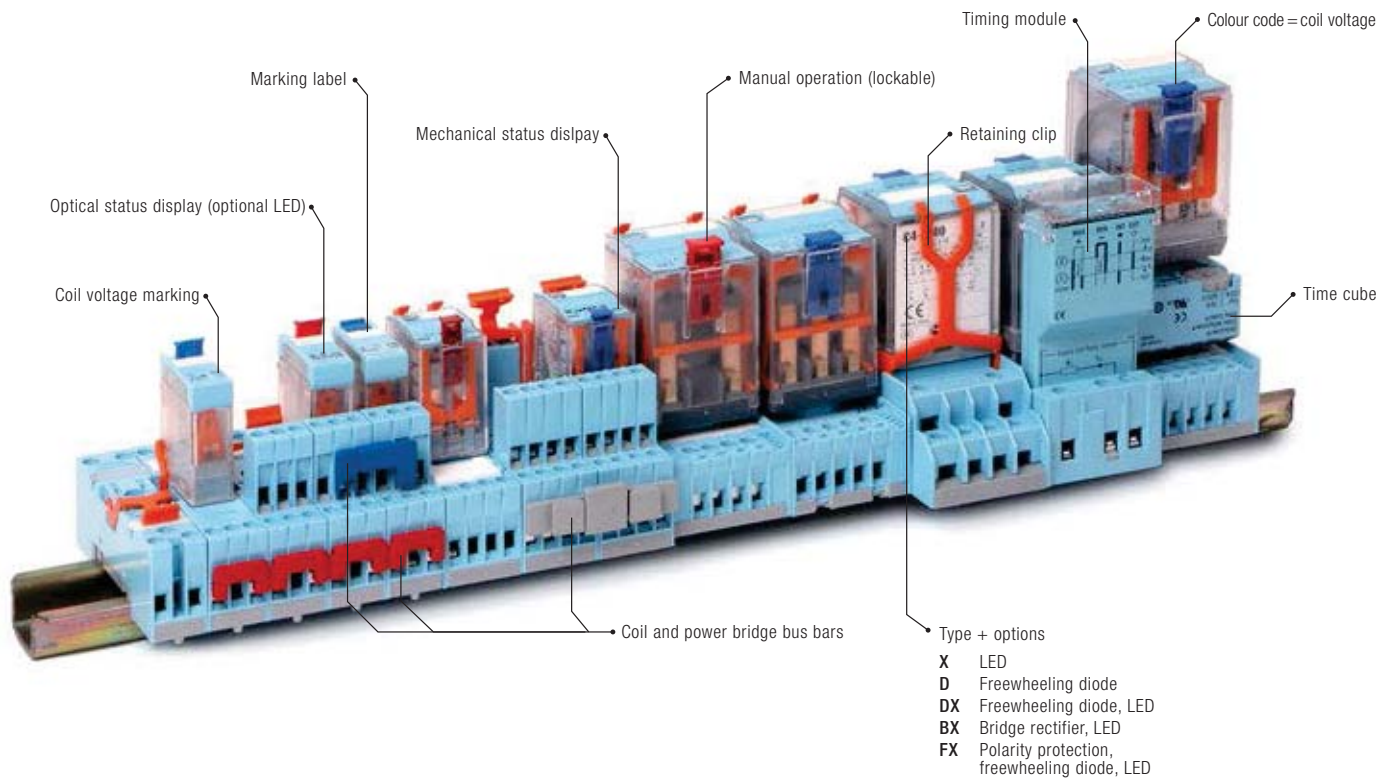
Contacts have a tendency to fuse.

Transformers, AC contactors

Switching on during zero-transition may lead to switch-on currents of 8 ... 15 x rated.

High inductive switch-off energy is possible. The load must be connected, not least due to EMC problems.

Full Features System



Type + options

- X LED
- D Freewheeling diode
- DX Freewheeling diode, LED
- BX Bridge rectifier, LED
- FX Polarity protection, freewheeling diode, LED

Five colours for an easier identification of coil voltage

-  **AC** red: 230 VAC (North America 120 VAC)
-  **AC** dark red: others VAC
-  **AU** grey: VAC/DC
-  **DC** blue: 24 VDC
-  **DC** dark blue: others VDC

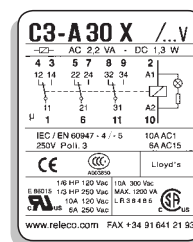
If you don't want to have the lockable function, you can use the orange "orange - push button". SO - OP for MRC - C and S9 - OP for QRC (5 pieces bag)

 Orange - push button






A black blanking plug is available if you don't want a test button. S= - NP for MR - C and S9 - NP for QRC (5 pieces bag)

 Blanking plug

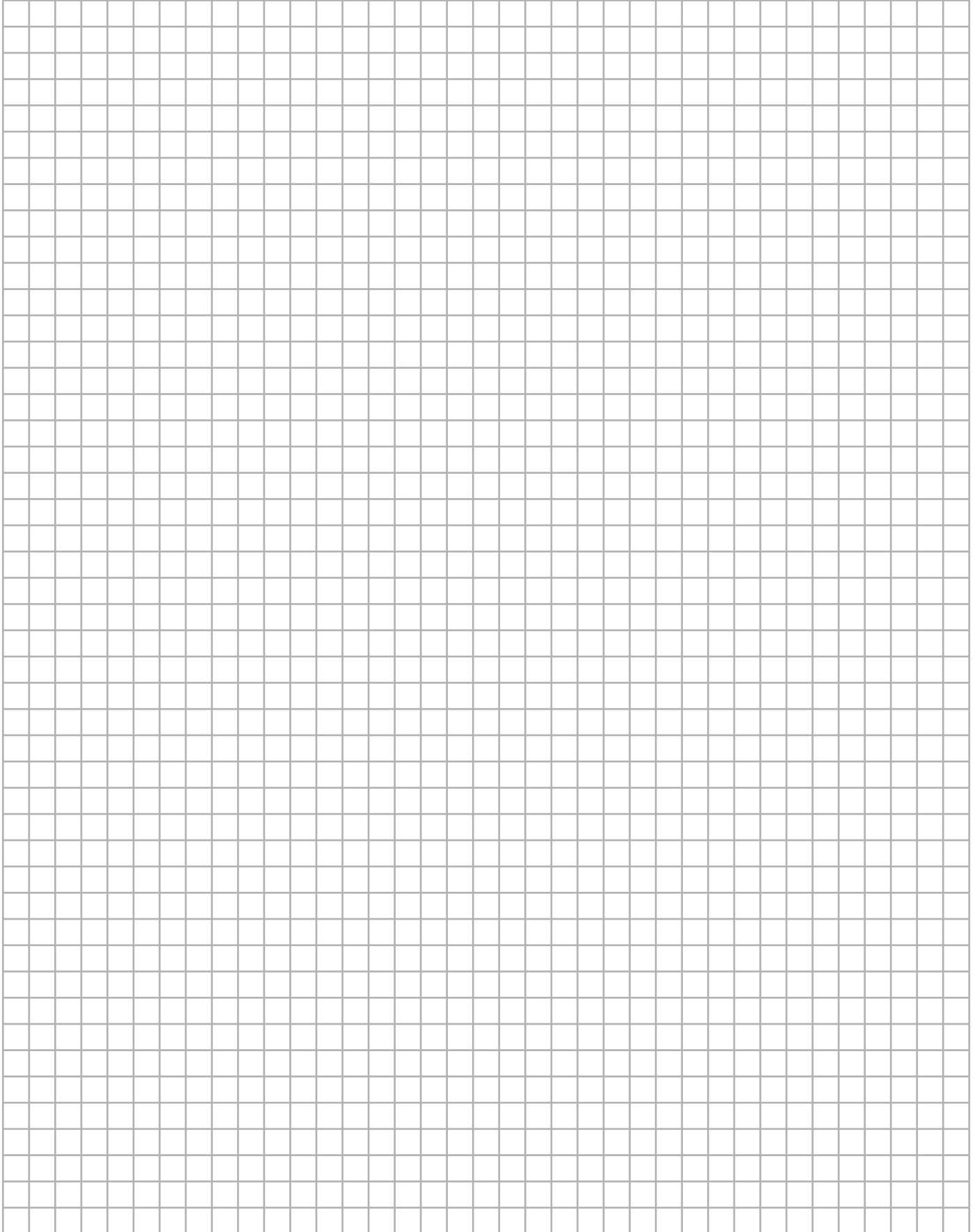
Comprehensive technical label



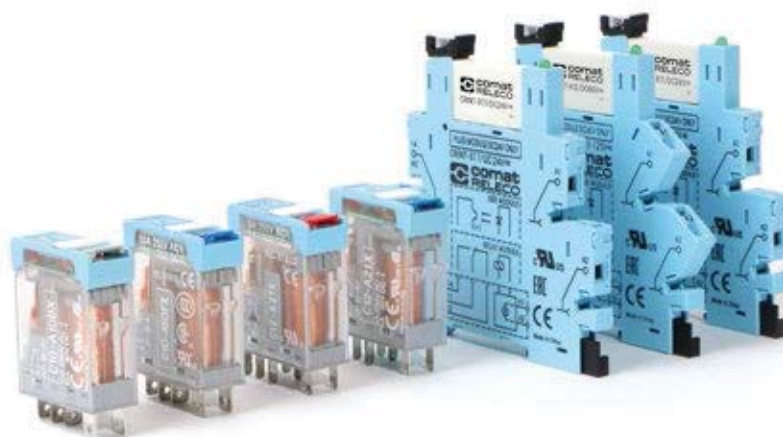
Part number
Coil details
Additional circuit diagram for coil
Electric diagram showing all additions to the coil
Wiring diagram with sequential and DIN numbers
Maximum switching capacity according to EN 60947 (IEC 947)
Approvals

















Country	Approval	Country	Approval
Canada	 Authority: CSA Specification: C 22,2: UL 508	United Kingdom	 Authority: Loyd's Register of Shipping
China	 Authority: CQC Specification: GB14048.5-2001	USA	 Authority: UL Specification: C 22,2; UL 508
Russia	 Authority: KORPORATSIA STANDART Specification: GOST R 50030.5.1		

Notes



1.1 Interface Relays – IRC & CRINT



Application	Types	Pins	Contacts	AC ratings	DC ratings	Socket
IRC – C10 Series						
Interface standard relay	C10-A1x			10 A / 250 V	10 A / 30 V	S10
DC load switching	C10-G1x			10 A / 250 V	10 A / 30 V	S10
Low switching load	C10-T1xx			6 A / 250 V	6 A / 30 V	S10
Low switching load	C10-GTxx			6 A / 250 V	6 A / 30 V	S10
IRC – C12 Series						
Interface relay	C12-A2x			5 A / 250 V	5 A / 30 V	S12
Interface DC relay	C12-G2x			5 A / 250 V	5 A / 30 V	S12
CRINT Series						
High power contact AgSnO ₂	CRINT-C1x1			6 A / 250 V	6 A / 30 V	
Low power contact AgSnO ₂ + 3μ Au	CRINT-C1x2			6 A / 250 V	6 A / 30 V	
DC solid state switch	CRINT-C1x5				2 A / 24 V	
AC solid state switch	CRINT-C1x8			1 A / 240 V		

Type	C10-A1x/ ... V Standard relay, 1 change-over contact Contact Ag Sn O2 to high inrush		
Maximum contact load	10 A/250 V AC-1	0,5 A/110 V DC-1	
	10 A/30 V DC-1	0,2 A/220 V DC-1	
	13 A/250 V AC-1	5A_{US}	
Recommended minimum contact load	10 mA/10 V Code 0,5		
	5 mA/5 V Code 8		

Contacts			
Material	Standard	Code 0	AgNi
	Optional	Code 8	AgNi+ 3 μ Au
	Optional	Code 5	Ag Sn O2
Rated current			10 A
Switch-on current max. (20 ms)			30 A (120 A for code 5)
Switching voltage max.			250 V
AC load (Fig 1)			2,5 kVA
DC load			see fig. 2

Coil	
Coil resistance	see table; tolerance ± 10 %
Pick-up voltage	≤ 0,8 x U _N
Release voltage	≥ 0,1 x U _N
Nominal power	1,1 VA (AC)/0,7 W (DC)

Coil table					
VAC	Ω	mA	VDC	Ω	mA
24	290	45	12	224	53
48	1200	23	24	742	32
115	7.300	9,5	48	3.500	13,7
230	28.800	4,7	110	19.900	5,5

Insulation	Volt rms, 1 min
Contact open	1000 V
Contact/coil	5 kV
Insulation resistance at 500 V	≥1 GΩ
Insulation, IEC 61810-1	4 kV/3

Specifications	
Ambient temperature operation/storage	-40 (no ice)...70 °C / -40 ... 80 °C
Pick-up time/bounce time	10 ms/ ≤ 1 ms
Release time/bounce time	5 ms/ ≤ 3 ms
Mechanical life ops	AC: 10 Mill./DC: 20 Mill.
DC voltage endurance at rated load	≥100000 switching cycles
Switching frequency at rated load	≤ 1200/h
Protection class	IP40
Weight	21 g

Standard types			
VAC 50 Hz/60 Hz: 24, 48, 115 (120), 230 (240)	C10-A10/AC...V	C10-A18/AC...V	C10-A15/AC ... V
LED	C10-A10X/AC...V	C10-A18X/AC...V	C10-A15X/AC...V
RC suppressor	C10-A10R/AC...V	C10-A18R/AC...V	C10-A15R/AC...V
VDC 12, 24, 48, 110	C10-A10/DC...V	C10-A18/DC...V	C10-A15/DC...V
LED	C10-A10X/DC...V	C10-A18X/DC...V	C10-A15X/DC...V
Polarity and free wheeling diode	C10-A10FX/DC...V	C10-A18FX/DC...V	C10-A15FX/DC...V
VAC/DC bridge rectifier 24 V, 48 V	C10-A10BX/UC...V	C10-A18BX/UC...V	C10-A15BX/UC...V

"..." Enter the voltage for full type designation

Accessories	
Socket:	S10, S10-M, S10-P



Connection diagram

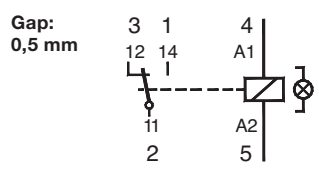


Fig. 1 AC voltage endurance

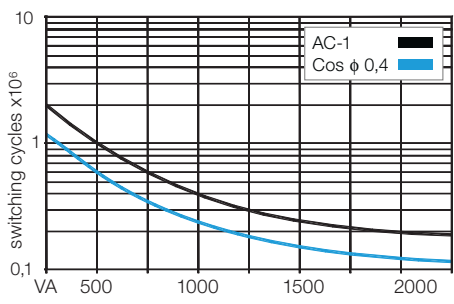
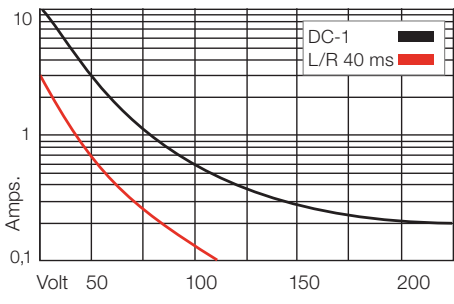
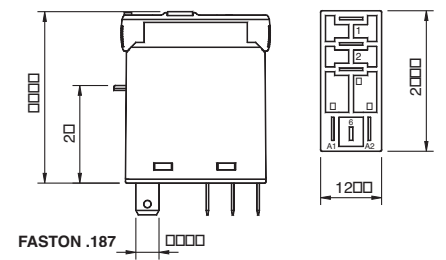


Fig. 2 DC load limit curve



Dimensions [mm]



Technical approvals, conformities



IEC 61810; EN 60947



Type	C10-G1X/ ... V Standard relay 1 open contact for high DC load Contact Ag Sn O2 to high inrush			
Maximum contact load	10 A/250 V AC-1	0,8 A/110 V DC-1		
	10 A/30 V DC-1	0,4 A/220 V DC-1		
Recommended minimum contact load	10 mA/10 V Code 0,5			
	5 mA/5 V Code 8			

Contacts			
Material	Standard	Code 0	AgNi
	Optional	Code 8	AgNi +3 μ Au
	Optional	Code 5	Ag SnO2
Rated current	10 A		
Switch-on current max. (20 ms)	30 A (120 A for code 5)		
Switching voltage max.	250 V		
AC load (Fig 1)	2,5 kVA		
DC load	see Fig. 2		

Coil			
Coil resistance	see table; tolerance ± 10 %		
Pick-up voltage	≤ 0,8 x U _N		
Release voltage	≥ 0,1 x U _N		
Nominal power	1,1 VA (AC)/0,7 W (DC)		

Coil table					
VAC	Ω	mA	VDC	Ω	mA
24	290	45	12	224	53
48	1200	23	24	742	32
115	7.300	9,5	48	3.500	13,7
230	28.800	4,7	110	19.900	5,5

Insulation	Volt rms, 1 min
Contact open	2000 V
Contact/coil	5 kV
Insulation resistance at 500 V	≥ 1 GΩ
Insulation, IEC 61810-1	4 kV/3

Specifications	
Ambient temperature operation/storage	-40 (no ice)...70 °C /-40 ... 80 °C
Pick-up time/bounce time	10 ms/≤ 1 ms
Release time/bounce time	8 ms
Mechanical life ops	AC: 10 Mill./DC: 20 Mill.
DC voltage endurance at rated load	≥ 100000 switching cycles
Switching frequency at rated load	≤ 1200/h
Protection class	IP40
Weight	21 g

Standard types		
VAC 50 Hz/60 Hz: 24, 48, 115 (120), 230 (240)	C10-G10/AC ... V	C10-G15/AC ... V
LED	C10-G10X/AC ... V	C10-G15X/AC ... V
RC suppressor	C10-G10R/AC...V	C10-G15R/AC...V
VDC 12, 24, 48, 110	C10-G10/DC ... V	C10-G15/DC ... V
LED	C10-G10X/DC ... V	C10-G15X/DC ... V
Polarity and free wheeling diode	C10-G10FX/DC ... V	C10-G15FX/DC... V
AC/DC bridge rectifier 24 V, 48 V	C10-G10BX/DC ... V	C10-G15BX/UC... V

"..." Enter the voltage for full type designation

Accessories	
Socket:	S10, S10-M, S10-P

Connection diagram

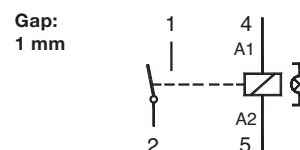


Fig. 1 AC voltage endurance

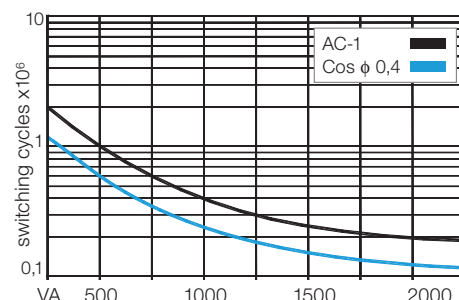
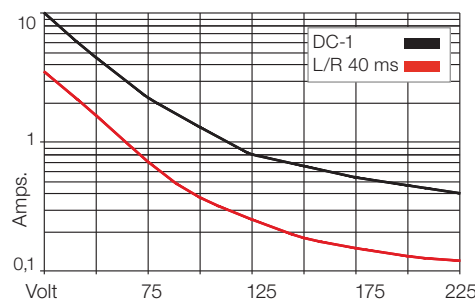
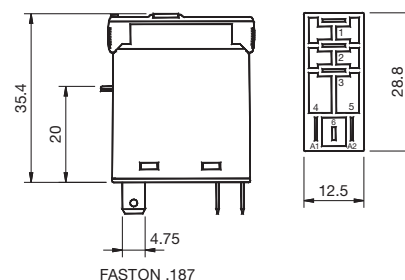


Fig. 2 DC load limit curve



Dimensions [mm]



Technical approvals, conformities



IEC 61810; EN 60947

Type	C10-T1x/ ... V Standard relay for low power application			
Maximum contact load	6 A/250 V	AC-1	0,5 A/110 V	DC-1
	6 A/30 V	DC-1	0,2 A/220 V	DC-1
Recommended minimum contact load	5 mA/5 V	Code 1		
	1 mA/5 V	Code 3		

Contacts			
Material	Standard	Code 1	AgNi + 0,2 μ Au
	Optional	Code 3	AgNi + 3 μ Au
Rated current	6 A		
Switch-on current max. (20 ms)	15 A		
Switching voltage max	250 V		
AC load (Fig 1)	1,5 kVA		
DC load	see fig. 2		

Coil			
Coil resistance	see table; tolerance ± 10 %		
Pick-up voltage	≤ 0,8 × U _N		
Release voltage	≥ 0,1 × U _N		
Nominal power	1,1 VA (AC)/0,7 W (DC)		

Coil table	VAC	Ω	mA	VDC	Ω	mA
	24	290	45	12	224	53
	48	1200	23	24	742	32
	115	7.300	9,5	48	3.500	13,7
	230	28.800	4,7	110	19.900	5,5

Insulation	Volt rms, 1 min
Contact open	1000 V
Contact/coil	5 kV
Insulation resistance at 500 V	≥ 1 GΩ
Insulation, IEC 61810-1	4 kV/3

Specifications	
Ambient temperature operation/storage	-40 (no ice)...70 °C /-40 ... 80 °C
Pick-up time/bounce time	10 ms/≤ 1 ms
Release time/bounce time	5 ms/≤ 3 ms
Mechanical life ops	AC: 10 Mill./DC: 20 Mill.
DC voltage endurance at rated load	≥ 100000 switching cycles
Switching frequency at rated load	1200/h
Protection class	IP40
Weight	21 g

Standard types		
VAC 50 Hz/60 Hz: 24, 48, 115 (120), 230 (240)	C10-T11/AC ... V	C10-T13/AC ... V
LED	C10-T11X/AC ... V	C10-T13X/AC ... V
RC suppresor	C10-T11R/AC...V	C10-T13R/AC...V
VDC12, 24, 48, 110	C10-T11/DC ... V	C10-T13/DC ... V
LED	C10-T11X/DC ... V	C10-T13X/DC ... V
Polarity and free wheeling diode	C10-T11FX/DC ... V	C10-T13FX/DC ... V
AC/DC bridge rectifier 24 V, 48 V	C10-T11BX/UC ... V	C10-T13BX/UC ... V

"..." Enter the voltage for full type designation

Accessories	
Socket:	S10, S10-P



Connection diagram

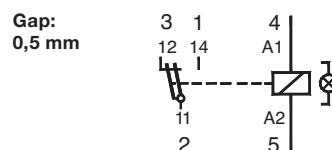


Fig. 1 AC voltage endurance

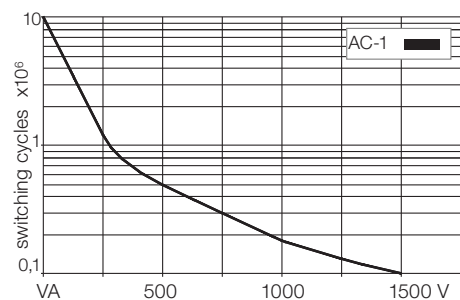
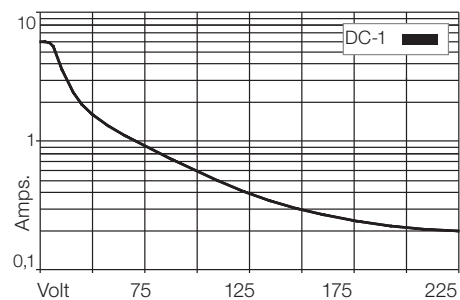
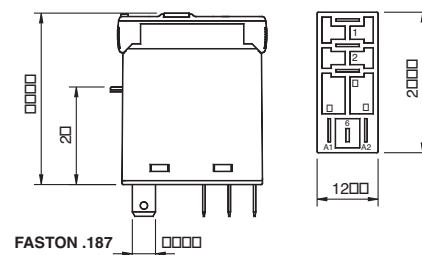


Fig. 2 DC load limit curve



Dimensions [mm]



Technical approvals, conformities



IEC 61810; EN 60947



Type	C10-GT1x/ ... V Standard relay for low power application 1 open contact			
Maximum contact load	6 A/250 V	AC-1	0,8 A/110 V	DC-1
	6 A/30 V	DC-1	0,4 A/220 V	DC-1
Recommended minimum contact load	5 mA/5 V	Code 3		

Contacts				
Material	Standard	Code 3	AgNi + 3 μ Au	
Rated current	6 A			
Switch-on current max. (20 ms)	15 A			
Switching voltage max	250 V			
AC load (Fig 1)	1,5 kVA			
DC load	see Fig. 2			

Coil				
Coil resistance	see table; tolerance ± 10 %			
Pick-up voltage	≤ 0,8 x U _N			
Release voltage	≥ 0,1 x U _N			
Nominal power	1,1 VA (AC)/0,7 W (DC)			

Coil table					
VAC	Ω	mA	VDC	Ω	mA
24	290	45	12	224	53
48	1200	23	24	742	32
115	7.300	9,5	48	3.500	13,7
230	28.800	4,7	110	19.900	5,5

Insulation		Volt rms, 1 min
Contact open	2000 V	
Contact/coil	5 kV	
Insulation resistance at 500 V	≥ 1 GΩ	
Insulation, IEC 61810-1	4 kV/3	

Specifications	
Ambient temperature operation/storage	-40 (no ice)...70 °C /-40 ... 80 °C
Pick-up time/bounce time	10 ms/≤ 1 ms
Release time/bounce time	5 ms/≤ 3 ms
Mechanical life ops	AC: 10 Mill./DC: 20 Mill.
DC voltage endurance at rated load	≥ 100000 switching cycles
Switching frequency at rated load	≤ 1200/h
Protection class	IP40
Weight	21 g

Standard types	
VAC 50 Hz/60 Hz: 24, 48, 115, (120), 230, (240)	C10-GT13/AC ... V
LED	C10-GT13X/AC ... V
RC suppresor	C10-GT13R/AC ... V
VDC 12, 24, 48, 110	C10-GT13/DC ... V
LED	C10-GT13X/DC ... V
Polarity and free wheeling diode	C10-GT13FX/DC ... V
AC/DC bridge rectifier 24 V, 48 V	C10-GT13BX/UC ... V

"..." Enter the voltage for full type designation

Accessories	
Socket:	S10, S10-M, S10-P

Connection diagram

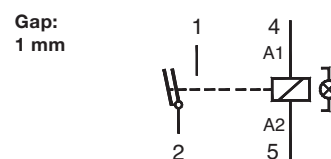


Fig. 1 AC voltage endurance

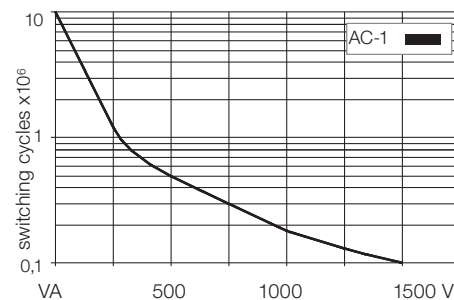
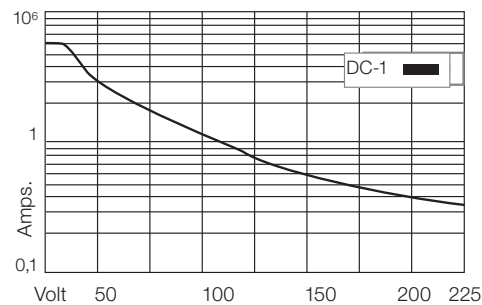
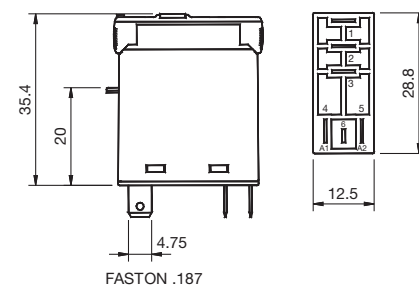


Fig. 2 DC load limit curve



Dimensions [mm]



Technical approvals, conformities



IEC 61810; EN 60947



Type	C12-A2x/ ... V Standard relay 2 change-over contact		
Maximum contact load	5 A/250 V AC-1	0,5 A/110 V DC-1	
	5 A/30 V DC-1	0,2 A/220 V DC-1	
Recommended minimum contact load	10 mA/10 V Code 1		
	5 mA/5 V Code 2		

Contacts			
Material	Standard	Code 1	AgNi + 0,2 μ Au
	Optional	Code 2	AgNi + 3 μ Au
Rated current	5 A		
Switch-on current max. (20 ms)	15 A		
Switching voltage max.	250 V		
AC load (Fig 1)	1,2 kVA		
DC load	see fig. 2		

Coil			
Coil resistance	see table; tolerance ± 10 %		
Pick-up voltage	≤ 0,8 × U _N		
Release voltage	≥ 0,1 × U _N		
Nominal power	1,1 VA (AC)/0,7 W (DC)		

Coil table					
VAC	Ω	mA	VDC	Ω	mA
24	290	45	12	224	53
48	1200	23	24	742	32
115	7.300	9,5	48	3.500	13,7
230	28.800	4,7	110	19.900	5,5

Insulation	Volt rms, 1 min
Contact open	1000 V
Contact/contact	3000 V
Contact/coil	5 kV
Insulation resistance at 500 V	≥1 GΩ
Insulation, IEC 61810-1	4 kV/3

Specifications	
Ambient temperature operation/storage	-40 (no ice)...60 °C /-40 ... 80 °C
Pick-up time/bounce time	10 ms/≤ 1 ms
Release time/bounce time	5 ms/≤ 3 ms
Mechanical life ops	AC: 10 Mill./DC: 20 Mill.
DC voltage endurance at rated load	≥100000 switching cycles
Switching frequency at rated load	≤ 1200/h
Protection class	IP40
Weight	21 g

Standard types		
VAC 50 Hz/60 Hz: 24, 48, 115 (120), 230 (240)	C12-A21/AC ... V	C12-A22/AC ... V
LED	C12-A21X/AC ... V	C12-A22X/AC ... V
RC suppressor	C12-A21R/AC ... V	C12-A22R/AC ... V
VDC 12, 24, 48, 110	C12-A21/DC ... V	C12-A22/DC ... V
LED	C12-A21X/DC ... V	C12-A22X/DC ... V
Polarity and free wheeling diode	C12-A21FX/DC ... V	C12-A22FX/DC ... V
AC/DC bridge rectifier 24 V, 48 V	C12-A21BX/UC ... V	C12-A22BX/UC ... V

"..." Enter the voltage for full type designation

Accessories	
Socket:	S12, S12-P

Connection diagram

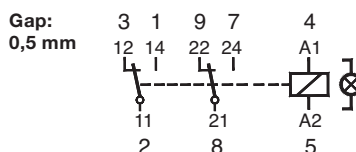


Fig. 1 AC voltage endurance

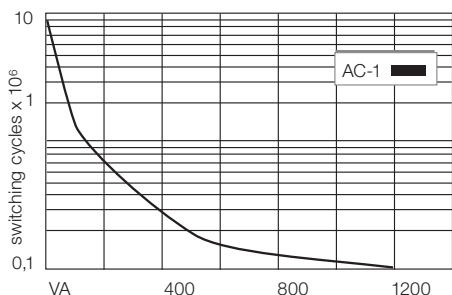
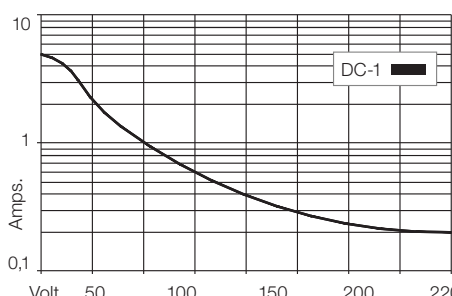
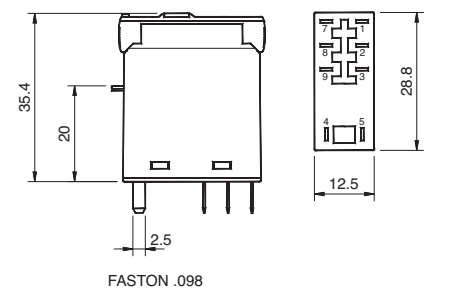


Fig. 2 DC load limit curve



Dimensions [mm]



Technical approvals, conformities



IEC 61810; EN 60947



Type	C12-G2x/ ... V Standard relay 2 open contacts			
-------------	--	--	--	--

Maximum contact load	5 A/250 V AC-1	0,8 A/110 V DC-1
	5 A/30 V DC-1	0,4 A/220 V DC-1
Recommended minimum contact load	10 mA/10 V Code 1	
	5 mA/5 V Code 2	

Contacts

Material	Standard	Code 1	AgNi + 0,2 μ Au
	Optional	Code 2	AgNi + 3 μ Au
Rated current	5 A		
Switch-on current max. (20 ms)	15 A		
Switching voltage max.	250 V		
AC load (Fig 1)	1,2 kVA		
DC load	see Fig. 2		

Coil

Coil resistance	see table; tolerance ± 10 %
Pick-up voltage	≥ 0,8 x U _N
Release voltage	≥ 0,1 x U _N
Nominal power	1,1 VA (AC)/0,7 W (DC)

Coil table

VAC	Ω	mA	VDC	Ω	mA
24	290	45	12	224	53
48	1200	23	24	742	32
115	7.300	9,5	48	3.500	13,7
230	28.800	4,7	110	19.900	5,5

Insulation

	Volt rms, 1 min
Contact open	2000 V
Contact/contact	3000 V
Contact/coil	5 kV
Insulation resistance at 500 V	≥ 1 GΩ
Insulation, IEC 61810-1	4 kV/3

Specifications

Ambient temperature operation/storage	-40 (no ice)...60 °C /-40 ... 80 °C
Pick-up time/bounce time	10 ms/≤ 1 ms
Release time/bounce time	5 ms/≤ 3 ms
Mechanical life ops	AC: 10 Mill./DC: 20 Mill.
DC voltage endurance at rated load	≥ 100000 switching cycles
Switching frequency at rated load	≤ 1200/h
Protection class	IP40
Weight	21 g

Standard types

VAC 50 Hz/60 Hz: 24, 48, 115, (120), 230, (240)

LED

RC suppressor

VDC 12, 24, 48, 110

LED

Polarity and free wheeling diode

AC/DC bridge rectifier 24 V, 48 V

C12-G21/AC ... V

C12-G21X/AC ... V

C12-G21R/AC ... V

C12-G21/DC ... V

C12G21X/DC ... V

C12-G21FX/DC ... V

C12-G21BX/UC ... V

C12-G22/AC ... V

C12-G22X/AC ... V

C12-G22R/AC ... V

C12-G22/DC ... V

C12-G22X/DC ... V

C12-G22FX/DC ... V

C12-G22BX/UC ... V

"..." Enter the voltage for full type designation

Accessories

Socket: **S12, S12-P**

Connection diagram

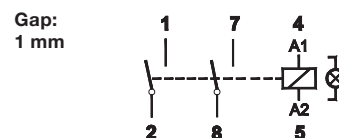


Fig. 1 AC voltage endurance

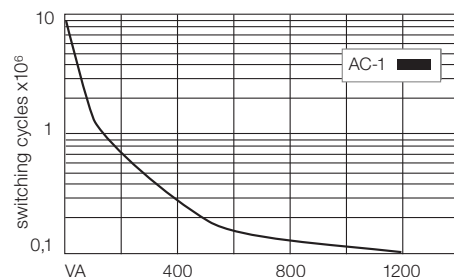
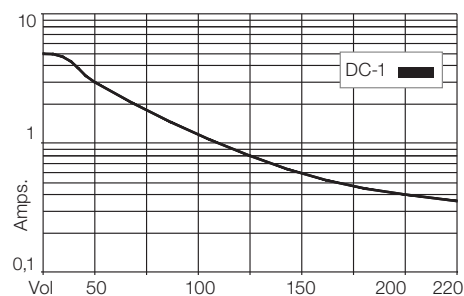
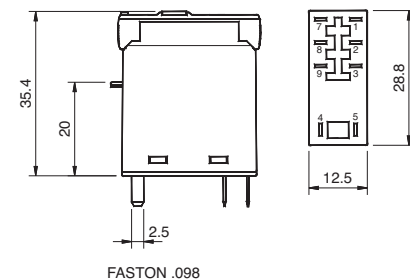


Fig. 2 DC load limit curve



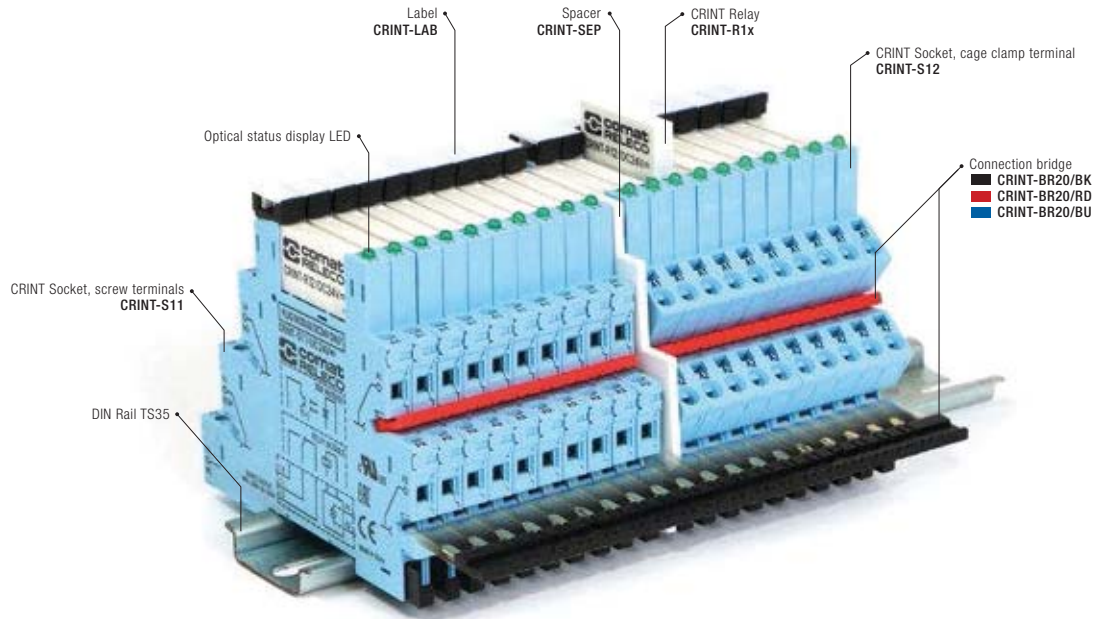
Dimensions [mm]



Technical approvals, conformities



IEC 61810; EN 60947



CRINT RELAY CODIFICATION AND ACCESSORIES

CRINT INTERFACE RELAY CONSISTS OF TWO COMPONENTS.

- RELAY
- SOCKET

CODIFICATION FOR COMPLETE RELAY MODULE RELAY AND SOCKET 6,2 MM

1		2	3	4	5	6	7	8
CRINT	-	C	1	1	1	R	/	UC 24V

1. Product family
CRINT

2. Type
C = Combined version (Socket and Relay)

3. Contact
1 = One change-over contact

4. Connection type
Screw terminal
Cage clamp terminal

5. Output
1 = AgSnO₂
2 = AgSnO₂ + 3μ Au
5 = NO / Solid-state DC
8 = NO / Solid-state AC

6. Options
- = Standard version
R = Railway version

7. Supply voltage
UC = AC/DC
DC = Only for C1x5 and C1x8

8. Nominal voltage
12V, 24V, 48V, 60V, 110-125V, 220-240V

RELAY CODIFICATION

1		2	3	4	5
CRINT	-	R	11	DC	12V

1. Product family
CRINT

2. Type
R = Relay

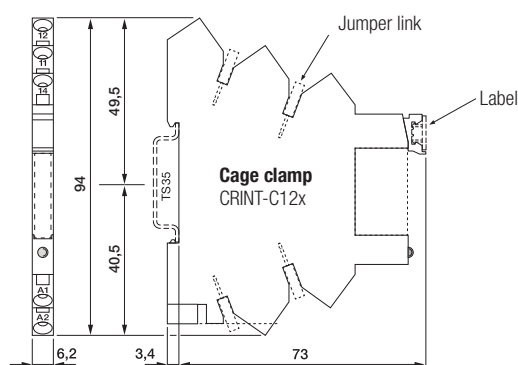
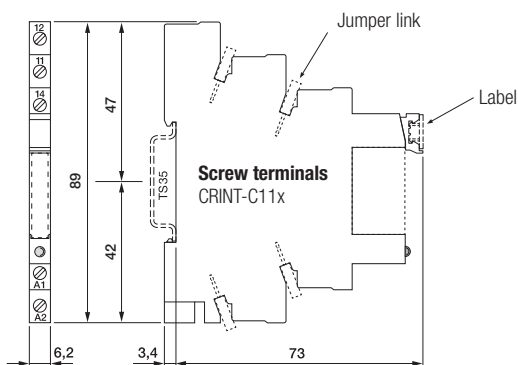
3. Contact
11 = AgSnO₂
12 = AgSnO₂ + 3μ Au
15 = NO / Solid-state DC
18 = NO / Solid-state AC

4. Supply voltage
DC

5. Nominal voltage
12V, 24V, 48V, 60V*

*60V Relay used for all sockets with a nominal voltage higher or equal 60V

Dimensions [mm]



CRINT 1x1 series

Interface module with mechanical CO output contact

DIN Rail mounting according to DIN 43 880

Types: CRINT-C111, CRINT-C121 / ...V

For PLC's and process control. High power contact AgSnO₂.
 With screw terminals (CRINT-S11) or cage clamp terminals (CRINT-S12).
 Recommended max. load 250 V 6 A resistive.

Max. contact load **6 A, 250 V AC-1** **6 A, 30 V DC-1**

Contact

Type	1 CO
Material	AgSnO ₂
Switching current _{TH}	6 A 250 V AC
Recommended minimal load	100 mA / 12 V
Switching power DC-1 30 V	180 W
Switching power AC-1 230 V	1500 VA
Switching power AC-15 230 V	300 VA
Peak inrush current	15 A/2.5 ms

Coil

Operation voltage AC 50/60 Hz / DC	0.8 ... 1.25 U _N
Nominal power DC/AC	408 / 900 mW

Insulation

Test voltage I / O	6 kVrms 1 minute
Pollution degree	3
Over voltage category	III
Open contact	1000 Vrms dielectric strength 1 min
Standard	EN61810-5

General Specifications

Ambient temperature: operation / storage	-40 ... +70 °C / -40 ... +85 °C
Typical response time @ V _n	7 ms
Typical release time @ V _n	15 ms
Switching cycles: mech./elec.	10 x 10 ⁶ / 3 x 10 ⁴
Cond. cross section screw terminal	2.5 mm ²
Cond. cross section spring cage	0.75 ... 2.5 mm ²
Ingress protection	IP 20
Mounting position	any
Housing material	Polyamide PA6

Order information

Screw terminal:	CRINT-C111/UC...V	UC12V UC24V UC48V
Cage clamp terminal:	CRINT-C121/UC...V	UC60V UC110-125V UC220-240V
„ ...“ enter the voltage for full type designation		

Accessories

Jumper link (5 pcs):	blue: CRINT-BR20-BU/5 red: CRINT-BR20-RD/5 black: CRINT-BR20-BK/5
Label plate (64 pcs):	CRINT-LAB/64
Spacer (5 pcs):	CRINT-SEP/5

Replacement relays:

CRINT-R11/DC...V	DC12V DC24V DC48V DC60V*
„ ...“ enter the voltage for full type designation	

*60V Relay used for all sockets with a nominal voltage higher or equal 60V



Connection diagram

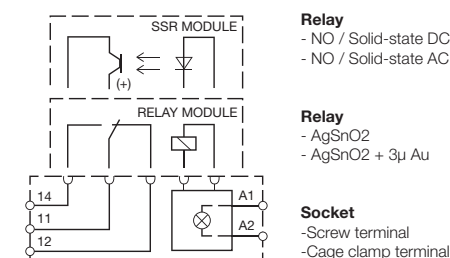


Fig.1 AC voltage endurance

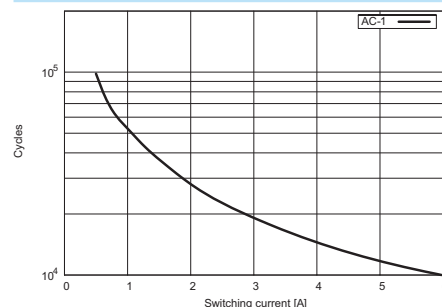
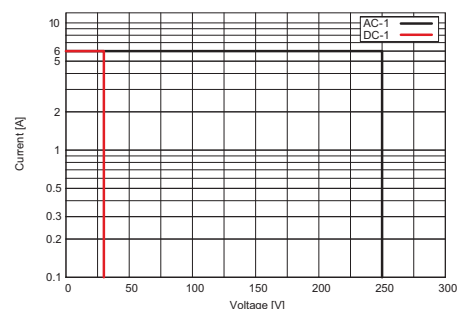


Fig. 2 DC load limit curve



Dimensions p.72

Technical approvals, conformities



CRINT 1x2 series

Interface module with mechanical CO output contact

DIN Rail mounting according to DIN 43 880



Types: CRINT-C112, CRINT-C122 / ...V

Specially for PLC, process controls with DC currents. Contact $\text{AgSnO}_2 + 3\mu\text{Au}$. For low power application. With screw terminals (CRINT-S11) or cage clamp terminals (CRINT-S12). No external freewheeling circuit required.

Max. contact load	6 A, 250 V AC-1	6 A, 30 V DC-1
Contact		
Type	1 CO	
Material	$\text{AgSnO}_2 + 3\mu\text{Au}$	
Switching current _{TH}	6 A 250 V AC	
Recommended minimal load	10 mA / 6 V	
Switching power DC-1 30 V	180 W	
Switching power AC-1 230 V	1500 VA	
Switching power AC-15 230 V	300 VA	
Peak inrush current	15 A/2.5 ms	

Coil		
Operation voltage AC 50/60 Hz / DC	0.8 ... 1.25 U _N	
Nominal power DC/AC	408 / 900 mW	

Insulation		
Test voltage I / O	6 kVrms 1 minute	
Pollution degree	3	
Over voltage category	III	
Open contact	1000 Vrms dielectric strength 1 min	
Standard	EN61810-5	

General Specifications		
Ambient temperature: operation / storage	-40 ... +70 °C / -40 ... +85 °C	
Typical response time @ V _n	7 ms	
Typical release time @ V _n	15 ms	
Switching cycles: mech./elec.	10 x 10 ⁶ / 3 x 10 ⁴	
Cond. cross section screw terminal	2.5 mm ²	
Cond. cross section spring cage	0.75 ... 2.5 mm ²	
Ingress protection	IP 20	
Mounting position	any	
Housing material	Polyamide PA6	

Order information		
Screw terminal:	CRINT-C112/UC...V	UC12V UC24V UC48V UC60V UC110-125V UC220-240V
Cage clamp terminal:	CRINT-C122/UC...V	
„ ...“ enter the voltage for full type designation		

Accessories		
Jumper link (5 pcs):	blue:	CRINT-BR20-BU/5
	red:	CRINT-BR20-RD/5
	black:	CRINT-BR20-BK/5
Label plate (64 pcs):		CRINT-LAB/64
Spacer (5 pcs):		CRINT-SEP/5
Replacement relays:		DC12V DC24V DC48V DC60V*
„ ...“ enter the voltage for full type designation		

*60V Relay used for all sockets with a nominal voltage higher or equal 60V



Connection diagram

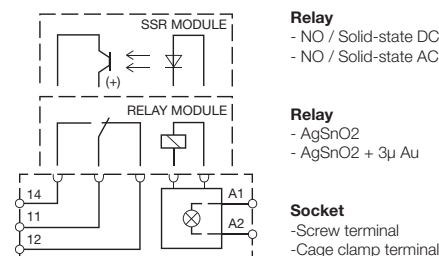


Fig.1 AC voltage endurance

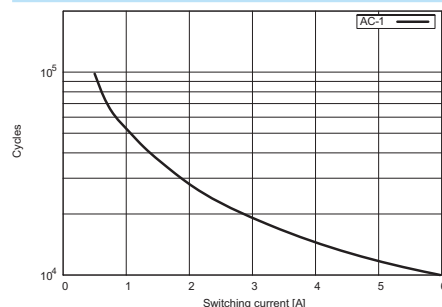
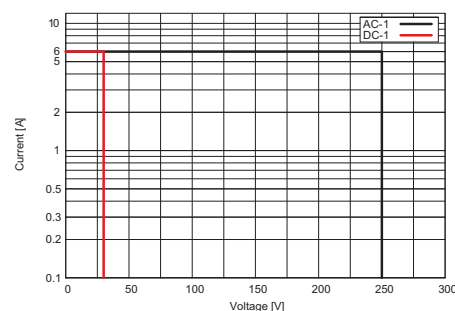


Fig. 2 DC load limit curve



Dimensions p.72

Technical approvals, conformities



CRINT 1x5 series

Solid state interface module with mechanical NO output contact

DIN Rail mounting according to DIN 43 880

Types: CRINT-C115, CRINT-C125 / ...V

For PLC's and process control. DC solid state switch, type NO.
For fast and high frequent switching. With screw terminals (CRINT-S11) or cage clamp terminals (CRINT-S12).

Max. contact load	2 A, 24 V DC-1
Contact	
Type	1 NO (Solid state DC)
Material	MOSFET
Switching current _{TH}	2 A 24 V DC
Recommended minimal load	20 mA / 5 V
Peak inrush current	48 A/10 ms
Coil	
Operation voltage AC 50/60 Hz / DC	0.8 ... 1.25 U _N
Nominal power DC/AC	160 / — mW
Insulation	
Test voltage I / O	2.5 kVrms 1 minute
Pollution degree	3
Over voltage category	III
Open contact	1000 Vrms dielectric strength 1 min
Standard	EN61810-5
General Specifications	
Ambient temperature: operation / storage	-30 ... +70 °C / -40 ... +85 °C
Typical response time @ V _n	1 ms
Typical release time @ V _n	1 ms
Cond. cross section screw terminal	2.5 mm ²
Cond. cross section spring cage	0.75 ... 2.5 mm ²
Ingress protection	IP 20
Mounting position	any
Housing material	Polyamide PA6

Order information

Screw terminal:	CRINT-C115/UC...V	UC12V UC24V UC48V UC60V UC110-125V UC220-240V
Cage clamp terminal:	CRINT-C125/UC...V	
„ ...“ enter the voltage for full type designation		

Accessories

Jumper link (5 pcs):	blue:	CRINT-BR20-BU/5
	red:	CRINT-BR20-RD/5
	black:	CRINT-BR20-BK/5

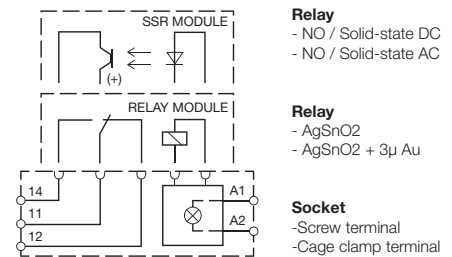
Label plate (64 pcs):	CRINT-LAB/64
Spacer (5 pcs):	CRINT-SEP/5

Replacement relays:	DC12V DC24V DC48V DC60V*
CRINT-R15/DC...V	
„ ...“ enter the voltage for full type designation	

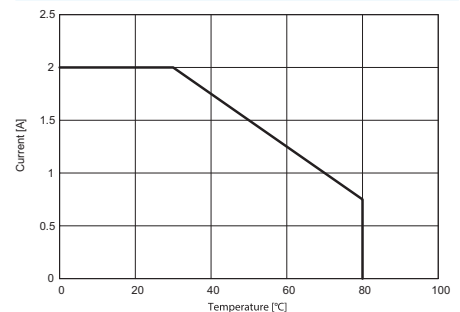
*60V Relay used for all sockets with a nominal voltage higher or equal 60V



Connection diagram



Output derating curve



Dimensions p.72

Technical approvals, conformities



CRINT 1x8 series

Solid state interface module with mechanical NO output contact

DIN Rail mounting according to DIN 43 880



Types: CRINT-C118, CRINT-C128 / ...V

For PLC's and process control.

AC output interface zero synchronous switching NO for resistive or similar load. (No transformer rec.) With screw terminals (CRINT-S11) or cage clamp terminals (CRINT-S12).

Max. contact load **1 A, 240 V AC-1**

Contact

Type	1 NO (Solid state AC)
Material	TRIAC
Switching current _{TH}	1 A 240 V AC
Recommended minimal load	22 mA / 12 V
Peak inrush current	80 A/10 ms

Coil

Operation voltage AC 50/60 Hz / DC	0.8 ... 1.25 U _N
Nominal power DC/AC	150 / — mW

Insulation

Test voltage I / O	2.5 kVrms 1 minute
Pollution degree	3
Over voltage category	III
Open contact	1000 Vrms dielectric strength 1 min
Standard	EN61810-5

General Specifications

Ambient temperature: operation / storage	-30 ... +70 °C / -40 ... +85 °C
Typical response time @ V _n	1 ms
Typical release time @ V _n	1 ms
Cond. cross section screw terminal	2.5 mm ²
Cond. cross section spring cage	0.75 ... 2.5 mm ²
Ingress protection	IP 20
Mounting position	any
Housing material	Polyamide PA6

Order information

Screw terminal:	CRINT-C118/UC...V	UC12V UC24V UC48V
Cage clamp terminal:	CRINT-C128/UC...V	UC60V UC110-125V UC220-240V

„ ...“ enter the voltage for full type designation

Accessories

Jumper link (5 pcs):	blue:	CRINT-BR20-BU/5
	red:	CRINT-BR20-RD/5
	black:	CRINT-BR20-BK/5

Label plate (64 pcs):	CRINT-LAB/64
Spacer (5 pcs):	CRINT-SEP/5

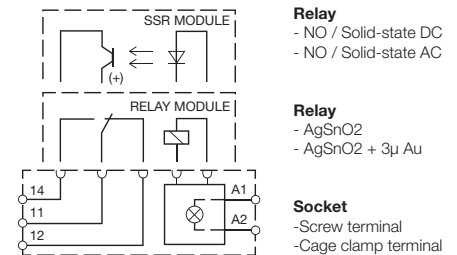
Replacement relays:	DC12V DC24V DC60V*
---------------------	---

„ ...“ enter the voltage for full type designation

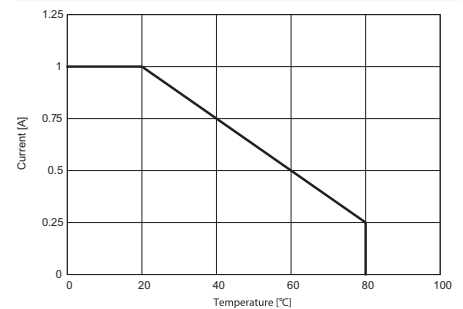
*60V Relay used for all sockets with a nominal voltage higher or equal 60V



Connection diagram



Output derating curve




Dimensions p.72

Technical approvals, conformities



1.2 Miniature Industrial Relays – QRC



Application	Types	Pins	Contacts	AC ratings	DC ratings	Socket
C7 Series						
Miniature power relay	C7-A1x			16 A / 250 V	0.5 A / 110 V	S7
General purpose	C7-A2x			10 A / 250 V	0.5 A / 110 V	S7
Low switching load	C7-T2x			6 A / 250 V	6 A / 30 V	S7
DC load switching	C7-G2x			10 A / 250 V	0.8 A / 110 V	S7
DC load switching double make	C7-X1x		>3mm 	10 A / 250 V	6 A / 110 V	S7
1 power and 1 signal contact	C7-H23			10 A / 250 V	6 A / 30 V	S7
Power relay for high inrush current	C7-W1x			10 A / 250 V 500 A / 2.5 ms inrush		S7
Railway application	R7-A2x			10 A / 250 V	10 A / 30 V	S7
Railway application	R7-T2x			6 A / 250 V	6 A / 30 V	S7
C9 Series						
Miniature relay	C9-A4x			5 A / 250 V	5 A / 30 V	S9
Sensitive Coil 500mW ... 800mW	C9-E2x			5 A / 250 V	5 mA / 30 V	S9
Latching relay	C9-R2x			5 A / 120 V	5 A / 30 V	S9

Type	C7-A1x/ ... V Standard relay 1 change-over contact
-------------	---

Maximum contact load	16 A/250 V AC-1	0,5 A/110 V DC-1
	16 A/30 V DC-1	0,2 A/220 V DC-1

Contacts			
Material	Standard	Code 0	AgNi
Rated current			16 A
Switch-on current max. (20 ms)			40 A
Switching voltage max.			250 V
AC load (Fig 1)			4 kVA
DC load			see Fig. 2
Relay compatible with socket S7-16			

Coil	
Coil resistance	see table; tolerance $\pm 10\%$
Pick-up voltage	$\leq 0,8 \times U_N$
Release voltage	$\geq 0,1 \times U_N$
Nominal power	1,2 VA (AC)/1,3 W (DC)

Coil table	VAC	Ω	mA	VDC	Ω	mA
	24	174	50	12	111	108
	48	686	25	24	432	55
	115	4K3	10,4	48	1K7	28
	230	18K6	5,2	110	9K2	12

Insulation	Volt rms, 1 min
Contact open	1000 V
Contact/coil	2,5 kV
Insulation resistance at 500 V	$\geq 1 \text{ G}\Omega$
Insulation, IEC 61810-1	2,5 kV/3

Specifications	
Ambient temperature operation/storage	-40 (no ice)...60 °C / -40 ... 80 °C
Pick-up time/bounce time	16 ms/ ≤ 3 ms
Release time/bounce time	8 ms/ ≤ 1 ms
Mechanical life ops	AC: 10 Mill./DC: 20 Mill.
DC voltage endurance at rated load	≥ 100000 switching cycles
Switching frequency at rated load	≤ 1200 /h
Protection class	IP40
Weight	43 g

Standard types	C7-A10/AC ... V C7-A10X/AC ... V
VAC 50 Hz/60 Hz: 24, 48, 115 (120), 230 (240) LED	
VDC 12, 24, 48, 110 LED	C7-A10/DC ... V C7-A10X/DC ... V
Free wheeling diode	C7-A10DX/DC ... V C7-A10FX/DC ... V
Polarity and free wheeling diode	
AC/DC bridge rectifier 24 V, 48 V, 60 V	C7-A10BX/UC ... V

"..." Enter the voltage for full type designation

Accessories	
Socket:	S7-16



Connection diagram

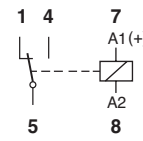


Fig. 1 AC voltage endurance

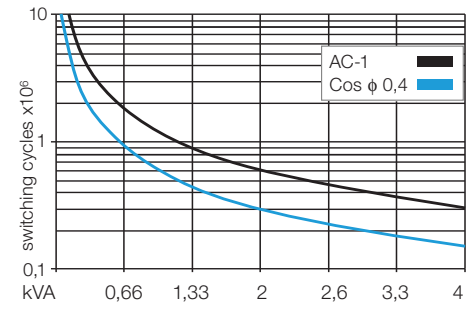
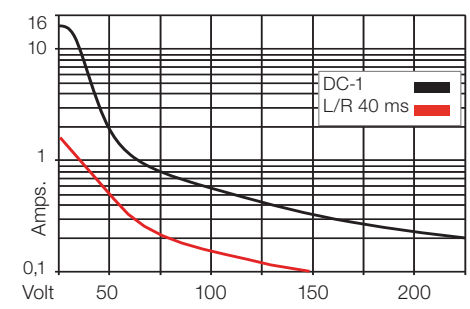
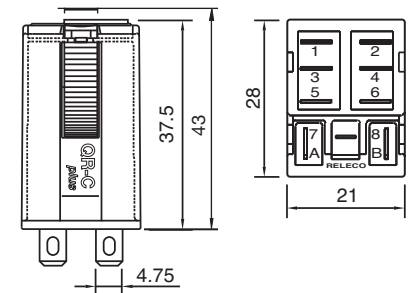


Fig. 2 DC load limit curve



Dimensions [mm]



Technical approvals, conformities



IEC 61810; EN 60947



Type	C7-A2x/ ... V Standard relay 2 change-over contact		
Maximum contact load	10 A/250 V AC-1	0,5 A/110 V DC-1	
	10 A/30 V DC-1	0,2 A/220 V DC-1	
Recommended minimum contact load	10 mA/10 V Code 0, 9		
	5 mA/5 V Code 8		

Contacts			
Material	Standard	Code 0	AgNi
	Optional	Code 8	AgNi + 10 μ Au
	Optional	Code 9	AgNi + 0,2 μ Au
Rated current	10 A		
Switch-on current max. (20 ms)	30 A		
Switching voltage max.	250 V		
AC load (Fig 1)	2,5 kVA		
DC load	see Fig. 2		

Coil	
Coil resistance	see table; tolerance ± 10 %
Pick-up voltage	≤ 0,8 × U _N
Release voltage	≥ 0,1 × U _N
Nominal power	1,2 VA (AC)/1 W (DC)

Coil table					
VAC	Ω	mA	VDC	Ω	mA
24	174	50	12	148	85
48	686	25	24	594	43
115	4K3	10,4	48	2K3	21
230	18K6	5,2	110	11K4	10

Insulation	
Contact open	Volt rms, 1 min
Contact/contact	1000 V
Contact/contact	2,5 kV
Contact/coil	2,5 kV
Insulation resistance at 500 V	≥ 1 G.Ω
Insulation, IEC 61810-1	2,5 kV/3

Specifications	
Ambient temperature operation/storage	-40 (no ice)...60 °C /-40 ... 80 °C
Pick-up time/bounce time	16 ms/≤ 3 ms
Release time/bounce time	8 ms/≤ 1 ms
Mechanical life ops	AC: 10 Mill./DC: 20 Mill.
DC voltage endurance at rated load	≥ 100000 switching cycles
Switching frequency at rated load	≤ 1200/h
Protection class	IP40
Weight	43 g

Standard types			
VAC 50 Hz/60 Hz:	24, 48, 115 (120), 230 (240)	C7-A20/AC ... V	C7-A28/AC ... V
LED		C7-A20X/AC ... V	C7-A28X/AC ... V
			C7-A29/AC ... V
			C7-A29X/AC ... V
VDC 12, 24, 48, 110		C7-A20/DC ... V	C7-A28/DC ... V
LED		C7-A20X/DC ... V	C7-A28X/DC ... V
Free wheeling diode		C7-A20DX/DC ... V	C7-A28DX/DC ... V
Polarity and free wheeling diode		C7-A20FX/DC ... V	C7-A28FX/DC ... V
			C7-A29DX/DC .V
			C7-A29FX/DC ... V
AC/DC bridge rectifier 24 V, 48 V, 60 V		C7-A20BX/UC ... V	C7-A28BX/UC ... V
			C7-A29BX/UC ... V

"..." Enter the voltage for full type designation

Accessories	
Socket:	S7-C, S7-I/O, S7-L, S7-P, S7-P0

Connection diagram

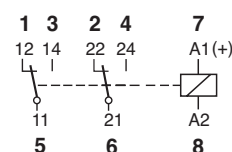


Fig. 1 AC voltage endurance

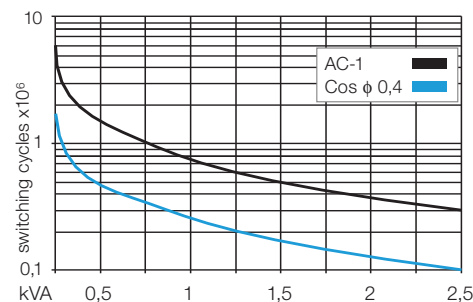
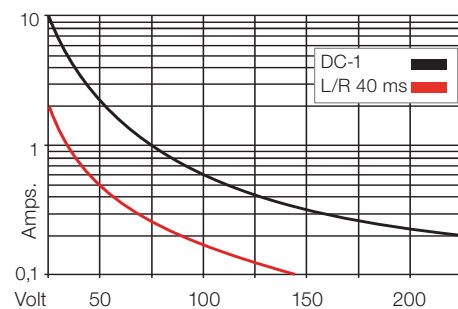
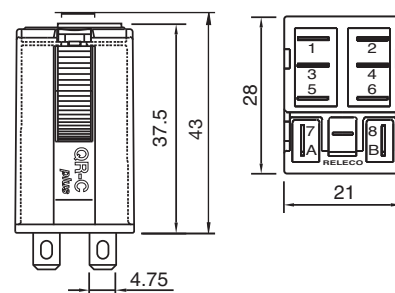


Fig. 2 DC load limit curve



Dimensions [mm]



Technical approvals, conformities



Type	C7-T2x/ ... V Standard relays for low level 2 change-over bifurcated contacts			
Maximum contact load	6 A/250 V	AC-1	6 A/30 V	DC-1
Recommended minimum contact load	5 mA/5 V	Code 1		
	1 mA/5 V	Code 2		

Contacts			
Material	Standard	Code 1	AgNi + 0,2 μ Au
	Optional	Code 2	AgNi + 10 μ Au
Rated current	6 A		
Switch-on current max. (20 ms)	15 A		
Switching voltage max.	250 V		
AC load (Fig 1)	1,2 kVA		
DC load	see fig. 2		

Coil			
Coil resistance	see table; tolerance ± 10 %		
Pick-up voltage	≤ 0,8 × U _N		
Release voltage	≥ 0,1 × U _N		
Nominal power	1,2 VA (AC)/1 W (DC)		

Coil table						
	VAC	Ω	mA	VDC	Ω	mA
	24	174	50	12	148	85
	48	686	25	24	594	43
	115	4K3	10,4	48	2K3	21
	230	18K6	5,2	110	11K4	10

Insulation	Volt rms, 1 min
Contact open	1000 V
Contact/contact	2,5 kV
Contact/coil	2,5 kV
Insulation resistance at 500 V	≥ 1 GΩ
Insulation, IEC 61810-1	2,5 kV/3

Specifications	
Ambient temperature operation/storage	-40 (no ice)...60 °C / -40 ... 80 °C
Pick-up time/bounce time	16 ms/≤ 3 ms
Release time/bounce time	8 ms/≤ 1 ms
Mechanical life ops	AC: 10 Mill./DC: 20 Mill.
DC voltage endurance at rated load	≥ 100000 switching cycles
Switching frequency at rated load	≤ 1200/h
Protection class	IP40
Weight	43 g

Standard types		
VAC 50 Hz/60 Hz: 24, 48, 115 (120), 230 (240) LED	C7-T21/AC ... V C7-T21X/AC ... V	C7-T22/AC ... V C7-T22X/AC ... V
VDC 12, 24, 48, 110 LED	C7-T21/DC ... V C7-T21X/DC ... V	C7-T22/DC ... V C7-T22X/DC ... V
Free wheeling diode	C7-T21DX/DC ... V	C7-T22DX/DC ... V
Polarity and free wheeling diode	C7-T21FX/DC ... V	C7-T22FX/DC ... V
AC/DC bridge rectifier 24 V, 48 V, 60 V	C7-T21BX/UC ... V	C7-T22BX/UC ... V

"..." Enter the voltage for full type designation

Accessories	
Socket:	S7-C, S7-I/O, S7-L, S7-P, S7-P0



Connection diagram

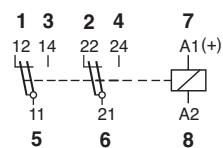


Fig. 1 AC voltage endurance

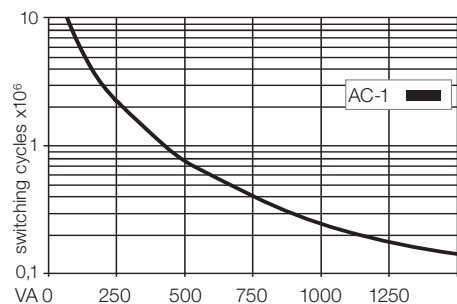
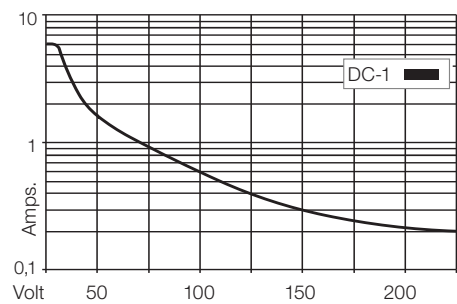
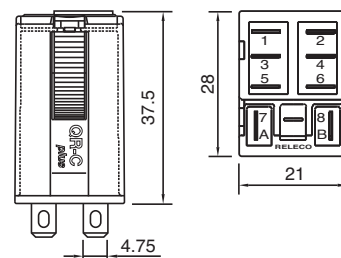


Fig. 2 DC load limit curve



Dimensions [mm]



Technical approvals, conformities



IEC 61810; EN 60947



Type	C7-G2x/ ... V Power relay, DC application 2 open contacts, gap 1,5mm		
-------------	---	--	--

Maximum contact load	10 A/250 V AC-1	0,8 A/110 V DC-1
	10 A/30 V DC-1	0,4 A/220 V DC-1

Contacts			
Material	Standard	Code 0	AgNi
Rated current			10 A
Switch-on current max. (20 ms)			30 A
Switching voltage max			250 V
AC load (Fig 1)			2,5 kVA
DC load			see fig. 2

Coil	
Coil resistance	see table; tolerance $\pm 10\%$
Pick-up voltage	$\leq 0,8 \times U_N$
Release voltage	$\geq 0,1 \times U_N$
Nominal power	1,5 VA (AC)/1,5 W (DC)

Coil table	VAC	Ω	mA	VDC	Ω	mA
	24	153	62	12	99	121
	48	611	31	24	388	61
	115	3K6	13	48	1K5	32
	230	14K6	6,5	110	8K	14

Insulation	Volt rms, 1 min
Contact open	2000 V
Contact/contact	2,5 kV
Contact/coil	2,5 kV
Insulation resistance at 500 V	$\geq 1 \text{ G}\Omega$
Insulation, IEC 61810-1	2,5 kV/3

Specifications	
Ambient temperature operation/storage	-40 (no ice)...60 °C / -40 ... 80 °C
Pick-up time/bounce time	20 ms/ ≤ 3 ms
Release time/bounce time	10 ms/ ≤ 1 ms
Mechanical life ops	AC: 10 Mill./DC: 20 Mill.
DC voltage endurance at rated load	≥ 100000 switching cycles
Switching frequency at rated load	≤ 1200 /h
Protection class	IP40
Weight	43 g

Standard types	C7-G20/AC ... V C7-G20X/AC ... V
VAC 50 Hz/60 Hz: 24, 48, 115 (120), 230 (240) LED	

VDC 12, 24, 48, 110 LED	C7-G20/DC ... V C7-G20X/DC ... V
Free wheeling diode	C7-G20DX/DC ... V C7-G20FX/DC ... V
Polarity and free wheeling diode	

AC/DC bridge rectifier 24 V, 48 V, 60 V	C7-G20BX/UC ... V
--	--------------------------

"..." Enter the voltage for full type designation

Accessories	
Socket:	S7-C, S7-I/O, S7-L, S7-P, S7-P0

Connection diagram

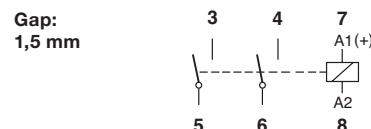


Fig. 1 AC voltage endurance

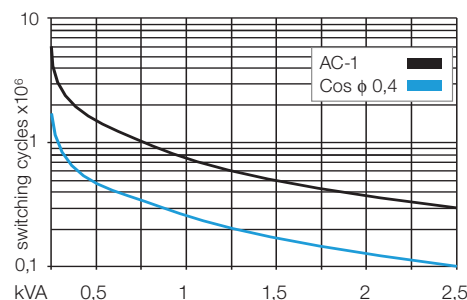
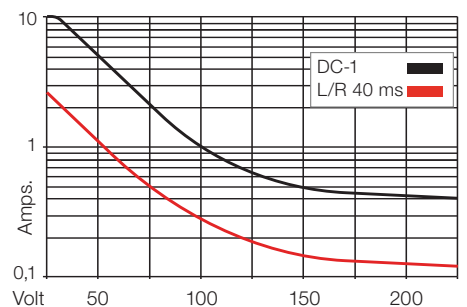
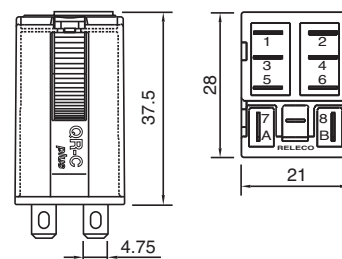


Fig. 2 DC load limit curve



Dimensions [mm]



Technical approvals, conformities



IEC 61810; EN 60947

Type	C7-X1x/ ... V Power relay, DC application 1 pole, NO, double make			
-------------	--	--	--	--

Maximum contact load	10 A/250 V AC-1	6 A/110 V DC-1		
	10 A/30 V DC-1	1 A/220 V DC-1		

Contacts				
Material	Standard	Code 0	AgNi	
Rated current	10 A			
Switch-on current max. (20 ms)	30 A			
Switching voltage max.	250 V			
AC load	2,5 kVA			
DC load	see Fig. 2			

Coil				
Coil resistance	see table; tolerance $\pm 10\%$			
Pick-up voltage	$\leq 0,8 \times U_N$			
Release voltage	$\geq 0,1 \times U_N$			
Nominal power	1,5 VA (AC)/1,3 W (DC)			

Coil table					
VAC	Ω	mA	VDC	Ω	mA
24	153	62	12	111	108
48	611	31	24	432	55
115	3K6	13	48	1K7	27
230	14K6	6,5	110	9K2	12

Insulation		Volt rms, 1 min
Contact open	2,5 kV	
Contact/coil	2,5 kV	
Insulation resistance at 500 V	$\geq 1 \text{ G}\Omega$	
Insulation, IEC 61810-1	2,5 kV/3	

Specifications	
Ambient temperature operation/storage	-40 (no ice)...60 °C / -40 ... 80 °C
Pick-up time/bounce time	20 ms/ ≤ 3 ms
Release time/bounce time	10 ms/ ≤ 1 ms
Mechanical life ops	AC: 10 Mill./DC: 20 Mill.
DC voltage endurance at rated load	≥ 100000 switching cycles
Switching frequency at rated load	$\leq 1200/\text{h}$
Protection class	IP40
Weight	43 g

Standard types	C7-X10/AC ... V C7-X10X/AC ... V
VAC 50 Hz/60 Hz: 24, 48, 115 (120), 230 (240) LED	

VDC 12, 24, 48, 110 LED	C7-X10/DC ... V C7-X10X/DC ... V
Free wheeling diode	C7-X10DX/DC ... V C7-X10FX/DC ... V
Polarity and free wheeling diode	

AC/DC bridge rectifier 24 V, 48 V, 60 V	C7-X10BX/UC ... V
--	--------------------------

"..." Enter the voltage for full type designation

Accessories	
Socket:	S7-C, S7-I/O, S7-L, S7-P, S7-P0



Connection diagram

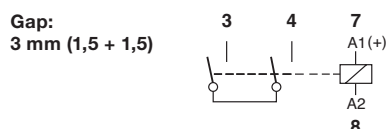


Fig. 1 AC voltage endurance

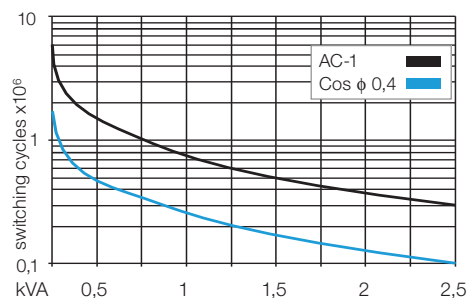
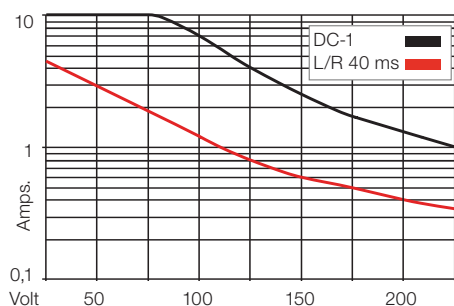
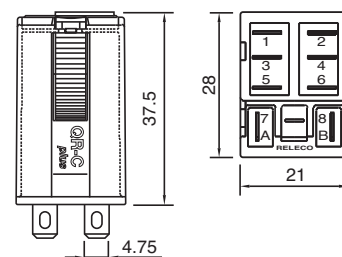


Fig. 2 DC load limit curve



Dimensions [mm]



Technical approvals, conformities



IEC 61810; EN 60947

Type	C7-H23/ ... V Special relays 1 x CO power contact 1 x CO twin contact		
Maximum contact load	10 A / 250 V AC-1	6 A / 250 V AC-1	AC-1
	10 A / 30 V DC-1	6 A / 30 V DC-1	DC-1
Recommended minimum contact load	10 mA/10 V (Power contacts) 5 mA/5V (twin contacts)		

Contacts	
Power contact	
Standard material	AgNi
Rated current	10 A
Switch-on current max. (20 ms)	30 A
Switching voltage max.	2,5 kV
AC load (Fig 1)	2,5 VA
DC load	see fig. 2
*Power contact only	

Twin contact	
Standard material	AgNi + 0,2 μ Au
Rated current	6 A
Switch-on current max. (20 ms)	15 A
Switching voltage max.	250 V

Coil	
Coil resistance	see table; tolerance ± 10 %
Pick-up voltage	≤ 0,8 x U _N
Release voltage	≥ 0,1 x U _N
Nominal power	1,2 VA (AC) / 1 W (DC)

Coil table	VAC Ω ± 10% mA	VDC Ω ± 10% mA
	24 174 50	12 148 81
	48 686 25	24 594 40
	115 4K3 10.4	48 2K3 21
	230 18K6 5.2	110 11K4 10

Insulation	Volt rms, 1 min
Contact open	1000 V
Contact/contact	2,5 kV
Contact/coil	2,5 kV
Insulation, IEC 61810-1:	2,5 kV/3

Specifications	
Ambient temperature operation/storage	40 (no ice)...60 °C / -40 ... 80 °C
Mechanical life ops	AC: 10 Mill./DC: 20 Mill.
Protection class	IP40
Weight	43 g

Standard types	C7-H23/AC ... V C7-H23X/AC ... V
VAC 50 Hz/60 Hz: 24, 48, 115 (120), 230 (240) LED	
VDC 12,24, 48, 110 LED	C7-H23/DC ... V C7-H23X/DC ... V
Free wheeling diode	C7-H23DX/DC ... V C7-H23FX/DC ... V
Polarity and free wheeling diode	
UC 24 V, 48 V, 60 V	C7-H23BX/UC ... V

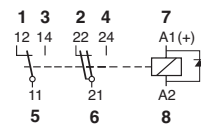
"..." Enter the voltage for full type designation

Accessories	
Socket:	S7-C, S7-I/O, S7-L, S7-P, S7-PO

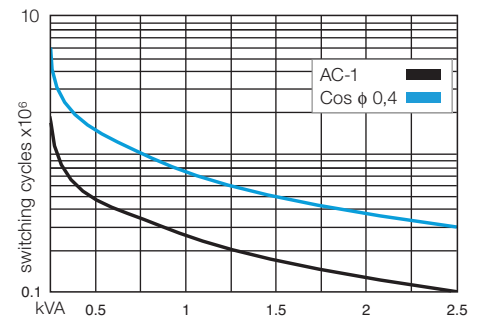
This issue replaces all previous issues. Availability, errors and specifications subject to change without notice.



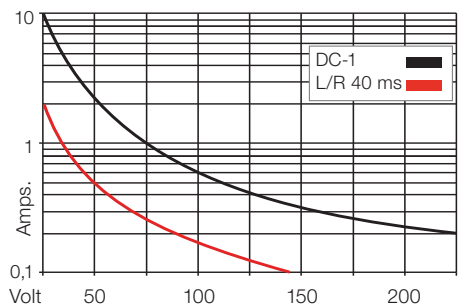
Connection diagram



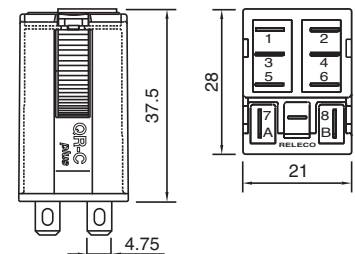
***Fig. 1 AC voltage endurance**



***Fig. 2 DC load limit curve**



Dimensions [mm]



Technical approvals, conformities



IEC 61810; EN 60947

C7-W1x

4-pin, miniature relay, 1-pole, tungsten contact, faston

Type: **C7-W1x/ ... V**
 Power relay for high inrush current
 1 pole normally open

Maximum contact load: **10 A/250 V AC-1 6 A/250 V AC-5a/b**
Recommended minimum contact load: **10 mA/10 V**

Contacts

Material	Standard	Code 0	AgNi/W
Rated current			10 A
Switch-on current max. (2,5 ms)			500 A
Switching voltage max.			250 V
AC load (Fig 1)			2,5 kVA
DC load			see fig. 2

Coil

Coil resistance	see table; tolerance ± 10 %
Pick-up voltage	≤ 0,8 × U _N
Release voltage	≥ 0,1 × U _N
Nominal power	1,5 VA (AC)/1,5 W (DC)

Coil table

VAC	Ω	mA	VDC	Ω	mA
24	153	62	12	99	121
48	611	31	24	388	61
115	3K6	13	48	1K5	32
230	14K5	6,5	110	8K	14

Insulation

	Volt rms, 1 min
Contact open	1000 V
Contact/coil	2,5 kV
Insulation resistance at 500 V	≥ 1 GΩ
Insulation, IEC 61810-1	2,5 kV

Specifications

Ambient temperature operation/storage	-40 (no ice)...60 °C / -40 ... 80 °C
Pick-up time/bounce time	20 ms/≤ 3 ms
Release time/bounce time	10 ms/≤ 1 ms
Mechanical life ops	AC: 10 Mill./DC: 20 Mill.
DC voltage endurance at rated load	≥ 100000 switching cycles
Switching frequency at rated load	≤ 1200/h
Protection class	IP40
Weight	43 g

Standard types

VAC 50 Hz/60 Hz: 24, 48, 115 (120), 230 (240) LED

VDC 12, 24, 48, 110 LED

Free wheeling diode

Polarity and free wheeling diode

AC/DC bridge rectifier 24 V, 48 V, 60 V

C7-W10/AC ... V
C7-W10X/AC ... V

C7-W10/DC ... V
C7-W10X/DC ... V
C7-W10DX/DC ... V
C7-W10FX/DC ... V

C7-W10BX/UC ... V

"..." Enter the voltage for full type designation

Accessories

Socket:
 Optional accessories (blanking plug):

S7-C, S7-I/O, S7-L, S7-P, S7-P0
S9-NP, S9-OP



Connection diagram

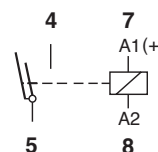


Fig. 1 AC voltage endurance

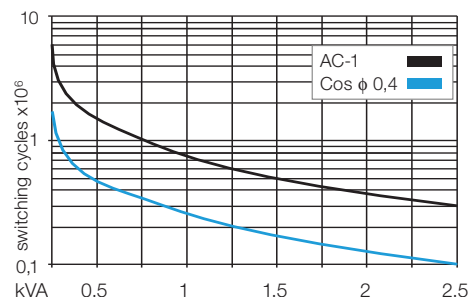
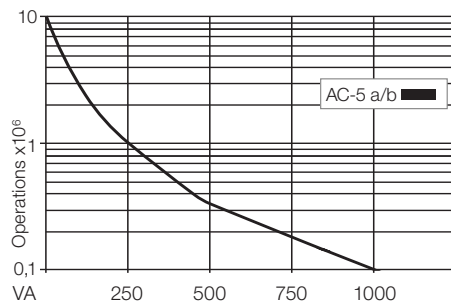
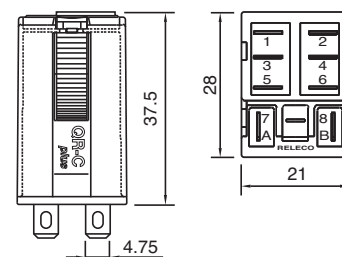


Fig. 2 AC voltage endurance



Dimensions [mm]



Technical approvals, conformities



IEC 61810; EN 60947

R7-A2x

8-pin, miniature standard relay, 2-pole, plug-in

Relay approval: EN 60077-1-2/99 - EN 61373/99 for Railway application

Type	R7-A2x/DC ... V Railway application Sensitive, 2 change-over contacts
-------------	--

Maximum contact load:	10 A/250 V AC-1 10A/30V DC-1
Recommended minimum contact load	10 mA/10 V Code 0, 4 5 mA/5 V Code 8

Contacts

Material	Standard	Code 0	AgNi
	Optional	Code 4	AgNi + 0,2µ Au
	Optional	Code 8	AgNi + 10µ Au
Rated current	10 A		
Switch-on current max. (20 ms)	30 A		
Switching voltage max.	250 V		
AC load	see fig. 1		
DC load	see fig. 2		

Coil

Coil resistance	see table; tolerance ± 10 %
Release voltage	0,7 U _N ... 1,25 U _N
Pick-up voltage	≥ 0,1 x U _N
Nominal power	1,07 W

Coil table

Voltage	Ω ± 10%	mA
24	535	45
48	2004	24
72	4750	15
110	11337	10

Insulation	Volt rms, 1 min
Pollution grade	PD3
Pulse (1,2 /50µs) Dielectric strenght (1Minute/V rms)	
Contact/coil	4KV / 2200V
Between different poles	4KV / 2200V
Between contact and the same pole	1550 / 850V

Specifications

Ambient temperature operation/storage	-25 (no ice)...70 °C /-40 ... 80 °C
Number of mechanical operations	>20millions
Thermic class	B (130° C)
Vibration : category / class	1 / B Body mounted
Vibration	5-150Hz (3 axes)
Shock	5g (3 axes)
Operation (UN) / release time	10 ms/ 15 ms
Weight	35 g
Weight avg. Relay + Socket (S7-M)	75g
Protection class	IP40

Standard types

VDC 24, 48, 72, 110	R7-A20/DC ... V	R7-A24/DC ... V	R7-A28/DC ... V
LED	R7-A20X/DC ... V	R7-A24X/DC ... V	R7-A28X/DC ... V
Free wheeling diode	R7-A20D/DC ... V	R7-A24D/DC ... V	R7-A28D/DC ... V
LED + free wheeling diode	R7-A20DX/DC...V	R7-A24DX/DC...V	R7-A28DX/DC...V

"..." Enter the voltage for full type designation

Accessories

Socket:	S7-C, S7-I/O, S7-L, S7-P, S7-PO
---------	--



Connection diagram

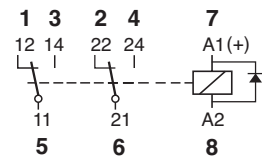


Fig. 1 AC voltage endurance

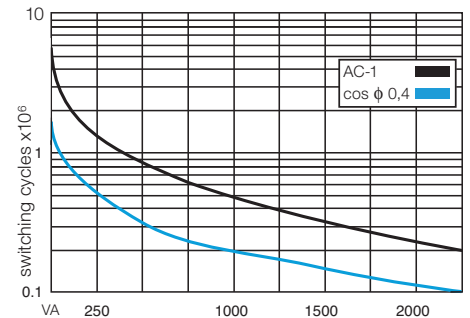
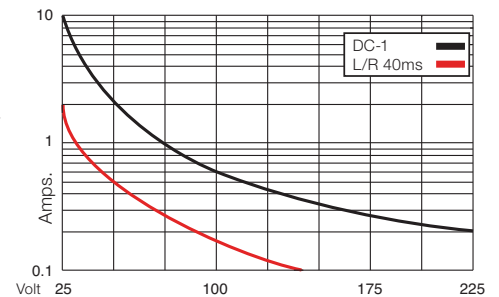
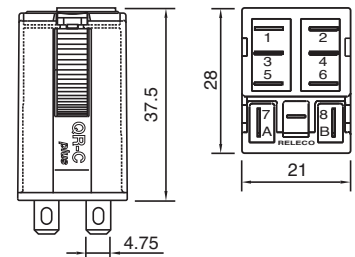


Fig. 2 DC load limit curve



Dimensions [mm]



Technical approvals, conformities



EN 60077-1-2/99; EN 61373/99

R7-T2x

8-pin, miniature industrial relay, 2-pole, change-over contact, faston
Relay approval: EN 60077-1-2/99 - EN 61373/99 for Railway application



Type	R7-T2x/DC ... V Railway application Sensitive, 2 change-over contact		
Maximum contact load	6 A/250 V AC-1		6 A/30 V DC-1
Recommended minimum contact load	5 mA/5 V Code 1 1 mA/5 V Code 2		

Contacts			
Material	Standard	Code 1	AgNi + 0,2μ Au
	Optional	Code 2	AgNi + 10μ Au
Rated current	6 A		
Switch-on current max. (20 ms)	15 A		
Switching voltage max.	250 V		
AC load	see fig. 1		
DC load	see fig. 2		

Coil	
Coil resistance	see table; tolerance ± 10 %
Operation range	0,7 U _N ... 1,25 U _N
Contact open	≥ 0,1 x U _N
Nominal power	1,07 W

Coil table			
	Voltage	Ω ± 10%	mA
	24	535	45
	48	2004	24
	72	4750	15
	110	11337	10

Insulation	Volt rms, 1 min
Pollution grade	PD3
Pulse (1,2 / 50μs) Dielectric strenght (1Minute/V rms)	
Contact/coil	4KV / 2200V
Between different poles	4KV / 2200V
Between contact and the same pole	1550 / 850V

Specifications	
Ambient temperature operation/storage	-25 (no ice)...70 °C / -40 ... 80 °C
Number of mechanical operations	≥ 20 millions
Thermic class	B (130° C)
Vibration : category / class	1 / B Body mounted
Vibration	5-150Hz (3 axes)
Shock	5g (3 axes)
Operation (UN) / release time	10 ms/ 15 ms
Weight	35 g
Weight avg. Relay + Socket (S7-M)	75g
Protection class	IP40

Standard types		
VDC 24, 48, 72, 110	R7-T21/DC ... V	R7-T22/DC ... V
LED	R7-T21X/DC ... V	R7-T22X/DC ... V
Free wheeling diode	R7-T21D/DC ... V	R7-T22D/DC ... V
LED + free wheeling diode	R7-T21DX/DC ... V	R7-T22DX/DC ... V

"..." Enter the voltage for full type designation

Accessories	
Socket:	S7-C, S7-I/O, S7-L, S7-P, S7-P0



Connection diagram

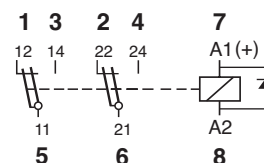


Fig. 1 AC voltage endurance

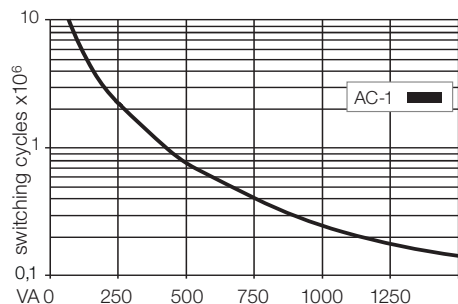
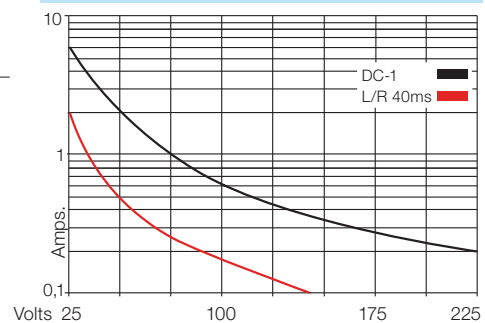
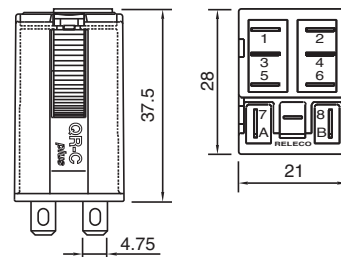


Fig. 2 DC load limit curve



Dimensions [mm]



Technical approvals, conformities



IEC 60077; EN 60077-1-2/99; EN 61373/99



Type	C9-A4x/ ... V Standard relays 4 change-over contacts			
-------------	---	--	--	--

Maximum contact load	5 A/250 V AC-1	5 A/30 V DC-1		
Recommended minimum contact load	10 mA/10 V Code 1			
	5 mA/5 V Code 2			

Contacts				
Material	Standard	Code 1	AgNi + 0,2 μ Au	
	Optional	Code 2	AgNi + 10 μ Au	
Rated current	5 A			
Switch-on current max. (20 ms)	15 A			
Switching voltage max (same polarity)	250 V			
AC load (Fig 1)	1,250 kVA			
DC load	see Fig. 2			

Coil				
Coil resistance	see table; tolerance ± 10 %			
Pick-up voltage	≤ 0,8 × U _N			
Release voltage	≥ 0,1 × U _N			
Nominal power	1,2 VA (AC)/1 W (DC)			

Coil table					
VAC	Ω	mA	VDC	Ω	mA
24	174	50	12	148	81
48	686	25	24	594	40
115	4K3	10,4	48	2K3	21
230	18K6	5,2	110	11K4	11

Insulation		Volt rms, 1 min
Contact open		1000 V
Contact/contact		2 kV
Contact/coil		2,5 kV
Insulation resistance at 500 V		≥ 1 GΩ
Insulation, IEC 61810-1		2,5 kV/3

Specifications	
Ambient temperature operation/storage	-40 (no ice)...60 °C / -40 ... 80 °C
Pick-up time/bounce time	10 ms/≤ 3 ms
Release time/bounce time	6 ms/≤ 1 ms
Mechanical life ops	AC: 10 Mill./DC: 20 Mill.
DC voltage endurance at rated load	≥ 100000 switching cycles
Switching frequency at rated load	≤ 1200/h
Protection class	IP40
Weight	43 g

Standard types		
VAC 50 Hz/60 Hz: 24, 48, 115, 230 (240) LED	C9-A41/AC ... V C9-A41X/AC ... V	C9-A42/AC ... V C9-A42X/AC ... V
VDC 12, 24, 48, 110 LED	C9-A41/DC ... V C9-A41X/DC ... V	C9-A42/DC ... V C9-A42X/DC ... V
Free wheeling diode	C9-A41DX/DC ... V	C9-A42DX/DC ... V
Polarity and free wheeling diode	C9-A41FX/DC ... V	C9-A42FX/DC ... V
AC/DC bridge rectifier 24 V, 48 V, 60 V	C9-A41BX/UC ... V	C9-A42BX/UC ... V

"..." Enter the voltage for full type designation

Accessories	
Socket:	S9-M, S9-L, S9-P, S9-P0
Optional accessories (blanking plug):	S9-NP, S9-OP

Connection diagram

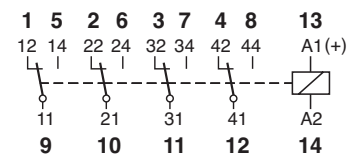


Fig. 1 AC voltage endurance

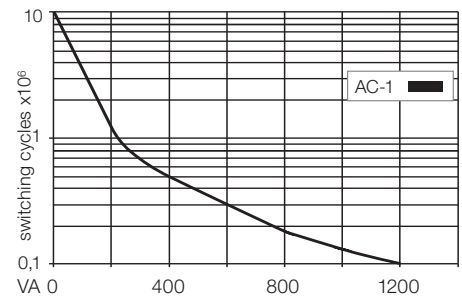
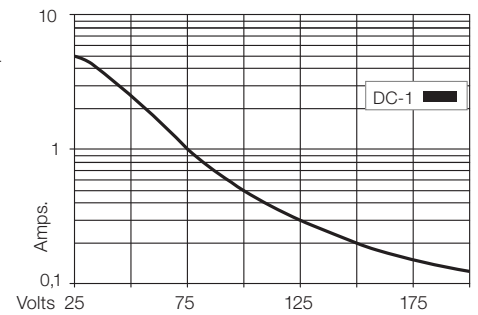
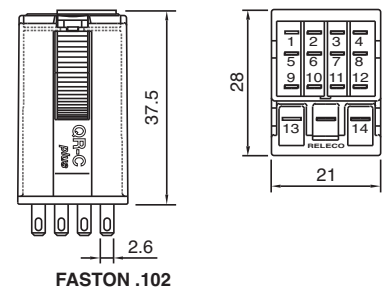


Fig. 2 DC load limit curve



Dimensions [mm]



Technical approvals, conformities



IEC 61810; EN 60947

C9-E2x

8-pin, miniature relay, 2-pole, plug-in, faston

Type	C9-E2x/ ... V Sensitive relay, 500 mW 2 change-over contacts			
DC operating range	0,8 ... 1,7 x U_N			
Maximum contact load	5 A/250 V	AC-1	5 A/30 V	DC-1
Recommended minimum contact load	10 mA/10 V	Code 1		
	5 mA/5 V	Code 2		

Contacts			
Material	Standard	Code 1	AgNi + 0,2 μ Au
	Optional,	Code 2	AgNi + 10 μ Au
Rated current	5 A		
Switch-on current max. (20 ms)	15 A		
Switching voltage max.	250 V		
AC load (Fig 1)	1200 VA		
DC load	see fig. 2		

Coil			
Coil resistance	see table; tolerance ± 10 %		
Pick-up voltage	≤ 0,8 x U _N		
Release voltage	≥ 0,1 x U _N		
Nominal power	0,8 VA (AC)/0,5 W (DC)		

Coil table					
VAC	Ω	mA	VDC	Ω	mA
24	238	33	12	288	42
48	1K	17	24	1K1	21
115	5K9	7	48	4K6	10
230	23K9	3,5	110	24K2	4,5

Insulation		Volt rms, 1 min
Contact open		1000 V
Contact/contact		2,5 kV
Contact/coil		2,5 kV
Insulation resistance at 500 V		≥ 1 GΩ
Insulation, IEC 61810-1		2,5 kV/3

Specifications	
Ambient temperature operation/storage	-40 (no ice)...60 °C / -40 ... 80 °C
Pick-up time/bounce time	10 ms/≤ 3 ms
Release time/bounce time	6 ms/≤ 1 ms
Mechanical life	AC: 10 Mill./DC: 20 Mill.
DC voltage endurance at rated load	≥ 100000 switching cycles
Switching frequency at rated load	≤ 1200/h
Protection class	IP40
Weight	40 g

Standard types		
VAC 50 Hz/60 Hz: 24, 48, 115, 230 (240) LED	C9-E21/AC ... V C9-E21X/AC ... V	C9-E22/AC ... V C9-E22X/AC ... V
VDC 12, 24, 48, 110, 220 LED	C9-E21/DC ... V C9-E21X/DC ... V	C9-E22/DC ... V C9-E22X/DC ... V
Free wheeling diode	C9-E21DX/DC ... V	C9-E22DX/DC ... V
Polarity and free wheeling diode	C9-E21FX/DC ... V	C9-E22FX/DC ... V
AC/DC bridge rectifier 24 V, 48 V, 60 V	C9-E21BX/UC ... V	C9-E22BX/UC ... V

"..." Enter the voltage for full type designation

Accessories	
Socket:	S9-M, S9-L, S9-P, S9-P0
Optional accessories (blanking plug):	S9-NP, S9-OP



Connection diagram

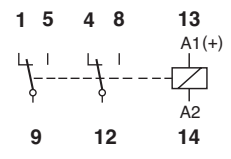


Fig. 1 AC voltage endurance

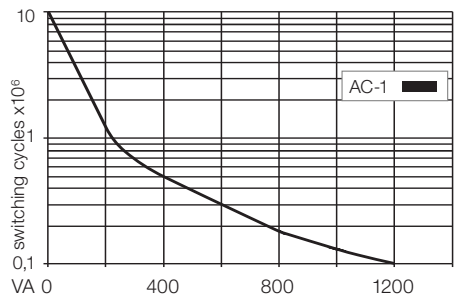
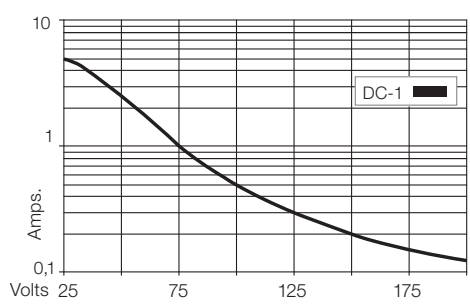
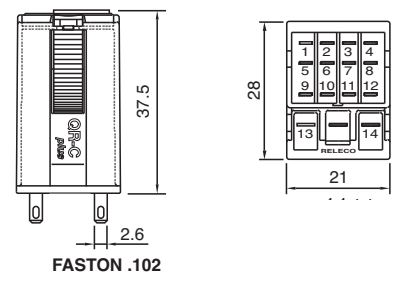


Fig. 2 DC load limit curve



Dimensions [mm]



Technical approvals, conformities





Type	C9-R2x/ ... V Magnetic latching relay 2 change-over contacts		
-------------	---	--	--

Maximum contact load	5 A/120V AC-1	5 A/30 V DC-1
Recommended minimum contact load	10 mA/10 V	

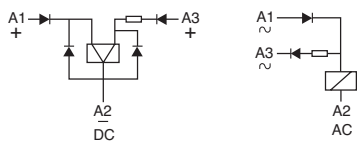
Contacts

Material	Standard	Code 1	AgNi + 0,2 μ Au
Rated current	5 A		
Switch-on current max. (20 ms)	15 A		
Switching voltage max.	120V		
AC load	600 VA		
DC load	see Fig. 2		

Coil

Coil resistance	see table; tolerance ± 10 %
ON pulse power	1,2 VA/W
OFF pulse power	0,3 VA/W
1 winding for AC, 2 winding for DC	

Internal Diagram:



Coil table

VAC	mA ON	mA OFF	VDC	mA ON	mA OFF
24	50	8	12	100	25
48	25	4	24	50	12
115	10	2	48	25	6
230	5	1	60	20	5

Insulation

	Volt rms, 1 min
Contact open	1000 V
Contact/contact	2 kV
Contact/coil	2 kV
Insulation resistance at 500 V	≥ 1 G.Ω
Insulation, IEC 61810-1	2,5 kV/2

Specifications

Ambient temperature operation/storage	-40 (no ice)...60 °C / -40 ... 80 °C
Minimum pulse ON/OFF	50 ms
Mechanical life	AC: 10 Mill./DC: 20 Mill.
DC voltage endurance at rated load	≥ 100000 switching cycles
Switching frequency at rated load	≤ 1200/h
Protection class	IP40
Weight	43 g

Standard types

AC 50 Hz/60 Hz: 24, 48, 115, (120), 230

C9-R21/AC ... V

DC 12, 24, 48, 60

C9-R21/DC ... V

"..." Enter the voltage for full type designation

Accessories

Socket:	S9-M, S9-L, S9-P, S9-P0
Optional accessories (blanking plug):	S9-NP, S9-OP

Connection diagram

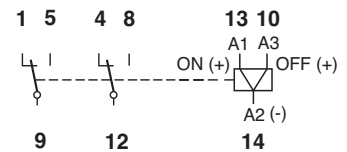


Fig. 1 AC voltage endurance

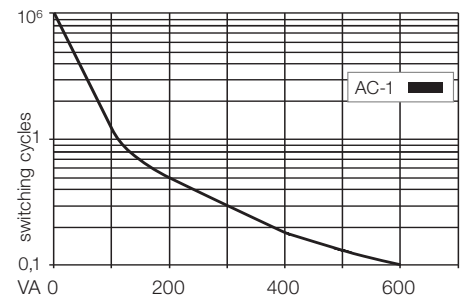
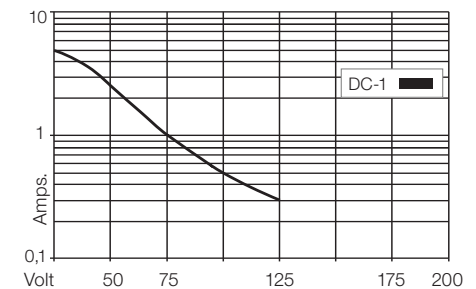
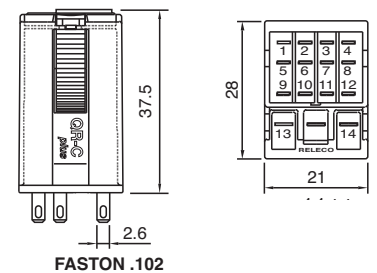


Fig. 2 DC load limit curve



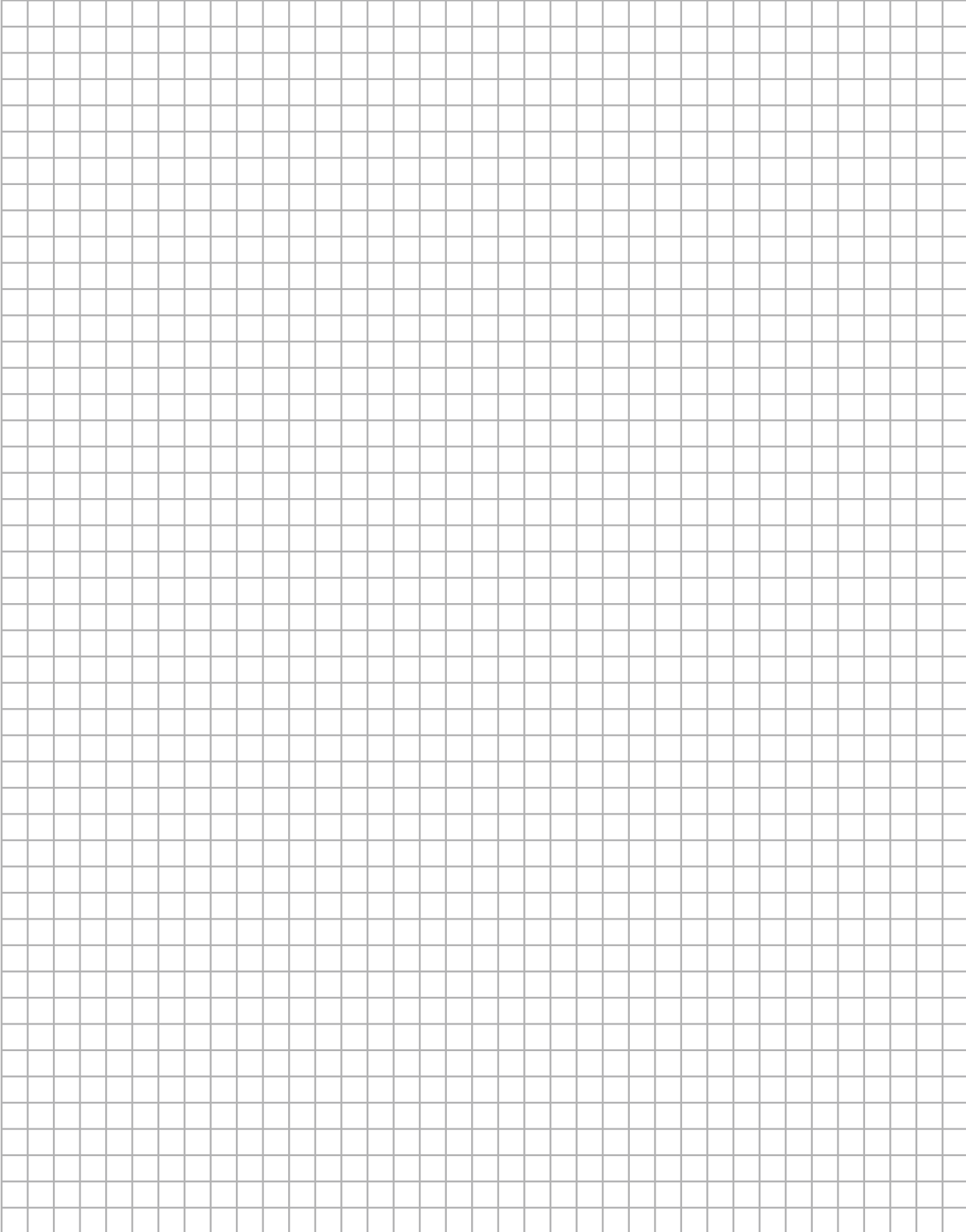
Dimensions [mm]



Technical approvals, conformities



Notes



1.3 Industrial Relays – MRC



Application	Types	Pins	Contacts	AC ratings	DC ratings	Socket
C2 Series						
General purpose	C2-A2x			10 A / 250 V	0.5 A / 110 V	S2
Low switching load	C2-T2x			6 A / 250 V	6 A / 30 V	S2
DC load switching	C2-G2x		1.7mm 	10 A / 250 V	1.2 A / 110 V	S2
C3 Series						
General purpose	C3-A3x			10 A / 250 V	0.5 A / 110 V	S3
Low switching load	C3-T3x			6 A / 250 V	6 A / 30 V	S3
DC load switching	C3-G3x		1.7mm 	10 A / 250 V	1.2 A / 110 V	S3
DC load switching with magnetic blow out	C3-M1x		>3mm 	10 A / 250 V	10 A / 220 V	S3
DC load switching double make	C3-X1x		>3mm 	10 A / 250V	7 A / 110 V	S3
Latching relay	C3-R2x		 Rem.	10 A / 250 V	0.5 A / 110 V	S3
Sensitive Coil 250mW ... 300mW	C3-S1x			6 A / 250 V	6 A / 30 V	S3
Sensitive Coil 500mW ... 800mW	C3-E2x			6 A / 250	6 A / 30 V	S3
Sensitive Coil 500mW ... 800mW	C3-N3x			6 A / 250	6 A / 30 V	S3
Railway application	R3-N3x			6 A / 250	6 A / 30 V	S3
C4 Series						
General purpose	C4-A4x			10 A / 250 V	0.5 A / 110 V	S4
DC load switching double make	C4-X2x		2x >3mm 	10 A / 250 V	7 A / 110 V	S4
Latching relay	C4-R3x		 Rem.	10 A / 250 V	0.5 A / 110 V	S4
C5 Series						
Power relay	C5-A2x			16 A / 400 V	0.5 A / 110 V	S5
Power relay	C5-A3x			16 A / 400 V	0.5 A / 110 V	S5
DC load switching	C5-G3x		1.7mm 	16 A / 400 V	1.2 A / 110 V	S5
DC load switching double make	C5-X1x		>3mm 	16 A / 400 V	7 A / 110 V	S5
DC load switching with magnetic blow out	C5-M1x		>3mm 	16 A / 400 V	10 A / 220 V	S5
DC load switching with magnetic blow out	C5-M2x		>3mm 	16 A / 250 V	7 A / 110 V	S5
Latching relay	C5-R2x		 Rem.	10 A / 400 V	10 A / 30 V	S5



Type	C2-A2x/ ... V Standard relay, 2 change-over contacts
-------------	---

Maximum contact load	10 A/250 V AC-1 0,5 A/110 V DC-1
	10 A/30 V DC-1 0,2 A/220 V DC-1
Recommended minimum contact load	10 mA/10 V Code 0, 9 5 mA/5 V Code 8

Contacts			
Material	Standard	Code 0	AgNi
	Optional	Code 8	AgNi + 10 μ Au
	Optional	Code 9	AgNi + 0,2 μ Au
Max. switching current	10 A		
Max. peak inrush current (20 ms.)	30 A		
Max. switching voltage	250 V		
Max. AC load (Fig 1 1)	2,5 kVA		
Max. DC load	See Fig 2		

Coils			
Coil resistance	see table; tolerance ± 10 %		
Pull-in voltage	≤ 0,8 x U _N		
Pull-in voltage	≥ 0,1 x U _N		
Nominal power	2,2 VA (AC)/1,3 W (DC)		

Table						
	VAC	Ω	mA	VDC	Ω	mA
	24	67	92	24	443	54
	48	296	46	48	1K8	27
	115	1K7	19	110	9K2	12
	230	7K1	9,5	220	36K1	6

Insulation	Volt rms, 1 min
Open contact	1000 V
Between adjacent poles	2,5 kV
Between contacts and coil	2,5 kV
Insulation resistance at 500 V	≥ 1 GΩ
Insulation, IEC 61810-1	2,5 kV/3

Specifications	
Ambient temperature operation/storage	-40 (no ice)...60 °C /-40 ... 80 °C
Pick-up time + bounce time	16 ms/≤ 3 ms
Release time + bounce time	8 ms/≤ 1 ms
Mechanical life ops	AC: 10 Mill./DC: 20 Mill.
DC voltage endurance at rated load	≥ 100000 ops. switching cycles
Operating frequency at nominal load	≤ 1200/ops/h
Protection degree	IP40
Weight	90 g

Standard types			
VAC 50 Hz/60 Hz: 24, 48, 115 (120), 230 (240)	C2-A20/AC ... V	C2-A28/AC ... V	C2-A29AC ... V
LED	C2-A20X/AC ... V	C2-A28X/AC ... V	C2-A29X/AC ... V
RC Suppressor	C2-A20R/AC ... V	C2-A28R/AC ... V	C2-A29R/AC ... V
VDC 24, 48, 110, 220	C2-A20/DC ... V	C2-A28/DC ... V	C2-A29/DC ... V
LED	C2-A20X/DC ... V	C2-A28X/DC ... V	C2-A29X/DC ... V
Free wheeling diode	C2-A20DX/DC ... V	C2-A28DX/DC ... V	C2-A29DX/DC ... V
Polarity and free wheeling diode	C2-A20FX/DC ... V	C2-A28FX/DC ... V	C2-A29FX/DC ... V
AC/DC bridge rectifier 24 V, 48 V, 60 V	C2-A20BX/UC ... V	C2-A28BX/UC ... V	C2-A29BX/UC ... V

"..." Enter the voltage for full type designation

Accessories	
Socket:	S2-B, S2-S, S2-L, S2-P, S2-P0
Optional accessories (blanking plug):	SO-NP, SO-OP

Connection diagram

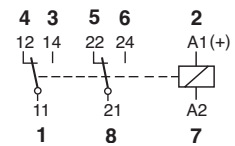


Fig. 1 AC voltage endurance

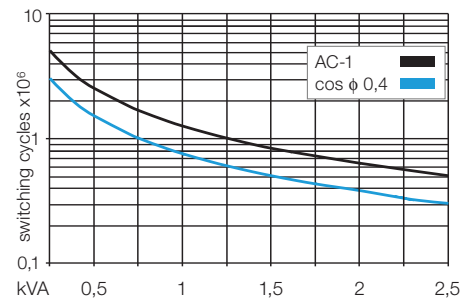
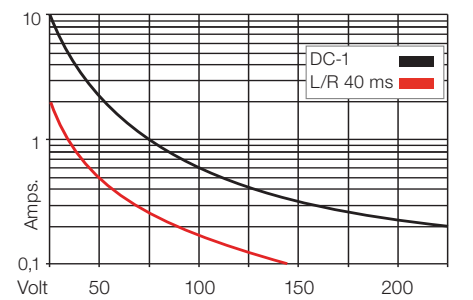
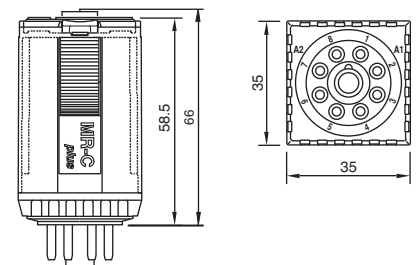


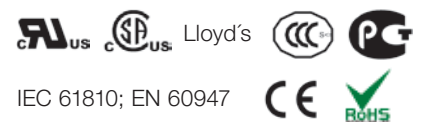
Fig. 2 DC load limit curve



Dimensions [mm]



Technical approvals, conformities



Type	C2-T2x/ ... V Standard relay for low level 2 Change-over contacts			
Maximum contact load	6 A/250 V	AC-1	6 A/30 V	DC-1
Recommended minimum contact load	5 mA/5 V	Code 1		
	1 mA/5 V	Code 2		

Contacts

Material	Standard	Code 1	AgNi + 0,2 μ Au
	Optional	Code 2	AgNi + 10 μ Au
Rated current	6 A		
Switch-on current max. (20 ms)	15 A		
Switching voltage max.	250 V		
AC load (Fig 1)	1,2 kVA		
DC load	see Fig. 2		

Coil

Coil resistance	see table; tolerance ± 10 %
Pick-up voltage	≤ 0,8 × U _N
Release voltage	≥ 0,1 × U _N
Nominal power	2,2 VA (AC)/1,3 W (DC)

Coil table

VAC	Ω	mA	VDC	Ω	mA
24	67	92	24	443	54
48	296	46	48	1K8	27
115	1K7	19	110	9K2	12
230	7K1	9,5	220	36K1	6

Insulation

	Volt rms, 1 min
Contact open	1000 V
Contact/contact	2,5 kV
Contact/coil	2,5 kV
Insulation resistance at 500 V	≥1 GΩ
Insulation, IEC 61810-1	2,5 kV/3

Specifications

Ambient temperature operation/storage	-40 (no ice)...60 °C / -40 ... 80 °C
Pick-up time/bounce time	16 ms/≤ 3 ms
Release time/bounce time	8 ms/≤ 1 ms
Mechanical life ops	AC: 10 Mill./DC: 20 Mill.
DC voltage endurance at rated load	≥100000 switching cycles
Switching frequency at rated load	≤ 1200/ops/h
Protection class	IP40
Weight	90 g

Standard types

VAC 50 Hz/60 Hz: 24, 48, 115 (120), 230 (240)

LED

RC Suppressor

VDC 24, 48, 110, 220

LED

Free wheeling diode

Polarity and free wheeling diode

AC/DC bridge rectifier 24 V, 48 V, 60 V

C2-T21/AC ... V
C2-T21X/AC ... V
C2-T21R/AC ... V

C2-T21/DC ... V
C2-T21X/DC ... V
C2-T21DX/DC ... V
C2-T21FX/DC ... V

C2-T21BX/UC ... V

C2-T22/AC ... V
C2-T22X/AC ... V
C2-T22R/AC ... V

C2-T22/DC ... V
C2-T22X/DC ... V
C2-T22DX/DC ... V
C2-T22FX/DC ... V

C2-T22BX/UC ... V

"..." Enter the voltage for full type designation

Accessories

Socket:
Optional accessories (blanking plug):

S2-B, S2-S, S2-L, S2-P, S2-P0
SO-NP, SO-OP



Connection diagram

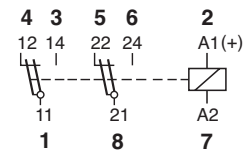


Fig. 1 AC voltage endurance

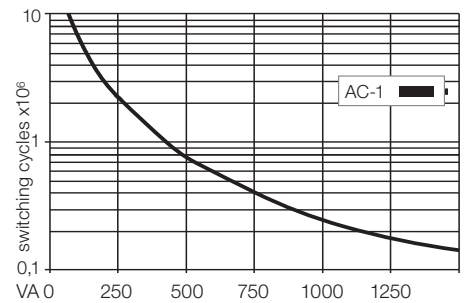
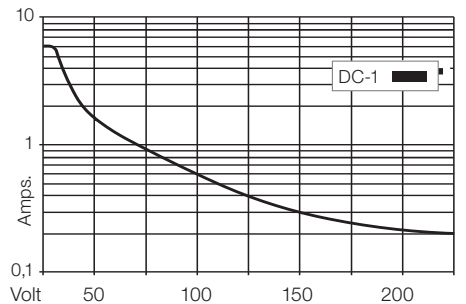
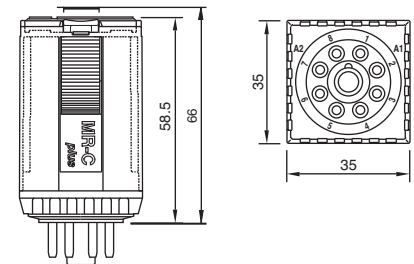


Fig. 2 DC load limit curve



Dimensions [mm]



Technical approvals, conformities



IEC 61810; EN 60947

Type	C2-G2x/ ... V Standard relays, DC application 2 open contacts		
Maximum contact load	10 A/250 V AC-1	1,2 A/110 V DC-1	
	10 A/30 V DC-1	0,4 A/220 V DC-1	

Contacts			
Material	Standard	Code 0	AgNi
Rated current			10 A
Switch-on current max. (20 ms)			30 A
Switching voltage max.			250 V
AC load (Fig 1)			2,5 kVA
DC load			see Fig. 2

Coil	
Coil resistance	see table; tolerance $\pm 10\%$
Pick-up voltage	$\leq 0,8 \times U_N$
Release voltage	$\geq 0,1 \times U_N$
Nominal power	2,4 VA (AC)/1,6 W (DC)

Coil table	VAC	Ω	mA	VDC	Ω	mA
	24	65	100	24	360	66
	48	286	50	48	1K4	34
	115	1K7	21	110	7K6	15
	230	6K8	10	220	30K3	7,5

Insulation	Volt rms, 1 min
Contact open	2000 V
Contact/contact	2,5 kV
Contact/coil	2,5 kV
Insulation resistance at 500 V	$\geq 1 \text{ G}\Omega$
Insulation, EN 61810-1	2,5 kV/3

Specifications	
Ambient temperature operation/storage	-40 (no ice)...60 °C /-40 ... 80 °C
Pick-up time/bounce time	20 ms/ $\leq 3 \text{ ms}$
Release time/bounce time	8 ms/ $\leq 1 \text{ ms}$
Mechanical life ops	AC: 10 Mill./DC: 20 Mill.
DC voltage endurance at rated load	≥ 100000 switching cycles
Switching frequency at rated load	≤ 1200 /ops/h
Protection class	IP40
Weight	90 g

Standard types
VAC 50 Hz/60 Hz: 24, 48, 115 (120), 230 (240)
LED
RC Suppressor

C2-G20/AC ... V
C2-G20X/AC ... V
C2-G20R/AC ... V

VDC 24, 48, 110, 220
LED
Free wheeling diode
Polarity and free wheeling diode

C2-G20/DC ... V
C2-G20X/DC ... V
C2-G20DX/DC ... V
C2-G20FX/DC ... V

AC/DC bridge rectifier 24 V, 48 V, 60 V

C2-G20BX/UC ... V

"..." Enter the voltage for full type designation

Accessories	
Socket:	S2-B, S2-S, S2-L, S2-P, S2-P0
Optional accessories (blanking plug):	SO-NP, SO-OP



Connection diagram

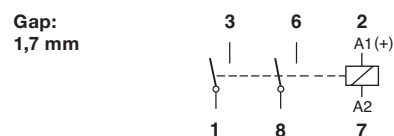


Fig. 1 AC voltage endurance

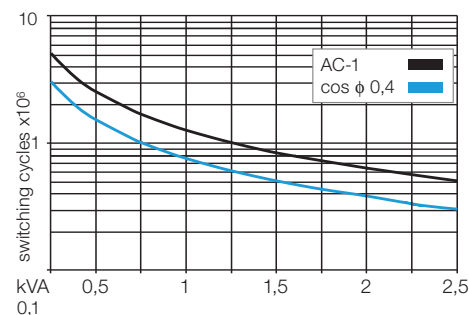
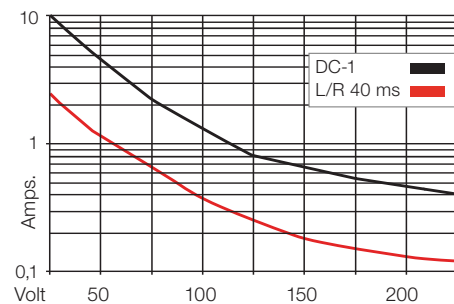
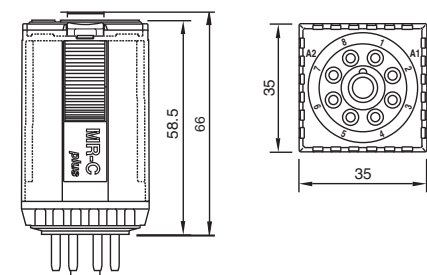


Fig. 2 DC load limit curve



Dimensions [mm]



Technical approvals, conformities



IEC 61810; EN 60947

C20-A20

8-pin standard relay, 2-pole, plug-in according to IEC 60067

Type	C20-A20/ ... V Standard relays 2 change-over contacts
Maximum contact load	10 A/250 V AC-1 0,5 A/110 V DC-1 10 A/30 V DC-1
Recommended minimum contact load	10 mA/10 V
Contacts	
Material	AgNi
Rated current	10 A
Switch-on-current max. (20 ms.)	30 A
Max. switching voltage	250 V
Max. AC load (Fig 1)	2,5 kVA
Max. DC load	See Fig 2

Coils	
Coil resistance	see table; tolerance $\pm 10\%$
Pick-up voltage	$\leq 0,8 \times U_N$
Release voltage	$\geq 0,1 \times U_N$
Nominal power	2,2 VA (AC)/1,3 W (DC)

Table																															
	<table border="1"> <thead> <tr> <th>VAC</th> <th>Ω</th> <th>mA</th> <th>VDC</th> <th>Ω</th> <th>mA</th> </tr> </thead> <tbody> <tr> <td>24</td> <td>67</td> <td>92</td> <td>12</td> <td>115</td> <td>104</td> </tr> <tr> <td>115</td> <td>1K7</td> <td>19</td> <td>24</td> <td>480</td> <td>50</td> </tr> <tr> <td>230</td> <td>7K1</td> <td>9,5</td> <td>48</td> <td>1K8</td> <td>26</td> </tr> <tr> <td></td> <td></td> <td></td> <td>110</td> <td>9K</td> <td>12</td> </tr> </tbody> </table>	VAC	Ω	mA	VDC	Ω	mA	24	67	92	12	115	104	115	1K7	19	24	480	50	230	7K1	9,5	48	1K8	26				110	9K	12
VAC	Ω	mA	VDC	Ω	mA																										
24	67	92	12	115	104																										
115	1K7	19	24	480	50																										
230	7K1	9,5	48	1K8	26																										
			110	9K	12																										

Insulation	Volt rms, 1 min
Contact open	1000 V
Contact/contact	2,5 kV
Contact/coil	2,5 kV
Insulation resistance at 500 V	$\geq 1 \text{ G}\Omega$
Insulation, IEC 61810-1	2,5 kV/3

Specifications	
Ambient temperature operation/storage	-40...70 °C DC (55 °C AC) / -40 ... 80 °C
Pick-up time bounce time typ.	8 ms/3 ms
Release time bounce time typ.	18 ms/1 ms
Mechanical life ops	AC: 10 Mill./DC: 20 Mill.
DC voltage endurance at rated load	≥ 100000 ops. switching cycles
Operating frequency at nominal load	≤ 1200 /ops/h
Protection degree	IP40
Weight	79 g

Standard types
VAC 50 Hz: 24, 115, 230
VAC 60 Hz: 120
LED

VDC 12, 24, 36, 48, 110
LED
Free wheeling diode
Polarity and free wheeling diode

AC/DC bridge rectifier 24 V

C20-A20/AC ... V
C20-A20/AC ... V 60 Hz
C20-A20X/AC ... V

C20-A20/DC ... V
C20-A20X/DC ... V
C20-A20DX/DC ... V
C20-A20FX/DC ... V

C20-A20BX/UC ... V

"..." Enter the voltage for full type designation

Accessories	
Socket:	S20-B
Blanking plug:	PB30-BK
Button without lockable function:	PB30-OR
Retaining clip, plastic:	S30-CM



Connection diagram

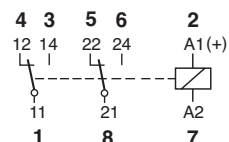


Fig. 1 AC voltage endurance

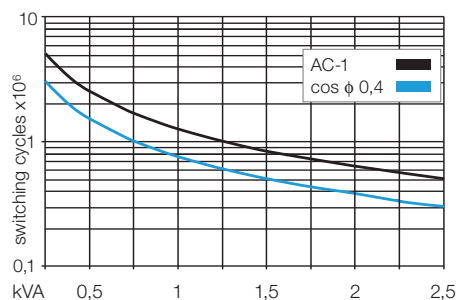
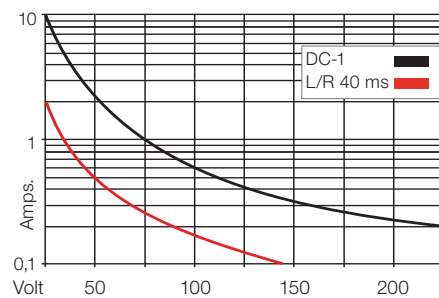
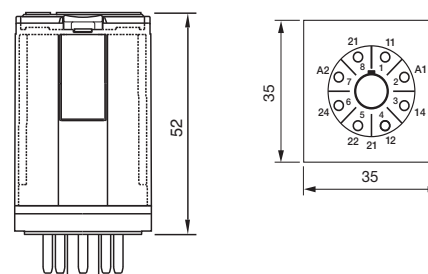


Fig. 2 DC load limit curve



Dimensions [mm]



Technical approvals, conformities



IEC 61810; EN 60947

Type	C3-A3x/ ... V Standard relays, 3 change-over contacts		
Maximum contact load	10 A/250	AC-1	0,5 A/110 V DC-1
Recommended minimum contact load	10 mA/30	DC-1	0,2 A/220 V DC-1
	10 mA/10 V	Code 0, 9	
	5 mA/5 V	Code 8	

Contacts			
Material	Standard	Code 0	AgNi
	Optional	Code 8	AgNi + 10 μ Au
	Optional	Code 9	AgNi + 0,2 μ Au
Rated current	10 A		
Switch-on current max. (20 ms)	30 A		
Switching voltage max.	250 V		
AC load (Fig 1)	2,5 kVA		
DC load	see Fig. 2		

Coil			
Coil resistance	see table; tolerance ± 10 %		
Pick-up voltage	≤ 0,8 × U _N		
Release voltage	≥ 0,1 × U _N		
Nominal power	2,2 VA (AC)/1,3 W (DC)		

Coil table	VAC	Ω	mA	VDC	mA
	24	67	92	24	443
	48	296	46	48	1K8
	115	1K7	19	110	9K2
	230	7K1	9,5	220	36K1

Insulation	Volt rms, 1 min
Contact open	1000 V
Contact/contact	2,5 kV
Contact/coil	2,5 kV
Insulation resistance at 500 V	≥ 1 GΩ
Insulation, IEC 61810-1	2,5 kV/3

Specifications	
Ambient temperature operation/storage	-40 (no ice)...60 °C / -40 ... 80 °C
Pick-up time/bounce time	16 ms/≤ 3 ms
Release time/bounce time	8 ms/≤ 1 ms
Mechanical life ops	AC: 10 Mill./DC: 20 Mill.
DC voltage endurance at rated load	≥ 100000 switching cycles
Switching frequency at rated load	≤ 1200/ops/h
Protection class	IP40
Weight	90 g

Standard types			
VAC 50 Hz/60 Hz: 24, 48, 115 (120), 230 (240)	C3-A30/AC ... V	C3-A38/AC ... V	C3-A39/AC ... V
LED	C3-A30X/AC ... V	C3-A38X/AC ... V	C3-A39X/AC ... V
RC Suppressor	C3-A30R/AC ... V	C3-A38R/AC...V	C3-A39R/AC...V
VDC 24, 48, 110, 220	C3-A30/DC ... V	C3-A38/DC ... V	C3-A39/DC ... V
LED	C3-A30X/DC ... V	C3-A38X/DC ... V	C3-A39X/DC ... V
Free wheeling diode	C3-A30DX/DC ... V	C3-A38DX/DC ... V	C3-A39DX/DC ... V
Polarity and free wheeling diode	C3-A30FX/DC ... V	C3-A38FX/DC ... V	C3-A39FX/DC ... V
AC/DC bridge rectifier 24 V, 48 V, 60 V	C3-A30BX/UC ... V	C3-A38BX/UC ... V	C3-A39BX/UC ... V

"..." Enter the voltage for full type designation

Accessories	
Socket:	S3-B, S3-S, S3-L, S3-P, S3-P0
Optional accessories (blanking plug):	SO-NP, SO-OP



Connection diagram

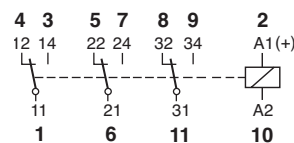


Fig. 1 AC voltage endurance

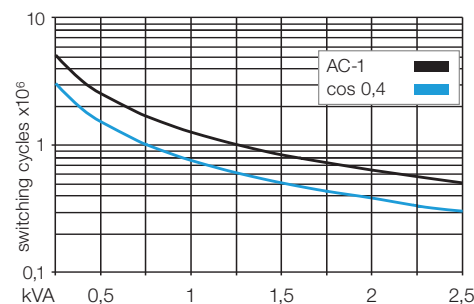
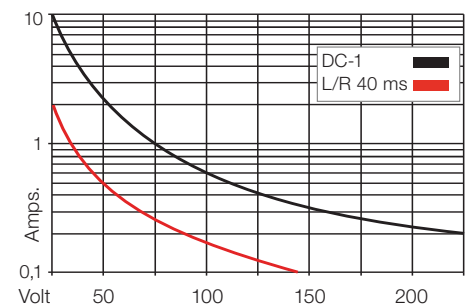
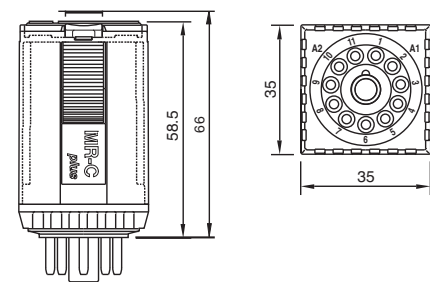


Fig. 2 DC load limit curve



Dimensions [mm]



Technical approvals, conformities



Type	C3-T3x/ ... V Standard relays for low level 3 change-over twin contacts			
Maximum contact load	6 A/250 V	AC-1	6 A/30 V	DC-1
Recommended minimum contact load	5 mA/5 V	Code 1		
	1 mA/5 V	Code 2		

Contacts			
Material	Standard	Code 1	AgNi + 0,2 μ Au
	Optional	Code 2	AgNi + 10 μ Au
Rated current	6 A		
Switch-on current max. (20 ms)	15 A		
Switching voltage max.	250 V		
AC load (Fig 1)	1,2 kVA		
DC load	see Fig. 2		

Coil			
Coil resistance	see table; tolerance ± 10 %		
Pick-up voltage	≤ 0,8 × U _N		
Release voltage	≥ 0,1 × U _N		
Nominal power	2,2 VA (AC)/1,3 W (DC)		

Coil table					
VAC	Ω	mA	VDC	Ω	mA
24	67	92	24	443	54
48	296	46	48	1K8	27
115	1K7	19	110	9K2	12
230	7K1	9,5	220	36K1	6

Insulation		Volt rms, 1 min
Contact open	1000 V	
Contact/contact	2,5 kV	
Contact/coil	2,5 kV	
Insulation resistance at 500 V	≥ 1 GΩ	
Insulation, EN 61810-1	2,5 kV/3	

Specifications	
Ambient temperature operation/storage	-40 (no ice)...60 °C /-40 ... 80 °C
Pick-up time/bounce time	16 ms/≤ 3 ms
Release time/bounce time	8 ms/≤ 1 ms
Mechanical life ops	AC: 10 Mill./DC: 20 Mill.
DC voltage endurance at rated load	≥ 100000 switching cycles
Switching frequency at rated load	≤ 1200/ops/h
Protection class	IP40
Weight	90 g

Standard types		
VAC 50 Hz/60 Hz: 24, 48, 115 (120), 230 (240)	C3-T31/AC ... V	C3-T32/AC ... V
LED	C3-T31X/AC ... V	C3-T32X/AC ... V
RC Suppressor	C3-T31R/AC ... V	C3-T32R/AC ... V
VDC 24, 48, 110, 220	C3-T31/DC ... V	C3-T32/DC ... V
LED	C3-T31X/DC ... V	C3-T32X/DC ... V
Free wheeling diode	C3-T31DX/DC ... V	C3-T32DX/DC ... V
Polarity and free wheeling diode	C3-T31FX/DC ... V	C3-T32FX/DC ... V
AC/DC bridge rectifier 24 V, 48 V, 60 V	C3-T31BX/UC ... V	C3-T32BX/UC ... V

"..." Enter the voltage for full type designation

Accessories	
Socket:	S3-B, S3-S, S3-L, S3-P, S3-P0
Optional accessories (blanking plug):	SO-NP, SO-OP



Connection diagram

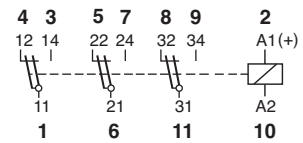


Fig. 1 AC voltage endurance

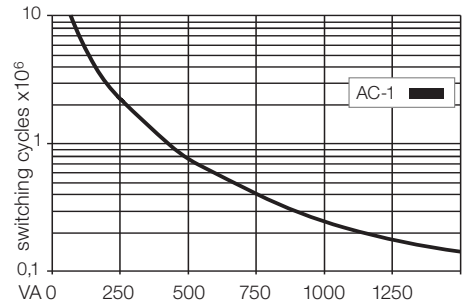
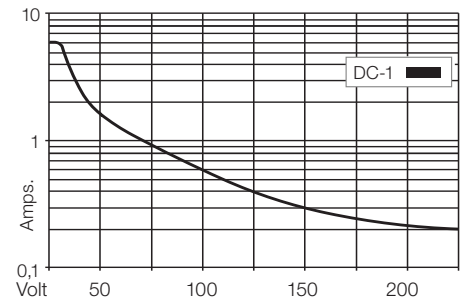
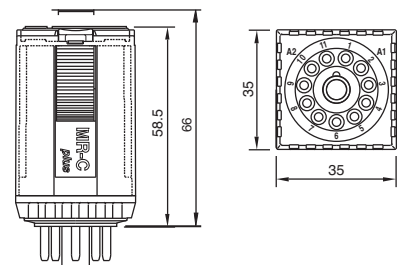


Fig. 2 DC load limit curve



Dimensions [mm]



Technical approvals, conformities



IEC 61810; EN 60947

Type	C3-G3x/ ... V Standard relays, DC application 3 open contacts		
Maximum contact load	10 A 250 V AC-1	1,2 A/110 V DC-1	
	10 A 30 V DC-1	0,4 A/220 V DC-1	

Contacts			
Material	Standard	Code 0	AgNi
Rated current			10 A
Switch-on current max. (20 ms)			30 A
Switching voltage max.			250 V
AC load (Fig 1)			2,5 kVA
DC load			see Fig. 2

Coil	
Coil resistance	see table; tolerance $\pm 10\%$
Pick-up voltage	$\leq 0,8 \times U_N$
Release voltage	$\geq 0,1 \times U_N$
Nominal power	2,4 VA (AC)/1,6 W (DC)

Coil table	VAC	Ω	mA	VDC	Ω	mA
	24	65	100	24	360	66
	48	286	50	48	1K4	34
	115	1K7	21	110	7K6	15
	230	6K8	10	220	30K3	7,5

Insulation		Volt rms, 1 min
Contact open		2000 V
Contact/contact		2,5 kV
Contact/coil		2,5 kV
Insulation resistance at 500 V		$\geq 1 \text{ G}\Omega$
Insulation, IEC 61810-1		2,5 kV/3

Specifications	
Ambient temperature operation/storage	-40 (no ice)...60 °C /-40 ... 80 °C
Pick-up time/bounce time	20 ms/ ≤ 3 ms
Release time/bounce time	8 ms/ ≤ 1 ms
Mechanical life ops	AC: 10 Mill./DC: 20 Mill.
DC voltage endurance at rated load	≥ 100000 switching cycles
Switching frequency at rated load	≤ 1200 /ops/ h
Protection class	IP40
Weight	90 g

Standard types	C3-G30/AC ... V C3-G30X/AC ... V C3-G30R/AC ... V
VAC 50 Hz/60 Hz: 24, 48, 115 (120), 230 (240)	
LED	
RC Suppressor	C3-G30/DC ... V C3-G30X/DC ... V C3-G30DX/DC... V C3-G30FX/DC ... V
VDC 24, 48, 110, 220	
LED	
Free wheeling diode	
Polarity and free wheeling diode	
AC/DC bridge rectifier 24 V, 48 V, 60 V	C3-G30BX/UC ... V

"..." Enter the voltage for full type designation

Accessories	
Socket:	S3-B, S3-S, S3-L, S3-P, S3-P0
Optional accessories (blanking plug):	SO-NP, SO-OP



Connection diagram

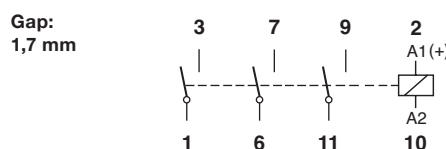


Fig. 1 AC voltage endurance

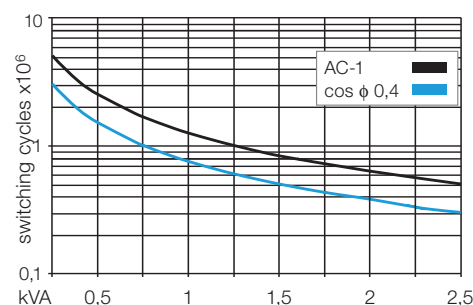
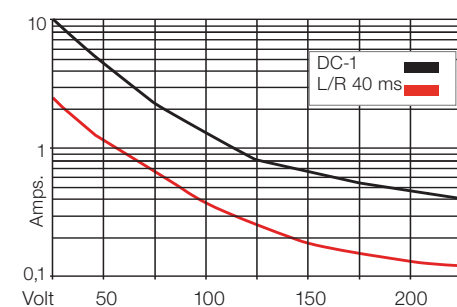
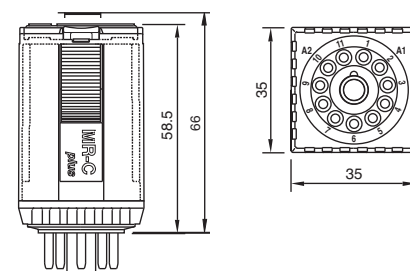


Fig. 2 DC load limit curve



Dimensions [mm]



Technical approvals, conformities



IEC 61810; EN 60947

Type	C3-M1x/ ... V Power relays, DC, application 1 pole, magnetic blow out
-------------	--

Maximum contact load	10 A 250 V AC-1 10 A 220 V DC-1 3,6 A 110 V L/R 40ms 2 A 220 V L/R 40ms
-----------------------------	--

Contacts			
Material	Standard	Code 0	AgNi
Rated current			10 A
Switch-on current max. (20 ms)			30 A
Switching voltage max.			250 V
AC load (Fig 1)			2,5 kVA
DC load			see Fig. 2

Coil	
Coil resistance	see table; tolerance ± 10 %
Pick-up voltage	≤ 0,8 x U _N
Release voltage	≥ 0,1 x U _N
Nominal power	2,4 VA (AC) / 1,3 W (DC)

Coil table																															
	<table border="1"> <thead> <tr> <th>VAC</th> <th>Ω</th> <th>mA</th> <th>VDC</th> <th>Ω</th> <th>mA</th> </tr> </thead> <tbody> <tr> <td>24</td> <td>65</td> <td>100</td> <td>24</td> <td>443</td> <td>54</td> </tr> <tr> <td>48</td> <td>286</td> <td>50</td> <td>48</td> <td>1K7</td> <td>27</td> </tr> <tr> <td>115</td> <td>1K7</td> <td>21</td> <td>110</td> <td>9K2</td> <td>12</td> </tr> <tr> <td>230</td> <td>6K8</td> <td>10</td> <td>220</td> <td>36K1</td> <td>6</td> </tr> </tbody> </table>	VAC	Ω	mA	VDC	Ω	mA	24	65	100	24	443	54	48	286	50	48	1K7	27	115	1K7	21	110	9K2	12	230	6K8	10	220	36K1	6
VAC	Ω	mA	VDC	Ω	mA																										
24	65	100	24	443	54																										
48	286	50	48	1K7	27																										
115	1K7	21	110	9K2	12																										
230	6K8	10	220	36K1	6																										

Insulation	Volt rms, 1 min
Contact open	2500 V
Contact/contact	2,5 kV
Contact/coil	2,5 kV
Insulation resistance at 500 V	≥ 1 GΩ
Insulation, IEC 61810-1:	2,5 KV / 3

Specifications	
Ambient temperature operation/storage	-40 (no ice)...60 °C / -40 ... 80 °C
Nominal coil power	2,4 VA (AC), 1,3 W (DC)
Pick-up time/bounce time	20 ms/≤ 3 ms
Release time/bounce time	10 ms/≤ 1 ms
Isolation: EN 60947, pollution rate 3, Gr C	250 V
Dielectric strength, Contact/Coil	2,5 KV

Standard types	
VAC 50 Hz/60 Hz: 24, 48, 115 (120), 230 (240)	C3-M10/AC ... V
LED	C3-M10X/AC ... V
RC Suppressor	C3-M10R/AC ... V
VDC 24, 48, 110, 220	C3-M10/DC ... V
LED	C3-M10X/DC ... V
Free wheeling diode	C3-M10DX/DC ... V
Polarity and free wheeling diode	C3-M10FX/DC ... V
AC/DC bridge rectifier 24 V, 48 V, 60 V	C3-M10BX/UC ... V

"..." Enter the voltage for full type designation

Accessories	
Socket:	S3-B, S3-S, S3-L, S3-P, S3-P0
Optional accessories (blanking plug):	SO-NP, SO-OP



Connection diagram

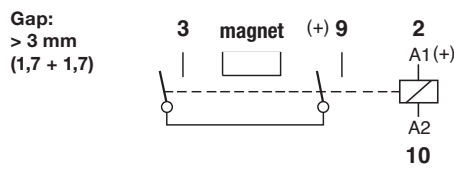


Fig. 1 AC voltage endurance

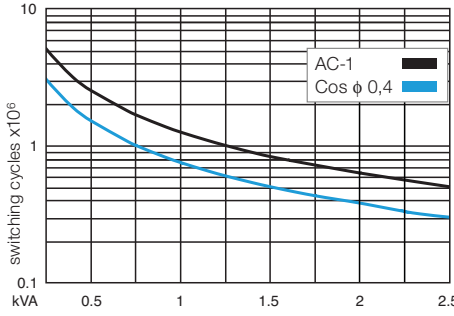
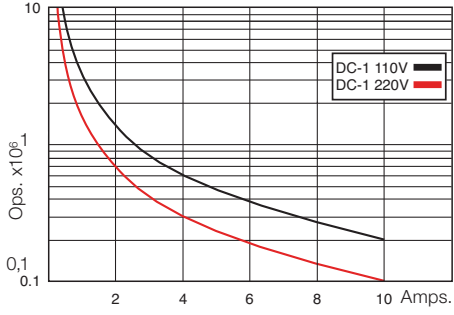
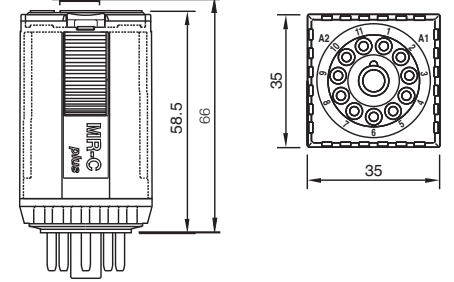


Fig. 2 DC voltage endurance



Dimensions [mm]



Technical approvals, conformities



IEC 61810; EN 60947

C3-X1x

11-pin power relay, 1-pole, double make, according to IEC 67-I-18a

Type	C3-X1x/ ... V Power relays for DC application 1 pole, NO, double make		
Maximum contact load	10 A/250 V AC-1	7 A/110 V DC-1	
	10 A/30 V DC-1	1,2 A/220 V DC-1	
Contacts			
Material	Standard	Code 0	AgNi
Rated current			10 A
Switch-on current max. (20 ms)			30 A
Switching voltage max.			250 V
AC load (Fig 1)			2,5 kVA
DC load			see Fig. 2

Coil	
Coil resistance	see table; tolerance ± 10 %
Pick-up voltage	≤ 0,8 × U _N
Release voltage	≥ 0,1 × U _N
Nominal power	2,4 VA (AC)/1,3 W (DC)

Coil table					
VAC	Ω	mA	VDC	Ω	mA
24	65	100	24	443	54
48	286	50	48	1K7	27
115	1K7	21	110	9K2	12
230	6K8	10	220	36K1	6

Insulation	Volt rms, 1 min
Contact open	2500 V
Contact/contact	2,5 kV
Contact/coil	2,5 kV
Insulation resistance at 500 V	≥ 1 G.Ω
Insulation, IEC 61810-1	2,5 kV/3

Specifications	
Ambient temperature operation/storage	-40 (no ice)...60 °C /-40 ... 80 °C
Pick-up time/bounce time	20 ms/≤ 3 ms
Release time/bounce time	10 ms/≤ 1 ms
Mechanical life ops	AC: 10 Mill./DC: 20 Mill.
DC voltage endurance at rated load	≥ 100000 switching cycles
Switching frequency at rated load	≤ 1200/ops/h
Protection class	IP40
Weight	90 g

Standard types
VAC 50 Hz/60 Hz: 24, 48, 115 (120), 230 (240)
LED
RC Suppressor

C3-X10/AC ... V
C3-X10X/AC ... V
C3-X10R/AC ... V

VDC 24, 48, 110, 220
LED
Free wheeling diode
Polarity and free wheeling diode

C3-X10/DC ... V
C3-X10X/DC ... V
C3-X10DX/DC ... V
C3-X10FX/DC ... V

AC/DC bridge rectifier 24 V, 48 V, 60 V

C3-X10BX/UC ... V

"..." Enter the voltage for full type designation

Accessories	
Socket:	S3-B, S3-S, S3-L, S3-P, S3-P0
Optional accessories (blanking plug):	SO-NP, SO-OP



Connection diagram

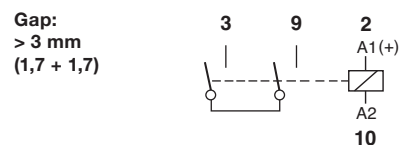


Fig. 1 AC voltage endurance

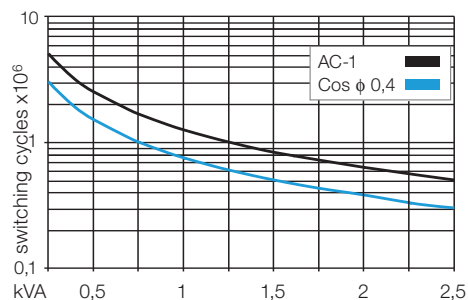
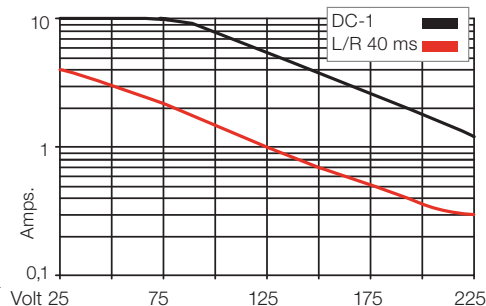
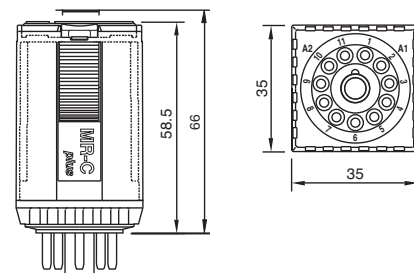


Fig. 2 DC load limit curve



Dimensions [mm]



Technical approvals, conformities



IEC 61810; EN 60947

C3-R2x

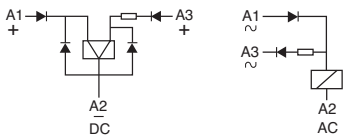
11-pin remanence relays, 2-pole, according to IEC 67-I-18a

Type	C3-R2x/ ... V Remanence plug-in relays, 2 change-over contacts			
Maximum contact load	10 A/250 V AC-1	0,5 A/110 V DC-1		
	10 A/30 V DC-1	0,2 A/220 V DC-1		
Recommended minimum contact load	10 mA/10 V Code 0, 9			
	5 mA/5 V Code 8			

Contacts			
Material	Standard	Code 0	AgNi
	Optional	Code 8	AgNi + 10 μ Au
	Optional	Code 9	AgNi + 0,2 μ Au
Rated current	10 A		
Switch-on current max. (20 ms)	30 A		
Switching voltage max.	250 V		
AC load (Fig 1)	2,5 kVA		
DC load	see Fig. 2		

Coil	
Coil resistance	see table; tolerance ± 10 %
ON pulse power	1,5 VA/W
OFF pulse power	0,5 VA/W
Pull-in ON/OFF	≤ 0,8 x U _N

Internal Diagram:



Coil table

VAC	mA ON	mA OFF	VDC	mA ON	mA OFF
24	75	12	12	125	41
48	38	6	24	63	21
115	16	2,5	48	31	10
230	8	1,3	110	14	4,5

Insulation	
Contact open	Volt rms, 1 min
Contact/contact	1000 V
Contact/contact	2,5 kV
Contact/coil	2,5 kV
Insulation resistance at 500 V	≥ 1 GΩ
Insulation, IEC 61810-1	2,5 kV/3

Specifications	
Ambient temperature operation/storage	-40 (no ice)...60 °C / -40 ... 80 °C
Minimum pulse length for ON/OFF	50 ms
Mechanical life ops	10 Mill.
DC voltage endurance at rated load	≥ 100000 switching cycles
Switching frequency at rated load	≤ 1200/ops/h
Protection class	IP40
Weight	95 g

Standard types			
VAC 50 Hz/60 Hz: 24, 48, 115 (120), 230 (240)	C3-R20/AC ... V	C3-R28/AC ... V	C3-R29/AC ... V
VDC 12, 24, 48, 110	C3-R20/DC ... V	C3-R28/DC ... V	C3-R29/DC ... V

"..." Enter the voltage for full type designation

Accessories	
Socket:	S3-B, S3-S, S3-L, S3-P, S3-P0
Optional accessories (blanking plug):	SO-NP, SO-OP



Connection diagram

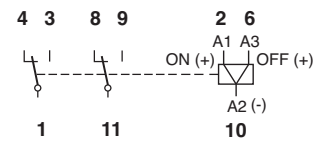


Fig. 1 AC voltage endurance

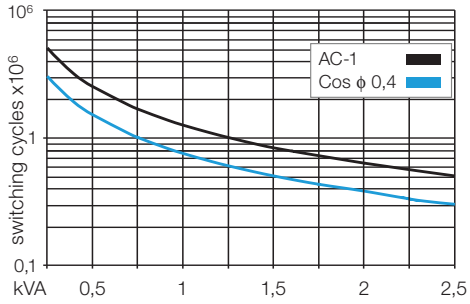
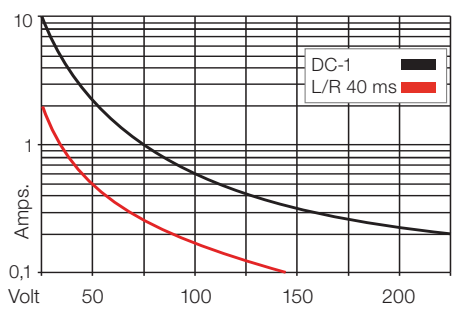
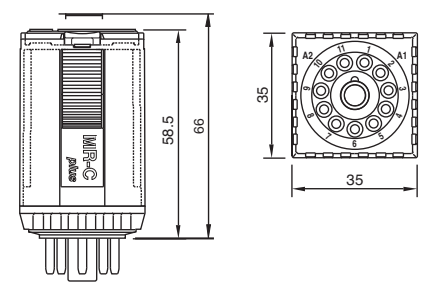


Fig. 2 DC load limit curve



Dimensions [mm]



Technical approvals, conformities



IEC 61810; EN 60947

Type	C3-S1x/ DC... V Sensitive relays, 250 mW, 1 change-over contacts			
Operating range	0,8 ... 2,5 x Un			
Maximum contact load	6 A/250 V	AC-1	6 A/30 V	DC-1
Recommended minimum contact load	10 mA/10 V	Code 4		
	5 mA/5 V	Code 8		

Contacts				
Material	Standard,	Code 4	AgNi + 0,2 μ Au	
	Optional,	Code 8	AgNi + 10 μ Au	
Rated current	6 A			
Switch-on current max. (20 ms)	15 A			
Switching voltage max.	250 V			
AC load (Fig 1)	1,5 kVA			
DC load	see Fig. 2			

Coil	
Coil resistance	see table; tolerance ± 10 %
Pick-up voltage	≤ 0,8 x U _N
Release voltage	≥ 0,1 x U _N
Nominal power	250 mW

Coil table	VDC	Ω	mA
	6	140	43
	12	536	22
	24	2164	11
	48	8651	5,5

Insulation	Volt rms, 1 min
Contact open	1000 V
Contact/contact	2,5 kV
Contact/coil	2,5 kV
Insulation resistance at 500 V	≥ 1 GΩ
Insulation, IEC 61810-1	2,5 kV/3

Specifications	
Ambient temperature operation/storage	-40 (no ice)...60 °C / -40 ... 80 °C
Pick-up time/bounce time	18 ms/≤ 3 ms
Release time/bounce time	10 ms/≤ 1 ms
Mechanical life ops	DC: 20 Mill.
DC voltage endurance at rated load	≥ 100000 switching cycles
Switching frequency at rated load	≤ 1200/ops/h
Protection class	IP40
Weight	73 g

Standard types

VDC 12, 24, 48	C3-S14/DC ... V	C3-S18/DC ... V
Free wheeling diode	C3-S14D/DC ... V	C3-S18D/DC ... V
Polarity and free wheeling diode	C3-S14F/DC ... V	C3-S18F/DC ... V

Connection of diodes to the coil will increase the release time.
LED available upon request.

"..." Enter the voltage for full type designation

Accessories

Socket:	S3-B, S3-S, S3-L, S3-P, S3-P0
Optional accessories (blanking plug):	SO-NP, SO-OP



Connection diagram

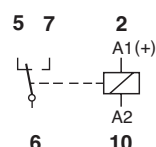


Fig. 1 AC voltage endurance

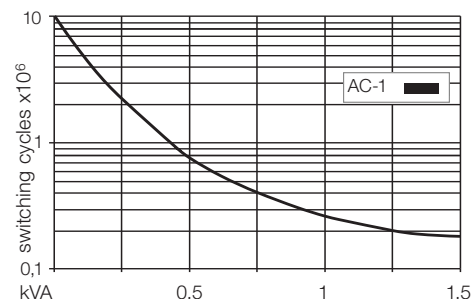
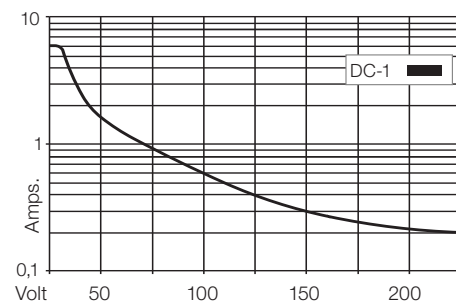
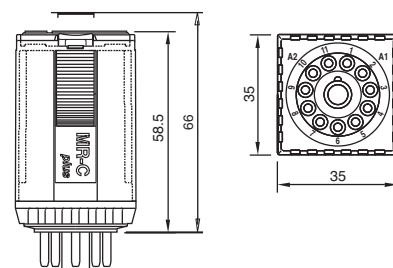


Fig. 2 DC load limit curve



Dimensions [mm]



Technical approvals, conformities



IEC 61810; EN 60947

Type	C3-E2x/ DC... V Sensitive relays, 500 mW, 2 change-over contacts			
Operating range	0,8 ... 1,7 x Un			
Maximum contact load	6 A/250 V	AC-1	6 A/30 V	DC-1
Recommended minimum contact load	10 mA/10 V	Code 4		
	5 mA/5 V	Code 8		

Contacts			
Material	Standard,	Code 4	AgNi + 0,2 μ Au
	Optional,	Code 8	AgNi + 10 μ Au
Rated current	6 A		
Switch-on current max. (20 ms)	15 A		
Switching voltage max.	250 V		
AC load (Fig 1)	1,5 kVA		
DC load	see Fig. 2		

Coil	
Coil resistance	see table; tolerance ± 10 %
Pick-up voltage	≤ 0,8 x U _N
Release voltage	≥ 0,1 x U _N
Nominal power	500 mW

Coil table																
	<table border="1"> <thead> <tr> <th>VDC</th> <th>Ω</th> <th>mA</th> </tr> </thead> <tbody> <tr> <td>24</td> <td>1K1</td> <td>21</td> </tr> <tr> <td>48</td> <td>4K6</td> <td>10</td> </tr> <tr> <td>60</td> <td>7K2</td> <td>8,3</td> </tr> <tr> <td>110</td> <td>24K2</td> <td>4,5</td> </tr> </tbody> </table>	VDC	Ω	mA	24	1K1	21	48	4K6	10	60	7K2	8,3	110	24K2	4,5
VDC	Ω	mA														
24	1K1	21														
48	4K6	10														
60	7K2	8,3														
110	24K2	4,5														

Insulation	Volt rms, 1 min
Contact open	1000 V
Contact/contact	2,5 kV
Contact/coil	2,5 kV
Insulation resistance at 500 V	≥1 GΩ
Insulation, IEC 61810-1	2,5 kV/3

Specifications	
Ambient temperature operation/storage	-40 (no ice)...60 °C / -40 ... 80 °C
Pick-up time/bounce time	18 ms/≤ 3 ms
Release time/bounce time	10 ms/≤ 1 ms
Mechanical life ops	DC: 20 Mill.
DC voltage endurance at rated load	≥100000 switching cycles
Switching frequency at rated load	≤ 1200/ops/h
Protection class	IP40
Weight	90 g

Standard types		
VDC 24, 48, 60, 110	C3-E24/DC ... V	C3-E28/DC ... V
Free wheeling diode	C3-E24D/DC ... V	C3-E28D/DC ... V
Polarity and free wheeling diode	C3-E24F/DC ... V	C3-E28F/DC ... V

Connection of diodes to the coil will increase the release time.
LED available upon request.

"..." Enter the voltage for full type designation

Accessories	
Socket:	S3-B, S3-S, S3-L, S3-P, S3-P0
Optional accessories (blanking plug):	SO-NP, SO-OP



Connection diagram

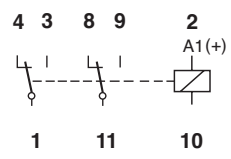


Fig. 1 AC voltage endurance

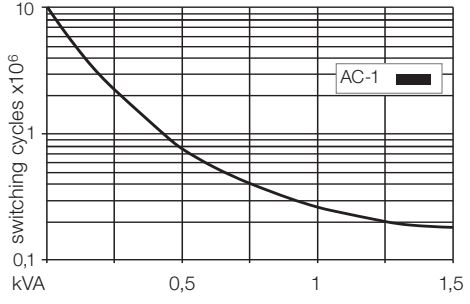
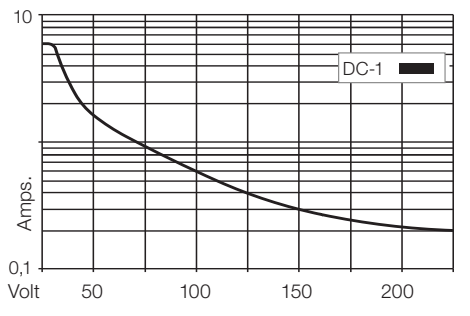
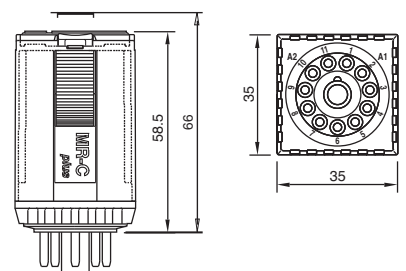


Fig. 2 DC load limit curve



Dimensions [mm]



Technical approvals, conformities



IEC 61810; EN 60947

Type	C3-N3x/DC ... V Sensitive relays, 800 mW 3 change-over contacts			
Operating range	0,8 ... 1,4 x Un			
Maximum contact load	6 A/250 V	AC-1	6 A/30 V	DC-1
Recommended minimum contact load	10 mA/10 V	Code 4		
	5 mA/ 5 V	Code 8		

Contacts				
Material	Standard	Code 4	AgNi + 0,2 μ Au	
	Optional	Code 8	AgNi + 10 μ Au	
Rated current	6 A			
Switch-on current max. (20 ms)	15 A			
Switching voltage max.	250 V			
AC load (Fig 1)	1,5 kVA			
DC load	see Fig. 2			

Coil	
Coil resistance	see table; tolerance ± 10 %
Pick-up voltage	≤ 0,8 x U _N
Release voltage	≥ 0,1 x U _N
Nominal power	800 mW

Coil table			
	VDC	Ω	mA
	24	720	33
	48	2K8	17
	60	4K5	13
	110	15K	7

Insulation	Volt rms, 1 min
Contact open	1000 V
Contact/contact	2,5 kV
Contact/coil	2,5 kV
Insulation resistance at 500 V	≥ 1 GΩ
Insulation, IEC 61810-5	2,5 kV/3

Specifications	
Ambient temperature operation/storage	-40 (no ice)...60 °C /-40 ... 80 °C
Pick-up time/bounce time	18 ms/≤ 3 ms
Release time/bounce time	10 ms/≤ 1 ms
Mechanical life ops	DC: 20 Mill.
DC voltage endurance at rated load	≥ 100000 switching cycles
Switching frequency at rated load	≤ 1200/ops/h
Protection class	IP40
Weight	90 g

Standard types		
VDC 24, 48, 60, 110	C3-N34/DC ... V	C3-N38/DC ... V
Free wheeling diode	C3-N34D/DC ... V	C3-N38D/DC ... V
Polarity and free wheeling diode	C3-N34F/DC ... V	C3-N38F/DC ... V

Connection of diodes to the coil will increase the release time.
LED available upon request.

"..." Enter the voltage for full type designation

Accessories	
Socket:	S3-B, S3-S, S3-L, S3-P, S3-P0
Optional accessories (blanking plug):	SO-NP, SO-OP



Connection diagram

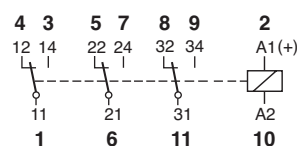


Fig. 1 AC voltage endurance

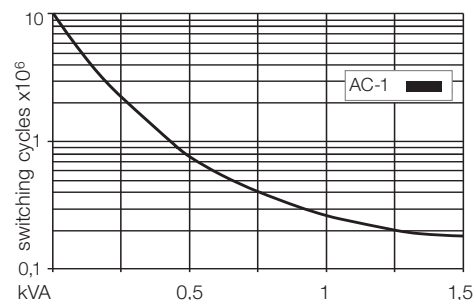
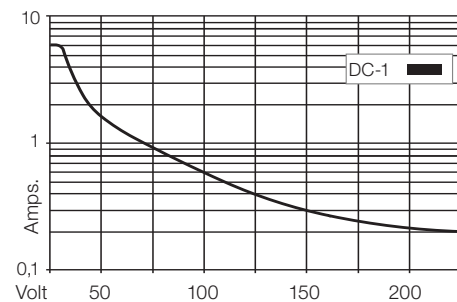
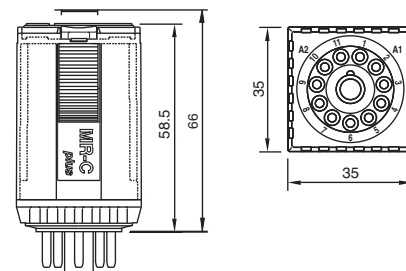


Fig. 2 DC load limit curve



Dimensions [mm]



Technical approvals, conformities



IEC 61810; EN 60947

R3-N3xD

11-pin, special relay, 3-pole, according to IEC 67-I-18a
Relay approval: EN 60077-1-2/99 - EN 61373/99 for Railway application

Type	R3-NxD/ ... V Relays for Railway application 3 change-over contacts special wide range voltage
-------------	--

Maximum contact load	6 A 250 V AC-1	6 A 30 V DC-1
Recommended minimum contact load	10 mA/10 V Code 0, 4 5 mA/5 V Code 8	

Contacts			
Material	Standard	Code 0	AgNi
	Optional	Code 4	AgNi + 0,2µ Au
	Optional	Code 8	AgNi + 10µ Au
Rated current	6 A		
Switch-on current max. (20 ms)	15 A		
Switching voltage max.	250 V		
Max. AC load	see Fig. 1		
DC load	see Fig. 2		

Coil	
Coil resistance	see table; tolerance ± 10 %
Operation range	0,7 U _N ... 1,25 U _N
Nominal power	1,1 W

Coil table	VDC	Ω	mA
	24	525	46
	48	2133	22
	72	4844	15
	110	12900	9

Insulation	
Pollution grade	PD3
With pulse (1,2 / 50 µs)/Dielectric strenght (1Minute/V rms)	
Contact/coil	4 kV / 2220 V
Contact/contact	4 kV / 2220 V
Between contact and the same pole	1550 V / 850 V

Specifications	
Ambient temperature operation/storage	-25 (no ice)...70 °C / -40 ... 80 °C
Number of mechanical operations	≥ 10 millions
Thermic class	B (130 °C)
Vibration : category / class	1 / B Body mounted 5 - 150 Hz (3 axes)
Shock	5 g (3 axes)
Pick-up time/bounce time	18 ms/≤ 3 ms
Release time/bounce time (D version)	35 ms/≤ 1 ms
Weight	95 g
Weight avg. Relay + Socket (S3-B)	150 g
Protection class	IP 40

Standard types			
DC 24, 48, 72, 110	R3-N30/DC ... V	R3-N34/DC ... V	R3-N38/DC ... V
Free wheeling diode	R3-N30D/DC ... V	R3-N34D/DC ... V	R3-N38D/DC ... V
LED	R3-N30X/DC ... V	R3-N34X/DC ... V	R3-N38X/DC ... V
LED + free wheeling diode	R3-N30DX/DC ... V	R3-N34DX/DC ... V	R3-N38DX/DC ... V*

"..." Enter the voltage for full type designation

Accessories	
Socket:	S3-B, S3-S, S3-L, S3-P, S3-P0
Optional accessories (blanking plug):	SO-NP, SO-OP



Connection diagram

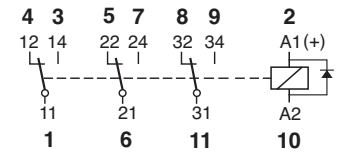


Fig. 1 AC voltage endurance

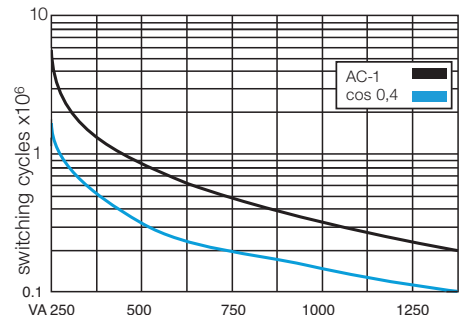
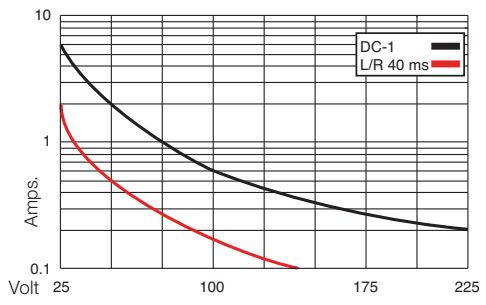
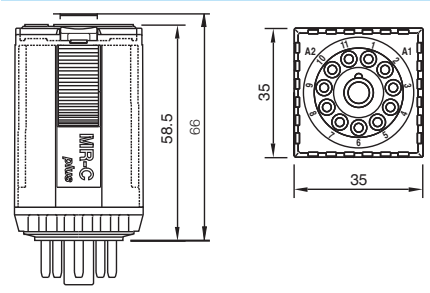


Fig. 2 DC load limit curve



Dimensions [mm]



Technical approvals, conformities

CE
 IEC 60077/EN60077-1-2/99; EN61373/99

C30-A30

11-pin standard relays, 3-pole, plug-in, according to IEC 60067

Type	C30-A30/ ... V Standard relays 3 change-over contacts		
Maximum contact load	10 A/250 V AC-1	0,5 A/110 V DC-1	
Recommended minimum contact load	10 A/30 V DC-1	0,2 A/220 V DC-1	

Contacts	
Material	AgNi
Rated current	10 A
Switch-on current max. (20 ms)	30 A
Switching voltage max.	250 V
AC load (Fig 1)	2,5 kVA
DC load	see Fig. 2

Coil	
Coil resistance	see table; tolerance $\pm 10\%$
Pick-up voltage	$\leq 0,8 \times U_N$
Release voltage	$\geq 0,1 \times U_N$
Nominal power	2,2 VA (AC)/1,3 W (DC)

Coil table	VAC	Ω	mA	VDC	Ω	mA
	24	67	92	12	115	104
	115	1K7	19	24	480	50
	230	7K1	9,5	48	1K8	26
				110	9K	12

Insulation	
	Volt rms, 1 min
Contact open	1000 V
Contact/contact	2,5 kV
Contact/coil	2,5 kV
Insulation resistance at 500 V	$\geq 1 \text{ G}\Omega$
Insulation, IEC 61810-1	2,5 kV/3

Specifications	
Ambient temperature operation/storage	-40...70 °C DC (55 °C AC)/-40 ... 80 °C
Pick-up time/bounce time typ.	8 ms/3 ms
Release time/bounce time typ.	18 ms/1 ms
Mechanical life ops	AC: 10 Mill./DC: 20 Mill.
DC voltage endurance at rated load	≥ 100000 switching cycles
Switching frequency at rated load	≤ 1200 /ops/h
Protection class	IP40
Weight	82 g

Standard types	
VAC 50 Hz: 24, 115, 230	C30-A30/AC ... V
VAC 60 Hz: 120	C30-A30/AC ... V 60 Hz
LED	C30-A30X/AC ... V
VDC 12, 24, 36, 48, 110	C30-A30/DC ... V
LED	C30-A30X/DC ... V
Free wheeling diode	C30-A30DX/DC ... V
Polarity and free wheeling diode	C30-A30FX/DC ... V
AC/DC bridge rectifier 24 V	C30-A30BX/UC ... V

"..." Enter the voltage for full type designation

Accessories	
Socket:	S30-B
Blanking plug:	PB30-BK
Button without lockable function:	PB30-OR
Retaining clip, plastic:	S30-CM



Connection diagram

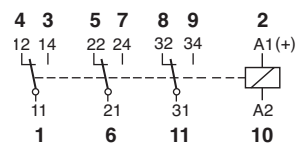


Fig. 1 AC voltage endurance

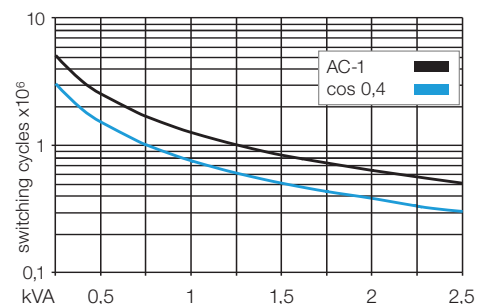
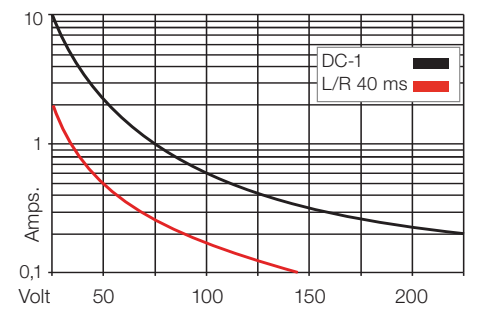
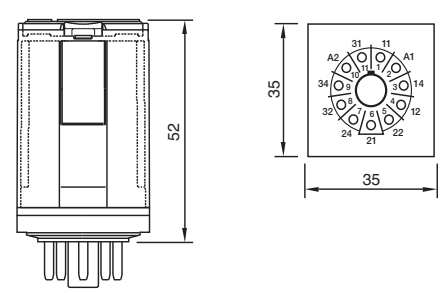


Fig. 2 DC load limit curve



Dimensions [mm]



Technical approvals, conformities



IEC 61810; EN 60947

C30-T30

11-pin standard relay, 3-pole, twin contact, plug-in according to IEC 60067

Type	C30-T30/ ... V Standard relays for low level 3 change-over twin contacts			
Maximum contact load	6 A/250 V AC-1	6 A/30 V DC-1		
Recommended minimum contact load	5 mA/5 V			

Contacts	
Material	AgNi
Rated current	6 A
Switch-on current max. (20 ms)	15 A
Switching voltage max.	250 V
AC load (Fig 1)	1,2 kVA
DC load	see Fig. 2

Coil	
Coil resistance	see table; tolerance $\pm 10\%$
Pick-up voltage	$\leq 0,8 \times U_N$
Release voltage	$\geq 0,1 \times U_N$
Nominal power	2,2 VA (AC)/1,3 W (DC)

Coil table	VAC	Ω	mA	VDC	Ω	mA
	24	67	92	12	115	104
	115	1K7	19	24	480	50
	230	7K1	9,5	48	1K8	26
				110	9K	12

Insulation	
Contact open	Volt rms, 1 min 1000 V
Contact/contact	2,5 kV
Contact/coil	2,5 kV
Insulation resistance at 500 V	≥ 1 G Ω
Insulation, EN 61810-1	2,5 kV/3

Specifications	
Ambient temperature operation/storage	-40...70 °C DC (55 °C AC)/-40 ... 80 °C
Pick-up time/bounce time typ.	8 ms/3 ms
Release time/bounce time typ.	18 ms/1 ms
Mechanical life ops	AC: 10 Mill./DC: 20 Mill.
DC voltage endurance at rated load	≥ 100000 switching cycles
Switching frequency at rated load	≤ 1200 /ops/h
Protection class	IP40
Weight	82 g

Standard types	C30-T30/AC ... V
VAC 50 Hz: 24, 115, 230	C30-T30/AC ... V 60 Hz
VAC 60 Hz: 120	C30-T30X/AC ... V
LED	
VDC 12, 24, 36, 48, 110	C30-T30/DC ... V
LED	C30-T30X/DC ... V
Free wheeling diode	C30-T30DX/DC ... V
Polarity and free wheeling diode	C30-T30FX/DC ... V
AC/DC bridge rectifier 24 V	C30-T30BX/UC ... V

"..." Enter the voltage for full type designation

Accessories	
Socket:	S30-B
Blanking plug:	PB30-BK
Button without lockable function:	PB30-OR
Retaining clip, plastic:	S30-CM



Connection diagram

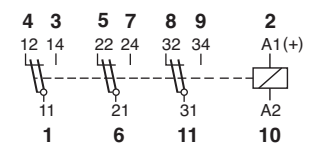


Fig. 1 AC voltage endurance

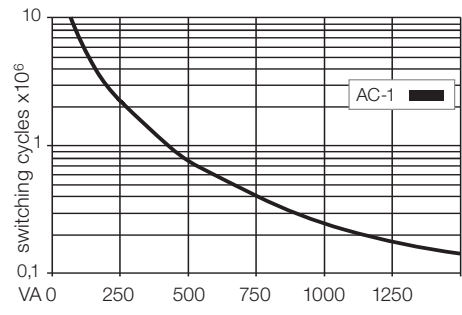
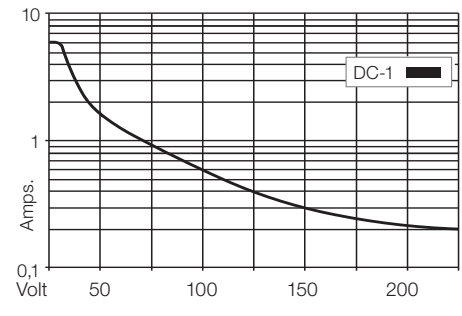
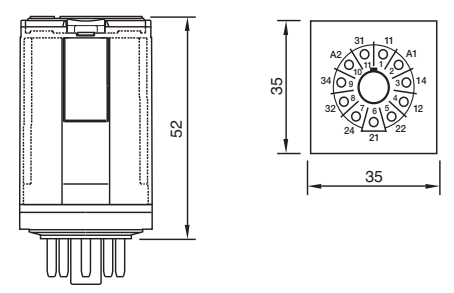


Fig. 2 DC load limit curve



Dimensions [mm]



Technical approvals, conformities



IEC 61810; EN 60947

C30-M10

11-pin power relay, 1-pole, magnetic blow out, according to IEC 60067

Type	C30-M10/ ... V Power relays for DC applications 1 pole, magnetic blow out
Maximum contact load	10 A/250 V AC-1 10 A/220 V DC-1
Contacts	
Material	AgNi
Rated current	10 A
Switch-on current max. (20 ms)	30 A
Switching voltage max.	250 V
AC load (Fig 1)	2,5 kVA
DC load	see Fig. 2

Coil	
Coil resistance	see table; tolerance $\pm 10\%$
Pick-up voltage	$\leq 0,8 \times U_N$
Release voltage	$\geq 0,1 \times U_N$
Nominal power	2,4 VA (AC) / 1,3 W (DC)

Coil table	
	VAC Ω mA VDC Ω mA
	24 65 100 24 480 50
	48 286 50 48 1K8 26
	115 1K7 21 110 9K 12
	230 6K8 10 220 29K 7,5

Insulation	Volt rms, 1 min
Contact open	2500 V
Contact/contact	2,5 kV
Contact/coil	2,5 kV
Insulation resistance at 500 V	$\geq 1 \text{ G}\Omega$
Insulation, IEC 61810-1:	2,5 KV / 3

Specifications	
Ambient temperature operation/storage	-40...70 °C DC (55 °C AC)/ -40 ... 80 °C
Pick-up time/bounce time typ.	8 ms/ 3 ms
Release time/bounce time typ.	18 ms/ 1 ms
DC voltage endurance at rated load	≥ 100000 switching cycles
Switching frequency at rated load	≤ 1200 /ops/h
Protection class	IP40
Weight	82 g

Standard types	
VAC 50 Hz: 24, 115, 230	C30-M10/AC ... V
VAC 60 Hz: 120	C30-M10/AC ... V 60 Hz
LED	C30-M10X/AC ... V
VDC 12, 24, 36, 48, 110, 220	C30-M10/DC ... V
LED	C30-M10X/DC ... V
Free wheeling diode	C30-M10DX/DC ... V
Polarity and free wheeling diode	C30-M10FX/DC ... V
AC/DC bridge rectifier 24 V	C30-M10BX/UC ... V

"..." Enter the voltage for full type designation

Accessories	
Socket:	S30-B
Blanking plug:	PB30-BK
Button without lockable function:	PB30-OR
Retaining clip, plastic:	S30-CM



Connection diagram

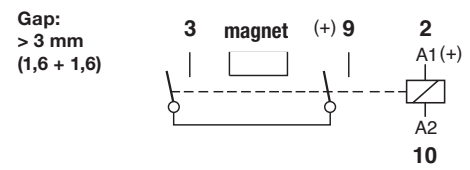


Fig. 1 AC voltage endurance

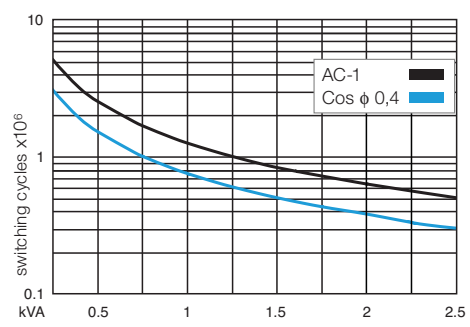
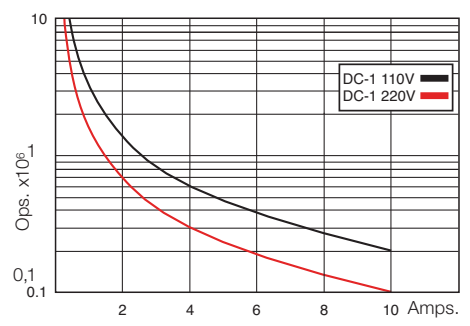
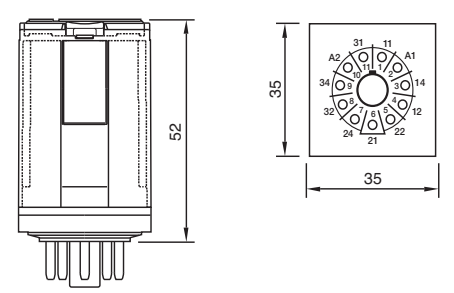


Fig. 2 DC voltage endurance



Dimensions [mm]



Technical approvals, conformities



IEC 61810; EN 60947

C30-X10

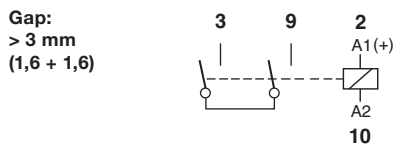
11-pin power relay, 1-pole, double make, according to IEC 60067



Type	C30-X10/ ... V Power relays for DC applications 1 pole, NO, double make			
Maximum contact load	10 A/250 V AC-1	7 A/110 V DC-1	10 A/30 V DC-1	1,2 A/220 V DC-1
Contacts	Material: AgNi Rated current: 10 A Switch-on current max. (20 ms): 30 A Switching voltage max.: 250 V AC load (Fig 1): 2,5 kVA DC load: see Fig. 2			



Connection diagram



Coil	see table; tolerance ± 10 %
Coil resistance	≤ 0,8 x U _N
Pick-up voltage	≥ 0,1 x U _N
Release voltage	2,4 VA (AC)/1,3 W (DC)
Nominal power	

Coil table			VAC	Ω	mA	VDC	Ω	mA
			24	65	100	24	480	50
			115	1K7	21	48	1K8	26
			230	6K8	10	110	9K	12
						220	29K	7,5

Insulation	Volt rms, 1 min
Contact open	2500 V
Contact/contact	2,5 kV
Contact/coil	2,5 kV
Insulation resistance at 500 V	≥ 1 GΩ
Insulation, IEC 61810-1	2,5 kV/3

Specifications	
Ambient temperature operation/storage	-40...70 °C DC (55 °C AC)/-40 ... 80 °C
Pick-up time/bounce time typ.	18 ms/3 ms
Release time/bounce time typ.	8 ms/1 ms
Mechanical life ops	AC: 10 Mill./DC: 20 Mill.
DC voltage endurance at rated load	≥ 100000 switching cycles
Switching frequency at rated load	≤ 1200/ops/h
Protection class	IP40
Weight	83 g

Standard types	
VAC 50 Hz: 24, 115, 230	C30-X10/AC ... V
VAC 60 Hz: 120	C30-X10/AC ... V 60 Hz
LED	C30-X10X/AC ... V
VDC 24, 48, 110, 220	C30-X10/DC ... V
LED	C30-X10X/DC ... V
Free wheeling diode	C30-X10DX/DC ... V
Polarity and free wheeling diode	C30-X10FX/DC ... V
AC/DC bridge rectifier 24 V	C30-X10BX/UC ... V

"..." Enter the voltage for full type designation

Accessories	
Socket:	S30-B
Blanking plug:	PB30-BK
Button without lockable function:	PB30-OR
Retaining clip, plastic:	S30-CM

Fig. 1 AC voltage endurance

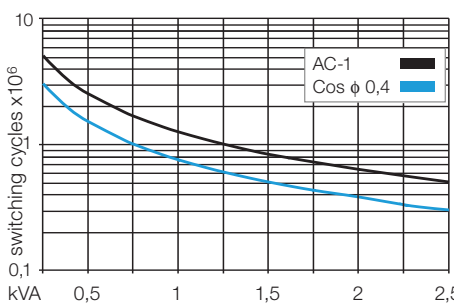
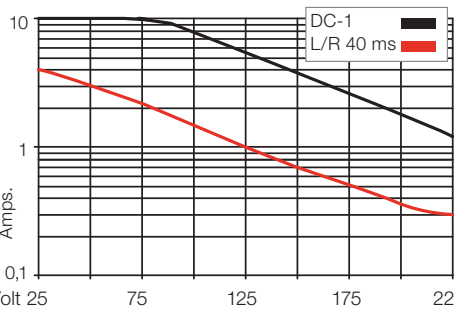
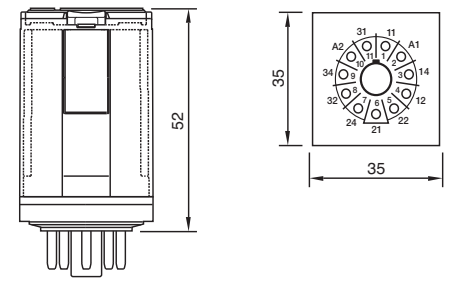


Fig. 2 DC load limit curve



Dimensions [mm]



Technical approvals, conformities



IEC 61810; EN 60947

Type	C4-A4x/ ... V Standard relays, 4 change-over contacts		
Maximum contact load	10 A/250 V AC-1	0,5 A/110 V DC-1	
	10 A/30 V DC-1	0,2 A/220 V DC-1	
Recommended minimum contact load	10 mA/10 V Code 0, 9		
	5 mA/5 V Code 8		
Contacts			
Material	Standard	Code 0	AgNi
	Optional	Code 8	AgNi + 10 μ Au
	Optional	Code 9	AgNi + 0,2 μ Au
Rated current	10 A		
Switch-on current max. (20 ms)	30 A		
Switching voltage max.	250 V		
AC load (Fig 1)	2,5 kVA		
DC load	see Fig. 2		

Coil			
Coil resistance	see table; tolerance ± 10 %		
Pick-up voltage	≤ 0,8 x U _N		
Release voltage	≥ 0,1 x U _N		
Nominal power	2,4 VA (AC)/1,4 W (DC)		

Coil table						
VAC	Ω	mA	VDC	Ω	mA	
24	65	100	24	414	58	
48	286	50	48	1K6	30	
115	1K7	21	110	8K1	13	
230	6K8	10	220	35K7	6,2	

Insulation	Volt rms, 1 min
Contact open	1000 V
Contact/contact	2,5 kV
Contact/coil	2,5 kV
Insulation resistance at 500 V	≥ 1 GΩ
Insulation, IEC 61810-1	2,5 kV/3

Specifications	
Ambient temperature operation/storage	-40 (no ice)...60 °C /-40 ... 80 °C
Pick-up time/bounce time	20 ms/≤ 3 ms
Release time/bounce time	8 ms/≤ 1 ms
Mechanical life ops	AC: 10 Mill./DC: 20 Mill.
DC voltage endurance at rated load	≥ 100000 switching cycles
Switching frequency at rated load	≤ 1200/ops/h
Protection class	IP40
Weight	90 g

Standard types		
VAC 50 Hz/60 Hz: 24, 48, 115, (120), 230, (240)	C4-A40/AC ... V	C4-A48/AC ... V
LED	C4-A40X/AC ... V	C4-A48X/AC ... V
RC suppressor	C4-A40R/AC ... V	C4-A48R/AC ... V
VDC 24, 48, 110, 220	C4-A40/DC ... V	C4-A48/DC ... V
LED	C4-A40X/DC ... V	C4-A48X/DC ... V
Free wheeling diode	C4-A40DX/DC ... V	C4-A48DX/DC ... V
Polarity and free wheeling diode	C4-A40FX/DC ... V	C4-A48FX/DC ... V
AC/DC bridge rectifier 24 V, 48 V, 60 V	C4-A40BX/UC ... V	C4-A48BX/UC ... V

"..." Enter the voltage for full type designation

Accessories	
Socket:	S4-J, S4-L, S4-P, S4-P0
Optional accessories (blanking plug):	SO-NP, SO-OP



Connection diagram

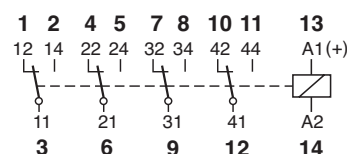


Fig. 1 AC voltage endurance

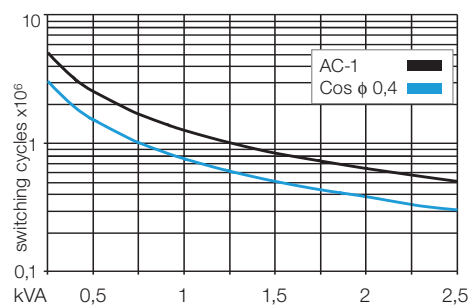
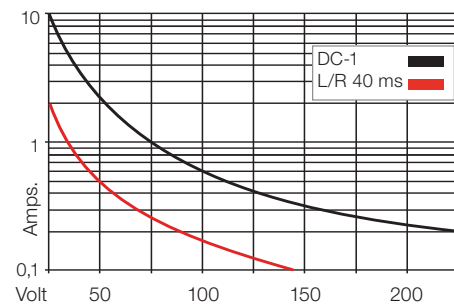
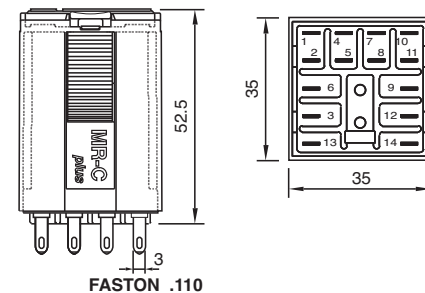


Fig. 2 DC load limit curve



Dimensions [mm]



Technical approvals, conformities



IEC 61810; EN 60947

C4-X2x

14-pin, power relay, double-make, faston

Type	C4-X2x/ ... V Power relays, DC application 2-pole, NO, double make
-------------	---

Maximum contact load	10 A/250 V AC-1	7 A/110 V DC-1
	10 A/30 V DC-1	1,2 A/220 V DC-1

Contacts			
Material	Standard	Code 0	AgNi
Rated current			10 A
Switch-on current max. (20 ms)			30 A
Switching voltage max			250 V
AC load (Fig 1)			2,5 kVA
DC load			see Fig. 2

Coil	
Coil resistance	see table; tolerance ± 10 %
Pick-up voltage	≤ 0,8 x U _N
Release voltage	≥ 0,1 x U _N
Nominal power	2,4 VA (AC)/1,3 W (DC)

Coil table					
VAC	Ω	mA	VDC	Ω	mA
24	65	100	24	443	54
48	286	50	48	1K8	27
115	1K7	21	110	9K2	12
230	6k8	10	220	36K1	6

Insulation	Volt rms, 1 min
Contact open	2500 V
Contact/contact	2,5 kV
Contact/coil	2,5 kV
Insulation resistance at 500 V	≥ 1 GΩ
Insulation, IEC 61810-1	2,5 kV/3

Specifications	
Ambient temperature operation/storage	-40 (no ice)...60 °C / -40 ... 80 °C
Pick-up time/bounce time	20 ms/≤ 3 ms
Release time/bounce time	8 ms/≤ 1 ms
Mechanical life ops	AC: 10 Mill./DC: 20 Mill.
DC voltage endurance at rated load	≥ 100000 switching cycles
Switching frequency at rated load	≤ 1200/ops/h
Protection class	IP40
Weight	90 g

Standard types	
VAC 50 Hz/60 Hz: 24, 48, 115, (120), 230, (240)	C4-X20/AC ... V
LED	C4-X20X/AC ... V
RC Suppressor	C4-X20R/AC ... V
VDC 24, 48, 110, 220	C4-X20/DC ... V
LED	C4-X20X/DC ... V
Free wheeling diode	C4-X20DX/DC ... V
Polarity and free wheeling diode	C4-X20FX/DC ... V
AC/DC bridge rectifier 24 V, 48 V, 60 V	C4-X20BX/UC ... V

"..." Enter the voltage for full type designation

Accessories	
Socket:	S4-S, S4-L, S4-P, S4-P0
Optional accessories (blanking plug):	SO-NP, SO-OP



Connection diagram

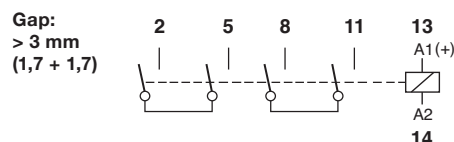


Fig. 1 AC voltage endurance

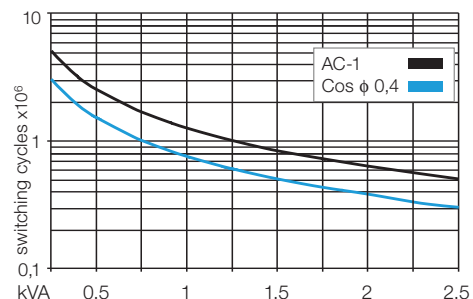
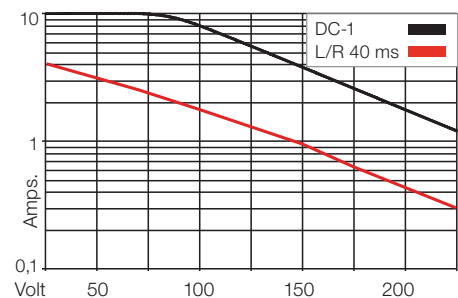
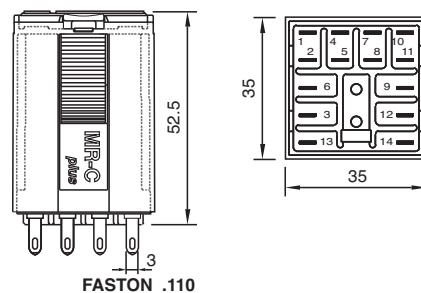


Fig. 2 DC load limit curve



Dimensions [mm]



Technical approvals, conformities



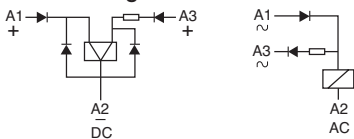
IEC 61810; EN 60947

Type	C4-R3x/ ... V Magnetic remanence relay 3 change-over contact
Maximum contact load	10 A/250 V AC-1 0,5 A/110 V DC-1 10 A/10 V DC-1 0,2 A/220 V DC-1
Recommended minimum contact load	10 mA/10 V Code 0, 9 5 mA/5 V Code 8

Contacts			
Material	Standard	Code 0	AgNi
	Optional	Code 8	AgNi + 10 μ Au
	Optional	Code 9	AgNi + 0,2 μ Au
Rated current	10 A		
Switch-on current max. (20 ms)	30 A		
Switching voltage max.	250 V		
AC load	2,5 kVA		
DC load	see Fig. 2		

Coil	
Coil resistance	see table; tolerance ± 10 %
ON pulse power	1,5 VA/W
OFF pulse power	0,5 VA/W
	1 Winding for AC, 2 Windings for DC
Pull-in ON/OFF	≤ 0,8 × U _N

Internal Diagram:



Coil table

VAC	mA ON	mA OFF	VDC	mA ON	mA OFF
24	75	12	12	125	41
48	38	6	24	63	21
115	16	2,5	48	31	10
230	8	1,3	110	14	4,5

Insulation	Volt rms, 1 min
Contact open	1000 V
Contact/contact	2,5 kV
Contact/coil	2,5 kV
Insulation resistance at 500 V	≥ 1 GΩ
Insulation, IEC 61810-1	2,5 kV/3

Specifications

Ambient temperature operation/storage	-40 (no ice)...60 °C /-40 ... 80 °C
Minimum pulse length for ON/OFF	50 ms
Mechanical life ops	AC: 10 Mill./DC: 20 Mill. switching cycles
DC voltage endurance at rated load	≥ 100000 switching cycles
Switching frequency at rated load	≤ 1200/h
Protection class	IP40
Weight	95 g

Standard types

VAC 50 Hz/60 Hz: 24, 48, 115 (120), 230 (240)

VDC 12, 24, 48, 110

C4-R30/AC ... V	C4-R38/AC ... V	C4-R39/AC ... V
C4-R30/DC ... V	C4-R38/DC ... V	C4-R39/DC ... V

"..." Enter the voltage for full type designation

Accessories

Socket:	S4-J, S4-L, S4-P, S4-P0
Optional accessories (blanking plug):	SO-NP, SO-OP



Connection diagram

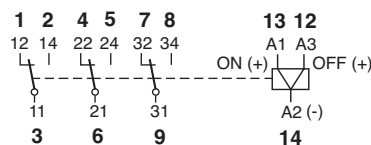


Fig. 1 AC voltage endurance

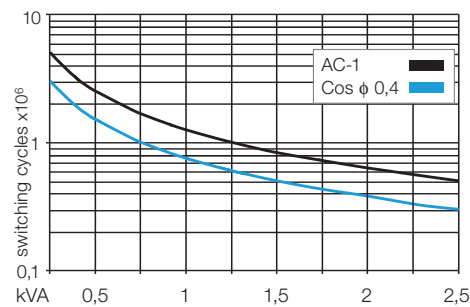
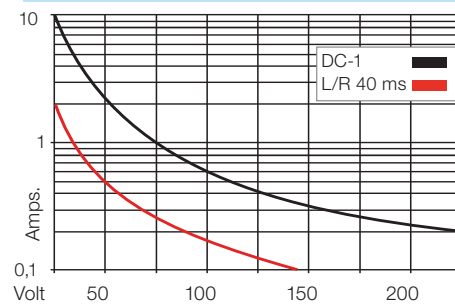
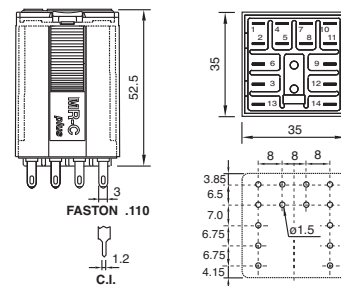


Fig. 2 DC load limit curve



Dimensions [mm]



Technical approvals, conformities



IEC 61810; EN 60947

Type	C5-A2x/ ... V Power relays, 2 change-over contacts		
Maximum contact load	16 A/400 V AC-1 16 A/30 V DC-1	0,5 A/110 V DC-1	0,2 A/220 V DC-1
Contacts	Material Standard Code 0	AgNi	
	Rated current	16 A	
	Switch-on current max. (20 ms)	40 A	
	Switching voltage max.	400 V	
	AC load (Fig 1)	4 kVA	
	DC load	see Fig. 2	

Coil	see table; tolerance ± 10 %
Coil resistance	≤ 0,8 × U _N
Pick-up voltage	≥ 0,1 × U _N
Release voltage	2,4 VA (AC)/1,4 W (DC)
Nominal power	

Coil table	VAC	Ω	mA	VDC	Ω	mA
	24	65	100	24	414	58
	48	286	50	48	1K6	30
	115	1K7	21	110	8K1	13
	230	6K8	10	220	35K6	6
	400	18K8	6			

Insulation	Volt rms, 1 min
Contact open	1000 V
Contact/contact	4 kV
Contact/coil	4 kV
Insulation resistance at 500 V	≥ 3 GΩ
Insulation, IEC 61810-1	4 kV/3

Specifications	-40 (no ice)...60 °C / -40 ... 80 °C
Ambient temperature operation/storage	20 ms/≤ 3 ms
Pick-up time/bounce time	10 ms/≤ 1 ms
Release time/bounce time	AC: 10 Mill./DC: 20 Mill.
Mechanical life ops	≥ 100000 switching cycles
DC voltage endurance at rated load	≤ 1200/ops/h
Switching frequency at rated load	IP40
Protection class	90 g
Weight	

Standard types
VAC 50 Hz/60 Hz: 24, 48, 115 (120), 230 (240)
LED
RC suppressor (max 250 V)

C5-A20/AC ... V
C5-A20X/AC ... V
C5-A20R/AC ... V

VDC 24, 48, 110, 220
LED
Free wheeling diode
Polarity and free wheeling diode

C5-A20/DC ... V
C5-A20X/DC ... V
C5-A20DX/DC ... V
C5-A20FX/DC ... V

AC/DC bridge rectifier 24 V, 48 V, 60 V

C5-A20BX/UC ... V

"..." Enter the voltage for full type designation

Accessories	S5-S, S5-L, S5-P, S5-P0, S5-M
Socket:	SO-NP, SO-OP
Optional accessories (blanking plug):	



Connection diagram

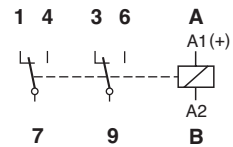


Fig. 1 AC voltage endurance

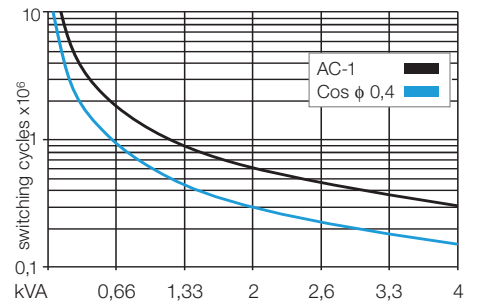
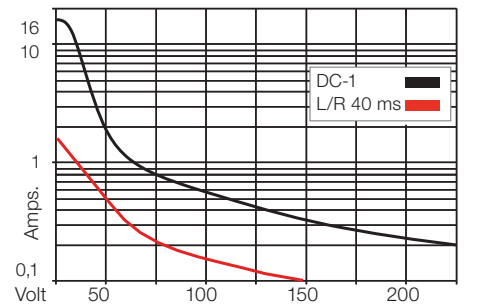
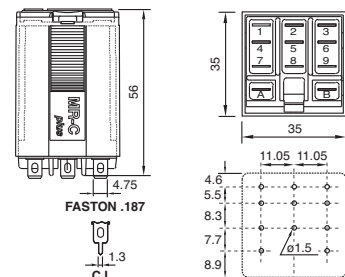


Fig. 2 DC load limit curve



Dimensions [mm]



Technical approvals, conformities



IEC 61810; EN 60947

Type	C5-A3x/ ... V Power relays, 3 change-over contacts		
Maximum contact load	16 A/400 V AC-1 16 A/30 V DC-1	0,5 A/110 V DC-1 0,2 A/220 V DC-1	
Contacts			
Material	Standard	Code 0	AgNi
Rated current			16 A
Switch-on current max. (20 ms)			40 A
Switching voltage max.			400 V
AC load (Fig 1)			4 kVA
DC load			see Fig. 2

Coil			
Coil resistance			see table; tolerance $\pm 10\%$
Pick-up voltage			$\leq 0,8 \times U_N$
Release voltage			$\geq 0,1 \times U_N$
Nominal power			2,4 VA (AC)/1,4 W (DC)

Coil table						
VAC	Ω	mA	VDC	Ω	mA	
24	65	100	24	414	58	
48	286	50	48	1K6	30	
115	1K7	21	110	8K1	13	
230	6K8	10	220	35K6	6,2	
400	18K8	6				

Insulation		Volt rms, 1 min
Contact open		1000 V
Contact/contact		4 kV
Contact/coil		4 kV
Insulation resistance at 500 V		$\geq 3 G\Omega$
Insulation, IEC 61810-1		4 kV/3

Specifications		
Ambient temperature operation/storage		-40 (no ice)...60 °C / -40 ... 80 °C
Pick-up time/bounce time		20 ms/ ≤ 3 ms
Release time/bounce time		10 ms/ ≤ 1 ms
Mechanical life ops		AC: 10 Mill./DC: 20 Mill.
DC voltage endurance at rated load		≥ 100000 switching cycles
Switching frequency at rated load		$\leq 1200/h$
Protection class		IP40
Weight		95 g

Standard types	
VAC 50 Hz/60 Hz: 24, 48, 115, (120), 230, (240)	C5-A30/AC ... V
LED	C5-A30X/AC ... V
RC suppressor (max 250 V)	C5-A30R/AC ... V
VDC 24, 48, 110, 220	C5-A30/DC ... V
LED	C5-A30X/DC ... V
Free wheeling diode	C5-A30DX/DC ... V
Polarity and free wheeling diode	C5-A30FX/DC ... V
AC/DC bridge rectifier 24 V, 48 V, 60 V	C5-A30BX/UC ... V

"..." Enter the voltage for full type designation

Accessories	
Socket:	S5-S, S5-L, S5-P, S5-P0, S5-M
Optional accessories (blanking plug):	SO-NP, SO-OP



Connection diagram

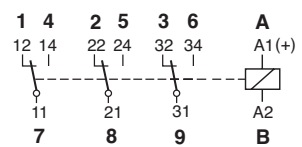


Fig. 1 AC voltage endurance

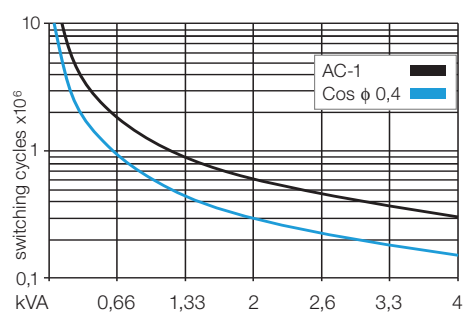
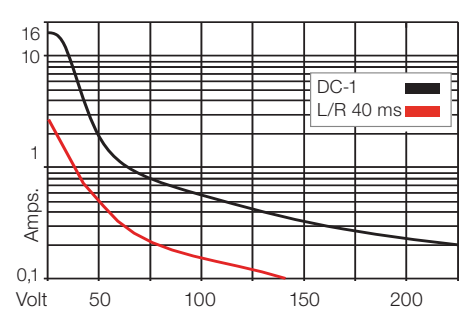
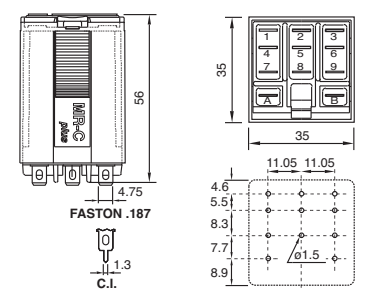


Fig. 2 DC load limit curve



Dimensions [mm]



Technical approvals, conformities



EN 60947; IEC 61810

Type	C5-G3x/ ... V Power relays, DC application. 3 open contacts		
Maximum contact load	16 A/400 V AC-1 16 A/30 V DC-1	1,2 A/110 V DC-1	0,4 A/220 V DC-1

Contacts			
Material	Standard	Code 0	AgNi
Rated current			16 A
Switch-on current max. (20 ms)			40 A
Switching voltage max.			400 V
AC load (Fig 1)			4 kVA
DC load			see Fig. 2

Coil	
Coil resistance	see table; tolerance ± 10 %
Pick-up voltage	≤ 0,8 × U _N
Release voltage	≥ 0,1 × U _N
Nominal power	2,4 VA (AC)/1,6 W (DC)

Coil table																																					
	<table border="1"> <thead> <tr> <th>VAC</th> <th>Ω</th> <th>mA</th> <th>VDC</th> <th>Ω</th> <th>mA</th> </tr> </thead> <tbody> <tr> <td>24</td> <td>65</td> <td>100</td> <td>12</td> <td>90</td> <td>133</td> </tr> <tr> <td>48</td> <td>286</td> <td>50</td> <td>24</td> <td>373</td> <td>66</td> </tr> <tr> <td>115</td> <td>1K7</td> <td>21</td> <td>48</td> <td>1K4</td> <td>34</td> </tr> <tr> <td>230</td> <td>6K8</td> <td>10</td> <td>110</td> <td>7K6</td> <td>15</td> </tr> <tr> <td>400</td> <td>18K8</td> <td>6</td> <td>220</td> <td>30K3</td> <td>7,5</td> </tr> </tbody> </table>	VAC	Ω	mA	VDC	Ω	mA	24	65	100	12	90	133	48	286	50	24	373	66	115	1K7	21	48	1K4	34	230	6K8	10	110	7K6	15	400	18K8	6	220	30K3	7,5
VAC	Ω	mA	VDC	Ω	mA																																
24	65	100	12	90	133																																
48	286	50	24	373	66																																
115	1K7	21	48	1K4	34																																
230	6K8	10	110	7K6	15																																
400	18K8	6	220	30K3	7,5																																

Insulation	Volt rms, 1 min
Contact open	2000 V
Contact/contact	4 kV
Contact/coil	4 kV
Insulation resistance at 500 V	≥ 3 GΩ
Insulation, IEC 61810-1	4 kV/3

Specifications	
Ambient temperature operation/storage	-40 (no ice)...60 °C / -40 ... 80 °C
Pick-up time/bounce time	20 ms/≤ 3 ms
Release time/bounce time	10 ms/≤ 1 ms
Mechanical life ops	AC: 10 Mill./DC: 20 Mill.
DC voltage endurance at rated load	≥ 100000 switching cycles
Switching frequency at rated load	≤ 1200/h
Protection class	IP40
Weight	95 g

Standard types	
VAC 50 Hz/60 Hz: 24, 48, 115, (120), 230, (240)	C5-G30/AC ... V
LED	C5-G30X/AC ... V
RC suppressor (max 250 V)	C5-G30R/AC ... V
VDC 12, 24, 48, 110, 220	C5-G30/DC ... V
LED	C5-G30X/DC ... V
Free wheeling diode	C5-G30DX/DC ... V
Polarity and free wheeling diode	C5-G30FX/DC ... V
AC/DC bridge rectifier 24 V, 48 V, 60 V	C5-G30BX/UC ... V

"..." Enter the voltage for full type designation

Accessories	
Socket:	S5-S, S5-L, S5-P, S5-P0, S5-M
Optional accessories (blanking plug):	SO-NP, SO-OP



Connection diagram

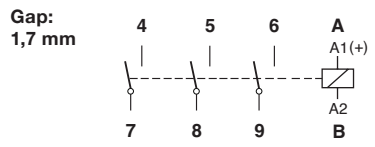


Fig. 1 AC voltage endurance

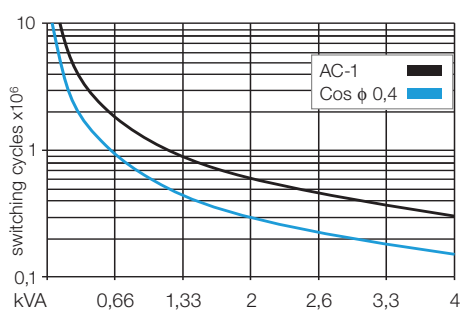
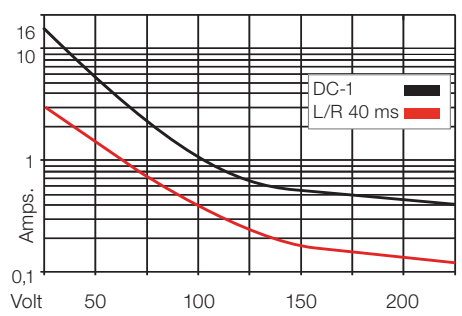
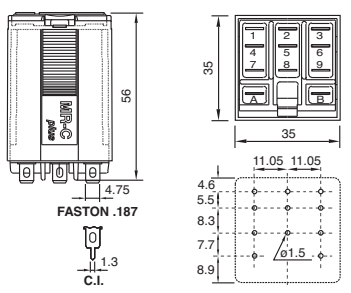


Fig. 2 DC load limit curve



Dimensions [mm]



Technical approvals, conformities



EN 60947; IEC 61810

Type	C5-X1x/ ... V Power relays, DC application 1 pole, NO, double make			
-------------	---	--	--	--

Maximum contact load	16 A/400 V AC-1	7 A/110 V DC-1
	16 A/30 V DC-1	1,2 A/220V DC-13

Contacts			
Material	Standard	Code 0	AgNi
Rated current			16 A
Switch-on current max. (20 ms)			40 A
Switching voltage max.			400 V
AC load (Fig 1)			4 kVA
DC load			see Fig. 2

Coil	
Coil resistance	see table; tolerance $\pm 10\%$
Pick-up voltage	$\leq 0,8 \times U_N$
Release voltage	$\geq 0,1 \times U_N$
Nominal power	2,4 VA (AC)/1,3 W (DC)

Coil table	VAC	Ω	mA	VDC	Ω	mA
	24	65	100	12	110	108
	48	286	50	24	443	54
	115	1K7	21	48	1K7	27
	230	6K8	10	110	9K2	12
	400	18K8	6	220	34K5	6,2

Insulation	
Volt rms, 1 min	4 kV
Contact open	4 kV
Contact/contact	4 kV
Contact/coil	4 kV
Insulation resistance at 500 V	$\geq 3 \text{ G}\Omega$
Insulation, IEC 61810-1	4 kV/3

Specifications	
Ambient temperature operation/storage	-40 (no ice)...60 °C / -40 ... 80 °C
Pick-up time/bounce time	20 ms/ ≤ 3 ms
Release time/bounce time	10 ms/ ≤ 1 ms
Mechanical life ops	AC: 10 Mill./DC: 20 Mill.
DC voltage endurance at rated load	≥ 100000 switching cycles
Switching frequency at rated load	≤ 1200 /h
Protection class	IP40
Weight	90 g

Standard types	
VAC 50 Hz/60 Hz: 24, 48, 115 (120), 230 (240)	C5-X10/AC ... V
LED	C5-X10X/AC ... V
RC suppressor (max 250 V)	C5-X10R/AC ... V
VDC 12, 24, 48, 110, 220	C5-X10/DC ... V
LED	C5-X10X/DC ... V
Free wheeling diode	C5-X10DX/DC ... V
Polarity and free wheeling diode	C5-X10FX/DC ... V
AC/DC bridge rectifier 24 V, 48 V, 60 V	C5-X10BX/UC ... V

"..." Enter the voltage for full type designation

Accessories	
Socket:	S5-S, S5-L, S5-P, S5-P0, S5-M
Optional accessories (blanking plug):	SO-NP, SO-OP



Connection diagram

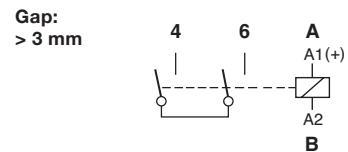


Fig. 1 AC voltage endurance

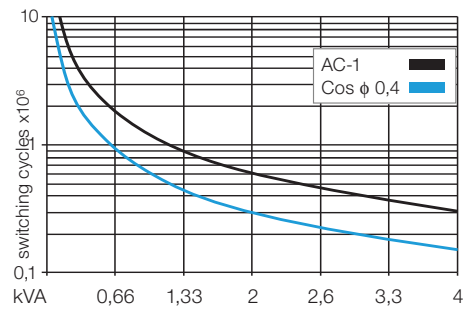
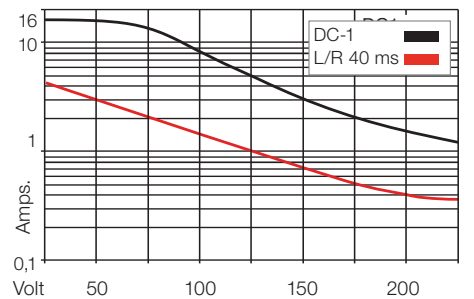
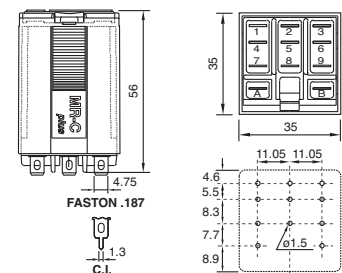


Fig. 2 DC load limit curve



Dimensions [mm]



Technical approvals, conformities



IEC 61810; EN 60947

C5-M1x

4-pin, power relay, 1-pole double make, magnetic blow out, faston

Type **C5-M1x/ ... V**
 Power relays, DC application
 1 pole, NO, magnetic blow out

Maximum contact load **16 A/400 V AC-1** **10 A/220 V DC-1**
3,6 A/110 V DC-13 **2 A/220 V DC-13**

Contacts
 Material Standard Code 0 AgNi
 Rated current 16 A
 Switch-on current max. (20 ms) 40 A
 Switching voltage max. 400 V
 AC load (Fig 1) 4 kVA
 DC load see Fig. 2

Coil
 Coil resistance see table; tolerance ± 10 %
 Pick-up voltage ≤ 0,8 × U_N
 Release voltage ≥ 0,1 × U_N
 Nominal power 2,4 VA (AC)/1,3 W (DC)

Coil table

VAC	Ω	mA	VDC	Ω	mA
24	65	100	12	110	108
48	286	50	24	443	54
115	1K7	21	48	1K7	27
230	6K8	10	110	9K2	12
400	18K8	6	220	34K5	6,2

Insulation Volt rms, 1 min
 Contact open 4000 V
 Contact/contact 4 kV
 Contact/coil 4 kV
 Insulation resistance at 500 V ≥ 3 GΩ
 Insulation, IEC 61810-1 4 kV/3

Specifications
 Ambient temperature operation/storage -40 (no ice)...60 °C /-40 ... 80 °C
 Pick-up time/bounce time 20 ms/≤ 3 ms
 Release time/bounce time 10 ms/≤ 1 ms
 Mechanical life ops AC: 10 Mill./DC: 20 Mill.
 DC voltage endurance see fig. 2
 Switching frequency at rated load ≤ 1200/h
 Protection class IP40
 Weight 90 g

Standard types
VAC 50 Hz/60 Hz: 24, 48, 115 (120), 230 (240) LED RC suppressor (max 250 V)
C5-M10/AC ... V
C5-M10X/AC ... V
C5-M10R/AC ... V
VDC 12, 24, 48, 110, 220 LED Free wheeling diode
C5-M10/DC ... V
C5-M10X/DC ... V
C5-M10DX/DC ... V
C5-M10FX/DC ... V
Polarity and free wheeling diode
C5-M10BX/UC ... V
AC/DC bridge rectifier 24 V, 48 V, 60 V

"..." Enter the voltage for full type designation

Accessories
 Socket: **S5-S, S5-L, S5-P, S5-P0, S5-M**
 Optional accessories (blanking plug): **SO-NP, SO-OP**



Connection diagram

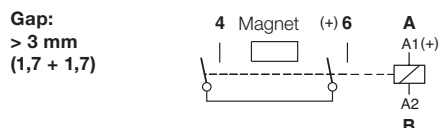


Fig. 1 AC voltage endurance

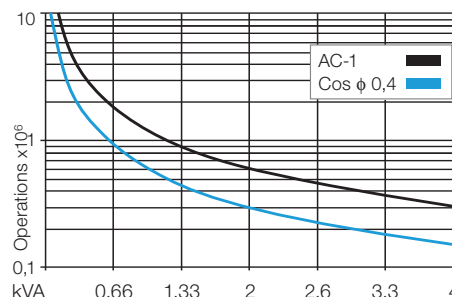
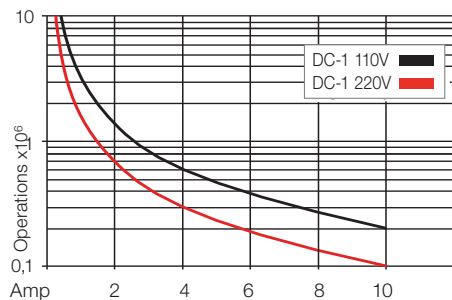
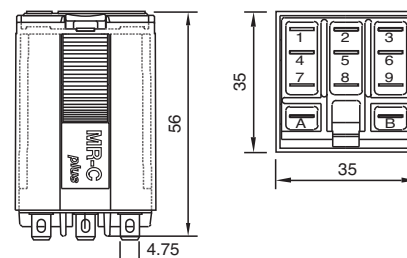


Fig. 2 DC voltage endurance



Dimensions [mm]



Technical approvals, conformities



IEC 61810; EN 60947

Type	C5-M2x/ ... V Power relays, DC application double pole, NO, magnetic blow out		
-------------	--	--	--

Maximum contact load	16 A / 250 V AC-1	7 A / 110 V DC-1	3 A / 220 V DC-1
-----------------------------	--------------------------	-------------------------	-------------------------

Contacts			
Material	Standard	Code 0	AgNi
Rated current			16 A
Switch-on current max. (20 ms)			40 A
Switching voltage max.			250 V
AC load (Fig 1)			4 kVA
DC load			see Fig. 2

Coil	
Coil resistance	see table; tolerance $\pm 10\%$
Pick-up voltage	$\geq 0,8 \times U_N$
Release voltage	$\geq 0,1 \times U_N$
Nominal power	2,4 VA (AC) / 1,6 W (DC)

Coil table						
VAC	Ω	mA	VDC	Ω	mA	
24	65	100	12	90	133	
48	286	50	24	373	66	
115	1K7	21	48	1K4	33	
230	6K8	10.4	110	7K6	15	

Insulation	Volt rms, 1 min
Contact open	2 kV
Contact/contact	4 kV
Contact/coil	3 kV
Insulation resistance at 500 V	$\geq 3 \text{ G}\Omega$
Insulation, EN 60947/IEC 61810-1:	4 KV/3

Specifications	
Ambient temperature operation/storage	-40 (no ice)...60 °C / -40 ... 80 °C
Pick-up time/bounce time	20 ms/ ≤ 3 ms
Release time/bounce time	10 ms/ ≤ 1 ms
Mechanical life ops	AC: 10 Mill./DC: 20 Mill. switching cycles
DC Rated load	≥ 75.000 switching cycles
Switching frequency at rated load	$\leq 1200/h$
Protection class	IP40
Weight	90 g

- Standard types**
VAC 50 Hz/60 Hz: 24, 48, 115 (120), 230 (240)
LED
RC suppressor (max 250 V)
- VDC 12, 24, 48, 110, 220**
LED
Free wheeling diode
Polarity and free wheeling diode
- AC/DC bridge rectifier 24 V, 48 V, 60 V**

- C5-M20/AC ... V**
C5-M20X/AC ... V
C5-M20R/AC ... V
- C5-M20/DC ... V**
C5-M20X/DC ... V
C5-M20DX/DC ... V
C5-M20FX/DC ... V
- C5-M20BX/UC ... V**

"..." Enter the voltage for full type designation

Accessories	
Socket:	S5-S, S5-L, S5-P, S5-P0, S5-M
Optional accessories (blanking plug):	SO-NP, SO-OP



Connection diagram

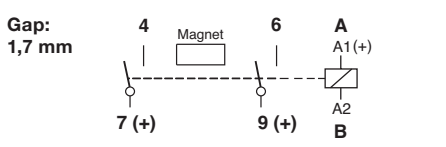


Fig. 1 AC voltage endurance

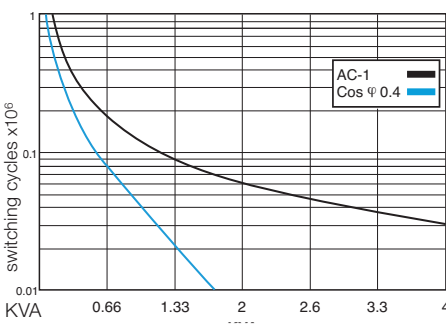
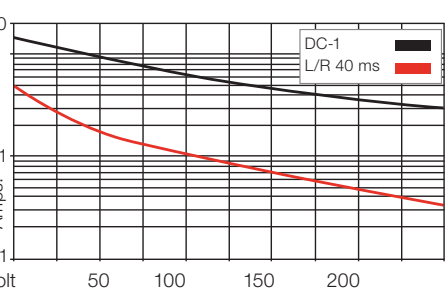
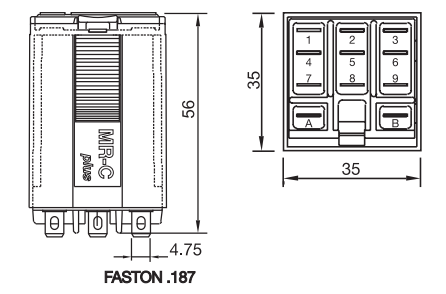


Fig. 2 DC load limit curve



Dimensions [mm]



Technical approvals, conformities



IEC 61810; EN 60947

C5-R2x

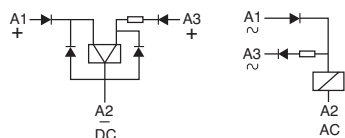
9-pin, remanence relay, 2-pole, faston

Type	C5-R2x/ ... V Magnetic latching – Remanence relays 2 change-over contact, 10A		
Maximum contact load	10 A/400 V AC-1 0,2 A/250 V DC-1	10 A/30 V DC-1 0,5 A/110 V DC-1	

Contacts			
Material	Standard	Code 0	AgNi
Rated current	10 A		
Switch-on current max. (20 ms)	30 A		
Switching voltage max.	400 V		
AC load (Fig 1)	4 kVA		
DC load	see Fig. 2		

Coil	
Coil resistance	see table; tolerance ± 10 %
ON pulse power	1,5 VA/W
OFF pulse power	0,5 VA/W
1 winding for AC, 2 winding for DC	
Pull-in ON/OFF	< 0,8 x U _N

Internal Diagram:



Coil table

VAC	mA ON	mA OFF	VDC	mA ON	mA OFF
24	75	12	12	125	41
48	38	6	24	63	21
115	16	2,5	48	31	10
230	8	1,3	110	14	4,5

Insulation	
Contact open	Volt rms, 1 min 1000 V
Contact/contact	4 kV
Contact/coil	4 kV
Insulation resistance at 500 V	≥3 GΩ
Insulation, EN 60947/IEC 61810-1	4 kV/3

Specifications	
Ambient temperature operation/storage	-40 (no ice)...60 °C / -40 ... 80 °C
Minimum pulse ON/OFF	50 ms
Mechanical life ops	AC: 10 Mill./DC: 20 Mill.
DC voltage endurance at rated load	≥100000 switching cycles
Switching frequency at rated load	≤ 1200/h
Protection class	IP40
Weight	95 g

Standard types

VAC 50 Hz/60 Hz: 24, 48, 115 (120), 230 (240)

C5-R20/AC ... V

VDC : 12, 24, 48, 110,

C5-R20/DC ... V

"..." Enter the voltage for full type designation

Accessories

Socket: **S5-S, S5-L, S5-P, S5-P0, S5-M**
Optional accessories (blanking plug): **SO-NP, SO-OP**



Connection diagram

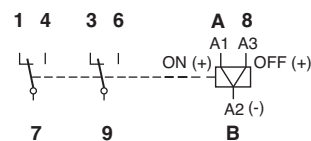


Fig. 1 AC voltage endurance

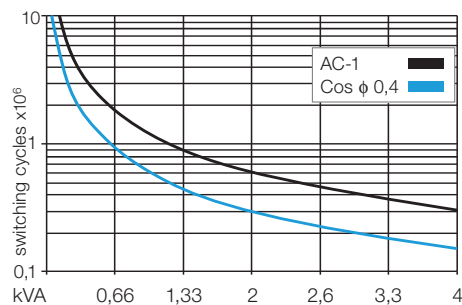
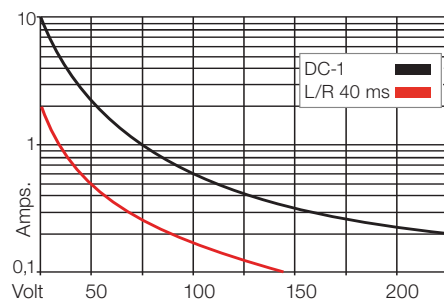
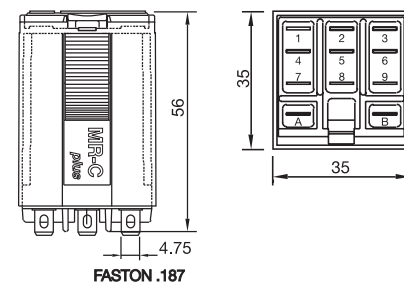


Fig. 2 DC load limit curves



Dimensions [mm]



Technical approvals, conformities


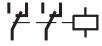

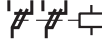

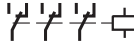

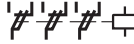


IEC 61810, EN 60947

1.4 Long Life Relays (Railway)

Long Life Series



Application	Types	Pins	Contacts	Contact ratings	Socket
C20 Series					
Long Life standard	C21			10 A / 250 V	S2
Long Life, reliable switching of lower loads	C22			5 A / 250 V	S2
C30 Series					
Long Life, Railway	C31			10 A / 250 V	S3
Long Life, reliable switching of lower loads, Railway	C32			5 A / 250 V	S3

C21 with single contacts

8 pin plug-in relay, 2-pole, according to IEC 67-I-5a

Type	C21/...V Long Life Relay 2 change over contacts Types with LED status indicator Types with free wheeling diode Manual actuator and mech. status indicator
-------------	---

Maximum contact load	10 A / 250 V AC-1, 10 A / 30 V DC-1
Recommended minimum contact load	50 mA / 10 V

Contacts	single contact micro disconnection
Type	AgCuNi
Material	10 A
Rated operational current	40 A
Max. inrush current (20 ms)	250 V
Rated switching voltage AC-1	2500 VA AC-1
Max. AC load	300 W / 90 W
Max. DC load 30 V / 230 V DC-1 (Fig. 2)	

Coils (Values are valid at 20 °C)	
Pick-up voltage	$\leq 0.8 \times V_N$
Release voltage AC / DC	$> 0.15 \times V_N / > 0.05 \times V_N$
Nominal power AC / DC	2.5 VA / 1.2 W

Coil Table

V_N AC	Ω	mA	V_N DC	Ω	mA
24	52	104	12	115	104
48	240	55	24	480	50
115	1350	23	48	1850	26
230	5600	11.5	110	9000	12
			220	29000	7.6

Types with LED indicator take additional 5 ... 10 mA @ < 80 V

Insulation	
Test voltage open contact	1.5 kVrms, 1 minute
Test voltage between adjacent poles	1.5 kVrms, 1 minute
Test voltage between contacts and coil	2 kVrms, 1 minute

General Specifications

Ambient temperature operation, storage	-40 ... +70 °C
Pickup time AC / DC	3 ... 10 ms / ≤ 12 ms
Release time AC / DC	2 ... 15 ms / ≤ 3.5 ms
Bounce time NO contact AC / DC	3 ... 6 ms / approx. 3.5 ms
Mechanical life	$\geq 10^8$ operations
Operating frequency at nominal load	≤ 360 operations / h
Ingress Protection degree	IP 40
Weight	80 g

Standard types

AC 50 Hz / 60 Hz: 24, 48, 115, 230

LED

DC: 12, 24, 48, 110, 220

Free wheeling diode

LED + Free wheeling diode

C21/AC...V
C21L/AC...V
C21/DC...V
C21D/DC...V
C21DL/DC...V

"..." enter the voltage for full type designation

Accessories

Socket: **EC-8, S2-B, S2-S, S2-L, S2-P, S2-PO**



Connection diagram

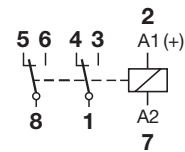


Fig.1 AC voltage endurance

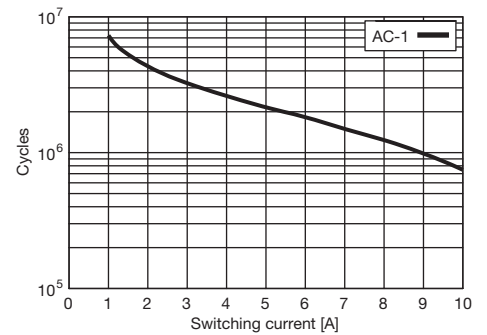
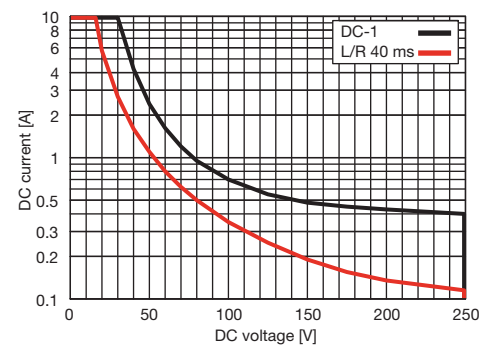
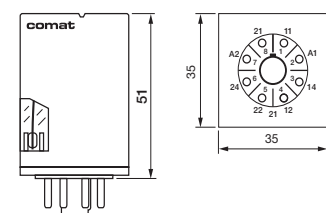


Fig. 2 DC load limit curve



Dimensions [mm]



Technical approvals, conformities



C22 with double contacts

8 pin plug-in relay, 2-pole, according to IEC 67-I-5a

Type	C22/...V Long Life Relay 2 change over double contacts Types with LED status indicator Types with free wheeling diode Manual actuator and mech. status indicator
-------------	--

Maximum contact load	6 A / 250 V AC-1 6 A / 30 V DC-1
Recommended minimum contact load	10 mA / 5 V

Contacts	
Type	double contact micro disconnection
Material	AgCuNi
Rated operational current	6 A
Max. inrush current (20 ms)	15 A
Rated switching voltage AC-1	250 V
Max. AC load	1500 VA AC-1
Max. DC load 30V / 230V DC-1 (Fig. 2)	200 W / 90 W

Coils (Values are valid at 20 °C)	
Pick-up voltage	$\leq 0.8 \times V_N$
Release voltage AC / DC	$> 0.15 \times V_N / > 0.05 \times V_N$
Nominal power AC / DC	2.5 VA / 1.2 W

Coil Table

V_N AC	Ω	mA	V_N DC	Ω	mA
24	52	104	12	115	104
48	240	55	24	480	50
115	1350	23	48	1850	26
230	5600	11.5	110	9000	12
			220	29000	7.6

Types with LED indicator take additional 5 ... 10 mA @ < 80 V

Insulation

Test voltage open contact	1.5 kVrms, 1 minute
Test voltage between adjacent poles	1.5 kVrms, 1 minute
Test voltage between contacts and coil	2 kVrms, 1 minute

General Specifications

Ambient temperature operation, storage	-40 ... +70 °C
Pickup time AC / DC	3 ... 10 ms / ≤ 12 ms
Release time AC / DC	2 ... 15 ms / ≤ 3.5 ms
Bounce time NO contact AC / DC	3 ... 6 ms / approx. 3.5 ms
Mechanical life	$\geq 10^8$ operations
Operating frequency at nominal load	≤ 360 operations / h
Ingress Protection degree	IP 40
Weight	80 g

Standard types

AC 50 Hz / 60 Hz: 24, 48, 115, 230

LED

DC: 12, 24, 48, 110, 220

Free wheeling diode

LED + Free wheeling diode

- C22/AC...V**
- C22L/AC...V**
- C22/DC...V**
- C22D/DC...V**
- C22DL/DC...V**

"..." enter the voltage for full type designation

Accessories

Socket:

EC-8, S2-B, S2-S, S2-L, S2-P, S2-PO



Connection diagram

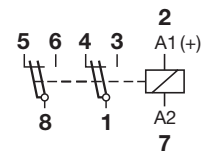


Fig.1 AC voltage endurance

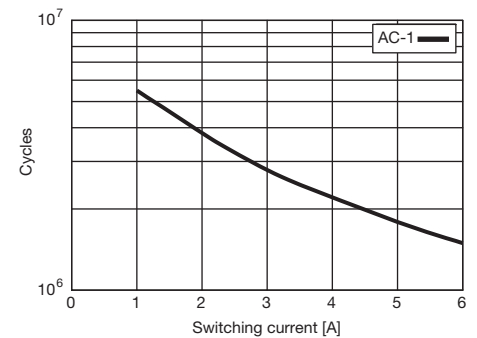
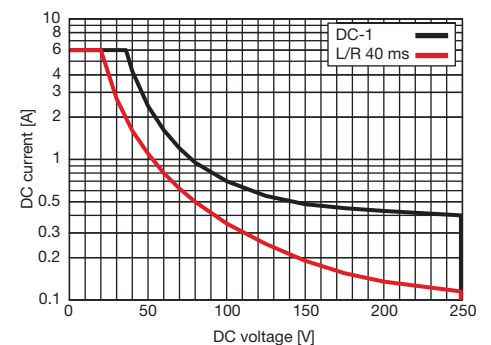
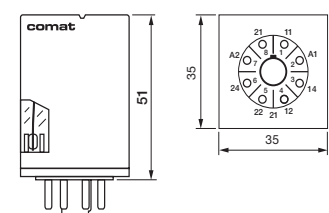


Fig. 2 DC load limit curve



Dimensions [mm]



Technical approvals, conformities



C31 with single contacts

11 pin plug-in relay, 3-pole, according to IEC 67-I-18a



Type	C31/...V Long Life Relay, according to EN 50 155 Railway 3 change over contacts Types with LED status indicator Types with free wheeling diode Manual actuator and mech. status indicator
-------------	---

Maximum contact load	10 A / 250 V AC-1 10 A / 30 V DC-1
Recommended minimum contact load	50 mA / 10 V

Contacts	
Type	single contact micro disconnection
Material	AgCuNi
Rated operational current	10 A
Max. inrush current (20 ms)	40 A
Rated switching voltage	250 V
Max. AC load	2500 VA AC-1
Max. DC load 30V / 230V DC-1 (Fig. 2)	300W / 90 W

Coils (Values are valid at 20 °C)	
Pick-up voltage	$\leq 0.8 \times V_N$
Release voltage AC / DC	$> 0.15 \times V_N / > 0.05 \times V_N$
Nominal power AC / DC	2.5 VA / 1.2 W

Coil Table					
V_N AC	Ω	mA	V_N DC	Ω	mA
24	52	104	12	115	104
48	240	55	24	480	50
115	1350	23	48	1850	26
230	5600	11.5	110	9000	12
			220	29000	7.6

Types with LED indicator take additional 5 ... 10 mA @ < 80 V

Insulation	
Test voltage open contact	1.5 kVrms, 1 minute
Test voltage between adjacent poles	1.5 kVrms, 1minute
Test voltage between contacts and coil	2 kVrms, 1minute

General Specifications	
Ambient temperature operation, storage	-40 ... +70 °C
Pickup time AC / DC	3 ... 10 ms / ≤ 12 ms
Release time AC / DC	2 ... 15 ms / ≤ 3.5 ms
Bounce time NO contact AC / DC	3 ... 6 ms / approx. 3.5 ms
Mechanical life	$\geq 10^8$ operations
Operating frequency at nominal load	≤ 360 operations / h
Ingress Protection degree	IP 40
Weight	80 g

Standard types	
AC 50 Hz / 60 Hz: 24, 48, 115, 230 (240)	C31/AC...V
LED	C31L/AC...V
DC: 12, 24, 48, 110, 220	C31/DC...V
Free wheeling diode	C31D/DC...V
LED + Free wheeling diode	C31DL/DC...V
Railway EN 50155; NF F 16-101/102	C31D/R DC...V

"..." enter the voltage for full type designation

Accessories	
Socket:	EC-11, EC11A, S3-B, S3-S, S3-L, S3-P, S3-PO



Connection diagram

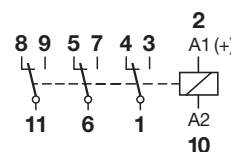


Fig.1 AC voltage endurance

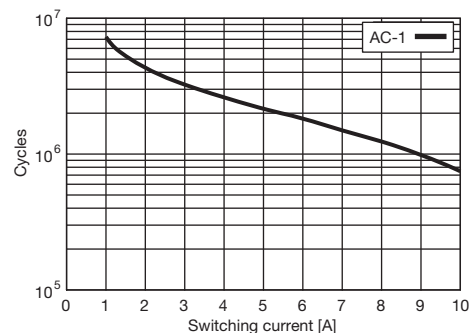
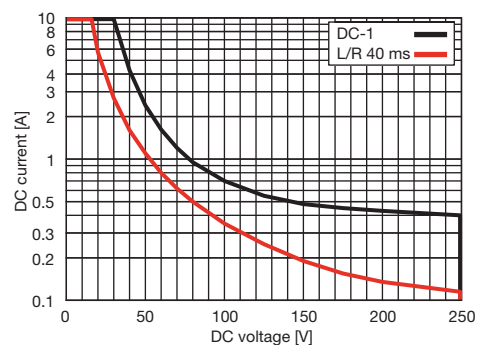
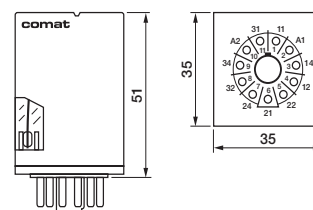


Fig. 2 DC load limit curve



Dimensions [mm]



Technical approvals, conformities



C32 with double contacts

11 pin plug-in relay, 3-pole, according to IEC 67-I-18a



Type	C32/...V Long Life Relay, according to EN 50 155 Railway 3 change over double contacts Types with LED status indicator Types with free wheeling diode Manual actuator and mech. status indicator
-------------	--

Maximum contact load	6 A / 250 V AC-1 6 A / 30 V DC-1
Recommended minimum contact load	10 mA / 5 V

Contacts	double contact micro disconnection
Type	double contact micro disconnection
Rated operational current	6 A
Max. inrush current (20 ms)	15 A
Rated switching voltage AC-1	250 V
Max. AC load	1500 VA AC-1
Max. DC load 30V / 230V DC-1 (Fig. 2)	200 W / 90 W

Coils (Values are valid at 20 °C)	
Pick-up voltage	$\leq 0.8 \times V_N$
Release voltage AC / DC	$> 0.15 \times V_N / > 0.05 \times V_N$
Nominal power AC / DC	2.5 VA / 1.2 W

Coil Table					
V_N AC	Ω	mA	V_N DC	Ω	mA
24	52	104	12	115	104
48	240	55	24	480	50
115	1350	23	48	1850	26
230	5600	11.5	110	9000	12
			220	29000	7.6

Types with LED indicator take additional 5 ... 10 mA @ < 80 V

Insulation	
Test voltage open contact	1.5 kVrms, 1 minute
Test voltage between adjacent poles	1.5 kVrms, 1 minute
Test voltage between contacts and coil	2 kVrms, 1 minute

General Specifications	
Ambient temperature operation, storage	-40 ... +70 °C
Pickup time AC / DC	3 ... 10 ms / ≤ 12 ms
Release time AC / DC	2 ... 15 ms / ≤ 3.5 ms
Bounce time NO contact AC / DC	3 ... 6 ms / approx. 3.5 ms
Mechanical life	$\geq 10^8$ operations
Operating frequency at nominal load	≤ 360 operations / h
Ingress Protection degree	IP 40
Weight	80 g

Standard types	
AC 50 Hz / 60 Hz: 24, 48, 115, 230 (240)	C32/AC...V
LED	C32L/AC...V
DC: 12, 24, 48, 110, 220	C32/DC...V
Free wheeling diode	C32D/DC...V
LED + Free wheeling diode	C32DL/DC...V
Railway EN 50155; NF F 16-101/102	C32D/R DC...V

"..." enter the voltage for full type designation

Accessories	
Socket:	EC-11, EC11A, S3-B, S3-S, S3-L, S3-P, S3-PO



Connection diagram

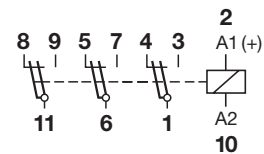


Fig.1 AC voltage endurance

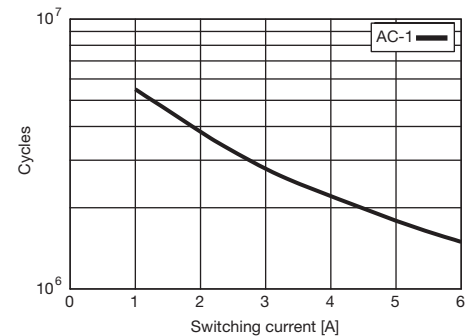
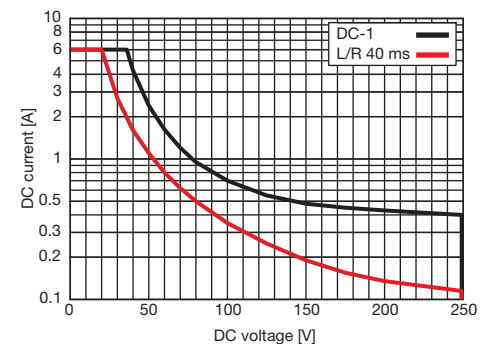
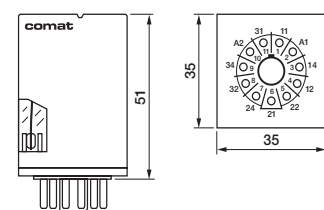


Fig. 2 DC load limit curve



Dimensions [mm]



Technical approvals, conformities



1.5 Solid State Relays



Application	Types	Pins	Contacts	AC ratings	DC ratings	Socket
CSS Series						
AC Solid state relay, Instantaneous switching	CSS-I			3 A / 250 V		S10
AC Solid state relay synch. to zero crossing	CSS-Z			3 A / 250 V		S10
NPN Solid state relay	CSS-N				6 A / 48 V	S10
PNP Solid state relay	CSS-P				6 A / 48 V	S10
CRINT Series						
DC solid state switch	CRINT-C1x5				2 A / 24 V	
AC solid state switch	CRINT-C1x8			1 A / 240 V		

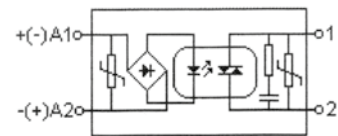
CSS-I

4-pin, Interface solid state relay, 1-pole, plug-in faston

Type	CSS-I Solid state relay For switching resistive and inductive AC loads Instantaneous
Output	1 N/O contact
Operating range	3 A, 24 ... 250 VAC, 50/60 Hz
Minimum contact load	35 mA
Control circuit	
Input voltage range	5 ... 48 VDC
Input current	10 mA
Output circuit	Instantaneous
Max. output current	3 A
Min. output current	35 mA
Output voltage range	24...250 VAC
Inrush current	150 A/10 ms
Residual current	1 mA
I ² t value	210 A ² s
Specifications	
Ambient temperature operation/storage	-40 ... 70 °C / -40 ... 85 °C
Pick-up time	0.06 ms
Release time	0.06 ms
Weight	28 g

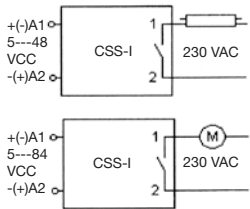


Fig. 1 CSS-I diagram

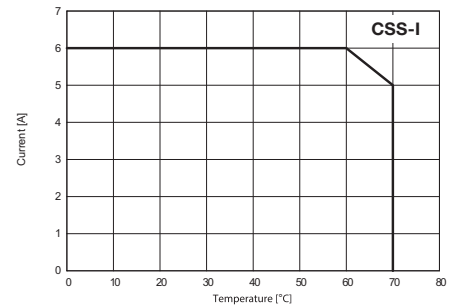


Applications

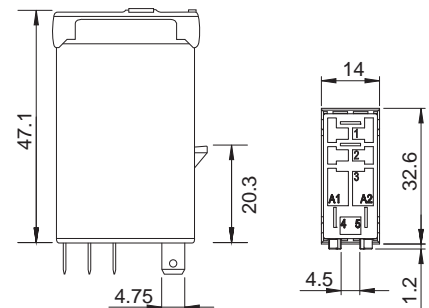
It is specially suitable to switch inductive loads up to 3A/250 VAC. For switching loads with a high inrush or overcurrent as transformers, motors or fluorescents, the maximum output current will limit to 2 A.



Tab. 2 AC derating curve



Dimensions [mm]



Technical approvals, conformities



CSS-Z

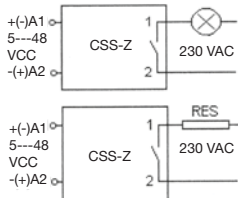
4-pin, Interface solid state relay, 1-pole, plug-in faston

Type	CSS-Z Solid state relay For switching resistive lamps and AC loads Synchronized to zero crossing
Output	1 N/O contact
Operating range	3 A, 24 ... 250 VAC, 50/60 Hz
Minimum contact load	35 mA
Control parameters	
Input voltage range	5 ... 48 VDC
Input current	10 mA
Output	Synchronized zero
Max. output current	3 A
Min. output current	35 mA
Output voltage range	24 ... 250 VAC
Inrush current	150 A/10 ms
Residual current	1 mA
I ² t value	210 A ² s
Specifications	
Ambient temperature operation/storage	-40...70 °C / -40 ... 85 °C
Pick-up time	10 ms
Release time	10 ms
Weight	28 g

Applications

Switches ohmic AC loads up to 3 A/250 VAC in the zero-point of the tension and avoids any overcurrent peak in the connection.

Suitable for switching resistors, incandescent lamps, signalling equipment, etc. Not suitable for inductive loads



Standard types

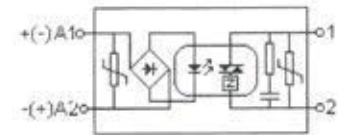
VDC 5-48 **CSS-Z12X/DC5-48V**

Accessories

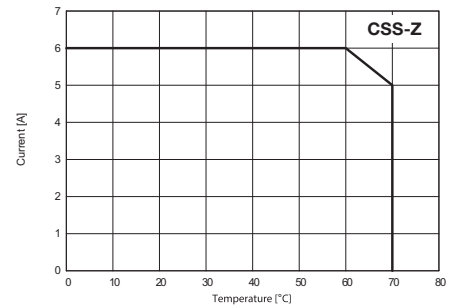
Socket: **S10, S10-M, S10-P**



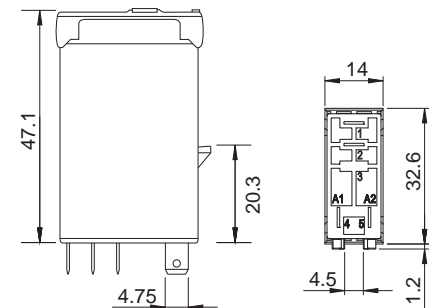
Fig. 1 CSS-Z diagram



Tab. 2 AC derating curve



Dimensions [mm]



Technical approvals, conformities



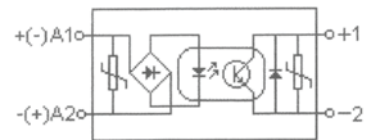
CSS-N

4-pin, Interface solid state relay, 1-pole, plug-in faston

Type	CSS-N NPN solid state relay Terminal commun 2 negative (S10 socket)
Output	1 N/O contact
Operating range	6 A, 5 ... 48 VDC
Minimum contact load	1 mA
Control parameters	
Input voltage range	5 ... 48 VDC
Input current	4 mA
Output	
Type	NPN
Max. output current	6 A
Output voltage range	5 ... 48 VDC
Switch-on current max.	40 A / 10 ms
Max. voltage drop	≤ 0,14 VDC
Residual current	0,1 mA
Specifications	
Ambient temperature operation/storage	-40 ... 70 °C/-40 ... 85 °C
Test voltage between input/output	4 kV rms/1 min.
Turn-on delay	0,06 ms
Release delay	0,06 ms
Weight	28 g



Fig. 1 CSS-N diagram

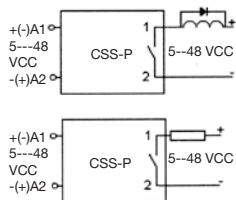


Negative common

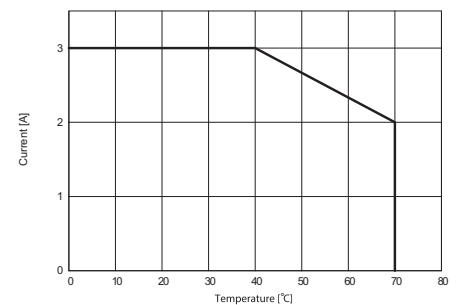
Applications

For switching heating elements, electro valves, motors, PLC input/output signals, solenoids, incandescent and fluorescent lamps, etc. (up to 48 VDC).

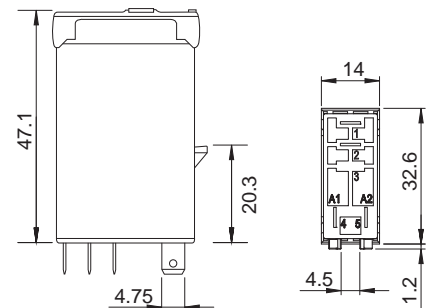
Inductive loads must be shunted with an antiparallel diode.



Tab. 2 DC derating curve



Dimensions [mm]



Technical approvals, conformities

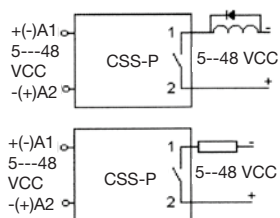


Type	CSS-P PNP solid state relay Terminal commun 2 positive (S10 socket)
Output	1 N/O contact
Operating range	6 A, 5 ... 48 VDC
Minimum contact load	1 mA
Control parameters	
Input voltage range	5 ... 48 VDC
Input current	4 mA
Output	
Type	PNP
Max. output current	6 A
Output voltage range	5 ... 48 VDC
Max. switch-on current	40 A / 10 ms
Max. voltage drop	0,14 VDC
Residual current	0,1 mA
Specifications	
Ambient temperature operation/storage	-40 ... 70 °C / -40 ... 85 °C
Turn-on delay	0,06 ms
Release delay	0,06 ms
Weight	28 g

Applications

For switching heating elements, electro valves, motors, PLC input/output signals, solenoids, incandescent and fluorescent lamps, etc. (up to 48 VDC).

Inductive loads must be shunted with an antiparallel diode.



Standard types

VDC 5-48

CSS-P13X/DC5-48V

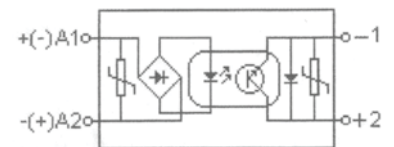
Accessories

Socket:

S10, S10-M, S10-P

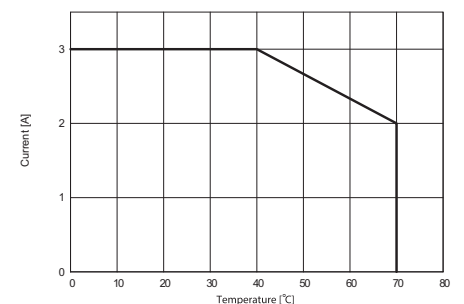


Fig. 1 CSS-P diagram

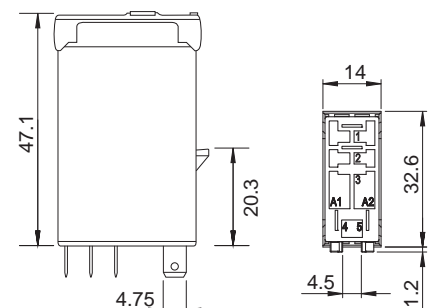


Positive common

Tab. 2 DC derating curve



Dimensions [mm]



Technical approvals, conformities



CRINT 1x5 series

Solid state interface module with mechanical NO output contact

DIN Rail mounting according to DIN 43 880



Types: CRINT-C115, CRINT-C125 / ...V

For PLC's and process control. DC solid state switch, type NO.
For fast and high frequent switching. With screw terminals (CRINT-S11) or cage clamp terminals (CRINT-S12).

Max. contact load	2 A, 24 V DC-1
Contact	
Type	1 NO (Solid state DC)
Material	MOSFET
Switching current _{TH}	2 A 24 V DC
Recommended minimal load	20 mA / 5 V
Peak inrush current	48 A/10 ms
Coil	
Operation voltage AC 50/60 Hz / DC	0.8 ... 1.25 U _N
Nominal power DC/AC	160 / — mW
Insulation	
Test voltage I / O	2.5 kVrms 1 minute
Pollution degree	3
Over voltage category	III
Open contact	1000 Vrms dielectric strength 1 min
Standard	EN61810-5

General Specifications

Ambient temperature: operation / storage	-30 ... +70 °C / -40 ... +85 °C
Typical response time @ V _n	1 ms
Typical release time @ V _n	1 ms
Cond. cross section screw terminal	2.5 mm ²
Cond. cross section spring cage	0.75 ... 2.5 mm ²
Ingress protection	IP 20
Mounting position	any
Housing material	Polyamide PA6

Order information

Screw terminal: CRINT-C115/UC...V	UC12V UC24V UC48V UC60V
Cage clamp terminal: CRINT-C125/UC...V	UC110-125V UC220-240V
„ ... “ enter the voltage for full type designation	

Accessories

Jumper link (5 pcs):	blue: CRINT-BR20-BU/5
	red: CRINT-BR20-RD/5
	black: CRINT-BR20-BK/5

Label plate (64 pcs):	CRINT-LAB/64
Spacer (5 pcs):	CRINT-SEP/5

Replacement relays:	DC12V DC24V DC48V DC60V*
„ ... “ enter the voltage for full type designation	

*60V Relay used for all sockets with a nominal voltage higher or equal 60V



Connection diagram

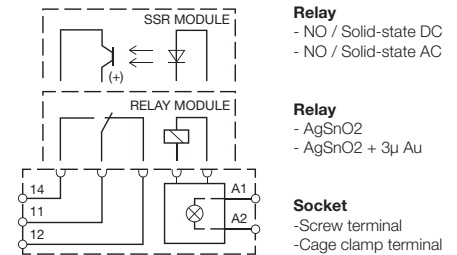


Fig.1 AC voltage endurance

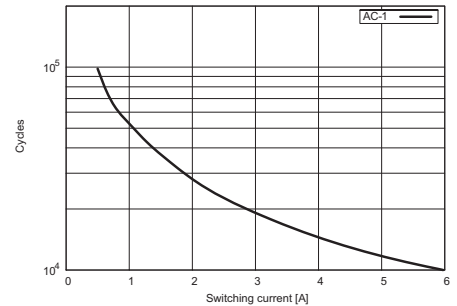
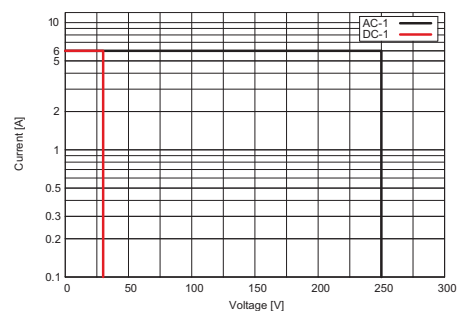
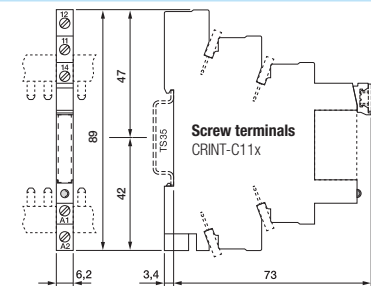


Fig. 2 DC load limit curve



Dimensions [mm]



Technical approvals, conformities



CRINT 1x8 series

Solid state interface module with mechanical NO output contact

DIN Rail mounting according to DIN 43 880

Types: CRINT-C118, CRINT-C128 / ...V

For PLC's and process control.

AC output interface zero synchronous switching NO for resistive or similar load. (No transformer rec.) With screw terminals (CRINT-S11) or cage clamp terminals (CRINT-S12).

Max. contact load	1 A, 240 V AC-1
Contact	
Type	1 NO (Solid state AC)
Material	TRIAC
Switching current _{TH}	1 A 240 V AC
Recommended minimal load	22 mA / 12 V
Peak inrush current	80 A/10 ms
Coil	
Operation voltage AC 50/60 Hz / DC	0.8 ... 1.25 U _N
Nominal power DC/AC	150 / — mW
Insulation	
Test voltage I / O	2.5 kVrms 1 minute
Pollution degree	3
Over voltage category	III
Open contact	1000 Vrms dielectric strength 1 min
Standard	EN61810-5

General Specifications	
Ambient temperature: operation / storage	-30 ... +70 °C / -40 ... +85 °C
Typical response time @ V _n	1 ms
Typical release time @ V _n	1 ms
Cond. cross section screw terminal	2.5 mm ²
Cond. cross section spring cage	0.75 ... 2.5 mm ²
Ingress protection	IP 20
Mounting position	any
Housing material	Polyamide PA6

Order information	
Screw terminal: CRINT-C118/UC...V	UC12V UC24V UC48V UC60V UC110-125V UC220-240V
Cage clamp terminal: CRINT-C128/UC...V	
„ ...“ enter the voltage for full type designation	

Accessories	
Jumper link (5 pcs):	blue: CRINT-BR20-BU/5 red: CRINT-BR20-RD/5 black: CRINT-BR20-BK/5

Label plate (64 pcs):	CRINT-LAB/64
Spacer (5 pcs):	CRINT-SEP/5

Replacement relays:	DC12V DC24V DC60V*
„ ...“ enter the voltage for full type designation	

*60V Relay used for all sockets with a nominal voltage higher or equal 60V



Connection diagram

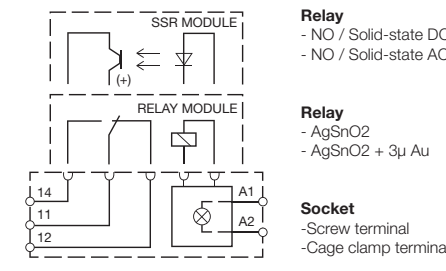


Fig.1 AC voltage endurance

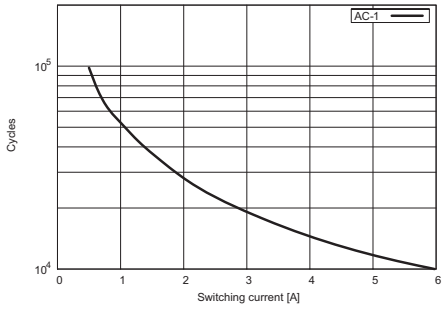
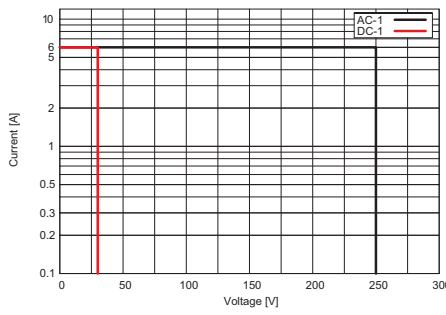
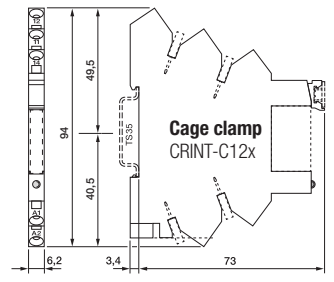


Fig. 2 DC load limit curve



Dimensions [mm]



Technical approvals, conformities



In combination with I/O sockets and the plug-in jumpers, the IRC relay series permits low-cost, clearly arranged and reliable realisation of interface circuits for the input and output ends of PLC and control systems.

S10-M and S12 sockets with one and two contacts, with inputs in series and identical arrangement of the contacts.

Identical order of coil and contacts on both sockets.

Coil terminal at level 1:

(A2, A2, A1)

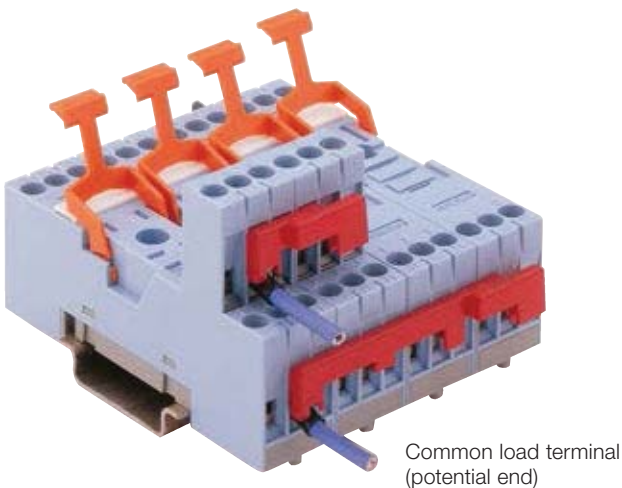
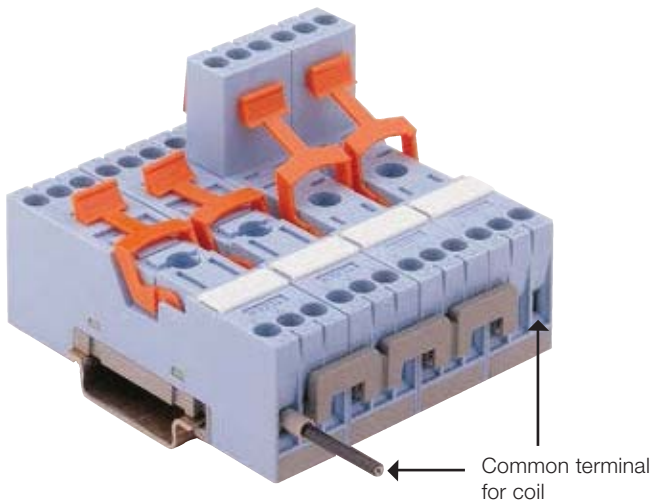
Power terminals at level 1:

(12, 11, 14)

Power terminals at level 2:

(22, 21, 24)

General



All plug-in jumpers are insulated. The plug-in jumpers at the drive end (coil) can be split manually to the required length, thus enabling the creation of any required interface groups.

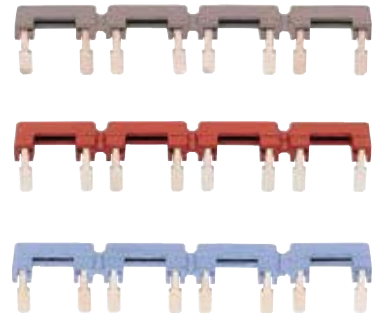
The jumpers are available in the colours grey, blue and red. .

Options:

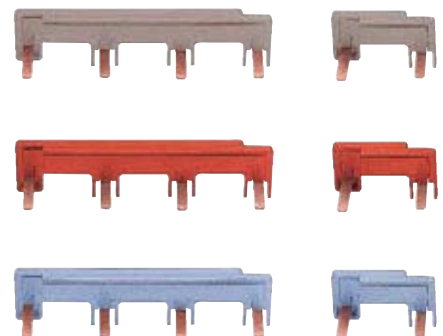
Colours used by RELECO in the relays' test buttons:

- Blue for DC circuits
- Red for AC circuits

B20 plug-in jumpers for the control end



V40 and V10 plug-in jumpers for the power end



V40, V10

Power bridge bars for sockets S10-M and S12

V40 bridges join four similar points in four aside adjacent sockets. They can join up either among themselves or to V10 units, to bridge an unlimited number of sockets S10-M and S12 in any combination.

V10 bridges are units to connect a single socket to the next one, so you bridge less or more than 4 sockets.

Made of copper with a current capacity of 40 A.

B20

Coil bridge bars for sockets S10-M and S12

B20 bridges points A2, internally connected, of every aside adjacent socket S10-M or S12.

Each element connects point 6 of the first socket to point 5 of the next one, always leaving free the point 5 of the first socket and the point 6 of the last one, to connect the common polarity cable.

V40-G



V10-G



B20-G



V40-R



V10-R



B20-R



V40-A



V10-A



B20-A



Jumper connection on S10-M and S12 sockets

The S10-M and S12 sockets and the new connection jumpers B20, V10 and V40 enable easy and fast wiring of rows of relays. The jumpers can be used in a mixed configuration of S10-M and S12 sockets.

Different jumper colours allow clear identification. This results in fewer errors, lower assembly costs and easier inspection and maintenance work. Available in grey (standard), red (AC) and blue (DC), in conformity with the colour coding used by RELECO for test buttons for relay identification.

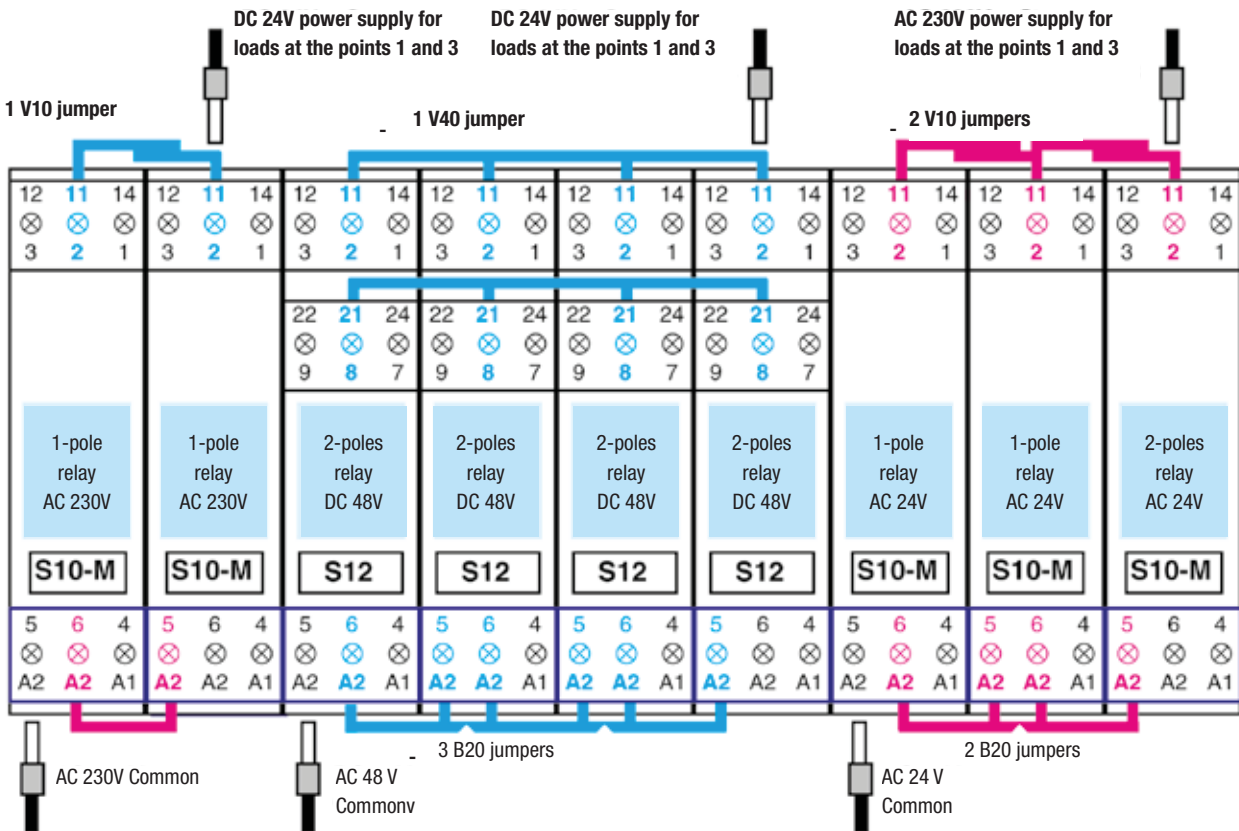
Attention needs to be paid only to the total current. At higher currents and also for safety reasons, a current supply at the start and end of a jumpered connection is recommended.

V40 plug-in jumpers for the power end

Contacts can be linked to the power ends with the aid of these jumpers. Normally, these are the changeover contacts, terminal 11 or 21. The jumpers can also be used to jumper NC or NO plug-in terminals. V40 jumpers link four identical contacts of four neighbouring sockets. They can either be linked to one another or to V10 jumpers to jumper a number of sockets in any combination.

V10 plug-in jumpers for the power end

V10 jumpers can be used to link individual sockets to one another in groups. A combination of V40 and V10 jumpers is possible, depending on the number of sockets.



B20 plug-in jumpers for the control end

The sockets S10-M and S12 are accessible via the plug-in terminals 5 and 6 for A2 (internal connection). Each element links terminal 6 of the first socket

to 5 of the next socket, and 5 of the first socket and 6 of the last socket are always left free to connect the cable. The jumper B20 consists of four coherent parts, which can be separated, however.

Input

Application

The CSS semiconductor switches have a useful life that is practically unlimited in terms of switching cycles. They operate without bounce and permit a high switching frequency

Drive

All versions feature an electrically isolated input for 5 to 32 V DC. The inputs are characterised by a minimum delay with a simultaneously high interference immunity.

DC semiconductor switches

There are two versions with identical performance data.

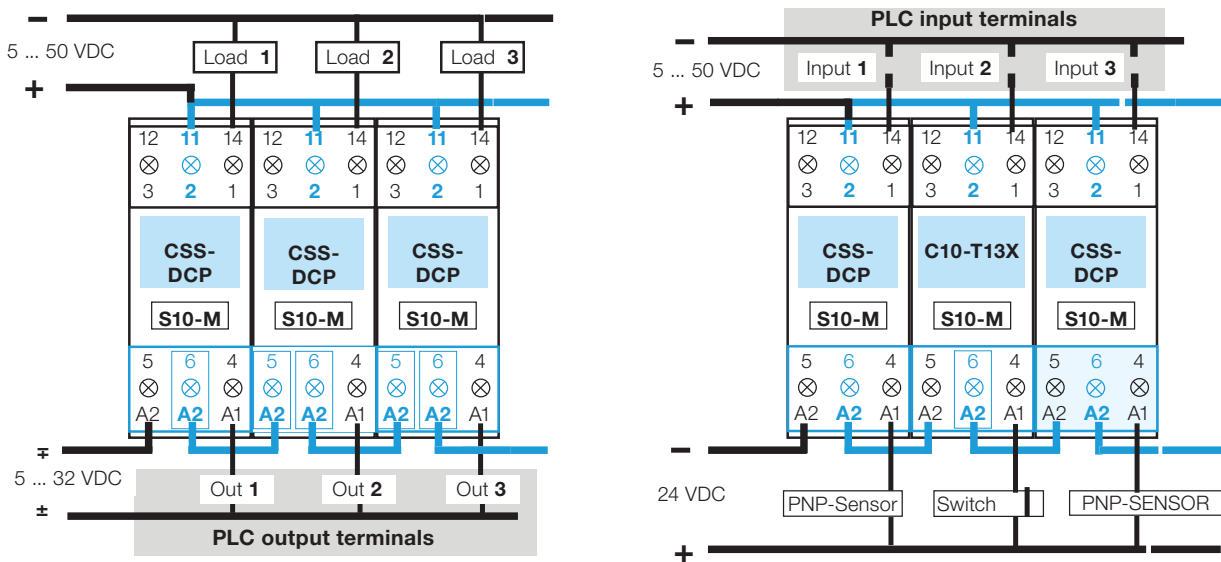
The CSS-DCN version has the common negative terminal 2, and the load is connected to terminal 1. The CSS-DCP has the common positive terminal at terminal 2. The load is connected to terminal 1. This corresponds to an NPN or PNP switch.

AC switches

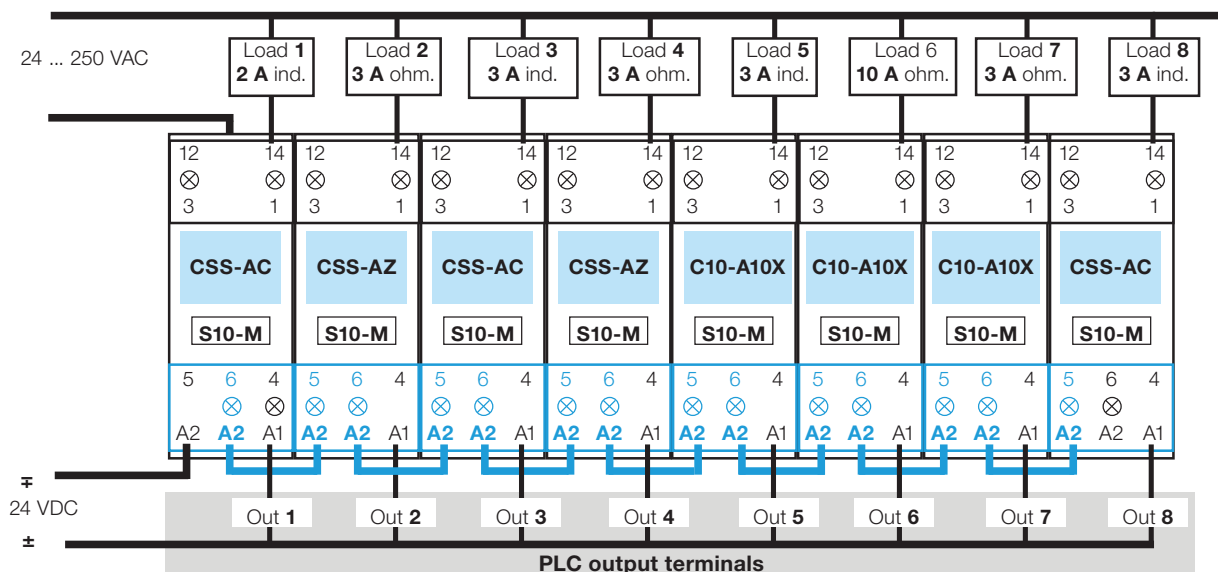
The CSS-AZ version switches synchronously, i.e. it switches during the passage through zero. The CSS-AC version switches asynchronously, i.e. the semiconductor switch switches through, independently of the phase, at the moment of detected triggering.

DC applications with mixed components

DC applications with mixed components



AC applications with mixed components



1.6 High Inrush Relays



Application	Types	Contacts	AC ratings	Socket
Power relay for high inrush current	C7-W1x	$\begin{matrix} / \\ \text{---} \\ \backslash \end{matrix}$	10 A / 250 V	S7
Hum-free installation contactor	RIC20	$\begin{matrix} / \\ \text{---} \\ \backslash \end{matrix}$ $\begin{matrix} / \\ \text{---} \\ \backslash \end{matrix}$ $\begin{matrix} / \\ \text{---} \\ \backslash \end{matrix}$	20 A / 400 V	DIN
Universal time relay for high inrush currents	CIM14	$\begin{matrix} / \\ \text{---} \\ \backslash \end{matrix}$	16 A / 250 V	DIN
Power relay for high inrush currents	CHI14	$\begin{matrix} / \\ \text{---} \\ \backslash \end{matrix}$	16 A / 250 V	DIN

OFTEN UNDERESTIMATED: HIGH INRUSH CURRENTS IN LIGHTING TECHNOLOGY

Lighting technology has been changing for some years now. Traditional light bulbs are rapidly being replaced with energy-efficient light sources such as fluorescent lamps and LEDs. All of these lamps have one thing in common: they require electronic control gear (ECG). The contacts on conventional relays wear out very quickly if used for triggering these devices.

Pre-devices such as relays and contactors are placed under an increased strain when switching ECGs and energy-saving lamps with integrated ECGs. This has to be taken into consideration when planning a new system. Even when refitting the lighting technology in an existing system, the new features have to be accounted for by adapting switching components to suit the new consumers. Be aware, however, that this issue affects more than just light sources. The structure of modern switching power supplies in many devices means that this problem is also found in other areas of electronics and installation. Modern devices require a low operating current but a very high inrush current, which has to be taken into account when designing switching devices.

ECG inrush processes

ECGs and switching power supplies allow for the inrush current to peak at the exact point the device is switched on. High inrush currents are created by the capacitors used in ECGs after the rectifier for smoothing out the current and as an energy store. If a capacitor is entirely discharged, a charging current, similar to an electrical short, may occur during the first micro-seconds of the inrush process.

Our example of an ECG for 2 × 24 W T5 fluorescent lamps shows that peak currents of more than 22 A – measured during the phase maximum – and a half-life of 305 μs may easily occur. During normal operation, this ECG absorbs a current of merely 220 mA. The inrush current is therefore 100 times higher than the nominal current in this example. The data sheets of renowned ECG manufacturers show, however, that inrush currents as high as 60 A may occur – with a lamp output of just 100 W. In daily life, complete lighting groups are most commonly switched on together, thus cumulating the effect of the high inrush current even further.

Great demand placed on relay performance

Common relay types use silver alloys such as silver-nickel (AgNi) for their contacts. They are not designed for inrush currents that are much higher than the nominal current. The thermic loads could weld the contacts shut after just a few switching-cycles. The result: the consumer can no longer be switched off.

An arc is created at the point the contact blades of a relay near each other during the switching process. The contact bounce found in mechanical contacts increases this arc even further. This effect is primarily influenced by the level and half-life of the inrush current. The temperatures created during the process can easily exceed the melting point of the contact alloy, thus leading to the contact blades being welded together.

The information provided in the data sheets of relay and consumer manufacturers is a first point of reference when calculating the correct specifications of a relay. They often disclose the inrush currents and peak times.

Disproportionately high inrush currents create an exceptionally high risk of welding, which is the reason why the contact material must be able to meet increased demands.

Relays for high inrush currents up to 800 A

Comat developed the high power relay CHI14 especially for inrush currents up to 800A.

The CHI14 has a tungsten (W/AgSnO₂) pre-contact with a higher melting point than ordinary silver alloys. This facilitates the switching of currents up to 800 A for 200 μs and 165 A for 20 ms. The switching during zero flow is another special feature of this high-tech product.

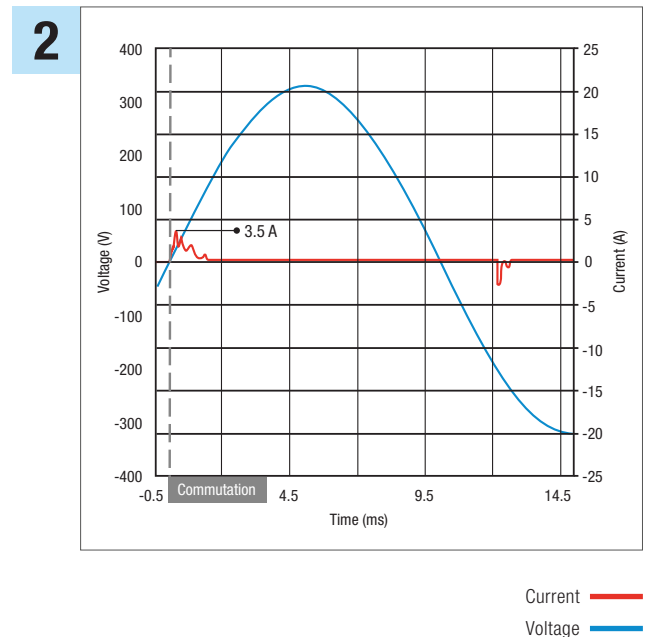
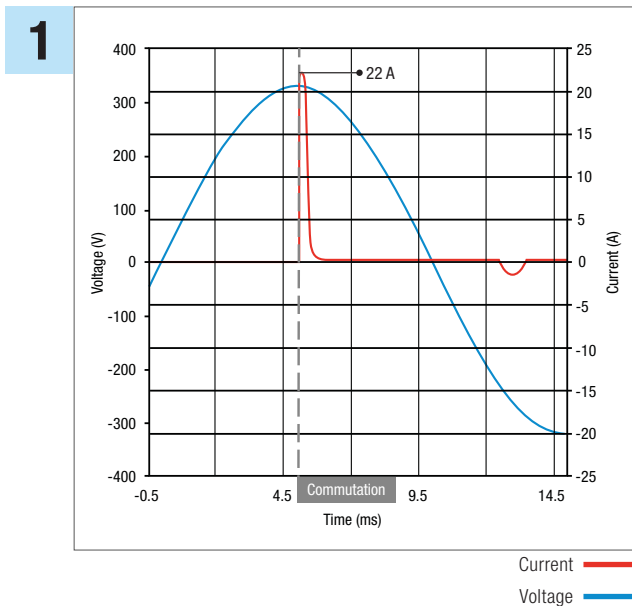
This significantly reduces the inrush current. The 2 × 24 W T5 ECG is an impressive example: Fig. 1 shows a inrush current without zero flow switching of 22 A. Thanks to the zero flow switching at almost 3.5 A, the inrush current is 85 % lower in Fig. 2.

With a 16A nominal current and a DIN housing with one module width, the CHI14 is suitable for installation in distributors and upgrading existing installations. It is also ideal for use in living areas as its switching process is almost entirely noiseless.

The multi-function time relay CIM14 of similar build features an additional 10 time functions such as stepping switches and automatic light switches in hallways.

The RIC series contactors have large-surface contacts that disconnect twice. Thanks to AgSnO₂ contacts, the RIC 40 and RIC63 types can switch currents up to 150 A for 100 ms. The RAC versions with on-off function and the RBC stepping switches are also interesting options for installation.

The movable relay C7-W10 is ideal for industrial applications. The tungsten (W/AgSnO₂) pre-contact makes it possible to handle inrush currents up to 500 A for 2.5 ms.



C7-W1x

4-pin, miniature relay, 1-pole, tungsten contact, faston

Type: **C7-W1x/ ... V**
 Power relay for high inrush current
 1 pole normally open

Maximum contact load: **10 A/250 V AC** **6 A/250 V AC5a/b**
Recommended minimum contact load: **10 mA/10 V**

Contacts

Material	Standard	Code 0	AgNi/W
Rated current			10 A
Switch-on current max. (2,5 ms)			500 A
Switching voltage max.			250 V
AC load (Fig 1)			2,5 kVA
DC load			see fig. 2

Coil

Coil resistance	see table; tolerance ± 10 %
Pick-up voltage	≤ 0,8 × U _N
Release voltage	≥ 0,1 × U _N
Nominal power	1,5 VA (AC)/1,5 W (DC)

Coil table

VAC	Ω	mA	VDC	Ω	mA
24	153	62	12	99	121
48	611	31	24	388	61
115	3K6	13	48	1K5	32
230	14K5	6,5	110	8K	14

Insulation

	Volt rms, 1 min
Contact open	1000 V
Contact/coil	2,5 kV
Insulation resistance at 500 V	≥ 1 GΩ
Insulation, IEC 61810-1	2,5 kV

Specifications

Ambient temperature operation/storage	-40 (no ice)...60 °C / -40 ... 80 °C
Pick-up time/bounce time	20 ms/≤ 3 ms
Release time/bounce time	10 ms/≤ 1 ms
Mechanical life ops	AC: 10 Mill./DC: 20 Mill.
DC voltage endurance at rated load	≥ 100000 switching cycles
Switching frequency at rated load	≤ 1200/h
Protection class	IP40
Weight	43 g

Standard types

VAC 50 Hz/60 Hz: 24, 48, 115 (120), 230 (240) LED

VDC 12, 24, 48, 110

LED

Free wheeling diode

Polarity and free wheeling diode

AC/DC bridge rectifier 24 V, 48 V, 60 V

C7-W10/AC ... V
C7-W10X/AC ... V

C7-W10/DC ... V
C7-W10X/DC ... V
C7-W10DX/DC ... V
C7-W10FX/DC ... V

C7-W10BX/UC ... V

"..." Enter the voltage for full type designation

Accessories

Socket: **S7-M, S7-I/O, S7-L, S7-P, S7-P0**
 Optional accessories (blanking plug): **S9-NP, S9-OP**



Connection diagram

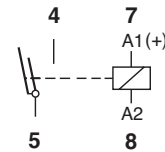


Fig. 1 AC voltage endurance

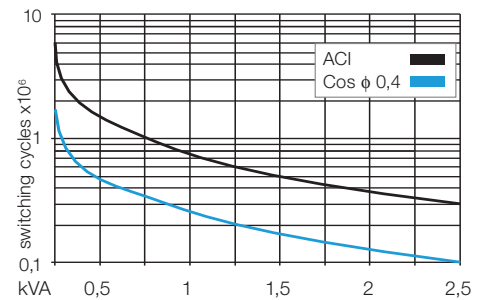
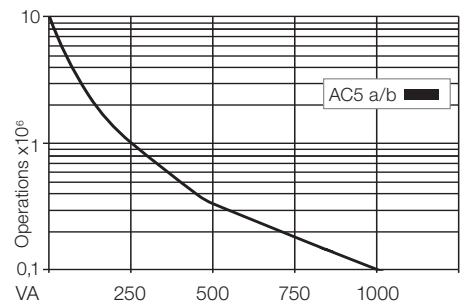
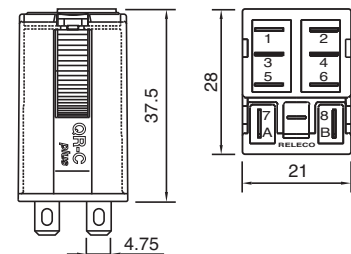


Fig. 2 AC voltage endurance



Dimensions [mm]



Technical approvals, conformities



IEC 61810; EN 60947

RIC20

20 A, AC/DC control voltage, silent operation
DIN rail mounting according to DIN 43 880



Type: RIC20-xxx/ ...V

Hum-free installation contactor, 2 contacts, 2 NO, 1 NO-1 NC, 2 NC types available

Rated operational power **4 kW / 230 V AC-1, 0.5 A / 220 V DC-1**
Recommended minimum contact load **10 mA / 24 V**

Contacts

Material	AgNi
Rated operational current	20 A
Max. inrush current (100ms)	50 A
Max. switching voltage	400 V
Max. AC load	AC-1, AC-7a AC-3
	4 kW / 230 V 1.3 kW /230 V (NO contact only)
Max. DC load	24 V / 220 V DC-1 (Fig. 1)
	480 W / 130 W

Control input V_n =

	UC 24 V	UC 36 V	UC 230 V
Operating voltage range [V]	20.4 ... 26.4	30.6 ... 39.6	195 ... 253
Typ. pic up voltage [V]	17	25	160
Typ. release voltage [V]	7	11	70
Power consumption [W]	≤ 2.5	≤ 2.5	≤ 2.5
Inductive turn-off voltage	None	None	None
Surge immunity EN 6100-4-5	2 kV	2 kV	2 kV

Insulation

Rated insulation voltage	230 V
Rated impulse withstand voltage	4 kV
Min. clearance of open contact	3.6 mm

General Specifications

Ambient temperature storage	-30 ... 80 °C
operation, Spacer after 2 contactors side by side	-5 ... 55 °C
operation, Spacer after 3 contactors side by side	-5 ... 40 °C
Pick-up time	15 ... 45 ms
Release time	20 ... 50 ms
Mechanical life	≥ 3 x 10 ⁶ operations
AC voltage endurance at rated load AC-3, AC-7b	≥ 3 x 10 ⁵ operations
DC voltage endurance at rated load DC-1	10 ⁵ operations
Operating frequency at rated load DC-1	≤ 300 operations / h
Operating frequency at rated load AC-1	≤ 600 operations / h
Conductor cross section coil /contacts	Stranded wire 2.5 mm ² / 6 mm ²
Max. Screw torque coil /contacts	0.6 Nm / 1.2 Nm
Ingress protection degree	IP 20
Weight	140 g

Standard types

UC (AC / DC) 50 / 60 Hz, 24, 36, 230

2NO	RIC20-200/UC ...V
1NO + 1NC	RIC20-110/UC ...V
2NC	RIC20-020/UC ...V

"..." enter the voltage for full type designation

Accessories

Sealing cover:	RIC-SEAL 20
Spacer:	RIC-DIST

Samples of lamp loads

Samples of lamp loads	Number of lamps
Incandescent lamps 230 V / 100 W	20
Fluorescent lamps not corrected 230 V / 36 W	17
Fluorescent lamps electronic ballast units 36 W	15

Find more information about RIC, RAC, RBC series on pages 117 – 127.

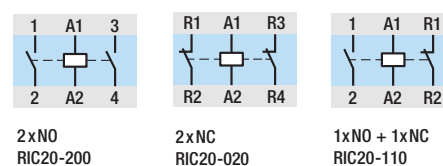
Mounting information

If multiple contactors are mounted side by side, spacers (RIC DIST) have to be inserted for the purpose of heat dissipation.

Example: Ambient temperature up to 40°C: 1 spacer after 3 RIC // 40...55°C: 1 spacer after 2 RIC.



Connection diagram



Coil circuit

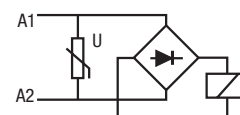
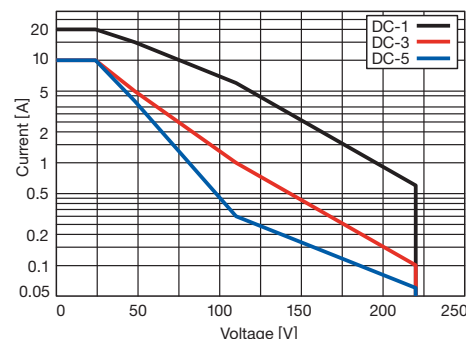
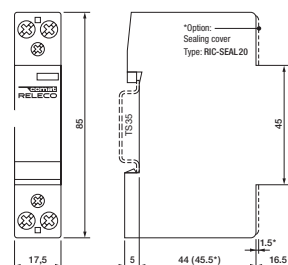


Fig. 1 DC load limit curve DC1



Dimensions [mm]



Technical approvals, conformities



IEC/EN 60947-4-1, VDE 0660
 IEC/EN 60947-5-1
 IEC/EN 61095, VDE 0637

CIM14

**Time relay with NO contact for high inrush currents up to 800 A
8 time functions + stepping function, ON-OFF switch, 50 ms ... 60 h,
DIN Rail mounting according to DIN 43 880**



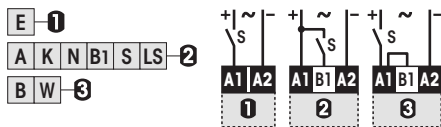
Type: CIM14/UC24-240V

Sophisticated multifunction time relay, 1 NO power contact for high inrush currents up to 800 A with zero crossing switching (50/60 Hz), 8 time functions, stepping function and service function ON/OFF, time ranges: 50 ms ... 60 h, multifunction LED state indicator, suitable for any time-control application and also staircase lighting, Light-switch neon lamp current absorption on input B1, Manual switching function for maintenance, emergency, etc., 16.6 Hz power supply applications. Railway version available.

Maximum contact load 16 A / 250 V AC-1 384 W DC-1
Recommended minimum contact load 100 mA / 12 V

Time functions and related connection diagrams (Function diagrams: refer to page 152)

The functions are selectable by rotary switch



LED function table:

LED	Relay	Time run
OFF	OFF	NO
Continuous ON	ON	NO
Short blinking	OFF	YES
Long blinking	ON	YES

Time data

7 partial time ranges, t_{max} (rotary switch) 0.6, 6, 60 s / 6, 60 min / 6, 60 h
 Fine adjustment range (rotary knob) $t_{min} \dots t_{max}$, 0.5 ... 6
 Time range tolerance t_{min} : -5 % ... +0 % / t_{max} : -0 % ... +5 %
 Repetition accuracy ± 0.1 % or DC: 2 ms / AC: 10 ms
 Response time, power on, on A1 ≤ 45 ms
 Min. trigger pulse on B1 20 ms (AC / DC)
 Reset time B1 (AC/DC) ≤ 30 ms
 Voltage failure buffering (50 / 60 Hz) ≥ 20 ms

Contacts

Material W / AgSnO₂
 Rated operational current at 40 °C / 60 °C 16 A / 13 A
 Max. inrush current 165 A / 20 ms
 800 A / 200 μ s
 Max. switching voltage AC-1 250 V
 Max. AC load AC-1 (Fig.1) 4 kVA
 Max. DC load DC-1 24 V 384 W

Power supply- and control input

Nominal voltage (A1, B1) **UC 24-240 V (UC = AC / DC)**
 Operating voltage range 16.8 ... 250 V
 Power consumption 1.2 VA / 0.43 W
 Frequency range 16 ... 60 Hz
 Allowed DC residual current into B1 ≤ 0.5 mA
 AC Neon lamp residual current into B1 ≤ 10 mA
 Trigger threshold voltage on B1, AC / DC 15 / 17 V

Insulation

Test voltage open contact 1 kVrms 1 minute
 Test voltage between contacts and control input 2.5 kVrms 1 minute

General Specifications

Ambient temperature storage /operation -40 ... 85 °C / -40 ... 60 °C
 Mechanical life of contact 5×10^6 operations
 Conductor cross section Stranded wire 2.5 mm², 2 x 1.5 mm²
 Ingress protection degree IP 20
 Max. Screw torque 0.4 Nm
 Housing material / weight Lexan / 70 g

Standard types

UC (AC/DC) 15...60 Hz

CIM14/UC24-240V



Connection diagram

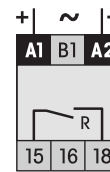


Fig.1 AC voltage endurance

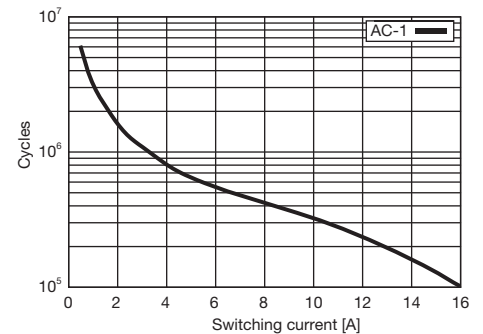
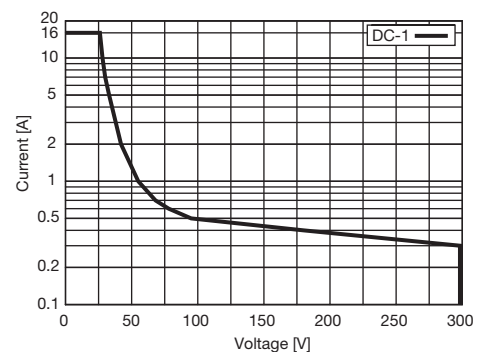
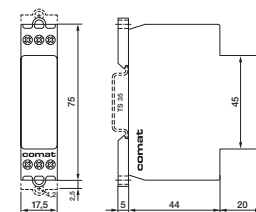


Fig. 2 DC load limit curve



Dimensions [mm]



Technical approvals, conformities

EN 50155, EN 60730



CHI14

Power relay for high inrush currents up to 800 A DIN Rail mounting according to DIN 43 880

Type: CHI14/UC24-240V

The CHI14 is a power relay for all applications effecting high inrush currents up to 800 A such as electronic control gears of energy saving lamps, power supplies of the latest LED lights and switching supplies of industrial components. These loads show an inrush current up to 250 times of their nominal current.

The CHI14 is equipped with a low noise operating NO contact with a nominal current up to 16 A and complies with the applicable DIN standards 43880 with installation dimension of 17.5 mm (1 module width).

Maximum contact load	16 A / 250 V AC-1 384 W DC-1
Recommended minimum contact load	100 mA / 12 V

Contacts

Material	W / AgSnO ₂
Rated operational current at 40 °C / 60 °C	16 A / 13 A
Max. inrush current	165 A / 20 ms 800 A / 200 µs
Max. switching voltage AC-1	250 V
Max. AC load AC-1 (Fig.1)	4 kVA
Max. DC load DC-1 24 V /	384 W

Power supply- and control input

Nominal voltage (A1, B1)	UC 24-240 V (UC = AC / DC)
Operating voltage range	16.8 ... 250 V
Power consumption	1.2 VA / 0.43 W
Frequency range	16 ... 60 Hz

Insulation

Test voltage open contact	1 kVrms 1 minute
Test voltage between contacts and control input	2.5 kVrms 1 minute

General Specifications

Ambient temperature storage /operation	-40 ... 85 °C / -40 ...60 °C
Mechanical life of contact	5 x 10 ⁶ operations
Conductor cross section	Stranded wire 2.5 mm ² , 2 x 1.5 mm ²
Ingress protection degree	IP 20
Max. Screw torque	0.4 Nm
Housing material / weight	Lexan / 70 g

Standard types

UC (AC/DC) 15...60 Hz

CHI14/UC24-240V



Connection diagram

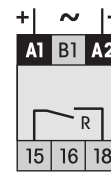


Fig.1 AC voltage endurance

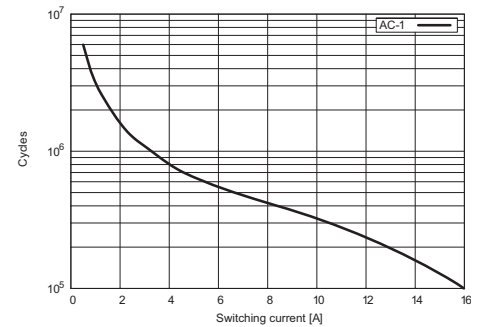
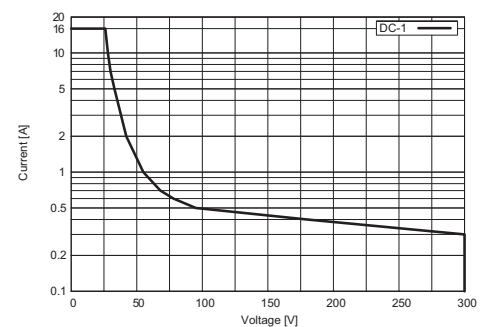
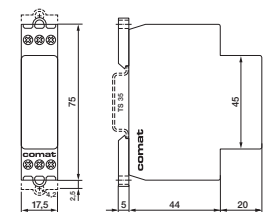


Fig. 2 DC load limit curve



Dimensions [mm]







Technical approvals, conformities

EN 50155, EN 60730



1.7 Motor Control Relays



Application	Types	Output	DC ratings	Mounting
DC Motor controller	CMC1	 2x MOSFET	16 A (20 A) / 24 V	DIN
	CMC15	 2x MOSFET H bridge	10 A (20 A) / 24 V	DIN
	CMC16	 2x MOSFET H bridge	10 A (20 A) / 24 V	DIN
DC Motor control relay	KDM3-24	 1x PNP & 1x NPN	3 A / 32 V	S7-C

CMC1

DC Motor controller with adjustable start and breaking ramps for DC motors up to 384W

Type: CMC1/DC12-24V

The CMC is a control device for DC motors and permits operation in both rotating directions, i. e. the rotating direction can be reversed with the input signal. Alternatively, two motors can be operated in the same direction.

The CMC1 allows also to control lamps or electromagnets. The start and breaking ramps of the connected loads can be adjusted by two potentiometers in the time range 0 - 4 seconds.

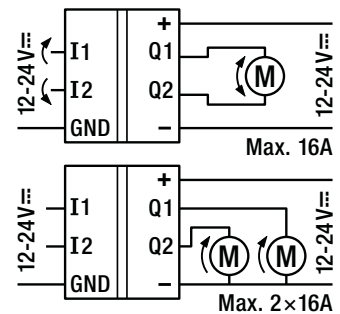
Maximum load	16 A / 24 V
Outputs	Drive
Type	MOSFET
Nominal switching current	16 A
Inrush current	20 A (short-term)
Nominal voltage	24 V
Switching power	384 W
Control input $V_n =$	12-24 V
Nominal operating voltage range (DC)	12 – 24 V
Admissible voltage range (DC)	8 – 28 V
Current consumption	DC
12 V	3 mA
24 V	6 mA
Power supply	
Nominal operating voltage (DC)	12 – 24 V
Operating voltage (DC)	8 – 28 V
Max. current consumption without load	10 mA
Max. power consumption	DC
12 V	120 mW
24 V	240 mW

General Specifications	
Ambient temperature storage/operation	-40 – +85°C / -25 – +60°C
Connection terminals	Screw terminal 2.5 mm ²
DC voltage endurance at rated load	> 100 000 h (at 25 °C)
Ingress protection degree	IP 20
Mounting	DIN rail TS35
Housing material	Aluminium
Weight	80 g

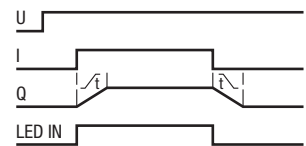
Standard types	
DC 12-24	CMC1/DC12-24V



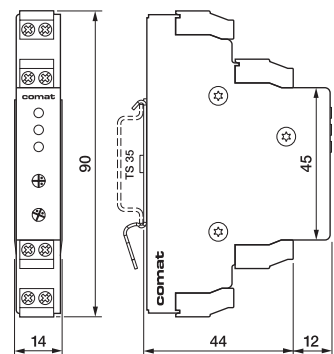
Connection diagram



Function diagramm



Dimensions [mm]



Technical approvals, conformities



CMC15

DC Motor controller with adjustable start and braking ramps and speed control by 0 ... 10 V signal for DC motors up to 240W

Type: CMC15/DC12-24V

The CMC15 is a control device for DC motors and permits operation in both rotating directions, i. e. the rotating direction can be reversed with the input signal. Alternatively two motors can be operated in the same rotating direction. The motor speed is set by a 0 – 10 V signal.

Maximum load **10 A / 24 V**

Outputs	Drive
Type	MOSFET H bridge
Nominal switching current	10 A
Inrush current	20 A / max. 3 s
Nominal voltage	24 V
Switching power	240 W

Analogue inputs	
Nominal operating voltage range (DC)	0 – 10 V
Resolution	8 Bit
Input impedance	55 kΩ

Power supply	
Nominal operating voltage (DC)	12 – 24 V
Operating voltage (DC)	8 – 28 V
Max. current consumption without load	10 mA
Max. power consumption	DC
12 V	120 mW
24 V	240 mW

Time response	
Start ramp	0 – 2 s
Braking ramp	0 – 2 s

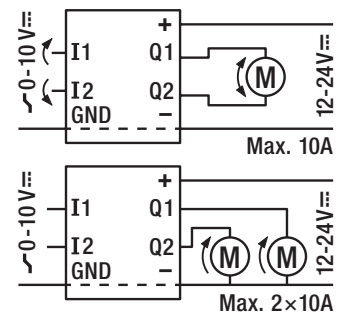
General Specifications	
Ambient temperature storage/operation	-40 – +85°C / -25 – +60°C
Connection terminals	Screw terminal 2.5 mm ²
DC voltage endurance at rated load	> 100 000 h (at 25 °C)
Ingress protection degree	IP 20
Mounting	DIN rail TS35
Housing material	Aluminium
Weight	80 g

Standard types

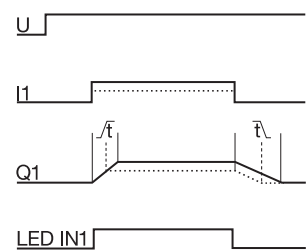
DC 12-24 **CMC15/DC12-24V**



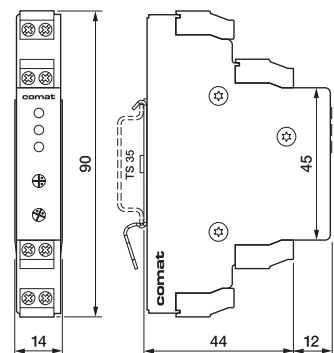
Connection diagram



Function diagramm



Dimensions [mm]



Technical approvals, conformities



CMC16

DC Motor controller with adjustable start and breaking ramps and speed control by 4 ... 20 mA signal for DC motors up to 240W

Type: CMC16/DC12-24V

The CMC16 is a control device for DC motors and permits operation in both rotating directions, i. e. the rotating direction can be reversed with the input signal. Alternatively two motors can be operated in the same rotating direction. The motor speed is set by a 4 – 20 mA signal.

Maximum load **10 A / 24 V**

Outputs	Drive
Type	MOSFET H bridge
Nominal switching current	10 A
Inrush current	20 A / max. 3 s
Nominal voltage	24 V
Switching power	240 W

Analogue inputs	
Nominal operating voltage range (DC)	4 – 20 mA
Resolution	8 Bit
Input impedance	190 Ω

Power supply	
Nominal operating voltage (DC)	12 – 24 V
Operating voltage (DC)	8 – 28 V
Max. current consumption without load	10 mA
Max. power consumption	DC
12 V	120 mW
24 V	240 mW

Time response	
Start ramp	0 – 2 s
Breaking ramp	0 – 2 s

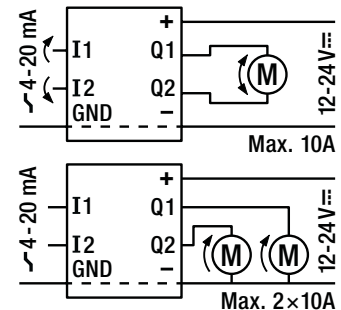
General Specifications	
Ambient temperature storage/operation	-40 – +85°C / -25 – +60°C
Connection terminals	Screw terminal 2.5 mm ²
DC voltage endurance at rated load	> 100 000 h (at 25 °C)
Ingress protection degree	IP 20
Mounting	DIN rail TS35
Housing material	Aluminium
Weight	80 g

Standard types

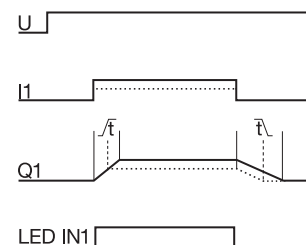
DC 12-24 **CMC16/DC12-24V**



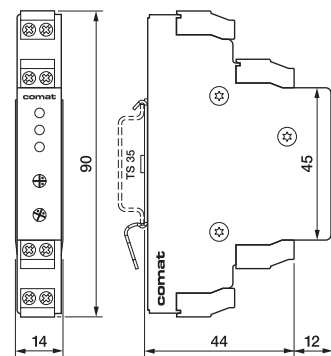
Connection diagram



Function diagramm



Dimensions [mm]



Technical approvals, conformities



KDM 3-24

DC Motor control relay with brake function, DC 24 V 1 high side switch and 1 N-channel brake switch

Type: KDM 3-24/DC12-24V R

Solid state relay for DC-motor control and similar applications
1 high side + 1 N channel transistor switch
All overload and short circuit protected
Adjustable or disabled brake function by external resistor or jumper
LED status indicator
Pluggable module

Maximum load **3 A / 32 V**

Outputs

Type: Power MOS FET
Max. switching current
Max. continuous current
Max. inrush current, 1 sec ²⁾
Switching voltage range
Max. Load
Thermal overload protection ²⁾
Over current limiting ²⁾
Clamp voltage
Max. inductive switch-off energy ²⁾
ON resistance @ 25 °C
Leakage current

Drive

High side
3 A
3 A (5 A) ¹⁾
20 A
10 ... 32 V
100 W
self restoring
typ. 35 A
typ. 58 V
1 Ws single pulse
≤ 50 mΩ
≤ 10 μA

Brake

N-channel
3 A, 10 sec
2 A
7
10 ... 32 V
65 W
self restoring
7 ... 14 A
60 ... 70 V
0.4 Ws single pulse
≤ 100 mΩ

¹⁾ Repetitive operation: When the ratio t_{pulse} / t_{cycle} is a low value then the current can be increased up to 5 A @ $T_A \leq 50$ °C.

²⁾ Not for continuous repetitive operation

Control input $V_N =$

Operating voltage range
Release voltage
Typical input current @ 12 / 24 V
Power consumption @ 12 / 24 V
Polarity reversal

DC 12-24 V

9 ... 28 V
≤ 2 V
2 / 6.5 mA
25 / 160 mW
protected

General Specifications

Ambient temperature storage/operation -40 ... +85°C / -25 ... +60°C
ON delay 1 ms
Release time 1 ms
Ingress protection degree IP 40 when the device is plugged in
Housing material Lexan
Weight 27 g

Standard types

DC 12-24

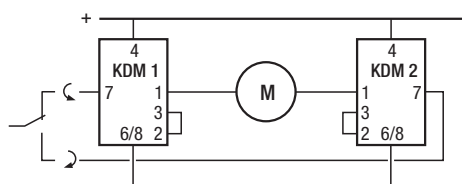
KDM3-24/DC12-24V R

Accessories

Socket: **S7-C**

Application example

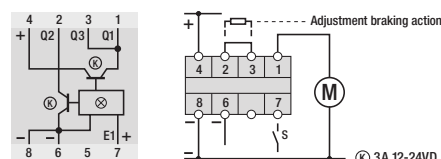
Four quadrant (forward / reversed) motor control



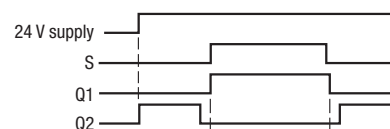
Operating with brake resistors (on 2–3) is not recommended in this application.



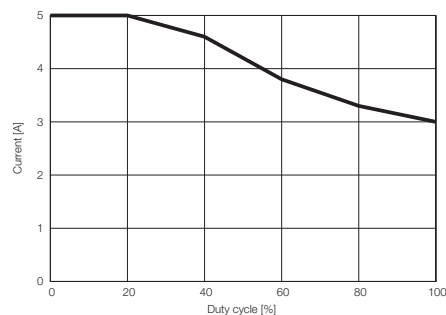
Connection diagram



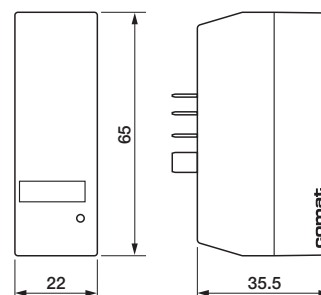
Function diagramm



Output current vs. duty cycle



Dimensions [mm]



Technical approvals, conformities



1.8 Installation Contactors



- Different versions NO; NC; NC + NO
- AC/DC Coil Hum free
- No EMC (free wheeling circuit included)
- Robust and compact
- Wide Range of application
- Mounting according DIN/EN 43880 on DIN Rail TS 35
- Sealing cover optional

RIC20

20 A, AC/DC control voltage, silent operation
DIN rail mounting according to DIN 43 880



Type: RIC20-xxx/ ...V

Hum-free installation contactor, 2 contacts, 2 NO, 1 NO-1 NC, 2 NC types available

Rated operational power	4 kW / 230 V AC-1, 0.6 A / 220 V DC-1
Recommended minimum contact load	50 mA / 24 V

Contacts

Material	AgNi
Rated operational current	20 A
Max. inrush current (100ms)	50 A
Max. switching voltage	230 V
Max. AC load	AC-1, AC-7a
	4 kW / 230 V
	AC-3
	1.3 kW / 230 V (NO) 0.75 kW / 230 V (NC)
Max. DC load 24 V / 220 V DC-1 (Fig. 1)	480 W / 130 V

Control input V_n =

	UC 24 V	UC 36 V	UC 230 V
Operating voltage range [V]	20.4 ... 26.4	30.6 ... 39.6	195 ... 253
Typ. pick up voltage [V]	17	25	160
Typ. release voltage [V]	7	11	70
Power consumption [W]	2.1	2.1	2.1
Inductive turn-off voltage	None	None	None
Surge immunity EN 6100-4-5	2 kV	2 kV	2 kV

Insulation

Rated insulation voltage	230 V
Rated impulse withstand voltage	4 kV
Min. clearance of open contact	3.6 mm

General Specifications

Ambient temperature storage	-30 ... 80 °C
operation, Spacer after 2 contactors side by side	-5 ... 55 °C
operation, Spacer after 3 contactors side by side	-5 ... 40 °C
Pick-up time	15 ... 45 ms
Release time	20 ... 50 ms
Mechanical life	≥ 3 x 10 ⁶ operations
AC voltage endurance at rated load AC-3, AC-7b	≥ 3 x 10 ⁵ operations
DC voltage endurance at rated load DC-1	10 ⁵ operations
Operating frequency at rated load DC-1	≤ 300 operations / h
Operating frequency at rated load AC-1	≤ 600 operations / h
Conductor cross section coil /contacts	Stranded wire 2.5 mm ² / 6 mm ²
Max. Screw torque coil /contacts	0.6 Nm / 1.2 Nm
Ingress protection degree	IP 20
Weight	140 g

Standard types

UC (AC / DC) 50 / 60 Hz, 24, 36, 230	2NO	RIC20-200/UC ...V
	1NO + 1NC	RIC20-110/UC ...V
	2NC	RIC20-020/UC ...V

"..." enter the voltage for full type designation

Accessories

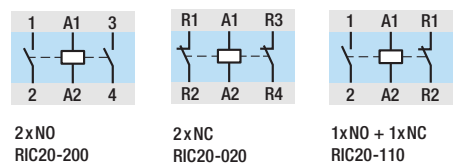
Sealing cover:	RIC-SEAL 20
Spacer:	RIC-DIST

Samples of lamp loads

Samples of lamp loads	Number of lamps
Incandescent lamps 230 V / 100 W	20
Fluorescent lamps not corrected 230 V / 36 W	17
Fluorescent lamps electronic ballast units 36 W	10



Connection diagram



Coil circuit

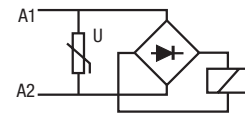
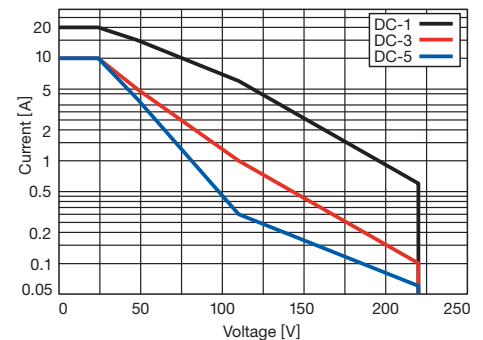
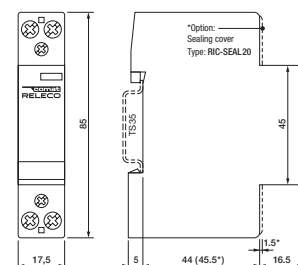


Fig. 1 DC load limit curve DC-1



Dimensions [mm]



Technical approvals, conformities

CE **RoHS**

IEC/EN 60947-4-1, VDE 0660
 IEC/EN 60947-5-1
 IEC/EN 61095, VDE 0637

Mounting information
 If multiple contactors are mounted side by side, spacers (RIC DIST) have to be inserted for the purpose of heat dissipation.
Example: Ambient temperature up to 40°C: 1 spacer after 3 RIC // 40...55°C: 1 spacer after 2 RIC.

RIC25

25 A, AC/DC control voltage, silent operation
DIN Rail mounting according to DIN 43 880



Type: RIC25-xxx/ ...V

Hum-free installation contactor, 4 contacts, 4 NO, 4 NC, 2 NO-2 NC types available

Rated operational power AC-1	Single phase: 5.4 kW/230 V, 0.6 A/220 V DC-1 3 phase 230 V: 9 kW 3 phase 400 V: 16 kW
Recommended minimum contact load	50 mA / 24 V

Contacts

Material	AgNi
Rated operational current	25 A
Max. inrush current (100ms)	50 A
Max. switching voltage	400 V
Max. AC load 3 phase AC-1, AC-7a	9 kW / 230 V, 16 kW / 400 V
AC-3	2.2 kW / 230 V, 4 kW / 400 V
Max. DC load 24V/220V DC-1 (Fig. 1)	600 W / 130 W

Control input V_n =

	UC 24 V	UC 36 V	UC 230 V
Operating voltage range [V]	20.4 ... 26.4	30.6 ... 39.6	195 ... 253
Typ. pic up voltage [V]	17	25	160
Typ. release voltage [V]	7	11	70
Power consumption [W]	2.6	2.6	2.6
Inductive turn-off voltage	None	None	None
Surge immunity EN 6100-4-5	2 kV	2 kV	2 kV

Insulation

Rated insulation voltage	440 V
Rated impulse withstand voltage	4 kV
Min. clearance of open contact	3.6 mm

General Specifications

Ambient temperature storage	-30 ... 80 °C
operation, Spacer after 2 contactors side by side	-5 ... 55 °C
operation, Spacer after 3 contactors side by side	-5 ... 40 °C
Pick-up time	15 ... 45 ms
Release time	20 ... 70 ms
Mechanical life	≥ 3 x 10 ⁶ operations
AC voltage endurance at rated load AC-3, AC-7b	≥ 5 x 10 ⁵ operations
DC voltage endurance at rated load DC-1	10 ⁵ operations
Operating frequency at rated load DC-1	≤ 300 operations / h
Operating frequency at rated load AC-1, AC-3	≤ 600 operations / h
Conductor cross section coil / contacts terminals	Stranded wire 2.5 mm ² / 6 mm ²
Max. Screw torque coil / contacts	0.6 Nm / 1.2 Nm
Ingress protection degree	IP 20
Weight	270 g

Standard types

UC (AC / DC) 50 / 60 Hz, 24, 36, 230

4NO	RIC25-400/UC ...V
2NO + 2NC	RIC25-220/UC ...V
4NC	RIC25-040/UC ...V

"..." enter the voltage for full type designation

Accessories

Auxiliary contact bloc:	RIC-AUX..
Sealing cover:	RIC-SEAL 25
Spacer:	RIC-DIST

Samples of lamp loads

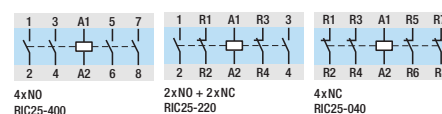
	Number of lamps
Incandescent lamps 230 V/ 100 W	20
Fluorescent lamps not corrected 230 V/ 36 W	20
Fluorescent lamps electronic ballast units 36 W	14

Mounting information

If multiple contactors are mounted side by side, spacers (RIC DIST) have to be inserted for the purpose of heat dissipation.

Example: Ambient temperature up to 40°C: 1 spacer after 3 RIC // 40...55°C: 1 spacer after 2 RIC.

Connection diagram



Coil circuit

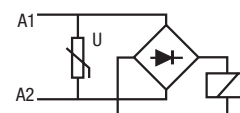
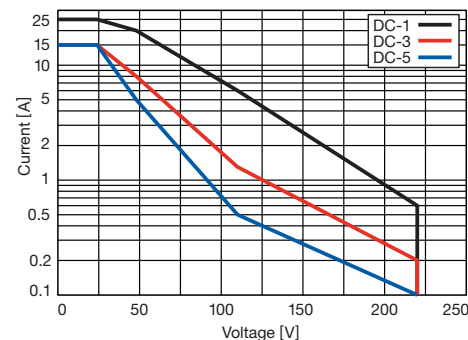
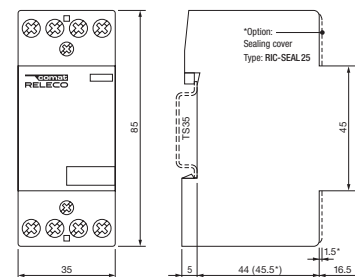


Fig. 1 DC load limit curve DC-1



Dimensions [mm]



Technical approvals, conformities

IEC/EN 60947-4-1
 IEC/EN 60947-5-1
 IEC/EN 61095

RIC40

40 A, AC/DC control voltage, silent operation

DIN rail mounting according to DIN 43 880



Type: RIC 40-xxx/...V

Hum-free installation contactor, 4 contacts, 4 NO, 2 NO-2 NC, 4 NC types available

Rated operational power AC-1	Single phase: 8.7 kW/230 V, 1.2 A / 220 V DC-1
	3 phase 230 V: 16 kW
	3 phase 400 V: 26 kW
Recommended minimum contact load	50 mA / 24 V

Contacts

Material	AgSnO ₂
Rated operational current	40 A
Max. inrush current (100ms)	150 A
Max. switching voltage	400 V
Max. AC load 3 phase AC-1, AC-7a	16 kW / 230 V, 26 kW / 400 V
AC-3	3.7 kW / 230 V, 11 kW / 400 V
Max. DC load 24V/220V DC-1(Fig. 1)	960 W / 260 V

Control input V_N = AC 50 / 60 Hz / DC

	UC 24 V	UC 230 V
Operating voltage range [V]	20.4 ... 26.4	195 ... 253
Typ. pic up voltage [V]	17	160
Typ. release voltage [V]	7	70
Power consumption [W]	6	5
Inductive turn-off voltage	None	None
Surge immunity EN 6100-4-5	2 kV	2 kV

Insulation

Rated insulation voltage	440 V
Rated impulse withstand voltage	4 kV
Min. clearance of open contact	3.6 mm

General Specifications

Ambient temperature storage	-30 ... 80 °C
operation, Spacer after 2 contactors side by side	-5 ... 55 °C
operation, Spacer after 3 contactors side by side	-5 ... 40 °C
Pick-up time	15 ... 20 ms
Release time	35 ... 45 ms
Mechanical life	≥ 3 x 10 ⁶ operations
AC voltage endurance at rated load AC-3, AC-7b	≥ 1.5 x 10 ⁵ operations
DC voltage endurance at rated load DC-1	10 ⁵ operations
Operating frequency at rated load DC-1	≤ 300 operations / h
Operating frequency at rated load AC-1, AC-3	≤ 600 operations / h
Conductor cross section coil /contacts terminals	Stranded wire 2.5 mm ² / 16 mm ²
Max. Screw torque coil /contacts	0.6 Nm / 3.5 Nm
Ingress protection degree	IP 20
Weight	420 g

Standard types

UC (AC / DC) 50 / 60 Hz, 24, 230	4NO	RIC40-400/UC ...V
	2NO + 2NC	RIC40-220/UC ...V
	4NC	RIC40-040/UC ...V

"..." enter the voltage for full type designation

Accessories

Auxiliary contact bloc:	RIC-AUX..
Sealing cover:	RIC-SEAL 40-63
Spacer:	RIC-DIST

Samples of lamp loads

Samples of lamp loads	Number of lamps
Incandescent lamps 230 V / 100 W	40
Fluorescent lamps not corrected 230 V / 36 W	65
Fluorescent lamps electronic ballast units 36 W	40

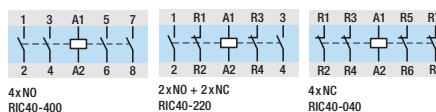
Mounting information

If multiple contactors are mounted side by side, spacers (RIC DIST) have to be inserted for the purpose of heat dissipation.

Example: Ambient temperature up to 40°C: 1 spacer after 3 RIC // 40...55°C: 1 spacer after 2 RIC.



Connection diagram



Coil circuit

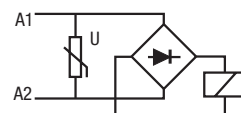
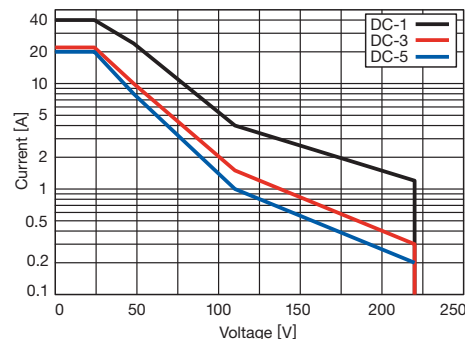
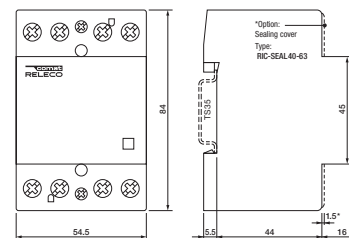


Fig. 1 DC load limit curve DC-1



Dimensions [mm]



Technical approvals, conformities



IEC/EN 60947-4-1
IEC/EN 60947-5-1
IEC/EN 61095

RIC63

63 A, AC/DC control voltage, silent operation

DIN Rail mounting according to DIN 43 880

Type: RIC 63-xxx/...V

Hum-free installation contactor, 4 contacts, 4 NO, 2 NO-2 NC types available

Rated operational power AC-1

Single phase: 13.3 kW/230 V, 1.2 A/220VDC-1

3 phase 230 V: 24 kW

3 phase 400 V: 40 kW

Recommended minimum contact load

50 mA / 24 V

Contacts

Material	AgSnO ₂	
Rated operational current	63 A	
Max. inrush current (100ms)	150 A	
Max. switching voltage	400 V	
Max. AC load 3 phase	AC-1, AC-7a	24 kW / 230 V, 40 kW / 400 V
	AC-3	5 kW / 230 V, 15 kW / 400 V
Max. DC load 24 V / 220 V DC-1(Fig. 1)		1500 W / 260 V

Control input V_N = AC 50 / 60 Hz / DC

	UC 24 V	UC 230 V
Operating voltage range [V]	20.4 ... 26.4	195 ... 253
Typ. pic up voltage [V]	17	160
Typ. release voltage [V]	7	70
Power consumption [W]	≤ 5	≤ 5
Inductive turn-off voltage	None	None
Surge immunity EN 6100-4-5	2 kV	2 kV

Insulation

Rated insulation voltage	440 V
Rated impulse withstand voltage	4 kV
Min. clearance of open contact	3.6 mm

General Specifications

Ambient temperature storage	-30 ... 80 °C
operation, Spacer after 2 contactors side by side	-5 ... 55 °C
operation, Spacer after 3 contactors side by side	-5 ... 40 °C
Pick-up time	15 ... 20 ms
Release time	35 ... 45 ms
Mechanical life	≥ 3 x 10 ⁶ operations
AC voltage endurance at rated load AC-3, AC-7b	≥ 1.5 x 10 ⁵ operations
DC voltage endurance at rated load DC-1	10 ⁵ operations
Operating frequency at rated load DC-1	≤ 300 operations / h
Operating frequency at rated load AC-1, AC-3	≤ 600 operations / h
Conductor cross section coil /contacts terminals	Stranded wire 2.5 mm ² / 16 mm ²
Max. Screw torque coil /contacts	0.6 Nm / 3.5 Nm
Ingress protection degree	IP 20
Weight	420 g

Standard types

UC (AC / DC) 50 / 60 Hz, 24, 230

"..." enter the voltage for full type designation

4NO	RIC63-400/UC ...V
2NO + 2NC	RIC63-220/UC ...V

Accessories

Auxiliary contact bloc:	RIC-AUX..
Sealing cover:	RIC-SEAL 40-63
Spacer:	RIC-DIST

Samples of lamp loads

Samples of lamp loads	Number of lamps
Incandescent lamps 230 V / 100 W	50
Fluorescent lamps not corrected 230 V / 36 W	95
Fluorescent lamps electronic ballast units 36 W	57

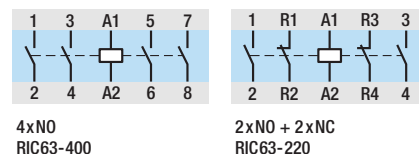
Mounting information

If multiple contactors are mounted side by side, spacers (RIC DIST) have to be inserted for the purpose of heat dissipation.

Example: Ambient temperature up to 40°C: 1 spacer after 3 RIC // 40...55°C: 1 spacer after 2 RIC.



Connection diagram



Coil circuit

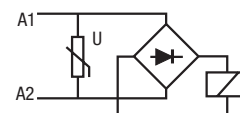
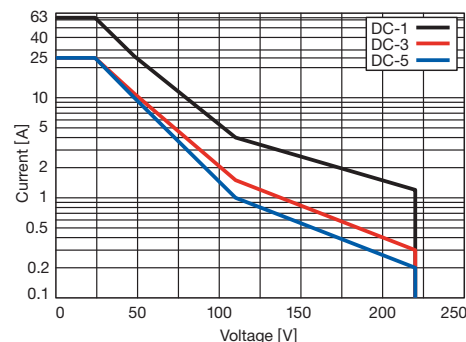
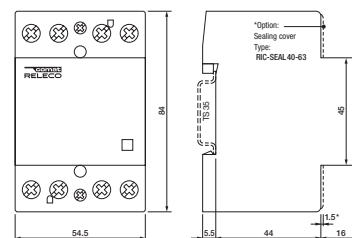


Fig. 1 DC load limit curve DC-1



Dimensions [mm]



Technical approvals, conformities

CE IEC/EN 60947-4-1
IEC/EN 60947-5-1
IEC/EN 61095

RIC-AUX

**4 A auxiliary contact bloc with 2 double contacts,
3 different combinations of NO / NC contacts**



Type: RIC AUXxx

2 double contacts, 2 NO, 1 NC-1 NO, 2 NC types available

Maximum contact load AC-15	4 A / 230 V, 4 A / 400 V
Recommended minimum contact load	5 mA / 24 V

Contacts

Material	AgNi
Rated operational current AC-15	4 A / 230 V, 4 A / 400 V
Max. switching voltage with RIC 20	400 V

Insulation

Rated insulation voltage	500 V
Rated impulse withstand voltage	4 kV

Specifications

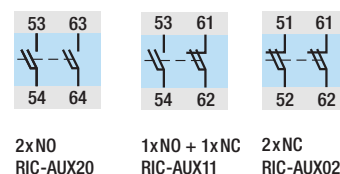
Ambient temperature storage / operation	-30 ... 80 °C / -5 ... 55 °C
Operating frequency at rated load	≤ 600 operations / h
Conductor cross section	Stranded wire 2.5 mm ²
Max. Screw torque	0.6 Nm
Ingress protection degree	IP 20
Weight	50 g

Standard types

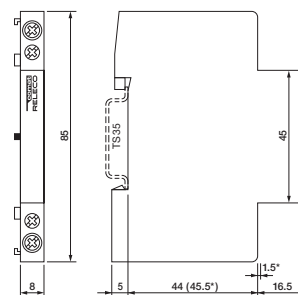
2NO	RIC-AUX20
1NO + 1NC	RIC-AUX11
2NC	RIC-AUX02



Connection diagram



Dimensions [mm]



Technical approvals, conformities



IEC/EN 60947-4-1
IEC/EN 60947-5-1
IEC/EN 61095

RAC20

20 A, AC/DC control voltage, silent operation
DIN rail mounting according to DIN 43 880



Type: RAC20-xxx/ ...V

Hum-free installation contactor, 2 contacts, 2 NO, 1 NO-1 NC, 2 NC types available.
 Manual actuating and locking

Rated operational power	4 kW / 230 V AC-1, 0.6 A / 220 V DC-1
Recommended minimum contact load	50 mA / 24 V

Contacts

Material	AgNi
Rated operational current	20 A
Max. inrush current (100ms)	50 A
Max. switching voltage	230 V
Max. AC load	AC-1, AC-7a AC-3
	4 kW / 230 V 1.3 kW / 230 V (NO) 0.75 kW / 230 V (NC)
Max. DC load 24 V / 220 V DC-1 (Fig. 1)	480 W / 130 W

Control input V_n =

	UC 24 V	UC 36 V	UC 230 V
Operating voltage range [V]	20.4 ... 26.4	30.6 ... 39.6	195 ... 253
Typ. pick up voltage [V]	17	25	160
Typ. release voltage [V]	7	11	70
Power consumption [W]	2.1	2.1	2.1
Inductive turn-off voltage	None	None	None
Surge immunity EN 6100-4-5	2 kV	2 kV	2 kV

Insulation

Rated insulation voltage	230 V
Rated impulse withstand voltage	4 kV
Min. clearance of open contact	3.6 mm

General Specifications

Ambient temperature storage	-30 ... 80 °C
operation, Spacer after 2 contactors side by side	-5 ... 55 °C
operation, Spacer after 3 contactors side by side	-5 ... 40 °C
Pick-up time	15 ... 45 ms
Release time	20 ... 50 ms
Mechanical life	≥ 3 x 10 ⁶ operations
AC voltage endurance at rated load AC-3, AC-7b	≥ 3 x 10 ⁵ operations
DC voltage endurance at rated load DC-1	10 ⁵ operations
Operating frequency at rated load DC-1	≤ 300 operations / h
Operating frequency at rated load AC-1	≤ 600 operations / h
Conductor cross section coil /contacts	Stranded wire 2.5 mm ² / 6 mm ²
Max. Screw torque coil /contacts	0.6 Nm / 1.2 Nm
Ingress protection degree	IP 20
Weight	140 g

Standard types

UC (AC / DC) 50 / 60 Hz, 24, 36, 230

2NO	RAC20-200/UC ...V
1NO + 1NC	RAC20-110/UC ...V
2NC	RAC20-020/UC ...V

"..." enter the voltage for full type designation

Accessories

Sealing cover:	RIC-SEAL 20
Spacer:	RIC-DIST

Samples of lamp loads

	Number of lamps
Incandescent lamps 230 V / 100 W	20
Fluorescent lamps not corrected 230 V / 36 W	17
Fluorescent lamps electronic ballast units 36 W	10

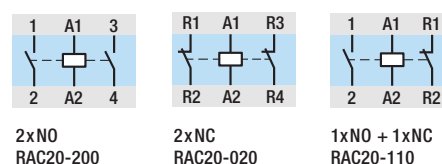
Mounting information

If multiple contactors are mounted side by side, spacers (RIC DIST) have to be inserted for the purpose of heat dissipation.

Example: Ambient temperature up to 40°C: 1 spacer after 3 RAC // 40...55°C: 1 spacer after 2 RAC.



Connection diagram



Coil circuit

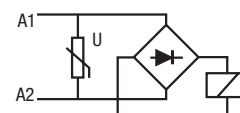
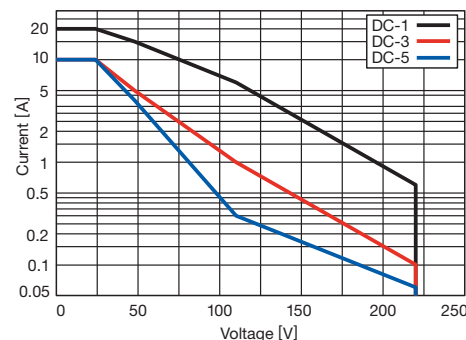
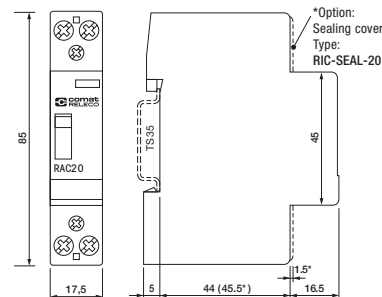


Fig. 1 DC load limit curve DC-1



Dimensions [mm]



Technical approvals, conformities

IEC/EN 60947-4-1, VDE 0660
 IEC/EN 60947-5-1
 IEC/EN 61095, VDE 0637

RAC25

25 A, AC/DC control voltage, silent operation
DIN Rail mounting according to DIN 43 880



Type: RAC25-xxx/ ...V

Hum-free installation contactor, 4 contacts, 4 NO, 4 NC, 2 NO-2 NC types available
 Manual actuating and locking

Rated operational power AC-1	Single phase: 5.4 kW/230 V, 0.6 A/220 V DC-1
	3 phase 230 V: 9 kW
	3 phase 400 V: 16 kW
Recommended minimum contact load	50 mA / 24 V

Contacts

Material	AgNi
Rated operational current	25 A
Max. inrush current (100ms)	50 A
Max. switching voltage	400 V
Max. AC load 3 phase AC-1, AC-7a	9 kW / 230 V, 16 kW / 400 V
AC-3	2.2 kW / 230 V, 4 kW / 400 V
Max. DC load 24V/220V DC-1 (Fig. 1)	600 W / 130 W

Control input V_n =

	UC 24 V	UC 36 V	UC 230 V
Operating voltage range [V]	20.4 ... 26.4	30.6 ... 39.6	195 ... 253
Typ. pick up voltage [V]	17	25	160
Typ. release voltage [V]	7	11	70
Power consumption [W]	2.6	2.6	2.6
Inductive turn-off voltage	None	None	None
Surge immunity EN 6100-4-5	2 kV	2 kV	2 kV

Insulation

Rated insulation voltage	440 V
Rated impulse withstand voltage	4 kV
Min. clearance of open contact	3.6 mm

General Specifications

Ambient temperature storage	-30 ... 80 °C
operation, Spacer after 2 contactors side by side	-5 ... 55 °C
operation, Spacer after 3 contactors side by side	-5 ... 40 °C
Pick-up time	15 ... 45 ms
Release time	20 ... 70 ms
Mechanical life	≥ 3 x 10 ⁶ operations
AC voltage endurance at rated load AC-3, AC-7b	≥ 5 x 10 ⁵ operations
DC voltage endurance at rated load DC-1	10 ⁵ operations
Operating frequency at rated load DC-1	≤ 300 operations / h
Operating frequency at rated load AC-1, AC-3	≤ 600 operations / h
Conductor cross section coil / contacts terminals	Stranded wire 2.5 mm ² / 6 mm ²
Max. Screw torque coil / contacts	0.6 Nm / 1.2 Nm
Ingress protection degree	IP 20
Weight	270 g

Standard types

UC (AC / DC) 50 / 60 Hz, 24, 36, 230	4NO	RAC25-400/UC ...V
	2NO + 2NC	RAC25-220/UC ...V
	4NC	RAC25-040/UC ...V

"..." enter the voltage for full type designation

Accessories

Sealing cover:	RIC-SEAL 25
Spacer:	RIC-DIST

Samples of lamp loads

	Number of lamps
Incandescent lamps 230 V/ 100 W	20
Fluorescent lamps not corrected 230 V/ 36 W	20
Fluorescent lamps electronic ballast units 36 W	14

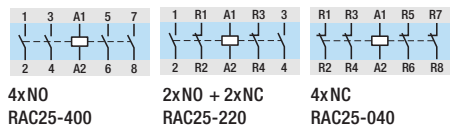
Mounting information

If multiple contactors are mounted side by side, spacers (RIC DIST) have to be inserted for the purpose of heat dissipation.

Example: Ambient temperature up to 40°C: 1 spacer after 3 RAC // 40...55°C: 1 spacer after 2 RAC.



Connection diagram



Coil circuit

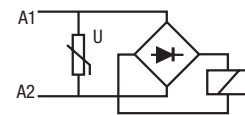
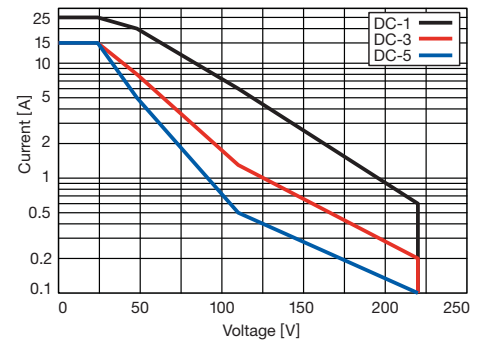
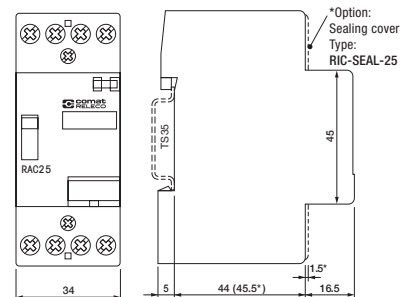


Fig. 1 DC load limit curve DC-1



Dimensions [mm]



Technical approvals, conformities

CE **RoHS**
 IEC/EN 60947-4-1
 IEC/EN 60947-5-1
 IEC/EN 61095

RBC20

20 A, AC/DC control voltage, silent operation
DIN rail mounting according to DIN 43 880



Type: RBC20-xxx/AC230V

Bistable installation contactor, 2 NO, 1 NO-1 NC types available
 Manually switchable

Rated operational power 4 kW / 230 V AC-1, 0.5 A / 220 V DC-1
Recommended minimum contact load 100 mA / 10 V

Contacts

Material	AgNi
Rated operational current	20 A
Max. inrush current (100ms)	50 A
Max. switching voltage	440 V
Max. AC load AC-1, AC-7a	4 kW / 230 V
AC-3	1.3 kW /230 V (NO contact only)
Max. DC load 24 V / 220 V DC-1 (Fig. 1)	480 W / 110 W

Control input V_n =

AC 230 V

Operating voltage range [V]	10 ... 440
Typ. pick up voltage [V]	160
Typ. release voltage [V]	70
Power consumption [W]	4
Inductive turn-off voltage	None
Surge immunity EN 6100-4-5	2 kV

Insulation

Rated insulation voltage	440 V
Rated impulse withstand voltage	4 kV
Min. clearance of open contact	3 mm

General Specifications

Ambient temperature storage	-30 ... 80 °C
operation	-25 ... 55 °C
Pick-up time	15 ... 45 ms
Release time	20 ... 50 ms
Mechanical life	10 ⁶ operations
AC voltage endurance at rated load AC-3, AC-7b	10 ⁵ operations
DC voltage endurance at rated load DC-1	10 ⁵ operations
Operating frequency at rated load DC-1	≤ 900 operations / h
Operating frequency at rated load AC-1	≤ 900 operations / h
Conductor cross section coil /contacts	Stranded wire 4 mm ² / 10 mm ²
Max. Screw torque coil /contacts	0.6 Nm / 1.2 Nm
Ingress protection degree	IP 20
Weight	132 g

Standard types

UC (AC / DC) 50 / 60 Hz, 24, 36, 230

„...“ enter the voltage for full type designation

2NO	RBC20-200/AC230V
1NO + 1NC	RBC20-110/AC230V

Accessories

Auxiliary contact bloc: **RBC-AUX..**

Samples of lamp loads

Number of lamps

Incandescent lamps 230 V / 100 W	20
Fluorescent lamps not corrected 230 V / 36 W	29
Fluorescent lamps electronic ballast units 36 W	38

Connection diagram

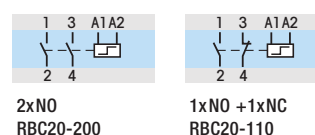
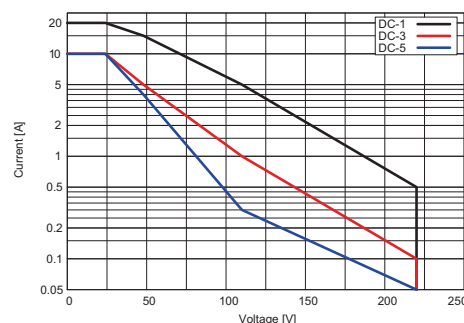
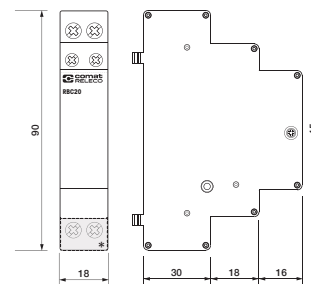


Fig. 1 DC load limit curve DC-1



Dimensions [mm]



Technical approvals, conformities

CE
 IEC/EN 60947-4-1, VDE 0660
 IEC/EN 60947-5-1
 IEC/EN 61095, VDE 0637

Mounting information

If multiple contactors are mounted side by side, spacers (RIC DIST) have to be inserted for the purpose of heat dissipation.

Example: Ambient temperature up to 40°C: 1 spacer after 3 RBC // 40...55°C: 1 spacer after 2 RBC.

RBC32

32 A, AC/DC control voltage, silent operation
DIN Rail mounting according to DIN 43 880



Type: RBC32-xxx/AC230V

Hum-free installation contactor, 4 contacts, 4 NO, 2 NO-2 NC types available

Rated operational power AC-1	Single phase: 5.4 kW/230 V, 0.5 A/220 V DC-1 3 phase 230 V: 9 kW 3 phase 400 V: 16 kW
Recommended minimum contact load	100 mA / 10 V

Contacts

Material	AgNi
Rated operational current	32 A
Max. inrush current (100ms)	50 A
Max. switching voltage	440 V
Max. AC load 3 phase AC-1, AC-7a	9 kW / 230 V, 16 kW / 400 V
AC-3	2.2 kW / 230 V, 4 kW / 400 V
Max. DC load 24V/220V DC-1 (Fig. 1)	600 W / 130 V

Control input V_n =

AC 230 V	
Operating voltage range [V]	195 ... 253
Typ. pic up voltage [V]	160
Typ. release voltage [V]	70
Power consumption [W]	4
Inductive turn-off voltage	None
Surge immunity EN 6100-4-5	2 kV

Insulation

Rated insulation voltage	440 V
Rated impulse withstand voltage	4 kV
Min. clearance of open contact	3 mm

General Specifications

Ambient temperature storage	-30 ... 80 °C
operation	-25 ... 55 °C
Pick-up time	15 ... 45 ms
Release time	20 ... 70 ms
Mechanical life	10 ⁶ operations
AC voltage endurance at rated load AC-3, AC-7b	10 ⁵ operations
DC voltage endurance at rated load DC-1	10 ⁵ operations
Operating frequency at rated load DC-1	≤ 900 operations / h
Operating frequency at rated load AC-1, AC-3	≤ 900 operations / h
Conductor cross section coil / contacts terminals	Stranded wire 4 mm ² / 10 mm ²
Max. Screw torque coil / contacts	0.6 Nm / 1.2 Nm
Ingress protection degree	IP 20
Weight	192 g

Standard types

UC (AC / DC) 50 / 60 Hz, 24, 36, 230	4NO	RBC32-400/AC230V
„...“ enter the voltage for full type designation	2NO + 2NC	RBC32-220/AC230V

Accessories

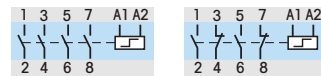
Auxillary contact bloc:	RBC-AUX..
-------------------------	------------------

Samples of lamp loads

Number of lamps	
Incandescent lamps 230 V/ 100 W	35
Fluorescent lamps not corrected 230 V/ 36 W	57
Fluorescent lamps electronic ballast units 36 W	75



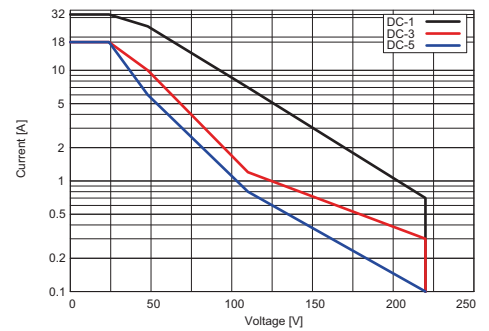
Connection diagram



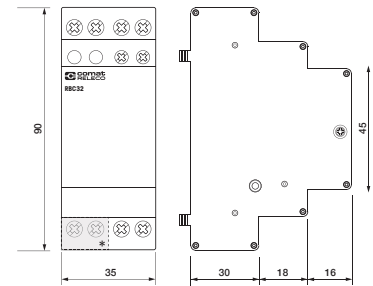
4xNO
RBC32-400

2xNO + 2xNC
RBC32-220

Fig. 1 DC load limit curve DC-1



Dimensions [mm]



Technical approvals, conformities



IEC/EN 60947-4-1
 IEC/EN 60947-5-1
 IEC/EN 61095

Mounting information
 If multiple contactors are mounted side by side, spacers (RBC DIST) have to be inserted for the purpose of heat dissipation.
Example: Ambient temperature up to 40°C: 1 spacer after 3 RIC // 40...55°C: 1 spacer after 2 RBC.

RBC-AUX

**4 A auxiliary contact bloc with 2 double contacts,
2 different combinations of NO / NC contacts**



Type: RBC AUXxx

2 double contacts, 2 NO, 1 NC-1 NO types available

Maximum contact load AC-15	4 A / 230 V
Recommended minimum contact load	5 mA / 12 V

Contacts

Material	AgNi
Rated operational current AC-15	4 A / 230 V
Max. switching voltage	250 V

Insulation

Rated insulation voltage	250 V
Rated impulse withstand voltage	4 kV

Specifications

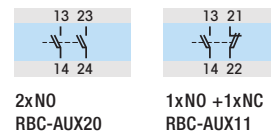
Ambient temperature storage / operation	-30 ... 80 °C / -25 ... 55 °C
Operating frequency at rated load	≤ 600 operations / h
Conductor cross section	Stranded wire 4 mm ²
Max. Screw torque	0.8 Nm
Ingress protection degree	IP 20
Weight	30 g

Standard types

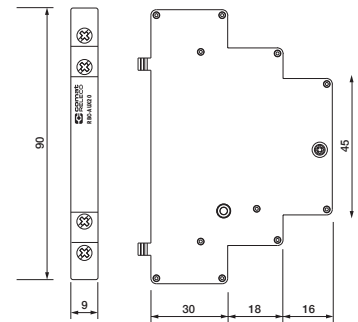
2NO	RBC-AUX20
1NO + 1NC	RBC-AUX11



Connection diagram



Dimensions [mm]



Technical approvals, conformities

CE **RoHS**
IEC/EN 60947-4-1
IEC/EN 60947-5-1
IEC/EN 61095

1.9 Solid State Contactors



- For frequent switching without contact bounce
- No wear and tear and silent operation thanks to semiconductor technology
- Non-hazardous switching of inductive loads
- Reduction of switch-on current thanks to zero voltage switching
- Clear LED status display
- Integrated overload protection
- DIN rack or screw assembly
- Space-saving: standard module width from 22.5 to 90 mm
- Integrated cooling element with optional thermal protector

Solid State Contactors

Three phase AC motors have proven themselves for the operation of pumps, conveyor belts, compressors and countless other drive technology applications. The direct start or the star-delta starter cause impact on the mechanical components in the drive train. This leads to signs of wear, damage and premature failures. On the other hand, abrupt starts lead to voltage drops which burden the power supply network and affect the surrounding components.

Softstarter by Comat Releco prevents disruptions and ensures a smooth start-up with a reduced starting torque and slow breaking sequences without loading the drive system. Thanks to modern semiconductor power amplifiers and fanless design, you can enjoy absolutely wear-free. The compact construction with integrated cooling element only requires little space in the control cabinet.

Softstarter by Comat Releco is available in four series:

The CCL range has been developed for the operation of heat pumps and compressors. Intelligent current limitation during start-up reduces the drive power by up to 65%. The integrated motor protection allows the adjustment of the nominal power and replaces an additional motor protection switch. Thanks to an integrated bypass relay, there are no additional costs for external bridging.

The CCM range is available with two or three switched phases and is designed for a large number of switching cycles per hour. The bypass is integrated in accordance with the version. Separate potentiometers allow the adjustment of start-up and breaking times, as well as the kick-start function, and the start-up torque can be limited to 0 to 85 % of the nominal value. The CCMB range also offers a dynamic break function with automatic standstill detection.

The starting torque limiters of the CTC range are activated via an upstream contactor. The start-up torque can be limited to 1 to 85 % of the nominal torque. Typical applications are blowers and smaller machinery.



Solid State Contactor – CC1H215 (one phase)

Type: CC1H215

The CC series solid-state contactors are suitable for the contactless and non-wearing switching of ohmic and inductive AC loads at high switching frequency. They come with an operating voltage up to 600 VAC and nominal current up to 50 A with two and three phases. They come with control voltages of either 5–24 VDC or 24–230 VAC/VDC.

Output

Switching element	Thyristor
Numbers of phases	1
Nominal voltage (U_{nom})	230 VAC
Output voltage range	12 – 240 VAC
Reverse voltage	1000 V _{rrm}
Peak reverse voltage	1100 V _{rsm}
Min. load	10 mA
Max. leakage current	1 mA
Max. inrush current	15 A
Operation current AC-1/51 @ U_{nom}	15 A
Operation current AC-3 @ U_{nom}	15 A
Operation current AC-55b @ U_{nom}	15 A
Operation current AC-56a @ U_{nom}	15 A
Response/Release time	20 ms
Limit load	1800 A ² t

Input

Voltage	24 – 230 VAC/VDC
Min. voltage	20,4 VAC/VDC
Max. voltage	253 VAC/VDC
Release voltage	7,2 VAC/VDC
Max. current	6 mA

General Specifications

Ambient temperature storage/operation	-20 – 80°C / -5 – 40°C
Connection terminals	Screw terminal 6 mm ²
Ingress protection degree	IP 20
Mounting	DIN rail T<S35
Housing material	PPE Noryl SE1 / Aluminium
Weight	270 g

Insulation

Insulation voltage	4 kV
Dielectric strength	660 V

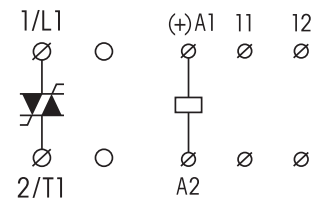
Standard type

Starting Torque Limiter

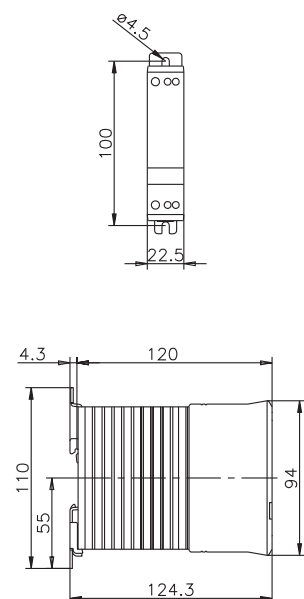
CC1H215



Connection diagram



Dimensions [mm]



Technical approvals, conformities



Solid State Contactor – CC1H230 (one phase)

Type: CC1H230

The CC series solid-state contactors are suitable for the contactless and non-wearing switching of ohmic and inductive AC loads at high switching frequency. They come with an operating voltage up to 600VAC and nominal current up to 50A with two and three phases. They come with control voltages of either 5–24 VDC or 24–230 VAC/VDC.

Output

Switching element	Thyristor
Numbers of phases	1
Nominal voltage (U_{nom})	230 VAC
Output voltage range	12 – 240 VAC
Reverse voltage	1000 V _{rrm}
Peak reverse voltage	1100 V _{rsm}
Min. load	10 mA
Max. leakage current	1 mA
Max. inrush current	30 A
Operation current AC-1/51 @ U_{nom}	30 A
Operation current AC-3 @ U_{nom}	15 A
Operation current AC-55b @ U_{nom}	20 A
Operation current AC-56a @ U_{nom}	15 A
Response/Release time	20 ms
Limit load	1800 A ² t

Input

Voltage	24 – 230 VAC/VDC
Min. voltage	20,4 VAC/VDC
Max. voltage	253 VAC/VDC
Release voltage	7,2 VAC/VDC
Max. current	6 mA

General Specifications

Ambient temperature storage/operation	-20 – 80°C / -5 – 40°C
Connection terminals	Screw terminal 10 mm ²
Ingress protection degree	IP 20
Mounting	DIN rail TS35
Housing material	PPE Noryl SE1 / Aluminium
Weight	650 g

Insulation

Insulation voltage	4 kV
Dielectric strength	660 V

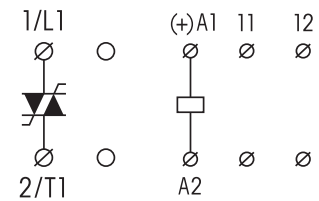
Standard type

Starting Torque Limiter

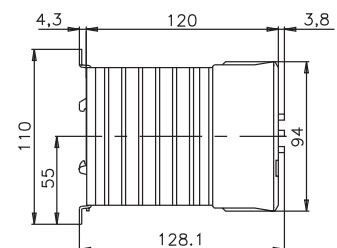
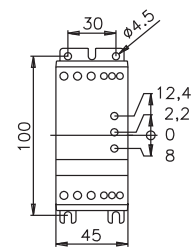
CC1H230



Connection diagram



Dimensions [mm]



Technical approvals, conformities



Solid State Contactor – CC1H250 (one phase)

Type: CC1H250

The CC series solid-state contactors are suitable for the contactless and non-wearing switching of ohmic and inductive AC loads at high switching frequency. They come with an operating voltage up to 600 VAC and nominal current up to 50 A with two and three phases. They come with control voltages of either 5–24 VDC or 24–230 VAC/VDC.

Output

Switching element	Thyristor
Numbers of phases	1
Nominal voltage (U_{nom})	230 VAC
Output voltage range	12 – 240 VAC
Reverse voltage	1000 V _{rrm}
Peak reverse voltage	1100 V _{rsm}
Min. load	10 mA
Max. leakage current	1 mA
Max. inrush current	50 A
Operation current AC-1/51 @ U_{nom}	50 A
Operation current AC-3 @ U_{nom}	15 A
Operation current AC-55b @ U_{nom}	20 A
Operation current AC-56a @ U_{nom}	15 A
Response/Release time	20 ms
Limit load	1800 A ² t

Input

Voltage	24 – 230 VAC/VDC
Min. voltage	20,4 VAC/VDC
Max. voltage	253 VAC/VDC
Release voltage	7,2 VAC/VDC
Max. current	6 mA

General Specifications

Ambient temperature storage/operation	-20 – 80°C / -5 – 40°C
Connection terminals	Screw terminal 10 mm ²
Ingress protection degree	IP 20
Mounting	DIN rail TS35
Housing material	PPE Noryl SE1 / Aluminium
Weight	1050 g

Insulation

Insulation voltage	4 kV
Dielectric strength	660 V

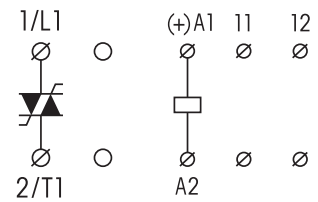
Standard type

Starting Torque Limiter

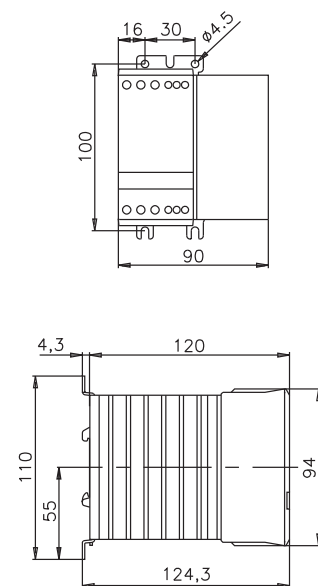
CC1H250



Connection diagram



Dimensions [mm]



Technical approvals, conformities



Solid State Contactor – CC1H415 (one phase)

Type: CC1H415

The CC series solid-state contactors are suitable for the contactless and non-wearing switching of ohmic and inductive AC loads at high switching frequency. They come with an operating voltage up to 600VAC and nominal current up to 50A with two and three phases. They come with control voltages of either 5–24 VDC or 24–230 VAC/VDC.

Output

Switching element	Thyristor
Numbers of phases	1
Nominal voltage (U_{nom})	400 VAC
Output voltage range	24 – 480 VAC
Reverse voltage	1200 V _{rrm}
Peak reverse voltage	1300 V _{rsm}
Min. load	10 mA
Max. leakage current	1 mA
Max. inrush current	15 A
Operation current AC-1/51 @ U_{nom}	15 A
Operation current AC-3 @ U_{nom}	15 A
Operation current AC-55b @ U_{nom}	15 A
Operation current AC-56a @ U_{nom}	15 A
Response/Release time	20 ms
Limit load	1800 A ² t

Input

Voltage	24 – 230 VAC/VDC
Min. voltage	20,4 VAC/VDC
Max. voltage	253 VAC/VDC
Release voltage	7,2 VAC/VDC
Max. current	6 mA

General Specifications

Ambient temperature storage/operation	-20 – 80°C / -5 – 40°C
Connection terminals	Screw terminal 6 mm ²
Ingress protection degree	IP 20
Mounting	DIN rail TS35
Housing material	PPE Noryl SE1 / Aluminium
Weight	270 g

Insulation

Insulation voltage	4 kV
Dielectric strength	660 V

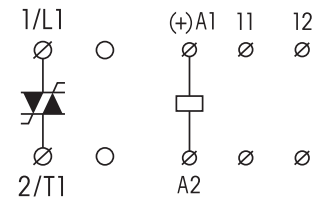
Standard type

Starting Torque Limiter

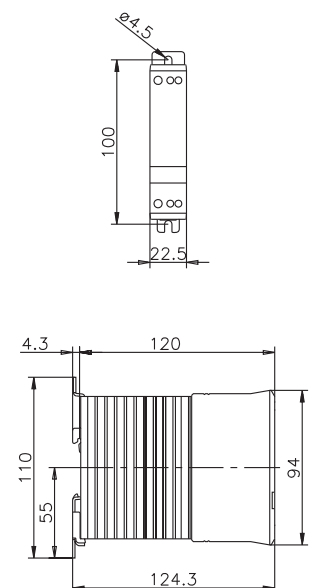
CC1H415



Connection diagram



Dimensions [mm]



Technical approvals, conformities



Solid State Contactor – CC1H450 (one phase)

Type: CC1H450

The CC series solid-state contactors are suitable for the contactless and non-wearing switching of ohmic and inductive AC loads at high switching frequency. They come with an operating voltage up to 600 VAC and nominal current up to 50 A with two and three phases. They come with control voltages of either 5–24 VDC or 24–230 VAC/VDC.

Output

Switching element	Thyristor
Numbers of phases	1
Nominal voltage (U_{nom})	400 VAC
Output voltage range	24 – 480 VAC
Reverse voltage	1200 V _{rrm}
Peak reverse voltage	1300 V _{rsm}
Min. load	10 mA
Max. leakage current	1 mA
Max. inrush current	50 A
Operation current AC-1/51 @ U_{nom}	50 A
Operation current AC-3 @ U_{nom}	15 A
Operation current AC-55b @ U_{nom}	20 A
Operation current AC-56a @ U_{nom}	15 A
Response/Release time	20 ms
Limit load	1800 A ² t

Input

Voltage	24 – 230 VAC/VDC
Min. voltage	20,4 VAC/VDC
Max. voltage	253 VAC/VDC
Release voltage	7,2 VAC/VDC
Max. current	6 mA

General Specifications

Ambient temperature storage/operation	-20 – 80°C / -5 – 40°C
Connection terminals	Screw terminal 10 mm ²
Ingress protection degree	IP 20
Mounting	DIN rail TS35
Housing material	PPE Noryl SE1 / Aluminium
Weight	1050 g

Insulation

Insulation voltage	4 kV
Dielectric strength	660 V

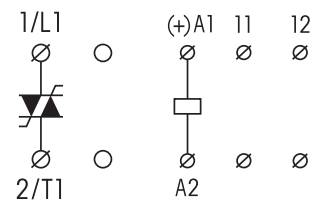
Standard type

Starting Torque Limiter

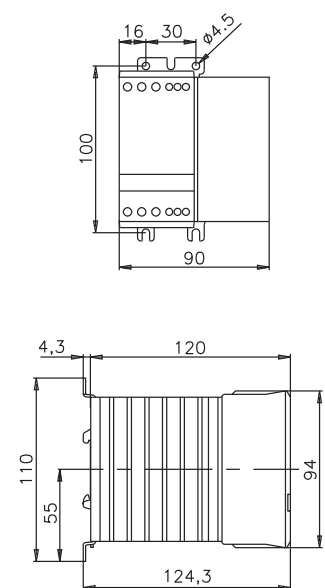
CC1H450



Connection diagram



Dimensions [mm]



Technical approvals, conformities



Solid State Contactor – CC2H230 (two phase)

Type: CC2H230

The CC series solid-state contactors are suitable for the contactless and non-wearing switching of ohmic and inductive AC loads at high switching frequency. They come with an operating voltage up to 600VAC and nominal current up to 50A with two and three phases. They come with control voltages of either 5–24 VDC or 24–230 VAC/VDC.

Output

Switching element	Thyristor
Numbers of phases	2
Nominal voltage (U_{nom})	230 VAC
Output voltage range	12 – 240 VAC
Reverse voltage	1000 V _{rrm}
Peak reverse voltage	1100 V _{rsm}
Min. load	10 mA
Max. leakage current	1 mA
Max. inrush current	30 A
Operation current AC-1/51 @ U_{nom}	30 A
Operation current AC-3 @ U_{nom}	15 A
Operation current AC-55b @ U_{nom}	20 A
Operation current AC-56a @ U_{nom}	15 A
Response/Release time	20 ms
Limit load	1800 A ² t

Input

Voltage	24 – 230 VAC/VDC
Min. voltage	20,4 VAC/VDC
Max. voltage	253 VAC/VDC
Release voltage	7,2 VAC/VDC
Max. current	6 mA

General Specifications

Ambient temperature storage/operation	-20 – 80°C / -5 – 40°C
Connection terminals	Screw terminal 10 mm ²
Ingress protection degree	IP 20
Mounting	DIN rail TS35
Housing material	PPE Noryl SE1 / Aluminium
Weight	650 g

Insulation

Insulation voltage	4 kV
Dielectric strength	660 V

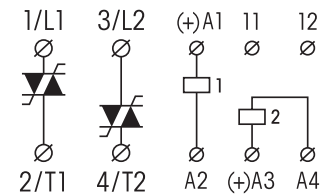
Standard type

Starting Torque Limiter

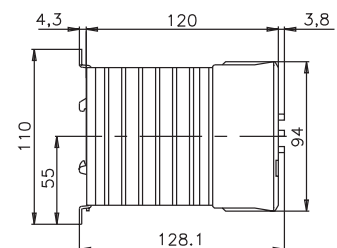
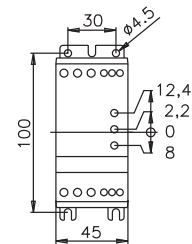
CC2H230



Connection diagram



Dimensions [mm]



Technical approvals, conformities



Solid State Contactor – CC3H410 (three phase)

Type: CC3H410

The CC series solid-state contactors are suitable for the contactless and non-wearing switching of ohmic and inductive AC loads at high switching frequency. They come with an operating voltage up to 600 VAC and nominal current up to 50 A with two and three phases. They come with control voltages of either 5–24 VDC or 24–230 VAC/VDC.

Output

Switching element	Thyristor
Numbers of phases	3
Nominal voltage (U_{nom})	400 VAC
Output voltage range	24 – 480 VAC
Reverse voltage	1200 V _{rrm}
Peak reverse voltage	1300 V _{rsm}
Min. load	10 mA
Max. leakage current	1 mA
Max. inrush current	10 A
Operation current AC-1/51 @ U_{nom}	10 A
Operation current AC-3 @ U_{nom}	10 A
Operation current AC-55b @ U_{nom}	10 A
Operation current AC-56a @ U_{nom}	5 A
Response/Release time	20 ms
Limit load	1800 A ² t

Input

Voltage	24 – 230 VAC/VDC
Min. voltage	20,4 VAC/VDC
Max. voltage	253 VAC/VDC
Release voltage	7,2 VAC/VDC
Max. current	6 mA

General Specifications

Ambient temperature storage/operation	-20 – 80°C / -5 – 40°C
Connection terminals	Screw terminal 6 mm ²
Ingress protection degree	IP 20
Mounting	DIN rail TS35
Housing material	PPE Noryl SE1 / Aluminium
Weight	650 g

Insulation

Insulation voltage	4 kV
Dielectric strength	660 V

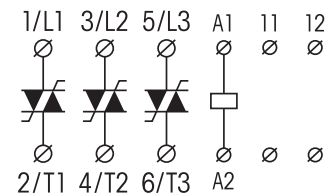
Standard type

Starting Torque Limiter

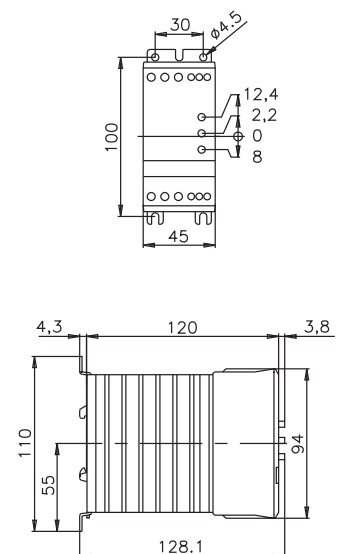
CC3H410



Connection diagram



Dimensions [mm]



Technical approvals, conformities



Solid State Contactor – CC3H420 (three phase)

Type: CC3H420

The CC series solid-state contactors are suitable for the contactless and non-wearing switching of ohmic and inductive AC loads at high switching frequency. They come with an operating voltage up to 600VAC and nominal current up to 50A with two and three phases. They come with control voltages of either 5–24 VDC or 24–230 VAC/VDC.

Output

Switching element	Thyristor
Numbers of phases	3
Nominal voltage (U_{nom})	400 VAC
Output voltage range	24 – 480 VAC
Reverse voltage	1200 V _{rrm}
Peak reverse voltage	1300 V _{rsm}
Min. load	10 mA
Max. leakage current	1 mA
Max. inrush current	20 A
Operation current AC-1/51 @ U_{nom}	20 A
Operation current AC-3 @ U_{nom}	10 A
Operation current AC-55b @ U_{nom}	10 A
Operation current AC-56a @ U_{nom}	5 A
Response/Release time	20 ms
Limit load	1800 A ² t

Input

Voltage	24 – 230 VAC/VDC
Min. voltage	20,4 VAC/VDC
Max. voltage	253 VAC/VDC
Release voltage	7,2 VAC/VDC
Max. current	6 mA

General Specifications

Ambient temperature storage/operation	-20 – 80°C / -5 – 40°C
Connection terminals	Screw terminal 10 mm ²
Ingress protection degree	IP 20
Mounting	DIN rail TS35
Housing material	PPE Noryl SE1 / Aluminium
Weight	1050 g

Insulation

Insulation voltage	4 kV
Dielectric strength	660 V

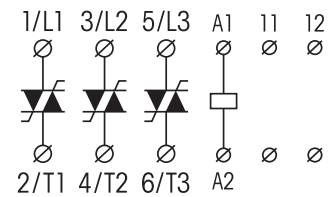
Standard type

Starting Torque Limiter

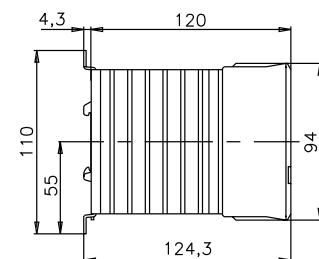
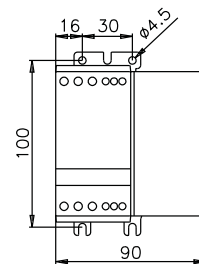
CC3H420



Connection diagram



Dimensions [mm]



Technical approvals, conformities



Solid State Contactor – CC3H610 (three phase)

Type: CC3H610

The CC series solid-state contactors are suitable for the contactless and non-wearing switching of ohmic and inductive AC loads at high switching frequency. They come with an operating voltage up to 600 VAC and nominal current up to 50 A with two and three phases. They come with control voltages of either 5–24 VDC or 24–230 VAC/VDC.

Output

Switching element	Thyristor
Numbers of phases	3
Nominal voltage (U_{nom})	400 VAC
Output voltage range	24 – 480 VAC
Reverse voltage	1200 V _{rrm}
Peak reverse voltage	1300 V _{rsm}
Min. load	10 mA
Max. leakage current	1 mA
Max. inrush current	10 A
Operation current AC-1/51 @ U_{nom}	10 A
Operation current AC-3 @ U_{nom}	10 A
Operation current AC-55b @ U_{nom}	10 A
Operation current AC-56a @ U_{nom}	5 A
Response/Release time	20 ms
Limit load	6300 A ² t

Input

Voltage	24 – 230 VAC/VDC
Min. voltage	20,4 VAC/VDC
Max. voltage	253 VAC/VDC
Release voltage	7,2 VAC/VDC
Max. current	6 mA

General Specifications

Ambient temperature storage/operation	-20 – 80°C / -5 – 40°C
Connection terminals	Screw terminal 6 mm ²
Ingress protection degree	IP 20
Mounting	DIN rail TS35
Housing material	PPE Noryl SE1 / Aluminium
Weight	650 g

Insulation

Insulation voltage	4 kV
Dielectric strength	660 V

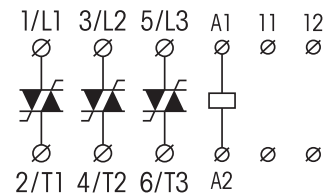
Standard type

Starting Torque Limiter

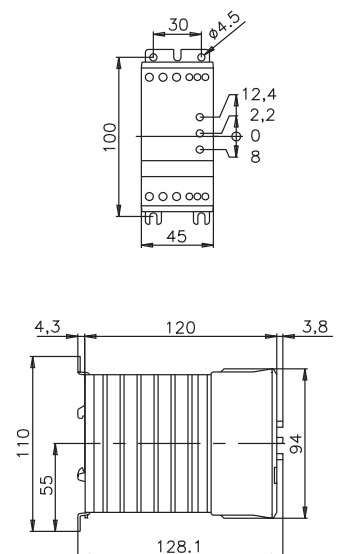
CC3H610



Connection diagram



Dimensions [mm]



Technical approvals, conformities



Solid State Contactor, switching of ohmic – CR11H210 (one phase)

Type: CR11H210

The CR series solid-state contactors are suitable for the contactless and non-wearing switching of ohmic and inductive AC loads at high switching frequency. They come with an operating voltage up to 400 VAC and nominal current up to 63 A with two and three phases. They come with control voltages of either 5–24 VDC or 24–230 VAC/VDC.

Output

Switching element	Thyristor
Numbers of phases	1
Nominal voltage (U_{nom})	230 VAC
Output voltage range	12 – 240 VAC
Reverse voltage	1000 V _{rrm}
Peak reverse voltage	1100 V _{rsm}
Min. load	10 mA
Max. leakage current	1 mA
Max. inrush current	10 A
Operation current AC-1/51 @ U_{nom}	10 A
Response/Release time	20 ms
Limit load	180 A ² t

Input

Voltage	24 – 230 VAC/VDC
Min. voltage	20,4 VAC/VDC
Max. voltage	253 VAC/VDC
Release voltage	7,2 VAC/VDC
Max. current	8 mA

General Specifications

Ambient temperature storage/operation	-20 – 80°C / -5 – 40°C
Connection terminals	Screw terminal 6 mm ²
Ingress protection degree	IP 20
Mounting	DIN rail TS35
Housing material	PPE Noryl SE1 / Aluminium
Weight	270 g

Insulation

Insulation voltage	4 kV
Dielectric strength	660 V

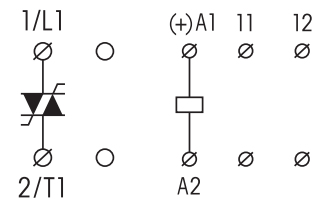
Standard type

Starting Torque Limiter

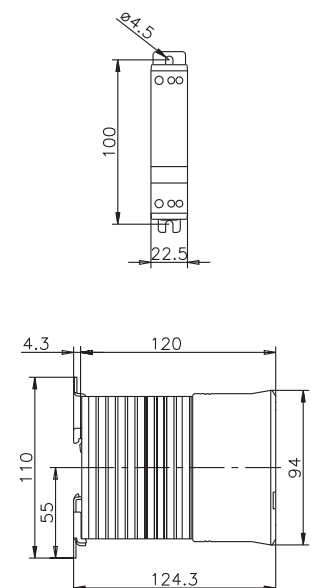
CR11H210



Connection diagram



Dimensions [mm]



Technical approvals, conformities



Solid State Contactor, switching of ohmic – CR11H430 (one phase)

Type: CR11H430

The CR series solid-state contactors are suitable for the contactless and non-wearing switching of ohmic and inductive AC loads at high switching frequency. They come with an operating voltage up to 400 VAC and nominal current up to 63 A with two and three phases. They come with control voltages of either 5–24 VDC or 24–230 VAC/VDC.

Output

Switching element	Thyristor
Numbers of phases	1
Nominal voltage (U_{nom})	400 VAC
Output voltage range	24 – 480 VAC
Reverse voltage	1200 V _{rsm}
Peak reverse voltage	1300 V _{rsm}
Min. load	10 mA
Max. leakage current	1 mA
Max. inrush current	30 A
Operation current AC-1/51 @ U_{nom}	30 A
Response/Release time	20 ms
Limit load	610 A ² t

Input

Voltage	24 – 230 VAC/VDC
Min. voltage	20,4 VAC/VDC
Max. voltage	253 VAC/VDC
Release voltage	7,2 VAC/VDC
Max. current	8 mA

General Specifications

Ambient temperature storage/operation	-20 – 80°C / -5 – 40°C
Connection terminals	Screw terminal 10 mm ²
Ingress protection degree	IP 20
Mounting	DIN rail TS35
Housing material	PPE Noryl SE1 / Aluminium
Weight	650 g

Insulation

Insulation voltage	4 kV
Dielectric strength	660 V

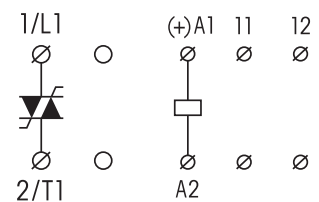
Standard type

Starting Torque Limiter

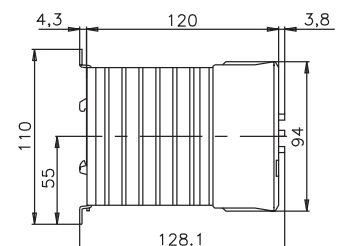
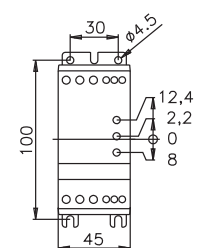
CR11H430



Connection diagram



Dimensions [mm]



Technical approvals, conformities



Solid State Contactor, switching of ohmic – CR11H480 (one phase)

Type: CR11H480

The CR series solid-state contactors are suitable for the contactless and non-wearing switching of ohmic and inductive AC loads at high switching frequency. They come with an operating voltage up to 400 VAC and nominal current up to 63 A with two and three phases. They come with control voltages of either 5–24 VDC or 24–230 VAC/VDC.

Output

Switching element	Thyristor
Numbers of phases	1
Nominal voltage (U_{nom})	400 VAC
Output voltage range	24 – 480 VAC
Reverse voltage	1200 V _{rrm}
Peak reverse voltage	1300 V _{rsm}
Min. load	10 mA
Max. leakage current	1 mA
Max. inrush current	80 A
Operation current AC-1/51 @ U_{nom}	80 A
Response/Release time	20 ms
Limit load	25300 A ² t

Input

Voltage	24 – 230 VAC/VDC
Min. voltage	20,4 VAC/VDC
Max. voltage	253 VAC/VDC
Release voltage	7,2 VAC/VDC
Max. current	8 mA

General Specifications

Ambient temperature storage/operation	-20 – 80°C / -5 – 40°C
Connection terminals	Screw terminal 35 mm ²
Ingress protection degree	IP 20
Mounting	DIN rail TS35
Housing material	PPE Noryl SE1 / Aluminium
Weight	1050 g

Insulation

Insulation voltage	4 kV
Dielectric strength	660 V

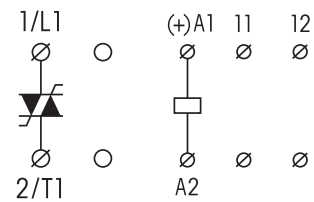
Standard type

Starting Torque Limiter

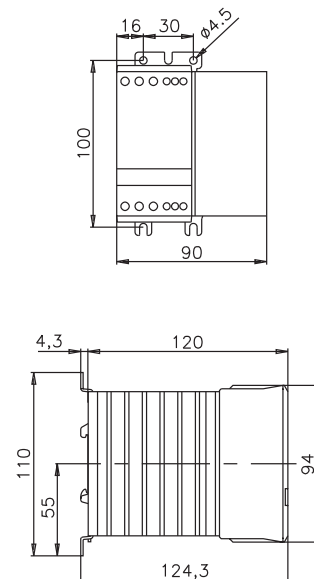
CR11H480



Connection diagram



Dimensions [mm]



Technical approvals, conformities



Solid State Contactor, switching of ohmic – CR11H4125 (one phase)

Type: CR11H4125

The CR series solid-state contactors are suitable for the contactless and non-wearing switching of ohmic and inductive AC loads at high switching frequency. They come with an operating voltage up to 400 VAC and nominal current up to 63 A with two and three phases. They come with control voltages of either 5–24 VDC or 24–230 VAC/VDC.

Output

Switching element	Thyristor
Numbers of phases	1
Nominal voltage (U_{nom})	400 VAC
Output voltage range	24 – 480 VAC
Reverse voltage	1200 V _{rrm}
Peak reverse voltage	1300 V _{rsm}
Min. load	10 mA
Max. leakage current	1 mA
Max. inrush current	125 A
Operation current AC-1/51 @ U_{nom}	125 A
Response/Release time	20 ms
Limit load	25300 A ² t

Input

Voltage	24 – 230 VAC/VDC
Min. voltage	20,4 VAC/VDC
Max. voltage	253 VAC/VDC
Release voltage	7,2 VAC/VDC
Max. current	8 mA

General Specifications

Ambient temperature storage/operation	-20 – 80°C / -5 – 40°C
Connection terminals	Screw terminal 35 mm ²
Ingress protection degree	IP 20
Mounting	DIN rail TS35
Housing material	PPE Noryl SE1 / Aluminium
Weight	1050 g

Insulation

Insulation voltage	4 kV
Dielectric strength	660 V

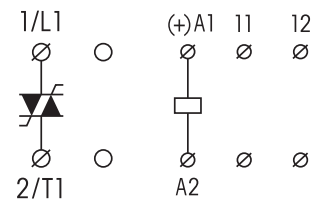
Standard type

Starting Torque Limiter

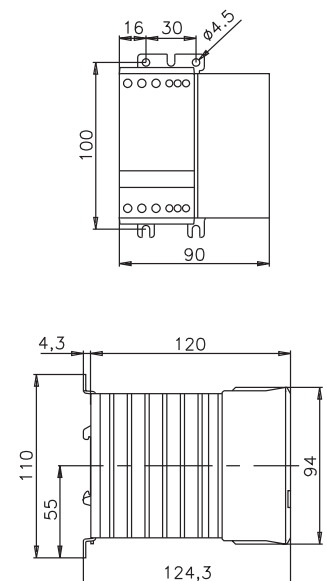
CR11H4125



Connection diagram



Dimensions [mm]



Technical approvals, conformities



Solid State Contactor, switching of ohmic – CR22H430 (two phase)

Type: CR22H430

The CR series solid-state contactors are suitable for the contactless and non-wearing switching of ohmic and inductive AC loads at high switching frequency. They come with an operating voltage up to 400 VAC and nominal current up to 63 A with two and three phases. They come with control voltages of either 5–24 VDC or 24–230 VAC/VDC.

Output

Switching element	Thyristor
Numbers of phases	2
Nominal voltage (U_{nom})	400 VAC
Output voltage range	24 – 480 VAC
Reverse voltage	1200 V _{rrm}
Peak reverse voltage	1300 V _{rsm}
Min. load	10 mA
Max. leakage current	1 mA
Max. inrush current	30 A
Operation current AC-1/51 @ U_{nom}	30 A
Response/Release time	20 ms
Limit load	25300 A ² t

Input

Voltage	24 – 230 VAC/VDC
Min. voltage	20,4 VAC/VDC
Max. voltage	253 VAC/VDC
Release voltage	7,2 VAC/VDC
Max. current	8 mA

General Specifications

Ambient temperature storage/operation	-20 – 80°C / -5 – 40°C
Connection terminals	Screw terminal 10 mm ²
Ingress protection degree	IP 20
Mounting	DIN rail TS35
Housing material	PPE Noryl SE1 / Aluminium
Weight	650 g

Insulation

Insulation voltage	4 kV
Dielectric strength	660 V

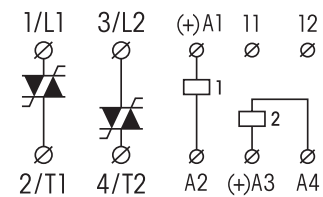
Standard type

Starting Torque Limiter

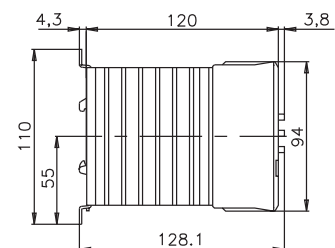
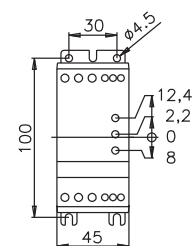
CR22H430



Connection diagram



Dimensions [mm]



Technical approvals, conformities



Solid State Contactor, switching of ohmic – CR33H420 (three phase)

Type: CR33H420

The CR series solid-state contactors are suitable for the contactless and non-wearing switching of ohmic and inductive AC loads at high switching frequency. They come with an operating voltage up to 400 VAC and nominal current up to 63 A with two and three phases. They come with control voltages of either 5–24 VDC or 24–230 VAC/VDC.

Output

Switching element	Thyristor
Numbers of phases	3
Nominal voltage (U_{nom})	400 VAC
Output voltage range	24 – 480 VAC
Reverse voltage	1200 V _{rrm}
Peak reverse voltage	1300 V _{rsm}
Min. load	10 mA
Max. leakage current	1 mA
Max. inrush current	20 A
Operation current AC-1/51 @ U_{nom}	20 A
Response/Release time	20 ms
Limit load	610 A ² t

Input

Voltage	24 – 230 VAC/VDC
Min. voltage	20,4 VAC/VDC
Max. voltage	253 VAC/VDC
Release voltage	7,2 VAC/VDC
Max. current	8 mA

General Specifications

Ambient temperature storage/operation	-20 – 80°C / -5 – 40°C
Connection terminals	Screw terminal 10 mm ²
Ingress protection degree	IP 20
Mounting	DIN rail TS35
Housing material	PPE Noryl SE1 / Aluminium
Weight	1050 g

Insulation

Insulation voltage	4 kV
Dielectric strength	660 V

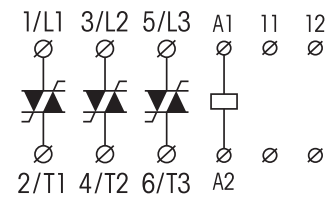
Standard type

Starting Torque Limiter

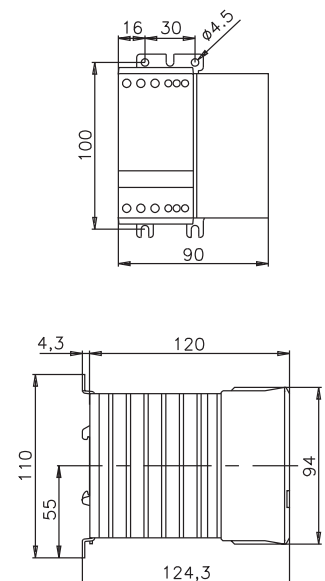
CR33H420



Connection diagram



Dimensions [mm]



Technical approvals, conformities



Reversing Contactor – CCR3H410 (three phase)

Type: CCR3H410

The CCR is a reversing contactor for asynchronous motors up to 10 A / 400 VAC. It has two separate electric control inputs for right and left motion that are interlocked. It comes with control voltages of either 5–24 VDC or 24–230 VAC/VDC.

Output

Switching element	Thyristor
Numbers of phases	3
Nominal voltage (U_{nom})	400 VAC
Output voltage range	24 – 480 VAC
Reverse voltage	1200 V _{rrm}
Peak reverse voltage	1300 V _{rsm}
Min. load	50 mA
Max. leakage current	5 mA
Max. inrush current	60 – 70 A
Operation current AC-1/51 @ U_{nom}	10 A
Operation current AC-53 @ U_{nom}	10 A
Response/Release time	20 ms
Limit load	610 A ² t

Input

Voltage	24 – 230 VAC/VDC
Min. voltage	20,4 VAC/VDC
Max. voltage	253 VAC/VDC
Release voltage	7,2 VAC/VDC
Max. current	6 mA

General Specifications

Ambient temperature storage/operation	-20 – 80°C / -5 – 40°C
Connection terminals	Screw terminal 6 mm ²
Ingress protection degree	IP 20
Mounting	DIN rail TS35
Housing material	PPE Noryl SE1 / Aluminium
Weight	650 g

Insulation

Insulation voltage	4 kV
Dielectric strength	660 V

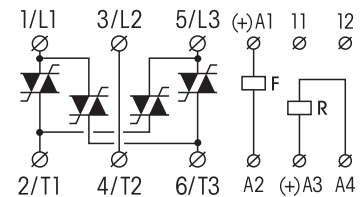
Standard type

Starting Torque Limiter

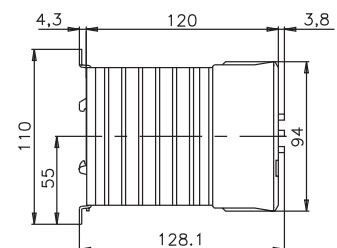
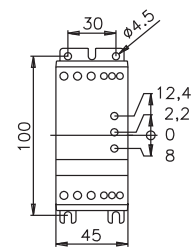
CCR3H410



Connection diagram



Dimensions [mm]



Technical approvals, conformities



Performance Regulator – CPC1230 (one phase)

Type: CPC1230

The one-phase solid-state performance regulator CPC is suitable for triggering heating elements, lamps and transformers up to 50 A. Performance is controlled through a potentiometer or analogue standard signal. It has a 24 VDC voltage supply.

Output

Switching element	Thyristor
Numbers of phases	1
Nominal voltage (U_{nom})	230 VAC
Output voltage range	380 – 480 VAC
Reverse voltage	1000 V _{rrm}
Peak reverse voltage	1100 V _{rsm}
Min. load	10 mA
Max. leakage current	1 mA
Max. inrush current	—
Operation current AC-1/51 @ U_{nom}	30 A
Operation current AC-53 @ U_{nom}	non uL
Response/Release time	20 ms
Limit load	1800 A ² t

Input

Voltage	24 VAC/VDC
Min. voltage	12 VAC/VDC
Max. voltage	35 VAC/VDC
Release voltage	12 VAC/VDC
Control signal	0 – 10 V, 4 – 20 mA
Potentiometer	10 kOhm

General Specifications

Ambient temperature storage/operation	-20 – 80°C / -5 – 40°C
Connection terminals	Screw terminal 2.5 mm ²
Ingress protection degree	IP 20
Mounting	DIN rail TS35
Housing material	PPE Noryl SE1 / Aluminium
Weight	650 g

Insulation

Insulation voltage	4 kV
Dielectric strength	660 V

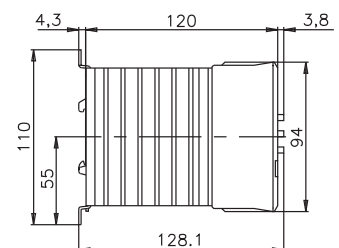
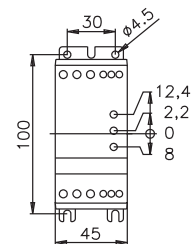
Standard type

Starting Torque Limiter

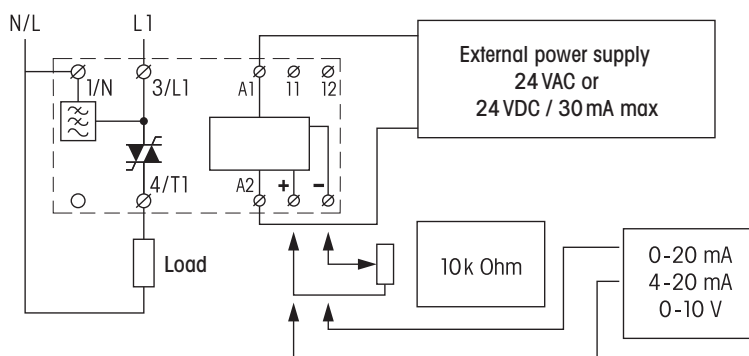
CPC1230



Dimensions [mm]



Connection diagram



Technical approvals, conformities



Performance Regulator – CPC1430 (one phase)

Type: CPC1430

The one-phase solid-state performance regulator CPC is suitable for triggering heating elements, lamps and transformers up to 50 A. Performance is controlled through a potentiometer or analogue standard signal. It has a 24 VDC voltage supply.

Output

Switching element	Thyristor
Numbers of phases	1
Nominal voltage (U_{nom})	400 VAC
Output voltage range	380 – 480 VAC
Reverse voltage	1200 V _{rrm}
Peak reverse voltage	1300 V _{rsm}
Min. load	10 mA
Max. leakage current	1 mA
Max. inrush current	—
Operation current AC-1/51 @ U_{nom}	30 A
Operation current AC-53 @ U_{nom}	non uL
Response/Release time	20 ms
Limit load	1800 A ² t

Input

Voltage	24 VAC/VDC
Min. voltage	12 VAC/VDC
Max. voltage	35 VAC/VDC
Release voltage	12 VAC/VDC
Control signal	0 – 10 V, 4 – 20 mA
Potentiometer	10 kOhm

General Specifications

Ambient temperature storage/operation	-20 – 80°C / -5 – 40°C
Connection terminals	Screw terminal 2,5 mm ²
Ingress protection degree	IP 20
Mounting	DIN rail TS35
Housing material	PPE Noryl SE1 / Aluminium
Weight	650 g

Insulation

Insulation voltage	4 kV
Dielectric strength	660 V

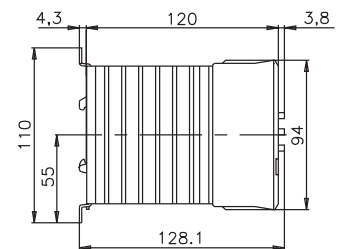
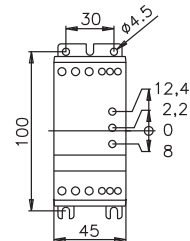
Standard type

Starting Torque Limiter

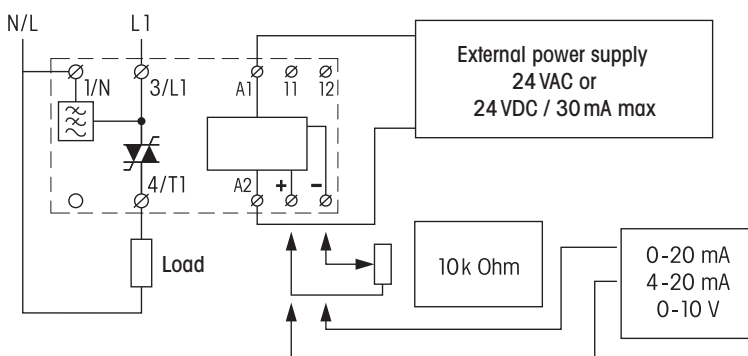
CPC1430



Dimensions [mm]



Connection diagram



Technical approvals, conformities



Performance Regulator – CPC1450 (one phase)

Type: CPC1450

The one-phase solid-state performance regulator CPC is suitable for triggering heating elements, lamps and transformers up to 50 A. Performance is controlled through a potentiometer or analogue standard signal. It has a 24 VDC voltage supply.

Output

Switching element	Thyristor
Numbers of phases	1
Nominal voltage (U_{nom})	400 VAC
Output voltage range	380 – 480 VAC
Reverse voltage	1200 V _{rrm}
Peak reverse voltage	1300 V _{rsm}
Min. load	10 mA
Max. leakage current	1 mA
Max. inrush current	—
Operation current AC-1/51 @ U_{nom}	50 A
Operation current AC-53 @ U_{nom}	non uL
Response/Release time	20 ms
Limit load	1800 A ² t

Input

Voltage	24 VAC/VDC
Min. voltage	12 VAC/VDC
Max. voltage	35 VAC/VDC
Release voltage	12 VAC/VDC
Control signal	0 – 10 V, 4 – 20 mA
Potentiometer	10 kOhm

General Specifications

Ambient temperature storage/operation	-20 – 80°C / -5 – 40°C
Connection terminals	Screw terminal 2,5 mm ²
Ingress protection degree	IP 20
Mounting	DIN rail TS35
Housing material	PPE Noryl SE1 / Aluminium
Weight	1050 g

Insulation

Insulation voltage	4 kV
Dielectric strength	660 V

Standard type

Starting Torque Limiter

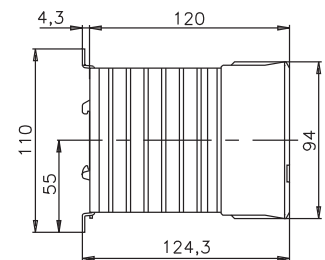
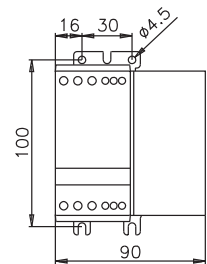
CPC1450



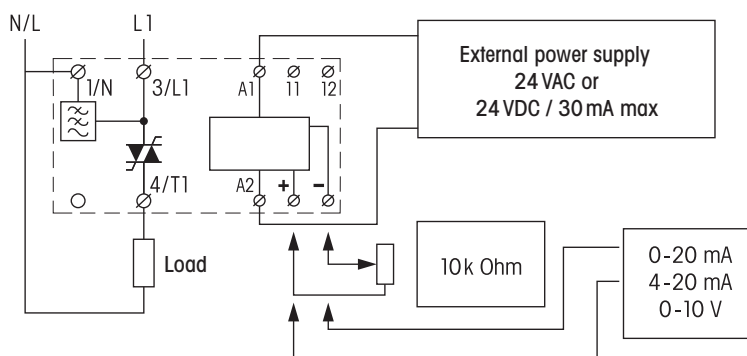
Relays 1.9

1

Dimensions [mm]



Connection diagram



Technical approvals, conformities



2.0 Time Relays



Delay functions

E On delay

S ⇒ R on with delay
S OFF ⇒ R off

A Off delay

S ⇒ R on
S OFF ⇒ R off with delay

F On and off delay

S ⇒ R on with delay (t₁)
S OFF ⇒ R off with delay (t₂)

Shot timing modes

W One shot leading edge

S ⇒ R on for t
S OFF ⇒ R off (pulse clipping)

N One shot trailing edge

S OFF ⇒ R on for t
S on for t ⇒ R off

Q One shot leading and trailing edge

S ⇒ R on for t₁
S OFF ⇒ R on for t₂
S OFF off for t₁ ⇒ R off

Puls shaping

K Puls shaping

S (pulse or continuous contact) ⇒ R on for t
S... no influence on R and t

L Pulse shaping, retrigger (subsequ.time operation from 0)

S (pulse or continuous contact) ⇒ R on for t
S on for t = tRESET

M Puls shaping

S OFF ⇒ R on for t
S... no influence on R and t

Blinker functions

B Blinker, pulse start

S ⇒ R on/off periodically according to t
S OFF ⇒ R off

B1 Blinker, pulse start, trailing pulse

S ⇒ R on/off periodically according to t
S OFF: last pulse = t

B2 Blinker, interval start

S ⇒ R after t on/off periodically according to t
S OFF ⇒ R off

Delayed pulse

G On delay single shot

S (pulse or continuous contact) ⇒ R after t₁ on for t₂
S... no influence on R and t

H On delay single shot

S ⇒ R after t₁ on for t₂
S OFF ⇒ R off

Repeat cycle timer

I Repeat cycle timer, pulse start

S ⇒ R on/off periodically according to t₁ and t₂
S OFF ⇒ R off

P Repeat cycle timer, interval start

S ⇒ R after t₁ (t₂) on/off periodically according to t₂ and t₁
S OFF ⇒ R off

C55, CT1: $\frac{t_2}{t_1}$

Special functions

Y Star-delta timer

S ⇒ R on for t
R OFF ⇒ Δ on with delay for t, Δ
S OFF ⇒ Δ off

X1 Restart delay

S ⇒ R on
S OFF ⇒ R off and starts t
S ⇒ R restart only after t

Special functions

S Step-on / Step-off switch

S ⇒ R on/off

LS Step-switching (staircase lighting timer), with time lapse

S ⇒ R on and starts t
S on for t ⇒ R off

Stop/Reset

tSTOP SSTOP interrupts t (t-addition) **T** t is stopped ⇒ R on/off

tRESET SRESET reset t t restarts immediately **T** Test

S = Triggering
R = Output circuit
⇒ = switches...
ON OFF

Pulse sequence monitoring

U S1/S2 P (t_p)

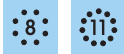
V S1/S2 P (t_p)

S1/S2 = Monitoring start
P = Pulse sequence
t_p = Pulse separation

≤: Pulse separation is **smaller** than the time t_p Start with S1 = **without** start-up short-out t_A t_v = settable alarm delay delay (t_A = t_v)
>: Pulse separation is **larger** than the time t_p Start with S2 = start-up short-out t_A

01/2018

Time Cubes



Type	Function																t-Stop	t-Reset	Ext. Polt	t max.												
	E	A	F	W	N	Q	K	L	M	B	B ₁	B ₂	G	H	I	P				S	LS	X ₁	U	V	sec	min	h	d	Page			
CT...E 30	●																										30				185	
CT...A 30		●																										30				185
CT...K 30				●				●																				30				185
CT...W 30					●																							30				185
CT...B 30										●																		30				185

Modular plug-in Time Relays (CT-System)



Type	Function																t-Stop	t-Reset	Ext. Polt	t max.												
	E	A	F	W	N	Q	K	L	M	B	B ₁	B ₂	G	H	I	P				S	LS	X ₁	U	V	sec	min	h	d	Page			
CT30...	●			●						●																		30				189
CT32...	●	●		●	●			●		●	●																	60*				189
CT33...	●	●	△	●	●	△		●	●	●	●		▲	▲														60*				189
CT36...															●	●												60*				189

Plug-in Time Relays



Type	Function																t-Stop	t-Reset	Ext. Polt	t max.													
	E	A	F	W	N	Q	K	L	M	B	B ₁	B ₂	G	H	I	P				S	LS	X ₁	U	V	sec	min	h	d	Page				
CS1	●			●						●	●																	60*				180	
CS2	●	●		●	●			●		●	●																		60*				181
CS3	●	●		●	●			●		●	●																		60*				182

DIN Time Relays



Type	Function																t-Stop	t-Reset	Ext. Polt	t max.													
	E	A	F	W	N	Q	K	L	M	B	B ₁	B ₂	G	H	I	P				S	LS	Y	U	V	sec	min	h	d	Page				
CMD11	●	●																										60				156	
CIM1	●	●		●	●			●		●	●						●	●											60*				163
CIM12	●	●		●	●			●		●	●						●	●											60*				164
CIM13	●	●		●	●			●		●	●						●	●											60*				165
CIM14	●	●		●	●			●		●	●						●	●											60*				166
CIM2	●	●						●	●			●	●	●															60*				167
CIM22	●	●						●	●			●	●	●															60*				168
CIM23	●	●						●	●			●	●	●															60*				169
CIM3			●			●							●	●	●														60*				170
CIM32			●			●							●	●	●														60*				171
CIM33			●			●							●	●	●														60*				172
CM3	●	●		●	●			●		●	●																		60*				173
CRV4	●	●	△	●	●	△		●	●	●	●		●	●	●			●	●										60*				174
CSV4	●	●	△	●	●	△		●	●	●	●		●	●	●			●	●										10*				175
CPF11	●							●	●																		0,6					176	

* TF-60 Setting of long times

The TF60 time setting method permits short examination of long delay time settings. Elapsing times of hours can be monitored in the sec. range.

Example for a delay time of 38h:

1. Set range switch to 60sec
2. Set 38sec on the potentiometer (e.g. check 38sec by chronometer)
3. Set range switch to 60h

The delay time now amounts to 38h.

- 1) alternatively with instantaneous contact
- without auxiliary voltage (relay bistable)
- without auxiliary voltage (relay monostable)

△ t₂ = t₁

▲ t₂ = 0,5s

2.1 Monofunction Time Relays



Application	Types	Functions*	Min. time	Max. time	contact rating	Socket
Monofunction Time Relay	CMD	A, E	50 ms	60 min	10 A / 250 V	DIN

*(Function diagrams: refer to page 152)

CMD11-A/UC12V, CMD11-E/UC12V

Monofunction Time Relay

On delay (E) or Off delay (A), 0.5 s ... 60 minutes

DIN Rail mounting according to DIN 43 880

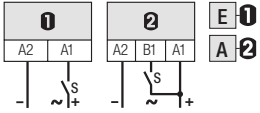


Type: CMD11-.../UC12V

The CMD is a cost-efficient timing relay supporting timing functions such as on-delay or off-delay and five time ranges from 50 ms to 60 minutes. It comes with an 8 A change-over contact and with four separate supplies (UC12V, UC24V, AC115V und AC230V). The output state is displayed by LED. The relay may be manually operated and blocked by ON/OFF switch.

Maximum contact load	10 A 250 V AC-1	6 A 25 V DC-1
Recommended minimum contact load	100 mA / 12 V	

Time functions and related connection diagrams (Function diagrams: refer to page 152)



Time data

5 partial time ranges, t_{max} (DIP switch)	0,6 s / 6 s / 60 s / 6 min / 60 min
Fine adjustment range (rotary knob)	$t_{min} \dots t_{max}$, 0.5 ... 6
Time range tolerance	t_{min} : -30 % ... +0 % / t_{max} : -0 % ... +30 %
Repetition accuracy	± 0.2 % or 20 ms
Response time, power on, on A1	≤ 50 ms
Min. trigger pulse width on input B1	100 ms (AC / DC)
Reset time B1 (AC/DC)	≤ 90 ms
Voltage failure buffering	≥ 5 ms

Contacts

Type	Single contact, CO
Material	AgNi
Rated operational current	10 A
Max. inrush current (10ms)	15 A
Max. switching voltage AC-1	250 V
Max. AC load AC-1 (Fig. 1)	2500 VA AC-1
Max. DC load DC-1 24 V / 220 V (Fig. 2)	150 W / 70 W

Power supply- and control input

CMD11-.../UC12V	
Nominal voltage (UC = AC / DC)	12 V AC/DC
Operating voltage range	9.6 ... 14.4 V AC/DC
Power consumption DC typ.	32 mA
Power consumption AC typ.	50 mA
Frequency range	48 ... 62 Hz
Input current into B1 typ. AC/DC	2.7/4.3 mA
Trigger threshold voltage on B1 typ AC / DC	5.2 / 8.8 V

Insulation

Test voltage open contact	1 kVrms 1 minute
Test voltage between contacts and control input	2 kVrms 1 minute

General Specifications

Ambient temperature storage /operation	-40 ... 85 °C / -40 ...60 °C
Life time of contacts 8 A, 250 V AC-1	75 x 10 ³
Conductor cross section	Stranded wire 2.5 mm ² , 2 x 1.5 mm ²
Ingress protection degree	IP 20
Max. Screw torque	0.5 Nm
Housing material / Weight	Polyamide PA-66 (UL94-V0) / 48 g

Standard types

Monofunction Time Relay (Off delay)
Monofunction Time Relay (On delay)

CMD11-A/UC12V
CMD11-E/UC12V



Connection diagram

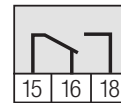


Fig.1 AC voltage endurance

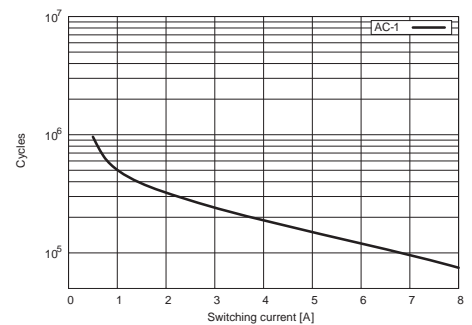
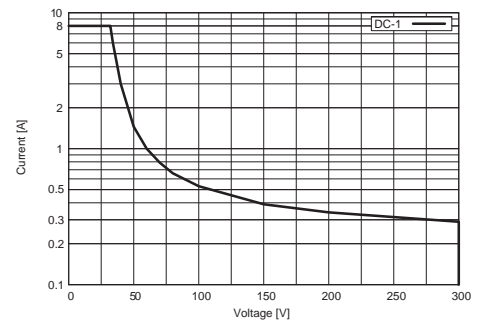
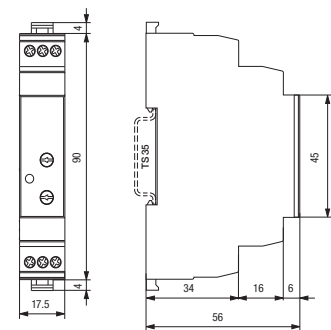


Fig. 2 DC load limit curve



Dimensions [mm]



Technical approvals, conformities



EN 60947

CMD11-A/UC24V, CMD11-E/UC24V

Monofunction Time Relay

On delay (E) or Off delay (A), 0.5 s ... 60 minutes

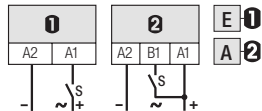
DIN Rail mounting according to DIN 43 880

Type: CMD11-.../UC12V

The CMD is a cost-efficient timing relay supporting timing functions such as on-delay or off-delay and five time ranges from 50 ms to 60 minutes. It comes with an 8 A change-over contact and with four separate supplies (UC12V, UC24V, AC115V und AC230V). The output state is displayed by LED. The relay may be manually operated and blocked by ON/OFF switch.

Maximum contact load	10 A 250 V AC-1	6 A 25 V DC-1
Recommended minimum contact load	100 mA / 12 V	

Time functions and related connection diagrams (Function diagrams: refer to page 152)



Time data

5 partial time ranges, t_{max} (DIP switch)	0,6 s / 6 s / 60 s / 6 min / 60 min
Fine adjustment range (rotary knob)	$t_{min} \dots t_{max}$, 0.5 ... 6
Time range tolerance	t_{min} : -30 % ... +0 % / t_{max} : -0 % ... +30 %
Repetition accuracy	± 0.2 % or 20 ms
Response time, power on, on A1	≤ 50 ms
Min. trigger pulse width on input B1	100 ms (AC / DC)
Reset time B1 (AC/DC)	≤ 90 ms
Voltage failure buffering	≥ 5 ms

Contacts

Type	Single contact, CO
Material	AgNi
Rated operational current	10 A
Max. inrush current (10ms)	15 A
Max. switching voltage AC-1	250 V
Max. AC load AC-1 (Fig. 1)	2500 VA AC-1
Max. DC load DC-1 24 V / 220 V (Fig. 2)	150 W / 70 W

Power supply- and control input

CMD11-.../UC24V	
Nominal voltage (UC = AC / DC)	24 V AC/DC
Operating voltage range	19.2 ... 28.8 V AC/DC
Power consumption DC typ.	12 mA
Power consumption AC typ.	21 mA
Frequency range	48 ... 62 Hz
Input current into B1 typ. AC/DC	11.6. /9.5 mA
Trigger threshold voltage on B1 typ AC / DC	9.5 / 14 V

Insulation

Test voltage open contact	1 kVrms 1 minute
Test voltage between contacts and control input	2 kVrms 1 minute

General Specifications

Ambient temperature storage /operation	-40 ... 85 °C / -40 ...60 °C
Life time of contacts 8 A, 250 V AC-1	75×10^3
Conductor cross section	Stranded wire 2.5 mm ² , 2 x 1.5 mm ²
Ingress protection degree	IP 20
Max. Screw torque	0.5 Nm
Housing material / Weight	Polyamide PA-66 (UL94-V0) / 48 g

Standard types

Monofunction Time Relay (Off delay)
Monofunction Time Relay (On delay)

CMD11-A/UC24V
CMD11-E/UC24V



Connection diagram

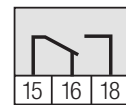


Fig.1 AC voltage endurance

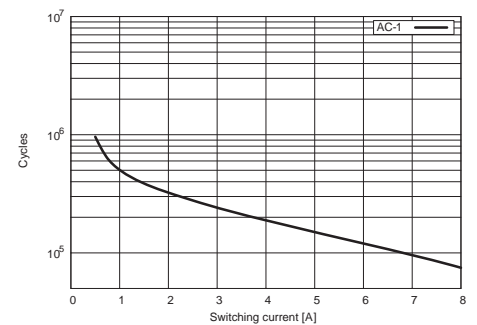
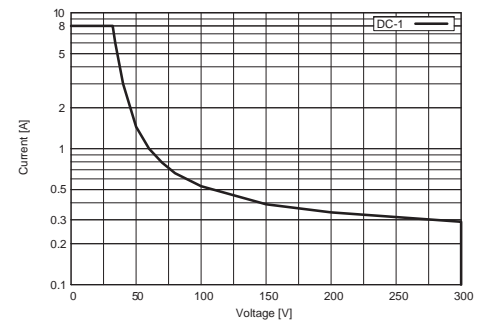
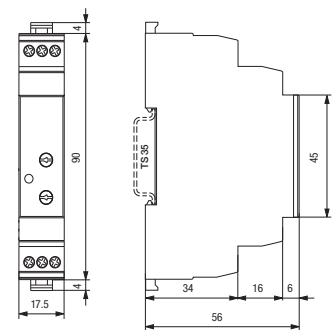


Fig. 2 DC load limit curve



Dimensions [mm]



Technical approvals, conformities



EN 60947

CMD11-A/AC115V, CMD11-E/AC115V

Monofunction Time Relay

On delay (E) or Off delay (A), 0.5 s ... 60 minutes

DIN Rail mounting according to DIN 43 880

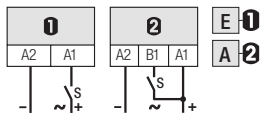


Type: CMD11-.../UC12V

The CMD is a cost-efficient timing relay supporting timing functions such as on-delay or off-delay and five time ranges from 50 ms to 60 minutes. It comes with an 8 A change-over contact and with four separate supplies (UC12V, UC24V, AC115V und AC230V). The output state is displayed by LED. The relay may be manually operated and blocked by ON/OFF switch.

Maximum contact load	10 A 250 V AC-1	6 A 25 V DC-1
Recommended minimum contact load	100 mA / 12 V	

Time functions and related connection diagrams (Function diagrams: refer to page 152)



Time data

5 partial time ranges, t_{max} (DIP switch)	0,6 s / 6 s / 60 s / 6 min / 60 min
Fine adjustment range (rotary knob)	$t_{min} \dots t_{max}$, 0.5 ... 6
Time range tolerance	t_{min} : -30 % ... +0 % / t_{max} : -0 % ... +30 %
Repetition accuracy	± 0.2 % or 20 ms
Response time, power on, on A1	≤ 50 ms
Min. trigger pulse width on input B1	100 ms (AC / DC)
Reset time B1 (AC/DC)	≤ 90 ms
Voltage failure buffering	≥ 5 ms

Contacts

Type	Single contact, CO
Material	AgNi
Rated operational current	10 A
Max. inrush current (10ms)	15 A
Max. switching voltage AC-1	250 V
Max. AC load AC-1 (Fig. 1)	2500 VA AC-1
Max. DC load DC-1 24 V / 220 V (Fig. 2)	150 W / 70 W

Power supply- and control input

Nominal voltage	CMD11-.../AC115V 115 V AC
Operating voltage range	92 ... 138 V AC
Power consumption AC typ.	47 mA
Frequency range	48 ... 62 Hz
Input current into B1 typ. AC	1.7 mA
Trigger threshold voltage on B1 typ AC	42 V

Insulation

Test voltage open contact	1 kVrms 1 minute
Test voltage between contacts and control input	2 kVrms 1 minute

General Specifications

Ambient temperature storage /operation	-40 ... 85 °C / -40 ... 60 °C
Life time of contacts 8 A, 250 V AC-1	75×10^3
Conductor cross section	Stranded wire 2.5 mm ² , 2 x 1.5 mm ²
Ingress protection degree	IP 20
Max. Screw torque	0.5 Nm
Housing material / Weight	Polyamide PA-66 (UL94-V0) / 48 g

Standard types

Monofunction Time Relay (Off delay)
Monofunction Time Relay (On delay)

CMD11-A/AC115V
CMD11-E/AC115V



Connection diagram

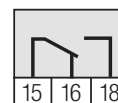


Fig.1 AC voltage endurance

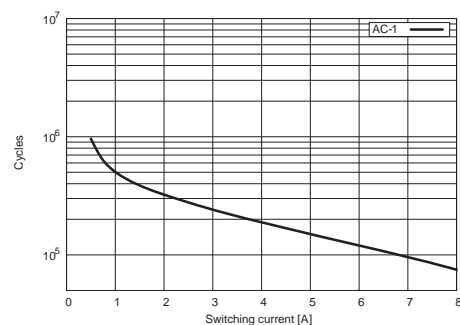
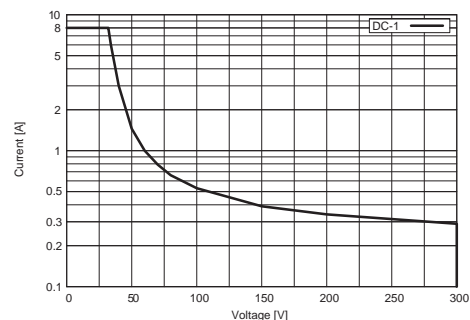
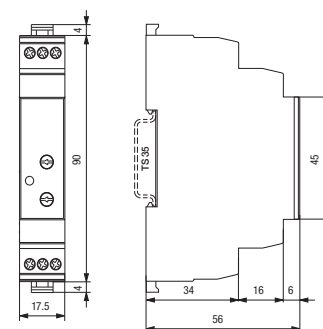


Fig. 2 DC load limit curve



Dimensions [mm]



Technical approvals, conformities



EN 60947

CMD11-A/AC230V, CMD11-E/AC230V

Monofunction Time Relay

On delay (E) or Off delay (A), 0.5 s ... 60 minutes

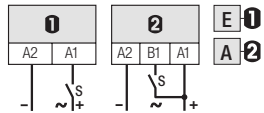
DIN Rail mounting according to DIN 43 880

Type: CMD11-.../AC230V

The CMD is a cost-efficient timing relay supporting timing functions such as on-delay or off-delay and five time ranges from 50 ms to 60 minutes. It comes with an 8 A change-over contact and with four separate supplies (UC12V, UC24V, AC115V und AC230V). The output state is displayed by LED. The relay may be manually operated and blocked by ON/OFF switch.

Maximum contact load	10 A 250 V AC-1	6 A 25 V DC-1
Recommended minimum contact load	100 mA / 12 V	

Time functions and related connection diagrams (Function diagrams: refer to page 152)



Time data

5 partial time ranges, t_{max} (DIP switch)	0,6 s / 6 s / 60 s / 6 min / 60 min
Fine adjustment range (rotary knob)	$t_{min} \dots t_{max}, 0.5 \dots 6$
Time range tolerance	$t_{min}: -30 \% \dots +0 \% / t_{max}: -0 \% \dots +30 \%$
Repetition accuracy	$\pm 0.2 \%$ or 20 ms
Response time, power on, on A1	≤ 50 ms
Min. trigger pulse width on input B1	100 ms (AC / DC)
Reset time B1 (AC/DC)	≤ 90 ms
Voltage failure buffering	≥ 5 ms

Contacts

Type	Single contact, CO
Material	AgNi
Rated operational current	10 A
Max. inrush current (10ms)	15 A
Max. switching voltage AC-1	250 V
Max. AC load AC-1 (Fig. 1)	2500 VA AC-1
Max. DC load DC-1 24 V / 220 V (Fig. 2)	150 W / 70 W

Power supply- and control input

Nominal voltage	CMD11-.../AC230V 230 V AC
Operating voltage range	184 ... 255 V AC
Power consumption AC typ.	60 mA
Frequency range	48 ... 62 Hz
Input current into B1 typ. AC	1.9 mA
Trigger threshold voltage on B1 typ AC	80 V

Insulation

Test voltage open contact	1 kVrms 1 minute
Test voltage between contacts and control input	2 kVrms 1 minute

General Specifications

Ambient temperature storage /operation	-40 ... 85 °C / -40 ...60 °C
Life time of contacts 8 A, 250 V AC-1	75×10^3
Conductor cross section	Stranded wire 2.5 mm ² , 2 x 1.5 mm ²
Ingress protection degree	IP 20
Max. Screw torque	0.5 Nm
Housing material / Weight	Polyamide PA-66 (UL94-V0) / 48 g

Standard types

Monofunction Time Relay (Off delay)
Monofunction Time Relay (On delay)

CMD11-A/AC230V
CMD11-E/AC230V



Connection diagram

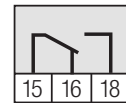


Fig.1 AC voltage endurance

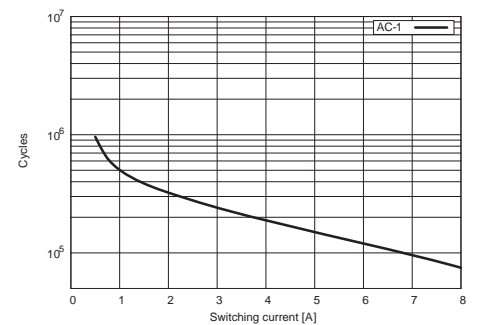
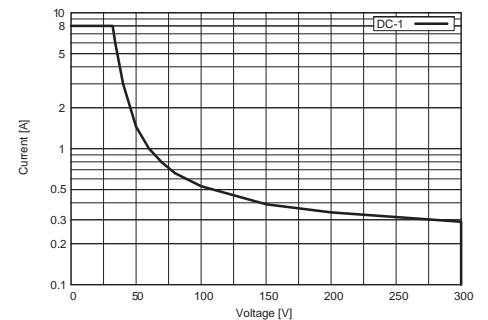
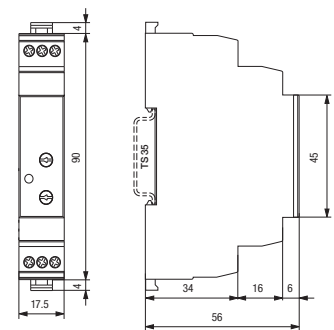


Fig. 2 DC load limit curve



Dimensions [mm]



Technical approvals, conformities



EN 60947

2.2 Multifunction Time Relays



Application	Types	Functions	Min. time	Max. time	Contact rating	Design
Universal time relay, 8 time functions & stepping function, ON/OFF switch, service function	CIM1	E, B, W, A, K, N, B1, S, LS	50 ms	60 h	16 A / 250 V	17.5 mm
Universal time relay, 8 time functions & stepping function, ON/OFF switch, AC solid state output	CIM12	E, B, W, A, K, N, B1, S, LS	50 ms	60 h	2 A / 250 V	17.5 mm
Universal time relay, 8 time functions & stepping function, ON/OFF switch, DC solid state output	CIM13	E, B, W, A, K, N, B1, S, LS	50 ms	60 h	5 A / 24 V DC	17.5 mm
Universal time relay for high inrush currents 8 time functions & stepping function, ON/OFF switch, service function	CIM14	E, B, W, A, K, N, B1, S, LS	50 ms	60 h	16 A / 250 V	17.5 mm
Universal time relay, 7 time functions, ON/OFF switch, service function	CIM2	E, A, L, M, G, B2, H	50 ms	60 h	16 A / 250 V	17.5 mm
Universal time relay, 7 time functions, ON/OFF switch, service function, AC solid state output	CIM22	E, A, L, M, G, B2, H	50 ms	60 h	2 A / 250 V	17.5 mm
Universal time relay, 7 time functions, ON/OFF switch, service function, DC solid state output	CIM23	E, A, L, M, G, B2, H	50 ms	60 h	5 A / 24 V DC	17.5 mm
Universal time relay, 6 time functions, ON/OFF switch, service function	CIM3	F, Q, G, H, I, P	50 ms	60 h	16 A / 250 V	17.5 mm
Universal time relay, 6 time functions, ON/OFF switch, service function, AC solid state output	CIM32	F, Q, G, H, I, P	50 ms	60 h	2 A / 250 V	17.5 mm
Universal time relay, 6 time functions, ON/OFF switch, service function, DC solid state output	CIM33	F, Q, G, H, I, P	50 ms	60 h	5 A / 24 V DC	17.5 mm
Universal timer, ON-OFF switch, 2 CO contacts	CM3	E, A, K, N, B1, B, W	50 ms	60 h	5 A / 250 V	17.5 mm
Multi function time relay, 16 time functions	CRV4	E1, W, B, B2, H, E2, K, A L, N, M, B1, G, F, Q, LS, S	0.6 s	60 h	6 A / 250 V	13 mm
Multi function time relay, 16 time functions	CSV4	E1, W, B, B2, H, E2, K, A L, N, M, B1, G, F, Q, LS, S	8 ms	10 h	1.5 A / 30 V	13 mm
Pulse shaper	CPF11	K, L, A	5 ms	600 ms	0.8 A / 24 V	17.5 mm

(Function diagrams: refer to page 152)

CIM1, CIM1R (Railway)

Time relay with mechanical changeover output contact
8 time functions + stepping function, ON-OFF switch, 50 ms ... 60 h,
DIN Rail mounting according to DIN 43 880



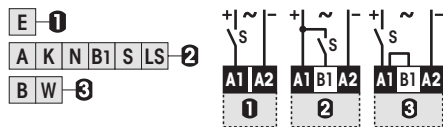
Type: CIM1/UC24-240V

Sophisticated multifunction time relay, 1 changeover power contact with zero crossing switching (50/60 Hz), 8 time functions, stepping function and service function ON/OFF, time ranges: 50 ms ... 60 h, multifunction LED state indicator, suitable for any time-control application and also staircase lighting, Light-switch neon lamp current absorption on input B1, Manual switching function for maintenance, emergency, etc., 16.6 Hz power supply applications. Railway version available.

Maximum contact load	16 A / 250 V AC-1 384 W DC-1
Recommended minimum contact load	10 mA / 10 V

Time functions and related connection diagrams (Function diagrams: refer to page 152)

The functions are selectable by rotary switch



LED function table:

LED	Relay	Time run
OFF	OFF	NO
Continuous ON	ON	NO
Short blinking	OFF	YES
Long blinking	ON	YES

Time data

7 partial time ranges, t_{max} (rotary switch)	0.6, 6, 60 s / 6, 60 min / 6, 60 h
Fine adjustment range (rotary knob)	$t_{min} \dots t_{max}$, 0.5 ... 6
Time range tolerance	t_{min} : -5 % ... +0 % / t_{max} : -0 % ... +5 %
Repetition accuracy	± 0.1 % or DC: 2 ms / AC: 10 ms
Response time, power on, on A1	≤ 45 ms
Min. trigger pulse on B1	20 ms (AC / DC)
Reset time B1 (AC/DC)	≤ 30 ms
Voltage failure buffering (50 / 60 Hz)	≥ 20 ms

Contacts

Material CIM1 / CIM1R / Type	AgNi / 1 CO, micro disconnection
Rated operational current at 40 °C / 60 °C	16 A / 13 A
Max. inrush current	30 A
Max. switching voltage AC-1	250 V
Max. AC load AC-1 (Fig.1)	4 kVA
Max. DC load DC-1 30 V / 250 V (Fig.2)	240 W / 85 W

Power supply- and control input

Nominal voltage (A1, B1)	UC 24-240 V (UC = AC / DC)
Operating voltage range	UC 19 ... 250 V
Power consumption	approx. 1 W
Frequency range	15 ... 60 Hz
Allowed DC residual current into B1	≤ 0.5 mA
AC Neon lamp residual current into B1	≤ 10 mA
Trigger threshold voltage on B1, AC / DC	15 / 17 V

Insulation

Test voltage open contact	1 kVrms 1 minute
Test voltage between contacts and control input	2.5 kVrms 1 minute

General Specifications

Ambient temperature storage /operation	-40 ... 85 °C / -40 ...60 °C (Railway: -46 °C)
Mechanical life of contact	30 x 10 ⁶ operations
Conductor cross section	Stranded wire 2.5 mm ² , 2 x 1.5 mm ²
Ingress protection degree	IP 20
Max. Screw torque	0.4 Nm
Housing material / weight	Lexan / 70 g

Standard types

UC (AC/DC) 15...60 Hz	CIM1/UC24-240V
Railway	CIM1R/UC24-240V



Connection diagram

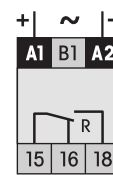


Fig.1 AC voltage endurance

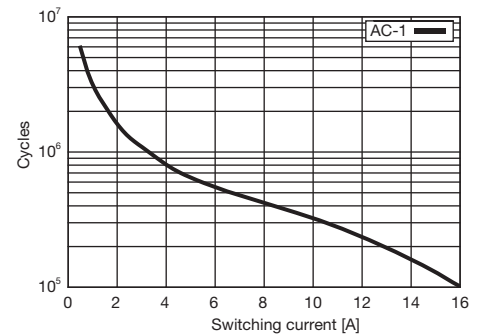
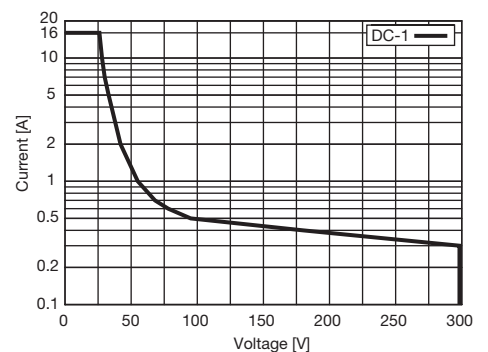
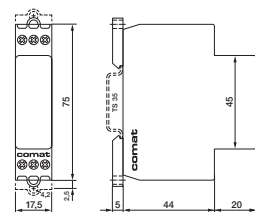


Fig. 2 DC load limit curve



Dimensions [mm]



Technical approvals, conformities

EN 50155, EN 60730



CIM12, CIM12R (Railway)

Time relay with AC solid-state output

8 time functions and stepping function, ON-OFF switch, 50 ms ... 60 h, DIN Rail mounting according to DIN 43 880



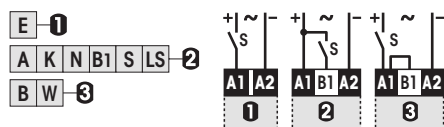
Type: CIM12/UC24-240V

Sophisticated multifunction time relay, 1 triac output, suitable for high frequency of operations and inductive loads, 8 time functions, stepping function and service function ON/OFF, time ranges: 50 ms ... 60 h, multifunction LED state indicator, suitable for any time-control application and also staircase lighting, Light-switch neon lamp current absorption on input B1, manual switching function for maintenance, emergency, etc., 16.6 Hz applications. Railway version available.

Maximum contact load	2 A / 250 V
Minimum contact load	50 mA

Time functions and related connection diagrams (Function diagrams: refer to page 152)

The functions are selectable by rotary switch



LED function table:

LED	Relay	Time run
OFF	OFF	NO
Continuous ON	ON	NO
Short blinking	OFF	YES
Long blinking	ON	YES

Time data

7 partial time ranges, t_{max} (rotary switch)	0.6, 6, 60 s / 6, 60 min / 6, 60 h
Fine adjustment range (rotary knob)	$t_{min} \dots t_{max}$, 0.5 ... 6
Time range tolerance	t_{min} : -5 % ... +0 % / t_{max} : -0 % ... +5 %
Repetition accuracy	± 0.1 % or DC: 2 ms / AC: 10 ms
Response time, power on, on A1	≤ 45 ms
Min. trigger pulse on B1	20 ms (AC / DC)
Reset time B1 (AC/DC)	≤ 30 ms
Voltage failure buffering (50 / 60 Hz)	≥ 20 ms

Output

Type	Triac, zero crossing
Rated operational current at 40 °C (Fig.1)	2 A
Max. inrush current (10 ms)	100 A
Max. switching voltage	250 V
Max. AC load AC-1	300 VA
I ² t value	78 A ² s
Leakage current	< 1 mA

Power supply- and control input

Nominal voltage	UC 24-240 V (UC = AC / DC)
Operating voltage range	UC 19 ... 250 V
Power consumption	approx. 1 W
Frequency range	15 ... 60 Hz
Allowed DC residual current into B1	≤ 0.5 mA
AC Neon lamp residual current into B1	≤ 10 mA
Trigger threshold voltage on B1, AC / DC	15 / 17 V

Insulation

Test voltage between output and control input	2.5 kVrms 1 minute
---	--------------------

General Specifications

Ambient temperature storage / operation	-40 ... 85 °C / -40 ... 60 °C (Railway: -70 °C)
Conductor cross section	Stranded wire 2.5 mm ² , 2 x 1.5 mm ²
Ingress protection degree	IP 20
Max. Screw torque	0.4 Nm
Housing material / weight	Lexan / 70 g

Standard types

UC (AC/DC), 15...60 Hz	CIM12/UC24-240V
Railway	CIM12R/UC24-240V



Connection diagram

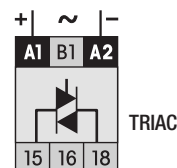
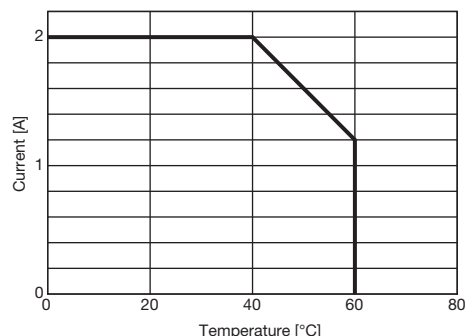
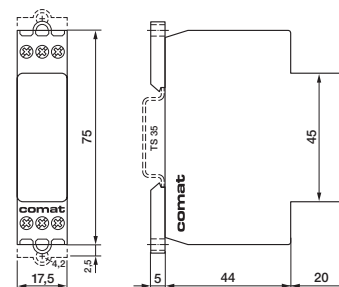


Fig. 1 Output derating curve



Dimensions [mm]



Technical approvals, conformities

EN 50155, EN 60730



CIM13, CIM13R (Railway)

Time relay with DC solid-state output

8 time functions and stepping function, ON-OFF switch, 50 ms ... 60 h
DIN Rail mounting according to DIN 43 880



comat
RELECO
WORLD OF RELAYS

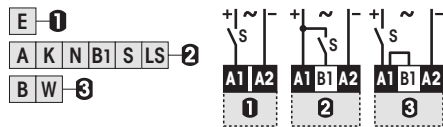
Type: CIM13/UC24-240V

Sophisticated multifunction time relay, 1 transistor output, 8 time functions, stepping function and service function ON/OFF, time ranges from 50 ms ... 60 h, multifunction LED state indicator, suitable for any time-control application and also staircase-light control, light-switch neon lamp current absorption on input B1, manual switching function for maintenance, emergency, etc., 16.6 Hz applications. Railway version available.

Maximum contact load 4 A / 30 V
Recommended minimum contact load 1 mA

Time functions and related connection diagrams (Function diagrams: refer to page 152)

The functions are selectable by rotary switch



LED function table:

LED	Relay	Time run
OFF	OFF	NO
Continuous ON	ON	NO
Short blinking	OFF	YES
Long blinking	ON	YES

Time data

7 partial time ranges, t_{max} (rotary switch) 0.6, 6, 60 s / 6, 60 min / 6, 60 h
Fine adjustment range (rotary knob) $t_{min} \dots t_{max}$, 0.5 ... 6
Time range tolerance t_{min} : -5 % ... +0 % / t_{max} : -0 % ... +5 %
Repetition accuracy ± 0.1 % or DC: 2 ms / AC: 10 ms
Response time, power on, on A1 ≤ 45 ms
Min. trigger pulse on B1 20 ms (AC / DC)
Reset time B1 (AC/DC) ≤ 30 ms
Voltage failure buffering (50 / 60 Hz) ≥ 20 ms

Output

Type MOS FET
Rated operational current (Fig. 1) 4 A
Max. inrush current (10 μ s) 40 A
Max. switching voltage 30 V
Leakage current $< 10 \mu$ A

Power supply- and control input

Nominal voltage (UC = AC / DC) **UC 24-240 V (UC = AC / DC)**
Operating voltage range UC 19 ... 250 V
Power consumption approx. 1 W
Frequency range 15 ... 60 Hz
Allowed DC residual current into B1 ≤ 0.5 mA
AC Neon lamp residual current into B1 ≤ 10 mA
Trigger threshold voltage on B1, AC / DC 15 / 17 V

Insulation

Test voltage between output and control input 2.5 kVrms 1 minute

General Specifications

Ambient temperature storage /operation -40 ... 85 °C / -40 ... 60 °C (Railway: -70 °C)
Conductor cross section Stranded wire 2.5 mm², 2 x 1.5 mm²
Ingress protection degree IP 20
Max. Screw torque 0.4 Nm
Housing material / Weight Lexan / 70 g

Standard types

UC (AC/DC), 15...60 Hz
Railway

CIM13/UC24-240V
CIM13R/UC24-240V



Connection diagram

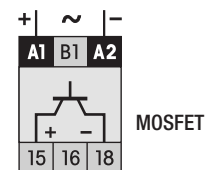
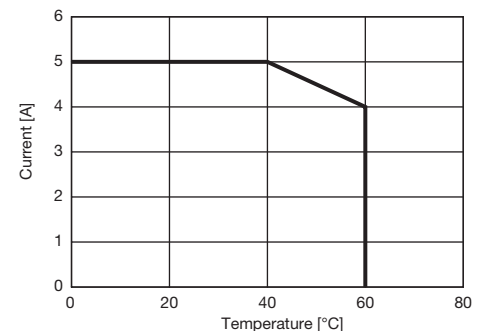
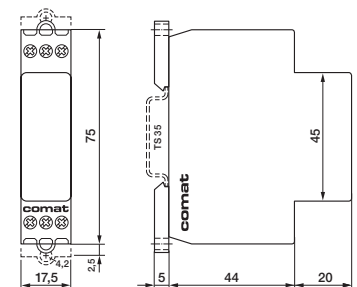


Fig. 1 Output derating curve



Dimensions [mm]



Technical approvals, conformities

EN 50155; EN 60730



CIM14

**Time relay with NO contact for high inrush currents up to 800 A
8 time functions + stepping function, ON-OFF switch, 50 ms ... 60 h,
DIN Rail mounting according to DIN 43 880**



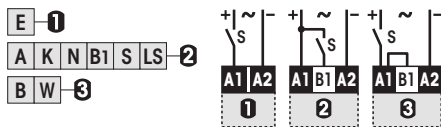
Type: CIM14/UC24-240V

Sophisticated multifunction time relay, 1 NO power contact for high inrush currents up to 800 A with zero crossing switching (50/60 Hz), 8 time functions, stepping function and service function ON/OFF, time ranges: 50 ms ... 60 h, multifunction LED state indicator, suitable for any time-control application and also staircase lighting, Light-switch neon lamp current absorption on input B1, Manual switching function for maintenance, emergency, etc., 16.6 Hz power supply applications. Railway version available.

Maximum contact load 16 A / 250 V AC-1 384 W DC-1
Recommended minimum contact load 100 mA / 12 V

Time functions and related connection diagrams (Function diagrams: refer to page 152)

The functions are selectable by rotary switch



LED function table:

LED	Relay	Time run
OFF	OFF	NO
Continuous ON	ON	NO
Short blinking	OFF	YES
Long blinking	ON	YES

Time data

7 partial time ranges, t_{max} (rotary switch) 0.6, 6, 60 s / 6, 60 min / 6, 60 h
Fine adjustment range (rotary knob) $t_{min} \dots t_{max}$, 0.5 ... 6
Time range tolerance t_{min} : -5 % ... +0 % / t_{max} : -0 % ... +5 %
Repetition accuracy ± 0.1 % or DC: 2 ms / AC: 10 ms
Response time, power on, on A1 ≤ 45 ms
Min. trigger pulse on B1 20 ms (AC / DC)
Reset time B1 (AC/DC) ≤ 30 ms
Voltage failure buffering (50 / 60 Hz) ≥ 20 ms

Contacts

Material W / AgSnO₂
Rated operational current at 40 °C / 60 °C 16 A / 13 A
Max. inrush current 165 A / 20 ms
800 A / 200 μ s
Max. switching voltage AC-1 250 V
Max. AC load AC-1 (Fig.1) 4 kVA
Max. DC load DC-1 24 V 384 W

Power supply- and control input

Nominal voltage (A1, B1) **UC 24-240 V (UC = AC / DC)**
Operating voltage range 16.8 ... 250 V
Power consumption 1.2 VA / 0.43 W
Frequency range 16 ... 60 Hz
Allowed DC residual current into B1 ≤ 0.5 mA
AC Neon lamp residual current into B1 ≤ 10 mA
Trigger threshold voltage on B1, AC / DC 15 / 17 V

Insulation

Test voltage open contact 1 kVrms 1 minute
Test voltage between contacts and control input 2.5 kVrms 1 minute

General Specifications

Ambient temperature storage /operation -40 ... 85 °C / -40 ... 60 °C
Mechanical life of contact 5 x 10⁶ operations
Conductor cross section Stranded wire 2.5 mm², 2 x 1.5 mm²
Ingress protection degree IP 20
Max. Screw torque 0.4 Nm
Housing material / weight Lexan / 70 g

Standard types

UC (AC/DC) 15...60 Hz

CIM14/UC24-240V



Connection diagram

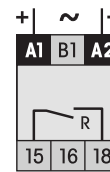


Fig.1 AC voltage endurance

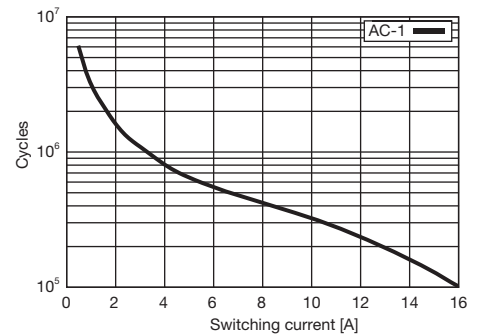
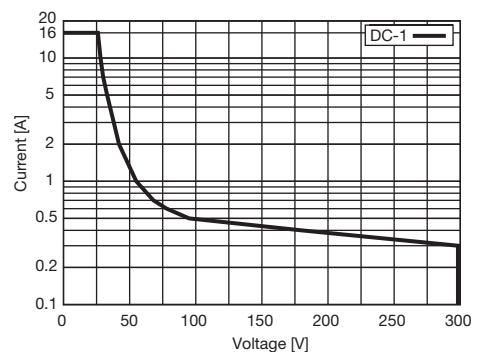
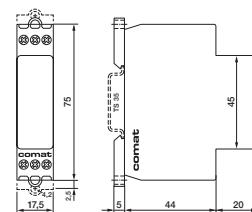


Fig. 2 DC load limit curve



Dimensions [mm]



Technical approvals, conformities

EN 50155, EN 60730



CIM2, CIM2R (Railway)

**Time relay with mechanical changeover output contact
7 time functions and 7 time ranges from 50 ms ... 60 h,
DIN Rail mounting according to DIN 43 880**



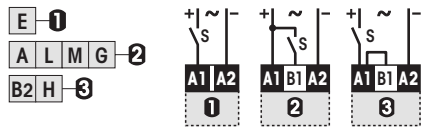
Type: CIM2/UC24-240V

Sophisticated multifunction time relay, 1 changeover power contact switching in zero crossing (50/60 Hz), 7 time functions and service function ON/OFF, 7 time ranges from 50 ms to 60 h, multifunction LED state indicator, suitable for any time-control application, light-switch neon lamp current absorption on input B1, manual switching function for maintenance, emergency, etc., 16.6 Hz power supply applications. Railway version available.

Maximum contact load 16 A / 250 V AC-1 384 W DC-1
Recommended minimum contact load 10 mA / 10 V

Time functions and related connection diagrams (Function diagrams: refer to page 152)

The functions are selectable by rotary switch



LED function table:

LED	Relay	Time run
OFF	OFF	NO
Continuous ON	ON	NO
Short blinking	OFF	YES
Long blinking	ON	YES

Time data

7 partial time ranges, t_{max} (rotary switch) 0.6, 6, 60 s / 6, 60 min / 6, 60 h
 Fine adjustment range (rotary knob) $t_{min} \dots t_{max}$, 0.5 ... 6
 Time range tolerance t_{min} : -5 % ... +0 % / t_{max} : -0 % ... +5 %
 Repetition accuracy ± 0.1 % or DC: 2 ms / AC: 10 ms
 Response time, power on, on A1 ≤ 45 ms
 Min. trigger pulse on B1 20 ms (AC / DC)
 Reset time B1 (AC/DC) ≤ 30 ms
 Voltage failure buffering (50 / 60 Hz) ≥ 20 ms

Contacts

Material CIM2 / CIM2R / Type AgNi / 1 CO, micro disconnection
 Rated operational current at 40 °C / 60 °C 16 A / 13 A
 Max. inrush current 30 A
 Max. switching voltage AC-1 250 V
 Max. AC load AC-1 (Fig.1) 4 kVA
 Max. DC load DC-1 30 V / 250 V (Fig.2) 240 W / 85 W

Power supply- and control input

Nominal voltage (A1, B1) **UC 24-240 V (UC = AC / DC)**
 Operating voltage range UC 19 ... 250 V
 Power consumption approx. 1 W
 Frequency range 15 ... 60 Hz
 Allowed DC residual current into B1 ≤ 0.5 mA
 AC Neon lamp residual current into B1 ≤ 10 mA
 Trigger threshold voltage on B1, AC / DC 15 / 17 V

Insulation

Test voltage open contact 1 kVrms 1 minute
 Test voltage between contacts and control input 2.5 kVrms 1 minute

General Specifications

Ambient temperature storage /operation -40 ... 85 °C / -40 ...60 °C (Railway: -46 °C)
 Mechanical life of contact 30×10^6 operations
 Conductor cross section Stranded wire 2.5 mm², 2 x 1.5 mm²
 Ingress protection degree IP 20
 Max. Screw torque 0.4 Nm
 Housing material / weight Lexan / 70 g

Standard types

UC (AC/DC) 15...60 Hz CIM2/UC24-240V
Railway CIM2R/UC24-240V



Connection diagram

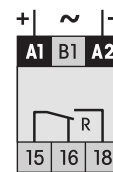


Fig.1 AC voltage endurance

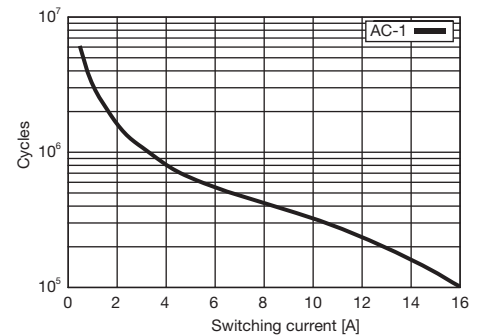
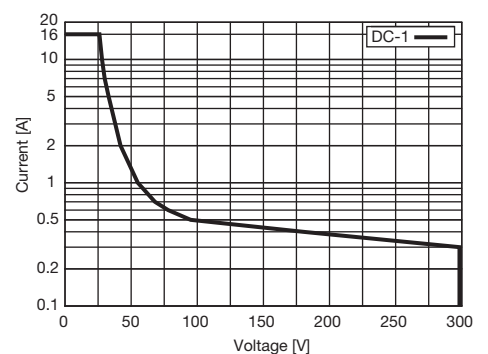
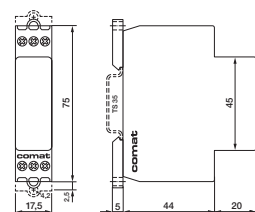


Fig. 2 DC load limit curve



Dimensions [mm]



Technical approvals, conformities

EN 50155, EN 60730



CIM22, CIM22R (Railway)

Time relay with AC solid-state output
7 time functions and 7 time ranges 50 ms ... 60 h,
DIN Rail mounting according to DIN 43 880



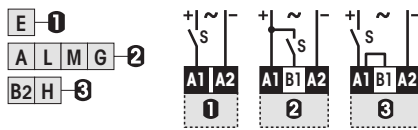
Type: CIM22/UC24-240V

Sophisticated multifunction time relay, 1 triac output, suitable for high frequency of operations and inductive loads, 7 time functions and service function ON/OFF, 7 time ranges from 50 ms ... 60 h, multifunction LED state indicator, suitable for any time-control application light-switch neon lamp current absorption on input B1, manual switching function for maintenance, emergency, etc., 16.6 Hz applications. Railway version available.

Maximum contact load 2 A / 250 V
Minimum contact load 50 mA

Time functions and related connection diagrams (Function diagrams: refer to page 152)

The functions are selectable by rotary switch



LED function table:

LED	Relay	Time run
OFF	OFF	NO
Continuous ON	ON	NO
Short blinking	OFF	YES
Long blinking	ON	YES

Time data

7 partial time ranges, t_{max} (rotary switch) 0.6, 6, 60 s / 6, 60 min / 6, 60 h
 Fine adjustment range (rotary knob) $t_{min} \dots t_{max}$, 0.5 ... 6
 Time range tolerance t_{min} : -5 % ... +0 % / t_{max} : -0 % ... +5 %
 Repetition accuracy ± 0.1 % or DC: 2 ms / AC: 10 ms
 Response time, power on, on A1 ≤ 45 ms
 Min. trigger pulse on B1 20 ms (AC / DC)
 Reset time B1 (AC/DC) ≤ 30 ms
 Voltage failure buffering (50 / 60 Hz) ≥ 20 ms

Output

Type Triac, zero crossing
 Rated operational current at 40 °C (Fig.1) 2 A
 Max. inrush current (10 ms) 100 A
 Max. switching voltage 250 V
 Max. AC load AC-1 300 VA
 I²t value 78 A²s
 Leakage current < 1 mA

Power supply- and control input

Nominal voltage **UC 24-240 V (UC = AC / DC)**
 Operating voltage range UC 19 ... 250 V
 Power consumption approx. 1 W
 Frequency range 15 ... 60 Hz
 Allowed DC residual current into B1 ≤ 0.5 mA
 AC Neon lamp residual current into B1 ≤ 10 mA
 Trigger threshold voltage on B1, AC / DC 15 / 17 V

Insulation

Test voltage between output and control input 2.5 kVrms 1 minute

General Specifications

Ambient temperature storage /operation -40 ... 85 °C / -40 ... 60 °C (Railway: -70 °C)
 Conductor cross section Stranded wire 2.5 mm², 2 x 1.5 mm²
 Ingress protection degree IP 20
 Max. Screw torque 0.4 Nm
 Housing material / weight Lexan / 70 g

Standard types

UC (AC/DC), 15...60 Hz CIM22/UC24-240V
Railway CIM22R/UC24-240V



Connection diagram

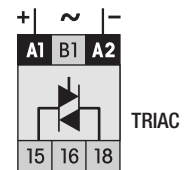
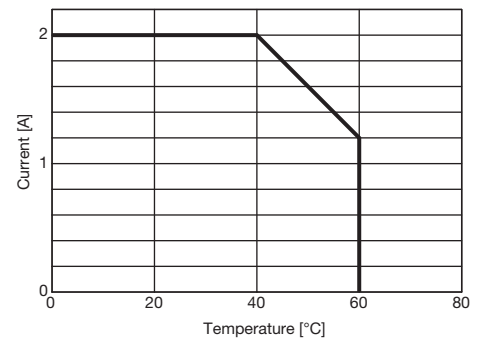
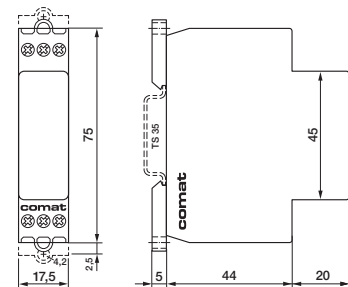


Fig. 1 Output derating curve



Dimensions [mm]



Technical approvals, conformities

EN 50155, EN 60730



CIM23, CIM23R (Railway)

Time relay with DC solid-state output
7 time functions and 7 time ranges from 50 ms ... 60 h
DIN Rail mounting according to DIN 43 880

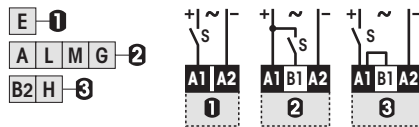


Type: CIM23/UC24-240V

Sophisticated multifunction time relay, 1 transistor output, 7 time functions and service function ON/OFF, 7 time ranges from 50 ms ... 60 h, multifunction LED state indicator suitable for any time-control application, light-switch neon lamp current absorption on input B1, manual switching function for maintenance, emergency, etc., 16.6 Hz applications. Railway version available.

Maximum contact load 4 A / 30 V
Recommended minimum contact load 1 mA

Time functions and related connection diagrams (Function diagrams: refer to page 152)
 The functions are selectable by rotary switch



LED function table:

LED	Relay	Time run
OFF	OFF	NO
Continuous ON	ON	NO
Short blinking	OFF	YES
Long blinking	ON	YES

Time data

7 partial time ranges, t_{max} (rotary switch) 0.6, 6, 60 s / 6, 60 min / 6, 60 h
 Fine adjustment range (rotary knob) $t_{min} \dots t_{max}$, 0.5 ... 6
 Time range tolerance t_{min} : -5 % ... +0 % / t_{max} : -0 % ... +5 %
 Repetition accuracy ± 0.1 % or DC: 2 ms / AC: 10 ms
 Response time, power on, on A1 ≤ 45 ms
 Min. trigger pulse on B1 20 ms (AC / DC)
 Reset time B1 (AC/DC) ≤ 30 ms
 Voltage failure buffering (50 / 60 Hz) ≥ 20 ms

Output

Type MOS FET
 Rated operational current (Fig. 1) 4 A
 Max. inrush current (10 μ s) 40 A
 Max. switching voltage 30 V
 Leakage current $< 10 \mu$ A

Power supply- and control input

Nominal voltage (UC = AC / DC) **UC 24-240 V (UC = AC / DC)**
 Operating voltage range UC 19 ... 250 V
 Power consumption approx. 1 W
 Frequency range 15 ... 60 Hz
 Allowed DC residual current into B1 ≤ 0.5 mA
 AC Neon lamp residual current into B1 ≤ 10 mA
 Trigger threshold voltage on B1, AC / DC 15 / 17 V

Insulation

Test voltage between output and control input 2.5 kVrms 1 minute

General Specifications

Ambient temperature storage /operation -40 ... 85 °C / -40 ... 60 °C (Railway: -70 °C)
 Conductor cross section Stranded wire 2.5 mm², 2 x 1.5 mm²
 Ingress protection degree IP 20
 Max. Screw torque 0.4 Nm
 Housing material / Weight Lexan / 70 g

Standard types

UC (AC/DC), 15...60 Hz
Railway

CIM23/UC24-240V
CIM23R/UC24-240V



Connection diagram

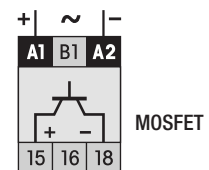
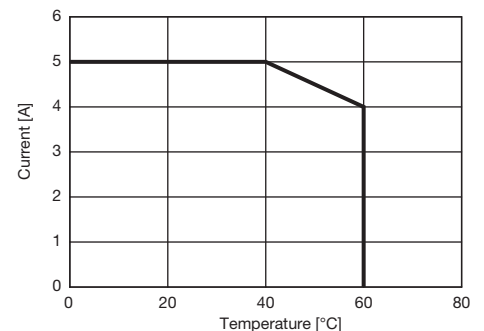
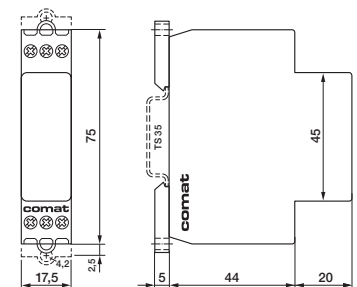


Fig. 1 Output derating curve



Dimensions [mm]



Technical approvals, conformities

EN 50155; EN 60730



CIM3, CIM3R (Railway)

Time relay with mechanical changeover output contact
6 time functions and service function, 7 time ranges from 50 ms...60 h,
DIN Rail mounting according to DIN 43 880



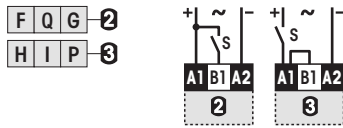
Type: CIM3/UC24-240V

Sophisticated multifunction time relay, 1 changeover power contact switching in zero crossing (50/60 Hz), 6 time functions and service function ON/OFF, 7 time ranges from 50 ms to 60 h, multifunction LED state indicator, suitable for any time-control application, light-switch neon lamp current absorption on input B1, manual switching function for maintenance, emergency, etc., 16.6 Hz power supply applications. Railway version available.

Maximum contact load 16 A / 250 V AC-1 384 W DC-1
Recommended minimum contact load 10 mA / 10 V

Time functions and related connection diagrams (Function diagrams: refer to page 152)

The functions are selectable by rotary switch



LED function table:

LED	Relay	Time run
OFF	OFF	NO
Continuous ON	ON	NO
Short blinking	OFF	YES
Long blinking	ON	YES

Time data

7 partial time ranges, t_{max} (rotary switch) 0.6, 6, 60 s / 6, 60 min / 6, 60 h
 Fine adjustment range (rotary knob) $t_{min} \dots t_{max}$, 0.5 ... 6
 Time range tolerance t_{min} : -5 % ... +0 % / t_{max} : -0 % ... +5 %
 Repetition accuracy ± 0.1 % or DC: 2 ms / AC: 10 ms
 Response time, power on, on A1 ≤ 45 ms
 Min. trigger pulse on B1 20 ms (AC / DC)
 Reset time B1 (AC/DC) ≤ 30 ms
 Voltage failure buffering (50 / 60 Hz) ≥ 20 ms

Contacts

Material CIM3 / CIM3R / Type AgNi / 1 CO, micro disconnection
 Rated operational current at 40 °C / 60 °C 16 A / 13 A
 Max. inrush current 30 A
 Max. switching voltage AC-1 250 V
 Max. AC load AC-1 (Fig.1) 4 kVA
 Max. DC load DC-1 30 V / 250 V (Fig.2) 240 W / 85 W

Power supply- and control input

Nominal voltage (A1, B1) **UC 24-240 V (UC = AC / DC)**
 Operating voltage range UC 19 ... 250 V
 Power consumption approx. 1 W
 Frequency range 15 ... 60 Hz
 Allowed DC residual current into B1 ≤ 0.5 mA
 AC Neon lamp residual current into B1 ≤ 10 mA
 Trigger threshold voltage on B1, AC / DC 15 / 17 V

Insulation

Test voltage open contact 1 kVrms 1 minute
 Test voltage between contacts and control input 2.5 kVrms 1 minute

General Specifications

Ambient temperature storage /operation -40 ... 85 °C / -40 ...60 °C (Railway: -46 °C)
 Mechanical life of contact 30 x 10⁶ operations
 Conductor cross section Stranded wire 2.5 mm², 2 x 1.5 mm²
 Ingress protection degree IP 20
 Max. Screw torque 0.4 Nm
 Housing material / weight Lexan / 70 g

Standard types

UC (AC/DC) 15...60 Hz CIM3/UC24-240V
Railway CIM3R/UC24-240V



Connection diagram

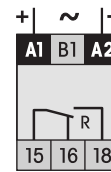


Fig.1 AC voltage endurance

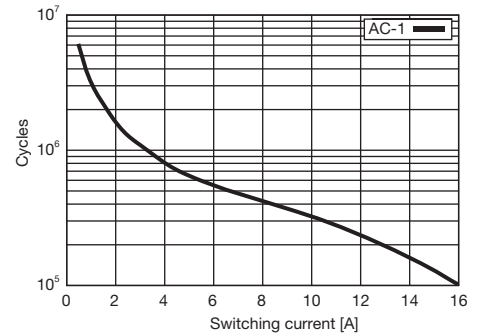
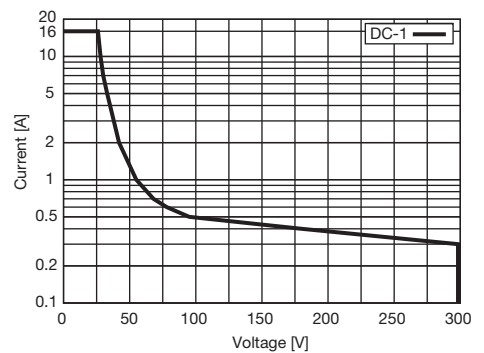
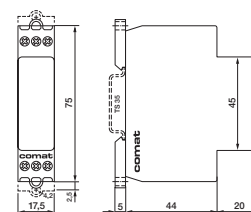


Fig. 2 DC load limit curve



Dimensions [mm]



Technical approvals, conformities

EN 50155, EN 60730



CIM32, CIM32R (Railway)

Time relay with AC solid-state output

6 time functions and service function, 7 time ranges from 50 ms...60 h, DIN Rail mounting according to DIN 43 880



comat
RELECO
WORLD OF RELAYS

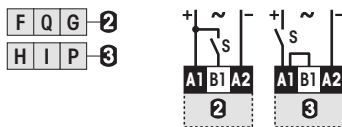
Type: CIM32/UC24-240V

Sophisticated multifunction time relay, 1 triac output, suitable for high frequency of operations and inductive loads, 6 time functions and service function ON/OFF, 7 time ranges from 50 ms ... 60 h, multifunction LED state indicator, suitable for any time-control application light-switch neon lamp current absorption on input B1, manual switching function for maintenance, emergency, etc., 16.6 Hz applications. Railway version available.

Maximum contact load 2 A / 250 V
Minimum contact load 50 mA

Time functions and related connection diagrams (Function diagrams: refer to page 152)

The functions are selectable by rotary switch



LED function table:

LED	Relay	Time run
OFF	OFF	NO
Continuous ON	ON	NO
Short blinking	OFF	YES
Long blinking	ON	YES

Time data

7 partial time ranges, t_{max} (rotary switch) 0.6, 6, 60 s / 6, 60 min / 6, 60 h
 Fine adjustment range (rotary knob) $t_{min} \dots t_{max}$, 0.5 ... 6
 Time range tolerance t_{min} : -5 % ... +0 % / t_{max} : -0 % ... +5 %
 Repetition accuracy ± 0.1 % or DC: 2 ms / AC: 10 ms
 Response time, power on, on A1 ≤ 45 ms
 Min. trigger pulse on B1 20 ms (AC / DC)
 Reset time B1 (AC/DC) ≤ 30 ms
 Voltage failure buffering (50 / 60 Hz) ≥ 20 ms

Output

Type Triac, zero crossing
 Rated operational current at 40 °C (Fig.1) 2 A
 Max. inrush current (10 ms) 100 A
 Max. switching voltage 250 V
 Max. AC load AC-1 300 VA
 I^2t value 78 A²s
 Leakage current < 1 mA

Power supply- and control input

Nominal voltage **UC 24-240 V (UC = AC / DC)**
 Operating voltage range UC 19 ... 250 V
 Power consumption approx. 1 W
 Frequency range 15 ... 60 Hz
 Allowed DC residual current into B1 ≤ 0.5 mA
 AC Neon lamp residual current into B1 ≤ 10 mA
 Trigger threshold voltage on B1, AC / DC 15 / 17 V

Insulation

Test voltage between output and control input 2.5 kVrms 1 minute

General Specifications

Ambient temperature storage /operation -40 ... 85 °C / -40 ...60 °C (Railway: -70 °C)
 Conductor cross section Stranded wire 2.5 mm², 2 x 1.5 mm²
 Ingress protection degree IP 20
 Max. Screw torque 0.4 Nm
 Housing material / weight Lexan / 70 g

Standard types

UC (AC/DC), 15...60 Hz
Railway

CIM32/UC24-240V

CIM32R/UC24-240V



Connection diagram

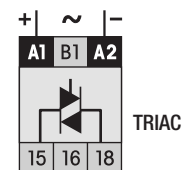
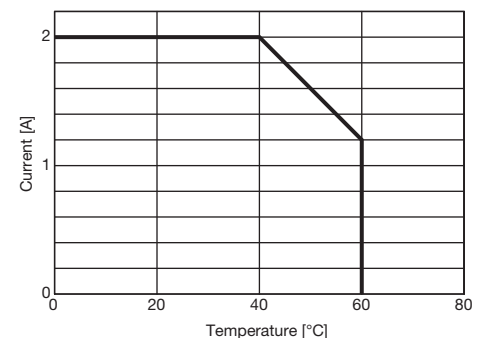
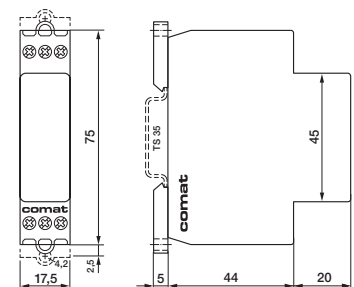


Fig. 1 Output derating curve



Dimensions [mm]



Technical approvals, conformities

EN 50155, EN 60730



CIM33, CIM33R (Railway)

Time relay with DC solid-state output

6 time functions and service function, 7 time ranges from 50 ms...60 h, DIN Rail mounting according to DIN 43 880



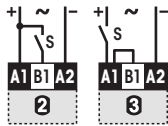
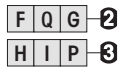
Type: CIM33/UC24-240V

Sophisticated multifunction time relay, 1 transistor output, 6 time functions and service function ON/OFF, 7 time ranges from 50 ms ... 60 h, Multifunction LED state indicator, suitable for any time-control application, light-switch neon lamp current absorption on input B1, manual switching function for maintenance emergency, etc., 16.6 Hz applications. Railway version available.

Maximum contact load	4 A / 30 V
Recommended minimum contact load	1 mA

Time functions and related connection diagrams (Function diagrams: refer to page 152)

The functions are selectable by rotary switch



LED function table:

LED	Relay	Time run
OFF	OFF	NO
Continuous ON	ON	NO
Short blinking	OFF	YES
Long blinking	ON	YES

Time data

7 partial time ranges, t_{max} (rotary switch)	0.6, 6, 60 s / 6, 60 min / 6, 60 h
Fine adjustment range (rotary knob)	$t_{min} \dots t_{max}$, 0.5 ... 6
Time range tolerance	t_{min} : -5 % ... +0 % / t_{max} : -0 % ... +5 %
Repetition accuracy	± 0.1 % or DC: 2 ms / AC: 10 ms
Response time, power on, on A1	≤ 45 ms
Min. trigger pulse on B1	20 ms (AC / DC)
Reset time B1 (AC/DC)	≤ 30 ms
Voltage failure buffering (50 / 60 Hz)	≥ 20 ms

Output

Type	MOS FET
Rated operational current (Fig. 1)	4 A
Max. inrush current (10 μs)	40 A
Max. switching voltage	30 V
Leakage current	< 10 μA

Power supply- and control input

Nominal voltage (UC = AC / DC)	UC 24-240 V (UC = AC / DC)
Operating voltage range	UC 19 ... 250 V
Power consumption	approx. 1 W
Frequency range	15 ... 60 Hz
Allowed DC residual current into B1	≤ 0.5 mA
AC Neon lamp residual current into B1	≤ 10 mA
Trigger threshold voltage on B1, AC / DC	15 / 17 V

Insulation

Test voltage between output and control input	2.5 kVrms 1 minute
---	--------------------

General Specifications

Ambient temperature storage / operation	-40 ... 85 °C / -40 ... 60 °C (Railway: -70 °C)
Conductor cross section	Stranded wire 2.5 mm ² , 2 x 1.5 mm ²
Ingress protection degree	IP 20
Max. Screw torque	0.4 Nm
Housing material / Weight	Lexan / 70 g

Standard types

UC (AC/DC), 15...60 Hz	CIM33/UC24-240V
Railway	CIM33R/UC24-240V



Connection diagram

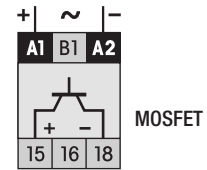
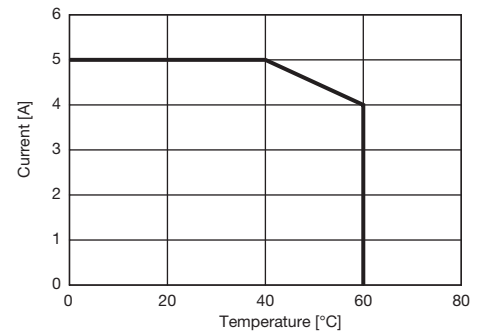
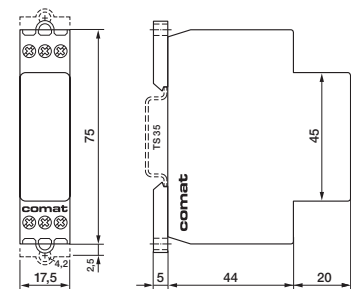


Fig. 1 Output derating curve



Dimensions [mm]



Technical approvals, conformities

EN 50155; EN 60730



CM3

Time relay with two mechanical changeover output contacts 7 time functions, ON-OFF function, 50 ms ... 60 h DIN Rail mounting according to DIN 43 880



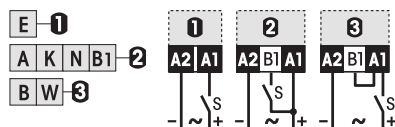
Type: CM3/... V R

Multifunction time relay, 7 time functions, time ranges: 50 ms ... 60 h, multifunction LED state indicator, ON / OFF switching function for maintenance, emergency, etc., suitable for railway applications

Maximum contact load	5 A / 250 V AC-1 150 W DC-1
Recommended minimum contact load	10 mA / 10 V

Time functions and related connection diagrams (Function diagrams: refer to page 152)

The functions are selectable by rotary switch



LED function table:

LED	Relay	Time run
OFF	OFF	NO
Continuous ON	ON	NO
Short blinking	OFF	YES
Long blinking	ON	YES

Time data

7 partial time ranges, t_{max} (rotary switch)	0.6, 6, 60 s / 6, 60 min / 6, 60 h
Fine adjustment range (rotary knob)	$t_{min} \dots t_{max}$, 0.5 ... 6
Time range tolerance	t_{min} : -5 % ... +0 % / t_{max} : -0 % ... +5 %
Repetition accuracy	± 0.1 % or DC: 2 ms / AC: 10 ms
Response time, power on, on A1	≤ 25 ms
Min. trigger pulse on B1	35 ms (AC / DC)
Reset time B1 (AC/DC)	≤ 40 ms
Voltage failure buffering	≥ 15 ms

Contacts

Type	2 CO, micro disconnection
Material	AgNi
Rated operational current	5 A
Max. inrush current	25 A
Max. switching voltage AC-1	250 V
Max. AC load AC-1 (Fig.1)	1250 VA
Max. DC load DC-1, 30 V / 250 V (Fig.2)	150 W / 75 W

Power supply and control input

	DC 12-24 V	DC 24-48 V / AC 24-240 V
Nominal voltage	DC 12-24 V	DC 24-48 V / AC 24-240 V
Operating voltage range	9.6 ... 28.8 V	DC 19 ... 60 V AC 19 ... 250 V
Power consumption	approx. 1.3 W	approx. 1.3 W
Frequency range	-	45 ... 63 Hz
Control current into B1	≤ 13.8 mA	≤ 6 mA
Allowed residual current into B1	≤ 4.5 mA	≤ 1.5 mA
Trigger threshold voltage on B1	5.8 ... 6.5 V	DC 13 ... 18 V AC 11 ... 15 V
Inrush current B1, $\tau = 0.4$ ms	≤ 2.6 A	- ≤ 2.6 A

Insulation

Test voltage open contact	1 kVrms 1 minute
Test voltage between poles	2.5 kVrms 1 minute
Test voltage between contacts and control input	2.5 kVrms 1 minute

General Specifications

Ambient temperature storage / operation	-40 ... 80 °C / -25 ... 60 °C
Mechanical life of contacts	15 x 10 ⁶ operations
Conductor cross section	Stranded wire 2.5 mm ² , 2 x 1.5 mm ²
Ingress protection degree	IP 20
Max. Screw torque	0.4 Nm
Housing material / weight	Lexan / 72 g

Standard types

DC	CM3/DC12-24V R
DC, AC 45...63 Hz	CM3/DC24 -48V/AC24-240V R



Connection diagram

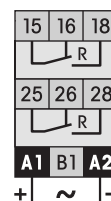


Fig.1 AC voltage endurance

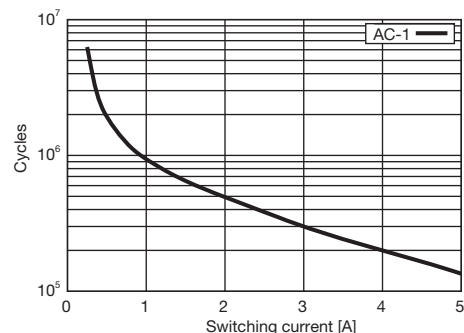
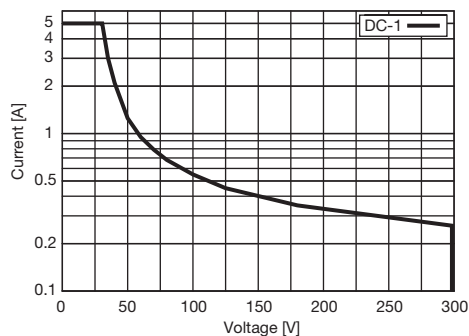
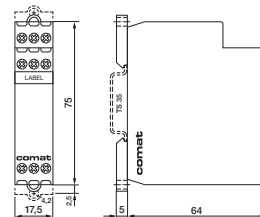


Fig. 2 DC load limit curve



Dimensions [mm]



Technical approvals, conformities



EN 50155, EN 60730

CRV4

Multifunction time relay with 16 functions and 7 time ranges 50 ms ... 60 h
DIN Rail mounting according to DIN 43 880



Type: CRV4/UC24-240V

16 timing functions
 6 A C.O. relay output
 Power supply UC 24 ... 240 V
 Option for external fine adjustment time range potentiometer
 LED state indicators for output and control input

Maximum output load **6 A / 250 V**

Time functions and related connection diagrams (Function diagrams: refer to page 152)



Time data

7 partial time ranges, t_{max} (rotary switch)	0,6 s / 6 s / 60 s / 6 m / 60 m / 6 h / 60 h
Time range tolerance	t_{min} : -5 % ... +0 % / t_{max} : -0 % ... +5 %
Repetition accuracy	± 0.1 % or 2 ms
Response time, power on, on A1	20 ms
Min. trigger pulse on B1	25 ms
Reset time B1 (AC/DC)	30 ms
Voltage failure buffering	10 ms

Output

Type	1 CO, micro disconnection
Material	AgNi
Rated operational current	6 A
Max. inrush current (10 ms)	15 A
Max. switching voltage AC-1	250 V
Max. AC load AC-1	1500 VA
Max. DC load DC-1 30 V / 250 V	180 W / 75 W

Power supply and control input

Nominal voltage	UC 24 – 240 V
Operating voltage range	19,2 ... 250 V
Power consumption max.	550 mW
Control current into B1 max.	7 mA
Allowed residual current into B1 max.	1,2 mA
Trigger threshold voltage on B1 typ. AC / DC	14,5 V / 17,5 V

General Specifications

Ambient temperature storage /operation	-40 ... 85 °C / -40 ...70 °C
Conductor cross section	Stranded wire 2.5 mm ² , 2 x 1 mm ²
Ingress Protection degree	IP 20
Max. Screw torque	0.6 Nm
Housing material / Weight	Lexan / 50 g

Standard types

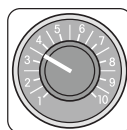
CRV4/UC24-240V

Accessories

External potentiometer 100k
 (Panel mounting + scale):
 Marking strip:

Large
 Small

SP-01/100k
BS-13G
BS-13K



Option:
 External
 Pot.-Meter
 SP-01/100k

Connection diagram

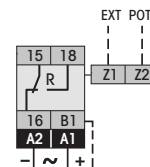


Fig.1 AC electrical endurance

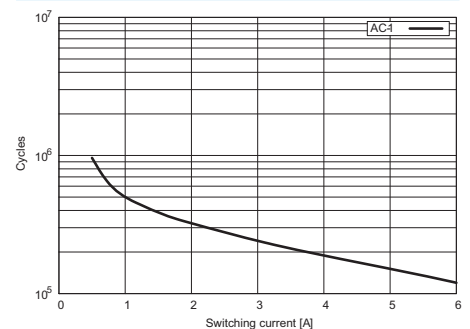
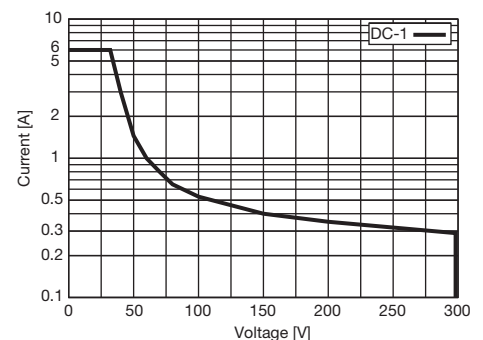
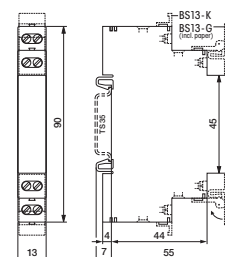


Fig. 2 DC load limit curve



Dimensions [mm]



Technical approvals, conformities



CSV4

**Multifunction time relay with 16 functions and 8 time ranges 0.8 ms ... 60 h
DIN Rail mounting according to DIN 43 880**

Type: CSV4/DC12-36V

16 timing functions
6 A C.O. relay output
Power supply DC 12 ... 36 V
Option for external fine adjustment time range potentiometer
LED state indicators for output and control input

Maximum output load 1.5 A / 24 V

Time functions and related connection diagrams (Function diagrams: refer to page 152)



Time data

8 partial time ranges, t_{max} (rotary switch)	10 ms / 0,1 s / 1 s / 10 s / 1 m / 10 m / 1 h / 10 h
Time range tolerance	t_{min} : -5 % ... +0 % / t_{max} : -0 % ... +5 %
Repetition accuracy	± 0.1 % or 0,2 ms
Response time, power on, on A1	0,7 ms
Min. trigger pulse on B1	0,15 ms
Reset time B1 (AC/DC)	0,05 ms
Voltage failure buffering	10 ms

Output

Type	MOSFET, PNP
Rated operational current	1.5 A
Max. inrush current (100 ms)	4 A
Max. switching voltage	30 V
Leakage current	10 μ A
Inductive switch-off voltage protection	Yes

Power supply and control input

Nominal voltage	DC 12 – 36 V
Operating voltage range	10,2 ... 45 V
Power consumption	200 mW
Control current into B1	4 mA
Allowed residual current into B1	1 mA
Trigger threshold voltage on B1 typ.	7,3 V

General Specifications

Ambient temperature storage /operation	-40 ... 85 °C / -40 ... 70 °C
Conductor cross section	Stranded wire 2.5 mm ² , 2 x 1 mm ²
Ingress Protection degree	IP 20
Max. Screw torque	0.6 Nm
Housing material / Weight	Lexan / 50 g

Standard types

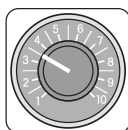
CSV4/DC12-36V

Accessories

External potentiometer 100k
(Panel mounting + scale):
Marking strip:

Large
Small

SP-01/100k
BS-13G
BS-13K



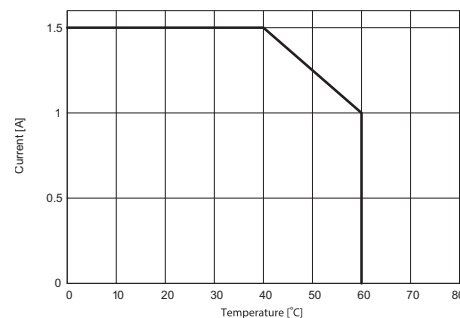
Option:
External
Pot.-Meter
SP-01/100k



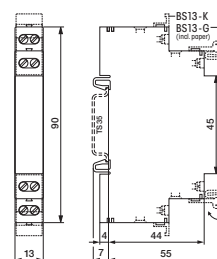
Connection diagram



Output current



Dimensions [mm]



Technical approvals, conformities



CPF11

**Versatile time relay with DC solid state output,
3 time functions for pulse shaping applications, 5 ... 600 ms
DIN Rail mounting according to DIN 43 880**



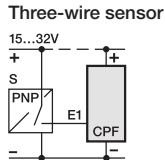
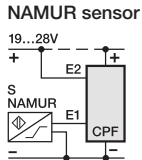
Type: CPF11/DC24V R

Pulse shaper. DC solid state output, short circuit proof. DC 24 V operating voltage. Very suitable as PLC-interface for contact- and sensor signals (NAMUR, 3 – wire) but also for inductive- or lamp loads. Selectable free wheeling diode built in. Adjustable input filter time. LED state indicators for output and control input. Also suitable for panel mounting 2 x M4

Maximum output load **2 A / 32 V**

Time functions and related connection diagrams (Function diagrams: refer to page 152)

K L A



Logical input setting E, \bar{E} : With \bar{E} the output becomes high when the input is low.

When set the shortest time and function A, the device can be used as a switching amplifier.

Time data

2 partial time ranges, t_{max} (DIP switch)	60 , 600 ms
Fine adjustment range (rotary knob)	$t_{min} \dots t_{max}$, 0.5 ... 6
Time range tolerance	t_{min} : -30 % ... +0 % / t_{max} : -0 % ... +30 %
Repetition accuracy	± 0.5 % or 2 ms
Min. trigger pulse width on input B1	1 ms / 5 ms selectable
Reset time B1	≤ 5 ms / ≤ 25 ms

Output

Type: Power MOS FET	High side switch
Rated operational current, $T_a = 60 \text{ }^\circ\text{C}$	0.7 A 100% duty cycle
Rated operational current, $T_a = 50 \text{ }^\circ\text{C}$	0.8 A 100% duty cycle
Operational pulse current	2 A when $t_{ON} \leq t_{OFF}$, $t_{ON} \leq 5 \text{ s}$
Short circuit current	≤ 7 A
Max. switching voltage	32 V
Leakage current (without free wheeling diode)	≤ 1 μA
Inductive switch-off voltage protection	Selectable free wheeling diode

Power supply and control input

Nominal voltage	DC 24 V
Operating voltage range normal operation	15 ... 32 V
Operating voltage range NAMUR operation (DIN 19234)	19 ... 28 V
Power consumption	≤ 0.6 W
Trigger threshold voltage E1	≤ 10 V
Trigger threshold voltage E2	≤ 15 V

General Specifications

Ambient temperature storage /operation	-40 ... 80 $^\circ\text{C}$ / -25 ... 60 $^\circ\text{C}$
Conductor cross section	Stranded wire 2.5 mm ² , 2 x 1 mm ²
Ingress Protection degree	Housing: IP 40, terminals: IP 20
Max. Screw torque	0.4 Nm
Housing material / Weight	Lexan / 60 g

Standard types

CPF11/DC24V R

Accessories

Label plate: (replacement) **BZS-DIN 17.5**



Connection diagram

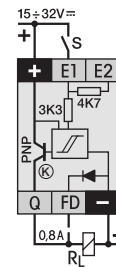


Fig. 1 Derating Curve

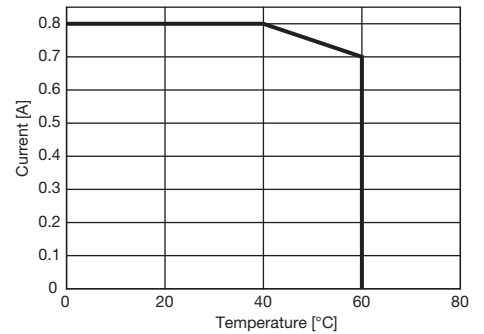
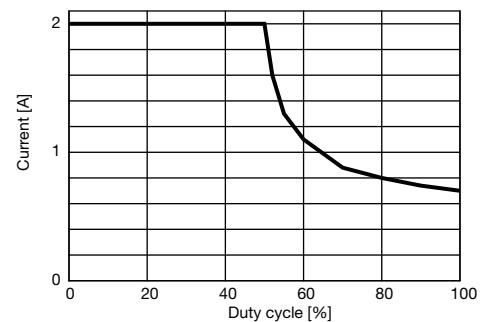
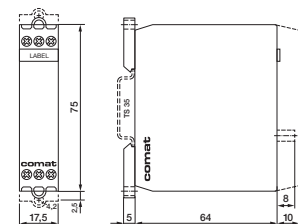


Fig. 2 Current vs. duty cycle



Dimensions [mm]



Technical approvals, conformities



2.3 Plug-in Time Relays



Application	Types	Functions*	Min. time	Max. time	contact rating	Socket
Timing and blinking relay	CS1	E, W, B, B2	50 ms	60 min	8 A / 250 V	S3-xx
Timing and blinking relay with external potentiometer option	CS2	E, W, B, B2, A, K, N	50 ms	60 h	8 A / 250 V	S3-xx
Universal timer with 2 CO contacts	CS3	E, W, B, B2, A, K, N	50 ms	60 h	6 A / 250 V	S3-xx

*(Function diagrams: refer to page 152)

CS1

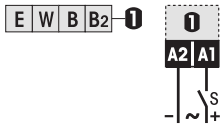
11 pin plug-in time relay according to IEC 67-I-18a, 50 ms ... 60 minutes for wide band 12 ... 240 V operating voltage, internal or external potentiometer operation

Type: CS1/UC 12-240V R

Plug-in time relay
1 change over contact
UC 12-240 V operating voltage
4 time functions, time ranges: 50 ms ... 60 min
LED for output state indication
Option for external fine adjustment time range potentiometer

Maximum contact load	8 A / 250 V AC-1
Recommended minimum contact load	10 mA / 10 V

Time functions and related connection diagrams (Function diagrams: refer to page 152)



External potentiometer (Pins 5, 7)
1 M Ω (see accessories)
Max. potentiometer cable length
50 m, shielded, GND on pin 5 (Z1)

Time data

5 partial time ranges, t_{max} (DIP switch)	0.6, 6, 60 s / 6, 60 min
Fine adjustment range (rotary knob)	$t_{min} \dots t_{max}$, 5 ... 60
Time range tolerance	t_{min} : -5 % ... +0 % / t_{max} : -0 % ... +5 %
Repetition accuracy	± 0.1 % or DC: 2 ms / AC: 10 ms
Reset time	≤ 30 ms
Voltage failure buffering	20 ms

Contacts

Type	1 CO, micro disconnection
Material	AgNi
Rated operational current	8 A
Max. switching voltage AC-1	250 V
Max. AC load AC-1 (Fig.1)	2000 VA
Max. DC load DC-1, 30 V / 250 V (Fig.2)	220 W / 75 W

Power supply- and control input (UC = AC / DC)

Nominal voltage (A1)	UC 12 ... 240 V
Operating voltage range	10.2 ... 265 V
Power consumption	≤ 1.4 W
Frequency range	45 ... 63 Hz

Insulation

Test voltage open contact	1 kVrms 1 minute
Test voltage between contacts and control input	2 kVrms 1 minute

General Specifications

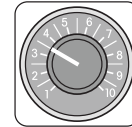
Ambient temperature storage /operation	-40 ... 85 $^{\circ}$ C / -25 ... 60 $^{\circ}$ C
Mechanical life of contacts	$\geq 30 \times 10^6$ operations
Ingress protection degree	IP 40 when plugged in
Housing material / Weight	Lexan / 75 g

Standard types

UC (AC/DC)	CS1/UC12-240V R
-------------------	------------------------

Accessories

External potentiometer 1 M (Panel mounting + scale)	SP-01/1M
Socket	S3-xx
Retaining clip	HF-50
Transparent front cover	FA-50
Front panel mounting set	FZ-50L (Frame + retaining clip + socket with soldering connections)



Option:
External
Pot.-Meter
SP-01/1M

Connection diagram

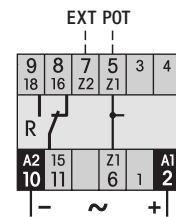


Fig.1 AC electrical endurance

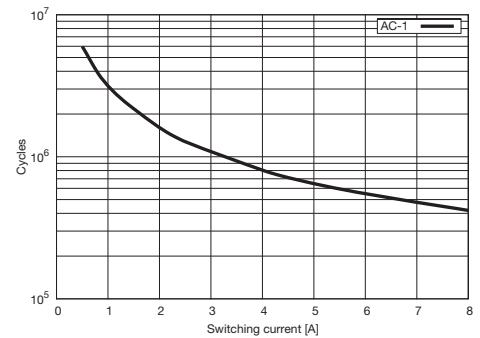
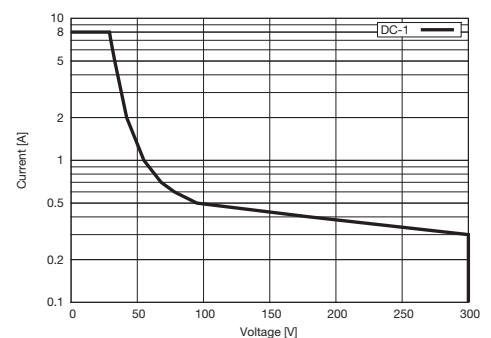
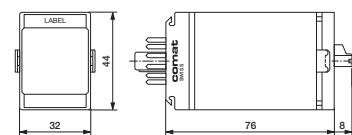


Fig. 2 DC load limit curve



Dimensions [mm]



Technical approvals, conformities



EN 60947

CS2

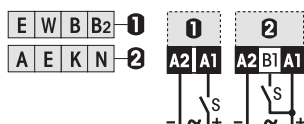
11 pin plug-in time relay according to IEC 67-I-18a, 50 ms ... 60 h for wide band 12 ... 240 V operating voltage, internal or external potentiometer operation

Type: CS2/UC 12-240V R

Plug-in time relay
 1 change over contact
 UC 12-240 V operating voltage
 7 time functions, time ranges: 50 ms ... 60 h
 LED for output state indication
 Option for external fine adjustment time range potentiometer

Maximum contact load 8 A / 250 V AC-1
Recommended minimum contact load 10 mA / 10 V

Time functions and related connection diagram (Function diagrams: refer to page 152)



External potentiometer pins 5, 7
 1 MΩ (see accessories)
Max. potentiometer cable length
 50 m, shielded, GND on pin5 (Z1)

Time data

7 partial time ranges, t_{max} (DIP switch) 0.6, 6, 60 s / 6, 60 min / 6, 60 h
 Fine adjustment range (rotary knob) $t_{min} \dots t_{max}$, 5 ... 60
 Time range tolerance t_{min} : -5 % ... +0 % / t_{max} : -0 % ... +5 %
 Repetition accuracy ± 0.1 % or DC: 2 ms / AC: 10 ms
 Min. trigger impulse on B1 ≥ 30 ms
 Reset time ≤ 30 ms
 Voltage failure buffering 20 ms

Contacts

Type 1 CO, micro disconnection
 Material AgNi
 Rated operational current 8 A
 Max. switching voltage AC-1 250 V
 Max. AC load AC-1 (Fig.1) 2000 VA
 Max. DC load DC-1, 30 V / 250 V (Fig.2) 220 W / 75 W

Power supply- and control input (UC = AC / DC)

Nominal voltage (A1, B1) **UC 12 ... 240 V**
 Operating voltage range 10.2 ... 265 V
 Power consumption ≤ 1.4 W
 Frequency range 45 ... 63 Hz
 Allowed residual current into B1 AC / DC ≤ 2.3 mA / 1.2 mA
 Trigger threshold voltage on B1, AC / DC 6.5 V / 7 V

Insulation

Test voltage open contact 1 kVrms 1 minute
 Test voltage between contacts and control input 2 kVrms 1 minute

General Specifications

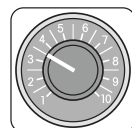
Ambient temperature storage /operation -40 ... 85 °C / -25 ... 60 °C
 Mechanical life of contacts $\geq 30 \times 10^6$ operations
 Ingress protection degree IP 40 when plugged in
 Housing material / Weight Lexan / 75 g

Standard types

UC (AC/DC) **CS2/UC12-240V R**

Accessories

External potentiometer 1 M (Panel mounting + scale) **SP-01/1M**
 Socket **S3-xx**
 Retaining clip **HF-50**
 Transparent front cover **FA-50**
 Front panel mounting set **FZ-50L** (Frame + retaining clip + socket with soldering connections)



Option:
 External
 Pot.-Meter
 SP-01/1M

Connection diagram

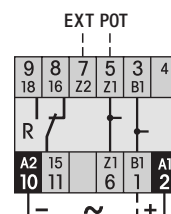


Fig.1 AC electrical endurance

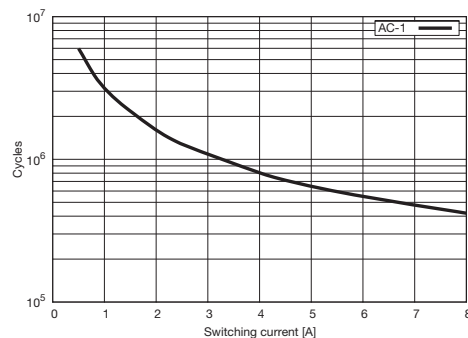
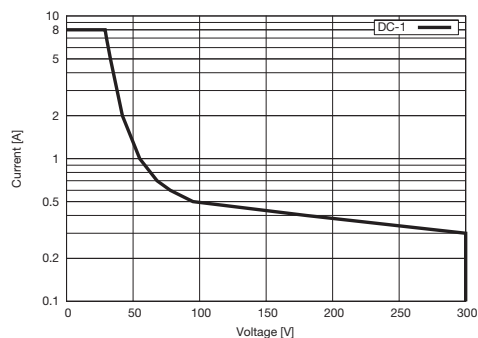
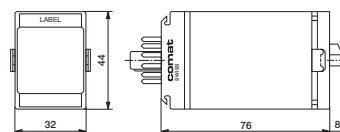


Fig. 2 DC load limit curve



Dimensions [mm]



Technical approvals, conformities



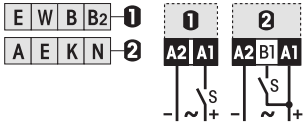
EN 60947

Type: CS3/UC 12-240V R

Plug-in time relay
2 change over contacts
UC 12-240 V operating voltage
7 time functions, time ranges: 50 ms ... 60 h
LED for output state indication

Maximum contact load	6 A / 250 V AC-1
Recommended minimum contact load	10 mA / 10 V

Time functions and related connection diagrams (Function diagrams: refer to page 152)



Time data

7 partial time ranges, t_{max} (DIP switch)	0.6, 6, 60 s / 6, 60 min / 6, 60 h
Fine adjustment range (rotary knob)	$t_{min} \dots t_{max}$, 5 ... 60
Time range tolerance	t_{min} : -5 % ... +0 % / t_{max} : -0 % ... +5 %
Repetition accuracy	± 0.1 % or DC: 2 ms / AC: 10 ms
Min. trigger start impulse on B1	≥ 30 ms
Reset time	≤ 30 ms
Voltage failure buffering	20 ms

Contacts

Type	2 CO, micro disconnection
Material	AgNi
Rated operational current	6 A
Max. switching voltage AC-1	250 V
Max. AC load AC-1 (Fig.1)	1500 VA
Max. DC load DC-1, 30 V / 250 V (Fig.2)	180 W / 60 W

Power supply- and control input (UC = AC / DC)

Nominal voltage (A1, B1)	UC 12 ... 240 V
Operating voltage range	10.2 ... 265 V
Power consumption	≤ 1.4 W
Frequency range	45 ... 63 Hz
Allowed residual current into B1 AC / DC	≤ 2.3 mA / 1.2 mA
Trigger threshold voltage on B1, AC / DC	6.5 V / 7 V

Insulation

Test voltage open contact	1 kVrms 1 minute
Test voltage between poles	2 kVrms 1 minute
Test voltage between contacts and control input	2 kVrms 1 minute

General Specifications

Ambient temperature storage /operation	-40 ... 85 °C / -25 ... 60 °C
Mechanical life of contacts	≥ 30 x 10 ⁶ operations
Ingress protection degree	IP 40 when plugged in
Housing material / Weight	Lexan / 75 g

Standard types

UC (AC/DC)	CS3/UC12-240V R
-------------------	------------------------

Accessories

Socket:	S3-xx
Retaining clip	HF-50
Transparent front cover	FA-50
Front panel mounting set	FZ-50L (Frame + retaining clip + socket with soldering connections)



Connection diagram

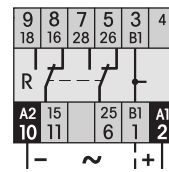


Fig.1 AC electrical endurance

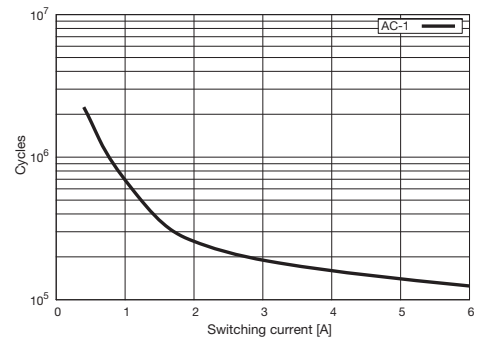
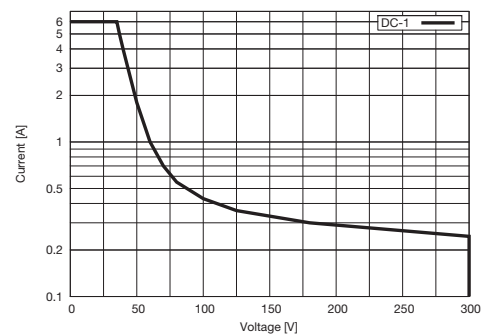
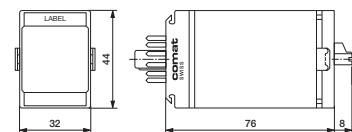


Fig. 2 DC load limit curve



Dimensions [mm]

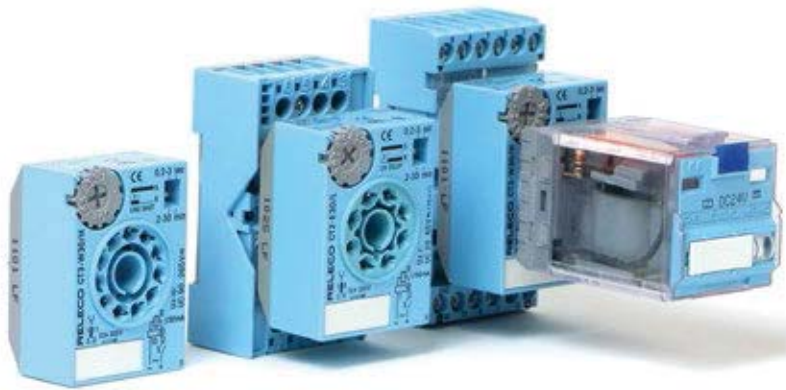


Technical approvals, conformities



EN 60947

2.4 Time Cubes



CT2, CT3

8-pin and 11-pin Timecube®



Type: CT2: 8 pole, CT3: 11 pole

The CT2 or CT3 Timecube® is an electronic timer that is inserted between the plug-in industrial relay and the socket. This combination is a modular complete time relay without additional space requirement. It offers up to three changeover contacts with a variety of signal contacts and power contacts.

The Timecubes® are suitable for all 8 pin and 11 pin standard industrial relays of the C2 and C3 series according to IEC 67 and also for relays of other manufacturers.

Time functions (Function diagrams: refer to page 152)

Operating voltage controlled types

- CT2- / CT3-E30: Function E, on delay
- CT2- / CT3-W30: Function W, one shot
- CT2- / CT3-B30: Function B, blinker

Trigger input controlled types

- CT2- / CT3-A30, off delay
- CT2- / CT3-K30, pulse shaping

Time data

4 partial time ranges (DIP switch)



Fine adjustment time range (rotary knob)

$t_{min} \dots t_{max}, 2 \dots 30$

Time range tolerance

$t_{min}: 0 \dots + 35 \%$

Repetition accuracy

$\pm 0.5 \%$ or ± 20 ms

Reset time

≤ 200 ms

Reset time B1 (trigg. inp.) A, K

≤ 80 ms

Voltage failure buffering

5 ms (except the relay)

Power supply- and control input (UC = AC or DC)

CT2- / CT3- ... / S	DC 9.5 ... 18 V	12 mA
CT2- / CT3- ... / L	UC 20 ... 65 V	6 mA
CT2- / CT3- ... / M	UC 90 ... 150 V	2 mA
CT2- / CT3- ... / U	UC 180 ... 265 V	2 mA
CT2- / CT3- ... / H	UC 90 ... 265 V	2 mA
Residual current E, W, B	≤ 0.3 mA	
Residual current B1 (trigg. inp.) A, K	≤ 0.2 mA	

General specifications

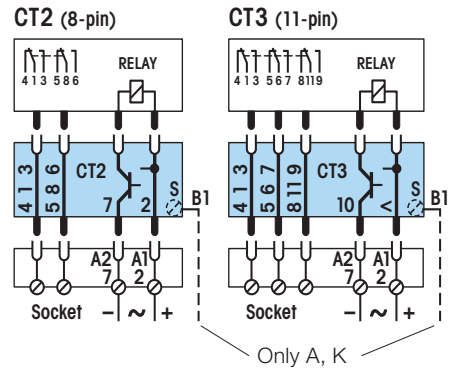
Ambient temperature storage / operation	-40 ... +70 °C / -25 ... +60 °C
Ingress protection degree	IP40
Housing material	Lexan
Weight	35 g

Standard types

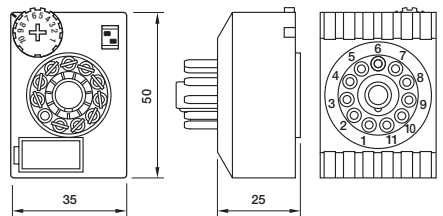
UC 50 Hz / 60 Hz: 20 ... 265 V
DC 12 V

8 pole	11 pole	Voltage
CT2-E30/S CT2-W30/S CT2-B30/S CT2-A30/S CT2-K30/S	CT3-E30/S CT3-W30/S CT3-B30/S CT3-A30/S CT3-K30/S	DC 9.5...18 V
CT2-E30/L CT2-W30/L CT2-B30/L CT2-A30/L CT2-K30/L	CT3-E30/L CT3-W30/L CT3-B30/L CT3-A30/L CT3-K30/L	UC 20...65 V
CT2-A30/M CT2-K30/M	CT3-A30/M CT3-K30/M	UC 90...150 V
CT2-A30/U CT2-K30/U	CT3-A30/U CT3-K30/U	UC 180...265 V
CT2-E30/H CT2-W30/H CT2-B30/H	CT3-E30/H CT3-W30/H CT3-B30/H	UC 90...265 V

Wiring diagram



Dimensions [mm]



Only 11-pin version shown.
The dimension of the 8-pin version are identical

Technical approvals, conformities



2.5 Time Modules



The modular timer system consists of individual plug-in timer modules with front cover, an 11-pole plug-in relay and a system socket with retaining spring.

The individual combination allows an optimal device selection for the foreseen application.

Later modifications as for example an exchange of relay from mechanical contacts to a relay with solid-state outputs are possible at any time. The user profits of a universal system of worldwide unique flexibility.

The modular Comat timer CT System

The time delay relays and monitoring relays consist of plug-in CT electronic modules and 11-pole output relays. Both system components can be combined in a variety of combinations. This allows adapting the system for the specific application.

Subsequent modifications, for example a change from mechanical contacts to solid-state outputs, are possible at any time just by replacing the relay.

This system provides the user a complete universal system with worldwide unmatched flexibility.



The system sockets C12B0 or C-155 serve as a basis for the secure reception of the electronic modules. The sockets have a 4-pole module slot in which the CT modules lock firmly and vibration proof also without the output relay. Contact is made with reliable twin knife contacts.

With the A2 connector bridge "C-A2", the neutral conductor (N/-) can be connected from socket to socket. It reduces wiring work considerably.

Robust terminals for wires up to 4 mm² and spacious labeling are other advantages of this practical Comat modular system.

Clear markings close to the terminal connections on the sockets make it easy to identify the connections for wiring and servicing.

The CT modules are proof of the practical oriented experiences of Comat in the field of industrial electronics. All control and display elements are arranged easy accessible at all times on the front side of the modules. The functions and settings are self-explanatory schematically illustrated on the front and allow to review the set values also during operation.

A transparent cover over the module setting components provides protection from unintentional settings and additionally links the module to the output relay.

Triggering is performed with the operating voltage. (L1 or +). No potential-free contacts are therefore required. The triggering complies to machine standards. Parallel connection to B1 is admissible.

The wide UC voltage range (AC/DC) of the modules give a wide flexibility. It permits the connection to AC or DC supplies and provides a high level of reliability in triggering.

Note: In case of even wider voltage ranges, for example UC 24-240V, triggering currents on B1 are often in the range of 100µA with simultaneous low threshold voltages of less than 20V. Due to capacitive or inductive pickups this may lead to unintentional triggering or switching errors caused by insufficient load on the control contacts (It is not seldom that 50V or more can be measured in open lines).

The output relays show the connection diagram and the technical values on the front side, (exception C3 and C5 relays). A color code indicates an AC coil with red and a DC coil with blue color. Most of the relays have a lockable test button for manual operation.

The standard contacts have proven its reliability for high switching current applications over many years. The contact material AgNi permits a wide switching range and due to the large dimensioning they are designed for a high number of switching cycles. The high breaking capacity of up to 10A/400V and a low load switching capability of 12V/10mA makes the contact suitable for the use in main circuits as well as for low voltage applications.

The twin contacts are switching the load circuit with 2 independent contact tongues. The switching safety for low currents is therefore 100 times higher compared to a single contact relay. Despite the high switching capacity of up to 6A/250V, these contacts are very suitable to switch low currents and voltages up to 1mA/6V.

The solid-state relays are an alternative to mechanical relays. In the standard version, the relay has a potential-free universal semiconductor output for AC or DC loads. The advantage is a bouncing- and wear-free, overload resistant, short circuit protected output with a practical unlimited life cycle.

Solid-state relays are specially recommended for applications of high switching cycles, for example for repeat cycle timers, flushing lights, but also for high inductive switching loads of solenoid valves, couplings, motors, etc. The solid state relays are also suitable for capacitive loads, for example long power lines, or compensated lighting circuits.

Additional protection circuits of the output or of the load are not necessary in any application for this type of Comat relays.

The solid-state relays are insensitive in any aggressive environment such as chemical plants, sewage plants etc. and are therefore an excellent choice for the employment in such environments.



The train symbol indicates products available in a special railway execution according to EN 50155. Please refer to our special railway brochure for details.

CT30, CT32, CT33, CT36

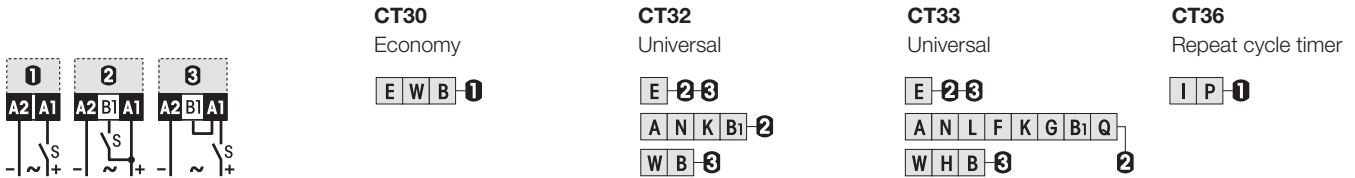
Plug-in time modules (combined with industrial relays)

Type **CT30, CT32, CT33, CT36, /...V R**

Plug-in time modules for sockets with module slot in combination with plug-in relays.
Power supply and control voltages 24 ... 240 V. Time ranges 30 ms up to 60 h.
LED output state indicator.



Time functions and related connection diagrams (Function diagrams: refer to page 152)



Time data	CT 30	CT 32	CT33	CT36
Type	CT 30	CT 32	CT33	CT36
Partial time ranges, t_{max}	3, 30 /s /min	1.5, 6, 15, 60 /s /min	150, 600 ms 1.5, 6, 15, 60 /s /min /h	2 x 600 ms 2 x 6, 60 /s /min /h
Min. time t_{min}	0.25 s	0.15 s	30 ms	2 x 50 ms
Fine adj. range $t_{min} \dots t_{max}$	2.5 ... 30	1 ... 10	0.2 ... 1	2 x 5 ... 60
Time range tolerance t_{min}	-25 ... 0 %	-25 ... 0 %	-25 ... 0 %	-25 ... 0 %
t_{max}	0 ... 35 %	0 ... 25 %	0 ... 25 %	0 ... 25 %
Repetition accuracy	± 0.2 % or 20 ms	± 0.2 % or 20 ms	± 0.2 % or 20 ms	± 0.2 % or 20 ms
Temperature drift of time	0.25 % / K	0.1 % / K	0.1 % / K	0.1 % / K
Min. trigger pulse width B1	-	≥ 30 ms	≥ 30 ms	-
Reset time pow. supply	≤ 200 ms	≤ 150 ms	≤ 150 ms	≤ 150 ms
Voltage failure buffering	≥ 20 ms	≥ 20 ms	≥ 20 ms	≥ 20 ms

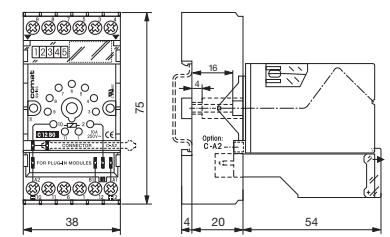
Output data	CT 30	CT 32	CT33	CT36
Nominal voltage	UC 24 – 48 V	110 – 240, 115, 230 V		
Type	Solid state	Solid state		
Rated operational current	150 mA	50 mA		
On-state resistance	$\leq 25 \Omega$	$\leq 100 \Omega$		
Leakage current	$\leq 150 \mu A$	$\leq 150 \mu A$		

Power supply and control input (UC = AC / DC)	CT 30	CT 32	CT33	CT36
Type	CT 30	CT 30	CT36	CT36
Nominal voltage	UC 24 – 48 V	UC 110 – 240 V	UC 24 – 48 V	UC 110 – 240 V
Operating voltage range	19 ... 75 V	90 ... 265 V	19...60 V	82 ... 265 V
Supply current	3 ... 5 mA	2 ... 4 mA	6 ... 12 mA	4 ... 8 mA
Type	CT32, CT33	CT32, CT33	CT32, CT33	
Nominal voltage	UC 24 – 48 V	UC 115 V	UC 230 V	
Operating voltage range	19 ... 60 V	90 ... 150 V	180 ... 265 V	
Input B1 inactive	≤ 9 V	≤ 60 V	≤ 100 V	
Supply current	5 ... 11 mA	4 ... 7 mA	1 ... 4 mA	

General Specification	CT 30	CT 32	CT33	CT36
Ambient temperature storage /operation		-40 ... 85 °C / -40 ... 60 °C		
Ingress Protection degree		IP 40 when plugged in		
Housing material		Lexan		
Weight		25 g		

Standard types	CT 30, CT32, CT33, CT36, UC24-48	CT30, CT36, UC110-240	CT32, CT33, UC115	CT32, CT33, UC230
	CT3x/UC24-48V R	CT3x/UC110-240V R	CT3x/UC115V R	CT3x/UC230V R

Dimensions [mm]



Technical approvals, conformities



Remark: This module is part of several ready for connection units consisting of socket, relay and module. A wide range of suitable relays are available.



Time Delay Relay-Set
Relay, Module and Socket



Relay data's see:
Section Industrial Relays



Power Relay



C3-A30X

Universal
Power Relay 10A.
With 3 power changeover-contacts
this is the robust relay for AC and
DC circuits ranging from
10mA 10V.

10A~
10mA 10V

Control Relay



C3-T31X

Relay with 3 twin contacts 6A
The control relay with highest
switching reliability for control
and signal circuits ranging from
5mA 5V.

6A 250V~
5mA 5V

Signal Relay

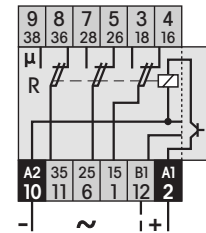
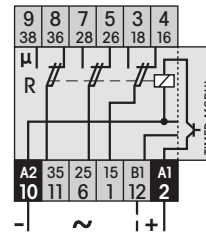
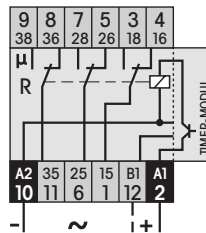
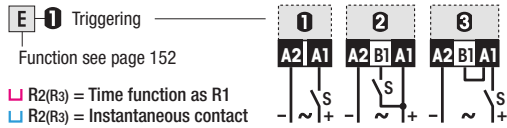


C3-T32X

Relay with 3 twin contacts, 10µ gold flush
The twin contact relay with high-
est switching reliability for signal
circuits ranging from 1mA 5V.
Recommend. upto 0,2A 30V.

6A 250V~
1mA 5V

Timer-Modul (Function diagrams: refer to page 152)



CT30 Economy timer

3 functions, voltage controlled,
output LED.
Seismic approved.



Function / Triggering
E 1

Time range
0,25s-30min
0,25-3s...
2,5-30min

Set Order-Nr.:

CT30.3-A30/...V R
AC 24, 48, 115, 230V
DC 24, 48, 110, 220V

Delivery includes:
• Relay C3-A30X/...V R
• Module CT30/...V R
• Front cover FS-R
• Socket C12B0 R
• Retaining clip S3-C

Set Order-Nr.:

CT30.3-T31/...V R
AC 24, 48, 115, 230V
DC 24, 48, 110, 220V

Delivery includes:
• Relay C3-T31X/...V R
• Module CT30/...V R
• Front cover FS-R
• Socket C12B0 R
• Retaining clip S3-C

Set Order-Nr.:

CT30.3-T32/...V R
AC 24, 48, 115, 230V
DC 24, 48, 110, 220V

Delivery includes:
• Relay C3-T32X/...V R
• Modul CT30/...V R
• Front cover FS-R
• Socket C12B0 R
• Retaining clip S3-C

CT32 Universal timer

7 functions, voltage controlled, time
lapse display, blinking.
Seismic approved.



Function / Triggering
E 2-3
A N K B1 2
W B 3



Time range
0,15s-60min
0,15-1,5s...
6-60min

Set Order-Nr.:

CT32.3-A30/...V R
AC 24, 48, 115, 230V
DC 24, 48, 110, 220V

Delivery includes:
• Relay C3-A30X/...V R
• Module CT32/...V R
• Front cover FS-R
• Socket C12B0 R
• Retaining clip S3-C

Set Order-Nr.:

CT32.3-T31/...V R
AC 24, 48, 115, 230V
DC 24, 48, 110, 220V

Delivery includes:
• Relay C3-T31X/...V R
• Module CT32/...V R
• Front cover FS-R
• Socket C12B0 R
• Retaining clip S3-C

Set Order-Nr.:

CT32.3-T32/...V R
AC 24, 48, 115, 230V
DC 24, 48, 110, 220V

Delivery includes:
• Relay C3-T32X/...V R
• Modul CT32/...V R
• Front cover FS-R
• Socket C12B0 R
• Retaining clip S3-C

CT33 Universal timer

12 functions, voltage controlled, time
lapse display, blinking, high setting
accuracy by dial graduation 1:5.



Function / Triggering
E 2-3 **W H B 3**
A N L F K G B1 Q 2
F Q t2=t1 **G H t2=0,5s**



Time range
30ms-60h
30-150ms...
12-60h

Set Order-Nr.:

CT33.3-A30/...V R
AC 24, 48, 115, 230V
DC 24, 48, 110, 220V

Delivery includes:
• Relay C3-A30X/...V R
• Module CT33/...V R
• Front cover FS-R
• Socket C12B0 R
• Retaining clip S3-C

Set Order-Nr.:

CT33.3-T31/...V R
AC 24, 48, 115, 230V
DC 24, 48, 110, 220V

Delivery includes:
• Relay C3-T31X/...V R
• Module CT33/...V R
• Front cover FS-R
• Socket C12B0 R
• Retaining clip S3-C

Set Order-Nr.:

CT33.3-T32/...V R
AC 24, 48, 115, 230V
DC 24, 48, 110, 220V

Delivery includes:
• Relay C3-T32X/...V R
• Modul CT33/...V R
• Front cover FS-R
• Socket C12B0 R
• Retaining clip S3-C

CT36 Repeat cycle timer

Pulse or pause start.
t1/t2 separately settable.
Time lapse display t1/t2.



Function / Triggering
I P 1



Time range
2x50ms-60h
2x 50-600ms...
5-60h

Set Order-Nr.:

CT36.3-A30/...V R
AC 24, 48, 115, 230V
DC 24, 48, 110, 220V

Delivery includes:
• Relay C3-A30X/...V R
• Module CT36/...V R
• Front cover FS-R
• Socket C12B0 R
• Retaining clip S3-C

Set Order-Nr.:

CT36.3-T31/...V R
AC 24, 48, 115, 230V
DC 24, 48, 110, 220V

Delivery includes:
• Relay C3-T31X/...V R
• Modul CT36/...V R
• Front cover FS-R
• Socket C12B0 R
• Retaining clip S3-C

Set Order-Nr.:

CT36.3-T32/...V R
AC 24, 48, 115, 230V
DC 24, 48, 110, 220V

Delivery includes:
• Relay C3-T32X/...V R
• Modul CT36/...V R
• Front cover FS-R
• Socket C12B0 R
• Retaining clip S3-C

Power Relay

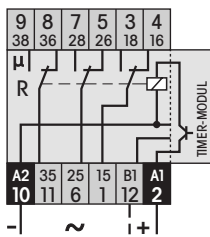


C31L

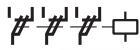
Universal Power Relay 10A
with 3 power changeover-contacts
this is the robust relay for AC and
DC circuits ranging from
50mA 10V.

10 A 250V~

50mA 10V



Control Relay



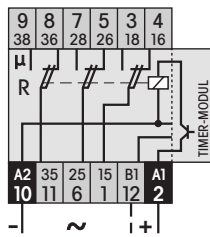
C32L

**Relay with
3 twin contacts 6A**

The control relay with highest
switching reliability for control
and signal circuits ranging from
10mA 5V.

6 A 250V~

10mA 5V



Set Order-Nr.:

CT30.31/...V

AC 24, 48, 115, 230V

DC 24, 48, 110, 220V

Delivery includes:

- Relay C31L/...V
- Module CT30/...V
- Front cover FS-C
- Socket C12B0
- Retaining clip HF-32

Set Order-Nr.:

CT30.32/...V

AC 24, 48, 115, 230V

DC 24, 48, 110, 220V

Delivery includes:

- Relay C32L/...V
- Module CT30/...V
- Front cover FS-C
- Socket C12B0
- Retaining clip HF-32

Set Order-Nr.:

CT32.31/...V

AC 24, 48, 115, 230V

DC 24, 48, 110, 220V

Delivery includes:

- Relay C31L/...V
- Module CT32/...V
- Front cover FS-C
- Socket C12B0
- Retaining clip HF-32

Set Order-Nr.:

CT32.32/...V

AC 24, 48, 115, 230V

DC 24, 48, 110, 220V

Delivery includes:

- Relay C32L/...V
- Module CT32/...V
- Front cover FS-C
- Socket C12B0
- Retaining clip HF-32

Set Order-Nr.:

CT33.31/...V

AC 24, 48, 115, 230V

DC 24, 48, 110, 220V

Delivery includes:

- Relay C31L/...V
- Module CT33/...V
- Front cover FS-C
- Socket C12B0
- Retaining clip HF-32

Set Order-Nr.:

CT33.32/...V

AC 24, 48, 115, 230V

DC 24, 48, 110, 220V

Delivery includes:

- Relay C32L/...V
- Module CT33/...V
- Front cover FS-C
- Socket C12B0
- Retaining clip HF-32

Set Order-Nr.:

CT36.31/...V

AC 24, 48, 115, 230V

DC 24, 48, 110, 220V

Delivery includes:

- Relay C31L/...V
- Modul CT36/...V
- Front cover FS-C
- Socket C12B0
- Retaining clip HF-32

Set Order-Nr.:

CT36.32/...V

AC 24, 48, 115, 230V

DC 24, 48, 110, 220V

Delivery includes:

- Relay C32L/...V
- Module CT36/...V
- Front cover FS-C
- Socket C12B0
- Retaining clip HF-32



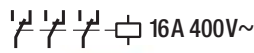
Time Delay Relay-Set
Relay, Module and Socket



Relay data's see:
Section industrial Relays



High Power Relay DC



C5-A30X

Universal Power Relay 16A
With 3 power changeover-contacts this is the robust relay for AC and DC circuits ranging from 10 mA 10V.

16 A 400V~
10 mA 10V

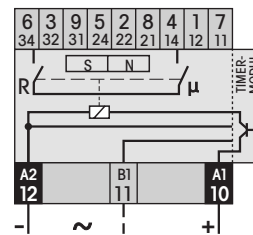
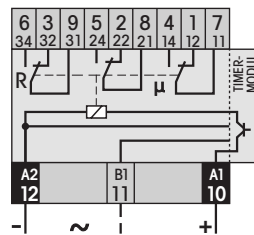
High Power Relay DC



C5-M10X

Highpower Relay, in particular for DC loads upto 10A 220V== (DC1)
With 2 NO contacts in series and a blow magnet for safe arc extinguishing.

16 A 400V~
10 mA 10V

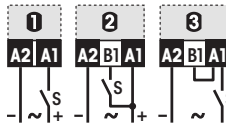


Timer-Modul (Function diagrams: refer to page 152)

E 1 Triggering

Function see page 152

- R2(R3) = Time function as R1
- R2(R3) = Instantaneous contact



CT30 Economy timer

3 functions, voltage controlled, output LED. Seismic approved.



Function / Triggering



Time range

0,25s - 30min
0,25-3s...
2,5-30min

Set Order-Nr.:

CT30.5-A30/...V R
AC 24, 115, 230V
DC 24, 110, 220V

Delivery includes:

- Relay C5-A30X/...V R
- Module CT30/...V R
- Front cover FS-C5
- Socket S-5M
- Retaining clip S3-C

Set Order-Nr.:

CT30.5-M10/...V R
AC 24, 230V
DC 24, 48, 110, 220V

Delivery includes:

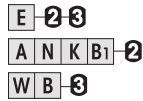
- Relay C5-M10X/...V R
- Module CT30/...V R
- Front cover FS-C5
- Socket S-5M
- Retaining clip S3-C

CT32 Universal timer

7 functions, voltage controlled, time lapse display, blinking. Seismic approved.



Function / Triggering



Time range

0,15s - 60min
0,15-1,5s...
6-60min

Set Order-Nr.:

CT32.5-A30/...V R
AC 24, 115, 230V
DC 24, 110, 220V

Delivery includes:

- Relay C5-A30X/...V R
- Module CT32/...V R
- Front cover FS-C5
- Socket S-5M
- Retaining clip S3-C

Set Order-Nr.:

CT32.5-M10/...V R
AC 24, 230V
DC 24, 48, 110, 220V

Delivery includes:

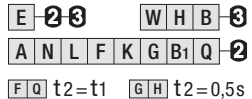
- Relay C5-M10X/...V R
- Module CT32/...V R
- Front cover FS-C5
- Socket S-5M
- Retaining clip S3-C

CT33 Universal timer

12 functions, voltage controlled, time lapse display, blinking, high setting accuracy by dial graduation 1:5.



Function / Triggering



Time range

30ms - 60h
30-150ms...
12-60h

Set Order-Nr.:

CT33.5-A30/...V R
AC 24, 115, 230V
DC 24, 110, 220V

Delivery includes:

- Relay C5-A30X/...V R
- Module CT33/...V R
- Front cover FS-C5
- Socket S-5M
- Retaining clip S3-C

Set Order-Nr.:

CT33.5-M10/...V R
AC 24, 230V
DC 24, 48, 110, 220V

Delivery includes:

- Relay C5-M10X/...V R
- Module CT33/...V R
- Front cover FS-C5
- Socket S-5M
- Retaining clip S3-C

CT36 Repeat cycle timer

Pulse or pause start. t1/t2 separately settable. Time lapse display t1/t2.



Function / Triggering



Time range

2x 50ms - 60h
2x 50-600ms...
5-60h

Set Order-Nr.:

CT36.5-A30/...V R
AC 24, 115, 230V
DC 24, 110, 220V

Delivery includes:

- Relay C5-A30X/...V R
- Module CT36/...V R
- Front cover FS-C5
- Socket S-5M
- Retaining clip S3-C

Set Order-Nr.:

CT36.5-M10/...V R
AC 24, 230V
DC 24, 48, 110, 220V

Delivery includes:











- Relay C5-M10X/...V R
- Module CT36/...V R
- Front cover FS-C5
- Socket S-5M
- Retaining clip S3-C

3.0 Monitoring Relays



3.1 Multifunction Monitoring



Application	Types	Monitoring	Monitoring ratings	Output contacts	Design
Multifunction monitoring, AC 15 ... 60 Hz / DC single phase	MRM11	    	U, I, P, f, cosφ	1 CO	35 mm
Multifunction monitoring, AC 15 ... 60 Hz / DC three phase	MRM32	    	U, I, P, f, cosφ	2 CO	35 mm

MRM11

Multifunction monitoring relay AC/DC, single phase DIN Rail mounting according to DIN 43 880

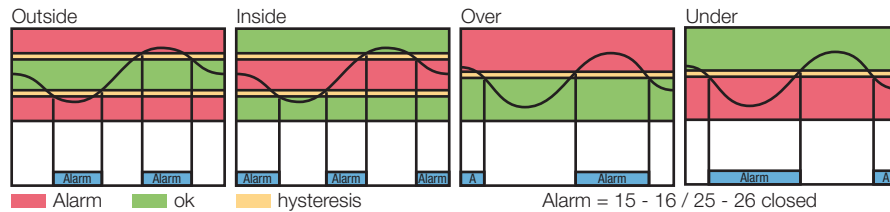


Type: MRM11/...V

Multifunctional monitoring relay for simultaneous measurement of current and voltage and monitoring of U, I, P, cosφ and f. Alarm delay setting. Alarm LED. Display for multimeter function, alarm signal and interactive parameter setting.

1 change-over alarm contact 5 A 250 V. Comfortable parameter setting.

Monitoring function



Measuring circuit data

Voltage setting ranges AC / DC	0.1 ... 480 V / ±0.1 ... 690 V
Current setting ranges AC / DC	0.1 ... 5 A
Frequency	AC 15 ... 150 Hz
Input resistance U / I	1 MΩ / 5 MΩ
Measured variables	U, I, f, P, S, cosφ

Time data

Voltage failure buffering	ca. 30 ms
---------------------------	-----------

Alarm contacts

Type / Material	1 CO / AgNi 0.15
Rated operational current	6 A
Max. inrush current	15 A
Max. switching voltage	250 V
Max. AC load AC-1 (Fig.1)	1250 VA
Max. DC load DC-1, 24 V / 220 V (Fig.2)	120 W / 25 V
Recommended min. contact load	10 mA / 10 V
Alarm delay setting time	0.1 ... 999.9 s (factory adjustment = 0.0 s)
Reset time setting range	0.1 ... 999.9 s (factory adjustment = 0.0 s)

Power supply

	UC12-48V	UC110-240V
Nominal voltage AC/DC	12 ... 48 V	110 ... 240 V
Operating voltage range	10 ... 60 V	85 ... 250 V
AC frequency	16 ... 63 Hz	16 ... 63 Hz
Power consumption	1.6 W / 3.2 VA	1.5 W / 2.6 VA

Insulation

Measuring input – Measuring input	1.5 kV 1 minute
Measuring input – Supply	2.0 kV 1 minute
Measuring input – Contact	2.0 kV 1 minute
Supply – Contact	2.0 kV 1 minute
Contact set – Contact set	1.5 kV 1 minute

General specifications

Ambient temperature storage /operation	-40 ... +85 °C / -40 ... +60 °C
	LCD: -20 ... +60 °C
Mechanical life of contacts	30 x 10 ⁶ operations
Conductor cross section	Stranded wire 2.5 mm ² , 2 x 1.5 mm ²
Ingress protection degree	IP20, (electronics: IP40)
Max. screw torque	0.4 Nm
Housing material	Lexan EXL 9330
Weight	107 g

Standard types

AC/DC 12-48 V, 15...60 Hz	MRM11/UC12-48V
AC/DC 110-240 V, 15...60 Hz	MRM11/UC110-240V



Connection diagram

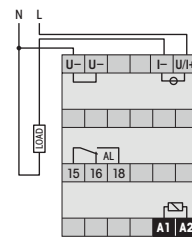


Fig.1 AC voltage endurance

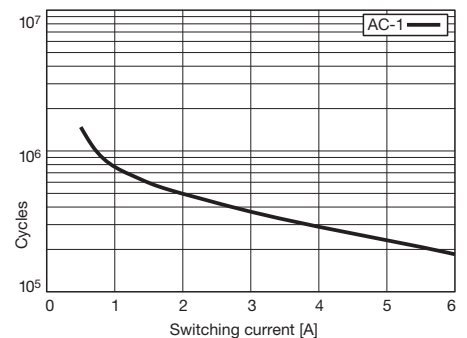
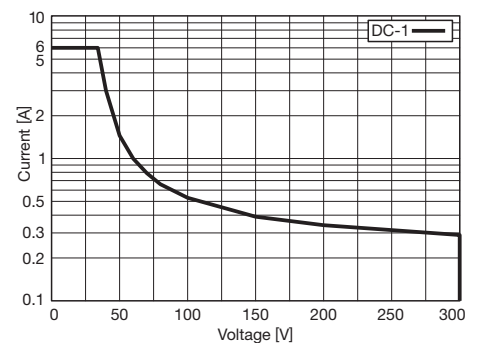
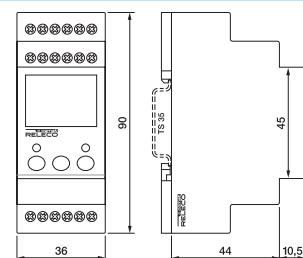


Fig. 2 DC load limit curve



Dimensions [mm]



Technical approvals, conformities



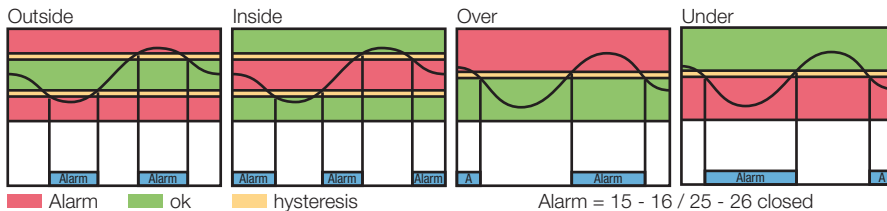
MRM32

Multifunction monitoring relay AC/DC, three phase DIN Rail mounting according to DIN 43 880

Type: MRM32/...V

Multifunctional monitoring relay for simultaneous measurement of current and voltage and monitoring of U, I, P, cosφ and f and Δφ. Alarm delay setting. Alarm LED. Display for multimeter function, alarm signal and interactive parameter setting.
2 change-over alarm contacts 5 A 250 V. Comfortable parameter setting.

Monitoring function



Measuring circuit data

Voltage setting ranges AC / DC	0.1 ... 480 V / ±0.1 ... 690 V
Current setting ranges AC / DC	0.1 ... 5 A
Frequency	AC 15 ... 150 Hz
Input resistance U / I	1 MΩ / 5 MΩ
Measured variables	U, I, f, P, S, cosφ und Δφ (phase sequence)

Time data

Voltage failure buffering	ca. 30 ms
---------------------------	-----------

Contacts

Type / Material	2 CO / AgNi 0.15
Rated operational current	6 A
Max. inrush current	15 A
Max. switching voltage	250 V
Max. AC load AC-1 (Fig.1)	1250 VA
Max. DC load DC-1, 24 V / 220 V (Fig.2)	120 W / 25 W
Recommended min. contact load	10 mA / 10 V
Alarm delay setting time	0.1 ... 999.9 s (factory adjustment = 0.0 s)
Reset time setting range	0.1 ... 999.9 s (factory adjustment = 0.0 s)

Power supply

	UC12-48V	UC110-240V
Nominal voltage AC/DC	12 ... 48 V	110 ... 240 V
Operating voltage range	10 ... 60 V	85 ... 250 V
AC frequency	16 ... 63 Hz	16 ... 63 Hz
Power consumption	1.6 W / 3.2 VA	1.5 W / 2.6 VA

Insulation

Measuring input – Measuring input	1.5 kV 1 minute
Measuring input – Supply	2.0 kV 1 minute
Measuring input – Contact	2.0 kV 1 minute
Supply – Contact	2.0 kV 1 minute
Contact set – Contact set	1.5 kV 1 minute

General specifications

Ambient temperature storage /operation	-40 ... +85 °C / -40 ... +60 °C
	LCD: -20 ... +60 °C
Mechanical life of contacts	30 x 10 ⁶ operations
Conductor cross section	Stranded wire 2.5 mm ² , 2 x 1.5 mm ²
Ingress protection degree	IP20, (electronics: IP40)
Max. screw torque	0.4 Nm
Housing material	Lexan EXL 9330
Weight	125 g

Standard types

AC/DC 12-48 V, 15...60 Hz	MRM32/UC12-48V
AC/DC 110-240 V, 15...60 Hz	MRM32/UC110-240V



Connection diagram

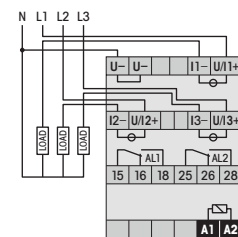


Fig.1 AC voltage endurance

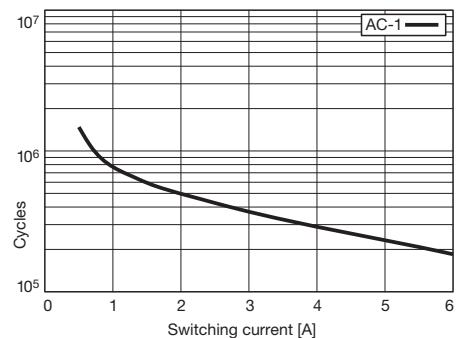
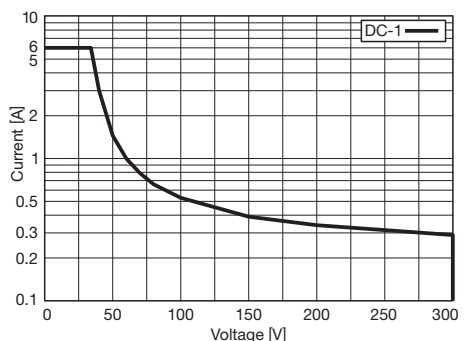
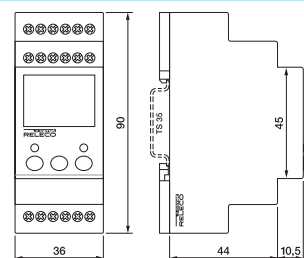


Fig. 2 DC load limit curve



Dimensions [mm]







Technical approvals, conformities



3.2 Voltage Monitoring



Application	Types	Monitoring	Monitoring ratings	Output contacts	Design
Voltage monitoring, AC 15 ... 60 Hz / DC single phase	MRU11	 	0.1 ... AC 480 V / DC 690 V	1 CO	35 mm
Voltage monitoring, AC 15 ... 60 Hz / DC three phase	MRU32	 	0.1 ... AC 480 V / DC 690 V	2 CO	35 mm

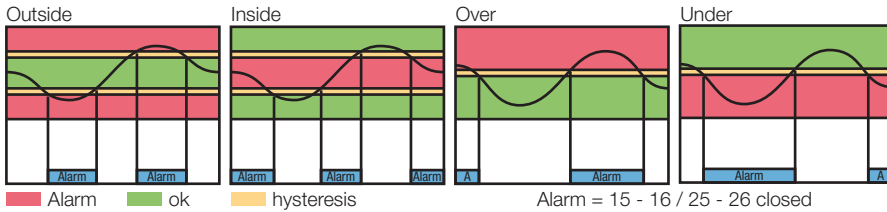
MRU11

Voltage monitoring relay AC/DC, single phase DIN Rail mounting according to DIN 43 880

Type: MRU11/...V

Voltage monitoring relay with over- and under voltage thresholds up to 700 V.
Alarm delay setting. Alarm LED. Display for voltmeter function, alarm signal and interactive parameter setting.
1 change-over alarm contact 5 A 250 V. Comfortable parameter setting.

Monitoring function



Measuring circuit data

Voltage setting ranges AC / DC	0.1 ... 480 V / ±0.1 ... 690 V
Frequency	AC 15 ... 150 Hz
Input resistance U / I	1 MΩ
Measured variables	U, f

Time data

Voltage failure buffering	ca. 30 ms
---------------------------	-----------

Alarm contacts

Type / Material	1 CO / AgNi 0.15
Rated operational current	6 A
Max. inrush current	15 A
Max. switching voltage	250 V
Max. AC load AC-1 (Fig.1)	1250 VA
Max. DC load DC-1, 24 V / 220 V (Fig.2)	120 W / 25 V
Recommended min. contact load	10 mA / 10 V
Alarm delay setting time	0.1 ... 999.9 s (factory adjustment = 0.0 s)
Reset time setting range	0.1 ... 999.9 s (factory adjustment = 0.0 s)

Power supply

	UC12-48V	UC110-240V
Nominal voltage AC/DC	12 ... 48 V	110 ... 240 V
Operating voltage range	10 ... 60 V	85 ... 250 V
AC frequency	16 ... 63 Hz	16 ... 63 Hz
Power consumption	1.6 W / 3.2 VA	1.5 W / 2.6 VA

Insulation

Measuring input – Measuring input	1.5 kV 1 minute
Measuring input – Supply	2.0 kV 1 minute
Measuring input – Contact	2.0 kV 1 minute
Supply – Contact	2.0 kV 1 minute
Contact set – Contact set	1.5 kV 1 minute

General specifications

Ambient temperature storage /operation	-40 ... +85 °C / -40 ... +60 °C
	LCD: -20 ... +60 °C
Mechanical life of contacts	30 x 10 ⁶ operations
Conductor cross section	Stranded wire 2.5 mm ² , 2 x 1.5 mm ²
Ingress protection degree	IP20, (electronics: IP40)
Max. screw torque	0.4 Nm
Housing material	Lexan EXL 9330
Weight	107 g

Standard types

AC/DC 12-48 V, 15...60 Hz
AC/DC 110-240 V, 15...60 Hz

MRU11/UC12-48V
MRU11/UC110-240V



Connection diagram

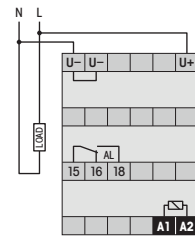


Fig.1 AC voltage endurance

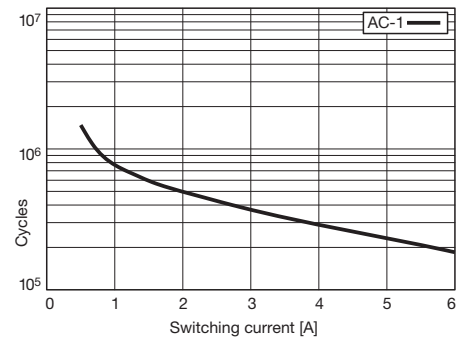
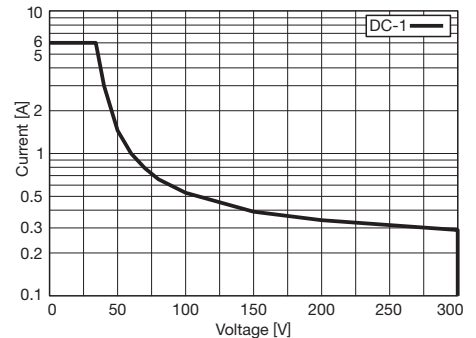
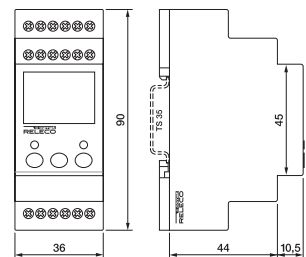


Fig. 2 DC load limit curve



Dimensions [mm]



Technical approvals, conformities



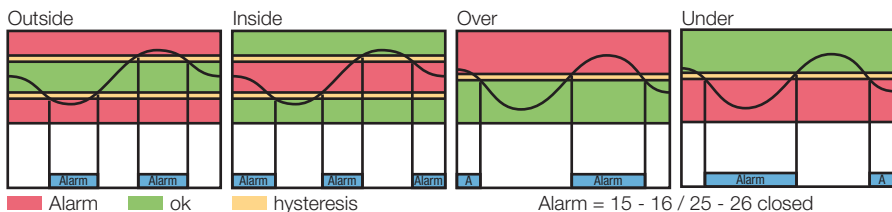
MRU32

Voltage monitoring relay AC/DC, three phase DIN Rail mounting according to DIN 43 880

Type: MRU32/...V

Voltage monitoring relay with over- and under voltage thresholds up to 700 V.
Alarm delay setting, Alarm LED. Display for voltmeter function, alarm signal and interactive parameter setting.
2 change-over alarm contacts 5 A 250 V. Comfortable parameter setting.

Monitoring function



Measuring circuit data

Voltage setting ranges AC / DC	0.1 ... 480 V / ±0.1 ... 690 V
Frequency	AC 15 ... 150 Hz
Input resistance U / I	1 MΩ
Measured variables	U, f, Δφ (phase sequence)

Time data

Voltage failure buffering	ca. 30 ms
---------------------------	-----------

Alarm contacts

Type / Material	2 CO / AgNi 0.15
Rated operational current	6 A
Max. inrush current	15 A
Max. switching voltage	250 V
Max. AC load AC-1 (Fig.1)	1250 VA
Max. DC load DC-1, 24 V / 220 V (Fig.2)	120 W / 25 W
Recommended min. contact load	10 mA / 10 V
Alarm delay setting time	0.1 ... 999.9 s (factory adjustment = 0.0 s)
Reset time setting range	0.1 ... 999.9 s (factory adjustment = 0.0 s)

Power supply

	UC12-48V	UC110-240V
Nominal voltage AC/DC	12 ... 48 V	110 ... 240 V
Operating voltage range	10 ... 60 V	85 ... 250 V
AC frequency	16 ... 63 Hz	16 ... 63 Hz
Power consumption	1.6 W / 3.2 VA	1.5 W / 2.6 VA

Insulation

Measuring input – Measuring input	1.5 kV 1 minute
Measuring input – Supply	2.0 kV 1 minute
Measuring input – Contact	2.0 kV 1 minute
Supply – Contact	2.0 kV 1 minute
Contact set – Contact set	1.5 kV 1 minute

General specifications

Ambient temperature storage /operation	-40 ... +85 °C / -40 ... +60 °C
	LCD: -20 ... +60 °C
Mechanical life of contacts	30 x 10 ⁶ operations
Conductor cross section	Stranded wire 2.5 mm ² , 2 x 1.5 mm ²
Ingress protection degree	IP20, (electronics: IP40)
Max. screw torque	0.4 Nm
Housing material	Lexan EXL 9330
Weight	125 g

Standard types

AC/DC 12-48 V, 15...60 Hz
AC/DC 110-240 V, 15...60 Hz

MRU32/UC12-48V
MRU32/UC110-240V



Connection diagram

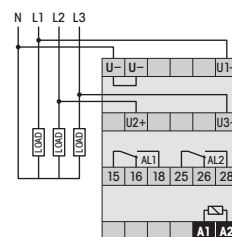


Fig.1 AC voltage endurance

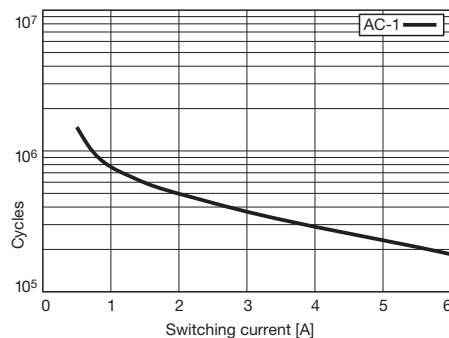
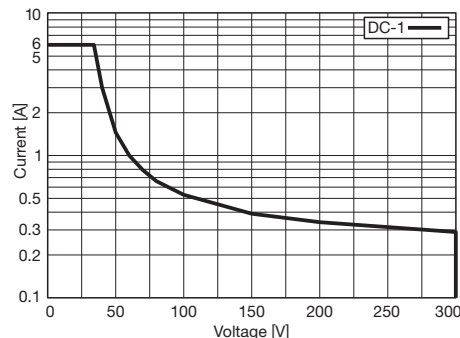
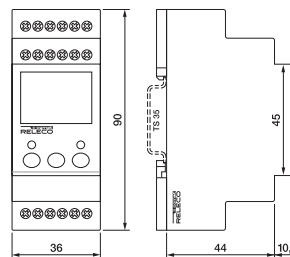


Fig. 2 DC load limit curve



Dimensions [mm]







Technical approvals, conformities



3.3 Current Monitoring



Application	Types	Monitoring	Monitoring ratings	Output contacts	Design
Current monitoring, AC 15 ... 60 Hz / DC single phase	MRI11		0.1 ... 5 A	1 CO	35 mm
Current monitoring, AC 15 ... 60 Hz / DC three phase	MRI32		0.1 ... 5 A	2 CO	35 mm
Over-current monitoring, 48 ... 62 Hz	EOCR		0.5 ... 6 A / 3 ... 30 A / 5 ... 60 A	1 CO	54 mm
Under-current monitoring, 48 ... 62 Hz	EUCR		0.5 ... 6 A / 3 ... 30 A / 5 ... 60 A	1 CO	54 mm

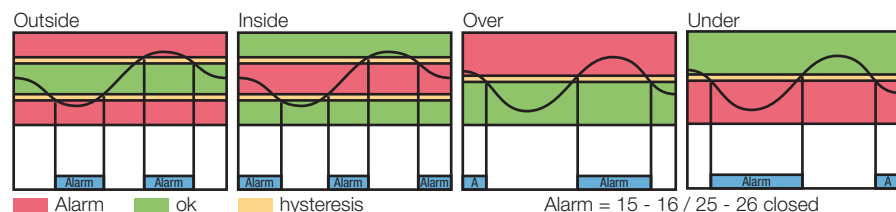
MRI11

Current monitoring relay AC/DC, single phase DIN Rail mounting according to DIN 43 880

Type: MRI11/...V

Current monitoring relay with over- and under voltage thresholds up to 5 A. Alarm delay setting. Alarm LED. Display for voltmeter function, alarm signal and interactive parameter setting.
1 change-over alarm contact 5 A 250 V. Comfortable parameter setting.

Monitoring function



Measuring circuit data

Current setting ranges AC / DC	0.1 ... 5 A
Frequency	AC 15 ... 150 Hz
Input resistance U / I	5 MΩ
Measured variables	I, f

Time data

Voltage failure buffering	ca. 30 ms
---------------------------	-----------

Alarm contacts

Type / Material	1 CO / AgNi 0.15
Rated operational current	6 A
Max. inrush current	15 A
Max. switching voltage	250 V
Max. AC load AC-1 (Fig.1)	1250 VA
Max. DC load DC-1, 24 V / 220 V (Fig.2)	120 W / 25 W
Recommended min. contact load	10 mA / 10 V
Alarm delay setting time	0.1 ... 999.9 s (factory adjustment = 0.0 s)
Reset time setting range	0.1 ... 999.9 s (factory adjustment = 0.0 s)

Power supply

	UC12-48V	UC110-240V
Nominal voltage AC/DC	12 ... 48 V	110 ... 240 V
Operating voltage range	10 ... 60 V	85 ... 250 V
AC frequency	16 ... 63 Hz	16 ... 63 Hz
Power consumption	1.6 W / 3.2 VA	1.5 W / 2.6 VA

Insulation

Measuring input – Measuring input	1.5 kV 1 minute
Measuring input – Supply	2.0 kV 1 minute
Measuring input – Contact	2.0 kV 1 minute
Supply – Contact	2.0 kV 1 minute
Contact set – Contact set	1.5 kV 1 minute

General specifications

Ambient temperature storage /operation	-40 ... +85 °C / -40 ...+60 °C
	LCD: -20 ... +60 °C
Mechanical life of contacts	30 x 10 ⁶ operations
Conductor cross section	Stranded wire 2.5 mm ² , 2 x 1.5 mm ²
Ingress protection degree	IP20, (electronics: IP40)
Max. screw torque	0.4 Nm
Housing material	Lexan EXL 9330
Weight	107 g

Standard types

AC/DC 12-48 V, 15...60 Hz
AC/DC 110-240 V, 15...60 Hz

MRI11/UC12-48V
MRI11/UC110-240V



Connection diagram

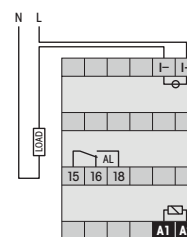


Fig.1 AC voltage endurance

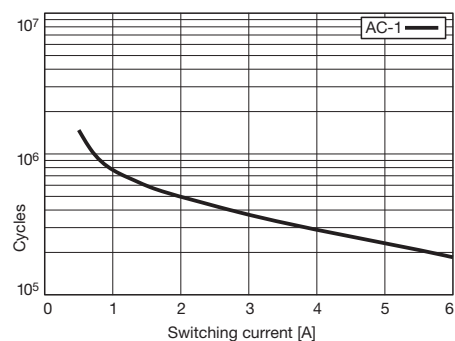
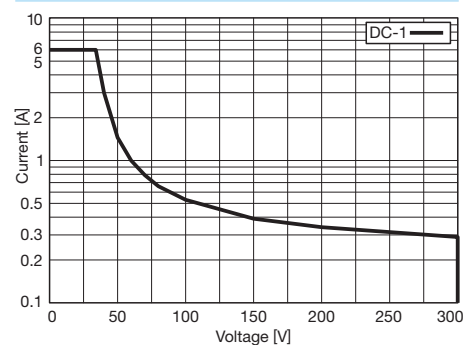
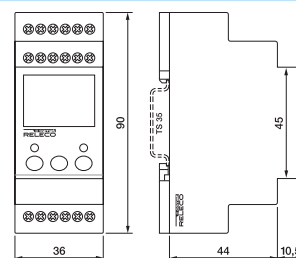


Fig. 2 DC load limit curve



Dimensions [mm]



Technical approvals, conformities



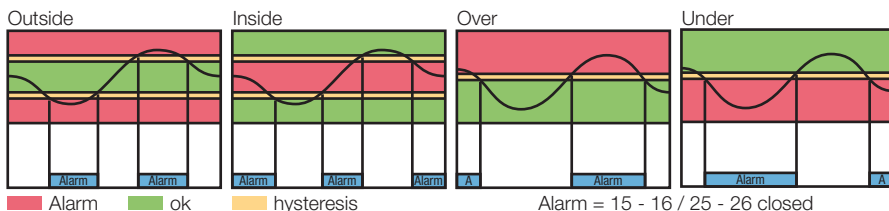
MRI32

Current monitoring relay AC/DC, three phase DIN Rail mounting according to DIN 43 880

Type: MRI32/...V

Current monitoring relay with over- and under current thresholds up to 5 A.
Alarm delay setting, Alarm LED. Display for voltmeter function, alarm signal and interactive parameter setting.
2 change-over alarm contacts 5 A 250 V. Comfortable parameter setting.

Monitoring function



Measuring circuit data

Current setting ranges AC / DC	0.1 ... 5 A
Frequency	AC 15 ... 150 Hz
Input resistance U / I	5 MΩ
Measured variables	I, f

Time data

Voltage failure buffering	ca. 30 ms
---------------------------	-----------

Contacts

Type / Material	2 CO / AgNi 0.15	
Rated operational current	6 A	
Max. inrush current	15 A	
Max. switching voltage	250 V	
Max. AC load AC-1 (Fig.1)	1250 VA	
Max. DC load DC-1, 24 V / 220 V (Fig.2)	120 W / 25 W	
Recommended min. contact load	10 mA / 10 V	
Alarm delay setting time	0.1 ... 999.9 s (factory adjustment = 0.0 s)	
Reset time setting range	0.1 ... 999.9 s (factory adjustment = 0.0 s)	

Power supply

	UC12-48V	UC110-240V
Nominal voltage AC/DC	12 ... 48 V	110 ... 240 V
Operating voltage range	10 ... 60 V	85 ... 250 V
AC frequency	16 ... 63 Hz	16 ... 63 Hz
Power consumption	1.6 W / 3.2 VA	1.5 W / 2.6 VA

Insulation

Measuring input – Measuring input	1.5 kV 1 minute
Measuring input – Supply	2.0 kV 1 minute
Measuring input – Contact	2.0 kV 1 minute
Supply – Contact	2.0 kV 1 minute
Contact set – Contact set	1.5 kV 1 minute

General specifications

Ambient temperature storage /operation	-40 ... +85 °C / -40 ...+60 °C
	LCD: -20 ... +60 °C
Mechanical life of contacts	30 x 10 ⁶ operations
Conductor cross section	Stranded wire 2.5 mm ² , 2 x 1.5 mm ²
Ingress protection degree	IP20, (electronics: IP40)
Max. screw torque	0.4 Nm
Housing material	Lexan EXL 9330
Weight	125 g

Standard types

AC/DC 12-48 V, 15...60 Hz	MRI32/UC12-48V
AC/DC 110-240 V, 15...60 Hz	MRI32/UC110-240V



Connection diagram

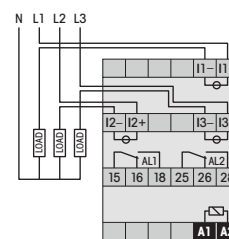


Fig.1 AC voltage endurance

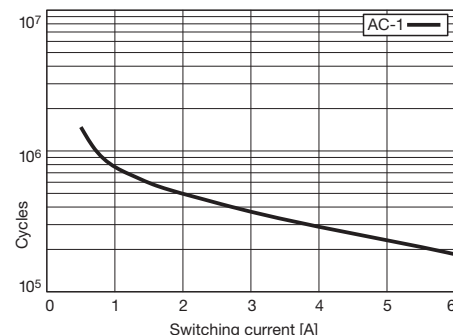
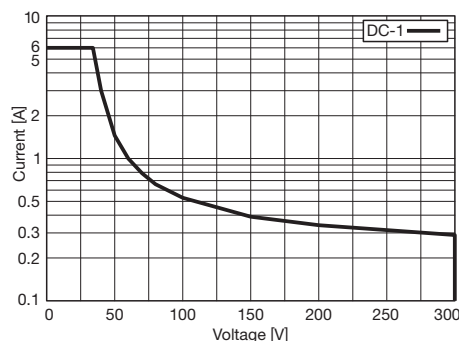
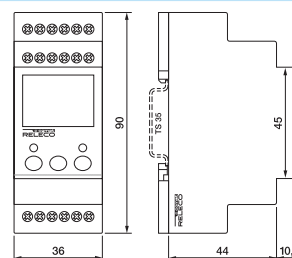


Fig. 2 DC load limit curve



Dimensions [mm]



Technical approvals, conformities



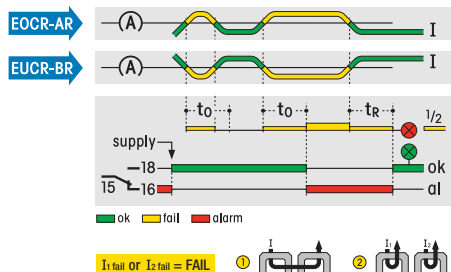
EOCR, EUCR

Current monitoring relay with 2 current inputs DIN Rail mounting according to DIN 43 880

Type: EOCR-AR-... / ... V (Over current), EUCR-BR-... / ... V (Under current)

AC current monitoring relay for 1 or 3 phase lines, 1 change over alarm contact 3 A / 250 V
Integrated current transformer coupling system, 6 A, 30 A, 60 A types

Monitoring function



The EOCR-AR and the EUCR-BR monitor over-current and undercurrent on AC power circuits. One or two current paths can be monitored directly up to 60 (75) A, by means of the integrated current loop transformers. The adjustable alarm delay (t_0) and the automatic alarm resetting (t_R) permit universal usage in motor and transformer protection systems, monitoring of electrical heating elements and in the control of pumps, ventilation systems, suction and feed devices.



Measuring circuit data

Setting ranges	0.5 ... 6 A / 3 ... 30 A / 5 ... 60 A
Frequency range	48 ... 62 Hz
Accuracy	2.5 %
Hysteresis	3 % from set value
Max. continuous current 6 / 30 / 60 A type	60 A / 90 A / 120 A
Peak current (1 sec) 6 / 30 / 60 A type	3 kA / 5 kA / 5 kA

1) Expansion of the current ranges:
Lower currents (see table at right):
Higher currents:

Two or more loops through the current transformer.
External current transformer. See accessories.

Time data

Alarm delay time adjustment range	0.3 ... 30 s
Reset time adjustment range	0.5 ... 150 s
Response time, power on, on A1	80 ... 150 ms

Contacts

Type / Material	1 CO, micro disconnection / AgNi
Rated operational current	3 A
Max. switching voltage, AC-1	250 V
Max. AC load	750 VA
Max. DC load	90 W

Power supply

	UC 24 V	AC 115 V	AC 230 V
Nominal voltage (UC = AC/DC)			
Operation voltage range [V]	19 ... 30	88 ... 130	184 ... 264
Power consumption [W]	1.5	1.5	1.5
Frequency [Hz]	50 / 60	50 / 60	50 / 60

Insulation

Test voltage between contacts and supply inp.	2 kVrms 1 minute
Test voltage between curr. transf. and other circuits	4 kVrms 1 minute

General specifications

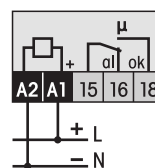
Ambient temperature storage /operation	-25 ... 85 °C / -20 ... 60 °C
Ingress protection degree	Housing: IP 40, terminals: IP 20
Max. screw torque	0.8 Nm
Weight	120 g

Standard types

Current [x] 05/30/60

Over current	Under current
EOCR-AR- x /UC24V	EUCR-BR-x /UC24V
EOCR-AR- x /AC115V	EUCR-BR-x /AC115V
EOCR-AR- x /AC230V	EUCR-BR-x /AC230V

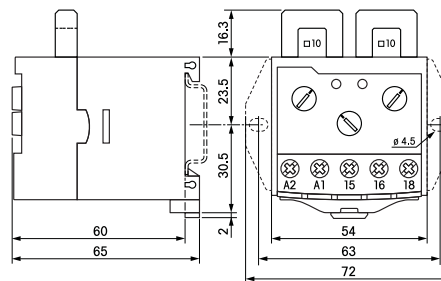
Connection diagram



Expansion of current ranges

[A]	1x	2x	3x	4x	5x
-05	0,5-6	0,25-3	0,17-2	0,13-1,5	0,1-1,2
-30	2,5-30	1,25-15	0,83-10	0,62-7,5	0,5-6
-60	5-60	2,5-30	1,7-20	1,25-15	1-12

Dimensions [mm]






Technical approvals, conformities



3.4 3-Phase Monitoring

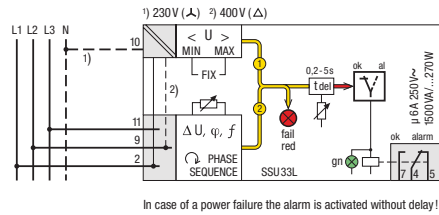


Application	Types	Monitoring	Monitoring ratings	Output contacts	Design
3 Phase monitoring	SSU33L		\star 230 V, Δ 400 V	1 CO	11 pin
Mains monitoring relay, 50 Hz	SSU34		100 V, 400 V, 500 V	2 CO	50 mm
Mains monitoring relay, 60 Hz	SSU36		208 V, 460 V, 480 V	2 CO	50 mm

Type: SSU33L/... V

1 change over alarm contact 6 A 250 V

Monitoring function



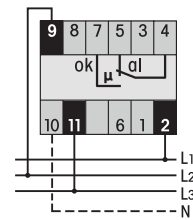
The SSU33 (50Hz) provides comprehensive monitoring of three-phase mains supplies with or without neutral. The following mains faults are monitored: Error signal ① U (V_λ, V_Δ): Exceeding or dropping below the fixed voltage values U_{min}/U_{max} for L1-N or L1-L2 (no differential voltage, phase position or frequency fault).

Error signal ② U, Δφ, Δf:

One or more of the three voltages, phase positions, phase sequence or the mains frequency are diverging from the required value. Depending on the nature of their occurrence Δ-errors are evaluated cumulatively. Any error is signalled by the red LED and is reported after expiry of the set alarmdelay time. In the correct status (ok) the green LED is illuminated (4-5 open, 4-7 closed).



Connection diagram



Measuring circuit data

	Type star with N	Type delta
Nominal mains voltage	230 V	400 V
Constant under voltage threshold ± 5 %	L1 – N ≤ 160 V	L1-L2 ≤ 280 V
Constant over voltage threshold ± 5 %	L1 – N ≥ 275 V	L1-L2 ≥ 480 V
Difference voltage adjustment range ¹⁾	20 ... 100 V	20 ... 100 V to N
φ adjustment range ¹⁾	3 ... 15 °	3 ... 15 °
f adjustment range ¹⁾	3 ... 15 Hz	3 ... 15 Hz

¹⁾ adjustment with the same rotary knob

Time data

Alarm delay adjustment range	0.2 ... 5 s
Reset time	50 ms

Contacts

Type / Material	1 CO, micro disconnection / AgNi
Rated operational current	6 A
Max. inrush current (10 ms)	30 A
Max. switching voltage	250 V
Max. AC load AC-1 (Fig.1)	1500 VA
Max. DC load DC-1, 30 V / 250 V (Fig.2)	180 W / 75 W
Recommended min. contact load	10 mA / 12 V

Power supply data

	Type star with N	Type delta
Nominal mains voltage	230 V	400 V
Operating voltage range	160 ... 275 V	280 ... 470 V
Power consumption	1.5 W	1.5 W
Input current	1.5 mA	1.5 mA
Frequency	50 Hz	50 Hz

Insulation

Test voltage between contacts and supply	2 kVrms 1 minute (basic insulation)
--	-------------------------------------

General specifications

Ambient temperature storage /operation	-40 ... +85 °C / -25 ...+60 °C
Mechanical life of contacts	30 x 10 ⁶ operations
Ingress protection degree	IP 40 when plugged in
Housing material	Lexan, alu front plate
Weight	300 g

Standard types

AC 230 50 Hz	SSU33L/AC230V (Star connection)
AC 400 50 Hz	SSU33L/AC400V (delta connection)

Accessories: Socket:
Retention clip:
Front panel mounting set:

S-3B
HF-24
FZ-23

Fig.1 AC voltage endurance

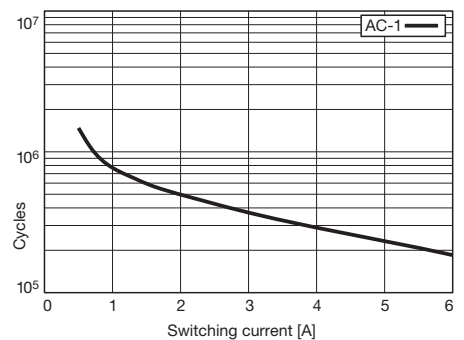
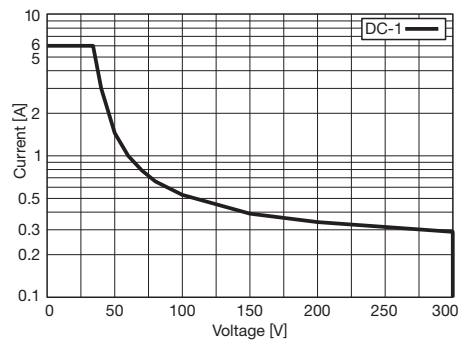
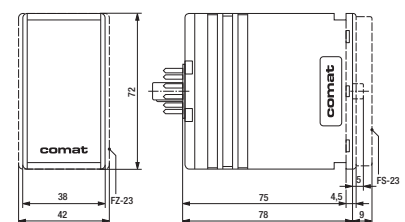


Fig. 2 DC load limit curve



Dimensions [mm]



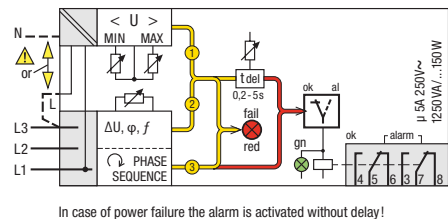
Technical approvals, conformities

EN 60947 CE RoHS

Type: SSU34/... V

Monitoring relay for under / over voltage, phase sequence, phase loss, phase angle, frequency, asymmetry. Star or delta operation. 2 change over alarm contacts 6 A 250V

Monitoring function



The SSU34 (50Hz) provide comprehensive monitoring of three-phase mains supplies with or without neutral.
The following mains faults are monitored:
Error signal ① U (V_{Δ} , V_{λ}):
Exceeding or dropping below the set voltage values U_{min}/U_{max} for L1-N or L1-L3,L (no differential voltage, phase position or frequency fault).

Error signal ② ΔU , $\Delta \phi$, Δf :

One or more of the three voltages, phase positions, or the mains frequency are diverging from the required value. Depending on the nature of their occurrence Δ -errors are evaluated cumulatively.

Error signal ③:

Connection polarity reversal (wrong phase-sequence). Any error is signalled by the red LED "fail" and is reported after expiry of the set alarm-delay time (for error signal ③ undelayed) via 5-6 and 7-8.

In the correct status (ok) the green LED is illuminated (5-6 and 7-8 open, 5-4 and 7-3 closed).

Measuring circuit data

	100 V	400 V	500 V
Nominal mains voltage	100 V	400 V	500 V
Under voltage adj. range [V] ¹⁾	40 ... 55	160 ... 225	200 ... 280
Over voltage adj. range [V] ¹⁾	61 ... 70	235 ... 275	300 ... 350
Δ voltage adj. range [V] ^{1) 2)}	5 ... 25	20 ... 100	20 ... 100
$\Delta \phi$ adjustment range [°] ²⁾	3 ... 15	3 ... 15	3 ... 15
Δf adjustment range [Hz] ²⁾	3 ... 15	3 ... 15	3 ... 15

¹⁾ L - N ²⁾ adjustment with the same rotary knob

Time data

Alarm delay adjustment range	0.2 ... 5 s
Reset time	100 ... 400 ms

Contacts

Type / material	2 CO, micro disconnection / AgNi
Rated operational current	5 A
Max. inrush current (20 ms)	15 A
Max. AC switching voltage AC-1	250 V
Max. AC load AC-1 (Fig.1)	1250 VA
Max. DC load 30 V / 250 V DC-1	150 W / 60 W
Recommended min. contact load	10 mA / 12 V

Power supply data

	100 V	400 V	500 V
Nominal mains voltage	100 V	400 V	500 V
Operating voltage range [V] ¹⁾	35 ... 70	140 ... 285	180 ... 360
Power consumption [W]	≤ 1.5	≤ 1.5	≤ 1.5
Input current [mA]	150	30	25
Frequency [Hz]	50	50	50

Insulation

Test voltage between contacts and supply	3 kVrms 1 minute (basic insulation)
--	-------------------------------------

General specifications

Ambient temperature storage /operation	-40 ... +85 °C/-10 ...+60 °C
Mechanical life of contacts	30 x 10 ⁶ operations
Ingress protection degree	Housing: IP 40, terminals: IP 20
Max. screw torque	0.5 Nm
Housing material / Weight	Lexan / 350 g

Standard types

50 Hz , AC 100, 400, 500

" ..." enter the voltage for full type designation

SSU34/AC...V



Connection diagram

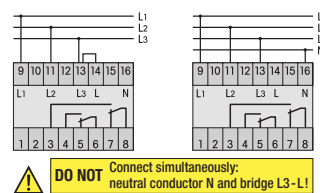


Fig. 1 AC electrical endurance

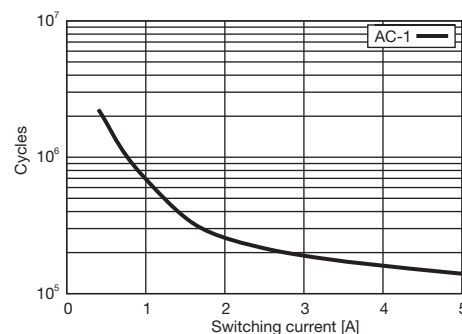
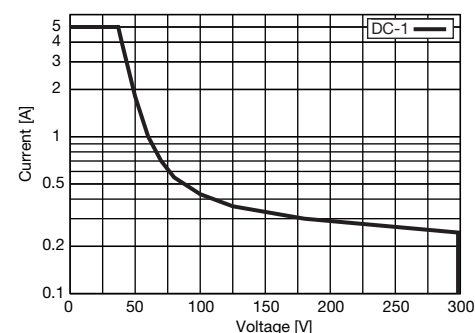
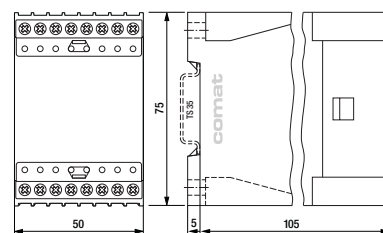


Fig. 2 DC load limit curve



Dimensions [mm]



Technical approvals, conformities



SSU36

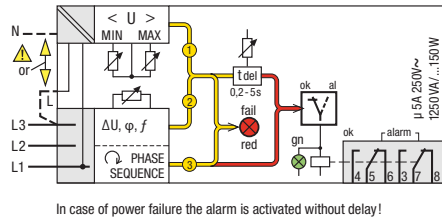
60 Hz, 3 phase monitoring relay DIN Rail mounting according to DIN 43 880



Type: SSU36/... V

Monitoring relay for under / over voltage, phase sequence, phase loss, phase angle, frequency, asymmetry. Star or delta operation. 2 change over alarm contacts 6 A 250V

Monitoring function



The SSU36 (60Hz) provide comprehensive monitoring of three-phase mains supplies with or without neutral.

The following mains faults are monitored:

Error signal \odot U (V_{Δ} , V_{λ}):

Exceeding or dropping below the set voltage values U_{min}/U_{max} for L1-N or L1-L3,L (no differential voltage, phase position or frequency fault).

Error signal \odot ΔU , $\Delta \phi$, Δf :

One or more of the three voltages, phase positions, or the mains frequency are diverging from the required value. Depending on the nature of their occurrence Δ -errors are evaluated cumulatively.

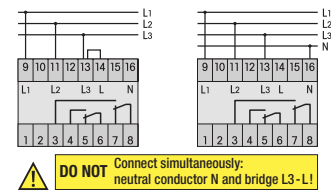
Error signal \odot :

Connection polarity reversal (wrong phase-sequence). Any error is signalled by the red LED "fail" and is reported after expiry of the set alarm-delay time (for error signal \odot undelayed) via 5-6 and 7-8.

In the correct status (ok) the green LED is illuminated (5-6 and 7-8 open, 5-4 and 7-3 closed).



Connection diagram



Measuring circuit data

Nominal mains voltage	208 V	460 V	480 V
Under voltage adj. range [V] ¹⁾	85 ... 115	186 ... 260	194 ... 270
Over voltage adj. range [V] ¹⁾	125 ... 145	270 ... 318	284 ... 332
Δ voltage adj. range [V] ^{1) 2)}	10 ... 50	20 ... 100	20 ... 100
$\Delta\phi$ adjustment range [°] ²⁾	5 ... 24	4 ... 21	4 ... 21
Δf adjustment range [Hz] ²⁾	3 ... 22	3 ... 19	3 ... 19

¹⁾ L - N ²⁾ adjustment with the same rotary knob

Time data

Alarm delay adjustment range	0.2 ... 5 s
Reset time	100 ... 400 ms

Contacts

Type / material	2 CO, micro disconnection / AgNi
Rated operational current	5 A
Max. inrush current (20 ms)	15 A
Max. AC switching voltage AC-1	250 V
Max. AC load AC-1 (Fig.1)	1250 VA
Max. DC load 30 V / 250 V DC-1	150 W / 60 W
Recommended min. contact load	10 mA / 12 V

Power supply data

Nominal mains voltage	208 V	460 V	480 V
Operating voltage range [V] ¹⁾	75 ... 150	160 ... 331	170 ... 346
Power consumption [W]	≤ 1.5	≤ 1.5	≤ 1.5
Input current [mA]	70	25	25
Frequency [Hz]	60	60	60

Insulation

Test voltage between contacts and supply	3 kVrms 1 minute (basic insulation)
--	-------------------------------------

General specifications

Ambient temperature storage /operation	-40 ... +85 °C / -10 ... +60 °C
Mechanical life of contacts	30 x 10 ⁶ operations
Ingress protection degree	Housing: IP 40, terminals: IP 20
Max. screw torque	0.5 Nm
Housing material / Weight	Lexan / 350 g

Standard types

60 Hz, AC 208, 460, 480

"..." enter the voltage for full type designation

SSU36/AC...V

Fig. 1 AC electrical endurance

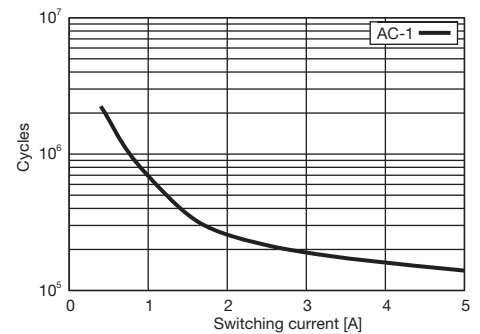
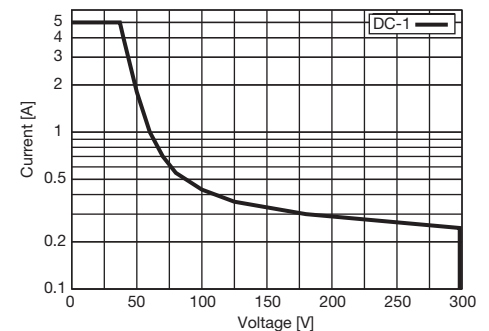
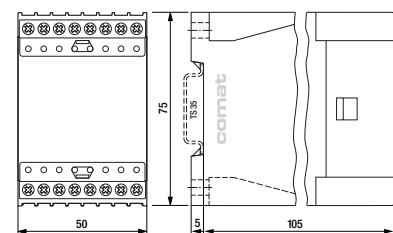


Fig. 2 DC load limit curve



Dimensions [mm]




Technical approvals, conformities



3.5 Isolation Monitoring



Application	Types	Monitoring	Monitoring ratings	Output contacts	Design
Isolation monitoring, DC networks	ESU-D2		1 ... 50 k Ω	1 CO / 1 CO+NO	50 mm

ESU-D2

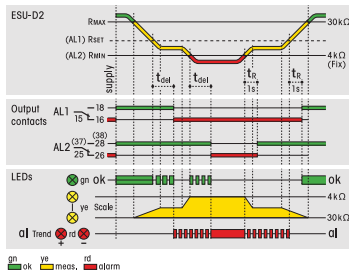
Insulation monitoring relay for unearthed DC-networks DIN Rail mounting according to DIN 43 880



Type: ESU-D2/... V

Earth insulation resistance monitoring relay
Pre alarm 1 CO and main alarm 1 NO + 1 CO contact outputs 5 A / 250 V
UC 24 ... 48 V, UC 110 ... 240 V operating voltages, monitoring of
DC 12 ... 48 V power supply networks. Monitoring of earth interruption on the device.
The device measures single or combined resistances occurring against + or - pole of the
DC network. Adjustable alarm delay. Proved reliability in rolling stock applications.

Monitoring function



The ESU-D2 monitors the isolation resistance in non-grounded DC-networks (24 – 48 V).
Two alarm steps (prealarm AL1 and main alarm AL2) are indicated via separate output contacts.
Displays: bargraph-display of the measured earthing resistance (green = ok). Two red LEDs show the ground tendency towards plus (+) or minus (-).
Output terminals 5 V for the external display of the earthing resistance (0,1 V/kΩ).
Test functions: Periodic automatic check, also with key "Test".
Environmental failures: monitoring of AC-short circuit, over-voltage, ground interruption.

Measuring circuit data

Measuring / setting range for pre alarm	1 ... 50 kΩ / 4 ... 30 kΩ
Constant value for main alarm	4 kΩ
Tolerance	≤ 10 %
Overvoltage alarm level of DC network	60 V
Input current + → -	≤ 5 mA
Sampling current pulses +/- → earth	0.2 mA
Overvoltage safety from earth to +/- poles	AC 250 V
Max. capacity +/- → earth	1.5 μF ¹⁾

¹⁾ Types for capacitances until 60 μF on request

Time data

Alarm delay time adjustment range	0.1 ... 10 s
Fault detection time	800 ms
Auto reset time, fail to OK	1 s

Contacts

Type / Material	2 CO, 1 NO micro disconnection / AgNi
Rated operational current / min. contact load	5 A / 1 mA 12 V
Max. switching voltage (Fig. 1)	250 V

Power supply

	UC 24-48 V	UC 110 – 240 V
Nominal voltage	18 ... 60 V	88 ... 265 V
Operation voltage range	2 W	2 W
Power consumption	≥ 50 ms	≥ 50 ms
Voltage failure buffering		

Insulation

Test voltage contacts to other circuits	2 kVrms 1 minute
---	------------------

General specifications

Ambient temperature storage /operation	-40 ... 85 °C / -10 ... 60 °C
Ingress protection degree	Housing: IP 40, terminals: IP 20
Max. screw torque	0.5 Nm
Weight	250 g

Standard types

UC 110-240	ESU-D2/UC110-240V
UC24-48	ESU-D2/UC24-48V



Connection diagram

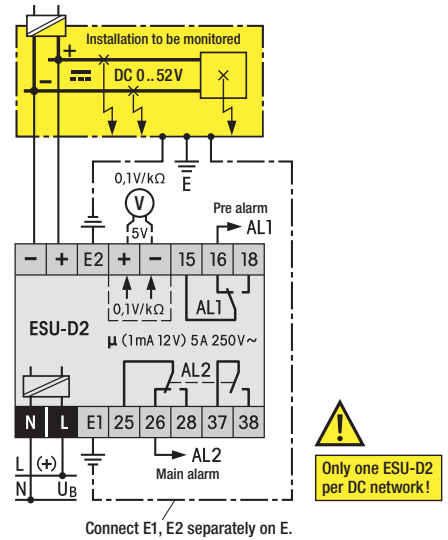
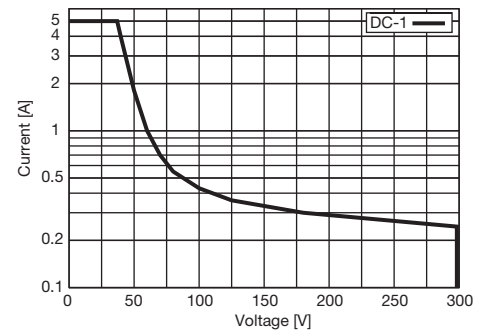
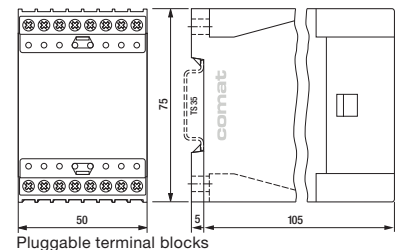


Fig. 1 DC load limit curve



Dimensions [mm]



Technical approvals, conformities

EN 60947



3.6 Monitoring Modules



The modular monitoring system consists of individual plug-in monitoring modules with front cover, an 11-pole plug-in relay and a system socket with retaining spring.

The individual combination allows an optimal device selection for the foreseen application.

Later modifications as for example an exchange of relay from mechanical contacts to a relay with solid-state outputs are possible at any time. The user profits of a universal system of worldwide unique flexibility.

The modular Comat monitoring CT System

The monitoring relays consist of plug-in CT electronic modules and 11-pole output relays. Both system components can be combined in a variety of combinations. This allows adapting the system for the specific application. Subsequent modifications, for example a change from mechanical contacts to solid-state outputs, are possible at any time just by replacing the relay.

This system provides the user a complete universal system with worldwide unmatched flexibility.



The system sockets C12B0 or CS-155 serve as a basis for the secure reception of the electronic modules. The sockets have a 4-pole module slot in which the CT modules lock firmly and vibration proof also without the output relay. Contact is made with reliable twin knife contacts.

With the A2 connector bridge "C-A2", the neutral conductor (N/-) can be connected from socket to socket. It reduces wiring work considerably.

Robust terminals for wires up to 4mm² and spacious labeling are other advantages of this practical Comat modular system.

Clear markings close to the terminal connections on the sockets make it easy to identify the connections for wiring and servicing.

The CT modules are proof of the practical oriented experiences of Comat in the field of industrial electronics. All control and display elements are arranged easy accessible at all times on the front side of the modules. The functions and settings are self-explanatory schematically illustrated on the front and allow to review the set values also during operation.

A transparent cover over the module setting components provides protection from unintentional settings and additionally links the module to the output relay.

Triggering is performed with the operating voltage. (L1 or +). No potential-free contacts are therefore required. The triggering complies to machine standards. Parallel connection to B1 is admissible.

The output relays show the connection diagram and the technical values on the front side, (exception C3 and C5 relays). A color code indicates an AC coil with red and a DC coil with blue color. Most of the relays have a lockable test button for manual operation.

The standard contacts have proven its reliability for high switching current applications over many years. The contact material AgNi permits a wide switching range and due to the large dimensioning they are designed for a high number of switching cycles. The high breaking capacity of up to 10A/400V and a low load switching capability of 12V/10mA makes the contact suitable for the use in main circuits as well as for low voltage applications.

The twin contacts are switching the load circuit with 2 independent contact tongues. The switching safety for low currents is therefore 100 times higher compared to a single contact relay. Despite the high switching capacity of up to 6A/250V, these contacts are very suitable to switch low currents and voltages up to 1mA/6V.

The solid-state relays are an alternative to mechanical relays. In the standard version, the relay has a potential-free universal semiconductor output for AC or DC loads. The advantage is a bouncing- and wear- free, overload resistant, short circuit protected output with a practical unlimited life cycle.

Solid-state relays are specially recommended for applications of high switching cycles, for example for repeat cycle timers, flushing lights, but also for high inductive switching loads of solenoid valves, couplings, motors, etc. The solid state relays are also suitable for capacitive loads, for example long power lines, or compensated lighting circuits.

Additional protection circuits of the output or of the load are not necessary in any application for this type of Comat relays.

The solid-state relays are insensitive in any aggressive environment such as chemical plants, sewage plants etc. and are therefore an excellent choice for the employment in such environments.



The train symbol indicates products available in a special railway execution according EN 50155. Please refer to our special railway brochure for details.

CT512, CT515, CT516

Plug-in current monitoring modules (combined with industrial relays)
0.2 A, 2 A, 6 A. DC 24 V operation

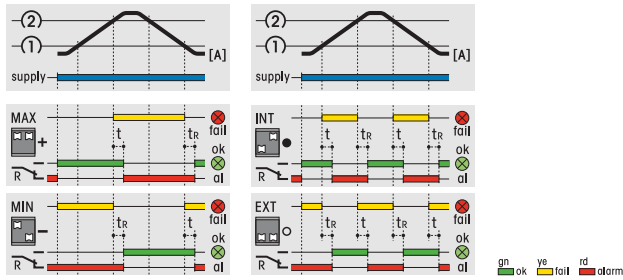


Type **CT512, CT515, CT516 /24V R** **CT512R, CT515R, CT516R /36V R**

Plug-in current monitoring modules for sockets with module slot in combination with plug-in relays. DC 24 V operation. LED alarm state indicators for OK and fail.
 Separate adjustment of upper and lower level.



Monitoring functions



Over / under voltage internal / external range

Measuring circuit data

Type	CT512	CT515	CT516
Measuring and setting ranges (rotary knobs)	0 ... 200 mA	0 ... 2 A	0 ... 6 A
Max. current 100% duty cycle	300 mA	3 A	7 A
Voltage drop on internal shunt res. @ I _{max}	300 mV	200 mV	100 mV
Temperature drift -25 ... 60 °C	≤ 3 %	≤ 3 %	≤ 3 %

Time data

Alarm delay time settings	100 ms, 500 ms, 2 s
Reset time	100 ms

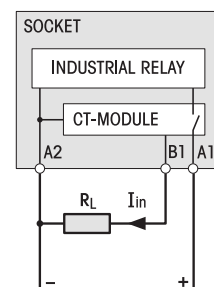
Power supply

	DC 24 V	DC 36 V
Nominal voltage	18 ... 30 V	18 ... 45 V
Operation voltage range	3 ... 7 mA	5 mA
Supply current	- 30 V	- 51 V
Polarity reversal protection		

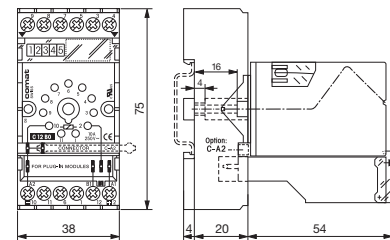
General specifications

Ambient temperature storage/operation	-40 ... 85 °C / -25 ... 60 °C
Ingress Protection degree	IP 40 when plugged in
Housing material	Lexan
Weight	25 g

Connection diagram



Dimensions [mm]



Standard types

CT512/, CT515/, CT516/ DC24 **CT51x/DC24V R**

Railway types:

CT512R/, CT515R/, CT516R/ DC24 **CT51xR/DC24V**
CT512R/, CT515R/, CT516R/ DC36 **CT51xR/DC36V**



Remark: This module is part of several ready for connection units consisting of socket, relay and module.
 A wide variety of suitable relays is available.

Technical approvals, conformities



CT524

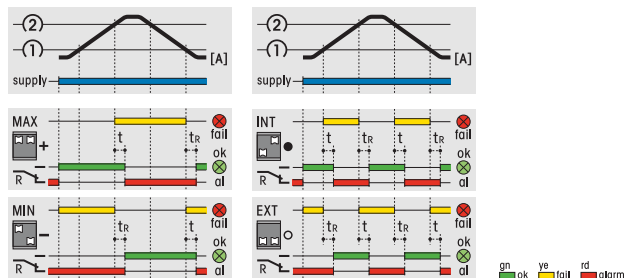
Plug-in DC voltage monitoring module. DC 24 V operation.
(combined with industrial relays)

Type CT524/24V R

Plug-in DC voltage monitoring module for sockets with module slot in combination with 11p plug-in relays. DC 24 V operation. LED alarm state indicators for OK and fail. Separate adjustment of upper and lower level.



Monitoring functions



Over / under voltage internal / external range

Measuring circuit data

Type	CT524
Measuring and setting ranges (rotary knobs)	0 ... 30 V
Over voltage (10 ms)	± 150 V
Input resistance	106 kΩ
Temperature drift -25 ... 60 °C	≤ 2 %

Time data

Alarm delay time settings	100 ms, 500 ms, 2 s
Reset time	100 ms

Power supply

Nominal voltage	DC 24 V
Operation voltage range	18 ... 30 V
Supply current	8 ... 13 mA
Polarity reversal protection (1 minute)	- 30 V

General specifications

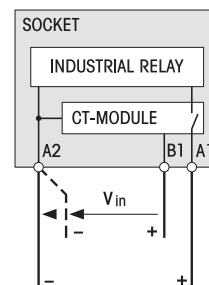
Ambient temperature storage/operation	-40 ... 85 °C / -25 ... 60 °C
Ingress Protection degree	IP 40 when plugged in
Housing material	Lexan
Weight	25 g

Standard types

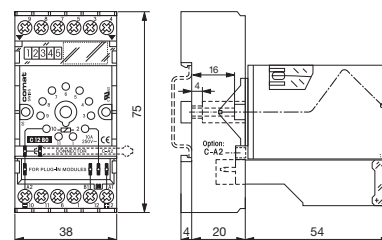
DC 24 **CT524/DC24V R**

Remark: This module is part of several ready for connection units consisting of socket, relay and module.
A wide variety of suitable relays is available.

Connection diagram



Dimensions [mm]



Technical approvals, conformities



DC Voltage Monitoring-Set
DC Current Monitoring-Set



Set-Delivery includes:

- Relay
- Module
- Front cover
- Socket
- Retaining clip

Monitoring Module

4 functions can be selected:
Overvoltage/undervoltage monitoring with adjustable hysteresis or 2 range monitors (INT or EXT). Adjustable alarm delay. LED display for errors and ok. Contact inspection window at the top. Manual safety operation.

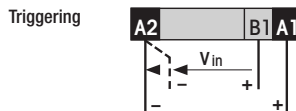
Relay data's see:
Section Industrial Relays



Alarm delay t	0,1/0,5/2s
Reset time t _R	100ms
Voltage tolerance	0,8...1,2Un
Power consumption	≤0,5W
Ambient temperature	-25...+60°C

CT524
DC Voltage Monitoring

Range: **0-30V**
U_{max}: **40V**



Input resistance
B1 → A2: 100kΩ

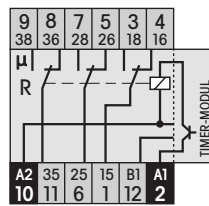
Power Relay



C3-A30X

Universal
Power Relay 10A.
With 3 power changeover-contacts this is the robust relay for AC and DC circuits ranging from 10mA 10V.

10A 250V~
10mA 10V



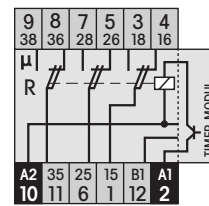
Control Relay



C3-T31X

Relay with 3 twin contacts 6A
The control relay with highest switching reliability for control and signal circuits ranging from 5mA 5V.

6A 250V~
5mA 5V



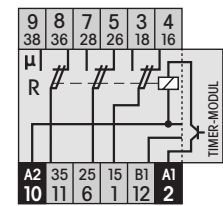
Signal Relay



C3-T32X

Relay with 3 twin contacts, 10μ gold flush
The twin contact relay with highest switching reliability for signal circuits ranging from 1mA 5V. Recommend. upto 0,2A 30V.

6A 250V~
1mA 5V



Set Order-Nr.:
CT524.3-A30/DC24V R

- Delivery includes:**
- Relay C3-A30X/DC24V R
 - Module CT524/DC24V R
 - Front cover FS-R
 - Socket C12B0 R
 - Retaining clip S3-C

Set Order-Nr.:
CT524.3-T31/DC24V R

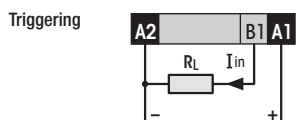
- Delivery includes:**
- Relay C3-T31X/DC24V R
 - Module CT524/DC24V R
 - Front cover FS-R
 - Socket C12B0 R
 - Retaining clip S3-C

Set Order-Nr.:
CT524.3-T32/DC24V R

- Delivery includes:**
- Relay C3-T32X/DC24V R
 - Module CT524/DC24V R
 - Front cover FS-R
 - Socket C12B0 R
 - Retaining clip S3-C

CT512
DC Current Monitoring

Range: **0-200mA**
I_{max}: **300mA**



Voltage drop
A1 → B1 ≤ 300mV

Set Order-Nr.:
CT512.3-A30/DC24V R

- Delivery includes:**
- Relay C3-A30X/DC24V R
 - Module CT512/DC24V R
 - Front cover FS-R
 - Socket C12B0 R
 - Retaining clip S3-C

Set Order-Nr.:
CT512.3-T31/DC24V R

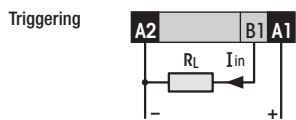
- Delivery includes:**
- Relay C3-T31X/DC24V R
 - Module CT512/DC24V R
 - Front cover FS-R
 - Socket C12B0 R
 - Retaining clip S3-C

Set Order-Nr.:
CT512.3-T32/DC24V R

- Delivery includes:**
- Relay C3-T32X/DC24V R
 - Module CT512/DC24V R
 - Front cover FS-R
 - Socket C12B0 R
 - Retaining clip S3-C

CT515
DC Current Monitoring

Range: **0-2A**
I_{max}: **3A**



Voltage drop
A1 → B1 ≤ 200mV

Set Order-Nr.:
CT515.3-A30/DC24V R

- Delivery includes:**
- Relay C3-A30X/DC24V R
 - Module CT515/DC24V R
 - Front cover FS-R
 - Socket C12B0 R
 - Retaining clip S3-C

Set Order-Nr.:
CT515.3-T31/DC24V R

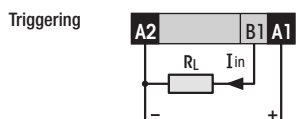
- Delivery includes:**
- Relay C3-T31X/DC24V R
 - Module CT515/DC24V R
 - Front cover FS-R
 - Socket C12B0 R
 - Retaining clip S3-C

Set Order-Nr.:
CT515.3-T32/DC24V R

- Delivery includes:**
- Relay C3-T32X/DC24V R
 - Module CT515/DC24V R
 - Front cover FS-R
 - Socket C12B0 R
 - Retaining clip S3-C

CT516
DC Current Monitoring

Range: **0-6A**
I_{max}: **7A**



Voltage drop
A1 → B1 ≤ 100mV

Set Order-Nr.:
CT516.3-A30/DC24V R

- Delivery includes:**
- Relay C3-A30X/DC24V R
 - Module CT516/DC24V R
 - Front cover FS-R
 - Socket C12B0 R
 - Retaining clip S3-C

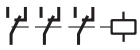
Set Order-Nr.:
CT516.3-T31/DC24V R

- Delivery includes:**
- Relay C3-T31X/DC24V R
 - Module CT516/DC24V R
 - Front cover FS-R
 - Socket C12B0 R
 - Retaining clip S3-C

Set Order-Nr.:
CT516.3-T32/DC24V R

- Delivery includes:**
- Relay C3-T32X/DC24V R
 - Module CT516/DC24V R
 - Front cover FS-R
 - Socket C12B0 R
 - Retaining clip S3-C

Power Relay

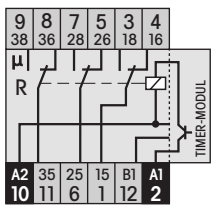


C31L

Universal Power Relay 10 A
with 3 power changeover-contacts
this is the robust relay for AC and
DC circuits ranging from
50 mA 10 V.

10 A 250 V~

50 mA 10 V



Control Relay

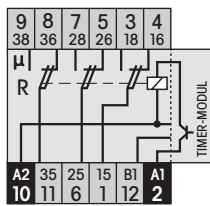


C32L

**Relay with
3 twin contacts 6 A**
The control relay with highest
switching reliability for control
and signal circuits ranging from
10 mA 5 V.

6 A 250 V~

10 mA 5 V



Set Order-Nr.:

CT524.31/DC24V

Delivery includes:

- Relay C31L/DC24V
- Module CT524/DC24V
- Front cover FS-C
- Socket C12B0
- Retaining clip HF-32

CT524.31R/...V 

DC 24, 36 V

Set Order-Nr.:

CT524.32/DC24V

Delivery includes:

- Relay C32L/DC24V
- Module CT524/DC24V
- Front cover FS-C
- Socket C12B0
- Retaining clip HF-32

CT524.32R/...V 

DC 24, 36 V

Set Order-Nr.:

CT512.31/DC24V

Delivery includes:

- Relay C31L/DC24V
- Module CT512/DC24V
- Front cover FS-C
- Socket C12B0
- Retaining clip HF-32

CT512.31R/...V 

DC 24, 36 V

Set Order-Nr.:

CT512.32/DC24V

Delivery includes:

- Relay C32L/DC24V
- Module CT512/DC24V
- Front cover FS-C
- Socket C12B0
- Retaining clip HF-32

CT512.32R/...V 

DC 24, 36 V

Set Order-Nr.:

CT515.31/DC24V

Delivery includes:

- Relay C31L/24V
- Module CT515/24V
- Front cover FS-C
- Socket C12B0
- Retaining clip HF-32

CT515.31R/...V 

DC 24, 36 V

Set Order-Nr.:

CT515.32/DC24V

Delivery includes:

- Relay C32L/24V
- Module CT515/24V
- Front cover FS-C
- Socket C12B0
- Retaining clip HF-32

CT515.32R/...V 

DC 24, 36 V

Set Order-Nr.:

CT516.31/DC24V

Delivery includes:

- Relay C31L/DC24V
- Module CT516/DC24V
- Front cover FS-C
- Socket C12B0
- Retaining clip HF-32

CT516.31R/...V 

DC 24, 36 V

Set Order-Nr.:

CT516.32/DC24V

Delivery includes:

- Relay C32L/DC24V
- Module CT516/DC24V
- Front cover FS-C
- Socket C12B0
- Retaining clip HF-32

CT516.32R/...V 

DC 24, 36 V

DC Voltage Monitoring-Set
DC Current Monitoring-Set

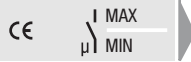


- Set-Delivery includes:
- Relay
 - Module
 - Front cover
 - Socket
 - Retaining clip

Monitoring Module

4 functions can be selected:
Overvoltage/undervoltage monitoring with adjustable hysteresis or 2 range monitors (INT or EXT). Adjustable alarm delay. LED display for errors and ok. Contact inspection window at the top. Manual safety operation.

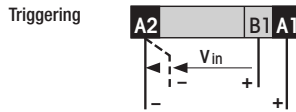
Relay data's see:
Section industrial Relays



Alarm delay t	0,1/0,5/2s
Reset time tR	100ms
Voltage tolerance	0,8-1,2Un
Power consumption	≤0,5W
Ambient temperature	-25...+60°C

CT524
DC Voltage Monitoring

Range: 0-30V
Umax: 40V



Input resistance
B1 → A2: 100kΩ

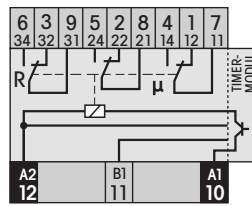
High Power Relay DC
16A 400V~



C5-A30X

Universal Power Relay 16A
With 3 power changeover-contacts this is the robust relay for AC and DC circuits ranging from 10mA 10V.

16A 400V~
10mA 10V



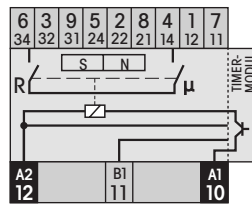
High Power Relay DC
10A @ 220V~



C5-M10X

Highpower Relay, in particular for DC loads upto 10A 220V~ (DC1)
With 2 NO contacts in series and a blow magnet for safe arc extinguishing.

16A 400V~
10mA 10V



Set Order-Nr.:
CT524.5-A30/DC24V R

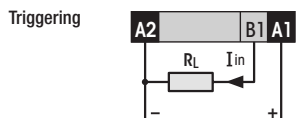
- Delivery includes:
- Relay C5-A30/DC24V R
 - Module CT524/DC24V R
 - Front cover FS-C5
 - Socket S-5M
 - Retaining clip S3-C

Set Order-Nr.:
CT524.5-M10/DC24V R

- Delivery includes:
- Relay C5-M10/DC24V R
 - Module CT524/DC24V R
 - Front cover FS-C5
 - Socket S-5M
 - Retaining clip S3-C

CT512
DC Current Monitoring

Range: 0-200mA
Imax: 300mA



Voltage drop
A1 → B1 ≤ 300mV

Set Order-Nr.:
CT512.5-A30/DC24V R

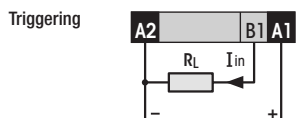
- Delivery includes:
- Relay C5-A30/DC24V R
 - Module CT512/DC24V R
 - Front cover FS-C5
 - Socket S-5M
 - Retaining clip S3-C

Set Order-Nr.:
CT512.5-M10/DC24V R

- Delivery includes:
- Relay C5-M10/DC24V R
 - Module CT512/DC24V R
 - Front cover FS-C5
 - Socket S-5M
 - Retaining clip S3-C

CT515
DC Current Monitoring

Range: 0-2A
Imax: 3A



Voltage drop
A1 → B1 ≤ 200mV

Set Order-Nr.:
CT515.5-A30/DC24V R

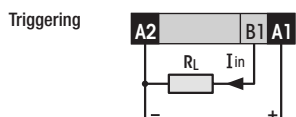
- Delivery includes:
- Relay C5-A30/DC24V R
 - Module CT515/DC24V R
 - Front cover FS-C5
 - Socket S-5M
 - Retaining clip S3-C

Set Order-Nr.:
CT515.5-M10/DC24V R

- Delivery includes:
- Relay C5-M10/DC24V R
 - Module CT515/DC24V R
 - Front cover FS-C5
 - Socket S-5M
 - Retaining clip S3-C

CT516
DC Current Monitoring

Range: 0-6A
Imax: 7A



Voltage drop
A1 B1 ≤ 100mV

Set Order-Nr.:
CT516.5-A30/DC24V R

- Delivery includes:
- Relay C5-A30/DC24V R
 - Module CT516/DC24V R
 - Front cover FS-C5
 - Socket S-5M
 - Retaining clip S3-C

Set Order-Nr.:
CT516.5-M10/DC24V R

- Delivery includes:
- Relay C5-M10/DC24V R
 - Module CT516/DC24V R
 - Front cover FS-C5
 - Socket S-5M
 - Retaining clip S3-C

4.0 Sockets



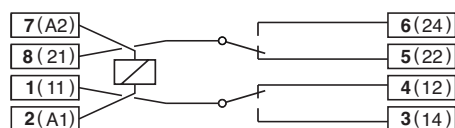
Type	S2-B 2-pole, 1 connection level Coding ring optional Integrated retaining clip and labelling space
Rated current	10 A
Specifications	
Rated load	10 A / 300 V
Insulation	Test voltage V rms / 1 min
– All terminals/DIN rail	2,5 kV
– Terminal/terminal	2,5 kV
Cross-section of connecting wire	
– Single-wire	4 mm ² or 2 x 2,5 mm ²
– Multi-wire	22 - 14 AWG
Max. screw torque	1,2 Nm
Screw dimensions	M3, Pozzi, slot
Integrated retaining clip/plastic	for relay series C2
Labelling space	detachable
Connection label	1...8; DIN/EN
Mounting	DIN rail T35 or mounting plate
Ambient temperature operation/storage	-40 (no ice)...60 °C / -40 ... 80 °C
Weight	48g



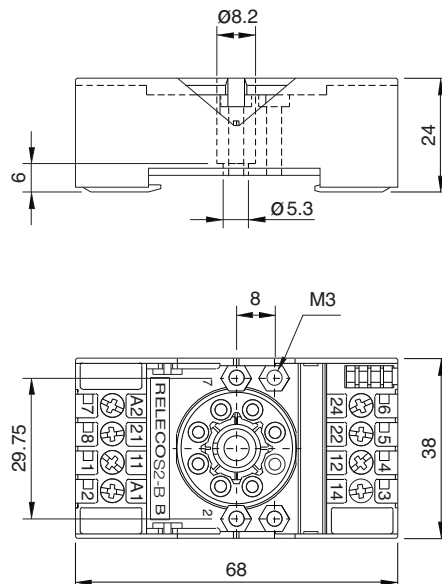
Associated, plug-in 8-pin MRC relays	C2-A, C2-G, C2-T
Suitable for holding the Releco coding ring For coding the relay and the socket.	

Accessories	
Coding ring, blue set:	S2-BC
Retaining spring, steel	Packaging unit: 5 pcs
Retaining clip, plastic	S3-C, S3-CT (with Timecube) CP-15B

Connection diagram



Dimensions [mm]

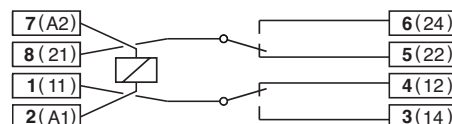
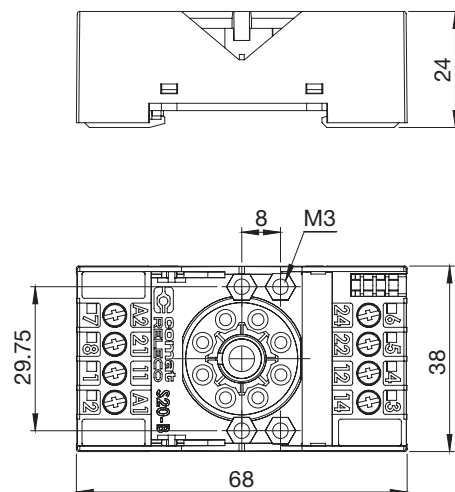


Technical approvals, conformities



EN 60947-1, EN 61810-1

Type	S20-B 2-pole, 1 connection level Integrated retaining clip and labelling space
Rated current	10 A
Specifications	
Rated load	10 A / 300 V
Insulation	Test voltage V rms / 1 min
– All terminals/DIN rail	2,5 kV
– Terminal/terminal	2,5 kV
Cross-section of connecting wire	
– Single-wire	2,5 mm ² or 2 x 1,5 mm ²
– Multi-wire	22 - 14 AWG
Max. screw torque	0,7 Nm
Screw dimensions	M3, Pozi, slot
Integrated retaining clip/plastic	for relay series C20
Labelling space	detachable
Connection label	1...8; DIN/EN
Mounting	DIN rail T35 or mounting plate
Ambient temperature operation/storage	-40 (no ice)...60 °C / -40 ... 80 °C
Weight	48 g
Associated, plug-in 8-pin relays	C20-A
Accessories	
Retaining spring, steel	HF-32, HF-33 (with Timecube)
Retaining clip, plastic	S30-CM

**Connection diagram****Dimensions [mm]****Technical approvals, conformities**

EN 60947-1, EN 61810-1

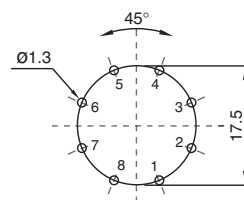
S2-L, S2-P, S2-PO

Socket for PCB and soldering according to IEC 67-I-5b for relays C2-...

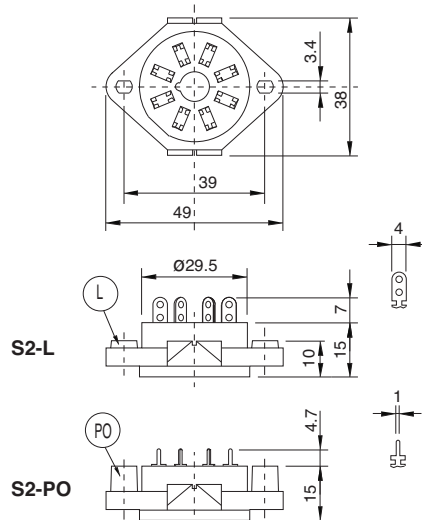
Type	S2-L 2-pole, flange panel mountable
	S2-P 2-pole, printed circuit
	S2-PO 2-pole, printed circuit with flange
Rated current	10 A
Specifications	
Rated load	10 A / 300 V
Insulation	test voltage Vrms / 1min
Between terminals	2,5 kV
Connection label	1...8; DIN/EN
Ambient temperature operation/storage	-40 (no ice)....60 °C / -40 ... 80 °C
Weight	17g
Accessories	
Retaining spring, steel	S3-C



Printed circuit lay-out [mm]



Dimensions [mm]



Technical approvals, conformities



Type	S3-B 3-pole, 1 connection level Coding ring optional Integrated retaining clip and labelling space
Rated current	10 A
Specifications	
Rated load	10 A / 250 V
Insulation	Test voltage V rms / 1 min
All terminals/DIN rail	2,5 kV
– Terminal/terminal	2,5 kV
Cross-section of connecting wire	
– Single-wire	4 mm ² or 2 x 2,5 mm ²
– Multi-wire	22 - 14 AWG
Max. screw torque	1,2 Nm
Screw dimensions	M3, Pozi, slot
Integrated retaining clip/plastic	for relay series C3
Labelling space	detachable
Connection label	1... 11; DIN/EN
Mounting	DIN rail T35 or mounting plate
Ambient temperature	-40 (no ice)...60 °C / -40 ... 80 °C
Weight	55g

Associated, plug-in 11-pin MRC relays

Suitable for holding the Releco coding ring
For coding the relay and the socket.

**C3-A, C3-G, C3-T, C3-X, C3-M, C3-R,
C3-E, C3-N, C3-S**

Accessories**Coding ring, blue set:**

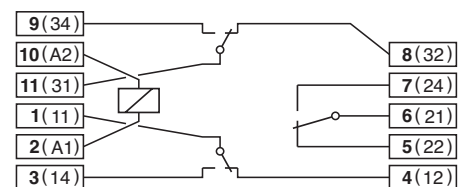
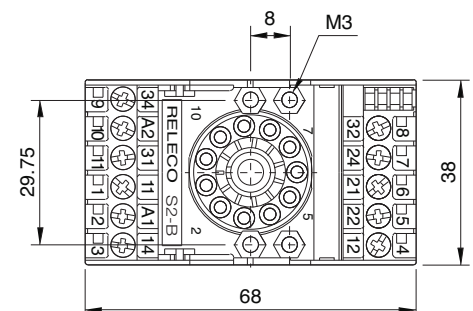
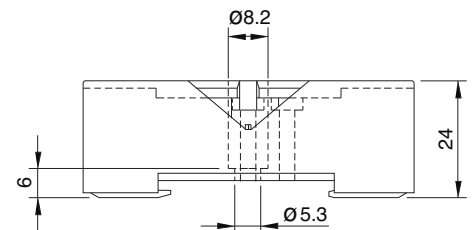
Retaining spring, steel
Retaining clip, plastic

S3-BC

Packaging unit: 5 pcs

S3-C, S3-CT (with Timecube)

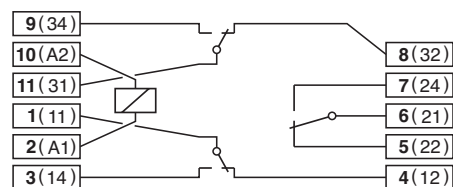
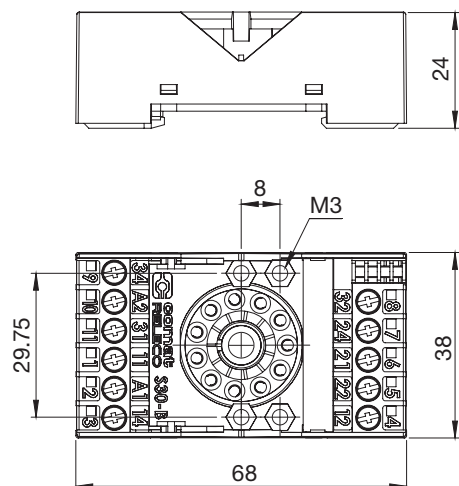
CP-15B

**Connection diagram****Dimensions [mm]****Technical approvals, conformities**

EN 60947-1, EN 61810-1

Socket for 11-pin standard relay according to IEC 60067

Type	S30-B 3-pole, 1 connection level Integrated retaining clip and labelling space
Rated current	10 A
Specifications	
Rated load	10 A / 250 V
Insulation	Test voltage V rms / 1 min
All terminals/DIN rail	2,5 kV
– Terminal/terminal	2,5 kV
Cross-section of connecting wire	
– Single-wire	2,5 mm ² or 2 x 1,5 mm ²
– Multi-wire	22 - 14 AWG
Max. screw torque	0,7 Nm
Screw dimensions	M3, Pozzi, slot
Integrated retaining clip/plastic	for relay series C30
Labelling space	detachable
Connection label	1... 11; DIN/EN
Mounting	DIN rail T35 or mounting plate
Ambient temperature	-40 (no ice)...60 °C / -40 ... 80 °C
Weight	55 g
Associated, plug-in 11-pin relays	C30-A, C30-M, C30-T, C30-R, C30-X
Accessories	
Retaining spring, steel	HF-32, HF-33 (with Timecube)
Retaining clip, plastic	S30-CM

**Connection diagram****Dimensions [mm]****Technical approvals, conformities**

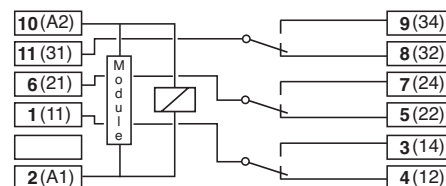
EN 60947-1, EN 61810-1

Type	S3-MP 3-pole, 1 connection level Integrated retaining clip and labelling space Accepts plug-in modules M3P in parallel with the coil
Rated current	10 A
Specifications	
Rated load	10 A / 250 V
Insulation	Test voltage V rms / 1 min
- All terminals/DIN rail	2,5 kV
- Terminal/terminal	2,5 kV
Cross-section of connecting wire	
- Single-wire	4 mm ² or 2 x 2,5 mm ²
- Multi-wire	22 - 14 AWG
Max. screw torque	1,2 Nm
Screw dimensions	M3, Pozi, slot
Integrated retaining clip/plastic	for relay series C3
Labelling space	detachable
Connection label	1...11; DIN/EN
Mounting	DIN rail T35 or mounting plate
Ambient temperature operation/storage	-40 (no ice)...60 °C / -40 ... 80 °C
Weight	54g
Associated, plug-in 11-pin MRC relays	C3-A, C3-G, C3-T, C3-X, C3-M, C3-R, C3-E, C3-N, C3-S
Suitable for holding the Releco coding ring	
For coding the relay and the socket.	

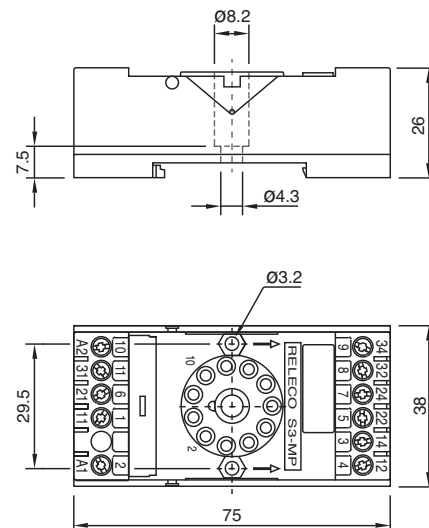


Accessories	
Coding ring, blue set:	S3-BC
	Packaging unit: 5 pcs
Parallel module	M3P
Retaining spring, steel	S3-C, S3-CT (with Timecube)
Retaining clip, plastic	CP-15B

Connection diagram



Dimensions [mm]



Technical approvals, conformities



EN 60947-1, EN 61810-1

Socket for 11-pin standard relay according to IEC 67-I-18b

Type	S3-S 3-pole, 2 connection level Coding ring optional Integrated retaining clip and labelling space
Rated current	10 A
Specifications	
Rated load	10 A / 250 V
Insulation	Test voltage V rms / 1 min
– All terminals/DIN rail	2,5 kV
– Terminal/terminal	2,5 kV
Cross-section of connecting wire	
– Single-wire	4 mm ² or 2 x 2,5 mm ²
– Multi-wire	22 - 14 AWG
Max. screw torque	1,2 Nm
Screw dimensions	M3, Pozi, slot
Integrated retaining clip/plastic	for relay series C3
Labelling space	detachable
Connection label	1...11; DIN/EN
Mounting	DIN rail T35 or mounting plate
Ambient temperature operation/storage	-40 (no ice)...60 °C / -40 ... 80 °C
Weight	69g

Associated, plug-in 11-pin MRC relays	C3-A, C3-G, C3-T, C3-X, C3-M, C3-R, C3-E, C3-N, C3-S
Suitable for holding the Releco coding ring	
For coding the relay and the socket.	

DIN rail or panel mounting. Removable label.
EN /DIN and sequential numbering. According to EN 60947.1 and IEC 61810.1

Accessories

Coding ring, Set red:

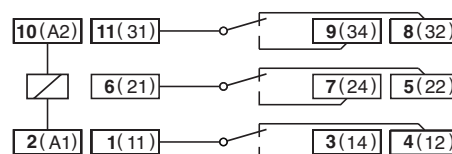
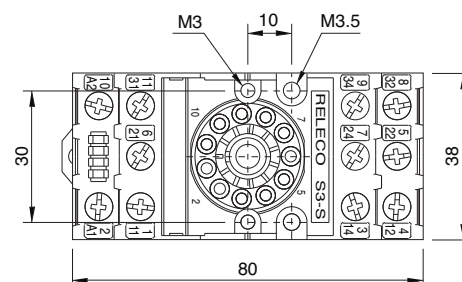
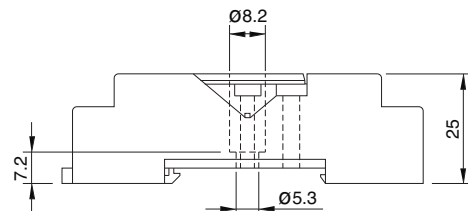
S3-BC

Packaging unit: 5 pcs

Retaining spring, steel

S3-C, S3-CT (with Timecube)

Retaining clip, plastic

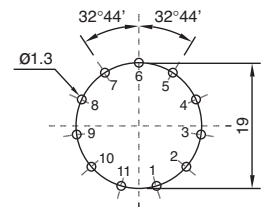
CP-15B**Connection diagram****Dimensions [mm]****Technical approvals, conformities**

EN 60947-1, EN 61810-1

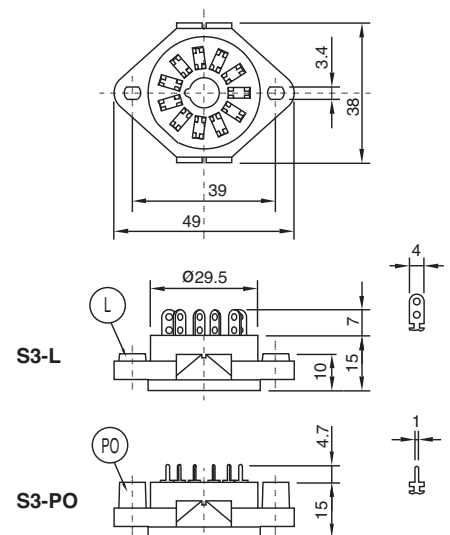
Type	S3-L 3-pole, flange panel mountable
	S3-PO 3-pole, printed circuit with flange
Rated current	10 A
Specifications	
Rated load	10 A / 250 V
Dielectric strength adjacent pin	2.5 kV
Weight	17g
Accessories	
Retaining spring, steel	S3-C



Printed circuit lay-out [mm]



Dimensions [mm]



Technical approvals, conformities



EN 60947-1, EN 61810-1

C12B0

Socket for 11 pin plug-in relays C3, C31, C32 and plug-in control modules



comat
RELECO
WORLD OF RELAYS

Type:	C12B0 R 3-pole, 1 level Module slot for timer- and monitoring modules, over voltage suppressing- and LED indicator modules coil bridge bus bar to connect in A2
--------------	---

Rated current	10 A
----------------------	-------------

Specifications

Rated load	10 A / 400 V (cURus: 250 V)
Insulation	Test voltage V_{rms} / 1 min
- All terminals/DIN rail	2,5 kV
- Terminal/terminal	2,5 kV
Cross-section of connecting wire	
- Single-wire	1 x 6 mm ² , 2 x 1,5 mm ²
- Multi-wire	1 x 4 mm ² /AWG12, 2 x 1,5 mm ² /AWG16
Max. screw torque	0,7 Nm
Screw dimensions	M3, Pozzi, slot
Labelling space	detachable
Connection label	1...12; DIN/EN
Mounting	DIN rail TS35 or panel mounting 1 x M4
Ambient temperature operation/storage	-25 (no ice)...60 °C / -40 ... 80 °C
Weight	61g

Associated plug-in 11-pin relays	C3, C31, C32
---	---------------------

Accessories

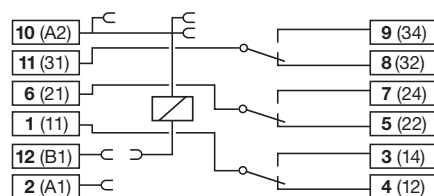
Retaining springs, steel	HF-32 (Relays C31, C32) S3-C (Relays C3) S3-CT (Timecube + Relays C3) HF-33 (Timecube + Relays C31, C32) C-A2 L-16/1 (under transp. plastic cover)
Coil bridge bus bar	
Marking strip cardboard white 8 x 16	

R-Modul

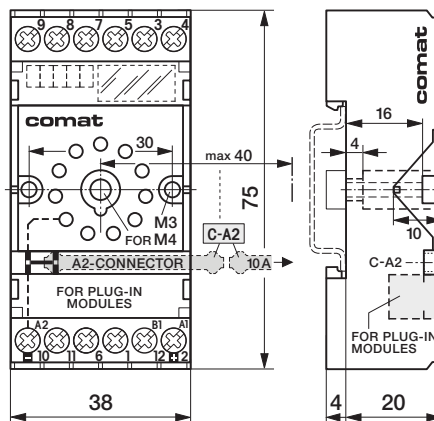
Module LED	RL1/UC 12-24 V RL1/AC 110-240 V
Module freewheeling diode	RD1/DC 12-220 V
Module freewheeling diode + LED	RDL1/DC 12-24 V RDL1/DC 48 V
Module RC-suppressor	RC1/UC 12-48 V RC1/UC 110-240 V
Module RC-suppressor + LED	RCL1/UC 24 V RCL1/UC 48 V RCL1/AC 110-240 V



Connection diagram



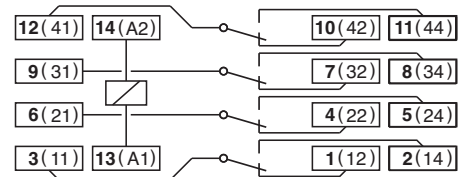
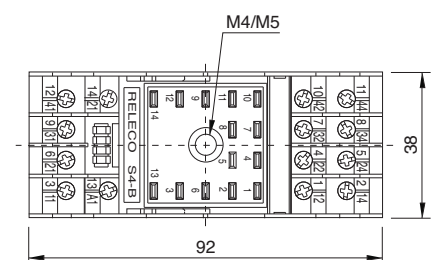
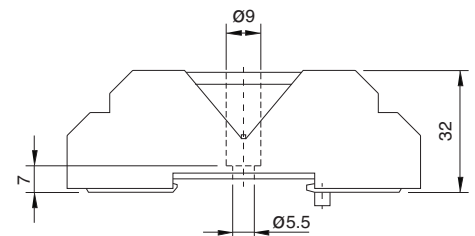
Dimensions [mm]



Technical approvals, conformities



Type	S4-J 4-pole, 2 connection level Logic wiring Integrated retaining clip and labelling space
Rated current	10 A
Specifications	
Rated load	10 A / 250 V
Insulation	Test voltage V rms / 1 min
– All terminals/DIN rail	2,5 kV
– Terminal/terminal	2,5 kV
Cross-section of connecting wire	
– Single-wire	4 mm ² or 2 x 2,5 mm ²
– Multi-wire	22 - 14 AWG
Max. screw torque	1 Nm
Screw dimensions	M3,5, Philips-slot (combo)
Integrated retaining clip/plastic	for relay series C4
Labelling space	detachable
Connection label	1...14; DIN/EN
Mounting	DIN rail TS35 or mounting plate
Ambient temperature	-40 (no ice)...60 °C / -40 ... 80 °C
Weight	80g
Associated, plug-in 11-pin MRC relays	C4-A, C4-X, C4-R
Accessories	
Retaining spring, steel	S4-C
Retaining clip, plastic	CP-15B

**Connection diagram****Dimensions [mm]****Technical approvals, conformities**

EN 60947, EN 61810

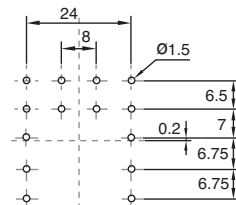
S4-L, S4-P, S4-PO

Socket for soldering and printed circuit for relays C4-...

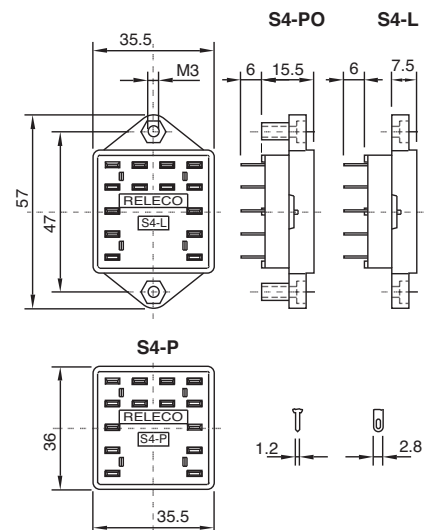
Type	S4-L 4-pole, flange panel mountable
	S4-P 4-pole, printed circuit
	S4-PO 4-pole, printed circuit with flange
Rated current	10 A
Specifications	
Rated load	10 A / 250 V
Test voltage benachbarte Pole	2.5 kV rms 1 min
Ambient temperature	-30 °C ... +60 °C
Weight	21g
Accessories	
Retaining spring, steel	S4-CL



Printed circuit lay-out [mm]



Dimensions [mm]



Technical approvals, conformities



EN 60947-1, EN 61810-1

Type	S5-S 3-pole, 2 level Logic wiring Integrated retaining clip and labelling space
-------------	---

Rated current	16 A
----------------------	-------------

Specifications

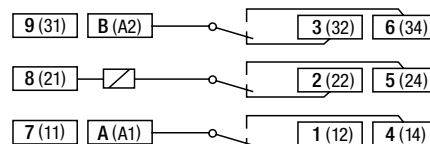
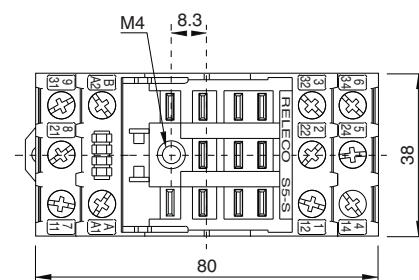
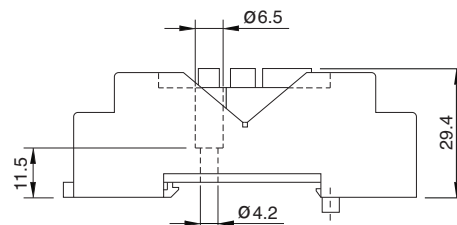
Rated load	16 A / 400 V
Insulation	Test voltage V rms / 1 min
– All terminals/DIN rail	4 kV
– Terminal/terminal	4 kV
Cross-section of connecting wire	
– Single-wire	4 mm ² or 2 x 2,5 mm ²
– Multi-wire	22 - 14 AWG
Max. screw torque	1,2 Nm
Screw dimensions	M3,5, Pozi, slot
Integrated retaining clip/plastic	for relay series C5
Labelling space	detachable
Connection label	1...9, A, B; DIN/EN
Mounting	DIN rail TS35 or mounting plate
Ambient temperature operation/storage	-40 (no ice)...60 °C / -40 ... 80 °C
Weight	81g

Associated, plug-in 11-pin MRC relays	C5-A, C5-G, C5-X, C5-M, C5-R
--	-------------------------------------

Mounting in DIN rail TS35 or mounting plate. Labelling space.
According to EN 60947 and IEC 61810

Accessories

Retaining spring, steel	S4-C
Retaining clip, plastic	CP-15B

**Connection diagram****Dimensions [mm]****Technical approvals, conformities**

EN 60947-1, EN 61810-1

Type:	S5-M 3-pole, 3 level Module slot for timer- and monitoring modules, over voltage suppressing- and LED indicator modules coil bridge bus bar to connect in A2
--------------	--

Rated current	16 A
----------------------	-------------

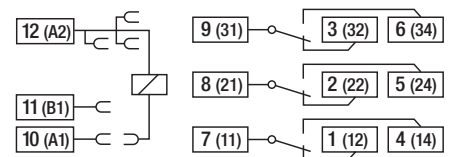
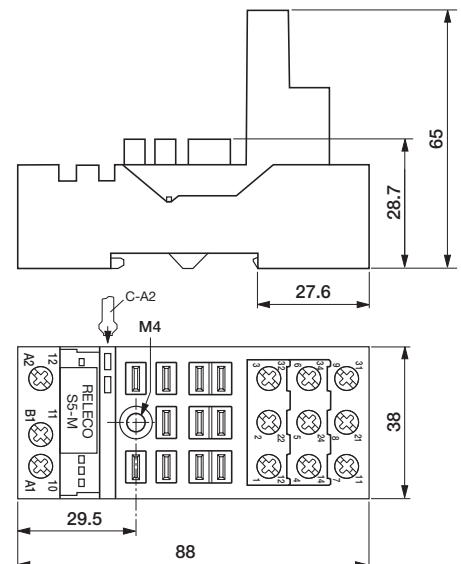
Specifications

Rated load	16 A / 400 V
Insulation	Test voltage V_{rms} / 1 min
- All terminal/DIN rail	4 kV
- Terminal/terminal	4 kV
Cross section of connecting wire	
- Single wire	1 x 6 mm ² , 2 x 2,5 mm ²
- Multi wire	1 x 6 mm ² /AWG10, 2 x 1,5 mm ² /AWG16
Max. screw torque	1 Nm
Screw dimensions	M3,5, Pozi, slot
Integrated retaining clip/plastic	for relay series C5
Labelling space	detachable
Connection label	1 ... 12, DIN/EN
Mounting	DIN rail TS35 or panel mounting 1 x M4
Ambient temperature operation / storage	-40 (no ice) ... 60° C / -40 ... 80° C
Weight	92g

Associated, plug-in 11-pin MRC relays	C5-A, C5-G, C5-X, C5-M, C5-R
--	-------------------------------------

Accessories

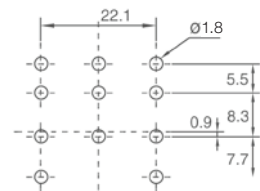
Coil bridge bus bar	C-A2
Retaining clip, plastic	S5MCP

**Connection diagram****Dimensions [mm]****Technical approvals, conformities**

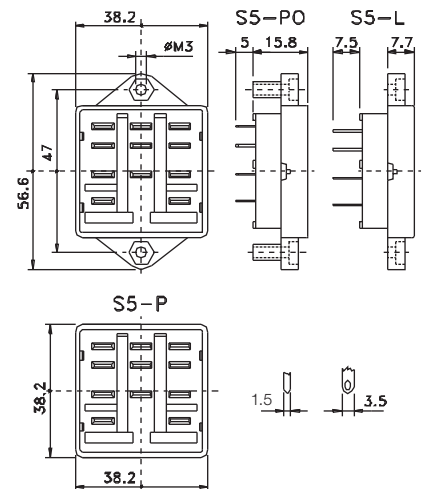
Type	<p>S5-L 3-pole, flange panel mountable</p> <p>S5-P 3-pole, printed circuit</p> <p>S5-PO 3-pole, printed circuit with flange</p>
Rated current	16 A
Specifications	<p>Rated load 16 A / 400 V (UL: 300 V)</p> <p>Ambient temperature operation/storage -40 (no ice)...60 °C / -40 ... 80 °C</p> <p>Weight 20g</p>
Accessories	<p>Retaining spring, steel S4-CL</p>



Printed circuit lay-out [mm]



Dimensions [mm]



Technical approvals, conformities



EN 60947-1, EN 61810-1

S7-C

Socket for miniature relays C7-... and C80 series time relays

Type:	S7-C 2-pole, 1 level integrated clip and marking label suitable for clips C80 series time relays coil bridge bus bar to connect in A2 plug-in slot for overvoltage suppressing units
--------------	--

Rated current	10 A
----------------------	-------------

Specifications	
Rated load	10 A / 250 V
Insulation	Test voltage V_{rms} / 1 min
- All terminal/DIN rail	2.5 kV
- Terminal/terminal	2.5 kV
Cross section of connecting wire	
- Single wire	4 mm ² , 2 x 1,5 mm ²
- Multi wire	2,5 mm ² / AWG 16, 2 x 1 mm ² / AWG 18
Max. screw torque	0.7 Nm
Screw dimensions	M3, Pozi, slot
Integrated retaining clip/plastic	for relays C7
Labelling space	detachable
Connection label	1 ... 8, DIN/EN
Mounting	DIN rail TS35 or mounting plate
Ambient temperature operation/storage	-40 (no ice) ... 60 °C / -40 ... 80 °C
Weight	37g

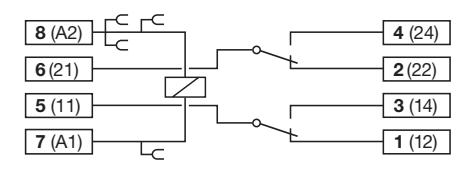
Associated plug-in 8-pin QRC relays	C7-A2x, C7-T, C7-G, C7-X, C7-W, C7-H
Associated C80 time relays	C83, C85, 84

Accessories	
Coil bridge bus bar	S7-BB
Retaining clip, plastic	CP-09B

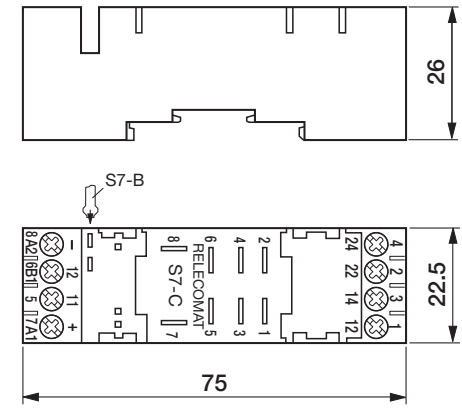
Please note:
This socket replaces former socket S7-M fully compatible



Connection diagram



Dimensions [mm]



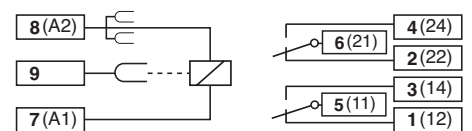
Technical approvals, conformities



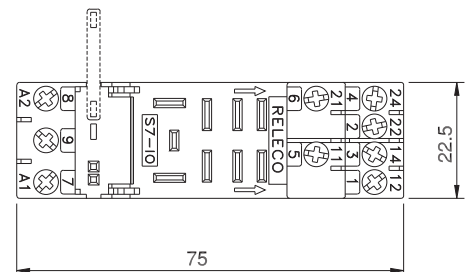
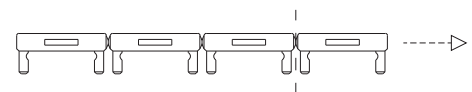
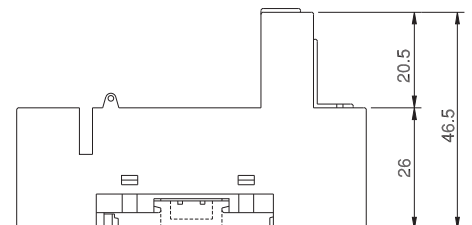
Type	S7-I/O 2-pole, 2 level Integrated clip and marking label Coil bridge bus bar to connect in A2 Logic wiring
Rated current	10 A
Specifications	
Rated load	10 A / 250 V
Insulation	Test voltage V rms / 1 min
- All terminals/DIN rail	2,5 kV
- Terminal/terminal	2,5 kV
Cross-section of connecting wire	
- Single-wire	4 mm ² or 2 x 2,5 mm ²
- Multi-wire	22 - 14 AWG
Max. screw torque	1,2 Nm
Screw dimensions	M3, Pozi, slot
Integrated retaining clip/plastic	for relay series C7
Labelling space	detachable
Connection label	1...8; DIN/EN
Mounting	DIN rail TS35 or mounting plate
Ambient temperature operation/storage	-40 (no ice)...60 °C / -40 ... 80 °C
Weight	38g
Associated, plug-in 8-pin QRC relays	C7-A2x, C7-T, C7-G, C7-X, C7-W, C7-H
Accessories	
Coil bridge bus bar	S7-BB
Retaining clip, plastic	CP-01B



Connection diagram



Dimensions [mm]



Sockets 4.0

4

Technical approvals, conformities



EN 60947-1, EN 61810-1

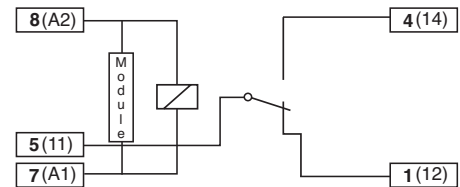
S7-16

Socket for miniature relays C7-A10...

Type	S7-16 1-pole, 1 level Integrated retaining clip and labelling space
Rated current	16 A
Specifications	
Rated load	16 A / 250 V
Insulation	Test voltage V rms / 1 min
– All terminals/DIN rail	2,5 kV
– Terminal/terminal	2,5 kV
Cross-section of connecting wire	
– Single-wire	4 mm ² or 2 x 2,5 mm ²
– Multi-wire	22 - 14 AWG
Max. screw torque	1,2 Nm
Screw dimensions	M3, Pozi, slot
Integrated retaining clip/plastic	for relay series C7-A10
Labelling space	detachable
Connection label	1...8; DIN/EN
Mounting	DIN rail TS35 or mounting plate
Ambient temperature operation/storage	-40 (no ice)...60 °C / -40 ... 80 °C
Weight	31g
Associated, plug-in 5-pin QRC relays	C7-A10
Accessories	
Retaining clip, plastic	CP-07B

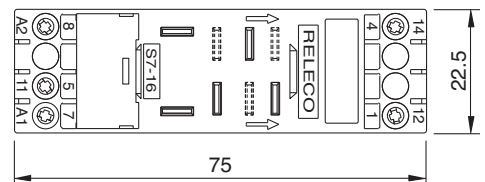
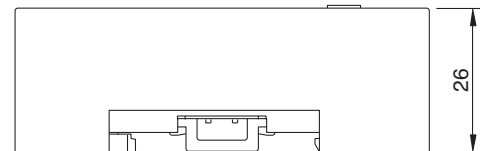


Connection diagram



Dimensions [mm]

S7-16 for relays C7-A10 (16 A)



Technical approvals, conformities

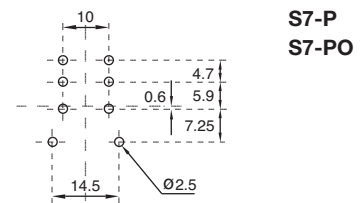


EN 60947-1, EN 61810-1

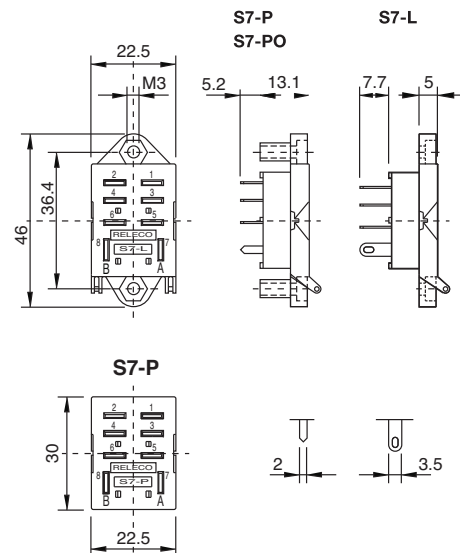
Type	S7-L 2-pole, flange panel mountable
	S7-P 2-pole, printed circuit
	S7-PO 2-pole, printed circuit with flange
Rated current	10 A
Specifications	
Rated load	10 A / 250 V
Dielectric strength adjacent pin	2.5 kV rms / 1 min
Connection label	1...8; DIN/EN
Integrated retaining clip/plastic	for relay series C7 S7-P: (CP-07B) S7-L + S7-PO: (CP-01B)
Ambient temperature operation/storage	-40 (no ice)...60 °C / -40 ... 80 °C
Weight	10g
Accessories	
Retaining clip, plastic for S7-P	CP-07B
Retaining clip, plastic for S7-L + S7-PO	CP-01B



Printed circuit lay-out [mm]



Dimensions [mm]



Technical approvals, conformities

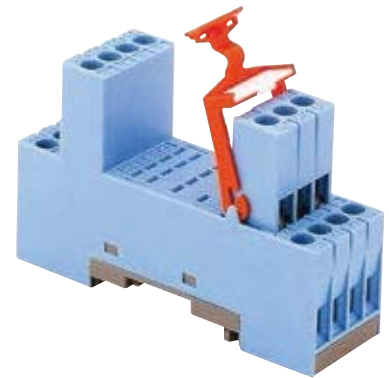


EN 60947-1, EN 61810-1

S9-M

Socket for miniature 4 pole relay C9-...

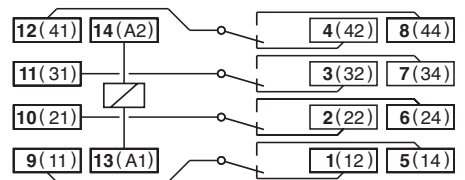
Type	S9-M 4-pole, 2 level Integrated clip and marking label
Rated current	6 A
Specifications	
Rated load	6 A / 250 V
Insulation	Test voltage V rms / 1 min
- All terminals/DIN rail	2,5 kV
- Terminal/terminal	2,5 kV
Cross-section of connecting wire	
- Single-wire	4 mm ² or 2 x 2,5 mm ²
- Multi-wire	22 - 14 AWG
Max. screw torque	0.7 Nm
Screw dimensions	M3, Pozi, slot
Integrated retaining clip/plastic	for relay series C9 (CP-01B)
Labelling space	detachable
Connection label	1...14; DIN/EN
Mounting	DIN rail TS35 or mounting plate
Ambient temperature operation/storage	-40 (no ice)...60 °C / -40 ... 80 °C
Weight	54g



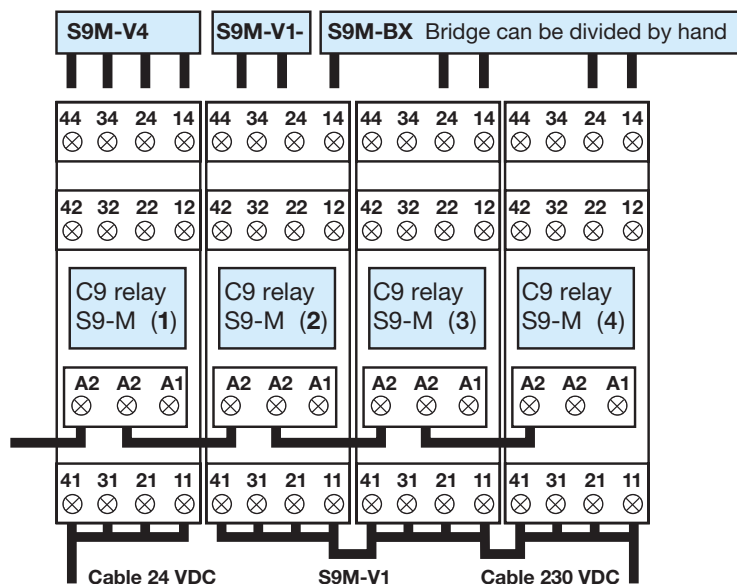
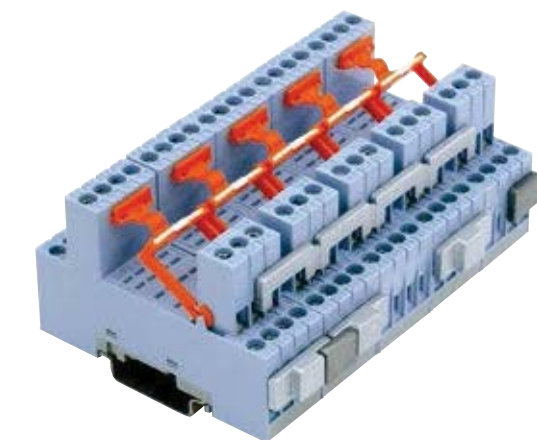
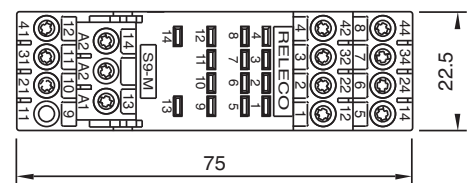
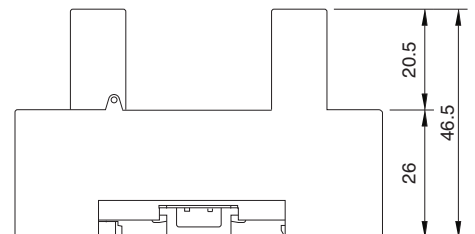
Socket for 4 poles, QRC relays	C9-A, C9-E, C9-R
---------------------------------------	-------------------------

Accessories	CP-01B
Retaining clip, plastic	

Connection diagram



Dimensions [mm]



Technical approvals, conformities



EN 60947-1, EN 61810-1

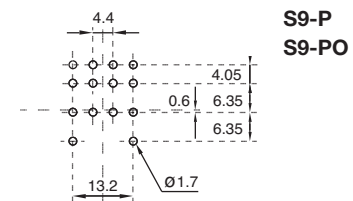
Type	S9-L 4-pole, flange panel mountable
	S9-P 4-pole, printed circuit
	S9-PO 4-pole, printed circuit with flange
Rated current	6 A

Specifications	
Rated load	6 A / 250 V
Dielectric strength adjacent pin	2.5 kV rms / 1 min
Connection label	1...14; DIN/EN
Integrated retaining clip/plastic	for relay series C9
Ambient temperature operation/storage	S9-P: (CP-07B) S9-L + S9-PO: (CP-01B) -40 (no ice)...60 °C / -40 ... 80 °C
Weight	12g

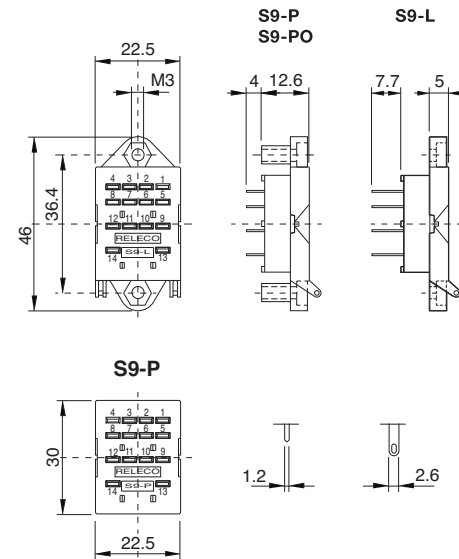
Accessories	
Retaining clip, plastic for S9-P	CP-07B
Retaining clip, plastic for S9-L + S9-PO	CP-01B



Printed circuit lay-out [mm]



Dimensions [mm]



Sockets 4.0

4

Technical approvals, conformities



EN 60947-1, EN 61810-1

S10

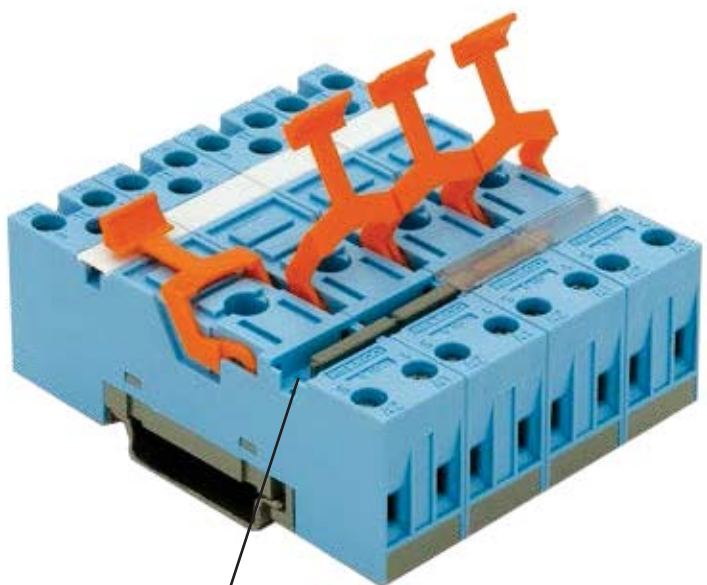
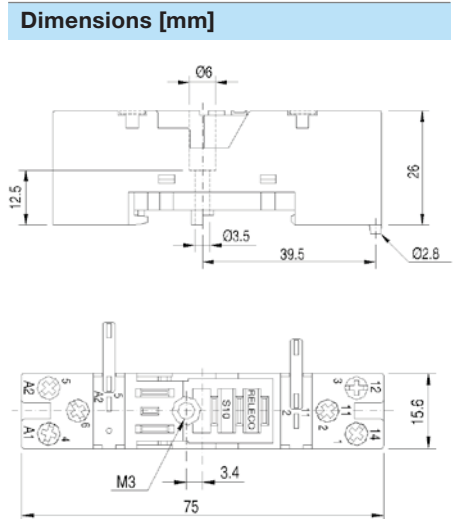
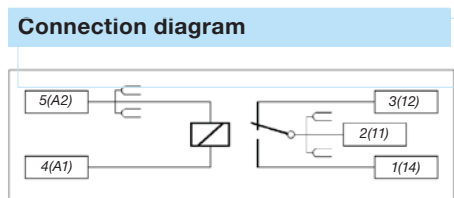
Socket for Interface relay

Type	S10 1-pole, 1 connection level Logic wiring Integrated retaining clip and labelling space Coil bridge bar for A2, 11
Rated current	10 A
Specifications	
Rated load	10 A / 250 V
Insulation	Test voltage V rms / 1 min
- All terminals/DIN rail	5 kV
Contact terminals	2,5 kV
Contact / Coil terminals	5 kV
Cross-section of connecting wire	
- Single-wire	4 mm ² or 2 x 2,5 mm ²
- Multi-wire	22 - 14 AWG
Max. screw torque	1,2 Nm
Screw dimensions	M3, Pozi, slot
Integrated retaining clip/plastic	for relay series C10, CSS (CP-17B)
Labelling space	detachable
Connection label	1...5; DIN/EN
Mounting	DIN rail TS35 or mounting plate
Ambient temperature operation/storage	-40 (no ice)...60 °C / -40 ... 80 °C
Weight	23g



Socket for plug-in 10A IRC relays	C10-A, C10-T, CSS, C10-G
--	---------------------------------

Accessories	
Coil bridge bars	S10-BB
Retaining clip, plastic	CP-17B



BRIDGE BAR

Technical approvals, conformities

EN 60947-1, EN 61810-1

S10-P

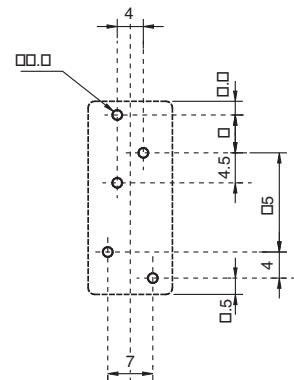
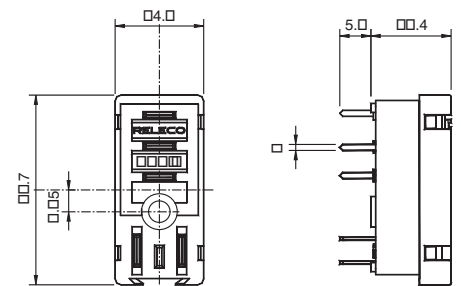
Printed circuit socket for Interface relays, C10 and CSS

Type:	S10-P Printed circuit socket for 1-pole IRC relay
Rated current	10 A
Specifications	
Rated load	10 A / 250 V
Insulation	Test voltage V rms / 1 min
Coil terminals to contacts	5 kV rms
Hard Brass tin-platted terminals	0,5 x 1 mm
Integrated retaining clip/plastic	for relay series C10, CSS (CP-24B)
Labelling space	detachable
Connection label	1...5; DIN/EN
Ambient temperature operation/storage	-40 (no ice)...60 °C / -40 ... 80 °C
Weight	7g

Accessories	
Retaining clip, plastic	CP-24B



Dimensions [mm]

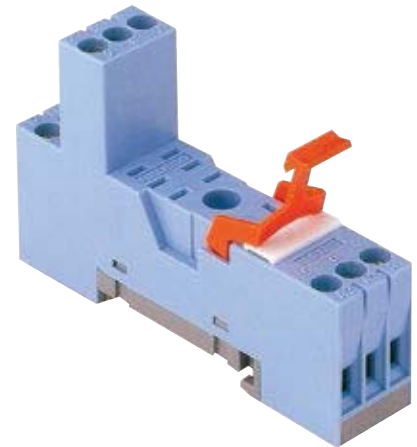


Technical approvals, conformities



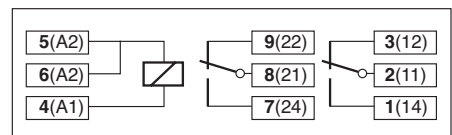
IEC 61810 EN 60947

Type	S12 I/O socket for C12 relays with 2 x CO Logic connection , 5 A
Rated current	5 A
Specifications	
Rated load	5 A / 250 V
Insulation	Test voltage V rms / 1 min
– All terminals/DIN rail	5 kV
Contacts terminals	2,5 kV
Contacts / Coil terminals	5 kV
Cross-section of connecting wire	
– Single-wire	4 mm ² or 2 x 2,5 mm ²
– Multi-wire	22 - 14 AWG
Max. screw torque	1,2 Nm
Screw dimensions	M3, Pozi, slot
Integrated retaining clip/plastic	for relay series C12 (CP-17B)
Labelling space	detachable
Connection label	1...9; DIN/EN
Mounting	DIN rail TS35 or mounting plate
Ambient temperature operation/storage	-40 (no ice)...60 °C / -40 ... 80 °C
Weight	31g

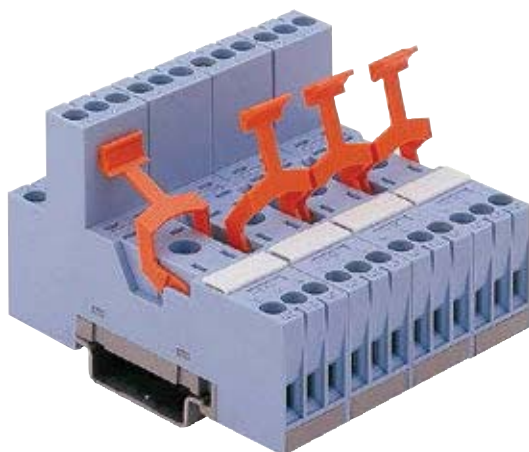
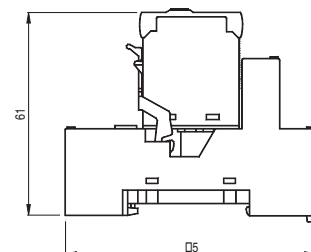
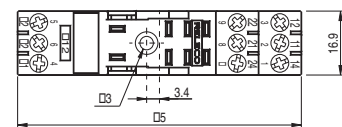
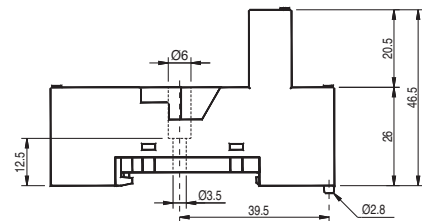


Socket for IRC relays	C12, C12G
Accessories	
Coil bridge bars	V10-G, V40-G, V10-R, V40-R, V10-A, V40-A B20-G, B20-R, B20-A, CP-07B CP-17B
Retaining clip, plastic	

Connection diagram



Dimensions [mm]



Technical approvals, conformities



IEC 61810 EN 60947

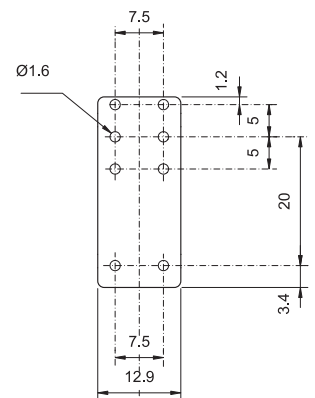
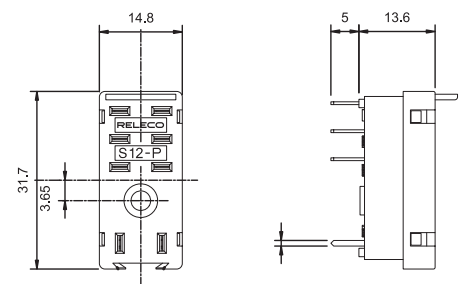
S12-P

Printed circuit socket for Interface relays, C12

Type:	S12-P Printed circuit socket for 2-pole C12 relay
Rated current	5 A
Specifications	
Rated load	5 A / 250 V
Insulation	Test voltage V rms / 1 min
– Pole / Pole	3 kV
– Coil / contact terminals	5 kV
Hard brass tin-plated terminals	0,5 x 1 mm
Weight	7g
Integrated retaining clip/plastic	for relay series C12, (CP-24B)
Accessories	
Retaining clip, plastic	CP-24B



Dimensions [mm]



Technical approvals, conformities

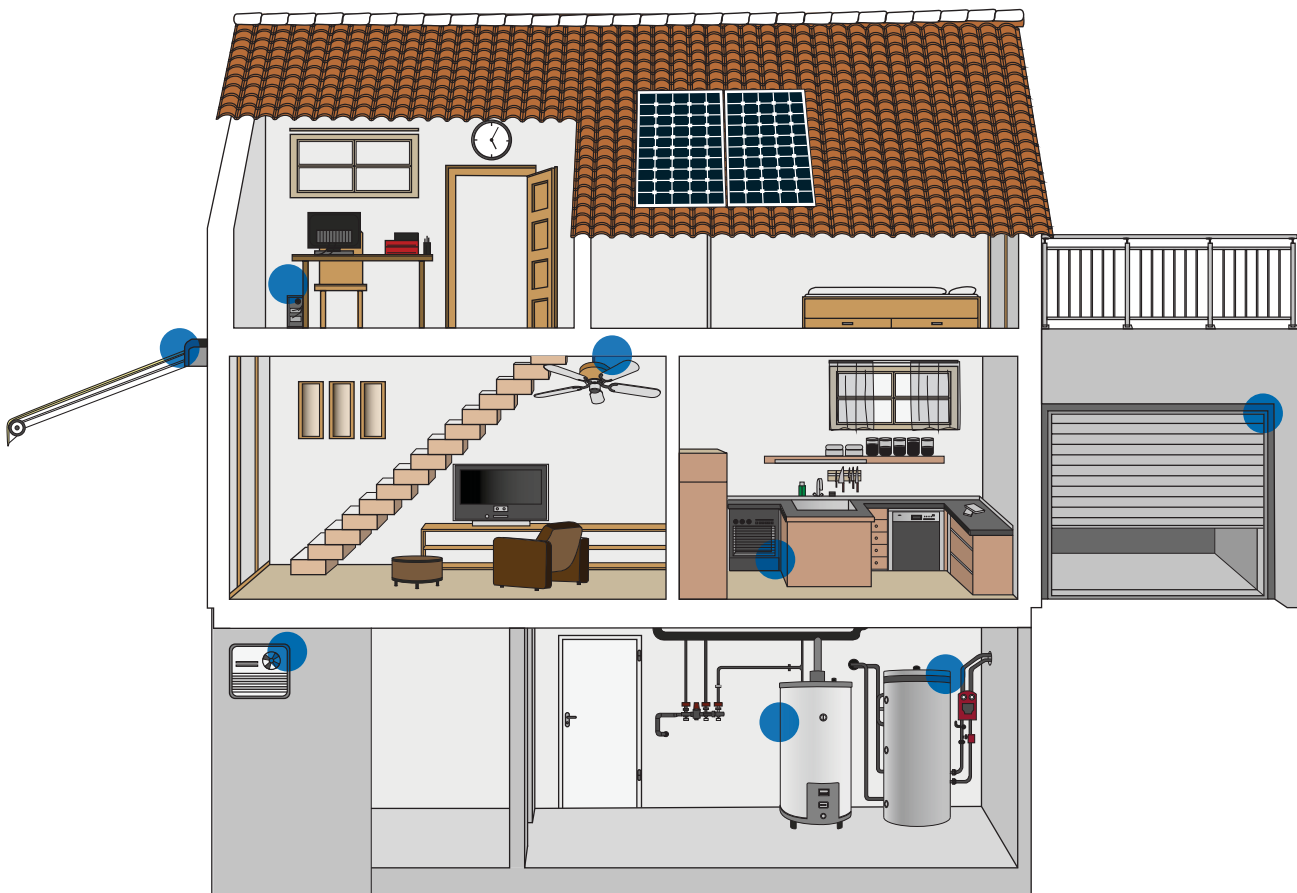


IEC 61810 EN 60947

5.0 SMS Relay



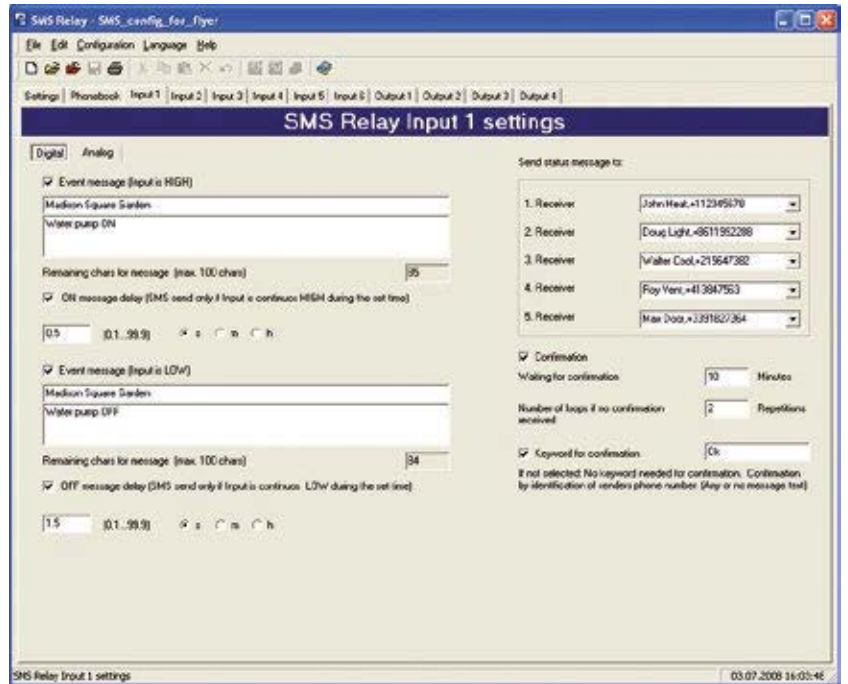
- Easy configuration with PC and «FAST SMS SET™» configuration software
- Sequential alert messaging to 5 different subscribers
- Analog and/or digital inputs
- Monitoring of all inputs and outputs with SMS messaging
- Request of analogue values by SMS
- Remote control of outputs by SMS
- Power failure notification by SMS messaging
- Status change messages by SMS
- User defined message text
- Remote access and status display by PC/Notebook
- Call-In Function
- Alarm messages by e-mail
- App for Android operated smartphones



Monitoring | Alerting | Controlling



Digital Inputs

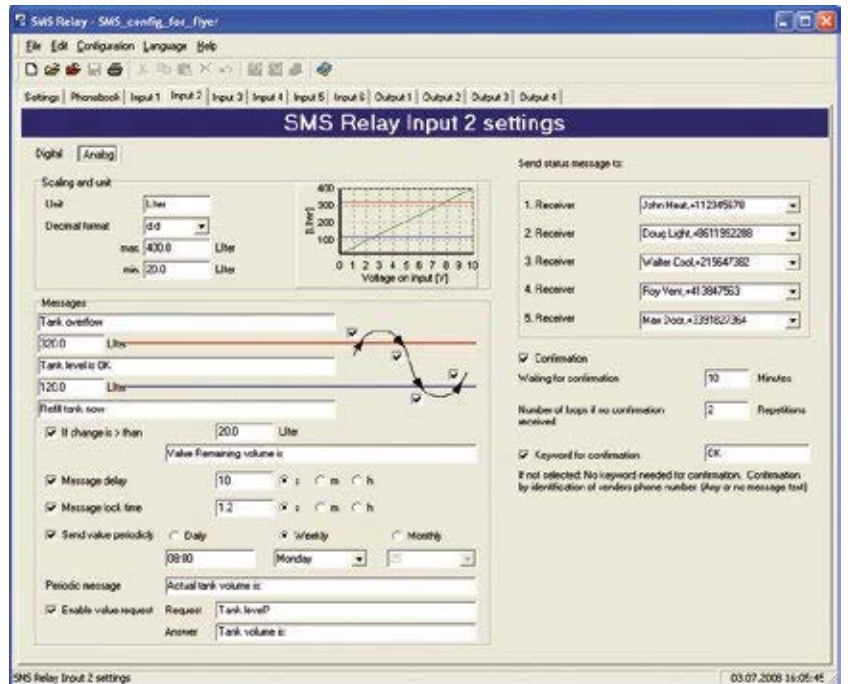


Language



Analog Inputs

- ✓ Free selectable units e.g.: l, kg, m³, psi, F, sqm, lbs
- ✓ Any min/max value can be defined. Scale adjustment automatic
- ✓ Value inquire by SMS
- ✓ Automatic alerting if min/max values are exceeded
- ✓ Status display on PC/Notebook via GSM network



One touch to have everything under control

Comat is presenting an app making handling, controlling, monitoring and remote switching of a SMS-Relay even more easily and clearly presented. Switch on your heating, open your garage door or irrigate your lawn simply by clicking a button. Your smart phone is thereby your remote control. After installation and configuration the SMS Relay from Comat and after download and installation of the App from Google Playstore, just import the device configuration data to your smart phone, enter the phone number of the device and it is ready for use.

You will find a specific instruction on our website www.comat.ch

With the Android App the display of all input states and the switching of the outputs is simple. It's available for download, free of charge in Google Playstore.

Characteristics

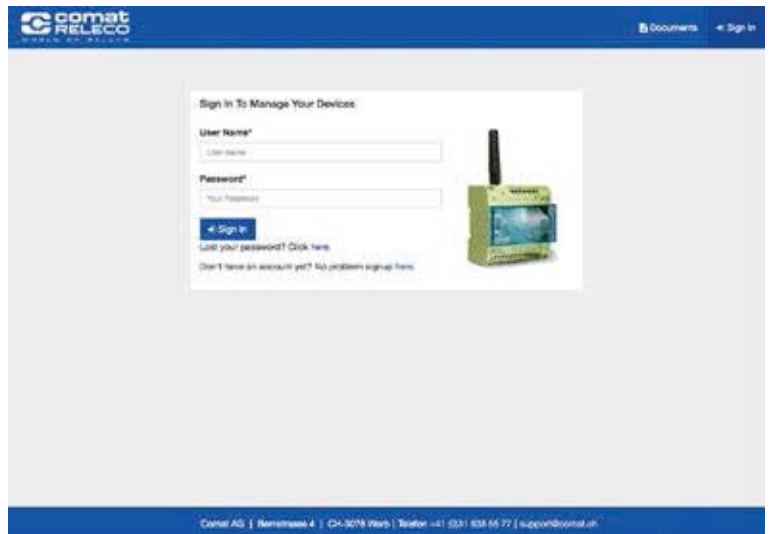
- Polling of input values
- Easy control of outputs
- Status display
- Monitoring of alarm history
- Simultaneous control of multiple SMS Relays



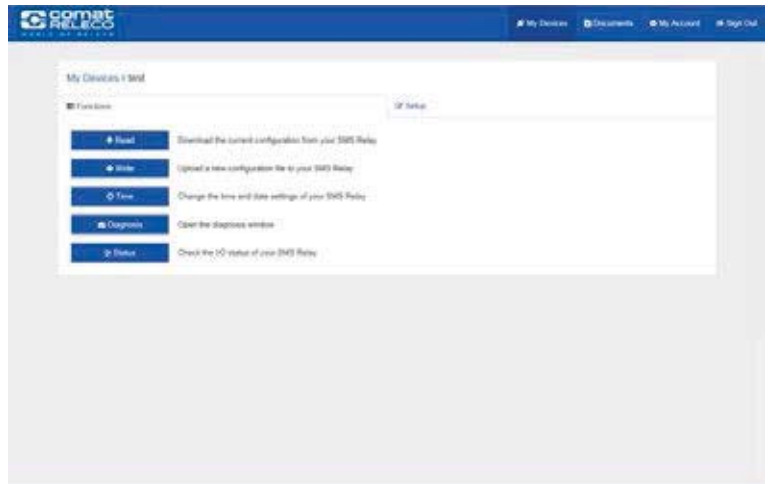
Attention!

The Android App simplifies the operation of the SMS Relay. The communication in the background is by chargeable text message.

Login screen



Function overview




Remote maintenance

The remote maintenance of the SMS Relay is performed via the Internet. Multiple SMS Relay can be managed from anywhere by a web access on the SMS Relay remote access portal.

- Upload / download the configuration file
- Diagnosis (signal strength, provider information, device information)
- Date / Time settings
- Monitoring inputs and switching outputs

Please find more information on our website www.comat.ch.

Technical Data's

Typ	CMS-10F/AC110-240V	CMS-10F/DC12-48V	CMS-10ADF/DC12-48V	CMS-10ACDF/DC12-48V
Operating voltage	AC 110-240V~ 50/60Hz	DC 12-48V= max. 10%	DC 12-48V= max. 10%	DC 12-48V= max. 10%
Power consumption	8VA/6W	4,2W	4,2W	4,2W
Switching capacity 	4 x 10 A 250 V; Sum of current max. 20A			
Temperature range	Tu: -25...+55° C; Rel. humidity: 10...95% (non condensing); Protection IP 20			
Inputs	6 x digital (trigger level 85V~)	6 x digital (trigger level 9,5V=)	6 x digital and/or analog (trigger level 9,5V=) (analog 0-10V=)	2 x analog (4-20 mA) 4 x digital and/or analog (trigger level 9,5V=) (analog 0-10V=)
Outputs	4 x CO contacts μ 10A/250V AC-1			
Provider (Phone/Network)	User selectable (dependent on SIM card)			
Frequency	GSM QuadBand (850; 900; 1800; 1900MHz)			

Installation note

The base unit device is delivered fully operational and includes the small aerial CMS-ANT.

Before installation, the final location of installation must be taken into consideration.

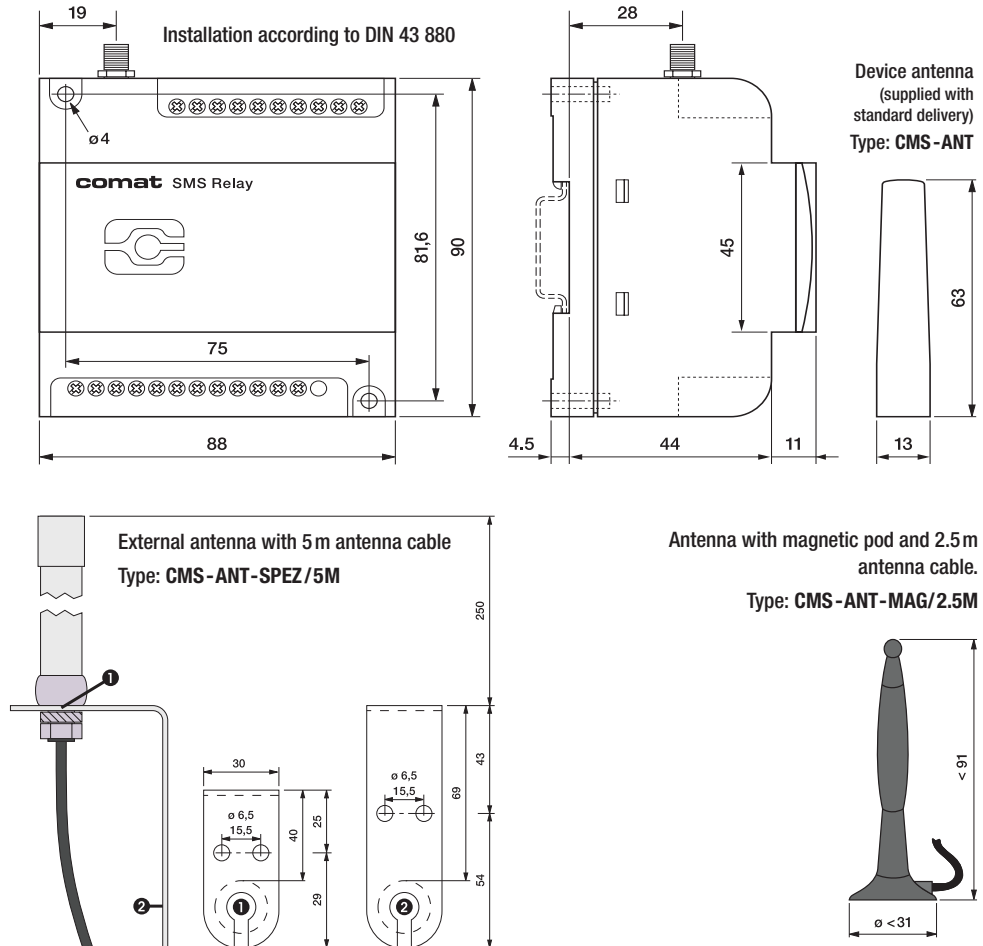
For installation inside a control panel, the small device aerial may not be suitable and needs to be replaced

by the antenna with magnetic pod (CMS-ANT-MAG/2.5M) or by the external antenna (CMS-ANT-SPEZ/5M).

These two antennas provide considerably better results and improve communication with the mobile network.

Please ask our product specialists if you require any support.

Dimensions



Typ	Description
CMS-10F/AC110-240V	SMS Relay AC 110-240V with 6 digital inputs incl. small antenna (CMS-ANT)
CMS-10F/DC12-48V	SMS Relay DC 12-48V with 6 digital inputs incl. small antenna (CMS-ANT)
CMS-10ADF/DC12-48V	SMS Relay DC 12-48V with 6 digital and analog inputs incl. small antenna (CMS-ANT)
CMS-10ACDF/DC12-48V	SMS Relay DC 12-48V with 2 analog current inputs and 4 analog and/or digital voltage inputs, incl. small antenna (CMS-ANT)
KIT consisting of: A base unit with small antenna, antenna with magnetic pod and 2.5 m cable, programming cable, USB-RS232 Interface connector, CD with «FAST SMS SET™»-up programming software and operation manual	
CMS-10FKIT/AC110-240V	Installation kit complete with 6 digital inputs (SMS Relay AC 110-240V)
CMS-10FKIT/DC12-48V	Installation kit complete with 6 digital inputs (SMS Relay DC 12-48V)
CMS-10ADFKIT/DC12-48V	Installation kit complete with 6 digital and/or analog inputs (SMS Relay DC 12-48V)
CMS-10ACDFKIT/DC12-48V	SMS Relay Kit DC 12-48V with 2 analog current inputs and 4 analog and/or digital voltage inputs
Accessories	
CMS-RS232	SMS Relay programming cable RS232
CMS-USB	USB-RS232 interface connector (including driver CD)
CMS-ANT	Small spare antenna for base unit, 63mm long
CMS-ANT-MAG/2.5M	Antenna with magnetic pod and 2.5m antenna cable
CMS-ANT-SPEZ/5M	External antenna with 5m antenna cable
CMS-ANT-KAB/5M	Antenna cable 5m (extension)
CMS-ANT-KAB/10M	Antenna cable 10m (extension)
CMS-ANT-KAB/20M	Antenna cable 20m (extension)
CMS-CAP	Device cover (spare)
CMS-CD	CD with FAST SMS SET -up programming software and manual
DR-15-24	Power supply 15W, 24V. DIN-rail mounting
DR-30-24	Power supply 36W, 24V. DIN-rail mounting
ZPT-10-H	PT100/PT1000 Amplifier
RF01-U	Room temperature sensor 0...50°C without display
RF01-U-D	Room temperature sensor 0...50°C with display
RTBSB-001-010	Room thermostat 5...30°C with operating controls
WF50 ext-U	Outdoor temperature sensor -50...+50°C
KS-110	AC sensor for monitoring of humidity and temperature in control panels, archives and cabinets
PS1	Water gauge suitable for application of level measurements in water installations



Type

CMS-10F/...
CMS-10ADF/...
CMS-10ACDF/...

SMS Relay

- SMS Relay incl. small antenna 63mm
- WITHOUT programming cable, magnetic pod antenna, USB converter and programming software
- Suitable for user which already possess the accessories



CMS-10FKIT/...
CMS-10ADFKIT/...
CMS-10ACDFKIT/...

SMS Relay KIT

- SMS Relay incl. small antenna 63mm
- Including programming cable, magnetic pod antenna with 2.5m cable, USB converter USB-RS232, and programming software "FAST SMS SET™" with manual
- Suitable for user first user

Type



DR-15-24

Power supply

- Input
 - Voltage range: 85-264V AC, 120-370V DC
 - Frequency range: 47-63Hz
 - Max. current: 0,88A
- Output
 - DC Nominal voltage: 24V
 - Setting range: 21,6-26,4V
 - Power range: 0-0,63A
 - Nominal load: 15,2W



DR-30-24

Power supply

- Input
 - Voltage range: 85-264V AC, 120-370V DC
 - Frequency range: 47-63Hz
 - Max. current: 0,88A
- Output
 - DC Nominal voltage: 24V
 - Setting range: 21,6-26,4V
 - Power range: 0-1,5A
 - Nominal load: 36W



ZPT-10-H

PT100/PT1000 Amplifier

- Input: PT100; PT1000: 2-, 3-line switching
- Output: 0...10V DC
- Supply voltage: 15...35V DC
- DIN rail mounting



RF01-U

Room temperature sensor without display

- Integrated transducer
- Output: 0...10V DC
- Measuring range: 0°C...50°C
- Supply voltage: 24V DC



RF01-U-D

Room temperature sensor with integrated display

- Integrated transducer
- Output: 0...10V DC
- Measuring range: 0°C...50°C
- Supply voltage: 24V DC



RTBSB-001-010

Room thermostat with operating controls

- Suitable for temperature monitoring in closed rooms
- Output: 1 CO
- Setting range: 5°C...30°C
- Supply voltage: 230V AC (24V DC)



WF50 ext-U

Outdoor temperature sensor

- Sensor for temperature measuring outdoors or in industrial storage- or cold chambers
- Output: 0...10V DC
- Measuring range: -50°C...+50°C
- Supply voltage: 15...24V DC
- Protection class: IP65

Type



KS-110

AC sensor for indoors and outdoors

- Measuring of humidity and temperature in control panels, archives and cabinets
- **Temperature**
 - Measuring range: -40°C...+80°C
 - Measuring element: Solid state
 - Output: 0-10V
- **Humidity**
 - Measuring range: 0%...100% relative humidity
 - Measuring element: Capacitive
 - Output: 0-10V



PS1

Level and water gauge

- Suitable for applications in fountains or in water installations up to a depth of 5m (0-0.5 bar)
Additional measuring ranges on request.
- Cable in special design with pressure compensation line
- Output signal: 0-10V, 3-wire
- Application temperature: +5°C bis +70 °C



App SMSrelay

App for Android operated smart phones

The App is available free of charge in the Google Playstore.

6.0 Softstarters



Performance electronics on the highest level

- Reduces wear in the entire drive train through soft start-up
- Optimal starting torque through intelligent current control during start-up
- Protects the engine through integrated, adjustable motor protection with I^2t -monitoring
- Minimises wiring effort and component costs: integrated bypass and motor protection
- Safe to use: comprehensive self-monitoring

Three phase AC motors have proven themselves for the operation of pumps, conveyor belts, compressors and countless other drive technology applications. The direct start or the star-delta starter cause impact on the mechanical components in the drive train. This leads to signs of wear, damage and premature failures. On the other hand, abrupt starts lead to voltage drops which burden the power supply network and affect the surrounding components.

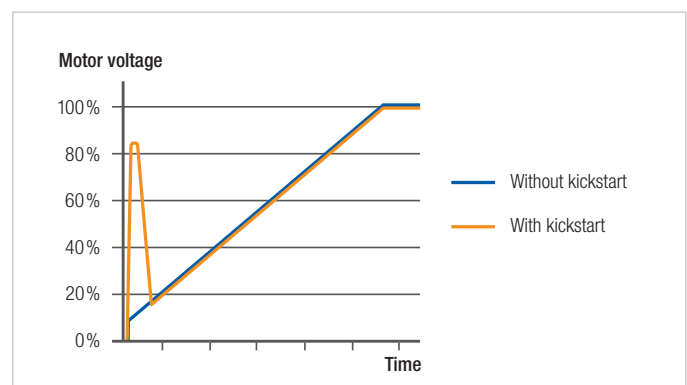
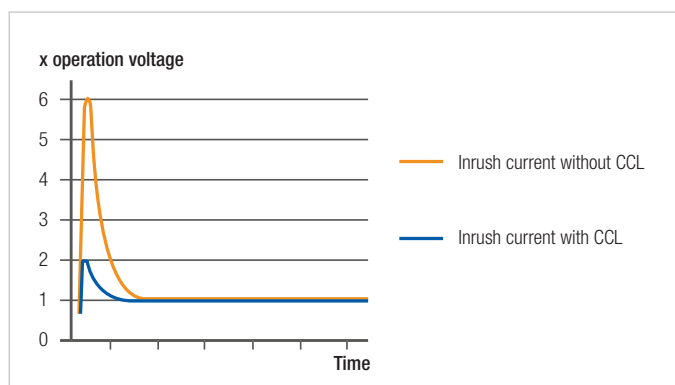
Softstarter by Comat Releco prevents disruptions and ensures a smooth start-up with a reduced starting torque and slow breaking sequences without loading the drive system. Thanks to modern semiconductor power amplifiers and fanless design, you can enjoy absolutely wear-free. The compact construction with integrated cooling element only requires little space in the control cabinet.

Softstarter by Comat Releco is available in four series:

The CCL range has been developed for the operation of heat pumps and compressors. Intelligent current limitation during start-up reduces the drive power by up to 65%. The integrated motor protection allows the adjustment of the nominal power and replaces an additional motor protection switch. Thanks to an integrated bypass relay, there are no additional costs for external bridging.

The CCM range is available with two or three switched phases and is designed for a large number of switching cycles per hour. The bypass is integrated in accordance with the version. Separate potentiometers allow the adjustment of start-up and breaking times, as well as the kick-start function, and the start-up torque can be limited to 0 to 85 % of the nominal value. The CCMB range also offers a dynamic break function with automatic standstill detection.

The starting torque limiters of the CTC range are activated via an upstream contactor. The start-up torque can be limited to 1 to 85 % of the nominal torque. Typical applications are blowers and smaller machinery.



Starting Torque Limiter – CTC3415

Type: CTC3415

The starting torque limiters of the CTC range are activated via an upstream contactor. The start-up torque can be limited to 1 to 85 % of the nominal torque. Typical applications are blowers and smaller machinery.

Output

Switching element	Thyristor
Numbers of phases	3
Nominal voltage (U _{nom})	400 VAC
Output voltage range	208 – 480 VAC
Reverse voltage	1200 V _{rrm}
Peak reverse voltage	1300 V _{rsm}
Min. load	50 mA
Max. leakage current	5 mA
Max. inrush current	120 A
Operation current AC-53B @ U _{nom}	15 A
Switching cycles/h	3000 cycles/h
Startup time	0,5 – 5 s
Max. response time	1 period
Limit load	1800 A ² t

Insulation

Insulation voltage	4 kV
Dielectric strength	660 V

General Specifications

Ambient temperature storage/operation	-20 – 80°C / -5 – 40°C
Connection terminals	Screw terminal 10 mm ²
Ingress protection degree	IP 20
Mounting	DIN rail TS35
Housing material	PPE Noryl SE1 / Aluminium
Weight	650 g

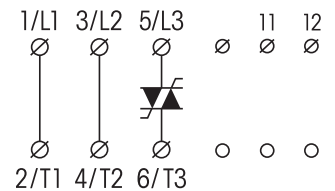
Standard type

Starting Torque Limiter

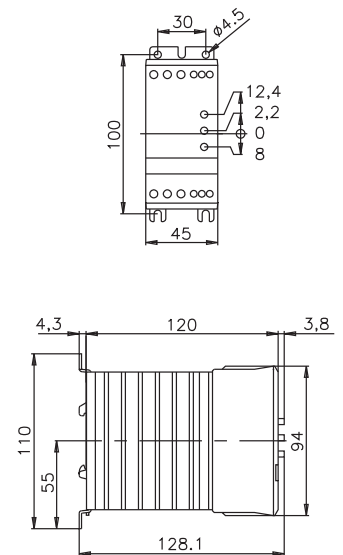
CTC3415



Connection diagram



Dimensions [mm]



Technical approvals, conformities



Starting Torque Limiter – CTC3425

Type: CTC3425

The starting torque limiters of the CTC range are activated via an upstream contactor. The start-up torque can be limited to 1 to 85 % of the nominal torque. Typical applications are blowers and smaller machinery.

Output

Switching element	Thyristor
Numbers of phases	3
Nominal voltage (U _{nom})	400 VAC
Output voltage range	208 – 480 VAC
Reverse voltage	1200 V _{rrm}
Peak reverse voltage	1300 V _{rsm}
Min. load	50 mA
Max. leakage current	5 mA
Max. inrush current	120 A
Operation current AC-53B @ U _{nom}	25 A
Switching cycles/h	3000 cycles/h
Startup time	0,5 – 5 s
Max. response time	1 period
Limit load	6300 A ² t

Insulation

Insulation voltage	4 kV
Dielectric strength	660 V

General Specifications

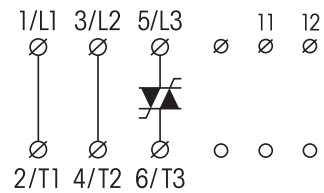
Ambient temperature storage/operation	-20 – 80°C / -5 – 40°C
Connection terminals	Screw terminal 10 mm ²
Ingress protection degree	IP 20
Mounting	DIN rail TS35
Housing material	PPE Noryl SE1 / Aluminium
Weight	650 g

Standard type

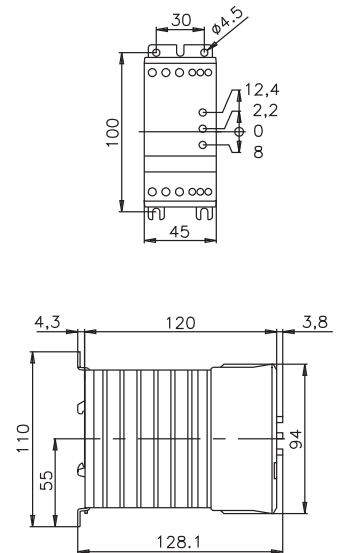
Starting Torque Limiter **CTC3425**



Connection diagram



Dimensions [mm]



Technical approvals, conformities



Compressor Softstarter – CCL33H415US

Type: CCL33H415US

The CCL range has been developed for the operation of heat pumps and compressors. Intelligent current limitation during start-up reduces the drive power by up to 65%. The integrated motor protection allows the adjustment of the nominal power and replaces an additional motor protection switch. Thanks to an integrated bypass relay, there are no additional costs for external bridging. Comprehensive monitoring detects over- and undercurrent, incorrect phase sequences and wiring errors. CCL Softstarter is available in three versions with a nominal current of up to 35 A. Cage clamp terminals allow quick wiring.

Output

Switching element	Thyristor
Numbers of phases	3
Bypass	integrated
Nominal voltage (U_{nom})	400 VAC
Output voltage range	230 – 400 Vrms
Reverse voltage	1200 Vrrm
Peak reverse voltage	1300 Vrsm
Min. load	10 A
Max. leakage current	5 mA
Max. inrush current ($t=450$ ms)	67 A
Operation current AC-58 @ U_{nom}	15 A
Switching cycles/h	max. 12 cycles/h
Response/Release time	500 ms
Limit load	610 A ^{2t}

Input

Voltage	230 VAC
Min. voltage	196 VAC
Max. voltage	264 VAC
Release voltage	110 VAC
Max. current	7 mA

Insulation

Insulation voltage	4 kV
Dielectric strength	660 V

General Specifications

Ambient temperature storage/operation	-20 – 80°C / -20 – 65°C
Connection terminals	Screw terminal 6 mm ²
Ingress protection degree	IP 20
Mounting	DIN rail TS35
Housing material	PPE Noryl SE1
Weight	470 g

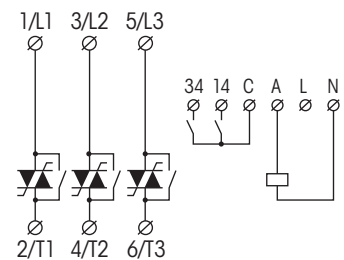
Standard type

Starting Torque Limiter

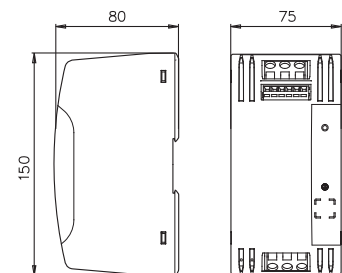
CCL33H415US



Connection diagram



Dimensions [mm]



Technical approvals, conformities



Compressor Softstarter – CCL33H425US

Type: CCL33H425US

The CCL range has been developed for the operation of heat pumps and compressors. Intelligent current limitation during start-up reduces the drive power by up to 65%. The integrated motor protection allows the adjustment of the nominal power and replaces an additional motor protection switch. Thanks to an integrated bypass relay, there are no additional costs for external bridging. Comprehensive monitoring detects over- and undercurrent, incorrect phase sequences and wiring errors. CCL Softstarter is available in three versions with a nominal current of up to 35 A. Cage clamp terminals allow quick wiring.

Output

Switching element	Thyristor
Numbers of phases	3
Bypass	integrated
Nominal voltage (U _{nom})	400 VAC
Output voltage range	230 – 400 V _{rms}
Reverse voltage	1200 V _{rsm}
Peak reverse voltage	1300 V _{rsm}
Min. load	10 A
Max. leakage current	5 mA
Max. inrush current (t=450 ms)	112 A
Operation current AC-58 @ U _{nom}	25 A
Switching cycles/h	max. 12 cycles/h
Response/Release time	500 ms
Limit load	1800 A ² t

Input

Voltage	230 VAC
Min. voltage	196 VAC
Max. voltage	264 VAC
Release voltage	110 VAC
Max. current	7 mA

Insulation

Insulation voltage	4 kV
Dielectric strength	660 V

General Specifications

Ambient temperature storage/operation	-20 – 80°C / -20 – 65°C
Connection terminals	Screw terminal 6 mm ²
Ingress protection degree	IP 20
Mounting	DIN rail TS35
Housing material	PPE Noryl SE1
Weight	470 g

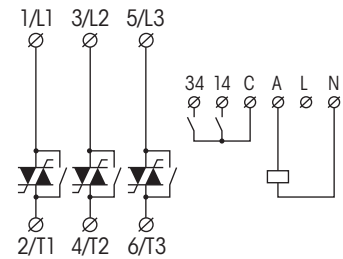
Standard type

Starting Torque Limiter

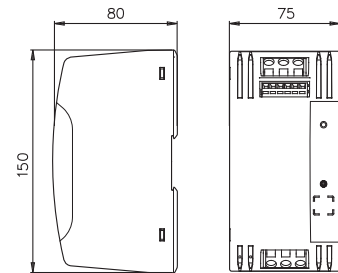
CCL33H425US



Connection diagram



Dimensions [mm]



Technical approvals, conformities



Compressor Softstarter – CCL33H435US

Type: CCL33H435US

The CCL range has been developed for the operation of heat pumps and compressors. Intelligent current limitation during start-up reduces the drive power by up to 65%. The integrated motor protection allows the adjustment of the nominal power and replaces an additional motor protection switch. Thanks to an integrated bypass relay, there are no additional costs for external bridging. Comprehensive monitoring detects over- and undercurrent, incorrect phase sequences and wiring errors. CCL Softstarter is available in three versions with a nominal current of up to 35 A. Cage clamp terminals allow quick wiring.

Output

Switching element	Thyristor
Numbers of phases	3
Bypass	integrated
Nominal voltage (U_{nom})	400 VAC
Output voltage range	230 – 400 Vrms
Reverse voltage	1200 Vrrm
Peak reverse voltage	1300 Vrsm
Min. load	10 A
Max. leakage current	5 mA
Max. inrush current ($t=450$ ms)	135 A
Operation current AC-58 @ U_{nom}	35 A
Switching cycles / h	max. 12 cycles/h
Response/Release time	500 ms
Limit load	1800 A ² t

Input

Voltage	230 VAC
Min. voltage	196 VAC
Max. voltage	264 VAC
Release voltage	110 VAC
Max. current	7 mA

Insulation

Insulation voltage	4 kV
Dielectric strength	660 V

General Specifications

Ambient temperature storage/operation	-20 – 80°C / -20 – 65°C
Connection terminals	Screw terminal 6 mm ²
Ingress protection degree	IP 20
Mounting	DIN rail TS35
Housing material	PPE Noryl SE1
Weight	470 g

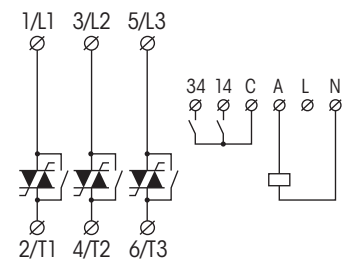
Standard type

Starting Torque Limiter

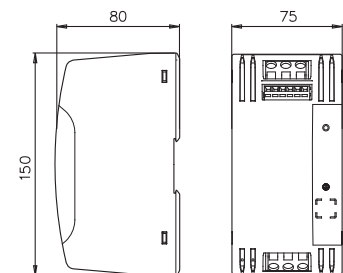
CCL33H435US



Connection diagram



Dimensions [mm]



Technical approvals, conformities



Softstarter 2 phases switched – CCM3H403USi

Type: CCM3H403USi

Softstarter CCM3 have two switched phases and are available with a nominal current of 3 to 50 A. The types CCM3...USi feature an integrated bypass. Separate potentiometers allow the adjustment of start-up and breaking times, as well as the kick-start function, and the start-up torque can be limited to 0 to 85 % of the nominal value.

Output

Switching element	Thyristor
Numbers of phases	2
Bypass	integrated
Nominal voltage (U_{nom})	400 VAC
Output voltage range	400 – 480 VAC
Reverse voltage	1200 V _{rrm}
Peak reverse voltage	1300 V _{rsm}
Min. load	3 A
Max. leakage current	5 mA
Max. inrush current	18 A
Operation current AC-53B @ U_{nom}	3 A
Switching cycles/h	120 cycles/h
Startup time	0,5 – 10 s
Deceleration time	0,5 – 10 s
Limit load	72 A ² t

Input

Voltage	24 – 230 VAC
Min. voltage	20,4 VAC
Max. voltage	253 VAC
Release voltage	5 VAC
Max. current	15 mA

Insulation

Insulation voltage	4 kV
Dielectric strength	660 V

General Specifications

Ambient temperature storage/operation	-20 – 80°C / -5 – 40°C
Connection terminals	Screw terminal 6 mm ²
Ingress protection degree	IP 20
Mounting	DIN rail TS35
Housing material	PPE Noryl SE1 / Aluminium
Weight	270 g

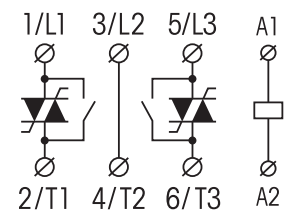
Standard type

Starting Torque Limiter

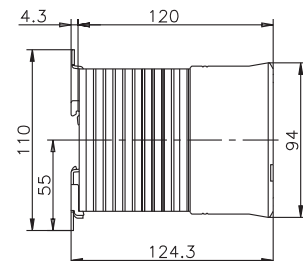
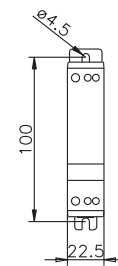
CCM3H403USi



Connection diagram



Dimensions [mm]



Technical approvals, conformities



Softstarter 2 phases switched – CCM3H415

Type: CCM3H415

Softstarter CCM3 have two switched phases and are available with a nominal current of 3 to 50 A. The types CCM3...USi feature an integrated bypass. Separate potentiometers allow the adjustment of start-up and breaking times, as well as the kick-start function, and the start-up torque can be limited to 0 to 85 % of the nominal value.

Output

Switching element	Thyristor
Numbers of phases	2
Bypass	—
Nominal voltage (U_{nom})	400 VAC
Output voltage range	400 – 480 VAC
Reverse voltage	1200 V _{rm}
Peak reverse voltage	1300 V _{rsm}
Min. load	3 A
Max. leakage current	5 mA
Max. inrush current	90 A
Operation current AC-53B @ U_{nom}	15 A
Switching cycles/h	3000 cycles/h
Startup time	0,5 – 10 s
Deceleration time	0,5 – 10 s
Limit load	1800 A ² t

Input

Voltage	24 – 230 VAC
Min. voltage	20,4 VAC
Max. voltage	253 VAC
Release voltage	5 VAC
Max. current	15 mA

Insulation

Insulation voltage	4 kV
Dielectric strength	660 V

General Specifications

Ambient temperature storage/operation	-20 – 80°C / -5 – 40°C
Connection terminals	Screw terminal 6 mm ²
Ingress protection degree	IP 20
Mounting	DIN rail TS35
Housing material	PPE Noryl SE1 / Aluminium
Weight	650 g

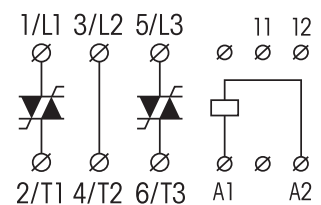
Standard type

Starting Torque Limiter

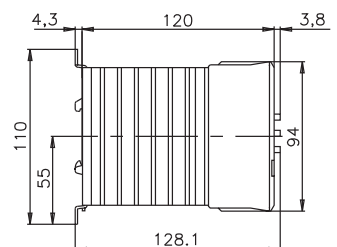
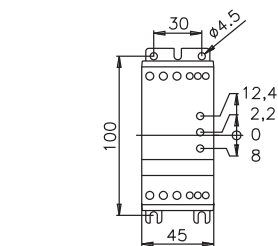
CCM3H415



Connection diagram



Dimensions [mm]



Technical approvals, conformities



Softstarter 2 phases switched- CCM3H425

Type: CCM3H425

Softstarter CCM3 have two switched phases and are available with a nominal current of 3 to 50 A. The types CCM3...USi feature an integrated bypass. Separate potentiometers allow the adjustment of start-up and breaking times, as well as the kick-start function, and the start-up torque can be limited to 0 to 85 % of the nominal value.

Output

Switching element	Thyristor
Numbers of phases	2
Bypass	—
Nominal voltage (U_{nom})	400 VAC
Output voltage range	400 – 480 VAC
Reverse voltage	1200 V _{rrm}
Peak reverse voltage	1300 V _{rsm}
Min. load	3 A
Max. leakage current	5 mA
Max. inrush current	150 A
Operation current AC-53B @ U_{nom}	25 A
Switching cycles/h	3000 cycles/h
Startup time	0,5 – 10 s
Deceleration time	0,5 – 10 s
Limit load	6300 A ² t

Input

Voltage	24 – 230 VAC
Min. voltage	20,4 VAC
Max. voltage	253 VAC
Release voltage	5 VAC
Max. current	15 mA

Insulation

Insulation voltage	4 kV
Dielectric strength	660 V

General Specifications

Ambient temperature storage/operation	-20 – 80°C / -5 – 40°C
Connection terminals	Screw terminal 10 mm ²
Ingress protection degree	IP 20
Mounting	DIN rail TS35
Housing material	PPE Noryl SE1 / Aluminium
Weight	1050 g

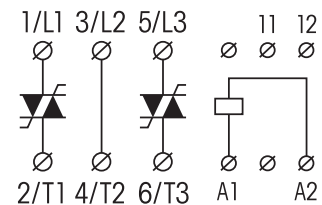
Standard type

Starting Torque Limiter

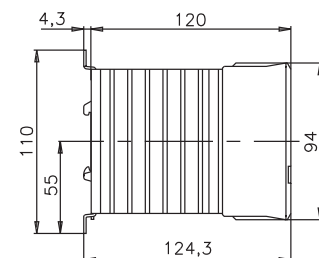
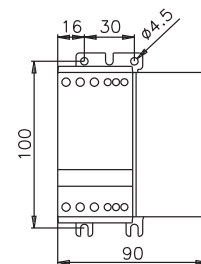
CCM3H425



Connection diagram



Dimensions [mm]



Technical approvals, conformities



Softstarter 2 phases switched- CCM3H415DS

Type: CCM3H415DS

The motor contactor CCM3H415DS have two switched phases and a nominal current of 15 A.

Output

Switching element	Thyristor
Numbers of phases	2
Bypass	—
Nominal voltage (U_{nom})	400 VAC
Output voltage range	400 – 480 VAC
Reverse voltage	1200 V _{rm}
Peak reverse voltage	1300 V _{rsm}
Min. load	3 A
Max. leakage current	5 mA
Max. inrush current	90 A
Operation current AC-53B @ U_{nom}	15 A
Switching cycles/h	3000 cycles/h
Startup time	1 period
Deceleration time	1 period
Limit load	1800 A ² t

Input

Voltage	24 – 60 VDC / 24 – 480 VAC
Min. voltage	20,4 VAC
Max. voltage	253 VAC
Release voltage	5 VAC
Max. current	15 mA

Insulation

Insulation voltage	4 kV
Dielectric strength	660 V

General Specifications

Ambient temperature storage/operation	-20 – 80°C / -5 – 40°C
Connection terminals	Screw terminal 6 mm ²
Ingress protection degree	IP 20
Mounting	DIN rail TS35
Housing material	PPE Noryl SE1 / Aluminium
Weight	650 g

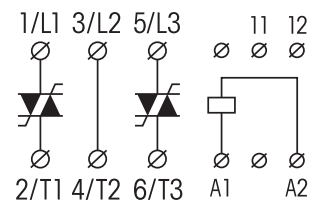
Standard type

Starting Torque Limiter

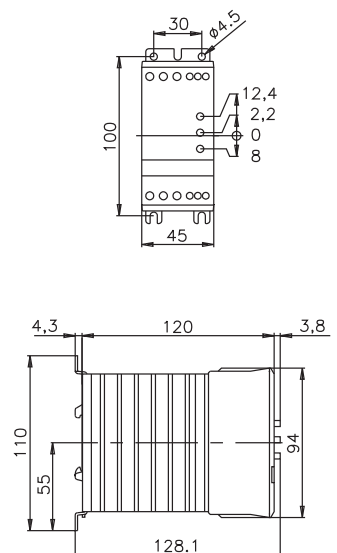
CCM3H415DS



Connection diagram



Dimensions [mm]



Technical approvals, conformities



Softstarter 3 phases switched – CCM33H425US

Type: CCM33H425US

Softstarter CCM33 have three switched phases and are available with a nominal current of up to 85 A. The types CCM33...USi feature an integrated bypass. Separate potentiometers allow the adjustment of start-up and breaking times, as well as the kick-start function, and the start-up torque can be limited to 0 to 85 % of the nominal value.

Output

Switching element	Thyristor
Numbers of phases	3
Bypass	externally
Nominal voltage (U_{nom})	400 VAC
Output voltage range	400 – 480 VAC
Reverse voltage	1200 V _{rrm}
Peak reverse voltage	1300 V _{rsm}
Min. load	3 A
Max. leakage current	5 mA
Max. inrush current ($t=450$ ms)	150 A
Operation current AC-53B @ U_{nom}	25 A
Switching cycles/h	120 cycles/h
Startup time	0,5 – 30 s
Deceleration time	0,5 – 60 s
Limit load	6300 A ² t

Input

Voltage	24 – 230 VAC
Min. voltage	20,4 VAC
Max. voltage	253 VAC
Release voltage	5 VAC
Max. current	15 mA

Insulation

Insulation voltage	4 kV
Dielectric strength	660 V

General Specifications

Ambient temperature storage/operation	-20 – 80°C / -5 – 40°C
Connection terminals	Screw terminal 10 mm ²
Ingress protection degree	IP 20
Mounting	DIN rail TS35
Housing material	PPE Noryl SE1 / Aluminium
Weight	1050 g

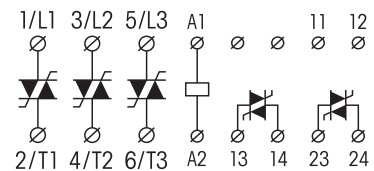
Standard type

Starting Torque Limiter

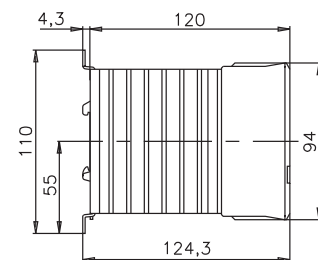
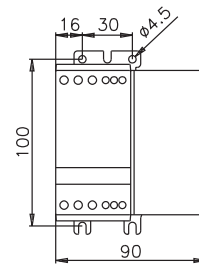
CCM33H425US



Connection diagram



Dimensions [mm]



Technical approvals, conformities



Softstarter 3 phases switched – CCM33H450US

Type: CCM33H450US

Softstarter CCM33 have three switched phases and are available with a nominal current of up to 85 A. The types CCM33...USi feature an integrated bypass. Separate potentiometers allow the adjustment of start-up and breaking times, as well as the kick-start function, and the start-up torque can be limited to 0 to 85 % of the nominal value.

Output

Switching element	Thyristor
Numbers of phases	3
Bypass	externally
Nominal voltage (U_{nom})	400 VAC
Output voltage range	400 – 480 VAC
Reverse voltage	1200 V _{rrm}
Peak reverse voltage	1300 V _{rsm}
Min. load	3 A
Max. leakage current	5 mA
Max. inrush current ($t=450$ ms)	300 A
Operation current AC-53B @ U_{nom}	50 A
Switching cycles / h	120 cycles/h
Startup time	0,5 – 30 s
Deceleration time	0,5 – 60 s
Limit load	25300 A ² t

Input

Voltage	24 – 230 VAC
Min. voltage	20,4 VAC
Max. voltage	253 VAC
Release voltage	5 VAC
Max. current	15 mA

Insulation

Insulation voltage	4 kV
Dielectric strength	660 V

General Specifications

Ambient temperature storage/operation	-20 – 80°C / -5 – 40°C
Connection terminals	Screw terminal 35 mm ²
Ingress protection degree	IP 20
Mounting	DIN rail TS35
Housing material	PPE Noryl SE1 / Aluminium
Weight	2600 g

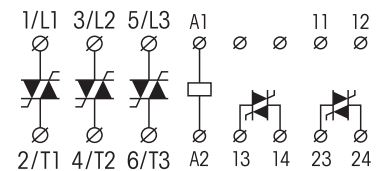
Standard type

Starting Torque Limiter

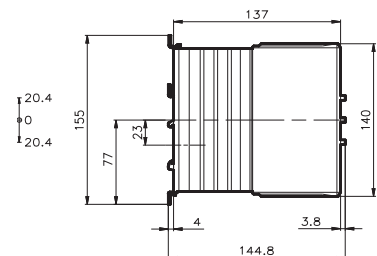
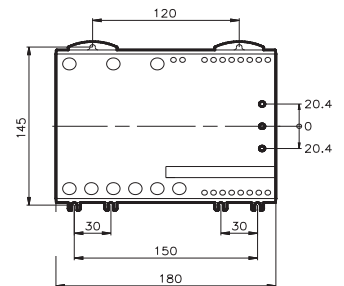
CCM33H450US



Connection diagram



Dimensions [mm]



Technical approvals, conformities



Softstarter 3 phases switched – CCM33H530USi

Type: CCM33H530USi

Softstarter CCM33 have three switched phases and are available with a nominal current of up to 85 A. The types CCM33...USi feature an integrated bypass. Separate potentiometers allow the adjustment of start-up and breaking times, as well as the kick-start function, and the start-up torque can be limited to 0 to 85 % of the nominal value.

Output

Switching element	Thyristor
Numbers of phases	3
Bypass	externally
Nominal voltage (U_{nom})	480 VAC
Output voltage range	200 – 480 VAC
Reverse voltage	1200 V _{rrm}
Peak reverse voltage	1300 V _{rsm}
Min. load	3 A
Max. leakage current	5 mA
Max. inrush current ($t=450$ ms)	180 A
Operation current AC-53B @ U_{nom}	30 A
Switching cycles/h	120 cycles/h
Startup time	0,5 – 30 s
Deceleration time	0,5 – 60 s
Limit load	6300 A ² t

Input

Voltage	24 – 230 VAC
Min. voltage	20,4 VAC
Max. voltage	253 VAC
Release voltage	5 VAC
Max. current	15 mA

Insulation

Insulation voltage	4 kV
Dielectric strength	660 V

General Specifications

Ambient temperature storage/operation	-20 – 80°C / -5 – 40°C
Connection terminals	Screw terminal 10 mm ²
Ingress protection degree	IP 20
Mounting	DIN rail TS35
Housing material	PPE Noryl SE1 / Aluminium
Weight	1050 g

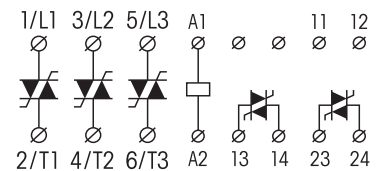
Standard type

Starting Torque Limiter

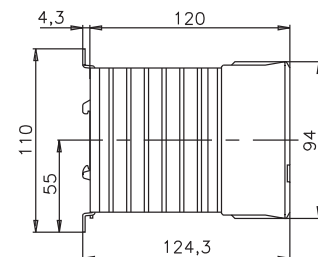
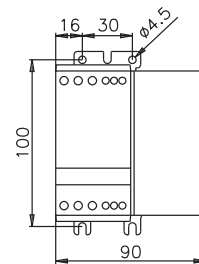
CCM33H530USi



Connection diagram



Dimensions [mm]



Technical approvals, conformities



Softstarter 3 phases switched – CCM33H550USi

Type: CCM33H550USi

Softstarter CCM33 have three switched phases and are available with a nominal current of up to 85 A. The types CCM33...USi feature an integrated bypass. Separate potentiometers allow the adjustment of start-up and breaking times, as well as the kick-start function, and the start-up torque can be limited to 0 to 85 % of the nominal value.

Output

Switching element	Thyristor
Numbers of phases	3
Bypass	externally
Nominal voltage (U_{nom})	480 VAC
Output voltage range	200 – 480 VAC
Reverse voltage	1200 V _{rrm}
Peak reverse voltage	1300 V _{rsm}
Min. load	3 A
Max. leakage current	5 mA
Max. inrush current ($t=450$ ms)	300 A
Operation current AC-53B @ U_{nom}	50 A
Switching cycles / h	120 cycles/h
Startup time	0,5 – 30 s
Deceleration time	0,5 – 60 s
Limit load	25300 A ² t

Input

Voltage	24 – 230 VAC
Min. voltage	20,4 VAC
Max. voltage	253 VAC
Release voltage	5 VAC
Max. current	15 mA

Insulation

Insulation voltage	4 kV
Dielectric strength	660 V

General Specifications

Ambient temperature storage/operation	-20 – 80°C / -5 – 40°C
Connection terminals	Screw terminal 35 mm ²
Ingress protection degree	IP 20
Mounting	DIN rail TS35
Housing material	PPE Noryl SE1 / Aluminium
Weight	2600 g

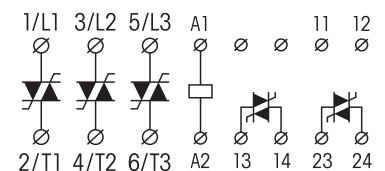
Standard type

Starting Torque Limiter

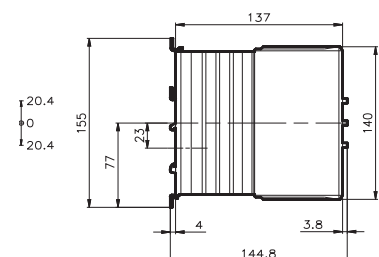
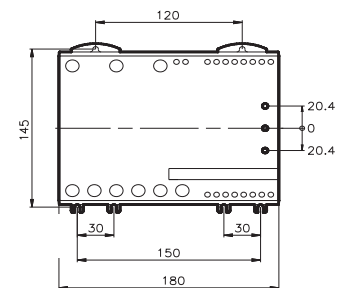
CCM33H550USi



Connection diagram



Dimensions [mm]



Technical approvals, conformities



Softstarter with dynamic breaking – CCMB3H425 (2 phases switched)

Type: **CCMB3H425**

Softstarter CCMB also offers a dynamic break function with automatic standstill detection in addition to the functions of the CCM3 range. They provide an output for an external bypass and have a nominal current of 25A.

Output

Switching element	Thyristor
Numbers of phases	2
Bypass	externally
Nominal voltage (U_{nom})	400 VAC
Output voltage range	400 – 480 VAC
Reverse voltage	1600 V _{rrm}
Peak reverse voltage	1650 V _{rsm}
Min. load	1 A
Max. leakage current	5 mA
Max. inrush current	200 A
Operation current AC-58 @ U_{nom}	25 A
Response/Release time	100 ms
Limit load	6300 A ² t

Input

Voltage	24 – 230 VAC
Min. voltage	20,4 VAC
Max. voltage	253 VAC
Release voltage	5 VAC
Max. current	15 mA

Insulation

Insulation voltage	4 kV
Dielectric strength	660 V

General Specifications

Ambient temperature storage/operation	-20 – 80°C / -5 – 65°C
Connection terminals	Screw terminal 6 mm ²
Ingress protection degree	IP 20
Mounting	DIN rail TS35
Housing material	PPE Noryl SE1 / Aluminium
Weight	1050 g

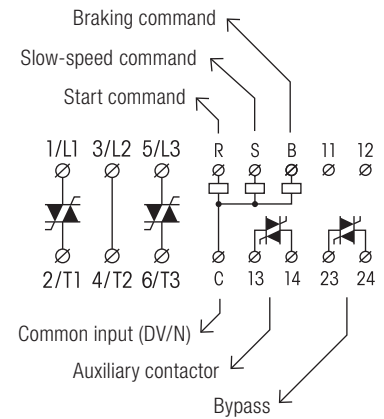
Standard type

Starting Torque Limiter

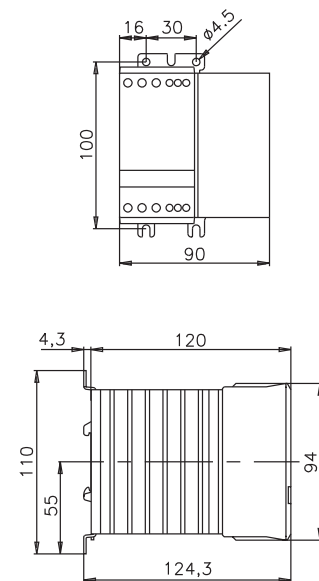
CCMB3H425



Connection diagram



Dimensions [mm]



Technical approvals, conformities



RELECO Worldwide Sales Net



ARGENTINA

WINTERS INSTRUMENTS S.A.
B1640BIN Martinez - Buenos Aires
www.winters.com.ar



AUSTRALIA

ARLIN PTY. LTD.
Springvale Vic 3171
www.arlin.com.au



AUSTRIA

AVS SCHMERSAL VERTRIEBS GMBH
1230 Wien
www.avs-schmersal.at



BELGIUM

MULTIPROX N.V.
9300 Aalst
www.multiprox.be



BOLIVIA

GRUPO LARCOS INDUSTRIAL LTDA.
La Paz
www.grupolarcos.com



BRAZIL

COMAT RELECO DO BRASIL
09550-190 Sao Caetano/Sao Paulo
www.comatreleco.com.br



CANADA

TURCK CHARTWELL CANADA INC.
Markham, Ontario L6G 1B5
www.chartwell.ca



CHILE

ELECTRÓNICA RHOMBERG LTD.
Santiago de Chile
www.rhomberg.cl



CHINA (Tianjin)

ELCO ELECTRONICS CO. LTD.
Tianjin 300385
www.elco-holding.com



COLOMBIA

ACJ HIGH VOLTAGE LTD.
Bogota D.C. Colombia
www.acj.com.co



CZECH REPUBLIC

OEM AUTOMATIC SPOL. S.R.O.
250 66 Zdiby
www.oem-automatic.cz



DENMARK

OEM AUTOMATIC KITSO A/S
3450 Allerød
www.oemautomatic.dk



ECUADOR

IANDCECONTROL S.A. (I & C)
Quito
www.iandcecontrol.com



FRANCE

RELECOMAT FRANCE SARL
06220 Sophia-Antipolis
www.relecomat.fr



FINLAND

OEM FINLAND OY
20750 Turku
www.oem.fi



GERMANY

COMAT RELECO GMBH
21465 Reinbek
www.comatreleco.de



GREECE

VASSILIS GETSOS
15562 Cholargos - Athens
www.ksa.gr



INDIA

PARAMOUNT INDUSTRIES
Bangalore 560 010
www.paramount.net.in



IRAN

SEYED GHASEM RIAZI TRADING
15949 Teheran
www.sgrtrading.com



IRELAND

TCM CONTROLS LTD.
Dublin 12
www.tcmcontrols.com



ITALY

SOFTING ITALIA SRL.
20090 Cesano Boscone
www.softingitalia.it



KOREA

MEC MAHANI ELECTRIC CO. LTD.
135-080 Seoul
www.mec.co.kr



LITHUANIA

HIDROTEKA ENGINEERING SERVICES
51333 Kaunas
www.hidroteka.lt



MALAYSIA

AMPTRONIC SDN BHD
Selangor, Malaysia
www.amptron.com.my



MAROCCO

MAGHREB ELECTRO-TECHNIQUE SARL.
Casablanca 20250
www.beltransfo.com



MEXICO

TURCK MEXICO S. DE R.L. DE C.V.
Saltillo Coahuila 25315
www.turck.com.mx



NETHERLANDS

VIERPOOL BV.
3606 AS Maarssen
www.vierpool.nl



NEW ZEALAND

CUTHBERT STEWART LTD
Wellington - Auckland
www.cuthbertstewart.co.nz



NORWAY

OEM AUTOMATIC AS
3044 Drammen
www.oem.no



PAKISTAN

GINZA INTERNATIONAL CORPORATION
Karachi - 74000
Ginza-int@cyber.net.pk



PERU

PROMOTORES ELÉCTRICOS S.A.
Lima 13 - La Victoria
www.promelsa.com.pe



POLAND

OEM AUTOMATIC SP. Z.O.O.
02-234 Warszawa
www.oemautomatic.com.pl



ROMANIA

SYSCOM 18 S.R.L.
011728 Bucharest
www.syscom.ro



RUSSIA

SENSORLINK LLC.
127591 Moscow
www.sensorlink.ru



RUSSIA

POLIGON JSC.
198020 St. Petersburg
www.poligon.info



SINGAPORE

FUTRON ELECTRONICS PTE. LTD.
Singapore 318995
www.futronelectronics.com.sg



SPAIN

DISAILECO, SL
08029 Barcelona
www.disaileco.com



SWEDEN

OEM INTERNATIONAL AB
573 28 Tranas
www.oem.se



SWITZERLAND

COMAT AG
3076 Worb
www.comat.ch



TAIWAN

Z-NANOCON
Kaohsiung, Taiwan
www.e-sensors.com.tw



TURKEY

ILERI OTOMASYON SISTEMLERI SAN. LTD. STI.
34384 Okmeydani/Istanbul
www.ileriotomasyon.com



THAILAND

ZIGMAACT CO. LTD.
Bangkok 10700
www.zigmaact.com



UNITED KINGDOM

OEM AUTOMATIC LTD.
Leicester LE8 6ZG
www.oem.co.uk



URUGUAY

ELEKTROSWEDEN S.A.
11100 Montevideo
www.elektrosweden.com.uy



USA

TURCK INC.
Plymouth MN 55441
www.turck-usa.com



COMAT AG • BERNSTR. 4
CH-3076 WORB
TEL. +41 (0)31 838 55 77
FAX +41 (0)31 838 55 99
www.comat.ch • info@comat.ch
www.releco.com • sales@releco.com