

April 2020

Approved Products Catalog
for Fiber Optic, Copper and
Overhead Hardware Products

**MMID Numbers and
Quote Drawings Included**



 COMMUNICATIONS  ENERGY  SPECIAL INDUSTRIES  SOLAR

ARMADILLO 

FIBERLIGN

GUY-GRIP®
Dead-end

COYOTE®
FIBER OPTICS

▶ SALES CONTACTS



COMMUNICATIONS SALES

▶ CUSTOMER SUPPORT

U.S. CUSTOMER & TECHNICAL SUPPORT

Tel: 440.461.5200

Fax: 440.442.8816

Email: inquiries@preformed.com

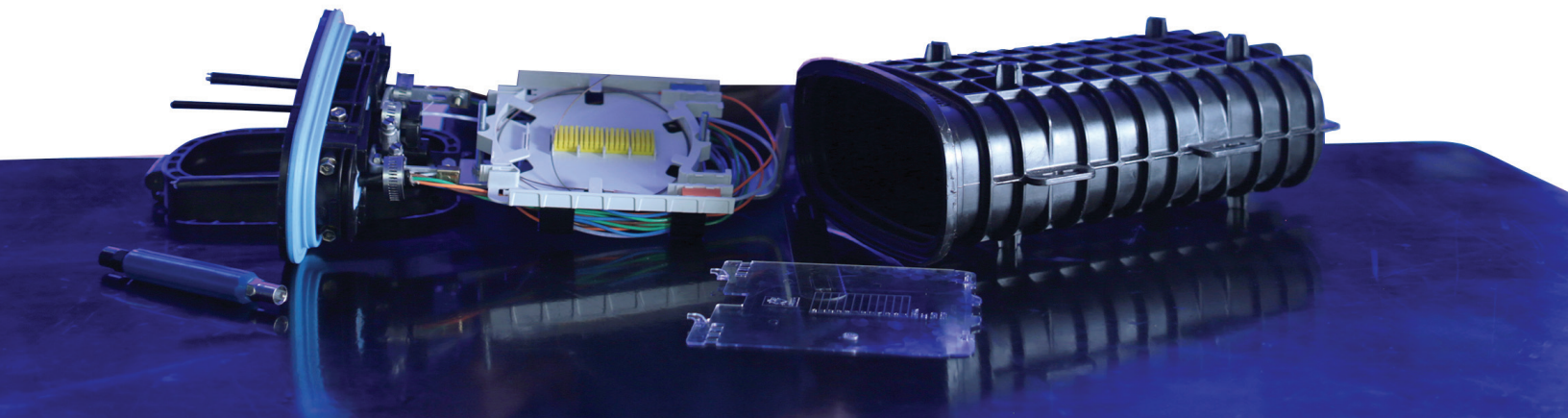

Verizon & PLP Approved Products – MMID Numbers

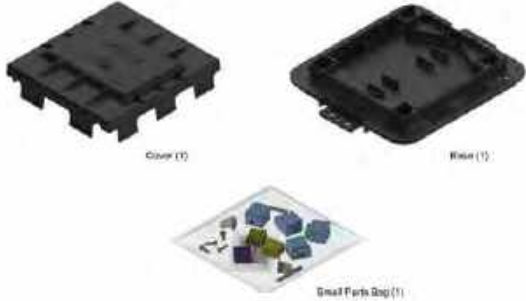

Table of Contents

Communications Sales Representative Locator	ii	FIBERLIGN Dielectric Support (FDS) for ADSS Cable.....	42
COYOTE® FIBER OPTICS		FIBERLIGN Aluminum Support (FAS) Structural Rods for ADSS Cable.....	42
COYOTE DTC Closures.....	4	FIBERLIGN Aluminum Suspension (FASN) w/ & w/o Structural Rods for ADSS Cable.....	43
COYOTE LCC Closures.....	5	FIBERLIGN Dielectric Dampers for ADSS Cable	43
COYOTE In-Line RUNT Closures	6-7	FIBERLIGN Cable Abrasion Protector for ADSS Cable.....	43
COYOTE ONE Dome Closures.....	8	ADSS-CORONA Coil.....	43
COYOTE Dome Closures (6.5" x 17", 6.5" x 22").....	9-12	FIBERLIGN Downlead Cushions for ADSS Cable.....	44
COYOTE Dome Closures (9.5" x 19", 9.5" x 28")	13-14	COYOTE® CLOSURES FOR COPPER	
COYOTE HD (High-Density) Dome Closure.....	15-17	COYOTE RUNT and COYOTE PUP Closures	44
COYOTE HD (High-Density) Dome Closure Accessories.....	18-19	ARMADILLO® SPLICE CASES	
COYOTE Dual Chamber Terminal Closure	20	ARMADILLO Stainless Steel Splice Cases	45-50
COYOTE Taut Closure	21	ARMADILLO Stainless Steel Splice Case End Plates	50-53
COYOTE Stainless Steel Splice Cases Vault 216 and 144 Tip Cables	21	ARMADILLO Stainless Steel Splice Case Accessories	53-56
COYOTE Closure Silicone Grommets	22	SERVISEAL® & BLACK-JACK™ Closures and Accessories	57
COYOTE Closure Splice Trays.....	22-23	Tri-Seal & Omni-Seal Closures.....	57
COYOTE Closure Accessories.....	24-26	REDDI™ Seal Closure Parts & Accessories.....	57
COYOTE Closure Mounting Brackets	26-27	SERVI-BOND™ Shield Connectors	57
COYOTE RUNT Closures	28	Pair Protectors	57
COYOTE Legacy Closures (6.0" x 22", 8.5" x 22")	29-31	OVERHEAD COMMUNICATIONS	
COYOTE Legacy Closure Accessories	32-33	Strand & Cable Products	58-60
COYOTE Urethane Grommets.....	34-35	Guy Guards, Tree Guards, and Pedestal Markers	60
COYOTE Fiber Wall Plate	35	Air Flow Spoilers.....	61
COYOTE Standard MPC (Multi-Purpose Closures).....	36	Pole Plugs.....	61
COYOTE Deep MPC (Multi-Purpose Closure).....	37	Safety Guy-Wire Dispenser	61
COYOTE MPC (Multi-Purpose Closures) Accessories	38	Cable Caps.....	61
COYOTE Fiber Cable Hoist Products.....	39		
FIBERLIGN® HARDWARE AND ACCESSORIES			
FIBERLIGN Cable Storage.....	40		
FIBERLIGN Dielectric Dead-Ends & Accessories for ADSS Cable.....	41-42		

Quote Drawings for COYOTE Fiber Optics

COYOTE DTC Closures.....	64-65	COYOTE Taut Closure	101
COYOTE LCC Closures.....	66-67	COYOTE Closure Silicone Grommets	102-112
COYOTE In-Line RUNT Closures	68-70	COYOTE Closure Splice Trays.....	113-129
COYOTE ONE Dome Closures.....	71	COYOTE Closure Accessories.....	130-146
COYOTE Dome Closures (6.5" x 17", 6.5" x 22").....	72-78	COYOTE Mounting Brackets	147-152
COYOTE Dome Closures (9.5" x 19", 9.5" x 28")	79-82	COYOTE RUNT Closure.....	153
COYOTE HD (High-Density) Dome Closure.....	83-87	COYOTE Legacy Closure Accessories	154
COYOTE HD (High-Density) Dome Closure Accessories.....	88-99	COYOTE Urethane Grommets.....	155-163
COYOTE Dual Chamber Terminal Closure	100	FIBERLIGN® Cable Storage	164-176

COYOTE® FIBER OPTICS for Verizon

COYOTE® DTC Closure						
PLP Part Number	Verizon SSI Code	Component Breakdown	Closure Capabilities			
COYOTE8400	11182591 MMID 10796975	<p>COYOTE® DTC Closure, Splice Only, For Flat and Small Drop Cables – Equipped With: (1) COYOTE DTC Closure Assembly, (4) 1-Hole Grommets 0.17"-0.25" and Flat Drop Cable, (2) LITE-GRIP® Single Fusion Splice Blocks, (1) LITE-GRIP Ribbon/Mass Fusion Splice Block and Cable Restraint Hardware</p> 	Max Splice Capacity	16 SF	Port Quantity	4
			Express Ribbons	2	Ground Studs	0
			Express Fibers	24	Above & Below Grade Application	
COYOTE8401	11283848 MMID 10796985	<p>COYOTE® DTC Closure, Splice Only, For Flat and Small Drop Cables – Equipped With: (1) COYOTE DTC Closure Assembly, (3) 1-Hole Grommets 0.17"-0.25" and Flat Drop Cable, (1) 2-Hole Grommet 0.156"-0.170", (1) LITE-GRIP® Single Fusion Splice Block, (1) LITE-GRIP Ribbon/Mass Fusion Splice Block, (1) Splice Tray Kit and Cable Restraint Hardware</p> 	Max Splice Capacity	16 SF	Port Quantity	4
			Express Ribbons	2	Ground Studs	0
			Express Fibers	24	Above & Below Grade Application	

Technical Specifications of the COYOTE DTC Closure

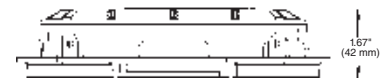
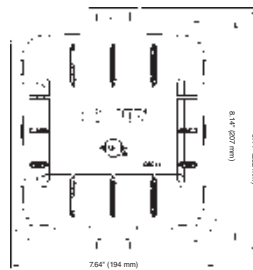

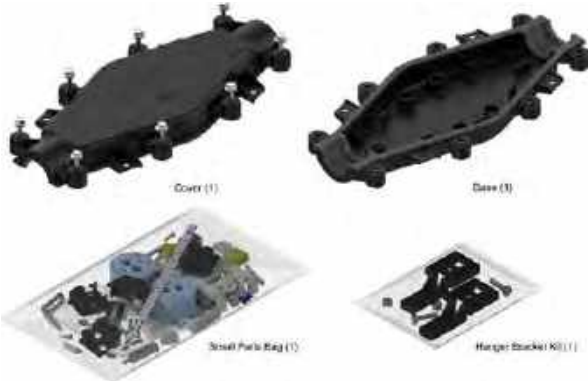
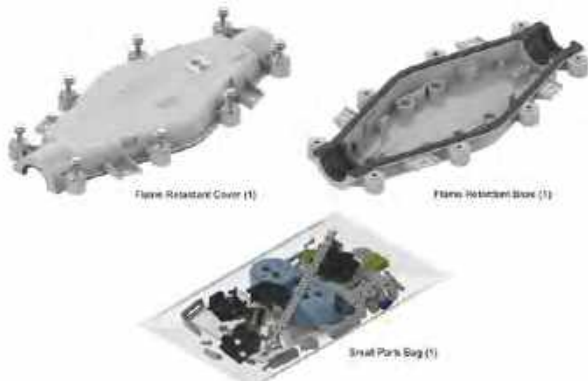

COYOTE® FIBER OPTICS for Verizon

COYOTE® LCC Closure						
PLP Part Number	Verizon SSI Code	Component Breakdown	Closure Capabilities			
VZ COYLCC-001	11083849 MMID 10796990	<p>COYOTE® LCC Closure – Equipped With: (1) COYOTE LCC Closure Assembly, (2) 4-Hole Grommets 0.50"-0.60" and 0.125"-0.250" and Flat Drop Cable, (2) LITE-GRIP® Single Fusion Splice Blocks, (1) LITE-GRIP Ribbon/Mass Fusion Splice Block, (1) Splice Platform, (1) Dual Strength Member Bracket, (1) L-Strength Member Bracket, (4) Fiber Management Clips, Cable Restraint Hardware, and (1) Universal Mounting Bracket</p> 	Max Splice Capacity	24 SF 72 MF	Port Quantity	2
			Express Ribbons	8	Ground Studs	0
			Express Fibers	48	Above & Below Grade Application	
VZ FRCOYLCC-001	11083848 MMID 10796965	<p>Flame Retardant COYOTE® LCC Closure – Equipped With: (1) COYOTE LCC Closure Assembly, (2) 4-Hole Grommets 0.50"-0.60" & 0.125"-0.250" and Flat Drop Cable, (2) LITE-GRIP® Single Fusion Splice Blocks, (1) LITE-GRIP Ribbon/Mass Fusion Splice Block, (1) Splice Platform, (1) Dual Strength Member Bracket, (1) L-Strength Member Bracket, (4) Fiber Management Clips, and Cable Restraint Hardware</p> 	Max Splice Capacity	24 SF 72 MF	Port Quantity	2
			Express Ribbons	8	Ground Studs	0
			Express Fibers	48	Indoor Use Only	

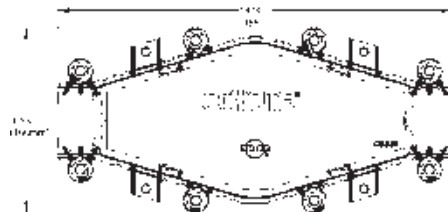
Technical Specifications of the COYOTE LCC Closure



COYOTE FIBER OPTICS for Verizon

COYOTE® In-Line RUNT Closure						
PLP Part Number	Verizon SSI Code	Component Breakdown	Closure Capabilities			
COYOTE8216	11023374 MMID 10796959	<p>COYOTE® In-Line RUNT Closure, Hermetically Sealed – Equipped With: (1) COYOTE In-Line RUNT Closure Assembly with Integrated Cable Restraint Hardware, (1) 2-Hole Wide Range Grommet 0.42"-0.60" or 0.60"-0.85", (2) 2-Hole Grommets 0.42"-0.60", (1) 7-Hole Grommet 0.42"-0.60" & 0.125"-0.250" and Flat Drop Cable, (1) Cable Restraint Bracket Kit, (1) Ribbon Organizer Kit, (1) 800012909 Universal, Short, Splice Tray, and (1) Universal Mounting Bracket</p> 	Max Splice Capacity	96 SF 288 MF	Port Quantity	4
			Express: Ribbons Buffer Tubes	18 8	Ground Studs	0
			Max Trays 800012909	2	Above & Below Grade Application	
COYOTE8203	11023369 MMID 10796982	<p>COYOTE® In-Line RUNT Closure, Free Breathing – Equipped With: (1) COYOTE In-Line RUNT Closure Assembly with Integrated Cable Restraint Hardware, (1) 2-Hole Wide Range Grommet 0.42"-0.60" or 0.60"-0.85", (2) 2-Hole Grommets 0.42"-0.60", (1) 7-Hole Grommet 0.42"-0.60" & 0.125"-0.250" and Flat Drop Cable, (1) Cable Restraint Bracket Kit, (1) Ribbon Organizer Kit, (1) Tubing Kit Consisting of: (1) 0.250" ID x 25" Long Transition Tube, (1) 0.375" OD x 36" Long Spiral Tube, (1) 800012909 Universal, Short, Splice Tray, and (1) Universal Mounting Bracket</p> 	Max Splice Capacity	96 SF 288 MF	Port Quantity	4
			Express: Ribbons Buffer Tubes	18 8	Ground Studs	0
			Max Trays 800012909	2	Above Grade Only	

COYOTE® FIBER OPTICS for Verizon

COYOTE® In-Line RUNT Closure											
PLP Part Number	Verizon SSI Code	Component Breakdown	Closure Capabilities								
COYOTE8802	11043138 MMID 10796986	<p>Flame Retardant COYOTE® In-Line RUNT Closure, Hermetically Sealed – Equipped With: (1) COYOTE In-Line RUNT Closure Assembly with Integrated Cable Restraint Hardware, (2) 2-Hole Wide Range Grommet 0.42"-0.60" or 0.60"-0.85", (2) 4-Hole Grommets 0.30"-0.43", (1) 6-Hole Grommet 0.125"-0.250" and Flat Drop Cable, (1) Cable Restraint Bracket Kit, (1) Ribbon Organizer Kit, (1) Torque Limiting Tool, (1) 800012909 Universal, Short, Splice Tray, and (1) Universal Mounting Bracket</p>  <p>The diagram shows the following components: Flame Retardant Cover (1), Flame Retardant Base (1), Torque Limiting Tool (1), Small Parts Bag (1), 4 Pack Grommet Kit (1) [Includes: (2) 4 Hole Grommets, 30"-43", (2) 2 Hole Wide Range Grommet, 42"-60" & 60"-85", & (1) 6-Hole Grommet, 125"-250"], Ribbon Organizer Kit (1), Short Metal Universal Splice Tray (1), and Universal Mounting Hanger Bracket Kit (1).</p>	<table border="1"> <tr> <td>Max Splice Capacity</td> <td>96 SF 288 MF</td> <td>Port Quantity</td> <td>4</td> </tr> <tr> <td>Express: Ribbons Buffer Tubes</td> <td>18 8</td> <td>Ground Studs</td> <td>0</td> </tr> </table>	Max Splice Capacity	96 SF 288 MF	Port Quantity	4	Express: Ribbons Buffer Tubes	18 8	Ground Studs	0
			Max Splice Capacity	96 SF 288 MF	Port Quantity	4					
			Express: Ribbons Buffer Tubes	18 8	Ground Studs	0					
Max Trays 800012909	2	Indoor Use Only									

Technical Specifications of the COYOTE In-Line RUNT Closure

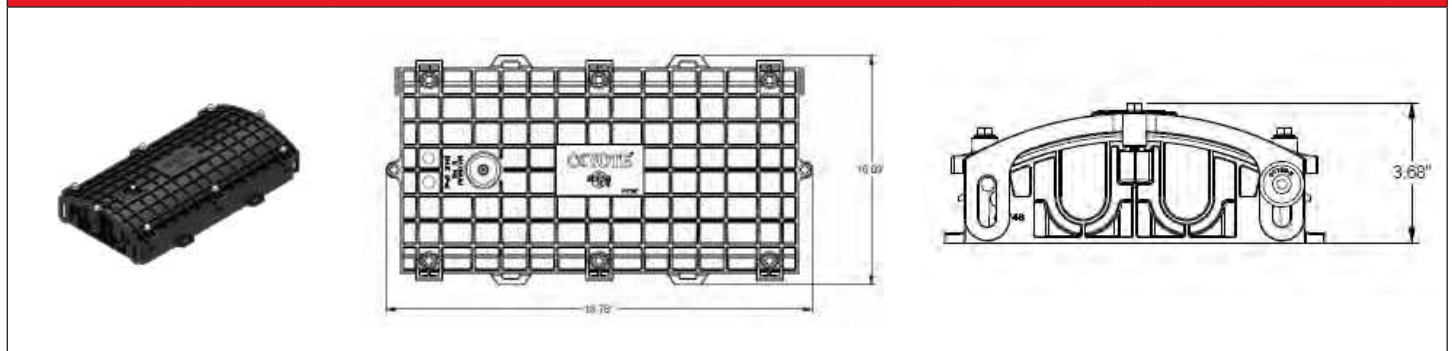



COYOTE® FIBER OPTICS for Verizon

COYOTE® ONE Dome Closure															
PLP Part Number	Verizon SSI Code	Component Breakdown	Closure Capabilities												
COYOTE1002	11280571 MMID 10796958	<p>COYOTE® ONE Dome Closure for Buffer Tube or Ribbon, Universal Organizer – Equipped With: (1) COYOTE ONE Dome End Plate with Organizer, Universal, (1) Dome, (1) Gasket, (1) Collar, (1) Transition Tube Kit Consisting of: (1) 0.135" ID x 25" Long Tube, (1) 0.170" ID x 25" Long Tube and (1) 0.25" ID x 25" Long Tube, (3) Short Strength Member Brackets, (2) 2-Hole Grommets 0.42"-0.60", and (1) 6-Hole Grommet 0.125"-0.250" and Flat Drop Cable</p> 	<table border="1"> <tr> <td>Max Splice Capacity</td> <td>96 SF 288 MF</td> <td>Port Quantity</td> <td>3</td> </tr> <tr> <td>Express: Ribbons</td> <td>24</td> <td>Ground Studs</td> <td>3</td> </tr> <tr> <td>Max Trays 80809958, 80808250, 80808945,</td> <td>3, 2, 2, 2</td> <td colspan="2">Above & Below Grade Application</td> </tr> </table>	Max Splice Capacity	96 SF 288 MF	Port Quantity	3	Express: Ribbons	24	Ground Studs	3	Max Trays 80809958, 80808250, 80808945,	3, 2, 2, 2	Above & Below Grade Application	
			Max Splice Capacity	96 SF 288 MF	Port Quantity	3									
			Express: Ribbons	24	Ground Studs	3									
Max Trays 80809958, 80808250, 80808945,	3, 2, 2, 2	Above & Below Grade Application													

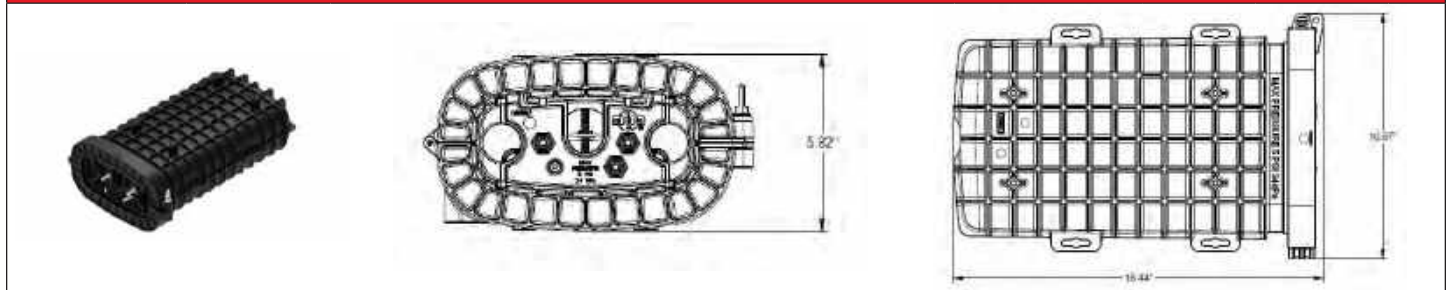
Technical Specifications of the COYOTE ONE Dome Closure



COYOTE® FIBER OPTICS for Verizon

COYOTE® 6.5" x 17" Dome Closure						
PLP Part Number	Verizon SSI Code	Component Breakdown	Closure Capabilities			
COYOTE8217B	11016543	<p>6.5" x 17" COYOTE® Dome Closure for Single Fusion, Buffer Tube Organizer – Equipped With: (1) COYOTE Dome 6.5" x 17" End Plate Organizer, Buffer Tube, (1) Dome, (1) Gasket, (1) Collar, (2) Long Strength Member Brackets, (2) Short Strength Member Brackets, (2) 1-Hole Grommets 0.40"-0.60", (2) 1-Hole Grommets 0.60"-0.85", (1) 6-Hole Grommet 0.125"-0.250" and Flat Drop Cable, (1) 80811337 LITE-GRIP® Deep-Profile, Short, Splice Tray, and (1) Universal Mounting Bracket</p> 	Max Splice Capacity	144 SF	Port Quantity	4
			Express: Buffer Tubes	16	Ground Studs	4
			Max Trays 80811337	3	Above & Below Grade Application	
COYOTE8217U	11016544 MMID 10796940	<p>6.5" x 17" COYOTE® Dome Closure for Ribbon, Shallow Slack Basket – Equipped With: (1) COYOTE Dome 6.5" x 17" End Plate Organizer, Shallow Slack Basket, (1) Dome, (1) Gasket, (1) Collar, (2) Transition Tube Kit Consisting of: (1) 0.250" ID x 25" Long Tube, (2) Long Strength Member Brackets, (2) Short Strength Member Brackets, (2) 1-Hole Grommets 0.40"-0.60", (2) 1-Hole Grommets 0.60"-0.85", (1) 6-Hole Grommet 0.125"-0.250" and Flat Drop Cable, (1) 80808250 LITE-GRIP® Deep-Profile, Short, Splice Tray, 12 Ct. and (1) Universal Mounting Bracket</p> 	Max Splice Capacity	144 SF 432 MF	Port Quantity	4
			Express: Ribbons	24	Ground Studs	4
			Max Trays 80808250	3	Above & Below Grade Application	



COYOTE® FIBER OPTICS for Verizon

COYOTE® 6.5" x 17" Dome Closure					
PLP Part Number	Verizon SSI Code	Component Breakdown	Closure Capabilities		
COYOTE8235XU	11053699 MMID 10796984	6.5" x 17" COYOTE® Dome Closure for Ribbon, Expanded Slack Basket – Equipped With: (1) COYOTE Dome 6.5" x 17" End Plate Organizer, Expanded Slack Basket, (1) Dome, (1) Gasket, (1) Collar, (2) Transition Tube Kits Consisting of: (1) 0.250" ID x 25" Long Tube, (2) Long Strength Member Brackets, (2) Short Strength Member Brackets, (2) 1-Hole Grommets 0.40"-0.60", (2) 1-Hole Grommets 0.60"-0.85", (1) 6-Hole Grommet 0.125"-0.250" and Flat Drop Cable, (1) 80811337 LITE-GRIP® Deep-Profile, Short, Splice Tray, and (1) Universal Mounting Bracket	Max Splice Capacity	96 SF 288 MF	Port Quantity 4
			Express: Ribbons	24	Ground Studs 4
			Max Trays 80811337	2	Above & Below Grade Application
COYOTE8805U	11073954 MMID 10796993	Flame Retardant 6.5" x 17" COYOTE® Dome Closure for Buffer Tube or Ribbon, Shallow Slack Basket – Equipped With: (1) COYOTE Dome 6.5" x 17" End Plate Organizer, Shallow Slack Basket, (1) Dome, (1) Gasket, (1) Collar, (2) Transition Tube Kits Consisting of: (1) 0.250" ID x 25" Long Tube, (2) Long Strength Member Brackets, (2) Short Strength Member Brackets, (2) 1-Hole Grommets 0.40"-0.60", (2) 1-Hole Grommets 0.60"-0.85", (1) 6-Hole Grommet 0.125"-0.250" and Flat Drop Cable, (1) 80808250 LITE-GRIP Deep-Profile, Short, Splice Tray, 12 Ct., and (1) Universal Mounting Bracket	Max Splice Capacity	144 SF 432 MF	Port Quantity 4
			Express: Ribbons Buffer Tubes	24 16	Ground Studs 4
			Max Trays 80808250	3	Indoor Use Only

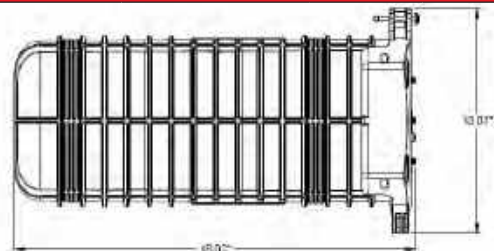
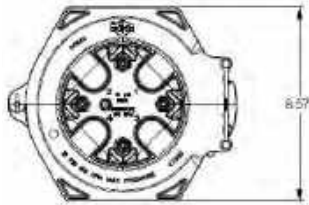

Technical Specifications of the COYOTE 6.5" x 17" Dome Closure



COYOTE® FIBER OPTICS for Verizon

COYOTE® 6.5" x 22" Dome Closure						
PLP Part Number	Verizon SSI Code	Component Breakdown	Closure Capabilities			
COYOTE8218B	11016541 MMID 10796960	<p>6.5" x 22" COYOTE® Dome Closure for Single Fusion, Buffer Tube Organizer – Equipped With: (1) COYOTE Dome 6.5" x 22" End Plate Organizer, Buffer Tube, (1) Dome, (1) Gasket, (1) Collar, (2) Long Strength Member Brackets, (2) Short Strength Member Brackets, (2) 1-Hole Grommets 0.40"-0.60", (2) 1-Hole Grommets 0.60"-0.85", (1) 6-Hole Grommet 0.125"-0.250" and Flat Drop Cable, (1) 80808251 LITE-GRIP® Deep-Profile, Long, Splice Tray, 36 Ct. and (1) Universal Mounting Bracket</p> 	Max Splice Capacity	240 SF	Port Quantity	4
			Express: Buffer Tubes	24	Ground Studs	4
			Max Trays 80808251	3	Above & Below Grade Application	
COYOTE8218U	11016542 MMID 10796961	<p>6.5" x 22" COYOTE® Dome Closure for Ribbon, Shallow Slack Basket – Equipped With: (1) COYOTE Dome 6.5" x 22" End Plate Organizer, Shallow Slack Basket, (1) Dome, (1) Gasket, (1) Collar, (2) Transition Tube Kit Consisting of: (1) 0.250" ID x 25" Long Tube, (2) Long Strength Member Brackets, (2) Short Strength Member Brackets, (2) 1-Hole Grommets 0.40"-0.60", (2) 1-Hole Grommets 0.60"-0.85", (1) 6-Hole Grommet 0.125"-0.250" and Flat Drop Cable, (1) 80811338 LITE-GRIP Deep-Profile, Long, Splice Tray, and (1) Universal Mounting Bracket</p> 	Max Splice Capacity	240 SF 648 MF	Port Quantity	4
			Express: Ribbons	36	Ground Studs	4
			Max Trays 80811338	3	Above & Below Grade Application	

COYOTE® FIBER OPTICS for Verizon

COYOTE® 6.5" x 22" Dome Closure						
PLP Part Number	Verizon SSI Code	Component Breakdown	Closure Capabilities			
COYO-TE8240XU	11053700 MMID 10796983	<p>6.5" x 22" COYOTE® Dome Closure for Ribbon, Expanded Slack Basket – Equipped With: (1) COYOTE Dome 6.5" x 22" End Plate Organizer, Expanded Slack Basket, (1) Dome, (1) Gasket, (1) Collar, (2) Transition Tube Kits Consisting of: (1) 0.250" ID x 25" Long Tube, (2) Long Strength Member Brackets, (2) Short Strength Member Brackets, (2) 1-Hole Grommets 0.40"-0.60", (2) 1-Hole Grommets 0.60"-0.85", (1) 6-Hole Grommet 0.125"-0.250" and Flat Drop Cable, (1) 80811338 LITE-GRIP® Deep-Profile, Long, Splice Tray, and (1) Universal Mounting Bracket</p> 	Max Splice Capacity	160 SF 432 MF	Port Quantity	4
			Express: Ribbons	36	Ground Studs	4
			Max Trays 80811338	2	Above & Below Grade Application	
COYOTE8806U	11073953 MMID 10796941	<p>Flame Retardant 6.5" x 22" COYOTE® Dome Closure for Buffer Tube or Ribbon, Shallow Slack Basket – Equipped With: (1) COYOTE Dome 6.5" x 22" End Plate Organizer, Shallow Slack Basket, (1) Dome, (1) Gasket, (1) Collar, (2) Transition Tube Kits Consisting of: (1) 0.250" ID x 25" Long Tube, (2) Long Strength Member Brackets, (2) Short Strength Member Brackets, (2) 1-Hole Grommets 0.40"-0.60", (2) 1-Hole Grommets 0.60"-0.85", (1) 12-Hole Grommet Flat Drop Cable Only, (1) 80808251 LITE-GRIP Deep-Profile, Long, Splice Tray, 36 Ct., and (1) Universal Mounting Bracket</p> 	Max Splice Capacity	240 SF 648 MF	Port Quantity	4
			Express: Ribbons Buffer Tubes	36 24	Ground Studs	4
			Max Trays 80808251	3	Indoor Use Only	

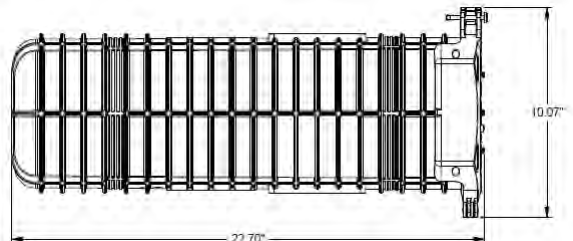
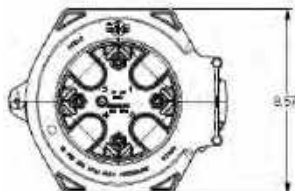

Technical Specifications of the COYOTE 6.5" x 22" Dome Closure



COYOTE® FIBER OPTICS for Verizon

COYOTE® 9.5" x 19" Dome Closure						
PLP Part Number	Verizon SSI Code	Component Breakdown	Closure Capabilities			
COYOTE8300B	11182594 MMID 10825617	<p>9.5" x 19" COYOTE® Dome Closure for Single Fusion, Buffer Tube Organizer – Equipped With: (1) COYOTE Dome 9.5" x 19" End Plate Organizer, Buffer Tube, (1) Dome, (1) Gasket, (1) Collar, (1) Spiral Tube Kit Consisting of: (1) 0.375" OD x 36" Long Tube, (2) Long Strength Member Brackets, (2) Short Strength Member Brackets, (2) 2-Hole Grommets 0.42"-0.60", (2) 1-Hole Grommets 1.00"-1.25", and (1) 80808945 LITE-GRIP® Deep-Profile, Short, Splice Tray, 40 Ct.</p> 	Max Splice Capacity	288 SF	Port Quantity	7
			Express: Buffer Tubes	36	Ground Studs	7
			Max Trays 80808945	6	Above & Below Grade Application	
COYOTE8300U	11182595 MMID 10796964	<p>9.5" x 19" COYOTE® Dome Closure for Ribbon, Shallow Slack Basket – Equipped With: (1) COYOTE Dome 9.5" x 19" End Plate Organizer, Shallow Slack Basket, (1) Dome, (1) Gasket, (1) Collar, (1) Transition Tube Kit Consisting of: (1) 0.250" ID x 25" Long Tube, (1) Spiral Tube Kit Consisting of: (1) 0.375" OD x 36" Long Tube, (2) Long Strength Member Brackets, (2) Short Strength Member Brackets, (2) 2-Hole Grommets 0.42"-0.60", (2) 1-Hole Grommets 1.00"-1.25", and (1) LGSTR144 LITE-GRIP® Deep-Profile, Short, Splice Tray, 144 Ct.</p> 	Max Splice Capacity	864 MF	Port Quantity	7
			Express: Ribbons	24	Ground Studs	7
			Max Trays LGSTR144	6	Above & Below Grade Application	
Technical Specifications of the COYOTE 9.5" x 19" Dome Closure						
						



COYOTE® FIBER OPTICS for Verizon

COYOTE® 9.5" x 28" Dome Closure						
PLP Part Number	Verizon SSI Code	Component Breakdown	Closure Capabilities			
COYOTE8219XU	11062231 MMID 10796974	<p>9.5" x 28" COYOTE® Dome Closure for Ribbon, Shallow Slack Basket – Equipped With: (1) COYOTE Dome 9.5" x 28" End Plate Organizer, Shallow Slack Basket, (1) Dome, (1) Gasket, (1) Collar, (1) Transition Tube Kit Consisting of: (1) 0.250" ID x 25" Long Tube, (1) Spiral Tube Kit Consisting of: (1) 0.375" OD x 36" Long Tube, (4) Long Strength Member Brackets, (2) 2-Hole Grommets 0.42"-0.60", (2) 1-Hole Grommets 1.00"-1.25", and (1) LGSTR216 LITE-GRIP® Deep-Profile, Long, Splice Tray, 216 Ct.</p> 	Max Splice Capacity	1728 MF	Port Quantity	7
			Express: Ribbons	36	Ground Studs	7
			Max Trays LGSTR216	8	Above & Below Grade Application	
800016107	11362868 MMID 10830367	<p>9.5" x 28" COYOTE® Dome Closure for Ribbon, Deep Metal Slack Basket – Equipped With: (1) COYOTE Dome 9.5" x 28" End Plate Organizer, Deep Metal Slack Basket, (1) Dome, (1) Gasket, (1) Collar, (1) Transport Tube Kit Consisting of: (6) 0.250" ID x 36" Long Tubes, (1) Spiral Tube Kit Consisting of: (12) 0.375" OD x 20" Long Tubes, (4) Long Strength Member Brackets, (2) 2-Hole Grommets 0.42"-0.60", (1) 1-Hole Grommet 0.60"-0.85", (2) 1-Hole Grommets 0.85"-1.00", (2) 1-Hole Grommets 1.00"-1.25", and (1) LGSTR216 LITE-GRIP Deep-Profile, Long, Splice Tray, 216 Ct.</p> 	Max Splice Capacity	1080 MF	Port Quantity	7
			Express: Ribbons	72	Ground Studs	7
			Max Trays LGSTR216	5	Above & Below Grade Application	

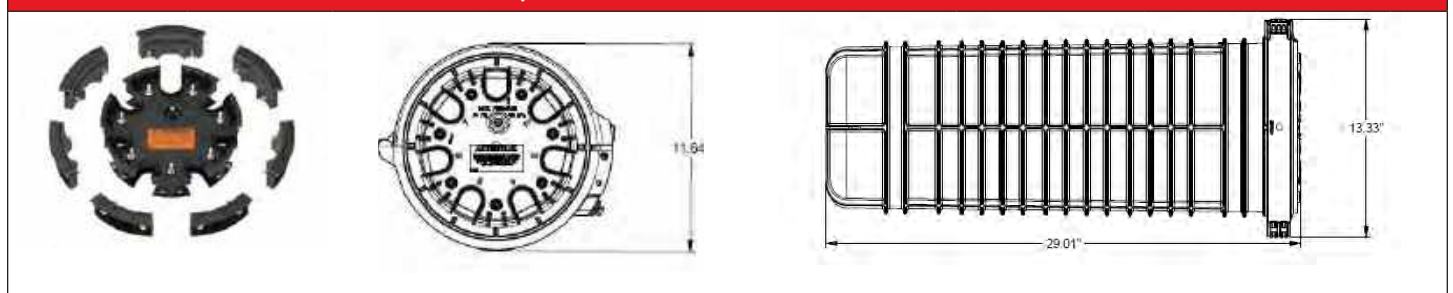
Technical Specifications of the COYOTE 9.5" x 28" Dome Closure





COYOTE® FIBER OPTICS for Verizon

COYOTE® HD (High-Density) Dome Closure for Ribbon						
PLP Part Number	Verizon SSI Code	Component Breakdown	Closure Capabilities			
800016003	11360971 MMID 10825636	<p>COYOTE® HD (High-Density) Dome Closure for Ribbon, No Basket for Cables Less Than 1.25" OD – Equipped With: (1) COYOTE HD Dome End Plate Organizer, No Basket, (1) Dome, (1) Gasket, (1) Collar, (1) Split Braided Sleeving Kit Consisting of: (12) 0.375" ID x 20" Long Tubes, (4) Long Strength Member Brackets, (2) Extended Strength Member Brackets for Large Central Strength Members, (2) 1-Hole Grommets 0.60"-0.85", (2) 1-Hole Grommets 0.85"-1.00", and (2) 1-Hole Grommets 1.00"-1.25"</p> 	Max Splice Capacity	1728 MF 3456 CR ¹	Port Quantity	7
					Ground Studs	7
			Max Trays 80813121, 80813122 ²	6, 12	Above & Below Grade Application	
800016004	11360972 MMID 10825626	<p>COYOTE® HD (High-Density) Dome Closure for Ribbon, Shallow Slack Basket for Cables Less Than 1.25" OD – Equipped With: (1) COYOTE HD Dome End Plate Organizer, Shallow Slack Basket, (1) Dome, (1) Gasket, (1) Collar, (1) Split Braided Sleeving Kit Consisting of: (12) 0.375" ID x 20" Long Tubes, (1) Transport Tube Kit Consisting of: (6) 0.25" ID x 36" Long Tubes, (4) Long Strength Member Brackets, (2) Extended Strength Member Brackets for Large Central Strength Members, (2) 1-Hole Grommets 0.60"-0.85", (2) 1-Hole Grommets 0.85"-1.00", and (2) 1-Hole Grommets 1.00"-1.25"</p> 	Max Splice Capacity	1152 MF 2304 CR ¹	Port Quantity	7
					Ground Studs	7
			Max Trays 80813121, 80813122 ²	4, 8	Above & Below Grade Application	

¹ CR is an abbreviation for Collapsible Ribbon

² The 80813122 thin-profile splice tray can only be used for cables that contain SpiderWeb Ribbon (SWR®) – AFL, Rollable Ribbon (RR) – OFS, Pliable Ribbon – Sumitomo, or FlexRibbon™ – Prysmian FlexRibbon™ is a registered trademark of Prysmian. SWR® is a registered trademark of AFL. Rollable Ribbon is a registered trademark of OFS Fitel, LLC.

COYOTE® FIBER OPTICS for Verizon

COYOTE® HD (High-Density) Dome Closure for Ribbon						
PLP Part Number	Verizon SSI Code	Component Breakdown	Closure Capabilities			
800016005	11360973 MMID 10825627	<p>COYOTE® HD (High-Density) Dome Closure for Ribbon, No Basket for Cables Greater Than 1.25" OD – Equipped With: (1) COYOTE HD Dome End Plate Organizer, No Basket, (1) Dome, (1) Gasket, (1) Collar, (1) Split Braided Sleeving Kit Consisting of: (12) 0.375" ID x 20" Long Tubes, (4) Long Strength Member Brackets, (2) Extended Strength Member Brackets for Large Central Strength Members, (2) 1-Hole Grommets 0.60"-0.85", (2) 1-Hole Grommets 0.85"-1.00", (2) 1-Hole Grommets 1.00"-1.25", and (2) 1-Hole Grommets 1.25"-1.38"</p> 	Max Splice Capacity	1728 MF 3456 CR ¹	Port Quantity	7
			Ground Studs		7	
			Max Trays 80813121, 80813122 ²	6, 12	Above & Below Grade Application	
800016006	11360974 MMID 10825637	<p>COYOTE® HD (High-Density) Dome Closure for Ribbon, Shallow Slack Basket for Cables Greater Than 1.25" OD – Equipped With: (1) COYOTE HD Dome End Plate Organizer, Shallow Slack Basket, (1) Dome, (1) Gasket, (1) Collar, (1) Split Braided Sleeving Kit Consisting of: (12) 0.375" ID x 20" Long Tubes, (1) Transport Tube Kit Consisting of: (6) 0.25" ID x 36" Long Tubes, (4) Long Strength Member Brackets, (2) Extended Strength Member Brackets for Large Central Strength Members, (2) 1-Hole Grommets 0.60"-0.85", (2) 1-Hole Grommets 0.85"-1.00", (2) 1-Hole Grommets 1.00"-1.25", and (2) 1-Hole Grommets 1.25"-1.38"</p> 	Max Splice Capacity	1152 MF 2304 CR ¹	Port Quantity	7
			Ground Studs		7	
			Max Trays 80813121, 80813122 ²	4, 8	Above & Below Grade Application	

¹ CR is an abbreviation for Collapsible Ribbon

² The 80813122 thin-profile splice tray can only be used for cables that contain SpiderWeb Ribbon (SWR®) – AFL, Rollable Ribbon (RR) – OFS, Pliable Ribbon – Sumitomo, or FlexRibbon™ – Prysmian FlexRibbon™ is a registered trademark of Prysmian. SWR® is a registered trademark of AFL. Rollable Ribbon is a registered trademark of OFS Fitel, LLC.

COYOTE® FIBER OPTICS for Verizon

COYOTE® HD (High-Density) Dome Closure for Ribbon									
PLP Part Number	Verizon SSI Code	Component Breakdown	Closure Capabilities						
800016381	11368447 MMID 10853149	<p>COYOTE® HD (High-Density) Dome Closure for Ribbon, Deep Metal Slack Basket for Cables Less Than 1.25" OD – Equipped With: (1) COYOTE HD Dome End Plate Organizer, Deep Metal Slack Basket, (1) Dome, (1) Gasket, (1) Collar, (1) Split Braided Sleeving Kit Consisting of: (12) 0.375" ID x 20" Long Tubes, (4) Long Strength Member Brackets, (2) Extended Strength Member Brackets for Large Central Strength Members, (2) 1-Hole Grommets 0.40"-0.60", (2) 1-Hole Grommets 0.60"-0.85", (2) 1-Hole Grommets 0.85"-1.00", (2) 1-Hole Grommets 1.00"-1.25", (3) 80813121 COYOTE HD Deep-Profile Splice Tray, 288 Ct., and (1) Universal Mounting Bracket</p> <p>End Plate Organizer with Deep Traction Tray (1) Dome (1) Universal Mounting Hanger Bracket Kit (1) Gasket (1) Collar (1) 1 Hole Grommet Kit (1.40"-0.60" Cable Diameter) - Contains 1 Grommet (2) 1 Hole Grommet Kit (0.60"-0.85" Cable Diameter) - Contains 2 Grommets (1) High Density Dome Seal Patch Bag (1) Split Braided Sleeving Kit - Contains 12 Pieces, 20" Long (1) 1 Hole Grommet Kit (0.85"-1.00" Cable Diameter) - Contains 2 Grommets (1) 1 Hole Grommet Kit (1.00"-1.25" Cable Diameter) - Contains 2 Grommets (1) Long Deep Profile 288ct HD Flip Splice Tray (3) Seal Patch Bag (1)</p>	<table border="1"> <tr> <td rowspan="2">Max Splice Capacity</td> <td rowspan="2">864 MF</td> <td>Port Quantity</td> <td>7</td> </tr> <tr> <td>Ground Studs</td> <td>7</td> </tr> </table>	Max Splice Capacity	864 MF	Port Quantity	7	Ground Studs	7
			Max Splice Capacity			864 MF	Port Quantity	7	
Ground Studs	7								
Max Trays 80813121	3	Above & Below Grade Application							

Technical Specifications of the COYOTE HD (High-Density) Dome Closure

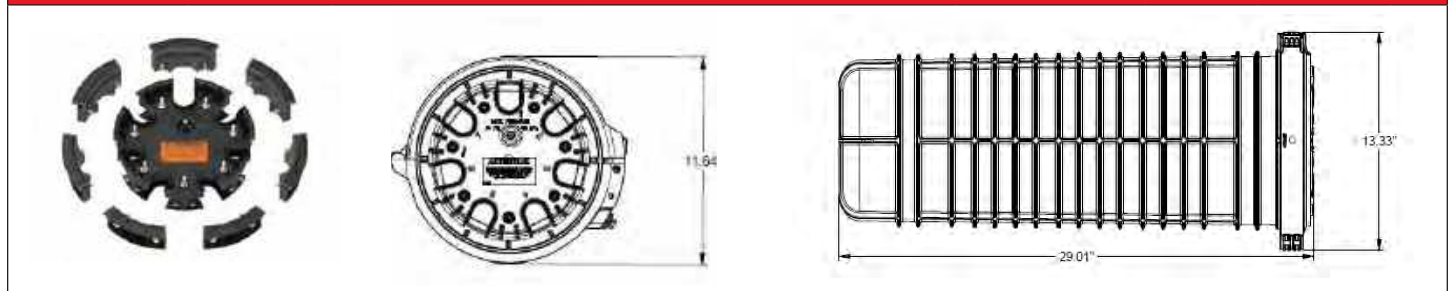







COYOTE® FIBER OPTICS for Verizon

COYOTE® HD (High-Density) Dome Closure Splice Trays			
PLP Part Number	Verizon SSI Code	Description	Visual Depiction
80813121	11360975 MMID 10825652	COYOTE HD Deep-Profile Flip Tray, 288 Ct. Mass Fusion for the COYOTE HD (High-Density) Dome Closure Only	
80813122 ¹	11360976 MMID 10825645	COYOTE HD Thin-Profile Flip Tray, 288 Ct. Mass Fusion for the COYOTE HD (High-Density) Dome Closure Only. Can only be used with OFS Rollable Ribbon, Sumitomo Pliable Ribbon, AFL SpiderWeb Ribbon, or Prysmian FlexRibbon™ Cables.	
80813123 ¹	11365924 MMID 10836424	COYOTE HD Thin-Profile Flip Tray, 72 Ct. Single Fusion for the COYOTE HD (High-Density) Dome Closure Only	
80813301 ¹	11365923 MMID 10836433	COYOTE HD Thin-Profile Flip Tray, 108 Ct. Single Fusion for the COYOTE HD (High-Density) Dome Closure Only	
80813362	11363952 MMID 10830557	Splice Block Kit – Includes (6) 12 Ct. Single Fusion Splice Blocks to be used in the COYOTE HD Splice Trays, 80813121, 80813122, 80813123, and 80813301.	
COYOTE HD (High-Density) Accessories			
80813267	11360977 MMID 10825649	Deep Transition Tray Kit for up to 864 Expressed Ribbon Applications for the COYOTE HD Dome Closure Only	
80061500	MMID 10838907	COYOTE HD Breakout Kit for Unitube Cables. Compatible with Unitube cables up to 864F. Note this kit can be used in the following catalog numbers: COYOTE8219XU, 800016107, 800016003, 800016004, 800016005, 800016006, and 800016381.	
8004154	11360978 MMID 10825629	125' Spool of Braided Expandable Sleeving, 3/8" Diameter, Blue	
8004155	11360979 MMID 10825630	125' Spool of Braided Expandable Sleeving, 3/8" Diameter, Orange	
8004156	11360980 MMID 10825642	125' Spool of Braided Expandable Sleeving, 3/8" Diameter, Green	
8004157	11360981 MMID 10825643	125' Spool of Braided Expandable Sleeving, 3/8" Diameter, Brown	
8004158	11360982 MMID 10825639	125' Spool of Braided Expandable Sleeving, 3/8" Diameter, Slate	
8004159	11360983 MMID 10825644	125' Spool of Braided Expandable Sleeving, 3/8" Diameter, White	

¹ The 80813122, 80813123 and 80813301 thin-profile splice trays can only be used for cables that contain SpiderWeb Ribbon (SWR®) – AFL, Rollable Ribbon (RR) – OFS, Pliable Ribbon – Sumitomo, or FlexRibbon™ – Prysmian FlexRibbon™ is a registered trademark of Prysmian. SWR® is a registered trademark of AFL. Rollable Ribbon is a registered trademark of OFS Fitel, LLC.

COYOTE[®] FIBER OPTICS for Verizon

COYOTE HD (High-Density) Accessories			
PLP Part Number	Verizon SSI Code	Description	Visual Depiction
8004174	11372376 MMID 10862105	100' Spool of Split Wrap, 3/8" Diameter, Blue	
8004175	11372375 MMID 10862154	100' Spool of Split Wrap, 3/8" Diameter, Orange	
8004176	11372374 MMID 10862147	100' Spool of Split Wrap, 3/8" Diameter, Green	
8004177	11372373 MMID 10862153	100' Spool of Split Wrap, 3/8" Diameter, Brown	
8004178	11372372 MMID 10862106	100' Spool of Split Wrap, 3/8" Diameter, Slate	
8004167	11371760 MMID 10862164	100' Spool of Split Wrap, 3/8" Diameter, White	
8004168	11371759 MMID 10862165	100' Spool of Split Wrap, 3/8" Diameter, Black	
80813518	11371758 MMID 10862166	Wire Loom Insertion Tool for Split Wrap	
80812881	11328393 MMID 10796957	100' Roll of 0.50" ID Spiral Wrap Tubing	
80813124	11360984 MMID 10825601	Splice Tray Locking Pin Kit – Includes (5) Tray Locking Pins – Used for locking tray stacks in place. Will be a consumable due to the clipping of the lock pin to match tray stack height. For the COYOTE HD Dome Closure Only	
80813125	11360985 MMID 10825648	Splice Tray Tether Kit – Includes (6) Splice Tray Tether Straps – Used for additional support of splice trays when in a hinged position. For the COYOTE HD Dome Closure Only	

COYOTE® FIBER OPTICS for Verizon

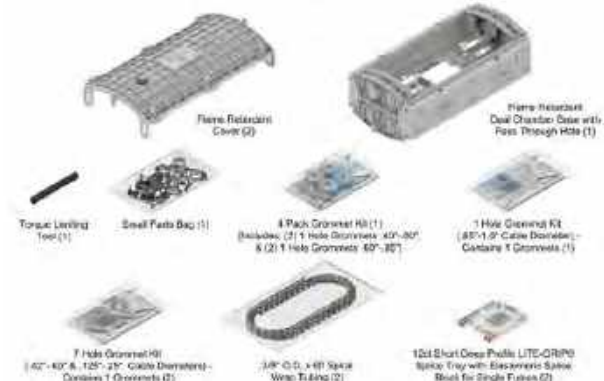
COYOTE® Dual Chamber Closure															
PLP Part Number	Verizon SSI Code	Component Breakdown	Closure Capabilities												
COYOTE8803	11053701 MMID 10796976	<p>Flame Retardant COYOTE® Dual Chamber Closure for Buffer Tube or Ribbon – Equipped With: (1) COYOTE Dual Chamber Closure Assembly with Integrated Cable Restraint Hardware and Pass Through Hole, (1) 1-Hole Grommets 0.40"-0.60", (2) 1-Hole Grommets 0.60"-0.85", (1) 1-Hole Grommet 0.85"-1.00", (2) 7-Hole Grommet 0.42"-0.60" & 0.125"-0.250" and Flat Drop Cable, (2) Spiral Tubing Kits Consisting of: (1) 0.375" ID x 72" Long Tube, (1) Torque Limiting Tool, and (2) 80808250 LITE-GRIP®, Deep-Profile, Short, Splice Tray, 12 Ct.</p>  <p>The diagram shows various components: Flame Retardant Cover (2), Flame Retardant Dual Chamber Case with Pass Through Hole (1), Torque Limiting Tool (1), Small Parts Bag (1), 8 Pack Grommet Kit (1) (Includes: (2) 1 Hole Grommets: 40"-60" & (2) 1 Hole Grommets: 60"-80"), 1 Hole Grommet Kit (80"-100" Cable Bundles) Containing 1 Grommet (1), 7 Hole Grommet Kit (40"-100" & 125"-250" Cable Bundles) Containing 1 Grommet (2), 1/8" O.D. x 48" Spiral Wire Tubing (2), and 12ct Short Deep Profile LITE-GRIP® Splice Tray with Backwards Slotted Side for Single Fibers (2).</p>	<table border="1"> <tr> <td>Max Splice Capacity</td> <td>192 SF 432 MF</td> <td>Port Quantity</td> <td>8</td> </tr> <tr> <td>Express: Ribbons Buffer Tubes</td> <td>18 8</td> <td>Ground Studs</td> <td>0</td> </tr> <tr> <td>Max Trays 80808250</td> <td>4</td> <td colspan="2">Indoor Use Only</td> </tr> </table>	Max Splice Capacity	192 SF 432 MF	Port Quantity	8	Express: Ribbons Buffer Tubes	18 8	Ground Studs	0	Max Trays 80808250	4	Indoor Use Only	
			Max Splice Capacity	192 SF 432 MF	Port Quantity	8									
			Express: Ribbons Buffer Tubes	18 8	Ground Studs	0									
Max Trays 80808250	4	Indoor Use Only													

Technical Specifications of the COYOTE Dual Chamber Closure

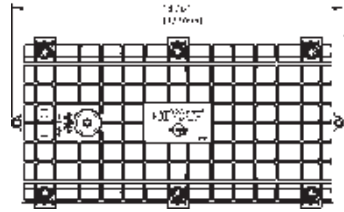
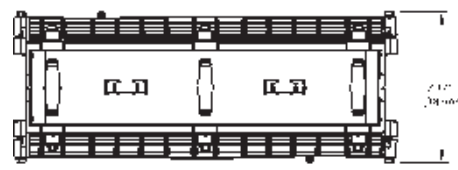





DUAL Chamber Closure with LITE-GRIP® Splice with 2 Standard Covers

COYOTE® FIBER OPTICS for Verizon

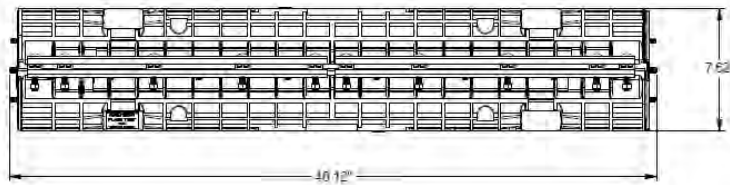
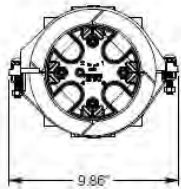
COYOTE® Taut Closure							
PLP Part Number	Verizon SSI Code	Component Breakdown	Closure Capabilities				
COYOTE8700	353803 MMID 10825664	<p>COYOTE® Taut Closure for Buffer Tube – Equipped With: (1) COYOTE 6.5" End Plate with Organizer, (2) 6.5" x 38" Shell Halves, (1) Bolt Bar Assembly, (2) 1-Hole Grommets 0.40"-0.60", (2) 1-Hole Grommets 0.60"-0.85", (2) Ground Wire Assemblies, (1) Aerial Hanger Bracket and Cable Restraint Hardware</p> 	<table border="1"> <tr> <td>Max Splice Capacity</td> <td>12 SF</td> <td>Port Quantity</td> <td>8</td> </tr> </table>	Max Splice Capacity	12 SF	Port Quantity	8
			Max Splice Capacity	12 SF	Port Quantity	8	
			<table border="1"> <tr> <td>Applications</td> <td>In-Line or Butt</td> <td>Ground Studs</td> <td>8</td> </tr> </table>	Applications	In-Line or Butt	Ground Studs	8
Applications	In-Line or Butt	Ground Studs	8				
Above Grade Only							

Technical Specifications of the COYOTE Taut Closure



COYOTE® Vault Splice Case 9.5" x 28"			
COYOTE8230UB	11023378	<p>Flame Retardant 9.5" x 28" COYOTE® Vault Splice Case for Buffer Tube or Ribbon – Equipped With: (2) 9.5" x 28" Shell Halves, (1) Organizer, (1) 9.5" Flame Retardant 2-Section Drillable End Plate, (1) 9.5" Flame Retardant 4-Section Drillable End Plate Kit, (1) Transport Tube Kit Consisting of: (1) 0.250" ID x 100' Long Tube, (6) Strength Member Brackets, (1) Tube of Silicone, and (6) 80808251 LITE-GRIP® Deep-Profile, Long, Splice Tray, 36 Ct.</p> <p>(Factory predrilled for 864 Ct. fiber cable end plates are available. Closure is designed for one 864 Ct. fiber cable and four 216 Ct. or 144 Ct. tip cables)</p>	

COYOTE® FIBER OPTICS for Verizon

COYOTE® Closure Silicone Grommets			
PLP Part Number	Verizon SSI Code	Description	Visual Depiction
8003691	11023365 MMID 10778898	1-Hole Silicone Grommet 0.40"-0.60" Cable Diameter Range	
8003692	11023366 MMID 10778915	1-Hole Silicone Grommet 0.60"-0.85" Cable Diameter Range	
8003693	11023367 MMID 10778897	1-Hole Silicone Grommet 0.85"-1.00" Cable Diameter Range	
8003694	11023425 MMID 10778906	1-Hole Silicone Grommet 1.00"-1.25" Cable Diameter Range	
8003663	11017879 MMID 10796921	2-Hole Silicone Grommet 0.42"-0.60" Cable Diameter Range	
8003664	11017880 MMID 10796972	4-Hole Silicone Grommet 0.30"-0.43" Cable Diameter Range	
8003665	11016545 MMID 10796947	6-Hole Silicone Grommet 0.125"-0.250" Cable Diameter Range & Flat Drop Cable	
8003676	11023362 MMID 10796937	7-Hole Silicone Grommet (1-Hole: 0.42"-0.60" Cable Diameter Range and 6-Holes: 0.125"-0.250" Cable Diameter Range & Flat Drop Cable)	
8003677	11023363 MMID 10796954	8-Hole Silicone Grommet 0.125"-0.250" Cable Diameter Range & Flat Drop Cable	
8004122	11360987 MMID 10825638	2-Hole Silicone Grommet for RPX Cable Only – For use in the COYOTE ONE, 6.5" & 9.5" Dome Closures	
8004152	11360986 MMID 10825628	3-Hole Silicone Grommet for RPX Cable and 0.125"-0.250" Cable Diameter Range & Flat Drop Cable – For use in the COYOTE LCC for Aerial Applications Only	
COYOTE Closure Splice Trays			
80809958	11315013 MMID 10778877	COYOTE LITE-GRIP® Short Low Profile Splice Tray for Single Fusion Splices, 24 Ct.	
80808250	11036252 MMID 10796949	COYOTE LITE-GRIP Short Deep Profile Splice Tray for Single Fusion Splices, 12 Ct.	
LGSTS16	11053702 MMID 10797002	COYOTE LITE-GRIP Short Deep Profile Splice Tray for Double Stacked Single Fusion Splices, 16 Ct.	
80808945	11372254 MMID 10862148	COYOTE LITE-GRIP Short Deep Profile Splice Tray for Double Stacked Single Fusion Splices, 40 Ct.	
LGSTR144	11053704 MMID 10796995	COYOTE LITE-GRIP Short Deep Profile Splice Tray for Mass Fusion Splices, 144 Ct.	
80810086	11315012 MMID 10778876	COYOTE LITE-GRIP Long Standard Profile Splice Tray for Single Fusion Splices, 36 Ct.	
80808251	11036251 MMID 10778907	COYOTE LITE-GRIP Long Deep Profile Splice Tray for Single Fusion Splices, 36 Ct.	

COYOTE® FIBER OPTICS for Verizon

COYOTE Closure Splice Trays (Continued)			
PLP Part Number	Verizon SSI Code	Description	Visual Depiction
LGSTS40	11053703 MMID 10796988	COYOTE LITE-GRIP® Long Deep Profile Splice Tray for Double Stacked Single Fusion Splices, 40 Ct.	
LGSTS72	11372255 MMID 10862149	COYOTE LITE-GRIP Long Deep Profile Splice Tray for Double Stacked Single Fusion Splices, 72 Ct.	
LGSTR216	11053705 MMID 10796989	COYOTE LITE-GRIP Long Deep Profile Splice Tray for Mass Fusion Splices, 216 Ct.	
800012909	11073249 MMID 10796889	Universal Short Splice Tray	
800012908	11073248 MMID 10796927	Universal Long Splice Tray	
80807701	11019290 MMID 10796953	COYOTE Legacy Short Low Profile Splice Tray for Single Fusion Splices, 12 Ct.	
80806033	586929 MMID 10560673	COYOTE Legacy Short Standard Profile Splice Tray for Single Fusion Splices, 12 Ct.	
80807114	926711 MMID 10796931	COYOTE Legacy Short Deep Profile Splice Tray for Mass Fusion Splices, 72 Ct.	
80805514	87016617 MMID 10778895	COYOTE Legacy Long Standard Profile Splice Tray for Single Fusion Splices, 36 Ct.	
8001127	926710	COYOTE Legacy Long Low Profile Splice Tray for Single Fusion Splices, 36 Ct.	
11622042	510577	COYOTE Legacy Long Standard Profile Splice Tray, Blank	
80805515	87234913 MMID 10796946	COYOTE Legacy Long Deep Profile Splice Tray for Mass Fusion Splices, 144 Ct.	
11622016	427595	COYOTE Legacy Long Deep Profile Splice Tray for Mass Fusion Splices, 144 Ct.	
8003814	11049976	COYOTE LCC Splice Platform, 24 Ct.	

COYOTE® FIBER OPTICS for Verizon

COYOTE® Closure Splice Tray Accessories			
PLP Part Number	Verizon SSI Code	Description	Visual Depiction
8003882	11073247	Splice Block Kit – Includes (6) Foam Splice Blocks This kit can be used in the following catalog numbers: 800012908 and 800012909	
LGRS1-25B	11058000 MMID 10796992	Retention Sleeve Kit – Includes (25) LITE-GRIP® 1-Hole Retention Sleeves, Blue	
LGRS1-25OR	11057999 MMID 10796977	Retention Sleeve Kit – Includes (25) LITE-GRIP 1-Hole Retention Sleeves, Orange	
LGRS6-25B	11058003	Retention Sleeve Kit – Includes (25) LITE-GRIP 6-Hole Retention Sleeves, Blue	
LGRS6-25OR	11058002	Retention Sleeve Kit – Includes (25) LITE-GRIP 6-Hole Retention Sleeves, Orange	
LGRS6-25G	11058001	Retention Sleeve Kit – Includes (25) LITE-GRIP 6-Hole Retention Sleeves, Green	
LGRO-25B	11057450	Ribbon Manager Kit – Includes (25) LITE-GRIP Ribbon Managers, Blue	
LGRO-25OR	11057451	Ribbon Manager Kit – Includes (25) LITE-GRIP Ribbon Managers, Orange	
11622040	510579	Splice Block Kit – Includes (3) 12 Ct. Elastomeric Single Fusion Splice Blocks, Light Blue	
LGSBS8-5	11053706 MMID 10796987	Splice Block Kit – Includes (5) LITE-GRIP 8 Ct. Double Stacked Single Fusion Splice Blocks, Yellow	
LGSBR3-5	11053707 MMID 10796994	Splice Block Kit – Includes (5) LITE-GRIP 36 Ct. Mass Fusion Splice Blocks, Purple	
80802962	510580	Felt Tape 3/4" wide x 9" long	
COYOTE® Closure Accessories			
80807989	11030435 MMID 10796938	100' Spool of 0.17" ID Transport Tube	
80807991	11030436 MMID 10796973	100' Spool of 0.25" ID Transport Tube	











COYOTE® FIBER OPTICS for Verizon

COYOTE® Closure Accessories			
PLP Part Number	Verizon SSI Code	Description	Visual Depiction
8003176	353802	Transport Tube Kit – Includes (8) 0.135" ID x 35" Long Tubes	
80806439	11023368 MMID 10796962	Transport Tube Kit – Includes (6) 0.170" ID x 34" Long Tubes	
11622032	427616	Transport Tube Kit – Includes (6) 0.135" ID x 34" Long Color-Coded Tubes	
11622029	427611	Transport Tube Kit – Includes (6) 0.135" ID x 34" Long Tubes	
8003280	469215	Transport Tube Kit – Includes (1) 0.135" ID x 24" Long Tubes, (1) 0.170" ID x 24" Long Tube and (1) 0.250" ID x 24" Long Tube	
8003681	MMID 10778886	COYOTE Dome 6.5" End Plate Kit – Includes (2) 1-Hole Grommets 0.40"-0.60" and (2) 1-Hole Grommets 0.60"-0.85"	
8003839	MMID 10778914	COYOTE Dome 9.5" End Plate Kit – Includes (2) 1-Hole Grommets 0.60"-0.85" and (2) 1-Hole Grommets 0.85"-1.00"	
80807332	11315015 MMID 10825631	COYOTE 6.5" Dome Collar – Used with COYOTE 6.5" x 17" and 6.5" x 22" Dome Closure	
80808528-1	11315014 MMID 10796950	COYOTE 9.5" Dome Collar – Used with COYOTE 9.5" x 19", 9.5" x 28" and HD Dome Closure	
80061193	11315016 MMID 10825640	COYOTE 6.5" Dome Collar and Gasket – Used with COYOTE 6.5" x 17" and 6.5" x 22" Dome Closure	
80061477	MMID 10825641	COYOTE 9.5" Dome Collar and Gasket – Used with COYOTE 9.5" x 19", 9.5" x 28" and HD Dome Closure	
8003855	11064215	Bolt Kit – 10 Pack for COYOTE Dome End Cap	
8003854	11064216	Bolt Kit – 10 Pack for COYOTE In-Line RUNT Cover Closure	
COYEPFIX1	11048730 MMID 108303	End Plate Fixture Assembly for the 6.5", 9.5" and COYOTE HD Dome Closures	
80061335	MMID 10830375	Deep Metal Slack Basket Kit (2.05" Depth) for up to 576 Expressed Ribbon Applications. For the Standard COYOTE 9.5" x 28" Dome Closure Only (COYOTE8219XU Slack Basket Field Replacement Swap)	
80061495	11362869 MMID 10830536	Deep Metal Slack Basket Kit (2.85" Depth) for up to 864 Expressed Ribbon Applications. For the Standard COYOTE 9.5" x 28" Dome Closure Only (COYOTE8219XU Slack Basket Field Replacement Swap)	

COYOTE® FIBER OPTICS for Verizon

COYOTE® Closure Accessories			
PLP Part Number	Verizon SSI Code	Description	Visual Depiction
80810011	11181381	COYOTE 6.5" x 17" Dome Closure Ribbon/Unitube Organizer with Expanded Slack Basket	
8004007	11181380 MMID 10796936	COYOTE 6.5" x 22" Dome Closure Ribbon/Unitube Organizer with Expanded Slack Basket	
80803633	11086579	4-Port Cable Retention Bobbin Kit	
80811036	11128570	6-Port Drop Cable Retention Bobbin Kit	
80812928	11372256 MMID 10862107	6/8-Port Drop Cable Retention Bobbin Kit	
8003175	353801	Strength Member Bracket Kit – Includes (4) Short Strength Member Brackets	
8003583	11064217 MMID 10796930	Silicone Lubricant Kit – Includes (6) 5 Gram Packets	
COYOTE® Closure Mounting Brackets			
8003830	11086580 MMID 10796983	COYOTE LCC Pole/Wall Mounting Bracket Kit	
8003704	11030434	COYOTE In-Line RUNT & Terminal Closure (Single Chamber) Aerial Mounting Bracket	
8003703	11372377 MMID 10862146	COYOTE In-Line RUNT & Terminal Closure Pole/Wall Mounting Bracket Kit	
8003705	11032792	COYOTE Terminal Closure (Dual Chamber) Offset Aerial Mounting Bracket Kit	
EVOBKT-ALC	11280701	COYOTE ONE Low Clearance Aerial Mounting Bracket Kit – Strand Applications	
EVOBKT-AE	11281275	COYOTE ONE Adjustable Offset Aerial Mounting Bracket Kit – Strand Applications	

COYOTE® FIBER OPTICS for Verizon

COYOTE® Closure Mounting Brackets			
PLP Part Number	Verizon SSI Code	Description	Visual Depiction
EVOBKT-PWM	11280700	COYOTE ONE Dome Pole/Wall Mounting Bracket Kit	
8003831	11063514	COYOTE 6.5" Dome and Terminal Dome Aerial Mounting Bracket Kit – Strand Applications	
8003851	11063513 MMID 10796934	COYOTE 6.5" Dome and Terminal Dome Adjustable Offset Aerial Mounting Bracket Kit – Strand Applications	
8003702	11074514	COYOTE 6.5" Dome & Terminal Dome Pole/Wall Mounting Bracket Kit	
8003941	11068025	COYOTE 9.5" Dome & Terminal Dome End Plate Adjustable Offset Aerial Mounting Bracket Kit – Strand Applications	
8003940	11068024 MMID 10796939	COYOTE 9.5" Dome & Terminal Dome Aerial Mounting Bracket Kit – Strand Applications	
8004037	11182593 MMID 10796955	COYOTE 9.5" Dome & Terminal Dome Adjustable Offset Aerial Mounting Bracket Kit – Strand Applications	
8003942	11068026 MMID 10778884	COYOTE 9.5" Dome & Terminal Dome Pole/Wall Mounting Bracket Kit	
8003860	11063512	COYOTE Universal Mounting Bracket Kit – Includes (3) Sets of Brackets	
8003835	11182592	COYOTE Universal Mounting Bracket Kit – Handhole Applications	



COYOTE® FIBER OPTICS for Verizon

COYOTE® RUNT Closure											
PLP Part Number	Verizon SSI Code	Component Breakdown	Closure Capabilities								
COYOTE8001	11016546 MMID 10796951	<p>COYOTE® RUNT Closure for Buffer Tube or Ribbon – Equipped With: (1) COYOTE RUNT Closure Assembly, (1) 1-Hole Grommets 0.40"-0.60", (2) 1-Hole Slit Urethane Grommets 0.43"-0.48" for 3/4" Port, (1) 4-Hole Urethane Grommet for Flat Drop Cable for 1" Port, Cable Restraint Hardware, and (1) 80806033 Legacy Standard-Profile, Short, Splice Tray, 12 Ct.</p> 	<table border="1"> <tr> <td>Max Splice Capacity</td> <td>48 SF</td> <td>Port Quantity</td> <td>3</td> </tr> <tr> <td>Max Trays 80809958, 80806033</td> <td>2, 2</td> <td>Ground Studs</td> <td>2</td> </tr> </table>	Max Splice Capacity	48 SF	Port Quantity	3	Max Trays 80809958, 80806033	2, 2	Ground Studs	2
			Max Splice Capacity	48 SF	Port Quantity	3					
			Max Trays 80809958, 80806033	2, 2	Ground Studs	2					
Above & Below Grade Application											

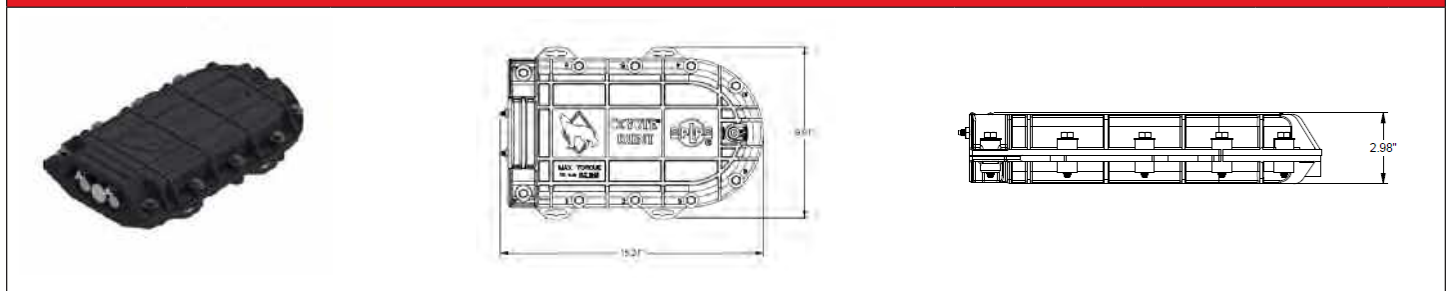
Technical Specifications of the COYOTE RUNT Closure



COYOTE® FIBER OPTICS for Verizon

COYOTE® 6.0" x 22" Closure						
PLP Part Number	Verizon SSI Code	Component Breakdown	Closure Capabilities			
11622003	427389	<p>6.0" x 22" COYOTE® Closure for Single Fusion – Equipped With: (1) 6.0" x 22" COYOTE Organizer, Buffer Tube, (2) 6.0" x 22" Shell Halves, (1) 6-Port 3-Section End Plate, (1) Blank End Plate, and Cable Restraint Hardware</p> 	Max Splice Capacity	216 SF 432 MF	Port Quantity	6
			Max Trays 8001127, 80805514, 11622016	6, 4, 3	Ground Studs	8
			Above & Below Grade Application			
800011591	11015077	<p>6.0" x 22" COYOTE® Closure for Single Fusion, In-Line – Equipped With: (1) 6.0" x 22" COYOTE Organizer, Buffer Tube, (2) 6.0" x 22" Shell Halves, (2) 6-Port 3-Section End Plate, (1) 3-Hole Urethane Grommet 0.20"-0.27" for 3/4" Ports, (1) Future Cable Port Kit, (1) 11622016 Legacy Deep-Profile, Long, Splice Tray, 144 Ct., (1) Adjustable Aerial Mounting Bracket for Strand, and Cable Restraint Hardware</p> 	Max Splice Capacity	216 SF 432 MF	Port Quantity	12
			Max Trays 8001127, 80805514, 11622016	6, 4, 3	Ground Studs	12
			Above & Below Grade Application			

COYOTE® FIBER OPTICS for Verizon

COYOTE® 6.0" x 22" Closure											
PLP Part Number	Verizon SSI Code	Component Breakdown	Closure Capabilities								
11622001	427338	<p>6.0" x 22" COYOTE® Closure for Ribbon, Shallow Basket – Equipped With: (1) 6.0" x 22" COYOTE Organizer, Shallow Basket, (2) 6.0" x 22" Shell Halves, (1) 6-Port 3-Section End Plate, (1) Blank End Plate, (1) Transition Tube Kit Consisting of: (1) 0.135" ID x 25" Long Tube, (1) 0.170" ID x 25" Long Tube, (1) 0.25" ID x 25" Long Tube, (1) Spiral Tube Kit Consisting of: (1) 0.375" ID x 72" Long Tube, (3) Transport Tube Kits Consisting of: (6) 0.135" ID x 35" Long Tubes, and Cable Restraint Hardware</p> 	<table border="1"> <tr> <td>Max Splice Capacity</td> <td>288 MF</td> <td>Port Quantity</td> <td>6</td> </tr> <tr> <td>Max Trays 80805515</td> <td>2</td> <td>Ground Studs</td> <td>8</td> </tr> </table>	Max Splice Capacity	288 MF	Port Quantity	6	Max Trays 80805515	2	Ground Studs	8
			Max Splice Capacity	288 MF	Port Quantity	6					
			Max Trays 80805515	2	Ground Studs	8					
Above & Below Grade Application											

Technical Specifications of the COYOTE 6.0" x 22" Closure

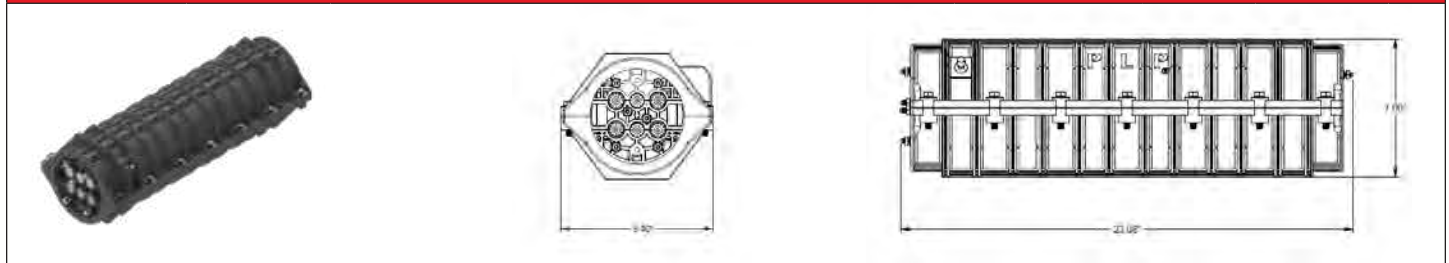

COYOTE® FIBER OPTICS for Verizon

COYOTE® 8.5" x 22" Closure							
PLP Part Number	Verizon SSI Code	Component Breakdown	Closure Capabilities				
11622002	427341	<p>8.5" x 22" COYOTE® Closure for Ribbon, Shallow Basket – Equipped With: (1) 8.5" x 22" COYOTE Organizer, Shallow Basket, (2) 8.5" x 22" Shell Halves, (1) 6-Port 3-Section End Plate, (1) Blank End Plate, (1) Transition Tube Kit Consisting of: (1) 0.135" ID x 25" Long Tube, (1) 0.170" ID x 25" Long Tube, (1) 0.25" ID x 25" Long Tube, (1) Spiral Tube Kit Consisting of: (1) 0.375" ID x 72" Long Tube, (3) Transport Tube Kits Consisting of: (6) 0.135" ID x 35" Long Tubes, and Cable Restraint Hardware</p> 	<table border="1"> <tr> <td>Max Splice Capacity</td> <td>576 MF</td> <td>Port Quantity</td> <td>6</td> </tr> </table>	Max Splice Capacity	576 MF	Port Quantity	6
			Max Splice Capacity	576 MF	Port Quantity	6	
			<table border="1"> <tr> <td>Max Trays 80805515</td> <td>4</td> <td>Ground Studs</td> <td>8</td> </tr> </table>	Max Trays 80805515	4	Ground Studs	8
Max Trays 80805515	4	Ground Studs	8				
Above & Below Grade Application							



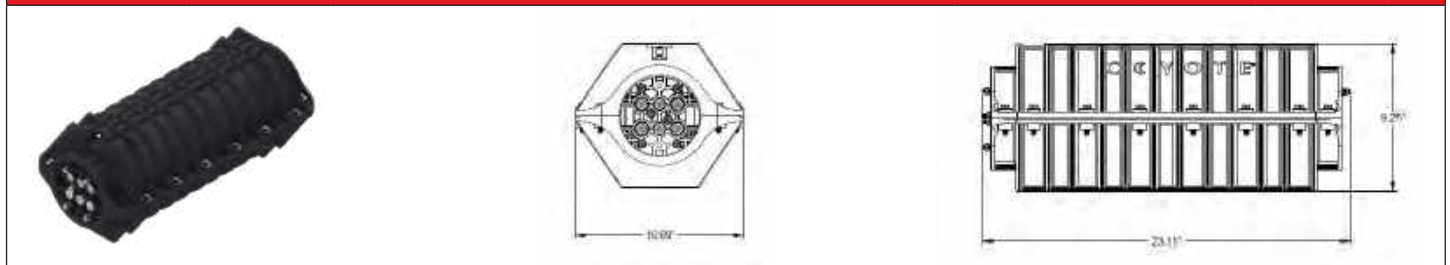



Technical Specifications of the COYOTE 8.5" x 22" Closure



























COYOTE® FIBER OPTICS for Verizon

COYOTE® Legacy Closure Accessories			
PLP Part Number	Verizon SSI Code	Description	Visual Depiction
8003371	506834	COYOTE End Plate Future Cable 7/8" Port Kit – Includes (1) Cable Port, (1) Hose Clamp and (1) Plug	
8003289	469214	COYOTE End Plate Future Cable 7/8" Port and Installation Kit – Includes (1) Cable Port, (1) Hose Clamp, (1) Plug, (1) 12" Piece of LOCK-TAPE™, (1) 4" Piece of Bead Sealant, (1) Emery Cloth, and (1) Strength Member Bracket	
8003407	538023	COYOTE End Plate Future Cable 1" Port Kit – Includes (1) Cable Port, (1) Hose Clamp and (1) Plug	
8003409	538025	COYOTE End Plate Future Cable 1-1/4" Port Kit – Includes (1) Cable Port, (1) Hose Clamp and (1) Plug	
8003291	469216	COYOTE End Plate Future Cable Installation Kit – Includes (1) 17" Piece of LOCK-TAPE™, (1) 4" Piece of Bead Sealant, (1) Emery Cloth, and (1) Strength Member Bracket	
80806180	598342	COYOTE End Plate Plug Kit for 7/8" Ports – Includes (2) Plugs	
80806038	486932	COYOTE End Plate Plug Kit for 1" Ports – Includes (2) Plugs	
80806181	598343	COYOTE End Plate Plug Kit for 1-1/4" Ports – Includes (2) Plugs	
8003574	926712	COYOTE RUNT Expanded Shell Kit – Includes (1) Top Shell and (1) Stud Kit	
80805795	538014 MMID 10560673	COYOTE PUP Shell Kit – Includes (1) Top Shell and (1) Bottom Shell	
11622033	427569	COYOTE 6.0" x 22" Closure Shell Kit – Includes (1) Top Shell and (1) Bottom Shell	
11622034	427570	COYOTE 8.5" x 22" Closure Shell Kit – Includes (1) Top Shell and (1) Bottom Shell	
11622013	427575	COYOTE 6.0" x 22" Closure Buffer Tube Organizer	
11622011	427572	COYOTE 6.0" x 22" Closure Ribbon/Unitube Organizer	
11622014	427576	COYOTE 8.5" x 22" Closure Buffer Tube Organizer	
11622012	427574	COYOTE 8.5" x 22" Closure Ribbon/Unitube Organizer	
8003467	586940	COYOTE RUNT Aerial Mounting Bracket	
8003470	586941	COYOTE RUNT Manhole Support Bracket	











COYOTE® FIBER OPTICS for Verizon



COYOTE® Legacy Closure Accessories				
PLP Part Number	Verizon SSI Code	Description	Visual Depiction	
8003325	475823	COYOTE 6.0" x 22" and 8.5" x 22" Closure Aerial Mounting Bracket – Strand Applications		
11622020	444404	COYOTE 6.0" x 22" and 8.5" x 22" Closure Manhole Support Bracket		
80803448	586939 MMID 10778885	B-Sealant for Moisture Blocking 3 oz. Tube		
11622010	427571	6-Port 3-Section End Plate Kit for use in COYOTE PUP, 6.0" x 22" and 8.5" x 22" COYOTE Closures		
80805739	538015	4-Port 3-Section End Plate Kit for use in COYOTE PUP, 6.0" x 22" and 8.5" x 22" COYOTE Closures		
80804985	386658	4", 2-Section End Plate with (3) Grounding Inserts for use in COYOTE Splice Cases		
80804986	386659	6.5", 3-Section End Plate with (6) Grounding Inserts for use in COYOTE Splice Cases		
8003163	353677	6.5", 3-Section End Plate with (4) Grounding Inserts for use in COYOTE Splice Cases		
80009670	353676	6.5", 2-Section End Plate with (2) Grounding Inserts for use in COYOTE Splice Cases		
8003093	346166	6.5", 3-Section End Plate with (4) Grounding Inserts and (2) 3/4" Future Cable Ports for use in COYOTE Splice Cases		
8003112	346167	6.5", 2-Section End Plate with (4) Grounding Inserts and (4) 3/4" Future Cable Ports for use in COYOTE Splice Cases. For Non-Pressurized Use ONLY.		
8003226	521472	6.5", 3-Section 6 Entry End Plate with (6) Grounding Inserts for use in FIBERLIGN® Uni-Closure Splice Case		
8003178	358165	6.5", 3-Section with (2) 3/4" Future Cable Ports and (5) Grounding Inserts for use in FIBERLIGN® Uni-Closure Splice Case		
8003227	521473	8", 3-Section 6 Entry End Plate with (6) Grounding Inserts for use in FIBERLIGN® Uni-Closure Splice Case		
8003213	358201	8", 3-Section with (2) 3/4" Future Cable Ports and (5) Grounding Inserts for use in FIBERLIGN® Uni-Closure Splice Case		
80805166	407585	9.5", 3-Section End Plate with (8) Grounding Inserts for use in FIBERLIGN® Uni-Closure Splice Case		
80805120	407586	9.5", 3-Section with (4) 3/4" Future Cable Ports and (12) Grounding Inserts for use in FIBERLIGN® Uni-Closure Splice Case		
80804347	358163	6.5", 3-Section (Left Side) End Plate with (3) Grounding Inserts and (2) 3/4" Future Cable Ports for use in FIBERLIGN® Taut Splice Cases		
80804346	358158	6.5", 3-Section (Right Side) End Plate with (3) Grounding Inserts and (2) 3/4" Future Cable Ports for use in FIBERLIGN® Taut Splice Cases		

COYOTE® FIBER OPTICS for Verizon





COYOTE® Urethane Grommets				
PLP Part Number	Verizon SSI Code	Description	Color Code	Visual Depiction
8003391	586935	3-Hole Urethane Grommet 0.20"-0.27" for 3/4" End Plate Port		
8003392	586934	2-Hole Urethane Grommet 0.27"-0.31" for 3/4" End Plate Port		
8003394	586933	1-Hole Urethane Grommet 0.31"-0.38" for 3/4" End Plate Port		
8003500	11023359	1-Hole Urethane Grommet 0.38"-0.43" for 3/4" End Plate Port		
8003671	11015783 MMID 10796935	1-Hole Pre-Slit Urethane Grommet 0.43"-0.48" for 3/4" End Plate Port		
8003596	11015784	1-Hole Urethane Grommet 0.43"-0.48" for 3/4" End Plate Port		
8003598	11023360 MMID 10796890	1-Hole Urethane Grommet 0.48"-0.53" for 3/4" End Plate Port		
8003600	11023361 MMID 10796945	1-Hole Urethane Grommet 0.53"-0.58" for 3/4" End Plate Port		
8003689	11023364 MMID 10796891	1-Hole Pre-Slit Urethane Grommet 0.48"-0.53" for 3/4" End Plate Port		
8003608	11014647 MMID 10796920	2-Hole Urethane Grommet Flat Drop Cable for 3/4" End Plate Port		
8003609	11014648 MMID 10796919	3-Hole Urethane Grommet Flat Drop Cable for 7/8" End Plate Port		
8003400	586937	3-Hole Urethane Grommet 0.31"-0.38" for 1" End Plate Port		
8003399	586936 MMID 10796944	2-Hole Urethane Grommet 0.38"-0.43" for 1" End Plate Port		
8003401	586942	4-Hole Urethane Grommet 0.20"-0.27" for 1" End Plate Port		
8003402	586938	3-Hole Urethane Grommet 0.20"-0.27" for 1" End Plate Port		
8003610	11014649 MMID 10796929	4-Hole Urethane Grommet Flat Drop Cable for 1" End Plate Port		
8003494	11032794 MMID 10796928	1-Hole Urethane Grommet 0.48"-0.53" for 1" End Plate Port		

COYOTE® FIBER OPTICS for Verizon

COYOTE® Urethane Grommets				
PLP Part Number	Verizon SSI Code	Description	Color Code	Visual Depiction
8003495	11032793	1-Hole Urethane Grommet 0.53"-0.58" for 1" End Plate Ports		
8003496	11014651	1-Hole Urethane Grommet 0.43"-0.48" for 1-1/4" End Plate Ports		
8003497	11037179	1-Hole Urethane Grommet 0.48"-0.53" for 1-1/4" End Plate Ports		
8003498	11037180	1-Hole Urethane Grommet 0.53"-0.58" for 1-1/4" End Plate Ports		
8003611	11014650	6-Hole Urethane Grommet Flat Drop Cable for 1-1/4" End Plate Ports		

COYOTE® Fiber Wall Plates			
PLP Part Number	Verizon SSI Code	Component Breakdown	Visual Depiction
8006992W	11031944	COYOTE® Fiber Wall Plate, White – Equipped With: (1) Base, (1) Cover, (1) SC/APC Factory Installed Adapter and (1) Mounting Hardware Kit	
8006992IV	11031943	COYOTE Fiber Wall Plate, Ivory – Equipped With: (1) Base, (1) Cover, (1) SC/APC Factory Installed Adapter and (1) Mounting Hardware Kit	

COYOTE® FIBER OPTICS for Verizon

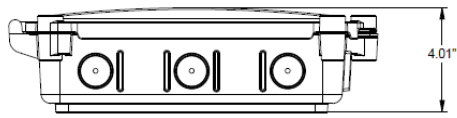
COYOTE® Standard MPC						
PLP Part Number	Verizon SSI Code	Component Breakdown	Closure Capabilities			
COYOTE8500	11049973	<p>COYOTE® Standard MPC – Equipped With: (1) COYOTE Standard MPC, OptiTap™ Adapter Bulkhead with (2) Adapters, (1) Adapter Port Shroud, (1) Organizer Clip Kit, (1) Storage Bracket Kit, (1) 4-Hole Grommet Port Adapter Kit 0.120"-0.275", and (1) 8-Hole Grommet Port Adapter Kit 0.120"-0.200"</p> 	Max Splice Capacity	96 SF	Max Trays 80809958, LGSTS16, 80808945	4 2 2
			Max Adapter Capacity	2 OptiTap Adapters		
COYOTE8510	11289993	<p>COYOTE® Standard MPC – Equipped With: (1) COYOTE Standard MPC, (2) Organizer Clip Kit and (1) Stepped Grommet Kit 0.070"-1.00"</p> 	Max Splice Capacity	96 SF	Max Trays 80809958, LGSTS16, 80808945	4 2 2
			Max Adapter Capacity	16 ST 24 SC 48 LC		
COYOTE8512	11061051	<p>COYOTE® Standard MPC – Equipped With: (1) COYOTE Standard MPC, (2) Organizer Clip Kit, (1) Splice Tray Support Kit, (1) Empty Bulkhead Kit, (1) Stepped Grommet Kit 0.070"-1.00", (1) Cable Restraint Bracket, and (1) LGSTS16 LITE-GRIP® Deep-Profile, Short, Splice Tray, 16 Ct.</p> 	Max Splice Capacity	96 SF	Max Trays 80809958, LGSTS16, 80808945	4 2 2
			Max Adapter Capacity	16 ST 24 SC 48 LC		
Technical Specifications of the COYOTE Standard MPC						
  						

COYOTE® FIBER OPTICS for Verizon

COYOTE® Deep MPC							
PLP Part Number	Verizon SSI Code	Component Breakdown	Closure Capabilities				
COYOTE8540	11289992	<p>COYOTE® Deep MPC – Equipped With: (1) COYOTE Deep MPC, (1) Dual Organizer Clip Kit and (1) Stepped Grommet Kit 0.070"-1.00"</p> 	<table border="1"> <tr> <td>Max Splice Capacity</td> <td>288 SF</td> <td>Max Trays 80809958, LGSTS16, 80808945</td> <td>12 6 6</td> </tr> </table>	Max Splice Capacity	288 SF	Max Trays 80809958, LGSTS16, 80808945	12 6 6
			Max Splice Capacity	288 SF	Max Trays 80809958, LGSTS16, 80808945	12 6 6	
<table border="1"> <tr> <td>Max Adapter Capacity</td> <td>32 ST 48 SC 96 LC</td> </tr> </table>	Max Adapter Capacity	32 ST 48 SC 96 LC					
Max Adapter Capacity	32 ST 48 SC 96 LC						

Technical Specifications of the COYOTE Deep MPC

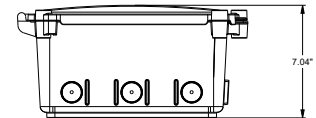













COYOTE® FIBER OPTICS for Verizon

COYOTE® MPC Accessories			
PLP Part Number	Verizon SSI Code	Description	Visual Depiction
8003827	11057445	1-Hole Grommet Port Adapter 0.40"-0.60"	
8003826	11057444	1-Hole Grommet Port Adapter 0.60"-0.825"	
8003825	11057443	1-Hole Grommet Port Adapter 0.825"-1.00"	
8003828	11057446	2-Hole Grommet Port Adapter 0.275"-0.500"	
8003812	11057447	4-Hole Grommet Port Adapter 0.120"-0.275"	
8003818	11057448	8-Hole Grommet Port Adapter 0.120"-0.200"	
80808618	11053688	Stepped Grommet Kit 0.070"-1.00"	
80808634	11067568	Bolt Kit – 5 Pack for COYOTE MPC Cover	
8003813	11049975	Organizer Clip Kit – Includes (3) Clips	
8003811	11049974	Storage Bracket Kit – Includes (2) Brackets	
8003829	11057449	Cable Restraint Bracket Kit – Includes (1) Restraint Bracket	
80808467	11049977	Adapter Port Shroud	
80808918	11068023	OptiTap™ 2-Port Internal Bracket Kit	
8003824	11056134	OptiTap™ 8-Port Internal Bracket Kit	
80808916	11262520	Empty Bulkhead Kit – Accepts 2 Adapter Modules	
8003881	11072612	Splitter Bracker – Accepts 1x8 PDI Splitter	

COYOTE® FIBER OPTICS for Verizon

COYOTE® Fiber Cable Hoist Products			
PLP Part Number	Verizon SSI Code	Description	Visual Depiction
COYFHS-001	11182877	COYOTE Fiber Hoist Housing Kit – Includes (1) Fiber Hoist Housing, (1) Standard Bracket, (1) Safety Tether, and (1) Warning Flag	
COYFHS-100	11182876	COYOTE Fiber Hoist Cable Installation Kit – Includes fiber hoisting clip, two (2) Dead-ends, temporary blocking tube for confirmation of bundle height	
COYFHS-002	11182875	COYOTE Fiber Hoist Wall Cap Bracket Kit – Includes bracket for mounting to the roof side of the knee wall when railings are an obstruction	
COYFHS-003	11182874	COYOTE Fiber Hoist Long Extension Bracket Kit – Includes bracket for extending beyond the wall cap to avoid a molding obstruction that may be several floors down	
COYFHS-200	11182873	Hoist Fiber System Weight Bag – Weight bag is used during the process of installing the pulling tape down the exterior surface of the building	
COYFHS-210	11257833	Stabilizer Weight	
COYFHS-300	11184742	Fiber Hoist Base Bracket	







FIBERLIGN® for Verizon





FIBERLIGN® Cable Storage			
PLP Part Number	Verizon SSI Code	Description	Visual Depiction
FIS12M	11363908 MMID 10830521	FIBERLIGN In-Span Storage – Includes (2) 12" diameter storage brackets with messenger hanger brackets; for cables up to 0.60" in diameter	
FIS12A	11363907 MMID 10830520	FIBERLIGN In-Span Storage – Includes (2) 12" diameter storage brackets with ADSS hanger brackets; for cables up to 0.60" in diameter	
FIS16M	11363906 MMID 10830560	FIBERLIGN In-Span Storage – Includes (2) 16" diameter storage brackets with messenger hanger brackets; for cables up to 0.80" in diameter	
FIS16A	11363905 MMID 10830572	FIBERLIGN In-Span Storage – Includes (2) 16" diameter storage brackets with ADSS hanger brackets; for cables up to 0.80" in diameter	
710012375A	11363901 MMID 10830546	FIBERLIGN CLAS (Center-Lock Aerial Slack Storage) System – Includes (2) CLAS for ADSS Cables with Abrasion Protectors for Pole Passing and (10) DELTEC Cable Ties	
FISA24MB	11363899 MMID 10832181	FIBERLIGN In-Span Storage, Aluminum – Includes (2) 24" diameter storage brackets with messenger hanger brackets; for cables up to 1.20" in diameter	
FISA24AB	11363898 MMID 10832203	FIBERLIGN In-Span Storage, Aluminum – Includes (2) 24" diameter storage brackets with ADSS hanger brackets; for cables up to 1.20" in diameter	
FISA30MB	11363897 MMID 10832180	FIBERLIGN In-Span Storage, Aluminum – Includes (2) 30" diameter storage brackets with messenger hanger brackets; for cables up to 1.50" in diameter	
FISA30AB	11363896 MMID 10832204	FIBERLIGN In-Span Storage, Aluminum – Includes (2) 30" diameter storage brackets with ADSS hanger brackets; for cables up to 1.50" in diameter	
FDC8M	11363904 MMID 10830517	FIBERLIGN Drop Cable Storage Bracket (FDC8) with messenger hanger brackets for In-Span Applications; for cables up to 0.40" in diameter	
FDC8A	11363903 MMID 10830563	FIBERLIGN Drop Cable Storage Bracket (FDC8) with ADSS hanger brackets for In-Span Applications; for cables up to 0.40" in diameter	
FDC8P	11363902 MMID 10830547	FIBERLIGN Drop Cable Storage Bracket (FDC8) with lag bolts for Pole/Wall Mount and Vault Applications; for cables up to 0.40" in diameter	
7400030	11363900 MMID 10830501	FDC8 Stacking Kit with Spacers for Aerial, Pole/Wall or Vault Applications	

FIBERLIGN[®] for Verizon

FIBERLIGN [®] Dielectric Dead-Ends & Accessories for ADSS Cable			
PLP Part Number	Verizon SSI Code	Description	Visual Depiction
2872004C1E1	747883 MMID 10833722	FIBERLIGN Limited Tension Dead-End for Cable Range 0.482"-0.510" with Thimble Clevis & Extension Link	
2872005C1E1	87278257 MMID 10833723	FIBERLIGN Limited Tension Dead-End for Cable Range 0.511"-0.542" with Thimble Clevis & Extension Link	
2872006C1E1	506852 MMID 10833691	FIBERLIGN Limited Tension Dead-End for Cable Range 0.543"-0.577" with Thimble Clevis & Extension Link	
2872007C1E1	506853 MMID 10833732	FIBERLIGN Limited Tension Dead-End for Cable Range 0.578"-0.613" with Thimble Clevis & Extension Link	
2872008C1E1	11051087 MMID 10833724	FIBERLIGN Limited Tension Dead-End for Cable Range 0.614"-0.651" with Thimble Clevis & Extension Link	
2872009C1E1	534403 MMID 10833733	FIBERLIGN Limited Tension Dead-End for Cable Range 0.652"-0.692" with Thimble Clevis & Extension Link	
2872010C1E1	87260985 MMID 10833696	FIBERLIGN Limited Tension Dead-End for Cable Range 0.693"-0.737" with Thimble Clevis & Extension Link	
2872011C1E1	87214589 MMID 10833713	FIBERLIGN Limited Tension Dead-End for Cable Range 0.738"-0.784" with Thimble Clevis & Extension Link	
2872012C1E1	523657 MMID 10833734	FIBERLIGN Limited Tension Dead-End for Cable Range 0.785"-0.834" with Thimble Clevis & Extension Link	
2872100C1E1	11051088 MMID 10833697	FIBERLIGN Medium Tension Dead-End for Cable Range 0.482"-0.510" with Thimble Clevis & Extension Link	
2872101C1E1	921449 MMID 10833714	FIBERLIGN Medium Tension Dead-End for Cable Range 0.511"-0.542" with Thimble Clevis & Extension Link	
2872102C1E1	534404 MMID 10833735	FIBERLIGN Medium Tension Dead-End for Cable Range 0.543"-0.577" with Thimble Clevis & Extension Link	
2872103C1E1	534472 MMID 10833715	FIBERLIGN Medium Tension Dead-End for Cable Range 0.578"-0.613" with Thimble Clevis & Extension Link	
2872104C1E1	534473 MMID 10833736	FIBERLIGN Medium Tension Dead-End for Cable Range 0.614"-0.651" with Thimble Clevis & Extension Link	
2872105C1E1	534466 MMID 10833698	FIBERLIGN Medium Tension Dead-End for Cable Range 0.652"-0.692" with Thimble Clevis & Extension Link	
2872106C1E1	534474 MMID 10833709	FIBERLIGN Medium Tension Dead-End for Cable Range 0.693"-0.737" with Thimble Clevis & Extension Link	
2872107C1E1	11051089 MMID 10833725	FIBERLIGN Medium Tension Dead-End for Cable Range 0.738"-0.784" with Thimble Clevis & Extension Link	
2872108C1E1	11051090 MMID 10833699	FIBERLIGN Medium Tension Dead-End for Cable Range 0.785"-0.834" with Thimble Clevis & Extension Link	
28729791C2E1	534475 MMID 10833700	FIBERLIGN High Tension Dead-End for Cable Range 0.580"-0.600" with Thimble Clevis & Extension Link	

FIBERLIGN® for Verizon



FIBERLIGN® Dielectric Dead-Ends & Accessories for ADSS Cable			
PLP Part Number	Verizon SSI Code	Description	Visual Depiction
71002366	523656 MMID 10833765	14" Extension Link with Eye Nut	
TC-5A	89005320 MMID 10833816	Thimble Clevis	
YC-5207	534482 MMID 10833842	20,000 lbs. Y-Clevis for ADSS Cable Range 0.459"-0.625"	
YC-5209	534483 MMID 10833843	25,000 lbs. Y-Clevis for ADSS Cable Range 0.626"-1.057"	
FIBERLIGN® Dielectric Support (FDS) for ADSS Cable			
44009952	87266750 MMID 10833743	FIBERLIGN Dielectric Support for Cable Range 0.476"-0.525". Used for cable spans up to 600 ft.	
44009823	477834 MMID 10833710	FIBERLIGN Dielectric Support for Cable Range 0.526"-0.575". Used for cable spans up to 600 ft.	
44009798	506854 MMID 10833726	FIBERLIGN Dielectric Support for Cable Range 0.576"-0.625". Used for cable spans up to 600 ft.	
44009776	534477 MMID 10833701	FIBERLIGN Dielectric Support for Cable Range 0.626"-0.675". Used for cable spans up to 600 ft.	
44009799	534476 MMID 10833727	FIBERLIGN Dielectric Support for Cable Range 0.676"-0.750". Used for cable spans up to 600 ft.	
44009878	562744 MMID 10833742	FIBERLIGN Dielectric Support for Cable Range 0.751"-0.825"	
44009963	523658 MMID 10833737	FIBERLIGN Dielectric Support for Cable Range 0.826"-0.900". Used for cable spans up to 600 ft.	
FIBERLIGN® Aluminum Support (FAS) Structural Rods for ADSS Cable			
4450100	933793 MMID 10833738	FIBERLIGN Aluminum Support for Cable Range 0.476"-0.525". Used for cable spans up to 600 ft.	
4450101	933794 MMID 10833739	FIBERLIGN Aluminum Support for Cable Range 0.526"-0.575". Used for cable spans up to 600 ft.	
4450102	933795 MMID 10833728	FIBERLIGN Aluminum Support for Cable Range 0.576"-0.625". Used for cable spans up to 600 ft.	
4450103	933796 MMID 10833711	FIBERLIGN Aluminum Support for Cable Range 0.626"-0.675". Used for cable spans up to 600 ft.	
4450104	933797 MMID 10833740	FIBERLIGN Aluminum Support for Cable Range 0.676"-0.750". Used for cable spans up to 600 ft.	

FIBERLIGN® Aluminum Suspension (FASN) with and without Structural Rods for ADSS Cable			
PLP Part Number	Verizon SSI Code	Description	Visual Depiction
4450200S	933783 MMID 10833741	FIBERLIGN Aluminum Suspension w/o Rods for Cable Range 0.476"-0.525". Used for cable spans up to 600 ft. and line angles up to 30°. Kit includes (1) AS-5L Anchor Shackle and (1) 5/8" Eye-Nut.	
4450201S	933784 MMID 10833752	FIBERLIGN Aluminum Suspension w/o Rods for Cable Range 0.526"-0.575". Used for cable spans up to 600 ft. and line angles up to 30°. Kit includes (1) AS-5L Anchor Shackle and (1) 5/8" Eye-Nut.	
4450202S	933785 MMID 10833716	FIBERLIGN Aluminum Suspension w/o Rods for Cable Range 0.576"-0.625". Used for cable spans up to 600 ft. and line angles up to 30°. Kit includes (1) AS-5L Anchor Shackle and (1) 5/8" Eye-Nut.	
4450203S	933786 MMID 10833729	FIBERLIGN Aluminum Suspension w/o Rods for Cable Range 0.626"-0.675". Used for cable spans up to 600 ft. and line angles up to 30°. Kit includes (1) AS-5L Anchor Shackle and (1) 5/8" Eye-Nut.	
4450204S	933787 MMID 10833762	FIBERLIGN Aluminum Suspension w/o Rods for Cable Range 0.676"-0.750". Used for cable spans up to 600 ft. and line angles up to 30°. Kit includes (1) AS-5L Anchor Shackle and (1) 5/8" Eye-Nut.	
4470200S	933788 MMID 10833744	FIBERLIGN Aluminum Suspension w/ Rods for Cable Range 0.476"-0.500" Used for cable spans up to 1200 ft. and line angles up to 30°. Kit includes (1) AS-5L Anchor Shackle and (1) 5/8" Eye-Nut.	
4470201S	933789 MMID 10833717	FIBERLIGN Aluminum Suspension w/ Rods for Cable Range 0.501"-0.550". Used for cable spans up to 1200 ft. and line angles up to 30°. Kit includes (1) AS-5L Anchor Shackle and (1) 5/8" Eye-Nut.	
4470202S	933790 MMID 10833763	FIBERLIGN Aluminum Suspension w/ Rods for Cable Range 0.551"-0.625". Used for cable spans up to 1200 ft. and line angles up to 30°. Kit includes (1) AS-5L Anchor Shackle and (1) 5/8" Eye-Nut.	
4470203S	933791 MMID 10833730	FIBERLIGN Aluminum Suspension w/ Rods for Cable Range 0.626"-0.700". Used for cable spans up to 1200 ft. and line angles up to 30°. Kit includes: (1) AS-5L Anchor Shackle and (1) 5/8" Eye-Nut.	
4470204S	933792 MMID 10833753	FIBERLIGN Aluminum Suspension w/ Rods for Cable Range 0.701"-0.737"; Used for cable spans up to 1200 ft. and line angles up to 30°. Kit includes: (1) AS-5L Anchor Shackle and (1) 5/8" Eye-Nut.	
FIBERLIGN® Dielectric Dampers for ADSS Cable			
50502272	395019 MMID 10833718	FIBERLIGN Dielectric Damper for Cable Range 0.327"-0.461"	
50502274	506859 MMID 10833745	FIBERLIGN Dielectric Damper for Cable Range 0.462"-0.563"	
50509862	506858 MMID 10833719	FIBERLIGN Dielectric Damper for Cable Range 0.564"-0.770"	
50503057	923679 MMID 10833721	FIBERLIGN Dielectric Damper for Cable Range 0.771"-0.876"	
FIBERLIGN® Cable Abrasion Protector for ADSS Cable			
PTG-0203	477836 MMID 10833832	FIBERLIGN Cable Abrasion Protector for Cable Range 0.501"-1.00" (6 ft length)	
ADSS-CORONA Coil			
50603760	921452 MMID 10833767	ADSS-CORONA Coil for FIBERLIGN Dead-Ends and Suspensions with O.D. range of Structural Reinforcing Rods 0.688"-0.741"	
50603745	921451 MMID 10833773	ADSS-CORONA Coil for FIBERLIGN Dead-Ends and Suspensions with O.D. range of Structural Reinforcing Rods 0.742"-0.844"	



FIBERLIGN[®] for Verizon

FIBERLIGN [®] Downlead Cushions for ADSS Cable			
PLP Part Number	Verizon SSI Code	Description	Visual Depiction
8003041	381110 MMID 10833755	FIBERLIGN Downlead Cushion for Cable Range 0.375"-0.468"	
8003042H1	921450 MMID 10833782	FIBERLIGN Downlead Cushion for Cable Range 0.469"-0.562". Includes Hardware Kit for wood pole mount	
8003042	77833	FIBERLIGN Downlead Cushion for Cable Range 0.469"-0.562"	
8003043	506857 MMID 10833754	FIBERLIGN Downlead Cushion for Cable Range 0.563"-0.656"	
8003044	534497 MMID 10833768	FIBERLIGN Downlead Cushion for Cable Range 0.657"-0.750"	

COYOTE[®] COPPER for Verizon

Classic COYOTE [®] Closures for Copper Applications			
800011397	11005685	COYOTE RUNT Closure for Copper Applications – Includes (1) Set of Shells and (1) Small Parts Bag	
800011398	11005684	COYOTE PUP Closure for Copper Applications – Includes (1) Set of Shells, (1) 6-Port 3-Section End Plate, (1) Blank End Plate, and (1) Small Parts Bag Kit does not include an organizer.	
800011399	11005683	COYOTE PUP Closure for Copper Applications – Includes (1) Set of Shells, (1) 4-Port 3-Section End Plate, (1) Blank End Plate, and (1) Small Parts Bag Kit does not include an organizer.	



ARMADILLO® Stainless Steel Splice Case Kits – Without Bonding			
PLP Part Number	Verizon SSI Code	Description	Visual Depiction
8006021	521351	4" x 25" ARMADILLO S.S.S.C. without Bonding Hardware – Includes (2) 2-Section End Plates and uses LOCK-TAPE™ Sealant	
8006319	521151	6.5" x 22" ARMADILLO S.S.S.C. without Bonding Hardware – Includes (2) 2-Section End Plates and uses LOCK-TAPE™ Sealant	
8006022	521350	6.5" x 28" ARMADILLO S.S.S.C. without Bonding Hardware – Includes (2) 2-Section End Plates and uses LOCK-TAPE™ Sealant	
8006024	521352	6.5" x 38" ARMADILLO S.S.S.C. without Bonding Hardware – Includes (2) 2-Section End Plates and uses LOCK-TAPE™ Sealant	
8006261	521152	8" x 28" ARMADILLO S.S.S.C. without Bonding Hardware – Includes (2) 2-Section End Plates and uses LOCK-TAPE™ Sealant	
8006262	341413	8" x 38" ARMADILLO S.S.S.C. without Bonding Hardware – Includes (2) 2-Section End Plates and uses LOCK-TAPE™ Sealant	
8006263	341414	8" x 45" ARMADILLO S.S.S.C. without Bonding Hardware – Includes (2) 2-Section End Plates and uses LOCK-TAPE™ Sealant	
8006023	521349	9.5" x 28" ARMADILLO S.S.S.C. without Bonding Hardware – Includes (2) 2-Section End Plates and uses LOCK-TAPE™ Sealant	
8006025	521348	9.5" x 38" ARMADILLO S.S.S.C. without Bonding Hardware – Includes (2) 2-Section End Plates and uses LOCK-TAPE™ Sealant	
8006177	529965	9.5" x 45" ARMADILLO S.S.S.C. without Bonding Hardware – Includes (2) 2-Section End Plates and uses LOCK-TAPE™ Sealant	
8006669	569380	9.5" x 53" ARMADILLO S.S.S.C. without Bonding Hardware – Includes (2) 2-Section End Plates and uses LOCK-TAPE™ Sealant	
8006251	528681	12.5" x 28" ARMADILLO S.S.S.C. without Bonding Hardware – Includes (2) 3-Section End Plates and uses LOCK-TAPE™ Sealant	
8006252	528682	12.5" x 38" ARMADILLO S.S.S.C. without Bonding Hardware – Includes (2) 3-Section End Plates and uses LOCK-TAPE™ Sealant	

ARMADILLO Stainless Steel Splice Case Kits with Bonding				
PLP Part Number	Verizon SSI Code	Description	Visual Depiction	
8006253	528683	12.5" x 45" ARMADILLO S.S.S.C. without Bonding Hardware – Includes (2) 3-Section End Plates and uses LOCK-TAPE™ Sealant		
8000624	521357	4" x 25" ARMADILLO S.S.S.C. with Bonding Hardware – Includes (2) 2-Section End Plates and uses LOCK-TAPE™ Sealant		
8006326	87205896	6.5" x 22" ARMADILLO S.S.S.C. with Bonding Hardware – Includes (2) 2-Section End Plates and uses LOCK-TAPE™ Sealant		
8000626	521358	6.5" x 28" ARMADILLO S.S.S.C. with Bonding Hardware – Includes (2) 2-Section End Plates and uses LOCK-TAPE™ Sealant		
8000634	521360	6.5" x 38" ARMADILLO S.S.S.C. with Bonding Hardware – Includes (2) 2-Section End Plates and uses LOCK-TAPE™ Sealant		
8006320	87016609	8" x 28" ARMADILLO S.S.S.C. with Bonding Hardware – Includes (2) 2-Section End Plates and uses LOCK-TAPE™ Sealant		
8006321	87207769	8" x 38" ARMADILLO S.S.S.C. with Bonding Hardware – Includes (2) 2-Section End Plates and uses LOCK-TAPE™ Sealant		
8006322	87040135	8" x 45" ARMADILLO S.S.S.C. with Bonding Hardware – Includes (2) 2-Section End Plates and uses LOCK-TAPE™ Sealant		
8000630	521359 MMID 10568142	9.5" x 28" ARMADILLO S.S.S.C. with Bonding Hardware – Includes (2) 2-Section End Plates and uses LOCK-TAPE™ Sealant		
8000635	521361	9.5" x 38" ARMADILLO S.S.S.C. with Bonding Hardware – Includes (2) 2 section End Plates and uses LOCK-TAPE™ Sealant		
8006176	11045523	9.5" x 45" ARMADILLO S.S.S.C. with Bonding Hardware – Includes (2) 2-Section End Plates and uses LOCK-TAPE™ Sealant		
8006668	11045572	9.5" x 53" ARMADILLO S.S.S.C. with Bonding Hardware – Includes (2) 2-Section End Plates and uses LOCK-TAPE™ Sealant		
8006219	87201117	12.5" x 28" ARMADILLO S.S.S.C. with Bonding Hardware – Includes (2) 3-Section End Plates and uses LOCK-TAPE™ Sealant		
8006220	11045525	12.5" x 38" ARMADILLO S.S.S.C. with Bonding Hardware – Includes (2) 3-Section End Plates and uses LOCK-TAPE™ Sealant		
8006221	11045524	12.5" x 45" ARMADILLO S.S.S.C. with Bonding Hardware – Includes (2) 3-Section End Plates and uses LOCK-TAPE™ Sealant		
ARMADILLO Stainless Steel Splice Case Kits with Filling Flange – No Bonding				
8006283	521136	4" x 25" ARMADILLO S.S.S.C. with Filling Flange and without Bonding Hardware – Includes (2) 2-Section End Plates and uses LOCK-TAPE™ Sealant		  <p>END PLATE</p>
8006394	521204	6.5" x 22" ARMADILLO S.S.S.C. with Filling Flange and without Bonding Hardware – Includes (2) 2-Section End Plates and uses LOCK-TAPE™ Sealant		
8006239	528699	6.5" x 28" ARMADILLO S.S.S.C. with Filling Flange and without Bonding Hardware – Includes (2) 2-Section End Plates and uses LOCK-TAPE™ Sealant		
8006241	528700	6.5" x 38" ARMADILLO S.S.S.C. with Filling Flange and without Bonding Hardware – Includes (2) 2-Section End Plates and uses LOCK-TAPE™ Sealant		
8006395	521205	8" x 28" ARMADILLO S.S.S.C. with Filling Flange and without Bonding Hardware – Includes (2) 2-Section End Plates and uses LOCK-TAPE™ Sealant		
8006396	521206	8" x 38" ARMADILLO S.S.S.C. with Filling Flange and without Bonding Hardware – Includes (2) 2-Section End Plates and uses LOCK-TAPE™ Sealant		
8006397	521207	8" x 45" ARMADILLO S.S.S.C. with Filling Flange and without Bonding Hardware – Includes (2) 2-Section End Plates and uses LOCK-TAPE™ Sealant		
8006240	528701	9.5" x 28" ARMADILLO S.S.S.C. with Filling Flange and without Bonding Hardware – Includes (2) 2-Section End Plates and uses LOCK-TAPE™ Sealant		
8006242	528702	9.5" x 38" ARMADILLO S.S.S.C. with Filling Flange and without Bonding Hardware – Includes (2) 2-Section End Plates and uses LOCK-TAPE™ Sealant		
8006249	520049	9.5" x 45" ARMADILLO S.S.S.C. with Filling Flange and without Bonding Hardware – Includes (2) 2-Section End Plates and uses LOCK-TAPE™ Sealant		
8006271	520984	12.5" x 28" ARMADILLO S.S.S.C. with Filling Flange and without Bonding Hardware – Includes (2) 3-Section End Plates and uses LOCK-TAPE™ Sealant		

ARMADILLO Stainless Steel Splice Case Kits with Filling Flange and Bonding			
PLP Part Number	Verizon SSI Code	Description	Visual Depiction
8006272	520985	12.5" x 38" ARMADILLO S.S.S.C. with Filling Flange and without Bonding Hardware – Includes (2) 3-Section End Plates and uses LOCK-TAPE™ Sealant	 <p>END PLATE</p>
8006273	520986	12.5" x 45" ARMADILLO S.S.S.C. with Filling Flange and without Bonding Hardware. Includes (2) 3-Section End Plates and uses LOCK-TAPE™ Sealant	
8006704	11045571	4" x 25" ARMADILLO S.S.S.C. with Filling Flange, Bonding Hardware, and Filling Flange Pressure Relief Valve – Includes (2) 2-Section End Plates and uses LOCK-TAPE™ Sealant	
8006705	11045570	6.5" x 28" ARMADILLO S.S.S.C. with Filling Flange, Bonding Hardware, and Filling Flange Pressure Relief Valve – Includes (2) 2-Section End Plates and uses LOCK-TAPE™ Sealant	
8006706	11045569	6.5" x 38" ARMADILLO S.S.S.C. with Filling Flange, Bonding Hardware, and Filling Flange Pressure Relief Valve – Includes (2) 2-Section End Plates and uses LOCK-TAPE™ Sealant	
8006707	11045568	8" x 28" ARMADILLO S.S.S.C. with Filling Flange, Bonding Hardware, and Filling Flange Pressure Relief Valve – Includes (2) 2-Section End Plates and uses LOCK-TAPE™ Sealant	
8006708	11045567	8" x 38" ARMADILLO S.S.S.C. with Filling Flange, Bonding Hardware, and Filling Flange Pressure Relief Valve – Includes (2) 2-Section End Plates and uses LOCK-TAPE™ Sealant	
8006710	11045565	9.5" x 28" ARMADILLO S.S.S.C. with Filling Flange, Bonding Hardware, and Filling Flange Pressure Relief Valve – Includes (2) 2-Section End Plates and uses LOCK-TAPE™ Sealant	
8006711	11045564	9.5" x 38" ARMADILLO S.S.S.C. with Filling Flange, Bonding Hardware, and Filling Flange Pressure Relief Valve – Includes (2) 2-Section End Plates and uses LOCK-TAPE™ Sealant	
8006712	11045563	9.5" x 45" ARMADILLO S.S.S.C. with Filling Flange, Bonding Hardware, and Filling Flange Pressure Relief Valve – Includes (2) 2-Section End Plates and uses LOCK-TAPE™ Sealant	
8006713	11045562	12.5" x 28" ARMADILLO S.S.S.C. with Filling Flange, Bonding Hardware, and Filling Flange Pressure Relief Valve – Includes (2) 3-Section End Plates and uses LOCK-TAPE™ Sealant	
8006714	11045561	12.5" x 38" ARMADILLO S.S.S.C. with Filling Flange, Bonding Hardware, & Filling Flange Pressure Relief Valve – Includes (2) 3-Section End Plates and uses LOCK-TAPE™ Sealant	
8006715	11045560	12.5" x 45" ARMADILLO S.S.S.C. with Filling Flange, Bonding Hardware, and Filling Flange Pressure Relief Valve – Includes (2) 3-Section End Plates and uses LOCK-TAPE™ Sealant	

ARMADILLO® Stainless Steel Splice Case – Shell Kits			
PLP Part Number	Verizon SSI Code	Description	Visual Depiction
8006041	526130	6.5" x 28" ARMADILLO S.S.S.C. Shell Kit	
8006043	528703	6.5" x 38" ARMADILLO S.S.S.C. Shell Kit	
8006387	521201	8" x 28" ARMADILLO S.S.S.C. Shell Kit	
8006388	521202	8" x 38" ARMADILLO S.S.S.C. Shell Kit	
8006389	521203	8" x 45" ARMADILLO S.S.S.C. Shell Kit	
8006186	525005	9.5" x 28" ARMADILLO S.S.S.C. Shell Kit	
8006187	525006	9.5" x 38" ARMADILLO S.S.S.C. Shell Kit	
8006188	525007	9.5" x 45" ARMADILLO S.S.S.C. Shell Kit	
8003461	11046985	9.5" x 53" ARMADILLO S.S.S.C. Shell Kit	
8006268	520094	12.5" x 28" ARMADILLO S.S.S.C. Shell Kit	
8006269	520619	12.5" x 38" ARMADILLO S.S.S.C. Shell Kit	
8006270	521155	12.5" x 45" ARMADILLO S.S.S.C. Shell Kit	
8006509	406958	12.5" x 65" ARMADILLO S.S.S.C. Shell Kit	
ARMADILLO® Stainless Steel Splice Case – Vault Kits with Bonding			
8006132	528689	4" x 25" ARMADILLO S.S.S.C. Vault Kit with Bonding Hardware – Includes (2) Flame Retardant 2-Section End Plates and uses LOCK-TAPE™ Sealant	
8006133	87203984	6.5" x 28" ARMADILLO S.S.S.C. Vault Kit with Bonding Hardware – Includes (2) Flame Retardant 2-Section End Plates and uses LOCK-TAPE™ Sealant	
8006134	11046983	6.5" x 38" ARMADILLO S.S.S.C. Vault Kit with Bonding Hardware – Includes (2) Flame Retardant 2-Section End Plates and uses LOCK-TAPE™ Sealant	
8006447	11045574	8" x 28" ARMADILLO S.S.S.C. Vault Kit with Bonding Hardware – Includes (2) Flame Retardant 2-Section End Plates and uses LOCK-TAPE™ Sealant	
8006448	11045573	8" x 38" ARMADILLO S.S.S.C. Vault Kit with Bonding Hardware – Includes (2) Flame Retardant 2-Section End Plates and uses LOCK-TAPE™ Sealant	
8006449	11046984	8" x 45" ARMADILLO S.S.S.C. Vault Kit with Bonding Hardware – Includes (2) Flame Retardant 2-Section End Plates and uses LOCK-TAPE™ Sealant	
8006066	11045577	9.5" x 28" ARMADILLO S.S.S.C. Vault Kit with Bonding Hardware – Includes (2) Flame Retardant 2-Section End Plates and uses LOCK-TAPE™ Sealant	
8006069	11045576	9.5" x 38" ARMADILLO S.S.S.C. Vault Kit with Bonding Hardware – Includes (2) Flame Retardant 2-Section End Plates and uses LOCK-TAPE™ Sealant	
8006197	11045575	9.5" x 45" ARMADILLO S.S.S.C. Vault Kit with Bonding Hardware – Includes (2) Flame Retardant 2-Section End Plates and uses LOCK-TAPE™ Sealant	
8006279	87208935	12.5" x 28" ARMADILLO S.S.S.C. Vault Kit with Bonding Hardware – Includes (2) Flame Retardant 3-Section End Plates and uses LOCK-TAPE™ Sealant	
8006280	87040136	12.5" x 38" ARMADILLO S.S.S.C. Vault Kit with Bonding Hardware – Includes (2) Flame Retardant 3-Section End Plates and uses LOCK-TAPE™ Sealant	
8006281	87040137	12.5" x 45" ARMADILLO S.S.S.C. Vault Kit with Bonding Hardware – Includes (2) Flame Retardant 3-Section End Plates and uses LOCK-TAPE™ Sealant	

ARMADILLO® Stainless Steel Splice Case – Shell Kit – No Air Valve, No Filling Flange			
PLP Part Number	Verizon SSI Code	Description	Visual Depiction
8006824	11045506	4" x 25" ARMADILLO S.S.S.C. Shell Kit without Air Valve and Filling Flange	
8006825	11045505	6.5" x 28" ARMADILLO S.S.S.C. Shell Kit without Air Valve and Filling Flange	
8006826	11045503	6.5" x 38" ARMADILLO S.S.S.C. Shell Kit without Air Valve and Filling Flange	
8006833	11046982	8" x 28" ARMADILLO S.S.S.C. Shell Kit without Air Valve and Filling Flange	
8006834	11046981	8" x 38" ARMADILLO S.S.S.C. Shell Kit without Air Valve and Filling Flange	
8006835	11046980	8" x 45" ARMADILLO S.S.S.C. Shell Kit without Air Valve and Filling Flange	
8006827	11045504	9.5" x 28" ARMADILLO S.S.S.C. Shell Kit without Air Valve and Filling Flange	
8006828	11045502	9.5" x 38" ARMADILLO S.S.S.C. Shell Kit without Air Valve and Filling Flange	
8006829	11046979	9.5" x 45" ARMADILLO S.S.S.C. Shell Kit without Air Valve and Filling Flange	
ARMADILLO® Stainless Steel Splice Case – Shell Kit – Air Valve Only			
8006750	11045051	4" x 25" ARMADILLO S.S.S.C. Shell Kit with Air Valve Only	
8006474	11045500	6.5" x 28" ARMADILLO S.S.S.C. Shell Kit with Air Valve Only	
8006751	11045498	6.5" x 38" ARMADILLO S.S.S.C. Shell Kit with Air Valve Only	
8006776	11046978	8" x 28" ARMADILLO S.S.S.C. Shell Kit with Air Valve Only	
8006777	11046977	8" x 38" ARMADILLO S.S.S.C. Shell Kit with Air Valve Only	
8006778	11046976	8" x 45" ARMADILLO S.S.S.C. Shell Kit with Air Valve Only	
8006779	11045499	9.5" x 28" ARMADILLO S.S.S.C. Shell Kit with Air Valve Only	
8006780	89006883	9.5" x 38" ARMADILLO S.S.S.C. Shell Kit with Air Valve Only	
8006781	11046975	9.5" x 45" ARMADILLO S.S.S.C. Shell Kit with Air Valve Only	
ARMADILLO® Stainless Steel Splice Case – Shell Kits with Filling Flange Only			
8006756	11045497	4" x 25" ARMADILLO S.S.S.C. Shell Kit with Filling Flange Only	
8006244	11045496	6.5" x 28" ARMADILLO S.S.S.C. Shell Kit with Filling Flange Only	
8006246	11045494	6.5" x 38" ARMADILLO S.S.S.C. Shell Kit with Filling Flange Only	
8006391	11046974	8" x 28" ARMADILLO S.S.S.C. Shell Kit with Filling Flange Only	
8006392	11046973	8" x 38" ARMADILLO S.S.S.C. Shell Kit with Filling Flange Only	
8006393	11046972	8" x 45" ARMADILLO S.S.S.C. Shell Kit with Filling Flange Only	
8006245	11045495	9.5" x 28" ARMADILLO S.S.S.C. Shell Kit with Filling Flange Only	
8006247	11045493	9.5" x 38" ARMADILLO S.S.S.C. Shell Kit with Filling Flange Only	
8006250	11046971	9.5" x 45" ARMADILLO S.S.S.C. Shell Kit with Filling Flange Only	

ARMADILLO® Stainless Steel Splice Case – Top Shell Kits with Filling Flange Only			
PLP Part Number	Verizon SSI Code	Description	Visual Depiction
8006413	521208	4" x 25" ARMADILLO S.S.S.C. Top Shell Half with Filling Flange, Netting and Funnel	
8006414	521209	6.5" x 22" ARMADILLO S.S.S.C. Top Shell Half with Filling Flange, Netting and Funnel	
8006415	521210	6.5" x 28" ARMADILLO S.S.S.C. Top Shell Half with Filling Flange, Netting and Funnel	
8006416	521211	6.5" x 38" ARMADILLO S.S.S.C. Top Shell Half with Filling Flange, Netting and Funnel	
8006417	521212	8" x 28" ARMADILLO S.S.S.C. Top Shell Half with Filling Flange, Netting and Funnel	
8006418	521213	8" x 38" ARMADILLO S.S.S.C. Top Shell Half with Filling Flange, Netting and Funnel	
8006419	521214	8" x 45" ARMADILLO S.S.S.C. Top Shell Half with Filling Flange, Netting and Funnel	
8006420	521215	9.5" x 28" ARMADILLO S.S.S.C. Top Shell Half with Filling Flange, Netting and Funnel	
8006421	521216	9.5" x 38" ARMADILLO S.S.S.C. Top Shell Half with Filling Flange, Netting and Funnel	
8006422	521217	9.5" x 45" ARMADILLO S.S.S.C. Top Shell Half with Filling Flange, Netting and Funnel	
8006423	521218	12.5" x 28" ARMADILLO S.S.S.C. Top Shell Half with Filling Flange, Netting and Funnel	
8006424	521219	12.5" x 38" ARMADILLO S.S.S.C. Top Shell Half with Filling Flange, Netting and Funnel	
8006425	521223	12.5" x 45" ARMADILLO S.S.S.C. Top Shell Half with Filling Flange, Netting and Funnel	
ARMADILLO Stainless Steel Splice Case End Plates – No Air Valve, No Ground Insert			
8003539	926681	4", 2-Section ARMADILLO Drillable End Plate without Air Valve or Grounding Insert – Includes (1) End Plate	 <p>END PLATE with NO Air Valve / NO Ground Insert</p>
8000379	522505	4", 2-Section ARMADILLO Drillable End Plate without Air Valve or Grounding Insert – Includes (2) End Plates	
8003540	926682	6.5", 2-Section ARMADILLO Drillable End Plate without Air Valve or Grounding Insert – Includes (1) End Plate	
8000380	522506	6.5", 2-Section ARMADILLO Drillable End Plate without Air Valve or Grounding Insert – Includes (2) End Plates	
8000361	522521	6.5", 3-Section ARMADILLO Drillable End Plate without Air Valve or Grounding Insert – Includes (1) End Plate	
8003541	926683	8", 2-Section ARMADILLO Drillable End Plate without Air Valve or Grounding Insert – Includes (1) End Plate	
8003098	521153	8", 2-Section ARMADILLO Drillable End Plate without Air Valve or Grounding Insert – Includes (2) End Plates	
8003110	521154	8", 3-Section ARMADILLO Drillable End Plate without Air Valve or Grounding Insert – Includes (1) End Plate	
8003542	926684	9.5", 2-Section ARMADILLO Drillable End Plate without Air Valve or Grounding Insert – Includes (1) End Plate	
8000381	522507	9.5", 2-Section ARMADILLO Drillable End Plate without Air Valve or Grounding Insert – Includes (2) End Plates	
800081098	522389	9.5", 3-Section ARMADILLO Drillable End Plate without Air Valve or Grounding Insert – Includes (1) End Plate	
8003284	87205428	12.5", 2-Section ARMADILLO Drillable End Plate without Air Valve or Grounding Insert – Includes (1) End Plate	
8003055	528685	12.5", 3-Section ARMADILLO Drillable End Plate without Air Valve or Grounding Insert – Includes (1) End Plate	



ARMADILLO Stainless Steel Splice Case End Plates with Air Valve and Ground Insert			
PLP Part Number	Verizon SSI Code	Description	Visual Depiction
8003560	926533	4", 2-Section ARMADILLO Drillable End Plate with Air Valve & Grounding Insert – Includes (1) End Plate	 <p>2-Section END PLATE with Air Valve and Ground Insert</p>  <p>3-Section END PLATE with Air Valve and Ground Insert</p>
8003561	926534	6.5", 2-Section ARMADILLO Drillable End Plate with Air Valve & Grounding Insert – Includes (1) End Plate	
80805365	926535	6.5", 3-Section ARMADILLO Drillable End Plate with Air Valve & Grounding Insert – Includes (1) End Plate	
8003562	926530	8", 2-Section ARMADILLO Drillable End Plate with Air Valve & Grounding Insert – Includes (1) End Plate	
8003533	926529	8", 3-Section ARMADILLO Drillable End Plate with Air Valve & Grounding Insert – Includes (1) End Plate	
8003563	926531	9.5", 2-Section ARMADILLO Drillable End Plate with Air Valve & Grounding Insert – Includes (1) End Plate	
80805376	89006880	9.5", 3-Section ARMADILLO Drillable End Plate with Air Valve & Grounding Insert – Includes (1) End Plate	
8003564	926532	12.5", 2-Section ARMADILLO Drillable End Plate with Air Valve & Grounding Insert – Includes (1) End Plate	
8003367	89006881	12.5", 3-Section ARMADILLO Drillable End Plate with Air Valve & Grounding Insert – Includes (1) End Plate	
ARMADILLO® Stainless Steel Splice Case – End Plates with Air Valve Only			
8003082	528686	6.5", 2-Section ARMADILLO Drillable End Plate with Air Valve Only – Includes (1) End Plate	 <p>2-Section END PLATE with Air Valve and Ground Insert</p>  <p>3-Section END PLATE with Air Valve and Ground Insert</p>
8003130	87234463	8", 2-Section ARMADILLO Drillable End Plate with Air Valve Only – Includes (1) End Plate	
8003083	528687	9.5", 2-Section ARMADILLO Drillable End Plate with Air Valve Only – Includes (1) End Plate	
8003122	528688	12.5", 3-Section ARMADILLO Drillable End Plate with Air Valve Only. Includes (1) End Plate	
8003086	87221629	12.5", 3-Section ARMADILLO Drillable End Plate with Air Valve Only – Includes (1) End Plate	
ARMADILLO Stainless Steel Splice Case – Sealing Washer End Plates			
8003514	918653	4", 2-Port ARMADILLO Sealing Washer End Plate – Includes (1) End Plate	
8003515	918654	6.5", 1-Port ARMADILLO Sealing Washer End Plate – Includes (1) End Plate	
8003516	918655	6.5", 2-Port ARMADILLO Sealing Washer End Plate – Includes (1) End Plate	
8003517	918656	6.5", 3-Port ARMADILLO Sealing Washer End Plate – Includes (1) End Plate	
8003518	918657	8", 1-Port ARMADILLO Sealing Washer End Plate – Includes (1) End Plate	
8003519	918658	8", 2-Port ARMADILLO Sealing Washer End Plate – Includes (1) End Plate	
8003520	918659	8", 3-Port ARMADILLO Sealing Washer End Plate – Includes (1) End Plate	
8003521	918660	9.5", 2-Port ARMADILLO Sealing Washer End Plate – Includes (1) End Plate	
8003522	918661	9.5", 3-Port ARMADILLO Sealing Washer End Plate – Includes (1) End Plate	
8003621	926679	12.5", 2-Port ARMADILLO Sealing Washer End Plate – Includes (1) End Plate	
8003620	926680	12.5", 3-Port ARMADILLO Sealing Washer End Plate – Includes (1) End Plate	

ARMADILLO Stainless Steel Splice Case – Vault Closure End Plate Kits			
PLP Part Number	Verizon SSI Code	Description	Visual Depiction
8003085	528698	ARMADILLO Drillable Vault End Plate for Feeder Cables. 6.5", 2-Section Includes (1) End Plate, Flame Retardant	 <p>END PLATE VAULT 2 Section with NO Air Valve / NO Ground Insert</p>
8003090	529515	ARMADILLO Drillable Vault End Plate for Tip Cables. 6.5", 2-Section Includes (1) End Plate, Flame Retardant	
8003074	528696	ARMADILLO Drillable Vault End Plates for Feeder Cables. 6.5", 3-Section Includes (1) End Plate, Flame Retardant	
8003084	528697	ARMADILLO Drillable Vault End Plate for Tip Cables. 6.5", 3-Section Includes (1) End Plate, Flame Retardant	
8003113	521199	ARMADILLO Drillable Vault End Plate for Feeder Cables. 8", 2-Section Includes (1) End Plate, Flame Retardant	
8003115	521200	ARMADILLO Drillable Vault End Plate for Feeder Cables. 8", 3-Section Includes (1) End Plate, Flame Retardant	
8080501	407981	ARMADILLO Drillable Vault End Plate for Tip Cables. 8", 3-Section Includes (1) End Plate, Flame Retardant	
80804320	521241	ARMADILLO Drillable Vault End Plate for Tip Cables. 8", 4-Section Includes (1) End Plate, Flame Retardant	
80804321	521242	ARMADILLO Drillable Vault End Plate for Tip Cables. 8", 5-Section Includes (1) End Plate, Flame Retardant	
80804322	521243	ARMADILLO Drillable Vault End Plate for Tip Cables. 8", 6-Section Includes (1) End Plate, Flame Retardant	
80802682	523881	ARMADILLO Drillable Vault End Plate for Feeder Cables. 9.5", 2-Section Includes (1) End Plate, Flame Retardant	
8000387	524999	ARMADILLO Drillable Vault End Plate for Feeder Cables. 9.5", 2-Section Includes (2) End Plate, Flame Retardant	
8003012	521369	ARMADILLO Drillable Vault End Plate for Feeder Cables. 9.5", 3-Section Includes (1) End Plate, Flame Retardant	
80802669	521370	ARMADILLO Drillable Vault End Plate for Feeder & Tip Cables. 9.5", 4-Section Includes (1) End Plate, Flame Retardant	
80802671	524997	ARMADILLO Drillable Vault End Plate for Feeder & Tip Cables. 9.5", 2-Section Includes (1) End Plate, Flame Retardant	
80802893	528977	ARMADILLO Drillable Vault End Plate for Feeder Cables. 9.5", 4-Section Includes (1) End Plate, Flame Retardant	
80802667	524996	ARMADILLO Drillable Vault End Plate for Tip Cables. 9.5", 4-Section Includes (1) End Plate, Flame Retardant	
80802511	529966	ARMADILLO Drillable Vault End Plate for Tip Cables. 9.5", 6-Section Includes (1) End Plate, Flame Retardant	
8000398	523205	ARMADILLO Drillable Vault End Plate for Tip Cables. 9.5", 2-Section 36-Port Includes (1) End Plate & B-Sealant, Flame Retardant	
8003081	528694	ARMADILLO Urethane Vault End Plate for Tip Cables. 9.5", 1-Section 36-Port Includes (1) End Plate & B-Sealant, Flame Retardant	
8003053	528684	ARMADILLO Drillable Vault End Plate for Feeder Cables. 12.5", 2-Section Includes (1) End Plate, Flame Retardant	
8003102	520201	ARMADILLO Drillable Vault End Plate for Feeder Cables. 12.5", 3-Section Includes (1) End Plate, Flame Retardant	
80804054	521156	ARMADILLO Drillable Vault End Plate for Feeder & Tip Cables. 12.5", 3-Section Includes (1) End Plate, Flame Retardant	
80804042	521157	ARMADILLO Drillable Vault End Plate for Feeder & Tip Cables. 12.5", 4-Section Includes (1) End Plate, Flame Retardant	
80804043	521158	ARMADILLO Drillable Vault End Plate for Feeder & Tip Cables. 12.5", 5-Section Includes (1) End Plate, Flame Retardant	

ARMADILLO Stainless Steel Splice Case – Vault Closure End Plate Kits			
PLP Part Number	Verizon SSI Code	Description	Visual Depiction
80803818	520562	ARMADILLO Drillable Vault End Plate Tip Cables. 12.5", 6-Section Includes (1) End Plate, Flame Retardant	
80803813	520687	ARMADILLO Drillable Vault End Plate Tip Cables. 12.5", 7-Section Includes (1) End Plate, Flame Retardant	
ARMADILLO Stainless Steel Splice Case Accessories			
8003543	918700	1" Sealing Washer Kit for ARMADILLO Sealing Washer End Plates	
8003544	918701	1.6" Sealing Washer Kit for ARMADILLO Sealing Washer End Plates	
8003545	918702	2.2" Sealing Washer Kit for ARMADILLO Sealing Washer End Plates	
8003546	918703	2.8" Sealing Washer Kit for ARMADILLO Sealing Washer End Plates	
8003547	918704	3.4" Sealing Washer Kit for ARMADILLO Sealing Washer End Plates	
8003624	700254462	Plug Spool Kit for ARMADILLO Sealing Washer End Plate, 1.6" or 2.2" Entry Ports	
8003625	700254463	Plug Spool Kit for ARMADILLO Sealing Washer End Plate, 2.8" or 3.4" Entry Ports	
8000480	918710	ARMADILLO Sealing Washer Cutter Tool Kit – Includes (1) Washer Cutter, (1) Spare Blade, and (1) Tote Bag	
8000481	918711	Blades for ARMADILLO Sealing Washer Cutter Tool – Includes (3) Blades	
8003089	529332	Coupler Kit for 6.5" ARMADILLO S.S.S.C.	
8003031	526117	Coupler Kit for 9.5" ARMADILLO S.S.S.C.	
8003105	521159	Re-encapsulation Kit – Includes (1) Check Valve and (1) Funnel with Tubing	
8003629	933544	Encapsulation Pressure Injection Kit	
80805925	11012055	1" Roll of LOCK-TAPE™ Sealant	
80801953	528125	1-1/2" W x 12' L Roll of LOCK-TAPE™ Sealant for ARMADILLO Drillable End Plates	
80801954	528126	2-1/2" W x 12' L Roll of LOCK-TAPE™ Sealant for ARMADILLO Drillable End Plates	
80801953	528125	1-1/2" W x 12' L Roll of LOCK-TAPE™ Sealant for ARMADILLO Drillable End Plates	
80801954	528126	2-1/2" W x 12' L Roll of LOCK-TAPE™ Sealant for ARMADILLO Drillable End Plates	
80801955	528127	3" W x 12' L Roll of LOCK-TAPE™ Sealant for ARMADILLO Drillable End Plates	
80801566	524241	Shell Lubricant (8 oz. jar)	
80801796	521231	Green Sealant. Used for blocking of air and moisture between sheath layers	
80806434	918706	1-1/2" W x 6' L Roll of R-Sealant for ARMADILLO Sealing Washer End Plates	
80802683	538067	10 oz. Tube of Silicone Sealant for ARMADILLO Drillable Vault End Plates	
80802377	521166	4 oz. can of C-Cement	
80805238	539476	1 oz. tube of C-Cement	



ARMADILLO Stainless Steel Splice Case Accessories			
PLP Part Number	Verizon SSI Code	Description	Visual Depiction
80802790	525002	LOCKBAR™ Fastening System for 4" x 25" ARMADILLO S.S.S.C.	
80802789	525003	LOCKBAR™ Fastening System for all 28" ARMADILLO S.S.S.C.	
80802791	525004	LOCKBAR™ Fastening System for all 38" ARMADILLO S.S.S.C.	
80802792	521339	LOCKBAR™ Fastening System for all 45" ARMADILLO S.S.S.C.	
80803792	521161	Stiffener Bar for 12.5" x 28" ARMADILLO S.S.S.C. (3rd support bar for 12.5" End Plate)	
80803799	521162	Stiffener Bar for 12.5" x 38" ARMADILLO S.S.S.C. (3rd support bar for 12.5" End Plate)	
80803877	521164	Stiffener Bar for 12.5" x 45" ARMADILLO S.S.S.C. (3rd support bar for 12.5" End Plate)	
80804938	912271	Stiffener Bar for 12.5" x 65" ARMADILLO S.S.S.C. (3rd support bar for 12.5" End Plate)	
80851245	521101	Torque Bar for 4" x 25" ARMADILLO S.S.S.C.	
80803994	521165	Torque Bar for 6.5" x 22" ARMADILLO S.S.S.C.	
80850952	521102	Torque Bar for 28" ARMADILLO S.S.S.C. (6.5", 8", & 9.5")	
80850985	521103	Torque Bar for 38" ARMADILLO S.S.S.C. (6.5", 8", & 9.5")	
80803788	521160	Torque Bar for 12.5" x 28" ARMADILLO S.S.S.C.	
80802591	521163	Torque Bar for 45" ARMADILLO S.S.S.C. (8", 9.5", & 12.5")	
8000452	632341	Power End Plate Cutter (only)	
8000454	405864	Power End Plate Cutter with Case and Blade Kit	
80801944	575119	Drill Chuck Socket Adapter for Power Drill	
8000468	407587	Power End Plate Cutter Lift Kit. Used for 9.5" and 12.5" Drillable End Plates with Future Cable Ports	
80803377	375897	Cutting Blade Adapter for Power End Plate Cutter	
8000445	573638	Carrying Case for Power End Plate Cutter	
8000428	575826	Torque Wrench Kit – Includes (1) 3/8" Drive Torque Wrench, (1) 3/8" Drive Ratchet Wrench, (1) 7/16" Socket, (1) 1/2" Socket, and (1) 6" Extension	
8000461	571929	Power End Plate Cutter Kit – Includes Cable Shaper, Blade and Bit Kit, Power End Plate Cutter and Carrying Case	

ARMADILLO® Stainless Steel Splice Case Accessories			
PLP Part Number	Verizon SSI Code	Description	Visual Depiction
8000453	571205	Blade Kit (Blades A-Z)	
80803501	952207	Cutting Blade Storage Box	
8000417A	573636	A Cutting Blade (3/8" Boring Bit) for Power End Plate Cutter – 1 blade	
8000417B	573637	B Cutting Blade (1/2" Boring Bit) for Power End Plate Cutter – 1 blade	
8000417C	570941	C Cutting Blade (5/8" Boring Bit) for Power End Plate Cutter – 1 blade	
8000417D	570942	D Cutting Blade (3/4" Boring Bit) for Power End Plate Cutter – 1 blade	
8000417E	570943	E Cutting Blade (.875") for Power End Plate Cutter – 1 blade	
8000417F	570944	F Cutting Blade (1.000") for Power End Plate Cutter – 1 blade	
8000417G	570945	G Cutting Blade (1.125") for Power End Plate Cutter – 1 blade	
8000417H	570946	H Cutting Blade (1.250") for Power End Plate Cutter – 1 blade	
8000417I	570947	I Cutting Blade (1.375") for Power End Plate Cutter – 1 blade	
8000417J	570948	J Cutting Blade (1.500") for Power End Plate Cutter – 1 blade	
8000417K	570949	K Cutting Blade (1.625") for Power End Plate Cutter – 1 blade	
8000417L	570950	L Cutting Blade (1.750") for Power End Plate Cutter – 1 blade	
8000417M	570951	M Cutting Blade (1.875") for Power End Plate Cutter – 1 blade	
8000417N	570952	N Cutting Blade (2.000") for Power End Plate Cutter – 1 blade	
8000417O	570953	O Cutting Blade (2.125") for Power End Plate Cutter – 1 blade	
8000417P	570954	P Cutting Blade (2.250") for Power End Plate Cutter – 1 blade	
8000417Q	570955	Q Cutting Blade (2.375") for Power End Plate Cutter – 1 blade	
8000417R	570956	R Cutting Blade (2.500") for Power End Plate Cutter – 1 blade	
8000417S	570957	S Cutting Blade (2.625") for Power End Plate Cutter – 1 blade	
8000417T	570958	T Cutting Blade (2.750") for Power End Plate Cutter – 1 blade	
8000417U	570959	U Cutting Blade (2.875") for Power End Plate Cutter – 1 blade	
8000417V	570960	V Cutting Blade (3.000") for Power End Plate Cutter – 1 blade	
8000417W	570961	W Cutting Blade (3.125") for Power End Plate Cutter – 1 blade	
8000417X	570914	X Cutting Blade (3.250") for Power End Plate Cutter – 1 blade	
8000417Y	575801	Y Cutting Blade (3.375") for Power End Plate Cutter – 1 blade	
8000417Z	575802	Z Cutting Blade (3.500") for Power End Plate Cutter – 1 blade	
8000417AA	571033	AA Cutting Blade (3.625") for Power End Plate Cutter – 1 blade	
8000417BB	571034	BB Cutting Blade (3.750") for Power End Plate Cutter – 1 blade	
8000417CC	571035	CC Cutting Blade (3.850") for Power End Plate Cutter – 1 blade	
8000417DD	571036	DD Cutting Blade (4.000") for Power End Plate Cutter – 1 blade	
80802134	375898	Blade Retaining Screw for Power End Plate Cutter	
80801151	952206	1/2" Deep Well Socket	
80805788	530832	3/8" Socket Drive Adapter	
8000420	575537	Socket Wrench Kit – Includes (1) 3/8" Drive Ratchet Wrench, (1) 7/16" Socket, (1) 1/2" Socket, & (1) 6" Extension	
80803967	579347	3/8" Drive Adjustable Torque Wrench	
80851659	700 247 373	Electric Drill with Socket for Power End Plate Cutter	

ARMADILLO® Stainless Steel Splice Case Accessories			
PLP Part Number	Verizon SSI Code	Description	Visual Depiction
8000432	575827	End Plate Removal Tool for Drillable End Plates	
8000422	578867	Cable Shaper Tool. Used to shape cable sheaths before installing end plates	
8003096	529516	Cable Sheath Restoral Kit	
80803344	528695	Vault Closure Plug. Used in unused ports of Urethane Fire Retardant End Plates	
8003045	526131	External Bond Clamp Kit for LOCKBAR™ Assemblies	
80801195	526132	External Bond Clamp Kit for Non-LOCKBAR™ Assemblies. Used on old style closures	
8003087	528704	External Ground Fitting Kit. Used with End Plates with Stainless Steel Air Flange Inserts	
80802545	529519	External Ground Screw (5/16" x 3/4" Hex Bolt)	
8006264	520385	BUNDLE-LOCK Kit. Used to wrap a splice bundle in unfilled closures	
8003527	918699	ARMADILLO S.S.S.C. Manhole Support Assembly Kit	
8003156	521237	ARMADILLO Strand Aerial Hanger Bracket. Contains 2 assemblies	
8000309	524155	Bolt & Nut Kit for 4" ARMADILLO S.S.S.C.	
8000308	952205	Bolt & Nut Kit for 6.5" and 9.5" ARMADILLO S.S.S.C.	
80806724	700 251599/ 918696	Bonding Kit for 4" x 25" ARMADILLO S.S.S.C. Kit – Includes (2) Large Red Pair Protectors, (2) Small Green Pair Protectors, (2) Bonding Braids with Eyelets, (1) 30" Braid with Insulation, and (3) Shield Connectors	
80806725	700 251 600/ 91869	Bonding Kit for 28" ARMADILLO S.S.S.C. Kit – Includes (6) Large Red Pair Protectors, (2) Small Green Pair Protectors, (2) Bonding Braids with Eyelets, (1) 42" Braid with Insulation, and (3) Shield Connectors	
80806726	700 251 601/ 918698	Bonding Kit for 38" ARMADILLO S.S.S.C. Kit – Includes (6) Large Red Pair Protectors, (2) Small Green Pair Protectors, (2) Bonding Braids with Eyelets, (1) 52" Braid with Insulation, and (3) Shield Connectors	
80803520	376844	Reducing Bushing (3/4" to 1/8") for ARMADILLO S.S.S.C.	
8003033	529517	Flame Retardant Tape Kit – Includes (1) 1-1/2" W x 27' L Roll	
80800552	520109	Air Flange Plug for ARMADILLO S.S.S.C.	
8003097	528800	24" W x 40' L Roll of Plastic Netting. Used to wrap splice bundles prior to encapsulation	
80806592	700 251 609/ 918705	25" Roll of Prep Tape for ARMADILLO Sealing Washer End Plates	

SERVISEAL® and BLACK-JACK™ Closures and Accessories			
PLP Part Number	Verizon SSI Code	Description	Visual Depiction
8006137	914156	Ranger SERVISEAL. Used for up to 6 pairs	
8006039	87001032	Super SERVISEAL. Used up to 12 pairs	
80008946	558037	Vial Replacement Kit for Ranger SERVISEAL	
80851909	377339	Vial Replacement Kit for Super SERVISEAL	
8006508	87210662	BLACK-JACK for 25-Pair In-Line Applications	
8006318	87004320	BLACK-JACK for 25-Pair Butt Applications	
8006681	87278547	BLACK-JACK for 50-Pair In-Line Applications	
Tri-Seal & Omni-Seal Closures			
8000574	930739	Tri-Seal with Connector Block Mounting Bar	
8000575	527736	Omni-Seal with 12 Pair Block, Prepotted Stub	
REDDI™ Seal Closure Parts & Accessories			
8000388	526116	4" REDDI Seal End Plate with Grounding Insert Kit	
8000389	525885	2-Section 6.5" REDDI Seal End Plate with Grounding Insert Kit	
8003094	529521	3-Section 6.5" REDDI Seal End Plate with Grounding Insert Kit	
8000390	526080	2-Section 9.5" REDDI Seal End Plate with Grounding Insert Kit	
8003013	529000	3-Section 9.5" REDDI Seal End Plate with Grounding Insert Kit	
8003020	525946	4" REDDI Seal Re-Entry Kit	
8003021	525947	6.5" REDDI Seal Re-Entry Kit	
8003022	525948	9.5" REDDI Seal Re-Entry Kit	
80802510	525370	Hanger Bracket	
SERVI-BOND Shield Connectors			
8000737	318249	4.5" Harness with Floating Hook Terminal SERVI-BOND Shield Connector. Used for 2 Pair or 3 Pair Service Cable	
8000738	318250	4.5" Harness with Floating Hook Terminal SERVI-BOND Shield Connector. Used for 5 Pair or 6 Pair Service Cable	
8000747	523766	14" Harness with Floating Hook Terminal SERVI-BOND Shield Connector. Used for 5 Pair or 6 Pair Service Cable	
8000749	386497	4.5" Harness with Floating Ring Terminal SERVI-BOND Shield Connector. Used for 2 Pair or 3 Pair Service Cable	
8000750	386499	4.5" Harness with Floating Ring Terminal SERVI-BOND Shield Connector. Used for 5 Pair or 6 Pair Service Cable	
8000752	512991	4.5" Harness with Floating Hook Terminal SERVI-BOND Shield Connector. Used for 12 Pair Service Cable	
800011296	934220	4.5" Harness with Floating Hook Terminal with 1/4" Stud Hole SERVI-BOND Shield Connector. Used for 5 Pair or 6 Pair Service Cable	
Pair Protectors			
8000719BX	11068625	Large Red Pair Protector (1.25" x 2.5")	
8000720BX	11068626	Small Green Pair Protector (1" x 2.5")	

OVERHEAD COMMUNICATIONS for Verizon

Strand & Cable Products			
PLP Part Number	Verizon SSI Code	Description	Visual Depiction
AWDE-4122	513116 MMID 10833747	GUY-GRIP® Dead-End (16M), Aluminum-Clad Steel	
BDE-9102	11063193 MMID 10833783	GUY-GRIP Dead-End (3/16"), *Mischmetal Alloy (AL/ZN) Strand	
BDE-9104	11001998 MMID 10833749	GUY-GRIP Dead-End (1/4"), Mischmetal Alloy (AL/ZN) Strand	
BDE-9106	11001999 MMID 10833784	GUY-GRIP Dead-End (5/16"), Mischmetal Alloy (AL/ZN) Strand	
BDE-9107	11002000 MMID 10833769	GUY-GRIP Dead-End (3/8"), Mischmetal Alloy (AL/ZN) Strand	
BDE-9108	11002001 MMID 10833770	GUY-GRIP Dead-End (7/16"), Mischmetal Alloy (AL/ZN) Strand	
GDE-2102	513103 MMID 10833803	GUY-GRIP® Dead-End (3/16"), Galvanized Steel C-Coat	
GDE-2104	513104 MMID 10833777	GUY-GRIP Dead-End (1/4"), Galvanized Steel C-Coat	
GDE-2106	513105 MMID 10833761	GUY-GRIP Dead-End (5/16"), Galvanized Steel C-Coat	
GDE-2107	513106 MMID 10833812	GUY-GRIP Dead-End (3/8"), Galvanized Steel C-Coat	
GDE-2108	513107 MMID 10833813	GUY-GRIP Dead-End (7/16"), Galvanized Steel C-Coat	
BG-2115	513108 MMID 10833793	Big-Grip Dead-End (1/2"), Galvanized Steel C-Coat	
BFDE-9121	11001997 MMID 10833775	False Dead-End (1/4"), Mischmetal Alloy (AL/ZN) Strand	
BFDE-9123	11001996 MMID 10833792	False Dead-End (5/16"), Mischmetal Alloy (AL/ZN) Strand	
BFDE-9124	11001995 MMID 10833771	False Dead-End (3/8"), Mischmetal Alloy (AL/ZN) Strand	
BFDE-9125	11001994 MMID 10833756	False Dead-End (7/16"), Mischmetal Alloy (AL/ZN) Strand	
GFDE-2121	522303 MMID 10833797	False Dead-End (1/4"), Galvanized Steel C-Coat	
GFDE-2123	5223304 MMID 10833796	False Dead-End (5/16"), Galvanized Steel C-Coat	
GFDE-2124	522305 MMID 1083308	False Dead-End (3/8"), Galvanized Steel C-Coat	
GFDE-2125	522306 MMID 10833807	False Dead-End (7/16"), Galvanized Steel C-Coat	
GFDE-2126	87202022 MMID 10833806	False Dead-End (1/2"), Galvanized Steel C-Coat	
DE-2506	574456 MMID 10833804	Figure-8 Messenger Dead-End (Cable Diameter 0.083"), Galvanized Steel	

NOTES: PLP mischmetal formed wire products are acceptable for use with Bezinal® and Galfan® coated strands.

*Bezinal® is a registered trademark of the Bekaert Corporation. Galfan® is a registered trademark of the Galfan Technology Centre, LLC.

OVERHEAD COMMUNICATIONS for Verizon

Strand & Cable Products			
PLP Part Number	Verizon SSI Code	Description	Visual Depiction
AWDE-4511	367235	Open Wire Dead-End (AWG-11), Aluminum-Clad Steel	
CWDE-5509	531302 MMID 10833760	Open Wire Dead-End (AWG-10), Copper-Clad Steel	
GDE-2501	531306 MMID 10833805	Open Wire Dead-End (BWG-12), Galvanized Steel	
GDE-2503	522315 MMID 10833814	Open Wire Dead-End (BWG-10), Galvanized Steel	
BLSR-9122	11001989 MMID 10833776	Reducing Splice (5/16" to 1/4"), Mischmetal Alloy (AL/ZN) Strand	
BLSR-9123	11001988 MMID 10833758	Reducing Splice (3/8" to 5/16"), Mischmetal Alloy (AL/ZN) Strand	
BLSR-9125	11063195 MMID 10833759	Reducing Splice (3/8" to 1/4"), Mischmetal Alloy (AL/ZN) Strand	
LSR-2122	526637 MMID 10833810	Reducing Splice (5/16" to 1/4"), Galvanized Steel C-Coat	
LSR-2123	526638 MMID 10833823	Reducing Splice (3/8" to 5/16"), Galvanized Steel C-Coat	
LSR-2124	526639 MMID 10833779	Reducing Splice (7/16" to 3/8"), Galvanized Steel C-Coat	
LSR-2125	343960 MMID 10833786	Reducing Splice (3/8" to 1/4"), Galvanized Steel C-Coat	
AWLS-4116	700 221 396 MMID 10833748	Strand Splice (10M), Aluminum-Clad Steel	
BLS-9104	11001993 MMID 10833751	Strand Splice (1/4"), *Mischmetal Alloy (AL/ZN) Strand	
BLS-9106	11001992 MMID 10833750	Strand Splice (5/16"), Mischmetal Alloy (AL/ZN) Strand	
BLS-9107	11001991 MMID 10833794	Strand Splice (3/8"), Mischmetal Alloy (AL/ZN) Strand	
BLS-9108	11001990 MMID 10833757	Strand Splice (7/16"), Mischmetal Alloy (AL/ZN) Strand	
GLS-2104	526625 MMID 10833778	Strand Splice (1/4"), Galvanized Steel Extra High Strength C-Coat	
GLS-2106	526626 MMID 10833815	Strand Splice (5/16"), Galvanized Steel Extra High Strength C-Coat	
GLS-2107	526624 MMID 10833809	Strand Splice (3/8"), Galvanized Steel Extra High Strength C-Coat	
GLS-2108	526627 MMID 10833785	Strand Splice (7/16"), Galvanized Steel Extra High Strength C-Coat	
GLS-2109	526628 MMID 10833811	Strand Splice (1/2"), Galvanized Steel Extra High Strength C-Coat	
NDE-8500	513120 MMID 10833824	Buried Line Wire Dead-End (2 #19 Copper)	
NDE-8501	551501 MMID 10833822	Buried Line Wire Dead-End (2 #16 Copper)	





NOTES: PLP mischmetal formed wire products are acceptable for use with Bezinal® and Galfan® coated strands.

*Bezinal® is a registered trademark of the Bekaert Corporation. Galfan® is a registered trademark of the Galfan Technology Centre, LLC.

OVERHEAD COMMUNICATIONS for Verizon

Strand & Cable Products			
PLP Part Number	Verizon SSI Code	Description	Visual Depiction
NDE-9502	531291 MMID 10833788	C-Rural Dead-End (2 #14 CW). 15" Length	
NDE-8502	531294 MMID 10833798	C-Rural Dead-End (2 #14 CW). 22" Length	
NDE-8503	531292 MMID 10833787	C-Rural Dead-End (2 #12 CW). 30" Length	
CWDE-5509	531302 MMID 10833760	Open Wire Dead-End (AWG-10), Copper-Clad Steel	
ETS-2101	537381 MMID 10833795	Tangent Support (2 #14 CW), Elongated Loop	
ETS-3101	574458 MMID 10833802	Tangent Support (2 #14 CW), Elongated Loop	
TS-2100	537383 MMID 10833834	Tangent Support (2 #14 CW), Standard Loop	
TS-2103	537382 MMID 10833801	Tangent Support (2 #12 CW), Standard Loop	
Guy Guards, Tree Guards, and Pedestal Markers			
GWM-7101	000 632 489	3/4" Ground Wire Molding	
PG-5750	475583 MMID 10833799	Guy Marker, Orange and Yellow, 2 Piece 8 ft. Round Profile with 2 Cable Tie Attachments	
PG-5752	478073 MMID 10833780	Guy Marker, Orange, 2 Piece Orange 8 ft. Round Profile with 2 Cable Tie Attachments	
PG-5718	MMID 10833823	Guy Marker, 8 ft., Yellow	
PM-6216	337431 MMID 10833826	Pedestal Marker, Orange 6 ft.	
7000200	347609 MMID 10833774	Pedestal Marker Clamp	
PTG-0130	522809 MMID 10833781	Tree Guard (Diameter Range 0.543"-0.568"), Grey 3 ft.	
PTG-0136	522810 MMID 10833800	Tree Guard (Diameter Range 0.599"-0.641"), Grey 3 ft.	
PTG-0139	522811 MMID 10833817	Tree Guard (Diameter Range 0.642"-0.706"), Grey 3 ft.	

OVERHEAD COMMUNICATIONS for Verizon

Air Flow Spoilers			
PLP Part Number	Verizon SSI Code	Description	Visual Depiction
5058101	395020 MMID 10833720	Air Flow Spoiler for Self-Supporting Cables (Diameter Range 0.327 -0.461") & Cables with Messenger Wire Diameter Range less than 0.400").	
5058102	528779 MMID 10833772	Air Flow Spoiler for Self-Supporting Cables (Diameter Range 0.462 -0.563") & Cables with Messenger Wire (Diameter Range 0.319 -0.574").	
5058103	528780 MMID 10833766	Air Flow Spoiler for Self-Supporting Cables (Diameter Range 0.564 -0.760") & Cables with Messenger Wire (Diameter Range 0.319"-0.717").	
5058104	528781 MMID 10833764	Air Flow Spoiler for Self-Supporting Cables (Diameter Range 0.761 -0.926") & Cables with Messenger Wire (Diameter Range 0.496"-0.896").	
5058105	528782 MMID 10833746	Air Flow Spoiler for Self-Supporting Cables (Diameter Range 0.927 -1.019") & Cables with Messenger Wire (Diameter Range 0.717"-1.041").	
50589319	528785 MMID 10833731	Air Flow Spoiler for Cables with Messenger Wire (Diameter Range 1.471 -1.770")	
Pole Plugs			
PP0625B	11284404 MMID 10833789	Pole Plug for 9/16" and 5/8". For steel and composite poles	
PP0750B	11284405 MMID 10833833	Pole Plug for 11/16" and 3/4". For steel and composite poles	
Safety Guy Wire Dispenser			
SGD-0700	401 398 540 MMID 10833827	Safety Guy-Wire Dispenser	
Cable Caps			
80803606	520392	Cable Cap with Air Valve (Diameter Range 0.75"-1.25")	
80803610	520394	Cable Cap with Air Valve (Diameter Range 1.25"-1.50")	
80803614	520396	Cable Cap with Air Valve (Diameter Range 1.75"-2.25")	
80803618	520398	Cable Cap with Air Valve (Diameter Range 2.25"-2.75")	
80803622	520400	Cable Cap with Air Valve (Diameter Range 2.75"-3.25")	
80803626	520402	Cable Cap with Air Valve (Diameter Range 3.25"-3.75")	

April 2020

QUOTE DRAWINGS

MMID Approved Products Catalog
for Fiber Optic and Overhead Hardware Products



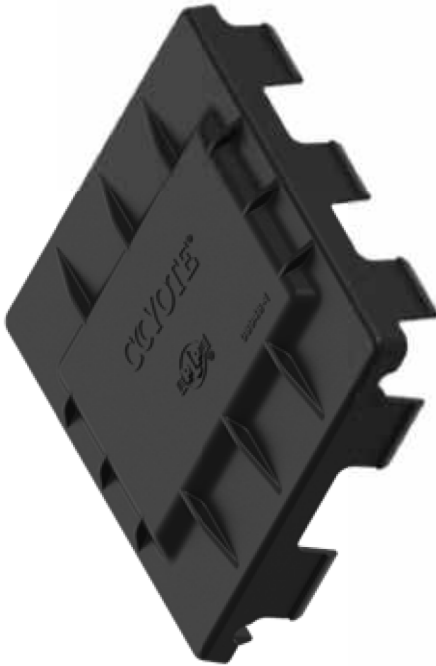

Cover (1)



Base (1)



Small Parts Bag (1)

ALL DIMENSIONS ARE APPROXIMATE AND MAY VARY PER FACTORY TOLERANCES. CONTACT PLP FOR MORE INFORMATION



PREFORMED
LINE PRODUCTS
www.preformed.com

CONFIDENTIAL
The data and information contained in this document are proprietary to PREFORMED Line Products (PLP). Such data and information are provided solely for use with PLP's products and shall not be disclosed, duplicated, or otherwise used without the express written approval of PLP. PLP MAINTAINS THE RIGHT TO CHANGE DRAWING SPECIFICATIONS AT ANY TIME. PLEASE CONTACT PLP TO VERIFY CURRENT VERSION

TITLE

P.N. COYOTE8400
COYOTE@DTC

DWG BY:	APR BY:	DATE:	SHEET:	FILE NAME:
MLA	MLA	8/11/17	1 of 1	COYOTE8400

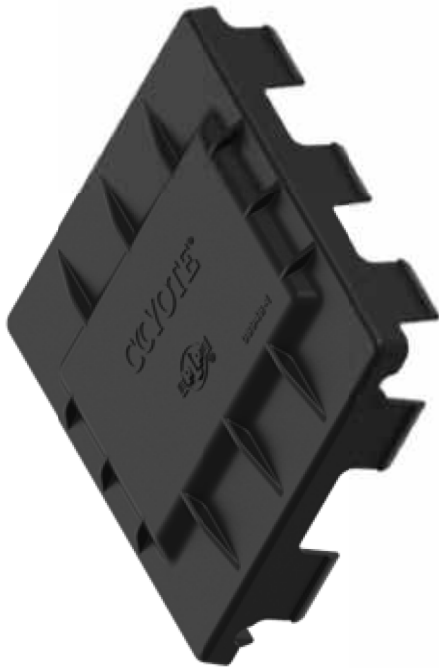

Cover (1)



Base (1)

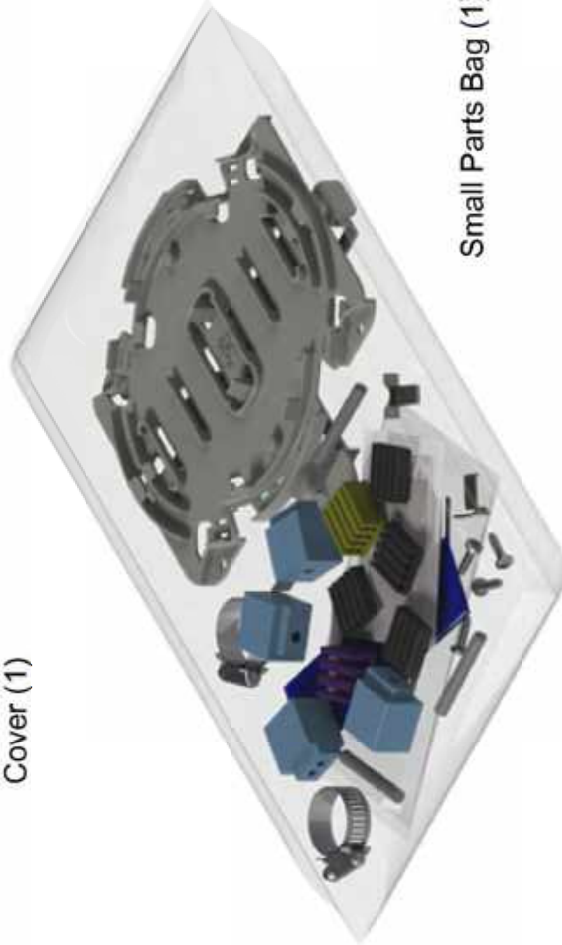

Small Parts Bag (1)

ALL DIMENSIONS ARE APPROXIMATE AND MAY VARY PER FACTORY TOLERANCES. CONTACT PLP FOR MORE INFORMATION



PREFORMED
LINE PRODUCTS
www.preformed.com

CONFIDENTIAL
The data and information contained in this document are proprietary to PREFORMED Line Products (PLP). Such data and information are provided solely for use with PLP's products and shall not be disclosed, duplicated, or otherwise used without the express written approval of PLP. PLP MAINTAINS THE RIGHT TO CHANGE DRAWING SPECIFICATIONS AT ANY TIME. PLEASE CONTACT PLP TO VERIFY CURRENT VERSION.

TITLE

P.N. COYOTE8401
COYOTE® DTC for Microcables

DWG BY:	APR BY:	DATE:	SHEET:	FILE NAME:
MLA	MLA	8/11/17	1 of 1	COYOTE8401



Cover (1)



Base (1)

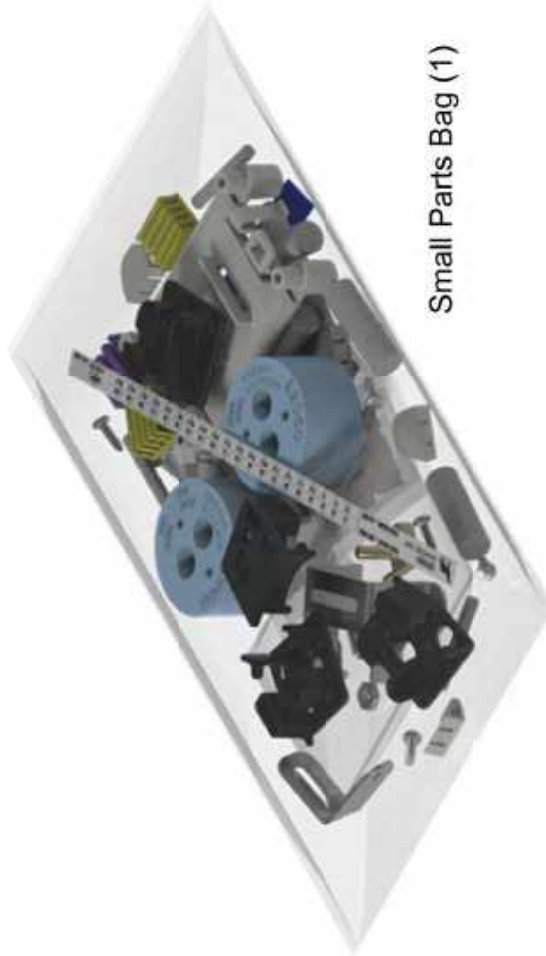

Small Parts Bag (1)



Hanger Bracket Kit (1)

ALL DIMENSIONS ARE APPROXIMATE AND MAY VARY PER FACTORY TOLERANCES. CONTACT PLP FOR MORE INFORMATION



PREFORMED
LINE PRODUCTS
www.preformed.com

CONFIDENTIAL
The data and information contained in this document are proprietary to PREFORMED Line Products (PLP). Such data and information are provided solely for use with PLP's products and shall not be disclosed, duplicated, or otherwise used without the express written approval of PLP. PLP MAINTAINS THE RIGHT TO CHANGE DRAWING SPECIFICATIONS AT ANY TIME. PLEASE CONTACT PLP TO VERIFY CURRENT VERSION

TITLE

P.N. VZCOYLCC-001
COYOTE@LCC

DWG BY:	APR BY:	DATE:	SHEET:	FILE NAME:
MLA	MLA	8/11/17	1 of 1	VZCOYLCC-001



Flame Retardant Cover (1)

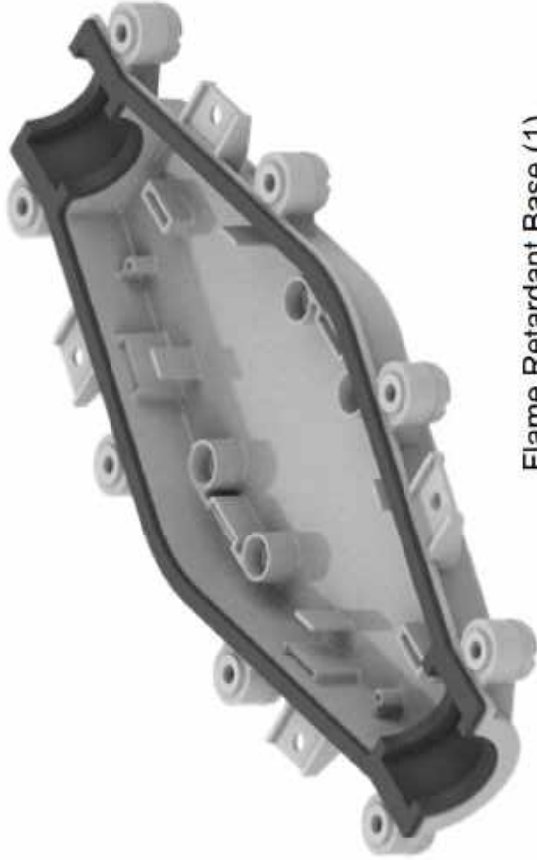

Flame Retardant Base (1)

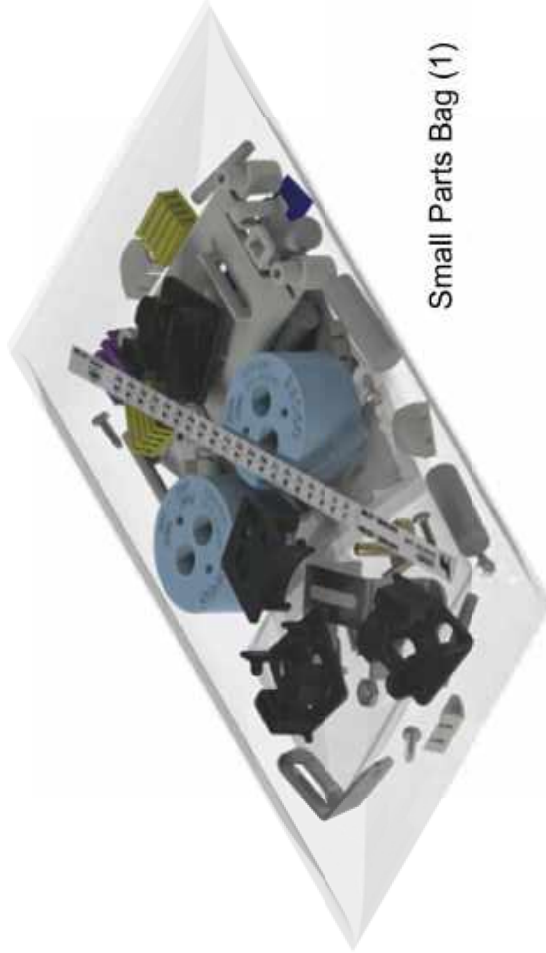

Small Parts Bag (1)

ALL DIMENSIONS ARE APPROXIMATE AND MAY VARY PER FACTORY TOLERANCES. CONTACT PLP FOR MORE INFORMATION



PREFORMED
LINE PRODUCTS
www.preformed.com

CONFIDENTIAL
The data and information contained in this document are proprietary to PREFORMED Line Products (PLP). Such data and information are provided solely for use with PLP's products and shall not be disclosed, duplicated, or otherwise used without the express written approval of PLP. PLP MAINTAINS THE RIGHT TO CHANGE DRAWING SPECIFICATIONS AT ANY TIME. PLEASE CONTACT PLP TO VERIFY CURRENT VERSION

TITLE

P.N. VZFRCOYLCC-001
Flame Retardant COYOTE® LCC

DWG BY:	APR BY:	DATE:	SHEET:	FILE NAME:
MLA	MLA	8/11/17	1 of 1	VZFRCOYLCC-001



Cover (1)



Base (1)



Cable Restraint Bracket Kit (1)



Small Parts Bag (1)



4 Pack Grommet Kit (1)

[Includes: (2) 2 Hole Grommets .42"- .60",
(1) 2 Hole Wide Range Grommet .42"- .60" & .60"- .85", &
(1) 7 Hole Grommet .42"- .60" & .125"- .25"]



Ribbon Organizer Kit (1)

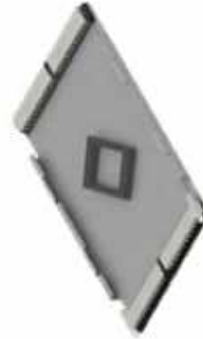

Short Metal Universal Splice Tray (1)



Universal Mounting Hanger Bracket Kit (1)

ALL DIMENSIONS ARE APPROXIMATE AND MAY VARY PER FACTORY TOLERANCES. CONTACT PLP FOR MORE INFORMATION



PREFORMED
LINE PRODUCTS
www.preformed.com

CONFIDENTIAL
The data and information contained in this document are proprietary to PREFORMED Line Products (PLP). Such data and information are provided solely for use with PLP's products and shall not be disclosed, duplicated, or otherwise used without the express written approval of PLP. PLP MAINTAINS THE RIGHT TO CHANGE DRAWING SPECIFICATIONS AT ANY TIME. PLEASE CONTACT PLP TO VERIFY CURRENT VERSION

TITLE

P.N. COYOTE8216

COYOTE® In-Line RUNT Closure (Hermetically Sealed) with Splice Tray

DWG BY:	APR BY:	DATE:	SHEET:	FILE NAME:
MLA	MLA	8/18/17	1 of 1	COYOTE8216



Cover (1)



Free Breathing Base (1)



Cable Restraint Bracket Kit (1)



Small Parts Bag (1)



4 Pack Grommet Kit (1)

[[Includes: (2) 2 Hole Grommets .42"- .60",
(1) 2 Hole Wide Range Grommet .42"- .60" & .60"- .85", &
(1) 7 Hole Grommet .42"- .60" & .125"- .25"]]



Tubing Kit (1)



Ribbon Organizer Kit (1)

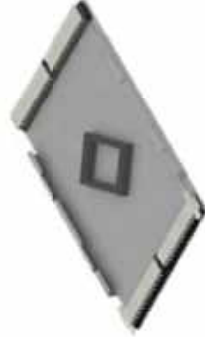

Short Metal Universal Splice Tray (1)



Universal Mounting Hanger Bracket Kit (1)

ALL DIMENSIONS ARE APPROXIMATE AND MAY VARY PER FACTORY TOLERANCES. CONTACT PLP FOR MORE INFORMATION



www.preformed.com

CONFIDENTIAL
The data and information contained in this document are proprietary to PREFORMED Line Products (PLP). Such data and information are provided solely for use with PLP's products and shall not be disclosed, duplicated, or otherwise used without the express written approval of PLP. PLP MAINTAINS THE RIGHT TO CHANGE DRAWING SPECIFICATIONS AT ANY TIME. PLEASE CONTACT PLP TO VERIFY CURRENT VERSION

TITLE

P.N. COYOTE8203

COYOTE® In-Line RUNT Closure (Free Breathing) with Splice Tray

DWG BY: MLA

APR BY: MLA

DATE: 8/18/17

SHEET: 1 of 1

FILE NAME: COYOTE8203



Flame Retardant Cover (1)



Flame Retardant Base (1)



Torque Limiting Tool (1)



Small Parts Bag (1)



4 Pack Grommet Kit (1)

[Includes: (2) 4 Hole Grommets .30"-.43",
(2) 2 Hole Wide Range Grommet .42"-.60" & .60"-.85", &
(1) 6 Hole Grommet .125"-.25"]



Ribbon Organizer Kit (1)

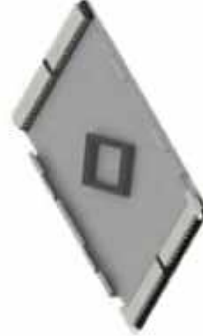

Short Metal Universal Splice Tray (1)



Universal Mounting Hanger Bracket Kit (1)

ALL DIMENSIONS ARE APPROXIMATE AND MAY VARY PER FACTORY TOLERANCES. CONTACT PLP FOR MORE INFORMATION



PREFORMED
LINE PRODUCTS
www.preformed.com

CONFIDENTIAL
The data and information contained in this document are proprietary to PREFORMED Line Products (PLP). Such data and information are provided solely for use with PLP's products and shall not be disclosed, duplicated, or otherwise used without the express written approval of PLP. PLP MAINTAINS THE RIGHT TO CHANGE DRAWING SPECIFICATIONS AT ANY TIME. PLEASE CONTACT PLP TO VERIFY CURRENT VERSION

TITLE

P.N. COYOTE8802

COYOTE® In-Line RUNT Closure (Flame Retardant) with Splice Tray

DWG BY: APR BY: MLA MLA

DATE: 8/18/17

SHEET: 1 of 1

FILE NAME: COYOTE8802



Cover (1)



End Plate with
Universal Organizer (1)



End Plate
Gasket (1)



Collar (1)



Transition Tube Kit (1)



2 Hole Grommet Kit
(.42"-.60" Cable Diameter) -
Contains 2 Grommets (1)



6 Hole Grommet Kit
(.125"-.25" Cable Diameter or Flat Drop) -
Contains 1 Grommet (1)



Small Parts Bag (1)

ALL DIMENSIONS ARE APPROXIMATE AND MAY VARY PER
FACTORY TOLERANCES. CONTACT PLP FOR MORE INFORMATION



PREFORMED
LINE PRODUCTS

www.pformed.com

CONFIDENTIAL
The data and information contained in this document are proprietary to
PREFORMED Line Products (PLP). Such data and information are
provided solely for use with PLP's products and shall not be disclosed,
duplicated, or otherwise used without the express written approval of PLP.
PLP MAINTAINS THE RIGHT TO CHANGE DRAWING SPECIFICATIONS AT ANY TIME.
PLEASE CONTACT PLP TO VERIFY CURRENT VERSION

TITLE

P.N. COYOTE1002
COYOTE® ONE Closure with
Universal Organizer

DWG BY: MLA
APR BY: MLA
DATE: 8/9/17

SHEET
1 of 1

FILE NAME:
COYOTE1002



End Plate with Ribbon Organizer (1)



Dome (1)



End Plate Gasket (1)



Collar (1)



Strength Member Bracket Kit (1)



Small Parts Bag (1)



4 Pack Grommet Kit (1)

[Includes: (2) 1 Hole Grommets .40"-.60", & (2) 1 Hole Grommets .60"-.85"]



6 Hole Grommet Kit
(.125"-.25" Cable Diameter or Flat Drop) -
Contains 1 Grommet (1)



1/4" I.D. x 24" Transition Tubes (2)



12ct Short Deep Profile LITE-GRIP® Splice Tray with Elastomeric Splice Block for Single Fusion (1)



Universal Mounting Hanger Brackets (2)

ALL DIMENSIONS ARE APPROXIMATE AND MAY VARY PER FACTORY TOLERANCES. CONTACT PLP FOR MORE INFORMATION

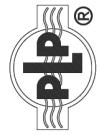

PREFORMED
LINE PRODUCTS
www.pformed.com

CONFIDENTIAL
The data and information contained in this document are proprietary to PREFORMED Line Products (PLP). Such data and information are provided solely for use with PLP's products and shall not be disclosed, duplicated, or otherwise used without the express written approval of PLP. PLP MAINTAINS THE RIGHT TO CHANGE DRAWING SPECIFICATIONS AT ANY TIME. PLEASE CONTACT PLP TO VERIFY CURRENT VERSION

TITLE

P.N. COYOTE8217U

COYOTE® Dome Closure 6.5"x17" with Ribbon Organizer & Splice Tray

FILE NAME:

COYOTE8217U

DWG BY:

MLA

APR BY:

MLA

DATE:

8/9/17

SHEET

1 of 1



End Plate with Expanded Ribbon Organizer (1)



Dome (1)



End Plate Gasket (1)



Collar (1)



Strength Member Bracket Kit (1)



Small Parts Bag (1)



4 Pack Grommet Kit (1)

[Includes: (2) 1 Hole Grommets .40"-.60", & (2) 1 Hole Grommets .60"-.85"]



6 Hole Grommet Kit
(.125"-.25" Cable Diameter or Flat Drop) -
Contains 1 Grommet (1)



1/4" I.D. x 24" Transition Tubes (2)



Short Deep Profile LITE-GRIP® Splice Tray for Single Fusion or Ribbon/Mass Fusion (1)



Universal Mounting Hanger Brackets (2)

ALL DIMENSIONS ARE APPROXIMATE AND MAY VARY PER FACTORY TOLERANCES. CONTACT PLP FOR MORE INFORMATION



www.preformed.com

CONFIDENTIAL
The data and information contained in this document are proprietary to PREFORMED Line Products (PLP). Such data and information are provided solely for use with PLP's products and shall not be disclosed, duplicated, or otherwise used without the express written approval of PLP. PLP MAINTAINS THE RIGHT TO CHANGE DRAWING SPECIFICATIONS AT ANY TIME. PLEASE CONTACT PLP TO VERIFY CURRENT VERSION

TITLE

P.N. COYOTE8235XU

COYOTE® Dome Closure 6.5"x17" with Expanded Ribbon Organizer & Splice Tray

DWG BY: MLA

APR BY: MLA

DATE: 8/8/17

SHEET: 1 of 1

FILE NAME:

COYOTE8235XU



Flame Retardant
End Plate with
Ribbon Organizer (1)



Flame
Retardant
Dome (1)



End Plate Gasket (1)



Flame
Retardant
Collar (1)



Strength Member
Bracket Kit (1)



Small Parts Bag (1)



1/4" I.D. x 24"
Transition Tubes (2)



4 Pack Grommet Kit (1)

[Includes: (2) 1 Hole Grommets .40"-.60",
& (2) 1 Hole Grommets .60"-.85"]



6 Hole Grommet Kit
(.125"-.25" Cable Diameter or Flat Drop) -
Contains 1 Grommet (1)



12ct Short Deep Profile LITE-GRIP®
Splice Tray with Elastomeric Splice
Block for Single Fusion (1)



Universal Mounting Hanger
Brackets (2)

ALL DIMENSIONS ARE APPROXIMATE AND MAY VARY PER
FACTORY TOLERANCES. CONTACT PLP FOR MORE INFORMATION



www.preformed.com

CONFIDENTIAL
The data and information contained in this document are proprietary to
PREFORMED Line Products (PLP). Such data and information are
provided solely for use with PLP's products and shall not be disclosed,
duplicated, or otherwise used without the express written approval of PLP.
PLP MAINTAINS THE RIGHT TO CHANGE DRAWING SPECIFICATIONS AT ANY TIME.
PLEASE CONTACT PLP TO VERIFY CURRENT VERSION

TITLE

P.N. COYOTE8805U

Flame Retardant COYOTE® Dome Closure 6.5"x17" with
Ribbon Organizer & Splice Tray

DWG BY:

APR BY:

DATE:

SHEET

FILE NAME:

MLA

MLA

8/9/17

1 of 1

COYOTE8805U



End Plate with Buffer Tube Organizer (1)



Dome (1)



End Plate Gasket (1)



Collar (1)



Strength Member Bracket Kit (1)



Small Parts Bag (1)



4 Pack Grommet Kit (1)

[Includes: (2) 1 Hole Grommets .40"-.60", & (2) 1 Hole Grommets .60"-.85"]



6 Hole Grommet Kit
(.125"-.25" Cable Diameter or Flat Drop) -
Contains 1 Grommet (1)



36ct Long Deep Profile LITE-GRIP®
Splice Tray with Elastomeric Splice
Blocks for Single Fusion (1)



Universal Mounting Hanger
Brackets (2)

ALL DIMENSIONS ARE APPROXIMATE AND MAY VARY PER FACTORY TOLERANCES. CONTACT PLP FOR MORE INFORMATION



www.preformed.com

CONFIDENTIAL
The data and information contained in this document are proprietary to PREFORMED Line Products (PLP). Such data and information are provided solely for use with PLP's products and shall not be disclosed, duplicated, or otherwise used without the express written approval of PLP. PLP MAINTAINS THE RIGHT TO CHANGE DRAWING SPECIFICATIONS AT ANY TIME. PLEASE CONTACT PLP TO VERIFY CURRENT VERSION

TITLE

P. N. COYOTE8218B

COYOTE® Dome Closure 6.5"x22" with Buffer Tube Organizer & Splice Tray

DWG BY:	APR BY:	DATE:	SHEET:	FILE NAME:
MLA	MLA	8/7/17	1 of 1	COYOTE8218B



End Plate with
Ribbon Organizer (1)



Dome (1)



End Plate Gasket (1)



Collar (1)



Strength Member
Bracket Kit (1)



Small Parts Bag (1)



4 Pack Grommet Kit (1)

[Includes: (2) 1 Hole Grommets .40"-.60",
& (2) 1 Hole Grommets .60"-.85"]



6 Hole Grommet Kit
(.125"-.25" Cable Diameter or Flat Drop) -
Contains 1 Grommet (1)



1/4" I.D. x 24"
Transition Tubes (2)



Long Deep Profile LITE-GRIP®
Splice Tray for Single Fusion or
Ribbon/Mass Fusion (1)



Universal Mounting Hanger
Brackets (2)

ALL DIMENSIONS ARE APPROXIMATE AND MAY VARY PER
FACTORY TOLERANCES. CONTACT PLP FOR MORE INFORMATION



www.preformed.com

CONFIDENTIAL
The data and information contained in this document are proprietary to
PERFORMED Line Products (PLP). Such data and information are
provided solely for use with PLP's products and shall not be disclosed,
duplicated, or otherwise used without the express written approval of PLP.
PLP MAINTAINS THE RIGHT TO CHANGE DRAWING SPECIFICATIONS AT ANY TIME.
PLEASE CONTACT PLP TO VERIFY CURRENT VERSION

TITLE

P.N. COYOTE8218U

COYOTE® Dome Closure 6.5"x22" with
Ribbon Organizer & Splice Tray

DWG BY:

APR BY:

DATE:

SHEET:

FILE NAME:

MLA

MLA

3/9/18

1 of 1

COYOTE8218U



End Plate with Expanded Ribbon Organizer (1)



Dome (1)



End Plate Gasket (1)



Collar (1)



Strength Member Bracket Kit (1)



Small Parts Bag (1)



4 Pack Grommet Kit (1)

[Includes: (2) 1 Hole Grommets .40"-.60", & (2) 1 Hole Grommets .60"-.85"]



6 Hole Grommet Kit
(.125"-.25" Cable Diameter or Flat Drop) -
Contains 1 Grommet (1)



1/4" I.D. x 24"
Transition Tubes (2)



Long Deep Profile LITE-GRIP®
Splice Tray for Single Fusion or
Ribbon/Mass Fusion (1)



Universal Mounting Hanger
Brackets (2)

ALL DIMENSIONS ARE APPROXIMATE AND MAY VARY PER
FACTORY TOLERANCES. CONTACT PLP FOR MORE INFORMATION



PREFORMED
LINE PRODUCTS

www.pformed.com

CONFIDENTIAL
The data and information contained in this document are proprietary to
PREFORMED Line Products (PLP). Such data and information are
provided solely for use with PLP's products and shall not be disclosed,
duplicated, or otherwise used without the express written approval of PLP.
PLP MAINTAINS THE RIGHT TO CHANGE DRAWING SPECIFICATIONS AT ANY TIME.
PLEASE CONTACT PLP TO VERIFY CURRENT VERSION

TITLE

P.N. COYOTE8240XU

COYOTE® Dome Closure 6.5"x22" with
Expanded Ribbon Organizer & Splice Tray

DWG BY:

MLA

APR BY:

MLA

DATE:

8/8/17

SHEET

1 of 1

FILE NAME

COYOTE8240XU



Flame Retardant End Plate with Ribbon Organizer (1)



Flame Retardant Dome (1)



End Plate Gasket (1)



Flame Retardant Collar (1)



Strength Member Bracket Kit (1)



Small Parts Bag (1)



4 Pack Grommet Kit (1)

[Includes: (2) 1 Hole Grommets .40"-.60" & (2) 1 Hole Grommets .60"-.85"]



12 Hole Grommet Kit (Flat Drop Cable Only) - Contains 1 Grommet (1)



1/4" I.D. x 24" Transition Tubes (2)



36ct Long Deep Profile LITE-GRIP® Splice Tray with Elastomeric Splice Blocks for Single Fusion (1)



Universal Mounting Hanger Brackets (2)

ALL DIMENSIONS ARE APPROXIMATE AND MAY VARY PER FACTORY TOLERANCES. CONTACT PLP FOR MORE INFORMATION



PREFORMED
LINE PRODUCTS
www.preformed.com

CONFIDENTIAL

The data and information contained in this document are proprietary to PREFORMED Line Products (PLP). Such data and information are provided solely for use with PLP's products and shall not be disclosed, duplicated, or otherwise used without the express written approval of PLP. PLP MAINTAINS THE RIGHT TO CHANGE DRAWING SPECIFICATIONS AT ANY TIME. PLEASE CONTACT PLP TO VERIFY CURRENT VERSION

DWS BY:		APR BY:		DATE:		SHEET:		FILE NAME:	
MLA	MLA	MLA	MLA	8/9/17	8/9/17	1 of 1	1 of 1	COYOTE8806U	COYOTE8806U

TITLE

P.N. COYOTE8806U

Flame Retardant COYOTE® Dome Closure 6.5"x22" with Ribbon Organizer & Splice Tray

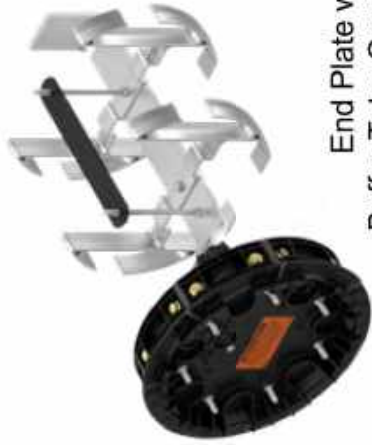

End Plate with
Buffer Tube Organizer (1)



Dome (1)



Collar (1)



End Plate Gasket (1)



2 Hole Grommet Kit
(.42\"/>



1 Hole Grommet Kit
(1.0\"/>



Small Parts Bag (1)



3/8\"/>



40ct Short Deep Profile LITE-GRIP®
Splice Tray for Single Fusion (1)

ALL DIMENSIONS ARE APPROXIMATE AND MAY VARY PER
FACTORY TOLERANCES. CONTACT PLP FOR MORE INFORMATION



www.preformmed.com

CONFIDENTIAL
The data and information contained in this document are proprietary to
PREFORMED Line Products (PLP). Such data and information are
provided solely for use with PLP's products and shall not be disclosed,
duplicated, or otherwise used without the express written approval of PLP.
PLP MAINTAINS THE RIGHT TO CHANGE DRAWING SPECIFICATIONS AT ANY TIME.
PLEASE CONTACT PLP TO VERIFY CURRENT VERSION

TITLE

P.N. COYOTE8300B

COYOTE® Dome Closure 9.5"x19" with
Buffer Tube Organizer & Splice Tray

FILE NAME:

SHEET

DATE:

APR BY:

DWG BY:

1 of 1

5/3/17

MLA

MLA

COYOTE8300B

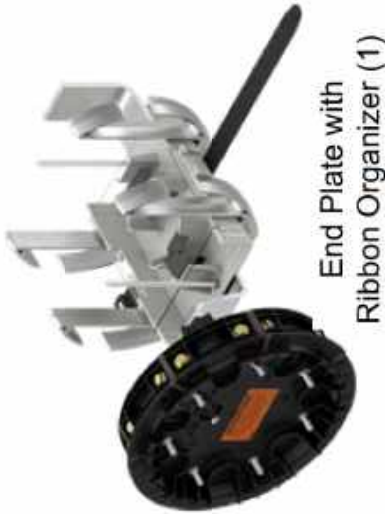

End Plate with
Ribbon Organizer (1)



End Plate Gasket (1)



Collar (1)



2 Hole Grommet Kit
(.42"-.60" Cable Diameter) -
Contains 2 Grommets (1)



1 Hole Grommet Kit
(1.0"-1.25" Cable Diameter) -
Contains 1 Grommets (2)



Small Parts Bag (1)



1/4" I.D. x 24"
Transition Tube (1)



3/8" O.D. x 3ft Spiral
Wrap Tubing (1)



144ct Short Deep Profile LITE-GRIP®
Splice Tray for Ribbon (1)

ALL DIMENSIONS ARE APPROXIMATE AND MAY VARY PER FACTORY TOLERANCES. CONTACT PLP FOR MORE INFORMATION



PREFORMED
LINE PRODUCTS
www.pformed.com

CONFIDENTIAL
The data and information contained in this document are proprietary to PREFORMED Line Products (PLP). Such data and information are provided solely for use with PLP's products and shall not be disclosed, duplicated, or otherwise used without the express written approval of PLP. PLP MAINTAINS THE RIGHT TO CHANGE DRAWING SPECIFICATIONS AT ANY TIME. PLEASE CONTACT PLP TO VERIFY CURRENT VERSION

TITLE				P.N. COYOTE8300U			
COYOTE® Dome Closure 9.5"x19" with Ribbon Organizer & Splice Tray				FILE NAME			
DWG BY:	APR BY:	DATE:	SHEET:	1 of 1			
MLA	MLA	8/9/17	1 of 1	COYOTE8300U			



End Plate with Ribbon Organizer (1)



2 Hole Grommet Kit
(.42"-.60" Cable Diameter) -
Contains 2 Grommets (1)



1 Hole Grommet Kit
(1.0"-1.25" Cable Diameter) -
Contains 1 Grommets (2)



Small Parts Bag (1)



3/8" O.D. x 3ft Spiral
Wrap Tubing (1)



216ct Long Deep Profile LITE-GRIP®
Splice Tray for Ribbon (1)



Dome (1)



End Plate Gasket (1)



Collar (1)



1/4" I.D. x 24"
Transition Tube (1)

ALL DIMENSIONS ARE APPROXIMATE AND MAY VARY PER FACTORY TOLERANCES. CONTACT PLP FOR MORE INFORMATION



www.preformed.com

CONFIDENTIAL
The data and information contained in this document are proprietary to PREFORMED Line Products (PLP). Such data and information are provided solely for use with PLP's products and shall not be disclosed, duplicated, or otherwise used without the express written approval of PLP. PLP MAINTAINS THE RIGHT TO CHANGE DRAWING SPECIFICATIONS AT ANY TIME. PLEASE CONTACT PLP TO VERIFY CURRENT VERSION

TITLE			
P.N. COYOTE8219XU			
COYOTE® Dome Closure 9.5"x28" with Ribbon Organizer & Splice Tray			
DWG BY:	APR BY:	DATE:	SHEET
MLA	MLA	8/9/17	1 of 1
FILE NAME:			COYOTE8219XU



End Plate Gasket (1)



Collar (1)



Transport Tubing Kit -
Contains 6 Pieces (1)



Spiral Wrap Tubing Kit -
Contains 12 Pieces (1)



Dome (1)



Small Parts Bag (1)



216ct Long Deep Profile LITE-GRIP®
Splice Tray for Ribbon (1)



End Plate with
Expanded Ribbon
Organizer (1)



1 Hole Grommet Kit
(.60\"-.85\" Cable Diameter) -
Contains 1 Grommet (1)



1 Hole Grommet Kit
(1.0\"-1.25\" Cable Diameter) -
Contains 1 Grommet (2)



2 Hole Grommet Kit
(.85\"-1.0\" Cable Diameter) -
Contains 2 Grommets (1)



1 Hole Grommet Kit
(.85\"-1.0\" Cable Diameter) -
Contains 2 Grommets (1)

CONFIDENTIAL
The data and information contained in this document are proprietary to PREFORMED Line Products (PLP). Such data and information are provided solely for use with PLP's products and shall not be disclosed, duplicated, or otherwise used without the express written approval of PLP. PLP MAINTAINS THE RIGHT TO CHANGE DRAWING SPECIFICATIONS AT ANY TIME. PLEASE CONTACT PLP TO VERIFY CURRENT VERSION.

ALL DIMENSIONS ARE APPROXIMATE AND MAY VARY PER FACTORY TOLERANCES. CONTACT PLP FOR MORE INFORMATION

PREFORMED
LINE PRODUCTS
www.preformed.com

TITLE		P.N. 800016107	
COYOTE® Dome Closure 9.5"x28" for Ribbon with Deep Metal Transition Tray (2.85" Depth)			
DWG BY:	APR BY:	DATE:	SHEET
MLA	MLA	10/26/18	1 of 1
FILE NAME:			800016107



End Plate with High Density Organizer without Transition Tray (1)



Dome (1)



End Plate Gasket (1)



Collar (1)



High Density Dome Small Parts Bag (1)



Split Braided Wrap Sleeving Kit - Contains 12 Pieces, 20" Long (1)



1 Hole Grommet Kit (.60\"-.85\" Cable Diameter) - Contains 2 Grommets (1)



1 Hole Grommet Kit (.85\"-1.00\" Cable Diameter) - Contains 2 Grommets (1)



1 Hole Grommet Kit (1.00\"-1.25\" Cable Diameter) - Contains 2 Grommets (1)



Small Parts Bag (1)

ALL DIMENSIONS ARE APPROXIMATE AND MAY VARY PER FACTORY TOLERANCES. CONTACT PLP FOR MORE INFORMATION



PREFORMED
LINE PRODUCTS
www.pformed.com

CONFIDENTIAL
The data and information contained in this document are proprietary to PREFORMED Line Products (PLP). Such data and information are provided solely for use with PLP's products and shall not be disclosed, duplicated, or otherwise used without the express written approval of PLP. PLP MAINTAINS THE RIGHT TO CHANGE DRAWING SPECIFICATIONS AT ANY TIME. PLEASE CONTACT PLP TO VERIFY CURRENT VERSION.

TITLE

P.N. 800016003

COYOTE® High Density Dome Closure 9.5"x28" without Transition Tray for Cable Diameters under 1.25"

DWG BY:	APR BY:	DATE:	SHEET:	FILE NAME:
MLA	MLA	11/15/19	1 of 1	800016003



End Plate with High Density Organizer with Transition Tray (1)



Dome (1)



End Plate Gasket (1)



Collar (1)



Transport Tubing Kit - Contains 6 Pieces (1)



Split Braided Wrap Sleeving Kit - Contains 12 Pieces, 20" Long (1)



High Density Dome Small Parts Bag (1)



1 Hole Grommet Kit (.60\"-.85\" Cable Diameter) - Contains 2 Grommets (1)



1 Hole Grommet Kit (.85\"-1.00\" Cable Diameter) - Contains 2 Grommets (1)



1 Hole Grommet Kit (1.00\"-1.25\" Cable Diameter) - Contains 2 Grommets (1)



Small Parts Bag (1)

ALL DIMENSIONS ARE APPROXIMATE AND MAY VARY PER FACTORY TOLERANCES. CONTACT PLP FOR MORE INFORMATION

PREFORMED
LINE PRODUCTS
www.preformed.com

CONFIDENTIAL
The data and information contained in this document are proprietary to PREFORMED Line Products (PLP). Such data and information are provided solely for use with PLP's products and shall not be disclosed, duplicated, or otherwise used without the express written approval of PLP. PLP MAINTAINS THE RIGHT TO CHANGE DRAWING SPECIFICATIONS AT ANY TIME. PLEASE CONTACT PLP TO VERIFY CURRENT VERSION

TITLE			
P.N. 800016004			
COYOTE® High Density Dome Closure 9.5"x28" with Transition Tray for Cable Diameters under 1.25"			
DWG BY:	APR BY:	DATE:	SHEET
MLA	MLA	3/20/20	1 of 1
FILE NAME:			800016004



End Plate with High Density Organizer without Transition Tray (1)



Dome (1)



End Plate Gasket (1)



Collar (1)



High Density Dome Small Parts Bag (1)



Split Braided Wrap Sleeving Kit - Contains 12 Pieces, 20" Long (1)



Small Parts Bag (1)



1 Hole Grommet Kit (.60\"-.85\" Cable Diameter) - Contains 2 Grommets (1)



1 Hole Grommet Kit (.85\"-1.00\" Cable Diameter) - Contains 2 Grommets (1)



1 Hole Grommet Kit (1.00\"-1.25\" Cable Diameter) - Contains 2 Grommets (1)



1 Hole Grommet Kit (1.25\"-1.38\" Cable Diameter) - Contains 2 Grommets (1)

ALL DIMENSIONS ARE APPROXIMATE AND MAY VARY PER FACTORY TOLERANCES. CONTACT PLP FOR MORE INFORMATION



CONFIDENTIAL
The data and information contained in this document are proprietary to PREFORMED Line Products (PLP). Such data and information are provided solely for use with PLP's products and shall not be disclosed, duplicated, or otherwise used without the express written approval of PLP. PLP MAINTAINS THE RIGHT TO CHANGE DRAWING SPECIFICATIONS AT ANY TIME. PLEASE CONTACT PLP TO VERIFY CURRENT VERSION

TITLE				P.N. 800016005			
COYOTE® High Density Dome Closure 9.5"x28" without Transition Tray for Cable Diameters over 1.25"							
DWS BY:	APR BY:	DATE:	SHEET:	FILE NAME:			
MLA	MLA	3/9/18	1 of 1	800016005			



End Plate with High Density Organizer with Transition Tray (1)



1 Hole Grommet Kit
(.85"-1.00" Cable Diameter) -
Contains 2 Grommets (1)



1 Hole Grommet Kit
(1.00"-1.25" Cable Diameter) -
Contains 2 Grommets (1)



High Density Dome
Small Parts Bag (1)



1 Hole Grommet Kit
(1.25"-1.38" Cable Diameter) -
Contains 2 Grommets (1)



1 Hole Grommet Kit
(1.25"-1.38" Cable Diameter) -
Contains 2 Grommets (1)



Dome (1)



Split Braided Wrap Sleeve Kit -
Contains 12 Pieces, 20" Long (1)



End Plate Gasket (1)



Collar (1)



Transport Tubing Kit -
Contains 6 Pieces (1)



Small Parts Bag (1)

ALL DIMENSIONS ARE APPROXIMATE AND MAY VARY PER FACTORY TOLERANCES. CONTACT PLP FOR MORE INFORMATION



PREFORMED
LINE PRODUCTS

www.pformed.com

CONFIDENTIAL

The data and information contained in this document are proprietary to PREFORMED Line Products (PLP). Such data and information are provided solely for use with PLP's products and shall not be disclosed, duplicated, or otherwise used without the express written approval of PLP. PLP MAINTAINS THE RIGHT TO CHANGE DRAWING SPECIFICATIONS AT ANY TIME. PLEASE CONTACT PLP TO VERIFY CURRENT VERSION

TITLE		P.N. 800016006	
COYOTE® High Density Dome Closure 9.5"x28" with Transition Tray for Cable Diameters over 1.25"			
DWG BY:	APR BY:	DATE:	SHEET
MLA	MLA	3/20/20	1 of 1
FILE NAME:			800016006



End Plate with High Density Organizer with Deep Transition Tray (1)



1 Hole Grommet Kit (.40"-1.00" Cable Diameter) - Contains 1 Grommets (2)



1 Hole Grommet Kit (.85"-1.00" Cable Diameter) - Contains 2 Grommets (1)



1 Hole Grommet Kit (.60"-1.25" Cable Diameter) - Contains 2 Grommets (1)



1 Hole Grommet Kit (1.00"-1.25" Cable Diameter) - Contains 2 Grommets (1)



Dome (1)



Universal Mounting Hanger Bracket Kit (1)



End Plate Gasket (1)



Collar (1)



Split Braided Wrap Sleeving Kit - Contains 12 Pieces, 20" Long (1)



High Density Dome Small Parts Bag (1)



Long Deep Profile 288ct HD Flip Splice Tray (3)



Small Parts Bag (1)

ALL DIMENSIONS ARE APPROXIMATE AND MAY VARY PER FACTORY TOLERANCES. CONTACT PLP FOR MORE INFORMATION



www.preformed.com

CONFIDENTIAL
The data and information contained in this document are proprietary to PREFORMED Line Products (PLP). Such data and information are provided solely for use with PLP's products and shall not be disclosed, duplicated, or otherwise used without the express written approval of PLP. PLP MAINTAINS THE RIGHT TO CHANGE DRAWING SPECIFICATIONS AT ANY TIME. PLEASE CONTACT PLP TO VERIFY CURRENT VERSION

TITLE

P.N. 800016381

COYOTE® High Density Dome Closure 9.5"x28" with Deep Transition Tray for Cable Diameters under 1.25"

DWG BY:	APR BY:	DATE:	SHEET:	FILE NAME:
MLA	MLA	9/10/19	1 of 1	800016381

1 of 1

800016381

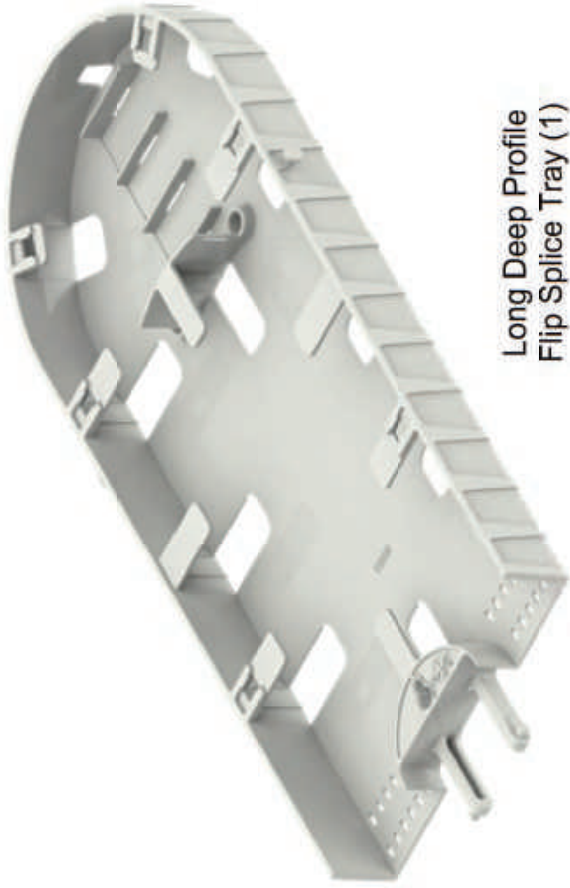

Long Deep Profile
Flip Splice Tray (1)

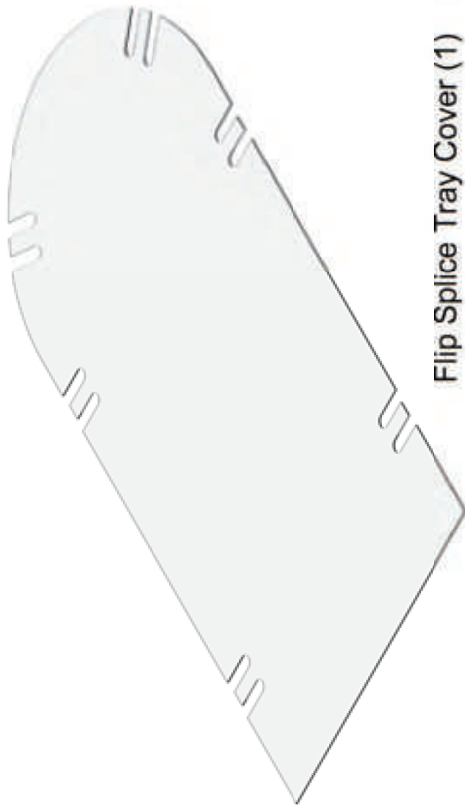

Flip Splice Tray Cover (1)



Tall Flip Splice Tray
Hinge Bracket (1)



Felt Strip (1)



Cable Tie Wraps -
Pack of 12 (1)



4ct Plastic Ribbon
Splice Block (6)



Flip Splice Tray
Splice Platform (1)

ALL DIMENSIONS ARE APPROXIMATE AND MAY VARY PER FACTORY TOLERANCES. CONTACT P.L.P. FOR MORE INFORMATION



PREFORMED
LINE PRODUCTS

www.prlformed.com

CONFIDENTIAL

The data and information contained in this document are proprietary to PREFORMED Line Products (PLP). Such data and information are provided solely for use with PLP's products and shall not be disclosed, duplicated, or otherwise used without the express written approval of PLP. PLP MAINTAINS THE RIGHT TO CHANGE DRAWING SPECIFICATIONS AT ANY TIME. PLEASE CONTACT P.L.P. TO VERIFY CURRENT VERSION

TITLE			
P.N. 80813121			
COYOTE® Long Deep Profile 288ct Flip Splice Tray Kit for Ribbon/Mass Fusion Splices			
DWG BY:	APR BY:	DATE:	SHEET:
MLA	MLA	2/14/18	1 of 1
FILE NAME:			80813121

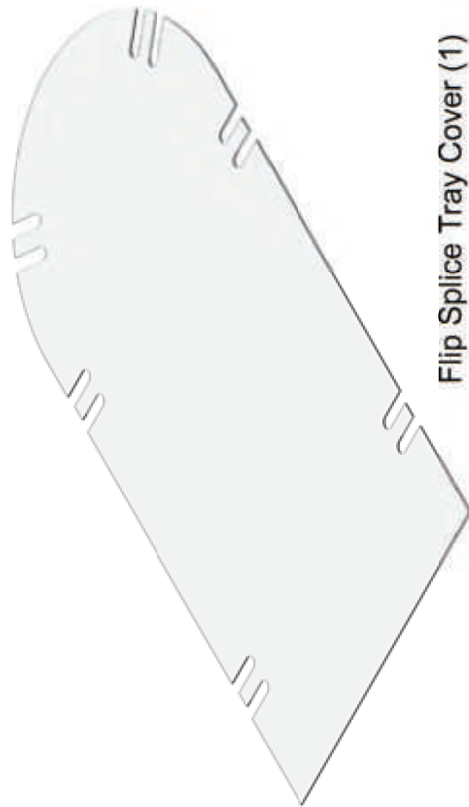

Flip Splice Tray Cover (1)

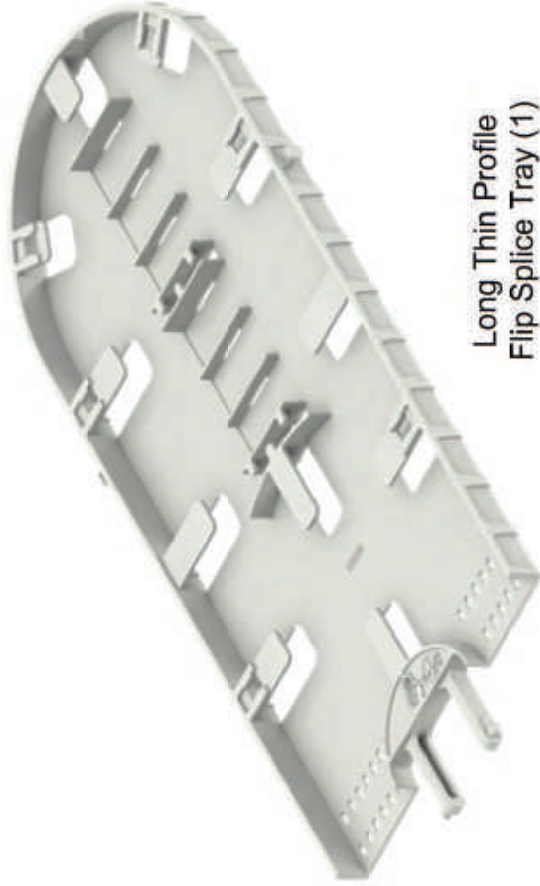

Long Thin Profile Flip Splice Tray (1)



Short Flip Splice Tray Hinge Bracket (1)



Felt Strip (1)



Cable Tie Wraps - Pack of 12 (1)



4ct Plastic Ribbon Splice Block (6)

ALL DIMENSIONS ARE APPROXIMATE AND MAY VARY PER FACTORY TOLERANCES. CONTACT PLP FOR MORE INFORMATION



www.preformed.com

CONFIDENTIAL
 The data and information contained in this document are proprietary to PREFORMED Line Products (PLP). Such data and information are provided solely for use with PLP's products and shall not be disclosed, duplicated, or otherwise used without the express written approval of PLP. PLP MAINTAINS THE RIGHT TO CHANGE DRAWING SPECIFICATIONS AT ANY TIME. PLEASE CONTACT PLP TO VERIFY CURRENT VERSION

TITLE

P.N. 80813122

COYOTE® Long Thin Profile 288ct Flip Splice Tray Kit for Ribbon/Mass Fusion Splices

DWG BY:	APR BY:	DATE:	SHEET:	FILE NAME:
MLA	MLA	2/14/18	1 of 1	80813122

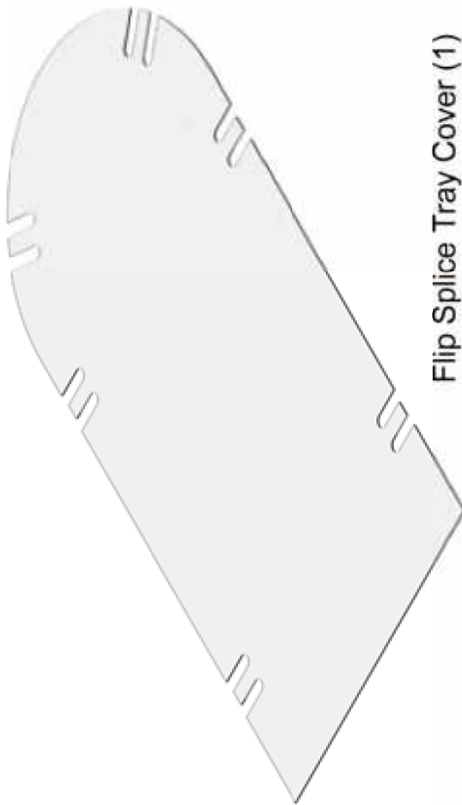

Flip Splice Tray Cover (1)



Long Thin Profile Flip Splice Tray (1)



Short Flip Splice Tray Hinge Bracket (1)



Felt Strip (1)



Cable Tie Wraps - Pack of 12 (1)



12ct Plastic Single Fusion Splice Blocks (6)

ALL DIMENSIONS ARE APPROXIMATE AND MAY VARY PER FACTORY TOLERANCES. CONTACT PLP FOR MORE INFORMATION



CONFIDENTIAL
 The data and information contained in this document are proprietary to PREFORMED Line Products (PLP). Such data and information are provided solely for use with PLP's products and shall not be disclosed, duplicated, or otherwise used without the express written approval of PLP. PLP MAINTAINS THE RIGHT TO CHANGE DRAWING SPECIFICATIONS AT ANY TIME. PLEASE CONTACT PLP TO VERIFY CURRENT VERSION

TITLE

Catalog #: 80813123
 COYOTE® Long Thin Profile 72ct Flip Splice Tray Kit for Single Fusion Splices

DWG BY:	APR BY:	DATE:	SHEET:	FILE NAME:
MLA	MLA	2/14/18	1 of 1	80813123

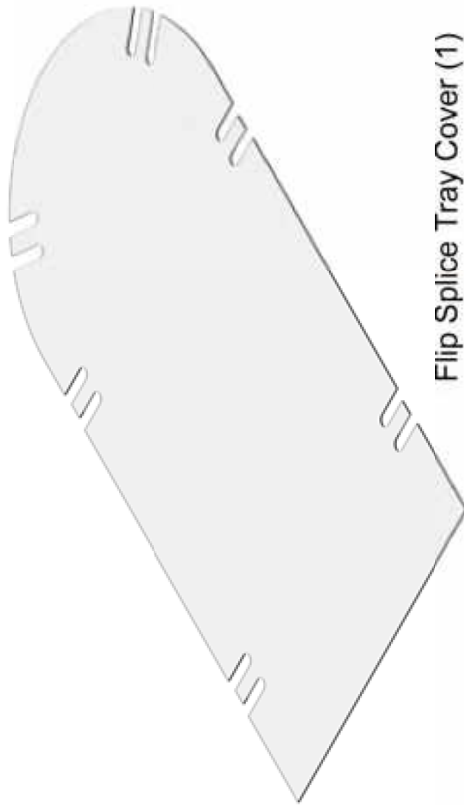

Flip Splice Tray Cover (1)



Long Thin Profile Flip Splice Tray (1)



Short Flip Splice Tray Hinge Bracket (1)



Felt Strip (1)



Cable Tie Wraps - Pack of 12 (1)



12ct Plastic Single Fusion Splice Blocks (9)

ALL DIMENSIONS ARE APPROXIMATE AND MAY VARY PER FACTORY TOLERANCES. CONTACT PLP FOR MORE INFORMATION



PREFORMED
LINE PRODUCTS
www.preformed.com

CONFIDENTIAL
The data and information contained in this document are proprietary to PREFORMED Line Products (PLP). Such data and information are provided solely for use with PLP's products and shall not be disclosed, duplicated, or otherwise used without the express written approval of PLP. PLP MAINTAINS THE RIGHT TO CHANGE DRAWING SPECIFICATIONS AT ANY TIME. PLEASE CONTACT PLP TO VERIFY CURRENT VERSION

TITLE

Catalog #: 80813301
COYOTE® Long Thin Profile 108ct Flip Splice Tray Kit for Single Fusion Splices

DWG BY: MLA

APR BY: MLA

DATE: 2/14/18

SHEET: 1 of 1

FILE NAME: 80813301

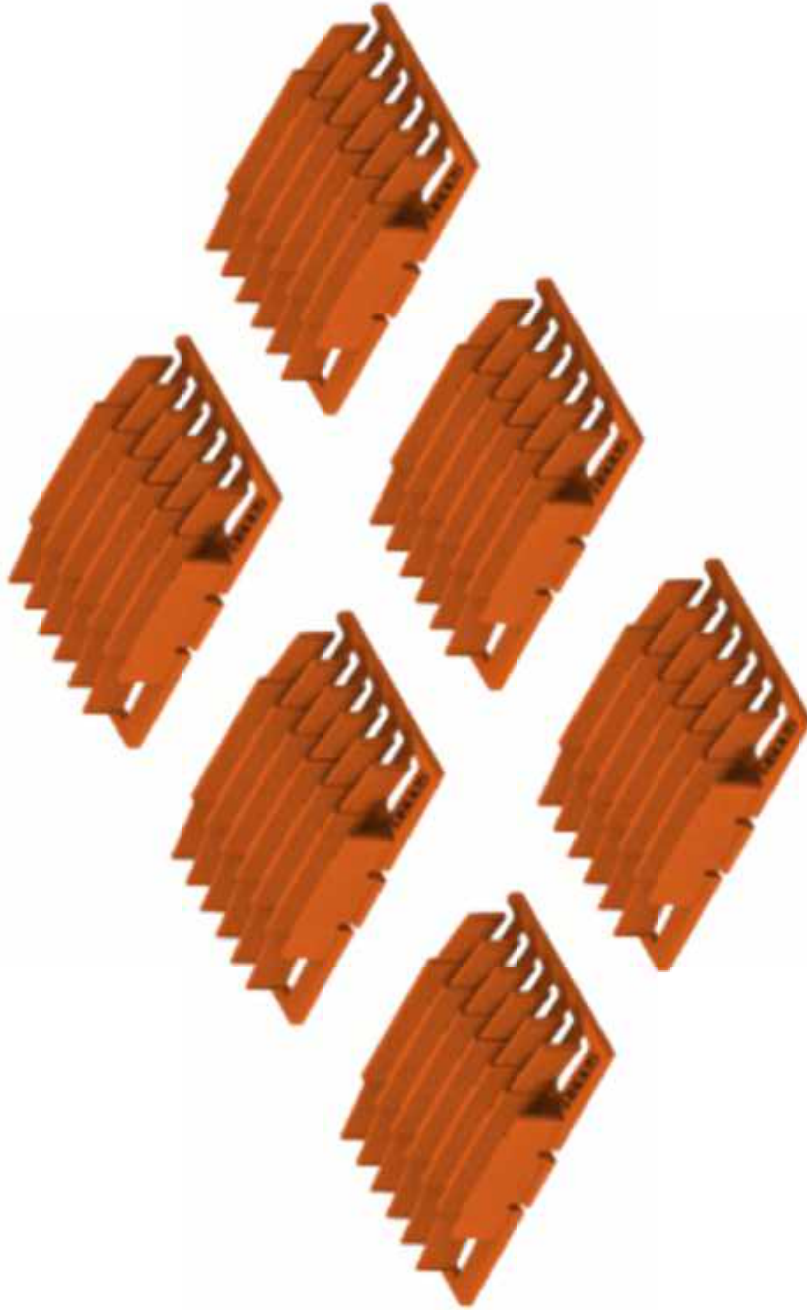

Plastic Splice Blocks for
Single Fusion Splices (6)

ALL DIMENSIONS ARE APPROXIMATE AND MAY VARY PER
FACTORY TOLERANCES. CONTACT PLP FOR MORE INFORMATION



CONFIDENTIAL
The data and information contained in this document are proprietary to
PREFORMED Line Products (PLP). Such data and information are
provided solely for use with PLP's products and shall not be disclosed,
duplicated, or otherwise used without the express written approval of PLP.
PLP MAINTAINS THE RIGHT TO CHANGE DRAWING SPECIFICATIONS AT ANY TIME.
PLEASE CONTACT PLP TO VERIFY CURRENT VERSION

DWG BY: MLA		APR BY: MLA	DATE: 10/26/18	SHEET: 1 of 1	FILE NAME: 80813362
TITLE: 12ct Single Fusion Splice Blocks to be used in COYOTE® HD Splice Trays 80813121 and 80813122 - 6 pack					Catalog #: 80813362



COYOTE® HD Dome Deep Transition Tray with Cover (1)

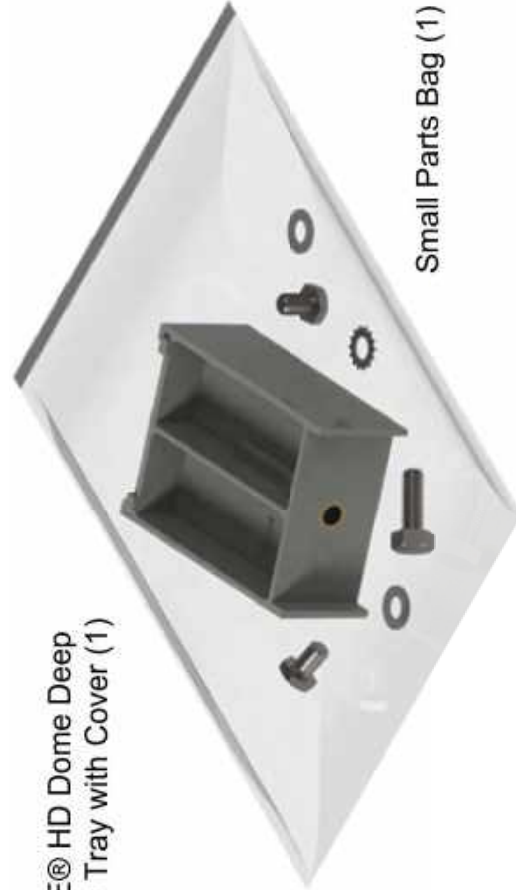

Small Parts Bag (1)

ALL DIMENSIONS ARE APPROXIMATE AND MAY VARY PER FACTORY TOLERANCES. CONTACT PLP FOR MORE INFORMATION



www.preformed.com

CONFIDENTIAL
 The data and information contained in this document are proprietary to PREFORMED Line Products (PLP). Such data and information are provided solely for use with PLP's products and shall not be disclosed, duplicated, or otherwise used without the express written approval of PLP. PLP MAINTAINS THE RIGHT TO CHANGE DRAWING SPECIFICATIONS AT ANY TIME. PLEASE CONTACT PLP TO VERIFY CURRENT VERSION

TITLE

P.N. 80813267
 COYOTE® HD Dome Deep Transition Tray Kit
 for 864 Expressed Applications

DWG BY:	APR BY:	DATE:	SHEET:	FILE NAME:
MLA	MLA	5/4/18	1 of 1	80813267

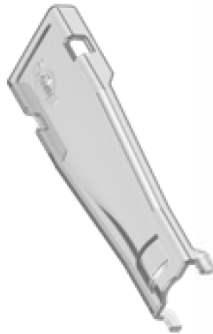

Breakout Cover (1)



Breakout Base (1)



Cable Tie Wraps - Pack of 12 (1)



Large Tie Wraps (3)



Felt Strips (2)



Transport Tubing Kit (1)

ALL DIMENSIONS ARE APPROXIMATE AND MAY VARY PER FACTORY TOLERANCES. CONTACT PLP FOR MORE INFORMATION



CONFIDENTIAL
The data and information contained in this document are proprietary to PREFORMED Line Products (PLP). Such data and information are provided solely for use with PLP's products and shall not be disclosed, duplicated, or otherwise used without the express written approval of PLP. PLP MAINTAINS THE RIGHT TO CHANGE DRAWING SPECIFICATIONS AT ANY TIME. PLEASE CONTACT PLP TO VERIFY CURRENT VERSION

TITLE

Catalog #: 80061500
COYOTE® HD Breakout Kit

DWG BY:	APR BY:	DATE:	SHEET	FILE NAME:
MLA	MLA	4/11/19	1 of 1	80061500

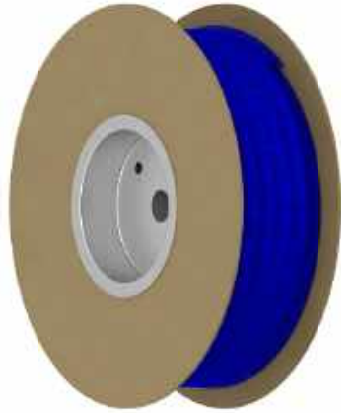

Part Number: 8004154
125 Foot Spool, 3/8" Braided Tubing,
Blue



Part Number: 8004155
125 Foot Spool, 3/8" Braided Tubing,
Orange

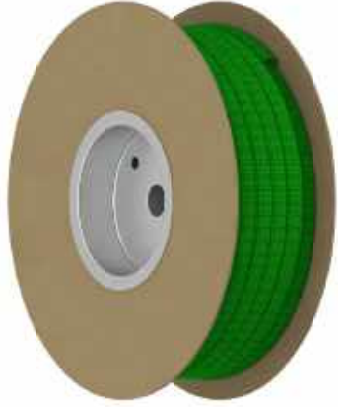

Part Number: 8004156
125 Foot Spool, 3/8" Braided Tubing,
Green



Part Number: 8004157
125 Foot Spool, 3/8" Braided Tubing,
Brown

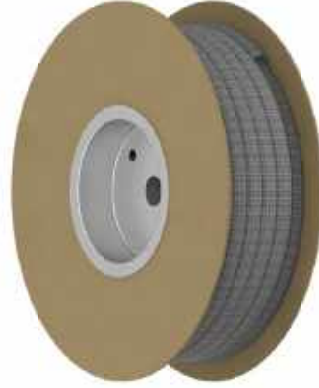

Part Number: 8004158
125 Foot Spool, 3/8" Braided Tubing,
Slate



Part Number: 8004159
125 Foot Spool, 3/8" Braided Tubing,
White

ALL DIMENSIONS ARE APPROXIMATE AND MAY VARY PER
FACTORY TOLERANCES. CONTACT PLP FOR MORE INFORMATION



CONFIDENTIAL
The data and information contained in this document are proprietary to
PREFORMED Line Products (PLP). Such data and information are
provided solely for use with PLP's products and shall not be disclosed,
duplicated, or otherwise used without the express written approval of PLP.
PLP MAINTAINS THE RIGHT TO CHANGE DRAWING SPECIFICATIONS AT ANY TIME.
PLEASE CONTACT PLP TO VERIFY CURRENT VERSION

TITLE
COYOTE® 125' Spool, 3/8" Braided Tubing,
Color Coded

DWG BY:	APR BY:	DATE:	SHEET	FILE NAME:
MLA	MLA	05/21/18	1 of 1	COYOTE_Braided_Tubing



Part Number: 8004174
100 Foot Spool, 3/8" Split Wrap,
Blue



Part Number: 8004175
100 Foot Spool, 3/8" Split Wrap,
Orange



Part Number: 8004176
100 Foot Spool, 3/8" Split Wrap,
Green



Part Number: 8004177
100 Foot Spool, 3/8" Split Wrap,
Brown



Part Number: 8004177
100 Foot Spool, 3/8" Split Wrap,
Slate



Part Number: 8004167
100 Foot Spool, 3/8" Split Wrap,
White



Part Number: 8004168
100 Foot Spool, 3/8" Split Wrap,
Black



Part Number: 80813518
Wire Loom Insertion Tool for
Split Wrap

ALL DIMENSIONS ARE APPROXIMATE AND MAY VARY PER
FACTORY TOLERANCES. CONTACT PLP FOR MORE INFORMATION



CLEVELAND, OHIO 44143 | 1-(440)-461-5200
preformed.com

DESCRIPTION:

CONFIDENTIAL
The data and information contained in this document are proprietary to
PREFORMED Line Products (PLP). Such data and information are
provided solely for use with PLP's products and shall not be disclosed,
duplicated, or otherwise used without the express written approval of PLP.

PLP MAINTAINS THE RIGHT TO CHANGE DRAWING SPECIFICATIONS AT ANY TIME.
PLEASE CONTACT PLP TO VERIFY CURRENT VERSION

COYOTE® 100' Spool, 3/8" Colored Split Wrap and Installation Tool

DRN BY: MAO	APR BY: MAO	DATE: 04/07/20	SCALE:	PAGE
FILENAME:				Colored Split Wrap

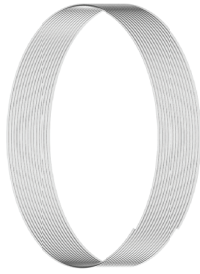

Part Number: 80807989
 100 Foot Coil, 0.17" ID x 0.20" OD
 Clear Transport Tube

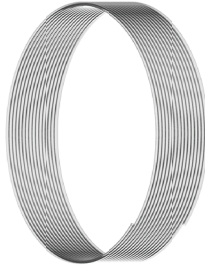

Part Number: 80807991
 100 Foot Coil, 0.25" ID x 0.37" OD
 Clear Transport Tube



Part Number: 80812881
 100 Foot Coil, 0.50" ID x 0.63" OD
 Spiral Tube

ALL DIMENSIONS ARE APPROXIMATE AND MAY VARY PER
 FACTORY TOLERANCES. CONTACT PLP FOR MORE INFORMATION

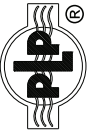

PREFORMED
 LINE PRODUCTS

www.pformed.com

CONFIDENTIAL
 The data and information contained in this document are proprietary to
 PREFORMED Line Products (PLP). Such data and information are
 provided solely for use with PLP's products and shall not be disclosed,
 duplicated, or otherwise used without the express written approval of PLP.
 PLP MAINTAINS THE RIGHT TO CHANGE DRAWING SPECIFICATIONS AT ANY TIME.
 PLEASE CONTACT PLP TO VERIFY CURRENT VERSION

TITLE

COYOTE® 100' Coil, Transport Tubing

DWG BY:	APR BY:	DATE:	SHEET	FILE NAME:
MLA	MLA	05/21/18	1 of 1	COYOTE_Transport_Tubing



Splice Tray Tethers (6)

ALL DIMENSIONS ARE APPROXIMATE AND MAY VARY PER FACTORY TOLERANCES. CONTACT PLP FOR MORE INFORMATION.



PREFORMED LINE PRODUCTS

CLEVELAND, OHIO 44143 | 1-(440)-461-5200
preformed.com

CONFIDENTIAL
The data and information contained in this document are proprietary to PREFORMED Line Products (PLP). Such data and information are provided solely for use with PLP's products and shall not be disclosed, duplicated, or otherwise used without the express written approval of PLP. PLP MAINTAINS THE RIGHT TO CHANGE DRAWING SPECIFICATIONS AT ANY TIME. PLEASE CONTACT PLP TO VERIFY CURRENT VERSION.

DESCRIPTION:

Catalog #: 80813125
COYOTE@Splice Tray Tether Kit - 6 pack

DRAWN BY: MLA APP BY: MLA DATE: 10/18/19 SCALE: PAGE: 1 of 1
FILENAME: 80813125



Splice Tray Locking Pins (5)

ALL DIMENSIONS ARE APPROXIMATE AND MAY VARY PER
FACTORY TOLERANCES. CONTACT PLP FOR MORE INFORMATION



CLEVELAND, OHIO 44143 | 1-(440)-461-5200
preformed.com

DESCRIPTION:

Coyote® Splice Tray Locking Pin Kit - 5 pack
Catalog #: 80813124

UNN BY: MLA APK BY: MLA DATE: 10/18/19 SCALE: PAGE: 1 of 1
FILENAME: 80813124

CONFIDENTIAL
The data and information contained in this document are proprietary to
PREFORMED Line Products (PLP). Such data and information are
provided solely for use with PLP's products and shall not be disclosed,
duplicated, or otherwise used without the express written approval of PLP.
PLP MAINTAINS THE RIGHT TO CHANGE DRAWING SPECIFICATIONS AT ANY TIME
PLEASE CONTACT PLP TO VERIFY CURRENT VERSION



Flame Retardant Cover (2)



Flame Retardant Dual Chamber Base with Pass Through Hole (1)



Small Parts Bag (1)



4 Pack Grommet Kit (1)

[Includes: (2) 1 Hole Grommets .40"-.60", & (2) 1 Hole Grommets .60"-.85"]



1 Hole Grommet Kit (.85"-1.0" Cable Diameter) - Contains 1 Grommets (1)



Torque Limiting Tool (1)



7 Hole Grommet Kit (.42"-.60" & .125"-.25" Cable Diameters) - Contains 1 Grommets (2)



3/8" O.D. x 6ft Spiral Wrap Tubing (2)



12ct Short Deep Profile LITE-GRIP® Splice Tray with Elastomeric Splice Block for Single Fusion (2)

ALL DIMENSIONS ARE APPROXIMATE AND MAY VARY PER FACTORY TOLERANCES. CONTACT PLP FOR MORE INFORMATION



CONFIDENTIAL
The data and information contained in this document are proprietary to PERFORMED Line Products (PLP). Such data and information are provided solely for use with PLP's products and shall not be disclosed, duplicated, or otherwise used without the express written approval of PLP. PLP MAINTAINS THE RIGHT TO CHANGE DRAWING SPECIFICATIONS AT ANY TIME. PLEASE CONTACT PLP TO VERIFY CURRENT VERSION

TITLE

P.N. COYOTE8803

COYOTE® Terminal Closure - Dual Chamber (Flame Retardant) with Splice Tray

DWG BY:

APR BY:

DATE:

SHEET

FILE NAME

MLA

MLA

8/10/17

1 of 1

COYOTE8803

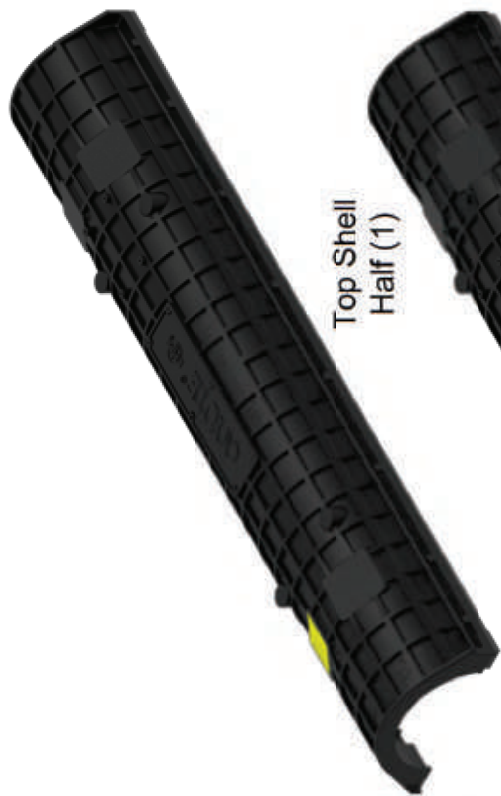

Top Shell Half (1)

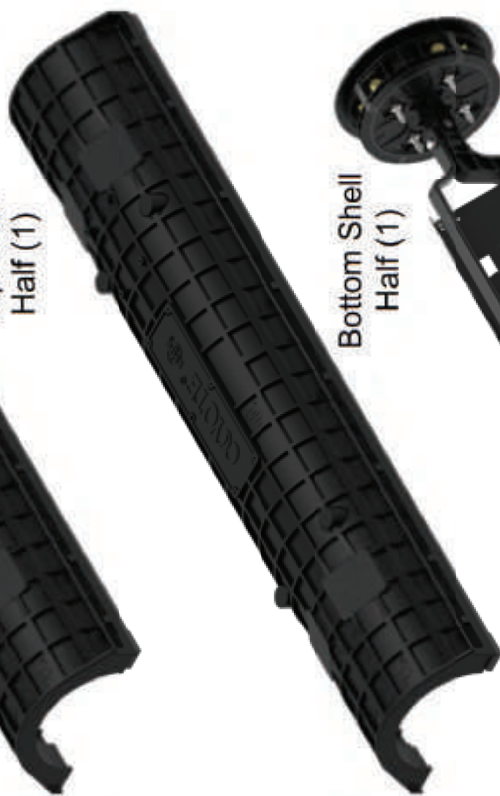

Bottom Shell Half (1)



Taut Organizer with End Plates (1)

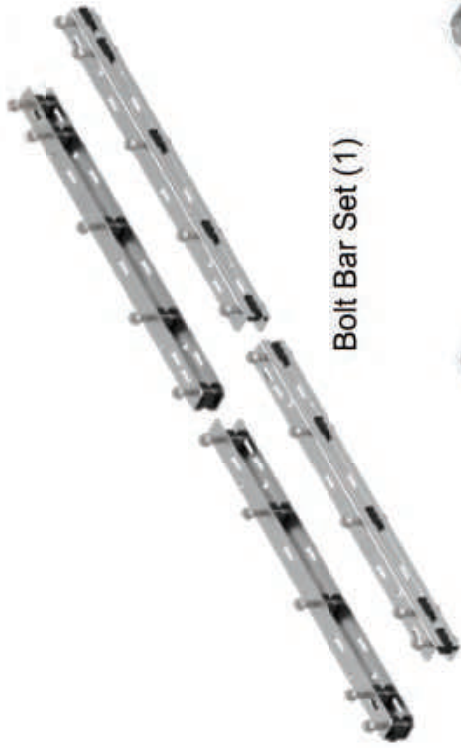

Bolt Bar Set (1)



Strength Member Bracket Kit (1)



Small Parts Bag (1)



Aerial Hanger Bracket Kit (1)



Ground Wire Assemblies (2)



Bag of Tie Wraps - 24 Pack (1)



Felt Strip (1)



1 Hole Grommet Kit (.60\"-.85\" Cable Diameter) - Contains 2 Grommets (1)



2 Hole Grommet Kit (.42\"-.60\" Cable Diameter) - Contains 2 Grommets (1)



Extended Aerial Hanger Bracket Kit (1)

ALL DIMENSIONS ARE APPROXIMATE AND MAY VARY PER FACTORY TOLERANCES. CONTACT PLP FOR MORE INFORMATION

PREFORMED
LINE PRODUCTS

www.pformed.com

CONFIDENTIAL

The data and information contained in this document are proprietary to PREFORMED Line Products (PLP). Such data and information are provided solely for use with PLP's products and shall not be disclosed, duplicated, or otherwise used without the express written approval of PLP. PLP MAINTAINS THE RIGHT TO CHANGE DRAWING SPECIFICATIONS AT ANY TIME. PLEASE CONTACT PLP TO VERIFY CURRENT VERSION

TITLE			
P.N. COYOTE8700			
COYOTE® Taut Closure for Buffer Tube Applications			
DWG BY:	APR BY:	DATE:	SHEET:
MLA	MLA	5/3/18	1 of 1
FILE NAME:			COYOTE8700

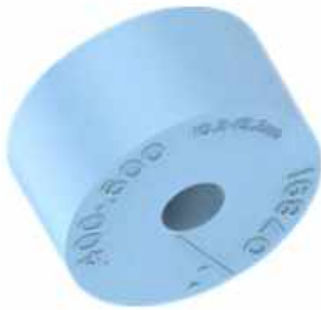

1 Hole Grommet
(.40" - .60"/10.16mm - 15.2mm Cable Diameters) (1)



5g Packet of
Silicone Lubricant (1)

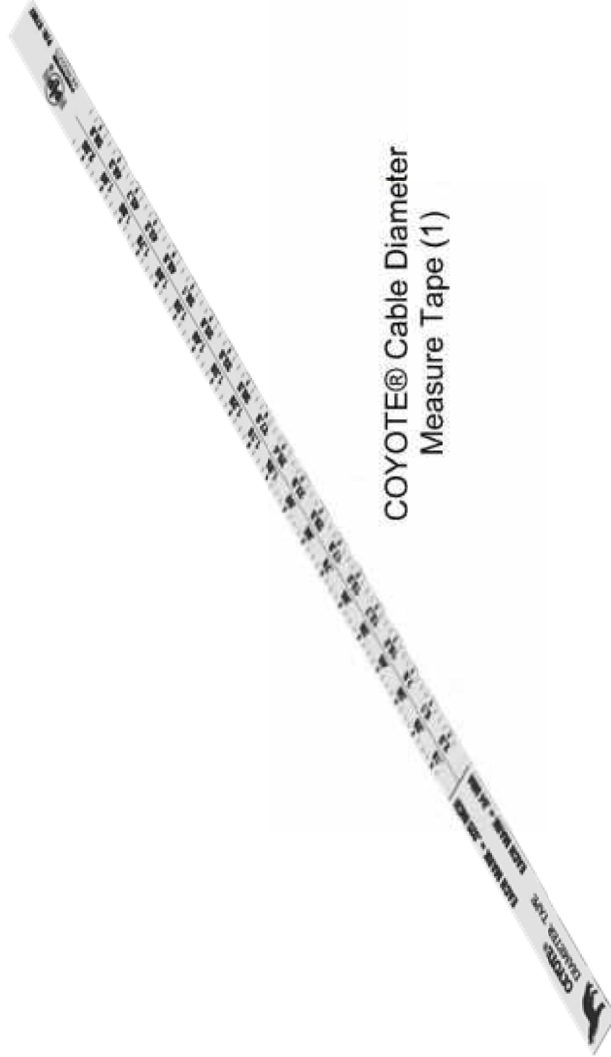

COYOTE® Cable Diameter
Measure Tape (1)

ALL DIMENSIONS ARE APPROXIMATE AND MAY VARY PER
FACTORY TOLERANCES. CONTACT PLP FOR MORE INFORMATION

PLP®
LINE PRODUCTS
www.pformed.com

CONFIDENTIAL
The data and information contained in this document are proprietary to
PREFORMED Line Products (PLP). Such data and information are
provided solely for use with PLP's products and shall not be disclosed,
duplicated, or otherwise used without the express written approval of PLP.
PLP MAINTAINS THE RIGHT TO CHANGE DRAWING SPECIFICATIONS AT ANY TIME
PLEASE CONTACT PLP TO VERIFY CURRENT VERSION

TITLE			
P.N. 8003691			
COYOTE® 1 Hole Grommet Kit for .40"-.60" (10.16mm - 15.2mm) Diameter Cables			
DWG BY:	APR BY:	DATE:	SHEET
MLA	MLA	8/29/17	1 of 1
FILE NAME:			8003691

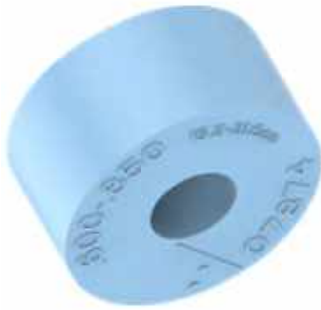

1 Hole Grommet
(.60" - .85"/15.2mm - 21.6mm Cable Diameters) (1)



5g Packet of
Silicone Lubricant (1)



COYOTE® Cable Diameter
Measure Tape (1)

ALL DIMENSIONS ARE APPROXIMATE AND MAY VARY PER
FACTORY TOLERANCES. CONTACT PLP FOR MORE INFORMATION



www.preformed.com

CONFIDENTIAL
The data and information contained in this document are proprietary to
PREFORMED Line Products (PLP). Such data and information are
provided solely for use with PLP's products and shall not be disclosed,
duplicated, or otherwise used without the express written approval of PLP.
PLP MAINTAINS THE RIGHT TO CHANGE DRAWING SPECIFICATIONS AT ANY TIME.
PLEASE CONTACT PLP TO VERIFY CURRENT VERSION

TITLE

P.N. 8003692

COYOTE® 1 Hole Grommet Kit for
.60"-.85" (15.2mm - 21.6mm) Diameter Cables

DWG BY:	APR BY:	DATE:	SHEET:	FILE NAME:
MLA	MLA	8/29/17	1 of 1	8003692



1 Hole Grommet
 (.85" - 1.0"/21.6mm - 25.4mm Cable Diameters) (1)



5g Packet of
 Silicone Lubricant (1)



COYOTE® Cable Diameter
 Measure Tape (1)

ALL DIMENSIONS ARE APPROXIMATE AND MAY VARY PER
 FACTORY TOLERANCES. CONTACT PLP FOR MORE INFORMATION



PREFORMED
 LINE PRODUCTS

www.preformed.com

CONFIDENTIAL
 The data and information contained in this document are proprietary to
 PREFORMED Line Products (PLP). Such data and information are
 provided solely for use with PLP's products and shall not be disclosed,
 duplicated, or otherwise used without the express written approval of PLP.
 PLP MAINTAINS THE RIGHT TO CHANGE DRAWING SPECIFICATIONS AT ANY TIME.
 PLEASE CONTACT PLP TO VERIFY CURRENT VERSION

TITLE

P.N. 8003693
 COYOTE® 1 Hole Grommet Kit for
 .85"-1.0" (21.6mm - 25.4mm) Diameter Cables

DWG BY:	APR BY:	DATE:	SHEET:	FILE NAME:
MLA	MLA	8/29/17	1 of 1	8003693

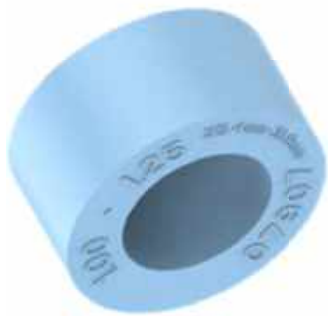

1 Hole Grommet
(1.0" - 1.25"/25.4mm - 31.6mm Cable Diameters) (1)



5g Packet of
Silicone Lubricant (1)



COYOTE® Cable Diameter
Measure Tape (1)

ALL DIMENSIONS ARE APPROXIMATE AND MAY VARY PER
FACTORY TOLERANCES. CONTACT PLP FOR MORE INFORMATION



www.preformed.com

CONFIDENTIAL
The data and information contained in this document are proprietary to
PREFORMED Line Products (PLP). Such data and information are
provided solely for use with PLP's products and shall not be disclosed,
duplicated, or otherwise used without the express written approval of PLP.
PLP MAINTAINS THE RIGHT TO CHANGE DRAWING SPECIFICATIONS AT ANY TIME.
PLEASE CONTACT PLP TO VERIFY CURRENT VERSION

TITLE

P.N. 8003694

COYOTE® 1 Hole Grommet Kit for
1.0"-1.25" (25.4mm - 31.6mm) Diameter Cables

DWG BY:	APP BY:	DATE:	SHEET
MLA	MLA	8/30/17	1 of 1

FILE NAME:
8003694

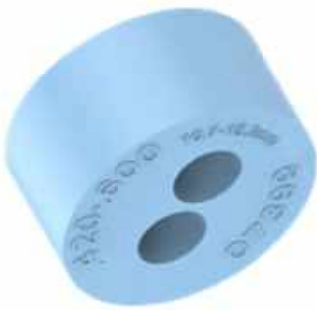

2 Hole Grommet
(.42" - .60"/10.7mm - 15.2mm Cable Diameter) (1)



5g Packet of
Silicone Lubricant (1)



Grommet Plugs (2)



COYTE® Cable Diameter
Measure Tape (1)

ALL DIMENSIONS ARE APPROXIMATE AND MAY VARY PER
FACTORY TOLERANCES. CONTACT P/LP FOR MORE INFORMATION



PREFORMED
LINE PRODUCTS
www.pformed.com

CONFIDENTIAL
The data and information contained in this document are proprietary to
PREFORMED Line Products (PLP). Such data and information are
provided solely for use with PLP's products and shall not be disclosed,
duplicated, or otherwise used without the express written approval of PLP.
PLP MAINTAINS THE RIGHT TO CHANGE DRAWING SPECIFICATIONS AT ANY TIME.
PLEASE CONTACT PLP TO VERIFY CURRENT VERSION

TITLE

P.N. 8003663

COYTE® 2 Hole Grommet Kit for
.42"-.60" (10.7mm - 15.2mm) Diameter Cables

DWG BY:	APR BY:	DATE:	SHEET:	FILE NAME:
MLA	MLA	8/15/17	1 of 1	8003663



4 Hole Grommet
(.30" - .43"/7.6mm - 10.9mm Cable Diameter) (1)



5g Packet of
Silicone Lubricant (1)



Grommet Plugs (4)



COYOTE® Cable Diameter
Measure Tape (1)

ALL DIMENSIONS ARE APPROXIMATE AND MAY VARY PER
FACTORY TOLERANCES. CONTACT PLP FOR MORE INFORMATION



CONFIDENTIAL
The data and information contained in this document are proprietary to
PREFORMED Line Products (PLP). Such data and information are
provided solely for use with PLP's products and shall not be disclosed,
duplicated, or otherwise used without the express written approval of PLP.
PLP MAINTAINS THE RIGHT TO CHANGE DRAWING SPECIFICATIONS AT ANY TIME.
PLEASE CONTACT PLP TO VERIFY CURRENT VERSION

TITLE				P.N. 8003664			
COYOTE® 4 Hole Grommet Kit for .30"-.43" (7.6mm - 10.9mm) Diameter Cables							
DWG BY:	APR BY:	DATE:	SHEET	FILE NAME			
MLA	MLA	8/15/17	1 of 1	8003664			



8 Hole Grommet
 (.125" - .25"/3.2mm - 6.4mm Cable Diameters
 or Flat Drop Cables) (1)



5g Packet of
 Silicone Lubricant (1)



Grommet Plugs (8)

ALL DIMENSIONS ARE APPROXIMATE AND MAY VARY PER
 FACTORY TOLERANCES. CONTACT PLP FOR MORE INFORMATION



CONFIDENTIAL
 The data and information contained in this document are proprietary to
 PREFORMED Line Products (PLP). Such data and information are
 provided solely for use with PLP's products and shall not be disclosed,
 duplicated, or otherwise used without the express written approval of PLP.
 PLP MAINTAINS THE RIGHT TO CHANGE DRAWING SPECIFICATIONS AT ANY TIME.
 PLEASE CONTACT PLP TO VERIFY CURRENT VERSION

TITLE

P.N. 8003677

COYOTE® 8 Hole Grommet Kit for
 .125"-.25" (3.2mm - 6.4mm) Diameter Cables or Flat Drop

DWG BY:

APR BY:

DATE:

SHEET

FILE NAME:

MLA

MLA

8/29/17

1 of 1

8003677

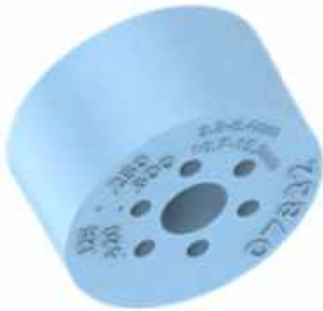

7 Hole Grommet
 (.42" - .60" & .125"-.25"/10.7mm - 15.2mm
 & 3.2mm - 6.4mm Cable Diameters) (1)
**NOTE: Flat Drop Cables can be
 used in the small holes**

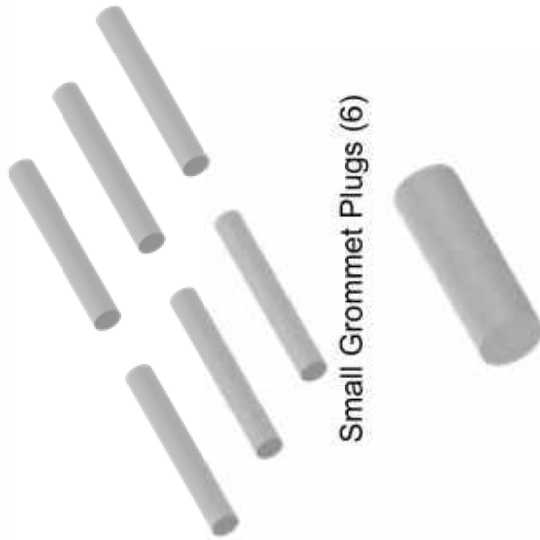

Small Grommet Plugs (6)

Large Grommet Plug (1)



5g Packet of
 Silicone Lubricant (1)



COYOTE® Cable Diameter
 Measure Tape (1)

ALL DIMENSIONS ARE APPROXIMATE AND MAY VARY PER
 FACTORY TOLERANCES. CONTACT PLP FOR MORE INFORMATION

PLP®
 LINE PRODUCTS
 www.preformed.com

CONFIDENTIAL
 The data and information contained in this document are proprietary to
 PREFORMED Line Products (PLP). Such data and information are
 provided solely for use with PLP's products and shall not be disclosed,
 duplicated, or otherwise used without the express written approval of PLP.
 PLP MAINTAINS THE RIGHT TO CHANGE DRAWING SPECIFICATIONS AT ANY TIME.
 PLEASE CONTACT PLP TO VERIFY CURRENT VERSION

TITLE			
P.N. 8003676			
COYOTE® 4 Hole Grommet Kit for .42"-.60" & .125"-.25" (10.7mm - 15.2mm & 3.2mm - 6.4mm) Diameter Cables			
DWG BY:	APR BY:	DATE:	SHEET
MLA	MLA	8/31/17	1 of 1
FILE NAME:			8003676



8 Hole Grommet
 (.125" - .25"/3.2mm - 6.4mm Cable Diameters
 or Flat Drop Cables) (1)



5g Packet of
 Silicone Lubricant (1)



Grommet Plugs (8)

ALL DIMENSIONS ARE APPROXIMATE AND MAY VARY PER
 FACTORY TOLERANCES. CONTACT PLP FOR MORE INFORMATION



CONFIDENTIAL
 The data and information contained in this document are proprietary to
 PREFORMED Line Products (PLP). Such data and information are
 provided solely for use with PLP's products and shall not be disclosed,
 duplicated, or otherwise used without the express written approval of PLP.
 PLP MAINTAINS THE RIGHT TO CHANGE DRAWING SPECIFICATIONS AT ANY TIME.
 PLEASE CONTACT PLP TO VERIFY CURRENT VERSION

TITLE			
P.N. 8003677			
COYOTE® 8 Hole Grommet Kit for			
.125"-.25" (3.2mm - 6.4mm) Diameter Cables or Flat Drop			
DWG BY:	APR BY:	DATE:	SHEET
MLA	MLA	8/29/17	1 of 1
FILE NAME:			8003677



2 Hole Grommet
(RPX Cables Only) (1)



5g Packet of
Silicone Lubricant (1)

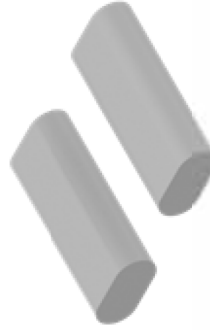

Grommet Plugs (2)

ALL DIMENSIONS ARE APPROXIMATE AND MAY VARY PER
FACTORY TOLERANCES. CONTACT PLP FOR MORE INFORMATION



www.pformed.com

CONFIDENTIAL
The data and information contained in this document are proprietary to
PREFORMED Line Products (PLP). Such data and information are
provided solely for use with PLP's products and shall not be disclosed,
duplicated, or otherwise used without the express written approval of PLP.
PLP MAINTAINS THE RIGHT TO CHANGE DRAWING SPECIFICATIONS AT ANY TIME.
PLEASE CONTACT PLP TO VERIFY CURRENT VERSION

TITLE:

P.N. 8004122
COYOTE® 2 Hole Grommet Kit for RPX Cables

DWG BY:	APR BY:	DATE:	SHEET:	FILE NAME:
MLA	MLA	3/9/18	1 of 1	8004122



3 Hole Grommet
 (RPX & Tethers, Flat Drop Cables, or Round Cables:
 .125"-.25"/3.2mm - 6.4mm Cable Diameters) (1)



Small Grommet Plugs (2)



Large Oval Grommet Plug (1)



**5g Packet of
 Silicone Lubricant (1)**



**COYOOTE® Cable Diameter
 Measure Tape (1)**

ALL DIMENSIONS ARE APPROXIMATE AND MAY VARY PER
 FACTORY TOLERANCES. CONTACT PLP FOR MORE INFORMATION



PREFORMED
 LINE PRODUCTS
www.preformed.com

CONFIDENTIAL
 The data and information contained in this document are proprietary to
 PREFORMED Line Products (PLP). Such data and information are
 provided solely for use with PLP's products and shall not be disclosed,
 duplicated, or otherwise used without the express written approval of PLP.
 PLP MAINTAINS THE RIGHT TO CHANGE DRAWING SPECIFICATIONS AT ANY TIME.
 PLEASE CONTACT PLP TO VERIFY CURRENT VERSION

TITLE			
P.N. 8004152			
COYOOTE® 3 Hole Grommet Kit for RPX Cables & Tethers (For use in the COYOOTE LCC - Aerial Applications Only)			
DWG BY:	APR BY:	DATE:	FILE NAME:
MLA	MLA	3/9/18	1 of 1
			8004152

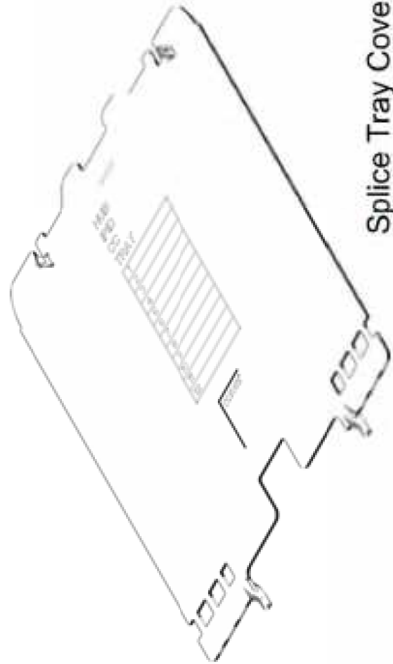

Splice Tray Cover (1)



LITE-GRIP Short Low Profile Splice Tray (1)



4 Hole LITE-GRIP Splice Blocks for Single Fusion Splices (6)



1 Hole LITE-GRIP Retention Sleeves (6)



2 Hole LITE-GRIP Retention Sleeves (2)



Felt Strip (1)

ALL DIMENSIONS ARE APPROXIMATE AND MAY VARY PER FACTORY TOLERANCES. CONTACT PLP FOR MORE INFORMATION



CONFIDENTIAL
 The data and information contained in this document are proprietary to PREFORMED Line Products (PLP). Such data and information are provided solely for use with PLP's products and shall not be disclosed, duplicated, or otherwise used without the express written approval of PLP. PLP MAINTAINS THE RIGHT TO CHANGE DRAWING SPECIFICATIONS AT ANY TIME. PLEASE CONTACT PLP TO VERIFY CURRENT VERSION

TITLE				Catalog #: 80809958			
COYOTE® LITE-GRIP® Short Low Profile 24ct Splice Tray Kit for Single Fusion Splices							
DWG BY:	APR BY:	DATE:	SHEET:	FILE NAME:			
MLA	MLA	8/29/17	1 of 1	80809958			

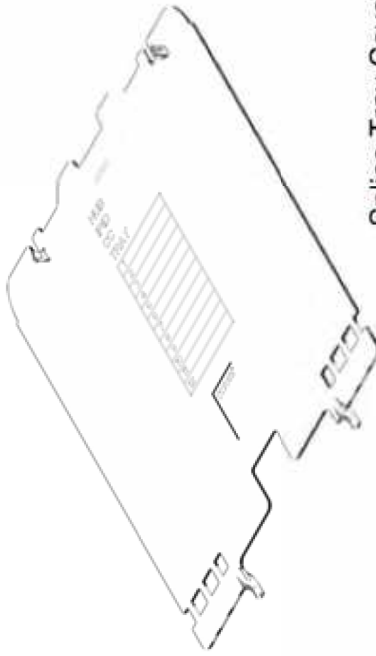

Splice Tray Cover (1)



Blank LITE-GRIP Short
Deep Profile Splice Tray (1)



Elastomeric Splice
Block for Single Fusion
Splices (1)



1 Hole Blue LITE-GRIP
Retention Sleeve (1)



6 Hole Blue LITE-GRIP
Retention Sleeves (1)



1 Hole Orange LITE-GRIP
Retention Sleeve (1)



6 Hole Orange LITE-GRIP
Retention Sleeves (1)



Felt Strip (1)

ALL DIMENSIONS ARE APPROXIMATE AND MAY VARY PER
FACTORY TOLERANCES. CONTACT PLP FOR MORE INFORMATION

PREFORMED
LINE PRODUCTS
www.preformed.com



CONFIDENTIAL

The data and information contained in this document are proprietary to
PREFORMED Line Products (PLP). Such data and information are
provided solely for use with PLP's products and shall not be disclosed,
duplicated, or otherwise used without the express written approval of PLP.
PLP MAINTAINS THE RIGHT TO CHANGE DRAWING SPECIFICATIONS AT ANY TIME.
PLEASE CONTACT PLP TO VERIFY CURRENT VERSION

TITLE P.N. 80808250

COYOTE® LITE-GRIP® Short Deep Profile 12ct Splice Tray Kit
with Elastomeric Splice Block for Single Fusion Splices

DWG BY:	APR BY:	DATE:	SHEET:	FILE NAME:
MLA	MLA	10/24/17	1 of 1	80808250

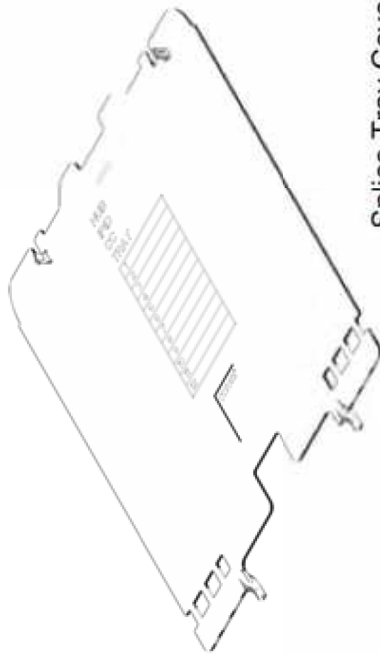

Splice Tray Cover (1)



LITE-GRIP Short Deep Profile Splice Tray (1)



8 Hole LITE-GRIP Splice Blocks for Single Fusion Splices (2)



1 Hole Blue LITE-GRIP Retention Sleeve (1)



6 Hole Blue LITE-GRIP Retention Sleeves (1)



1 Hole Orange LITE-GRIP Retention Sleeve (1)



6 Hole Orange LITE-GRIP Retention Sleeves (1)



Felt Strip (1)

ALL DIMENSIONS ARE APPROXIMATE AND MAY VARY PER FACTORY TOLERANCES. CONTACT PLP FOR MORE INFORMATION



CONFIDENTIAL
 The data and information contained in this document are proprietary to PREFORMED Line Products (PLP). Such data and information are provided solely for use with PLP's products and shall not be disclosed, duplicated, or otherwise used without the express written approval of PLP. PLP MAINTAINS THE RIGHT TO CHANGE DRAWING SPECIFICATIONS AT ANY TIME. PLEASE CONTACT PLP TO VERIFY CURRENT VERSION

TITLE		P. N. LGSTS16	
COYOTE® LITE-GRIP® Short Deep Profile 16ct Splice Tray Kit for Single Fusion Splices			
DWG BY:	APR BY:	DATE:	SHEET
MLA	MLA	8/17/17	1 of 1
FILE NAME:			LGSTS16



LITE-GRIP Short Deep Profile Splice Tray (1)

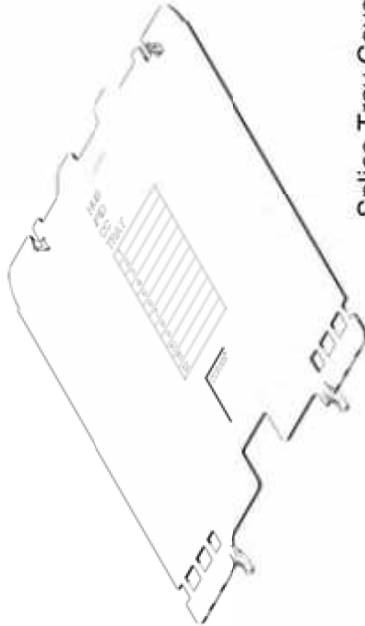

Splice Tray Cover (1)



8 Hole LITE-GRIP Splice Blocks for Single Fusion Splices (5)



1 Hole Blue LITE-GRIP Retention Sleeve (1)



1 Hole Orange LITE-GRIP Retention Sleeve (1)



6 Hole Blue LITE-GRIP Retention Sleeves (1)



6 Hole Orange LITE-GRIP Retention Sleeves (1)



Felt Strip (1)

ALL DIMENSIONS ARE APPROXIMATE AND MAY VARY PER FACTORY TOLERANCES. CONTACT PLP FOR MORE INFORMATION



CONFIDENTIAL

The data and information contained in this document are proprietary to PREFORMED Line Products (PLP). Such data and information are provided solely for use with PLP's products and shall not be disclosed, duplicated, or otherwise used without the express written approval of PLP. PLP MAINTAINS THE RIGHT TO CHANGE DRAWING SPECIFICATIONS AT ANY TIME. PLEASE CONTACT PLP TO VERIFY CURRENT VERSION

DESCRIPTION:

CATALOG #: 80808945
 COYOTE® LITE-GRIP® Short Deep Profile 40ct Splice Tray Kit for Single Fusion Splices

DWN BY: MLA APK BY: MLA DATE: 12/12/19 SCALE: PAGE: 1 OF 1
 FILENAME: 80808945

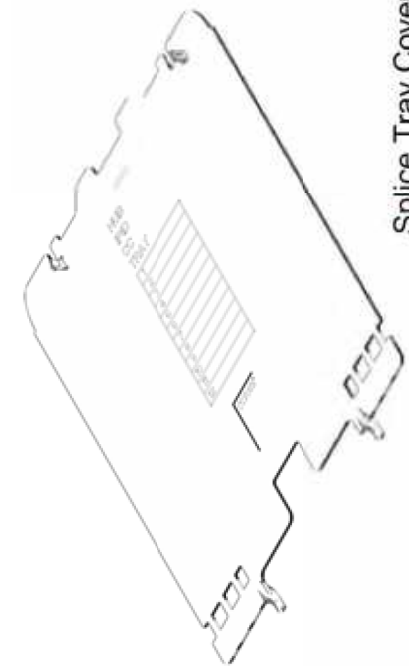

Splice Tray Cover (1)



LITE-GRIP Short Deep Profile Splice Tray (1)



3 Hole LITE-GRIP Splice Blocks for Ribbon/Mass Fusion Splices (4)



1 Hole Blue LITE-GRIP Retention Sleeve (1)



6 Hole Blue LITE-GRIP Retention Sleeves (1)



1 Hole Orange LITE-GRIP Retention Sleeve (1)



6 Hole Orange LITE-GRIP Retention Sleeves (1)



Felt Strip (1)

ALL DIMENSIONS ARE APPROXIMATE AND MAY VARY PER FACTORY TOLERANCES. CONTACT PLP FOR MORE INFORMATION



CONFIDENTIAL
 The data and information contained in this document are proprietary to PREFERRED Line Products (PLP). Such data and information are provided solely for use with PLP's products and shall not be disclosed, duplicated, or otherwise used without the express written approval of PLP. PLP MAINTAINS THE RIGHT TO CHANGE DRAWING SPECIFICATIONS AT ANY TIME. PLEASE CONTACT PLP TO VERIFY CURRENT VERSION

TITLE			
P.N. LGSTR144			
COYOTE@ LITE-GRIP® Short Deep Profile 144ct Splice Tray Kit for Ribbon/Mass Fusion Splices			
DWG BY:	APR BY:	DATE	SHEET
MLA	MLA	8/17/17	1 of 1
FILE NAME			LGSTR144

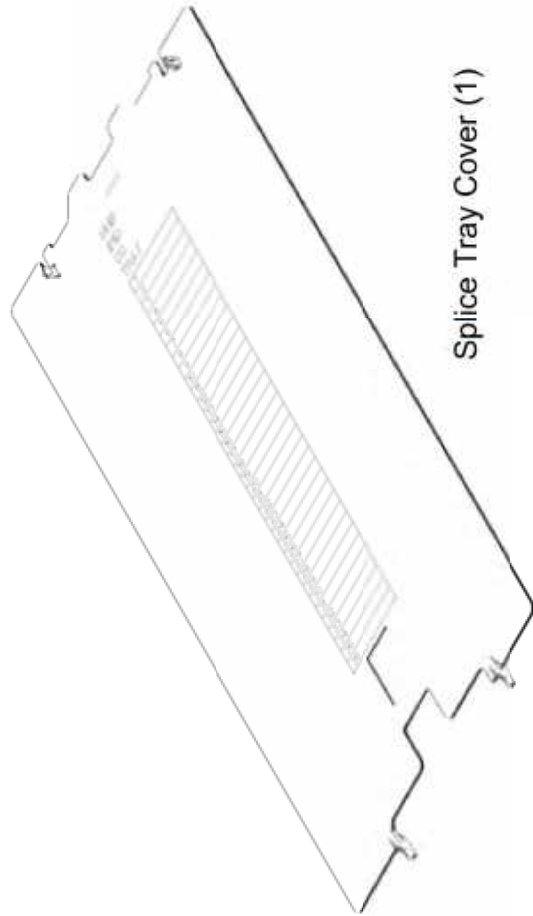

Splice Tray Cover (1)



LITE-GRIP Long Standard Profile Splice Tray (1)



4 Hole LITE-GRIP Splice Blocks for Single Fusion Splices (9)



1 Hole LITE-GRIP Retention Sleeves (6)



2 Hole LITE-GRIP Retention Sleeves (4)



Felt Strip (1)

ALL DIMENSIONS ARE APPROXIMATE AND MAY VARY PER FACTORY TOLERANCES. CONTACT PLP FOR MORE INFORMATION



PREFORMED
LINE PRODUCTS

www.preformed.com

CONFIDENTIAL
The data and information contained in this document are proprietary to PREFORMED Line Products (PLP). Such data and information are provided solely for use with PLP's products and shall not be disclosed, duplicated, or otherwise used without the express written approval of PLP. PLP MAINTAINS THE RIGHT TO CHANGE DRAWING SPECIFICATIONS AT ANY TIME. PLEASE CONTACT PLP TO VERIFY CURRENT VERSION

TITLE

Catalog #: 80810086

COYOTE® LITE-GRIP® Long Standard Profile 36ct Splice Tray Kit for Single Fusion Splices

DWG BY:	APR BY:	DATE:	SHEET
MLA	MLA	8/30/17	1 of 1

FILE NAME:
80810086

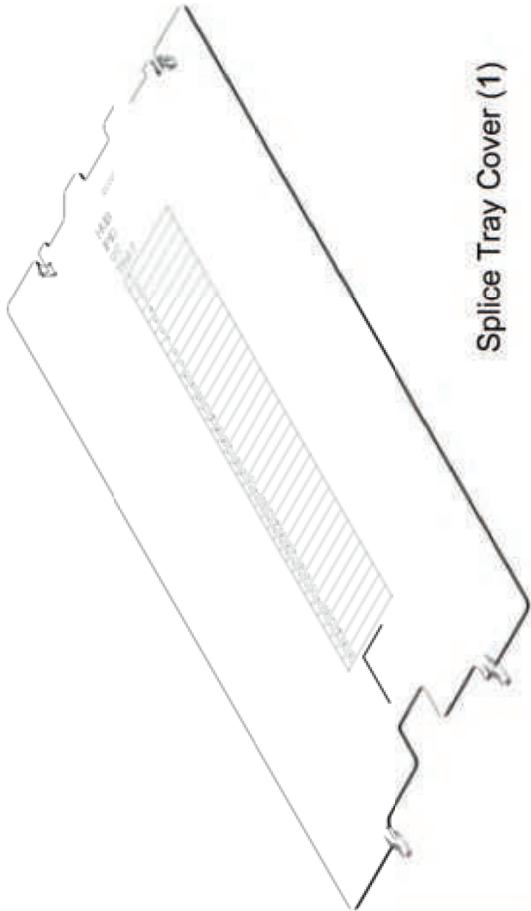

Splice Tray Cover (1)



Blank LITE-GRIP Long
Deep Profile Splice Tray (1)

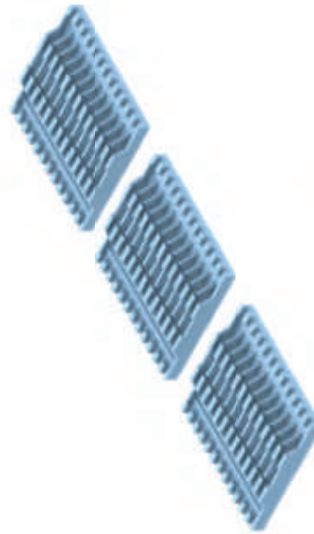

Elastomeric Splice
Blocks for Single Fusion
Splices (3)



1 Hole Blue LITE-GRIP
Retention Sleeve (1)



6 Hole Blue LITE-GRIP
Retention Sleeves (1)



1 Hole Orange LITE-GRIP
Retention Sleeve (1)



6 Hole Orange LITE-GRIP
Retention Sleeves (1)



Felt Strip (1)

ALL DIMENSIONS ARE APPROXIMATE AND MAY VARY PER
FACTORY TOLERANCES. CONTACT PLP FOR MORE INFORMATION



PREFORMED
LINE PRODUCTS

www.pformed.com

CONFIDENTIAL
The data and information contained in this document are proprietary to
PREFORMED Line Products (PLP). Such data and information are
provided solely for use with PLP's products and shall not be disclosed,
duplicated, or otherwise used without the express written approval of PLP.
PLP MAINTAINS THE RIGHT TO CHANGE DRAWING SPECIFICATIONS AT ANY TIME.
PLEASE CONTACT PLP TO VERIFY CURRENT VERSION

TITLE

P.N. 80808251
COYOTE® LITE-GRIP® Long Deep Profile 36ct Splice Tray Kit
with Elastomeric Splice Blocks for Single Fusion Splices

DWG BY:	APR BY:	DATE:	SHEET:	FILE NAME:
MLA	MLA	3/15/18	1 of 1	80808251

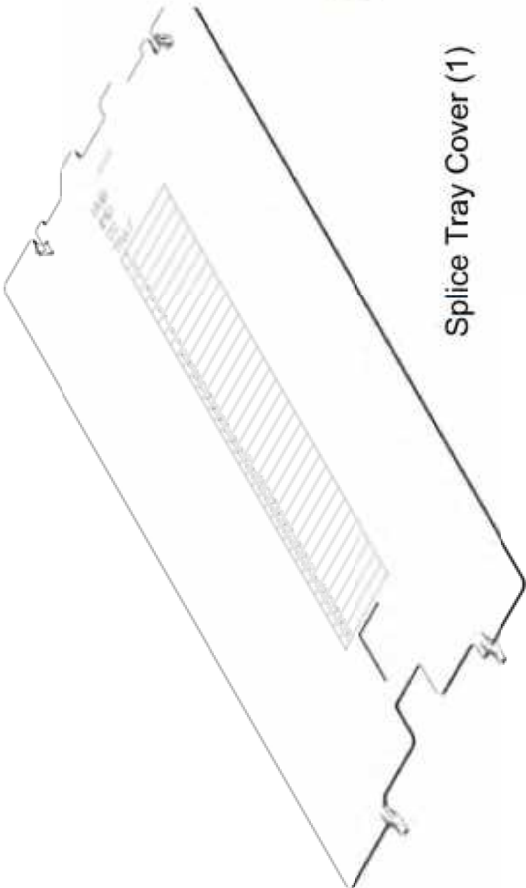

Splice Tray Cover (1)



LITE-GRIP Long Deep Profile Splice Tray (1)



8 Hole LITE-GRIP Splice Blocks for Single Fusion Splices (5)



1 Hole Blue LITE-GRIP Retention Sleeve (1)



6 Hole Blue LITE-GRIP Retention Sleeves (1)



1 Hole Orange LITE-GRIP Retention Sleeve (1)



6 Hole Orange LITE-GRIP Retention Sleeves (1)



Felt Strip (1)

ALL DIMENSIONS ARE APPROXIMATE AND MAY VARY PER FACTORY TOLERANCES. CONTACT PLP FOR MORE INFORMATION



PREFORMED
LINE PRODUCTS
www.preformed.com

CONFIDENTIAL
The data and information contained in this document are proprietary to PREFORMED Line Products (PLP). Such data and information are provided solely for use with PLP's products and shall not be disclosed, duplicated, or otherwise used without the express written approval of PLP. PLP MAINTAINS THE RIGHT TO CHANGE DRAWING SPECIFICATIONS AT ANY TIME. PLEASE CONTACT PLP TO VERIFY CURRENT VERSION

TITLE		P.N. LGSTS40	
COYOTE® LITE-GRIP® Long Deep Profile 40ct Splice Tray Kit for Single Fusion Splices			
DWG BY:	APR BY:	DATE:	SHEET:
MLA	MLA	8/17/17	1 of 1
FILE NAME:			LGSTS40



LITE-GRIP Long Deep Profile Splice Tray (1)

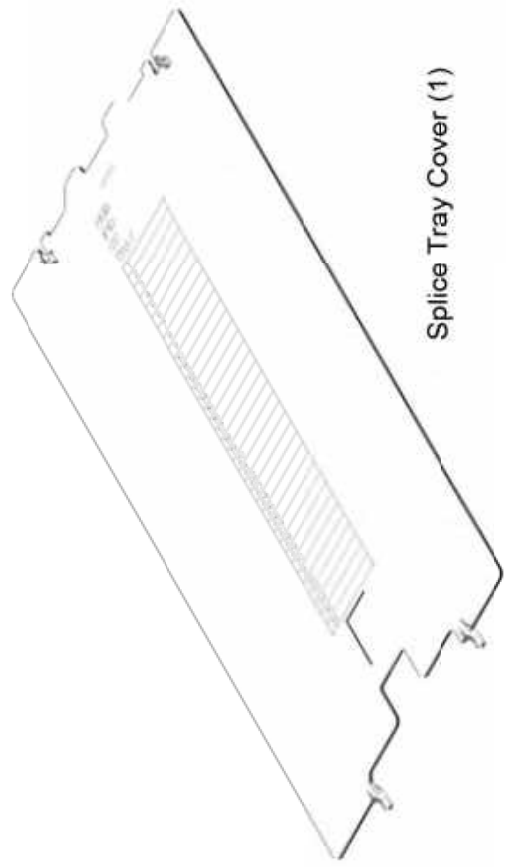

Splice Tray Cover (1)



6 Hole Blue LITE-GRIP Retention Sleeves (2)



6 Hole Orange LITE-GRIP Retention Sleeves (2)



1 Hole Blue LITE-GRIP Retention Sleeve (1)



1 Hole Orange LITE-GRIP Retention Sleeve (1)



8 Hole LITE-GRIP Splice Blocks for Single Fusion Splices (9)



Felt Strip (1)

ALL DIMENSIONS ARE APPROXIMATE AND MAY VARY PER FACTORY TOLERANCES. CONTACT PLP FOR MORE INFORMATION

PLP **PREFORMED LINE PRODUCTS**
 CLEVELAND, OHIO 44143 | 1-(440)-461-5200
 preformed.com

CONFIDENTIAL
 The data and information contained in this document are proprietary to PREFORMED Line Products (PLP). Such data and information are provided solely for use with PLP's products and shall not be disclosed, duplicated, or otherwise used without the express written approval of PLP. PLP MAINTAINS THE RIGHT TO CHANGE DRAWING SPECIFICATIONS AT ANY TIME PLEASE CONTACT PLP TO VERIFY CURRENT VERSION

DESCRIPTION: Catalog #: LGSTS72
 COYOTE® LITE-GRIP® Long Deep Profile 72ct Splice Tray Kit for Single Fusion Splices
 DRN BY: MLA APR BY: MLA DATE: 10/21/19 SCALE: 1 of 1
 FILENAME: LGSTS72



LITE-GRIP Long Deep Profile Splice Tray (1)

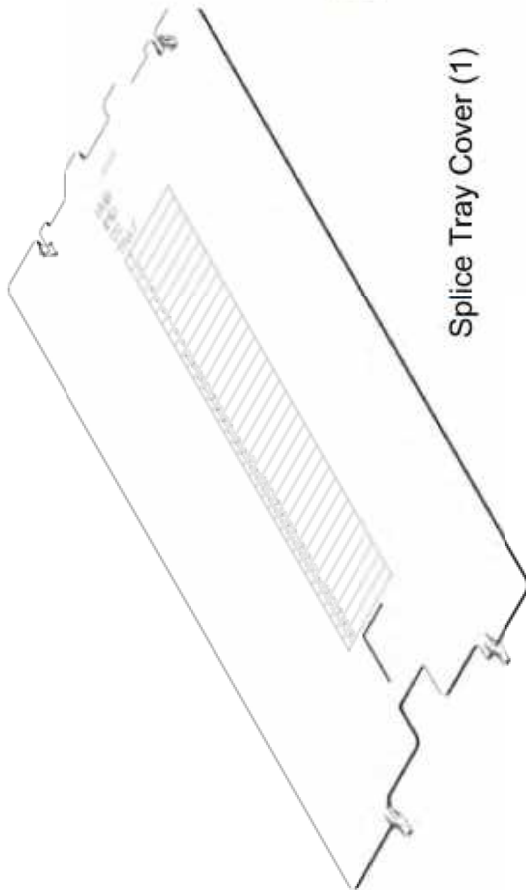

Splice Tray Cover (1)



3 Hole LITE-GRIP Splice Blocks for Ribbon/Mass Fusion Splices (6)



1 Hole Blue LITE-GRIP Retention Sleeve (1)



6 Hole Blue LITE-GRIP Retention Sleeves (1)



1 Hole Orange LITE-GRIP Retention Sleeve (1)



6 Hole Orange LITE-GRIP Retention Sleeves (1)



Felt Strip (1)

ALL DIMENSIONS ARE APPROXIMATE AND MAY VARY PER FACTORY TOLERANCES. CONTACT PLP FOR MORE INFORMATION



PREFORMED
LINE PRODUCTS
www.pformed.com

CONFIDENTIAL
The data and information contained in this document are proprietary to PREFORMED Line Products (PLP). Such data and information are provided solely for use with PLP's products and shall not be disclosed, duplicated, or otherwise used without the express written approval of PLP. PLP MAINTAINS THE RIGHT TO CHANGE DRAWING SPECIFICATIONS AT ANY TIME. PLEASE CONTACT PLP TO VERIFY CURRENT VERSION

TITLE		P. N. LGSTR216	
COYOTE® LITE-GRIP® Long Deep Profile 216ct Splice Tray Kit for Ribbon/Mass Fusion Splices			
DWG BY:	APR BY:	DATE:	SHEET:
MLA	MLA	8/17/17	1 of 1
FILE NAME:			LGSTR216



Splice Tray Cover (1)



Short Universal Splice Tray (1)



Splice Block Cover
for Ribbons (2)



Splice Block Cover
for Buffer Tubes (2)



Splice Block (1)

ALL DIMENSIONS ARE APPROXIMATE AND MAY VARY PER
FACTORY TOLERANCES. CONTACT PLP FOR MORE INFORMATION



CONFIDENTIAL
The data and information contained in this document are proprietary to
PERFORMED Line Products (PLP). Such data and information are
provided solely for use with PLP's products and shall not be disclosed,
duplicated, or otherwise used without the express written approval of PLP.
PLP MAINTAINS THE RIGHT TO CHANGE DRAWING SPECIFICATIONS AT ANY TIME.
PLEASE CONTACT PLP TO VERIFY CURRENT VERSION

TITLE

P.N. 800012909

COYOTE® Short Universal Splice Tray Kit
for Single Fusion or Ribbon/Mass Fusion Splices

FILE NAME

1 of 1

DATE

8/18/17

APR BY:

MLA

DWG BY:

MLA

SHEET

800012909

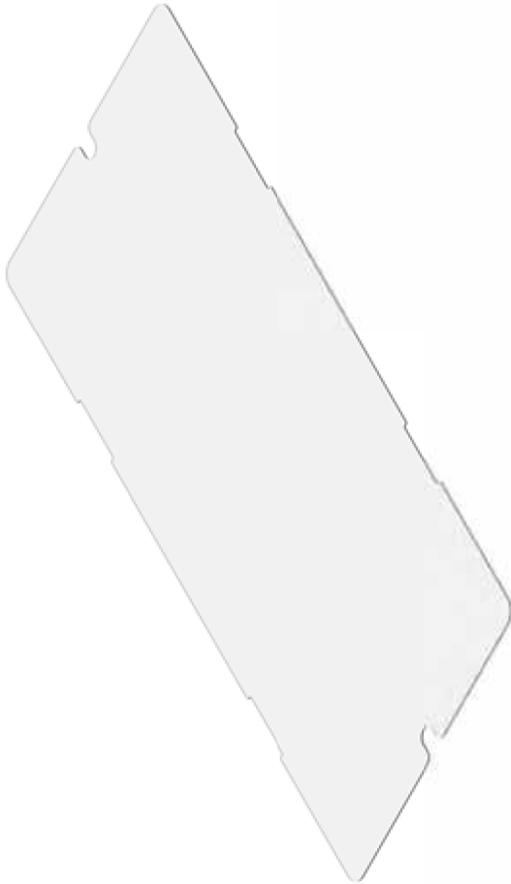

Splice Tray Cover (1)



Short Universal Splice Tray (1)



Splice Block Cover for Ribbons (2)



Splice Block Cover for Buffer Tubes (2)



Splice Blocks (2)

ALL DIMENSIONS ARE APPROXIMATE AND MAY VARY PER FACTORY TOLERANCES. CONTACT PLP FOR MORE INFORMATION



CONFIDENTIAL
The data and information contained in this document are proprietary to PREFORMED Line Products (PLP). Such data and information are provided solely for use with PLP's products and shall not be disclosed, duplicated, or otherwise used without the express written approval of PLP. PLP MAINTAINS THE RIGHT TO CHANGE DRAWING SPECIFICATIONS AT ANY TIME. PLEASE CONTACT PLP TO VERIFY CURRENT VERSION

TITLE

P.N. 800012908
COYOTE@ Long Universal Splice Tray Kit
for Single Fusion or Ribbon/Mass Fusion Splices

DWG BY:	APR BY:	DATE:	SHEET:	FILE NAME:
MLA	MLA	8/18/17	1 of 1	800012908



Short Low Profile
Splice Tray (1)



Splice Tray Cover (1)



Felt Strip (1)

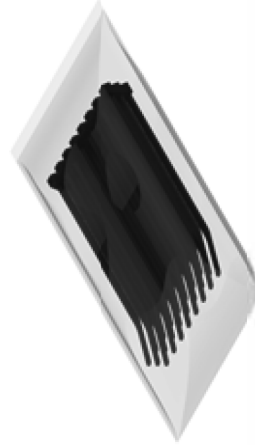

Cable Tie Wraps -
Pack of 12 (1)



Splice Tray
Recording Label (1)

ALL DIMENSIONS ARE APPROXIMATE AND MAY VARY PER
FACTORY TOLERANCES. CONTACT PLP FOR MORE INFORMATION



CONFIDENTIAL
The data and information contained in this document are proprietary to
PREFORMED Line Products (PLP). Such data and information are
provided solely for use with PLP's products and shall not be disclosed,
duplicated, or otherwise used without the express written approval of PLP.
PLP MAINTAINS THE RIGHT TO CHANGE DRAWING SPECIFICATIONS AT ANY TIME.
PLEASE CONTACT PLP TO VERIFY CURRENT VERSION

TITLE
COYOTE® Legacy Short Low Profile 12ct Splice Tray Kit
for Single Fusion Splices

P. N. 80807701

DWG BY:	APR BY:	DATE:	SHEET:	FILE NAME:
MLA	MLA	8/18/17	1 of 1	80807701



Splice Tray Cover (1)



Short Standard Profile Splice Tray (1)



Felt Strips (2)



Cable Tie Wraps - Pack of 12 (1)



Elastomeric Splice Block (1)



Splice Tray Recording Label (1)

ALL DIMENSIONS ARE APPROXIMATE AND MAY VARY PER FACTORY TOLERANCES. CONTACT PLP FOR MORE INFORMATION



PREFORMED
LINE PRODUCTS
www.prefomed.com

CONFIDENTIAL
The data and information contained in this document are proprietary to PREFORMED Line Products (PLP). Such data and information are provided solely for use with PLP's products and shall not be disclosed, duplicated, or otherwise used without the express written approval of PLP. PLP MAINTAINS THE RIGHT TO CHANGE DRAWING SPECIFICATIONS AT ANY TIME. PLEASE CONTACT PLP TO VERIFY CURRENT VERSION

TITLE

P. N. 80806033
COYOTE® Legacy Short Standard Profile 12ct Splice Tray Kit for Single Fusion Splices

FILE NAME:

SHEET

DATE:

APR BY: MLA

MLA

10/20/17

1 of 1

80806033



Splice Tray Cover (1)



Short Deep Profile
Splice Tray (1)



Felt Strips (2)



Cable Tie Wraps -
Pack of 12 (1)



Elastomeric
Splice Block (1)



Splice Tray
Recording Label (1)

ALL DIMENSIONS ARE APPROXIMATE AND MAY VARY PER
FACTORY TOLERANCES. CONTACT PLP FOR MORE INFORMATION

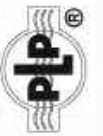

PREFORMED
LINE PRODUCTS

www.pformed.com

CONFIDENTIAL
The data and information contained in this document are proprietary to
PREFORMED Line Products (PLP). Such data and information are
provided solely for use with PLP's products and shall not be disclosed,
duplicated, or otherwise used without the express written approval of PLP.
PLP MAINTAINS THE RIGHT TO CHANGE DRAWING SPECIFICATIONS AT ANY TIME.
PLEASE CONTACT PLP TO VERIFY CURRENT VERSION

TITLE

P. N. 80807114
COYOTE® Legacy Short Deep Profile 72ct Splice Tray Kit for
Ribbon/Mass Fusion Splices

DWG BY: MLA

APR BY: MLA

DATE: 10/20/17

SHEET: 1 of 1

FILE NAME: 80807114

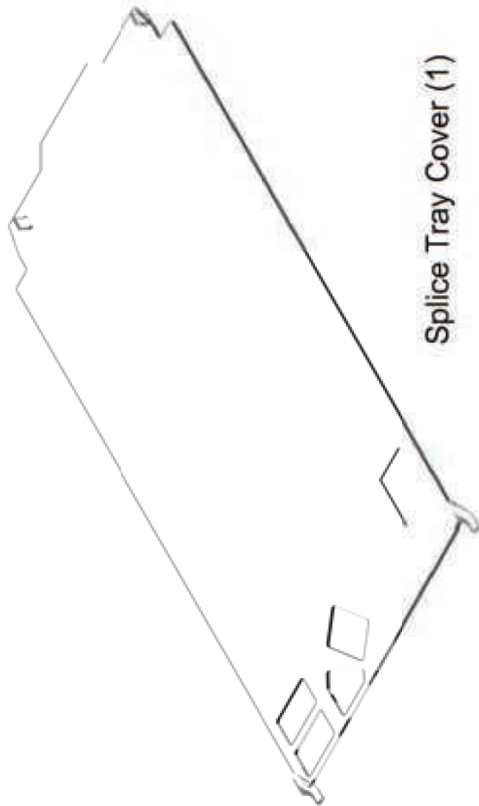

Splice Tray Cover (1)



Long Standard Profile Splice Tray (1)



Felt Strips (2)



Cable Tie Wraps - Pack of 24 (1)

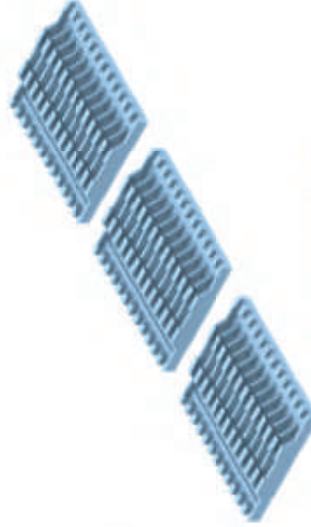

Elastomeric Splice Blocks (3)



Splice Tray Recording Label (1)

ALL DIMENSIONS ARE APPROXIMATE AND MAY VARY PER FACTORY TOLERANCES. CONTACT PLP FOR MORE INFORMATION



PREFORMED
LINE PRODUCTS

www.pformed.com

CONFIDENTIAL
The data and information contained in this document are proprietary to PREFORMED Line Products (PLP). Such data and information are provided solely for use with PLP's products and shall not be disclosed, duplicated, or otherwise used without the express written approval of PLP. PLP MAINTAINS THE RIGHT TO CHANGE DRAWING SPECIFICATIONS AT ANY TIME. PLEASE CONTACT PLP TO VERIFY CURRENT VERSION

TITLE:

P.N. 80805514
COYOTE® Legacy Long Standard Profile 36ct Splice Tray
for Single Fusion Splices

DWG BY:	APR BY:	DATE:	SHEET:	FILE NAME:
MLA	MLA	8/29/17	1 of 1	80805514

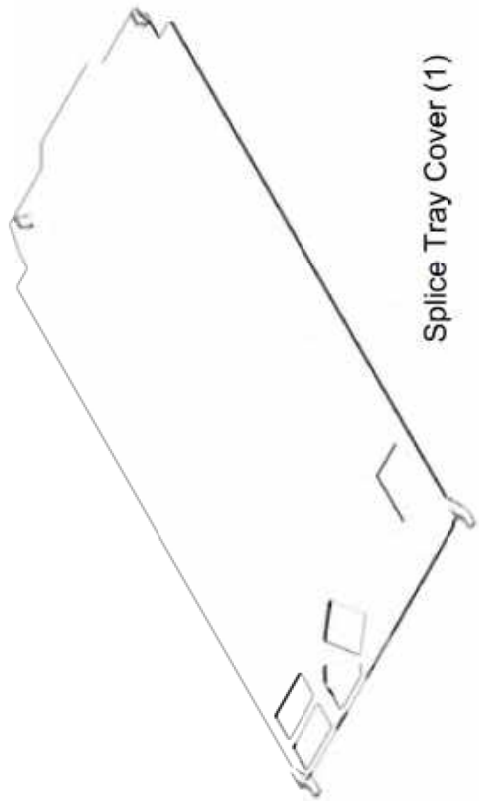

Splice Tray Cover (1)



Long Deep Profile Splice Tray (1)



Elastomeric Splice Blocks (2)

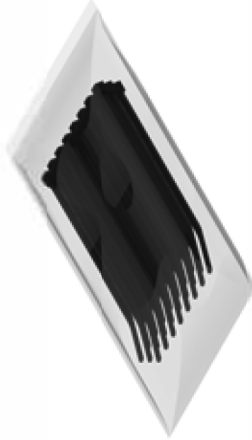

Cable Tie Wraps - Pack of 24 (1)



Felt Strips (2)



Ribbon Fiber Guide Wires (2)

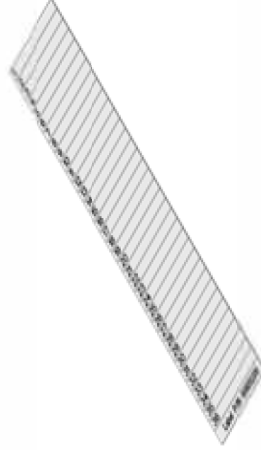

Splice Tray Recording Label (1)

ALL DIMENSIONS ARE APPROXIMATE AND MAY VARY PER FACTORY TOLERANCES. CONTACT PLP FOR MORE INFORMATION

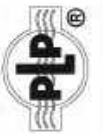

PREFORMED
LINE PRODUCTS
www.preformed.com

CONFIDENTIAL
The data and information contained in this document are proprietary to PREFORMED Line Products (PLP). Such data and information are provided solely for use with PLP's products and shall not be disclosed, duplicated, or otherwise used without the express written approval of PLP. PLP MAINTAINS THE RIGHT TO CHANGE DRAWING SPECIFICATIONS AT ANY TIME. PLEASE CONTACT PLP TO VERIFY CURRENT VERSION

TITLE

P.N. 80805515

COYOTE® Legacy Long Deep Profile 144ct Splice Tray Kit
for Ribbon/Mass Fusion Splices

DWG BY: MLA

APR BY: MLA

DATE: 8/18/17

SHEET: 1 of 1

FILE NAME: 80805515

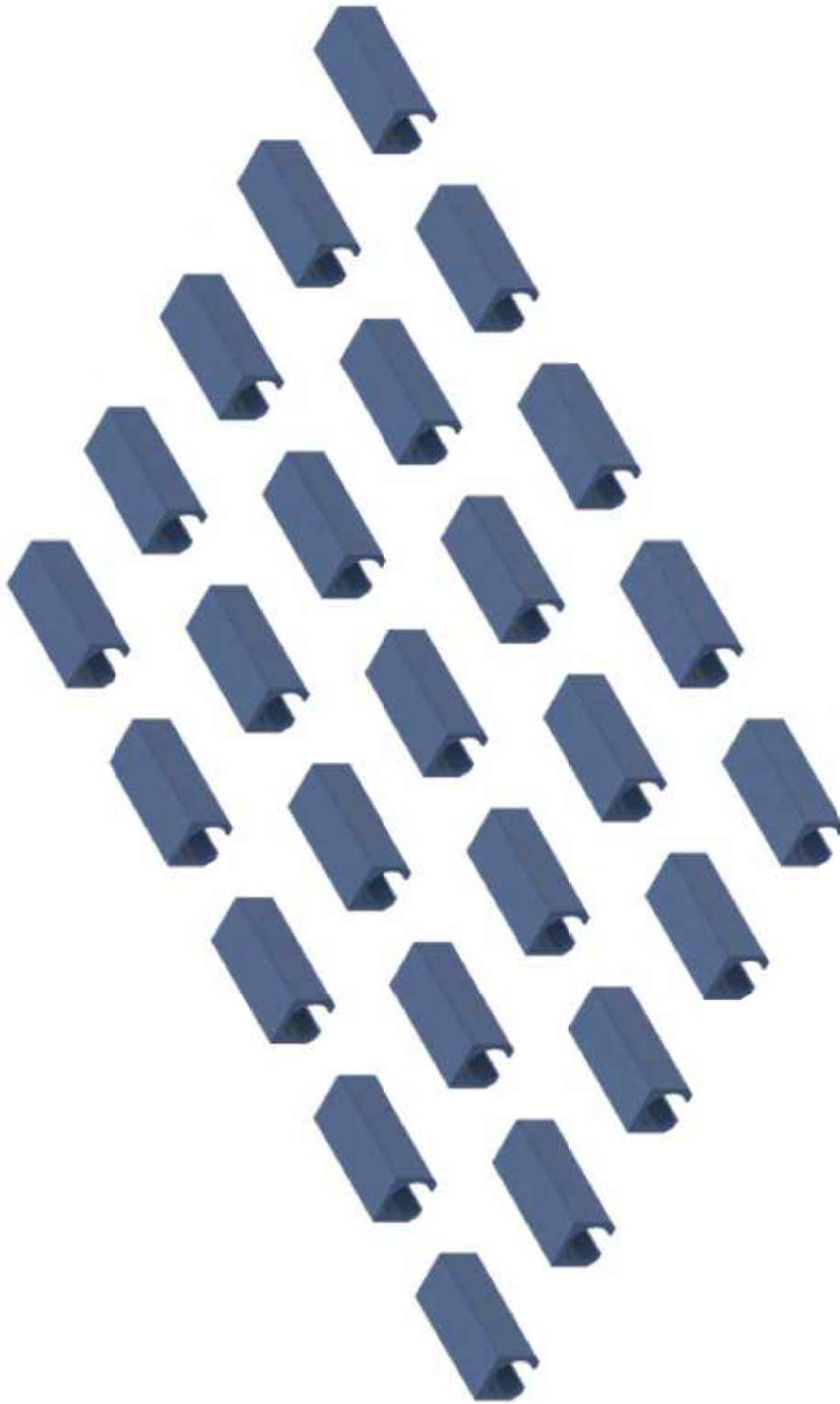

LITE-GRIP® 1 Hole Blue
Retention Sleeves (25)

<p>ALL DIMENSIONS ARE APPROXIMATE AND MAY VARY PER FACTORY TOLERANCES. CONTACT PLP FOR MORE INFORMATION</p>		<p>CONFIDENTIAL</p> <p>The data and information contained in this document are proprietary to PREFORMED Line Products (PLP). Such data and information are provided solely for use with PLP's products and shall not be disclosed, duplicated, or otherwise used without the express written approval of PLP. PLP MAINTAINS THE RIGHT TO CHANGE DRAWING SPECIFICATIONS AT ANY TIME. PLEASE CONTACT PLP TO VERIFY CURRENT VERSION</p>		<p>TITLE</p> <p>P.N. LGRS1-25B</p> <p>COYOTE® LITE-GRIP® 1 Hole Blue Retention Sleeves - Pack of 25</p>	
<p>DWG BY:</p> <p>MLA</p>	<p>APR BY:</p> <p>MLA</p>	<p>DATE:</p> <p>8/15/17</p>	<p>SHEET:</p> <p>1 of 1</p>	<p>FILE NAME:</p> <p>LGRS1-25B</p>	
<p>www.pformed.com</p>		<p>PLP® LINE PRODUCTS</p>			

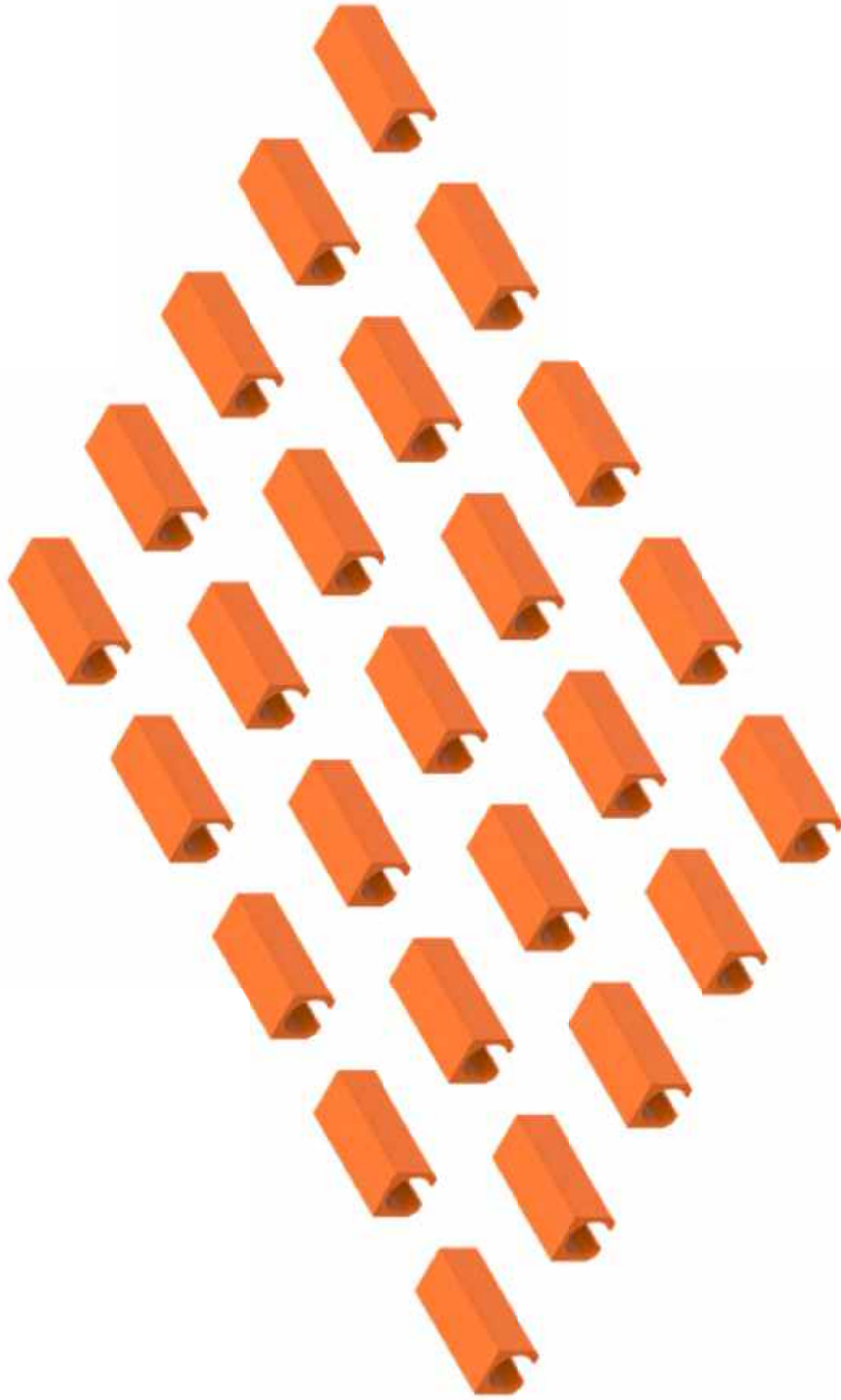

LITE-GRIP® 1 Hole Blue
Retention Sleeves (25)

ALL DIMENSIONS ARE APPROXIMATE AND MAY VARY PER
FACTORY TOLERANCES. CONTACT PLP FOR MORE INFORMATION



CONFIDENTIAL
The data and information contained in this document are proprietary to
PREFORMED Line Products (PLP). Such data and information are
provided solely for use with PLP's products and shall not be disclosed,
duplicated, or otherwise used without the express written approval of PLP.
PLP MAINTAINS THE RIGHT TO CHANGE DRAWING SPECIFICATIONS AT ANY TIME.
PLEASE CONTACT PLP TO VERIFY CURRENT VERSION

TITLE			
COYOTE® LITE-GRIP® 1 Hole Orange Retention Sleeves - Pack of 25		P.N. LGRS1-25OR	
DWG BY:	APR BY:	DATE:	SHEET:
MLA	MLA	8/15/17	1 of 1
			FILE NAME:
			LGRS1-25OR



8 Hole LITE-GRIP Splice Blocks
for Single Fusion Splices (5)

ALL DIMENSIONS ARE APPROXIMATE AND MAY VARY PER
FACTORY TOLERANCES. CONTACT PLP FOR MORE INFORMATION



PREFORMED
LINE PRODUCTS
www.pformed.com

CONFIDENTIAL
The data and information contained in this document are proprietary to
PREFORMED Line Products (PLP). Such data and information are
provided solely for use with PLP's products and shall not be disclosed,
duplicated, or otherwise used without the express written approval of PLP.
PLP MAINTAINS THE RIGHT TO CHANGE DRAWING SPECIFICATIONS AT ANY TIME.
PLEASE CONTACT PLP TO VERIFY CURRENT VERSION

TITLE			
P.N. LGSBS8-5			
COYOTE® LITE-GRIP® Splice Block Kit for Single Fusion Splices			
DWG BY:	APR BY:	DATE:	SHEET:
MLA	MLA	8/1/17	1 of 1
			FILE NAME:
			LGSBS8-5



3 Hole LITE-GRIP Splice
Blocks for Ribbon/Mass
Fusion Splices (5)

ALL DIMENSIONS ARE APPROXIMATE AND MAY VARY PER
FACTORY TOLERANCES. CONTACT PLP FOR MORE INFORMATION



CONFIDENTIAL
The data and information contained in this document are proprietary to
PREFORMED Line Products (PLP). Such data and information are
provided solely for use with PLP's products and shall not be disclosed,
duplicated, or otherwise used without the express written approval of PLP.
PLP MAINTAINS THE RIGHT TO CHANGE DRAWING SPECIFICATIONS AT ANY TIME.
PLEASE CONTACT PLP TO VERIFY CURRENT VERSION

TITLE
P. N. LGSBR3-5
COYOTE® LITE-GRIP® Splice Block Kit for
Ribbon/Mass Fusion Splices

DWG BY:	APR BY:	DATE:	SHEET:	FILE NAME:
MLA	MLA	8/1/17	1 of 1	LGSBR3-5

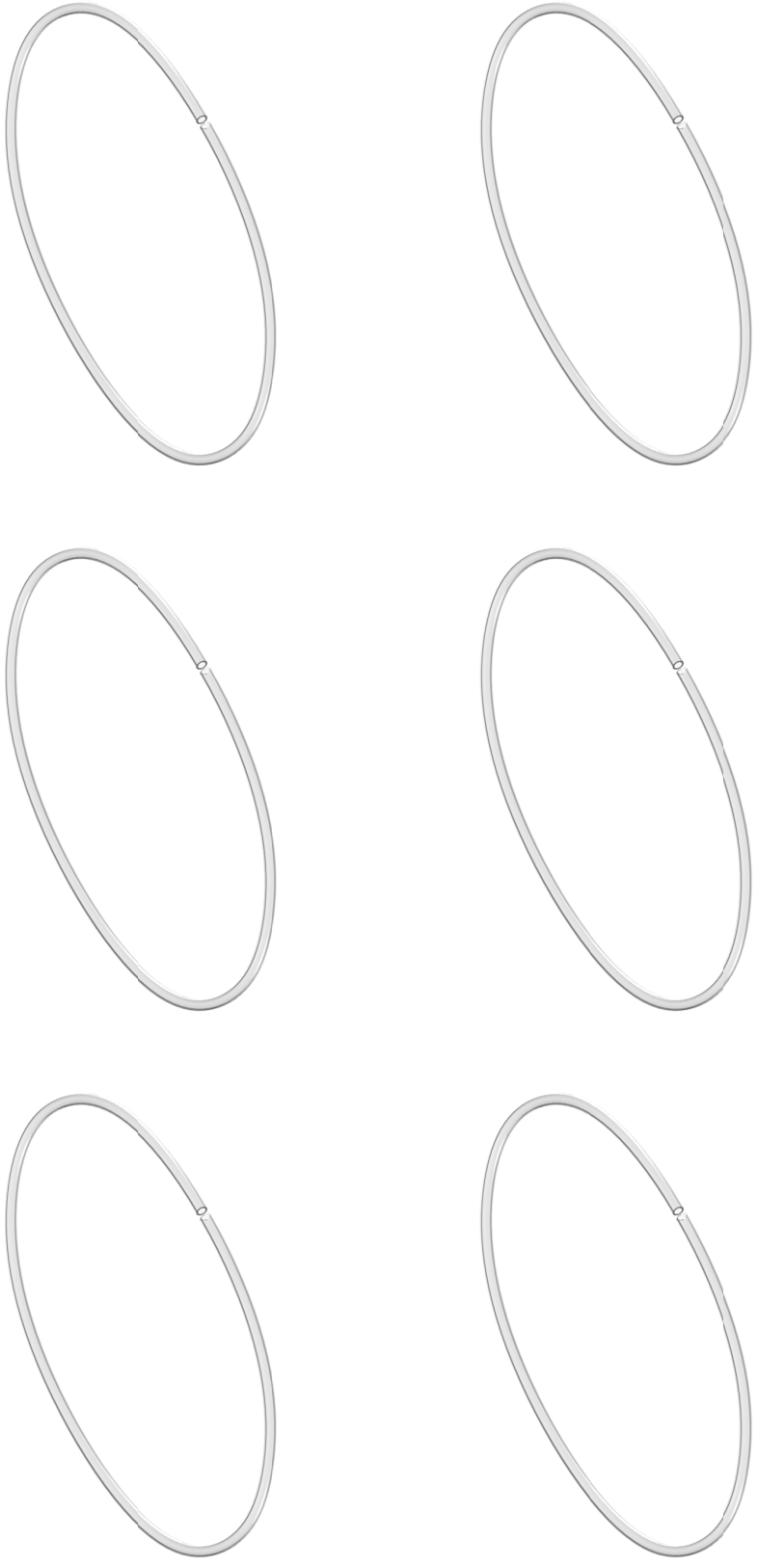

.17" I.D. x 34.5" Long Transport Tube (6)

ALL DIMENSIONS ARE APPROXIMATE AND MAY VARY PER
FACTORY TOLERANCES. CONTACT PLP FOR MORE INFORMATION

PREFORMED LINE PRODUCTS
 CLEVELAND, OHIO 44143 | 1-(440)-461-5200
 preformed.com

CONFIDENTIAL
 The data and information contained in this document are proprietary to
 PREFORMED Line Products (PLP). Such data and information are
 provided solely for use with PLP's products and shall not be disclosed,
 duplicated, or otherwise used without the express written approval of PLP.
 PLP MAINTAINS THE RIGHT TO CHANGE DRAWING SPECIFICATIONS AT ANY TIME
 PLEASE CONTACT PLP TO VERIFY CURRENT VERSION

DESCRIPTION:		Catalog #: 80806439	
		Transport Tube Kit - Contains	
		(6) .17" I.D. x 34.5" Long Transport Tubes	
URN BY:	MLA	DATE:	SCALE:
MLA	APR BY:	MLA	1/8/20
FILENAME:			80806439
		PAGE:	1 of 1



6.5" Dome End Plate (1)



4 Pack Grommet Kit (1)
[Includes: (2) 1 Hole Grommets .40"-.60",
& (2) 1 Hole Grommets .60"-.85"]



Small Parts Bag (1)

ALL DIMENSIONS ARE APPROXIMATE AND MAY VARY PER
FACTORY TOLERANCES. CONTACT PLP FOR MORE INFORMATION



PREFORMED LINE PRODUCTS
CLEVELAND, OHIO 44143 | 1-(440)-461-5200
preformed.com

CONFIDENTIAL

The data and information contained in this document are proprietary to
PREFORMED Line Products (PLP). Such data and information are
provided solely for use with PLP's products and shall not be disclosed,
duplicated, or otherwise used without the express written approval of PLP.
PLP MAINTAINS THE RIGHT TO CHANGE DRAWING SPECIFICATIONS AT ANY TIME.
PLEASE CONTACT PLP TO VERIFY CURRENT VERSION

DESCRIPTION:

Catalog Number 8003681
COYOTE® 6.5" Dome End Plate Kit

DRN BY: MAO APR BY: MAO DATE: 04/09/20 SCALE: PAGE
FILENAME: 8003681



9.5" Dome End Plate (1)

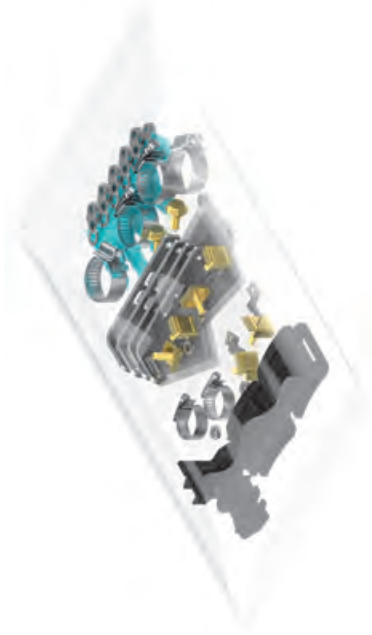

Small Parts Bag (1)



1 Hole Grommet Kit (1)
 (.85"-1.00" Cable Diameter) -
 Contains 2 Grommets (1)



1 Hole Grommet Kit (1)
 (1.00"-1.25" Cable Diameter)
 - Contains 2 Grommets (1)

ALL DIMENSIONS ARE APPROXIMATE AND MAY VARY PER
 FACTORY TOLERANCES. CONTACT PLP FOR MORE INFORMATION



PREFORMED LINE PRODUCTS
 CLEVELAND, OHIO 44143 | 1-(440)-461-5200
preformed.com

CONFIDENTIAL
 The data and information contained in this document are proprietary to
 PREFORMED Line Products (PLP). Such data and information are
 provided solely for use with PLP's products and shall not be disclosed,
 duplicated, or otherwise used without the express written approval of PLP.
 PLP MAINTAINS THE RIGHT TO CHANGE DRAWING SPECIFICATIONS AT ANY TIME.
 PLEASE CONTACT PLP TO VERIFY CURRENT VERSION

DESCRIPTION:

Catalog Number 8003839
 COYOTE@ 9.5" Dome End Plate Kit

DRN BY: MAO	APR BY: MAO	DATE: 04/09/20	SCALE:	PAGE
FILENAME: 8003839				



COYOTE® Dome Closure 6.5" Collar (1)

ALL DIMENSIONS ARE APPROXIMATE AND MAY VARY PER
FACTORY TOLERANCES. CONTACT PLP FOR MORE INFORMATION

PLP **PREFORMED LINE PRODUCTS**
CLEVELAND, OHIO 44143 | 1-(440)-461-5200
preformed.com

DESCRIPTION:

Catalog #: 80807332
COYOTE® Dome Closure 6.5" Collar

DRN BY: MLA APR BY: MLA DATE: 1/6/20 SCALE: PAGE 1 of 1
FILENAME: 80807332

CONFIDENTIAL
The data and information contained in this document are proprietary to
PREFORMED Line Products (PLP). Such data and information are
provided solely for use with PLP's products and shall not be disclosed,
duplicated, or otherwise used without the express written approval of PLP.
PLP MAINTAINS THE RIGHT TO CHANGE DRAWING SPECIFICATIONS AT ANY TIME
PLEASE CONTACT PLP TO VERIFY CURRENT VERSION



COYOTE® Dome Closure 9.5" Collar (1)

ALL DIMENSIONS ARE APPROXIMATE AND MAY VARY PER
FACTORY TOLERANCES. CONTACT PLP FOR MORE INFORMATION



PREFORMED LINE PRODUCTS

CLEVELAND, OHIO 44143 | 1-(440)-461-5200
preformed.com

DESCRIPTION:

Catalog #: 80808528-1
COYOTE® Dome Closure 9.5" Collar

DWN BY: MLA	APR BY: MLA	DATE: 1/6/20	SCALE:	PAGE: 1 of 1
FILENAME:				80808528-1

CONFIDENTIAL
The data and information contained in this document are proprietary to
PREFORMED Line Products (PLP). Such data and information are
provided solely for use with PLP's products and shall not be disclosed,
duplicated, or otherwise used without the express written approval of PLP.
PLP MAINTAINS THE RIGHT TO CHANGE DRAWING SPECIFICATIONS AT ANY TIME
PLEASE CONTACT PLP TO VERIFY CURRENT VERSION



COYOTE® Dome Closure 6.5" Collar (1)



COYOTE® Dome Closure 6.5" Gasket (1)

ALL DIMENSIONS ARE APPROXIMATE AND MAY VARY PER
FACTORY TOLERANCES. CONTACT PLP FOR MORE INFORMATION



PREFORMED LINE PRODUCTS
CLEVELAND, OHIO 44143 | 1-(440)-461-5200
preformed.com

CONFIDENTIAL
The data and information contained in this document are proprietary to
PREFORMED Line Products (PLP). Such data and information are
provided solely for use with PLP's products and shall not be disclosed,
duplicated, or otherwise used without the express written approval of PLP.
PLP MAINTAINS THE RIGHT TO CHANGE DRAWING SPECIFICATIONS AT ANY TIME.
PLEASE CONTACT PLP TO VERIFY CURRENT VERSION

DESCRIPTION: COYOTE® Dome Closure 6.5" Collar and Gasket
Catalog #: 80061193

DWN BY: MLA AFR BY: MLA DATE: 1/6/20 SCALE: PAGE 1 of 1
FILENAME: 80061193



COYOTE® Dome Closure 9.5" Collar (1)



COYOTE® Dome Closure 9.5" Gasket (1)

ALL DIMENSIONS ARE APPROXIMATE AND MAY VARY PER
FACTORY TOLERANCES. CONTACT PLP FOR MORE INFORMATION



PREFORMED LINE PRODUCTS

CLEVELAND, OHIO 44143 | 1-(440)-461-5200
preformed.com

CONFIDENTIAL
The data and information contained in this document are proprietary to
PREFORMED Line Products (PLP). Such data and information are
provided solely for use with PLP's products and shall not be disclosed,
duplicated, or otherwise used without the express written approval of PLP.
PLP MAINTAINS THE RIGHT TO CHANGE DRAWING SPECIFICATIONS AT ANY TIME
PLEASE CONTACT PLP TO VERIFY CURRENT VERSION

DESCRIPTION:

COYOTE® Dome Closure 9.5" Collar and Gasket

Catalog #: 80061477

DRN BY: MLA	APR BY: MLA	DATE: 1/6/20	SCALE:	PAGE: 1 of 1
FILENAME:				80061477

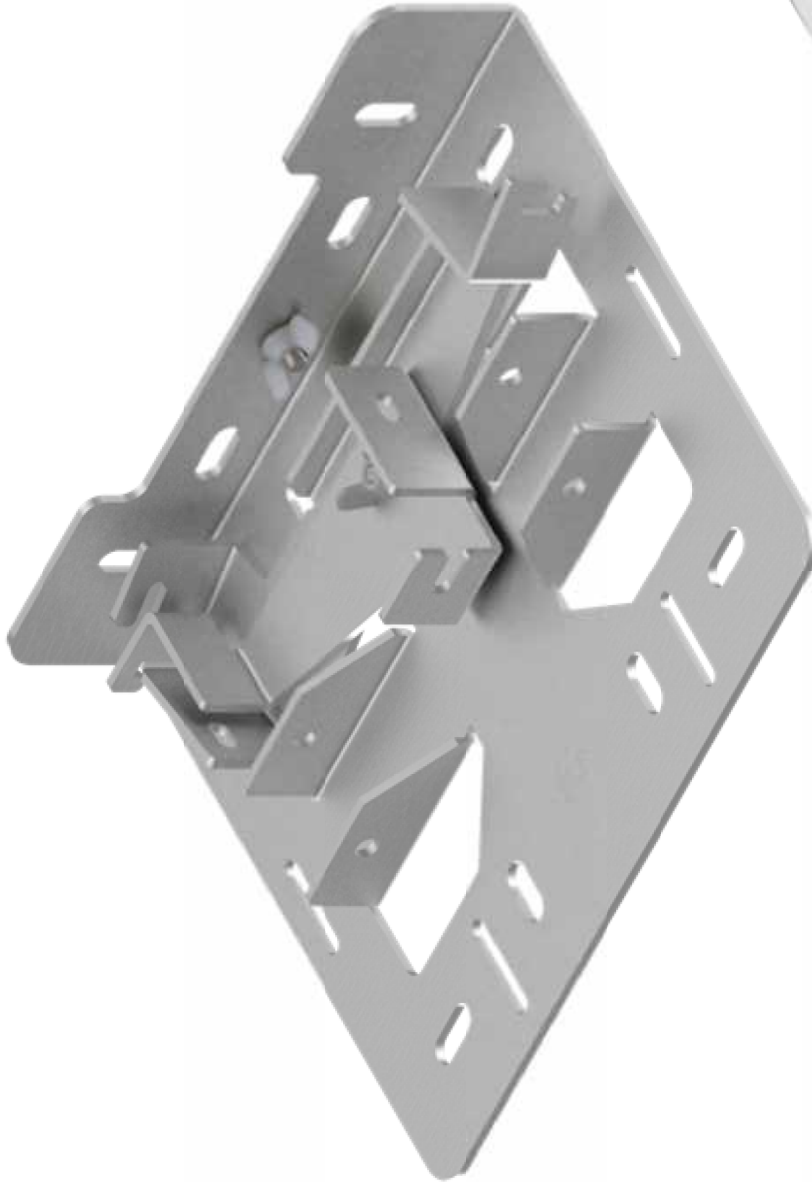

End Plate Support Fixture



Small Parts Bag

ALL DIMENSIONS ARE APPROXIMATE AND MAY VARY PER FACTORY TOLERANCES. CONTACT PLP FOR MORE INFORMATION



CONFIDENTIAL
 The data and information contained in this document are proprietary to PREFORMED Line Products (PLP). Such data and information are provided solely for use with PLP's products and shall not be disclosed, duplicated, or otherwise used without the express written approval of PLP. PLP MAINTAINS THE RIGHT TO CHANGE DRAWING SPECIFICATIONS AT ANY TIME. PLEASE CONTACT PLP TO VERIFY CURRENT VERSION

TITLE Catalog #: COYEPPFIX1

COYOTE® Dome End Plate Support Fixture
 for 6.5" & 9.5" End Plates

DWG BY:	APR BY:	DATE:	SHEET:	FILE NAME:
MLA	MLA	4/27/18	1 of 1	COYEPPFIX1



COYOTE® Dome Long Metal
Slack Basket (2.05" Depth)
with Cover (1)



Small Parts Bag (1)

ALL DIMENSIONS ARE APPROXIMATE AND MAY VARY PER
FACTORY TOLERANCES. CONTACT P/LP FOR MORE INFORMATION



PREFORMED LINE PRODUCTS

CLEVELAND, OHIO 44143 | 1-(440)-461-5200
preformed.com

CONFIDENTIAL

The data and information contained in this document are proprietary to
PREFORMED Line Products (PLP). Such data and information are
provided solely for use with PLP's products and shall not be disclosed,
duplicated, or otherwise used without the express written approval of PLP.

PLP MAINTAINS THE RIGHT TO CHANGE DRAWING SPECIFICATIONS AT ANY TIME
PLEASE CONTACT P/LP TO VERIFY CURRENT VERSION

DESCRIPTION:

Catalog #: 80061335
COYOTE® Dome Deep Slack Basket Kit (2.05" Depth) for up to 576ct Expressed
Ribbon Applications

DRN BY: MLA	APR BY: MLA	DATE: 10/30/19	SCALE:	PAGE: 1 of 1
FILENAME: 80061335				



COYOTE® Dome Long Deep Metal
Transition Tray with Cover (1)



Small Parts Bag (1)

ALL DIMENSIONS ARE APPROXIMATE AND MAY VARY PER
FACTORY TOLERANCES. CONTACT PLP FOR MORE INFORMATION



CONFIDENTIAL
The data and information contained in this document are proprietary to
PERFORMED Line Products (PLP). Such data and information are
provided solely for use with PLP's products and shall not be disclosed,
duplicated, or otherwise used without the express written approval of PLP.
PLP MAINTAINS THE RIGHT TO CHANGE DRAWING SPECIFICATIONS AT ANY TIME.
PLEASE CONTACT PLP TO VERIFY CURRENT VERSION

TITLE

P.N. 80061495

Deep Metal Transition Tray (2.85" Depth) for up to 864
Expressed Ribbon Applications

DWG BY:	APR BY:	DATE:	SHEET:	FILE NAME:
MLA	MLA	10/26/18	1 of 1	80061495

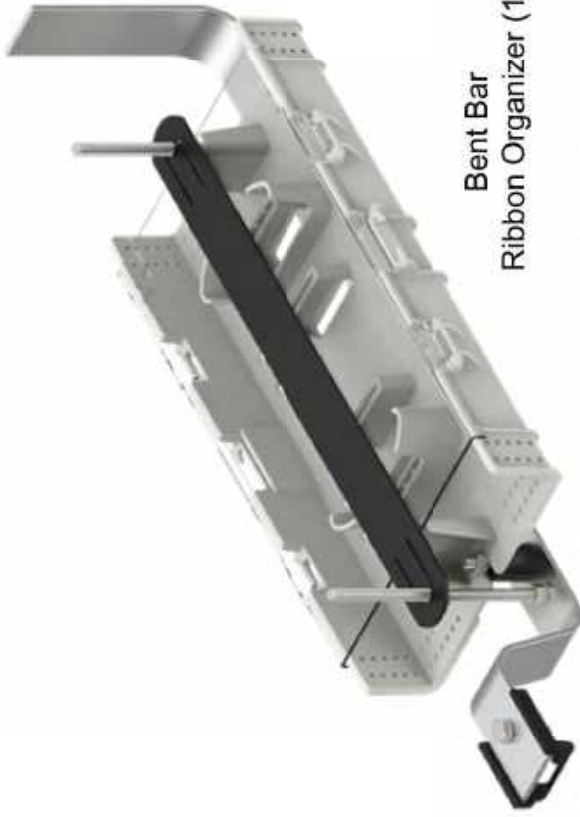

Bent Bar
Ribbon Organizer (1)



Transition Tube Kit (1)



Transport Tube Kit (2)

ALL DIMENSIONS ARE APPROXIMATE AND MAY VARY PER FACTORY TOLERANCES. CONTACT PLP FOR MORE INFORMATION

PLP®
PREFORMED
LINE PRODUCTS
www.preformed.com

CONFIDENTIAL
The data and information contained in this document are proprietary to PREFORMED Line Products (PLP). Such data and information are provided solely for use with PLP's products and shall not be disclosed, duplicated, or otherwise used without the express written approval of PLP. PLP MAINTAINS THE RIGHT TO CHANGE DRAWING SPECIFICATIONS AT ANY TIME. PLEASE CONTACT PLP TO VERIFY CURRENT VERSION.

TITLE		P.N. 8004007	
COYOTE® Dome Closure 6.5"x22"		Ribbon Organizer Kit	
DWG BY:	APR BY:	DATE:	SHEET
MLA	MLA	8/9/17	1 of 1
FILE NAME:			8004007



6/8 Position Drop Cable Retention Bobbin (1)



6/8 Position Drop Cable Retention Bobbin Cap (1)



Hose Clamp (1)



Self-Tapping Screw (1)

ALL DIMENSIONS ARE APPROXIMATE AND MAY VARY PER FACTORY TOLERANCES. CONTACT PLP FOR MORE INFORMATION

 **PREFORMED LINE PRODUCTS**
 CLEVELAND, OHIO 44143 | 1-(440)-461-5200
 preformed.com

CONFIDENTIAL
 The data and information contained in this document are proprietary to PREFORMED Line Products (PLP). Such data and information are provided solely for use with PLP's products and shall not be disclosed, duplicated, or otherwise used without the express written approval of PLP. PLP MAINTAINS THE RIGHT TO CHANGE DRAWING SPECIFICATIONS AT ANY TIME. PLEASE CONTACT PLP TO VERIFY CURRENT VERSION

DESCRIPTION: COYOTE® 6 or 8 Port Drop Cable Retention Bobbin Kit
 Catalog #: 8082928
 DRN BY: MLA APR BY: MLA DATE: 10/21/19 SCALE: PAGE 1 of 1
 FILENAME: 8082928



Silicone Lubricant Pack (6)

ALL DIMENSIONS ARE APPROXIMATE AND MAY VARY PER FACTORY TOLERANCES. CONTACT PLP FOR MORE INFORMATION



CLEVELAND, OHIO 44143 | 1-(440)-461-5200
preformed.com

CONFIDENTIAL
The data and information contained in this document are proprietary to PREFORMED Line Products (PLP). Such data and information are provided solely for use with PLP's products and shall not be disclosed, duplicated, or otherwise used without the express written approval of PLP. PLP MAINTAINS THE RIGHT TO CHANGE DRAWING SPECIFICATIONS AT ANY TIME. PLEASE CONTACT PLP TO VERIFY CURRENT VERSION

DESCRIPTION:

Catalog Number: 8003583
COYOTE® Silicone Lubricant Kit - 6 Pack

DRN BY: MAO	APR BY: MAO	DATE: 04/08/20	SCALE:	PAGE
FILENAME: 8003583				



Pole/Wall Mount Brackets (2)

1/4"-20 x 1-1/2" Hex Head Bolts (4)

ALL DIMENSIONS ARE APPROXIMATE AND MAY VARY PER FACTORY TOLERANCES. CONTACT PLP FOR MORE INFORMATION



CONFIDENTIAL
 The data and information contained in this document are proprietary to PREFORMED Line Products (PLP). Such data and information are provided solely for use with PLP's products and shall not be disclosed, duplicated, or otherwise used without the express written approval of PLP. PLP MAINTAINS THE RIGHT TO CHANGE DRAWING SPECIFICATIONS AT ANY TIME. PLEASE CONTACT PLP TO VERIFY CURRENT VERSION

TITLE			
COYOTE@ LCC Pole/Wall Mount Bracket Kit			
P.N. 8003830			
DWG BY:	APR BY:	DATE:	SHEET
MLA	MLA	8/22/17	1 of 1
FILE NAME:			8003830



Pole/Wall Mounting Bracket (1)



1/4"-20 Nyloc Nuts (4)



Mounting Brackets (2)



1/4"-20 x 3/4" Hex Head Bolts (4)

ALL DIMENSIONS ARE APPROXIMATE AND MAY VARY PER FACTORY TOLERANCES. CONTACT PLP FOR MORE INFORMATION



PREFORMED LINE PRODUCTS

CLEVELAND, OHIO 44143 | 1-(440)-461-5200
preformed.com

CONFIDENTIAL

The data and information contained in this document are proprietary to PREFORMED Line Products (PLP). Such data and information are provided solely for use with PLP's products and shall not be disclosed, duplicated, or otherwise used without the express written approval of PLP. PLP MAINTAINS THE RIGHT TO CHANGE DRAWING SPECIFICATIONS AT ANY TIME. PLEASE CONTACT PLP TO VERIFY CURRENT VERSION

DESCRIPTION:

COYOTE® COYOTE In-Line RUNT and Terminal Closure
Pole/Wall Mounting Bracket

Catalog Number 8003703

DRN BY: MAO APR BY: MAO DATE: 04/08/20 SCALE: PAGE
FILENAME: 8003703



"A" Aerial Hanger Brackets (2)



"B" Aerial Hanger Brackets (2)



1/4"-20 x 1"
Hex Bolts (6)



1/4"-20 Hex
Nuts (6)

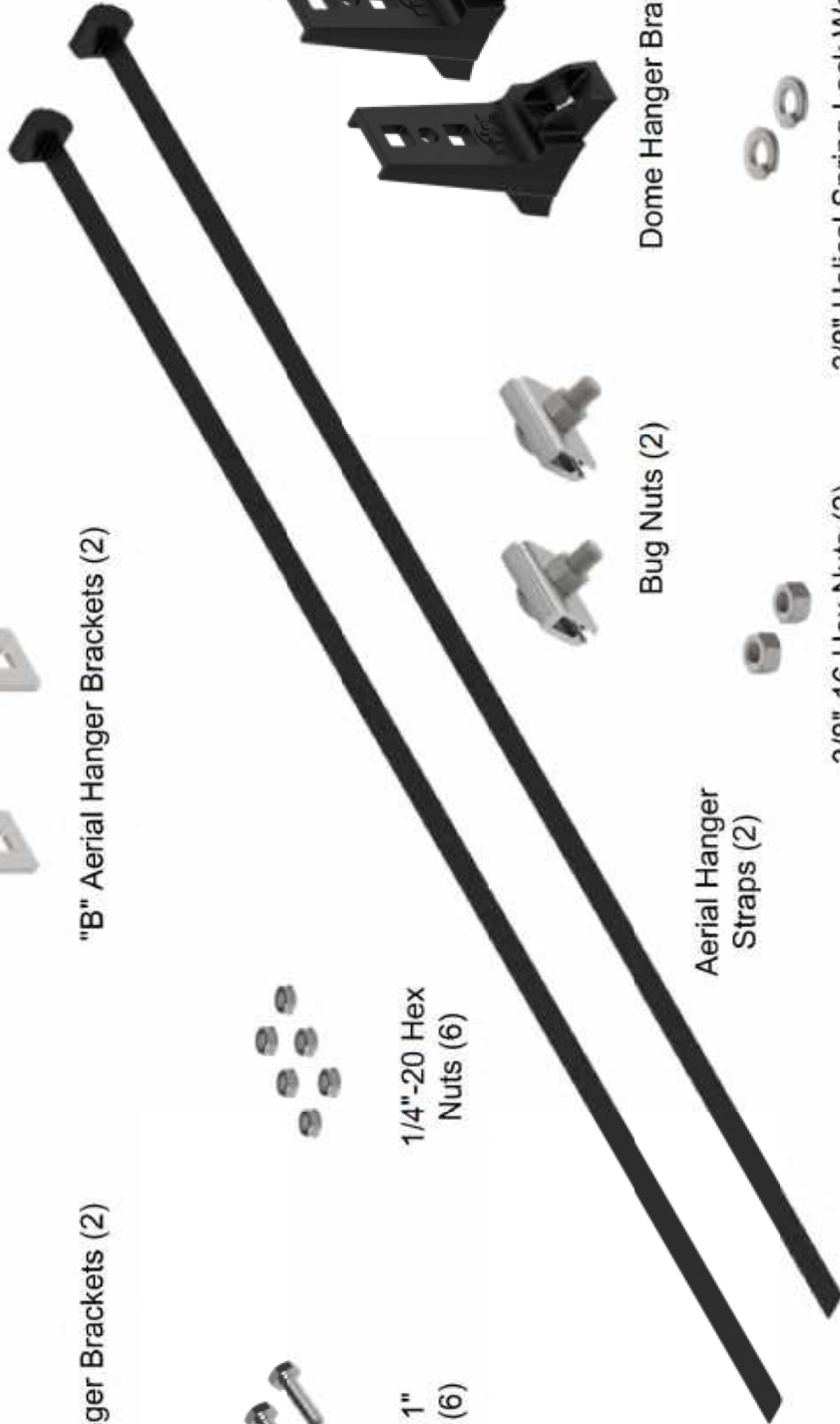

Aerial Hanger
Straps (2)



Bug Nuts (2)



Dome Hanger Brackets (2)



3/8"-16 Hex Nuts (2)



3/8" Helical Spring Lock Washers (2)

ALL DIMENSIONS ARE APPROXIMATE AND MAY VARY PER
FACTORY TOLERANCES. CONTACT PLP FOR MORE INFORMATION



CONFIDENTIAL
The data and information contained in this document are proprietary to
PREFORMED Line Products (PLP). Such data and information are
provided solely for use with PLP's products and shall not be disclosed,
duplicated, or otherwise used without the express written approval of PLP.
PLP MAINTAINS THE RIGHT TO CHANGE DRAWING SPECIFICATIONS AT ANY TIME.
PLEASE CONTACT PLP TO VERIFY CURRENT VERSION

TITLE P.N. 8003851

COYOTE® 6.5" Dome Closure Adjustable Offset Aerial
Hanger Bracket Kit for Strand with Plastic Hanger Brackets

DWG BY:	APR BY:	DATE	SHEET	FILE NAME
MLA	MLA	8/22/17	1 of 1	8003851



Hose Clamps (4)



Dome Hanger Brackets (2)



Bug Nuts (2)



3/8"-16 Hex Nuts (2)



3/8" Helical Spring
Lock Washers (2)

ALL DIMENSIONS ARE APPROXIMATE AND MAY VARY PER
FACTORY TOLERANCES. CONTACT P/LP FOR MORE INFORMATION



PREFORMED
LINE PRODUCTS
www.prefarmed.com

CONFIDENTIAL
The data and information contained in this document are proprietary to
PREFORMED Line Products (PLP). Such data and information are
provided solely for use with PLP's products and shall not be disclosed,
duplicated, or otherwise used without the express written approval of PLP.
PLP MAINTAINS THE RIGHT TO CHANGE DRAWING SPECIFICATIONS AT ANY TIME.
PLEASE CONTACT PLP TO VERIFY CURRENT VERSION.

TITLE				P. N. 8003940	
COYOTE® 9.5" Dome Closure Aerial Hanger Bracket Kit for Strand with Plastic Hanger Brackets					
DWG BY:	APR BY:	DATE:	SHEET	FILE NAME:	
MLA	MLA	8/22/17	1 of 1	8003940	



"A" Aerial Hanger Brackets (2)



"B" Aerial Hanger Brackets (2)



Hose Clamps (4)



Bug Nuts (2)



1/4"-20 x 3/4"
Hex Bolts (2)



Keps Nuts (2)

ALL DIMENSIONS ARE APPROXIMATE AND MAY VARY PER FACTORY TOLERANCES. CONTACT PLP FOR MORE INFORMATION



PREFORMED
LINE PRODUCTS
www.pformed.com

CONFIDENTIAL
The data and information contained in this document are proprietary to PREFORMED Line Products (PLP). Such data and information are provided solely for use with PLP's products and shall not be disclosed, duplicated, or otherwise used without the express written approval of PLP. PLP MAINTAINS THE RIGHT TO CHANGE DRAWING SPECIFICATIONS AT ANY TIME. PLEASE CONTACT PLP TO VERIFY CURRENT VERSION.

TITLE

P. N. 8004037

COYOTE® 9.5" Dome Closure Adjustable Offset Aerial
Hanger Bracket Kit for Strand

DWG BY: MLA APR BY: MLA DATE: 8/22/17 SHEET: 1 of 1 FILE NAME: 8004037



Gusset Bracket (1)

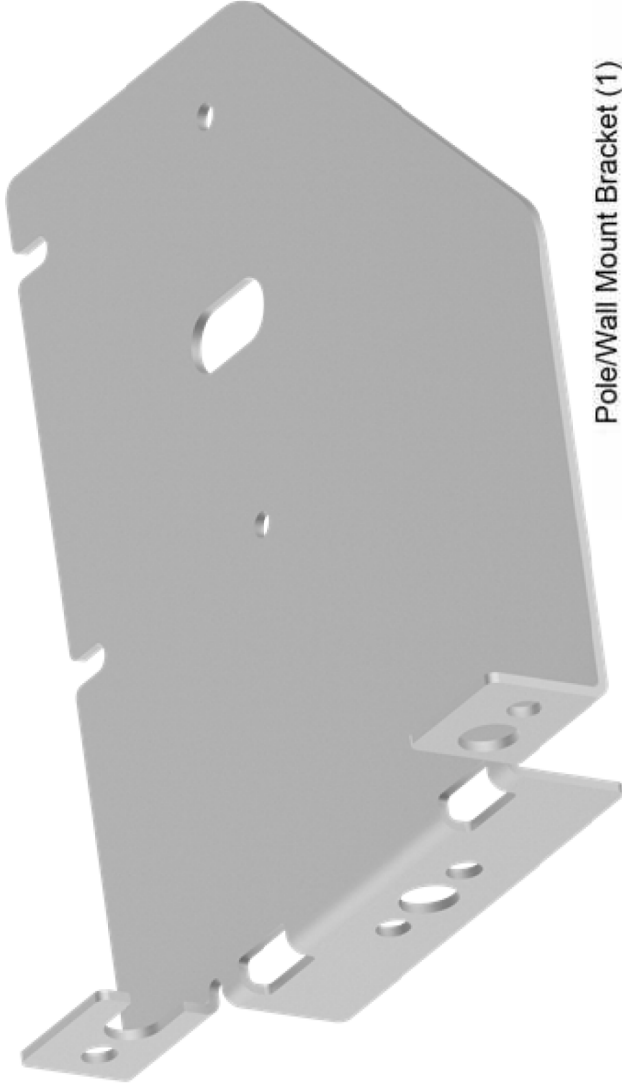

Pole/Wall Mount Bracket (1)

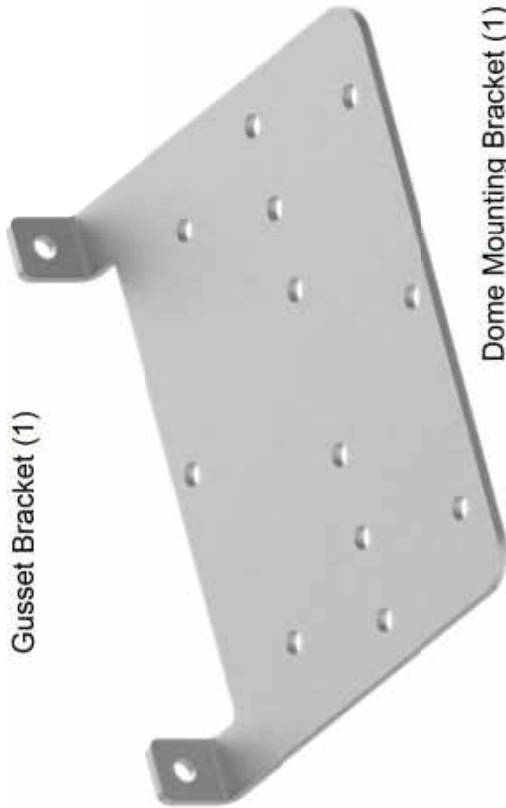

Dome Mounting Bracket (1)



1/4" Split Lock Washers (9)



1/4" -20 Hex Nuts (9)



1/4" -20 x 1/2" Hex Head Bolts (6)

ALL DIMENSIONS ARE APPROXIMATE AND MAY VARY PER FACTORY TOLERANCES. CONTACT PLP FOR MORE INFORMATION.



PREFORMED LINE PRODUCTS
 CLEVELAND, OHIO 44143 | 1-(440)-461-5200
 preformed.com

DESCRIPTION:

Catalog #: 8003942
 Pole/Wall Mounting Bracket Kit for
 COYOTE® Dome Closures 9.5"x19" & 9.5"x28"

DRAWN BY: MLA APK BY: MLA DATE: 10/21/19 SCALE: PAGE: 1 of 1
 FILENAME: 8003942

CONFIDENTIAL
 The data and information contained in this document are proprietary to PREFORMED Line Products (PLP). Such data and information are provided solely for use with PLP's products and shall not be disclosed, duplicated, or otherwise used without the express written approval of PLP.
 PLP MAINTAINS THE RIGHT TO CHANGE DRAWING SPECIFICATIONS AT ANY TIME
 PLEASE CONTACT PLP TO VERIFY CURRENT VERSION



Cover (1)



Base with End Plate (1)



12ct Short Standard Profile Legacy Splice Tray for Single Fusion (1)



Small Parts Bag (1)



Slit 1 Hole Urethane Grommet Kit for 3/4" Port (.43"-.48" Cable Diameter) (2)



4 Hole Urethane Grommet Kit for 1" Port (Flat Drop Cable Only) (1)

ALL DIMENSIONS ARE APPROXIMATE AND MAY VARY PER FACTORY TOLERANCES. CONTACT PLP FOR MORE INFORMATION



CONFIDENTIAL
The data and information contained in this document are proprietary to PREFORMED Line Products (PLP). Such data and information are provided solely for use with PLP's products and shall not be disclosed, duplicated, or otherwise used without the express written approval of PLP. PLP MAINTAINS THE RIGHT TO CHANGE DRAWING SPECIFICATIONS AT ANY TIME. PLEASE CONTACT PLP TO VERIFY CURRENT VERSION.

TITLE

P.N. COYOTE8001

COYOTE® RUNT Closure with Splice Tray

DWG BY: MLA

APR BY: MLA

DATE: 10/23/17

SHEET: 1 of 1

FILE NAME: COYOTE8001



Top Shell with Air Valve (1)



Bottom Shell (1)

ALL DIMENSIONS ARE APPROXIMATE AND MAY VARY PER
FACTORY TOLERANCES. CONTACT PLP FOR MORE INFORMATION



PREFORMED LINE PRODUCTS
CLEVELAND, OHIO 44143 | 1-(440)-461-5200
preformed.com

CONFIDENTIAL
The data and information contained in this document are proprietary to
PREFORMED Line Products (PLP). Such data and information are
provided solely for use with PLP's products and shall not be disclosed,
duplicated, or otherwise used without the express written approval of PLP.
PLP MAINTAINS THE RIGHT TO CHANGE DRAWING SPECIFICATIONS AT ANY TIME.
PLEASE CONTACT PLP TO VERIFY CURRENT VERSION

DESCRIPTION:

Catalog Number 80805795
COYOTE® PUP Shell Kit

DRN BY: MAO	APR BY: MAO	DATE: 04/08/20	SCALE:	PAGE
FILENAME:			80805795	



1 Hole Urethane Grommet
(.43" - .48" Cable Diameters) (1)



5g Packet of
Silicone Lubricant (2)

ALL DIMENSIONS ARE APPROXIMATE AND MAY VARY PER
FACTORY TOLERANCES. CONTACT PLP FOR MORE INFORMATION



PREFORMED LINE PRODUCTS
CLEVELAND, OHIO 44143 | 1-(440)-461-5200
preformed.com

CONFIDENTIAL
The data and information contained in this document are proprietary to
PREFORMED Line Products (PLP). Such data and information are
provided solely for use with PLP's products and shall not be disclosed,
duplicated, or otherwise used without the express written approval of PLP.
PLP MAINTAINS THE RIGHT TO CHANGE DRAWING SPECIFICATIONS AT ANY TIME.
PLEASE CONTACT PLP TO VERIFY CURRENT VERSION

DESCRIPTION:

Catalog Number 8003671
COYOTE® 1 Hole Pre-Slit Urethane Grommet Kit for
.43-.48" Diameter Cables for .75" Ports

DRN BY: MAO APR BY: MAO DATE: 04/08/20 SCALE: PAGE 1 of 1
FILENAME: 8003671



1 Hole Urethane Grommet
(.48" - .53" Cable Diameters) (1)



5g Packet of
Silicone Lubricant (2)



Grommet Plug (1)

ALL DIMENSIONS ARE APPROXIMATE AND MAY VARY PER
FACTORY TOLERANCES. CONTACT PLP FOR MORE INFORMATION



CLEVELAND, OHIO 44143 | 1-(440)-461-5200
preformed.com

CONFIDENTIAL
The data and information contained in this document are proprietary to
PERFORMED Line Products (PLP). Such data and information are
provided solely for use with PLP's products and shall not be disclosed,
duplicated, or otherwise used without the express written approval of PLP.
PLP MAINTAINS THE RIGHT TO CHANGE DRAWING SPECIFICATIONS AT ANY TIME.
PLEASE CONTACT PLP TO VERIFY CURRENT VERSION

DESCRIPTION:

Catalog Number 8003598
COYOTE® 1 Hole Urethane Grommet Kit for
.48-.53" Diameter Cables for .75" Ports

DRN BY: MAO APR BY: MAO DATE: 04/08/20 SCALE: PAGE 1 of 1
FILENAME: 8003598



1 Hole Urethane Grommet
(.53" - .58" Cable Diameters) (1)



5g Packet of
Silicone Lubricant (2)



Grommet Plug (1)

ALL DIMENSIONS ARE APPROXIMATE AND MAY VARY PER
FACTORY TOLERANCES. CONTACT PLP FOR MORE INFORMATION



CLEVELAND, OHIO 44143 | 1-(440)-461-5200
preformed.com

CONFIDENTIAL
The data and information contained in this document are proprietary to
PREFORMED Line Products (PLP). Such data and information are
provided solely for use with PLP's products and shall not be disclosed,
duplicated, or otherwise used without the express written approval of PLP.
PLP MAINTAINS THE RIGHT TO CHANGE DRAWING SPECIFICATIONS AT ANY TIME.
PLEASE CONTACT PLP TO VERIFY CURRENT VERSION

DESCRIPTION: Catalog Number 8003600
COYOTE® 1 Hole Urethane Grommet Kit for
.53"-.58" Diameter Cables for .75" Ports

DRN BY: MAO APR BY: MAO DATE: 04/08/20 SCALE: PAGE 1 of 1
FILENAME: 8003600



1 Hole Pre-Slit Urethane Grommet
(.48" - .53" Cable Diameters) (1)



5g Packet of
Silicone Lubricant (2)

ALL DIMENSIONS ARE APPROXIMATE AND MAY VARY PER
FACTORY TOLERANCES. CONTACT PLP FOR MORE INFORMATION



CLEVELAND, OHIO 44143 | 1-(440)-461-5200
preformed.com

CONFIDENTIAL
The data and information contained in this document are proprietary to
PREFORMED Line Products (PLP). Such data and information are
provided solely for use with PLP's products and shall not be disclosed,
duplicated, or otherwise used without the express written approval of PLP.
PLP MAINTAINS THE RIGHT TO CHANGE DRAWING SPECIFICATIONS AT ANY TIME
PLEASE CONTACT PLP TO VERIFY CURRENT VERSION

DESCRIPTION:

Catalog Number 8003689
COYTE® 1 Hole Pre-Slit Urethane Grommet Kit for
.48"- .53" Diameter Cables for .75" Ports

DRN BY: MAO APR BY: MAO DATE: 04/08/20 SCALE: PAGE 1 of 1
FILENAME: 8003689



2 Hole Urethane Grommet
for Flat Drop Cable (1)



5g Packet of
Silicone Lubricant (2)



Grommet Plugs (2)

ALL DIMENSIONS ARE APPROXIMATE AND MAY VARY PER
FACTORY TOLERANCES. CONTACT PLP FOR MORE INFORMATION



PREFORMED LINE PRODUCTS

CLEVELAND, OHIO 44143 | 1-(440)-461-5200
preformed.com

CONFIDENTIAL
The data and information contained in this document are proprietary to
PREFORMED Line Products (PLP). Such data and information are
provided solely for use with PLP's products and shall not be disclosed,
duplicated, or otherwise used without the express written approval of PLP.
PLP MAINTAINS THE RIGHT TO CHANGE DRAWING SPECIFICATIONS AT ANY TIME.
PLEASE CONTACT PLP TO VERIFY CURRENT VERSION

DESCRIPTION:

Catalog Number 8003608
COYOTE® 2 Hole Urethane Grommet Kit for Flat Drop Cables for .75" Ports

DRN BY: MAO	APR BY: MAO	DATE: 04/08/20	SCALE:	PAGE	1 of 1
FILENAME:				8003608	



3 Hole Urethane Grommet
for Flat Drop Cable (1)



5g Packet of
Silicone Lubricant (2)



Grommet Plugs (3)

ALL DIMENSIONS ARE APPROXIMATE AND MAY VARY PER
FACTORY TOLERANCES. CONTACT PLP FOR MORE INFORMATION



PREFORMED LINE PRODUCTS

CLEVELAND, OHIO 44143 | 1-(440)-461-5200
preformed.com

CONFIDENTIAL
The data and information contained in this document are proprietary to
PREFORMED Line Products (PLP). Such data and information are
provided solely for use with PLP's products and shall not be disclosed,
duplicated, or otherwise used without the express written approval of PLP.
PLP MAINTAINS THE RIGHT TO CHANGE DRAWING SPECIFICATIONS AT ANY TIME.
PLEASE CONTACT PLP TO VERIFY CURRENT VERSION

DESCRIPTION: Catalog Number 8003609
COYOTE® 3 Hole Urethane Grommet Kit for Flat Drop Cables for .875" Ports

DRN BY: MAO | APR BY: MAO | DATE: 04/08/20 | SCALE: | PAGE: 1 of 1
FILENAME: 8003609



2 Hole Urethane Grommet
(.38" - .43" Cable Diameters) (1)



5g Packet of
Silicone Lubricant (2)



Grommet Plugs (2)

ALL DIMENSIONS ARE APPROXIMATE AND MAY VARY PER
FACTORY TOLERANCES. CONTACT PLP FOR MORE INFORMATION



PREFORMED LINE PRODUCTS
CLEVELAND, OHIO 44143 | 1-(440)-461-5200
preformed.com

CONFIDENTIAL

The data and information contained in this document are proprietary to PREFORMED Line Products (PLP). Such data and information are provided solely for use with PLP's products and shall not be disclosed, duplicated, or otherwise used without the express written approval of PLP. PLP MAINTAINS THE RIGHT TO CHANGE DRAWING SPECIFICATIONS AT ANY TIME. PLEASE CONTACT PLP TO VERIFY CURRENT VERSION.

DESCRIPTION:

Catalog Number 8003399
COYOTE® 2 Hole Urethane Grommet Kit for
.38"-.43" Diameter Cables for 1.00" Ports

DRN BY: MAO APR BY: MAO DATE: 04/08/20 SCALE: PAGE 1 of 1
FILENAME: 8003399



4 Hole Urethane Grommet
for Flat Drop Cables (1)



5g Packet of
Silicone Lubricant (2)



Grommet Plugs (4)

ALL DIMENSIONS ARE APPROXIMATE AND MAY VARY PER
FACTORY TOLERANCES. CONTACT PLP FOR MORE INFORMATION



CLEVELAND, OHIO 44143 | 1-(440)-461-5200
preformed.com

DESCRIPTION:

Catalog Number 8003610
COYOTE® 4 Hole Urethane Grommet Kit for
Flat Drop Cables for 1.00" Ports

DRN BY: MAO	APR BY: MAO	DATE: 04/08/20	SCALE:	PAGE
FILENAME: 8003610				1 of 1

CONFIDENTIAL
The data and information contained in this document are proprietary to
PREFORMED Line Products (PLP). Such data and information are
provided solely for use with PLP's products and shall not be disclosed,
duplicated, or otherwise used without the express written approval of PLP.
PLP MAINTAINS THE RIGHT TO CHANGE DRAWING SPECIFICATIONS AT ANY TIME.
PLEASE CONTACT PLP TO VERIFY CURRENT VERSION



1 Hole Urethane Grommet
(.48" - .53" Cable Diameters) (1)



5g Packet of
Silicone Lubricant (2)



Grommet Plug (1)

ALL DIMENSIONS ARE APPROXIMATE AND MAY VARY PER
FACTORY TOLERANCES. CONTACT PLP FOR MORE INFORMATION



CLEVELAND, OHIO 44143 | 1-(440)-461-5200
preformed.com

DESCRIPTION:

Catalog Number 8003494
COYOTE® 1 Hole Urethane Grommet Kit for
.48"-.53" Diameter Cables for 1.00" Ports

DRN BY: MAO APR BY: MAO DATE: 04/08/20 SCALE: PAGE 1 of 1
FILENAME: 8003494

CONFIDENTIAL
The data and information contained in this document are proprietary to
PREFERRED Line Products (PLP). Such data and information are
provided solely for use with PLP's products and shall not be disclosed,
duplicated, or otherwise used without the express written approval of PLP.
PLP MAINTAINS THE RIGHT TO CHANGE DRAWING SPECIFICATIONS AT ANY TIME.
PLEASE CONTACT PLP TO VERIFY CURRENT VERSION



2 Pack of FIBERLIGN 12" Diameter Aerial
Slack Storage Brackets (1)



Messenger Hanger
Bracket Kit (1)

ALL DIMENSIONS ARE APPROXIMATE AND MAY VARY PER
FACTORY TOLERANCES. CONTACT PLP FOR MORE INFORMATION



PREFORMED
LINE PRODUCTS

www.pformed.com

CONFIDENTIAL
The data and information contained in this document are proprietary to
PREFORMED Line Products (PLP). Such data and information are
provided solely for use with PLP's products and shall not be disclosed,
duplicated, or otherwise used without the express written approval of PLP.
PLP MAINTAINS THE RIGHT TO CHANGE DRAWING SPECIFICATIONS AT ANY TIME.
PLEASE CONTACT PLP TO VERIFY CURRENT VERSION

TITLE

P.N. FIS12M

FIBERLIGN® In-Span Storage - 2 Pack of 12" Diameter
Storage Brackets with Messenger Hanger Brackets

DWG BY:	APR BY:	DATE:	SHEET	FILE NAME:
MLA	MLA	10/29/18	1 of 1	FIS12M

MLA

MLA

10/29/18

1 of 1

FIS12M



2 Pack of FIBERLIGN 12" Diameter Aerial
Slack Storage Brackets (1)



ADSS Hanger Bracket Kit (1)

ALL DIMENSIONS ARE APPROXIMATE AND MAY VARY PER
FACTORY TOLERANCES. CONTACT PLP FOR MORE INFORMATION



PREFORMED
LINE PRODUCTS

www.pformed.com

CONFIDENTIAL
The data and information contained in this document are proprietary to
PREFORMED Line Products (PLP). Such data and information are
provided solely for use with PLP's products and shall not be disclosed,
duplicated, or otherwise used without the express written approval of PLP.
PLP MAINTAINS THE RIGHT TO CHANGE DRAWING SPECIFICATIONS AT ANY TIME.
PLEASE CONTACT PLP TO VERIFY CURRENT VERSION

TITLE

P.N. FIS12A

FIBERLIGN® In-Span Storage - 2 Pack of 12" Diameter
Storage Brackets with ADSS Hanger Brackets

DWG BY:

MLA

DATE:

10/29/18

SHEET

1 of 1

FILE NAME:

FIS12A



2 Pack of FIBERLIGN 16" Diameter Aerial
Slack Storage Brackets (1)



Messenger Hanger
Bracket Kit (1)

ALL DIMENSIONS ARE APPROXIMATE AND MAY VARY PER
FACTORY TOLERANCES. CONTACT PLP FOR MORE INFORMATION



CONFIDENTIAL
The data and information contained in this document are proprietary to
PREFORMED Line Products (PLP). Such data and information are
provided solely for use with PLP's products and shall not be disclosed,
duplicated, or otherwise used without the express written approval of PLP.
PLP MAINTAINS THE RIGHT TO CHANGE DRAWING SPECIFICATIONS AT ANY TIME.
PLEASE CONTACT PLP TO VERIFY CURRENT VERSION

TITLE		P.N. FIS16M	
FIBERLIGN® In-Span Storage - 2 Pack of 16" Diameter Storage Brackets with Messenger Hanger Brackets			
DWG BY:	APR BY:	DATE:	SHEET
MLA	MLA	10/29/18	1 of 1
FILE NAME:			FIS16M



2 Pack of FIBERLIGN 16" Diameter Aerial
Slack Storage Brackets (1)



ADSS Hanger Bracket Kit (1)

ALL DIMENSIONS ARE APPROXIMATE AND MAY VARY PER
FACTORY TOLERANCES. CONTACT PIP FOR MORE INFORMATION



PERFORMED
LINE PRODUCTS

www.performed.com

CONFIDENTIAL

The data and information contained in this document are proprietary to
PERFORMED Line Products (PLP). Such data and information are
provided solely for use with PLP's products and shall not be disclosed,
duplicated, or otherwise used without the express written approval of PLP.
PLP MAINTAINS THE RIGHT TO CHANGE DRAWING SPECIFICATIONS AT ANY TIME.
PLEASE CONTACT PIP TO VERIFY CURRENT VERSION

TITLE: P.N. FIS 16A
FIBERLIGN® In-Span Storage - 2 Pack of 16" Diameter
Storage Brackets with ADSS Hanger Brackets

DWG BY:	APR BY:	DATE:	SHEET:	FILE NAME:
MLA	MLA	10/29/18	1 of 1	FIS 16A



2 Pack of FIBERLIGN CLAS Brackets (1)



Cable Abrasion
Protector Kit (1)

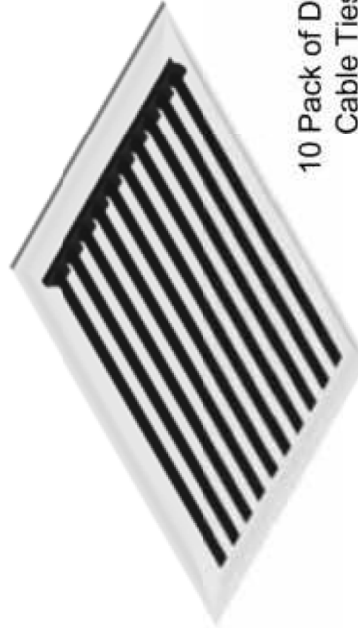

10 Pack of DELTEC
Cable Ties (1)



ALL DIMENSIONS ARE APPROXIMATE AND MAY VARY PER
FACTORY TOLERANCES. CONTACT PLP FOR MORE INFORMATION



PREFORMED
LINE PRODUCTS
www.pformed.com

CONFIDENTIAL
The data and information contained in this document are proprietary to
PREFORMED Line Products (PLP). Such data and information are
provided solely for use with PLP's products and shall not be disclosed,
duplicated, or otherwise used without the express written approval of PLP.
PLP MAINTAINS THE RIGHT TO CHANGE DRAWING SPECIFICATIONS AT ANY TIME.
PLEASE CONTACT PLP TO VERIFY CURRENT VERSION

TITLE

P. N. 710012375A

FIBERLIGN® CLAS System - 2 Pack of CLAS Brackets for
ADSS Cables with Abrasion Protectors & Cable Ties

DWG BY	APR BY	DATE	SHEET	FILE NAME
MLA	MLA	10/29/18	1 of 1	710012375A



Pair of 24" FIBERLIGN In-Span Black
Aluminum Snowshoes (1)



Aerial Hanger Bracket Kit
for Strand (1)

ALL DIMENSIONS ARE APPROXIMATE AND MAY VARY PER
FACTORY TOLERANCES. CONTACT PLP FOR MORE INFORMATION



CONFIDENTIAL
The data and information contained in this document are proprietary to
PREFORMED Line Products (PLP). Such data and information are
provided solely for use with PLP's products and shall not be disclosed,
duplicated, or otherwise used without the express written approval of PLP.
PLP MAINTAINS THE RIGHT TO CHANGE DRAWING SPECIFICATIONS AT ANY TIME.
PLEASE CONTACT PLP TO VERIFY CURRENT VERSION

TITLE		P.N. FISA24MB	
FIBERLIGN® In-Span Aluminum Storage - 24" Black Snowshoes for Messenger (2 Pack)			
DWG BY:	APR BY:	DATE:	SHEET
MLA	MLA	8/10/17	1 of 1
FILE NAME:			FISA24MB



Pair of 24" FIBERLIGN In-Span Black
Aluminum Snowshoes (1)



ADSS Hanger Bracket Kit (1)

ALL DIMENSIONS ARE APPROXIMATE AND MAY VARY PER
FACTORY TOLERANCES. CONTACT PLP FOR MORE INFORMATION



PREFORMED
LINE PRODUCTS
www.pformed.com

CONFIDENTIAL
The data and information contained in this document are proprietary to
PREFORMED Line Products (PLP). Such data and information are
provided solely for use with PLP's products and shall not be disclosed,
duplicated, or otherwise used without the express written approval of PLP.
PLP MAINTAINS THE RIGHT TO CHANGE DRAWING SPECIFICATIONS AT ANY TIME.
PLEASE CONTACT PLP TO VERIFY CURRENT VERSION

TITLE			
P. N. FISA24AB			
FIBERLIGN® In-Span Aluminum Storage - 2 Pack of 24"			
Diameter Black Storage Brackets w/ ADSS Hanger Brackets			
DWG BY:	APR BY:	DATE:	SHEET
MLA	MLA	12/3/18	1 of 1
FILE NAME:			FISA24AB



Pair of 30" FIBERLIGN In-Span Black
Aluminum Snowshoes (1)



Aerial Hanger Bracket Kit
for Strand (1)

ALL DIMENSIONS ARE APPROXIMATE AND MAY VARY PER
FACTORY TOLERANCES. CONTACT P.L.P. FOR MORE INFORMATION



PREFORMED
LINE PRODUCTS
www.pformed.com

CONFIDENTIAL
The data and information contained in this document are proprietary to
PREFORMED Line Products (PLP). Such data and information are
provided solely for use with PLP's products and shall not be disclosed,
duplicated, or otherwise used without the express written approval of PLP.
PLP MAINTAINS THE RIGHT TO CHANGE DRAWING SPECIFICATIONS AT ANY TIME.
PLEASE CONTACT PLP TO VERIFY CURRENT VERSION

TITLE

P.N. FISA30MB

FIBERLIGN® In-Span Aluminum Storage - 30" Black
Snowshoes for Messenger (2 Pack)

DWG BY:	APR BY:	DATE:	SHEET	FILE NAME:
MLA	MLA	8/10/17	1 of 1	FISA30MB



Pair of 30" FIBERLIGN In-Span Black Aluminum Snowshoes (1)



ADSS Hanger Bracket Kit (1)

ALL DIMENSIONS ARE APPROXIMATE AND MAY VARY PER FACTORY TOLERANCES. CONTACT PLP FOR MORE INFORMATION



CONFIDENTIAL
 The data and information contained in this document are proprietary to PREFORMED Line Products (PLP). Such data and information are provided solely for use with PLP's products and shall not be disclosed, duplicated, or otherwise used without the express written approval of PLP. PLP MAINTAINS THE RIGHT TO CHANGE DRAWING SPECIFICATIONS AT ANY TIME. PLEASE CONTACT PLP TO VERIFY CURRENT VERSION

TITLE		P.N. FISA30AB	
FIBERLIGN® In-Span Aluminum Storage - 2 Pack of 30" Diameter Black Storage Brackets w/ ADSS Hanger Brackets			
DWG BY:	APR BY:	DATE:	SHEET:
MLA	MLA	12/3/18	1 of 1
FILE NAME:			FISA30AB



FIBERLIGN Drop Cable
Storage Bracket (1)



Messenger Hanger
Bracket Kit (1)

ALL DIMENSIONS ARE APPROXIMATE AND MAY VARY PER
FACTORY TOLERANCES. CONTACT PLP FOR MORE INFORMATION



PREFORMED
LINE PRODUCTS

www.pformed.com

CONFIDENTIAL
The data and information contained in this document are proprietary to
PREFORMED Line Products (PLP). Such data and information are
provided solely for use with PLP's products and shall not be disclosed,
duplicated, or otherwise used without the express written approval of PLP.
PLP MAINTAINS THE RIGHT TO CHANGE DRAWING SPECIFICATIONS AT ANY TIME.
PLEASE CONTACT PLP TO VERIFY CURRENT VERSION

TITLE: P.N. FDC8M

FIBERLIGN® Drop Cable Storage Bracket with
Messenger Hanger Brackets for In-Span Applications

DWG BY:	APR BY:	DATE:	SHEET:	FILE NAME:
MLA	MLA	10/29/18	1 of 1	FDC8M



FIBERLIGN Drop Cable
Storage Bracket (1)



ADSS Hanger Bracket Kit (1)

ALL DIMENSIONS ARE APPROXIMATE AND MAY VARY PER
FACTORY TOLERANCES. CONTACT PLP FOR MORE INFORMATION



PREFORMED
LINE PRODUCTS

www.preformed.com

CONFIDENTIAL
The data and information contained in this document are proprietary to
PREFORMED Line Products (PLP). Such data and information are
provided solely for use with PLP's products and shall not be disclosed,
duplicated, or otherwise used without the express written approval of PLP.
PLP MAINTAINS THE RIGHT TO CHANGE DRAWING SPECIFICATIONS AT ANY TIME.
PLEASE CONTACT PLP TO VERIFY CURRENT VERSION

TITLE

P.N: FDC8A

FIBERLIGN® Drop Cable Storage Bracket with
ADSS Hanger Brackets for In-Span Applications

DWG BY:	APR BY:	DATE:	SHEET:	FILE NAME:
MLA	MLA	10/29/18	1 of 1	FDC8A



FIBERLIGN Drop Cable
Storage Bracket (1)



1/4" x 3" HDG Lag Bolts (2)



1/4" HDG Washers (2)

ALL DIMENSIONS ARE APPROXIMATE AND MAY VARY PER
FACTORY TOLERANCES. CONTACT PLP FOR MORE INFORMATION



PREFORMED
LINE PRODUCTS

www.preformed.com

CONFIDENTIAL
The data and information contained in this document are proprietary to
PREFORMED Line Products (PLP). Such data and information are
provided solely for use with PLP's products and shall not be disclosed,
duplicated, or otherwise used without the express written approval of PLP.
PLP MAINTAINS THE RIGHT TO CHANGE DRAWING SPECIFICATIONS AT ANY TIME.
PLEASE CONTACT PLP TO VERIFY CURRENT VERSION

TITLE

P.N. FDC8P
FIBERLIGN® Drop Cable Storage Bracket with Lag Bolts
for Pole/Wall Mount and Vault Applications

DWG BY:	APR BY:	DATE:	SHEET:	FILE NAME:
MLA	MLA	10/29/18	1 of 1	FDC8P



1/4"-20 x 3" Hex Head Bolts (4)



Spacers (4)



1/4"-20 Hex Nuts (4)



1/4" Flat Washers (8)

ALL DIMENSIONS ARE APPROXIMATE AND MAY VARY PER FACTORY TOLERANCES. CONTACT PLP FOR MORE INFORMATION



CONFIDENTIAL
 The data and information contained in this document are proprietary to PREFORMED Line Products (PLP). Such data and information are provided solely for use with PLP's products and shall not be disclosed, duplicated, or otherwise used without the express written approval of PLP. PLP MAINTAINS THE RIGHT TO CHANGE DRAWING SPECIFICATIONS AT ANY TIME. PLEASE CONTACT PLP TO VERIFY CURRENT VERSION

TITLE
 FDC8 Stacking Kit for Aerial, Pole/Wall Mount, and Vault Applications

P.N. 7400030

DWG BY:	APR BY:	DATE:	SHEET	FILE NAME
MLA	MLA	10/30/18	1 of 1	7400030



PREFORMED
LINE PRODUCTS

Global Headquarters
660 Beta Drive
Cleveland, Ohio 44143

Mailing Address:
P.O. Box 91129
Cleveland, Ohio 44101

Telephone: 440.461.5200
Fax: 440.442.8816
Website: preformed.com
Email: inquiries@preformed.com

© 2020 Preformed Line Products
Printed in U.S.A.
CO-ML-1298
05.20.5C