



**Muffin AC - MU2A1 - 028021**  
 (Family) (Model) (Part Number)

### Electrical Specifications

Rated Voltage:	115 VAC
AC Frequency:	60 Hz
Power Supply:	14.0 Watts
Line Current:	0.16 Amps
Locked Rotor Current	0.25 Amps
Nominal Speed:	3100 RPM



### Mechanical Specifications

Dimensions:	4.72in x 1.50in
Weight	17.2 oz
Max Airflow @ 0 in H <sub>2</sub> O	102.0 CFM
Max Pressure @ 0 CFM	0.296 in H <sub>2</sub> O
Noise	45.1 dBA



### Fan Performance

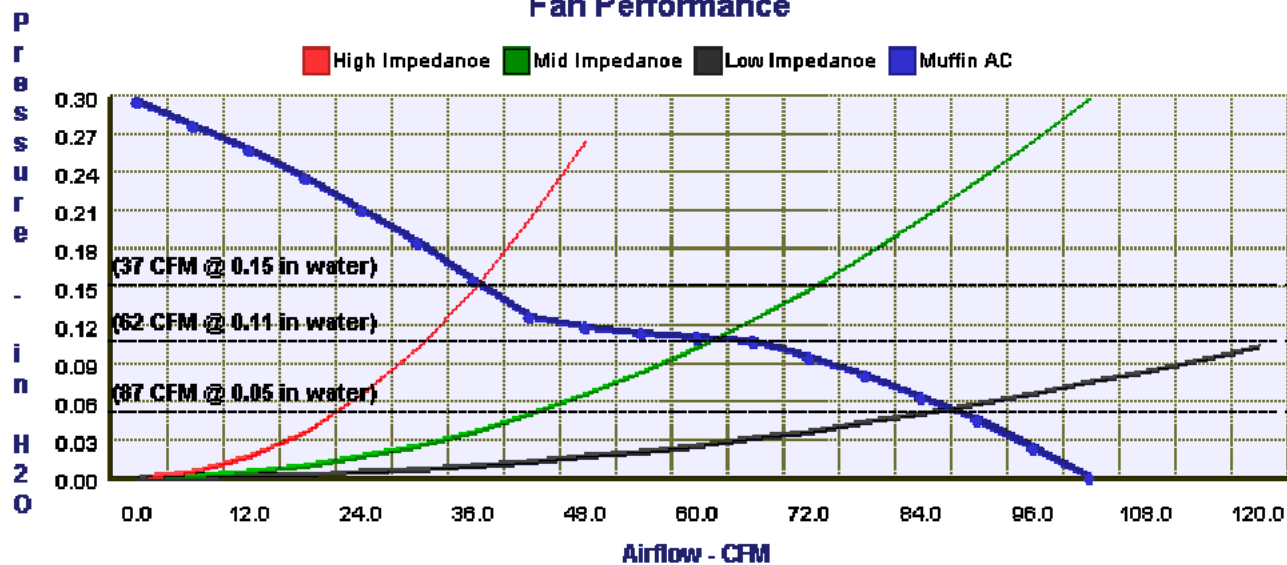

Comair Rotron, Inc.  
 Phone: 619.651.2000  
 sales@comairrotron.com

Comair Rotron Europe, Ltd.  
 Phone: +44.1527.520525  
 saleseurope@comairrotron.com

Comair Rotron Fan Company Ltd.  
 Phone: +86.21.52260581  
 salesasia@comairrotron.com

Print Date: Monday, March 22, 2010 at 11:10:18 - AC Fan Datasheet - Web Version 1.0 Rev. A



## Mechanical Drawing

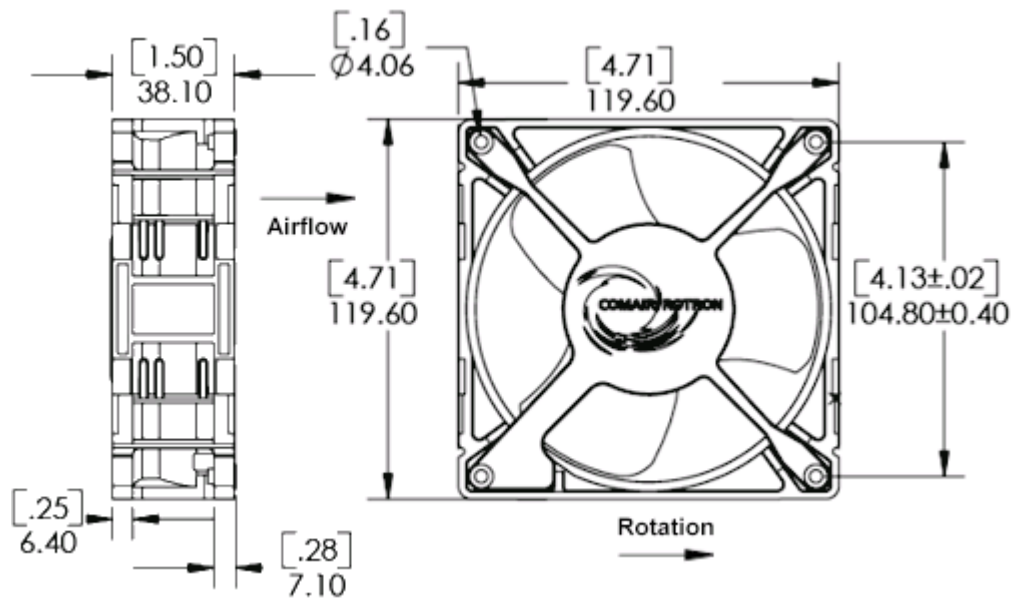

## Options

Part Number	Model Number	Bearing Type	Fan Rotation	Termination	In-Stock (Click 'Yes' for current stock)
<input type="radio"/> 028027	MU2B1	Ball	Normal	Terminals	No
<input type="radio"/> 028028	MU2B2	Ball	Normal	Terminals, No Venturi	No
<input type="radio"/> 039666	MU2B4	Ball	Reverse	Terminals, No Venturi	No
<input checked="" type="radio"/> 028021	MU2A1	Sleeve	Normal	Terminals	No
<input type="radio"/> 028022	MU2A2	Sleeve	Normal	Terminals, No Venturi	No
<input type="radio"/> 027300	MU2A3	Sleeve	Reverse	Terminals	No
<input type="radio"/> 027301	MU2A4	Sleeve	Reverse	Terminals, No Venturi	No

## Accessories [\(Click on part number for detailed drawing.\)](#)

**428056**  
Plug and Cord

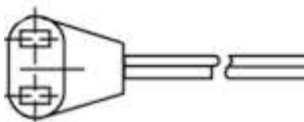

**477663**  
Mounting Clip



**551590**  
Filter Assembly



**554148**  
Filter Guard Assembly

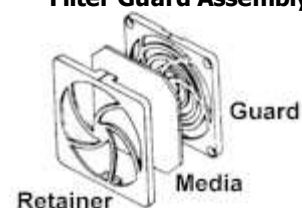

□ **552934**  
**Finger Guard**

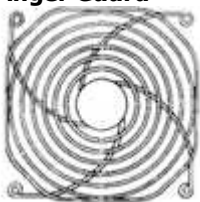

□ **476042**  
**Finger Guard**

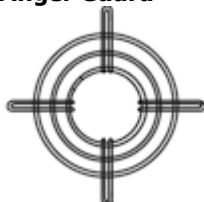

□ **550481**  
**Finger Guard**

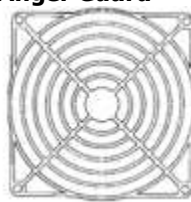

□ **551147**  
**Finger Guard**



**Comair Rotron, Inc.**  
**Phone: 619.651.2000**  
**sales@comairrottron.com**

**Comair Rotron Europe, Ltd.**  
**Phone: +44.1527.520525**  
**saleseurope@comairrottron.com**

**Comair Rotron Fan Company Ltd.**  
**Phone: +86.21.52260581**  
**salesasia@comairrottron.com**

**Print Date: Monday, March 22, 2010 at 11:10:18 - AC Fan Datasheet - Web Version 1.0 Rev. A**