

Please Visit The Other E.R. Wagner Mfg. Co. Business Units

www.erwagner.com

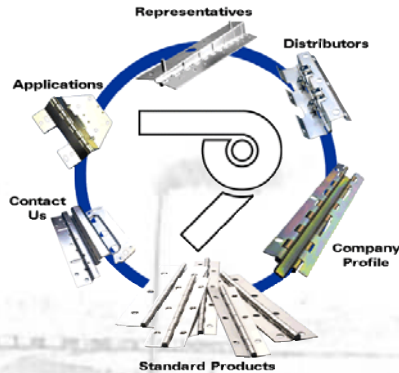

Stocker Hinge
 8822 West 47th Street
 P.O. Box 149
 Brookfield, IL 60513-0149
 (800) 631-2600
 (708) 485-0058



Engineered & Tubular Products

4611 North 32nd Street
 Milwaukee, WI 53209
 (800) 558-5596
 (414) 449-8286

E.R. Wagner
 CASTERS & WHEELS Manufacturing Co.

331 Riverview Drive
 Hustisford, WI 53034-0405
 TEL 920-349-3271
 800-558-0117
 FAX 920-349-3487
www.erwagner.com

icwm Institute of
 Caster & Wheel
 Manufacturers

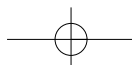



STANDARD PRODUCT OFFERING CATALOG
Special items not displayed in this catalog are available upon request.

E.R. Wagner
CASTERS & WHEELS Manufacturing Co.

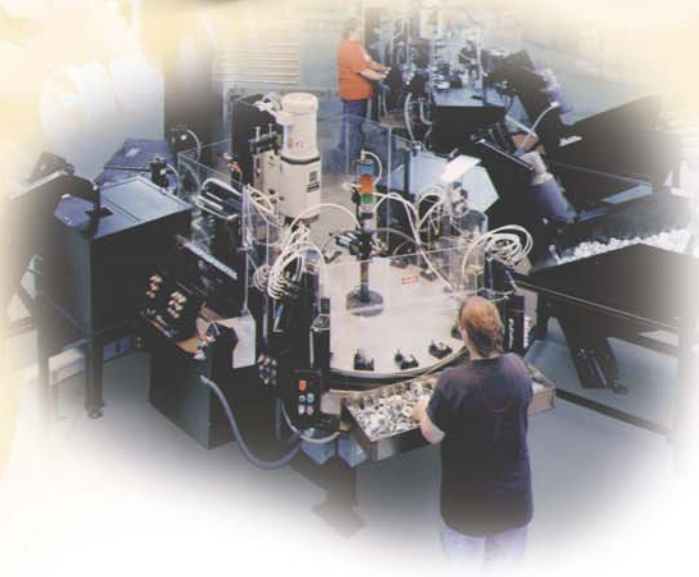
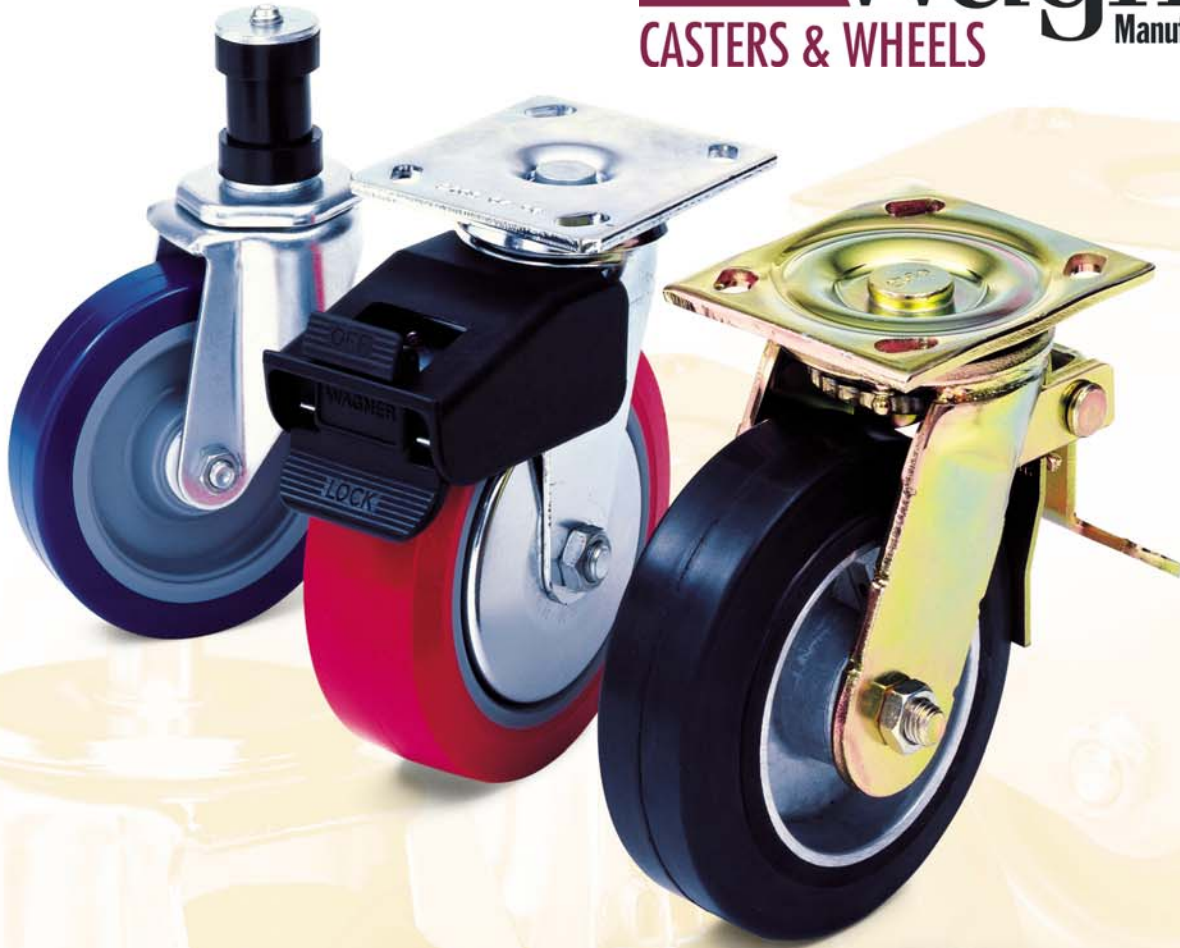

50TH ANNIVERSARY COLLECTORS EDITION!!!

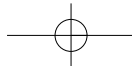

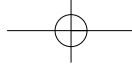

Exceeding Expectations

E.R. Wagner Casters & Wheels manufactures the highest quality products for a broad range of applications and markets, including industrial, commercial, institutional, food service, health care, and other specialized areas.



the forefront of our industry. Most metal stamping, forming, and product assembly is performed in house to ensure exacting quality standards are met. Further, our casters and wheels meet guidelines established by the Institute of Caster and Wheel Manufacturers (ICWM) and are NSF certified where applicable.

Our knowledgeable inside sales staff is ready to help you select the proper caster or wheel for your application. For your convenience, sales representatives are located throughout the United States for on-site field assistance.

The **E.R. Wagner Casters & Wheels** difference is marked by a long tradition of incredibly high standards, exceptional quality, knowledgeable staff, and on-time delivery. We endeavor to do more than satisfy; we are driven to exceed expectations.

We do more than manufacture quality casters, wheels, and accessories; we develop ways to make them last longer and perform better. Our engineers employ the latest design and engineering technology to remain at



NSF Certified



E.R. Wagner
CASTERS & WHEELS Manufacturing Co.

Driven to Exceed Expectations

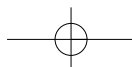

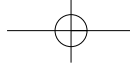

Table of Contents

TABLE OF CONTENTS 1

SELECTING A CASTER 2-3

LIGHT DUTY PLATE & STEM CASTERS

 100 to 145 lbs. capacity (1" wheel tread width)
 Series 2F68, 1F63 Swivel and Rigid Plate & Series 2F69 Swivel Stem 4-5

LIGHT-MEDIUM DUTY CASTERS

 120 to 280 lbs. capacity (1-1/4" wheel tread width)
 Series 2F98, 1F93 Swivel and Rigid Plate & Series 2F99 Swivel Stem 6-7

MEDIUM DUTY CASTERS

 200 to 400 lbs. capacity (1-3/8" to 1-1/2" wheel tread width)
 Series 1F28, 1F23 Swivel and Rigid Plate & Series 1F29 Swivel Stem 8-9

MEDIUM DUTY INSTITUTIONAL CASTERS

 125 to 450 lbs. capacity (1-1/4" to 1-1/2" wheel tread width)
 Americaster™ Series 3F08, 3F28, 3F03, 3F23, 3F09, 3F29 Swivel and Rigid Plate, Swivel Stem ... 10-12

STAINLESS STEEL CASTERS

 200 to 300 lbs. capacity (1-1/4" wheel tread width)
 Series 7F08, 7F03, 7F09 Swivel and Rigid Plate, Swivel Stem 13

LOW PROFILE CASTERS

 150 to 500 lbs. capacity (13/16" dual to 1-3/4" wheel tread width)
 Series 1F58, 1F53, 1F59 Swivel and Rigid Plate, Swivel Stem 14-15

MEDIUM-HEAVY DUTY CASTERS (Series 4F88, 4F83)

 300 to 700 lbs. capacity (2" wheel tread width)
 Total-Lock Swivel, Swivel, Directional-Lock Swivel and Rigid Plate Casters 16-17

HEAVY DUTY CASTERS (Series 1F88, 1FA8, 1F83)

 300 to 1200 lbs. capacity (2" wheel tread width)
 Swivel and Rigid Plate, Swivel Plate with Total-Lock Brake, and 4-Position Swivel Lock 18-19

SPECIALTY CASTERS

 Cart & Tool Box Casters 20

 Ro-To Fix Spring Cup Casters 20

 Pneumatic Wheel Casters & Foam Filled Wheel Casters 21

 Low Profile Utility Swivel Casters 22

 Low Profile Rigid Casters 22

 Gate Casters & Scaffolding Casters 23

LIGHT DUTY PLATE & STEM FURNITURE CASTERS

 Series 9F48 Swivel & Series 9F49, 8F49 Swivel Stem Casters 24-25

 Hooded Twin Wheel Casters & Hooded Ball Casters 26

 Hooded Twin Wheel Chair Casters & Open Twin Wheel Casters 27

DRUM DOLLIES

 30- & 55-gallon Standard & Stainless Steel Drum Dollies 28

ACCESSORIES

 Sockets & Brackets 29

SELECTING A WHEEL 30-31

WHEEL BEARINGS 31

WHEELS

 Soft Tread Wheels

 Poly II Rubber 32

 Cushionex Supreme Soft Rubber 33

 Pneumatic & Foam Filled Wheels & Mold-On Rubber 33

 Hard Tread Wheels

 Mold-On Polyurethane 34

 Poly II Urethane 34

 Spartan Supreme & High Temperature Nylon Glass-Filled 35

 Durafoam & Poly II Poly 36

 Duratex Phenolic & Semi-Steel 37

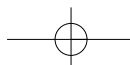

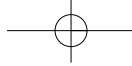

Selecting a Caster

What is the Load Rating for the Application?

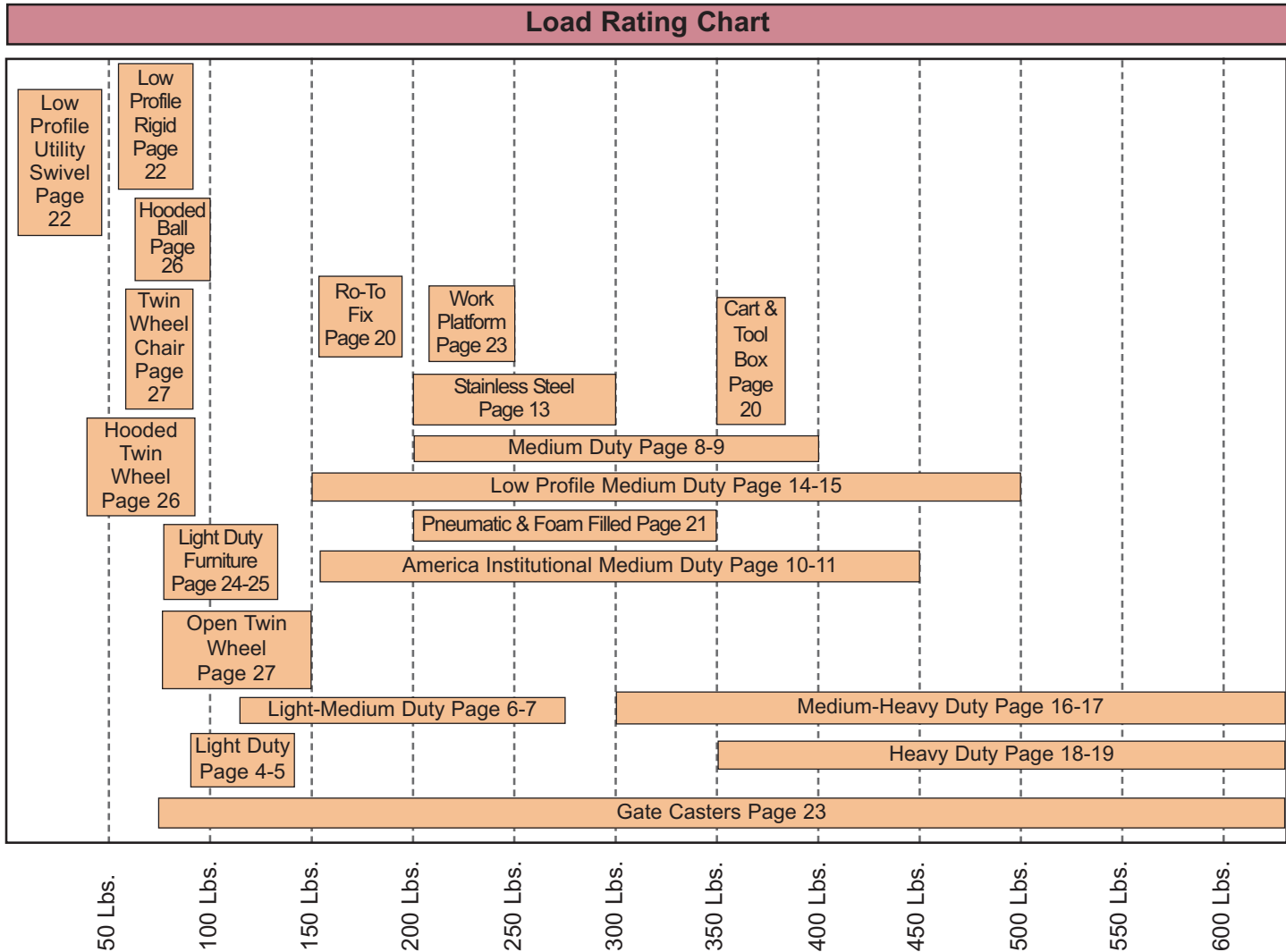

What Mounting Type is Needed?

Castors come in a variety of stem and plate mounting choices. E.R. Wagner has Threaded, Friction Ring, Grip Neck, Round, Square/Octagon and Expanding Stems. Not every Series of Caster has all stem options. The plate options are determined by what are the most used plates for each Series of Caster. The plates will match any standard plate in the industry.

Are Brakes Needed?

Brakes are designed to restrict movement of the rolling unit. This is useful on uneven floors, such as floors tapered to a floor drain. Also, brakes may be needed if the unit is to be in a stationary position. Check each Caster Series for the brake options available

Do Any Adverse Conditions Exist?

Extreme heat and cold can be a problem for casters. Some wheels are not intended for extreme temperature conditions. Consult E.R. Wagner for information.

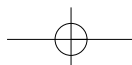

Selecting a Caster

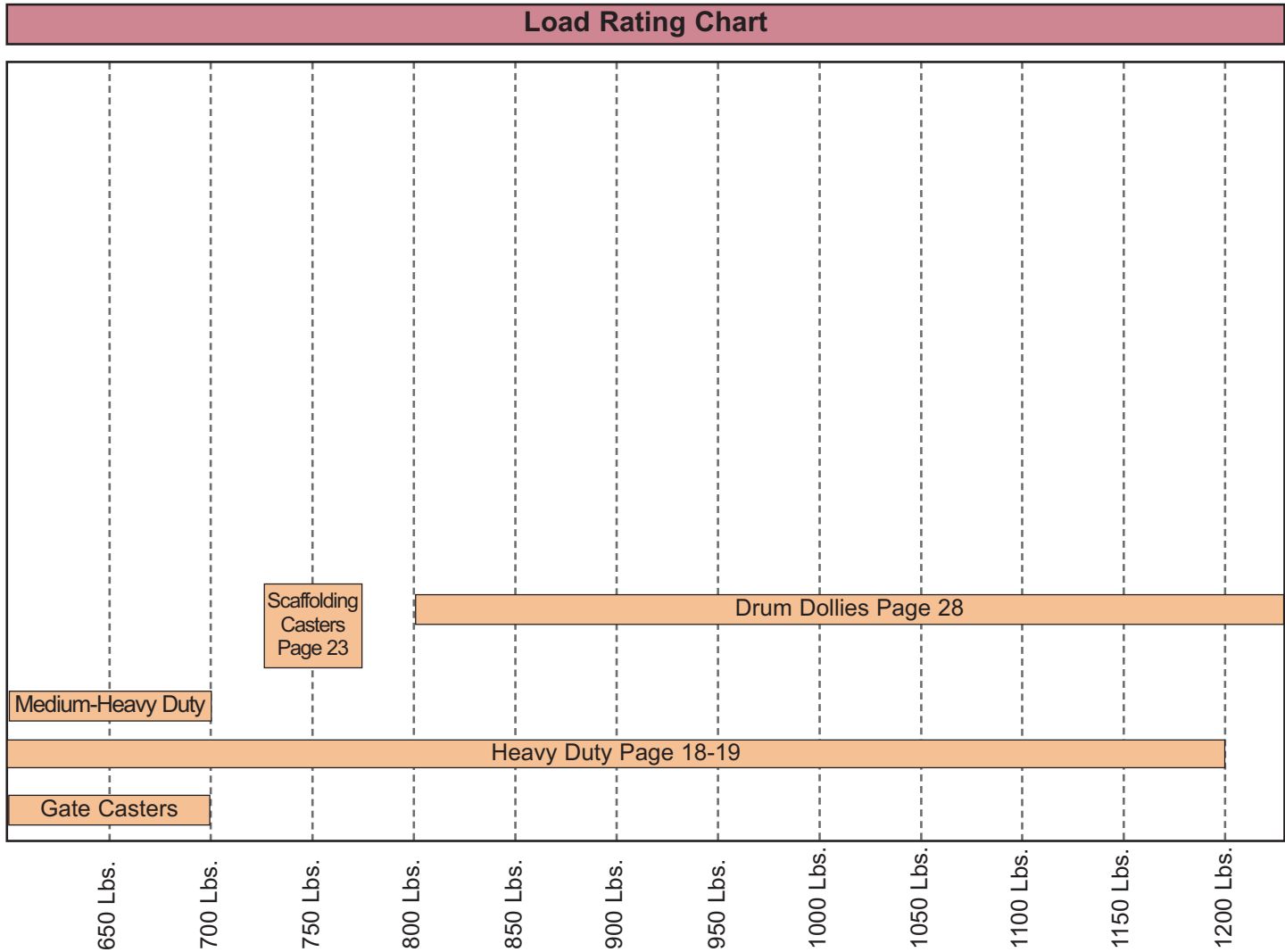

What Type of Wheel Material is Needed?

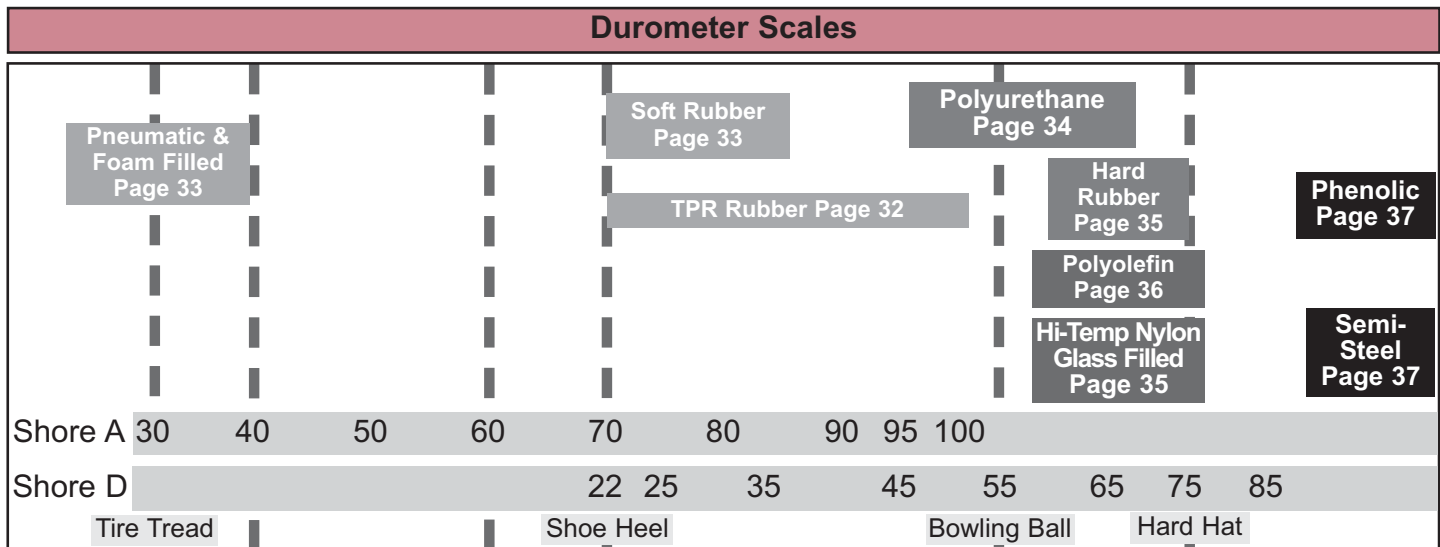

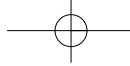

Light Duty Casters

Light Duty Casters

MADE IN U.S.A.



STANDARD FEATURES

- Light duty applications.
- Double row swivel construction.
- 5/16" diameter nut and bolt axle.
- Zinc-plated finish for corrosion resistance and appearance.
- Optional NSF Certified casters.



BRAKES

Side Pinch Type Wheel Brake

Strap Type Wheel Brake

Wheel Types

Cushionex Supreme
Black soft rubber tread molded to black hard rubber core.

Poly II Rubber
Dark gray thermoplastic rubber tread molded to light gray polypropylene core.

Spartan Supreme
Black hard rubber tread molded to black hard rubber core.

Durafoam (Dished)
Black molded polypropylene.

Poly II Urethane
Dark blue polyurethane tread molded to light gray polypropylene core.

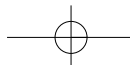

Light Duty Casters

Wheel Dia. (In.)	Tread Width (In.)	Load Capacity (Lbs.)	Wheel Bearing Type	Overall Height (In.)	Swivel Radius (In.)	Swivel Weight (Lbs.)	Swivel Pack Qty.	Swivel Caster Part No.	Rigid Weight (Lbs.)	Rigid Pack Qty.	Rigid Caster Part No.
PLATE CASTERS											
CUSHIONEX SUPREME WHEEL (Soft Rubber All Black)											
3	1	100	Delrin	3-13/16	2-3/4	1-1/4	52	2F68030040001**	1-1/4	52	1F63030040001**
4	1	115	Delrin	4-13/16	3-1/4	1-1/2	32	2F68040040001**	1-1/2	32	1F63040040001**
5	1	125	Delrin	5-13/16	4	2	20	2F68050040001**	2	20	1F63050040001**
POLY II RUBBER WHEEL (GRAY THERMOPLASTIC Rubber Tread on Gray Polyolefin Hub)											
3	1	125	Plain	3-13/16	2-3/4	1	52	2F6803P260001**	1	52	1F6303P260001**
4	1	135	Plain	4-13/16	3-1/4	1-1/4	32	2F6804P260001**	1-1/4	32	1F6304P260001**
5	1	145	Plain	5-13/16	4	1-1/2	20	2F6805P260001**	1-1/2	20	1F6305P260001**
SPARTAN SUPREME WHEEL (Hard Rubber All Black)											
3	1	125	Delrin	3-13/16	2-3/4	1-1/4	52	2F68030090001**	1-1/4	52	1F63030090001**
4	1	140	Delrin	4-13/16	3-1/4	1-1/2	32	2F68040090001**	1-1/2	32	1F63040090001**
5	1	145	Delrin	5-13/16	4	2	20	2F68050090001**	2	20	1F63050090001**
DURAFOAM WHEEL (Polyolefin All Black)											
3	1	125	Plain	3-13/16	2-3/4	1	52	2F68030270001**	1	52	1F63030270001**
4	1	140	Plain	4-13/16	3-1/4	1-1/4	32	2F68040270001**	1-1/4	32	1F63040270001**
5	1	145	Plain	5-13/16	4	1-1/2	20	2F68050270001**	1-1/2	20	1F63050270001**
POLY II URETHANE WHEEL (Blue Polyurethane Tread on Gray Polyolefin Hub)											
3	1	125	Plain	3-13/16	2-3/4	1	52	2F6803P250001**	1	52	1F6303P250001**
4	1	140	Plain	4-13/16	3-1/4	1-1/4	32	2F6804P250001**	1-1/4	32	1F6304P250001**
5	1	145	Plain	5-13/16	4	1-1/2	20	2F6805P250001**	1-1/2	20	1F6305P250001**
STEM CASTERS											
CUSHIONEX SUPREME WHEEL (Soft Rubber All Black)											
3	1	100	Delrin	3-3/4	2-3/4	1-1/4	52	2F69030040001**			
4	1	115	Delrin	4-11/16	3-1/4	1-1/2	32	2F69040040001**			
5	1	125	Delrin	5-11/16	4	2	24	2F69050040001**			
POLY II RUBBER WHEEL (GRAY THERMOPLASTIC Rubber Tread on Gray Polyolefin Hub)											
3	1	125	Plain	3-3/4	2-3/4	1	52	2F6903P260001**			
4	1	135	Plain	4-11/16	3-1/4	1-1/4	32	2F6904P260001**			
5	1	145	Plain	5-11/16	4	1-1/2	24	2F6905P260001**			
SPARTAN SUPREME WHEEL (Hard Rubber All Black)											
3	1	125	Delrin	3-3/4	2-3/4	1-1/4	52	2F69030090001**			
4	1	140	Delrin	4-11/16	3-1/4	1-1/2	32	2F69040090001**			
5	1	145	Delrin	5-11/16	4	2	24	2F69050090001**			
DURAFOAM WHEEL (Polyolefin All Black)											
3	1	125	Plain	3-3/4	2-3/4	1	52	2F69030270001**			
4	1	140	Plain	4-11/16	3-1/4	1-1/4	32	2F69040270001**			
5	1	145	Plain	5-11/16	4	1-1/2	24	2F69050270001**			
POLY II URETHANE WHEEL (Blue Polyurethane Tread on Gray Polyolefin Hub)											
3	1	125	Plain	3-3/4	2-3/4	1	52	2F6903P250001**			
4	1	140	Plain	4-11/16	3-1/4	1-1/4	32	2F6904P250001**			
5	1	145	Plain	5-11/16	4	1-1/2	24	2F6905P250001**			

** NOTE: For your mount choice, replace ** in part number with mount code number shown in top mount choices.

**** Code Number Mounting Options**

Small Plates

	Overall Size: 2-3/4" x 3-3/4" Hole Spacing: 1-3/4" x 3" Hole Diameter: 11/32" Bolt Diameter: 5/16"
---	---

	Overall Size: 2-3/4" x 3-3/4" Hole Spacing: 1-3/4" x 2-5/8" to 3" Hole Diameter: 11/32" x 1/2" slots Bolt Diameter: 5/16"
---	--

Large Plate

	Overall Size: 3-1/8" x 4-1/8" Hole Spacing: 1-3/4" x 3" to 2-3/8" x 3-3/8" Hole Diameter: 3/8" x 3/4" slots Bolt Diameter: 5/16"
---	---

Stems

Size	Stem Type	Stem #
3/8-16 x 1"	Threaded	04
3/8-16 x 1-1/2"	Threaded	07
3/8-16 x 1-9/16"	Threaded	64
7/16" x 1-3/8"	Friction Ring	01
7/16" 1-29/32"	Friction Ring	03
7/16-14 x 1-1/2"	Threaded	05
1/2-13 x 3/4"	Threaded	06
1/2-13 x 1"	Threaded	61
1/2-13 x 1-1/2"	Threaded	10
1/2-13 x 1-5/8"	Threaded	Z3
1/2-13 x 9/16"	Threaded	Z4
13/16" x 1-3/4"	Friction Ring	37



Other stem sizes available upon request. Minimum Order Quantities

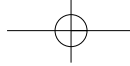

Light-Medium Duty Casters

Light-Medium Duty Casters

MADE IN U.S.A.



STANDARD FEATURES

- Light-medium duty applications.
- Double row swivel construction.
- 5/16" diameter nut and bolt axle.
- Zinc-plated finish for corrosion resistance and appearance.
- Optional NSF Certified casters.



BRAKES

Side Pinch Type Wheel Brake



Strap Type Wheel Brake



Wheel Types



Cushionex Supreme
Black soft rubber tread molded to black hard rubber core.



Poly II Rubber
Dark gray thermoplastic rubber tread molded to light gray polypropylene core.



Spartan Supreme
Black hard rubber tread molded to black hard rubber core.



Durafoam
Black molded polypropylene.



Poly II Urethane
Dark blue polyurethane tread molded to light gray polypropylene core.

** Code Number

Top Plates

Small Plates



Overall Size: 2-3/4" x 3-3/4"
Hole Spacing: 1-3/4" x 3"
Hole Diameter: 11/32"
Bolt Diameter: 5/16"



Overall Size: 2-3/4" x 3-3/4"
Hole Spacing: 1-3/4" x 2-5/8" to 3"
Hole Diameter: 11/32" x 1/2" slots
Bolt Diameter: 5/16"



Overall Size: 2-1/2" x 5"
Hole Spacing: 1-1/16" x 3-15/32" to 1-3/16" x 4"
Hole Diameter: 11/32" x 39/64" slots
Bolt Diameter: 5/16"
AT top plate is available for rigid casters only.

Large Plates



Overall Size: 3-1/8" x 4-1/8"
Hole Spacing: 1-3/4" x 3" to 2-3/8" x 3-3/8"
Hole Diameter: 3/8" x 3/4" slots
Bolt Diameter: 5/16"



Overall Size: 3-1/8" x 4-1/8"
Hole Spacing: 2-3/8" x 3-7/16"
Hole Diameter: 11/32"
Bolt Diameter: 5/16"

E.R.Wagner
CASTERS & WHEELS Manufacturing Co.

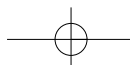

Light-Medium Duty Casters

Wheel Dia. (In.)	Tread Width (In.)	Load Capacity (Lbs.)	Wheel Bearing Type	Overall Height (In.)	Swivel Radius (In.)	Swivel Weight (Lbs.)	Swivel Plate Pack Qty. Small/Large	Swivel Caster Part No.	Rigid Weight (Lbs.)	Rigid Plate Pack Qty. Small/Large	Rigid Caster Part No.
PLATE CASTERS											
CUSHIONEX SUPREME WHEEL (Soft Rubber All Black)											
2-1/2	1-1/8	120	Sintered	3-7/16	2-1/4	1-1/8	40	2F98070040001**	1	40	1F93070040001**
3	1-1/4	125	Delrin	3-3/4	2-3/8	1-1/4	40/28	2F98030040001**	1-1/8	40/28	1F93030040001**
4	1-1/4	165	Delrin	4-11/16	3-3/8	1-1/2	30/24	2F98040040001**	1-1/4	30/24	1F93040040001**
5	1-1/4	190	Delrin	5-5/8	4-1/8	2-1/4	20	2F98050040001**	2	20	1F93050040001**
POLY II RUBBER WHEEL (GRAY THERMOPLASTIC Rubber Tread on Gray Polyolefin Hub)											
3	1-1/4	210	Delrin	3-3/4	2-3/8	1-1/8	40/28	2F9803B260001**	1	40/28	1F9303B260001**
4	1-1/4	275	Delrin	4-11/16	3-3/8	1-1/2	30/24	2F9804B260001**	1-1/4	30/24	1F9304B260001**
5	1-1/4	280	Delrin	5-5/8	4-1/8	1-3/4	20	2F9805B260001**	1-1/2	20	1F9305B260001**
SPARTAN SUPREME WHEEL (Hard Rubber All Black)											
2-1/2	1-1/8	175	Sintered	3-7/16	2-1/4	1	40	2F98070090001**	1	40	1F93070090001**
3	1-1/4	210	Delrin	3-3/4	2-3/8	1-1/4	40/28	2F98030090001**	1-1/8	40/28	1F93030090001**
4	1-1/4	255	Delrin	4-11/16	3-3/8	1-1/2	30/24	2F98040090001**	1-1/4	30/24	1F93040090001**
5	1-1/4	280	Delrin	5-5/8	4-1/8	2-1/4	20	2F98050090001**	2	20	1F93050090001**
DURAFOAM WHEEL (Polyolefin All Black)											
2-1/2	1-1/4	175	Plain	3-7/16	2-1/4	1	40	2F98071270001**	1	40	1F93071270001**
3	1-1/4	210	Plain	3-3/4	2-3/8	1-1/8	40/28	2F98030270001**	1	40/28	1F93030270001**
4	1-1/4	255	Plain	4-11/16	3-3/8	1-1/4	30/24	2F98040270001**	1-1/4	30/24	1F93040270001**
5	1-1/4	280	Plain	5-5/8	4-1/8	1-1/2	20	2F98050270001**	1-1/2	20	1F93050270001**
POLY II URETHANE WHEEL (Blue Polyurethane Tread on Gray Polyolefin Hub)											
3	1-1/4	210	Delrin	3-3/4	2-3/8	1	40/28	2F9803B250001**	1	40/28	1F9303B250001**
4	1-1/4	275	Delrin	4-11/16	3-3/8	1-1/2	30/24	2F9804B250001**	1-1/4	30/24	1F9304B250001**
5	1-1/4	280	Delrin	5-5/8	4-1/8	1-3/4	20	2F9805B250001**	1-1/2	20	1F9305B250001**
STEM CASTERS											
CUSHIONEX SUPREME WHEEL (Soft Rubber All Black)											
2-1/2	1-1/8	120	Sintered	3-5/16	2-1/4	1	52	2F99070040001**			
3	1-1/4	125	Delrin	3-5/8	2-3/8	1-1/4	52	2F99030040001**			
4	1-1/4	165	Delrin	4-1/2	3-3/8	1-1/2	32	2F99040040001**			
5	1-1/4	190	Delrin	5-1/2	4-1/8	2-1/4	24	2F99050040001**			
POLY II RUBBER WHEEL (GRAY THERMOPLASTIC Rubber Tread on Gray Polyolefin Hub)											
3	1-1/4	210	Delrin	3-5/8	2-3/8	1	52	2F9903B260001**			
4	1-1/4	275	Delrin	4-1/2	3-3/8	1-1/2	32	2F9904B260001**			
5	1-1/4	280	Delrin	5-1/2	4-1/8	1-3/4	24	2F9905B260001**			
SPARTAN SUPREME WHEEL (Hard Rubber All Black)											
2-1/2	1-1/8	175	Sintered	3-5/16	2-1/4	1	52	2F99070090001**			
3	1-1/4	210	Delrin	3-5/8	2-3/8	1-1/4	52	2F99030090001**			
4	1-1/4	255	Delrin	4-1/2	3-3/8	1-1/2	32	2F99040090001**			
5	1-1/4	280	Delrin	5-1/2	4-1/8	2-1/4	24	2F99050090001**			
DURAFOAM WHEEL (Polyolefin All Black)											
2-1/2	1-1/4	175	Plain	3-5/16	2-1/4	1	52	2F99071270001**			
3	1-1/4	210	Plain	3-5/8	2-3/8	1	52	2F99030270001**			
4	1-1/4	255	Plain	4-1/2	3-3/8	1-1/4	32	2F99040270001**			
5	1-1/4	280	Plain	5-1/2	4-1/8	1-1/2	24	2F99050270001**			
POLY II URETHANE WHEEL (Blue Polyurethane Tread on Gray Polyolefin Hub)											
3	1-1/4	210	Delrin	3-5/8	2-3/8	1	52	2F9903B250001**			
4	1-1/4	275	Delrin	4-1/2	3-3/8	1-1/2	32	2F9904B250001**			
5	1-1/4	280	Delrin	5-1/2	4-1/8	1-3/4	24	2F9905B250001**			

** NOTE: For your mount choice, replace ** in part number with mount code number shown in top mount choices.

**** Code Number Stems**

Size	Stem Type	Stem #
5/16-18 x 1"	Threaded	17
3/8-16 x 1"	Threaded	04
3/8-16 x 1-1/2"	Threaded	07
7/16" x 1-3/8"	Friction Ring	01
7/16" 1-29/32"	Friction Ring	03
7/16-14 x 7/8"	Threaded	23
7/16-14 x 1-1/2"	Threaded	05
1/2" X 1-3/8"	Friction Ring	16
1/2-13 x 3/4"	Threaded	06
1/2-13 x 1"	Threaded	61

Size	Stem Type	Stem #
1/2-13 x 1-1/2"	Threaded	10
1/2-13 x 2-1/2"	Threaded	25
13/16" x 1-3/4"	Friction Ring	37
3/4" x 2"	Square	74
0.856" x 2"	Square	36
0.750" - 0.999"	Expanding	E1
1.000" - 1.249"	Expanding	E2
1.250" - 1.499"	Expanding	E3
1.500" - 1.749"	Expanding	E4

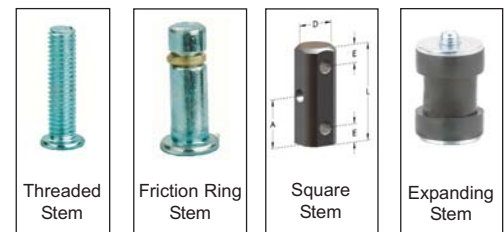

Other stem sizes available upon request. Minimum Order Quantities

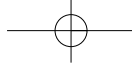

Medium Duty Casters

Medium Duty Casters

MADE IN U.S.A.



STANDARD FEATURES

- **Medium duty applications.**
- **Double row swivel construction.**
- **3/8" diameter nut and bolt axle.**
- **Zinc-plated finish for corrosion resistance and appearance.**

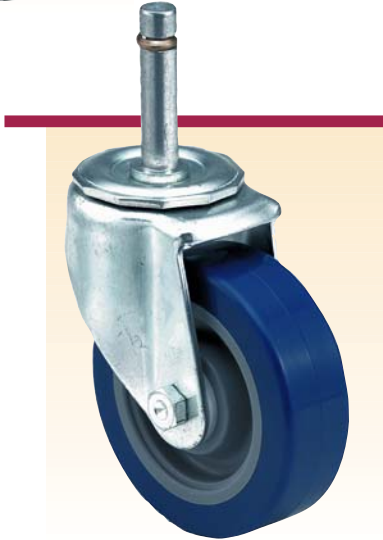

BRAKE

Side Pinch Type Wheel Brake



- Side mount pinch type wheel brake available for all swivel models.

Wheel Types



Cushionex Supreme
Black soft rubber tread molded to black hard rubber core.



Spartan Supreme
Black hard rubber tread molded to black hard rubber core.



Poly II Rubber
Dark gray thermoplastic rubber tread molded to light gray polypropylene core.



Poly II Poly
Black polypropylene tread molded to black polypropylene core.



Poly II Urethane
Dark blue polyurethane tread molded to light gray polypropylene core.



Medium Duty Casters

Wheel Dia. (In.)	Tread Width (In.)	Load Capacity (Lbs.)	Wheel Bearing Type	Overall Height (In.)	Swivel Radius (In.)	Swivel Weight (Lbs.)	Swive Pack Qty. Small/Large	Swivel Caster Part No.	Rigid Weight (Lbs.)	Rigid Pack Qty. Small/Large	Rigid Caster Part No.
PLATE CASTERS											
CUSHIONEX SUPREME WHEEL (Soft Rubber All Black)											
4	1-3/8	200	Delrin	5-1/16	3-3/8	2-1/2	20/16	1F28040040001**	2-1/4	20/16	1F23040040001**
5	1-3/8	240	Delrin	6-1/16	3-15/16	3	16/10	1F28050040001**	2-3/4	16/10	1F23050040001**
6	1-3/8	280	Delrin	7-1/16	4-15/16	4	10	1F28060040001**	3-3/4	10	1F23060040001**
POLY II RUBBER WHEEL (GRAY THERMOPLASTIC Rubber Tread on Gray Polyolefin Hub)											
4	1-1/2	275	Delrin	5-1/16	3-3/8	2	20/16	1F2804B260001**	1-3/4	20/16	1F2304B260001**
5	1-1/2	300	Delrin	6-1/16	3-15/16	2-1/4	16/10	1F2805B260001**	2	16/10	1F2305B260001**
6	1-1/2	300	Delrin	7-1/16	4-15/16	2-1/2	10	1F2806B260001**	2-1/4	10	1F2306B260001**
SPARTAN SUPREME WHEEL (Hard Rubber All Black)											
4	1-3/8	300	Delrin	5-1/16	3-3/8	2-1/2	20/16	1F28040090001**	2-1/4	20/16	1F23040090001**
5	1-3/8	350	Delrin	6-1/16	3-15/16	3	16/10	1F28050090001**	2-3/4	16/10	1F23050090001**
6	1-3/8	400	Delrin	7-1/16	4-15/16	4	10	1F28060090001**	3-3/4	10	1F23060090001**
POLY II POLY WHEEL (Polyolefin All Black)											
4	1-3/8	375	Delrin	5-1/16	3-3/8	2	20/16	1F2804B270001**	1-3/4	20/16	1F2304B270001**
5	1-3/8	400	Delrin	6-1/16	3-15/16	2-1/4	16/10	1F2805B270001**	2	16/10	1F2305B270001**
6	1-3/8	400	Delrin	7-1/16	4-15/16	2-1/2	10	1F2806B270001**	2-1/4	10	1F2306B270001**
POLY II URETHANE WHEEL (Blue Polyurethane Tread on Gray Polyolefin Hub)											
4	1-1/2	375	Delrin	5-1/16	3-3/8	2	20/16	1F2804B250001**	1-3/4	20/16	1F2304B250001**
5	1-1/2	400	Delrin	6-1/16	3-15/16	2-1/4	16/10	1F2805B250001**	2	16/10	1F2305B250001**
6	1-1/2	400	Delrin	7-1/16	4-15/16	2-1/2	10	1F2806B250001**	2-1/4	10	1F2306B250001**
STEM CASTERS											
CUSHIONEX SUPREME WHEEL (Soft Rubber All Black) (GRAY THERMOPLASTIC Rubber Tread on Gray Polyolefin Hub)											
4	1-3/8	200	Delrin	4-7/8	3-3/8	2-1/4	24	1F29440040001**			
5	1-3/8	240	Delrin	5-7/8	3-15/16	2-3/4	20	1F29450040001**			
6	1-3/8	280	Delrin	6-7/8	4-15/16	3-3/4	16	1F29460040001**			
POLY II RUBBER WHEEL (GRAY THERMOPLASTIC Rubber Tread on Gray Polyolefin Hub)											
4	1-1/2	275	Delrin	4-7/8	3-3/8	1-3/4	24	1F2944B260001**			
5	1-1/2	300	Delrin	5-7/8	3-15/16	2	20	1F2945B260001**			
6	1-1/2	300	Delrin	6-7/8	4-15/16	2-1/4	16	1F2946B260001**			
SPARTAN SUPREME WHEEL (Hard Rubber All Black)											
4	1-3/8	300	Delrin	4-7/8	3-3/8	2-1/4	24	1F29440090001**			
5	1-3/8	350	Delrin	5-7/8	3-15/16	2-3/4	20	1F29450090001**			
6	1-3/8	400	Delrin	6-7/8	4-15/16	3-3/4	16	1F29460090001**			
POLY II POLY WHEEL (Polyolefin All Black)											
4	1-3/8	375	Delrin	4-7/8	3-3/8	1-3/4	24	1F2944B270001**			
5	1-3/8	400	Delrin	5-7/8	3-15/16	2	20	1F2945B270001**			
6	1-3/8	400	Delrin	6-7/8	4-15/16	2-1/4	16	1F2946B270001**			
POLY II URETHANE WHEEL (Blue Polyurethane Tread on Gray Polyolefin Hub)											
4	1-1/2	375	Delrin	4-7/8	3-3/8	1-3/4	24	1F2944B250001**			
5	1-1/2	400	Delrin	5-7/8	3-15/16	2	20	1F2945B250001**			
6	1-1/2	400	Delrin	6-7/8	4-15/16	2-1/4	16	1F2946B250001**			

** NOTE: For your mount choice, replace ** in part number with mount code number shown in top mount choices.

**** Code Number Mounting Options**

Small Plate



Overall Size: 2-3/4" x 3-3/4"
 Hole Spacing: 1-3/4" x 2-5/8" to 3"
 Hole Diameter: 11/32" x 1/2" slots
 Bolt Diameter: 5/16"

Large Plates



Overall Size: 3-1/8" x 4-1/8"
 Hole Spacing: 1-3/4" x 3" to 2-3/8" x 3-3/8"
 Hole Diameter: 3/8" x 3/4" slots
 Bolt Diameter: 5/16"



Overall Size: 3-1/8" x 4-1/8"
 Hole Spacing: 2-3/8" x 3-7/16"
 Hole Diameter: 11/32"
 Bolt Diameter: 5/16"

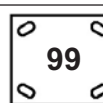

Overall Size: 3-3/4" x 4-5/8"
 Hole Spacing: 2-5/8" x 3-5/8" to 3" x 3"
 Hole Diameter: 3/8" x 3/4" slots
 Bolt Diameter: 5/16"

Stems

Size	Stem Type	Stem #
7/16" x 1-3/8"	Friction Ring	01
7/16" 1-29/32"	Friction Ring	03
1/2-13 x 1"	Threaded	61
1/2-13 x 1-1/2"	Threaded	10
5/8" x 1-3/8"	Friction Ring	65



Threaded Stem



Friction Ring Stem

Other stem sizes available upon request.
 Minimum Order Quantities

For options and ordering, call 1-800-558-0117

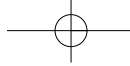

Medium Duty Institutional Casters

Americaster™ Institutional Series Casters

MADE IN U.S.A.



STANDARD FEATURES

- **Medium duty applications.**
- **Double row swivel construction.**
- **3/8" diameter nut and bolt axle.**
- **Delrin wheel bearing offers a long life due to its resistance to thermal and chemical deterioration.**
- **Zinc-plated finish for corrosion resistance and appearance.**
- **Assembly wrench 8G000192797**
- **All Casters NSF Certified.**

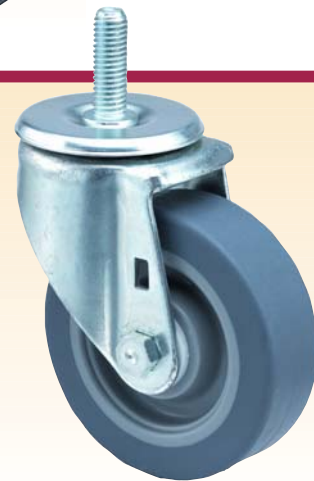
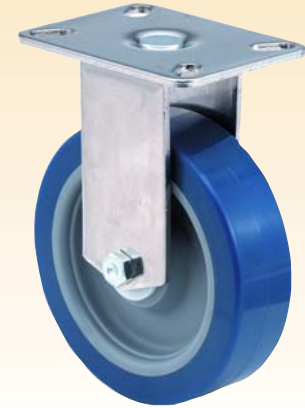

OPTIONS

Strap Type Wheel Brake



Grease Seal/Dust Cover
not recommended for high temperature applications



Roller Bearings

For 3F23, 3F28 & 3F29 casters



Finishes

Nickel-Plated Finish
For 3F23, 3F28 & 3F29 casters

Wheel Types



Cushionex Supreme
Black soft rubber tread molded to black hard rubber core.



Poly II Rubber
Dark gray thermoplastic rubber tread molded to light gray polypropylene core.



Spartan Supreme
Black hard rubber tread molded to black hard rubber core.



Poly II Poly
Black polypropylene tread molded to black polypropylene core.



Poly II Urethane
Dark blue polyurethane tread molded to light gray polypropylene core.



Duratex Phenolic
Black phenolic resin reinforced with macerated fabric.



Semi-steel
Cast iron enriched with steel.

E.R.Wagner
CASTERS & WHEELS Manufacturing Co.

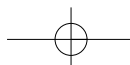

Medium Duty Institutional Casters

Wheel Dia. (In.)	Tread Width (In.)	Load Capacity (Lbs.)	Wheel Bearing Type	Overall Height (In.)	Swivel Radius (In.)	Swivel Weight (Lbs.)	Swivel Pack Qty. Small/Large	Swivel Plate Caster Part No.	Rigid Weight (Lbs.)	Rigid Pack Qty. Small/Large	Rigid Caster Part No.
PLATE CASTERS											
CUSHIONEX SUPREME WHEEL (Soft Rubber All Black)											
3-1/2	1-1/4	155	Delrin	4-5/8	3-3/16	2-1/4	24/NA	3F08B9D040001**	2	24/NA	3F0349D040001**
4	1-1/4	165	Delrin	5-1/8	3-3/8	2-1/2	24/16	3F08B4D040001**	2-1/4	24/16	3F0344D040001**
4	1-3/8	200	Delrin	5-3/8	3-3/8	2-3/4	20/16	3F28B4D040001**	2-1/2	20/16	3F2344D040001**
5	1-1/4	200	Delrin	6-1/4	3-15/16	3-1/4	20/12	3F08B5D040001**	3	20/12	3F0345D040001**
5	1-3/8	240	Delrin	6-3/8	3-15/16	3-1/2	16/10	3F28B5D040001**	3-1/4	16/10	3F2345D040001**
6	1-3/8	280	Delrin	7-3/8	4-7/16	4-1/2	16/10	3F28B6D040001**	4-1/4	16/10	3F2346D040001**
POLY II RUBBER WHEEL (GRAY THERMOPLASTIC Rubber Tread on Gray Polyolefin Hub)											
3-1/2	1-1/4	250	Delrin	4-5/8	3-3/16	2	24/NA	3F08B9B260001**	1-3/4	24/NA	3F0349B260001**
4	1-1/4	275	Delrin	5-1/8	3-3/8	2	24/16	3F08B4B260001**	1-3/4	24/16	3F0344B260001**
4	1-1/2	275	Delrin	5-3/8	3-3/8	2-1/4	20/16	3F28B4B260001**	2	20/16	3F2344B260001**
5	1-1/4	300	Delrin	6-1/4	3-15/16	2-1/2	20/12	3F08B5B260001**	2-1/4	20/12	3F0345B260001**
5	1-1/2	300	Delrin	6-3/8	3-15/16	2-3/4	16/10	3F28B5B260001**	2-1/2	16/10	3F2345B260001**
6	1-1/2	300	Delrin	7-3/8	4-7/16	3-1/4	16/10	3F28B6B260001**	3	16/10	3F2346B260001**
SPARTAN SUPREME WHEEL (Hard Rubber All Black)											
3-1/2	1-1/4	250	Delrin	4-5/8	3-3/16	2-1/4	24/NA	3F08B9D090001**	2	24/NA	3F0349D090001**
4	1-1/4	255	Delrin	5-1/8	3-3/8	2-1/2	24/16	3F08B4D090001**	2-1/4	24/16	3F0344D090001**
4	1-3/8	300	Delrin	5-3/8	3-3/8	2-3/4	20/16	3F28B4D090001**	2-1/2	20/16	3F2344D090001**
5	1-1/4	280	Delrin	6-1/4	3-15/16	3-1/4	20/12	3F08B5D090001**	3	20/12	3F0345D090001**
5	1-3/8	350	Delrin	6-3/8	3-15/16	3-1/2	16/10	3F28B5D090001**	3-1/4	16/10	3F2345D090001**
6	1-3/8	400	Delrin	7-3/8	4-7/16	4-1/2	16/10	3F28B6D090001**	4-1/4	16/10	3F2346D090001**
POLY II POLY WHEEL (Polyolefin All Black)											
3-1/2	1-1/4	250	Delrin	4-5/8	3-3/16	2	24/NA	3F08B9B270001**	1-3/4	24/NA	3F0349B270001**
4	1-3/8	375	Delrin	5-1/8	3-3/8	2	24/16	3F08B4B270001**	1-3/4	24/16	3F0344B270001**
4	1-3/8	375	Delrin	5-3/8	3-3/8	2-1/4	20/16	3F28B4B270001**	2	20/16	3F2344B270001**
5	1-3/8	450	Delrin	6-1/4	3-15/16	2-1/2	20/12	3F08B5B270001**	2-1/4	20/12	3F0345B270001**
5	1-3/8	450	Delrin	6-3/8	3-15/16	2-3/4	16/10	3F28B5B270001**	2-1/2	16/10	3F2345B270001**
6	1-3/8	450	Delrin	7-3/8	4-7/16	3-1/4	16/10	3F28B6B270001**	3-1/4	16/10	3F2346B270001**
POLY II URETHANE WHEEL (Blue Polyurethane Tread on Gray Polyolefin Hub)											
3-1/2	1-1/4	250	Delrin	4-5/8	3-3/16	2	24/NA	3F08B9B250001**	1-3/4	24/NA	3F0349B250001**
4	1-1/4	275	Delrin	5-1/8	3-3/8	2	24/16	3F08B4B250001**	1-3/4	24/16	3F0344B250001**
4	1-1/2	375	Delrin	5-3/8	3-3/8	2-1/4	20/16	3F28B4B250001**	2	20/16	3F2344B250001**
5	1-1/4	300	Delrin	6-1/4	3-15/16	2-1/2	20/12	3F08B5B250001**	2-1/4	20/12	3F0345B250001**
5	1-1/2	450	Delrin	6-3/8	3-15/16	2-3/4	16/10	3F28B5B250001**	2-1/2	16/10	3F2345B250001**
6	1-1/2	450	Delrin	7-3/8	4-7/16	3-1/4	16/10	3F28B6B250001**	3	16/10	3F2346B250001**
DURATEX WHEEL (Phenolic Resin All Black)											
3	1-1/2	350	Roller	4-3/8	3-1/8	2-1/4	24/NA	3F08B34380801**	2	24/NA	3F03434380801**
3(H)	1-1/2	300	Roller	4-3/8	3-1/8	2-1/4	24/NA	3F08B34340801**	2	24/NA	3F03434340801**
4	1-1/2	450	Roller	5-3/8	3-3/8	2-3/4	20/16	3F28B44380001**	2-1/2	20/16	3F23444380001**
4(H)	1-1/2	375	Roller	5-1/16	3-3/8	2-3/4	20/16	1F28444340001**	2-1/2	20/16	1F23444340001**
5	1-1/2	450	Roller	6-3/8	3-15/16	3-1/2	16/10	3F28B54380001**	3-1/4	16/10	3F23454380001**
5(H)	1-1/2	400	Roller	6-1/16	3-15/16	3-1/2	16/10	1F28454340001**	3-1/4	16/10	1F23454340001**
6	1-1/2	450	Roller	7-3/8	4-7/16	4-1/4	16/10	3F28B64380001**	4	16/10	3F23464380001**
SEMI-STEEL WHEEL (Cast Iron Mixed with Steel All Black)											
3	1-1/4	450	Roller	4-3/8	2-15/16	2-3/4	24/NA	3F08B34110801**	2-1/2	24/NA	3F03434110801**
4	1-1/2	450	Roller	5-3/8	3-3/8	3-3/4	20/16	3F28B44110001**	3-1/2	20/16	3F23444110001**

** NOTE: For your plate choice, replace ** in part number with plate code number shown in top plate choices. (H) Wheel is high- temperature phenolic with an operative range of 475°F continuous, 525°F intermittent.

**** Code Number Top Plate Choices**

Small Plate

 Overall Size: 2-3/4" x 3-3/4"
Hole Spacing: 1-3/4" x 2-5/8" to 3"
Hole Diameter: 11/32" x 1/2" slots
Bolt Diameter: 5/16"

Large Plates

 Overall Size: 3-1/8" x 4-1/8"
Hole Spacing: 1-3/4" x 3" to 2-3/8" x 3-3/8"
Hole Diameter: 3/8" x 3/4" slots
Bolt Diameter: 5/16"

 Overall Size: 3-3/4" x 4-5/8"
Hole Spacing: 2-5/8" x 3-5/8" to 3" x 3"
Hole Diameter: 3/8" x 3/4" slots
Bolt Diameter: 5/16"

 Overall Size: 3-1/8" x 4-1/8"
Hole Spacing: 2-3/8" x 3-7/16"
Hole Diameter: 11/32"
Bolt Diameter: 5/16"

 Overall Size: 4" x 5"
Hole Spacing: 3" x 4"
Hole Diameter: 13/32"
Bolt Diameter: 3/8"
AS top plate is for swivel casters only.

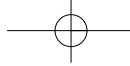

Medium Duty Institutional Casters

Americaster™ Institutional Series Casters

(Continued)

MADE IN U.S.A.



Wheel Dia. (In.)	Tread Width (In.)	Load Rating (Lbs.)	Wheel Bearing Type	Overall Height (In.)	Swivel Radius (In.)	Approximate Weight (Lbs.)	Swivel Weight (Lbs.)	Swivel Pack Qty.	Swivel Caster Part No.
STEM CASTERS									
CUSHIONEX SUPREME WHEEL (Soft Rubber All Black)									
3-1/2	1-1/4	155	Delrin	4-1/2	3-3/16	2-1/4	?	28	3F09B9D040001**
4	1-1/4	165	Delrin	5	3-3/8	2-1/2	?	24	3F09B4D040001**
4	1-3/8	200	Delrin	5-1/4	3-3/8	2-3/4	?	24	3F29B4D040001**
5	1-1/4	200	Delrin	6-1/8	3-15/16	3-1/4	?	20	3F09B5D040001**
5	1-3/8	240	Delrin	6-1/4	3-15/16	3-1/2	?	20	3F29B5D040001**
6	1-3/8	280	Delrin	7-1/4	4-7/16	4-1/2	?	16	3F29B6D040001**
POLY II RUBBER WHEEL (GRAY THERMOPLASTIC Rubber Tread on Gray Polyolefin Hub)									
3-1/2	1-1/4	250	Delrin	4-1/2	3-3/16	2	?	28	3F09B9B260001**
4	1-1/4	275	Delrin	5	3-3/8	2	?	24	3F09B4B260001**
4	1-1/2	275	Delrin	5-1/4	3-3/8	2-1/4	?	24	3F29B4B260001**
5	1-1/4	300	Delrin	6-1/8	3-15/16	2-1/2	?	20	3F09B5B260001**
5	1-1/2	300	Delrin	6-1/4	3-15/16	2-3/4	?	20	3F29B5B260001**
6	1-1/2	300	Delrin	7-1/4	4-7/16	3-1/4	?	16	3F29B6B260001**
SPARTAN SUPREME WHEEL (Hard Rubber All Black)									
3-1/2	1-1/4	250	Delrin	4-1/2	3-3/16	2-1/4	?	28	3F09B9D090001**
4	1-1/4	255	Delrin	5	3-3/8	2-1/2	?	24	3F09B4D090001**
4	1-3/8	300	Delrin	5-1/4	3-3/8	2-3/4	?	24	3F29B4D090001**
5	1-1/4	280	Delrin	6-1/8	3-15/16	3-1/4	?	20	3F09B5D090001**
5	1-3/8	350	Delrin	6-1/4	3-15/16	3-1/2	?	20	3F29B5D090001**
6	1-3/8	400	Delrin	7-1/4	4-7/16	4-1/2	?	16	3F29B6D090001**
POLY II POLY WHEEL (Polyolefin All Black)									
3-1/2	1-1/4	250	Delrin	4-1/2	3-3/16	2	?	28	3F09B9B270001**
4	1-3/8	375	Delrin	5	3-3/8	2	?	24	3F09B4B270001**
4	1-3/8	375	Delrin	5-1/4	3-3/8	2-1/4	?	24	3F29B4B270001**
5	1-3/8	450	Delrin	6-1/8	3-15/16	2-1/2	?	20	3F09B5B270001**
5	1-3/8	450	Delrin	6-1/4	3-15/16	2-3/4	?	20	3F29B5B270001**
6	1-3/8	450	Delrin	7-1/4	4-7/16	3-1/4	?	16	3F29B6B270001**
POLY II URETHANE WHEEL (Blue Polyurethane Tread on Gray Polyolefin Hub)									
3-1/2	1-1/4	250	Delrin	4-1/2	3-3/16	2	?	28	3F09B9B250001**
4	1-1/4	275	Delrin	5	3-3/8	2	?	24	3F09B4B250001**
4	1-1/2	375	Delrin	5-1/4	3-3/8	2-1/4	?	24	3F29B4B250001**
5	1-1/4	300	Delrin	6-1/8	3-15/16	2-1/2	?	20	3F09B5B250001**
5	1-1/2	450	Delrin	6-1/4	3-15/16	2-3/4	?	20	3F29B5B250001**
6	1-1/2	450	Delrin	7-1/4	4-7/16	3-1/4	?	16	3F29B6B250001**
DURATEX WHEEL (Phenolic Resin All Black)									
3	1-1/2	350	Roller	4-1/4	3-1/8	2-1/4	?	28	3F09B3438001**
4	1-1/2	450	Roller	5-1/4	3-3/8	2-3/4	?	24	3F29B4438001**
5	1-1/2	450	Roller	6-1/4	3-15/16	3-1/2	?	20	3F29B5438001**
6	1-1/2	450	Roller	7-1/4	4-7/16	4-1/4	?	16	3F29B6438001**

** NOTE: For your stem choice, replace ** in part number with stem code number shown in stem choices. (H) Wheel is high-temperature phenolic with an operative range of 475°F continuous, 525°F intermittent.

** Code Number			Stems		
Size	Stem Type	Stem #	Size	Stem Type	Stem #
3/8-16 x 1"	Threaded	04	3/4" x 2"	Square	74
3/8-16 x 1-1/2"	Threaded	07	0.856" x 2"	Square	36
7/16" x 1-3/8"	Friction Ring	01	0.750" - 0.999"	Expanding	E1
7/16" x 1-29/32"	Friction Ring	03	1.000" - 1.249"	Expanding	E2
1/2-13 x 1"	Threaded	61	1.250" - 1.499"	Expanding	E3
1/2-13 x 1-1/2"	Threaded	10	1.500" - 1.749"	Expanding	E4
1/2-13 x 2-1/2"	Threaded	25			

Other stem sizes available upon request. Minimum Order Quantities

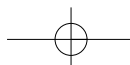

Medium Duty Stainless Steel Plate Casters

STANDARD FEATURES

- **3/8" diameter nut and bolt axle with grease zerk fitting.**
- **Swivels have a dust cover with a zerk grease fitting and upper and lower grease seals (except high temperature wheels).**
- **All casters are NSF certified.**



Top Plates

Swivel Plate



Overall Size: 2-3/8" x 3-5/8"
Hole Spacing: 1-3/4" x 2-11/16"
slotted to 3"
Bolt Diameter: 5/16"

Rigid Plate



Overall Size: 2-5/8" x 3-5/8"
Hole Spacing: 1-3/4" x 2-11/16"
slotted to 3"
Bolt Diameter: 5/16"

Wheel Dia. (In.)	Tread Width (In.)	Load Capacity (Lbs.)	Wheel Bearing Type	Overall Height (In.)	Swivel Radius (In.)	Swivel Weight (Lbs.)	Swivel Pack Qty.	Swivel Caster Part No.	Rigid Weight (Lbs.)	Rigid Pack Qty.	Rigid Caster Part No.
TPR SOFT RUBBER FLAT TREAD (GRAY THERMOPLASTIC Rubber Tread on Gray Polyolefin Hub)											
3	1-1/4	200	Delrin	4-1/16	3	1-1/4	24	7F08A3B52080FAM	3/4	24	7F0343B52050FAM
3-1/2	1-1/4	250	Delrin	4-9/16	3-1/4	2	24	7F08A9B52080FAM	1-1/2	24	7F0349B52050FAM
4	1-1/4	275	Delrin	5-1/16	3-1/2	2-1/4	24	7F08A4B52080FAM	1-3/4	24	7F0344B52050FAM
5	1-1/4	300	Delrin	6-3/16	4	2-3/4	20	7F08A5B52080FAM	2-1/4	20	7F0345B52050FAM
TPR SOFT RUBBER DONUT TREAD (GRAY THERMOPLASTIC Rubber Tread on Gray Polyolefin Hub)											
3	1-1/4	200	Delrin	4-1/16	3	1-1/4	24	7F08A3B55080FAM	3/4	24	7F0343B55050FAM
3-1/2	1-1/4	225	Delrin	4-9/16	3-1/4	2	24	7F08A9B55080FAM	1-1/2	24	7F0349B55050FAM
4	1-1/4	250	Delrin	5-1/16	3-1/2	2-1/4	24	7F08A4B55080FAM	1-3/4	24	7F0344B55050FAM
5	1-1/4	250	Delrin	6-3/16	4	2-3/4	20	7F08A5B55080FAM	2-1/4	20	7F0345B55050FAM
POLYURETHANE FLAT TREAD (Gray Tread / Light Gray Hub)											
3	1-1/4	200	Delrin	4-1/16	3	1-1/4	24	7F08A3B56080FAM	3/4	24	7F0343B56050FAM
3-1/2	1-1/4	250	Delrin	4-9/16	3-1/4	2	24	7F08A9B56080FAM	1-1/2	24	7F0349B56050FAM
4	1-1/4	275	Delrin	5-1/16	3-1/2	2-1/4	24	7F08A4B56080FAM	1-3/4	24	7F0344B56050FAM
5	1-1/4	300	Delrin	6-3/16	4	2-3/4	20	7F08A5B56080FAM	2-1/4	20	7F0345B56050FAM
DURAFoam WHEEL (Polyolefin All Black)											
3	1-1/4	200	Plain	4-1/16	3	1-1/4	24	7F08A3127080FAM	3/4	24	7F0343127050FAM
3-1/2	1-1/4	250	Plain	4-9/16	3-1/4	2	24	7F08A9127080FAM	1-1/2	24	7F0349127050FAM
4	1-1/4	275	Plain	5-1/16	3-1/2	2-1/4	24	7F08A4127080FAM	1-3/4	24	7F0344127050FAM
5	1-1/4	300	Plain	6-3/16	4	2-3/4	20	7F08A5127080FAM	2-1/4	20	7F0345127050FAM
HIGH TEMPERATURE NYLON GLASS FILLED (All Black) Operative Range of 475°F Continuous, 525°F Intermittent											
3	1-1/4	200	Plain	4-1/16	3	1-1/4	24	7F08B3044080FAM	3/4	24	7F0343044050FAM
3-1/2	1-1/4	250	Plain	4-9/16	3-1/4	2	24	7F08B9044080FAM	1-1/2	24	7F0349044050FAM
4	1-1/4	275	Plain	5-1/16	3-1/2	2-1/4	24	7F08B4044080FAM	1-3/4	24	7F0344044050FAM
5	1-1/4	300	Plain	6-3/16	4	2-3/4	20	7F08B5044080FAM	2-1/4	20	7F0345044050FAM

BRAKE

Strap Type Wheel Brake



Wheel Types



TPR Soft Rubber Flat & Donut Soft Tread
TPR material chemically bonded to a polyolefin applications. Color: Gray Tread / Light Gray Hub



Polyurethane Flat Tread
Polyurethane tread mechanically molded to a polyolefin hub. Color: Gray Tread / Light Gray Hub



High Temperature Nylon Glass Filled Wheels
High temperature nylon glass filled wheels are manufactured from fiberglass and reinforced with nylon. Color: All black



Polyolefin
One piece molded polyolefin. Color: All Black

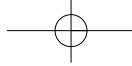

Low Profile Medium Duty Casters

Low Profile Medium Duty Casters

MADE IN U.S.A.



STANDARD FEATURES

- **Medium duty applications.**
- **Double row swivel construction.**
- **3/8" diameter nut and bolt axle.**
- **Zinc-plated finish for corrosion resistance and appearance.**
- **Ideal for electronic and business machines, display stands and racks and other applications needing a high capacity, low height caster.**
- **Assembly wrench 8G000192797**



OPTIONS

Side Pinch Type Wheel Brake



- Side mount pinch type wheel brake available for 3" diameter wheel swivel casters.

Thumb Screw Wheel Brake



- Thumb screw type wheel brake available for all swivel models.

Wheel Types



Cushionex Supreme
Black soft rubber tread molded to black hard rubber core.



Poly II Urethane
Dark blue polyurethane tread molded to light gray polypropylene core.



Spartan Supreme
Black hard rubber tread molded to black hard rubber core.



Durafoam
Black molded polypropylene.



Duratex Phenolic
Black phenolic resin reinforced with macerated fabric.

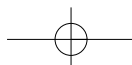

Low Profile Medium Duty Casters

Wheel Dia. (In.)	Tread Width (In.)	Load Capacity (Lbs.)	Wheel Bearing Type	Overall Height (In.)	Swivel Radius (In.)	Swivel Weight (Lbs.)	Swivel Pack Qty. Small/Large	Swivel Caster Part No.	Rigid Weight (Lbs.)	Rigid Pack Qty. Small/Large	Rigid Caster Part No.
PLATE CASTERS											
CUSHIONEX SUPREME DUAL WHEEL (Soft Rubber All Black)											
2	13/16 ea.	150	Delrin	2-15/16	1-7/8	1-1/2	44/40	1F58027040001**	1-1/2	44/40	1F53027040001**
2-1/2	13/16 ea.	175	Delrin	3-1/2	2-7/32	1-3/4	28	1F58077040001**	1-5/8	28	1F53077040001**
3	13/16 ea.	250	Delrin	3-7/8	2-1/4	1-3/4	24	1F58037040001**	1-3/4	24	1F53037040001**
POLY II URETHANE SINGLE WHEEL (Blue Polyurethane Tread on Gray Polyolefin Hub)											
3	1-3/4	250	Standard Ball	3-7/8	2-1/4	2	24	1F5803A250001**	1-1/2	24	1F5303A250001**
3	1-3/4	450	Precision Ball	3-7/8	2-1/4	2	24	1F5803K250001**	1-1/2	24	1F5303K250001**
SPARTAN SUPREME DUAL WHEEL (Hard Rubber All Black)											
2	13/16 ea.	200	Delrin	2-15/16	1-7/8	1-1/2	44/40	1F58027090001**	1-1/2	44/40	1F53027090001**
2-1/2	13/16 ea.	300	Delrin	3-1/2	2-7/32	1-3/4	28	1F58077090001**	1-5/8	28	1F53077090001**
3	13/16 ea.	350	Delrin	3-7/8	2-1/4	1-3/4	24	1F58037090001**	1-3/4	24	1F53037090001**
DURAFOAM SINGLE WHEEL (Polyolefin All Black)											
2-1/2	1-3/4	300	Plain	3-1/2	2-7/32	1-1/2	28	1F58070270001**	1-1/4	28	1F53070270001**
3	1-3/4	350	Sintered	3-7/8	2-1/4	1-1/2	24	1F58030270001**	1-1/2	24	1F53030270001**
3	1-3/4	350	Roller	3-7/8	2-1/4	1-1/2	24	1F58034270001**	1-1/2	24	1F53034270001**
DURATEX SINGLE WHEEL (Phenolic Resin All Black)											
2-1/2	1-3/4	300	Roller	3-1/2	2-7/32	1-3/4	28	1F58074380001**	1-1/2	28	1F53074380001**
2-5/8	1-3/4	350	Roller	3-9/16	2-1/4	1-3/4	28	1F58014380001**	1-5/8	28	1F53014380001**
3	1-13/16	500	Roller	3-7/8	2-1/4	2-1/4	24	1F5803438HD01**	1-3/4	24	1F5303438HD01**
STEM CASTERS											
CUSHIONEX SUPREME DUAL WHEEL (Soft Rubber All Black)											
2	13/16 ea.	150	Delrin	2-3/4	1-7/8	1-1/2	48	1F59027040001**			
2-1/2	13/16 ea.	175	Delrin	3-3/8	2-7/32	1-3/4	40	1F59077040001**			
3	13/16 ea.	250	Delrin	3-3/4	2-1/4	1-3/4	32	1F59037040001**			
POLY II URETHANE SINGLE WHEEL (Blue Polyurethane Tread on Gray Polyolefin Hub)											
3	1-3/4	250	Standard Ball	3-3/4	2-1/4	2	32	1F5903A250001**			
3	1-3/4	450	Precision Ball	3-3/4	2-1/4	2	32	1F5903K250001**			
SPARTAN SUPREME DUAL WHEEL (Hard Rubber All Black)											
2	13/16 ea.	200	Delrin	2-3/4	1-7/8	1-1/2	48	1F59027090001**			
2-1/2	13/16 ea.	300	Delrin	3-3/8	2-7/32	1-3/4	40	1F59077090001**			
3	13/16 ea.	350	Delrin	3-3/4	2-1/4	1-3/4	32	1F59037090001**			
DURAFOAM SINGLE WHEEL (Polyolefin All Black)											
2-1/2	1-3/4	300	Plain	3-3/8	2-7/32	1-1/2	40	1F59070270001**			
3	1-3/4	350	Sintered	3-3/4	2-1/4	1-1/2	32	1F59030270001**			
3	1-3/4	350	Roller	3-3/4	2-1/4	1-1/2	32	1F59034270001**			
DURATEX SINGLE WHEEL (Phenolic Resin All Black)											
2-1/2	1-3/4	300	Roller	3-3/8	2-7/32	1-3/4	40	1F59074380001**			
2-5/8	1-3/4	350	Roller	3-7/16	2-1/4	1-3/4	40	1F59014380001**			
3	1-13/16	500	Roller	3-3/4	2-1/4	2-1/4	32	1F5903438HD01**			

** NOTE: For your mount choice, replace ** in part number with mount code number shown in mount choices.

**** Code Number Mounting Options**

Small Plate

	Overall Size:	2-3/4" x 3-3/4"
	Hole Spacing:	1-3/4" x 2-5/8" to 3"
	Hole Diameter:	11/32" x 1/2" slots
	Bolt Diameter:	5/16"

Large Plates

	Overall Size:	3-1/8" x 4-1/8"
	Hole Spacing:	1-3/4" x 3" to 2-3/8" x 3-3/8"
	Hole Diameter:	3/8" x 3/4" slots
	Bolt Diameter:	5/16"

	Overall Size:	3-3/4" x 4-5/8"
	Hole Spacing:	2-5/8" x 3-5/8" to 3" x 3"
	Hole Diameter:	3/8" x 3/4" slots
	Bolt Diameter:	5/16"

Stems

Size	Stem Type	Stem #
3/8-16 x 1"	Threaded	04
3/8-16 x 1-1/2"	Threaded	07
7/16" x 1-3/8"	Friction Ring	01
7/16-14 x 1-1/2"	Threaded	05
1/2-13 x 3/4"	Threaded	06
1/2-13 x 1"	Threaded	61
1/2-13 x 1-1/2"	Threaded	10
1/2-13 x 2-1/2" (leveling)	Threaded	18



Other stem sizes available upon request. Minimum Order Quantities

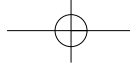

Medium-Heavy Duty Casters

Medium-Heavy Duty Swivel, Total-Lock, 4-Position Swivel-Lock and Rigid Plate Casters

MADE IN U.S.A.



STANDARD FEATURES

- Ideal for mobile tool chests and work benches, platform and stock trucks, carts and dollies, laundry and refuse hampers and trucks, and more.
- Bright chromed zinc finish.
- Roller bearing wheel and 1/2" nut and bolt axle with grease zerk fitting.
- All swivel casters have a unique upper race which also serves as a dust cover to block out contaminants.
- Swivel caster with total lock brake simultaneously locks brake and swivel.
- 4-Position Swivel Lock, locks the caster in 90° increments to become a temporary rigid casters.
- The load capacity is exceptional for a top plate with bolt hole spacing of 1-3/4" x 3!"



OPTIONS

Thread Guards



Wheel Types



Poly II Rubber
Black thermoplastic rubber tread molded to gray polypropylene core.



Poly II Urethane
Red polyurethane tread molded to gray polypropylene core.



Poly II Poly
Black polypropylene tread molded to black polypropylene core.



Duratex
Black phenolic resin reinforced with macerated fabric.

E.R.Wagner
CASTERS & WHEELS Manufacturing Co.

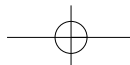

Medium-Heavy Duty Casters

Wheel Dia. (In.)	Tread Width (In.)	Load Capacity (Lbs.)	Wheel Bearing Type	Overall Height (In.)	Swivel Radius (In.)	Swivel Weight (Lbs)	Swivel Pack Qty.	Swivel Caster Part No.	Rigid Weight (Lbs.)	Rigid Pack Qty.	Rigid Caster Part No.
SWIVEL & RIGID PLATE CASTERS.											
POLY II RUBBER WHEEL (GRAY THERMOPLASTIC Rubber Tread on Gray Polyolefin Hub)											
4	2	300	Roller	5-5/8	4	3.6	12	4F8804C260001**	3	12	4F8304C260001**
5	2	350	Roller	6-1/2	4-1/8	4	10	4F8805C260001**	3-1/2	10	4F8305C260001**
6	2	400	Roller	7-1/2	4-5/8	4.5	8	4F8806C260001**	4	8	4F8306C260001**
POLY II URETHANE WHEEL (Red Polyurethane Tread on Gray Polyolefin Hub)											
4	2	600	Roller	5-5/8	4	3.6	12	4F8804C250001**	3	12	4F8304C250001**
5	2	650	Roller	6-1/2	4-1/8	4	10	4F8805C250001**	3-1/2	10	4F8305C250001**
6	2	700	Roller	7-1/2	4-5/8	4.5	8	4F8806C250001**	4	8	4F8306C250001**
POLY II POLY WHEEL (Polyolefin All Black)											
4	2	600	Roller	5-5/8	4	3.6	12	4F8804C270001**	3	12	4F8304C270001**
5	2	650	Roller	6-1/2	4-1/8	4	10	4F8805C270001**	3-1/2	10	4F8305C270001**
6	2	700	Roller	7-1/2	4-5/8	4.5	8	4F8806C270001**	4	8	4F8306C270001**
DURATEX WHEEL (Phenolic Resin All Black)											
4	2	600	Roller	5-5/8	4	4	12	4F88044380001**	3-1/2	12	4F83044380001**
5	2	650	Roller	6-1/2	4-1/8	4.6	10	4F88054380001**	4	10	4F83054380001**
6	2	700	Roller	7-1/2	4-5/8	5.4	8	4F88064380001**	4-3/4	8	4F83064380001**
Wheel Dia. (In.)	Tread Width (In.)	Load Capacity (Lbs.)	Wheel Bearing Type	Overall Height (In.)	Swivel Radius (In.)	Total-Lock Weight (Lbs.)	Total-Lock Pack Qty.	Total-Lock Caster Part No.	4-Position Swivel-Lock Weight (Lbs.)	4-Position Swivel-Lock Pack Qty.	4-Position Swivel Caster Part No.
TOTAL-LOCK & 4-POSITION SWIVEL-LOCK PLATE CASTERS											
POLY II RUBBER WHEEL (GRAY THERMOPLASTIC Rubber Tread on Gray Polyolefin Hub)											
4	2	300	Roller	5-5/8	5-1/2	4	12	4F8804C260071**	4	12	4F8804C2600D1**
5	2	350	Roller	6-1/2	5-1/2	4.5	10	4F8805C260071**	4-1/2	10	4F8805C2600D1**
6	2	400	Roller	7-1/2	5-1/2	5	8	4F8806C260071**	5	8	4F8806C2600D1**
POLY II URETHANE WHEEL (Red Polyurethane Tread on Gray Polyolefin Hub)											
4	2	600	Roller	5-5/8	5-1/2	4	12	4F8804C250071**	4	12	4F8804C2500D1**
5	2	650	Roller	6-1/2	5-1/2	4.5	10	4F8805C250071**	4-1/2	10	4F8805C2500D1**
6	2	700	Roller	7-1/2	5-1/2	5	8	4F8806C250071**	5	8	4F8806C2500D1**
POLY II POLY WHEEL (Polyolefin All Black)											
4	2	600	Roller	5-5/8	5-1/2	4	12	4F8804C270071**	4	12	4F8804C2700D1**
5	2	650	Roller	6-1/2	5-1/2	4.5	10	4F8805C270071**	4-1/2	10	4F8805C2700D1**
6	2	700	Roller	7-1/2	5-1/2	5	8	4F8806C270071**	5	8	4F8806C2700D1**
DURATEX WHEEL (Phenolic Resin All Black)											
4	2	600	Roller	5-5/8	5-1/2	4.5	12	4F88044380071**	4-1/2	12	4F880443800D1**
5	2	650	Roller	6-1/2	5-1/2	5	10	4F88054380071**	5	10	4F880543800D1**
6	2	700	Roller	7-1/2	5-1/2	5.5	8	4F88064380071**	5-1/2	8	4F880643800D1**

* Swivel Radius represents a swivel caster with Total Lock Brake (Non Brake versions will be less).** NOTE: For your plate choice, replace ** in part number with plate code number shown in top plate choices.

**** Code Number Top Plate Choices**

Small Plate



Overall Size: 2-3/4" x 3-3/4"
 Hole Spacing: 1-3/4" x 2-7/8" to 3"
 Hole Diameter: 11/32" x 13/32" slots
 Bolt Diameter: 5/16"

Large Plate



Overall Size: 4" x 4-5/8"
 Hole Spacing: 2-5/8" x 3-5/8" to 3" x 3"
 Hole Diameter: 3/8" x 3/4" slots
 Bolt Diameter: 3/8"

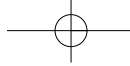

Heavy Duty Casters

Heavy Duty Swivel, Total-Lock, 4-Position Swivel-Lock and Rigid Plate Casters

STANDARD FEATURES

- Double row swivel construction with extra large raceways for long service life.
- 1/2" dia. nut & bolt grease fitting axle.
- Zinc-plated finish for corrosion resistance and appearance.
- 1/4" thick steel top plate and welded leg construction.
- 3/4" dia. swivel kingpin rivet.



MADE IN U.S.A.



SWIVEL WITH TOTAL-LOCK BRAKE

- Foot-operated lever simultaneously locks wheel and swivel.
- Upward pressure on lever releases brakes.

SWIVEL WITH 4-POSITION SWIVEL LOCK

- Caster swivel locks in 90° increments.
- Downward pressure on lever engages lock; upward pressure releases lock.

OPTIONS

Side Pinch Type Wheel Brake



Grease Seals



Upper and/or Lower Swivel Raceway
(Total-Lock and Four-Position Swivel Lock available only with upper seal).

NSF Certified Casters Available



Finishes

Yellow Chromate Zinc

- Withstands 100 hrs. salt spray corrosion test.

Blue Powder Coat

- Withstands 750 hrs. salt spray corrosion test.



Thread Guards



Wheel Types



Mold-On Rubber
Black soft rubber tread bonded to a cast aluminum core.



Poly II Rubber
Black thermoplastic rubber tread molded to light gray polypropylene core.



Poly II Urethane
Red polyurethane tread molded to light gray polypropylene core.



Mold-On Polyurethane
Red polyurethane tread molded to an aluminum core.



Poly II Poly
Black polypropylene tread molded to black polypropylene core.



Duratex
Black phenolic resin reinforced with macerated fabric.



Semi-Steel
Cast iron enriched with steel.

** Code Number Top Plate Choices

Small Plate

Overall Size: 4" x 4-5/8"
Hole Spacing: 2-5/8" x 3-5/8" to 3" x 3"
Hole Diameter: 3/8" x 3/4" slots
Bolt Diameter: 3/8"

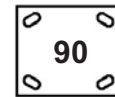

Large Plate

Overall Size: 5" x 5-1/2"
Hole Spacing: 4-1/8" x 4-1/2"
Hole Diameter: 25/64"
Bolt Diameter: 3/8"

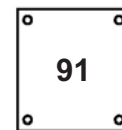

E.R. Wagner
CASTERS & WHEELS Manufacturing Co.

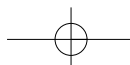

Heavy Duty Casters

Wheel Dia. (In.)	Tread Width (In.)	Load Capacity (Lbs.)	Wheel Bearing Type	Overall Height (In.)	Swivel Radius (In.)	Swivel Weight (Lbs.)	Swivel Pack Qty. Small/Large	Swivel Caster Part No.	Rigid Weight (Lbs.)	Rigid Pack Qty. Small/Large	Rigid Caster Part No.
SWIVEL & RIGID PLATE CASTERS											
MOLD-ON RUBBER WHEEL											
4	2	300	Roller	5-5/8	3-7/16	5-3/4	10/6	1F88045140001**	4-1/4	10/6	1F83045140001**
5	2	350	Roller	6-1/2	4-1/8	6-1/4	8/6	1F88055140001**	4-1/2	8/6	1F83055140001**
6	2	410	Roller	7-1/2	4-7/8	6-3/4	6/4	1F88065140001**	5-1/4	6/4	1F83065140001**
8	2	500	Roller	9-1/2	6-1/8	8-1/4	4	1FA8085140001**	6-1/2	4	1F83085140001**
POLY II RUBBER WHEEL											
4	2	300	Roller	5-5/8	3-7/16	5	10/6	1F8804C260001**	3-1/2	10/6	1F8304C260001**
5	2	325	Roller	6-1/2	4-1/8	5-3/4	8/6	1F8805C260001**	4	8/6	1F8305C260001**
6	2	400	Roller	7-1/2	4-7/8	6-1/4	6/4	1F8806C260001**	4-3/4	6/4	1F8306C260001**
8	2	475	Roller	9-1/2	6-1/8	7-1/2	4	1FA808C260001**	5-3/4	4	1F8308C260001**
POLY II POLY WHEEL											
4	2	400	Roller	5-5/8	3-7/16	5	10/6	1F8804C270001**	3-1/2	10/6	1F8304C270001**
5	2	750	Roller	6-1/2	4-1/8	5-3/4	8/6	1F8805C270001**	4	8/6	1F8305C270001**
6	2	900	Roller	7-1/2	4-7/8	6-1/4	6/4	1F8806C270001**	4-3/4	6/4	1F8306C270001**
8	2	900	Roller	9-1/2	6-1/8	7-1/2	4	1FA808C270001**	5-3/4	4	1F8308C270001**
POLY II URETHANE WHEEL											
4	2	600	Roller	5-5/8	3-7/16	5	10/6	1F8804C250001**	3-1/2	10/6	1F8304C250001**
5	2	750	Roller	6-1/2	4-1/8	5-3/4	8/6	1F8805C250001**	4	8/6	1F8305C250001**
6	2	900	Roller	7-1/2	4-7/8	6-1/4	6/4	1F8806C250001**	4-3/4	6/4	1F8306C250001**
8	2	900	Roller	9-1/2	6-1/8	7-1/2	4	1FA808C250001**	5-3/4	4	1F8308C250001**
MOLD-ON POLYURETHANE WHEEL											
4	2	750	Roller	5-5/8	3-7/16	5-3/4	10/6	1F88045250001**	4-1/4	10/6	1F83045250001**
5	2	1050	Roller	6-1/2	4-1/8	7-1/2	8/6	1F88055250001**	5-3/4	8/6	1F83055250001**
6	2	1200	Roller	7-1/2	4-7/8	8	6/4	1F88065250001**	6-1/2	6/4	1F83065250001**
8	2	1200	Roller	9-1/2	6-1/8	8-3/4	4	1FA8085250001**	7	4	1F83085250001**
DURATEX WHEEL											
3-1/4	2	700	Roller	5-1/4	3-1/16	5-1/4	10/6	1F880A4380801**	3-3/4	10/6	1F830A4380801**
4	2	800	Roller	5-5/8	3-7/16	5-3/4	10/6	1F88044380001**	4-1/4	10/6	1F83044380001**
4 (H)	2	600	Roller	5-5/8	3-7/16	5-3/4	10/6	1F88044340001**	4-1/4	10/6	1F83044340001**
5	2	1000	Roller	6-1/2	4-1/8	6	8/6	1F88054380001**	4-1/4	8/6	1F83054380001**
5 (H)	2	750	Roller	6-1/2	4-1/8	6	8/6	1F88054340001**	4-1/4	8/6	1F83054340001**
6	2	1200	Roller	7-1/2	4-7/8	7	6/4	1F88064380001**	5-1/2	6/4	1F83064380001**
6 (H)	2	900	Roller	7-1/2	4-7/8	7	6/4	1F88064340001**	5-1/2	6/4	1F83064340001**
8	2	1200	Roller	9-1/2	6-1/8	9	4	1FA8084380001**	7-1/4	4	1F83084380001**
SEMI-STEEL WHEEL											
4	2	1000	Roller	5-5/8	3-7/16	9	10/6	1F88044110001**	7-1/2	10/6	1F83044110001**
5	2	1000	Roller	6-1/2	4-1/8	9-1/2	8/6	1F88054110001**	7-3/4	8/6	1F83054110001**
6	2	1200	Roller	7-1/2	4-7/8	10	6/4	1F88064110001**	8-1/2	6/4	1F83064110001**
8	2	1200	Roller	9-1/2	6-1/8	14	4	1FA8084110001**	12-1/4	4	1F83084110001**
TOTAL-LOCK & 4-POSITION SWIVEL-LOCK CASTERS											
Wheel Dia. (In.)	Tread Width (In.)	Load Capacity (Lbs.)	Wheel Bearing Type	Overall Height (In.)	Total-Lock Radius (In.)	Total-Lock Weight (Lbs.)	Total-Lock Pack Qty. Small/Large	4-Position Caster Part No.	4-Position Weight (Lbs.)	4-Position Pack Qty. Small/Large	4-Position Caster Part No.
MOLD-ON RUBBER WHEEL											
5	2	350	Roller	6-1/2	5-1/8	7	8/6	1F88055140071**	7	8/6	1F880551400D1**
6	2	410	Roller	7-1/2	5-1/8	8-1/2	6/4	1F88065140071**	8-1/2	6/4	1F880651400D1**
8	2	500	Roller	9-1/2	6-1/8	9	4	1FA8085140071**	9	4	1FA80851400D1**
POLY II RUBBER WHEEL											
5	2	325	Roller	6-1/2	5-1/8	6-1/2	8/6	1F8805C260071**	6-1/2	8/6	1F8805C2600D1**
6	2	400	Roller	7-1/2	5-1/8	8	6/4	1F8806C260071**	8	6/4	1F8806C2600D1**
8	2	475	Roller	9-1/2	6-1/8	8-1/2	4	1FA808C260071**	8-1/2	4	1FA808C2600D1**
POLY II POLY WHEEL											
5	2	650	Roller	6-1/2	5-1/8	6-1/2	8/6	1F8805C270071**	6-1/2	8/6	1F8805C2700D1**
6	2	700	Roller	7-1/2	5-1/8	8	6/4	1F8806C270071**	8	6/4	1F8806C2700D1**
8	2	900	Roller	9-1/2	6-1/8	8-1/2	4	1FA808C270071**	8-1/2	4	1FA808C2700D1**
POLY II URETHANE WHEEL											
5	2	750	Roller	6-1/2	5-1/8	6-1/2	8/6	1F8805C250071**	6-1/2	8/6	1F8805C2500D1**
6	2	900	Roller	7-1/2	5-1/8	8	6/4	1F8806C250071**	8	6/4	1F8806C2500D1**
8	2	900	Roller	9-1/2	6-1/8	8-1/2	4	1FA808C250071**	8-1/2	4	1FA808C2500D1**
MOLD-ON POLYURETHANE WHEEL											
5	2	1050	Roller	6-1/2	5-1/8	7-1/2	8/6	1F88055250071**	7-1/2	8/6	1F880552500D1**
6	2	1200	Roller	7-1/2	5-1/8	8	6/4	1F88065250071**	8	6/4	1F880652500D1**
8	2	1200	Roller	9-1/2	6-1/8	9-1/2	4	1FA8085250071**	9-1/2	4	1FA80852500D1**
DURATEX WHEEL											
5	2	1000	Roller	6-1/2	5-1/8	6-3/4	8/6	1F88054380071**	6-3/4	8/6	1F880543800D1**
6	2	1200	Roller	7-1/2	5-1/8	7-3/4	6/4	1F88064380071**	7-3/4	6/4	1F880643800D1**
8	2	1200	Roller	9-1/2	6-1/8	9-1/2	4	1FA8084380071**	9-1/2	4	1FA80843800D1**
SEMI-STEEL WHEEL											
5	2	1000	Roller	6-1/2	5-1/8	10-1/4	8/6	1F88054110071**	10-1/4	8/6	1F880541100D1**
6	2	1200	Roller	7-1/2	5-1/8	11-3/4	6/4	1F88064110071**	11-3/4	6/4	1F880641100D1**
8	2	1200	Roller	9-1/2	6-1/8	14-3/4	4	1FA8084110071**	14-3/4	4	1FA80841100D1**

** NOTE: For your plate choice, replace ** in part number with plate code number shown in top plate choices. - (H) High temperature phenolic wheel.

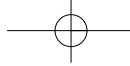

Specialty Casters

Cart & Tool Box Casters

MADE IN U.S.A.



STANDARD FEATURES SERIES 1F38 AND 1F30

- **Medium duty applications.**
- **Double row swivel construction.**
- **Zinc-plated finish for corrosion resistance and appearance.**
- **3/8" diameter nut and bolt axle.**



Wheel Dia. (In.)	Tread Width (In.)	Load Rating (Lbs.)	Wheel Bearing	Overall Height (In.)	Swivel Radius (In.)	Approximate Weight (Lbs.)	Swivel Caster Pack Qty.	Swivel Caster Part No.	Rigid Caster Pack Qty.	Rigid Caster Part No.
CUSHIONEX SUPREME WHEEL										
5	2	350	Delrin	6	4-3/16	4	16	1F3805004000100	16	1F3005004000100
POLY II RUBBER WHEEL										
5	2	350	Delrin	6	4-3/16	2-3/4	16	1F3805B26000100	16	1F3005B26000100
SPARTAN SUPREME WHEEL										
5	2	375	Delrin	6	4-3/16	3-3/4	16	1F3805009000100	16	1F3005009000100
DURAFOAM WHEEL										
5	2	375	Plain	6	4-3/16	2-3/4	16	1F3805027000100	16	1F3005027000100
POLY II URETHANE WHEEL										
5	2	375	Delrin	6	4-3/16	2-3/4	16	1F3805B25000100	16	1F3005B25000100
DURATEX WHEEL										
5	2	375	Roller	6	4-3/16	3-3/4	16	1F3805438000100	16	1F3005438000100

Wheel Types

 <p>Cushionex Supreme Black soft rubber tread molded to black hard rubber core.</p>	 <p>Spartan Supreme Black hard rubber tread molded to black hard rubber core.</p>	 <p>Poly II Urethane Red polyurethane tread molded to light gray polypropylene core.</p>
 <p>Poly II Rubber Black thermoplastic rubber tread molded to light gray polypropylene core.</p>	 <p>Durafoam (Solid) Black molded polypropylene.</p>	 <p>Duratex Black phenolic resin reinforced with macerated fabric.</p>

Top Plate

Overall Size: 2-3/4" x 3-3/4"
 Hole Spacing: 1-3/4" x 3"
 Hole Diameter: 11/32"
 Bolt Diameter: 5/16"



Ro-To Fix Spring Cup Casters

STANDARD FEATURES

- **Attaches to wooden cabinets and furniture bases.**
- **Very low profile.**
- **Recesses into predrilled hole.**
- **No tools needed for installation.**



Overall Rim Dia. (In.)	Hole Dia. (In.)	Load Capacity (Lbs.)	Insertion Depth (In.)	Material Thickness (In.)	Wheel Tread Material	Overall Height (In.)	Pack Qty.	Part No.
4-3/32	3-3/8	165	3/4	0.063	Nylon Tread	3/4	30	W9035ABLXFTCXXX
4-3/32	3-3/8	165	3/4	0.063	Urethane Tread	3/4	30	W9035QLXFTCXXX

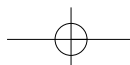

Specialty Casters

Pneumatic Wheel Casters

STANDARD FEATURES

PNEUMATIC WHEEL CASTERS

- **Double row swivel construction with extra large raceways for long service life.**
- **Full pneumatic wheel gives a cushioned ride to protect delicate loads. Provides very quiet operation and superior protection for floors.**

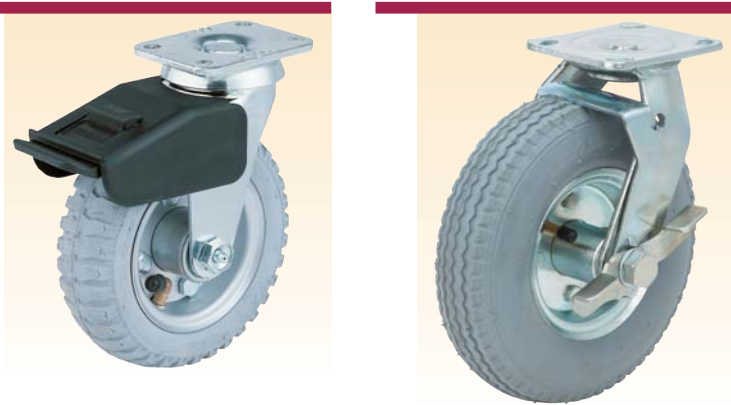

Wheel Dia. (In.)	Tread Width (In.)	Load Capacity (Lbs.)	Wheel Bearing Type	Overall Height (In.)	Swivel Radius* (In.)	Approximate Weight (Lbs.)†	All Caster Pack Qty.	Swivel Caster Part No.	Swivel w/Brake Total-Lock (6") Strap Brake (8")	Rigid Caster Part No.
FULLY PNEUMATIC SOFT TREAD WHEEL/STEEL HUB (SILVER HUB/GRAY TREAD)										
6	2	200	Ball	7-1/2	5-1/2	4-1/2	8	4FN8062540001AR	4FN8062540071AR	4FN3062540001AR
6	2	200	Ball	7-1/2	5-1/2	5	8	4FN806254000190	4FN806254007190	4FN306254000190
8	2.80/2.50-4	300	Ball	10	7	7	4	8FN808254000190	8FN808254005190	8FN308254000190
10	4.10/3.10-4	350	Ball	11-13/16	7-5/8	7-1/2	2	8FN80T254000190	N/A	8FN30T254000190

(* Swivel Radius on the 6" represents a swivel caster with Total-Lock Brake (Non Brake versions will be less).

† Weight represents a swivel caster (Brake version will be 1/2 lb. more and Rigid will be 1/2 lb. less).

Small Plate

Overall Size: 2-3/4" x 3-3/4"
 Hole Spacing: 1-3/4" x 2-7/8" to 3"
 Hole Diameter: 11/32" x 13/32" slots
 Bolt Diameter: 5/16"

Large Plate

Overall Size: 4" x 4-1/2"
 Hole Spacing: 2-5/8" x 3-5/8" to 3" x 3"
 Hole Diameter: 3/8" x 3/4" slots
 Bolt Diameter: 3/8"

Plate choices same for both Series

Foam Filled Wheel Casters

STANDARD FEATURES

FOAM FILLED WHEEL CASTERS

- **Double row swivel construction with extra large raceways for long service life.**
- **Foam filled wheel gives a cushioned ride to protect delicate loads. Provides very quiet operation and superior protection for floors. Tires won't go flat.**

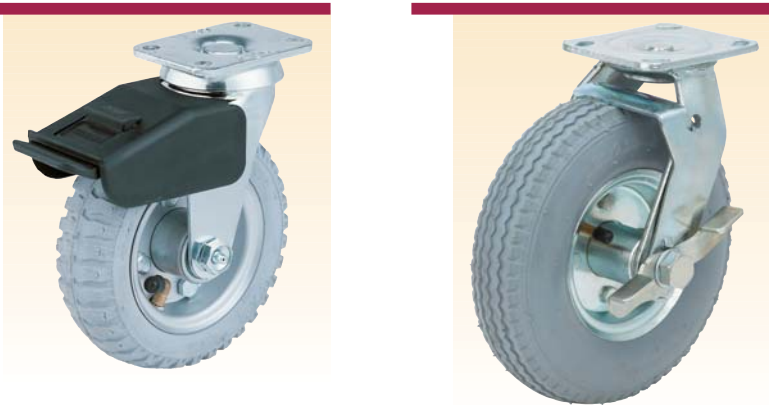

Wheel Dia. (In.)	Tread Width (In.)	Load Capacity (Lbs.)	Wheel Bearing Type	Overall Height (In.)	Swivel Radius* (In.)	Approximate Weight (Lbs.)†	All Caster Pack Qty.	Swivel Caster Part No.	Swivel w/Brake Total-Lock (6") Strap Brake (8")	Rigid Caster Part No.
FOAM FILLED SOFT TREAD WHEEL/STEEL HUB (SILVER HUB/GRAY TREAD)										
6	2	200	Ball	7-1/2	5-1/2	4-1/2	8	4FN8062610001AR	4FN8062610071AR	4FN3062610001AR
6	2	200	Ball	7-1/2	5-1/2	5	8	4FN806261000190	4FN806261007190	4FN306261000190
8	2.80/2.50-4	300	Ball	10	7	7	4	8FN808261000190	8FN808261005190	8FN308261000190
10	4.10/3.10-4	350	Ball	11-13/16	7-5/8	7-1/2	2	8FN80T261000190	N/A	8FN30T261000190

(* Swivel Radius on the 6" represents a swivel caster with Total-Lock Brake (Non Brake versions will be less).

† Weight represents a swivel caster (Brake version will be 1/2 lb. more and Rigid will be 1/2 lb. less).

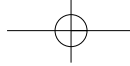

Speciality Casters

Low Profile Utility Swivel Casters

STANDARD FEATURES

- Light duty for low profile applications.
- Top ball bearing raceway.
- 1/4" diameter rivet axle.
- Zinc-plated finish for corrosion resistance and appearance.



Top Plate		
	Overall Size:	1-3/16" x 1-3/4"
	Hole Spacing:	13/16" x 1-3/8"
	Hole Diameter:	3/16"

TYPICAL APPLICATIONS

- Light Home Furniture
- Humidifiers
- Canister Vacuums
- Planter Dollies

Wheel Dia. (In.)	Tread Width (In.)	Load Capacity (Lbs.)	Wheel Bearing Type	Overall Height (In.)	Swivel Radius (In.)	Weight (Lbs.)	Pack Qty.	Caster Part No.
CUSHIONEX SUPREME WHEEL (Soft Rubber All Black)								
1-1/4	1/2	20	Delrin	1-7/16	1-1/16	1/2	150	9FL25E0040001T1
DURAFOAM WHEEL (Polyolefin All Black)								
1-1/4	1/2	20	Plain	1-7/16	1-1/16	1/2	150	9FL25E1270001T1

Low Profile Rigid Casters

STANDARD FEATURES

- Light duty for low profile applications.
- 1/4" diameter rivet axle.
- Zinc-plated finish for corrosion resistance and appearance.



TYPICAL APPLICATIONS

- Day Beds
- Studio Couches
- Camper Door Guards

Wheel Dia. (In.)	Tread Width (In.)	Load Rating (Lbs.)	Wheel Color	Overall Height (In.)	Mounting Plate (In.)	Weight (Lbs.)	Pack Qty.	Caster Part No.
CUSHIONEX SUPREME WHEEL (Soft Rubber All Black)								
1-5/8	11/16	60	Black	1-11/16	1-3/16 x 1-7/16	1/4	100	9F405B00400012H
2	3/4	75	Black	2-1/16	1-3/16 x 1-7/16	1/4	100	9F4052D0400012H
SPARTAN SUPREME WHEEL (Hard Rubber All Black)								
2	3/4	75	Black	2-1/16	1-3/16 x 1-7/16	1/4	100	9F4052D0900012H
DURAFOAM WHEEL (Polyolefin)								
1-5/8	11/16	60	White	1-11/16	1-3/16 x 1-7/16	1/4	100	9F405BN2700012H
1-5/8	11/16	60	Black	1-11/16	1-3/16 x 1-7/16	1/4	100	9F405B12700012H
2	3/4	75	Black	2-1/16	1-3/16 x 1-7/16	1/4	100	9F405212700012H

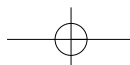

Speciality Casters

Gate Casters

STANDARD FEATURES

- Gate casters are designed to help make gates and doors perform easier.
- Casters have a side mounting plate.
- Multiple mounting plates for various applications.
- Casters have a clear zinc finish

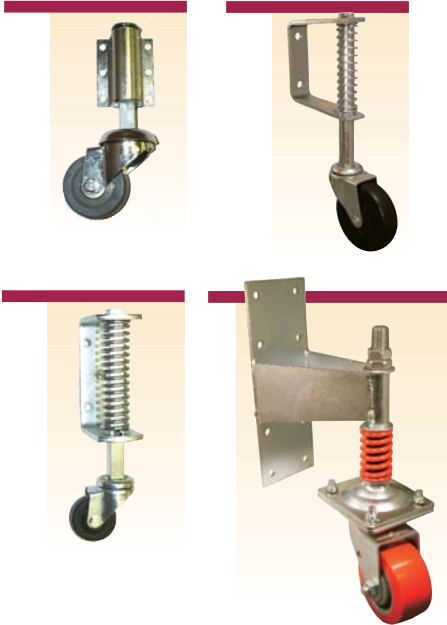

Mounting Options

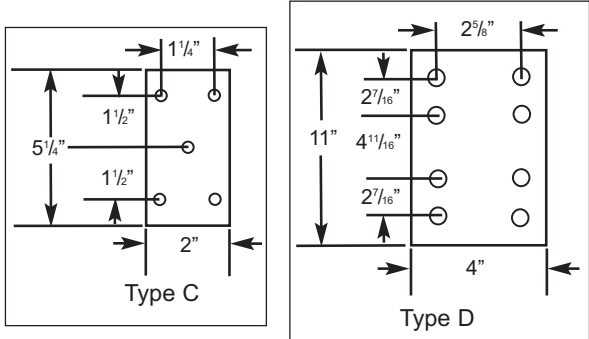
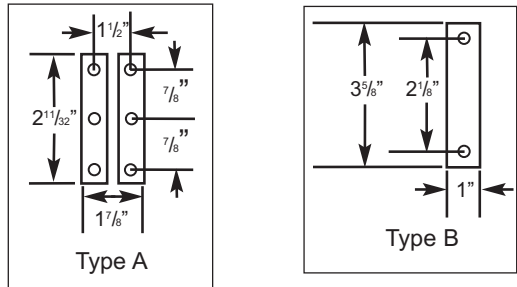

Wheel Dia. (In.)	Tread Width (In.)	Load Capacity (Lbs.)	Overall Height (In.)	Wheel Material	Approximate Weight (Lbs.)	Maximum Compression Force (Lbs.)	Maximum Spring Deflection (In.)	Mount Plate Type	Caster Weight (Lbs.)	Caster Pack Qty.	Part Number
2	13/16	75	2-1/2	TPR Rubber	1	38	7/8	A	1	4	8F4902A260001GAR
3	13/16	100	3-9/16	Soft Rubber	2-1/8	28	2	B	2	4	9F49530040001GBR
3	13/16	125	3-9/16	Hard Rubber	2-1/8	28	2	B	2	4	9F49530090001GBR
2	13/16	100	2-1/2	Hard Rubber	3-1/4	100	1-3/4	C	3-1/2	4	9F49520090001GCR
3	13/16	125	3-9/16	Hard Rubber	3-1/2	100	1-3/4	C	3-3/4	4	9F49530090001GCR
4	2	600	5-5/8	Polyurethane	11-3/4	180	7/8	D	11-3/4	2	4F8804B250001GDR
5	2	700	6-1/2	Polyurethane	12-1/2	180	7/8	D	14-1/4	2	4F8805B250001GDR
6	2	700	7-1/2	Polyurethane	13-1/8	180	7/8	D	15	2	4F8806B250001GDR
8	2	700	9-1/2	Polyurethane	14-1/4	180	7/8	D	16-1/4	2	8W8808B250001GDR

Scaffolding Casters

STANDARD FEATURES

- Double row swivel construction.
- Zinc-plated finish for corrosion resistance and appearance.
- Each caster has a Total-Lock Brake.
- Fits standard scaffolding structures.



Type A Stem
1.25" x 4" square stem
w/7/16" hole located 2-1/2" up

Type B Stem
1.25" x 2-1/2" round stem
w/7/16" hole located 1" up

Type C Stem
1.0475" x 2-3/4" round stem
w/7/16" hole located 1-1/4" up

Wheel Dia. (In.)	Tread Width (In.)	Load Capacity (Lbs.)	Overall Height (In.)	Caster Finish	Wheel Material	Swivel Radius (In.)	Mount Stem Type	Caster Weight (Lbs.)	Caster Pack Qty.	Caster Part Number
5	1-1/4	240	6-9/32	Zinc	Soft Rubber	4-1/4	A	4-1/2	16	1FC955004007173R
5	1-1/4	240	6-1/4	Zinc	Soft Rubber	4-1/4	B	4-1/8	4	1FC9550040071ZYR
5	1-1/4	240	6-1/4	Zinc	Soft Rubber	4-1/4	C	3-1/2	4	1FC955004087173R

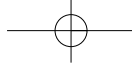

Furniture Casters

Light Duty Plate & Stem Furniture Casters

MADE IN U.S.A.



STANDARD FEATURES

- **Light duty for general use.**
- **Double row swivel construction.**
- **1/4" diameter rivet axle.**
- **Zinc-plated finish for corrosion resistance and appearance.**



OPTIONS
(9F48 Series only)

Wheel Brake



- Side mount pinch type wheel brake available for all swivel models (except Semi Steel).

Wheel Types



Cushionex Supreme
Black soft rubber tread molded to black hard rubber core.



Poly II Rubber
Gray thermoplastic rubber tread molded to black polypropylene core.



Spartan Supreme
Black hard rubber tread molded to black hard rubber core.



Durafoam (Dished)
Black molded polypropylene.



Sintered Metal
Powdered iron compacted and sintered.

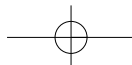





Furniture Casters

Wheel Dia. (In.)	Tread Width (In.)	Load Capacity (Lbs.)	Wheel Bearing Type	Overall Height (In.)	Swivel Radius (In.)	Swivel Weight (Lbs.)	Swivel Pack Qty.	Swivel Caster Part No.
PLATE CASTERS								
CUSHIONEX SUPREME WHEEL (Soft Rubber All Black)								
2	13/16	75	Delrin	2-5/8	1-7/8	1/2	52	9F48520040001**
2-1/2	13/16	90	Delrin	3-3/16	2-1/8	1/2	40	9F48570040001**
3	13/16	100	Delrin	3-11/16	2-1/2	3/4	28	9F48530040001**
POLY II RUBBER WHEEL (GRAY THERMOPLASTIC Rubber Tread on Black Polyolefin Hub)								
2	13/16	75	Plain	2-5/8	1-7/8	1/2	52	9F4852P260001**
2-1/2	13/16	90	Plain	3-3/16	2-1/8	1/2	40	9F4857P260001**
3	13/16	100	Plain	3-11/16	2-1/2	3/4	28	9F4853P260001**
SPARTAN SUPREME WHEEL (Hard Rubber All Black)								
2	13/16	100	Delrin	2-5/8	1-7/8	1/2	52	9F48520090001**
2-1/2	13/16	115	Delrin	3-3/16	2-1/8	1/2	40	9F48570090001**
3	13/16	125	Delrin	3-11/16	2-1/2	3/4	28	9F48530090001**
DURAFoAM WHEEL (Polyolefin All Black)								
2	3/4	100	Plain	2-5/8	1-7/8	1/2	52	9F48521270001**
2-1/2	13/16	115	Plain	3-3/16	2-1/8	1/2	40	9F48571270001**
3	3/4	125	Plain	3-11/16	2-1/2	1/2	28	9F48531270001**
SINTERED METAL WHEEL (All Silver)								
2	15/16	125	Plain	2-5/8	1-7/8	3/4	52	9F48520110001**
STEM CASTERS								
CUSHIONEX SUPREME WHEEL (Soft Rubber All Black)								
2	13/16	75	Delrin	2-1/2	1-7/8	1/2	52	9F49520040001**
2-1/2	13/16	90	Delrin	3-1/16	2-1/8	1/2	40	9F49570040001**
3	13/16	100	Delrin	3-9/16	2-1/2	3/4	28	9F49530040001**
POLY II RUBBER WHEEL (GRAY THERMOPLASTIC Rubber Tread on Black Polyolefin Hub)								
2	13/16	75	Plain	2-1/2	1-7/8	1/2	52	9F4952P260001**
2-1/2	13/16	90	Plain	3-1/16	2-1/8	1/2	40	9F4957P260001**
3	13/16	100	Plain	3-9/16	2-1/2	3/4	28	9F4953P260001**
SPARTAN SUPREME WHEEL (Hard Rubber All Black)								
2	13/16	100	Delrin	2-1/2	1-7/8	1/2	52	9F49520090001**
2-1/2	13/16	115	Delrin	3-1/16	2-1/8	1/2	40	9F49570090001**
3	13/16	125	Delrin	3-9/16	2-1/2	3/4	28	9F49530090001**
DURAFoAM WHEEL (Polyolefin All Black)								
2	3/4	100	Plain	2-1/2	1-7/8	1/2	52	9F49521270001**
2-1/2	3/4	115	Plain	3-1/16	2-1/8	1/2	40	9F49571270001**
3	3/4	125	Plain	3-9/16	2-1/2	1/2	28	9F49531270001**
LADDER STEM CASTERS								
CUSHIONEX SUPREME WHEEL (Soft Rubber All Black)								
2	13/16	75	Delrin	2-1/2	1-11/16	1/2	125	8F4952004000180
3	13/16	100	Delrin	3-1/2	2-9/16	3/4	100	8F4953004000180
DURAFoAM WHEEL (Polyolefin All Black)								
2	3/4	100	Plain	2-1/2	1-7/8	1/2	125	8F4952127000180
3	3/4	125	Plain	3-9/16	2-1/2	1/2	100	8F4953127000180

** NOTE: For your mount choice, replace ** in part number with code number shown in mount choices.

**** Code Number Mounting Options**

Plates

	Overall Size: 1-3/16" x 2" Hole Spacing: 13/16" x 1-9/16" Hole Diameter: 1/4" Bolt Diameter: #10 Screw
	Overall Size: 1-29/32" x 2-5/8" Hole Spacing: 15/16" x 2-1/8" Hole Diameter: 9/32" Bolt Diameter: 1/4"
	Overall Size: 1-29/32" x 2-5/8" Hole Spacing: 1-13/32" x 2-1/8" Hole Diameter: 13/64" Bolt Diameter: 3/16"
	Overall Size: 1-7/8" x 2-5/8" Hole Spacing: 31/32" x 1-7/8" Hole Diameter: 1/4" Bolt Diameter: #10 Screw

Stems

Size	Stem Type	Stem #
5/16" x 1-9/16"	Grip Neck	22
5/16-18 x 3/4"	Threaded	84
5/16-18 x 1"	Threaded	17
5/16-18 x 1-1/2"	Threaded	08
5/16-18 x 4.936" (ladder)	Threaded	80
3/8" x 1-5/8"	Grip Neck	55
3/8-16 x 1/2"	Threaded	71
3/8-16 x 1"	Threaded	04
3/8-16 x 1-1/4"	Threaded	59
3/8-16 x 1-1/2"	Threaded	07
7/16" x 1"	Friction Ring	12
7/16" x 1-3/8"	Friction Ring	01
7/16" 1-29/32"	Friction Ring	03
7/16" x 1-29/32"	Round	02
1/2-13 x 1"	Threaded	61
1/2-13 x 1-1/2"	Threaded	10

Other stem sizes available upon request. Minimum Order Quantities



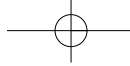

Furniture Casters

Hooded Twin Wheel Swivel Casters

- **Meets or exceeds Industry Seating Standards**
(2" & 2-1/2" only)
- **Furniture & Displays**
- **Office Equipment**



Wheel Dia. (In.)	Caster Width (In.)	Load Rating (Lbs.)	Wheel Color	Caster Finish	Wheel Material	Overall Height (In.)	Caster Weight (Lbs.)	Pack Qty.	Caster Type	Part Numbers
1-5/8	1-9/16	40	Black	Black	Nylon	1-15/16	1/4	150	Swivel	TX040ABLX***XXX
1-5/8	1-9/16	40	Black	Black	Nylon	2-1/4	1/4	150	Swivel w/Brake	TX040ABLX***1XX
2	1-13/16	75	Black	Black	Nylon	2-7/16	1/3	150	Swivel	TX050ABLX***XXX
2	1-13/16	75	Black	Black	Nylon	2-5/8	1/3	150	Swivel w/Brake	TX050ABLX***1XX
2	1-13/16	75	Black	Black	Urethane	2-7/16	1/3	150	Swivel	TX050QBBX***XXX
2	1-13/16	75	Black	Black	Urethane	2-5/8	1/3	150	Swivel w/Brake	TX050QBBX***1XX
2-1/2	2	90	Black	Black	Nylon	2-3/4	1/2	100	Swivel	TX060ABLX***XXX
2-1/2	2	90	Black	Black	Nylon	2-15/16	1/2	100	Swivel w/Brake	TX060ABLX***1XX

Plates

	Overall Size: 1-1/4" x 1-5/8" Hole Spacing: 7/8" x 1-1/4" Hole Diameter: 3/16" Available on 1-5/8" wheel only
	Overall Size: 1-1/2" x 1-1/2" Hole Spacing: 1" x 1" Hole Diameter: 9/32"
	Overall Size: 1-3/16" x 2" Hole Spacing: 13/16" x 1 9/16" Hole Diameter: 1/4"

*** Code Number Mounting Options

Stems

Size	Stem Type	Stem #	Size	Stem Type	Stem #
5/16" x 1-9/16"	Grip Neck	A70	3/8-16 x 1"	Threaded	K16
5/16-18 x 3/4"	Threaded	M12	3/8-16 x 1-1/4"	Threaded	K20
5/16-18 x 1"	Threaded	M16	3/8-16 x 1-3/4"	Threaded	K28
3/8" x 1-5/8"	Grip Neck	B70	7/16" x 7/8"	Friction Ring	D14
3/8" x 1"	Friction Ring	G16	7/16" x 1-1/4"	Friction Ring	D20
3/8-16 x 3/4"	Threaded	K12	7/16" x 1-3/8"	Friction Ring	D22



Hooded Ball Casters

STANDARD FEATURES

- **Meets or Exceeds Industry Seating Standards**
- **1/4" diameter rivet axle.**
- **Chrome-plated finish for corrosion resistance and appearance.**



Plate

Overall Size: 1-3/16" x 2" Hole Spacing: 13/16" x 1-9/16" Hole Diameter: 1/4" Bolt Diameter: #10 Screw	
---	--

** Code Number Mounting Options

Stems

Size	Stem Type	Stem #	Size	Stem Type	Stem #
5/16" x 1-9/16"	Grip Neck	22	3/8-16 x 1"	Threaded	04
5/16-18 x 3/4"	Threaded	84	7/16" x 1"	Friction Ring	12
5/16-18 x 1"	Threaded	17	7/16" x 1-3/8"	Friction Ring	01
3/8-16 x 3/4"	Threaded	24			



Wheel Dia. (In.)	Tread Width (In.)	Load Capacity (Lbs.)	Wheel Bearing	Overall Height (In.)	Swivel Radius (In.)	Swivel Weight (Lbs.)	Swivel Pack Qty	Swivel Part No.
CUSHIONEX SUPREME WHEEL (Soft Rubber All Black)								
2	Ball	75	Sintered	2-11/16	1-7/8	1/2	52	9F7852004000292
VINYL WHEEL (All Black)								
2	Ball	100	Sintered	2-11/16	1-7/8	1/2	52	9F7852027000292
CUSHIONEX SUPREME WHEEL (Soft Rubber All Black)								
2	Ball	75	Sintered	2-5/8	1-7/8	1/2	52	9F79520040002**
VINYL WHEEL (All Black)								
2	Ball	100	Sintered	2-5/8	1-7/8	1/2	52	9F79520270002**

** NOTE: For your stem choice, replace ** in part number with stem code number shown in stem choices.

E.R. Wagner
CASTERS & WHEELS Manufacturing Co.

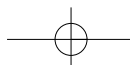

Hooded Twin Wheel Chair Casters

STANDARD FEATURES

- Meets or exceeds Industry Seating Standards
- Sold in packs of 5



Wheel Dia. (In)	Caster Width (In)	Caster Capacity (Lbs)	Barrel Dia. (In)	Overall Height (In)	Wheel Material	5-Pack Weight (Lbs)	5-Pack Qty.	Chair Caster Part No.
2-3/16	2-1/8	75	1-1/2	2-9/16	Nylon	1-1/4	23	8FTS55611112587R
2-3/16	2-1/8	75	1-3/4	2-9/16	Nylon	1-1/2	23	8FTS55611114587R
2-3/16	2-1/8	75	1-1/2	2-9/16	Polyurethane	1-1/4	23	8FTS55612112587R
2-3/16	2-1/8	75	1-3/4	2-9/16	Polyurethane	1-1/2	23	8FTS55612114587R



Open Twin Wheel Casters

TYPICAL APPLICATIONS

- Medical Equipment
- Displays
- Office Equipment
- Store Fixtures
- Institutional Furniture



Wheel Dia. (In)	Caster Width (In)	Load Rating (Lbs)	Wheel Color	Caster Finish	Wheel Material	Overall Height (In)	Caster Weight (Lbs)	Pack Qty.	Caster Type	Part Numbers
2-1/2	2-5/16	90	Black	Black	Nylon	2-3/4	1/2	40	Swivel	O0060ABLX***XXX
2-1/2	2-5/16	90	Black	Black	Nylon	2-3/4	1/2	40	Swivel w/Brake	O0060ABLX***1XX
3	2-7/16	125	Black	Black	Nylon	3-3/16	5/8	35	Swivel	O0075ABLX***XXX
3	2-7/16	125	Black	Black	Nylon	3-3/16	5/8	35	Swivel w/Brake	O0075ABLX***1XX
4	2-15/16	140	Black	Black	Nylon	4-1/4	1	30	Swivel	O0100ABLX***XXX
4	2-15/16	140	Black	Black	Nylon	4-1/4	1	30	Swivel w/Brake	O0100ABLX***1XX
5	3-7/16	150	Black	Black	Nylon	5-5/16	1-1/4	20	Swivel	O0125ABLX***XXX
5	3-7/16	150	Black	Black	Nylon	5-5/16	1-1/4	20	Swivel w/Brake	O0125ABLX***1XX
2-1/2	2-5/16	90	Black	Black	Urethane	2-3/4	1/2	40	Swivel	O0060QBBX***XXX
2-1/2	2-5/16	90	Black	Black	Urethane	2-3/4	1/2	40	Swivel w/Brake	O0060QBBX***1XX
3	2-7/16	125	Black	Black	Urethane	3-3/16	5/8	35	Swivel	O0075QBBX***XXX
3	2-7/16	125	Black	Black	Urethane	3-3/16	5/8	35	Swivel w/Brake	O0075QBBX***1XX
4	2-15/16	140	Black	Black	Urethane	4-1/4	1	30	Swivel	O0100QBBX***XXX
4	2-15/16	140	Black	Black	Urethane	4-1/4	1	30	Swivel w/Brake	O0100QBBX***1XX
5	3-7/16	150	Black	Black	Urethane	5-5/16	1-1/4	20	Swivel	O0125QBBX***XXX
5	3-7/16	150	Black	Black	Urethane	5-5/16	1-1/4	20	Swivel w/Brake	O0125QBBX***1XX

Stem casters overall heights are 3/16" higher than plate casters.

Plates

	Overall Size: 1-1/2" x 1-1/2" Hole Spacing: 1" x 1" Hole Diameter: 9/32" 2-1/2" & 3" Only
	Overall Size: 1-3/4" x 3" Hole Spacing: 1-1/16" x 2-1/4" Hole Diameter: 9/32"
	Overall Size: 2-1/8" x 2-1/2" Hole Spacing: 1-5/8" x 2" Hole Diameter: 5/16"

***** Code Number Mounting Options**

Stems

Size	Stem Type	Stem #
5/16" x 1-9/16"	Grip Neck 2-1/2" & 3" Only	A10
3/8-16 x 1"	Threaded Not on 5"	K16
7/16" x 1-3/8"	Friction Ring	D22
1/2-13" x 1"	Threaded 4" & 5" Only	H16



Replace the *** with the Plate or Stem Code Number to achieve the final part number.

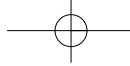

Furniture Casters

Powder Coated Drum Dollies

MADE IN U.S.A.



STANDARD FEATURES

- Heavy duty steel construction.
- Spotwelded for extra strength.
- Gray powder coat enamel finish.
- The five outriggered casters provide a wider stance and shorter distance between wheels for extra stability.
- Polypropylene and semi-steel wheels are impervious to fat, acid, and grease.
- Optional sixth caster part numbers:

Polypropylene:
3 x 1-1/4"
2F9803027000100
5 x 2"
1F3805027000100
Semi-steel:
2F9803011000100

Four Wheel Drum Dolly



(2F000249890E)

Five Wheel Drum Dolly



(2F004378790)

Optional Sixth Caster Location

Drum Size (Gal.)	Dolly Model Number	Dolly Capacity (Lbs.)	Overall Height (In.)	Inside Dimension (In.)	Outside Dimensions (In.)	Wheel Type	Wheel Size (In.)	Replacement Caster Pack Number
FOUR WHEEL DRUM DOLLIES								
30	2F000249990E	1000	6-1/2	19-1/8	19-1/2	Polyolefin	3 x 1-1/4	2J000247894
55	2F000249890E	1000	6-1/2	23-1/8	23-1/2	Polyolefin	3 x 1-1/4	2J000247894
FIVE WHEEL DRUM DOLLIES								
55	2F004378690E	1250	6-1/2	23-1/8	23-1/2	Polyolefin	3 x 1-1/4	2J000273294
55	2F004378790E	1400	6-1/2	23-1/8	23-1/2	Semi-Steel	3 x 1	2J000270294

STANDARD FEATURES

- Heavy duty steel construction.
 - Spotwelded for extra strength.
 - 304 stainless steel material.
 - The five outriggered casters provide a wider stance and shorter distance between wheels for extra stability.
 - Polypropylene wheels are impervious to fat, acid, and grease.
 - Choice of stainless steel and zinc plated casters.
 - Optional zinc sixth caster part numbers:
- Polypropylene 3" x 1-1/4":**
2F9803027000100
Polypropylene 5" x 2":
1F3805027000100
- Optional stainless steel sixth caster part number:
Polypropylene 3" x 1-1/4":
7F08A3127080FAM

Stainless Steel Drum Dollies

Four Wheel Drum Dolly



(7F004454894E)

Five Wheel Drum Dolly



(1F004455394E)

Optional Sixth Caster Location

Drum Size (Gal.)	Dolly Model Number	Dolly Capacity (Lbs.)	Overall Height (In.)	Inside Dimension (In.)	Outside Dimensions (In.)	Wheel Size (In.)	Caster Type	Replacement Caster Pack Number
FOUR WHEEL DRUM DOLLIES								
30	7F004454894E	800	6-1/2	19-1/8	19-1/2	3 x 1-1/4	Stainless Steel	7J030373594
55	7F004454994E	800	6-1/2	23-1/8	23-1/2	3 x 1-1/4	Stainless Steel	7J030373594
55	2F004455094E	800	6-1/2	23-1/8	23-1/2	3 x 1-1/4	Clear zinc	2J000385594
FIVE WHEEL DRUM DOLLIES								
55	7F004455194E	1100	6-1/2	23-1/8	23-1/2	3 x 1-1/4	Stainless Steel	7J030373694
55	2F004455294E	1100	6-1/2	23-1/8	23-1/2	3 x 1-1/4	Clear zinc	2J000385694
55	1F004455394E	1100	8-3/4	23-1/8	23-1/2	5 x 2	Clear zinc	1J000374694

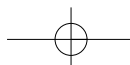

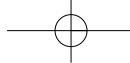

Sockets

Plastic Sockets For Round & Square Tubes

Tube O.D.	Tube Gauge	Caster Stem	Style	Part Number Natural	Part Number Black
3/4" Round	16 Ga.	5/16 Grip Neck	Top Swivel	N/A	SKTA1216BRDXP
3/4" Square	16 Ga.	5/16 Grip Neck	Top Swivel	N/A	SKTA1216BSQXP
3/4" Round	18 Ga.	5/16 Grip Neck	Top Swivel	SKTA1218NRD	SKTA1218BRD
3/4" Round	18 Ga.	5/16 Grip Neck	Top Swivel	N/A	SKTA1218BSQ
3/4" Square	18 Ga.	3/8 Friction Ring	Top Swivel	N/A	SKTB1218BSQXP
7/8" Round	22 Ga.	5/16 Grip Neck	Top Swivel	SKTA1422NRD	N/A
1" Square	16 Ga.	5/16 Grip Neck	Top Swivel	SKTA1616NSQ	SKTA1616BSQ
1" Square	16 Ga.	3/8 Friction Ring	Top Swivel	SKTB1616NSQ	SKTB1616BSQ
1" Round	17 Ga.	5/16 Grip Neck	Top Swivel	SKTA1617NRD	N/A
1" Round	18 Ga.	5/16 Grip Neck	Top Swivel	SKTA1618NRD	SKTA1618BRD
1" Round	18 Ga.	3/8 Friction Ring	Top Swivel	SKTB1618NRD	SKTB1618BRD
1" Square	18 Ga.	5/16 Grip Neck	Top Swivel	N/A	SKTA1618BSQ
1" Square	18 Ga.	3/8 Friction Ring	Top Swivel	SKTB1618NSQ	SKTB1618BSQ
1" Square	18 Ga.	7/16 Friction Ring	Top Swivel	SKTD1618NSQ	SKTD1618BSQ
1" Square	18 Ga.	7/16 Round	Top Swivel	N/A	SKTE1618BSQ
1" Round	19 Ga.	3/8 Friction Ring	Top Swivel	N/A	SKTB1619BRD
1" Round	20 Ga.	5/16 Grip Neck	Top Swivel	SKTA1620NRD	SKTA1620BRD
1" Round	22 Ga.	7/16 Round	Open Top	N/A	SKTE1622BRD
1-1/4" Round	18 Ga.	5/16 Grip Neck	Top Swivel	SKTA2018NRD	SKTA2018BRD



Wood Applications • Straight Holes • Wing Brackets

Metal Sockets For Wood Applications

Hole Size	Caster Stem	Style	Part Number Unplated
3/8"	5/16 Grip Neck	Top Swivel	SKT44RAWHT

Metal Sockets

Hole Size	Caster Stem	Style	Part Number Unplated
9/16"	7/16 Friction Ring	Top Swivel	SKT23RAW

Plastic Sockets For Straight Holes

Hole Size.	Caster Stem	Style	Part Number Natural	Part Number Black
3/8"	1/4 Friction Ring	Top Swivel	SKTPP33N	N/A
7/16"	5/16 Grip Neck	Top Swivel	SKT46N	SKT46B
7/16"	5/16 Grip Neck	Top Swivel	SKTR51248T	N/A
1/2"	3/8 Grip Neck	Top Swivel	SKT19N	N/A
1/2"	3/8-16 Threaded	Threaded	N/A	SKT49B
5/8"	7/16 Friction Ring	Top Swivel	SKT22N	N/A
9/16"	7/16 Friction Ring	Top Swivel	SKT38NXHD	N/A



** Approximate size - Actual size should be determined by customer

Specials - Metal Wing Brackets

Socket I.D.	Style	Caster Stem	Angle (Degrees)	Part Number Un-Plated
35-20 X 90 Bracket	Open Top	7/16 Friction Ring	90° Corner	WNG352090RAW0
35-20 X 180 Bracket	Open Top	7/16 Friction Ring	180° Flat	HM005019594

Metal Sockets

Tube O.D.	Caster Stem	Style	Tube Gauge	Part Number Plated
7/8" Round	7/16 Round	Top Swivel	18 Ga.	SKT28Z
1" Round	7/16 Round	Top Swivel	16 Ga.	SKT30Z
1" Round	7/16 Round	Top Swivel	18 Ga.	SKT31Z
1" Round	7/16 Round	Top Swivel	20 Ga.	SKT32Z

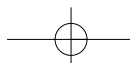

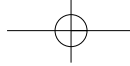

Drum Dollies

Selecting a Wheel

WHEEL MATERIAL COMPARISONS																							
WHEEL TYPE	TREAD HARDNESS	LOAD CAPACITY RANGE (LBS.)	TEMPERATURE RANGE	FLOOR SURFACES										OPERATING CONDITIONS									
				CARPET	BRICK	CONCRETE	LINOLEUM	ASPHALT	TERRAZZO	WOOD	STEEL, SMOOTH	STEEL, RIBBED	TILE	WATER	STEAM	MILD CHEMICALS	OIL & GREASE	METAL CHIPS	HIGH HEAT (+250°F)	EXTREME COLD (-10°F)	ANIMAL FATS	NOISE REDUCTION	FLOOR PROTECTION
2 PIECE WHEEL - TREAD IS BONDED, MOLDED OR MECHANICALLY LOCKED TO A CORE (TREAD / CORE MATERIAL)																							
Fully Pneumatic / Metal	Soft	200 - 350	-45° F to 180°F	X	X	X	X	X	X	X	X	X	X	X	X	X	X	X	X	X	X	X	X
Soft Rubber / Hard Rubber		75 - 350	-45° F to 125°F	X	X	X	X	X	X	X	X	X	X	X	X	X	X	X	X	X	X	X	X
TPR (Thermoplastic Rubber) / Polyolefin		75 - 475	-45° F to 180°F	X	X	X	X	X	X	X	X	X	X	X	X	X	X	X	X	X	X	X	X
Rubber / Aluminum		300 - 500	-45° F to 180°F	X	X	X	X	X	X	X	X	X	X	X	X	X	X	X	X	X	X	X	X
Polyurethane / Polyolefin		125 - 900	-45° F to 180°F	X	X	X	X	X	X	X	X	X	X	X	X	X	X	X	X	X	X	X	X
Polyurethane / Steel		1600 - 2000	-45° F to 180°F	X	X	X	X	X	X	X	X	X	X	X	X	X	X	X	X	X	X	X	X
Polyurethane / Aluminum		Hard	750 - 1350	-45° F to 180°F	X	X	X	X	X	X	X	X	X	X	X	X	X	X	X	X	X	X	X
1 PIECE SOLID MOLDED WHEEL																							
Nylon Twin Wheel	Hard	125 - 150	-45° F to 180°F	X	X	X					X	X	X	X	X	X	X	X	X	X	X	X	
All Hard Rubber		100 - 560	-45° F to 125°F	X	X	X					X			X	X	X			X			X	
Polypropylene (a.k.a.) Polyolefin		100 - 900	-45° F to 180°F	X	X	X	X					X			X	X	X			X	X		X
Phenolic Resin		250 - 1200	-45° F to 300°F	X	X	X					X	X			X	X	X	X	X	X	X		
High Temperature Phenolic & Nylon		300 - 900	-45° F to 475°F	X	X	X					X	X			X	X	X	X	X	X	X		
Semi-Steel / Cast Iron	Hardest	175 - 1400	-45° F to 500°F			X		X		X	X				X	X	X	X	X	X			

This chart is intended only as a general comparison, and not as a recommendation for any particular wheel in a specific application.

SOFT TREAD WHEELS

TPR Soft Rubber

Thermoplastic rubber tread wheel is molded and mechanically locked to a polypropylene plastic hub. It rolls easily and quietly. Comes in both flat and donut treads. Tread hardness: 65 to 75 Shore A.



Poly II Rubber

Durable wheel has a thermoplastic rubber tread molded and mechanically locked to a polypropylene plastic hub. It rolls easily and quietly. Tread hardness: 90 to 100 Shore A.



Cushionex Supreme

All-rubber wheel has a soft rubber tread integrally molded and bonded to a hard rubber core. It provides a cushioned ride and quiet operation. Tread hardness: 70 to 85 Shore A.



Mold-On Rubber

Soft rubber tread is permanently bonded to an aluminum hub. It provides quiet operation, absorbs shock, and protects floors. Tread hardness: 70 to 85 Shore A.



Soft tread wheels have lighter load ratings than equal size hard tread wheels. They roll quietly by absorbing floor surface imperfections which are normally transmitted through the caster. Soft tread wheels provide better swiveling action under light loads. They are recommended for:

- Light to medium loads
- Hard, uneven surfaces
- Quiet operation
- Frequent movement of loads
- Swiveling traction of light loads
- Applications where rolling ease is not critical

Wagner offers three standard soft tread wheels: Poly II Rubber, Cushionex Supreme, Mold-on Rubber, .

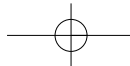

Selecting a Wheel

HARD TREAD WHEELS

Hard tread wheels have greater load ratings than soft tread wheels, primarily because hard treads do not flatten as easily. As a result, they roll with less effort, swivel easier under heavy loads and take less compression set. Hard tread wheels are recommended for:

- Rolling ease
- Light to heavy loads
- Seldom moved applications, either light or heavy
- Carpeted areas
- Outdoors
- When quiet operation is not critical

Wagner offers seven different types of standard hard tread wheels: Poly II Urethane, Mold-on Polyurethane, Durafoam, Poly II Poly, Spartan Supreme, Duratex Phenolic, and Semi-steel.

Poly II Urethane

Polyurethane tread molded and mechanically locked to a polypropylene plastic hub. Excellent floor protection and abrasion resistance, rolling ease, quiet operation, and resistance to water, acids, oil, and most chemicals. Tread hardness: 50 to 60 Shore D.



Mold-On Polyurethane

Polyurethane tread permanently molded and mechanically locked to an aluminum hub. It provides easy rolling, high load capacity, good floor protection, and long service life. Tread hardness: 50 to 60 Shore D.



Durafoam and Poly II Poly

Polyolefin compound that exhibits superior resistance to abrasion, compression set, acids, oils, grease, and impact. They provide easy rolling and good floor protection. Tread hardness: 75 to 85 Shore D.



Spartan Supreme

All-hard rubber compound. It rolls effortlessly and is an economical and versatile choice for many applications. Tread hardness: 75 to 85 Shore D.



Duratex

Molded of phenolic resin which is reinforced with fibrous material, generally canvas. It features a high load capacity and provides better floor protection than semi-steel wheels. Tread hardness: 102 Shore E.



Semi-Steel

Cast iron enriched with steel wheel. It rolls easily under heavy loads, has superior wear resistance, and takes shock impact well. It is not recommended where noise, shock protection of loads, or floor protection are of concern.



Wheel Bearings

Plain Bearings



Most economical bearings because the hub bore material functions as the bearing. Plain bearings are most common in plastic hub wheels because the plastic material has natural lubricative properties. They are ideal for corrosive applications, require infrequent or no oil lubrication, and wear well.

Delrin® Bearings



DuPont.

Made of an engineered plastic material press fit into the wheel hub bore. They are very durable, corrosion resistant, and typically require infrequent or no oil lubrication. Delrin is a registered trademark of

Ball Bearings



Flanged ball bearings provide optimum start-up and rolling ease. Ball bearing wheels are recommended for use with load capacities up to 250 lbs.

Roller Bearings



Carry a heavier load capacity and typically last longer than ball bearings. They provide good start-up and rolling ease and require periodic grease lubrication. Roller bearings have hardened rollers and are inserted into a hardened split outer race which is inserted into the wheel bore. Roller bearings for 2" tread wheels include a wheel spanner bushing, which is not required for most other tread widths.

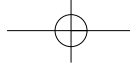

Wheels

Poly II Rubber Wheels

TPR Soft Rubber wheels are thermoplastic rubber treads bonded to polyolefin hubs. These wheels are ideal in food service and institutional applications. They provide a soft quiet cushioned ride that protects floors and are resistant to most solvents and chemicals. These wheels have superior rollability and

are ideal for handling heavy or bulky loads. They are a cost effective wheel that can be used in a variety of applications. These wheels come with a precision ball bearing, Delrin® bearing or a roller bearing. They come with a donut tread as well as a flat tread. Temperature range: -40°F to 180°F



Wheel Diameter (In.)	Tread Width (In.)	Load Capacity (Lbs.)	Tread Hardness	Tread/Hub Color	Bearing Type	Hub Width (In.)	Bore Size (In.)	Spanner Bushing Required	Axle Size (In.)	Wheel Part No.
SUPER SOFT POLY II RUBBER WHEEL - FLAT TREAD										
3	1	100	65-75 Shore A	Gray/Black	Plain	1-1/4	5-16	No	5-16	7G003222094
3	1-1/4	200	65-75 Shore A	Gray/Gray	Precision Ball	1-5/8	3/8	No	3/8	7G003226394
3	1-1/4	200	65-75 Shore A	Gray/Gray	Delrin®	1-1/2	1/2	Yes	3/8	7G003226494
3-1/2	1-1/4	250	65-75 Shore A	Gray/Gray	Precision Ball	1-5/8	3/8	No	3/8	7G003223394
3-1/2	1-1/4	250	65-75 Shore A	Gray/Gray	Delrin®	1-1/2	1/2	Yes	3/8	7G003226794
4	1	115	65-75 Shore A	Gray/Black	Plain	1-1/4	5-16	No	5-16	7G003222394
4	1-1/4	275	65-75 Shore A	Gray/Gray	Precision Ball	1-5/8	3/8	No	3/8	7G003223994
4	1-1/4	275	65-75 Shore A	Gray/Gray	Delrin®	1-1/2	1/2	Yes	3/8	7G003226894
5	1	125	65-75 Shore A	Gray/Black	Plain	1-1/4	5/16	No	5/16	7G003225194
5	1-1/4	300	65-75 Shore A	Gray/Gray	Precision Ball	1-5/8	3/8	No	3/8	7G003224594
5	1-1/4	300	65-75 Shore A	Gray/Gray	Delrin®	1-1/2	1/2	Yes	3/8	7G003226994
SUPER SOFT POLY II RUBBER WHEEL - DONUT TREAD										
3	1-1/4	175	65-75 Shore A	Gray/Gray	Delrin®	1-1/2	1/2	Yes	3/8	7G003229594
3-1/2	1-1/4	225	65-75 Shore A	Gray/Gray	Precision Ball	1-5/8	3/8	No	3/8	7G003223294
3-1/2	1-1/4	225	65-75 Shore A	Gray/Gray	Delrin®	1-1/2	1/2	Yes	3/8	7G003226694
4	1-1/4	250	65-75 Shore A	Gray/Gray	Precision Ball	1-5/8	3/8	No	3/8	7G003223794
4	1-1/4	250	65-75 Shore A	Gray/Gray	Delrin®	1-1/2	1/2	Yes	3/8	7G003223894
5	1-1/4	250	65-75 Shore A	Gray/Gray	Precision Ball	1-5/8	3/8	No	3/8	7G003224394
5	1-1/4	250	65-75 Shore A	Gray/Gray	Delrin®	1-1/2	1/2	Yes	3/8	7G003224494
5	2	325	65-75 Shore A	Gray/Gray	Plain	2-3/8	3/4	Yes	1/2	7G003230994
6	1-1/4	300	65-75 Shore A	Gray/Gray	Precision Ball	1-5/8	3/8	No	3/8	7G003227094
6	1-1/4	300	65-75 Shore A	Gray/Gray	Delrin®	1-1/2	1/2	Yes	3/8	7G003227194
6	2	450	65-75 Shore A	Gray/Gray	Plain	2-3/8	3/4	Yes	1/2	7G003231094
8	2	500	65-75 Shore A	Gray/Gray	Plain	2-3/8	3/4	Yes	1/2	7G003231194
POLY II RUBBER WHEEL										
3	1	125	90-100 Shore A	Dark Gray/Gray	Plain	1-1/8	5/16	No	5/16	1G003188594
3	1-1/4	210	90-100 Shore A	Dark Gray/Gray	Delrin®	1-27/64	5/16	No	5/16	1G003308194
3-1/2	1-1/4	250	90-100 Shore A	Dark Gray/Gray	Delrin®	1-1/2	3/8	No	3/8	1G003243794
4	1	135	90-100 Shore A	Dark Gray/Gray	Plain	1-1/8	5/16	No	5/16	1G003189494
4	1-1/4	275	90-100 Shore A	Dark Gray/Gray	Delrin®	1-27/64	5/16	No	5/16	1G003308494
4	1-1/4	275	90-100 Shore A	Dark Gray/Gray	Delrin®	1-1/2	3/8	No	3/8	1G003243494
4	1-1/2	275	90-100 Shore A	Dark Gray/Gray	Delrin®	1-1/2	3/8	No	3/8	1G003309794
4	1-1/2	275	90-100 Shore A	Dark Gray/Gray	Roller	1-1/2	3/8	No	3/8	1J003180094
4	2	300	90-100 Shore A	Black/Gray	Roller	2-3/16	3/4	Yes	1/2	1J003198094
5	1	145	90-100 Shore A	Dark Gray/Gray	Plain	1-1/8	5/16	No	5/16	1G003190394
5	1-1/4	280	90-100 Shore A	Dark Gray/Gray	Delrin®	1-27/64	5/16	No	5/16	1G003308894
5	1-1/4	300	90-100 Shore A	Dark Gray/Gray	Delrin®	1-1/2	3/8	No	3/8	1G003178394
5	1-1/2	300	90-100 Shore A	Dark Gray/Gray	Delrin®	1-1/2	3/8	No	3/8	1G003309494
5	1-1/2	300	90-100 Shore A	Dark Gray/Gray	Roller	1-1/2	3/8	No	3/8	1J003177394
5	2	325	90-100 Shore A	Black/Gray	Roller	2-3/16	3/4	Yes	1/2	1J003192594
6	1-1/2	300	90-100 Shore A	Dark Gray/Gray	Delrin®	1-1/2	3/8	No	3/8	1G003309094
6	1-1/2	300	90-100 Shore A	Dark Gray/Gray	Roller	1-1/2	3/8	No	3/8	1J003181294
6	2	400	90-100 Shore A	Black/Gray	Roller	2-3/16	3/4	Yes	1/2	1J003192794
8	2	475	90-100 Shore A	Black/Gray	Roller	2-3/16	3/4	Yes	1/2	1J003192994

(*) These wheels have a plain bore and can be fitted for Delrin®, or Roller Bearing.

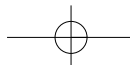

Wheels

Cushionex Supreme Wheels

Cushionex Supreme all rubber wheels consist of a black soft rubber tread molded to a black hard rubber core. Recommended for light to medium loads on hard surfaced floors, Cushionex wheels provide excellent load protection,

quiet operation, and absorb shock and vibration. Recommended operating temperature range is -20°F to 125°F.

Wheel Diameter (In.)	Tread Width (In.)	Load Capacity (Lbs.)	Tread Hardness	Tread/Hub Color	Bearing Type	Hub Width (In.)	Bore Size (In.)	Spanner Bushing Required	Axle Size (In.)	Wheel Part No.
2	Ball	75	70-85 Shore A	All Black	Sintered	—	1/4	No	1/4	1G003136794
2	13/16	75	70-85 Shore A	All Black	Delrin®	15/16	1/4	No	1/4	1G003109994
2	13/16	75	70-85 Shore A	All Black	Delrin®	15/16	3/8	No	3/8	1G003110394
2-1/2	13/16	90	70-85 Shore A	All Black	Delrin®	15/16	1/4	No	1/4	1G003111394
2-1/2	13/16	90	70-85 Shore A	All Black	Delrin®	15/16	3/8	No	3/8	1G003111794
2-1/2	1-1/8	120	70-85 Shore A	All Black	Delrin®	1-27/64	5/16	No	5/16	1G003105094
3	13/16	100	70-85 Shore A	All Black	Delrin®	15/16	1/4	No	1/4	1G003102694
3	13/16	100	70-85 Shore A	All Black	Delrin®	15/16	3/8	No	3/8	1G003103494
3	1	100	70-85 Shore A	All Black	Delrin®	1-1/8	5/16	No	5/16	1G003146194
3	1-1/4	125	70-85 Shore A	All Black	Delrin®	1-27/64	5/16	No	5/16	1G003106294
3-1/2	1-1/4	155	70-85 Shore A	All Black	Delrin®	1-1/2	3/8	No	3/8	1G003182194
4	1	115	70-85 Shore A	All Black	Delrin®	1-1/8	5/16	No	5/16	1G003100294
4	1-1/4	165	70-85 Shore A	All Black	Delrin®	1-27/64	5/16	No	5/16	1G003107494
4	1-1/4	165	70-85 Shore A	All Black	Delrin®	1-27/64	3/8	No	3/8	1G003182294
4	1-3/8	200	70-85 Shore A	All Black	Delrin®	1-1/2	3/8	No	3/8	1G003124094
4	1-3/8	200	70-85 Shore A	All Black	Roller	1-1/2	3/8	No	3/8	1J003125294
5	1	125	70-85 Shore A	All Black	Delrin®	1-1/8	5/16	No	5/16	1G003101494
5	1-1/4	190	70-85 Shore A	All Black	Delrin®	1-27/64	5/16	No	5/16	1G003108694
5	1-1/4	200	70-85 Shore A	All Black	Delrin®	1-1/2	3/8	No	3/8	1G003182394
5	1-3/8	240	70-85 Shore A	All Black	Delrin®	1-1/2	3/8	No	3/8	1G003124494
5	1-3/8	240	70-85 Shore A	All Black	Roller	1-1/2	3/8	No	3/8	1J003124894
5	2	350	70-85 Shore A	All Black	Delrin®	2-1/4	3/8	No	3/8	1G003169494
5	2	350	70-85 Shore A	All Black	Roller	2-1/4	3/8	No	3/8	1J003176394
6	1-3/8	280	70-85 Shore A	All Black	Delrin®	1-1/2	3/8	No	3/8	1G003126594
6	1-3/8	280	70-85 Shore A	All Black	Roller	1-1/2	3/8	No	3/8	1J003126994



Pneumatic & Foam Filled Wheels

Pneumatic and foam filled wheels give a cushioned ride to protect delicate loads. Quiet operation and superior protection for floors. Foam filled wheels

will never go flat. Three piece steel hub comes standard with zinc plating. Not intended for towing applications. Wheels are fully inflated at 50 P.S.I.

Wheel Diameter (In.)	Tread Width (In.)	Load Capacity (Lbs.)	Tread Type	Bearing Type	Hub Width (In.)	Bearing Bore Size (In.)	Spanner Bushing Required	Fits Axle Size (In.)	Wheel Part No.
GRAY PNEUMATIC WHEEL									
6	2	200	Knobby	Ball	3-1/4	3/4	Yes	1/2	8G003215594
8	2.80/2.50	300	Sawtooth	Ball	3-1/4	1/2	No	1/2	7G003280594
10	4.10/3.10	350	Sawtooth	Ball	3-1/4	1/2	No	1/2	7G003305794
GRAY FOAM FILLED WHEEL									
6	2	200	Knobby	Ball	3-1/4	3/4	Yes	1/2	8G003236594
8	2.80/2.50	300	Sawtooth	Ball	3-1/4	1/2	No	1/2	7G003280694
10	4.10/3.10	350	Sawtooth	Ball	3-1/4	1/2	No	1/2	?



Mold-On Rubber Wheels

Mold-on rubber wheels consist of a soft black rubber tread permanently bonded to an aluminum core. Recommended for light to medium loads on hard surfaced floors. Mold-on rubber wheels provide excellent floor and load protection, quiet operation,

and absorb shock and vibration. Recommended operating temperature range is -20°F to 160°F.

Wheel Diameter (In.)	Tread Width (In.)	Load Capacity (Lbs.)	Tread Hardness	Tread/Hub Color	Bearing Type	Hub Width (In.)	Bore Size (In.)	Spanner Bushing Required	Axle Size (In.)	Wheel Part No.
4	2	300	70-85 Shore A	Black/Aluminum	Roller	2-3/16	3/4	Yes	1/2	1J003144194
5	2	350	70-85 Shore A	Black/Aluminum	Roller	2-3/16	3/4	Yes	1/2	1J003164094
6	2	410	70-85 Shore A	Black/Aluminum	Roller	2-3/16	3/4	Yes	1/2	1J003163994
8	2	500	70-85 Shore A	Black/Aluminum	Roller	2-3/16	3/4	Yes	1/2	1J003163894



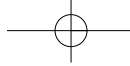

Wheels

Mold-On Polyurethane Wheels

Mold-on polyurethane wheels consist of a polyurethane tread molded and mechanically locked to an aluminum core. Recommended for medium to heavy loads on carpeted and hard surfaced floors. Mold-on polyurethane

wheels provide good floor protection, quiet operation, abrasion resistance, rolling ease, impact resistance, and are non-marking. Recommended operating temperature range is -20°F to 180°F.



Wheel Diameter (In.)	Tread Width (In.)	Load Capacity (Lbs.)	Tread Hardness	Tread/Hub Color	Bearing Type	Hub Width (In.)	Bore Size (In.)	Spanner Bushing Required	Axle Size (In.)	Wheel Part No.
4	2	750	50-60 Shore D	Red/Aluminum	Roller	2-3/16	3/4	Yes	1/2	1J003205494
4	2	750	50-60 Shore D	Blue/Aluminum	Roller	2-3/16	3/4	Yes	1/2	1J003205594
5	2	1050	50-60 Shore D	Red/Aluminum	Roller	2-3/16	3/4	Yes	1/2	1J003185794
5	2	1050	50-60 Shore D	Blue/Aluminum	Roller	2-3/16	3/4	Yes	1/2	1J003200794
6	2	1200	50-60 Shore D	Red/Aluminum	Roller	2-3/16	3/4	Yes	1/2	1J003185694
6	2	1200	50-60 Shore D	Blue/Aluminum	Roller	2-3/16	3/4	Yes	1/2	1J003200894
8	2	1350	50-60 Shore D	Red/Aluminum	Roller	2-3/16	3/4	Yes	1/2	1J003142794
8	2	1350	50-60 Shore D	Blue/Aluminum	Roller	2-3/16	3/4	Yes	1/2	1J003200994

Poly II Urethane Wheels

Poly II Urethane wheels are injection co-molded from a polyurethane tread molded and mechanically locked to polypropylene plastic core. Recommended for light to heavy loads on carpeted and hard surfaced floors. Poly II Urethane wheels provide excellent floor protection, abrasion resistance, rolling ease, good

impact strength, and quiet operation. They are non-marking, and resistant to water, oil, and most acids and chemicals. Recommended operating temperature range is -20°F to 180°F. Poly II Urethane wheels are available with plain, Delrin®, precision ball, or roller bearing. Special colors available in quantity.



Wheel Diameter (In.)	Tread Width (In.)	Load Capacity (Lbs.)	Tread Hardness	Tread/Hub Color	Bearing Type	Hub Width (In.)	Bore Size (In.)	Spanner Bushing Required	Axle Size (In.)	Wheel Part No.
3	1	125	50-60 Shore D	Blue/Gray	Plain	1-1/8	5/16	No	5/16	1G003188294
3	1-1/4	210	50-60 Shore D	Blue/Gray	Delrin®	1-27/64	5/16	No	5/16	1G003308094
3	1-1/4	210	50-60 Shore D	Blue/Gray	Delrin®	1-1/2	3/8	No	3/8	1G003310994
3-1/2	1-1/4	250	50-60 Shore D	Blue/Gray	Delrin®	1-1/2	3/8	No	3/8	1G003310494
3-1/2	1-1/4	250	50-60 Shore D	Gray/Gray	Precision Ball	1-1/2	3/8	No	3/8	7G003223194
4	1	140	50-60 Shore D	Blue/Gray	Plain	1-1/8	5/16	No	5/16	1G003189194
4	1	140	50-60 Shore D	Blue/Gray	Delrin®	1-1/8	5/16	No	5/16	1G003189294
4	1-1/4	250	50-60 Shore D	Gray/Gray	Precision Ball	1-1/2	3/8	No	3/8	7G003223594
4	1-1/4	275	50-60 Shore D	Blue/Gray	Delrin®	1-27/64	5/16	No	5/16	1G003308394
4	1-1/4	275	50-60 Shore D	Blue/Gray	Delrin®	1-1/2	3/8	No	3/8	1G003310094
4	1-1/2	375	50-60 Shore D	Blue/Gray	Delrin®	1-1/2	3/8	No	3/8	1G003309694
4	1-1/2	375	50-60 Shore D	Blue/Gray	Roller	1-1/2	3/8	No	3/8	1J003179694
4	2	600	50-60 Shore D	Red/Gray	Roller	2-3/16	3/4	Yes*	1/2	1J003198394
5	1	145	50-60 Shore D	Blue/Gray	Plain	1-1/8	5/16	No	5/16	1G003190094
5	1	145	50-60 Shore D	Blue/Gray	Delrin®	1-1/8	5/16	No	5/16	1G003190194
5	1-1/4	250	50-60 Shore D	Gray/Gray	Precision Ball	1-1/2	3/8	No	3/8	7G003224194
5	1-1/4	280	50-60 Shore D	Blue/Gray	Delrin®	1-27/64	5/16	No	5/16	1G003308794
5	1-1/4	300	50-60 Shore D	Blue/Gray	Delrin®	1-1/2	3/8	No	3/8	1G003177994
5	1-1/2	450	50-60 Shore D	Blue/Gray	Delrin®	1-1/2	3/8	No	3/8	1G003309394
5	1-1/2	450	50-60 Shore D	Blue/Gray	Roller	1-1/2	3/8	No	3/8	1J003176994
5	2	750	50-60 Shore D	Red/Gray	Roller	2-3/16	3/4	Yes*	1/2	1J003192694
6	1-1/2	450	50-60 Shore D	Blue/Gray	Delrin®	1-1/2	3/8	No	3/8	1G003308994
6	1-1/2	450	50-60 Shore D	Blue/Gray	Roller	1-1/2	3/8	No	3/8	1J003180894
6	2	900	50-60 Shore D	Red/Gray	Roller	2-3/16	3/4	Yes*	1/2	1J003192894
8	2	900	50-60 Shore D	Red/Gray	Roller	2-3/16	3/4	Yes*	1/2	1J003193094

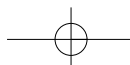

Spartan Supreme Wheels

Spartan Supreme all rubber wheels consist of all black solid hard rubber material. Recommended for light to heavy loads on carpeted and hard surfaced floors. Spartan Supreme wheels provide good rolling ease, are non-sparking,

and resistant to water, oil, and most acids. Recommended operating temperature range is -20°F to 125°F.

Wheel Diameter (In.)	Tread Width (In.)	Load Capacity (Lbs.)	Tread Hardness	Tread/Hub Color	Bearing Type	Hub Width (In.)	Bearing Bore Size (In.)	Spanner Bushing Required	Fits Axle Size (In.)	Wheel Part No.
2	Ball	100	70-85 Shore D	All Black	Sintered	—	1/4	No	1/4	1G003137994
2	13/16	100	70-85 Shore D	All Black	Delrin®	15/16	1/4	No	1/4	1G003110894
2	13/16	100	70-85 Shore D	All Black	Delrin®	15/16	3/8	No	3/8	1G003111094
2-1/2	13/16	115	70-85 Shore D	All Black	Delrin®	15/16	1/4	No	1/4	1G003112294
2-1/2	13/16	115	70-85 Shore D	All Black	Delrin®	15/16	3/8	No	3/8	1G003112494
2-1/2	1-1/8	175	70-85 Shore D	All Black	Delrin®	1-27/64	5/16	No	5/16	1G003105894
3	13/16	125	70-85 Shore D	All Black	Delrin®	15/16	1/4	No	1/4	1G003104294
3	13/16	125	70-85 Shore D	All Black	Delrin®	15/16	3/8	No	3/8	1G003104694
3	1	125	70-85 Shore D	All Black	Delrin®	1-1/8	5/16	No	5/16	1G003146794
3	1-1/4	210	70-85 Shore D	All Black	Delrin®	1-27/64	5/16	No	5/16	1G003107094
3-1/2	1-1/4	250	70-85 Shore D	All Black	Delrin®	1-1/2	3/8	No	3/8	1G003192194
4	1	140	70-85 Shore D	All Black	Delrin®	1-1/8	5/16	No	5/16	1G003101094
4	1-1/4	255	70-85 Shore D	All Black	Delrin®	1-27/64	5/16	No	5/16	1G003108294
4	1-1/4	255	70-85 Shore D	All Black	Delrin®	1-27/64	3/8	No	3/8	1G003192294
4	1-3/8	300	70-85 Shore D	All Black	Delrin®	1-1/2	3/8	No	3/8	1G003124294
4	1-3/8	300	70-85 Shore D	All Black	Delrin®	1-1/2	3/8	No	3/8	1J003129294
5	1	145	70-85 Shore D	All Black	Delrin®	1-1/8	5/16	No	5/16	1G003102294
5	1-1/4	280	70-85 Shore D	All Black	Delrin®	1-27/64	5/16	No	5/16	1G003109494
5	1-1/4	280	70-85 Shore D	All Black	Delrin®	1-1/2	3/8	No	3/8	1G003192394
5	1-1/4	280	70-85 Shore D	All Black	Delrin®	1-1/2	5/16	No	5/16	1G003165794
5	1-3/8	350	70-85 Shore D	All Black	Delrin®	1-1/2	3/8	No	3/8	1G003124694
5	1-3/8	350	70-85 Shore D	All Black	Roller	1-1/2	3/8	No	3/8	1J003125094
5	2	450	70-85 Shore D	All Black	Delrin®	2-1/4	3/8	No	3/8	1G003166094
5	2	450	70-85 Shore D	All Black	Roller	2-1/4	3/8	No	3/8	1J003174894
6	1-3/8	400	70-85 Shore D	All Black	Delrin®	1-1/2	3/8	No	3/8	1G003126794
6	1-3/8	400	70-85 Shore D	All Black	Roller	1-1/2	3/8	No	3/8	1J003129694



High Temperature Nylon Glass Filled Wheels

High temperature nylon glass filled wheels are manufactured from fiberglass and reinforced with nylon. Intended for high temperature applications and are non-marking, easy rolling, and have high impact resistance. Impervious to

acids, moisture, and harsh chemicals. Recommended operating temperature range is -20°F to 475°F - 550°F intermittent.

Wheel Diameter (In.)	Tread Width (In.)	Load Capacity (Lbs.)	Tread Hardness	Tread/Hub Color	Bearing Type	Hub Width (In.)	Bearing Bore Size (In.)	Spanner Bushing Required	Fits Axle Size (In.)	Wheel Part No.
3	1-1/4	250	60-70 Shore D	All Black	Plain	1-1/2	1/2	Yes	3/8	1G003229794
3-1/2	1-1/4	250	60-70 Shore D	All Black	Plain	1-1/2	1/2	Yes	3/8	1G003229894
4	1-1/4	300	60-70 Shore D	All Black	Plain	1-1/2	1/2	Yes	3/8	1G003229994
5	1-1/4	300	60-70 Shore D	All Black	Plain	1-1/2	1/2	Yes	3/8	1G003230094



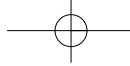

Wheels

Durafoam Wheels

Durafoam wheels are one-piece injection molded from black polypropylene plastic. Recommended for light to heavy loads on carpeted and hard surfaced floors. Durafoam wheels provide good floor protection and impact strength, excellent rolling ease, are non-marking, and resistant to water, oil, and most

acids and chemicals. Recommended operating temperature range is -20°F to 180°F. Durafoam wheels require no bearing and are ideal for corrosive applications which cause continual bearing replacement.



Solid



Dished

Wheel Diameter (In.)	Tread Width (In.)	Load Capacity (Lbs.)	Tread Hardness	Wheel Type	Hub Bearing Type	Bore Width (In.)	Spanner Size (In.)	Axle Bushing Required	Size (In.)	Wheel Part No.
2	3/4	100	60-75 Shore D	Dished	Plain	15/16	1/4	No	1/4	1G003168594
2-1/2	1-1/4	175	60-75 Shore D	Dished	Plain	1-27/64	5/16	No	5/16	1G003164294
2-1/2	13/16	115	60-75 Shore D	Dished	Plain	15/16	1/4	No	1/4	1G003243094
3	3/4	125	60-75 Shore D	Dished	Plain	15/16	1/4	No	1/4	1G003170594
3	1	125	60-75 Shore D	Solid	Plain	1-1/8	5/16	No	5/16	1G003159394
3	1-1/4	210	60-75 Shore D	Dished	Plain	1-27/64	5/16	No	5/16	1G003167194
3	1-3/4	350	60-75 Shore D	Solid	Sintered	1-7/8	3/8	No	3/8	1G003148694
3	1-3/4	350	60-75 Shore D	Solid	Roller	1-7/8	3/8	No	3/8	1J003148794
4	1	140	60-75 Shore D	Dished	Plain	1-1/8	5/16	No	5/16	HB005041194
4	1-1/4	255	60-75 Shore D	Solid	Plain	1-27/64	5/16	No	5/16	1G003168094
4	1-3/8	300	60-75 Shore D	Solid	Plain	1-1/2	3/8	No	3/8	1G003147094
4	1-1/2	300	60-75 Shore D	Dished	Roller	1-5/8	3/8	No	3/8	1J003161694
5	1	145	60-75 Shore D	Solid	Plain	1-1/8	5/16	No	5/16	1G003167794
5	1 1/4	280	60-75 Shore D	Dished	Plain	1-27/64	5/16	No	5/16	1G003237194
5	1-3/8	350	60-75 Shore D	Solid	Plain	1-1/2	3/8	No	3/8	1G003147194
5	1-1/2	350	60-75 Shore D	Dished	Roller	1-5/8	3/8	No	3/8	1J003195094
5	2	450	60-75 Shore D	Solid	Plain	2-1/4	3/8	No	3/8	1G003185194
5	2	450	60-75 Shore D	Dished	Roller	2-3/16	3/8	No	3/8	1J003167094
6	1-3/8	400	60-75 Shore D	Solid	Roller	1-1/2	3/8	No	3/8	1J003148194
6	1-3/8	400	60-75 Shore D	Solid	Plain	1-1/2	3/8	No	3/8	1G003147294
6	1-1/2	400	60-75 Shore D	Dished	Plain	1-5/8	3/8	No	3/8	1G003174494
6	1-1/2	400	60-75 Shore D	Dished	Roller	1-5/8	3/8	No	3/8	1J003161994

Poly II Poly Wheels

Poly II Poly wheels are injection co-molded from a black polypropylene tread molded and mechanically locked to a black polypropylene plastic core. Recommended for light to heavy loads on carpeted and hard surfaced floors. Poly II Poly wheels provide good floor protection, abrasion resistance, rolling

ease, good impact strength and quiet operation. They are non-marking, are resistant to water, oil, and most acids and chemicals. Recommended operating temperature range is -20°F to 180°F. Poly II Poly wheels are available with a choice of Delrin® or roller bearings. Special colors available in quantity.



Solid

Wheel Diameter (In.)	Tread Width (In.)	Load Capacity (Lbs.)	Tread Hardness	Wheel Type	Bearing Type	Hub Width (In.)	Bearing Bore Size (In.)	Spanner Bushing Required	Fits Axle Size (In.)	Wheel Part No.
3-1/2	1-1/4	250	60-75 Shore D	Solid	Delrin®	1-1/2	3/8	No	3/8	1G003183294
4	1-3/8	375	60-75 Shore D	Solid	Delrin®	1-1/2	3/8	No	3/8	1G003311394
4	1-3/8	375	60-75 Shore D	Solid	Roller	1-1/2	3/8	No	3/8	1J003211994
4	2	400	60-75 Shore D	Solid	Roller	2-3/16	3/4	Yes	1/2	1J003198694
5	1-3/8	450	60-75 Shore D	Solid	Roller	1-1/2	3/8	No	3/8	1J003212394
5	2	750	60-75 Shore D	Solid	Roller	2-3/16	3/4	Yes	1/2	1J003196694
6	1-3/8	450	60-75 Shore D	Solid	Delrin®	1-1/2	3/8	No	3/8	1G003311694
6	1-3/8	450	60-75 Shore D	Solid	Roller	1-1/2	3/8	No	3/8	1J003212694
6	2	900	60-75 Shore D	Solid	Roller	2-3/16	3/4	Yes	1/2	1J003197094
8	2	900	60-75 Shore D	Solid	Roller	2-3/16	3/4	Yes	1/2	1G003219894

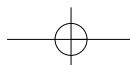

Wheels

Duratex Phenolic Wheels

Duratex wheels consist of a black phenolic resin impregnated and reinforced with macerated fabric to provide a very hard tread and high capacity wheel. Recommended for medium to heavy loads on carpeted and hard surfaced floors. Duratex wheels provide good floor protection, are quieter than steel

wheels, have excellent rolling ease, high impact resistance, and are resistant to most chemicals and acids. Recommended operating temperature range is -45°F to 300°F. Tread hardness: 102 Shore E.

Wheel Diameter (In.)	Tread Width (In.)	Load Capacity (Lbs.)	Wheel Color	Bearing Type	Hub Width (In.)	Bearing Bore Size (In.)	Spanner Bushing Required	Fits Axle Size (In.)	Wheel Part No.
DURATEX PHENOLIC WHEEL									
2-1/2	1-3/4	300	Black	Roller	1-7/8	3/8	No	3/8	1J003219994
2-5/8	1-3/4	350	Black	Roller	1-7/8	3/8	No	3/8	1J003220094
3	1-1/2	500	Black	Roller	1-5/8	5/8	Yes	3/8	1J003193794
3	1-3/4	500	Black	Roller	1-7/8	3/8	No	3/8	1J003172894
4(H)	1-1/2	400	Brown	Roller	1-5/8	3/8	No	3/8	1J003220894
4	1-1/2	500	Black	Plain	1-5/8	1/2	Yes	3/8	1G003197494
4	1-1/2	500	Black	Roller	1-5/8	3/8	No	3/8	1J003196494
4(H)	2	600	Brown	Roller	2-3/16	3/4	Yes	1/2	1J003221094
4	2	800	Black	Roller	2-3/16	3/4	Yes	1/2	1J003175494
5(H)	1-1/2	400	Brown	Roller	1-5/8	1/2	Yes	3/8	1G003218994
5	1-1/2	500	Black	Roller	1-5/8	1/2	Yes	3/8	1J003127394
5(H)	2	750	Brown	Roller	2-3/16	3/4	Yes	1/2	1J003218794
5	2	500	Black	Roller	2-3/16	3/8	No	3/8	1J003211194
5	2	1000	Black	Roller	2-3/16	3/4	Yes	1/2	1J003169094
6	1-1/2	500	Black	Roller	1-5/8	1/2	Yes	3/8	1J003205294
6(H)	2	900	Brown	Roller	2-3/16	3/4	Yes	1/2	1J003217294
6	2	1200	Black	Roller	2-3/16	3/4	Yes	1/2	1J003167994
8	2	1200	Black	Roller	2-3/16	3/4	Yes	1/2	1G003168494



(H) Wheel is high temperature phenolic with an operative range of 475°F continuous, 525°F intermittent.

Semi-Steel Wheels

Semi-steel wheels consist of cast iron enriched with steel. Recommended for medium to heavy loads on rough and metal debris littered floors and where floor protection and noise are not critical. Semi-steel wheels provide long

service life, high load capacity, excellent impact resistance, easy rolling, and superior performance and durability in extreme high and low temperature conditions. Recommended operating temperature range is -50°F to 500°F.

Wheel Diameter (In.)	Tread Width (In.)	Load Capacity (Lbs.)	Wheel Color	Bearing Type	Hub Width (In.)	Bearing Bore Size (In.)	Spanner Bushing Required	Fits Axle Size (In.)	Wheel Part No.
SEMI-STEEL WHEEL									
3	1-1/4	450	Black	Roller	1-1/2	15/32	Yes (included)	3/8	8G003193690
4	1-1/4	500	Black	Plain	1-1/2	1/2	Yes (included)	3/8	8G003197890
4	1-1/2	650	Black	Roller	1-11/16	15/32	Yes (included)	3/8	8G003193590
4	2	1000	Black	Roller	2-3/16	3/4	Yes	1/2	8G003228990
5	2	1000	Black	Roller	2-3/16	3/4	Yes	1/2	8G003229090
6	2	1200	Black	Roller	2-3/16	3/4	Yes	1/2	8G003229190
8	2	1400	Black	Roller	2-3/16	3/4	Yes	1/2	8G003229290

