

TRANSPORTATION TECHNOLOGY SUPPORT FOR DEVELOPING COUNTRIES

COMPENDIUM 5

Roadside Drainage

**Drenaje del borde de
carretera**

**Drainage des bas-cotes
de la route**

**TRANSPORTATION RESEARCH BOARD
NATIONAL ACADEMY OF SCIENCES**

PROJECT STEERING COMMITTEE

KERMIT L. BERGSTRAH, *Bergstrah Associates, Inc.*, chairman
G. A. EDMONDS, *International Labor Office (ILO liaison)*
CLELL G. HARRAL, *International Bank for Reconstruction and Development (IBRD liaison)*
WILLIAM G. HARRINGTON, *Linn County, Iowa*
R. G. HICKS, *Oregon State University*
W. RONALD HUDSON, *University of Texas at Austin*
LYNNE H. IRWIN, *Cornell University*
WILLIAM C. LaBAUGH, JR., *Daniel Mann, Johnson and Mendenhall*
MELVIN B. LARSEN, *Illinois Department of Transportation*
VOYCE J. MACK, *U.S. Department of Transportation (DOT liaison)*
RAY MILLARD, *International Bank for Reconstruction and Development (PIARC liaison)*
WILBUR J. MORIN, *Lyon Associates, Inc.*
CLARKSON H. OGLESBY, *Stanford, California*
ADRIAN PELZNER, *U.S. Forest Service*
GEORGE W. RING, III, *Federal Highway Administration (FHWA liaison)*
EDWARD C. SULLIVAN, *Institute of Transportation Studies, University of California, Berkeley*
PETER H. THORMANN, *U.S. Agency for International Development (AID liaison)*
W. G. WILSON, *International Road Federation (IRF liaison)*
ELDON J. YODER, *Purdue University*
JOHN P. ZEDALIS, *U.S. Agency for International Development (AID liaison)*

PROJECT STAFF AND LIAISON STAFF

PAUL E. IRICK, *Assistant Director for Special Technical Activities, TRB*
LLOYD R. CROWTHER, *Project Engineer, TRB*
H. STANLEY SCHOFER, *Manager, Information Systems Development and Operations, TRB*
JOHN W. GUINNEE, *Engineer of Soils, Geology, and Foundations, TRB (Division A liaison)*
THOMAS L. COPAS, *Project Engineer, TRB (NCHRP liaison)*
ANN R. SWEENEY, *Librarian, TRB*
VICTOR RABINOWITCH, *Commission on International Relations, National Research Council (NRC liaison)*
MARY SECOY, *Administrative Assistant, TRB*
JUDITH L. FAULS, *Project Secretary, TRB*
BRENDA CUTRELL, *(Spanish)*
SUZANNE D. SCRUGGS, *(French), TRB*
RUKMINI SEEVARATNAM, *(Index), TRB*

The Transportation Research Board is an agency of the National Research Council, which serves the National Academy of Sciences and the National Academy of Engineering. The Board's purpose is to stimulate research concerning the nature and performance of transportation systems, to disseminate information that the research produces, and to encourage the application of appropriate research findings. The Board's program is carried out by more than 150 committees and task forces composed of more than 1800 administrators, engineers, social scientists, and educators who serve without compensation. The program is supported by state transportation and highway departments, the U.S. Department of Transportation, and other organizations interested in the development of transportation.

The Transportation Research Board operates within the Commission on Sociotechnical Systems of the National Research Council. The Council was organized in 1916 at the request of President Woodrow Wilson as an agency of the National Academy of Sciences to enable the broad community of scientists and engineers to associate their efforts with those of the Academy membership. Members of the Council are appointed by the president of the Academy and are drawn from academic, industrial, and

governmental organizations throughout the United States.

The National Academy of Sciences was established by a congressional act of incorporation signed by President Abraham Lincoln on March 3, 1863, to further science and its use for the general welfare by bringing together the most qualified individuals to deal with scientific and technological problems of broad significance. It is a private, honorary organization of more than 1000 scientists elected on the basis of outstanding contributions to knowledge and is supported by private and public funds. Under the terms of its congressional charter, the Academy is called upon to act as an official—yet independent—advisor to the federal government in any matter of science and technology, although it is not a government agency and its activities are not limited to those on behalf of the government.

To share in the task of furthering science and engineering and of advising the federal government, the National Academy of Engineering was established on December 5, 1964, under the authority of the act of incorporation of the National Academy of Sciences. Its advisory activities are closely coordinated with those of the National Academy of Sciences, but it is independent and autonomous in its organization and election of members.

TRANSPORTATION TECHNOLOGY SUPPORT
FOR DEVELOPING COUNTRIES

COMPENDIUM 5

Roadside Drainage

**Drenaje del borde de
la carretera**

**Drainage des bas-côtés
de la route**

prepared under contract AID/OTR-C-1591, project 931-1116,
U.S. Agency for International Development

Transportation Research Board
Commission on Sociotechnical Systems
National Research Council

Library of Congress Cataloging in Publication Data

National Research Council. Transportation Research Board.
Roadside Drainage. Drenaje del borde de la carretera -
Drainage des bas-côtés de la route.

(Transportation technology support for developing countries;
compendium 5)

"Prepared under contract AID OTR-C-1591."

Bibliography: p.

Includes index.

1. Underdeveloped areas - Road drainage - Addresses, essays,
lectures. I. Title. II. Title: Drenaje del borde de la carretera.
III. Title: Drainage des bas-côtés de la route. IV. Series.
TE215.N3 1979 625.7'34 79-14548
ISBN 0-309-02820-5

Notice

The project that is the subject of this report was approved by the Governing Board of the National Research Council, whose members are drawn from the councils of the National Academy of Sciences, the National Academy of Engineering, and the Institute of Medicine. The members of the committee responsible for the report were chosen for their special competence and with regard for appropriate balance.

This report has been reviewed by a group other than the authors according to procedures approved by a Report Review Committee consisting of members of the National Academy of Sciences, the National Academy of Engineering, and the Institute of Medicine.

Cover photo: Labor-intensive ditch maintenance, Oaxaca, Mexico.



Contents

Tabla de Materias

Table des Matières

PROJECT DESCRIPTION	v
DESCRIPCION DEL PROYECTO	
DESCRIPTION DU PROJET	
FOREWORD AND ACKNOWLEDGMENTS	ix
PREFACIO Y AGRADECIMIENTOS	
AVANT-PROPOS ET REMERCIEMENTS	
OVERVIEW	xi
VISTA GENERAL	
EXPOSE	
SELECTED TEXTS	1
TEXTOS SELECCIONADOS	
TEXTES CHOISIS	
1. <i>Design of Roadside Drainage Channels</i>	3
(El diseño de canales de drenaje del borde del camino)	
(Dimensionnement des fossés de drainage des bas-côtés de la route)	
U.S. Federal Highway Administration, 1973 reprint	
2. <i>Design Charts for Open-Channel Flow</i>	65
(Diagramas de diseño para flujo en canal abierto)	
(Cartes de calcul pour l'écoulement des fossés à ciel ouvert)	
U.S. Federal Highway Administration, 1977 reprint	
3. <i>Handbook of Hydraulics</i>	89
(Manual de hidráulicas)	
(Manuel d'hydraulique)	
H.W. King, 1954	
4. <i>Grading Illustrated</i>	101
(Nivelación, Ilustrada)	
(Le nivellement illustré)	
Aveling-Barford Ltd., 1974	

5. *Road Maintenance Practic*. 157
(Prácticas de manutención de caminos)
(Entretien de la route)
National Association of Australian State Road Authorities, 1975

BIBLIOGRAPHY 187
BIBLIOGRAFIA
BIBLIOGRAPHIE

INDEX 192
INDICE
INDEX

Project Description

The development of agriculture, the distribution of food, the provision of health services, and the access to information through educational services and other forms of communication in rural regions of developing countries all heavily depend on transport facilities. Although rail and water facilities may play important roles in certain areas, a dominant and universal need is for road systems that provide an assured and yet relatively inexpensive means for the movement of people and goods. The bulk of this need is for low-volume roads that generally carry only 5 to 10 vehicles a day, and

that seldom carry as many as 400 vehicles a day.

The planning, design, construction, and maintenance of low-volume roads for rural regions of developing countries can be greatly enhanced with respect to economics, quality, and performance by the use of low-volume road technology that is available in many parts of the world. Much of this technology has been produced during the developmental phases of what are now the more developed countries, and some is continually produced in both the less and the more developed countries. Some of the technology has been doc-

Descripción del Proyecto

El desarrollo de la agricultura, la distribución de víveres, la provisión de servicios de sanidad, y el acceso a información por medio de servicios educacionales y otras formas de comunicación en las regiones rurales de países en desarrollo todos dependen en gran parte de los medios de transporte. Aunque en ciertas áreas los medios de ferrocarril y agua desempeñan una parte importante, una necesidad universal y dominante es para sistemas viales que proveen un medio asegurado pero relativamente poco costoso para el movimiento de gente y mercancías. La gran parte de esta necesidad es para caminos de bajo volumen que generalmente mueven

unicamente unos 5 a 10 vehículos por día y que pocas veces mueven tanto como 400 vehículos por día.

Con respecto a la economía, calidad, y rendimiento, el planeamiento, diseño, construcción y manutención de caminos de bajo volumen para regiones rurales de países en desarrollo pueden ser mejorados en gran parte por el uso de la tecnología de caminos de bajo volumen que se encuentra disponible en muchas partes del mundo. Mucha de esta tecnología ha sido producida durante las épocas de desarrollo de lo que ahora son los países mas desarrollados, y alguna se produce continuamente en los países menos y mas

Description du Projet

Dans les régions rurales des pays en voie de développement, l'exploitation agricole, la distribution des produits alimentaires, l'accès aux services médicaux, l'accès à l'information par l'intermédiaire de moyens éducatifs et d'autres moyens de communication, dépendent en grande partie des moyens de transport. Bien que les transports par voie ferrée et par voie navigable jouent un rôle important dans certaines régions, un besoin dominant et universel existe d'un réseau routier qui puisse assurer avec certitude et d'une façon relativement bon marché, le déplacement des habitants, et le transport des marchandises. La plus grande partie de ce besoin peut

être satisfaite par la construction de routes à faible capacité, capables d'accueillir un trafic de 5 à 10 véhicules par jour, ou plus rarement, jusqu'à 400 véhicules par jour.

L'utilisation des connaissances en technologie, qui existent déjà et sont accessibles dans beaucoup de pays, peut faciliter l'étude des projets de construction, tracé et entretien, de routes à faible capacité dans les régions rurales des pays en voie de développement, surtout en ce qui concerne l'économie, la qualité, et la performance de ces routes. La majeure partie de cette technologie a été produite durant la phase de développement des pays que l'on appelle maintenant dé-

umented in papers, articles, and reports that have been written by experts in the field. But much of the technology is undocumented and exists mainly in the minds of those who have developed and applied the technology through necessity. In either case, existing knowledge about low-volume road technology is widely dispersed geographically, is quite varied in the language and the form of its existence, and is not readily available for application to the needs of developing countries.

In October 1977 the Transportation Research Board (TRB) began this 3-year special project under the sponsorship of the U.S. Agency for International Development (AID) to enhance rural transportation in developing countries by providing improved access to existing information

on the planning, design, construction, and maintenance of low-volume roads. With advice and guidance from a project steering committee, TRB defines, produces, and transmits information products through a network of correspondents in developing countries. Broad goals for the ultimate impact of the project work are to promote effective use of existing information in the economic development of transportation infrastructure and thereby to enhance other aspects of rural development throughout the world.

In addition to the packaging and distribution of technical information, personal interactions with users are provided through field visits, conferences in the United States and abroad, and

desarrollados. Parte de la tecnología se ha documentado en disertaciones, artículos, e informes que han sido escritos por expertos en el campo. Pero mucha de la tecnología no está documentada y existe principalmente en las mentes de aquellos que han desarrollado y aplicado la tecnología por necesidad. En cualquier caso, los conocimientos en existencia sobre la tecnología de caminos de bajo volumen están grandemente esparcidos geográficamente, varían bastante con respecto al idioma y su forma, y no se encuentran fácilmente disponibles para su aplicación a las necesidades de los países en desarrollo.

En octubre de 1977 el Transportation Research Board (TRB) comenzó con este proyecto especial de tres años de duración bajo el patrocinio de la U.S. Agency for International Development (AID) para mejorar

el transporte rural en los países en desarrollo acrecentando la disponibilidad de la información en existencia sobre el planeamiento, diseño, construcción, y manutención de caminos de bajo volumen. Con el consejo y dirección de un comité de iniciativas para el proyecto, el TRB define, produce, y transmit productos informativos a través de una red de corresponsales en países en desarrollo. Las metas generales para el impacto final del trabajo del proyecto son la promoción del uso efectivo de la información en existencia en el desarrollo económico de la infraestructura de transporte y de esta forma mejorar otros aspectos del desarrollo rural a través del mundo.

Además de la recolección y distribución de la información técnica, se provee acciones recíprocas personales con los usuarios por

veloppés, et elle continue à être produite à la fois dans ces pays et dans les pays en voie de développement. Certains aspects de cette technologie ont été documentés dans des articles ou rapports écrits par des experts. Mais une grande partie des connaissances n'existe que dans l'esprit de ceux qui ont développé et appliqué cette technologie par nécessité. De plus, dans ces deux cas, les écrits et connaissances sur la technologie des routes à faible capacité, sont dispersés géographiquement, sont écrits dans des langues différentes, et ne sont pas assez aisément accessibles pour être appliqués aux besoins des pays en voie de développement.

En octobre 1977, le Transportation Research Board (TRB) initia ce projet, d'une durée de 3 ans, sous le patronage de l'U.S. Agency for International Development (AID), pour

améliorer le transport rural dans les pays en voie de développement, en rendant plus accessible la documentation existante sur la conception, le tracé, la construction, et l'entretien des routes à faible capacité. Avec le conseil et sous la conduite d'un Comité de Direction, TRB définit, produit, et transmet cette documentation à l'aide d'un réseau de correspondants dans les pays en voie de développement. Généralement, l'aboutissement final de ce projet sera de favoriser l'utilisation de cette documentation, pour aider au développement économique de l'infrastructure des transports, et de cette façon mettre en valeur d'autres aspects d'exploitation rurale à travers le monde.

En plus de la dissémination de cette documentation technique, des visites, des conférences aux Etats Unis et à l'étranger, et

other forms of communication.

Steering Committee

The Steering Committee is composed of experts who have knowledge of the physical and social characteristics of developing countries, knowledge of the needs of developing countries for transportation, knowledge of existing transportation technology, and experience in its use.

Major functions of the Steering Committee are to assist in the definition of users and their needs, the definition of information products that match user needs, and the identification of informational and human resources for development of the information products. Through its member-

medio de visitas de campaña, conferencias en los Estados Unidos de Norte América y en el extranjero, y otras formas de comunicación.

Comité de Iniciativas

El Comité de Iniciativas se compone de expertos que tienen conocimiento de las características físicas y sociales de los países en desarrollo, conocimiento de las necesidades de transporte de los países en desarrollo, conocimiento de la tecnología de transporte en existencia, y experiencia en su uso.

Las funciones importantes del Comité de Iniciativas son las de asistir en la definición de usuarios y sus necesidades, de productos informativos que se asemejan a las necesidades del usuario, y la identificación de recursos de conocimientos y humanos para

d'autres formes de communication permettent une interaction constante avec les usagers.

Comité de Direction

Le Comité de Direction est composé d'experts qui ont à la fois des connaissances sur les caractéristiques physiques et sociales des pays en voie de développement, sur leurs besoins au point de vue transports, sur la technologie actuelle des transports, et ont aussi de l'expérience quant à l'utilisation pratique de cette technologie.

Les fonctions majeures de ce comité sont d'abord d'aider à définir les usagers et leurs besoins, puis de définir leurs besoins en matière de documentation, et d'identifier les ressources documentaires et humaines nécessaires pour le développement de cette docu-

ship the committee provides liaison with project-related activities and provides guidance for interactions with users. In general the Steering Committee gives overview advice and direction for all aspects of the project work.

The project staff has responsibility for the preparation and transmittal of information products, the development of a correspondence network throughout the user community, and interactions with users.

Information Products

Three types of information products are prepared: compendiums of documented information on relatively narrow topics, syntheses of knowledge and

el desarrollo de los productos informativos. A través de sus miembros el comité provee vínculos con actividades relacionadas con el proyecto y también una guía para la interacción con los usuarios. En general el Comité de Iniciativas proporciona consejos y dirección general para todos los aspectos del trabajo de proyecto.

El personal de proyecto tiene la responsabilidad para la preparación y transmisión de los productos informativos, el desarrollo de una red de correspondientes a través de la comunidad de usuarios, y la interacción con los usuarios.

Productos Informativos

Se preparan tres tipos de productos informativos: los compendios de la información documentada sobre relativamente limitados

mentation. Par l'intermédiaire de ses membres, le comité pourvoit à la liaison entre les différentes fonctions relatives au projet, et dirige l'interaction avec les usagers. En général, le Comité de Direction conseille et dirige toutes les phases du projet.

Le personnel attaché à ce projet est responsable de la préparation et de la dissémination des documents, du développement d'un réseau de correspondants pris dans la communauté d'usagers, et de l'interaction avec les usagers.

La Documentation

Trois genres de documents sont préparés: des recueils dont le sujet sera relativement limité, des synthèses de connaissances et de pratique sur des sujets beaucoup plus généraux, et finalement des comptes-rendus

practice on somewhat broader subjects, and proceedings of low-volume road conferences that are totally or partially supported by the project. Compendiums are prepared by project staff at the rate of about 6 per year; consultants are employed to prepare syntheses at the rate of 2 per year. At least one conference proceedings will be published during the 3-year period. In summary, this project aims to produce and distribute between 20 and 30 publications that cover much of what is known about low-volume road technology.

Interactions With Users

A number of mechanisms are used to provide in-

teractions between the project and the user community. Project news is published in each issue of *Transportation Research News*. Feedback forms are transmitted with the information products so that recipients have opportunity to say how the products are beneficial and how they may be improved. Through semiannual visits to developing countries, the project staff acquires first-hand suggestions for the project work and can assist directly in specific technical problems. Additional opportunities for interaction with users arise through international and in-country conferences in which there is project participation. Finally, annual colloquiums are held for students from developing countries who are enrolled at U.S. universities.

viii

temas, la síntesis del conocimiento y practica sobre temas un poco mas amplios, y los expedientes de conferencias de caminos de bajo volumen que están totalmente o parcialmente amparados por el proyecto. El personal de proyecto prepara los compendios a razón de unos 6 por año; se utilizan consultores para preparar las sintesis a razón de 2 por año. Se publicará por lo menos un expediente de conferencia durante el período de tres años. En breve, este proyecto pretende producir y distribuir entre 20 y 30 publicaciones que cubren mucho de lo que se conoce de la tecnología de caminos de bajo volumen.

Interacción con los Usuarios

Se utilizan varios mecanismos para proveer las interacciones entre el proyecto y la

comunidad de usuarios. Se publican las noticias del proyecto en cada edición de la *Transportation Research News*. Se transmiten formularios de retroacción con los productos informativos para que los recipientes tengan oportunidad de decir cómo benefician los productos y cómo pueden ser mejorados. A través de visitas semianuales a los países en desarrollo, el personal del proyecto adquiere directo de fuentes originales sugerencias para el trabajo del proyecto y puede asistir directamente en problemas técnicos específicos. Surgen oportunidades adicionales para la interacción con los usuarios a través de conferencias internacionales y nacionales en donde participa el proyecto. Finalmente, se organizan diálogos con estudiantes de países en desarrollo que están inscriptos en universidades norteamericanas.

de conférences sur les routes à faible capacité qui seront organisées complètement ou en partie par ce projet. Environ 6 recueils par an sont préparés par le personnel attaché au projet. Deux synthèses par an sont écrites par des experts. Les comptes-rendus d'au moins une conférence seront écrits dans une période de 3 ans. En résumé, l'objet de ce projet est de produire et disséminer entre 20 et 30 documents qui couvriront l'essentiel des connaissances sur la technologie des routes à faible capacité.

Interaction Avec les Usagers

Un certain nombre de mécanismes sont utilisés pour assurer l'interaction entre le personnel du projet et la communauté d'usagers. Un bulletin d'information est publié dans chaque

numéro de *Transportation Research News*. Des formulaires sont joints aux documents, afin que les usagers aient l'opportunité de juger de la valeur de ces documents et de donner leur avis sur les moyens de les améliorer. Au cours de visites semi-annuelles dans les pays en voie de développement, le personnel obtient de première main des suggestions sur le bon fonctionnement du projet et peut aider à résoudre sur place certains problèmes techniques spécifiques. En outre, des conférences tenues soit aux Etats Unis, soit à l'étranger, sont l'occasion d'un échange d'idées entre le personnel et les usagers. Finalement, des colloques annuels sont organisés pour les étudiants des pays en voie de développement qui étudient dans les universités américaines.

Foreword and Acknowledgments

This compendium is the fifth product of the Transportation Research Board's project on Transportation Technology Support for Developing Countries under the sponsorship of the U.S. Agency for International Development. The objective of this book is that it provide useful and practical information for those in developing countries who have direct responsibility for roadside drainage activities. Feedback from correspondents in developing countries will be solicited and used to assess the degree to which this objective has been

attained and to influence the nature of later products.

Acknowledgment is made to the following publishers for their kind permission to reprint the Selected Text portions of this compendium:

Aveling-Barford, Ltd., Grantham, England;
Federal Highway Administration, Washington, D.C.;

McGraw-Hill Book Company, New York;
National Association of Australian State Road Authorities, Sydney, Australia.

Prefacio y Agradecimientos

Este compendio es el quinto producto del proyecto del Transportation Research Board sobre Apoyo de Tecnología de Transporte para Países en Desarrollo bajo el patrocinio de la U.S. Agency for International Development. El objetivo de este libro es el de proveer información útil y práctica para aquellos en países en desarrollo quienes tienen responsabilidad directa para el drenaje del borde de la carretera. Se pedirá a los correspondientes en los países en desarrollo información sobre los resultados, para utilizarse en el asesoramiento del grado al cual se ha obtenido ese objetivo y para

influenciar la naturaleza de productos subsecuentes.

Se reconoce a los siguientes editores por el permiso dado para re-imprimir las porciones de texto seleccionadas de este compendio:

Aveling-Barford, Ltd., Grantham, England;
Federal Highway Administration, Washington, D.C.;

McGraw-Hill Book Company, New York;
National Association of Australian State Road Authorities, Sydney, Australia.

ix

Avant-propos et Remerciements

Ce recueil représente le cinquième de projet du Transportation Research Board sur la Technologie des Transports à l'Usage des Pays en Voie de Développement. Ce projet est placé sous le patronage de l'U.S. Agency for International Development. L'objet de ce recueil est de réunir une documentation pratique et utile qui puisse aider les responsables de drainage des bas côtés de la route. La réaction des correspondants des pays en voie de développement sera sollicitée et utilisée pour évaluer à quel point le but proposé de ce projet

a été atteint et pour influencer la nature des ouvrages à venir.

Nous remercions des éditeurs qui ont gracieusement donné leur permission de reproduire les textes sélectionnés pour ce recueil:

Aveling-Barford, Ltd., Grantham, England;
Federal Highway Administration, Washington, D.C.;

McGraw-Hill Book Company, New York;
National Association of Australian State Road Authorities, Sydney, Australia.

Appreciation is also expressed to libraries and information services that provided references and documents from which final selections were made for the Selected Texts and Bibliography of this compendium. Special acknowledgment is made to the U.S. Department of Transportation Library Services Division and to the Library and Information Service of the U.K. Transport and Road Research Laboratory (TRRL). Photographs provided by TRRL have been reproduced by permission of Her Majesty's Stationery Office.

Finally, the Transportation Research Board acknowledges the valuable advice and direction that have been provided by the project Steering Committee and is especially grateful to William G. Harrington, Linn County, Iowa, Joyce J. Mack, U.S. Department of Transportation, and Adrian Pelzner, U.S. Forest Service, who provided special assistance on this particular compendium.

x También se reconoce a las bibliotecas y servicios de información que proveen las referencias y documentos de los cuales se hacen las selecciones finales para los Textos Seleccionados y la Bibliografía en este compendio. Se hace un especial reconocimiento a la Library Services Division de la U.S. Department of Transportation y el Library and Information Service de la U.K. Transport and Road Research Laboratory (TRRL). Las fotografías proveídas por TRRL fueron reproducidas bajo permisión de Her Majesty's Stationery Office.

Finalmente, el Transportation Research Board agradece el consejo y dirección valiosos provisto por el Comité de Iniciativas, con especial reconocimiento a los señores William G. Harrington, Linn County, Iowa, Joyce J. Mack, U.S. Department of Transportation, y Adrian Pelzner, U.S. Forest Service, que prestaron ayuda especial para este compendio en particular.

Nos remercions aussi aux bibliothèques et bureaux de documentation qui nous ont fourni les documents et les références utilisés dans les Textes Choisis et Bibliographie de ce recueil. Nous remercions spécialement la U.S. Department of Transportation Library Services Division et les Library and Information Service of the U.K. Transport and Road Research Laboratory (TRRL). Les photos fournies par le TRRL ont été reproduites avec la permission de Her Majesty's Stationery Office.

Finalment, le Transportation Research Board reconnait la grande valeur de la direction et de l'assistance des membres du Comité de Direction et les remercie de leur concours et de la façon dont ils dirigent le projet, spécialement Messieurs William G. Harrington, Linn County, Iowa, Joyce J. Mack, U.S. Department of Transportation, et Adrian Pelzner, U.S. Forest Service, qui ont bien voulu prêter leur assistance à la préparation de ce recueil.

Overview

Background and Scope

If a road is to be used in all types of weather, adequate drainage is necessary. In Compendium 3 it was noted that small drainage structures with fixed capacities cannot be upgraded economically. Therefore, small drainage structures must be sized and installed correctly as the first step in roadway development. In addition, when sizing drainage structures, the engineer must anticipate possible future changes in land use that may affect runoff.

Compendium 4 stressed that initial construction cost of a low-volume road can be reduced,

if a country is willing to accept road closings during short periods of stream or river flooding. A low-volume road is not termed an all-weather road unless stream and river crossings operate full time. This can be accomplished in stages as increasing traffic warrants such improvements. The construction of roadside drainage begins with the construction of the road. Roadside drainage includes the construction of all the roadside drainage channels that divert or remove surface water from the road right-of-way. The primary purpose of roadside drainage is to

Vista General

Antecedentes y alcance

Caminos que son utilizados durante todo el año deben estar proveídos con drenaje adecuado. Se indicó en el Compendio 3 que pequeñas estructuras de drenaje con capacidades fijas no pueden ser económicamente mejoradas. Por esta razón las pequeñas estructuras de drenaje deben ser escogidas de acuerdo a su tamaño e instaladas correctamente como el primer paso en el desarrollo del camino. Además, al medir las estructuras de drenaje, el ingeniero debe anticipar cambios futuros en el uso del terreno, los cuales podrían afectar el drenaje.

El Compendio 4 enfatiza que el costo inicial de construcción de un camino de bajo volumen puede ser reducido si un país está dispuesto a

aceptar caminos clausurados durante los cortos períodos de inundación de arroyos ó ríos. Un camino de bajo volumen no se llama camino de toda intemperie hasta que los travesías de arroyo y río operen continuamente. Esto se puede lograr por etapas a medida que el aumento en el volumen del tránsito justifica tales mejoras. La construcción de los drenajes del borde del camino comienza con la construcción inicial del camino. El drenaje del borde del camino incluye la construcción de todos los canales de drenaje que desvían ó quitan las pequeñas aberturas del derecho de vía. El propósito principal del drenaje del borde del camino es para impedir que el agua que se desagua del terreno llegue hasta el camino, y para eficiente-

xi

Exposé

Historique et description

Un drainage adéquat est nécessaire si une route doit être praticable par tous temps. Dans le recueil no 3, nous avons indiqué que de petits ouvrages de drainage, à capacité fixe, ne peuvent pas être agrandis économiquement. Les petits ouvrages de drainage doivent donc être dimensionnés et installés correctement dès le début de l'aménagement de la route. En outre, l'ingénieur, quand il calcule le dimensionnement des ouvrages de drainage, doit prévoir les changements futurs de l'utilisation du sol qui seraient susceptibles d'affecter le débit.

Le recueil no 4 met l'emphase sur le fait que le

coût initial de la construction d'une route économique peut être abaissé, si l'on est disposé à accepter la fermeture de cette route au trafic pendant de courtes périodes d'inondation des rivières ou des fleuves. Une route à faible capacité n'est appelée une route tous temps que dans le cas où l'on peut toujours franchir les rivières ou les fleuves. Ceci peut être accompli de façon progressive, au fur et à mesure de l'accroissement du trafic routier. La construction du drainage des bas-côtés de la route se fait au stade initial de l'implantation de la route. Ce dispositif de drainage inclut la construction de ca-

prevent surface runoff from reaching the roadway and to remove efficiently the rainfall or surface water that reaches the roadway.

Compendium 5 deals specifically with roadside drainage channels. It includes information for three different groups of highway personnel — design engineers, construction engineers, and maintenance engineers. The subject matter treats design of roadside drainage channels, physical construction of roadside ditches and adjacent embankments, and routine maintenance of the drainage features of unsurfaced roads including roadside drainage channels.

Roadside drainage channels should be designed and constructed properly during the first step in roadway development. Improper design,

construction, or maintenance can cause costly failures. Because some uncertainty exists in the assumptions made in the design of roadside channels, the channels should be observed carefully during the rainy periods immediately after construction. This extra precaution will ensure the discovery of design or construction deficiencies before they cause major failures. Any inadequacies should be corrected immediately before future runoff increases the damage.

Rationale for This Compendium

Compendium 5 describes the various types and purposes of roadside drainage channels. It presents a technique for estimating storm runoff

mente quitar el agua de lluvia ó de drenaje que le llegue hasta el camino.

El Compendio 5 trata específicamente sobre canales de aberturas del borde del camino, incluyendo su diseño, construcción y manutención. Los canales de drenaje del borde del camino deberán ser correctamente diseñados y construídos durante el primer paso en el desarrollo del camino. Un diseño, construcción ó manutención incorrecto pueden causar fracasos costosos. Ya que hay ciertas incertidumbres en las suposiciones hechas en el diseño de los canales del borde del camino, éstos deberán observarse cuidadosamente durante los períodos de lluvia inmediatamente después de la construcción. Esta precaución asegurará que se en-

cuentren las deficiencias de diseño o construcción antes de que causen importantes fracasos. Las insuficiencias descubiertas deberán corregirse inmediatamente antes de que futuras aguas de drenaje tengan oportunidad de aumentar el daño.

Exposición razonada para este compendio

El Compendio 5 describe los varios tipos y propósitos de canales de drenaje del borde del camino y sus propósitos. Presenta una técnica para calcular el agua de drenaje de tormenta de pequeñas áreas de drenaje. Esta técnica puede utilizarse para calcular la cantidad de agua que

xii

nalisations ou fossés qui détournent ou enlèvent les eaux de ruissellement de toute la largeur de l'emprise. L'objectif principal du drainage des bas-côtés de la route est à la fois d'empêcher que les eaux de surface atteignent la plateforme, et d'enlever de façon efficace les eaux de pluie ou de ruissellement qui sont sur la plateforme.

Le recueil no 5 s'adresse spécifiquement aux fossés de drainage des bas-côtés de la route. Les données qu'il contient intéresseront trois groupes d'ingénieurs routiers: ceux qui s'occupent des calculs, ceux qui feront la construction, et ceux qui seront responsables de l'entretien. Trois sujets seront donc traités ici: le dimensionnement des dispositifs de drainage du bas-côté de la route, la construction de fossés et de remblais, et l'entretien courant des ouvrages de drainage de la route en terre, y compris les dispositifs de drainage du bas-côté de la route.

Les fossés de drainage devraient être calcu-

lés et construits correctement durant le premier stade de l'aménagement de la route. Des erreurs dans le calcul, la construction ou l'entretien de ces fossés, peuvent résulter en un échec complet et coûteux. Comme il existe un certain degré d'incertitude lors du dimensionnement de ces dispositifs de drainage, ils devraient être observés avec soin durant la première période de pluie qui suivra leur construction. Cette précaution permettra de découvrir tout de suite les erreurs de calcul ou de construction avant qu'elles ne causent de très gros ennuis. Chaque défaut devrait être corrigé immédiatement pour éviter des dégâts additionnels lors de prochaines pluies.

Objet de ce recueil

Le recueil no 5 décrit les différentes sortes de fossés de drainage pour les bas-côtés de la route et leur fonction. Une technique pour calcu-

from small drainage areas. This technique can be used to calculate the quantity of water to expect in a specific drainage channel.

This compendium reviews the hydraulics of drainage channels. It describes design procedures based on hydraulic principles. Examples of channel designs are included. The general design of drainage channels is valid for urban and rural areas and for all classes of roads from tracks to divided highways. Pipes flowing partially full are also designed as open drainage channels.

The information in this compendium will help engineers to design and construct rural low-volume roads that have an average daily traffic flow of up to 400 vehicles. Supplementary de-

sign charts are included for open-channel flow in trapezoidal and triangular channels to assist the designer in the solution of problems likely to appear in the drainage of low-volume roads. Most of these charts are based on a channel side slope of 2:1 with varying bottom widths. Instructions are included for the construction of similar design charts that use other side slopes for open-channel flow. Compendium 5 also includes tables to simplify computations for the direct solution of open-channel flow problems. These tables cover a range of side slopes from vertical to 4:1. Channel side slopes most commonly used in low-volume road design fall within this range.

This compendium includes a discussion of

podrá esperarse en un canal específico de drenaje.

El compendio repasa las hidráulicas de canales de drenaje. Describe los procedimientos de diseño que se utilizan basados en los principios de hidráulica presentados. Se incluyen numerosos ejemplos del diseño de canales para ilustrar el procedimiento descrito. El diseño general de canales de drenaje es válido para áreas urbanas y rurales y para todas clases de caminos, de huellas a carreteras divididas. Los tubos que fluyen parcialmente llenos también se diseñan como canales abiertos de drenaje.

La información contenida en este compendio ayudará a los ingenieros de diseño y de la construcción de caminos rurales de bajo volumen teniendo un TMDA de hasta 400 vehículos. Por lo tanto se incluyen diagramas de diseño suple-

mentarios para flujo de canal abierto en canales trapezoidales y triangulares para asistir al diseñador en la solución de problemas que probablemente pueden aparecer en el drenaje de caminos de bajo volumen.

Casi todos estos diagramas se basan sobre una pendiente lateral del canal de 2:1 con anchos de fondo variables. Se incluyen instrucciones para la construcción de diagramas de diseño similares que utilizan otras pendientes laterales para flujo de canal abierto. Este compendio también incluye tablas para simplificar las computaciones para la solución inmediata de problemas de flujo de canal abierto. Estas tablas incluyen todas las pendientes laterales desde la vertical hasta 4:1. Las pendientes laterales de canal que más comúnmente se utilizan en el diseño de caminos de bajo volumen

xiii

ler le débit des averses sur de petites surfaces à drainer est présentée. Cette technique peut être utilisée pour calculer la quantité d'eau à évacuer par un ouvrage spécifique.

Ce recueil examine l'hydraulique des fossés de drainage. Il décrit des procédés de dimensionnement basés sur les principes de l'hydraulique. Des exemples sont inclus. Les principes généraux de calcul de ces fossés sont valables pour les régions urbaines et les régions rurales, et pour toutes classes de routes allant de la piste à la route divisée. Les méthodes de calcul des canalisations conçues pour évacuer un volume d'eau inférieur à leur capacité totale sont les mêmes que celles utilisées pour le dimensionnement de fossés à ciel ouvert.

Les informations contenues dans ce recueil aideront l'ingénieur routier à calculer et à construire les routes à faible capacité dont le trafic

moyen journalier atteint 400 véhicules. Des tables de calcul supplémentaires sont incluses pour les fossés à ciel ouvert dont la section transversale est triangulaire ou trapezoïdale. Ces tables aideront l'ingénieur à résoudre les problèmes les plus courants du drainage des routes à faible capacité. La plupart de ces tables sont basées sur des talus latéraux de pentes de 2:1 avec des largeurs de fond variables. Des instructions sont incluses qui permettent de développer des tables de calcul similaires pour des dispositifs à ciel ouvert dont le talus latéral a des pentes différentes. Le recueil no 5 contient aussi des tables qui simplifient le calcul et permettent de trouver immédiatement la solution des problèmes relatifs aux dispositifs à ciel ouvert. Ces tables ont un champ d'application qui va de la verticale à 4:1 pour les pentes des talus latéraux. Les pentes des talus latéraux de route

construction methods for open channels with various types of linings. It also contains text and illustrations that show the use of a grader (a) to construct a basic earth road using material from the ditch cut, (b) to clean ditches, (c) to construct slope banks, and (d) to construct terraced channels. Because the proper sequence of blade settings for each operation is also described, an excerpt about controlling the grader blade is included for reference.

Compendium 5 discusses maintenance of various roadway drainage elements. These include not only the types of roadside drainage channels that are discussed here, but also some of the

drainage structures first described in Compendiums 3 and 4.

Discussion of Selected Texts

The first text, *Design of Roadside Drainage Channels*, was issued by the U.S. Department of Transportation as *Hydraulic Engineering Circular No. 4*. It is reproduced here from the December 1973 reprint of the May 1965 publication. It notes that the need to prevent erosion is not limited to highway drainage channels, but extends throughout the right of way. Erosion prevention is an essential feature of adequate drainage de-

caen dentro de estos límites.

El Compendio 5 incluye una exposición de los métodos de construcción para canales abiertos con varios tipos de revestimientos. También incluye el texto e ilustraciones que muestran el uso de la niveladora para (a) construir un camino básico de tierra utilizando el material del corte de la zanja, (b) limpiar zanjas, (c) construir superficies de bancos, y (d) construir canales terraplizados. Ya que este texto únicamente describe la secuencia correcta de posiciones de la cuchilla para cada operación, para propósitos de referencia se incluye una sección de texto que describe el control de la cuchilla de la niveladora.

El Compendio 5 discute el mantenimiento de varios de los componentes de drenaje del camino. Estos incluyen no solo los tipos de canales de drenaje del borde del camino descritos en este compendio, sino también algunas de las estructuras de drenaje mencionadas en los Compendios 2 y 3.

Presentación de los textos seleccionados

El primer texto, *Design of Roadside Drainage Channels* (El diseño de canales de drenaje del borde del camino), fue publicado por el U.S. Department of Transportation como *Circular No. 4 de Ingeniería Hidráulica* (este ha sido reproducido a partir de la reimpresión de diciembre 1973 de la publicación original en mayo de 1965).

Dice que la necesidad de impedir la erosión no solo se limita a los canales de drenaje viales, sino que se extiende a través de todo el derecho de vía. Prevención de la erosión es una característica esencial del diseño de drenaje adecuado. La erosión y manutención pueden ser minimizados por la correcta consideración de los siguientes factores:

1. Pendientes laterales planos, redondeados y combinados con el terreno natural;
2. Consideraciones de diseño de canal de drenaje (ubicación, ancho, profundidad, taludes,

xiv

à faible capacité sont généralement comprises dans ce champ d'application.

Une discussion des méthodes de construction des fossés à ciel ouvert et de différentes sortes de revêtements est incluse. Ce recueil contient aussi un texte et des illustrations qui démontrent l'emploi de la niveleuse (a) pour construire une route de terre en se servant du matériau extrait des fossés, (b) nettoyer les fossés, (c) pour construire les pentes des talus, et (d) pour construire des redans ou gradins. Comme ce texte décrit aussi l'ordre de l'avoyage des lames pour chaque opération, un extrait sur la commande des lames de la niveleuse est aussi inclus comme référence.

L'entretien des différents éléments des dispositifs de drainage est aussi discuté. Il ne s'agit

pas seulement des fossés de drainage, mais aussi de l'entretien de plusieurs ouvrages d'art qui sont cités dans les recueils 3 et 4.

Discussion des textes choisis

Le premier texte, *Design of Roadside Drainage Channels* (Dimensionnement des fossés de drainage des bas-côtés de la route), a été publié par le U.S. Department of Transportation comme *Hydraulic Engineering Circular No. 4* en 1965. Le texte reproduit ici est la réimpression de Décembre 1973. Ce texte remarque que la protection contre l'érosion n'est pas limitée au drainage de la route elle-même, mais doit s'étendre sur toute la largeur de l'emprise. La protection contre l'érosion est une des caracté-

sign. Erosion and maintenance can be minimized by proper consideration of the following factors:

1. Flat side slopes, rounded and blended with the natural terrain;
 2. Drainage channel design considerations (location, width, depth, slopes, horizontal and vertical alignment, protective treatment);
 3. Proper facilities for ground water interception;
 4. Protective devices such as dikes and berms; and
 5. Protective ground covers and planting.
- The discussion in this publication is limited to providing erosion control in drainage channels by proper design, including the selection of an economical channel lining.

The first step in designing a channel is to determine the quantity of water the channel is to carry. The use of the rational formula for calculating runoff from small areas is recommended. This text notes deficiencies that are inherent in the formula. It states that many refinements to the formula have been suggested to improve the runoff estimate. However, the collection of additional data and the increased work required by these refinements do not appear warranted in the design of drainage channels.

The text reviews the hydraulics of flow in open channels and defines steady and unsteady flow. Steady flow is further classified as uniform flow, if the velocity and depth of flow are constant. Uniform flow conditions are rarely attained in drainage channels. However, the error in assuming

alineamiento horizontal y vertical, y tratamiento protectorio);

3. Dispositivos correctos para la intercepción de agua de drenaje;
4. Dispositivos protectivos tales como diques y bermas; y
5. Coberturas del terreno y plantaciones protectorias.

El tema presentado en esta publicación se limita a proveer control de la erosión en los canales de drenaje por un diseño correcto, incluyendo la selección de un revestimiento de canal económico.

El primer paso en el diseño de un canal es determinar la cantidad de agua que portará. El texto recomienda el uso de la fórmula racional para calcular el agua de drenaje de pequeñas áreas. Nota las deficiencias que son inherentes en la fórmula. Afirma que se han sugerido mu-

chos refinamientos a la fórmula para una posible mejora en los cálculos del agua de drenaje. Sin embargo, la colección de datos adicionales y el aumento de trabajo requerido por estos refinamientos no parecen justificarse en el diseño de canales de desagüe.

El texto repasa las hidráulicas de flujo en canales abiertos y define el flujo estable y no-estable. Además el flujo estable se clasifica como uniforme si la velocidad y profundidad de flujo son constantes. Raras veces se llega a condiciones de flujo uniforme en los canales de desagüe pero el error en asumir un flujo uniforme en un canal de pendiente y sección transversal bastante constantes es pequeño cuando se lo compara al error en determinar la descarga de diseño. El uso de la ecuación Manning dará resultados fidedignos para el diseño de canales que tienen una distancia suficiente de

xv

ristiques les plus importantes d'un bon système de drainage. L'érosion et l'entretien peuvent être réduits au minimum si l'on observe avec soin les points suivants:

1. La pente des talus doit être rectiligne et être raccordée par courbes au terrain naturel;
 2. Le calcul des fossés latéraux doit se faire en tenant compte de l'emplacement, la largeur, la profondeur, les talus, les tracés horizontaux et verticaux, et les mesures de protection;
 3. Un dispositif correct pour intercepter l'eau phréatique;
 4. Des dispositifs de protection comme des digues ou des risbermes; et
 5. Une couverture végétale de protection.
- Dans cette publication, la discussion est limitée au contrôle de l'érosion des fossés latéraux par

un dimensionnement correct, et au choix d'un revêtement économique.

Le premier stade du dimensionnement d'un fossé consiste à évaluer la quantité d'eau à évacuer. L'emploi d'une formule rationnelle pour calculer le débit d'une petite surface à drainer est recommandé. Ce texte cite les défauts inhérents à cette formule, et remarque que de nombreux perfectionnements ont été suggérés pour estimer le débit. Cependant, le travail additionnel et la collection de données causés par ces perfectionnements, ne justifient pas leur emploi pour le calcul des fossés latéraux.

Le texte passe en revue l'écoulement hydraulique des fossés et donne la définition de l'écoulement stationnaire et de l'écoulement irrégulier. L'écoulement stationnaire est classé comme écoulement uniforme, si la vitesse et la hauteur

uniform flow in a channel of fairly constant slope and cross section is small, when compared with the error in determining the design discharge. The use of the Manning equation provides reliable results for the design of channels that have sufficient distance of constant cross section, roughness, and slope to establish essentially uniform flow. Examples demonstrate the use of the Manning equation by direct calculation, the use of prepared charts, and the use of tables combined with direct calculations.

Nonuniform or varied flow, critical flow, subcritical flow around curves, supercritical flow around curves, and the Froude number are all defined and discussed. Appropriate formulas are given for each condition.

Design procedures are described for the layout of the drainage system, channel grade, channel alignment, channel section, and chan-

nel capacity. The use of channel charts and hydraulic tables contained in various handbooks is explained. The significance of the channel roughness coefficient is discussed. Channel protection, along with examples, is described. The problems of the buoyancy of empty channels with rigid linings and the application of combined linings are considered.

Several methods of lining channels are described. The necessity of filter blankets under certain channel linings is explained as well as a method of designing layers of filter materials.

Design of Roadside Drainage Channels also contains a chapter about construction methods for the various channels previously described. Another chapter on the maintenance of open channels is included. This chapter emphasizes that maintenance is necessary to keep the capacity of the channel at the design level.

sección transversal, textura de superficie y pendiente constantes para establecer un flujo esencialmente uniforme.

Se dan ejemplos para demostrar el uso de la ecuación Manning (a) por cálculo directo, (b) por el uso de diagramas preparadas, y (c) por el uso de tablas en combinación con cálculos directos.

xvi Se definen y se habla sobre el flujo no-uniforme ó no-estable, flujo crítico, flujo subcrítico en curvas, flujo supercrítico en curvas y la cifra Froude. Se dan las fórmulas apropiadas para cada condición.

Se describen los procedimientos de diseño para (a) la disposición del sistema de drenaje, (b) pendiente de canal, (c) alineamiento de canal, (d) sección de canal, y (e) capacidad de

canal. Se explica el uso de diagramas de canal y tablas hidráulicas contenidas en varios manuales. Se habla sobre el significado del coeficiente de la textura de superficie del canal. Se describe la protección de canal con ejemplos ilustrativos. Se toma nota de los problemas de flotabilidad de canales vacíos con revestimientos rígidos. Se trata sobre la aplicación de revestimientos combinados.

Se describen varios métodos de revestir canales. Se explica la necesidad de coberturas de filtro bajo ciertos revestimientos de canal junto con un método de diseñar capas de materiales de filtro.

Este texto también contiene un capítulo sobre métodos de construcción para los varios canales previamente descritos.

de l'eau sont constantes. Ces conditions sont rarement atteintes dans les fossés de drainage. Cependant, l'erreur commise en présumant l'état d'écoulement uniforme dans un fossé dont les pentes et la section transversale sont à peu près constantes, est petite, comparée à l'erreur que l'on peut commettre en calculant le débit à évacuer. L'emploi de la formule de Manning donne de bons résultats pour le calcul de fossés qui ont des longueurs suffisantes de section transversale, pente et rugosité constantes pour établir un écoulement essentiellement uniforme. Des exemples démontrent l'utilisation de la formule de Manning pour des calculs directs, en se servant de tables ou en se servant à la fois de tables et de calculs directs.

L'écoulement irrégulier, critique, sous-critique

autour des courbes, sur-critique autour des courbes et le nombre de Froude sont définis et discutés. Des formules appropriées sont données pour chaque condition.

Des méthodes de calcul sont décrites pour le tracé du système de drainage, la pente longitudinale du fossé, son tracé, sa section transversale et sa capacité. L'emploi des tables de calcul et des tableaux hydrauliques est expliqué. L'importance du coefficient de rugosité est discutée. Les moyens de protection des fossés sont décrits, et illustrés par des exemples. Les problèmes causés par la poussée dans les fossés qui ont un revêtement rigide, et l'utilisation des revêtements combinés, sont considérés.

Plusieurs méthodes de revêtement des fossés sont décrites. La nécessité d'avoir plusieurs

This selected text discusses the economics of drainage channels. Economical drainage design means doing an adequate job at the lowest cost. The lowest cost adequate channel maintains proper balance between first cost, flood damage, and maintenance cost. It should have the capacity and protection to carry the runoff for which it was designed.

The second text consists of three excerpts from *Design Charts for Open-Channel Flow*, issued by the U.S. Department of Transportation as *Hydraulic Design Series No. 3*. The text is reproduced from the November 1977 reprint of the August 1961 publication. The material describes (a) instructions for design charts that have been excerpted, (b) the charts, and (c) instructions on

Se incluye un otro corto capítulo sobre el mantenimiento de canales abiertos. Este capítulo subraya que se necesita mantenimiento para sostener la capacidad del canal al nivel de diseño.

El texto seleccionado habla sobre los costos relacionados con los beneficios de canales de drenaje. Un diseño económico de drenaje significa realizar un trabajo adecuado al menor costo posible. El canal adecuado de costo más bajo mantiene un correcto equilibrio entre el primer costo, daño por inundación, y costo de mantenimiento, y tiene la capacidad y protección para portar el agua de desagüe para el cuál se diseñó.

El segundo texto consiste de tres extractos de *Design Charts for Open-Channel Flow* (Diagramas de diseño para flujo en canal abierto), publicado por el U.S. Department of Transportation como *Serie de diseño hidráulico No. 3*. El texto ha sido reproducido de la reimpression de noviembre 1977 de la publicación de agosto 1961. Los extractos hablan sobre (a) instrucciones para diagramas de diseño que han sido extraídos, (b) los diagramas de diseño extraídos y (c) las instrucciones que describen la preparación de diagramas de diseño para canales trapezoidales no incluidos en el texto.

Los diagramas de diseño extraídos incluyen los siguientes:

1. Diagramas de la sección transversal de canales trapezoidales utilizando una (n) de 0.03 y pendientes laterales de 2:1 (horizontal a vertical). Se provee un diagrama aparte para cada pie de ancho de fondo desde 2 pies a 10 pies (0.6 m a 3.1 m) y para cada pie (0.3 m) integral de ancho desde 10 pies a 20 pies (3.1 m a 6.2 m). El diagrama del fondo de 4 pies (1.2 m) de ancho aparece en el *Design of Roadside Channels*, por lo tanto no se repite en éste.

2. Un diagrama de una sección transversal triangular para utilizarse en secciones de zanja de forma V de poca profundidad. Las instrucciones de este diagrama deben ser cuidadosamente ejecutados, ya que puede también utilizarse para secciones de calle encintadas.

3. Un diagrama de un canal con cobertura de pasto de forma trapezoidal para pendientes laterales de 2:1 y ancho de fondo de 4 pies (1.2 m).

La tercera sección del segundo texto es el Apéndice B de *Construction of Design Charts for Open-Channel Flow* (Construcción de diagramas de diseño para flujo en canal abierto). Describe la construcción de diagramas de diseño para canales trapezoidales con pendientes

xvii

couches différentes de matériau filtrant sous certains revêtements est expliquée, et la méthode de calcul des différentes couches de matériau filtrant est incluse.

Le livre, *Design of Roadside Drainage Channels*, contient aussi un chapitre sur la construction des fossés de drainage qui sont décrits antérieurement. Un autre chapitre, sur l'entretien des fossés à ciel ouvert, est aussi inclus. Ce chapitre met l'emphase sur le fait qu'il faut entretenir ces fossés constamment pour qu'ils continuent à pouvoir évacuer le débit prévu lors de leur dimensionnement.

Ce texte choisi discute les fossés latéraux d'un point de vue économique. Un fossé de drainage est appelé économique s'il fournit une évacuation des eaux adéquate pour un coût minimum. Pour cela, il faut équilibrer le coût initial

de construction, le coût des dégradations causées par les inondations, et le coût de l'entretien. En même temps, ce fossé doit avoir la capacité d'évacuer le débit prévu, et être protégé contre l'érosion.

Le deuxième texte choisi consiste en trois extraits de *Design Charts for Open-Channel Flow* (Cartes de calcul pour l'écoulement des fossés à ciel ouvert), publié par le U.S. Department of Transportation sous le titre *Hydraulic Design Series No. 3*. Ce texte est la reproduction de la réimpression en Novembre 1977 de la publication originale d'Août 1961. Les extraits discutent de (a) les instructions pour les cartes de calcul qui ont été choisies, (b) ces cartes de calcul, et (c) les instructions pour préparer des cartes de calcul pour les fossés de forme trapezoïdale qui ne sont pas inclus dans le texte.

preparing design charts for trapezoidal channels not included in the text.

The excerpted design charts include the following:

1. Trapezoidal cross-section channel charts using an "n" of 0.03 and side slopes of 2:1 (horizontal to vertical). A separate chart is provided for each foot (0.3 m) of bottom width from 2 to 10 ft (from 0.6 m to 3.1 m) and for each even foot of width from 10 to 20 ft (from 3.1 m to 6.2 m). The 4-ft (1.2-m) bottom width chart appears in *Design of Roadside Drainage Channels*, so it is not repeated here.

2. A triangular cross-section chart for use in shallow V-shaped ditch sections. The instruc-

tions on this chart must be carefully followed because it can also be used for curbed street sections.

3. A trapezoidal grass-lined channel chart for side slopes of 2:1 and a bottom width of 4 ft.

Appendix B – Construction of Design Charts for Open-Channel Flow, the third excerpt from this second text, describes the construction of design charts for trapezoidal channels with side slopes, bottom widths, and roughness coefficients other than the ones presented in the preceding charts. It describes the construction of similar design charts for various configurations of grassed channels.

The third selected text consists of selected

laterales, anchos de fondo y coeficientes de textura de superficie otros que no sean los presentados en los diagramas previos. La descripción también incluye la construcción de diagramas de diseño similares para varias configuraciones de canales con cobertura de pasto.

El tercer texto consiste en tablas seleccionadas del *Handbook of Hydraulics* (Manual de hidráulicas) (H.W. King, Cuarta Edición, 1954). Esta publicación es un manual de hidráulica de autoridad reconocida que en este momento está en su sexta edición (ver Referencia 6). El primer texto de este Compendio hace referencia a ciertas tablas de esta publicación por su número de tabla en la página 29 del Compendio.

El texto contiene varios ejemplos para demostrar cómo se puede ahorrar tiempo utilizando las tablas. Cada ejemplo se referencia a una tabla específica. Las tablas seleccionadas son como sigue: Tabla 92 — Raíces Cuadradas de Números Decimales; Tabla 95 — Números elevados a ocho-terceros de Potencia; y Tabla 97 — Valores de K' en la Fórmula $Q = \frac{K' b^{2.48} S^{1/2}}{n}$ para Canales Trapezoidales. Estas tablas han

sido renumeradas en las ediciones posteriores del manual.

El cuarto texto es un extracto de *Grading Illustrated* (Nivelación, Ilustrada), Publicación TP 549 del Departamento de Publicaciones Técnicas de Aveling-Barford Ltd., Grantham, England (1974). Describe los métodos básicos de construcción de caminos utilizando varios tipos de niveladoras de Aveling-Barford. Que se lo ha incluido en este compendio no significa el respaldo de esta marca de niveladora en particular. El texto se escogió únicamente por la claridad y concisión de la información presentada.

El texto da instrucciones e ilustraciones para las varias tareas que pueden ser llevadas a cabo por una niveladora. La descripción de la construcción de caminos de tierra comienza en la página 136 del Compendio. Las etapas de construcción detalladas son para (a) quitar el césped, (b) nivelar la superficie, (c) señalar la zanja, (d) hacer un corte de zanja, (e) trasladar la tierra del corte, (f) repetir los cortes de zanja, (g) nivelar la pendiente exterior de la zanja, (h) limpiar la zanja, y (i) terminar el peralte.

Les cartes de calcul choisies comprennent les suivantes:

1. Des cartes de calcul pour les fossés de section transversale trapezoïdale qui utilisent un "n" de 0.03 et des pentes de talus de 2:1 (de l'horizontale à la verticale). Une autre carte est fournie par pied de largeur de fond du fossé de 2 à 10 pieds (0.6 m à 3.1 m) et pour chaque nombre pair de 10 à 20 pieds (3.1 m à 6.2 m). La carte de 4 pieds (1.2 m) de largeur de fond du fossé est incluse dans *Design of Roadside Drainage*, donc nous ne l'avons pas reproduite ici.

2. Une carte de section transversale triangulaire à utiliser dans les fosses peu profonds en forme de "V". Les instructions pour se servir de cette carte doivent être suivies très attentivement car cette carte peut être utilisée aussi pour le calcul des rues à bordure.

3. Une carte pour les fossés de forme trapezoïdale avec une couverture végétale et des pentes de talus de 2:1 et une largeur de fond de 4 pieds (1.2 m).

Le troisième extrait de ce second texte choisi, *Appendix B – Construction of Design Charts for Open-Channel Flow* (Annex B — Construction

tables from the *Handbook of Hydraulics* (H. W. King, Fourth Edition, 1954). This publication is a standard hydraulic handbook now in its sixth edition (see Reference 6). The first selected text in this compendium refers to selected tables from this handbook by number (see Compendium 5, page 29). It also contains several examples to show how time can be saved by using tables. Each example refers to a specific table. The selected tables are Table 92 — Square Roots of Decimal Numbers; Table 95 — Eight-thirds Powers of Numbers; and Table 97 — Values of K' in Formula $Q = \frac{K'}{n} b^{8/3} S^{1/2}$ for

Trapezoidal Channels. These tables have been renumbered in later editions of the handbook.

The fourth selected text is an excerpt from *Grading Illustrated*, Publication TP 549 of the Technical Publications Department of Aveling-Barford Ltd., Grantham, England (1974). It describes basic roadbuilding methods using various types of Aveling-Barford graders. Inclusion in this compendium, however, does not represent an endorsement of this grader. The text was chosen solely for its clarity and conciseness.

The text gives instructions and illustrations for various tasks that can be performed with a grader. (See Compendium 5, page 136). The

El texto describe en el mismo método de paso por paso la construcción de zanjas (trapezoidales) de fondo plano y la formación de pendientes graves. El texto también describe la construcción de terraplén. Los terraplenes se llaman canales de interceptación en el primer Texto Seleccionado.

Cada paso de cada operación se describe en detalle. Algunos pasos se describen como operaciones independientes y preceden la descripción de la construcción de caminos de tierra. Las instrucciones contienen tales detalles como "Ajustar el borde superior de la cuchilla para atrás para realizar cortes". La primera sección del texto describe los métodos correctos de controlar la cuchilla para seguir tales instrucciones. Por lo tanto este texto incluye información sobre la operación de la cuchilla de la niveladora y técnicas básicas de nivelación. Se suministra esta información como antecedente de las instrucciones sobre construcción de canales.

El quinto texto consiste de extractos de *Road Maintenance Practice* (Prácticas de mantenimiento de caminos), publicado por el National Association of Australian State Road Authorities en 1975. El primer extracto, *Section 1 – Introduction* (Sección 1 — Introducción) presenta anteceden-

tes para el resto de la publicación. Sugiere que el propósito de un programa de manutención es el de controlar la velocidad de deterioro de un camino. El programa debería asegurar que la utilidad del camino no caiga debajo de algún nivel mínimo que sea determinado por los recursos y política de la autoridad vial que se concierne con él. El manual mismo dá un plan general de procedimientos para el correcto cumplimiento de una manutención rutinaria.

El segundo extracto, *Section 4 – Drainage* (Sección 4 — Drenaje) es reproducido totalmente. Incluye información sobre el mantenimiento del drenaje en superficies de cascajo y superficies no-pavimentadas. Las superficies no-pavimentadas se definen como las superficies que se componen de material natural que se encuentra en las capas superiores del terreno sobre el cuál cruza el camino. Describe la manutención de los varios elementos de desagüe que se encuentran a lo largo de un camino, incluyendo (a) desagües de meseta ó canales de calzada, (b) drenajes de talud ó vertederos, (c) desagües laterales ó canales de la base de terraplén, (d) drenajes de desviación, (e) drenajes colectores o canales interceptantes, (f) cruces inundados y vados, (g) alcantarillas, (h) puentes

xix

de cartes de calcul pour fossés à ciel ouvert), donne les éléments pour construire des cartes de calcul pour les fossés de forme trapezoidale avec des pentes de talus, largeurs de fond et coefficients de rugosité différents de ceux qui sont offerts dans les cartes précédentes. Il explique aussi comment construire des cartes de calcul pour des fossés à couverture végétale de configurations différentes.

Le troisième texte choisi en tables extraites du livre *Handbook of Hydraulics* (Manuel d'hydraulique, H.W. King, 4^e Edition, 1954). Ce

livre est maintenant à sa sixième édition (voir référence 6). Le premier texte choisi de ce recueil mentionne certaine tables de ce manuel en citant le numéro de la table (voir Recueil no 5, page 29). Il faut remarquer que le numéro de ces tables est différent dans les éditions ultérieures. Plusieurs exemples montrent comment on peut gagner du temps en se servant de ces tables. Chaque exemple se rapporte à une table spécifique. Les tables dont nous parlons ici sont les suivantes: Table 92 — Racines carrées de nombres décimaux; Table 95 — Puissance 8/3

step-by-step construction stages describe how (a) to remove the turf, (b) to level the surface, (c) to mark out the ditch, (d) to make a ditch cut, (e) to move the windrow over, (f) to repeat the ditch cuts, (g) to grade the ditch outslope, (h) to clean the ditch, and (i) to finish the camber.

The text describes the step-by-step construction of flat bottom (trapezoidal) ditches, the banking of steep slopes, and terrace construction. Terraces are called intercepting channels in the first selected text.

Each step of each operation is described in detail. Some steps are described as independent operations and precede the description of earth road construction. The instructions contain such details as "set blade pitch back at the top for cutting". The first section of the text describes the proper methods of controlling the blade to follow such instructions. This text, therefore, includes information on operating the grader blade and basic grading techniques. Such information is provided as background for the instructions on channel construction.

The fifth text consists of excerpts from *Road Maintenance Practice* (National Association of Australian State Road Authorities, 1975). The first excerpt, *Section 1 – Introduction*, serves as a background for the rest of the publication. It suggests that the purpose of a maintenance program is to control the rate of road deterioration. The program should ensure that the serviceability of the road does not fall below some minimum level. This level is determined by the resources and policy of the road authority concerned. The manual outlines procedures for proper performance of routine maintenance.

The second excerpt, *Section 4 – Drainage*, is reprinted in full. It includes information about drainage maintenance for both gravel surfaces and unpaved surfaces. Unpaved surfaces are defined as surfaces consisting of natural material found in the top layers of ground over which the road passes. It describes the maintenance of the various drainage elements found along a roadway, including table drains or roadway channels, batter drains or chutes, side drains or

e (i) drenajes de subsuelo.

El tercer extracto, *Section 10 – Bridges and Culverts* (Sección 10 — Puentes y alcantarillas) es también reproducido totalmente. Trata con la inspección y manutención de estructuras de puentes y alcantarillas. Incluye las reparaciones que requieren atención inmediata que podrían ser ejecutadas por el personal de manutención del camino. No trata sobre inspecciones detalladas ni reparaciones estructurales.

Bibliografía

Los textos seleccionados son seguidos por una breve bibliografía que contiene datos de referencia y abstractos para 11 publicaciones. Los primeros 5 describen los textos seleccionados. Los otros 6 describen publicaciones que se asocian íntimamente con los textos seleccionados. Aunque hay muchos artículos, informes, y libros que podrían haber sido nombrados en la

de nombres; et Table 97 — Valeur de K' dans la formule $Q = \frac{K'}{n} b^3 S^2$ pour les fossés de

forme trapezoïdale.

Le quatrième texte choisi est extrait de *Grading Illustrated* (Le nivellement illustré, Publication TP 549 du Technical Publications Department, Aveling-Barford Ltd., Grantham, England, 1974). Ce texte décrit les méthodes de base de construction d'une route en utilisant différents types de niveleuse Aveling-Barford. Le fait que ce texte est inclus dans ce recueil n'implique pas une recommandation de cette marque. Ce texte a été choisi uniquement pour sa clarté et sa concision.

Ce texte comprend des instructions avec illustrations pour les différentes sortes de travaux que l'on peut exécuter avec une niveleuse. La description des terrassements commence à la page 136 de ce recueil. On décrit pas-à-pas les stades progressifs de la construction: comment décaper la terre végétale, niveler la surface,

marquer l'emplacement des fossés, creuser les fossés, étaler le cordon en sol, re-creuser les fossés, niveler les contre-pentes, déblayer les fossés et finir le bombement de la plateforme.

Ce texte décrit pas-à-pas la construction de fossés à fonds plats (forme trapezoïdale), le talutage de pentes très inclinées, et la construction en redans ou gradins. Dans le premier texte choisi on utilise les mots anglais "intercepting channels", que nous avons traduit par "redans" ou "gradins", alors que dans le quatrième texte choisi, on utilise le mot anglais "terrace" pour dire la même chose.

Chaque stade de l'opération est expliqué en détail. Certains stades sont décrits comme des opérations indépendantes et précèdent la description des travaux de construction de la route. Les instructions contiennent des détails comme "Inclinez le haut de la lame en arrière pour excaver". La première partie du texte décrit la méthode à employer pour contrôler l'angle de la lame, et ainsi pouvoir suivre ces instructions. Ce

toe-of-slope channels, diversion drains, catch drains or intercepting channels, floodways and fords, culverts, bridges, and subsoil drains.

The third excerpt, **Section 10 – Bridges and Culverts**, is also reprinted in full. It concerns inspection and maintenance of bridge and culvert structures. It includes repairs that require prompt attention and that might be done by road maintenance personnel. Detailed inspections or structural repairs are not discussed.

Bibliography

The Selected Texts are followed by a brief bib-

liography containing reference data and abstracts for 11 publications. The first five describe the Selected Texts. The other six describe publications related to the Selected Texts. Although there are many articles, reports, and books that could be listed, it is not the purpose of this bibliography to contain all possible references related to the subject of this compendium. The bibliography contains only those publications from which a text has been selected or basic publications that would have been selected had there been no limit on the number of pages in this compendium.

bibliografía, no es el propósito de ésta contener todas las referencias posibles sobre el tema. La bibliografía contiene únicamente aquellas publicaciones de las cuales se seleccionó texto ó publicaciones básicas que hubieran sido seleccionadas si no hubiera un límite al número de páginas en este compendio.

xxi

texte donc comprend à la fois les instructions pour utiliser la lame de la niveleuse, et des instructions pour les techniques de base du nivellement. Nous avons inclus ces données de base comme préparation aux instructions sur la construction des fossés.

Le cinquième texte choisi consiste en des extraits de **Road Maintenance Practice** (Entretien de la route, National Association of Australian State Road Authorities, 1975). Le premier extrait, **Section – Introduction**, présente les données de base pour le reste de la publication. Il suggère que le but d'un programme d'entretien est de contrôler la vitesse de dégradation de la route. Ce programme devrait assurer que l'état de praticabilité de la route ne tombe pas au dessous d'un certain niveau. Ce niveau est déterminé par les allocations et la politique routière des autorités. Le manuel esquisse les techniques pour assurer la bonne performance d'un programme d'entretien.

Le second extrait, **Section 4 – Drainage**, est

reproduit en entier. Il comprend des informations sur l'entretien des dispositifs de drainage pour les surfaces en gravier et les surfaces non traitées. Les surfaces non traitées sont définies comme des surfaces composées de sol naturel qui se trouve dans les couches supérieures de terrain sur lequel la route passe. L'entretien des divers dispositifs de drainage d'une route est expliqué, entre autre, l'entretien des fossés latéraux de déblais, des avaloirs, des fossés de remblais, des saignées latérales de dégagement (arêtes de poisson), des fossés captants ou de garde, des radiers et des gués, des ponceaux, des ponts et des drains sous-chaussée.

Le troisième extrait, **Section 10 – Bridges and Culverts** (Ponts et ponceaux), est aussi reproduit en entier. Il concerne l'inspection et l'entretien des ouvrages d'art. Les réparations qui demandent l'attention immédiate, et qui peuvent être faites par les équipes d'entretien, sont aussi incluses. Les inspections en détail et les réparations des structures ne sont pas discutées.

Bibliographie

Les Textes Choisis sont suivis d'une brève bibliographie contenant les références et les résumés de onze publications. Les cinq premières se rapportent aux Textes Choisis. Les six autres à des publications qui ont rapport aux Textes Choisis. Bien qu'il y ait beaucoup d'autres articles, rapports et livres qui pourraient être inclus,

l'objectif de cette bibliographie n'est pas d'énumérer toutes les références possibles ayant rapport au sujet de ce recueil. Donc, notre bibliographie, telle quelle, se rapporte seulement aux publications dont nous avons choisi des extraits, ou aux textes de base que nous aurions choisi s'il n'y avait pas de limites quant au nombre de pages de ce recueil.

Selected Texts

This section of the compendium contains selected pages from each text that is listed in the Table of Contents. Rectangular frames are used to enclose pages that have been reproduced from the original publication. Some of the original pages have been reduced in size to fit inside the frames. No other changes have been made in the original material except for the insertion of occasional explanatory notes. Thus, any errors that existed in the selected text have been reproduced in the compendium itself.

Page numbers of the original text appear inside the frames. Page numbers for the compendium are

outside the frames and appear in the middle left or middle right outside margins of the pages. Page numbers that are given in the Table of Contents and in the Index refer to the compendium page numbers.

Each text begins with one or more pages of introductory material that was contained in the original publication. This material generally includes a title page, or a table of contents, or both. Asterisks that have been added to original tables of contents have the following meanings:

*Some pages (or parts of pages) in this part of

Textos Seleccionados

Esta sección del compendio contiene páginas seleccionadas de cada texto que se catalogaron en la Tabla de Materias. Se utilizan recuadros rectangulares para encerrar las páginas que han sido reproducidas de la publicación original. Algunas de las páginas originales han sido reducidos para entrar en los recuadros. No se han hecho ningunos otros cambios en el material original exceptuando algunas notas aclaradoras que de vez en cuando han sido agregadas. De esta forma, cualquier error que hubiera existido en el texto seleccionado ha sido reproducido en el compendio mismo.

Los números de páginas del texto original

aparecen dentro de los recuadros. Los números de páginas para el compendio están fuera de los recuadros y aparecen en los márgenes medio izquierdo o medio derecho de las páginas. Los números de páginas que se dan en los índices del compendio se refieren a los del compendio.

Cada texto comienza con una o más páginas de material de introducción que contenía la publicación original. Este material generalmente incluye una página título, un índice, o ambas. Los asteriscos que han sido agregados al índice original significan lo siguiente:

* Algunas páginas (o partes de páginas) en

Textes Choisis

Cette partie du recueil contient les pages sélectionnées de chaque texte qui est énuméré dans la Table des Matières. Les pages du texte original qui sont reproduites sont entourées d'un encadrement rectangulaire. Certaines pages ont dû être réduites pour pouvoir être placées dans l'encadrement. Le texte original n'a pas été changé sauf pour quelques explications qui ont été insérées. Donc, si le texte original contient des erreurs, elles sont reproduites dans le recueil.

La pagination originale apparaît à l'intérieur de l'encadrement. La pagination du recueil est

à l'extérieur de l'encadrement, soit à droite, soit à gauche de la marge extérieure des pages et est celle qui est citée dans la table des matières et dans l'index du recueil.

Chaque texte commence par une ou plusieurs pages d'introduction qui étaient incluses dans le texte original. Ces pages sont généralement le titre, ou la table des matières, ou les deux. Des astérisques ont été ajoutés à la table des matières d'origine pour les raisons suivantes:

* Certaines pages, ou portions des pages,

the original document appear in the selected text, but other pages (or parts of pages) in this part of the original publication have been omitted.

**All pages in this part of the original document appear in the selected text.

The selected texts therefore include only those

parts of the original documents that are preceded by asterisks in the tables of contents of the respective publications.

Broken lines across any page of selected text indicate those places where original text has been omitted. In a number of places, the selected text contains explanatory notes that have been inserted by the project staff. Such notes are set off within dashed-line boxes and begin with the word NOTE.

esta parte del documento original aparecen en el texto original, pero otras páginas (o partes de páginas) en esta parte de la publicación original han sido omitidas.

** Todas las páginas en esta parte del documento original también aparecen en el texto seleccionado.

2

Por lo tanto, los textos seleccionados únicamente incluyen aquellas partes de los docu-

mentos originales que están precedidas por asteriscos en el índice de las publicaciones respectivas.

Lineas de guiones cruzando cualquier pagina del texto seleccionado significan que en ese lugar se ha omitido texto original. En varios lugares el texto seleccionado contiene notas aclaradoras que han sido introducidas por el personal del proyecto. Tales notas estan insertadas en recuadros de guiones y comienzan con la palabra NOTE.

dans cet extrait du document original sont incluses dans les Textes Choisis, mais d'autres pages (ou portion de pages) de l'édition originale ont été omises.

** Toutes les pages dans cet extrait du document original sont incluses dans les Textes Choisis.

Les Textes Choisis, donc, incluent seulement ces extraits des documents originaux qui sont

précédés d'un astérique dans les tables des matières des publications respectives.

Les lignes brisées sur les pages des textes choisis indiquent les endroits où le texte original a été omis. A certains endroits, les textes choisis contiennent des explications qui ont été insérées par le personnel attaché à ce projet. Ces explications sont entourées d'un encadrement en pointillé et commencent toujours par le mot NOTE.

DESIGN OF ROADSIDE DRAINAGE CHANNELS

Hydraulic Design Series No. 4

By the Hydraulics Branch, Bridge Division,
Office of Engineering

Reported by James K. Searcy, Hydraulic Engineer



U.S. DEPARTMENT OF TRANSPORTATION

FEDERAL HIGHWAY ADMINISTRATION

May 1965

Reprinted December 1973

For sale by the Superintendent of Documents, U.S. Government Printing Office
Washington, D.C. 20402 - Price \$1.25
Stock Number 050-001-00068-7
Catalog Number TD 2.33:4

NOTE: This text has been reproduced with the permission of the Federal Highway Administration, U.S. Department of Transportation.

PREFACE

This publication, the fourth in a series published by the Federal Highway Administration on the hydraulic design of highway drainage structures, contains methods of open-channel design including determination of the size of channel and protection required to prevent erosion. Principles and procedures are explained but no set of rules can be furnished that will apply to all of the many diverse combinations of topography, soil, and climate that exist where highways are built. Design of roadside drainage channels will continue to require an engineer well versed in hydraulic theory and in highway drainage practice. The open-channel flow charts of Hydraulic Design Series No. 3 and hydraulic tables such as those of reference 28 will greatly reduce the work of computing channel capacity.

This reprint is identical with the 1965 edition of Hydraulic Design Series No. 4 with the exception of a redesigned cover, revised preface, and updated references.

CONTENTS

	Page		Page
** Preface.....	iii	4.9 Concrete-lined channels.....	26
** Letter symbols and units.....	vii	4.9-1 Buoyancy of empty channels.....	28
** Principal equations.....	vii	4.10 Channels with combination linings.....	28
** Chapter I—Introduction		4.11 Bituminous linings.....	29
1.1 General.....	1	4.12 Channels lined with stone.....	29
1.2 Factors in design.....	1	4.12-1 Dumped-stone linings.....	30
1.3 Types of drainage channels.....	2	4.12-2 Hand-placed stone linings.....	33
1.4 Gutters.....	2	4.12-3 Grouted-stone linings.....	34
1.5 Chutes.....	3	a Filter blankets.....	34
1.6 Roadway channels.....	3	b Wecks.....	34
1.7 Toe-of-slope channels.....	3	c Drop structures.....	35
1.8 Intercepting channels.....	3	4.15 Chutes.....	35
1.9 Median swales.....	4	4.16 Bank and shore protection.....	37
1.10 Channel changes.....	4	4.17 Drainage structures in channel.....	38
1.11 Alinement and grade.....	4	** Chapter V—Construction	
1.12 Protection from erosion.....	4	5.1 General.....	39
** Chapter II—Estimating Storm Runoff from Small Areas		5.2 Supervision.....	39
2.1 General.....	6	5.3 Excavation.....	39
2.2 Storm runoff.....	6	5.4 Grass-lined channels.....	39
2.3 Rainfall intensity-duration-frequency analysis.....	6	5.5 Concrete-lined channels and chutes.....	39
2.4 The rational method.....	7	5.6 Bituminous-lined channels.....	40
2.4-1 Runoff coefficient.....	7	5.7 Stone-lined channels.....	40
2.4-2 Time of concentration.....	9	5.8 Ditch checks.....	41
2.4-3 Rainfall intensity.....	9	** Chapter VI—Maintenance	
2.4-4 Drainage area.....	9	6.1 General.....	42
2.4-5 Computing the design discharge.....	9	6.2 Effect of maintenance on channel capacity.....	42
2.4-6 Computing the design discharge for complex drainage areas.....	11	** Chapter VII—Economics of Drainage Channels	
** Chapter III—Hydraulics of Drainage Channels		7.1 General.....	43
3.1 General.....	12	7.2 Frequency of the design storm.....	43
3.2 Uniform flow.....	12	7.3 Effect of channel section.....	43
3.2-1 The Manning equation.....	12	7.4 Effect of topography.....	44
3.2-2 Aids in solution of the Manning equation.....	13	7.5 Effect of channel lining.....	44
3.3 Nonuniform or varied flow.....	16	7.6 Drop structures.....	44
3.3-1 Energy of flow.....	16	** Chapter VIII—Illustrative Problem in Channel Design	
3.3-2 Critical flow.....	17	8.1 General.....	45
3.3-3 Problems in nonuniform flow.....	19	8.2 Layout of the drainage system.....	45
3.3-4 Subcritical flow around curves.....	20	8.3 Channel 3.....	46
3.3-5 Supercritical flow around curves.....	20	8.4 Channel 4.....	47
3.4 The Froude number.....	20	8.5 Channel 5.....	47
** Chapter IV—Design Procedure		8.6 Channel 6.....	50
4.1 General.....	21	8.7 Channels 7, 8 and 9.....	50
4.2 Layout of the drainage system.....	21	** References.....	51
4.3 Channel grade.....	21	** Appendix A—TABLES	
4.4 Channel alinement.....	21	1. Values of runoff coefficient (C) for use in the rational method.....	53
4.5 Channel section.....	21	2. Manning n roughness coefficients.....	53
4.6 Channel capacity.....	21	3. Maximum permissible velocities in erodible channels.....	54
4.6-1 Use of channel charts.....	22	4. Maximum permissible velocities in channels lined with uniform stands of various grass covers.....	54
4.6-2 Use of King's tables.....	22	5. Classification of vegetal covers as to degree of retardance.....	55
4.6-3 Significance of the roughness coefficient (Manning n).....	23	** Appendix B	
4.7 Channel protection.....	23	Nomograph for solution of Manning Equation.....	56
4.8 Grass-lined channels.....	24		

6

FIGURES	Page
1. Elements of the highway cross section.....	vi
2. Types of roadside drainage channels.....	2
3. Location of vertical curves in channel cross section.....	3
4. Poorly designed ditch checks.....	5
5. Time of concentration of small drainage basins..	8
6. Rainfall intensity-duration-frequency curve for Washington, D.C.....	10
7. Map of the contiguous United States showing 2-year 30-minute rainfall intensity.....	11
8. Trapezoidal channel.....	13
9. Open-channel chart.....	14
10. Irregular-channel section.....	15
11. Water-surface profile of channel with uniform flow.....	16
12. Water-surface profile of channel with non-uniform flow.....	17
13. Specific-head diagram for constant Q.....	18
14. Water-surface profile of channel with sudden change in grade.....	19
15. Approximate distribution of velocities in a straight trapezoidal channel.....	24
16. Manning n for vegetal-lined channels.....	25
17. Open-channel chart for grass-lined channel....	27
18. Trapezoidal channel with combination lining..	29
19. Relation of Manning n to size of stone.....	30
20. Average velocity against stone on channel bottom.....	31
21. Size of stone that will resist displacement for various velocities and side slopes.....	32
22. Chute with sharp change in alinement.....	36
23. Section of concrete-lined channel showing treatment of edges.....	40
24. Gradation curves for dumped-stone protection..	41
25. Layout of drainage system for illustrative problem.....	45
26. Identification of drainage channels.....	46

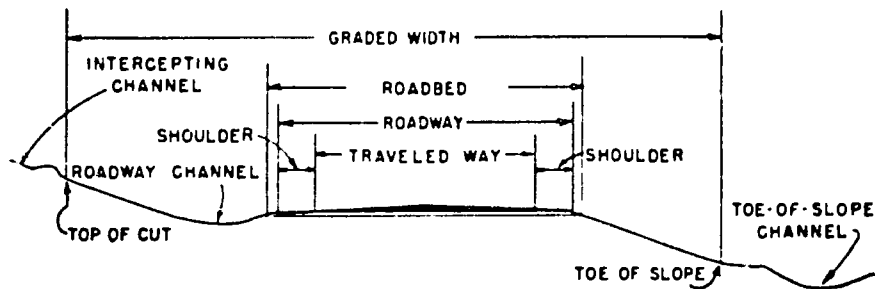

Figure 1.—Elements of the highway cross section.

LETTER SYMBOLS AND UNITS

Symbol	Units	Description	Symbol	Units	Description
A	acres	Drainage area of a stream at a specified location	n		Manning roughness coefficient
A	sq. ft.	Area of cross section of flow	Q	c.f.s.	Rate of discharge
B	ft.	Width of rectangular channel or conduit	R	ft.	Hydraulic radius = $\frac{A}{WP}$
b	ft.	Bottom width of a trapezoidal channel	S	ft./ft.	Slope of the energy grade line (total head line). When the Manning equation applies, $S=S_0$
C		Runoff coefficient in the rational formula	S ₀	ft./ft.	Slope that produces the allowable velocity for a given discharge
D	ft.	Height of conduit or diameter of circular conduit	S _c	ft./ft.	That particular slope of a uniform channel at which normal depth equals critical depth for a given discharge
d	ft.	Depth of flow at any section	S _f	ft./ft.	Minimum slope required to overcome friction
d _c	ft.	Critical depth of flow in channel	S ₀	ft./ft.	Slope of the flow line of a channel (bed slope)
d _m	ft.	Mean depth of flow ($\frac{A}{T}$)	T	ft.	Top width of water surface in a channel
d _n	ft.	Normal depth of flow in uniform channel for steady flow	T _c	min.	Time of concentration of a watershed
F		Froude number = $\frac{V}{\sqrt{gd_m}}$	V	f.p.s.	Mean velocity of flow
g	ft./sec. ²	Acceleration of gravity = 32.2	V _c	f.p.s.	Mean velocity of flow in a channel when flow is at critical depth (critical velocity)
H	ft.	Total head	V _n	f.p.s.	Mean velocity of flow in a channel when flow is at normal depth
H _e	ft.	Specific head at minimum energy = $d + V^2/2g$	V _s	f.p.s.	Mean velocity of flow against stone in a rocklined channel
H _s	ft.	Specific head = $d + V^2/2g$	w	lb./ft. ³	Unit weight of stone used for channel linings
h	ft.	Vertical drop in ditch check	WP	ft.	Wetted perimeter—length of line of contact between the flowing water and the channel
h _L	ft.	Cumulative losses in a channel reach	Z	ft.	Elevation of bed of channel above a datum
i	in./hr.	Average rainfall intensity during the time of concentration	z		Slope of sides of a channel (ratio of horizontal to vertical)
K		Channel conveyance = $\frac{1.49}{n} AR^{2/3}$			
k	ft.	Stone diameter for bank protection (165 lb./ft. ³ stone)			
k _e		Entrance loss coefficient			
k _s	ft.	Stone diameter for bank protection for stone weighing other than 165 lb./ft. ³			
L	ft.	Length of channel reach			

PRINCIPAL EQUATIONS

Rational formula (p. 7):

$$Q = CiA \tag{1}$$

Manning equation (p. 12):

$$V = \frac{1.49}{n} R^{2/3} S^{1/2} \tag{2}$$

$$Q = \frac{1.49}{n} AR^{2/3} S^{1/2} \tag{5}$$

$$S = \left(\frac{Vn}{1.49R^{2/3}} \right)^2 \tag{13}$$

Critical depth (p. 17):

Rectangular section:

$$d_c = 0.315 \sqrt[3]{\left(\frac{Q}{B}\right)^3} \tag{15}$$

Trapezoidal channel:

$$d_c = \frac{4zH_0 - 3b + \sqrt{16z^2H_0^2 + 16zH_0b + 9b^2}}{10z} \tag{16}$$

Triangular channel:

$$d_c = 0.574 \sqrt[3]{\left(\frac{Q}{z}\right)^3} \tag{17}$$

Froude number (p. 20):

$$F = \frac{V}{\sqrt{gd_m}} \tag{26}$$

Chapter I.—INTRODUCTION

1.1 **General.** Roadside drainage channels perform the vital function of diverting or removing surface water from the highway right-of-way. They should provide the most efficient disposal system consistent with cost, importance of the road, economy of maintenance, and legal requirements. One standard channel will rarely provide the most satisfactory drainage for all sections of a highway, although it might be adequate for most locations. Thus, the design engineer needs procedures for designing various types of channels. This publication discusses flow in roadside drainage channels, estimation of peak discharges from small areas, prevention of channel erosion, and presents methods for the design of drainage channels required to remove runoff from the area immediately adjacent to the highway.

Drainage channel design requires, first, the determination of where surface or ground water will occur, in what quantity, and with what frequency. This is a hydrologic problem. Then structures of appropriate capacity must be designed to divert water from the highway roadway, to remove water that reaches the roadway, and to pass collected water under the roadway. This is a hydraulic problem. This publication will discuss only the part of the problem that deals with roadside drainage channels; however, many of the principles discussed also apply to natural streams.

Erosion control (1)¹ is a necessary part of good drainage design. Unless the side slopes and the drainage channels themselves are protected from erosion, unsightly gullies appear, maintenance costs increase, and sections of the highway may be damaged or even destroyed.

Drainage design begins with the road location. Locations that avoid poorly drained areas, unstable soil, frequently flooded areas, and unnecessary stream crossings greatly reduce the drainage problem. Data gathered in the field permit solution of the drainage problems that cannot be avoided when locating the highway. Adequate notes on farm drainage, terraces, and manmade channels are particularly important, as these channels are seldom shown on topographic maps.

The design of roadside drainage channels has been discussed by Izzard (2), and criteria for drainage channel design appears in the publication, "A Policy on Geometric Design of Rural Highways" (1). Subsurface drainage of highways is discussed in Highway Research Board Bulletin 209 (3) and the function of highway shoulders in surface drainage is discussed by Ackroyd (4).

In this publication, types and sections of drainage chan-

nels are first discussed, followed by a discussion of channel alignment, grade, and protection from erosion. Hydrologic and hydraulic principles are discussed briefly and design procedures are presented with typical charts for determining channel size. Finally, the methods described are applied in the design of the channels illustrated in figure 2. For convenience of the user, all tables are placed in appendix A.

The design procedures discussed in this publication are only tools to aid in solving the surface drainage problem—there is no standard solution. The drainage problem of each section of highway is individual and for solution requires adequate field data and an engineer experienced in highway drainage.

1.2 **Factors in design.** The primary purpose of roadside drainage channels is to prevent surface runoff from reaching the roadway and to efficiently remove the rainfall or surface water that reaches the roadway. To achieve this purpose, the drainage channels should have adequate capacity for the peak rates of runoff that recur with a frequency depending upon the class of road and the risk involved. On less important roads where little damage would result from overtopping of the drainage channel and where traffic would suffer only minor inconvenience, a peak runoff that recurs frequently might be satisfactory. On major highways or on minor highways where serious erosion damage would result from overtopping the drainage channels, a less frequent peak runoff might be used as the design runoff.

The frequency used depends somewhat upon the climate, the topography of the area, and the cost of the drainage system. Water standing on the edge of the traveled way for a few minutes during an intense storm might not interfere with traffic movement any more than the storm itself, but should water remain for a long time or collect in pavement sags or in underpass depressions, a traffic hazard will result. At locations where shoulder gutters protect high fills highly susceptible to erosion, the peak discharge for which the channels are designed might be greater than the class of the road would otherwise warrant.

Bureau of Public Roads policy requires that on Interstate System projects, all drainage facilities other than culverts and bridges be designed to keep the traveled ways usable during storms at least as great as that for a 10-year frequency, except that a 50-year frequency shall be used for underpass or other depressed roadways where ponded water can be removed only through the storm-drain system.

¹ Italic numbers in parentheses refer to the references on p. 31.

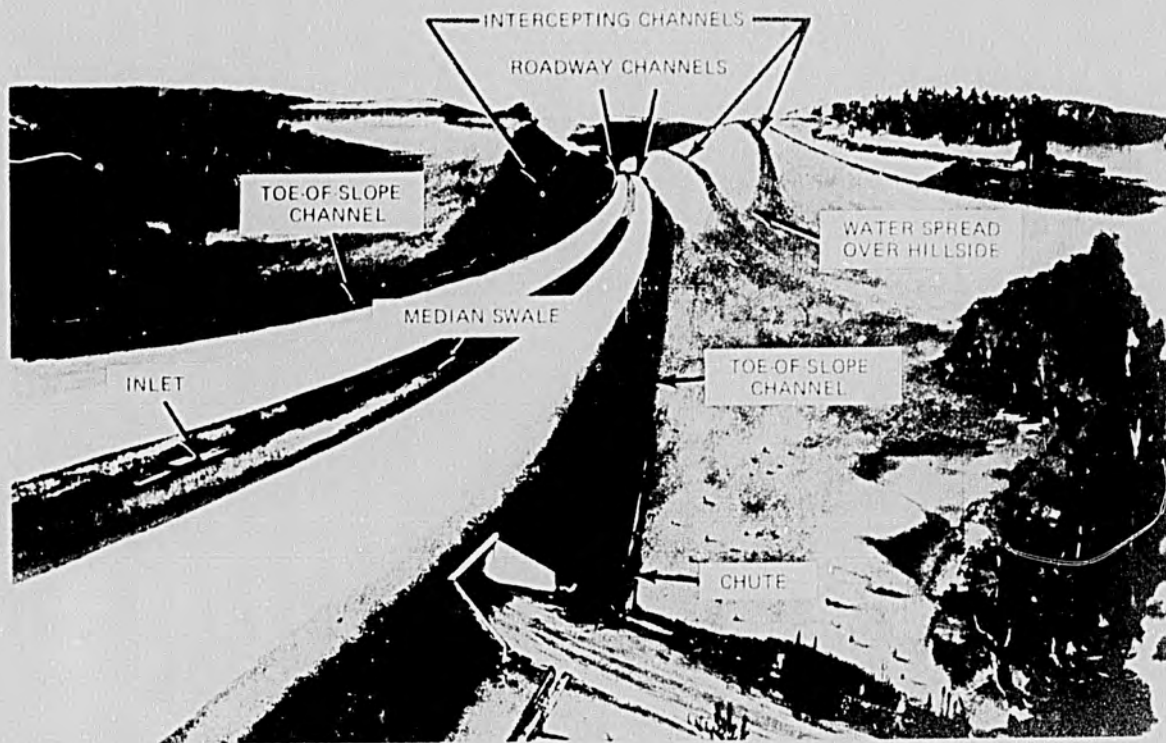

Figure 2.—Types of roadside drainage channels.

The capacity of a drainage channel carrying uniform flow depends upon its shape, size, slope, and roughness. For a given channel, the capacity becomes greater when the grade or the depth of flow is increased. The channel capacity decreases as the channel surface becomes rougher. For example, a rubble or stone gutter has only about half the capacity of a concrete gutter of the same size, shape, and slope because of the differences in channel roughness. A rough channel is sometimes an advantage on steep slopes where it is desirable to keep velocities from becoming too high.

The most efficient shape of channel is that of a semi-circle, but hydraulic efficiency is not the sole criterion. In addition to performing its hydraulic function, the drainage channel should be economical to construct, and require little maintenance during the life of the roadway. Channels should also be safe for vehicles accidentally leaving the traveled way, pleasing in appearance, and dispose of collected water without damage to the abutting property. Most of these additional requirements for drainage channels reduce the hydraulic capacity of the channel. Thus, the best design for a particular section

of highway is a compromise among the various requirements, sometimes with each requirement having a different influence on the design from that of another section.

1.3 Types of drainage channels. Highway drainage channels may be classified according to function as gutters, chutes, roadway channels, toe-of-slope channels, intercepting channels, median swales, and channel changes. Figure 2 shows a typical divided highway in a humid region where several types of drainage channels are needed to drain the highway. Starting at the outer edge of the right-of-way are the intercepting channels on the natural ground outside the cut or fill slope, or on benches breaking the cut slope. Next are the roadway channels between the cut slope and the shoulder of the road and the toe-of-slope channels which take the water discharged from the roadway channels and convey it along or near the edge of the roadway embankment to a point of disposal. A shallow depression or swale drains the median. The types of drainage channels are defined and discussed in subsequent sections of this chapter.

1.4 Gutters. Gutters are the channels at the edges of the pavement or the shoulder formed by a curb or by a

shallow depression. Gutters are invariably paved with concrete, brick, stone blocks, or some other structural material.

Gutters are generally used in lieu of other type channels for urban highway drainage and are sometimes used in rural areas, particularly on parkways, in mountainous regions, in sections with limited right-of-way, in areas of poor soil stability, and for special drainage problems such as traffic interchanges and underpasses.

In areas where vegetative cover cannot be used to prevent erosion damage to high fills, shoulders are designed to serve as a gutter with a curb constructed at the outer edge to confine the water to the shoulder. The water collected in the gutter is discharged down the slope through chutes. The curb may be made of earth, bituminous material, portland cement concrete, or cut stone.

1.5 Chutes. Chutes, as used in this publication, are steeply inclined open or closed channels, which convey the collected water to a lower level. Chutes are also called flumes and spillways. The most common applications in highway construction are the chutes used to convey water down cut or fill slopes. Open chutes can be metal or be paved with portland cement concrete, bituminous material, stone, or sod, depending upon the volume and velocity of the water to be removed. On long slopes, closed (pipe) chutes are generally preferable to open chutes because in an open chute the high velocity water is likely to jump out of the channel, erode the slope, and destroy the chute. Also, open chutes may interfere with machine-mowing operations on the roadway slopes. The inlet of all chutes must be adequately designed to prevent water bypassing the chute and eroding the slope. Frequently energy dissipators or other types of erosion protection are needed at the chute outlet.

1.6 Roadway channels. Roadway channels are the channels provided in the cut section to remove the runoff from rain falling on the roadway and on the cut slopes. These channels are sometimes called gutters when paved; however, in this publication paved channels separated from the traveled way will be called roadway channels.

A well-designed roadway channel removes storm water from the cut areas with the lowest overall cost including cost of maintenance, and with the least hazard to traffic. The channel should also be pleasing in appearance. To meet these requirements, the AASHO (1) "Policy on Geometric Design of Rural Highways" recommends that where terrain permits, roadside drainage channels built-in earth should have side slopes not steeper than 4 horizontal to 1 vertical, and a rounded bottom at least 4 feet wide. Flatter side slopes are desirable on channels beside low fills. The depth of channel should be sufficient to remove the water without saturating the pavement subgrade.

It is unnecessary to standardize the design of roadside drainage channels for any length of highway. Not only can the depth and breadth of the channel be varied with variation in the amounts of runoff, rate of channel grade, and distance between lateral outfall culverts, but the dimensions can be varied by the use of different types of channel lining. Nor is it necessary to standardize the lateral distance between the channel and the edge of pave-

ment. Often liberal offsets can be obtained where cuts are slight and where cuts end and fills begin.

Automobile proving ground tests reported by Stonex (6) show that the most important element in controlling the shock of impact when driving into a flat-sloped channel is the length of vertical curve between the side slopes and the channel bottom. (See fig 3.) For a speed of 65 miles per hour and a striking angle of 15° with the channel centerline, on a channel with a 6:1 side slope, a vertical curve 61½ feet long is recommended and a vertical curve about 10 feet long is recommended for a channel with a 4:1 side slope.

1.7 Toe-of-slope channels. Toe-of-slope channels are located at or near the toe of a fill when it is necessary to convey water collected by the roadway channel to the point of disposal. On the downhill side of the highway, this channel can often be laid on a mild slope and the lower end flared to spread the water over the hillside. Where this practice would cause erosion or permit water to drain into the highway embankment, the toe-of-slope channel must convey the storm water to a natural watercourse.

In arid and semiarid regions, the water draining out of the roadway cut should be diverted away from the fill far enough so that it does not come back to the highway. The landowner will seldom object to receiving storm water from the highway, provided it is delivered without causing erosion.

1.8 Intercepting channels. Intercepting channels are located on the natural ground near the top edge of a cut slope or along the edge of the right-of-way, to intercept the runoff from a hillside before it reaches the roadway. Intercepting the surface flow reduces erosion of cut slopes, lessens silt deposition and infiltration in the roadbed area, and decreases the likelihood of flooding the highway in severe storms.

Intercepting surface water is particularly important in arid and semiarid regions. Intercepting dikes may be built well back from the top of the cut slope and generally on a flat grade until the water can be spread or emptied into a natural watercourse. In most cases, the owners of rangeland will permit highway departments to construct a series of contour furrows beyond the right-of-way in order to recover the water.

An intercepting channel constructed by forming a dike with borrow material is superior to an excavated channel because the latter destroys the natural ground cover and is more likely to erode. Care should be taken to avoid ponding water at the tops of slopes subject to sliding. In slide areas, storm water should be intercepted and removed as rapidly as practicable and sections of the channel crossing highly permeable soil might require lining with impermeable material.

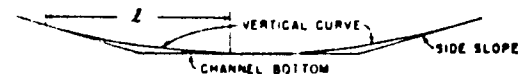

Figure 3.—Location of vertical curves in channel cross section.

1.9 Median swales. Median swales are the shallow depressed areas at or near the center of medians used to drain the median area and portions of the roadway. The depressed area or swale is sloped longitudinally for drainage, and at intervals the water is intercepted by inlets and discharged from the roadway. It is not necessary that the longitudinal slope of the swale conform to the pavement grade, particularly on flat grades. (See sec. 4.3.)

Generally, curbs are not provided on the edge of the pavement and the median swale drains part or all of the pavement area in addition to the median area. Even where curbs are provided, it is preferable to slope medians wider than 15 feet to a swale. This keeps water in the median off the pavement and prevents snowmelt water from running onto the pavement and becoming a hazard after a quick freeze. Medians less than 15 feet wide are generally crowned for drainage, and if under 6 feet in width the median is usually paved. Six feet is about the minimum width that can be mowed with mechanical equipment (see 1).

1.10 Channel changes. Channel changes alter the alignment or cross sections of natural watercourses. Replacing a long sinuous natural channel by a shorter improved channel will increase the channel slope and usually decrease the channel roughness. Both of these changes cause an increase in the velocity of the flowing water, sometimes enough to cause damage to the highway embankment near the stream or excessive scour around footings of structures. At other times damage occurs because the stream continues to use the old channel rather than the new because adequate training works are not provided to divert the stream into the new channel. In addition to possible damage to the highway, a major channel change may be detrimental to fish and other aquatic life because of increased velocities, decreased depth of flow, and the removal of boulders and irregularities in the channel. Placing boulders at random in the new channel will aid in restoring the fish habitat.

Occasionally, small watercourses crossing the highway can be diverted into an adjacent watercourse at a lower cost than by providing separate cross drains. Channel changes in the vicinity of a highway or at a highway crossing are sometimes made to secure borrow material for the roadway embankment with the thought of incidental improvement in the channel cross section or alignment. Such a practice on a stabilized stream channel almost always results in future maintenance problems. Channel changes also incur a legal liability for damage to private property that might be brought about by the changed channel. Thus, channel changes should always be studied for their value and effect rather than made to secure borrow material or to save the cost of a cross drain.

Borrow ditches should not be placed near the toe of embankments adjacent to natural streams which overflow their banks. A ditch so located will often carry flow at high velocities with attendant damage to the embankment section during flood periods. In some locations borrow ditches on the upstream side of the fill will direct the high-velocity water back into the main channel in a manner that induces scour at bridge piers and abutments.

1.11 Alignment and grade. The width of the right-of-way usually allows little choice in the alignment or in the grade of the channel, but insofar as practicable abrupt changes in alignment or in grade should be avoided. A sharp change in alignment presents a point of attack for the flowing water, and abrupt changes in grade cause deposition of transported material when the grade is flattened or scour when grade is steepened.

A drainage channel should have a grade that produces velocities that neither erode nor cause deposition in the channel. This optimum velocity also depends upon the size and shape of channel, the quantity of water flowing, the material used to line the channel, and upon the nature of the soil and the type of sediment being transported by the stream.

Ordinarily the highway drainage channel must be located where it will best serve its intended purpose, using the grade and alignment obtainable at the location. The capacity of the channel and the degree of protection given the channel are then determined as explained in chapter 4.

The point of discharge of a drainage channel into the natural watercourse requires particular attention. The alignment of the drainage channel should not cause eddies with attendant scour in the natural watercourse or near drainage structures. In erodible soils, if the flow line of the drainage channel is appreciably higher than that of the watercourse at the point of entry, a spillway or chute should be provided to discharge the water into the watercourse in order to prevent erosion in the drainage channel. The chute should be designed to prevent being undermined and destroyed.

1.12 Protection from erosion. The need for erosion prevention is not limited to the highway drainage channels; it extends throughout the right-of-way and is an essential feature of adequate drainage design. Erosion and maintenance are minimized largely by the use of flat side slopes, rounded and blended with natural terrain; drainage channels designed with due regard to location, width, depth, slopes, alignment, and protective treatment; proper facilities for ground water interception; dikes, berms, and other protective devices; and protective ground covers and planting (1).

The discussion in this publication is limited to providing erosion control in drainage channels by proper design, including the selection of an economical channel lining. Lining as applied to drainage channels includes vegetative coverings. The type of lining should be consistent with the degree of protection required, overall cost, safety requirements, and esthetic considerations. Control of erosion caused by overland or sheet flow is not discussed.

In general, when a lining is needed, the lowest cost lining that affords satisfactory protection should be used. This is often sod in humid regions, used alone or in combination with other types of linings. Thus, a channel might be grass lined on the flatter slopes and lined with more resistant material on the steeper slopes. In cross section, the channel might be lined with a highly resistant material within the depth required to carry floods occurring frequently and lined with grass above that depth for protection from the rare floods.

Ditch checks were once used extensively to prevent erosion

in roadway channels. In recent years they have become unpopular in humid areas as grade-control structures in channels because they are often a hazard to vehicles driving off the highway, they are difficult to maintain, they are often unsightly, and in most locations, their job can be done better and more cheaply with a vegetative lining. Figure 4 shows what happened to a channel protected by poorly designed ditch checks.

In semiarid and arid regions, some erosion of cut and fill slopes is inevitable. Occurring infrequently at any one location, the damage can be repaired without excessive average annual cost. The roadbed is generally protected by paving or treating the road shoulders. Channels in cut sections can be protected by rubble or by paving. Channels off the roadway can best be protected by laying them on grades which will not produce velocities in excess of those permissible (see table 3) for the soil of that locality

and by spreading the collected water over the hillside as soon as it can be released without reaching the roadway. When steeper channel grades cannot be avoided, vertical drops or properly designed ditch checks can be used to maintain noneroding grades between drops. If the spacing of the drops is close, their cost should be compared with the cost of paving the entire channel and providing an adequate outlet structure. High drop structures require careful design (6, 7, and 8) and though hazardous to traffic and at times unsightly, they are to be preferred to a deep gully.

Systematic maintenance is essential to any drainage channel. Without proper maintenance, a well-designed channel becomes an unsightly gully. Maintenance methods should be considered in the design of drainage channels so that the channel sections will be suitable for the methods and equipment that will be used for their maintenance.



Figure 4.— Poorly designed ditch checks.

Chapter II.—ESTIMATING STORM RUNOFF FROM SMALL AREAS

2.1 General. The first step in designing a channel is to determine the quantity of water the channel is to carry. This is a far more difficult problem than computing the size of channel needed to carry the design flow and determining what protection is required to prevent channel erosion.

Many formulas have been developed (9) for estimating peak storm runoff, but most of the formulas were developed from data collected from a limited area and can be considered applicable only to the area and under the conditions for which the data were collected. Runoff from developed surfaces, drainage areas of comparatively uniform slope and surface characteristics, can be determined by the method described by Izzard (10) if there is sufficient regularity in surface to justify the work required.

Some of the storm-runoff formulas used in the past give the size of structure directly, but modern practice (11, p. 90) is to first calculate the anticipated discharge and then design the waterway or channel to accommodate the discharge. A formula which gives only a required waterway area ignores the great difference in capacity of structures which have the same waterway area but have different hydraulic characteristics.

In the design of storm sewers, more than 90 percent (12, p. 31) of the engineering offices in the United States use the rational method which has been in use since 1889. Application of this method to channel design is described in this chapter. The method is recommended for use in determining the design discharge for roadside drainage channels draining less than about 200 acres. For larger areas, the methods described by Potter (13), by Dalrymple (14), or by the Soil Conservation Service (15) are more applicable. There is no clearly defined line where one method should end and another method be used. The methods sometimes give results for the same area that agree quite well, and in other instances they may disagree by 50 or more percent. Discrepancies between methods approaching 50 percent may be expected because of the small sample (length and number of streamflow records) available for estimating magnitude and frequency of storm runoff by any method. However, when estimated runoff rates obtained by two methods differ by ratios of 2 to 1 or more, the relative accuracy of the methods becomes important, and must be judged by the quantity and quality of the data upon which the method is based.

The expected frequency of occurrence of the design discharge (sec. 1.2) is of concern because economy is always a factor in the design. Overdesign and underdesign both involve excessive costs on a longtime basis. A channel designed to carry a 1-year flood would have a low first cost, but the maintenance cost would be high because the channel would be damaged by storm runoff almost every year. On the other hand, a channel designed to carry the 100-year flood would be high in first

cost but low in maintenance cost. Somewhere between these limits lies the design which will produce the lowest annual cost.

2.2 Storm runoff. Runoff comes from precipitation falling on the land and water surfaces of the watershed. A small part of the precipitation evaporates as it falls and some is intercepted by vegetation. Of the precipitation that reaches the ground, a part infiltrates the ground, a part fills the depressions in the ground surface, and the remainder flows over the surface (overland flow) to reach defined watercourses. The surface runoff is sometimes augmented by subsurface flow that flows just beneath the ground surface and reaches the watercourse in time to be a part of the storm runoff.

The precipitation infiltrating the ground replenishes the soil moisture and adds to the ground-water storage. Some of this underground water reaches the stream long after the storm runoff has passed and some is withdrawn by the life processes of vegetation or by man for his use.

The storm runoff which must be carried by the roadside drainage channels is thus the residual of the precipitation after losses (the extractions for interception, infiltration, and depression storage). The rate of water loss depends upon the amount of the precipitation and the rate at which it falls (intensity), upon temperature, and upon the characteristics of the land surface.

Not only does the rate of runoff vary with the permeability of the land surface and the vegetal cover, but it varies from time to time for the same surface depending upon the antecedent conditions. It would be impracticable, even if the data were available, to determine for each channel drainage area the frequency of recurrence of the numerous factors which affect the rainfall-runoff relation and thus compute the magnitude of the runoff for a given frequency rainfall.

If a long-period record of storm runoff existed for every site for which we wish to design a drainage channel, we could determine the frequency of various magnitudes of storm runoff. However, runoff records for areas of less than 200 acres are practically nonexistent and we are forced to estimate runoff frequency from frequency of rainfall by assuming the rainfall to have the same frequency as runoff when the design storm occurs. (See sec. 2.4-1.)

2.3 Rainfall intensity—duration—frequency analysis. The intensity of rainfall is the rate at which the rain falls. Intensity is usually stated in inches per hour regardless of the duration of the rainfall, although it may be stated as total rainfall in a particular period. Frequency can be expressed as the probability of a given intensity of rainfall being equaled or exceeded or it can be expressed in terms of the average interval (recurrence interval) between rainfall intensities of a given or greater amount. The frequency of rainfall intensity cannot be stated without

specifying the duration of the rainfall because the rainfall intensity varies with the duration of rainfall. (See fig. 6.)

Frequency analysis of rainfall intensity is discussed by Chow (16) and others (17, 18). Two methods are in general use for selecting the rainfall data used in frequency analyses. These methods are the annual series and the partial-duration series. The annual-series analysis considers only the maximum rainfall of each year (usually calendar year) and ignores the other rainfalls during the year. These lesser rainfalls during the year sometimes exceed the maximum rainfalls of other years. The partial-duration series analysis considers all of the high rainfalls regardless of the number occurring within a particular year. In designing drainage channels for return periods greater than 10 years, the difference between the two series is unimportant. When the return period (design frequency) is less than 10 years, the partial-duration series is believed to be more appropriate. To change the frequency curves based on the annual series to one based on the partial-duration series, multiply the annual series values by the following factors (19, p. 1):

2-year return period.....	1.13
5-year return period.....	1.04
10-year return period.....	1.01
20-year or more.....	1.00

The Weather Bureau has prepared a Rainfall-Frequency Atlas of the United States (20). This Atlas contains maps of rainfall frequency for 30-minute, 1-, 2-, 3-, 6-, 12-, and 24-hour durations in each of the return periods 1-, 2-, 5-, 10-, 25-, 50-, and 100-year. The rainfall lines on the maps in the Atlas are based on a partial-duration series analysis and represent total rainfall, in inches, for the stated duration.

Also of value to the designer of roadside drainage channels is Weather Bureau Technical Paper 25 (19) which contains rainfall intensity-duration-frequency curves for selected stations in the United States, Alaska, Hawaiian Islands, and Puerto Rico. The curves in this publication are based on the annual series and the preceding corrections should be used for return periods less than 10 years.

2.4 The rational method. Rainfall intensity is converted into rate of storm runoff by the rational formula:

$$Q = CiA \quad (1)$$

Where

- Q = peak rate of runoff, in cubic feet per second.
- C = weighted runoff coefficient (average of the coefficients assigned to the different types of contributing areas).
- i = average rainfall intensity, in inches per hour, for the selected frequency and for duration equal to the time of concentration.
- A = drainage area, in acres, tributary to the point under design.

The formula is not dimensionally correct; however, a 1-inch depth of rainfall applied at a uniform rate in 1 hour to an area of 1 acre will produce 1.008 cubic feet per second of runoff if there are no losses. This makes the

numerical value of Q very nearly equal to the product of i and A. The coefficient C accounts for the losses (sec. 2.4-1).

The rational formula is based on the thesis that if a uniform rainfall of intensity i were falling on an impervious area of size A, the maximum rate of runoff at the outlet to the drainage area would be reached when all portions of the drainage area were contributing; the runoff rate would then become constant. The time required for runoff from the most remote point (point from which the time of flow is greatest) of the drainage area to arrive at the outlet is called the time of concentration.

Actual runoff is far more complicated than the rational formula indicates. Rainfall intensity is seldom the same over an area of appreciable size or for any substantial length of time during the same storm. If a uniform intensity of rainfall of duration equal to the time of concentration were to occur on all parts of the drainage area, the rate of runoff would vary in different parts of the area because of differences in the characteristics of the land surface and the nonuniformity of antecedent conditions. Under some conditions maximum rate of runoff occurs before all of the drainage area is contributing. (See sec. 2.4-6.) The temporary storage of storm water en route toward defined channels and within the channels themselves accounts for a considerable reduction in the peak rate of flow except on very small areas. The error in the runoff estimate increases as the size of the drainage area increases. For these reasons, the rational method should not be used to determine the rate of runoff from large drainage areas. For the design of highway drainage structures, the use of the rational method should be restricted to drainage areas less than 200 acres unless no other method is available to estimate the design discharge.

Many refinements have been suggested in the application of the rational method. A few of the discussions of the method are listed in the references (12, 21, 22, and 23, app. A). The suggested refinements in the method probably improve the runoff estimate, but the collection of additional data required and the increased work involved do not appear warranted in the design of drainage channels.

2.4-1 Runoff coefficient. The runoff coefficient C in the rational formula is the ratio of the rate of runoff to the rate of rainfall at an average intensity i when all the drainage area is contributing. The coefficient C varies widely from storm to storm, but Horner and Flynt (24) state that when rainfall intensity and runoff (based on a 20-year record) were considered separately it was found that the ratio,

$$C = \frac{\text{Peak runoff rate of a given frequency}}{\text{Average rainfall intensity of the same frequency}}$$

remained reasonably constant for the various frequencies.

The range in values of C listed in table 1, appendix A, permit some allowance for land slope and differences in permeability for the same type cover. For flat slopes and permeable soil, use the lower values.

Where the drainage area is composed of several types of ground cover, the runoff coefficient is weighted (see example 1) according to the area of each type of cover present.

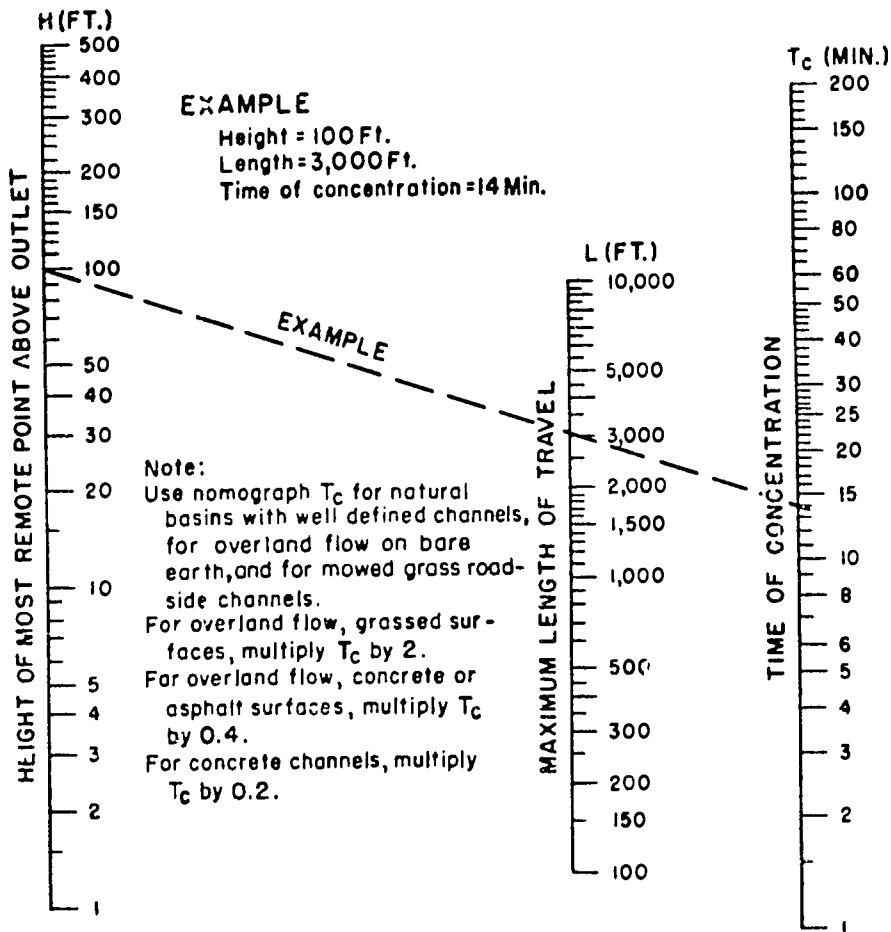

Based on study by P. Z. Kirpich,
 Civil Engineering, Vol. 10, No. 6, June 1940, p. 362

Figure 5.—Time of concentration of small drainage basins.

Example 1

Given: An area tributary to a roadway channel. The area has a fairly uniform cross section as follows: 12 ft. of concrete pavement; 26 ft. gravel shoulder, channel, and backslope; 200 ft. of grassed pasture. The length of the area is 400 ft.

Find: Runoff coefficient, *C*

Solution:

Area (sq. ft.)	Type of surface	<i>C</i> (Table 1)	<i>C</i> <i>A</i> (sq. ft.)
4,800	Concrete pavement	0.9	4,320
10,400	Shoulder, channel and backslope5	5,200
80,000	Pasture3	24,000
95,200	Total		33,520

$$\text{Weighted } C = \frac{33,520}{95,200} = 0.35$$

For use in the rational formula, the *C**A* product (33,520) can be converted to acres and multiplied by *i* without computing the weighted *C*.

2.4-2 Time of concentration. The time of concentration (defined in sec. 2.4) varies with the size and shape of the drainage area, the land slope, the type of surface, the intensity of rainfall, whether flow is overland or channelized and many other factors. Extreme precision is not warranted in determining time of concentration for the design of drainage channels on rural highways. Time of concentration can be obtained from figure 5 which is based on a study by Kirpich (22, p. 309-318) of six watersheds which varied in size from 1.25 to 112 acres. The watersheds were all located on a single farm in Tennessee. Research is badly needed on the time of concentration of other types of watersheds. The values of *T_c* from figure 5 are based on meager data, and should only be used when better information is not available. A minimum time of concentration of 5 minutes is recommended for finding the intensity used for estimating the design discharge.

Use of figure 5 requires the length (*L*) of the drainage area measures along the principal drainage line to the most remote (longest *T_c*) point and the height of this point above the outlet at which the flow is to be estimated.

2.4-3 Rainfall intensity. Rainfall intensity-frequency data (sec. 2.3) are taken from Weather Bureau Atlas Technical Paper 40 (20) or from Weather Bureau Technical Paper 25 (19). A chart such as that of figure 6 (19, p. 9) is constructed for the project location, but the project chart need contain only the curves for the frequencies to be used for the project designs for the *T_c* values likely to be encountered. If the project is near a Weather Bureau station for which a rainfall intensity-duration-frequency curve is given in Technical Paper 25 (19), the Weather Bureau chart can be used directly or for frequencies less than 10 years convert chart values to the partial-duration series. For other areas, the design chart should be constructed from the maps in the Rainfall-Frequency Atlas of the United States (20). For use in the rational method, the values of total rainfall are converted to rainfall intensity

by dividing the map value by the duration expressed in hours.

When the Weather Bureau Atlas is not available, approximate rainfall intensity-duration-frequency data can be obtained from figure 7 by the use of coefficients. Figure 7 is adapted from a map in the Weather Bureau Atlas by converting total rainfall for 30 minutes to 30-minute rainfall intensity (divide map value by 0.5) for the 2-year recurrence interval. The 2-year rainfall intensity for other durations is obtained by multiplying the 30-minute rainfall intensity for the project location from figure 7 by the following factors:

Duration (minutes)	Factor	Duration (minutes)	Factor
5.....	2.22	60.....	0.8
10.....	1.71	90.....	0.7
15.....	1.44	120.....	0.6
20.....	1.25		0.5
30.....	1.0		0.4

To convert 2-year recurrence interval rainfall for a given duration to other recurrence intervals, multiplying by the following factors gives acceptable results in much of the country. The use of these factors should be checked against the Weather Bureau Atlas before extensive use in a particular locality. More accurate results can be obtained by using the maps or the method given in reference 20 (using the relation of 2-year and 100-year rainfall).

Recurrence interval (years):	Factor
1.....	0.75
2.....	1.0
5.....	1.3
10.....	1.6
25.....	1.9
50.....	2.2

2.4-4 Drainage area. The drainage area, in acres, contributing to the point for which channel capacity is to be determined, can be measured on a topographic map or determined in the field by estimation, pacing, or a survey comparable in accuracy to the stadia-compass traverse. The data required to determine time of concentration (sec. 2.4-2) and the runoff coefficient (sec. 2.4-1) should be noted at the time of the preliminary field survey.

2.4-5 Computing the design discharge. The design discharge is computed by the formula, *Q* = *C**A* (sec. 2.4) as explained in example 2.

Example 2

Given: The contributing area as described in example 1 (sec. 2.4-1). The weighted *C* is 0.35; the channel grade is 0.5 percent; and the outer edge of the contributing area at the crest of the hill is 4 ft. above the bottom of the channel. The location is near Washington, D.C.

Find: The discharge for a 10-year frequency rainfall at the outlet of a grassed roadside channel 400 ft. from the crest of a hill.

Solution: The time of concentration is obtained from figure 5. The distance from the channel to the ridge of the area is 210 ft. (200 ft. of grassed pasture and 10 ft.

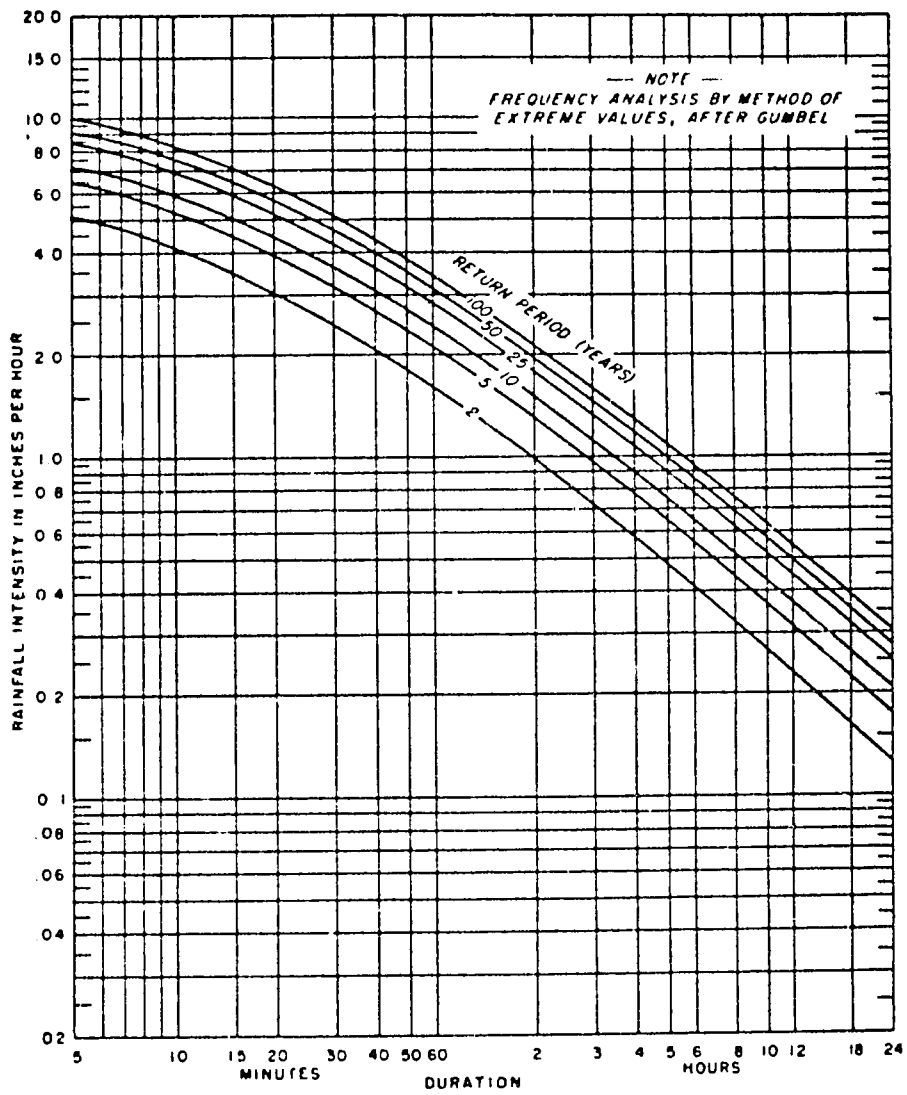

Figure 6.—Rainfall intensity—duration—frequency curve for Wash. D.C., 1896-97, 1899-1953 (U.S. Weather Bureau).

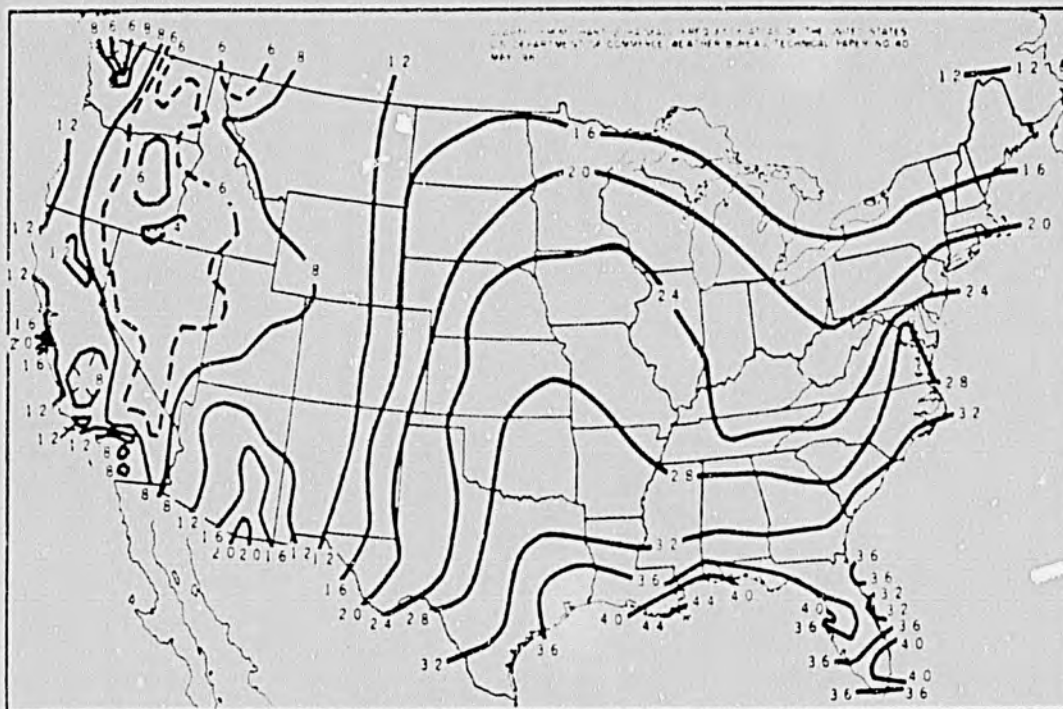

Figure 7.—Map of the contiguous United States showing 2-year, 30-minute rainfall intensity.

18

of ditch bank slope) and that of the channel is 400 ft., making $L=610$ ft. The height of the most remote point above the outlet $=4$ ft. $+(0.005 \times 400) = 6$ ft. From figure 5, $T_c=7$ min.

The rainfall intensity for a 7-minute duration and 10-year return period is 6.8 in./hr. (fig. 6).

The drainage area $=238 \times 400 = 95,200$ sq. ft. or

$$\frac{95,200}{43,560} = 2.2 \text{ acres}$$

Then $Q = 0.35 \times 6.8 \times 2.2 = 5.2$ c.f.s.

2.4-6 Computing the design discharge for complex drainage areas. Example 2 explains the rational method for a simple drainage area. For other points along the channel, the design discharge is computed using the longest time of travel to the point for which the discharge is to be determined. Generally, less work is required to compute the runoff from the separate areas as is done for point 5B in section 8.5 rather than obtain a weighted C for the whole area.

On some combinations of drainage areas, the maximum rate of runoff will be reached from the higher intensity rainfall for periods less than the time of concentration for the whole area, even though only a part of the drainage area is contributing. One example of such an occurrence is the discharge for point 5C, section 8.5. In this example

the longest time of concentration is 14 minutes, but 20.0 acres of the total of 21.4 acres has a time of concentration of only 5 minutes. The 20 acres with a 5-minute intensity produces a higher peak discharge than the total area with a 14-minute intensity. Another combination of drainage areas that might produce the maximum rate of runoff from a partial contribution of the total area is a downstream impervious area with a high runoff coefficient and a short time of concentration. This could produce the same effect as the unbalanced area combination just described.

Extreme precision is not warranted in determining the combination of contributing areas (CA) and rainfall intensity (i) that would produce the greatest peak runoff. Unless the areas or times of concentration are considerably out of balance, as the example in the preceding paragraph, it is unnecessary to check the peak from part of the area.

The discharges in the illustrative problems of chapter 8 were also computed by the rational method, using combinations and assumptions other than those explained in this publication in order to check the sensitivity of the method. It was found that the method was stable for any reasonable assumption and that the results by different assumptions were well within the range of accuracy of the method.

Chapter III.—HYDRAULICS OF DRAINAGE CHANNELS

3.1 General. Most highway drainage channels can be designed by using the open-channel charts in Hydraulic Design Series No. 2 (26) or the tables and formulae presented in this publication. The tables contained in references 26 through 28 are helpful in designing channels not included in reference 25. These aids reduce the work required to design drainage channels, but they cannot replace engineering judgment and a knowledge of the hydraulics of open-channel flow. Open-channel flow also includes flow through conduits with a free water surface. The discussion of hydraulics in this chapter does not provide the knowledge of open-channel flow needed for the more difficult design problems; nevertheless, a brief review of some of the hydraulic principles governing open-channel flow should be helpful to the designer of highway drainage channels. A movie, "Introduction to Highway Hydraulics," illustrates many of the principles of open-channel flow. The movie is available on loan from the Bureau of Public Roads.

Flow in open channels is classified as steady or unsteady. Unsteady flow results from variations in the supply and will not be covered in this publication. Although the flow in most channels during the storm period is an excellent example of unsteady flow, we are usually interested in designing a channel to carry a peak flow that recurs with a selected frequency. Considering the peak flow as steady flow greatly simplifies the design of drainage channels.

Steady flow occurs when the quantity of water passing any section of the stream is constant. Steady flow is further classified as uniform if velocity and depth of flow are constant, and nonuniform or varied if velocity and depth of flow changes from section to section. Although most drainage channels are designed on the assumption of uniform flow, a knowledge of varied flow is needed to solve the more complex flow problems. Another classification of flow, subcritical (tranquil) or supercritical (rapid or shooting), will be discussed in section 3.3-2.

3.2 Uniform flow. To have uniform flow, the grade must be constant and all cross sections of flow must be identical in form, roughness, and area, necessitating a constant mean velocity. Under uniform flow conditions, the depth (d_n) and the mean velocity (V_n) for a particular discharge are said to be normal. Under these conditions, the water surface is parallel to the streambed (fig. 11). Normal depth is also defined as the depth at which uniform flow will occur when a given quantity of water flows through a long channel of uniform dimensions, roughness (n), and slope (S_0).

Uniform flow conditions are rarely attained in drainage channels, but the error in assuming uniform flow in a channel of fairly constant slope and cross section is small in comparison to the error in determining the design dis-

charge. If the channel cross section, roughness, and slope are fairly constant over a sufficient distance to establish essentially uniform flow, equations such as that of Manning give reliable results.

3.2-1 The Manning equation. Water flows in a sloping drainage channel because of the force of gravity. The flow is resisted by the friction between the water and the wetted surface of the channel. The quantity of water flowing (Q), the depth of flow (d), and the velocity of flow (V) depend upon the channel shape, roughness, and slope (S_0). Various equations have been devised to express the flow of water in open channels. A useful equation for channel design is that named for Robert Manning, an Irish engineer. The Manning equation for velocity of flow in open channels is:

$$V = \frac{1.49}{n} R^{2/3} S^{1/2} \tag{2}$$

Where

V = mean velocity in feet per second (f.p.s.).

n = Manning coefficient of channel roughness.

R = hydraulic radius, in feet.

S = slope, in feet per foot. When the Manning equation applies, $S = S_0$.

The value of the Manning coefficient n is determined by experiment. Some n values for various types of channels are given in table 2, appendix A.

R , the hydraulic radius, is a shape factor that depends only upon the channel dimensions and the depth of the flow. It is computed by the equation,

$$R = \frac{A}{WP} \tag{3}$$

Where

A = cross-sectional area of the flowing water in square feet taken at right angles to the direction of flow.

WP = wetted perimeter or the length, in feet, of the wetted contact between a stream of water and its containing channel, measured in a plane at right angles to the direction of flow.

Another basic equation in hydraulics is

$$Q = AV \tag{4}$$

or discharge (Q) is the product of the cross-sectional area (A) and the mean velocity (V).

By combining equations (2) and (4), the Manning equation can be used to compute discharge directly or

$$Q = \frac{1.49}{n} A R^{2/3} S^{1/2} \tag{5}$$

In many computations it is convenient to group the properties peculiar to the cross section, in one term, called conveyance (K) or

$$K = \frac{1.49}{n} A R^{2/3} \quad (6)$$

then

$$Q = K S^{1/2} \quad (7)$$

When a channel cross section is irregular in shape such as one with a relatively narrow deep main channel and a wide shallow overbank channel, the cross section must be subdivided and the flow computed separately for the main channel and for the overbank channel. (See 29, sec. 8.5.) The same procedure is used when different parts of the cross section have different roughness coefficients. In computing the hydraulic radius of the subsections, the water depth common to two adjacent subsections is not counted as wetted perimeter.

Conveyance can be computed and a curve drawn for any channel cross section. The area and hydraulic radius are computed for various assumed depths and the corresponding value of K is computed from equation (6). The values of conveyance are plotted against the depths of flow and a smooth curve connecting the plotted points is the conveyance curve. If the section was subdivided, the conveyance of each subsection (k_1, k_2, \dots, k_n) is computed and the total conveyance of the channel is the sum of the conveyances of the subsections or $K = \Sigma k_1 + k_2 + \dots + k_n$. Discharge can be computed using equation (7). The discharge in each subsection can also be computed with equation (7), using the conveyance of the subsection.

The concept of channel conveyance is useful when computing the distribution of overbank flood flows in the stream cross section and the distribution through the openings in a proposed stream crossing (29). The discharge through each opening can be assumed to have the same ratio to the total discharge as the ratio of conveyance of the opening bears to the total conveyance of the channel.

Discharges computed by the Manning equation do not have the accuracy to which the computation can be carried. Results of the discharge computations are generally rounded off to avoid an inference of great accuracy.

3.2-2 Aids in solution of the Manning equation. The examples in this section show the solution of the Manning equation and the use of the computation aids mentioned in section 3.1. Figure 9, used in example 4, is typical of the open-channel charts in reference 25. Nomographs such as that in appendix B provide a graphical solution of

the Manning equation (see example 3). Tables in references 26-28 contain the channel properties (A, R) of many channel sections and tables of velocity for various combinations of slope and hydraulic radius. Their use is explained in example 3. In addition to tables of channel properties, reference 23 contains tables for the direct solution of the Manning equation. (See sec. 4.6-2.) Charts in reference 30 can be used to compute flow in rectangular and trapezoidal sections and circular sections with free water surface.

The Manning equation can be readily solved for a given channel when the normal depth (d_n) is known. The nomograph, appendix B, can be used to solve the equation graphically as explained in example 3.

Example 3

Given A trapezoidal channel, of straight alinement and uniform cross section in earth, bottom width 2 ft., side slopes 1 to 1, slope 0.003, and normal depth 1 ft.

Find Velocity and discharge.

Solution

1. In table 2, appendix A, for a weathered earth channel in fair condition, n is 0.020.
2. The cross-sectional area (A) of the channel is 3.0 sq. ft. and the hydraulic radius (R) is 0.6 ft. (A and R can be computed or obtained from tables such as that on p. 121 of reference 26.)
3. Using the nomograph of appendix B, lay a straightedge between the outer lines at the values of $S=0.003$ and $n=0.02$. Mark the point where the straightedge intersects the turning line.
4. Then place the straightedge so as to line up the point on the turning line and the hydraulic radius of 0.6 ft.
5. Read the velocity, 2.9 f.p.s. on the velocity line.
6. The discharge, $Q=AV$, is 3.0 sq. ft. times 2.9 f.p.s. or 8.7 c.f.s. The velocity can also be obtained from the table on page 383 of reference 26.

The preceding example showed the solution of the Manning equation for the velocity and discharge in a channel of given dimensions when the normal depth is known. The more common problem in channel design is to find the size of channel required to carry the design discharge on the available slope and to compute the velocity in the channel in order to determine what protection is needed to prevent channel erosion. Unless channel charts (25) or special tables (28) are available, this problem requires a trial-and-error procedure illustrated by example 4.

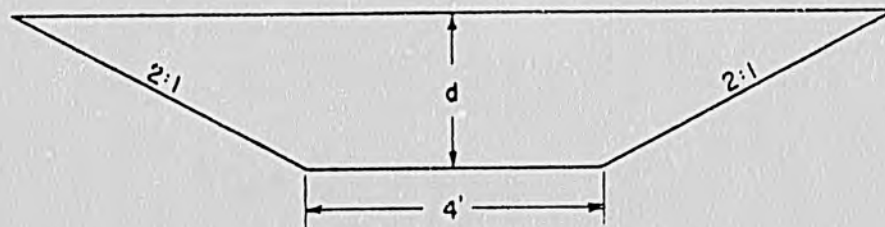

Figure 8.—Trapezoidal channel.

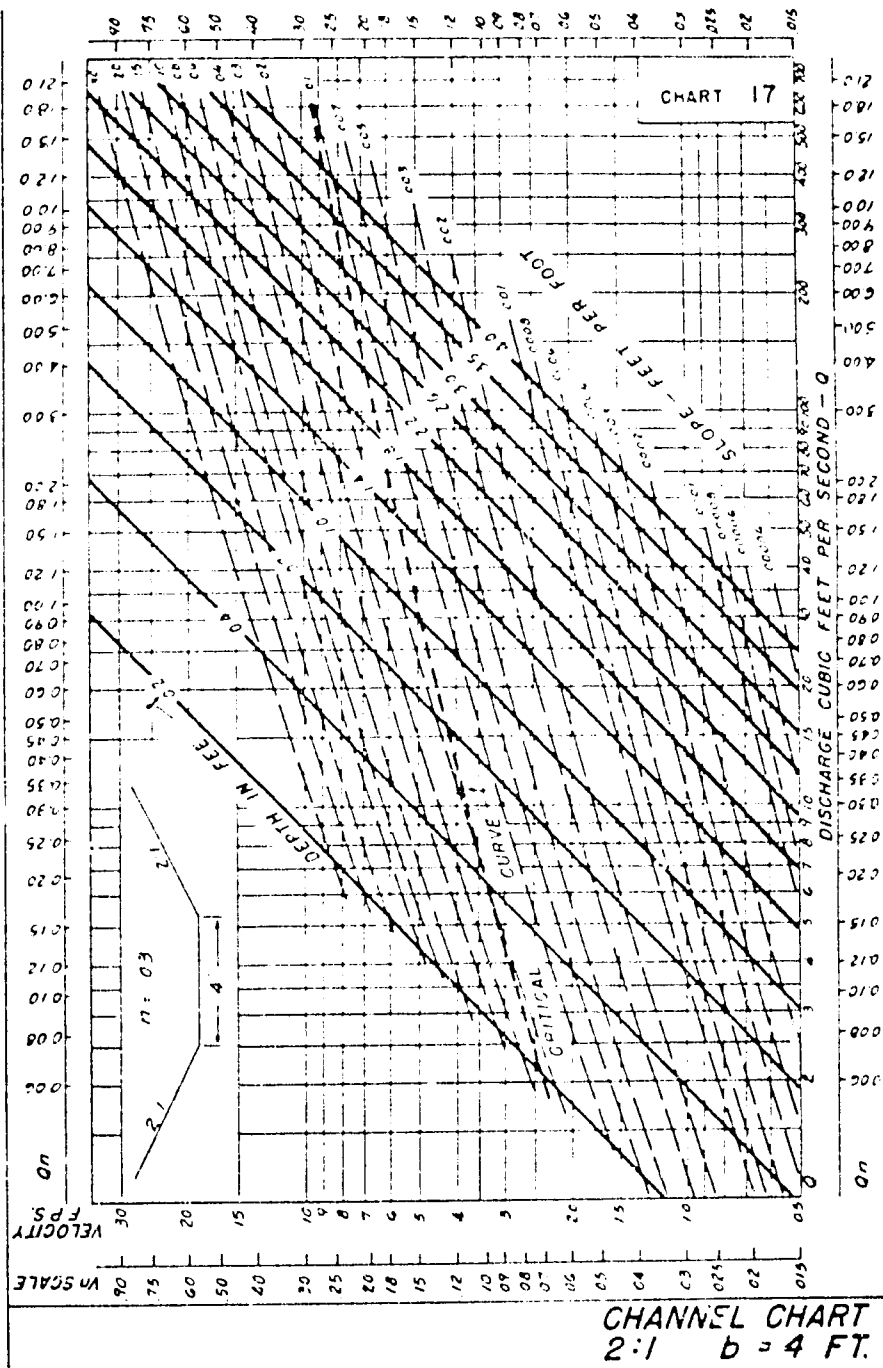

Figure 9.—Open-channel chart (from design charts for open-channel flow, hydraulic design series No. 3).

Example 4

Given: A trapezoidal channel (fig. 8) in stiff clay, bottom width 4 ft., side slopes 2:1, $n = 0.03$, slope 0.005, and discharge 100 c.f.s., water carries fine silt.

Find: Depth, d , and velocity, V .

Solution:

1. General solution of area and hydraulic radius.

$$A = (4 + 2d)d$$

$$WP = 4 + 2d\sqrt{5} = 4 + 4.47d$$

$$R = \frac{A}{WP} = \frac{(4 + 2d)d}{4 + 4.47d}$$

2. Try: $d = 3$ ft.

$$A = (4 + 6)3 = 30 \text{ sq. ft.}$$

$$WP = 4 + 13.4 = 17.4 \text{ ft.}$$

$$R = 1.72 \text{ ft.}$$

From the nomograph of appendix B, $V = 5.1$ f.p.s.

$$Q = 30 (5.1) = 153 \text{ c.f.s.} \quad \text{too high}$$

3. Try: $d = 2.5$ ft.

$$A = (4 + 5)(2.5) = 22.5 \text{ sq. ft.}$$

$$WP = 4 + (4.47)(2.5) = 15.2 \text{ ft.}$$

$$R = 1.48 \text{ ft.}$$

From the nomograph, $V = 4.6$ f.p.s.

$$Q = 22.5 (4.6) = 104 \text{ c.f.s.} \quad \text{too high}$$

4. Try: $d = 2.4$ ft.

$$A = (4 + 4.8)2.4 = 21.1 \text{ sq. ft.}$$

$$WP = 4 + 4.47(2.4) = 14.7 \text{ ft.}$$

$$R = 1.44 \text{ ft.}$$

From the nomograph, $V = 4.5$ f.p.s.

$$Q = 4.5 (21.1) = 95 \text{ c.f.s.} \quad \text{too low}$$

The last two trials ($d = 2.5$ and 2.4 ft.) are about equally high and low, thus, the solution is $d = 2.45$ ft., $V = 4.6$ f.p.s.

Where design charts are available, the problem is greatly simplified; for example, see figure 9 taken from reference 25. For $Q = 100$ c.f.s. and $S = 0.005$, the value of d is about 2.45 ft. and $V = 4.6$ f.p.s. See also section 4.6-2 for a direct solution using King's table.

Table 3, appendix A, shows a velocity of 5.0 f.p.s. can be permitted in a channel in stiff clay. Thus the natural material will withstand erosion.

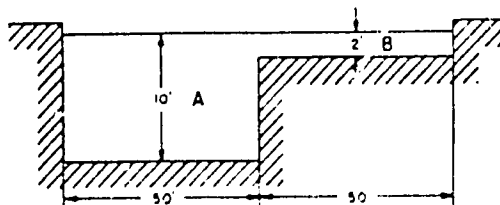

Figure 10.—Irregular-channel section.

The discharge in an irregular section is computed by dividing the channel into subsections, each approximately regular in shape. See example 5 for a two-subsection channel.

Example 5

Given: The channel in figure 10, $n = 0.02$, and slope 0.005.

Find: Discharge, Q . The average velocity has little meaning in a channel of this shape.

Solution:

1. Subsection A:

$$A = 10 (50) = 500 \text{ sq. ft.}$$

$$WP = 10 + 50 + 8 = 68 \text{ ft.}$$

$$R = \frac{500}{68} = 7.35$$

The velocity by formula (2) is:

$$V = \frac{1.49}{0.020} (7.35)^{1.49} (0.005)^{1/1.49} = 19.9 \text{ f.p.s.}$$

The velocity could have been obtained from the nomograph, appendix B, or page 388 of reference 26.

$$Q = 19.9 (500) = 9,950 \text{ c.f.s.}$$

2. Subsection B:

$$A = 2 (50) = 100 \text{ sq. ft.}$$

$$WP = 50 + 2 = 52 \text{ ft.}$$

$$R = \frac{100}{52} = 1.92 \text{ ft.}$$

$$V = 8.1 \text{ f.p.s.}$$

$$Q = 100 (8.1) = 810 \text{ c.f.s.}$$

3. For the entire channel

$$A = 500 + 100 = 600 \text{ sq. ft.}$$

$$Q = 9,950 + 810 = 10,800 \text{ c.f.s.}$$

If the channel had been considered as a whole without subdividing, the following results would have been obtained.

$$A = 600 \text{ sq. ft.}$$

$$WP = 52 + 68 = 120 \text{ ft.}$$

$$R = \frac{600}{120} = 5.00 \text{ ft.}$$

$$V = 15.4 \text{ f.p.s.}$$

$$Q = 15.4 (600) = 9,240 \text{ c.f.s.}$$

The discharge (9,240 c.f.s.) computed for channel considered as a whole is less than the discharge computed separately for subsection A (9,950 c.f.s.). This paradox is brought about by the effect of the hydraulic radius on the computations. It also illustrates the necessity of subdividing highly irregular sections whether irregular in shape or in roughness and shows the difference in mean velocities in a shallow section as compared with the mean velocity of the main channel. The true discharge of this channel is perhaps less than 10,800 c.f.s., but it is much closer to 10,800 than to 9,240 c.f.s.

3.3 Nonuniform or varied flow. Varied steady flow occurs when the quantity of water remains constant, but the depth of flow, velocity, or cross section changes from section to section. The relation of all cross sections will be:

$$Q = A_1 V_1 = A_2 V_2 = A_n V_n \quad (8)$$

Equation 8 is sometimes called the equation of continuity.

Velocity of uniform flow in open channels can be computed by the Manning equation, using the slope of the channel bed as the slope of the energy line but nonuniform steady flow computations require other methods.

The hydraulic design engineer needs a knowledge of varied flow in order to determine the behavior of the flowing water when changes in channel resistance, size, shape, or slope occur. A discussion of varied flow properly begins with a discussion of energy of the flowing water.

3.3-1 Energy of flow. Water flowing in an open channel possesses energy of two kinds—potential energy and kinetic energy. The potential energy is due to the position of the water above some datum, and kinetic energy is due to the velocity of the flowing water. In channel problems, energy is conveniently expressed in terms of head. Thus, a column of water 20 feet high has a potential (static) head of 20 feet with respect to the bottom of the column. Flowing water has both *potential head* and *velocity head*, the velocity head being equal to

$$\frac{V^2}{2g}$$

Where

V = the mean velocity in feet per second
 g = acceleration of gravity or 32.2 feet per second per second.

A useful hydraulic concept of the energy of the flowing water within one vertical cross section of the channel is that of *specific head* (also called *specific energy*)

$$\text{Specific head } (H_s) = d + \frac{V^2}{2g} \quad (9)$$

If the potential head is related to some datum (fig. 11), at or below the bed of the channel at the outlet, energy can be expressed in terms of total head. If Z is the elevation of the channel bottom, total head at any section is:

$$\text{Total head } (H) = d + \frac{V^2}{2g} + Z \quad (10)$$

The energy losses due to friction, channel contractions, changes in alignment, and other factors are termed *head losses* (h_L). The law of conservation of energy (Bernoulli's theorem) states that the total head at any section is equal to the total head at any section downstream, plus intervening head losses or for the channel in figure 11, is equal to the total head at section 2, plus head loss between sections 1 and 2, or

$$d_1 + \frac{V_1^2}{2g} + Z_1 = d_2 + \frac{V_2^2}{2g} + Z_2 + h_L \quad (11)$$

In figure 11, the head loss, in a channel of uniform cross section, equals the change in Z or $(Z_1 - Z_2)$. Thus, the water surface is parallel to the streambed, and

$$d_1 + \frac{V_1^2}{2g} = d_2 + \frac{V_2^2}{2g}$$

The flow is uniform and can be computed by the Manning equation. The head loss

$$(Z_1 - Z_2) = LS_0 \quad (12)$$

Where

L = horizontal distance between section 1 and section 2

S_0 = channel slope or $\frac{Z_1 - Z_2}{L}$

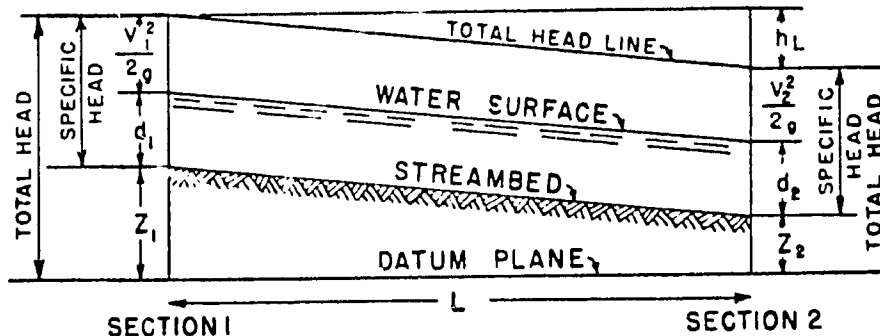

Figure 11.—Water-surface profile of channel with uniform flow.

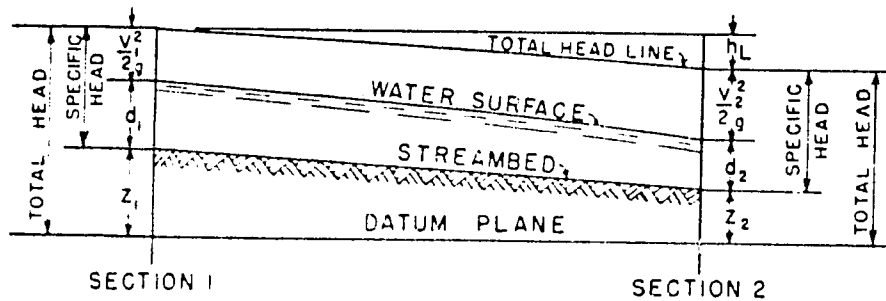

Figure 12.—Water-surface profile of channel with nonuniform flow.

S_0 in uniform flow is sometimes called the friction slope. For uniform flow, the Manning equation, (see 3-2-1) can be computed for $S = S_0$:

$$S = \left(\frac{V_n}{1.49K^{1/3}} \right)^2 \quad (13)$$

When the head loss does not equal the change in Z , nonuniform flow occurs and the depth of flow either increases or decreases in a uniform channel. In figure 12, flow takes place with decreasing depth.

Between sections 1 and 2, the velocity is increasing and the rate of losing energy is, therefore, not constant. This condition could be caused by a channel slope steeper than that needed to overcome frictional resistance or by a change in channel cross section. Thus, the total head line (also called the energy line or energy gradient) is not a straight line. The water surface line in an open channel is sometimes called the hydraulic grade line.

3.3-2 Critical Flow. With a constant discharge passing a cross section, changing the depth of flow causes a different specific head for each depth. If specific head is plotted against depth of flow, the result is a specific-head (energy) diagram. (See fig. 13)

The specific-head curve is asymptotic to the line representing the energy due to depth and the vertical line of zero depth. Examination of figure 13 reveals several important facts. Starting at the upper right of the curve with a large depth and small velocity, the specific head decreases with decrease in depth, reaching a minimum value at depth d_c , known as *critical depth*, sometimes called the depth of the minimum energy content. Further decrease in depth results in rapid increase in specific head. For any value of specific head except that corresponding to critical depth, there are alternate depths at which the flow could occur. These alternate depths are sometimes referred to as equal energy depths.

When the flow occurs at depths greater than critical depth (velocity less than critical), the flow is called *subcritical* or *tranquil*. When the flow occurs at depths less than critical depth (velocities greater than critical), the flow is called *supercritical*, *rapid*, or *shooting*. The change from supercritical to subcritical flow is often very abrupt, resulting in the phenomenon known as *hydraulic jump*.

Flow at the critical depth is called *critical flow* and the velocity at critical depth is the *critical velocity*. The channel slope which produces critical depth and critical velocity for given discharge is the *critical slope*.

Critical depth for a particular discharge is dependent on channel size and shape only and is independent of channel slope and roughness. Critical slope depends upon the channel roughness, the channel geometry and the discharge. For a given critical depth and critical velocity, the critical slope for a particular roughness can be computed by the Manning equation (see 3-2-1).

Supercritical flow is difficult to control because abrupt changes in alignment or in cross section produce waves which travel downstream, alternating from side to side, and sometimes cause the water to overtop the channel sides. Changes in channel shape, slope, or roughness cannot be reflected upstream except for very short distances (upstream control). Supercritical flow is common in steep flumes, and in mountain streams. Pulsating flow (30) can occur at depths as great as 5 feet.

Subcritical flow is relatively easy to control. Changes in channel shape, slope, and roughness affect the flow for some distances upstream (downstream control). Subcritical flow is characteristic of the streams located in the plains and valleys regions where stream slopes are relatively flat.

Critical depth is important in hydraulic analyses because it is always a hydraulic control. The flow must pass through critical depth in going from one type of flow to the other. Typical locations of critical depth are:

- (1) At abrupt changes in slope when a flat (subcritical) slope is sharply increased to a steep (supercritical) slope.
- (2) At a channel constriction such as a culvert entrance under some conditions.
- (3) At the unsubmerged outlet of a culvert or flume on a subcritical slope, discharging into a wide channel or with a free fall at the outlet.
- (4) At the crest of an overflow dam or weir.

Distinguishing between the types is important in channel design, thus the location of critical depth and the determination of critical slope for a cross section of given shape, size, and roughness becomes necessary. When flow occurs at critical depth

$$\frac{A^3}{T} = \frac{Q^2}{g} \quad (14)$$

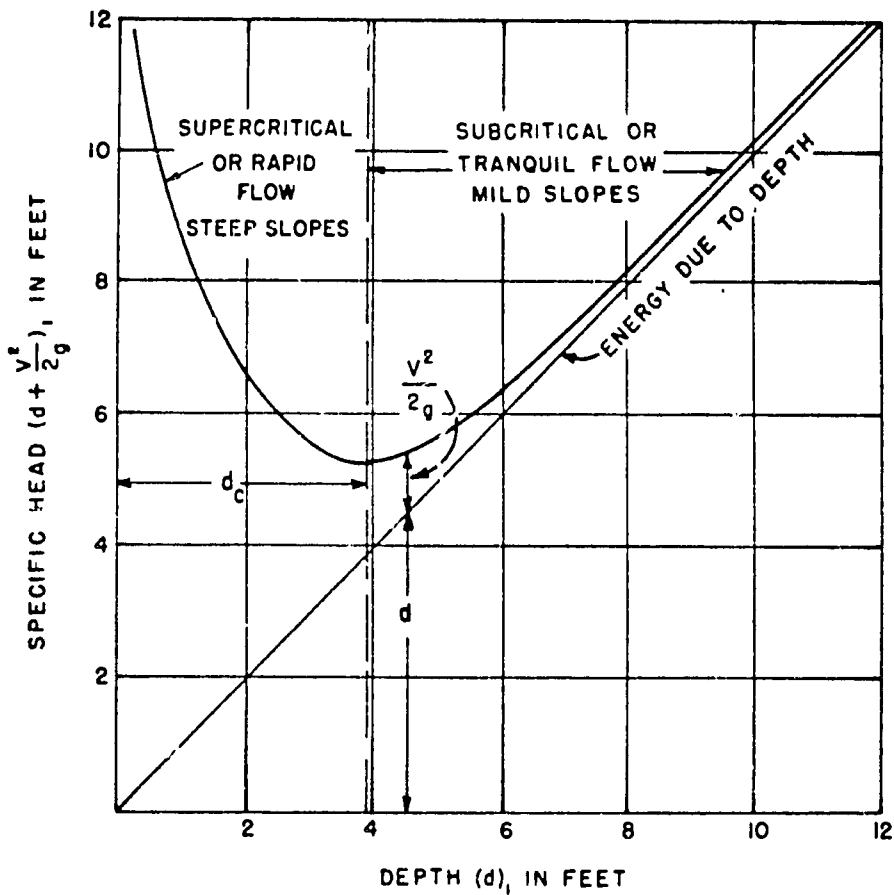

Figure 13.—Specific head diagram for constant Q.

Critical depth (d_c) can be found from the design charts in reference 25 or computed for various channel cross sections (see 29, p. 8-7) by the following equations:

Rectangular sections

$$d_c = 0.315 \sqrt[3]{\left(\frac{Q}{B}\right)^3} \quad (15)$$

Trapezoidal sections

$$d_c = \frac{4zH_0 - 3b + \sqrt{16z^2H_0^2 + 16zH_0b + 9b^2}}{10z} \quad (16)$$

The tables in King's Handbook, (28) provide a much easier solution for critical depth than equation (16).

Triangular sections

$$d_c = 0.574 \sqrt[5]{\left(\frac{Q}{z}\right)^5} \quad (17)$$

Circular sections, approximate solution (31)

$$d_c = 0.325 \left(\frac{Q}{D}\right)^{1.48} + 0.083D \quad (18)$$

Accurate only when $\frac{d_c}{D}$ lies between 0.3 and 0.9.

Where

- A = area of cross section of flow, in square feet.
- B = the width of a rectangular channel, in feet.
- b = bottom width of a trapezoidal channel, in feet.
- D = diameter of circular conduit, in feet.
- g = acceleration of gravity, 32.2 feet per second².
- H₀ = specific head in section, in feet (equation 9).
- Q = rate of discharge, in cubic feet per second.
- T = top width of water surface, in feet.
- V = mean velocity of flow, in feet per second.
- z = slope of sides of a channel (horizontal to vertical).

For irregular sections, critical depth may be found by a trial-and-error solution using equation (14). An expression for the critical velocity (V_c) in channels of any cross section is:

$$V_c = \sqrt{gd_m} \quad (19)$$

where d_m = the mean depth of flow $\left(\frac{A}{T}\right)$

In a given channel when the velocity head $\left(\frac{V^2}{2g}\right)$ is less than one-half the mean depth, the flow is subcritical; if the velocity head is equal to one-half the mean depth, the flow is critical; and if the velocity head is greater than one-half the mean depth, the flow is supercritical.

Uniform flow within about 10 percent of critical depth (30) is unstable and should be avoided in design. The reason for the unstable flow can be seen by referring to figure 13. As the flow approaches the critical depth from either limb of the curve, a very small change in energy is required for the depth to abruptly change to the alternate depth on the opposite limb of the specific-head curve. If the unstable flow region cannot be avoided in design, the least favorable type of flow should be assumed for the design.

3.3-2 Problems in nonuniform flow. Problems in nonuniform flow include computing the water surface profile, design of channel transitions, and dissipation of energy of the flowing water. All of these problems are beyond the scope of this publication, however, two cases of nonuniform flow are discussed briefly, subcritical flow around bends and a case that must be considered in the design of chutes. (See sec. 4.15.) The latter is a case of a sudden change in channel grade from one less than critical to one greater than critical. (See fig. 14.)

The depth of flow at section 1 can be computed using the Manning equation. The flow at section 2 (which for practical purposes can be assumed to occur at the change in grade) passes through critical depth (d_c). If the channel grade downstream from section 2 is equal to the critical slope, the flow will become uniform at a depth equal to d_c . However, when a drainage channel discharges into a chute, the chute grade is steeper than critical slope and the flow is nonuniform and accelerating. Section 2 becomes the control section for both the flow in the channel (downstream control) and the flow in the chute (upstream control).

Knowing the specific head (H_1) in the approach channel, the capacity of the chute entrance, such as section 2 (fig. 14), for a rectangular channel can be computed by a weir formula:

$$Q = 3.09 k_e B H_1^{3/2} \quad (20)$$

For a trapezoidal channel the capacity can be computed by the formula (23, p. 79):

$$Q = 8.03 k_e (H_1 - d_c)^{3/2} (d_c) (b + z d_c) \quad (21)$$

Where

d_c = critical depth at section 2.

H_1 = specific head at section 1.

k_e = coefficient which represents the entrance loss—varies from 1.0 for perfect entrance of smooth curves and gradual transitions to 0.52 for rectangular shaped structure with square corners.

z = slope of sides of a channel (horizontal to vertical).

The critical depth, d_c , is computed by equations (15-19) of section 3.3-2.

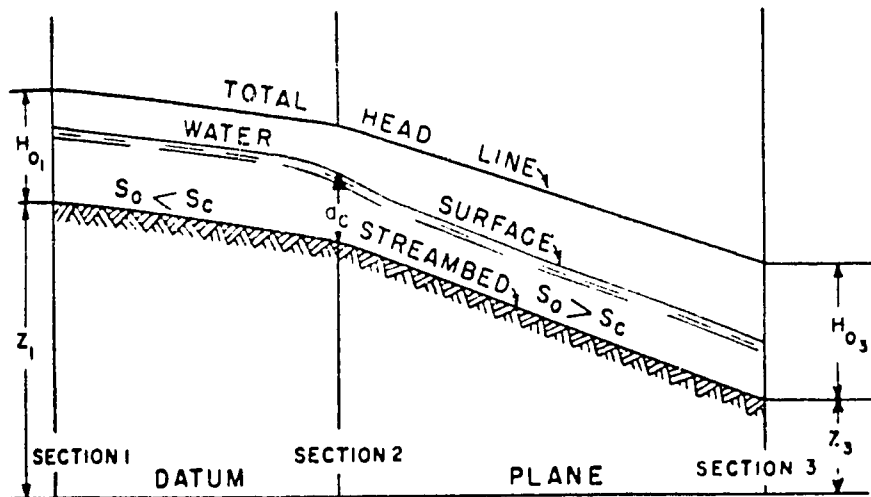

Figure 14.—Water-surface profile of channel with sudden change in grade.

The usual problem is to determine the size of chute channel required to carry a given discharge. The bottom width at the chute entrance (see 2) can be computed by equation (22) for a rectangular channel,

$$B = \frac{0.324Q}{k_s H_0^{3/2} n} \quad (22)$$

and approximately by equation (23) for a trapezoidal channel (23, p. 84).

$$b = \frac{0.324Q}{k_s H_0^{3/2} n} - 0.7zH_0 \quad (23)$$

where the symbols are the same as those in equations (20) and (21) from which equations (22) and (23) were derived.

The flow through the chute must satisfy equation (11). If the head loss (h_L) through the chute is solely from friction, it can be expressed in terms of the hydraulic properties at each end of the chute, the roughness coefficient (n), and the length of chute (L) or

$$h_L = \frac{n^2}{4.41} \left[\left(\frac{V_1}{R_1^{2/3}} \right)^2 + \left(\frac{V_2}{R_2^{2/3}} \right)^2 \right] L \quad (24)$$

If the flow is accelerating ($h_L < LS_0$), the cross section of a large chute can be gradually reduced in order to provide a more economical section, by the method described on page 8.41 of reference 28.

3.3-4 Subcritical flow around curves. When the flow is subcritical, the water surface is elevated on the outside of the curve and lowered on the inside of the curve. The approximate difference in elevation (ΔE) between the water surface along the sides of the curved channel can be found by the equation

$$\Delta E = \frac{B V^2}{r g} \quad (25)$$

Where

- B = width, in feet, of a rectangular channel.
- g = acceleration of gravity, 32.2 feet per second per second.
- r = mean radius, in feet, of curvature.
- V = mean velocity, in feet per second.

The equation gives values of ΔE somewhat lower than will occur in the natural channel because of assumption of uniform velocity and uniform curvature but the com-

puted value will be generally less than twenty percent in error (22, p. 523).

Other problems introduced by curved alignment of channels with subcritical flow include spiral flow, changes in velocity distribution, and increased friction losses within the curved channel as contrasted with the straight channel. Flow around bends is discussed by Chow (32) and others. (See references in ch. 16 of reference 32).

3.3-5 Supercritical flow around curves. Changes in alignment of supercritical flow are difficult to make. The water traveling at supercritical velocities around bends of smooth channels builds up waves which may climb out of the channel and set up wave action continuing for some distance downstream. Changes in alignment, whenever possible, should be made near the upper end of the section—before the supercritical velocity has developed. If a change in alignment is necessary in a channel carrying supercritical flow, the channel should be rectangular in cross section, preferably enclosed and satisfy equation 31. Changes in alignment of open channels should be designed to reduce the wave action, resulting from changing the direction of flow. (See ch. 8, reference 22 and reference 33 and 34.) Many designs involving supercritical flow should be model tested to develop the best design.

3.4 The Froude number. A useful parameter of flow is the Froude number, one form of which is

$$F = \frac{V}{\sqrt{gd_m}} = \frac{V}{V_c} \quad (26)$$

Where

- d_m = mean depth of flow in feet. In the general expression any characteristic dimension of flow might be used.
- g = acceleration of gravity = 32.2 f.p.s.²
- V = mean velocity in feet per second.
- V_c = critical velocity for the channel and discharge.

The Froude number uniquely describes the flow pattern when gravity and inertia forces are the dominant factor in the flow. For example, in figure 13 each point on the specific-head curve has a single value of the Froude number, although two values on the curve can be found for a particular value of specific head. The Froude number of critical flow is one; values greater than one indicate supercritical flow and values less than one indicate subcritical flow.

Chapter IV.—DESIGN PROCEDURE

4.1 General. Highway drainage channels provide surface drainage for the highway right-of-way. They must be placed where they will adequately perform their drainage function. The principles are simple, but the actual layout and design of the drainage system requires an experienced hydraulic engineer who is familiar with both the construction and the maintenance problems involved.

After the highway has been located, the topography and other factors largely fix the location, alignment, and grade of the channels and determine the quantity of surface water entering the channels. Design of the channel then consists of determining a suitable channel section and specifying the type of channel lining needed to protect the channel from erosion.

4.2 Layout of the drainage system. The layout of the drainage system should preferably be made on a topographic map which contains the location of the highway, the location of all drainage structures, and the accentuated ridge and drainage lines. (See fig. 25.) The edges of the right-of-way and of the roadway are drawn on the map. Then the drainage channels necessary to intercept the water before it reaches the roadbed are sketched in, followed by the channels required to remove the water that cannot be intercepted before reaching the roadway. The quantities of water which must be removed when the design storm occurs are estimated for a few points along the drainage channels using the method explained in chapter II for areas smaller than 200 acres. It is rarely necessary to compute the incremental additions to the flow along the channels.

When the highway location cuts across tilled farmland, the highway drainage plan should be coordinated with the farmer's drainage system. Some farms are terraced and plowed on contour lines. Thus, the overland flow is collected and concentrated at points where the highway intersects the farm drainage channels, rather than occurring in a more or less uniform sheet over the hillside. Adequate notes by the locating party describing the farm drainage channels in the vicinity of the location center line are essential to the design of facilities for handling the storm runoff.

4.3 Channel grade. The approximate grade of the channel is computed from the topographic map. To prevent deposition of sediment, the minimum gradient for earth and grass-lined channels should be about 0.5 percent. The channel grade should be kept constant or increasing in the downstream direction, insofar as practicable, to avoid deposition. The grade affects both the size of the channel required to carry a given flow and the velocity at which the flow occurs. The flow should

be subcritical whenever possible in order to avoid the adverse characteristics of supercritical flow.

4.4 Channel alignment. Changes in channel alignment should be as gradual as the width of right-of-way and terrain permits. Whenever practicable, changes in alignment should be made in the reaches of the channel which have the flatter slopes, particularly if the flow becomes supercritical on the steeper slopes.

4.5 Channel section. In general, open channels adjacent to the roadway should have a section with side slopes not steeper than 4:1 (horizontal to vertical) and a rounded bottom at least 4 feet wide (1). The rounding (vertical curves) at the junctions of the side slopes and the bottom do not appreciably affect the capacity, but they do add greatly to the safety and appearance of the channel.

Stonex (5, p. 26) states that for roads designed for speeds above 65 miles per hour, the minimum channel section required for safety should have side slopes 6:1, a bottom width of 6.5 feet, and vertical curves 6.5 feet long connecting sides and bottom. The depth of the channel need only be deep enough to carry the flow with a freeboard of from 0.3 to 0.5 ft. on flat slopes (2), except where sub-drainage requires a deeper channel.

Safety considerations are not as important for drainage channels inaccessible to highway traffic; however, shallow, wide channels disturb the natural surface least and are much easier to maintain. Intercepting channels formed by dikes of borrow material do not disturb the existing topsoil and thus are less susceptible to erosion than are excavated channels. In most soils, the channel side slope should be no steeper than 1:1; but the limit will vary with the type of material, from vertical in rock and 1/2:1 in stiff clay to 2:1 or flatter in loam and sandy soils. Side slopes of vegetative-lined channels should be flat enough for easy maintenance and have suitable slopes for growing grass in the particular soil type and climate.

On some highways, storm water is removed through inlets and underground storm drains. The design of these facilities is beyond the scope of this publication.

4.6 Channel capacity. Determination of channel capacity was explained in section 3.2-2. Generally, the discharge to be carried is estimated for several points along the channel. The points selected should include a section immediately above sharp breaks in grade and the points of entry of concentrated flow. Channel charts (25) or King's tables (23) provide a direct solution of the size of channel needed to carry the flow. Without these aids a trial size of channel must be selected and the depth of channel required to carry the flow computed. The trial size is adjusted until a size is found that will carry the

design discharge and the need for protection is determined (see 4.7). Freeboard is added to the required depth.

Where a standard channel section has been adopted as a minimum section, a capacity table for various grades and types of lining could be prepared as a guide to the adequacy of the standard channel section for a particular site.

The capacity of the trial channel can be increased by increasing the grade, the bottom width, the depth, or by decreasing the resistance of the channel through the use of a smoother lining. Increasing the bottom width has the least effect on the velocity of the flow and is generally the desirable way to increase capacity for a given depth and type of channel when the velocity is near the permissible limit.

4.6-1 Use of channel charts. Charts such as that in figure 9, taken from reference 25, greatly facilitate the design of drainage channels. Construction of the chart is explained in appendix B of reference 25. Each chart provides a direct solution to the Manning equation for a channel of given shape and roughness, but auxiliary scales make the charts applicable to other values of n . The abscissa scale is discharge, in cubic feet per second, and the ordinate scale is velocity, in feet per second. The chart contains a series of heavy solid lines for depths of flow (normal depth, d_n) and another series of lighter dashed lines for channel slope. Given any two of the conditions for flow, the other two elements of the flow can be read from the chart. A heavy dashed line shows the position of the critical curve. For channels having the same value of n as that for which the chart was constructed, values above the critical curve indicate supercritical flow and steep slopes, while values below the line indicate subcritical flow and mild slopes. Use of the channel charts for channels having the same value of n as that for which the charts were constructed is explained by example 6. Use of the charts with values of n other than that for which the chart was constructed is explained by example 7.

Example 6

Given: A trapezoidal channel in erosion-resistant soil; bottom width 4 ft.; side slopes 2:1; grade 0.5 percent; $n=0.030$, and discharge 30 c.f.s. The channel is to be lined with a mixed grass sod.

Find: Depth, velocity, critical slope, and adequacy of the channel lining.

Solution:

1. On figure 9 at the point of intersection of $Q=30$ c.f.s. and the slope line 0.005, the depth (without freeboard) is 1.4 ft. and the velocity is 3.2 f.p.s. Flow is subcritical, since the point of intersection is below the dashed critical curve. The maximum permissible velocity from table 4 is about 5 f.p.s.

2. Critical slope is read or interpolated from the slope line at the intersection of the design Q and the critical curve, 0.017 in this example.

The channel charts can be used for values of n other than that for which the chart was constructed by using the Q_n and V_n scales. The design discharge is first multiplied

by the design value of n . Next the chart is entered with the value of Q_n on the Q_n scale and at the intersection of the Q_n value with the slope line read the value of V_n . V is then the V_n value divided by n . The value of the critical depth is read at the intersection of the Q line (not Q_n) and the critical curve and the critical velocity is the V value for this point. Critical slope varies with channel roughness and when the value of n is other than that for which the chart was constructed, proceed as shown in example 7.

Example 7

Given: The same cross section and design discharge (30 c.f.s.) as in example 6, but with a concrete lining (n is 0.015).

Find: Depth, velocity, and critical depth, velocity and slope.

Solution:

1. $Q_n=30(0.015)=0.45$, and from the chart (fig. 9), V_n is 0.08 and $d=0.9$ ft. Then $V=0.08/0.015=5.3$ f.p.s.

2. Critical depth is 1.0 ft. and critical velocity is 5 f.p.s. (both read at intersection of Q and critical curve). Flow is in the supercritical range, since V is greater than V_c and d is less than d_c .

3. The critical slope is found by first finding the critical depth (1.0 ft.). The critical slope is then read or interpolated from the intersection of this depth line and the Q_n value on the Q_n scale. In this example the critical slope is 0.004, a lesser slope than in example 6 because of the reduced roughness of the channel.

4.6-2 Use of King's tables. "Handbook of Hydraulics" (28) contains tables for the direct solution of open-channel flow problems. The use of these tables to find the depth of channel required for a given discharge is explained by examples 8 and 15. The references to King's Handbook applies to section 4 of the 4th edition, but the corresponding references to chapter 7 of the 3d edition follows, in parentheses.

King's solution for depth of flow requires the computation of a discharge factor, K' , by his equation 37 (40), which is

$$K' = \frac{Qn}{b^{5/3}S^{2/3}} \tag{27}$$

Where

Q = discharge, in cubic feet per second.

n = Manning coefficient of channel roughness.

b = bottom width of a trapezoidal channel, in feet.

S = slope of channel, in feet per foot.

King's table 95 (111) contains values of numbers to the 8/3 power which facilitate the preceding computation.

Then in table 97 (113), for a trapezoidal channel, find the value of $\frac{d_n}{b}$ (King's Handbook uses D for d_n) for the computed value of K' and the given channel side slopes.

The depth of flow is then b multiplied by the tabular value of $\frac{d_n}{b}$.

Example 8

Given: A trapezoidal channel; bottom width 4 ft.; side slopes 2:1; grade 1 percent, $n=0.03$; discharge 100 c.f.s.

Find: Depth and mean velocity.

Solution:

1. Compute.

$$K' = \frac{Qn}{64.8S^{0.5}} = \frac{100(0.03)}{(4.14)(0.01)^{0.5}} = \frac{3}{(40.3)(0.1)} = 0.74$$

2. In King's table 97 (113) for $K'=0.74$ and side slopes 2:1, $\frac{d_o}{b} = 0.52$. Then $d_o = 0.52(4) = 2.1$ ft.

3. The mean velocity is found from equation (4), $Q = AV$, after computing the area which is

$$A = d(b + zd) = 2.1[4 + 2(2.1)] = 17.2 \text{ sq. ft.}$$

$$V = \frac{Q}{A} = \frac{100}{17.2} = 5.8 \text{ f.p.s.}$$

4.6-3 Significance of the roughness coefficient (Manning n). Table 2 (app. A) lists n values for channels with various degrees of roughness. A value about midway in the range of values is ordinarily used for design. When new, the carrying capacity of the channel will be greater than that for which the channel is designed. This is ordinarily good, but when the design velocities are near the permissible velocity for the lining of the channel, damage might occur before the channel reaches the design condition. This is illustrated in example 9.

Example 9

Given: A trapezoidal channel in easily eroded soil; bottom width 4 ft.; side slopes 4:1; $d=1.9$ ft.; grade 2 percent; to be lined with Bermuda grass, kept mowed to 2 in.; $n=0.035$ (table 2).

Find: Adequacy of channel lining if seeding is used to establish the grass.

Solution: As designed, the channel would carry 36 c.f.s. at a velocity of 4.5 f.p.s. If the channel received the design flow (36 c.f.s.) before the grass had taken hold (when $n=0.02$), the velocity would be 6.7 f.p.s. The channel would probably be damaged. (See table 4. If the risk of a damaging discharge occurring before the grass is established is great, soil or temporary protection should probably be used. (See sec. 5.4.)

Another type of problem is the determination of the more economical of two suitable linings of different roughness.

Example 10

Given: A trapezoidal channel in easily eroded soil; bottom width 3 ft.; side slopes 3:1; grade 2 percent; and design discharge 40 c.f.s.

Find: Which is the more economical lining for the channel—concrete ($n=0.015$) or stone ($n=0.030$)?

Solution: Using the tables of reference 26 or King's tables (see 4.6-2), the comparative channel characteristics

(without freeboard) are:

	Concrete	Stone
A (area).....	4.32	7.00
d (depth).....	.8	1.1
Q (discharge = VA).....	40.0	38.5
V (velocity).....	9.3	5.5

With the required cross sections for the two linings computed, allowance for freeboard is added and the cost of excavation and lining is computed for each type, thus determining the more economical channel lining.

A third type of problem (example 11) involves using a rougher channel lining to decrease the velocity from supercritical to subcritical.

Example 11

Given: A trapezoidal channel paralleling the highway; bottom width 4 ft.; side slopes 3:1; discharge 225 c.f.s., and grade 1.0 percent. At the lower end of the channel, the flow must be turned and passed under the roadway.

Find: A suitable type of channel lining.

Solution:

1. For a concrete-lined channel ($n=0.015$) the required data from p. 201 of reference 26 are:

$$\begin{aligned} A &= 20.0 \text{ sq. ft.} \\ d &= 2.0 \text{ ft.} \\ R &= 1.2 \text{ ft.} \\ T &= 16.0 \text{ ft.} \end{aligned}$$

and from p. 370 of reference 26, the velocity for a hydraulic radius of 1.2 ft. and slope 0.01 is 11.2 f.p.s. The discharge is computed to be 224 c.f.s. which checks the design discharge. However, water flowing at 11.2 f.p.s. is supercritical, since from equation (19) $V_c = \sqrt{(32.2) \frac{20.0}{16.0}} = 6.3$ f.p.s. Supercritical flow will be difficult to turn.

2. If the channel is lined with grass ($n=0.040$), the required data from reference 26 are:

$$\begin{aligned} A &= 41.3 \text{ sq. ft.} \\ d &= 3.1 \text{ ft.} \\ Q &= 223 \text{ c.f.s.} \\ R &= 1.75 \text{ ft.} \\ T &= 22.6 \text{ ft.} \\ V &= 5.4 \text{ f.p.s.} \end{aligned}$$

The grass-lined channel requires a much larger cross section, but the water flowing at 5.4 f.p.s. is subcritical ($V_c=7.7$ f.p.s.) and will be much easier to handle than the same quantity of water flowing at supercritical velocity of over 11 f.p.s. in the concrete-lined channel.

4.7 Channel protection. Maximum permissible velocities for channels in various soil types are given in table 3, appendix A. If the mean velocity at the design flow exceeds the permissible velocity for the particular soil type, the channel should be protected from erosion. Channel protection can be provided by linings of grass, concrete, bituminous material, stone, fiber glass, or a preformed material such as metal or wood fiber impregnated with pitch. Generally, the lowest cost (including

maintenance cost) lining that provides adequate protection should be used. The type of channel lining might vary along the length of the channel, using a low-cost lining such as grass on the flatter slopes and a high-cost lining such as concrete on the steeper slopes. The capacity of the channel varies with the roughness (n value) of the lining, thus the channel dimensions must often be changed when the channel lining is changed.

Research on vegetative linings (35, 36) by the Soil Conservation Service and others has demonstrated the value of grass linings for drainage channels in regions where grass can be grown. Minor erosion damage to grass linings often "heals" itself where rigid-type linings progressively deteriorate unless repaired. Maximum permissible velocities for channels lined with various vegetal covers are given in table 4, appendix A.

Grass linings are particularly suitable for use in combination with other types of paving. Figure 15 shows one

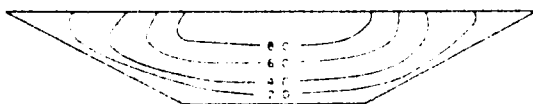

Figure 15.—Approximate distribution of velocities in a straight trapezoidal channel.

reason why this is true. Velocities in a straight, uniform channel are generally greatest in the upper part of the middle portion. Velocities decrease toward the channel sides and bottom approximating the distribution shown in figure 15. Although the mean velocity might exceed the permissible value for a grass lining and thus require a higher cost lining, the mean velocity in the triangular section embracing the upper edge of the bank slope might be low enough for grass. The most economical solution would probably be the combination of a rigid-type lining in the lowest part of the channel and grass lining on the upper bank slopes.

Combination linings are also used where the channel bottom requires protection which could be furnished by a grass lining, but low flows of long duration, from snow melt or seepage, retard the growth of grass. In such a situation, the channel could be paved with a rigid-type lining to carry the low flow and with grass above the elevation of the continued low flow.

If grass is to be seeded, a strip of grass sodding should be placed along the edge of rigid-type linings (at the time of construction) to prevent undermining of the grass lining.

4.8 Grass-lined channels. The method presented in this publication for the design of grass-lined channels is based principally upon the experiments of the Soil Conservation Service (35, 36). The Manning equation can be used to determine the capacity of a grass-lined channel, but the value of n varies with the type of grass, the development of the grass cover, the depth of flow, and the velocity of flow.

The permissible velocity in a grass-lined channel depends upon the type of grass, the condition of the grass cover, the texture of the soil comprising the channel bed, the channel slope and to some extent upon the size and shape of the drainage channel. To guard against overtopping, the channel capacity should be computed for taller grass than is expected to be maintained, while the velocity used to check the adequacy of the protection should be computed assuming a lower grass height which will likely be maintained.

The variable value of n complicates the solution of the Manning equation. The depth and velocity of flow must be estimated and the Manning equation solved using the n value (table 2, app. A) which corresponds to the estimated depth and velocity. The trial solution provides better estimates of the depth and velocity for a new value of n and the equation is again solved. The procedure is repeated until a depth is found that carries the design discharge.

Three methods will be explained for designing a grass-lined channel. The first method (example 12) uses table 2 to obtain a trial value of n for solving the Manning equation. The second method (example 13) follows more closely the method used by the Soil Conservation Service (36) and can be used for values outside the range of table. The third method (example 14) provides a direct solution through the use of channel charts (25). The third method is preferred if a chart is available for the type of channel to be used. Construction of channel charts for grass-lined channels is explained in appendix B of reference 25.

Example 12

Given: A trapezoidal channel; bottom width 4 ft.; side slopes of 4:1; grade 1 percent; lined with Bermuda grass kept mowed to a height of 2 to 4 inches; in easily erodible soil.

Find: Depth required to carry the design flow of 100 c.f.s. and the adequacy of the grass lining.

Solution:

1. Assume a depth of 2 ft. and a velocity of 4 f.p.s.
2. From section IV of table 2, appendix A, the value of n for tall grass is about 0.04. The increased depth (2 as compared with 1.5 ft.) compensates for the lesser velocity of flow (5 as compared with 6 ft. per sec.). For 2-inch grass, the value of n is about 0.035. The solution of the Manning equation is the same as for an unlined ditch.
3. The following data are taken from p. 241 of reference 26 (King's tables, sec. 4.6-2 could be used):

$n = 0.04$
 $A = 24.0$ sq. ft.
 $d = 2.0$ ft.
 $R = 1.17$ ft.
 $T = 20.0$ ft.

and from p. 450 of reference 26

$V = 4.1$ f.p.s.

Then $Q = 95$ c.f.s. which nearly equals the design discharge.

4. For computing the adequacy of the lining ($n = 0.035$), the velocity is 4.6 f.p.s. and d is 1.9 ft.

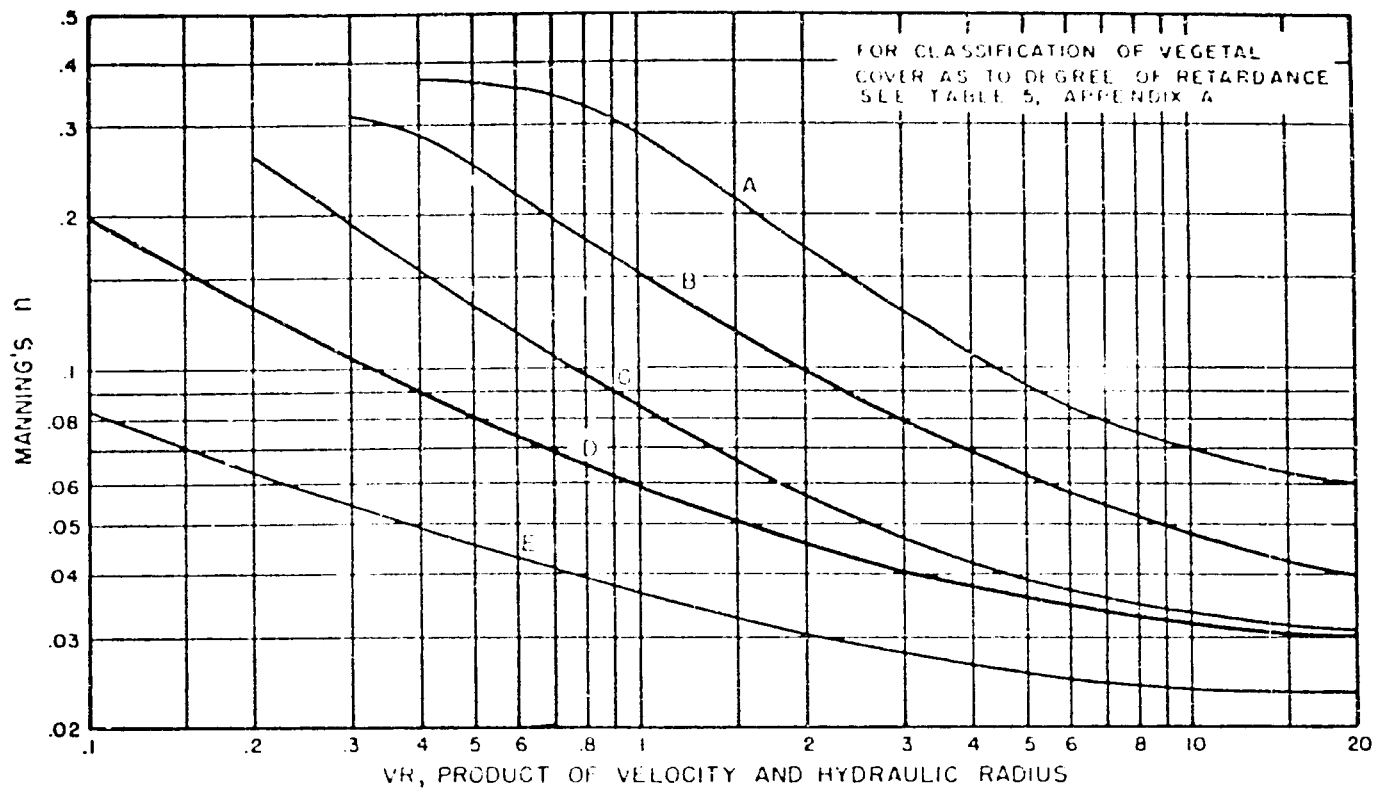

Figure 16.—Manning n for vegetated channels (from handbook of channel design for soil and water conservation SCS-TP-61 revised June 1964).

Table 4, appendix A, gives the allowable velocity as 6 f.p.s. which exceeds the computed value. The Bermuda grass will provide adequate protection.

A more general solution for example 12 for values that lie outside the range of table 2 is: First classify the retardance of the grass cover from the information given in table 5, appendix A. Then from the product of the estimated velocity and the estimated hydraulic radius obtain the estimated value and repeat the procedure until a depth is found that carries the design discharge. See example 13.

Example 13

Given: The same data as in example 12.

Find: Depth and adequacy of grass lining.

Solution:

1. In the example, the retardance in Class C (table 5), using slightly taller grass than 4 inches, and the hydraulic radius is 1.17 ft. for an assumed depth of 2 ft. The assumed velocity is 5 f.p.s.

2. From figure 16, the Manning n for a VR product of 5.85 is about 0.04 (0.05 for Class D, 2.5-inch grass). It will be noted that the value of n could have been read to greater refinement, but this is sufficiently accurate for practical problems.

3. The problem now becomes the same as that illustrated in example 12 and the 2-ft. depth (before allowing for freeboard) is satisfactory. The Bermuda grass provides adequate protection.

Example 14

Given: The same data as in example 12.

Find: Depth and adequacy of grass lining.

Solution:

1. Channel charts (Nos. 30 to 33, ref. 25) have been prepared for trapezoidal channels with bottom width 4 feet and various side slopes, having retardance classifications, C and D. Charts for median swales are also supplied (No. 34, ref. 25).

2. To use the channel charts, first find the retardance classification in table 5, appendix A, or table 5, appendix A, of reference 25, and select the appropriate chart in reference 25 for the bottom width, side slope, and retardance classification. Enter the chart with the design discharge and channel slopes and read the depth and velocity from the graph.

3. In this example, the retardance classification for capacity is C (table 5), and the appropriate chart is No. 31 (fig. 17). Entering the bottom graph of figure 17 with $Q=100$ c.f.s. and $S=0.01$, the depth is 2 ft. and the velocity is 4.1 f.p.s. For allowable velocity (retardance D), the depth is 1.9 ft. and the velocity is 4.6 f.p.s.

4.9 Concrete-lined channels. Concrete linings are generally used for protection against erosion on steep slopes, however, they are sometimes used on very flat slopes to increase the velocity of flow to a non-silting velocity, to more efficiently remove water from ponded areas, or to reduce the size of channel needed to carry the design discharge. The capacity of concrete-lined channels can be computed as described for channels in sections

3.2-2 and 4.6. Values of the Manning coefficient for concrete linings are given in table 2, appendix A.

For economy of construction, the side slopes of concrete-lined trapezoidal sections should not be so steep (no steeper than 1½:1 and preferably no steeper than 2:1) that surface forms would be needed. Other construction details are discussed in section 5.5.

Velocities in concrete-lined channels on the steeper longitudinal grades are usually supercritical. At high velocities air entrainment occurs. This produces a bulking effect which increases the depth of flow. Air entrainment also causes a reduction in channel friction with a resulting increase in velocity over that computed using the Manning n from table 2. An n of about 0.008 is recommended (57, p. 286) for computing velocity and specific energy in concrete-lined channels carrying supercritical flow.

To allow for the bulking effect of the entrained air, the depth of channel required to carry the air-water mixture must be greater than that computed by Manning's equation using the n value from table 2. One method (57, p. 289) is to use an n of 0.018 for computing normal depth. Another method for computing the depth of the air-water mixture in a rectangular channel is adapted from a formula given on page 547 of reference 22 in which:

$$d = 0.11(Q/E)^{2/3} \tag{23}$$

Both methods of allowing for air entrainment are rough approximations and do not include an allowance for freeboard.

The effect of the high velocity flow at the channel exit must be considered and some provision made to dissipate the excess energy. Otherwise, erosion might occur at the channel outlet, resulting in damage to embankment slopes or in undermining of the channel outlet. Design of stilling basins and energy dissipators is discussed in references 38 and 39.

High-velocity flow can damage the lining itself if projections of the lining occur as a result of faulty design or construction or through unequal settlement of the supporting soil. Offsets at construction or expansion joints cause negative pressures beneath the joint and loss of the supporting soil. To avoid offsets, transverse joints should be made so that the upstream edge of the lower slab cannot heave without moving the downstream edge of the upper slab a like amount. The edge of the lower slab should be constructed about one-half inch lower than the edge of the upper slab. Keyed joints are unsatisfactory because the abutting slabs are subject to differential movement which might result in high stresses on the keys or keyways and cause them to spall. An unkeyed joint with slip dowels is the preferred type for large concrete channels (57, p. 340).

Concrete-lined channels built on steep slopes should be anchored to the sub-grade by cutoff walls at both the upper and lower ends of the channel. On channels longer than about 50 feet, intermediate anchor walls may be necessary. The cutoff wall also minimizes erosion underneath the lining. The absence of a cutoff wall at the outlet often results in the loss of part of the concrete lining. The cutoff wall at the outlet is particularly necessary where a hydraulic jump occurs. Cutoffs on pipe chutes usually take the form of collars bolted to the pipe.

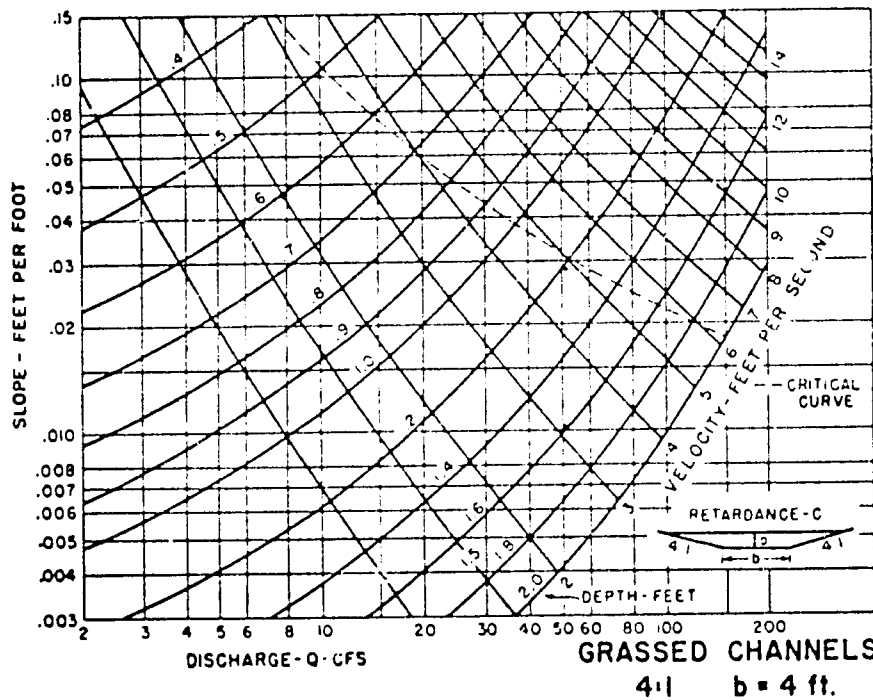
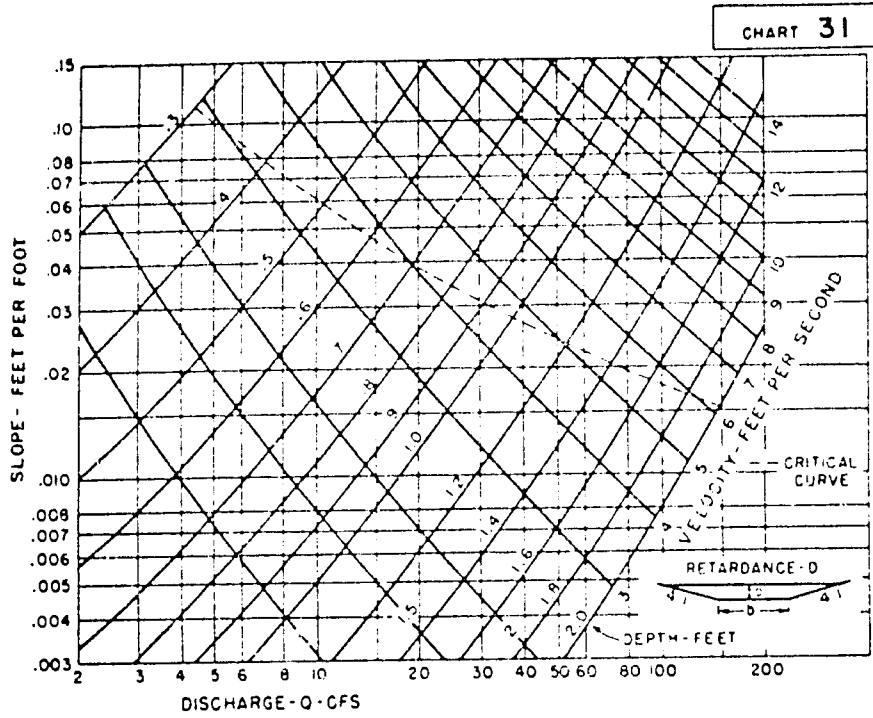

Figure 17.—Open-channel chart for grass-lined channel (from design charts for channel flow, hydraulic design series No. 3).

34

Another frequent cause of failure of concrete-lined channels is overtopping of the channel when the freeboard is insufficient to contain the waves generated by disturbance of the high-velocity flow. (See sec. 4.15.)

4.9-1 Buoyancy of empty channels. In saturated soils, empty channels with rigid linings may float or break up because of the uplift water pressure. The total upward force is equal to the weight of the water displaced by the channel or 62.4 times the volume in cubic feet of the portion of channel cross section which lies below the water table.

The uplift pressure is resisted by the total weight of the lining. When the weight of the lining is less than the uplift pressure, the channel is unstable in saturated soils. The lining should then be increased in thickness to add additional weight or if the flow is subcritical, weep holes may be placed at intervals in the channel bottom to relieve the upward water pressure in the channel. The diameter of weep holes varies from 2 inches to 4 inches and the spacing depends upon soil conditions. When flow is supercritical, subdrainage should be used rather than weep holes to reduce uplift pressure.

A companion problem in northern regions is frost heave which is probably the greatest factor in the destruction of concrete linings in regions with subfreezing temperatures. Unless the subgrade is free draining, subdrainage might be required. All rigid linings require a firm, well-compacted subgrade. (See sec. 5.5.)

4.10 Channels with combination linings. At some locations grass alone does not provide sufficient protection to the channel because of high-velocity flow or the inability of grass to become established in the bottom of the channel. The best solution for some of these locations might be a combination channel where the lower part of the channel cross section is lined with stone or a rigid type of lining and the upper part of the channel cross section is grassed.

Another application of combination channels might be on slight slopes where a smooth rigid lining is used to maintain nonsilting velocities at low flows and grass provides protection to the upper part of the channel.

The top of a rigid lining should be protected by a strip of sod at the time of construction and the edge of the lining finished as described in section 5.5. The design of channels with combination linings is illustrated by example 15.

Example 15

Given: A trapezoidal channel; bottom width 4 ft.; side slopes 3:1; grade 0.5 percent; in sandy loam; carrying flood water containing fine silts and a spring flow which reaches 30 c.f.s.

Find: A suitable design for the design flood of 170 c.f.s. (including spring flow).

Solution:

A. Unlined Channel

1. Table 3 gives a permissible velocity of 2.5 f.p.s. for an unprotected channel. The n value of the unprotected channel (table 2) is 0.020. The channel will be designed using King's tables. (See sec. 4.6-3.) The tables referred to in the computations following are from section 7, reference 28, but the corresponding table in chapter 7 of the

3d edition of King's Handbook is given in parentheses. Compute K' from equation (27), section 4.6-2.

$$K' = \frac{Qn}{b^{5/3}S^{1/2}} = \frac{170(0.020)}{(4)^{5/3}(0.005)^{1/2}} = 1.19$$

King's table 95 (111) contains 8/3 power of numbers and his table 92 (108) contains 1/2 power of decimal numbers.

2. In King's table 97 (113), for $K' = 1.19$ and side slopes 3:1, $\frac{d_s}{b} = 0.59$. Then $d_s = 0.59(4) = 2.4$ ft.

3. The velocity is computed from formula (4), $Q = AV$ where A for a trapezoidal channel = $(b + zd) = 2.4[4 + 3(2.4)] = 26.9$ sq. ft. Then

$$V = \frac{170}{26.9} = 6.3 \text{ f.p.s.}$$

A channel 2.4 ft. deep (2.7 ft. with freeboard) will carry the design discharge, but the velocity of 6.3 f.p.s. exceeds that allowable. Therefore the channel should be protected.

B. Concrete-Lined Channel

1. For a concrete-lined channel ($n = 0.015$). The computations are similar to part A of this example.

$$2. K' = \frac{170(0.015)}{(4)^{5/3}(0.005)^{1/2}} = 0.89 \text{ or}$$

$$K'_s = K'_n \frac{n_n}{n_s} = 1.19 \frac{(0.015)}{(0.020)} = 0.89$$

$$3. \frac{d_s}{b} = 0.52 \text{ and } d_s = (4)(0.52) = 2.1 \text{ ft.}$$

$$4. A = 2.1[4 + 3(2.1)] = 21.6 \text{ sq. ft.}$$

$$V = \frac{170}{21.6} = 7.9 \text{ f.p.s.}$$

5. The Froude number (sec. 3.4) of the flow is 0.96, which indicates that the flow is in the unstable range just below critical flow. The flow should be considered as supercritical in allowing for freeboard or in attempting to change the channel alignment.

C. Combination Lining

1. A more economical lining than that of part B might be a combination lining with a concrete-lined channel designed to carry the spring flow of 30 c.f.s. and with the channel slopes above the concrete lined with Bermuda grass mowed to 2 inches. This design will have the cross section shown in figure 18. The depth (without freeboard) of the concrete-lined channel is first determined.

$$2. K' = \frac{30(0.015)}{(4)^{5/3}(0.005)^{1/2}} = 0.16$$

$$3. \frac{d_s}{b} = 0.22 \quad d_s = (4)(0.22) = 0.9 \text{ ft.}$$

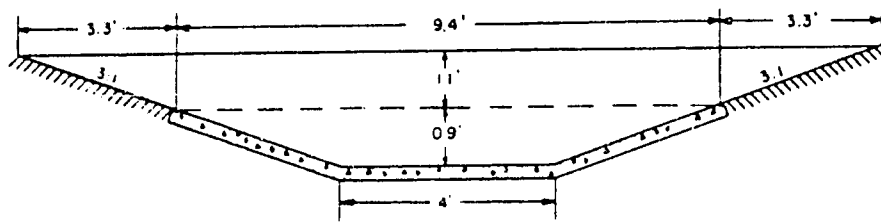

Figure 18.—Trapezoidal channel with combination lining.

4. Area = $0.9[4 + 3(0.9)] = 6.0$ sq. ft.

$$V = \frac{30}{6.0} = 5.0 \text{ f.p.s.}$$

Top width = $b + 2zd = 4 + (2)(3)(0.9) = 9.4$ ft.

A concrete-lined channel 0.9 ft. deep will satisfactorily carry the design flow of 30 c.f.s.

The next step is to estimate the total depth of the channel. As a guide, a rectangular channel of top width 9.4 ft. can be estimated to carry the flow. The velocity will be somewhat higher than the 5.0 f.p.s. velocity in the 0.9 ft. depth of the concrete-lined section, say 9 f.p.s. The discharge per foot of depth is 9×9.4 or 85 c.f.s. The trial depth is then $170/85$ or 2 ft. (1.1 ft. above concrete lining).

For a trial depth of 2 ft. the computation for the section above the concrete lining is:

$$A = 6.0 + 9.4 \times 1.1 = 16.4 \text{ sq. ft.}$$

$$WP = 9.7 \text{ f'}$$

$$R = \frac{A}{WP} = \frac{16.4}{9.7} = 1.69$$

$V = 10.0$ f.p.s. (from nomograph, app. B for $S = 0.005$, $n = 0.015$, and $R = 1.69$)

$$Q = 16.4(10.0) = 164 \text{ c.f.s.}$$

The water carried in one of the triangular sections above the grass would be computed as follows:

$$A = \frac{1}{2}(3.3 \times 1.1) = 1.81 \text{ sq. ft.}$$

$$WP = \sqrt{(3.3)^2 + (1.1)^2} = 3.5 \text{ f'}$$

$$R = \frac{1.81}{3.5} = 0.52$$

The value of n from table 2 is 0.050 for a depth of between 0.7 and 1.5 ft. and estimated velocity of 2 f.p.s. Then $V = 1.25$ f.p.s. (app. B) and $Q = 1.25(1.81) = 2.3$ c.f.s.

The water carried by the two triangular grassed sections will be 4.6 c.f.s. and the total capacity of the combination

ditch (without freeboard) is $164 + 4.6$, or 169 c.f.s., which nearly equals the design discharge.

The small quantity of water (4.6 c.f.s. in this example) and low mean velocities carried in the few feet of channel near each bank is a powerful argument for using combination ditches rather than lining the entire channel section with a rigid lining. In this example concrete paving throughout the slope would have increased the discharge by only 12.5 c.f.s., but would have required an additional 7.0 sq. ft. of concrete lining per linear foot of channel.

4.11 Bituminous linings. Capacity of channels lined with bituminous material can be computed as described in sections 3.2-2 and 4.6. The Manning roughness coefficient (table 2, app. A) for bituminous linings is about the same as that of portland cement concrete linings, thus the channel size and the velocities developed in the channel are about equal for the two types of lining. Channel side slopes for asphalt concrete-lined channels less than 10 feet deep should be no steeper than 1.5:1.

Bituminous linings are more flexible than portland cement linings and can more readily adjust to minor subgrade settlement, but the bituminous lining has less strength and weight to resist uplift from frost action or hydrostatic pressure. (See sec. 4.9-1.)

Weeds and other plants are a potential hazard to bituminous linings when conditions are favorable to their growth. Soil sterilization of the lining subgrade is sometimes required.

Additional information on bituminous linings for channels is contained in The Asphalt Institute's Manual No. 12 (40).

4.12 Channels lined with stone. Stone channel linings can be constructed (sec. 5.7) of dumped stone, hand-placed stone, or grouted stone. The channel bed and slopes can be lined throughout the area that will be in contact with the design flood or stone can be used in a combination channel with grass or concrete. The size of stone used ranges from gravel size to large stone several feet in diameter. The size of stone needed to protect a particular channel from erosion may be calculated as explained in sections 4.12-1 to 4.12-3. Bank and shore protection is discussed in section 4.16.

A dumped stone lining is the most flexible of the three types and will more readily adjust itself to uneven bank settlement (sec. 7.5). In areas where stone is plentiful, dumped stone is generally the least costly type.

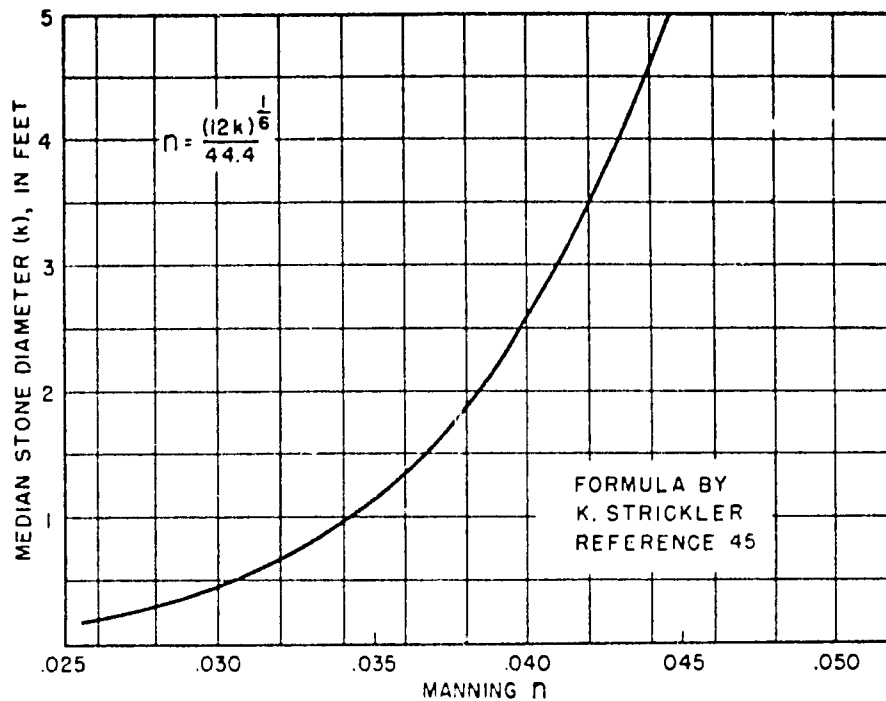

Figure 19.— Relation of Manning n to size of stone.

Hand-placed stone linings require less material than dumped stone linings and might be used where the cost of stone is exceptionally high. Hand placement is generally restricted to larger size stone and includes both manually and machine placed stone. (See sec. 5.7.) The finished appearance of the hand-placed lining is somewhat more uniform than dumped stone but its performance is less satisfactory. (See sec. 4.12-2.)

Grouted stone is seldom used except in small channels carrying high-velocity flow or where the available stone is not large enough to withstand the expected velocities. Even here the use of wire mesh baskets filled with stone might be preferable to grouted stone.

All types of stone linings should be laid on a filter blanket of gravel or crushed stone and the gradation of the natural soil is such that it will not filter up through the stone lining. The design of the filter blanket is discussed in section 4.12-4.

The procedures for selection of stone size which follow are based largely upon the report of the Subcommittee on Slope Protection of the Committee on Earth Dams of the Soil Mechanics and Foundations Division, American Society of Civil Engineers (41). The size of stone needed for slope protection (see fig. 21) is based on the Ishbash formula. This formula is compared with all available (through 1958) experimental data on Corps of Engineers Chart 712-1, reference 42.

The California Division of Highways discusses the design of stone slope protection (45, pp. 110-126) in their bulletin on Bank and Shore Protection. The use of stone saucages for highway fill protection is discussed by Posey (44). Reference 39 (p. 209) gives a curve showing the maximum stone size recommended by the Bureau of Reclamation for protection downstream from stilling basins. This curve would lie slightly to the left of the curve for a 1:1 slope in figure 21.

When the cost of stone linings is great, alternate means of channel protection by reducing the velocity should be investigated.

4.12-1 Dumped-stone linings. The resistance of stone to displacement by moving water depends upon—

1. Weight, size, and shape of the individual stones.
2. The gradation of the stone.
3. Depth of water over stone lining.
4. The steepness of the protected slope.
5. The stability and efficiency of the filter blanket and the embankment on which the stone is placed.
6. The velocity of the flowing water against the stone.

The size of stone required is determined by first computing the mean velocity of the water and the size of the channel required to carry the design discharge. Next, a

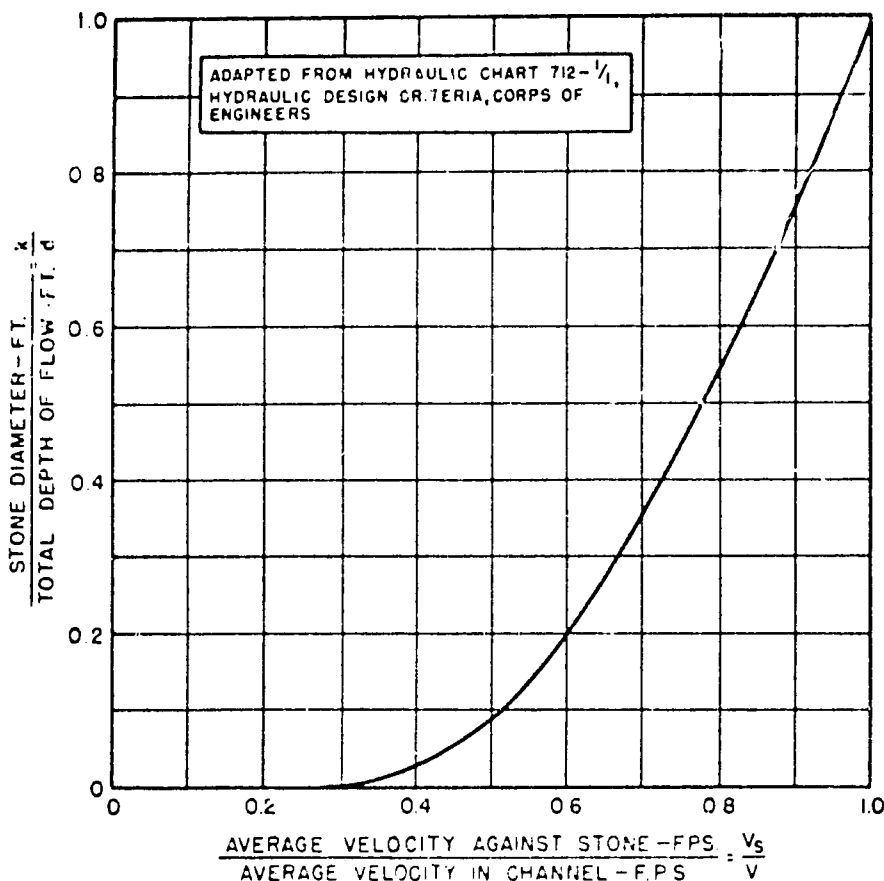

Figure 20.—Average velocity against stone on channel bottom.

size of stone (k) is selected that will withstand the expected velocity. A direct solution of the problem is impracticable, unless charts similar to the charts (Nos. 39-34) for grassed channels in reference 25 are constructed, because the value of the Manning n increases with increase in the size of stone used; this requires a trial and error procedure (See example 16.) The steps in the procedure are as follows.

1. Select a trial value of n from figure 19 corresponding to the estimated size of stone to be used. Figure 19 applies to a stone lining on both sides and bottom of channel; when only the channel sides are lined, the n value might require weighting when the bottom width exceeds 4 times the depth of flow. The value of the Manning n also varies with the ratio of stone size to the hydraulic radius (45). The effect of this variation is generally minor in the determination of stone size.

2. Compute a size of channel, using the Manning equation, that will carry the design discharge.

3. Divide the assumed stone diameter (k), in feet, by the computed depth of flow in the channel (d) to obtain the k/d ratio.

4. Enter figure 20 with this ratio to obtain the V_s/V ratio.

5. Multiply the computed mean value of V by the V_s/V ratio from figure 20 obtain the value of V_s .

6. Enter figure 21 with the value of the V_s and read the stone size, in feet at the intersection of the V_s and the curve corresponding to the channel side slope.

7. If the estimated stone size (step 1) is smaller or much greater than the required size (step 6), select a different size stone and repeat steps 1 through 6, until the estimated size agrees with the required size.

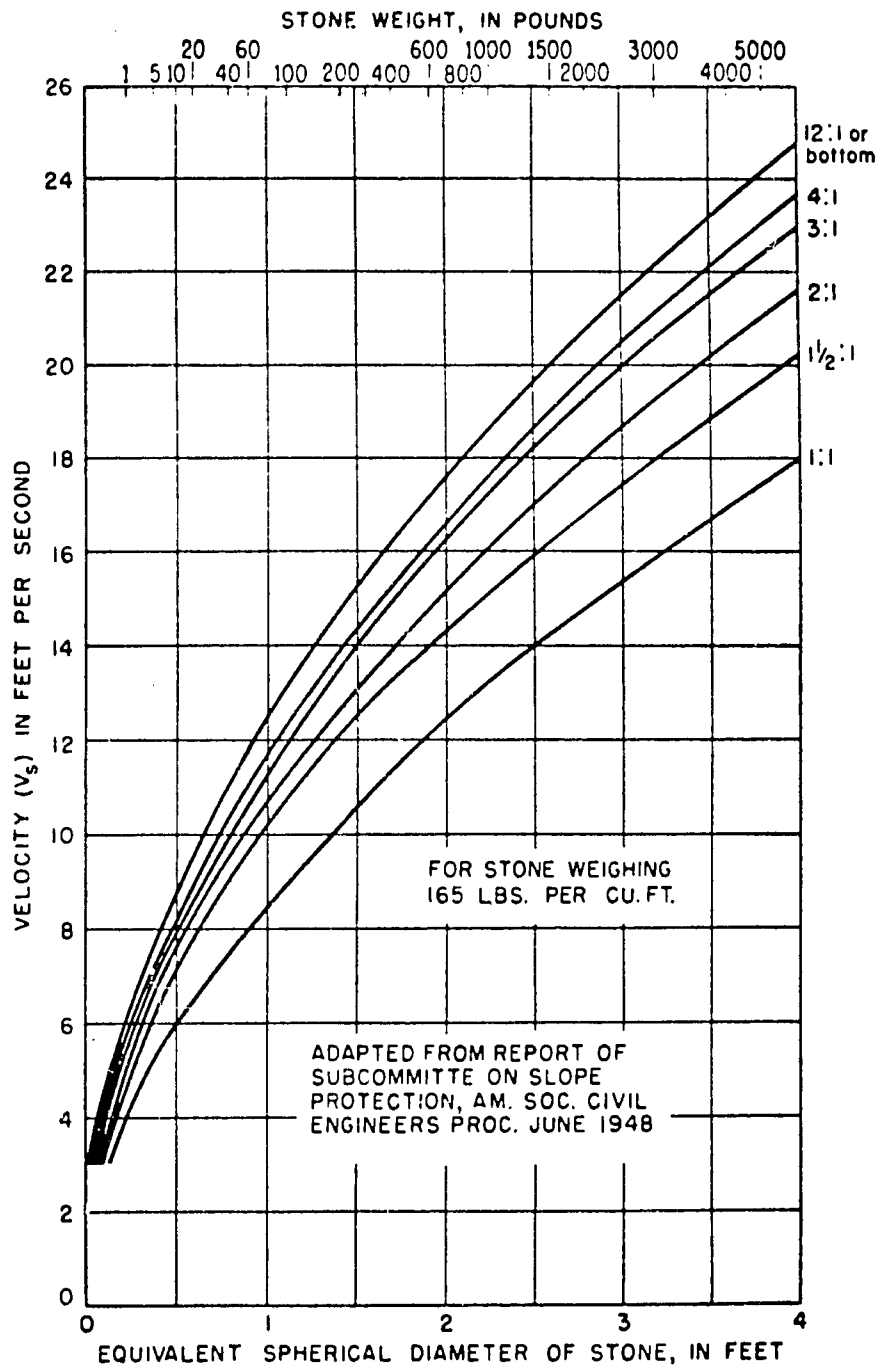

Figure 21.—Size of stone that will resist displacement for various velocities and side slopes.

Determining the size of stone placed within about 50 B of the downstream end of a chute or culvert carrying high-velocity flow requires a modification of steps 4 and 5 of the foregoing procedure. The average velocity at the end of the chute should be used to enter figure 21 rather than V_c from figure 20 which applies to fully developed boundary flow.

The size of stone required to resist displacement from direct impingement of the current as might occur with a sharp change in alignment is probably greater than the value obtained from figure 21, although research data are lacking on just how much larger the stone should be. The California Division of Highways (43) recommends doubling the velocity against the stone as determined for straight alignment (step 5) before entering figure 21 for stone size. Lane (45) recommends reducing the allowable velocity by 22 percent for very sinuous channels, or for determining stone size the velocity is increased. The factor applied to the velocity V_c for increasing the stone size at the point of impingement would vary from 1 to 2 depending upon the severity of the attack by the current. The area where the larger stone is placed should be determined by the conditions at each site. It is obvious that protection is not required on a bank where deposition occurs.

The size of stone (k) taken from figure 21 is for stone with a unit weight of 165 pounds per cubic foot. The stone size (k_w) for stone of other weights can be computed from Creager's equation (discussion of reference 41):

$$k_w = \frac{102.5k}{w - 62.5} \quad (29)$$

The American Society of Civil Engineers Subcommittee (41) recommends the following rules as to the gradation of the stone:

1. Stone equal to or larger than the theoretical size from figure 21 with a few larger stones, up to about twice the weight of the theoretical size tolerated for reasons of economy in the utilization of the quarried rock, should make up 50 percent of the rock by weight.
2. The gradation of the lower 50 percent should be selected to satisfy the filter requirements (sec. 4-12-4) between the stone and the upper layer of the filter blanket.
3. The depth of the stone should accommodate the theoretically sized stone with a tolerance in surface elevations designed to permit the oversized stones mentioned in rule 1. (This requires a tolerance of about 30 percent of the thickness of the stone.)
4. Within the preceding limitations, the gradation from largest to smallest sizes should be quarry run. (See fig. 24 for good gradation curve.)

Tests made at the U.S. Army Engineer Waterways Experiment Station (48) show the importance of gradation as compared with maximum size of stone. Two gradations failed under the same conditions although one gradation had maximum pieces 36 inches in equivalent diameter (2,300 pounds), as opposed to 24 inches (700 pounds) for the other gradation. The 50-percent size of each gradation was 16 inches (200 pounds). Two other gradations failed under the same conditions, one with maximum

pieces 24 inches (700 pounds) in equivalent diameter and the other 16 inches (200 pounds) in equivalent diameter. However, 75 percent of each of these gradations consisted of stone 10 inches (50 pounds) in equivalent diameter or smaller. In the model tests, the large pieces were dislodged by undercutting resulting from the removal of the smaller pieces. Murphy and Grace (46) concluded that pieces of stone larger than those which represented some critical size (the 60- to 65-percent size in these tests) do not increase the effectiveness of the particular gradation.

Example 16 shows a sample calculation of stone size for a roadside channel. Bank protection of stream channels is briefly discussed in section 4.16 and placing of riprap is discussed in section 5.7.

Example 16

Given: A trapezoidal channel in easily eroded soil; bottom width 4 ft.; side slopes 3:1; grade 2 percent; and design discharge 75 c.f.s.

Find: Depth of channel and design a dumped stone lining.

Solution:

1. The channel without lining ($n=0.020$) would have a depth of 1.15 ft. and $V=8.8$ f.p.s. With rougher stone lining, the velocity will be reduced to approximately $\frac{0.02}{0.03}$ (8.8) = 6 f.p.s. The velocity against the stone (fig. 20) would be about 0.8 (estimating $k=0.5$ ft.) of this, or 5 f.p.s. This velocity (fig. 21) would require stone of about 0.25-ft. diameter. The trial value of n (for $k=0.25$) from figure 19 is 0.028.

2. From p. 201, reference 26, for a trial depth of 1.35 ft., $A=10.9$ sq. ft., $R=0.86$ ft.

On p. 43C for $n=0.030$, $V=6.3$ f.p.s., and for $n=0.028$, $V = \frac{0.030}{0.028} (6.3) = 6.8$ f.p.s. Then $Q=10.9 (6.8) = 74$ c.f.s., which checks the design Q .

3. $\frac{k}{d} = \frac{0.25}{1.35} = 0.18$.

4. $\frac{V_c}{V}$ ratio from figure 20 is 0.58.

5. $V_c = 0.58V$, $V_c = 0.58 (6.8) = 3.9$ f.p.s.

6. In figure 21 for $V_c = 3.9$ and slope 3:1, the size of stone is about 0.1 ft. which checks the assumed size of 0.25 ft. (step 1). Use 2-inch stone.

The depth of the channel after lining is 1.35 ft. (without freeboard allowance). The minimum thickness of the linings is 2 inches with a tolerance of about 1 inch in surface elevation. Stone of equivalent spherical diameter, equal to or larger than 2 inches with a few larger stone not exceeding 3 inches, should make up 50 percent of the rock by weight.

4.12-2 Hand-placed stone linings. Hand-placed stone linings consist of stones placed by hand following a more or less definite pattern with the voids in the larger stones filled with smaller stones and the surface kept relatively even. The stone should be placed on a filter blanket of graded gravel or crushed stone. (See sec. 4.12-4.) Enough voids should be left in the surface of the stone lining to properly vent the subsurface. The depth and

size of the stone required to resist displacement is generally specified as one-half ($\frac{1}{2}$) of that required for dumped stone (41, p. 857), but the experience of the Corps of Engineers (47) is that a half thickness of hand-placed stone is not satisfactory as a substitute for dumped stone. (See sec. 7.) Although data are lacking for a definite conclusion, it is probable that hand-placed stone is inferior to an equal thickness of dumped stone because it is not as flexible as dumped stone and does not have the structural strength to bridge over local bank failures.

4.12-3 Grouted-stone linings. Grouted-stone linings are either hand-placed or dumped-stone linings with the voids filled with portland cement mortar. The stone is placed on a gravel or crushed stone filter blanket and the grout is broomed and rodded into the voids. Some of the holes or joints are left ungrouted in order to avoid uplift from hydrostatic pressure, but care should be exercised to avoid openings that permit escape of the bank or filter material. Grouted stone is seldom used except for lining high-velocity channels, although its use might be justifiable where stones large enough for dumped stone linings are not available or when the stone available is not adaptable to hand placing.

4.12-4 Filter blankets. A filter blanket is often needed beneath the stone lining to prevent the bank material from passing through the voids in the stone blanket and escaping. The loss of bank material leaves cavities behind the stone blanket and a failure of the blanket might result. Whether a filter blanket is needed will depend upon the gradation of the bank material and the openings or voids in the riprap cover. In general, a filter ratio of 5 or less between successive layers will result in a stable condition. The filter ratio (48) is defined as the ratio of the 15-percent particle size (D_{15}) of the coarser layer to the 85-percent particle size (D_{85}) of the finer layer. An additional requirement for stability is that the ratio of the 15-percent particle size of the coarse material to the 15-percent particle size of the fine material should exceed 5 and be less than 40. These requirements can be stated as follows:

$$\frac{D_{15} \text{ (of coarser layer)}}{D_{85} \text{ (of finer layer)}} < 5 < \frac{D_{15} \text{ (of coarser layer)}}{D_{15} \text{ (of finer layer)}} < 40$$

If a single layer of filter material will not satisfy the filter requirements, one or more additional layers of filter material should be used. The filter requirement applies between the bank material and the filter blanket; between successive layers of filter blanket material, if more than one layer is used; and between the filter blanket and the stone lining. In addition to the filter requirements, the grain size curves for the various layers should be approximately parallel to minimize the infiltration of the fine material into the coarse material. The filter material should contain not more than 5 percent of material passing the No. 200 sieve.

The thickness of the filter blanket ranges from 6 inches to 15 inches for a single layer, or from 4 inches to 8 inches for individual layers of a multiple layer blanket. The thicker layer is used where the gradation curves of adjacent layers are not approximately parallel.

An example of filter design follows:

Example 17

Given

Material	Particle size (mm)	
	D_{15}	D_{85}
Riprap ("B" curve, fig. 24).....	90	308
Streambank.....	.006	.10
Sand.....	.14	2.4
Gravel.....	4.0	80

Find: Design filter, if needed.

Solution:

1. Is filter required?

$$\frac{D_{15} \text{ (riprap)}}{D_{85} \text{ (streambank)}} = \frac{90}{0.10} = 900 > 5 \quad \text{Yes}$$

2. Can a single layer of gravel be used?

$$\frac{D_{15} \text{ (riprap)}}{D_{85} \text{ (gravel)}} = \frac{90}{50} = 1.8 < 5 \quad \text{OK}$$

$$\frac{D_{15} \text{ (gravel)}}{D_{85} \text{ (streambank)}} = \frac{4.0}{0.10} = 40 > 5 \quad \text{No}$$

3. Can a layer of sand and a layer of gravel be used?
1st requirement:

$$\frac{D_{15} \text{ (sand)}}{D_{85} \text{ (streambank)}} = \frac{0.14}{0.10} = 1.4 < 5 \quad \text{OK}$$

$$\frac{D_{15} \text{ (gravel)}}{D_{85} \text{ (sand)}} = \frac{4.0}{2.4} = 1.7 < 5 \quad \text{OK}$$

$$\frac{D_{15} \text{ (riprap)}}{D_{85} \text{ (gravel)}} = \frac{90}{50} = 1.8 < 5 \quad \text{OK}$$

2d requirement:

$$\frac{D_{15} \text{ (sand)}}{D_{15} \text{ (streambank)}} = \frac{0.14}{0.006} = 23 < 40 \quad \text{OK}$$

$$\frac{D_{15} \text{ (gravel)}}{D_{15} \text{ (sand)}} = \frac{4.0}{0.14} = 29 < 40 \quad \text{OK}$$

$$\frac{D_{15} \text{ (riprap)}}{D_{15} \text{ (gravel)}} = \frac{90}{4.0} = 22 < 40 \quad \text{OK}$$

If the gradation of the sand and the gravel is satisfactory and adequate placing methods are to be used, two minimum thickness layers (4 or 5 inches) can be used, one of sand and one of gravel.

4.13 Ditch checks. In humid areas ditch checks (grade-control structures) are seldom used in the roadway and toe-of-slope channels because they are a hazard to vehicles driving off the road, they are often unsightly, they hamper the use of power mowing equipment, and in most locations their jobs can be done better with protective cover. (See example 15.) In channels not accessible to vehicles or in arid and semiarid regions, ditch checks or

drop structures may be used to maintain noneroding velocities in the channel section. Their use, however, should be limited because of cost and vulnerability to damage at times of unusual flooding.

The purpose of ditch checks is to reduce the channel grade to a series of parallel grades which will keep the velocity within allowable limits (table 3) for the material of the channel or for the channel lining. The difference between the allowable grade and the existing grade is taken up in the drop at the ditch checks. The drop at each check in a roadway channel is preferably from 7 to 12 inches. Ditch checks may be constructed of local stone, concrete, timber, or other suitable material. The ditch check should be well anchored in the channel side slopes, have a cutoff wall, and have an apron with a sill or lip at the lower end forming a shallow pool to dissipate the energy of the falling water. The crest of the check is ordinarily built as a trapezoidal weir, the same cross section as the channel, and with the weir crest on level with the bottom of the upper channel. The weir capacity (sec. 3.3-3) should be sufficient to prevent overtopping of the wings which should extend above the design depth of flow by the amount of the freeboard.

The spacing of ditch checks, in feet, is computed from the equation,

$$\text{spacing} = \frac{100 A}{S - S_0} \quad (30)$$

Where

A = vertical drop, in feet.

S = slope of channel without checks, in percent.

S₀ = slope of channel, in percent, for allowable velocity.

The size of the channel is computed for the design discharge and slope of channel as described in section 3.2-2. If the velocity exceeds that allowed (table 3) for the soil type or channel lining, ditch checks may be considered. Reducing the velocity also reduces the channel capacity and thus requires an increase in channel size. (See example 18.)

Example 18

Given: A trapezoidal channel, bottom width 4 ft, side slopes 3:1, grade 0.3 percent, and discharge 65 c.f.s. The channel is in firm loam and carries clear water.

Find: Dimensions of a channel to carry the discharge using ditch checks if needed.

Solution:

A. Unprotected Channel

1. In appendix A from table 2, $n = 0.020$, and from table 3, the allowable velocity (V_a) = 2.5 f.p.s.
2. From reference 26, p. 201 and 378:

$$\begin{aligned} d &= 1.7 \text{ ft.} & R &= 1.05 \text{ ft.} \\ T &= 14.2 \text{ ft.} & V &= 4.2 \text{ f.p.s.} \\ A &= 15.5 \text{ sq. ft.} & Q &= 65 \text{ c.f.s.} \end{aligned}$$

3. The channel selected has adequate capacity, but the velocity (4.2 f.p.s.) exceeds the allowable velocity (2.5 f.p.s.)

B. Ditch Checks

If 6-inch (0.5 ft.) ditch checks are to be used to reduce the velocity to a noneroding velocity, what is the spacing of checks and what channel section will be required with the checks?

1. On p. 387 of reference 26, a velocity of 2.5 f.p.s. requires a slope of 0.10 percent, with n of 0.020 and R of 1.1 ft.

The spacing by equation (30) is:

$$\text{Spacing, in feet} = \frac{100(0.5)}{0.3 - 0.10} = 250 \text{ ft.}$$

2. The new channel on a slope of 0.10 percent and a velocity of 2.5 f.p.s. will require about 65 c.f.s./2.5 f.p.s. = 26 sq. ft. of cross-sectional area, provided R is kept at about 1.1 ft. From p. 243 and 387 of reference 26, for a bottom width of 14 ft. and side slopes 4:1:

Trial 1	Trial 2	Trial 3	Units
$d = 1.4$	$d = 1.5$	$d = 1.45$	ft.
$T = 25.2$	$T = 26.0$	$T = 25.6$	ft.
$A = 27.4$	$A = 30.0$	$A = 28.7$	sq. ft.
$R = 1.07$	$R = 1.14$	$R = 1.10$	ft.
$V = 2.2$	$V = 2.3$	$V = 2.25$	f.p.s.
$Q = 60$	$Q = 66$	$Q = 65$	c.f.s.

The data for $d = 1.45$ ft. are interpolated, but are sufficiently accurate to show that this depth channel meets the requirements. Various other combinations of channel section and check spacing could be used.

C. Grass-Lined Channel

The larger channel required with ditch checks often eliminates their use particularly in a humid section when any sod-forming grass would adequately protect the channel (table 3). Changing the drop at the check changes the spacing of the checks but does not affect the size of channel required to carry a stated discharge.

For example, the channel dimensions with a sod-forming grass lining are depth, 2.35 ft.; bottom width, 6 ft.; side slopes 3:1. This channel has about same capacity as the channel with 6-inch checks, depth, 1.45 ft.; bottom width, 14 ft.; and side slopes 4:1. The same freeboard allowance would be added to either design.

4.14 Drop structures. Drop structures are sometimes used to convey water from a higher to a lower elevation. One application of drop structures is conveying water from a drainage channel into a watercourse that is at a lower elevation. The design of drop structures is beyond the scope of this publication but information on their design may be found in references 6, 7, 8, and 49.

4.15 Chutes. Chutes (see sec. 1.5) are characterized by their steep grade and short length. They carry water at supercritical velocity (see sec. 4.9) and unless excavated in rock, they will require lining to prevent channel erosion. Concrete linings are frequently used, often without providing for the high velocities at the outlet. When the

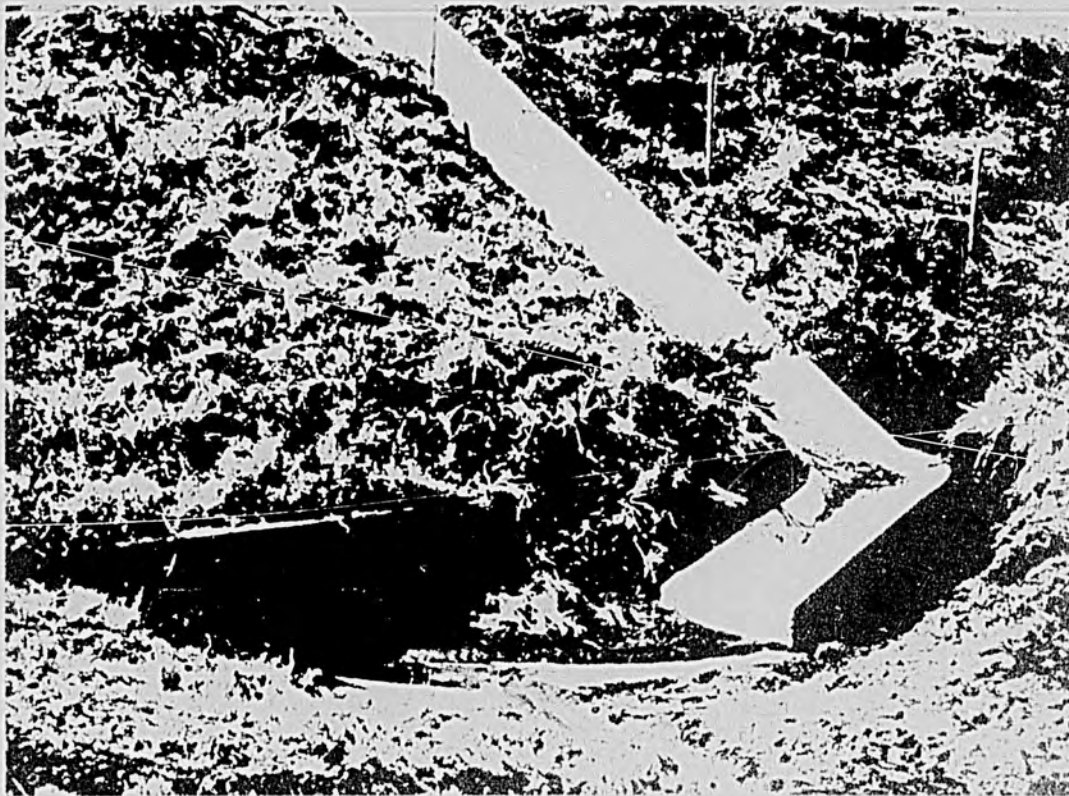

Figure 22.—Chute with sharp change in alignment. Note erosion due to sharp curvature.

quantity of water to be carried is small, sodded flumes may be used, however, the sod must generally be held in place by stakes and chicken wire until the sod has time to become established. Stone linings (see 4.12) not only furnish protection from erosion but they also reduce the velocity of flow. For long cut or embankment slopes, pipes are generally preferred to open channels because the flow is confined and the water cannot spill out to cause erosion under the sides. The design of piped rains and outlets for shoulder drains will be discussed in a later publication.

The channel section after lining must be of sufficient size to carry the design flow, but a section far larger than needed to carry the design flow or required for easy maintenance is wasteful. A common design is a grass-lined channel on a flat slope discharging into a concrete-lined chute of the same cross section. The carrying capacities of the two sections are often in a ratio of more than 10 to 1. In such cases the channel section should be tapered to a section of equivalent capacity when changing type of lining.

The freeboard allowance on an open chute is greater than that used for channels on mild slopes because of the

wave action in chute channels and the greater damage caused by the high-velocity water. Freeboard allowances vary, depending upon the amount of wave action and turbulence expected in the chute, but the minimum freeboard should be about 1 foot for small chutes.

Changes in channel alignment or in section must be made smoothly in order to avoid violent wave action and resultant overtopping of the channel sides. Figure 22 shows the effect of too sharp a change in alignment. Large chutes require careful hydraulic design. (See 22, ch. 8 and 27, ch. 8.) On small chutes, experiments have shown (27, p. 240) that an angular variation of the flow boundaries should not exceed that produced by the equation:

$$\tan \alpha = \frac{1}{3F} \quad (31)$$

where F is the Froude number (see 3.4) and α is the angular variation.

The chute outlet is always a problem. The energy of the high-velocity flow must be dissipated to prevent erosion. Often this requires an apron or a stilling basin at the chute outlet. Design of stilling basins and energy

dissipators suitable for this purpose is discussed in reference 39 and in an ASCE symposium by Bradley and Peterka and others (38). A bibliography containing other references to spillway design is included with paper 1406 (39).

When the velocity in the chute is supercritical, the chute capacity is determined by the cross section and conditions at the inlet (upstream control). If the chute is long, its cross section can often be reduced to maintain economic proportions. (See sec. 3.3-3.)

Equations are given in section 3.3-3 for computing the discharge of chutes with inlet channel in line with the chute. The design of chutes discharging flow from a channel perpendicular to the chute axis is discussed on pages 283-285 of reference 37. The application of these equations to the design of a small concrete chute is explained by example 19.

Example 19

Given: The channel in example 4 (sec. 3.2-2) discharging into a concrete chute, 120 ft. long (horizontally) on a 50-percent grade.

Find: The chute dimensions for a trapezoidal section with side slopes 2:1 ($z=2$) and entrance loss coefficient = 1.

Solution:

A. Entrance

1. From example 4, at section 1 (see fig. 14),

$$Q = 100 \text{ c.f.s.}$$

$$d_1 = 2.45 \text{ ft.}$$

$$V_1 = 4.6 \text{ f.p.s.}$$

2. The specific head (H_s) (sec. 3.3-1, equation 9) just upstream from entrance of the chute is $2.45 + \frac{(4.6)^2}{2(32.2)} = 2.78 \text{ ft.}$ Substituting in equation 23 (sec. 3.3-3):

$$b = \frac{0.324(100)}{(2.78)^{3/2}} - 0.7(2.0)(2.78) = 3.09 \text{ ft., use } 3.0 \text{ ft.}$$

3. The depth at the entrance will be critical, or by equation 16 (sec. 3.3-2).

$$d_c = \frac{\left[\frac{4(2)(2.78) - 3(3)}{-\sqrt{16(2)^2(2.78)^3 - 16(2)(2.78)(3) + 9(3)^2}}{10(2)} \right]}{2} = 2.12 \text{ ft.}$$

4. The mean velocity (V_c) at the entrance section is the discharge, 100 c.f.s. divided by the flow area of the entrance section ($b=3 \text{ ft.}$ and $d=2.12 \text{ ft.}$), 15.4 sq. ft. or $V_c=6.5 \text{ f.p.s.}$, $R=1.23 \text{ ft.}$ (25, p. 161).

The value of d_c and V_c could have been read directly from chart 16, reference 25 by noting the coordinates of the intersection of the critical flow line and the discharge, 100 c.f.s.

B. Chute

The minimum depth at which the flow in the chute will occur can be computed by the Manning equation, using King's tables (sec. 4.6-2), or following the method in

example 4 (sec. 3.2-2), the final trial is as follows (26, p. 161):

$$\begin{aligned} d &= 0.7 \text{ ft.} & S &= 0.5 \\ A &= 3.10 \text{ sq. ft.} & S^{1/2} &= 0.707 \\ R &= 0.50 \text{ ft.} & n &= 0.018 \text{ (sec. 4.9)} \\ R^{2/3} &= 0.63 \text{ ft.} \end{aligned}$$

$$V = \frac{1.49}{n} R^{2/3} S^{1/2} = \frac{1.49}{0.018} (0.63)(0.707) = 36.9 \text{ f.p.s.}$$

$$Q = 3.10(36.9) = 114 \text{ c.f.s.}$$

This checks the design discharge 100 c.f.s. A freeboard of at least 1 foot should be provided and a stilling basin or energy dissipator will be needed in most situations to dissipate the energy of the high velocity flow

C. Check of Fall in Chute

Had the n value (0.015) from table 2 been used, the calculated depth would have been 0.6 ft., $R=0.44$ and $V=40.5$. These values are used to determine if the fall in chute (60 ft. in this example) is sufficient to develop the specific head required at normal depth plus the friction loss. Specific head is computed by equation (9).

$$H_s = d + \frac{V^2}{2g} = 0.6 + \frac{(40.5)^2}{64.4} = 26.0 \text{ ft.}$$

The friction loss (h_L) is computed by equation (24).

$$h_L = \frac{n^2}{4.41} \left[\left(\frac{V_1}{R_1^{2/3}} \right)^2 + \left(\frac{V_2}{R_2^{2/3}} \right)^2 \right] L$$

$$h_L = \frac{(0.015)^2}{4.41} \left[\left(\frac{6.5}{(1.23)^{2/3}} \right)^2 + \left(\frac{40.5}{(0.44)^{2/3}} \right)^2 \right] 120$$

$$h_L = 30.3 \text{ ft.}$$

Total head required is $26.0 + 30.3 = 56.3 \text{ ft.}$ The available head (60 ft.) is sufficient to develop the specific head plus the friction loss.

Fully developed air-entrained flow on a slope of 0.5 would have developed a velocity of over 80 f.p.s. (using $n=0.095$, sec. 4.9) and would require a head in excess of 100 ft.

Refining the cross section of this chute will provide little saving. For larger chutes, see section 3.3-3.

4.16 Bank and shore protection. The discussion in sections 4.12 to 4.12-4 on stone channel linings is intended to apply to roadside channels where both banks and streambed are protected by a blanket of stone. At times, however, highways encroach on rivers or are built along the seacoast or beside large bodies of water, thus exposing roadway embankments to attack by current velocity or wave action. Stream crossings are unavoidable, but most crossings expose highway embankments to attack by the stream. Wave action can be a more severe form of attack

than water flowing parallel to the embankment. Protection from wave action is discussed in references 37, 41, 43, and 50.

Problems involving scour of streambanks vary for many reasons and standard solutions cannot be specified even for types of problems. Sometimes the best solution is to relocate the highway and avoid the hazard or to move the attacking water away from the embankment by a channel change (sec. 1.10).

Usually the severity of the attack and the availability and cost of materials dictate the type and the extent of protection. Where vegetal cover will grow and velocities of flood waters are moderate, grass (sec. 4.8), shrubs, and vines are low in cost and give adequate protection after they become established. Where high velocities and wave action are encountered, stone provides suitable protection (secs. 4.12 to 4.12-4).

The method given in section 4.12-1 for computing stone size might require modification for deep swift streams.

When the depth, d , is great the $\frac{k}{d}$ ratio becomes small and figure 20 shows a low velocity against the stone. This results in a size of stone (fig. 21) which while adequate at the total depth, may not provide sufficient protection for the bank near the water surface. The depth used in figure 20 should be the depth of most severe attack rather than the total depth.

The most common cause of failure in protective covers is the undermining of the toe or the termini of the protection. All protective covers of structural materials should

be firmly anchored in the protected bank at the upstream and downstream termini, and at the toe of the embankment (sec. 5.7). If the protective cover is long, intermediate anchorages might be required to reduce the hazard of complete failure. The upper vertical limit of the protective cover should extend to an elevation that provides protection from floods and waves having a recurrence interval consistent with the importance of the highway, initial investment, and replacement costs. Sod placed above more rigid protection will provide considerable protection from unusual floods.

The beginning of the protection should extend above and below the point of reverse curvature on the outside of a curved channel. Bank protection is usually not required on the inside of the curve unless return of over-bank flow creates a scour problem. On a straight channel, bank protection should begin and end at a stable feature in the bank if practicable. Such features might be outcroppings of erosion-resistant materials, trees, vegetation, or other evidence of stability.

4.17 Drainage structures in channel. Where driveways or access roads cross a drainage channel, culverts or other structures are placed in the channel to carry the flow underneath the crossing. These structures affect the capacity of the drainage channel and at some locations create problems. Silt and debris may be deposited in the channel upstream from structure and scour may occur at the culvert outlet. The design of the culvert (51) and the channel should be coordinated to insure the proper functioning of both.

Chapter V.—CONSTRUCTION

5.1 General. Construction methods depend upon the equipment used and the experience of the contractor and are outside the scope of this publication. This chapter will discuss a few of the procedures that should be followed to construct satisfactory highway drainage channels.

Drainage channels should be constructed early in the grading operations and the necessary channel protection should be provided before erosion damage occurs. Effective drainage during construction frequently eliminates costly delays as well as later failures that might result from a saturated subgrade. Slopes should be protected from erosion as early as practicable in order to minimize damage and lessen the discharge of eroded soil into existing and newly constructed channels or into drainage structures.

Elements of farm drainage systems, such as terrace outlets and tile drains, that are cut by the highway should be properly drained to avoid ponding or erosion on adjacent property or on the highway.

5.2 Supervision. Proper design of drainage channels will not produce an adequate drainage system without careful supervision during construction. Supervision of drainage structure construction means not only seeing that the construction complies with the plans and specifications but that any omissions in the plans are corrected. The channel drainage work should be shown on the construction plans together with sufficient hydraulic design data, such as drainage area and design discharge, so that the construction engineer has the necessary information to solve unforeseen drainage problems. Some guides for showing drainage information on project plans are given in reference 52.

5.3 Excavation. Channels are usually dug from the outlet toward the higher end so that the channel will drain during construction. Dikes for intercepting channels are preferably built from material excavated from the adjacent cuts without disturbing the natural soil at the channel location.

5.4 Grass-lined channels. Grass lining can best be attained by sodding. The upper parts of the channel may be sprigged or seeded if the cost of sod makes this necessary, but the time of the year, and the likelihood of damaging rains occurring before the seedlings become established, should be considered. A type of grass should be selected that is adapted to the locality and to the site conditions (53). Sod grasses are preferred to bunch grasses because of their superior performance in resisting erosion.

Seeding can be protected by mulch, temporary cover grasses, jute or fiber bagging, and fiber glass. At some locations, sod strips 18 inches by 10 feet or more can be laid perpendicular to the channel centerline at 10-foot intervals to protect the intervening seeded area. These

strips have proved very effective in some locations. Their use is restricted to channels designed for velocities between 2 feet and 4 feet per second.

Sod can be used alone or in combination with seeding. Sod might be used in the channel bottom and up part of the side slope for immediate protection with the remainder of channel slope seeded. In some States sod chutes have been used successfully at the downhill end of bridges to conduct the runoff from the end of the bridge to natural ground level. The sod is held in place by chicken wire and staked to the embankment.

A strip of sod should be placed along the edges of all concrete, riprap, and similar linings, and along the edges of open chutes to prevent erosion and undermining the linings. If sod cannot be maintained as in semiarid or arid regions, adequate freeboard should be provided in the lined channel.

5.5 Concrete-lined channels and chutes. Concrete channel linings can be cast-in-place, shotcrete, or precast. Soil-cement linings have been successful at some locations. The construction of concrete channel linings as applied to irrigation canals is discussed in reference 54. State highway specifications usually give requirements for constructing concrete drainage channels.

Concrete lining must be placed on a firm well-drained foundation to prevent cracking or failure of the lining. Soils of low density should be thoroughly compacted or removed and replaced with suitable material. Where the soil is deep loess, concrete or other type rigid linings might not be suitable. Expansive clays are extremely hazardous to rigid-type linings because their movement buckles the linings as well as producing an unstable support. Reference 54, page 30, discusses methods of controlling or reducing damage to linings which must be placed on expansive clays.

The Bureau of Reclamation found (57, p. 535) that when placing an unformed slab on a slope, a tendency exists to use a stiff concrete mix that will not slough. Drill cores showed that placement of such low-slump concrete without thorough vibration usually results in considerable honeycombing on the underside. To avoid such results the concrete should not be stiffer than a 2½-inch slump. Concrete of this consistency will barely stay on a steep slope. After spreading, the concrete should be thoroughly vibrated. Reference 37 (p. 536) shows the use of a steel-faced slipform screed.

The linings of channels that carry high-velocity flow should be poured as nearly monolithic as possible, without expansion joints or weepholes, and using as few construction joints as possible. Construction joints should be made watertight. Longitudinal and transverse reinforcing steel should be used throughout to control cracking with



Figure 23.—Section of concrete-lined channel showing treatment of edges.

the longitudinal steel carried through the construction joints. The lining should be anchored to the slope as necessary by reinforced cutoff walls to prevent sliding.

Proper curing of the concrete lining is important, particularly in warm, dry, windy weather, to prevent the early drying of corners, edges, and surfaces. A well-moistened subgrade and wet burlap in contact with the exposed concrete surfaces is excellent for curing purposes.

The edges of newly constructed channels should be protected by a strip of sod at the time of construction. The design of the lining edges should allow enough depth of soil to permit the growth of grass, and the channel side corners of the top edge should be beveled as shown in figure 23.

5.6 Bituminous-lined channels. The construction of bituminous-lined channels is described in reference 40. A well-drained subgrade is necessary beneath a bituminous lining because the strength and weight of the lining is not sufficient to withstand high hydrostatic uplift pressure. Weed control (40, p. 12) measures are sometimes necessary before the lining is placed. These measures consist of careful grubbing of the subgrade followed by the application of a soil sterilant (40, p. 13).

5.7 Stone-lined channels. All stone used for channel linings or bank protection should be hard, dense, and durable. Most of the igneous and metamorphic rocks, many of the limestones, and some of the sandstones make excellent linings. Shale is not suitable and limestones and sandstones that have shale seams are undesirable. Quarried stones, angular in shape, are preferred to rounder boulders or cobbles. If rounded stones are used, the size of stone and thickness of the blanket, determined by the methods of section 4.12-1, should be increased, particularly if the rounded stones are relatively uniform in size (57, p. 207). Neither breadth or thickness of a single stone should be less than one-third of its length. Figure 24 shows two sample gradation curves which were found to be very satisfactory in tests at the U.S. Army Engineer Waterways Experiment Station (46). Curves approximately parallel to these curves and passing through the theoretical size (sec. 4.12-1) at the 50-percent point should make an acceptable gradation.

The stone lining or bank protection should be placed on a filter blanket of gravel or crushed stone meeting the requirements of section 4.12-4 unless the natural soil meets the requirements of a filter blanket.

The stones should be placed on the filter blanket or prepared natural slope in a manner which will produce a reasonably well-graded mass of stone with the minimum practicable percentage of voids. Stone protection should be placed to its full course thickness at one operation and in such a manner as to avoid displacing the underlying material. Placing of stone protection in layers or by dumping into chutes or by similar methods likely to cause segregation should not be permitted. The larger stones should be well distributed and the entire mass of stones should roughly conform to the gradation specified. The stone protection should be so placed and distributed as to avoid large accumulations or areas composed largely of either the larger or smaller sizes of stone. The mass should be fairly compact, with all sizes of material placed in their proper proportions. Hand placing or rearranging of individual stones by mechanical equipment may be required to the extent necessary to secure the results specified above. The desired distribution of the various sizes of stone throughout the mass might be obtained by selective loading at the quarry, by controlled dumping of successive loads during placing, or by a combination of these methods. Ordinarily the stone protection should be placed in conjunction with the construction of the embankment, with only sufficient delay in construction of the stone protection as may be necessary to prevent mixture of embankment and stone.

Bank protection, where the channel is composed of sand or silt, should extend a minimum vertical distance of 5 feet below the streambed on a continuous slope with the embankment. Where the streambed is of material other than sand or silt, the bank protection should be terminated in a rock toe at the level of the streambed to prevent undermining the bank protection. The toe should have a minimum base width of 6 feet and a minimum thickness of 3 feet with 1 on 1½ side slopes. On large rivers, or tidal estuaries, having a considerable depth of flow at low water stages, the stone protection need be carried down only 5 feet vertically below mean low water and the toe can be omitted.

Hand-placed stone should be carefully laid to produce a more or less definite pattern with a minimum of voids and with the top surface relatively smooth. Joints should be staggered between courses. The stone used for hand-placed protection should be of better quality than the minimum quality suitable for dumped stone protection (57, p. 208). Stones that are roughly square

and of fairly uniform thickness are much easier to place than irregular stones. Stones of a flat stratified nature should be placed with the principal bedding planes normal to the slope. Openings to the subsurface should be filled with rock fragments; however, enough voids or openings should be left to vent the subsurface properly.

5.8 Ditch checks. Ditch checks must be firmly anchored into the banks of the drainage channels. The choice of material determines the methods used, but all

checks should have a suitable apron at the toe of the drop and a cutoff wall at the downstream end of the apron. The apron should have a depression or a sill at the downstream edge so that a pool will be created to dissipate the energy of the falling water. If clay is available, local stone can be laid up in a rich clay mortar. This makes the check almost watertight and results in less maintenance than if the stones are laid up loose with the expectation that the check will become impermeable in time.

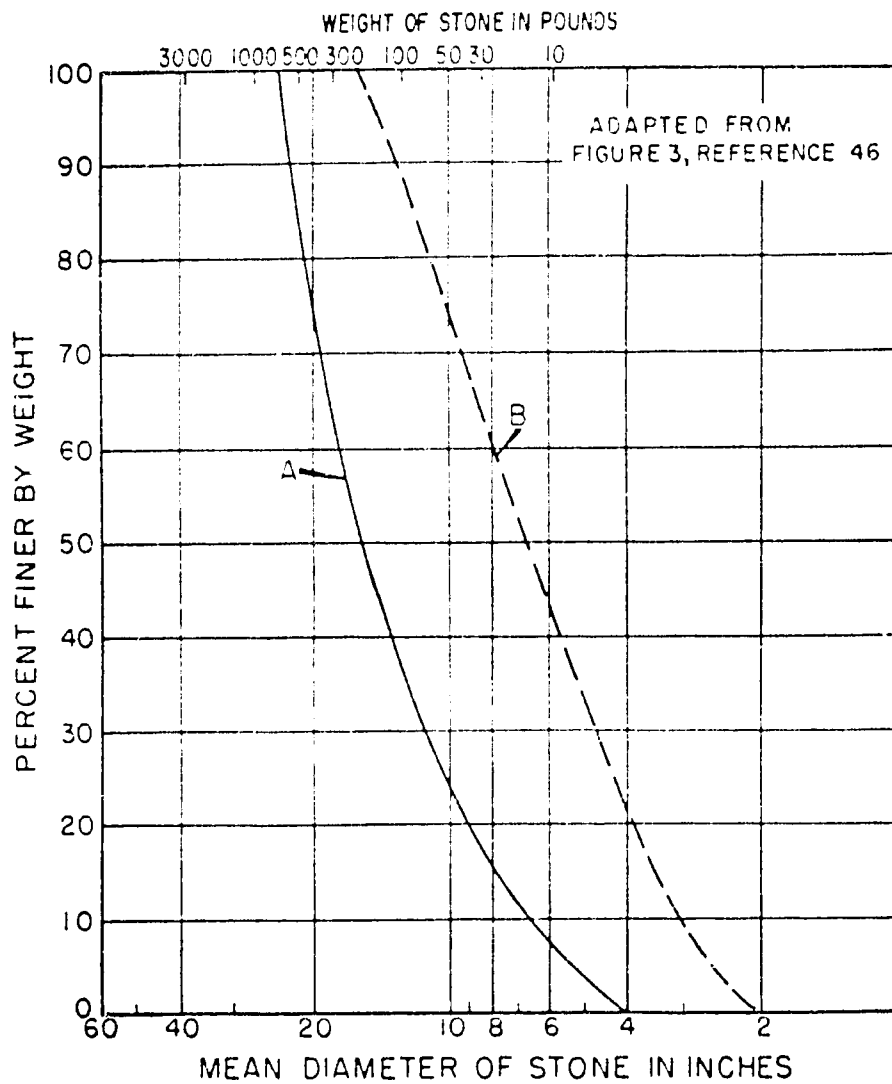

Figure 24. - Gradation curves for dumped-stone protection.

Chapter VI.—MAINTENANCE

6.1 General. Drainage channels rapidly lose their effectiveness unless they are adequately maintained. Thus, a good maintenance program is of equal importance with the proper design and construction of the channels. In fact, a knowledge of the equipment to be used in maintenance and the methods to be employed is a prerequisite of proper design.

Maintenance of vegetative cover on slopes and in drainage channels requires continued attention. The original treatment applied during construction will not last forever. Repeated applications of fertilizer, lime, or organic material at intervals are as necessary on the highway roadside as on the home lawn. Areas often need reseeding or resodding to restore the vegetative cover. This should be done before serious erosion occurs.

Minor erosion damage within the highway right-of-way should be repaired immediately after it occurs and action taken to prevent a recurrence of the damage. The damage caused by light storms reveals the points of weakness in the drainage system. If these weaknesses are corrected when repairing the damage itself, the drainage system will likely carry the design discharge without damage. Deficiencies that are found in the drainage systems and the corrective action taken should be reported to the hydraulic or design engineer so that similar troubles will not occur on future construction. Reports on drainage works that

function well during severe storms are equally valuable to the designer.

6.2 Effect of maintenance on channel capacity. Maintenance of highway channels includes repairing erosion damage, mowing grass, and removing any sediment or debris deposited in the channel. All these measures keep the capacity of the channel at the design level. If the channel cross section contains brush, sediment, or debris, the channel cannot carry the flow for which it was designed. In addition, the sediment and debris may kill the vegetative lining with subsequent erosion damage during higher flood flows. In some situations, sediment traps and debris barriers might be constructed in the channel in order to collect the objectionable material for easy removal.

The effect of weed growth in the channel can be seen by reference to table 2, appendix A. For example, if a channel section 1.5 feet deep is designed for a velocity of 6 feet per second with a grass lining, mowed to a length of 2 inches, the value of n is 0.035. If the channel is not maintained and dense weeds 2 feet high are allowed to grow, the value of n becomes 0.01. The effect of the weed growth is that the channel will only carry $\frac{0.035}{0.01}$, or about one-third the flow for which it was designed. The remainder of the design flow must overflow the channel and cause flooding or possible erosion.

Chapter VII.—ECONOMICS OF DRAINAGE CHANNELS

7.1 General. Providing adequate drainage is essential to the existence of the highway. Economical drainage design is achieved through doing an adequate job at the lowest cost.

The lowest cost adequate channel maintains proper balance between first cost, flood damage, and maintenance cost, and has the capacity and protection to carry the runoff for which it was designed. Selection of the frequency (see sec. 1.2) of the design runoff is a matter of economics, while estimating the magnitude of the storm runoff for a selected frequency belongs in the field of hydrology. (See ch. II.)

In this chapter some of the factors to be considered in the economic selection of highway drainage channels are discussed.

7.2 Frequency of the design storm. The average annual cost of a drainage channel is the sum of (1) the first cost divided by the expected life of the channel, plus (2) the average annual maintenance cost, plus (3) the annual charge for possible damage from runoff exceeding the channel capacity. Computation of first cost is discussed briefly by Hewes and Oglesby (55, p. 59). The average annual maintenance cost might also include the annual charge for flood damage if a flood exceeding the channel capacity has occurred. It is probably better to separate these costs. The damage to a channel designed to carry a 10-year runoff from a chance occurrence of, say, a 200-year runoff in a few years' record of maintenance expenditures would distort the average annual maintenance cost. The annual charge for possible flood damage should consider the frequency of the design storm and equals the cost of damage from runoff exceeding the channel capacity divided by the return period, in years, of the design storm.

If these costs could be evaluated for various combinations of the component costs, the most economical channel could be determined as the channel with the lowest average annual cost. The optimum frequency of the design storm would then be the frequency associated with the storm runoff that, in combination with other costs, produced the lowest average annual cost. The three cost items are interrelated and are difficult to evaluate, particularly the item of damage by runoff that exceeds the design runoff. The cost of storm damage includes the cost of traffic interruption by floodwaters or washed-out highway, as well as the cost of repairing the damage to the highway and drainage channels and the additional damage to the abutting property directly attributable to the presence of the highway. A further complication is the variation in damage due to the magnitude by which the runoff exceeds the design runoff.

Individual analysis for each small channel is impractical if not impossible. The best solution appears to be a

study of average conditions and selection of the frequency of design runoff to be used for various drainage structures according to the class of the highway. The designated frequencies might vary from State to State or even within a State composed of areas differing widely in topography or population density.

Individual variations in the designated frequency of the design storm might be needed at locations where damage by flooding would be great and the cost of a channel large enough to carry a less frequent storm is moderate.

7.3 Effect of channel section. Roadway channels built in earth (sec. 1.6) should have side slopes not steeper than 4:1, and rounded bottoms at least 4 feet wide. Table 6 gives a comparison of trapezoidal channels of the same capacity by showing the ratios of area, wetted perimeter, and velocity for the various channels to those for the 4-foot bottom, 4:1 side slope channel. The depth of channel in table 6 is equal to the depth of flow. When the side slope remains 4:1, changing the bottom width from 2 to 5 feet changes excavation by 3 percent (compare ratio A); changes amount of lining by about 10 percent (compare ratio WP); and changes the velocity by 3 percent (compare ratio V). The depth of flow changes from 1.03 feet to 0.80 foot.

Table 6.—Properties of trapezoidal channels of the same capacity, with $n=0.03$ and slope $=0.01$

(Denominator of ratio is corresponding characteristic of a 4-foot bottom channel with side slopes 4:1)

Side slope	Property	Bottom widths			
		2	3	4	5
4:1	d, ft	1.03	0.94	0.87	0.80
	A, sq ft	6.32	6.30	6.54	70.74
	P, ft	6.60	5.9	5.8	5.7
	V, fps	3.52	3.48	3.44	3.40
	Q, cfs	22.2	22.2	22.5	22.5
	WP, ft	10.5	10.6	11.2	11.6
	Ratio A	97	98	1.00	1.00
	Ratio WP	94	96	1.00	1.04
Ratio V	1.02	1.01	1.00	99	
3:1	d, ft	1.11	1.02	0.91	0.84
	A, sq ft	5.96	6.19	6.15	6.34
	P, ft	6.66	6.5	6.3	6.1
	V, fps	3.73	3.71	3.63	3.56
	Q, cfs	22.4	22.9	22.3	22.6
	WP, ft	9.0	9.6	9.8	10.3
	Ratio A	91	94	94	97
	Ratio WP	80	85	88	92
Ratio V	1.00	1.06	1.06	1.03	

Changing the side slopes to 3:1 has a greater effect on channel costs than changing the bottom width. Excavation ranges from 91 to 97 percent of that of the recommended channel; lining required ranges from 80 to 92

percent of that of the recommended channel; and velocities range from 3 to 9 percent greater. Depth of flow ranges from 0.04 to 0.08 foot deeper than that of the recommended channel.

The comparison of channel area in table 6 is only the area occupied by water without freeboard. In a cut section, the quantity of excavations would increase with increase in bottom width of the roadway channel because of the added width of the cut section. The percentages would change with change in channel slope. Change in the value of *n* would change both *Q* and *V*, for the same depth, but the velocity ratio would remain the same.

7.4 Effect of topography. In deep-cut sections the added excavation necessary for a trapezoidal roadway channel is oftentimes prohibitive in cost. A more economical drainage system might be a gutter of small capacity at the toe of the cut slope, with frequent inlets connected to a storm sewer under the roadbed. A similar system is sometimes used on parkways in combination with curbs and gutters; however, this choice is often made for appearance rather than economy.

7.5 Effect of channel lining. The choice in channel lining is limited to linings which can withstand the expected channel velocities (See tables 3 and 4, app. A.) In comparing the cost of channel linings, the effect of channel roughness should be considered (sec. 4.6-3, example 10) so that the comparison is made among channels of equal capacity rather than that of equal size.

In regions where grass grows readily, grass-lined channels are generally the lowest in cost. In some areas, however, salt used for ice removal makes the maintenance of grass linings difficult and such factors should be considered when selecting the type of lining.

Where a choice must be made between concrete and stone for lining, a survey by the U.S. Corps of Engineers (37, p. 204) of the performance of materials in upstream slope protection of earth dams is interesting although not directly applicable to channel linings. The survey of approximately 100 dams, from 5 to 50 years old, located in various sections of the United States, with a wide variety of climatic conditions and wave severity, showed that—

- (1) dumped riprap failed in 5 percent of the cases where used, failures being attributed to improper size of stones;
- (2) hand-placed riprap failed in 30 percent of the cases where used;
- (3) concrete pavement failed in 36 percent of the cases where used.

This comparison of the performance of concrete and stone suggests that when hand-placed riprap or concrete pavement is used for channel linings, greater support is needed from the subgrade than when dumped stone is used. Perhaps more attention should be given to the drainage

and preparation of the subgrade for a rigid type of lining than for a more flexible type of lining.

When hand-placed stone is used, a better quality of stone is required than the minimum quality suitable for dumped stone (37, p. 208). However, hand-placed stone should not be used where settlement or heavy ice action is anticipated. Settlement is also detrimental to concrete linings.

In making a comparison of channel lining costs, the designer should consider the velocity of the water in the channel and include the cost of any measures required to dissipate the energy of flow that would not be required with an alternate type of lining.

7.6 Drop structures versus chutes. Either drop structures or chutes are frequently needed to convey water down steep slopes or into natural watercourses with incised channels. An economic comparison of several types of such structures for specific conditions indicated a wide range in cost. The types studied were a sodded channel on the maximum permissible grade; a corrugated metal pipe culvert with flared inlet without stilling basin, a reinforced concrete drop structure, and a gravel-lined channel on the maximum permissible grade. The results of this study for structures with drops of 4-, 6-, and 10-foot designed for a discharge of 10 cubic feet per second are given in table 7, following. The comparison is given by the ratio of the cost of the structure to the cost of a sodded channel with the same drop.

Table 7.—Cost comparison of drop structures

Type of structure	Cost ratio drop, in feet		
	4	6	10
Sodded channel.....	1.00	1.00	1.00
C.M. pipe culvert on a 5-percent grade.....	5.96	4.33	2.33
C.M. pipe culvert on a 26-percent grade.....	2.15	1.33	.66
Reinforced concrete drop.....	6.50	3.84	2.17
Gravel-lined channel.....	3.43	3.44	2.38

The variation in cost of the sodded channel with the fall, based on the 4-foot fall, are: 4-foot fall, 1.00; 6-foot fall, 2.20; 10-foot fall, 7.12.

The ratios in table 7 apply only to the specific conditions of this analysis and might vary locally with the availability of materials. The costs used were the average of several 1960 bid prices in 10 widely dispersed states. Except for the 10-foot drop, the sodded channel is the lowest cost means of conveying 10 cubic feet per second of water down steep slopes. The apparent advantage of the pipe culvert on the steeper grades might be offset at some locations by the added cost of dissipating the energy of water at the outlet. On the other hand, the use of a sodded channel requires that sufficient length be available to place the channel on a noneroding grade.

Chapter VIII.—ILLUSTRATIVE PROBLEM IN CHANNEL DESIGN

8.1 General. The procedures given in this publication are used to design several of the drainage channels shown in figures 2 and 25. The site of the highway is assumed to be in the vicinity of Washington, D.C., and the runoff from a 10-year storm has been selected for the design discharge. Typical cross sections of the roadway are not shown, but the maximum depths of cut and fill, at the centerline, are 50 ft. and 26 ft., respectively.

The design of drainage channels is in three phases: (1) laying out the drainage system (sec. 4.2), (2) estimating storm runoff (ch. II), and (3) designing the channels (ch. IV). For convenience, the design will be completed for each drainage channel, combining the estimate of runoff and the computation of size of channel before proceeding to the next channel.

8.2 Layout of the drainage system. Figure 25 is a plan view of figure 2. The roadbed and right-of-way lines have been drawn and the drainage divides are shown by heavy dashed lines, but other roadway details have been omitted in this problem. The drainage channels are indicated by short dashed lines with arrows to indicate direction of flow and are numbered as shown in figure 26. The points for which channel sizes are computed are indicated by letters. The numbers are for identification in this problem, however, a similar system might be helpful in an actual design problem. The channels are numbered on the assumption that the road project began at Station 45 and the stream at Station 55 is the third drainage channel in the project.

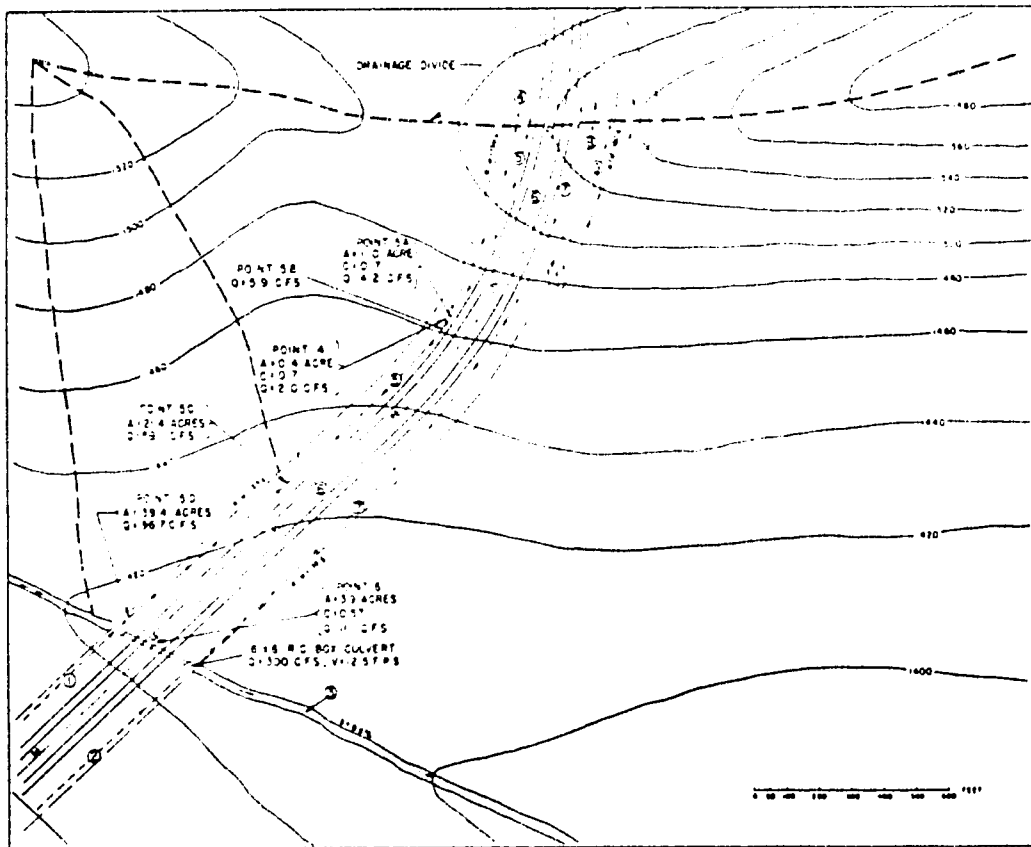

Figure 25.—Layout of drainage system for illustrative problem.

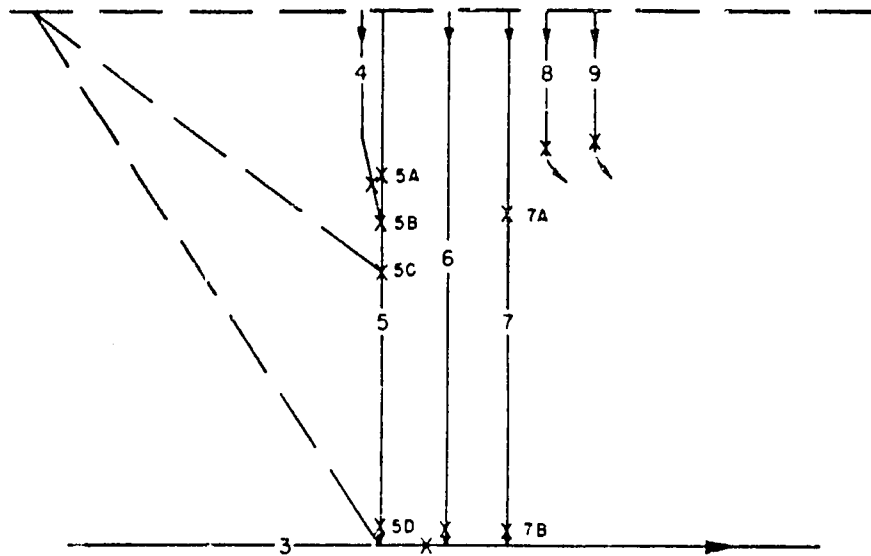

Figure 26.—Identification of drainage channels.

In figure 25, roadway channels (Nos. 5 and 7) and the median swale (No. 6) drain the roadway cut. The water from the roadway channels must be carried to the natural water course through the toe-of-slope channels which continue to carry the channel number. Intercepting channels (Nos. 4 and 8) are placed on the cut slopes to illustrate their design. The depth of cut in this problem would seldom require intercepting channels located on the side slope. Note that the exit of channel 8 is flared and the flow is spread over the hillside rather than brought into channel 7, while the water in channel 4 is conducted to channel 5.

The intercepting channel (No. 9) at the top of the cut on the right prevents storm water from running down the cut slope; its flow is distributed over the hillside. This type of disposal is preferable wherever the quantity of water intercepted is small and the topography and land use permit. On the left side of the cut, the natural ground slopes away from the cut edge and an intercepting channel is not required.

8.3 Channel 3. The grade of the small stream is 0.5 percent and the design discharge is 300 c.f.s. Using the charts of Hydraulic Engineering Circular No. 5 (51) a 6-ft. by 6-ft. reinforced-concrete box culvert is selected. The outlet velocity is 12 f.p.s. and the depth of flow at the outlet is 4.2 ft. when carrying the design discharge. The specific head at the culvert outlet, computed by equation (9), is 6.4 ft. The channel downstream from the culvert outlet is to be trapezoidal with bottom width 6 ft. and side slopes 2:1.

In going from the rectangular culvert section to the larger open-channel section, the flow expands with some loss in energy, accompanied by a decrease in depth and an

increase in velocity. The depth and velocity at the expanded section can be approximated by assuming a loss in the expansion of 20 percent of the velocity head. This determination of expansion loss is somewhat arbitrary and is based on an analogy to pipe flow. See any text on hydraulics. In this problem the approximate loss is $0.2 \frac{(12)^2}{64.4} = 0.5$. The specific head at the expanded section is then $6.4 - 0.5 = 5.9$ ft.

The depth and velocity at the expanded section can be computed by finding a combination of depth and velocity which will produce the specific head at the section (5.9 ft. in this problem). The computation is a trial-and-error procedure which can be facilitated by the tables in reference 26 or the charts in reference 25. A good starting depth for the trial computations is about one-half the depth at the culvert outlet, or 2.0 ft. Using table 10 on page 162 of reference 26, the area of the trapezoidal channel can be found. The discharge is divided by the area to obtain the velocity. The velocity is squared and divided by 64.4 (2g) to obtain the velocity head, H_v . H_v is added to the depth to obtain the specific head, H_s . The data for this problem are:

Quantity	Trial 1	Trial 2	Units
d.....	2.0	1.9	ft.
A.....	20.0	15.6	sq. ft.
V.....	15.0	16.1	f.p.s.
H_v	3.5	4.0	ft.
H_s	5.5 too low	5.9 OK	ft.

A velocity of 16.1 f.p.s. will require a reduction in velocity

(stilling basin) or protection of the channel in most materials. Dumped stone will be used in this problem. When the stone size becomes too large, a stilling basin at the culvert outlet might be considered. A concrete-lined channel would only move the erosion problem downstream.

To compute the size of stone (see sec. 4.12-1), assume a stone size (k) = 2.25 ft.

$$\frac{k}{d} = \frac{2.25}{1.9} = 1.2 \quad \text{thus} \quad \frac{V_c}{V} = 1.0 \text{ and } V_c = 16.1 \text{ f.p.s.}$$

From figure 21, the required stone size is 2.25 ft., which checks the assumed size.

The increased roughness of the stone lining will reduce flow velocities and change the depth of flow from that at the beginning of the channel. The new channel depth will be 4.3 ft., computed as follows:

From figure 19, for 2.25-ft. stone, $n = 0.04$, and from page 162 and page 448, of reference 26:

$$\begin{aligned} d &= 4.3 \text{ ft.} \\ A &= 62.3 \text{ sq. ft.} \\ R &= 2.49 \text{ ft.} \\ V &= 4.8 \text{ f.p.s. for } n = 0.04 \text{ and } S = 0.5 \text{ percent} \\ Q &= 301 \text{ c.f.s.} \end{aligned}$$

The channel will be lined with 2½ ft. equivalent diameter stone (see sec. 5.7 for gradation) with a minimum lining thickness of 3.0 ft. The lined channel will have a depth of 6 ft. (including about 1½ ft. of freeboard) at the culvert outlet. The depth of the lined channel will be gradually decreased to 4.7 ft. (0.4 ft. freeboard) at the edge of the right-of-way. The stone will be dumped on a filter blanket, designed after a soil analysis of the bank and bed material. The side slope above the stone lining would be grassed lined.

The freeboard allowance is somewhat arbitrary. The larger freeboard at the culvert outlet is to allow for the turbulence and the hydraulic jump in the reach in which some of the energy is being dissipated. The velocity of flow in the channel at a depth of 4.3 ft. is computed to be 4.8 f.p.s. This is only an approximation because the reach of channel is too short to develop the normal velocity. Stone 2½ ft. in diameter would not be required at such a low velocity. The depth after the hydraulic jump is about 4.3 ft.

8.4 Channel 4. This channel is an intercepting channel extending from Station 68 to Station 75 on the left side of the highway. The design runoff need only be estimated at the downstream end of the channel.

Estimating Runoff (See Ch. II)

The channel drains the grassed cut slope which ranges in width from 0 to 50 ft. and is 700 ft. long.

The components of the formula $Q = CiA$ are:

$$\begin{aligned} C &= 0.7 \text{ (table 1).} \\ i &\text{ read from fig. 6 after computing } T_r. \\ \text{Computation } T_r &\text{ (sec. 2.4-2).} \end{aligned}$$

	Cut slope	Channel	Total	Units of reference
$I =$	33	28	61	ft.
$L =$	50	700	750	ft.

$$\begin{aligned} T_r &= 3.3 \text{ min. (fig. 5). Use 5 min.} \\ i &\text{ (fig. 6) for 10-year return period and } T_r \text{ of 5 min.} \\ &= 7.1 \text{ in. per hr.} \\ A &= \frac{50}{2} \times \frac{(700)}{(43,560)} = 0.4 \text{ acre.} \end{aligned}$$

$$\text{Then } Q = CiA = 0.7 \times 7.1 \times 0.4 = 2.0 \text{ c.f.s.}$$

Computing Channel Section (See Sec. 4.8)

For a 2-ft. bottom, grass-lined channel, 2:1 side slopes, $Q = 2.0$ c.f.s., $n = 0.10$ (table 2), $S = 0.04$. Chart 15 reference 25 can be used to find d and V .

$$\begin{aligned} Qn &= 2.0 (0.10) = 0.20. \\ d &= 0.5 \text{ and } Vn = 0.14. \\ V &= \frac{0.14}{0.10} = 1.4 \text{ f.p.s.} \end{aligned}$$

Note that a high value of n (0.10) is used to compute the size of channel because the grass might be allowed to grow taller than anticipated. To check the adequacy of the lining, a low n value (0.05), based on the channel being maintained at design conditions, is used. If the lower value of n is effective, the velocity in the channel from chart 15 ($Qn = 0.10$, $Vn = 0.115$) is 2.3 f.p.s. This velocity would not endanger the grass lining of the channel. The freeboard needed for this channel is negligible, as the capacity was computed for the downstream point on the channel and little damage would result from an overtopping of the channel.

8.5 Channel 5. This channel is the left roadway channel from Station 68 to Station 75 and a toe-of-slope channel from Station 55 to Station 68. The design runoff will be estimated (see fig. 26) just before (5A) and just after (5B) the entrance of channel 4; and below the entry of runoff from each of the two large areas on the hillside to the left (5C and 5D).

Estimating Runoff (See ch. II)

Point 5A (Sta. 68) above junction

The section is on a curve and the channel (Sta. 68 to Sta. 75) must carry the runoff from the left lane (24 ft. \times 700 ft. = 16,800 sq. ft., $C = 0.9$), the shoulder and ditch section and the runoff from the triangular section of cut slope not intercepted by channel 4 ($\frac{80}{2}$ ft. \times 700 ft. = 28,000 sq. ft., $C = 0.6$)

The components of the formula $Q = CiA$ are:

Weighted C (see sec. 2.4-1).	Sq. ft.	C	
pavement =	16,800	$\times 0.9 =$	15,120
shoulder ditch and slope =	28,000	$\times 0.6 =$	16,800
			44,800
Weighted C			31,920
			= 0.7

i is read from figure 6 after computing T_c .
Computation T_c (sec. 2.4-2).

	Cut slope	Channel	Units or reference
H =	21	10.5	ft
L =	700	700	ft
T_c =	1 (approx.)	6	min.

T_c for pavement about 4 minutes (estimated).
Total $T_c = 4 + 6 = 10$ min.

Note that the 1 min. T_c for the side slope is concurrent with the 4 min. T_c for the pavement area and only the longer time is used. i (fig. 6) for a 10-year return period and T_c of 10 min. = 6.0 in. per hr.

$$A = \frac{44,800}{(43,560)} = 1.0 \text{ acre. (See calculation of } C.)$$

$$\text{Then } Q = CA = 0.7 \times 6.0 \times 1.0 = 4.2 \text{ c.f.s.}$$

Point 5B (Sta. 68) below junction

The discharge below the junction of channel 4 and the channel above 5A is computed from the longer time of concentration (10 min.) of the two areas. The intensity (fig. 6) for a 10-year return period and $T_c = 10$ min. is 6.0 in. per hr. The discharge for point 5B is:

$$Q \text{ (above 5A)} = 0.7 \times 6.0 \times 1.0 = 4.2 \text{ c.f.s.}$$

$$Q \text{ (channel 4)} = 0.7 \times 6.0 \times 0.4 = 1.7 \text{ c.f.s.}$$

$$\text{Total } Q = \dots\dots\dots 5.9 \text{ c.f.s.}$$

Point 5C (Sta. 61)

This channel must carry the runoff from above point 5B plus the contribution from the triangular area to the left of the channel ($A = 19$ acres, $H = 110$ ft., $L = 1,200$ ft.) plus the runoff from the roadway area ($A = 1$ acre, weighted $C = 0.66$) between channel 5 and the center of the left lane. The T_c for the roadway area is obviously much less than that of the larger area to the left of the channel and need not be computed as it runs off concurrently. T_c for the runoff above point 5B was computed as 10 minutes. This runoff must flow down to point 5C in the toe-of-slope channel ($L = 700$ ft., $H = 24.5$ ft.) This requires 4 minutes (fig. 5) or a total T_c of 14 min. T_c for the 19-acre area is:

$$H = 100 \text{ ft.}$$

$$L = 1,200 \text{ ft.}$$

$$T_c = 5 \text{ min. (fig. 5)}$$

The runoff from the two areas is concurrent and ordinarily the longer T_c would be used. i (fig. 6) = 5.1 in. per hr. for a 10-year return period and $T_c = 14$ min.

The conventional computation is made by recomputing the discharge of the separate areas using an i corresponding to a T_c of 14 min. and adding the discharges rather than computing a weighted C for the entire area above point 5C. This discharge is:

Above point 5B:

$$\text{At point 4, } Q = 0.7 \times 5.1 \times 0.4 = 1.4 \text{ c.f.s.}$$

$$\text{At point 5A, } Q = 0.7 \times 5.1 \times 1.0 = 3.6 \text{ c.f.s.}$$

$$\text{5.0 c.f.s.}$$

Between points 5B and 5C:

$$Q = 0.4 \times 5.1 \times 19.0 = 38.8 \text{ c.f.s.}$$

$$Q = 0.66 \times 5.1 \times 1.0 = 3.4 \text{ c.f.s.}$$

$$\text{42.2 c.f.s.}$$

$$\text{Total } Q \text{ for point 5C} = 47.2 \text{ c.f.s.}$$

The discharge estimated by the conventional method is probably low because 19.0 acres of the total 21.4 acres has a T_c of 5 minutes and 4 minutes are required for the flow to reach point 5C from point 5B (1.4 acres, $T_c = 10$ minutes). It appears likely that the peak at point 5C will be reached before the total area is contributing because this would take 14 minutes.

Extreme precision is not warranted in determining the combination of contributing area (CA) and rainfall intensity (i) that would produce the greatest peak runoff. Neither the data available for a particular problem nor the rational method are of sufficient accuracy to justify a trial-and-error solution to the problem. In this problem we will assume that the 5-minute time of concentration for the 19-acre area will produce the greatest peak runoff. In this 5 minutes ($i = 7.1$ in. per hr.) runoff will arrive from all of the 19-acre area and from the roadway area (1 acre between points 5C and 5B, plus that portion of the area above point 5B that can arrive in 5 minutes). The contributing portion of the area above point 5B can be estimated closely enough in most problems by assuming that the contributing area bears the same relation to the total area as the times of concentration of the respective areas. In this problem after allowing 4 minutes for channel flow time, only that portion of the area (total $T_c = 10$ min.) that can reach point 5B in 1 minute will contribute to the peak discharge. This area is assumed to be one-tenth of 1.4 acres = 0.1 acre.

The discharge at point 5C for part of the area contributing ($T_c = 5$ min.) is:

$$Q = 0.4 \times 7.1 \times 19.0 = 53.9 \text{ c.f.s.}$$

$$Q = 0.66 \times 7.1 \times 1.0 = 4.7 \text{ c.f.s.}$$

$$Q = 0.7 \times 7.1 \times 0.1 = 0.5 \text{ c.f.s.}$$

$$\text{Total } Q = \dots\dots\dots 59.1 \text{ c.f.s.}$$

The design discharge is 59.1 c.f.s., the peak from the partial area because it is larger than the peak of 47.2 c.f.s. from the total area.

Point 5D (Sta. 56)

The area to the left of the channel between point 5C and 5D is 17.0 acres ($H = 128$, $L = 1,600$ ft., $C = 0.4$) and that to the right is 1.0 acre (weighted $C = 0.65$).

T_c for the 17-acre area is:

$$H = 128 \text{ ft.}$$

$$L = 1,600 \text{ ft.}$$

$$T_c = 6 \text{ min. (fig. 5).}$$

The T_s for the area above point 5C is 5 minutes plus the time required for the water to flow from point 5C to point 5D ($L=600$ ft., $H=8.5$ ft., $T=5.5$ min.). The total $T_s=5$ min. + 5.5 min. = 10.5 min. and from figure 6, $t=5.9$ in. per hr. The design discharge is:

Between points 5C and 5D:

$$Q \text{ (left side)} = 0.4 \times 5.9 \times 17.0 = 40.1 \text{ c.f.s.}$$

$$Q \text{ (right side)} = 0.65 \times 5.9 \times 1.0 = 3.8 \text{ c.f.s.}$$

43.9 c.f.s.

Above point 5C:

$$Q = 0.4 \times 5.9 \times 19.0 = 44.8 \text{ c.f.s.}$$

$$Q = 0.66 \times 5.9 \times 1.0 = 3.9 \text{ c.f.s.}$$

$$Q = 0.7 \times 5.9 \times 0.1 = 4.1 \text{ c.f.s.}$$

52.8 c.f.s.

Total $Q=96.7$ c.f.s.

It will be noted that computations of weighted C , and area once determined are used in successive computations. It is interesting to note that the size of the channel at point 5C is computed for a discharge (59.1 c.f.s.) different from the discharge (52.8 c.f.s.) contributed by the same area to the design discharge of point 5D.

Computing Channel Section (See Sec. 4.d)

The following computations are for depth of water area and do not include freeboard. The channel section at points 5B, 5C, and 5D can be designed with chart 17 (using the Q_n scale), reference 25, with much less work than the method used here.

Point 5A (Sta. 68) above junction

$Q=4.2$ c.f.s., $S=0.015$, $n=0.09$, for grass-lined channel (table 2). The channel section is trapezoidal with a 4-ft. bottom and side slopes 4:1 on the pavement side and 1½:1 on the cut-slope side. Data from reference 26 for the final trials are:

$d = 0.6$	0.8 ft.
$A = 3.39$	4.96 sq. ft.
$R = 0.46$57 ft.
$V = 1.18$	1.37 f.p.s.
$Q = 4.0$	6.8 c.f.s.

A channel with a depth of 0.7 ft. will have a capacity of about 5.4 c.f.s. which will carry the design discharge. The data listed cannot be found directly in reference 26 because of the unequal side slopes and the absence of a table of velocities for $n=0.09$. However, the values of A and R for a particular value of d can be taken from the table for a channel with a 4-ft. bottom and 1½:1 side slopes, and averaged with value of A and R for the same value of d taken from table for a channel with a 4-ft. bottom and 4:1 side slopes. The velocity was taken from the table for $n=0.045$ and divided by 2 to obtain the value for $n=0.09$.

Point 5B (Sta. 68) below junction

$$Q=5.9 \text{ c.f.s.}, S=0.065, n=0.08 \text{ (table 2).}$$

The channel is at a fill section at point 5B and will have a grass-lined trapezoidal section with 4 ft. bottom width and

side slopes 2:1. Data for the final trials from reference 26 are:

$d = 0.6$	0.4 ft.
$A = 3.12$	1.92 sq. ft.
$R = 0.47$33 ft.
$V = 2.85$	2.24 f.p.s.
$Q = 8.9$	4.3 c.f.s.

A channel with a depth of 0.5 ft. will have a capacity of about 8.6 c.f.s., which will carry the design discharge at a velocity which will not erode the grass lining (table 4). Caution should be observed in selecting the value of n for shallow depths in grass-lined channels. The value of n changes with changes in either depth of flow or velocity. It will be noted in table 2 that the worst condition (tall grass) was used to compute the channel capacity. (See sec. 4.8.) The best condition, mowed grass, should be used to compute the velocity for checking the ability of the lining to withstand the flow. The velocities in this channel are well within the allowable velocity for grass and the check is not necessary.

Point 5C (Sta. 61)

$Q=59.1$ c.f.s., $S=0.035$, $n=0.05$, grass-lined trapezoidal section with a 4-ft. bottom and side slopes 2:1. Data for the final trials from reference 26 are:

$d = 1.4$	1.5 ft.	
$A = 9.52$	10.52 sq. ft.	
$R = 0.93$98 ft.	
$V = 5.3$	5.5 f.p.s.	
$Q = 51$	57.8 c.f.s.	OK

For checking permissible velocity of the channel lining, $n=0.035$ (table 2). The velocity with this n is approxi-

mately $\frac{0.05}{0.035} (5.5) = 7.9$ f.p.s. This velocity is less than that permitted, 8 f.p.s., in erosion-resistant soil (table 4). The 7.9-f.p.s. velocity is for the same depth of flow. The velocity for the same discharge and an $n=0.035$ is 7.3 f.p.s.

Point 5D (Sta. 55)

$Q=96.7$ c.f.s., $S=0.01$, $n=0.03$, grass-lined trapezoidal section with 4-ft. bottom, and side slopes 2:1. Data for the final trial from reference 26 are

$d = 2.1$ ft
$A = 17.24$ sq. ft
$R = 1.29$ ft.
$V = 5.9$ f.p.s
$Q = 102$ c.f.s.

For checking permissible velocity of the channel lining, $n=0.025$ (table 2). The velocity with this n is approximately $\frac{0.03}{0.025} (5.9) = 7.1$ f.p.s. This velocity is less than that permitted, 8 f.p.s., in erosion-resistant soil (table 4).

Channel 5 from Sta. 68 to Sta. 65

The toe-of-slope channel can be kept at the same bottom width (4 ft.) and side slopes (2:1) and the depth progressively increased between the points for which computations were made. A freeboard of from 0.3 to 0.5 ft.

should be sufficient and a Bermuda grass lining is satisfactory throughout the length of the channel. The berm between the edge of the channel and the toe of the fill slope should be sloped to drain into the channel.

8.6 Channel 6. The capacity of the median swale and the velocity of flow will be checked at Station 55 to determine the feasibility of bringing the runoff from the top of the hill (Sta. 75+30) to Station 55.

Estimating Runoff (See Ch. II)

The components of the formula $Q = CiA$ are:

	ft.	C
pavement =	24	$0.9 = 21.6$
shoulders =	12	$0.6 = 7.2$
swale =	48	$0.4 = 19.2$
	84	48.0
Weighted C		= 0.57

Note that the width rather than the area was used to weight C, as the section was uniform throughout the length. After computing T_c , i is read from figure 6.

Computation T_c (sec. 2.4-2):

	Cross slope	Channel	Total	Units or reference
$H =$	3.3	30.4	33.7	ft.
$L =$	54	2,030	2,084	ft.

$T_c = 14$ min. (fig. 5).
 i (fig. 6) for 10-yr. return period and T_c of 14 min.
 $= 5.1$ in. per hr.
 $A = \frac{(84)(2030)}{43,560} = 3.91$ acres.

Then $Q = CiA = 0.57 \times 5.1 \times 3.91 = 11.3$ c.f.s.

Computing Channel Section (See Sec. 4.8)

The median swale has a bottom width of 4 ft.; side slopes, 6:1; grade, 1.5 percent; Bermuda grass lining; and a depth of 3.3 ft. below the shoulder edge.

From table 2, for an estimated depth of 0.8 ft., and estimated velocity of 2 f.p.s., $n = 0.05$ for 2-in. grass, and 0.06 for 6-in. grass. The final trial is for an 0.8 ft. depth ($n = 0.06$).

$A = 7.04$ sq. ft.
 $WP = 13.6$ ft.
 $R = 0.52$ ft.
 $V = 1.9$ (reference 26).
 $Q = 13.4$ c.f.s.

The computed depth of flow, 0.8 ft., is less than the available depth, 3.3 ft., and the approximate velocity, 2.3 f.p.s. ($1.9 \times 0.06 / 0.05$), is below the permissible velocity (table 4) for Bermuda grass. Thus, the design runoff can be safely carried to an inlet at Station 55 and dropped into the culvert at that location.

Note that this channel could have been designed by chart 32 of reference 25 with much less work than was required by the trial solution shown here, particularly since the area, wetted perimeter, and hydraulic radius had to be computed for each trial depth.

8.7 Channels 7, 8, and 9. Design of channels 7, 8, and 9 will not be shown because they do not introduce additional design problems.

REFERENCES

- (1) American Association of State Highway Officials, *A Policy on Geometric Design of Rural Highways*, Washington, D.C., 1954, 655 pp.
- (2) Izzard, C. F., *The Design of Roadside Drainage Channels*, Public Roads, Vol. 23, No. 1, March 1942, pp. 1-4, 13, 14.
- (3) Highway Research Board, *Subsurface Drainage of Highways and Airports*, Bull. 209, Washington, D.C., 1959, 21 pp.
- (4) Ackroyd, Richard, *Highway Shoulders as Related to Surface Drainage*, Highway Research Board Bull. 151, Washington, D.C., 1957, 27 pp.
- (5) Stonez, K. A., *Roadside Design for Safety*, General Motors Proving Ground, Milford, Mich., March 1960, 35 pp.
- (6) Morris, B. T., and Johnson, D. C., *Hydraulic Design of Drop Structures for Gully Control*, Trans. ASCE, Vol. 105, 1943, pp. 887-940.
- (7) Donnelly, C. A., and Blaisdell, F. W., *Straight Drop Spillway Stilling Basin*, St. Anthony Falls Hydraulic Laboratory Technical Paper No. 15, Series B, Minneapolis, Minn., November 1954, 35 pp.
- (8) Blaisdell, F. W., and Donnelly, C. A., *The Box Inlet Drop Spillway and Its Outlet*, Trans. ASCE, Vol. 121, 1956, pp. 955-986.
- (9) Jarvis, C. S., and others, *Floods in the United States, Magnitude and Frequency*, U.S. Geological Survey, Water-Supply Paper 771, Washington, D.C., 1936, pp. 28-67.
- (10) Izzard, C. F., *Hydraulics of Runoff from Developed Surfaces*, Proceedings Highway Research Board, Vol. 26, 1946, pp. 129-150.
- (11) ASCE, *Hydrology Handbook*, Manual of Engineering Practice, No. 25, 1949, 4-4 pp.
- (12) ASCE, *Design and Construction of Sanitary and Storm Sewers*, Manual of Engineering Practice, No. 37, 1960, 283 pp.
- (13) Potter, W. D., *Peak Rates of Runoff from Small Watersheds*, U.S. Bureau of Public Roads, Hydraulic Design Series, No. 2, U.S. Government Printing Office, Washington, D.C., 1961.
- (14) Dalrymple, Tate, *Flood-Frequency Analyses*, U.S. Geological Survey, Water-Supply Paper 1543-A, Washington, D.C., 1960, 89 pp.
- (15) U.S. Soil Conservation Service, *Hydrology*, Section 4, including Supplement A, SCS National Engineering Handbook, Washington, D.C.
- (16) Chow, V. T., *Frequency Analysis of Hydrologic Data with Special Application to Rainfall Intensities*, University of Illinois Engineering Experiment Station Bull. 414, Urbana, Ill., 1953, 80 pp.
- (17) Yarnell, D. L., *Rainfall Intensity-Frequency Data*, U.S. Department of Agriculture, Misc. Pub. 204, Washington, D.C., 1935, 68 pp.
- (18) Miami Conservancy District, *Storm Rainfall of Eastern United States*, Tech. Rep., pt. 5, Rev., Dayton, Ohio, 1936, 352 pp.
- (19) U.S. Weather Bureau, *Rainfall Intensity—Duration—Frequency Curves For Selected Stations in the United States, Alaska, Hawaiian Islands, and Puerto Rico*, Tech. Paper 25, Washington, D.C., 1955, 53 pp.
- (20) U.S. Weather Bureau, *Rainfall-Frequency Atlas of the United States*, Tech. Paper 40, Washington, D.C., 1961.
- (21) Gregory, R. L., and Arnold, C. E., *Runoff-Rational Runoff Formulas*, Trans. ASCE, Vol. 96, 1932, pp. 1038-1177.
- (22) Rouse, Hunter, ed., *Engineering Hydraulics*, John Wiley & Sons, Inc., New York, 1950, 1039 pp.
- (23) National Resources Committee, *Low Dams*, U.S. Government Printing Office, Washington, D.C., 1938, 431 pp. (out of print).
- (24) Horner, W. W., and Flynt, F. L., *Relation Between Rainfall and Runoff from Small Urban Areas*, Trans. ASCE, Vol. 101, 1936, pp. 140-206.
- (25) U.S. Bureau of Public Roads, *Design Charts for Open-Channel Flow*, Hydraulic Design Series, No. 3, Government Printing Office, Washington, D.C., 1961, p. 105.
- (26) War Department, Corps of Engineers, *Hydraulic Tables*, U.S. Government Printing Office, Washington, D.C., 1944, 565 pp.
- (27) U.S. Bureau of Reclamation, *Hydraulic and Excavation Tables*, U.S. Government Printing Office, Washington, D.C., 10 ed., 1950, 173 pp.
- (28) King, H. W., *Handbook of Hydraulics*, McGraw-Hill Book Co., Inc., New York, 4th ed., 1954.
- (29) Bradley, J. N., *Hydraulics of Bridge Waterways*, U.S. Bureau of Public Roads, Hydraulic Design Series, No. 1, Government Printing Office, Washington, D.C., 1960, 53 pp.
- (30) War Department, Corps of Engineers, *Types of Flow in Open Channels*, U.S.W.E.S. Misc. Paper No. 2-498, Vicksburg, Miss., June 1962.
- (31) Braine, C. D. C., *Draw-down and Other Factors Relating to the Design of Storm-water Outflows on Sewers*, Jour. Inst. of Civil Engineers, Vol. 28, No. 6, pp. 136-163, London, April 1947.
- (32) Chow, V. T., *Open Channel Hydraulics*, McGraw-Hill Book Co., Inc., New York, 1959, 680 pp.
- (33) ASCE, *High Velocity Flow in Open Channels*, A Symposium, Proc. November 1949, pp. 1287-1385.

- (34) Hall, L. S., *Open Channel Flow at High Velocities*, Trans. ASCE, Vol. 108, 1943, pp. 1394-1434
- (35) Rec, W. O., and Palmer, V. J., *Flow of Water in Channels Protected by Vegetative Linings*, U.S. Department of Agriculture, Tech. Bull. 967, Washington, D.C., 1949, 115 pp.
- (36) U.S. Soil Conservation Service, *Handbook of Channel Design for Soil and Water Conservation*, SCS-TP-61, Washington, D.C., Rev. June 1954, 34 pp.
- (37) U.S. Bureau of Reclamation, *Design of Small Dams*, U.S. Government Printing Office, Washington, D.C., 1960, 611 pp.
- (38) ASCE, *Symposium on Stilling Basins and Energy Dissipators*, Proc. Symp. Series No. 5, June 1961.
- (39) U.S. Bureau of Reclamation, *Hydraulic Design of Stilling Basins and Energy Dissipators*, Engineering Monograph No. 25, U.S. Government Printing Office, Washington, D.C., 1964, 224 pp.
- (40) The Asphalt Institute, *Asphalt in Hydraulic Structures*, Manual Series No. 12, College Park, Md., September 1961, 128 pp.
- (41) ASCE, *Review of Slope Protection Methods*, Proc. Vol. 74, 1948, pp. 845-866.
- (42) War Department, Corps of Engineers, *Hydraulic Design Criteria*, Waterways Experiment Station, Vicksburg, Miss., 1959, chart 712-1/1.
- (43) California Division of Highways, *Bank and Shore Protection in California Highway Practice*, Sacramento, Calif., November 1960, 423 pp.
- (44) Posey, C. J., *Flood-Erosion Protection for Highway Fills*, Trans. ASCE, Vol. 122, 1957, pp. 531-555.
- (45) Lane, E. W., *Design of Stable Channels*, Trans. ASCE, Vol. 120, 1955, p. 1248.
- (46) Murphy, T. E., and Grace, J. L., *Riprap Requirements for Inflow Embankments*, Highway Research Board Record, No. 30, Washington, D.C., 1963, 55 pp.
- (47) War Department, Corps of Engineers, *Slope Protection for Earth Dams*, Preliminary Report, Waterways Experimental Station, Vicksburg, Miss., March 1949.
- (48) War Department, Corps of Engineers, *Investigation of Filter Requirements for Underdrains*, Waterways Experiment Station Tech. Memo No. 183-1, Vicksburg, Miss., December 1941.
- (49) U.S. Soil Conservation Service, *Drop Spillways*, Section 11, SCS National Engineering Handbook, Washington, D.C.
- (50) War Department, Corps of Engineers, *Shore Protection Planning and Design*, Beach Erosion Board, Tech. Rept. No. 4, U.S. Government Printing Office, Washington, D.C., 1961.
- (51) U.S. Bureau of Public Roads, *Hydraulic Charts for the Selection of Highway Culverts*, Hydraulic Engineering Circular No. 5, Bridge Division, Washington, D.C.
- (52) U.S. Bureau of Public Roads, *A Guide for Showing Roadside Improvements on Project Plans*, Highway Design Division, Washington, D.C., 1959.
- (53) War Department, Corps of Engineers, *Planting Turf*, Manual EM 1110-1-321, Washington, D.C., October 1961, 44 pp.
- (54) U.S. Bureau of Reclamation, *Linings for Irrigation Canals*, U.S. Government Printing Office, Washington, D.C., 1963, 149 pp.
- (55) Hewes, L. I., and Oglesby, C. H., *Highway Engineering*, John Wiley & Sons, Inc., New York, 1954, 658 pp.

UPDATED REFERENCES

The following list contains the most recent editions and printings of some of the preceding references.

- (1) American Association of State Highway Officials, *A Paper on Geometric Design of Rural Highways*, Washington, D.C., 1965, 650 pp.
- (12) ASCE, *Design and Construction of Sanitary and Storm Sewers*, Manuals and Reports on Engineering Practice, No. 37, 1969, 332 pp.
- (13) Out of Print—Individual circulars for parts of some States east of 105 meridian available from Hydraulics Branch, Bridge Division, Office of Engineering, Federal Highway Administration, Washington, D.C. 20530.
- (25) Federal Highway Administration, *Design Charts for Open-Channel Flow*, Hydraulic Design Series No. 3, U.S. Government Printing Office, Washington, D.C., Reprinted 1973, 105 pp.
- (27) U.S. Bureau of Reclamation, *Hydraulic and Excavation Tables*, U.S. Government Printing Office, Washington, D.C., 11th ed., 1957, 350 pp.
- (28) King, H. W., and Brater, E. F., *Handbook of Hydraulics*, McGraw-Hill Book Co., Inc., New York, 5th ed., 1963.
- (29) Bradley, J. N., *Hydraulics of Bridge Waterways*, Hydraulic Design Series No. 1, Federal Highway Administration, U.S. Government Printing Office, Washington, D.C., Reprinted 1973, 111 pp.
- (37) U.S. Bureau of Reclamation, *Design of Small Dams*, U.S. Government Printing Office, Washington, D.C., 1973, 816 pp.
- (40) The Asphalt Institute, *Asphalt in Hydraulic Structures*, Manual Series No. 12, College Park, Md., November 1961, 128 pp.
- (42) Corps of Engineers, *Hydraulic Design Criteria*, Waterways Experiment Station, Vicksburg, Mississippi, 1959, chart 712-1-1.
- (50) Corps of Engineers, Beach Erosion Board, *Shore Protection Planning and Design*, Technical Report No. 4, U.S. Government Printing Office, Washington, D.C., 1961, 578 pp.
- (51) Federal Highway Administration, *Hydraulic Charts for the Selection of Highway Culverts*, Hydraulic Engineering Circular No. 5, Office of Engineering, Bridge Division, Washington, D.C. 20530.
- (53) Corps of Engineers, *Planting Turf*, TM 5-830-2, Adjutant General Depot, St. Louis, Mo., October 1961, 44 pp.
- (55) Oglesby, C. H. and Hewes, L. I., *Highway Engineering*, John Wiley & Sons, New York, 2nd ed., 1963, 793 pp.

Appendix A.—TABLES

Table 1. Values of Runoff Coefficients (C) for Use in the Rational Method

Type of surface	Runoff coefficient (C) ¹
Rural Areas	
Concrete or sheet asphalt pavement	0.6-0.9
Asphalt macadam pavement	0.5-0.8
Gravel roads or shoulders	0.4-0.6
Bare earth	0.2-0.9
Steep grassed areas (2 ft)	0.5-0.7
Turf meadows	0.1-0.4
Forested areas	0.1-0.3
Cultivated fields	0.2-0.4
Urban Areas²	
At residential, with about 30 percent of area impervious	0.40
At residential, with about 60 percent of area impervious	0.55
Moderately steep residential, with about 50 percent of area impervious	0.65
Moderately steep built up area, with about 70 percent of area impervious	0.80
Flat commercial, with about 90 percent of area impervious	0.80

¹ For flat slopes or permeable soil, use the lower values. For steep slopes or impermeable soil, use the higher values.
² See reference 12, pp. 48-49 for more detailed data.

Table 2.—Manning Roughness Coefficients, n¹

	Manning n range ²
I. Closed conduits:	
A. Concrete pipe	0.011-0.013
B. Corrugated metal pipe or pipe arch	
1. 24- by 14-in. corrugation (riveted pipe) ³	
a. Plain or fully coated	0.024
b. Paved invert (range values are for 25 and 60 percent of circumference paved)	
(1) Flow full depth	0.021-0.018
(2) Flow 0.8 depth	0.021-0.018
(3) Flow 0.6 depth	0.019-0.013
2. 3- by 1-in. corrugation	0.027
3. 6- by 3-in. corrugation (field bolted)	0.032
C. Vitribed clay pipe	0.012-0.014
D. Cast iron pipe, uncoated	0.013
E. Steel pipe	0.009-0.011
F. Brick	0.014-0.017
G. Mortar rubble concrete	
1. Wood forms, rough	0.015-0.017
2. Wood forms, smooth	0.014-0.014
3. Steel forms	0.012-0.013
H. Cemented rubble masonry walls	
1. Concrete floor and top	0.017-0.022
2. Natural floor	0.019-0.025
I. Laminated treated wood	0.015-0.017
J. Vitribed clay liner plates	0.015
II. Lined open channels:	
A. Concrete, with surfaces as indicated	
1. Formed, no finish	0.013-0.017
2. Trowel finish	0.012-0.014
3. Float finish	0.013-0.015
4. Float finish, some gravel on bottom	0.015-0.017
5. Gunite, good section	0.019-0.019
6. Gunite, wavy section	0.019-0.022
B. Concrete bottom float finished, sides as indicated	
1. Dressed stone in mortar	0.015-0.017
2. Random stone in mortar	0.017-0.020
3. Cement rubble masonry	0.020-0.025
4. Cement rubble masonry, plastered	0.015-0.020
5. Dry rubble (rip-rap)	0.020-0.030
C. Gravel bottom, sides as indicated	
1. Formed concrete	0.017-0.020
2. Random stone in mortar	0.020-0.023
3. Dry rubble (rip-rap)	0.021-0.033
D. Rock	0.014-0.017

¹ Footnotes to Table 2 appear on p. 54.

II. Lined open channels—Continued		Manning n range²
E. Asphalt		
1. Smooth		0.013
2. Rough		0.016
F. Wood, planed, clean		0.011-0.013
G. Concrete, lined excavated rock		
1. Good section		0.017-0.020
2. Irregular section		0.022-0.027
III. Unlined open channels		
A. Earth, uniform section		
1. Clean, recently completed		0.016-0.018
2. Clean, after weathering		0.018-0.020
3. With short grass, few weeds		0.022-0.027
4. In grassy areas, uniform section, clean		0.022-0.025
B. Earth, fairly uniform section		
1. No vegetation		0.022-0.025
2. Grass, some weeds		0.025-0.030
3. Dense weeds or aquatic plants in deep channels		0.030-0.035
4. Silted, clean, gravel bottom		0.025-0.030
5. Silted, clean, rubble bottom		0.030-0.040
C. Draggings excavated or dredged		
1. No vegetation		0.026-0.033
2. Light brush on banks		0.035-0.050
D. Rock		0.035
1. Based on design section		
2. Based on actual mean section		
a. Smooth and uniform		0.035-0.040
b. Jagged and irregular		0.040-0.045
E. Channels not lined with weeds and brush on top		
1. Dense weeds to height of flow depth		0.08-0.12
2. Clean bottom, brush on sides		0.05-0.08
3. Clean bottom, brush on sides, highest stage of flow		0.07-0.11
4. Dense brush, high stage		0.10-0.14
IV. Highway channels and swales with maintained vegetation³		
* Values shown are for velocities of 2 and 6 ft per second.		
A. Depth of flow up to 1 foot		
1. Bermuda grass, Kentucky bluegrass, buffalo grass		
a. Mowed to 2 inches		0.07-0.045
b. Length 4 to 6 inches		0.09-0.05
2. Good stand, any grass		
a. Length about 12 inches		0.15-0.09
b. Length about 24 inches		0.20-0.15
3. Fair stand, any grass		
a. Length about 12 inches		0.14-0.08
b. Length about 24 inches		0.25-0.13
B. Depth of flow 7-1.5 feet		
1. Bermuda grass, Kentucky bluegrass, buffalo grass		
a. Mowed to 2 inches		0.05-0.035
b. Length 4 to 6 inches		0.06-0.04
2. Good stand, any grass		
a. Length about 12 inches		0.12-0.07
b. Length about 24 inches		0.20-0.10
3. Fair stand, any grass		
a. Length about 12 inches		0.10-0.06
b. Length about 24 inches		0.17-0.09
V. Streets and easements with gutters		0.012
A. Concrete, with street finish		
B. Asphalt pavement		
1. Smooth texture		0.012
2. Rough texture		0.016
C. Concrete gutter with asphalt pavement		
1. Smooth		0.013
2. Rough		0.015
D. Concrete pavement		
1. Flat finish		0.014
2. Brown finish		0.016
E. For gutters with small slope, where sediment may accumulate, increase all above values of n by		0.002
VI. Natural stream channels		
A. Minor streams ⁴ (surface width at flood stage less than 100 ft)		
1. Fairly regular section		
a. Some grass and weeds, little or no brush		0.030-0.035
b. Dense growth of weeds, depth of flow materially greater than weed height		0.035-0.05
c. Some weeds, light brush on banks		0.04-0.06
d. Some weeds, heavy brush on banks		0.05-0.07
e. Some weeds, dense willow on banks		0.06-0.08
f. For trees within channel, with branches submerged at high stage, increase all above values by		0.01-0.10
2. Irregular sections, with rocky, slight channel meander, increase values in flow stage		
3. Multiple meanders, no vegetation in channel, banks usually steep, trees and brush along banks submerged at low stage		0.01-0.02
a. Bottom of gravel, cobbles, and few boulders		0.04-0.05
b. Bottom of cobbles, with large boulders		0.05-0.07

VI. Natural stream channels—Continued

	Manning n range ¹
B. Flood plains (adjacent to natural streams)	
1. Pasture, no brush	0.035-0.035
a. Short grass	0.035-0.05
b. High grass	0.035-0.05
2. Cultivated areas	0.03-0.04
a. No crop	0.035-0.045
b. Mature row crops	0.04-0.05
c. Mature field crops	0.05-0.07
3. Heavy brush scattered brush	0.05-0.07
4. Light brush and trees ²	0.05-0.06
a. Winter	0.06-0.08
b. Summer	0.06-0.08
5. Medium to dense brush ³	0.07-0.11
a. Winter	0.10-0.16
b. Summer	0.15-0.20
7. Cleared land with tree stumps, 100-150 per acre	0.04-0.05
a. No sprouts	0.06-0.08
b. With heavy growth of sprouts	0.06-0.08
8. Heavy stand of timber, a few down trees, little undergrowth	0.10-0.12
a. Flood depth below branches	0.12-0.16
b. Flood depth reaches branches	0.12-0.16
C. Major streams (surface width at flood stage more than 100 ft.) Roughness coefficient is usually less than for minor streams of similar description on account of less effective resistance offered by irregular banks or vegetation on banks. Values of n may be somewhat reduced. Follow recommendation of note 7 if possible. The value of n for larger streams of most regular sections, with no boulders or brush, may be in the range of from	
	0.025-0.033

Footnotes to Table 2

¹ Estimates are by Bureau of Public Roads unless otherwise noted and are for straight alignment. A small increase in value of n may be made for channel alignment other than straight.
² Returns for sees 1 through III are for good to fair construction. For poor quality construction, use larger values of n.

³ *Friction Losses in Corrugated Metal Pipe*, by M. J. Webster and L. R. Metcalf, Corps of Engineers, Department of the Army, published in Journal of the Hydraulics Division, Proceedings of the American Society of Civil Engineers, Vol. 85, No. 11, September 1959, Paper No. 2149, pp. 35-67.
⁴ For important work and where accurate determination of water profiles is necessary, the designer is urged to consult the following references and to select n by comparison of the specific conditions with the channels tested: *Flow of Water in Channels, Dams and Similar Canals*, by F. C. Scobey, U.S. Department of Agriculture, Technical Bulletin No. 62, February 1939; *Flow of Water in Drainage Channels*, by C. F. Roman, U.S. Department of Agriculture, Technical Bulletin No. 129, November 1929.

⁵ *Flow of Water in Channels Protected by Vegetation Listings*, by W. O. Rea and V. J. Palmer, Division of Drainage and Water Control, Research, Soil Conservation Service, U.S. Department of Agriculture, Tech. Bull. No. 967, February 1949.

⁶ For calculations of stage or discharge in natural stream channels, it is recommended that the designer consult the local District Office of the Surface Water Branch of the U.S. Geological Survey, to obtain data regarding values of n applicable to streams of any specific locality. Where this procedure is not followed, the table may be used as a guide. The values of n tabulated here have been derived from data reported by C. E. Ramser (see footnote 4) and from other incomplete data.

⁷ The tentative values of n cited are principally derived from measurements made on fairly short but straight reaches of natural streams. Where slopes calculated from flood elevations along a considerable length of channel, involving meanders and bends, are to be used in velocity calculations by the Manning formula, the value of n must be increased to provide for the additional loss of energy caused by bends. The increase may be in the range of perhaps 3 to 15 percent.

⁸ The presence of foliage on trees and brush under flood stage will materially increase the value of n. Therefore, roughness coefficients for vegetation in leaf will be larger than for bare branches. For trees in channels or on banks, and for brush on banks where submergence of branches increases with depth of flow, n will increase with rising stage.

Table 3.—Maximum permissible velocities in erodible channels, based on uniform flow in continuously wet, aged channels¹

Material	Maximum permissible velocities for—		
	Clear water	Water carrying fine silts	Water carrying sand and gravel
	F.p.s.	F.p.s.	F.p.s.
Fine sand (noncolloidal)	1.5	2.5	1.5
Sandy loam (noncolloidal)	1.7	2.5	2.0
Silt loam (noncolloidal)	2.0	3.0	2.0
Ordinary firm loam	2.5	3.5	2.2
Volcanic ash	2.5	5.0	3.7
Fine gravel	3.7	5.0	3.0
Silt clay (very colloidal)	3.7	5.0	5.0
Graded, loam to cobbles (noncolloidal)	4.0	5.5	5.0
Graded, silt to cobbles (colloidal)	2.0	3.5	2.0
Alluvial silts (noncolloidal)	3.7	5.0	3.0
Alluvial silts (colloidal)	4.0	6.0	6.5
Coarse gravel (noncolloidal)	5.0	5.5	6.5
Cobbles and shingles	6.0	6.0	5.0
Boulders and hard pans	6.0	6.0	5.0

¹ As recommended by Special Committee on Irrigation Research, American Society of Civil Engineers, 1926, for channels with straight alignment. For sinuous channels multiply allowable velocity by 0.95 for slightly sinuous, by 0.9 for moderately sinuous channels, and by 0.8 for highly sinuous channels (44, p. 1257).

Table 4.—Maximum permissible velocities in channels lined with uniform stands of various grass covers, well maintained^{1, 2}

Cover	Slope range	Maximum permissible velocity, ft.—	
		Erosion-resistant soils	Easily eroded soils
		f.p.s.	f.p.s.
Bermudagrass	10-5%	8	6
	5-10%	7	5
	Over 10%	6	4
Buffalograss	10-5%	7	5
	5-10%	6	4
	Over 10%	5	3
Smooth brome	10-5%	5	4
	5-10%	4	3
	Over 10%	3	2
Grass mixture	10-5%	5	4
	5-10%	4	3
	Over 10%	3	2
Lespedeza sericea			
Weeping lovegrass			
Yellow bluestem			
Kudzu	10-5%	3.5	2.5
Alfalfa			
Crabgrass			
Common lespedeza			
Sudangrass ³	10-5%	3.5	2.5

¹ From *Handbook of Channel Design for Soil and Water Conservation*. (See footnote 5, table 2.)

² Use velocities over 5 f.p.s. only where good covers and proper maintenance can be obtained.

³ Do not use on slopes steeper than 10 percent.

⁴ Use on slopes steeper than 5 percent is not recommended.

⁵ Annuals, used on mild slopes or as temporary protection until permanent covers are established.

Table 5.—Classification of vegetal covers as to degree of retardance ¹

[Notes: Covers classified have been tested in experimental channels. Covers were green and generally uniform]

Retardance	Cover	Condition
A.....	Weeping lovegrass	Excellent stand, tall (average 30 inches)
	Yellow bluestem (chae-rouru)	Excellent stand, tall (average 36 inches)
	Kudzu	Very dense growth, uncut
	Bermudagrass	Good stand, tall (average 12 inches)
B.....	Native grass mixture (little bluestem, blue grama, and other long and short midwest grasses)	Good stand, unmowed
	Weeping lovegrass	Good stand, tall (average 24 inches)
	Lespedeza sericea	Good stand, not woody, tall (average 19 inches)
	Alfalfa	Good stand, uncut (average 11 inches)
	Weeping lovegrass	Good stand, mowed (average 13 inches)
	Kudzu	Dense growth, uncut
	Blue grama	Good stand, uncut (average 13 inches)
	Crabgrass	Fair stand, uncut (10 to 18 inches)
	Bermudagrass	Good stand, mowed (average 6 inches)
	Common lespedeza	Good stand, uncut (average 11 inches)
C.....	Grass-legume mixture—summer orchard grass, redtop, Italian ryegrass, and common lespedeza)	Good stand, uncut (6 to 8 inches)
	Centipede grass	Very dense cover (average 6 inches)
	Kentucky bluegrass	Good stand, headed (6 to 12 inches)
	Bermudagrass	Good stand, cut to 2.5-inch height
	Common lespedeza	Excellent stand, uncut (average 4.5 inches)
	Buffalograss	Good stand, uncut (3 to 6 inches)
D.....	Grass-legume mixture—fall, spring orchard grass, redtop, Italian ryegrass, and common lespedeza)	Good stand, uncut (4 to 5 inches)
	Lespedeza sericea	After cutting to 2-inch height. Very good stand before cutting
E.....	Bermudagrass	Good stand, cut to 1.5 inches height
	Bermudagrass	Burned stubble

¹ From *Handbook of Channel Design for Soil and Water Conservation* (See footnote 3, table 1.)

Appendix B

Nomograph for solution of Manning Equation

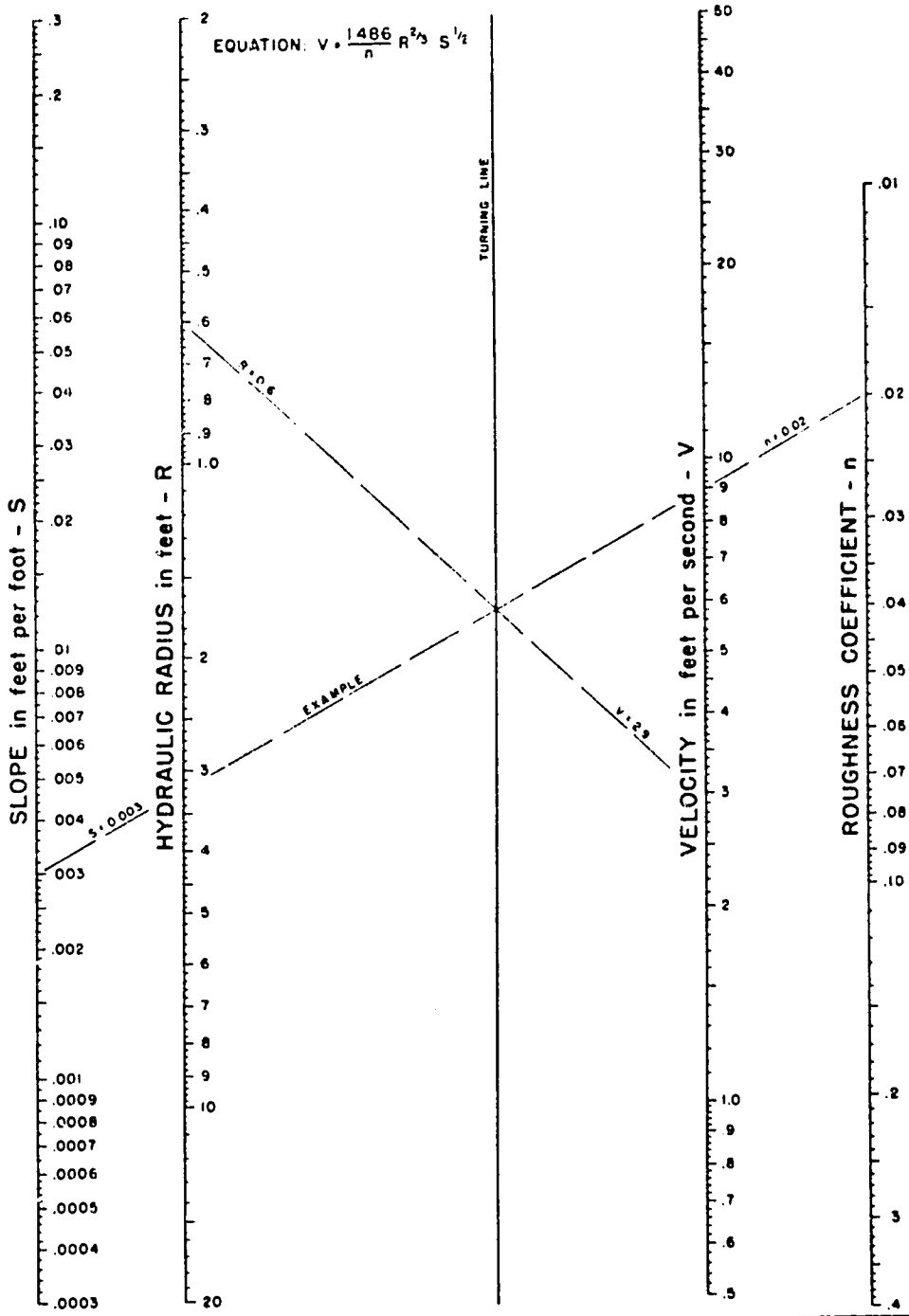

(See sec. 3.2-2)

U.S. GOVERNMENT PRINTING OFFICE 1975 O-578-371

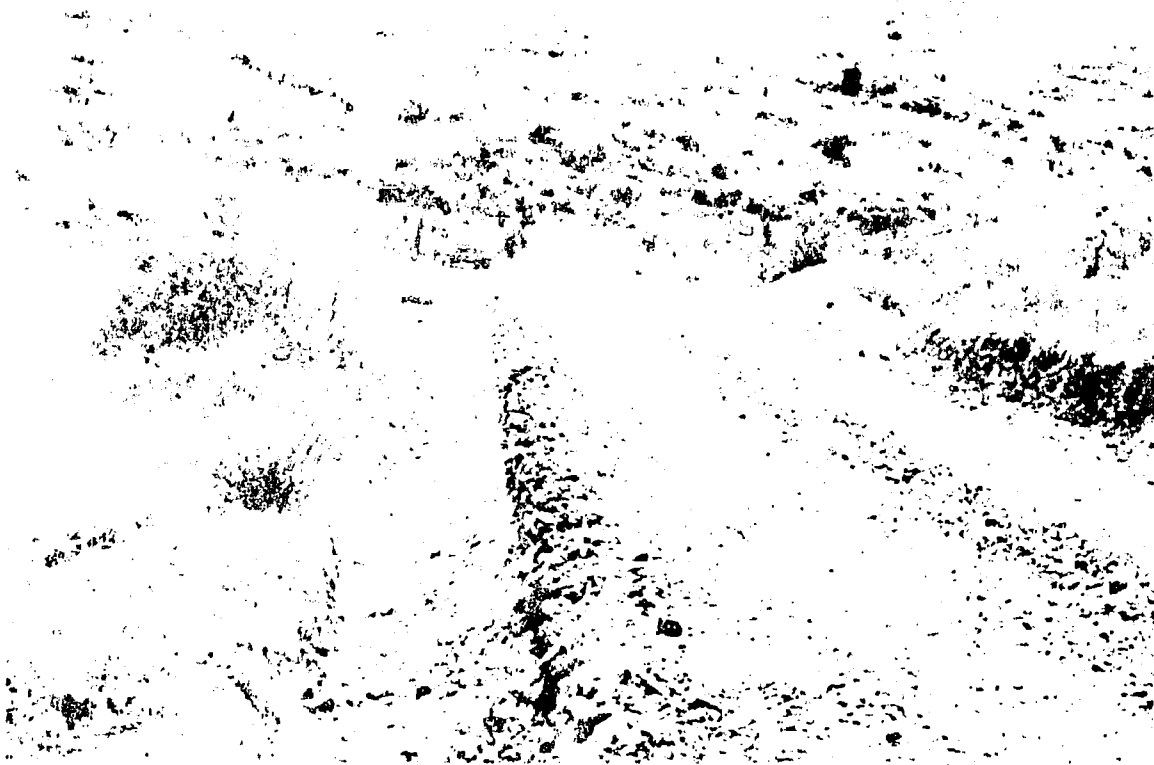

Typical earthen drainage channel constructed with labor-intensive methods, Oaxaca, Mexico.

DESIGN CHARTS FOR OPEN-CHANNEL FLOW

Hydraulic Design Series No. 3

U.S. Department of Transportation
Federal Highway Administration

August 1961
Reprinted November 1977

For sale by the Superintendent of Documents, U.S. Government Printing Office
Washington, D.C. 20402

*NOTE: This text has been reproduced with the permission of the
Federal Highway Administration, U.S. Department of Transportation.*

PREFACE

This publication, the third in a series on the hydraulic design of highway drainage structures published by the Federal Highway Administration, makes generally available a group of hydraulic charts which facilitate the computation of uniform flow in open channels. Some of the charts are also useful in the design of storm drains.

The text is not intended to be a treatise on the design of open channels, although a brief discussion of the principles of flow in open channels is included. It is intended rather, as a working tool that should be of considerable service to the designer already familiar with the subject.

This publication contains charts which provide direct solution of the Manning equation for uniform flow in open prismatic channels of various cross sections; instructions for using the charts; a table of recommended values of n for use in the Manning equation; tables of permissible velocities in earth and vegetated channels; instructions for constructing charts similar to those presented; and a nomogram for use in the solution of the Manning equation. Charts are included for rectangular, trapezoidal, and triangular channels, grass-lined channels, circular pipe channels (part-full flow), pipe-arch channels, and oval concrete pipe channels.

Much of the material in this publication was developed by the Region 3 Office of the Federal Highway Administration (then Region 2, Bureau of Public Roads), in cooperation with the Division of Hydraulic Research (now Environmental Control Group), Office of Research. The publication was assembled by the Hydraulics Branch, Bridge Division, Office of Engineering, and the Division of Hydraulic Research, Office of Research. The only changes in this reprint of the 1961 publication consist of a redesigned cover and revised preface.

CONTENTS

	Page		Page
** Preface	iii	Chapter 5.—Continued	
Chapter 1.—Introduction		5.3-3 Use of charts to find velocity of flow	47
1.1 Content of publication	1	5.3-4 Use of charts to find slope required to maintain flow	47
1.2 Arrangement of publication	1	5.3-5 Use of charts to find critical flow	47
1.3 Definition of symbols	2	Examples 14-17	47
Chapter 2.—Principles of Flow in Open Channels		Chapter 6.—Pipe-Arch Channels	
2.1 Design of highway drainage channels	3	6.1 Description of charts	74
2.2 Types of flow	3	6.2 Instructions for use of charts 61-73	74
2.3 Uniform flow	3	6.2-1 Use of charts to find discharge	74
2.4 Energy of flow	3	6.2-2 Use of charts to find depth of uniform flow	74
2.5 Critical flow	4	6.2-3 Use of charts to find velocity of flow	74
2.6 Nonuniform flow	5	6.2-4 Use of charts to find slope required to maintain flow	75
* Chapter 3.—Rectangular, Trapezoidal, and Triangular Channels		6.2-5 Use of charts to find critical flow	75
** 3.1 Description of charts	7	Examples 18-21	75
* 3.2 General instructions for use of charts	7	Chapter 7.—Oval Concrete-Pipe Channels	
** 3.2-1 Use of charts 1-28 with basic chart-design value of n	7	7.1 Description of charts	89
Example 1	7	7.2 Instructions for use of charts 74-82	89
Example 2	8	7.2-1 Use of charts to find discharge	89
Example 3	8	7.2-2 Use of charts to find depth of uniform flow	89
** 3.2-2 Use of charts 1-28 with other than basic chart-design value of n	8	7.2-3 Use of charts to find velocity of flow	89
Example 4	8	7.2-4 Use of charts to find slope required to maintain flow	89
3.2-3 Closed rectangular conduits flowing full	8	7.2-5 Use of charts to find critical flow	90
Example 5	8	Examples 22-25	90
* Chapter 4.—Grassed Channels		Appendix A.—Tables:	
4.1 Description of charts	38	Table 1.—Manning roughness coefficients	100
4.2 General instructions for use of charts 30-34	39	Table 2.—Permissible velocities for channels with erodible linings	101
Examples 6-9	39	Table 3.—Permissible velocities for channels lined with uniform stands of various grass covers	101
Chapter 5.—Circular-Pipe Channels		Table 4.—Factors for adjustment of discharge to allow for increased resistance caused by friction against the top of a closed rectangular conduit	101
5.1 Description of charts	45	Table 5.—Guide to selection of retardance curve	101
5.2 Instructions for use of charts 35-51, for pipes 1-8 feet in diameter	45	** Appendix B.—Construction of design charts for open-channel flow:	
5.2-1 Use of charts with basic chart-design value of n	45	B.1 Charts with Manning's n constant	102
Example 10	45	B.2 Charts for grassed channels with n variable	103
Example 11	46	Appendix C.—Graphic solution of the Manning equation	
5.2-2 Use of charts with other than basic chart-design values of n	46		
Example 12	46		
5.2-3 Pipes flowing full	46		
Example 13	46		
5.3 Instructions for use of charts 52-60, for pipes 1-15 feet in diameter	46	Lists of figures and charts	
5.3-1 Use of charts to find discharge	46	vi	
5.3-2 Use of charts to find depth of uniform flow	47		

FIGURES AND CHARTS

<i>Figures</i>		<i>Page</i>
1.	Definition sketch of specific head.....	4
2.	Water-surface profile in flow from a channel to a pool.....	5
3.	Water-surface profile in changing from sub-critical to supercritical channel slope.....	6
4.	Water-surface profile illustrating hydraulic jump.....	6
5.	Degrees of vegetal retardance for which the Manning n has been determined.....	38
 <i>Charts</i> (A quick index of the charts, grouped by purpose of use, appears on the outside back cover.)		
<i>Number</i>		<i>Page</i>
Rectangular channel flow:		
1-9	For widths 2-10 feet, by 1-foot increments.....	9-17
10-14	For widths 12-20 feet, by 2-foot increments.....	18-22
Trapezoidal channel flow; 2:1 side slopes:		
* 15-23	For bottom widths 2-10 feet, by 1-foot increments.....	23-31
** 24-28	For bottom widths 12-20 feet, by 2-foot increments.....	32-36
Triangular channel flow:		
** 29	Nomograph for triangular channels.....	37
Grassed channel flow:		
* 30-33	Trapezoidal channels, bottom width 4 feet.....	40-43
34	Triangular channels.....	44
Circular-pipe flow (one-step charts):		
35-43	For 12-36 inch diameter, by 3-inch increments.....	45-56
44-49	For 42-72 inch diameter, by 6-inch increments.....	57-62
50-51	For 84- and 96-inch diameter.....	63-64
Circular-pipe flow (up to 15-foot diameter):		
52-54	For full flow.....	65-67
55	For part-full flow.....	68
56-60	For critical flow.....	69-73
Pipe-arch flow (spans 25 inches to 16 feet, 7 inches):		
61-65	For unpaved inverts.....	76-80
66-68	For 40-percent paved inverts (Charts 63 and 64 are used with this group).....	81-83
69-73	For field-bolted corrugated metal pipe-arches.....	84-88
Oval concrete-pipe flow (long axis diameter 23-151 inches):		
74	For full flow.....	91
75-76	For part-full flow.....	92-93
77-82	For critical flow.....	94-99
Graphic solution of the Manning equation:		
83	Nomograph for graphic solution of the Manning equation.....	105

Chapter 3. RECTANGULAR, TRAPEZOIDAL, AND TRIANGULAR CHANNELS

3.1 Description of Charts. Charts 1-29 are designed for use in the direct solution of the Manning equation for various-sized open channels of rectangular, trapezoidal, and triangular cross section. Each chart (except the triangular cross-section channel chart, No. 29) is prepared for a channel of given bottom width, and having a particular value of Manning's n , but auxiliary scales make the charts applicable to other values of n .

The rectangular cross-section channel charts, Nos. 1-14, are prepared for an n of 0.015 (average value for concrete). A separate chart is provided for each foot of width from 2 feet to 10 feet and for each even foot of width from 10 feet to 20 feet.

The trapezoidal cross-section channel charts, Nos. 15-28, are prepared for an n of 0.03 and side slopes of 2:1 (horizontal to vertical). A separate chart is provided for each foot of bottom width from 2 feet to 10 feet and for each even foot of width from 10 feet to 20 feet. Charts for other side slopes may be constructed according to the method explained in appendix B. Charts for grass-lined channels, where n varies with both depth and type of grass, are given in chapter 4.

The charts for rectangular and trapezoidal cross-section channels are similar in design and method of use. The abscissa scale is discharge, in cubic feet per second (c.f.s.) and the ordinate scale is velocity, in feet per second (f.p.s.). Both scales are logarithmic. Superimposed on the logarithmic grid are steeply inclined lines representing depth (in feet), and slightly inclined lines representing channel slope (in feet per foot). A heavy dashed line on each chart shows the position of critical flow. Auxiliary abscissa and ordinate scales are provided for use with values of n other than those values used in preparing the chart.

In these charts, and subsequent ones similarly designed, interpolations may be made with confidence, not only on the ordinate and abscissa scales, but between the inclined lines representing depth and slope.

The triangular cross-section channel chart, No. 29, is prepared in nomograph form. It may be used for street sections with a vertical (or nearly vertical) curb face. (The curbed street section is a triangular section with one leg vertical.) The equation given on the chart ignores the resistance of the curb face, but this resistance is negligible from a practical viewpoint, provided the width of flow is at least 10 times the depth of the curb face; that is, if $Z > 10$. The equation gives a discharge about 19 percent greater than will be obtained by the common procedure of computing discharge from the hydraulic radius of the entire section. The latter procedure is not recommended for shallow flow with continuously varying depth. The nomograph may also be used for shallow V-shaped sections by following the instructions on the chart.

3.2 General instructions for use of charts 1-28. Charts 1-28 provide a solution of the Manning equation for flow in open channels of uniform slope, cross section, and roughness, provided the flow is not affected by backwater and the channel has a length sufficient to establish uniform flow. The charts provide accuracy sufficient for the design of highway drainage channels of fairly uniform cross section and slope. Rounding of the intersection of the side slopes with the bottom of the channel does not appreciably affect the channel capacity.

The charts may also be used to obtain rough approximations for depths and velocities in natural channels of nearly the normal cross section. For such channels, a straight line drawn through irregularities in the bed profile may be used to define the slope. The rectangular cross-section charts can be used for closed rectangular conduits flowing full, by following the procedure described in section 3.2-3.

The use of charts 1-28 is described, with examples, in the following subsections. Instructions and example for chart 29 are given on the chart itself.

3.2-1 Use of charts 1-28 with basic chart-design value of n . For a given slope and cross section of channel, when n is 0.015 for rectangular channels or 0.03 for trapezoidal channels, the depth and velocity of uniform flow may be read directly from the chart for that size channel. The initial step is to locate the intersection of a vertical line through the discharge (abscissa) and the appropriate slope line. At this intersection, the depth of flow is read from the depth lines; and the mean velocity is read on the ordinate scale opposite the point of intersection (see examples 1 and 2). The procedure is reversed to determine the discharge at a given depth of flow (see example 3). Critical depth, slope, and velocity for a given discharge can be read on the appropriate line or scale (velocity) at the intersection of the critical curve and a vertical line through the discharge.

Example 1

Given: A rectangular concrete channel 5 ft wide, with $n = 0.015$, on a 1-percent slope ($S = 0.01$), discharging 200 c.f.s. *Find:* Depth, velocity, and type of flow.

1. Select the rectangular chart for a 5-ft. width, chart 4.
2. From 200 c.f.s. on the Q scale, move vertically to intersect the slope line $S = 0.01$, and from the depth lines read $d_n = 3.2$ ft.
3. Move horizontally from the same intersection and read the normal velocity, $V = 12.5$ f.p.s., on the ordinate scale.
4. The intersection lies above the critical curve, and the flow is therefore in the supercritical range.

Example 2

Given: A trapezoidal channel with 2:1 side slopes and a 4-ft. bottom width, with $n=0.030$, on a 2-percent slope ($S=0.02$), discharging 150 c.f.s. Find Depth, velocity, and type of flow.

1. Select the trapezoidal chart for $b=4$ ft., chart 17.
2. From 150 c.f.s. on the Q scale, move vertically to intersect the slope line $S=0.02$, and from the depth lines read $d_n=2.1$ ft.
3. Move horizontally from the same intersection and read the normal velocity, $V=8.4$ f.p.s., on the ordinate scale.
4. The intersection lies above the critical curve, and the flow is therefore in the supercritical range.

Example 3

Given: A trapezoidal channel with 2:1 side slopes, a 6-ft. bottom width, and a depth of 4.0 ft., with $n=0.030$, on a 0.5-percent slope ($S=0.005$). Find: Discharge, velocity, and type of flow.

1. Select the trapezoidal chart for $b=6$ ft., chart 19.
2. Locate the intersection of the 4-ft. depth line and the slope line $S=0.005$ and, moving vertically to the abscissa scale, read the corresponding discharge, $Q=350$ c.f.s.
3. Move horizontally from the intersection and read the normal velocity, $V=6.1$ f.p.s., on the ordinate scale.
4. The intersection lies below the critical curve, and the flow is therefore in the subcritical range.

3.2-2 Use of charts 1-28 with other than basic chart-design value of n . Auxiliary scales, labeled Qn (abscissa) and Vn (ordinate), are provided on charts 1-28 so that the charts may be used for values of n other than those for which the charts were basically prepared. To use the auxiliary scales, multiply the discharge by the value of n and use the Qn and Vn scales instead of the Q and V scales, except for computation of critical depth or critical velocity (see step 5 of example 4). To obtain normal velocity V from a value on the Vn scale, divide the value by n (see example 4).

Example 4

Given: A rectangular cement rubble masonry channel 5 ft. wide, with $n=0.025$, on a 1.5-percent slope ($S=0.015$), discharging 200 c.f.s. Find: Depth, velocity, and type of flow.

1. Select the rectangular chart for a 5-ft. width, chart 4.
2. Multiply Q by n to obtain Qn : $200 \times 0.025=5.00$.
3. From 5.00 on the Qn scale, move vertically to intersect the slope line, $S=0.015$, and at the intersection read $d_n=4.1$ ft.
4. Move horizontally from the intersection and read $Vn=0.24$ on the Vn scale. The normal velocity $V=Vn/n=0.24/0.025=9.6$ f.p.s.
5. Critical depth and critical velocity are independent of the value of n and their values can be read at the intersection of the critical curve with a vertical line through the discharge. For 200 c.f.s., on chart 4, $d_c=3.7$ ft. and $V_c=10.8$ f.p.s. The normal velocity, 9.6 f.p.s. (from step 4), is less than the critical velocity, and the flow is therefore subcritical. It will also be noted that the normal depth,

4.1 ft., is greater than the critical depth, 3.7 ft., which is also an indication of subcritical flow.

6. To determine the critical slope for $Q=200$ c.f.s. and $n=0.025$, start at the intersection of the critical curve and a vertical line through the discharge, $Q=200$ c.f.s., finding d_c (3.7 ft.) at this point. Follow along this d_c line to its intersection with a vertical line through $Qn=5.00$ (step 2), and at this intersection read the slope value $S_c=0.019$.

NOTE: The deleted material refers to a modification of Charts 1-14. These charts are not included in this excerpt.

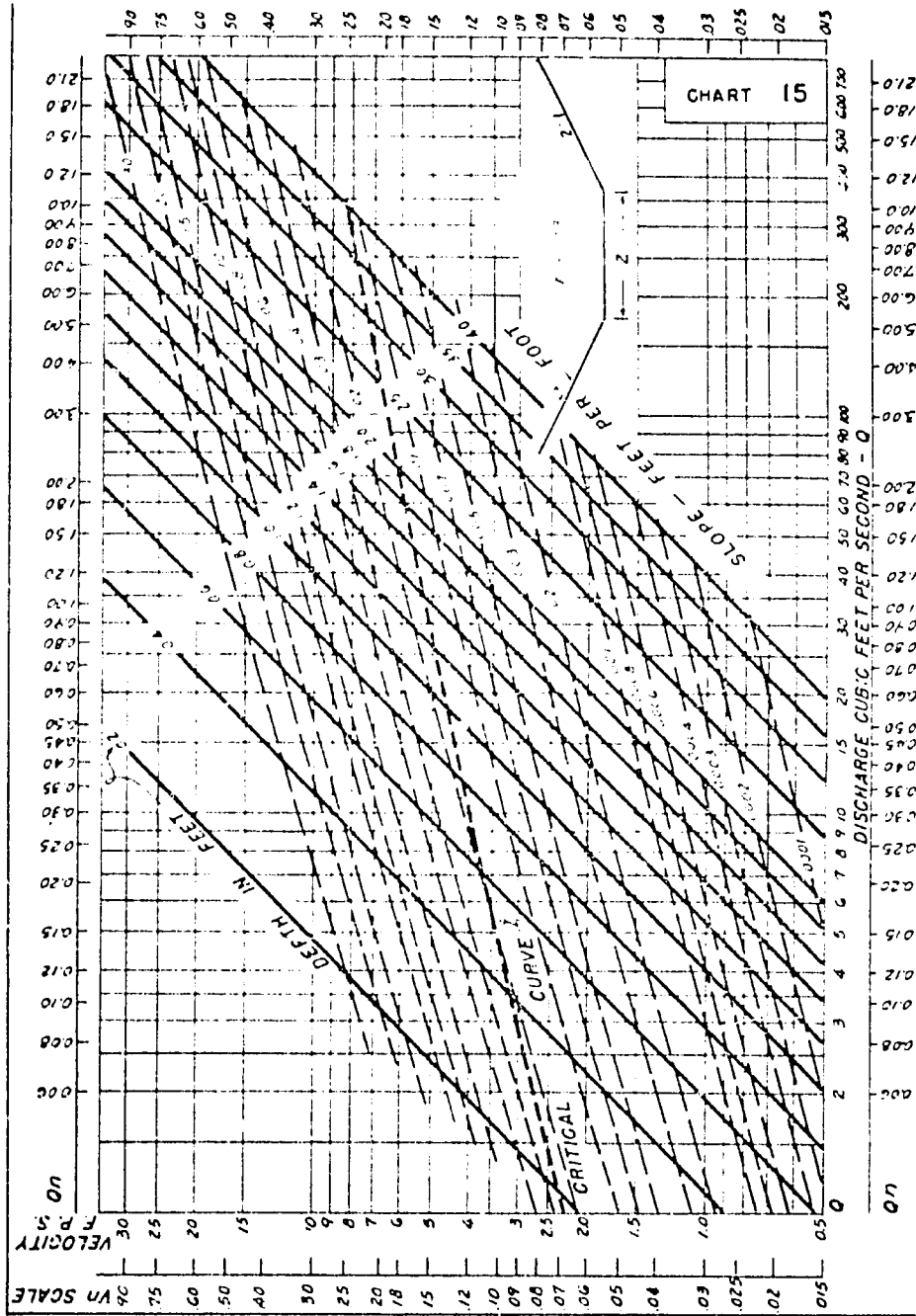

CHANNEL CHART
2:1 b = 2 FT.

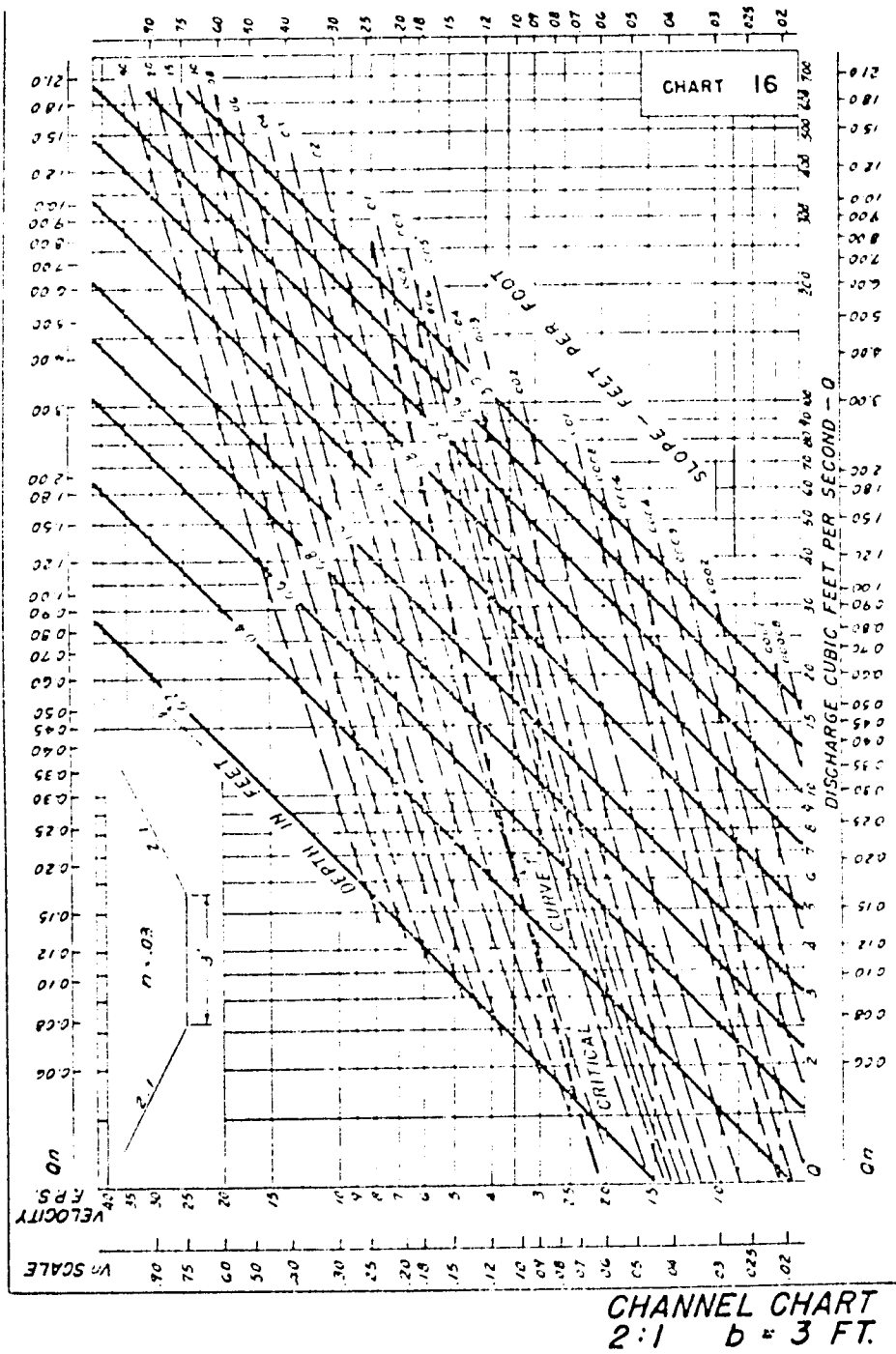

72

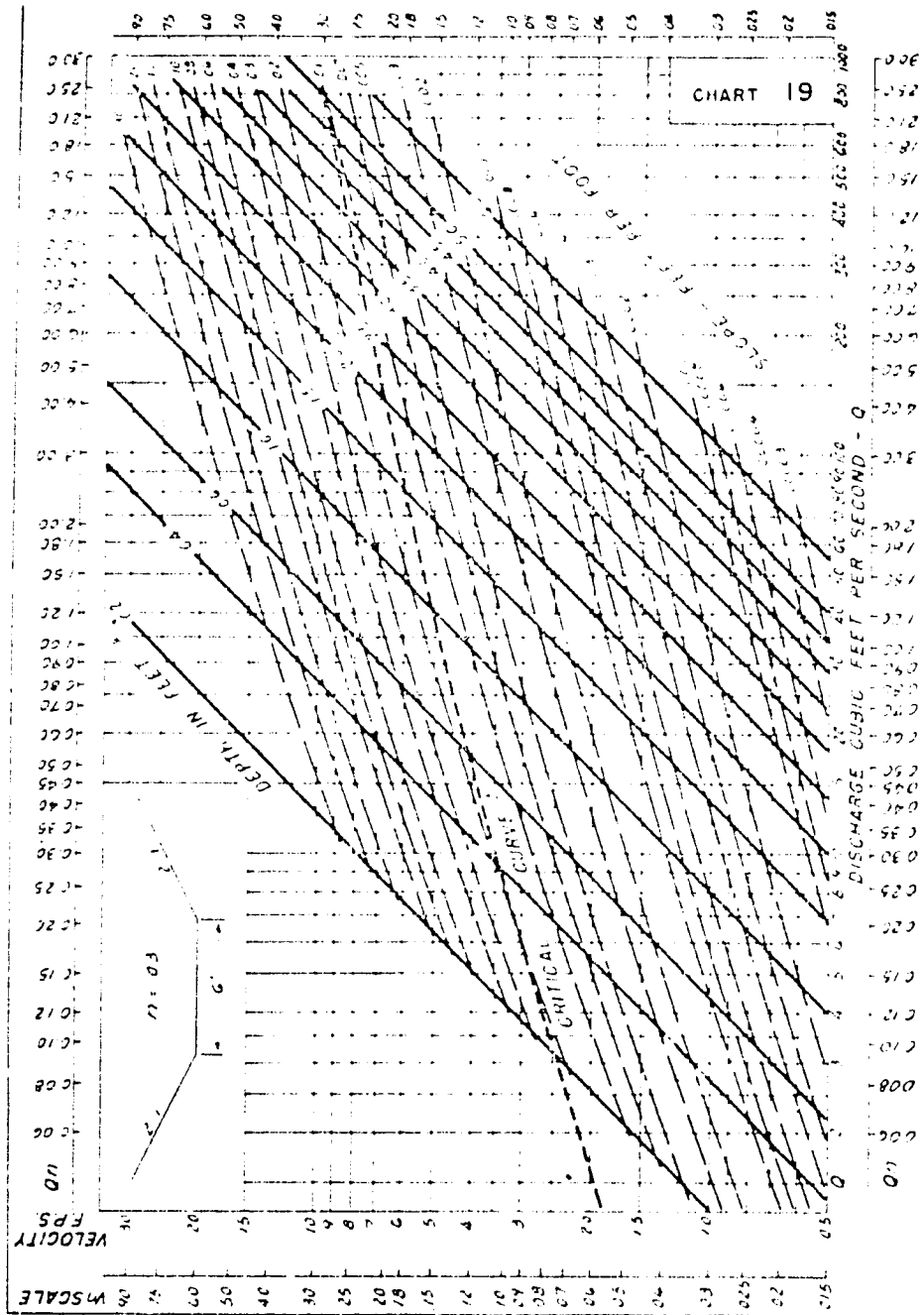

74

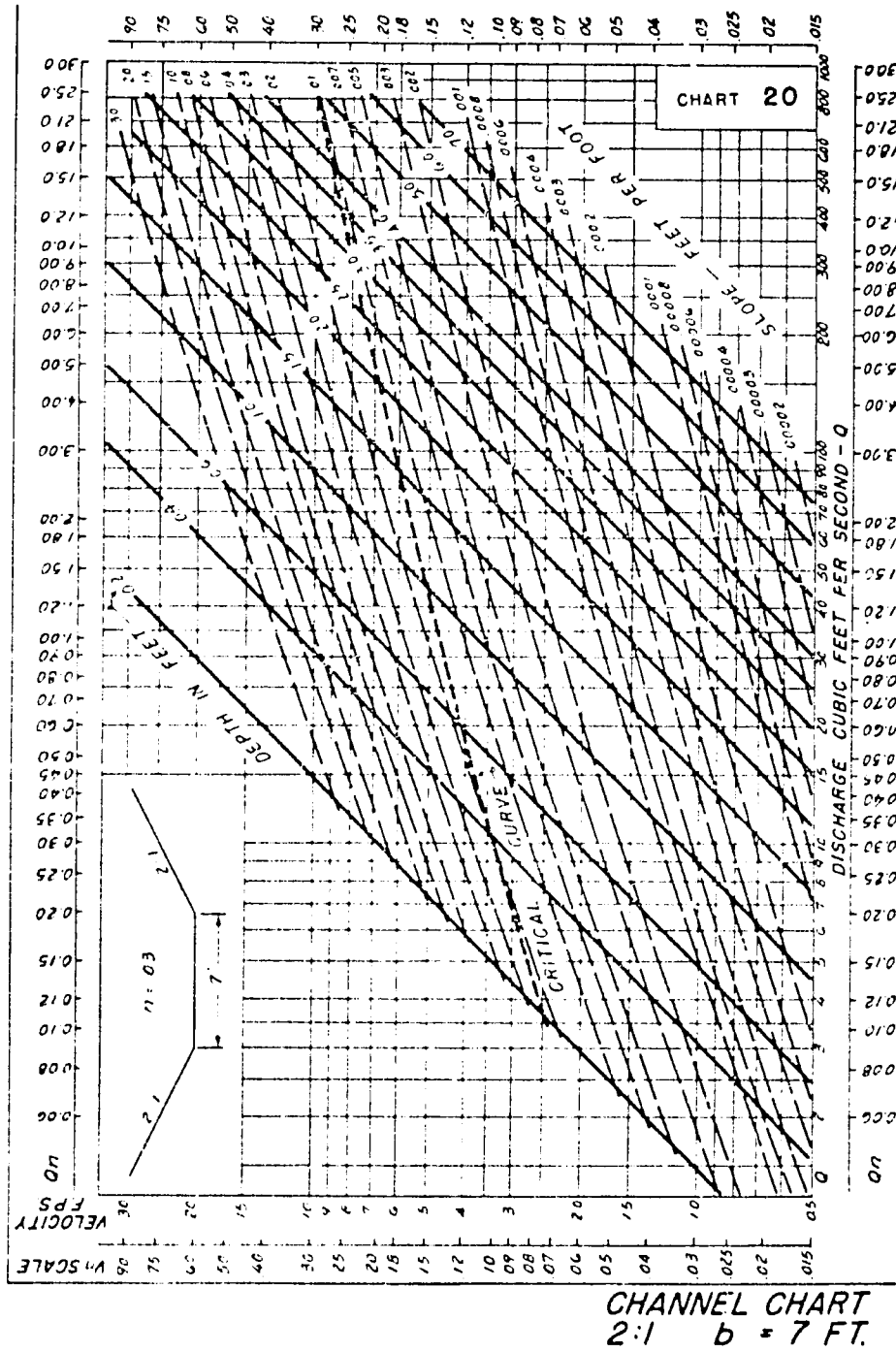

76

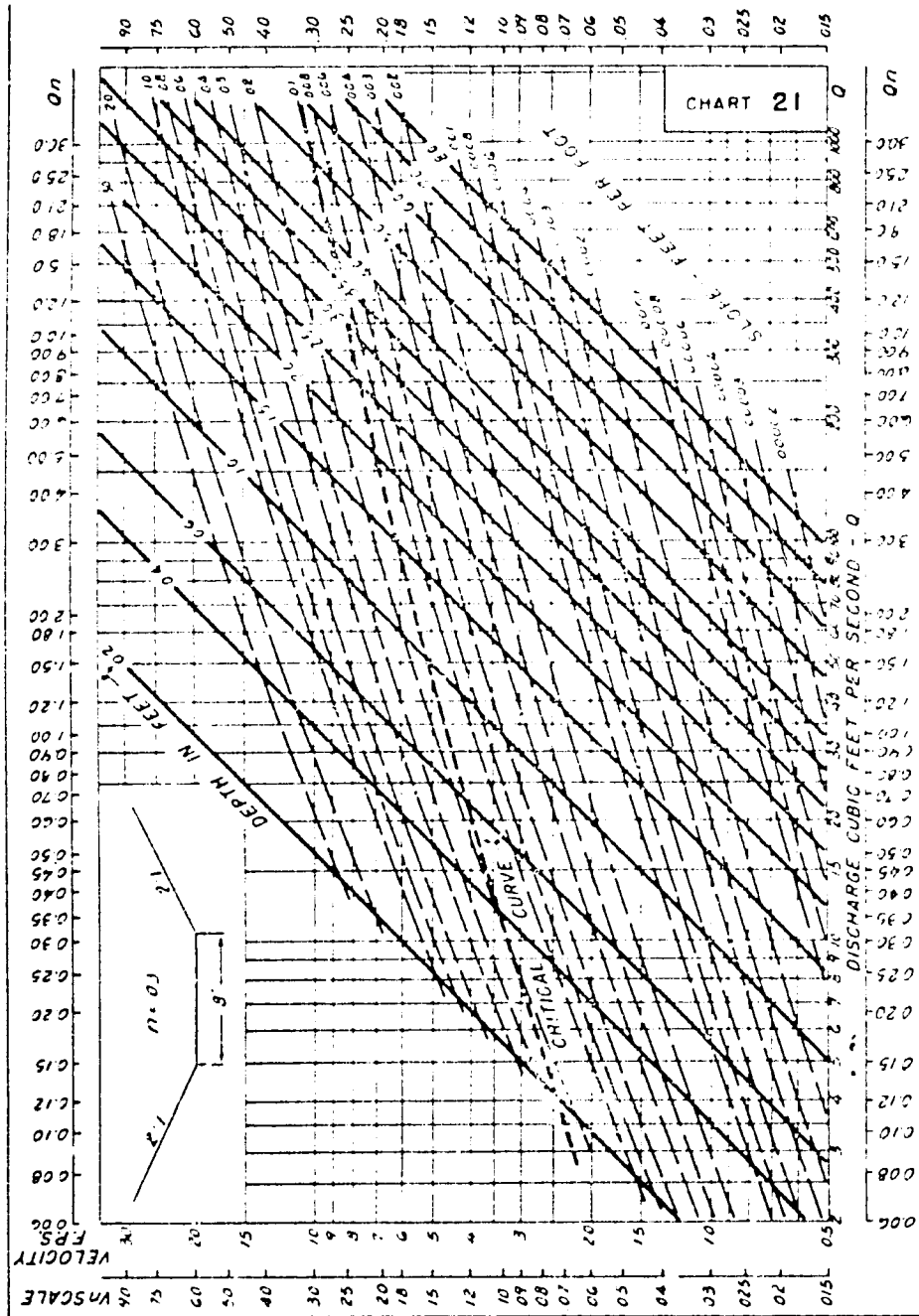

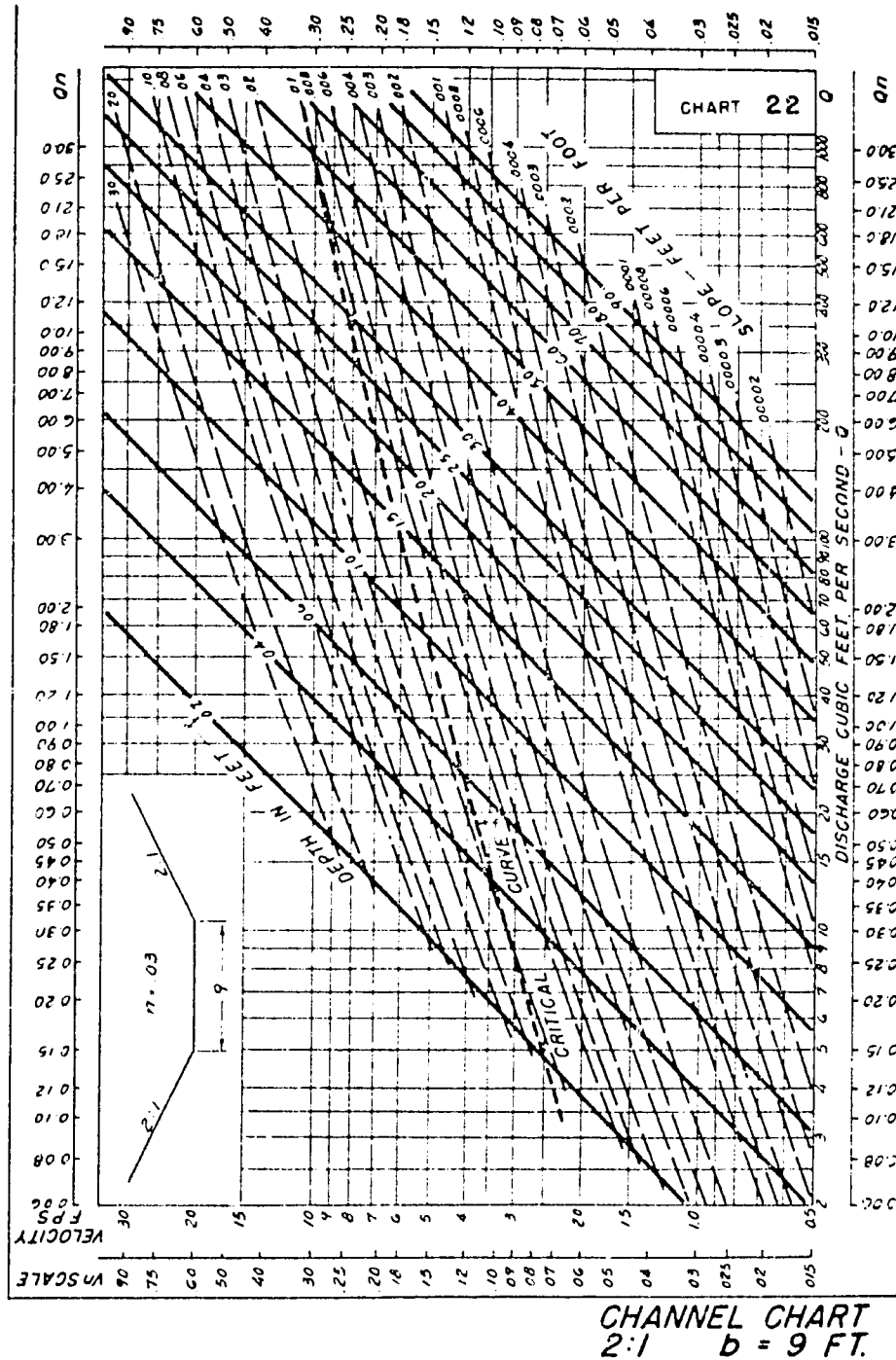

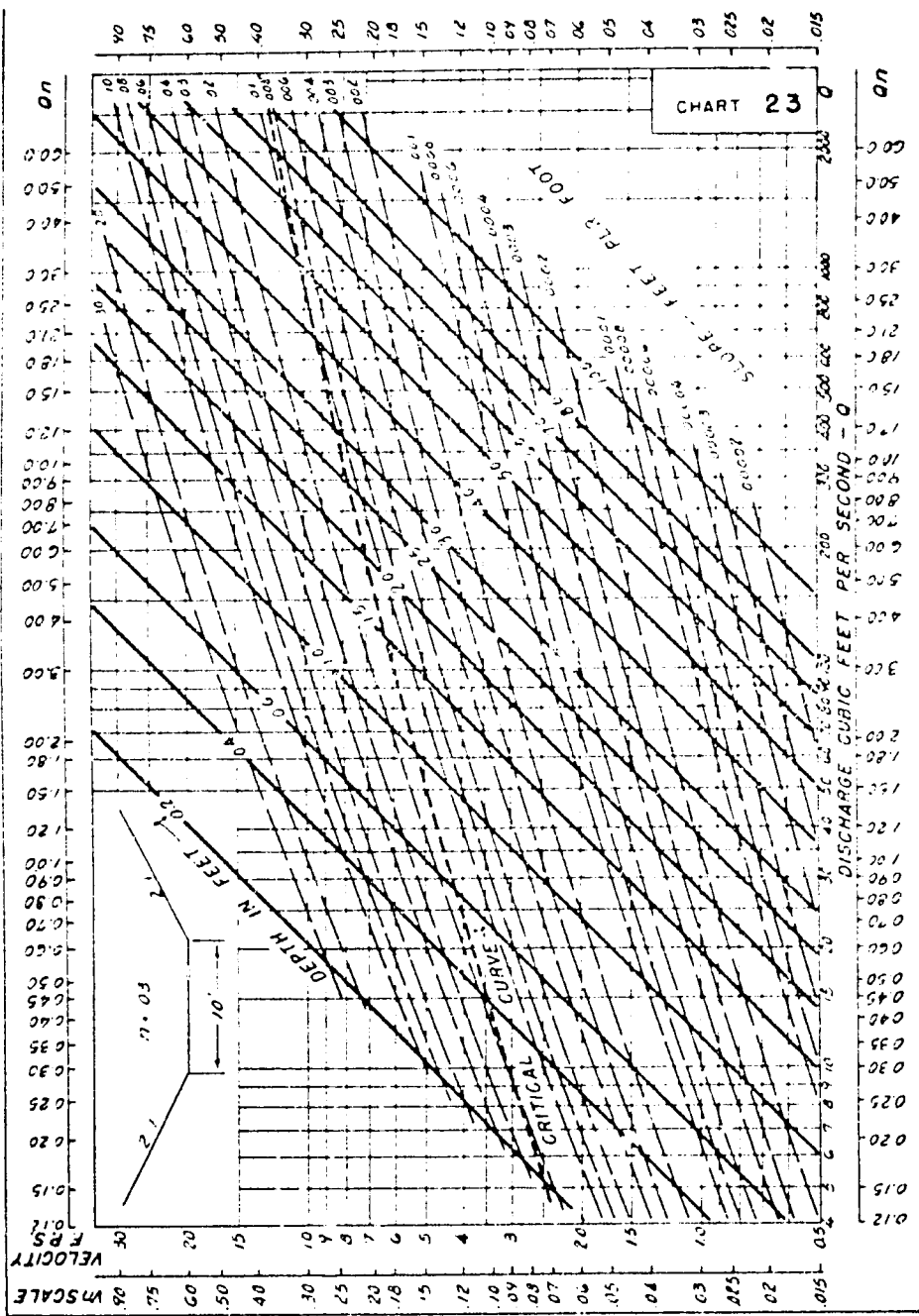

CHANNEL CHART
2:1 b = 10 FT.

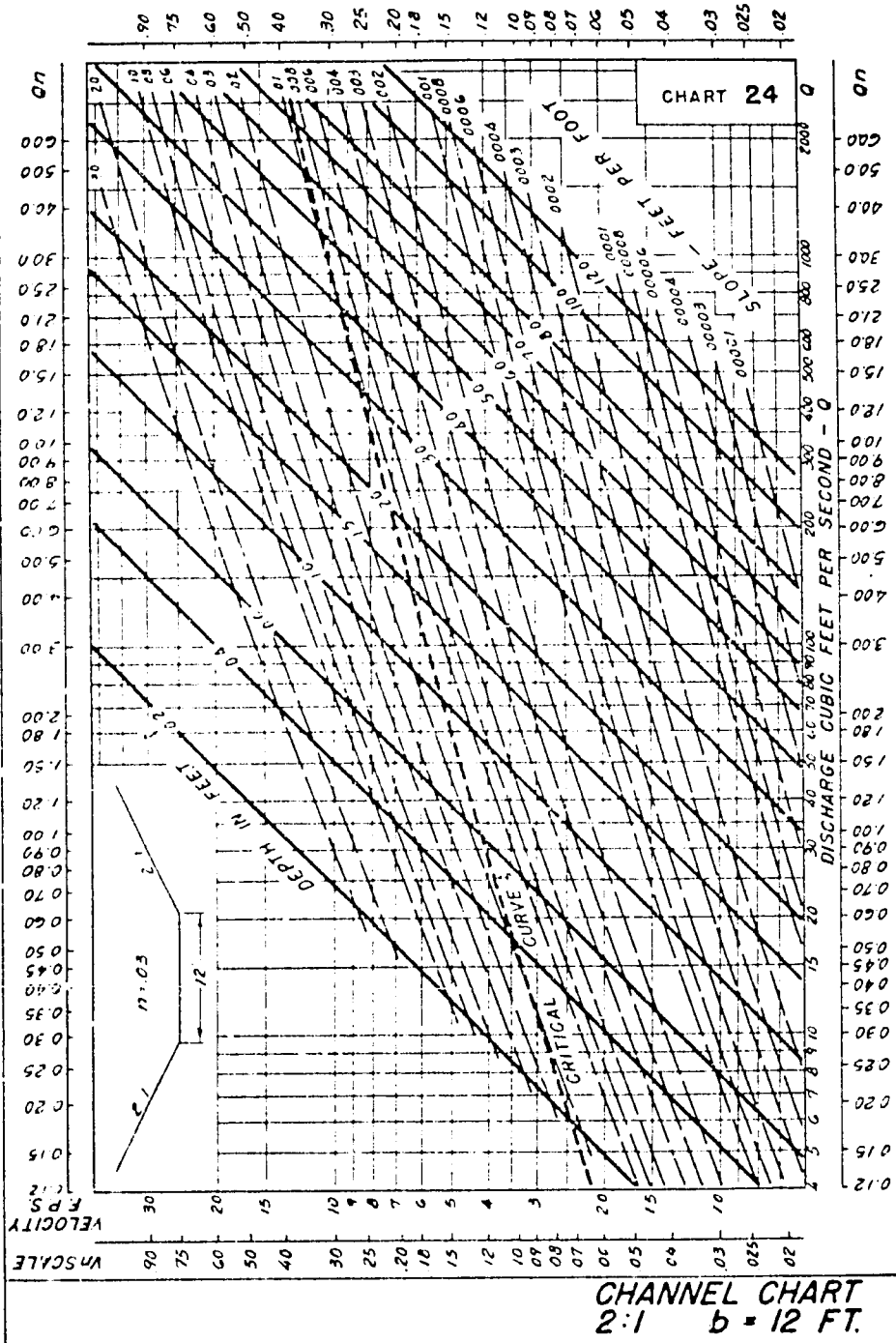

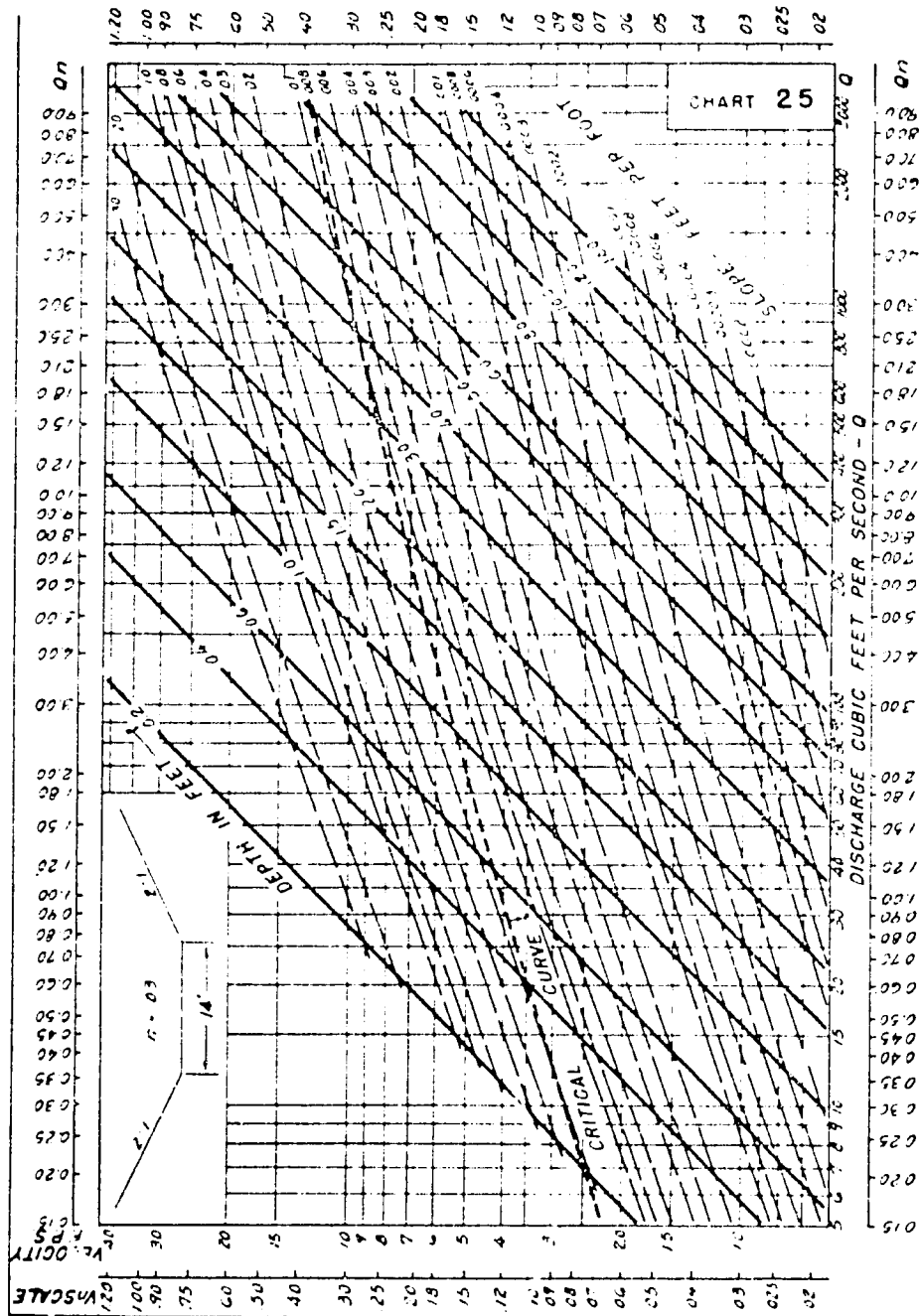

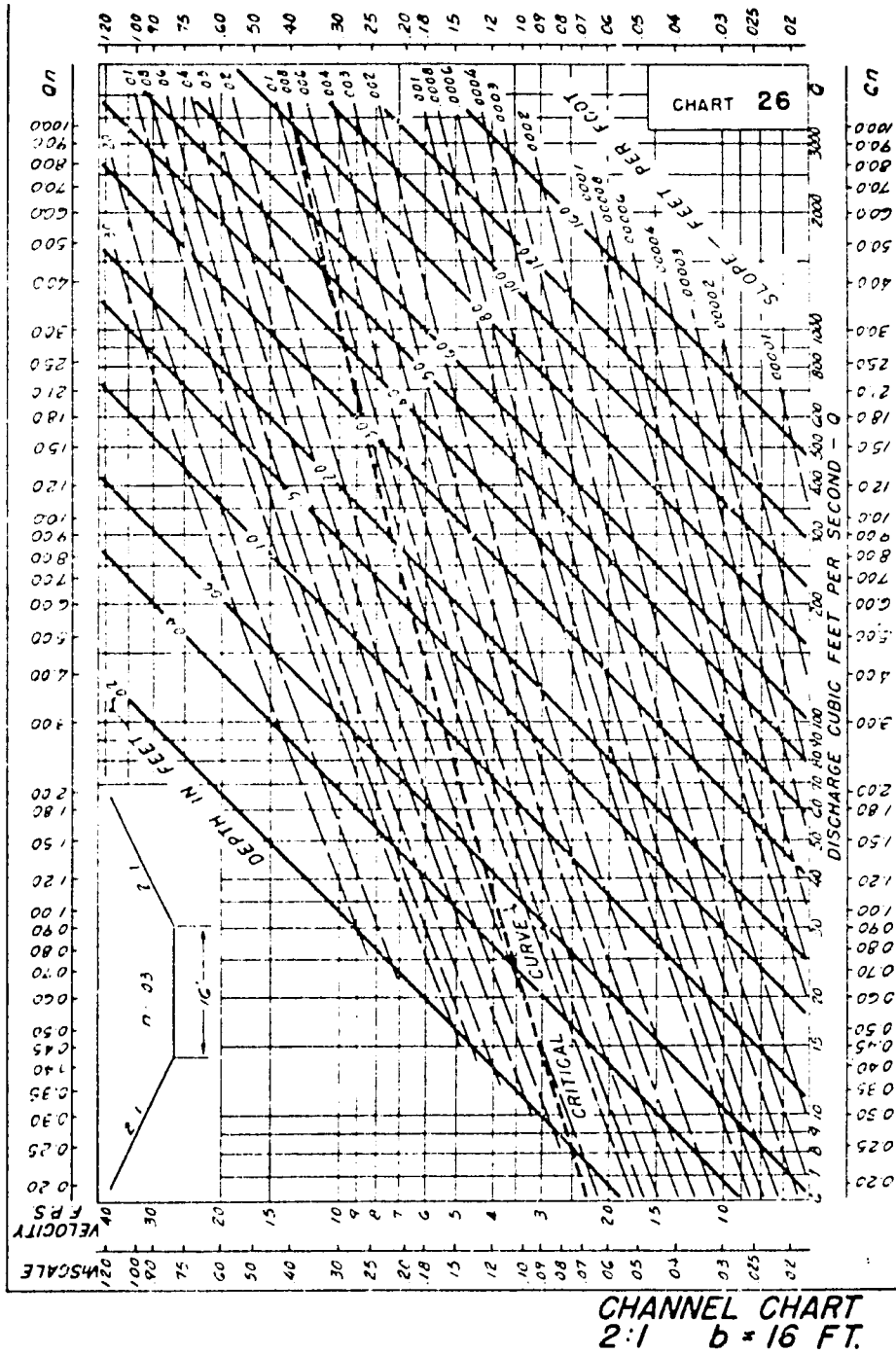

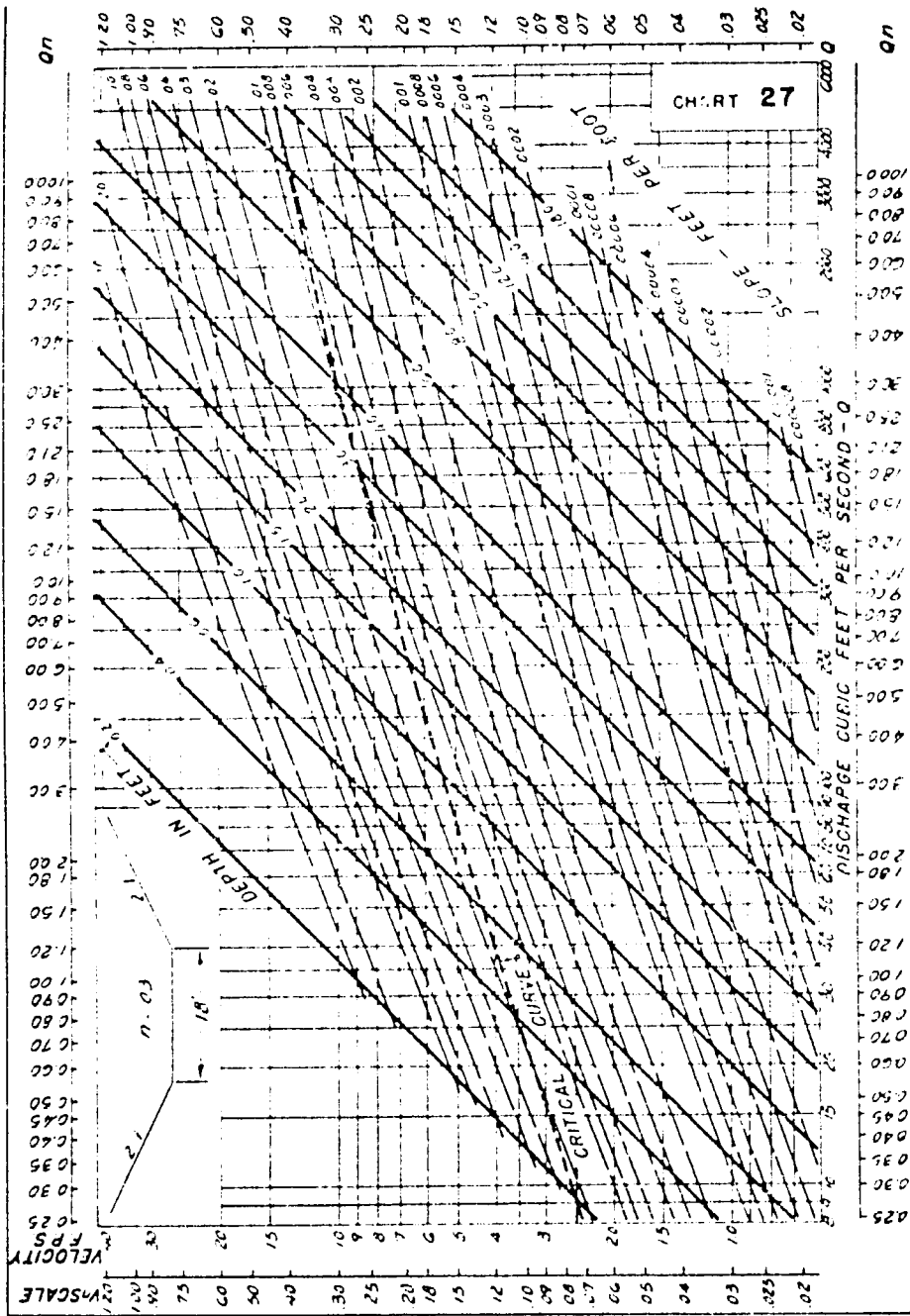

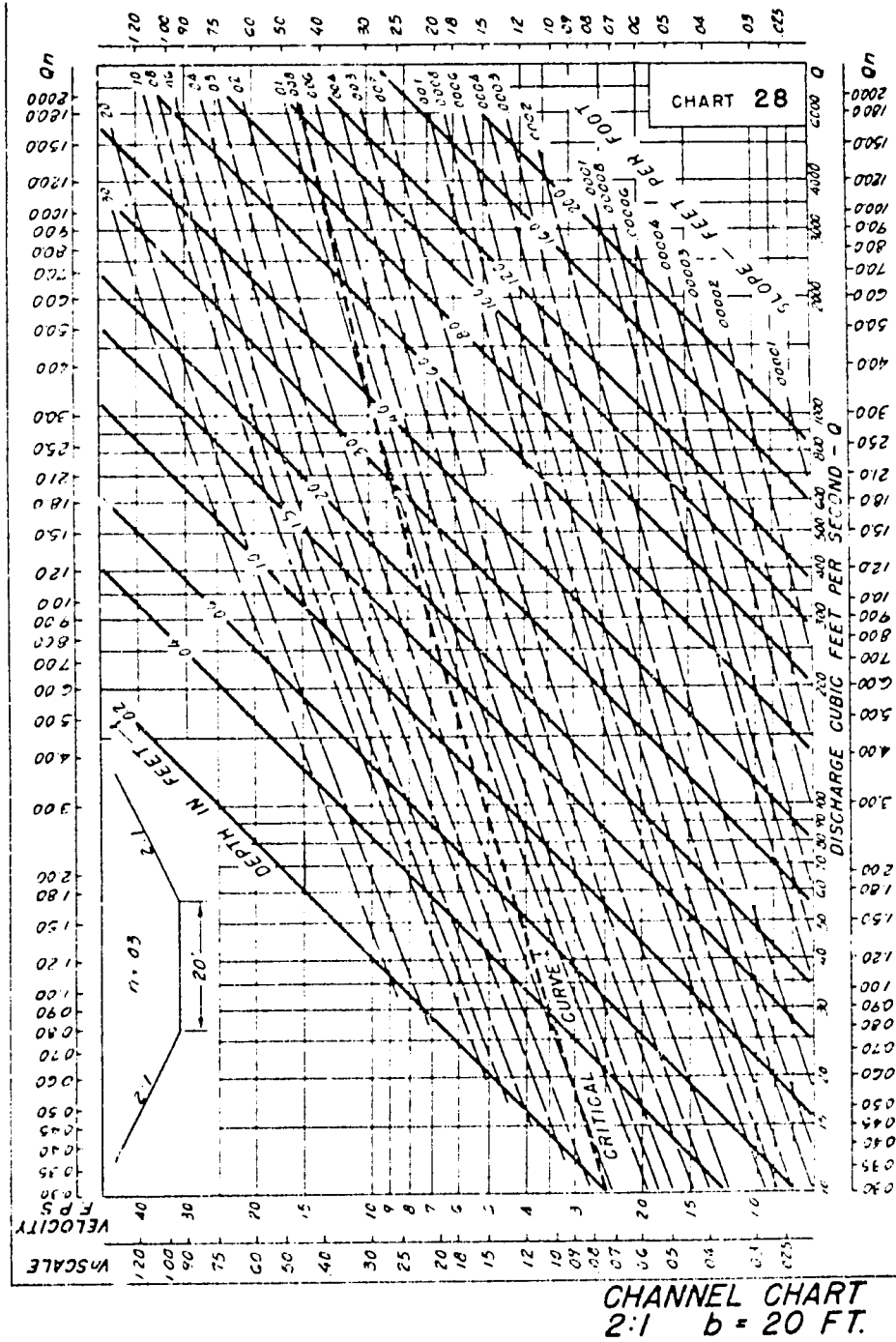

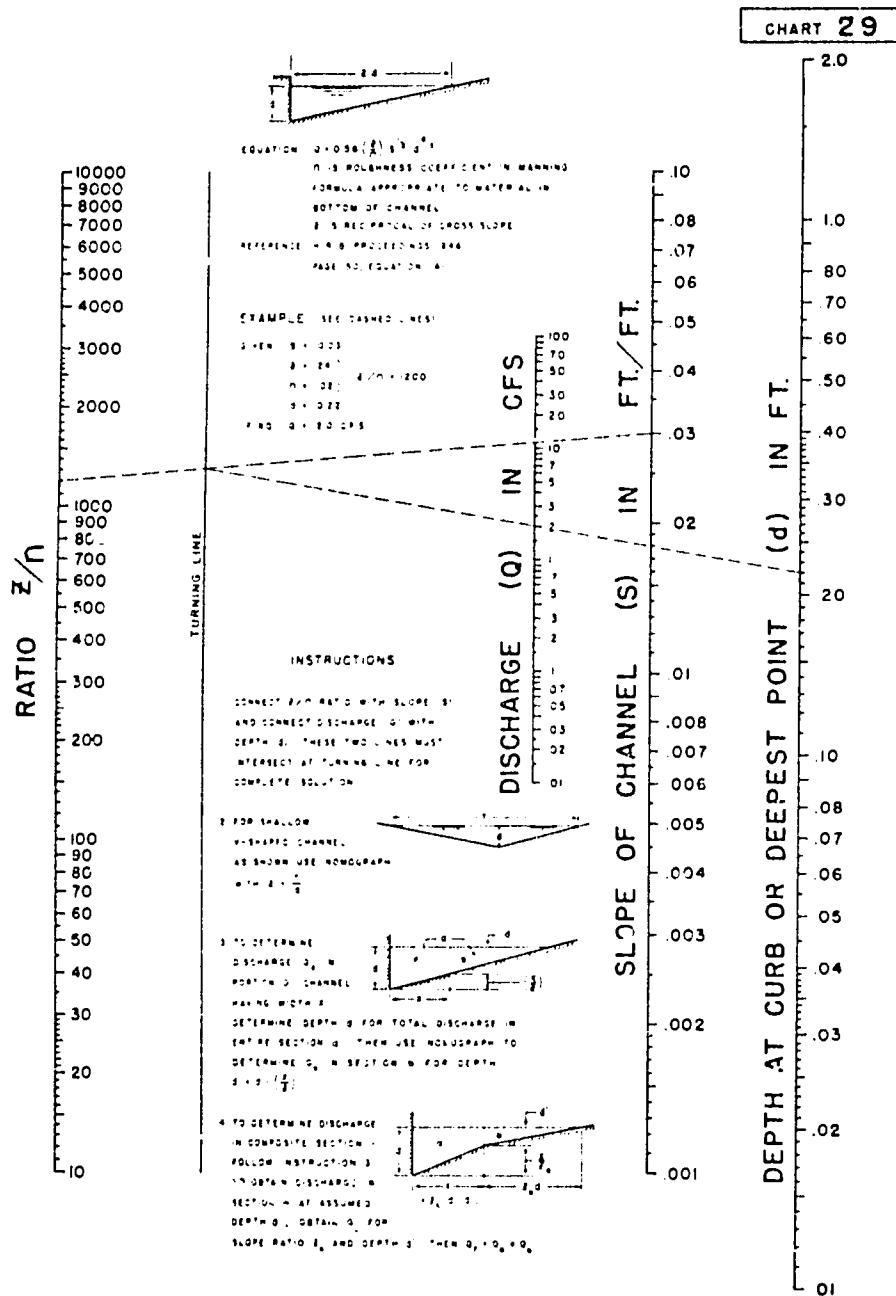

**NOMOGRAPH FOR FLOW
 IN TRIANGULAR CHANNELS**

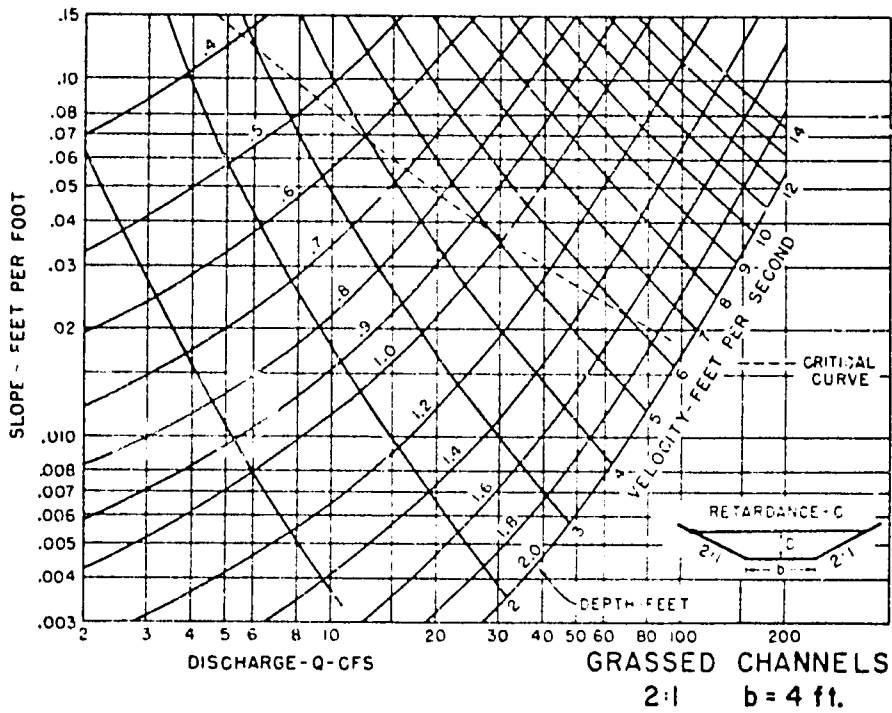
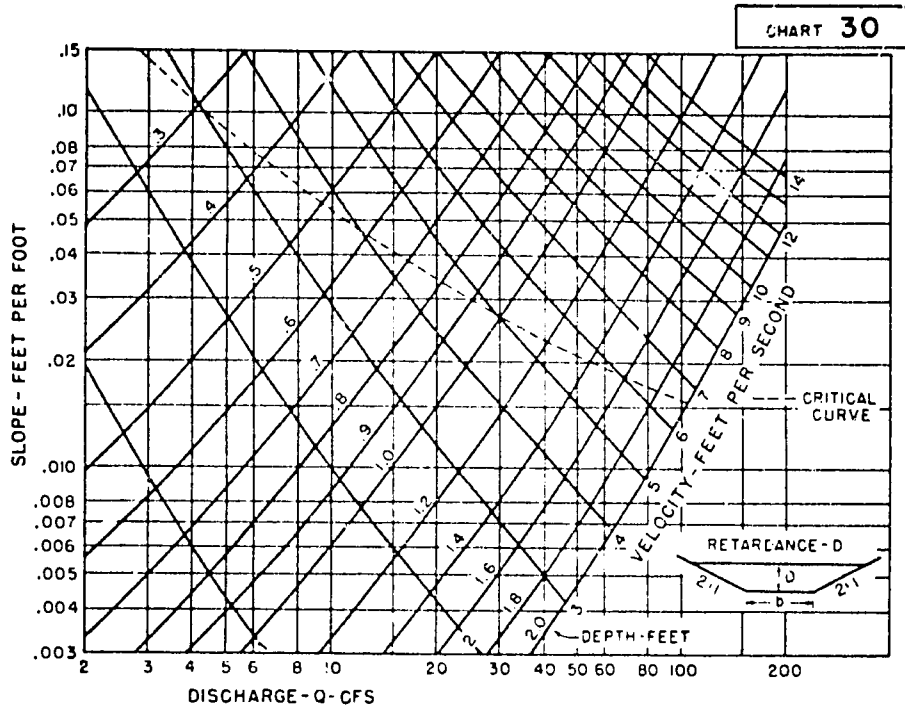

Appendix B.—CONSTRUCTION OF DESIGN CHARTS FOR OPEN-CHANNEL FLOW

B.1 Charts with Manning's *n* constant. Design charts for open-channel flow, such as those presented in chapter 3, are plotted on logarithmic paper. Each chart is constructed for a fixed cross section and a given value of Manning's *n* by the following steps. Table B-1 serves as an illustrative example. (See note at end of section.)

1. Prepare a table with column headings as shown in table B-1.
2. Tabulate desired increments of depth in the first column.
3. Compute *A*, *WP*, *R*=*A*/*WP*, *R*^{3/2}, *T*, and *d_m*=*A*/*T* for each depth.
4. Using Manning's equation,

$$V = \frac{1.49}{n} R^{2/3} S^{1/2}$$

and the given value of *n*, compute *V* for a slope of *S*=0.01, for each depth.

5. From the values of *V*, derived in step 4, compute values for *Q*=*AV*.

6. Compute values of *V* and *Q* for *S*=0.10 for each depth, by multiplying the tabulated values of *V* and *Q* for *S*=0.01 by the factor (0.10/0.01)^{1/2}=3.162. Similarly, compute values of *V* and *Q* for *S*=0.001 for each depth, by multiplying the tabulated values of *V* and *Q* for *S*=0.01 by the factor (0.001/0.01)^{1/2}=0.3162.

7. On logarithmic paper with a sufficient number of cycles, plot *V* against *Q* for *S*=0.01, 0.10, and 0.001. Note the value of the corresponding depth, using a small number written alongside each plotted point.

8. Draw a smooth curve through the points for each slope. A point not falling on this smooth curve presumably indicates that an error has been made either in computing or in plotting.

9. Draw straight lines through points of equal *d_m*. This provides another check on the accuracy of computing and plotting. These equal-depth lines must be straight, since the equation is *V*=*Q*/*A*, where *A* is a constant for a given depth.

10. The graph now has all the depth lines but only three slope lines. Other slope lines may be laid out by marking off a logarithmic scale along enough depth lines to define the slight curvature in the slope lines. The length of the log cycle is the distance between either two of the three slope curves already drawn, and will be the same along any depth line. A simple graphic device to obtain the logarithmic spacing for any length of cycle can be made by laying off a log scale along the leg of a right triangle with a long base line, and then drawing straight lines from the divisions on the scale to the opposite vertex. The spacing of these lines along any line laid across them will be logarithmic and it is merely necessary to position the triangle so that the distance from the base to a point on the hypotenuse corresponds to the length of cycle desired.

11. Critical curves are an essential part of the charts. For plotting points, compute, for each depth, *gd_m*=32.2 *d_m* and tabulate (—*d_m* has already been tabulated in the table.) Next compute, for each depth, *V_c*=(*gd_m*)^{1/3}.

Table B-1.—Sample computations for channel-flow chart: Trapezoidal channel, 1:1 side slopes, 10-foot bottom width, *n*=0.03

<i>d</i>	<i>A</i>	<i>WP</i>	<i>R</i>	<i>R</i> ^{3/2}	<i>T</i>	<i>d_m</i>	For <i>S</i> =0.01		For <i>S</i> =0.10		For <i>S</i> =0.001		Critical curve	
							<i>V</i>	<i>Q</i>	<i>V</i>	<i>Q</i>	<i>V</i>	<i>Q</i>	<i>gd_m</i>	<i>V_c</i>
0.2	2.74	10.57	0.193	0.334	10.4	0.1922	1.65	3.37	5.25	16.7	0.523	1.07	6.318	2.51
4	4.14	11.13	374	519	19.5	3652	2.57	10.7	8.13	33.8	1.13	3.38	17.40	7.52
6	6.36	11.70	544	666	11.2	679	3.36	21.0	16.4	66.4	1.64	4.94	18.79	4.28
1.0	11.60	12.83	827	952	12.6	9167	4.47	49.1	14.1	155	1.41	15.5	29.52	5.43
1.5	17.25	14.74	1211	1337	13.6	1327	5.63	97.2	17.8	367	1.74	30.7	42.73	6.54
2.0	24.00	15.66	1533	1530	14.0	1714	6.59	158	20.5	590	2.08	50.0	55.19	7.43
2.5	31.25	17.07	1831	1497	15.0	2083	7.42	232	23.4	733	2.34	73.3	67.07	8.19
3.0	39.00	18.48	2110	1545	16.0	2438	8.15	315	25.5	1,099	2.56	100	78.50	8.86
3.5	47.25	19.90	2379	1579	17.0	2779	8.81	416	27.9	1,326	2.79	132	89.48	9.46
4.0	56.00	21.31	2627	1604	18.0	3111	9.43	528	29.8	1,670	2.98	167	100.2	10.0
5.0	75.00	24.14	3107	2129	20.0	3750	10.5	791	33.3	2,500	3.34	250	120.8	11.0
6.0	96.00	26.97	3460	2331	24.0	4364	11.5	1,110	36.5	3,510	3.65	350	140.5	11.8
7.0	119.0	29.80	3925	2517	28.0	4958	12.5	1,480	39.4	4,690	3.94	469	159.6	12.6
8.0	144.0	32.63	4414	2691	28.0	5538	13.3	1,920	42.2	6,070	4.22	607	178.3	13.4
10.0	200.0	38.28	5224	3011	30.0	6667	14.9	2,960	47.2	9,430	4.72	943	214.7	14.6

Plotting points of intersection of $V = V_c$ with respective depth lines locates the critical curve.

12. The usefulness of the chart may be expanded by adding scales along the ordinate and the abscissa, corresponding to the products Vn and Qn , respectively. It must be borne in mind, however, that the critical curve may be used only with the value of n for which the chart was drawn.

Note. Computations in steps 3 and 4 for many channel sections can be found in the Corps of Engineers' *Hydraulic Tables* and the Bureau of Reclamation *Hydraulic and Excavation Tables*.¹

B.2 Charts for grassed channels with n variable. Design charts for open-channel flow in grassed channels, such as those presented in chapter 4, are computed by the Manning equation with n varying as a function of VR (see fig. 5, p. 38). On these charts the ordinate is channel slope S and the abscissa is discharge Q . For a given cross section, each depth and velocity curve must be computed separately according to the following steps. Table B-2 serves as an illustrative example.

1. Prepare table with column headings as shown in table B-2. Select desired increments of depth. A separate table is required for each depth.

2. For each depth d , compute A , WP , $R = A/WP$, T , $d_m = A/T$, R^2 , and $(1.49R^2)^2$. Arrange these constants at the top of the table.²

3. Select desired increments of velocity, usually 0.5 f.p.s. and 1 to 10 f.p.s. by units of one, and list in the first column of the table.

4. Replot the appropriate retardance curve from figure 5 on logarithmic paper. The purpose of this is to obtain consistent readings of n , so that the velocity curves to be plotted later will be smooth curves. (This does not mean, however, that velocities determined in the completed graph are actually that accurate since the true value of retardance may vary considerably.)

5. For each selected depth (that is, in each table being computed for a selected increment of d):

5a. Compute VR for each velocity V , and tabulate.

5b. From the retardance curve plotted as step 4, read and tabulate n for each value of VR .

5c. Compute $(Vn)^2$.

5d. Compute and tabulate $S = (Vn)^2 / (1.49R^2)^2$. The denominator has already been computed as one of the constants.

5e. Compute and tabulate $Q = AV$.

6. Select logarithmic graph paper having sufficient cycles to cover the desired range of Q and S , and for each depth:

6a. Plot S against Q for each velocity; label each plotted point with the corresponding value of V .

Table B-2.—Computations for grassed channel:¹ Trapezoidal channel, 8:1 side slopes, $b=4$, retardance C

CONSTANTS					
$d=0.8$		$R=0.491$		$RP=0.621$	
$A=4.32$		$T=16.84$		$(1.49R^2)^2=0.857$	
$WP=16.94$		$d_m=0.424$			
V	VR	n	$(Vn)^2$	S	Q
<i>F.p.s.</i>	<i>Ft. Mins.</i>			<i>Ft./ft.</i>	<i>Cfs.</i>
0.5	0.246	0.225	0.0127	0.0148	4.16
1	.491	.135	.0182	.0212	8.32
2	.982	.084	.0262	.0317	16.6
3	1.473	.067	.0404	.0471	25.0
4	1.964	.057	.0520	.0607	33.3
5	2.455	.052	.0676	.0789	41.6
6	2.946	.047	.0756	.0928	49.9
7	3.437	.044	.0849	.111	58.2
8	3.928	.043	.1183	.138	66.6
9	4.419	.041	.1323	.174	74.9
10	4.910	.040	.1600	.187	83.2
$V_c=3.99$	1.96	0.057	0.0517	0.0903	33.20

Similar computations must be made for each selected depth.

6b. Draw a curve for each depth through the plotted points. This should be a smoothly curving line. A point not falling on the curve presumably indicates that an error has been made either in computing or in reading the n values.

7. Connect lines of equal velocity, which again should be smoothly curving lines. Points will not fit perfectly because of minor discrepancies in reading the retardance curve, but wide variations indicate major errors in computation.

9. Critical slope is calculated for each depth as follows; the computed values being entered across the bottom of the table as shown in table B-2:

9a. Compute $V_c = (gd_m)^{1/2}$.

9b. Compute $V_c R$.

9c. Read from the retardance curve the value of n for $V_c R$.

9d. Solve for slope S_c as in step 5d.

9e. Compute $Q_c = AV_c$.

9. Plot critical slope S_c against Q_c for each depth, and draw a smooth curve through the points.

10. Examine the plotted curves for consistency. If equal increments of depth and velocity have been used, curves should show a systematic change in spacing, becoming closer as depth increases or velocity increases, as the case may be. At any point of intersection of depth and velocity curves, the product AV must equal the value of Q read for that point.

11. Changes in retardance must be taken into account. Unlike the open-channel charts for a fixed value of n , where a single chart may be used for other values of n , the grassed channel chart must be replotted for a different retardance. However, only two additional columns are required in the computation table: the n for the new retardance and the solution for S as in step 5d. The new S is then plotted against Q as previously calculated (in step 5e), to obtain a new set of curves for this retardance.

¹ See footnote 1, p. 3.
² The value $(1.49R^2)^2 = 2.202R^4$. A table of values for the reciprocal of the latter will be found in *Handbook of Hydraulics, for the Solution of Hydraulic Problems*, by H. W. King, revised by E. F. Brater, McGraw-Hill Book Co., 1954. (See table 107 in 3d edition or table 91 in 4th edition.)



Ditch banks constructed of *Ipomoea* stakes, Kenya (Photo courtesy of TRRL, U.K.)

HANDBOOK OF HYDRAULICS

FOR THE SOLUTION OF
HYDRAULIC PROBLEMS

BY
HORACE WILLIAMS KING

REVISED BY
ERNEST F. BRATER
PROFESSOR OF HYDRAULIC ENGINEERING
UNIVERSITY OF MICHIGAN

NOTE: This text has been reproduced with the permission of McGraw-Hill Book Company. Copyright © 1954 by the McGraw-Hill Book Company.

FOURTH EDITION

McGRAW-HILL BOOK COMPANY, INC.
NEW YORK TORONTO LONDON
1954

CONTENTS

	PAGE
Preface	v
List of Tables	xiii
Section 1	
Fluid Properties and Hydraulic Units	
Fluid properties	1-1
Hydraulic units.	1-5
Tables.	1-8
Section 2	
Hydrostatics	
Fluid pressure	2-1
Atmospheric pressure	2-2
Manometers	2-4
Pressure forces on plane surfaces	2-7
Pressure forces on curved surfaces	2-11
Pressures on spillway sections of dams.	2-14
Pressure under dams on rock foundations	2-15
Pressure under dams on earth foundations.	2-17
Hydrostatic tables	2-22
Section 3	
Orifices, Gates, and Tubes	
Contraction of the jet.	3-1
Fundamental equations	3-3
Orifice coefficients	3-4
Path of jet	3-7
Head lost in orifice	3-8
Orifices under low heads.	3-8
Discharge under falling head.	3-9
Velocity of approach	3-10
Submerged orifices	3-11
Gates	3-11
Pipe orifices	3-15
Venturi meters.	3-16

viii	CONTENTS	PAGE
	Cavitation	3-18
	Short tubes	3-19
	Nozzles	3-21
	Culverts	3-22
	Short siphons	3-26
	Tables for orifices, gates, tubes, and culverts.	3-28

Section 4

Sharp-crested Weirs

Contraction of the nappe	4-1
Velocity of approach	4-3
Rectangular weirs with free discharge	4-4
Fundamental formulas	4-4
Experiments on sharp-crested rectangular weirs	4-5
Formulas for sharp-crested rectangular weirs	4-7
Discussion of weir formulas	4-8
Measurement of head	4-12
Solution of weir formulas	4-12
V-notch weirs	4-13
Trapezoidal weirs	4-15
The Cipolletti weir	4-15
Choice of weir	4-16
Submerged sharp-crested weirs	4-17
Tables for solving weir formulas	4-21

Section 5

Weirs Not Sharp Crested

Formula	5-1
Modifications of nappe form	5-3
Broad-crested weirs	5-4
Modifications of broad-crested weirs	5-5
Weirs of triangular section	5-6
Weirs of trapezoidal section	5-7
Weirs of irregular section	5-8
Spillways	5-10
Weirs for measuring stream flow	5-10
Falls and drops	5-11
Tables of weir coefficients	5-12

Section 6

Pipes

Fundamental principles	6-2
Loss of energy due to friction	6-4

CONTENTS	ix
	PAGE

Laminar flow in pipes	6-5
Turbulent flow in pipes	6-8
The Manning formula	6-12
Minor losses	6-14
Loss of head at entrance	6-15
Loss of head due to enlargement	6-15
Loss of head due to contractions	6-17
Loss of head due to gate valves	6-18
Loss of head due to bends	6-18
Compound pipes	6-19
Water hammer	6-21
Tables to assist in solution of pipe problems	6-28

Section 7

*** Open Channels with Uniform Flow**

Characteristics of open-channel flow	7-1
Elements of a cross section	7-2
Sectional forms	7-3
Most efficient section	7-6
Energy and head	7-7
Momentum	7-9
Velocity head and momentum corrections	7-9
Losses of head	7-13
Open-channel formulas	7-14
The Chezy formula	7-15
The Kutter formula	7-15
The Manning formula	7-19
The Bazin formula	7-21
Application of Manning formula	7-26
Discharge factor	7-26
Solution of problems by Manning formula	7-28
Nonsilting velocities	7-30
Noneroding velocities	7-31
Laminar flow with a free surface	7-33
* Tables	7-36

Section 8

Open Channels with Nonuniform Flow

Rapidly varied flow	8-2
Constant-discharge relations	8-3
Constant-energy relations	8-4
Analytical solutions of constriction problems	8-5

CONTENTS

	PAGE
Tables for solving constriction problems	8-6
Critical depth—general case	8-7
Critical depth in rectangular channels	8-8
Critical depth in triangular channels	8-9
Critical depth in parabolic channels	8-10
Critical depth in trapezoidal sections	8-11
Critical depth in circular channels	8-13
Critical-depth meters	8-14
Critical slope	8-16
Increase of slope or section	8-17
The fall	8-19
Channel entrance	8-21
Hydraulic jump	8-23
Force equation	8-25
Hydraulic jump computations	8-26
Jump in rectangular channels	8-27
Transitions	8-28
Transitions with all depths above critical	8-29
Obstructions	8-31
Transition through critical depth without jump	8-33
Gradually varied flow	8-34
Equations of gradually varied flow and generalized profiles	8-34
Methods of computing water-surface profiles	8-37
Short channels	8-39
Chute	8-41
Flow over very steep inclines	8-42
Position of jump	8-44
Translatory waves	8-47
Sudden increases of stage	8-47
Abrupt waves in rectangular channels	8-50
Examples of abrupt waves	8-51
Sloping waves	8-53
Influence of frictional loss on waves	8-56
Hydraulics of natural streams	8-57
Backwater curve	8-61
Leach's backwater method	8-65
Tables	8-68

Section 9

Measurement of Flowing Water

Velocities in open channels	9-1
---------------------------------------	-----

CONTENTS

	PAGE
Vertical velocity curves	9-1
Velocities in pipes	9-4
Methods of measuring discharge	9-4
The current meter	9-7
Rating the current meter	9-8
Current-meter measurements	9-9
The pitot tube	9-13
Floats	9-17
Traveling screen	9-19
The color method	9-20
The salt-velocity method	9-21
The Gibson method	9-22
Venturi meter	9-24
Pipe orifices	9-29
Standardized nozzles	9-33
California-pipe method	9-33
Venturi flume	9-34
Control meter	9-37
Contracted opening	9-39
Chemical gaging	9-40

Section 10

Tables

Use of logarithms	10-1
Logarithmic and other tables	10-4

Index

OPEN CHANNELS WITH UNIFORM FLOW 7-53

Table 92. Square Roots of Decimal Numbers

Number	---0	---1	---2	---3	---4	---5	-- 6	-- 7	---8	---9
.0001	.003162	.00317	.003184	.003196	.003207	.003218	.003229	.003240	.003251	.003262
.0002	.004472	.004483	.004495	.004506	.004517	.004528	.004539	.004550	.004561	.004572
.0003	.005477	.005488	.005499	.005510	.005521	.005532	.005543	.005554	.005565	.005576
.0004	.006425	.006433	.006441	.006449	.006457	.006465	.006473	.006481	.006489	.006497
.0005	.007071	.007141	.007211	.007281	.007351	.007421	.007491	.007561	.007631	.007701
.0006	.007746	.007810	.007874	.007937	.008000	.008062	.008124	.008185	.008246	.008307
.0007	.008367	.008426	.008485	.008544	.008602	.008660	.008718	.008775	.008832	.008888
.0008	.008944	.009000	.009055	.009110	.009165	.009220	.009274	.009327	.009381	.009434
.0009	.009487	.009539	.009592	.009644	.009695	.009747	.009798	.009849	.009899	.009950
.0010	.010000	.010050	.010100	.010149	.010198	.010247	.010296	.010344	.010392	.010440
.0011	.010488	.010536	.010584	.010631	.010678	.010725	.010772	.010819	.010865	.010912
.0012	.010958	.011004	.011050	.011096	.011141	.011187	.011232	.011277	.011322	.011367
.0013	.011411	.011456	.011501	.011546	.011591	.011635	.011679	.011723	.011767	.011811
.0014	.011855	.011898	.011942	.011985	.012028	.012071	.012114	.012157	.012200	.012242
.0015	.012285	.012327	.012369	.012411	.012453	.012495	.012537	.012578	.012620	.012661
.0016	.012703	.012744	.012785	.012826	.012867	.012907	.012948	.012988	.013028	.013068
.0017	.013108	.013148	.013188	.013228	.013268	.013307	.013347	.013386	.013426	.013465
.0018	.013505	.013544	.013583	.013622	.013661	.013700	.013739	.013778	.013816	.013855
.0019	.013894	.013932	.013970	.014008	.014046	.014084	.014122	.014160	.014198	.014236
.0020	.014274	.014311	.014348	.014385	.014422	.014459	.014496	.014533	.014570	.014607
.0021	.014644	.014681	.014717	.014754	.014791	.014827	.014864	.014900	.014937	.014973
.0022	.015009	.015045	.015081	.015117	.015153	.015189	.015225	.015261	.015296	.015332
.0023	.015367	.015403	.015438	.015474	.015509	.015545	.015580	.015615	.015651	.015686
.0024	.015721	.015756	.015791	.015826	.015861	.015896	.015931	.015966	.016001	.016036
.0025	.016071	.016105	.016140	.016175	.016210	.016245	.016280	.016315	.016350	.016385
.0026	.016419	.016454	.016489	.016524	.016559	.016594	.016629	.016664	.016699	.016734
.0027	.016769	.016803	.016838	.016873	.016908	.016943	.016978	.017013	.017048	.017083
.0028	.017118	.017152	.017187	.017222	.017257	.017292	.017327	.017362	.017397	.017432
.0029	.017467	.017501	.017536	.017571	.017606	.017641	.017676	.017711	.017746	.017781
.0030	.017816	.017850	.017885	.017920	.017955	.017990	.018025	.018060	.018095	.018130
.0031	.018165	.018199	.018234	.018269	.018304	.018339	.018374	.018409	.018444	.018479
.0032	.018513	.018548	.018583	.018618	.018653	.018688	.018723	.018758	.018793	.018828
.0033	.018863	.018898	.018933	.018968	.019003	.019038	.019073	.019108	.019143	.019178
.0034	.019213	.019248	.019283	.019318	.019353	.019388	.019423	.019458	.019493	.019528
.0035	.019563	.019598	.019633	.019668	.019703	.019738	.019773	.019808	.019843	.019878
.0036	.019913	.019948	.019983	.020018	.020053	.020088	.020123	.020158	.020193	.020228
.0037	.020263	.020298	.020333	.020368	.020403	.020438	.020473	.020508	.020543	.020578
.0038	.020613	.020648	.020683	.020718	.020753	.020788	.020823	.020858	.020893	.020928
.0039	.020963	.020998	.021033	.021068	.021103	.021138	.021173	.021208	.021243	.021278
.0040	.021313	.021348	.021383	.021418	.021453	.021488	.021523	.021558	.021593	.021628
.0041	.021663	.021698	.021733	.021768	.021803	.021838	.021873	.021908	.021943	.021978
.0042	.022013	.022048	.022083	.022118	.022153	.022188	.022223	.022258	.022293	.022328
.0043	.022363	.022398	.022433	.022468	.022503	.022538	.022573	.022608	.022643	.022678
.0044	.022713	.022748	.022783	.022818	.022853	.022888	.022923	.022958	.022993	.023028
.0045	.023063	.023098	.023133	.023168	.023203	.023238	.023273	.023308	.023343	.023378
.0046	.023413	.023448	.023483	.023518	.023553	.023588	.023623	.023658	.023693	.023728
.0047	.023763	.023798	.023833	.023868	.023903	.023938	.023973	.024008	.024043	.024078
.0048	.024113	.024148	.024183	.024218	.024253	.024288	.024323	.024358	.024393	.024428
.0049	.024463	.024498	.024533	.024568	.024603	.024638	.024673	.024708	.024743	.024778
.0050	.024813	.024848	.024883	.024918	.024953	.024988	.025023	.025058	.025093	.025128
.0051	.025163	.025198	.025233	.025268	.025303	.025338	.025373	.025408	.025443	.025478
.0052	.025513	.025548	.025583	.025618	.025653	.025688	.025723	.025758	.025793	.025828
.0053	.025863	.025898	.025933	.025968	.026003	.026038	.026073	.026108	.026143	.026178
.0054	.026213	.026248	.026283	.026318	.026353	.026388	.026423	.026458	.026493	.026528
.0055	.026563	.026598	.026633	.026668	.026703	.026738	.026773	.026808	.026843	.026878
.0056	.026913	.026948	.026983	.027018	.027053	.027088	.027123	.027158	.027193	.027228
.0057	.027263	.027298	.027333	.027368	.027403	.027438	.027473	.027508	.027543	.027578
.0058	.027613	.027648	.027683	.027718	.027753	.027788	.027823	.027858	.027893	.027928
.0059	.027963	.027998	.028033	.028068	.028103	.028138	.028173	.028208	.028243	.028278
.0060	.028313	.028348	.028383	.028418	.028453	.028488	.028523	.028558	.028593	.028628
.0061	.028663	.028698	.028733	.028768	.028803	.028838	.028873	.028908	.028943	.028978
.0062	.029013	.029048	.029083	.029118	.029153	.029188	.029223	.029258	.029293	.029328
.0063	.029363	.029398	.029433	.029468	.029503	.029538	.029573	.029608	.029643	.029678
.0064	.029713	.029748	.029783	.029818	.029853	.029888	.029923	.029958	.029993	.030028
.0065	.030063	.030098	.030133	.030168	.030203	.030238	.030273	.030308	.030343	.030378
.0066	.030413	.030448	.030483	.030518	.030553	.030588	.030623	.030658	.030693	.030728
.0067	.030763	.030798	.030833	.030868	.030903	.030938	.030973	.031008	.031043	.031078
.0068	.031113	.031148	.031183	.031218	.031253	.031288	.031323	.031358	.031393	.031428
.0069	.031463	.031498	.031533	.031568	.031603	.031638	.031673	.031708	.031743	.031778
.0070	.031813	.031848	.031883	.031918	.031953	.031988	.032023	.032058	.032093	.032128
.0071	.032163	.032198	.032233	.032268	.032303	.032338	.032373	.032408	.032443	.032478
.0072	.032513	.032548	.032583	.032618	.032653	.032688	.032723	.032758	.032793	.032828
.0073	.032863	.032898	.032933	.032968	.033003	.033038	.033073	.033108	.033143	.033178
.0074	.033213	.033248	.033283	.033318	.033353	.033388	.033423	.033458	.033493	.033528
.0075	.033563	.033598	.033633	.033668	.033703	.033738	.033773	.033808	.033843	.033878
.0076	.033913	.033948	.033983	.034018	.034053	.034088	.034123	.034158	.034193	.034228
.0077	.034263	.034298	.034333	.034368	.034403	.034438	.034473	.034508	.034543	.034578
.0078	.034613	.034648	.034683	.034718	.034753	.034788	.034823	.034858	.034893	.034928
.0079	.034963	.034998	.035033	.035068	.035103	.035138	.035173	.035208	.035243	.035278
.0080	.035313	.035348	.035383	.035418	.035453	.035488	.035523	.035558	.035593	.035628
.0081	.035663	.035698	.035733	.035768	.035803	.035838	.035873	.035908	.035943	.035978
.0082	.036013	.036048	.036083	.036118	.036153	.036188	.036223	.036258	.036293	.036328
.0083	.036363	.036398	.036433	.036468	.036503	.036538	.036573	.036608	.036643	.036678
.0084	.036713	.036748	.036783	.036818	.036853	.036888	.036923	.036958	.036993	.037028
.0085	.037063	.037098	.037133	.037168	.037203	.037238	.037273	.037308	.037343	.037378
.0086	.037413	.037448	.037483	.037518	.037553	.037588	.037623	.037658	.037693	.037728
.0087	.037763	.037798	.037833	.037868	.037903	.037938	.037973	.038008	.038043	.038078
.0088	.038113	.038148	.038183	.038218	.038253	.038288	.038323	.038358	.038393	.038428
.0089	.038463	.038498	.038533	.038568	.038603	.038638	.038673	.038708	.038743	.038778
.0090	.038813	.038848	.038883	.038918	.038953	.038988	.039023	.039058	.039093	.039128
.0091	.039163	.039198	.039233	.039268	.039303	.039338	.039373	.039408	.039443	.039478
.0092	.039513	.039548	.039583	.039618	.039653	.039688	.039723	.039758	.039793	.039828
.0093	.039863	.039898	.039933	.039968	.040003	.040038	.040073	.040108	.040143	.040178
.0094	.040213	.040248	.040283	.040318	.040353	.040388	.040423	.040458	.040493	.040528
.0095	.040563	.040598	.040633	.040668	.040703	.040738	.040773	.040808	.040843	.040878
.0096	.040913	.040948	.040983	.041018	.041053	.041088	.041123	.041158	.041193	.041228
.0097	.041263	.041298	.041333	.041368	.041403	.041438	.041473	.041508	.041543	.041578
.0098	.041613	.041648	.0							

Table 95. Eight-thirds Powers of Numbers

Number	.00	.01	.02	.03	.04	.05	.06	.07	.08	.09
.1	.002	.005	.004	.004	.005	.006	.008	.009	.010	.012
.2	.014	.016	.018	.020	.022	.025	.028	.030	.034	.037
.3	.040	.044	.048	.052	.056	.061	.066	.071	.076	.081
.4	.087	.093	.099	.105	.112	.119	.126	.134	.141	.149
.5	.157	.166	.175	.184	.193	.203	.213	.223	.234	.245
.6	.256	.263	.279	.292	.304	.317	.330	.344	.358	.372
.7	.386	.401	.416	.432	.448	.464	.481	.498	.516	.533
.8	.552	.570	.589	.608	.628	.648	.669	.690	.711	.733
.9	.755	.774	.801	.824	.848	.872	.897	.922	.948	.973
1.0	1.000	1.027	1.054	1.082	1.110	1.139	1.168	1.198	1.228	1.258
1.1	1.29	1.32	1.35	1.39	1.42	1.45	1.49	1.52	1.55	1.59
1.2	1.63	1.66	1.70	1.74	1.77	1.81	1.85	1.89	1.93	1.97
1.3	2.01	2.05	2.10	2.14	2.18	2.23	2.27	2.32	2.36	2.41
1.4	2.45	2.50	2.55	2.60	2.64	2.69	2.74	2.79	2.84	2.90
1.5	2.95	3.00	3.05	3.11	3.16	3.22	3.27	3.33	3.39	3.44
1.6	3.50	3.56	3.62	3.68	3.74	3.80	3.86	3.93	3.99	4.05
1.7	4.12	4.18	4.25	4.31	4.38	4.45	4.51	4.58	4.65	4.72
1.8	4.79	4.87	4.94	5.01	5.08	5.16	5.25	5.31	5.39	5.46
1.9	5.54	5.62	5.69	5.77	5.85	5.93	6.02	6.10	6.18	6.26
2.0	6.35	6.43	6.52	6.61	6.69	6.78	6.87	6.96	7.05	7.14
2.1	7.23	7.32	7.42	7.51	7.60	7.70	7.80	7.89	7.99	8.09
2.2	8.19	8.29	8.39	8.49	8.59	8.69	8.80	8.90	9.00	9.11
2.3	9.22	9.32	9.43	9.54	9.65	9.76	9.87	9.98	10.10	10.21
2.4	10.33	10.44	10.56	10.67	10.79	10.91	11.03	11.15	11.27	11.39
2.5	11.51	11.64	11.76	11.88	12.01	12.14	12.26	12.39	12.52	12.65
2.6	12.8	12.9	13.0	13.2	13.3	13.4	13.6	13.7	13.9	14.0
2.7	14.1	14.3	14.4	14.6	14.7	14.8	15.0	15.1	15.3	15.4
2.8	15.6	15.7	15.9	16.0	16.2	16.3	16.5	16.6	16.8	16.9
2.9	17.1	17.3	17.4	17.6	17.7	17.9	18.1	18.2	18.4	18.6
3.0	18.7	18.9	19.1	19.2	19.4	19.6	19.7	19.9	20.1	20.3
3.1	20.4	20.6	20.8	21.0	21.1	21.3	21.5	21.7	21.9	22.1
3.2	22.2	22.4	22.6	22.8	23.0	23.2	23.4	23.6	23.7	23.9
3.3	24.1	24.3	24.5	24.7	24.9	25.1	25.3	25.5	25.7	25.9
3.4	26.1	26.3	26.6	26.8	27.0	27.2	27.4	27.6	27.8	28.0
3.5	28.2	28.5	28.7	28.9	29.1	29.3	29.5	29.8	30.0	30.2
3.6	30.4	30.7	30.9	31.1	31.4	31.6	31.8	32.0	32.3	32.5
3.7	32.7	33.0	33.2	33.5	33.7	33.9	34.2	34.4	34.7	34.9
3.8	35.2	35.4	35.7	35.9	36.2	36.4	36.7	36.9	37.2	37.4
3.9	37.7	37.9	38.2	38.5	38.7	39.0	39.3	39.5	39.8	40.0
4.0	40.3	40.6	40.9	41.1	41.4	41.7	42.0	42.2	42.5	42.8
4.1	43.1	43.3	43.6	43.9	44.2	44.5	44.8	45.1	45.3	45.6
4.2	45.9	46.2	46.5	46.8	47.1	47.4	47.7	48.0	48.3	48.6
4.3	48.9	49.2	49.5	49.8	50.1	50.4	50.7	51.0	51.4	51.7
4.4	52.0	52.3	52.6	52.9	53.3	53.6	53.9	54.2	54.5	54.9
4.5	55.2	55.5	55.9	56.2	56.5	56.8	57.2	57.5	57.9	58.2
4.6	58.5	58.9	59.2	59.5	59.9	60.2	60.6	60.9	61.3	61.6
4.7	62.0	62.3	62.7	63.0	63.4	63.8	64.1	64.5	64.8	65.2
4.8	65.6	65.9	66.3	66.7	67.0	67.4	67.8	68.1	68.5	68.9
4.9	69.3	69.6	70.0	70.4	70.8	71.2	71.6	71.9	72.3	72.7
5.0	73.1	73.5	73.9	74.3	74.7	75.1	75.5	75.9	76.3	76.7

Table 95. Eight-thirds Powers of Numbers (Continued)

Number	.00	.01	.02	.03	.04	.05	.06	.07	.08	.09
5.1	77.1	77.5	77.9	78.3	78.7	79.1	79.5	79.9	80.3	80.7
5.2	81.2	81.6	82.0	82.4	82.8	83.3	83.7	84.1	84.5	85.0
5.3	85.4	85.8	86.3	86.7	87.1	87.6	88.0	88.4	88.9	89.3
5.4	89.8	90.2	90.6	91.1	91.5	92.0	92.4	92.9	93.3	93.8
5.5	94.3	94.7	95.2	95.6	96.1	96.6	97.0	97.5	98.0	98.4
5.6	98.9	99.4	99.8	100	101	101	102	102	103	103
5.7	104	104	105	105	106	106	107	107	108	108
5.8	109	109	110	110	111	111	112	112	113	113
5.9	114	114	115	115	116	116	117	117	118	118
6.0	119	119	120	120	121	122	122	123	123	124
6.1	124	125	125	126	126	127	128	128	129	129
6.2	130	130	131	131	132	133	133	134	134	135
6.3	135	136	137	137	138	138	139	139	140	141
6.4	141	142	142	143	144	144	145	145	146	147
6.5	147	148	148	149	150	150	151	151	152	153
6.6	153	154	155	155	156	156	157	158	158	159
6.7	160	160	161	161	162	163	163	164	165	165
6.8	166	167	167	168	169	169	170	171	171	172
6.9	173	173	174	175	175	176	177	177	178	179
7.0	179	180	181	181	182	183	183	184	185	186
7.1	186	187	188	188	189	190	190	191	192	193
7.2	193	194	195	195	196	197	198	198	199	200
7.3	201	201	202	203	203	204	205	206	206	207
7.4	208	209	209	210	211	212	212	213	214	215
7.5	216	216	217	218	219	219	220	221	222	222
7.6	223	224	225	226	226	227	228	229	230	230
7.7	231	232	233	234	234	235	236	237	238	238
7.8	239	240	241	242	243	243	244	245	246	247
7.9	248	248	249	250	251	252	253	253	254	255
8.0	256	257	258	259	259	260	261	262	263	264
8.1	265	265	266	267	268	269	270	271	272	273
8.2	273	274	275	276	277	278	279	280	281	282
8.3	282	283	284	285	286	287	288	289	290	291
8.4	292	293	293	294	295	296	297	298	299	300
8.5	301	302	303	304	305	306	307	308	309	309
8.6	310	311	312	313	314	315	316	317	318	319
8.7	320	321	322	323	324	325	326	327	328	329
8.8	330	331	332	333	334	335	336	337	338	339
8.9	340	341	342	343	344	345	346	347	348	349
9.0	350	352	353	354	355	356	357	358	359	360
9.1	361	362	363	364	365	366	367	368	369	371
9.2	371	373	374	375	376	377	378	379	380	381
9.3	382	384	385	386	387	388	389	390	391	392
9.4	394	395	396	397	398	399	400	401	403	404
9.5	405	406	407	408	409	411	412	413	414	415
9.6	416	417	419	420	421	422	423	424	426	427
9.7	428	429	430	431	433	434	435	436	437	439
9.8	440	441	442	443	445	446	447	448	449	451
9.9	452	453	454	456	457	458	459	460	462	463
10.0	464	465	467	468	469	470	472	473	474	475

Table 95. Eight-thirds Powers of Numbers (Continued)

Number	.00	.01	.02	.03	.04	.05	.06	.07	.08	.09
10.1	477	478	479	480	482	483	484	485	487	488
10.2	489	491	492	493	494	496	497	498	500	501
10.3	502	504	505	506	507	509	510	511	513	514
10.4	515	517	518	519	521	522	523	525	526	527
10.5	529	530	531	533	534	535	537	538	539	541
10.6	542	544	545	546	548	549	550	552	553	555
10.7	556	557	559	560	561	563	564	566	567	568
10.8	570	571	573	574	576	577	578	580	581	583
10.9	584	586	587	588	590	591	593	594	596	597
11.0	598	600	601	603	604	606	607	609	610	612
11.1	613	615	616	618	619	620	622	623	625	626
11.2	628	629	631	632	634	635	637	638	640	641
11.3	643	645	646	648	649	651	652	654	655	657
11.4	658	660	661	663	664	666	668	669	671	672
11.5	674	675	677	678	680	682	683	685	686	688
11.6	690	691	693	694	696	697	699	701	702	704
11.7	705	707	709	710	712	714	715	717	718	720
11.8	722	723	725	727	728	730	732	733	735	736
11.9	738	740	741	743	745	746	748	750	751	753
12.0	755	756	758	760	762	763	765	767	768	770
12.1	772	773	775	777	778	780	782	784	785	787
12.2	789	791	792	794	796	797	799	801	803	804
12.3	806	808	810	811	813	815	817	818	820	822
12.4	824	826	827	829	831	833	834	836	838	840
12.5	842	843	845	847	849	851	852	854	856	858
12.6	860	861	863	865	867	869	871	872	874	876
12.7	878	880	882	884	885	887	889	891	893	895
12.8	897	898	900	902	904	906	908	910	912	913
12.9	915	917	919	921	923	925	927	929	931	932
13.0	934	936	938	940	942	944	946	948	950	952
13.1	954	956	958	959	961	963	965	967	969	971
13.2	973	975	977	979	981	983	985	987	989	991
13.3	993	995	997	999	1001	1003	1005	1007	1009	1011
13.4	1013	1015	1017	1019	1021	1023	1025	1027	1029	1031
13.5	1033	1035	1037	1039	1041	1044	1046	1048	1050	1052
13.6	1050	1060	1060	1060	1060	1060	1070	1070	1070	1070
13.7	1070	1080	1080	1080	1080	1090	1090	1090	1090	1090
13.8	1100	1100	1100	1100	1100	1110	1110	1110	1110	1110
13.9	1120	1120	1120	1120	1130	1130	1130	1130	1130	1140
14.0	1140	1140	1140	1150	1150	1150	1150	1150	1160	1160
14.1	1160	1160	1160	1170	1170	1170	1180	1180	1180	1190
14.2	1180	1180	1190	1190	1190	1200	1200	1200	1200	1200
14.3	1200	1210	1210	1210	1220	1220	1220	1220	1230	1230
14.4	1230	1230	1230	1230	1240	1240	1240	1240	1250	1250
14.5	1250	1250	1250	1260	1260	1260	1260	1270	1270	1270
14.6	1270	1280	1280	1280	1280	1290	1290	1290	1290	1290
14.7	1300	1300	1300	1300	1310	1310	1310	1320	1320	1320
14.8	1320	1320	1330	1330	1330	1330	1330	1340	1340	1340
14.9	1340	1350	1350	1350	1350	1360	1360	1360	1370	1370
15.0	1370	1370	1370	1380	1380	1380	1380	1390	1390	1390

Table 95. Eight-thirds Powers of Numbers (Continued)

Number	.00	.01	.02	.03	.04	.05	.06	.07	.08	.09
15.1	1390	1400	1400	1400	1400	1410	1410	1410	1410	1420
15.2	1420	1420	1420	1430	1430	1430	1430	1440	1440	1440
15.3	1440	1450	1450	1450	1450	1460	1460	1460	1460	1470
15.4	1470	1470	1470	1480	1480	1480	1480	1490	1490	1490
15.5	1490	1500	1500	1500	1500	1510	1510	1510	1510	1520
15.6	1520	1520	1520	1530	1530	1530	1540	1540	1540	1540
15.7	1550	1550	1550	1550	1560	1560	1560	1560	1570	1570
15.8	1570	1570	1580	1580	1580	1590	1590	1590	1590	1600
15.9	1600	1600	1600	1610	1610	1610	1610	1620	1620	1620
16.0	1630	1630	1630	1630	1640	1640	1640	1640	1650	1650
16.1	1650	1650	1660	1660	1660	1670	1670	1670	1670	1680
16.2	1680	1680	1680	1690	1690	1690	1700	1700	1700	1710
16.3	1710	1710	1710	1720	1720	1720	1730	1730	1730	1730
16.4	1740	1740	1740	1750	1750	1750	1760	1760	1760	1760
16.5	1760	1770	1770	1770	1780	1780	1780	1780	1790	1790
16.6	1790	1800	1800	1800	1800	1810	1810	1810	1820	1820
16.7	1820	1830	1830	1830	1830	1840	1840	1840	1850	1850
16.8	1850	1850	1860	1860	1860	1870	1870	1870	1870	1880
16.9	1880	1880	1890	1890	1890	1900	1900	1900	1900	1910
17.0	1910	1910	1920	1920	1920	1930	1930	1930	1930	1940
17.1	1940	1940	1950	1950	1950	1960	1960	1960	1970	1970
17.2	1970	1970	1980	1980	1980	1990	1990	1990	2000	2000
17.3	2000	2010	2010	2010	2010	2020	2020	2020	2030	2030
17.4	2030	2040	2040	2040	2040	2050	2050	2050	2060	2060
17.5	2060	2070	2070	2070	2080	2080	2080	2090	2090	2090
17.6	2100	2100	2100	2110	2110	2110	2110	2120	2120	2120
17.7	2130	2130	2130	2140	2140	2140	2150	2150	2150	2160
17.8	2160	2160	2170	2170	2170	2180	2180	2180	2190	2190
17.9	2190	2190	2200	2200	2200	2210	2210	2210	2220	2220
18.0	2230	2230	2230	2240	2240	2240	2250	2250	2250	2260
18.1	2260	2260	2270	2270	2270	2280	2280	2280	2290	2290
18.2	2290	2300	2300	2300	2310	2310	2310	2320	2320	2320
18.3	2330	2330	2330	2340	2340	2340	2350	2350	2350	2360
18.4	2360	2360	2370	2370	2370	2380	2380	2380	2390	2390
18.5	2390	2400	2400	2400	2410	2410	2410	2420	2420	2430
18.6	2430	2430	2440	2440	2440	2450	2450	2450	2460	2460
18.7	2470	2470	2470	2470	2480	2480	2480	2490	2490	2500
18.8	2500	2500	2510	2510	2510	2520	2520	2520	2530	2530
18.9	2540	2540	2540	2550	2550	2550	2560	2560	2560	2570
19.0	2570	2570	2580	2580	2580	2590	2590	2600	2600	2600
19.1	2610	2610	2610	2620	2620	2620	2630	2630	2640	2640
19.2	2640	2650	2650	2650	2660	2660	2670	2670	2670	2680
19.3	2680	2680	2690	2690	2690	2700	2700	2710	2710	2710
19.4	2720	2720	2720	2730	2730	2730	2740	2740	2750	2750
19.5	2750	2760	2760	2760	2770	2770	2770	2780	2780	2790
19.6	2790	2800	2800	2800	2810	2810	2820	2820	2830	2830
19.7	2840	2840	2840	2850	2850	2850	2860	2860	2870	2870
19.8	2870	2870	2880	2880	2880	2890	2890	2900	2900	2900
19.9	2910	2910	2920	2920	2920	2930	2930	2940	2940	2940
20.0	2950	2950	2960	2960	2960	2970	2970	2980	2980	2980

OPEN CHANNELS WITH UNIFORM FLOW 7-71

7-70

HANDBOOK OF HYDRAULICS

Table 95. Eight-thirds Powers of Numbers (Continued)

Number	.00	.01	.02	.03	.04	.05	.06	.07	.08	.09
20.1	2990	2990	2990	3000	3000	3010	3010	3010	3020	3020
20.2	3030	3030	3030	3040	3040	3050	3050	3050	3060	3060
20.3	3070	3070	3070	3080	3080	3090	3090	3090	3100	3100
20.4	3110	3110	3120	3120	3120	3130	3130	3140	3140	3140
20.5	3150	3150	3160	3160	3160	3170	3170	3180	3180	3180
20.6	3190	3190	3200	3200	3210	3210	3210	3220	3220	3230
20.7	3230	3230	3240	3240	3250	3250	3260	3260	3260	3270
20.8	3270	3280	3280	3280	3290	3290	3300	3300	3310	3310
20.9	3310	3320	3320	3330	3330	3340	3340	3350	3350	3350
21.0	3360	3360	3370	3370	3370	3380	3380	3390	3390	3400
21.1	3400	3400	3410	3410	3420	3420	3430	3430	3430	3440
21.2	3440	3450	3450	3460	3460	3460	3470	3470	3480	3480
21.3	3490	3490	3490	3500	3500	3510	3510	3520	3520	3530
21.4	3530	3530	3540	3540	3550	3550	3560	3560	3570	3570
21.5	3570	3580	3580	3590	3590	3600	3600	3610	3610	3610
21.6	3620	3620	3630	3630	3640	3640	3650	3650	3660	3660
21.7	3660	3670	3670	3680	3680	3690	3690	3700	3700	3700
21.8	3710	3710	3720	3720	3730	3730	3740	3740	3750	3750
21.9	3750	3760	3760	3770	3770	3780	3780	3790	3790	3800
22.0	3800	3800	3810	3810	3820	3820	3830	3830	3840	3840
22.1	3850	3850	3860	3860	3870	3870	3880	3880	3890	3890
22.2	3890	3900	3900	3910	3910	3920	3920	3930	3930	3940
22.3	3940	3940	3950	3950	3960	3960	3970	3970	3980	3980
22.4	3990	3990	4000	4000	4010	4010	4020	4020	4030	4030
22.5	4030	4040	4040	4050	4050	4060	4060	4070	4070	4080
22.6	4080	4090	4090	4100	4100	4110	4110	4120	4120	4130
22.7	4130	4140	4140	4150	4150	4160	4160	4170	4170	4170
22.8	4180	4180	4190	4190	4200	4200	4210	4210	4220	4220
22.9	4230	4230	4240	4240	4250	4250	4260	4260	4270	4270
23.0	4280	4280	4290	4290	4300	4300	4310	4310	4320	4320
23.1	4330	4330	4340	4340	4350	4350	4360	4360	4370	4370
23.2	4380	4380	4390	4390	4400	4400	4410	4410	4420	4420
23.3	4430	4430	4440	4440	4450	4450	4460	4460	4470	4470
23.4	4480	4480	4490	4490	4500	4500	4510	4510	4520	4530
23.5	4530	4540	4540	4550	4550	4560	4560	4570	4570	4580
23.6	4580	4590	4590	4600	4600	4610	4610	4620	4620	4630
23.7	4630	4640	4640	4650	4650	4660	4660	4670	4670	4680
23.8	4690	4690	4700	4700	4710	4710	4720	4720	4730	4730
23.9	4740	4740	4750	4750	4760	4760	4770	4770	4780	4790
24.0	4790	4800	4800	4810	4810	4820	4820	4830	4840	4840
24.1	4850	4850	4860	4860	4870	4870	4880	4880	4890	4890
24.2	4900	4910	4910	4920	4920	4930	4930	4940	4940	4950
24.3	4950	4960	4960	4970	4980	4980	4990	4990	5000	5000
24.4	5010	5010	5020	5020	5030	5040	5040	5050	5050	5060
24.5	5060	5070	5070	5080	5080	5090	5090	5100	5100	5110
24.6	5120	5120	5130	5140	5140	5150	5150	5160	5160	5170
24.7	5170	5180	5190	5190	5200	5200	5210	5210	5220	5220
24.8	5230	5240	5240	5250	5250	5260	5260	5270	5280	5280
24.9	5290	5290	5300	5300	5310	5310	5320	5320	5330	5340
25.0	5340	5350	5360	5360	5370	5370	5380	5380	5390	5400

Table 95. Eight-thirds Powers of Numbers (Continued)

Number	.00	.01	.02	.03	.04	.05	.06	.07	.08	.09
25.1	5400	5410	5410	5420	5420	5430	5440	5440	5450	5450
25.2	5460	5460	5470	5470	5480	5480	5490	5490	5500	5510
25.3	5520	5520	5530	5530	5540	5550	5550	5560	5560	5570
25.4	5570	5580	5590	5590	5600	5600	5610	5610	5620	5630
25.5	5630	5640	5650	5650	5660	5660	5670	5670	5680	5690
25.6	5690	5700	5700	5710	5710	5720	5730	5730	5740	5750
25.7	5750	5760	5760	5770	5770	5780	5780	5790	5790	5800
25.8	5810	5820	5820	5830	5830	5840	5850	5850	5860	5870
25.9	5870	5880	5880	5890	5890	5900	5900	5910	5910	5920
26.0	5930	5940	5950	5950	5960	5960	5970	5980	5980	5990
26.1	5990	6000	6010	6010	6020	6020	6030	6040	6040	6050
26.2	6060	6060	6070	6070	6080	6080	6090	6090	6100	6110
26.3	6120	6120	6130	6130	6140	6140	6150	6150	6160	6170
26.4	6180	6190	6190	6200	6200	6210	6210	6220	6220	6230
26.5	6240	6250	6250	6260	6260	6270	6270	6280	6280	6290
26.6	6300	6310	6320	6320	6330	6340	6340	6350	6360	6360
26.7	6370	6370	6380	6390	6390	6400	6410	6410	6420	6430
26.8	6430	6440	6450	6450	6460	6460	6470	6480	6480	6490
26.9	6500	6500	6510	6520	6520	6530	6540	6540	6550	6550
27.0	6560	6570	6570	6580	6580	6590	6600	6610	6610	6620
27.1	6630	6630	6640	6650	6650	6660	6670	6670	6680	6680
27.2	6690	6700	6700	6710	6720	6720	6730	6740	6740	6750
27.3	6760	6760	6770	6780	6780	6790	6800	6800	6810	6820
27.4	6820	6830	6840	6850	6850	6860	6870	6880	6880	6890
27.5	6900	6900	6910	6920	6920	6930	6940	6940	6950	6950
27.6	6960	6960	6970	6980	6980	6990	7000	7000	7010	7020
27.7	7020	7030	7040	7040	7050	7060	7070	7070	7080	7090
27.8	7090	7100	7110	7110	7120	7130	7130	7140	7150	7150
27.9	7160	7170	7170	7180	7190	7190	7200	7210	7220	7220
28.0	7230	7240	7240	7250	7260	7260	7270	7280	7280	7290
28.1	7300	7310	7310	7320	7330	7330	7340	7350	7350	7360
28.2	7370	7370	7380	7390	7400	7400	7410	7420	7420	7430
28.3	7440	7440	7450	7460	7470	7470	7480	7490	7490	7500
28.4	7510	7510	7520	7530	7540	7540	7550	7560	7560	7570
28.5	7580	7590	7590	7600	7610	7610	7620	7630	7640	7640
28.6	7650	7660	7660	7670	7680	7690	7690	7700	7710	7710
28.7	7720	7730	7740	7740	7750	7760	7760	7770	7780	7790
28.8	7790	7800	7810	7810	7820	7830	7840	7840	7850	7860
28.9	7870	7870	7880	7890	7890	7900	7910	7920	7920	7930
29.0	7940	7950	7950	7960	7970	7970	7980	7990	8000	8000
29.1	8010	8020	8030	8030	8040	8050	8060	8060	8070	8080
29.2	8090	8090	8100	8110	8110	8120	8130	8140	8140	8150
29.3	8160	8170	8170	8180	8190	8200	8200	8210	8220	8230
29.4	8230	8240	8250	8260	8260	8270	8280	8290	8290	8300
29.5	8310	8320	8320	8330	8340	8350	8350	8360	8370	8380
29.6	8390	8400	8400	8410	8410	8420	8430	8440	8440	8450
29.7	8460	8470	8470	8480	8490	8500	8510	8510	8520	8530
29.8	8540	8540	8550	8560	8570	8570	8580	8590	8600	8600
29.9	8610	8620	8630	8640	8640	8650	8660	8670	8680	8680
30.0	8690	8700	8700	8710	8720	8730	8740	8740	8750	8760

7-72

HANDBOOK OF HYDRAULICS

Table 95. Eight-thirds Powers of Numbers (Concluded)

Number	.00	.01	.02	.03	.04	.05	.06	.07	.08	.09
30.1	8770	8770	8780	8790	8800	8810	8810	8820	8830	8840
30.2	8840	8850	8860	8870	8880	8880	8890	8900	8910	8920
30.3	8920	8930	8940	8950	8950	8960	8970	8980	8990	8990
30.4	9000	9010	9020	9030	9030	9040	9050	9060	9070	9070
30.5	9080	9090	9100	9100	9110	9120	9130	9140	9140	9150
30.6	9160	9170	9180	9180	9190	9200	9210	9220	9220	9230
30.7	9240	9250	9260	9260	9270	9280	9290	9300	9300	9310
30.8	9320	9330	9340	9350	9350	9360	9370	9380	9390	9390
30.9	9400	9410	9420	9430	9430	9440	9450	9460	9470	9480
31.0	9480	9490	9500	9510	9520	9520	9530	9540	9550	9560
31.1	9570	9570	9580	9590	9600	9610	9610	9620	9630	9640
31.2	9650	9660	9660	9670	9680	9690	9700	9710	9710	9720
31.3	9730	9740	9750	9760	9760	9770	9780	9790	9800	9800
31.4	9810	9820	9830	9840	9850	9850	9860	9870	9880	9890
31.5	9900	9910	9910	9920	9930	9940	9950	9960	9960	9970
31.6	9980	9990	10000	10010	10010	10020	10030	10040	10050	10060
31.7	10070	10070	10080	10090	10100	10110	10120	10120	10130	10140
31.8	10150	10160	10170	10180	10180	10190	10200	10210	10220	10230
31.9	10240	10240	10250	10260	10270	10280	10290	10300	10300	10310
32.0	10320	10330	10340	10350	10360	10360	10370	10380	10390	10400
32.1	10410	10420	10420	10430	10440	10450	10460	10470	10480	10490
32.2	10490	10500	10510	10520	10530	10540	10550	10560	10560	10570
32.3	10580	10590	10600	10610	10620	10630	10630	10640	10650	10660
32.4	10670	10680	10690	10700	10700	10710	10720	10730	10740	10750
32.5	10760	10770	10770	10780	10790	10800	10810	10820	10830	10840
32.6	10850	10850	10860	10870	10880	10890	10900	10910	10920	10930
32.7	10930	10940	10950	10960	10970	10980	10990	11000	11010	11010
32.8	11020	11030	11040	11050	11060	11070	11080	11090	11100	11100
32.9	11110	11120	11130	11140	11150	11160	11170	11180	11190	11190
33.0	11200	11210	11220	11230	11240	11250	11260	11270	11280	11290
33.1	11290	11300	11310	11320	11330	11340	11350	11360	11370	11380
33.2	11390	11400	11400	11410	11420	11430	11440	11450	11460	11470
33.3	11480	11490	11500	11510	11510	11520	11530	11540	11550	11560
33.4	11570	11580	11590	11600	11610	11620	11630	11630	11640	11650
33.5	11660	11670	11680	11690	11700	11710	11720	11730	11740	11750
33.6	11760	11760	11770	11780	11790	11800	11810	11820	11830	11840
33.7	11850	11860	11870	11880	11890	11900	11910	11910	11920	11930
33.8	11940	11950	11960	11970	11980	11990	12000	12010	12020	12030
33.9	12040	12050	12060	12070	12080	12080	12090	12100	12110	12120
34.0	12130	12140	12150	12160	12170	12180	12190	12200	12210	12220
34.1	12230	12240	12250	12260	12270	12280	12290	12300	12300	12310
34.2	12320	12330	12340	12350	12360	12370	12380	12390	12400	12410
34.3	12420	12430	12440	12450	12460	12470	12480	12490	12500	12510
34.4	12520	12530	12540	12550	12560	12570	12570	12580	12590	12600
34.5	12610	12620	12630	12640	12650	12660	12670	12680	12690	12700
34.6	12710	12720	12730	12740	12750	12760	12770	12780	12790	12800
34.7	12810	12820	12830	12840	12850	12860	12870	12880	12890	12900
34.8	12910	12920	12930	12940	12950	12960	12970	12980	12990	13000
34.9	13010	13020	13030	13040	13050	13060	13070	13080	13090	13100
35.0	13110									

Table 97. Values of K' in Formula $Q = \frac{K'}{n} b^{5/3} s^{1/2}$ for Trapezoidal Channels

D = depth of water and b = bottom width of channel.

$\frac{D}{b}$	Side slopes of channel, ratio of horizontal to vertical									
	Vertical	$\frac{1}{4}-1$	$\frac{1}{2}-1$	$\frac{3}{4}-1$	1-1	$1\frac{1}{2}-1$	2-1	$2\frac{1}{2}-1$	3-1	4-1
.01	.00068	.00058	.00069	.00069	.00069	.00069	.00069	.00070	.00070	.00070
.02	.00213	.00215	.00216	.00217	.00218	.00220	.00221	.00222	.00223	.00225
.03	.00414	.00419	.00423	.00426	.00428	.00433	.00436	.00439	.00443	.00449
.04	.00650	.00670	.00679	.00685	.00691	.00700	.00708	.00716	.00723	.00736
.05	.00946	.00964	.00979	.00991	.01002	.01019	.01033	.01047	.01060	.01086
.06	.0127	.0130	.0132	.0134	.0136	.0138	.0141	.0143	.0145	.0150
.07	.0162	.0166	.0170	.0173	.0175	.0180	.0183	.0187	.0190	.0197
.08	.0200	.0206	.0211	.0215	.0219	.0225	.0231	.0236	.0240	.0250
.09	.0241	.0249	.0256	.0262	.0267	.0275	.0282	.0289	.0296	.0310
.10	.0284	.0294	.0304	.0311	.0318	.0329	.0339	.0348	.0358	.0376
.11	.0329	.0343	.0354	.0364	.0373	.0387	.0400	.0413	.0424	.0448
.12	.0376	.0393	.0408	.0420	.0431	.0450	.0465	.0482	.0497	.0527
.13	.0425	.0446	.0464	.0480	.0493	.0516	.0537	.0556	.0575	.0613
.14	.0476	.0502	.0524	.0542	.0559	.0587	.0612	.0636	.0659	.0706
.15	.0528	.0559	.0585	.0608	.0627	.0662	.0692	.0721	.0749	.0805
.16	.0582	.0619	.0650	.0676	.0700	.0740	.0777	.0811	.0845	.0912
.17	.0638	.0680	.0716	.0748	.0775	.0823	.0866	.0907	.0947	.1026
.18	.0695	.0744	.0786	.0822	.0854	.0910	.0960	.1008	.1055	.1148
.19	.0753	.0809	.0857	.0899	.0936	.1001	.1059	.1115	.1169	.1277
.20	.0812	.0876	.0931	.0979	.1021	.1096	.1163	.1227	.1290	.1414
.21	.0873	.0945	.101	.106	.111	.120	.127	.135	.142	.156
.22	.0934	.1015	.109	.115	.120	.130	.139	.147	.155	.171
.23	.0997	.1087	.117	.124	.130	.141	.150	.160	.169	.187
.24	.1061	.1161	.125	.133	.140	.152	.163	.173	.184	.204
.25	.1125	.1236	.133	.142	.150	.163	.176	.188	.199	.222
.26	.119	.131	.142	.152	.160	.175	.189	.202	.215	.241
.27	.126	.139	.151	.162	.171	.188	.203	.218	.232	.260
.28	.132	.147	.160	.172	.182	.201	.217	.234	.249	.281
.29	.139	.155	.170	.182	.194	.214	.232	.250	.268	.302
.30	.146	.163	.179	.193	.205	.228	.245	.267	.287	.324
.31	.153	.172	.189	.204	.218	.242	.264	.285	.306	.347
.32	.160	.180	.199	.215	.230	.256	.281	.304	.327	.371
.33	.167	.189	.209	.227	.243	.271	.298	.323	.348	.396
.34	.174	.198	.219	.238	.256	.287	.316	.343	.370	.423
.35	.181	.207	.230	.251	.269	.303	.334	.363	.392	.450
.36	.189	.216	.241	.263	.283	.319	.353	.385	.416	.478
.37	.196	.225	.252	.275	.297	.336	.372	.406	.440	.507
.38	.203	.234	.263	.288	.312	.353	.392	.429	.465	.537
.39	.211	.244	.274	.301	.326	.371	.413	.452	.491	.568
.40	.218	.253	.286	.315	.341	.389	.434	.476	.518	.600
.41	.226	.263	.297	.328	.357	.408	.456	.501	.546	.633
.42	.233	.273	.309	.342	.373	.427	.478	.526	.574	.668
.43	.241	.283	.321	.357	.389	.447	.501	.553	.603	.703
.44	.248	.293	.334	.371	.405	.467	.525	.580	.633	.740
.45	.256	.303	.346	.386	.422	.488	.549	.607	.664	.777

Table 97. Values of K' in Formula $Q = \frac{K'}{n} b^{5/3} s^{1/2}$ for Trapezoidal Channels (Continued)

D = depth of water and b = bottom width of channel.

$\frac{D}{b}$	Side slopes of channel, ratio of horizontal to vertical									
	Vertical	$\frac{1}{4}-1$	$\frac{1}{2}-1$	$\frac{3}{4}-1$	1-1	$1\frac{1}{2}-1$	2-1	$2\frac{1}{2}-1$	3-1	4-1
.46	.264	.313	.359	.401	.439	.509	.574	.636	.696	.816
.47	.271	.323	.372	.416	.457	.531	.599	.665	.729	.856
.48	.279	.334	.385	.432	.474	.553	.625	.695	.763	.897
.49	.287	.344	.398	.447	.493	.575	.652	.725	.797	.939
.50	.295	.355	.412	.463	.511	.598	.679	.757	.833	.983
.51	.303	.366	.425	.480	.530	.622	.707	.789	.869	1.03
.52	.311	.377	.439	.496	.549	.646	.736	.822	.907	1.07
.53	.319	.388	.453	.513	.569	.671	.765	.856	.945	1.12
.54	.327	.399	.467	.531	.589	.696	.795	.891	.984	1.17
.55	.335	.410	.482	.548	.609	.722	.826	.926	1.025	1.22
.56	.343	.422	.497	.566	.630	.748	.857	.963	1.07	1.27
.57	.351	.433	.511	.584	.651	.775	.889	1.000	1.11	1.32
.58	.359	.445	.526	.602	.673	.802	.922	1.038	1.15	1.37
.59	.367	.456	.542	.621	.694	.830	.956	1.077	1.20	1.43
.60	.375	.468	.557	.640	.717	.858	.990	1.117	1.24	1.49
.61	.383	.480	.573	.659	.739	.887	1.02	1.16	1.29	1.54
.62	.391	.492	.588	.678	.762	.916	1.06	1.20	1.33	1.60
.63	.399	.504	.604	.698	.785	.946	1.10	1.24	1.38	1.66
.64	.408	.516	.620	.718	.809	.977	1.13	1.28	1.43	1.72
.65	.416	.529	.637	.738	.833	1.008	1.17	1.33	1.48	1.79
.66	.424	.541	.653	.759	.857	1.04	1.21	1.37	1.53	1.85
.67	.433	.553	.670	.780	.882	1.07	1.25	1.42	1.59	1.91
.68	.441	.566	.687	.801	.907	1.10	1.29	1.47	1.64	1.98
.69	.449	.579	.704	.822	.933	1.14	1.33	1.51	1.69	2.05
.70	.457	.592	.722	.844	.959	1.17	1.37	1.56	1.75	2.12
.71	.466	.604	.739	.866	.985	1.21	1.41	1.61	1.81	2.19
.72	.474	.617	.757	.889	1.012	1.24	1.46	1.66	1.86	2.26
.73	.483	.631	.775	.911	1.039	1.28	1.50	1.71	1.92	2.34
.74	.491	.644	.793	.934	1.067	1.31	1.54	1.77	1.98	2.41
.75	.499	.657	.811	.957	1.095	1.35	1.59	1.82	2.05	2.49
.76	.508	.670	.830	.981	1.12	1.39	1.63	1.87	2.11	2.57
.77	.516	.684	.849	1.005	1.15	1.43	1.68	1.92	2.17	2.65
.78	.525	.698	.868	1.029	1.18	1.46	1.73	1.99	2.24	2.73
.79	.533	.711	.887	1.053	1.21	1.50	1.78	2.04	2.30	2.81
.80	.542	.725	.906	1.078	1.24	1.54	1.83	2.10	2.37	2.90
.81	.550	.739	.925	1.10	1.27	1.58	1.88	2.16	2.44	2.98
.82	.559	.753	.945	1.13	1.30	1.62	1.93	2.22	2.51	3.07
.83	.567	.767	.965	1.15	1.33	1.67	1.98	2.28	2.58	3.16
.84	.576	.781	.985	1.18	1.36	1.71	2.03	2.34	2.65	3.25
.85	.585	.796	1.006	1.21	1.40	1.75	2.08	2.41	2.72	3.35
.86	.593	.810	1.03	1.23	1.43	1.79	2.14	2.47	2.80	3.44
.87	.602	.825	1.05	1.26	1.46	1.84	2.19	2.54	2.87	3.54
.88	.610	.839	1.07	1.29	1.49	1.88	2.25	2.60	2.95	3.63
.89	.619	.854	1.09	1.31	1.53	1.93	2.31	2.67	3.03	3.73
.90	.628	.869	1.11	1.34	1.56	1.98	2.36	2.74	3.11	3.83

Table 97. Values of K' in Formula $Q = \frac{K'}{n} b^{3/2} s^{1/2}$ for Trapezoidal Channels (Continued)

D = depth of water and b = bottom width of channel.

$\frac{D}{b}$	Side slopes of channel, ratio of horizontal to vertical									
	Vertical	$\frac{3}{4}-1$	$\frac{1}{2}-1$	$\frac{1}{4}-1$	1-1	$1\frac{1}{2}-1$	2-1	$2\frac{1}{2}-1$	3-1	4-1
.91	.836	.884	1.13	1.37	1.60	2.02	2.42	2.81	3.19	3.93
.92	.845	.899	1.15	1.40	1.63	2.07	2.48	2.88	3.27	4.04
.93	.853	.914	1.18	1.43	1.67	2.12	2.54	2.95	3.35	4.14
.94	.862	.929	1.20	1.46	1.70	2.17	2.60	3.02	3.44	4.25
.95	.871	.944	1.22	1.49	1.74	2.22	2.66	3.10	3.52	4.36
.96	.880	.960	1.24	1.52	1.78	2.27	2.73	3.17	3.61	4.47
.97	.888	.975	1.27	1.55	1.81	2.32	2.79	3.25	3.70	4.58
.98	.897	.991	1.29	1.58	1.85	2.37	2.85	3.33	3.79	4.70
.99	.906	1.006	1.31	1.61	1.89	2.42	2.92	3.40	3.88	4.81
1.00	.914	1.022	1.33	1.64	1.93	2.47	2.99	3.48	3.97	4.93
1.01	.923	1.04	1.36	1.67	1.97	2.53	3.05	3.56	4.06	5.05
1.02	.932	1.05	1.38	1.70	2.01	2.58	3.12	3.65	4.16	5.17
1.03	.941	1.07	1.41	1.73	2.05	2.63	3.19	3.73	4.26	5.30
1.04	.949	1.09	1.43	1.77	2.09	2.69	3.26	3.81	4.35	5.42
1.05	.958	1.10	1.46	1.80	2.13	2.75	3.33	3.90	4.45	5.55
1.06	.967	1.12	1.48	1.83	2.17	2.80	3.40	3.98	4.55	5.68
1.07	.976	1.14	1.50	1.86	2.21	2.86	3.48	4.07	4.66	5.81
1.08	.984	1.15	1.53	1.90	2.25	2.92	3.55	4.16	4.76	5.94
1.09	.993	1.17	1.56	1.93	2.29	2.98	3.62	4.25	4.86	6.07
1.10	.802	1.19	1.58	1.97	2.34	3.04	3.70	4.34	4.97	6.21
1.11	.811	1.20	1.61	2.00	2.38	3.10	3.78	4.43	5.08	6.35
1.12	.820	1.22	1.63	2.04	2.42	3.16	3.85	4.53	5.19	6.49
1.13	.829	1.24	1.66	2.07	2.47	3.22	3.93	4.62	5.30	6.63
1.14	.837	1.25	1.69	2.11	2.51	3.28	4.01	4.72	5.41	6.77
1.15	.846	1.27	1.71	2.14	2.56	3.35	4.09	4.81	5.52	6.92
1.16	.855	1.29	1.74	2.18	2.61	3.41	4.17	4.91	5.63	7.06
1.17	.864	1.31	1.77	2.22	2.65	3.47	4.25	5.01	5.75	7.21
1.18	.873	1.32	1.79	2.25	2.70	3.54	4.34	5.11	5.87	7.36
1.19	.882	1.34	1.82	2.29	2.75	3.61	4.42	5.21	5.99	7.52
1.20	.891	1.36	1.85	2.33	2.79	3.67	4.51	5.32	6.11	7.67
1.21	.899	1.38	1.88	2.37	2.84	3.74	4.59	5.42	6.23	7.83
1.22	.908	1.40	1.90	2.41	2.89	3.81	4.68	5.52	6.35	7.99
1.23	.917	1.41	1.93	2.44	2.94	3.88	4.77	5.63	6.48	8.15
1.24	.926	1.43	1.96	2.48	2.99	3.95	4.86	5.74	6.61	8.31
1.25	.935	1.45	1.99	2.52	3.04	4.02	4.95	5.85	6.73	8.48
1.26	.944	1.47	2.02	2.56	3.09	4.09	5.04	5.96	6.86	8.64
1.27	.953	1.49	2.05	2.60	3.14	4.16	5.13	6.07	6.99	8.81
1.28	.962	1.51	2.08	2.64	3.19	4.23	5.22	6.18	7.13	8.98
1.29	.971	1.52	2.11	2.69	3.24	4.31	5.32	6.30	7.26	9.16
1.30	.980	1.54	2.14	2.73	3.30	4.38	5.41	6.41	7.40	9.33
1.31	.989	1.56	2.17	2.77	3.35	4.46	5.51	6.53	7.53	9.51
1.32	.997	1.58	2.20	2.81	3.40	4.53	5.61	6.65	7.67	9.69
1.33	1.006	1.60	2.23	2.85	3.46	4.61	5.71	6.77	7.81	9.87
1.34	1.015	1.62	2.26	2.90	3.51	4.69	5.81	6.89	7.96	10.05
1.35	1.024	1.64	2.29	2.94	3.57	4.77	5.91	7.01	8.10	10.24

Table 97. Values of K' in Formula $Q = \frac{K'}{n} b^{3/2} s^{1/2}$ for Trapezoidal Channels (Continued)

D = depth of water and b = bottom width of channel.

$\frac{D}{b}$	Side slopes of channel, ratio of horizontal to vertical									
	Vertical	$\frac{3}{4}-1$	$\frac{1}{2}-1$	$\frac{1}{4}-1$	1-1	$1\frac{1}{2}-1$	2-1	$2\frac{1}{2}-1$	3-1	4-1
1.36	1.03	1.66	2.32	2.98	3.62	4.35	6.01	7.14	8.24	10.4
1.37	1.04	1.68	2.35	3.03	3.68	4.34	6.11	7.26	8.39	10.6
1.38	1.05	1.70	2.38	3.07	3.74	4.31	6.21	7.39	8.54	10.8
1.39	1.06	1.72	2.42	3.11	3.79	4.29	6.32	7.51	8.69	11.0
1.40	1.07	1.74	2.45	3.16	3.85	4.27	6.42	7.64	8.84	11.2
1.41	1.08	1.76	2.48	3.21	3.91	4.25	6.53	7.77	8.99	11.4
1.42	1.09	1.78	2.51	3.25	3.97	4.24	6.64	7.91	9.15	11.6
1.43	1.10	1.80	2.55	3.30	4.03	4.22	6.75	8.04	9.31	11.8
1.44	1.11	1.82	2.58	3.34	4.09	4.21	6.86	8.17	9.46	12.0
1.45	1.11	1.84	2.61	3.39	4.15	4.20	6.97	8.31	9.62	12.2
1.46	1.12	1.86	2.65	3.44	4.21	4.19	7.08	8.45	9.78	12.4
1.47	1.13	1.88	2.68	3.49	4.27	4.18	7.20	8.59	9.95	12.6
1.48	1.14	1.90	2.71	3.53	4.33	4.17	7.31	8.73	10.11	12.8
1.49	1.15	1.92	2.75	3.58	4.39	4.16	7.43	8.87	10.28	13.1
1.50	1.16	1.94	2.78	3.63	4.46	4.15	7.54	9.01	10.45	13.3
1.51	1.17	1.96	2.82	3.68	4.52	4.14	7.66	9.15	10.6	13.5
1.52	1.18	1.98	2.85	3.73	4.59	4.13	7.78	9.30	10.8	13.7
1.53	1.19	2.00	2.89	3.78	4.65	4.12	7.90	9.45	11.0	14.0
1.54	1.20	2.03	2.92	3.83	4.71	4.11	8.02	9.59	11.1	14.2
1.55	1.20	2.05	2.96	3.88	4.78	4.10	8.15	9.74	11.3	14.4
1.56	1.21	2.07	3.00	3.93	4.85	4.09	8.27	9.89	11.5	14.6
1.57	1.22	2.09	3.04	3.98	4.91	4.08	8.40	10.05	11.7	14.9
1.58	1.23	2.11	3.07	4.03	4.98	4.07	8.52	10.20	11.9	15.1
1.59	1.24	2.13	3.11	4.09	5.05	4.06	8.65	10.36	12.0	15.3
1.60	1.25	2.16	3.14	4.14	5.12	4.05	8.78	10.52	12.2	15.6
1.61	1.26	2.18	3.18	4.19	5.18	4.04	8.91	10.7	12.4	15.8
1.62	1.27	2.20	3.22	4.25	5.25	4.03	9.04	10.8	12.6	16.1
1.63	1.28	2.22	3.25	4.30	5.32	4.02	9.17	11.0	12.8	16.3
1.64	1.29	2.24	3.29	4.35	5.40	4.01	9.30	11.2	13.0	16.6
1.65	1.29	2.27	3.33	4.41	5.47	4.00	9.44	11.3	13.2	16.8
1.66	1.30	2.29	3.37	4.46	5.54	3.99	9.57	11.5	13.4	17.1
1.67	1.31	2.31	3.41	4.52	5.61	3.98	9.71	11.7	13.6	17.3
1.68	1.32	2.33	3.45	4.57	5.68	3.97	9.85	11.8	13.8	17.6
1.69	1.33	2.36	3.49	4.63	5.76	3.96	9.99	12.0	14.0	17.9
1.70	1.34	2.38	3.52	4.69	5.83	3.95	10.13	12.2	14.2	18.1
1.71	1.35	2.40	3.56	4.74	5.90	3.94	10.27	12.3	14.4	18.4
1.72	1.36	2.43	3.60	4.80	5.98	3.93	10.41	12.5	14.6	18.7
1.73	1.37	2.45	3.64	4.86	6.06	3.92	10.55	12.7	14.8	18.9
1.74	1.38	2.47	3.68	4.92	6.13	3.91	10.69	12.9	15.0	19.2
1.75	1.39	2.50	3.73	4.98	6.21	3.90	10.83	13.1	15.2	19.5
1.76	1.39	2.52	3.77	5.04	6.29	3.89	10.97	13.2	15.4	19.8
1.77	1.40	2.54	3.81	5.10	6.36	3.88	11.11	13.4	15.7	20.1
1.78	1.41	2.57	3.85	5.16	6.44	3.87	11.25	13.6	15.9	20.3
1.79	1.42	2.59	3.89	5.22	6.52	3.86	11.39	13.8	16.1	20.6
1.80	1.43	2.62	3.93	5.28	6.60	3.85	11.53	14.0	16.3	20.9

7-82 HANDBOOK OF HYDRAULICS

Table 97. Values of K' in Formula $Q = \frac{K'}{n} b^{3/2} s^{1/2}$ for Trapezoidal Channels (Concluded)

D = depth of water and b = bottom width of channel.

$\frac{D}{b}$	Side slopes of channel, ratio of horizontal to vertical									
	Vertical	$\frac{1}{2}-1$	$\frac{3}{4}-1$	$1-1$	$1\frac{1}{4}-1$	$2-1$	$2\frac{1}{2}-1$	$3-1$	$4-1$	
1.81	1.44	2.64	3.97	5.34	6.68	9.27	11.7	14.2	16.5	21.2
1.82	1.45	2.66	4.02	5.40	6.76	9.39	11.9	14.4	16.8	21.5
1.83	1.46	2.69	4.06	5.46	6.84	9.51	12.1	14.5	17.0	21.8
1.84	1.47	2.71	4.10	5.52	6.93	9.63	12.2	14.7	17.2	22.1
1.85	1.48	2.74	4.15	5.59	7.01	9.75	12.4	14.9	17.5	22.4
1.86	1.49	2.76	4.19	5.65	7.09	9.87	12.5	15.1	17.7	22.7
1.87	1.49	2.76	4.23	5.71	7.18	9.99	12.7	15.3	17.9	23.0
1.88	1.50	2.81	4.28	5.78	7.26	10.12	12.9	15.5	18.2	23.3
1.89	1.51	2.84	4.32	5.84	7.34	10.24	13.0	15.7	18.4	23.6
1.90	1.52	2.86	4.36	5.91	7.43	10.37	13.2	15.9	18.6	24.0
1.91	1.53	2.89	4.41	5.97	7.52	10.5	13.4	16.1	18.9	24.3
1.92	1.54	2.91	4.45	6.04	7.60	10.6	13.5	16.3	19.1	24.6
1.93	1.55	2.94	4.50	6.10	7.69	10.8	13.7	16.6	19.4	24.9
1.94	1.56	2.96	4.55	6.17	7.78	10.9	13.9	16.8	19.6	25.3
1.95	1.57	2.99	4.59	6.24	7.87	11.0	14.0	17.0	19.9	25.6
1.96	1.58	3.02	4.64	6.31	7.96	11.1	14.2	17.2	20.1	25.9
1.97	1.59	3.04	4.68	6.37	8.05	11.3	14.4	17.4	20.4	26.2
1.98	1.60	3.07	4.73	6.44	8.14	11.4	14.6	17.6	20.6	26.6
1.99	1.60	3.09	4.78	6.51	8.23	11.5	14.7	17.8	20.9	26.9
2.00	1.61	3.12	4.82	6.58	8.32	11.7	14.9	18.1	21.2	27.3
2.01	1.62	3.15	4.87	6.65	8.41	11.8	15.1	18.3	21.4	27.6
2.02	1.63	3.17	4.92	6.72	8.50	12.0	15.3	18.5	21.7	28.0
2.03	1.64	3.20	4.97	6.79	8.60	12.1	15.5	18.7	22.0	28.3
2.04	1.65	3.23	5.01	6.86	8.69	12.2	15.6	19.0	22.2	28.7
2.05	1.66	3.25	5.06	6.93	8.79	12.4	15.8	19.2	22.5	29.0
2.06	1.67	3.28	5.11	7.00	8.88	12.5	16.0	19.4	22.8	29.4
2.07	1.68	3.31	5.16	7.08	8.98	12.7	16.2	19.7	23.0	29.7
2.08	1.69	3.33	5.21	7.15	9.08	12.8	16.4	19.9	23.3	30.1
2.09	1.70	3.36	5.26	7.22	9.17	12.9	16.6	20.1	23.6	30.5
2.10	1.70	3.39	5.31	7.30	9.27	13.1	16.8	20.4	23.9	30.8
2.11	1.71	3.42	5.36	7.37	9.37	13.2	17.0	20.6	24.2	31.2
2.12	1.72	3.44	5.41	7.44	9.47	13.4	17.2	20.8	24.5	31.6
2.13	1.73	3.47	5.46	7.52	9.57	13.5	17.4	21.1	24.7	32.0
2.14	1.74	3.50	5.51	7.60	9.67	13.7	17.6	21.3	25.0	32.3
2.15	1.75	3.53	5.56	7.67	9.77	13.8	17.8	21.6	25.3	32.7
2.16	1.76	3.56	5.61	7.75	9.87	14.0	18.0	21.8	25.6	33.1
2.17	1.77	3.58	5.66	7.82	9.97	14.1	18.2	22.1	25.9	33.5
2.18	1.78	3.61	5.72	7.90	10.08	14.3	18.4	22.3	26.2	33.9
2.19	1.79	3.64	5.77	7.98	10.18	14.5	18.6	22.6	26.5	34.3
2.20	1.80	3.67	5.82	8.06	10.28	14.6	18.8	22.8	26.8	34.7
2.21	1.81	3.70	5.87	8.14	10.4	14.8	19.0	23.1	27.1	35.1
2.22	1.81	3.73	5.93	8.22	10.5	14.9	19.2	23.3	27.4	35.5
2.23	1.82	3.75	5.98	8.29	10.6	15.1	19.4	23.6	27.7	35.9
2.24	1.83	3.78	6.03	8.37	10.7	15.2	19.6	23.9	28.0	36.3
2.25	1.84	3.81	6.09	8.46	10.8	15.4	19.8	24.1	28.4	36.7

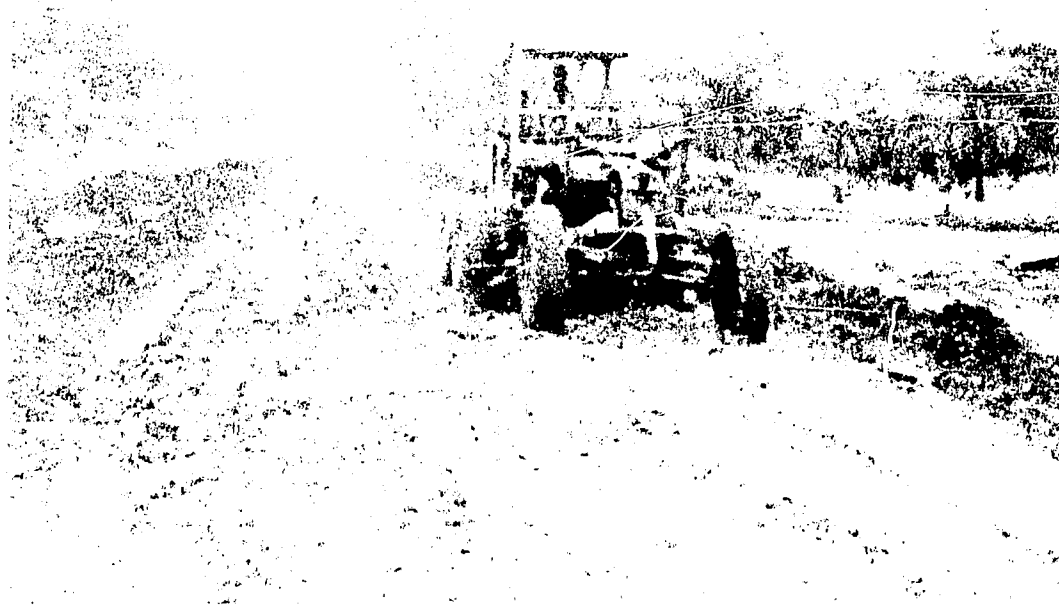

Lack of grading material for proper cross-slope during construction creates windrows at roadway's edge, causing rainfall to seep into roadbed and saturate material (Liberia).

Grading Illustrated

NOTE: This text has been reproduced with the permission of Aveling-Barford, Limited.

Aveling-Barford Ltd., Grantham, England.

Technical Publications Dept.

Publication TP549

Foreword

This book is solely concerned with grading methods and how to get the best work out of your grader.

The comprehensive range of Aveling-Barford graders covers four wheel and six wheel machines and in most cases these have all wheel drive and all wheel steer.

There are also six wheel machines which feature leaning front wheels.

Grading methods for machines with leaning front wheels differ in some respects from methods used for other types, but grading instructions for all Aveling-Barford graders have been included in this book.

The illustrations throughout show typical Aveling-Barford graders in action and are not intended to depict any particular model. Also, machine details such as pipe work, brackets, tyre treads etc, have been omitted for the sake of simplicity and clarity of presentation.

No attempt has been made to relate the operation of the graders to the controls as these vary with each model and it is therefore essential for the operator to study the operating instructions for his machine in the Instruction Book or the Operators Handbook before moving on to study grading techniques.

We commence with the most elementary instruction so that new operators may make a start and then move on to all forms and situations of grading where, it is hoped, even the experienced operator will find something to improve his performance.

Contents

** Blade Control	1
** Grading Techniques	2
Grader Attachments	3

** **Blade Control**

1

Control Rams 1-1
Blade Control 1-2, 1-3, 1-4
Circle Sideshift 1-5, 1-6, 1-7
Blade Pitch 1-8, 1-9
Blade High Lift 1-10, 1-11
Blade Carry Position 1-12

** Grading Techniques

2

Forming a Windrow 2-1, 2-2

Handling a Windrow 2-3, 2-4

Principles to Remember 2-5

Grading Curves 2-6

Grading Around Obstacles 2-7, 2-8

Earth Road Maintenance 2-9

Earth Road Construction 2-10, 2-11, 2-12

Ditch Cleaning 2-13, 2-14

Bank Sloping 2-15

Getting Out When Bogged 2-16

Terrace Construction 2-17, 2-18

Spreading Bituminous Materials 2-19

Blade Control

The Blade or Mouldboard (1) is the principle tool of the grader. It is carried by a rotating circle (2) and is readily manoeuvrable to a wide range of cutting positions by the hydraulic controls (3).

The blade and circle are mounted on an "A" frame (4) which is supported at the front of the machine by a ball joint (5) also known as the "goose neck".

Movement and positioning of the blade is shown in the following pages, but first refer to the appropriate Instruction Book or Operators Handbook for details on the operating controls that are applicable to your particular grader.

1-1 Control Rams

The Rams used to manoeuvre the blade and circle are as follows:—

Blade Sideshift Ram (6)

Lift Rams (7) and (8)

Rotate Circle Motors (9)

Circle High Lift & Sideshift (10) or (11). See fig. 1-6 and 1-7.

Mouldboard Power Tilt Rams (12) if fitted. These enable the blade pitch to be altered without the operator having to leave the cab to make adjustments.

Safety Note

Ensure that all personnel are clear of the machine when practising blade manoeuvres.

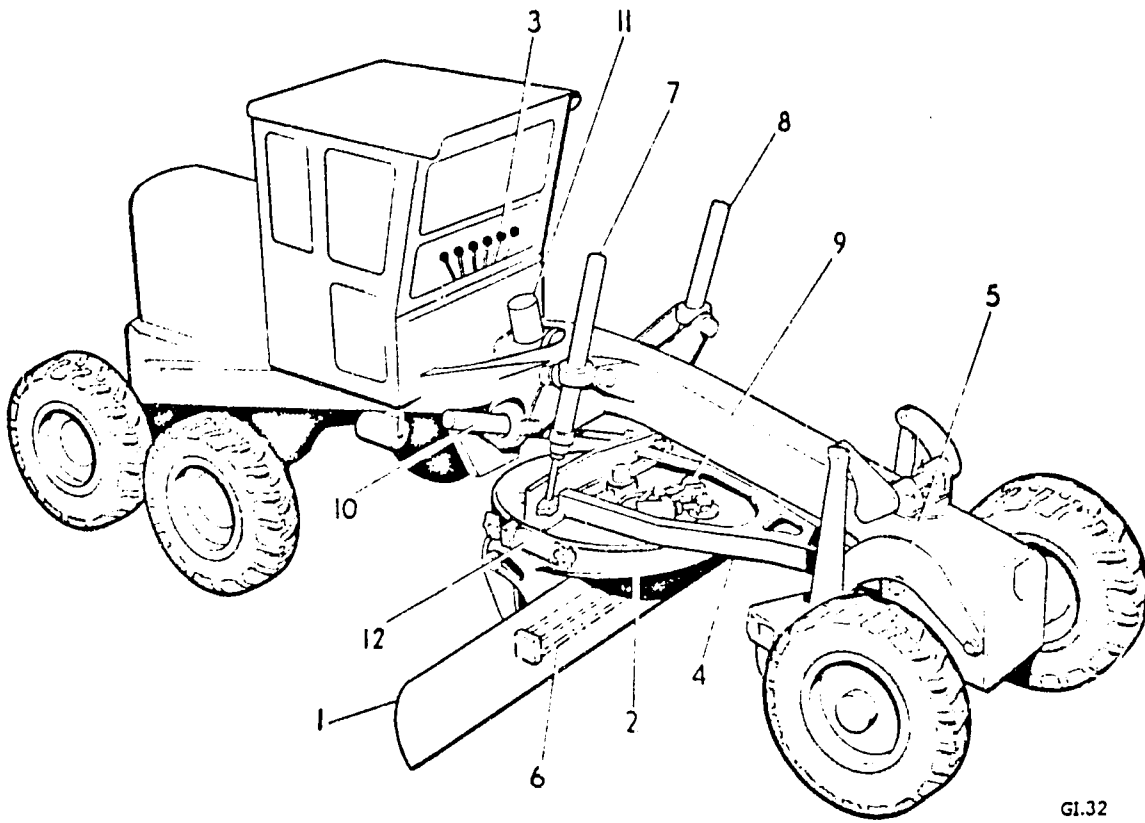

GI.32

1-1

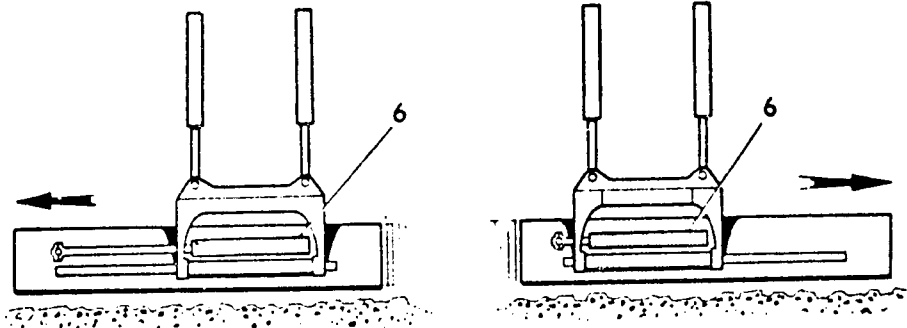

GL3

1-2

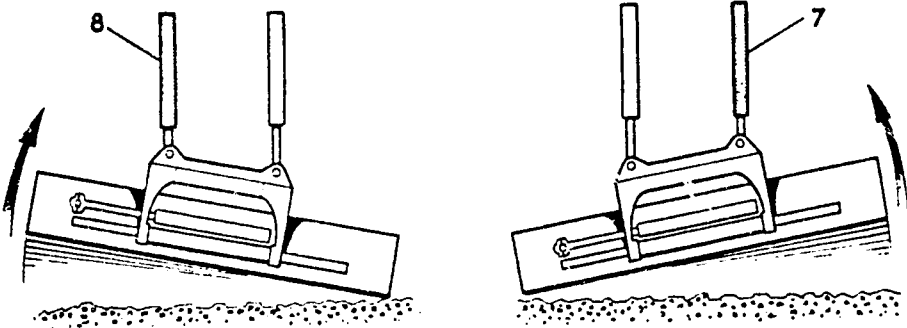

108

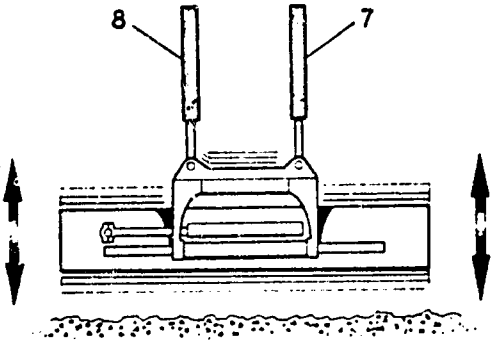

GL4

1-3

Blade Control – continued

1–2 Sideshift the Blade

Sideshift the blade to the right and left with ram (6).

1–3 Lift the Blade

Lift and lower the blade with rams (7) and (8) using both rams to keep blade horizontal and then separately to raise left or right hand side.

Blade Control – continued

1-4 Rotate the Circle

Rotate the circle and blade with the hydraulic motors (9).

(If circle lock is fitted press control pedal to unlock: releasing pedal automatically locks circle again).

- ① Rotate blade clockwise to position shown at (A) and anticlockwise to position, (B).
- ② The blade may be rotated into a completely reverse position but watch points (X) to avoid damage by blade as it rotates.
- ③ To Reverse Blade

See that circle is level all round before commencing.

Rotate blade to position (A) and then sideshift blade to the right to avoid danger points (X).

Continue rotating until blade is in reverse.

Once in reverse the blade can be sideshifted back to a more central position as required.

Reverse the above procedure to return the blade to its normal forward operating position, always taking care that points X are cleared.

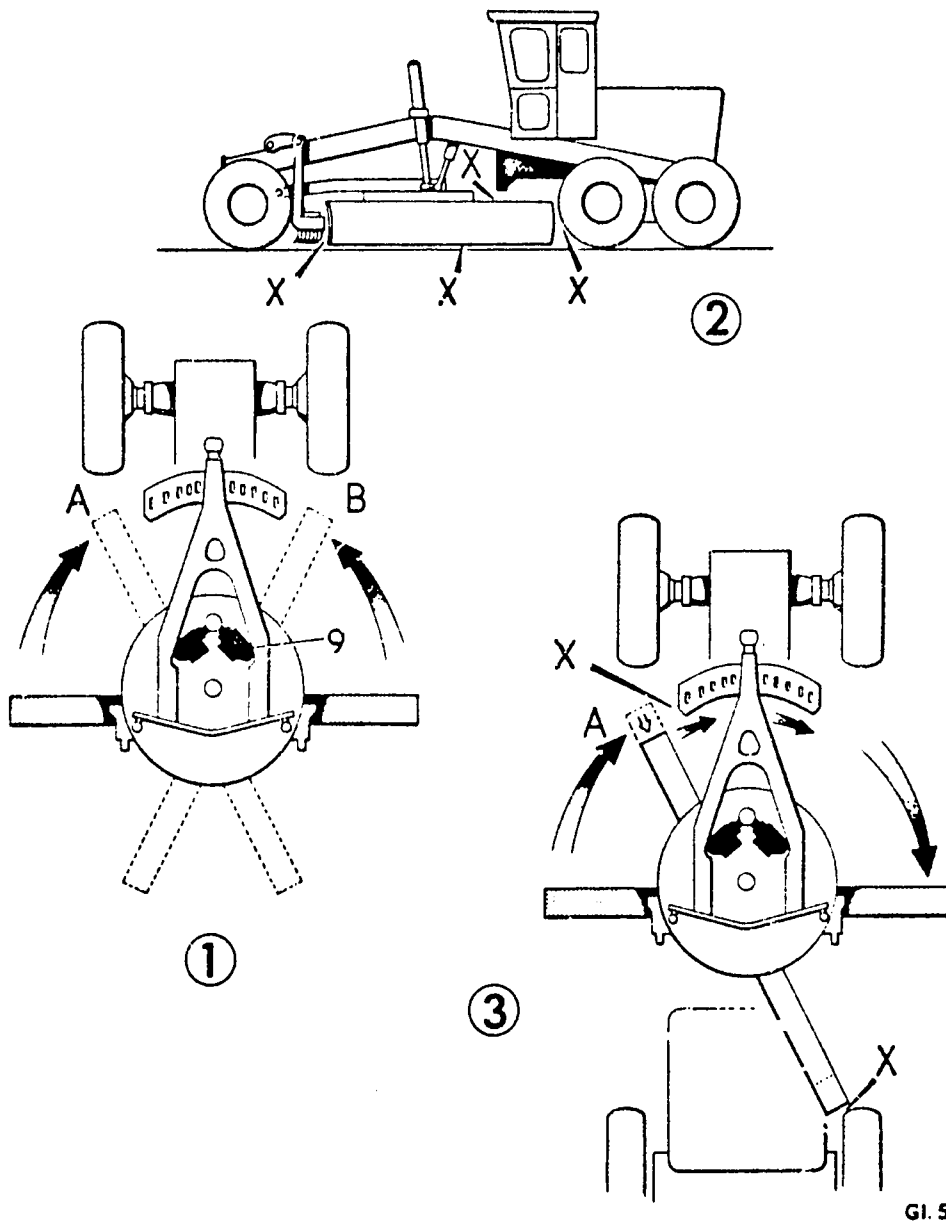

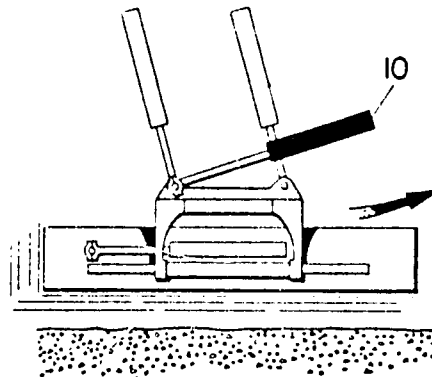
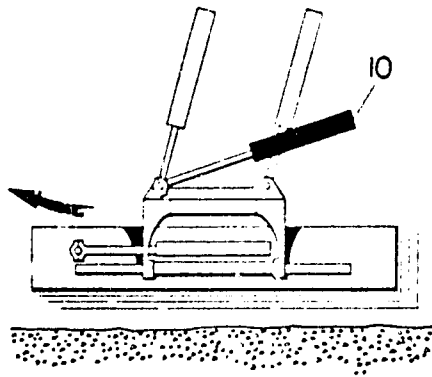

GI.6

1-5

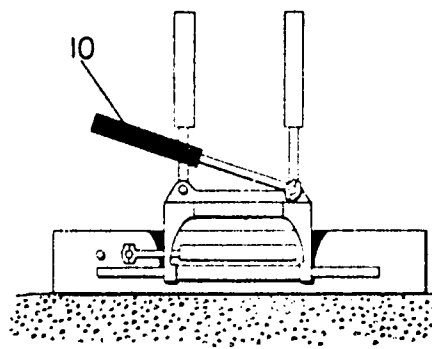
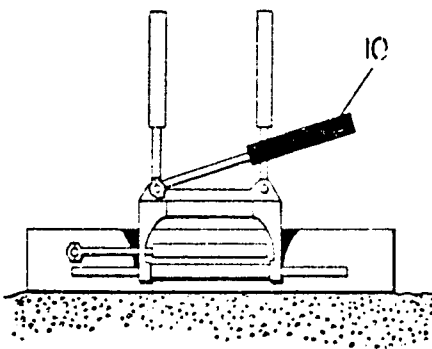

GI.16

1-6

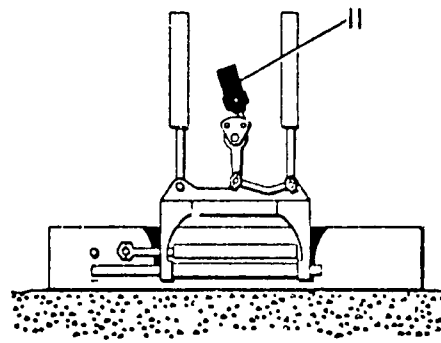
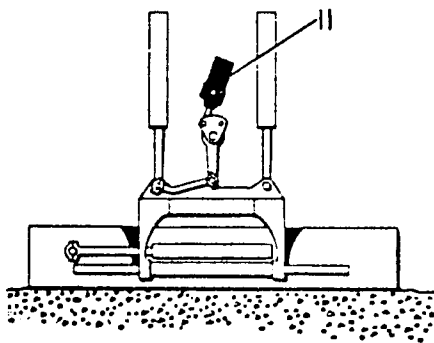

GI.14

1-7

Blade Control – continued

Circle Sideshift

1–5 Side shift the circle to right and left, remembering that the movement to the left is limited by the mounting of the Circle Sideshift Ram 10. Illustration 1–5 shows sideshift with Ram 10 mounted on right hand side.

1–6 Some types of Aveling-Barford Grader have side-mounted ram 10, and other
1–7 types are fitted with centrally mounted ram and link 11. Both types leave the works fitted for right hand high lift operation.

If left hand high lift operation is required these rams must be changed over as shown in illustration 1–6 and 1–7, and the Blade Sideshift Ram adjusted on the blade. Detailed instructions for changing over are given in the Workshop Manual.

All blade movements described so far should be practiced, with machine stationary, until they can be performed with ease. When these basic blade settings have been mastered it will be possible to study the blade High Lift position shown in section 1–10.

Blade Control – continued

Blade Pitch

- 1–8** The vertical angle of the blade can be adjusted, either manually, Fig. 1–8,
1–9 or by power tilt rams, Fig. 1–9, if these are fitted.

The adjustment is made to suit the type of work the blade has to do.

- ① When cutting hard pan or clay the blade should be set back at the top. This is the most effective cutting angle.
- ② For most normal grading work the blade is set to a more vertical position.
- ③ General Maintenance, where a spreading or dragging action is required, is best done with blade set forward at the Top.

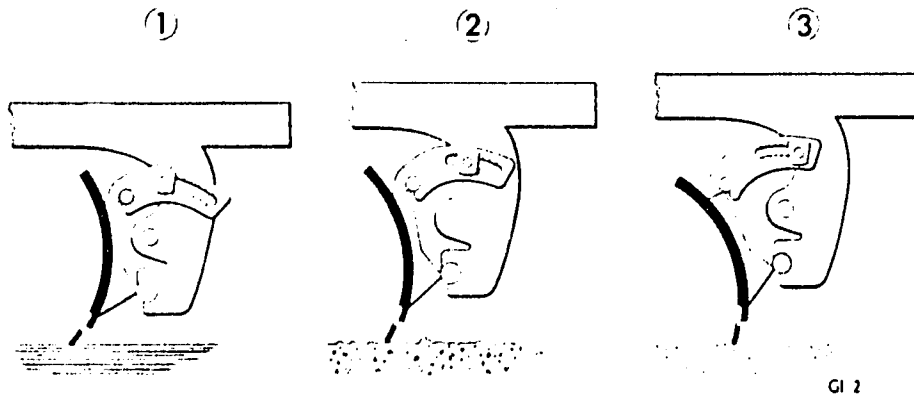

1-8

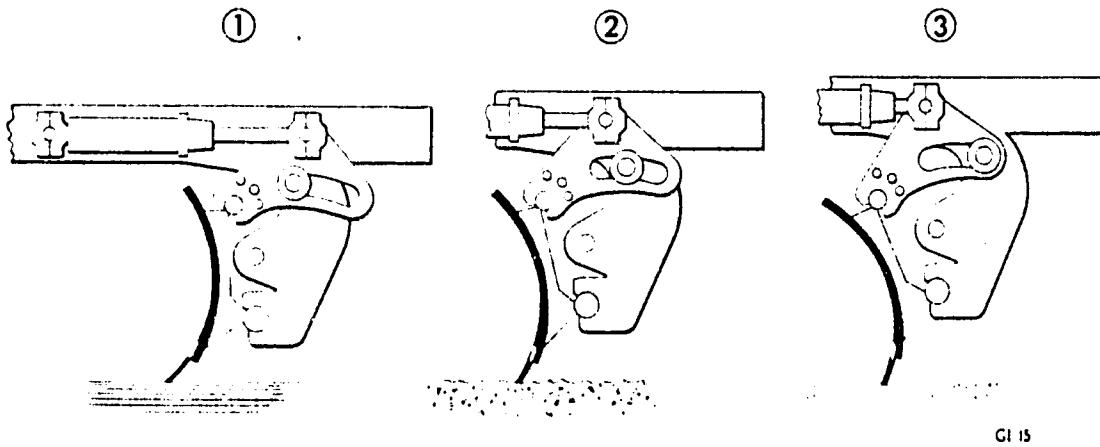

1-9

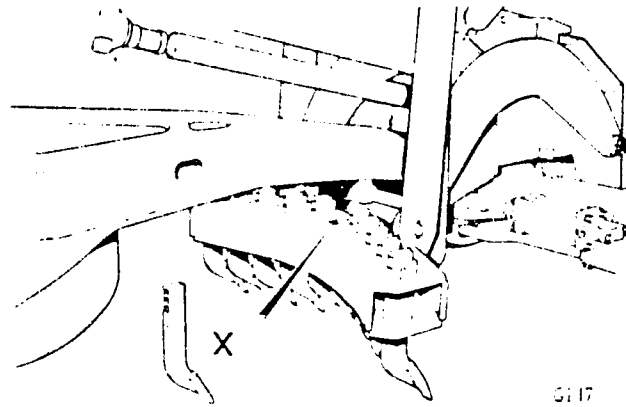

1-10

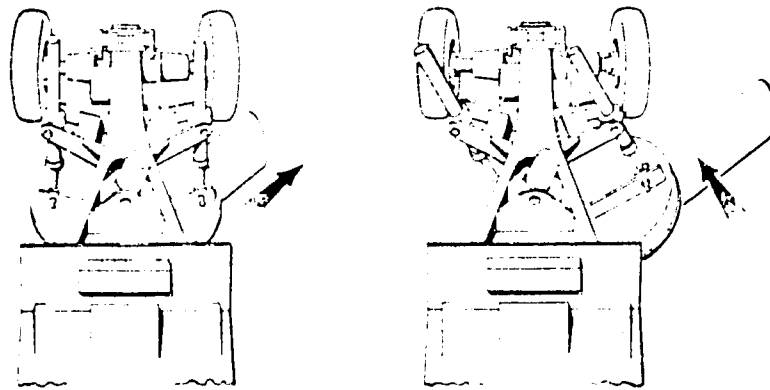

①

②

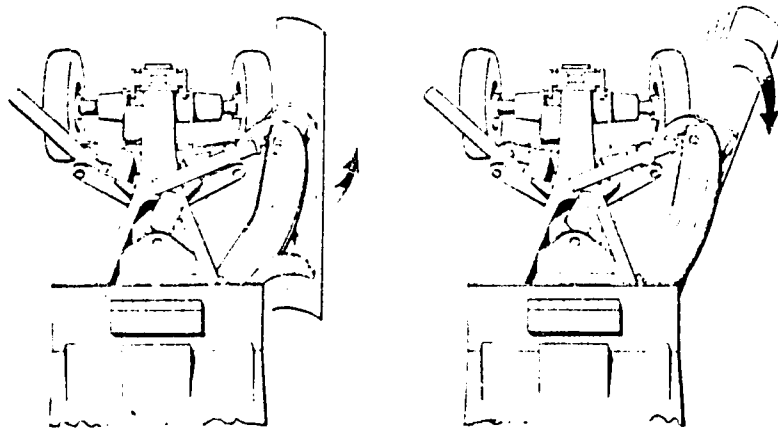

③

④

G118

1-11

Blade Control – continued

Blade High Lift

Having practiced and become familiar with the blade positions already described, the more complicated movement of Blade High Lift can be considered. Remember that blade high lift cannot be performed on left hand side of machine until high lift ram is changed over as shown in figures 1-6 and 1-7.

- 1-10** If a scarifier is fitted it will be necessary to remove the centre tine to avoid it being fouled by the gooseneck at X. Three centre tines should be removed from some machines to avoid damage to hoses when going into high lift.

Detailed instructions for removing tines are given in the Operators Handbook.

- 1-11** To commence right hand High Lift, the blade should be parallel to, and not more than, 3" (76mm) above the ground.

- ① Rotate circle anti-clockwise and sideshift blade to the right.
- ② Raise right hand blade lift ram to maximum.
- ③ Tilt circle up to the right by lowering left hand Lift Ram and at the same time raising circle high lift ram.
- ④ Rotate circle clockwise to bring blade to position required.

Reverse the above movement to return blade to normal position. Rotate circle anti-clockwise and take the blade forward on right hand side. Lower circle back to a horizontal position while watching that blade does not foul the machine or the ground. Bring circle in central and return the blade to normal position.

Blade Control – continued

1–12 Blade Carry Position

Rotate circle clockwise and tilt slightly up to the left, as shown in illustration.

This brings the blade within the limits of the machine and consequently has less chance of causing damage.

Always stow the blade like this for travelling between jobs and for parking or leaving the machine overnight.

If the grader is to stand for two or three weeks, protect the blade surface with a coat of oil or grease to prevent rust.

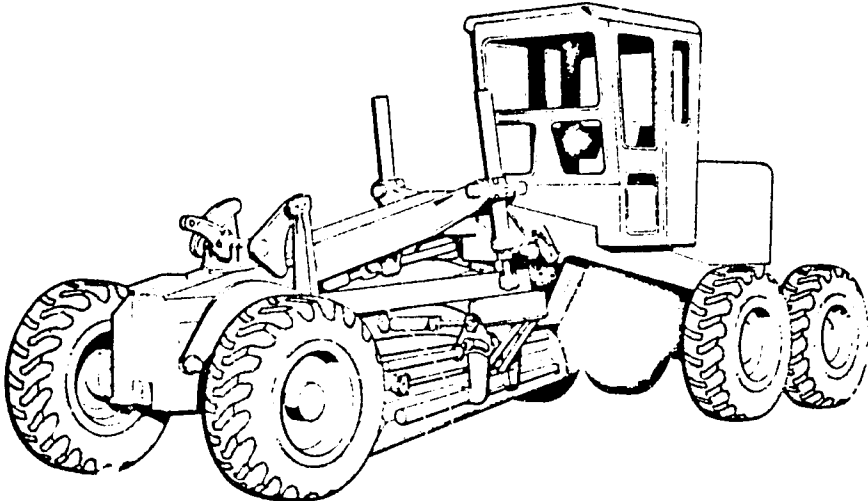

1-12

GI 9

Grading Techniques

In the following pages it is assumed that the operator has studied the Operators Handbook to be familiar with all controls and has also practised the basic blade movements as described in the previous chapter.

Real proficiency means that all these operations can be carried out without having to stop and look at controls.

Basic Principles

Practically all grading is carried out with the grader travelling forward and with the blade lowered and set at an angle across the frame.

This action causes the cut earth to 'boil' along the blade to the outer edge where it is deposited as a windrow.

Forming and handling windrows is the basis of most grading operations.

Note

The type of grader used for most of the illustrations in this book is the heavy all wheel drive machine, but with minor features omitted for the sake of clarity of presentation.

Most operations are common to all types, but where special techniques apply to certain machines, such as the leaning wheels type, these alternatives will be illustrated alongside as necessary.

2-1 Forming a Windrow

- ① Set all wheels in the straight ahead position and angle the blade until rear end is just outside rear wheel.
The angle should be just sharp enough to let material roll freely off the end of the blade.
- ② Travel forward slowly in a low gear and lower blade 2 or 3 inches into the ground – **keeping it level. TRY TO MATCH GEAR AND SPEED TO GROUND DENSITY.**
Note action of earth and try slight alterations of blade angle and forward speed until earth rolls along blade and forms a windrow.
Most beginners do not angle the blade sufficiently to allow material to roll freely. They consequently use too much engine power. This is wasteful and causes unnecessary wear.
The expert operator learns to match engine power to work being done.

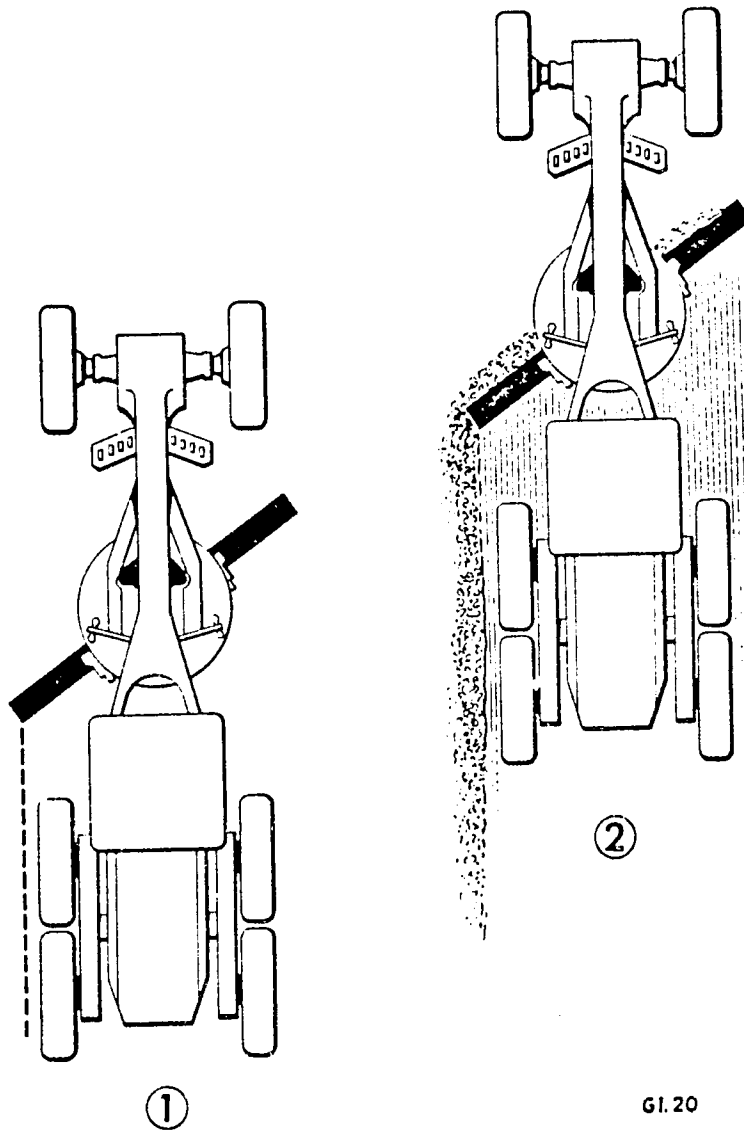

GI.20

2-1

122

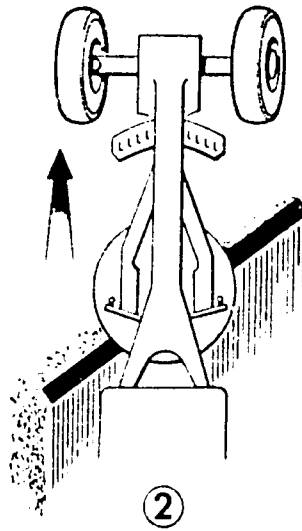
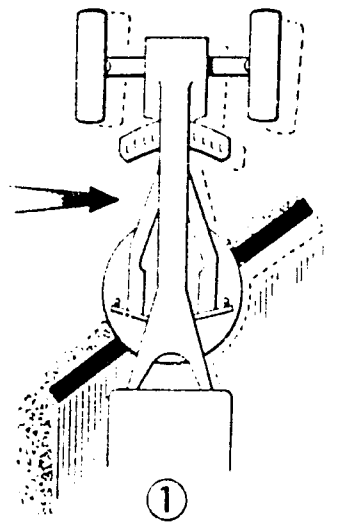

G1.21

2-2

Grading Techniques – continued

2-2 Forming a Windrow – continued

- ① Most Grader work places a side load on the machine, tending to push the front end sideways.
- ② On leaning wheel graders, lean the wheels in the same direction that the earth moves off the blade. This will help to counter the side thrust and keep the machine going straight ahead.
- ③ On all-wheel-steer machines practice using the rear steer to offset the wheels. The front wheels are then steered to maintain correct direction.

More material can be moved with the wheels offset.

- ④ In some operations the windrow may pass between the rear wheels but **NEVER** let the wheels run into a windrow.

Note

Illustrations show windrow being formed to the left.

Similar, but opposite, positioning of blade and machine will of course form windrow to the right.

Grading Techniques – continued

2–3 Handling a Windrow

Once formed, a windrow may have to be moved sideways across the road, or perhaps new material may have to be mixed with it. Whether moving or mixing, the routine is always to use the blade to pick up the windrow from one side of the machine and pass it to the other.

Loose windrowed dirt looks easy to move but this may not be the case. Depending on the type of material, you could have a full blade and get bogged down in just a few feet of travel.

The Right Way

- ① For an all-wheel-steer machine, offset it to place front wheels on one side of windrow and rear wheels clear of windrow that has been transferred. In this position the front wheels pull the heel (rear end) of the blade and rear wheels push the toe (front end) of blade, and maximum balance and power are obtained. Also the blade may be more nearly square to the direction of travel and so handle more material and move it further.
- ② To get more power behind the blade ON LEANING WHEEL MACHINES lean the wheels against the side thrust and angle the blade towards the windrow to reduce the load.

Angle blade to left or right according to job requirement. (Right hand is illustrated) and so moves windrow to the left). On approaching the windrow lower blade onto the ground, ensuring that it is level.

Travel slowly forward in a low gear and steer machine until toe of blade picks up windrow. Note action of earth along blade and try alterations of blade angle, steering and speed until windrow passes smoothly from one side of machine to the other.

The Wrong Way

- ③ This illustration and also No. 4 show what to avoid. In this attempt to move a windrow with an all-wheel-steer machine, the frame is offset but there is not enough space for the windrow to pass the front wheel and be picked up properly by the blade.
- ④ If the blade is side-shifted to obtain more space, then the rear wheels could run into windrow that has been transferred. Also as the grader moves forward the front wheel will be pulled into windrow as shown by wavy arrow.

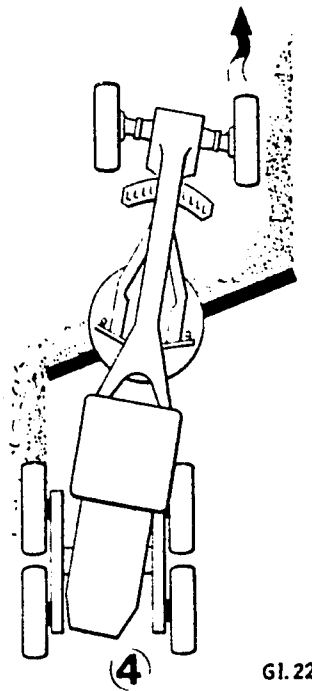
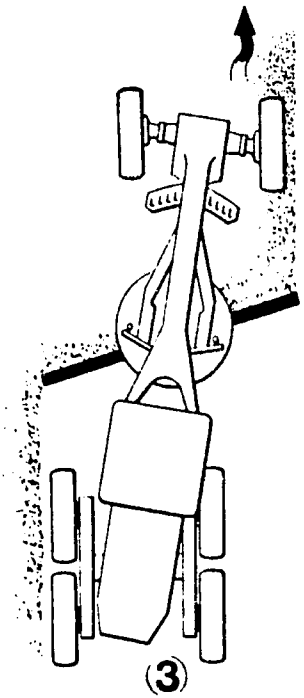
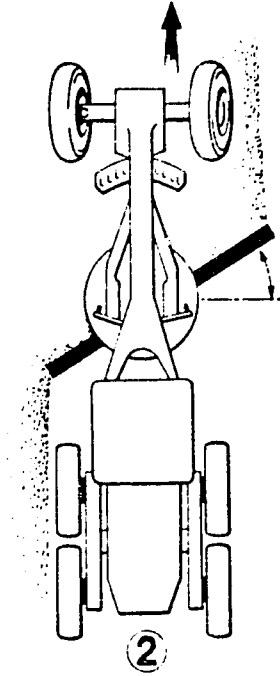
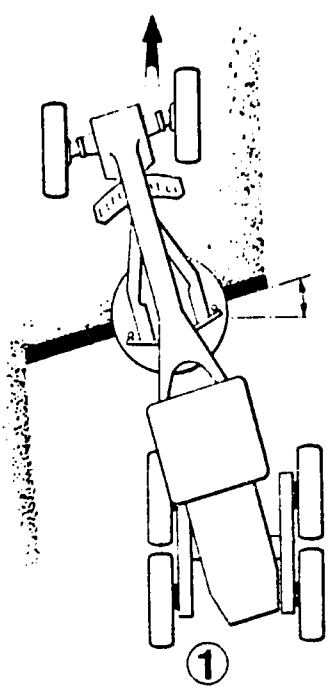

GI.22

2-3

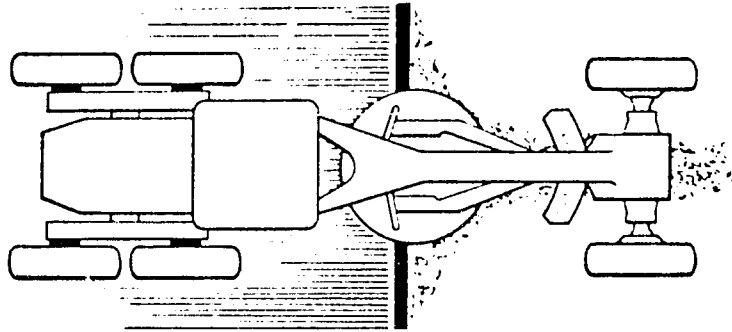

1

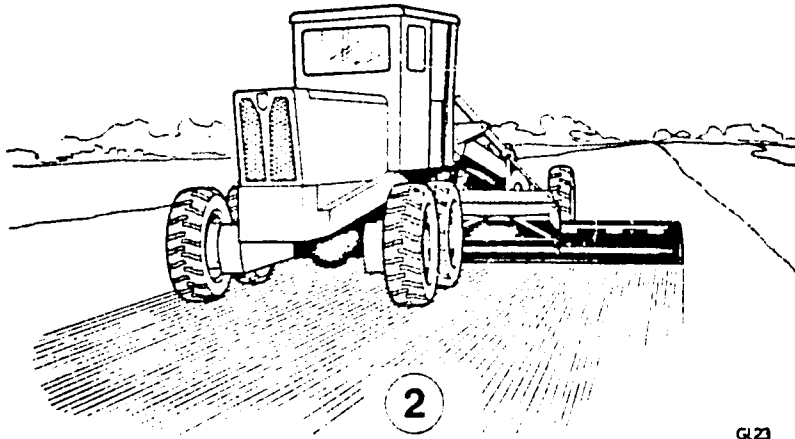

2

GL23

2-4

Grading Techniques – continued

2-4 Spreading a Windrow and Finishing

- ① Windrows that have been deposited may have to be spread to a set thickness and usually the surface that is achieved is adequate for most site requirements.

Commence by having all the wheels straight and front wheels astride the windrow.

The blade must be level and square to windrow.

Remember that for spreading, the blade pitch should be forward at the top. See illustrations 1-8 and 1-9.

Set cutting edge of blade above the ground a distance equal to depth to which material is to be spread.

As grader moves forward in low gear the windrow is spread out by blade under full length of the cutting edge. If windrow is very heavy more than one pass may be needed to spread all material to the required depth.

- ②

Finishing Without Leaving Tyre Marks

Occasionally however, the surface may have to be finished to fine limits – on airfield runways and on motorways for example.

In such cases make the finishing pass with the blade only slightly angled and set to skim the surface. Blade pitch forward at top.

With maximum circle and blade sideshift it is possible to reach well beyond the rear tyre and so leave a fine graded surface without tyre marks.

Off-setting the wheels on all wheel steer graders will of course increase this advantage.

Work in low gear and avoid sudden jerky movements on controls. With practice it will be possible to work to the finest limits.

Grading Techniques – continued

2–5 Important Principles To Remember

① Keep Rear Wheels On Level Ground

Keep rear wheels on level ground whenever possible – the grader is easier to control and the blade setting is kept true.

② Offset The Wheels

Offset the wheels whenever you can – you will move more dirt further and faster: effective track is greatly increased giving extra stability and power. This is the basic reason why all-wheel drive and steer graders out-perform other types.

③ Do Not Use High-Lift Unless Really Necessary

Do not use high-lift if the job can be done without it. The grader is most efficient when the blade is under the frame, especially for rough grading where more weight is required on the blade.

If possible grade so that earth is transferred downhill: it is easier to work with gravity than against it.

Leaning wheel machines lean top of front wheels towards the top of slope.

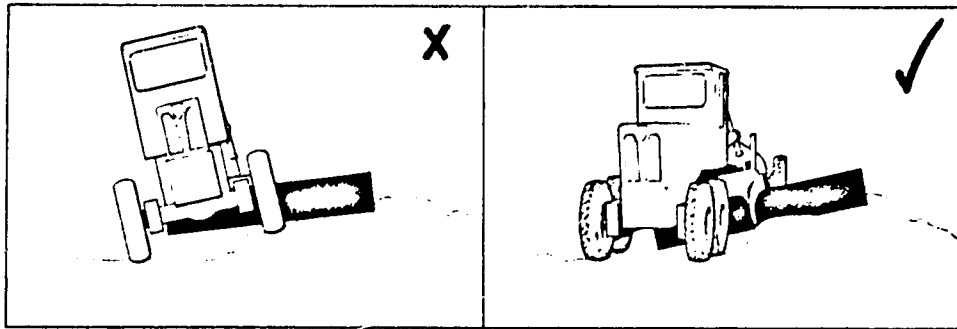

1

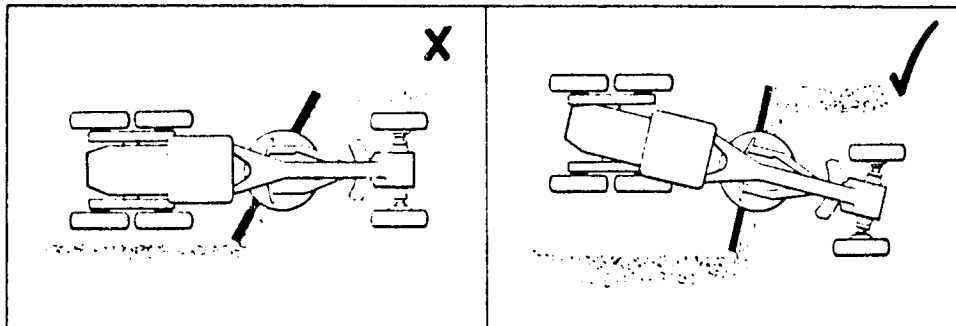

2

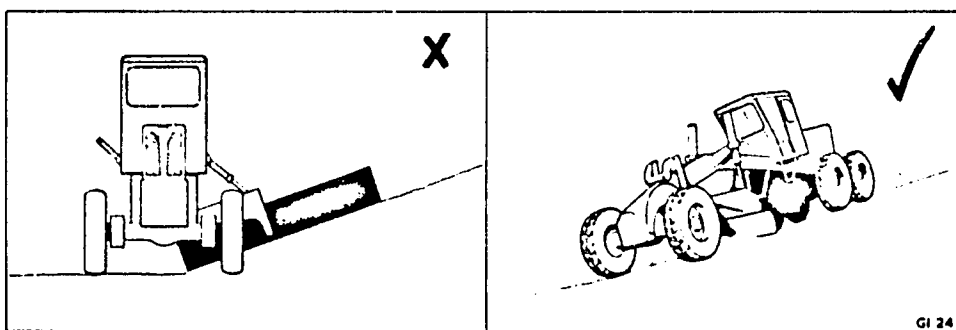

3

2-5

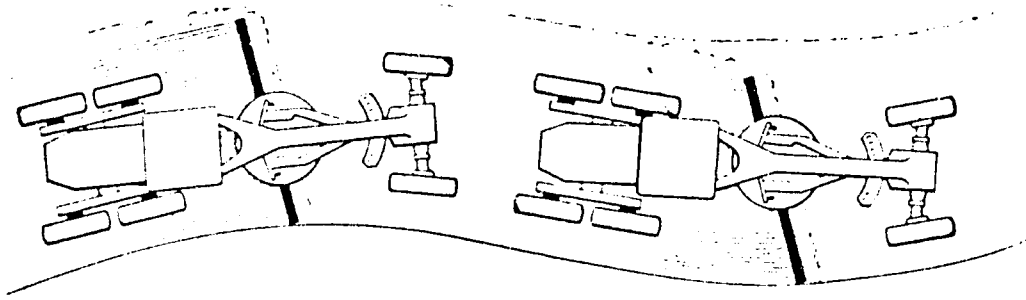

G125

2-6

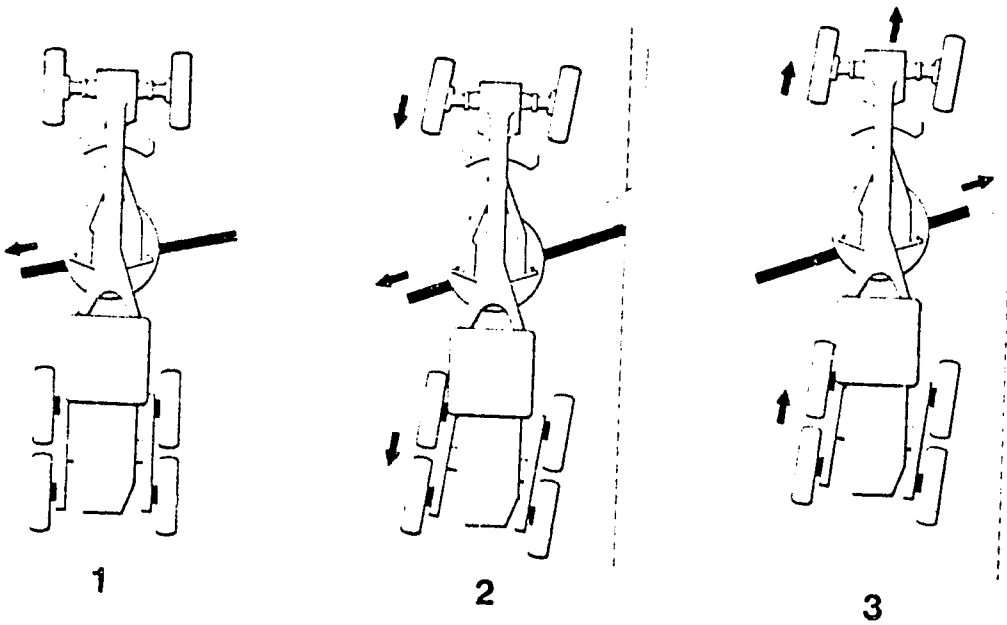

G126

2-7

Grading Techniques – continued

2-6 Grading Curves

Steer front and rear wheels as shown in illustration and use blade sideshift to assist in following the curve as the machine moves forward.

To keep a smooth and continuous finish do not stop whilst sideshifting the blade.

On leaning wheel graders always lean the top of the front wheels in the direction of the turn to help the grader to follow the sharper bends.

The ability to lean the front wheels can also be used to make minor adjustments to the point of the blade in order to follow an accurate line.

2-7 Grading Around Obstacles

Do Not Force The Blade Through Obstruction

- ① Where the obstruction is not in the path of the wheels but only of the blade, sideshift the blade to avoid obstruction, move forward and return blade when obstacle is passed.
- ② When the obstacle is more extensive or is partly concealed, sideshift blade and back out 'Crab-wise'.
- ③ Drive grader past obstruction and return to original line as soon as possible.

Grading Techniques – continued

2–8 Grading Around Obstacles

- ① When obstacle is large enough to be in the path of wheels and blade, work as near as possible before steering away and side shifting the blade out to make up the away movement.
- ② Take the blade as near to the obstruction as safety permits before side-shifting the blade in, and steering rear wheels to clear obstruction.
- ③ Straighten rear wheels and grade past obstacle.
- ④ Steer front wheels and sideshift blade to return to original path.
- ⑤ Straighten front wheels along original path and sideshift blade.
- ⑥ Steer rear wheels back to original path and adjust blade as necessary.

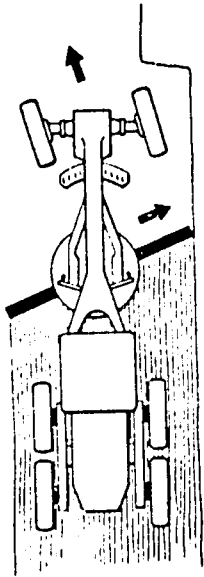

①

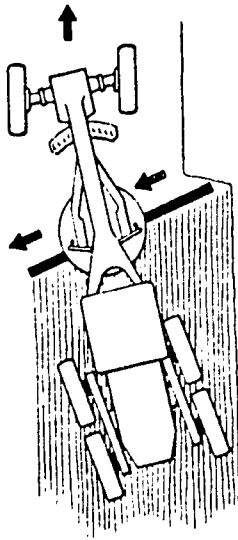

②

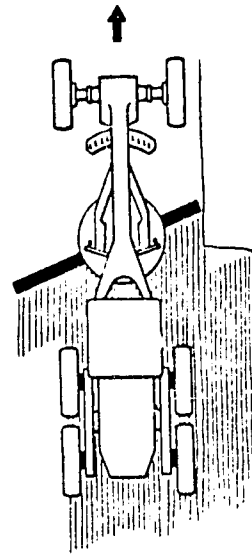

③

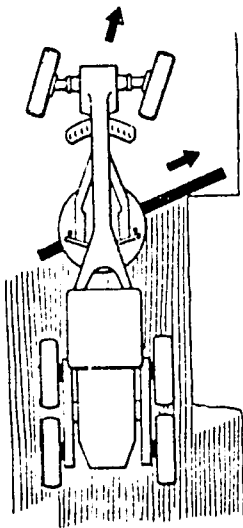

④

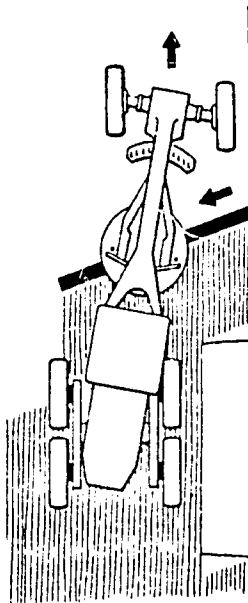

⑤

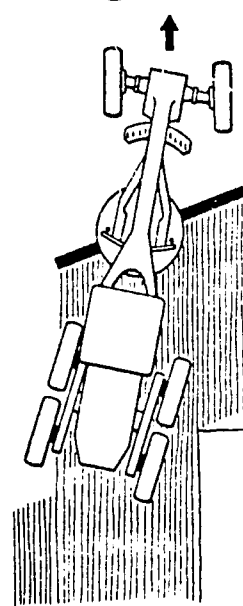

⑥

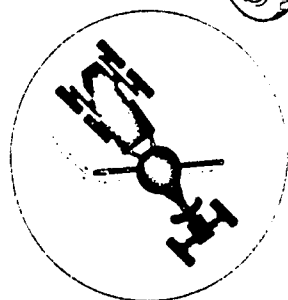
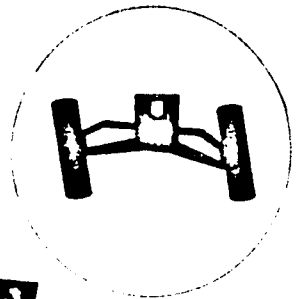
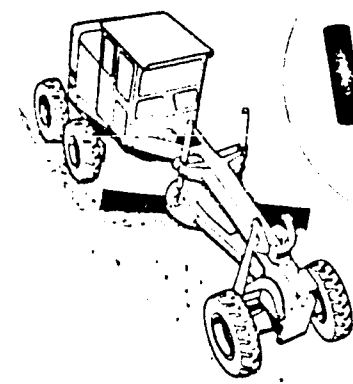
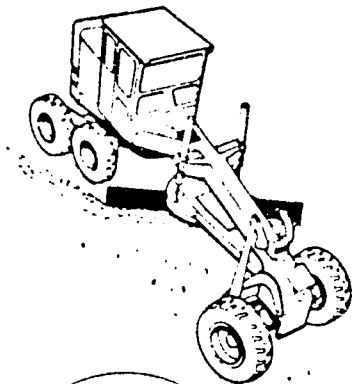

①

②

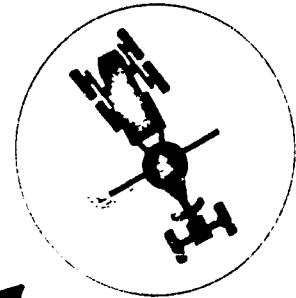
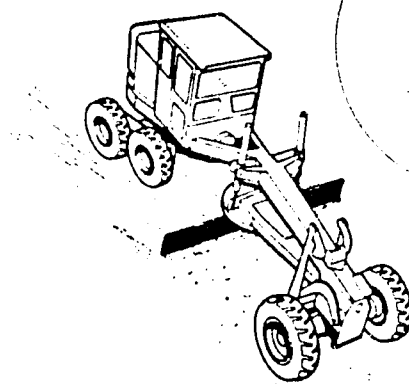
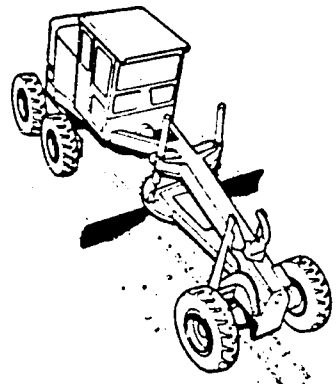

③

④

GL28

2-9

Grading Techniques – continued

2-9 Earth Road Maintenance

Since light maintenance does not require moving large amounts of material, both types of grader operate in a similar manner. The blade is circled and sideshifted to make windrows outside or between rear wheels; dropped to cut high areas and lifted to fill low areas.

However where conditions are rough, such as on haul roads where large dump trucks and other heavy equipment leave deep ruts and holes, it needs a powerful machine to level these out and keep the road in good condition.

- ① Set the blade to cut just below ruts and potholes and move forward to form a windrow, use first or second gear depending on nature of ground and depth of cut.

If road is wide enough, work along one side and back along the other so that windrows form down middle of road. Set blade pitch back at the top for cutting.

The all wheel steer grader should be offset. This widens its stance and gives greater stability and more power at the blade.

- ② On leaning wheel machines, if load is heavy, lean front wheels over against the side thrust and angle the blade towards the delivery side to reduce the load.

- ③ When an even surface is obtained, set blade at right angles to re-spread windrows, angling blade vertically to give required camber or crossfall. For spreading, blade pitch should be forward at the top. Use second gear if possible.

- ④ If there are low spots in the road, drop material into these areas by steering REAR wheels one way or the other so that dirt spills off end of blade into low spot.

Do not touch the blade controls.

Straighten grader again when low spot has been passed.

Grading Techniques -- continued

2-10 Earth Road Construction

① Remove Turf

if turf has to be stripped off, set blade square to machine with cutting edge level. Lower the blade just sufficient to roll up turf as grader moves forward in first gear.

Usually only a few feet of turf can be cut before it has to be moved out of the way for the grader to continue. Once a long enough strip has been cleared it can be widened much easier by taking about one third of a blade length of turf at a time.

Work along road line as indicated by marker stakes if possible, but actual direction of operation may depend upon arrangements for disposal of turf.

② Level Surface

After stripping turf, level the surface, filling hollows and holes left by trees etc. with a light cut. Keep blade square and work along one side of road line and back down other side. Use second gear.

③ Mark Out Ditch

The primary objective now is to establish a straight ditch line.

Line up front and rear wheels just inside ditch line stakes. Turn blade 45 degrees forward and sideshift it to bring toe just to outside edge of right front tyre.

Raise the heel of blade until material will fall off its centre to form windrow between rear wheels. Take a light cut of 9" to 12" (30 cm) at first. Work both sides of road line -- up one side and down the other -- using first gear. Keep front wheels upright on leaning wheel graders unless there is much resistance, when wheels should be leaned away from ditch to help keep to a straight line.

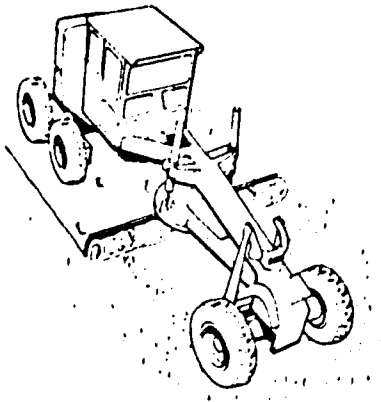

①

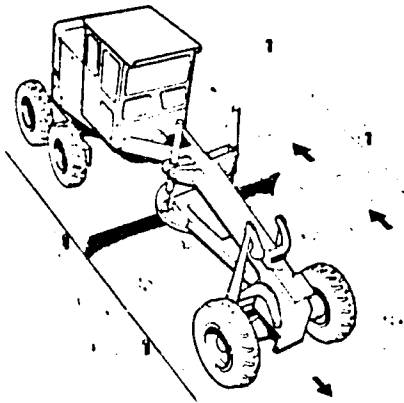

②

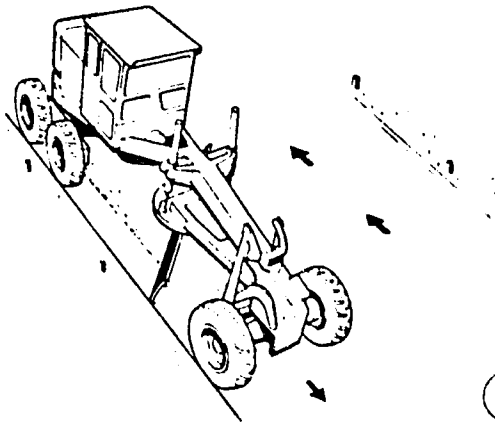

③



GL 29

2-10

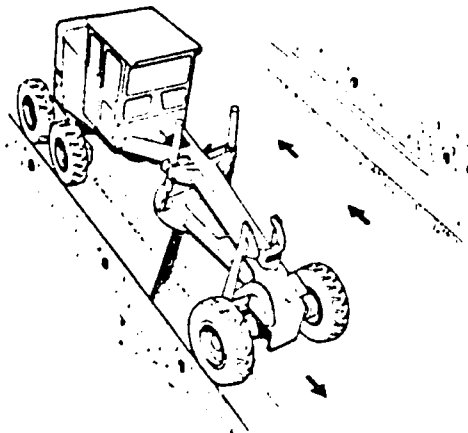

④

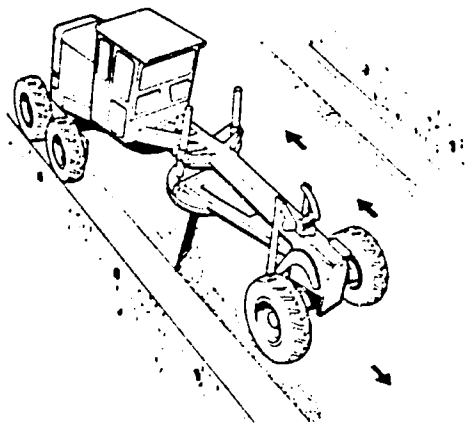

⑤

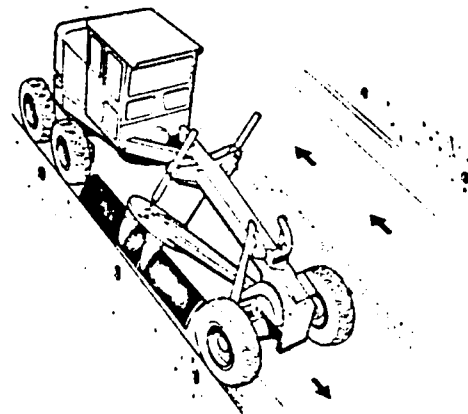
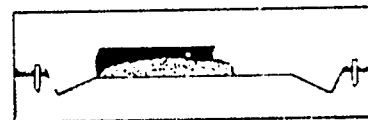

⑥



GL30

2-11

Grading Techniques – continued

2-11 Earth Road Construction – continued

④ First Ditch Cut

When an accurate ditch line is established along both sides of road, more material may be moved on successive passes. Line up the blade as when marking out ditch and lower the toe to cut about 6" (15 cm) deeper or to a depth as will allow grader to move forward smoothly.

Raise heel of blade to let windrow form between rear wheels as before. Use second gear if possible, and keeping right hand front and rear wheels in the ditch.

⑤ Move Windrow Over

After one or two ditch cuts it will be necessary to move windrow over to centre out of the way. Trying to operate with tyres running into soft loose soil will only result in difficult and uneven work.

Use rear steer to offset, leaving right rear wheel in ditch to help grader keep on course, and front wheels out of the ditch.

Set blade to pick up windrow and move it to centre of road, passing it to left of rear wheels. Use second gear.

Repeat Ditch Cuts

Repeat ditch cuts as already described until required depth of ditch is reached, moving windrow over or spreading on road as necessary.

⑥ Grade Ditch Outslope

When ditch is deep enough the outslope should be graded to leave a clean finish and prevent the edge breaking down into the new ditch.

Steer right front wheels to ride bottom of ditch and right rear wheels to barely ride the outslope.

Set heel of blade at ditch bottom and toe well forward.

Pass windrow between rear wheels. Use first gear.

On leaning wheel machines, lean top towards the bank slightly – an exception to the usual rule but it helps in keeping the blade accurately positioned.

Grading Techniques – continued

2-12 Earth Road Construction – continued

⑦ Clean Ditch

Material that might have fallen into the ditch during the outsloping operation may be removed by making a finishing pass to clean it up.

With right rear wheels in ditch and front wheels on the road, set blade to pick up windrow, move it up ditch inslope and deposit it on shoulder between rear wheels.

Use first gear.

When ditch is cleared down both sides of road, move windrows into the centre and spread as shown in illustration 2-4.

⑧ Finish Camber

If a camber to the earth road is required, set the blade square to the machine and angled vertically to give the required camber. The end of the blade should just reach the ditch shoulder. Take a very light cut and do not let dirt fall into ditch. Use second gear.

Grading In Reverse

In all the above "earth road" instructions the operator is advised to work up one side of the road and down the other, and this is much the easiest way of working. In some situations however it may be necessary to grade in reverse and this is described in section 2-14.

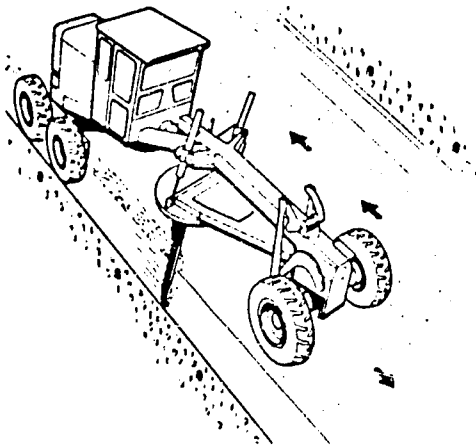

7

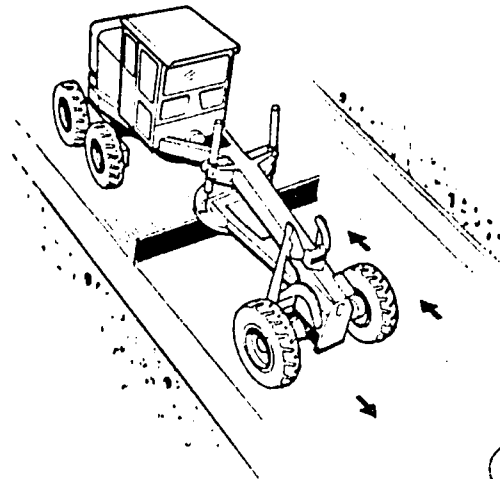
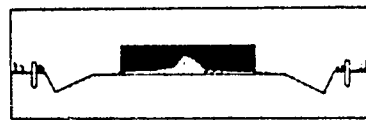

8

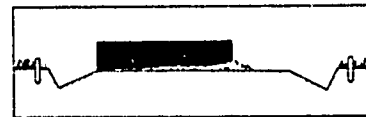

2-12

GI.3I

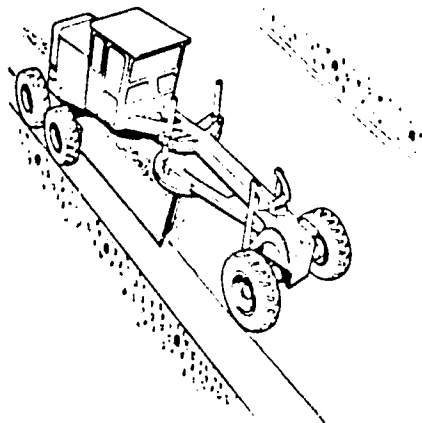

①

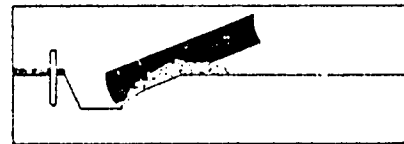
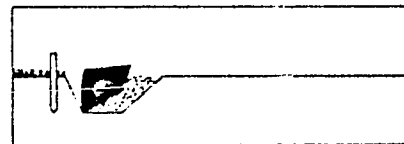
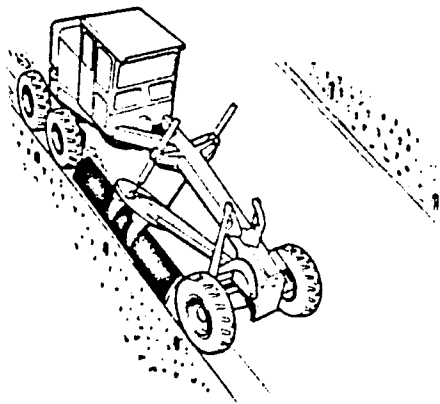

②

142

GL33

2-13

Grading Techniques – continued

2-13 Flat Bottom Ditches

①

It is sometimes necessary to widen the ditch bottom for greater drainage capacity. The first step in making the flat bottom ditch is to cut another 'V' ditch on the inside slope of the first, or as far from the centre as the desired width of the flat bottom.

More than one cut may have to be made to make the second ditch a similar depth to the first. Resulting windrows to be moved up out of the way as before.

②

When the second 'V' trench is cut, set the grader straight with right wheels in the ditch close to the outslope.

The full length of the blade should be placed level along the bottom of the ditch with toe behind the front wheel and heel at the base of the inner 'V' trench. This will give a narrow flat cut for the bottom of the ditch, and leave the material on the inner slope, to be moved up later onto the shoulder and spread.

The rear wheel will compact the flat bottom.

Note that rotating the blade in the ditch will adjust the width of the flat bottom. Work in the first gear, keeping machine steady so as not to bite into outslope with toe of the blade.

On leaning wheel graders lean top of front wheels away from ditch.

Grading Techniques – continued

2--14 Ditch Cleaning

- ① If ditch is dry, set right hand front and rear wheels in ditch and toe of blade in bottom of ditch.
Angle the blade vertically so that material spills off centre of blade to deposit windrow between rear wheels.
In dealing with a wet ditch keep rear wheels on firm ground and set front wheels in the ditch followed by toe of blade. The blade is angled vertically as before to leave windrow between rear wheels.
Use first gear.

Grading In Reverse

- ② When necessary the blade can be turned right round to operate in reverse direction. No need to remove scarifier tines.
This is illustrated in section 1-4.
Reverse operation is useful in narrow situations where it is difficult to turn the grader round, and also on short stretches of work to avoid frequent turns. On ditch cleaning jobs, the windrow formed on the inslope or shoulder in one direction can be moved over on the return trip merely by sideshifting and rotating the blade about 80°.
Use rear steer to guide grader in reverse.

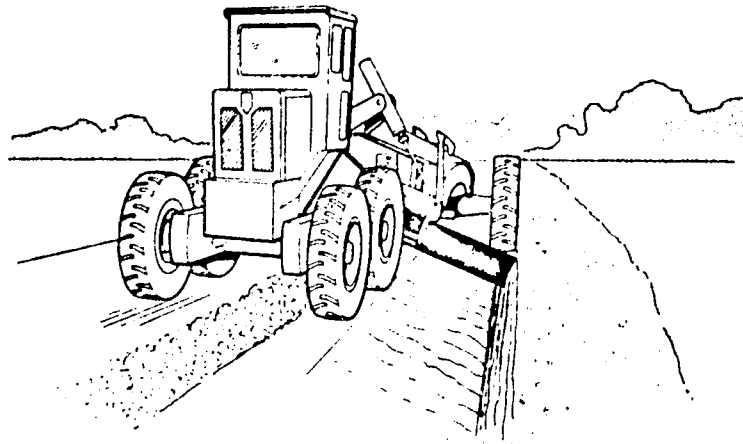

①

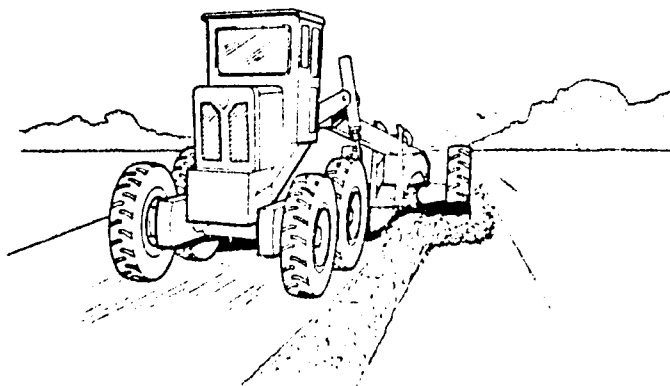

②

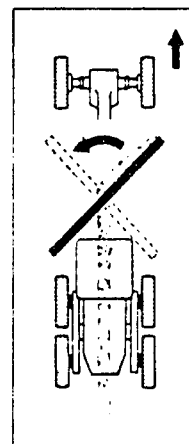

GL34

2-14

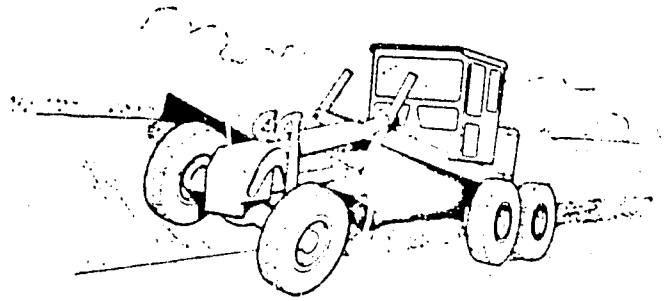

①

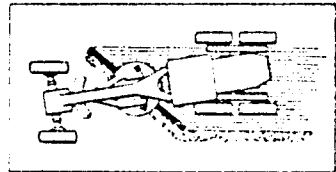
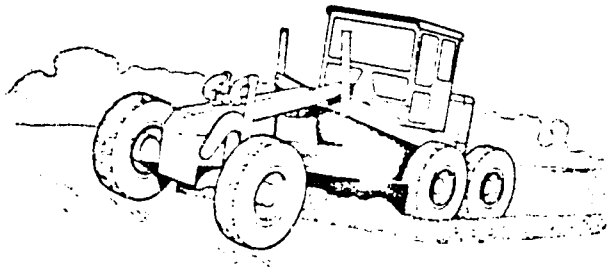

②

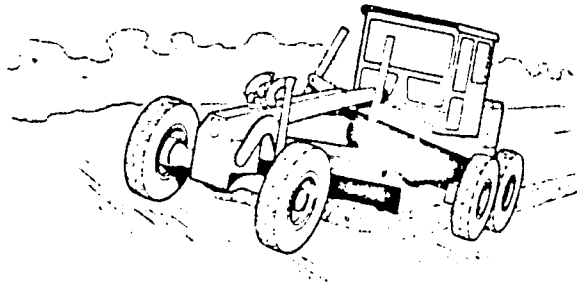
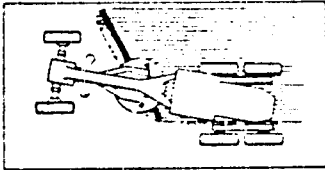

③

G/35

146

2-15

Grading Techniques – continued

2-15 Bank Sloping

Steep Banks

For steep banks the blade should be set in the high lift position. This is usually operated on the right hand side, but if it is necessary to work with left hand high lift, the change over can be made as shown in section 1-11 and in the machine instruction books.

- ① In this illustration for right hand high lift the toe of the blade is well forward and heel adjusted to deposit windrow between rear wheels. Rear wheels should be close in to the bank. If possible ride one or both front wheels on the bank – this allows the blade to reach further and to be kept nearer the normal position under the frame.
Use first gear.
It is sometimes possible to vary the depth of cut by steering rear wheels – away from bank to DEEPEN a cut and into the bank for a LIGHTER cut. Leaning wheel graders lean top of front wheels towards the bank.

Wide Slopes

- ② Grading wide slopes such as those for motorway cuttings, dams and reservoirs can prove difficult as down pressure of the blade combines with gravity to slide the grader downhill. All wheel drive and steer graders can work on slopes of up to 2 in 1 without assistance. Power on front as well as rear wheels together with increased track by offsetting, gives the greater stability needed to operate at this angle.
(Leaning wheel graders lean wheels towards top of slope to increase leverage).
Offset with front wheels downhill and blade to pass windrow downhill outside the rear wheels.
- ③ For lighter finishing pass, offset with rear wheels downhill and blade extended beyond front wheel to erase tyre marks and pass windrow downhill between rear wheels.

Grading Techniques – continued

2--16 Getting Out When Bogged

With their extra power and manoeuvrability it is not often that all wheel drive and all wheel steer graders get stuck. Should this happen however do not try to drive out -- wheels will only spin and sink deeper.

Use the down pressure of the blade to lift the machine out.

- ① Set the blade level and square and with timbers under the cutting edge. Lower the blade to the timbers and keep lift ram valves open until front wheels lift off the ground.
- ② Then using circle sideshift, move the whole front end of the grader over as far as possible towards firmer ground. Lower the wheels to the ground and repeat the operation until the grader can get sufficient grip to drive out.

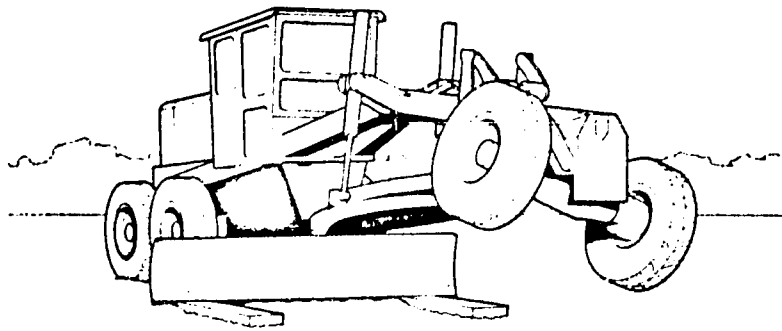

①

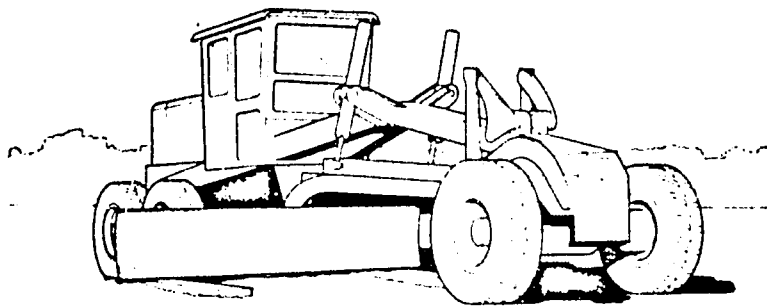

②

2-16

GI36

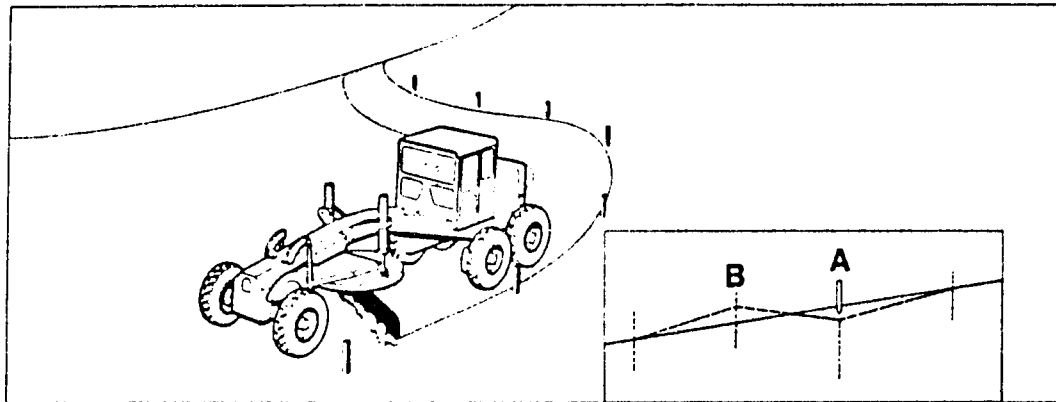

①

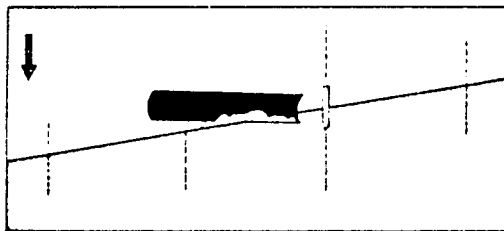

②

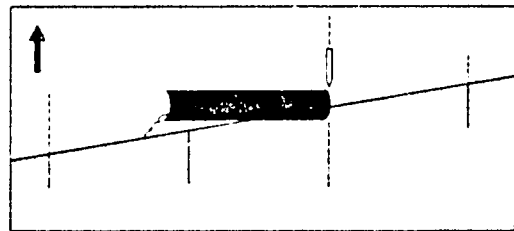

③

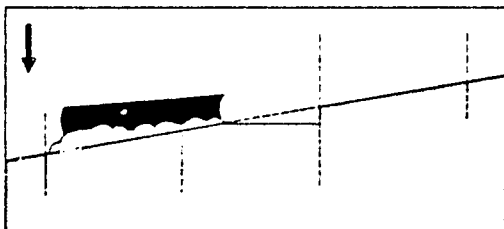

④

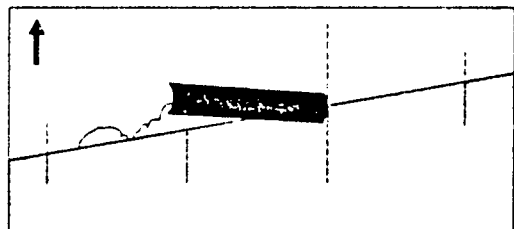

⑤

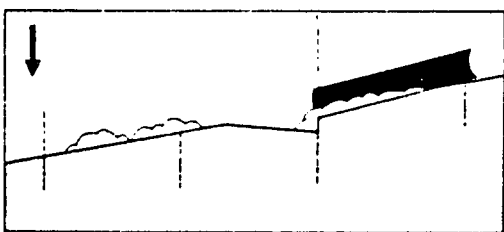

⑥

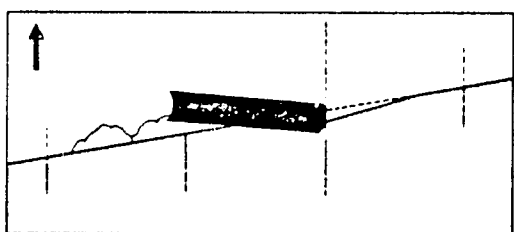

⑦

GI. 38

150

Grading Techniques – continued

2-17 Terrace Construction

Terracing for soil conservation is an important job which can be done very efficiently by graders.

Soil conditions and gradients vary greatly and therefore size and cross section of suitable terraces can be very different. However the basic manoeuvres are similar and the following illustrations are typical.

- ① Terraces must follow the contour of the hill and be kept level. The centre line of the channel (A) is first staked out for the operator to follow. Soil cut to make the channel is graded to form the ridges (B).
- ② Make the first cut about 12" (30.5 cm) downhill of the centre stakes and form windrow downhill. If bends are sharp use all wheel steer and also sideshift the blade to follow the curve as shown in section 2-6. Use first gear.
- ③ The second cut is taken on the return trip, deepening the channel and extending the blade to reach centre stakes. Hold the right rear wheels against the first cut to guide the grader. Use first or second gear.
- ④ The third pass is used to move downhill the windrow made so far.
- ⑤ At least one more full cut is usually necessary to make the required depth of channel.
- ⑥ Having established the channel base now cut the uphill side. Use extreme blade reach with rear wheels on downhill side. Cast windrow down into channel.
- ⑦ With this pass move the windrow from the last up hill cut out of channel and downhill.

Grading Techniques – continued

2–18 Terrace Construction – continued

- ⑧ Earth that has been moved out of the channel should now be moved over to build up the ridge. Use a higher gear for windrow moving passes.
- ⑨ Another heavy cut on the outside slope, delivering windrow into the channel again.
- ⑩ Once more clear the channel, moving soil towards the ridge.
- ⑪ This cut on the high side should finish the outslope and be deep enough to meet the channel on the centre line.
- ⑫ The uphill slope is now finished and the channel has to be cleared for the last time by moving the windrow from the last uphill cut out towards the ridge.
- ⑬ Clean up and finish the top side of the ridge to the required level.
- ⑭ Soil to form the downhill side of the ridge is now graded into shape. If windrows are heavy keep the blade under the machine and ride the slope if possible. Use extreme blade reach on the finishing pass to erase tyre marks. The above sequence of operations illustrates the basic principles of terrace building and although some operators may have their own variations, this procedure has been found satisfactory by many good terrace builders.

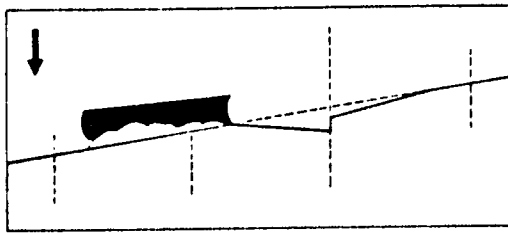

8

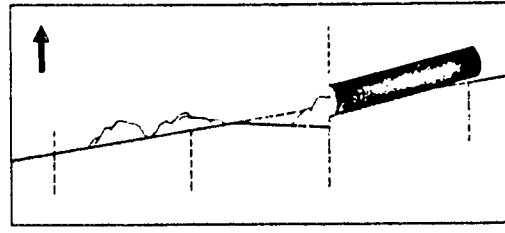

9

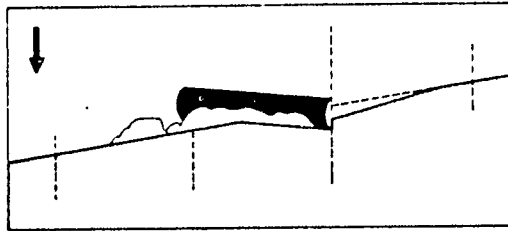

10

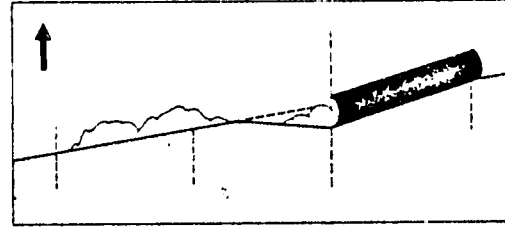

11

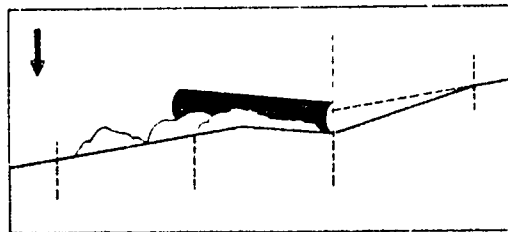

12

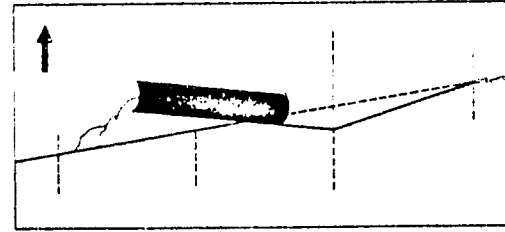

13

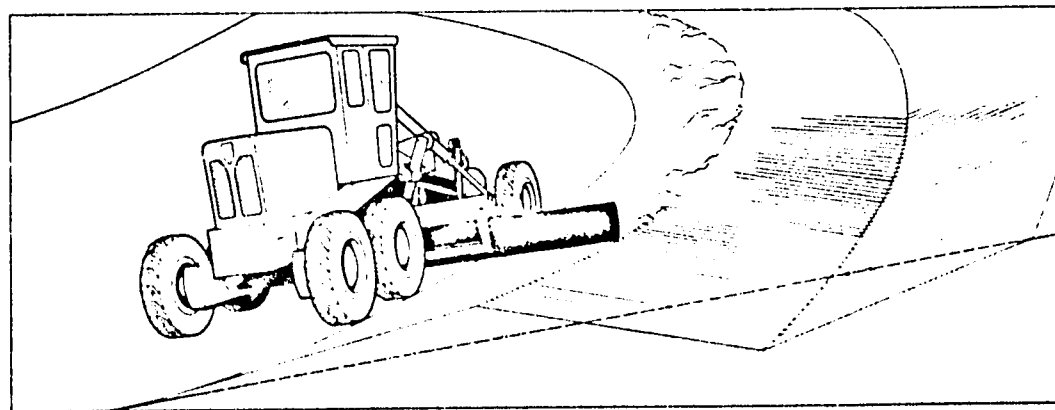

14

G1.39

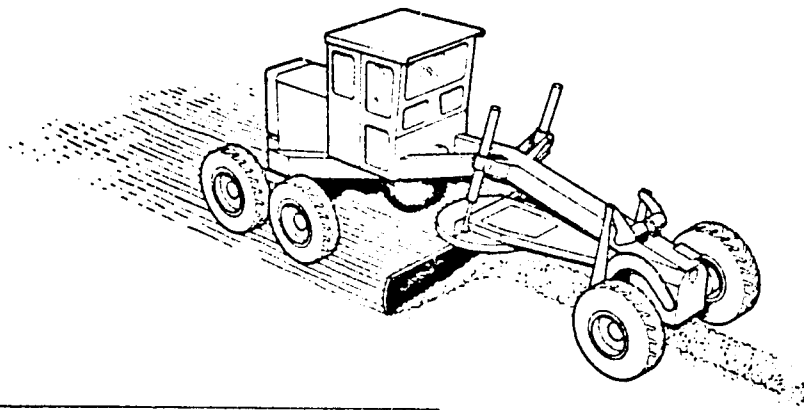
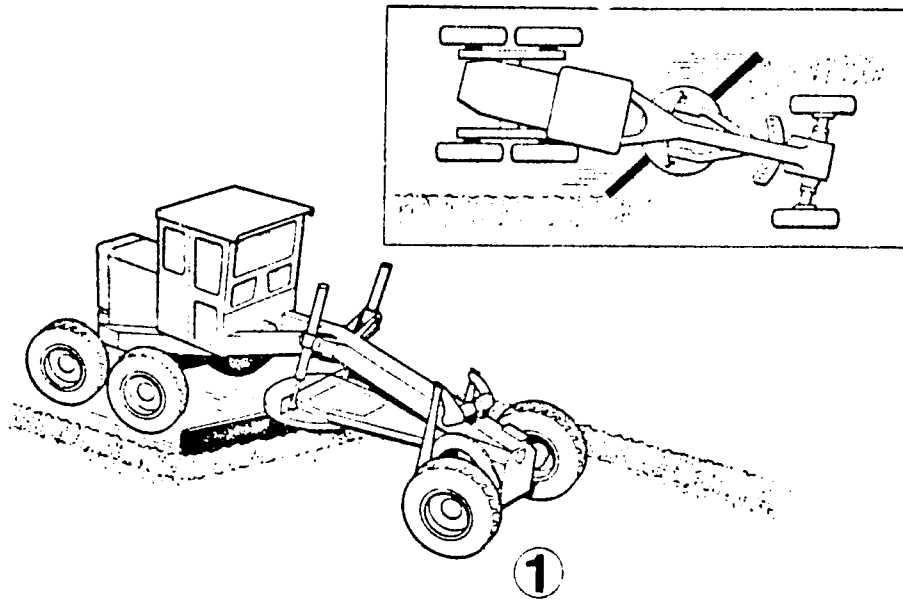

154

2-19

Grading Techniques – continued

2–19 Spreading Bituminous Materials

Road surfacing with asphalt, coated macadam or similar material is now usually done hot by a paving machine.

Should it be necessary however to use a grader on patching or repair work or where a paving machine is not available the blade should first be painted with oil to prevent material sticking.

- ① If mixing has to be done, move material from one side of the road to the other and back again. Do this at a fair speed in third gear to give the material a good rolling action.
Angle the blade forward to about 30° and offset wheels, using front wheels to steer.
- ② When thoroughly mixed spread material to the required depth with blade square across the machine and pitch forward at top.
Set front wheels astride the windrow and engage second gear.



Sideborrow construction often creates standing water, a situation that requires proper ditching before road is completed (Liberia). (Photo courtesy of USAID/Liberia.)

ROAD MAINTENANCE PRACTICE



Sydney

NATIONAL ASSOCIATION OF AUSTRALIAN
STATE ROAD AUTHORITIES

1975

*NOTE: This text has been reproduced with the permission of the
National Association of Australian State Road Authorities.*

FOREWORD

The National Association of Australian State Road Authorities works towards uniformity of practice in the design, construction and user aspects of roads and bridges and, with this purpose in view, arranges for the preparation and publication of standards and general procedures.

This publication on road maintenance is intended to help and guide those directing or planning maintenance work. The aspects covered range from helping the public, to sweeping the road, clearing drains, the roadside and the shoulders, grading and forming gravel roads, seal patching bituminous surfaces and maintaining traffic control devices.

The methods described have been adapted from the practices followed in the various member authorities organisations and represent current Australian practice. A companion volume on bridge maintenance is in the course of preparation.

*Sydney,
December, 1975*

CONTENTS

** Section 1 — Introduction	Page
1.1 General	1
1.2 Scope of Maintenance	1
1.3 Organisation and Management	1
1.4 Scope	2
1.5 Terms Used	2
Section 2 — Public Relations	
2.1 General	3
2.2 Standards of Maintenance	3
2.3 Roadside Appearance	3
2.4 Personnel and Equipment	4
2.5 Damage to Public Utilities	4
2.6 Assistance to the Public in Emergencies	4
2.7 Road Blockages, Side-tracks and Deviations	5
2.8 Negotiations with Property Owners	5
Section 3 — Provision for Traffic at Works in Progress	
3.1 General	6
3.2 SAA Manual of Uniform Traffic Control Devices	6
3.3 Roadwork Signs, Lights, Barriers and Other Devices	6
3.4 Temporary Medians, Delineators and Pavement Markings	7
3.5 The Use of Flaps and Cones	7
3.6 Barriers	8
3.7 Warning Lamps	9
3.8 Traffic Control Flagmen	10
3.9 Removal of Signs	11
3.10 Side-tracks and Detours	11
** Section 4 — Drainage	
4.1 General	13
4.2 Drainage of Bituminous and Concrete Pavements	13
4.3 Drainage of Gravel Surfaces	14

CONTENTS

4.4	Drainage of Unpaved Surfaces	15
4.5	Drainage Elements and their Maintenance	16
4.5.1	Table Drains	16
4.5.2	Batter Drains	16
4.5.3	Side Drains	18
4.5.4	Diversion Drains	18
4.5.5	Catch Drains	20
4.5.6	Cross Drainage Channels controlled by Other Authorities ..	21
4.5.7	Floodways and Fords	21
4.5.8	Culverts	22
4.5.9	Bridges	22
4.5.10	Subsoil Drains and Shoulder Drains	22
4.6	Roadside Drainage	24
4.7	Underground Drains and Pits	25
Section 5 — Earth and Gravel Roads		
5.1	General	27
5.1.1	Earth Roads	27
5.1.2	Gravel Surfaced Roads	28
5.2	Maintenance Operations	28
5.2.1	Grading	28
5.2.2	Scarifying and Reshaping	32
5.2.3	Patching of Potholes, Depressions and Scours	33
5.3	Gravel Surfacing and Resheeting	33
5.3.1	Tying	33
5.3.2	Thickness of Surfacing	33
5.3.3	Quality of Gravel	34
5.3.4	Gravel Sources	34
5.3.5	Spreading	35
5.3.6	Compaction	35
5.4	Dust	36
5.5	Corrugations	36
Section 6 — Bituminous Surfaced Pavements		
6.1	Scope	38
6.2	General	38
6.3	Types of Bituminous Surface	38
6.3.1	Sprayed Seal	38
6.3.2	Bituminous Mixes	38
6.3.3	Penetration Macadam	38
6.3.4	Further information	39
6.4	Repair Methods	39
6.4.1	General	39
6.4.2	Basic Patching Procedures	40

CONTENTS

6.4.3	Seal Patching	40
6.4.4	Premix Patching	41
6.5	Particular Types of Defects and their Repair	44
6.5.1	Ravelled Surface	44
6.5.2	Stripped Surface	44
6.5.3	Fatty or Slick Surface	45
6.5.4	Polished Aggregate Surface	47
6.5.5	Shoving	49
6.5.6	Rutting	49
6.5.7	Cracks	49
6.5.8	Pot Holes	53
6.5.9	Edge Failures	57
6.5.10	Large Depressions	59
6.6	Reseals	59

Section 7 -- Concrete Pavements

7.1	General	60
7.2	Defects of Concrete Pavements	60
7.3	Maintenance of Joints	61
7.4	Attention to Cracks	62
7.5	Treatment of Spalled Joints	62
7.6	Replacement of Damaged Sections	63
7.7	Treatment of Worn areas or Slippery Surfaces	63
7.8	Pumping	63
7.9	Mudjacking	65
7.10	Treatment of Failed Concrete Pavements	67

Section 8 -- Shoulders

8.1	General	68
8.2	Function of a Shoulder	68
8.3	Shoulder Types	68
8.4	Earth and Gravel Shoulders	68
8.4.1	Maintenance Methods	68
8.4.2	Grading	70
8.4.3	Edge Rutting	71
8.4.4	Material	71
8.4.5	Resheeting	71
8.5	Sealed Shoulders	71
8.6	Stabilised Shoulders	71
8.7	Grassed Shoulders	72
8.8	Safety Precautions	73
8.9	Roadside Furniture	73

CONTENTS

Section 9 — Road Openings for Public and Private Utility Installations

9.1 General	74
9.2 Notice of Intention to make a Road Opening	75
9.3 Types of Road Openings	75
9.4 Excavation of Open Trenches	76
9.5 Backfilling	77
9.6 Restoration of Pavement	77

**** Section 10 — Bridges and Culverts**

10.1 General	79
10.2 Safety	79
10.3 Inspections of Bridges	79
10.4 Inspection of Culverts	80
10.5 Reporting on Flood Heights	80
10.6 Maintenance	80
10.6.1 Clearing and Removal of Debris	80
10.6.2 Bridge Approaches	82
10.6.3 Timber Bridges	82
10.7 Treatment of Slippery Timber Decks	82
10.8 Cattle Grids	82

Section 11 — Signs, Markings and other Road Furniture

11.1 General	84
11.2 Location and Erection of Signs	84
11.2.1 Basic Requirements	84
11.2.2 Lateral Location of Signs	84
11.2.3 Longitudinal Location of Signs	85
11.2.4 Height of Signs	85
11.3 Maintenance of Signs	85
11.3.1 Material Used for Signs	86
11.3.2 Legibility of Signs	86
11.3.3 Posts Supporting Signs	86
11.3.4 Vegetation	86
11.3.5 Repainting	86
11.3.6 Cleaning of Signs	86
11.3.7 Clear Coating of Retro-reflective Signs	87
11.3.8 Repairs to Signs	88
11.4 Guide Posts	89
11.4.1 Types of Guide Posts	89
11.4.2 Dimensions of Guide Posts	89
11.4.3 Alignment of Posts	89
11.4.4 Spacing of Posts	90
11.4.5 Snow Indicators (Poles)	91
11.4.6 Maintenance of Guide Posts	91

CONTENTS

11.5 Delineators.....	91
11.5.1 General.....	91
11.5.2 Colours and Size.....	91
11.5.3 Erection.....	91
11.5.4 Spacing.....	91
11.5.5 Maintenance of Delineators.....	91
11.6 Guard and Safety Fencing.....	92
11.6.1 General.....	92
11.6.2 Location.....	93
11.6.3 Maintenance of Fencing.....	93
11.7 Kilometre Posts.....	93
11.7.1 General.....	93
11.7.2 Materials.....	93
11.7.3 Location.....	93
11.7.4 Maintenance.....	93
11.8 Pavement Markings.....	94
11.8.1 General.....	94
11.8.2 Maintenance Requirements.....	95
11.8.3 Thermoplastics and Precut Sheeting.....	96
11.8.4 Raised Pavement Markers.....	97
 Section 12 — Medians and Channelised Intersections	
12.1 Medians.....	99
12.1.1 General.....	99
12.1.2 Raised Medians.....	99
12.1.3 Depressed Medians.....	99
12.1.4 Painted Medians.....	100
12.2 Channelised Intersections.....	100
12.2.1 General.....	100
12.2.2 Traffic Islands.....	100
12.2.3 Roundabouts.....	100
12.2.4 Signs.....	101
12.3 Maintenance Procedures.....	101
12.3.1 Kerbing.....	101
12.3.2 Pavement and Drains.....	101
12.3.3 Safety Bars.....	101
12.3.4 Painting of Kerbs.....	101
12.3.5 Surface Areas.....	101
12.3.6 Trees and Shrubs.....	101
 Section 13 — Roadside	
13.1 General.....	102
13.2 Services and Public Utilities.....	102

CONTENTS

13.3 Areas of Involvement	102
13.3.1 Road User Facilities	102
13.3.2 Litter	106
13.3.3 Conservation	106
13.3.4 Control of Vegetation	106
13.3.5 Erosion and Sand Drift	106
13.3.6 Drainage	106
13.3.7 Landscaped Areas	107
13.3.8 Shrub and Tree Planting	107
13.3.9 Preservation of Objects and Features	107
13.3.10 Noxious Weeds	108
13.3.11 Advertising Signs	109
13.3.12 Stockpile Sites	109
13.3.13 Other Roadside Facilities and Works	109
13.4 Operations	109
13.4.1 Burning-off	109
13.4.2 Weed and Pest Spraying	109
13.4.3 Pruning — Pollarding — Lopping	110
13.4.4 Mowing	110

Section 14 — Snow Clearing and Treatment of Ice on Pavements

14.1 General	112
14.2 Physical Properties of Snow	112
14.3 Snow Fall Intensities	112
14.4 Snow Clearing Procedure	113
14.5 Icing of Pavements	113
14.6 Use of Chemicals to Control Icing of Pavements	116
14.7 Use of Grit to Aid Traction	116
14.8 Stockpiles of Chemicals and Grit	116
14.9 Snow Fences	117
14.10 Snow Poles	117
14.10.1 On Straights	117
14.10.2 On Crests	117
14.10.3 On Curves	118
14.10.4 At Culverts	118
14.10.5 At Bridges	118
14.10.6 At Protection Fencing	118
14.10.7 Reflectors	118
14.11 Provision for Traffic	118
14.12 Miscellaneous Precautions	119
14.12.1 Snow Banks	119
14.12.2 Culverts and Drains	119
14.12.3 Railway Level Crossings	119

CONTENTS

Section 15 — Painting

15.1 Introduction	120
15.2 Timber	120
15.2.1 General	120
15.2.2 Guide Posts	121
15.2.3 Signs and Sign Posts	124
15.2.4 Bridge Posts and Rails	124
15.3 Concrete	124
15.4 Steel	124
15.4.1 General Considerations	124
15.4.2 Galvanised Surfaces	124
15.5 Recommended Practices	130
15.5.1 Cleaning Painted Surfaces	130
15.5.2 Application Methods	130
15.6 Safety Precautions	130
15.6.1 General	130
15.6.2 Hazards of Spray Painting	130
15.6.3 Storage of Paint	130

Section 16 — Storage and Handling of Materials

16.1 General	131
16.2 General Depot Requirements	131
16.2.1 Security from Theft and Vandalism	131
16.2.2 Protection from Fire	131
16.2.3 Accessibility	132
16.2.4 Loading and Unloading of Materials	132
16.2.5 Aesthetics	132
16.3 Maintenance Materials	133
16.3.1 Hand Tools, Hardware and Small Plant	133
16.3.2 Petrol and Distillate	133
16.3.3 Bituminous Materials	134
16.3.4 Explosives	134
16.3.5 Guardrail	134
16.3.6 Paint and Paint Brushes	134
16.3.7 Maintenance of Plant	135
16.3.8 Signs and Other Warning Devices	135
16.3.9 Timber	136
16.3.10 Herbicides	136

Section 1

INTRODUCTION

1.1 GENERAL

Roads are designed to varying standards and built out of natural processed materials to meet the needs of the communities they serve. Like all other structures they are subject to deterioration which commences as each part of a road is completed. If the facility is to give the standard of service for which it was designed, maintenance must begin as soon as construction ends.

Ideally, maintenance would ensure that the road always functioned as efficiently as when it was first constructed, but in planning maintenance due regard must be paid to limitations of manpower and funds. For this reason the maintenance programme is adjusted to control the rate of deterioration and to ensure that the serviceability of the road does not fall below some minimum level, depending upon the resources and policy of the road authority concerned.

1.2 SCOPE OF MAINTENANCE

Road maintenance activities relate to the repair of faults and attention to the road structure and facilities to ensure the preservation of the asset and the convenience and safety of road users. It includes routine maintenance which may be organised and done by permanent gangs, and special maintenance which requires detailed technical planning and supervision and is usually done by gangs specialising in the type of work involved.

1.3 ORGANISATION AND MANAGEMENT

The size of the maintenance organisation, arrangement of gangs, location of depots and requirements for plant will vary according to the types and lengths of roads and the nature of work in hand.

Routine maintenance is normally undertaken by relatively small labour groups suitably equipped with hand tools. Each group is provided with a truck for its own transport. Such groups generally operate over defined lengths of road under the continuous direction of a supervisor. Labour is usually directly employed by the road authority but there may be exceptions such as the employment on a contract basis of individual owner-drivers or fleet owners in the operation of trucks.

or other plant items. The groups frequently operate from depots in towns but in the less populated areas they may be required to operate from mobile camps.

Special maintenance is generally arranged by the use of additional resources of labour, materials and equipment that may operate as a separate organisation or may supplement local units. This work may be undertaken by directly employed labour or by contract.

Effective use of available resources requires regular inspections, adequate planning of operations to prevent or correct defects, and thorough training and supervision of personnel to ensure the use of sound techniques. The organisation to provide these requirements will vary according to the structure of the various road authorities.

When maintenance is being planned both preventive and restorative work must be considered, the balance between them being based on experience of local conditions and the resources available.

While all defects should be corrected soon after they occur, they must often be left until there is sufficient other work to justify the movement of a gang to the location. However, there will be times when correction of isolated deficiencies may not be deferred either for reasons of safety, to restore communications, or to prevent extensive deterioration of the asset.

1.4 SCOPE

This manual outlines the procedures for proper performance of routine maintenance. For information about special tasks the reader is referred to other publications. The methods and procedures outlined have been adapted from the practices of state road authorities but owing to differences in geology, topography, climatic conditions, and traffic volumes, they may need to be varied to suit local conditions.

1.5 TERMS USED

The terms used in this manual are those adopted in AS 1348, Terms Used in Road Engineering.

Section 4 DRAINAGE

4.1 GENERAL

The drainage system is a most important part of any road. Its functions include:

- the removal of rain or flood water from the carriageway in particular, and the road formation and road reserve in general;
- the interception of surface water flowing towards the road formation and its ultimate satisfactory disposal downstream of the road, so that it will not cause damage to the road itself or to adjacent property; and
- the interception and disposal of ground water that would otherwise penetrate the subgrade and reduce the bearing strength of the material supporting the running surface of the road.

It is a cardinal principle of good drainage practice that the concentration of water should be increased as little as possible. When, because of road works, increased concentration is unavoidable the flow should be so controlled that it does not cause scouring or other damage.

As a general rule it is good practice to interfere as little as possible with the natural flow of water. Water flowing towards a road formation should be allowed to return to its natural course as soon as possible after being passed under the formation (where it will, of necessity, be concentrated to some extent).

It is usually bad practice to concentrate water from several water courses into one in order to reduce the number of culverts under the formation. Nevertheless any breakdown in the drainage system which permits water to bypass its normal course should be corrected without delay.

4.2 DRAINAGE OF BITUMINOUS AND CONCRETE PAVEMENTS*

Bituminous and concrete pavements are normally impervious to water so that drainage is effected by providing the surface of the pavement with a crossfall normal to the alignment of the road. Most pavements of this type have crossfalls of 2 to 3 percent. On straight roads with flat grades the surface water is shed directly towards the shoulders, but if the grades are steep or the horizontal alignment is curved there will be sections of the surface where water will tend to flow more or

* See also the NAASRA publication *Report of an Investigation into the Drainage of Wide Flat Pavements*, 1974, ISBN 0 85588 057 0.

less parallel with the centre line. The concentrated sheet of water so formed may adversely affect the serviceability of the road as follows:

- On smooth surfaces the tyres of high speed vehicles may aquaplane resulting in loss of traction and control by the driver.
- If the relatively concentrated water flows along the edge of the hard pavement and a softer shoulder, scour will develop leading to dangerous conditions for vehicles and loss of edge support for the pavement.

Sheet flow along the pavement may be alleviated by the maintenance organisation if care is taken to ensure that the flow of water from the pavement across the shoulder is not hampered by grass growth, silt deposition, windrows, or debris left after grading operations. In any case, the correction of shoulder scour should be given high priority.

The seal should be maintained in a waterproof condition by the prompt sealing of cracks in the surface and by filling minor depressions that would hold surface water. (See also Sections 6 and 7.)



Debris on Shoulder

4.3 DRAINAGE OF GRAVEL SURFACES

To compensate for the absence of a waterproof surface the crossfall of a gravel pavement is usually 4 to 5 percent. Shoulders may be steeper depending upon the nature of the shoulder material.

While the steeper crossfall to some extent aids the shedding of water it also produces higher velocities with the consequent removal of fines and the creation of transverse scouring of the pavement and shoulder.

Ponding of water in depressions in the pavement can have serious results because of the consequent weakening of the pavement material and its displace-

ment under wheel loading. Not only do the deepened depressions become potholes but they also assist the entry of the water to the subgrade, thus leading to subsidence of the pavement surrounding the pothole.

To prevent serious damage from water and to maintain unsealed surfaces in reasonable condition for traffic, scours and depressions must be promptly filled and the whole surface kept in a smooth and self-draining condition by frequent grading.

4.4 DRAINAGE OF UNPAVED SURFACES

Most unpaved surfaces are composed of the natural material found in the top layers of the ground over which the road passes. The material quality varies over a wide range from plastic clays that are unstable when wet to natural gravels that are capable of supporting traffic under all weather conditions, provided they have been properly compacted.

As with sealed pavements the principal means of draining an unpaved formation is to provide a crossfall normal to the centre line that will remove surface water as quickly as possible. Many unpaved surfaces are subject to severe damage when traversed by vehicles in wet weather. A common form of damage is the development of wheel ruts which are deepened and made worse by succeeding vehicles *tracking*, and also because the ruts themselves hold water. Potholing is also likely to be a common defect because the surface material of an unpaved formation may vary widely in quality with numerous unstable patches.

Grading to restore the crossfall and to fill potholes and ruts is the major activity to maintain riding conditions and surface drainage efficiency. The work is best carried out after rain has ceased to fall but while the surface material is still damp enough to bind into a solid mass under the action of the grader and traffic.



Lack of Suitable Drainage leaving Pools of Water and causing Potholing on Open Surface Road

4.5 DRAINAGE ELEMENTS AND THEIR MAINTENANCE

Under this clause the various types of drains used in association with road works and their maintenance are described.

4.5.1 Table Drains. The function of a table drain is to collect water that has fallen on the carriageway or the batters of a cutting and flowed to the edge of the formation. Table drains are essential wherever the road is in cutting and are often desirable along the shoulders of embankments.

Because table drains are often built on very flat grades to suit the road grade, they must either have a large cross-sectional area or be provided with frequent discharge points where the water can escape. Depending upon the nature of the material in which they are constructed and their longitudinal grade, table drains may need to be lined with stone, concrete, or a bitumen seal to resist scouring.

Table drains require frequent maintenance, such as grading of unlined drains to remove silt and other debris that may easily block the flow, and to restore the original shape. The lining of table drains needs checking at frequent intervals so that any failed section may be repaired before extensive damage occurs.

Scours in table drains need prompt attention to prevent serious damage that may lead to undermining of the drain lining, the carriageway, or the cutting batters. Short term measures, such as placing loose rock, etc., in scours to arrest their development may be necessary on occasion, but such action should generally be discouraged because it can lead to even more serious damage before final remedial measures can be effected. Whenever a table drain is susceptible to scour it is usually necessary to line it with some type of durable material.

4.5.2 Batter Drains. It sometimes happens that water from table drains must be discharged down the embankment batters. There will also be occasions when it is necessary to discharge water down a cutting batter to avoid overloading a catch drain above. In such cases the slope of the invert of the drain down the batter is too steep to allow the water to flow over most natural materials because the high velocity induced would lead to serious scouring.

Batter drains are, therefore, generally lined with concrete, metal, or some other hard material such as grouted stone. When the batter drain is on earth the protective lining should be flexible enough to adjust to any settlement of the filling or movement with weather conditions.

It is important that batter drains should be inspected frequently and immediate steps taken to make good any undermining and repair any breaks in the lining. The flow of water in batter drains should be observed during heavy rain to assess their adequacy.

The protection of batters on embankments and in cuttings from surface water, springs, or seepage is normally expensive and not always effective. Such work, other than that of a very minor nature, is beyond the scope of normal maintenance and should be undertaken during construction, the work being properly designed by experts after a thorough investigation of all relevant conditions at the site.

4.5

DRAINAGE

17

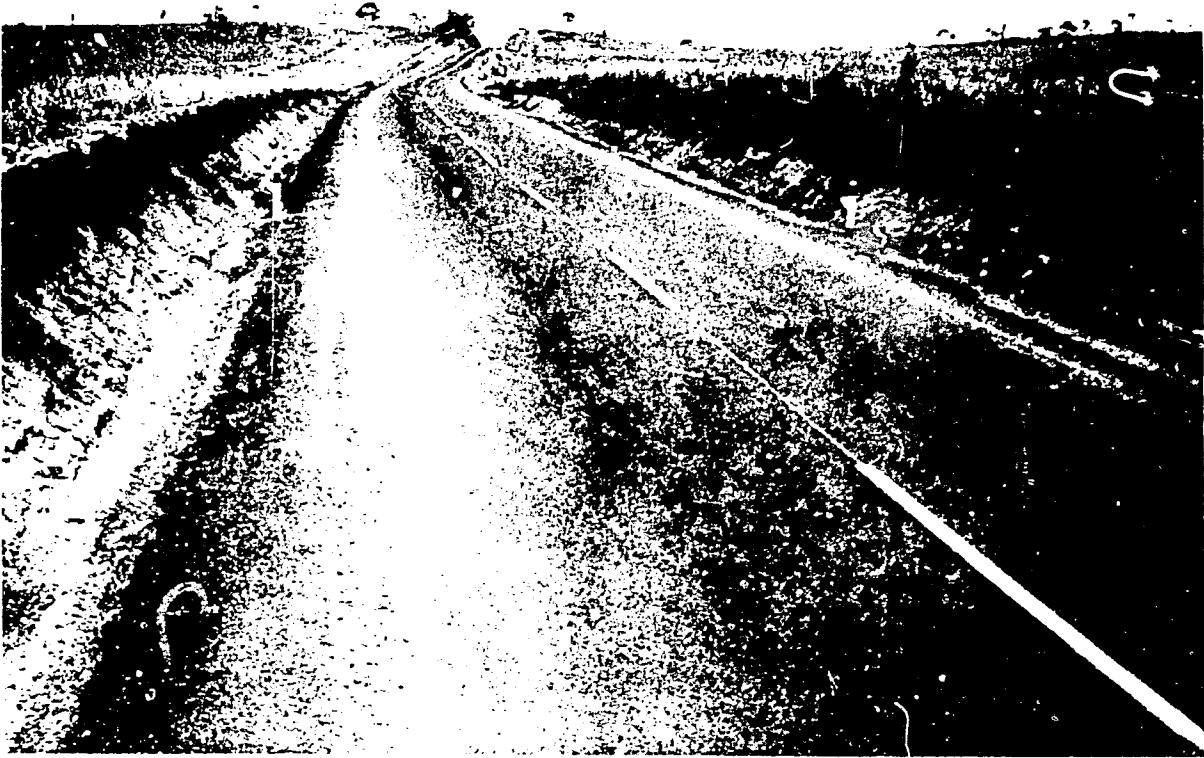

Well Maintained Table Drain

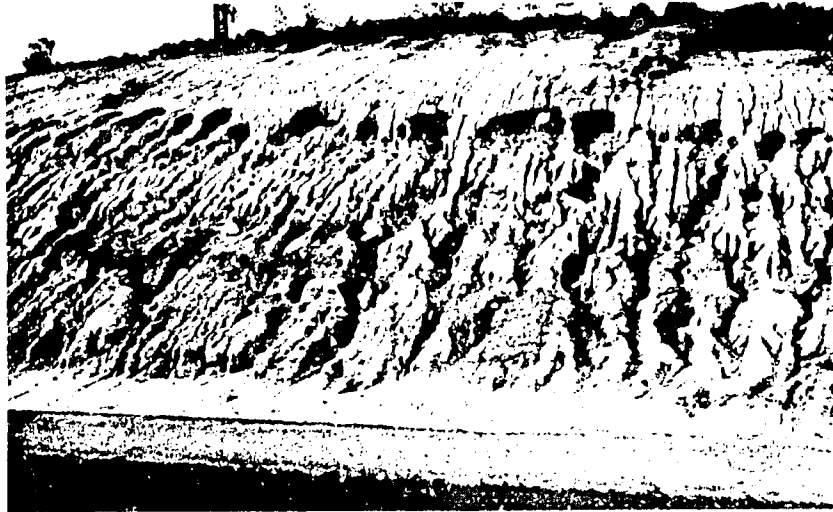

Scouring of Batter due to Lack of Suitable Drainage

4.5.3 Side Drains. A side drain is a surface drain approximately parallel to and between the formation and the road boundary. Its main purpose is to convey water discharged from table drains, catch drains, or culverts, to a point where the water may be safely discharged into natural water courses, diversion drains, or cross drainage channels.

In friable country, side drains may scour to excessive depths and widths, thus undermining boundary fencing or the road formation. Any evidence of scouring should be investigated as soon as noted and the appropriate corrective work put in hand without delay. This may include widening the drain, flattening the invert, grassing the invert and batters. Blankets of loose stone contained in heavy gauge wire mesh may be used to good effect to protect the invert where the grade is steep. It may also be necessary to install properly designed drop structures to reduce the gradient, and to construct pitching where it is essential to prevent the scour extending. The use of loose rock, tree branches, etc., is seldom likely to be effective.

4.5.4 Diversion Drains. The purpose of a diversion drain is to convey water from a table drain, catch drain, or side drain so that it can be disposed of by soakage or by spreading over the natural surface where its velocity is small and the likelihood of damage by erosion is reduced.

Special attention needs to be given to the junction of the diversion drain with the side drain where both scouring and siltation can easily occur. Similar problems may also arise at the extreme end of the diversion drain where it has virtually no grade.

Periodic grading of diversion drains, preferably in conjunction with the side drains, is the main maintenance attention required. If serious scouring develops it might be better to construct a new diversion drain in a better location rather than persevere with the old one, which should be effectively blocked off.



Grassed Waterway



Diversion Drain

4.5.5 Catch Drains. The primary function of a catch drain (or intercepting channel) is to intercept surface water flowing towards the road cutting or formation embankment. It thus prevents the water flowing down the cut batter or along the toe of the embankment, which may cause severe scouring. Catch drains are usually open earth channels with spoil from the excavation being placed on the lower side to form a bank.

Maintenance involves periodic inspection, clearing of obstructions, repairing of breached banks, and the filling of scours. If the bank is shown to have been breached by overtopping, the adequacy of the drain should be investigated and its size increased to prevent a recurrence. Alternatively, relief may be obtained by leading some of the water in the catch drain into a batter drain or a diversion drain, depending upon whether the catch drain is above a cutting or above an embankment. Scours are repaired by regrading the drain or by backfilling the scour and covering the damaged area with paving of concrete, stone pitching, or bituminous material.



Paved and Unpaved Catch Drains

4.5.6 Cross Drainage Channels controlled by other Authorities. Some cross drainage channels may be controlled by other authorities such as private drainage trusts, flood mitigation councils, irrigation commissions, etc. Such channels and the easements in which they lie are normally maintained by the authority controlling them. However, road maintenance organisations retain the responsibility for the safety of the road user and the integrity of road assets and because of this they should inspect and report any deficiency in the channel or the easement likely to have an adverse effect on road users or road structures.

4.5.7 Floodways and Fords. Floodways and fords are used where construction of suitable waterways under the roadway cannot be justified. Floodways and fords are either intended to be covered by deep water for short periods or to remain trafficable for extended periods. Quite often the floodway is supplemented by a relatively small culvert under the higher approach with its invert below the pavement level of the floodway so that the pavement over the floodway is dry when the cross flow is low.

On all but very primitive roads the pavement of the floodway consists of hard durable material that is stable under traffic when it is wet. The pavement may be concrete, grouted stone, stabilised gravel, or packed rubble. In some cases it may have a bitumen seal or be sheeted in asphaltic concrete. The batters of floodways must be composed of material that will resist erosion by flowing water. Sometimes a concrete or similar head wall is provided to give edge support to the carriageway. Maintenance of floodways and fords may be divided into three types as follows.

(a) **DURING DRY WEATHER.** The pavement, batters, and supplementary culverts require routine maintenance similar to that of a normal road. Warning signs and depth indicators need special attention, the former because they warn of a dip in the pavement during dry weather as well as indicating the possible presence of water over the pavement in wet weather, the latter because they must be easily read at a distance when there is water over the floodway.

(b) **DURING FLOODING.** Regular inspection is necessary to ensure that the floodway is safe for traffic, having regard to the fact that deep holes and washed out batters may not be apparent to all drivers. Debris that may collect on the floodway should be removed and holes under the water filled with rock pending permanent repair when the water has receded.

(c) **AFTER FLOODING.** High priority must be given to the restoration of physical damage so that the floodway is safe for traffic and is not further damaged by subsequent floods. Debris should be cleared from the upstream channels leading to the floodway and culvert, if any. Markers and signs should also receive attention.

Many dry water courses contain loose sand which may be deposited on the floodway in sufficient thickness to prevent the passage of vehicles or at least create hazardous conditions for them. The removal of this loose material is generally the most urgent restoration work after floods. In some cases it may also be desirable to raise the pavement level of the floodway to inhibit the further deposition of

sand when the water course next carries water, providing this did not cause damage upstream by afflux or lead to scour due to increased velocity.

4.5.8 Culverts. Culverts are key structures in any road drainage system and since they often provide the only passage for surface water from one side of the road to the other failure usually has serious consequences. Failure of the culvert may cause damage to the road formation if it is overtopped by flood water or damage to the culvert or formation by scour due to high velocity. Structural failure of the culvert itself may occur because of settlement, overloading, or corrosion.

There is usually ample physical warning of the likelihood of failure but the detection of this involves close inspection of the inside of the culvert as well as both the inlet and the outlet. Systematic inspection is most important followed by appropriate remedial measures. Since many culverts are not apparent to an observer moving along a road some sort of distinctive marking on guide posts may assist in drawing the attention of maintenance gangs to their presence.

Maintenance tasks include the constant clearing of debris and growth from the channel, particularly after forest fires, or in seasons when trees shed their leaves. In problem areas debris screens may be required. The accumulation of silt or drift sand in the culvert barrel must also be removed periodically by mechanical or hydraulic means.

Scour in the vicinity of culverts must be recognised in the early stages and repaired promptly before the damage becomes extensive.

Corroded metal inverts, or any abraded inverts, should be built up with concrete mortar. Open joints between precast segments should be repaired by grouting or patching with mortar.

In new pipe culverts under high fills structural failure may become evident from the distortion of the pipe: the vertical diameter of the pipe decreases and the horizontal diameter increases with cracks appearing in the barrel. Emergency action consists of tomming the pipe to prevent complete failure pending permanent remedial measures.

4.5.9 Bridges. Road maintenance gangs perform a caretaking role in relation to bridge structures, their main task being to repair failures in the deck or running surface. Debris collected against piers or in the channels should be destroyed and vegetation that may impede the even flow of water should be kept in check.

4.5.10 Subsoil Drains and Shoulder Drains. The two main purposes of subsoil drains are to lower the level of the water table and to intercept or drain underground water trapped or held by impervious material. To be effective subsoil drains need to be not less than 500 mm below the subgrade level.

A shoulder drain is a special type of subsoil drain that is installed across the shoulder of a road to drain water that may be trapped on an impervious subgrade.

Subsoil drains are constructed near the outside edge of the pavement parallel to the centre line of the road, but it is not uncommon for transverse drains to extend as branches from longitudinal drains to at least the centre line of the pavement. Should isolated weaknesses occur in the pavement, due to trapping pockets of

4.5.10

DRAINAGE

23



Culvert Blocked with Silt

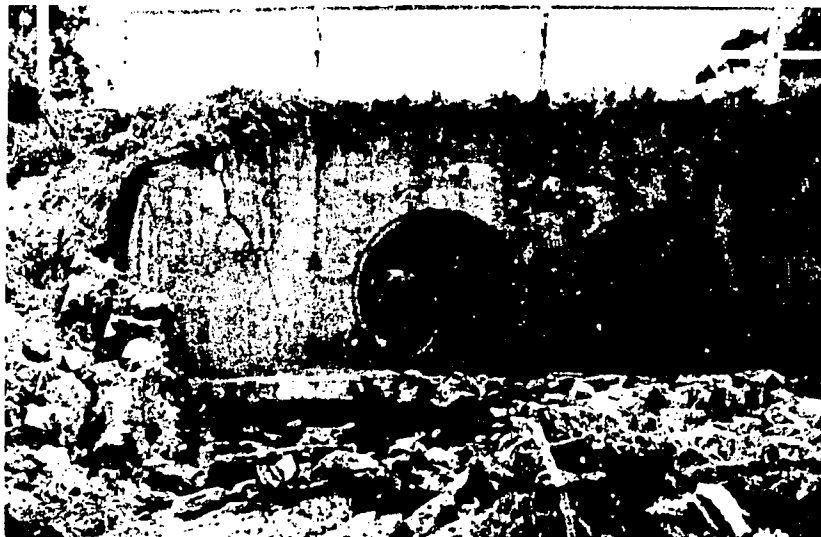

Culvert Scour and Cracking

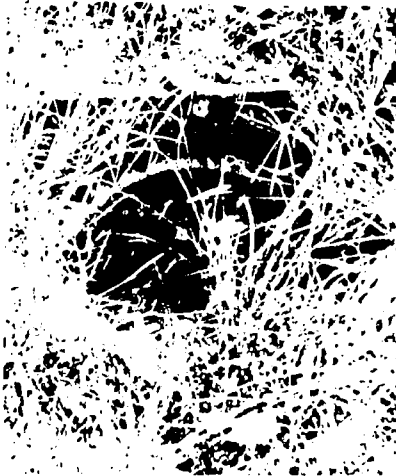

Culvert filled with Growth

water, these may often be drained by transverse branches connected to the main longitudinal drain

The road maintenance organisation should have a plan of each system to locate subsoil drains which are not evident on the surface. The commencing points and the outlets of the drains should be indicated by distinctive reference pegs. Maintenance action for buried drains consists primarily of inspection of outlets from time to time to ensure that water is seeping from them. This should, of course, be done immediately after a period of rain, but in some cases even after a dry season there will be some evidence such as staining indicating that the drain is working.

Any growth or siltation at the outlet should be cleared and if verminproof screens or flaps are provided these should be repaired or replaced as required. Damp areas or water seepage at any location above a subsoil drain should be investigated because this will probably indicate a blockage of the drain. Pavement failures due to softening of the subgrade in roads served by subsoil drains generally indicate the need to construct a further transverse branch to the main drain or to construct deeper subsoil drains.

4.6 ROADSIDE DRAINAGE

The nature of roadside drainage depends on the degree of development of the roadside itself.

In rural situations drainage of the roadside is undertaken primarily to prevent water lying in depressions where it could cause a nuisance. The most satisfactory form of drainage is achieved if the roadside is smoothed to follow the natural contours of the land and to permit the flow of surface water in a sheet into roadside drains and thence into natural watercourses. If the land slopes downwards from

the road formation towards the road boundary sheet flow should be disturbed as little as possible so that the adjoining property owners do not receive surface water that has been concentrated by road works (other than in natural water-courses).

It sometimes happens that the road is located through low lying swamp areas, or on sloping country with swamp areas, or soaks at a higher level than the pavement itself. There is little that the road maintenance organisation can do about each situation other than keep outlet drains clear of weed growth, rubbish, and silt. Periodic inspections should be made of road cuttings below swamps or soaks because of the danger of seepage water causing slips in the cutting batters or instability in the subgrade. If either problem is encountered consideration should be given to the installation of deep catch drains or subsoil drains between the elevated swamp and the top of the cutting batter, and also subsoil drains through the cutting.

4.7 UNDERGROUND DRAINS AND PITS

Underground drainage systems, which are rare in a rural situation but rather common where the road passes through urban or built-up areas, consist of both longitudinal pipes or conduits running generally parallel to the road centre line and transverse pipes passing under the road formation. Underground drains are installed where surface drains of sufficient capacity to handle the runoff cannot be constructed. These conditions will be encountered in multilane roads separated by raised medians, and generally all roads that are paved from kerb to kerb.

Inlets to underground drainage systems consist of brick or concrete gully pits covered by metal or reinforced concrete gratings sometimes supplemented by slots under the kerb to facilitate the entry of fast flowing water. Inlets are located at road intersections and at frequent enough intervals in between to prevent the capacity of the surface drain being exceeded. To guard against siltation of any part of the buried drainage system each pit is equipped with a sump or silt trap that extends some distance below the invert of the underground drain inlet.

The underground drainage system quite often drains both the road reserve and the adjoining district and, as such, may be the joint responsibility of the road authority and the local government authority controlling the area. Responsibility for the maintenance of the drainage system will be a matter for mutual agreement between the two authorities concerned and the road maintenance organisation must limit its action accordingly. However, even where it is not responsible for maintenance the road maintenance organisation should report any deficiencies noted since a breakdown in any part of the system could result in traffic disruption or damage to the road itself.

To permit inspection and cleaning of blockages by rodding or jetting it is usual to provide a pit over each substantial angle in the pipeline and at junctions of branches with lines.

Frequent inspection and cleaning of the drainage system is essential because serious damage can be caused if surface water bypasses inlets and overloads the

system at other locations leading to flooding of the road or adjoining property. Blockages occur when newspapers, garden clippings, and other debris collect on gratings and where sand and smaller rubbish fill the silt trap causing siltation of the pipe inlets or the pipes themselves.

Other maintenance tasks include replacement of damaged gully gratings, repair of structural damage to the pit itself, and inspection of the outlet of the drainage system to ensure that this has not been undermined by scour or blocked by silt.

Section 10

BRIDGES AND CULVERTS

10.1 GENERAL

This chapter deals with inspection and maintenance of bridge and culvert structures, including repairs requiring prompt attention which might be carried out by road maintenance personnel.

It is not intended to cover detailed inspections or structural repairs which are dealt with in the NAASRA publication *Bridge Maintenance Manual* (in course of preparation)

10.2 SAFETY

All inspections and repair work should be carried out with adequate provision for safety of both workmen and traffic and in accordance with laws, regulations, and standards covering traffic and construction safety. Reference should be made to Section 3 concerning matters affecting traffic safety.

If a structure has been damaged temporary measures may be necessary to protect the public or the structure. The temporary measures may include the erection of signs, barriers, and other traffic control devices, closure of traffic lanes, diversion of traffic, erection of temporary guardrails etc. Where permanent repairs are beyond the scope of the road maintenance organisation, details of the damage sustained by the structure and the temporary measures taken should be promptly reported to the responsible authority.

10.3 INSPECTIONS OF BRIDGES

Bridge and culvert inspections should be done as part of normal road inspections and after heavy rains. The following features should be checked:

- Damaged or misplaced clearance markers.
- Damaged or missing signs.
- Settlement or roughness of approaches.
- Encroaching vegetation.
- Scaled or deteriorated paint on timber rails and kerbs.
- Damaged or deteriorated rails and kerbs.
- Uneven or cracked bridge approaches or deck surfaces.
- Broken or loose timber decking.

- Blocked drains.
- Accumulated dirt or debris on decks.
- Ineffective tomming or underpinning.
- Loose bolts.
- Accumulated flood debris adjacent to abutments and piers.
- Fire hazards.
- Erosions and damage to rip rap, etc.

10.4 INSPECTION OF CULVERTS

In addition to matters covered in Section 4, drainage culverts should be inspected for the following structural defects:

- In concrete culverts, signs of cracking or spalling, exposure and rusting of reinforcing steel, etc.
- In galvanised steel culverts, damage to galvanising, damage to protective treatment or invert paving, rust and distortion (particularly where steel plates overlap), ponding of water and deposits of silt likely to cause rust.
- Subsidence, scours likely to cause subsidence, lateral displacement, tipping of wing walls, open joints, etc.

10.5 REPORTING FLOOD HEIGHTS

To provide adequate hydraulic data for future design, records should be taken and reported of the maximum flood height reached at any bridge, large culvert, or floodway during exceptionally heavy downpours. If possible, flood levels should be marked with pegs or paint on wing walls, abutments, or piers. Where flood levels are marked on structures the date of occurrence should always be recorded.

10.6 MAINTENANCE

10.6.1. Clearing and Removal of Debris. The waterway, both upstream and downstream, should be maintained clear of wind blown debris, water-borne soils, gravel, and vegetation. Logs, stumps, and other debris should be cleared as soon as possible, see figure. During heavy floods debris should, if possible, be assisted through the bridge with poles or ropes.

The area in the vicinity of the bridge should be kept clear of undergrowth rubbish. Special attention will be required for timber bridges and culverts during summer when bush fires could occur.

The decks of bridges, culverts, and approaches should be kept free of loose material. Sweeping may be required at intervals. Scuppers should be kept clear so that drainage of the deck is effective. See figure.

Weepholes in abutments should be cleaned periodically to ensure that the hole through the wall is not blocked by foreign matter which could prevent the free flow of seepage water.

10.6.1

BRIDGES AND CULVERTS

81

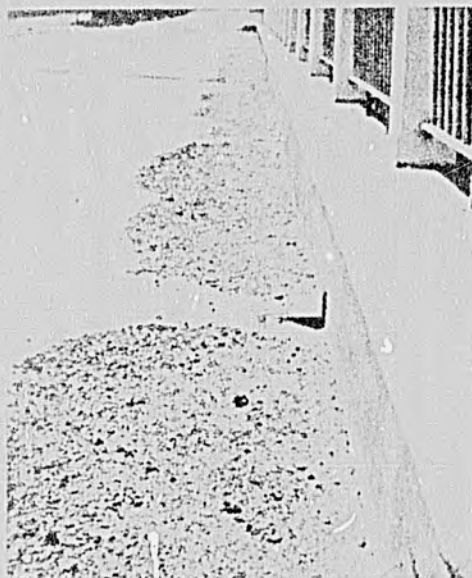

Remove Debris from Bridge Deck

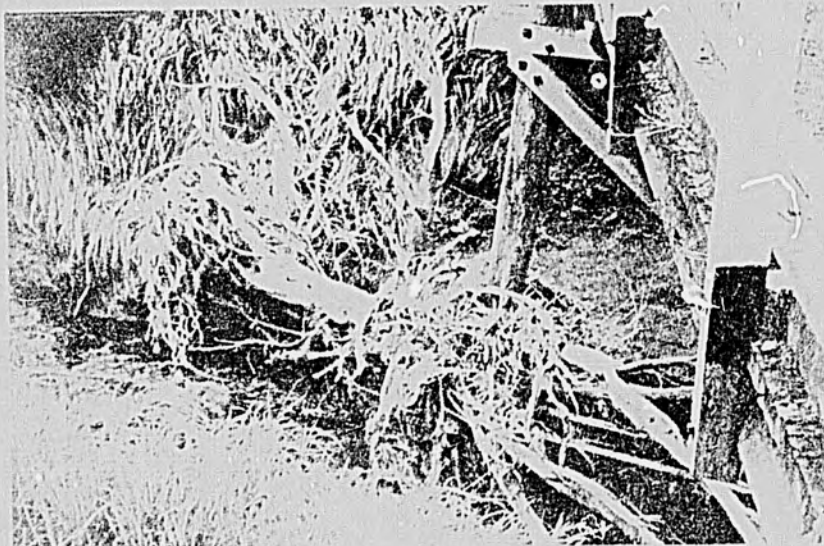

Remove Debris Below Bridge Deck

10.6.2 Bridge Approaches. Depressions near abutments should be filled and, if extensive, the cause investigated.

10.6.3 Timber Bridges. Loose longitudinal planks should be tightened and any broken deck or longitudinal planks replaced. Wide gaps between deck planks may require a length of timber packing nailed into one side of the planks. It is desirable to hold small stocks of the most frequently used timber sizes at the nearest field depot for urgent repairs, the quantity and sizes held depend on availability. Timber should be stacked clear of the ground with adequate and even support, and with sufficient separation to allow the free circulation of air.

10.7 TREATMENT OF SLIPPERY TIMBER DECKS

A method of correcting slipperiness in timber decking of bridges using a sprayed bituminous seal coat is as follows.

- Remove all the high spots, sharp edges, and abrupt changes in level. Caulk all gaps (e.g. with timber strips or with oakum) and cover all knotholes and large gaps (e.g. with 5 mm thick black iron).
- Clean the deck thoroughly, allow to dry, and apply a tack coat. Petroleum tars should not be used for the tack coat on decks made from creosoted unseasoned timber as the creosote can affect the seal coat bond. The surface to be sealed should preferably not be creosoted or alternatively the creosote allowed to dry thoroughly before applying the seal coat.
- Apply a seal coat of R90 bitumen with 10 or 14 mm cover aggregate.

A premixed bituminous deck wearing surface may also be used for this purpose provided it does not overstress the structure. In such cases, the deck should be tight to minimise cracking of the surfacing. (The cramping of transverse deck planks between longitudinal planks placed above and below the deck and bolted through the deck planks, has been used as a means of tightening the deck.)

10.8 CATTLE GRIDS

Cattle grids are sometimes constructed in place of road boundary fencing on lightly trafficked roads in sparsely populated areas. Inspections and maintenance of these structures is similar to that for bridges and culverts.

In particular they should be checked for loose, cracked or broken grid bars, cracked or broken welding, and excessive silt, dirt, or debris under the structure. The maintenance supervisor should know who owns each grid and be familiar with the road authority's policies or administrative procedures with respect to their maintenance.



Cattle Grid
(A well installed and maintained cattle grid on an open surface road)

Bibliography

The following bibliography contains two sets of references. The first set consists of a reference for each selected text that appeared in the preceding part of this compendium. The second set consists of references to additional publications that either were cited in the selected texts or are closely associated with material that was presented in the Overview and Selected Texts. Each reference has five parts that are explained and illustrated below.

(a) Reference number: This number gives the

position of the reference within this particular bibliography. It is used in the compendium index but should *not* be used when ordering publications.

(b) Title: This is either the title of the complete publication or the title of an article or section within a journal, report, or book.

(c) Bibliographic data: This paragraph gives names of personal or organizational authors (if any), the publisher's name and location, the date of publication, and the number of pages represented by the title as given above. In some references, the paragraph ends

Bibliografía

La siguiente bibliografía contiene dos series de referencias. La primera serie consiste en una referencia para cada texto seleccionado que apareció en la parte anterior de este compendio. La segunda serie consiste de referencias a publicaciones adicionales que fueron mencionadas en los textos seleccionados o que se asocian íntimamente con el material que se presentó en la Vista General y los Textos Seleccionados. Cada referencia tiene cinco partes que se explican e ilustran abajo.

(a) Número de referencia: Este número da

la posición de la referencia dentro de esta bibliografía en particular. Se utiliza en el índice del compendio pero *no* deberá utilizarse al pedir publicaciones.

(b) Título: Este es el título de la publicación completa o el título de un artículo o sección dentro de una revista, informe, o libro.

(c) Datos bibliográficos: Este párrafo da los nombres de autores personales o organizacionales (si hay alguno), el nombre del editor y su dirección, la fecha de publicación, y el número de páginas representadas por el título en la parte (b). En algunas referencias el párrafo termina con

187

Bibliographie

La bibliographie qui suit contient deux catégories de références. La première catégorie consiste en une référence pour chaque texte choisi qui est inclus dans la partie précédente de ce recueil. La deuxième catégorie contient des références pour des documents qui ont soit été cités dans les textes choisis, ou soit sont étroitement associés avec des écrits qui sont présentés dans l'Exposé ou les Textes Choisis. Chaque référence est composée de cinq parties qui sont expliquées et illustrées ci-dessous.

(a) Numéro de la référence: Ce numéro

indique la position de cette référence dans cette bibliographie. Ce numéro est indiqué dans l'index du recueil mais *ne doit pas* être utilisé pour les commandes de publications.

(b) Titre: Cela indique ou le titre du livre entier, ou le titre d'un article ou d'une section d'une revue, un rapport, ou un livre.

(c) Données bibliographiques: Ce paragraphe indique les noms des auteurs personnels (quand il y en a) ou des auteurs collectifs (organisation), le nom de l'éditeur et son adresse, la date de l'édition, et le nombre de pages qui sont incluses sous le titre dans (b). Certaines

with an order number for the publication in parentheses.

(d) Availability information: This paragraph tells how the referenced publication is available to the reader. If the publication is out-of-print but may be consulted at a particular library, the name of the library is given. If the publication can be or-

dered, name and address of the organization from which it is available are given. *The order should include all information given in parts (b) and (c) above.*

(e) Abstract: This paragraph contains an abstract of the publication whose title was given in part (b).

un número de pedido para la publicación en paréntesis

(d) Disponibilidad de la información: Este párrafo explica que la publicación referenciada esta disponible al lector en una de dos formas como sigue: (1) La publicación esta agotada pero puede ser consultada en la biblioteca indicada donde se sabe que se

posee una copia. (2) La publicación puede ser pedida de la organización cuyo nombre y dirección están indicados. *El pedido deberá incluir toda la información dada en las partes (b) y (c).*

(e) Resumen: Este párrafo es un resumen de la publicación cuyo título se dió en la parte (b).

références se terminent par un numero entre parenthèses qui indique le numero de commande.

(d) Disponibilité des Documents: Ce paragraphe indique les deux façons dont le lecteur peut acquérir les documents: (1) L'édition est épuisée, mais une certaine bibliothèque detient ce document et il peut être consulte. (2) Le

document peut être commandé à l'organisation dont le nom et l'adresse sont indiqués ici. *L'ordre de commande doit inclure toutes les informations données dans les parties (b) et (c).*

(e) Analyse: Ce paragraphe est une analyse du texte dont le titre est cite dans la partie (b).

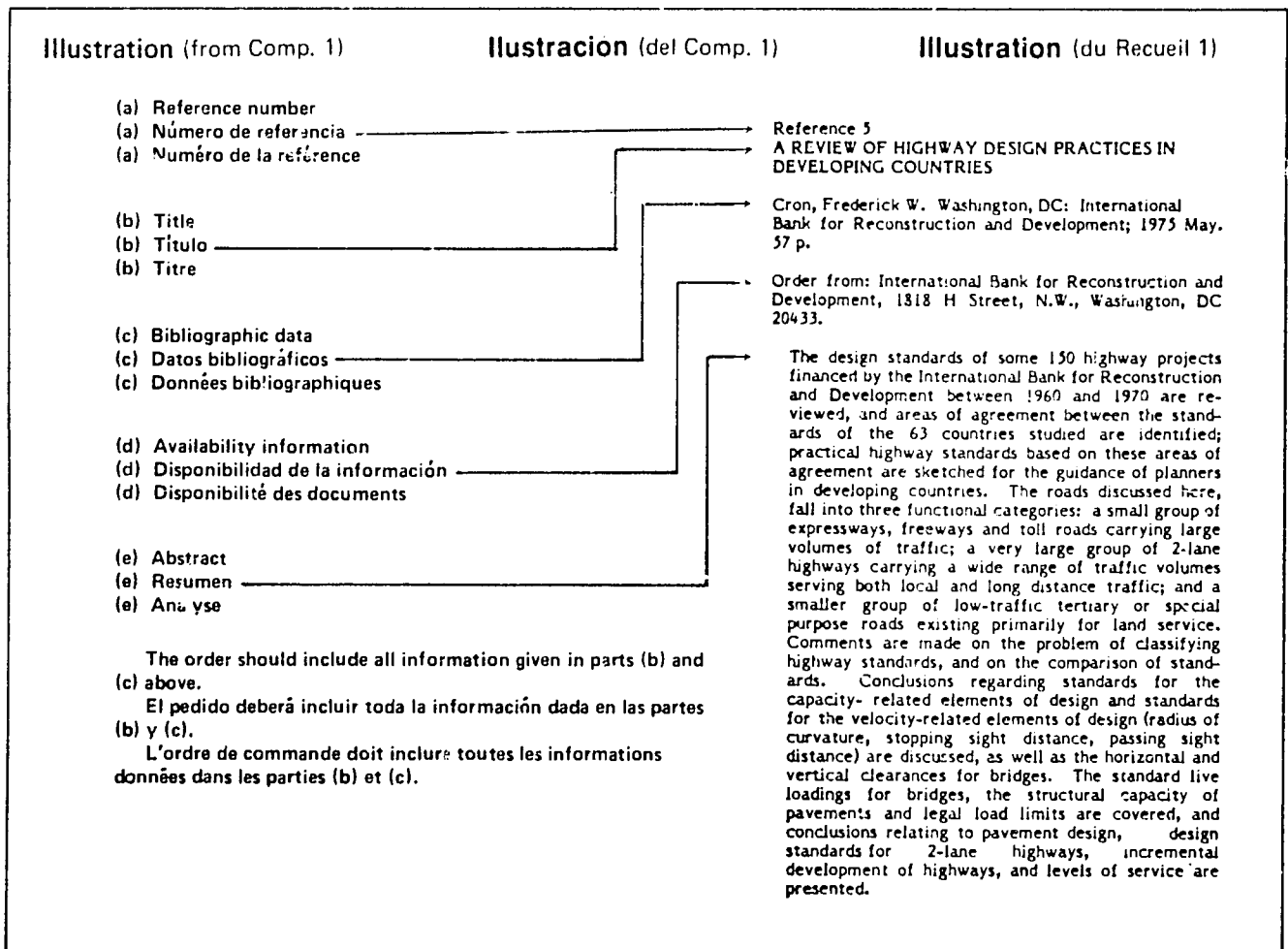

SELECTED TEXT REFERENCES

Reference 1

DESIGN OF ROADSIDE DRAINAGE CHANNELS

Searcy, James K.; U.S. Federal Highway Administration, Office of Engineering, Bridge Division, Hydraulics Branch. Washington, DC: U.S. Federal Highway Administration; 1965 May. (Reprinted 1973 December). 56 p. (Hydraulic Design Series Number 4).

Order from: U.S. Federal Highway Administration, Office of Engineering, Bridge Division, HNG-31, Washington, DC 20590.

Methods of open-channel design including the determination of both size of channel and the protection required to prevent erosion are discussed. The estimation of storm-water run-off from small areas, the hydraulics of drainage channels and their design, construction, maintenance, and economics are presented. The publication also includes illustrative problems in channel design.

Reference 2

DESIGN CHARTS FOR OPEN-CHANNEL FLOW

U.S. Federal Highway Administration. Washington, DC; 1961 August. (Reprinted 1977 November). 165 p. (Hydraulic Design Series Number 3; stock number 050-002-00026-8).

Order from: Superintendent of Documents, U.S. Government Printing Office, Washington, DC 20402.

This publication, the third in a series on the hydraulic design of highway drainage structures, is intended as a working tool for the designer already familiar with the subject. The text includes a brief discussion of the principles of flow in open channels. Charts which provide direct solution of the Manning equation for uniform flow in open prismatic channels of various cross sections are presented, together with instructions for using them. A table of recommended values for n for use in the Manning equation, tables of permissible velocities in earth and vegetated channels, instructions for constructing charts similar to those presented, and a nomograph for use in the solution of the Manning equation are also included. Charts are included for rectangular, trapezoidal, and triangular channels, grass-lined channels, and oval concrete pipe channels.

Reference 3

HANDBOOK OF HYDRAULICS FOR THE SOLUTION OF HYDRAULIC PROBLEMS

4th ed. King, Horace Williams; Brater, Ernest F., reviser. New York, New York: McGraw-Hill Book Company, Inc.; 1954. Various paging.

Out-of-print; may be consulted at U.S. Department of Transportation, Library Services Division, Room 2200, 400 Seventh Street, S.W., Washington, DC 20590.

This handbook presents information regarding the properties of water and other fluids, as well as the principles of hydrostatics and their application to hydraulic engineering problems. Orifices, gates and

tubes are discussed, and weirs (sharp crested and not sharp crested) are considered. Pipes, open channels with uniform flow, and open channels with nonuniform flow are covered in detail. The measurement of flowing water is also covered. Tables are provided which enable quick and accurate routine computations. Different methods have been presented for the solution of many hydraulic problems. Thus, the Darcy-Weisbach equation, the Manning formula, and the Hazen-Williams formula for the solution of problems involving flow of water at ordinary temperatures are considered. A discussion of viscosity and the numerical values of viscosity, and new data on flow through orifices and through culverts are also included. Recent research on submerged weirs is presented. The equations which are the basis for the tables for determining critical depth and depth after the hydraulic jump in trapezoidal channels and for determining critical depth in triangular parabolic and circular channels are presented with appropriate derivations. The methods of analyzing flow conditions on the downstream side of sluice gates are discussed. Equations for laminar flow in open channels, and methods of solving problems involving flow in thin sheets are presented.

Reference 4

GRADING ILLUSTRATED

Aveling-Barford, Ltd., Technical Publications Department. Grantham, U.K.; 1974. Various paging. (Publication TP549).

Order from: Aveling-Barford, Ltd., Technical Publications Department, Invicta Works, Houghton Road, Grantham NG31 6JE, U.K.

This book is concerned with grading methods and is designed to assist the operator to get the best work out of a grader. The book is divided into three sections: (1) blade control; (2) grading techniques; (3) grader attachments. Grading instructions for all Aveling-Barford graders have been included, and the illustrations throughout show typical Aveling-Barford graders in action. The book commences with elementary instruction for new operators and moves on to forms and situations of grading for experienced operators.

Reference 5

ROAD MAINTENANCE PRACTICE

National Association of Australian State Road Authorities. Sydney; 1975. 136 p.

Out-of-print; may be consulted at U.S. Department of Transportation, Library Services Division, Room 2200, 400 Seventh Street, S.W., Washington, DC 20590.

This manual is intended to help and guide those directing or planning maintenance work. It gives the procedures for proper performance of routine maintenance; other publications are referred to for detailed information on specific tasks. The scope and organization of the work are outlined. The treatment of paved and unpaved roads and the maintenance of efficient drainage are discussed. Advice is given on the grading and forming of gravel roads, seal patching bituminous surfaces and maintaining traffic control. Defects encountered in concrete pavements are described and advice is given on their treatment.

Methods of making and restoring road openings for private and public utilities are recommended. The treatment of road signs, markings and other street furniture is discussed. Advice is given on methods of snow clearing and treatment of ice. The storage and handling of materials is discussed.

ADDITIONAL REFERENCES

Reference 6 HANDBOOK OF HYDRAULICS FOR THE SOLUTION OF HYDRAULIC ENGINEERING PROBLEMS

6th ed. Brater, Ernest F.; King, Horace Williams. New York, New York: McGraw-Hill Book Company; 1976. 584 p.

Order from: McGraw-Hill Book Company, 1221 Avenue of the Americas, New York, New York 10020.

This handbook presents fundamentals needed to solve hydraulics problems and provides appropriate tables, graphs and computer techniques to facilitate solutions. In this 6th edition (see Reference 3 for 4th edition) pertinent new material has been included throughout the book. This edition also includes new material on the metric system, the design of pipe networks, and a completely new section describing the applications of numerical methods and digital computers to hydraulic engineering. This section introduces hydraulic engineers to techniques used in programming problems for solution by digital computers. It includes ten examples of hydraulic engineering problems with flow charts, corresponding computer problems and outputs. An appendix to the new section provides explanations of the more important numerical methods used in applying computers to hydraulic problems.

Reference 7 OPEN-CHANNEL HYDRAULICS

Chow, Ven Te. New York, New York: McGraw-Hill Book Company; 1959. 690 p. (McGraw-Hill Civil Engineering Series).

Order from: McGraw-Hill Book Company, 1221 Avenue of the Americas, New York, New York 10020.

This book which gives a broad coverage of recent developments is organized into five parts; Basic principles, uniform flow, gradually varied flow, rapidly varied flow, and unsteady flow. In Part I the type of flow in open channels is classified according to the variation in the parameters of flow with respect to space and time. The state of flow is classified according to the range of the invariants of flow with respect to viscosity and gravity. Four coefficients for velocity and pressure distributions are introduced. The energy and momentum principles which constitute the basis of interpretation for most hydraulic phenomena are treated thoroughly. In Part II, several uniform flow formulas are introduced. The design for uniform flow covers nonerodible, erodible and grassed channels. In the third Part, several methods for the computation of flow profiles are discussed. A new method of direct integration is

introduced which requires the use of a varied flow function table. The method of singular points for the analysis of flow profiles is also discussed. Part IV on rapidly varied flow discusses problems supported by experimental data. The use of the flow-net method and the method of characteristics is mentioned. In Part V on unsteady flow, the treatment is general but practical.

Reference 8 USE OF RIPRAP FOR BANK PROTECTION

Searcy, James K. Washington, DC: U.S. Federal Highway Administration, Office of Engineering and Traffic Operations, Bridge Division, Hydraulics Branch; 1967 June. (Reprinted 1978 February). Various paging. (Hydraulic Engineering Circular Number 11).

Order from: U.S. Federal Highway Administration, Office of Engineering, Bridge Division, HNG-31, Washington, DC 20590.

The design and construction of riprap protection for highway embankments and streambanks are described, and the design criteria used by several governmental agencies are compared in an appendix. A sample specification for riprap is also appended. The riprap slope protection discussed here include: dumped riprap (graded stone dumped on a prepared slope), hand-placed riprap (stone laid carefully by hand or derrick following a more or less definite pattern with the voids between the larger stone filled with smaller stone and the surface kept relatively even), wire-enclosed riprap (stones placed in wire baskets or wire covered mats), grouted riprap (riprap with interstices filled with portable cement mortar), concrete riprap in bags (concrete in cement sacks or suitable burlap bags handplaced in contact with adjacent bags), and concrete slab riprap (plain or reinforced concrete slabs poured or placed on the surface to be protected). A filter layer under all riprap is essential unless the bank material meets the filter requirements. It is also noted that broken concrete may be substituted for stone when it meets the requirements for stone.

Reference 9 TENTATIVE DESIGN PROCEDURE FOR RIPRAP- LINED CHANNELS

Anderson, Alvin G.; Paintal, Amreek S.; Davenport, John T. Washington, DC: Highway Research Board; 1970. 75 p. (NCHRP Report 108).

Order from: University Microfilms International, 300 North Zeeb Road, Ann Arbor, Michigan 48106.

The erosion-resistant riprap lining has protective qualities which lie between those of a grassed drainage channel and a concrete-lined drainage channel. It consists of a layer of discrete fragments of rock of sufficient size to resist the erosive forces of the flow. The design of such riprap-lined drainage channels involves the interrelationship between the discharge, the longitudinal slope, the size and shape of the channel, and the size distribution of the riprap lining. This report describes these interrelationships and develops design criteria by which a riprap-lined drainage channel can be proportioned and the riprap lining can be specified for a given discharge and

longitudinal slope. The relationships so developed have been reduced to design charts, the use of which permits rapid and simple establishment of channel shape and size as well as of the properties of the riprap lining. Highway drainage channels are divided into two groups. In the first group are those that serve as median or side ditches for the drainage of the roadways. These are relatively small and often approach a triangular cross section because of the relatively flat side slopes and generally small bottom width. In the second group are large drainage channels that convey a larger discharge and are usually trapezoidal in cross section. A set of design charts for each type has been prepared. Limited experimental data are presented which serve to verify the design procedure, to test the efficacy of channels designed according to this procedure, and to examine somewhat more closely the phenomenon of leaching of base material through the riprap interstices. These experiments, although preliminary in character, indicate that the design procedures are suitable and incorporate sufficiently large factors of safety to provide stable channels.

Reference 10
DESIGN OF STABLE CHANNELS WITH FLEXIBLE LININGS

McWhorter, J.C.; Anderson, Alvin G.; Cox, Allen L. Washington, DC: U.S. Federal Highway Administration, Office of Engineering, Bridge Division, Hydraulics Branch; 1975 October. 136 p. (Hydraulic Engineering Circular Number 15; stock number 050-902-00101-9).

Order from: Superintendent of Documents, U.S. Government Printing Office, Washington, DC 20402.

This circular presents design methods developed from recent research results for temporary linings, vegetative linings and rock riprap linings. The temporary lining materials for which design information was produced were: bare soil, Erosionet 315 (a paper yarn with openings approximately 7/8-inch by 1/2-inch), jute mesh (woven mat with openings about 3/8-inch by 3/4-inch), stranded fiber glass roving with Erosionet 315, 3/8-inch fiber glass mat, 1/2-inch fiber glass mat, Excelsior mat (dried shredded wool held together with a fine paper net and secured with steel pins), and straw with Erosionet. A complete description of each temporary lining material is presented along with design charts. Maximum permissible depth charts have been developed for three different types of vegetation: Bermuda grass of various lengths, uncut grass mixtures, and common Lespedeza. The development of the maximum permissible depth of flow curves for dumped rock riprap channel linings are discussed. Criteria for plastic filter cloth design and a new procedure for design of channel protection in bends are also included. Design concepts, design procedure, composite channel lining

design and charts are presented for all cases and example problems are discussed. The development of flow rate versus slope curves for a selected channel geometry, and a method of programming channel design procedure are detailed.

Reference 11
HIGHWAY ENGINEERING

3rd ed. Oglesby, Clarkson H. New York, New York: John Wiley & Sons, Inc.; 1975. 783 p.

Order from: John Wiley & Sons, Inc., 605 Third Avenue, New York, New York 10016.

This text is designed for use in college courses and for use as a starting point for advanced study for those with a special interest in this field. The book also offers a summary of new developments in technology as an aid to practicing engineers and administrators. The history and future of highway developments are discussed and highway systems, organization and associations are reviewed in the first two chapters. The third chapter, Highway and Urban Transportation Planning, deals with planning techniques as well as the role of the professional and the public in today's decisionmaking. Chapter 4, Highway Economy, presents recent data on vehicle operating and accident costs, and develops techniques for evaluating highway improvements in terms of savings to users in operating, time, and accident costs. Chapter 5 on Highway Finance reviews past and present highway and urban transportation financing by the various levels of government and traces their effects. Chapter 6, Highway Surveys, Plans, Computations, emphasizes the importance of remote sensing (photogrammetry) and computers in modern practice. Chapter 7 treats the problems encountered in taking property for public purposes and in compensating owners for land improvements and loss of light, air, view and privacy. It also outlines the legal and administrative problems associated with the displacement of people and activities from rights of way. Topics related to geometric design, traffic engineering, and highway safety are incorporated in chapters 8, 9 and 10. Chapter 11 emphasizes the value of engineering analysis in highway engineering, particularly in relation to highway drainage. This chapter discusses the means for collecting, transporting, and disposing of surface water originating on or near the highway right of way or flowing in streams crossing or bordering that right of way. Chapter 12 analyzes recent environmental legislation and its effects on highway practices and presents procedures for predicting air pollution and noise impacts of highway and traffic control measures. The Chapters (13-19) on soils, bases, and pavements, present research findings and test results related to roadway and pavement design. A representative group of design procedures for flexible and rigid pavements is given in detail. Chapter 20, Highway Maintenance, discusses traditional maintenance practices as well as outlines new developments in maintenance management.

Index

The following index is an alphabetical list of subject terms, names of people, and names of organizations that appear in one or another of the previous parts of this compendium, i.e., in the Overview, Selected Texts, or Bibliography. The subject terms listed are those that are most basic to the understanding of the topic of the compendium.

Subject terms that are not proper nouns are shown in lower case. Personal names that are listed generally represent the authors of selected texts and other references given in the bibliography, but they

may also represent people who are otherwise identified with the compendium subjects. Personal names are listed as surname followed by initials. Organizations listed are those that have produced information on the topic of the compendium and that continue to be a source of information on the topic. For this reason, postal addresses are given for each organization listed.

Numbers that follow a subject term, personal name, or organization name are the page numbers of this compendium on which the term or name ap-

Indice

El siguiente índice es una lista alfabética del vocablo del tema, nombres de personas, y nombres de organizaciones que aparecen en una u otra de las partes previas de este compendio, es decir, en el Vista General, Textos Seleccionados, o Bibliografía. Los vocablos del tema que se listean son aquellos básicos necesarios para el entendimiento de la materia del compendio.

Los vocablos del tema que no son nombres propios aparecen en letras minúsculas. Los nombres personales que aparecen representan los autores de los textos seleccionados y otras referencias dadas en la bibliografía.

pero también pueden representar a personas que de otra manera están conectadas a los temas del compendio. Los nombres personales están listeados como apellido seguido por las iniciales. Las organizaciones nombradas son las que han producido información sobre la materia del compendio y que siguen siendo una fuente de información sobre alguna parte o el alcance total del compendio. Por esta razón se dan las direcciones postales para cada organización listeadas.

Los números que siguen a un vocablo del tema, nombre personal, o nombre de organización son los números de página del com-

Index

Cet index se compose d'une liste alphabétique de mots-clés, noms d'auteurs, et noms d'organisations qui paraissent dans une section ou une autre de ce recueil, c'est à dire dans l'Exposé, les Textes Choisis, ou la Bibliographie. Les mots-clés cités sont ceux qui sont le plus élémentaires à la compréhension de ce recueil.

Les mots-clés qui ne sont pas des noms propres sont imprimés en minuscules. Les noms propres cités sont les noms des auteurs des textes choisis ou de textes de référence

cités dans la bibliographie, ou alors les noms de personnes identifiées avec les sujets de ce recueil. Le nom de famille est suivi des initiales des prénoms. Les organisations citées sont celles qui ont écrit sur le sujet de ce recueil et qui continueront d'être une source de documentation. Les adresses de toutes ces organisations sont incluses.

Le numéro qui suit chaque mot-clé, nom d'auteur, ou nom d'organisation est le numéro de la page où ce nom ou mot-clé paraît. Les numéros écrits en chiffres romains se rappor-

pears. Roman numerals refer to pages in the Overview, Arabic numerals refer to pages in the Selected Texts, and reference numbers (e.g., Ref. 5) refer to references in the Bibliography.

Some subject terms and organization names are followed by the word *see*. In such cases, the compendium page numbers should be sought under the

alternative term or name that follows the word *see*. Some subject terms and organization names are followed by the words *see also*. In such cases, relevant references should be sought among the page numbers listed under the terms that follow the words *see also*.

The foregoing explanation is illustrated below.

pendio donde el vocablo o nombre aparecen. Los números romanos se refieren a las páginas en la Vista General, los números arábigos se refieren a páginas en los Textos Seleccionados, y los números de referencia (por ejemplo, Ref. 12) indican referencias en la Bibliografía.

Algunos vocablos del tema y nombres de organizaciones están seguidos por la palabra *see*. En tales casos los números de página

del compendio se encontrarán bajo el término o nombre alternativo que sigue a la palabra *see*. Algunos vocablos del tema y nombres de organizaciones están seguidos por las palabras *see also*. En tales casos las referencias pertinentes se encontrarán entre los números de página indicadas bajo los términos que siguen a las palabras *see also*.

La explicación anterior esta subsiguientemente ilustrada.

tent aux pages de l'Exposé et les numéros écrits en chiffres arabes se rapportent aux pages des Textes Choisis. Les numéros de référence (par exemple Ref. 12) indiquent les numéros des références de la Bibliographie.

Certains mots-clés et noms d'organisations sont suivis du terme *see*. Dans ces cas, le numéro des pages du recueil se trouvera après

le mot-clé ou le nom d'organisation qui suit le terme *see*. D'autres mots-clés ou noms d'organisations sont suivis des mots *see also*. Dans ce cas, les références qui les touchent se trouveront citées après les mots-clés qui suivent la notation *see also*.

Ces explications sont illustrées ci-dessous.

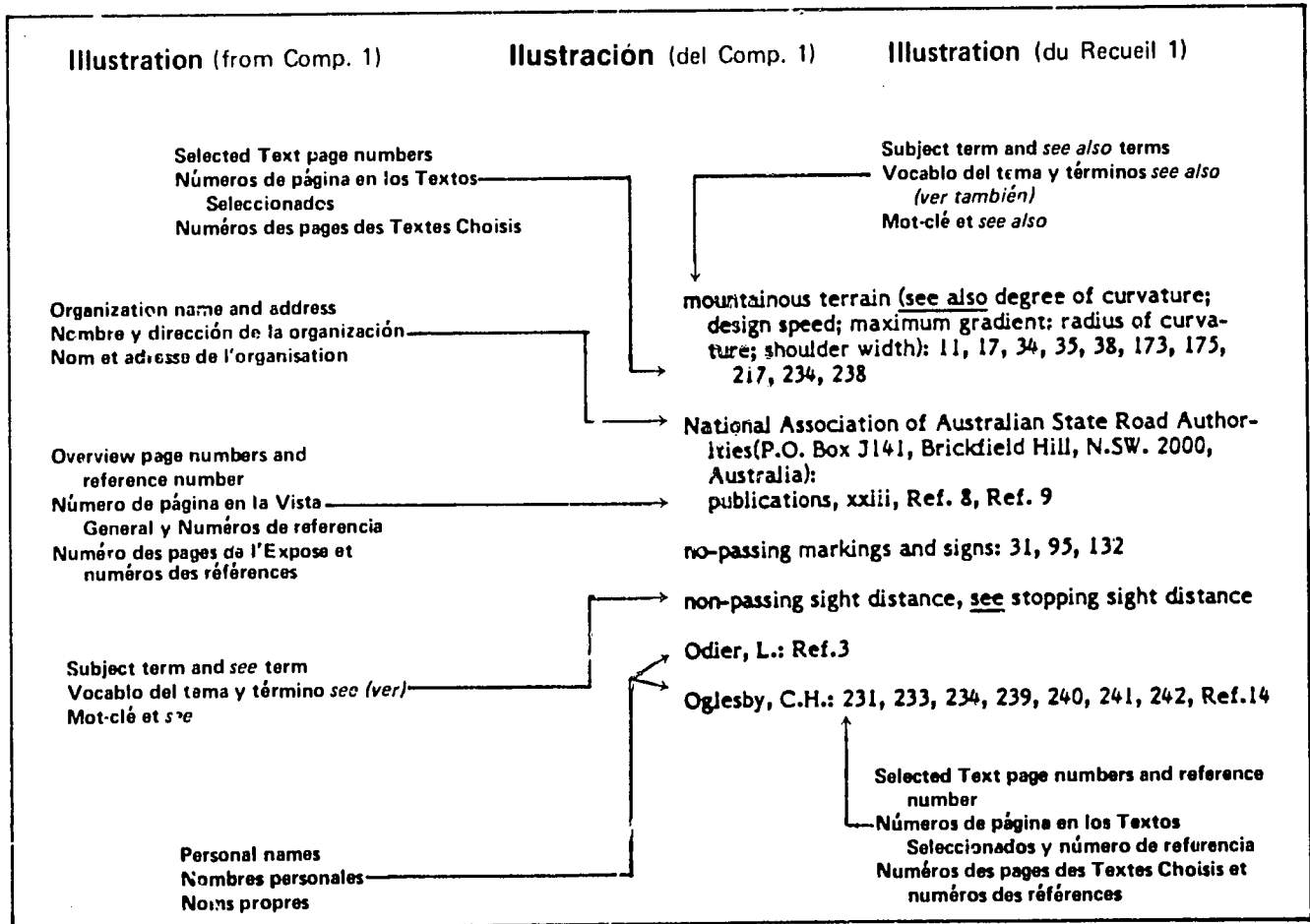

- American Society of Civil Engineers, Soil Mechanics and Foundation Division, Committee on Earth Dams, Subcommittee on Slope Protection (345 East 47th Street, New York, New York 10017): 37, 4
- Anderson, Alvin G.: Ref. 9, Ref. 10
- arid regions: 10, 12, 41-42
- Aveling-Barford, Ltd. (Technical Publications Department, Invicta Works, Houghton Road, Grantham, Lincolnshire, NG31 6JE, U.K.): xix, Ref. 4
- bank slopes, see slope banks
- batter drains (see also chutes): xx, 171, 176
- bibliographies: xxi
channel design, 58-59
- bituminous materials (see also channel linings): 155
- Brater, Ernest F.: Ref. 3, Ref. 6
- bridges: xxi, 177
inspection and maintenance, 182-186
- buoyancy of channels: 35
- California Division of Highways (California Department of Transportation, P.O. Box 1499, Sacramento, California 95807): 37, 40
- catch drains (see also intercepting channels): xxi, 9, 175, 180
- cattle grids: 185-186
- channel changes: 9, 11
- channel construction: xvi, Ref. 1
- channel design (see also design charts): xiv-xvi, 8, 14, 28-45, 52-57, Ref. 1, Ref. 10
- channel economics: xvii, 50-51, Ref. 1
- channel linings: xiv, xv, xvi, xviii, 11, 30-42, 51, 60, 175, Ref. 8, Ref. 9, Ref. 10
bituminous, 36, 47
combination, 35-36
concrete, 33-35, 36, 43, 46-47, 54
grass, xviii, 30-33, 34, 42-44, 46, 51, 60, 69, 85, 87, 174, Ref. 2, Ref. 7, Ref. 10
rigid, xvi, 35
stone, 36-41, 44-45, 47-48, 51, 54, Ref. 8
vegetative, 11, 12, 28, 31, 32, 49, 62
- channel maintenance: xvi, 12, 49, 171-179, 183, Ref. 1, Ref. 5
- channel protection (see also channel linings; erosion prevention and control): xv, xvii
- channels, see buoyancy of channels; cross drainage channels; intercepting channels; open channels; rectangular channels; roadway channels; terraced channels; toe-of-slope channels; trapezoidal channels, triangular channels; unlined channels
- charts (see also design charts): 38
for calculating Manning equation, xvi, 69, 71-85, Ref. 2
- Chow, Ven Te: Ref. 7
- chutes (see also batter drains): 9, 10, 11, 26, 27, 33, 40, 42-45, 46, 51
- computer techniques: Ref. 6
- construction, see channel construction; road building; terrace construction
- Cox, Allen L.: Ref. 10
- Creager's equation: 40
- critical depth: 24, 25, 26, 69
- critical flow: 24
- cross drainage channels: 176
- crossfall: 169, 170
- culverts: xxi, 51, 177, 178
inspection and maintenance, 182-186
- cutoff walls: 33, 42, 48
- Davenport, John T.: Ref. 9
- debris clearing and removal: 183
- design, see channel design; design charts; design runoff; design storm; rational formula and method
- design charts (see also charts): xiii, xvii-xviii, 21, 29, 33, 86-87, Ref. 2, Ref. 9, Ref. 10
- design runoff: 8
- design storm: 50
- ditches: xviii, xx, 136-145
borrow, 11
checks, 11-12, 41-42, 48
cleaning, xiv
- diversion drains: xxi, 173-174
- drainage: Ref. 11
of bituminous and concrete pavements, 168-169
of gravel surfaces, 169-170
of small areas, 13-18
of unpaved surfaces, 170
- drains, see batter drains; catch drains; diversion drains; shoulder drains; side drains; subsoil drains; table drains; underground drains and pits
- earth roads: xiv
construction, 136-141
maintenance, 134-135, Ref. 5
- energy dissipators: 33, 43-44
- equations (see also Creager's equation; Manning equation; rational formula and method; weir formula): 7
- erosion prevention and control (see also channel linings; riprap): xiv, 8, 11-12, 30-31, 33, Ref. 1, Ref. 8, Ref. 9
- filter blankets: 41, 47
- floodways and fords: xxi, 176-177
- flow, see critical flow; sheet flow; steady flow; subcritical flow; supercritical flow; unsteady flow

flumes, see chutes

fords: xxi, 176-177

formulas, see equations; rational formula and method; weir formula

Froude number: xvi, 7, 27, 43

graders (see also grading): xiv, xix, 104-155

grading (see also graders): xix-xx, 104-155, 170, 171, 174, Ref. 4

gravel surfaces: xx, Ref. 5

ground covers: xv

gutters: 9-10

Highway Research Board (now Transportation Research Board, 2101 Constitution Avenue, N.W., Washington, D.C. 20418): Ref. 9

hydraulic jump: 33

hydraulic radius: 7, 23, 32, 33, 69

hydraulics (see also hydraulic jump; hydraulic radius): xiii, xv, xix, 19-27, Ref. 1, Ref. 3, Ref. 6, Ref. 7

intercepting channels (see also catch drains): 9, 10, 53

John Wiley & Sons Inc. (605 Third Avenue, New York, New York 10016): Ref. 11

King, Horace Williams: xix, Ref. 3, Ref. 6

lined channels, see channel linings

loess soil: 46

low-volume roads: xiii

maintenance, see channel maintenance; road maintenance

Manning equation: xvi, 7, 19-20, 23, 26, 33, 69, Ref. 2, Ref. 3

Manning roughness coefficient, n : 7, 19, 30, 32, 33, 37, 38, 60, 69, Ref. 2

McGraw-Hill Book Company, Inc. (1221 Avenue of the Americas, New York, New York 10020): Ref. 3, Ref. 6, Ref. 7

McWhorter, J.C.: Ref. 10

median swales: 9, 11

National Association of Australian State Road Authorities (Box 3141, Brickfield Hill, New South Wales 2000 Australia): publications, xx, 182, Ref. 5

nomographs: 20, 69, 84, Ref. 2

nonuniform flow, see steady flow

Oglesby, Clarkson H.: Ref. 11

open channels (see also design charts): xiii, xv, xvii, xviii, 19, 21, 34, 69, 86-87, 92-99, 175, Ref. 1, Ref. 2, Ref. 3, Ref. 7

Paintal, Amreek S.: Ref. 9

peak runoff: 8, 14

pipes: Ref. 2, Ref. 3, Ref. 6

rainfall: 13-16
frequency analysis, 13-14
intensity, 13-16, 17, 18

rational formula and method: xv, 7, 14, 16, 18, 60

rectangular channels: 69-85

riprap: Ref. 8, Ref. 10

road building (see also road location): xx
earth roads, 136-141

road location: 8

road maintenance: xx, 166-186, Ref. 5
earth roads, 134-135, Ref. 5

roads, see earth roads; low-volume roads

roadway channels (see also table drains): 9, 10, 16

runoff (see also design runoff, peak runoff):
coefficient, 14-16, 60
estimation, 13-18, 54-56, Ref. 1

safety: 28
during inspection and repair, 182
factors, Ref. 9
of grading personnel, 106

scour: 11, 169, 170, 171, 173, 175, 177, 178, 179, 181

Searcy, James K.: Ref. 1, Ref. 8

sheet flow: 169, 179-180

shoulder drains: 177-179

side drains: xv, 173

side slope: xiii, xv, xviii, 50

slope banks: xiv, 146-147

small drainage areas: 13-18

soil, loess: 46

spillways, see chutes

steady flow: xv, 19
nonuniform flow, xvi, 23-24, 26-27, Ref. 3
uniform flow, xv-xvi, 9, 19-23, 24, 26, 92-99, Ref. 2, Ref. 7

stilling basins: 33, 37, 43-44, 54

subcritical flow: 24, 26, 27, 35

subsoil drains: xxi, 177-179, 180

supercritical flow: 24, 27, 42, 44

table drains: xx, 171, 172

terrace construction: 151-153

terraced channels (see also terrace construction): xiv
toe-of-slope channels (see also side drains): 9, 10
trapezoidal channels: xviii, xx, 7, 20, 22, 29, 30, 33, 35, 50, 51, 69-85, Ref. 2
triangular channels: 7, 69-85, Ref. 2
underground drains and pits: 180-181
uniform flow, see steady flow
United States Army Engineer Waterways Experiment Station (P.O. Box 631, Vicksburg, Mississippi 39180): 40
United States Bureau of Reclamation (18th and C Streets, N.W., Washington, DC 20240): 46
United States Department of Transportation (400 Seventh Street, S.W., Washington, D.C. 20590) (see also United States Federal Highway Administration, Office of Engineering, Bridge Division, Hydraulics Branch): publications, xiv, xvii

United States Federal Highway Administration, Office of Engineering, Bridge Division, Hydraulics Branch (HNG-31, Washington, D.C. 20590): Ref. 1, Ref. 2, Ref. 8, Ref. 10

United States Weather Bureau (now U.S. National Weather Service, 8060 13th Street, Silver Spring, Maryland 20910): 14, 17

unlined channels: 35, 42, 60, 175

unpaved surfaces (see also earth roads): xx

unsteady flow: 19, Ref. 7

varied flow (nonuniform flow), see steady flow

warning signs: 176

weep holes: 35

weir formula: 26

Project Publications

The publications listed below have been produced in the Transportation Technology Support for Developing Countries project and may be ordered from TRB postpaid at the prices shown.

Publicaciones del Proyecto

Los compendios citados abajo fueron publicados en el apoyo De la Tecnología de Transportación en los Países en Vía de Desarrollo y pueden ser Ordenados franco de porte a los precios indicados para cada publicación.

Publications du Projet

Les recueils cités ci-dessous ont été publiés pour le projet sur la Technologie des Transports pour les Pays en Voie de Développement et peuvent être commandés en port-payé au TRB. Les prix sont indiqués pour chaque publication.

Transportation Research Board
National Research Council
2101 Constitution Avenue, N.W.
Washington, DC 20418 USA

- Compendium 1: Geometric Design Standards for Low-Volume Roads. \$12.00
Normas de diseño geométrico para caminos de bajo volumen.
Normes de dimensionnement géométrique pour routes à faible capacité.
- Compendium 2: Drainage and Geological Considerations in Highway Location. \$12.00
Consideraciones de drenaje y geológicas en la ubicación de carreteras.
Considérations sur les facteurs de drainage et de géologie qui influencent le choix de l'emplacement d'une route.
- Compendium 3: Small Drainage Structures. \$12.00
Pequeñas estructuras de drenaje.
Petits ouvrages de drainage.
- Compendium 4: Low-Cost Water Crossings. \$9.00
Travesías de agua de bajo costo.
Ouvrages de franchissement d'eau économiques.
- Compendium 5: Roadside Drainage. \$9.00
Drenaje del borde de la carretera.
Drainage des bas-côtés de la route.