

# Data Projector

## Operating Instructions

Before operating the unit, please read this manual and supplied Quick Reference Manual thoroughly and retain it for future reference.

### VPL-FH65/FH60

Not all models are available in all countries and area. Please check with your local Sony Authorized Dealer.



---

# Table of Contents

---

## **Overview**

Location and Function of Controls ....	4
Main Unit .....	4
Terminals .....	5
Remote Commander and Control Panel .....	6

---

## **Preparation**

Connecting the Projector .....	9
Connecting a Computer .....	9
Connecting Video Equipment ....	10
Connecting an External Monitor and Audio Equipment .....	12
Connecting Network Equipment .....	13
Connecting to HDBaseT™ Equipment .....	14
Attaching the terminal cover .....	16

---

## **Projecting/Adjusting an Image**

Projecting an Image .....	17
Adjusting the Focus, Size, and Position of the Projected Image .....	18
Correcting for Trapezoidal Distortion of the Projected Image (Keystone Adjustment) .....	19
Correcting Image Twist (Warp Correction Feature) .....	20
Blending Projections from Multiple Projectors on a Screen .....	21
Turning Off the Power .....	22

---

## **Adjustments and Settings Using a Menu**

Using a Menu .....	24
The Picture Menu .....	25
The Screen Menu .....	28
The Function Menu .....	31
The Operation Menu .....	32
The Connection/Power Menu .....	34
The Installation Menu .....	36
The Information Menu .....	39

---

## **Network**

Using Network Features .....	40
Displaying the Control Window of the Projector with a Web Browser .....	40
Confirming the Information regarding the Projector .....	41
Operating the Projector from a Computer .....	41
Using the e-mail Report Function .....	41
Setting the LAN Network of the projector .....	43
Setting the Control Protocol of the Projector .....	44

---

## ***Others***

Indicators .....	47
Messages List .....	49
Troubleshooting .....	50
Replacing the Lamp .....	52
Cleaning the Air Filter .....	54
Replacing the Projection Lens .....	55
Removing .....	55
Attaching .....	56
Specifications .....	57
Projection Distance and Lens Shift	
Range .....	63
Dimensions .....	66
Index .....	69

# Location and Function of Controls

## Main Unit

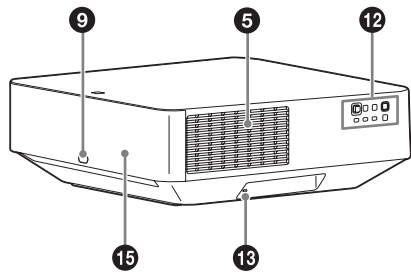
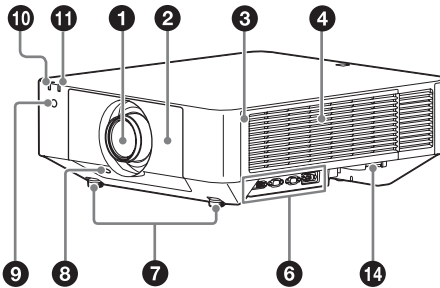

**1 Lens (page 55)**

**2 Front panel**

**3 Side cover (page 54)**

**4 Ventilation holes (intake)**

**5 Ventilation holes (exhaust)**

**Caution**

Do not place anything near the ventilation holes as this may cause internal heat buildup. Do not place your hand near the ventilation holes (exhaust) and the circumference as this may cause injury.

**6 Terminals (page 5)**

**7 Front feet (adjustable) (page 18)**

**8 LENS RELEASE button (page 55)**

**9 Remote control receiver**  
The remote control receivers are located at the front and rear of the projector.

**10 ON/STANDBY indicator (page 47)**

**11 WARNING indicator (page 47)**

**12 Control panel (page 6)**

**13 Antitheft lock**  
Connects to an optional antitheft cable manufactured by Kensington. For details, visit the Kensington's web site.  
<http://www.kensington.com/>

**14 Antitheft bar**  
Connects to a commercially available antitheft chain or wire.

**15 Rear panel (page 48)**

## Terminals

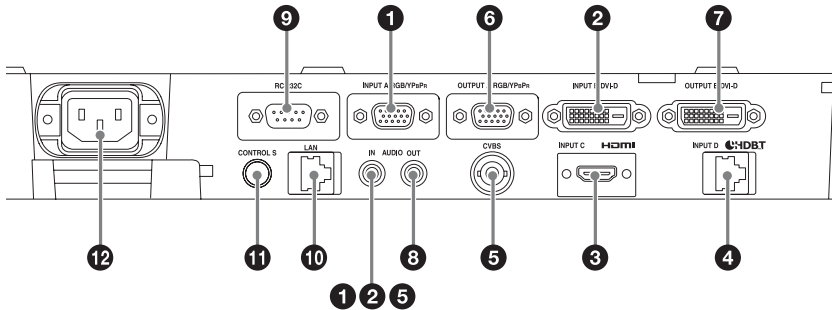

### Input (page 9)

#### 1 INPUT A

Video: RGB/Y/Pb/Pk input terminal (RGB/Y/Pb/Pk)

Audio: Audio input terminal (AUDIO)

#### 2 INPUT B

Video: DVI-D input terminal (DVI-D)

Audio: Audio input terminal (AUDIO)

#### 3 INPUT C

Video: HDMI input terminal (HDMI)

Audio: HDMI input terminal (HDMI)

#### 4 INPUT D

HDBaseT terminal

#### 5 VIDEO (VIDEO IN)

Video: Video input terminal

Audio: Audio input terminal (AUDIO)

#### Notes

- The audio input terminals of the projector are for output to external equipment. Connect external audio equipment to output audio (page 12).
- The audio inputs of INPUT A, INPUT B, and VIDEO are shared.

### Output (page 12)

#### 6 OUTPUT A

Video: RGB/Y/Pb/Pk output terminal (RGB/Y/Pb/Pk)

#### 7 OUTPUT B

Video: DVI-D output terminal (DVI-D)

#### 8 AUDIO OUT

Audio: Audio output terminal (AUDIO)

#### Note

These terminals output projected images or audio. As for images, the signal input from INPUT A is output from OUTPUT A, and the signal input from INPUT B is output from OUTPUT B. However, if the signal input from INPUT B is protected by HDCP, the signal is not output from OUTPUT B. As for audio, when INPUT A or B, or VIDEO is selected, the audio signal input from the audio input terminal is output; when INPUT C or D is selected, the audio signal input from the selected input terminal is output.

### Others

#### 9 RS-232C terminal

RS-232C compatible control terminal

#### 10 LAN terminal (page 13)

#### 11 CONTROL S input terminal (DC power supply) (CONTROL S)

Connects to the CONTROL S output terminal on the supplied Remote Commander with a connecting cable (stereo mini plug (not supplied)) when using it as a wired Remote Commander. You do not need to install batteries in the Remote Commander, as the power is supplied from this terminal.

## 12 AC IN socket

Connects the supplied AC power cord.

## Remote Commander and Control Panel

### Remote Commander

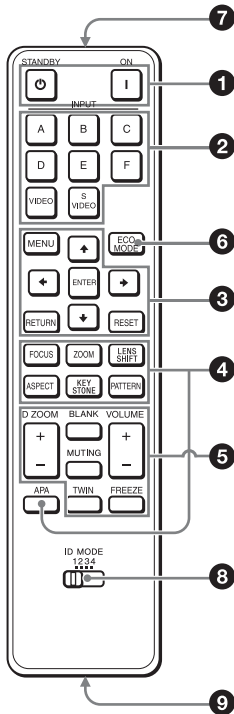

### Control Panel

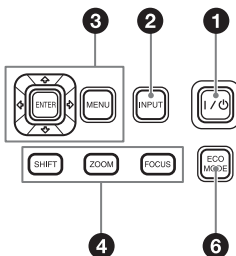

### 1 Turning on the power/Going to standby

I (On) key  
⏻ (Standby) key

### 2 Selecting an input signal (page 17)

#### INPUT key

#### Direct input select keys

The E, F, and S VIDEO keys are not used with this projector.

### 3 Operating a menu (page 24)

#### ENTER /▲/▼/◀/▶ (arrow) keys

#### MENU key

#### RETURN key

#### RESET key

### 4 Adjusting the image (page 18)

#### FOCUS key

Use this key when attaching the power focus lens.

#### ZOOM key

Use this key when attaching the power zoom lens.

#### LENS SHIFT/SHIFT key

#### ASPECT key (pages 28, 30)

Changes the aspect ratio of the projected image.

#### KEYSTONE key (page 19)

#### PATTERN key (page 18)

#### APA (Auto Pixel Alignment) key

Automatically adjusts a picture to its clearest while a signal from a computer is input via the RGB input terminal (INPUT A). You can cancel the adjustment by pressing the APA key again while adjusting.

### 5 Using various functions during projecting

#### D ZOOM (Digital Zoom) key

Enlarges a portion of the image while projecting.

Use this key when inputting a computer signal. But it may not be enabled, depending on the resolution of the input signal and when displaying two pictures.

- 1 Press the D ZOOM + key to display the digital zoom icon on the projected image.
- 2 Press the  $\uparrow/\downarrow/\leftarrow/\rightarrow$  keys to move the digital zoom icon to the point on the image you wish to enlarge.
- 3 Press the D ZOOM + key or the D ZOOM – key repeatedly to change the enlargement ratio. The image can be enlarged up to 4 times.

Press the RESET key to restore the previous image.

### TWIN (Twin Picture) key

You can project the images from two input signals on the screen as a main picture and subpicture at the same time. To switch between one and two pictures, press the TWIN key.

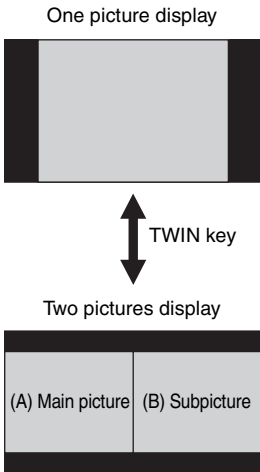

You can select the image to project to the main picture.

The subpicture is preset to source the signal input from INPUT A. INPUT A is only compatible with signals from computers.

## Combinations of input signals

Main picture	Subpicture
INPUT B (DVI-D)	INPUT A (RGB)
INPUT C (HDMI)	
INPUT D (HDBaseT)	

### Notes

- When “Screen Aspect” (page 37) is set to “4:3,” the two picture function is not available.
- When displaying two pictures, the input signal icon  $\text{Ⓢ}$  does not appear in the input select window (page 17).
- Picture settings set for one picture may not be reflected as two pictures.
- When displaying two pictures, the I (On) key,  $\text{⏻}$  (standby) key, INPUT key, and BLANK key are available.

### BLANK key

Cuts off the image. Press again to restore the image.

### MUTING key

Mutes the audio output. Press again to restore the previous volume.

### VOLUME key

For adjusting the volume output from the audio output terminal of the projector.

### FREEZE key

Pauses a projected image. Press again to restore the image.

Use this key when inputting a computer signal.

## 6 Setting the energy-saving mode easily

### ECO MODE key

Energy-saving mode can be set easily. Energy-saving mode consists of “With No Input,” and “Standby Mode.”

- 1 Press the ECO MODE key to display the ECO Mode menu.

## ECO Mode menu

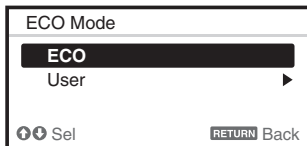

- 2 Press the  $\uparrow/\downarrow$  key or ECO MODE key to select “ECO” or “User” mode.

**ECO:** Sets each mode to the optimum energy-saving value.

- With No Input: Standby
- Standby Mode: Low

**User:** Sets each item of the energy-saving mode menu as you desire.

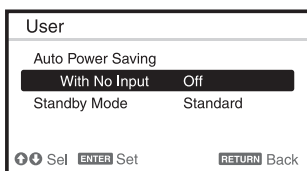

- 3 Press the RETURN key to restore the previous image.

For details on ECO Mode settings, see “With No Input,” and “Standby Mode” on the Connection/Power menu (page 34).

### Note

If you set “ECO Mode” to “ECO,” or “Standby Mode” (in “User”) to “Low,” the network control function will be disabled in standby mode. If the external control is being performed by using the network or network control function, do not select “ECO,” or do not set “Standby Mode” (in “User”) to “Low.”

---

## Others

### 7 Infrared transmitter

### 8 ID MODE switch (page 32)

Sets an ID mode of the Remote Commander. If you assign a different ID number to each projector when multiple projectors are used, you can control only the projector with the same ID mode as that of the Remote Commander.

### 9 CONTROL S output terminal

Connects to the CONTROL S input terminal on the projector with a connecting cable (stereo mini plug (not supplied)) when using the Remote Commander as a wired one.

You do not need to install batteries in the Remote Commander, as the power is supplied from the projector.

### About Remote Commander operation

- Direct the Remote Commander toward the remote control receiver.
- The shorter the distance between the Remote Commander and the projector is, the wider the angle within which the Remote Commander can control the projector becomes.
- If there is any obstruction between the Remote Commander and the remote control receiver on the projector, the projector may not be able to receive signals from the Remote Commander.



# Connecting the Projector

## Notes

- Turn off all equipment before making any connections.
- Use the proper cables for each connection.
- Insert the cable plugs firmly; Loose connections may reduce performance of picture signals or cause a malfunction. When pulling out a cable, be sure to grip it by the plug, not the cable itself.
- For more information, refer also to the instruction manuals of the equipment you are connecting.
- Use a no-resistance audio cable.

## Connecting a Computer

Connection with a computer is explained for each input signal.

### INPUT A

For connecting a computer with an RGB output terminal.

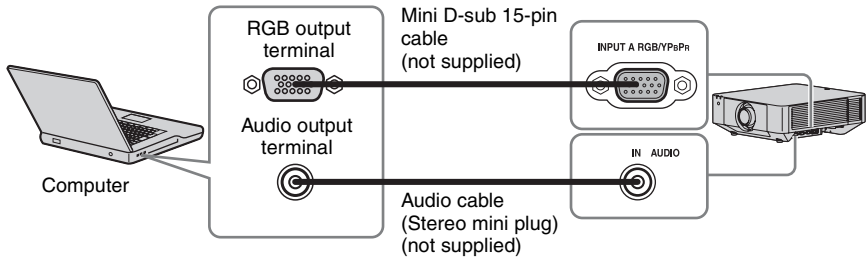

### Note

It is recommended that you set the resolution of your computer to 1920 × 1200 pixels for the external monitor.

### INPUT B

For connecting a computer with a DVI-D output terminal.

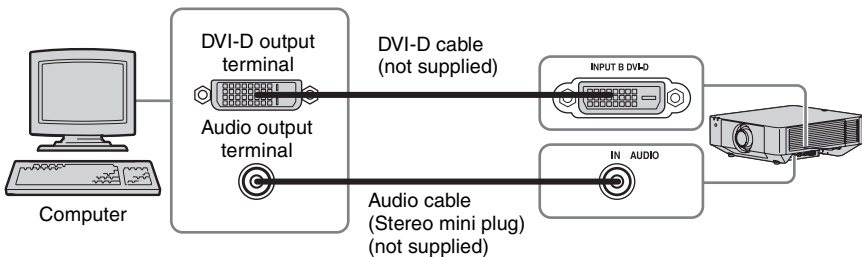

---

## INPUT C

For connecting a computer with an HDMI output terminal.

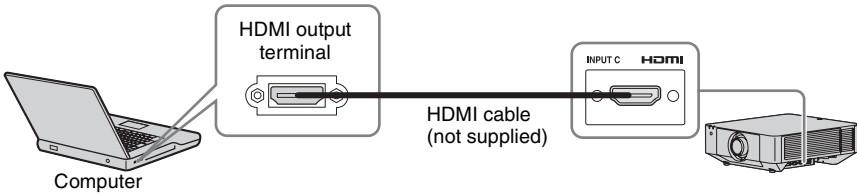

### Notes

- Use HDMI-compatible equipment which has the HDMI Logo.
- Use a high speed HDMI cable(s) on which the cable type logo is specified. (Sony products are recommended.)
- The HDMI terminal of this projector is not compatible with DSD (Direct Stream Digital) signal or CEC (Consumer Electronics Control) signal.

## Connecting Video Equipment

Connections with a VHS videocassette recorder, DVD player, or BD player are explained for each input signal.

---

## VIDEO IN

For connecting video equipment with a video output terminal.

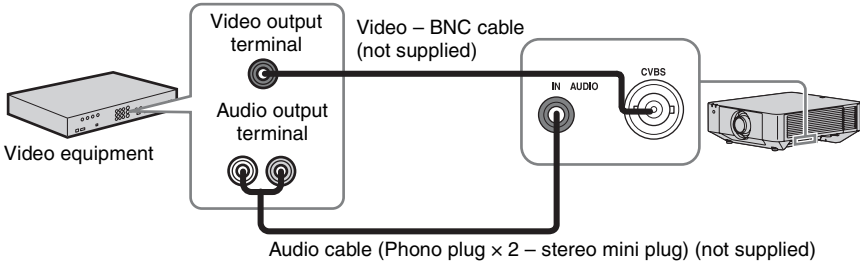

---

## INPUT A

For connecting video equipment with a YPbPr output terminal.

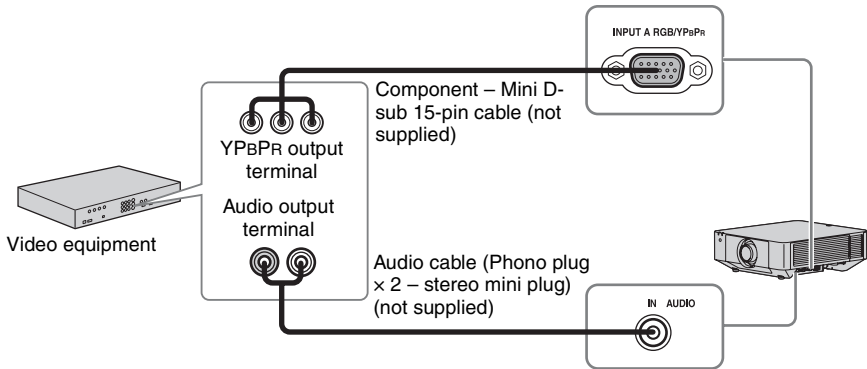

---

## INPUT C

For connecting video equipment with an HDMI output terminal.

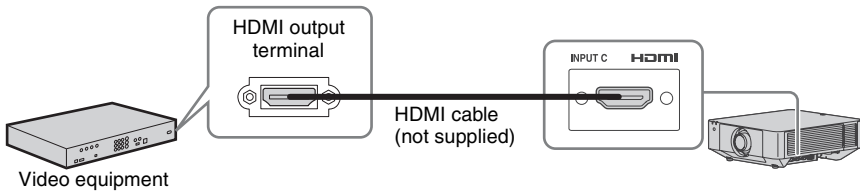

### Notes

- Use HDMI-compatible equipment which has the HDMI Logo.
- Use a high speed HDMI cable(s) on which the cable type logo is specified. (Sony products are recommended.)
- The HDMI terminal of this projector is not compatible with DSD (Direct Stream Digital) signal or CEC (Consumer Electronics Control) signal.

### To fix the HDMI cable

Fix the cable to the cable tie holders at the sides of the terminals using a commercially available cable tie, as shown in the illustration.

Use a cable tie of less than 1.9 mm × 3.8 mm in thickness.

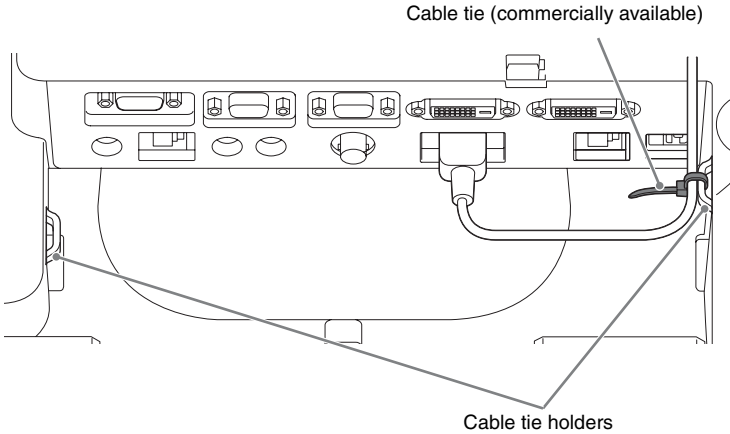

## Connecting an External Monitor and Audio Equipment

Projected images and input audio can be output to display equipment such as a monitor and audio equipment such as speakers with a built-in amplifier.

### OUTPUT A

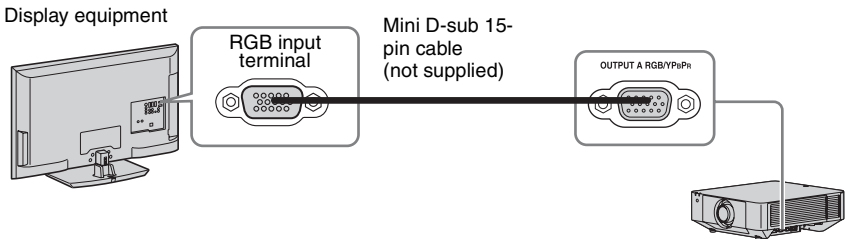

#### Note

This terminal outputs projected images. The images are output when a computer signal or video signal is input from the RGB/YpPr input terminal (INPUT A).

---

## OUTPUT B

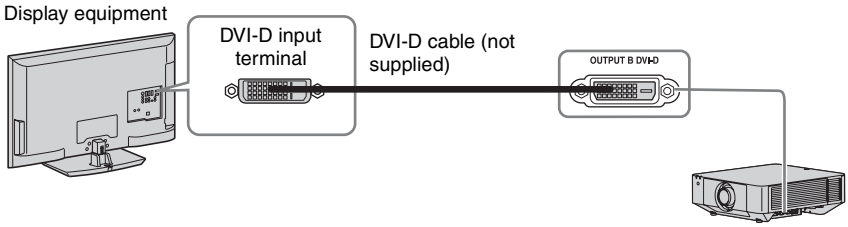

### Note

This terminal outputs projected images. The images are output when a computer signal is input from the DVI-D input terminal (INPUT B). However, if the signal input from INPUT B is protected by HDCP, the signal is not output to OUTPUT B.

---

## AUDIO output

When INPUT A or B, or VIDEO is selected, the audio input from the audio input terminal is output; when INPUT C or D is selected, the audio input from the selected input terminal is output.

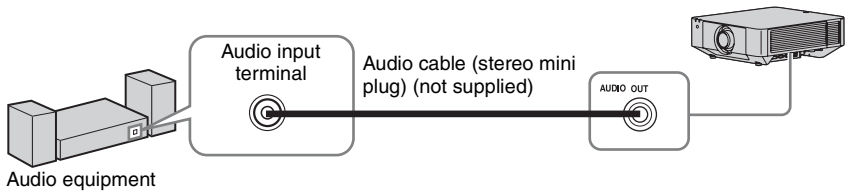

---

## Connecting Network Equipment

---

### Connecting network equipment

LAN terminal

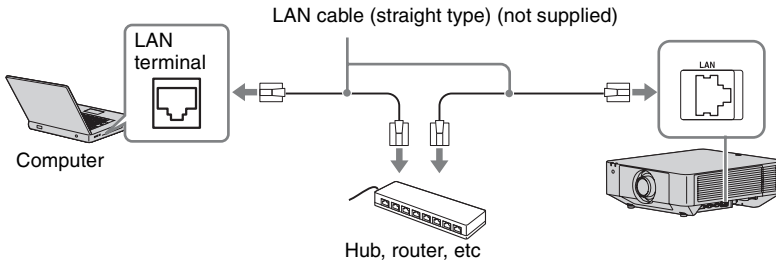

### Note

When using network features via the LAN terminal, be sure to check if "LAN Setting" is set to "LAN Port" (page 34).

## Connecting to HDBaseT™ Equipment

For connecting the computer, video equipment, and network equipment via the HDBaseT transmitter.

### Connecting to the computer

INPUT D

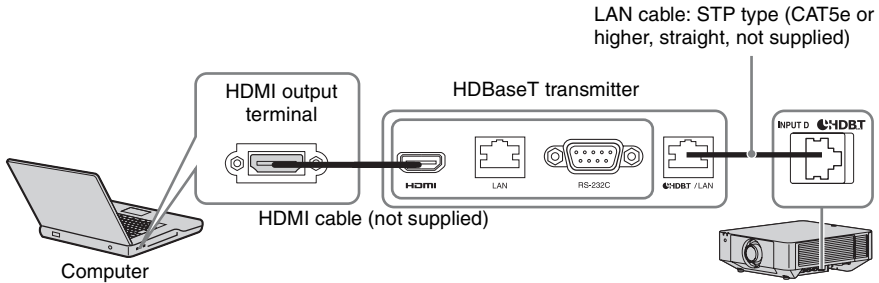

### Connecting to video equipment

INPUT D

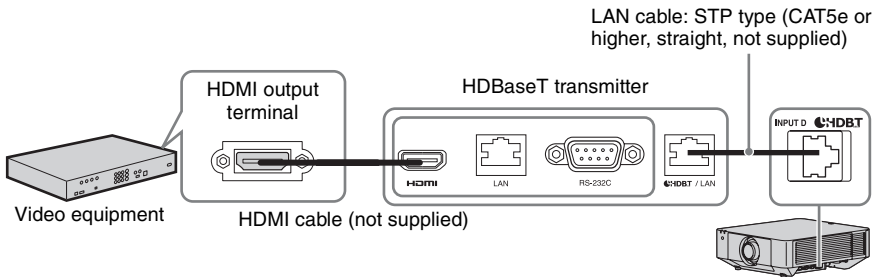

### Notes for connecting this unit and the HDBaseT transmitter

- Ask a professional or Sony dealer to perform wiring. If wiring is not correct, the transmission characteristics of the cable will not be achieved, and image or sound may break up or you may experience unstable performance.
- Connect the cable directly to the HDBaseT transmitter without going through a hub or router.
- Use cables that meet the following conditions.
  - CAT5e or higher
  - Shielded type (covering connectors)
  - Straight wire connection
  - Single wire
- When installing the cables, use a cable tester, cable analyzer, or similar device to check if the cables meet the CAT5e or higher requirement. If there is a transit connector between this unit and the HDBaseT transmitter, include it when measuring.
- To reduce the affect of noise, install and use the cable in a manner where it is not rolled up and it is as straight as possible.
- Install the cable away from the other cables (especially the power cable).
- When installing multiple cables, do not bind them and keep the running parallel distance as short as possible.

- The transmittable distance of the cable is 100 m (approx. 328 feet) maximum. If it exceeds 100 m (approx. 328 feet), it may cause the image or the sound to break up, or cause a malfunction in LAN communication. Do not use the HDBaseT transmitter beyond the transmittable distance.
- Inquire about operation or function problems caused by other manufacturer's devices with the relevant manufacturer.

## Connecting to network equipment

For connecting to network equipment via the HDBaseT terminal to control the projector.

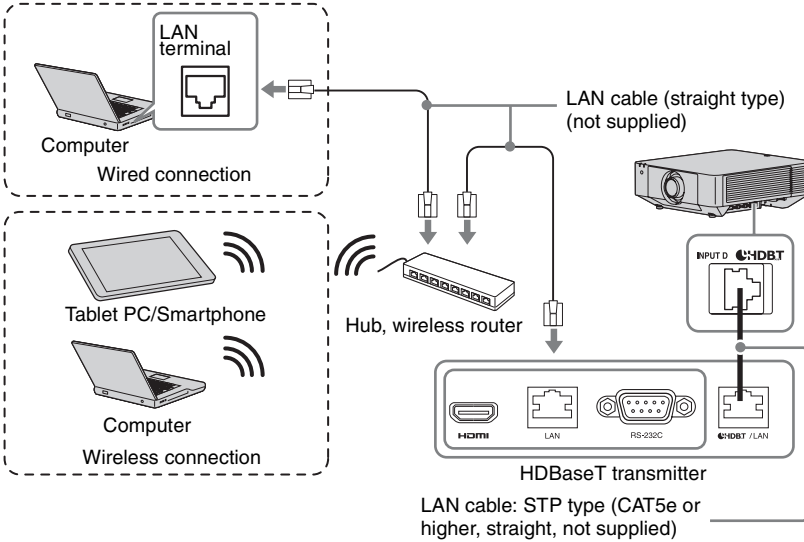

### Notes

- When using network features, be sure to check if “LAN Setting” is set to “via HDBaseT” (page 34).
- Connect this unit and the HDBaseT transmitter directly without a hub or router.

## Attaching the terminal cover

You can attach the supplied terminal cover to prevent dust from entering the terminals to maintain a neat appearance.

- 1 Fit one shaft on the side of the terminal cover into the hole on the bottom, then fit the other shaft by bending the cover slightly.

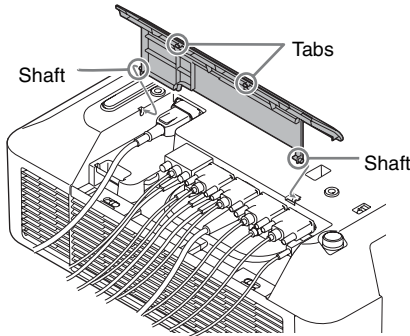

- 2 Close the terminal cover.  
Close the terminal cover until the two tabs on the terminal cover click.

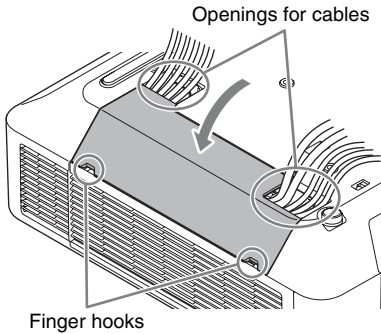

Example of the cable layout in the cover

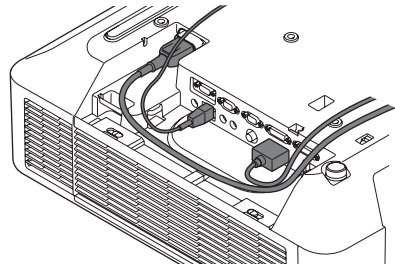

### Note

The terminal cover may not be attached depending on the installation method, such as due to the condition of the connected cables or when installing the unit on the floor. However, this has no impact on normal use.

### Opening the terminal cover

Raise the cover by inserting your fingers into the finger hooks.



## Projecting an Image

The size of a projected image depends on the distance between the projector and screen. Install the projector so that the projected image fits the screen size. For details on projection distances and projected image sizes, see “Projection Distance and Lens Shift Range” (page 63).

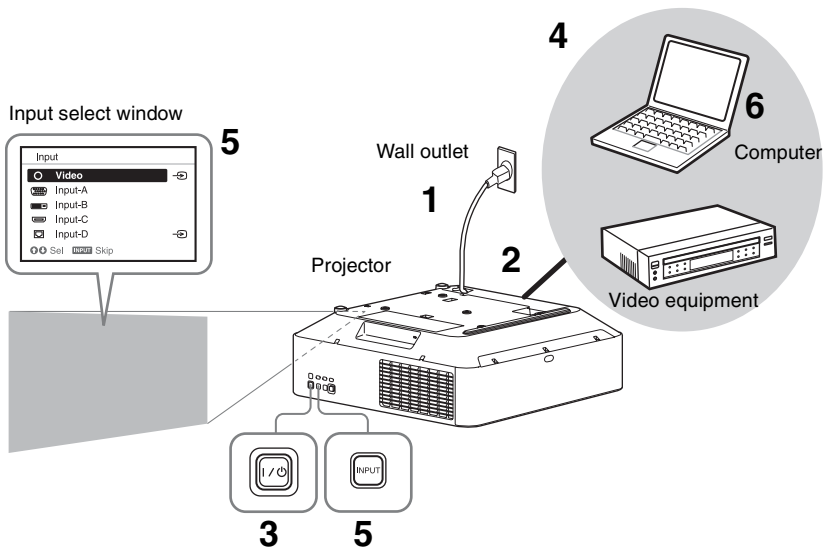

- 1** Plug the AC power cord into a wall outlet.
- 2** Connect all equipment to the projector (page 9).
- 3** Turn on the projector.  
Press the I/⏻ key on the main unit or the I key on the Remote Commander.
- 4** Turn on the connected equipment.
- 5** Select the input source.  
Press the INPUT key on the projector to display the input select window. Press the INPUT key repeatedly or the ⬆/⬇ key to select an image to be projected. The signal icon -Ⓢ appears on the right side in the input select window when a signal is input.

You can select the input source using Direct input select keys on the Remote Commander (page 6).



- 6** Switch your computer to output to external display by changing your computer's setting.  
How to switch the computer to output to the projector varies, depending on the type of computer.

(Example)

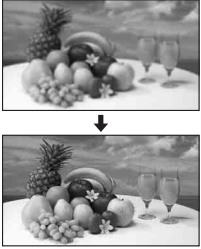

- 7** Adjust the focus, size, and position of the projected image (page 18).

## Adjusting the Focus, Size, and Position of the Projected Image

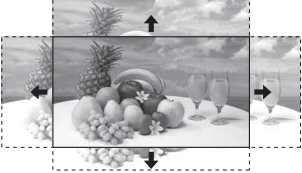
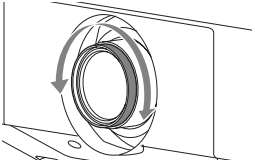
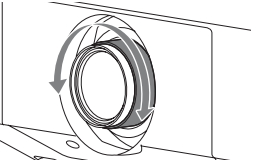
Focus	Size (Zoom)	Position (Lens shift)
		
<p><b>When attaching the Electric focus lens</b> Press the FOCUS key on the projector or the Remote Commander then press the <b>▲/▼/◀/▶</b> key to adjust the focus.</p> <p><b>When attaching the Manual focus lens</b> Turn the Focus Ring to adjust the focus.</p> 	<p><b>When attaching the Electric zoom lens</b> Press the ZOOM key on the projector or the Remote Commander then press the <b>▲/▼/◀/▶</b> key to adjust the size.</p> <p><b>When attaching the Manual zoom lens</b> Turn the Zoom Ring to adjust the size.</p> 	<p>Press the LENS SHIFT/SHIFT key on the projector or the Remote Commander then press the <b>▲/▼/◀/▶</b> key to adjust the position.</p> <p><b>To return the lens to the center position of the projected image</b> Press the RESET key on the Remote Commander while adjusting.</p>

### Adjusting the tilt of the projector with the front feet (adjustable)

When the projector is installed on an uneven surface, you can adjust using the front feet (adjustable).

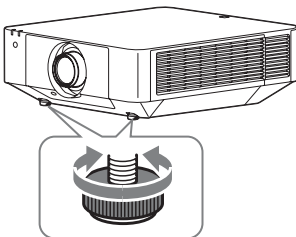

### Notes

- Be careful not to let the projector down on your fingers.
- Do not push hard on the top of the projector with the front feet (adjustable) extended. It may cause a malfunction.

### Displaying a pattern for adjusting an image

You can display a pattern for adjusting the projected image with the PATTERN key on the Remote Commander. Use **▲/▼** to change the pattern and **◀/▶** to change its color. Press the PATTERN key again to restore the previous image.

## Correcting for Trapezoidal Distortion of the Projected Image (Keystone Adjustment)

If the screen is tilted, or you are projecting from an oblique angle, perform keystone adjustment.

### If the projected image is trapezoidally-distorted in the vertical plane

- 1 Press the KEYSTONE key on the Remote Commander once or select “Screen Fitting” in the Installation menu (page 36).  
The “Screen Fitting” menu is displayed.
- 2 Select “V Keystone.”
- 3 Adjust the value using  $\leftarrow/\rightarrow$ .  
The higher the setting, the narrower the top of the projected image. The lower the setting, the narrower the bottom of the projected image.

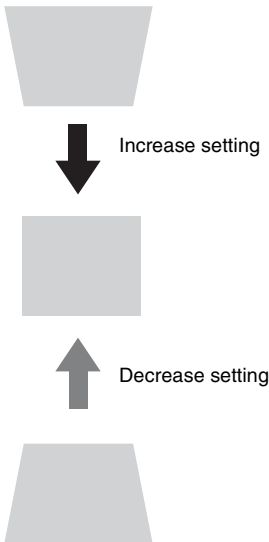

Press the RESET key to restore the projected image before adjustment. \*1

### If the projected image is trapezoidally-distorted in the lateral plane

- 1 Press the KEYSTONE key on the Remote Commander once or select “Screen Fitting” in the Installation menu (page 36).  
The “Screen Fitting” menu is displayed.
- 2 Select “H Keystone.”
- 3 Adjust the value using  $\leftarrow/\rightarrow$ .  
The higher the setting, the narrower the right side of the projected image. The lower the setting, the narrower the left side of the projected image.

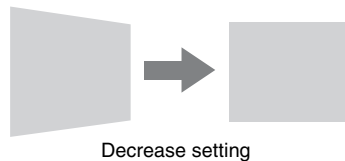

Press the RESET key to restore the projected image before adjustment. \*1

#### Notes

- \*1: The setting may not be reset depending on the combination of adjustment values of the Screen Fitting setting items. In this case, reset all of the Screen Fitting setting items.
- Keystone adjustment is an electronic correction. Consequently the image quality may deteriorate.
  - Depending on the position adjusted with the lens shift feature, using the Keystone feature may change the aspect ratio of the original image, or the projected image may be distorted.

## Correcting Image Twist (Warp Correction Feature)

You can correct image twist with the warp correction feature.

- 1 Press the **KEYSTONE** key on the Remote Commander once or select “Screen Fitting” in the Installation menu (page 36).  
The “Screen Fitting” menu is displayed.

- 2 Select “Warping.”  
The guide is displayed.

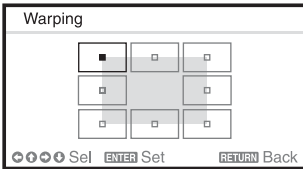

### When correcting the corner(s) of the image

- 1 Move ■ using **▲/▼/◀/▶** to select the corner you want to correct.
- 2 Press the **ENTER** key.  
The cursor appears.

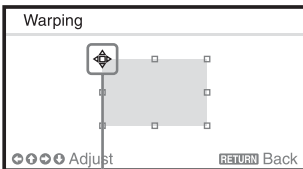

Adjust using this cursor

- 3 Adjust the position of the corner you want to correct, using **▲/▼/◀/▶**.

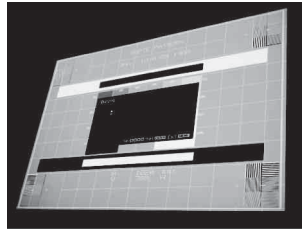

Press the **RESET** key to restore the projected image before adjustment.\*1

### When correcting deflection on the left/right sides of the image

- 1 Move ■ using **▲/▼/◀/▶** to select the side you want to correct.

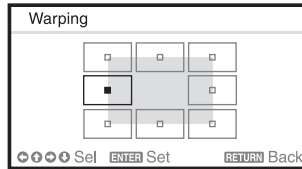

- 2 Press the **ENTER** key.  
The cursor appears.

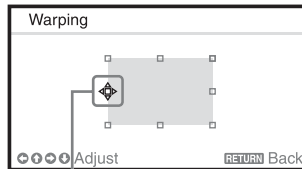

Adjust using this cursor

- 3 Adjust the deflection of the side, using **▲/▼/◀/▶**.  
You can adjust the center point of deflection using **▲/▼**. For the range of deflection, use **◀/▶**. You can adjust the left/right side independently.



Press the RESET key to restore the projected image before adjustment.\*1

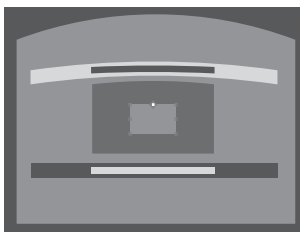
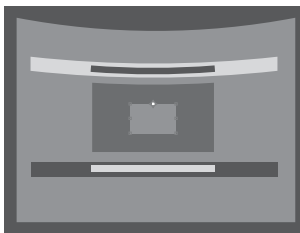

Press the RESET key to restore the projected image before adjustment.\*1

## When correcting deflection on the top/bottom sides of the image

- 1 Move **■** using **▲/▼/◀/▶** to select the side you want to correct.

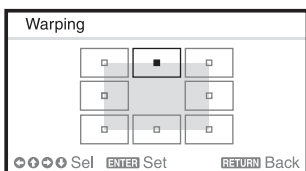

- 2 Press the ENTER key.  
The cursor appears.

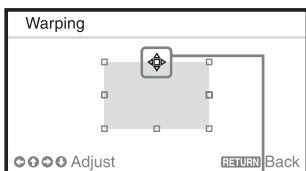

Adjust using this cursor

- 3 Adjust the deflection of the side, using **▲/▼/◀/▶**.

You can adjust the center point of deflection using **◀/▶**. For the range of deflection, use **▲/▼**. You can adjust the top/bottom independently.

### Note

\*1: The setting may not be reset depending on the combination of adjustment values of the Screen Fitting setting items. In this case, reset all of the Screen Fitting setting items.

## Blending Projections from Multiple Projectors on a Screen

- 1 Install the projectors.  
Input a pattern, etc., to adjust the projected positions from multiple projectors.
- 2 Set the ID mode.  
Set a different ID mode for each projector (page 32).
- 3 Set the picture mode.  
Set the picture mode of the multiple projectors to "Multi Screen" (page 25).
- 4 Unify the color space.  
Set the color space of the multiple projectors to the same mode (Custom 1 to 3) (page 36). R/G/B can be finely adjusted as necessary.

- 5 Adjust the color matching setting.  
Finely adjust each tone as necessary (page 36).
- 6 Set the Edge Blending setting.  
When overlaying multiple projections, the Edge Blending setting is available. Select “Multi Screen” in the Installation menu, then select “Edge Blending” (page 36).
- 7 Enable the Edge Blending function.  
In “Blend Settings,” set “Edge Blending” to “On” for each blending position.
- 8 Set the blending width.  
Set the blending width according to the overlapping range for the source signal.

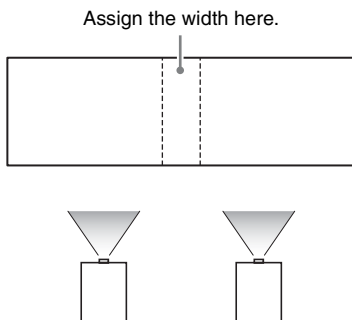

- 9 Adjust using “Blend Fitting.”  
Finely adjust the overlapped area.
- 10 Adjust using “Zone Black Level Adj.”  
Adjust each correction zone by “Zone Black Level Adj.” for the most uniform black level between each zone. During this adjustment, a black image is automatically projected.

#### Notes

- Depending on the blending start position or the blending width, the menu may overlap with the blending area and become invisible. If you want to operate the projector while viewing the menu, set “Edge Blending” to “Off” once and make adjustments. Then, set “Edge Blending” to “On.”

- The procedure shown above is for general guidance. Your own installation may vary according to the situation.
- When multiple projectors are set up in a line, the temperature inside the projectors may increase due to exhaust vent proximity, and an error indication may result. In this case, space the projectors farther apart and/or install deflection partitioning between them.  
For more details, consult with qualified Sony personnel.

## Turning Off the Power

- 1 Press the I/⏻ key on the unit or the remote commander.  
The projector starts shutdown and turns off. If you press the I/⏻ key within 10 seconds again, shutdown is cancelled.

#### Note

Do not turn off the projector soon after the lamp lights. It may cause a malfunction of the lamp (does not light, etc.).

- 2 Unplug the AC power cord from the wall outlet.

---

### To turn off without displaying confirmation message

Press and hold the I/⏻ key on the unit for a few seconds (page 34).

#### Notes

- If you turn off the unit soon after the lamp is turned on, the confirmation message will be displayed and may take a longer time for the unit to turn off.
- If you turn on the unit soon after the unit is turned off, it may take a longer time for the unit to put out the image.

---

## ECO gauge

This gauge indicates the current effectiveness of the projector's ECO function. (For details on the ECO function, see "ECO MODE key" (page 7) and "ECO" (page 34).)

The leaf icons are displayed when the projector is shut down. The number of displayed icons varies according to how much energy is saved as a result of using the ECO function.

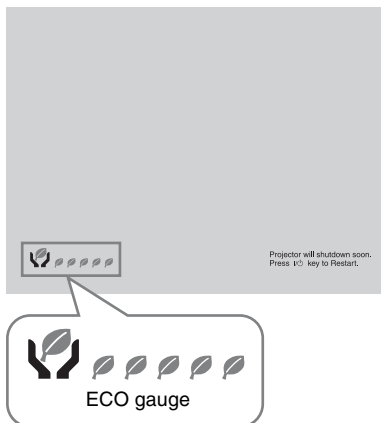

# Using a Menu

**Note**

The menu displays used for the explanation below may be different depending on the model you are using.

- 1 Press the MENU key to display the menu.
- 2 Select the setting menu.  
Use the  $\uparrow$  or  $\downarrow$  key to select the setting menu, then press  $\rightarrow$  or ENTER key.

Setting menu

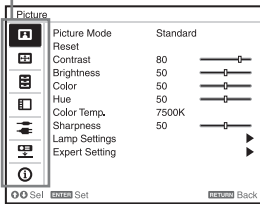

- 3 Select the setting item.  
Use the  $\uparrow$  or  $\downarrow$  key to select the setting menu, then press  $\rightarrow$  or ENTER key.  
To return to the selection screen of the setting menu, press the  $\leftarrow$  key or the RETURN key.

Setting items

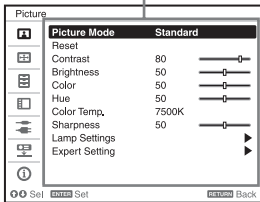

- 4 Make the setting or adjustment for the selected item.  
Menu operation differs depending on the setting item. If the next menu window is displayed, select the item according to the operations in step 3 and then press the ENTER key to register the setting.

To return to the selection screen of the setting items, press the  $\leftarrow$  key or the RETURN key. Also, to reset the setting value of an item to its factory preset value, press the RESET key during setting or adjusting.

**Using a pop-up menu**

Press the  $\uparrow/\downarrow/\leftarrow/\rightarrow$  key to select an item. Press the ENTER key to register the setting. The previous screen is restored.

Selecting items

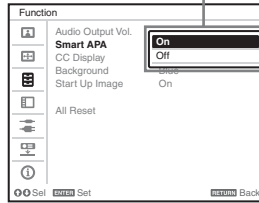

**Using the setting menu**

Press the  $\uparrow$  or  $\downarrow$  key to select the item. Press the ENTER key to register the setting. The previous screen is restored.

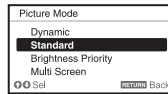

**Using the adjustment menu**

To increase the number, press the  $\uparrow$  or  $\rightarrow$  key and to decrease the number, press the  $\downarrow$  or  $\leftarrow$  key. Press the ENTER key to register the setting. The previous screen is restored.



- 5 Press the MENU key to clear the menu.  
The menu disappears automatically if no key is pressed for a while.



## The Picture Menu

For adjusting the picture for each input signal.

Setting items	Description
Picture Mode	<b>Dynamic:</b> Emphasizes the contrast to produce a “dynamic” picture. <b>Standard:</b> Makes the picture be natural and well balanced. <b>Brightness Priority:</b> Makes the picture bright to suit a bright environment. <b>Multi Screen:</b> Optimizes the picture quality to suit projecting using multiple projectors.
Reset	The picture settings are initialized to their factory preset values. However, “Picture Mode” and “Custom 1,” “Custom 2,” “Custom 3,” and “Custom 4” of “Color Temp.” do not return to the factory preset values.
Contrast	The higher the setting, the greater the contrast. The lower the setting, the lower the contrast.
Brightness	The higher the setting, the brighter the picture. The lower the setting, the darker the picture.
Color	The higher the setting, the greater the intensity. The lower the setting, the lower the intensity.
Hue	The higher the setting, the more greenish the picture becomes. The lower the setting, the more reddish the picture becomes.
Color Temp.	<b>9300K/7500K/6500K:</b> The higher the temperature, the more bluish the picture. The lower the temperature, the more reddish the picture. <b>Brightness Priority:</b> Projects images at the maximum brightness. <b>Custom 1/ Custom 2/ Custom 3/ Custom 4:</b> An adjusted color temperature setting can be stored for each item. The factory settings are Custom 1: 9300K, Custom 2: 7500K, Custom 3: 6500K, Custom 4: Brightness Priority.
Sharpness	The higher the setting, the sharper the picture. The lower the setting, the softer the picture.
Lamp Settings	<b>Lamp Mode:</b> Adjusts brightness of the lamp. <b>High:</b> The image becomes brighter, and power consumption becomes higher. <b>Standard:</b> Power consumption becomes lower; however, the image will be darker. <b>Custom:</b> You can adjust brightness from “High” to “Standard.”

Setting items	Description
Expert Setting	
Reality Creation	<p>Adjusts the detail and noise processing of images. (Super-resolution function)</p> <p><b>On:</b> Adjusts the settings of “Reality Creation.”</p> <p><b>Resolution:</b> When you increase the setting value, the texture and detail of the image become sharper.</p> <p><b>Noise Filtering:</b> When you increase the setting value, the noise (picture roughness) becomes less prominent.</p> <p><b>Test: On/Off:</b> Switches “On” and “Off” at a certain frequency to check the effect of “Reality Creation.” *1</p> <p><b>Off:</b> The “Reality Creation” function is not applied.</p>
Contrast Enhancer	<p>Corrects the level of bright and dark parts automatically to optimize contrast according to a scene. Increases image sharpness and makes image dynamic.</p> <p><b>High/Middle/Low:</b> You can adjust the contrast enhancer.</p> <p><b>Off:</b> The “Contrast Enhancer” function is not applied.</p>
Gamma Mode	<p><b>2.2:</b> Equivalent to a 2.2 gamma curve.</p> <p><b>2.4:</b> Equivalent to a 2.4 gamma curve.</p> <p><b>Gamma 3:</b> Applies a gamma curve that prioritizes the brightness to suit use in a relatively bright environment.</p> <p><b>Gamma 4:</b> Enhances black and white contrast to suit use in a relatively dark environment.</p> <p><b>DICOM GSDF Sim.*2:</b> Gamma setting is in accordance with the Grayscale Standard Display Function (GSDF) of the Digital Imaging and Communications in Medicine (DICOM) standards.</p>
Color Space	<p>Converts the color space.</p> <p><b>Custom 1:</b> Produces images with vivid colors.</p> <p><b>Custom 2:</b> Produces images with muted colors.</p> <p><b>Custom 3:</b> Reproduces image colors true to the original image source. You can select R/G/B for the selected color space and adjust the R/G/B chromaticity points in the x and y directions in the CIExy chromaticity diagram respectively.</p> <p><b>Color Select:</b> Select the color to adjust from “Red,” “Green,” and “Blue.”</p> <p><b>Cyan - Red (x):</b> Adjusts the chromaticity point of the selected color toward cyan-red (x).</p> <p><b>Magenta - Green (y):</b> Adjusts the chromaticity point of the selected color toward magenta-green (y).</p>
Color Correction	<p><b>On:</b> Adjusts the hue, saturation, and brightness for the selected color. Repeat steps 1 and 2 described below to specify the target color.</p> <p><b>1</b> Press <b>▲/▼</b> to select “Color Select,” then press <b>◀/▶</b> to select the color you want to adjust among “Red,” “Yellow,” “Green,” “Cyan,” “Blue,” and “Magenta.”</p> <p><b>2</b> Press <b>▲/▼</b> to select “Hue,” “Saturation” or “Brightness,” then adjust them to suit your taste using <b>◀/▶</b> while watching the projected picture.</p> <p><b>Off:</b> The “Color Correction” function is not applied.</p>
Film Mode*3 *4	<p><b>Auto:</b> Precisely reproduces the image from a film source to suit the original film source. Normally, select this option.</p> <p><b>Off:</b> Select this option if the images are rough around the edges when “Auto” is selected.</p>

## Notes

\*1: The display position of the status during the test works together with the “Menu Position” setting (page 32).

- \*2: Available when a computer signal is input from the DVI-D input terminal (INPUT B), HDMI input terminal (INPUT C), or HDBaseT input terminal (INPUT D). This projector is not to be used as a device for medical diagnosis.
- \*3: When a video signal is input, this option is available.
- \*4: When a progressive signal is input, this option is not available.

# The Screen Menu

For adjusting the size, position, and aspect ratio of the projected image for each input signal.

Setting items	Description
Aspect <sup>*1</sup>	Changes the aspect ratio of the projected image (page 30).
When the computer signal is input	<p><b>Full 1:</b> Displays the image to fit the maximum projected image size without changing the aspect ratio of the input signal.</p> <p><b>Full 2:</b> Displays the image to fit the maximum projected image size.</p> <p><b>Normal:</b> Displays the image on the center point of the projected image without changing the resolution of the input signal or enlarging the image.</p>
When the video signal is input	<p><b>4:3:</b> Displays the image to fit the maximum projected image size with an aspect ratio fixed to 4:3.</p> <p><b>16:9:</b> Displays the image to fit the maximum projected image size with an aspect ratio fixed to 16:9.</p> <p><b>Full:</b> Displays the image to fit the maximum projected image size.</p> <p><b>Zoom:</b> Display the center point of the projected image to zoom.</p>
V Center <sup>*2 *3</sup>	Adjust the whole projected image by moving up and down on the screen. As the selected number increases, the screen moves up, and as the selected number decreases, the projected image moves down.
Vertical Size <sup>*2 *3</sup>	Reduces or enlarges the image vertically. The projected image is enlarged as the setting increases and reduced as the setting decreases. If the subtitle of a movie, etc. cannot be seen, use this together with “V Center.”
Overscan <sup>*2</sup>	<b>On/Off:</b> Hides the outline of the image when set to “On.” Select “On” if noise appears along the edge of the image.
Adjust Signal <sup>*6</sup>	Adjusts the image of a computer signal. Use this item if the edge of the image is cut and reception is bad.
APA <sup>*4 *5</sup>	Automatically adjusts the projected image to an optimum quality when you press the ENTER key.
Phase <sup>*4</sup>	Adjusts the dot phase of the display pixel and the input signal. Set to the value where looks clearest.
Pitch <sup>*4</sup>	The higher the setting, the wider the horizontal image elements (pitch). The lower the setting, the narrower the horizontal image elements (pitch).
Shift <sup>*6</sup>	<p><b>H:</b> The higher the setting, the farther right the image is projected on the screen. The lower the setting, the image farther left.</p> <p><b>V:</b> The higher the setting, the farther up the image is projected on the screen. The lower the setting, the image farther down.</p>

## Notes

- \*1: • Note that if the projector is used for profit or for public viewing, modifying the original picture by switching to the aspect mode may constitute an infringement of the rights of authors or producers, which are legally protected.
- Depending on the input signal or “Screen Aspect” setting, setting items for aspect ratio or some other setting items cannot be set in some cases, or changing the aspect ratio setting may have no effect.
  - A part of the image may be displayed in black, depending on the setting item.

- \*2: Available when a video signal is input from the RGB/YPbPr input terminal (INPUT A), DVI-D input terminal, HDMI input terminal, and HDBaseT terminal.
- \*3: Available when “Aspect” is “Zoom” and “Screen Aspect” is 16:10 or 16:9.
- \*4: Available when a computer signal is input from the RGB/YPbPr input terminal (INPUT A).
- \*5: If the projected image includes a large amount of black portion around it, the APA function will not work properly and a part of the image may not be displayed on the screen. In addition, an optimum image cannot be obtained, depending on the type of input signal. In this case, adjust the “Phase,” “Pitch,” and “Shift” items manually.
- \*6: Available when a computer or video signal is input from the RGB/YPbPr input connector (INPUT A). This option is available only when “Aspect” is set to “Zoom.”

# Aspect

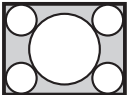
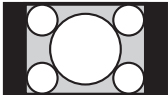
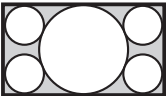
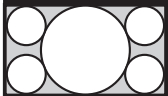
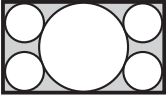
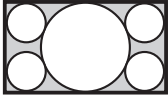
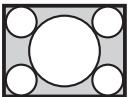
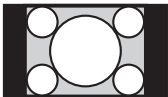
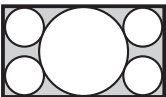
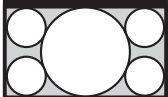
	Input signal	Recommended setting value and projected image
Computer signal	(4:3) 	(Full 1) <sup>*1 *2</sup> 
	(16:9) 	(Full 1) <sup>*1 *2</sup> 
	(16:10) 	(Full 1) <sup>*1</sup> 
Video signal	(4:3) 	(4:3) <sup>*3 *5</sup> 
	(16:9) 	(16:9) <sup>*4 *5</sup> 

\*1: If you select “Normal,” the image is projected in the same resolution as the input signal without changing the aspect ratio of the original image.



\*2: If you select “Full 2,” the image is projected to fit the projected image size, regardless of the aspect ratio of the image.



\*3: Depending on the input signal, the projected image may be projected as illustrated below. In this a case, select “16:9.”



\*4: Depending on the input signal, the image may be projected as illustrated below. In this a case, select “Zoom.”



\*5: If you select “Full,” the image is projected to fit the projected image size, regardless of the aspect ratio of the image.



# The Function Menu

The Function menu is used for setting various functions of the projector.

Setting items	Description
Audio Output Vol.	The higher the setting, the higher an audio level output from the audio output terminal. The lower the setting, the lower the audio level.
Smart APA	<b>On/Off:</b> When set to “On,” executes APA automatically when a signal is input.*1
CC Display	<b>CC1/CC2/CC3/CC4/Text1/Text2/Text3/Text4:</b> Select the closed caption service (Captions or Text). <b>Off:</b> Closed caption does not appear.
Lamp Timer Reset	When replacing the lamp, resets the lamp timer (page 52).
Background*2	<b>Blue/Black/Image:</b> Sets the background for when there is no input signal. When set to “Image,” the Start Up Image is displayed.
Start Up Image	<b>On/Off:</b> When set to “On,” the Start Up Image is displayed on the screen upon startup of the projector.
All Reset	All settings are initialized to their factory preset values.











## Notes

\*1: Executes APA when a computer signal is input via the RGB/YPbPr input terminal (INPUT A).

\*2: When using the Twin Picture display mode and there is no input signal, the background will be black even if you set this item to “Image”.

# The Operation Menu

The Operation menu is used for setting for the operations by using the menu or the Remote Commander.

Setting items	Description
Language	Selects the language used in the menu and on-screen displays.
Menu Position	<b>Bottom Left/Center:</b> For selecting the position of the menu displayed on the projected image.
Status	<b>On:</b> All on-screen statuses are enabled. <b>Off:</b> Displays only the menus, the message when turning off the power, and warning messages. <b>All Off:</b> Turns off the on-screen displays, other than certain menus, and a message when turning off the power.*1*2
IR Receiver	<b>Front &amp; Rear/Front/Rear:</b> Selects the remote control receivers (IR Receiver) on the front and rear of the projector.
ID Mode	<b>All/1/2/3/4:</b> Assigns an ID number to the projector. When set to “All,” you can control the projector with the Remote Commander independently of the assigned ID Mode. Refer also to “ID MODE switch” of the Remote Commander on page 8.
Security Lock*3	<b>On/Off:</b> This function enables restriction of the projector to authorized users by password. The setting procedures for security locking are as follows: <ol style="list-style-type: none"><li>1 Select “On” then press the ENTER key to display the setting menu.</li><li>2 Input the password with the MENU, , , , , and ENTER keys. (The default password setting is “ENTER, ENTER, ENTER, ENTER.”)</li><li>3 Input a new password with the MENU, , , , , and ENTER keys.</li><li>4 Enter the password again to confirm.</li></ol> Enter the password when you turn on the projector after disconnecting and reconnecting the AC power cord. When it is set to “Off,” you can cancel the security lock. You are required to input the password again. If you fail to enter the correct password after three consecutive times, the projector cannot be used. In this case, press the  key to go standby mode then turn on the power again.
Control Key Lock	<b>On/Off:</b> When set to “On,” locks all the control keys of the projector. However, you can enable operation by performing the following even when “Control Key Lock” is set to “On.” <ul style="list-style-type: none"><li>• Press and hold the  key for approximately 10 seconds during standby mode.<ul style="list-style-type: none"><li>→ The projector turns on.</li></ul></li><li>• Press and hold the MENU key for approximately 10 seconds during power on.<ul style="list-style-type: none"><li>→ “Control Key Lock” is set to “Off” and enables operation of all control panel keys on the projector.</li></ul></li></ul>
Lens Control	<b>On/Off:</b> When set to “On,” you can adjust the lens (focus, zoom, and lens shift) from the Remote commander or the projector. To prevent unintentional operation, set it to “Off” after adjusting the lens.

## Note

\*1: When “All Off” is selected, warning message for high temperature is not displayed.

\*2: Note that Sony is not liable for failure of the unit or any accident caused by selecting “All Off.”



\*3: You will not be able to use the projector if you forget your password. If you call qualified Sony personnel because you have forgotten the password, you will be asked to verify the projector's serial number and your identity. (This process may differ in other countries/regions.) Once your identity has been confirmed, we will provide you with the password.

# The Connection/Power Menu

The Connection/Power menu is used for setting for the connections and power.

Setting items	Description
Network Setting	
IPv4 Setting	
IP Address Setup	<b>Auto(DHCP):</b> The IP address is assigned automatically from the DHCP server such as a router. <b>Manual:</b> To specify the IP Address manually.
IP Address/ Subnet Mask/ Default Gateway/Primary DNS/Secondary DNS	When “Manual” is selected for “IP Address Setup,” select the item with the ◀ or ▶ key and input the value with ▲ or ▼ key. When all items are entered, select “Apply” then press the ENTER key. The entered settings will be registered.
IPv6 Information	Displays the IPv6 address information. When setting the address of IPv6, set it from the browser (page 43).
HDBaseT Settings	
LAN Setting	<b>via HDBaseT/LAN Port:</b> You can select either via the LAN of the HDBaseT equipment connected to the HDBaseT terminal or via the network connection with the LAN terminal of the main unit. *1 *2
RS-232C Setting *3	<b>via HDBaseT:</b> You can connect this unit to the RS-232C terminal via the HDBaseT transmitter. (Baud rate: 9,600 bps) <b>RS-232C:</b> Use when connecting to the RS-232C terminal of this unit directly.
Dynamic Range *4	Sets the image input level of the INPUT B/C/D terminal. <b>Auto:</b> Distinguishes the image input level automatically. <b>Limited:</b> Set when the image input level is 16-235. <b>Full:</b> Set when the image input level is 0-255.
HDMI Cable	<b>Long/Normal:</b> Select “Long” when the image is disturbed or not projected.
Input-A Signal Sel.	<b>Auto/Computer/Video GBR/Component:</b> When set to “Auto,” selects the type of video signal input automatically when “Input-A” is selected with the INPUT key. *5
Color System	<b>Auto/NTSC3.58/PAL/SECAM/NTSC4.43/PAL-M/PAL-N:</b> When set to “Auto,” selects the color system automatically when “Video” is selected with the INPUT key. *5
ECO	
Auto Power Saving	
With No Input	<b>Lamp Cutoff:</b> The lamp turns off automatically and power consumption is reduced if no signal is input for about 10 minutes. The lamp lights again when a signal is input or any key is pressed. In Lamp Cutoff, the ON/STANDBY indicator lights in orange. (page 47) <b>Standby *6:</b> If no signal is input to the unit for about 10 minutes, the power turns off automatically, and the unit enters standby mode. <b>Off:</b> The “With No Input” function is disabled.
Standby Mode *7	<b>Standard/Low:</b> When set to “Low,” lowers power consumption in standby mode.

Setting items	Description
Direct Power On	<b>On/Off:</b> When set to “On,” you can turn the power on without going to standby mode when the AC power cord is connected to a wall outlet. You can also unplug the AC power cord without going to standby mode when you turn off the projector. <sup>*8</sup> You may unplug the AC power cord without going to standby mode.

### Notes

- \*1: When connecting via HDBaseT, only the 100BASE-TX can be used for connection. When using the LAN terminal of the main unit, you can connect with the 10BASE-T/100BASE-TX.
- \*2: The IP addresses when using HDBaseT and when using the LAN terminal should be set respectively.
  - Setting the IP address when using a LAN via HDBaseT.  
Set “LAN Setting” to “via HDBaseT” in “HDBaseT Settings,” then set the IP address in “Network Setting.”
  - Setting the IP address when using the LAN terminal.  
Set “LAN Setting” to “LAN Port” in “HDBaseT Settings,” then set the IP address in “Network Setting.”
- \*3: When connecting via HDBaseT, the connection is at 9,600 bps. When using the RS-232C terminal of the main unit, you can connect at 38,400 bps.
- \*4: If the image input setting of the HDMI connection equipment is not correct, the brighter part becomes too bright and the darker part becomes too dark.
- \*5: The image may not be adjusted properly depending on the type of input signal. In such a case, adjust it manually to suit to the connected equipment.
- \*6: Select “Off” to avoid entering standby mode when there is no input signal.
- \*7: When “Standby Mode” is set to “Low,” the network and network control function cannot be operated while the projector is in standby mode.
- \*8: Do not turn off the projector soon after the lamp lights. It may cause a malfunction of the lamp (does not light ,etc.).

# The Installation Menu

The Installation menu is used for installing the projector.

Setting items	Description
Screen Fitting	<p>Adjusts the distortion of the projected image that occurs due to installation conditions or when a portion of the image spreads beyond the screen.*<sup>1</sup></p> <p><b>Warping:</b> Select an adjustment point and move it vertically/horizontally to adjust the image distortion.</p> <p><b>V Keystone:</b> Adjusts the vertical keystone distortion. The higher the setting, the narrower the upper side of the projected image. The lower the setting, the narrower the lower side of the projected image.*<sup>2</sup></p> <p><b>H Keystone:</b> Adjusts the horizontal keystone distortion. The higher the setting, the shorter the right side of the projected image.*<sup>2</sup> The lower the setting, the shorter the left side of the projected image.*<sup>2</sup></p> <p><b>V Linearity:</b> Adjusts the projected image so that the height of the upper half and lower half will be the same. The higher the setting, the narrower the upper half of the projected image. The lower the setting, the narrower the lower half of the projected image.</p> <p><b>H Linearity:</b> Adjusts the projected image so that the width of the right half and left half will be the same. The higher the setting, the narrower the right half of the projected image. The lower the setting, the narrower the left half of the projected image.</p> <p><b>Reset:</b> Resets all of the Screen Fitting items.</p>
Multi Screen	<p>When composing one screen with multiple projections, you can overlap portions of different projections or tile the projections.</p>
Color Space	<p>Changes the color space. The same adjustments as in “Color Space” (page 26) in the Picture menu are available.</p>
Color Matching* <sup>3</sup>	<p>Adjusts the overall brightness and hue of the projected image.</p> <p><b>Adjust:</b> Select one of 6 signal levels and adjust the brightness or hue.</p> <p><b>Level 1 - 6:</b> Select the brightness level to adjust.</p> <p><b>Brightness:</b> Adjusts the brightness of the selected brightness level.</p> <p><b>Color:</b> Adjusts the hue of the selected brightness level.</p> <p><b>Reset:</b> Resets all of the adjusted values.</p>
Edge Blending	<p>Sets the settings regarding edge blending.</p> <p><b>Reset:</b> Resets all of the Blend Settings, Blend Fitting, and Zone Black Level Adj. values.</p>

Setting items	Description
Blend Settings	<p>Configure the Edge Blending setting for the top, bottom, right, and left of the screen respectively.</p> <p><b>Left/Right/Top/Bottom:</b> Set the Edge Blending effect for each position.</p> <p><b>Edge Blending:</b> Set “On” to set “Blending Range” or “Blend Start Pos.”</p> <p><b>Blending Range:</b> Set the width where images are overlapped.</p> <p><b>Blend Start Pos.:</b> Set the start position from which images are overlapped.</p> <p><b>Blend Cursor:</b> Displays the cursors at the start and end positions for edge blending. When set to “On,” the cursors are displayed during Blend settings.</p> <p><b>Start Pos. Color:</b> Select the color of the cursor that indicates the start position.</p> <p><b>End Pos. Color:</b> Select the color of the cursor that indicates the end position.</p> <p><b>Reset:</b> Resets all of the Blend Settings values.</p>
Blend Fitting	<p>Finely adjusts the overlapped part.</p> <p><b>Adjust:</b> Specify a position in the overlapped area and move image pixels. Use <b>▲/▼/◀/▶</b> to select the position to adjust. Press the ENTER key to determine the position and use <b>▲/▼/◀/▶</b> to move the image pixels vertically/horizontally so that neighboring images overlap.</p> <p><b>Reset:</b> Resets all of the Blend Fitting values.</p>
Zone Black Level Adj. <sup>*4</sup> <sup>*5</sup>	<p>Adjusts so that the overlapped part is not noticeably bright when a dark image is displayed.</p> <p>Select the correction zone “Adjust Zone 1” through “Adjust Zone 9,” and set the adjustment values.</p> <p><b>Reset:</b> Resets all of the Zone Black Level Adj. values.</p>
Image Split	<p><b>Off/Left-side Area/Right-side Area:</b> Divides the input signal from the computer in half, and displays an enlarged image of the left-side or right-side area on the screen.<sup>*6</sup></p>
Image Flip	<p><b>HV/H/V/Off/Auto:</b> Flips the projected image horizontally and/or vertically according to the installation method.</p>
High Altitude Mode	<p><b>On/Off:</b> Set to “On” when using the projector at an altitude of 1,500 m or higher. Continuing to use the wrong setting may affect component reliability.</p>
Filter Cleaning	<p>Turns off the projector and cleans the air filter.</p>
Screen Aspect	<p><b>16:10/16:9/4:3:</b> For switching the display area to suit to the screen.</p>
Blanking	<p>This feature allows you to adjust the displayable region within the four directions of the projection surface.</p> <p>Select the edge to adjust from “Left,” “Right,” “Top,” and “Bottom” using the <b>▲/▼</b> keys.</p> <p>Adjust the amount of blanking using the <b>◀/▶</b> keys.<sup>*7</sup></p>

Setting items	Description
Panel Alignment <sup>*8</sup>	<p>This feature allows you to adjust the gaps in the color of characters or the picture.</p> <p>When set to “On,” “Adjust Color” and “Pattern Color” can be assigned and adjusted.</p> <p><b>Adjust Item:</b> Selects how to make adjustments from below.</p> <p><b>Shift:</b> Shifts the whole picture and makes adjustments.</p> <p><b>Zone:</b> Selects the desired range and makes adjustments.</p> <p><b>Adjust Color:</b> Assigns the desired color to adjust the gaps in color. Select “R” (Red) or “B” (Blue) to make adjustments based on “G” (Green).</p> <p><b>Pattern Color:</b> Select “R/G” (Red and Green) or “R/G/B” (White, all colors) when “Adjust Color” is “R” (Red). Select “B/G” (Blue and Green) or “R/G/B” (White, all colors) when the “Adjust Color” is “B” (Blue).</p> <p><b>Adjust:</b> The shift adjustment and zone adjustment of the color selected in “Adjust Color” can be made with <math>\blacktriangle/\blacktriangledown/\blacktriangleleft/\blacktriangleright</math> keys.</p> <p><b>Reset:</b> The panel alignment settings are initialized to their factory preset values.</p>

### Notes

- \*1: Since the Keystone/Warping/Linearity adjustment is an electronic correction, the image may deteriorate.
- \*2: Depending on the position adjusted with the lens shift feature, the aspect ratio of the image may change from the original or projected image may be distorted with Keystone adjustment.
- \*3: The brightness and color of the projected image may not match completely, even after you adjust “Brightness” and “Color.”
- \*4: You cannot adjust anything other than the targeted adjustment zones in “Zone Black Level Adj.”
- \*5: When selecting the correction zone of “Zone Black Level Adj.,” the targeted correction zone flashes twice.
- \*6: If the Screen Aspect is set to 16:10 and input signal is 16:10 or 16:9, the image will be projected at the correct aspect. This function is not available when displaying two pictures.
- \*7: When the projected image is displayed smaller than the entire projection surface using the Aspect or Screen Aspect setting, blanking may not be applied.
- \*8: Depending on the adjustment value of “Panel Alignment,” the color and resolution may be changed.

---

## The Information Menu

The Information menu is used to check projector status, such as total usage time of the lamp.

<b>Items</b>	<b>Description</b>
Model Name	Displays the model name.
Serial No.	Displays the serial number.
fH / fV (horizontal frequency/vertical frequency) <sup>*1</sup>	Displays the horizontal frequency/vertical frequency/signal type of the current input signal.
Lamp Timer	Indicates the total usage time of a lamp.

### **Note**

\*1: These items may not be displayed depending on the input signal.

# Using Network Features

Connection to the network allows you to operate the following features:

- Checking the current status of the projector via a Web browser.
- Remotely controlling the projector via a Web browser.
- Receiving the e-mail report for the projector.
- Making the network settings for the projector.
- Supports network monitoring and control protocol (Advertisement, ADCP, PJ Talk, PJ Link, SNMP, AMX DDDP [Dynamic Device Discovery Protocol], Crestron RoomView).

## Notes

- When connecting this projector with the network, consult with the network administrator. The network must be secured.
- When using this projector connected with the network, access the control window via a Web browser and change the access limitation of the factory preset values (page 41). It is recommended to change the password regularly.
- When the setting on the Web browser is completed, close the Web browser to log out.
- The menu displays used for the explanation below may be different depending on the model you are using.
- Supported Web browsers are Internet Explorer and Safari.
- The menu displays only English.
- If the browser of your computer is set to [Use a proxy server] when you have access to the projector from your computer, click the check mark to set accessing without using a proxy server.
- SNMP, AMX DDDP, and Crestron RoomView do not support IPv6.

## Displaying the Control Window of the Projector with a Web Browser

**1** Connect the LAN cable (page 13).

**2** Set the network settings for the projector using “Network Setting” on the Connection/Power menu (page 34).

**3** Start a web browser on the computer, enter the following in the address field, then press the Enter key on your computer.

http://xxx.xxx.xxx.xxx

(xxx.xxx.xxx.xxx: IP address for the projector)

### When connecting with IPv6 addresses

http://[xxxx:xxxx:••• xxxx]

You can confirm the IP address of the projector under “Network Setting” on the Connection/Power menu (page 34).

The following window appears in the Web browser:

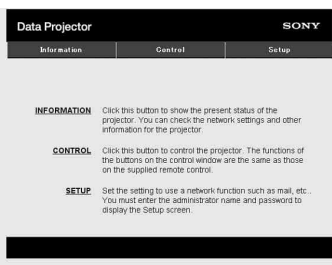

Once you make the network settings, you can open the control window only by performing step **3** of this procedure.

## How to operate the control window

### Switching the page

Click one of the Page Switching buttons to display the desired setting page.

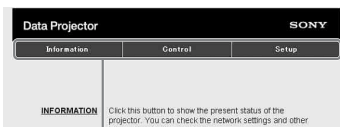

Page Switching buttons



## Setting the access limitation

You can limit a user for accessing any particular page.

**Administrator:** Allowed access to all pages

**User:** Allowed access to all pages except the Setup page

When you access the Setup page for the first time, input “root” as the user name and “Projector” as the password in the authentication dialog.

When you log in for the first time, the window that prompts you to change the password is displayed. Follow the instructions on the screen to change the password.

The name of the administrator is preset to “root.”

Entry area for [Administrator]

Entry area for [User]

The password can be changed in the Password page in the Setup page.

When you change the password, input a new password after deleting the password (\*\*\*\*\*) that was set.

The password of the administrator and user should be 8 to 16 characters that includes both alphabet and numeric characters.

Alphabet is case-sensitive.

The default password “Projector” cannot be set as a new password.

### Note

If you forget your password, consult with qualified Sony personnel.

## Confirming the Information regarding the Projector

You can confirm the current settings for the projector on the Information page.

Information area

## Operating the Projector from a Computer

You can control the projector from the computer on the Control page.

Operation area

The functions of the buttons shown in the operation area are the same as those of the keys on the supplied Remote Commander.

## Using the e-mail Report Function

Set the e-mail report function on the Setup page.

Entered values will not be applied unless you click on [Apply].

- 1 Click on [Owner information] to enter the owner information recorded in the e-mail report.

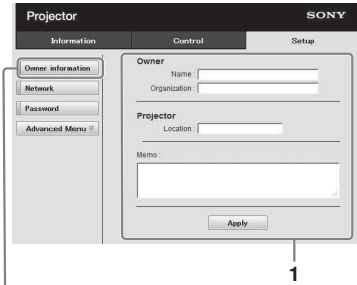

Owner information button

- 2 Set the timing of the e-mail report. Click on [Advanced Menu] to display the [E-mail] button, then click on [E-mail] to open the E-mail page. **Maintenance Reminder:** Set the timing for maintenance. To reset Maintenance Reminder, check the RESET check box and then click on [Apply].

E-mail button

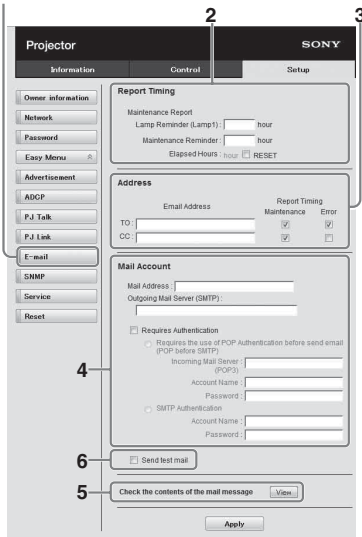

- 3 Enter the outgoing e-mail address in the Email Address box then check the Report Timing check box of the e-mail report to be sent.

- 4 Set the mail account for sending e-mail reports.

**Mail Address:** Enter the e-mail address.  
**Outgoing Mail Server (SMTP):** Enter the address of outgoing mail server (SMTP).

**Required Authentication:** Check this check box if authentication is required for sending e-mail.

**Requires the use of POP**

**Authentication before send email**

**(POP before SMTP):** Check this check box to arrange for POP authentication to be performed before sending e-mail.

**Incoming Mail Server (POP3):** Enter the address of the incoming-mail server (POP3) to be used for POP3 authentication.

**Account Name:** Enter the mail account.

**Password:** Enter the password.

**SMTP Authentication:** Check this check box to arrange for SMTP authentication to be performed before sending e-mail.

**Account Name:** Enter the mail account.

**Password:** Enter the password.

- 5 Confirm the contents of the e-mail report.

When you click on [View] is pressed, the contents of the e-mail report are displayed.

- 6 Send the test mail.

Check on the Send test mail check box then click on [Apply] to send your test mail to the e-mail address you set.

**Notes**

- The e-mail report function is not available because the network which Outbound Port25 Blocking is used cannot be connected to the SMTP server.
- You cannot use the following characters to enter the characters in the text box: " ' " , " " " , " \ " , " & " , " < " , " > "

## Setting the LAN Network of the projector

Set the LAN network function on the Setup page. Entered values will not be applied unless you click on [Apply].

- 1 Click on [Network] to open the Network page.

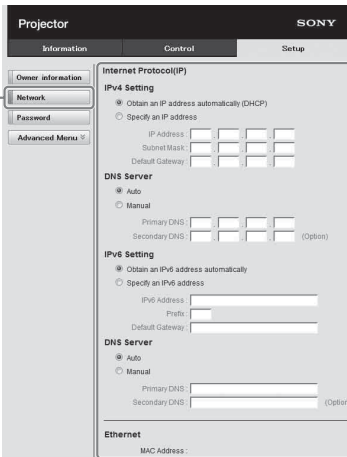

Network button

LAN Network setting area

- 2 Set the items for internet protocol.

### (a) Setting the IPv4 address

#### Obtain an IP address automatically:

Automatically provides the network settings by a DHCP server function, such as the router. The IP Address, Subnet Mask, Default Gateway, Primary DNS, and Secondary DNS display the values provided by a DHCP server.

**Specify an IP address:** Set the network manually.

**-IP Address:** Input the IP address of the projector.

**-Subnet Mask:** Input the subnet mask of the projector.

**-Default Gateway:** Input the default gateway of the projector.

**-Primary DNS:** Input the primary DNS server of the projector.

**-Secondary DNS:** Input the secondary DNS server of the projector.

### (b) Setting the IPv6 address

#### Obtain an IPv6 address

**automatically:** Automatically provides the network settings by a DHCP server function, such as a router. The IPv6 Address, Prefix, Default Gateway, Primary DNS, and Secondary DNS display the values provided by a DHCP server.

**Specify an IPv6 address:** Set the network manually.

**-IPv6 Address:** Input the IP address of the projector.

**-Prefix:** Input the prefix of the projector.

**-Default Gateway:** Input the default gateway of the projector.

**-Primary DNS:** Input the primary DNS server of the projector.

**-Secondary DNS:** Input the secondary DNS server of the projector.

- 3 Set the items for Ethernet.

**MAC Address:** Displays the MAC address of the projector.

## Setting the Control Protocol of the Projector

Change the settings for the control protocol on the Setup page. Entered values will not be applied unless you click on [Apply].

- 1 Click on [Advanced Menu] to display the buttons for more settings.

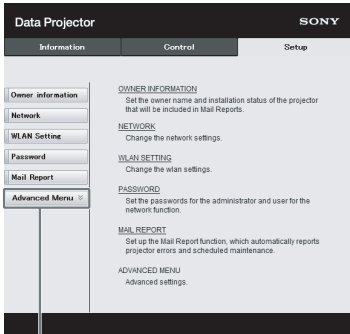

Advanced Menu button

- 2 (a) Set Advertisement.

Advertisement Service setting area

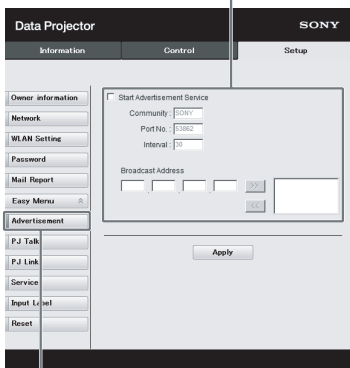

Advertisement button

**Start Advertisement Service:** Set Advertisement to enabled or disabled. Items for Advertisement are enabled only when this function is enabled. The function is disabled at the factory default.

### -Community:

Input the community name for Advertisement and PJ Talk. If the community name for Advertisement is changed, the one for PJ Talk will also be changed. Only four alphanumeric characters can be input. The factory default setting is “SONY.” It is recommended that the community name be changed from the factory setting to avoid unnecessary access to the projector from other computers.

### -Port No.:

Input the transmit port of Advertisement. The factory default setting is “53862.”

### -Interval:

Input the transmission interval (minutes) of Advertisement. The factory default setting is “30.”

### -Broadcast Address:

Input the destination of data via Advertisement. If nothing is input, the data will be broadcast in the same subnetwork.

- (b) Set ADCP.

ADCP Service setting area

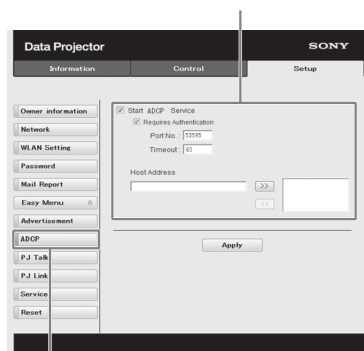

ADCP button

**Start ADCP Service:** Set ADCP to enabled or disabled. Items for ADCP are enabled only when this function is enabled. The function is disabled at the factory default.

**-Requires Authentication:** Set the authentication for ADCP to enabled or

disabled. The password is the same as that of the Web page administrator.

**-Port No.:** Input the server port of ADCP. The factory default setting is “53595.”

**-Timeout:** Input the time (minutes) until ADCP communication is terminated in case it is disconnected. The factory default setting is “60.”

**-Host Address:** Input the IP address that the ADCP server is allowed to receive. If no IP address is input, receiving commands will be allowed from any IP address. From the moment the IP address is input, access will be allowed only from that input IP address. For security reasons, it is recommended to input an IP address to restrict access.

### (c) Set PJ Talk.

PJ Talk Service setting area

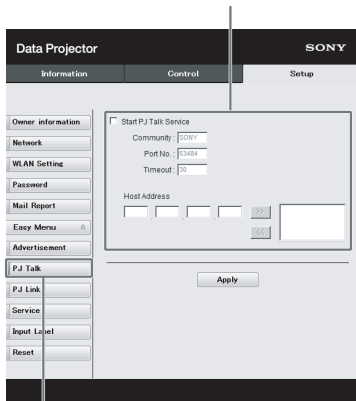

PJ Talk button

#### Start PJ Talk Service:

Set PJ Talk to enabled or disabled. Items for PJ Talk are enabled only when this function is enabled. The function is disabled at the factory default.

#### -Community:

Input the community name of Advertisement and PJ Talk. If the community name for PJ Talk is changed, the one for Advertisement will also be changed. Only four alphanumeric characters can be input. The factory default setting is “SONY.” It is recommended that the community name

be changed from the factory setting to avoid unnecessary access to the projector from other computers.

#### -Port No.:

Input the server port of PJ Talk. The factory default setting is “53484.”

#### -Timeout:

Input the time (minutes) until PJ Talk communication is terminated in the case that it is disconnected. The factory default setting is “30.”

#### -Host Address:

Input the IP address that the PJ Talk server is allowed to receive. If no IP address is input, receiving commands will be allowed from any IP address. From the moment the IP address is input, access will be allowed only from that input IP address. For security reasons, it is recommended to input an IP address to restrict access.

### (d) Set PJ Link.

PJ Link Service setting area

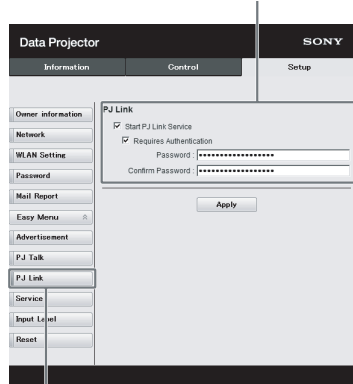

PJ Link button

#### Start PJ Link Service:

Set PJ Link to enabled or disabled. Items for PJ Link are enabled only when this function is enabled. This function is disabled at the factory setting.

#### -Requires Authentication:

Set the authentication for PJ Link to enabled or disabled.

#### -Password:

Input the authentication password for PJ Link. For the factory default password, refer to the PJ Link specifications.

**(e) Set the system service.**

System service setting area

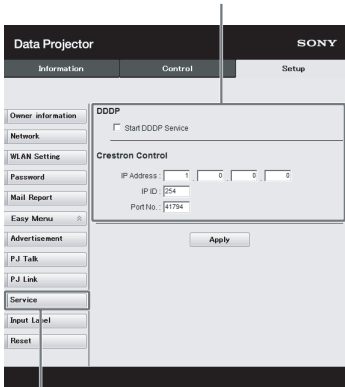

Service button

**Start DDDP Service:**

Set DDDP to enabled or disabled. For details, refer to the DDDP specifications in the reference from AMX Corporation. The function is disabled at the factory default.

**Crestron Control:**

For details, refer to the specifications in product catalogues, etc., from Crestron Corporation.

**-IP Address:**

Input the Crestron system server.

**-IP ID:**

Input the IP ID for the CIP protocol.

**-Port No.:**

Input the port number for the CIP protocol server.

**(f) Reset the network settings.**

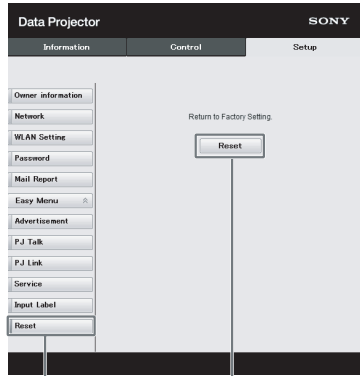

Reset button

Reset

**Reset:**

Reset all Web browser settings to their factory defaults.

# Indicators

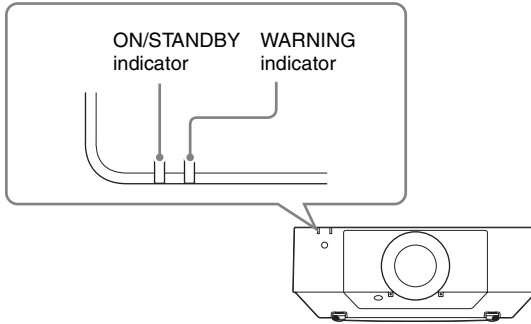

You can check the projector status or abnormality by checking the lighting/flashing status of the ON/STANDBY indicator and WARNING indicator on the front. If the indicators flash in red, address the problem in accordance with “Warning indicators and remedies” (page 48).



## Operating status indication

Indicator status	Operating status	Meaning
<p>(Lights in red) (Off)</p>	Standby	The power is supplied to the projector and the projector is in a standby mode according to the setting.
<p>(Flashes in green) (Off)</p>	Warm-up/Cool-down	The projector is warming up after it is turned on, or cooling down after turned off.
<p>(Lights in green) (Off)</p>	Power on	The projector is ready for projection.
<p>(Lights in orange)(Off)</p>	Other standby status	The projector is in With No Input (Lamp Cutoff).

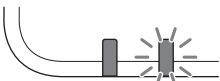
## Warning indicators and remedies

Indicator status	The number of flashes	Meaning	Remedies
 <p>(Lights in red) (Flashes in red)</p>	Twice	The rear panel, side cover, or air filter is not installed securely.	Check how the rear panel, side cover, and air filter are attached and install securely.
	Three times	The lamp does not light properly.	<p>The temperature of the lamp is unusually high. Turn off the projector and turn it on again after the lamp has cooled. If the same symptom occurs, turn off the projector again and remove the lamp (page 52), then check if the lamp is not broken.</p> <p>If the lamp is not broken, reattach the lamp and turn on the projector again.</p> <p>If the symptom occurs again, the lamp may be exhausted. In this case, replace the lamp with a new one (page 52).</p> <p>If the lamp is broken, do not exchange the lamp by yourself. Consult a qualified Sony consultant.</p>
	Eight times	The lens is not securely attached.	Check how the lens is attached and install it securely.
	Nine times	The projector is installed at the wrong angle.	<ul style="list-style-type: none"> <li>Refer to "On Installation" in Quick Reference Manual and install at a correct angle.</li> </ul>
 <p>(Flashes in red) (Flashes in red) Both indicators flash</p>	Twice	The temperature in the projector is abnormal.	<ul style="list-style-type: none"> <li>Check if the air filter is clogged, then clean or replace it (page 54).</li> <li>Check if the ventilation holes (intake/exhaust) are not blocked by the wall or an object and secure a sufficient gap.</li> <li>Check the ambient temperature and use the projector within the range of operating temperature.</li> </ul>

If the indicators flash in a manner other than described above, unplug the AC power cord and make sure the ON/STANDBY indicator turns off, then plug the AC power cord into the wall outlet and turn on the projector.

If the problem still persists, consult with qualified Sony personnel.



# Messages List

When any of the messages listed below appears on the projected image, address the problem in accordance with the table below.

Message	Meaning/Remedy	Page
Clean the filter. Projector temperature is high. Switching to High Altitude Mode.	Temperature in the projector has increased. As a countermeasure against use at an altitude of 1,500 m or higher, set "High Altitude Mode" to "On." If you are not using the projector at a high altitude, perform the remedies below and set "High Altitude Mode" to "Off." <ul style="list-style-type: none"> <li>• Check that the air filter is clogged, then clean or replace it.</li> <li>• Check that the ventilation holes (intake/exhaust) are not blocked by a wall or an object and secure a sufficient gap.</li> <li>• Check the ambient temperature and use the projector within the range of operating temperature.</li> </ul>	4, 54
Clean the filter. High temp.! Lamp off in 1 min.	Temperature in the projector has increased. Perform the remedies below. <ul style="list-style-type: none"> <li>• Check that the air filter is clogged, then clean or replace it.</li> <li>• Check that the ventilation holes (intake/exhaust) are not blocked by a wall or an object and secure a sufficient gap.</li> <li>• Check the ambient temperature and use the projector within the range of operating temperature.</li> <li>• "High Altitude Mode" on this projector is set to "On." Set the setting that suits the operating environment.</li> </ul>	4, 54
Frequency is out of range!	Change the output setting of the connected equipment to one for signals supported by the projector.	61
Please check Input-A Signal Sel.	Set "Input-A Signal Sel." to "Auto" or select the input signal type to suit to the input signal.	34
Not applicable!	Invalid key pressed.	6
The control keys are locked!	"Control Key Lock" is set to "On."	32
Lens Control is locked!	"Lens Control" is set to "Off."	32
Function is locked!	The function is locked by external control.	6, 19, 20, 21, 36
Filter cleaning will start.	The filter will be automatically cleaned after the projector is turned off.	37
Filter cleaning completed.	The filter was automatically cleaned when the projector was turned on.	37
Please replace the Lamp and clean the Filter.	Replace the lamp with a new one and clean the air filter. The message appears whenever you turn on the power until you replace the lamp and reset the lamp timer.	52, 54

# Troubleshooting

Before asking to have the projector repaired, try to diagnose the problem, following the instructions below.

Symptom	Remedy	Page
The power is not turned on.	Check if the AC power cord is firmly connected.	–
	When the “Control Key Lock” is set to “On,” you cannot turn on the projector using the I/⏻ key on the projector.	32
	Check how the air filter is attached and install it securely.	54
No image.	Check if the connecting cable is connected to external equipment properly.	9
	Check if the computer signal is set for output to an external monitor. If you set your computer, such as a notebook computer, to output the signal to both your computer’s display and an external monitor, the picture of the external monitor may not appear properly. Set your computer to output the signal to only an external monitor.	17
	Check if the input source is correctly selected.	17
	Check if the picture is muted.	7
	During “Zone Black Level Adj.” adjustment, a black image is automatically projected.	37
No image/image disturbance	Set “HDMI Cable” to “Long.”	34
On-screen display does not appear.	The on-screen display does not appear when “Status” in the Operation menu is set to “Off” or “All Off.”	32
The aspect ratio of the display is not right/the image is displayed smaller /a portion of image does not appear.	The image may not be displayed correctly with an input signal the projector cannot interpret correctly. In such a case, set “Aspect” manually.	28, 30
	Check if “Screen Aspect” is correctly selected.	37
The image is a trapezoid.	The images become trapezoidal because of the projection angle. In such a case, you can correct the trapezoidal distortion, using a Keystone feature.	6, 19, 36
Edges of the image are cut off or dark.	If you use the lens shift function with a setting outside the recommended range, edges of the image may be cut off or appear dark. Use a setting within the normal range for the lens shift function.	63
The image is distorted.	Warping is set. Disable the warp correction feature.	20, 36
The image is dark/too bright.	The settings for “Brightness,” “Contrast,” and “Lamp Mode” affect brightness of the image. Check if the value is appropriate.	25
	When video signal is not input, the lamp is dimmed to reduce power consumption.	34

Symptom	Remedy	Page
The image is not clear.	Check if the projector is in focus.	18
	The picture will not be clear if condensation has accumulated on the lens. In such a case, let the projector sit for about two hours with the power on.	–
The image is noisy.	Check if the connecting cable is connected to external equipment properly.	9
No sound.	Check that the connecting cables between the projector and external video or audio equipment are securely connected.	9
	Check if the output setting of connected external audio equipment is set for output the audio signal from the projector.	–
	Audio is not output if audio muting is activated.	7
	Check if the “Audio Output Vol.” is set to minimum.	31
The image becomes darker or brighter.	When the lamp is dimmed for a long time, brightness may increase temporarily, but this is not malfunction.	–
The Remote Commander does not work.	Check that the batteries are installed correctly.	–
	Check that the batteries are not exhausted.	–
	Check if the “ID Mode” of the projector corresponds to that of the Remote Commander.	8, 32
	Check the setting for “IR Receiver.”	32
The fan is noisy.	The sound from the fan is often greater than normal to cool the lamp, etc. in the following cases. <ul style="list-style-type: none"> <li>• “Lamp Mode” is set to “High.”</li> <li>• The projector is in at high altitude (“High Altitude Mode” is set to “On”)</li> <li>• Temperature is very high.</li> </ul>	25, 37
	<ul style="list-style-type: none"> <li>• Check that the air filter is clogged, then clean or replace it.</li> <li>• Check that the ventilation holes (intake/exhaust) are not blocked by a wall or an object and secure a sufficient gap.</li> </ul>	4

# Replacing the Lamp

Replace the lamp with a new one if a message displayed on the projected image (page 49). Use an LMP-F370/F280 projector lamp (not supplied) for replacement.

## Caution

- The lamp remains hot after the projector is turned off. **If you touch the lamp, you may burn your finger. When you replace the lamp, wait for at least an hour after turning off the projector for the lamp to cool sufficiently.**
- Do not allow any metallic or inflammable objects into the lamp replacement slot after removing the lamp, otherwise it may cause electrical shock or fire. Do not put your hands into the slot.

## Notes

- **If the lamp breaks, contact qualified Sony personnel. Do not replace the lamp yourself.**
- When removing the lamp, be sure to pull it out straight, by holding the designated location. If you touch a part of the lamp other than the designated location, you may be burned or injured. If you pull out the lamp while the projector is tilted, the pieces may scatter if the lamp breaks any may cause injury.

- 1** Turn off the projector, and disconnect the AC power cord from a wall outlet.
- 2** When the lamp has cooled sufficiently, open the rear panel by loosening the 3 screws.

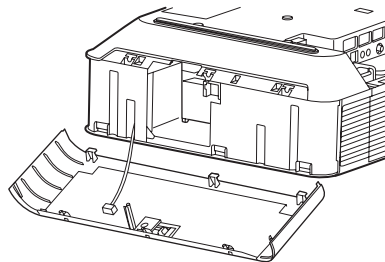
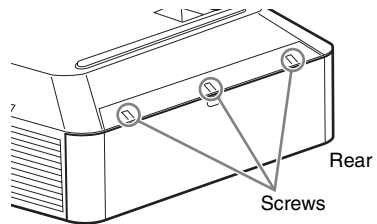

- 3** Loosen the 3 screws on the lamp (❶) then pull out the lamp by its grab (❷).

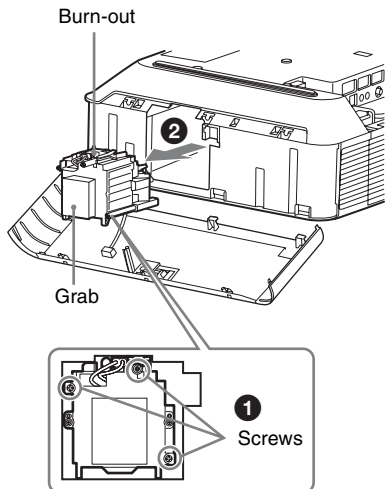

- 4** Insert the new lamp all the way in until it is securely in place (❶). Tighten the 3 screws (❷).

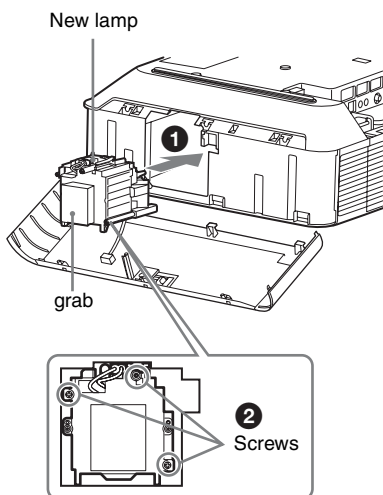

- 5** Close the rear panel and tighten the 3 screws.

**Note**

Be sure to install the lamp and rear panel securely as it was. If not, the projector cannot be turned on.

- 6** Connect the AC power cord to a wall outlet and turn on the projector.

- 7** Reset the lamp timer for notification of the next replacement time.

Select "Lamp Timer Reset" on the SET SETTING menu then press the ENTER key. When a message appears, select "Yes" to reset the lamp timer (page 31).

**Caution**

**For the customers in the U.S.A. and Canada**

(Hg) Lamp contains mercury. Dispose according to applicable local, state/province and federal laws. For additional information, see [www.sony.com/mercury](http://www.sony.com/mercury)

# Cleaning the Air Filter

When the message that prompts cleaning the air filter appears, clean the air filter.  
If the dust cannot be removed from the air filter even after cleaning, replace the air filter with a new one.  
For details on a new air filter, consult with qualified Sony personnel.

## Caution

**If you continue to use the projector even after the message is displayed, dust may accumulate, clogging it. As a result, the temperature may rise inside the unit, leading to a possible malfunction or fire.**

- 1 Turn off the projector and disconnect the AC power cord from a wall outlet.
- 2 Slide the lock switch on the side cover toward UNLOCK to unlock the cover.

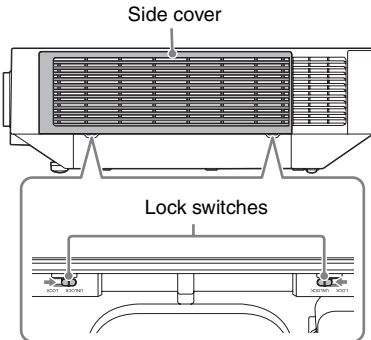

- 3 Slide the side cover downward by pushing its upper corners on both sides to remove the side cover.

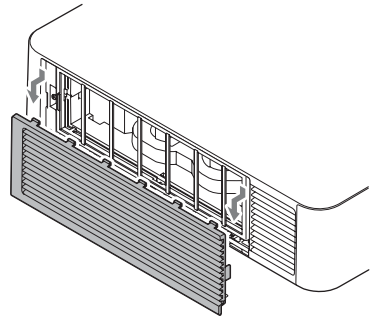

- 4 Loosen the screws (four) and pull out the filter cover by pinching the grab on the left side.

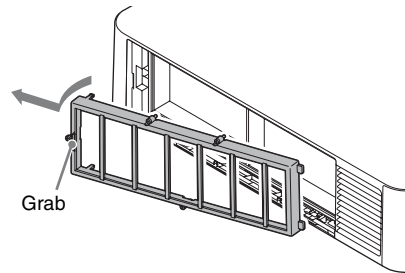
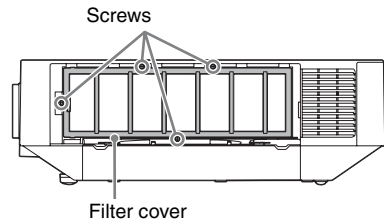

- 5 Pull out the air filter from the main unit.

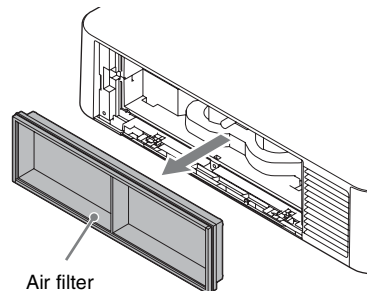

- 6** Clean the air filter with a vacuum cleaner.
- 7** Replace the air filter and attach the filter cover.
- When attaching the filter cover, fit the two tabs on the right into place, turn the filter cover using the right side as an axis, and fit the two tabs on the left into place. Then, tighten the four screws.

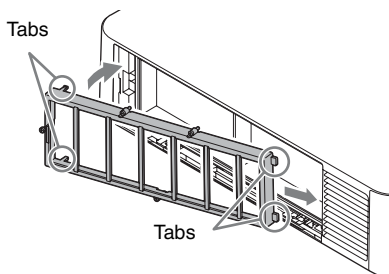

- 8** Fit the two tabs on the side cover into place and slide the side cover upward.

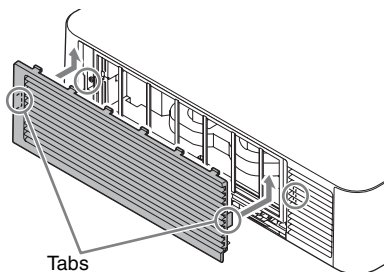

- 9** Lock the side cover.

**Note**

Be sure to attach the air filter firmly; the power cannot be turned on if it is not attached securely.

## Replacing the Projection Lens

**Notes**

- Avoid removing/attaching the lens with the projector installed suspended from a ceiling.
- For usable projection lenses, see “Optional accessories” (page 59).
- Do not attach any lens other than the specified accessory lens sold separately.
- Be careful not to drop the projection lens.
- Avoid touching the lens surface.

### Removing

- 1** Return the projection lens to the center position.
- While the unit is turned on, press the LENS SHIFT button on the Remote Commander, then press the RESET button on it. The projection lens returns to the center position.

**Note**

The projection lens cannot be removed unless it has returned to the center position.

- 2** Turn off the projector, then unplug the AC power cord from the wall outlet.

**Caution**

When replacing the lens, your eyes may be damaged if a strong light accidentally gets into your eyes. Before replacing the lens, turn off the projector and then unplug the AC power cord.

- 3** While pressing and holding down the LENS RELEASE button, rotate the

projection lens counterclockwise to pull out the lens straight.

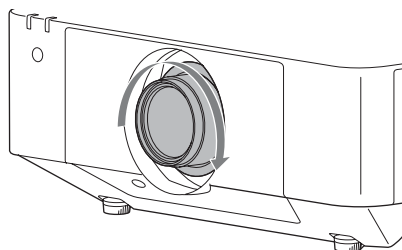
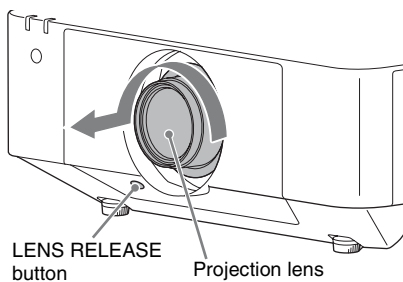

**Note**

When attaching the projection lens, do not press the LENS RELEASE button.

## Attaching

- 1 Fully insert the projection lens with the index on the lens facing toward the top surface of the main unit.

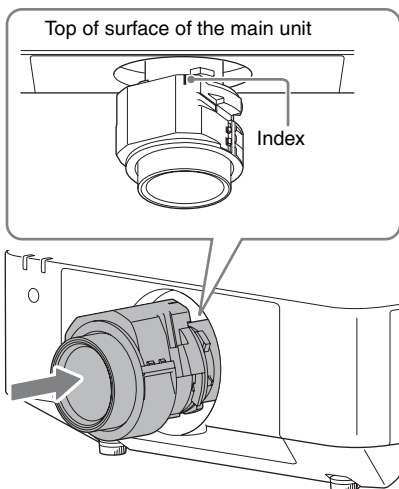

- 2 Rotate the lens clockwise until it clicks.



# Specifications

Item	Description	
<b>Model name</b>	<b>VPL-FH65/VPL-FH60</b>	
Display system	3 LCD system	
Display device	Size of effective display area	0.76" (19.3 mm) × 3, Aspect ratio 16:10
	Number of pixels	6,912,000 (1920 × 1200 × 3) pixels
Light source	High-pressure mercury lamp	
Light output	VPL-FH65: 6,000 lm (when "Lamp Mode" is set to "High") VPL-FH60: 5,000 lm (when "Lamp Mode" is set to "High")	
Displayable scanning frequency *1	Horizontal: 15 kHz to 92 kHz, Vertical: 48 Hz to 92 Hz	
Display resolution	Computer signal input	Maximum display resolution: 1920 × 1200 dots Panel display resolution: 1920 × 1200 dots
	Video signal input	NTSC, PAL, SECAM, 480/60i, 576/50i, 480/60p, 576/50p, 720/60p, 720/50p, 1080/60i, 1080/50i, 1080/60p, 1080/50p, 1080/24p
Color system	NTSC <sup>3.58</sup> , PAL, SECAM, NTSC <sup>4.43</sup> , PAL-M, PAL-N, PAL60	
Computer and video signal input/output	INPUT A	<b>RGB/YPbPr input terminal:</b> Mini D-sub 15-pin female, G with sync/Y: 1 V <sub>p-p</sub> ± 2 dB, sync negative, 75 ohms terminated, RGB/PbPr: 0.7 V <sub>p-p</sub> ± 2 dB, 75 ohms terminated, Sync signal: TTL level high impedance, positive/negative <b>Audio input terminal:</b> Stereo mini jack, rated input 500 mVrms, input impedance more than 47 kilohms
	INPUT B	<b>DVI-D input terminal:</b> DVI-D 24-pin (Single link), DVI 1.0 compliant, HDCP support <b>Audio input terminal:</b> Shared with INPUT A
	INPUT C	<b>HDMI input connector:</b> HDMI 19-pin, digital RGB/YPbPr, HDCP support, HDMI audio support
	INPUT D	<b>HDBaseT terminal:</b> RJ45 HDBaseT transmittable signal: HDMI (Video, Audio), RS-232C, Ethernet (100BASE-TX) HDBaseT LAN cable: STP type (CAT5e or higher, straight, not supplied), Maximum length: 100 m
	VIDEO IN	<b>Video input terminal:</b> BNC, 1 V <sub>p-p</sub> ± 2 dB, sync negative, 75 ohms terminated <b>Audio input terminal:</b> Shared with INPUT A

Item	Description	
Model name	VPL-FH65/VPL-FH60	
OUTPUT A	<b>MONITOR output terminal:</b> Mini D-sub 15-pin female, G with sync/Y: 1 Vp-p $\pm$ 2 dB, sync negative, 75 ohms terminated, RGB/PbPr: 0.7 Vp-p $\pm$ 2 dB, 75 ohms terminated, Sync signal: HD, VD 4 V (open), 1 Vp-p (75 ohms), positive/negative <b>Audio output terminal:</b> Stereo mini jack, stereo, 1 Vrms (maximum volume, when inputting 500 mVrms), output impedance 5 kilohms	
OUTPUT B	<b>DVI-D output terminal:</b> DVI-D 24-pin (Single link), DVI 1.0 compliant, non-HDCP compliant	
Control signal input/output	<b>RS-232C terminal:</b> D-Sub 9 pin male	
	<b>LAN terminal:</b> RJ45, 10BASE-T/100BASE-TX	
	<b>CONTROL S input terminal (DC power supply):</b> Stereo mini jack, 5 Vp-p, Plug in power DC 5 V	
Operating temperature/ Operating humidity	0 °C to 40 °C (32 °F to 104 °F)/20% to 80% (no condensation)	
Storage temperature/ Storage humidity	-10 °C to +60 °C (14 °F to +140 °F)/ 20% to 80% (no condensation)	
Power required	VPL-FH65: AC 100 V to 240 V, 5.0 A to 2.1 A, 50/60 Hz VPL-FH60: AC 100 V to 240 V, 4.3 A to 1.8 A, 50/60 Hz	
Power consumption	AC 100 V to 120 V	VPL-FH65: 498 W VPL-FH60: 429 W
	AC 220 V to 240 V	VPL-FH65: 483 W VPL-FH60: 416 W
Power consumption (Standby Mode)	AC 100 V to 120 V	VPL-FH65: 0.5 W (when "Standby Mode" is set to "Low") VPL-FH60: 0.5 W (when "Standby Mode" is set to "Low")
	AC 220 V to 240 V	VPL-FH65: 0.5 W (when "Standby Mode" is set to "Low") VPL-FH60: 0.5 W (when "Standby Mode" is set to "Low")
Power consumption (Networked Standby Mode)	AC 100 V to 120 V	VPL-FH65: 15.0 W (LAN), 15.0 W (HDBaseT), 15.0 W (All Terminals and Networks Connected) (when "Standby Mode" is set to "Standard") VPL-FH60: 15.0 W (LAN), 15.0 W (HDBaseT), 15.0 W (All Terminals and Networks Connected) (when "Standby Mode" is set to "Standard")
	AC 220 V to 240 V	VPL-FH65: 13.3 W (LAN), 13.3 W (HDBaseT), 13.3 W (All Terminals and Networks Connected) (when "Standby Mode" is set to "Standard") VPL-FH60: 13.3 W (LAN), 13.3 W (HDBaseT), 13.3 W (All Terminals and Networks Connected) (when "Standby Mode" is set to "Standard")

Item	Description	
Model name	VPL-FH65/VPL-FH60	
Heat dissipation	AC 100 V to 120 V	VPL-FH65: 1699 BTU/h VPL-FH60: 1464 BTU/h
	AC 220 V to 240 V	VPL-FH65: 1648 BTU/h VPL-FH60: 1419 BTU/h
Outside dimensions		460 × 175 × 515 mm (18 1/8" × 6 7/8" × 20 9/32") (W/H/D)
		460 × 169 × 515 mm (18 1/8" × 6 21/32" × 20 9/32") (W/H/D) (without protrusions)
Mass		VPL-FH65: Approx. 13 kg (28 lb) VPL-FH60: Approx. 13 kg (28 lb)
Supplied accessories		See "Checking the Supplied Accessories" in the supplied Quick Reference Manual.
Optional accessories *2 *3		<b>Projection Lens VPLL-3007:</b> Manual focus, Projected image size: 60" to 300" (1.52 m to 7.62 m), Maximum external dimensions (W × H × D): 150 × 150 × 222 mm (5 29/32" × 5 29/32" × 8 3/4"), Mass: 1.7 kg (3.7 lb 60 oz)
		<b>Projection Lens VPLL-Z3009:</b> Manual focus/zoom, Projected image size: 60" to 300" (1.52 m to 7.62 m), Maximum external dimensions (W × H × D): 150 × 150 × 217 mm (5 29/32" × 5 29/32" × 8 19/32"), Mass: 1.7 kg (3.7 lb 60 oz)
		<b>Projection Lens VPLL-Z3024:</b> Electric focus/zoom, (when attaching to this projector), Projected image size: 40" to 600" (1.02 m to 15.24 m), Maximum external dimensions (W × H × D): 97 × 105 × 177 mm (3 13/16" × 4 9/64" × 6 31/32"), Mass: 1.2 kg (2.6 lb 42 oz)
		<b>Projection Lens VPLL-Z3032:</b> Electric focus/zoom, (when attaching to this projector), Projected image size: 40" to 600" (1.02 m to 15.24 m), Maximum external dimensions (W × H × D): 97 × 105 × 177 mm (3 13/16" × 4 9/64" × 6 31/32"), Mass: 1.2 kg (2.6 lb 42 oz)

## Notes

The values for mass and dimensions are approximate.

\*1: For details, refer to "Acceptable Input Signals" on page 61.

\*2: Not all optional accessories are available in all countries and area. Please check with your local Sony Authorized Dealer.

\*3: Information on accessories in this manual is current as of August 2015.

Design and specifications of the unit, including the optional accessories, are subject to change without notice.

## Pin assignment

### DVI-D terminal (DVI-D, female)

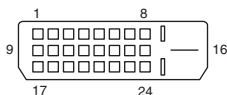

1	T.M.D.S. Data2-	14	+5 V Power
2	T.M.D.S. Data2+	15	Ground (return for +5 V)
3	T.M.D.S. Data2 Shield	16	Hot Plug Detect
4	NC	17	T.M.D.S. Data0-
5	NC	18	T.M.D.S. Data0+
6	DDC Clock	19	T.M.D.S. Data0 Shield
7	DDC Data	20	NC
8	NC	21	NC
9	T.M.D.S. Data1-	22	T.M.D.S. Clock Shield
10	T.M.D.S. Data1+	23	T.M.D.S. Clock+
11	T.M.D.S. Data1 Shield	24	T.M.D.S. Clock-
12	NC		
13	NC		

### RGB input terminal (Mini D-sub 15-pin, female)

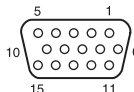

1	Video input (red) R	9	Power supply input for DDC
2	Video input (green) G	10	GND
3	Video input (blue) B	11	GND
4	GND	12	DDC/SDA
5	RESERVE	13	Horizontal sync signal
6	GND (R)	14	Vertical sync signal
7	GND (G)	15	DDC/SCL
8	GND (B)		

### RS-232C terminal (D-Sub 9-pin, male)

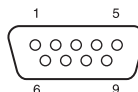

1	NC	6	NC
2	RXDA	7	RTS
3	TXDA	8	CTS
4	DTR	9	NC
5	GND		

## HDMI terminal (HDMI, female)

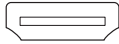

1	T.M.D.S. Data2+	11	T.M.D.S. Clock Shield
2	T.M.D.S. Data2 Shield	12	T.M.D.S. Clock-
3	T.M.D.S. Data2-	13	NC
4	T.M.D.S. Data1+	14	RESERVED (N.C.)
5	T.M.D.S. Data1 Shield	15	SCL
6	T.M.D.S. Data1-	16	SDA
7	T.M.D.S. Data0+	17	GND
8	T.M.D.S. Data0 Shield	18	+5V Power
9	T.M.D.S. Data0-	19	Hot Plug Detect
10	T.M.D.S. Clock+		

### Acceptable Input Signals

#### Computer signal

Resolution	fH [kHz]/ fV [Hz]	Input terminal	
		INPUT A	INPUT B/ INPUT C/ INPUT D
640 × 350	31.5/70	●	–
	37.9/85	●	–
640 × 400	31.5/70	●	–
	37.9/85	●	–
640 × 480	31.5/60	●	●
	35.0/67	●	–
	37.9/73	●	–
	37.5/75	●	–
	43.3/85	●	–

Resolution	fH [kHz]/ fV [Hz]	Input terminal	
		INPUT A	INPUT B/ INPUT C/ INPUT D
800 × 600	35.2/56	●	–
	37.9/60	●	●
	48.1/72	●	–
	46.9/75	●	–
832 × 624	53.7/85	●	–
	49.7/75	●	–
1024 × 768	48.4/60	●	●
	56.5/70	●	–
	60.0/75	●	–
	68.7/85	●	–
1152 × 864	64.0/70	●	–
	67.5/75	●	–
	77.5/85	●	–
1152 × 900	61.8/66	●	–
1280 × 960	60.0/60	●	●
	75.0/75	●	–
1280 × 1024	64.0/60	●	●
	80.0/75	●	–
	91.1/85	●	–
1400 × 1050	65.3/60	●	●
1600 × 1200	75.0/60	●	●
1280 × 768	47.8/60	●	●
1280 × 720	45.0/60	●	● <sup>*2</sup>
1920 × 1080	67.5/60	–	● <sup>*2</sup>
1366 × 768	47.7/60	●	●
1440 × 900	55.9/60	●	●
1680 × 1050	65.3/60	●	●
1280 × 800	49.7/60	●	●
1920 × 1200	74.0/60	● <sup>*1</sup>	● <sup>*1</sup>
1600 × 900	60.0/60	● <sup>*1</sup>	● <sup>*1</sup>

## Video signal

Signal	fV [Hz]	Input terminal		
		VIDEO	INPUT A	INPUT B/ INPUT C/ INPUT D
NTSC	60	●	–	–
PAL/ SECAM	50	●	–	–
480i	60	–	●	●
576i	50	–	●	●
480p	60	–	●	●
576p	50	–	●	●
1080i	60	–	●	●
1080i	50	–	●	●
720p	60	–	●	● <sup>*2</sup>
720p	50	–	●	●
1080p	60	–	–	● <sup>*2</sup>
1080p	50	–	–	●
1080p	24	–	–	●

### Notes

- \*1: Available for VESA Reduced Blanking signals only.
- \*2: INPUT B is determined as a computer signal; INPUT C/INPUT D is determined as a video signal.
- When a signal other than the signals listed in table is input, the picture may not be displayed properly.
- An input signal meant for screen resolution different from that of the panel will not be displayed in its original resolution. Text and lines may be uneven.
- Some actual value may differ slightly from the design values given in the table.

# Projection Distance and Lens Shift Range

The projection distance refers to the distance between the front of the lens and the projected surface.

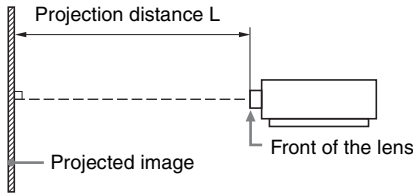

The lens shift range represents the distance in percent (%) by which the lens can be shifted from the center of the projected image. The lens shift range is regarded as 0% when the point (A) in the illustration (point where a line drawn from the center of the lens and the projected image cross at right angles) is aligned with the center of the projected image and full width or full height of the projected image is regarded as 100%.

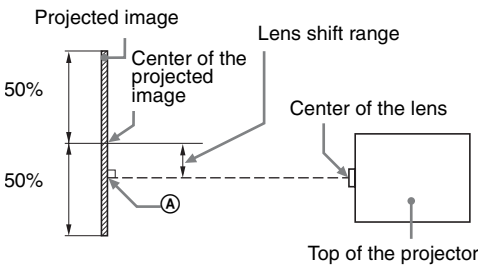
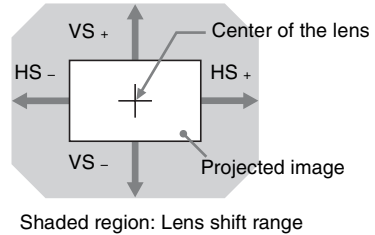
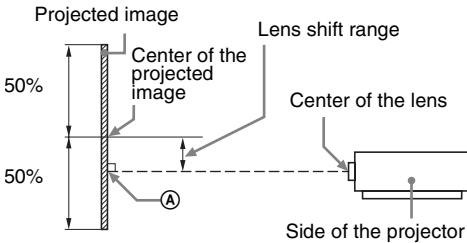

- VS +: Vertical lens shift range (up) [%]
- VS -: Vertical lens shift range (down) [%]
- HS +: Horizontal lens shift range (right) [%]
- HS -: Horizontal lens shift range (left) [%]

## Projection distance

Unit: m (inches)

Projection image size		Projection distance L		
Diagonal	Width × Height	Standard lens	VPLL-3007	VPLL-Z3009
80" (2.03 m)	1.72 × 1.08 (68 × 42)	2.36 – 3.86 (93 – 152)	1.09 (43)	1.44 – 1.69 (57 – 66)
100" (2.54 m)	2.15 × 1.35 (85 × 53)	2.96 – 4.84 (117 – 191)	1.38 (54)	1.82 – 2.13 (72 – 84)
120" (3.05 m)	2.58 × 1.62 (102 × 64)	3.57 – 5.82 (141 – 229)	1.67 (66)	2.20 – 2.57 (87 – 101)
150" (3.81 m)	3.23 × 2.02 (127 × 79)	4.47 – 7.29 (176 – 287)	2.11 (83)	2.76 – 3.23 (109 – 127)
200" (5.08 m)	4.31 × 2.69 (170 × 106)	5.97 – 9.73 (235 – 383)	2.83 (112)	3.70 – 4.34 (146 – 170)

Projection image size	Projection distance L	
Diagonal	VPLL-Z3024	VPLL-Z3032
80" (2.03 m)	4.00 – 5.48 (158 – 215)	5.45 – 8.32 (215 – 327)
100" (2.54 m)	5.03 – 6.87 (198 – 270)	6.84 – 10.43 (270 – 410)
120" (3.05 m)	6.05 – 8.27 (238 – 325)	8.24 – 12.55 (325 – 494)
150" (3.81 m)	7.59 – 10.36 (299 – 408)	10.33 – 15.72 (407 – 619)
200" (5.08 m)	10.15 – 13.85 (400 – 545)	13.82 – 21.00 (544 – 827)

## Projection distance formula

D: Projected image size (Diagonal)

Unit: m (inches)

Lens	Projection distance L (minimal length)	Projection distance L (maximal length)
Standard lens	$L = 0.030453 \times D - 0.0465$ ( $L = 1.198941 \times D - 1.8307$ )	$L = 0.048463 \times D - 0.0443$ ( $L = 1.907978 \times D - 1.7435$ )
VPLL-3007	$L = 0.014518 \times D - 0.0700$ ( $L = 0.571579 \times D - 2.7563$ )	–
VPLL-Z3009	$L = 0.018832 \times D - 0.0678$ ( $L = 0.741408 \times D - 2.6702$ )	$L = 0.022017 \times D - 0.0635$ ( $L = 0.866824 \times D - 2.4985$ )
VPLL-Z3024	$L = 0.051187 \times D - 0.0973$ ( $L = 2.015234 \times D - 3.8296$ )	$L = 0.069717 \times D - 0.0930$ ( $L = 2.744761 \times D - 3.6617$ )
VPLL-Z3032	$L = 0.069792 \times D - 0.1414$ ( $L = 2.747720 \times D - 5.5654$ )	$L = 0.105707 \times D - 0.1323$ ( $L = 4.161687 \times D - 5.2083$ )



## Lens shift range

### ■ Standard lens, VPLL-Z3024, VPLL-Z3032

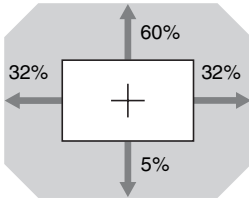

$$VS_{+} = 60 - 1.875 \times (HS_{+} \text{ or } HS_{-}) \text{ [%]}$$

$$VS_{-} = 5 - 0.156 \times (HS_{+} \text{ or } HS_{-}) \text{ [%]}$$

$$HS_{+} = HS_{-} = 32 - 0.533 \times VS_{+} \text{ [%]}$$

$$HS_{+} = HS_{-} = 32 - 6.400 \times VS_{-} \text{ [%]}$$

### ■ VPLL-3007

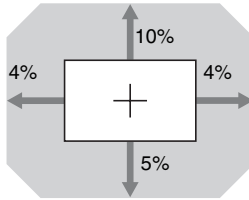

$$VS_{+} = 10 - 2.500 \times (HS_{+} \text{ or } HS_{-}) \text{ [%]}$$

$$VS_{-} = 5 - 1.250 \times (HS_{+} \text{ or } HS_{-}) \text{ [%]}$$

$$HS_{+} = HS_{-} = 4 - 0.400 \times VS_{+} \text{ [%]}$$

$$HS_{+} = HS_{-} = 4 - 0.800 \times VS_{-} \text{ [%]}$$

### ■ VPLL-Z3009

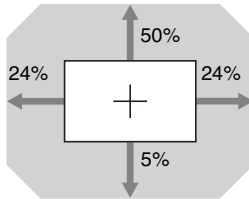

$$VS_{+} = 50 - 2.083 \times (HS_{+} \text{ or } HS_{-}) \text{ [%]}$$

$$VS_{-} = 5 - 0.208 \times (HS_{+} \text{ or } HS_{-}) \text{ [%]}$$

$$HS_{+} = HS_{-} = 24 - 0.480 \times VS_{+} \text{ [%]}$$

$$HS_{+} = HS_{-} = 24 - 4.800 \times VS_{-} \text{ [%]}$$

# Dimensions

Front

Unit: mm (inches)

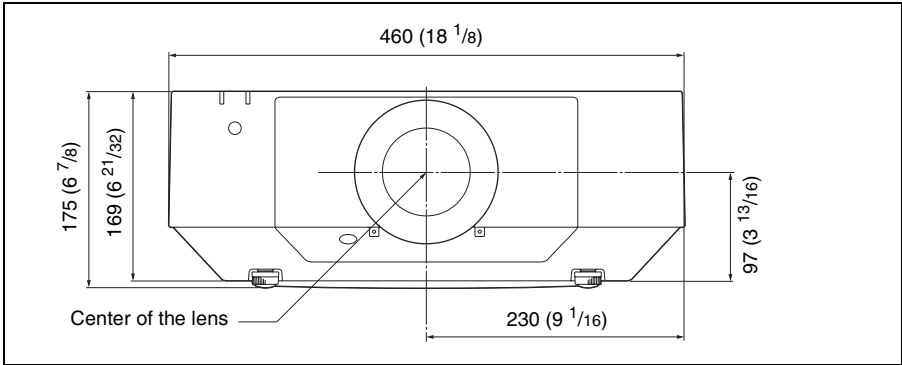

Bottom

Unit: mm (inches)

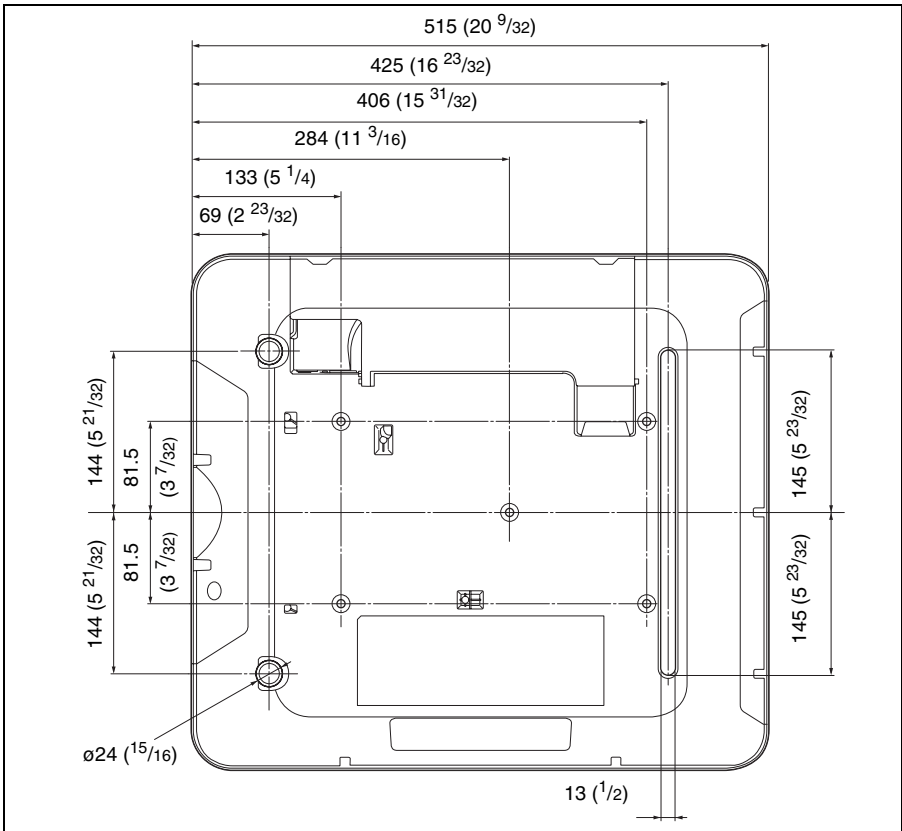

# When using the PSS-610 projector suspension support

Unit: mm (inches)

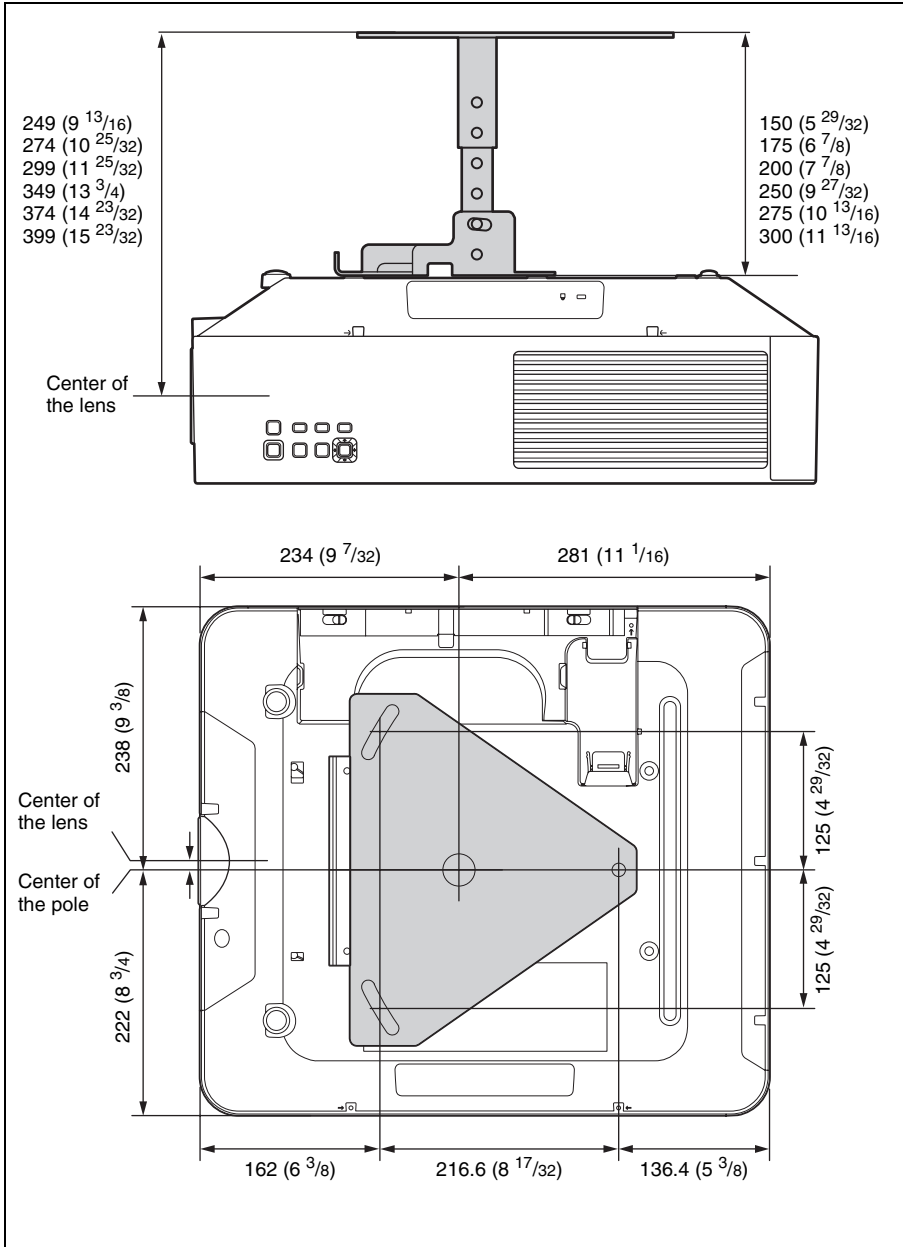

**The distance L' between the front of the lens (center) and the front of the cabinet**

Unit: mm (inches)

Lens	L'
Standard lens	1.2 ( $\frac{1}{16}$ )
VPLL-3007	52.4 ( $2 \frac{1}{16}$ )
VPLL-Z3009	51.2 ( $2 \frac{1}{32}$ )
VPLL-Z3024	9.9 ( $\frac{3}{8}$ )
VPLL-Z3032	9.9 ( $\frac{3}{8}$ )

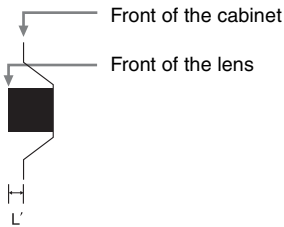

**About Trademarks**

- Adobe Acrobat is a trademark of Adobe Systems Incorporated.
- Kensington is a registered trademark of Kensington Technology Group.
- Internet Explorer is registered trademarks of Microsoft Corporation in the United States and/or other countries.
- PJLink is a registered trademark of Japan Business Machine and Information System Industries Association.
- AMX is a trademark of AMX Corporation.
- The terms HDMI and HDMI High-Definition Multimedia Interface, and the HDMI Logo are trademarks or registered trademarks of HDMI Licensing LLC in the United States and other countries.
- Crestron RoomView is a trademark of Crestron Corporation.
- HDBaseT™ and the HDBaseT Alliance logo are trademarks of the HDBaseT Alliance.
- All other trademarks and registered trademarks are trademarks or registered trademarks of their respective holders. In this manual, ™ and ® marks are not specified.

---

# Index

## A

AC IN socket .....	6
Acceptable input signal .....	61
Adjust Signal .....	28
All Reset .....	31
Antitheft bar .....	4
Antitheft lock .....	4
APA .....	6, 28
Aspect .....	6, 28, 30
Audio Output Vol. ....	31
Auto Power Saving .....	34

## B

Background .....	31
Blanking .....	37
Brightness .....	25

## C

CC Display .....	31
Cleaning the air filter .....	54
Color .....	25
Color Correction .....	26
Color Matching .....	36
Color Space .....	26, 36
Color System .....	34
Color Temp. ....	25
Connecting a computer .....	9
Connecting an external monitor and audio equipment .....	12
Connecting network equipment .....	13
Connecting to HDBaseT equipment .....	14
Connecting video equipment .....	10
Connection/Power menu .....	34
Contrast .....	25
Contrast Enhancer .....	26
Control Key Lock .....	32
Control panel .....	6
CONTROL S input terminal .....	5
CONTROL S output terminal .....	8
Control window .....	40

## D

Digital Zoom .....	6
Dimensions .....	66
Direct Power On .....	35
Dynamic Range .....	34

## E

ECO .....	34
ECO MODE (Energy-saving mode) .....	7
Edge Blending .....	36
E-mail report .....	41
Expert Setting .....	26

## F

fH .....	39
Film Mode .....	26
Filter Cleaning .....	37
Focus .....	6, 18
FREEZE .....	7
Front feet (adjustable) .....	4, 18
Function menu .....	31
fV .....	39

## G

Gamma Mode .....	26
------------------	----

## H

HDBaseT Settings .....	34
HDMI Cable .....	34
High Altitude Mode .....	37
Hue .....	25

## I

ID Mode .....	32
ID MODE switch .....	8
Image Flip .....	37
Image Split .....	37
Indicators .....	47
Information menu .....	39
Input .....	5
Input-A Signal Sel. ....	34
Installation menu .....	36
IP Address Setup .....	34
IR Receiver .....	32

## K

Keystone adjustment .....	19
---------------------------	----

## L

Lamp Mode .....	25
Lamp Timer .....	39
Lamp Timer Reset .....	31
LAN terminal .....	5, 13
Language .....	32
Lens Control .....	32

Lens shift .....	18
Lens shift range .....	65
Location and function of controls .....	4

## M

Main unit .....	4
Menu Position .....	32
Messages list .....	49
Model Name .....	39
Multi Screen .....	36

## N

Network Setting .....	34
-----------------------	----

## O

ON/STANDBY indicator .....	4
Operation menu .....	32
Output .....	5
Overscan .....	28

## P

Panel Alignment .....	38
Pattern .....	18
Phase .....	28
Picture menu .....	25
Picture Mode .....	25
Pin assignment .....	60
Pitch .....	28
Projecting an image .....	17
Projection distance .....	64
Projection distance and lens shift range .....	63
Projection distance formula .....	64

## R

Reality Creation .....	26
Remote commander .....	6
Remote control receiver .....	4
Replacing the lamp .....	52
Replacing the projection lens .....	55
Reset .....	25
RS-232C terminal .....	5

## S

Screen Aspect .....	37
Screen Fitting .....	36
Screen menu .....	28
Security Lock .....	32
Selecting an input signal .....	6
Serial No. ....	39

Sharpness .....	25
Shift .....	28
Side cover .....	4
Smart APA .....	31
Specifications .....	57
Standby .....	6
Standby Mode .....	34
Start Up Image .....	31
Status .....	32

## T

Terminals .....	4, 5
Troubleshooting .....	50
Turn off .....	22
Turn on .....	6, 17
Twin picture .....	7

## U

Using a menu .....	24
Using network features .....	40

## V

V Center .....	28
Ventilation holes .....	4
Vertical Size .....	28
Volume .....	7

## W

WARNING indicator .....	4, 47
Warp correction .....	20
With No Input .....	34

## Z

Zoom .....	6, 18
------------	-------

