

**RENESAS**

Preliminary

# HD66781

720-channel Source Driver  
for a-Si TFT/Low Temperature Poly-Si TFT Panels  
with 262,144-color display RAM

REJxxxxxxx-xxxxZ  
Rev.0.5  
July.31.2003

• Index

Description .....	6
Features .....	7
Block Diagram .....	8
Pin Functions .....	9
HD66781 power-supply specification.....	14
Pad Arrangement.....	15
Pad Coordinate.....	16
Bump Arrangement.....	18
Example of Connecting HD66781 and HD66783 .....	19
Example of Connecting HD66781 and HD667P21 .....	20
Block Function.....	21
(1) System interface.....	21
(2) External Display Interface (RGB I/F, VSYNC I/F).....	22
(3) Address Counter (AC).....	22
(4) Graphic RAM (GRAM).....	22
(5) Grayscale Voltage Generation Circuit.....	22
(6) Timing generator.....	23
(7) Oscillation Circuit (OSC) .....	23
(8) Liquid Crystal Display Driver Circuit .....	23
(9) Gate driver/power supply IC interfacing circuit .....	23
GRAM Address MAP .....	24
Relation between GRAM addresses and Screen positions (SS=0, BGR=0).....	24
Relation between GRAM data and Display data (SS=0, BGR=0).....	25
Relation between GRAM address and Screen position (SS=1, BGR=1).....	28
Relation between GRAM data and Display data (SS=1, BGR=1).....	29



Instruction .....	32
Outline .....	32
Instruction data format .....	33
Basic Operation modes .....	34
Index/Status/Display control instruction .....	35
Index (IR).....	35
Status read (SR) .....	35
Start Oscillation (R000h) .....	35
Driver Output Control (R001h).....	36
LCD Driving Wave Control (R002h) .....	36
Entry Mode 1 (R003h).....	37
Resizing Control 1/2 (R004/R005h) .....	42
Display Control 1 (R007h).....	44
Display Control 2 (R008h).....	46
Display Control 3 (R009h).....	47
Display Control 4 (R00Bh).....	49
External Display interface Control 1 (R00Ch).....	51
Frame Cycle Control (R00Dh).....	54
External Display Interface Control 2 (R00Eh).....	55
External Display Interface Control 3 (R00Fh).....	55
Gate Driver/LTPS LCD Panel Interface Control 1 (R010h).....	56
Gate Driver/LTPS LCD Panel Interface Control 2 (R011h).....	57
Gate Driver/LTPS LCD Panel Interface Control 3 (R012h).....	58
Gate Driver/LTPS LCD Panel Interface Control 4 (R013h).....	59
Gate Driver/LTPS LCD Panel Interface Control 5 (R015h).....	60
Gate Driver/LTPS LCD Panel Interface Control 6 (R016h).....	61
Gate Driver/LTPS LCD Panel Interface Control 7 (R017h).....	62
Gate Driver/LTPS LCD Panel Interface Control 8 (R018h).....	63
Gate Driver/LTPS LCD Panel Interface Control 9 (R019h).....	64
Gate Driver/LTPS LCD Panel Interface Control 10 (R01Bh) .....	65
Power control 1 (R100h).....	68
Gate Driver/ Power Supply IC Interface Control 1 (R110h).....	70
Gate Driver/ Power Supply IC Interface Control 2 (R111h).....	70
Setting examples .....	72
Common registers for HD66783 and HD667P21 .....	73
Registers of HD66783.....	73
Registers of HD667P21 .....	74
RAM Address set in horizontal/vertical directions (R200h/R201h) .....	76
RAM Access through RGB-I/F and System I/F.....	86
RAM Write Data Mask 1/2 (R203h/R204h).....	89
Window Address Control Instructions.....	90
$\gamma$ Control (R300h ~ R309h).....	91
Base image display control instructions.....	92
Instruction list .....	96
Reset Function .....	98

RAM Address and Display Position on the Panel .....	99
Notes to the setting of panel control registers .....	100
Screen settings .....	100
Base image display .....	100
OSD and $\alpha$ blending functions .....	102
OSD image data format.....	103
OSD image display setting.....	103
Resizing function .....	105
Contraction.....	105
Resizing setting.....	106
Instructions for Resizing .....	107
Notes to the resizing function .....	108
Magnification.....	109
Interface specification .....	112
System Interface.....	114
80-system 18-bit interface.....	115
80-system 16-bit interface.....	116
Data transmission synchronization in 16-bit bus interface mode.....	118
80-system 9-bit interface.....	119
Data transmission synchronization in 9-bit bus interface mode.....	120
80-system 8-bit interface (Big endian).....	121
Data transmission synchronization in 8-bit bus interface mode.....	124
Serial Peripheral interface (SPI) .....	125
80-system 8-bit interface (Little endian).....	128
Data transmission synchronization in 8-bit bus interface mode.....	130
DMA transfer Single Address mode .....	131
VSYNC Interface.....	134
Notes to the VSYNC interface.....	137
External Display Interface .....	139
Polarities of VSYNC, HSYNC, ENABLE, DOTCLK signals .....	140
RGB interface timing.....	140
Moving picture display in RGB Interface.....	142
RAM access through the system interface in RGB-I/F mode .....	142
6-bit RGB interface.....	143
Transfer synchronization function for a 6-bit bus interface .....	144
16-bit RGB interface.....	145
18-bit RGB interface.....	146
Notes to the external display interface.....	147
Display Synchroniaing Data Transfer.....	148
Notes to the display synchronizing GRAM data transfer mode.....	150

Timing interfacing with LCD panel signals.....	151
High-Speed Burst RAM Write Function .....	153
Notes to the high-speed RAM write mode.....	154
High-Speed RAM Write with Window Address Function.....	155
Window Address Function .....	156
$\gamma$ -Correction Function .....	157
Grayscale Amplifier Configuration.....	158
$\gamma$ -Correction Registers.....	160
Ladder resistors and 8 to 1 selector.....	162
Variable resistors .....	162
Relationship between RAM data and output level (REV =0) .....	167
Relationship between RAM data and output level (REV =1) .....	168
Low Power Consumption Display Mode.....	169
8-color Display Mode .....	172
Oscillation Circuit.....	173
n-raster-row Inversion alternating Drive .....	174
Interlaced Drive .....	175
Alternating Timing.....	177
Frame-Frequency Adjustment Function .....	178
Relationship between Liquid Crystal Drive Duty and Frame Frequency .....	178
Partial Display Function .....	179
Power-saving drive settings .....	180
Equalization function .....	183
Specifications of external element of HD66781 .....	184
Instruction Setting.....	185
Power-supply/display ON (LPTS = 0: a-Si TFT panel, with HD66783).....	186
Power-supply/display OFF (LPTS = 0: a-Si TFT panel, with HD66783) .....	187
Power-supply/display ON (LPTS = 1: LTPS TFT panel, with HD667P21).....	188
Power-supply/display OFF (LPTS = 1: LTPS TFT panel, with HD667P21) .....	189
Standby/Sleep mode.....	190
Deep standby mode.....	191
Low power consumption display mode.....	192
8-color mode .....	192

Partial display mode.....	193
Absolute Maximum Values .....	194

## Description

The HD66781 is a 720-channel source driver with graphics acceleration function, incorporating RAM compliant to 262,144 TFT colors and 240RGB x 320 dot graphics. In combination with the HD66783, which incorporates a power-supply integrated circuit and a gate driver on a single chip, the HD66781 can drive an a-Si TFT panel of 240 RGB x 320 dots at maximum. Also in combination with the HD667P21, which is a power-supply IC chip, the HD66781 can drive a low-temperature poly-Si TFT panel of 240 RGB x 320 dots at maximum with an incorporated gate driver.

The HD66781's high-speed RAM-write function through a high-speed interface of 8/9/16/18-bit bus enables efficient data transfer with high-speed burst RAM write function. The HD66781 is compliant to DMA transfer single address mode to keep control on bus traffic occupation when a large volume of data is transferred from external memory. The HD66781 can also handle moving picture display through an RGB interface (VSYNC, HSYNC, DOTCLK, ENABLE, and PD 17 to 0).

The HD66781 incorporates RAM with the capacity of one QVGA-sized whole screen of 240 RGB x 320 x 18bits plus 96 raster-rows. In addition to OSD and  $\alpha$  blending functions, which use this RAM area, the HD66781 also handles resizing function, which is compliant to data transfer for a large screen display. These functions make the HD66781 the best solution for the efficient and various ways of display.

The combined use of HD66781 with HD66783 or HD667P21 supports the function to reduce power consumption by a liquid crystal display system. The HD66781's RAM can display 240 RGB x 320-dot color display (max.) with low voltage operation up to 1.7 V. The HD66781 incorporates a voltage follower circuit to generate liquid crystal driving voltages and an interfacing circuit that enables through HD66781 to make instruction settings to HD66783 and HD667P21. In addition, the HD66781 supports power-saving modes such as standby mode and 8-color display mode, which allow precise power management by software. These features make this LSI the ideal solution for medium or small-sized portable battery-driven products such as digital cellular phones or small PDA with color displays, where long battery life and board size are a major concern.

## Features

- Drive 262,144 TFT-color 240RGB x 320 dot graphics display in combination with HD66783 (a-Si TFT panel) or HD667P21 (low-temperature poly-Si TFT panel)
- Output signals to control HD66783, which incorporates a power supply integrated circuit and a gate driver on a single chip.
- Output signals to control a low-temperature poly-Si TFT panel with an incorporated gate driver (combined use with HD667P21)
- System interface
  - High-speed bus interface with 8-/9-/16-/18-bit data bus
  - Serial Peripheral Interface (SPI)
- Interfaces for moving picture display
  - RGB interface with 6-/16-/18-bit data bus (VSYNC, HSYNC, DOTCLK, ENABLE, PD17-0)
  - VSYNC interface (System interface + VSYNC)
- High-speed burst RAM write function
- Compliant to single address mode for DMA transfer that controls data bus occupation ratio when transferring data from external SRAM
- Window address function to write data to a rectangular area of RAM specified by the window address
  - Interfaces for moving picture display, which write data to a rectangular RAM address area
  - Reduce data transfer by transferring only the data for the moving picture display area
  - Simultaneous display of moving picture area and still picture area that displays the contents of internal RAM
  - Resizing function (contraction rate: x1/2, x1/4 / magnification rate: x2, x4)
- Various functions to control color display
  - Simultaneous availability of 262,144 colors (settings are programmable)
  - Partial OSD function
  - $\alpha$ -blending function (transmission rate: 0%, 25%, 50%, 75%, 100%)
- Features for low-power architecture
  - Interface I/O power supply IOVcc = 1.7 ~ 3.3 V  
Vcc1 = 1.7 ~ 3.3 V
  - Logic regulator power supply Vcc = 2.5 ~ 3.3 V
  - Source driver liquid crystal driving voltage DDVDH-GND = 4.0 ~ 5.9 V
  - Power saving functions: standby mode, deep standby mode etc.
  - Step-up circuits to generate liquid crystal drive voltage up to 12 times (HD66783 and HD667P21)
  - Voltage followers for a liquid crystal drive power-supply, which fends off the direct current from bleeder-resistors
- Cst structure only (Common Vcom formula)
- 224,640-byte (240 x (320+96) x 18bits) internal RAM
- Incorporated LCD driver with 720 source outputs
- Compliant to COG

Block Diagram

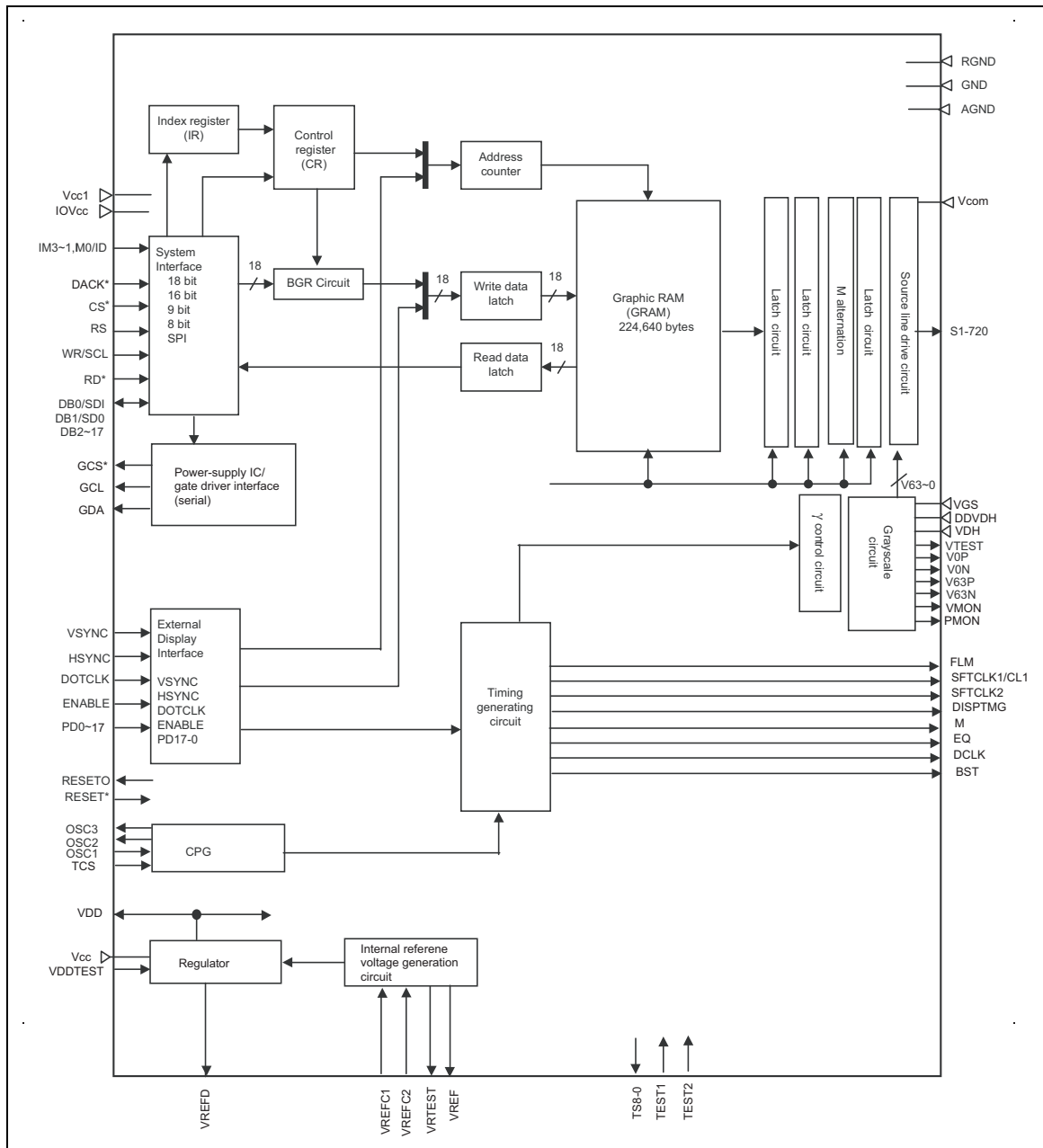



Pin Functions

Signals	Number of Pins	I/O	Connected to	Functions	Unused pins																																																																																											
IM3~1, IM0/ID	4	I	GND or Vcc1	Pins to select an interfacing mode with MPU.	-																																																																																											
				<table border="1"> <thead> <tr> <th>IM3</th> <th>IM2</th> <th>IM1</th> <th>IM0</th> <th>MPU-Interface Mode</th> <th>DB Pins</th> <th>Colors</th> </tr> </thead> <tbody> <tr> <td>0</td> <td>0</td> <td>0</td> <td>0</td> <td>Setting disabled</td> <td>-</td> <td>-</td> </tr> <tr> <td>0</td> <td>0</td> <td>0</td> <td>1</td> <td>Setting disabled</td> <td>-</td> <td>-</td> </tr> <tr> <td>0</td> <td>0</td> <td>1</td> <td>0</td> <td>80-system 16-bit interface</td> <td>DB17-10, DB8-1</td> <td>65,536 Note 1)</td> </tr> <tr> <td>0</td> <td>0</td> <td>1</td> <td>1</td> <td>80-system 8-bit interface (Big-endian)</td> <td>DB17-10</td> <td>65,536 Note 2)</td> </tr> <tr> <td>0</td> <td>1</td> <td>0</td> <td>*</td> <td>Serial peripheral interface (SPI)</td> <td>DB1-0</td> <td>65,536</td> </tr> <tr> <td>0</td> <td>1</td> <td>1</td> <td>0</td> <td>Setting disabled</td> <td>-</td> <td>-</td> </tr> <tr> <td>0</td> <td>1</td> <td>1</td> <td>1</td> <td>80-system 8-bit interface (Little-endian)</td> <td>DB17-10</td> <td>65,536 Note 2)</td> </tr> <tr> <td>1</td> <td>0</td> <td>0</td> <td>0</td> <td>Setting disabled</td> <td>-</td> <td>-</td> </tr> <tr> <td>1</td> <td>0</td> <td>0</td> <td>1</td> <td>Setting disabled</td> <td>-</td> <td>-</td> </tr> <tr> <td>1</td> <td>0</td> <td>1</td> <td>0</td> <td>80-system 18-bit interface</td> <td>DB17-10</td> <td>262,144</td> </tr> <tr> <td>1</td> <td>0</td> <td>1</td> <td>1</td> <td>80-system 9-bit interface</td> <td>DB17-9</td> <td>262,144</td> </tr> <tr> <td>1</td> <td>1</td> <td>*</td> <td>*</td> <td>Setting disabled</td> <td>-</td> <td>-</td> </tr> </tbody> </table>		IM3	IM2	IM1	IM0	MPU-Interface Mode	DB Pins	Colors	0	0	0	0	Setting disabled	-	-	0	0	0	1	Setting disabled	-	-	0	0	1	0	80-system 16-bit interface	DB17-10, DB8-1	65,536 Note 1)	0	0	1	1	80-system 8-bit interface (Big-endian)	DB17-10	65,536 Note 2)	0	1	0	*	Serial peripheral interface (SPI)	DB1-0	65,536	0	1	1	0	Setting disabled	-	-	0	1	1	1	80-system 8-bit interface (Little-endian)	DB17-10	65,536 Note 2)	1	0	0	0	Setting disabled	-	-	1	0	0	1	Setting disabled	-	-	1	0	1	0	80-system 18-bit interface	DB17-10	262,144	1	0	1	1	80-system 9-bit interface	DB17-9	262,144	1	1	*	*	Setting disabled	-	-
				IM3		IM2	IM1	IM0	MPU-Interface Mode	DB Pins	Colors																																																																																					
				0		0	0	0	Setting disabled	-	-																																																																																					
				0		0	0	1	Setting disabled	-	-																																																																																					
				0		0	1	0	80-system 16-bit interface	DB17-10, DB8-1	65,536 Note 1)																																																																																					
				0		0	1	1	80-system 8-bit interface (Big-endian)	DB17-10	65,536 Note 2)																																																																																					
				0		1	0	*	Serial peripheral interface (SPI)	DB1-0	65,536																																																																																					
				0		1	1	0	Setting disabled	-	-																																																																																					
				0		1	1	1	80-system 8-bit interface (Little-endian)	DB17-10	65,536 Note 2)																																																																																					
				1		0	0	0	Setting disabled	-	-																																																																																					
				1		0	0	1	Setting disabled	-	-																																																																																					
				1		0	1	0	80-system 18-bit interface	DB17-10	262,144																																																																																					
				1		0	1	1	80-system 9-bit interface	DB17-9	262,144																																																																																					
1	1	*	*	Setting disabled	-	-																																																																																										
Note 1) 262,144 colors available (max.) in 2-transfer mode. Note 2) 262,144 colors available (max.) in 3-transfer mode.																																																																																																
CS*	1	I	MPU	Select the HD66781. Low: the HD66781 is selected and is accessible High: the HD66781 is not selected and is inaccessible	IOVcc																																																																																											
RS	1	I	MPU	Select the register. Low: Index/status registers High: Control registers	IOVcc																																																																																											
WR*/SCL	1	I	MPU	Write strobe signal in the 80-system bus interface Write data at the "Low" level.  In the Serial Peripheral Interface, a synchronizing clock signal.	-																																																																																											
RD*	1	I	MPU	Read-strobe signal in the 80-system bus interface Read data at the "Low" level.	IOVcc																																																																																											
DACK*	1	I	MPU	Select the HD66781 in the DMA transfer single address mode. Low: Select the HD66781 (Accessible) High: Not Select the HD66781 (Inaccessible)	Vcc1																																																																																											
DB0/SDI	1	I/O	MPU	18-bit parallel bi-directional data bus. 8-bit bus: DB17-DB10 9-bit bus: DB17-DB9 16-bit bus: DB17-DB10 and DB8-DB1 18-bit bus: DB17-DB0  Serial data input pin (SDI) in the Serial Peripheral Interface mode to input data on the rising edge of SCL signal.	IOVcc																																																																																											

Signals	Number of Pins	I/O	Connected to	Functions	Unused pins
DB1/SDO	1	I/O	MPU	18-bit parallel bi-directional data bus. 8-bit bus: DB17-DB10 9-bit bus: DB17-DB9 16-bit bus: DB17-DB10 and DB8-DB1 18-bit bus: DB17-DB0 Serial data output pin (SDO) in the Serial Peripheral Interface mode to output data on the falling edge of SCL signal.	IOVcc
DB2-DB17	16	I/O	MPU	18-bit parallel bi-directional data bus. 8-bit bus: DB17-DB10 9-bit bus: DB17-DB9 16-bit bus: DB17-DB10 and DB8-DB1 18-bit bus: DB17-DB0	IOVcc
RESET*	1	I	MPU or external R-C circuit	Reset pin. Initialize the LSI at the "Low" level. A power-on reset required after turning on the power.	-
RESETO1 RESETO2	2	O	HD66783 or HD667P21	Output the same polarity level as RESET*. Control both HD66781 and HD66783 or HD66781 and HD667P21 by connecting to HD66783 or HD667P21.	Open
OSC1 OSC2	2	I or O	Oscillation resistor	Connect an external resistor for R-C oscillation.	-
ENABLE	1	I	MPU or LCDC	Data enable signal in the RGB interface mode. Low: Select (accessible) High: Not select (inaccessible)  ENABLE signal inverts the polarity according to the setting of EPL resistor. Set ENABLE inactive while it is not used and its level is fixed or the polarity is set with registers.	GND/ IOVcc
VSYNC	1	I	MPU or LCDC	Frame synchronizing signal. This signal is active low.  The polarity of VSYNC is inverted by setting VSPL register. Set VSYNC inactive while it is not used and its level is fixed or the polarity is set with registers.	GND/ IOVcc
HSYNC	1	I	MPU or LCDC	Line synchronizing signal. This signal is active low.  The polarity of HSYNC is inverted by setting HSPL register. Set HSYNC inactive while it is not used and its level is fixed or the polarity is set with registers.	GND/ IOVcc
DOTCLK	1	I	MPU or LCDC	Dot clock signal. The timing of data input is determined at the rising edge. This signal is active low.  The polarity of DOTCLK is inverted by setting DPL register. Set DOTCLK inactive while it is not used and its level is fixed or the polarity is set with registers.	GND/ IOVcc
PD0-PD17	18	I	MPU or LCDC	18-bit bus for RGB data. 6-bit bus: PD17-PD12 16-bit bus: PD17-PD13 and PD11-PD1 18-bit bus: PD17-PD0	GND/ IOVcc

Signals	Number of Pins	I/O	Connected to	Functions	Unused pins
BST	1	O	MPU or LCDC	Output a pulse that indicates the start of blank (front porch). When writing data in synchronization with display scan, serve as a trigger signal. Amplitude: Vcc1 and GND.	Open
S1~S720	720	O	Liquid Crystal	Output a voltage applied to liquid crystal. The correspondence between the RAM write address and source output signal is changeable with SS bit. When SS=0, data in the RAM address "h00000" are output from S1-3. When SS=1, data in the RAM address "h00000" are output from S718-720. S1, S4, S7, ... display red (R), S2, S5, S8, ... display green (G), and S3, S6, S9, ... display blue (B) (SS = 0).	Open
FLM1 FLM2	2	O	HD66783 or HD667P21	Output a frame head pulse.	Open
CL11/ SFTCLK11 CL12/ SFTCLK12	2	O	HD66783 or HD667P21	Output a different signal according to the LTPS register setting. LTPS=0: Output a pulse of one line cycle. Connect to CL1 pin of HD66783. LTPS=1: Gate shift clock for LTPS. Output a pulse of 2-line cycles.	Open
SFTCLK21 SFTCLK22	2	O	HD667P21	Output a different signal according to the LTPS register setting. LTPS=0: Output is GND. No connection with HD66783 is required. LTPS=1: Gate shift clock for LTPS. Output a pulse of 2-line cycles.	Open
DISPTMG1 DISPTMG2	2	O	HD66783 or HD667P21	Gate off signal during partial display. Low: Voff output High: Normal output For an LTPS LCD panel, a control signal for the gate driver incorporated therein.	Open
M1 M2	2	O	HD66783 or HD667P21	Output alternating pulse.	Open
EQ1 EQ2	2	O	HD66783 or HD667P21	Make Vcom output Hi-z in Vcom transition timing during Vcom alternating drive. Low: Output VcomH or VcomL from Vcom High: Make Vcom output Hi-z	Open
DCCLK1 DCCLK2	2	O	HD66783 or HD667P21	Output step-up clocks.	Open
GCL1 GCL2	2	O	HD66783 or HD667P21	Clock signal for making a serial transfer of values set in registers to gate driver/power supply IC. Output data from the falling edge of the clock.	Open
GDA1 GDA2	2	O	HD66783 or HD667P21	Data signal for making a serial transfer of values set in registers to gate driver/power supply IC.	Open
GCS1* GCS2*	2	O	HD66783 or HD667P21	Select the HD66781. Low: Select the HD66781 (Serial transfer) High: Not select the HD66781 (Serial transfer not available)	Open

Signals	Number of Pins	I/O	Connected to	Functions	Unused pins
GND	1	-	Power supply	Ground for the logic side. GND = 0V When assembled on COG, connect to GND on the FPC to avoid effects from the noise.	-
AGND	1	-	Power supply	Ground for the I/O side and analogue circuits other than logic circuits and the internal GRAM, which operate with VDD voltage. AGND = 0V When assembled on COG, connect to GND on the FPC to avoid effects from the noise.	-
RGND	1	-	Power supply	Ground for the internal RAM. RGND = 0V. When assembled on COG, connect to GND on the FPC to avoid effects from the noise.	-
IOVcc	1	-	Power supply	Supply with the power supply voltage for interface pins. IOVcc = 1.7~3.3V. IOVcc ≤ Vcc1 ≤ Vcc	-
Vcc	1	I	Power supply	Power supply for internal logic regulator. Connect to an external power supply of Vcc = 2.5~3.3V. IOVcc ≤ Vcc1 ≤ Vcc	-
Vcc1	1	I	Power supply	Power supply voltage for a deep standby control circuit and the I/O side. IOVcc ≤ Vcc1 ≤ Vcc	-
VREF	1	O	Power supply	Reference voltage output for internal logic regulator. Leave open.	Open
VDD	1	I/O	Stabilizing Capacitor	Power supply output for an internal logic. Do not connect to other than stabilizing capacitors.	-
DDVDH	1	I	HD66783 or HD667P21	Supply with a liquid crystal drive voltage through HD66783 or HD667P21. DDVDH = +4.0V~+5.9V	-
VDH	1	I	HD66783 or HD667P21	A reference level for a grayscale voltage generation circuit. Can be supplied through HD66783 or HD667P21.	-
VGS	1	I	GND or External Resistor	A reference level for a grayscale voltage generation circuit. Connect to an external variable resistor to make a level adjustment for each panel.	-
Vcom	1	I	HD66783 or HD667P21	Signal for equalization. Short-circuit all liquid crystal output (S1~S720) to Vcom level (Hi-z) while EQ = High. Leave open when Vcom < 0V.	Open
TEST1 TEST2	2	I	GND	Test pins. Must be fixed to the GND level.	-
TSC	1	I	GND	Test pin. Must be fixed to the GND level.	-
OSC3	1	O	Open	Test pin. Leave open.	Open
TS8-0	9	O	Open	Test pins. Leave open.	Open
VTEST	1	O	Open	Test pin. Leave open.	Open
VRTEST	1	O	Open	Test pin. Leave open.	Open
VREFC1 VREFC2	2	I	GND	Test pins. Must be fixed to GND level.	-

Signals	Number of Pins	I/O	Connected to	Functions	Unused pins
VDDTEST	1	I	GND	Test pin. Must be fixed to GND level.	-
VREFD	1	O	Open	Test pin. Leave open.	Open
PMON	1	O	Open	Test pin. Leave open.	Open
VMON	1	O	Open	Test pin. Leave open.	Open
V0P V63P	2	I or O	Open	Test pins. Leave open.	-
V0N V63N	2	I or O	Open	Test pins. Leave open.	-
TIN1	1	I	GND	Test pin. Must be fixed to GND level.	-
TOUT1-3	3	O	Open	Test pins. Leave open.	Open
TVcc1 TVcc2	2	I	GND	Test pins. Must be fixed to GND level.	-
DUMMY14 DUMMY15	2	-	-	Dummy pads. DUMMY 14 and DUMMY 15 are short-circuited within the LSI. Available for measuring COG contact resistor.	Open
DUMMY 1~13, 16~30	28	-	Open	Dummy pads. Must be left open.	Open
IOVccDUM 1~3	3	O	Input pins	Output an internal IOVcc level. When neighboring input pins are fixed to IOVcc, short-circuit them.	Open
Vcc1DUM1 Vcc1DUM2	2	O	Input pins	Output an internal Vcc1 level. When neighboring input pins are fixed to Vcc1, short-circuit them.	Open
AGNDDUM 1-4	4	O	Input pins	Output an internal AGND level. When neighboring input pins are fixed to AGND, short-circuit them.	Open
TESTO1 TESTO2	2	O	Open	Test pins. Leave open.	-

## HD66781 power-supply specification

Item			Voltage range	Specification
Input Voltage	IOVcc	Interface voltage 1	+1.7V~+3.3V	Power supply for signals interfacing with MPU or LCDC. Supply through the system. Power supply for CS*, RS, WR*/SCL, RD*, DB17-2, DB1/SDO, DB0/SDI, VSYNC, HSYNC, ENABLE, PD17-0. Connect on the FPC when using at the same electric potential with Vcc1.
	Vcc1	Interface voltage 2	+1.7V~+3.3V	Power supply for signals interfacing with a gate driver/power supply IC and a deep standby mode control circuit that halts the logic regulator. Supply with the same electric potential with Vcc of HD66783 or HD667P21 though the system. Power supply for FLM1, FLM2, CL11/SFTCLK11, CL12/SFTCLK12, SFTCLK21, SFTCLK22, M1, M2, EQ1, EQ2, DCCLK1, DCCLK2, GCL1, GCL2, GDA1, GDA2, GCS1*, GCS2*, RESET*, RESETO1, RESETO2, DACK*, BST, M3-1, IM0/ID. Connect on the FPC when using at the same potential with IOVcc.
	Vcc	Power supply for the logic regulator	+2.5V~+3.3V	Supply through the system. Connect on the FPC when using at the same electric potential with Vci of HD66783 or HD667P21.
	VDD	Power supply for the Internal logic	-	Generated from the internal logic regulator. Supply through the system is not required.
	GND	-	0V	GND for the internal logic circuit. Connect to GND on the FPC.
	RGND	-	0V	GND for the internal GRAM. Connect to GND on the FPC.
	AGND	-	0V	GND for the I/O side and analogue circuits other than logic circuits and the internal GRAM, which operate with VDD voltage. Connect to GND on the FPC.
LCD drive voltage	DDVDH	-	+4.5V~+5.9V	Connect to DDVDH of HD66783 or HD667P21.
Source driver grayscale reference voltage	VDH	-	+3.0V~(DDVDH-0.5)V	Connect to VREG1OUT of HD66783 or HD667P21.
	VGS	-	-	Connect to GND or variable resistor.
LCD drive output	S1~S720	V0~V63 grayscale level	-	-

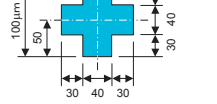

(2) Arrangement Coordinate  
(2-a) Coordinate (X,Y) = (-8339.6, 1364.6)  
Cell Name: MARK\_EN\_A



(2-b) Coordinate (X,Y) = (8339.6, 1364.6)  
Cell Name: MARK\_EN\_B

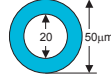

(3) Arrangement Coordinate  
(3-a) Coordinate (X,Y) = (-8339.6, 1274.3)  
Cell Name: MARK\_L\_A

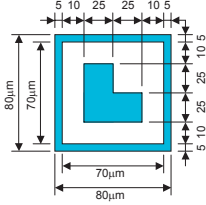

(3-b) Coordinate (X,Y) = (8339.6, 1274.3)  
Cell Name: MARK\_L\_B

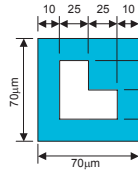

● Long cell : ◆  
(4) Arrangement Coordinate : 4 places  
Cell Name: ZBASFLONGSCALELCD  
(4-a) Coordinate (X,Y) = (-8339.6, -1197.9)  
(4-b) Coordinate (X,Y) = (8339.6, -1197.9)  
(4-c) Coordinate (X,Y) = (8339.6, 1197.9)  
(4-d) Coordinate (X,Y) = (-8339.6, 1197.9)

● Short cell : ◇  
(5) Arrangement Coordinate : 1 place  
(5-a) Coordinate (X,Y) = (8339.6, -1276.1)  
Cell Name: ZBSHORTSCALE\_L0106

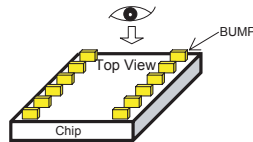

# HD667B81 Laced Output Arrangement

## Top View

HSYNC	<input type="checkbox"/>
DOTCLK	<input type="checkbox"/>
ENABLE	<input type="checkbox"/>
PD17	<input type="checkbox"/>
PD16	<input type="checkbox"/>
PD15	<input type="checkbox"/>
PD14	<input type="checkbox"/>
PD13	<input type="checkbox"/>
PD12	<input type="checkbox"/>
PD11	<input type="checkbox"/>
PD10	<input type="checkbox"/>
PD9	<input type="checkbox"/>
PD8	<input type="checkbox"/>
PD7	<input type="checkbox"/>
PD6	<input type="checkbox"/>
PD4	<input type="checkbox"/>
PD3	<input type="checkbox"/>
PD2	<input type="checkbox"/>
PD1	<input type="checkbox"/>
PD0	<input type="checkbox"/>
IOVcc	<input type="checkbox"/>
IOVcc	<input type="checkbox"/>
IOVcc	<input type="checkbox"/>
Vcc1	<input type="checkbox"/>
Vcc1	<input type="checkbox"/>
Vcc1	<input type="checkbox"/>
Vcc	<input type="checkbox"/>
Vcc	<input type="checkbox"/>
Vcc	<input type="checkbox"/>
Vcc	<input type="checkbox"/>
Vcc	<input type="checkbox"/>
VDD	<input type="checkbox"/>
VDD	<input type="checkbox"/>
VDD	<input type="checkbox"/>
VDD	<input type="checkbox"/>
VDD	<input type="checkbox"/>
VDD	<input type="checkbox"/>
VDD	<input type="checkbox"/>
VDD	<input type="checkbox"/>
VDD	<input type="checkbox"/>
VDD	<input type="checkbox"/>
GND	<input type="checkbox"/>
GND	<input type="checkbox"/>
GND	<input type="checkbox"/>
RGND	<input type="checkbox"/>
RGND	<input type="checkbox"/>
RGND	<input type="checkbox"/>
RGND	<input type="checkbox"/>
RGND	<input type="checkbox"/>
RGND	<input type="checkbox"/>
RGND	<input type="checkbox"/>
RGND	<input type="checkbox"/>
RGND	<input type="checkbox"/>
RGND	<input type="checkbox"/>
AGND	<input type="checkbox"/>
AGND	<input type="checkbox"/>
AGND	<input type="checkbox"/>
AGND	<input type="checkbox"/>
AGND	<input type="checkbox"/>
AGND	<input type="checkbox"/>
AGND	<input type="checkbox"/>
DDVDH	<input type="checkbox"/>
DDVDH	<input type="checkbox"/>
DDVDH	<input type="checkbox"/>
DDVDH	<input type="checkbox"/>
DDVDH	<input type="checkbox"/>
DDVDH	<input type="checkbox"/>
DDVDH	<input type="checkbox"/>
VOP	<input type="checkbox"/>
VON	<input type="checkbox"/>
V63P	<input type="checkbox"/>
V63N	<input type="checkbox"/>
VGS	<input type="checkbox"/>
VDH	<input type="checkbox"/>
PMON	<input type="checkbox"/>
VMON	<input type="checkbox"/>
VTEST	<input type="checkbox"/>
Vcom	<input type="checkbox"/>
Vcom	<input type="checkbox"/>
DUMMY5	<input type="checkbox"/>
VREFD	<input type="checkbox"/>
VRTTEST	<input type="checkbox"/>
VREF	<input type="checkbox"/>
DUMMY6	<input type="checkbox"/>
VREFC1	<input type="checkbox"/>
VREFC2	<input type="checkbox"/>
VDDTEST	<input type="checkbox"/>
DUMMY7	<input type="checkbox"/>
TSC	<input type="checkbox"/>
AGNDDUM1	<input type="checkbox"/>
DUMMY8	<input type="checkbox"/>
OSC1	<input type="checkbox"/>
DUMMY9	<input type="checkbox"/>
DUMMY10	<input type="checkbox"/>
OSC2	<input type="checkbox"/>
DUMMY11	<input type="checkbox"/>
Vcc1DUM2	<input type="checkbox"/>
OSC3	<input type="checkbox"/>
IOVccDUM3	<input type="checkbox"/>
IM0ID	<input type="checkbox"/>
IM1	<input type="checkbox"/>
IM2	<input type="checkbox"/>
IM3	<input type="checkbox"/>
AGNDDUM2	<input type="checkbox"/>
TEST1	<input type="checkbox"/>
TEST2	<input type="checkbox"/>
TS8	<input type="checkbox"/>
TS7	<input type="checkbox"/>
TS6	<input type="checkbox"/>
TS5	<input type="checkbox"/>
TS4	<input type="checkbox"/>
TS3	<input type="checkbox"/>
TS2	<input type="checkbox"/>
TS1	<input type="checkbox"/>
TS0	<input type="checkbox"/>
RESET02	<input type="checkbox"/>
DCCLK2	<input type="checkbox"/>
GCL2	<input type="checkbox"/>
GCS2*	<input type="checkbox"/>
GA2	<input type="checkbox"/>
DISPTMG2	<input type="checkbox"/>
EQ2	<input type="checkbox"/>
M2	<input type="checkbox"/>
CL12/SFTCLK12	<input type="checkbox"/>
SFTCLK22	<input type="checkbox"/>
FLM2	<input type="checkbox"/>
AGNDDUM3	<input type="checkbox"/>
TIN1	<input type="checkbox"/>
TOUT1	<input type="checkbox"/>
TOUT2	<input type="checkbox"/>
TOUT3	<input type="checkbox"/>
AGNDDUM4	<input type="checkbox"/>
TVcc1	<input type="checkbox"/>
TVcc2	<input type="checkbox"/>
DUMMY12	<input type="checkbox"/>
DUMMY13	<input type="checkbox"/>
DUMMY14	<input type="checkbox"/>
DUMMY15	<input type="checkbox"/>
DUMMY16	<input type="checkbox"/>
TEST02	<input type="checkbox"/>
DUMMY17	<input type="checkbox"/>
NO.199	<input type="checkbox"/>
NO.200	<input type="checkbox"/>
DUMMY18	<input type="checkbox"/>
DUMMY19	<input type="checkbox"/>
DUMMY20	<input type="checkbox"/>
S72	<input type="checkbox"/>
884	<input type="checkbox"/>
885	<input type="checkbox"/>
DUMMY21	<input type="checkbox"/>
DUMMY22	<input type="checkbox"/>
DUMMY23	<input type="checkbox"/>

TypeCode : HD667B81

Short-circuit

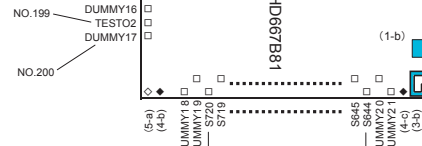







**Bump Arrangement**

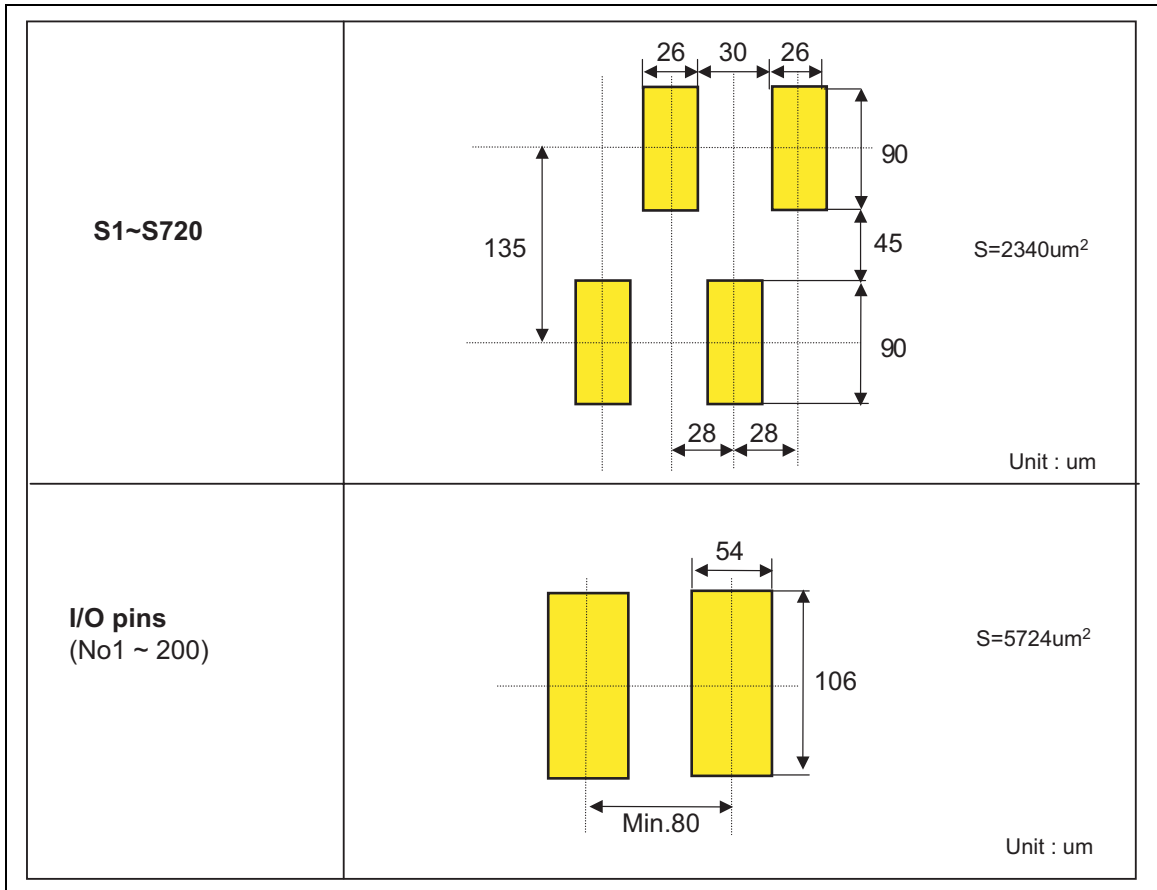

(Bottom view)  
Laced Output  
Arrangement

a-Si TFT

IOVcc = 1.7V~3.3V (HD66781)  
Vcc1 = 1.7~3.3V (HD66781)  
Vcc = 2.5~3.3V (HD66781)  
VCC = 1.7~3.3V (HD667P21)  
VCI = 2.5~3.3V (HD667P21)  
Supply a same potential to Vcc1 of HD66781 and VCC of HD667P21.  
Make sure that IOVcc Vcc1 Vcc (HD66781).

Source Electrode

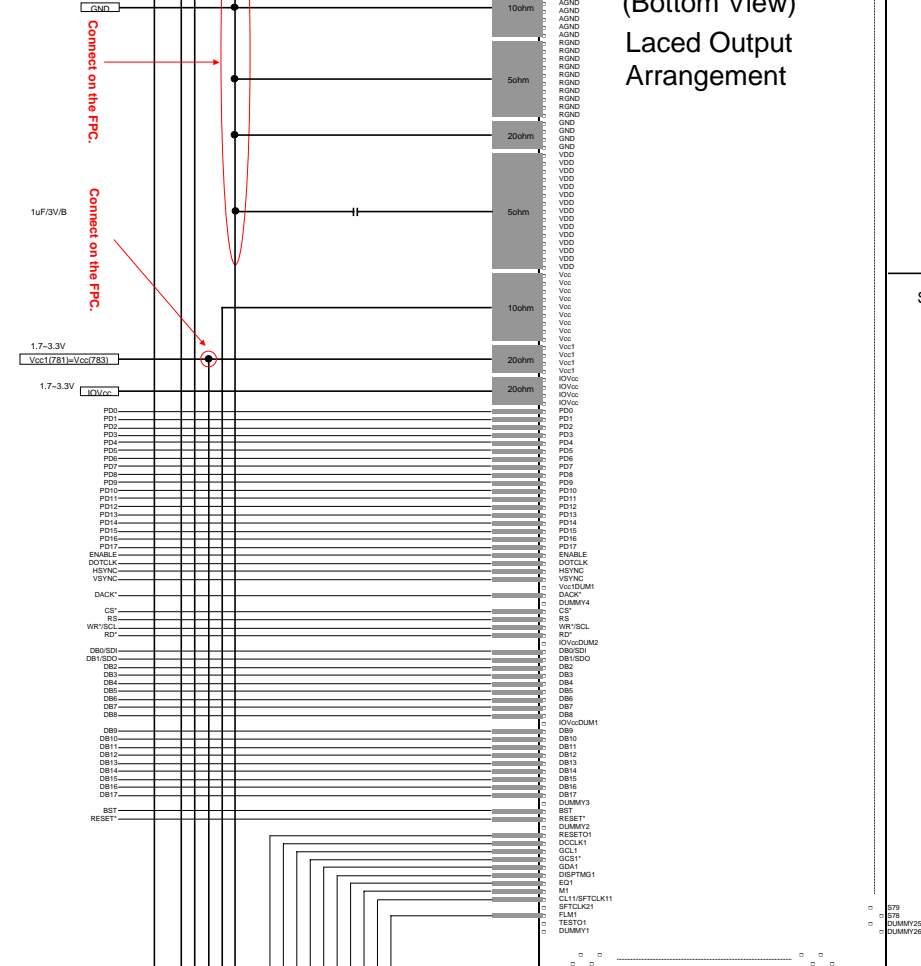

HD667B83  
(Bottom View)  
Laced Output  
Arrangement

Gate electrode

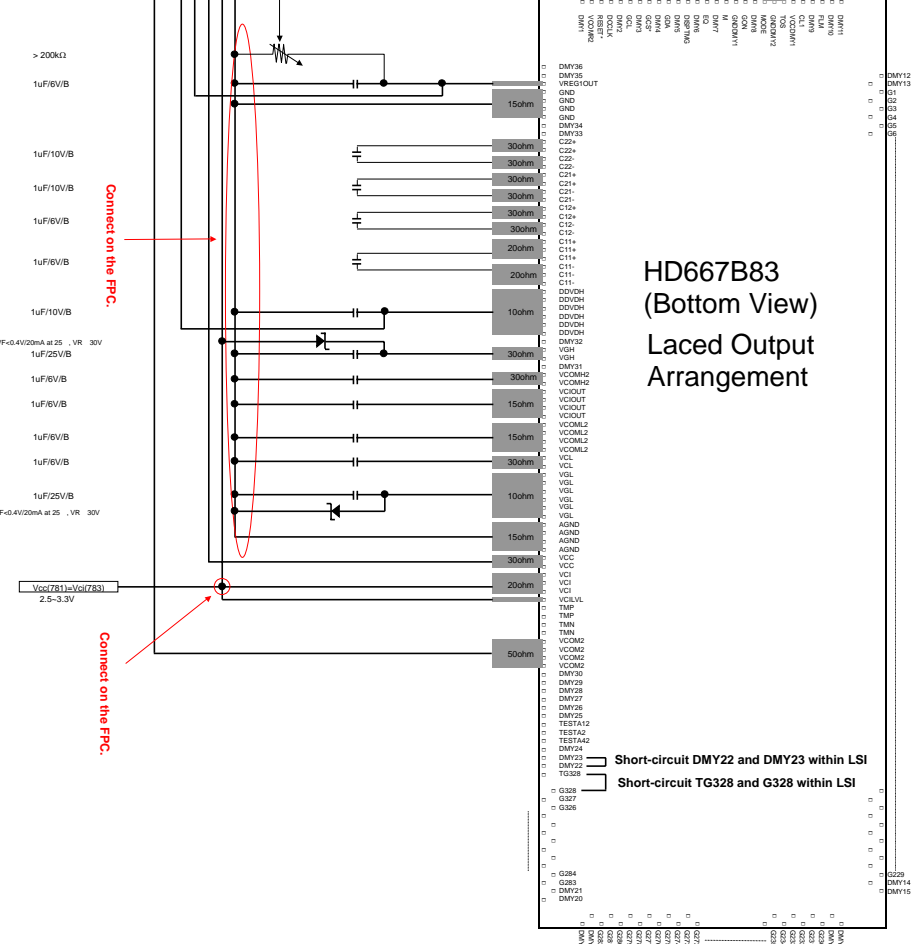

Gate electrode

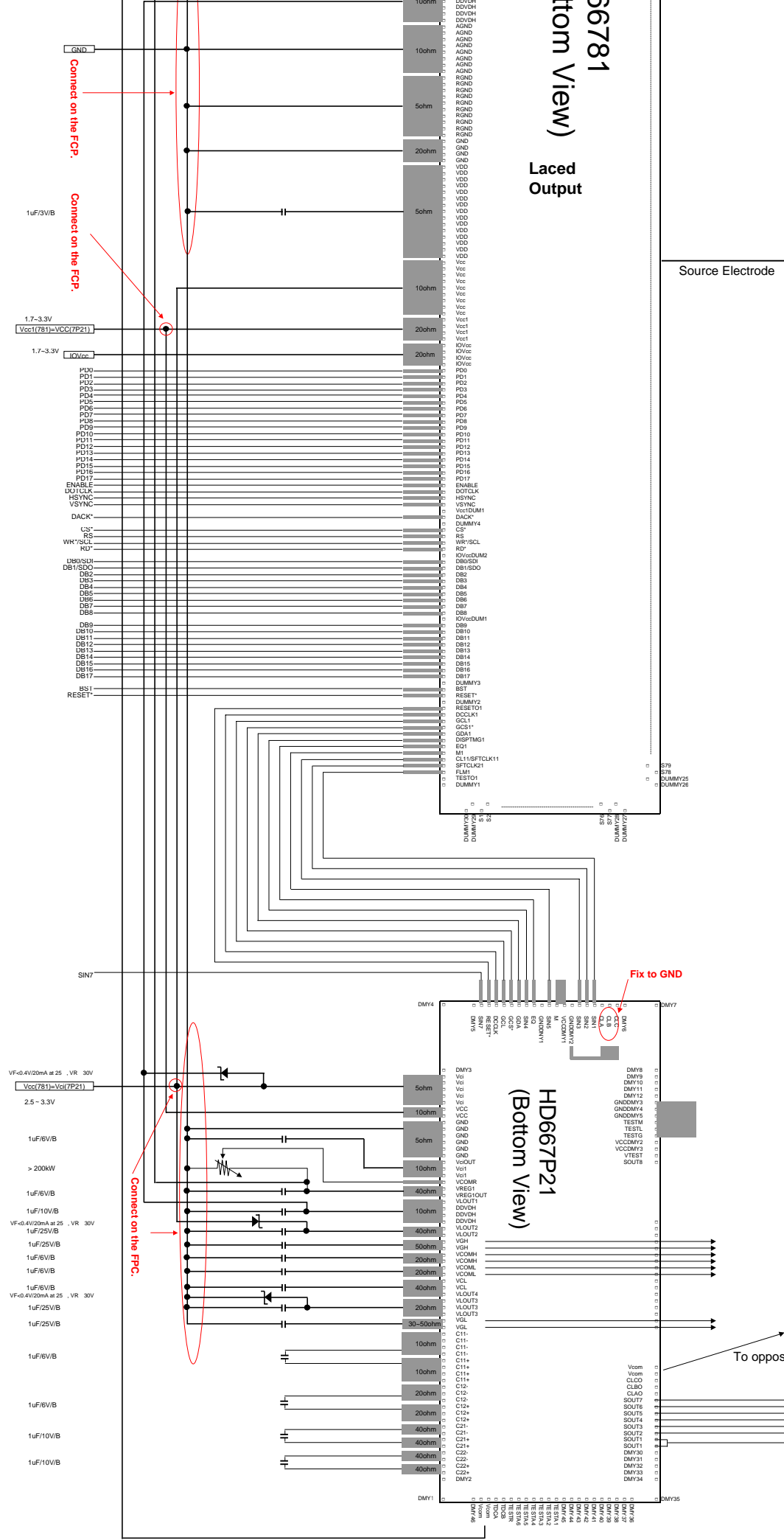

Poly-Si TFT

IOVcc = 1.7V-3.3V (HD66781)  
 Vcc1 = 1.7-3.3V (HD66781)  
 Vcc = 2.5-3.3V (HD66781)  
 VCC = 1.7-3.3V (HD667P21)  
 VCI = 2.5-3.3V (HD667P21)  
 Supply a same potential to Vcc1 of HD66781 and Vcc1 of HD667P21.  
 Make sure that IOVcc Vcc1 Vcc (HD66781).

To opposing electrodes on the panel(Vcom)

Gate Circuit

## Block Function

### (1) System interface

The HD66781 has 2 kinds of high-speed system interfaces: 80-system 18-/16-/9-/8-bit bus interfaces and Serial Peripheral Interface (SPI) ports. The 8-bit bus interface is compliant to both big and little endian data outputs from the microcomputer. The interface mode is selected with the IM3-0 pins.

The HD66781 incorporates 16-bit index register (IR), write-data register (WDR), and 16-bit read-data register (RDR). The IR stores index information from the control register and GRAM. The WDR temporarily stores data to write into the control register and GRAM, and the RDR temporarily stores data read from GRAM. Data written into GRAM from MPU is first written into the WDR and then automatically written to GRAM by internal operation. Since data are read through the RDR from GRAM, the data that are read out first are invalid and the ensuing data are read out normally.

The execution time for the instructions other than oscillation start is 0-clock cycle, which enables writing instructions consecutively.

**Table 1 Register Selection (8/9/16/18 parallel interface)**

80-system bus			Operation
WR*	RD*	RS	
0	1	0	Write index to IR.
1	0	0	Read internal status
0	1	1	Write to control registers/GRAM through WDR
1	0	1	Read from GRAM through RDR

**Table 2 Register Selection (SPI)**

Start byte		Operation
RW	RS	
0	0	Write index to IR.
1	0	Read internal status
0	0	Write to control registers/GRAM through WDR
1	1	Read from GRAM through RDR

The HD66781 incorporates DMA single address mode interface to keep control on the bus occupation ratio when transferring a large volume of data. The DMA controller supporting a single address mode controls the DACK pin of HD66781 to recognize out-enable signal (OE) for SRAM as a write strobe signal. The HD66781 enables data transfer with less bus cycle by using a same bus cycle for a readout operation from an external SRAM and a write operation to HD66781. See “DMA transfer single address mode” (p.131) for details on controlling the execution of transfer and conditions in using this mode.

## (2) External Display Interface (RGB I/F, VSYNC I/F)

The HD66781 incorporates RGB and VSYNC interfaces as an external interface for displaying moving pictures. When the RGB-I/F is selected, the operation is synchronized with externally supplied signals, VSYNC, HSYNC, and DOTCLK. The display data (PD17-0) are written in accordance with the data enable signal (ENABLE). Accordingly, the display on the screen does not flicker when RAM data are being updated internally.

When the VSYNC-I/F is selected, the operation is synchronized with internal clocks except frame synchronization, which is synchronized with VSYNC signal. The display data is written to GRAM through a system interface. In this case, there are constraints on the speed and methods of updating RAM data when the VSYNC I/F is selected. For details, see the “External Display Interface” section (p.139).

The switch from and to the system interface is made through instructions. An optimum interface can be selected for the kind of display (still and/or moving pictures). The display data are all written to GRAM through the RGB-I/F. This enables transmission of data only when the display on the screen is being updated, and thereby reduces the data transmission as well as consumption of power when a moving picture is displayed.

## (3) Address Counter (AC)

The address counter (AC) assigns the address to GRAM. When a set-address instruction is written to the IR, the address information is sent from the IR to the AC. After writing data into GRAM, the AC is automatically incremented or decremented by 1, while after data are read from GRAM, the AC is not updated. Window address function enables data write only in the rectangular area of GRAM specified by the window address.

## (4) Graphic RAM (GRAM)

GRAM is a graphics RAM that stores 224,640-byte bit-pattern data, where one pixel is expressed by 18 bits. Maximum 240 RGB x 320 can be displayed by using both main/sub panels. Besides data of 240 RGB x 320 lines for a base image, it can store OSD data of 240 RGB x 96 lines. The allocation of the numbers of lines for a base image and an OSD image is changeable.

## (5) Grayscale Voltage Generation Circuit

The grayscale voltage generation circuit generates an LCD drive voltage according to the grayscale level set in the  $\gamma$ -correction register. Simultaneously 262,144 colors are available for display.

**(6) Timing generator**

Timing generator generates a timing signal for the operation of internal circuits such as GRAM. The timing for display operation such as RAM read and the internal operation timing such as access from MPU are generated in a way to avoid mutual interfere. Also the signals interfacing with gate driver/power supply IC (M, FLM, CL1/SFTCLK1, SFTCLK2, EQ, DCCLK, and DISPTMG) are generated.

**(7) Oscillation Circuit (OSC)**

The HD66781 generates R-C oscillation simply by placing an external oscillation-resistor between the OSC1 and OSC2 pins. The oscillation frequency is changeable with the value of external resistor. Adjust oscillation frequency in accordance to an operation voltage, display size, and frame frequency. During the standby mode, the R-C oscillation is halted to reduce power consumption. For details, see "Oscillation Circuit" (p.173).

**(8) Liquid Crystal Display Driver Circuit**

The LCD driver circuit consists of a 720-output source driver (S1 ~ S720). Display pattern data are latched when 720-bit data arrive. The latched data controls the source driver and generates drive waveforms. The shift direction of 720-bit output from source driver is changeable with SS bit. Select an appropriate shift direction for the assembly.

**(9) Gate driver/power supply IC interfacing circuit**

Gate driver/power supply IC interfacing circuit is a serial interface circuit to interface with the HD66783 and the HD667P21. When making settings for instructions to the HD66783 or the HD667P21 through the HD66781, values set in the register of HD66781 are transferred through this serial interface circuit. The transfer starts by making a serial transfer ENABLE setting. Both transfer of instruction to the HD66783/HD667P21 and read out from the HD66781 are impossible during standby mode. For details, see "Gate Driver/Power Supply IC interface control" (p.70).

**(10) Internal Logic Power Supply Regulator**

Internal logic power supply regulator generates power supply VDD for the internal logic.





**Relation between GRAM data and Display data (SS=0, BGR=0)**

The following figure illustrates the relationship between data on GRAM and display data through each interface.

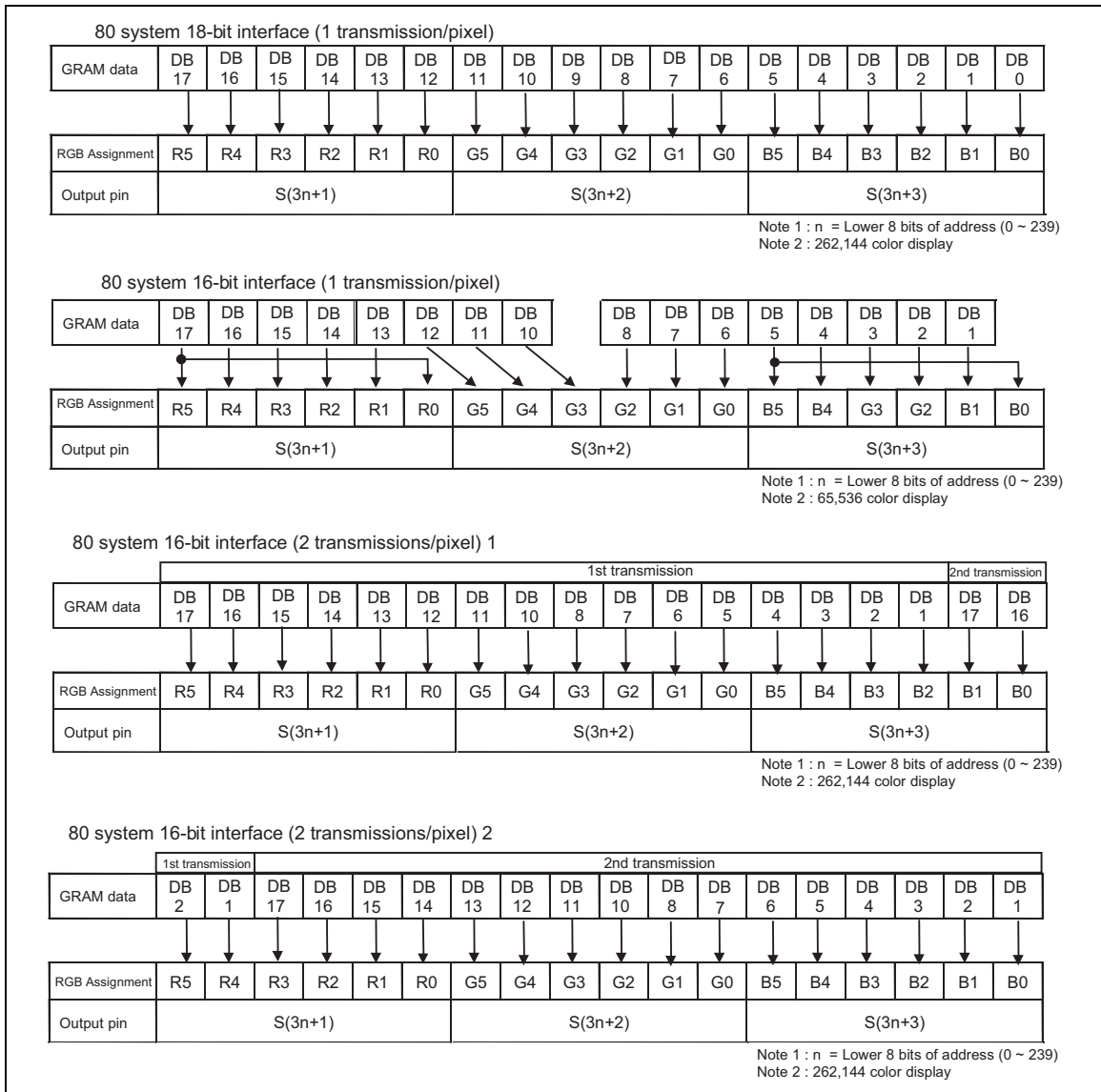

**80-system 18/16-bit interface (SS = 0, BGR = 0)**

80 system 9-bit interface (2 transmissions/pixel)

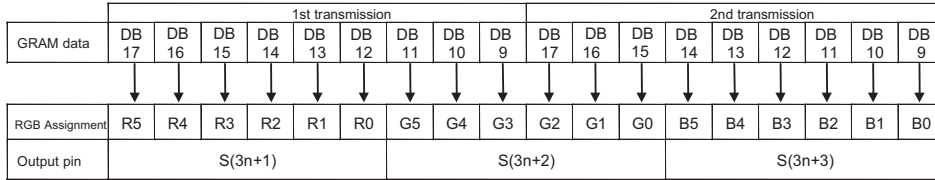

Note 1 : n = Lower 8 bits of address (0 ~ 239)  
 Note 2 : 262,144 color display

80 system 8-bit interface (big endian)/ SPI (2 transmissions/pixel)

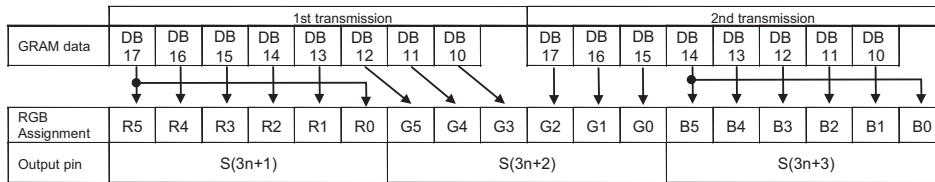

Note 1 : n = lower 8 bits of address (0 ~ 239)  
 Note 2 : 65,536 color display

80 system 8-bit interface / (3 transmissions/pixel) 1

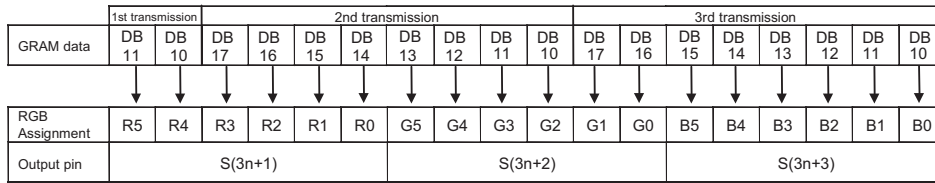

Note 1 : n = lower 8 bits of address (0 ~ 239)  
 Note 2 : 262,144 color display

80 system 8-bit interface / (3 transmissions/pixel) 2

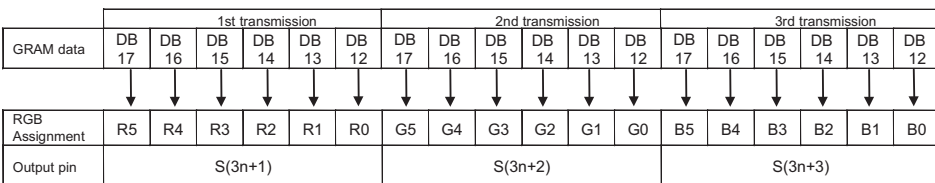

Note 1 : n = lower 8 bits of address (0 ~ 239)  
 Note 2 : 262,144 color display  
 Note 3 : Upper 2-bit data of each transmission are not used.

80 system 8-bit interface (little endian) / (2 transmissions/pixel)

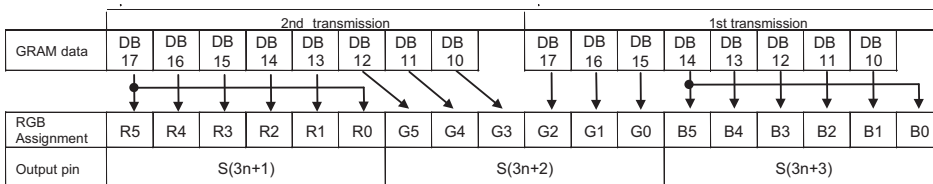

Note 1 : n = lower 8 bits of address (0 ~ 239)  
 Note 2 : 65,536 color display

**80-system 9/8-bit interface (SS = 0, BGR = 0)**

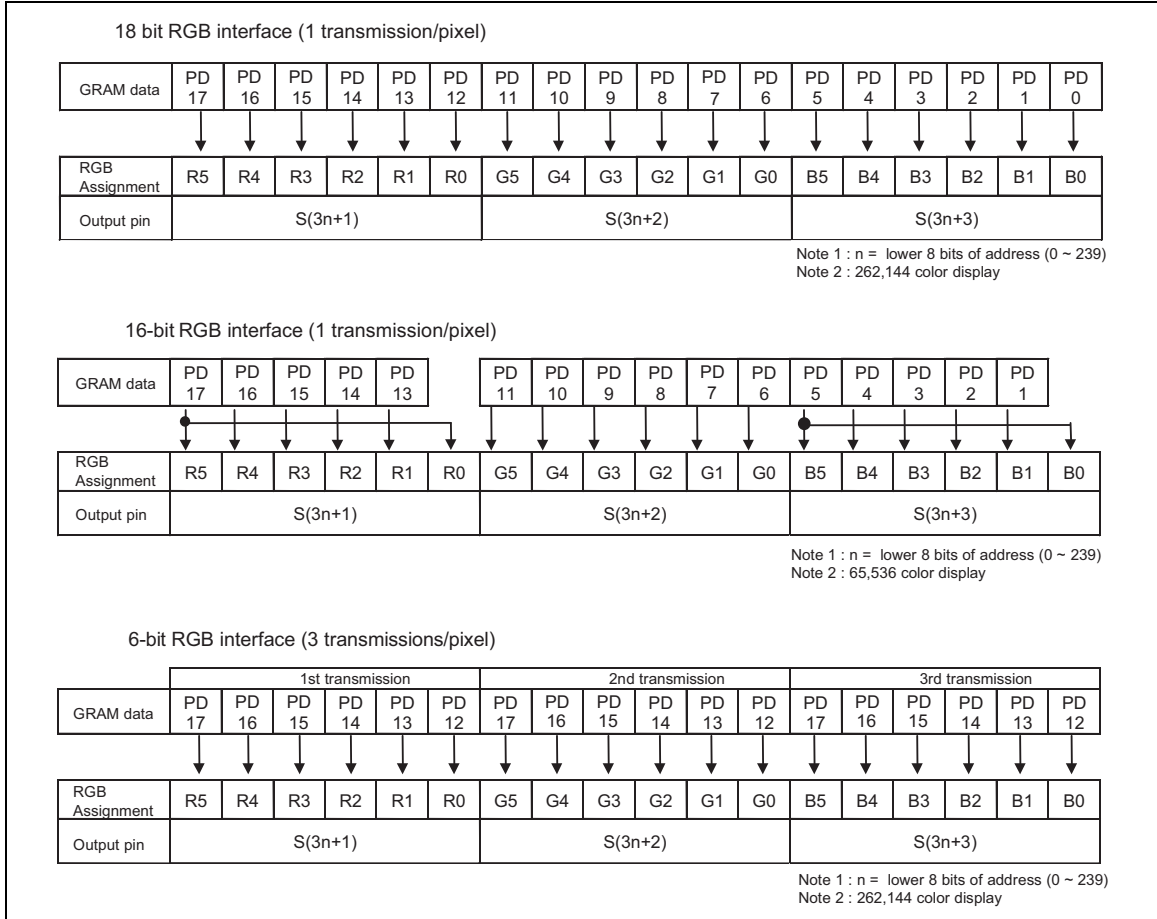

**RGB interface (SS = 0, BGR = 0)**



Relation between GRAM data and Display data (SS=1, BGR=1)

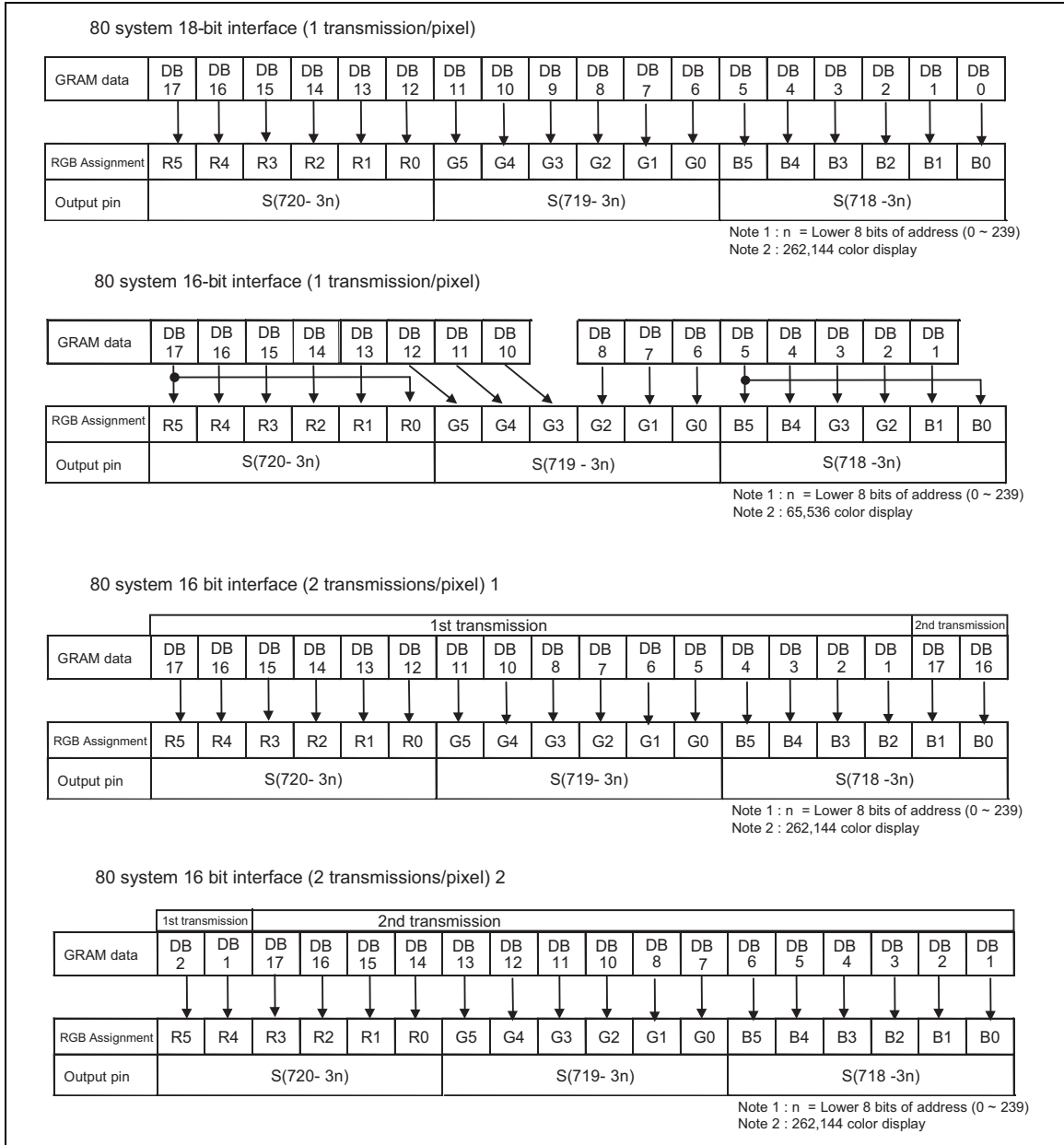

80 system 9-bit interface (2 transmissions/pixel)

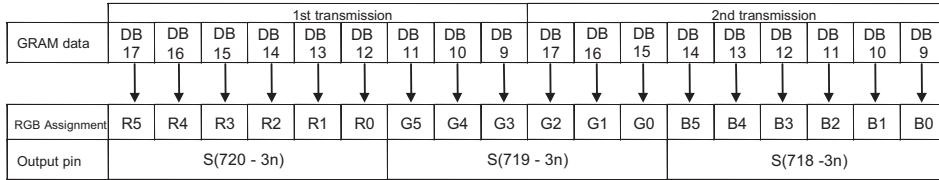

Note 1 : n = Lower 8 bits of address (0 ~ 239)  
 Note 2 : 262,144 color display

80 system 8-bit interface (big endian) / SPI (2 transmissions/pixel)

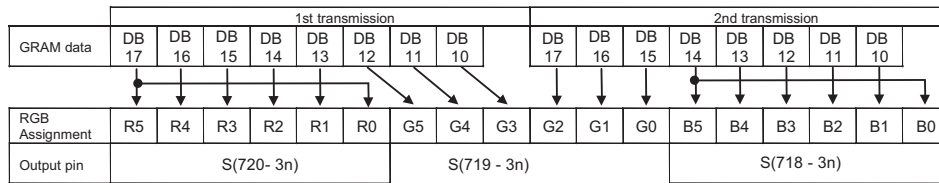

Note 1 : n = lower 8 bits of address (0 ~ 239)  
 Note 2 : 65,536 color display

80 system 8-bit interface / (3 transmissions/pixel) 1

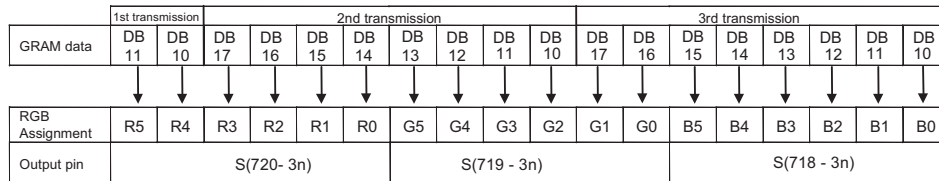

Note 1 : n = lower 8 bits of address (0 ~ 239)  
 Note 2 : 262,144 color display

80 system 8-bit interface / (3 transmissions/pixel) 2

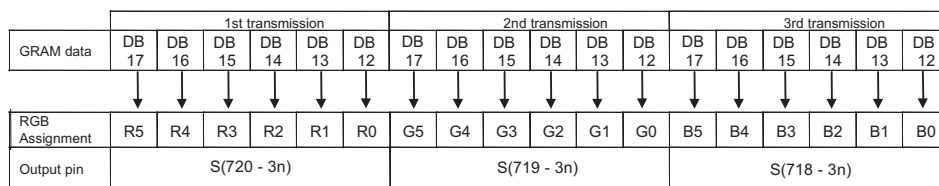

Note 1 : n = lower 8 bits of address (0 ~ 239)  
 Note 2 : 262,144 color display  
 Note 3 : Upper 2-bit data of each transmission are not used.

80 system 8-bit interface (little endian) / (2 transmissions/pixel)

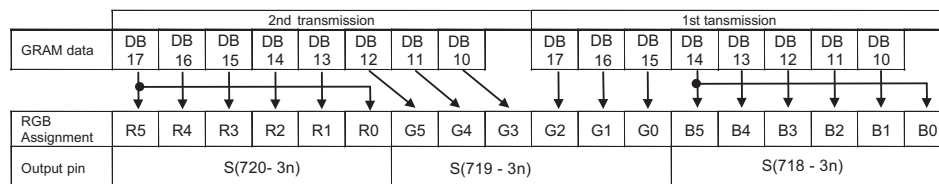

Note 1 : n = lower 8 bits of address (0 ~ 239)  
 Note 2 : 65,536 color display

**80-system 9/8-bit interface (SS = 1, BGR = 1)**

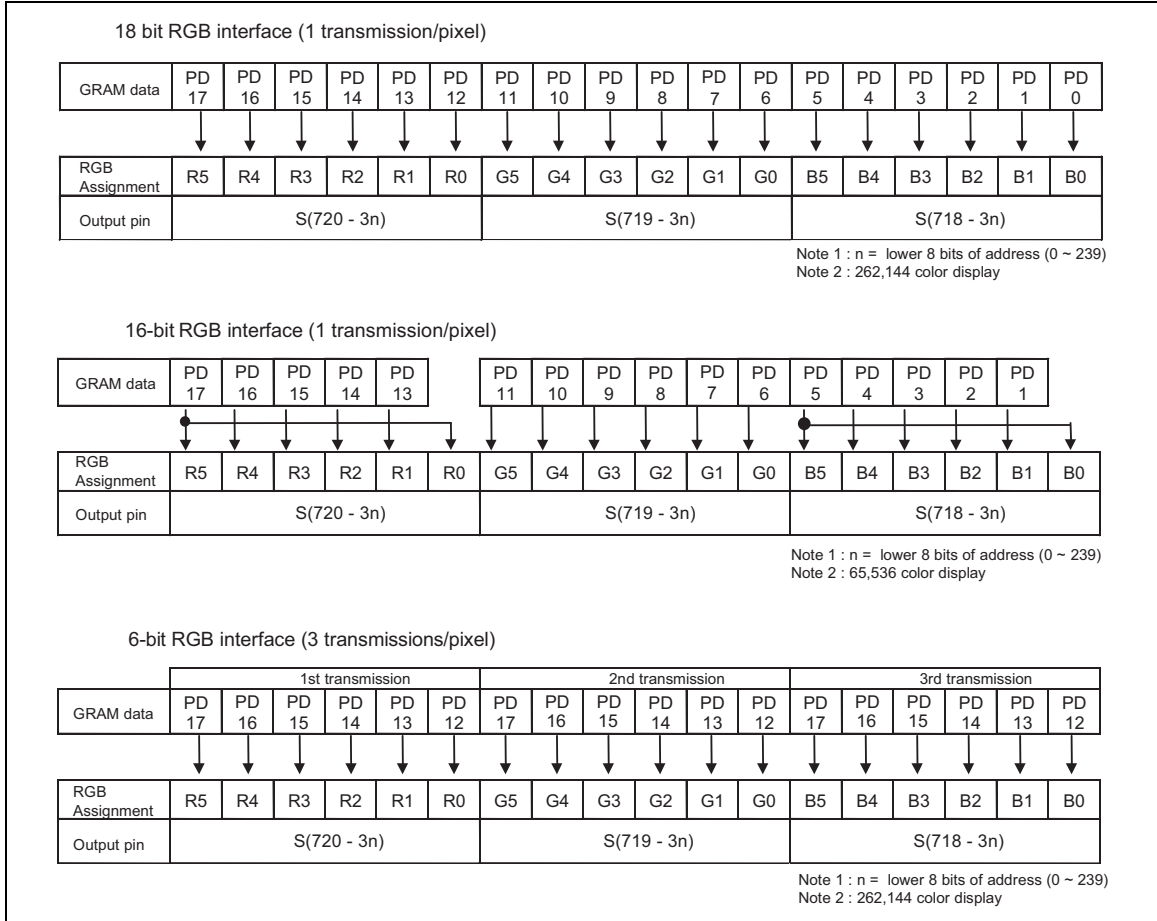

**RGB interface (SS = 1, BGR = 1)**

## Instruction

### Outline

The HD66781 adapts an 18-bit bus architecture that enables high-speed interfacing with high-performance microcomputers. The HD66781 starts internal processing of 18/16/9/8/-bit data sent from external after storing control information in the instruction register (IR) and data register (DR). Since the internal operation of HD66781 is determined by signals sent from the microcomputer, register selection signal (RS), read/write signal (R/W), and internal 16-bit data bus signals (DB15 to DB0) are called instructions. GRAM is accessed through internal 18-bit data bus. The HD66781 has ten categories of instruction.

1. Specify index
2. Read status
3. Control display
4. Power management control
5. Graphics data processing
6. Set internal GRAM address
7. Transfer data to and from internal GRAM
8. Make an internal  $\gamma$ -adjustment
9. Control a panel
10. Control OSD display

Normally, the instruction to write data on GRAM is used the most often. The address of internal GRAM is updated automatically after data are written to the internal GRAM. With window address function, this reduces the amount of data transmission to minimum and thereby lightens the load on the program processed by the microcomputer. Since instructions are executed in 0 cycle, it is possible to write instructions consecutively.



**Instruction data format**

As the following figure shows, the assignment to the 16 instruction bits (IB15-0) varies according to the interface in use. An instruction must adopt the data format for each interface.

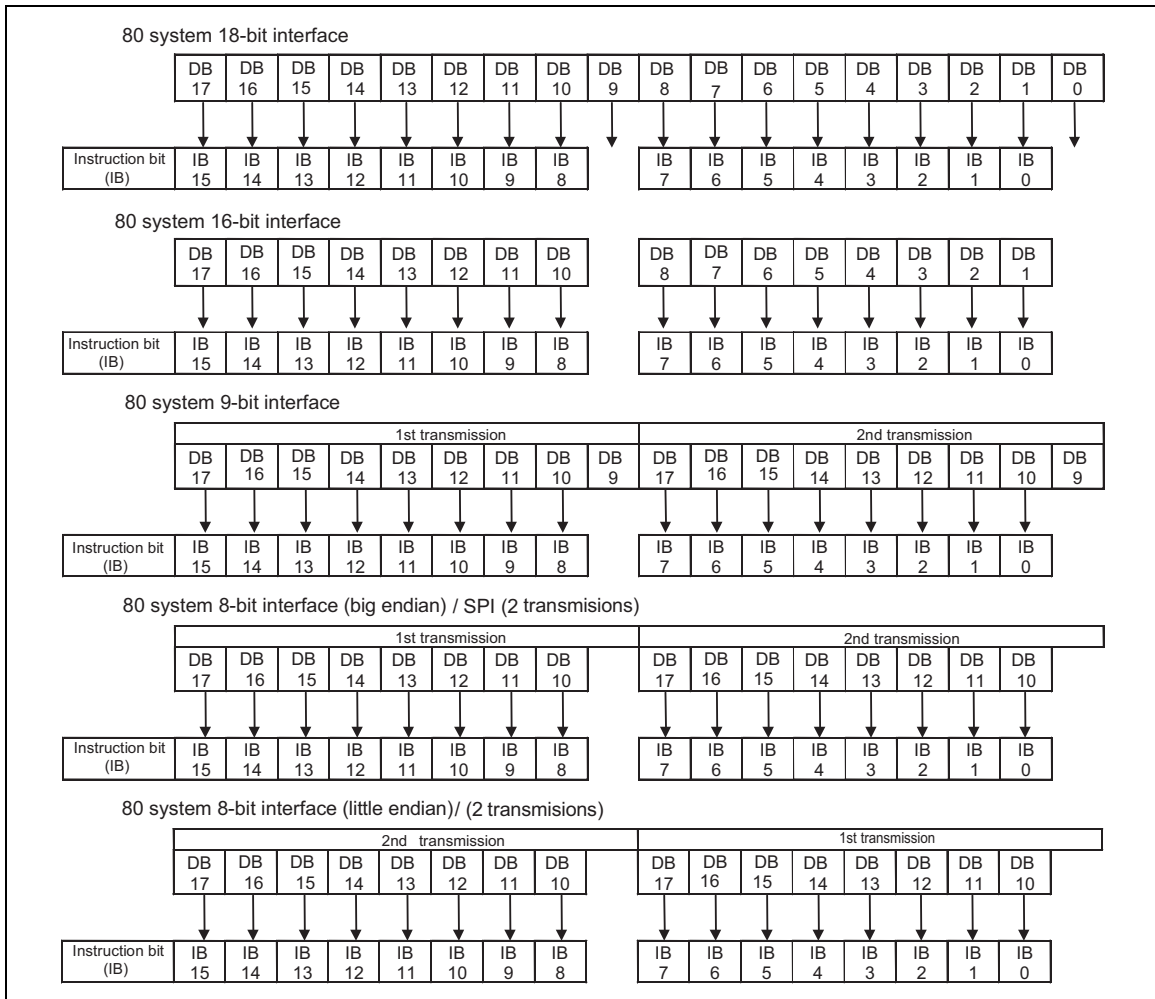

**80-system interface instruction data format**

### Basic Operation modes

The basic operation modes of HD66781 and transitions between the modes are illustrated as follows. A transition between the modes must be made according to the instruction setting flow.

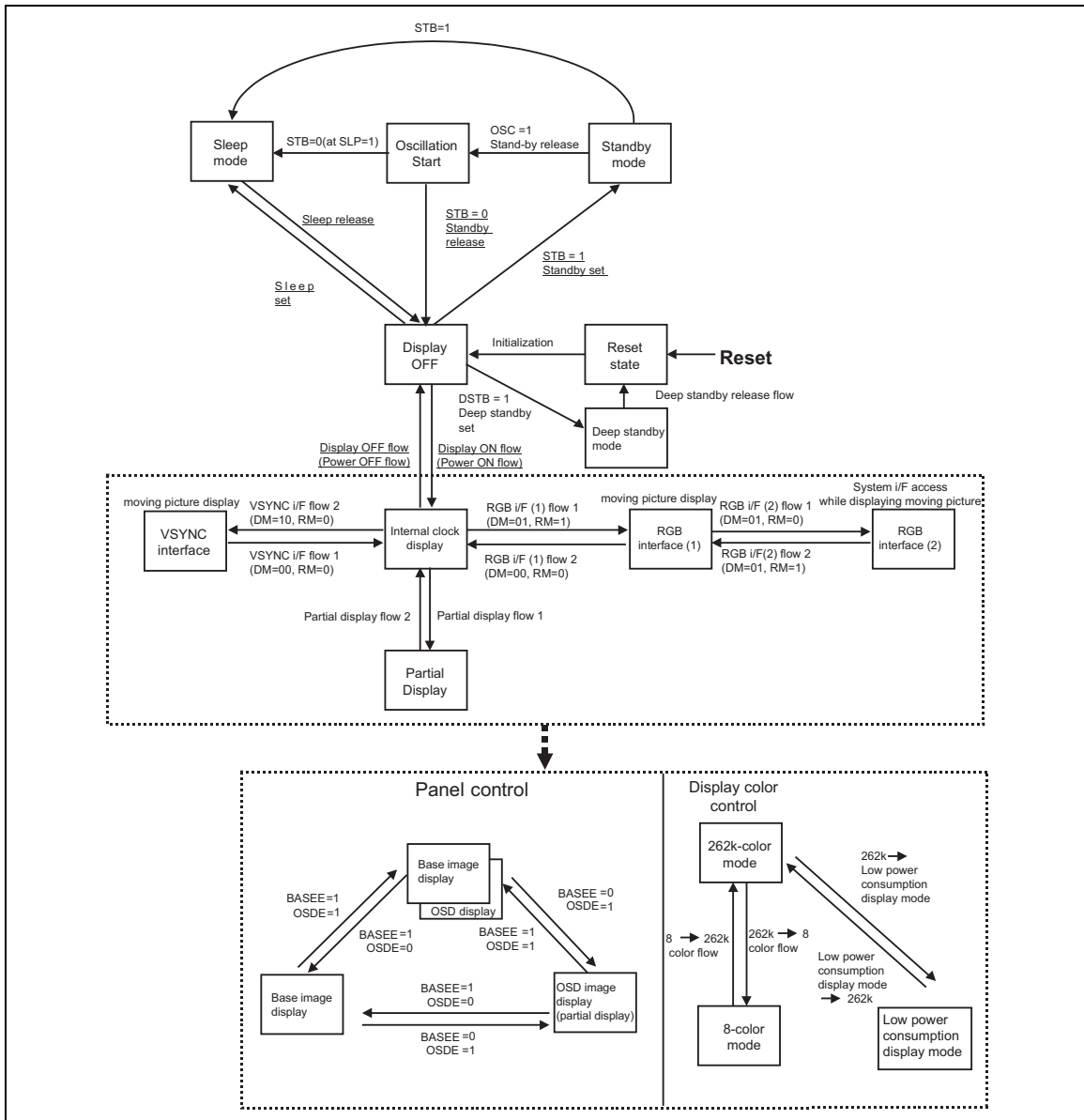

Basic operation modes

**Instructions**

The following are detail explanations of instructions with illustrations of instruction bits (IB15-0) assigned to each interface.

**Index/Status/Display control instruction**

**Index (IR)**

R/W	RS	IB15	IB14	IB13	IB12	IB11	IB10	IB9	IB8	IB7	IB6	IB5	IB4	IB3	IB2	IB1	IB0
W	0	*	*	*	*	*	ID10	ID9	ID8	ID7	ID6	ID5	ID4	ID3	ID2	ID1	ID0

The index instruction specifies the control register and the RAM control indexes that are accessed (R000h to R508h). The register number is set in binary from “000\_0000\_0000” to “101\_0000\_1000”. Do not access to the registers and bits to which the index and the instruction bit are not assigned.

**Status read (SR)**

R/W	RS	IB15	IB14	IB13	IB12	IB11	IB10	IB9	IB8	IB7	IB6	IB5	IB4	IB3	IB2	IB1	IB0
R	0	0	0	0	0	0	0	0	L8	L7	L6	L5	L4	L3	L2	L1	L0

SR read the internal status of HD66781.

**L[8:0]:** Indicate the position of the raster-row driving liquid crystal.

**Start Oscillation (R000h)**

R/W	RS	IB15	IB14	IB13	IB12	IB11	IB10	IB9	IB8	IB7	IB6	IB5	IB4	IB3	IB2	IB1	IB0
W	1	*	*	*	*	*	*	*	*	*	*	*	*	*	*	*	1
R	1	0	0	0	0	0	1	1	1	1	0	0	0	0	1	0	0

The start oscillation instruction restarts the oscillator in a halt state during the standby mode. After executing this instruction, wait at least 10ms for stabilizing oscillation before issuing a next instruction. For details, see “ Standby/Sleep mode” (p190.). The device code “0781”H is read out when this register is forced to read out.

**Driver Output Control (R001h)**

R/W	RS	IB15	IB14	IB13	IB12	IB11	IB10	IB9	IB8	IB7	IB6	IB5	IB4	IB3	IB2	IB1	IB0
W	1	0	0	0	LTPS	0	0	0	SS	0	0	0	0	0	0	0	0

**LTPS:** Select the type of a panel. The output waveforms from SFTCLK1, 2 vary according to the setting of the panel. When LTPS = 0, a-Si TFT panel waveforms are output. When LTPS = 1, low temperature poly-Si TFT panel waveforms are output. See SFTCLK waveforms (p.67) for detail.

Make a setting for this register when D[1:0] = 2'h0.

**SS:** Select the correspondence between RAM write address and source driver output.

SS = "0": data written in H'00000 is output from S1.

SS = "1": data written in H'00000 is output from S720.

For details, see "GRAM Address Map".

By making settings for both SS and RGB bits, the assignment of RGB dots to the S1 ~ S720 pins is determined.

When SS = 0 and BGR = 0, R, G, B are assigned interchangeably in this order from S1 to S720.

When SS = 1 and BGR = 1, R, G, B are assigned interchangeably in this order from S720 to S1.

Changes in the SS and BGR settings require RAM data rewrite.

**LCD Driving Wave Control (R002h)**

R/W	RS	IB15	IB14	IB13	IB12	IB11	IB10	IB9	IB8	IB7	IB6	IB5	IB4	IB3	IB2	IB1	IB0
W	1	0	0	0	0	FLD1	FLD0	B/C	EOR	0	0	NW5	NW4	NW3	NW2	NW1	NW0

**NW[5:0]:** Specify "n", the number of raster-rows from 1 to 64, to alternate every n+1 raster-rows when C-pattern waveform is generated (B/C = 1).

**EOR:** When EOR = 1, alternations occur by applying EOR (exclusive OR) operation to an odd/even frame select signal and an n-raster-row inversion signal while a C-pattern waveform is generated (B/C=1). This instruction is used when liquid crystal alternate drive is not available due to a combination of numbers of LCD raster-rows and the value of "n". For details, see "n-raster-row inversion Alternate drive"(p.174).

**B/C:** When B/C =0, field alternating waveforms are generated. Alternation occurs every frame to drive liquid crystal. When B/C=1, alternation occurs every n raster-rows. For details, see the "n-raster-row Inversion alternating Drive" section.

**FLD[1:0]:** Specify the number of fields for n-field interlaced drive. For details, see the “Interlaced Drive”(p.175) section.

**Table 5**

FLD [1:0]	Numbers of fields
2'h0	Setting disabled
2'h1	1 field (= 1 frame)
2'h2	Setting disabled
2'h3	3 fields

Note 1) This instruction is not available with the external display interface. In the external display interface mode, make sure FLD[1:0] = 2'h1.

The following functions are not available during interlaced drive (FLD =2'h3).

**Table 6**

Unavailable functions when FLD = 2'h3
External display interface
OSD function ( $\alpha$ blending)
Scroll function
Resizing function (vertical direction magnification)

**Entry Mode 1 (R003h)**

R/W	RS	IB15	IB14	IB13	IB12	IB11	IB10	IB9	IB8	IB7	IB6	IB5	IB4	IB3	IB2	IB1	IB0
W	1	TRI	DFM	0	BGR	0	0	HWM	0	0	0	I/D1	I/D0	AM	0	OSD	ODF

This instruction is for writing data from the microcomputer to the internal GRAM of HD66781.

**ODF:** Set the format to write OSD data to the internal RAM. When ODF =0, assign transmission rate bits ( $\alpha$  channel) to the LSB of RGB data. When ODF = 1, assign transmission rate bit ( $\alpha$  channel) to the MSB. OSD bit must be “1” when writing OSD data.

**Table 7 BGR = 0**

OSD	ODF	D17	D16	D15	D14	D13	D12	D11	D10	D9	D8	D7	D6	D5	D4	D3	D2	D1	D0
0	*	R5	R4	R3	R2	R1	R0	G5	G4	G3	G2	G1	G0	B5	B4	B3	B2	B1	B0
1	0	R5	R4	R3	R2	R1	$\alpha 2$	G5	G4	G3	G2	G1	$\alpha 1$	B5	B4	B3	B2	B1	$\alpha 0$
1	1	$\alpha 2$	$\alpha 1$	$\alpha 0$	R4	R3	R2	R1	R0	G4	G3	G2	G1	G0	B4	B3	B2	B1	B0

**Table 8 BGR =1**

OSD	ODF	D17	D16	D15	D14	D13	D12	D11	D10	D9	D8	D7	D6	D5	D4	D3	D2	D1	D0
0	*	B5	B4	B3	B2	B1	B0	G5	G4	G3	G2	G1	G0	R5	R4	R3	R2	R1	R0
1	0	B5	B4	B3	B2	B1	$\alpha 0$	G5	G4	G3	G2	G1	$\alpha 1$	R5	R4	R3	R2	R1	$\alpha 2$
1	1	$\alpha 0$	$\alpha 1$	$\alpha 2$	B4	B3	B2	B1	B0	G4	G3	G2	G1	G0	R4	R3	R2	R1	R0

**Table 9**

$\alpha 2$	$\alpha 1$	$\alpha 0$	Transmission rate	Display screen
0	0	0	0%	Base picture display
0	0	1	-	Setting disabled
0	1	0	25%	Base picture (75%) + OSD image (25%) display
0	1	1	75%	Base picture (25%) + OSD image (75%) display
1	0	0	50%	Base picture (50%) + OSD image (50%) display
1	0	1	-	Setting disabled
1	1	0	100%	OSD image display
1	1	1	-	Setting disabled

**OSD:** Set RAM write data as OSD data. Set OSD =1, when writing OSD data. By setting OSD to 1, OSD data are written to the internal RAM according to the format set by ODF.

OSD =0: Write normal picture data (18-bit RGB) to RAM

OSD =1: Write OSD image data (18-bit ( $\alpha$ +RGB)) to RAM

**AM:** Set the automatic updating method of address counter after data are written to GRAM.

AM =0, the address counter is updated in horizontal direction.

AM =1, the address counter is updated in vertical direction.

When a window-address range is specified, data are written in the window-address range specified within the GRAM in accordance with I/D1-0 and AM setting.

**I/D[1:0]:** I/D sets automatic increment (+1) and automatic decrement (-1) of address counter (AC) after data are written to GRAM. When I/D=0, the address counter is incremented or decremented in horizontal direction (lower address: AD7-0). When I/D=1, the address counter is incremented or decremented in vertical direction (upper address: AD16-8). The AM bit specifies the address transition direction when data are being written to GRAM.

**HWM:** When HWM =1, data are written to GRAM in high speed with low power consumption. In power saving high-speed write mode, the data in the horizontal line of rectangular area specified by the window address are stored in the line buffer and one-line data are written to GRAM at once. This minimizes the number of RAM access required to write data and thereby reduces power consumption.

When HWM =1, the data write in horizontal direction must be executed by line of the specified window-address range. If data write is terminated in the middle of the line, data in that line are not correctly written to GRAM.

Note 1) Insertion of dummy write is not required in high-speed write mode.

Note 2) Data in the buffer will be erased if RAM write is terminated in the middle of a line and other instruction set is executed.

Note 3) In the high-speed write mode, wait at least 2 write cycles ( $t_{cyw}$ ) of the normal write mode after RAM write before making a transition from RAM write to index write.

**BGR:** Change the order of (R), (G), (B) dots to (B), (G), (R) when the dots are assigned to the 18-bit write data.

BGR=0, the dot order (R), (G), (B) is not changed when 18-bit data are written to GRAM.

BGR =1, the dot order changes from (R), (G), (B) to (B), (G), (R) when 18-bit data are written to GRAM. The assignment of  $\alpha$  bit of OSD data is also changed.

**DFM:** Set the data format for 3-RAM-write 18-bit data transfers in 80-system 8-bit interface (big-endian) mode when IM3-0 = GND/GND/ Vcc1/Vcc1 in conjunction with TRI.

DFM =0, RGB 18-bit data are written to GRAM by byte-boundary 3 transfers.

DFM =1, RGB 18-bit data are written to GRAM by 3 x 6-bit transfer.

Set the data format for 2-RAM-write 18-bit data transfers in 80-system 16-bit interface mode when IM3-0 = GND/GND/Vcc1/GND in conjunction with TRI.

DFM =0, RGB 18-bit data are written to GRAM in the MSB format by 2 transfers.

DFM =1, RGB 18-bit data are written to GRAM in the LSB format by 2 transfers.

DFM must be set to 0, when not using 8- or 16-bit interface.

**TRI:** Make the 3-RAM-write transfers available in 80-system 8-bit interface (big-endian) when IM3-0 = GND/GND/Vcc1/Vcc1.

TRI =0, 16-bit RAM data are transferred in 2 transfers.

TRI =1, 18-bit RAM data are transferred in 3 transfers.

Make the 2-RAM-write transfers available in 80-system 16-bit interface (big-endian) when IM3-0 = GND/GND/Vcc1/GND.

TRI =0, 16-bit RAM data are transferred in one transfer.

TRI =1, 18-bit RAM data are transferred in 2 transfers.

TRI must be set to 0, when not using 8- or 16-bit interface. During RAM read, set TRI = 0.

TRI	DFM	8-bit interface RAM write transmission formula
0	*	<p>IM3-0 = (GND, GND, Vcc1, Vcc1)</p> <p>80 system 8-bit interface(big endian) (2 transmissions/pixel) 65,536 colors</p> <p>GRAM data: 1st transmission (DB 17, DB 16, DB 15, DB 14, DB 13, DB 12, DB 11, DB 10); 2nd transmission (DB 17, DB 16, DB 15, DB 14, DB 13, DB 12, DB 11, DB 10)</p> <p>RGB Assignment: R5, R4, R3, R2, R1, R0, G5, G4, G3, G2, G1, G0, B5, B4, B3, B2, B1, B0</p>
0	*	<p>IM3-0 = (GND, Vcc1, Vcc1, Vcc1)</p> <p>80 system 8-bit interface (little endian) (2 transmissions/pixel) 65,536 colors</p> <p>GRAM data: 2nd transmission (DB 17, DB 16, DB 15, DB 14, DB 13, DB 12, DB 11, DB 10); 1st transmission (DB 17, DB 16, DB 15, DB 14, DB 13, DB 12, DB 11, DB 10)</p> <p>RGB Assignment: R5, R4, R3, R2, R1, R0, G5, G4, G3, G2, G1, G0, B5, B4, B3, B2, B1, B0</p>
1	0	<p>IM3-0 = (GND, GND, Vcc1, Vcc1)</p> <p>80 system 8-bit interface (3 transmissions/pixel) 262,144 colors</p> <p>GRAM data: 1st transmission (DB 11, DB 10, DB 17, DB 16, DB 15, DB 14, DB 13, DB 12, DB 11, DB 10); 2nd transmission (DB 17, DB 16, DB 15, DB 14, DB 13, DB 12, DB 11, DB 10); 3rd transmission (DB 17, DB 16, DB 15, DB 14, DB 13, DB 12, DB 11, DB 10)</p> <p>RGB Assignment: R5, R4, R3, R2, R1, R0, G5, G4, G3, G2, G1, G0, B5, B4, B3, B2, B1, B0</p>
1	1	<p>IM3-0 = (GND, GND, Vcc1, Vcc1)</p> <p>80 system 8-bit interface (3 transmissions/pixel) 262,144 colors</p> <p>GRAM data: 1st transmission (DB 17, DB 16, DB 15, DB 14, DB 13, DB 12, DB 17, DB 16, DB 15, DB 14, DB 13, DB 12); 2nd transmission (DB 17, DB 16, DB 15, DB 14, DB 13, DB 12); 3rd transmission (DB 17, DB 16, DB 15, DB 14, DB 13, DB 12)</p> <p>RGB Assignment: R5, R4, R3, R2, R1, R0, G5, G4, G3, G2, G1, G0, B5, B4, B3, B2, B1, B0</p>

**8-bit interface: RAM write transmission**

Note 1) Instruction setting is transferred by 2 x 8-bit transmissions regardless of TRI and DFM settings.



TRI	DFM	16-bit interface RAM write transmission formula
0	*	<p>80 system 16-bit interface (1 transmission/pixel) 65,536 colors</p>
1	0	<p>80 system 16-bit interface (2 transmissions/pixel) 262,144 colors</p>
1	1	<p>80 system 16-bit interface (2 transmissions/pixel) 262,144 colors</p>

**16-bit interface: RAM write transmission**

Note 1) Instruction setting is transferred by 1 x 16-bit transmission regardless of TRI and DFM settings.

Direction Setting	I/D1-0 = "00" Horizontal: Decrement Vertical: Decrement	I/D1-0 = "01" Horizontal: Increment Vertical: Decrement	I/D1-0 = "10" Horizontal: Decrement Vertical: Increment	I/D1-0 = "11" Horizontal: Increment Vertical: Increment
AM = "0" Horizontal				
AM = "1" Vertical				

**Address direction setting**

Note 1) When a window-address range is specified, write operation is executed only within the specified window-address range of GRAM.

**Resizing Control 1/2 (R004/R005h)**

R/W	RS	IB15	IB14	IB13	IB12	IB11	IB10	IB9	IB8	IB7	IB6	IB5	IB4	IB3	IB2	IB1	IB0
W	1	0	0	0	0	0	0	RCV <sub>1</sub>	RCV <sub>0</sub>	0	0	RCH1	RCH0	0	0	RSR1	RSR0
W	1	RSE <sub>V7</sub>	RSE <sub>V6</sub>	RSE <sub>V5</sub>	RSE <sub>V4</sub>	RSE <sub>V3</sub>	RSE <sub>V2</sub>	RSE <sub>V1</sub>	RSE <sub>V0</sub>	0	0	0	0	0	0	0	RSEH

**RSR[1:0]:** Set the contraction scale which is applied during RAM write. When the resizing scale is set, data are written to RAM according to this bit scale in horizontal and vertical directions. See the “Resizing Function” (p.105) section for details.

**RCH[1:0]:** RCH specifies the number of surplus pixels in the horizontal direction, which are made after resizing a picture. By specifying the number of surplus pixels, it is possible to disregard the surplus pixels when data are transferred. This instruction is only available with resizing function. Set RCH = 2'h0 when resizing function is not used (RSR = 2'h0).

**RCV[1:0]:** RCV specifies the number of surplus pixels in the vertical direction, which are made after resizing a picture. By specifying the number of surplus pixels, it is possible to disregard the surplus pixels when data are transferred. This instruction is only available with resizing function. Set RCV = 2'h0 when resizing function is not used (RSR = 2'h0).

**RSEH:** Set the magnifying scale in the horizontal direction of a picture. When the magnifying scale is set, data are written to RAM according to the bit scale in horizontal direction. See “Resizing Function” for details.

**RSEV[7:0]:** Set magnifying scale in the vertical direction of a picture. When the magnifying scale is set, the data in the internal RAM are magnified when displayed.

Note 1) When using picture magnification function, the picture resizing scale register (contraction) must be RSR1-0 = 2'h0.

Note 2) When using picture contraction function, the picture resizing scale (magnification) must be set RSEV7-0 = 8'h00, RSEH = 0.

Note 3) Base picture scrolling function and vertical-direction display magnification function cannot be used simultaneously.

**Settings for resizing scales****Table 10 Resizing scale ratio setting (RSR)**

RSR[1:0]	Resizing scale
2'h0	No resizing (x 1)
2'h1	x 1/2
2'h2	Setting disabled
2'h3	x 1/4

**Table 11** Setting for the number of surplus pixel in the horizontal/vertical direction (RCV, RCH)

RCH [1:0] / RCV [1:0]	Number of pixel surplus in horizontal/vertical direction
2'h0	0 pixel
2'h1	1 pixel
2'h2	2 pixels
2'h3	3 pixels

Note 1) 1 pixel = 1RGB

**Table 12** magnification in horizontal direction (RSEH)

RSEH	Magnification
2'h0	No resizing (x1)
2'h1	2 times (x2)

**Table 13** BASE picture magnification in the vertical direction (RSEV)

RSEV [1:0]	Magnification
2'h0	No resizing (x1)
2'h1	2 times (x2)
2'h2	Setting disabled
2'h3	Setting disabled

**Table 14** OSD image 1 magnification in the vertical direction (RSEV)

RSEV [3:2]	Magnification
2'h0	No resizing (x1)
2'h1	2 times (x2)
2'h2	4 times (x4)
2'h3	Setting disabled

**Table 15** OSD image 2 magnification in the vertical direction (RSEV)

RSEV [5:4]	Magnification
2'h0	No resizing (x1)
2'h1	2 times (x2)
2'h2	4 times (x4)
2'h3	Setting disabled

**Table 16 OSD image 3 magnification in the vertical direction (RSEV)**

RSEV [7:6]	Magnification
2'h0	No resizing (x1)
2'h1	2 times (x2)
2'h2	4 times (x4)
2'h3	Setting disabled

**Display Control 1 (R007h)**

R/W	RS	IB15	IB14	IB13	IB12	IB11	IB10	IB9	IB8	IB7	IB6	IB5	IB4	IB3	IB2	IB1	IB0
W	1	0	OSD E2	OSD E1	OSD E0	0	0	0	BASE E	0	0	0	DTE	0	0	D1	D0

**D[1:0]:** The graphics display is shown when D[1] = 1, and turned off when D[1] = 0. When setting D[1] = 0, the data are retained in GRAM. This means the graphics display is instantly shown when setting D[1] to 1. When D[1] is 0 (i.e. the display is not shown) all source outputs are set to the GND level. This reduces the charged/discharged current on LCD, which is generated during liquid crystal alternate drive.

When D = 2'b01, the display operation is being executed inside the HD66781 even while the external display is turned off. When D = 2'b00, both internal and external display operations are halted.

In combination with GON and DTE bits, D1-0 bits control ON/OFF of display. For details, see the "Instruction Setting"(p.185) section.

**Table 17**

D[1:0]	Source output	HD66781 internal operation	Gate control signal/Power supply IC, LCD panel control signal (FLM, CL1/SFTCLK1, 2, DCCLK, EQ)
2'h0	GND	Halt	Halt
2'h1	GND	Continue	Continue
2'h2	Non-lit display	Continue	Continue
2'h3	Display	Continue	Continue

Note 1) Data from the microcomputer can be written to GRAM irrespective of D bit setting.

Note 2) D = 2'h00 during the standby mode. In this case, the register setting of D bit is not changed.

Note 3) A picture displayed when D = 2'b11 is specified by the BASEE setting.

**DTE:** Control the DISPTMG output.

**Table 18**

DTE	DISPTMG
0	GND
1	Vcc1/GND

**BASEE:** Set display enable of a base image. The D-bit setting takes precedence over the BASEE-bit setting.

**Table 19**

D[1:0]	BASEE	Source Output (S1~S720)
2'h0	*	GND
2'h1	*	GND
2'h2	*	Non-lit level
2'h3	0	Non-lit display
	1	Display BASE image

Note 1) The source output at the "non-lit display" level is determined according to the PTS bit setting.

Note 2) Gate lines are scanned in the manner determined by the PTS bit setting during the non-lit display.

**OSDE0:** Display enable bit for OSD image 1.

**OSDE1:** Display enable bit for OSD image 2.

**OSDE2:** Display enable bit for OSD image 3.

OSDE0/OSDE1/OSDE2 = 0, the HD66781 does not display OSD images. Only base images are displayed.

OSDE0/OSDE1/OSDE2 = 1, the HD66781 displays OSD images according to the  $\alpha$  channel bits in the pixel data of the OSD image.

When OSDE =1, while a base image is not displayed (BASEE =0), an OSD is displayed with 100% transmission rate.

**Display Control 2 (R008h)**

R/W	RS	IB15	IB14	IB13	IB12	IB11	IB10	IB9	IB8	IB7	IB6	IB5	IB4	IB3	IB2	IB1	IB0
W	1	0	0	0	0	FP3	FP2	FP1	FP0	0	0	0	0	BP3	BP2	BP1	BP0

**FP [3:0]:** Set the number of lines for a front porch (a blank period made before the end of display).

**BP [3:0]:** Set the number of lines for a back porch (a blank period made after the beginning of display).

In the external display interface mode, a back porch (BP) period starts at the falling edge of VSYNC and display operation starts after the back porch period. A front porch (FP) period starts after the numbers of raster-rows set with NL bit are driven for display. After the front porch period, a blank period continues until the next VSYNC input.

**Table 20**

FP [3:0] BP [3:0]	Number of Front porch line Number of Back porch line
4'h0	Setting disabled
4'h1	Setting disabled
4'h2	2 lines
4'h3	3 lines
4'h4	4 lines
4'h5	5 lines
4'h6	6 lines
4'h7	7 lines
4'h8	8 lines
4'h9	9 lines
4'hA	10 lines
4'hB	11 lines
4'hC	12 lines
4'hD	13 lines
4'hE	14 lines
4'hF	Setting disabled

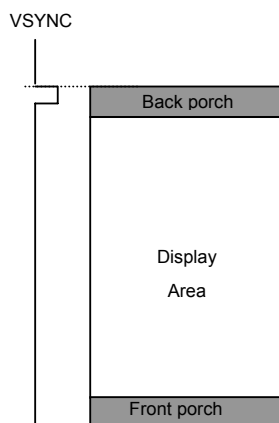

Note: The output timing to the LCD panel is delayed by 2 lines in relation to the input-synchronizing signal

Set BP, FP, and MP within the range indicated below.

**Table 21**

Internal clock operation	FLD = 2'h1	BP ≥ 2 lines	FP ≥ 2 lines	FP+BP ≤ 16 lines
	FLD = 2'h3	BP = 3 lines	FP = 5 lines	
RGB interface		BP ≥ 2 lines	FP ≥ 2 lines	FP+BP ≤ 16 lines
VSYNC interface		BP ≥ 2 lines	FP ≥ 2 lines	FP+BP = 16 lines

**Display Control 3 (R009h)**

R/W	RS	IB15	IB14	IB13	IB12	IB11	IB10	IB9	IB8	IB7	IB6	IB5	IB4	IB3	IB2	IB1	IB0
W	1	0	0	0	0	0	PTS2	PTS1	PTS0	0	0	PTG1	PTG0	ISC3	ISC2	ISC1	ISC0

**ISC [3:0]:** Specify the cycle to scan gate lines, when PTG bits set the scan mode in the non-display area to the interval scan mode. The scan cycle is always odd number of frames, and polarity inversion is applied each timing when gate lines are scanned.

**Table 22**

ISC [3:0]	Scan cycle	When (fFLM) = 60Hz
4'h0	Setting disabled	-
4'h1	3 frames	50ms
4'h2	5 frames	84ms
4'h3	7 frames	117ms
4'h4	9 frames	150ms
4'h5	11 frames	184ms
4'h6	13 frames	217ms
4'h7	15 frames	251ms
4'h8	17 frames	284ms
4'h9	19 frames	317ms
4'hA	21 frames	351ms
4'hB	23 frames	384ms
4'hC	25 frames	418ms
4'hD	27 frames	451ms
4'hE	29 frames	484ms
4'hF	31 frames	518ms

**PTG [1:0]:** Set the DISPTMG output to determine the gate bus line scan mode in non-display area. The setting is applied to all no-display areas and front/back porch periods of the entire panel.

**Table 23**

PTG[1:0]	DISPTMG output	Gate output in non-display area	Source output in non-display area
2'h0	Normal drive	Normal scan	PT setting
2'h1	GND	VGL (fixed)	PT setting
2'h2	Interval drive	Interval scan	PT setting
2'h3	Setting disabled	-	-

Note 1) Set alternating drive to frame cycle when using interval scan.

**PTS [2:0]:** Determine the kind of source outputs in the no-display area, which is applied to the front/back porch periods and non-display area of partial display. When PTS [2] =1, the grayscale voltage generating amplifiers are halted except those for the V0 and V63 levels during no-display area drive period to reduce power consumption.

Table 24

PTS[2:0]	Non-display source output		Non-display area	Non-display area
	Positive polarity	Negative polarity	Operation of grayscale amplifier	Step up clock frequency
3'h0	V63	V0	V0 to V63	DC0, DC1 setting
3'h1	Setting disabled	Setting disabled	-	DC0, DC1 setting
3'h2	GND	GND	V0 to V63	DC0, DC1 setting
3'h3	Hi-Z	Hi-Z	V0 to V63	DC0, DC1 setting
3'h4	V63	V0	V0, V63	DC0, DC1 setting x 1/2
3'h5	Setting disabled	Setting disabled	-	-
3'h6	GND	GND	V0, V63	DC0, DC1 setting x 1/2
3'h7	Hi-z	Hi-z	V0, V63	DC0, DC1 setting x 1/2

Note 1) Gate outputs in non-display area are controlled by the off-scan mode (PTG).

Note 2) Grayscale amplifier operation halt and slowdown of step-up clocks are applied to the non-display area.

Note 3) When DC[4:3]=2'h3, the frequency of step-up clocks in the non-display area are not slowed down half even if PTS[2:0] is set to 4, 6 or 7.



**Display Control 4 (R00Bh)**

R/W	RS	IB15	IB14	IB13	IB12	IB11	IB10	IB9	IB8	IB7	IB6	IB5	IB4	IB3	IB2	IB1	IB0
W	1	0	FRCON	D16B	0	0	0	0	0	0	0	0	0	0	0	COL1	COL0

**FRCON:** Make a setting for the FRC mode. Control on and off of the FRC mode.

**D16B:** When FRCON=1, the FRC mode sets in. When COL[1:0]=2'h1 and the low-power display mode, where only 32 operational amplifiers are used, the FRC mode enables display with abundant colors. For details, see “low-power display mode”(p.169).

Set D16B to 1 when using a 16-bit interface (one-transfer 16-bit interface, 2-transfer 8-bit interface, 16-bit SPI, RGB interfaces).

**Table 25**

Interface mode	FRCON	D16B	Colors
18-bit, 16-bit x2, 9-bit x2, 8-bit x3, RGB 18-bit, 6-bit x3	0	*	262,144
	1	0	250,047
16-bit x1, 8-bit x2, SPI	0	*	65,536
	1	1	64,512

Note 1) When the FRC mode is on, do not switch the interface mode settings (M, TRI, D16B registers)

Note 2) When the FRC mode is on, 18-bit format data and 16-bit format data are not displayed simultaneously.

**COL[1:0]:** When COL=2'h1, 32 grayscale operational amplifiers are halted. When making a setting, it must follow the setting sequence in the “Low Power Consumption Display Mode” section.

When COL = 2'h2, 8-color mode sets in. When making a setting, it must follow the setting sequence in the “8-Color Display Mode” section. All operational amplifiers except V0 and V63 levels are halted for low power consumption display.

**Table 26**

COL[1:0]	Amplifiers in operation	Available colors for display	
		FRCON = 0	FRCON = 1
2'h0	64	262,144 colors/65,536 colors	-
2'h1	32	32,768 colors	250,047 colors/64,512 colors
2'h2	2	8 colors	-
2'h3	Setting disabled	Setting disabled	Setting disabled

Note 1) When COL[1:0] =2'h1 and FRCON = 0, do not write data that correspond to the grayscale levels the amplifiers of which are halted.

Table 27 grayscale level amplifiers in operation (when REV=0)

amplifier	COL[1:0]			GRAM data RGB	
	2'h0	2'h1	2'h2		
V0	*	*	*	6'h00	6'h3F
V1	*			6'h01	6'h3E
V2	*	*		6'h02	6'h3D
V3	*			6'h03	6'h3C
V4	*	*		6'h04	6'h3B
V5	*			6'h05	6'h3A
V6	*	*		6'h06	6'h39
V7	*			6'h07	6'h38
V8	*	*		6'h08	6'h37
V9	*			6'h09	6'h36
V10	*	*		6'h0A	6'h35
V11	*			6'h0B	6'h34
V12	*	*		6'h0C	6'h33
V13	*			6'h0D	6'h32
V14	*	*		6'h0E	6'h31
V15	*			6'h0F	6'h30
V16	*	*		6'h10	6'h2F
V17	*			6'h11	6'h2E
V18	*	*		6'h12	6'h2D
V19	*			6'h13	6'h2C
V20	*	*		6'h14	6'h2B
V21	*			6'h15	6'h2A
V22	*	*		6'h16	6'h29
V23	*			6'h17	6'h28
V24	*	*		6'h18	6'h27
V25	*			6'h19	6'h26
V26	*	*		6'h1A	6'h25
V27	*			6'h1B	6'h24
V28	*	*		6'h1C	6'h23
V29	*			6'h1D	6'h22
V30	*	*		6'h1E	6'h21
V31	*			6'h1F	6'h20
V32	*			6'h20	6'h1F
V33	*	*		6'h21	6'h1E
V34	*			6'h22	6'h1D
V35	*	*		6'h23	6'h1C
V36	*			6'h24	6'h1B
V37	*	*		6'h25	6'h1A
V38	*			6'h26	6'h19
V39	*	*		6'h27	6'h18
V40	*			6'h28	6'h17
V41	*	*		6'h29	6'h16
V42	*			6'h2A	6'h15
V43	*	*		6'h2B	6'h14
V44	*			6'h2C	6'h13
V45	*	*		6'h2D	6'h12
V46	*			6'h2E	6'h11
V47	*	*		6'h2F	6'h10
V48	*			6'h30	6'h0F
V49	*	*		6'h31	6'h0E
V50	*			6'h32	6'h0D
V51	*	*		6'h33	6'h0C
V52	*			6'h34	6'h0B
V53	*	*		6'h35	6'h0A
V54	*			6'h36	6'h09
V55	*	*		6'h37	6'h08
V56	*			6'h38	6'h07
V57	*	*		6'h39	6'h06
V58	*			6'h3A	6'h05
V59	*	*		6'h3B	6'h04
V60	*			6'h3C	6'h03
V61	*	*		6'h3D	6'h02
V62	*			6'h3E	6'h01
V63	*	*	*	6'h3F	6'h00

\*: amplifier in operation

**External Display interface Control 1 (R00Ch)**

R/W	RS	IB15	IB14	IB13	IB12	IB11	IB10	IB9	IB8	IB7	IB6	IB5	IB4	IB3	IB2	IB1	IB0
W	1	0	0	0	0	0	0	0	RM	0	0	DM [1]	DM [0]	0	0	RIM [1]	RIM [0]

**RIM[1:0]** Make settings for the RGB interface mode when the RGB interface is selected with DM and RM bits. The setting must be made before the display through an external display interface. Do not make changes to the setting during display.

**Table 28**

RIM[1:0]	RGB interface mode	Colors
2'h0	18-bit RGB interface (1 transmission/pixel)	262,144
2'h1	16-bit RGB interface (1 transmission/pixel)	65,536
2'h2	6-bit RGB interface (3 transmission/pixel)	262,144
2'h3	Setting disabled	-

Note 1) The instruction register setting is made only through a system interface.

Note 2) Data transfer and DOTCLK input must be by the RGB unit when a 6-bit RGB interface is selected.

**DM[1:0]:** Set a display operation mode. An interface for display operation is selected by the DM setting. DM allows switching between the internal clock operation mode and the external display interface mode. Do not try to switch between the external interface modes (RGB-I/F and VSYNC-I/F).

**Table 29**

DM[1:0]	Display operation interface
2'h0	Internal clock operation
2'h1	RGB interface
2'h2	VSYNC interface
2'h3	Setting disabled-

**RM:** Set a RAM access interface. RAM access is made only through the interface specified by the RM setting. Set RM to 1 when writing display data through the RGB interface. This setting is valid irrespective of the display operation mode. Changes in display data can be made by setting RM to 0, which enables RAM data overwrite through a system interface, even while the screens are displayed through the RGB interface mode.

**Table 30**

RM	Display operation interface
0	Internal clock operation/VSYNC interface
1	RGB interface

As the following table shows, an optimum interface is selected for the kind of display by the external display interface control setting.

Write display data during moving picture display (through RGB and VSYNC interfaces) in the high-speed write mode (HWM=1), which enables high-speed RAM access with low power consumption.

**Table 31**

Kind of Display	Operation mode	RAM access setting (RM)	Display operation mode (DM)
still picture	internal clock operation only	system interface (RM = 0)	internal clock operation (DM = 2'h0)
moving picture	RGB interface (1)	RGB interface (RM = 1)	RGB interface (DM = 2'h1)
Write over still picture area during moving picture display	RGB interface (2)	system interface (RM = 0)	RGB interface (DM = 2'h1)
moving picture	VSYNC interface	system interface (RM = 0)	VSYNC interface (DM = 2'h2)

Note 1) The instruction register settings are made only through a system interface.

Note 2) No switching between the RGB and VSYNC interfaces is made.

Note 3) No change in the settings of RGB interface mode (RIM) is made during the RGB interface operation.

Note 4) See "External Display Interface" for reference to the transition flows between the modes.

Note 5) Use the RGB and VSYNC interfaces in the high-speed write mode (HWM =1).

**Internal clock mode:** All display operations are controlled by signals generated by the internal clock in internal clock operation mode. All inputs through the external display interface are invalid. The internal RAM is accessible only through a system interface.

**RGB interface mode (1):** Display operation is controlled by the frame synchronizing clock (VSYNC), line synchronizing signal (VSYNC), and dot clock (DOTCLK) in the RGB interface mode. These signals must be supplied throughout the display operation in this mode.

All display data are stored in the internal RAM, transmitted through DB17-0 bits by pixel. The combination with the window address function enables simultaneous display of both moving picture areas and the internal RAM area. The data are transmitted only when the screen is being updated, thereby reducing the overall data transmission to minimum.

The periods of the front (FP) and back (BP) porches and the display period (NL) are automatically generated in the HD66782 by counting the clock of line synchronizing signal (HSYNC) in accordance to the frame synchronizing signal (VSYNC). Transmit pixel data through DB17-0 bits in accordance with the aforementioned setting.

**RGB interface mode (2):** When RGB-I/F is selected, RAM data are changeable through the system interface. This write operation must be performed while display data are not being transmitted through the RGB-I/F (ENABLE = High). When reverting from the system interface mode to the data transmission through the RGB interface, make a new setting for the address set and index (R202h) after changing the aforementioned settings.

**VSYNC interface mode:** The internal display operation is synchronized with the frame-synchronizing signal (VSYNC) in the VSYNC interface mode. By writing data to RAM at a fixed speed on the falling edge of VSYNC, it enables moving pictures display with a system interface. In this case, there are some constraints in the RAM write speed and methods. For details, see “External Display Interface” (p.139).

In the VSYNC-I/F mode, only VSYNC input is valid. Other input signals for the external display interface are invalid.

The front porch (FP), back porch (BP) periods and display period (NL) are automatically generated in accordance to the frame synchronizing signal (VSYNC) according to the register setting of HD66781.

**Frame Cycle Control (R00Dh)**

R/W	RS	IB15	IB14	IB13	IB12	IB11	IB10	IB9	IB8	IB7	IB6	IB5	IB4	IB3	IB2	IB1	IB0
W	1	0	0	0	0	0	0	DIVI1	DIVI0	0	0	0	RTNI 4	RTNI 3	RTNI 2	RTNI 1	RTNI 0

**RTNI[4:0]:** Set IH (line) period.

**DIVI[1:0]:** Set the division ratio of clocks for internal operations (DIV1-0). The internal operations are executed by the clocks, the frequency of which is divided according to the DIV1-0 setting. When changing the number of raster-rows to drive, adjust the frame frequency too. For details, see “Frame Frequency Adjustment Function”(p.178).

**Table 32**

RTNI[3:0]	clocks per line	DIVI[1:0]	division ratio	internal operation clock frequency
5'h00	Setting disabled	2'h0	1/1	fosc / 1
:	:	2'h1	1/2	fosc / 2
5'h0F	Setting disabled	2'h2	1/4	fosc / 4
5'h10	16 clocks	2'h3	1/8	fosc / 8
5'h11	17 clocks			
5'h12	18 clocks			
5'h13	19 clocks			
5'h14	20 clocks			
5'h15	21 clocks			
5'h16	22 clocks			
5'h17	23 clocks			
5'h18	24 clocks			
5'h19	25 clocks			
5'h1A	26 clocks			
5'h1B	27 clocks			
5'h1C	28 clocks			
5'h1D	29 clocks			
5'h1E	30 clocks			
5'h1F	31 clocks			

Note 1) fosc : R-C oscillation frequency

**Formula for frame frequency**

$$\text{frame frequency} = \frac{fosc}{\text{Number of clock per line} \times \text{division ratio} \times (\text{Line} + \text{FP} + \text{BP})} \quad [\text{Hz}]$$

fosc : R-C oscillation frequency  
Line : Number of drive raster-rows (NL bit)  
division ration : DIV1 bit  
clocks per line : RTNI bit

**External Display Interface Control 2 (R00Eh)**

R/W	RS	IB15	IB14	IB13	IB12	IB11	IB10	IB9	IB8	IB7	IB6	IB5	IB4	IB3	IB2	IB1	IB0
W	1	0	0	0	0	0	0	DIVE	DIVE	0	RTNE	RTNE	RTNE	RTNE	RTNE	RTNE	RTNE
								1	0		6	5	4	3	2	1	0

**RTNE[6:0]:** Specify the number of clocks for internal operation per 1H (line). Set the value of the number of DOTCLK input in 1H period, divided by the division ratio.

**DIVE[1:0]:** Set the internal division ratio of DOTCLK (DIVE). The internal operation is executed according to the clocks divided by the division ratio set by DIVE.

**Table 33**

RTNE[6:0]	Clocks per line	DIVE[1:0]	Division	Internal operation clock frequency
7'h00	Setting disabled	2'h0	Setting disabled	
:	:	2'h1	1/4	f <sub>dotclk</sub> / 4
7'h0F	Setting disabled	2'h2	1/8	f <sub>dotclk</sub> / 8
7'h10	16 clocks	2'h3	1/16	f <sub>dotclk</sub> / 16
7'h11	17 clocks	f <sub>dotclk</sub> : DOTCLK frequency		
7'h12	18 clocks			
:	:			
7'h7D	125 clocks			
7'h7E	126 clocks			
7'h7F	127 clocks			

**External Display Interface Control 3 (R00Fh)**

R/W	RS	IB15	IB14	IB13	IB12	IB11	IB10	IB9	IB8	IB7	IB6	IB5	IB4	IB3	IB2	IB1	IB0
W	1	0	0	0	0	0	0	0	0	0	0	0	VSPL	HSPL	0	EPL	DPL

**DPL:** Specify the polarities of signals on DOTCLK pin.

- DPL=0: Input data on a rising edge of DOTCLK.
- DPL=1: Input data on a falling edge of DOTCLK.

**EPL:** Specify the polarities of signals on ENABLE pin.

- EDL = 0      Data are written to PD17 to PD 0 when ENABLE = 0. No data are written when ENABLE = 1.
- EDL = 1      Data are written to PD17 to PD 0 when ENABLE = 1. No data are written when ENABLE = 0.

**HSPL:** Specify the polarities of signals on HSYNC pin.

HSPL=0: Low active.

HSPL=1: High active.

**VSPL:** Specify the polarities of signals on VSYNC pin.

VSPL=0: Low active.

VSPL=1: High active.

#### Gate Driver/LTPS LCD Panel Interface Control 1 (R010h)

R/W	RS	IB15	IB14	IB13	IB12	IB11	IB10	IB9	IB8	IB7	IB6	IB5	IB4	IB3	IB2	IB1	IB0
W	1	0	0	0	FWI 4	FWI 3	FWI 2	FWI 1	FWI 0	0	0	0	0	0	FTI2	FTI1	FTI0

**FTI[2:0]:** FTI bits specify the rising position of FLM during display operation with internal clocks (DM = 2'h0 or 2'h2) when LTPS = 1. The setting of this register is invalid when LTPS = 0. In this case, the rising position of FLM is at a reference point.

**FWI[4:0]:** FWI bits specifies the width of "High" of FLM during display operation with internal clocks (DM = 2'h0 or 2'h2) when LTPS = 1. The setting of this register is invalid when LTPS = 0. In this case, the width of "High" of FLM is 1H.

See the figures (page 66, 67) with regard to how the signal waveform of each gate driver and LTPS LCD panel interface are controlled by these settings.

**Table 34**

FTI[2:0]	FLM Rising position	FWI[4:0]	FLM "High" width
2'h0	0 clock	5'h00	0 clock
2'h1	1 clock	5'h01	1 clock
2'h2	2 clocks	5'h02	2 clocks
2'h3	3 clocks	5'h03	3 clocks
		:	:
		5'h1D	29 clocks
		5'h1E	30 clocks
		5'h1F	31 clocks

Note 1) The clocks in the tables are measured from the reference point. The reference point is the position where SFTCLK rises when the rising position of SFTCLK is set to 0 clock.



**Gate Driver/LTPS LCD Panel Interface Control 2 (R011h)**

R/W	RS	IB15	IB14	IB13	IB12	IB11	IB10	IB9	IB8	IB7	IB6	IB5	IB4	IB3	IB2	IB1	IB0
W	1	0	0	0	SWI 4	SWI 3	SWI 2	SWI 1	SWI 0	0	0	0	0	0	0	STI1	STI0

**STI[1:0]:** STI bits specifies the rising position of SFTCLK1/2 during display operation with internal clocks (DM = 2'h0 or 2'h2) when LTPS = 1. The setting of this register is invalid when LTPS = 0. In this case, the rising position of CL1 is 8 clocks away from a reference point.

**SWI[4:0]:** SWI bits specifies the width of “High” of SFTCLK1/2 during display operation with internal clocks (DM = 2'h0 or 2'h2) when LTPS = 1. The setting of this register is invalid when LTPS = 0. In this case, the falling position of CL1 is at a reference point.

See the figures (page 66, 67) with regard to how the signal waveform of each gate driver and LTPS LCD panel interface are controlled by these settings.

**Table 35**

<b>STI[1:0]</b>	<b>CL1/SFTCLK1, 2 Rising position</b>	<b>SWI[4:0]</b>	<b>CL1/SFTCLK1, 2 “High” width</b>
2'h0	0 clock	5'h00	0 clock
2'h1	1 clock	5'h01	1 clock
2'h2	2 clocks	5'h02	2 clocks
2'h3	3 clocks	5'h03	3 clocks
		:	:
		5'h1D	29 clocks
		5'h1E	30 clocks
		5'h1F	31 clocks

Note 1) The clocks in the tables are measured from a reference point. The reference point is the position where SFTCLK rises when the rising position of SFTCLK is set to 0 clock.

**Gate Driver/LTPS LCD Panel Interface Control 3 (R012h)**

R/W	RS	IB15	IB14	IB13	IB12	IB11	IB10	IB9	IB8	IB7	IB6	IB5	IB4	IB3	IB2	IB1	IB0
W	1	0	0	0	0	0	0	0	0	0	0	0	0	0	0	SDTI 1	SDTI 0

**SDTI[1:0]:** Specify the delay from a reference point of the source output during display operation with internal clocks (DM = 2'h0 or 2'h2).

See the figures (page 66, 67) with regard to how the signal waveform of each gate driver and LTPS LCD panel interface are controlled by these settings.

**Table 36**

<b>SDTI[1:0]</b>	<b>Source output delay</b>
2'h0	1 clock
2'h1	2 clocks
2'h2	3 clocks
2'h3	4 clocks

Note 1) The clocks in the tables are measured from a reference point. The reference point is the position where SFTCLK rises when the rising position of SFTCLK is set to 0 clock.

## Gate Driver/LTPS LCD Panel Interface Control 4 (R013h)

R/W	RS	IB15	IB14	IB13	IB12	IB11	IB10	IB9	IB8	IB7	IB6	IB5	IB4	IB3	IB2	IB1	IB0
W	1	0	0	0	DPW I4	DPW I3	DPW I2	DPW I1	DPW I0	0	0	0	0	0	0	DPTI 1	DPTI 0

**DPTI[1:0]:** Specify the rising position of DISPTMG during display operation with internal clocks (DM = 2'h0 or 2'h2).

**DPWI[4:0]:** DPWI bits specifies the width of “High” of DISPTMG during display operation with internal clocks (DM = 2'h0 or 2'h2) when LTPS = 1. The setting of this register is invalid when LTPS = 0. In this case, the falling position of CL1 is at a reference point.

See the figures (page 66, 67) with regard to how the signal waveform of each gate driver and LTPS LCD panel interface are controlled by these settings.

Table 37

DPTI[1:0]	DISPTMG Rising position	DPWI[4:0]	DISPTMG “High” width
2'h0	0 clock	5'h00	0 clock
2'h1	1 clock	5'h01	1 clock
2'h2	2 clocks	5'h02	2 clocks
2'h3	3 clocks	5'h03	3 clocks
		:	:
		5'h1D	29 clocks
		5'h1E	30 clocks
		5'h1F	31 clocks

Note 1) The clocks in the tables are measured from a reference point. The reference point is the position where SFTCLK rises when the rising position of SFTCLK is set to 0 clock.

Note 2) The gate non-overlap period can be set to 0 when DPTI = “2'h0” and DPWI is set to the number of clocks more than that of the 1H period.

**Gate Driver/LTPS LCD Panel Interface Control 5 (R015h)**

R/W	RS	IB15	IB14	IB13	IB12	IB11	IB10	IB9	IB8	IB7	IB6	IB5	IB4	IB3	IB2	IB1	IB0
W	1	0	0	0	0	0	0	EQW <sub>I1</sub>	EQW <sub>I0</sub>	0	0	0	0	0	0	0	0

**EQWI[1:0]:** Specify the width of “High” of EQ during display operation with internal clocks (DM = 2’h0 or 2’h2).

See the figures (page 66, 67) with regard to how the signal waveform of each gate driver and LTPS LCD panel interface are controlled by these settings. Also see “Equalizing Function” for details on equalization.

**Table 38**

EQWI[1:0]	EQ “High” width
2’h0	0 clock
2’h1	1 clock
2’h2	2 clocks
2’h3	3 clocks

Note 1) The clocks in the tables are measured from the source output alternating point.

## Gate Driver/LTPS LCD Panel Interface Control 6 (R016h)

R/W	RS	IB15	IB14	IB13	IB12	IB11	IB10	IB9	IB8	IB7	IB6	IB5	IB4	IB3	IB2	IB1	IB0
W	1	0	0	FWE 5	FWE 4	FWE 3	FWE 2	FWE 1	FWE 0	0	0	0	0	0	FTE2	FTE1	FTE0

**FTE[2:0]:** FTE bits specifies the rising position of FLM during display operation with DOTCLK (DM = 2'h1) when LTPS = 1. The setting of this register setting is invalid when LTPS = 0. In this case, the rising position of FLM is at a reference point.

**FWE[5:0]:** FWE bits specifies the width of "High" of FLM during display operation with DOTCLK (DM = 2'h1) when LTPS = 1. The register setting is invalid when LTPS = 0. In this case, the width of "High" of FLM is 1H.

See the figures (page 66, 67) with regard to how the signal waveform of each gate driver and LTPS LCD panel interface are controlled by these settings.

Table 39

FTE[2:0]	FLM Rising position	FWE[5:0]	FLM "High" width
3'h0	0 clock	6'h00	0 clock
3'h1	1 clock	6'h01	1 clock
3'h2	2 clocks	6'h02	2 clocks
3'h3	3 clocks	6'h03	3 clocks
3'h4	4 clocks	:	:
3'h5	5 clocks	6'h3D	61 clocks
3'h6	6 clocks	6'h3E	62 clocks
3'h7	7 clocks	6'h3F	63 clocks

Note 1) The clocks in the tables are DOTCLK / division ratio for the 1H period, measured from a reference point. The reference point is the position where SFTCLK rises when the rising position of SFTCLK is set to 0 clock.

**Gate Driver/LTPS LCD Panel Interface Control 7 (R017h)**

R/W	RS	IB15	IB14	IB13	IB12	IB11	IB10	IB9	IB8	IB7	IB6	IB5	IB4	IB3	IB2	IB1	IB0
W	1	0	0	SWE 5	SWE 4	SWE 3	SWE 2	SWE 1	SWE 0	0	0	0	0	0	STE2	STE1	STE0

**STE[2:0]:** STE bits specifies the rising position of SFTCLK1/2 during display operation with DOTCLK (DM = 2'h1) when LTPS = 1. The register setting is invalid when LTPS = 0. In this case, the rising position of CL1 is 8 clocks away from a reference point.

**SWE[5:0]:** SWE bits specifies the width of “High” of SFTCLK1/2 during display operation with DOTCLK (DM = 2'h1) when LTPS = 1. The register setting is invalid when LTPS = 0. In this case, the falling position of CL1 is at a reference point.

See the figures (page 66, 67) with regard to how the signal waveform of each gate driver and LTPS LCD panel interface are controlled by these settings.

**Table 40**

<b>STE[2:0]</b>	<b>CL1/SFTCLK1,2 Rising position</b>	<b>SWE[5:0]</b>	<b>CL1/SFTCLK1,2 “High” width</b>
3'h0	0 clock	6'h00	0 clock
3'h1	1 clock	6'h01	1 clock
3'h2	2 clocks	6'h02	2 clocks
3'h3	3 clocks	6'h03	3 clocks
3'h4	4 clocks	:	:
3'h5	5 clocks	6'h3D	61 clocks
3'h6	6 clocks	6'h3E	62 clocks
3'h7	7 clocks	6'h3F	63 clocks

Note 1) The clocks in the tables are DOTCLK / division ratio for the 1H period, measured from a reference point. The reference point is the position where SFTCLK rises when the rising position of SFTCLK is set to 0 clock.

**Gate Driver/LTPS LCD Panel Interface Control 8 (R018h)**

R/W	RS	IB15	IB14	IB13	IB12	IB11	IB10	IB9	IB8	IB7	IB6	IB5	IB4	IB3	IB2	IB1	IB0
W	1	0	0	0	0	0	0	0	0	0	0	0	0	0	SDTE 2	SDTE 1	SDTE 0

**SDTE[2:0]:** Specify the delay from a reference point of the source output during display operation with DOTCLK (DM = 2'h1).

See the figures (page 66, 67) with regard to how the signal waveform of each gate driver and LTPS LCD panel interface are controlled by these settings.

**Table 41**

<b>SDTE[2:0]</b>	<b>Source output delay</b>
3'h0	1 clock
3'h1	2 clocks
3'h2	3 clocks
3'h3	4 clocks
3'h4	5 clocks
3'h5	6 clocks
3'h6	7 clocks
3'h7	Setting disabled

Note 1) The clocks in the tables are DOTCLK / division ratio for the 1H period, measured from a reference point. The reference point is the position where SFTCLK rises when the rising position of SFTCLK is set to 0 clock.

## Gate Driver/LTPS LCD Panel Interface Control 9 (R019h)

R/W	RS	IB15	IB14	IB13	IB12	IB11	IB10	IB9	IB8	IB7	IB6	IB5	IB4	IB3	IB2	IB1	IB0
W	1	0	0	DPW E5	DPW E4	DPW E3	DPW E2	DPW E1	DPW E0	0	0	0	0	0	DPTE 2	DPTE 1	DPTE 0

**DPTE[2:0]:** Specify the rising position of DISPTMG during display operation with DOTCLK (DM = 2'h1).

**DPWE[5:0]:** DPWE specifies the width of “High” of DISPTMG during display operation with DOTCLK (DM = 2'h1) when LTPS = 1. The register setting is invalid when LTPS = 0. In this case, the falling position of CL1 is at a reference point.

See the figures (page 66, 67) with regard to how the signal waveform of each gate driver and LTPS LCD panel interface are controlled by these settings.

Table 42

DPTE[2:0]	DISPTMG Rising position	DPWE[5:0]	DISPTMG “High” width
3'h0	0 clock	6'h00	0 clock
3'h1	1 clock	6'h01	1 clock
3'h2	2 clocks	6'h02	2 clocks
3'h3	3 clocks	6'h03	3 clocks
3'h4	4 clocks	:	:
3'h5	5 clocks	6'h3D	61 clocks
3'h6	6 clocks	6'h3E	62 clocks
3'h7	7 clocks	6'h3F	63 clocks

Note 1) The clocks in the tables are DOTCLK / division ratio for the 1H period, measured from a reference point. The reference point is the position where SFTCLK rises when the rising position of SFTCLK is set to 0 clock.

Note 2) The gate non-overlap period can be set to 0 when DPTI = “2'h0” and DPWI is set to the number of clocks more than that of the 1H period.



**Gate Driver/LTPS LCD Panel Interface Control 10 (R01Bh)**

R/W	RS	IB15	IB14	IB13	IB12	IB11	IB10	IB9	IB8	IB7	IB6	IB5	IB4	IB3	IB2	IB1	IB0
W	1	0	0	0	0	0	EQW E2	EQW E1	EQW E0	0	0	0	0	0	0	0	0

**EQWE[2:0]:** Specify the width of “High” of EQ DISPTMG during display operation with DOTCLK (DM = 2’h1).

See the figures (page 66, 67) with regard to how the signal waveform of each gate driver and LTPS LCD panel interface are controlled by these settings. Also see “Equalizing Function” for details on equalization.

**Table 43**

EQWE[2:0]	EQ “High” width
3’h0	0 clock
3’h1	1 clock
3’h2	2 clocks
3’h3	3 clocks
3’h4	4 clocks
3’h5	5 clocks
3’h6	6 clocks
3’h7	7 clocks

Note 1) The clocks in the tables are DOTCLK / division ratio for the 1H period, measured from the source output change.

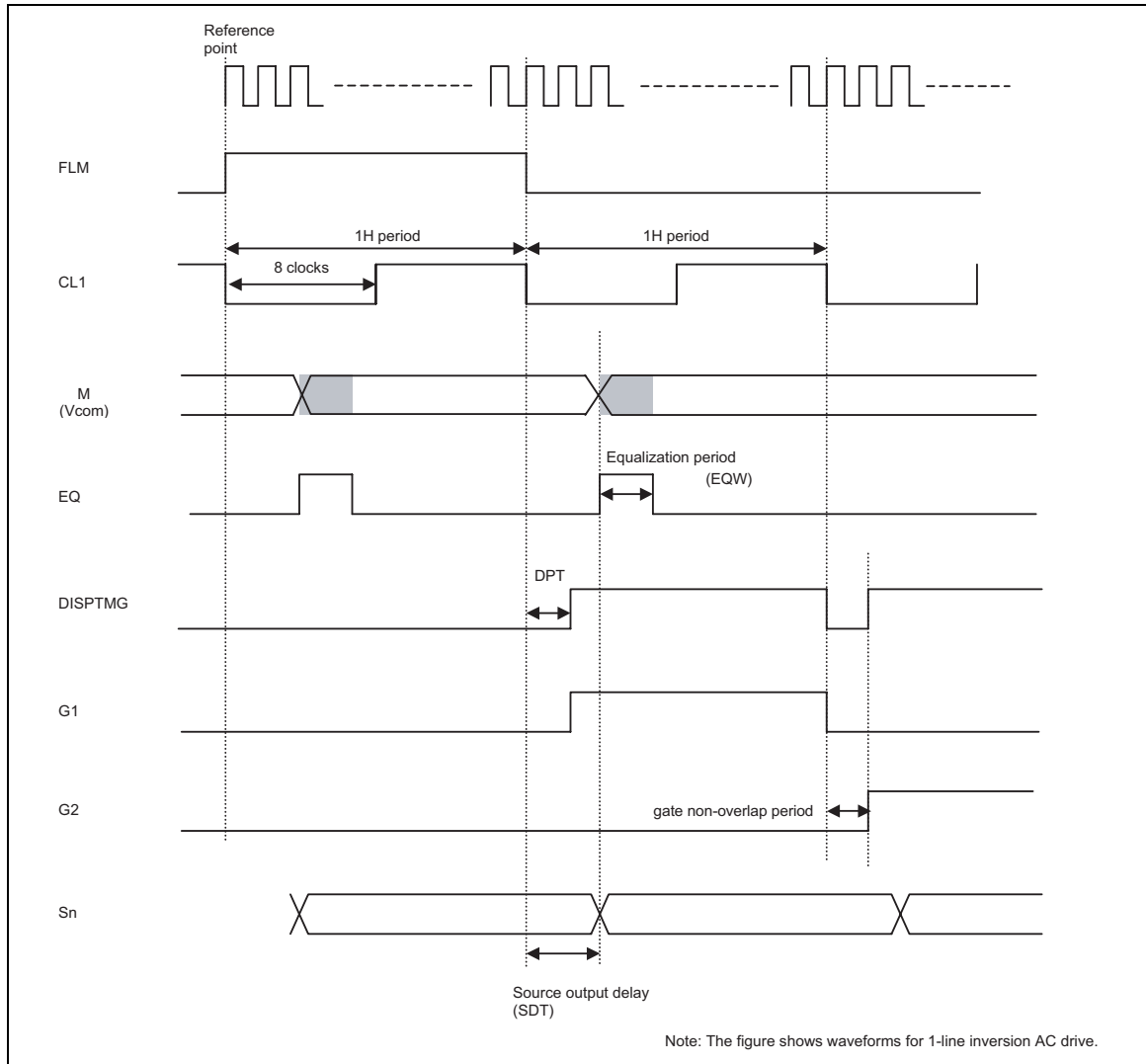

Output waveforms of a-Si TFT panel (LTPS = 0)

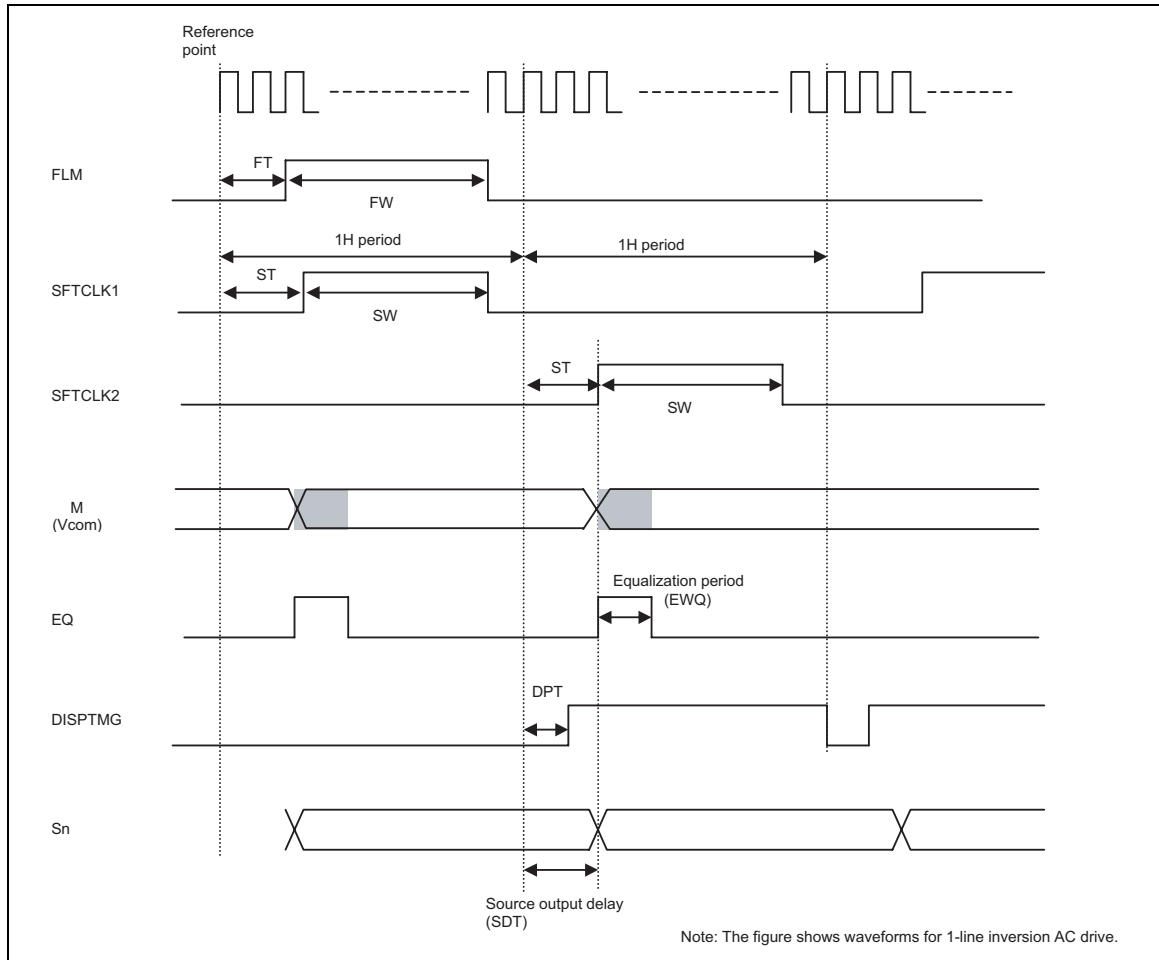

Output waveforms of low-temperature poly-Si TFT panel (LTPS = 1)

**Power control 1 (R100h)**

R/W	RS	IB15	IB14	IB13	IB12	IB11	IB10	IB9	IB8	IB7	IB6	IB5	IB4	IB3	IB2	IB1	IB0
W	1	DC 4	DC 3	0	0	0	SAP 2	SAP 1	SAP 0	0	AP 2	AP 1	AP 0	0	DS TB	SLP	STB

**STB:** When STB = 1, the HD66781 enters into the standby mode. In the standby mode, display operation is completely halted, and all internal operations including the internal R-C oscillator and reception of external clock pulse, are halted. Only instructions to release from the standby mode (STB = 0) and to start oscillation are accepted during the standby mode.

In the standby mode, a serial transfer to the gate driver/power supply IC cannot be made and it requires retransfer after release from the standby mode. Also in the standby mode, any change in the GRAM data or instruction setting cannot be made, but GRAM data are retained.

**SLP:** When SLP = 1, the HD66781 enters into the sleep mode. In the sleep mode, internal display operation is halted except the R-C oscillator to reduce current consumption. No change is made to the GRAM data or instructions during the sleep mode, and the GRAM data and the instructions are retained.

**DSTB:** When DSTB = 1, the HD66781 enters into the deep standby mode, where the power supply for the internal logic is turned off to save more power than the standby mode. The GRAM data and the instruction setting are destroyed in the deep standby mode and it requires resetting after release from the deep standby mode. Also in the deep standby mode, a serial transfer to the gate driver cannot be made and it requires a retransfer after the release from the deep standby mode.

**AP[2:0]:** Adjust the amount of constant current in the operational amplifier in the liquid crystal drive power supply. When the amount of constant current is set large, the liquid crystal drive capacity will be enhanced and the display quality will improve, while the current consumption will increase. Select an optimum amount of current taking both the display quality and the current consumption into account. When no display operation is required, set AP[2:0] = "3'h0" to halt the operation of operational amplifier and step-up circuits to reduce the current consumption. Also if AP[2:0] is set to other than 0, the clock for the step-up circuit DCCLK is output.

**SAP[2:0]:** Adjust the amount of constant current in the operational amplifier of source driver. When the amount of constant current is set large, the liquid crystal drive capacity is enhanced and the display quality will improve, while the current consumption will increase. Select an optimum amount of current taking both the display quality and the current consumption into account. When no display operation is required, set SAP[2:0] = "3'h0" to halt the operation of operational amplifier and step-up circuits to reduce the current consumption.

**DC[4:3]:** Select the frequency of clocks for the step-up circuit (DCCLK). If the DCCLK frequency is set high, display quality is enhanced due to increased drive capacity of step-up circuit, while power consumption will be increased. Make an adjustment taking both display quality and power consumption into consideration.

Note: The AP[2:0] in the above description is the instruction bits for gate driver/power supply IC. The instruction setting in the AP[2:0] must be transferred to the gate driver/power supply IC before an instruction is executed. For details, see “Gate driver/power supply IC Serial Transfer”.

**Table 44** SAP setting**DC setting**

<b>SAP[2:0]</b>	<b>Current in the operational amplifier</b>	<b>DC[4:3]</b>	<b>DCCLK frequency</b>
3'h0	operation halt : op-amp, step-up circuit	2'h0	Fosc / 4
3'h1	op-amp constant current flow rate : 0.65	2'h1	fosc / 8
3'h2	op-amp constant current flow rate : 0.80	2'h2	fosc / 16
3'h3	op-amp constant current flow rate : 1.00	2'h3	fosc / 32
3'h4	op-amp constant current flow rate : 1.35		
3'h5	op-amp constant current flow rate : 1.60		
3'h6	Setting disabled		
3'h7	Setting disabled		

Note 1) The amount of current in the above table is shown as a ratio against that of SAP[2:0] = 3'h3 as 1.

**Gate Driver/ Power Supply IC Interface Control 1 (R110h)**

R/W	RS	IB15	IB14	IB13	IB12	IB11	IB10	IB9	IB8	IB7	IB6	IB5	IB4	IB3	IB2	IB1	IB0
W	1	0	0	0	0	0	0	0	TE	0	0	0	0	0	IDX 2	IDX 1	IDX 0
R	1	0	0	0	0	0	0	0	TE	0	0	0	0	0	IDX 2	IDX 1	IDX 0

**Gate Driver/ Power Supply IC Interface Control 2 (R111h)**

R/W	RS	IB15	IB14	IB13	IB12	IB11	IB10	IB9	IB8	IB7	IB6	IB5	IB4	IB3	IB2	IB1	IB0
W	1	0	0	0	TB 12	TB 11	TB 10	TB 9	TB 8	TB 7	TB 6	TB 5	TB 4	TB 3	TB 2	TB 1	TB 0

**IDX[2:0]:** The index register of the instruction, which is transferred to the gate driver/power supply IC. The instruction that corresponds to the index as determined by the IDX[2:0] setting is transferred to the gate driver or power supply IC through a serial interface for the gate/power supply IC. The following figures illustrates the bit array with which instructions are transferred. The upper 3 bits in the figures corresponds to the IDX[2:0] bits. The instructions of the indexes determined by the IDX[2:0] settings as below are transferred to the gate driver/power supply IC.

When any change will be made to the instruction setting to the gate driver/power supply IC, the setting must be made first in the R111h register of HD 66781 before making a setting for IDX[2:0]. The transfer start (TE = 1) starts transferring the instructions, which is then followed by the execution.

**TE:** The ENABLE for the serial transfer to the gate driver/power supply IC. TE=0 enables a serial transfer. TE=1 starts a transfer to the gate driver/power supply IC. When the transfer is completed, TE=0 is returned.

A serial transfer takes 18 clocks at maximum (with reference to internal clocks). Do not make any changes to the instructions that are being transferred. Other instructions can be executable even during the instruction transfer.

Note 1) The transfer of the NL[5:0], AP[2:0], FLD[1:0] settings to the gate driver/power supply IC must be made right after the instruction setting of HD66781. Make a same setting to the HD66781 and HD66783/HD667P21 with regard to NL, AP, FLD registers. Otherwise, a proper operation is not guaranteed.

Note 2) As in the following figures, the bits to which no register is assigned must be overwritten with "0" or "1".

HD66783 Instructions															
IDX2	IDX1	IDX0	TB12	TB11	TB10	TB9	TB8	TB7	TB6	TB5	TB4	TB3	TB2	TB1	TB0
0	0	0	0	GON	VCO MG	BT[2]	BT[1]	BT[0]	DC0 [2]	DC0 [1]	DC0 [0]	AP [2]	AP [1]	AP [0]	0
0	0	1	0	DK	1	EQM	0	PON	VRH [3]	VRH [2]	VRH [1]	VRH [0]	VC [2]	VC [1]	VC [0]
0	1	0	DC1 [2]	DC1 [1]	DC1 [0]	VDV [4]	VDV [3]	VDV [2]	VDV [1]	VDV [0]	VCM [4]	VCM [3]	VCM [2]	VCM [1]	VCM [0]
0	1	1	Setting disabled												
1	0	0	Setting disabled												
1	0	1	Setting disabled												
1	1	0	GS	NL [5]	NL [4]	NL [3]	NL [2]	NL [1]	NL [0]	SC N [5]	SC N [4]	SC N [3]	SC N [2]	SC N [1]	SC N [0]
1	1	1	0	0	0	0	0	0	0	0	0	0	0	NL [1]	NL [0]

HD667P21 Instructions															
IDX2	IDX1	IDX0	TB12	TB11	TB10	TB9	TB8	TB7	TB6	TB5	TB4	TB3	TB2	TB1	TB0
0	0	0	0	GON	VCO MG	BT[2]	BT[1]	BT[0]	DC [2]	DC [1]	DC [0]	AP [2]	AP [1]	AP [0]	0
0	0	1	0	0	0	0	0	PON	VRH [3]	VRH [2]	VRH [1]	VRH [0]	VC [2]	VC [1]	VC [0]
0	0	1	0	1	0	DK [1]	DK [0]	0	0	0	0	0	0	0	0
0	1	0	0	0	0	VDV [4]	VDV [3]	VDV [2]	VDV [1]	VDV [0]	VCM [4]	VCM [3]	VCM [2]	VCM [1]	VCM [0]
0	1	1	Setting disabled												
1	0	0	Setting disabled												
1	0	1	Setting disabled												
1	1	0	Setting disabled												
1	1	1	0	0	VGL [4]	VGL [3]	VGL [2]	VGL [1]	VGL [0]	0	VGH [4]	VGH [3]	VGH [2]	VGH [1]	VGH [0]

**HD66783 / HD667P21 instructions**

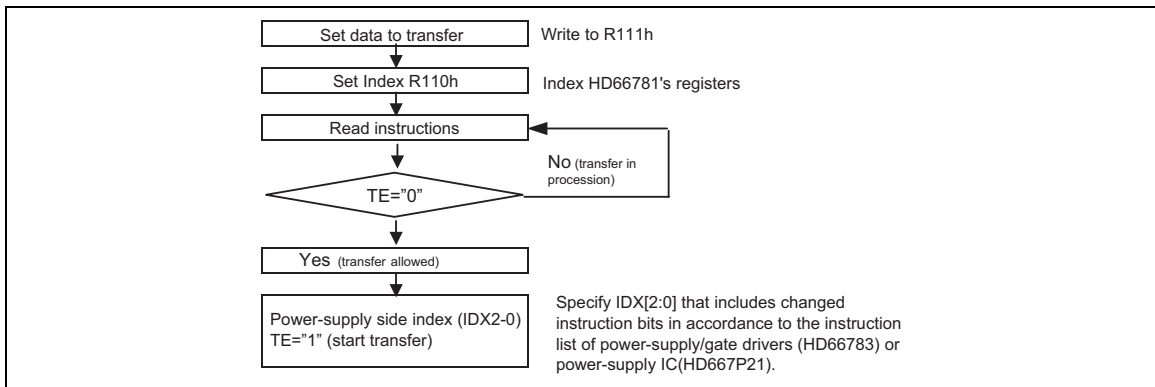

**Serial transfer sequence: gate driver/power supply IC interface**

**Setting examples**

1. Set DC1[2:0], VDV[4:0], VCM of HD66783 to 3'h2, 5'h2, 5'h3 respectively.
  - (1) Instruction set: R111h
  - (2) Data write: 16'h0843 (DC1[2:0]=3'h2, VDV[4:0]=5'h2, VCM[4:0]=5'h3)
  - (3) Instruction set: R110h
  - (4) Data read: (make sure TE=0)
  - (5) Data write: 16'h0102 (TE=1, IDX[2:0]=3'h2)
  
2. Set NL of HD66781 and HD66783 to 6'h20 (NL, AP, FLD are the registers that require a setting in both HD66781 and HD66783).
  - (1) Instruction set: R400h
  - (2) Data write: 16'h0020  
↓
  - (3) Instruction set: R111h
  - (4) Data write: 16'h0800 (GS=0, NL[5:0]=6'h20, SCN[5:0]=6'h00)
  - (5) Instruction set: R110h
  - (6) Data read: (make sure TE=0)
  - (7) Data write: 16'h0102 (TE=1, IDX[2:0]=3'h6)

Note 1) Make a same setting to the HD66781 and HD66783 at one time. (1) and (2) are the setting for the HD66781.  
(3)~(7) are the setting for the HD66783.



**Common registers for HD66783 and HD667P21**

**BT[2:0]:** Change the output scale of step-up circuits. Adjust the step-up scale according to the voltage in use. To set power consumption lower, it is necessary to set the step-up scale smaller. For details, see the datasheets of HD66783 and HD667P21.

**VCOMG:** Make settings for the output level of VcomL.

- |           |   |
|-----------|---|
| VCOMG = 0 | The low-side output of Vcom is fixed to GND and the instruction (VDV) setting becomes invalid. Outputs from VcomL and VCL are halted.<br>For this reason, the VCOMG setting is related to the power-supply startup sequence. Make a VCOMG setting by following the power-supply setting sequence. |
| VCOMG = 1 | The low-side output of Vcom becomes VcomL. The output voltage of VcomL is set by instruction (VDV) setting. VCOMG = 1 is valid when PON = 1.  |

**VC[2:0]:** Adjust the reference voltages of VREG1OUT, VREG2OUT, and Vci1 voltages according to Vci as the reference voltage. For details, see the datasheets of HD66783 and HD667P21.

**VRH[3:0]:** Set the amplifying scale of VREG1OUT with the values set in VC bits (REGP) as an input. For details, see the datasheets of HD66783 and HD667P21.

**VCM[4:0]:** Make a setting for VcomH (the “High” of Vcom). VcomH can be amplified to VREG1OUT x 0.41 ~ 1.00. When VCM = 5'h01, VcomH is not adjusted by the internal volume adjustment but by an external resistor from VcomR. For details on whether to generate the VcomH level with internal electronic volume or an external resistor, see the datasheets of HD66783 and HD667P21.

**VDV[4:0]:** Set the Vcom alternating amplitude. The setting is invalid without Vcom alternating drive. For details, see the datasheets of HD66783 and HD667P21.

**Registers of HD66783**

**AP[2:0]:** Adjust the amount of constant current in the operational amplifier in the liquid crystal drive power supply. When the amount of constant current is set large, the liquid crystal drive capacity is enhanced and the display quality will improve, while the current consumption will increase. Select an optimum amount of current taking both the display quality and the current consumption into account. When no display operation is required, set AP[2:0] = “3'h0” to halt the operation of operational amplifiers and step-up circuits to reduce the current consumption. To set AP[2:0] otherwise, it starts step-up circuits to output VGH. For details, see the datasheets of HD66783.

**DC0[2:0]:** Select the operation frequency of step-up circuit 1. If the step-up operation frequency is set high, display quality will be enhanced due to increased drive capacity of step-up circuit, while power consumption will be increased. Make an adjustment taking both display quality and power consumption into consideration. For details, see the datasheets of HD66783.

**GON:** When GON=0, the output level of G1~G320 pins of HD66783 becomes VGH and the Vcom level becomes GND.

**PON:** Set start/halt of VGL, VCL operations. Set PON according to the power supply start sequence.

PON=0: Halt  
 PON=1: Start

**EQM:** Select the operation mode of Vcom2 output. Set EQM = 0.

**DK:** Control the start-up of DDVDH. See “Instruction Setting Flow” (p.185) for details on the setting.

**VCM[4:0]:** Make a setting for VcomH (the High voltage of Vcom). VcomH can be amplified to the level  $VREG1OUT \times 0.40 \sim 0.98$ . When VCM[4:0] = 5'h0F, internal volume is halted and VcomH is adjusted by an external resistor from VcomR. See the datasheet of HD66783 whether to generate VcomH level with internal electronic volume or an external resistor.

**DC1[2:0]:** Select the operation frequency of step-up circuit 2. If the step-up operation frequency is set high, display quality will be enhanced due to increased drive capacity of step-up circuit, while power consumption will be increased. Make an adjustment taking both display quality and power consumption into consideration. See the datasheet of HD66783 for details.

**SCN[5:0]:** Set the start position of scanning gate bus line. For details, see the datasheets of HD66783.

**NL[5:0]:** Set the number of liquid crystal drive raster-rows. The number of raster-rows can be set to 8 multiples. The value should be set equal to or more than to drive the number of raster-rows required for the panel size.

Note: Set SCN[5:0] and NL[5:0] to satisfy the following equation:

$$(\text{Output start position}) + (\text{Number of drive raster-rows}) - 1 \leq 320 (\text{raster-rows})$$

**GS:** Set the scan direction of gate bus lines. The direction is changeable according to the gate driver's position on the assembly. For details, see the datasheets of HD66783.

**FLD[1:0]:** Set the number of valid lines to drive n-line interlacing. For details, see the datasheets of HD66783.

### Registers of HD667P21

**AP[2:0]:** Adjust the amount of constant current in the operational amplifier in the liquid crystal drive power supply. When the amount of constant current is set large, the liquid crystal drive capacity will be enhanced and the display quality will improve, while the current consumption will increase. Select an optimum amount of current taking both the display quality and the current consumption into account. When no display operation is required, set AP[2:0] = “3'h0” to halt the operation of operational amplifier and step-up circuits to reduce the current consumption. If AP[2:0] is set otherwise, it starts step-up circuit to output VLOUT1, VLOUT2. For details, see the datasheets of HD667P21.

**DC[2:0]:** Select the operation frequency of step-up circuit 1. If the step-up operation frequency is set high, display quality will be enhanced due to increased drive capacity of step-up circuit, while power consumption will be increased. Make an adjustment taking both display quality and power consumption into consideration. For details, see the datasheets of HD66783.

**GON:** When GON=0, the Vcom level becomes GND.

**PON:** Set start/halt of VLOUT3 operation. Set PON according to the power supply start sequence.

PON=0: Halt

PON=1: Start

**VCM[4:0]:** Make a setting for VcomH (the High voltage of Vcom). VcomH can be amplified to the level  $VREG1OUT \times 0.41 \sim 1.00$ . When  $VCM[4:0] = 5'h1F$ , internal volume is halted and VcomH is adjusted by an external resistor from VcomR. See the datasheet of HD667P21 whether to generate VcomH level with internal electronic volume or an external resistor.

**VGH[4:0]:** Set the VGH regulator output level. The setting can be made from 2.82 to 4.06 times of REGP voltage.

**VGL[4:0]:** Set the VGL regulator output level. The setting can be made from  $-1.60$  to  $-2.84$  times of REGP voltage.

**RAM Address set in horizontal/vertical directions (R200h/R201h)**

R/W	RS	IB15	IB14	IB13	IB12	IB11	IB10	IB9	IB8	IB7	IB6	IB5	IB4	IB3	IB2	IB1	IB0
W	1	0	0	0	0	0	0	0	0	AD [7]	AD [6]	AD [5]	AD [4]	AD [3]	AD [2]	AD [1]	AD [0]
W	1	0	0	0	0	0	0	0	AD [16]	AD [15]	AD [14]	AD [13]	AD [12]	AD [11]	AD [10]	AD [9]	AD [8]

Note : Top R200h, Bottom R201h

**AD[16:0]:** Initialize GRAM address at AC (Address Counter). The address counter is automatically updated in accordance with AM, I/D settings after data are written to GRAM. Data can be written consecutively without making a new address setting. The address counter is not automatically updated when data are read out from GRAM.

**Table 45 GRAM address range**

<b>AD[16:0]</b>	<b>GRAM Setting</b>
17'h00000 – 17'h000EF	Bitmap data for G1
17'h00100 – 17'h001EF	Bitmap data for G2
17'h00200 – 17'h002EF	Bitmap data for G3
17'h00300 – 17'h003EF	Bitmap data for G4
17'h00400 – 17'h004EF	Bitmap data for G5
:	:
17'h13F00 – 17'h13CEF	Bitmap data for G317
17'h13F00 – 17'h13DEF	Bitmap data for G318
17'h13F00 – 17'h13EEF	Bitmap data for G319
17'h13F00 – 17'h13FEF	Bitmap data for G320

Note 1) An address set is made every frame within the GRAM address range set by AD[16:0] at the falling edge of VSYNC when RGB interface (RM=1) is selected.

Note 2) An address set is made when instructions are executed in the internal clock operation or the VSYNC interface mode (RM = 0).

Note 3) Register values are loaded in both horizontal/vertical address counters when a setting is made for either one of the R200h/R201h registers.

**Write Data to GRAM (R202h)**

R/W	RS	
W	1	The DB[17:0] pins are assigned to RAM write data (WD[17:0]) differently according to an interface.
RGB interface		The DB[17:0] pins are assigned to RAM write data (WD[17:0]) differently according to an interface .

**WD[17:0]:** All data are expanded into 18 bits internally before being written to GRAM. The way of expanding data into 18 bits is different according to the interface.

The grayscale level is selected according to the GRAM data. The address is automatically updated according to the setting with the AM and I/D bits after data are written to GRAM. During the standby mode, no access is allowed to GRAM. When the 8 or 16 bit interface modes are selected, the data in the MSB of R and B pixels are also written to the LSB of R and B pixels respectively to expand the 8/16-bit data into the 18-bit data internally.

During the RGB interface mode, when writing data to RAM through a system interface, make sure to avoid conflicts between writing through the RGB interface and writing through system interface.

When the 18-bit RGB interface is selected, the 18-bit data in PD17-0 bits are written, and 262,144 colors are available. When the 16-bit RGB interface is selected, the data in the MSB of R and B pixels are also written to the LSB of R and B pixels respectively, and 65,536 colors are available.

The upper 3 bits of OSD image data are used as a transmission-rate bit ( $\alpha$  channel).

**Table 46 BGR = 0**

OSD	ODF	D17	D16	D15	D14	D13	D12	D11	D10	D9	D8	D7	D6	D5	D4	D3	D2	D1	D0
0	*	R5	R4	R3	R2	R1	R0	G5	G4	G3	G2	G1	G0	B5	B4	B3	B2	B1	B0
1	0	R5	R4	R3	R2	R1	$\alpha$ 2	G5	G4	G3	G2	G1	$\alpha$ 1	B5	B4	B3	B2	B1	$\alpha$ 0
1	1	$\alpha$ 2	$\alpha$ 1	$\alpha$ 0	R4	R3	R2	R1	R0	G4	G3	G2	G1	G0	B4	B3	B2	B1	B0

**Table 47 BGR =1**

OSD	ODF	D17	D16	D15	D14	D13	D12	D11	D10	D9	D8	D7	D6	D5	D4	D3	D2	D1	D0
0	*	B5	B4	B3	B2	B1	B0	G5	G4	G3	G2	G1	G0	R5	R4	R3	R2	R1	R0
1	0	B5	B4	B3	B2	B1	$\alpha$ 0	G5	G4	G3	G2	G1	$\alpha$ 1	R5	R4	R3	R2	R1	$\alpha$ 2
1	1	$\alpha$ 0	$\alpha$ 1	$\alpha$ 2	B4	B3	B2	B1	B0	G4	G3	G2	G1	G0	R4	R3	R2	R1	R0

**Table 48     $\alpha$  channel**

$\alpha 2$	$\alpha 1$	$\alpha 0$	transmission rate	displayed picture
0	0	0	0%	Base image display
0	0	1		Setting disabled
0	1	0	25%	Base image 75%+OSD 25%
0	1	1	75%	Base image 25%+OSD 75%
1	0	0	50%	Base image 50%+OSD 50%
1	0	1		Setting disabled
1	1	0	100%	OSD image display
1	1	1		Setting disabled

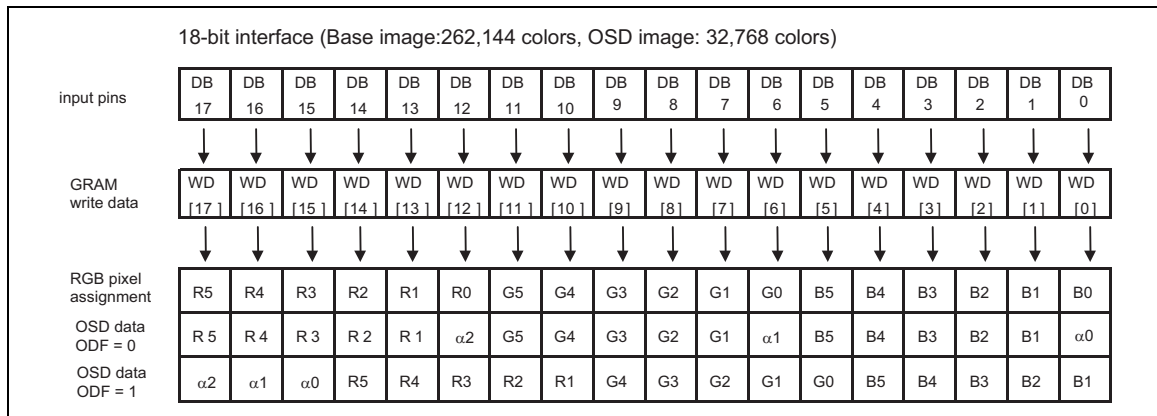

**RAM data write in 18-bit interface (Base image 262,144 colors/OSD image 8,192 colors)**

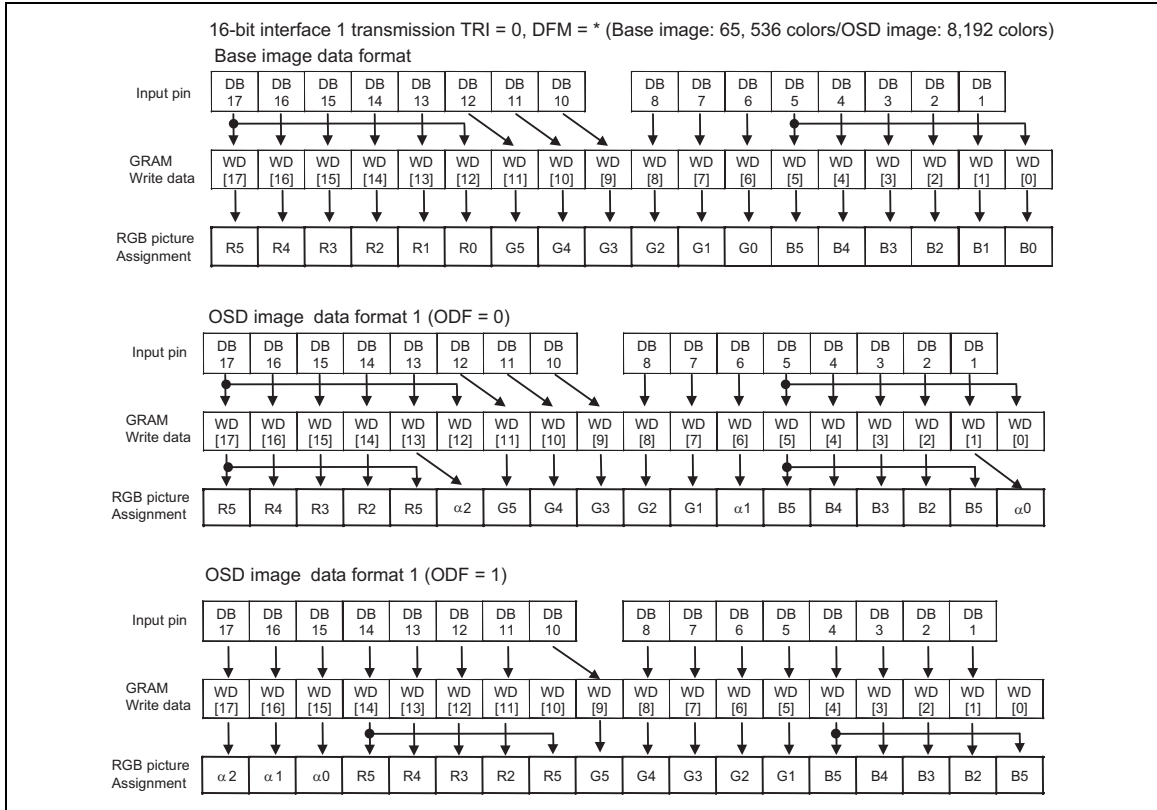

**RAM data write in 16-bit interface (Base image 65,536 colors/OSD image 32,768 colors)**

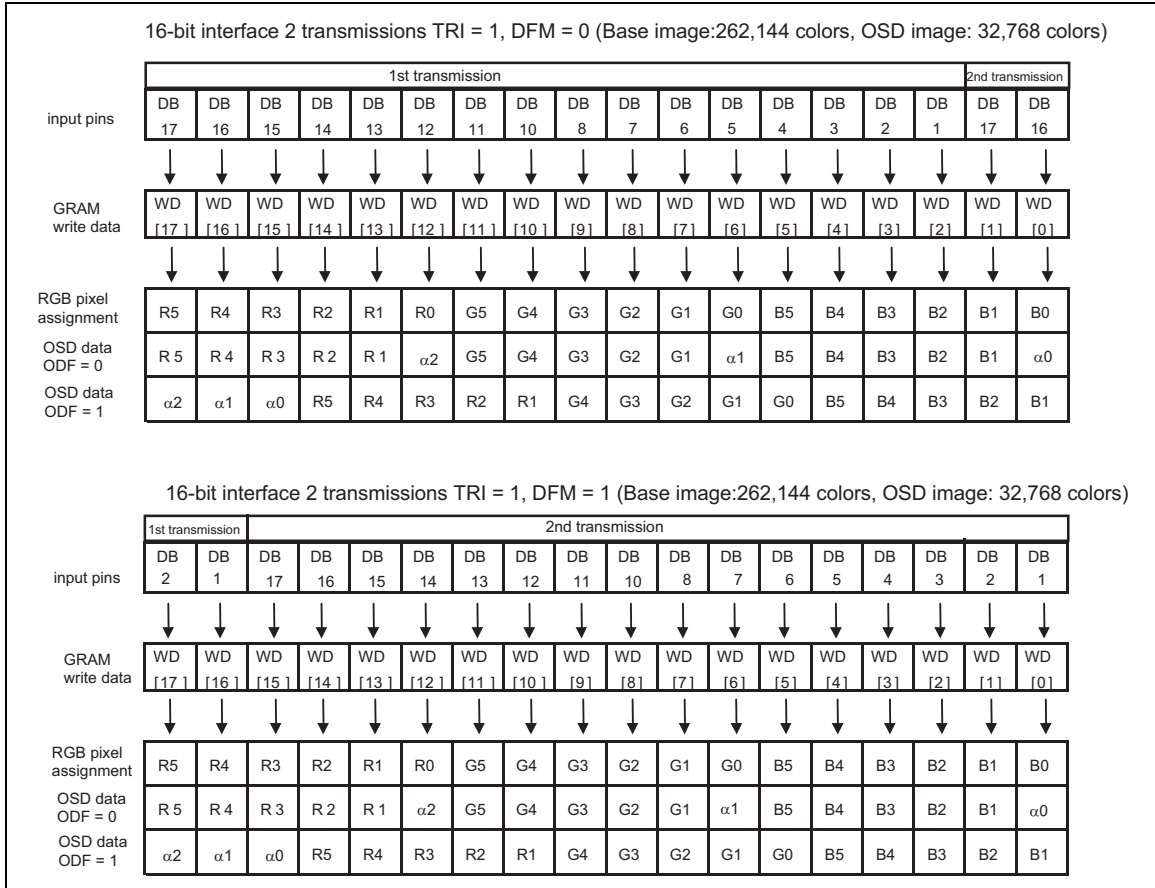

RAM data write in 16-bit interface (Base image 262,144 colors/OSD image 32,768 colors)

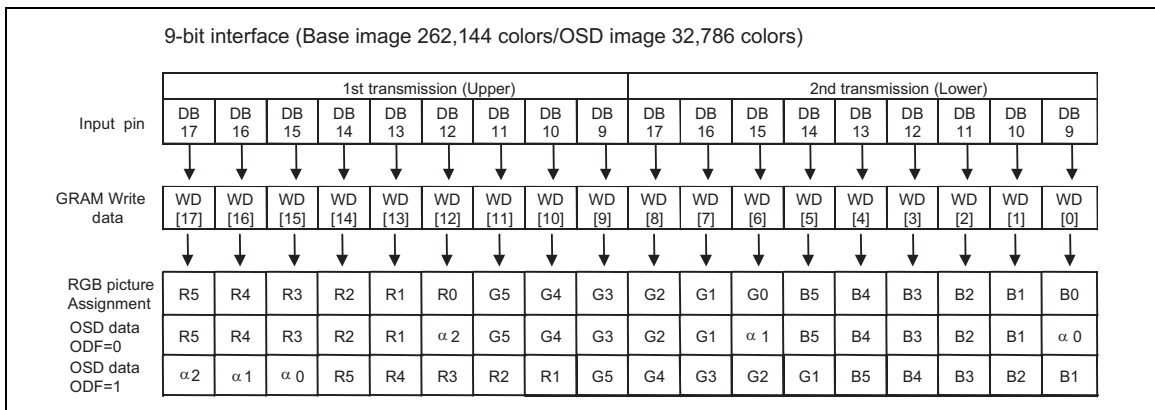

RAM data write in 9-bit interface (Base image 262,144 colors /OSD image 32,768 colors)



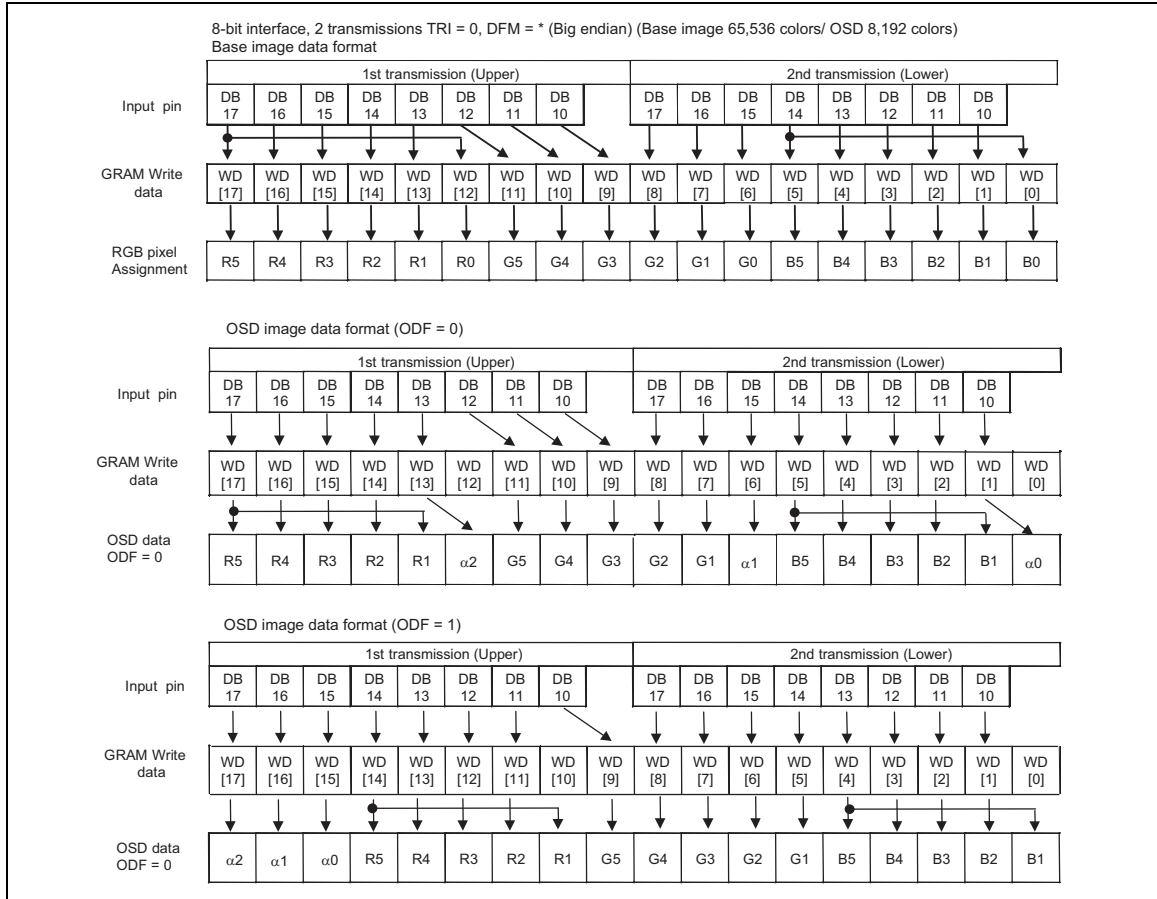

RAM data write in 8-bit interface, big endian (Base image/OSD image)

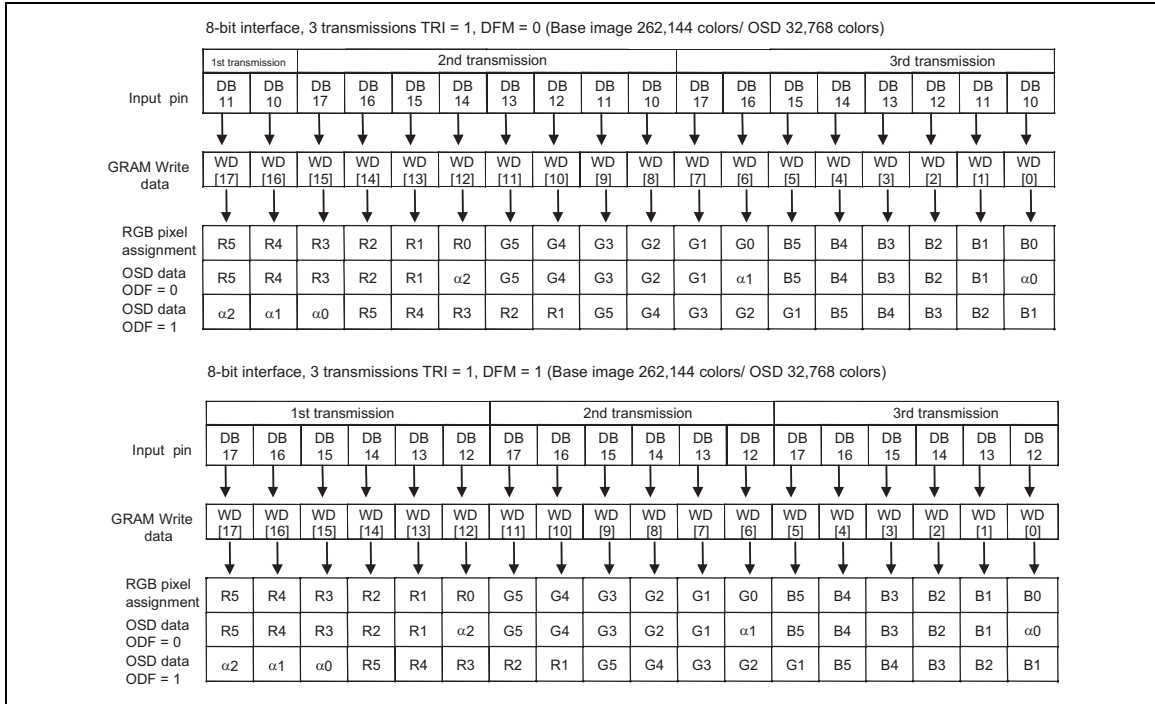

RAM data write in 8-bit interface, 3 transmissions (Base image/OSD image)

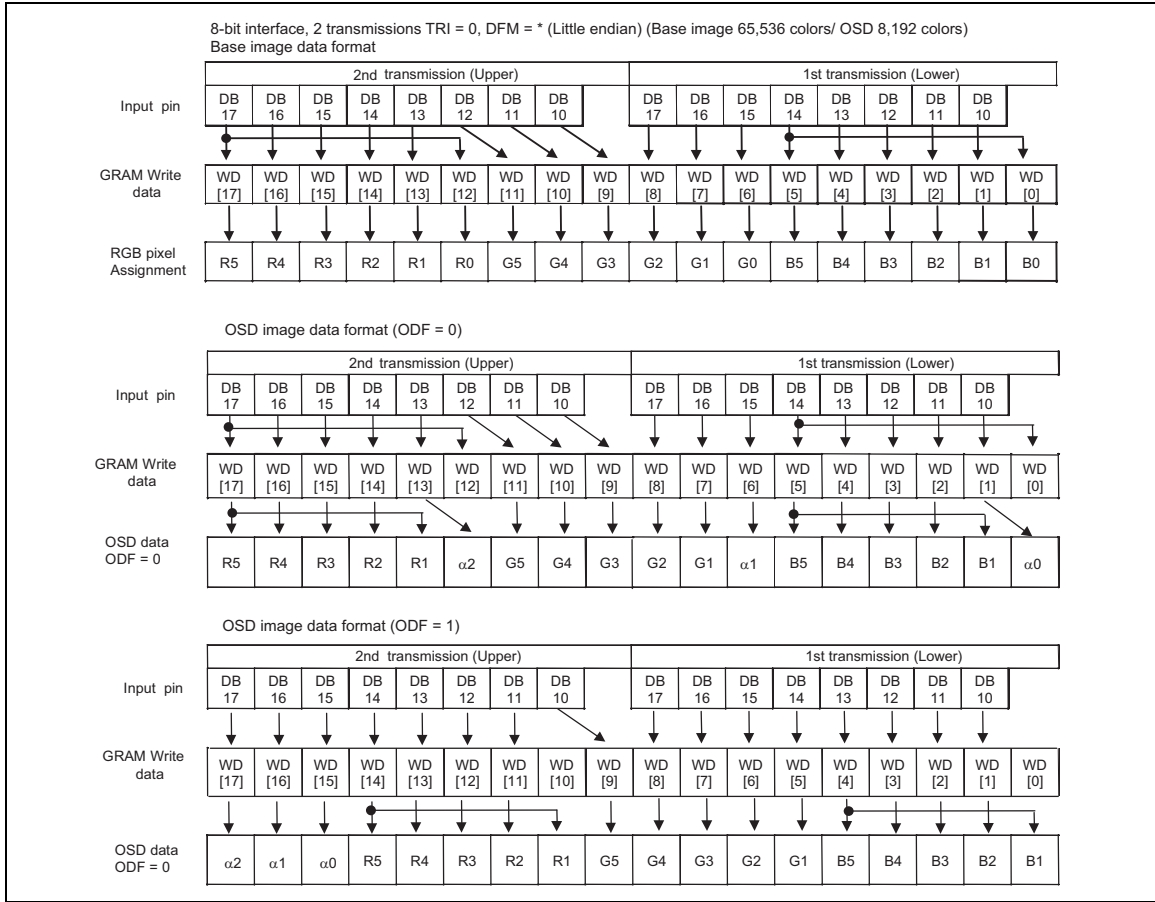

RAM data write in 8-bit interface, little endian (Base image/OSD image)

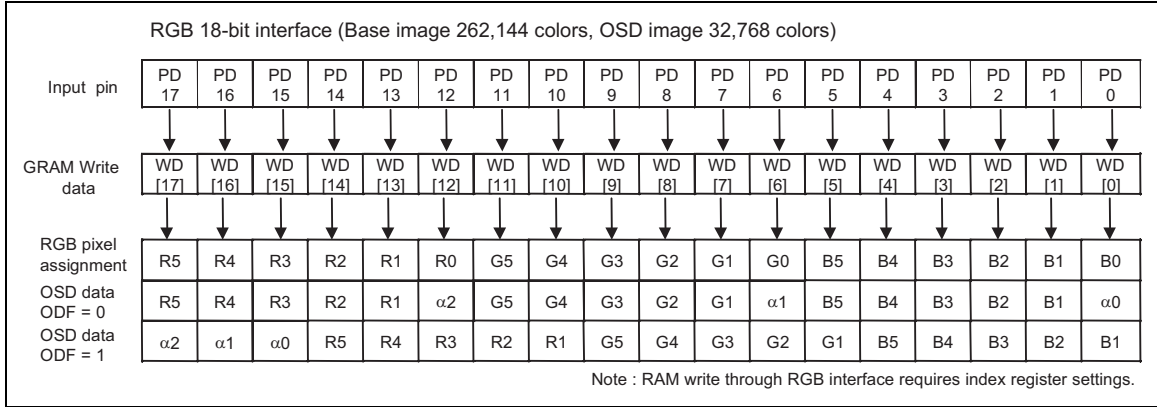

**RGB 18-bit interface (Base/OSD image display)**

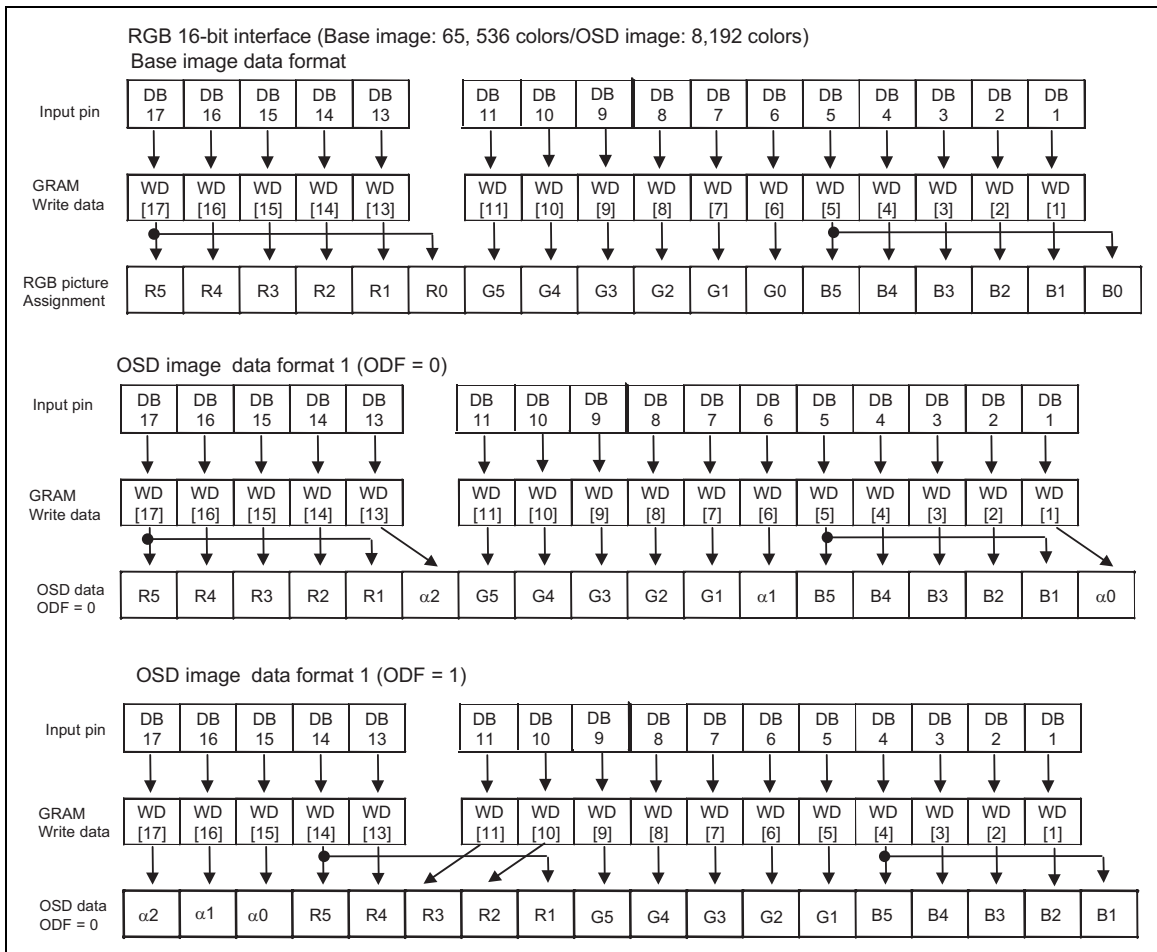

**RGB 16-bit interface (Base/OSD image display)**

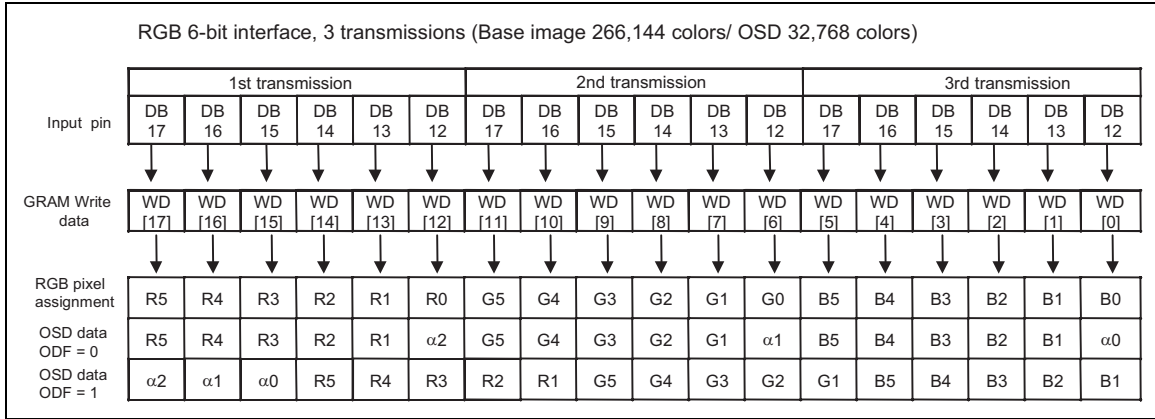

RGB 6-bit interface (Base/OSD image)

Table 49 GRAM data and LCD output level (REV = 0)

GRAM data RGB	Selected grayscale level		GRAM data RGB	Selected grayscale level	
	Positive	Negative		Positive	Negative
6'h00	V0	V63	6'h20	V32	V31
6'h01	V1	V62	6'h21	V33	V30
6'h02	V2	V61	6'h22	V34	V29
6'h03	V3	V60	6'h23	V35	V28
6'h04	V4	V59	6'h24	V36	V27
6'h05	V5	V58	6'h25	V37	V26
6'h06	V6	V57	6'h26	V38	V25
6'h07	V7	V56	6'h27	V39	V24
6'h08	V8	V55	6'h28	V40	V23
6'h09	V9	V54	6'h29	V41	V22
6'h0A	V10	V53	6'h2A	V42	V21
6'h0B	V11	V52	6'h2B	V43	V20
6'h0C	V12	V51	6'h2C	V44	V19
6'h0D	V13	V50	6'h2D	V45	V18
6'h0E	V14	V49	6'h2E	V46	V17
6'h0F	V15	V48	6'h2F	V47	V16
6'h10	V16	V47	6'h30	V48	V15
6'h11	V17	V46	6'h31	V49	V14
6'h12	V18	V45	6'h32	V50	V13
6'h13	V19	V44	6'h33	V51	V12
6'h14	V20	V43	6'h34	V52	V11
6'h15	V21	V42	6'h35	V53	V10
6'h16	V22	V41	6'h36	V54	V9
6'h17	V23	V40	6'h37	V55	V8
6'h18	V24	V39	6'h38	V56	V7
6'h19	V25	V38	6'h39	V57	V6
6'h1A	V26	V37	6'h3A	V58	V5
6'h1B	V27	V36	6'h3B	V59	V4
6'h1C	V28	V35	6'h3C	V60	V3
6'h1D	V29	V34	6'h3D	V61	V2
6'h1E	V30	V33	6'h3E	V62	V1
6'h1F	V31	V32	6'h3F	V63	V0

**RAM Access through RGB-I/F and System I/F**

The HD66781 writes all display data to the internal RAM even in the RGB-I/F mode. Through the RGB-I/F mode, only the data for the moving picture area as well as for the frames to update screens can be transmitted. By writing data in the high-speed write mode (HWM = 1) and with the window address function, the HD66781 achieves high-speed access to RAM with low power consumption while displaying moving pictures. In the frames other than the moving picture screen update, the display data in the area other than the moving picture area can be updated through a system interface.

RAM access is also possible through the system interface even in the RGB-I/F mode. In the RGB interface mode, data are written to RAM in synchronization with the DOTCLK input during ENABLE = "Low". When writing data in the RGB-I/F mode through the system interface, it is necessary to set ENABLE "High" to stop writing through the RGB interface. After accessing RAM through the system interface, wait an enough time for the write/read bus cycle before starting RAM access through the RGB interface.

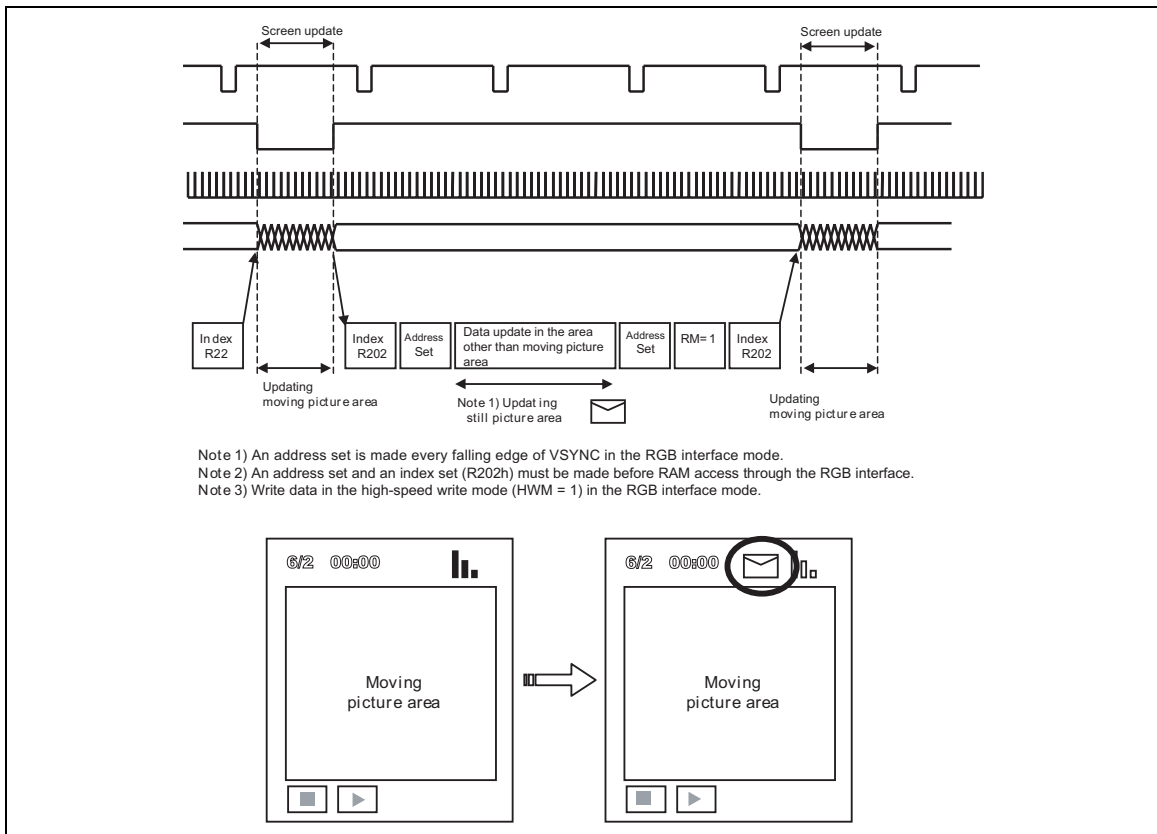

**Updating still picture area while displaying a moving picture**

**Read Data from GRAM (R202h)**

R/W	RS	
R	1	RAM read data (RD[17:0]) are assigned differently to the DB[17:0] pins according to an interface .

**RD[17:0]:** Read 18-bit data from GRAM. The RAM read data (RD[17:0]) are assigned differently to the DB[17:0] pins according to an interface.

When data are read out from GRAM to the microcomputer, the first-word data read immediately after the GRAM address set are latched in the internal read-data latch, and the data in the data bus (DB17-0) are nullified. The data are read as valid data from the second word.

When the 8-/16-bit interfaces are selected, the GRAM data in the LSBs of R and B pixels are not read out. When reading out OSD data, it takes the data format when ODF = 0. This function is not available in the RGB interface mode. Set TRI = 0 while data read is executed.

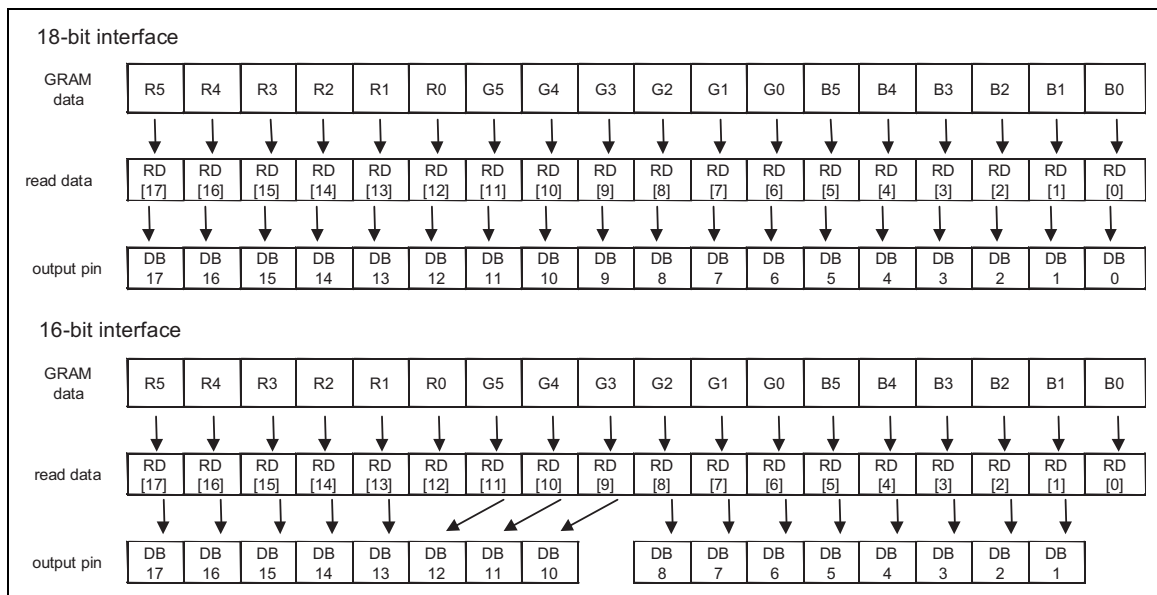

**Read data from GRAM: 18/16-bit interface**

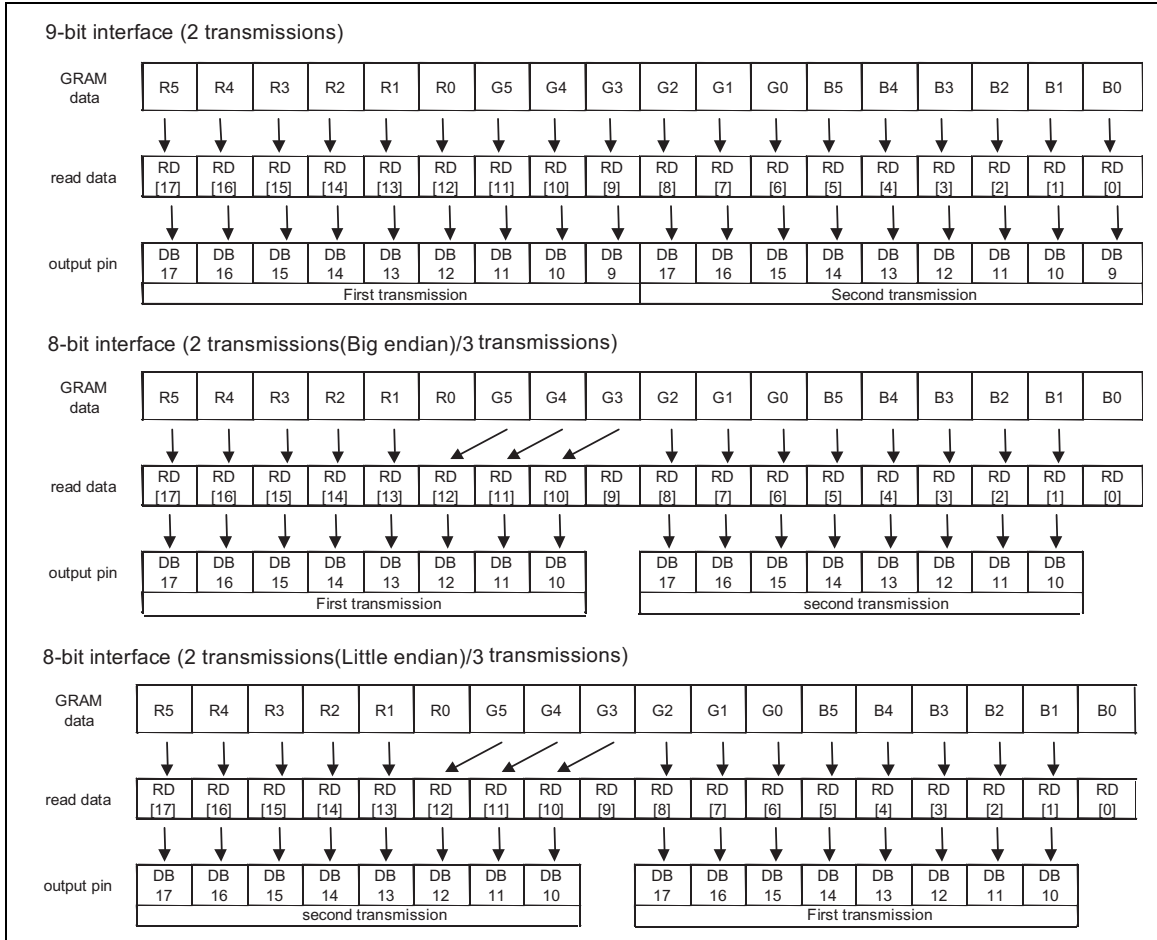

**Read data from GRAM: 9/8-bit interface**

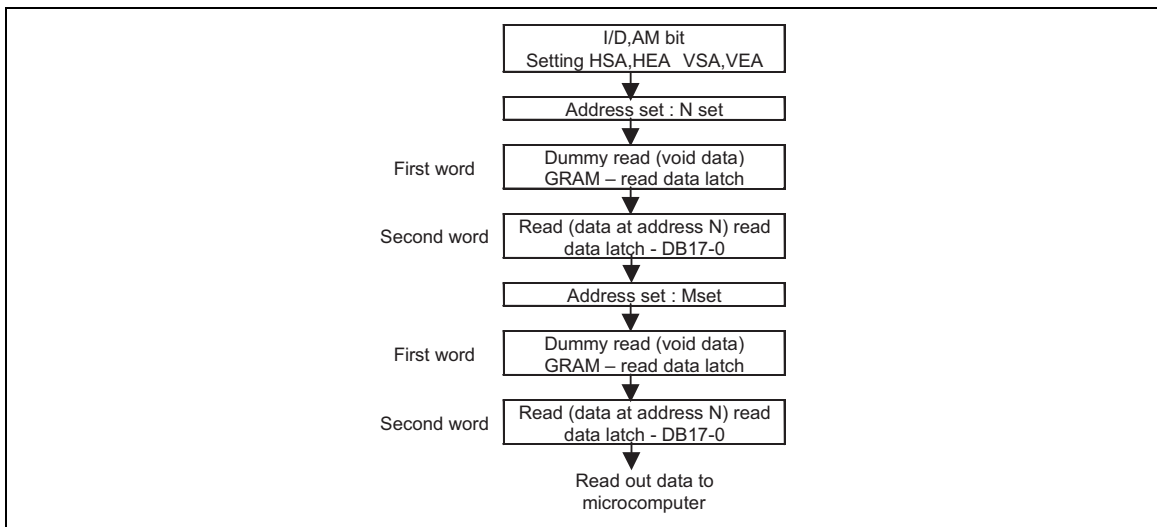

**GRAM read sequence**



**RAM Write Data Mask 1/2 (R203h/R204h)**

R/W	RS	IB15	IB14	IB13	IB12	IB11	IB10	IB9	IB8	IB7	IB6	IB5	IB4	IB3	IB2	IB1	IB0
W	1	0	0	WM [11]	WM [10]	WM [9]	WM [8]	WM [7]	WM [6]	0	0	WM [5]	WM [4]	WM [3]	WM [2]	WM [1]	WM [0]
W	1	0	0	0	0	0	0	0	0	0	0	WM [17]	WM [16]	WM [15]	WM [14]	WM [13]	WM [12]

Note 1) Top R203, bottom R204

**WM[17:0]:** Write-mask data by bit when the data are written to GRAM. For example, if WM17 = 1, the WM17 write-mask the MSB of the data to write to GRAM so that the data in the MSB is not written to GRAM. The rest of WM16 ~ 0 bits also write-mask the data in the corresponding bits of GRAM write data as well when they are set to 1.

The WM17-0 bits write-mask the 18-bit data to write to GRAM.

Note 1) This function is not available in the RGB-I/F mode.

Note 2) OSD image data are written to RAM in the ODF = 0 format. The write-mask setting for OSD images must be made for the ODF = 0 format.

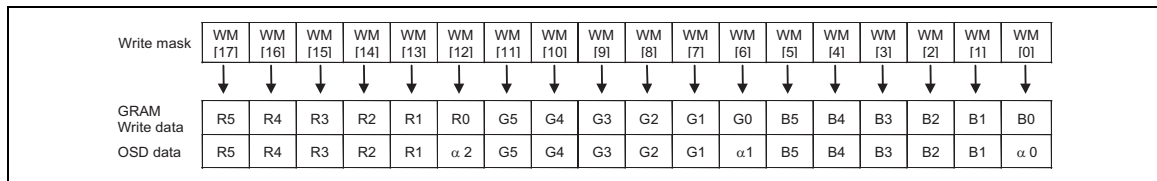

**RAM write data mask**

**Window Address Control Instructions**

**Window horizontal RAM address Start/End (R210h/ R211h)**

**Window vertical RAM address Start/End (R212h/R213h)**

	R/W	RS	IB15	IB14	IB13	IB12	IB11	IB10	IB9	IB8	IB7	IB6	IB5	IB4	IB3	IB2	IB1	IB0	
R50	W	1	0	0	0	0	0	0	0	0	HSA [7]	HSA [6]	HSA [5]	HSA [4]	HSA [3]	HSA [2]	HSA [1]	HSA [0]	
R51	W	1	0	0	0	0	0	0	0	0	HEA [7]	HEA [6]	HEA [5]	HEA [4]	HEA [3]	HEA [2]	HEA [1]	HEA [0]	
R52	W	1	0	0	0	0	0	0	0	0	VSA [8]	VSA [7]	VSA [6]	VSA [5]	VSA [4]	VSA [3]	VSA [2]	VSA [1]	VSA [0]
R53	W	1	0	0	0	0	0	0	0	0	VEA [8]	VEA [7]	VEA [6]	VEA [5]	VEA [4]	VEA [3]	VEA [2]	VEA [1]	VEA [0]

**HSA[7:0]** Specify the start position of a window-address range in the horizontal direction by address.

**HEA[7:0]** Specify the end position of a window-address range in the horizontal direction by address. Data are written to a rectangular area within GRAM from the address specified by HSA to the address specified by HEA. The setting of the address is required before writing data to RAM. Make sure the address is set to satisfy  $8'h00 \leq HSA < HEA \leq 8'hEF$  and  $8'h4 \leq HEA - HSA$ .

**VSA[7:0]** Specify the start position of a window-address range in the vertical direction to access to RAM.

**VEA[7:0]** Specify the end position of a window-address range in the vertical direction to access to RAM. Data are written to a rectangular area within GRAM from the address specified by VSA to the address specified by VEA. The setting of addresses is required before writing data to RAM. Make sure the addresses are set to satisfy  $9'h00 \leq VSA < VEA \leq 9'h19F$ .

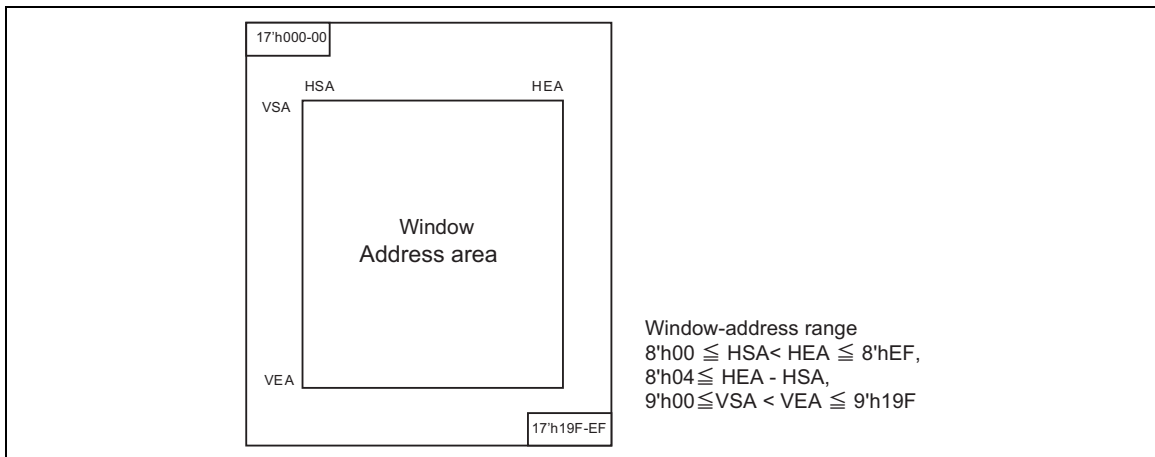

**GRAM address map and window-address range**

Note 1) Set a window-address range within the GRAM address map.

Note 2) In the high-speed write mode, data are written to GRAM by one horizontal line. Write data to GRAM by horizontal line unit.

Note 3) Make an address set within the window address area. In the high-speed write mode, make an address set from the first line of the window address area.

$\gamma$  Control (R300h ~ R309h)

	R/W	RS	IB15	IB14	IB13	IB12	IB11	IB10	IB9	IB8	IB7	IB6	IB5	IB4	IB3	IB2	IB1	IB0	
R300	W	1	0	0	0	0	0	PK P1[2]	PK P1[1]	PK P1[0]	0	0	0	0	0	PK P0[2]	PK P0[1]	PK P0[0]	
R301	W	1	0	0	0	0	0	PK P3[2]	PK P3[1]	PK P3[0]	0	0	0	0	0	PK P2[2]	PK P2[1]	PK P2[0]	
R302	W	1	0	0	0	0	0	PK P5[2]	PK P5[1]	PK P5[0]	0	0	0	0	0	PK P4[2]	PK P4[1]	PK P4[0]	
R303	W	1	0	0	0	0	0	PR P1[2]	PR P1[1]	PR P1[0]	0	0	0	0	0	PR P0[2]	PR P0[1]	PR P0[0]	
R304	W	1	0	0	0	VR P1[4]	VR P1[3]	VR P1[2]	VR P1[1]	VR P1[0]	0	0	0	0	0	VR P0[3]	VR P0[2]	VR P0[1]	VR P0[0]
R305	W	1	0	0	0	0	0	PK N1[2]	PK N1[1]	PK N1[0]	0	0	0	0	0	PK P0[2]	PK P0[1]	PK P0[0]	
R306	W	1	0	0	0	0	0	PK N3[2]	PK N3[1]	PK N3[0]	0	0	0	0	0	PK N2[2]	PK N2[1]	PK N2[0]	
R307	W	1	0	0	0	0	0	PK N5[2]	PK N5[1]	PK N5[0]	0	0	0	0	0	PK N4[2]	PK N4[1]	PK N4[0]	
R308	W	1	0	0	0	0	0	PR N1[2]	PR N1[1]	PR N1[0]	0	0	0	0	0	PR N0[2]	PR N0[1]	PR N0[0]	
R309	W	1	0	0	0	VR N1[4]	VR N1[3]	VR N1[2]	VR N1[1]	VR N1[0]	0	0	0	0	0	VR N0[3]	VR N0[2]	VR N0[1]	VR N0[0]

- PKP5-0[2:0]:**  $\gamma$  fine adjustment registers for positive polarity
- PRP1-0[2:0]:**  $\gamma$  gradient adjustment registers for positive polarity
- VRP(N)0[3:0]:** amplitude adjustment resistor for positive polarity
- PKN5-0[2:0]:**  $\gamma$  fine adjustment registers for negative polarity
- PRN1-0[2:0]:**  $\gamma$  gradient adjustment registers for negative polarity
- VRP(N)1[4:0]:** amplitude average adjustment resistor for negative polarity

**Base image display control instructions**

**Number of Line (R400h)**

**Base image display position (R401h)**

**Base picture RAM Address (R402h)**

**Base picture RAM Address (R403h)**

**Vertical scroll Control (R404h)**

**Base image expansion area/start line address (R405h)**

**Base image expansion area/end line address (R406h)**

	R/W	RS	IB15	IB14	IB13	IB12	IB11	IB10	IB9	IB8	IB7	IB6	IB5	IB4	IB3	IB2	IB1	IB0
R400	W	1	0	0	0	0	0	0	0	0	0	0	NL1 [5]	NL1 [4]	NL1 [3]	NL1 [2]	NL1 [1]	NL1 [0]
R401	W	1	0	0	0	0	0	0	0	0	0	0	0	0	0	0	VLE	REV
R402	W	1	0	0	0	0	0	0	0	BSA [8]	BSA [7]	BSA [6]	BSA [5]	BSA [4]	BSA [3]	BSA [2]	BSA [1]	BSA [0]
R403	W	1	0	0	0	0	0	0	0	BEA [8]	BEA [7]	BEA [6]	BEA [5]	BEA [4]	BEA [3]	BEA [2]	BEA [1]	BEA [0]
R404	W	1	0	0	0	0	0	0	0	VL [8]	VL [7]	VL [6]	VL [5]	VL [4]	VL [3]	VL [2]	VL [1]	VL [0]
R405	W	1	0	0	0	0	0	0	0	ESA [8]	ESA [7]	ESA [6]	ESA [5]	ESA [4]	ESA [3]	ESA [2]	ESA [1]	ESA [0]
R406	W	1	0	0	0	0	0	0	0	EEA [8]	EEA [7]	EEA [6]	EEA [5]	EEA [4]	EEA [3]	EEA [2]	EEA [1]	EEA [0]

**Base image control instructions**

**NL0[5:0]:** Set the number of liquid crystal drive raster-rows. The number of raster-rows can be set to 8 multiples. The GRAM address mapping is made irrespective of the value set for the number of raster-rows to drive liquid crystal. The value should be set equal to or more than to drive the number of raster-rows required for the panel size.

**REV:** When REV = 1, a reverse display is shown within the display area. The grayscale level inversion enables to use same data to display on both normally white and normally black panels. The REV setting is effective for both OSD and base image areas.

The source outputs during front and back porches and a blank period during partial display mode depend on the setting of PTS bits.

**Table 50**

REV0	GRAM data	Source output level in display area	
		Positive polarity	Negative polarity
0	18'h00000	V63	V0
	18'h3FFFF	V0	V63
1	18'h00000	V0	V63
	18'h3FFFF	V63	V0

Note 1) The source outputs during front and back porches and a blank period during partial display mode depend on the setting of PTS bits.

**VLE:** When VLE = 1, settings for the vertical scroll display is made valid. The start line is displayed according to the VL[8:0] setting. The raster-rows that display a base image are scrolled by the number of lines set by VL bits. OSD area is not affected by the base-picture scrolling. This function is not available while external display interface is selected. While external display interface is selected, make sure that VLE= 0.

Table 51

VLE	Base image
0	Fixed display
1	Scrolling display

Note 1) Scroll function is not available during the interlaced drive (FLD = 2'h3)

**BSA[8:0]/BEA[8:0]:** Set the start line address (BSA) and the end line address (BEA) of the base image display RAM area.

Display RAM data from the one set at BSA bits from the first line. Make sure that base image display RAM area (BSA/BEA) is equal to or more than the number of raster-rows driving a panel (= NL ≤ BSA – BEA). In case of BSA – BEA ≤ NL, outside the base image area becomes non-lit display.

**VL[8:0]** Set the number of raster-rows that are scrolled for a base image. The numbers of raster-rows set by VL bits are scrolled within the base image.

**ESA[8:0]/EEA[8:0]** Set the start line address (ESA) and the end line address (EEA) of the area which is magnified in the base image display RAM area.

A base image in the area specified with ESA and EEA is magnified on display. Make sure that BSA ≤ ESA ≤ EEA ≤ BEA. A magnified base image is not available with the scrolling function.

Table 52 Liquid crystal drive raster-rows

NL[5:0]	Number of raster-rows	NL[5:0]	Number of raster-rows
6'h00	Setting disabled	6'h14	168
6'h01	16	6'h15	176
6'h02	24	6'h16	184
6'h03	32	6'h17	192
6'h04	40	6'h18	200
6'h05	48	6'h19	208
6'h06	56	6'h1A	216
6'h07	64	6'h1B	224
6'h08	72	6'h1C	232
6'h09	80	6'h1D	240
6'h0A	88	6'h1E	248
6'h0B	96	6'h1F	256
6'h0C	104	6'h20	264
6'h0D	112	6'h21	272
6'h0E	120	6'h22	280
6'h0F	128	6'h23	288
6'h10	136	6'h24	296
6'h11	144	6'h25	304
6'h12	152	6'h26	312
6'h13	160	6'h27	320

**OSD control instructions**

- OSD image 1 display position (R500h)**
- OSD image 1 RAM Address /Start line Address (R501h)**
- OSD image 1 RAM Address /End line Address (R502h)**
- OSD image 2 display position (R503h)**
- OSD image 2 RAM Address/Start line Address (R504h)**
- OSD image 2 RAM Address/End line Address (R505h)**
- OSD image 3 display position (R506h)**
- OSD image 3 RAM Address/Start line Address (R507h)**
- OSD image 3 RAM Address/End line Address (R508h)**

	R/W	RS	IB15	IB14	IB13	IB12	IB11	IB10	IB9	IB8	IB7	IB6	IB5	IB4	IB3	IB2	IB1	IB0
R500	W	1	0	0	0	0	0	0	0	ODP0 0 [8]	ODP0 0 [7]	ODP0 0 [6]	ODP0 0 [5]	ODP0 0 [4]	ODP0 0 [3]	ODP0 0 [2]	ODP0 0 [1]	ODP0 0 [0]
R501	W	1	0	0	0	0	0	0	0	OSA0 0 [8]	OSA0 0 [7]	OSA0 0 [6]	OSA0 0 [5]	OSA0 0 [4]	OSA0 0 [3]	OSA0 0 [2]	OSA0 0 [1]	OSA0 0 [0]
R502	W	1	0	0	0	0	0	0	0	OEA0 0 [8]	OEA0 0 [7]	OEA0 0 [6]	OEA0 0 [5]	OEA0 0 [4]	OEA0 0 [3]	OEA0 0 [2]	OEA0 0 [1]	OEA0 0 [0]
R503	W	1	0	0	0	0	0	0	0	ODP1 1 [8]	ODP1 1 [7]	ODP1 1 [6]	ODP1 1 [5]	ODP1 1 [4]	ODP1 1 [3]	ODP1 1 [2]	ODP1 1 [1]	ODP1 1 [0]
R504	W	1	0	0	0	0	0	0	0	OSA1 1 [8]	OSA1 1 [7]	OSA1 1 [6]	OSA1 1 [5]	OSA1 1 [4]	OSA1 1 [3]	OSA1 1 [2]	OSA1 1 [1]	OSA1 1 [0]
R505	W	1	0	0	0	0	0	0	0	OEA1 1 [8]	OEA1 1 [7]	OEA1 1 [6]	OEA1 1 [5]	OEA1 1 [4]	OEA1 1 [3]	OEA1 1 [2]	OEA1 1 [1]	OEA1 1 [0]
R506	W	1	0	0	0	0	0	0	0	ODP2 2 [8]	ODP2 2 [7]	ODP2 2 [6]	ODP2 2 [5]	ODP2 2 [4]	ODP2 2 [3]	ODP2 2 [2]	ODP2 2 [1]	ODP2 2 [0]
R507	W	1	0	0	0	0	0	0	0	OSA2 2 [8]	OSA2 2 [7]	OSA2 2 [6]	OSA2 2 [5]	OSA2 2 [4]	OSA2 2 [3]	OSA2 2 [2]	OSA2 2 [1]	OSA2 2 [0]
R508	W	1	0	0	0	0	0	0	0	OEA2 2 [8]	OEA2 2 [7]	OEA2 2 [6]	OEA2 2 [5]	OEA2 2 [4]	OEA2 2 [3]	OEA2 2 [2]	OEA2 2 [1]	OEA2 2 [0]

- ODP0[8:0]:** ODP0 : Set the display position of OSD image 1.
- ODP1[8:0]:** ODP1 : Set the display position of OSD image 2.
- ODP2[8:0]:** ODP2 : Set the display position of OSD image 3.

The display areas for OSD images 1, 2, 3 should not overlap one another. Set each area as follows.

- Display area of OSD image 1: ODP0, ODP0+(OEA0 – OSA0)
- Display area of OSD image 2: ODP1, ODP1+(OEA1 – OSA1)
- Display area of OSD image 3: ODP2, ODP2+(OEA2 – OSA2)

Make sure that

display area of OSD image 1 < Display area of OSD image 2 < Display area of OSD image 3.

If ODP0 is set “9’h000”, OSD image 1 is displayed from the start line of the base image on the first panel. The OSD is not available during interlaced drive (FLD = 2’h3).

**OSA0[8:0] OEA0[8:0]:** OSA0, OEA0 : Set the start line address and end line address for display RAM area of the OSD image 1.

**OSA1[8:0] OEA1[8:0]**: OSA1, OEA1 : Set the start line address and end line address for display RAM area of the OSD image 2.

**OSA2[8:0] OEA2[8:0]**: OSA2, OEA2 : Set the start line address and end line address for display RAM area of the OSD image 3.

Instruction list

Main Category	Sub Category	Upper Code																Lower Code																Note	
		IB15	IB14	IB13	IB12	IB11	IB10	IB9	IB8	IB7	IB6	IB5	IB4	IB3	IB2	IB1	IB0	IB15	IB14	IB13	IB12	IB11	IB10	IB9	IB8	IB7	IB6	IB5	IB4	IB3	IB2	IB1	IB0		
0**	Display Control System	000h	Status Read																Start Oscillation																
		001h	Device Code Read																Driver Output Control																
		002h	Liquid Crystal Drive Alternating Control																Entry Mode																
		003h	Resizing Control (1)																Resizing Control (2)																
		006h	Setting Disabled																Display Control (1)																
		007h	Display Control (2)																Display Control (3)																
		008h	Display Control (4)																External Display Interface Control (1)																
		009h	Frame Cycle Adjustment Control																External Display Interface Control (2)																
		00Fh	External Display Interface Control (3)																Gate Driver/TPS Liquid Crystal Panel Interface Control (1)																
		010h	Gate Driver/TPS Liquid Crystal Panel Interface Control (2)																Gate Driver/TPS Liquid Crystal Panel Interface Control (3)																
		011h	Gate Driver/TPS Liquid Crystal Panel Interface Control (4)																Gate Driver/TPS Liquid Crystal Panel Interface Control (5)																
		012h	Gate Driver/TPS Liquid Crystal Panel Interface Control (6)																Gate Driver/TPS Liquid Crystal Panel Interface Control (7)																
		013h	Gate Driver/TPS Liquid Crystal Panel Interface Control (8)																Gate Driver/TPS Liquid Crystal Panel Interface Control (9)																
		014h	Gate Driver/TPS Liquid Crystal Panel Interface Control (10)																Gate Driver/TPS Liquid Crystal Panel Interface Control (11)																
		015h	Gate Driver/TPS Liquid Crystal Panel Interface Control (12)																Gate Driver/TPS Liquid Crystal Panel Interface Control (13)																
		016h	Gate Driver/TPS Liquid Crystal Panel Interface Control (14)																Gate Driver/TPS Liquid Crystal Panel Interface Control (15)																
		017h	Gate Driver/TPS Liquid Crystal Panel Interface Control (16)																Gate Driver/TPS Liquid Crystal Panel Interface Control (17)																
		018h	Gate Driver/TPS Liquid Crystal Panel Interface Control (18)																Gate Driver/TPS Liquid Crystal Panel Interface Control (19)																
		019h	Gate Driver/TPS Liquid Crystal Panel Interface Control (20)																Gate Driver/TPS Liquid Crystal Panel Interface Control (21)																
		01Ah	Setting Disabled																Gate Driver/TPS Liquid Crystal Panel Interface Control (22)																
		01Bh	Setting Disabled																Gate Driver/TPS Liquid Crystal Panel Interface Control (23)																
		01Ch-0FFh	Setting Disabled																Gate Driver/TPS Liquid Crystal Panel Interface Control (24)																
1**	Power Control System (Gate Driver / Power Supply IC Interface)	100h	Power Control (1)																Gate Driver / Power Supply IC IF Control (1)																
		102h-10Fh	Setting Disabled																Gate Driver / Power Supply IC IF Control (2)																
		110h	Gate Driver / Power Supply IC IF Control (1)																Gate Driver / Power Supply IC IF Control (2)																
		111h	Gate Driver / Power Supply IC IF Control (1)																Gate Driver / Power Supply IC IF Control (2)																
		112h-1FFh	Setting Disabled																Gate Driver / Power Supply IC IF Control (2)																
2**	RAM Access System	200h	RAM Address Set (1)																RAM Address Set (2)																
		201h	RAM Address Set (1)																RAM Address Set (2)																
		202h	RAM Address Set (1)																RAM Address Set (2)																
		203h	RAM Address Set (1)																RAM Address Set (2)																
		204h	RAM Address Set (1)																RAM Address Set (2)																
		205h-20Fh	Setting Disabled																RAM Address Set (2)																
		210h	Horizontal RAM Address Position (1)																Horizontal RAM Address Position (2)																
		211h	Horizontal RAM Address Position (1)																Horizontal RAM Address Position (2)																
		212h	Vertical RAM Address Position (1)																Vertical RAM Address Position (2)																
		213h	Vertical RAM Address Position (1)																Vertical RAM Address Position (2)																
		214h-2FFh	Setting Disabled																Vertical RAM Address Position (2)																
3**	γ Control	300h	Control (1)																Control (2)																
		301h	Control (1)																Control (2)																
		302h	Control (1)																Control (2)																
		303h	Control (1)																Control (2)																
		304h	Control (1)																Control (2)																
		305h	Control (1)																Control (2)																
		306h	Control (1)																Control (2)																
		307h	Control (1)																Control (2)																
		308h	Control (1)																Control (2)																
		309h	Control (1)																Control (2)																
		30Ah-3FFh	Setting Disabled																Control (2)																
4**	Coordinate Control System	400h	Line Number Control																Screen Control																
		401h	Line Number Control																Screen Control																
		402h	Base Picture RAM Area (Start Line)																Base Picture RAM Area (End Line)																
		403h	Base Picture RAM Area (Start Line)																Base Picture RAM Area (End Line)																
		404h	Base Picture RAM Area (Start Line)																Base Picture RAM Area (End Line)																
		405h	Base Picture RAM Area (Start Line)																Base Picture RAM Area (End Line)																
		406h	Base Picture RAM Area (Start Line)																Base Picture RAM Area (End Line)																
		407h-4FFh	Setting Disabled																Base Picture RAM Area (End Line)																
5**	OSD Control	500h	OSD Picture 1 Display Position																OSD Picture 1 RAM Area (Start Line)																
		501h	OSD Picture 1 Display Position																OSD Picture 1 RAM Area (Start Line)																
		502h	OSD Picture 1 Display Position																OSD Picture 1 RAM Area (Start Line)																
		503h	OSD Picture 1 Display Position																OSD Picture 1 RAM Area (Start Line)																
		504h	OSD Picture 1 Display Position																OSD Picture 1 RAM Area (Start Line)																
		505h	OSD Picture 1 Display Position																OSD Picture 1 RAM Area (Start Line)																
		506h	OSD Picture 1 Display Position																OSD Picture 1 RAM Area (Start Line)																
		507h	OSD Picture 1 Display Position																OSD Picture 1 RAM Area (Start Line)																
		508h	OSD Picture 1 Display Position																OSD Picture 1 RAM Area (Start Line)																
		509h-5FFh	Setting Disabled																OSD Picture 1 RAM Area (Start Line)																
		600h-6FFh	Setting Disabled																OSD Picture 1 RAM Area (Start Line)																

Note 1) Numerals in parentheses in instruction bit cells are initial value.  
 Note 2) Do not try to access to the index where setting is disabled.



HD66783 Instruction Table

IDX[2]	IDX[1]	IDX[0]	TB[12]	TB[11]	TB[10]	TB[9]	TB[8]	TB[7]	TB[6]	TB[5]	TB[4]	TB[3]	TB[2]	TB[1]	TB[0]	
0	0	0	0	GON	VCOMG	BT[2]	BT[1]	BT[0]	DC[2]	DC[1]	DC[0]	AP[2]	AP[1]	AP[0]	0	
0	0	1	0	DK	1	EQM	0	PON	VRH[3]	VRH[2]	VRH[1]	VRH[0]	VC[2]	VC[1]	VC[0]	
0	1	0	DC[2]	DC[1]	DC[0]	VDV[4]	VDV[3]	VDV[2]	VDV[1]	VDV[0]	VCM[4]	VCM[3]	VCM[2]	VCM[1]	VCM[0]	
0	1	1	Setting Disabled													
1	0	0	Setting Disabled													
1	0	1	Setting Disabled													
1	1	0	GS	NL[5]	NL[4]	NL[3]	NL[2]	NL[1]	NL[0]	SCN[5]	SCN[4]	SCN[3]	SCN[2]	SCN[1]	SCN[0]	
1	1	1	0	0	0	0	0	0	0	0	0	0	0	0	FLD[1]	FLD[0]

HD667P21 Instruction Table

IDX[2]	IDX[1]	IDX[0]	TB[12]	TB[11]	TB[10]	TB[9]	TB[8]	TB[7]	TB[6]	TB[5]	TB[4]	TB[3]	TB[2]	TB[1]	TB[0]
0	0	0	0	GON	VCOMG	BT[2]	BT[1]	BT[0]	DC[2]	DC[1]	DC[0]	AP[2]	AP[1]	AP[0]	0
0	0	1	0	0	0	0	0	PON	VRH[3]	VRH[2]	VRH[1]	VRH[0]	VC[2]	VC[1]	VC[0]
0	0	1	0	1	0	DK[1]	DK[0]	0	0	0	0	0	0	0	0
0	1	0	0	0	0	VDV[4]	VDV[3]	VDV[2]	VDV[1]	VDV[0]	VCM[4]	VCM[3]	VCM[2]	VCM[1]	VCM[0]
0	1	1	Setting Disabled												
1	0	0	Setting Disabled												
1	0	1	Setting Disabled												
1	1	0	Setting Disabled												
1	1	1	0	0	VGL[4]	VGL[3]	VGL[2]	VGL[1]	VGL[0]	0	VGH[4]	VGH[3]	VGH[2]	VGH[1]	VGH[0]

AP and NL require a same and separate setting for each HD66781 and the register to transfer (Different Setting Disabled).

- Setting for AP register of 781
- Setting for AP register of 783/7P21 (R111h, TB[3]-[1])
- Serial Transfer to 783/7P21 (IDX000)

- Setting for NL register of 781
- Setting for NL register of 783 (R111h TB[11]-[6])
- Serial Transfer to 783 (IDX110)

- Setting for FLD register of 781
- Setting for FLD register of 783 (R111h TB[1]-[0])
- Serial Transfer to 783 (IDX111)

## Reset Function

The HD66781 is internally initialized by RESET input. During the reset period, internal settings are initialized. No access to instructions or GRAM data from the MPU is accepted during the reset period. The gate driver and the power supply are also automatically initialized when RESET input enters into the HD66781. The RESET period must be secured for at least 1 ms. In case of resetting by turning on the power supply (power-on reset), wait until the R-C oscillation frequency becomes stable after power is supplied (10 ms). During this period, do not access GRAM or make any initial instruction setting.

## Instruction Set Initialization

See the parenthesis number in each bit in the instruction list for the initial value.

## RAM Data Initialization

The RAM data are not automatically initialized by RESET input and must be initialized by software during the display-off period (D1-0 = 00).

## Output Pin Initialization

- |  |  |
|--|--|
| 1. LCD driver output pins (source outputs) | : Output GND level (All pins)  |
| 2. Vcom                                    | : Halt (Output GND)  |
| 3. Gate driver control signal              | : Halt (Output GND)<br>(FLM1, FLM2, CL11/SFTCLK11,<br>CL12/SFTCLK12, SFTCLK21, SFTCLK22,<br>M1, M2, DISPTMG1, DISPTMG2, EQ1, EQ2,<br>DCCLK1, DCCLK2) |
| 4. Gate driver serial interface            | : Halt GCS, GCL, GDA (Vcc1 output)   |
| 5. Oscillator output pin                   | : Oscillate  |
| 6. Synchronizing signal (BST)              | : Output GND   |
| 7. RESET signal output                     | : Same polarity with the RESET* input  |

## RAM Address and Display Position on the Panel

The HD66781 incorporates a memory for 240RGB x 416-line display, and enables to drive QVGA-size panel (240RGB x 320 lines). Unused display memory is available for a partial OSD area. These features realize various ways of display with a single chip.

The HD66781 allows independent settings for the display panel and the drive position, where the RAM area of each image is specified in relation to the display panel that is assigned to gate pins to fit into the assembly. Accordingly, in designing a panel, it is not necessary to take the assembly position into account.

The HD66781 allows realizes various ways of display with the following settings:

1. Specify the RAM area of a base image (BSA, BEA)
2. Specify the RAM area of an OSD image (OSAx, OEAx)
3. Specify the display position of the OSD image (step 2) on the panel (ODPx).
4. Specify the gate pins for driving the panel displaying a base image (SCN, NL) and the scan order (GS).
5. Execute display ENABLE (BASEE, OSDE0/1/2) for each image after turning on display.

A base image is a display that is set to be a basic display on each panel. An OSD image is a picture that is set to display on the base image. The panel-drive settings are made with gate scan starting position (SCN), the number of raster-rows to drive (NL), and scan direction (GS). The gate scan direction can be set differently for each panel to fit into the assembly. To change the display position horizontally, the setting of SS bit is required during RAM write.

**Table 53**

	Display ENABLE	Numbers of lines	RAM area
<b>(Base image 1)</b>	BASEE	NL	(BSA, BEA)

Note 1) The base image is displayed from the start line of each panel.

Note 2) Make sure that base image RAM area is  $NL \leq BEA - BSA$ .

**Table 54**

	Display ENABLE	Display position	RAM area
<b>OSD image 1</b>	OSDE0	ODP0	(OSA0, OEA0)
<b>OSD image 2</b>	OSDE1	ODP1	(OSA1, OEA1)
<b>OSD image 3</b>	OSDE2	ODP2	(OSA2, OEA2)

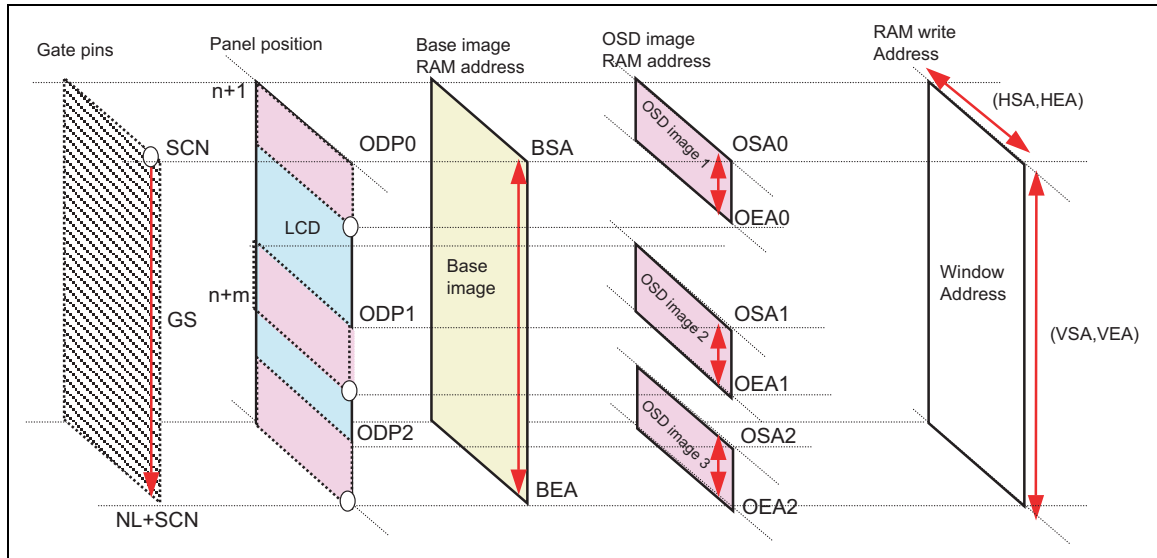

RAM Address, display position and drive position

**Notes to the setting of panel control registers**

The HD66781 has some constraints in setting the coordinate with regard to the display data, position, and OSD.

**Screen settings**

The following equation must be observed in making a setting for the screen.

$$NL \leq 320 \text{ lines}$$

$$0 \leq SCN < SCN + NL \leq 320 \text{ lines}$$

**Base image display**

Base image is displayed from the first line of each panel. Base image display start position:  $SCN = BSA$

Set the base image RAM area (BSA, BEA) equal to or more than the number of lines (NL) required driving a panel.  $NL \leq BEA - BSA$

**OSD image display**

Set the OSD image RAM area (OSAx, OEAx) not to overlap one another. Set the OSD positions not to overlap one another.

$$0 \leq ODP0 \leq ODP0 + n \times (OEA0 - OSA0 + 1) - 1 <$$

$$ODP1 \leq ODP1 + n \times (OEA1 - OSA1 + 1) - 1 <$$

$$ODP2 \leq ODP2 + n \times (OEA2 - OSA2 + 1) - 1 \leq NL$$

n: OSD image magnification scale

The OSD images are displayed 100% when base image is turned off (BASEE = 0). The arrangement of  $\alpha$  channels is also changed when changing RGB order to BGR. The OSD data are read out in the format when ODF is set to 0. During interlaced drive (FLD = 2'h3), OSD and  $\alpha$  blending functions are not available.

Following figure shows the relationship among RAM address, display position, and panel drive.

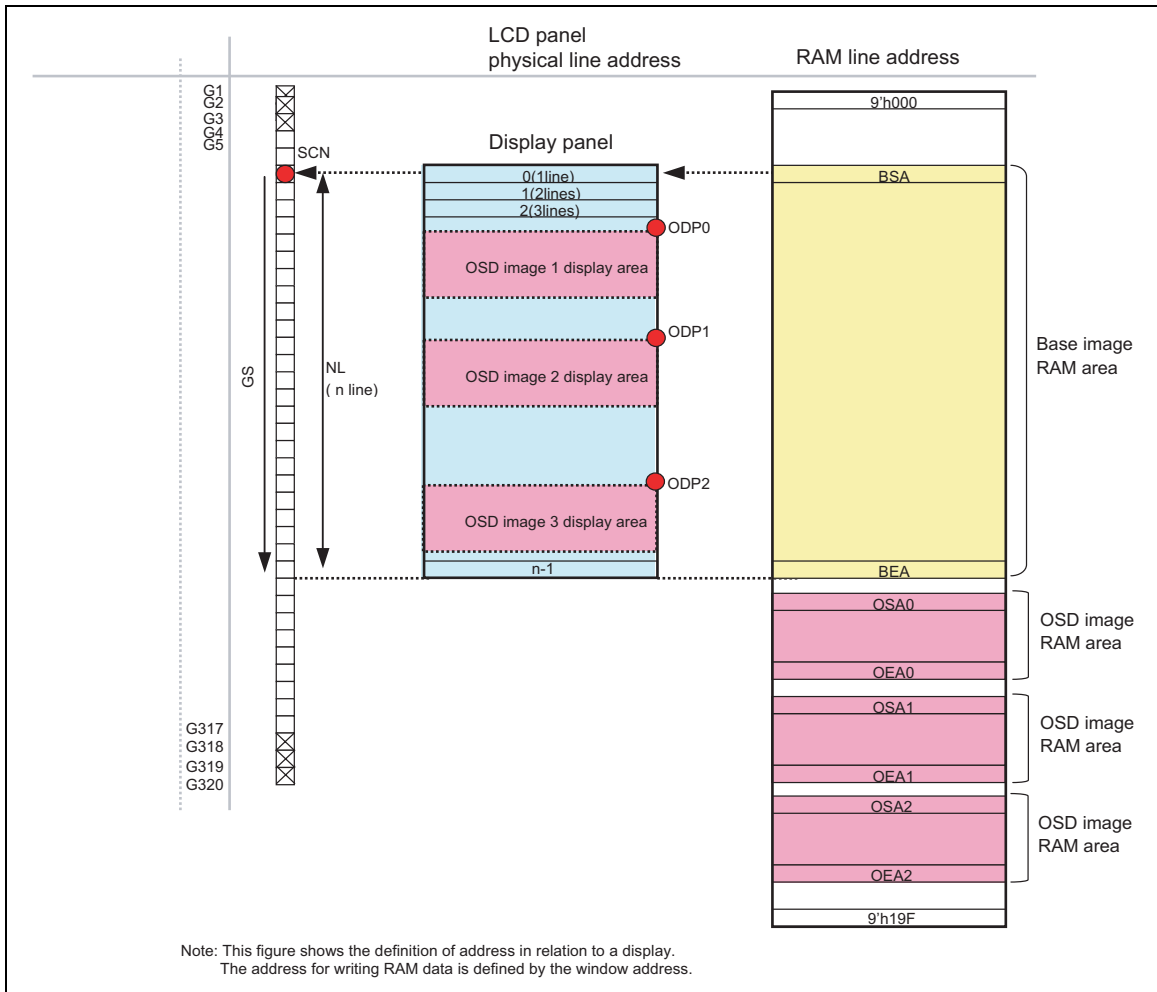

**Display RAM address and panel display position**

## OSD and $\alpha$ blending functions

The HD66781 incorporates OSD and  $\alpha$  blending functions. The OSD image data has 3  $\alpha$  bits to select transmission rates among 0, 25, 50, 75, 100%. The HD66781 not only handles 32,678-color OSD at maximum but also enables picture display data as OSD, in addition to usual single color text display. The HD66781 realizes various ways of display with a single-chip configuration.

The HD66781 eliminates the processing of OSD and  $\alpha$  blending from the microcomputer. Just transmitting OSD image data including  $\alpha$  bits into the LCD driver as usual enables OSD and  $\alpha$  blending display.

### OSD and $\alpha$ blending processing

The HD66781 writes data to RAM as an OSD image according to the setting of OSD bit. An image read out as OSD according to the OSD image display setting is displayed after being processed according to the transmission rate set by  $\alpha$  bits. OSD and  $\alpha$  blending settings can be made by pixels (RGB).

**Table 55**

$\alpha 2$	$\alpha 1$	$\alpha 0$	Transmission rate	Picture processing (Display data)	Picture processing (Display data)
0	0	0	0%	Base image display	Base image x 1.0 + OSD image x 0
0	0	1	-	Setting disabled	-
0	1	0	25%	Base image (75%) + OSD image (25%) display	25% transmission
0	1	1	75%	Base image (25%) + OSD image (75%) display	75% transmission
1	0	0	50%	Base image (50%) + OSD image (50%) display	Base image x 0.5 + OSD image x 0.5
1	0	1	-	Setting disabled	-
1	1	0	100%	OSD image display	Base image x 0 + OSD image x 1.0
1	1	1	-	Setting disabled	-

Note 1) The OSD image is displayed 100% when base image is turned off (BASEE = 0).

**OSD and  $\alpha$  blending processing**

The following is an example of display with OSD and  $\alpha$  blending functions with the HD66781. In the following example, the unused RAM area, which is not used for base image display, is used for OSD and  $\alpha$  blending RAM area.

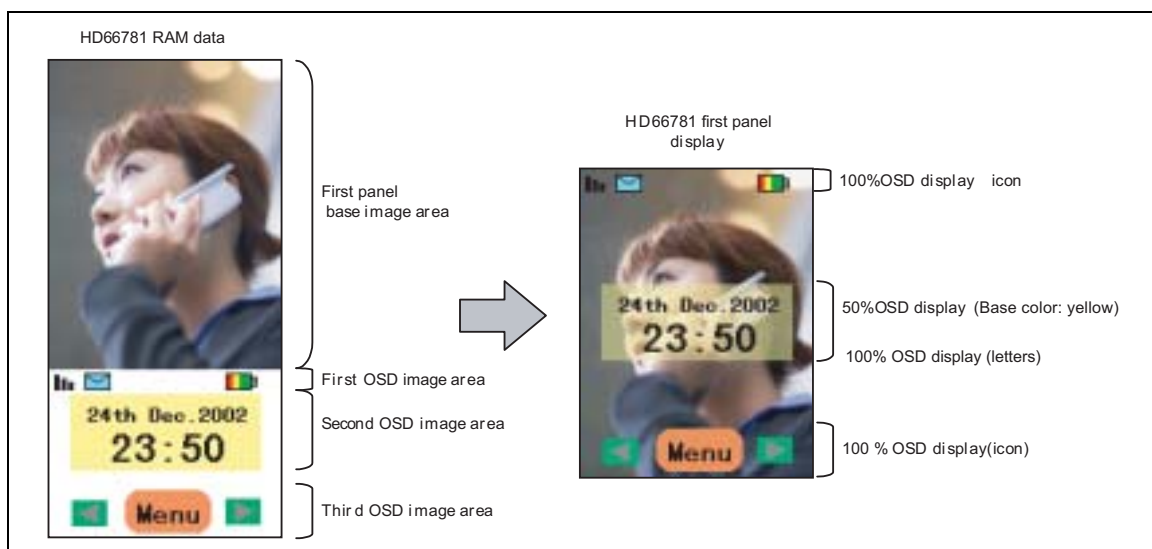

**Display with OSD and  $\alpha$  blending**

**OSD image data format**

OSD image data format ( $\alpha$  bit arrangement) is changeable with ODF bits. Select an appropriate format for the system to process. When writing an OSD image to RAM, set OSD to 1 beforehand. Specify the RAM write area by the window address.

**OSD image data format**

ODF	D 17	D 16	D 15	D 14	D 13	D 12	D 11	D 10	D9	D8	D7	D6	D5	D4	D3	D2	D1	D0
0	R5	R4	R3	R2	R1	2	G5	G4	G3	G2	G1	1	B5	B4	B3	B2	B1	0
1	2	1	0	R4	R3	R2	R1	R0	G4	G3	G2	G1	G0	B4	B3	B2	B1	B0
Normal data	R5	R4	R3	R2	R1	R0	G5	G4	G3	G2	G1	G0	B5	B4	B3	B2	B1	B0

**OSD image display setting**

To make a setting for OSD image display,

1. Specify OSD RAM area (OSA, OEA)
2. Specify OSD position
3. Set OSD ENABLE (OSDE)

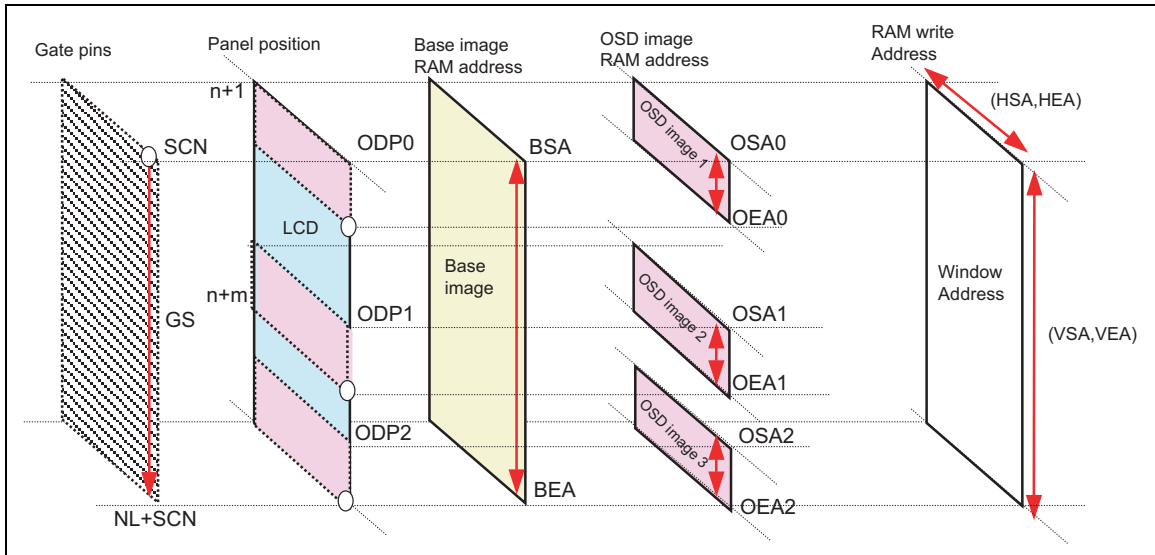

**RAM Address, display position, drive position**

Whenever making an OSD image setting, the following must be observed.

1. Set the OSD RAM area with OSAx, OEAx not to overlap one another.
2. Set the OSD position so that an OSD image does not overlap one another.

$$\begin{aligned}
 0 &\leq \text{ODP0} \leq \text{ODP0} + n \times (\text{OEA0} - \text{OSA0} + 1) - 1 < \\
 &\text{ODP1} \leq \text{ODP1} + n \times (\text{OEA1} - \text{OSA1} + 1) - 1 < \\
 &\text{ODP2} \leq \text{ODP2} + n \times (\text{OEA2} - \text{OSA2} + 1) - 1 \leq \text{NL}
 \end{aligned}$$

“n” is a magnification scale of an OSD image.

3. An OSD image is displayed 100% when the base image is turned off (BASEE = 0).
4. During the interlaced drive (FLD = 2'h3), the OSD and  $\alpha$  blending functions are not available.

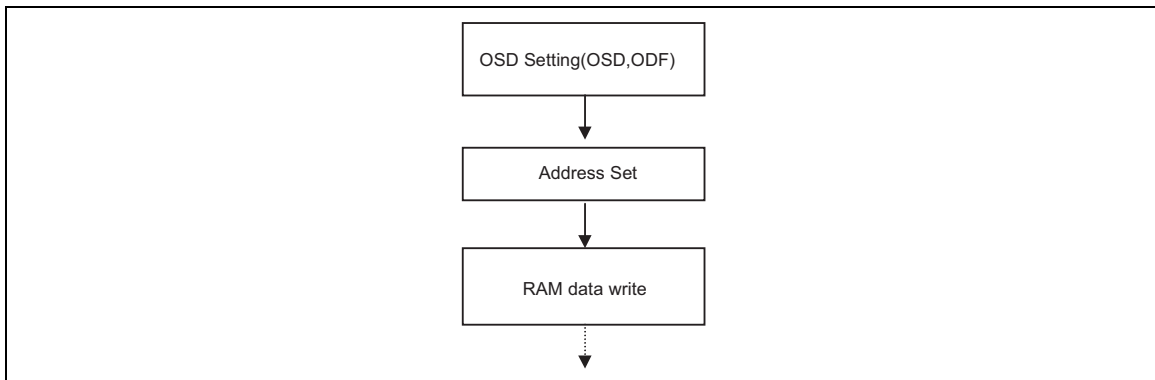

**OSD data write flow**



**Resizing function**

The HD66781 incorporates resizing function (contraction: x 1/2, x 1/4, magnification: x2) available when writing picture data.

**Contraction**

The HD66781 enables to write resized image data to RAM by simply transmitting original image data to the window address as usual with the setting of RSR bit that specifies the contraction rate.

This means the HD66781 allows the system simply to transmit data as usual even if resizing is required, and therefore makes resized images easily available on cameras, sub panels, or as a thumbnail display of a picture.

The HD66781 performs contraction resizing simply by selecting pixels. The resized image may seem distorted from the original image. Check the resized image before use.

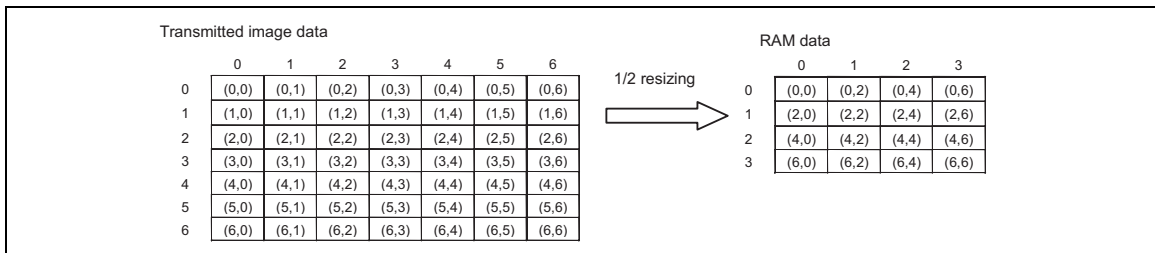

**Resizing: contraction**

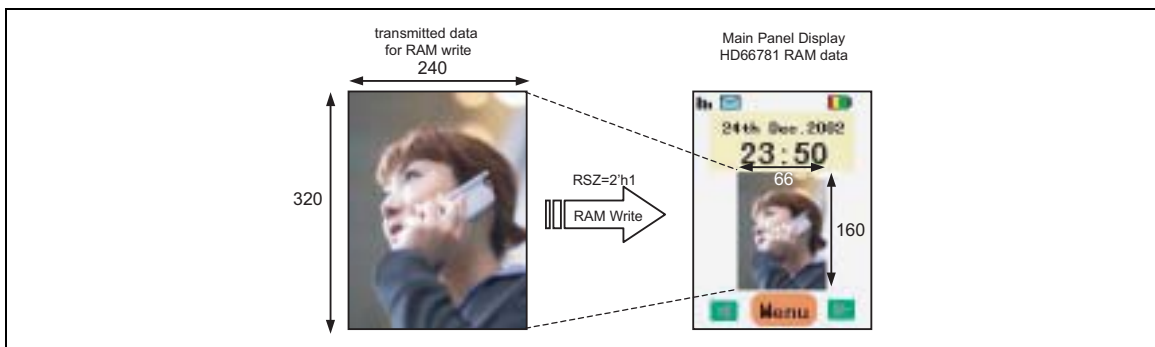

**Resizing transmission, display example**

**Table 56**

Original image size (X x Y)	Resized image size	
	1/2 (RSZ = 2'h1)	1/4 (RSZ = 2'h3)
640x480(VGA)	320x240	160x120
352x268 (CIF)	176x144	88x72
320x240 (QVGA)	160x120	80x60
176x144 (QCIF)	88x72	44x36
120x160	60x80	30x40
132x176	66x88	33x44

**Resizing setting**

The HD66781 selects resizing (contraction) rate according to the setting of RSR bit. Specify the RAM window-address range to fit into the resized picture. If resizing creates surplus pixels according to the result of calculation using the following formulas, set them in RCV, RCH registers before writing data to RAM.

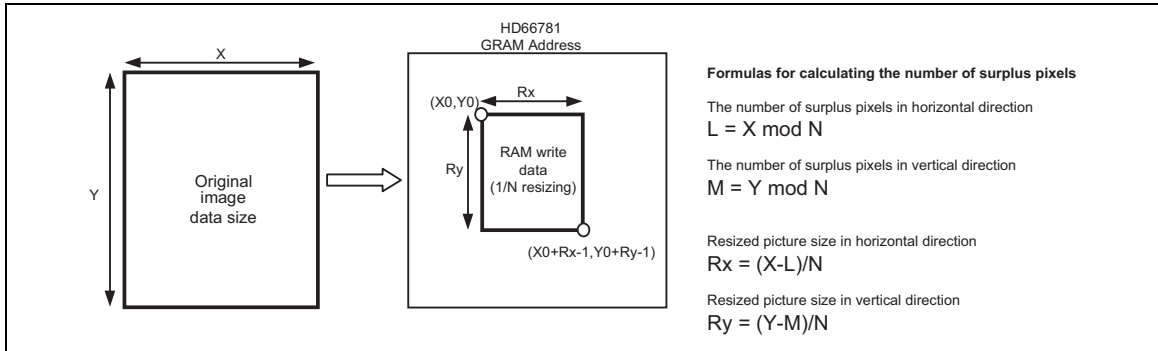

**Resizing Setting, surplus pixel calculation**

**Table 57**

**Original image (before resizing)**

number of data in horizontal direction	X
number of data in vertical direction	Y
resizing ratio	1/N

**HD66781 settings**

Resizing setting	RSR	N-1
number of data in horizontal direction	RCV	L
number of data in vertical direction	RCH	M

RAM writing start address	AD	(X0, Y0)
RAM window address	HSA	X0
	HEA	X0+Rx - 1
	VSA	Y0
	VEA	Y0+Ry - 1

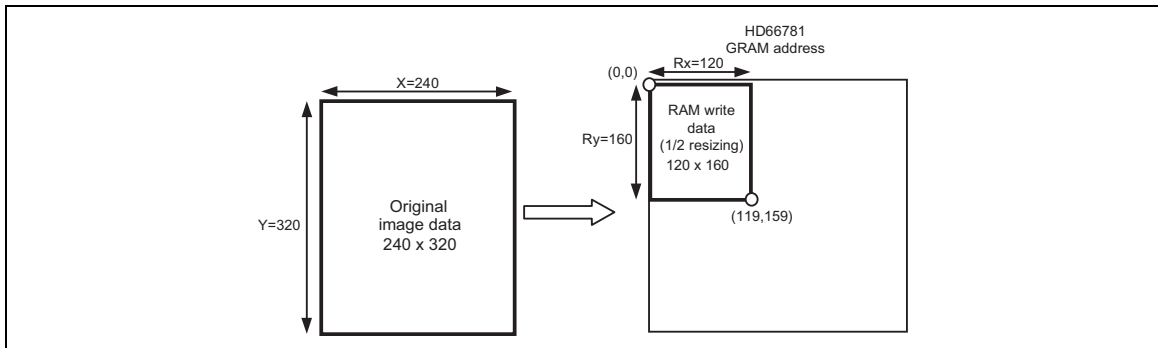

**Resizing setting example (1/2 size)**

**Table 58**

**Original image (before resizing)**

number of data in horizontal direction	X	240
number of data in vertical direction	Y	320
resizing ratio	1/N	1/2

**HD66781 settings**

Resizing setting	RSR	2'h1
number of data in horizontal direction	RCV	2'h0
number of data in vertical direction	RCH	2'h0

RAM writing start address	AD	17'h00000
RAM window address	HSA	8'h00
	HEA	8'h77
	VSA	8'h00
	VEA	8'h9F

**Instructions for Resizing**

**Table 59 Resizing ratio**

RSR[1:0]	ratio
2'h0	No resizing (x 1)
2'h1	1/2 resizing (x 1/2)
2'h2	setting disabled
2'h3	1/4 resizing (x 1/4)

**Table 60 Surplus pixels**

**vertical direction**

RCV[1:0]	surplus pixels
2'h0	0
2'h1	1 pixel
2'h2	2 pixels
2'h3	3 pixels

1 pixel = 1 RGB

**horizontal direction**

RCH[1:0]	surplus pixels
2'h0	0
2'h1	1 pixel
2'h2	2 pixels
2'h3	3 pixels

1 pixel = 1 RGB

**Notes to the resizing function**

1. Make settings for resizing instructions (RSR, RCV, and RCH) before writing data to RAM.
2. Write data to RAM from the start position of the window address by line when using resizing function.
3. Fit the window-address range into the size of the resized picture.
4. Make an address set before writing data to RAM when using resizing function.
5. Settings for RCH, RCV are only required when using resizing function. Otherwise (RSR = 2'h0), set RCH = RCV = 2'h0.

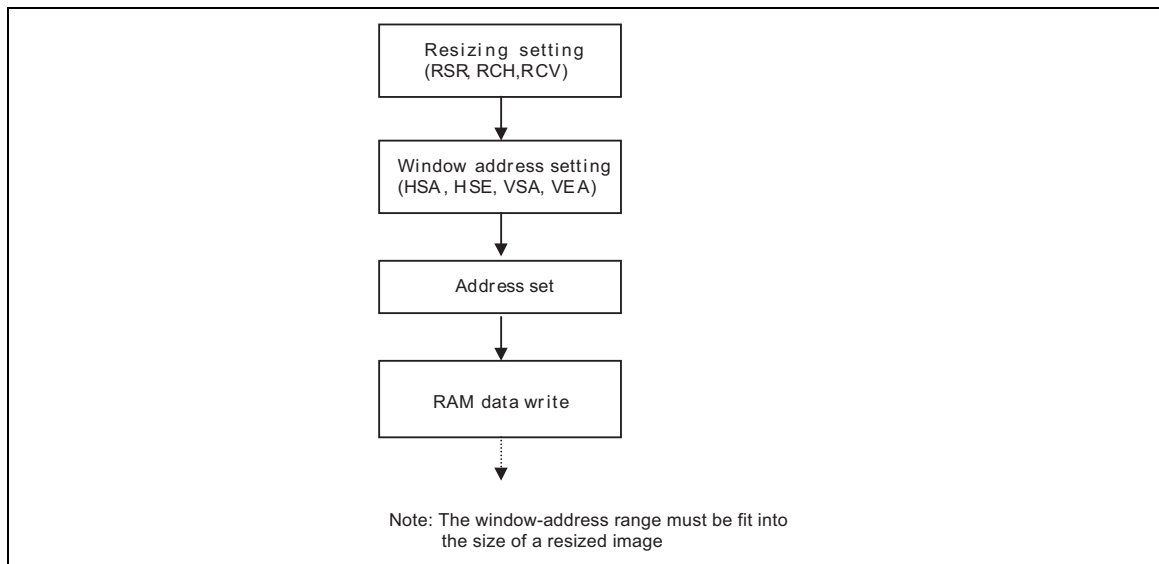
**RAM Writing flow when using resizing**

**Magnification**

The HD66781 enables to write resized image data to RAM by simply transmitting original image data to the window address as usual with the settings of RESH/RESEV[7:0] bits that specify the magnification rate each for the base and OSD images. The magnification rate is specified each for the base and OSD images. Also, only a part of RAM area of a base image can be magnified on display in the vertical direction. This means the HD66781 allows the system simply to transmit an original data as usual even when displaying a magnified image on a large screen, and therefore enables to reduce the data transmission required for a large screen display.

The display magnification in the vertical direction should be specified by line.

Base image: The image specified by ESA[8:0] and EEA[8:0] on RAM is magnified on display by the scale set by the RSEV[1:0] setting.

OSD image: The image specified by OSAx[8:0] and OEAx[8:0] on RAM is magnified on display in the manner set by the RSEV[7:2] setting.

When magnifying in the horizontal direction, the window-address settings (HSA[0], HEA[0]), RAM address set (AD[0]), and horizontal incremental direction of the counter (I/D[0]) as follows.

**Table 61**

Registers	Register setting
HSA[0]	1'b0
HEA[0]	1'b1
AD[0]	1'b0 when I/D[0]=0
	1'b1 when I/D[0]=1

The HD66781 performs magnification resizing simply by inserting pixels. The resized image is an extended original image in both horizontal and vertical direction. Check the resized image before use.

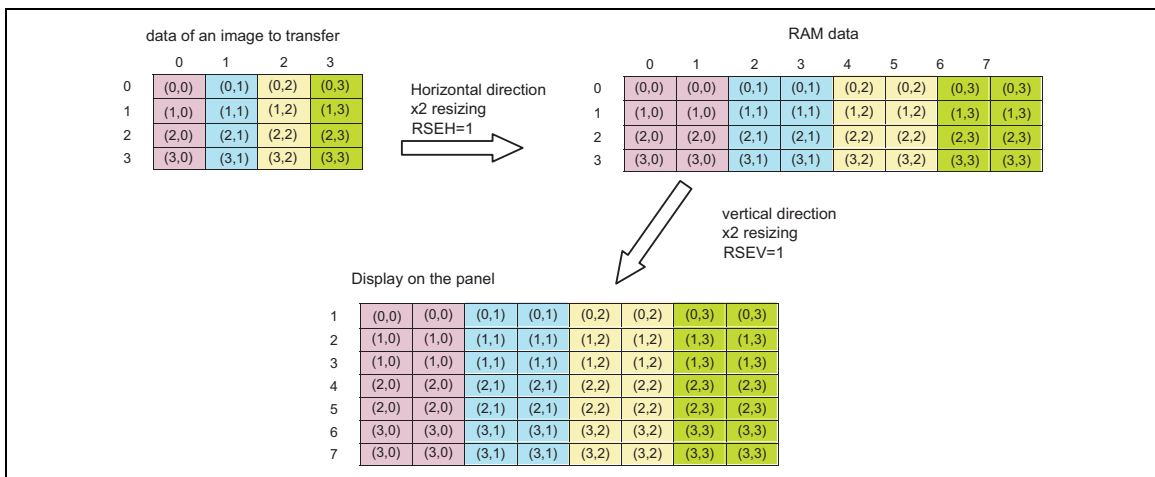

**Resizing: magnification**

The following figure illustrates the relationship of RAM address, display position and panel driving position when a base image is magnified in the vertical direction.

$$RESV[1:0] = 2'h1$$

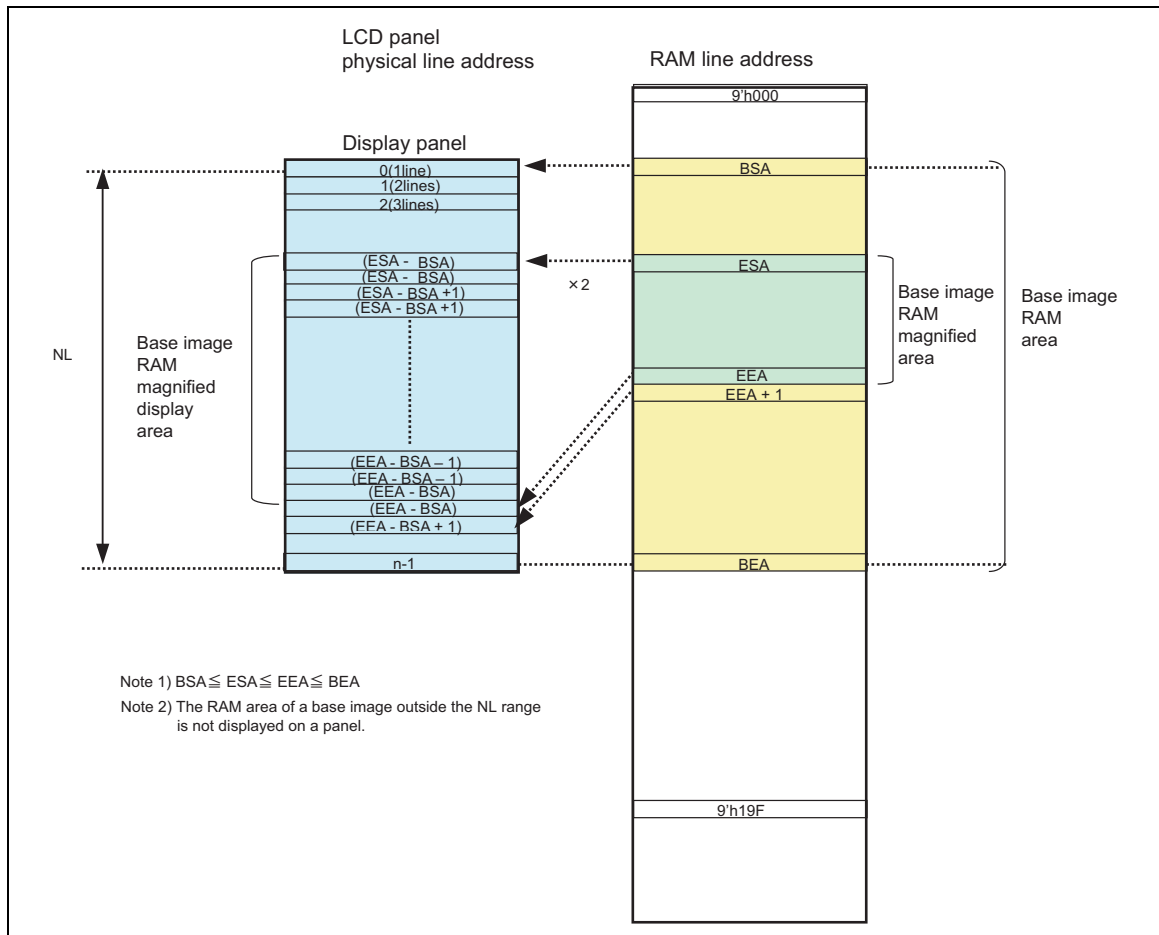

RSEV[3:2] = 2'h1, RSEV[5:4] = 2'h0, RSEV[7:6] = 2'h0

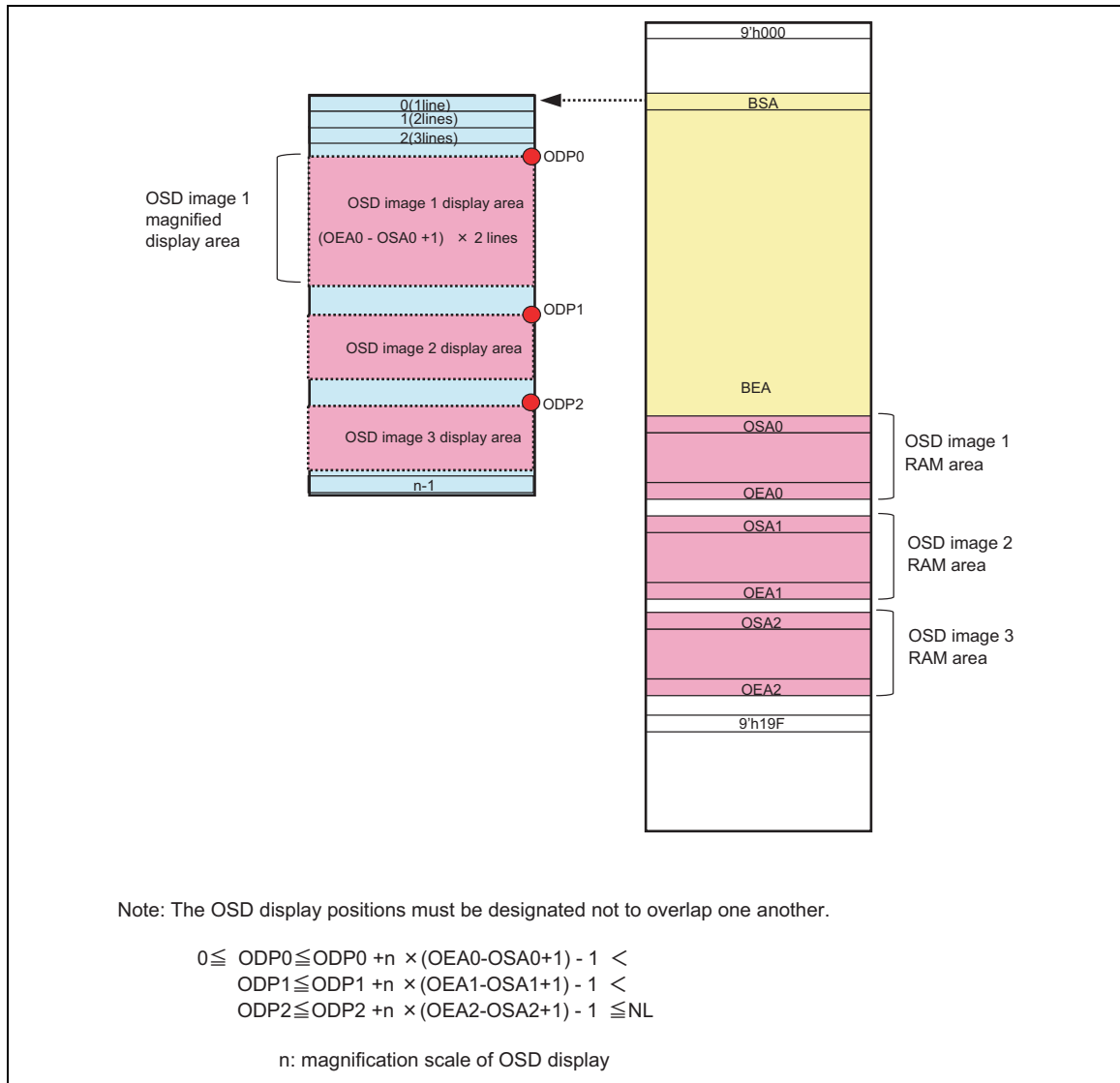

## Interface specification

The HD66781 incorporates a system interface to make settings for instructions and an external display interface to display moving pictures. The HD66781 allows selecting an optimum interface for display (moving or still picture, or both) to transmit data efficiently.

The external display interface includes RGB interface and VSYNC interface, which enable flicker-free screen update.

In the RGB-I/F mode, the display operation is performed in synchronization with the signals (VSYNC, HSYNC, and DOTCLK). The display data are written according to the values of the data enable signal (ENABLE), and PD17-0 bits in synchronization with the VSYNC, HSYNC, and DOTCLK signals. The display data are written to GRAM to reduce the data transmission to minimum, i.e. only when the displays are being changed. With the window address function, only the RAM area used for moving picture display is overwritten, and therefore the simultaneous display of moving picture area, which is overwritten, and the RAM data in the area other than the moving picture area, which is not overwritten, is possible. In the RGB and VSYNC interface modes, write data to GRAM in the high speed write mode (HWM = 1) during displaying moving pictures to access to GRAM in high speed with low power consumption.

In the VSYNC interface mode, the frame synchronization signal (VSYNC) synchronizes internal display operations. By writing data in synchronization with the falling edge of VSYNC at a fixed speed to GRAM through a system interface, moving pictures are displayed with the system interface in use. In this case, there are some constraints in the speed and method to write data to RAM.

The HD66781 handles the following 4 operational modes according to the type of display. All settings are made through the external display interface. Transition between the modes must be done according to the transitional flow charts.

**Table 62**

Operation Mode	RAM Access Setting (RM)	Display Operation Mode (DM1-0)
Internal operating clock only (Displaying still picture)	System interface (RM = 0)	Internal operating clock (DM1-0 = 00)
RGB interface (1) (Displaying moving picture)	RGB interface (RM = 1)	RGB interface (DM1-0 = 01)
RGB interface (2) (Rewriting still picture while displaying moving pictures)	System interface (RM = 0)	RGB interface (DM1-0 = 01)
VSYNC interface (Displaying moving pictures)	System interface (RM = 0)	VSYNC interface (DM1-0 = 10)

Note 1) Instructions are set only through a system interface.

Note 2) RGB-I/F and VSYNC-I/F are not used simultaneously.

Note 3) Do not make a change to the RGB-I/F mode (RIM-0) while the RGB I/F is operating.

Note 4) When making transitions between the interfaces, see the "External Display Interface" (p.139) for the transition flow chart

Note 5) RGB-I/F and VSYNC-I/F modes should be used with the high-speed write mode (HWM = 1).



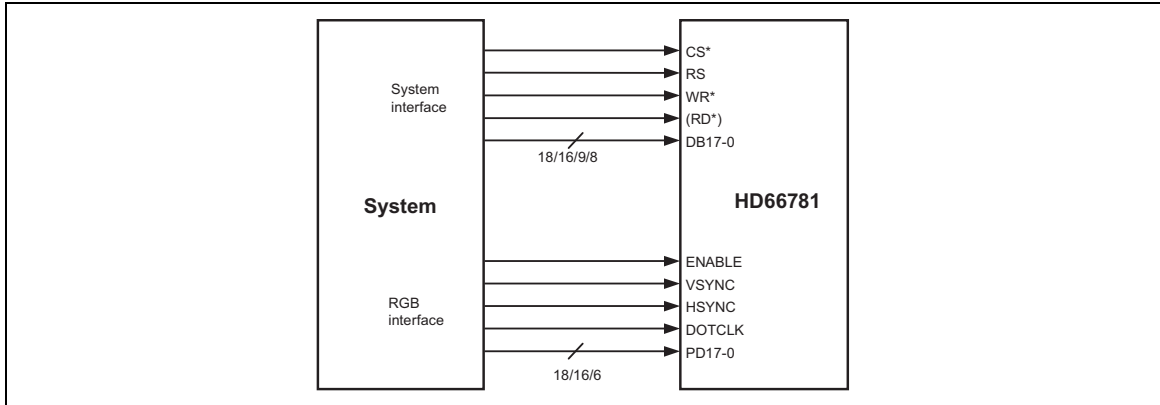

HD66781 Interface

## System Interface

The setting with IM3/2/1/0 pins allows selecting among the following system interfaces. The system interface enables instruction settings and RAM access.

**Table 63** IM bits settings and system interface

IM3	IM2	IM1	IM0	Interfacing mode with MPU	DB Pin	Colors
0	0	0	0	Setting disabled		
0	0	0	1	Setting disabled		
0	0	1	0	80-system 16-bit interface	DB17 to 10 and 8 to 1	65,536 (262,144) <sup>Note 2)</sup>
0	0	1	1	80-system 8-bit interface (Big endian)	DB17 to 10	65,536 (262,144) <sup>Note 2)</sup>
0	1	0	*	Serial Peripheral interface (SPI)	DB1 to 0	65,536
0	1	1	0	Setting disabled		
0	1	1	1	80-system 8-bit interface (Little endian)	DB17 to 10	65,536 (262,144) <sup>Note 2)</sup>
1	0	0	0	Setting disabled		
1	0	0	1	Setting disabled		
1	0	1	0	80-system 18-bit interface	DB17 to 0	262,144
1	0	1	1	80-system 9-bit interface	DB17 to 9	262,144
1	1	*	*	Setting disabled		

Note 1) 262,144 colors in 16-bit data bus 2-transmission mode.

Note 2) 262,144 colors in 8-bit data bus 3-transmission mode.

**80-system 18-bit interface**

80-system 18-bit parallel data transmission is selected by setting IM3/2/1/0 pins to Vcc1/GND/Vcc1/GND levels.

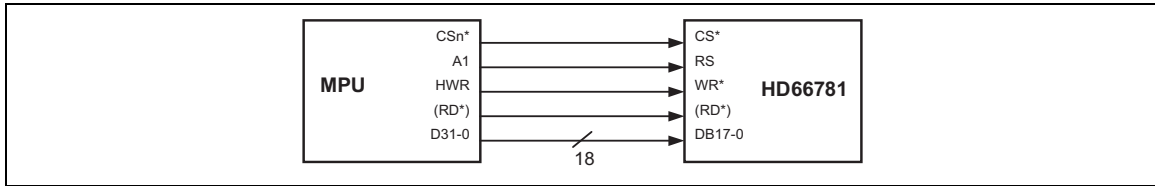

**Example of Interface with the 18-bit Microcomputer**

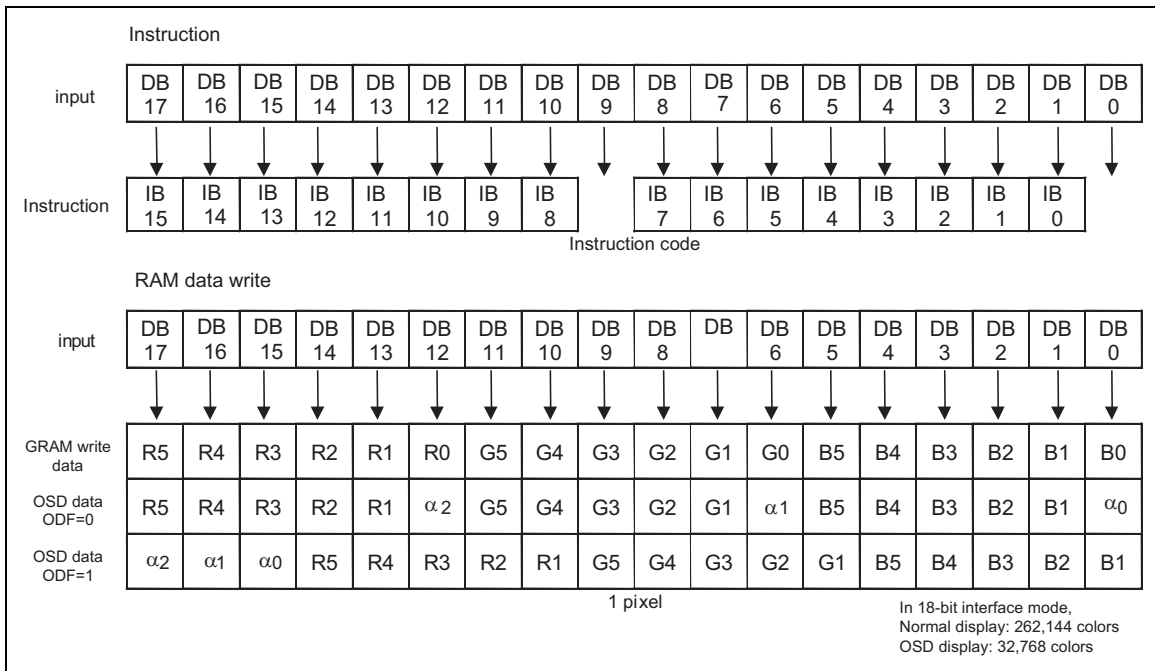

**18-bit interface data format (Instruction / RAM write data)**

**80-system 16-bit interface**

80-system 16-bit parallel data transmission is selected by setting IM3/2/1/0 pins to GND/GND/Vcc1/GND levels.

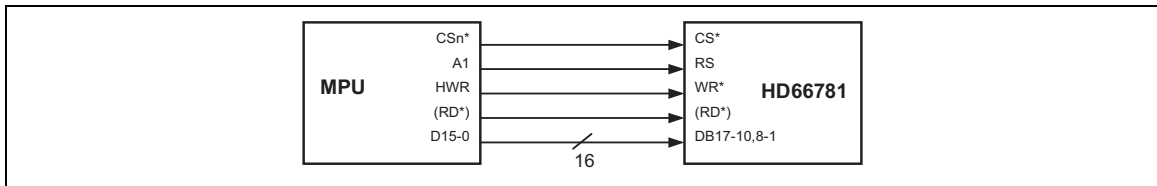

**16-bit microcomputer and interface (example)**

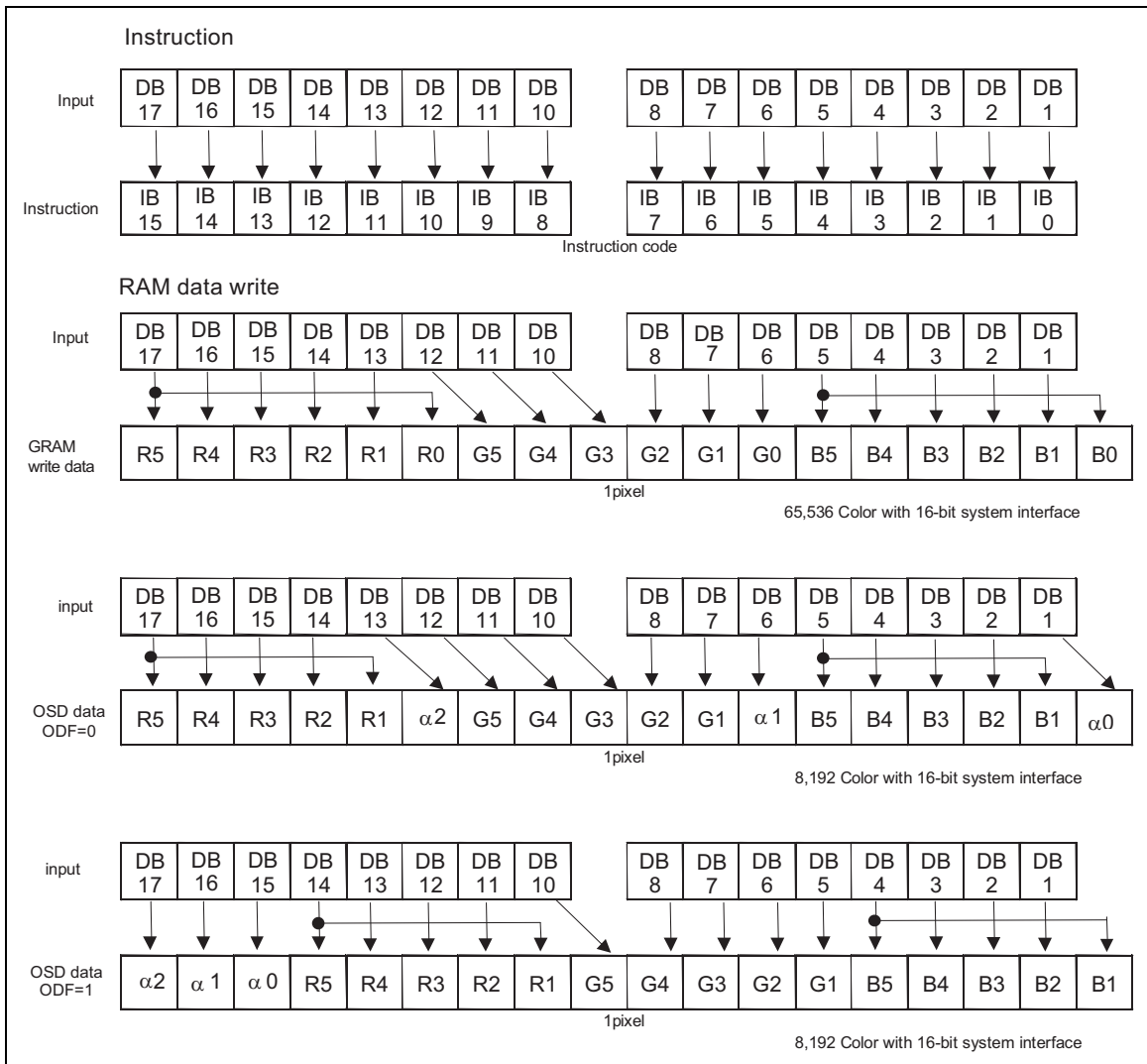

**16-bit interface data format (Instruction / RAM write data)**

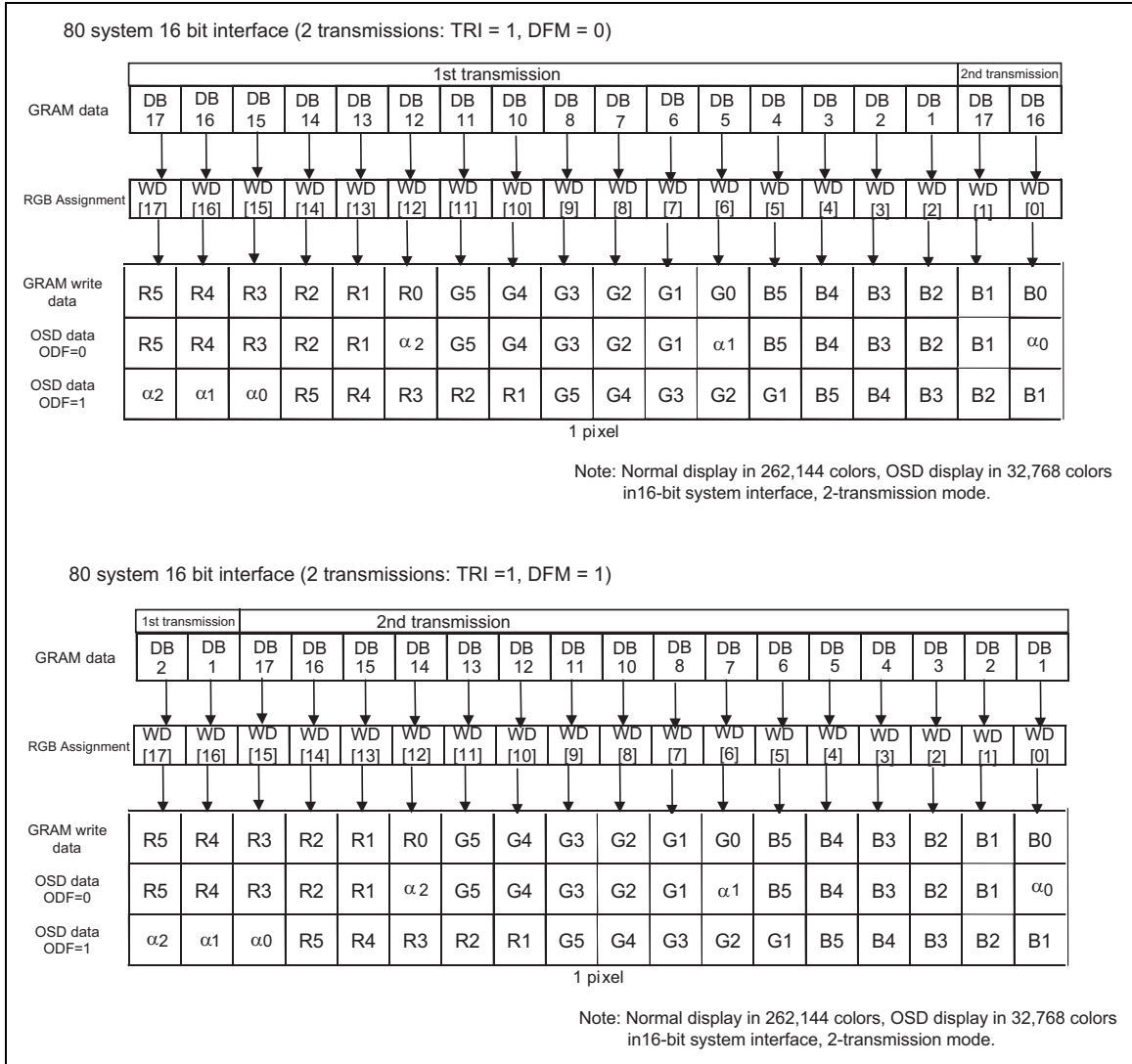

**16-bit interface data format (RAM write data in 2-transmission mode)**

**Data transmission synchronization in 16-bit bus interface mode**

The HD66781 supports the data transmission synchronization function, which resets the counter that counts the number of data transmission of upper 2 bits and lower 16 bits or upper 16 bits and lower 2 bits in the 16-bit data bus interface 2-transmission mode. When a discrepancy occurs in the data transmission of the upper/lower bits due to effects from noise and so on, the "000" H instruction is written 4 times consecutively to reset the upper/lower counters so that data transmission restarts with the upper bit transmission. Periodical execution of synchronization function allows the display system to recover from excursion.

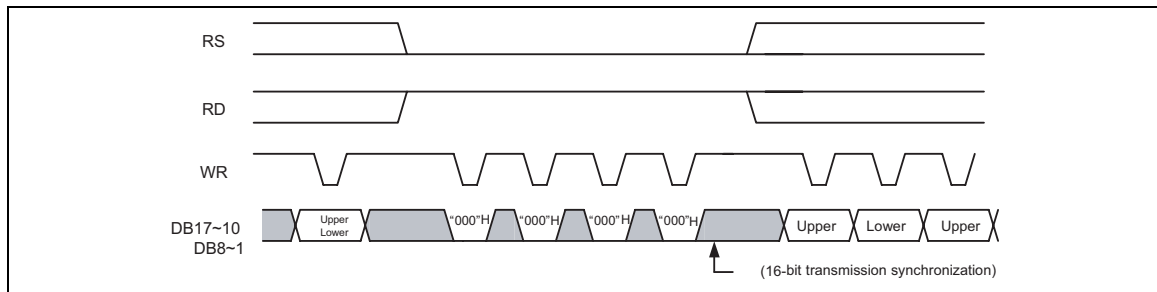

**Data Transmission Synchronization**

**80-system 9-bit interface**

The 80-system 9-bit parallel data transmission through DB17-9 pins is selected by setting IM3/2/1/0 pins to Vcc1/GND/Vcc1/Vcc1 levels respectively. When transmitting a 16-bit instruction, it is divided into upper and lower 8 bits (the LSB is not used) and the upper 8 bits are transmitted first. The RAM data is also divided into the upper and lower 9 bits, and the upper bits are transmitted first. The DB8-0 pins, that are not used, must be fixed to either IOVcc level. When writing the index register, the upper byte (8 bits) must be written.

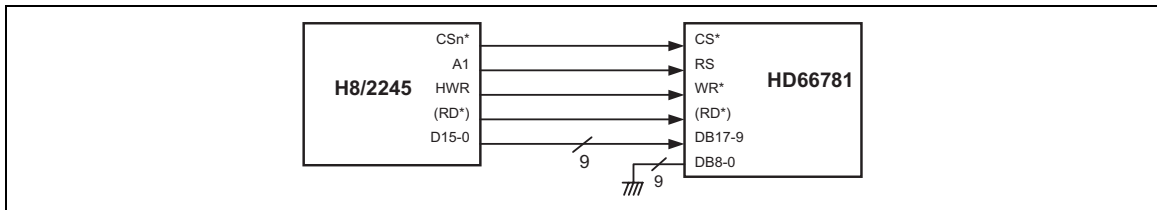

**Example of Interface with the 9-bit Microcomputer**

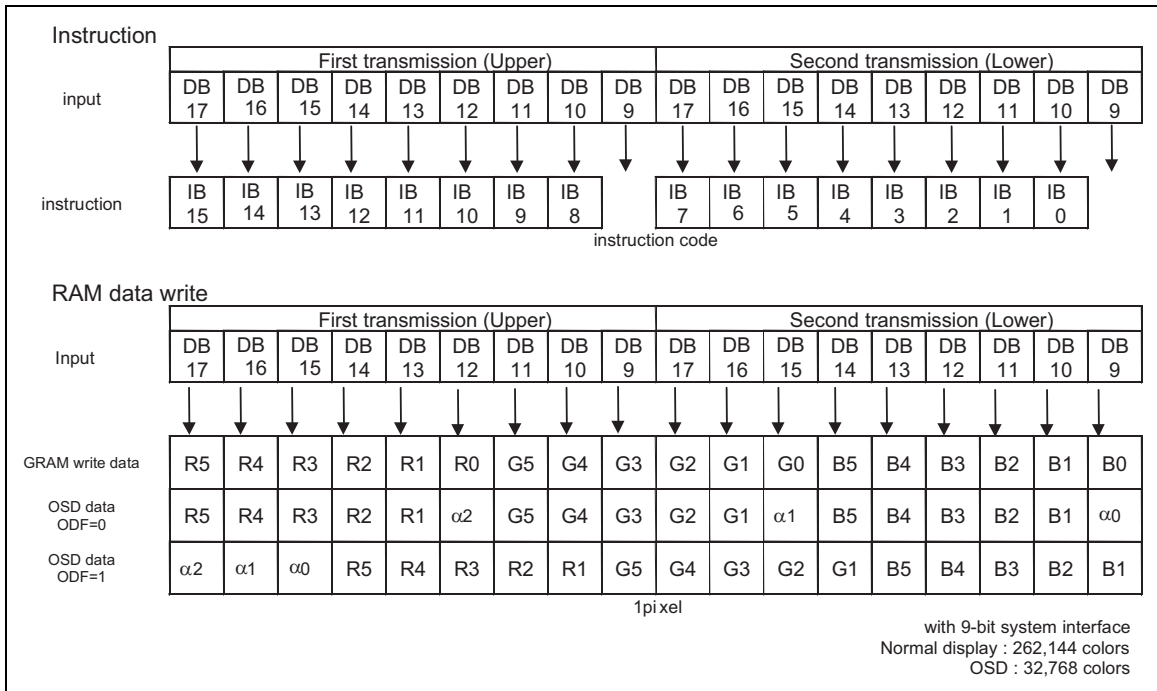

**9-bit interface data format**

**Data transmission synchronization in 9-bit bus interface mode**

The HD66781 supports the data transmission synchronization function, which resets the upper/lower counters that count the number of data transmission of upper/lower 9 bits in the 9-bit bus interface mode. When a discrepancy occurs in the data transmission of the upper/lower 9 bits due to effects from noise and so on, the "000" H instruction is written 4 times consecutively to reset the upper/lower counters so that data transmission restarts with the upper 9-bit transmission. Periodical execution of synchronization function allows the display system to recover from excursion.

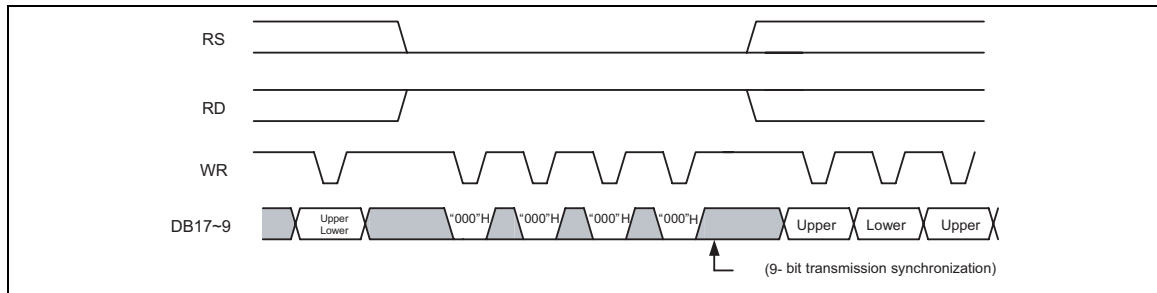

**9-bit Transfer Synchronization**



**80-system 8-bit interface (Big endian)**

The 80-system 8-bit parallel data transmission is selected by setting IM3/2/1/0 pins to GND/GND/Vcc1/Vcc1 levels respectively. When transmitting a 16-bit instruction, it is divided into upper and lower 8 bits and the upper 8 bits are transmitted first. The RAM data is also divided into the upper and lower 8 bits, and the upper bits are transmitted first. The data to write to RAM are expanded into 18 bits internally. The DB9-0 pins, that are not used, must be fixed to either IOVcc level. When writing the index register, the upper byte (8 bits) must be written.

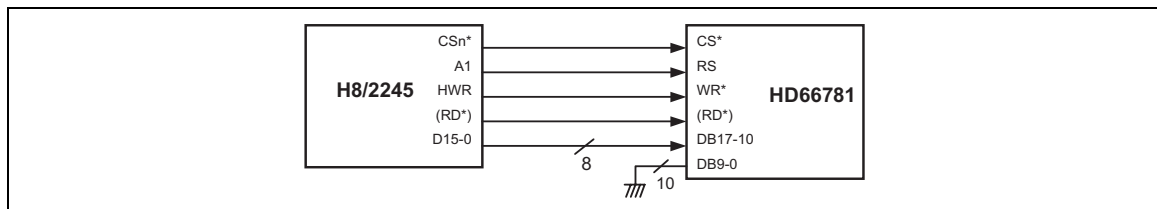

**Example of Interface with the 8-bit Microcomputer**

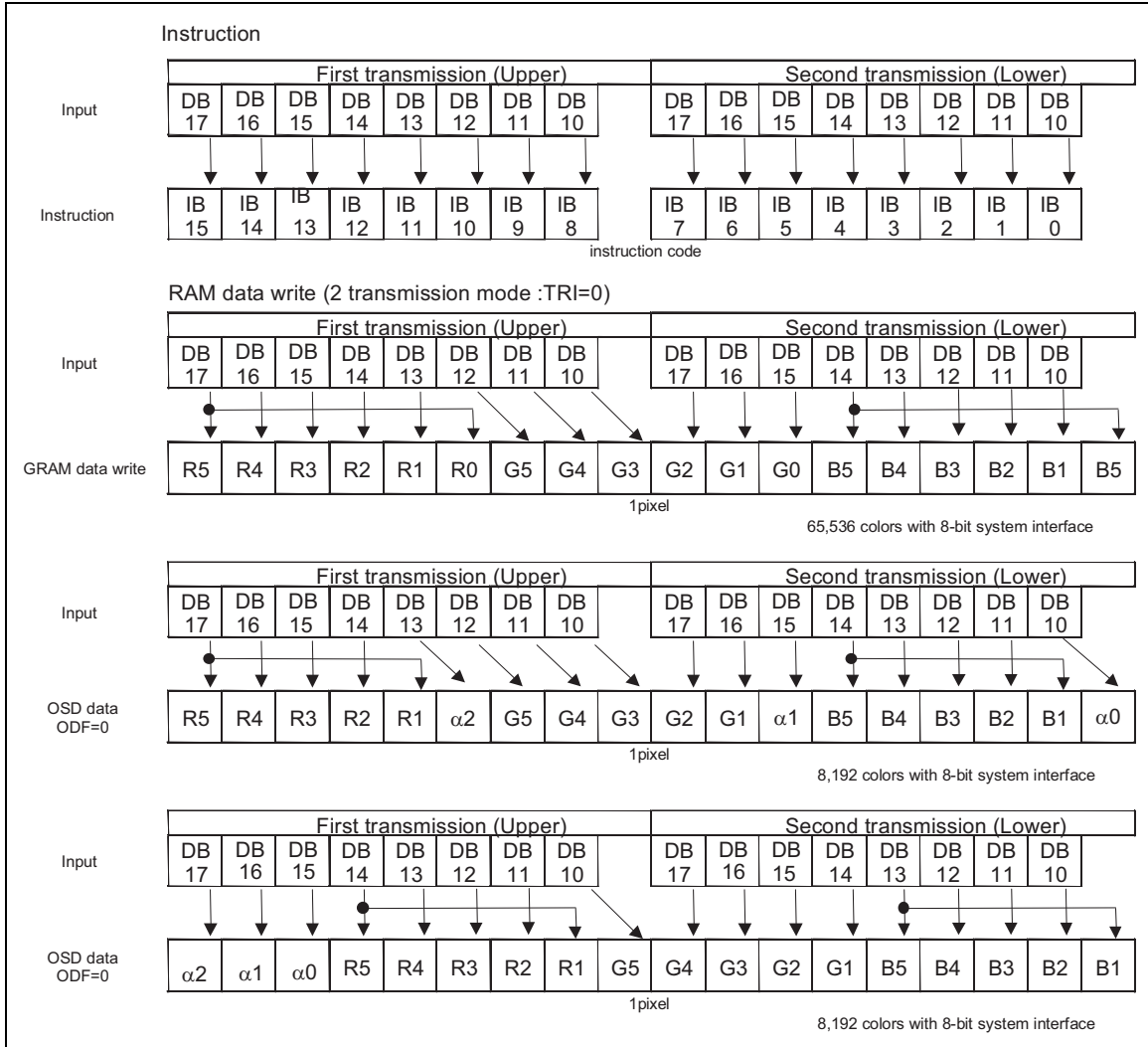

8-bit interface data format, RAM data write (2-transmission mode)

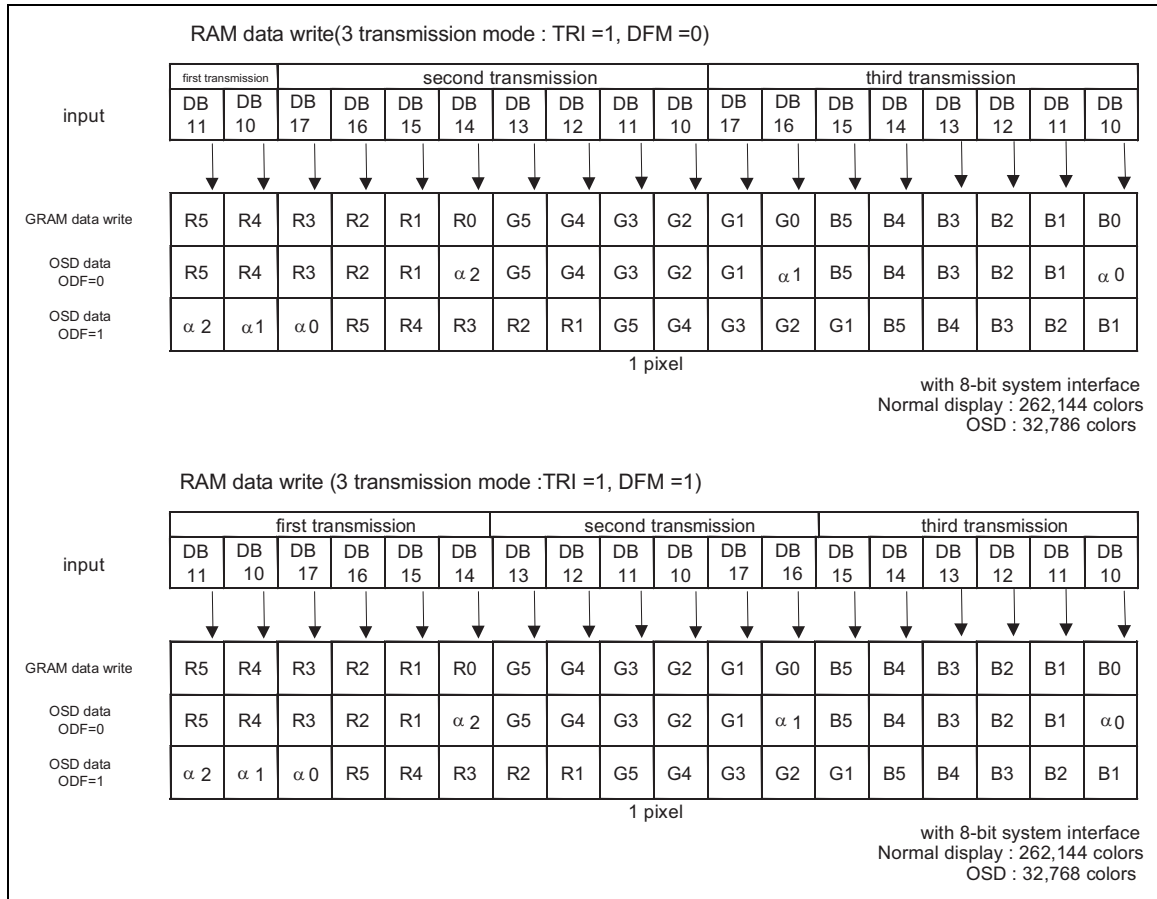

**8-bit interface data format, RAM data write (3-transmission mode)**

**Data transmission synchronization in 8-bit bus interface mode**

The HD66781 supports the data transmission synchronization function, which resets the upper/lower counters that count the number of data transmission of upper/lower 8 bits in the 8-bit bus interface mode. When a discrepancy occurs in the data transmission of the upper/lower 8 bits due to effects from noise and so on, the "00" H instruction is written 4 times consecutively to reset the upper/lower counters so that data transmission restarts with the upper 8-bit transmission. Periodical execution of synchronization function allows the display system to recover from excursion.

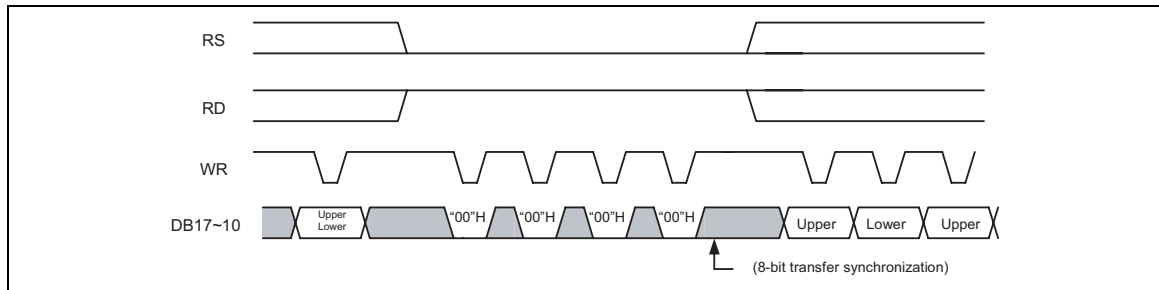

**8-bit data transmission synchronization**

### Serial Peripheral interface (SPI)

The Serial Peripheral Interface (SPI) is selected by setting IM3/2/1 pins to GND/Vcc1/GND levels respectively. The SPI is available through the chip select line (CS), serial transfer clock line (SCL), serial data input (SDI), and serial data output (SDO). In the SPI mode, the IM0/ID pin functions as ID pin. In the SPI mode, the DB17-2 pins, which are not used, must be fixed at either IOVcc level.

The HD66781 recognizes the start of data transfer at the falling edge of CS input to initiate the transfer of start byte. It recognizes the end of data transfer at the rising edge of CS input. The HD66781 is selected when the 6-bit chip address in the start byte transferred from the transmission device and the 6-bit device identification code assigned to the HD66781 are compared and both 6-bit data correspond. When selected, the HD66781 starts taking in the subsequent data string. The setting for the least significant bit of the identification code is made with the ID pin. The five upper bits of the identification code must be 01110. Two different chip addresses must be assigned to the HD66781 because the seventh bit of the start byte is assigned to a register select bit (RS). When RS = 0, index register write or status read is executed. When RS = 1, instruction write or RAM read/write is executed. The eighth bit of the start byte is to specify read or write (R/W bit). The data are received when the R/W bit is 0, and are transmitted when the R/W bit is 1.

In the SPI mode, the data are written to GRAM after two-byte data transmission. The data are expanded into 18 bits by adding one bit (the same data as the MSB of RB) to the LSB of RB data.

After receiving the start byte, the HD66781 starts to transmit or receive data by byte. The data transmission adopts a format by which the MSB is first transmitted. All HD66781 instructions consist of 16 bits and they are executed internally after two bytes are transmitted with the MSB first (DB15 to 0). The data to write to RAM are expanded into 18-bit data. After the start byte is received, the first byte is always fetched as the upper eight bits of the instruction and the second byte is fetched as the lower eight bits of the instruction. The 4-byte data that are read from RAM right after the start byte are made invalid. The HD66781 reads as valid data from the 5th-byte data.

### Start Byte Format

Transmitted bits	S	1	2	3	4	5	6	7	8
Start byte format	Transmission start	Device ID code						RS	R/W
		0	1	1	1	0	ID		

Note 1) ID bit is selected with the IM0/ID pin.

Table 64

RS	R/W	Function
0	0	Set index register
0	1	Read status
1	0	Write instruction or RAM data
1	1	Read instruction or RAM data

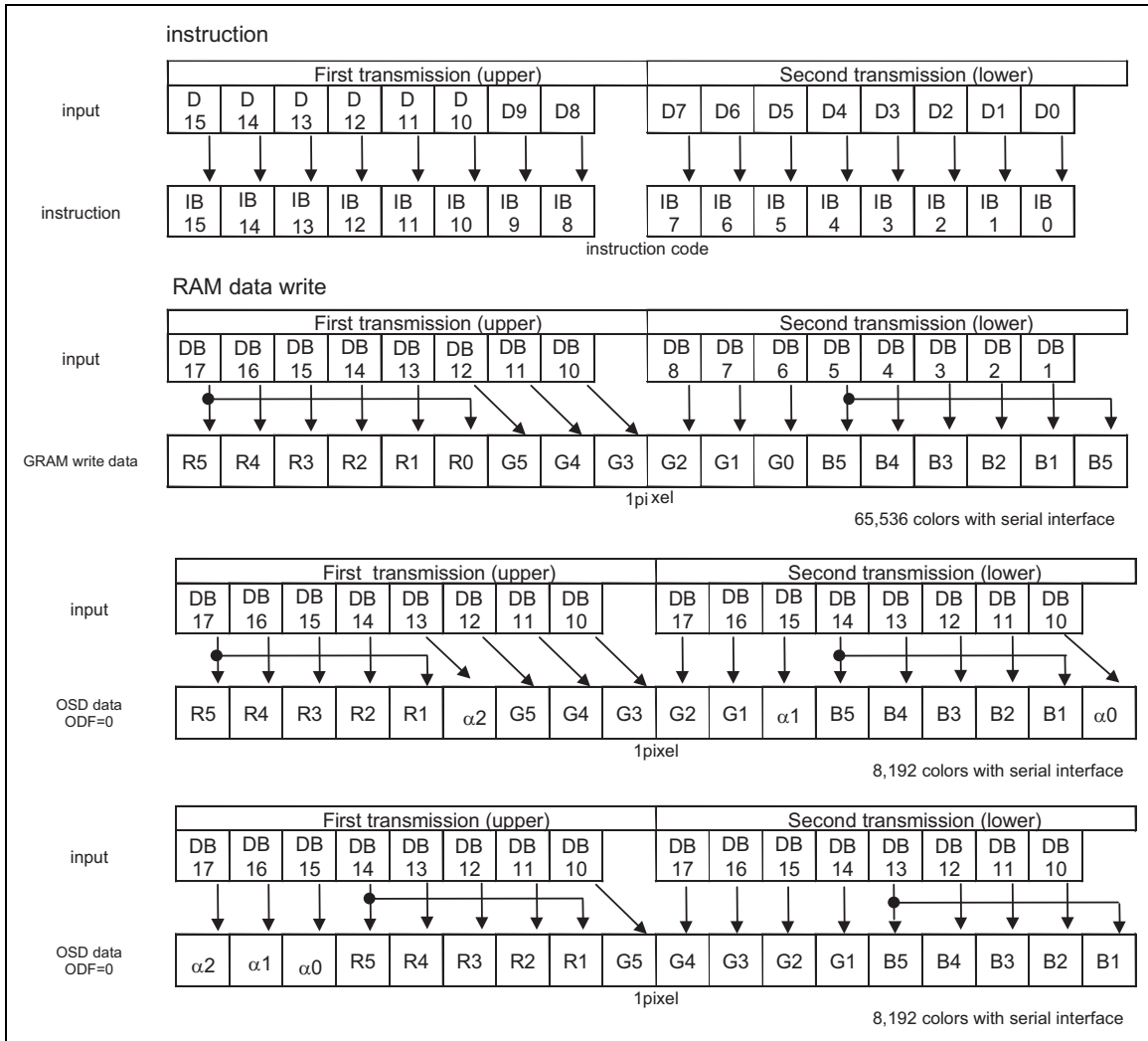

Data format for Serial Peripheral Interface

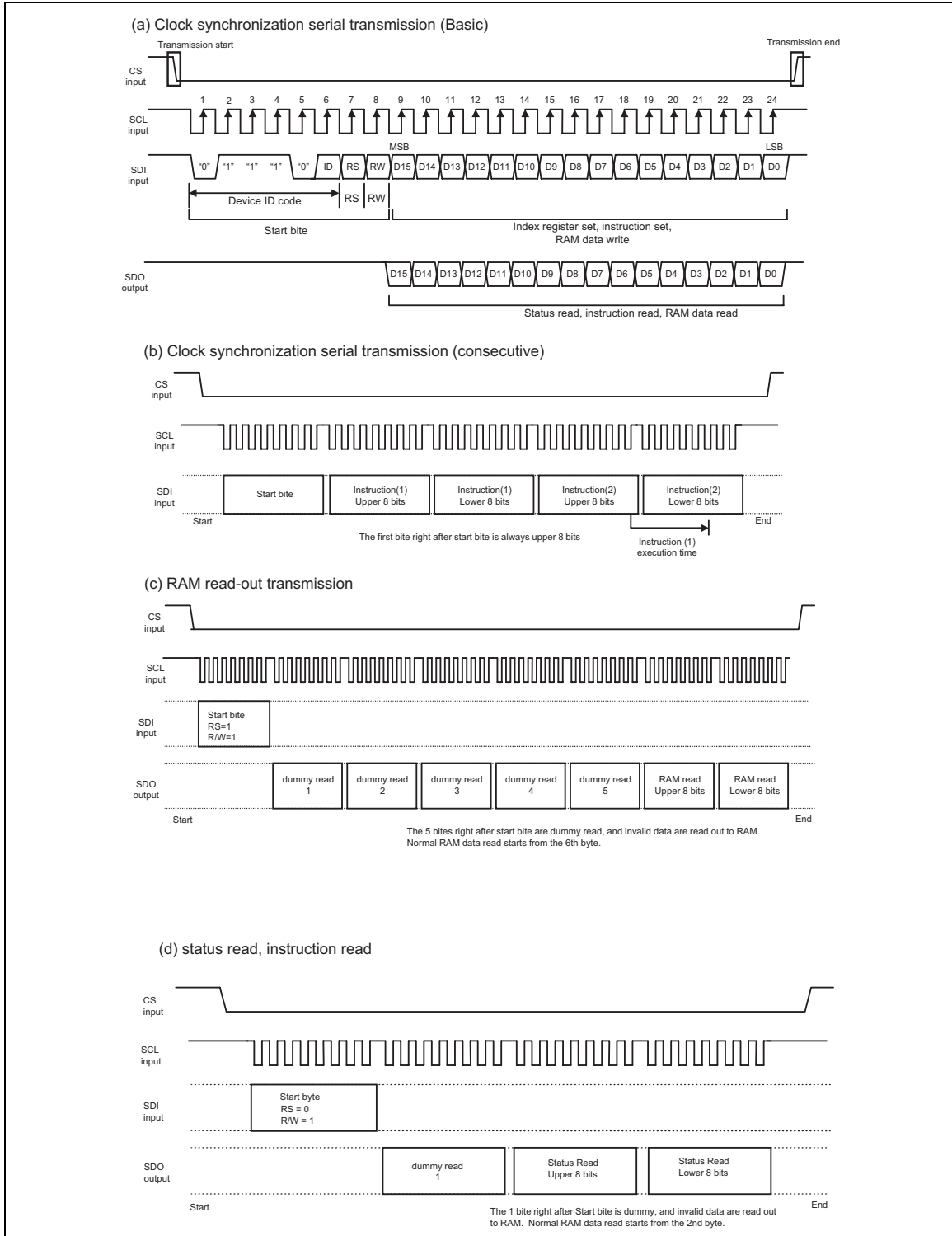

**Serial Peripheral Interface: data transfer**

**80-system 8-bit interface (Little endian)**

The 80-system 8-bit parallel data transmission is selected by setting IM3/2/1/0 pins to GND/Vcc1/Vcc1/Vcc1 levels respectively. When transmitting a 16-bit instruction, it is divided into upper and lower 8 bits and the upper 8 bits are transmitted first. The RAM data is also divided into the upper and lower 8 bits, and the upper bits are transmitted first. The data to write to RAM are expanded into 18 bits internally. The DB9-0 pins, that are not used, must be fixed to either IOVcc level. When writing into the index register, the upper byte (8 bits) must be written.

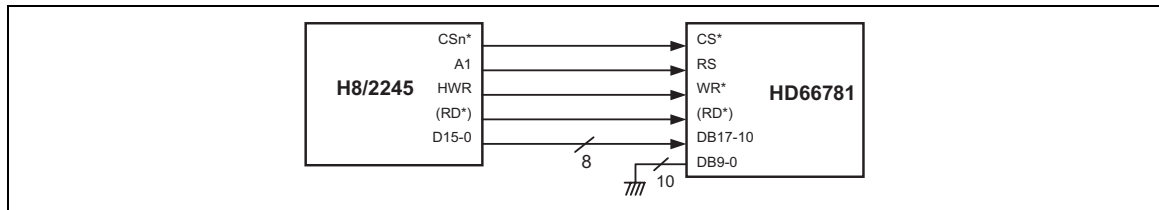

**Example of Interface with the 8-bit Microcomputer**



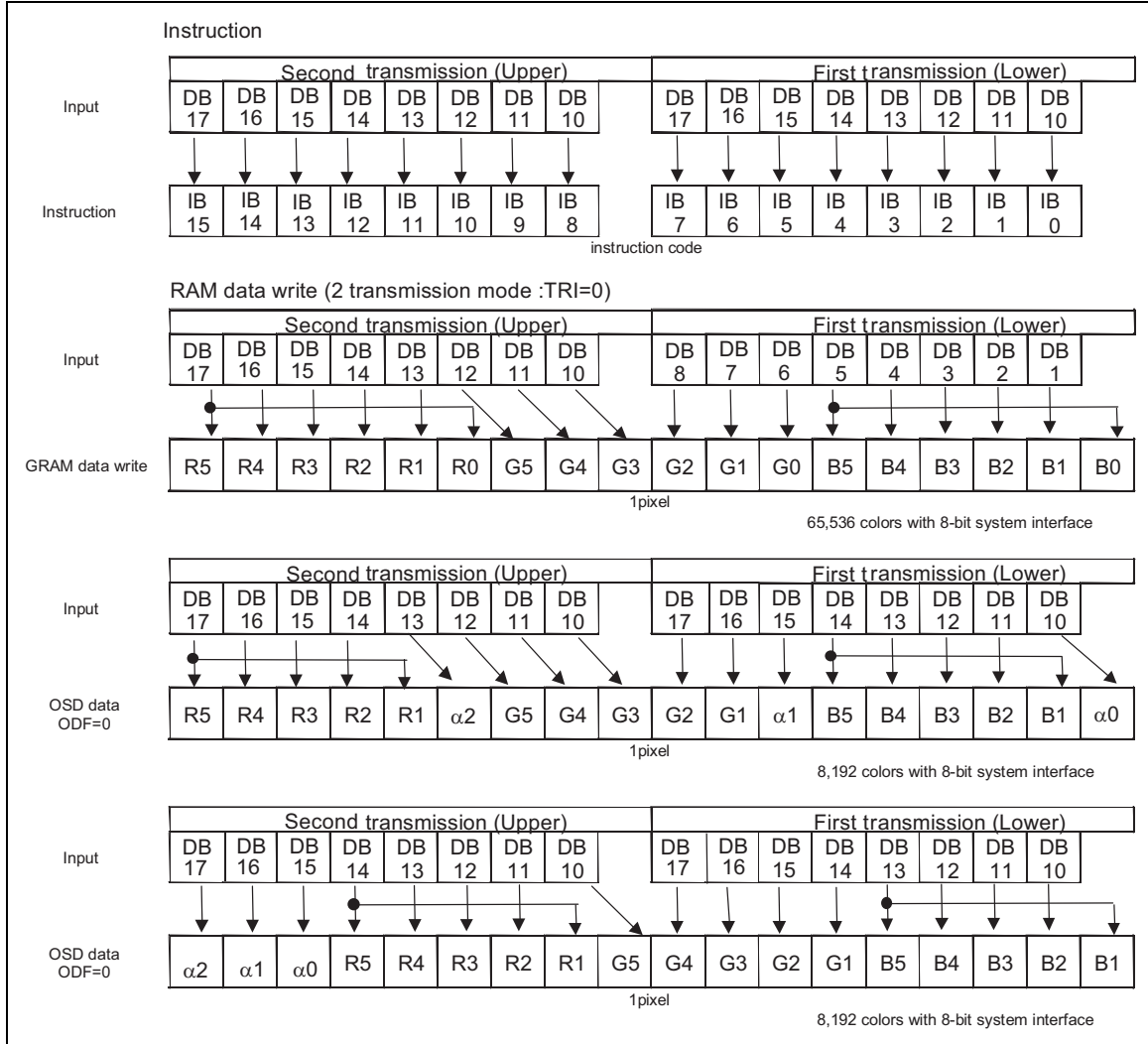

8-bit interface data format, RAM data write (2-transmission mode)

**Data transmission synchronization in 8-bit bus interface mode**

The HD66781 supports the data transmission synchronization function, which resets the upper/lower counters that count the number of data transmission of upper/lower 8 bits in the 8-bit bus interface mode. When a discrepancy occurs in the data transmission of the upper/lower 8 bits due to effects from noise and so on, the "00" H instruction is written 4 times consecutively to reset the upper/lower counters so that data transmission restarts with the upper 8-bit transmission. Periodical execution of synchronization function allows the display system to recover from excursion.

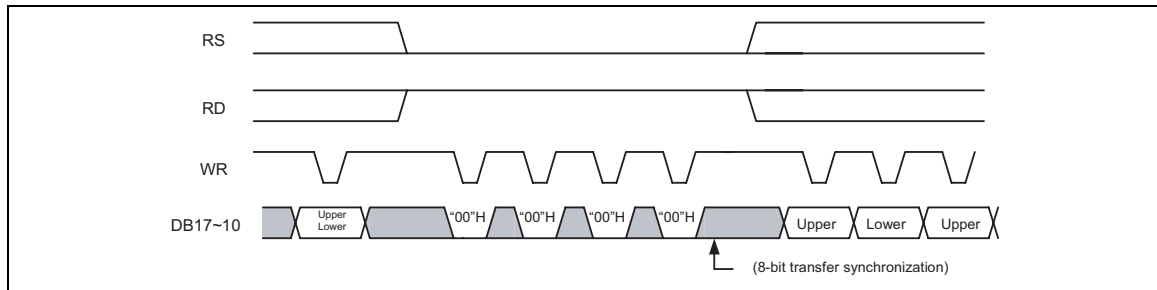

**8-bit data transmission synchronization**

## DMA transfer Single Address mode

When connecting a microcomputer or an application processor, which are compliant to DMA transfer single address mode, with the HD66781, and SRAM or pseudo SRAM, the HD66781 allows using same bus cycle for data read from memory and data write to the HD66781. This reduces transfer time and controls bus occupation ratio when transferring a large volume of data from external memory to a LCD driver.

### 1. Pin functions in DMA single address mode

**DACK:** In DMA single address mode, it has the same function as CS in normal operation mode.

**RD:** Recognize write strobe (WR) internally when DACK is at the low level (active).

**WR:** Fix to High.

**CS:** Fix to High.

**RS:** Recognize a high level (data transfer) inside the HD66781 under any condition when DACK is at the low level (active).

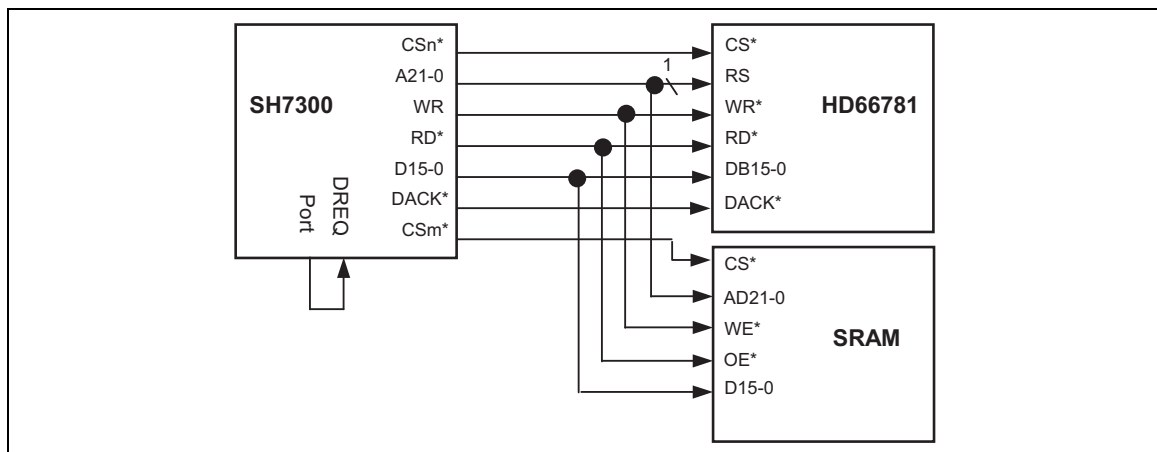

Interfacing with microcomputer and SRAM

2. Transfer procedure in DMA single address mode

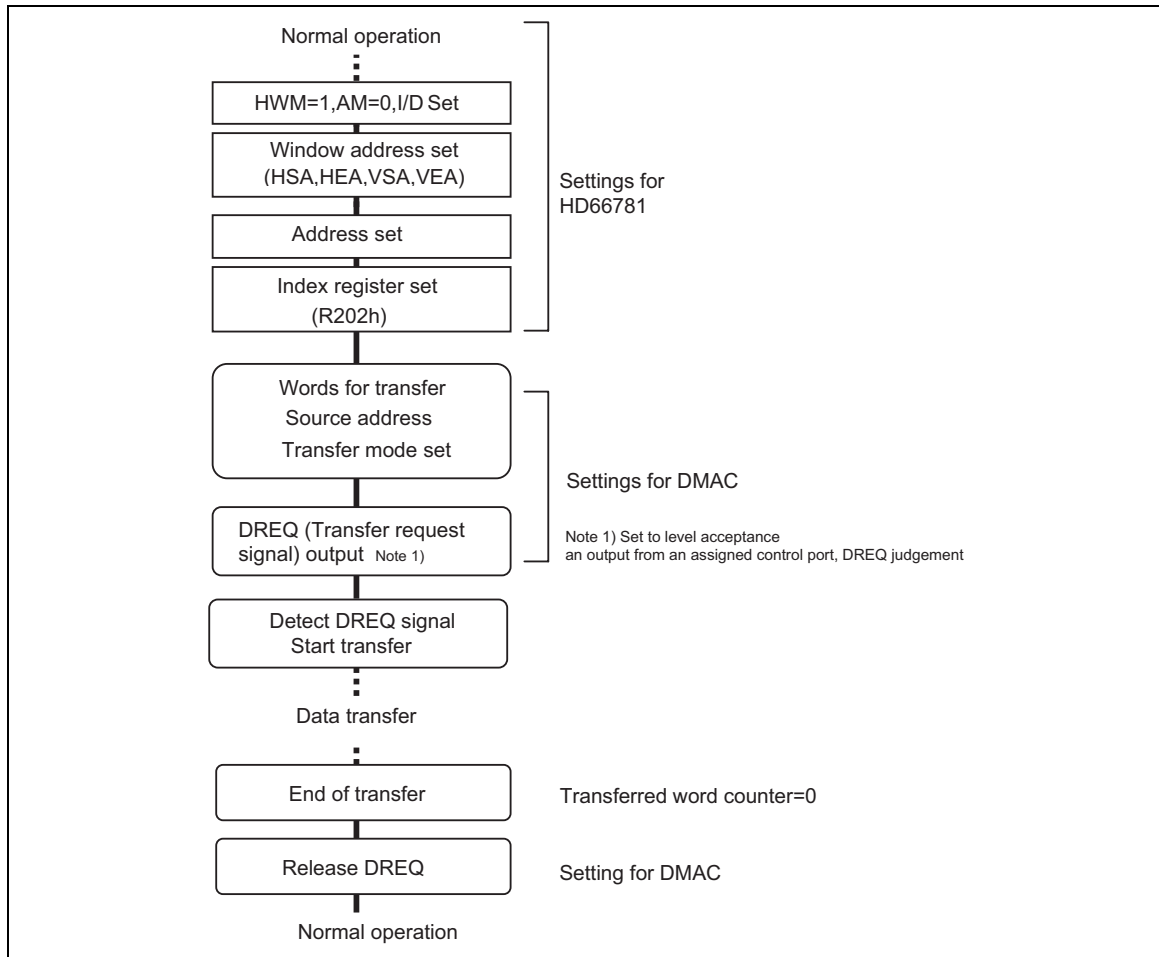

3. Notes to the DMA single address mode

1. DACK\*pin and CS\*pin cannot be made at a low level (active) simultaneously.
2. Once starting a transfer in the DMA single address mode, no command access to the HD66781 will be allowed until the end of the transfer.
3. The DMA single address mode must be used with the window address function to make sure the number of data transfer in the DMA mode and the numbers of data in the specified window address area correspond.
4. After transferring in the DMA mode, wait at least for RAM write execution time (bus cycle time in the normal write mode,  $t_{cycw}$ ) before issuing a next instruction.
5. It is not possible to make a transfer from the HD66781 to external memory in the DMA single address mode.
6. The DMA single address mode is compatible with the normal cycle still mode and the burst mode.

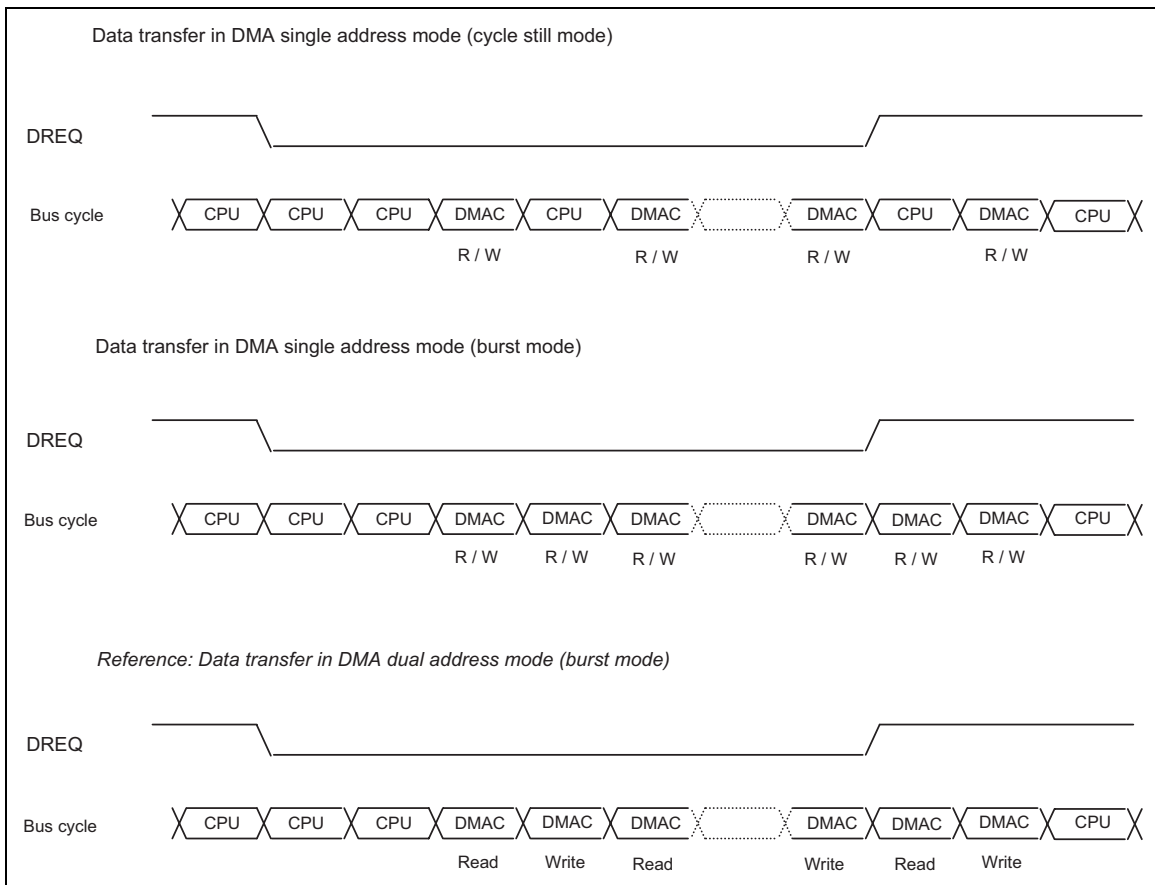

**VSYNC Interface**

The HD66781 incorporates a VSYNC-I/F, which enables moving picture display with a system interface and the frame synchronization signal (VSYNC) only. This interface enables the display of moving pictures with minimum modification to the conventional system.

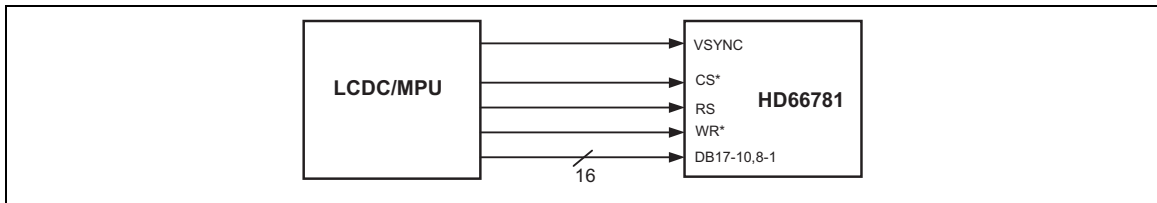

**VSYNC interface**

The VSYNC-I/F is selected by setting DM1-0 = 10 and RM = 0. In the VSYNC I/F mode, the internal display operations are synchronized with VSYNC. By writing data to RAM through the system interface in a speed that is higher for more than a fixed speed than the internal display operation speed, it enables moving picture display through a system interface and flicker-free screen update.

Display operations are executed by the internal clock generated by the internal oscillator and the VSYNC input. All display data are stored in RAM. Therefore, it only requires transfer of the data that is written over to update the screen, thereby minimizing the numbers of data transfers while displaying moving picture. The use of high-speed write mode (HWM = 1) with VSYNC interface enables RAM access in high speed with low power consumption.

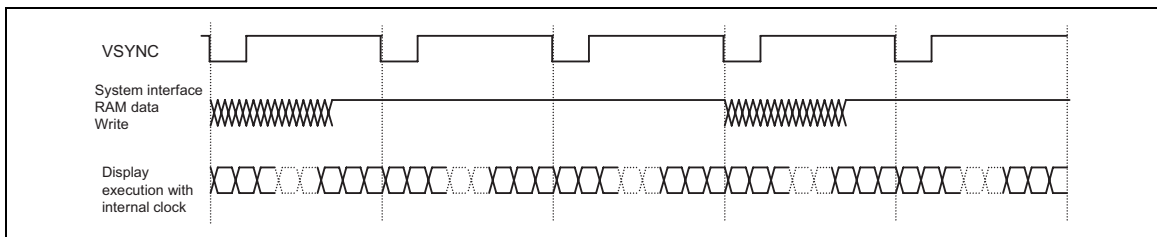

**Moving picture data transmission through VSYNC interface**

Note 1) Data must be written to RAM in the high-speed write mode (HWM = 1) in VSYNC interface mode.

The VSYNC-I/F has limits on the minimum speed for RAM write through the system interface and the frequency of the internal clock. It requires RAM write speed more than the calculated result from the following formula.

$$\begin{aligned} &\text{Internal clock frequency (fosc) [Hz]} \\ &= \text{Frame frequency} \times (\text{Display raster-row (NL)} + \text{Front porch (FP)} + \text{Back porch (BP)}) \times 16 \text{ clocks} \\ &\quad \times \text{Fluctuation} \\ &\text{RAM writing speed (min.) [Hz]} \\ &> 320 \times \text{Display lines (NL)} / \{(\text{Back porch (BP)} + \text{Display lines (NL)} - \text{margin}) \times 16 \text{ clocks}\} / \text{fosc} \end{aligned}$$

When RAM write does not start immediately after the falling edge of VSYNC, the period from the falling edge of VSYNC to the start of RAM write must also be taken into consideration.

An example of calculations for the internal clock frequency and RAM write speed in the VSYNC interface mode is as follows.

- Calculation Example: moving picture display in VSYNC I/F
- Panel size 240 RGB × 320 raster-rows (NL0 = 6'27)
- Total number of raster-rows(NL) 320 raster-rows
- Back, Front porches 14, 2, raster-rows  
(BP = 4'hE, FP = 4'h2)
- Frame frequency 60Hz

$$\begin{aligned} &\text{Internal clock frequency (fosc) Hz} \\ &= 60 \text{ Hz} \times (320 + 2 + 14) \text{ raster-rows} \times 16 \text{ clocks} \times 1.1 / 0.9 = 394 \text{ [kHz]} \end{aligned}$$

When calculating an internal clock frequency, possible causes of fluctuations must also be taken into consideration. The allowance for this fluctuation is  $\pm 10\%$  from the center value, and the range of the frequency must be within the VSYNC cycle.

As the causes of fluctuations, the above example takes the variation in the LSI fabrication and the room temperature into account. Other possible causes of fluctuations, such as variation in the external resistors or the voltage change are not considered in the above calculation. It is necessary to make a setting with enough margins to include the allowances for these factors.

$$\begin{aligned} &\text{Minimum RAM writing speed [Hz]} \\ &> 240 \times 320 / \{((14 + 320 - 2) \text{ raster-rows} \times 16 \text{ clocks}) / 394 \text{ kHz}\} = 5.70 \text{ [MHz]} \end{aligned}$$

In this case, RAM write is performed on the input of VSYNC.

When the data for one frame are written to RAM completely, there must be 2 raster-rows or more of a margin before the display raster-rows.

According to the above calculation results, writing data to RAM on the input of VSYNC at the speed of 5.7 MHz or more, the data for the entire screen on RAM are overwritten before the display operation starts. Accordingly, the flicker due to moving picture update can be avoided even if displaying a moving picture.

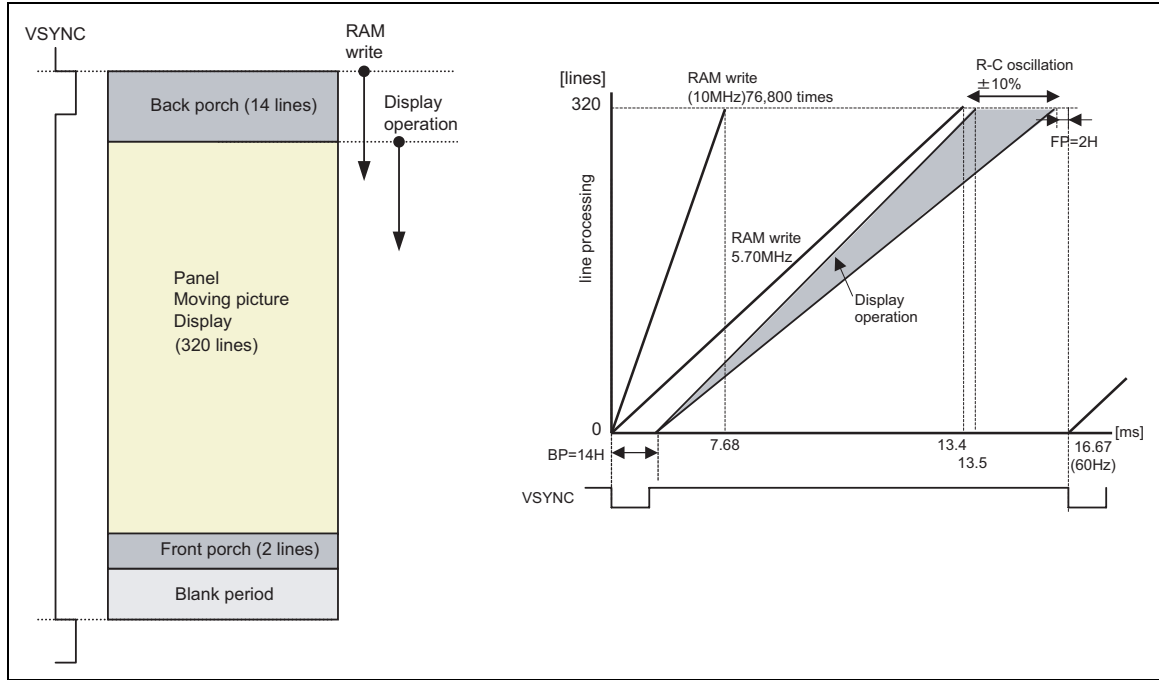

Minimum RAM write speed and internal clock frequency in VSYNC interface



### Notes to the VSYNC interface

1. The aforementioned example of calculation is just a result of calculation. In the actual settings, causes for the fluctuations such as internal oscillators and so on should be taken into consideration. It is necessary to make a setting for RAM write speed with enough margins.
2. The aforementioned example of calculation is the value in case of writing over the entire screen. Limiting the area for the moving picture display will create more margins for the RAM write speed.

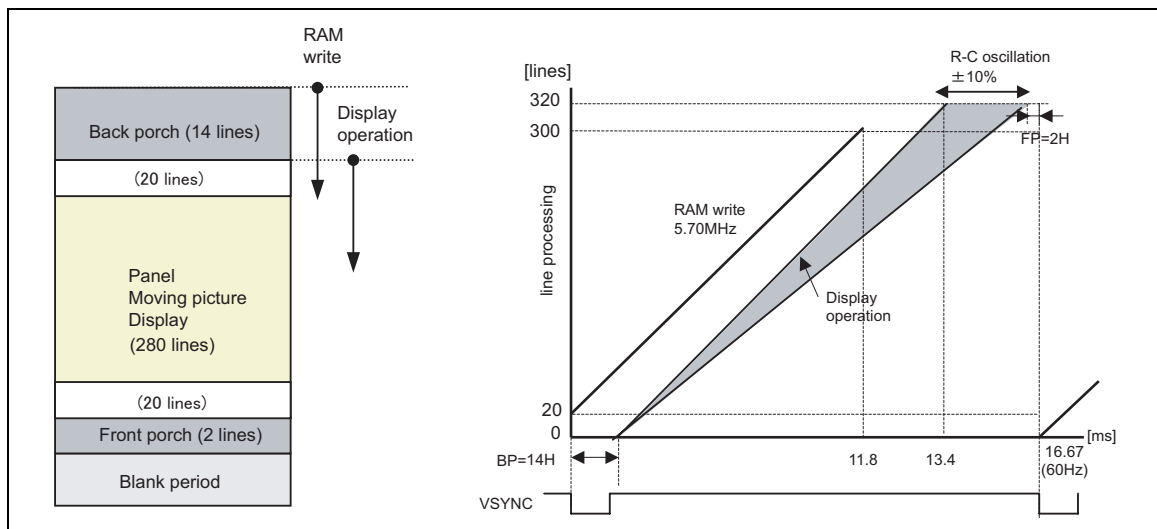

### Condition on using VSYNC interface

3. A front porch period continues after the completion of 1 frame display and until the next input of VSYNC.
4. The transition between the internal clock operation mode (DM1-0 = 00) and the VSYNC interface mode becomes effective after displaying one frame made during instruction setting.
5. In the VSYNC interface mode, the partial display, vertical scroll, and interlaced drive functions are not available.
6. In the VSYNC interface mode, set AM to 0 to transmit display data in the aforementioned method.
7. In the VSYNC interface mode, write display data to RAM in the high speed write mode (HWM = 1)

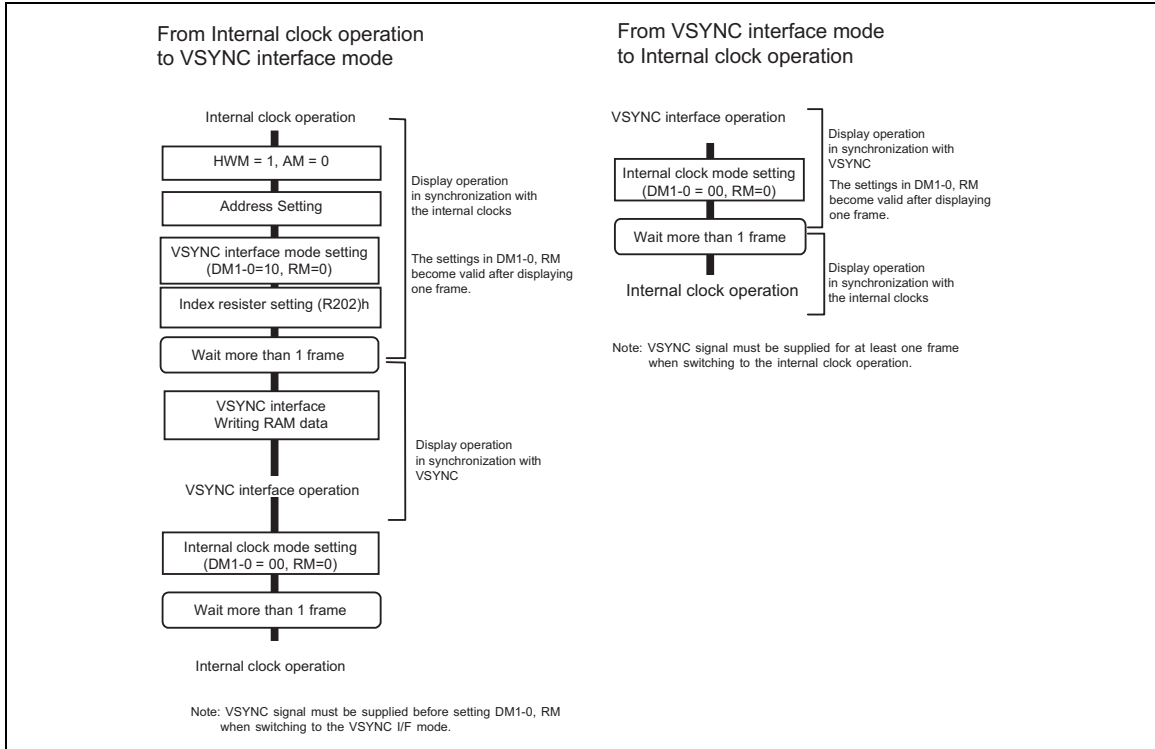

**Transition between VSYNC and Internal clock operation modes**

### External Display Interface

The following interfaces are available as an external display interface (RGB interface). The interface is selected by setting RIM1-0 bits. The RGB interface allows RAM access.

**Table 65**

RIM1	RIM0	RGB Interface	PD Pin
0	0	18-bit RGB interface	PD17-0
0	1	16-bit RGB interface	PD17-13, 11-1
1	0	6-bit RGB interface	PD17-12
1	1	Setting disabled	-

Note 1) It is not possible to use multiple interfaces at the same time.

Through the RGB-I/F, the display operation is in synchronization with VSYNC, HSYNC, and DOTCLK. The RGB interface enables data transmission in high speed with low power consumption by only overwriting the area that is needed to update in the high-speed write mode in combination with window address function. Front and back porches must be set before and after the display period. Front and back porches must be set before and after the display period.

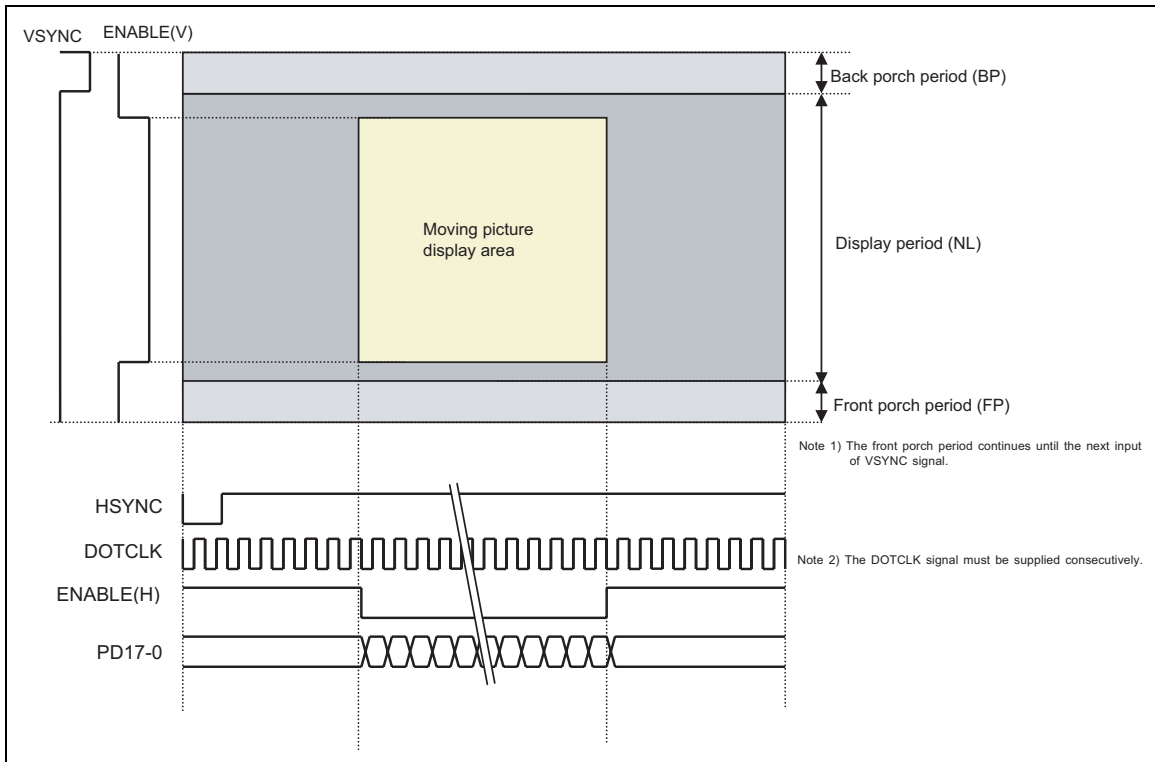

VSYNC: Frame synchronization signal  
 HSYNC: Line synchronization signal  
 DOTCLK: DOT clock  
 ENABLE: Data enable signal  
 PD17-0: RGB(6:6:6)display data

Back porch period (BP):  
 Front porch period (FP):  
 Display Period  
 The numbers of raster-rows for 1 frame

$14H \geq BP \geq 2H$   
 $14H \geq FP \geq 2H$   
 $FP + BP = 16H$   
 $NL \leq 320H$   
 $FP + NL + BP$

In the RGB interface mode, VSYNC, HSYNC and DOTCLK must be supplied more than to achieve the resolution on the liquid crystal panels.

**Polarities of VSYNC, HSYNC, ENABLE, DOTCLK signals**

The polarities of VSYNC, HSYNC, ENABLE, DOTCLK signals are changeable by instruction settings (DPL, EPL, HSPL, and VSPL) to conform to the system.

**RGB interface timing**

**Timing chart of signals in 16/18-bit RGB interface mode**

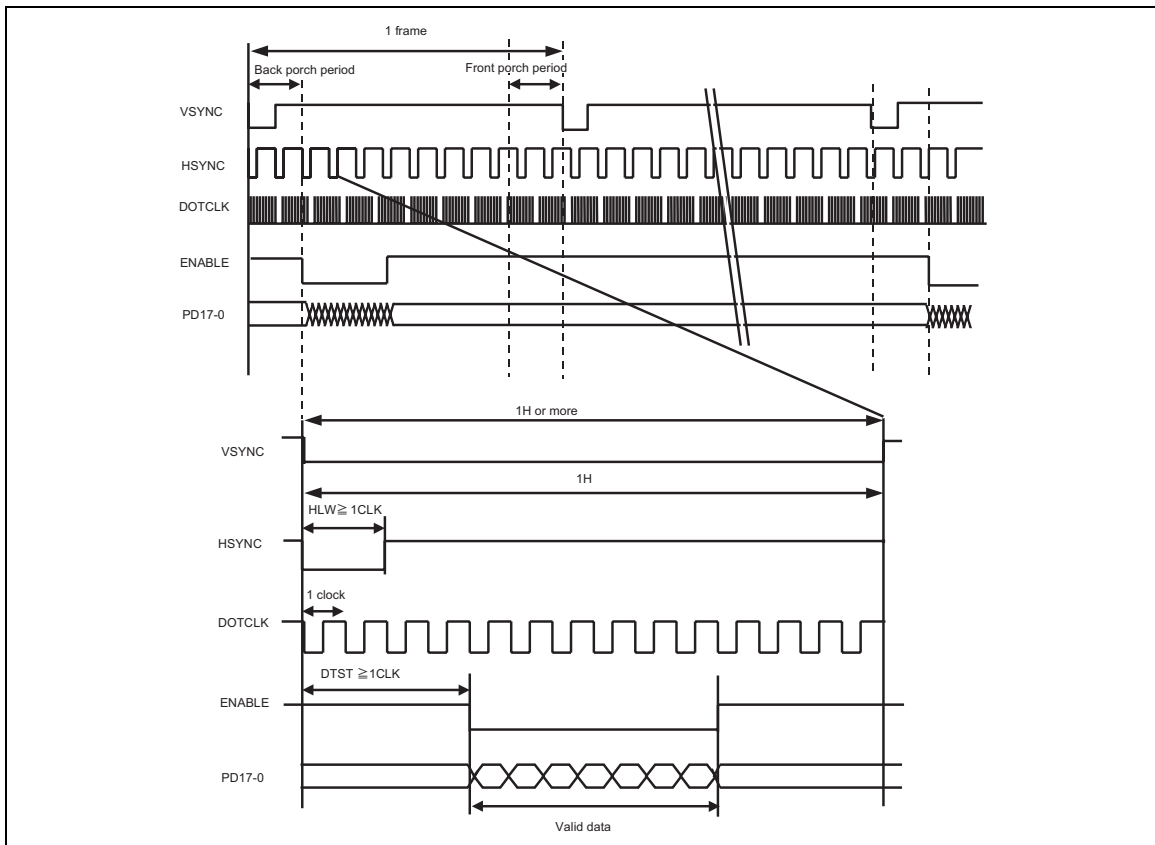

- Note 1) VLW: VSYNC "Low" period
- HLW: HSYNC "Low" period
- DTST: Setup time for data transfer

Note 2) Write data in the high speed write mode (HWM = 1) in the RGB I/F mode.

Timing chart of signals in 6-bit RGB interface mode

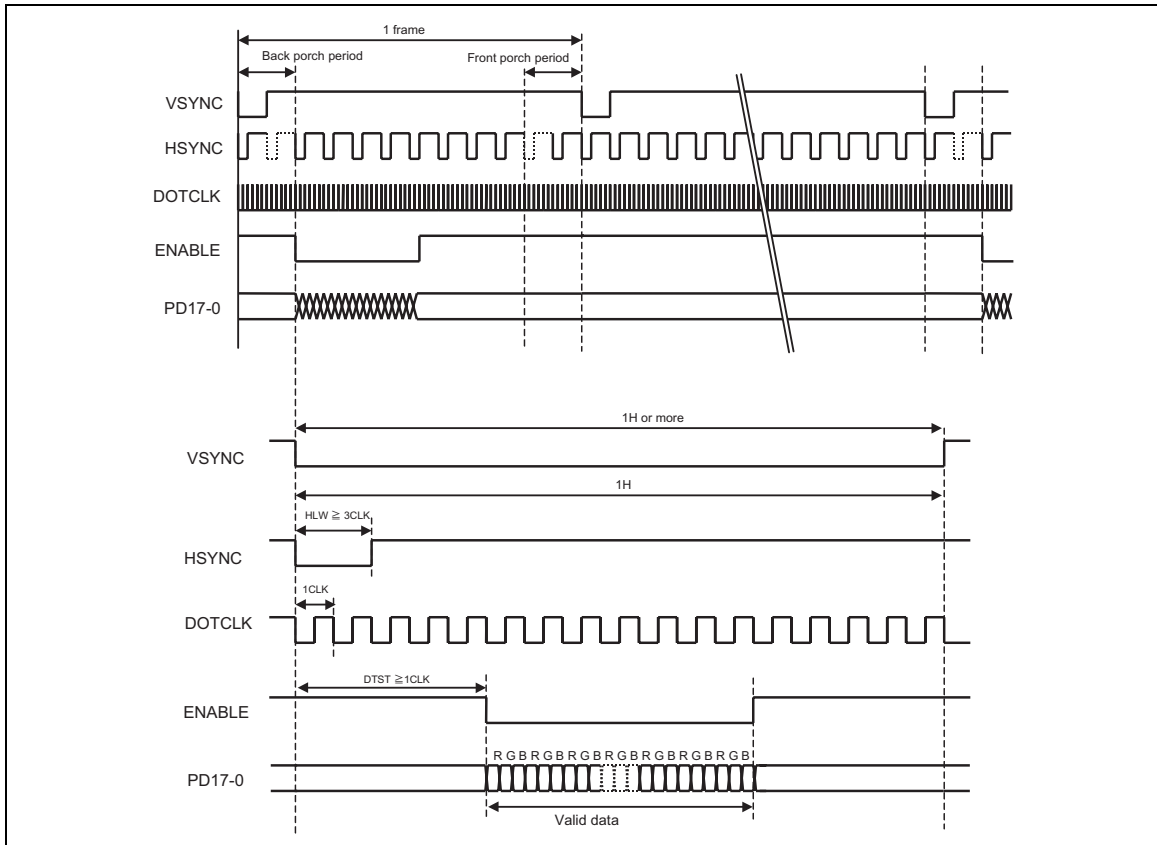

- Note 1) VLW: VSYNC "Low" period
- HLW: HSYNC "Low" period
- DTST: Setup time for data transfer

Note 2) Write data in the high speed write mode (HWM = 1) in the RGB I/F mode.

Note 3) VSYNC, HSYNC, EVABLE, DOTCLK, and PD17-0 must be transmitted by 3 clocks.

**Moving picture display in RGB Interface**

The HD66781 incorporates the RGB interface to display moving pictures and RAM to store display data, which provides the following merits in displaying moving pictures.

- The window address function enables the transfer of only data for the moving picture area.
- The high-speed write modes enables high-speed access to RAM with low power consumption
- Only transfer data that are written over the moving picture area.
- Reduced transmission contributes to the reduction of power consumption of the entire system.
- In combination with the system interface, the still picture area, such as an icon, can be updated while displaying moving pictures.

**RAM access through the system interface in RGB-I/F mode**

RAM is accessible through the system interface in the RGB-I/F mode. In the RGB interface mode, data are being written to RAM in synchronization with the DOTCLK input while the ENABLE is “Low”. When writing data to RAM through the system interface, it is necessary to set ENABLE to “High” to stop data write through the RGB-I/F. Setting RM = 0 allows RAM access through the system interface. When reverting to the RGB interface mode, wait a write/read bus cycle. Then, set RM = 1 and the index to R202h to start RAM access through the RGB-I/F. When RAM write through the RGB and system interfaces conflicts, it is not guaranteed that the data are properly written to RAM.

The following is an example of moving picture display through the RGB-I/F and updating still picture area through the system interface.

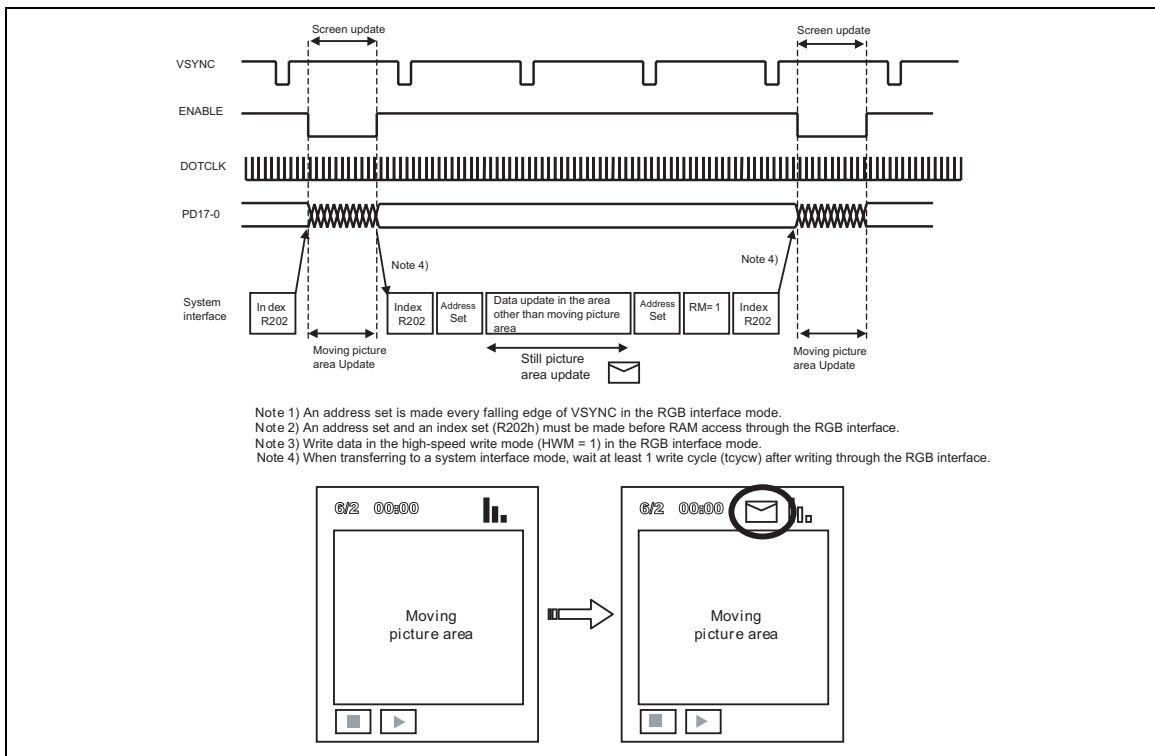

**Updating still picture area during moving picture display**

**6-bit RGB interface**

The 6-bit RGB interface is selected by setting RIM1-0 bits to 10. The display operation is synchronized with VSYNC, HSYNC, and DOTCLK signals. Display data are transmitted to RAM in synchronization with the display operation through 6-bit RGB data bus (PD17-12) according to the data enable signal (ENABLE). Unused pins (PD11 to 0) must be fixed to either IOVcc or GND level.

The instructions are set only through the system interface.

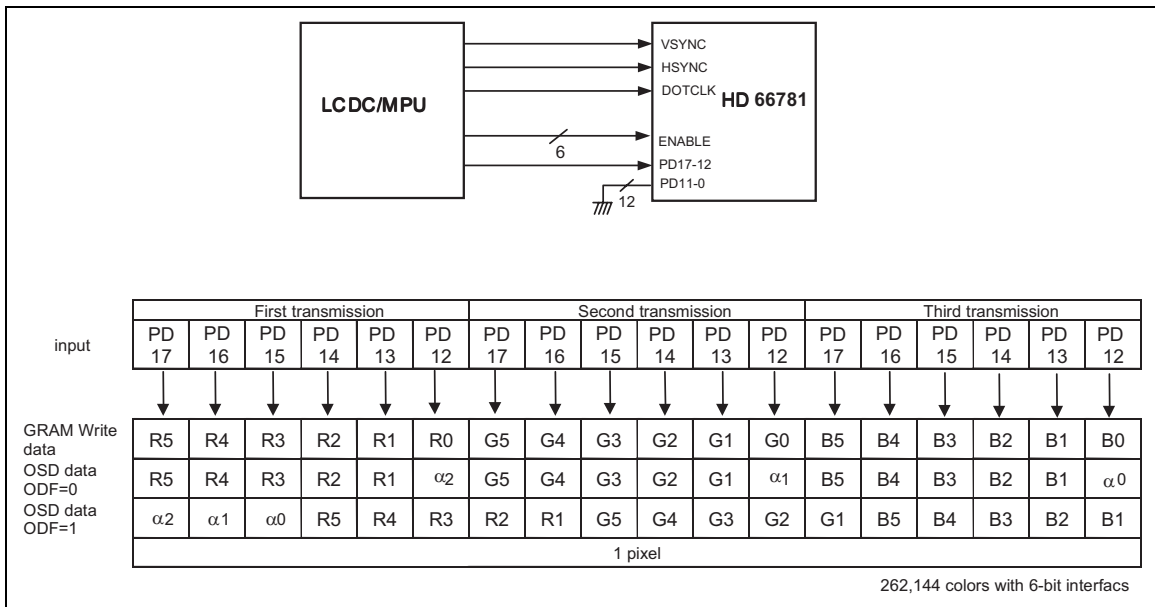

**Example of 6-Bit RGB Interface and data format**

**Transfer synchronization function for a 6-bit bus interface**

The HD66781 incorporates a transmission counter to count the first, second, third data transmissions in 6-bit RGB interface mode. The transmission counter is always reset to the first transmission on the falling edge of the VSYNC. When a discrepancy occurs in the transmission of first, second and third data, the counter is reset to the first data transmission at the start of each frame (the falling edge of VSYNC) and the data transmission restarts in the correct order from the next frame. In case of displaying moving pictures, which requires consecutive data transfer, this function minimizes the effect from the discrepancy in the data transmission and facilitates to return to the normal display.

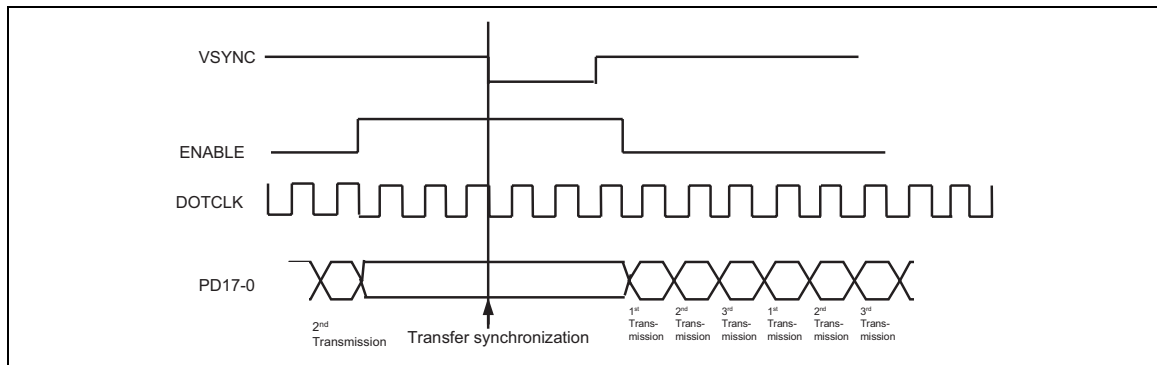

**6-bit Transfer Synchronization**



**16-bit RGB interface**

The 16-bit RGB interface is selected by setting RIM1-0 bits to 01. The display operation is synchronized with VSYNC, HSYNC, and DOTCLK signals. Display data are transmitted to RAM in synchronization with the display operation through 16-bit RGB data bus (PD17-13, 11-1) according to the data enable signal (ENABLE).

The instructions are set only through the system interface.

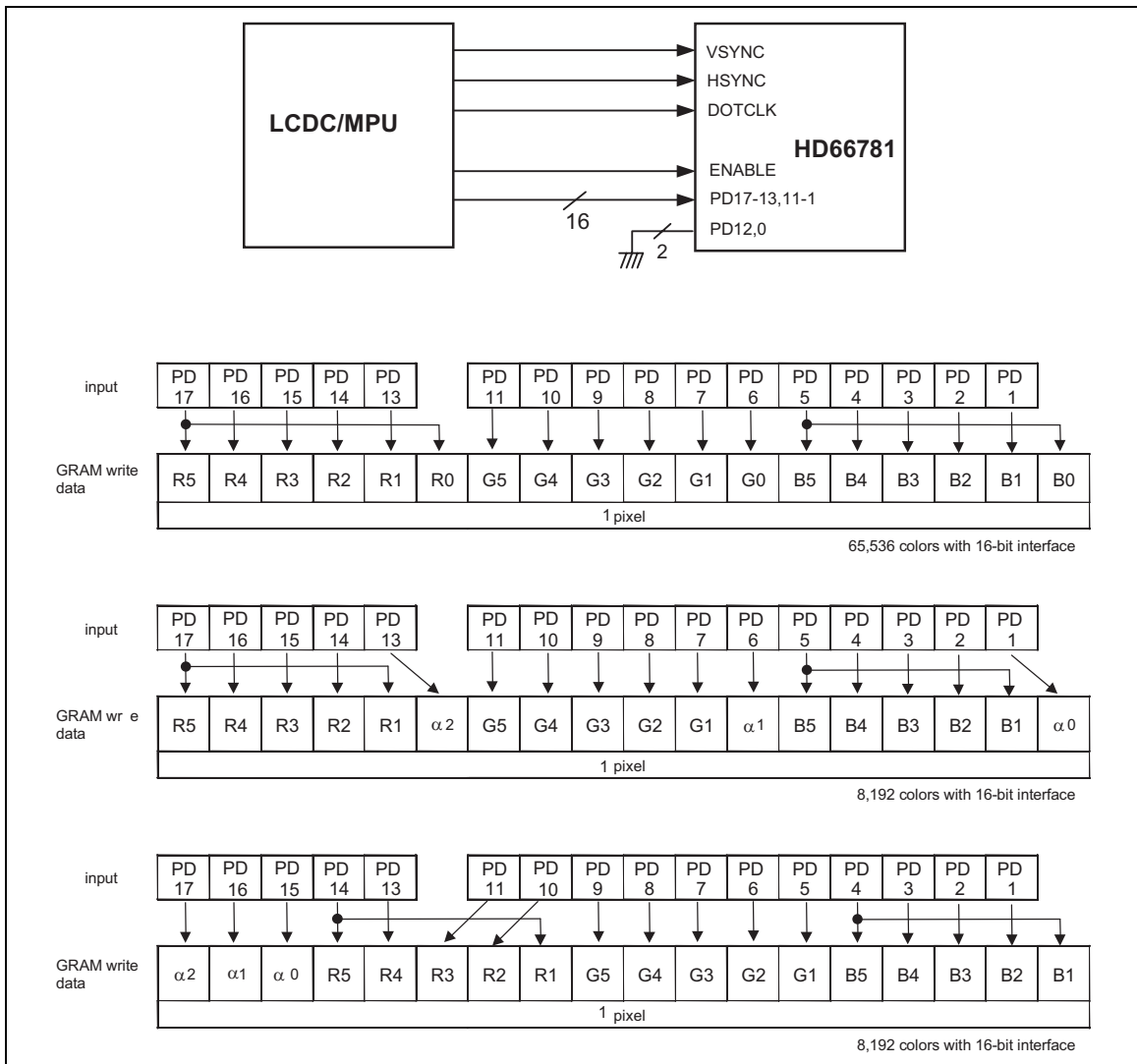

**Example of 16-Bit RGB Interface and data format**

**18-bit RGB interface**

The 18-bit RGB interface is selected by setting RIM1-0 bits to 10. The display operation is synchronized with VSYNC, HSYNC, and DOTCLK signals. Display data are transmitted to RAM in synchronization with the display operation through 18-bit RGB data bus (PD17-0) according to the data enable signal (ENABLE).

The instructions are set only through the system interface.

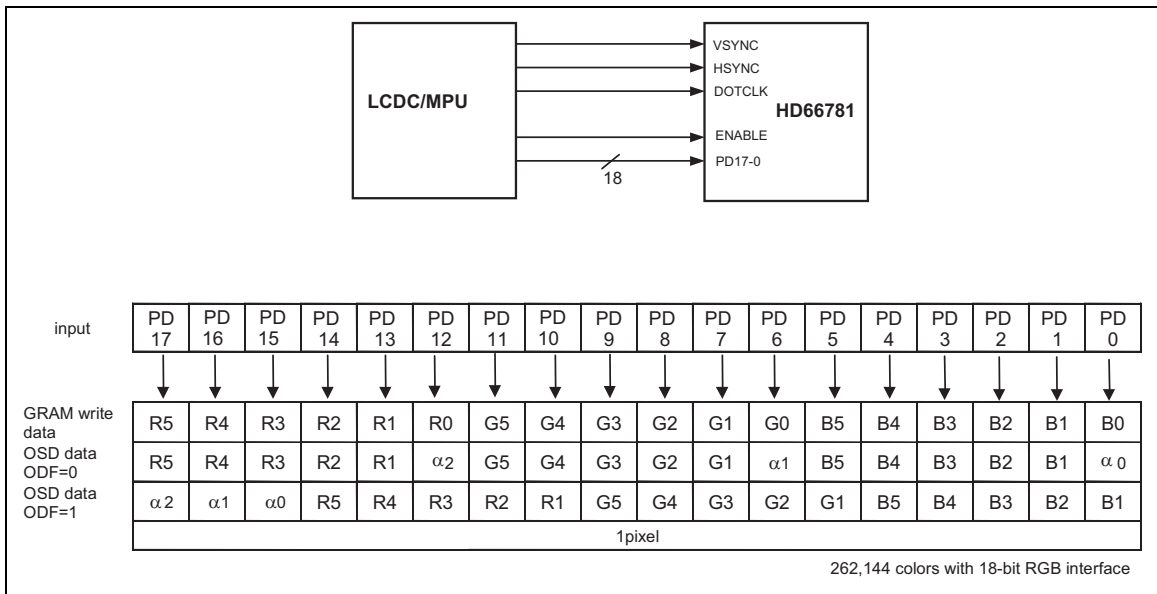

**Example of 18-Bit RGB Interface and data format**

**Notes to the external display interface**

1. While an external display interface is selected, the following functions are not available.

**Table 66**

Function	External Display Interface	Internal Display Operation
Partial display	Not available	Available
Scroll function	Not available	Available
Interlaced drive	Not available	Available

2. The VSYNC, HSYNC, and DOTCLK signals must be supplied through the display operation through the RGB-I/F.
3. When making settings for gate driver/LTPS panel controlling signal in the RGB-I/F modes, the reference clock is DOTCLK, not the internal operation clocks.
4. In the 6-bit RGB-I/F mode, the RGB (pixels) data are transmitted by three clocks.
5. In the 6-bit RGB-I/F mode, the interface signals, VSYNC, HSYNC, DOTCLK, ENABLE, and PD17-0, should be set by RGB (pixels) unit in convenience for the transmitting RGB pixels.
6. The transitions between the internal operation mode and external display interface should be made according to the mode switching sequence below.
7. In the RGB-I/F mode, the front porch period continues after displaying one frame data until the next VSYNC signal input.
8. In the RGB-I/F mode, the data must be written in the high-speed write mode (HWM = 1).
9. In the RGB-I/F mode, the address is set every frame on the falling edge of VSYNC.

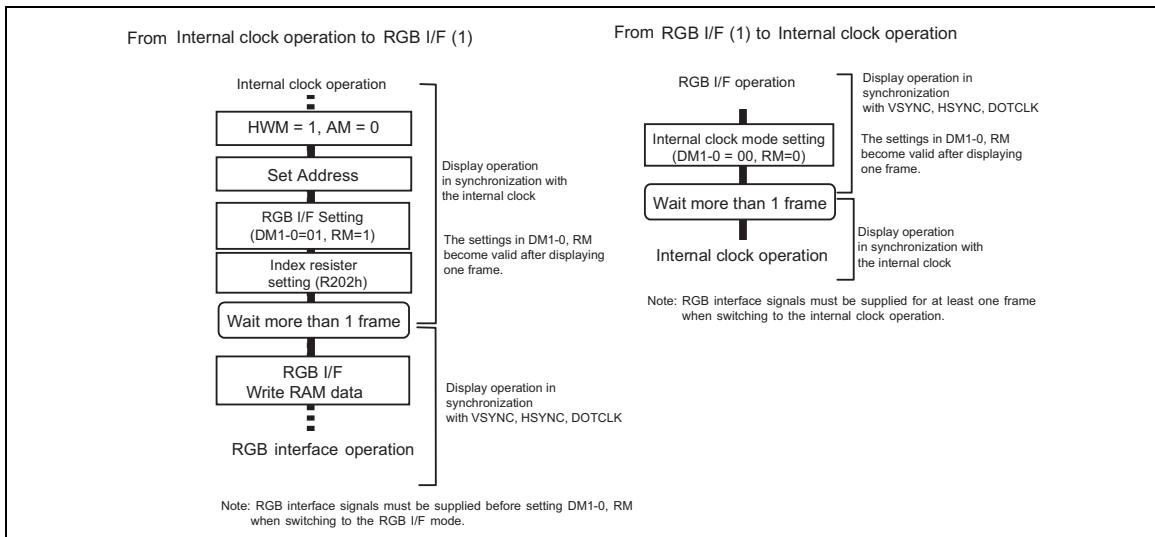

### Display Synchronizing Data Transfer

The HD66781 outputs BST signal that indicates the start of vertical retrace line period for flicker-free screen update. The BST signal is used as trigger to start internal GRAM write so that data transfer is synchronized with display scan.

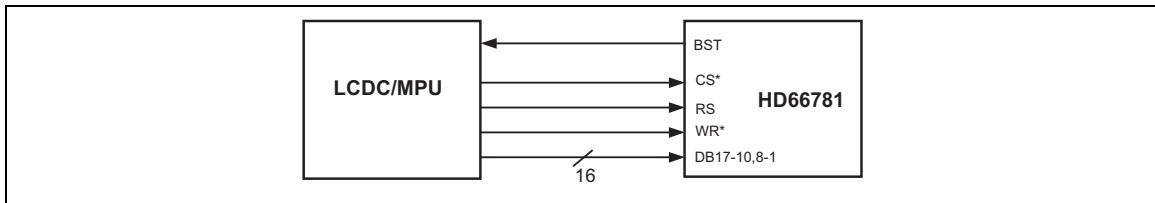

**Display synchronizing data transfer: Interface example**

By writing data to RAM through the system interface in a speed that is higher for more than a fixed speed than the internal display operation speed, it enables moving picture display through an conventional interface and flicker-free screen update.

All display data are stored in RAM. Therefore, it only requires transfer of the data that is written over to update the screen, thereby minimizing the numbers of data transfers while displaying moving picture. The use of high-speed write mode (HWM = 1) with VSYNC interface enables RAM access in high speed with low power consumption.

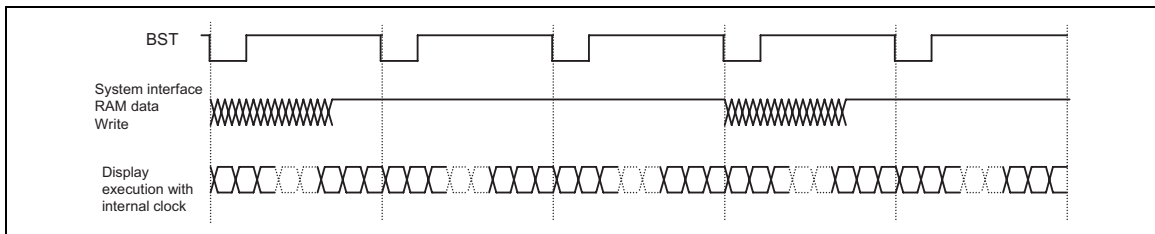

**Moving picture data transmission through VSYNC interface**

Note 1) Data must be written to RAM in the high-speed write mode (HWM = 1) in VSYNC interface mode.

The display synchronizing data transfer mode has limits on the minimum speed for RAM write through the system interface and the frequency of the internal clock. It requires RAM write speed more than the calculated result from the following formula.

$$\begin{aligned} & \text{Internal clock frequency (fosc) [Hz]} \\ & = \text{Frame frequency} \times (\text{Display raster-row (NL)} + \text{Front porch (FP)} + \text{Back porch (BP)}) \times 16 \text{ clocks} \\ & \quad \times \text{Fluctuation} \end{aligned}$$

$$\begin{aligned} & \text{RAM writing speed (min.) [Hz]} \\ & > 320 \times \text{Display lines (NL)} / \{[(\text{Front porch (FP)} + \text{Back porch (BP)} + \text{Display lines (NL)} - \text{margin}) \times 16 \text{ clocks}] / \text{fosc}\} \end{aligned}$$

When RAM write does not start immediately after the rising edge of BST, the period from the rising edge of BST to the start of RAM write must also be taken into consideration.

An example of calculations for the internal clock frequency and RAM write speed in the display synchronizing data transfer mode is as follows.

- Calculation Example: moving picture display in VSYNC I/F
- Panel size 240 RGB × 320 raster-rows (NL0 = 6'27)
- Total number of raster-rows(NL) 320 raster-rows
- Back, Front porches 14, 2, raster-rows  
(BP = 4'hE, FP = 4'h2)
- Frame frequency 60Hz

$$\begin{aligned} & \text{Internal clock frequency (fosc) Hz} \\ & = 60 \text{ Hz} \times (320 + 2 + 14) \text{ raster-rows} \times 16 \text{ clocks} \times 1.1 / 0.9 = 394 \text{ [kHz]} \end{aligned}$$

When calculating an internal clock frequency, possible causes of fluctuations must also be taken into consideration. The allowance for this fluctuation is  $\pm 10\%$  from the center value, and the range of the frequency must be within the BST signal cycle.

As the causes of fluctuations, the above example takes the variation in the LSI fabrication and the room temperature into account. Other possible causes of fluctuations, such as variation in the external resistors or the voltage change are not considered in the above calculation. It is necessary to make a setting with enough margins to include the allowances for these factors.

$$\begin{aligned} & \text{Minimum RAM writing speed [Hz]} \\ & > 240 \times 320 / \{((2+14 + 320 - 2) \text{ raster-rows} \times 16 \text{ clocks}) / 394 \text{ kHz}\} = 5.66 \text{ [MHz]} \end{aligned}$$

In this case, RAM write is performed on the rising edge of BST.

When the data for one frame are written to RAM completely, there must be 2 raster-rows or more of a margin before the display raster-rows.

According to the above calculation results, writing data to RAM on the rising of BST at the speed of 5.66 MHz or more, the data for the entire screen on RAM are overwritten before the display operation starts. Accordingly, the flicker due to moving picture update can be avoided even if displaying a moving picture.

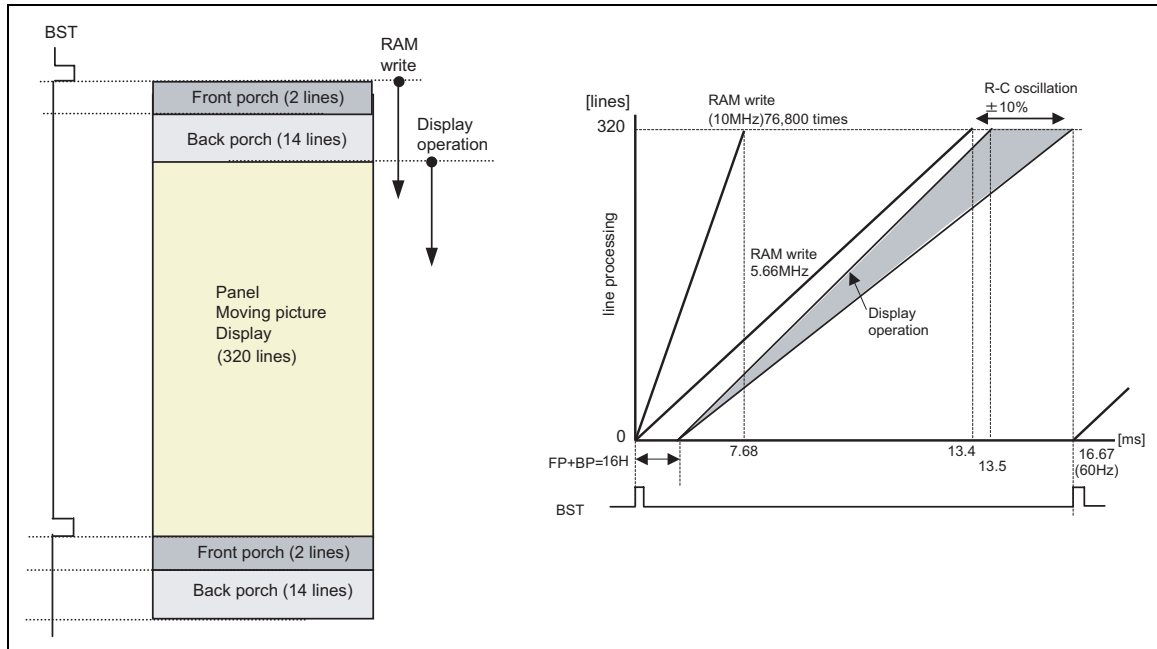

Minimum RAM write speed and internal clock frequency in VSYNC interface

Notes to the display synchronizing GRAM data transfer mode

1. The aforementioned example of calculation is just a result of calculation. In the actual settings, causes for the fluctuations such as internal oscillators and so on should be taken into consideration. It is necessary to make a setting for RAM write speed with enough margins.
2. In the display synchronizing GRAM data transfer mode, write display data to RAM in the high speed write mode (HWM = 1)

**Timing interfacing with LCD panel signals**

The relationship between RGB I/F signals and LCD panel signals during internal operation is as follows.

**Timing interfacing with liquid crystal panel signals in RGB interface mode**

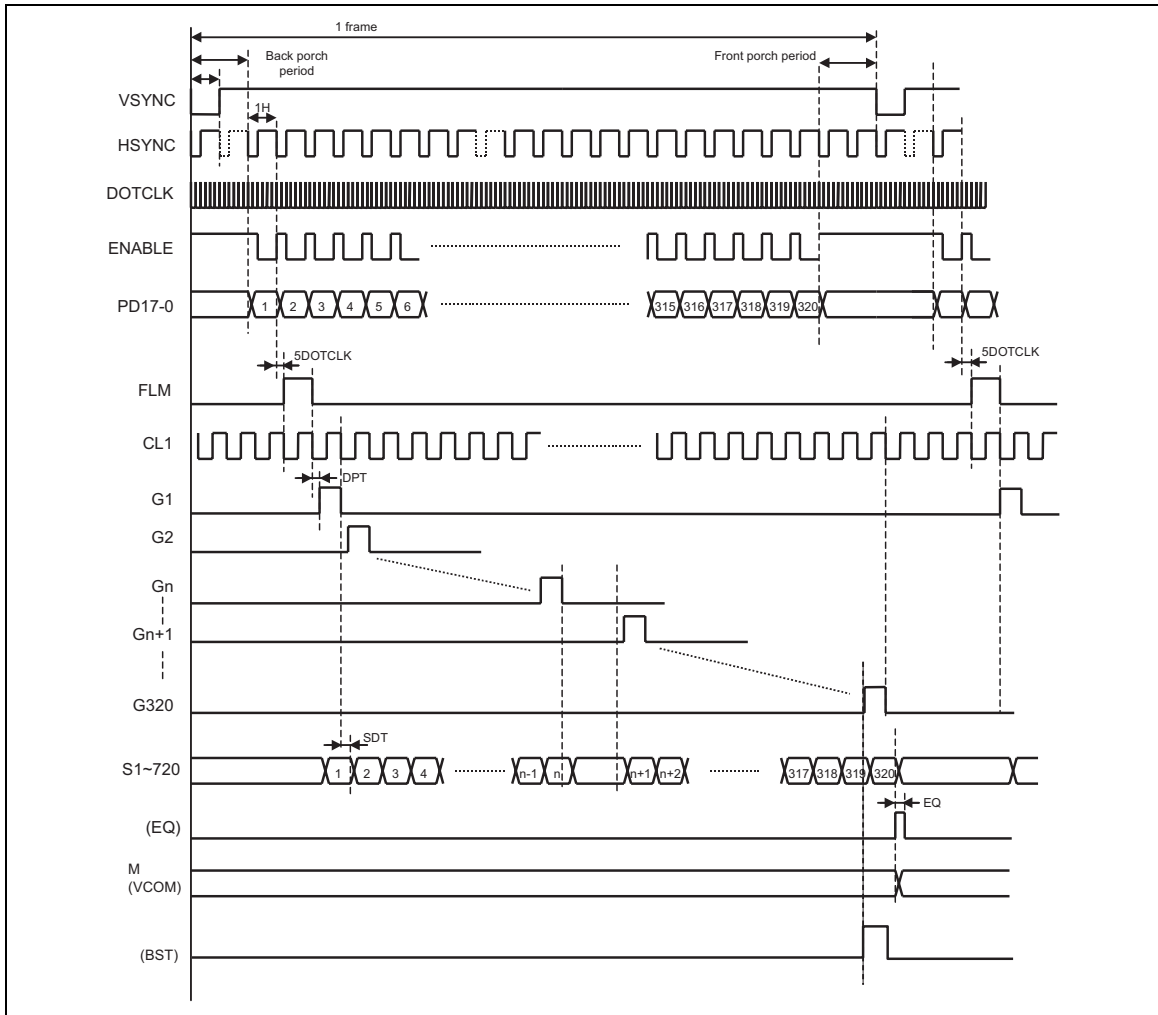

Note 1) This figure is the example when DIVE[1:0] = 2'h2

Timing interfacing with liquid crystal panel signals in internal clock operation mode

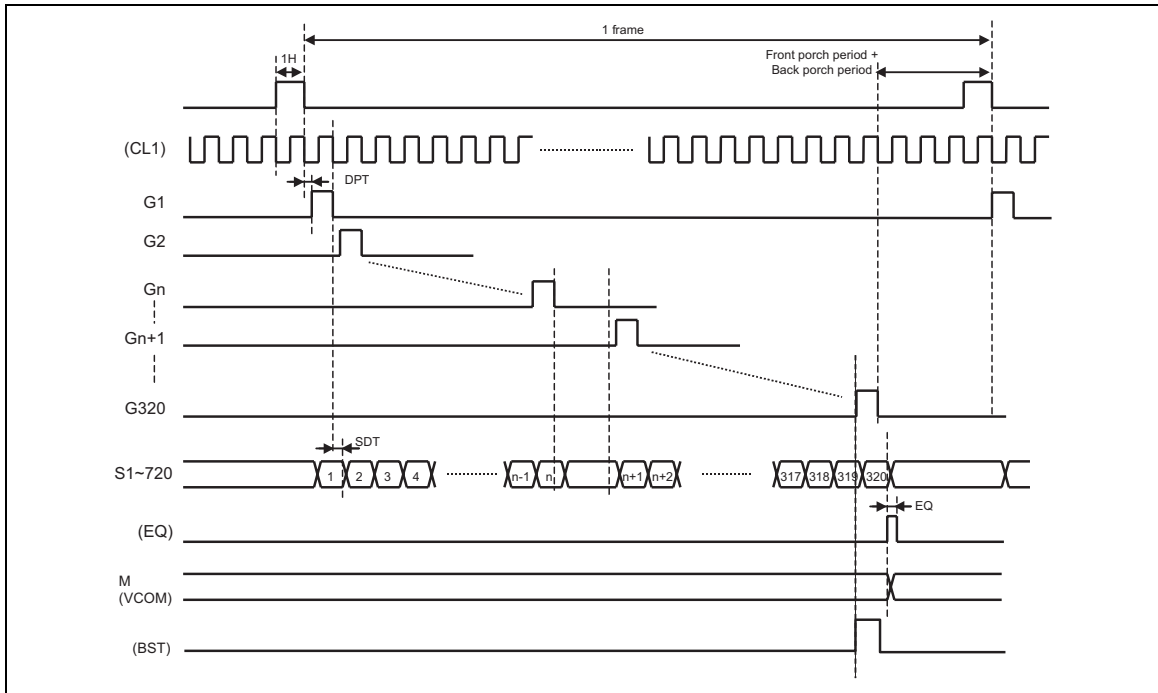



### High-Speed Burst RAM Write Function

The HD66781 incorporates high-speed burst RAM-write function, which writes data to RAM about half the time required for the normal RAM write. This function is especially useful for applications, which require high-speed display data rewrite, such as colored moving picture display and so on.

In the high-speed RAM-write mode (HWM=1), data to write to RAM is temporarily stored to the internal register of HD66781 and then written to RAM by horizontal line in the area specified by the window address. Since the data stored in the register are written to RAM at once, it is possible to write next data to the internal register while data are being written from the internal register to RAM. This reduces the frequency of RAM access to minimum and enables consecutive high-speed access to the internal RAM with low power consumption, which is required for moving picture display.

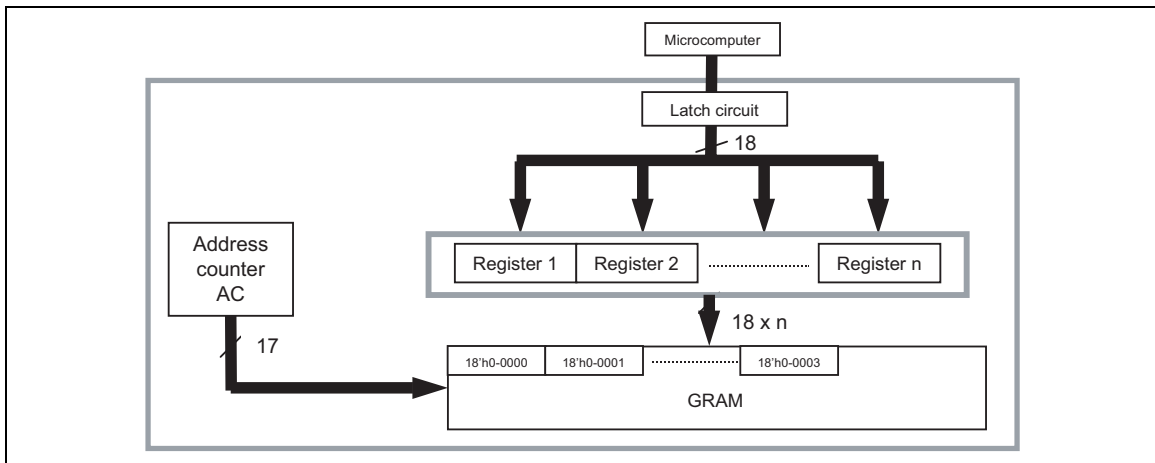

High-speed consecutive access to RAM, operational flow

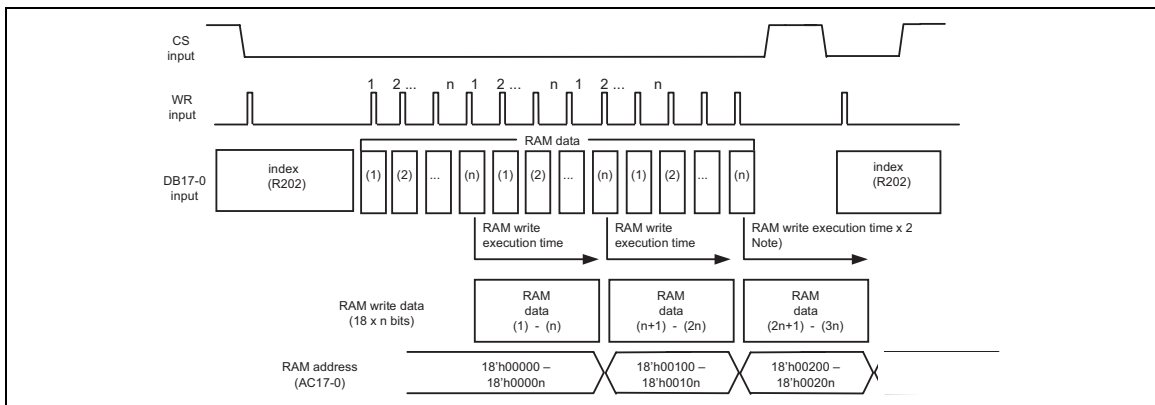

High-speed consecutive access to RAM (HWM = "1")

Note 1) When making a transition from the high-speed RAM write to the index write, wait at least 2 bus cycle time ( $t_{cyw}$ ) in the normal write mode after RAM write before executing next instructions.

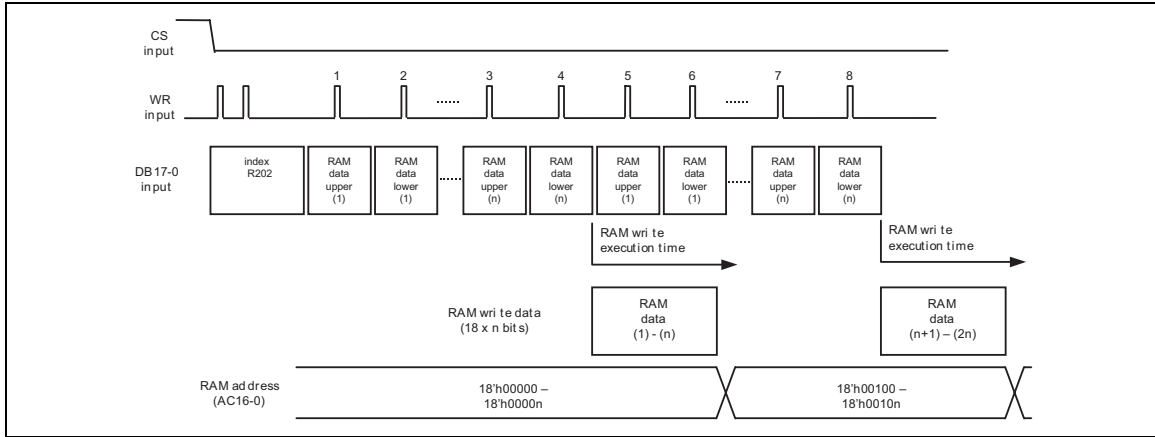

**High-speed consecutive access to RAM (9-bit interface)**

Note 1) The high-speed RAM write mode (HWM=1) writes data to RAM by n words. In the 9-bit interface mode, data are written to RAM 2xn times per line.

**Notes to the high-speed RAM write mode**

1. RAM write is executed by line. If write operation is terminated before it reaches the end of horizontal line of the window-address area, it is not guaranteed that data are properly written on that line.
2. The index register for the RAM data write (202H), if selected, executes the first data write operation. This setting does not allow RAM data read. HWM must be set to 0 during RAM read.
3. The high-speed RAM write mode is not compatible with the normal RAM write mode. Whenever switching to the other mode, it is necessary to set the address before starting RAM write.

**Table 67**

	<b>Normal RAM Write (HWM=0)</b>	<b>High-Speed RAM Write (HWM=1)</b>
BGR function	Available	Available
Write mask function	Available	Available
RAM address set	Set by words	Set by words
RAM read	Set by words	Not available
RAM write	Set by words	Set by lines
Window address	Set by words (minimum range: 1 word x 1 line)	Set by words (minimum range: 8 word x 1 line)
External display interface	Available	Available
AM	AM = 1/0	AM = 0

**High-Speed RAM Write with Window Address Function**

Specifying a window-address range (minimum range: 8 words x 1 word) enables consecutive high-speed RAM data write in an arbitrary rectangular area on RAM.

In the high-speed write mode, data must be written to RAM by horizontal lines. If RAM write is terminated in the middle of the line, there is no guarantee that data are properly written on that line.

The following figure illustrates an example of high-speed RAM write in the window-address range on RAM.

By setting the window address specifying bits (HSA = 8'h10, HEA = 8'h2F, VSA = 9'h020, VEA = 9'h05F), data are written consecutively in high speed in the window-address range specified by these bits.

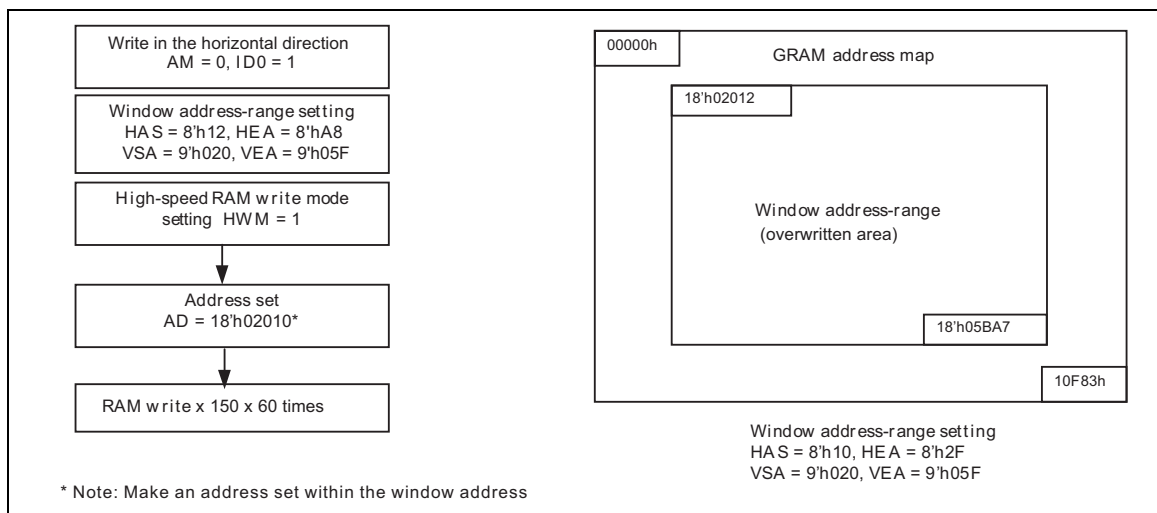

**Window Address Function**

The window address function writes data consecutively to the on-chip GRAM within the rectangular window-address range specified by the horizontal address registers (start: HSA7-0, end: HEA 7-0) and the vertical address registers (start: VSA7-0, end: VEA7-0).

The address transition direction is determined by AM bit (either increment or decrement). This allows writing data, including picture data, consecutively without taking the data wrap position into consideration.

The window-address range must be specified within the GRAM address area. An address set must be made within the window-address range.

[Conditions on setting window-address range]	
(horizontal direction)	$8'h00 \leq HSA \leq HEA \leq 8'hEF$
(vertical direction)	$9'h000 \leq VSA \leq VEA \leq 9'h19F$
[Conditions on making an address set within the window-address range]	
(RAM address)	$HSA \leq AD7-0 \leq HEA$
	$VSA \leq AD16-8 \leq VEA$

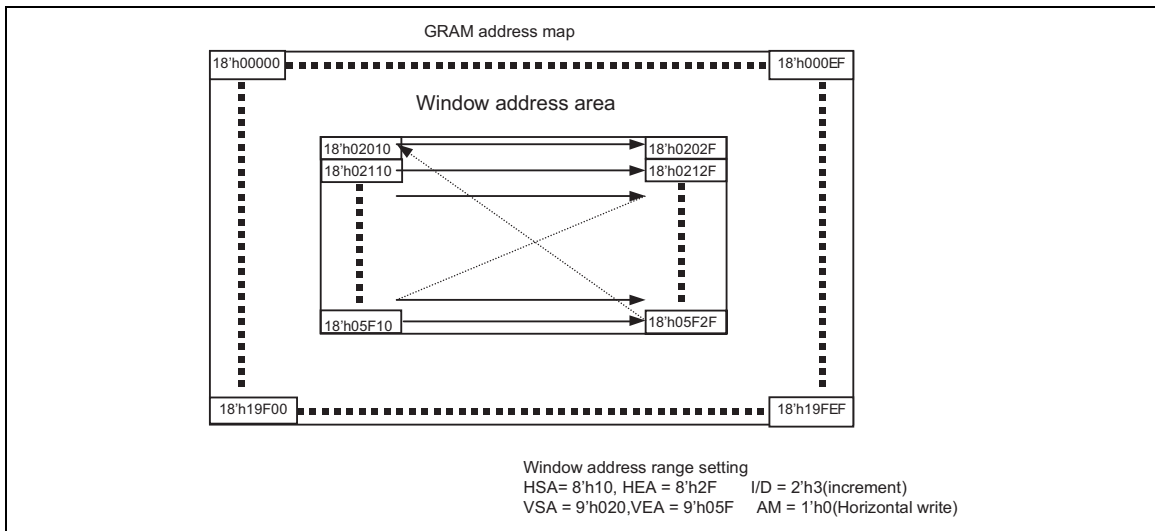

**Address transition direction in specified window-address range**

**$\gamma$ -Correction Function**

The HD66781 incorporates  $\gamma$ -correction function to simultaneously display 262,144 colors, by which 8-level grayscale is determined by the gradient-adjustment and fine-adjustment registers. The HD66781 incorporates gradient-adjustment and fine-adjustment registers for both positive and negative polarities and allows selecting either positive or negative polarity according to the characteristics of a liquid crystal panel.

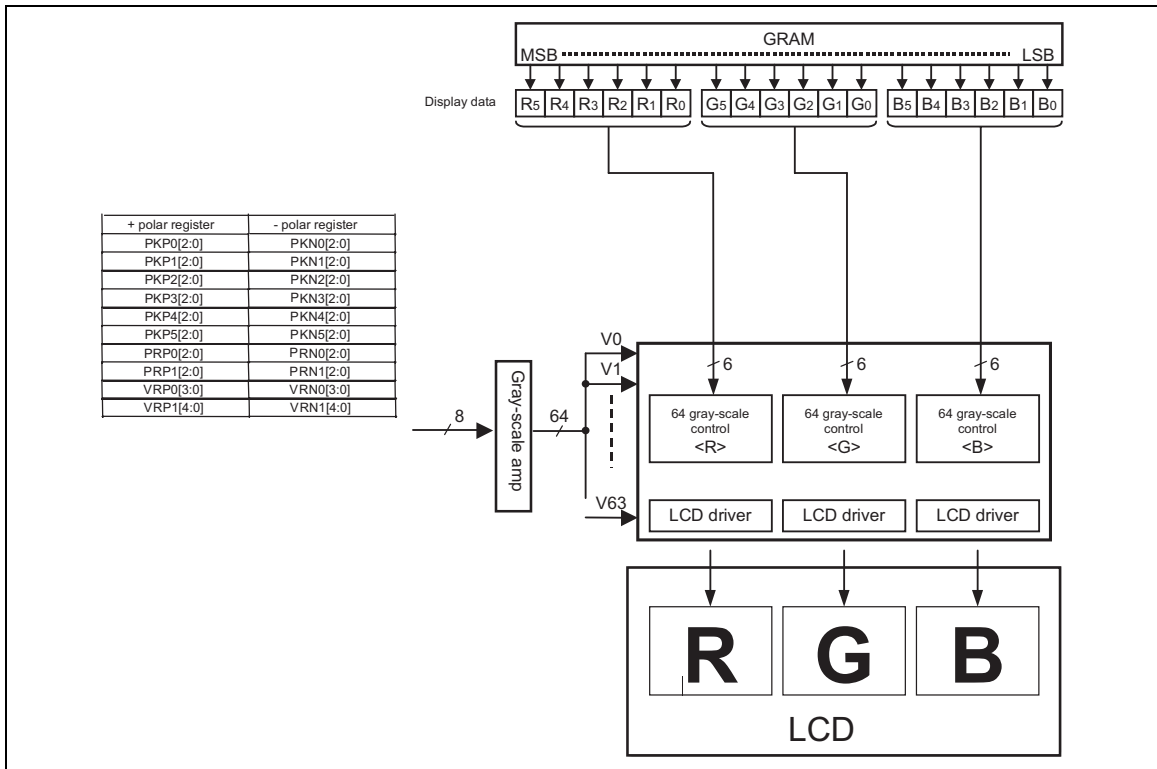

**Grayscale control**

**Grayscale Amplifier Configuration**

The following figure illustrates the configuration of grayscale amplifier.

The eight-level grayscales (VIN0-7) are determined by the gradient adjustment and fine adjustment registers. The 8 levels are then divided by the ladder resistors placed between each level into 64 levels (V0-63).

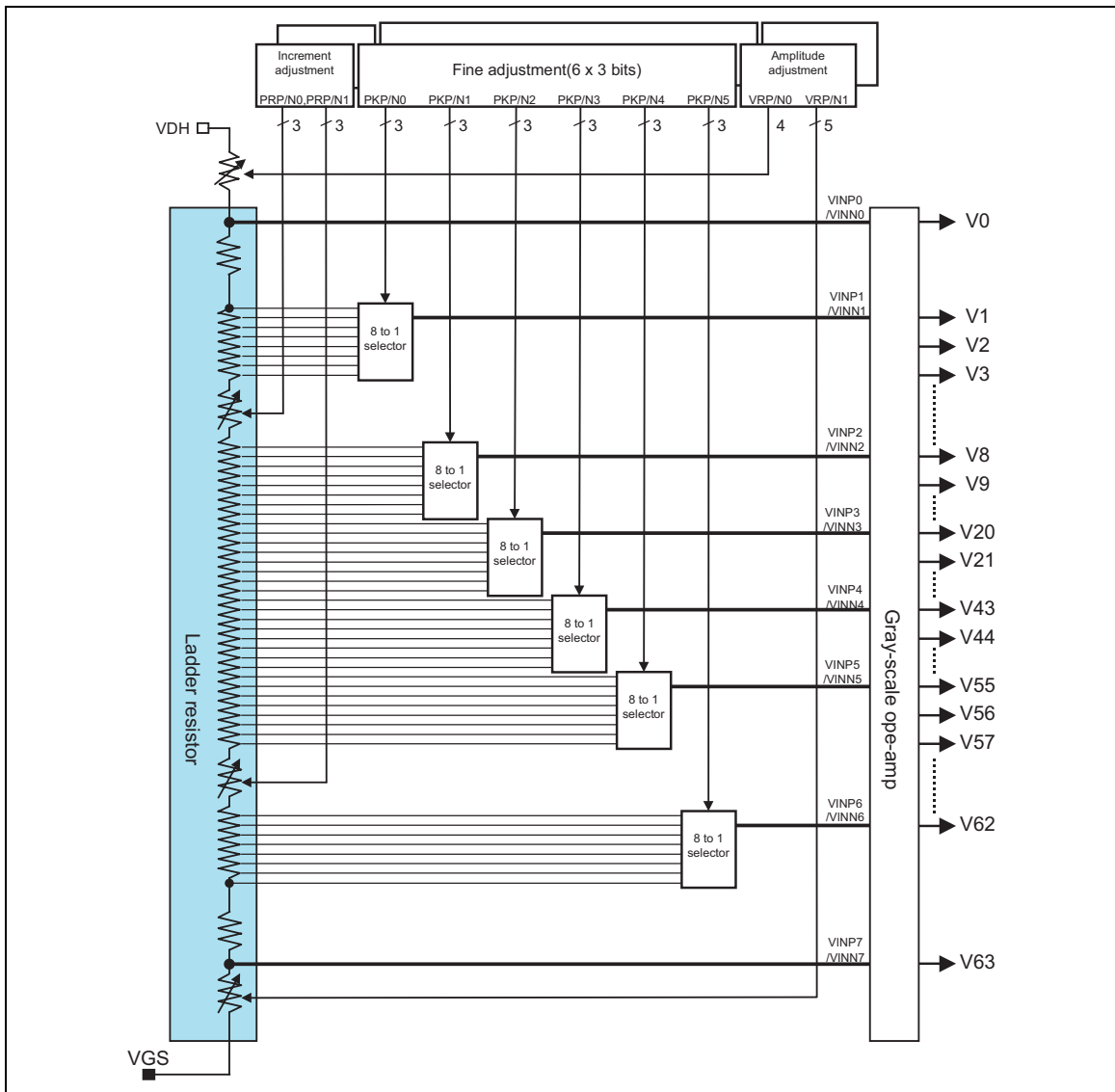

**Grayscale amplifier**

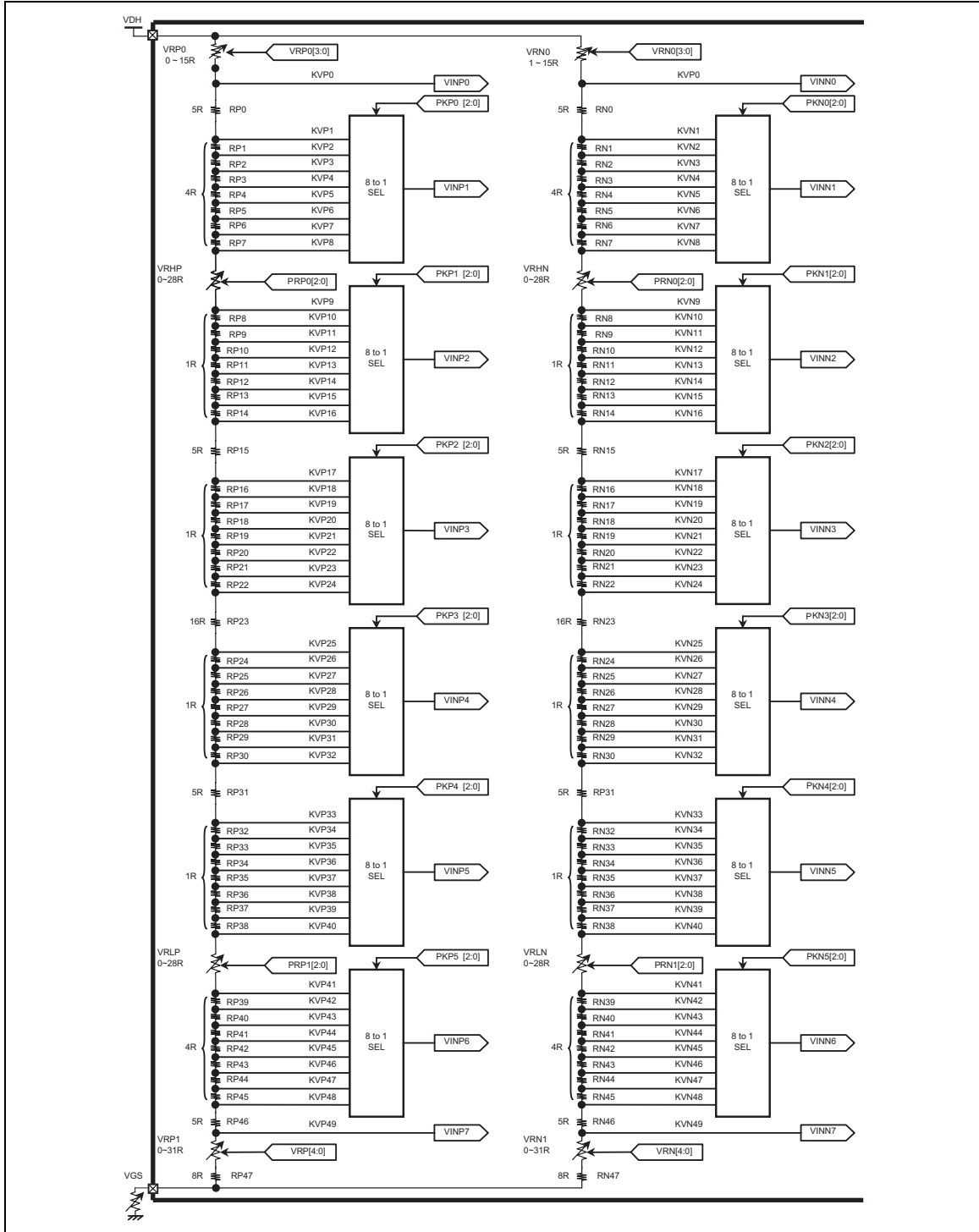

Ladder Resistors and 8 to 1 Selectors

### $\gamma$ -Correction Registers

The  $\gamma$ -adjustment register is a group of registers to set an appropriate grayscale voltage for the  $\gamma$ -characteristics of a liquid crystal panel. The register group is categorized into the ones adjusting gradient, amplitude, and reference value and fine-tuning in relation to grayscale number and grayscale voltage characteristics. Each register group can make an independent setting for the positive/negative polarity. The reference value and RGB are common to both polarities.

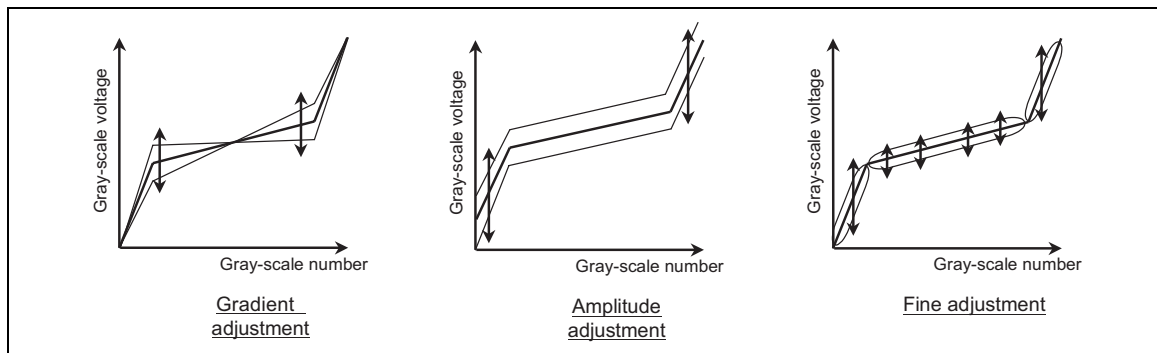

**Gradient, Amplitude, Fine Adjustments**

#### 1. Gradient adjustment registers

The gradient adjustment registers are used to adjust the gradient around the middle of the grayscale number and voltage characteristics without changing a dynamic range. To adjust a gradient, the values of the variable resistors (VRHP (N)/VRLP (N)) in the ladder resistor block for grayscale voltage generation are controlled. The registers incorporate separate registers for positive and negative polarities to be compatible with asymmetric drive.

#### 2. Amplitude adjustment registers

The amplitude adjustment registers are used to adjust the amplitude of the grayscale voltage. To adjust the amplitude, the values of the variable resistors (VRP(N)1/0) in the upper and lower parts of the ladder resistor block for grayscale voltage generation are adjusted. Same with the gradient registers, the amplitude adjustment registers also incorporate separate registers for positive and negative polarities.

#### 3. Fine adjustment registers

The fine adjustment register is to fine-adjust the grayscale voltage level. To fine-adjust the grayscale voltage level, 8-to-1 selectors control each level of 8-level reference voltages generated from the ladder registers. Same with the other registers, the fine adjustment registers also incorporate separate registers for positive and negative polarities.



**Table 68 List of output signals**

Register Groups	Positive Polarity	Negative Polarity	Description
<b>Gradient adjustment</b>	PRP0 [2:0]	PRN0 [2:0]	Variable resistor VRHP (N)
	PRP1 [2:0]	PRN1 [2:0]	Variable resistor VRLP (N)
<b>Amplitude adjustment</b>	VRP0 [3:0]	VRN0 [3:0]	Variable resistor VRP (N) 0
	VRP1 [4:0]	VRN1 [4:0]	Variable resistor VRP (N) 1
<b>Fine adjustment</b>	PKP0 [2:0]	PKN0 [2:0]	8-to-1 selector (voltage level of grayscale 1)
	PKP1 [2:0]	PKN1 [2:0]	8-to-1 selector (voltage level of grayscale 8)
	PKP2 [2:0]	PKN2 [2:0]	8-to-1 selector (voltage level of grayscale 20)
	PKP3 [2:0]	PKN3 [2:0]	8-to-1 selector (voltage level of grayscale 43)
	PKP4 [2:0]	PKN4 [2:0]	8-to-1 selector (voltage level of grayscale 55)
	PKP5 [2:0]	PKN5 [2:0]	8-to-1 selector (voltage level of grayscale 62)

## Ladder resistors and 8 to 1 selector

### Block configuration

The block configuration of page **159** consists of two ladder resistors including variable resistors, and 8 to 1 selectors, which select the voltage generated by the ladder resistors, to output the reference voltage for the grayscale voltage. The  $\gamma$ -correction registers control the variable resistors and the 8 to 1 selectors. Pins that are connected to a variable resistor are also provided to compensate the variation among the panels.

### Variable resistors

There are three kinds of variable resistors for the gradient adjustment (VRHP(N)/VRLP(N)), the amplitude adjustment (VRP(N)), and the reference adjustment (VDR). The resistance is determined by the gradient adjustment and amplitude adjustment registers as is shown below.

**Table 69**

Gradient adjustment		Amplitude adjustment		Reference adjustment	
Register PRP(N)0/1[2:0]	Resistance VRHP(N) VRLP(N)	Register VRP(N)0[3:0]	Resistance VRP(N)0	Register VRP(N)1[4:0]	Resistance VRP(N)1
000	0R	0000	0R	00000	0R
001	4R	0001	1R	00001	1R
010	8R	0010	2R	00010	2R
011	12R	:	:	:	:
100	16R	:	:	:	:
101	20R	1101	13R	11101	29R
110	24R	1110	14R	11110	30R
111	28R	1111	15R	11111	31R

### 8 to 1 selector

The 8-to-1 selectors select a voltage level generated by the ladder resistors according to the fine adjustment registers, and output as a reference voltage of either one of the following VIN1 ~ VIN 6. The relationship between the fine adjustment register and the selected voltage is as follows

**Table 70**

Contents of Register PKP(N) 0/1 [2:0]	Selected Voltage					
	VINP(N)1	VINP(N)2	VINP(N)3	VINP(N)4	VINP(N)5	VINP(N)6
000	KVP(N)1	KVP(N)9	KVP(N)17	KVP(N)25	KVP(N)33	KVP(N)41
001	KVP(N)2	KVP(N)10	KVP(N)18	KVP(N)26	KVP(N)34	KVP(N)42
010	KVP(N)3	KVP(N)11	KVP(N)19	KVP(N)27	KVP(N)35	KVP(N)43
011	KVP(N)4	KVP(N)12	KVP(N)20	KVP(N)28	KVP(N)36	KVP(N)44
100	KVP(N)5	KVP(N)13	KVP(N)21	KVP(N)29	KVP(N)37	KVP(N)45
101	KVP(N)6	KVP(N)14	KVP(N)22	KVP(N)30	KVP(N)38	KVP(N)46
110	KVP(N)7	KVP(N)15	KVP(N)23	KVP(N)31	KVP(N)39	KVP(N)47
111	KVP(N)8	KVP(N)16	KVP(N)24	KVP(N)32	KVP(N)40	KVP(N)48

The gray scale levels (V0-V63) are calculated according to the following formulas.

**Formulas for calculating voltage (Positive polarity) (1)**

Pins	Formula	Fine-adjustment registers	Reference voltage
KVP0	VDH- $V^*VxP0/SUMRP$	-	VINP0
KVP1	VDH- $V^*(VxRP0+5R)/SUMRP$	PKP0[2:0]="000"	VINP1
KVP2	VDH- $V^*(VxRP0+9R)/SUMRP$	PKP0[2:0]="001"	
KVP3	VDH- $V^*(VxRP0+13R)/SUMRP$	PKP0[2:0]="010"	
KVP4	VDH- $V^*(VxRP0+17R)/SUMRP$	PKP0[2:0]="011"	
KVP5	VDH- $V^*(VxRP0+21R)/SUMRP$	PKP0[2:0]="100"	
KVP6	VDH- $V^*(VxRP0+25R)/SUMRP$	PKP0[2:0]="101"	
KVP7	VDH- $V^*(VxRP0+29R)/SUMRP$	PKP0[2:0]="110"	
KVP8	VDH- $V^*(VxRP0+33R)/SUMRP$	PKP0[2:0]="111"	
KVP9	VDH- $V^*(VxRP0+33R+VRHP)/SUMRP$	PKP1[2:0]="000"	VINP2
KVP10	VDH- $V^*(VxRP0+34R+VRHP)/SUMRP$	PKP1[2:0]="001"	
KVP11	VDH- $V^*(VxRP0+35R+VRHP)/SUMRP$	PKP1[2:0]="010"	
KVP12	VDH- $V^*(VxRP0+36R+VRHP)/SUMRP$	PKP1[2:0]="011"	
KVP13	VDH- $V^*(VxRP0+37R+VRHP)/SUMRP$	PKP1[2:0]="100"	
KVP14	VDH- $V^*(VxRP0+38R+VRHP)/SUMRP$	PKP1[2:0]="101"	
KVP15	VDH- $V^*(VxRP0+39R+VRHP)/SUMRP$	PKP1[2:0]="110"	
KVP16	VDH- $V^*(VxRP0+40R+VRHP)/SUMRP$	PKP1[2:0]="111"	
KVP17	VDH- $V^*(VxRP0+45R+VRHP)/SUMRP$	PKP2[2:0]="000"	VINP3
KVP18	VDH- $V^*(VxRP0+46R+VRHP)/SUMRP$	PKP2[2:0]="001"	
KVP19	VDH- $V^*(VxRP0+47R+VRHP)/SUMRP$	PKP2[2:0]="010"	
KVP20	VDH- $V^*(VxRP0+48R+VRHP)/SUMRP$	PKP2[2:0]="011"	
KVP21	VDH- $V^*(VxRP0+49R+VRHP)/SUMRP$	PKP2[2:0]="100"	
KVP22	VDH- $V^*(VxRP0+50R+VRHP)/SUMRP$	PKP2[2:0]="101"	
KVP23	VDH- $V^*(VxRP0+51R+VRHP)/SUMRP$	PKP2[2:0]="110"	
KVP24	VDH- $V^*(VxRP0+52R+VRHP)/SUMRP$	PKP2[2:0]="111"	
KVP25	VDH- $V^*(VxRP0+68R+VRHP)/SUMRP$	PKP3[2:0]="000"	VINP4
KVP26	VDH- $V^*(VxRP0+69R+VRHP)/SUMRP$	PKP3[2:0]="001"	
KVP27	VDH- $V^*(VxRP0+70R+VRHP)/SUMRP$	PKP3[2:0]="010"	
KVP28	VDH- $V^*(VxRP0+71R+VRHP)/SUMRP$	PKP3[2:0]="011"	
KVP29	VDH- $V^*(VxRP0+72R+VRHP)/SUMRP$	PKP3[2:0]="100"	
KVP30	VDH- $V^*(VxRP0+73R+VRHP)/SUMRP$	PKP3[2:0]="101"	
KVP31	VDH- $V^*(VxRP0+74R+VRHP)/SUMRP$	PKP3[2:0]="110"	
KVP32	VDH- $V^*(VxRP0+75R+VRHP)/SUMRP$	PKP3[2:0]="111"	
KVP33	VDH- $V^*(VxRP0+80R+VRHP)/SUMRP$	PKP4[2:0]="000"	VINP5
KVP34	VDH- $V^*(VxRP0+81R+VRHP)/SUMRP$	PKP4[2:0]="001"	
KVP35	VDH- $V^*(VxRP0+82R+VRHP)/SUMRP$	PKP4[2:0]="010"	
KVP36	VDH- $V^*(VxRP0+83R+VRHP)/SUMRP$	PKP4[2:0]="011"	
KVP37	VDH- $V^*(VxRP0+84R+VRHP)/SUMRP$	PKP4[2:0]="100"	
KVP38	VDH- $V^*(VxRP0+85R+VRHP)/SUMRP$	PKP4[2:0]="101"	
KVP39	VDH- $V^*(VxRP0+86R+VRHP)/SUMRP$	PKP4[2:0]="110"	
KVP40	VDH- $V^*(VxRP0+87R+VRHP)/SUMRP$	PKP4[2:0]="111"	
KVP41	VDH- $V^*(VxRP0+87R+VRHP+VRLP)/SUMRP$	PKP4[2:0]="000"	VINP6
KVP42	VDH- $V^*(VxRP0+91R+VRHP+VRLP)/SUMRP$	PKP5[2:0]="001"	
KVP43	VDH- $V^*(VxRP0+95R+VRHP+VRLP)/SUMRP$	PKP5[2:0]="010"	
KVP44	VDH- $V^*(VxRP0+99R+VRHP+VRLP)/SUMRP$	PKP5[2:0]="011"	
KVP45	VDH- $V^*(VxRP0+103R+VRHP+VRLP)/SUMRP$	PKP5[2:0]="100"	
KVP46	VDH- $V^*(VxRP0+107R+VRHP+VRLP)/SUMRP$	PKP5[2:0]="101"	
KVP47	VDH- $V^*(VxRP0+111R+VRHP+VRLP)/SUMRP$	PKP5[2:0]="110"	
KVP48	VDH- $V^*(VxRP0+115R+VRHP+VRLP)/SUMRP$	PKP5[2:0]="111"	
KVP49	VDH- $V^*(VxRP0+120R+VRHP+VRLP)/SUMRP$	-	VINP7

Note 1) Sum of ladder resistors with positive polarities = 128R+VRHP+VRLP+VRP0+VRP1

Note 2) Sum of ladder resistors with negative polarities = 128R+VRHN+VRLN+VRN0+VRN1

Note 3) ΔV :Electric potential difference between VDH and VGS

## Formulas for calculating voltage (Positive polarity) (2)

Grayscale voltage	Formula
V0	VINP0
V1	VINP1
V2	$V8+(V1-V8)*(30/48)$
V3	$V8+(V1-V8)*(23/48)$
V4	$V8+(V1-V8)*(16/48)$
V5	$V8+(V1-V8)*(12/48)$
V6	$V8+(V1-V8)*(8/48)$
V7	$V8+(V1-V8)*(4/48)$
V8	VINP2
V9	$V20+(V8-V20)*(22/24)$
V10	$V20+(V8-V20)*(20/24)$
V11	$V20+(V8-V20)*(18/24)$
V12	$V20+(V8-V20)*(16/24)$
V13	$V20+(V8-V20)*(14/24)$
V14	$V20+(V8-V20)*(12/24)$
V15	$V20+(V8-V20)*(10/24)$
V16	$V20+(V8-V20)*(8/24)$
V17	$V20+(V8-V20)*(6/24)$
V18	$V20+(V8-V20)*(4/24)$
V19	$V20+(V8-V20)*(2/24)$
V20	VINP3
V21	$V43+(V20-V43)*(22/23)$
V22	$V43+(V20-V43)*(21/23)$
V23	$V43+(V20-V43)*(20/23)$
V24	$V43+(V20-V43)*(19/23)$
V25	$V43+(V20-V43)*(18/23)$
V26	$V43+(V20-V43)*(17/23)$
V27	$V43+(V20-V43)*(16/23)$
V28	$V43+(V20-V43)*(15/23)$
V29	$V43+(V20-V43)*(14/23)$
V30	$V43+(V20-V43)*(13/23)$
V31	$V43+(V20-V43)*(12/23)$

Grayscale voltage	Formula
V32	$V43+(V20-V43)*(11/23)$
V33	$V43+(V20-V43)*(10/23)$
V34	$V43+(V20-V43)*(9/23)$
V35	$V43+(V20-V43)*(8/23)$
V36	$V43+(V20-V43)*(7/23)$
V37	$V43+(V20-V43)*(6/23)$
V38	$V43+(V20-V43)*(5/23)$
V39	$V43+(V20-V43)*(4/23)$
V40	$V43+(V20-V43)*(3/23)$
V41	$V43+(V20-V43)*(2/23)$
V42	$V43+(V20-V43)*(1/23)$
V43	VINP4
V44	$V55+(V43-V55)*(22/24)$
V45	$V55+(V43-V55)*(20/24)$
V46	$V55+(V43-V55)*(18/24)$
V47	$V55+(V43-V55)*(16/24)$
V48	$V55+(V43-V55)*(14/24)$
V49	$V55+(V43-V55)*(12/24)$
V50	$V55+(V43-V55)*(10/24)$
V51	$V55+(V43-V55)*(8/24)$
V52	$V55+(V43-V55)*(6/24)$
V53	$V55+(V43-V55)*(4/24)$
V54	$V55+(V43-V55)*(2/24)$
V55	VINP5
V56	$V62+(V55-V62)*(44/48)$
V57	$V62+(V55-V62)*(40/48)$
V58	$V62+(V55-V62)*(36/48)$
V59	$V62+(V55-V62)*(32/48)$
V60	$V62+(V55-V62)*(28/48)$
V61	$V62+(V55-V62)*(24/48)$
V62	VINP6
V63	VINP7

Note 1) Make sure DDVDH – V0 > 0.5V, DDVDH – V4 > 1.1V, V55-GND > 1.1V

## Formulas for calculating voltage (Negative polarity) (1)

Pins	Formula	Fine-adjustment registers	Reference voltage
KVN0	VDH- $V^*VxRN0/SUMRN$	-	VINN0
KVN1	VDH- $V^*(VxRN0+5R)/SUMRN$	PKN0[2:0]="000"	VINN1
KVN2	VDH- $V^*(VxRN0+9R)/SUMRN$	PKN0[2:0]="001"	
KVN3	VDH- $V^*(VxRN0+13R)/SUMRN$	PKN0[2:0]="010"	
KVN4	VDH- $V^*(VxRN0+17R)/SUMRN$	PKN0[2:0]="011"	
KVN5	VDH- $V^*(VxRN0+21R)/SUMRN$	PKN0[2:0]="100"	
KVN6	VDH- $V^*(VxRN0+25R)/SUMRN$	PKN0[2:0]="101"	
KVN7	VDH- $V^*(VxRN0+29R)/SUMRN$	PKN0[2:0]="110"	
KVN8	VDH- $V^*(VxRN0+33R)/SUMRN$	PKN0[2:0]="111"	
KVN9	VDH- $V^*(VxRN0+33R+VRHN)/SUMRN$	PKN1[2:0]="000"	VINN2
KVN10	VDH- $V^*(VxRN0+34R+VRHN)/SUMRN$	PKN1[2:0]="001"	
KVN11	VDH- $V^*(VxRN0+35R+VRHN)/SUMRN$	PKN1[2:0]="010"	
KVN12	VDH- $V^*(VxRN0+36R+VRHN)/SUMRN$	PKN1[2:0]="011"	
KVN13	VDH- $V^*(VxRN0+37R+VRHN)/SUMRN$	PKN1[2:0]="100"	
KVN14	VDH- $V^*(VxRN0+38R+VRHN)/SUMRN$	PKN1[2:0]="101"	
KVN15	VDH- $V^*(VxRN0+39R+VRHN)/SUMRN$	PKN1[2:0]="110"	
KVN16	VDH- $V^*(VxRN0+40R+VRHN)/SUMRN$	PKN1[2:0]="111"	
KVN17	VDH- $V^*(VxRN0+45R+VRHN)/SUMRN$	PKN2[2:0]="000"	VINN3
KVN18	VDH- $V^*(VxRN0+46R+VRHN)/SUMRN$	PKN2[2:0]="001"	
KVN19	VDH- $V^*(VxRN0+47R+VRHN)/SUMRN$	PKN2[2:0]="010"	
KVN20	VDH- $V^*(VxRN0+48R+VRHN)/SUMRN$	PKN2[2:0]="011"	
KVN21	VDH- $V^*(VxRN0+49R+VRHN)/SUMRN$	PKN2[2:0]="100"	
KVN22	VDH- $V^*(VxRN0+50R+VRHN)/SUMRN$	PKN2[2:0]="101"	
KVN23	VDH- $V^*(VxRN0+51R+VRHN)/SUMRN$	PKN2[2:0]="110"	
KVN24	VDH- $V^*(VxRN0+52R+VRHN)/SUMRN$	PKN2[2:0]="111"	
KVN25	VDH- $V^*(VxRN0+68R+VRHN)/SUMRN$	PKN3[2:0]="000"	VINN4
KVN26	VDH- $V^*(VxRN0+69R+VRHN)/SUMRN$	PKN3[2:0]="001"	
KVN27	VDH- $V^*(VxRN0+70R+VRHN)/SUMRN$	PKN3[2:0]="010"	
KVN28	VDH- $V^*(VxRN0+71R+VRHN)/SUMRN$	PKN3[2:0]="011"	
KVN29	VDH- $V^*(VxRN0+72R+VRHN)/SUMRN$	PKN3[2:0]="100"	
KVN30	VDH- $V^*(VxRN0+73R+VRHN)/SUMRN$	PKN3[2:0]="101"	
KVN31	VDH- $V^*(VxRN0+74R+VRHN)/SUMRN$	PKN3[2:0]="110"	
KVN32	VDH- $V^*(VxRN0+75R+VRHN)/SUMRN$	PKN3[2:0]="111"	
KVN33	VDH- $V^*(VxRN0+80R+VRHN)/SUMRN$	PKN4[2:0]="000"	VINN5
KVN34	VDH- $V^*(VxRN0+81R+VRHN)/SUMRN$	PKN4[2:0]="001"	
KVN35	VDH- $V^*(VxRN0+82R+VRHN)/SUMRN$	PKN4[2:0]="010"	
KVN36	VDH- $V^*(VxRN0+83R+VRHN)/SUMRN$	PKN4[2:0]="011"	
KVN37	VDH- $V^*(VxRN0+84R+VRHN)/SUMRN$	PKN4[2:0]="100"	
KVN38	VDH- $V^*(VxRN0+85R+VRHN)/SUMRN$	PKN4[2:0]="101"	
KVN39	VDH- $V^*(VxRN0+86R+VRHN)/SUMRN$	PKN4[2:0]="110"	
KVN40	VDH- $V^*(VxRN0+87R+VRHN)/SUMRN$	PKN4[2:0]="111"	
KVN41	VDH- $V^*(VxRN0+87R+VRHN+VRLN)/SUMRN$	PKN4[2:0]="000"	VINN6
KVN42	VDH- $V^*(VxRN0+91R+VRHN+VRLN)/SUMRN$	PKN5[2:0]="001"	
KVN43	VDH- $V^*(VxRN0+95R+VRHN+VRLN)/SUMRN$	PKN5[2:0]="010"	
KVN44	VDH- $V^*(VxRN0+99R+VRHN+VRLN)/SUMRN$	PKN5[2:0]="011"	
KVN45	VDH- $V^*(VxRN0+103R+VRHN+VRLN)/SUMRN$	PKN5[2:0]="100"	
KVN46	VDH- $V^*(VxRN0+107R+VRHN+VRLN)/SUMRN$	PKN5[2:0]="101"	
KVN47	VDH- $V^*(VxRN0+111R+VRHN+VRLN)/SUMRN$	PKN5[2:0]="110"	
KVN48	VDH- $V^*(VxRN0+115R+VRHN+VRLN)/SUMRN$	PKN5[2:0]="111"	
KVN49	VDH- $V^*(VxRN0+120R+VRHN+VRLN)/SUMRN$	-	VINN7

Note 1) Sum of ladder resistors with positive polarities = 128R+VRHP+VRLP+VRP0+VRP1

Note 2) Sum of ladder resistors with negative polarities = 128R+VRHN+VRLN+VRN0+VRN1

Note 3)  $\Delta V$  :Electric potential difference between VDH and VGS

## Formulas for calculating voltage (Negative polarity) (2)

Grayscale voltage	Formula	Grayscale voltage	Formula
V0	VINN0	V32	$V43+(V20-V43)*(11/23)$
V1	VINN1	V33	$V43+(V20-V43)*(10/23)$
V2	$V8+(V1-V8)*(30/48)$	V34	$V43+(V20-V43)*(9/23)$
V3	$V8+(V1-V8)*(23/48)$	V35	$V43+(V20-V43)*(8/23)$
V4	$V8+(V1-V8)*(16/48)$	V36	$V43+(V20-V43)*(7/23)$
V5	$V8+(V1-V8)*(12/48)$	V37	$V43+(V20-V43)*(6/23)$
V6	$V8+(V1-V8)*(8/48)$	V38	$V43+(V20-V43)*(5/23)$
V7	$V8+(V1-V8)*(4/48)$	V39	$V43+(V20-V43)*(4/23)$
V8	VINN2	V40	$V43+(V20-V43)*(3/23)$
V9	$V20+(V8-V20)*(22/24)$	V41	$V43+(V20-V43)*(2/23)$
V10	$V20+(V8-V20)*(20/24)$	V42	$V43+(V20-V43)*(1/23)$
V11	$V20+(V8-V20)*(18/24)$	V43	VINN4
V12	$V20+(V8-V20)*(16/24)$	V44	$V55+(V43-V55)*(22/24)$
V13	$V20+(V8-V20)*(14/24)$	V45	$V55+(V43-V55)*(20/24)$
V14	$V20+(V8-V20)*(12/24)$	V46	$V55+(V43-V55)*(18/24)$
V15	$V20+(V8-V20)*(10/24)$	V47	$V55+(V43-V55)*(16/24)$
V16	$V20+(V8-V20)*(8/24)$	V48	$V55+(V43-V55)*(14/24)$
V17	$V20+(V8-V20)*(6/24)$	V49	$V55+(V43-V55)*(12/24)$
V18	$V20+(V8-V20)*(4/24)$	V50	$V55+(V43-V55)*(10/24)$
V19	$V20+(V8-V20)*(2/24)$	V51	$V55+(V43-V55)*(8/24)$
V20	VINN3	V52	$V55+(V43-V55)*(6/24)$
V21	$V43+(V20-V43)*(22/23)$	V53	$V55+(V43-V55)*(4/24)$
V22	$V43+(V20-V43)*(21/23)$	V54	$V55+(V43-V55)*(2/24)$
V23	$V43+(V20-V43)*(20/23)$	V55	VINN5
V24	$V43+(V20-V43)*(19/23)$	V56	$V62+(V55-V62)*(44/48)$
V25	$V43+(V20-V43)*(18/23)$	V57	$V62+(V55-V62)*(40/48)$
V26	$V43+(V20-V43)*(17/23)$	V58	$V62+(V55-V62)*(36/48)$
V27	$V43+(V20-V43)*(16/23)$	V59	$V62+(V55-V62)*(32/48)$
V28	$V43+(V20-V43)*(15/23)$	V60	$V62+(V55-V62)*(25/48)$
V29	$V43+(V20-V43)*(14/23)$	V61	$V62+(V55-V62)*(18/48)$
V30	$V43+(V20-V43)*(13/23)$	V62	VINN6
V31	$V43+(V20-V43)*(12/23)$	V63	VINN7

Note 1) Make sure DDVDH – V0 > 0.5V, DDVDH – V4 > 1.1V, V55-GND > 1.1V

**Relationship between RAM data and output level (REV =0)**

The relationship between the RAM data and the source output level is as follows.

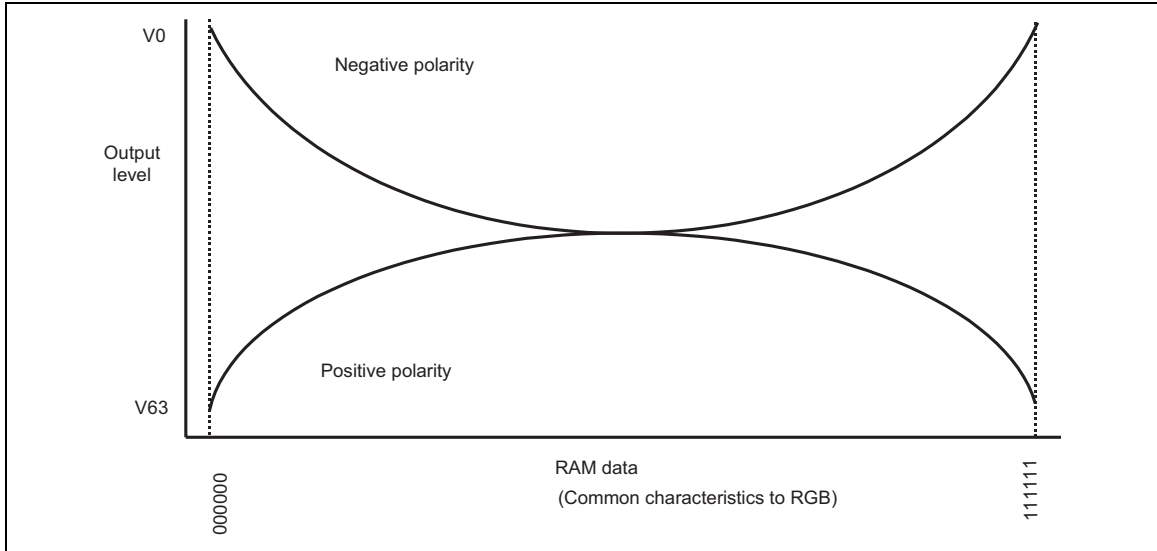

**RAM data and the output voltage (REV = 0)**

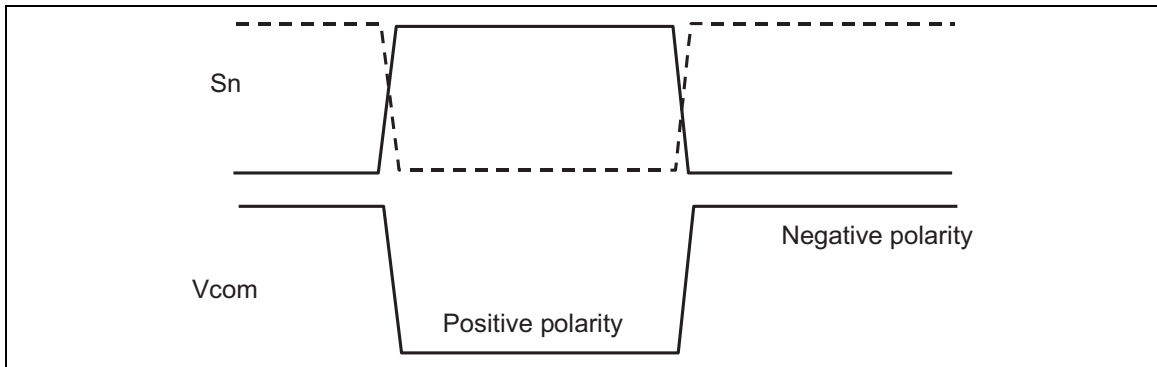

**Source output and Vcom**

**Relationship between RAM data and output level (REV =1)**

The relationship between the RAM data and the source output level is as follows.

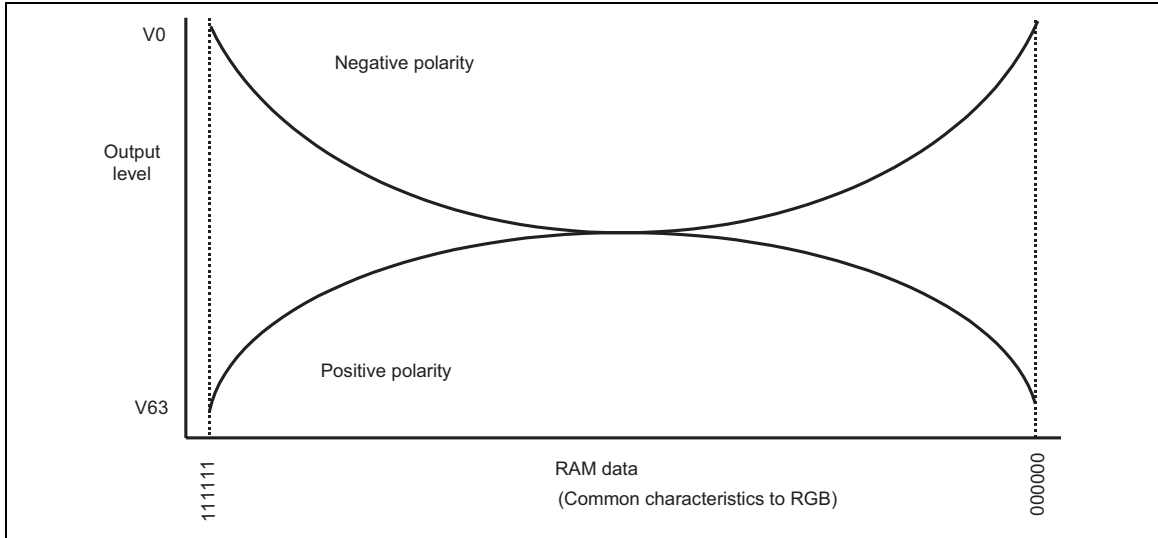

**RAM data and the output voltage (REV = 1)**

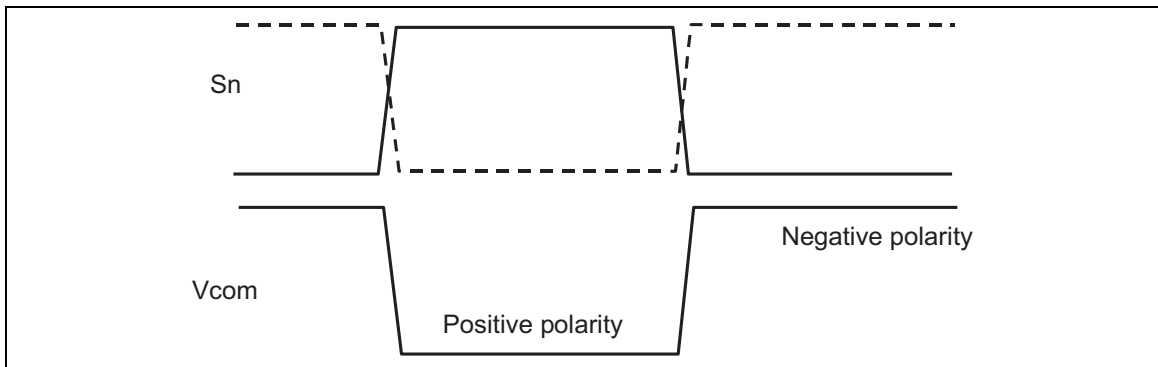

**Source output and Vcom**



## Low Power Consumption Display Mode

Setting COL[1:0] to 2'h1 halts 32 amplifiers among V0 ~ V63 grayscale amplifiers to display with low power consumption. In combination with the FRC mode setting, it is possible to realize display with low power consumption in abundant colors.

To make a setting for the low power consumption display, set in accordance to the following table according to the interface in use. The setting must be made in accordance to the setting sequence for low power consumption display mode.

Using this mode with short screen refreshing cycle may affect the quality of display. Consider the trade-off between the display quality and power-saving effects before use.

**Table 71**

Interface mode	FRCON	D16B	Available colors
18 bit, 16 bit x2, 9 bit x2, 8 bit x3, RGB18bit, 6 bit x3	0	*	262,144
	1	0	250,047
16bit x1, 8 bit x2, SPI	0	*	65,536
	1	1	64,512

Note 1) When the FRC mode is on, do not switch the interface mode settings (M, TRI, D16B registers)

Note 2) When the FRC mode is on, 18-bit format data and 16-bit format data are not displayed simultaneously.

**Table 72**

COL[1:0]	Amplifiers in operation	Available colors for display	
		FRCON = 0	FRCON = 1
2'h0	64	262,144 colors/65,536 colors	-
2'h1	32	32,768 colors	250,047 colors/64,512 colors
2'h2	2	8 colors	-
2'h3	Setting disabled	Setting disabled	Setting disabled

Note 1) When COL[1:0] = 2'h1 and FRCON = 0, do not write data that correspond to the grayscale levels for which the amplifiers are halted.

Table 73 grayscale level amplifiers in operation

amplifier	COL[1:0]			GRAM data RGB	
	2'h0	2'h1	2'h2		
V0	*	*	*	6'h00	6'h3F
V1	*			6'h01	6'h3E
V2	*	*		6'h02	6'h3D
V3	*			6'h03	6'h3C
V4	*	*		6'h04	6'h3B
V5	*			6'h05	6'h3A
V6	*	*		6'h06	6'h39
V7	*			6'h07	6'h38
V8	*	*		6'h08	6'h37
V9	*			6'h09	6'h36
V10	*	*		6'h0A	6'h35
V11	*			6'h0B	6'h34
V12	*	*		6'h0C	6'h33
V13	*			6'h0D	6'h32
V14	*	*		6'h0E	6'h31
V15	*			6'h0F	6'h30
V16	*	*		6'h10	6'h2F
V17	*			6'h11	6'h2E
V18	*	*		6'h12	6'h2D
V19	*			6'h13	6'h2C
V20	*	*		6'h14	6'h2B
V21	*			6'h15	6'h2A
V22	*	*		6'h16	6'h29
V23	*			6'h17	6'h28
V24	*	*		6'h18	6'h27
V25	*			6'h19	6'h26
V26	*	*		6'h1A	6'h25
V27	*			6'h1B	6'h24
V28	*	*		6'h1C	6'h23
V29	*			6'h1D	6'h22
V30	*	*		6'h1E	6'h21
V31	*			6'h1F	6'h20

amplifier	COL[1:0]			GRAM data RGB	
	2'h0	2'h1	2'h2		
V32	*			6'h20	6'h1F
V33	*	*		6'h21	6'h1E
V34	*			6'h22	6'h1D
V35	*	*		6'h23	6'h1C
V36	*			6'h24	6'h1B
V37	*	*		6'h25	6'h1A
V38	*			6'h26	6'h19
V39	*	*		6'h27	6'h18
V40	*			6'h28	6'h17
V41	*	*		6'h29	6'h16
V42	*			6'h2A	6'h15
V43	*	*		6'h2B	6'h14
V44	*			6'h2C	6'h13
V45	*	*		6'h2D	6'h12
V46	*			6'h2E	6'h11
V47	*	*		6'h2F	6'h10
V48	*			6'h30	6'h0F
V49	*	*		6'h31	6'h0E
V50	*			6'h32	6'h0D
V51	*	*		6'h33	6'h0C
V52	*			6'h34	6'h0B
V53	*	*		6'h35	6'h0A
V54	*			6'h36	6'h09
V55	*	*		6'h37	6'h08
V56	*			6'h38	6'h07
V57	*	*		6'h39	6'h06
V58	*			6'h3A	6'h05
V59	*	*		6'h3B	6'h04
V60	*			6'h3C	6'h03
V61	*	*		6'h3D	6'h02
V62	*			6'h3E	6'h01
V63	*	*	*	6'h3F	6'h00

\*: amplifier in operation

The following table shows the relationship between GRAM data and liquid crystal grayscale level.

**Table 74 GRAM data and LCD grayscale level (REV = 0) in FRC mode**

GRAM data RGB	Selected grayscale level		GRAM data RGB	Selected grayscale level	
	positive	negative		positive	negative
6'h00	V0	V63	6'h20	$(V30+V33)/2$	$(V30+V33)/2$
6'h01	$(V0+V2)/2$	$(V61+V63)/2$	6'h21	V33	V30
6'h02	V2	V61	6'h22	$(V33+V35)/2$	$(V28+V30)/2$
6'h03	$(V2+V4)/2$	$(V59+V61)/2$	6'h23	V35	V28
6'h04	V4	V59	6'h24	$(V35+V37)/2$	$(V26+V28)/2$
6'h05	$(V4+V6)/2$	$(V57+V59)/2$	6'h25	V37	V26
6'h06	V6	V57	6'h26	$(V37+V39)/2$	$(V24+V26)/2$
6'h07	$(V6+V8)/2$	$(V55+V57)/2$	6'h27	V39	V24
6'h08	V8	V55	6'h28	$(V39+V41)/2$	$(V22+V24)/2$
6'h09	$(V8+V10)/2$	$(V53+V55)/2$	6'h29	V41	V22
6'h0A	V10	V53	6'h2A	$(V41+V43)/2$	$(V20+V22)/2$
6'h0B	$(V10+V12)/2$	$(V51+V53)/2$	6'h2B	V43	V20
6'h0C	V12	V51	6'h2C	$(V43+V45)/2$	$(V18+V20)/2$
6'h0D	$(V12+V14)/2$	$(V49+V51)/2$	6'h2D	V45	V18
6'h0E	V14	V49	6'h2E	$(V45+V47)/2$	$(V16+V18)/2$
6'h0F	$(V14+V16)/2$	$(V47+V49)/2$	6'h2F	V47	V16
6'h10	V16	V47	6'h30	$(V47+V49)/2$	$(V14+V16)/2$
6'h11	$(V16+V18)/2$	$(V45+V47)/2$	6'h31	V49	V14
6'h12	V18	V45	6'h32	$(V49+V51)/2$	$(V12+V14)/2$
6'h13	$(V18+V20)/2$	$(V43+V45)/2$	6'h33	V51	V12
6'h14	V20	V43	6'h34	$(V51+V53)/2$	$(V10+V12)/2$
6'h15	$(V20+V22)/2$	$(V41+V43)/2$	6'h35	V53	V10
6'h16	V22	V41	6'h36	$(V53+V55)/2$	$(V8+V10)/2$
6'h17	$(V22+V24)/2$	$(V39+V41)/2$	6'h37	V55	V8
6'h18	V24	V39	6'h38	$(V55+V57)/2$	$(V6+V8)/2$
6'h19	$(V24+V26)/2$	$(V37+V39)/2$	6'h39	V57	V6
6'h1A	V26	V37	6'h3A	$(V57+V59)/2$	$(V4+V6)/2$
6'h1B	$(V26+V28)/2$	$(V35+V37)/2$	6'h3B	V59	V4
6'h1C	V28	V35	6'h3C	$(V59+V61)/2$	$(V2+V4)/2$
6'h1D	$(V28+V30)/2$	$(V33+V35)/2$	6'h3D	V61	V2
6'h1E	V30	V33	6'h3E	$(V61+V63)/2$	$(V0+V2)/2$
6'h1F	$(V30+V33)/2$	$(V30+V33)/2$	6'h3F	V63	V0

Note 1) This table shows effective grayscale levels by FRC grayscale.

### 8-color Display Mode

The HD66781 incorporates an 8-color display mode. The available grayscale levels are V0 and V63, and the voltages for the other levels (V1-V62) are halted to reduce power consumption.

The  $\gamma$ -fine-adjustment registers, PKP0-PKP5 and PKN0-PKN5 are not available in the 8-color display mode. Since the power supplies for the levels V1-V62 are halted in the 8-color mode, data are converted to automatically select V0/V63 levels: the MSB of each R, G, B, pixel of GRAM data is allocated to the lower 5 bits of R, G, B of display data. The HD 66781 enables to switch between 8-color and normal display modes without rewriting GRAM data only with the COL setting.

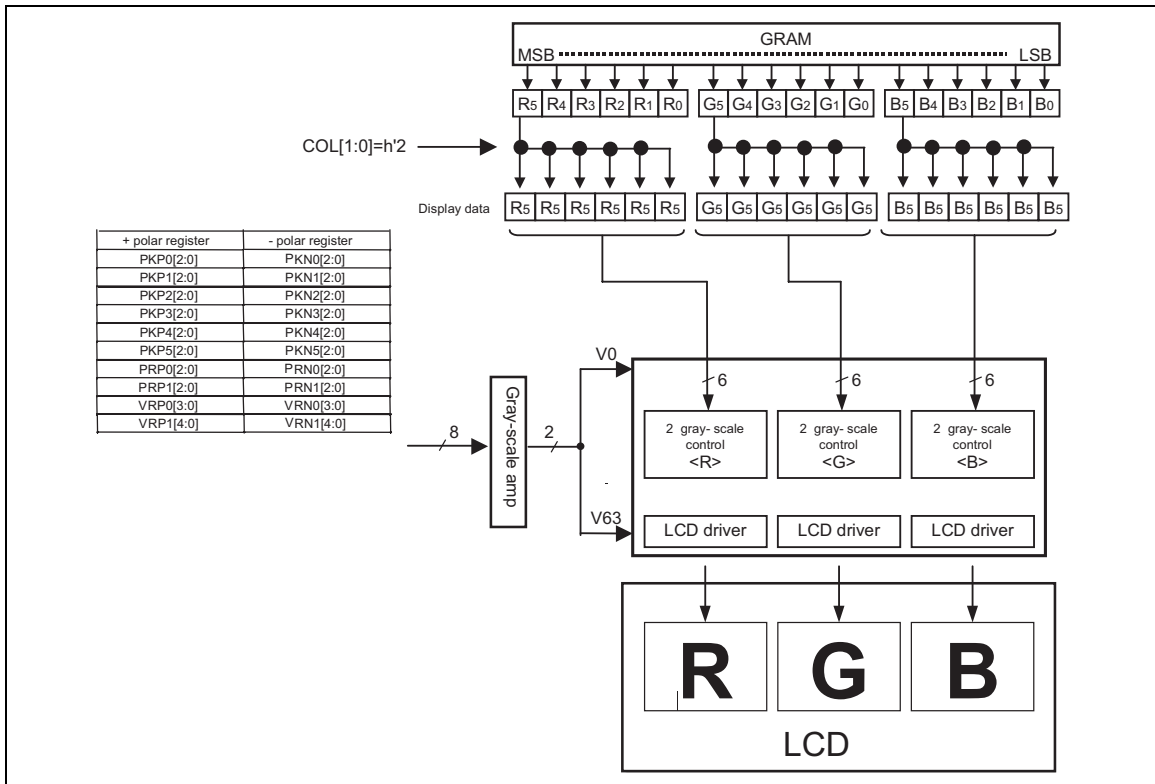

## Oscillation Circuit

The HD66781 generates oscillation by an internal R-C oscillator with an external oscillation resistor placed between the OSC1 and OSC2 pins. The oscillation frequency varies depending on the value of external resistor, the distance of wiring, and the operational power supply voltage. For example, the oscillation frequency becomes low when increasing the value of  $R_f$  resistor, or lowering the power supply voltage. See the “Notes to Electric Characteristics” section for the relationship between the  $R_f$  resistor value and the oscillation frequency.

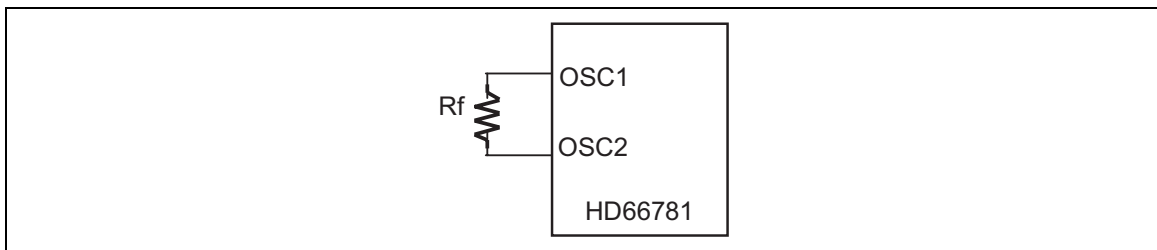

### External Resistor Oscillation Mode

Note 1) Place the  $R_f$  resistor as close to the OSC1, OSC2 pins as possible.

Note 2) Make sure not to arrange other wiring close to or beneath OSC1-OSC2 wiring to avoid effects from coupling

**n-raster-row Inversion alternating Drive**

The HD66781, in addition to LCD inversion alternating drive by frame, supports n-raster-row inversion alternating drive where alternation occurs by n raster-rows, where n takes a number from 1 to 64. The n-raster-row inversion alternating drive enables to overcome the problems related to display quality.

In determining n (the value set by the NW bit +1), the number of raster-rows by which alternation occurs, check the display quality on the actual liquid crystal panel. Setting a small number of raster-rows will raise the alternating frequency of the liquid crystal and increase the charge/discharge current on the liquid crystal cells.

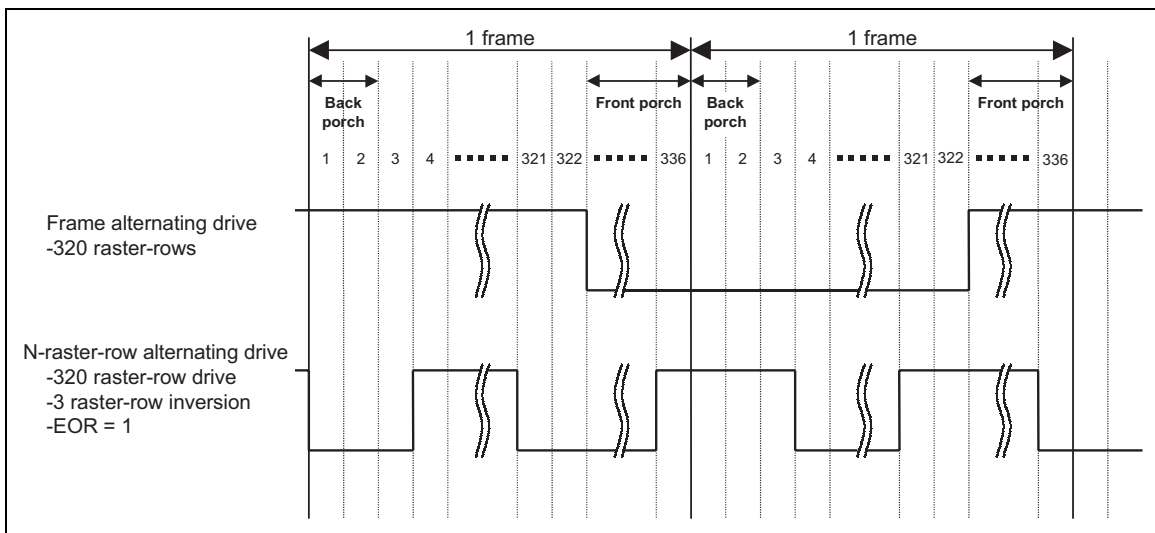

**n-raster-row alternating drive**

Note 1) Make sure to set EOR = 1 to avoid direct bias on liquid crystal during n-raster-row alternating drive.

### Interlaced Drive

The HD66781 supports interlaced drive, which divides one frame into n fields and then drives to prevent flickers.

To determine the number of fields (n: value set by the FLD bits), check the display quality on the actual liquid crystal panel. The following table shows the gate selection for each number of fields, 1 to 3. The figure illustrates the output waveforms of the 3-field interlaced drive.

Table 75

GA=0, SM=0, GS0=0, GS1=0					GA=1, SM=0, GS0=0, GS1=1				
FLD1-0	2'h1		2'h3		FLD1-0	2'h1		2'h3	
Field	-	1	2	3	Field	-	1	2	3
<b>Gate</b>					<b>Gate</b>				
G1	0	0			G328	0	0		
G2	0		0		G327	0		0	
G3	0			0	G326	0			0
G4	0	0			G325	0	0		
G5	0		0		G324	0		0	
G6	0			0	G323	0			0
G7	0	0			G322	0	0		
G8	0		0		G321	0		0	
G9	0			0	G320	0			0
•	•	•	•	•	•	•	•	•	•
•	•	•	•	•	•	•	•	•	•
•	•	•	•	•	•	•	•	•	•
G317	0		0		G12	0		0	
G318	0			0	G11	0			0
G319	0	0			G10	0	0		
G320	0		0		G9	0		0	

Note 1) Interlaced drive is not available in RGB interface mode.

Note 2) Middle porch must be set to BP = 3 (3 lines) for interlaced drive.

Note 3) OSD ( $\alpha$  blending), scrolling, and resizing functions are not available with interlaced drive.

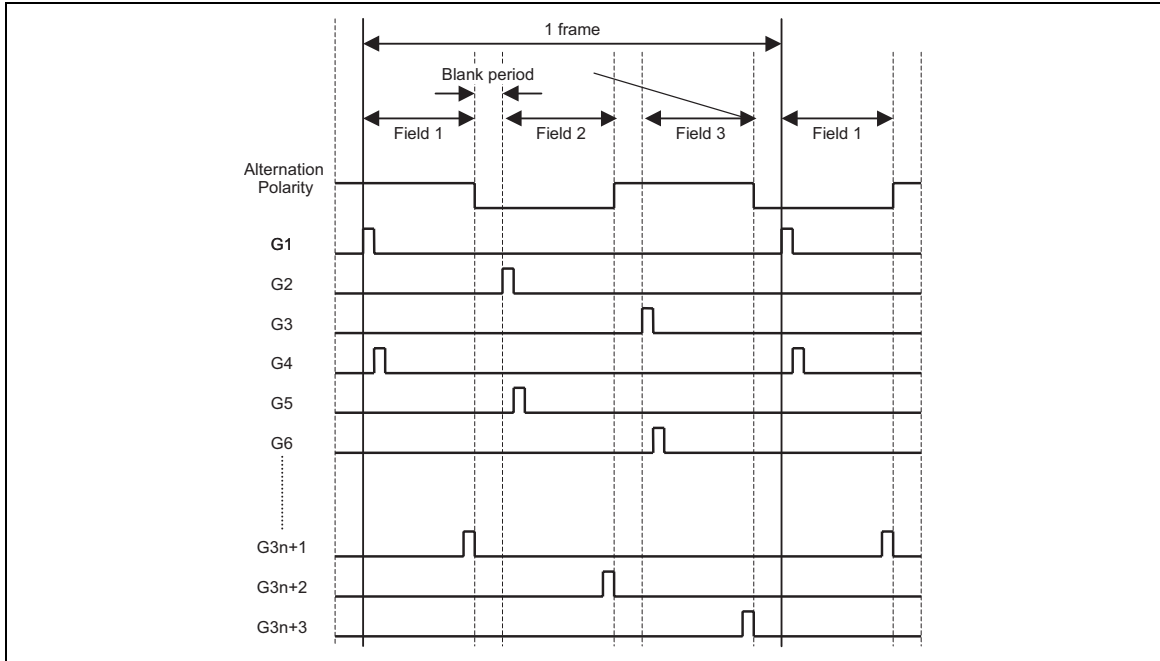

3-field interlaced drive: gate output timing



### Alternating Timing

The following figure illustrates the alternating timing of each alternating drive formula. In case of frame inversion alternating drive, alternation occurs at the completion of one frame, followed by a blank that lasts for 16H periods. In case of interlaced drive, alternation occurs at the completion of one field, followed by a blank. The total period of the blanks in one frame adds up to 16H period. In case of n-raster-row, a blank lasting 16H period is inserted after all screens are drawn.

During interlaced drive, make the numbers of back, front porches more than the numbers of fields.

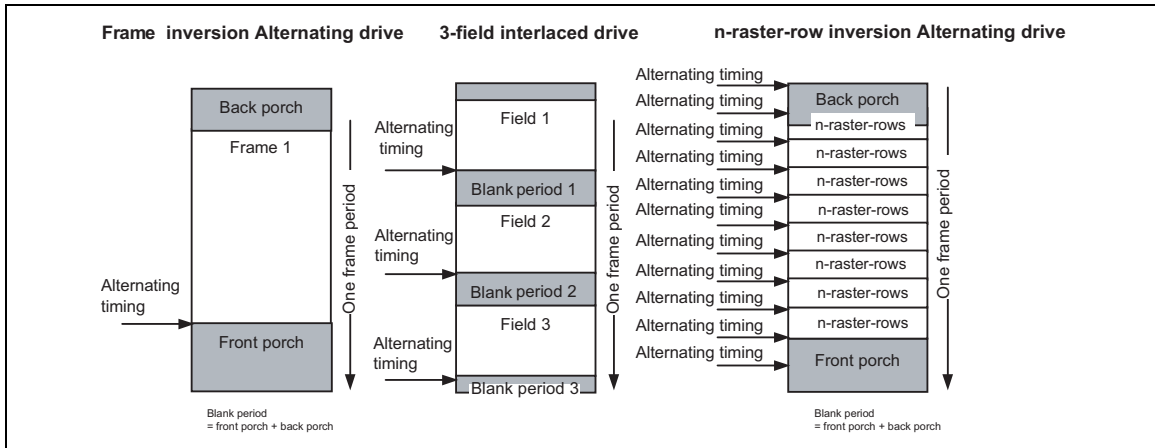

Alternating timing

## Frame-Frequency Adjustment Function

The HD66781 incorporates frame frequency adjustment function. The frame frequency during the liquid crystal drive is adjusted by the instruction setting (DIVI, RTNI) while keeping the oscillation frequency fixed.

By setting the oscillation frequency high in advance, it becomes possible to switch the frame frequency in accordance to the kind of displayed picture (i.e. moving/still picture). When displaying a still picture, set the frame frequency low to save power consumption, while setting the frame frequency high when displaying a moving picture which requires high-speed screen switching.

### Relationship between Liquid Crystal Drive Duty and Frame Frequency

The relationship between the liquid crystal drive duty and the frame frequency is calculated by the following formula. The frame frequency is adjusted by the instruction setting with the 1-H period adjustment bit (RTNI bit) and the operation clock division bit (DIVI bit).

(Formula for the frame frequency)

$$\text{Frame frequency} = \frac{f_{\text{osc}}}{\text{Clock cycles per raster-row} \times \text{division ratio} \times (\text{Line} + \text{BP} + \text{FP})} \quad [\text{Hz}]$$

$f_{\text{osc}}$	: R-C oscillation frequency
Clock cycles per raster-row	: RTNI bits
Division ratio	: DIVI bit
Line	: number of drive raster-rows (NL)
Front Porch	: FP bits
Back Porch	: BP bits

Calculation Example      The maximum frame frequency = 60 Hz

Number of drive raster-row	: 320
1-H period	: 16 clock cycles (RTNI[4:0] = 2'h10)
Operation clock division ratio	: 1 division

$$f_{\text{osc}} = 60 \text{ Hz} \times 16 \text{ clocks} \times 1 \text{ division} \times (320 + 2 + 14) \text{ lines} = 323 \text{ (kHz)}$$

In this case, the R-C oscillation frequency becomes 323 kHz. Adjust the value of external resistor for R-C oscillator to set the frequency 323kHz.

## Partial Display Function

The HD66781 enables arbitrary settings for on-display picture RAM area and the display position on the screen with the use of OSD. When the display of base image is turned off (BASEE=0), OSD is displayed 100%.

By making settings for OSD RAM area (OSA, OEA) and OSD position (ODP), the HD66781 allows displaying an arbitrary set of data. Other than OSD area becomes no-display area to reduce power consumption.

The partial display area using OSD can be made up to 3 areas.

In combination with 8-color mode and off-scan settings (PTS, PTG, ISC), more power-saving display will be obtained. Make an appropriate setting taking power-saving effect and display quality into consideration.

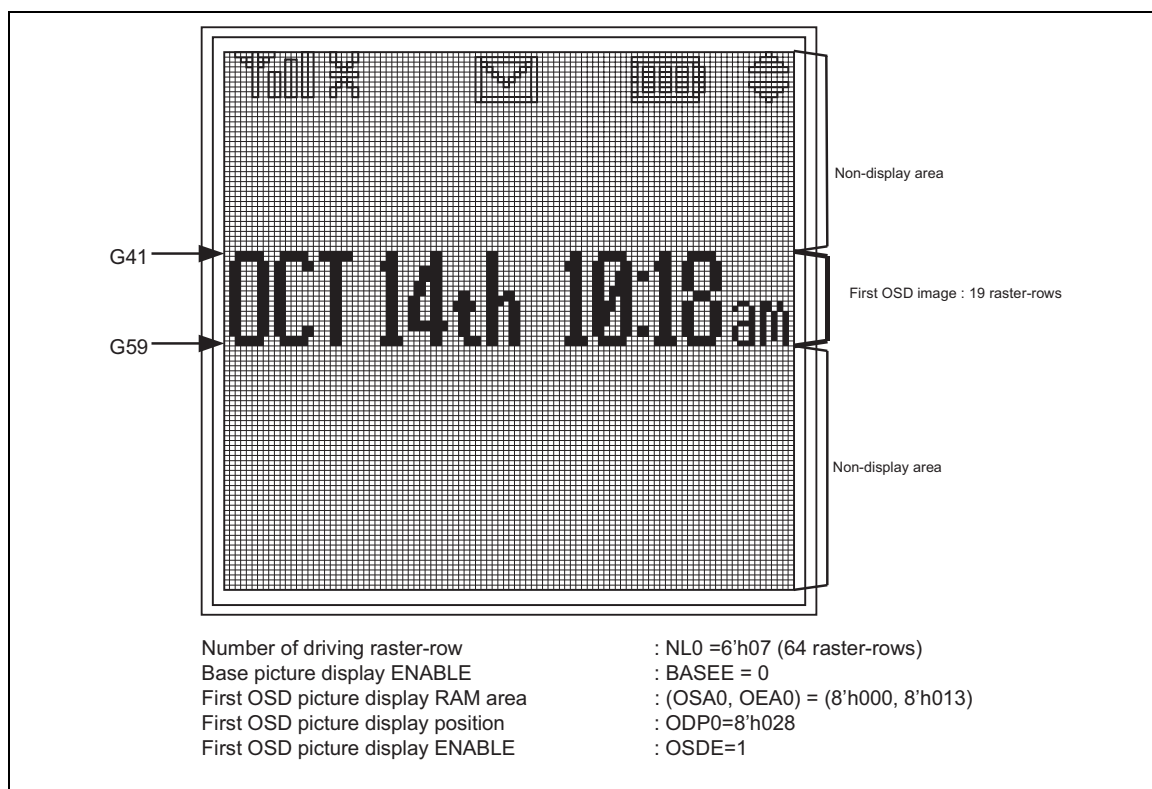

### Partial Display

Note 1) See the "RAM Address and Display Position on the Panel" for more details on the relationship between the display area and the setting of RAM area.

## Power-saving drive settings

The HD66781 incorporates various settings for lower power consumption display. The low power consumption and the quality of display are in trade-off, and the power-saving effect may vary depending on the characteristics of a panel. Make an appropriate setting among the settings listed below taking the trade-off into consideration.

### 1. 8-color display mode (COL)

When this mode is selected (COL [1:0] = 2'h2), voltage generation for grayscale levels other than V0 and V63 levels is halted. In this mode, only 8 colors are available for display for saving power.

### 2. Low power consumption display mode (COL, FRC)

Setting COL[1:0] to 2'h1 halts 32 amplifiers among V0 ~ V63 grayscale amplifiers to display with low power consumption. In combination with the FRC mode setting, it is possible to realize display with low power consumption in abundant colors.

In this mode, 250,047 colors are available with 18-bit, 16-bit x2, 9-bit x2, 8-bit x3 (RGB 6 bits each) interfaces and 64,512 colors are available with 16-bit x1, 8-bit x2 interfaces and SPI (R, B: 5 bits, G: 6 bits). Using this mode with short screen refreshing cycle may affect the quality of display. Consider the trade-off between the display quality and power-saving effects before use. See the "Low power consumption display mode" (p.169) for details.

### 3. Partial display (OSD)

The partial display is made with OSD and base image display off setting (BASEE = 0). Display operation is limited to the partial display area to save power. Power saving effects will increase as the number of partial display lines decreases. Also, see "Partial Display Function" (p.139) for details.

### 4. Non-lit drive setting

The non-lit drive setting is available for partial display and allows specifying the kind of source outputs in the non-lit drive area with PTS bits. Also, in the non-lit drive area, grayscale generation amplifier is halted and step-up clock cycle is slowed down to half.

PTG bits can specify the scan mode of gate bus lines in the non-lit drive area. In the interval gate scan mode, gate bus lines are scanned by the frame cycle specified by ISC bits to hold power consumption required for scanning gate bus lines to minimum. The longer scan cycle may affect the quality of display. Make an appropriate setting by taking trade-off between power-saving effects and display quality.

**Table 76 Source outputs in non-display area**

PTS[2:0]	Source output in non-display area		Non-display area Grayscale amp operation	Non-display area Step-up clock frequency
	Positive polarity	Negative polarity		
3'h0	V63	V0	V0 to V63	DC0,DC1Setting
3'h1	Setting disabled	Setting disabled	-	-
3'h2	GND	GND	V0 to V63	DC0,DC1Setting
3'h3	Hi-Z	Hi-Z	V0 to V63	DC0,DC1Setting
3'h4	V63	V0	V0,V63	DC0,DC1Setting x1/2
3'h5	Setting disabled	Setting disabled	-	-
3'h6	GND	GND	V0,V63	DC0,DC1Setting x1/2
3'h7	Hi-Z	Hi-Z	V0,V63	DC0,DC1Setting x1/2

Note 1) Gate outputs in non-lit drive area can be controlled by off-scan mode (with PTG bits).

Note 2) The operation halt of grayscale amplifier and the slowdown of step-up clock frequency are valid only to the non-display area.

Note 3) When DC[4:3]=2'h3, the frequency of step-up clocks in the non-display area are not slowed down half even if PTS[2:0] is set to 4, 6 or 7.

**Table 77 Gate outputs in non-display area**

PTG[1:0]	DISPTMG output	Gate output in non-display area	Source output in non-display area
2'h0	Normal drive	Normal scan	PTS setting
2'h1	GND	DISPTMG (Fixed)	PTS setting
2'h2	Internal drive	Interval scan	PTS setting
2'h3	Setting disabled	-	-

Note 1) When the interval scan is executed, make setting for the frame alternating drive.

**Table 78 Interval gate scan frequency**

ISC[3:0]	Scan frequency	When (fFLM) = 60Hz
4'h0	Setting disabled	-
4'h1	3 frames	50ms
4'h2	5 frames	84ms
4'h3	7 frames	117ms
4'h4	9 frames	150ms
4'h5	11 frames	184ms
4'h6	13 frames	217ms
4'h7	15 frames	251ms
4'h8	17 frames	284ms
4'h9	19 frames	317ms
4'hA	21 frames	351ms
4'hB	23 frames	384ms
4'hC	25 frames	418ms
4'hD	27 frames	451ms
4'hE	29 frames	484ms
4'hF	31 frames	518ms

**5. Frame frequency setting**

Frame frequency adjusting functions (with DIVI, RTNI bits) allows changing liquid crystal alternating frequency through instructions. Frame frequency can be reduced to achieve low power consumption while display method with low power consumption such as partial display mode is employed. See “Frame Frequency Adjustment Function”(p.178) section for details.

Generally, the lower frame frequency and the quality of display are in trade-off. The power-saving effects and the quality of display also vary depending on the characteristics of a panel. Check the quality of display on the panel before use.

**6. Liquid crystal alternating drive**

The HD66781 allows selecting among frame alternating drive, 3-field interlace drive, and line inversion alternating drive through instructions (B/C, EOR, NW, and FLD). Select an appropriate alternating drive method for the kind of display. See the “Alternating Timing”(p.177) section for details.

Generally, the lower frame frequency and the quality of display are in trade-off. The power-saving effects and the quality of display also vary depending on the characteristics of a panel. Check the quality of display on the panel before use.

### Equalization function

The HD66781 incorporates source-Vcom equalization function, which short-circuits source outputs S1-S720 and Vcom at alternating points to equalize the electric potential of source capacities and Vcom capacities during “High” period of EQ signal.

By driving source and Vcom from the equalized electric potential, the electric charges accumulated in the source and Vcom capacities are reallocated, and power consumption is reduced.

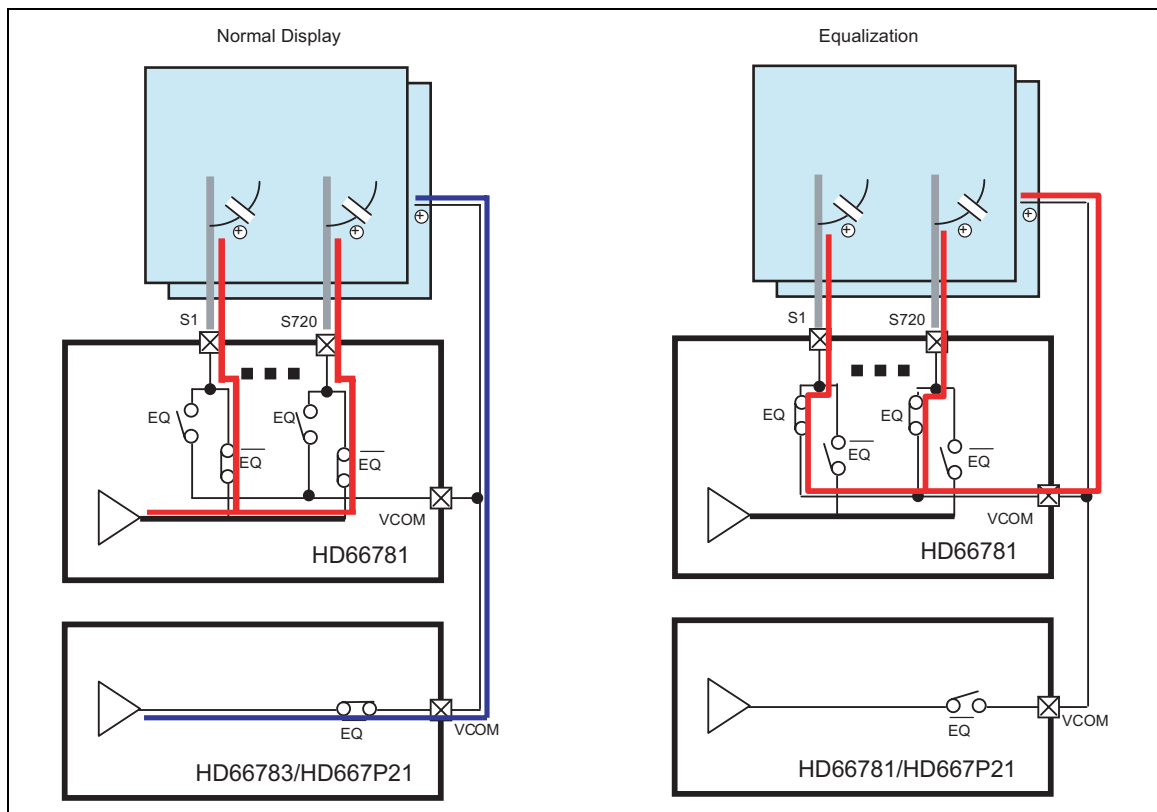

Note 1) Equalization function is only available when Vcom Low level  $\geq 0V$

Note 2) Power-saving effects depend on display data.

**Specifications of external element of HD66781**

The specifications of external element connected to power supply circuit of HD66781 are as follows.

**Table 79 Capacitor**

Capacitor capacitance	Recommended capacitor voltage	Connection pin
1 $\mu$ F Characteristics B	3V	VDD



## Instruction Setting

The following flowcharts show the sequences with respect to power on/off of the combined use of HD66781 and HD66783 or HD667P21, display on/off, standby set/release, and sleep set/release. Whenever turning on or off the power supply and so on, it must be done in accordance to the following procedures.

A serial interface is used to make instruction settings to the HD66783 and HD667P21, where a serial transfer is always required. The serial transfer must be made in accordance to the serial transfer sequence and right after the instructions are set.

Timing of the instruction setting is necessary to take into consideration the delay of 16-cycle internal clocks (OSC) from the start of serial transfer from the HD66781 through TE and IDX2-0 before each of the following mode settings becomes effective on the HD66783 and HD667P21.

Power-supply/display ON (LPTS = 0: a-Si TFT panel, with HD66783)

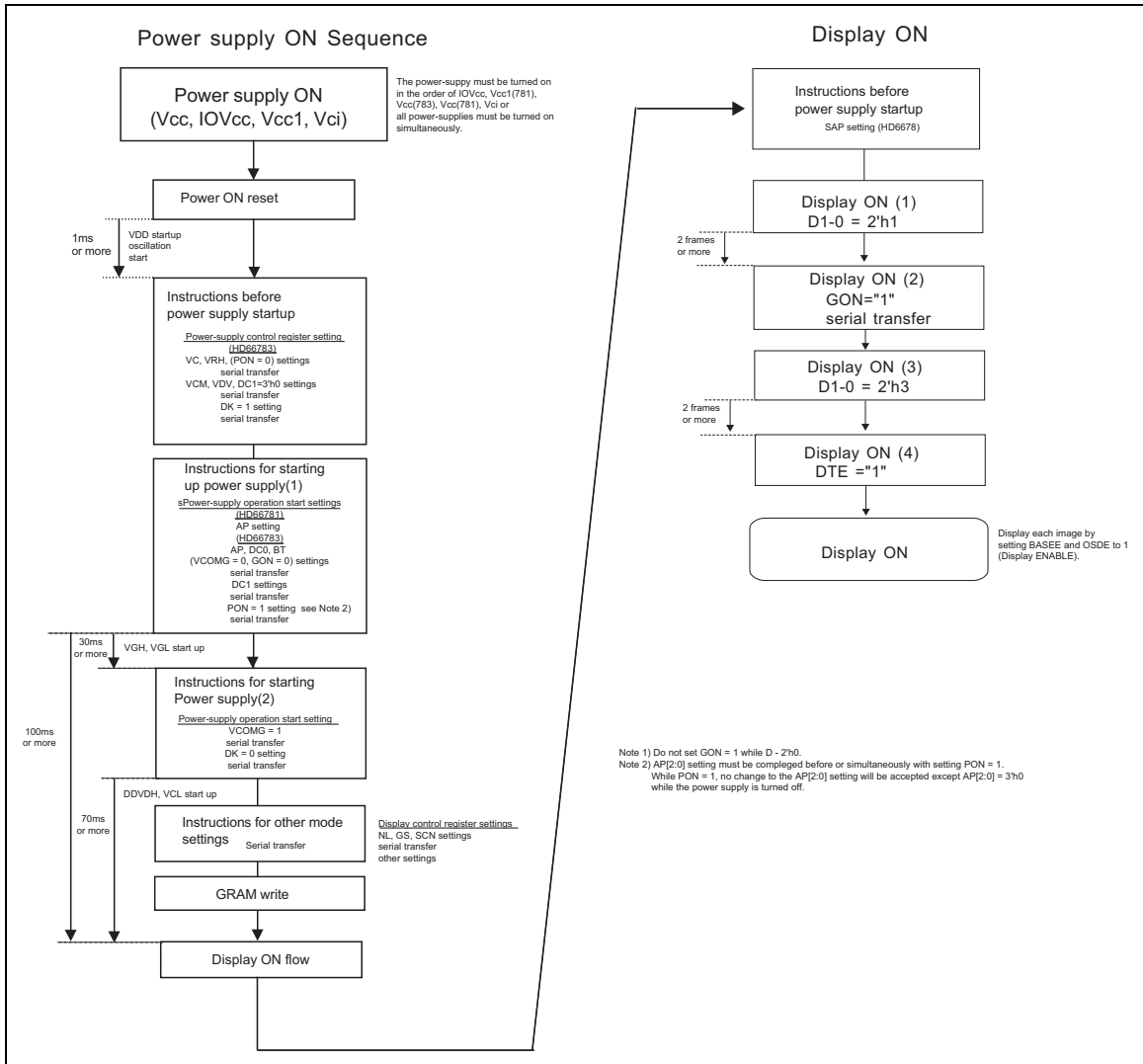

**Power-supply/display OFF (LPTS = 0: a-Si TFT panel, with HD66783)**

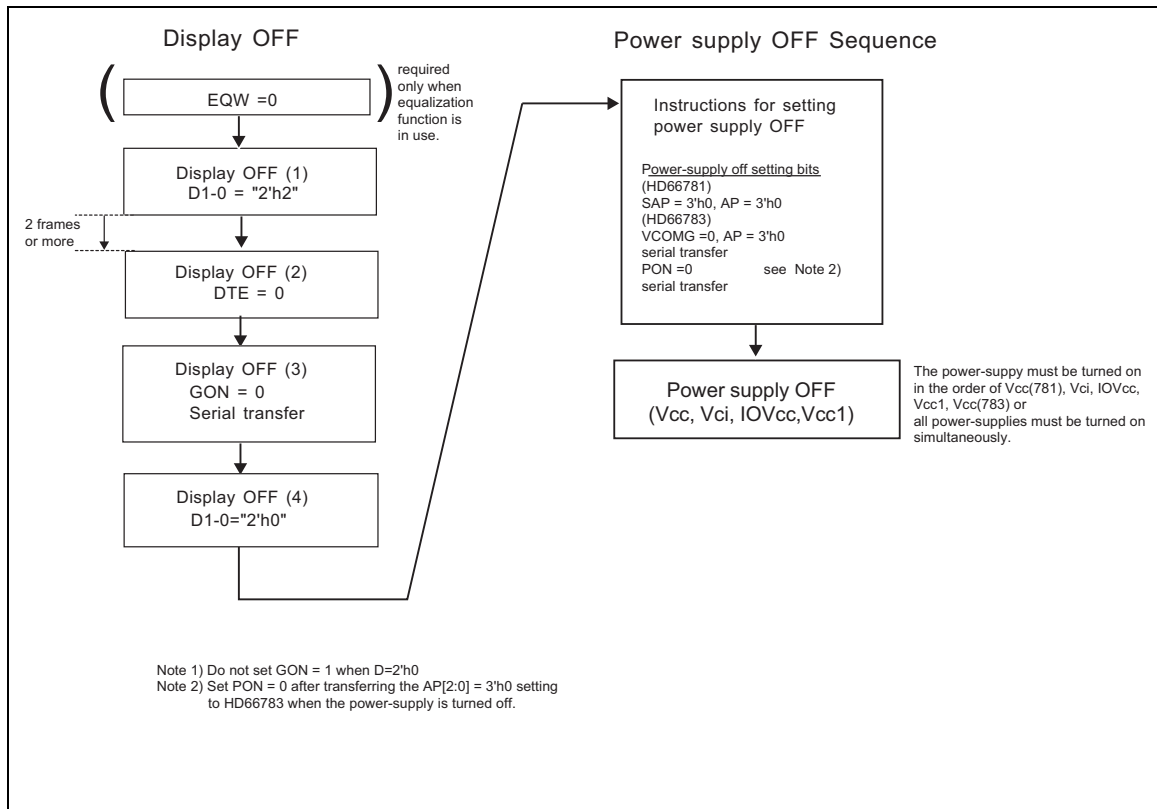

Power-supply/display ON (LPTS = 1: LTPS TFT panel, with HD667P21)

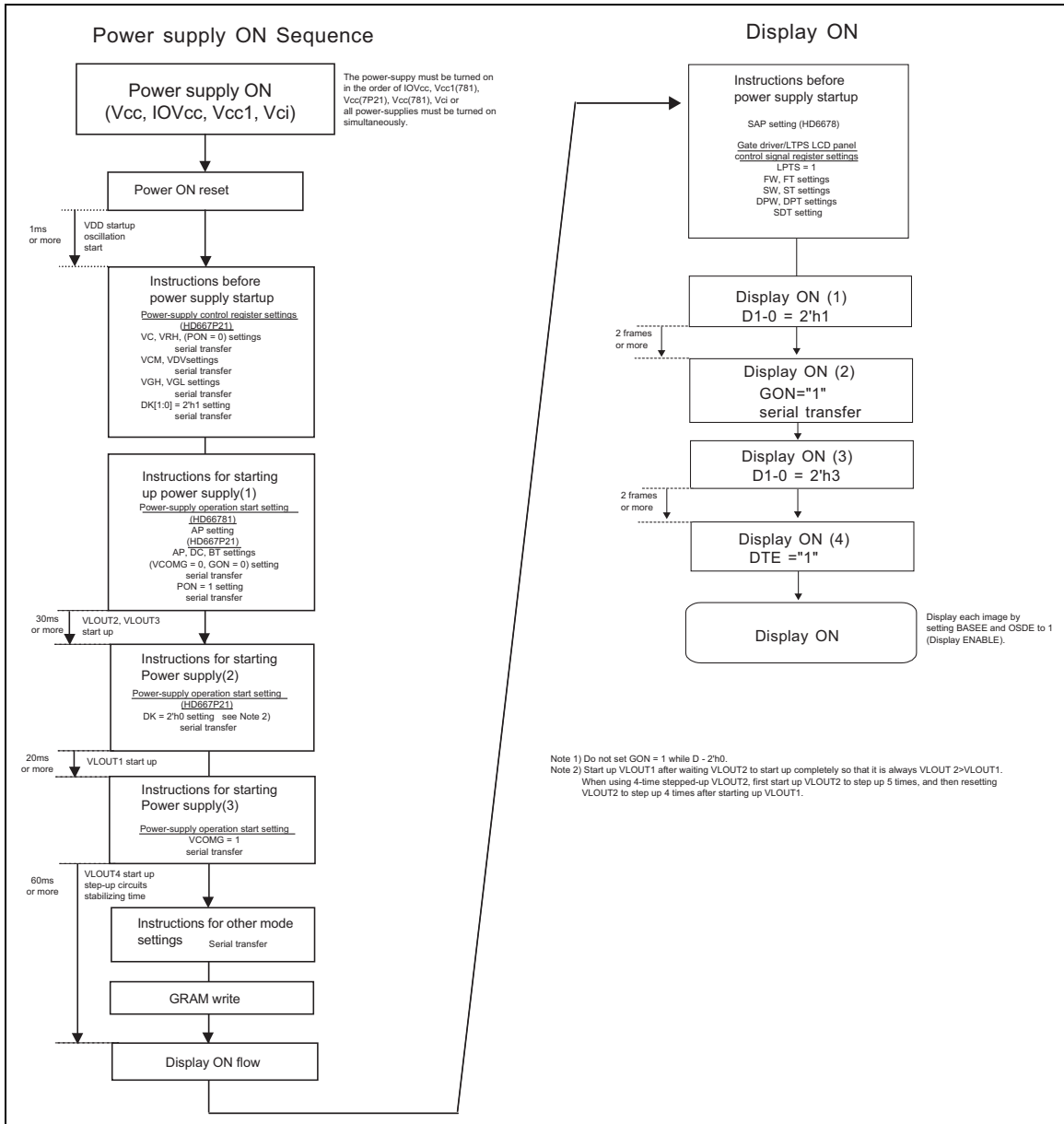

**Power-supply/display OFF (LPTS = 1: LPTS TFT panel, with HD667P21)**

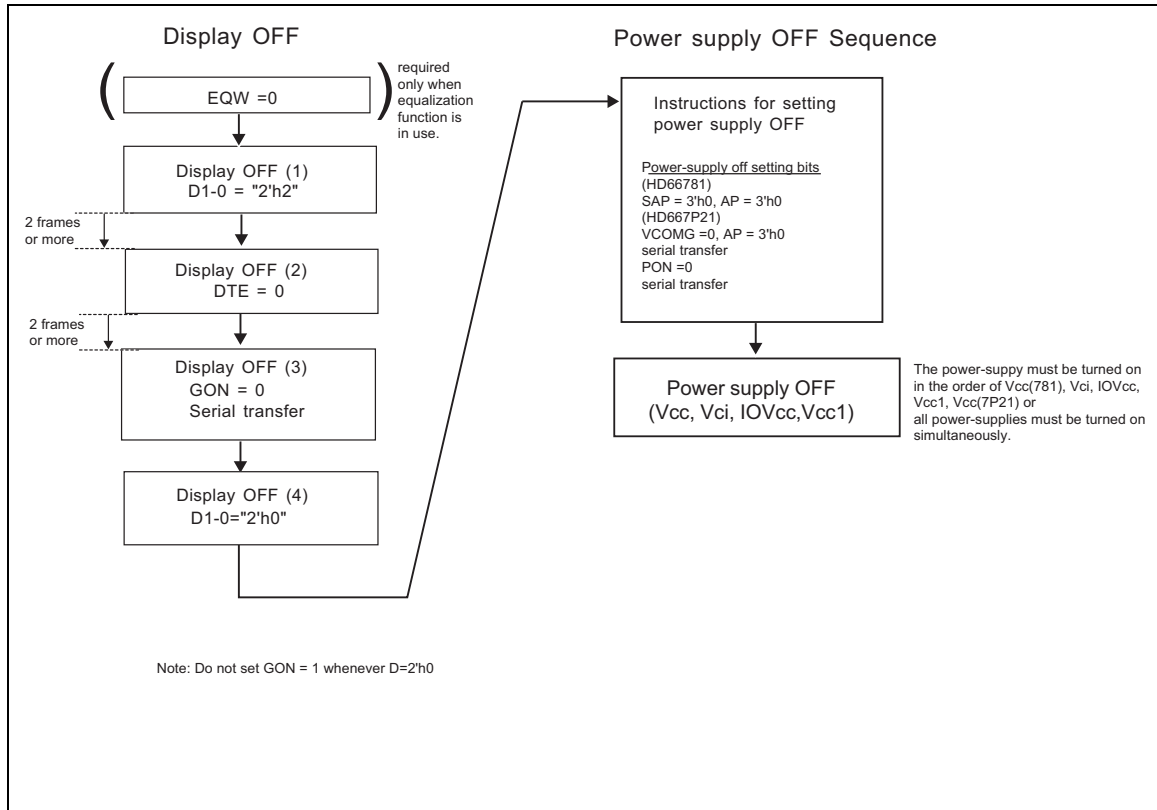

Standby/Sleep mode

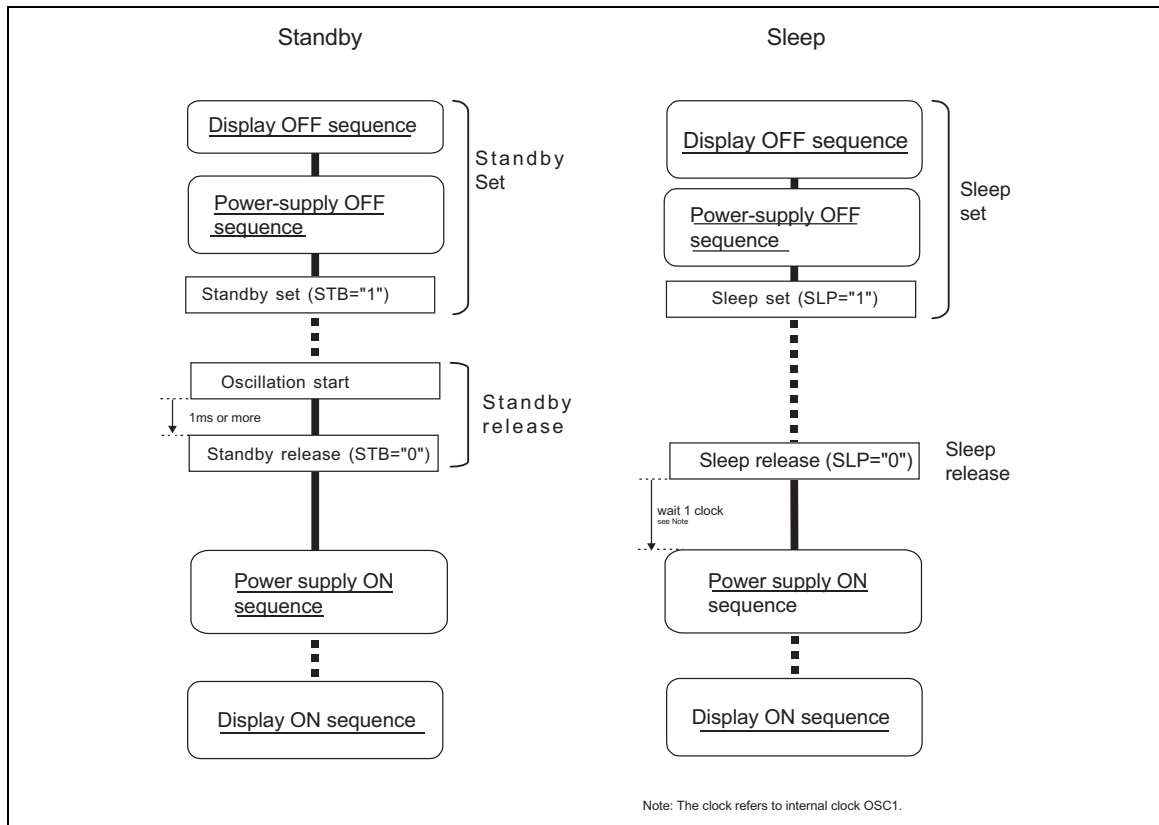

Deep standby mode

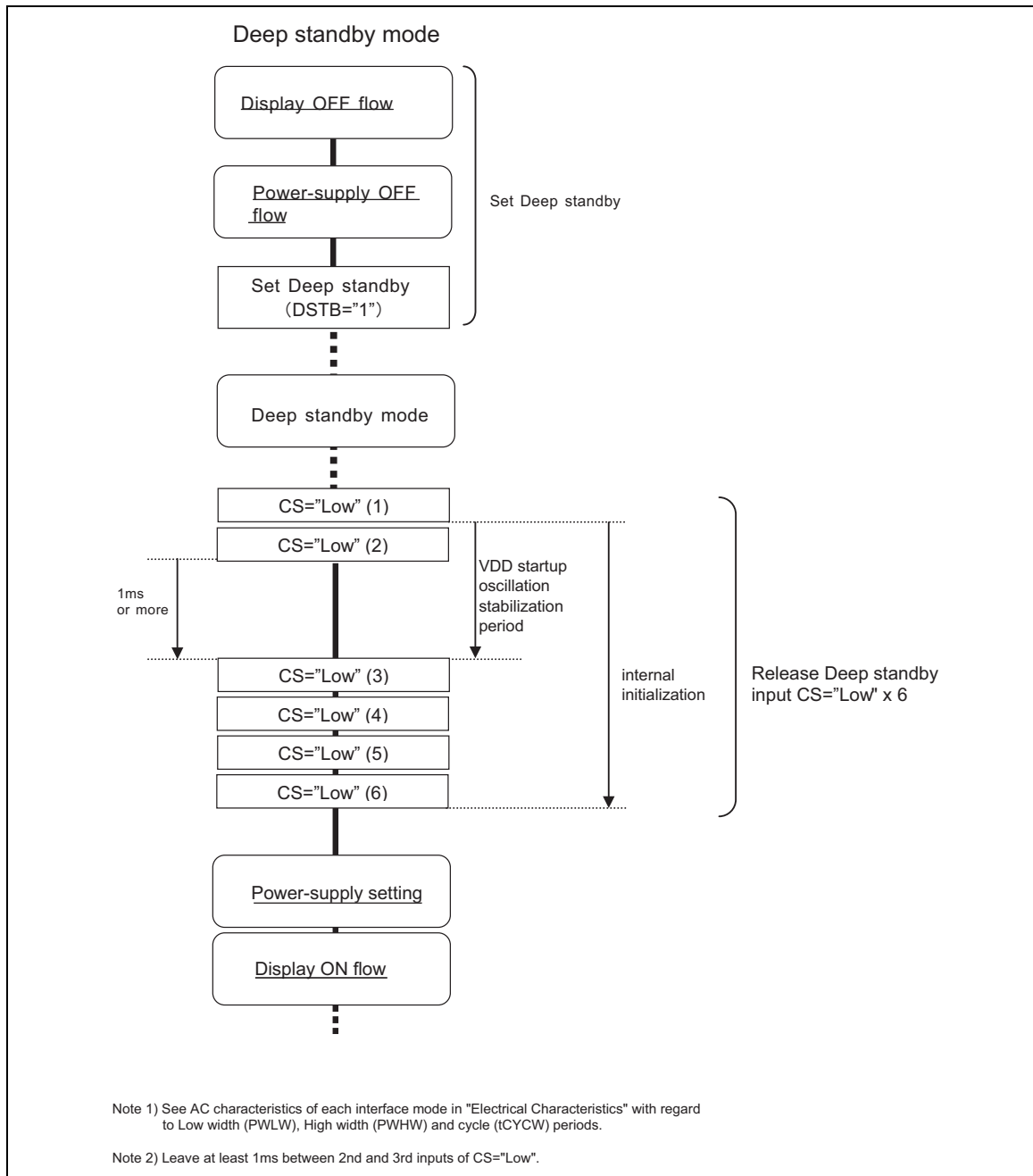

**Low power consumption display mode**

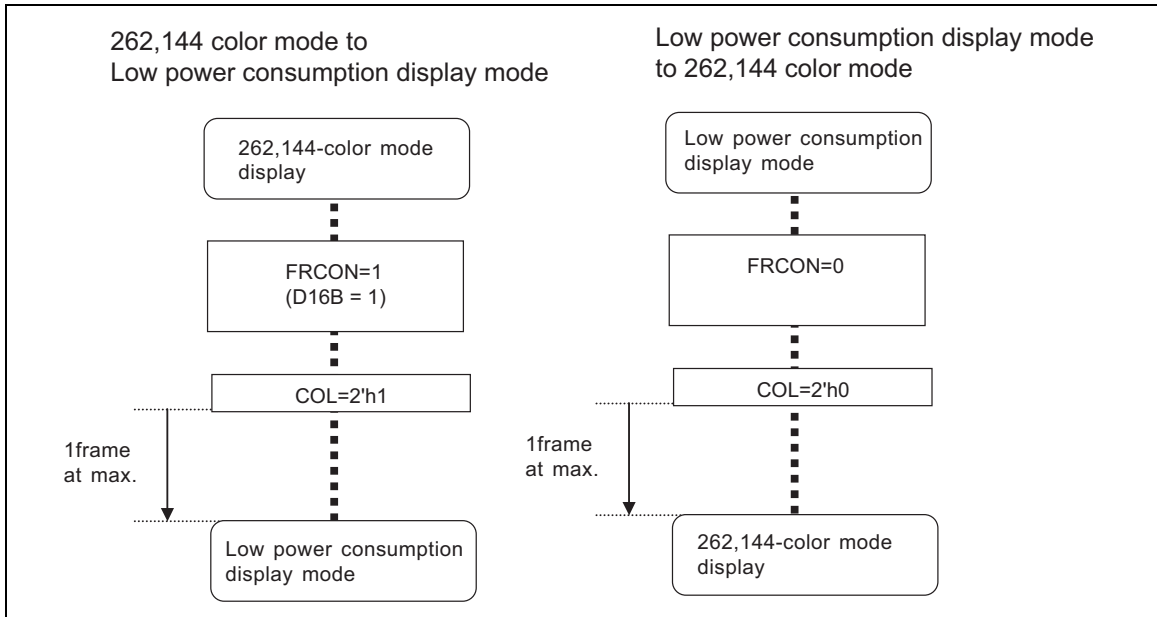

**8-color mode**

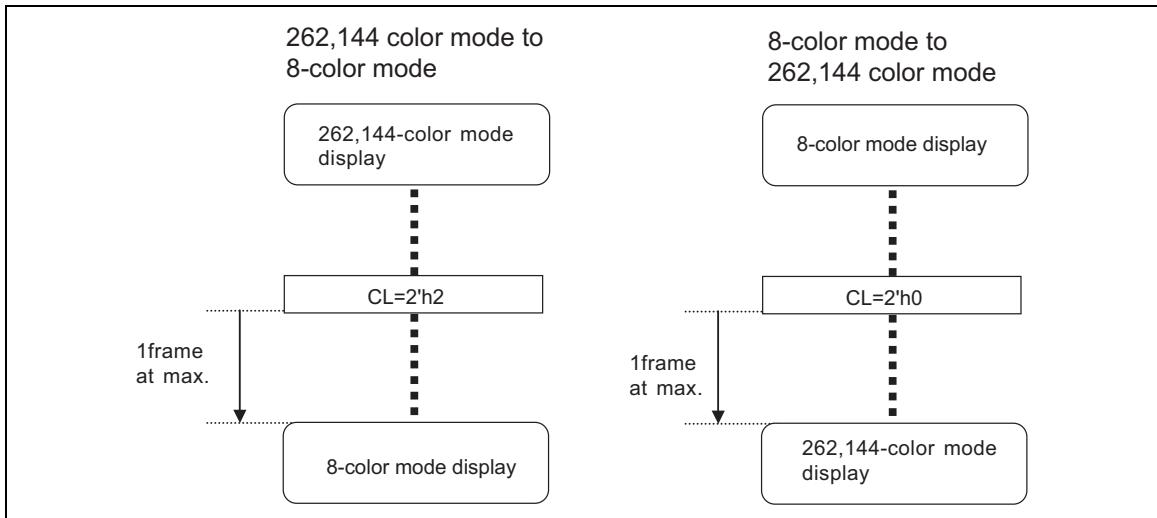



Partial display mode

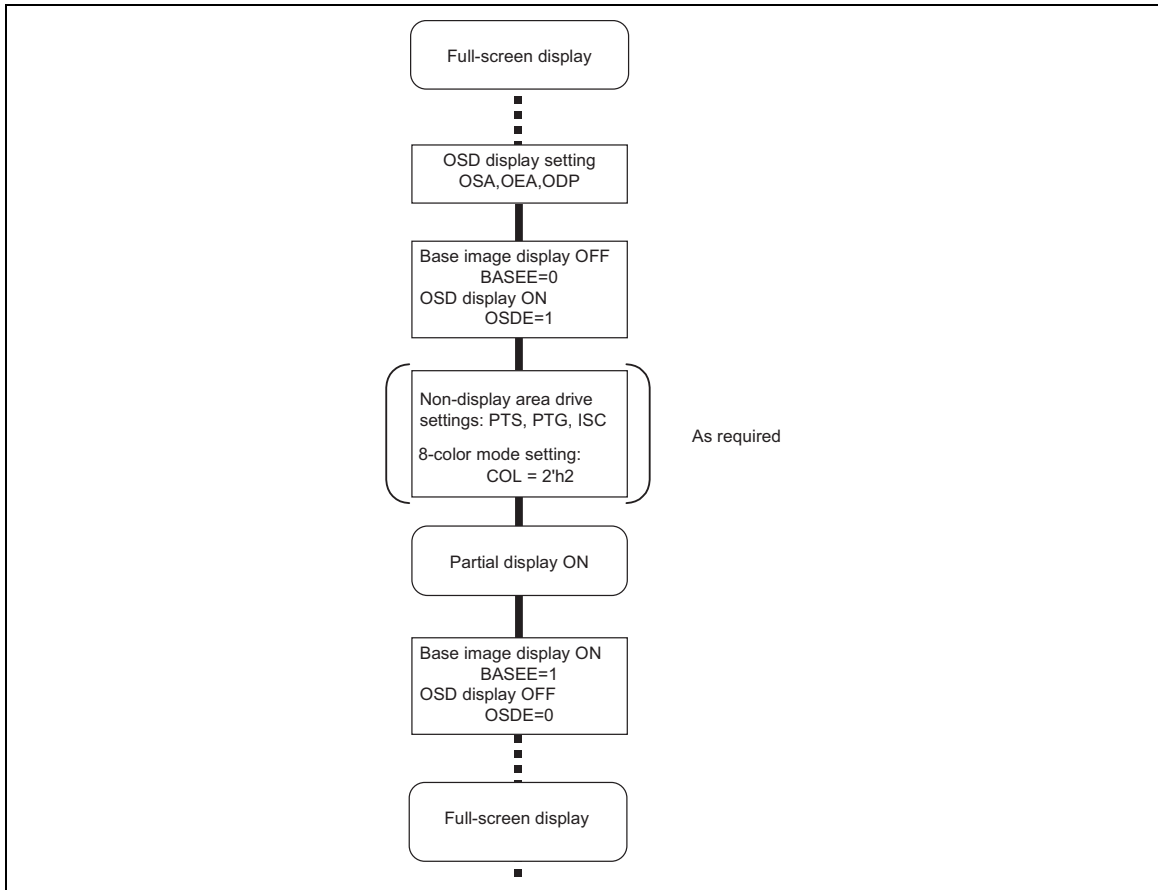

### Absolute Maximum Values

Item	Symbol	Unit	Value	Notes
Power supply voltage (1)	IOVcc, Vcc1	V	-0.3 ~ + 4.6	1, 2, 5
Power supply voltage (2)	Vcc - GND	V	-0.3 ~ + 4.6	1, 3, 5
Power supply voltage (3)	DDVDH - GND	V	-0.3 ~ + 6.5	1, 4
Input voltage	Vt	V	-0.3 ~ Vcc + 0.3	1
Operating temperature	Topr	°C	-40 ~ + 85	1, 6

Note 1) The LSI may be permanently damaged if it is used under the condition exceeding the above absolute maximum values. It is also recommended to use the LSI within the limit of its electric characteristics during normal operation. Exceeding the conditions may lead to malfunction of LSI and affect its credibility.

Note 2)  $IOVcc(High) \geq GND(Low)$ ,  $Vcc1(High) \geq GND(Low)$  must be observed.

Note 3)  $Vcc(High) \geq GND(Low)$  must be observed.

Note 4)  $DDVDH(High) \geq GND(Low)$  must be observed.

Note 5)  $Vcc(High) \geq IOVcc(Low)$ ,  $Vcc(High) \geq Vcc1(Low)$  must be observed.

Note 6) The DC and AC characteristics of chip and wafer products are guaranteed at 85 °C.

Note 7) The electric potential of this LSI's substrate is GND. The electrical connection of the other side of the chip must be at the electric potential of an insulated state or GND. The electrical and operational characteristics of the LSI will not be guaranteed otherwise.

---

**Renesas Technology Corp.** Sales Strategic Planning Div. Nippon Bldg., 2-6-2, Ohte-machi, Chiyoda-ku, Tokyo 100-0004, Japan

---

**Keep safety first in your circuit designs!**

1. Renesas Technology Corporation puts the maximum effort into making semiconductor products better and more reliable, but there is always the possibility that trouble may occur with them. Trouble with semiconductors may lead to personal injury, fire or property damage. Remember to give due consideration to safety when making your circuit designs, with appropriate measures such as (i) placement of substitutive, auxiliary circuits, (ii) use of nonflammable material or (iii) prevention against any malfunction or mishap.

**Notes regarding these materials**

1. These materials are intended as a reference to assist our customers in the selection of the Renesas Technology Corporation product best suited to the customer's application; they do not convey any license under any intellectual property rights, or any other rights, belonging to Renesas Technology Corporation or a third party.
  2. Renesas Technology Corporation assumes no responsibility for any damage, or infringement of any third-party's rights, originating in the use of any product data, diagrams, charts, programs, algorithms, or circuit application examples contained in these materials.
  3. All information contained in these materials, including product data, diagrams, charts, programs and algorithms represents information on products at the time of publication of these materials, and are subject to change by Renesas Technology Corporation without notice due to product improvements or other reasons. It is therefore recommended that customers contact Renesas Technology Corporation or an authorized Renesas Technology Corporation product distributor for the latest product information before purchasing a product listed herein.  
The information described here may contain technical inaccuracies or typographical errors.  
Renesas Technology Corporation assumes no responsibility for any damage, liability, or other loss rising from these inaccuracies or errors.  
Please also pay attention to information published by Renesas Technology Corporation by various means, including the Renesas Technology Corporation Semiconductor home page (<http://www.renesas.com>).
  4. When using any or all of the information contained in these materials, including product data, diagrams, charts, programs, and algorithms, please be sure to evaluate all information as a total system before making a final decision on the applicability of the information and products. Renesas Technology Corporation assumes no responsibility for any damage, liability or other loss resulting from the information contained herein.
  5. Renesas Technology Corporation semiconductors are not designed or manufactured for use in a device or system that is used under circumstances in which human life is potentially at stake. Please contact Renesas Technology Corporation or an authorized Renesas Technology Corporation product distributor when considering the use of a product contained herein for any specific purposes, such as apparatus or systems for transportation, vehicular, medical, aerospace, nuclear, or undersea repeater use.
  6. The prior written approval of Renesas Technology Corporation is necessary to reprint or reproduce in whole or in part these materials.
  7. If these products or technologies are subject to the Japanese export control restrictions, they must be exported under a license from the Japanese government and cannot be imported into a country other than the approved destination.  
Any diversion or reexport contrary to the export control laws and regulations of Japan and/or the country of destination is prohibited.
  8. Please contact Renesas Technology Corporation for further details on these materials or the products contained therein.
- 

<http://www.renesas.com>

Copyright © 2003. Renesas Technology Corporation, All rights reserved. Printed in Japan.  
Colophon 0.0

**Revision Record**

<b>Rev.</b>	<b>Date</b>	<b>Contents of Modification</b>	<b>Drawn by</b>	<b>Approved by</b>
0.5	2003, July 31	First issue		

---