



<p>(51) <b>International Patent Classification:</b> A61K 31/7115 (2006.01)</p> <p>(21) <b>International Application Number:</b> PCT/US20 13/030068</p> <p>(22) <b>International Filing Date:</b> 9 March 2013 (09.03.2013)</p> <p>(25) <b>Filing Language:</b> English</p> <p>(26) <b>Publication Language:</b> English</p> <p>(30) <b>Priority Data:</b></p>	<p>61/681,704 10 August 2012 (10.08.2012) US</p> <p>61/681,720 10 August 2012 (10.08.2012) US</p> <p>61/681,742 10 August 2012 (10.08.2012) US</p> <p>61/681,645 10 August 2012 (10.08.2012) US</p> <p>61/681,650 10 August 2012 (10.08.2012) US</p> <p>61/681,661 10 August 2012 (10.08.2012) US</p> <p>61/681,648 10 August 2012 (10.08.2012) US</p> <p>61/681,712 10 August 2012 (10.08.2012) US</p> <p>61/696,381 4 September 2012 (04.09.2012) US</p> <p>61/709,303 3 October 2012 (03.10.2012) US</p> <p>61/712,490 11 October 2012 (11.10.2012) US</p> <p>61/737,168 14 December 2012 (14.12.2012) US</p> <p>61/737,203 14 December 2012 (14.12.2012) US</p> <p>61/737,155 14 December 2012 (14.12.2012) US</p> <p>61/737,213 14 December 2012 (14.12.2012) US</p> <p>61/737,139 14 December 2012 (14.12.2012) US</p> <p>61/737,174 14 December 2012 (14.12.2012) US</p> <p>61/737,135 14 December 2012 (14.12.2012) US</p> <p>61/737,152 14 December 2012 (14.12.2012) US</p> <p>61/737,184 14 December 2012 (14.12.2012) US</p> <p>61/737,160 14 December 2012 (14.12.2012) US</p> <p>61/737,130 14 December 2012 (14.12.2012) US</p> <p>61/737,191 14 December 2012 (14.12.2012) US</p> <p>61/737,134 14 December 2012 (14.12.2012) US</p> <p>61/737,147 14 December 2012 (14.12.2012) US</p>
---	---

- (71) **Applicant:** MODERNA THERAPEUTICS [US/US];  
161 First Street, First Floor, Cambridge, MA 02142 (US).
- (72) **Inventors:** BANCEL, **Stephane**; 68 Pinckney Road, Boston, MA 021 14 (US). HUANG, **Eric, Yi-Chun**; 90 Wareham Street #302, Boston, MA 021 18 (US).
- (74) **Agent:** WARD, **Donna, T.**; DT WARD, P.C., 142A Main Street, Groton, MA 01450 (US).
- (81) **Designated States** (unless otherwise indicated, for every kind of national protection available): AE, AG, AL, AM, AO, AT, AU, AZ, BA, BB, BG, BH, BN, BR, BW, BY,

[Continued on nextpage]

(54) **Title:** MODIFIED POLYNUCLEOTIDES FOR THE PRODUCTION OF COSMETIC PROTEINS AND PEPTIDES

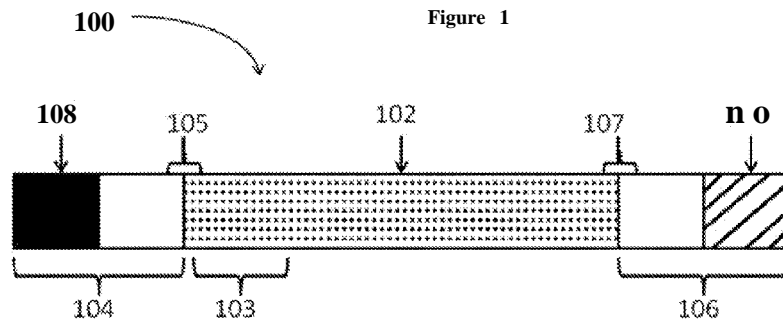

(57) **Abstract:** Described herein are compositions, methods, processes, kits and devices for the design, preparation, manufacture and/or formulation of modified mRNA (mmRNA) molecules encoding at least one cosmetic polypeptide of interest. The present invention provides a method of treating a disease, disorder and/or condition in a subject in need thereof by increasing the level of at least one cosmetic polypeptide of interest comprising administering to said subject an isolated polynucleotide selected from the group consisting of SEQ ID NOs 884-161 1 and 5691-5707 comprising, a first region of linked nucleosides, said first region encoding the cosmetic polypeptide of interest, a first flanking region located at the 5' terminus of said first region comprising a sequence of linked nucleosides selected from the group consisting of the native 5' untranslated region (UTR).

WO2013/151671 A1



BZ, CA, CH, CL, CN, CO, CR, CU, CZ, DE, DK, DM, DO, DZ, EC, EE, EG, ES, FI, GB, GD, GE, GH, GM, GT, HN, HR, HU, ID, IL, IN, IS, JP, KE, KG, KM, KN, KP, KR, KZ, LA, LC, LK, LR, LS, LT, LU, LY, MA, MD, ME, MG, MK, MN, MW, MX, MY, MZ, NA, NG, NI, NO, NZ, OM, PA, PE, PG, PH, PL, PT, QA, RO, RS, RU, RW, SC, SD, SE, SG, SK, SL, SM, ST, SV, SY, TH, TJ, TM, TN, TR, TT, TZ, UA, UG, US, UZ, VC, VN, ZA, ZM, ZW.

(84) **Designated States** (unless otherwise indicated, for every kind of regional protection available): ARIPO (BW, GH, GM, KE, LR, LS, MW, MZ, NA, RW, SD, SL, SZ, TZ,

UG, ZM, ZW), Eurasian (AM, AZ, BY, KG, KZ, RU, TJ, TM), European (AL, AT, BE, BG, CH, CY, CZ, DE, DK, EE, ES, FI, FR, GB, GR, HR, HU, IE, IS, IT, LT, LU, LV, MC, MK, MT, NL, NO, PL, PT, RO, RS, SE, SI, SK, SM, TR), OAPI (BF, BJ, CF, CG, CI, CM, GA, GN, GQ, GW, ML, MR, NE, SN, TD, TG).

**Published:**

- with international search report (Art. 21(3))
- with sequence listing part of description (Rule 5.2(a))

**MODIFIED POLYNUCLEOTIDES FOR THE PRODUCTION OF  
COSMETIC PROTEINS AND PEPTIDES**

**REFERENCE TO SEQUENCE LISTING**

[0001] The present application is being filed along with a Sequence Listing in electronic format. The Sequence Listing file entitled MNCI\_20SQLST.txt, created on March 09, 2013 which is 17,037,558 bytes in size. The information in electronic format of the sequence listing is incorporated herein by reference in its entirety.

**CROSS REFERENCE TO RELATED APPLICATIONS**

[0002] This application claims priority to U.S. Provisional Patent Application No 61/681,742, filed, August 10, 2012, entitled Modified Polynucleotides for the Production of Oncology-Related Proteins and Peptides, U.S. Provisional Patent Application No 61/737,224, filed December 14, 2012, entitled Terminally Optimized Modified RNAs, International Application No PCT/US2012/069610, filed December 14, 2012, entitled Modified Nucleoside, Nucleotide, and Nucleic Acid Compositions, U.S. Provisional Patent Application No 61/618,862, filed April 2, 2012, entitled Modified Polynucleotides for the Production of Biologies, U.S. Provisional Patent Application No 61/681,645, filed August 10, 2012, entitled Modified Polynucleotides for the Production of Biologies, U.S. Provisional Patent Application No 61/737,130, filed December 14, 2012, entitled Modified Polynucleotides for the Production of Biologies, U.S. Provisional Patent Application No 61/618,866, filed April 2, 2012, entitled Modified Polynucleotides for the Production of Antibodies, U.S. Provisional Patent Application No 61/681,647, filed August 10, 2012, entitled Modified Polynucleotides for the Production of Antibodies, U.S. Provisional Patent Application No 61/737,134, filed December 14, 2012, entitled Modified Polynucleotides for the Production of Antibodies, U.S. Provisional Patent Application No 61/618,868, filed April 2, 2012, entitled Modified Polynucleotides for the Production of Vaccines, U.S. Provisional Patent Application No 61/681,648, filed August 10, 2012, entitled Modified Polynucleotides for the Production of Vaccines, U.S. Provisional Patent Application No 61/737,135, filed December 14, 2012, entitled Modified Polynucleotides for the Production of Vaccines, U.S. Provisional Patent Application No 61/618,870, filed April 2, 2012, entitled Modified Polynucleotides for the

Production of Therapeutic Proteins and Peptides, U.S. Provisional Patent Application No 61/681,649, filed August 10, 2012, entitled Modified Polynucleotides for the Production of Therapeutic Proteins and Peptides, U.S. Provisional Patent Application No 61/737,139, filed December 14, 2012, Modified Polynucleotides for the Production of Therapeutic Proteins and Peptides, U.S. Provisional Patent Application No 61/618,873, filed April 2, 2012, entitled Modified Polynucleotides for the Production of Secreted Proteins, U.S. Provisional Patent Application No 61/681,650, filed August 10, 2012, entitled Modified Polynucleotides for the Production of Secreted Proteins, U.S. Provisional Patent Application No 61/737,147, filed December 14, 2012, entitled Modified Polynucleotides for the Production of Secreted Proteins, U.S. Provisional Patent Application No 61/618,878, filed April 2, 2012, entitled Modified Polynucleotides for the Production of Plasma Membrane Proteins, U.S. Provisional Patent Application No 61/681,654, filed August 10, 2012, entitled Modified Polynucleotides for the Production of Plasma Membrane Proteins, U.S. Provisional Patent Application No 61/737,152, filed December 14, 2012, entitled Modified Polynucleotides for the Production of Plasma Membrane Proteins, U.S. Provisional Patent Application No 61/618,885, filed April 2, 2012, entitled Modified Polynucleotides for the Production of Cytoplasmic and Cytoskeletal Proteins, U.S. Provisional Patent Application No 61/681,658, filed August 10, 2012, entitled Modified Polynucleotides for the Production of Cytoplasmic and Cytoskeletal Proteins, U.S. Provisional Patent Application No 61/737,155, filed December 14, 2012, entitled Modified Polynucleotides for the Production of Cytoplasmic and Cytoskeletal Proteins, U.S. Provisional Patent Application No 61/618,896, filed April 2, 2012, entitled Modified Polynucleotides for the Production of Intracellular Membrane Bound Proteins, U.S. Provisional Patent Application No 61/668,157, filed July 5, 2012, entitled Modified Polynucleotides for the Production of Intracellular Membrane Bound Proteins, U.S. Provisional Patent Application No 61/681,661, filed August 10, 2012, entitled Modified Polynucleotides for the Production of Intracellular Membrane Bound Proteins, U.S. Provisional Patent Application No 61/737,160, filed December 14, 2012, entitled Modified Polynucleotides for the Production of Intracellular Membrane Bound Proteins, U.S. Provisional Patent Application No 61/618,911, filed April 2, 2012, entitled Modified Polynucleotides for the Production of Nuclear Proteins, U.S. Provisional Patent

Application No 61/681,667, filed August 10, 2012, entitled Modified Polynucleotides for the Production of Nuclear Proteins, U.S. Provisional Patent Application No 61/737,168, filed December 14, 2012, entitled Modified Polynucleotides for the Production of Nuclear Proteins, U.S. Provisional Patent Application No 61/618,922, filed April 2, 2012, entitled Modified Polynucleotides for the Production of Proteins, U.S. Provisional Patent Application No 61/681,675, filed August 10, 2012, entitled Modified Polynucleotides for the Production of Proteins, U.S. Provisional Patent Application No 61/737,174, filed December 14, 2012, entitled Modified Polynucleotides for the Production of Proteins, U.S. Provisional Patent Application No 61/618,935, filed April 2, 2012, entitled Modified Polynucleotides for the Production of Proteins Associated with Human Disease, U.S. Provisional Patent Application No 61/681,687, filed August 10, 2012, entitled Modified Polynucleotides for the Production of Proteins Associated with Human Disease, U.S. Provisional Patent Application No 61/737,184, filed December 14, 2012, entitled Modified Polynucleotides for the Production of Proteins Associated with Human Disease, U.S. Provisional Patent Application No 61/618,945, filed April 2, 2012, entitled Modified Polynucleotides for the Production of Proteins Associated with Human Disease, U.S. Provisional Patent Application No 61/681,696, filed August 10, 2012, entitled Modified Polynucleotides for the Production of Proteins Associated with Human Disease, U.S. Provisional Patent Application No 61/737,191, filed December 14, 2012, entitled Modified Polynucleotides for the Production of Proteins Associated with Human Disease, U.S. Provisional Patent Application No 61/618,953, filed April 2, 2012, entitled Modified Polynucleotides for the Production of Proteins Associated with Human Disease, U.S. Provisional Patent Application No 61/681,704, filed August 10, 2012, entitled Modified Polynucleotides for the Production of Proteins Associated with Human Disease, U.S. Provisional Patent Application No 61/737,203, filed December 14, 2012, entitled Modified Polynucleotides for the Production of Proteins Associated with Human Disease, U.S. Provisional Patent Application No 61/618,961, filed April 2, 2012, entitled Dosing Methods for Modified mRNA, U.S. Provisional Patent Application No 61/648,286, filed May 17, 2012, entitled Dosing Methods for Modified mRNA, the contents of each of which are herein incorporated by reference in its entirety.

[0003] This application is also related to International Publication No. PCT/US2012/58519, filed October 3, 2012, entitled Modified Nucleosides, Nucleotides, and Nucleic Acids, and Uses Thereof and International Publication No. PCT/US2012/69610, filed December 14, 2012, entitled Modified Nucleoside, Nucleotide, and Nucleic Acid Compositions.

[0004] The instant application is also related to co-pending applications, each filed concurrently herewith on March 9, 2013 and having Attorney Docket Number M300.20, (PCT/US 13/XXXXXX) entitled Modified Polynucleotides for the Production of Biologies and Proteins Associated with Human Disease; Attorney Docket Number M301.20, (PCT/US 13/XXXXXX) entitled Modified Polynucleotides; Attorney Docket Number M304.20 (PCT/US 13/XXXXXX), entitled Modified Polynucleotides for the Production of Secreted Proteins; Attorney Docket Number M304.20 (PCT/US 13/XXXXXX), entitled Modified Polynucleotides for the Production of Secreted Proteins; Attorney Docket Number M305.20 (PCT/US 13/XXXXXX), entitled Modified Polynucleotides for the Production of Membrane Proteins; Attorney Docket Number M306.20 (PCT/US 13/XXXXXX), entitled Modified Polynucleotides for the Production of Cytoplasmic and Cytoskeletal Proteins; Attorney Docket Number M308.20 (PCT/US 13/XXXXXX), entitled Modified Polynucleotides for the Production of Nuclear Proteins; Attorney Docket Number M309.20 (PCT/US 13/XXXXXX), entitled Modified Polynucleotides for the Production of Proteins; Attorney Docket Number M310.20 (PCT/US 13/XXXXXX), entitled Modified Polynucleotides for the Production of Proteins Associated with Human Disease; and Attorney Docket Number MNC2.20 (PCT/US 13/XXXXXX), entitled Modified Polynucleotides for the Production of Oncology-Related Proteins and Peptides, the contents of each of which are herein incorporated by reference in its entirety.

#### **FIELD OF THE INVENTION**

[0005] The invention relates to compositions, methods, processes, kits and devices for the design, preparation, manufacture and/or formulation of cosmetic polynucleotides, cosmetic primary constructs and cosmetic modified mRNA molecules (mmRNA).

**BACKGROUND OF THE INVENTION**

[0006] Expression and/or levels of cosmetic polypeptides and other biomolecules may change with age, injury or exposure to environmental factors. For example, cosmetic polypeptides such as collagen, elastin, growth factors and repair enzymes may decline with age and matrix metalloproteinase may increase with age increases collagen breakdown causing undesirable changes in aesthetics. Genetic therapy can provide for a targeted approach for the improvement, treatment and maintenance of the cell, tissue and/or organism related to cosmetic appearance.

[0007] To this end, the inventors have shown that certain modified mRNA sequences have the potential as therapeutics with benefits beyond just evading, avoiding or diminishing the immune response. Such studies are detailed in published co-pending applications International Application PCT/US2011/046861 filed August 5, 2011 and PCT/US2011/054636 filed October 3, 2011, International Application number PCT/US2011/054617 filed October 3, 2011, the contents of which are incorporated herein by reference in their entirety.

[0008] The present invention addresses this need by providing nucleic acid based compounds or cosmetic polynucleotides which encode a cosmetic polypeptide of interest (e.g., modified mRNA or mniRNA) and which have structural and/or chemical features that avoid one or more of the problems in the art.

**SUMMARY OF THE INVENTION**

[0009] Described herein are compositions, methods, processes, kits and devices for the design, preparation, manufacture and/or formulation of modified mRNA (mmRNA) molecules encoding at least one cosmetic polypeptide of interest.

[00010] The present invention provides a method of treating a disease, disorder and/or condition in a subject in need thereof by increasing the level of at least one cosmetic polypeptide of interest comprising administering to said subject an isolated polynucleotide selected from the group consisting of SEQ ID NOs 884-161 and 5691-5707 comprising, a first region of linked nucleosides, said first region encoding the cosmetic polypeptide of interest, a first flanking region located at the 5' terminus of said first region comprising a sequence of linked nucleosides selected from the group consisting of the native 5' untranslated region (UTR) of any of SEQ ID NOs: 884-

161 land 5691-5707, SEQ ID NO: 1-4 and functional variants thereof and a second flanking region located at the 3' terminus of said first region comprising a sequence of linked nucleosides selected from the group consisting of the native 3' UTR of any of SEQ ID NOs: 884-161 land 5691-5707, SEQ ID NOs: 5-21 and functional variants thereof and a 3' tailing sequence of linked nucleosides. The isolated polynucleotide may further be substantially purified.

**[00011]** The present invention also provides a method of altering, modifying and/or changing the appearance of a member of the integumentary system of a subject comprising contacting said member with an isolated polynucleotide comprising administering to said subject an isolated polynucleotide selected from the group consisting of SEQ ID NOs 884-161 land 5691-5707 comprising, a first region of linked nucleosides, said first region encoding the cosmetic polypeptide of interest, a first flanking region located at the 5' terminus of said first region comprising a sequence of linked nucleosides selected from the group consisting of the native 5' untranslated region (UTR) of any of SEQ ID NOs: 884-161 land 5691-5707 SEQ ID NO: 1-4 and functional variants thereof and a second flanking region located at the 3' terminus of said first region comprising a sequence of linked nucleosides selected from the group consisting of the native 3' UTR of any of SEQ ID NOs: 884-161 land 5691-5707 , SEQ ID NOs: 5-21 and functional variants thereof and a 3' tailing sequence of linked nucleosides. The isolated polynucleotide may further be substantially purified.

**[00012]** The isolated polynucleotides of the present invention may alter, modify and/or change the appearance of a member of the integumentary system of a subject such as, but not limited, to skin, hair and nails. In a further embodiment, the subject may suffer from at least one disease, disorder and/or condition.

**[00013]** Further, the first region of the isolated polynucleotides of the present may comprise two stop codons. In one embodiment, the first region further comprises a first stop codon "TGA" and a second stop codon selected from the group consisting of "TAA," "TGA" and "TAG."

**[00014]** The 3' tailing sequence of the isolated polynucleotides of the present invention may further include linked nucleosides such as, but not limited to, a poly-A tail of approximately 130 nucleotides and a poly A-G quartet.



[00015] The first flanking region of the isolated polynucleotide may further comprise at least one 5' terminal cap such as, but not limited to, CapO, CapI, ARCA, inosine, N1-methyl-guanosine, 2'fluoro-guanosine, 7-deaza-guanosine, 8-oxo-guanosine, 2-amino-guanosine, LNA-guanosine, and 2-azido-guanosine.

[00016] The nucleotides of the isolated polynucleotides of the present invention may comprise at least two modifications and a translatable region. The modification may be on at least one nucleoside and/or the backbone of said nucleotides, on both a nucleoside and a backbone linkage or on a sugar of the nucleoside. The modification may comprise replacing at least one phosphodiester linkage with a phosphorothioate linkage. The modification may include, but are not limited to, pyridin-4-one ribonucleoside, 5-aza-uridine, 2-thio-5-aza-uridine, 2-thiouridine, 4-thio-pseudouridine, 2-thio-pseudouridine, 5-hydroxyuridine, 3-methyluridine, 5-carboxymethyl-uridine, 1-carboxymethyl-pseudouridine, 5-propynyl-uridine, 1-propynyl-pseudouridine, 5-taurinomethyluridine, 1-taurinomethyl-pseudouridine, 5-taurinomethyl-2-thio-uridine, 1-taurinomethyl-4-thio-uridine, 5-methyl-uridine, 1-methyl-pseudouridine, 4-thio-1-methyl-pseudouridine, 2-thio-1-methyl-pseudouridine, 1-methyl-1-deaza-pseudouridine, 2-thio-1-methyl-1-deaza-pseudouridine, dihydrouridine, dihydropseudouridine, 2-thio-dihydrouridine, 2-thio-dihydropseudouridine, 2-methoxyuridine, 2-methoxy-4-thio-uridine, 4-methoxy-pseudouridine, 4-methoxy-2-thio-pseudouridine, 5-aza-cytidine, pseudoisocytidine, 3-methyl-cytidine, N4-acetylcytidine, 5-formylcytidine, N4-methylcytidine, 5-hydroxymethylcytidine, 1-methyl-pseudoisocytidine, pyrrolo-cytidine, pyrrolo-pseudoisocytidine, 2-thio-cytidine, 2-thio-5-methyl-cytidine, 4-thio-pseudoisocytidine, 4-thio-1-methyl-pseudoisocytidine, 4-thio-1-methyl-1-deaza-pseudoisocytidine, 1-methyl-1-deaza-pseudoisocytidine, zebularine, 5-aza-zebularine, 5-methyl-zebularine, 5-aza-2-thio-zebularine, 2-thio-zebularine, 2-methoxy-cytidine, 2-methoxy-5-methyl-cytidine, 4-methoxy-pseudoisocytidine, 4-methoxy-1-methyl-pseudoisocytidine, 2-aminopurine, 2,6-diaminopurine, 7-deaza-adenine, 7-deaza-8-aza-adenine, 7-deaza-2-aminopurine, 7-deaza-8-aza-2-aminopurine, 7-deaza-2,6-diaminopurine, 7-deaza-8-aza-2,6-diaminopurine, 1-methyladenosine, N6-methyladenosine, N6-isopentenyladenosine, N6-(cis-hydroxyisopentenyl)adenosine, 2-methylthio-N6-(cis-hydroxyisopentenyl)adenosine, N6-glycylcarbamoyladenosine, N6-threonylcarbamoyladenosine, 2-

methylthio-N6-threonyl carbamoyladenine, N6,N6-dimethyladenine, 7-methyladenine, 2-methylthio-adenine, 2-methoxy-adenine, inosine, 1-methyl-inosine, wyosine, wybutosine, 7-deaza-guanosine, 7-deaza-8-aza-guanosine, 6-thio-guanosine, 6-thio-7-deaza-guanosine, 6-thio-7-deaza-8-aza-guanosine, 7-methyl-guanosine, 6-thio-7-methyl-guanosine, 7-methylinosine, 6-methoxy-guanosine, 1-methyl-guanosine, N2-methyl-guanosine, N2,N2-dimethyl-guanosine, 8-oxo-guanosine, 7-methyl-8-oxo-guanosine, 1-methyl-6-thio-guanosine, N2-methyl-6-thio-guanosine, and N2,N2-dimethyl-6-thio-guanosine. The backbone linkage may be modified by the replacement of one or more oxygen atoms. The nucleobase modified may be selected from, but is not limited to, cytosine, guanine, adenine, thymine and uracil.

**[00017]** The isolated polypeptides of the present invention may be used to treat a disease, disorder and/or condition and/or may alter, modify or change the appearance of a member of the integumentary system of a subject suffering from a disease, disorder and/or condition such as, but not limited to, acne vulgaris, acne aestivalis, acne conglobata, acne cosmetic, acne fulminans, acne keloidalis nuchae, acne mechanica, acne medicamentosa, acne miliaris necrotica, acne necrotica, acne rosacea, actinic keratosis, acne vulgaris, acne aestivalis, acne conglobata, acne cosmetic, acne fulminans, acne keloidalis nuchae, acne mechanica, acne medicamentosa, acne miliaris necrotica, acne necrotica, acne rosacea, acute urticaria, allergic contact dermatitis, alopecia areata, angioedema, athlete's foot, atopic dermatitis, autoeczematization, baby acne, balding, bastomycosis, blackheads, birthmarks and other skin pigmentation problems, boils, bruises, bug bites and stings, burns, cellulitis, chiggers, chloracne, cholinergic or stress uricaria, chronic urticaria, cold type urticaria, confluent and reticulated papillomatosis, corns, cysts, dandruff, dermatitis herpetiformis, dermatographism, dyshidrotic eczema, diaper rash, dry skin, dyshidrosis, ectodermal dysplasia such as, hypohidrotic ectodermal dysplasia and X-linked hypohidrotic ectodermal dysplasia, eczema, epidermaodysplasia verruciformis, erythema nodosum, excoriated acne, exercise-induced anaphylaxis folliculitis, excess skin oil, folliculitis, freckles, frostbite, fungal nails, hair density, hair growth rate, halogen acne, hair loss, heat rash, hematoma, herpes simplex infections (non-genital), hidradenitis suppurativa, hives, hyperhidrosis, hyperpigmentation, hypohidrotic ectodermal dysplasia, hypopigmentation, impetigo, ingrown hair, heat type

urticaria, ingrown toenail, infantile acne or neonatal acne, itch, irritant contact dermatitis, jock itch, keloid, keratosis pilaris, lichen planus, lichen sclerosus, lupus miliaris disseminatus faciei, melasma, moles, molluscum contagiosum, nail growth rate, nail health, neurodermatitis, nummular eczema, occupational acne, oil acne, onychomycosis, physical urticaria, pilonidal cyst, pityriasis rosea, pityriasis versicolor, poison ivy, pomade acne, pseudofolliculitis barbae or acne keloidalis nuchae, psoriasis, psoriatic arthritis, pressure or delayed pressure urticaria, puncture wounds such as cuts and scrapes, rash, rare or water type urticaria, rhinoplasty, ringworm, rosacea, rothmund-thomson syndrome, sagging of the skin, scabies, scars, seborrhea, seborrheic dermatitis, shingles, skin cancer, skin tag, solar type urticaria, spider bite, stretch marks, sunburn, tar acne, tropical acne, thinning of skin, thrush, tinea versicolor, transient acantholytic dermatosis, tycoon's cap or acne necrotica miliaris, uneven skin tone, varicose veins, venous eczema, vibratory angioedema, vitiligo, warts, Weber-Christian disease, wrinkles, x-linked hypohidrotic ectodermal dysplasia, xerotic eczema, yeast infection and general signs of aging.

**[00018]** The isolated polynucleotides of the present invention may be formulated. The formulation may comprise a lipid which may include, but is not limited to, DLin-DMA, DLin-K-DMA, DLin-KC2-DMA, 98N12-5, C12-200, DLin-MC3-DMA, PLGA, PEG, PEG-DMG, PEGylated lipids and mixtures thereof.

**[00019]** The isolated polynucleotides of the present invention may be administered at a total daily dose of between 1 ug and 150 ug. The administration may be by injection, topical administration, ophthalmic administration and intranasal administration. The injection may include injections such as, but not limited to, intradermal, subcutaneous and intramuscular. The topical administration may be, but is not limited to, a cream, lotion, ointment, gel, spray, solution and the like. The topical administration may further include a penetration enhancer such as, but not limited to, surfactants, fatty acids, bile salts, chelating agents, non-chelating non-surfactants, polyoxyethylene-9-lauryl ether, polyoxyethylene-20-cetyl ether, fatty acids and/or salts in combination with bile acids and/or salts, sodium salt in combination with lauric acid, capric acid and UDCA, and the like. The topical administration may also include a fragrance, a colorant, a sunscreen, an antibacterial and/or a moisturizer.

[00020] The isolated polynucleotides of the present invention may be administered to at least one site such as, but not limited to, forehead, scalp, hair follicles, hair, upper eyelids, lower eyelids, eyebrows, eyelashes, infraorbital area, periorbital areas, temple, nose, nose bridge, cheeks, tongue, nasolabial folds, lips, periobicular areas, jaw line, ears, neck, breast, forearm, upper arm, palm, hand, finger, nails, back, abdomen, sides, buttocks, thigh, calf, feet, toes and the like.

[00021] The present invention provides a cosmetic composition comprising an isolated polynucleotide selected from the group consisting of SEQ ID NOs 884-161 and 5691-5707 comprising, a first region of linked nucleosides, said first region encoding the cosmetic polypeptide of interest, a first flanking region located at the 5' terminus of said first region comprising a sequence of linked nucleosides selected from the group consisting of the native 5' untranslated region (UTR) of any of SEQ ID NOs: 884-161 and 5691-5707, SEQ ID NO: 1-4 and functional variants thereof and a second flanking region located at the 3' terminus of said first region comprising a sequence of linked nucleosides selected from the group consisting of the native 3' UTR of any of SEQ ID NOs: 884-161 and 5691-5707, SEQ ID NOs: 5-21 and functional variants thereof and a 3' tailing sequence of linked nucleosides. The isolated polynucleotide may further be substantially purified.

[00022] The cosmetic composition may further include a pharmaceutical acceptable excipient such as, but not limited to, a solvent, aqueous solvent, non-aqueous solvent, dispersion media, diluent, dispersion, suspension aid, surface active agent, isotonic agent, thickening or emulsifying agent, preservative, lipid, lipidoids liposome, lipid nanoparticle, core-shell nanoparticles, polymer, lipoplex, peptide, protein, cell, hyaluronidase, and mixtures thereof.

[00023] The cosmetic composition may further include a lipid such as, but not limited to, DLin-DMA, DLin-K-DMA, DLin-KC2-DMA, 98N12-5, C12-200, DLin-MC3-DMA, PEG, PEG-DMG, PEGylated lipids, PLGA and mixtures thereof.

[00024] The details of various embodiments of the invention are set forth in the description below. Other features, objects, and advantages of the invention will be apparent from the description and the drawings, and from the claims.

#### **BRIEF DESCRIPTION OF THE DRAWINGS**

[00025] The foregoing and other objects, features and advantages will be apparent from the following description of particular embodiments of the invention, as illustrated in the accompanying drawings in which like reference characters refer to the same parts throughout the different views. The drawings are not necessarily to scale, emphasis instead being placed upon illustrating the principles of various embodiments of the invention.

[00026] FIG. 1 is a schematic of a cosmetic primary construct of the present invention.

[00027] FIG. 2 illustrates lipid structures in the prior art useful in the present invention. Shown are the structures for 98N12-5 (TETA5-LAP), DLin-DMA, DLin-K-DMA (2,2-Dilinoleyl-4-dimethylaminomethyl-[1,3]-dioxolane), DLin-KC2-DMA, DLin-MC3-DMA and C12-200.

[00028] FIG. 3 is a representative plasmid useful in the IVT reactions taught herein. The plasmid contains Insert 64818, designed by the instant inventors.

[00029] FIG. 4 is a gel profile of modified mRNA encapsulated in PLGA microspheres.

#### **DETAILED DESCRIPTION**

[00030] It is of great interest in the fields of therapeutics, diagnostics, reagents and for biological assays to be able to deliver a nucleic acid, e.g., a ribonucleic acid (RNA) inside a cell, whether *in vitro*, *in vivo*, *in situ* or *ex vivo*, such as to cause intracellular translation of the nucleic acid and production of an encoded polypeptide of interest. Of particular importance is the delivery and function of a non-integrative polynucleotide.

[00031] Described herein are compositions (including pharmaceutical compositions) and methods for the design, preparation, manufacture and/or formulation of polynucleotides encoding one or more cosmetic polypeptides of interest. Also provided are systems, processes, devices and kits for the selection, design and/or utilization of the polynucleotides encoding the cosmetic polypeptides of interest described herein.

[00032] According to the present invention, these cosmetic polynucleotides are preferably modified as to avoid the deficiencies of other polypeptide-encoding molecules of the art. Hence these polynucleotides are referred to as modified mRNA or mmRNA.

[00033] The use of modified polynucleotides in the fields of antibodies, viruses, veterinary applications and a variety of *in vivo* settings has been explored by the

inventors and these studies are disclosed in for example, co-pending and co-owned United States provisional patent application serial numbers 61/470,451 filed March 31, 2011 teaching in vivo applications of mmRNA; 61/517,784 filed on April 26, 2011 teaching engineered nucleic acids for the production of antibody polypeptides; 61/519,158 filed May 17, 2011 teaching veterinary applications of mmRNA technology; 61/533,537 filed on September 12, 2011 teaching antimicrobial applications of mmRNA technology; 61/533,554 filed on September 12, 2011 teaching viral applications of mmRNA technology, 61/542,533 filed on October 3, 2011 teaching various chemical modifications for use in mmRNA technology; 61/570,690 filed on December 14, 2011 teaching mobile devices for use in making or using mmRNA technology; 61/570,708 filed on December 14, 2011 teaching the use of mmRNA in acute care situations; 61/576,651 filed on December 16, 2011 teaching terminal modification architecture for mmRNA; 61/576,705 filed on December 16, 2011 teaching delivery methods using lipidoids for mmRNA; 61/578,271 filed on December 21, 2011 teaching methods to increase the viability of organs or tissues using mmRNA; 61/581,322 filed on December 29, 2011 teaching mmRNA encoding cell penetrating peptides; 61/581,352 filed on December 29, 2011 teaching the incorporation of cytotoxic nucleosides in mmRNA and 61/631,729 filed on January 10, 2012 teaching methods of using mmRNA for crossing the blood brain barrier; all of which are herein incorporated by reference in their entirety.

**[00034]** Provided herein, in part, are cosmetic polynucleotides, cosmetic primary constructs and/or cosmetic mmRNA encoding cosmetic polypeptides of interest which have been designed to improve one or more of the stability and/or clearance in tissues, receptor uptake and/or kinetics, cellular access by the compositions, engagement with translational machinery, mRNA half-life, translation efficiency, immune evasion, protein production capacity, secretion efficiency (when applicable), accessibility to circulation, protein half-life and/or modulation of a cell's status, function and/or activity.

#### **I. Compositions of the Invention (mmRNA)**

**[00035]** The present invention provides nucleic acid molecules, specifically cosmetic polynucleotides, cosmetic primary constructs and/or cosmetic mmRNA which encode one or more cosmetic polypeptides of interest. The term "nucleic acid," in its broadest sense, includes any compound and/or substance that comprise a polymer of nucleotides.

These polymers are often referred to as polynucleotides. Exemplary nucleic acids or polynucleotides of the invention include, but are not limited to, ribonucleic acids (RNAs), deoxyribonucleic acids (DNAs), threose nucleic acids (TNAs), glycol nucleic acids (GNAs), peptide nucleic acids (PNAs), locked nucleic acids (LNAs, including LNA having a  $\beta$ -D-ribo configuration,  $\alpha$ -LNA having an  $\alpha$ -L-ribo configuration (a diastereomer of LNA), 2'-amino-LNA having a 2'-amino functionalization, and 2'-amino- $\alpha$ -LNA having a 2'-amino functionalization) or hybrids thereof.

**[00036]** In preferred embodiments, the nucleic acid molecule is a messenger RNA (mRNA). As used herein, the term "messenger RNA" (mRNA) refers to any cosmetic polynucleotide which encodes a cosmetic polypeptide of interest and which is capable of being translated to produce the encoded cosmetic polypeptide of interest *in vitro*, *in vivo*, *in situ* or *ex vivo*.

**[00037]** Traditionally, the basic components of an mRNA molecule include at least a coding region, a 5'UTR, a 3'UTR, a 5' cap and a poly-A tail. Building on this wild type modular structure, the present invention expands the scope of functionality of traditional mRNA molecules by providing cosmetic polynucleotides or cosmetic primary RNA constructs which maintain a modular organization, but which comprise one or more structural and/or chemical modifications or alterations which impart useful properties to the polynucleotide including, in some embodiments, the lack of a substantial induction of the innate immune response of a cell into which the cosmetic polynucleotide is introduced. As such, modified mRNA molecules of the present invention are termed "mmRNA." As used herein, a "structural" feature or modification is one in which two or more linked nucleotides are inserted, deleted, duplicated, inverted or randomized in a cosmetic polynucleotide, cosmetic primary construct or cosmetic mmRNA without significant chemical modification to the nucleotides themselves. Because chemical bonds will necessarily be broken and reformed to effect a structural modification, structural modifications are of a chemical nature and hence are chemical modifications. However, structural modifications will result in a different sequence of nucleotides. For example, the polynucleotide "ATCG" may be chemically modified to "AT-5meC-G". The same polynucleotide may be structurally modified from "ATCG" to "ATCCCG". Here, the

dinucleotide "CC" has been inserted, resulting in a structural modification to the cosmetic polynucleotide.

#### mmRNA Architecture

[00038] The mmRNA of the present invention are distinguished from wild type mRNA in their functional and/or structural design features which serve to, as evidenced herein, overcome existing problems of effective polypeptide production using nucleic acid-based therapeutics.

[00039] Figure 1 shows a representative polynucleotide primary construct **100** of the present invention. As used herein, the term "primary construct" or "primary mRNA construct" refers to a cosmetic polynucleotide transcript which encodes one or more cosmetic polypeptides of interest and which retains sufficient structural and/or chemical features to allow the cosmetic polypeptide of interest encoded therein to be translated. Cosmetic primary constructs may be cosmetic polynucleotides of the invention. When structurally or chemically modified, the cosmetic primary construct may be referred to as a cosmetic mmRNA.

[00040] Returning to FIG. 1, the cosmetic primary construct **100** here contains a first region of linked nucleotides **102** that is flanked by a first flanking region **104** and a second flanking region **106**. As used herein, the "first region" may be referred to as a "coding region" or "region encoding" or simply the "first region." This first region may include, but is not limited to, the encoded cosmetic polypeptide of interest. The cosmetic polypeptide of interest may comprise at its 5' terminus one or more signal sequences encoded by a signal sequence region **103**. The flanking region **104** may comprise a region of linked nucleotides comprising one or more complete or incomplete 5' UTRs sequences. The flanking region **104** may also comprise a 5' terminal cap **108**. The second flanking region **106** may comprise a region of linked nucleotides comprising one or more complete or incomplete 3' UTRs. The flanking region **106** may also comprise a 3' tailing sequence **110**.

[00041] Bridging the 5' terminus of the first region **102** and the first flanking region **104** is a first operational region **105**. Traditionally this operational region comprises a start codon. The operational region may alternatively comprise any translation initiation sequence or signal including a start codon.



[00042] Bridging the 3' terminus of the first region **102** and the second flanking region **106** is a second operational region **107**. Traditionally this operational region comprises a stop codon. The operational region may alternatively comprise any translation initiation sequence or signal including a stop codon. According to the present invention, multiple serial stop codons may also be used. In one embodiment, the operation region of the present invention may comprise two stop codons. The first stop codon may be "TGA" and the second stop codon may be selected from the group consisting of "TAA," "TGA" and "TAG."

[00043] Generally, the shortest length of the first region of the cosmetic primary construct of the present invention can be the length of a nucleic acid sequence that is sufficient to encode for a dipeptide, a tripeptide, a tetrapeptide, a pentapeptide, a hexapeptide, a heptapeptide, an octapeptide, a nonapeptide, or a decapeptide. In another embodiment, the length may be sufficient to encode a peptide of 2-30 amino acids, e.g. 5-30, 10-30, 2-25, 5-25, 10-25, or 10-20 amino acids. The length may be sufficient to encode for a peptide of at least 11, 12, 13, 14, 15, 17, 20, 25 or 30 amino acids, or a peptide that is no longer than 40 amino acids, e.g. no longer than 35, 30, 25, 20, 17, 15, 14, 13, 12, 11 or 10 amino acids. Examples of dipeptides that the polynucleotide sequences can encode or include, but are not limited to, carnosine and anserine.

[00044] Generally, the length of the first region encoding the cosmetic polypeptide of interest of the present invention is greater than about 30 nucleotides in length (e.g., at least or greater than about 35, 40, 45, 50, 55, 60, 70, 80, 90, 100, 120, 140, 160, 180, 200, 250, 300, 350, 400, 450, 500, 600, 700, 800, 900, 1,000, 1,100, 1,200, 1,300, 1,400, 1,500, 1,600, 1,700, 1,800, 1,900, 2,000, 2,500, and 3,000, 4,000, 5,000, 6,000, 7,000, 8,000, 9,000, 10,000, 20,000, 30,000, 40,000, 50,000, 60,000, 70,000, 80,000, 90,000 or up to and including 100,000 nucleotides). As used herein, the "first region" may be referred to as a "coding region" or "region encoding" or simply the "first region."

[00045] In some embodiments, the cosmetic polynucleotide, cosmetic primary construct, or cosmetic mmRNA includes from about 30 to about 100,000 nucleotides (e.g., from 30 to 50, from 30 to 100, from 30 to 250, from 30 to 500, from 30 to 1,000, from 30 to 1,500, from 30 to 3,000, from 30 to 5,000, from 30 to 7,000, from 30 to 10,000, from 30 to 25,000, from 30 to 50,000, from 30 to 70,000, from 100 to 250, from

100 to 500, from 100 to 1,000, from 100 to 1,500, from 100 to 3,000, from 100 to 5,000, from 100 to 7,000, from 100 to 10,000, from 100 to 25,000, from 100 to 50,000, from 100 to 70,000, from 100 to 100,000, from 500 to 1,000, from 500 to 1,500, from 500 to 2,000, from 500 to 3,000, from 500 to 5,000, from 500 to 7,000, from 500 to 10,000, from 500 to 25,000, from 500 to 50,000, from 500 to 70,000, from 500 to 100,000, from 1,000 to 1,500, from 1,000 to 2,000, from 1,000 to 3,000, from 1,000 to 5,000, from 1,000 to 7,000, from 1,000 to 10,000, from 1,000 to 25,000, from 1,000 to 50,000, from 1,000 to 70,000, from 1,000 to 100,000, from 1,500 to 3,000, from 1,500 to 5,000, from 1,500 to 7,000, from 1,500 to 10,000, from 1,500 to 25,000, from 1,500 to 50,000, from 1,500 to 70,000, from 1,500 to 100,000, from 2,000 to 3,000, from 2,000 to 5,000, from 2,000 to 7,000, from 2,000 to 10,000, from 2,000 to 25,000, from 2,000 to 50,000, from 2,000 to 70,000, and from 2,000 to 100,000).

**[00046]** According to the present invention, the first and second flanking regions may range independently from 15-1,000 nucleotides in length (e.g., greater than 30, 40, 45, 50, 55, 60, 70, 80, 90, 100, 120, 140, 160, 180, 200, 250, 300, 350, 400, 450, 500, 600, 700, 800, and 900 nucleotides or at least 30, 40, 45, 50, 55, 60, 70, 80, 90, 100, 120, 140, 160, 180, 200, 250, 300, 350, 400, 450, 500, 600, 700, 800, 900, and 1,000 nucleotides).

**[00047]** According to the present invention, the tailing sequence may range from absent to 500 nucleotides in length (e.g., at least 60, 70, 80, 90, 120, 140, 160, 180, 200, 250, 300, 350, 400, 450, or 500 nucleotides). Where the tailing region is a polyA tail, the length may be determined in units of or as a function of polyA binding protein binding. In this embodiment, the polyA tail is long enough to bind at least 4 monomers of polyA binding protein. PolyA binding protein monomers bind to stretches of approximately 38 nucleotides. As such, it has been observed that polyA tails of about 80 nucleotides and 160 nucleotides are functional.

**[00048]** According to the present invention, the capping region may comprise a single cap or a series of nucleotides forming the cap. In this embodiment the capping region may be from 1 to 10, e.g. 2-9, 3-8, 4-7, 1-5, 5-10, or at least 2, or 10 or fewer nucleotides in length. In some embodiments, the cap is absent.

**[00049]** According to the present invention, the first and second operational regions may range from 3 to 40, e.g., 5-30, 10-20, 15, or at least 4, or 30 or fewer nucleotides in

length and may comprise, in addition to a start and/or stop codon, one or more signal and/or restriction sequences.

*Cyclic mmRNA*

[00050] According to the present invention, a cosmetic primary construct or cosmetic mmRNA may be cyclized, or concatemerized, to generate a translation competent molecule to assist interactions between poly-A binding proteins and 5'-end binding proteins. The mechanism of cyclization or concatemerization may occur through at least 3 different routes: 1) chemical, 2) enzymatic, and 3) ribozyme catalyzed. The newly formed 5'-/3'-linkage may be intramolecular or intermolecular.

[00051] In the first route, the 5'-end and the 3'-end of the nucleic acid may contain chemically reactive groups that, when close together, form a new covalent linkage between the 5'-end and the 3'-end of the molecule. The 5'-end may contain an NHS-ester reactive group and the 3'-end may contain a 3'-amino-terminated nucleotide such that in an organic solvent the 3'-amino-terminated nucleotide on the 3'-end of a synthetic mRNA molecule will undergo a nucleophilic attack on the 5'-NHS-ester moiety forming a new 5'-/3'-amide bond.

[00052] In the second route, T4 RNA ligase may be used to enzymatically link a 5'-phosphorylated nucleic acid molecule to the 3'-hydroxyl group of a nucleic acid forming a new phosphodiester linkage. In an example reaction, 1 $\mu$ g of a nucleic acid molecule is incubated at 37°C for 1 hour with 1-10 units of T4 RNA ligase (New England Biolabs, Ipswich, MA) according to the manufacturer's protocol. The ligation reaction may occur in the presence of a split oligonucleotide capable of base-pairing with both the 5'- and 3'-region in juxtaposition to assist the enzymatic ligation reaction.

[00053] In the third route, either the 5'-or 3'-end of the cDNA template encodes a ligase ribozyme sequence such that during *in vitro* transcription, the resultant nucleic acid molecule can contain an active ribozyme sequence capable of ligating the 5'-end of a nucleic acid molecule to the 3'-end of a nucleic acid molecule. The ligase ribozyme may be derived from the Group I Intron, Group I Intron, Hepatitis Delta Virus, Hairpin ribozyme or may be selected by SELEX (systematic evolution of ligands by exponential enrichment). The ribozyme ligase reaction may take 1 to 24 hours at temperatures between 0 and 37°C.

*mmRNA Multimers*

[00054] According to the present invention, multiple distinct cosmetic polynucleotides, cosmetic primary constructs or cosmetic mmRNA may be linked together through the 3'-end using nucleotides which are modified at the 3'-terminus. Chemical conjugation may be used to control the stoichiometry of delivery into cells. For example, the glyoxylate cycle enzymes, isocitrate lyase and malate synthase, may be supplied into HepG2 cells at a 1:1 ratio to alter cellular fatty acid metabolism. This ratio may be controlled by chemically linking cosmetic polynucleotides, cosmetic primary constructs or cosmetic mmRNA using a 3'-azido terminated nucleotide on one cosmetic polynucleotide, cosmetic primary construct or cosmetic mmRNA species and a C5-ethynyl or alkynyl-containing nucleotide on the opposite cosmetic polynucleotide, cosmetic primary construct or cosmetic mmRNA species. The modified nucleotide is added post-transcriptionally using terminal transferase (New England Biolabs, Ipswich, MA) according to the manufacturer's protocol. After the addition of the 3'-modified nucleotide, the two cosmetic polynucleotide, cosmetic primary construct or cosmetic mmRNA species may be combined in an aqueous solution, in the presence or absence of copper, to form a new covalent linkage via a click chemistry mechanism as described in the literature.

[00055] In another example, more than two cosmetic polynucleotides may be linked together using a functionalized linker molecule. For example, a functionalized saccharide molecule may be chemically modified to contain multiple chemical reactive groups (SH-, NH<sub>2</sub>-, N<sub>3</sub>, etc. .) to react with the cognate moiety on a 3'-functionalized cosmetic mRNA molecule (i.e., a 3'-maleimide ester, 3'-NHS-ester, alkynyl). The number of reactive groups on the modified saccharide can be controlled in a stoichiometric fashion to directly control the stoichiometric ratio of conjugated cosmetic polynucleotide, cosmetic primary construct or cosmetic mmRNA.

*mmRNA Conjugates and Combinations*

[00056] In order to further enhance cosmetic protein production, cosmetic primary constructs or cosmetic mmRNA of the present invention can be designed to be conjugated to other polynucleotides, cosmetic polypeptides, dyes, intercalating agents (*e.g.* acridines), cross-linkers (*e.g.* psoralene, mitomycin C), porphyrins (TPPC4,

texaphyrin, Sapphyrin), polycyclic aromatic hydrocarbons (*e.g.*, phenazine, dihydrophenazine), artificial endonucleases (*e.g.* EDTA), alkylating agents, phosphate, amino, mercapto, PEG (*e.g.*, PEG-40K), MPEG, [MPEG]<sub>2</sub>, polyamino, alkyl, substituted alkyl, radiolabeled markers, enzymes, haptens (*e.g.* biotin), transport/absorption facilitators (*e.g.*, aspirin, vitamin E, folic acid), synthetic ribonucleases, proteins, *e.g.*, glycoproteins, or peptides, *e.g.*, molecules having a specific affinity for a co-ligand, or antibodies *e.g.*, an antibody, that binds to a specified cell type such as a cancer cell, endothelial cell, or bone cell, hormones and hormone receptors, non-peptidic species, such as lipids, lectins, carbohydrates, vitamins, cofactors, or a drug.

[00057] Conjugation may result in increased stability and/or half life and may be particularly useful in targeting the cosmetic polynucleotides, cosmetic primary constructs or cosmetic mmRNA to specific sites in the cell, tissue or organism.

[00058] According to the present invention, the cosmetic mmRNA or cosmetic primary constructs may be administered with, or further encode one or more of RNAi agents, siRNAs, shRNAs, miRNAs, miRNA binding sites, antisense RNAs, ribozymes, catalytic DNA, tRNA, RNAs that induce triple helix formation, aptamers or vectors, and the like.

#### *Bifunctional mmRNA*

[00059] In one embodiment of the invention are bifunctional cosmetic polynucleotides (*e.g.*, bifunctional cosmetic primary constructs or cosmetic bifunctional mmRNA). As the name implies, bifunctional cosmetic polynucleotides are those having or capable of at least two functions. These molecules may also by convention be referred to as multi-functional.

[00060] The multiple functionalities of bifunctional cosmetic polynucleotides may be encoded by the RNA (the function may not manifest until the encoded product is translated) or may be a property of the polynucleotide itself. It may be structural or chemical. Bifunctional modified cosmetic polynucleotides may comprise a function that is covalently or electrostatically associated with the polynucleotides. Further, the two functions may be provided in the context of a complex of a mmRNA and another molecule.

[00061] Bifunctional cosmetic polynucleotides may encode cosmetic peptides which are anti-proliferative. These peptides may be linear, cyclic, constrained or random coil. They may function as aptamers, signaling molecules, ligands or mimics or mimetics thereof. Anti-proliferative peptides may, as translated, be from 3 to 50 amino acids in length. They may be 5-40, 10-30, or approximately 15 amino acids long. They may be single chain, multichain or branched and may form complexes, aggregates or any multi-unit structure once translated.

*Noncoding cosmetic polynucleotides and primary constructs*

[00062] As described herein, provided are cosmetic polynucleotides and cosmetic primary constructs having sequences that are partially or substantially not translatable, e.g., having a noncoding region. Such noncoding region may be the "first region" of the cosmetic primary construct. Alternatively, the noncoding region may be a region other than the first region. Such molecules are generally not translated, but can exert an effect on protein production by one or more of binding to and sequestering one or more translational machinery components such as a ribosomal protein or a transfer RNA (tRNA), thereby effectively reducing protein expression in the cell or modulating one or more pathways or cascades in a cell which in turn alters protein levels. The cosmetic polynucleotide and/or cosmetic primary construct may contain or encode one or more long noncoding RNA (lncRNA, or lincRNA) or portion thereof, a small nucleolar RNA (sno-RNA), micro RNA (miRNA), small interfering RNA (siRNA) or Piwi-interacting RNA (piRNA).

Cosmetic polypeptides of interest

[00063] According to the present invention, the cosmetic primary construct is designed to encode one or more cosmetic polypeptides of interest or fragments thereof. A cosmetic polypeptide of interest may include, but is not limited to, whole polypeptides, a plurality of polypeptides or fragments of polypeptides, which independently may be encoded by one or more nucleic acids, a plurality of nucleic acids, fragments of nucleic acids or variants of any of the aforementioned. As used herein, the term "cosmetic polypeptides of interest" refers to any polypeptide which is selected to be encoded in the cosmetic primary construct of the present invention. As used herein, "polypeptide" means a polymer of amino acid residues (natural or unnatural) linked together most often by

peptide bonds. The term, as used herein, refers to proteins, polypeptides, and peptides of any size, structure, or function. In some instances the polypeptide encoded is smaller than about 50 amino acids and the polypeptide is then termed a peptide. If the polypeptide is a peptide, it will be at least about 2, 3, 4, or at least 5 amino acid residues long. Thus, polypeptides include gene products, naturally occurring polypeptides, synthetic polypeptides, homologs, orthologs, paralogs, fragments and other equivalents, variants, and analogs of the foregoing. A polypeptide may be a single molecule or may be a multi-molecular complex such as a dimer, trimer or tetramer. They may also comprise single chain or multichain polypeptides such as antibodies or insulin and may be associated or linked. Most commonly disulfide linkages are found in multichain polypeptides. The term polypeptide may also apply to amino acid polymers in which one or more amino acid residues are an artificial chemical analogue of a corresponding naturally occurring amino acid.

**[00064]** The term "polypeptide variant" refers to molecules which differ in their amino acid sequence from a native or reference sequence. The amino acid sequence variants may possess substitutions, deletions, and/or insertions at certain positions within the amino acid sequence, as compared to a native or reference sequence. Ordinarily, variants will possess at least about 50% identity (homology) to a native or reference sequence, and preferably, they will be at least about 80%, more preferably at least about 90% identical (homologous) to a native or reference sequence.

**[00065]** In some embodiments "variant mimics" are provided. As used herein, the term "variant mimic" is one which contains one or more amino acids which would mimic an activated sequence. For example, glutamate may serve as a mimic for phospho-threonine and/or phospho-serine. Alternatively, variant mimics may result in deactivation or in an inactivated product containing the mimic, e.g., phenylalanine may act as an inactivating substitution for tyrosine; or alanine may act as an inactivating substitution for serine.

**[00066]** "Homology" as it applies to amino acid sequences is defined as the percentage of residues in the candidate amino acid sequence that are identical with the residues in the amino acid sequence of a second sequence after aligning the sequences and introducing gaps, if necessary, to achieve the maximum percent homology. Methods and computer

programs for the alignment are well known in the art. It is understood that homology depends on a calculation of percent identity but may differ in value due to gaps and penalties introduced in the calculation.

[00067] By "homologs" as it applies to polypeptide sequences means the corresponding sequence of other species having substantial identity to a second sequence of a second species.

[00068] "Analog" is meant to include polypeptide variants which differ by one or more amino acid alterations, e.g., substitutions, additions or deletions of amino acid residues that still maintain one or more of the properties of the parent or starting polypeptide.

[00069] The present invention contemplates several types of compositions which are polypeptide based including variants and derivatives. These include substitutional, insertional, deletion and covalent variants and derivatives. The term "derivative" is used synonymously with the term "variant" but generally refers to a molecule that has been modified and/or changed in any way relative to a reference molecule or starting molecule.

[00070] As such, mmRNA encoding cosmetic polypeptides containing substitutions, insertions and/or additions, deletions and covalent modifications with respect to reference sequences, in particular the cosmetic polypeptide sequences disclosed herein, are included within the scope of this invention. For example, sequence tags or amino acids, such as one or more lysines, can be added to the peptide sequences of the invention (e.g., at the N-terminal or C-terminal ends). Sequence tags can be used for peptide purification or localization. Lysines can be used to increase peptide solubility or to allow for biotinylation. Alternatively, amino acid residues located at the carboxy and amino terminal regions of the amino acid sequence of a peptide or protein may optionally be deleted providing for truncated sequences. Certain amino acids (e.g., C-terminal or N-terminal residues) may alternatively be deleted depending on the use of the sequence, as for example, expression of the sequence as part of a larger sequence which is soluble, or linked to a solid support.

[00071] "Substitutional variants" when referring to polypeptides are those that have at least one amino acid residue in a native or starting sequence removed and a different amino acid inserted in its place at the same position. The substitutions may be single,



where only one amino acid in the molecule has been substituted, or they may be multiple, where two or more amino acids have been substituted in the same molecule.

[00072] As used herein the term "conservative amino acid substitution" refers to the substitution of an amino acid that is normally present in the sequence with a different amino acid of similar size, charge, or polarity. Examples of conservative substitutions include the substitution of a non-polar (hydrophobic) residue such as isoleucine, valine and leucine for another non-polar residue. Likewise, examples of conservative substitutions include the substitution of one polar (hydrophilic) residue for another such as between arginine and lysine, between glutamine and asparagine, and between glycine and serine. Additionally, the substitution of a basic residue such as lysine, arginine or histidine for another, or the substitution of one acidic residue such as aspartic acid or glutamic acid for another acidic residue are additional examples of conservative substitutions. Examples of non-conservative substitutions include the substitution of a non-polar (hydrophobic) amino acid residue such as isoleucine, valine, leucine, alanine, methionine for a polar (hydrophilic) residue such as cysteine, glutamine, glutamic acid or lysine and/or a polar residue for a non-polar residue.

[00073] "Insertional variants" when referring to polypeptides are those with one or more amino acids inserted immediately adjacent to an amino acid at a particular position in a native or starting sequence. "Immediately adjacent" to an amino acid means connected to either the alpha-carboxy or alpha-amino functional group of the amino acid.

[00074] "Deletional variants" when referring to polypeptides are those with one or more amino acids in the native or starting amino acid sequence removed. Ordinarily, deletional variants will have one or more amino acids deleted in a particular region of the molecule.

[00075] "Covalent derivatives" when referring to polypeptides include modifications of a native or starting protein with an organic proteinaceous or non-proteinaceous derivatizing agent, and/or post-translational modifications. Covalent modifications are traditionally introduced by reacting targeted amino acid residues of the protein with an organic derivatizing agent that is capable of reacting with selected side-chains or terminal residues, or by harnessing mechanisms of post-translational modifications that function in selected recombinant host cells. The resultant covalent derivatives are useful in programs

directed at identifying residues important for biological activity, for immunoassays, or for the preparation of anti-protein antibodies for immunoaffinity purification of the recombinant glycoprotein. Such modifications are within the ordinary skill in the art and are performed without undue experimentation.

[00076] Certain post-translational modifications are the result of the action of recombinant host cells on the expressed cosmetic polypeptide. Glutaminyl and asparaginyl residues are frequently post-translationally deamidated to the corresponding glutamyl and aspartyl residues. Alternatively, these residues are deamidated under mildly acidic conditions. Either form of these residues may be present in the cosmetic polypeptides produced in accordance with the present invention.

[00077] Other post-translational modifications include hydroxylation of proline and lysine, phosphorylation of hydroxyl groups of seryl or threonyl residues, methylation of the alpha-amino groups of lysine, arginine, and histidine side chains (T. E. Creighton, *Proteins: Structure and Molecular Properties*, W.H. Freeman & Co., San Francisco, pp. 79-86 (1983)).

[00078] "Features" when referring to polypeptides are defined as distinct amino acid sequence-based components of a molecule. Features of the polypeptides encoded by the **mmRNA** of the present invention include surface manifestations, local conformational shape, folds, loops, half-loops, domains, half-domains, sites, termini or any combination thereof.

[00079] As used herein when referring to polypeptides the term "surface manifestation" refers to a polypeptide based component of a protein appearing on an outermost surface.

[00080] As used herein when referring to polypeptides the term "local conformational shape" means a polypeptide based structural manifestation of a protein which is located within a definable space of the protein.

[00081] As used herein when referring to polypeptides the term "fold" refers to the resultant conformation of an amino acid sequence upon energy minimization. A fold may occur at the secondary or tertiary level of the folding process. Examples of secondary level folds include beta sheets and alpha helices. Examples of tertiary folds include

domains and regions formed due to aggregation or separation of energetic forces.

Regions formed in this way include hydrophobic and hydrophilic pockets, and the like.

**[00082]** As used herein the term "turn" as it relates to protein conformation means a bend which alters the direction of the backbone of a peptide or polypeptide and may involve one, two, three or more amino acid residues.

**[00083]** As used herein when referring to polypeptides the term "loop" refers to a structural feature of a polypeptide which may serve to reverse the direction of the backbone of a peptide or polypeptide. Where the loop is found in a polypeptide and only alters the direction of the backbone, it may comprise four or more amino acid residues. Oliva et al. have identified at least 5 classes of protein loops (J. Mol Biol 266 (4): 814-830; 1997). Loops may be open or closed. Closed loops or "cyclic" loops may comprise 2, 3, 4, 5, 6, 7, 8, 9, 10 or more amino acids between the bridging moieties. Such bridging moieties may comprise a cysteine-cysteine bridge (Cys-Cys) typical in polypeptides having disulfide bridges or alternatively bridging moieties may be non-protein based such as the dibromozylyl agents used herein.

**[00084]** As used herein when referring to polypeptides the term "half-loop" refers to a portion of an identified loop having at least half the number of amino acid residues as the loop from which it is derived. It is understood that loops may not always contain an even number of amino acid residues. Therefore, in those cases where a loop contains or is identified to comprise an odd number of amino acids, a half-loop of the odd-numbered loop will comprise the whole number portion or next whole number portion of the loop (number of amino acids of the loop/2+/-0.5 amino acids). For example, a loop identified as a 7 amino acid loop could produce half-loops of 3 amino acids or 4 amino acids ( $7/2=3.5\pm 0.5$  being 3 or 4).

**[00085]** As used herein when referring to polypeptides the term "domain" refers to a motif of a polypeptide having one or more identifiable structural or functional characteristics or properties (e.g., binding capacity, serving as a site for protein-protein interactions).

**[00086]** As used herein when referring to polypeptides the term "half-domain" means a portion of an identified domain having at least half the number of amino acid residues as the domain from which it is derived. It is understood that domains may not always

contain an even number of amino acid residues. Therefore, in those cases where a domain contains or is identified to comprise an odd number of amino acids, a half-domain of the odd-numbered domain will comprise the whole number portion or next whole number portion of the domain (number of amino acids of the domain/2+/-0.5 amino acids). For example, a domain identified as a 7 amino acid domain could produce half-domains of 3 amino acids or 4 amino acids ( $7/2=3.5\pm 0.5$  being 3 or 4). It is also understood that sub-domains may be identified within domains or half-domains, these subdomains possessing less than all of the structural or functional properties identified in the domains or half domains from which they were derived. It is also understood that the amino acids that comprise any of the domain types herein need not be contiguous along the backbone of the polypeptide (i.e., nonadjacent amino acids may fold structurally to produce a domain, half-domain or subdomain).

[00087] As used herein when referring to polypeptides the terms "site" as it pertains to amino acid based embodiments is used synonymously with "amino acid residue" and "amino acid side chain." A site represents a position within a peptide or polypeptide that may be modified, manipulated, altered, derivatized or varied within the polypeptide based molecules of the present invention.

[00088] As used herein the terms "termini" or "terminus" when referring to polypeptides refers to an extremity of a peptide or polypeptide. Such extremity is not limited only to the first or final site of the peptide or polypeptide but may include additional amino acids in the terminal regions. The polypeptide based molecules of the present invention may be characterized as having both an N-terminus (terminated by an amino acid with a free amino group (NH<sub>2</sub>)) and a C-terminus (terminated by an amino acid with a free carboxyl group (COOH)). Proteins of the invention are in some cases made up of multiple polypeptide chains brought together by disulfide bonds or by non-covalent forces (multimers, oligomers). These sorts of proteins will have multiple N- and C-termini. Alternatively, the termini of the polypeptides may be modified such that they begin or end, as the case may be, with a non-polypeptide based moiety such as an organic conjugate.

[00089] Once any of the features have been identified or defined as a desired component of a polypeptide to be encoded by the cosmetic primary construct or cosmetic

mmRNA of the invention, any of several manipulations and/or modifications of these features may be performed by moving, swapping, inverting, deleting, randomizing or duplicating. Furthermore, it is understood that manipulation of features may result in the same outcome as a modification to the molecules of the invention. For example, a manipulation which involved deleting a domain would result in the alteration of the length of a molecule just as modification of a nucleic acid to encode less than a full length molecule would.

[00090] Modifications and manipulations can be accomplished by methods known in the art such as, but not limited to, site directed mutagenesis. The resulting modified molecules may then be tested for activity using *in vitro* or *in vivo* assays such as those described herein or any other suitable screening assay known in the art.

[00091] According to the present invention, the cosmetic polypeptides may comprise a consensus sequence which is discovered through rounds of experimentation. As used herein a "consensus" sequence is a single sequence which represents a collective population of sequences allowing for variability at one or more sites.

[00092] As recognized by those skilled in the art, protein fragments, functional protein domains, and homologous proteins are also considered to be within the scope of cosmetic polypeptides of interest of this invention. For example, provided herein is any protein fragment (meaning a cosmetic polypeptide sequence at least one amino acid residue shorter than a reference cosmetic polypeptide sequence but otherwise identical) of a reference cosmetic protein 10, 20, 30, 40, 50, 60, 70, 80, 90, 100 or greater than 100 amino acids in length. In another example, any cosmetic protein that includes a stretch of about 20, about 30, about 40, about 50, or about 100 amino acids which are about 40%, about 50%, about 60%, about 70%, about 80%, about 90%, about 95%, or about 100% identical to any of the sequences described herein can be utilized in accordance with the invention. In certain embodiments, a polypeptide to be utilized in accordance with the invention includes 2, 3, 4, 5, 6, 7, 8, 9, 10, or more mutations as shown in any of the sequences provided or referenced herein.

Encoded Cosmetic Polypeptides

[00093] The cosmetic primary constructs or cosmetic mmRNA of the present invention may be designed to encode cosmetic polypeptides of interest such as cosmetic peptides and proteins.

In one embodiment cosmetic primary constructs or cosmetic mmRNA of the present invention may encode variant polypeptides which have a certain identity with a reference cosmetic polypeptide sequence. As used herein, a "reference cosmetic polypeptide sequence" refers to a starting cosmetic polypeptide sequence. Reference sequences may be wild type sequences or any sequence to which reference is made in the design of another sequence. A "reference polypeptide sequence" may, e.g., be any one of SEQ ID NOs: 884-161 or 5691-5707 as disclosed herein, e.g., any of SEQ ID NOs 884, 885, 886, 887, 888, 889, 890, 891, 892, 893, 894, 895, 896, 897, 898, 899, 900, 901, 902, 903, 904, 905, 906, 907, 908, 909, 910, 911, 912, 913, 914, 915, 916, 917, 918, 919, 920, 921, 922, 923, 924, 925, 926, 927, 928, 929, 930, 931, 932, 933, 934, 935, 936, 937, 938, 939, 940, 941, 942, 943, 944, 945, 946, 947, 948, 949, 950, 951, 952, 953, 954, 955, 956, 957, 958, 959, 960, 961, 962, 963, 964, 965, 966, 967, 968, 969, 970, 971, 972, 973, 974, 975, 976, 977, 978, 979, 980, 981, 982, 983, 984, 985, 986, 987, 988, 989, 990, 991, 992, 993, 994, 995, 996, 997, 998, 999, 1000, 1001, 1002, 1003, 1004, 1005, 1006, 1007, 1008, 1009, 1010, 1011, 1012, 1013, 1014, 1015, 1016, 1017, 1018, 1019, 1020, 1021, 1022, 1023, 1024, 1025, 1026, 1027, 1028, 1029, 1030, 1031, 1032, 1033, 1034, 1035, 1036, 1037, 1038, 1039, 1040, 1041, 1042, 1043, 1044, 1045, 1046, 1047, 1048, 1049, 1050, 1051, 1052, 1053, 1054, 1055, 1056, 1057, 1058, 1059, 1060, 1061, 1062, 1063, 1064, 1065, 1066, 1067, 1068, 1069, 1070, 1071, 1072, 1073, 1074, 1075, 1076, 1077, 1078, 1079, 1080, 1081, 1082, 1083, 1084, 1085, 1086, 1087, 1088, 1089, 1090, 1091, 1092, 1093, 1094, 1095, 1096, 1097, 1098, 1099, 1100, 1101, 1102, 1103, 1104, 1105, 1106, 1107, 1108, 1109, 1110, 1111, 1112, 1113, 1114, 1115, 1116, 1117, 1118, 1119, 1120, 1121, 1122, 1123, 1124, 1125, 1126, 1127, 1128, 1129, 1130, 1131, 1132, 1133, 1134, 1135, 1136, 1137, 1138, 1139, 1140, 1141, 1142, 1143, 1144, 1145, 1146, 1147, 1148, 1149, 1150, 1151, 1152, 1153, 1154, 1155, 1156, 1157, 1158, 1159, 1160, 1161, 1162, 1163, 1164, 1165, 1166, 1167, 1168, 1169, 1170, 1171, 1172, 1173, 1174, 1175, 1176, 1177, 1178, 1179, 1180, 1181, 1182, 1183, 1184, 1185, 1186, 1187, 1188, 1189, 1190, 1191, 1192, 1193, 1194, 1195, 1196, 1197, 1198, 1199, 1200, 1201, 1202, 1203,

1204, 1205, 1206, 1207, 1208, 1209, 1210, 121 1, 1212, 1213, 1214, 1215, 1216, 1217,  
1218, 1219, 1220, 1221, 1222, 1223, 1224, 1225, 1226, 1227, 1228, 1229, 1230, 1231,  
1232, 1233, 1234, 1235, 1236, 1237, 1238, 1239, 1240, 1241, 1242, 1243, 1244, 1245,  
1246, 1247, 1248, 1249, 1250, 1251, 1252, 1253, 1254, 1255, 1256, 1257, 1258, 1259,  
1260, 1261, 1262, 1263, 1264, 1265, 1266, 1267, 1268, 1269, 1270, 1271, 1272, 1273,  
1274, 1275, 1276, 1277, 1278, 1279, 1280, 1281, 1282, 1283, 1284, 1285, 1286, 1287,  
1288, 1289, 1290, 1291, 1292, 1293, 1294, 1295, 1296, 1297, 1298, 1299, 1300, 1301,  
1302, 1303, 1304, 1305, 1306, 1307, 1308, 1309, 1310, 131 1, 1312, 1313, 1314, 1315,  
1316, 1317, 1318, 1319, 1320, 1321, 1322, 1323, 1324, 1325, 1326, 1327, 1328, 1329,  
1330, 1331, 1332, 1333, 1334, 1335, 1336, 1337, 1338, 1339, 1340, 1341, 1342, 1343,  
1344, 1345, 1346, 1347, 1348, 1349, 1350, 1351, 1352, 1353, 1354, 1355, 1356, 1357,  
1358, 1359, 1360, 1361, 1362, 1363, 1364, 1365, 1366, 1367, 1368, 1369, 1370, 1371,  
1372, 1373, 1374, 1375, 1376, 1377, 1378, 1379, 1380, 1381, 1382, 1383, 1384, 1385,  
1386, 1387, 1388, 1389, 1390, 1391, 1392, 1393, 1394, 1395, 1396, 1397, 1398, 1399,  
1400, 1401, 1402, 1403, 1404, 1405, 1406, 1407, 1408, 1409, 1410, 1411, 1412, 1413,  
1414, 1415, 1416, 1417, 1418, 1419, 1420, 1421, 1422, 1423, 1424, 1425, 1426, 1427,  
1428, 1429, 1430, 1431, 1432, 1433, 1434, 1435, 1436, 1437, 1438, 1439, 1440, 1441,  
1442, 1443, 1444, 1445, 1446, 1447, 1448, 1449, 1450, 1451, 1452, 1453, 1454, 1455,  
1456, 1457, 1458, 1459, 1460, 1461, 1462, 1463, 1464, 1465, 1466, 1467, 1468, 1469,  
1470, 1471, 1472, 1473, 1474, 1475, 1476, 1477, 1478, 1479, 1480, 1481, 1482, 1483,  
1484, 1485, 1486, 1487, 1488, 1489, 1490, 1491, 1492, 1493, 1494, 1495, 1496, 1497,  
1498, 1499, 1500, 1501, 1502, 1503, 1504, 1505, 1506, 1507, 1508, 1509, 1510, 1511,  
1512, 1513, 1514, 1515, 1516, 1517, 1518, 1519, 1520, 1521, 1522, 1523, 1524, 1525,  
1526, 1527, 1528, 1529, 1530, 1531, 1532, 1533, 1534, 1535, 1536, 1537, 1538, 1539,  
1540, 1541, 1542, 1543, 1544, 1545, 1546, 1547, 1548, 1549, 1550, 1551, 1552, 1553,  
1554, 1555, 1556, 1557, 1558, 1559, 1560, 1561, 1562, 1563, 1564, 1565, 1566, 1567,  
1568, 1569, 1570, 1571, 1572, 1573, 1574, 1575, 1576, 1577, 1578, 1579, 1580, 1581,  
1582, 1583, 1584, 1585, 1586, 1587, 1588, 1589, 1590, 1591, 1592, 1593, 1594, 1595,  
1596, 1597, 1598, 1599, 1600, 1601, 1602, 1603, 1604, 1605, 1606, 1607, 1608, 1609,  
1610, 161 1, 5674, 5675, 5676, 5677, 5678, 5679, 5680, 5681, 5682, 5683, 5684, 5685,  
5686, 5687, 5688, 5689, 5690, 5691, 5692, 5693, 5694, 5695, 5696, 5697, 5698, 5699,

5700, 5701, 5702, 5703, 5704, 5705, 5706, 5707, 5708, 5709, 5710, 5711, 5712, 5713, 5714, 5715, 5716, 5717, 5718, 5719, 5720, 5721, 5722, 5723, 5724, 5725, 5726, 5727, 5728, 5729, 5730, 5731, 5732, 5733, 5734, 5735, 5736, 5737, 5738, 5739, 5740, 5741, 5742, 5743, 5744, 5745, 5746, 5747, 5748, 5749, 5750, 5751, 5752, 5753, 5754.

[00094] The term "identity" as known in the art, refers to a relationship between the sequences of two or more peptides, as determined by comparing the sequences. In the art, identity also means the degree of sequence relatedness between peptides, as determined by the number of matches between strings of two or more amino acid residues. Identity measures the percent of identical matches between the smaller of two or more sequences with gap alignments (if any) addressed by a particular mathematical model or computer program (i.e., "algorithms"). Identity of related peptides can be readily calculated by known methods. Such methods include, but are not limited to, those described in Computational Molecular Biology, Lesk, A. M., ed., Oxford University Press, New York, 1988; Biocomputing: Informatics and Genome Projects, Smith, D. W., ed., Academic Press, New York, 1993; Computer Analysis of Sequence Data, Part 1, Griffin, A. M., and Griffin, H. G., eds., Humana Press, New Jersey, 1994; Sequence Analysis in Molecular Biology, von Heinje, G., Academic Press, 1987; Sequence Analysis Primer, Gribskov, M. and Devereux, J., eds., M. Stockton Press, New York, 1991; and Carillo et al, SIAM J. Applied Math. 48, 1073 (1988).

[00095] In some embodiments, the polypeptide variant may have the same or a similar activity as the reference cosmetic polypeptide. Alternatively, the variant may have an altered activity (e.g., increased or decreased) relative to a reference cosmetic polypeptide. Generally, variants of a particular cosmetic polynucleotide or cosmetic polypeptide of the invention will have at least about 40%, 45%, 50%, 55%, 60%, 65%, 70%, 75%, 80%, 85%, 90%, 91%, 92%, 93%, 94%, 95%, 96%, 97%, 98%, 99% but less than 100% sequence identity to that particular reference cosmetic polynucleotide or cosmetic polypeptide as determined by sequence alignment programs and parameters described herein and known to those skilled in the art. Such tools for alignment include those of the BLAST suite (Stephen F. Altschul, Thomas L. Madden, Alejandro A. Schaffer, Jinghui Zhang, Zheng Zhang, Webb Miller, and David J. Lipman (1997), "Gapped BLAST and PSI-BLAST: a new generation of protein database search programs", Nucleic Acids Res.



25:3389-3402.) Other tools are described herein, specifically in the definition of "Identity."

[00096] Default parameters in the BLAST algorithm include, for example, an expect threshold of 10, Word size of 28, Match/Mismatch Scores 1, -2, Gap costs Linear. Any filter can be applied as well as a selection for species specific repeats, e.g., Homo sapiens.

[00097] In one embodiment, the cosmetic polynucleotides, cosmetic primary constructs and/or cosmetic mmRNA may restore and/or enhance a biochemical and/or physiological process that will have a positive effect on a subject's outward appearance. In another embodiment, the cosmetic polynucleotides, cosmetic primary constructs and/or cosmetic mmRNA may reduce a biochemical and/or physiological process that will have a negative effect on a subject's outward appearance. In a further embodiment, the cosmetic polynucleotides, cosmetic primary constructs and/or cosmetic mmRNA may improve the production of molecules which can enhance the health and/or longevity of such cells. The biochemical and/or physiological process may affect cells such as skin, fat, muscle, connective tissue, nerve cells found in the epidermis, dermis and subcutaneous layers including nail root or nail bed, nail matrix and nail plate, and scalp, hair follicles and hair strands, as well as muscles found under the subcutaneous fat layer and the tongue; cells found in the eye including the iris and stroma covering the iris.

*Cosmetic proteins or cosmetic peptides*

[00098] The cosmetic primary constructs or cosmetic mmRNA disclosed herein, may encode one or more validated or "in testing" cosmetic proteins or cosmetic peptides. As used herein, a "cosmetic protein" or a "cosmetic peptide" refers to a protein or peptide that upon contact or administration can enhance, alter, modify, and/or change the phenotype or aesthetic presentation of a cell, tissue, system, and/or organism.

[00099] According to the present invention, one or more cosmetic proteins or cosmetic peptides currently being marketed or in development may be encoded by the cosmetic polynucleotides, cosmetic primary constructs or cosmetic mmRNA of the present invention. While not wishing to be bound by theory, it is believed that incorporation into the cosmetic primary constructs or cosmetic mmRNA of the invention will result in improved therapeutic efficacy due at least in part to the specificity, purity and selectivity of the construct designs.

**[000100]** Cosmetic proteins and peptides encoded in the cosmetic polynucleotides, cosmetic primary constructs or cosmetic mmRNA of the invention may be utilized to treat diseases, disorders, and/or conditions in many therapeutic areas such as, but not limited to, those effecting the ingumentary system; hereditary diseases, disorders and/or conditions; genetic mutations; genetic disease, disorder and/or conditions; and diseases, disorders and/or conditions caused by fungus and/or yeast.

**[000101]** The cosmetic polynucleotides, cosmetic primary constructs and/or cosmetic mmRNA may alter a biological and/or physiological process to reduce skin sagging, increase skin thickness, increase skin volume, reduce the number of wrinkles, the length of wrinkles and/or the depth of wrinkles, increase skin tightness, firmness, tone and/or elasticity, increase skin hydration and ability to retain moisture, water flow and osmotic balance. In another embodiment, the cosmetic polynucleotides, cosmetic primary constructs and/or cosmetic mmRNA may alter a biological and/or physiological process may increase the levels of skin lipids; increase the extracellular matrix and/or adhesion and communication polypeptides; increase skin energy production; utilization and conservation; improve oxygen utilization; improve skin cell life; improve skin cell immunity defense, heat shock/stress response, antioxidant defense capacity to neutralize free radicals, and/or toxic defense; improve the protection and recovery from ultraviolet rays; improve skin cell communication and skin cell innervations; improve cell cohesion/adhesion; improve calcium mineral and other mineral metabolism; improve cell turnover; and improve cell circadian rhythms.

**[000102]** In one embodiment, the use of the cosmetic polynucleotides, cosmetic primary constructs and/or cosmetic mmRNA may result in improved skin texture, smoothness, softness, radiance, glow, reduced discoloration and/or unevenness of skin color including, but not limited to, redness, hyperpigmentation and hypopigmentation, improved blood vessel health, improved dermalepidermal junction, increased lipolysis to reduce cellulite (or dimpling), reduced pore size, decreased or increased contraction of muscles, increased size of skin cells.

**[000103]** In a further embodiment, the cosmetic polynucleotides, cosmetic primary constructs and/or cosmetic mmRNA may change the cells of the ingumentary system by producing permanent or temporary color and pigmentation changes including, but not

limited to, fluorescence, iridescence, phosphorescence, reflectance, refraction, photoluminescence, chemiluminescence and/or bioluminescence.

Flanking Regions: Untranslated Regions (UTRs)

**[000104]** Untranslated regions (UTRs) of a gene are transcribed but not translated. The 5'UTR starts at the transcription start site and continues to the start codon but does not include the start codon; whereas, the 3'UTR starts immediately following the stop codon and continues until the transcriptional termination signal. There is growing body of evidence about the regulatory roles played by the UTRs in terms of stability of the nucleic acid molecule and translation. The regulatory features of a UTR can be incorporated into the cosmetic polynucleotides, cosmetic primary constructs and/or cosmetic mmRNA of the present invention to enhance the stability of the molecule. The specific features can also be incorporated to ensure controlled down-regulation of the transcript in case they are misdirected to undesired organs sites.

*5' UTR and Translation Initiation*

**[000105]** Natural 5'UTRs bear features which play roles in for translation initiation. They harbor signatures like Kozak sequences which are commonly known to be involved in the process by which the ribosome initiates translation of many genes. Kozak sequences have the consensus CCR(A/G)CCAUGG, where R is a purine (adenine or guanine) three bases upstream of the start codon (AUG), which is followed by another 'G'. 5'UTR also have been known to form secondary structures which are involved in elongation factor binding.

**[000106]** By engineering the features typically found in abundantly expressed genes of specific target organs, one can enhance the stability and cosmetic protein production of the cosmetic polynucleotides, cosmetic primary constructs or cosmetic mmRNA of the invention. For example, introduction of 5' UTR of liver-expressed mRNA, such as albumin, serum amyloid A, Apolipoprotein A/B/E, transferrin, alpha fetoprotein, erythropoietin, or Factor VIII, could be used to enhance expression of a nucleic acid molecule, such as a mmRNA, in hepatic cell lines or liver. Likewise, use of 5' UTR from other tissue-specific mRNA to improve expression in that tissue is possible for muscle (MyoD, Myosin, Myoglobin, Myogenin, Herculin), for endothelial cells (Tie-1, CD36), for myeloid cells (C/EBP, AML1, G-CSF, GM-CSF, CD11b, MSR, Fr-1, i-NOS), for

leukocytes (CD45, CD18), for adipose tissue (CD36, GLUT4, ACRP30, adiponectin) and for lung epithelial cells (SP-A/B/C/D).

[000107] Other non-UTR sequences may be incorporated into the 5' (or 3' UTR) UTRs. For example, introns or portions of introns sequences may be incorporated into the flanking regions of the cosmetic polynucleotides, cosmetic primary constructs or cosmetic mmRNA of the invention. Incorporation of intronic sequences may increase protein production as well as mRNA levels.

#### *3' UTR and the AU Rich Elements*

[000108] 3' UTRs are known to have stretches of Adenosines and Uridines embedded in them. These AU rich signatures are particularly prevalent in genes with high rates of turnover. Based on their sequence features and functional properties, the AU rich elements (AREs) can be separated into three classes (Chen et al, 1995): Class I AREs contain several dispersed copies of an AUUUA motif within U-rich regions. C-Myc and MyoD contain class I AREs. Class II AREs possess two or more overlapping UUAUUUA(U/A)(U/A) nonamers. Molecules containing this type of AREs include GM-CSF and TNF- $\alpha$ . Class III AREs are less well defined. These U rich regions do not contain an AUUUA motif. c-Jun and Myogenin are two well-studied examples of this class. Most proteins binding to the AREs are known to destabilize the messenger, whereas members of the ELAV family, most notably HuR, have been documented to increase the stability of mRNA. HuR binds to AREs of all the three classes. Engineering the HuR specific binding sites into the 3' UTR of nucleic acid molecules will lead to HuR binding and thus, stabilization of the message *in vivo*.

[000109] Introduction, removal or modification of 3' UTR AU rich elements (AREs) can be used to modulate the stability of cosmetic polynucleotides, cosmetic primary constructs or cosmetic mmRNA of the invention. When engineering specific cosmetic polynucleotides, cosmetic primary constructs or cosmetic mmRNA, one or more copies of an ARE can be introduced to make cosmetic polynucleotides, cosmetic primary constructs or cosmetic mmRNA of the invention less stable and thereby curtail translation and decrease production of the resultant protein. Likewise, AREs can be identified and removed or mutated to increase the intracellular stability and thus increase translation and production of the resultant protein. Transfection experiments can be conducted in

relevant cell lines, using cosmetic polynucleotides, cosmetic primary constructs or cosmetic mmRNA of the invention and protein production can be assayed at various time points post-transfection. For example, cells can be transfected with different ARE-engineering molecules and by using an ELISA kit to the relevant protein and assaying protein produced at 6 hour, 12 hour, 24 hour, 48 hour, and 7 days post-transfection.

*Incorporating microRNA Binding Sites*

**[000110]** microRNAs (or miRNA) are 19-25 nucleotide long noncoding RNAs that bind to the 3'UTR of nucleic acid molecules and down-regulate gene expression either by reducing nucleic acid molecule stability or by inhibiting translation. The cosmetic polynucleotides, cosmetic primary constructs or cosmetic mmRNA of the invention may comprise one or more microRNA target sequences, microRNA sequences, or microRNA seeds. Such sequences may correspond to any known microRNA such as those taught in US Publication US2005/0261218 and US Publication US2005/0059005, the contents of which are incorporated herein by reference in their entirety.

**[000111]** A microRNA sequence comprises a "seed" region, i.e., a sequence in the region of positions 2-8 of the mature microRNA, which sequence has perfect Watson-Crick complementarity to the miRNA target sequence. A microRNA seed may comprise positions 2-8 or 2-7 of the mature microRNA. In some embodiments, a microRNA seed may comprise 7 nucleotides (e.g., nucleotides 2-8 of the mature microRNA), wherein the seed-complementary site in the corresponding miRNA target is flanked by an adenine (A) opposed to microRNA position 1. In some embodiments, a microRNA seed may comprise 6 nucleotides (e.g., nucleotides 2-7 of the mature microRNA), wherein the seed-complementary site in the corresponding miRNA target is flanked by an adenine (A) opposed to microRNA position 1. See for example, Grimson A, Farh KK, Johnston WK, Garrett-Engle P, Lim LP, Bartel DP; Mol Cell. 2007 Jul 6;27(1):91-105 ; each of which is herein incorporated by reference in their entirety. The bases of the microRNA seed have complete complementarity with the target sequence. By engineering microRNA target sequences into the 3'UTR of cosmetic polynucleotides, cosmetic primary constructs or cosmetic mmRNA of the invention one can target the molecule for degradation or reduced translation, provided the microRNA in question is available. This process will reduce the hazard of off target effects upon nucleic acid molecule delivery.

Identification of microRNA, microRNA target regions, and their expression patterns and role in biology have been reported (Bonauer et al., *Curr Drug Targets* 2010 11:943-949; Anand and Cheresch *Curr Opin Hematol* 2011 18:171-176; Contreras and Rao *Leukemia* 2012 26:404-413 (2011 Dec 20. doi: 10.1038/leu.2011.356); Barrelet *Cell* 2009 136:215-233; Landgraf et al, *Cell*, 2007 129:1401-1414 ; each of which is herein incorporated by reference in their entirety).

**[000112]** For example, if the nucleic acid molecule is an mRNA and is not intended to be delivered to the liver but ends up there, then miR-122, a microRNA abundant in liver, can inhibit the expression of the gene of interest if one or multiple target sites of miR-122 are engineered into the 3'UTR of the cosmetic polynucleotides, cosmetic primary constructs or cosmetic mmRNA. Introduction of one or multiple binding sites for different microRNA can be engineered to further decrease the longevity, stability, and protein translation of a cosmetic polynucleotides, cosmetic primary constructs or cosmetic mmRNA. As used herein, the term "microRNA site" refers to a microRNA target site or a microRNA recognition site, or any nucleotide sequence to which a microRNA binds or associates. It should be understood that "binding" may follow traditional Watson-Crick hybridization rules or may reflect any stable association of the microRNA with the target sequence at or adjacent to the microRNA site.

**[000113]** Conversely, for the purposes of the cosmetic polynucleotides, cosmetic primary constructs or cosmetic mmRNA of the present invention, microRNA binding sites can be engineered out of (i.e. removed from) sequences in which they naturally occur in order to increase protein expression in specific tissues. For example, miR-122 binding sites may be removed to improve protein expression in the liver. Regulation of expression in multiple tissues can be accomplished through introduction or removal of one or several microRNA binding sites.

**[000114]** Examples of tissues where microRNA are known to regulate mRNA, and thereby protein expression, include, but are not limited to, liver (miR-122), muscle (miR-133, miR-206, miR-208), endothelial cells (miR-17-92, miR-126), myeloid cells (miR-142-3p, miR-142-5p, miR-16, miR-21, miR-223, miR-24, miR-27), adipose tissue (let-7, miR-30c), heart (miR-149), kidney (miR-192, miR-194, miR-204), and lung epithelial cells (let-7, miR-133, miR-126). MicroRNA can also regulate complex

biological processes such as angiogenesis (miR-132) (Anand and Cheresch Curr Opin Hematol 2011 18:171-176 ; herein incorporated by reference in its entirety). In the cosmetic polynucleotides, cosmetic primary constructs or cosmetic mmRNA of the present invention, binding sites for microRNAs that are involved in such processes may be removed or introduced, in order to tailor the expression of the cosmetic polynucleotides, cosmetic primary constructs or cosmetic mmRNA expression to biologically relevant cell types or to the context of relevant biological processes. A listing of MicroRNA, miR sequences and miR binding sites is listed in Table 9 of U.S. Provisional Application No. 61/753,661 filed January 17, 2013, in Table 9 of U.S. Provisional Application No. 61/754,159 filed January 18, 2013, and in Table 7 of U.S. Provisional Application No. 61/758,921 filed January 31, 2013, each of which are herein incorporated by reference in their entireties.

**[000115]** Lastly, through an understanding of the expression patterns of microRNA in different cosmetic cell types, cosmetic polynucleotides, cosmetic primary constructs or cosmetic mmRNA can be engineered for more targeted expression in specific cell types or only under specific biological conditions. Through introduction of tissue-specific microRNA binding sites, cosmetic polynucleotides, cosmetic primary constructs or cosmetic mmRNA could be designed that would be optimal for cosmetic protein expression in a tissue or in the context of a biological condition. Examples of use of microRNA to drive tissue or disease-specific gene expression are listed (Getner and Naldini, Tissue Antigens. 2012, 80:393-403; herein incorporated by reference in its entirety). In addition, microRNA seed sites can be incorporated into mRNA to decrease expression in certain cells which results in a biological improvement. An example of this is incorporation of miR-142 sites into a UGT1A1-expressing lentiviral vector. The presence of miR-142 seed sites reduced expression in hematopoietic cells, and as a consequence reduced expression in antigen-presenting cells, leading to the absence of an immune response against the virally expressed UGT1A1 (Schmitt et al, Gastroenterology 2010; 139:999-1007; Gonzalez-Asequinolaza et al. Gastroenterology 2010, 139:726-729; both herein incorporated by reference in its entirety) . Incorporation of miR-142 sites into modified mRNA could not only reduce expression of the encoded protein in hematopoietic cells, but could also reduce or abolish immune responses to the

mRNA-encoded protein. Incorporation of miR-142 seed sites (one or multiple) into mRNA would be important in the case of treatment of patients with complete protein deficiencies (UGT1A1 type I, LDLR-deficient patients, CRIM-negative Pompe patients, etc.) .

[000116] Transfection experiments can be conducted in relevant cell lines, using engineered cosmetic polynucleotides, cosmetic primary constructs or cosmetic mmRNA and protein production can be assayed at various time points post-transfection. For example, cells can be transfected with different microRNA binding site-engineering cosmetic polynucleotides, cosmetic primary constructs or cosmetic mmRNA and by using an ELISA kit to the relevant protein and assaying protein produced at 6 hour, 12 hour, 24 hour, 48 hour, 72 hour and 7 days post-transfection. *In vivo* experiments can also be conducted using microRNA-binding site-engineered molecules to examine changes in tissue-specific expression of formulated cosmetic polynucleotides, cosmetic primary constructs or cosmetic mmRNA.

#### *5' Capping*

[000117] The 5' cap structure of an mRNA is involved in nuclear export, increasing mRNA stability and binds the mRNA Cap Binding Protein (CBP), which is responsible for mRNA stability in the cell and translation competency through the association of CBP with poly(A) binding protein to form the mature cyclic mRNA species. The cap further assists the removal of 5' proximal introns removal during mRNA splicing.

[000118] Endogenous mRNA molecules may be 5'-end capped generating a 5'-ppp-5'-triphosphate linkage between a terminal guanosine cap residue and the 5'-terminal transcribed sense nucleotide of the mRNA molecule. This 5'-guanylate cap may then be methylated to generate an N7-methyl-guanylate residue. The ribose sugars of the terminal and/or anteterminal transcribed nucleotides of the 5' end of the mRNA may optionally also be 2'-O-methylated. 5'-decapping through hydrolysis and cleavage of the guanylate cap structure may target a nucleic acid molecule, such as an mRNA molecule, for degradation.

[000119] Modifications to the cosmetic polynucleotides, cosmetic primary constructs, and cosmetic mmRNA of the present invention may generate a non-hydrolyzable cap structure preventing decapping and thus increasing mRNA half-life. Because cap



structure hydrolysis requires cleavage of 5'-ppp-5' phosphodiester linkages, modified nucleotides may be used during the capping reaction. For example, a Vaccinia Capping Enzyme from New England Biolabs (Ipswich, MA) may be used with a-thio-guanosine nucleotides according to the manufacturer's instructions to create a phosphorothioate linkage in the 5'-ppp-5' cap. Additional modified guanosine nucleotides may be used such as a-methyl-phosphonate and seleno-phosphate nucleotides.

**[000120]** Additional modifications include, but are not limited to, 2'-O-methylation of the ribose sugars of 5'-terminal and/or 5'-antiterminal nucleotides of the mRNA (as mentioned above) on the 2'-hydroxyl group of the sugar ring. Multiple distinct 5'-cap structures can be used to generate the 5'-cap of a nucleic acid molecule, such as an mRNA molecule.

**[000121]** Cap analogs, which herein are also referred to as synthetic cap analogs, chemical caps, chemical cap analogs, or structural or functional cap analogs, differ from natural (i.e. endogenous, wild-type or physiological) 5'-caps in their chemical structure, while retaining cap function. Cap analogs may be chemically (i.e. non-enzymatically) or enzymatically synthesized and/or linked to a nucleic acid molecule.

**[000122]** For example, the Anti-Reverse Cap Analog (ARCA) cap contains two guanines linked by a 5'-5'-triphosphate group, wherein one guanine contains an N7 methyl group as well as a 3'-O-methyl group (i.e., N7,3'-O-dimethyl-guanosine-5'-triphosphate-5'-guanosine ( $m^7G$ -3'mppp-G; which may equivalently be designated 3' O-Me- $m^7G(5')ppp(5')G$ ). The 3'-O atom of the other, unmodified, guanine becomes linked to the 5'-terminal nucleotide of the capped nucleic acid molecule (e.g. an mRNA or mmRNA). The N7- and 3'-O-methylated guanine provides the terminal moiety of the capped nucleic acid molecule (e.g. mRNA or mmRNA).

**[000123]** Another exemplary cap is mCAP, which is similar to ARCA but has a 2'-O-methyl group on guanosine (i.e., N7,2'-O-dimethyl-guanosine-5'-triphosphate-5'-guanosine,  $m^7Gm$ -ppp-G).

**[000124]** While cap analogs allow for the concomitant capping of a nucleic acid molecule in an in vitro transcription reaction, up to 20% of transcripts can remain uncapped. This, as well as the structural differences of a cap analog from an endogenous

5'-cap structures of nucleic acids produced by the endogenous, cellular transcription machinery, may lead to reduced translational competency and reduced cellular stability.

**[000125]** Cosmetic polynucleotides, cosmetic primary constructs and cosmetic mmRNA of the invention may also be capped post-transcriptionally, using enzymes, in order to generate more authentic 5'-cap structures. As used herein, the phrase "more authentic" refers to a feature that closely mirrors or mimics, either structurally or functionally, an endogenous or wild type feature. That is, a "more authentic" feature is better representative of an endogenous, wild-type, natural or physiological cellular function and/or structure as compared to synthetic features or analogs, etc., of the prior art, or which outperforms the corresponding endogenous, wild-type, natural or physiological feature in one or more respects. Non-limiting examples of more authentic 5'cap structures of the present invention are those which, among other things, have enhanced binding of cap binding proteins, increased half life, reduced susceptibility to 5' endonucleases and/or reduced 5'decapping, as compared to synthetic 5'cap structures known in the art (or to a wild-type, natural or physiological 5'cap structure). For example, recombinant Vaccinia Virus Capping Enzyme and recombinant 2'-O-methyltransferase enzyme can create a canonical 5'-5'-triphosphate linkage between the 5'-terminal nucleotide of an mRNA and a guanine cap nucleotide wherein the cap guanine contains an N7 methylation and the 5'-terminal nucleotide of the mRNA contains a 2'-O-methyl. Such a structure is termed the Cap1 structure. This cap results in a higher translational-competency and cellular stability and a reduced activation of cellular pro-inflammatory cytokines, as compared, e.g., to other 5'cap analog structures known in the art. Cap structures include , but are not limited to, 7mG(5')ppp(5')N,pN2p (cap 0), 7mG(5<sup>\*</sup>)ppp(5')NlmpNp (cap 1), and 7mG(5<sup>\*</sup>)-ppp(5<sup>\*</sup>)NlmpN2mp (cap 2).

**[000126]** Because the cosmetic polynucleotides, cosmetic primary constructs or cosmetic mmRNA may be capped post-transcriptionally, and because this process is more efficient, nearly 100% of the cosmetic polynucleotides, cosmetic primary constructs or cosmetic mmRNA may be capped. This is in contrast to ~80% when a cap analog is linked to an mRNA in the course of an *in vitro* transcription reaction.

**[000127]** According to the present invention, 5' terminal caps may include endogenous caps or cap analogs. According to the present invention, a 5' terminal cap may comprise

a guanine analog. Useful guanine analogs include , but are not limited to, inosine, NI-methyl-guanosine, 2'fluoro-guanosine, 7-deaza-guanosine, 8-oxo-guanosine, 2-amino-guanosine, LNA-guanosine, and 2-azido-guanosine.

#### *Viral Sequences*

[000128] Additional viral sequences such as, but not limited to, the translation enhancer sequence of the barley yellow dwarf virus (BYDV-PAV), the Jaagsiekte sheep retrovirus (JSRV) and/or the Enzootic nasal tumor virus (See e.g., International Pub. No. WO2012129648; herein incorporated by reference in its entirety) can be engineered and inserted in the 3' UTR of the cosmetic polynucleotides, cosmetic primary constructs or cosmetic mmiRNA of the invention and can stimulate the translation of the construct *in vitro* and *in vivo*. Transfection experiments can be conducted in relevant cell lines at and protein production can be assayed by ELISA at 12hr, 24hr, 48hr, 72 hr and day 7 post-transfection.

#### *IRES Sequences*

[000129] Further, provided are cosmetic polynucleotides, cosmetic primary constructs or cosmetic mmRNA which may contain an internal ribosome entry site (IRES). First identified as a feature Picorna virus RNA, IRES plays an important role in initiating protein synthesis in absence of the 5' cap structure. An IRES may act as the sole ribosome binding site, or may serve as one of multiple ribosome binding sites of an mRNA. Cosmetic polynucleotides, cosmetic primary constructs or cosmetic mmRNA containing more than one functional ribosome binding site may encode several cosmetic peptides or cosmetic polypeptides that are translated independently by the ribosomes ("multicistronic nucleic acid molecules"). When cosmetic polynucleotides, cosmetic primary constructs or cosmetic mmRNA are provided with an IRES, further optionally provided is a second translatable region. Examples of IRES sequences that can be used according to the invention include without limitation, those from picornaviruses (e.g. FMDV), pest viruses (CFFV), polio viruses (PV), encephalomyocarditis viruses (ECMV), foot-and-mouth disease viruses (FMDV), hepatitis C viruses (HCV), classical swine fever viruses (CSFV), murine leukemia virus (MLV), simian immune deficiency viruses (SIV) or cricket paralysis viruses (CrPV).

#### *Poly-A tails*

**[000130]** During RNA processing, a long chain of adenine nucleotides (poly-A tail) may be added to a cosmetic polynucleotide such as an mRNA molecule in order to increase stability. Immediately after transcription, the 3' end of the transcript may be cleaved to free a 3' hydroxyl. Then poly-A polymerase adds a chain of adenine nucleotides to the RNA. The process, called polyadenylation, adds a poly-A tail that can be between , for example, approximately 100 and 250 residues long.

**[000131]** It has been discovered that unique poly-A tail lengths provide certain advantages to the cosmetic polynucleotides, cosmetic primary constructs or cosmetic mmRNA of the present invention.

**[000132]** Generally, the length of a poly-A tail of the present invention is greater than 30 nucleotides in length. In another embodiment, the poly-A tail is greater than 35 nucleotides in length (e.g., at least or greater than about 35, 40, 45, 50, 55, 60, 70, 80, 90, 100, 120, 140, 160, 180, 200, 250, 300, 350, 400, 450, 500, 600, 700, 800, 900, 1,000, 1,100, 1,200, 1,300, 1,400, 1,500, 1,600, 1,700, 1,800, 1,900, 2,000, 2,500, and 3,000 nucleotides). In some embodiments, the cosmetic polynucleotide, cosmetic primary construct, or cosmetic mmRNA includes from about 30 to about 3,000 nucleotides (e.g., from 30 to 50, from 30 to 100, from 30 to 250, from 30 to 500, from 30 to 750, from 30 to 1,000, from 30 to 1,500, from 30 to 2,000, from 30 to 2,500, from 50 to 100, from 50 to 250, from 50 to 500, from 50 to 750, from 50 to 1,000, from 50 to 1,500, from 50 to 2,000, from 50 to 2,500, from 50 to 3,000, from 100 to 500, from 100 to 750, from 100 to 1,000, from 100 to 1,500, from 100 to 2,000, from 100 to 2,500, from 100 to 3,000, from 500 to 750, from 500 to 1,000, from 500 to 1,500, from 500 to 2,000, from 500 to 2,500, from 500 to 3,000, from 1,000 to 1,500, from 1,000 to 2,000, from 1,000 to 2,500, from 1,000 to 3,000, from 1,500 to 2,000, from 1,500 to 2,500, from 1,500 to 3,000, from 2,000 to 3,000, from 2,000 to 2,500, and from 2,500 to 3,000).

**[000133]** In one embodiment, the poly-A tail is designed relative to the length of the overall cosmetic polynucleotides, cosmetic primary constructs or cosmetic mmRNA. This design may be based on the length of the coding region, the length of a particular feature or region (such as the first or flanking regions), or based on the length of the ultimate product expressed from the cosmetic polynucleotides, cosmetic primary constructs or cosmetic mmRNA.

[000134] In this context the poly-A tail may be 10, 20, 30, 40, 50, 60, 70, 80, 90, or 100% greater in length than the cosmetic polynucleotides, cosmetic primary constructs or cosmetic mmRNA or feature thereof. The poly-A tail may also be designed as a fraction of cosmetic polynucleotides, cosmetic primary constructs or cosmetic mmRNA to which it belongs. In this context, the poly-A tail may be 10, 20, 30, 40, 50, 60, 70, 80, or 90% or more of the total length of the construct or the total length of the construct minus the poly-A tail. Further, engineered binding sites and conjugation of cosmetic polynucleotides, cosmetic primary constructs or cosmetic mmRNA for Poly-A binding protein may enhance expression.

[000135] Additionally, multiple distinct cosmetic polynucleotides, cosmetic primary constructs or cosmetic mmRNA may be linked together to the PABP (Poly-A binding protein) through the 3'-end using modified nucleotides at the 3'-terminus of the poly-A tail. Transfection experiments can be conducted in relevant cell lines and cosmetic protein production can be assayed by ELISA at 12hr, 24hr, 48hr, 72 hr and day 7 post-transfection.

[000136] In one embodiment, the cosmetic polynucleotide and cosmetic primary constructs of the present invention are designed to include a polyA-G Quartet. The G-quartet is a cyclic hydrogen bonded array of four guanine nucleotides that can be formed by G-rich sequences in both DNA and RNA. In this embodiment, the G-quartet is incorporated at the end of the poly-A tail. The resultant cosmetic mmRNA construct is assayed for stability, protein production and other parameters including half-life at various time points. It has been discovered that the polyA-G quartet results in protein production equivalent to at least 75% of that seen using a poly-A tail of 120 nucleotides alone.

#### Quantification

[000137] In one embodiment, the cosmetic polynucleotides, cosmetic primary constructs or cosmetic mmRNA of the present invention may be quantified in exosomes derived from one or more bodily fluid. As used herein "bodily fluids" include peripheral blood, serum, plasma, ascites, urine, cerebrospinal fluid (CSF), sputum, saliva, bone marrow, synovial fluid, aqueous humor, amniotic fluid, cerumen, breast milk, bronchoalveolar lavage fluid, semen, prostatic fluid, cowper's fluid or pre-ejaculatory

fluid, sweat, fecal matter, hair, tears, cyst fluid, pleural and peritoneal fluid, pericardial fluid, lymph, chyme, chyle, bile, interstitial fluid, menses, pus, sebum, vomit, vaginal secretions, mucosal secretion, stool water, pancreatic juice, lavage fluids from sinus cavities, bronchopulmonary aspirates, blastocyl cavity fluid, and umbilical cord blood. Alternatively, exosomes may be retrieved from an organ selected from the group consisting of lung, heart, pancreas, stomach, intestine, bladder, kidney, ovary, testis, skin, colon, breast, prostate, brain, esophagus, liver, and placenta.

[000138] In the quantification method, a sample of not more than 2mL is obtained from the subject and the exosomes isolated by size exclusion chromatography, density gradient centrifugation, differential centrifugation, nanomembrane ultrafiltration, immunoabsorbent capture, affinity purification, microfluidic separation, or combinations thereof. In the analysis, the level or concentration of a cosmetic polynucleotide, cosmetic primary construct or cosmetic mmRNA may be an expression level, presence, absence, truncation or alteration of the administered construct. It is advantageous to correlate the level with one or more clinical phenotypes or with an assay for a human disease biomarker. The assay may be performed using construct specific probes, cytometry, qRT-PCR, real-time PCR, PCR, flow cytometry, electrophoresis, mass spectrometry, or combinations thereof while the exosomes may be isolated using immunohistochemical methods such as enzyme linked immunosorbent assay (ELISA) methods. Exosomes may also be isolated by size exclusion chromatography, density gradient centrifugation, differential centrifugation, nanomembrane ultrafiltration, immunoabsorbent capture, affinity purification, microfluidic separation, or combinations thereof.

[000139] These methods afford the investigator the ability to monitor, in real time, the level of cosmetic polynucleotides, cosmetic primary constructs or cosmetic mmRNA remaining or delivered. This is possible because the cosmetic polynucleotides, cosmetic primary constructs or cosmetic mmRNA of the present invention differ from the endogenous forms due to the structural and/or chemical modifications.

## **II. Design and synthesis of mmRNA**

[000140] Cosmetic polynucleotides, cosmetic primary constructs or cosmetic mmRNA for use in accordance with the invention may be prepared according to any available technique including, but not limited to chemical synthesis, enzymatic synthesis, which is

generally termed *in vitro* transcription (IVT) or enzymatic or chemical cleavage of a longer precursor, etc. Methods of synthesizing RNAs are known in the art (see, *e.g.*, Gait, M.J. (ed.) *Oligonucleotide synthesis: a practical approach*, Oxford [Oxfordshire], Washington, DC: IRL Press, 1984; and Herdewijn, P. (ed.) *Oligonucleotide synthesis: methods and applications*, Methods in Molecular Biology, v. 288 (Clifton, N.J.) Totowa, N.J.: Humana Press, 2005; both of which are incorporated herein by reference).

**[000141]** The process of design and synthesis of the cosmetic primary constructs of the invention generally includes the steps of gene construction, mRNA production (either with or without modifications) and purification. In the enzymatic synthesis method, a target cosmetic polynucleotide sequence encoding the cosmetic polypeptide of interest is first selected for incorporation into a vector which will be amplified to produce a cDNA template. Optionally, the target cosmetic polynucleotide sequence and/or any flanking sequences may be codon optimized. The cDNA template is then used to produce mRNA through *in vitro* transcription (IVT). After production, the mRNA may undergo purification and clean-up processes. The steps of which are provided in more detail below.

#### Gene Construction

**[000142]** The step of gene construction may include, but is not limited to gene synthesis, vector amplification, plasmid purification, plasmid linearization and clean-up, and cDNA template synthesis and clean-up.

#### Gene Synthesis

**[000143]** Once a cosmetic polypeptide of interest, or target, is selected for production, a cosmetic primary construct is designed. Within the cosmetic primary construct, a first region of linked nucleosides encoding the polypeptide of interest may be constructed using an open reading frame (ORF) of a selected nucleic acid (DNA or RNA) transcript. The ORF may comprise the wild type ORF, an isoform, variant or a fragment thereof. As used herein, an "open reading frame" or "ORF" is meant to refer to a nucleic acid sequence (DNA or RNA) which is capable of encoding a cosmetic polypeptide of interest. ORFs often begin with the start codon, ATG and end with a nonsense or termination codon or signal.

[000144] Further, the nucleotide sequence of the first region may be codon optimized. Codon optimization methods are known in the art and may be useful in efforts to achieve one or more of several goals. These goals include to match codon frequencies in target and host organisms to ensure proper folding, bias GC content to increase mRNA stability or reduce secondary structures, minimize tandem repeat codons or base runs that may impair gene construction or expression, customize transcriptional and translational control regions, insert or remove protein trafficking sequences, remove/add post translation modification sites in encoded protein (e.g. glycosylation sites), add, remove or shuffle protein domains, insert or delete restriction sites, modify ribosome binding sites and mRNA degradation sites, to adjust translational rates to allow the various domains of the protein to fold properly, or to reduce or eliminate problem secondary structures within the mRNA. Codon optimization tools, algorithms and services are known in the art, non-limiting examples include services from GeneArt (Life Technologies), DNA2.0 (Menlo Park CA) and/or proprietary methods. In one embodiment, the ORF sequence is optimized using optimization algorithms. Codon options for each amino acid are given in Table 1.

**Table 1. Codon Options**

Amino Acid	Single Letter Code	Codon Options
Isoleucine	I	ATT, ATC, ATA
Leucine	L	CTT, CTC, CTA, CTG, TTA, TTG
Valine	V	GTT, GTC, GTA, GTG
Phenylalanine	F	TTT, TTC
Methionine	M	ATG
Cysteine	C	TGT, TGC
Alanine	A	GCT, GCC, GCA, GCG
Glycine	G	GGT, GGC, GGA, GGG
Proline	P	CCT, CCC, CCA, CCG
Threonine	T	ACT, ACC, ACA, ACG
Serine	S	TCT, TCC, TCA, TCG, AGT, AGC
Tyrosine	Y	TAT, TAC
Tryptophan	W	TGG
Glutamine	Q	CAA, CAG
Asparagine	N	AAT, AAC
Histidine	H	CAT, CAC
Glutamic acid	E	GAA, GAG
Aspartic acid	D	GAT, GAC
Lysine	K	AAA, AAG
Arginine	R	CGT, CGC, CGA, CGG, AGA, AGG
Selenocysteine	Sec	UGA in mRNA in presence of Selenocystein



		insertion element (SECIS)
Stop codons	Stop	TAA, TAG, TGA

[000145] Features, which may be considered beneficial in some embodiments of the present invention, may be encoded by the cosmetic primary construct and may flank the ORF as a first or second flanking region. The flanking regions may be incorporated into the cosmetic primary construct before and/or after optimization of the ORF. It is not required that a cosmetic primary construct contain both a 5' and 3' flanking region.

Examples of such features include, but are not limited to, untranslated regions (UTRs), Kozak sequences, an oligo(dT) sequence, and detectable tags and may include multiple cloning sites which may have XbaI recognition.

[000146] In some embodiments, a 5' UTR and/or a 3' UTR may be provided as flanking regions. Multiple 5' or 3' UTRs may be included in the flanking regions and may be the same or of different sequences. Any portion of the flanking regions, including none, may be codon optimized and any may independently contain one or more different structural or chemical modifications, before and/or after codon optimization. Combinations of features may be included in the first and second flanking regions and may be contained within other features. For example, the ORF may be flanked by a 5' UTR which may contain a strong Kozak translational initiation signal and/or a 3' UTR which may include an oligo(dT) sequence for templated addition of a poly-A tail. 5' UTR may comprise a first polynucleotide fragment and a second polynucleotide fragment from the same and/or different genes such as the 5'UTRs described in US Patent Application Publication No. 20100293625, herein incorporated by reference in its entirety.

[000147] Tables 2 and 3 provide a listing of exemplary UTRs which may be utilized in the cosmetic primary construct of the present invention as flanking regions. Shown in Table 2 is a listing of a 5'-untranslated region of the invention. Variants of 5' UTRs may be utilized wherein one or more nucleotides are added or removed to the termini, including A, T, C or G.

**Table 2. 5'-Untranslated Regions**

5' UTR Identifier	Name/Description	Sequence	SEQ ID NO.
5UTR-001	Upstream UTR	GGGAAATAAGAGAGAAAAGAAGAGTAA	1

		GAAGAAATATAAGAGCCACC	
5UTR-002	Upstream UTR	GGGAGATCAGAGAGAAAAGAAGAGTAA GAAGAAATATAAGAGCCACC	2
5UTR-003	Upstream UTR	GGAATAAAAAGTCTCAACACAACATATAC AAAACAAACGAATCTCAAGCAATCAAG CATTCTACTTCTATTGCAGCAATTTAAAT CATTCTTTTAAAGCAAAGCAATTTTCT GAAAATTTTCACCATTACGAACGATAG CAAC	3
5UTR-004	Upstream UTR	GGGAGACAAGCUUGGCAUUCGGUACU GUUGGUAAGCCACC	4

[000148] Shown in Table 3 is a representative listing of 3'-untranslated regions of the invention. Variants of 3' UTRs may be utilized wherein one or more nucleotides are added or removed to the termini, including A, T, C or G.

**Table 3. 3'-Untranslated Regions**

3' UTR Identifier	Name/Description	Sequence	SEQ ID NO.
3UTR-001	Creatine Kinase	GCGCCTGCCACCTGCCACCGACTGCTGG AACCCAGCCAGTGGGAGGGCCTGGCCCA CCAGAGTCCTGCTCCCTCACTCCTCGCCC CGCCCCCTGTCCCAGAGTCCCACCTGGGG GCTCTCTCCACCCTTCTCAGAGTTCAGT TTCAACCAGAGTCCAACCAATGGGCTCC ATCCTCTGGATTCTGGCCAATGAAATATC TCCCTGGCAGGGTCCTCTTCTTTCCAG AGCTCCACCCCAACCAGGAGCTCTAGTTA ATGGAGAGCTCCCAGCACACTCGGAGCT TGTGCTTTGTCTCCACGCAAAGCGATAAA TAAAAGCATTGGTGGCCTTTGGTCTTTGA ATAAAGCCTGAGTAGGAAGTCTAGA	5
3UTR-002	Myoglobin	GCCCCCTGCCGCTCCCACCCCAACCCATCT GGGCCCCGGGTTCAAGAGAGAGCGGGGT CTGATCTCGTGTAGCCATATAGAGTTTGC TTCTGAGTGTCTGCTTTGTTTAGTAGAGG TGGGCAGGAGGAGCTGAGGGGCTGGGGC TGGGGTGTGAAGTTGGCTTTGCATGCC AGCGATGCGCCTCCCTGTGGGATGTCATC ACCCTGGGAACCGGGAGTGGCCCTTGGC TCACTGTGTTCTGCATGGTTTGGATCTGA ATTAATTGTCCTTTCTTCTAAATCCCAACC GAACTTCTTCCAACCTCCAAACTGGCTGT AACCCCAAATCCAAGCCATTA ACTACACC TGACAGTAGCAATTGTCTGATTAATCACT GGCCCCTTGAAGACAGCAGAATGTCCCTT	6

		TGCAATGAGGAGGAGATCTGGGCTGGGC GGGCCAGCTGGGGAAGCATTGACTATCT GGAACCTGTGTGTGCCTCCTCAGGTATGG CAGTGACTIONACCTGGTTTTAATAAAACAA CCTGCAACATCTCATGGTCTTTGAATAAA GCCTGAGTAGGAAGTCTAGA	
3UTR-003	$\alpha$ -actin	ACACACTCCACCTCCAGCACGCGACTTCT CAGGACGACGAATCTTCTCAATGGGGGG GCGGCTGAGCTCCAGCCACCCCGCAGTC ACTTCTTTGTAACAACCTCCGTTGCTGCC ATCGTAAACTGACACAGTGTTTATAACGT GTACATACTAATACTTATTACCTCATTTT GTTATTTTTTCGAAACAAAGCCCTGTGGAA GAAAATGGAAAACCTGAAGAAGCATTA AGTCATTCTGTTAAGCTGCGTAAATGGTC TTTGAATAAAGCCTGAGTAGGAAGTCTA GA	7
3UTR-004	Albumin	CATCACATTTAAAAGCATCTCAGCCTACC ATGAGAATAAGAGAAAGAAAATGAAGAT CAAAGCTTATTCATCTGTTTTTCTTTTTC GTTGGTGTAAGCCAACACCCTGTCTAAA AAACATAAATTTCTTTAATCATTTTGCCT CTTTCTCTGTGCTTCAATTAATAAAAAA TGGAAGAATCTAATAGAGTGGTACAGC ACTGTTATTTTTCAAAGATGTGTTGCTAT CCTGAAAATTCTGTAGGTTCTGTGGAAGT TCCAGTGTCTCTCTTATTCCACTTCGGTA GAGGATTTCTAGTTTCTTGTGGGCTAATT AAATAAATCATTAATACTCTTCTAATGGT CTTTGAATAAAGCCTGAGTAGGAAGTCTA GA	8
3UTR-005	$\alpha$ -globin	GCTGCCTTCTGCGGGGCTTGCCTTCTGGC CATGCCCTTCTTCTCCTTGCACCTGTA CCTCTGGTCTTTGAATAAAGCCTGAGTA GGAAGGCGGCCGCTCGAGCATGCATCTA GA	9
3UTR-006	G-CSF	GCCAAGCCCTCCCCATCCCATGTATTTAT CTCTATTTAATATTTATGTCTATTTAAGCC TCATATTTAAAGACAGGGAAGAGCAGAA CGGAGCCCCAGGCCTCTGTGTCCTTCCCT GCATTTCTGAGTTTCATTCTCCTGCCTGTA GCAGTGAGAAAAGCTCCTGTCTCCTCCAT CCCCTGGACTGGGAGGTAGATAGGTAAA TACCAAGTATTTATTACTATGACTGCTCC CCAGCCCTGGCTCTGCAATGGGCACTGGG ATGAGCCGCTGTGAGCCCCTGGTCCTGAG GGTCCCCACCTGGGACCCTTGAGAGTATC AGGTCTCCACGTGGGAGACAAGAAATC CCTGTTAATATTTAAACAGCAGTGTTC CCATCTGGGTCTTGCACCCCTCACTCTG	10

		<p>GCCTCAGCCGACTGCACAGCGGCCCTGC                  ATCCCCTTGGCTGTGAGGCCCTGGACAA                  GCAGAGGTGGCCAGAGCTGGGAGGCATG                  GCCCTGGGGTCCCACGAATTTGCTGGGA                  ATCTCGTTTTTCTTCTTAAGACTTTTGGGA                  CATGGTTTGACTCCCGAACATCACCGACG                  CGTCTCCTGTTTTTCTGGGTGGCCTCGGG                  ACACCTGCCCTGCCCCACGAGGGTCAG                  GACTGTGACTCTTTTTAGGGCCAGGCAGG                  TGCCTGGACATTTGCCTTGTGGACGGGG                  ACTGGGGATGTGGGAGGGAGCAGACAGG                  AGGAATCATGTCAGGCCTGTGTGTGAAA                  GGAAGCTCCACTGTCACCCTCCACCTCTT                  CACCCCCACTCACAGTGTCCCCTCCAC                  TGTCACATTGTAAGTAACTTCAGGATAA                  TAAAGTGTGGCTCCATGGTCTTTGAAT                  AAAGCCTGAGTAGGAAGGCGGCCGCTCG                  AGCATGCATCTAGA</p>	
3UTR-007	Colla2; collagen, type I, alpha 2	<p>ACTCAATCTAAATTAAGAAAGAAAGAAA                  TTTGAAAAACTTTCTCTTTGCCATTTCTT                  CTTCTTCTTTTTTAAGTAAAGCTGAATCC                  TTCCATTTCTTCTGCACATCTACTTGCTTA                  AATTGTGGGCAAAAGAGAAAAAGAAGGA                  TTGATCAGAGCATTGTGCAATACAGTTTC                  ATTAACCTTCCCCCGCTCCCCAAAAA                  TTTGAATTTTTTTTTCAACACTCTTACACC                  TGTTATGGAAAATGTCAACCTTTGTAAGA                  AAACCAAAATAAAAATTGAAAAATAAAA                  ACCATAAACATTTGCACCACTTGTGGCTT                  TTGAATATCTTCCACAGAGGGAAGTTTAA                  AACCCAACTTCCAAAGGTTTAACTACC                  TCAAAACACTTTCCCATGAGTGTGATCCA                  CATTGTTAGGTGCTGACCTAGACAGAGAT                  GAACTGAGGTCCTTGTGTTTGTGTTTCAT                  AATACAAAGGTGCTAATTAATAGTATTTT                  AGATACTTGAAGAATGTTGATGGTGCTAG                  AAGAATTTGAGAAGAAATACTCCTGTATT                  GAGTTGTATCGTGTGGTGTATTTTTTAAA                  AAATTTGATTTAGCATTTCATTTTTCCATC                  TTATTCCCAATTAAGTATGCAGATTAT                  TTGCCCAAATCTTCTTCAGATTCAGCATT                  TGTTCTTTGCCAGTCTCATTTTCATCTTCT                  TCCATGGTTCCACAGAAGCTTTGTTTCTT                  GGGCAAGCAGAAAAATTAATTTGTACCT                  ATTTTGTATATGTGAGATGTTTAAATAAA                  TTGTGAAAAAATGAAATAAAGCATGTT                  TGGTTTTCCAAAAGAACATAT</p>	11
3UTR-008	Col6a2; collagen, type VI, alpha 2	<p>CGCCGCCGCCCAGGGCCCCGCAGTCGAGG                  GTCGTGAGCCCACCCCGTCCATGGTGCTA                  AGCGGGCCCAGGTCCCACACGGCCAGCA                  CCGCTGCTCACTCGGACGACGCCCTGGGC</p>	12

		<p>CTGCACCTCTCCAGCTCCTCCCACGGGGT                  CCCCCTAGCCCCGGCCCCCGCCCAGCCCC                  AGGTCTCCCCAGGCCCTCCGCAGGCTGCC                  CGGCCTCCCTCCCCCTGCAGCCATCCCAA                  GGCTCCTGACCTACCTGGCCCCCTGAGCTC                  TGGAGCAAGCCCTGACCCAATAAAGGCT                  TTGAACCCAT</p>	
3UTR-009	RPN1; ribophorin I	<p>GGGGCTAGAGCCCTCTCCGCACAGCGTG                  GAGACGGGGCAAGGAGGGGGGTTATTAG                  GATTGGTGGTTTTGTTTTGCTTTGTTTAAA                  GCCGTGGGAAAATGGCACAACCTTTACCTC                  TGTGGGAGATGCAACACTGAGAGCCAAG                  GGGTGGGAGTTGGGATAATTTTTATATAA                  AAGAAGTTTTTCCACTTTGAATTGCTAAA                  AGTGGCATTTTTTCTATGTGCAGTCACTC                  CTCTCATTTCTAAAATAGGGACGTGGCCA                  GGCACGGTGGCTCATGCCTGTAATCCCAG                  CACTTTGGGAGGCCGAGGCAGGCGGCTC                  ACGAGGTCAGGAGATCGAGACTATCCTG                  GCTAACACGGTAAAACCCCTGTCTCTACTA                  AAAGTACAAAAAATTAGCTGGGCGTGGT                  GGTGGGCACCTGTAGTCCCAGCTACTCGG                  GAGGCTGAGGCAGGAGAAAGGCATGAAT                  CCAAGAGGCAGAGCTTGCAGTGAGCTGA                  GATCACGCCATTGCACTCCAGCCTGGGCA                  ACAGTGTTAAGACTCTGTCTCAAATATAA                  ATAAATAAATAAATAAATAAATAAATAA                  ATAAAAATAAAGCGAGATGTTGCCCTCA                  AA</p>	13
3UTR-010	LRP1; low density lipoprotein receptor-related protein 1	<p>GGCCCTGCCCCGTCGGACTGCCCCCAGAA                  AGCCTCCTGCCCCCTGCCAGTGAAGTCCT                  TCAGTGAGCCCCCTCCCCAGCCAGCCCTTC                  CCTGGCCCCGCCGATGTATAAATGTA                  AATGAAGGAATTACATTTTATATGTGAGC                  GAGCAAGCCGGCAAGCGAGCACAGTATT                  ATTTCTCCATCCCCTCCCTGCCTGCTCCTT                  GGCACCCCCATGCTGCCTTCAGGGAGAC                  AGGCAGGGAGGGCTTGGGGCTGCACCTC                  CTACCCTCCCACCAGAACGCACCCCACTG                  GGAGAGCTGGTGGTGCAGCCTTCCCCTCC                  CTGTATAAGACACTTTGCCAAGGCTCTCC                  CCTCTCGCCCCATCCCTGCTTGCCCCGCTC                  CCACAGCTTCTGAGGGCTAATTCTGGGA                  AGGGAGAGTTCTTTGCTGCCCCCTGTCTGG                  AAGACGTGGCTCTGGGTGAGGTAGGCGG                  GAAAGGATGGAGTGTTTTAGTTCTTGGGG                  GAGGCCACCCCAAACCCAGCCCCAACT                  CCAGGGGCACCTATGAGATGGCCATGCT                  CAACCCCCCTCCCAGACAGGCCCTCCCTG                  TCTCCAGGGCCCCACCGAGGTTCCCAGG                  GCTGGAGACTTCTCTGGTAAACATTCT</p>	14

		<p>CCAGCCTCCCCTCCCCTGGGGACGCCAAG  GAGGTGGGCCACACCCAGGAAGGGAAAG  CGGGCAGCCCCGTTTTGGGGACGTGAAC  GTTTTAATAATTTTTGCTGAATTCCTTTAC  AACTAAATAACACAGATATTGTTATAAAT  AAAATTGT</p>	
<p>3UTR-01 1</p>	<p>Nntl;  cardiotrophin-  like cytokine  factor 1</p>	<p>ATATTAAGGATCAAGCTGTTAGCTAATAA  TGCCACCTCTGCAGTTTTGGGAACAGGCA  AATAAAGTATCAGTATACATGGTGATGTA  CATCTGTAGCAAAGCTCTTGGAGAAAAT  GAAGACTGAAGAAAGCAAAGCAAAAAC  GTATAGAGAGATTTTTCAAAGCAGTAAT  CCCTCAATTTTAAAAAAGGATTGAAAATT  CTAAATGTCTTTCTGTGCATATTTTTGTG  TTAGGAATCAAAGTATTTTATAAAAGG  AGAAAGAACAGCCTCATTTTAGATGTAGT  CCTGTTGGATTTTTTATGCCTCCTCAGTAA  CCAGAAATGTTTTAAAAAACTAAGTGTTT  AGGATTTCAAGACAACATTATACATGGCT  CTGAAATATCTGACACAATGTAAACATTG  CAGGCACCTGCATTTTATGTTTTTTTTTC  AACAAATGTGACTAATTTGAAACTTTTAT  GAACTTCTGAGCTGTCCCCTTGCAATICA  ACCGCAGTTTGAATTAATCATATCAAATC  AGTTTTAATTTTTTAAATTGACTTCAGA  GTCTATATTTCAAGGGCACATTTTCTCAC  TACTATTTAATACATTAAAGGACTAAAT  AATCTTTCAGAGATGCTGGAAACAAATC  ATTTGCTTTATATGTTTCATTAGAATACC  AATGAAACATACAACTTGAAAATTAGTA  ATAGTATTTTTGAAGATCCCATTTCTAAT  TGGAGATCTCTTAAATTTGATCAACTTA  TAATGTGTAGTACTATATTAAGTGCACCT  GAGTGGAATTCAACATTTGACTAATAAA  ATGAGTTCATCATGTTGGCAAGTGATGTG  GCAATTATCTCTGGTGACAAAAGAGTAA  AATCAAATATTTCTGCCTGTTACAAATAT  CAAGGAAGACCTGCTACTATGAAATAGA  TGACATTAATCTGTCTTCACTGTTTATAAT  ACGGATGGATTTTTTTTTCAAATCAGTGTG  TGTTTTGAGGTCTTATGTAATTGATGACA  TTTGAGAGAAATGGTGGCTTTTTTTAGCT  ACCTCTTTGTTCATTTAAGCACCAGTAAA  GATCATGTCTTTTTATAGAAGTGATAGATT  TTCTTTGTGACTTTGCTATCGTGCCTAAA  GCTCTAAATATAGGTGAATGTGTGATGAA  TACTCAGATTATTTGTCTCTCTATATAATT  AGTTTGGTACTAAGTTTCTCAAAAAATTA  TTAACACATGAAAGACAATCTCTAAACC  AGAAAAAGAAGTAGTACAAATTTTGTTA  CTGTAATGCTCGCGTTTAGTGAGTTTAAA</p>	<p>15</p>

		<p>ACACACAGTATCTTTTGGTTTTATAATCA          GTTICTATTTTGCTGTGCCTGAGATTAAG          ATCTGTGTATGTGTGTGTGTGTGTGTG          CGTTTGTGTGTTAAAGCAGAAAAGACTTT          TTTAAAAGTTTTAAGTGATAAATGCAATT          TGTTAATTGATCTTAGATCACTAGTAAAC          TCAGGGCTGAATTATACCATGTATATTCT          ATTAGAAGAAAGTAAACACCATCTTTATT          CCTGCCCTTTTTCTTCTCTCAAAGTAGTTG          TAGTTATATCTAGAAAAGAAGCAATTTTGA          TTTCTTGAAAAGGTAGTTCCTGCACTCAG          TTTAAACTAAAAATAATCATACTTGGATT          TTATTTATTTTTGTCATAGTAAAAATTTTA          ATTTATATATATTTTTATTTAGTATTATCT          TATTCCTTGCTATTTGCCAATCCTTTGTCA          TCAATTGTGTTAAATGAATTGAAAATTCA          TGCCCTGTTCATTTTATTTACTTTATTGG          TTAGGATATTTAAAGGATTTTTGTATATA          TAATTTCTTAAATTAATATTCCAAAAGGT          TAGTGGACTTAGATTATAAATTATGGCAA          AAATCTAAAAACAACAAAATGATTTTT          ATACATTCTATTTCAATTTCCTCTTTTTTC          CAATAAGTCATACAATTGGTAGATATGAC          TTATTTTATTTTTGTATTATTCACTATATC          TTTATGATATTTAAGTATAAATAATTA          AAAATTTATTGTACCTTATAGTCTGTCAC          CAAAAAAAAAAAAATTATCTGTAGGTAGT          GAAATGCTAATGTTGATTTGTCTTTAAGG          GCTTGTTAACTATCCTTTATTTTCTCATTT          GTCTTAAATTAGGAGTTTGTGTTTAAATT          ACTCATCTAAGCAAAAAATGTATATAAAT          CCCATTACTGGGTATATACCCAAAGGATT          ATAAATCATGCTGCTATAAAGACACATGC          ACACGTATGTTTATTGCAGCACTATTCAC          AATAGCAAAGACTTGGAACCAACCCAAA          TGTCATCAATGATAGACTTGATTAAGAA          AATGTGCACATATACCCATGGAATACTA          TGCAGCCATAAAAAAGGATGAGTTCATG          TCCTTTGTAGGGACATGGATAAAGCTGGA          AACCATCATTCTGAGCAAACCTATTGCAAG          GACAGAAAACCAACACTGCATGTTCTC          ACTCATAGGTGGGAATTGAACAATGAGA          ACACTTGGACACAAGGTGGGGAACACCA          CACACCAGGGCCTGTCATGGGGTGGGGG          GAGTGGGGAGGGATAGCATTAGGAGATA          TACCTAATGTAAATGATGAGTTAATGGGT          GCAGCACACCAACATGGCACATGTATAC          ATATGTAGCAAACCTGCACGTTGTGCACA          TGTACCCTAGAACCTTAAAGTATAATTA          AAAAAAAAAAGAAAACAGAAGCTATTTATA          AAGAAGTTATTTGCTGAAATAAATGTGAT</p>	
--	--	--	--

		<p>CTTTCCCATTAATAAAAAATAAAGAAATTTT                  GGGGTAAAAAACACAATATATTGTATT                  CTTGAAAAATTCTAAGAGAGTGGATGTG                  AAGTGTTCACCACAAAAGTGATAACTA                  ATTGAGGTAATGCACATATTAATTAGAAA                  GATTTTGTCAATCCACAATGTATATATAC                  TAAAAAATATGTTATACACAATAAATACA                  TACATTAATAAAAAATAAGTAAATGTA</p>	
3UTR-012	Col6a1; collagen, type VI, alpha 1	<p>CCCACCCTGCACGCCGGCACCAAACCCTG                  TCCTCCCACCCCTCCCCTCATCACTAA                  ACAGAGTAAAATGTGATGCGAATTTTCCC                  GACCAACCTGATTCGCTAGATTTTTTTTA                  AGGAAAAGCTTGGAAAGCCAGGACACAA                  CGCTGCTGCCTGCTTTGTGCAGGGTCCTC                  CGGGGCTCAGCCCTGAGTTGGCATCACCT                  GCGCAGGGCCCTCTGGGGCTCAGCCCTG                  AGCTAGTGTCACCTGCACAGGGCCCTCTG                  AGGCTCAGCCCTGAGCTGGCGTCACCTGT                  GCAGGGCCCTCTGGGGCTCAGCCCTGAG                  CTGGCCTCACCTGGGTTCCCCACCCCGGG                  CTCTCCTGCCCTGCCCTCCTGCCCGCCCTC                  CCTCCTGCCTGCGCAGCTCCTTCCCTAGG                  CACCTCTGTGCTGCATCCCACCAGCCTGA                  GCAAGACGCCCTCTCGGGGCCTGTGCCGC                  ACTAGCCTCCCTCTCCTCTGTCCCATAG                  CTGGTTTTTCCCACCAATCCTCACCTAAC                  AGTFACTTTACAATTAAACTCAAAGCAAG                  CTCTTCTCCTCAGCTTGGGGCAGCCATTG                  GCCTCTGTCTCGTTTTTGGGAAACCAAGGT                  CAGGAGGCCGTTGCAGACATAAATCTCG                  GCGACTCGGCCCCGTCTCCTGAGGGTCCT                  GCTGGTGACCGGCCTGGACCTTGGCCCTA                  CAGCCCTGGAGGCCGCTGCTGACCAGCA                  CTGACCCCGACCTCAGAGAGTACTCGCA                  GGGGCGCTGGCTGCACTCAAGACCCTCG                  AGATTAACGGTGCTAACCCCGTCTGCTCC                  TCCCTCCCGCAGAGACTGGGGCCTGGACT                  GGACATGAGAGCCCCTTGGTGCCACAGA                  GGGCTGTGTCTTACTAGAAACAACGCAA                  ACCCTCCTTCCTCAGAATAGTGATGTGT                  TCGACGTTTTATCAAAGGCCCCCTTTCTA                  TGTTTCATGTTAGTTTTGCTCCTTCTGTGTT                  TTTTCTGAACCATATCCATGTTGCTGACT                  TTTCAAATAAAGGTTTTTCACTCCTCTC</p>	16
3UTR-013	Calr; calreticulin	<p>AGAGGCCTGCCTCCAGGGCTGGACTGAG                  GCCTGAGCGCTCCTGCCGAGAGCTGGCC                  GCGCCAAATAATGTCTCTGTGAGACTCGA                  GAACTTTCATTTTTTCCAGGCTGGTTCCG                  GATTTGGGGTGGATTTTGGTTTTGTCC                  CTCTCCACTCTCCCCACCCCTCCCCG                  CCCTTTTTTTTTTTTTTTTTTAAACTGGTAT</p>	17



		<p>TTTATCTTTGATTCTCCTTCAGCCCTCACC                  CCTGGTTCTCATCTTTCTTGATCAACATCT                  TTTCTTGCCTCTGTCCCCTTCTCTCATCTC                  TTAGCTCCCCTCCAACCTGGGGGGCAGTG                  GTGTGGAGAAGCCACAGGCCTGAGATTT                  CATCTGCTCTCCTTCTGGAGCCAGAGG                  AGGGCAGCAGAAGGGGGTGGTGTCTCCA                  ACCCCCCAGCACTGAGGAAGAACGGGGC                  TCTTCTCATTTACCCCCTCCCTTTCTCCCC                  TGCCCCAGGACTGGGCCACTTCTGGGTG                  GGGCAGTGGGTCCCAGATTGGCTCACACT                  GAGAATGTAAGAACTACAAACAAAATTT                  CTATTAATTAATTTTGTGTCTCC</p>	
<p>3UTR-014</p>	<p>Collal;                  collagen, type                  I, alpha 1</p>	<p>CTCCCTCCATCCCAACCTGGCTCCCTCCC                  ACCCAACCAACTTTCCCCCAACCCGGAA                  ACAGACAAGCAACCCAACTGAACCCCC                  TCAAAAGCCAAAAAATGGGAGACAATTT                  CACATGGACTTTGGAAAATATTTTTTTC                  TTTGCATTATCTCTCAAACCTAGTTTTTA                  TCTTTGACCAACCGAACATGACCAAAAA                  CAAAAGTGCATTCAACCTTACCAAAAA                  AAAAAAAAAAAAAAGAATAAATAAATA                  ACTTTTTAAAAAAGGAAGCTTGGTCCACT                  TGCTTGAAGACCCATGCGGGGGTAAGTC                  CCTTTCTGCCCGTTGGGCTTATGAAACCC                  CAATGCTGCCCTTTCTGCTCCTTTCTCCAC                  ACCCCCCTGGGGCCTCCCCTCCACTCCT                  TCCCAAATCTGTCTCCCAGAACACAG                  GAAACAATGTATTGTCTGCCAGCAATCA                  AAGGCAATGCTCAAACACCCAAGTGGCC                  CCCACCCTCAGCCCGCTCCTGCCCGCCA                  GCACCCCAGGCCCTGGGGGACCTGGGG                  TTCTCAGACTGCCAAAGAAGCCTTGCCAT                  CTGGCGCTCCCATGGCTCTTGCAACATCT                  CCCCTTCGTTTTTGAGGGGGTCATGCCGG                  GGGAGCCACCAGCCCCTCACTGGGTTCG                  GAGGAGAGTCAGGAAGGGCCACGACAAA                  GCAGAAACATCGGATTTGGGGAACGCGT                  GTCAATCCCTTGTGCCGCAGGGCTGGGCG                  GGAGAGACTGTTCTGTTCCTTGTGTA                  ACTGTGTTGCTGAAAGACTACCTCGTTCTTGT                  CTTGATGTGTCACCGGGGCAACTGCCTGG                  GGGCGGGGATGGGGCAGGGTGGAAGCG                  GCTCCCCATTTTATACCAAAGGTGCTACA                  TCTATGTGATGGGTGGGGTGGGGAGGGA                  ATCACTGGTGCTATAGAAATTGAGATGCC                  CCCCAGGCCAGCAAATGTTCTTTTTTGT                  TCAAAGTCTATTTTTATTCTTGATATTTT                  TCTTTTTTTTTTTTTTTTTTTTGGGATGGG                  GACTTGTGAATTTTCTAAAGGTGCTATT                  TAACATGGGAGGAGAGCGTGTGCGGCTC</p>	<p>18</p>

		<p>CAGCCCAGCCCGCTGCTCACTTTCCACCC  TCTCTCCACCTGCCTCTGGCTTCTCAGGC  CTCTGCTCTCCGACCTCTCTCCTCTGAAA  CCCTCCTCCACAGCTGCAGCCCATCCTCC  CGGCTCCCTCCTAGTCTGTCCTGCGTCCT  CTGTCCCCGGGTTTCAGAGACAACCTCCC  AAAGCACAAAGCAGTTTTTCCCCCTAGGG  GTGGGAGGAAGCAAAGACTCTGTACCT  ATTTTGTATGTGTATAATAATTTGAGATG  TTTTTAATTATTTTGATTGCTGGAATAAA  GCATGTGGAAATGACCCAAACATAATCC  GCAGTGGCCTCCTAATTCCTTCTTTGGA  GTTGGGGGAGGGGTAGACATGGGGAAGG  GGCTTTGGGGTGATGGGCTTGCCTTCCAT  TCCTGCCCTTTCCTCCCCACTATTCTCTT  CTAGATCCCTCCATAACCCCACTCCCCTT  TCTCTCACCTTCTTATACCGCAAACCTTT  CTACTTCCTCTTTCATTTTCTATTCTTGCA  ATTCCTTGACCTTTTCCAAATCCTCTTC  TCCCCTGCAATACCATAACAGGCAATCCAC  GTGCACAACACACACACACACTCTTCACA  TCTGGGGTTGTCCAAACCTCATACCCACT  CCCCTTCAAGCCCATCCACTCTCCACCCC  CTGGATGCCCTGCACTTGGTGGCGGTGGG  ATGCTCATGGATACTGGGAGGGTGAGGG  GAGTGGAACCCGTGAGGAGGACCTGGGG  GCCTCTCCTTGAAGTACATGAAGGGTCA  TCTGGCCTCTGCTCCCTTCTCACCCACGCT  GACCTCCTGCCGAAGGAGCAACGCAACA  GGAGAGGGGTCTGCTGAGCCTGGCGAGG  GTCTGGGAGGGACCAGGAGGAAGGCGTG  CTCCCTGCTCGCTGTCCTGGCCCTGGGGG  AGTGAGGGAGACAGACACCTGGGAGAGC  TGTGGGGAAGGCACTCGCACCGTGCTCTT  GGGAAGGAAGGAGACCTGGCCCTGCTCA  CCACGACTGGGTGCCTCGACCTCCTGAA  TCCCCAGAACAACAACCCCCCTGGGCTGG  GGTGGTCTGGGGAACCATCGTGCCCCCGC  CTCCCGCTACTCCTTTTTTAAGCTT</p>	
<p>3UTR-015</p>	<p>Plodl;  procollagen-  lysine, 2-  oxoglutarate 5-  dioxygenase 1</p>	<p>TTGGCCAGGCCTGACCCTCTTGGACCTTT  CTTCTTTGCCGACAACCACTGCCAGCAG  CCTCTGGGACCTCGGGTCCCAGGGAAC  CCAGTCCAGCCTCCTGGCTGTTGACTTCC  CATTGCTCTTGGAGCCACCAATCAAAGAG  ATTCAAAGAGATTCTGCAGGCCAGAGG  CGGAACACACCTTTATGGCTGGGGCTCTC  CGTGGTGTCTGGACCCAGCCCCTGGAGA  CACCATTCACTTTTACTGCTTTGTAGTGA  CTCGTGCTCTCCAACCTGTCTTCTGAAA  AACCAAGGCCCCCTTCCCCACCTCTTCC  ATGGGGTGAGACTTGAGCAGAACAGGGG</p>	<p>19</p>

		<p>CTTCCCAAGTTGCCAGAAAGACTGTCT  GGGTGAGAAGCCATGGCCAGAGCTTCTC  CCAGGCACAGGTGTTGCACCAGGGACTT  CTGCTTCAAGTTTTGGGGTAAAGACACCT  GGATCAGACTCCAAGGGCTGCCCTGAGT  CTGGGACTTCTGCCTCCATGGCTGGTCAT  GAGAGCAAACCGTAGTCCCCTGGAGACA  GCGACTCCAGAGAACCTCTTGGGAGACA  GAAGAGGCATCTGTGCACAGCTCGATCTT  CTACTTGCCTGTGGGGAGGGGAGTGACA  GGTCCACACACCACACTGGGTACCCTGT  CCTGGATGCCTCTGAAGAGAGGGACAGA  CCGTCAGAACTGGAGAGTTTCTATTA  GGTCATTTAAACCA</p>	
3UTR-016	Nucbl; nucleobindin 1	<p>TCCTCCGGACCCCAGCCCTCAGGATTCC  TGATGCTCCAAGGCGACTGATGGGCGCT  GGATGAAGTGGCACAGTCAGCTTCCCTG  GGGGCTGGTGTGTCATGTTGGGCTCCTGGGG  CGGGGGCACGGCCTGGCATTTCACGCATT  GCTGCCACCCCAGGTCCACCTGTCTCCAC  TTTCACAGCCTCCAAGTCTGTGGCTCTTC  CCTTCTGTCTCCGAGGGGCTTGCCTTCT  CTCGTGTCCAGTGAGGTGCTCAGTGATCG  GCTTAACTTAGAGAAGCCCGCCCCCTCCC  CTTCTCCGTCTGTCCCAAGAGGGTCTGCT  CTGAGCCTGCGTTCCTAGGTGGCTCGGCC  TCAGCTGCCTGGGTTGTGGCCGCCCTAGC  ATCCTGTATGCCACAGCTACTGGAATCC  CCGCTGCTGCTCCGGGCCAAGCTTCTGGT  TGATTAATGAGGGCATGGGGTGGTCCCTC  AAGACCTTCCCCTACCTTTTGTGGAACCA  GTGATGCCTCAAAGACAGTGTCCCCTCCA  CAGCTGGGTGCCAGGGGCAGGGGATCCT  CAGTATAGCCGGTGAACCCTGATACCAG  GAGCCTGGGCCTCCCTGAACCCCTGGCTT  CCAGCCATCTCATCGCCAGCCTCCTCCTG  GACCTCTTGGCCCCCAGCCCCTTCCCCAC  ACAGCCCCAGAAGGGTCCCAGAGCTGAC  CCCCTCCAGGACCTAGGCCAGCCCCTC  AGCCTCATCTGGAGCCCCTGAAGACCAGT  CCCACCCACCTTCTGGCCTCATCTGACA  CTGCTCCGCATCCTGCTGTGTGTCCTGTTC  CATGTTCCGGTTCCATCCAATACTTT  CTGGAACAAA</p>	20
3UTR-017	a-globin	<p>GCTGGAGCCTCGGTGGCCATGCTTCTTGC  CCCTTGGGCCTCCCCCAGCCCCTCCTCC  CCTTCTGCACCCGTACCCCGTGGTCTT  TGAATAAAGTCTGAGTGGGCGGC</p>	21

**[000149]** It should be understood that those listed in the previous tables are examples and that any UTR from any gene may be incorporated into the respective first or second flanking region of the primary construct. Furthermore, multiple wild-type UTRs of any known gene may be utilized. It is also within the scope of the present invention to provide artificial UTRs which are not variants of wild type genes. These UTRs or portions thereof may be placed in the same orientation as in the transcript from which they were selected or may be altered in orientation or location. Hence a 5' or 3' UTR may be inverted, shortened, lengthened, made chimeric with one or more other 5' UTRs or 3' UTRs. As used herein, the term "altered" as it relates to a UTR sequence, means that the UTR has been changed in some way in relation to a reference sequence. For example, a 3' or 5' UTR may be altered relative to a wild type or native UTR by the change in orientation or location as taught above or may be altered by the inclusion of additional nucleotides, deletion of nucleotides, swapping or transposition of nucleotides. Any of these changes producing an "altered" UTR (whether 3' or 5') comprise a variant UTR.

**[000150]** In one embodiment, a double, triple or quadruple UTR such as a 5' or 3' UTR may be used. As used herein, a "double" UTR is one in which two copies of the same UTR are encoded either in series or substantially in series. For example, a double beta-globin 3' UTR may be used as described in US Patent publication 20100129877, the contents of which are incorporated herein by reference in its entirety.

**[000151]** It is also within the scope of the present invention to have patterned UTRs. As used herein "patterned UTRs" are those UTRs which reflect a repeating or alternating pattern, such as ABABAB or AABBAABBAABB or ABCABCABC or variants thereof repeated once, twice, or more than 3 times. In these patterns, each letter, A, B, or C represent a different UTR at the nucleotide level.

**[000152]** In one embodiment, flanking regions are selected from a family of transcripts whose proteins share a common function, structure, feature of property. For example, cosmetic polypeptides of interest may belong to a family of proteins which are expressed in a particular cell, tissue or at some time during development. The UTRs from any of these genes may be swapped for any other UTR of the same or different family of proteins to create a new chimeric primary transcript. As used herein, a "family of proteins" is used in the broadest sense to refer to a group of two or more cosmetic

polypeptides of interest which share at least one function, structure, feature, localization, origin, or expression pattern.

[000153] After optimization (if desired), the cosmetic primary construct components are reconstituted and transformed into a vector such as, but not limited to, plasmids, viruses, cosmids, and artificial chromosomes. For example, the optimized construct may be reconstituted and transformed into chemically competent *E. coli*, yeast, neurospora, maize, drosophila, etc. where high copy plasmid-like or chromosome structures occur by methods described herein.

[000154] The untranslated region may also include translation enhancer elements (TEE). As a non-limiting example, the TEE may include those described in US Application No. 20090226470, herein incorporated by reference in its entirety, and those known in the art.

#### *Stop Codons*

[000155] In one embodiment, the cosmetic primary constructs of the present invention may include at least two stop codons before the 3' untranslated region (UTR). The stop codon may be selected from TGA, TAA and TAG. In one embodiment, the cosmetic primary constructs of the present invention include the stop codon TGA and one additional stop codon. In a further embodiment the addition stop codon may be TAA. In another embodiment, the primary constructs of the present invention include three stop codons.

#### *Vector Amplification*

[000156] The vector containing the cosmetic primary construct is then amplified and the plasmid isolated and purified using methods known in the art such as, but not limited to, a maxi prep using the Invitrogen PURELINK™ HiPure Maxiprep Kit (Carlsbad, CA).

#### *Plasmid Linearization*

[000157] The plasmid may then be linearized using methods known in the art such as, but not limited to, the use of restriction enzymes and buffers. The linearization reaction may be purified using methods including, for example Invitrogen's PURELINK™ PCR Micro Kit (Carlsbad, CA), and HPLC based purification methods such as, but not limited to, strong anion exchange HPLC, weak anion exchange HPLC, reverse phase HPLC (RP-HPLC), and hydrophobic interaction HPLC (HIC-HPLC) and Invitrogen's standard

PURELINK™ PCR Kit (Carlsbad, CA). The purification method may be modified depending on the size of the linearization reaction which was conducted. The linearized plasmid is then used to generate cDNA for in vitro transcription (IVT) reactions.

#### *cDNA Template Synthesis*

[000158] A cDNA template may be synthesized by having a linearized plasmid undergo polymerase chain reaction (PCR). Table 4 is a listing of primers and probes that may be useful in the PCR reactions of the present invention. It should be understood that the listing is not exhaustive and that primer-probe design for any amplification is within the skill of those in the art. Probes may also contain chemically modified bases to increase base-pairing fidelity to the target molecule and base-pairing strength. Such modifications may include 5-methyl-Cytidine, 2, 6-di-amino-purine, 2'-fluoro, phosphoro-thioate, or locked nucleic acids.

**Table 4. Primers and Probes**

Primer/ Probe Identifier	Sequence (5'-3')	Hybridization target	SEQ ID NO.
UFP	TTGGACCCTCGTACAGAAGCTAA TACG	cDNA Template	22
URP	T <sub>x160</sub> CTTCCTACTCAGGCTTTATTC AAAGACCA	cDNA Template	23
GBA1	CCTTGACCTTCTGGAAGCTTC	Acid glucocerebrosidase	24
GBA2	CCAAGCACTGAAACGGATAT	Acid glucocerebrosidase	25
LUC1	GATGAAAAGTGCTCCAAGGA	Luciferase	26
LUC2	AACCGTGATGAAAAGGTACC	Luciferase	27
LUC3	TCATGCAGATTGGAAAGGTC	Luciferase	28
G-CSF1	CTTCTTGGACTGTCCAGAGG	G-CSF	29
G-CSF2	GCAGTCCCTGATACAAGAAC	G-CSF	30
G-CSF3	GATTGAAGGTGGCTCGCTAC	G-CSF	31

\*UFP is universal forward primer; URP is universal reverse primer.

[000159] In one embodiment, the cDNA may be submitted for sequencing analysis before undergoing transcription.

#### *mRNA Production*

[000160] The process of mRNA or mmRNA production may include, but is not limited to, *in vitro* transcription, cDNA template removal and RNA clean-up, and mRNA capping and/or tailing reactions.

#### *In Vitro Transcription*

[000161] The cDNA produced in the previous step may be transcribed using an *in vitro* transcription (IVT) system. The system typically comprises a transcription buffer, nucleotide triphosphates (NTPs), an RNase inhibitor and a polymerase. The NTPs may be manufactured in house, may be selected from a supplier, or may be synthesized as described herein. The NTPs may be selected from, but are not limited to, those described herein including natural and unnatural (modified) NTPs. The polymerase may be selected from, but is not limited to, T7 RNA polymerase, T3 RNA polymerase and mutant polymerases such as, but not limited to, polymerases able to be incorporated into modified nucleic acids.

#### *RNA Polymerases*

[000162] Any number of RNA polymerases or variants may be used in the design of the cosmetic primary constructs of the present invention.

[000163] RNA polymerases may be modified by inserting or deleting amino acids of the RNA polymerase sequence. As a non-limiting example, the RNA polymerase may be modified to exhibit an increased ability to incorporate a 2'-modified nucleotide triphosphate compared to an unmodified RNA polymerase (see International Publication WO2008078180 and U.S. Patent 8,101,385; herein incorporated by reference in their entirety).

[000164] Variants may be obtained by evolving an RNA polymerase, optimizing the RNA polymerase amino acid and/or nucleic acid sequence and/or by using other methods known in the art. As a non-limiting example, T7 RNA polymerase variants may be evolved using the continuous directed evolution system set out by Esvelt *et al.* (Nature (2011) 472(7344):499-503; herein incorporated by reference in its entirety) where clones of T7 RNA polymerase may encode at least one mutation such as, but not limited to, lysine at position 93 substituted for threonine (K93T), I4M, A7T, E63V, V64D, A65E, D66Y, T76N, C125R, S128R, A136T, N165S, G175R, H176L, Y178H, F182L, L196F, G198V, D208Y, E222K, S228A, Q239R, T243N, G259D, M267I, G280C, H300R,

D351A, A354S, E356D, L360P, A383V, Y385C, D388Y, S397R, M401T, N410S, K450R, P451T, G452V, E484A, H523L, H524N, G542V, E565K, K577E, K577M, N601S, S684Y, L699I, K713E, N748D, Q754R, E775K, A827V, D851N or L864F. As another non-limiting example, T7 RNA polymerase variants may encode at least one mutation as described in U.S. Pat. Nos. 20100120024 and 200701 171 12; herein incorporated by reference in their entireties. Variants of RNA polymerase may also include, but are not limited to, substitutional variants, conservative amino acid substitution, insertional variants, deletional variants and/or covalent derivatives.

**[000165]** In one embodiment, the cosmetic primary construct may be designed to be recognized by the wild type or variant RNA polymerases. In doing so, the cosmetic primary construct may be modified to contain sites or regions of sequence changes from the wild type or parent primary construct.

**[000166]** In one embodiment, the cosmetic primary construct may be designed to include at least one substitution and/or insertion upstream of an RNA polymerase binding or recognition site, downstream of the RNA polymerase binding or recognition site, upstream of the TATA box sequence, downstream of the TATA box sequence of the cosmetic primary construct but upstream of the coding region of the cosmetic primary construct, within the 5'UTR, before the 5'UTR and/or after the 5'UTR.

**[000167]** In one embodiment, the 5'UTR of the cosmetic primary construct may be replaced by the insertion of at least one region and/or string of nucleotides of the same base. The region and/or string of nucleotides may include, but is not limited to, at least 3, at least 4, at least 5, at least 6, at least 7 or at least 8 nucleotides and the nucleotides may be natural and/or unnatural. As a non-limiting example, the group of nucleotides may include 5-8 adenine, cytosine, thymine, a string of any of the other nucleotides disclosed herein and/or combinations thereof.

**[000168]** In one embodiment, the 5'UTR of the cosmetic primary construct may be replaced by the insertion of at least two regions and/or strings of nucleotides of two different bases such as, but not limited to, adenine, cytosine, thymine, any of the other nucleotides disclosed herein and/or combinations thereof. For example, the 5'UTR may be replaced by inserting 5-8 adenine bases followed by the insertion of 5-8 cytosine



bases. In another example, the 5'UTR may be replaced by inserting 5-8 cytosine bases followed by the insertion of 5-8 adenine bases.

**[000169]** In one embodiment, the cosmetic primary construct may include at least one substitution and/or insertion downstream of the transcription start site which may be recognized by an RNA polymerase. As a non-limiting example, at least one substitution and/or insertion may occur downstream the transcription start site by substituting at least one nucleic acid in the region just downstream of the transcription start site (such as, but not limited to, +1 to +6). Changes to region of nucleotides just downstream of the transcription start site may affect initiation rates, increase apparent nucleotide triphosphate (NTP) reaction constant values, and increase the dissociation of short transcripts from the transcription complex during initial transcription (Briebe et al, *Biochemistry* (2002) 41: 5 144-5 149; herein incorporated by reference in its entirety). The modification, substitution and/or insertion of at least one nucleic acid may cause a silent mutation of the nucleic acid sequence or may cause a mutation in the amino acid sequence.

**[000170]** In one embodiment, the cosmetic primary construct may include the substitution of at least 1, at least 2, at least 3, at least 4, at least 5, at least 6, at least 7, at least 8, at least 9, at least 10, at least 11, at least 12 or at least 13 guanine bases downstream of the transcription start site.

**[000171]** In one embodiment, the cosmetic primary construct may include the substitution of at least 1, at least 2, at least 3, at least 4, at least 5 or at least 6 guanine bases in the region just downstream of the transcription start site. As a non-limiting example, if the nucleotides in the region are GGGAGA the guanine bases may be substituted by at least 1, at least 2, at least 3 or at least 4 adenine nucleotides. In another non-limiting example, if the nucleotides in the region are GGGAGA the guanine bases may be substituted by at least 1, at least 2, at least 3 or at least 4 cytosine bases. In another non-limiting example, if the nucleotides in the region are GGGAGA the guanine bases may be substituted by at least 1, at least 2, at least 3 or at least 4 thymine, and/or any of the nucleotides described herein.

**[000172]** In one embodiment, the cosmetic primary construct may include at least one substitution and/or insertion upstream of the start codon. For the purpose of clarity, one

of skill in the art would appreciate that the start codon is the first codon of the protein coding region whereas the transcription start site is the site where transcription begins. The cosmetic primary construct may include, but is not limited to, at least 1, at least 2, at least 3, at least 4, at least 5, at least 6, at least 7 or at least 8 substitutions and/or insertions of nucleotide bases. The nucleotide bases may be inserted or substituted at 1, at least 1, at least 2, at least 3, at least 4 or at least 5 locations upstream of the start codon. The nucleotides inserted and/or substituted may be the same base (e.g., all A or all C or all T or all G), two different bases (e.g., A and C, A and T, or C and T), three different bases (e.g., A, C and T or A, C and T) or at least four different bases. As a non-limiting example, the guanine base upstream of the coding region in the cosmetic primary construct may be substituted with adenine, cytosine, thymine, or any of the nucleotides described herein. In another non-limiting example the substitution of guanine bases in the cosmetic primary construct may be designed so as to leave one guanine base in the region downstream of the transcription start site and before the start codon (see Esvelt *et al.* Nature (2011) 472(7344):499-503; herein incorporated by reference in its entirety). As a non-limiting example, at least 5 nucleotides may be inserted at 1 location downstream of the transcription start site but upstream of the start codon and the at least 5 nucleotides may be the same base type.

#### *cDNA Template Removal and Clean-Up*

[000173] The cDNA template may be removed using methods known in the art such as, but not limited to, treatment with Deoxyribonuclease I (DNase I). RNA clean-up may also include a purification method such as, but not limited to, AGENCOURT® CLEANSEQ® system from Beckman Coulter (Danvers, MA), HPLC based purification methods such as, but not limited to, strong anion exchange HPLC, weak anion exchange HPLC, reverse phase HPLC (RP-HPLC), and hydrophobic interaction HPLC (HIC-HPLC) .

#### *Capping and/or Tailing Reactions*

[000174] The cosmetic primary construct or cosmetic mmRNA may also undergo capping and/or tailing reactions. A capping reaction may be performed by methods known in the art to add a 5' cap to the 5' end of the cosmetic primary construct. Methods

for capping include, but are not limited to, using a Vaccinia Capping enzyme (New England Biolabs, Ipswich, MA).

[000175] A poly-A tailing reaction may be performed by methods known in the art, such as, but not limited to, 2' O-methyltransferase and by methods as described herein. If the cosmetic primary construct generated from cDNA does not include a poly-T, it may be beneficial to perform the poly-A-tailing reaction before the cosmetic primary construct is cleaned.

#### *mRNA Purification*

[000176] Primary construct or mmRNA purification may include, but is not limited to, mRNA or mmRNA clean-up, quality assurance and quality control. mRNA or mmRNA clean-up may be performed by methods known in the arts such as, but not limited to, AGENCOURT® beads (Beckman Coulter Genomics, Danvers, MA), poly-T beads, LNA™ oligo-T capture probes (EXIQON® Inc, Vedbaek, Denmark) or HPLC based purification methods such as, but not limited to, strong anion exchange HPLC, weak anion exchange HPLC, reverse phase HPLC (RP-HPLC), and hydrophobic interaction HPLC (HIC-HPLC). The term "purified" when used in relation to a polynucleotide such as a "purified mRNA or mmRNA" refers to one that is separated from at least one contaminant. As used herein, a "contaminant" is any substance which makes another unfit, impure or inferior. Thus, a purified cosmetic polynucleotide (e.g., DNA and RNA) is present in a form or setting different from that in which it is found in nature, or a form or setting different from that which existed prior to subjecting it to a treatment or purification method.

[000177] A quality assurance and/or quality control check may be conducted using methods such as, but not limited to, gel electrophoresis, UV absorbance, or analytical HPLC.

[000178] In another embodiment, the cosmetic mRNA or cosmetic mmRNA may be sequenced by methods including, but not limited to reverse-transcriptase-PCR.

[000179] In one embodiment, the cosmetic mRNA or cosmetic mmRNA may be quantified using methods such as, but not limited to, ultraviolet visible spectroscopy (UV/Vis). A non-limiting example of a UV/Vis spectrometer is a NANODROP® spectrometer (ThermoFisher, Waltham, MA). The quantified cosmetic mRNA or

cosmetic mmRNA may be analyzed in order to determine if the cosmetic mRNA or cosmetic mmRNA may be of proper size, check that no degradation of the cosmetic mRNA or cosmetic mmRNA has occurred. Degradation of the cosmetic mRNA and/or cosmetic mmRNA may be checked by methods such as, but not limited to, agarose gel electrophoresis, HPLC based purification methods such as, but not limited to, strong anion exchange HPLC, weak anion exchange HPLC, reverse phase HPLC (RP-HPLC), and hydrophobic interaction HPLC (HIC-HPLC), liquid chromatography-mass spectrometry (LCMS), capillary electrophoresis (CE) and capillary gel electrophoresis (CGE).

### *Signal Sequences*

**[000180]** The cosmetic primary constructs or cosmetic mmRNA may also encode additional features which facilitate trafficking of the cosmetic polypeptides to therapeutically relevant sites. One such feature which aids in protein trafficking is the signal sequence. As used herein, a "signal sequence" or "signal peptide" is a polynucleotide or polypeptide, respectively, which is from about 9 to 200 nucleotides (3-60 amino acids) in length which is incorporated at the 5' (or N-terminus) of the coding region or polypeptide encoded, respectively. Addition of these sequences result in trafficking of the encoded cosmetic polypeptide to the endoplasmic reticulum through one or more secretory pathways. Some signal peptides are cleaved from the protein by signal peptidase after the proteins are transported.

**[000181]** Table 5 is a representative listing of protein signal sequences which may be incorporated for encoding by the cosmetic polynucleotides, cosmetic primary constructs or cosmetic mmRNA of the invention.

**Table 5. Signal Sequences**

ID	Description	NUCLEOTIDE SEQUENCE (5'-3')	SEQ ID NO.	ENCODED PEPTIDE	SEQ ID NO.
SS-001	$\alpha$ -1-antitrypsin	ATGATGCCATCCTCAGTCTCAT GGGGTATTTGCTCTTGGCGGG TCTGTGCTGTCTCGTGCCGGTGT CGCTCGCA	32	MMPSSVSW GILLAGLCC LVPVSLA	94
SS-002	G-CSF	ATGGCCGGACCGGCGACTCAGT CGCCCATGAACTCATGGCCCT GCAGTTGTTGCTTTGGCACTCA GCCCTCTGGACCGTCCAAGAGG	33	MAGPATQS PMKLMALQ LLLWHSAL WTVQEA	95

		CG			
SS-003	Factor IX	ATGCAGAGAGTGAACATGATTA TGGCCGAGTCCCCATCGCTCAT CACAATCTGCCTGCTTGGTACC TGCTTTCCGCCGAATGCACTGT CTTTCTGGATCACGAGAATGCG AATAAGATCTTGAACCGACCCA AACGG	34	MQRVNMIM AESPLITIC LLGYLLSAE CTVFLDHE NANKILNRP KR	96
SS-004	Prolactin	ATGAAAGGATCATTGCTGTTGC TCCTCGTGTGAAACCTTCTGCTT TGCCAGTCCGTAGCCCCC	35	MKGSLLLL LVSNLLLCQ SVAP	97
SS-005	Albumin	ATGAAATGGGTGACGTTTCTCT CACTGTTGTTTTTGTTCCTCGTCC GCCTACTCCAGGGGAGTATTCC GCCGA	36	MKWVTFIS LLFLFSSAY SRG VFRR	98
SS-006	HMMSP38	ATGTGGTGGCGGCTCTGGTGGC TGCTCCTGTTGCTCCTCTTGCTG TGGCCCATGGTGTGGGCA	37	MWWRLW WLLLLLLL PMWA	99
MLS-001	ornithine carbamoyltran sferase	TGCTCTTTAACCTCCGCATCCTG TTGAATAACGCTGCGTTCGAA ATGGGCATAACTTCATGGTACG CAACTTCAGATGCGGCCAGCCA CTCCAG	38	MLFNLRILL NNAAFRNG HNFMRNF RCGQPLQ	100
MLS-002	Cytochrome C Oxidase subunit 8A	ATGTCCGTCTTGACACCCCTGC TCTTGAGAGGGCTGACGGGGTC CGCTAGACGCCTGCCGGTACCG CGAGCGAAGATCCACTCCCTG	39	MSVLTPLLL RGLTGSAR RLPVRAKI HSL	101
MLS-003	Cytochrome C Oxidase subunit 8A	ATGAGCGTGCTCACTCCGTTGC TTCTTCGAGGGCTTACGGGATC GGCTCGGAGGTTGCCCGTCCCG AGAGCGAAGATCCATTCTGTTG	40	MSVLTPLLL RGLTGSAR RLPVRAKI HSL	102
SS-007	Type III, bacterial	TGACAAAAATAACTTTATCTCC CCAGAAATTTAGAATCCAAAAA CAGGAAACCACACTACTAAAA GAAAAATCAACCGAGAAAAAT TCTTTAGCAAAAAGTATTCTCG CAGTAAAAATCACTTCATCGAA TTAAGGTCAAATTATCGGAAC GTTTTATTTCGCATAAGAACAC T	41	MVTKITLSP QNFRIQKQE TTLLKEKST EKNSLAKSI LAVKNHFIE LRSKLSERF ISHKNT	103
SS-008	Viral	ATGCTGAGCTTTGTGGATACCC GCACCCTGCTGCTGCTGGCGGT GACCAGCTGCCTGGCGACCTGC CAG	42	MLSFVDTR TLLLLAVTS CLATCQ	104
SS-009	viral	ATGGGCAGCAGCCAGGCGCCG CGCATGGGCAGCGTGGGCGGCC ATGGCCTGATGGCGCTGCTGAT GGCGGGCCTGATTCTGCCGGGC ATTCTGGCG	43	MGSSQAPR MGSVGGHG LMALLMAG LILPGILA	105

SS-010	Viral	ATGGCGGGCATT TTTTATTTTCT GTTTAGCTTTCTGTTTGGCATT GCGAT	44	MAGIFYFLF SFLFGICD	106
SS-011	Viral	ATGGAAAACCGCCTGCTGCGCG TGTTTCTGGTGTGGGCGGCGCT GACCATGGATGGCGCGAGCGC G	45	MENRLLRV FLVWAALT MDGASA	107
SS-012	Viral	ATGGCGCGCCAGGGCTGCTTTG GCAGCTATCAGGTGATTAGCCT GTTTACCTTTGCGATTGGCGTG AACCTGTGCCTGGGC	46	MARQGCFG SYQVISLFT FAIGVNLCL G	108
SS-013	<i>Bacillus</i>	ATGAGCCGCTGCCGGTGCTGC TGCTGCTGCAGCTGCTGGTGCG CCCGGGCCTGCAG	47	MSRLPVL LQLLRPGL Q	109
SS-014	<i>Bacillus</i>	ATGAAACAGCAGAAACGCCTGT ATGCGCGCCTGCTGACCCTGCT GTTTGCCTGATTTTCTGCTGC CGCATAGCAGCGCGAGCGCG	48	MKQQKRLY ARLLTLLFA LIFLLPHSSA SA	110
SS-015	Secretion signal	ATGGCGACGCCGCTGCCTCCGC CCTCCCCGCGCACCTGCGGCT GCTGCGGCTGCTGCTCTCCGCC CTCGTCCTCGGC	49	MATPLPPPS PRHLRLLRL LLSG	111
SS-016	Secretion signal	ATGAAGGCTCCGGGTCGGCTCG TGCTCATCATCCTGTGCTCCGTG GTCTTCTCT	50	MKAPGRLV LIILCSVVS	112
SS-017	Secretion signal	ATGCTTCAGCTTTGGAACTTG TTCTCCTGTGCGCGTGCTCACT	51	MLQLWKLL CGVLT	113
SS-018	Secretion signal	ATGCTTTATCTCCAGGGTTGGA GCATGCCTGCTGTGGCA	52	MLYLQGWS MPAVA	114
SS-019	Secretion signal	ATGGATAACGTGCAGCCGAAA ATAAAACATCGCCCCTTCTGCT TCAGTGTGAAAGGCCACGTGAA GATGCTGCGGCTGGATATTATC AACTCACTGGTAACAACAGTAT TCATGCTCATCGTATCTGTGTTG GCACTGATACCA	53	MDNVQPKI KHRPFCFSV KGHVKMLR LDIINSLVTT VFMLIVSVL ALIP	115
SS-020	Secretion signal	ATGCCCTGCCTAGACCAACAGC TCACTGTTTCATGCCCTACCCTGC CCTGCCAGCCCTCCTCTCTGG CCTTCTGCCAAGTGGGGTTCTT AACAGCA	54	MPCLDQQL TVHALPCP AQPSSL AFC QVGFLTA	116
SS-021	Secretion signal	ATGAAAACCTTGTTCAATCCAG CCCCTGCCATTGCTGACCTGGA TCCCCAGTTCTACACCCTCTCA GATGTGTTCTGCTGCAATGAAA GTGAGGCTGAGATTTAACTGG CCTCACGGTGGGCAGCGCTGCA GATGCT	55	MKTLFNPA PAIADLDPQ FYTLSDVFC CNESEAEIL TGLTVGSA ADA	117

SS-022	Secretion signal	ATGAAGCCTCTCCTTGTGTGTT TGTCTTTCTTTTCCTTTGGGATC CAGTGCTGGCA	56	MKPLL VVF VFLFLWDP VLA	118
SS-023	Secretion signal	ATGTCCTGTTCCCTAAAGTTTAC TTTGATTGTAATTTTTTTTTACT GTTGGCTTTCATCCAGC	57	MSCSLKFTL IVIFFTCTLS SS	119
SS-024	Secretion signal	ATGGTCTTACTAAACCTCTTCA AAGAAATGGCAGCATGATGAG CTTTGAAAATGTGAAAGAAAAG AGCAGAGAAGGAGGGCCCAT GCACACACACCCGAAGAAGAA TTGTGTTTCGTGGTAACACACT ACCCTCAGGTT CAGACCACACT CAACCTGTTTTTCCATATATTCA AGGTTCTTACTCAACCACTTTC CTTCTGTGGGGT	58	MVLTKPLQ RNGSMMSF ENVKEKSR EGGPHAHT PEEELCFVV THTPQVQT TLNLFHIF KVL TQPLSL LWG	120
SS-025	Secretion signal	ATGGCCACCCCGCCATTCCGGC TGATAAGGAAGATGTTTTCTT CAAGGTGAGCAGATGGATGGG GCTTGCCTGCTTCCGGTCCCTG GCGGCATCC	59	MATPPFRLI RKMFSFKV SRWMGLAC FRSLAAS	121
SS-026	Secretion signal	ATGAGCTTTTTCCAACCTCCTGAT GAAAAGGAAGGAACTCATTCCC TTGGTGGTGTTCATGACTGTGG CGGCGGGTGGAGCCTCATCT	60	MSFFQLLM KRKELIPLV VFMTVAAG GASS	122
SS-027	Secretion signal	ATGGTCTCAGCTCTGCGGGGAG CACCCCTGATCAGGGTGC ACTC AAGCCCTGTTTCTTCTCCTTCTG TGAGTGGACCACGGAGGCTGGT GAGCTGCCTGTCATCCCAAAGC TCAGCTCTGAGC	61	MVSALRGA PLIRVHSSP VSSPSVSGP AALVSCLSS QSSALS	123
SS-028	Secretion signal	ATGATGGGGTCCCCAGTGAGTC ATCTGCTGGCCGGCTTCTGTGT GTGGGTCTGCTTGGGC	62	MMGSPVSH LLAGFCVW VVLG	124
SS-029	Secretion signal	ATGGCAAGCATGGCTGCCGTGC TCACCTGGGCTCTGGCTTCTT TCAGCGTTTTTCGGCCACCCAGG CA	63	MASMAAVL T WALALLS AFSATQA	125
SS-030	Secretion signal	ATGGTGCTCATGTGGACCAGTG GTGACGCCTTCAAGACGGCCTA CTTCTGCTGAAGGGTGCCCT CTGCAGTTCTCCGTGTGCGGCC TGCTGCAGGTGCTGGTGGACCT GGCCATCCTGGGGCAGGCCTAC GCC	64	MVLMWTS GDAFKTAY FLLKGAPLQ FSVCGLLQ VLVDLAILG QATA	126
SS-031	Secretion signal	ATGGATTTTGTGCTGGAGCCA TCGGAGGCGTCTGCGGTGTTGC TGTGGGCTACCCCTGGACACG GTGAAGGTCAGGATCCAGACG GAGCCAAAGTACACAGGCATCT	65	MDFVAGAI GGVCGVAV GYPLDTVK VRIQTEPLY TGIWHCVR	127

		GGCACTGCGTCCGGGATACGTA TCACCGAGAGCGCGTGTGGG GCTTCTACCGGGGCTCTCGCT GCCCCGTGTGCACGGTGTCCCTG GTATCTTCC		DTYHPVERV WGFYRGLS LPVCTVSLV SS	
SS-032	Secretion signal	ATGGAGAAGCCCCTCTTCCCAT TAGTGCCTTTGCATTGGTTTGGC TTTGGCTACACAGCACTGGTTG TTTCTGGTGGGATCGTTGGCTA TGTA AAAACAGGCAGCGTGCCG TCCCTGGCTGCAGGGCTGCTCT TCGGCAGTCTAGCC	66	MEKPLFPLV PLHWFVFG YTALVVSG GIVGYVKT GSVPSLAA GLLFGSLA	128
SS-033	Secretion signal	ATGGGTCTGCTCCTTCCCCTGG CACTCTGCATCCTAGTCCTGTG C	67	MGLLLPLA LCILVLC	129
SS-034	Secretion signal	ATGGGGATCCAGACGAGCCCCG TCCTGCTGGCCTCCCTGGGGGT GGGGCTGGTCACTCTGCTCGGC CTGGCTGTGGGC	68	MGIQTSPVL LASLGVGL VTLLGLAV G	130
SS-035	Secretion signal	ATGTCGGACCTGCTACTACTGG GCCTGATTGGGGGCTGACTCT CTTACTGCTGCTGACGCTGCTA GCCTTTGCC	69	MSDLLLLG LIGGLTLL LLTLLAFA	131
SS-036	Secretion signal	ATGGAGACTGTGGTGATTGTTG CCATAGGTGTGCTGGCCACCAT GTTTCTGGCTTCGTTTGCAGCCT TGGTGCTGGTTTGCAGGCAG	70	METVVIVAI GVLATIFLA SFAALVLV CRQ	132
SS-037	Secretion signal	ATGCGCGGCTCTGTGGAGTGCA CCTGGGGTTGGGGGCACTGTGC CCCCAGCCCCCTGCTCCTTTGG ACTCTACTTCTGTTTGCAGCCCC ATTTGGCCTGCTGGGG	71	MAGSVECT WGWGHCA PSPLLLWTL LLFAAPFGL LG	133
SS-038	Secretion signal	ATGATGCCGTCCTGACCAACC TGGCTACTGGAATCCCCAGTAG TAAAGTGAAATATTCAAGGCTC TCCAGCACAGACGATGGCTACA TTGACCTTCAGTTTAAGAAAAC CCCTCCTAAGATCCCTTATAAG GCCATCGCACTTGCCACTGTGC TGTTTTTGATTGGCGCC	72	MMPSRTNL ATGIPSSKV KYSRLSSTD DGYIDLQFK KTPPKIPYK AIALATVLF LIGA	134
SS-039	Secretion signal	ATGGCCCTGCCCCAGATGTGTG ACGGGAGCCACTTGGCCTCCAC CCTCCGCTATTGCATGACAGTC AGCGGCACAGTGGTTCTGGTGG CCGGGACGCTCTGCTTCGCT	73	MALPQMCD GSHLASTLR YCMTVSGT VVLVAGTL CFA	135
SS-041	Vrg-6	TGAAAAAGTGGTTCGTTGCTGC CGGCATCGGCGCTGCCGACTC ATGCTCTCCAGCGCCGCA	74	MKKWFVA AGIGAGLL MLSSAA	136
SS-042	PhoA	ATGAAACAGAGCACCATTGCGC TGCGCTGCTGCCGCTGCTGTT	75	MKQSTIAL ALLPLLFTP	137



		TACCCCGGTGACCAAAGCG		VTKA	
SS-043	OmpA	ATGAAAAAAACCGCGATTGCG ATTGCGGTGGCGCTGGCGGGCT TTGCGACCGTGGCGCAGGCG	76	MKKTAIAlA VALAGFAT VAQA	138
SS-044	STI	ATGAAAAAACTGATGCTGGCGA TTTTTTTTAGCGTGCTGAGCTTT CCGAGCTTTAGCCAGAGC	77	MKKLMLAI FFSVLSFPSF SQS	139
SS-045	STII	ATGAAAAAAAACATTGCGTTTC TGCTGGCGAGCATGTTTGTGTT TAGCATTGCGACCAACGCGTAT GCG	78	MKKNIAFL LASMVFVSI ATNAYA	140
SS-046	Amylase	ATGTTTTCGAAACGCTTTAAAA CCAGCCTGCTGCCGCTGTTTGC GGGCTTTCTGCTGCTGTTTCATC TGGTGCTGGCGGGCCCGGCGGC GGCGAGC	79	MFAKRFKT SLLPLFAGF LLLFHLVLA GPAAAS	141
SS-047	Alpha Factor	ATGCGCTTTCCGAGCATTTTTAC CGCGGTGCTGTTTTCGCGCGAGC AGCGCGCTGGCG	80	MRFPSIFTA VLFAASSAL A	142
SS-048	Alpha Factor	ATGCGCTTTCCGAGCATTTTTAC CACCGTGCTGTTTTCGCGCGAGC AGCGCGCTGGCG	81	MRFPSIFTT VLFAASSAL A	143
SS-049	Alpha Factor	ATGCGCTTTCCGAGCATTTTTAC CAGCGTGCTGTTTTCGCGCGAGC AGCGCGCTGGCG	82	MRFPSIFTS VLFAASSAL A	144
SS-050	Alpha Factor	ATGCGCTTTCCGAGCATTTTTAC CCATGTGCTGTTTTCGCGCGAGC AGCGCGCTGGCG	83	MRFPSIFTH VLFAASSAL A	145
SS-051	Alpha Factor	ATGCGCTTTCCGAGCATTTTTAC CATTGTGCTGTTTTCGCGCGAGC AGCGCGCTGGCG	84	MRFPSIFTIV LFAASSALA	146
SS-052	Alpha Factor	ATGCGCTTTCCGAGCATTTTTAC CTTTGTGCTGTTTTCGCGCGAGC AGCGCGCTGGCG	85	MRFPSIFTF VLFAASSAL A	147
SS-053	Alpha Factor	ATGCGCTTTCCGAGCATTTTTAC CGAAGTGCTGTTTTCGCGCGAGC AGCGCGCTGGCG	86	MRFPSIFTE VLFAASSAL A	148
SS-054	Alpha Factor	ATGCGCTTTCCGAGCATTTTTAC CGGCGTGCTGTTTTCGCGCGAGC AGCGCGCTGGCG	87	MRFPSIFTG VLFAASSAL A	149
SS-055	Endoglucanase V	ATGCGTTCCTCCCCCTCCTCCG CTCCGCCGTTGTGGCCGCCCTG CCGGTGTTGGCCCTTGCC	88	MRSSPLLR AVVAALPV LALA	150
SS-056	Secretion signal	ATGGGCGCGCGGCCGCTGCGCT GGCACTTGTGCGTGCTGCTGGC CCTGGGCACACGCGGGCGGCTG	89	MGAAAVR WHLCVLLA LGTRGRL	151
SS-057	Fungal	ATGAGGAGCTCCCTTGTGCTGT TCTTTGICTCTGCGTGACGGC CTTGCCAG	90	MRSSLVLF VSAWTALA	152

SS-058	Fibronectin	ATGCTCAGGGGTCCGGGACCCG GGCGGCTGCTGCTGCTAGCAGT CCTGTGCCTGGGGACATCGGTG CGCTGCACCGAAACCGGGAAG AGCAAGAGG	91	MLRGP GPG RLLLLAVLC LGTSVRCTE TGKSKR	153
SS-059	Fibronectin	ATGCTTAGGGGTCCGGGGCCCG GGCTGCTGCTGCTGGCCGTCCA GCTGGGGACAGCGGTGCCCTCC ACG	92	MLRGP GPG LLLLAVQC LGTAVPSTG A	154
SS-060	Fibronectin	ATGCGCCGGGGGGCCCTGACCG GGCTGCTCCTGGTCCTGTGCCT GAGTGTGTGCTACGTGCAGCC CCCTCTGCAACAAGCAAGAAGC GCAGG	93	MRRGALTG LLLVLCLSV VLRAAPSA TSKRR	155

[000182] In the table, SS is secretion signal and MLS is mitochondrial leader signal. The cosmetic primary constructs or cosmetic mmRNA of the present invention may be designed to encode any of the signal sequences of SEQ ID NOs 94-155, or fragments or variants thereof. These sequences may be included at the beginning of the cosmetic polypeptide coding region, in the middle or at the terminus or alternatively into a flanking region. Further, any of the cosmetic polynucleotide primary constructs of the present invention may also comprise one or more of the sequences defined by SEQ ID NOs 32-93. These may be in the first region or either flanking region.

[000183] Additional signal sequences which may be utilized in the present invention include those taught in, for example, databases such as those found at <http://www.signalpeptide.de/> or <http://proline.bic.nus.edu.sg/spdb/>. Those described in US Patents 8,124,379; 7,413,875 and 7,385,034 are also within the scope of the invention and the contents of each are incorporated herein by reference in their entirety.

#### *Target Selection*

According to the present invention, the cosmetic primary constructs comprise at least a first region of linked nucleosides encoding at least one cosmetic polypeptide of interest. The cosmetic polypeptides of interest or "targets" or cosmetic proteins and cosmetic peptides of the present invention are listed in Tables 6 and 7. Shown in Table 6, in addition to the target number (Target No), name and description of the gene encoding the cosmetic polypeptide of interest (Target Description) are the ENSEMBL Transcript ID (ENST) and SEQ ID NO (Trans SEQ ID NO), the ENSEMBL Protein ID (ENSP) and

SEQ ID NO (Peptide SEQ ID NO) and when available the optimized ORF identifier (Optimized ORF SEQ ID). For any particular gene there may exist one or more variants or isoforms. Where these exist, they are shown in the tables as well. It will be appreciated by those of skill in the art that disclosed in the Tables are potential flanking regions. These are encoded in each ENST transcript or NCBI nucleotide sequence either to the 5' (upstream) or 3' (downstream) of the ORF or coding region. The coding region is definitively and specifically disclosed by teaching the ENSP protein sequence. Consequently, the sequences taught flanking that encoding the protein are considered flanking regions. It is also possible to further characterize the 5' and 3' flanking regions by utilizing one or more available databases or algorithms. Databases have annotated the features contained in the flanking regions of the ENST transcripts and these are available in the art.

[000184]

**Table 6. Cosmetic Targets**

Target No.	Target Description	ENST	Trans SEQ ID NO	ENSP	Peptide SEQ ID NO	Optimized ORF SEQ ID
1	actin gamma 1	573283	156	458435	884	1612, 2337, 3062, 3787, 4512
2	actin, alpha 2, smooth muscle, aorta	224784	157	224784	885	1613, 2338, 3063, 3788, 4513
3	actin, alpha 2, smooth muscle, aorta	415557	158	396730	886	1614, 2339, 3064, 3789, 4514
4	actin, alpha 2, smooth muscle, aorta	458159	159	398239	887	1615, 2340, 3065, 3790, 4515
5	actin, alpha 2, smooth muscle, aorta	458208	160	402373	888	1616, 2341, 3066, 3791, 4516
6	actin, alpha 2, smooth muscle, aorta	544901	161	439477	889	1617, 2342, 3067, 3792, 4517
7	actin, alpha, cardiac muscle 1	290378	162	290378	890	1618, 2343, 3068, 3793, 4518

8	actin, alpha, cardiac muscle 1	544062	163	445797	891	1619, 2344, 3069, 3794, 4519
9	actin, beta	320713	164	440549	892	1620, 2345, 3070, 3795, 4520
10	actin, beta	331789	165	349960	893	1621, 2346, 3071, 3796, 4521
11	actin, beta	400179	166	438481	894	1622, 2347, 3072, 3797, 4522
12	actin, beta	414620	167	401032	895	1623, 2348, 3073, 3798, 4523
13	actin, beta	417101	168	399487	896	1624, 2349, 3074, 3799, 4524
14	actin, beta	432588	169	407473	897	1625, 2350, 3075, 3800, 4525
15	actin, beta	443528	170	393951	898	1626, 2351, 3076, 3801, 4526
16	actin, beta	445914	171	414839	899	1627, 2352, 3077, 3802, 4527
17	actin, beta-like 2	423391	172	416706	900	1628, 2353, 3078, 3803, 4528
18	actin, gamma 1	331925	173	331514	901	1629, 2354, 3079, 3804, 4529
19	actin, gamma 1	447294	174	438755	902	1630, 2355, 3080, 3805, 4530
20	actin, gamma 2, smooth muscle, enteric	345517	175	295137	903	1631, 2356, 3081, 3806, 4531
21	actin, gamma 2, smooth muscle, enteric	409624	176	386857	904	1632, 2357, 3082, 3807, 4532
22	actin-like 6A	392662	177	376430	905	1633, 2358, 3083, 3808, 4533
23	actin-like 6A	429709	178	397552	906	1634, 2359, 3084, 3809, 4534
24	actin-like 6A	450518	179	394014	907	1635, 2360, 3085, 3810,

						4535
25	actin-like 6A	490364	180	420153	908	1636, 2361, 3086, 3811, 4536
26	actin-like 6B	160382	181	160382	909	1637, 2362, 3087, 3812, 4537, 5237, 5352
27	actin-like 7A	333999	182	334300	910	1638, 2363, 3088, 3813, 4538
28	actin-like 7B	374667	183	363799	911	1639, 2364, 3089, 3814, 4539
29	actin-like 8	375406	184	364555	912	1640, 2365, 3090, 3815, 4540
30	actin-like 9	324436	185	316674	913	1641, 2366, 3091, 3816, 4541
31	androgen receptor	374690	186	363822	914	1642, 2367, 3092, 3817, 4542
32	androgen receptor	396043	187	379358	915	1643, 2368, 3093, 3818, 4543
33	androgen receptor	396044	188	379359	916	1644, 2369, 3094, 3819, 4544
34	androgen receptor	538891	189	445174	917	1645, 2370, 3095, 3820, 4545
35	androgen receptor	544984	190	438166	918	1646, 2371, 3096, 3821, 4546
36	attractin	262919	191	262919	919	1647, 2372, 3097, 3822, 4547
37	attractin	340500	192	344367	920	1648, 2373, 3098, 3823, 4548
38	attractin	446916	193	416587	921	1649, 2374, 3099, 3824, 4549
39	brain-derived neurotrophic factor	314915	194	320002	922	1650, 2375, 3100, 3825, 4550

40	brain-derived neurotrophic factor	356660	195	349084	923	1651, 2376, 3101, 3826, 4551
41	brain-derived neurotrophic factor	395978	196	379302	924	1652, 2377, 3102, 3827, 4552
42	brain-derived neurotrophic factor	395980	197	379304	925	1653, 2378, 3103, 3828, 4553
43	brain-derived neurotrophic factor	395981	198	379305	926	1654, 2379, 3104, 3829, 4554
44	brain-derived neurotrophic factor	395983	199	379307	927	1655, 2380, 3105, 3830, 4555
45	brain-derived neurotrophic factor	395986	200	379309	928	1656, 2381, 3106, 3831, 4556
46	brain-derived neurotrophic factor	418212	201	400502	929	1657, 2382, 3107, 3832, 4557
47	brain-derived neurotrophic factor	420794	202	389564	930	1658, 2383, 3108, 3833, 4558
48	brain-derived neurotrophic factor	438929	203	414303	931	1659, 2384, 3109, 3834, 4559
49	brain-derived neurotrophic factor	439476	204	389345	932	1660, 2385, 3110, 3835, 4560
50	brain-derived neurotrophic factor	525528	205	437138	933	1661, 2386, 3111, 3836, 4561
51	brain-derived neurotrophic factor	525950	206	432035	934	1662, 2387, 3112, 3837, 4562
52	brain-derived neurotrophic factor	530861	207	435564	935	1663, 2388, 3113, 3838, 4563
53	brain-derived neurotrophic factor	532997	208	435805	936	1664, 2389, 3114, 3839, 4564
54	brain-derived neurotrophic factor	533131	209	432727	937	1665, 2390, 3115, 3840, 4565
55	brain-derived neurotrophic factor	533246	210	432376	938	1666, 2391, 3116, 3841, 4566
56	brain-derived neurotrophic factor	530786	211	433003	939	1667, 2392, 3117, 3842,

						4567
57	calponin 1, basic, smooth muscle	252456	212	252456	940	1668, 2393, 3118, 3843, 4568
58	calponin 1, basic, smooth muscle	535659	213	442031	941	1669, 2394, 3119, 3844, 4569
59	calponin 1, basic, smooth muscle	544952	214	437470	942	1670, 2395, 3120, 3845, 4570
60	calponin 2	263097	215	263097	943	1671, 2396, 3121, 3846, 4571
61	calponin 2	348419	216	340129	944	1672, 2397, 3122, 3847, 4572
62	calponin 2	442531	217	411272	945	1673, 2398, 3123, 3848, 4573
63	calponin 3, acidic	370206	218	359225	946	1674, 2399, 3124, 3849, 4574
64	calponin 3, acidic	394202	219	377752	947	1675, 2400, 3125, 3850, 4575
65	calponin 3, acidic	415017	220	401452	948	1676, 2401, 3126, 3851, 4576
66	calponin 3, acidic	538964	221	437665	949	1677, 2402, 3127, 3852, 4577
67	calponin 3, acidic	545882	222	440081	950	1678, 2403, 3128, 3853, 4578
68	caspase recruitment domain family member 14	570421	223	461806	951	1679, 2404, 3129, 3854, 4579
69	caspase recruitment domain family member 14	573882	224	458715	952	1680, 2405, 3130, 3855, 4580
70	caspase recruitment domain family, member 14	309710	225	308507	953	1681, 2406, 3131, 3856, 4581
71	caspase recruitment domain family, member 14	344227	226	344549	954	1682, 2407, 3132, 3857, 4582
72	caspase recruitment domain family, member 14	392434	227	376229	955	1683, 2408, 3133, 3858, 4583

73	coiled-coil alpha-helical rod protein 1	376266	228	365442	956	1684, 2409, 3134, 3859, 4584
74	coiled-coil alpha-helical rod protein 1	383341	229	372832	957	1685, 2410, 3135, 3860, 4585
75	coiled-coil alpha-helical rod protein 1	383527	230	373019	958	1686, 2411, 3136, 3861, 4586
76	coiled-coil alpha-helical rod protein 1	396263	231	379561	959	1687, 2412, 3137, 3862, 4587
77	coiled-coil alpha-helical rod protein 1	396268	232	379566	960	1688, 2413, 3138, 3863, 4588
78	coiled-coil alpha-helical rod protein 1	400351	233	383204	961	1689, 2414, 3139, 3864, 4589
79	coiled-coil alpha-helical rod protein 1	400352	234	383205	962	1690, 2415, 3140, 3865, 4590
80	coiled-coil alpha-helical rod protein 1	400406	235	383257	963	1691, 2416, 3141, 3866, 4591
81	coiled-coil alpha-helical rod protein 1	400412	236	383263	964	1692, 2417, 3142, 3867, 4592
82	coiled-coil alpha-helical rod protein 1	412245	237	413000	965	1693, 2418, 3143, 3868, 4593
83	coiled-coil alpha-helical rod protein 1	412577	238	399555	966	1694, 2419, 3144, 3869, 4594
84	coiled-coil alpha-helical rod protein 1	414614	239	398934	967	1695, 2420, 3145, 3870, 4595
85	coiled-coil alpha-helical rod protein 1	416163	240	408012	968	1696, 2421, 3146, 3871, 4596
86	coiled-coil alpha-helical rod protein 1	416392	241	403628	969	1697, 2422, 3147, 3872, 4597
87	coiled-coil alpha-helical rod protein 1	416552	242	396696	970	1698, 2423, 3148, 3873, 4598
88	coiled-coil alpha-helical rod protein 1	416850	243	410052	971	1699, 2424, 3149, 3874, 4599
89	coiled-coil alpha-helical rod protein 1	417501	244	394964	972	1700, 2425, 3150, 3875,



						4600
90	coiled-coil alpha-helical rod protein 1	417776	245	414578	973	1701, 2426, 3151, 3876, 4601
91	coiled-coil alpha-helical rod protein 1	419528	246	391181	974	1702, 2427, 3152, 3877, 4602
92	coiled-coil alpha-helical rod protein 1	419592	247	403227	975	1703, 2428, 3153, 3878, 4603
93	coiled-coil alpha-helical rod protein 1	420262	248	390479	976	1704, 2429, 3154, 3879, 4604
94	coiled-coil alpha-helical rod protein 1	423825	249	408031	977	1705, 2430, 3155, 3880, 4605
95	coiled-coil alpha-helical rod protein 1	425351	250	410018	978	1706, 2431, 3156, 3881, 4606
96	coiled-coil alpha-helical rod protein 1	425500	251	400469	979	1707, 2432, 3157, 3882, 4607
97	coiled-coil alpha-helical rod protein 1	425620	252	393042	980	1708, 2433, 3158, 3883, 4608
98	coiled-coil alpha-helical rod protein 1	426967	253	402432	981	1709, 2434, 3159, 3884, 4609
99	coiled-coil alpha-helical rod protein 1	427654	254	405010	982	1710, 2435, 3160, 3885, 4610
100	coiled-coil alpha-helical rod protein 1	428174	255	389303	983	1711, 2436, 3161, 3886, 4611
101	coiled-coil alpha-helical rod protein 1	428677	256	416029	984	1712, 2437, 3162, 3887, 4612
102	coiled-coil alpha-helical rod protein 1	429943	257	404757	985	1713, 2438, 3163, 3888, 4613
103	coiled-coil alpha-helical rod protein 1	431539	258	390347	986	1714, 2439, 3164, 3889, 4614
104	coiled-coil alpha-helical rod protein 1	432736	259	388264	987	1715, 2440, 3165, 3890, 4615
105	coiled-coil alpha-helical rod protein 1	433804	260	414411	988	1716, 2441, 3166, 3891, 4616

106	coiled-coil alpha-helical rod protein 1	437027	261	409907	989	1717, 2442, 3167, 3892, 4617
107	coiled-coil alpha-helical rod protein 1	437918	262	412157	990	1718, 2443, 3168, 3893, 4618
108	coiled-coil alpha-helical rod protein 1	438424	263	393508	991	1719, 2444, 3169, 3894, 4619
109	coiled-coil alpha-helical rod protein 1	438739	264	404715	992	1720, 2445, 3170, 3895, 4620
110	coiled-coil alpha-helical rod protein 1	438812	265	396200	993	1721, 2446, 3171, 3896, 4621
111	coiled-coil alpha-helical rod protein 1	439536	266	391018	994	1722, 2447, 3172, 3897, 4622
112	coiled-coil alpha-helical rod protein 1	439820	267	388748	995	1723, 2448, 3173, 3898, 4623
113	coiled-coil alpha-helical rod protein 1	440185	268	397125	996	1724, 2449, 3174, 3899, 4624
114	coiled-coil alpha-helical rod protein 1	444737	269	409157	997	1725, 2450, 3175, 3900, 4625
115	coiled-coil alpha-helical rod protein 1	444855	270	397856	998	1726, 2451, 3176, 3901, 4626
116	coiled-coil alpha-helical rod protein 1	447252	271	405118	999	1727, 2452, 3177, 3902, 4627
117	coiled-coil alpha-helical rod protein 1	447874	272	412354	1000	1728, 2453, 3178, 3903, 4628
118	coiled-coil alpha-helical rod protein 1	448141	273	414323	1001	1729, 2454, 3179, 3904, 4629
119	coiled-coil alpha-helical rod protein 1	448162	274	390027	1002	1730, 2455, 3180, 3905, 4630
120	coiled-coil alpha-helical rod protein 1	449364	275	408519	1003	1731, 2456, 3181, 3906, 4631
121	coiled-coil alpha-helical rod protein 1	450631	276	399391	1004	1732, 2457, 3182, 3907, 4632
122	coiled-coil alpha-helical rod	451337	277	396155	1005	1733, 2458,

	protein 1					3183, 3908, 4633
123	coiled-coil alpha-helical rod protein 1	451470	278	390313	1006	1734, 2459, 3184, 3909, 4634
124	coiled-coil alpha-helical rod protein 1	451521	279	401039	1007	1735, 2460, 3185, 3910, 4635
125	coiled-coil alpha-helical rod protein 1	452333	280	404917	1008	1736, 2461, 3186, 3911, 4636
126	coiled-coil alpha-helical rod protein 1	452419	281	389758	1009	1737, 2462, 3187, 3912, 4637
127	coiled-coil alpha-helical rod protein 1	453360	282	397446	1010	1738, 2463, 3188, 3913, 4638
128	coiled-coil alpha-helical rod protein 1	454570	283	401869	1011	1739, 2464, 3189, 3914, 4639
129	coiled-coil alpha-helical rod protein 1	455279	284	398715	1012	1740, 2465, 3190, 3915, 4640
130	coiled-coil alpha-helical rod protein 1	455669	285	408590	1013	1741, 2466, 3191, 3916, 4641
131	coiled-coil alpha-helical rod protein 1	456365	286	395434	1014	1742, 2467, 3192, 3917, 4642
132	coiled-coil alpha-helical rod protein 1	456712	287	391707	1015	1743, 2468, 3193, 3918, 4643
133	coiled-coil alpha-helical rod protein 1	457929	288	389131	1016	1744, 2469, 3194, 3919, 4644
134	coiled-coil alpha-helical rod protein 1	502557	289	425377	1017	1745, 2470, 3195, 3920, 4645
135	coiled-coil alpha-helical rod protein 1	503934	290	425595	1018	1746, 2471, 3196, 3921, 4646
136	coiled-coil alpha-helical rod protein 1	506831	291	425435	1019	1747, 2472, 3197, 3922, 4647

137	coiled-coil alpha-helical rod protein 1	507226	292	424335	1020	1748, 2473, 3198, 3923, 4648
138	coiled-coil alpha-helical rod protein 1	507751	293	420941	1021	1749, 2474, 3199, 3924, 4649
139	coiled-coil alpha-helical rod protein 1	507829	294	420911	1022	1750, 2475, 3200, 3925, 4650
140	coiled-coil alpha-helical rod protein 1	507892	295	424164	1023	1751, 2476, 3201, 3926, 4651
141	coiled-coil alpha-helical rod protein 1	508683	296	421393	1024	1752, 2477, 3202, 3927, 4652
142	coiled-coil alpha-helical rod protein 1	513222	297	425682	1025	1753, 2478, 3203, 3928, 4653
143	coiled-coil alpha-helical rod protein 1	515274	298	422975	1026	1754, 2479, 3204, 3929, 4654
144	collagen type VI alpha 3	392004	299	375861	1027	1755, 2480, 3205, 3930, 4655
145	collagen type VI alpha 3	472056	300	418285	1028	1756, 2481, 3206, 3931, 4656
146	collagen type XXV alpha 1	399127	301	382078	1029	1757, 2482, 3207, 3932, 4657
147	collagen, type I, alpha 1	225964	302	225964	1030	1758, 2483, 3208, 3933, 4658
148	collagen, type II, alpha 1	337299	303	338213	1031	1759, 2484, 3209, 3934, 4659
149	collagen, type II, alpha 1	380518	304	369889	1032	1760, 2485, 3210, 3935, 4660
150	collagen, type II, alpha 1	395281	305	378696	1033	1761, 2486, 3211, 3936, 4661

151	collagen, type IV, alpha 1	375815	306	364973	1034	1762, 2487, 3212, 3937, 4662, 5238, 5353
152	collagen, type IV, alpha 1	375820	307	364979	1035	1763, 2488, 3213, 3938, 4663, 5239, 5354
153	collagen, type IV, alpha 1	397198	308	380382	1036	1764, 2489, 3214, 3939, 4664, 5240, 5355
154	collagen, type IV, alpha 1	543140	309	443348	1037	1765, 2490, 3215, 3940, 4665, 5241, 5356
155	collagen, type IV, alpha 3 (Goodpasture antigen) binding protein	261415	310	261415	1038	1766, 2491, 3216, 3941, 4666
156	collagen, type IV, alpha 3 (Goodpasture antigen) binding protein	357457	311	350046	1039	1767, 2492, 3217, 3942, 4667
157	collagen, type IV, alpha 3 (Goodpasture antigen) binding protein	380494	312	369862	1040	1768, 2493, 3218, 3943, 4668
158	collagen, type IV, alpha 3 (Goodpasture antigen) binding protein	405807	313	383996	1041	1769, 2494, 3219, 3944, 4669
159	collagen, type IV, alpha 3 (Goodpasture antigen) binding protein	508809	314	424244	1042	1770, 2495, 3220, 3945, 4670
160	collagen, type IV, alpha 4	329662	315	328553	1043	1771, 2496, 3221, 3946, 4671
161	collagen, type IV, alpha 4	396625	316	379866	1044	1772, 2497, 3222, 3947, 4672
162	collagen, type IV, alpha 5	328300	317	331902	1045	1773, 2498, 3223, 3948, 4673
163	collagen, type IV, alpha 5	361603	318	354505	1046	1774, 2499, 3224, 3949, 4674
164	collagen, type IV, alpha 5	508186	319	425614	1047	1775, 2500, 3225, 3950, 4675
165	collagen, type IV, alpha 6	334504	320	334733	1048	1776, 2501, 3226, 3951, 4676

166	collagen, type IV, alpha 6	372216	321	361290	1049	1777, 2502, 3227, 3952, 4677
167	collagen, type IV, alpha 6	394872	322	378340	1050	1778, 2503, 3228, 3953, 4678
168	collagen, type IV, alpha 6	418180	323	406002	1051	1779, 2504, 3229, 3954, 4679
169	collagen, type IV, alpha 6	538570	324	445236	1052	1780, 2505, 3230, 3955, 4680
170	collagen, type IV, alpha 6	545689	325	443707	1053	1781, 2506, 3231, 3956, 4681
171	collagen, type IX, alpha 1	320755	326	315252	1054	1782, 2507, 3232, 3957, 4682
172	collagen, type IX, alpha 1	357250	327	349790	1055	1783, 2508, 3233, 3958, 4683
173	collagen, type IX, alpha 1	370496	328	359527	1056	1784, 2509, 3234, 3959, 4684
174	collagen, type IX, alpha 1	370499	329	359530	1057	1785, 2510, 3235, 3960, 4685
175	collagen, type IX, alpha 2	372736	330	361821	1058	1786, 2511, 3236, 3961, 4686, 5242, 5357
176	collagen, type IX, alpha 2	372748	331	361834	1059	1787, 2512, 3237, 3962, 4687, 5243, 5358
177	collagen, type IX, alpha 3	343916	332	341640	1060	1788, 2513, 3238, 3963, 4688, 5244, 5359
178	collagen, type IX, alpha 3	452372	333	394280	1061	1789, 2514, 3239, 3964, 4689, 5245, 5360
179	collagen, type IX, alpha 3	537652	334	438537	1062	1790, 2515, 3240, 3965, 4690, 5246, 5361

180	collagen, type V, alpha 1	355306	335	347458	1063	1791, 2516, 3241, 3966, 4691, 5247, 5362
181	collagen, type V, alpha 1	371817	336	360882	1064	1792, 2517, 3242, 3967, 4692, 5248, 5363
182	collagen, type V, alpha 1	371820	337	360885	1065	1793, 2518, 3243, 3968, 4693, 5249, 5364
183	collagen, type V, alpha 3	264828	338	264828	1066	1794, 2519, 3244, 3969, 4694
184	collagen, type VI, alpha 3	295550	339	295550	1067	1795, 2520, 3245, 3970, 4695, 5250, 5365
185	collagen, type VI, alpha 3	346358	340	295546	1068	1796, 2521, 3246, 3971, 4696, 5251, 5366
186	collagen, type VI, alpha 3	347401	341	315609	1069	1797, 2522, 3247, 3972, 4697, 5252, 5367
187	collagen, type VI, alpha 3	353578	342	315873	1070	1798, 2523, 3248, 3973, 4698, 5253, 5368
188	collagen, type VI, alpha 3	392003	343	375860	1071	1799, 2524, 3249, 3974, 4699, 5254, 5369
189	collagen, type VI, alpha 3	409809	344	386844	1072	1800, 2525, 3250, 3975, 4700, 5255, 5370
190	collagen, type VI, alpha 5	265379	345	265379	1073	1801, 2526, 3251, 3976, 4701, 5256, 5371
191	collagen, type VI, alpha 5	312481	346	309762	1074	1802, 2527, 3252, 3977, 4702, 5257, 5372

192	collagen, type VI, alpha 5	373157	347	362250	1075	1803, 2528, 3253, 3978, 4703, 5258, 5373
193	collagen, type VI, alpha 5	432398	348	390895	1076	1804, 2529, 3254, 3979, 4704, 5259, 5374
194	collagen, type VI, alpha 5	512482	349	424968	1077	1805, 2530, 3255, 3980, 4705, 5260, 5375
195	collagen, type VI, alpha 6	358511	350	351310	1078	1806, 2531, 3256, 3981, 4706, 5261, 5376
196	collagen, type VI, alpha 6	453409	351	399236	1079	1807, 2532, 3257, 3982, 4707, 5262, 5377
197	collagen, type VIII, alpha 2	303143	352	305913	1080	1808, 2533, 3258, 3983, 4708
198	collagen, type VIII, alpha 2	373172	353	362267	1081	1809, 2534, 3259, 3984, 4709
199	collagen, type VIII, alpha 2	397799	354	380901	1082	1810, 2535, 3260, 3985, 4710
200	collagen, type VIII, alpha 2	481785	355	436433	1083	1811, 2536, 3261, 3986, 4711
201	collagen, type X, alpha 1	243222	356	243222	1084	1812, 2537, 3262, 3987, 4712
202	collagen, type X, alpha 1	327673	357	327368	1085	1813, 2538, 3263, 3988, 4713
203	collagen, type X, alpha 1	418500	358	392712	1086	1814, 2539, 3264, 3989, 4714
204	collagen, type X, alpha 1	452729	359	411285	1087	1815, 2540, 3265, 3990, 4715
205	collagen, type XI, alpha 2	341947	360	339915	1088	1816, 2541, 3266, 3991, 4716, 5263, 5378



206	collagen, type XI, alpha 2	357486	361	350079	1089	1817, 2542, 3267, 3992, 4717, 5264, 5379
207	collagen, type XI, alpha 2	361917	362	355123	1090	1818, 2543, 3268, 3993, 4718, 5265, 5380
208	collagen, type XI, alpha 2	374708	363	363840	1091	1819, 2544, 3269, 3994, 4719, 5266, 5381
209	collagen, type XI, alpha 2	374712	364	363844	1092	1820, 2545, 3270, 3995, 4720, 5267, 5382
210	collagen, type XI, alpha 2	374713	365	363845	1093	1821, 2546, 3271, 3996, 4721, 5268, 5383
211	collagen, type XI, alpha 2	374714	366	363846	1094	1822, 2547, 3272, 3997, 4722, 5269, 5384
212	collagen, type XI, alpha 2	383087	367	372565	1095	1823, 2548, 3273, 3998, 4723
213	collagen, type XI, alpha 2	383088	368	372566	1096	1824, 2549, 3274, 3999, 4724
214	collagen, type XI, alpha 2	383219	369	372706	1097	1825, 2550, 3275, 4000, 4725
215	collagen, type XI, alpha 2	395194	370	378620	1098	1826, 2551, 3276, 4001, 4726, 5270, 5385
216	collagen, type XI, alpha 2	395196	371	378622	1099	1827, 2552, 3277, 4002, 4727, 5271, 5386
217	collagen, type XI, alpha 2	395197	372	378623	1100	1828, 2553, 3278, 4003, 4728, 5272, 5387
218	collagen, type XI, alpha 2	420405	373	394196	1101	1829, 2554, 3279, 4004, 4729
219	collagen, type XI, alpha 2	425729	374	408123	1102	1830, 2555, 3280, 4005,

						4730
220	collagen, type XI, alpha 2	433947	375	388108	1103	1831, 2556, 3281, 4006, 4731
221	collagen, type XI, alpha 2	434780	376	408523	1104	1832, 2557, 3282, 4007, 4732
222	collagen, type XI, alpha 2	435763	377	396587	1105	1833, 2558, 3283, 4008, 4733
223	collagen, type XI, alpha 2	438711	378	398256	1106	1834, 2559, 3284, 4009, 4734
224	collagen, type XI, alpha 2	439039	379	410284	1107	1835, 2560, 3285, 4010, 4735
225	collagen, type XI, alpha 2	443125	380	402987	1108	1836, 2561, 3286, 4011, 4736
226	collagen, type XI, alpha 2	443138	381	404513	1109	1837, 2562, 3287, 4012, 4737
227	collagen, type XI, alpha 2	447349	382	388309	1110	1838, 2563, 3288, 4013, 4738, 5273, 5388
228	collagen, type XI, alpha 2	447741	383	400813	1111	1839, 2564, 3289, 4014, 4739, 5274, 5389
229	collagen, type XI, alpha 2	447855	384	415296	1112	1840, 2565, 3290, 4015, 4740
230	collagen, type XI, alpha 2	448717	385	408627	1113	1841, 2566, 3291, 4016, 4741
231	collagen, type XI, alpha 2	451040	386	398170	1114	1842, 2567, 3292, 4017, 4742
232	collagen, type XI, alpha 2	452044	387	416619	1115	1843, 2568, 3293, 4018, 4743
233	collagen, type XI, alpha 2	452730	388	388775	1116	1844, 2569, 3294, 4019, 4744, 5275, 5390
234	collagen, type XI, alpha 2	452937	389	406347	1117	1845, 2570, 3295, 4020, 4745

235	collagen, type XI, alpha 2	457788	390	405520	1118	1846, 2571, 3296, 4021, 4746, 5276, 5391
236	collagen, type XI, alpha 2	546402	391	448494	1119	1847, 2572, 3297, 4022, 4747
237	collagen, type XI, alpha 2	546998	392	446968	1120	1848, 2573, 3298, 4023, 4748
238	collagen, type XI, alpha 2	547261	393	450150	1121	1849, 2574, 3299, 4024, 4749
239	collagen, type XI, alpha 2	547561	394	448817	1122	1850, 2575, 3300, 4025, 4750
240	collagen, type XI, alpha 2	547597	395	449605	1123	1851, 2576, 3301, 4026, 4751
241	collagen, type XI, alpha 2	547846	396	447511	1124	1852, 2577, 3302, 4027, 4752, 5277, 5392
242	collagen, type XI, alpha 2	547883	397	448628	1125	1853, 2578, 3303, 4028, 4753
243	collagen, type XI, alpha 2	547999	398	446903	1126	1854, 2579, 3304, 4029, 4754
244	collagen, type XI, alpha 2	548137	399	448090	1127	1855, 2580, 3305, 4030, 4755
245	collagen, type XI, alpha 2	548637	400	447422	1128	1856, 2581, 3306, 4031, 4756
246	collagen, type XI, alpha 2	548739	401	448990	1129	1857, 2582, 3307, 4032, 4757
247	collagen, type XI, alpha 2	549088	402	449993	1130	1858, 2583, 3308, 4033, 4758, 5278, 5393
248	collagen, type XI, alpha 2	549289	403	448643	1131	1859, 2584, 3309, 4034, 4759
249	collagen, type XI, alpha 2	549290	404	446543	1132	1860, 2585, 3310, 4035, 4760
250	collagen, type XI, alpha 2	549381	405	448464	1133	1861, 2586, 3311, 4036,

						4761
251	collagen, type XI, alpha 2	549491	406	450084	1134	1862, 2587, 3312, 4037, 4762
252	collagen, type XI, alpha 2	549811	407	449275	1135	1863, 2588, 3313, 4038, 4763
253	collagen, type XI, alpha 2	549836	408	448701	1136	1864, 2589, 3314, 4039, 4764
254	collagen, type XI, alpha 2	549885	409	448931	1137	1865, 2590, 3315, 4040, 4765, 5279, 5394
255	collagen, type XI, alpha 2	550101	410	446840	1138	1866, 2591, 3316, 4041, 4766
256	collagen, type XI, alpha 2	550517	411	448206	1139	1867, 2592, 3317, 4042, 4767
257	collagen, type XI, alpha 2	550561	412	449393	1140	1868, 2593, 3318, 4043, 4768
258	collagen, type XI, alpha 2	550955	413	447413	1141	1869, 2594, 3319, 4044, 4769, 5280, 5395
259	collagen, type XI, alpha 2	550998	414	450046	1142	1870, 2595, 3320, 4045, 4770
260	collagen, type XI, alpha 2	551234	415	446501	1143	1871, 2596, 3321, 4046, 4771
261	collagen, type XI, alpha 2	551262	416	450208	1144	1872, 2597, 3322, 4047, 4772
262	collagen, type XI, alpha 2	551413	417	448715	1145	1873, 2598, 3323, 4048, 4773
263	collagen, type XI, alpha 2	551536	418	447371	1146	1874, 2599, 3324, 4049, 4774
264	collagen, type XI, alpha 2	551542	419	447864	1147	1875, 2600, 3325, 4050, 4775
265	collagen, type XI, alpha 2	551559	420	449887	1148	1876, 2601, 3326, 4051, 4776

266	collagen, type XI, alpha 2	551572	421	448571	1149	1877, 2602, 3327, 4052, 4777
267	collagen, type XI, alpha 2	551637	422	447869	1150	1878, 2603, 3328, 4053, 4778, 5281, 5396
268	collagen, type XI, alpha 2	551758	423	447062	1151	1879, 2604, 3329, 4054, 4779
269	collagen, type XI, alpha 2	551785	424	448880	1152	1880, 2605, 3330, 4055, 4780
270	collagen, type XI, alpha 2	551786	425	446509	1153	1881, 2606, 3331, 4056, 4781
271	collagen, type XI, alpha 2	552134	426	449320	1154	1882, 2607, 3332, 4057, 4782
272	collagen, type XI, alpha 2	552473	427	446870	1155	1883, 2608, 3333, 4058, 4783, 5282, 5397
273	collagen, type XI, alpha 2	552556	428	448922	1156	1884, 2609, 3334, 4059, 4784
274	collagen, type XI, alpha 2	552765	429	448124	1157	1885, 2610, 3335, 4060, 4785, 5283, 5398
275	collagen, type XI, alpha 2	552796	430	448204	1158	1886, 2611, 3336, 4061, 4786
276	collagen, type XI, alpha 2	552971	431	450055	1159	1887, 2612, 3337, 4062, 4787
277	collagen, type XI, alpha 2	553210	432	447529	1160	1888, 2613, 3338, 4063, 4788, 5284, 5399
278	collagen, type XI, alpha 2	553240	433	448622	1161	1889, 2614, 3339, 4064, 4789
279	collagen, type XII, alpha 1	322507	434	325146	1162	1890, 2615, 3340, 4065, 4790, 5285, 5400

280	collagen, type XII, alpha 1	345356	435	305147	1163	1891, 2616, 3341, 4066, 4791, 5286, 5401
281	collagen, type XII, alpha 1	432784	436	406049	1164	1892, 2617, 3342, 4067, 4792, 5287, 5402
282	collagen, type XIII, alpha 1	354547	437	346553	1165	1893, 2618, 3343, 4068, 4793
283	collagen, type XIII, alpha 1	356340	438	348695	1166	1894, 2619, 3344, 4069, 4794
284	collagen, type XIII, alpha 1	357811	439	350463	1167	1895, 2620, 3345, 4070, 4795
285	collagen, type XIII, alpha 1	398964	440	381936	1168	1896, 2621, 3346, 4071, 4796
286	collagen, type XIII, alpha 1	398966	441	381938	1169	1897, 2622, 3347, 4072, 4797
287	collagen, type XIII, alpha 1	398968	442	381940	1170	1898, 2623, 3348, 4073, 4798
288	collagen, type XIII, alpha 1	398969	443	381941	1171	1899, 2624, 3349, 4074, 4799
289	collagen, type XIII, alpha 1	398971	444	381943	1172	1900, 2625, 3350, 4075, 4800
290	collagen, type XIII, alpha 1	398972	445	381944	1173	1901, 2626, 3351, 4076, 4801
291	collagen, type XIII, alpha 1	398973	446	381945	1174	1902, 2627, 3352, 4077, 4802
292	collagen, type XIII, alpha 1	398974	447	381946	1175	1903, 2628, 3353, 4078, 4803
293	collagen, type XIII, alpha 1	398978	448	381949	1176	1904, 2629, 3354, 4079, 4804
294	collagen, type XIII, alpha 1	517713	449	430061	1177	1905, 2630, 3355, 4080, 4805
295	collagen, type XIII, alpha 1	520133	450	430173	1178	1906, 2631, 3356, 4081, 4806

296	collagen, type XIII, alpha 1	520267	451	428057	1179	1907, 2632, 3357, 4082, 4807
297	collagen, type XIV, alpha 1	247781	452	247781	1180	1908, 2633, 3358, 4083, 4808
298	collagen, type XIV, alpha 1	297848	453	297848	1181	1909, 2634, 3359, 4084, 4809
299	collagen, type XIV, alpha 1	309791	454	311809	1182	1910, 2635, 3360, 4085, 4810
300	collagen, type XIV, alpha 1	537875	455	443974	1183	1911, 2636, 3361, 4086, 4811
301	collagen, type XIX, alpha 1	322773	456	316030	1184	1912, 2637, 3362, 4087, 4812
302	collagen, type XIX, alpha 1	393333	457	377006	1185	1913, 2638, 3363, 4088, 4813
303	collagen, type XV, alpha 1	375001	458	364140	1186	1914, 2639, 3364, 4089, 4814
304	collagen, type XV, alpha 1	536083	459	445833	1187	1915, 2640, 3365, 4090, 4815
305	collagen, type XVI, alpha 1	271069	460	271069	1188	1916, 2641, 3366, 4091, 4816
306	collagen, type XVI, alpha 1	373672	461	362776	1189	1917, 2642, 3367, 4092, 4817
307	collagen, type XVII, alpha 1	353479	462	340937	1190	1918, 2643, 3368, 4093, 4818, 5288, 5403
308	collagen, type XVII, alpha 1	393211	463	376905	1191	1919, 2644, 3369, 4094, 4819, 5289, 5404
309	collagen, type XVII, alpha 1	433822	464	388832	1192	1920, 2645, 3370, 4095, 4820, 5290, 5405
310	collagen, type XVII, alpha 1	541872	465	438701	1193	1921, 2646, 3371, 4096, 4821, 5291, 5406

311	collagen, type XX, alpha 1	326996	466	323077	1194	1922, 2647, 3372, 4097, 4822, 5292, 5407
312	collagen, type XX, alpha 1	358894	467	351767	1195	1923, 2648, 3373, 4098, 4823, 5293, 5408
313	collagen, type XX, alpha 1	422202	468	414753	1196	1924, 2649, 3374, 4099, 4824, 5294, 5409
314	collagen, type XX, alpha 1	435874	469	408690	1197	1925, 2650, 3375, 4100, 4825, 5295, 5410
315	collagen, type XXI, alpha 1	244728	470	244728	1198	1926, 2651, 3376, 4101, 4826
316	collagen, type XXI, alpha 1	370808	471	359844	1199	1927, 2652, 3377, 4102, 4827
317	collagen, type XXI, alpha 1	370811	472	359847	1200	1928, 2653, 3378, 4103, 4828
318	collagen, type XXI, alpha 1	370817	473	359853	1201	1929, 2654, 3379, 4104, 4829
319	collagen, type XXI, alpha 1	370819	474	359855	1202	1930, 2655, 3380, 4105, 4830
320	collagen, type XXI, alpha 1	535941	475	444384	1203	1931, 2656, 3381, 4106, 4831
321	collagen, type XXII, alpha 1	303045	476	303153	1204	1932, 2657, 3382, 4107, 4832
322	collagen, type XXII, alpha 1	435777	477	387655	1205	1933, 2658, 3383, 4108, 4833
323	collagen, type XXII, alpha 1	545577	478	443522	1206	1934, 2659, 3384, 4109, 4834
324	collagen, type XXIV, alpha 1	370571	479	359603	1207	1935, 2660, 3385, 4110, 4835
325	collagen, type XXIV, alpha 1	436319	480	392531	1208	1936, 2661, 3386, 4111, 4836



326	collagen, type XXIV, alpha 1	496682	481	434740	1209	1937, 2662, 3387, 4112, 4837
327	collagen, type XXV, alpha 1	333642	482	329626	1210	1938, 2663, 3388, 4113, 4838
328	collagen, type XXV, alpha 1	399126	483	382077	1211	1939, 2664, 3389, 4114, 4839
329	collagen, type XXV, alpha 1	399132	484	382083	1212	1940, 2665, 3390, 4115, 4840
330	collagen, type XXV, alpha 1	401873	485	385796	1213	1941, 2666, 3391, 4116, 4841
331	collagen, type XXV, alpha 1	443653	486	388334	1214	1942, 2667, 3392, 4117, 4842
332	collagen, type XXV, alpha 1	505591	487	422266	1215	1943, 2668, 3393, 4118, 4843
333	collagen, type XXV, alpha 1	512961	488	426841	1216	1944, 2669, 3394, 4119, 4844
334	collagen, type XXVII, alpha 1	356083	489	348385	1217	1945, 2670, 3395, 4120, 4845
335	collagen, type XXVII, alpha 1	357257	490	349802	1218	1946, 2671, 3396, 4121, 4846
336	collagen, type XXVII, alpha 1	374106	491	363219	1219	1947, 2672, 3397, 4122, 4847
337	collagen, type XXVIII, alpha 1	399419	492	382347	1220	1948, 2673, 3398, 4123, 4848
338	collagen, type XXVIII, alpha 1	399429	493	382356	1221	1949, 2674, 3399, 4124, 4849
339	collagen, type XXVIII, alpha 1	448652	494	399021	1222	1950, 2675, 3400, 4125, 4850
340	collagen, type XXVIII, alpha 1	453441	495	391380	1223	1951, 2676, 3401, 4126, 4851
341	corneodesmosin	259726	496	259726	1224	1952, 2677, 3402, 4127, 4852
342	corneodesmosin	376288	497	365465	1225	1953, 2678, 3403, 4128,

						4853
343	corneodesmosin	383531	498	373023	1226	1954, 2679, 3404, 4129, 4854
344	corneodesmosin	418599	499	392863	1227	1955, 2680, 3405, 4130, 4855
345	corneodesmosin	445893	500	388386	1228	1956, 2681, 3406, 4131, 4856
346	corneodesmosin	457875	501	399604	1229	1957, 2682, 3407, 4132, 4857
347	dopachrome tautomerase (dopachrome delta-isomerase, tyrosine-related protein 2)	377021	502	366220	1230	1958, 2683, 3408, 4133, 4858
348	dopachrome tautomerase (dopachrome delta-isomerase, tyrosine-related protein 2)	377028	503	366227	1231	1959, 2684, 3409, 4134, 4859
349	dopachrome tautomerase (dopachrome delta-isomerase, tyrosine-related protein 2)	446125	504	392762	1232	1960, 2685, 3410, 4135, 4860
350	ectodysplasin A receptor	258443	505	258443	1233	1961, 2686, 3411, 4136, 4861
351	ectodysplasin A receptor	376651	506	365839	1234	1962, 2687, 3412, 4137, 4862
352	ectodysplasin A receptor	409271	507	386371	1235	1963, 2688, 3413, 4138, 4863
353	ectodysplasin A2 receptor	253392	508	253392	1236	1964, 2689, 3414, 4139, 4864
354	ectodysplasin A2 receptor	374719	509	363851	1237	1965, 2690, 3415, 4140, 4865
355	ectodysplasin A2 receptor	396050	510	379365	1238	1966, 2691, 3416, 4141, 4866
356	ectodysplasin A2 receptor	450752	511	402929	1239	1967, 2692, 3417, 4142, 4867
357	ectodysplasin A2 receptor	451436	512	415242	1240	1968, 2693, 3418, 4143, 4868
358	ectodysplasin A2 receptor	456230	513	393935	1241	1969, 2694, 3419, 4144, 4869

359	EDAR-associated death domain	334232	514	335076	1242	1970, 2695, 3420, 4145, 4870
360	EDAR-associated death domain	359362	515	352320	1243	1971, 2696, 3421, 4146, 4871
361	EDAR-associated death domain	439430	516	405815	1244	1972, 2697, 3422, 4147, 4872
362	elastin	252034	517	252034	1245	1973, 2698, 3423, 4148, 4873, 5296, 5411
363	elastin	320399	518	313565	1246	1974, 2699, 3424, 4149, 4874, 5297, 5412
364	elastin	357036	519	349540	1247	1975, 2700, 3425, 4150, 4875, 5298, 5413
365	elastin	358929	520	351807	1248	1976, 2701, 3426, 4151, 4876, 5299, 5414
366	elastin	380575	521	369949	1249	1977, 2702, 3427, 4152, 4877, 5300, 5415
367	elastin	380576	522	369950	1250	1978, 2703, 3428, 4153, 4878, 5301, 5416
368	elastin	417091	523	411092	1251	1979, 2704, 3429, 4154, 4879, 5302, 5417
369	elastin	428787	524	399499	1252	1980, 2705, 3430, 4155, 4880, 5303, 5418
370	elastin	429192	525	391129	1253	1981, 2706, 3431, 4156, 4881, 5304, 5419
371	elastin	438880	526	389206	1254	1982, 2707, 3432, 4157, 4882, 5305, 5420

372	elastin	438906	527	406949	1255	1983, 2708, 3433, 4158, 4883, 5306, 5421
373	elastin	442310	528	403961	1256	1984, 2709, 3434, 4159, 4884, 5307, 5422
374	elastin	442462	529	403940	1257	1985, 2710, 3435, 4160, 4885, 5308, 5423
375	elastin	445912	530	389857	1258	1986, 2711, 3436, 4161, 4886, 5309, 5424
376	elastin	458204	531	403162	1259	1987, 2712, 3437, 4162, 4887, 5310, 5425
377	fibroblast growth factor 11	293829	532	293829	1260	1988, 2713, 3438, 4163, 4888
378	fibroblast growth factor 12	264730	533	264730	1261	1989, 2714, 3439, 4164, 4889
379	fibroblast growth factor 12	392454	534	376248	1262	1990, 2715, 3440, 4165, 4890
380	fibroblast growth factor 12	418610	535	395517	1263	1991, 2716, 3441, 4166, 4891
381	fibroblast growth factor 12	445105	536	393686	1264	1992, 2717, 3442, 4167, 4892
382	fibroblast growth factor 12	450716	537	397635	1265	1993, 2718, 3443, 4168, 4893
383	fibroblast growth factor 12	454309	538	413496	1266	1994, 2719, 3444, 4169, 4894
384	fibroblast growth factor 13	305414	539	303391	1267	1995, 2720, 3445, 4170, 4895
385	fibroblast growth factor 13	315930	540	322390	1268	1996, 2721, 3446, 4171, 4896
386	fibroblast growth factor 13	370603	541	359635	1269	1997, 2722, 3447, 4172, 4897

387	fibroblast growth factor 13	421460	542	388688	1270	1998, 2723, 3448, 4173, 4898
388	fibroblast growth factor 13	436198	543	396198	1271	1999, 2724, 3449, 4174, 4899
389	fibroblast growth factor 13	441825	544	409276	1272	2000, 2725, 3450, 4175, 4900
390	fibroblast growth factor 13	448673	545	411999	1273	2001, 2726, 3451, 4176, 4901
391	fibroblast growth factor 13	455663	546	406916	1274	2002, 2727, 3452, 4177, 4902
392	fibroblast growth factor 13	541469	547	437903	1275	2003, 2728, 3453, 4178, 4903
393	fibroblast growth factor 14	376131	548	365301	1276	2004, 2729, 3454, 4179, 4904
394	fibroblast growth factor 14	376143	549	365313	1277	2005, 2730, 3455, 4180, 4905
395	fibroblast growth factor 16	439435	550	399324	1278	2006, 2731, 3456, 4181, 4906
396	fibroblast growth factor 17	359441	551	352414	1279	2007, 2732, 3457, 4182, 4907, 5311, 5426
397	fibroblast growth factor 17	518533	552	431041	1280	2008, 2733, 3458, 4183, 4908, 5312, 5427
398	fibroblast growth factor 18	274625	553	274625	1281	2009, 2734, 3459, 4184, 4909, 5467- 5553
399	fibroblast growth factor 19	294312	554	294312	1282	2010, 2735, 3460, 4185, 4910
400	fibroblast growth factor 20	180166	555	180166	1283	2011, 2736, 3461, 4186, 4911
401	fibroblast growth factor 20	381981	556	371411	1284	2012, 2737, 3462, 4187, 4912

402	fibroblast growth factor 22	166133	557	166133	1285	2013, 2738, 3463, 4188, 4913, 5313, 5428
403	fibroblast growth factor 22	215530	558	215530	1286	2014, 2739, 3464, 4189, 4914
404	fibroblast growth factor 23	237837	559	237837	1287	2015, 2740, 3465, 4190, 4915, 5554-5640
405	fibroblast growth factor 3	334134	560	334122	1288	2016, 2741, 3466, 4191, 4916
406	fibroblast growth factor 4	168712	561	168712	1289	2017, 2742, 3467, 4192, 4917, 5314, 5429
407	fibroblast growth factor 5	312465	562	311697	1290	2018, 2743, 3468, 4193, 4918
408	fibroblast growth factor 5	456523	563	398353	1291	2019, 2744, 3469, 4194, 4919
409	fibroblast growth factor 6	228837	564	228837	1292	2020, 2745, 3470, 4195, 4920
410	fibroblast growth factor 8 (androgen-induced)	320185	565	321797	1293	2021, 2746, 3471, 4196, 4921
411	fibroblast growth factor 8 (androgen-induced)	344255	566	340039	1294	2022, 2747, 3472, 4197, 4922
412	fibroblast growth factor 8 (androgen-induced)	346714	567	344306	1295	2023, 2748, 3473, 4198, 4923
413	fibroblast growth factor 8 (androgen-induced)	347978	568	321945	1296	2024, 2749, 3474, 4199, 4924
414	fibroblast growth factor 9 (glia-activating factor)	382353	569	371790	1297	2025, 2750, 3475, 4200, 4925
415	filaggrin family member 2	388718	570	373370	1298	2026, 2751, 3476, 4201, 4926

416	heparin-binding EGF-like growth factor	230990	571	230990	1299	2027, 2752, 3477, 4202, 4927
417	heparin-binding EGF-like growth factor	507104	572	425696	1300	2028, 2753, 3478, 4203, 4928
418	insulin-like growth factor binding protein 2, 36kDa	233809	573	233809	1301	2029, 2754, 3479, 4204, 4929
419	insulin-like growth factor binding protein 6	301464	574	301464	1302	2030, 2755, 3480, 4205, 4930, 5315, 5430
420	insulin-like growth factor binding protein 6	548176	575	449344	1303	2031, 2756, 3481, 4206, 4931, 5316, 5431
421	insulin-like growth factor binding protein 6	548547	576	448953	1304	2032, 2757, 3482, 4207, 4932, 5317, 5432
422	insulin-like growth factor binding protein-like 1	377694	577	366923	1305	2033, 2758, 3483, 4208, 4933, 5318, 5433
423	interleukin 1 family, member 10 (theta)	337569	578	338418	1306	2034, 2759, 3484, 4209, 4934, 5319, 5434
424	interleukin 1 family, member 10 (theta)	341010	579	341794	1307	2035, 2760, 3485, 4210, 4935, 5320, 5435
425	interleukin 1 family, member 10 (theta)	393197	580	376893	1308	2036, 2761, 3486, 4211, 4936, 5321, 5436
426	interleukin 1, alpha	263339	581	263339	1309	2037, 2762, 3487, 4212, 4937
427	interleukin 11	264563	582	264563	1310	2038, 2763, 3488, 4213, 4938, 5322, 5437
428	interleukin 12B (natural killer cell stimulatory factor 2, cytotoxic lymphocyte maturation factor 2, p40)	231228	583	231228	1311	2039, 2764, 3489, 4214, 4939

429	interleukin 13	304506	584	304915	1312	2040, 2765, 3490, 4215, 4940
430	interleukin 16	302987	585	302935	1313	2041, 2766, 3491, 4216, 4941
431	interleukin 16	329842	586	329317	1314	2042, 2767, 3492, 4217, 4942
432	interleukin 16	355368	587	347528	1315	2043, 2768, 3493, 4218, 4943
433	interleukin 16	394652	588	378147	1316	2044, 2769, 3494, 4219, 4944
434	interleukin 16	394653	589	378148	1317	2045, 2770, 3495, 4220, 4945
435	interleukin 16	394655	590	378150	1318	2046, 2771, 3496, 4221, 4946
436	interleukin 16	394656	591	378151	1319	2047, 2772, 3497, 4222, 4947
437	interleukin 16	394660	592	378155	1320	2048, 2773, 3498, 4223, 4948
438	interleukin 16	559383	593	453250	1321	2049, 2774, 3499, 4224, 4949
439	interleukin 17A	340057	594	344192	1322	2050, 2775, 3500, 4225, 4950
440	interleukin 17B	261796	595	261796	1323	2051, 2776, 3501, 4226, 4951
441	interleukin 17C	244241	596	244241	1324	2052, 2777, 3502, 4227, 4952
442	interleukin 17D	304920	597	302924	1325	2053, 2778, 3503, 4228, 4953
443	interleukin 17F	336123	598	337432	1326	2054, 2779, 3504, 4229, 4954
444	interleukin 20	367096	599	356063	1327	2055, 2780, 3505, 4230, 4955
445	interleukin 20	367098	600	356065	1328	2056, 2781, 3506, 4231,



						4956
446	interleukin 20	391930	601	375796	1329	2057, 2782, 3507, 4232, 4957
447	interleukin 22	328087	602	329384	1330	2058, 2783, 3508, 4233, 4958
448	interleukin 22	538666	603	442424	1331	2059, 2784, 3509, 4234, 4959
449	interleukin 23 receptor	347310	604	321345	1332	2060, 2785, 3510, 4235, 4960
450	interleukin 23 receptor	371002	605	360041	1333	2061, 2786, 3511, 4236, 4961
451	interleukin 23 receptor	395227	606	378652	1334	2062, 2787, 3512, 4237, 4962
452	interleukin 23 receptor	416525	607	388654	1335	2063, 2788, 3513, 4238, 4963
453	interleukin 23 receptor	425614	608	387640	1336	2064, 2789, 3514, 4239, 4964
454	interleukin 23 receptor	431791	609	395010	1337	2065, 2790, 3515, 4240, 4965
455	interleukin 23 receptor	441823	610	399293	1338	2066, 2791, 3516, 4241, 4966
456	interleukin 23 receptor	540775	611	444746	1339	2067, 2792, 3517, 4242, 4967
457	interleukin 23 receptor	540911	612	445271	1340	2068, 2793, 3518, 4243, 4968
458	interleukin 23 receptor	543799	613	443793	1341	2069, 2794, 3519, 4244, 4969
459	interleukin 23, alpha subunit p19	228534	614	228534	1342	2070, 2795, 3520, 4245, 4970
460	interleukin 24	294984	615	294984	1343	2071, 2796, 3521, 4246, 4971, 5323, 5438

461	interleukin 24	367093	616	356060	1344	2072, 2797, 3522, 4247, 4972, 5324, 5439
462	interleukin 24	391929	617	375795	1345	2073, 2798, 3523, 4248, 4973, 5325, 5440
463	interleukin 25	329715	618	328111	1346	2074, 2799, 3524, 4249, 4974
464	interleukin 25	397242	619	380417	1347	2075, 2800, 3525, 4250, 4975
465	interleukin 26	229134	620	229134	1348	2076, 2801, 3526, 4251, 4976
466	interleukin 27	356897	621	349365	1349	2077, 2802, 3527, 4252, 4977
467	interleukin 28A (interferon, lambda 2)	331982	622	333639	1350	2078, 2803, 3528, 4253, 4978
468	interleukin 28B (interferon, lambda 3)	413851	623	409000	1351	2079, 2804, 3529, 4254, 4979
469	interleukin 29 (interferon, lambda 1)	333625	624	329991	1352	2080, 2805, 3530, 4255, 4980
470	interleukin 31	377035	625	366234	1353	2081, 2806, 3531, 4256, 4981, 5326, 5441
471	interleukin 32	8180	626	8180	1354	2082, 2807, 3532, 4257, 4982, 5327, 5442
472	interleukin 32	325568	627	324742	1355	2083, 2808, 3533, 4258, 4983
473	interleukin 32	382213	628	371648	1356	2084, 2809, 3534, 4259, 4984
474	interleukin 32	396887	629	380096	1357	2085, 2810, 3535, 4260, 4985

475	interleukin 32	396890	630	380099	1358	2086, 2811, 3536, 4261, 4986
476	interleukin 32	440815	631	405063	1359	2087, 2812, 3537, 4262, 4987
477	interleukin 32	444393	632	411958	1360	2088, 2813, 3538, 4263, 4988
478	interleukin 32	525643	633	432218	1361	2089, 2814, 3539, 4264, 4989
479	interleukin 32	526464	634	450364	1362	2090, 2815, 3540, 4265, 4990
480	interleukin 32	528163	635	432850	1363	2091, 2816, 3541, 4266, 4991
481	interleukin 32	529550	636	437020	1364	2092, 2817, 3542, 4267, 4992
482	interleukin 32	530538	637	436929	1365	2093, 2818, 3543, 4268, 4993
483	interleukin 32	530890	638	433747	1366	2094, 2819, 3544, 4269, 4994
484	interleukin 32	531965	639	433177	1367	2095, 2820, 3545, 4270, 4995
485	interleukin 32	533097	640	432917	1368	2096, 2821, 3546, 4271, 4996
486	interleukin 32	534507	641	431775	1369	2097, 2822, 3547, 4272, 4997
487	interleukin 32	548476	642	449483	1370	2098, 2823, 3548, 4273, 4998
488	interleukin 32	548652	643	446624	1371	2099, 2824, 3549, 4274, 4999
489	interleukin 32	548807	644	448354	1372	2100, 2825, 3550, 4275, 5000
490	interleukin 32	549213	645	447812	1373	2101, 2826, 3551, 4276, 5001
491	interleukin 32	551122	646	447496	1374	2102, 2827, 3552, 4277,

						5002
492	interleukin 32	552356	647	446978	1375	2103, 2828, 3553, 4278, 5003
493	interleukin 32	552664	648	448683	1376	2104, 2829, 3554, 4279, 5004
494	interleukin 33	381434	649	370842	1377	2105, 2830, 3555, 4280, 5005
495	interleukin 33	417746	650	394039	1378	2106, 2831, 3556, 4281, 5006
496	interleukin 33	456383	651	414238	1379	2107, 2832, 3557, 4282, 5007
497	interleukin 34	288098	652	288098	1380	2108, 2833, 3558, 4283, 5008
498	interleukin 34	429149	653	397863	1381	2109, 2834, 3559, 4284, 5009
499	interleukin 36, alpha	259211	654	259211	1382	2110, 2835, 3560, 4285, 5010
500	interleukin 36, alpha	397653	655	380773	1383	2111, 2836, 3561, 4286, 5011
501	interleukin 36, beta	259213	656	259213	1384	2112, 2837, 3562, 4287, 5012
502	interleukin 36, beta	327407	657	328420	1385	2113, 2838, 3563, 4288, 5013
503	interleukin 36, gamma	259205	658	259205	1386	2114, 2839, 3564, 4289, 5014
504	interleukin 36, gamma	447128	659	411639	1387	2115, 2840, 3565, 4290, 5015
505	interleukin 37	263326	660	263326	1388	2116, 2841, 3566, 4291, 5016
506	interleukin 37	311328	661	309883	1389	2117, 2842, 3567, 4292, 5017
507	interleukin 37	349806	662	263328	1390	2118, 2843, 3568, 4293, 5018

508	interleukin 37	352179	663	263327	1391	2119, 2844, 3569, 4294, 5019
509	interleukin 37	353225	664	309208	1392	2120, 2845, 3570, 4295, 5020
510	interleukin 4 induced 1	341114	665	342557	1393	2121, 2846, 3571, 4296, 5021
511	interleukin 4 induced 1	391826	666	375702	1394	2122, 2847, 3572, 4297, 5022
512	interleukin 4 induced 1	595948	667	472474	1395	2123, 2848, 3573, 4298, 5023
513	interleukin 5 (colony- stimulating factor, eosinophil)	231454	668	231454	1396	2124, 2849, 3574, 4299, 5024
514	interleukin 9	274520	669	274520	1397	2125, 2850, 3575, 4300, 5025
515	interleukin enhancer binding factor 3 90kDa	589998	670	465219	1398	2126, 2851, 3576, 4301, 5026
516	interleukin enhancer binding factor 3, 90kDa	250241	671	250241	1399	2127, 2852, 3577, 4302, 5027
517	interleukin enhancer binding factor 3, 90kDa	318511	672	315205	1400	2128, 2853, 3578, 4303, 5028
518	interleukin enhancer binding factor 3, 90kDa	336059	673	337305	1401	2129, 2854, 3579, 4304, 5029
519	interleukin enhancer binding factor 3, 90kDa	407004	674	384660	1402	2130, 2855, 3580, 4305, 5030
520	interleukin enhancer binding factor 3, 90kDa	420083	675	405436	1403	2131, 2856, 3581, 4306, 5031
521	interleukin enhancer binding factor 3, 90kDa	449870	676	404121	1404	2132, 2857, 3582, 4307, 5032
522	kallikrein-related peptidase 5	336334	677	337733	1405	2133, 2858, 3583, 4308,

						5033
523	kallikrein-related peptidase 5	391809	678	375685	1406	2134, 2859, 3584, 4309, 5034
524	kallikrein-related peptidase 5	593428	679	471966	1407	2135, 2860, 3585, 4310, 5035
525	kinesin family member 3A	378735	680	368009	1408	2136, 2861, 3586, 4311, 5036
526	kinesin family member 3A	378746	681	368020	1409	2137, 2862, 3587, 4312, 5037
527	kinesin family member 3A	450914	682	407601	1410	2138, 2863, 3588, 4313, 5038
528	kinesin family member 3A	541316	683	445791	1411	2139, 2864, 3589, 4314, 5039
529	lysophosphatidic acid receptor 6	345941	684	344353	1412	2140, 2865, 3590, 4315, 5040
530	lysophosphatidic acid receptor 6	378434	685	367691	1413	2141, 2866, 3591, 4316, 5041
531	macrophage stimulating 1 (hepatocyte growth factor-like)	383728	686	373234	1414	2142, 2867, 3592, 4317, 5042
532	macrophage stimulating 1 (hepatocyte growth factor-like)	449682	687	414287	1415	2143, 2868, 3593, 4318, 5043
533	macrophage stimulating 1 (hepatocyte growth factor-like)	545762	688	437535	1416	2144, 2869, 3594, 4319, 5044
534	macrophage stimulating 1 (hepatocyte growth factor-like) pseudogene 9	334998	689	439273	1417	2145, 2870, 3595, 4320, 5045, 5328, 5443
535	macrophage stimulating 1 (hepatocyte growth factor-like) pseudogene 9	389184	690	445850	1418	2146, 2871, 3596, 4321, 5046
536	macrophage stimulating 1 (hepatocyte growth factor-like) pseudogene 9	442552	691	438833	1419	2147, 2872, 3597, 4322, 5047, 5329, 5444
537	major histocompatibility complex, class I, C	376228	692	365402	1420	2148, 2873, 3598, 4323, 5048

538	major histocompatibility complex, class I, C	376237	693	365412	1421	2149, 2874, 3599, 4324, 5049
539	major histocompatibility complex, class I, C	383323	694	372813	1422	2150, 2875, 3600, 4325, 5050
540	major histocompatibility complex, class I, C	383329	695	372819	1423	2151, 2876, 3601, 4326, 5051
541	major histocompatibility complex, class I, C	383483	696	372975	1424	2152, 2877, 3602, 4327, 5052
542	major histocompatibility complex, class I, C	383487	697	372979	1425	2153, 2878, 3603, 4328, 5053
543	major histocompatibility complex, class I, C	396254	698	379553	1426	2154, 2879, 3604, 4329, 5054
544	major histocompatibility complex, class I, C	400341	699	383195	1427	2155, 2880, 3605, 4330, 5055
545	major histocompatibility complex, class I, C	400394	700	383244	1428	2156, 2881, 3606, 4331, 5056
546	major histocompatibility complex, class I, C	400395	701	383245	1429	2157, 2882, 3607, 4332, 5057
547	major histocompatibility complex, class I, C	414249	702	390282	1430	2158, 2883, 3608, 4333, 5058
548	major histocompatibility complex, class I, C	415537	703	400410	1431	2159, 2884, 3609, 4334, 5059
549	major histocompatibility complex, class I, C	419135	704	407431	1432	2160, 2885, 3610, 4335, 5060
550	major histocompatibility complex, class I, C	419590	705	390860	1433	2161, 2886, 3611, 4336, 5061

551	major histocompatibility complex, class I, C	420206	706	410214	1434	2162, 2887, 3612, 4337, 5062
552	major histocompatibility complex, class I, C	422726	707	389248	1435	2163, 2888, 3613, 4338, 5063
553	major histocompatibility complex, class I, C	422921	708	397867	1436	2164, 2889, 3614, 4339, 5064
554	major histocompatibility complex, class I, C	423509	709	403624	1437	2165, 2890, 3615, 4340, 5065
555	major histocompatibility complex, class I, C	424832	710	414063	1438	2166, 2891, 3616, 4341, 5066
556	major histocompatibility complex, class I, C	429840	711	413189	1439	2167, 2892, 3617, 4342, 5067
557	major histocompatibility complex, class I, C	430940	712	413992	1440	2168, 2893, 3618, 4343, 5068
558	major histocompatibility complex, class I, C	433153	713	415025	1441	2169, 2894, 3619, 4344, 5069
559	major histocompatibility complex, class I, C	434884	714	398169	1442	2170, 2895, 3620, 4345, 5070
560	major histocompatibility complex, class I, C	437368	715	407494	1443	2171, 2896, 3621, 4346, 5071
561	major histocompatibility complex, class I, C	438171	716	393374	1444	2172, 2897, 3622, 4347, 5072
562	major histocompatibility complex, class I, C	445075	717	412426	1445	2173, 2898, 3623, 4348, 5073
563	major histocompatibility complex, class I, C	448362	718	410661	1446	2174, 2899, 3624, 4349, 5074



564	major histocompatibility complex, class I, C	449884	719	411867	1447	2175, 2900, 3625, 4350, 5075
565	major histocompatibility complex, class I, C	453809	720	388708	1448	2176, 2901, 3626, 4351, 5076
566	major histocompatibility complex, class I, C	454033	721	391250	1449	2177, 2902, 3627, 4352, 5077
567	major histocompatibility complex, class I, C	456487	722	393458	1450	2178, 2903, 3628, 4353, 5078
568	major histocompatibility complex, class I, C	457806	723	407051	1451	2179, 2904, 3629, 4354, 5079
569	major histocompatibility complex, class I, C	457903	724	390851	1452	2180, 2905, 3630, 4355, 5080
570	major histocompatibility complex, class I, C	458192	725	404526	1453	2181, 2906, 3631, 4356, 5081
571	major histocompatibility complex, class I, C	458668	726	403541	1454	2182, 2907, 3632, 4357, 5082
572	major histocompatibility complex, class I, C	458701	727	410579	1455	2183, 2908, 3633, 4358, 5083
573	major histocompatibility complex, class I, C	461937	728	436842	1456	2184, 2909, 3634, 4359, 5084
574	major histocompatibility complex, class I, C	464914	729	433897	1457	2185, 2910, 3635, 4360, 5085
575	major histocompatibility complex, class I, C	469544	730	436915	1458	2186, 2911, 3636, 4361, 5086
576	major histocompatibility complex, class I, C	476248	731	435957	1459	2187, 2912, 3637, 4362, 5087

577	major histocompatibility complex, class I, C	479595	732	433088	1460	2188, 2913, 3638, 4363, 5088
578	major histocompatibility complex, class I, C	485321	733	431141	1461	2189, 2914, 3639, 4364, 5089
579	major histocompatibility complex, class I, C	488273	734	431347	1462	2190, 2915, 3640, 4365, 5090
580	major histocompatibility complex, class I, C	491984	735	433409	1463	2191, 2916, 3641, 4366, 5091
581	major histocompatibility complex, class I, C	539307	736	440406	1464	2192, 2917, 3642, 4367, 5092
582	major histocompatibility complex, class I, C	549351	737	447743	1465	2193, 2918, 3643, 4368, 5093
583	major histocompatibility complex, class I, C	552865	738	448156	1466	2194, 2919, 3644, 4369, 5094
584	matrix metallopeptidase 15 (membrane-inserted)	219271	739	219271	1467	2195, 2920, 3645, 4370, 5095
585	matrix metallopeptidase 16 (membrane-inserted)	286614	740	286614	1468	2196, 2921, 3646, 4371, 5096
586	matrix metallopeptidase 17 (membrane-inserted)	360564	741	353767	1469	2197, 2922, 3647, 4372, 5097
587	matrix metallopeptidase 17 (membrane-inserted)	535291	742	441106	1470	2198, 2923, 3648, 4373, 5098
588	matrix metallopeptidase 17 (membrane-inserted)	545790	743	441710	1471	2199, 2924, 3649, 4374, 5099
589	matrix metallopeptidase 19	322569	744	313437	1472	2200, 2925, 3650, 4375, 5100, 5330, 5445
590	matrix metallopeptidase 19	394182	745	377736	1473	2201, 2926, 3651, 4376, 5101, 5331, 5446

591	matrix metallopeptidase 19	409200	746	386625	1474	2202, 2927, 3652, 4377, 5102, 5332, 5447
592	matrix metallopeptidase 20	260228	747	260228	1475	2203, 2928, 3653, 4378, 5103
593	matrix metallopeptidase 21	368808	748	357798	1476	2204, 2929, 3654, 4379, 5104
594	matrix metallopeptidase 23B	356026	749	348308	1477	2205, 2930, 3655, 4380, 5105, 5333, 5448
595	matrix metallopeptidase 23B	378675	750	367945	1478	2206, 2931, 3656, 4381, 5106, 5334, 5449
596	matrix metallopeptidase 23B	412415	751	411590	1479	2207, 2932, 3657, 4382, 5107, 5335, 5450
597	matrix metallopeptidase 23B	512731	752	423780	1480	2208, 2933, 3658, 4383, 5108, 5336, 5451
598	matrix metallopeptidase 24 (membrane-inserted)	246186	753	246186	1481	2209, 2934, 3659, 4384, 5109, 5337, 5452
599	matrix metallopeptidase 24 (membrane-inserted)	540655	754	441902	1482	2210, 2935, 3660, 4385, 5110
600	matrix metallopeptidase 25	325800	755	324953	1483	2211, 2936, 3661, 4386, 5111
601	matrix metallopeptidase 25	336577	756	337816	1484	2212, 2937, 3662, 4387, 5112
602	matrix metallopeptidase 26	300762	757	300762	1485	2213, 2938, 3663, 4388, 5113
603	matrix metallopeptidase 26	380390	758	369753	1486	2214, 2939, 3664, 4389, 5114

604	matrix metallopeptidase 27	260229	759	260229	1487	2215, 2940, 3665, 4390, 5115, 5338, 5453
605	matrix metallopeptidase 28	250144	760	250144	1488	2216, 2941, 3666, 4391, 5116, 5339, 5454
606	matrix metallopeptidase 28	338839	761	340652	1489	2217, 2942, 3667, 4392, 5117, 5340, 5455
607	matrix metallopeptidase 28	538544	762	437605	1490	2218, 2943, 3668, 4393, 5118, 5341, 5456
608	matrix metallopeptidase 28	589103	763	468709	1491	2219, 2944, 3669, 4394, 5119, 5342, 5457
609	matrix metallopeptidase 8 (neutrophil collagenase)	236826	764	236826	1492	2220, 2945, 3670, 4395, 5120
610	matrix metallopeptidase 8 (neutrophil collagenase)	534942	765	440388	1493	2221, 2946, 3671, 4396, 5121
611	matrix metallopeptidase 8 (neutrophil collagenase)	544383	766	446018	1494	2222, 2947, 3672, 4397, 5122
612	melanocortin 1 receptor (alpha melanocyte stimulating hormone receptor)	555147	767	451605	1495	2223, 2948, 3673, 4398, 5123
613	melanocortin 2 receptor (adrenocorticotropic hormone)	327606	768	333821	1496	2224, 2949, 3674, 4399, 5124
614	melanocortin 2 receptor (adrenocorticotropic hormone)	399821	769	382718	1497	2225, 2950, 3675, 4400, 5125
615	melanocortin 3 receptor	243911	770	243911	1498	2226, 2951, 3676, 4401, 5126
616	melanocortin 4 receptor	299766	771	299766	1499	2227, 2952, 3677, 4402, 5127
617	melanocortin 5 receptor	324750	772	318077	1500	2228, 2953, 3678, 4403, 5128

618	microphthalmia-associated transcription factor	314557	773	324246	1501	2229, 2954, 3679, 4404, 5129
619	microphthalmia-associated transcription factor	314589	774	324443	1502	2230, 2955, 3680, 4405, 5130
620	microphthalmia-associated transcription factor	328528	775	327867	1503	2231, 2956, 3681, 4406, 5131
621	microphthalmia-associated transcription factor	352241	776	295600	1504	2232, 2957, 3682, 4407, 5132
622	microphthalmia-associated transcription factor	394351	777	377880	1505	2233, 2958, 3683, 4408, 5133
623	microphthalmia-associated transcription factor	394355	778	377884	1506	2234, 2959, 3684, 4409, 5134
624	microphthalmia-associated transcription factor	448226	779	391803	1507	2235, 2960, 3685, 4410, 5135
625	microphthalmia-associated transcription factor	451708	780	398639	1508	2236, 2961, 3686, 4411, 5136
626	microphthalmia-associated transcription factor	457080	781	391276	1509	2237, 2962, 3687, 4412, 5137
627	microphthalmia-associated transcription factor	531774	782	435909	1510	2238, 2963, 3688, 4413, 5138
628	microphthalmia-associated transcription factor	472437	783	418845	1511	2239, 2964, 3689, 4414, 5139
629	NLR family pyrin domain containing 1	572272	784	460475	1512	2240, 2965, 3690, 4415, 5140
630	NLR family pyrin domain containing 1	577119	785	460216	1513	2241, 2966, 3691, 4416, 5141

631	NLR family, pyrin domain containing 1	262467	786	262467	1514	2242, 2967, 3692, 4417, 5142
632	NLR family, pyrin domain containing 1	269280	787	269280	1515	2243, 2968, 3693, 4418, 5143
633	NLR family, pyrin domain containing 1	345221	788	324366	1516	2244, 2969, 3694, 4419, 5144
634	NLR family, pyrin domain containing 1	354411	789	346390	1517	2245, 2970, 3695, 4420, 5145
635	NLR family, pyrin domain containing 1	537069	790	438391	1518	2246, 2971, 3696, 4421, 5146
636	NLR family, pyrin domain containing 1	544378	791	442029	1519	2247, 2972, 3697, 4422, 5147
637	nuclear factor of kappa light polypeptide gene enhancer in B-cells 2 (p49/p100)	189444	792	189444	1520	2248, 2973, 3698, 4423, 5148
638	nuclear factor of kappa light polypeptide gene enhancer in B-cells 2 (p49/p100)	336486	793	337001	1521	2249, 2974, 3699, 4424, 5149
639	nuclear factor of kappa light polypeptide gene enhancer in B-cells 2 (p49/p100)	369966	794	358983	1522	2250, 2975, 3700, 4425, 5150
640	nuclear factor of kappa light polypeptide gene enhancer in B-cells 2 (p49/p100)	428099	795	410256	1523	2251, 2976, 3701, 4426, 5151
641	ovo-like 1(Drosophila)	335987	796	337862	1524	2252, 2977, 3702, 4427, 5152
642	phospholipase C, gamma 2 (phosphatidylinositol-specific)	563193	797	455533	1525	
643	phospholipase C, gamma 2 (phosphatidylinositol-specific)	563375	798	454536	1526	
644	phospholipase C, gamma 2 (phosphatidylinositol-specific)	565054	799	455956	1527	
645	platelet derived growth factor D	302251	800	302193	1528	2253, 2978, 3703, 4428, 5153, 5343, 5458

646	platelet derived growth factor D	393158	801	376865	1529	2254, 2979, 3704, 4429, 5154, 5344, 5459
647	platelet-derived growth factor beta polypeptide	331163	802	330382	1530	2255, 2980, 3705, 4430, 5155, 5345, 5460
648	platelet-derived growth factor beta polypeptide	381551	803	370963	1531	2256, 2981, 3706, 4431, 5156, 5346, 5461
649	platelet-derived growth factor beta polypeptide	440375	804	405780	1532	2257, 2982, 3707, 4432, 5157, 5347, 5462
650	platelet-derived growth factor beta polypeptide	455790	805	402306	1533	2258, 2983, 3708, 4433, 5158, 5348, 5463
651	proopiomelanocortin	264708	806	264708	1534	2259, 2984, 3709, 4434, 5159
652	proopiomelanocortin	380794	807	370171	1535	2260, 2985, 3710, 4435, 5160
653	proopiomelanocortin	395826	808	379170	1536	2261, 2986, 3711, 4436, 5161
654	proopiomelanocortin	405623	809	384092	1537	2262, 2987, 3712, 4437, 5162
655	proopiomelanocortin	449220	810	387993	1538	2263, 2988, 3713, 4438, 5163
656	psoriasis susceptibility 1 candidate 1	259881	811	259881	1539	2264, 2989, 3714, 4439, 5164
657	psoriasis susceptibility 1 candidate 1	376289	812	365466	1540	2265, 2990, 3715, 4440, 5165
658	psoriasis susceptibility 1 candidate 1	420214	813	396568	1541	2266, 2991, 3716, 4441, 5166
659	psoriasis susceptibility 1 candidate 1	433334	814	391443	1542	2267, 2992, 3717, 4442, 5167

660	psoriasis susceptibility 1 candidate 1	441092	815	398278	1543	2268, 2993, 3718, 4443, 5168
661	psoriasis susceptibility 1 candidate 1	448455	816	389875	1544	2269, 2994, 3719, 4444, 5169
662	psoriasis susceptibility 1 candidate 1	549149	817	446589	1545	2270, 2995, 3720, 4445, 5170
663	psoriasis susceptibility 1 candidate 2	259845	818	259845	1546	2271, 2996, 3721, 4446, 5171, 5349, 5464
664	psoriasis susceptibility 1 candidate 2	383530	819	373022	1547	2272, 2997, 3722, 4447, 5172
665	psoriasis susceptibility 1 candidate 2	413924	820	398734	1548	2273, 2998, 3723, 4448, 5173
666	psoriasis susceptibility 1 candidate 2	416027	821	390931	1549	2274, 2999, 3724, 4449, 5174
667	psoriasis susceptibility 1 candidate 2	422316	822	403456	1550	2275, 3000, 3725, 4450, 5175
668	psoriasis susceptibility 1 candidate 2	458589	823	414952	1551	2276, 3001, 3726, 4451, 5176
669	Putative caspase-14-like protein	428155	824	400592	1552	2277, 3002, 3727, 4452, 5177
670	ribosomal protein S6 kinase, 52kDa, polypeptide 1	366959	825	355926	1553	2278, 3003, 3728, 4453, 5178
671	ribosomal protein S6 kinase, 52kDa, polypeptide 1	366960	826	355927	1554	2279, 3004, 3729, 4454, 5179
672	ribosomal protein S6 kinase, 52kDa, polypeptide 1	543354	827	439282	1555	2280, 3005, 3730, 4455, 5180



673	ribosomal protein S6 kinase, 52kDa, polypeptide 1	543470	828	442306	1556	2281, 3006, 3731, 4456, 5181
674	ribosomal protein S6 kinase, 70kDa, polypeptide 2	312629	829	308413	1557	2282, 3007, 3732, 4457, 5182
675	ribosomal protein S6 kinase, 70kDa, polypeptide 2	528964	830	432847	1558	2283, 3008, 3733, 4458, 5183
676	ribosomal protein S6 kinase, 70kDa, polypeptide 2	539188	831	442949	1559	2284, 3009, 3734, 4459, 5184
677	ribosomal protein S6 kinase, 90kDa, polypeptide 3	379548	832	368865	1560	2285, 3010, 3735, 4460, 5185
678	ribosomal protein S6 kinase, 90kDa, polypeptide 3	379565	833	368884	1561	2286, 3011, 3736, 4461, 5186
679	ribosomal protein S6 kinase, 90kDa, polypeptide 3	438357	834	388512	1562	2287, 3012, 3737, 4462, 5187
680	ribosomal protein S6 kinase, 90kDa, polypeptide 3	457145	835	407655	1563	2288, 3013, 3738, 4463, 5188
681	ribosomal protein S6 kinase, 90kDa, polypeptide 3	540702	836	444837	1564	2289, 3014, 3739, 4464, 5189
682	ribosomal protein S6 kinase, 90kDa, polypeptide 3	544447	837	440220	1565	2290, 3015, 3740, 4465, 5190
683	ribosomal protein S6 kinase, 90kDa, polypeptide 4	294261	838	294261	1566	2291, 3016, 3741, 4466, 5191
684	ribosomal protein S6 kinase, 90kDa, polypeptide 4	334205	839	333896	1567	2292, 3017, 3742, 4467, 5192
685	ribosomal protein S6 kinase, 90kDa, polypeptide 4	528057	840	435580	1568	2293, 3018, 3743, 4468, 5193

686	ribosomal protein S6 kinase, 90kDa, polypeptide 4	530504	841	432945	1569	2294, 3019, 3744, 4469, 5194
687	ribosomal protein S6 kinase, 90kDa, polypeptide 5	261991	842	261991	1570	2295, 3020, 3745, 4470, 5195
688	ribosomal protein S6 kinase, 90kDa, polypeptide 5	418736	843	402787	1571	2296, 3021, 3746, 4471, 5196
689	ribosomal protein S6 kinase, 90kDa, polypeptide 5	536315	844	442803	1572	2297, 3022, 3747, 4472, 5197
690	ribosomal protein S6 kinase, 90kDa, polypeptide 6	262752	845	262752	1573	2298, 3023, 3748, 4473, 5198
691	ribosomal protein S6 kinase, 90kDa, polypeptide 6	543399	846	440830	1574	2299, 3024, 3749, 4474, 5199
692	ribosomal protein S6 kinase-like 1	354625	847	346644	1575	2300, 3025, 3750, 4475, 5200
693	ribosomal protein S6 kinase-like 1	358328	848	351086	1576	2301, 3026, 3751, 4476, 5201
694	ribosomal protein S6 kinase-like 1	555647	849	452027	1577	2302, 3027, 3752, 4477, 5202
695	ribosomal protein S6 kinase-like 1	556776	850	451338	1578	2303, 3028, 3753, 4478, 5203
696	ribosomal protein S6 kinase-like 1	557413	851	450567	1579	2304, 3029, 3754, 4479, 5204
697	solute carrier family 24 (sodium/potassium/calcium exchanger), member 4	298877	852	298877	1580	2305, 3030, 3755, 4480, 5205
698	solute carrier family 24 (sodium/potassium/calcium exchanger), member 4	318079	853	316957	1581	2306, 3031, 3756, 4481, 5206
699	solute carrier family 24 (sodium/potassium/calcium exchanger), member 4	351924	854	337789	1582	2307, 3032, 3757, 4482, 5207
700	solute carrier family 24 (sodium/potassium/calcium exchanger), member 4	393265	855	376948	1583	2308, 3033, 3758, 4483, 5208
701	solute carrier family 24	531433	856	433302	1584	2309, 3034,

	(sodium/potassium/calcium exchanger), member 4					3759, 4484, 5209
702	solute carrier family 24 (sodium/potassium/calcium exchanger), member 4	532405	857	431840	1585	2310, 3035, 3760, 4485, 5210
703	solute carrier family 24, member 5	341459	858	341550	1586	2311, 3036, 3761, 4486, 5211
704	solute carrier family 24, member 5	449382	859	389966	1587	2312, 3037, 3762, 4487, 5212
705	superoxide dismutase 2, mitochondrial	337404	860	337127	1588	2313, 3038, 3763, 4488, 5213
706	superoxide dismutase 2, mitochondrial	367054	861	356021	1589	2314, 3039, 3764, 4489, 5214
707	superoxide dismutase 2, mitochondrial	367055	862	356022	1590	2315, 3040, 3765, 4490, 5215
708	superoxide dismutase 2, mitochondrial	538183	863	446252	1591	2316, 3041, 3766, 4491, 5216
709	superoxide dismutase 2, mitochondrial	546087	864	442920	1592	2317, 3042, 3767, 4492, 5217
710	superoxide dismutase 3, extracellular	382120	865	371554	1593	2318, 3043, 3768, 4493, 5218
711	tachykinin, precursor 1	319273	866	321106	1594	2319, 3044, 3769, 4494, 5219
712	tachykinin, precursor 1	346867	867	289574	1595	2320, 3045, 3770, 4495, 5220
713	tachykinin, precursor 1	350485	868	289576	1596	2321, 3046, 3771, 4496, 5221
714	thyroid stimulating hormone, beta	256592	869	256592	1597	2322, 3047, 3772, 4497, 5222, 5350, 5465

715	thyroid stimulating hormone, beta	369517	870	358530	1598	2323, 3048, 3773, 4498, 5223, 5351, 5466
716	transmembrane channel-like 6	590602	871	465261	1599	2324, 3049, 3774, 4499, 5224
717	transmembrane channel-like 8	301627	872	301627	1600	2325, 3050, 3775, 4500, 5225
718	transmembrane channel-like 8	318430	873	325561	1601	2326, 3051, 3776, 4501, 5226
719	tumor necrosis factor	376122	874	365290	1602	2327, 3052, 3777, 4502, 5227
720	tumor necrosis factor	383496	875	372988	1603	2328, 3053, 3778, 4503, 5228
721	tumor necrosis factor	412275	876	392858	1604	2329, 3054, 3779, 4504, 5229
722	tumor necrosis factor	420425	877	410668	1605	2330, 3055, 3780, 4505, 5230
723	tumor necrosis factor	443707	878	389492	1606	2331, 3056, 3781, 4506, 5231
724	tumor necrosis factor	448781	879	389490	1607	2332, 3057, 3782, 4507, 5232
725	tumor necrosis factor	449264	880	398698	1608	2333, 3058, 3783, 4508, 5233
726	tyrosinase-related protein 1	381137	881	370529	1609	2334, 3059, 3784, 4509, 5234
727	tyrosinase-related protein 1	388918	882	373570	1610	2335, 3060, 3785, 4510, 5235
728	tyrosinase-related protein 1	473763	883	419006	1611	2336, 3061, 3786, 4511, 5236

*Protein Cleavage Signals and Sites*

[000185] In one embodiment, the cosmetic polypeptides of the present invention may include at least one protein cleavage signal containing at least one protein cleavage site. The protein cleavage site may be located at the N-terminus, the C-terminus, at any space between the N- and the C- termini such as, but not limited to, half-way between the N- and C-termini, between the N-terminus and the half way point, between the half way point and the C-terminus, and combinations thereof.

[000186] The cosmetic polypeptides of the present invention may include, but is not limited to, a proprotein convertase (or prohormone convertase), thrombin or Factor Xa protein cleavage signal. Proprotein convertases are a family of nine proteinases, comprising seven basic amino acid-specific subtilisin-like serine proteinases related to yeast kexin, known as prohormone convertase 1/3 (PC 1/3), PC2, furin, PC4, PC5/6, paired basic amino-acid cleaving enzyme 4 (PACE4) and PC7, and two other subtilases that cleave at non-basic residues, called subtilisin kexin isozyme 1 (SKI-1) and proprotein convertase subtilisin kexin 9 (PCSK9). Non-limiting examples of protein cleavage signal amino acid sequences are listing in Table 7. In Table 7, "X" refers to any amino acid, "n" may be 0, 2, 4 or 6 amino acids and "\*" refers to the protein cleavage site. In Table 7, SEQ ID NO: 5643 refers to when n=4 and SEQ ID NO: 5644 refers to when n=6.

**Table 7. Protein Cleavage Site Sequences**

Protein Cleavage Signal	Amino Acid Cleavage Sequence	SEQ ID NO
Proprotein convertase	R-X-X-R*	5641
	R-X-K/R-R*	5642
	K/R-X <sub>n</sub> -K/R*	5643 or 5644
Thrombin	L-V-P-R*-G-S	5645
	L-V-P-R*	5646
	A/F/G/I/L/T/V/M-A/F/G/I/L/T/V/W-P-R*	5647
Factor Xa	I-E-G-R*	5648
	I-D-G-R*	5649
	A-E-G-R*	5650
	A/F/G/I/L/T/V/M-D/E-G-R*	5651

[000187] In one embodiment, the cosmetic primary constructs and the cosmetic mmRNA of the present invention may be engineered such that the cosmetic primary

construct or cosmetic mmRNA contains at least one encoded protein cleavage signal. The encoded protein cleavage signal may be located before the start codon, after the start codon, before the coding region, within the coding region such as, but not limited to, half way in the coding region, between the start codon and the half way point, between the half way point and the stop codon, after the coding region, before the stop codon, between two stop codons, after the stop codon and combinations thereof.

**[000188]** In one embodiment, the cosmetic primary constructs or cosmetic mmRNA of the present invention may include at least one encoded protein cleavage signal containing at least one protein cleavage site. The encoded protein cleavage signal may include, but is not limited to, a proprotein convertase (or prohormone convertase), thrombin and/or Factor Xa protein cleavage signal. One of skill in the art may use Table 1 above or other known methods to determine the appropriate encoded protein cleavage signal to include in the cosmetic primary constructs or mmRNA of the present invention. For example, starting with the signal of Table 7 and considering the codons of Table 1 one can design a signal for the cosmetic primary construct which can produce a protein signal in the resulting cosmetic polypeptide.

**[000189]** In one embodiment, the cosmetic polypeptides of the present invention include at least one protein cleavage signal and/or site.

**[000190]** As a non-limiting example, U.S. Pat. No. 7,374,930 and U.S. Pub. No. 20090227660, herein incorporated by reference in their entireties, use a furin cleavage site to cleave the N-terminal methionine of GLP-1 in the expression product from the Golgi apparatus of the cells. In one embodiment, the polypeptides of the present invention include at least one protein cleavage signal and/or site with the proviso that the polypeptide is not GLP-1.

**[000191]** In one embodiment, the cosmetic primary constructs or cosmetic mmRNA of the present invention includes at least one encoded protein cleavage signal and/or site.

**[000192]** In one embodiment, the cosmetic primary constructs or cosmetic mmRNA of the present invention includes at least one encoded protein cleavage signal and/or site with the proviso that the cosmetic primary construct or cosmetic mmRNA does not encode GLP-1.

[000193] In one embodiment, the cosmetic primary constructs or cosmetic mmRNA of the present invention may include more than one coding region. Where multiple coding regions are present in the cosmetic primary construct or cosmetic mmRNA of the present invention, the multiple coding regions may be separated by encoded protein cleavage sites. As a non-limiting example, the cosmetic primary construct or cosmetic mmRNA may be signed in an ordered pattern. On such pattern follows AXBY form where A and B are coding regions which may be the same or different coding regions and/or may encode the same or different cosmetic polypeptides, and X and Y are encoded protein cleavage signals which may encode the same or different protein cleavage signals. A second such pattern follows the form AXYBZ where A and B are coding regions which may be the same or different coding regions and/or may encode the same or different cosmetic polypeptides, and X, Y and Z are encoded protein cleavage signals which may encode the same or different protein cleavage signals. A third pattern follows the form ABXCY where A, B and C are coding regions which may be the same or different coding regions and/or may encode the same or different cosmetic polypeptides, and X and Y are encoded protein cleavage signals which may encode the same or different protein cleavage signals.

[000194] In one embodiment, the cosmetic polypeptides, cosmetic primary constructs and cosmetic mmRNA can also contain sequences that encode protein cleavage sites so that the cosmetic polypeptides, cosmetic primary constructs and cosmetic mmRNA can be released from a carrier region or a fusion partner by treatment with a specific protease for said protein cleavage site.

[000195] In one embodiment, the cosmetic polypeptides, primary constructs and mmRNA of the present invention may include a sequence encoding the 2A peptide. In one embodiment, this sequence may be used to separate the coding region of two or more polypeptides of interest. As a non-limiting example, the sequence encoding the 2A peptide may be between coding region A and coding region B (A-2Apep-B). The presence of the 2A peptide would result in the cleavage of one long protein into protein A, protein B and the 2A peptide. Protein A and protein B may be the same or different polypeptides of interest. In another embodiment, the 2A peptide may be used in the

cosmetic polynucleotides, primary constructs and/or mmRNA of the present invention to produce two, three, four, five, six, seven, eight, nine, ten or more proteins.

*Incorporating Post Transcriptional Control Modulators*

[000196] In one embodiment, the cosmetic polynucleotides, primary constructs and/or mmRNA of the present invention may include at least one post transcriptional control modulator. These post transcriptional control modulators may be, but are not limited to, small molecules, compounds and regulatory sequences. As a non-limiting example, post transcriptional control may be achieved using small molecules identified by PTC Therapeutics Inc. (South Plainfield, NJ) using their GEMST<sup>TM</sup> (Gene Expression Modulation by Small-Molecules) screening technology.

[000197] The post transcriptional control modulator may be a gene expression modulator which is screened by the method detailed in or a gene expression modulator described in International Publication No. WO2006022712, herein incorporated by reference in its entirety. Methods identifying RNA regulatory sequences involved in translational control are described in International Publication No. WO2004067728, herein incorporated by reference in its entirety; methods identifying compounds that modulate untranslated region dependent expression of a gene are described in International Publication No. WO200406556 1, herein incorporated by reference in its entirety.

[000198] In one embodiment, the cosmetic polynucleotides, primary constructs and/or mmRNA of the present invention may include at least one post transcriptional control modulator is located in the 5' and/or the 3' untranslated region of the cosmetic polynucleotides, primary constructs and/or mmRNA of the present invention

[000199] In another embodiment, the cosmetic polynucleotides, primary constructs and/or mmRNA of the present invention may include at least one post transcription control modulator to modulate premature translation termination. The post transcription control modulators may be compounds described in or a compound found by methods outlined in International Publication Nso. WO2004010106, WO2006044456, WO2006044682, WO2006044503 and WO2006044505, each of which is herein incorporated by reference in its entirety. As a non-limiting example, the compound may



bind to a region of the 28S ribosomal RNA in order to modulate premature translation termination (See e.g., WO2004010106, herein incorporated by reference in its entirety).

[000200] In one embodiment, the cosmetic polynucleotides, primary constructs and/or mmRNA of the present invention may include at least one post transcription control modulator to alter protein expression. As a non-limiting example, the expression of VEGF may be regulated using the compounds described in or a compound found by the methods described in International Publication Nos. WO2005118857, WO2006065480, WO2006065479 and WO2006058088, each of which is herein incorporated by reference in its entirety.

[000201] The cosmetic polynucleotides, primary constructs and/or mmRNA of the present invention may include at least one post transcription control modulator to control translation. In one embodiment, the post transcription control modulator may be a RNA regulatory sequence. As a non-limiting example, the RNA regulatory sequence may be identified by the methods described in International Publication No. WO2006071903, herein incorporated by reference in its entirety.

### **III. Modifications**

[000202] Herein, in a cosmetic polynucleotide (such as a cosmetic primary construct or a cosmetic mRNA molecule), the terms "modification" or, as appropriate, "modified" refer to modification with respect to A, G, U or C ribonucleotides. Generally, herein, these terms are not intended to refer to the ribonucleotide modifications in naturally occurring 5'-terminal mRNA cap moieties. In a polypeptide, the term "modification" refers to a modification as compared to the canonical set of 20 amino acids, moiety)

[000203] The modifications may be various distinct modifications. In some embodiments, the coding region, the flanking regions and/or the terminal regions may contain one, two, or more (optionally different) nucleoside or nucleotide modifications. In some embodiments, a modified cosmetic polynucleotide, cosmetic primary construct, or cosmetic mmRNA introduced to a cell may exhibit reduced degradation in the cell, as compared to an unmodified cosmetic polynucleotide, cosmetic primary construct, or cosmetic mmRNA.

[000204] The cosmetic polynucleotides, cosmetic primary constructs, and cosmetic mmRNA can include any useful modification, such as to the sugar, the nucleobase, or the

internucleoside linkage (e.g. to a linking phosphate / to a phosphodiester linkage / to the phosphodiester backbone). One or more atoms of a pyrimidine nucleobase may be replaced or substituted with optionally substituted amino, optionally substituted thiol, optionally substituted alkyl (e.g., methyl or ethyl), or halo (e.g., chloro or fluoro). In certain embodiments, modifications (e.g., one or more modifications) are present in each of the sugar and the internucleoside linkage. Modifications according to the present invention may be modifications of ribonucleic acids (RNAs) to deoxyribonucleic acids (DNAs), threose nucleic acids (TNAs), glycol nucleic acids (GNAs), peptide nucleic acids (PNAs), locked nucleic acids (LNAs) or hybrids thereof). Additional modifications are described herein.

**[000205]** As described herein, the cosmetic polynucleotides, cosmetic primary constructs, and cosmetic mmRNA of the invention do not substantially induce an innate immune response of a cell into which the rriRNA is introduced. Features of an induced innate immune response include 1) increased expression of pro-inflammatory cytokines, 2) activation of intracellular PRRs (RIG-I, MDA5, etc, and/or 3) termination or reduction in protein translation.

**[000206]** In certain embodiments, it may be desirable to intracellularly degrade a modified nucleic acid molecule introduced into the cell. For example, degradation of a modified cosmetic nucleic acid molecule may be preferable if precise timing of protein production is desired. Thus, in some embodiments, the invention provides a modified cosmetic nucleic acid molecule containing a degradation domain, which is capable of being acted on in a directed manner within a cell. In another aspect, the present disclosure provides cosmetic polynucleotides comprising a nucleoside or nucleotide that can disrupt the binding of a major groove interacting, e.g. binding, partner with the polynucleotide (e.g., where the modified nucleotide has decreased binding affinity to major groove interacting partner, as compared to an unmodified nucleotide).

**[000207]** The cosmetic polynucleotides, cosmetic primary constructs, and cosmetic mmRNA can optionally include other agents (e.g., RNAi-inducing agents, RNAi agents, siRNAs, shRNAs, miRNAs, antisense RNAs, ribozymes, catalytic DNA, tRNA, RNAs that induce triple helix formation, aptamers, vectors, etc.). In some embodiments, the cosmetic polynucleotides, cosmetic primary constructs, or cosmetic mmRNA may

include one or more messenger RNAs (mRNAs) and one or more modified nucleoside or nucleotides (e.g., mmRNA molecules). Details for these cosmetic polynucleotides, cosmetic primary constructs, and cosmetic mmRNA follow.

*Cosmetic Polynucleotides and Cosmetic Primary Constructs*

[000208] The cosmetic polynucleotides, primary constructs, and mmRNA of the invention includes a first region of linked nucleosides encoding a polypeptide of interest, a first flanking region located at the 5' terminus of the first region, and a second flanking region located at the 3' terminus of the first region.

[000209] In some embodiments, the cosmetic polynucleotide, primary construct, or mmRNA (e.g., the first region, first flanking region, or second flanking region) includes n number of linked nucleosides having Formula (Ia) or Formula (Ia-1):

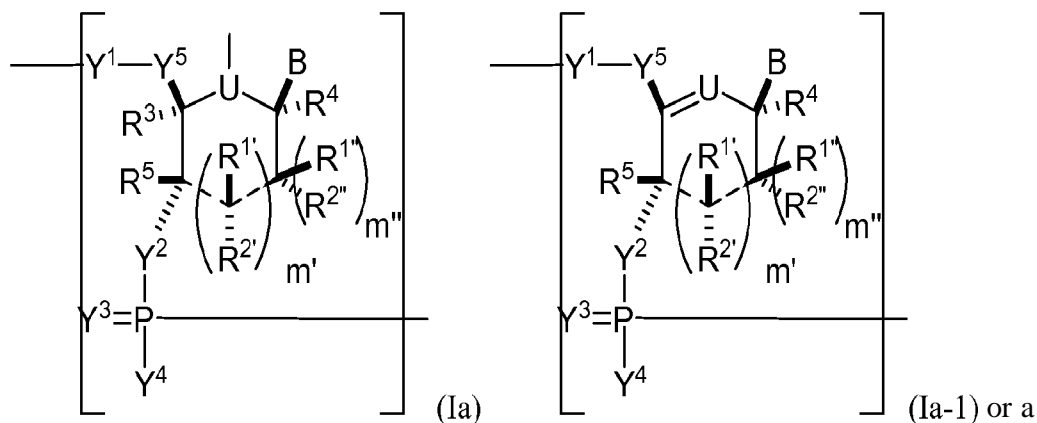

pharmaceutically acceptable salt or stereoisomer thereof,

[000210] wherein

[000211] U is O, S,  $N(R^u)_{n_u}$ , or  $C(R^u)_{n_u}$ , wherein  $n_u$  is an integer from 0 to 2 and each  $R^u$  is, independently, H, halo, or optionally substituted alkyl;

[000212] --- is a single bond or absent;

[000213] each of  $R^1$ ,  $R^2$ ,  $R^{1'}$ ,  $R^{2'}$ ,  $R^1$ ,  $R^2$ ,  $R^3$ ,  $R^4$ , and  $R^5$  is, independently, if present, H, halo, hydroxy, thiol, optionally substituted alkyl, optionally substituted alkoxy, optionally substituted alkenyloxy, optionally substituted alkynyloxy, optionally substituted aminoalkoxy, optionally substituted alkoxyalkoxy, optionally substituted hydroxyalkoxy, optionally substituted amino, azido, optionally substituted aryl, optionally substituted aminoalkyl, optionally substituted aminoalkenyl, optionally substituted aminoalkynyl, or absent; wherein the combination of  $R^3$  with one or more of  $R^1$ ,  $R^{1'}$ ,  $R^{2'}$ , or  $R^5$  (e.g., the combination of  $R^1$  and  $R^3$ , the combination of  $R^{1'}$  and

$R^3$ , the combination of  $R^{2'}$  and  $R^3$ , the combination of  $R^{2''}$  and  $R^3$ , or the combination of  $R^5$  and  $R^3$ ) can join together to form optionally substituted alkylene or optionally substituted heteroalkylene and, taken together with the carbons to which they are attached, provide an optionally substituted heterocyclyl (e.g., a bicyclic, tricyclic, or tetracyclic heterocyclyl); wherein the combination of  $R^5$  with one or more of  $R^{1'}$ ,  $R^{1''}$ ,  $R^{2'}$ , or  $R^{2''}$  (e.g., the combination of  $R^{1'}$  and  $R^5$ , the combination of  $R^{1''}$  and  $R^5$ , the combination of  $R^{2'}$  and  $R^5$ , or the combination of  $R^{2''}$  and  $R^5$ ) can join together to form optionally substituted alkylene or optionally substituted heteroalkylene and, taken together with the carbons to which they are attached, provide an optionally substituted heterocyclyl (e.g., a bicyclic, tricyclic, or tetracyclic heterocyclyl); and wherein the combination of  $R^4$  and one or more of  $R^{1'}$ ,  $R^{1''}$ ,  $R^{2'}$ ,  $R^{2''}$ ,  $R^3$ , or  $R^5$  can join together to form optionally substituted alkylene or optionally substituted heteroalkylene and, taken together with the carbons to which they are attached, provide an optionally substituted heterocyclyl (e.g., a bicyclic, tricyclic, or tetracyclic heterocyclyl); each of  $m'$  and  $m''$  is, independently, an integer from 0 to 3 (e.g., from 0 to 2, from 0 to 1, from 1 to 3, or from 1 to 2);

[000214] each of  $Y^1$ ,  $Y^2$ , and  $Y^3$ , is, independently, 0, S, Se,  $-NR^{N1}$ -, optionally substituted alkylene, or optionally substituted heteroalkylene, wherein  $R^{N1}$  is H, optionally substituted alkyl, optionally substituted alkenyl, optionally substituted alkynyl, optionally substituted aryl, or absent;

[000215] each  $Y^4$  is, independently, H, hydroxy, thiol, boranyl, optionally substituted alkyl, optionally substituted alkenyl, optionally substituted alkynyl, optionally substituted alkoxy, optionally substituted alkenyloxy, optionally substituted alkynyloxy, optionally substituted thioalkoxy, optionally substituted alkoxyalkoxy, or optionally substituted amino;

[000216] each  $Y^5$  is, independently, O, S, Se, optionally substituted alkylene (e.g., methylene), or optionally substituted heteroalkylene;

[000217]  $n$  is an integer from 1 to 100,000; and

[000218]  $B$  is a nucleobase (e.g., a purine, a pyrimidine, or derivatives thereof), wherein the combination of  $B$  and  $R^{1'}$ , the combination of  $B$  and  $R^{2'}$ , the combination of  $B$  and  $R^{1''}$ , or the combination of  $B$  and  $R^{2''}$  can, taken together with the carbons to which they

are attached, optionally form a bicyclic group (e.g., a bicyclic heterocyclyl) or wherein the combination of B, R<sup>1'</sup>, and R<sup>3</sup> or the combination of B, R<sup>2''</sup>, and R<sup>3</sup> can optionally form a tricyclic or tetracyclic group (e.g., a tricyclic or tetracyclic heterocyclyl, such as in Formula (IIo)-(IIp) herein). In some embodiments, the cosmetic polynucleotide, primary construct, or mmRNA includes a modified ribose. In some embodiments, the cosmetic polynucleotide, primary construct, or mmRNA (e.g., the first region, the first flanking region, or the second flanking region) includes n number of linked nucleosides having Formula (Ia-2)-(Ia-5) or a pharmaceutically acceptable salt or stereoisomer thereof.

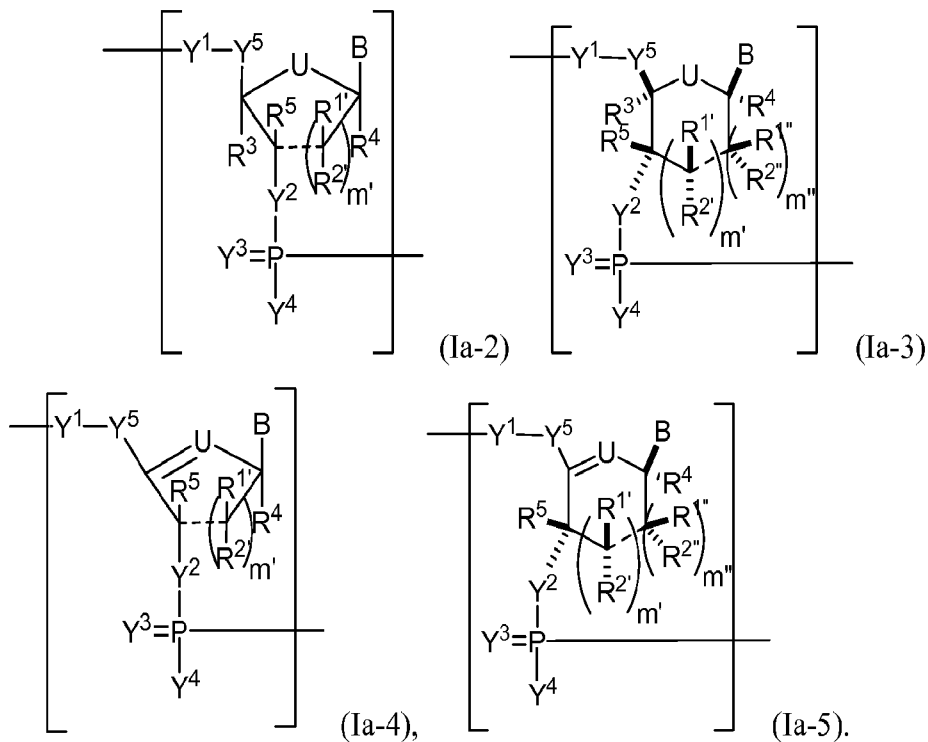

[000219] In some embodiments, the cosmetic polynucleotide, primary construct, or mmRNA (e.g., the first region, the first flanking region, or the second flanking region) includes n number of linked nucleosides having Formula (Ib) or Formula (Ib-1):

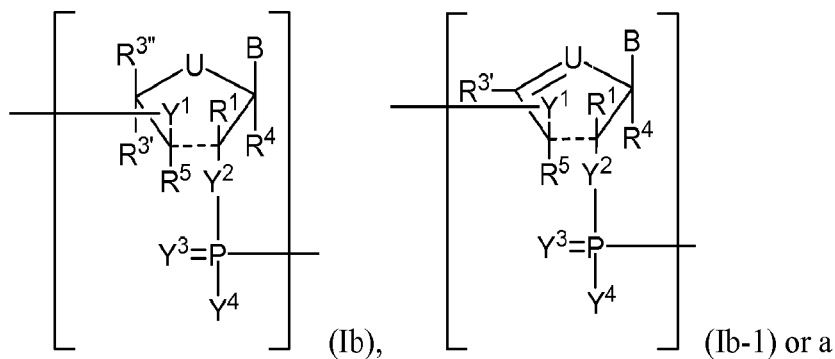

pharmaceutically acceptable salt or stereoisomer thereof,

[000220] wherein

[000221] U is 0, S,  $N(R^u)_{n_u}$ , or  $C(R^u)_{n_u}$ , wherein nu is an integer from 0 to 2 and each  $R^u$  is, independently, H, halo, or optionally substituted alkyl;

[000222] --- is a single bond or absent;

[000223] each of  $R^1$ ,  $R^{3'}$ ,  $R^{3''}$ , and  $R^4$  is, independently, H, halo, hydroxy, optionally substituted alkyl, optionally substituted alkoxy, optionally substituted alkenyloxy, optionally substituted alkynyloxy, optionally substituted aminoalkoxy, optionally substituted alkoxyalkoxy, optionally substituted hydroxyalkoxy, optionally substituted amino, azido, optionally substituted aryl, optionally substituted aminoalkyl, optionally substituted ammoalkenyl, optionally substituted aminoalkynyl, or absent; and wherein the combination of  $R^1$  and  $R^{3'}$  or the combination of  $R^1$  and  $R^{3''}$  can be taken together to form optionally substituted alkylene or optionally substituted heteroalkylene (e.g., to produce a locked nucleic acid);

[000224] each  $R^5$  is, independently, H, halo, hydroxy, optionally substituted alkyl, optionally substituted alkoxy, optionally substituted alkenyloxy, optionally substituted alkynyloxy, optionally substituted aminoalkoxy, optionally substituted alkoxyalkoxy, or absent;

[000225] each of  $Y^1$ ,  $Y^2$ , and  $Y^3$  is, independently, O, S, Se,  $-NR^{N1}$ -, optionally substituted alkylene, or optionally substituted heteroalkylene, wherein  $R^{N1}$  is H, optionally substituted alkyl, optionally substituted alkenyl, optionally substituted alkynyl, or optionally substituted aryl;

[000226] each  $Y^4$  is, independently, H, hydroxy, thiol, boranyl, optionally substituted alkyl, optionally substituted alkenyl, optionally substituted alkynyl, optionally substituted alkoxy, optionally substituted alkenyloxy, optionally substituted alkynyloxy, optionally substituted alkoxyalkoxy, or optionally substituted amino;

[000227] n is an integer from 1 to 100,000; and

[000228] B is a nucleobase.

[000229] In some embodiments, the cosmetic polynucleotide, primary construct, or mmRNA (e.g., the first region, first flanking region, or second flanking region) includes n number of linked nucleosides having Formula (Ic):

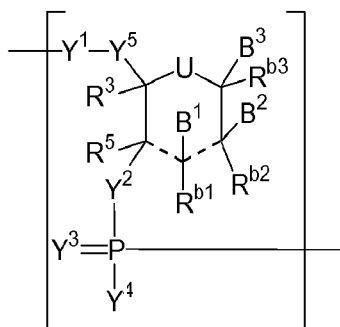

(Ic), or a pharmaceutically acceptable salt or stereoisomer thereof,

[000230] wherein

[000231] U is O, S, N(R<sup>u</sup>)<sub>nu</sub>, or C(R<sup>u</sup>)<sub>nu</sub>, wherein nu is an integer from 0 to 2 and each R<sup>u</sup> is, independently, H, halo, or optionally substituted alkyl;

[000232] --- is a single bond or absent;

[000233] each of B<sup>1</sup>, B<sup>2</sup>, and B<sup>3</sup> is, independently, a nucleobase (e.g., a purine, a pyrimidine, or derivatives thereof, as described herein), H, halo, hydroxy, thiol, optionally substituted alkyl, optionally substituted alkoxy, optionally substituted alkenyloxy, optionally substituted alkynyloxy, optionally substituted aminoalkoxy, optionally substituted alkoxyalkoxy, optionally substituted hydroxyalkoxy, optionally substituted amino, azido, optionally substituted aryl, optionally substituted aminoalkyl, optionally substituted aminoalkenyl, or optionally substituted aminoalkynyl, wherein one and only one of B<sup>1</sup>, B<sup>2</sup>, and B<sup>3</sup> is a nucleobase;

[000234] each of R<sup>b1</sup>, R<sup>b2</sup>, R<sup>b3</sup>, R<sup>3</sup>, and R<sup>5</sup> is, independently, H, halo, hydroxy, thiol, optionally substituted alkyl, optionally substituted alkoxy, optionally substituted alkenyloxy, optionally substituted alkynyloxy, optionally substituted aminoalkoxy, optionally substituted alkoxyalkoxy, optionally substituted hydroxyalkoxy, optionally substituted amino, azido, optionally substituted aryl, optionally substituted aminoalkyl, optionally substituted aminoalkenyl or optionally substituted aminoalkynyl;

[000235] each of Y<sup>1</sup>, Y<sup>2</sup>, and Y<sup>3</sup> is, independently, O, S, Se, -NR<sup>N1</sup>-, optionally substituted alkylene, or optionally substituted heteroalkylene, wherein R<sup>N1</sup> is H, optionally substituted alkyl, optionally substituted alkenyl, optionally substituted alkynyl, or optionally substituted aryl;

[000236] each Y<sup>4</sup> is, independently, H, hydroxy, thiol, boranyl, optionally substituted alkyl, optionally substituted alkenyl, optionally substituted alkynyl, optionally substituted

alkoxy, optionally substituted alkenyloxy, optionally substituted alkynyloxy, optionally substituted thioalkoxy, optionally substituted alkoxyalkoxy, or optionally substituted amino;

[000237] each  $Y^5$  is, independently, O, S, Se, optionally substituted alkylene (e.g., methylene), or optionally substituted heteroalkylene;

[000238]  $n$  is an integer from 1 to 100,000; and

[000239] wherein the ring including U can include one or more double bonds.

[000240] In particular embodiments, the ring including U does not have a double bond between  $U-CB^3R^{b3}$  or between  $CB^3R^{b3}-C^{B2}R^{b2}$ .

[000241] In some embodiments, the cosmetic polynucleotide, primary construct, or mmRNA (e.g., the first region, first flanking region, or second flanking region) includes  $n$  number of linked nucleosides having Formula (Id):

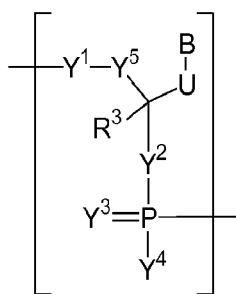

(Id), or a pharmaceutically acceptable salt or stereoisomer thereof,

[000242] wherein

[000243] U is O, S,  $N(R^u)_{n_u}$ , or  $C(R^u)_{n_u}$ , wherein  $n_u$  is an integer from 0 to 2 and each  $R^u$  is, independently, H, halo, or optionally substituted alkyl;

[000244] each  $R^3$  is, independently, H, halo, hydroxy, thiol, optionally substituted alkyl, optionally substituted alkoxy, optionally substituted alkenyloxy, optionally substituted alkynyloxy, optionally substituted aminoalkoxy, optionally substituted alkoxyalkoxy, optionally substituted hydroxyalkoxy, optionally substituted amino, azido, optionally substituted aryl, optionally substituted aminoalkyl, optionally substituted aminoalkenyl, or optionally substituted aminoalkynyl;

[000245] each of  $Y^1$ ,  $Y^2$ , and  $Y^3$  is, independently, O, S, Se,  $-NR^{N1}$ -, optionally substituted alkylene, or optionally substituted heteroalkylene, wherein  $R^{N1}$  is H, optionally substituted alkyl, optionally substituted alkenyl, optionally substituted alkynyl, or optionally substituted aryl;



[000246] each  $Y^4$  is, independently, H, hydroxy, thiol, boranyl, optionally substituted alkyl, optionally substituted alkenyl, optionally substituted alkynyl, optionally substituted alkoxy, optionally substituted alkenyloxy, optionally substituted alkynyloxy, optionally substituted thioalkoxy, optionally substituted alkoxyalkoxy, or optionally substituted amino;

[000247] each  $Y^5$  is, independently, O, S, optionally substituted alkylene (e.g., methylene), or optionally substituted heteroalkylene;

[000248]  $n$  is an integer from 1 to 100,000; and

[000249]  $B$  is a nucleobase (e.g., a purine, a pyrimidine, or derivatives thereof).

[000250] In some embodiments, the cosmetic polynucleotide, primary construct, or mmRNA (e.g., the first region, first flanking region, or second flanking region) includes  $n$  number of linked nucleosides having Formula (Ie):

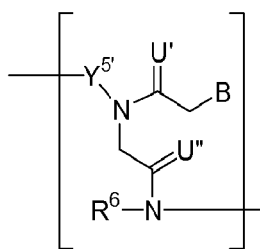

(Ie), or a pharmaceutically acceptable salt or stereoisomer thereof,

[000251] wherein

[000252] each of  $U'$  and  $U''$  is, independently, O, S,  $N(R^u)_{nu}$ , or  $C(R^u)_{nu}$ , wherein  $nu$  is an integer from 0 to 2 and each  $R^u$  is, independently, H, halo, or optionally substituted alkyl;

[000253] each  $R^6$  is, independently, H, halo, hydroxy, thiol, optionally substituted alkyl, optionally substituted alkoxy, optionally substituted alkenyloxy, optionally substituted alkynyloxy, optionally substituted aminoalkoxy, optionally substituted alkoxyalkoxy, optionally substituted hydroxyalkoxy, optionally substituted amino, azido, optionally substituted aryl, optionally substituted aminoalkyl, optionally substituted aminoalkenyl, or optionally substituted aminoalkynyl;

[000254] each  $Y^5$  is, independently, O, S, optionally substituted alkylene (e.g., methylene or ethylene), or optionally substituted heteroalkylene;

[000255]  $n$  is an integer from 1 to 100,000; and

[000256]  $B$  is a nucleobase (e.g., a purine, a pyrimidine, or derivatives thereof).

[000257] In some embodiments, the cosmetic polynucleotide, primary construct, or mmRNA (e.g., the first region, first flanking region, or second flanking region) includes n number of linked nucleosides having Formula (If) or (If-1):

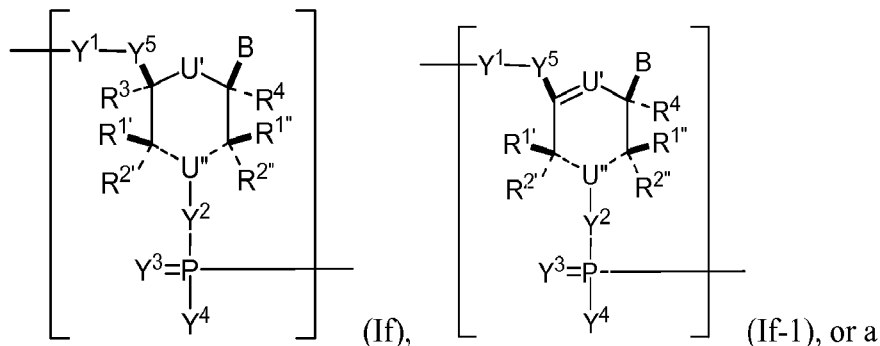

pharmaceutically acceptable salt or stereoisomer thereof,

[000258] wherein

[000259] each of U' and U'' is, independently, O, S, N, N(R<sup>U</sup>)<sub>nu</sub>, or C(R<sup>U</sup>)<sub>nu</sub>, wherein nu is an integer from 0 to 2 and each R<sup>u</sup> is, independently, H, halo, or optionally substituted alkyl (e.g., U' is O and U'' is N);

[000260] --- is a single bond or absent;

[000261] each of R<sup>1'</sup>, R<sup>2'</sup>, R<sup>1''</sup>, R<sup>2''</sup>, R<sup>3</sup>, and R<sup>4</sup> is, independently, H, halo, hydroxy, thiol, optionally substituted alkyl, optionally substituted alkoxy, optionally substituted alkenyloxy, optionally substituted alkynyloxy, optionally substituted aminoalkoxy, optionally substituted alkoxyalkoxy, optionally substituted hydroxyalkoxy, optionally substituted amino, azido, optionally substituted aryl, optionally substituted aminoalkyl, optionally substituted aminoalkenyl, optionally substituted aminoalkynyl, or absent; and wherein the combination of R<sup>1'</sup> and R<sup>3</sup>, the combination of R<sup>1''</sup> and R<sup>3</sup>, the combination of R<sup>2'</sup> and R<sup>3</sup>, or the combination of R<sup>2''</sup> and R<sup>3</sup> can be taken together to form optionally substituted alkylene or optionally substituted heteroalkylene (e.g., to produce a locked nucleic acid); each of m' and m'' is, independently, an integer from 0 to 3 (e.g., from 0 to 2, from 0 to 1, from 1 to 3, or from 1 to 2);

[000262] each of Y<sup>1</sup>, Y<sup>2</sup>, and Y<sup>3</sup> is, independently, O, S, Se, -NR<sup>N1</sup>-, optionally substituted alkylene, or optionally substituted heteroalkylene, wherein R<sup>N1</sup> is H, optionally substituted alkyl, optionally substituted alkenyl, optionally substituted alkynyl, optionally substituted aryl, or absent;

[000263] each Y<sup>4</sup> is, independently, H, hydroxy, thiol, boranyl, optionally substituted alkyl, optionally substituted alkenyl, optionally substituted alkynyl, optionally substituted alkoxy, optionally substituted alkenyloxy, optionally substituted alkynyloxy, optionally substituted thioalkoxy, optionally substituted alkoxyalkoxy, or optionally substituted amino;

[000264] each Y<sup>5</sup> is, independently, O, S, Se, optionally substituted alkylene (e.g., methylene), or optionally substituted heteroalkylene;

[000265] n is an integer from 1 to 100,000; and

[000266] B is a nucleobase (e.g., a purine, a pyrimidine, or derivatives thereof).

[000267] In some embodiments of the cosmetic polynucleotides, primary constructs, or mmRNA (e.g., Formulas (Ia), (Ia-1)-(Ia-3), (Ib)-(If), and (IIa)-(IIp)), the ring including U has one or two double bonds.

[000268] In some embodiments of the cosmetic polynucleotides, primary constructs, or mmRNA (e.g., Formulas (Ia)-(Ia-5), (Ib)-(If-1), (Ha)-(IIp), (IIb-1), (IIb-2), (IIc-1)-(IIc-2), (IIn-1), (IIn-2), (IVa)-(IVl), and (IXa)-(IXr)), each of R<sup>1</sup>, R<sup>1'</sup>, and R<sup>1''</sup>, if present, is H. In further embodiments, each of R<sup>2</sup>, R<sup>2'</sup>, and R<sup>2''</sup>, if present, is, independently, H, halo (e.g., fluoro), hydroxy, optionally substituted alkoxy (e.g., methoxy or ethoxy), or optionally substituted alkoxyalkoxy. In particular embodiments, alkoxyalkoxy is -

$(\text{CH}_2)_{s_2}(\text{OCH}_2\text{CH}_2)_{s_1}(\text{CH}_2)_{s_3}\text{OR}'$ , wherein s<sub>1</sub> is an integer from 1 to 10 (e.g., from 1 to 6 or from 1 to 4), each of s<sub>2</sub> and s<sub>3</sub>, independently, is an integer from 0 to 10 (e.g., from 0 to 4, from 0 to 6, from 1 to 4, from 1 to 6, or from 1 to 10), and R' is H or C<sup>o</sup> alkyl). In some embodiments, s<sub>2</sub> is 0, s<sub>1</sub> is 1 or 2, s<sub>3</sub> is 0 or 1, and R' is C<sub>i-6</sub> alkyl.

[000269] In some embodiments of the cosmetic polynucleotides, primary constructs, or mmRNA (e.g., Formulas (Ia)-(Ia-5), (Ib)-(If-1), (IIa)-(IIp), (IIb-1), (IIb-2), (IIc-1)-(IIc-2), (IIn-1), (IIn-2), (IVa)-(IVl), and (IXa)-(IXr)), each of R<sup>2</sup>, R<sup>2'</sup>, and R<sup>2''</sup>, if present, is H. In further embodiments, each of R<sup>1</sup>, R<sup>1'</sup>, and R<sup>1''</sup>, if present, is, independently, H, halo (e.g., fluoro), hydroxy, optionally substituted alkoxy (e.g., methoxy or ethoxy), or optionally substituted alkoxyalkoxy. In particular embodiments, alkoxyalkoxy is -

$(\text{CH}_2)_{s_2}(\text{OCH}_2\text{CH}_2)_{s_1}(\text{CH}_2)_{s_3}\text{OR}'$ , wherein s<sub>1</sub> is an integer from 1 to 10 (e.g., from 1 to 6 or from 1 to 4), each of s<sub>2</sub> and s<sub>3</sub>, independently, is an integer from 0 to 10 (e.g., from 0

to 4, from 0 to 6, from 1 to 4, from 1 to 6, or from 1 to 10), and R' is H or C<sup>o</sup> alkyl). In some embodiments, s<sub>2</sub> is 0, s<sub>i</sub> is 1 or 2, s<sub>3</sub> is 0 or 1, and R' is C<sub>1-6</sub> alkyl.

**[000270]** In some embodiments of the cosmetic polynucleotides, primary constructs, or mmRNA (e.g., Formulas (Ia)-(Ia-5), (Ib)-(If-1), (Ha)-(IIp), (IIb-1), (IIb-2), (IIc-1)-(IIc-2), (IIn-1), (IIn-2), (IVa)-(IVl), and (IXa)-(IXr)), each of R<sup>3</sup>, R<sup>4</sup>, and R<sup>5</sup> is, independently, H, halo (e.g., fluoro), hydroxy, optionally substituted alkyl, optionally substituted alkoxy (e.g., methoxy or ethoxy), or optionally substituted alkoxyalkoxy. In particular embodiments, R<sup>3</sup> is H, R<sup>4</sup> is H, R<sup>5</sup> is H, or R<sup>3</sup>, R<sup>4</sup>, and R<sup>5</sup> are all H. In particular embodiments, R<sup>3</sup> is C<sub>i-6</sub> alkyl, R<sup>4</sup> is C<sub>1-6</sub> alkyl, R<sup>5</sup> is C<sub>1-6</sub> alkyl, or R<sup>3</sup>, R<sup>4</sup>, and R<sup>5</sup> are all C<sub>1-6</sub> alkyl. In particular embodiments, R<sup>3</sup> and R<sup>4</sup> are both H, and R<sup>5</sup> is C<sub>i-6</sub> alkyl.

**[000271]** In some embodiments of the cosmetic polynucleotides, primary constructs, or mmRNA (e.g., Formulas (Ia)-(Ia-5), (Ib)-(If-1), (Ha)-(IIp), (IIb-1), (IIb-2), (IIc-1)-(IIc-2), (IIn-1), (IIn-2), (IVa)-(IVl), and (IXa)-(IXr)), R<sup>3</sup> and R<sup>5</sup> join together to form optionally substituted alkylene or optionally substituted heteroalkylene and, taken together with the carbons to which they are attached, provide an optionally substituted heterocyclyl (e.g., a bicyclic, tricyclic, or tetracyclic heterocyclyl, such as trans-3',4' analogs, wherein R<sup>3</sup> and R<sup>5</sup> join together to form heteroalkylene (e.g., -(CH<sub>2</sub>)<sup>b1</sup>O(CH<sub>2</sub>)<sup>b2</sup>O(CH<sub>2</sub>)<sup>b3</sup>-, wherein each of b<sub>1</sub>, b<sub>2</sub>, and b<sub>3</sub> are, independently, an integer from 0 to 3).

**[000272]** In some embodiments of the cosmetic polynucleotides, primary constructs, or mmRNA (e.g., Formulas (Ia)-(Ia-5), (Ib)-(If-1), (Ha)-(IIp), (IIb-1), (IIb-2), (IIc-1)-(IIc-2), (IIn-1), (IIn-2), (IVa)-(IVl), and (IXa)-(IXr)), R<sup>3</sup> and one or more of R<sup>1'</sup>, R<sup>1''</sup>, R<sup>2'</sup>, R<sup>2''</sup>, or R<sup>5</sup> join together to form optionally substituted alkylene or optionally substituted heteroalkylene and, taken together with the carbons to which they are attached, provide an optionally substituted heterocyclyl (e.g., a bicyclic, tricyclic, or tetracyclic heterocyclyl, R<sup>3</sup> and one or more of R<sup>1'</sup>, R<sup>1''</sup>, R<sup>2'</sup>, R<sup>2''</sup>, or R<sup>5</sup> join together to form heteroalkylene (e.g., -(CH<sub>2</sub>)<sup>b1</sup>O(CH<sub>2</sub>)<sup>b2</sup>O(CH<sub>2</sub>)<sup>b3</sup>-, wherein each of b<sub>1</sub>, b<sub>2</sub>, and b<sub>3</sub> are, independently, an integer from 0 to 3).

**[000273]** In some embodiments of the cosmetic polynucleotides, primary constructs, or mmRNA (e.g., Formulas (Ia)-(Ia-5), (Ib)-(If-1), (Ha)-(IIp), (IIb-1), (IIb-2), (IIc-1)-(IIc-2), (IIn-1), (IIn-2), (IVa)-(IVl), and (IXa)-(IXr)), R<sup>5</sup> and one or more of R<sup>1'</sup>, R<sup>1''</sup>, R<sup>2'</sup>, or R<sup>2''</sup> join together to form optionally substituted alkylene or optionally substituted

heteroalkylene and, taken together with the carbons to which they are attached, provide an optionally substituted heterocyclyl (e.g., a bicyclic, tricyclic, or tetracyclic heterocyclyl,  $R^5$  and one or more of  $R^{1'}$ ,  $R^{1''}$ ,  $R^{2'}$ , or  $R^{2''}$  join together to form heteroalkylene (e.g.,  $-(CH_2)_{b1}O(CH_2)_{b2}(CH_2)_{b3}-$ , wherein each of  $b1$ ,  $b2$ , and  $b3$  are, independently, an integer from 0 to 3).

[000274] In some embodiments of the cosmetic polynucleotides, primary constructs, or mmRNA (e.g., Formulas (Ia)-(Ia-5), (Ib)-(Ib-1), (Ib)-(Ib-2), (Ic)-(Ic-1), (Ic)-(Ic-2), (Ic)-(Ic-3), (IVa)-(IVl), and (IXa)-(IXr)), each  $Y^2$  is, independently, O, S, or  $-NR^{N1}$ , wherein  $R^{N1}$  is H, optionally substituted alkyl, optionally substituted alkenyl, optionally substituted alkynyl, or optionally substituted aryl. In particular embodiments,  $Y^2$  is  $NR^{N1}$ , wherein  $R^{N1}$  is H or optionally substituted alkyl (e.g.,  $C_{1-6}$  alkyl, such as methyl, ethyl, isopropyl, or n-propyl).

[000275] In some embodiments of the cosmetic polynucleotides, primary constructs, or mmRNA (e.g., Formulas (Ia)-(Ia-5), (Ib)-(Ib-1), (Ib)-(Ib-2), (Ic)-(Ic-1), (Ic)-(Ic-2), (Ic)-(Ic-3), (IVa)-(IVl), and (IXa)-(IXr)), each  $Y^3$  is, independently, O or S.

[000276] In some embodiments of the cosmetic polynucleotides, primary constructs, or mmRNA (e.g., Formulas (Ia)-(Ia-5), (Ib)-(Ib-1), (Ib)-(Ib-2), (Ic)-(Ic-1), (Ic)-(Ic-2), (Ic)-(Ic-3), (IVa)-(IVl), and (IXa)-(IXr)),  $R^1$  is H; each  $R^2$  is, independently, H, halo (e.g., fluoro), hydroxy, optionally substituted alkoxy (e.g., methoxy or ethoxy), or optionally substituted alkoxyalkoxy (e.g.,  $-(CH_2)_{s2}(OCH_2CH_2)_{s1}(CH_2)_{s3}OR'$ , wherein  $s1$  is an integer from 1 to 10 (e.g., from 1 to 6 or from 1 to 4), each of  $s2$  and  $s3$ , independently, is an integer from 0 to 10 (e.g., from 0 to 4, from 0 to 6, from 1 to 4, from 1 to 6, or from 1 to 10), and  $R'$  is H or  $C_{1-20}$  alkyl, such as wherein  $s2$  is 0,  $s1$  is 1 or 2,  $s3$  is 0 or 1, and  $R'$  is  $C_{1-6}$  alkyl); each  $Y^2$  is, independently, O or  $-NR^{N1}$ , wherein  $R^{N1}$  is H, optionally substituted alkyl, optionally substituted alkenyl, optionally substituted alkynyl, or optionally substituted aryl (e.g., wherein  $R^{N1}$  is H or optionally substituted alkyl (e.g.,  $C_{1-6}$  alkyl, such as methyl, ethyl, isopropyl, or n-propyl)); and each  $Y^3$  is, independently, O or S (e.g., S). In further embodiments,  $R^3$  is H, halo (e.g., fluoro), hydroxy, optionally substituted alkyl, optionally substituted alkoxy (e.g., methoxy or ethoxy), or optionally substituted alkoxyalkoxy. In yet further embodiments, each  $Y^1$  is, independently, O or  $-NR^{N1}$ , wherein  $R^{N1}$  is H, optionally substituted alkyl, optionally substituted alkenyl,

optionally substituted alkynyl, or optionally substituted aryl (e.g., wherein  $R^{N1}$  is H or optionally substituted alkyl (e.g.,  $C_{1-6}$  alkyl, such as methyl, ethyl, isopropyl, or n-propyl)); and each  $Y^4$  is, independently, H, hydroxy, thiol, optionally substituted alkyl, optionally substituted alkoxy, optionally substituted thioalkoxy, optionally substituted alkoxyalkoxy, or optionally substituted amino.

[000277] In some embodiments of the cosmetic polynucleotides, primary constructs, or mmRNA (e.g., Formulas (Ia)-(Ia-5), (Ib)-(Ib-1), (Ic)-(Ic-1), (Ic-2), (Id-1), (Id-2), (Ie)-(Ie-1), (Ie-2), (If)-(If-1), (If-2), (Ig)-(Ig-1), (Ig-2), (Ih)-(Ih-1), (Ih-2), (Ii)-(Ii-1), (Ii-2), (Ij)-(Ij-1), (Ij-2), (Ik)-(Ik-1), (Ik-2), (Il)-(Il-1), (Il-2), (Im)-(Im-1), (Im-2), (In)-(In-1), (In-2), (IVa)-(IVl), and (IXa)-(IXr)), each  $R^1$  is, independently, H, halo (e.g., fluoro), hydroxy, optionally substituted alkoxy (e.g., methoxy or ethoxy), or optionally substituted alkoxyalkoxy (e.g.,  $-(CH_2)_{s2}(OCH_2CH_2)_{s1}(CH_2)_{s3}OR'$ , wherein  $s_i$  is an integer from 1 to 10 (e.g., from 1 to 6 or from 1 to 4), each of  $s_2$  and  $s_3$ , independently, is an integer from 0 to 10 (e.g., from 0 to 4, from 0 to 6, from 1 to 4, from 1 to 6, or from 1 to 10), and  $R'$  is H or  $C_{1-20}$  alkyl, such as wherein  $s_2$  is 0,  $s_1$  is 1 or 2,  $s_3$  is 0 or 1, and  $R'$  is  $C_{1-6}$  alkyl);  $R^2$  is H; each  $Y^2$  is, independently, O or  $-NR^{N1}$ , wherein  $R^{N1}$  is H, optionally substituted alkyl, optionally substituted alkenyl, optionally substituted alkynyl, or optionally substituted aryl (e.g., wherein  $R^{N1}$  is H or optionally substituted alkyl (e.g.,  $C_{1-6}$  alkyl, such as methyl, ethyl, isopropyl, or n-propyl)); and each  $Y^3$  is, independently, O or S (e.g., S). In further embodiments,  $R^3$  is H, halo (e.g., fluoro), hydroxy, optionally substituted alkyl, optionally substituted alkoxy (e.g., methoxy or ethoxy), or optionally substituted alkoxyalkoxy. In yet further embodiments, each  $Y^1$  is, independently, O or  $-NR^{N1}$ , wherein  $R^{N1}$  is H, optionally substituted alkyl, optionally substituted alkenyl, optionally substituted alkynyl, or optionally substituted aryl (e.g., wherein  $R^{N1}$  is H or optionally substituted alkyl (e.g.,  $C_{1-6}$  alkyl, such as methyl, ethyl, isopropyl, or n-propyl)); and each  $Y^4$  is, independently, H, hydroxy, thiol, optionally substituted alkyl, optionally substituted alkoxy, optionally substituted thioalkoxy, optionally substituted alkoxyalkoxy, or optionally substituted amino.

[000278] In some embodiments of the cosmetic polynucleotides, primary constructs, or mmRNA (e.g., Formulas (Ia)-(Ia-5), (Ib)-(Ib-1), (Ic)-(Ic-1), (Ic-2), (Id-1), (Id-2), (Ie)-(Ie-1), (Ie-2), (If)-(If-1), (If-2), (Ig)-(Ig-1), (Ig-2), (Ih)-(Ih-1), (Ih-2), (Ii)-(Ii-1), (Ii-2), (Ij)-(Ij-1), (Ij-2), (Ik)-(Ik-1), (Ik-2), (Il)-(Il-1), (Il-2), (Im)-(Im-1), (Im-2), (In)-(In-1), (In-2), (IVa)-(IVl), and (IXa)-(IXr)), the ring including U is in the  $\beta$ -D (e.g.,  $\beta$ -D-ribo) configuration.

**[000279]** In some embodiments of the cosmetic polynucleotides, primary constructs, or mmRNA (e.g., Formulas (Ia)-(Ia-5), (Ib)-(If-1), (Ha)-(Hf), (Iib-1), (Iib-2), (Iic-1)-(Iic-2), (Iin-1), (Iin-2), (IVa)-(IVl), and (IXa)-(IXr)), the ring including U is in the a-L (e.g., a-L-ribo) configuration.

**[000280]** In some embodiments of the cosmetic polynucleotides, primary constructs, or mmRNA (e.g., Formulas (Ia)-(Ia-5), (Ib)-(If-1), (IIa)-(IIp), (Iib-1), (Iib-2), (Iic-1)-(Iic-2), (Iin-1), (Iin-2), (IVa)-(IVl), and (IXa)-(IXr)), one or more B is not pseudouridine ( $\psi$ ) or 5-methyl-cytidine ( $m^5C$ ). In some embodiments, about 10% to about 100% of n number of B nucleobases is not  $\psi$  or  $m^5C$  (e.g., from 10% to 20%, from 10% to 35%, from 10% to 50%, from 10% to 60%, from 10% to 75%, from 10% to 90%, from 10% to 95%, from 10% to 98%, from 10% to 99%, from 20% to 35%, from 20% to 50%, from 20% to 60%, from 20% to 75%, from 20% to 90%, from 20% to 95%, from 20% to 98%, from 20% to 99%, from 20% to 100%, from 50% to 60%, from 50% to 75%, from 50% to 90%, from 50% to 95%, from 50% to 98%, from 50% to 99%, from 50% to 100%, from 75% to 90%, from 75% to 95%, from 75% to 98%, from 75% to 99%, and from 75% to 100% of n number of B is not  $\psi$  or  $m^5C$ ). In some embodiments, B is not  $\psi$  or  $m^5C$ .

**[000281]** In some embodiments of the cosmetic polynucleotides, primary constructs, or mmRNA (e.g., Formulas (Ia)-(Ia-5), (Ib)-(If-1), (IIa)-(IIp), (Iib-1), (Iib-2), (Iic-1)-(Iic-2), (Iin-1), (Iin-2), (IVa)-(IVl), and (IXa)-(IXr)), when B is an unmodified nucleobase selected from cytosine, guanine, uracil and adenine, then at least one of  $Y^1$ ,  $Y^2$ , or  $Y^3$  is not O.

**[000282]** In some embodiments, the cosmetic polynucleotide, primary construct, or mmRNA includes a modified ribose. In some embodiments, the cosmetic polynucleotide, primary construct, or mmRNA (e.g., the first region, the first flanking region, or the second flanking region) includes n number of linked nucleosides having Formula (IIa)-(IIc):

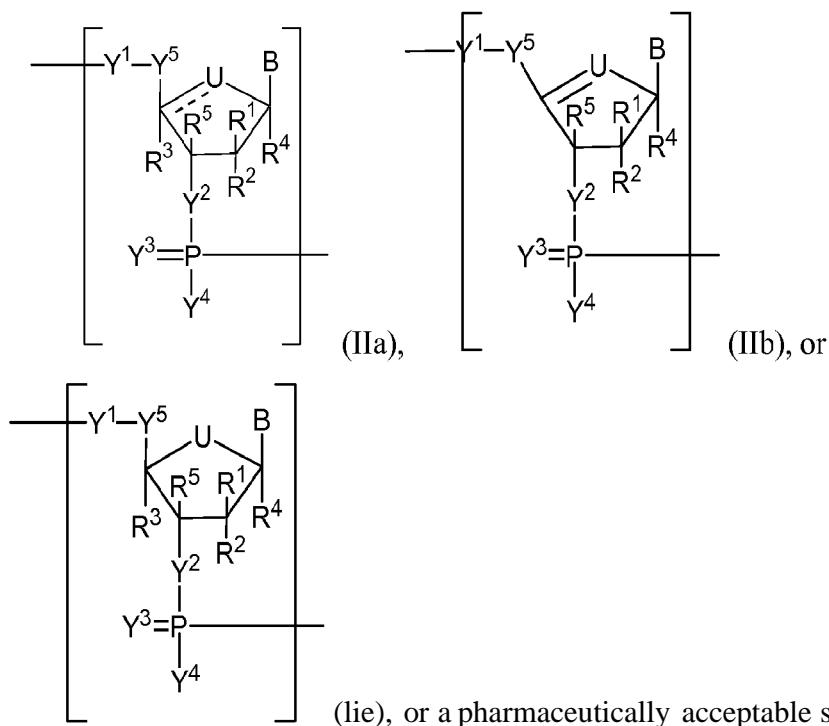

thereof. In particular embodiments, U is 0 or  $C(R^U)_{nu}$ , wherein nu is an integer from 0 to 2 and each  $R^u$  is, independently, H, halo, or optionally substituted alkyl (e.g., U is  $-C^{3/4}$ - or  $-CH-$ ). In other embodiments, each of  $R^1$ ,  $R^2$ ,  $R^3$ ,  $R^4$ , and  $R^5$  is, independently, H, halo, hydroxy, thiol, optionally substituted alkyl, optionally substituted alkoxy, optionally substituted alkenyloxy, optionally substituted alkynyloxy, optionally substituted aminoalkoxy, optionally substituted alkoxyalkoxy, optionally substituted hydroxyalkoxy, optionally substituted amino, azido, optionally substituted aryl, optionally substituted aminoalkyl, optionally substituted aminoalkenyl, optionally substituted aminoalkynyl, or absent (e.g., each  $R^1$  and  $R^2$  is, independently, H, halo, hydroxy, optionally substituted alkyl, or optionally substituted alkoxy; each  $R^3$  and  $R^4$  is, independently, H or optionally substituted alkyl; and  $R^5$  is H or hydroxy), and  $\text{---}$  is a single bond or double bond. In particular embodiments, the polynucleotides or mmRNA includes n number of linked nucleosides having Formula (Iib-1)-(Iib-2):



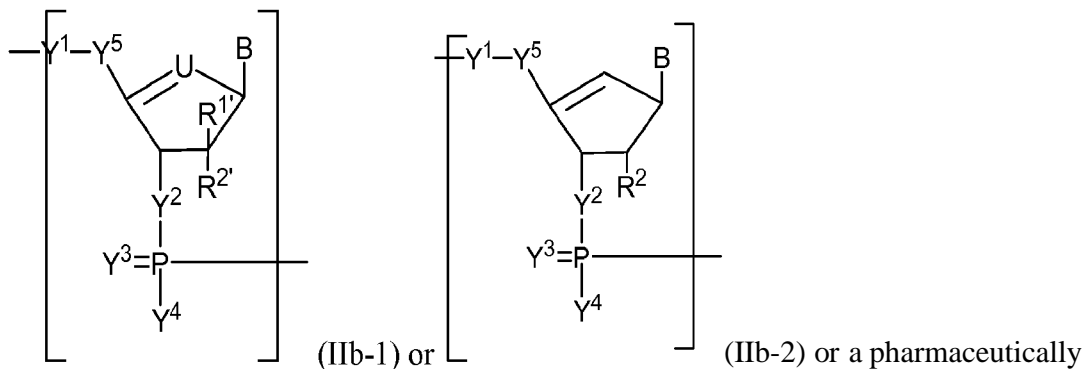

acceptable salt or stereoisomer thereof. In some embodiments, U is 0 or  $C(R^U)_{nu}$ , wherein nu is an integer from 0 to 2 and each  $R^U$  is, independently, H, halo, or optionally substituted alkyl (e.g., U is  $-CH_2-$  or  $-CH-$ ). In other embodiments, each of  $R^1$  and  $R^2$  is, independently, H, halo, hydroxy, thiol, optionally substituted alkyl, optionally substituted alkoxy, optionally substituted alkenyloxy, optionally substituted alkynyloxy, optionally substituted aminoalkoxy, optionally substituted alkoxyalkoxy, optionally substituted hydroxyalkoxy, optionally substituted amino, azido, optionally substituted aryl, optionally substituted aminoalkyl, optionally substituted aminoalkenyl, optionally substituted aminoalkynyl, or absent (e.g., each  $R^1$  and  $R^2$  is, independently, H, halo, hydroxy, optionally substituted alkyl, or optionally substituted alkoxy, e.g., H, halo, hydroxy, alkyl, or alkoxy). In particular embodiments,  $R^2$  is hydroxy or optionally substituted alkoxy (e.g., methoxy, ethoxy, or any described herein).

**[000283]** In particular embodiments, the cosmetic polynucleotide, primary construct, or mmRNA includes n number of linked nucleosides having Formula (IIc-1)-(IIc-4):

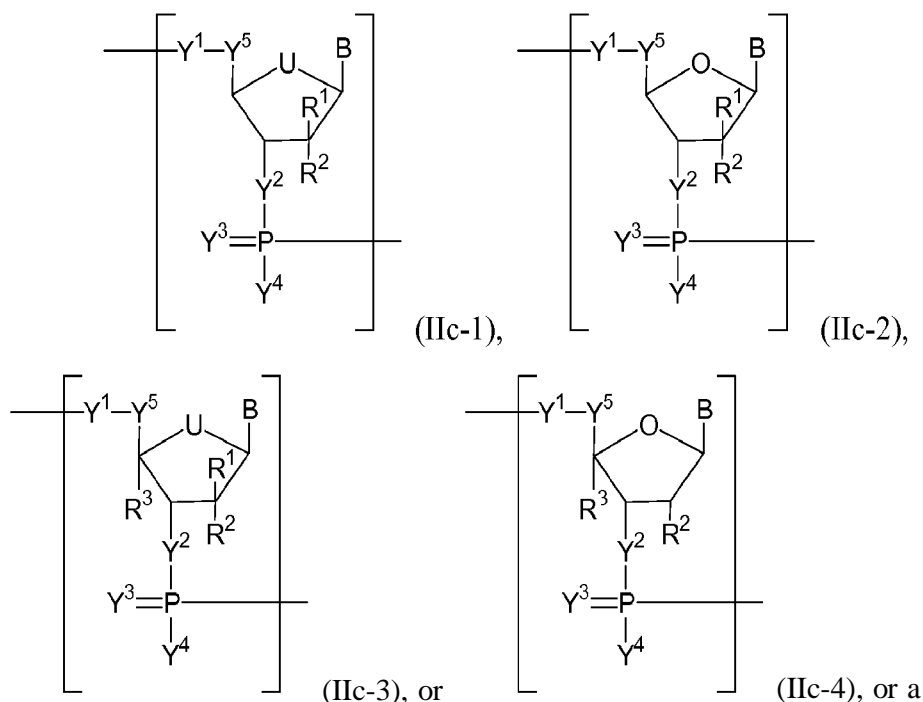

pharmaceutically acceptable salt or stereoisomer thereof. In some embodiments, U is 0 or  $C(R^u)_{nu}$ , wherein nu is an integer from 0 to 2 and each  $R^u$  is, independently, H, halo, or optionally substituted alkyl (e.g., U is  $-CH_2-$  or  $-CH-$ ). In some embodiments, each of  $R^1$ ,  $R^2$ , and  $R^3$  is, independently, H, halo, hydroxy, thiol, optionally substituted alkyl, optionally substituted alkoxy, optionally substituted alkenyloxy, optionally substituted alkynyloxy, optionally substituted aminoalkoxy, optionally substituted alkoxyalkoxy, optionally substituted hydroxyalkoxy, optionally substituted amino, azido, optionally substituted aryl, optionally substituted aminoalkyl, optionally substituted aminoalkenyl, optionally substituted aminoalkynyl, or absent (e.g., each  $R^1$  and  $R^2$  is, independently, H, halo, hydroxy, optionally substituted alkyl, or optionally substituted alkoxy, e.g., H, halo, hydroxy, alkyl, or alkoxy; and each  $R^3$  is, independently, H or optionally substituted alkyl)). In particular embodiments,  $R^2$  is optionally substituted alkoxy (e.g., methoxy or ethoxy, or any described herein). In particular embodiments,  $R^1$  is optionally substituted alkyl, and  $R^2$  is hydroxy. In other embodiments,  $R^1$  is hydroxy, and  $R^2$  is optionally substituted alkyl. In further embodiments,  $R^3$  is optionally substituted alkyl.

**[000284]** In some embodiments, the cosmetic polynucleotide, primary construct, or mmRNA includes an acyclic modified ribose. In some embodiments, the cosmetic polynucleotide, primary construct, or mmRNA (e.g., the first region, the first flanking

region, or the second flanking region) includes n number of linked nucleosides having Formula (II d)-(II f):

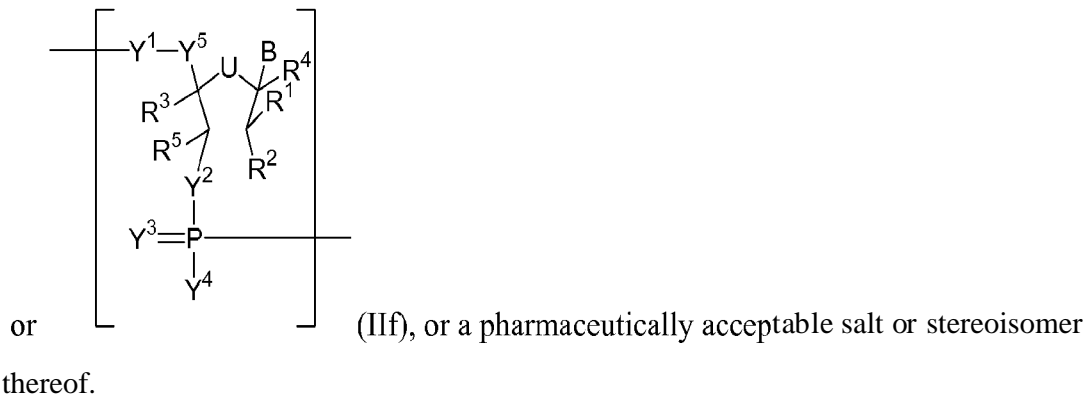
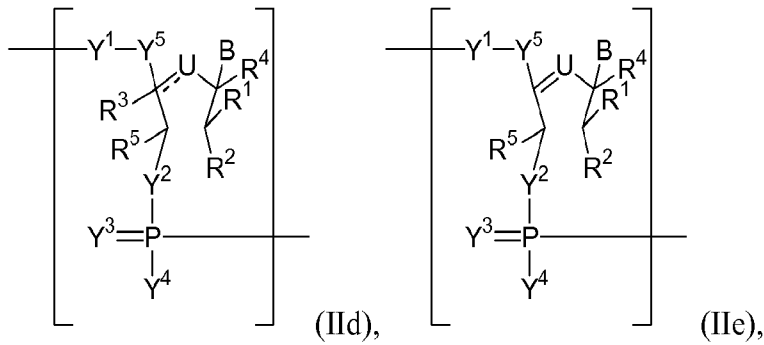

[000285] In some embodiments, the cosmetic polynucleotide, primary construct, or mmRNA includes an acyclic modified hexitol. In some embodiments, the cosmetic polynucleotide, primary construct, or mmRNA (e.g., the first region, the first flanking region, or the second flanking region) includes n number of linked nucleosides Formula (II g)-(II j):

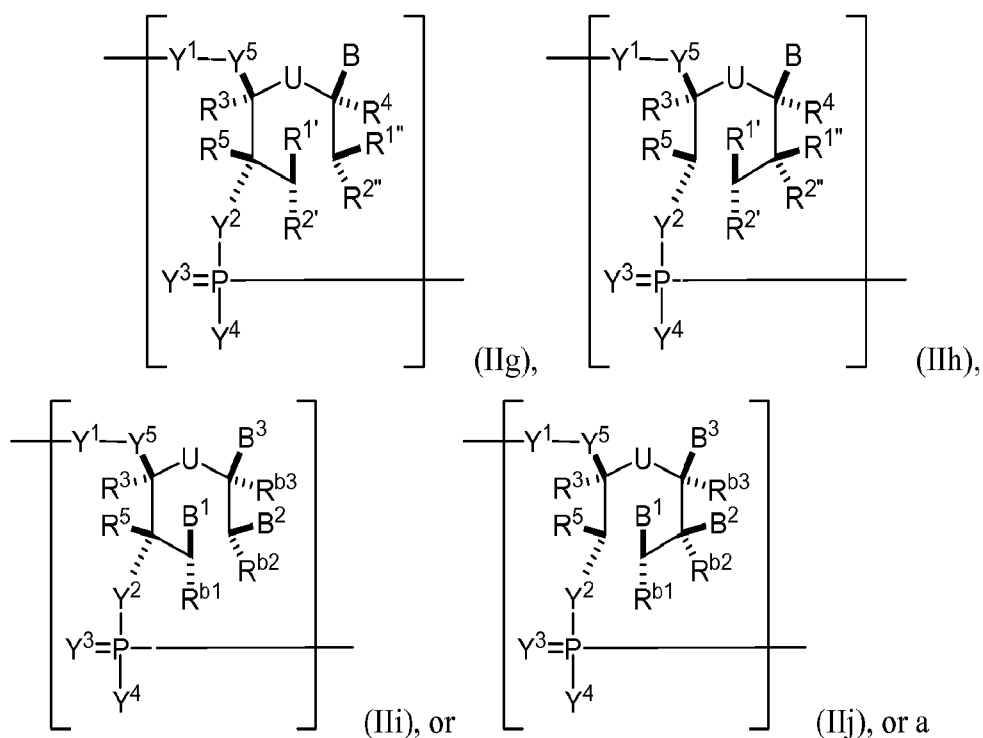

pharmaceutically acceptable salt or stereoisomer thereof.

[000286] In some embodiments, the cosmetic polynucleotide, primary construct, or mmRNA includes a sugar moiety having a contracted or an expanded ribose ring. In some embodiments, the cosmetic polynucleotide, primary construct, or mmRNA (e.g., the first region, the first flanking region, or the second flanking region) includes n number of linked nucleosides having Formula (IIk)-(IIm):

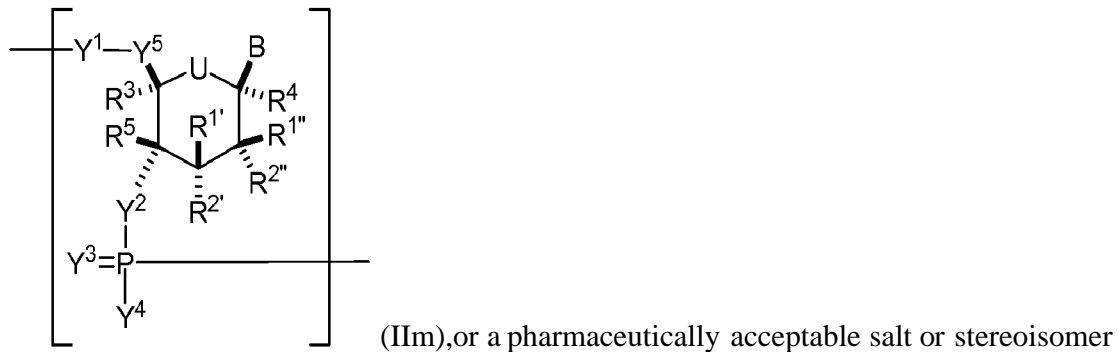
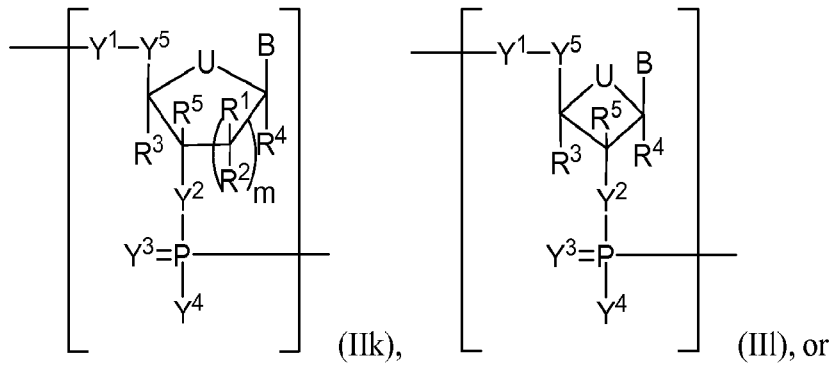

thereof, wherein each of R<sup>1'</sup>, R<sup>1''</sup>, R<sup>2'</sup>, and R<sup>2''</sup> is, independently, H, halo, hydroxy, optionally substituted alkyl, optionally substituted alkoxy, optionally substituted alkenyloxy, optionally substituted alkynyloxy, optionally substituted aminoalkoxy, optionally substituted alkoxyalkoxy, or absent; and wherein the combination of R<sup>2'</sup> and R<sup>3</sup> or the combination of R<sup>2''</sup> and R<sup>3</sup> can be taken together to form optionally substituted alkylene or optionally substituted heteroalkylene.

[000287] In some embodiments, the cosmetic polynucleotide, primary construct, or mmRNA includes a locked modified ribose. In some embodiments, the cosmetic polynucleotide, primary construct, or mmRNA (e.g., the first region, the first flanking region, or the second flanking region) includes n number of linked nucleosides having Formula (IIn):

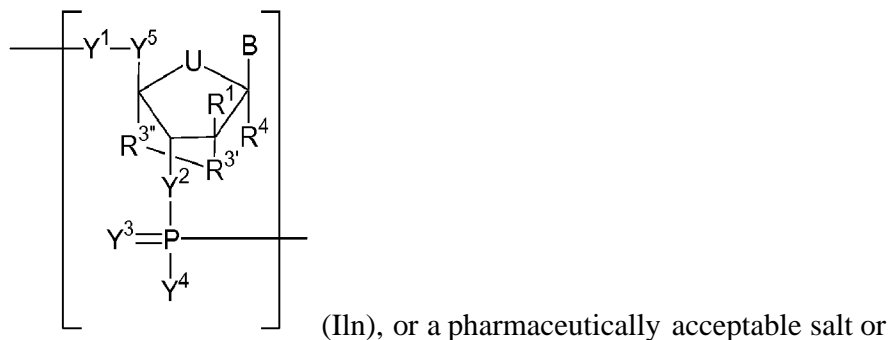

stereoisomer thereof, wherein R<sup>3'</sup> is 0, S, or -NR<sup>N1</sup>-, wherein R<sup>N1</sup> is H, optionally

substituted alkyl, optionally substituted alkenyl, optionally substituted alkynyl, or optionally substituted aryl and  $R^{3''}$  is optionally substituted alkylene (e.g.,  $-\text{CH}_2-$ ,  $-\text{CH}_2\text{CH}_2-$ , or  $-\text{CH}_2\text{CH}_2\text{CH}_2-$ ) or optionally substituted heteroalkylene (e.g.,  $-\text{CH}_2\text{NH}-$ ,  $-\text{CH}_2\text{CH}_2\text{NH}-$ ,  $-\text{CH}_2\text{OCH}_2-$ , or  $-\text{CH}_2\text{CH}_2\text{OCH}_2-$ ) (e.g.,  $R^{3'}$  is  $\mathbf{0}$  and  $R^{3''}$  is optionally substituted alkylene (e.g.,  $-\text{CH}_2-$ ,  $-\text{CH}_2\text{CH}_2-$ , or  $-\text{CH}_2\text{CH}_2\text{CH}_2-$ )).

[000288] In some embodiments, the cosmetic polynucleotide, primary construct, or mmRNA includes n number of linked nucleosides having Formula (II-n-1)-(II-n-2):

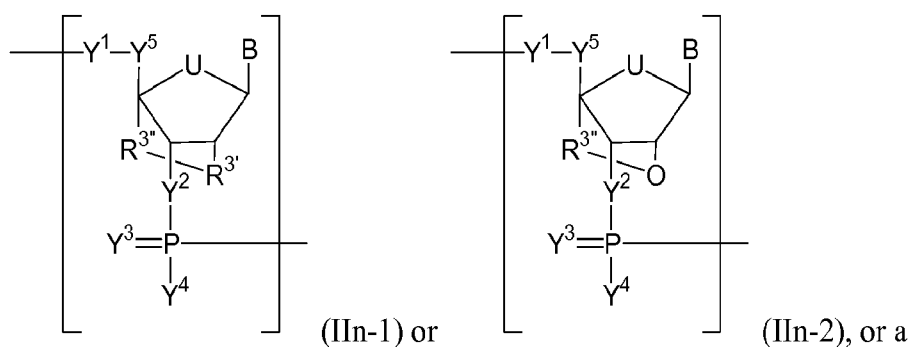

pharmaceutically acceptable salt or stereoisomer thereof, wherein  $R^{3'}$  is  $\mathbf{0}$ , S, or  $-\text{NR}^{\text{N}1}$ , wherein  $R^{\text{N}1}$  is H, optionally substituted alkyl, optionally substituted alkenyl, optionally substituted alkynyl, or optionally substituted aryl and  $R^{3''}$  is optionally substituted alkylene (e.g.,  $-\text{CH}_2-$ ,  $-\text{CH}_2\text{CH}_2-$ , or  $-\text{CH}_2\text{CH}_2\text{CH}_2-$ ) or optionally substituted heteroalkylene (e.g.,  $-\text{CH}_2\text{NH}-$ ,  $-\text{CH}_2\text{CH}_2\text{NH}-$ ,  $-\text{CH}_2\text{OCH}_2-$ , or  $-\text{CH}_2\text{CH}_2\text{OCH}_2-$ ) (e.g.,  $R^{3'}$  is O and  $R^{3''}$  is optionally substituted alkylene (e.g.,  $-\text{CH}_2-$ ,  $-\text{CH}_2\text{CH}_2-$ , or  $-\text{CH}_2\text{CH}_2\text{CH}_2-$ )).

[000289] In some embodiments, the cosmetic polynucleotide, primary construct, or mmRNA includes a locked modified ribose that forms a tetracyclic heterocyclyl. In some embodiments, the cosmetic polynucleotide, primary construct, or mmRNA (e.g., the first region, the first flanking region, or the second flanking region) includes n number of linked nucleosides having Formula (IIo):

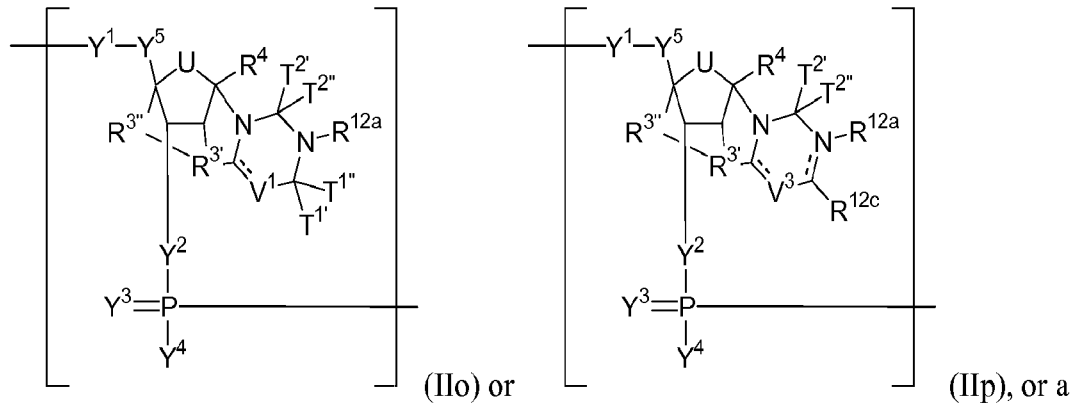

pharmaceutically acceptable salt or stereoisomer thereof, wherein  $R^{12a}$ ,  $R^{12c}$ ,  $T^1$ ,  $T^{1'}$ ,  $T^{2'}$ ,  $T^{2''}$ ,  $V^1$ , and  $V^3$  are as described herein.

[000290] Any of the formulas for the cosmetic polynucleotides, primary constructs, or mmRNA can include one or more nucleobases described herein (e.g., Formulas (b1)-(b43)).

[000291] In one embodiment, the present invention provides methods of preparing a polynucleotide, primary construct, or mmRNA, wherein the polynucleotide comprises n number of nucleosides having Formula (Ia), as defined herein:

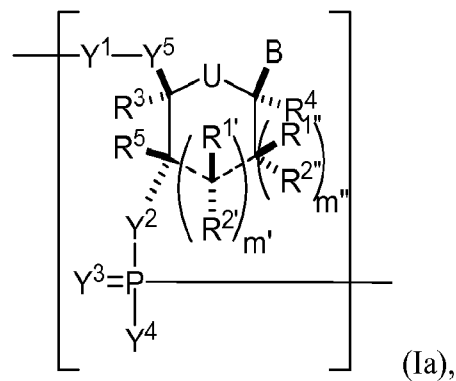

the method comprising reacting a compound of Formula (IIia), as defined herein:

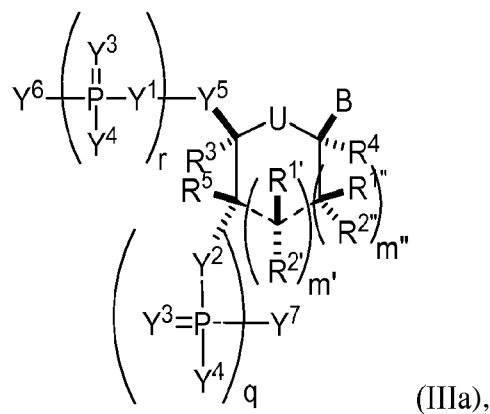

with an RNA polymerase, and a cDNA template.

[000292] In a further embodiment, the present invention provides methods of amplifying a polynucleotide, primary construct, or mmRNA comprising at least one nucleotide (e.g., mmRNA molecule), the method comprising:

reacting a compound of Formula (IIa), as defined herein, with a primer, a cDNA template, and an RNA polymerase.

[000293] In one embodiment, the present invention provides methods of preparing a polynucleotide, primary construct, or mmRNA comprising at least one nucleotide (e.g., mmRNA molecule), wherein the polynucleotide comprises n number of nucleosides having Formula (Ia), as defined herein:

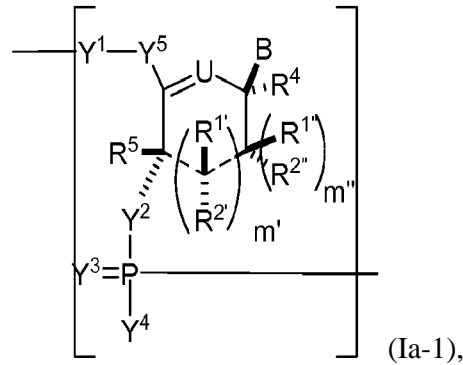

the method comprising reacting a compound of Formula (IIIa-1), as defined herein:

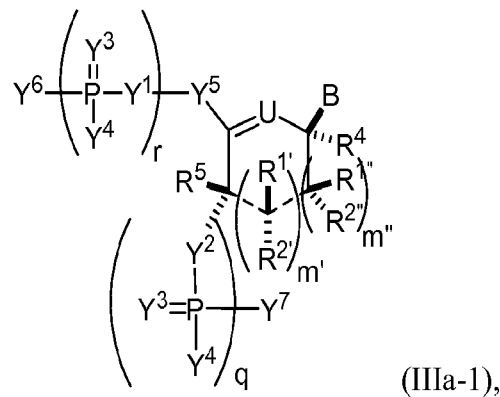

with an RNA polymerase, and a cDNA template.

[000294] In a further embodiment, the present invention provides methods of amplifying a polynucleotide, primary construct, or mmRNA comprising at least one nucleotide (e.g., mmRNA molecule), the method comprising:



reacting a compound of Formula (IIIa-1), as defined herein, with a primer, a cDNA template, and an RNA polymerase.

[000295] In one embodiment, the present invention provides methods of preparing a modified mRNA comprising at least one nucleotide (e.g., mmRNA molecule), wherein the polynucleotide comprises n number of nucleosides having Formula (Ia-2), as defined herein:

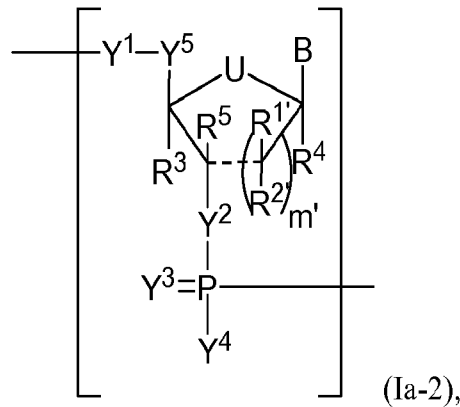

the method comprising reacting a compound of Formula (IIIa-2), as defined herein:

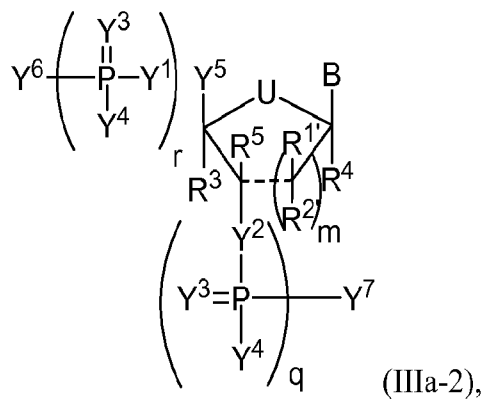

with an RNA polymerase, and a cDNA template.

[000296] In a further embodiment, the present invention provides methods of amplifying a modified mRNA comprising at least one nucleotide (e.g., mmRNA molecule), the method comprising:

[000297] reacting a compound of Formula (IIIa-2), as defined herein, with a primer, a cDNA template, and an RNA polymerase.

[000298] In some embodiments, the reaction may be repeated from 1 to about 7,000 times. In any of the embodiments herein, B may be a nucleobase of Formula (b1)-(b43).

[000299] The cosmetic polynucleotides, primary constructs, and mmRNA can optionally include 5' and/or 3' flanking regions, which are described herein.

*Modified RNA (mmRNA) Molecules*

[000300] The present invention also includes building blocks, e.g., modified ribonucleosides, modified ribonucleotides, of modified RNA (mmRNA) molecules. For example, these building blocks can be useful for preparing the cosmetic polynucleotides, primary constructs, or mmRNA of the invention.

[000301] In some embodiments, the building block molecule has Formula (IIia) or (IIIa-1):

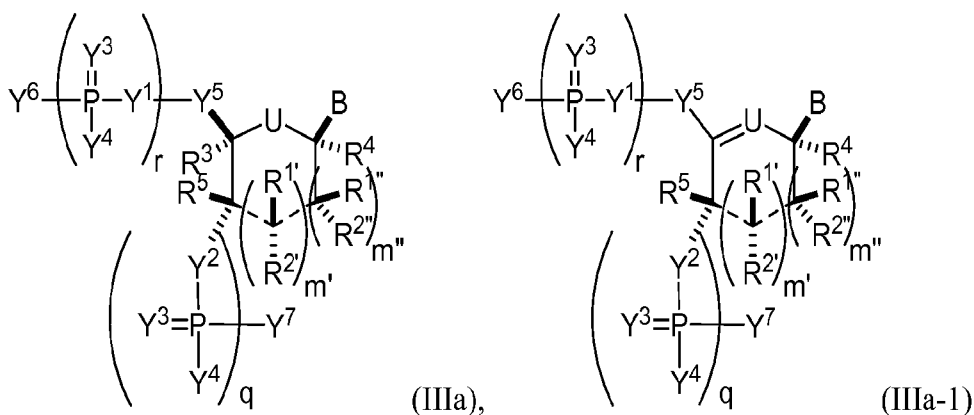

or a pharmaceutically acceptable salt or stereoisomer thereof, wherein the substituents are as described herein (e.g., for Formula (Ia) and (Ia-1)), and wherein when B is an unmodified nucleobase selected from cytosine, guanine, uracil and adenine, then at least one of Y<sup>1</sup>, Y<sup>2</sup>, or Y<sup>3</sup> is not O.

[000302] In some embodiments, the building block molecule, which may be incorporated into a polynucleotide, primary construct, or mmRNA, has Formula (IVa)-(IVb):

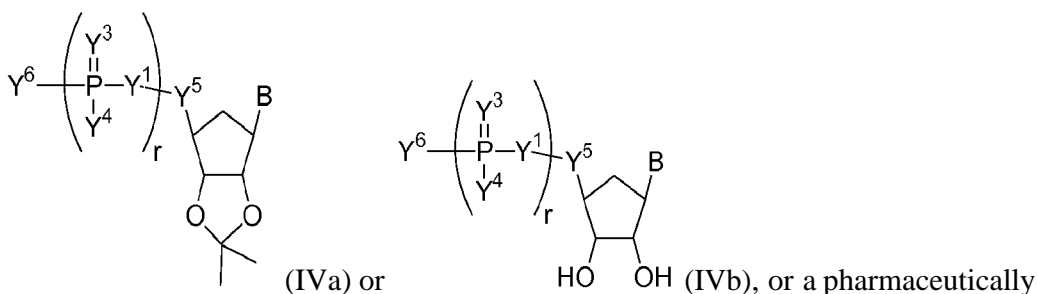

acceptable salt or stereoisomer thereof, wherein B is as described herein (e.g., any one of (bl)-(b43)). In particular embodiments, Formula (IVa) or (IVb) is combined with a modified uracil (e.g., any one of formulas (bl)-(b9), (b21)-(b23), and (b28)-(b31), such

as formula (bl), (b8), (b28), (b29), or (b30)). In particular embodiments, Formula (IVa) or (IVb) is combined with a modified cytosine (e.g., any one of formulas (M0)-(b14), (b24), (b25), and (b32)-(b36), such as formula (bl0) or (b32)). In particular embodiments, Formula (IVa) or (IVb) is combined with a modified guanine (e.g., any one of formulas (bl5)-(bl7) and (b37)-(b40)). In particular embodiments, Formula (IVa) or (IVb) is combined with a modified adenine (e.g., any one of formulas (bl8)-(b20) and (b41)-(b43)).

[000303] In some embodiments, the building block molecule, which may be incorporated into a polynucleotide, primary construct, or mmRNA, has Formula (IVc)-(IVk):

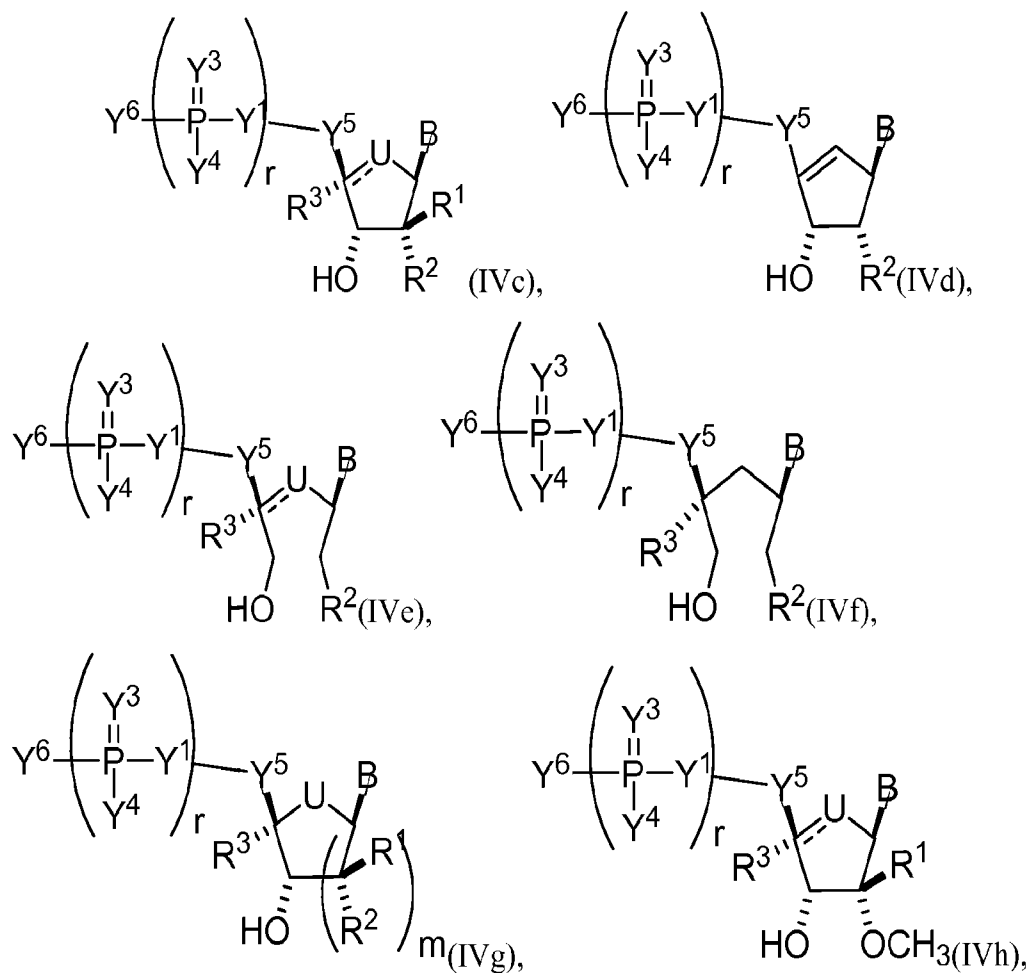

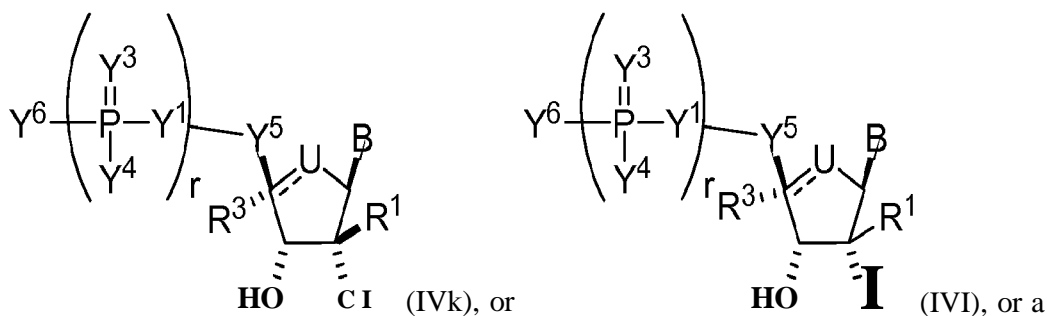
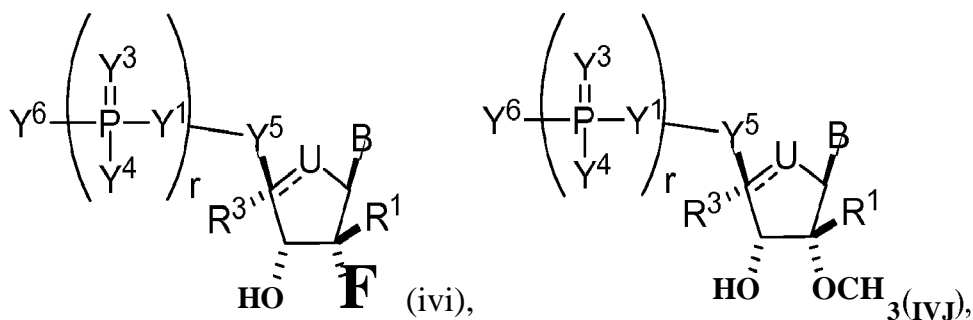

pharmaceutically acceptable salt or stereoisomer thereof, wherein B is as described herein (e.g., any one of (bl)-(b43)). In particular embodiments, one of Formulas (IVc)-(IVk) is combined with a modified uracil (e.g., any one of formulas (bl)-(b9), (b21)-(b23), and (b28)-(b31), such as formula (bl), (b8), (b28), (b29), or (b30)). In particular embodiments, one of Formulas (IVc)-(IVk) is combined with a modified cytosine (e.g., any one of formulas (blO)-(M4), (b24), (b25), and (b32)-(b36), such as formula (blO) or (b32)). In particular embodiments, one of Formulas (IVc)-(IVk) is combined with a modified guanine (e.g., any one of formulas (bl5)-(bl7) and (b37)-(b40)). In particular embodiments, one of Formulas (IVc)-(IVk) is combined with a modified adenine (e.g., any one of formulas (bl8)-(b20) and (b41)-(b43)).

[000304] In other embodiments, the building block molecule, which may be incorporated into a polynucleotide, primary construct, or mmRNA, has Formula (Va) or (Vb):

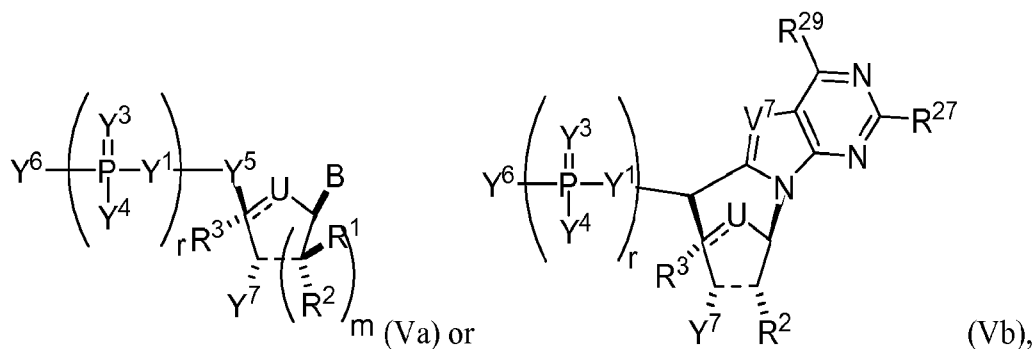

or a pharmaceutically acceptable salt or stereoisomer thereof, wherein **B** is as described herein (e.g., any one of (b1)-(b43)).

**[000305]** In other embodiments, the building block molecule, which may be incorporated into a polynucleotide, primary construct, or mmRNA, has Formula (IXa)-(IXd):

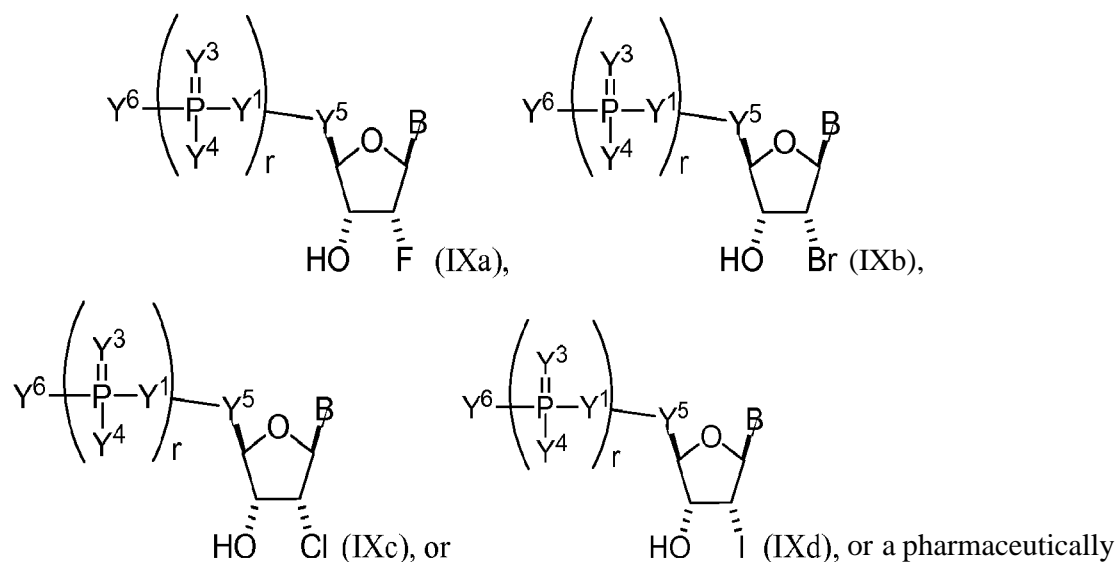

acceptable salt or stereoisomer thereof, wherein **B** is as described herein (e.g., any one of (b1)-(b43)). In particular embodiments, one of Formulas (IXa)-(IXd) is combined with a modified uracil (e.g., any one of formulas (b1)-(b9), (b21)-(b23), and (b28)-(b31), such as formula (b1), (b8), (b28), (b29), or (b30)). In particular embodiments, one of Formulas (IXa)-(IXd) is combined with a modified cytosine (e.g., any one of formulas (M0)-(b14), (b24), (b25), and (b32)-(b36), such as formula (b10) or (b32)). In particular embodiments, one of Formulas (IXa)-(IXd) is combined with a modified guanine (e.g., any one of formulas (b15)-(b17) and (b37)-(b40)). In particular embodiments, one of Formulas (IXa)-(IXd) is combined with a modified adenine (e.g., any one of formulas (M8)-(b20) and (b41)-(b43)).

[000306] In other embodiments, the building block molecule, which may be incorporated into a polynucleotide, primary construct, or mmRNA, has Formula (IXe)-(Kg):

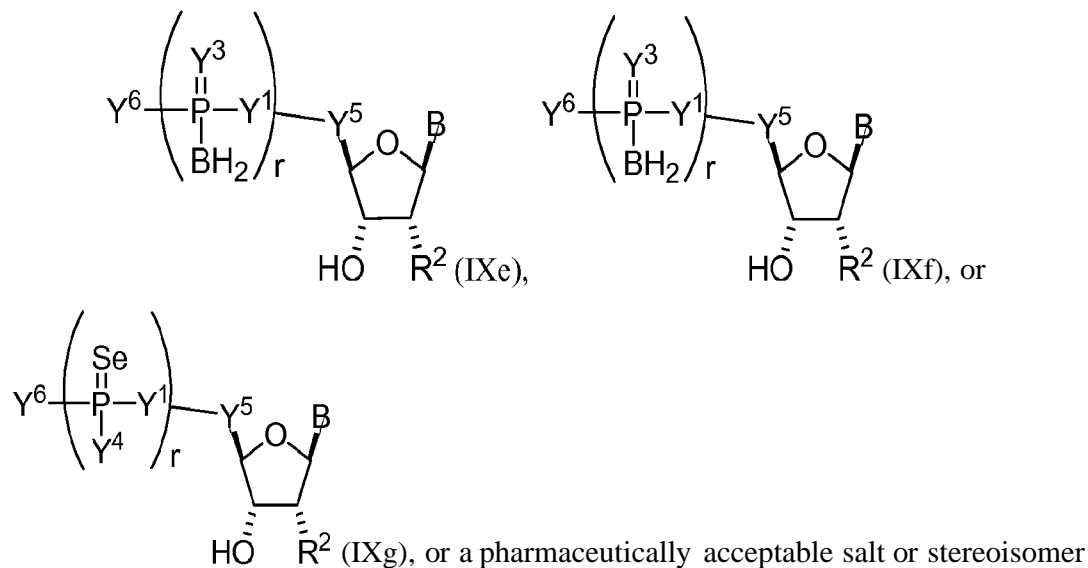

In particular embodiments, one of Formulas (IXe)-(IXg) is combined with a modified uracil (e.g., any one of formulas (b1)-(b9), (b21)-(b23), and (b28)-(b31), such as formula (b1), (b8), (b28), (b29), or (b30)). In particular embodiments, one of Formulas (IXe)-(IXg) is combined with a modified cytosine (e.g., any one of formulas (M0)-(b14), (b24), (b25), and (b32)-(b36), such as formula (b10) or (b32)). In particular embodiments, one of Formulas (IXe)-(IXg) is combined with a modified guanine (e.g., any one of formulas (b15)-(b17) and (b37)-(b40)). In particular embodiments, one of Formulas (IXe)-(IXg) is combined with a modified adenine (e.g., any one of formulas (M8)-(b20) and (b41)-(b43)).

[000307] In other embodiments, the building block molecule, which may be incorporated into a polynucleotide, primary construct, or mmRNA, has Formula (IXh)-(IXk):

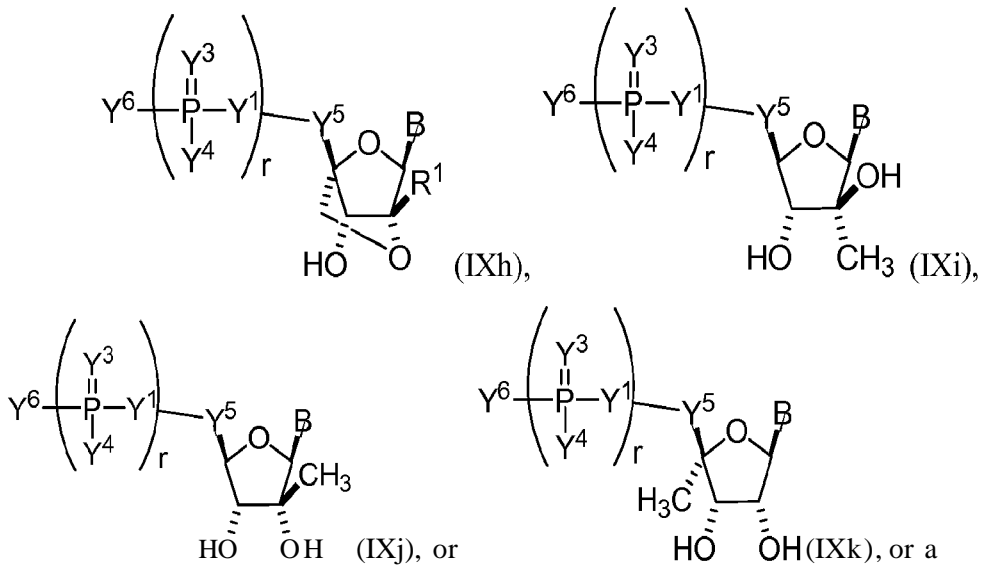

pharmaceutically acceptable salt or stereoisomer thereof, wherein B is as described herein (e.g., any one of (bl)-(b43)). In particular embodiments, one of Formulas (IXh)-(IXk) is combined with a modified uracil (e.g., any one of formulas (bl)-(b9), (b21)-(b23), and (b28)-(b31), such as formula (bl), (b8), (b28), (b29), or (b30)). In particular embodiments, one of Formulas (IXh)-(IXk) is combined with a modified cytosine (e.g., any one of formulas (blO)-(M4), (b24), (b25), and (b32)-(b36), such as formula (blO) or (b32)). In particular embodiments, one of Formulas (IXh)-(IXk) is combined with a modified guanine (e.g., any one of formulas (bl5)-(bl7) and (b37)-(b40)). In particular embodiments, one of Formulas (IXh)-(IXk) is combined with a modified adenine (e.g., any one of formulas (M8)-(b20) and (b41)-(b43)).

[000308] In other embodiments, the building block molecule, which may be incorporated into a polynucleotide, primary construct, or mmRNA, has Formula (IXl)-(IXr):

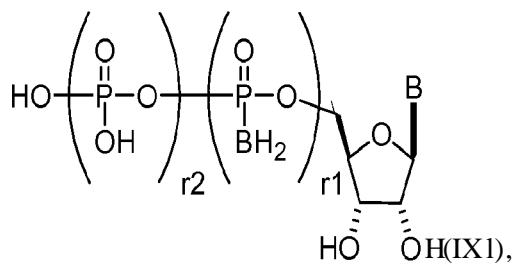

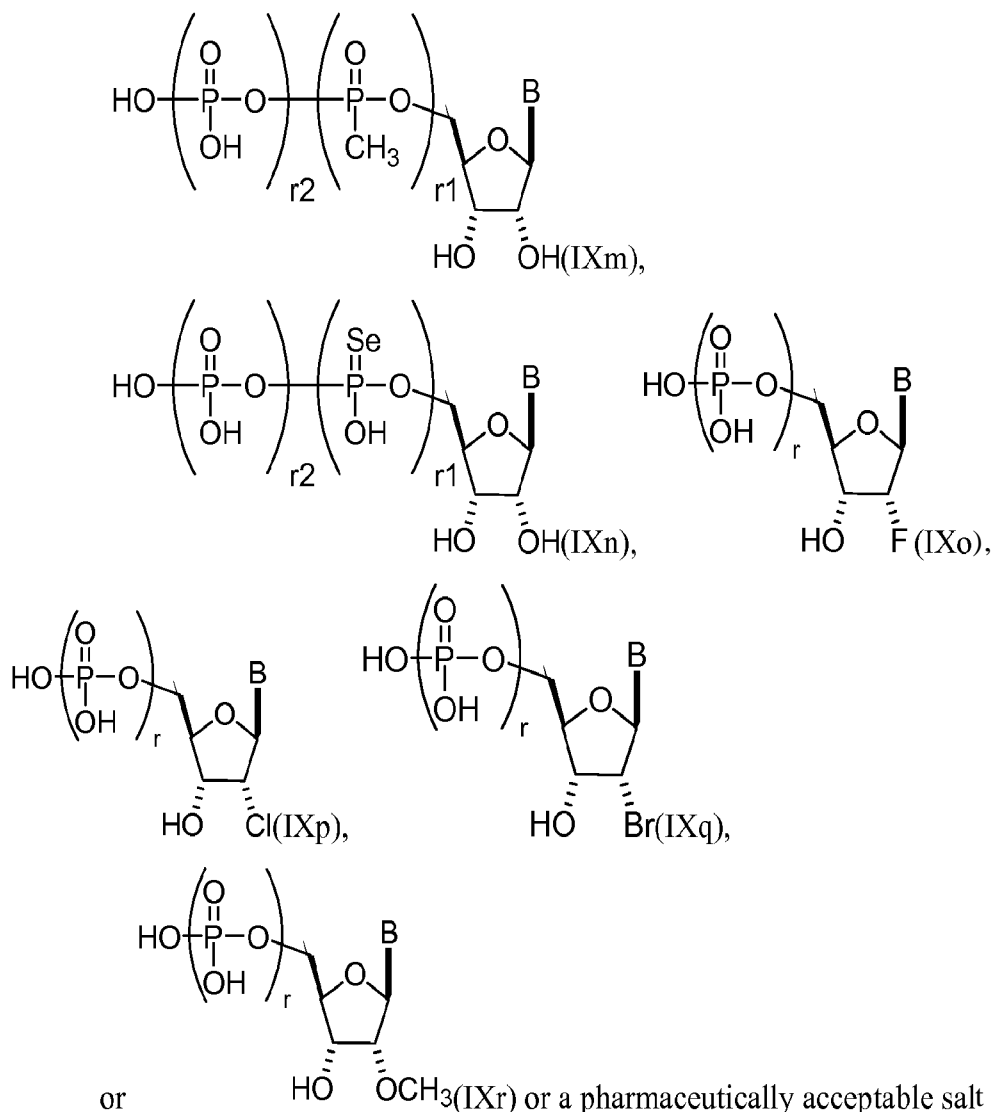

or stereoisomer thereof, wherein each  $r_1$  and  $r_2$  is, independently, an integer from 0 to 5 (e.g., from 0 to 3, from 1 to 3, or from 1 to 5) and B is as described herein (e.g., any one of (b1)-(b43)). In particular embodiments, one of Formulas (IX1)-(IXr) is combined with a modified uracil (e.g., any one of formulas (b1)-(b9), (b21)-(b23), and (b28)-(b31), such as formula (b1), (b8), (b28), (b29), or (b30)). In particular embodiments, one of Formulas (IX1)-(IXr) is combined with a modified cytosine (e.g., any one of formulas (M0)-(b14), (b24), (b25), and (b32)-(b36), such as formula (b10) or (b32)). In particular embodiments, one of Formulas (IX1)-(IXr) is combined with a modified guanine (e.g., any one of formulas (b15)-(b17) and (b37)-(b40)). In particular embodiments, one of Formulas (IX1)-(IXr) is combined with a modified adenine (e.g., any one of formulas (M8)-(b20) and (b41)-(b43)).



[000309] In some embodiments, the building block molecule, which may be incorporated into a polynucleotide, primary construct, or mmRNA, can be selected from

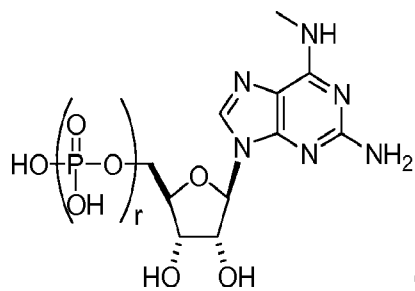

the group consisting of:

(BB- 1),

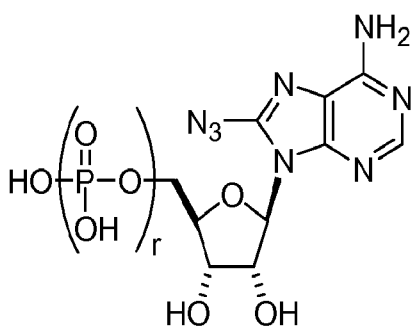

(BB- 2),

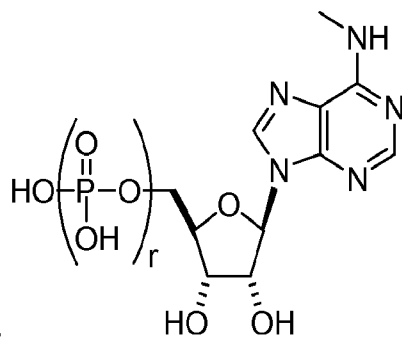

(BB- 3),

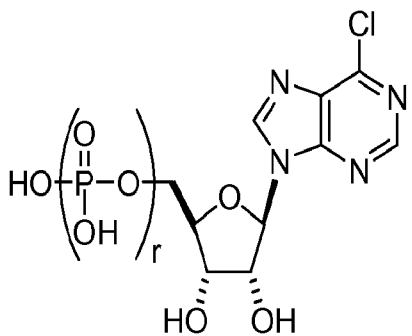

(BB- 4),

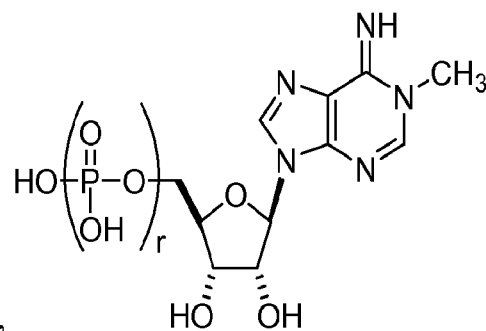

(BB- 5),

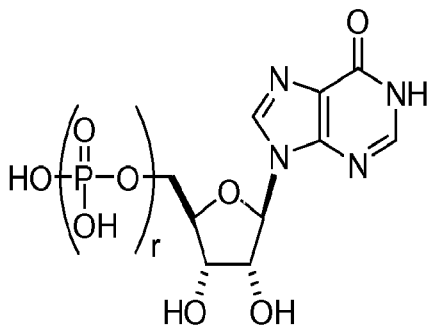

(BB- 6),

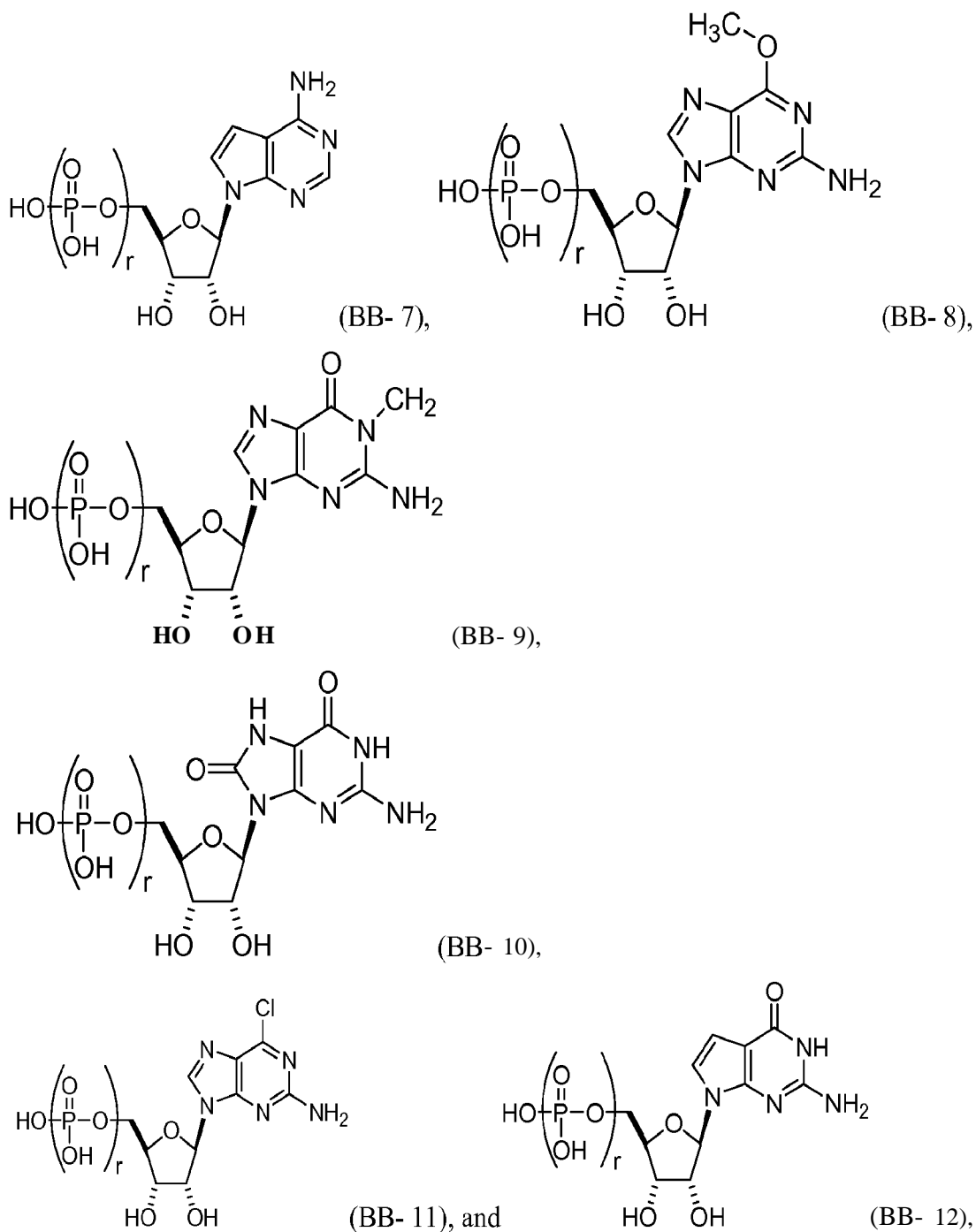

or a pharmaceutically acceptable salt or stereoisomer thereof, wherein each  $r$  is, independently, an integer from 0 to 5 (e.g., from 0 to 3, from 1 to 3, or from 1 to 5).

**[000310]** In some embodiments, the building block molecule, which may be incorporated into a polynucleotide, primary construct, or mmRNA, can be selected from the group consisting of:

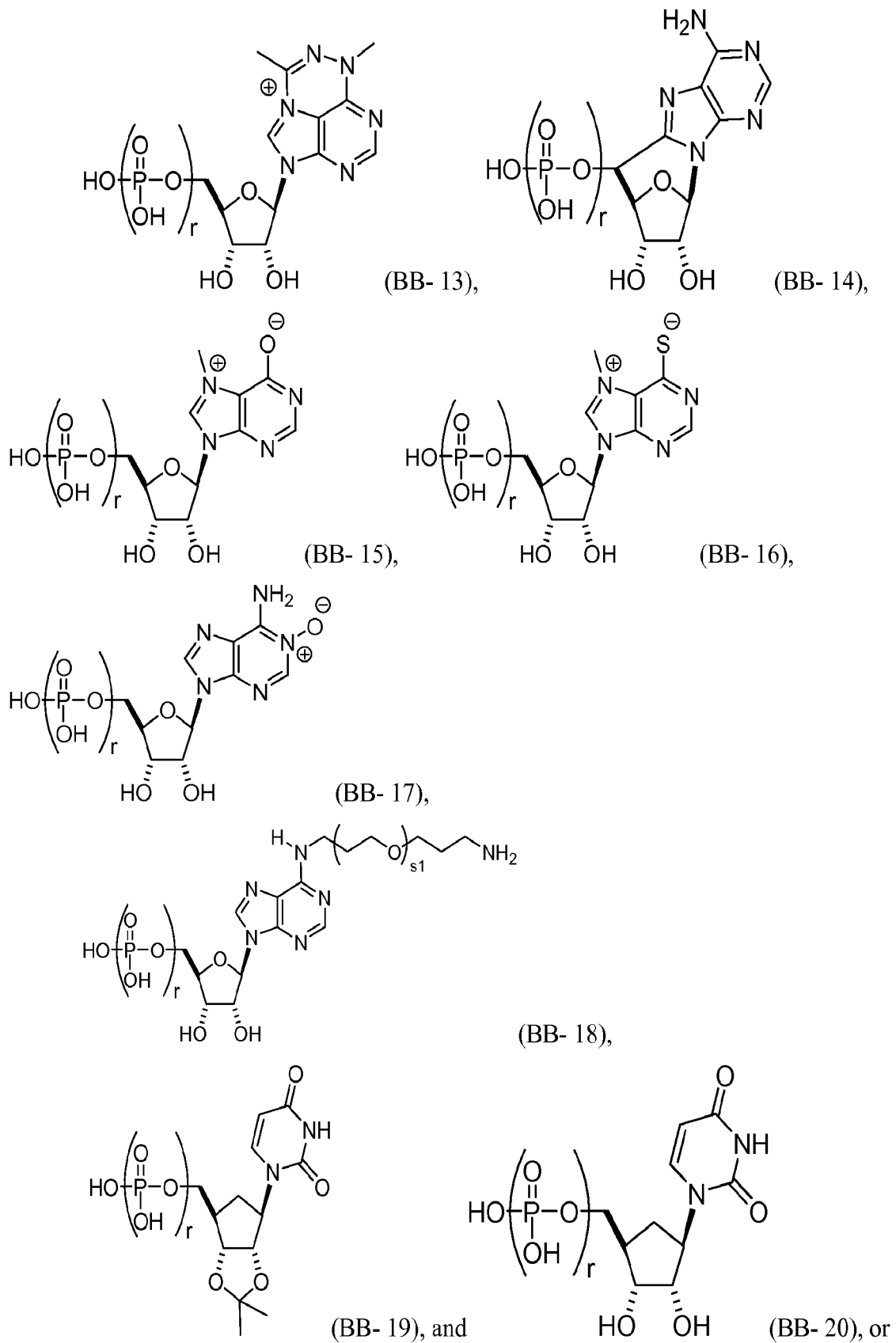

a pharmaceutically acceptable salt or stereoisomer thereof, wherein each r is,

independently, an integer from 0 to 5 (e.g., from 0 to 3, from 1 to 3, or from 1 to 5) and *si* is as described herein.

[000311] In some embodiments, the building block molecule, which may be incorporated into a nucleic acid (e.g., RNA, mRNA, polynucleotide, primary construct, or mmRNA), is a modified uridine (e.g., selected from the group consisting of:

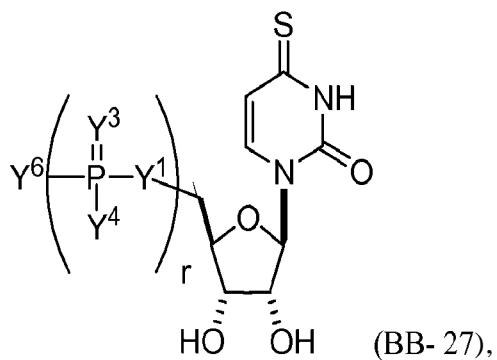
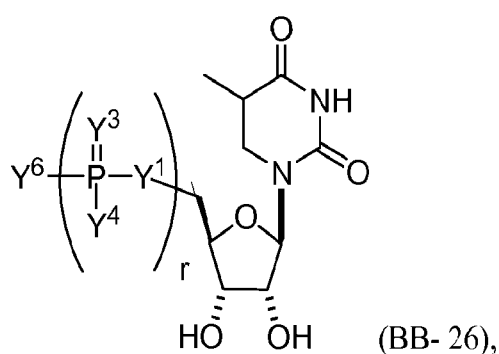
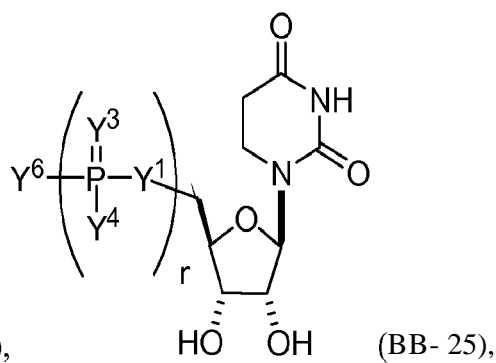
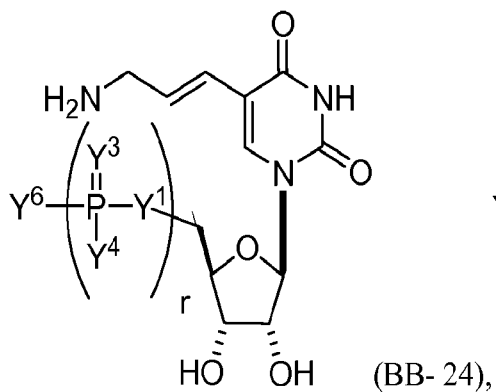
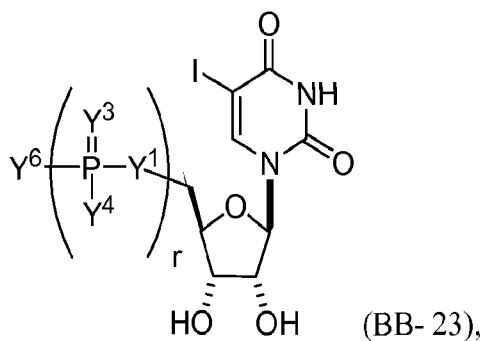
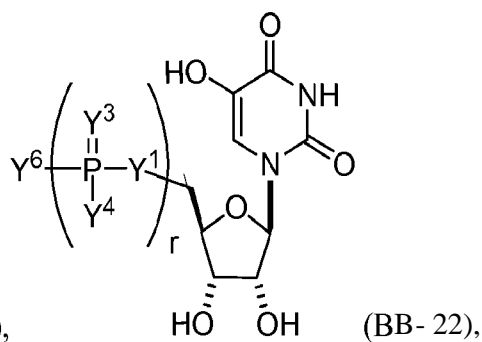
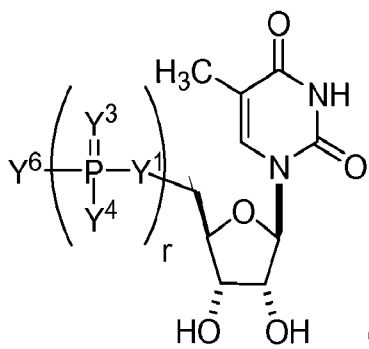

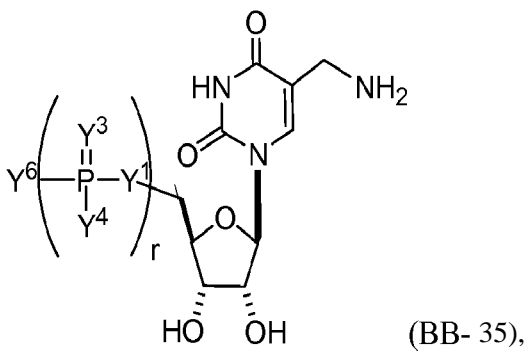
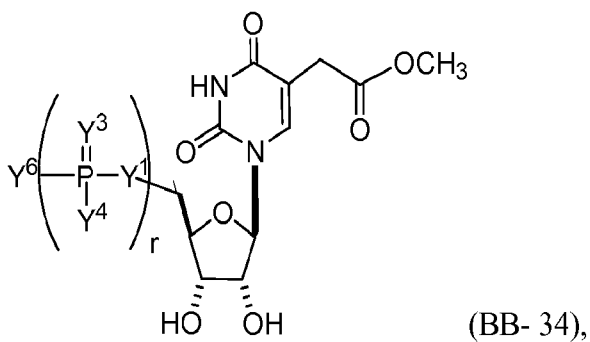
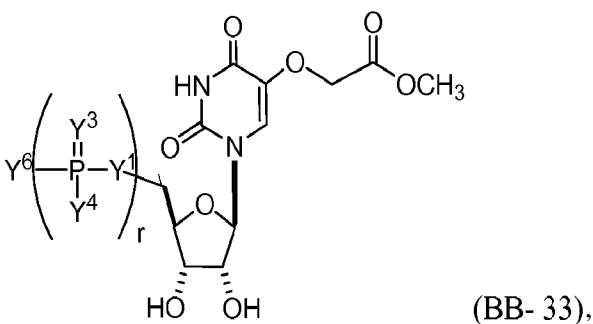
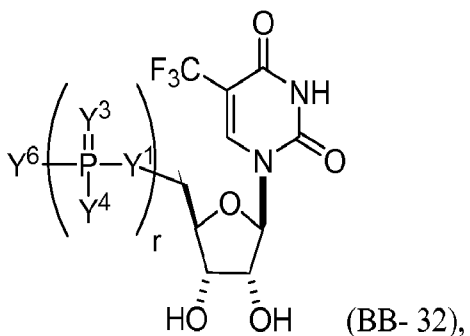
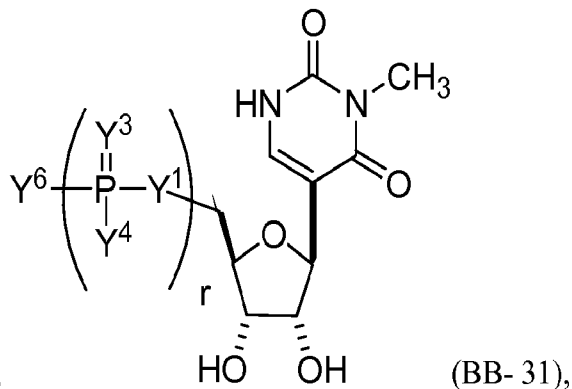
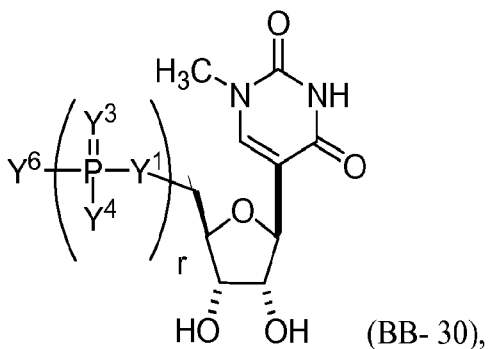
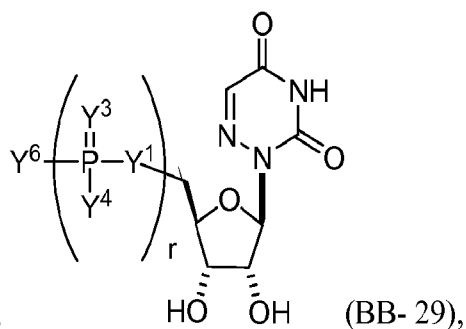
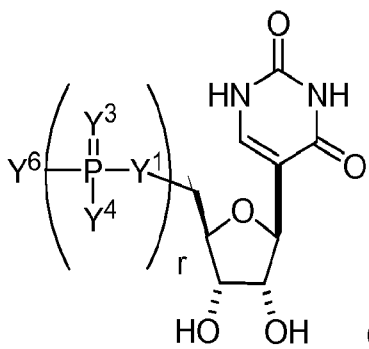

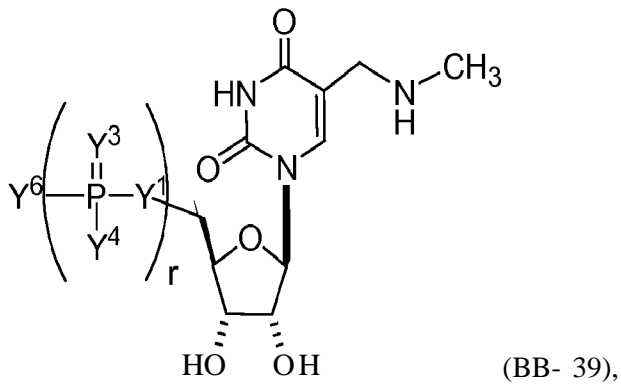
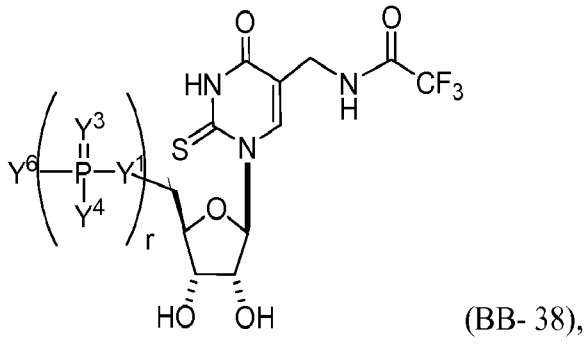
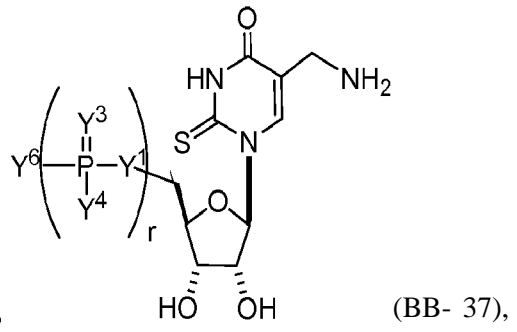
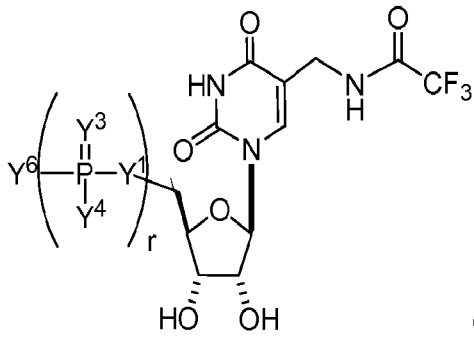

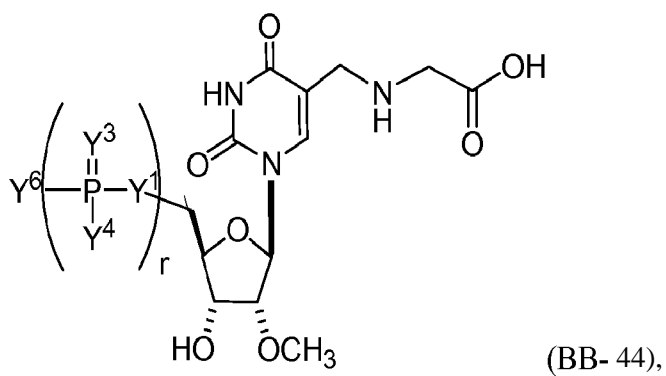
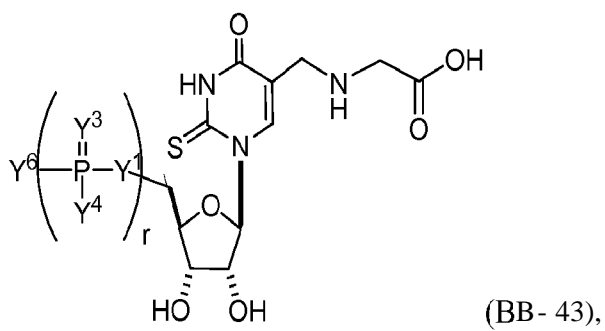
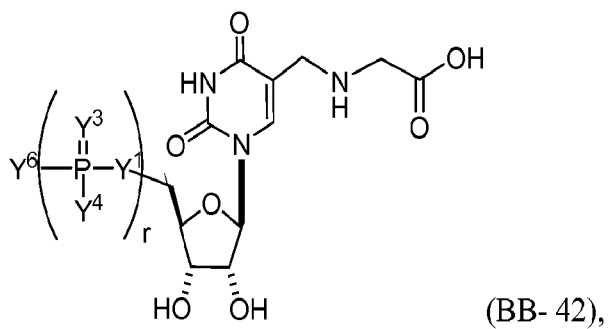
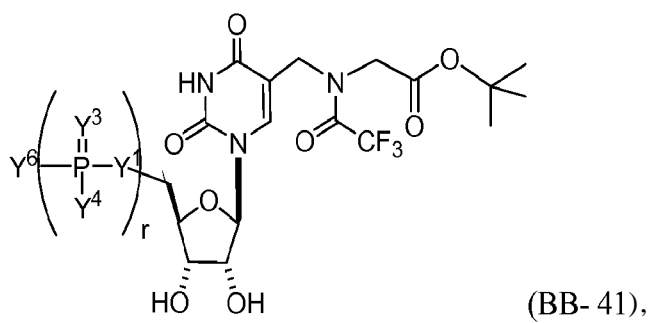
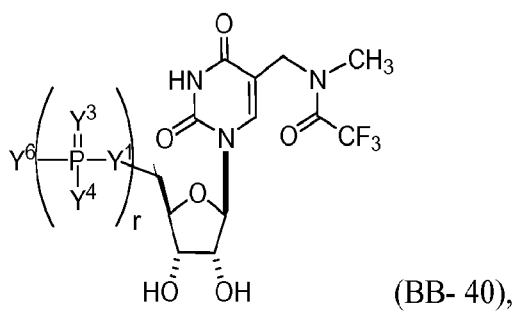

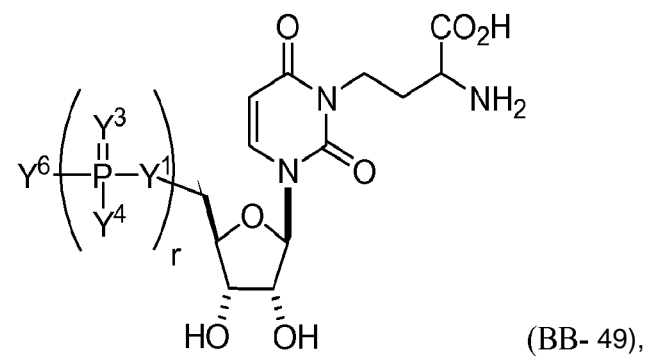
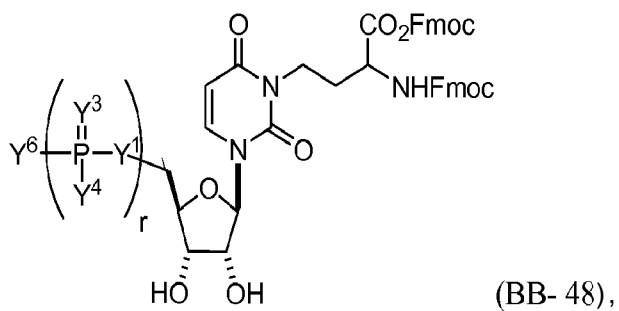
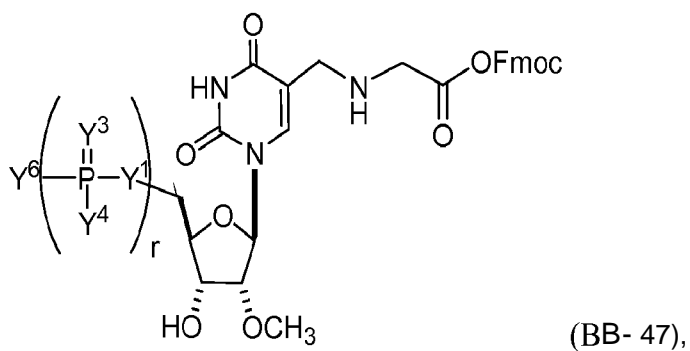
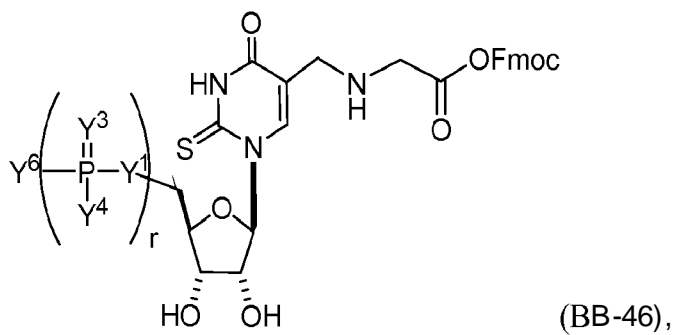
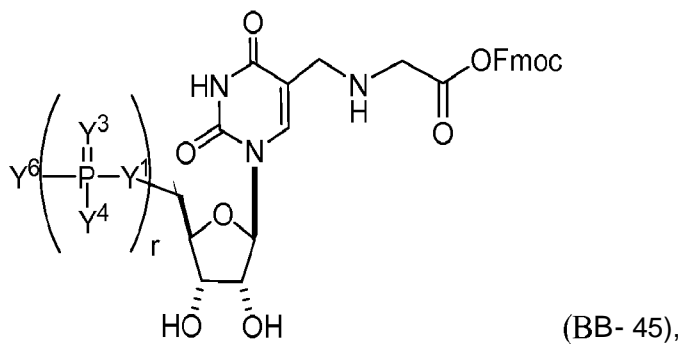



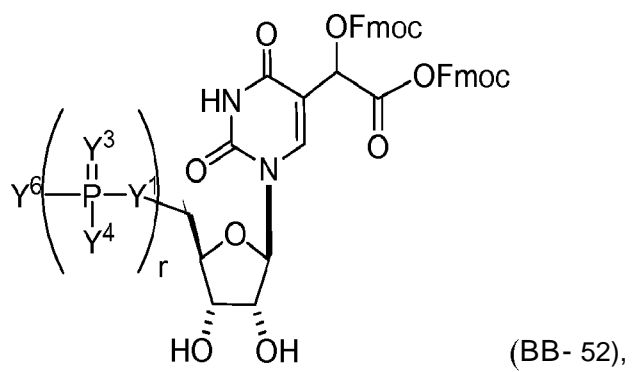
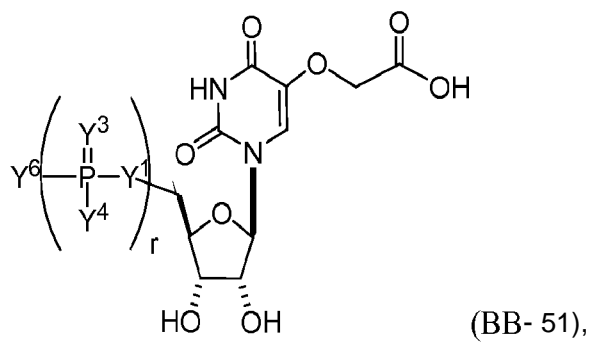
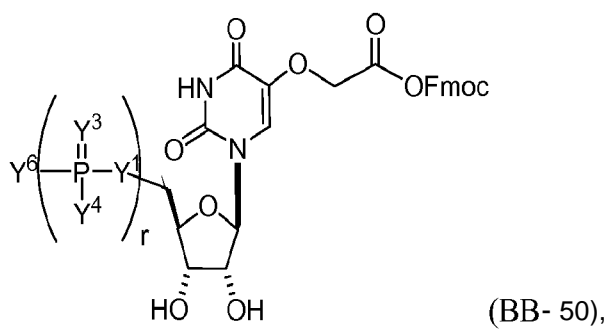

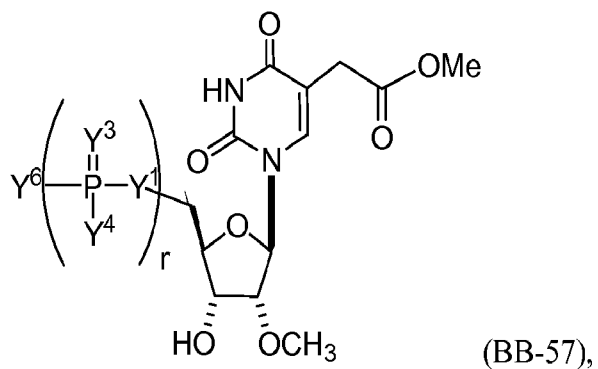
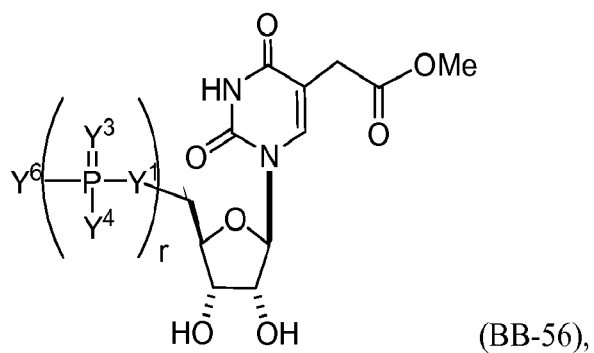
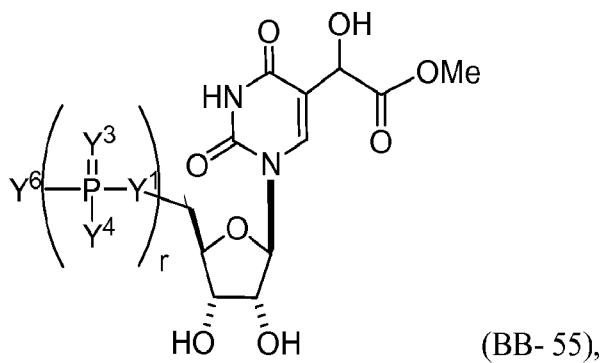
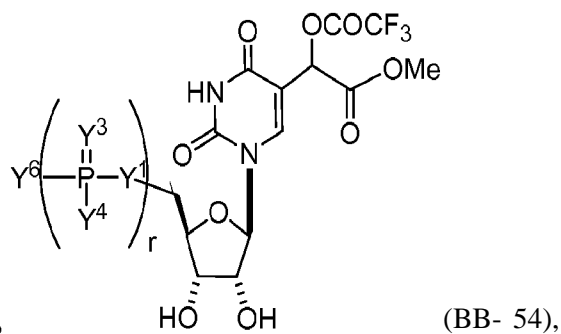
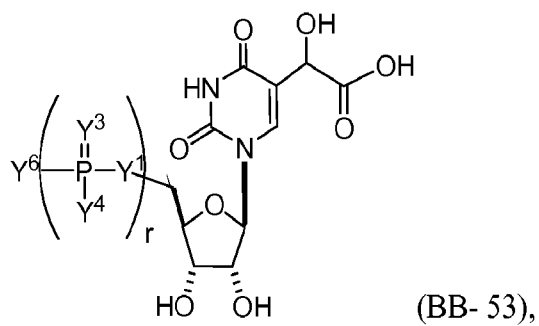

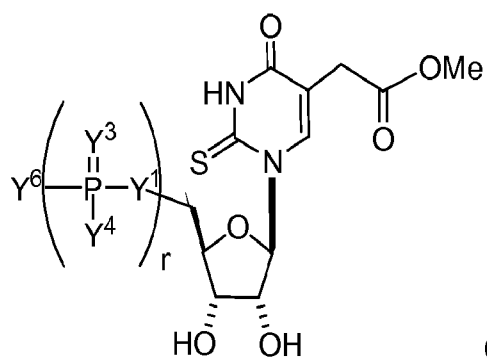

(BB- 58),

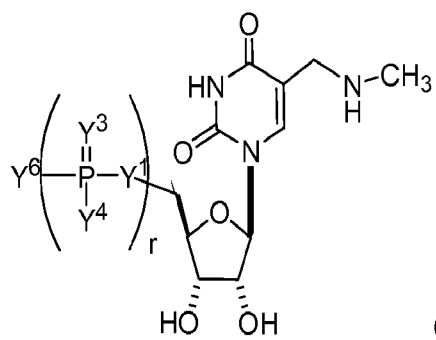

(BB- 59),

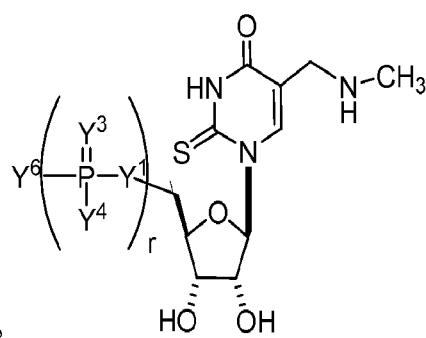

(BB- 60),

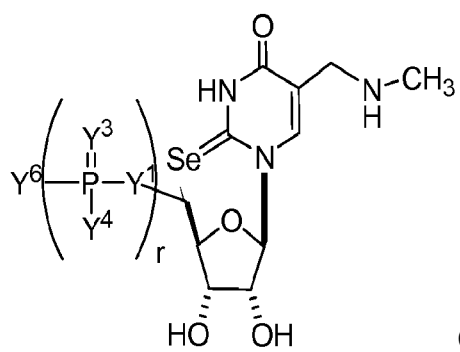

(BB- 61),

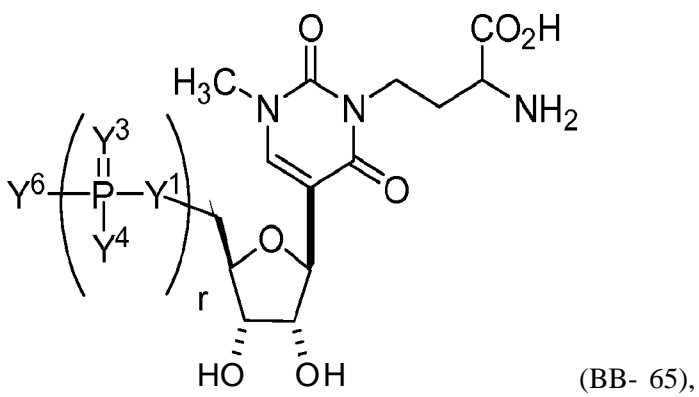
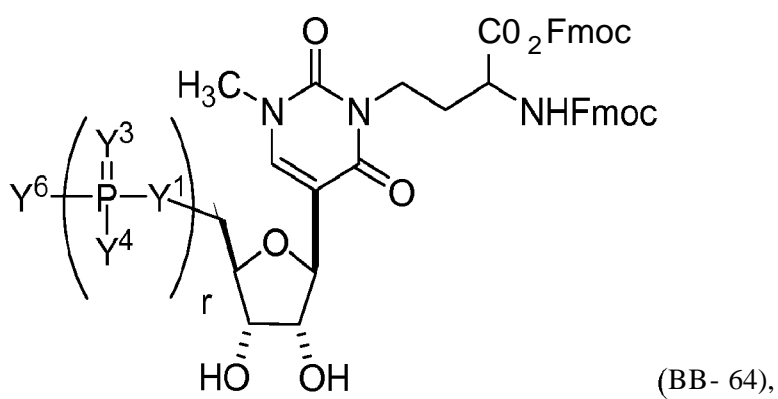
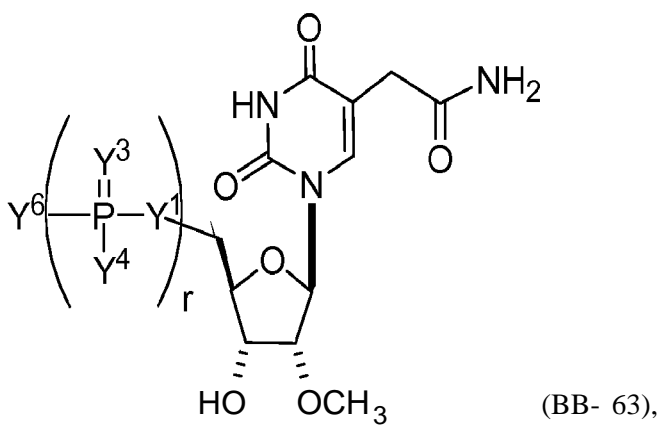
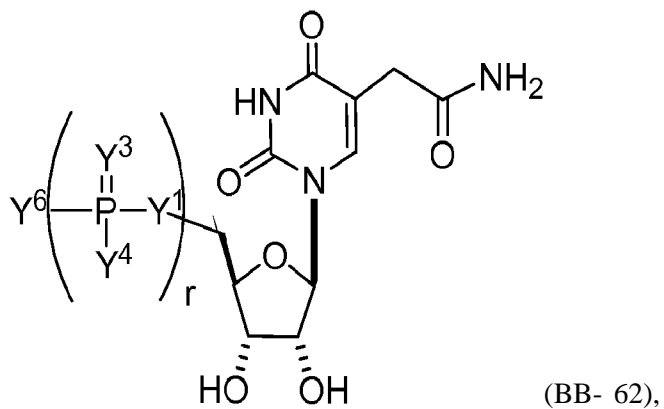

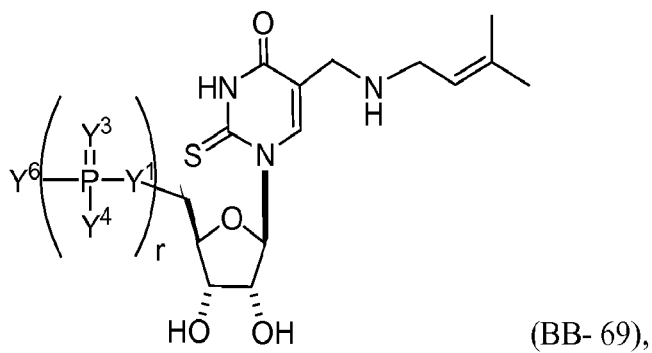
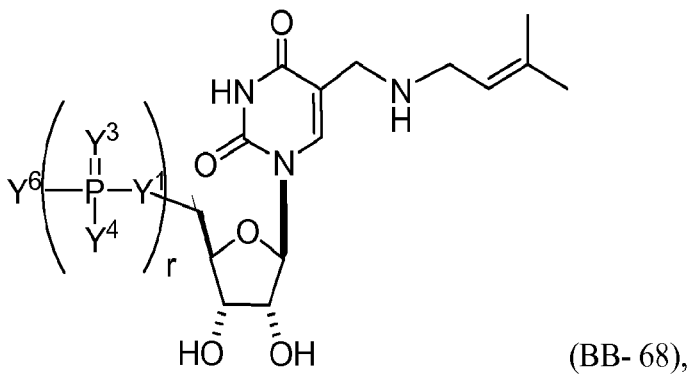
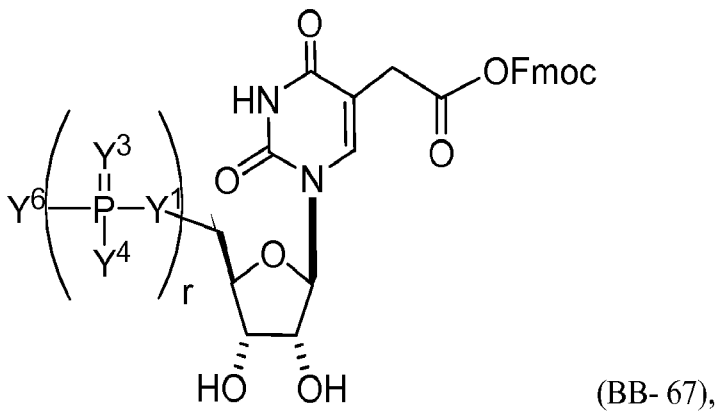
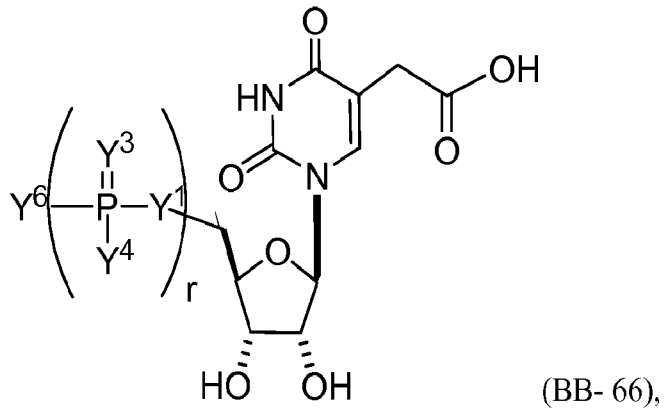

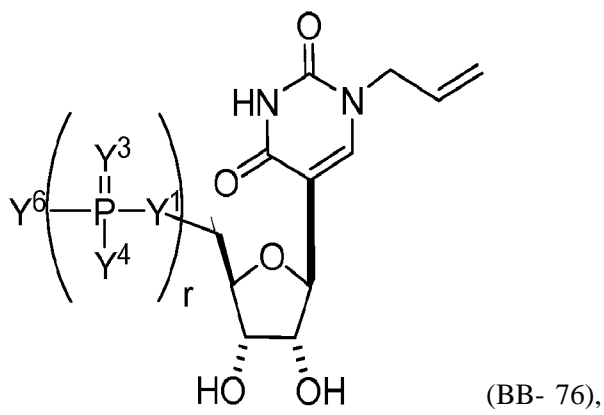
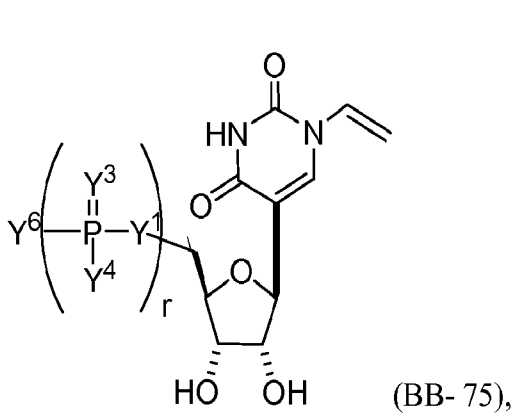
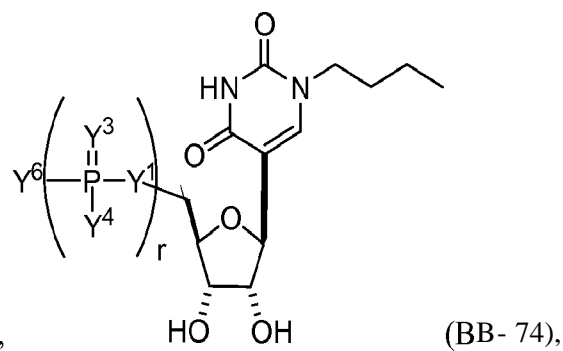
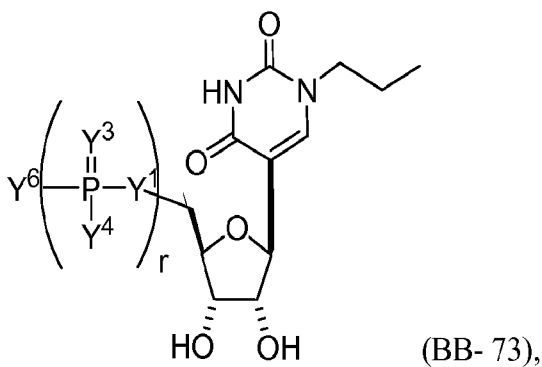
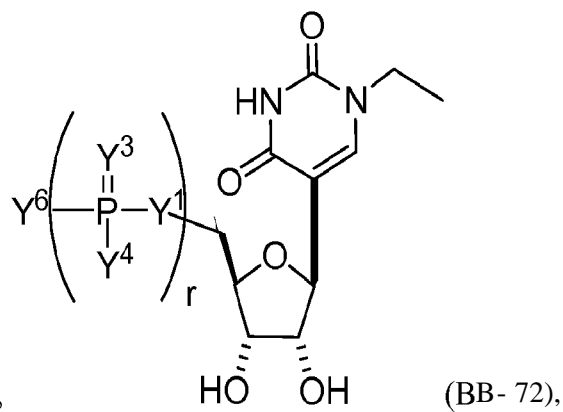
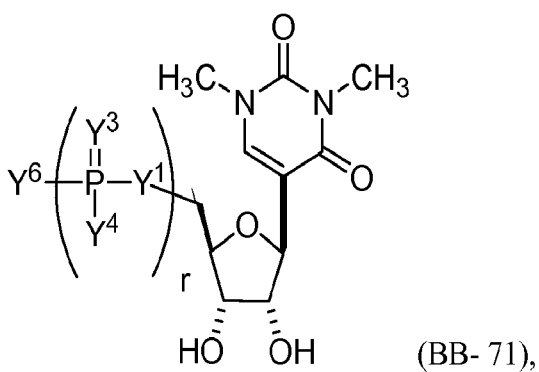
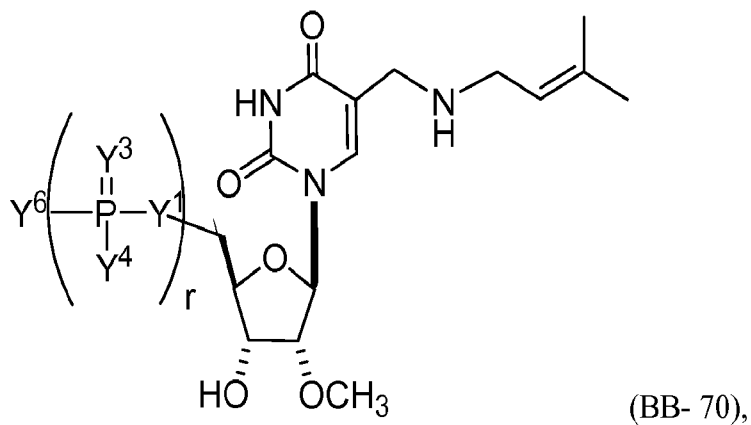

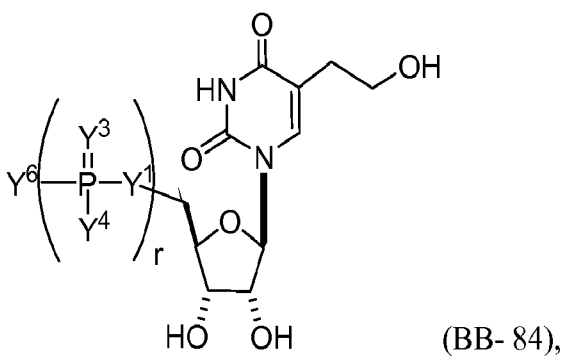
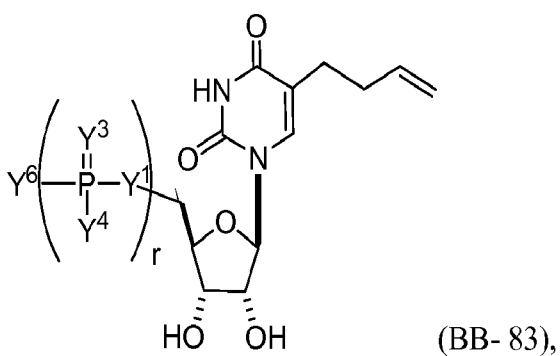
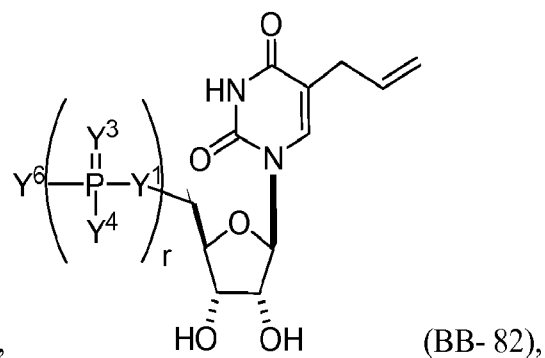
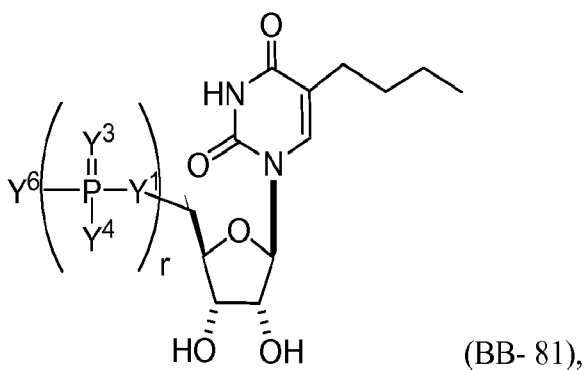
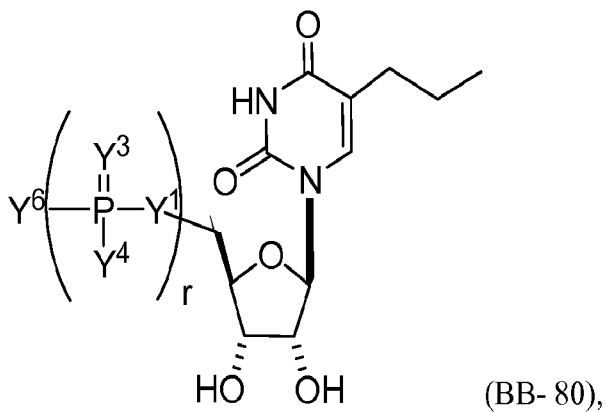
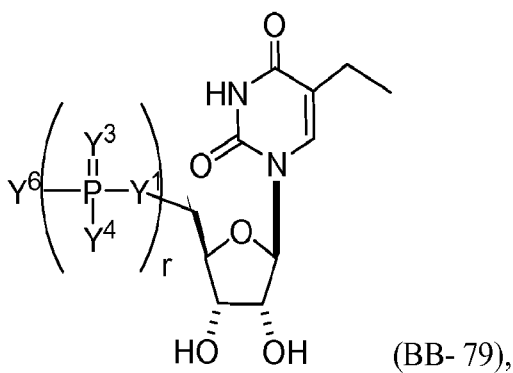
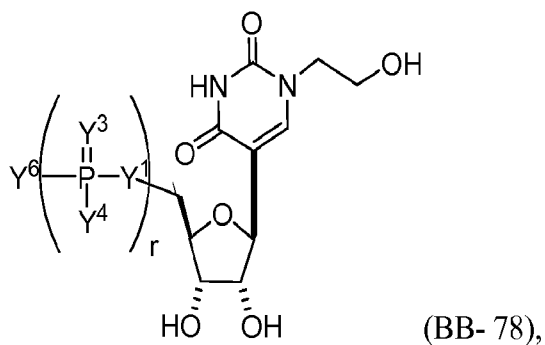
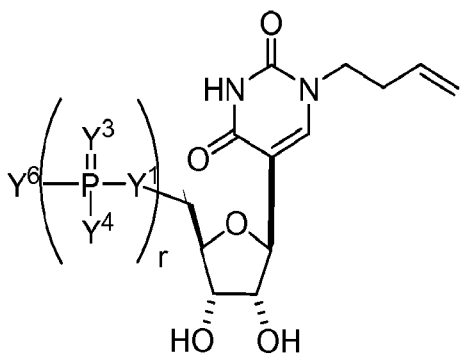

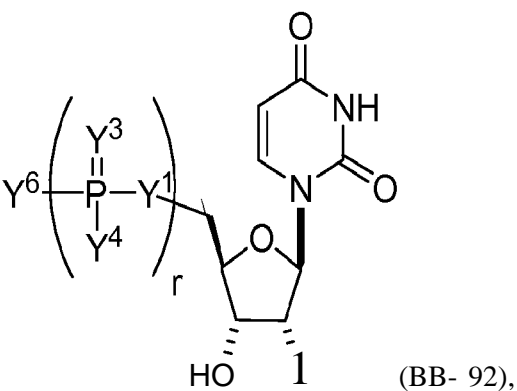
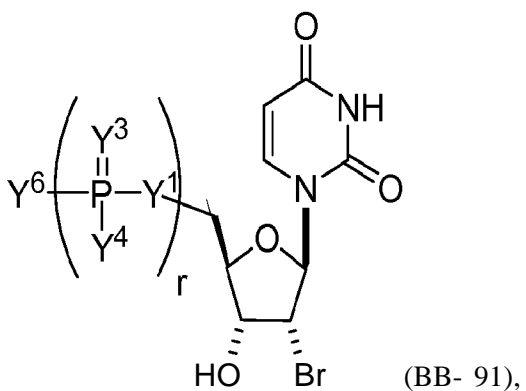
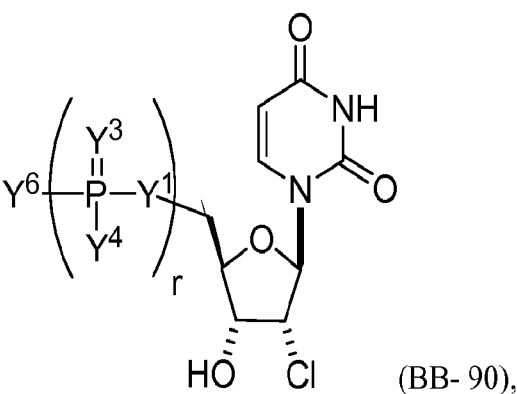
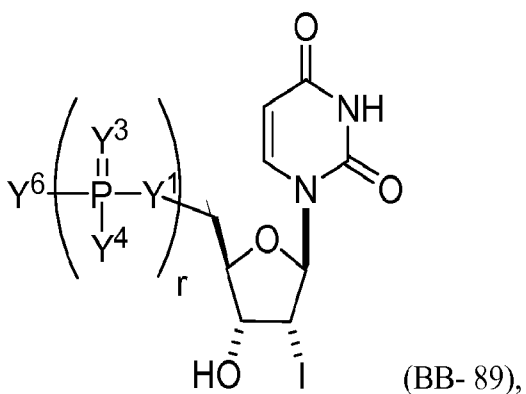
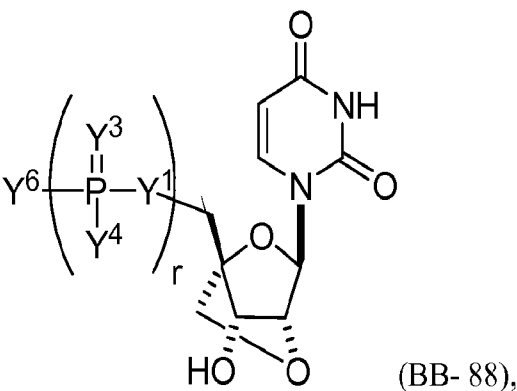
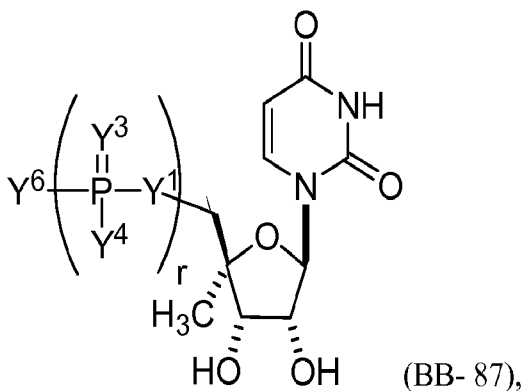
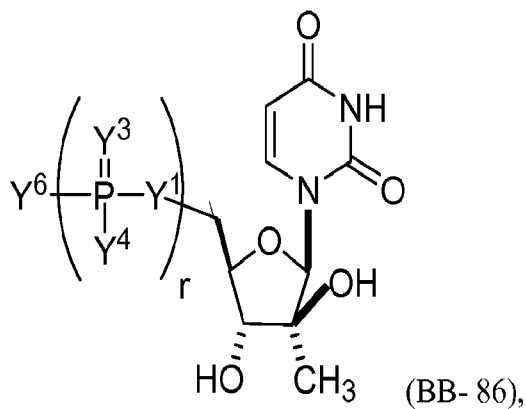
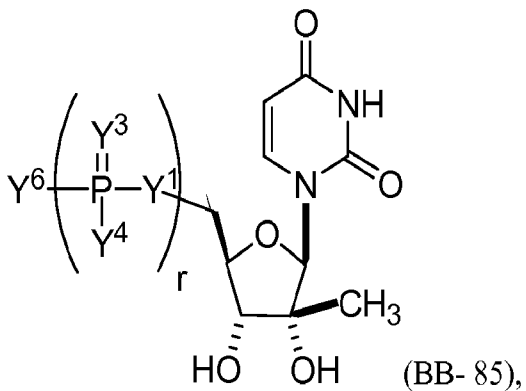



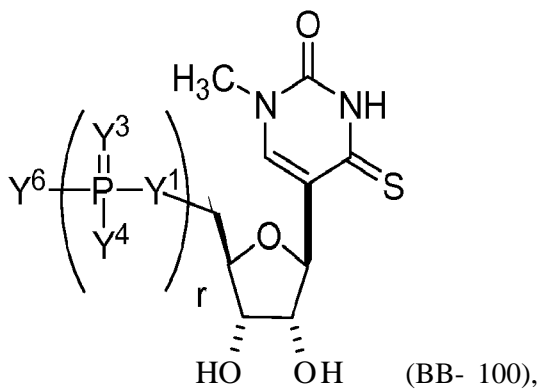
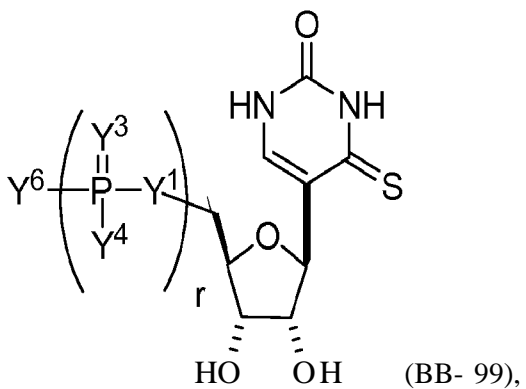
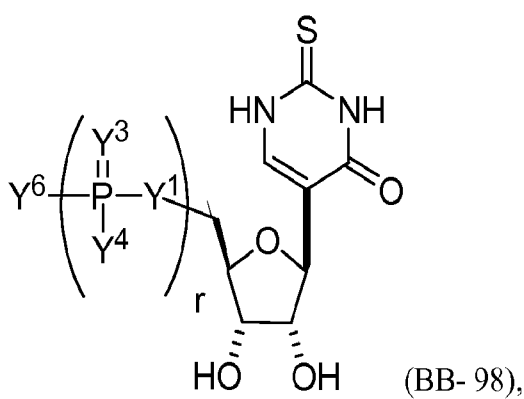
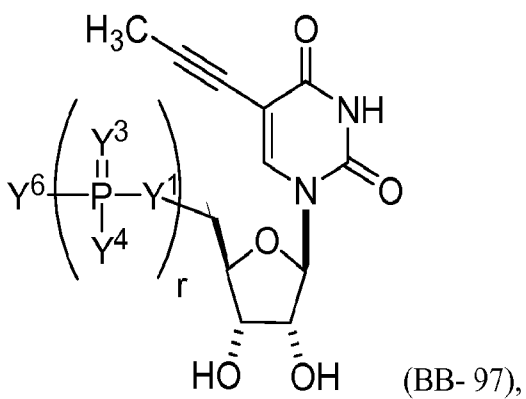
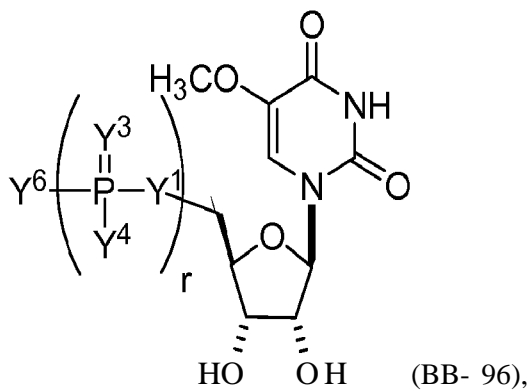
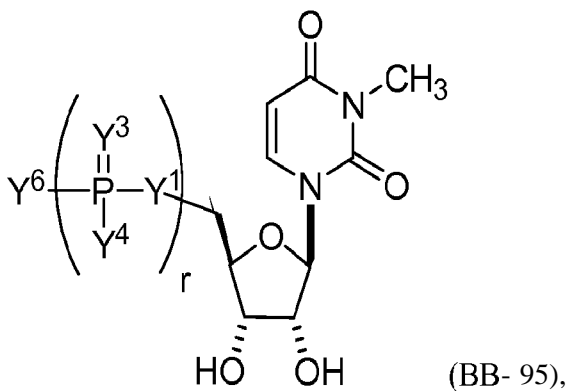
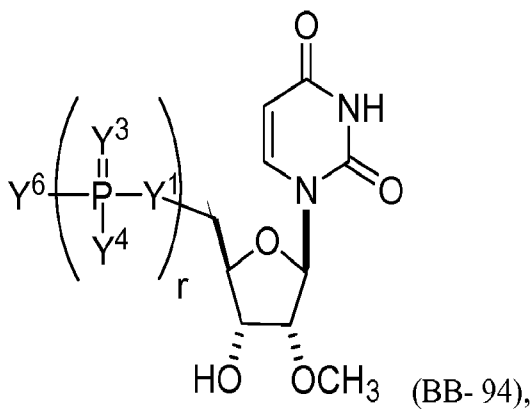
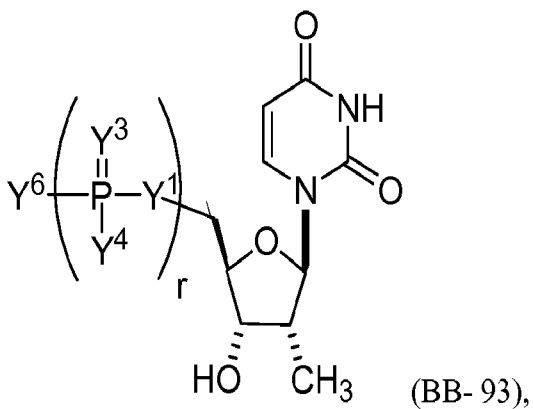

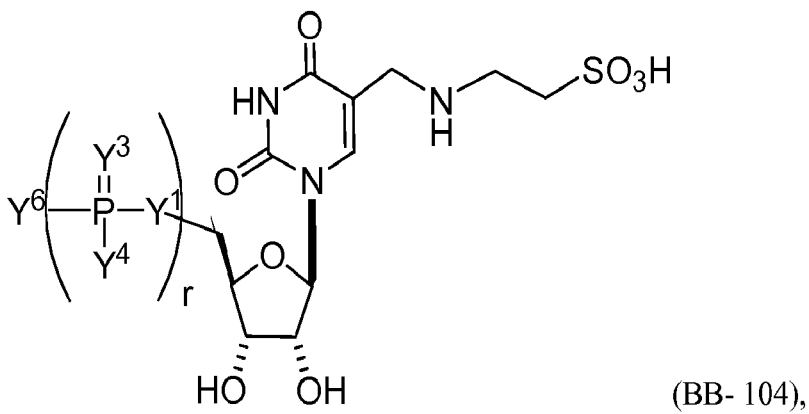
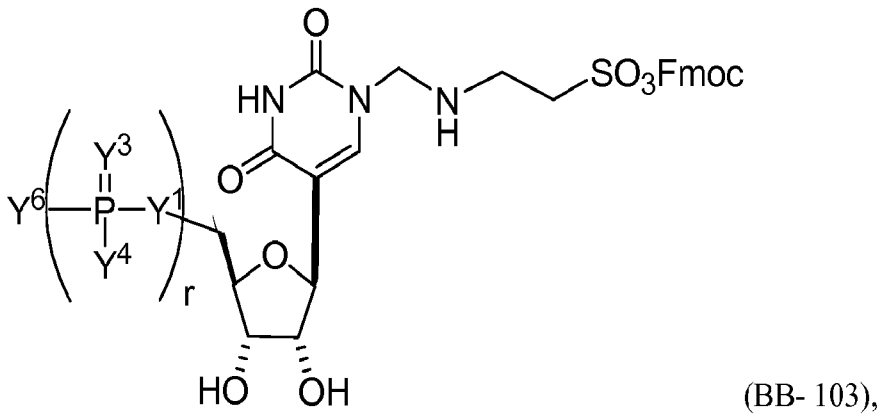
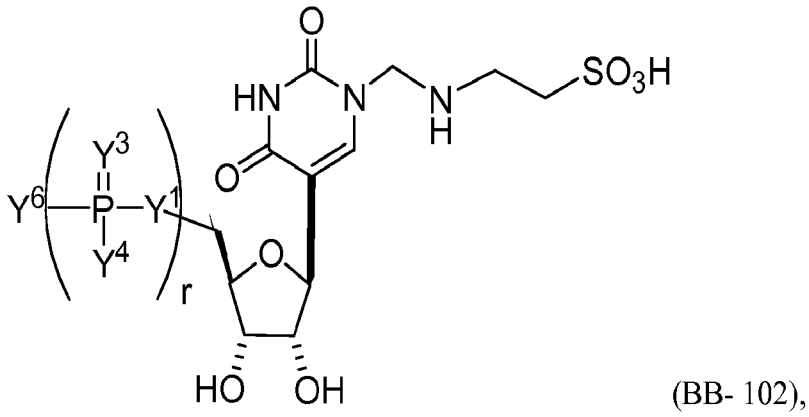
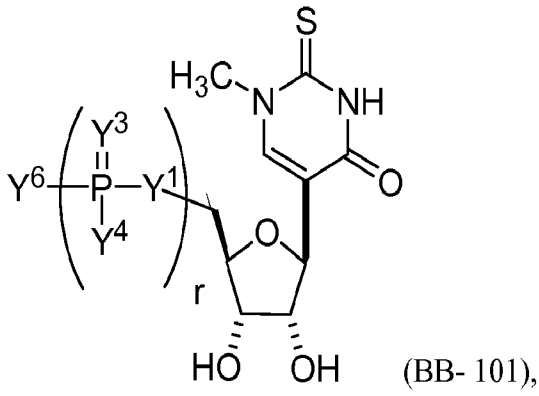

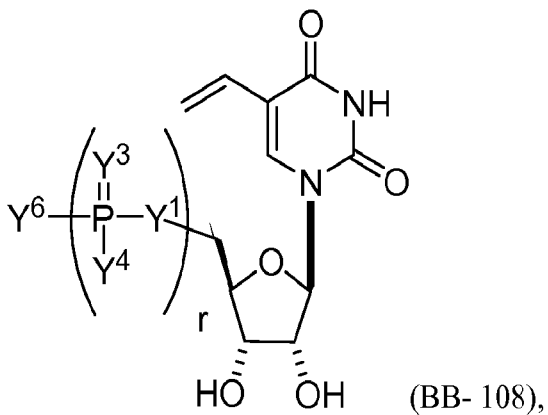
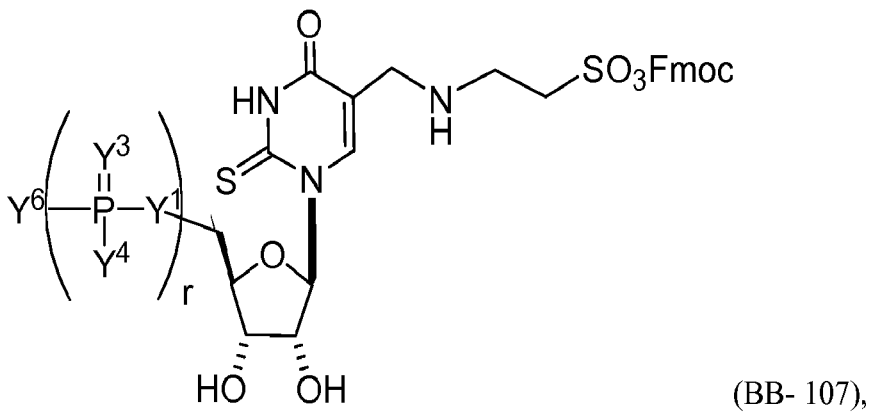
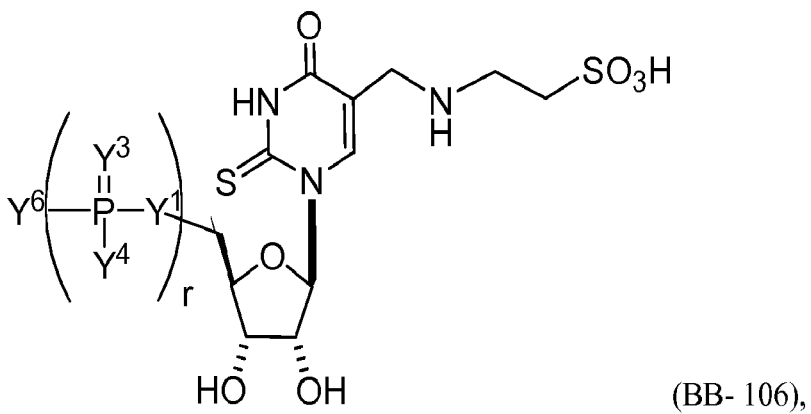
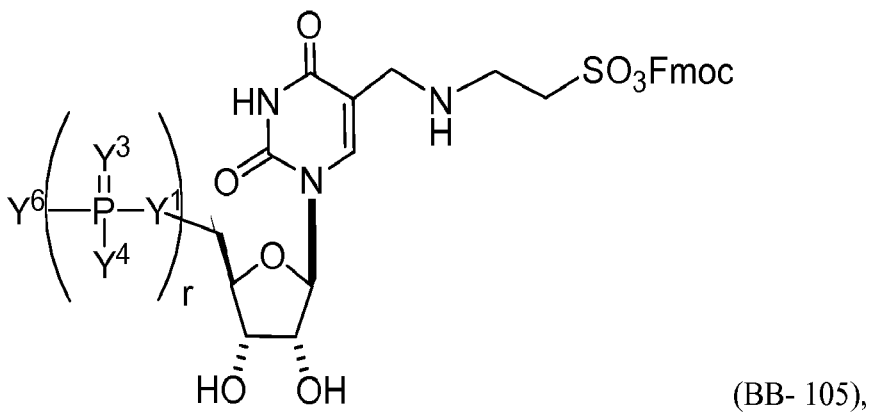

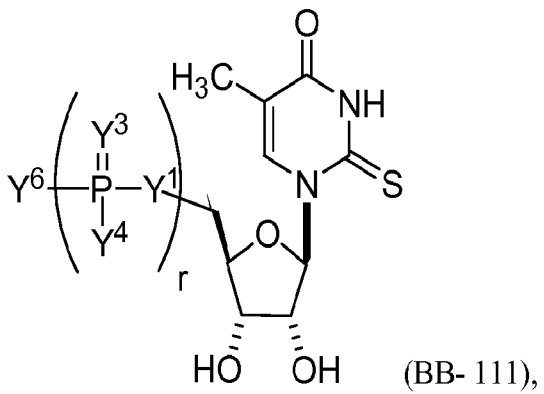
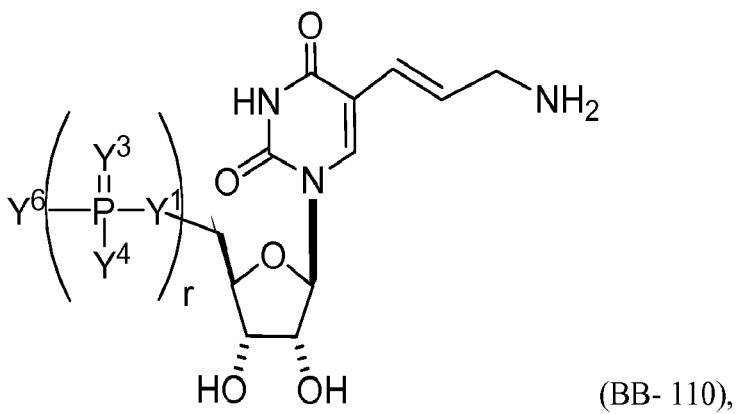
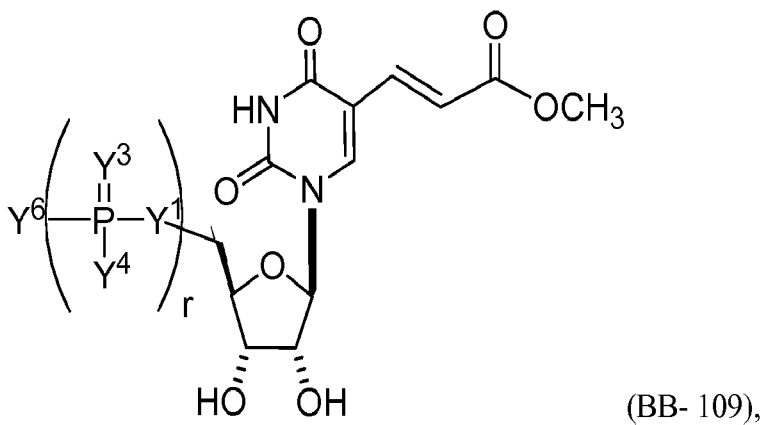

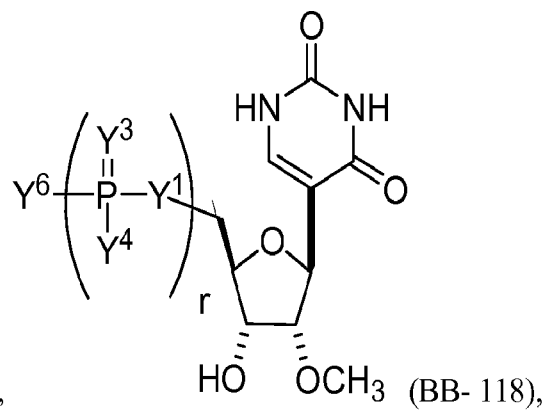
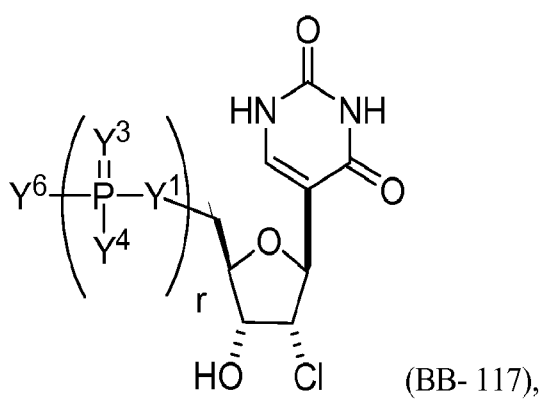
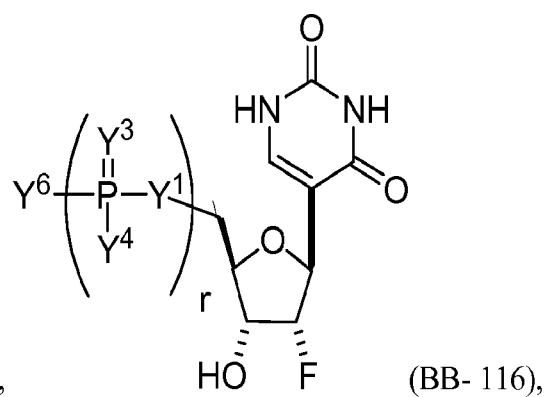
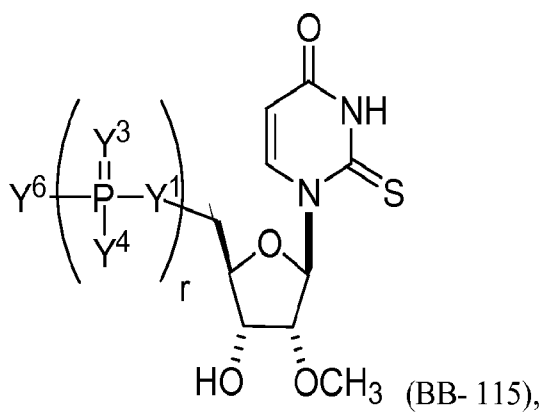
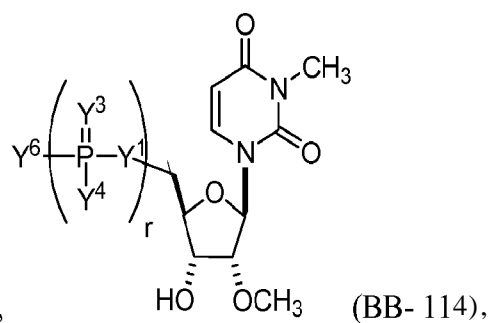
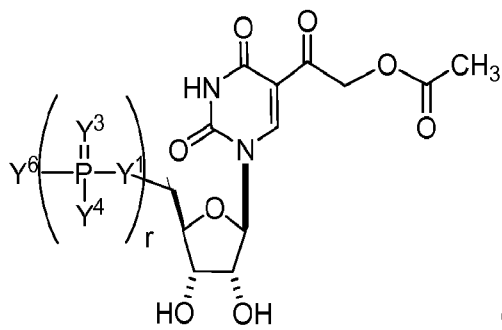
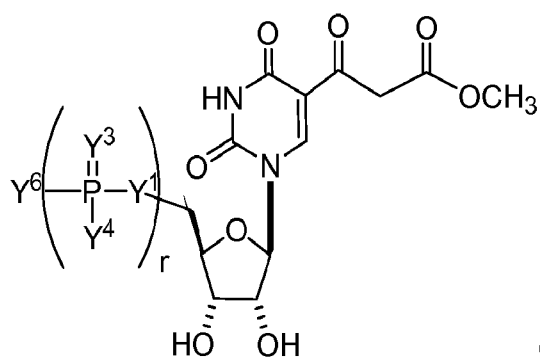

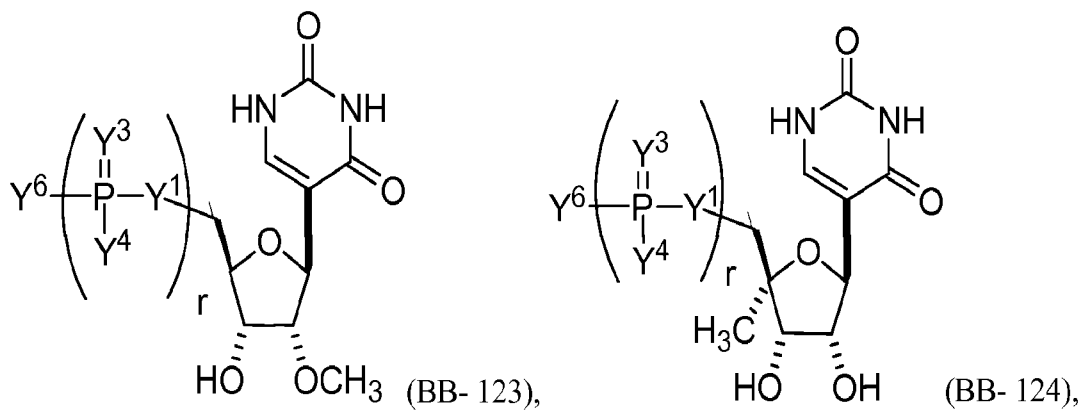
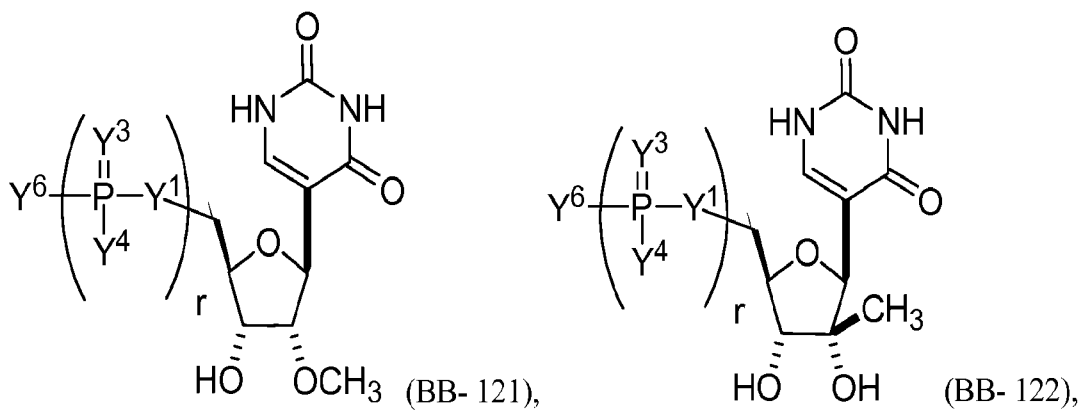
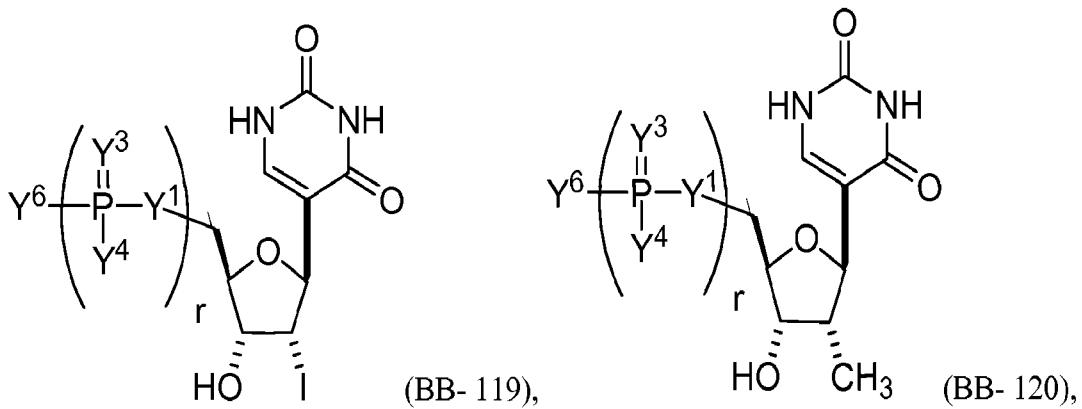

and (BB- 125), or a pharmaceutically acceptable salt or stereoisomer thereof, wherein Y<sup>1</sup>, Y<sup>3</sup>, Y<sup>4</sup>, Y<sup>6</sup>, and r are as described herein (e.g., each r is, independently, an integer from 0 to 5, such as from 0 to 3, from 1 to 3, or from 1 to 5)).

[000312] In some embodiments, the building block molecule, which may be incorporated into a polynucleotide, primary construct, or mmRNA, is a modified cytidine (e.g., selected from the group consisting of:

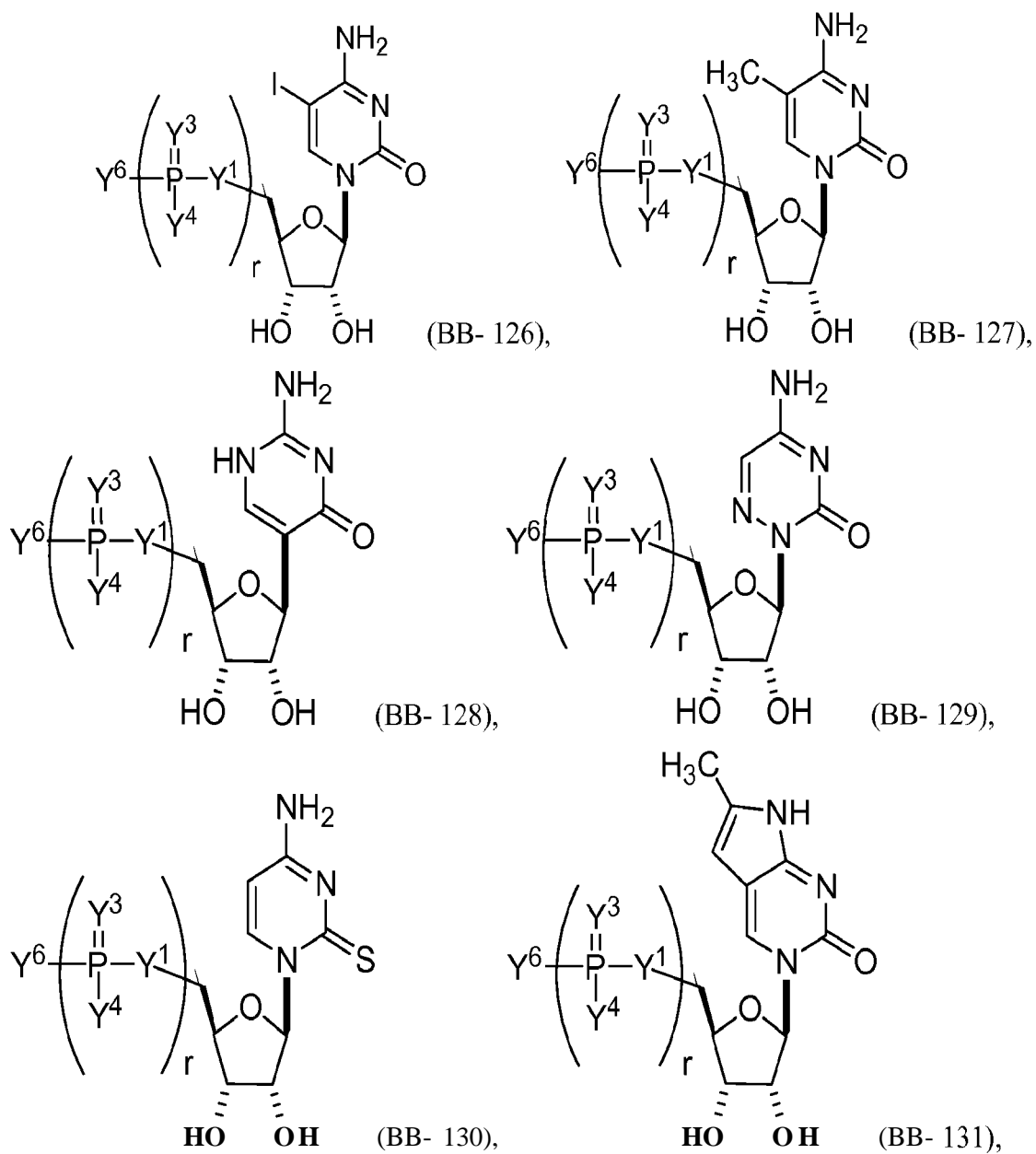

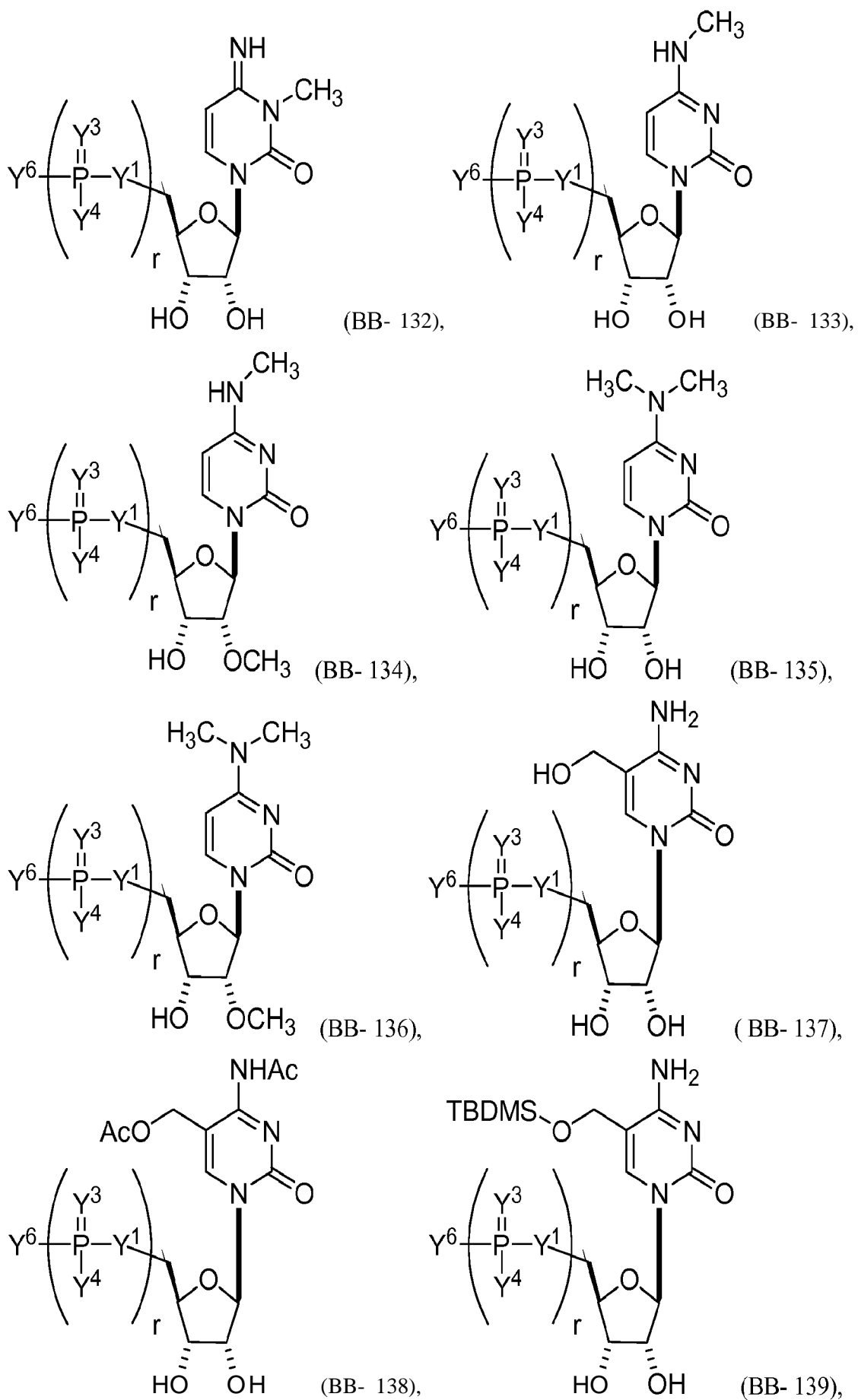



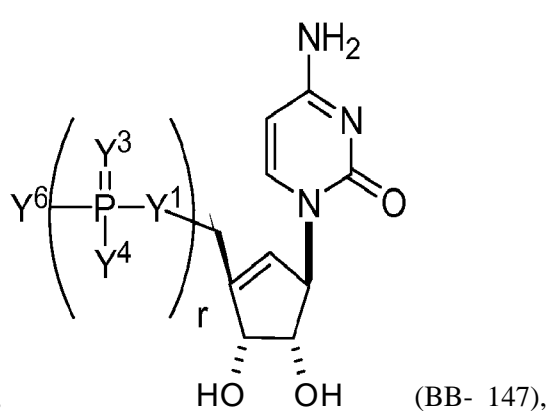
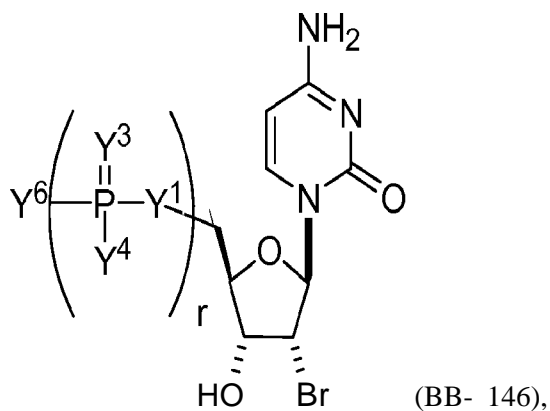
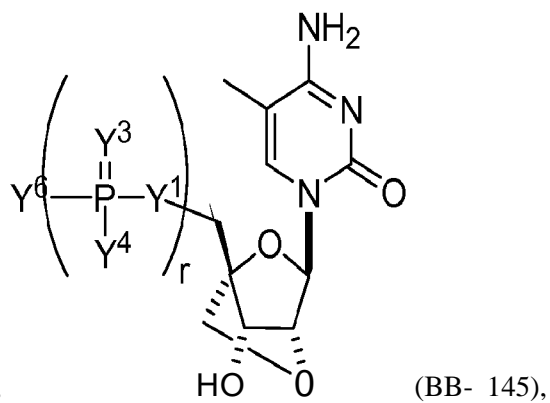
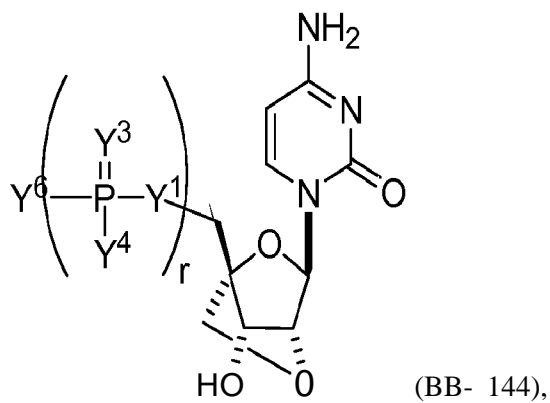
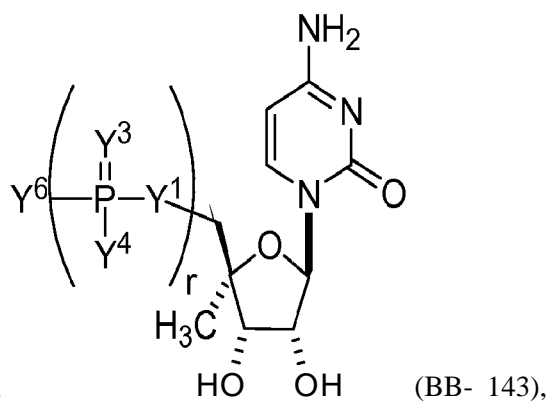
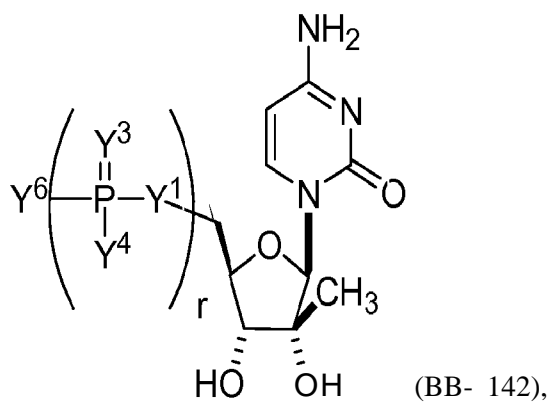
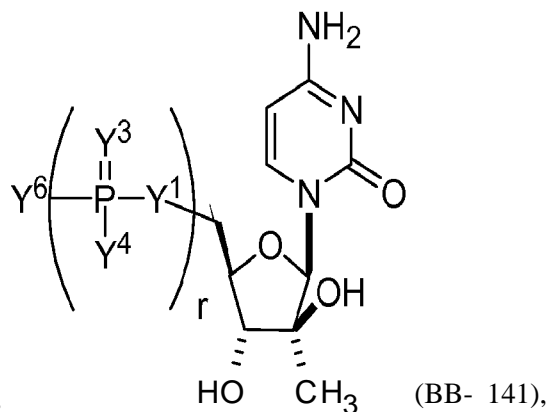
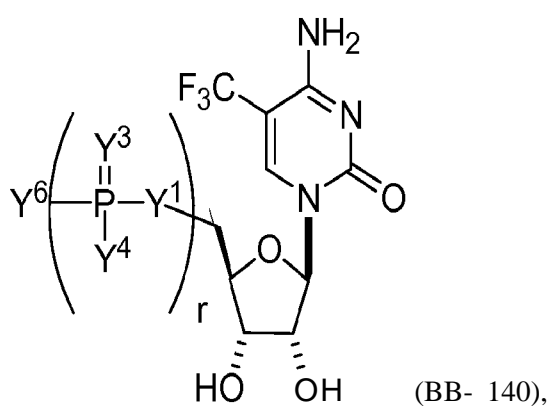

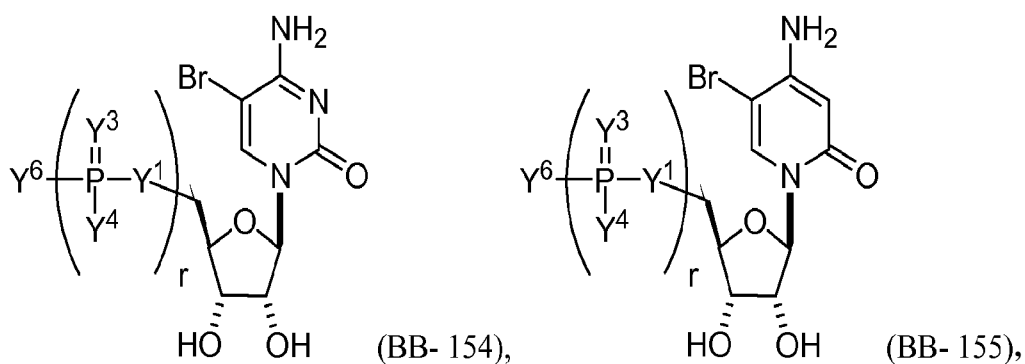
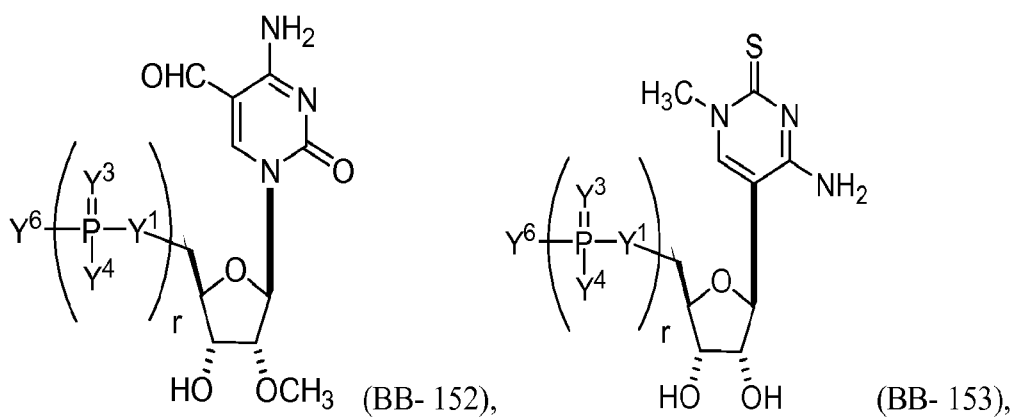
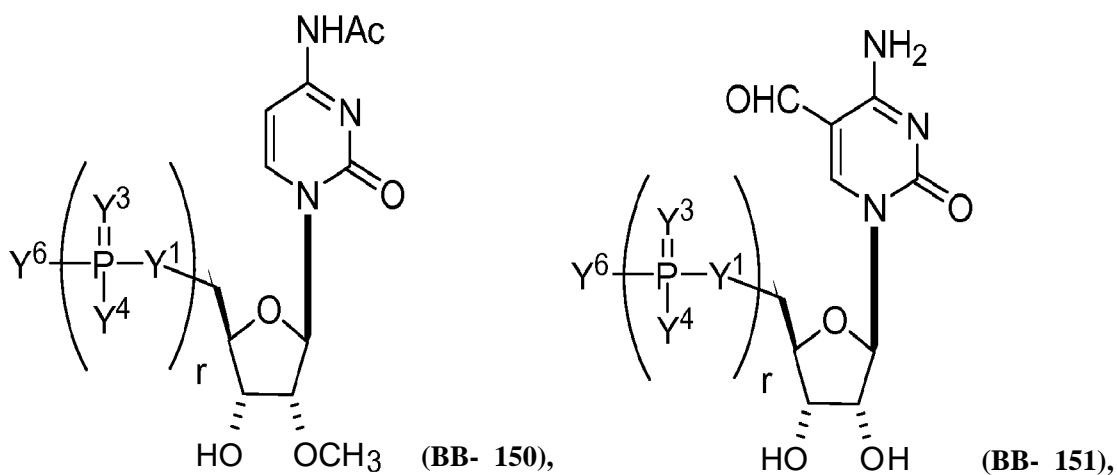
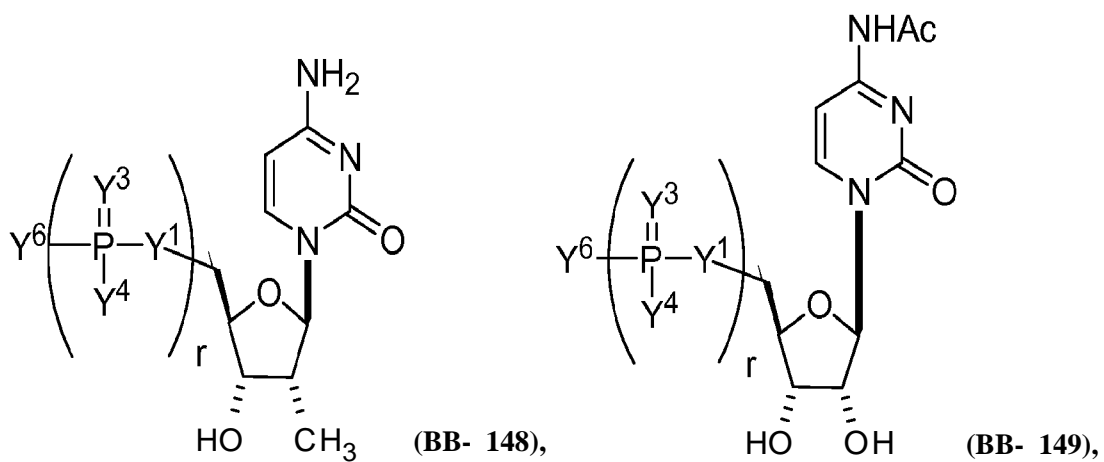

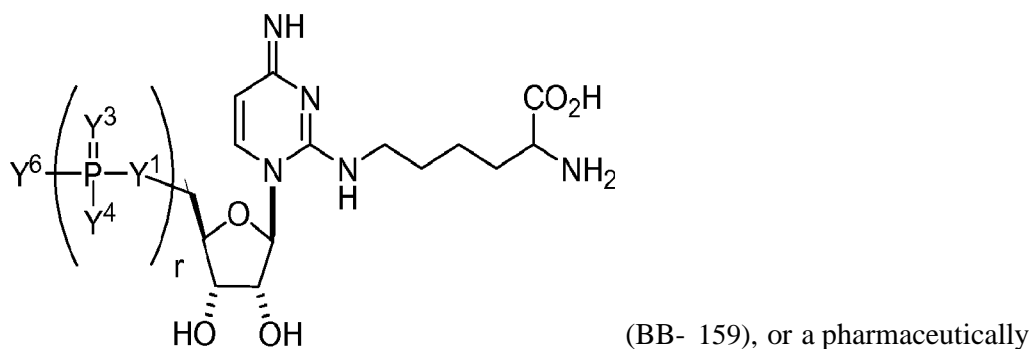
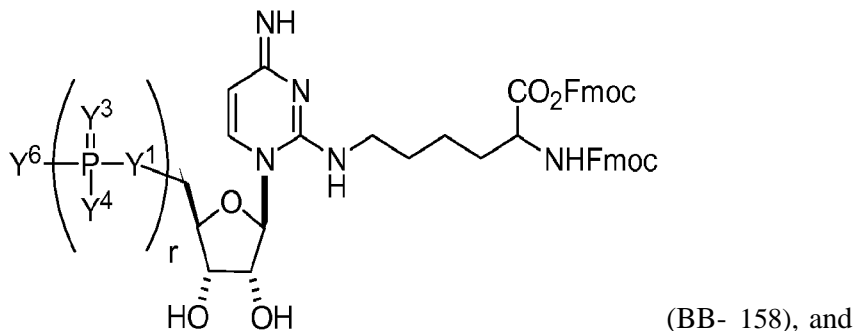
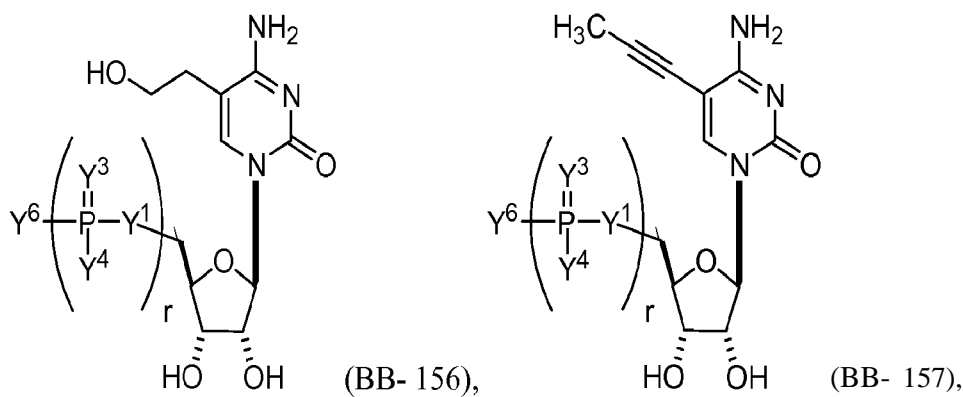

acceptable salt or stereoisomer thereof, wherein Y<sup>1</sup>, Y<sup>3</sup>, Y<sup>4</sup>, Y<sup>6</sup>, and r are as described herein (e.g., each r is, independently, an integer from 0 to 5, such as from 0 to 3, from 1 to 3, or from 1 to 5)). For example, the building block molecule, which may be incorporated into a polynucleotide, primary construct, or mmRNA, can be:

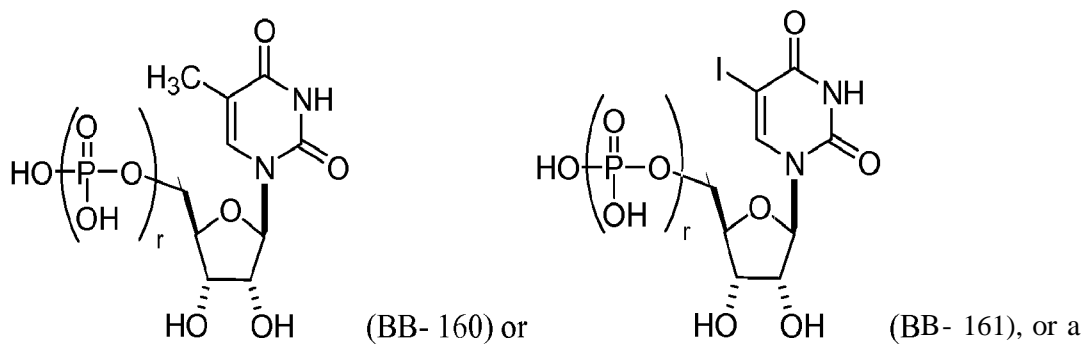

pharmaceutically acceptable salt or stereoisomer thereof, wherem each r is, independently, an integer from 0 to 5 (e.g., from 0 to 3, from 1 to 3, or from 1 to 5).

[000313] In some embodiments, the building block molecule, which may be incorporated into a polynucleotide, primary construct, or mmRNA, is a modified adenosine (e.g., selected from the group consisting of:

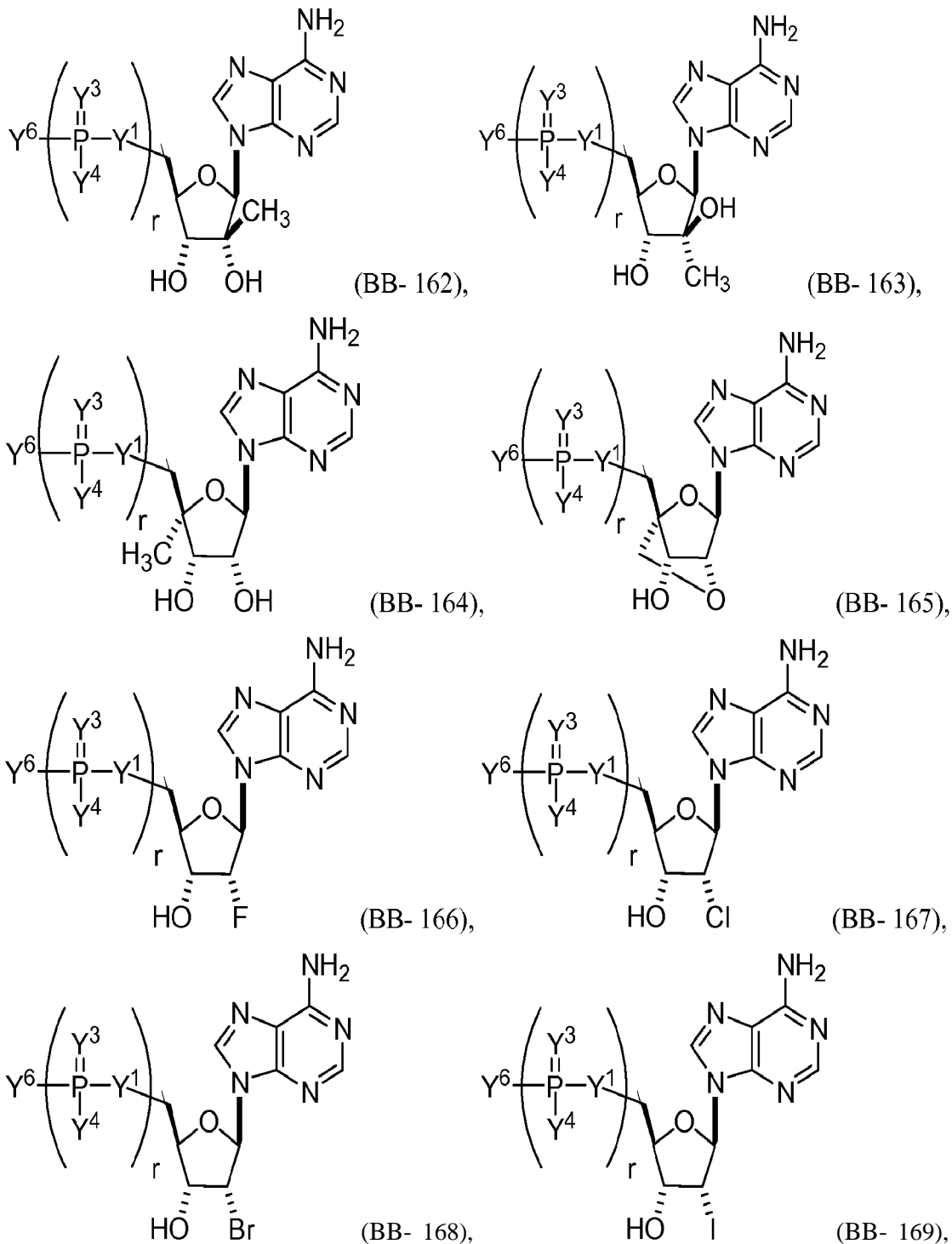

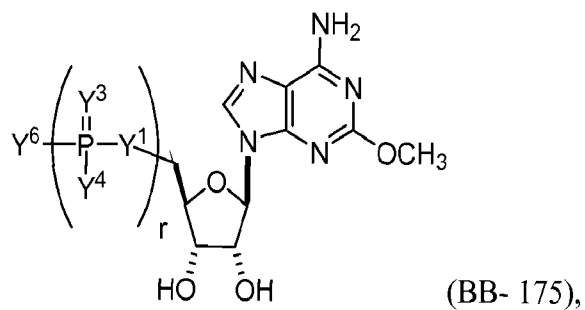
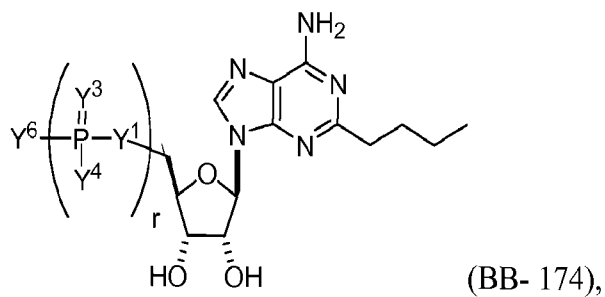
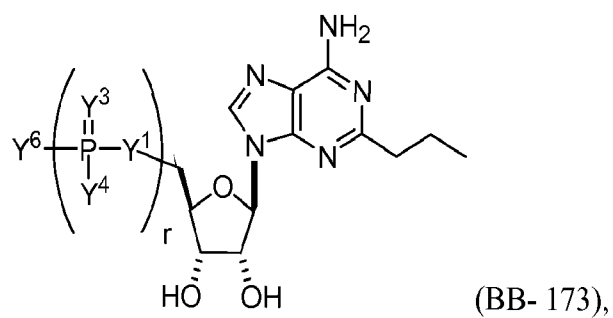
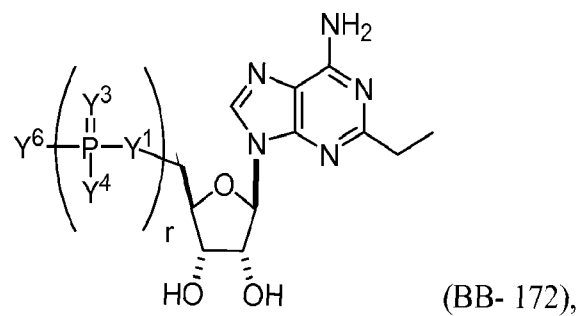
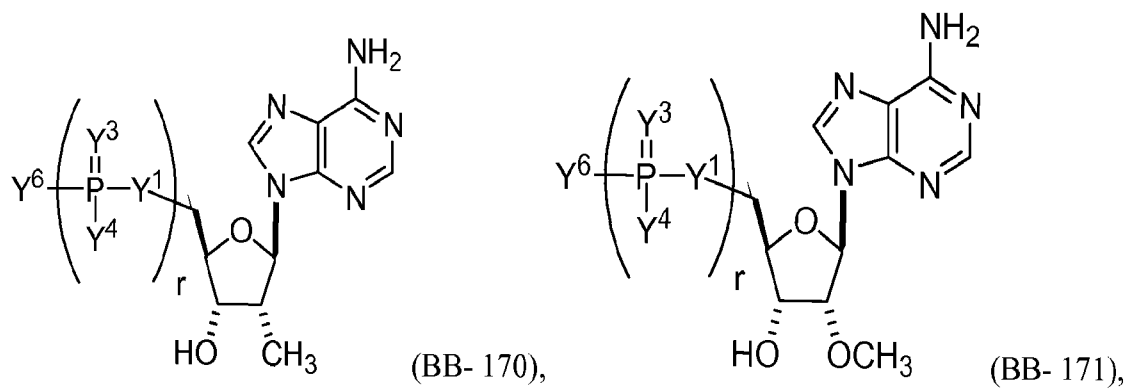

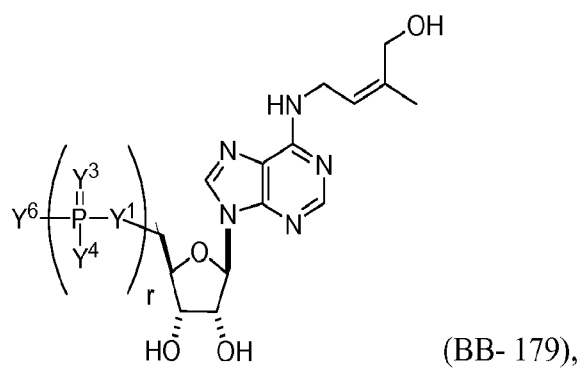
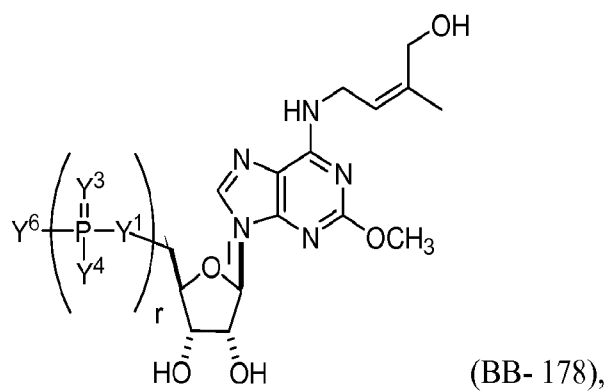
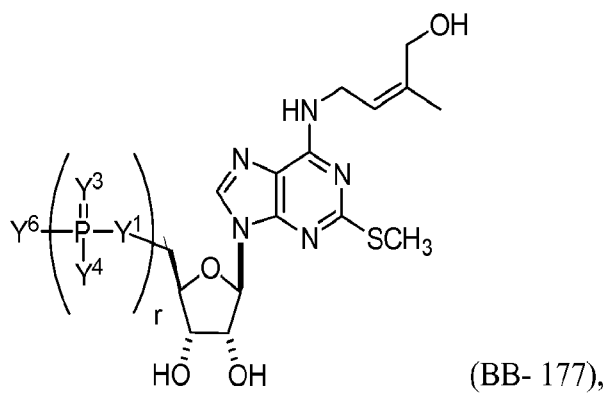
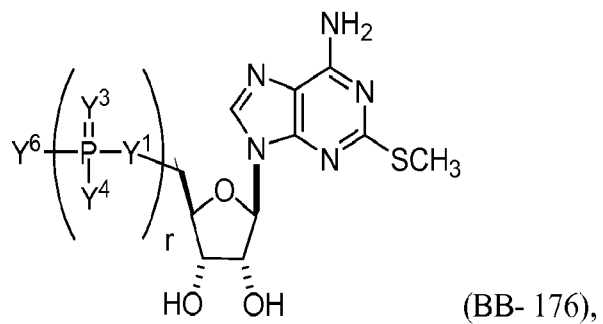

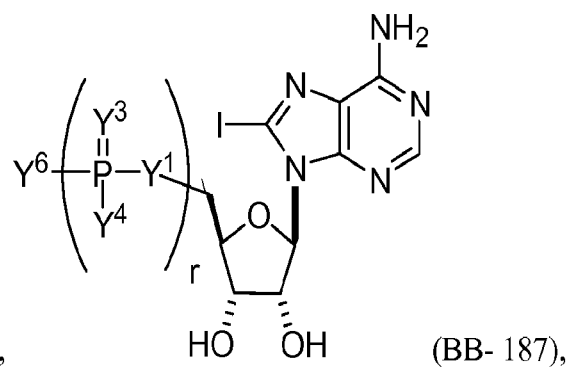
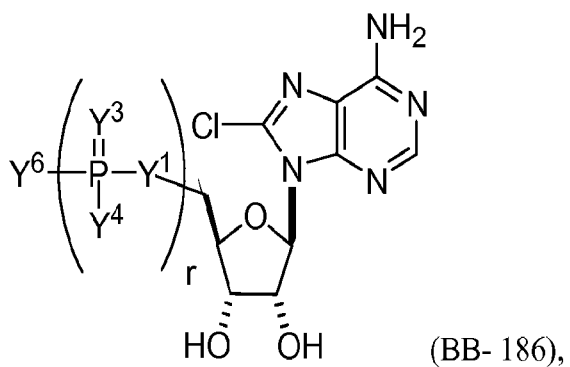
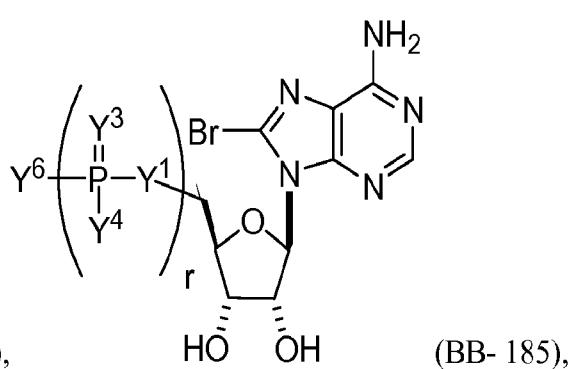
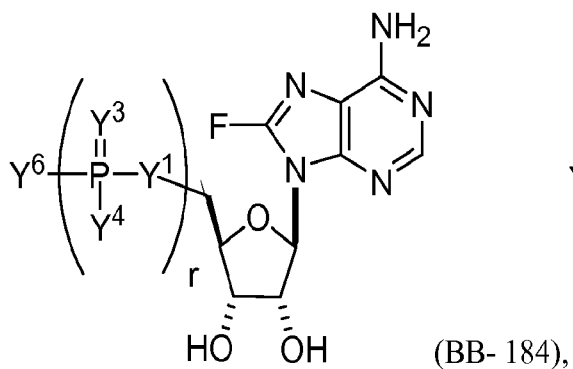
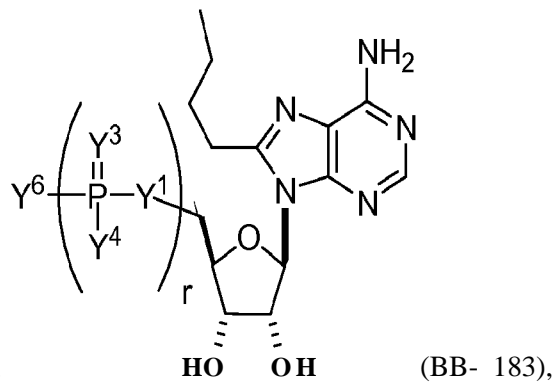
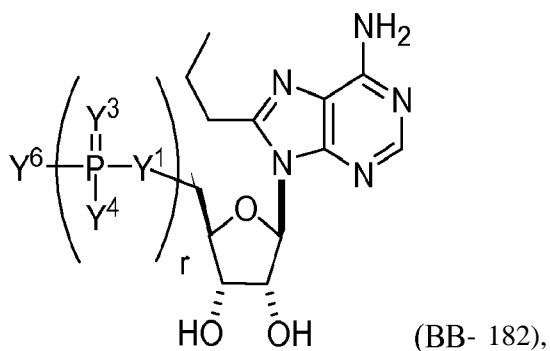
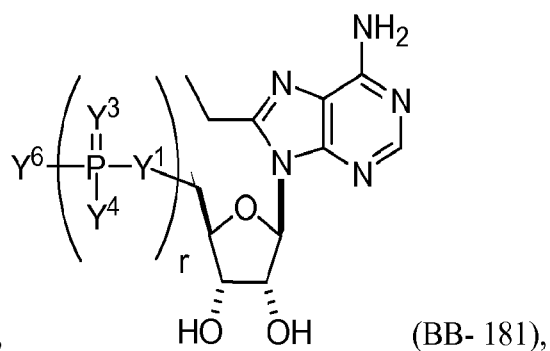
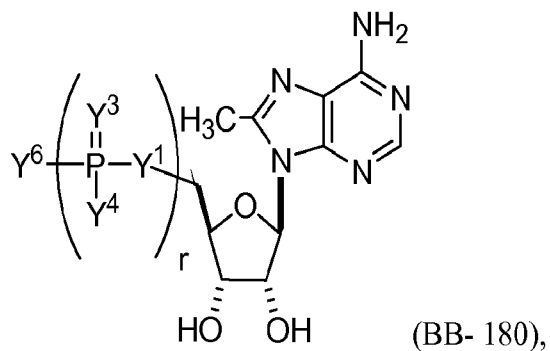

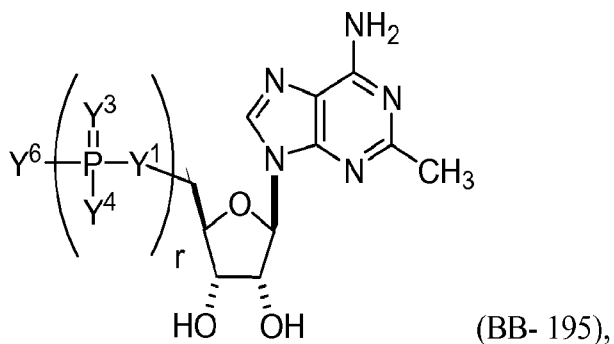
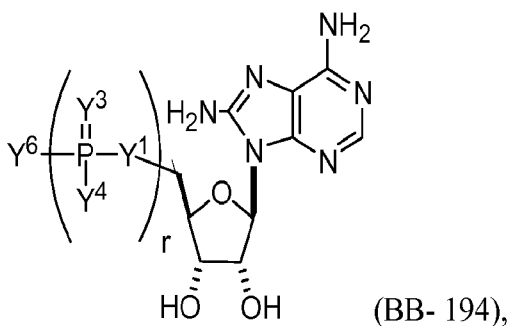
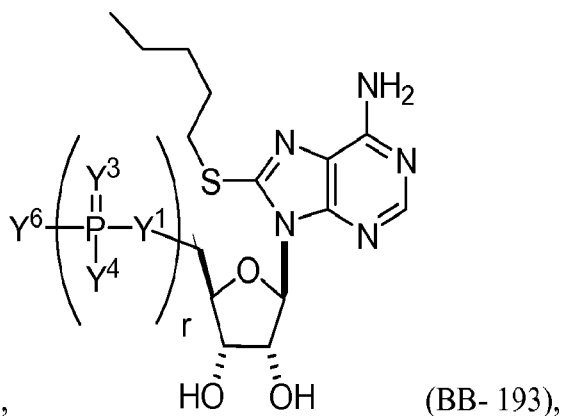
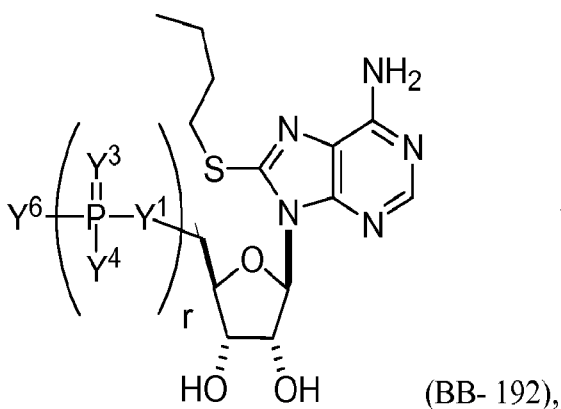
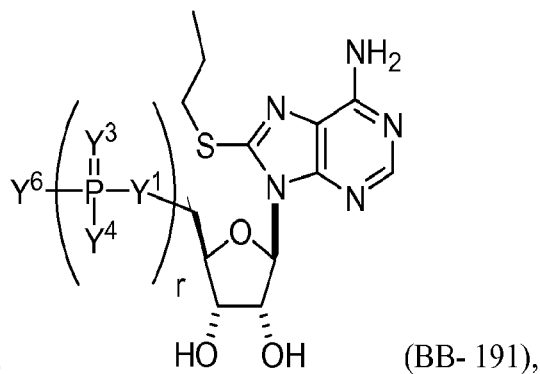
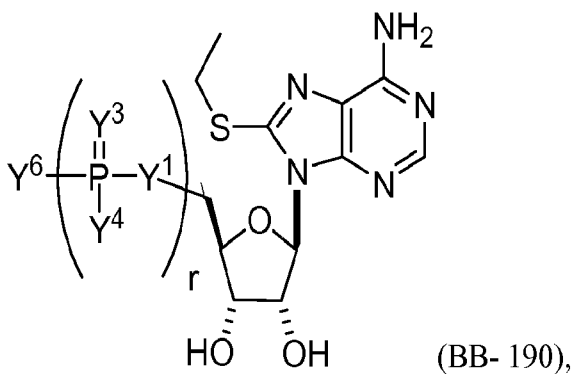
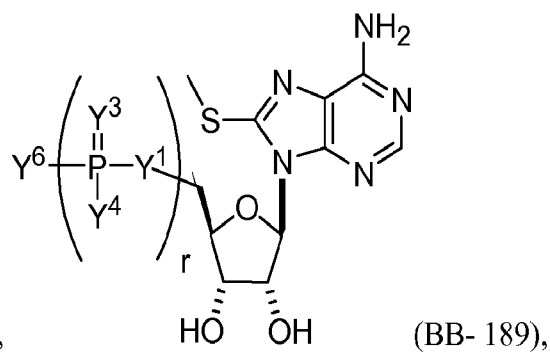
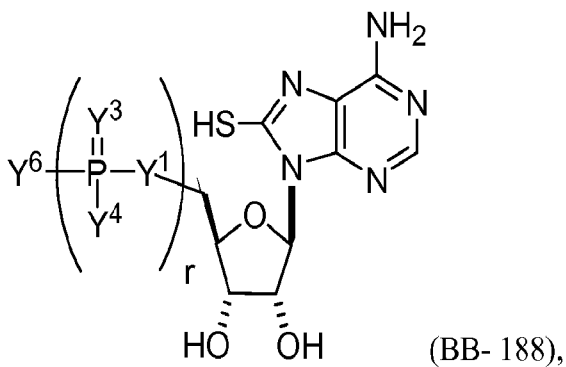



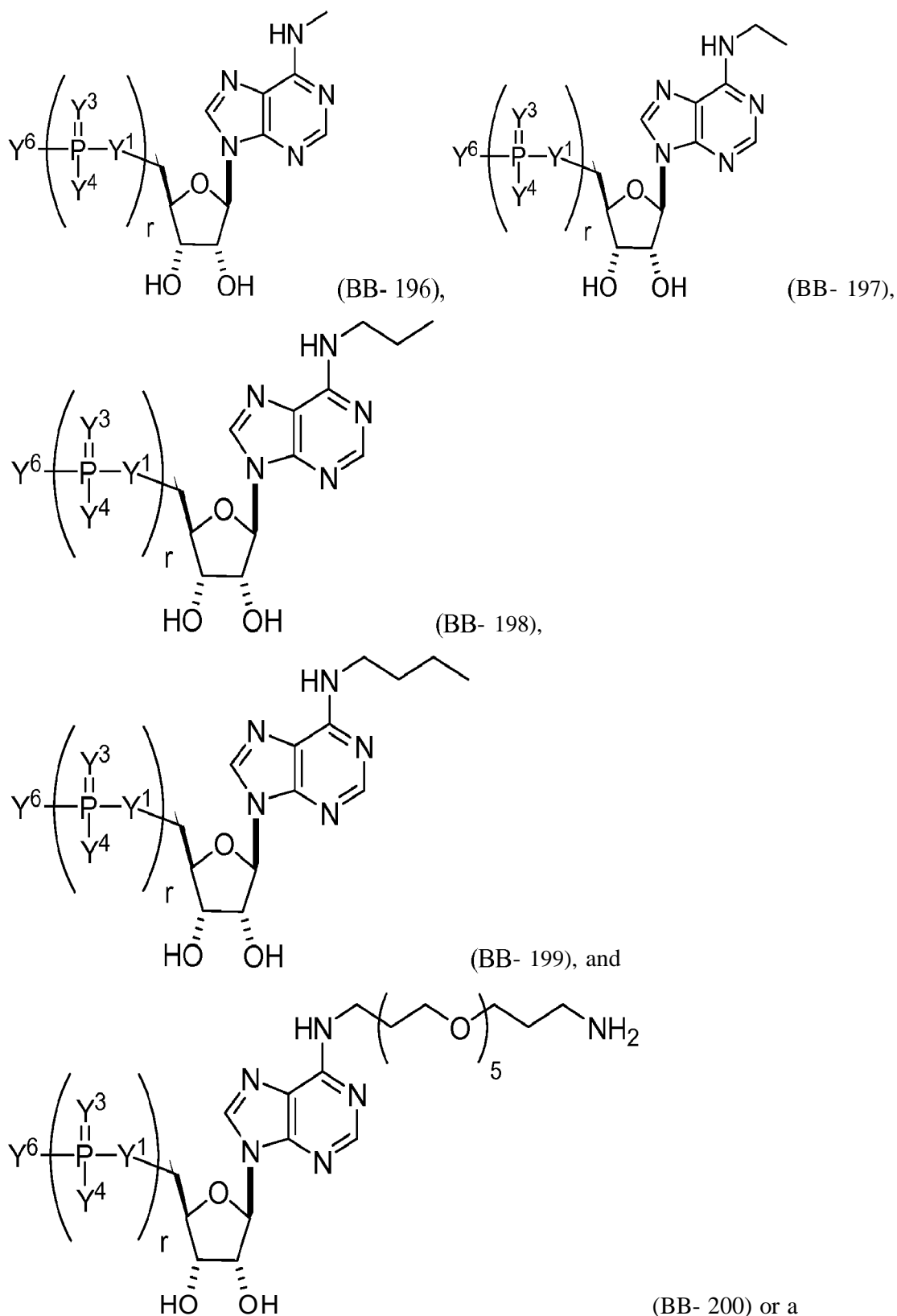

pharmaceutically acceptable salt or stereoisomer thereof, wherein  $Y^1$ ,  $Y^3$ ,  $Y^4$ ,  $Y^6$ , and  $r$  are as described herein (e.g., each  $r$  is, independently, an integer from 0 to 5, such as from 0 to 3, from 1 to 3, or from 1 to 5)).

[000314] In some embodiments, the building block molecule, which may be incorporated into a polynucleotide, primary construct, or mmRNA, is a modified guanosine (e.g., selected from the group consisting of:

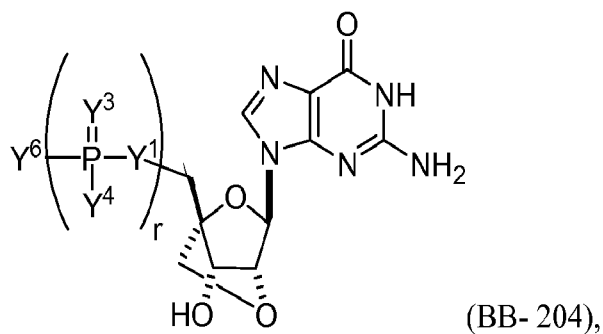
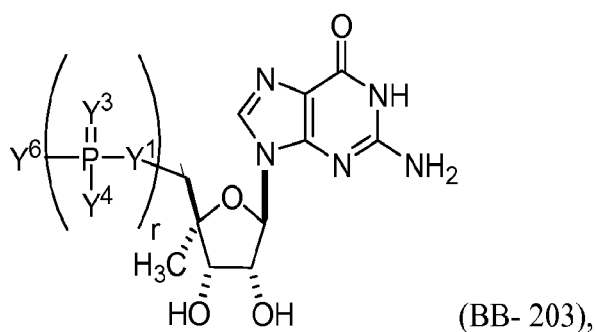
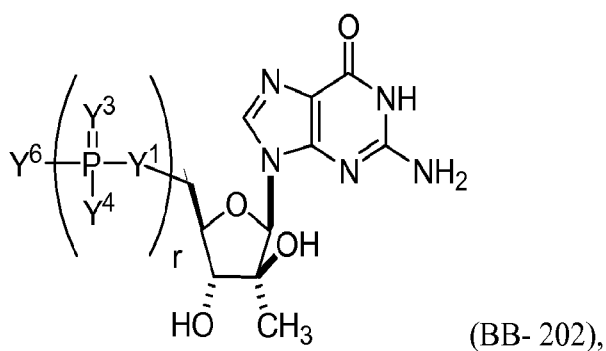
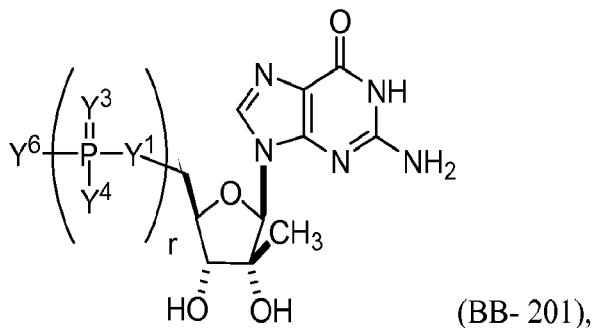

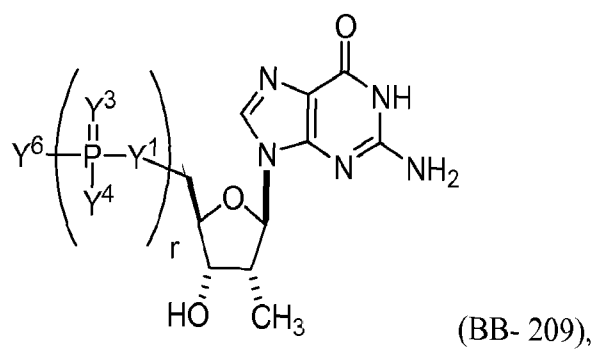
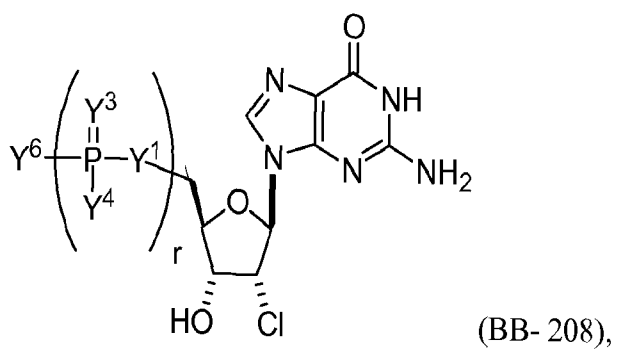
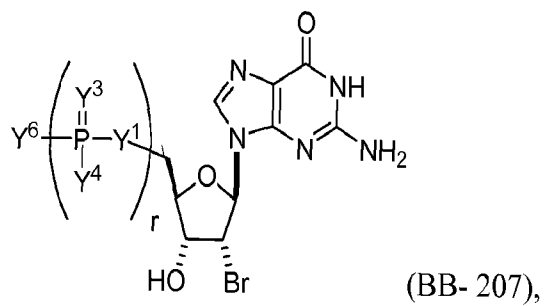
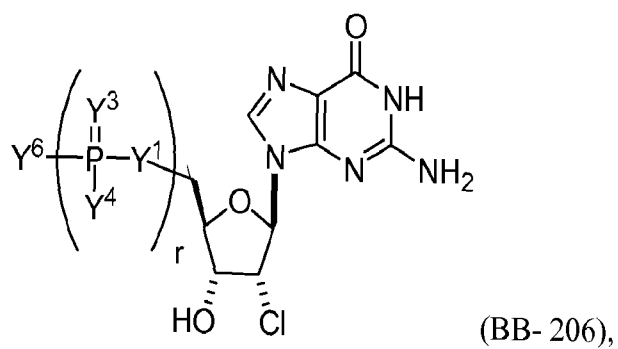
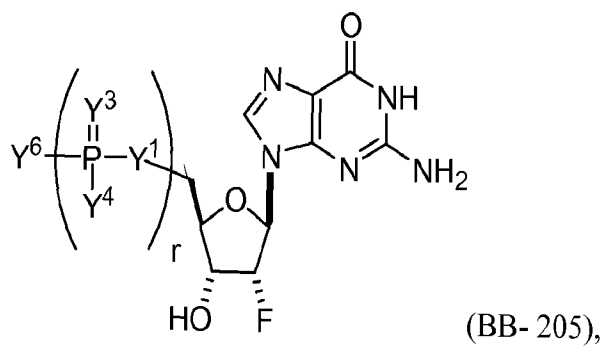

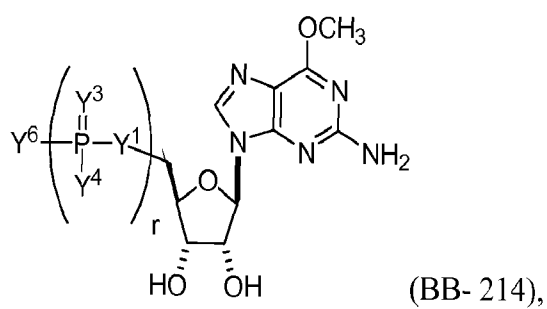
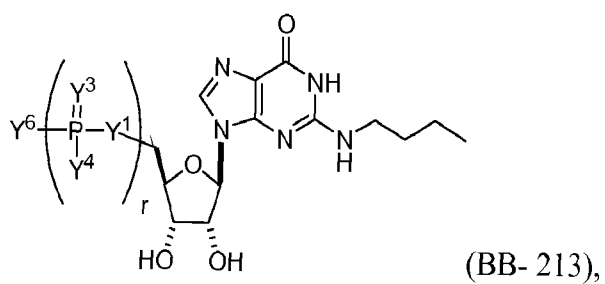
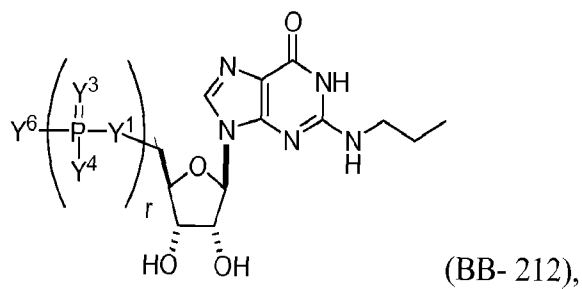
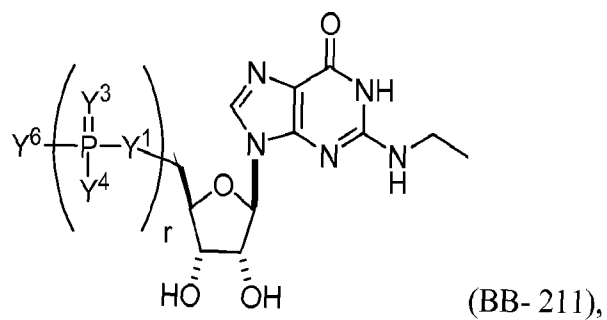
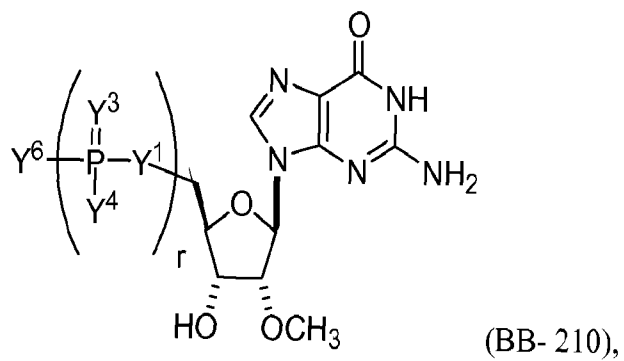

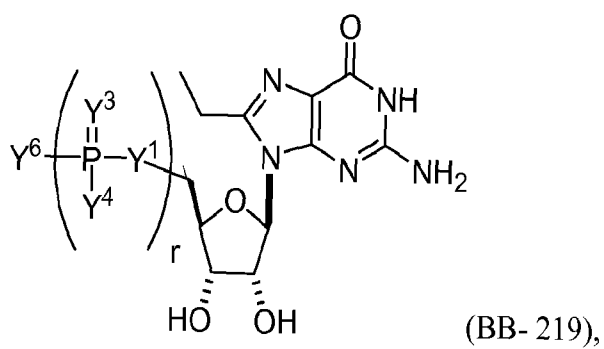
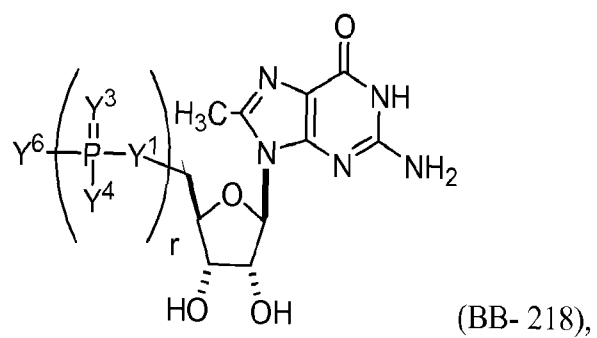
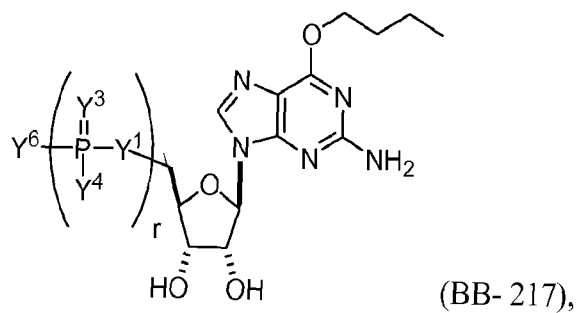
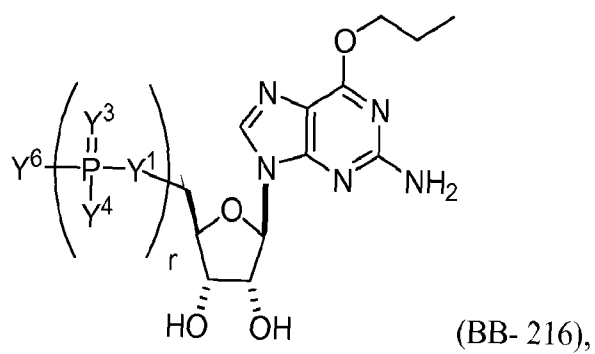
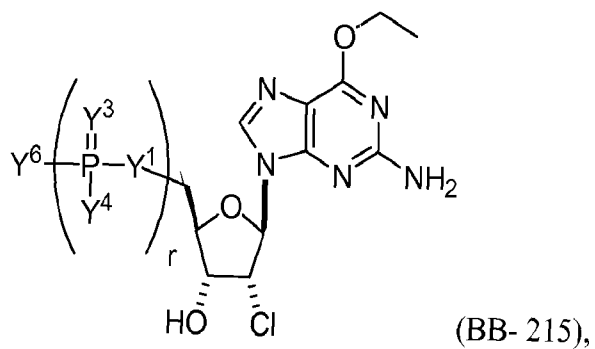

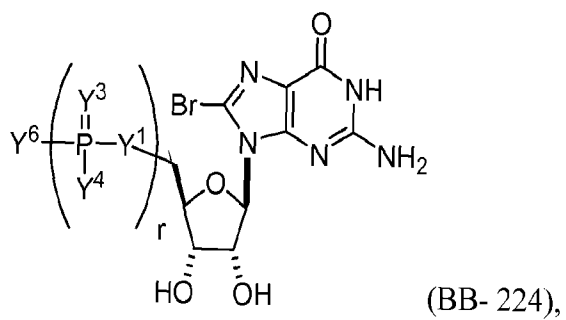
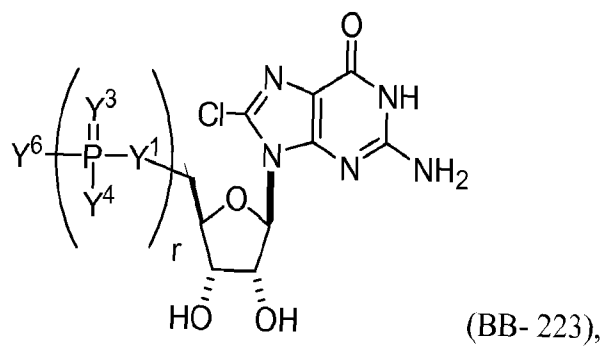
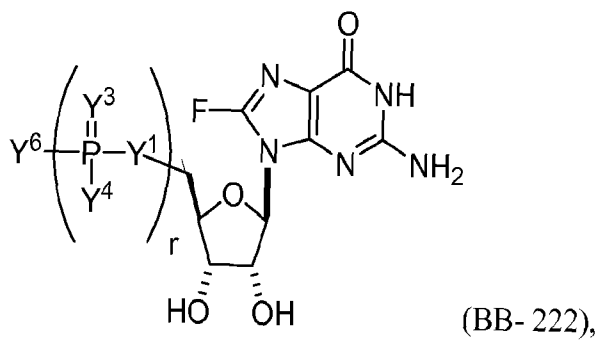
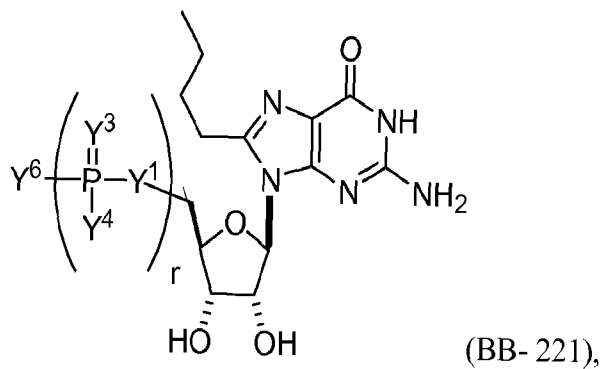
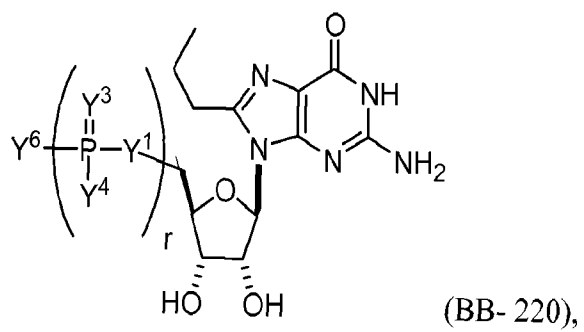

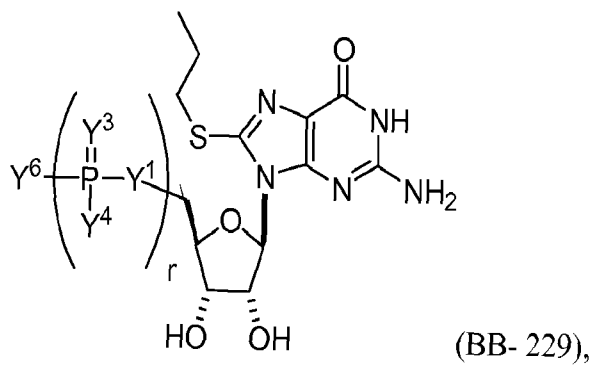
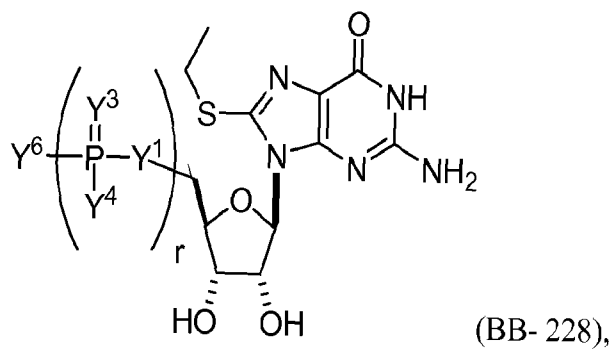
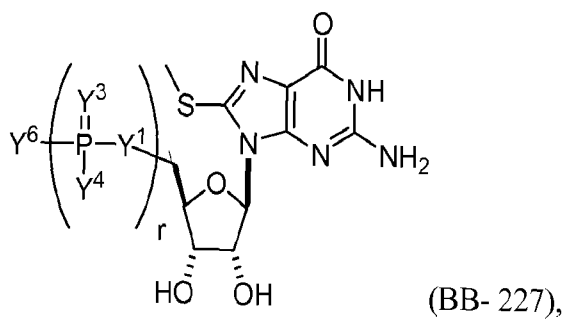
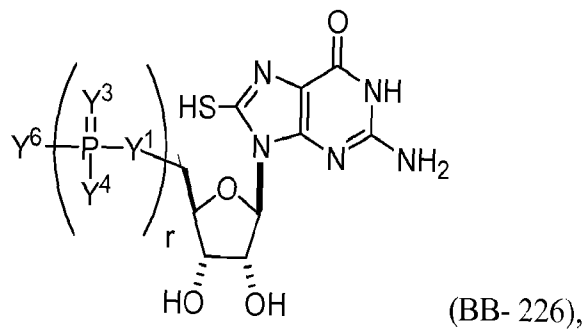
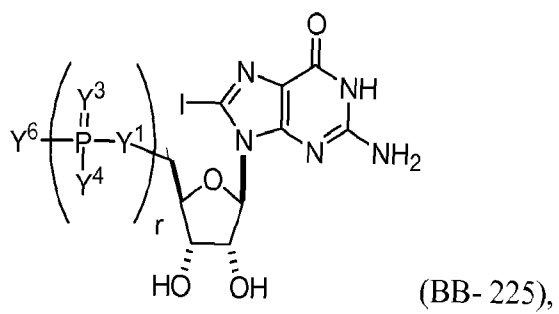

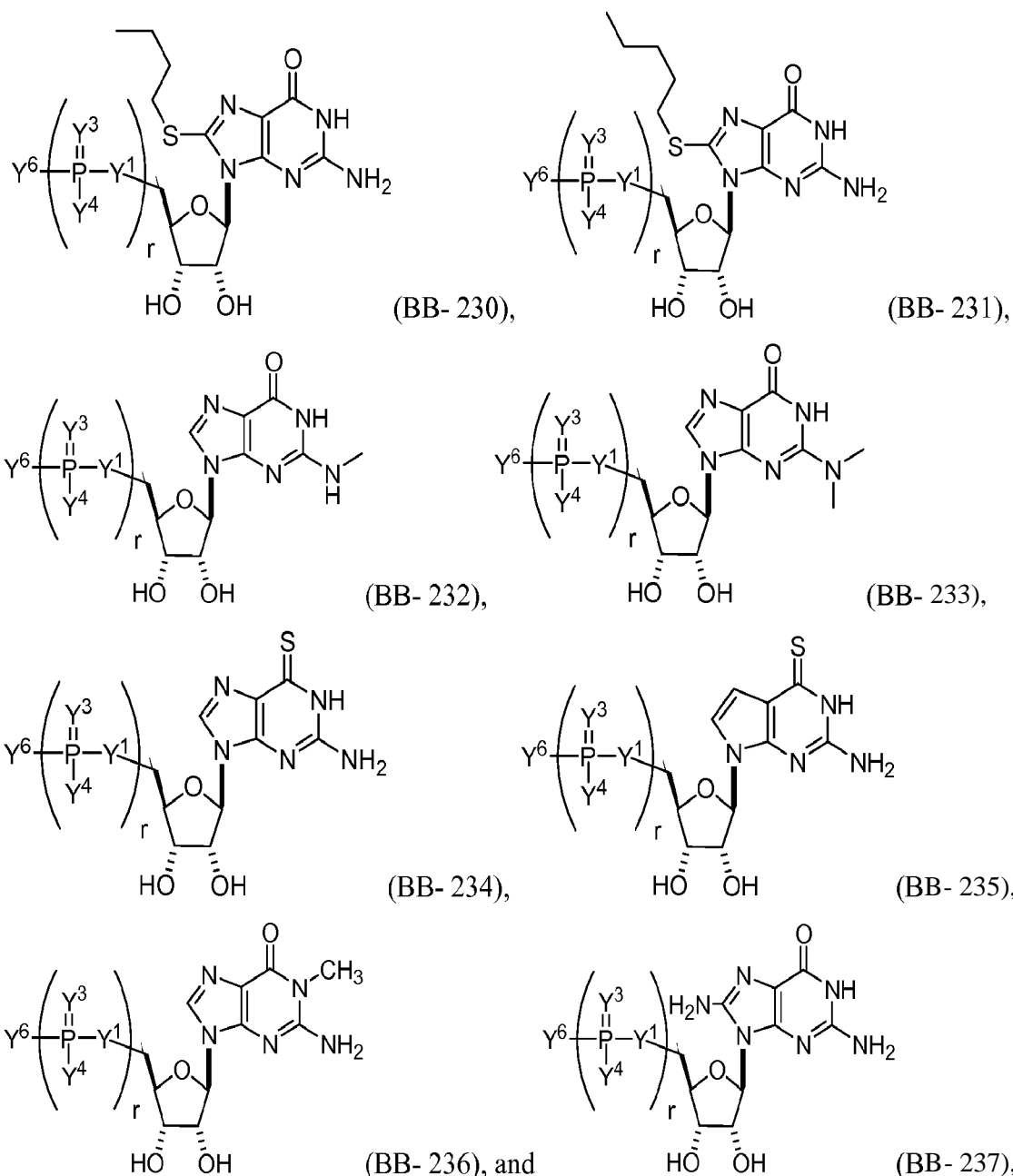

or a pharmaceutically acceptable salt or stereoisomer thereof, wherein  $Y^1$ ,  $Y^3$ ,  $Y^4$ ,  $Y^6$ , and  $r$  are as described herein (e.g., each  $r$  is, independently, an integer from 0 to 5, such as from 0 to 3, from 1 to 3, or from 1 to 5)).

**[000315]** In some embodiments, the chemical modification can include replacement of C group at C-5 of the ring (e.g., for a pyrimidine nucleoside, such as cytosine or uracil) with N (e.g., replacement of the  $>CH$  group at C-5 with  $>NR^{N1}$  group, wherein  $R^{N1}$  is H or optionally substituted alkyl). For example, the building block molecule, which may be incorporated into a polynucleotide, primary construct, or mmRNA, can be:



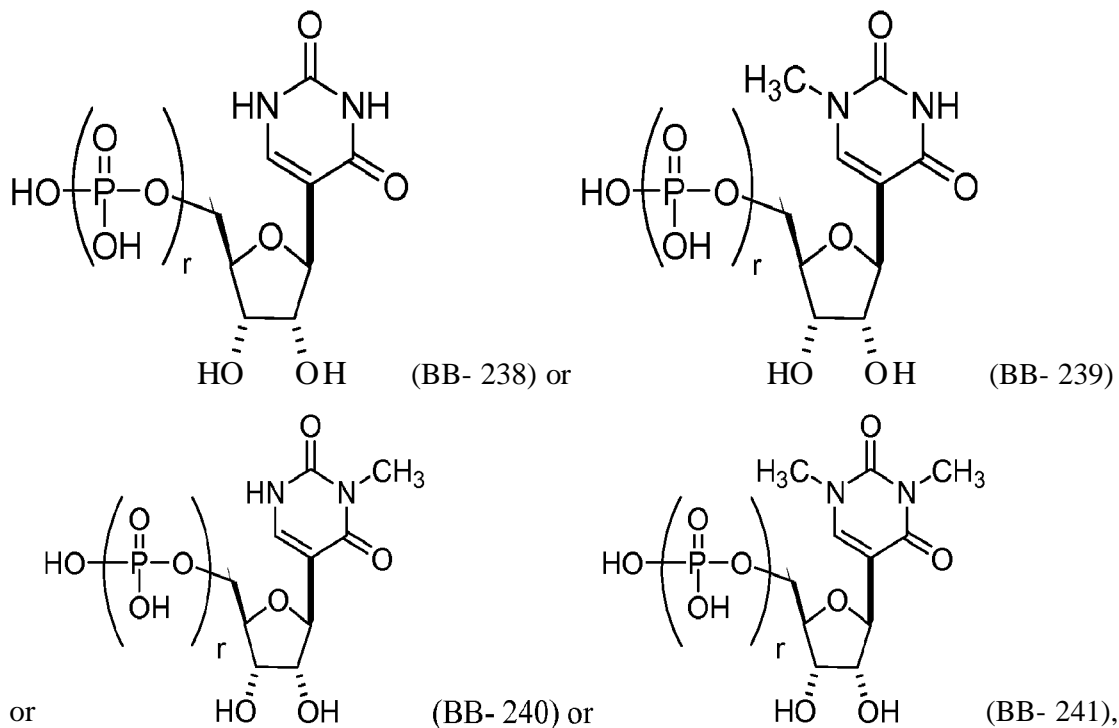

or a pharmaceutically acceptable salt or stereoisomer thereof, wherein each  $r$  is,

independently, an integer from 0 to 5 (e.g., from 0 to 3, from 1 to 3, or from 1 to 5).

**[000316]** In another embodiment, the chemical modification can include replacement of the hydrogen at C-5 of cytosine with halo (e.g., Br, Cl, F, or I) or optionally substituted alkyl (e.g., methyl). For example, the building block molecule, which may be incorporated into a polynucleotide, primary construct, or mmmRNA, can be:

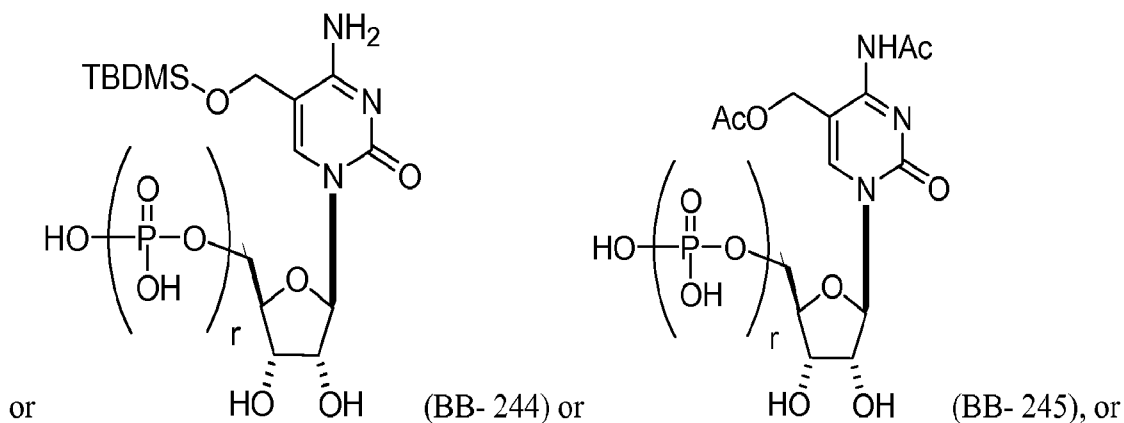
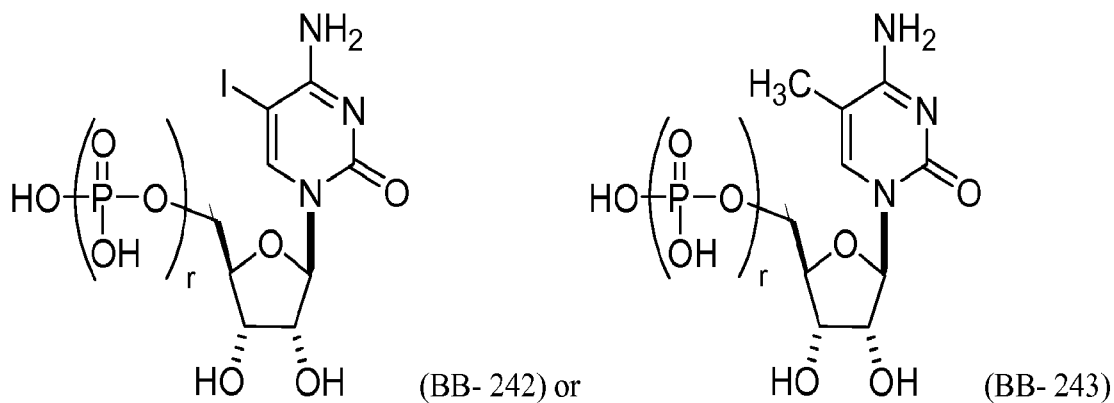

a pharmaceutically acceptable salt or stereoisomer thereof, wherein each  $r$  is,

independently, an integer from 0 to 5 (e.g., from 0 to 3, from 1 to 3, or from 1 to 5).

[000317] In yet a further embodiment, the chemical modification can include a fused ring that is formed by the N<sup>3/4</sup> at the C-4 position and the carbon atom at the C-5 position. For example, the building block molecule, which may be incorporated into a polynucleotide, primary construct, or mmRNA, can be:

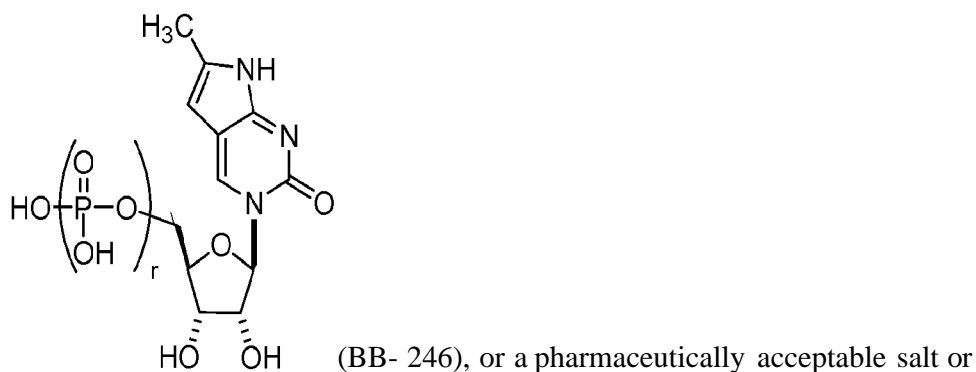

stereoisomer thereof, wherein each  $r$  is, independently, an integer from 0 to 5 (e.g., from 0 to 3, from 1 to 3, or from 1 to 5).

*Modifications on the Sugar*

**[000318]** The modified nucleosides and nucleotides (e.g., building block molecules), which may be incorporated into a polynucleotide, primary construct, or mmRNA (e.g., RNA or mRNA, as described herein), can be modified on the sugar of the ribonucleic acid. For example, the 2' hydroxyl group (OH) can be modified or replaced with a number of different substituents. Exemplary substitutions at the 2'-position include, but are not limited to, H, halo, optionally substituted  $C_{1-6}$  alkyl; optionally substituted  $C_{1-6}$  alkoxy; optionally substituted  $C_{6-10}$  aryloxy; optionally substituted  $C_{3-8}$  cycloalkyl; optionally substituted  $C_{3-8}$  cycloalkoxy; optionally substituted  $C_{6-1}$  aryloxy; optionally substituted  $C_{6-10}$  aryl- $C_{1-6}$  alkoxy, optionally substituted  $C_{1-12}$  (heterocycl)oxy; a sugar (e.g., ribose, pentose, or any described herein); a polyethyleneglycol (PEG), - $O(CH_2CH_2O)_nCH_2CH_2OR$ , where R is H or optionally substituted alkyl, and n is an integer from 0 to 20 (e.g., from 0 to 4, from 0 to 8, from 0 to 10, from 0 to 16, from 1 to 4, from 1 to 8, from 1 to 10, from 1 to 16, from 1 to 20, from 2 to 4, from 2 to 8, from 2 to 10, from 2 to 16, from 2 to 20, from 4 to 8, from 4 to 10, from 4 to 16, and from 4 to 20); "locked" nucleic acids (LNA) in which the 2'-hydroxyl is connected by a  $C_{1-6}$  alkylene or  $C_{1-6}$  heteroalkylene bridge to the 4'-carbon of the same ribose sugar, where exemplary bridges included methylene, propylene, ether, or amino bridges; aminoalkyl, as defined herein; aminoalkoxy, as defined herein; amino as defined herein; and amino acid, as defined herein

**[000319]** Generally, RNA includes the sugar group ribose, which is a 5-membered ring having an oxygen. Exemplary, non-limiting modified nucleotides include replacement of the oxygen in ribose (e.g., with S, Se, or alkylene, such as methylene or ethylene); addition of a double bond (e.g., to replace ribose with cyclopentenyl or cyclohexenyl); ring contraction of ribose (e.g., to form a 4-membered ring of cyclobutane or oxetane); ring expansion of ribose (e.g., to form a 6- or 7-membered ring having an additional carbon or heteroatom, such as for anhydrohexitol, alritol, mannitol, cyclohexanyl, cyclohexenyl, and morpholino that also has a phosphoramidate backbone); multicyclic forms (e.g., tricyclo; and "unlocked" forms, such as glycol nucleic acid (GNA) (e.g., R-GNA or S-GNA, where ribose is replaced by glycol units attached to phosphodiester bonds), threose nucleic acid (TNA, where ribose is replace with  $\alpha$ -L-threofuranosyl-(3'→2')) , and peptide nucleic acid (PNA, where 2-amino-ethyl-glycine linkages replace

the ribose and phosphodiester backbone). The sugar group can also contain one or more carbons that possess the opposite stereochemical configuration than that of the corresponding carbon in ribose. Thus, a polynucleotide, primary construct, or mmRNA molecule can include nucleotides containing, e.g., arabinose, as the sugar.





#### *Modifications on the Nucleobase*

[000320] The present disclosure provides for modified nucleosides and nucleotides. As described herein "nucleoside" is defined as a compound containing a sugar molecule (e.g., a pentose or ribose) or a derivative thereof in combination with an organic base (e.g., a purine or pyrimidine) or a derivative thereof (also referred to herein as "nucleobase"). As described herein, "nucleotide" is defined as a nucleoside including a phosphate group. The modified nucleotides may be synthesized by any useful method, as described herein (e.g., chemically, enzymatically, or recombinantly to include one or more modified or non-natural nucleosides).

[000321] The modified nucleotide base pairing encompasses not only the standard adenosine-thymine, adenosine-uracil, or guanosine-cytosine base pairs, but also base pairs formed between nucleotides and/or modified nucleotides comprising non-standard or modified bases, wherein the arrangement of hydrogen bond donors and hydrogen bond acceptors permits hydrogen bonding between a non-standard base and a standard base or between two complementary non-standard base structures. One example of such non-standard base pairing is the base pairing between the modified nucleotide inosine and adenine, cytosine or uracil.

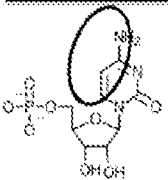
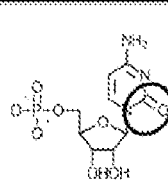
[000322] The modified nucleosides and nucleotides can include a modified nucleobase. Examples of nucleobases found in RNA include, but are not limited to, adenine, guanine, cytosine, and uracil. Examples of nucleobase found in DNA include, but are not limited to, adenine, guanine, cytosine, and thymine. These nucleobases can be modified or wholly replaced to provide cosmetic polynucleotides, primary constructs, or mmRNA molecules having enhanced properties, e.g., resistance to nucleases through disruption of the binding of a major groove binding partner. Table 8 below identifies the chemical faces of each canonical nucleotide. Circles identify the atoms comprising the respective chemical regions.

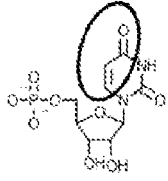
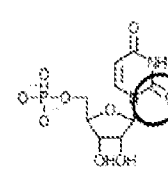
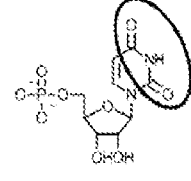
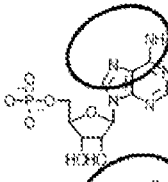
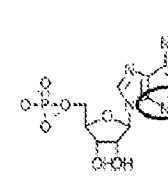
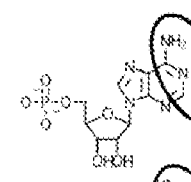
Table 8

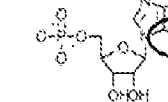
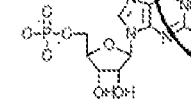
	Major Groove Face	Minor Groove Face	Watson-Crick Base-pairing Face
Pyrimidines	Cytidine: 		
	Uridine: 		
Purines	Adenosine: 		
	Guanosine: 		

[000323] In some embodiments, B is a modified uracil. Exemplary modified uracils include those having Formula (b1)-(b5):

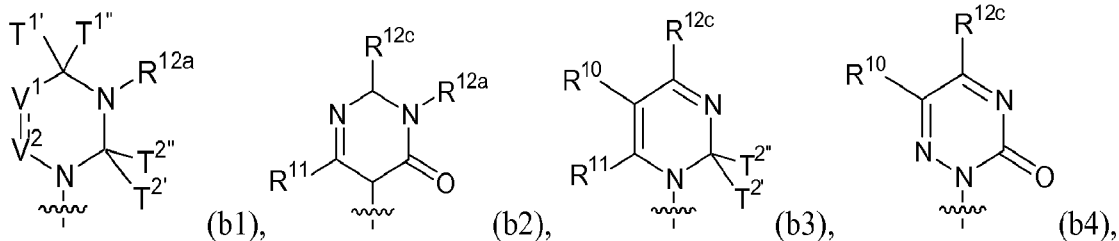

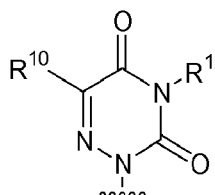
 or (b5), or a pharmaceutically acceptable salt or stereoisomer thereof,

[000324] wherein

[000325]  is a single or double bond;

[000326] each of  $T^{1'}$ ,  $T^{1''}$ ,  $T^{2'}$ , and  $T^{2''}$  is, independently, H, optionally substituted alkyl, optionally substituted alkoxy, or optionally substituted thioalkoxy, or the combination of  $T^{1'}$  and  $T^{1''}$  or the combination of  $T^{2'}$  and  $T^{2''}$  join together (e.g., as in  $T^2$ ) to form O (oxo), S (thio), or Se (seleno);

[000327] each of  $V^1$  and  $V^2$  is, independently, O, S,  $N(R^{Vb})_{nv}$ , or  $C(R^{Vb})_{nv}$ , wherein  $nv$  is an integer from 0 to 2 and each  $R^{Vb}$  is, independently, H, halo, optionally substituted amino acid, optionally substituted alkyl, optionally substituted haloalkyl, optionally substituted alkenyl, optionally substituted alkynyl, optionally substituted alkoxy, optionally substituted alkenyloxy, optionally substituted alkynyloxy, optionally substituted hydroxyalkyl, optionally substituted hydroxyalkenyl, optionally substituted hydroxyalkynyl, optionally substituted aminoalkyl (e.g., substituted with an N-protecting group, such as any described herein, e.g., trifluoroacetyl), optionally substituted aminoalkenyl, optionally substituted aminoalkynyl, optionally substituted acylaminoalkyl (e.g., substituted with an N-protecting group, such as any described herein, e.g., trifluoroacetyl), optionally substituted alkoxy-carbonylalkyl, optionally substituted alkoxy-carbonylalkenyl, optionally substituted alkoxy-carbonylalkynyl, or optionally substituted alkynyloxy (e.g., optionally substituted with any substituent described herein, such as those selected from (1)-(21) for alkyl);

[000328]  $R^{10}$  is H, halo, optionally substituted amino acid, hydroxy, optionally substituted alkyl, optionally substituted alkenyl, optionally substituted alkynyl, optionally substituted aminoalkyl, optionally substituted hydroxyalkyl, optionally substituted hydroxyalkenyl, optionally substituted hydroxyalkynyl, optionally substituted aminoalkenyl, optionally substituted aminoalkynyl, optionally substituted alkoxy, optionally substituted alkoxy-carbonylalkyl, optionally substituted alkoxy-carbonylalkenyl, optionally substituted alkoxy-carbonylalkynyl, optionally substituted alkoxy-carbonylalkoxy, optionally substituted carboxyalkoxy, optionally substituted carboxyalkyl, or optionally substituted carbamoylalkyl;

[000329]  $R^{11}$  is H or optionally substituted alkyl;

[000330]  $R^{12a}$  is H, optionally substituted alkyl, optionally substituted hydroxyalkyl, optionally substituted hydroxyalkenyl, optionally substituted hydroxyalkynyl, optionally substituted aminoalkyl, optionally substituted aminoalkenyl, or optionally substituted

aminoalkynyl, optionally substituted carboxyalkyl (e.g., optionally substituted with hydroxy), optionally substituted carboxyalkoxy, optionally substituted carboxyaminoalkyl, or optionally substituted carbamoylalkyl; and

[000331]  $R^{12c}$  is H, halo, optionally substituted alkyl, optionally substituted alkoxy, optionally substituted thioalkoxy, optionally substituted amino, optionally substituted hydroxyalkyl, optionally substituted hydroxyalkenyl, optionally substituted hydroxyalkynyl, optionally substituted aminoalkyl, optionally substituted aminoalkenyl, or optionally substituted aminoalkynyl.

[000332] Other exemplary modified uracils include those having Formula (b6)-(b9):

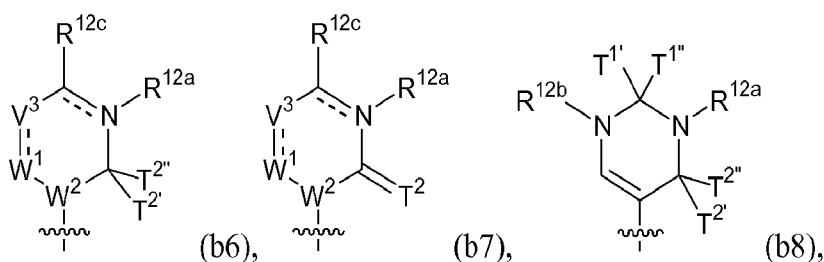

or (b9), or a pharmaceutically acceptable salt or stereoisomer thereof,

[000333] wherein

[000334] is a single or double bond;

[000335] each of  $T^{1'}$ ,  $T^{1''}$ ,  $T^{2'}$ , and  $T^{2''}$  is, independently, H, optionally substituted alkyl, optionally substituted alkoxy, or optionally substituted thioalkoxy, or the combination of  $T^{1'}$  and  $T^{1''}$  join together (e.g., as in  $T^1$ ) or the combination of  $T^{2'}$  and  $T^{2''}$  join together (e.g., as in  $T^2$ ) to form O (oxo), S (thio), or Se (seleno), or each  $T^1$  and  $T^2$  is, independently, O (oxo), S (thio), or Se (seleno);

[000336] each of  $W^1$  and  $W^2$  is, independently,  $N(R^{Wa})_{nw}$  or  $C(R^{Wa})_{nw}$ , wherein  $nw$  is an integer from 0 to 2 and each  $R^{Wa}$  is, independently, H, optionally substituted alkyl, or optionally substituted alkoxy;

[000337] each  $V^3$  is, independently, O, S,  $N(R^{Va})_{nv}$ , or  $C(R^{Va})_{nv}$ , wherein  $nv$  is an integer from 0 to 2 and each  $R^{Va}$  is, independently, H, halo, optionally substituted amino acid, optionally substituted alkyl, optionally substituted hydroxyalkyl, optionally

substituted hydroxyalkenyl, optionally substituted hydroxyalkynyl, optionally substituted alkenyl, optionally substituted alkynyl, optionally substituted heterocyclyl, optionally substituted alkheterocyclyl, optionally substituted alkoxy, optionally substituted alkenyloxy, or optionally substituted alkynyloxy, optionally substituted aminoalkyl (e.g., substituted with an N-protecting group, such as any described herein, e.g., trifluoroacetyl, or sulfoalkyl), optionally substituted aminoalkenyl, optionally substituted aminoalkynyl, optionally substituted acylaminoalkyl (e.g., substituted with an N-protecting group, such as any described herein, e.g., trifluoroacetyl), optionally substituted alkoxy-carbonylalkyl, optionally substituted alkoxy-carbonylalkenyl, optionally substituted alkoxy-carbonylalkynyl, optionally substituted alkoxy-carbonylacyl, optionally substituted alkoxy-carbonylalkoxy, optionally substituted carboxyalkyl (e.g., optionally substituted with hydroxy and/or an *O*-protecting group), optionally substituted carboxyalkoxy, optionally substituted carboxyaminoalkyl, or optionally substituted carbamoylalkyl (e.g., optionally substituted with any substituent described herein, such as those selected from (1)-(21) for alkyl), and wherein R<sup>Va</sup> and R<sup>12c</sup> taken together with the carbon atoms to which they are attached can form optionally substituted cycloalkyl, optionally substituted aryl, or optionally substituted heterocyclyl (e.g., a 5- or 6-membered ring);

[000338] R<sup>12a</sup> is H, optionally substituted alkyl, optionally substituted hydroxyalkyl, optionally substituted hydroxyalkenyl, optionally substituted hydroxyalkynyl, optionally substituted aminoalkyl, optionally substituted aminoalkenyl, optionally substituted aminoalkynyl, optionally substituted carboxyalkyl (e.g., optionally substituted with hydroxy and/or an *O*-protecting group), optionally substituted carboxyalkoxy, optionally substituted carboxyaminoalkyl, optionally substituted carbamoylalkyl, or absent;

[000339] R<sup>12b</sup> is H, optionally substituted alkyl, optionally substituted alkenyl, optionally substituted alkynyl, optionally substituted hydroxyalkyl, optionally substituted hydroxyalkenyl, optionally substituted hydroxyalkynyl, optionally substituted aminoalkyl, optionally substituted aminoalkenyl, optionally substituted aminoalkynyl, optionally substituted alkaryl, optionally substituted heterocyclyl, optionally substituted alkheterocyclyl, optionally substituted amino acid, optionally substituted alkoxy-carbonylacyl, optionally substituted alkoxy-carbonylalkoxy, optionally substituted alkoxy-carbonylalkyl, optionally substituted alkoxy-carbonylalkenyl, optionally substituted



alkoxycarbonylalkynyl, optionally substituted alkoxycarbonylalkoxy, optionally substituted carboxyalkyl (e.g., optionally substituted with hydroxy and/or an O-protecting group), optionally substituted carboxyalkoxy, optionally substituted carboxyaminoalkyl, or optionally substituted carbamoylalkyl,

[000340] wherein the combination of  $R^{12b}$  and  $T^1$  or the combination of  $R^{12b}$  and  $R^{12c}$  can join together to form optionally substituted heterocyclyl; and

[000341]  $R^{12c}$  is H, halo, optionally substituted alkyl, optionally substituted alkoxy, optionally substituted thioalkoxy, optionally substituted amino, optionally substituted aminoalkyl, optionally substituted aminoalkenyl, or optionally substituted aminoalkynyl.

[000342] Further exemplary modified uracils include those having Formula (b28)-031):

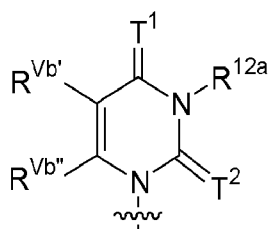

(b28),

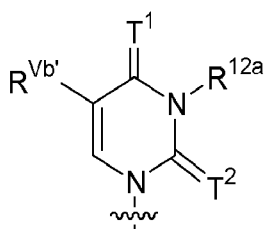

(b29),

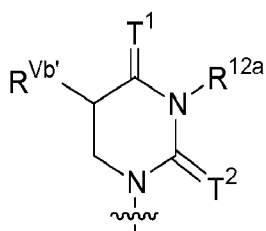
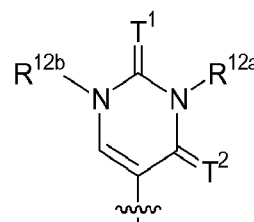

(b30), or

(b31), or a pharmaceutically acceptable salt or

stereoisomer thereof,

[000343] wherein

[000344] each of  $T^1$  and  $T^2$  is, independently, O (oxo), S (thio), or Se (seleno);

[000345] each  $R^{Vb'}$  and  $R^{Vb''}$  is, independently, H, halo, optionally substituted amino acid, optionally substituted alkyl, optionally substituted haloalkyl, optionally substituted hydroxyalkyl, optionally substituted hydroxyalkenyl, optionally substituted hydroxyalkynyl, optionally substituted alkenyl, optionally substituted alkynyl, optionally substituted alkoxy, optionally substituted alkenyloxy, optionally substituted alkynyloxy, optionally substituted aminoalkyl (e.g., substituted with an N-protecting group, such as any described herein, e.g., trifluoroacetyl, or sulfoalkyl), optionally substituted aminoalkenyl, optionally substituted aminoalkynyl, optionally substituted acylaminoalkyl

(e.g., substituted with an N-protecting group, such as any described herein, e.g., trifluoroacetyl), optionally substituted alkoxy carbonylalkyl, optionally substituted alkoxy carbonylalkenyl, optionally substituted alkoxy carbonylalkynyl, optionally substituted alkoxy carbonylacyl, optionally substituted alkoxy carbonylalkoxy, optionally substituted carboxyalkyl (e.g., optionally substituted with hydroxy and/or an *O*-protecting group), optionally substituted carboxyalkoxy, optionally substituted carboxy aminoalkyl, or optionally substituted carbamoylalkyl (e.g., optionally substituted with any substituent described herein, such as those selected from (1)-(21) for alkyl) (e.g., R<sup>Vb'</sup> is optionally substituted alkyl, optionally substituted alkenyl, or optionally substituted aminoalkyl, e.g., substituted with an N-protecting group, such as any described herein, e.g., trifluoroacetyl, or sulfoalkyl);

[000346] R<sup>12a</sup> is H, optionally substituted alkyl, optionally substituted carboxy aminoalkyl, optionally substituted aminoalkyl (e.g., e.g., substituted with an N-protecting group, such as any described herein, e.g., trifluoroacetyl, or sulfoalkyl), optionally substituted aminoalkenyl, or optionally substituted aminoalkynyl; and

[000347] R<sup>12b</sup> is H, optionally substituted alkyl, optionally substituted alkenyl, optionally substituted alkynyl, optionally substituted hydroxyalkyl, optionally substituted hydroxyalkenyl, optionally substituted hydroxyalkynyl, optionally substituted aminoalkyl, optionally substituted aminoalkenyl, optionally substituted aminoalkynyl (e.g., e.g., substituted with an N-protecting group, such as any described herein, e.g., trifluoroacetyl, or sulfoalkyl),

[000348] optionally substituted alkoxy carbonylacyl, optionally substituted alkoxy carbonylalkoxy, optionally substituted alkoxy carbonylalkyl, optionally substituted alkoxy carbonylalkenyl, optionally substituted alkoxy carbonylalkynyl, optionally substituted alkoxy carbonylalkoxy, optionally substituted carboxyalkoxy, optionally substituted carboxyalkyl, or optionally substituted carbamoylalkyl.

[000349] In particular embodiments, T<sup>1</sup> is O (oxo), and T<sup>2</sup> is S (thio) or Se (seleno). In other embodiments, T<sup>1</sup> is S (thio), and T<sup>2</sup> is O (oxo) or Se (seleno). In some embodiments, R<sup>Vb'</sup> is H, optionally substituted alkyl, or optionally substituted alkoxy.

[000350] In other embodiments, each R<sup>12a</sup> and R<sup>12b</sup> is, independently, H, optionally substituted alkyl, optionally substituted alkenyl, optionally substituted alkynyl, or

optionally substituted hydroxyalkyl. In particular embodiments,  $R^{12a}$  is H. In other embodiments, both  $R^{12a}$  and  $R^{12b}$  are H.

[000351] In some embodiments, each  $R^{Vb'}$  of  $R^{12b}$  is, independently, optionally substituted aminoalkyl (e.g., substituted with an N-protecting group, such as any described herein, e.g., trifluoroacetyl, or sulfoalkyl), optionally substituted aminoalkenyl, optionally substituted aminoalkynyl, or optionally substituted acylaminoalkyl (e.g., substituted with an N-protecting group, such as any described herein, e.g., trifluoroacetyl). In some embodiments, the amino and/or alkyl of the optionally substituted aminoalkyl is substituted with one or more of optionally substituted alkyl, optionally substituted alkenyl, optionally substituted sulfoalkyl, optionally substituted carboxy (e.g., substituted with an *O*-protecting group), optionally substituted hydroxy (e.g., substituted with an *O*-protecting group), optionally substituted carboxyalkyl (e.g., substituted with an *O*-protecting group), optionally substituted alkoxyalkyl (e.g., substituted with an *O*-protecting group), or *N*-protecting group. In some embodiments, optionally substituted aminoalkyl is substituted with an optionally substituted sulfoalkyl or optionally substituted alkenyl. In particular embodiments,  $R^{12a}$  and  $R^{Vb''}$  are both H. In particular embodiments,  $T^1$  is O (oxo), and  $T^2$  is S (thio) or Se (seleno).

[000352] In some embodiments,  $R^{Vb'}$  is optionally substituted alkoxyalkyl or optionally substituted carbamoylalkyl.

[000353] In particular embodiments, the optional substituent for  $R^{12a}$ ,  $R^{12b}$ ,  $R^{12c}$ , or  $R^{Va}$  is a polyethylene glycol group (e.g.,  $-(CH_2)_{s2}(OCH_2CH_2)_{s1}(CH_2)_{s3}OR'$ , wherein  $s_1$  is an integer from 1 to 10 (e.g., from 1 to 6 or from 1 to 4), each of  $s_2$  and  $s_3$ , independently, is an integer from 0 to 10 (e.g., from 0 to 4, from 0 to 6, from 1 to 4, from 1 to 6, or from 1 to 10), and  $R'$  is H or  $C^{1-6}$  alkyl); or an amino-polyethylene glycol group (e.g.,  $-NR^{N1}(CH_2)_{s2}(CH_2CH_2O)_{s1}(CH_2)_{s3}NR^{N1}$ , wherein  $s_1$  is an integer from 1 to 10 (e.g., from 1 to 6 or from 1 to 4), each of  $s_2$  and  $s_3$ , independently, is an integer from 0 to 10 (e.g., from 0 to 4, from 0 to 6, from 1 to 4, from 1 to 6, or from 1 to 10), and each  $R^{N1}$  is, independently, hydrogen or optionally substituted  $C_{1-6}$  alkyl).

[000354] In some embodiments, B is a modified cytosine. Exemplary modified cytosines include compounds of Formula (b10)-(b14):

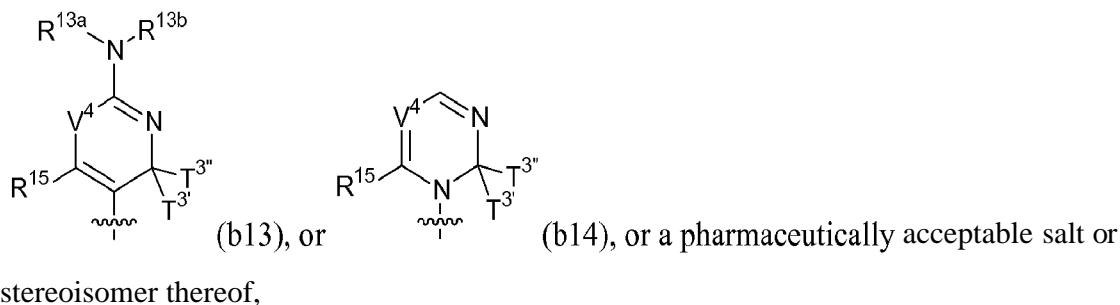
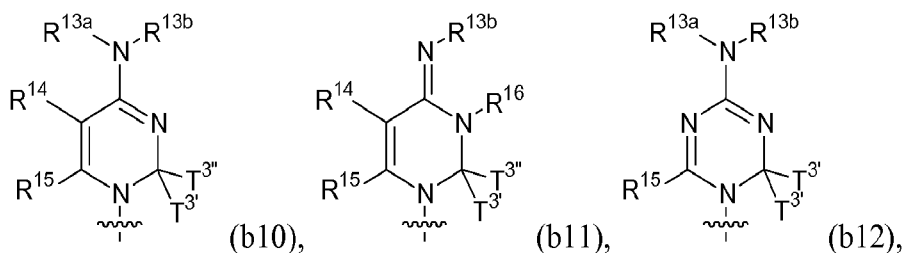

[000355] wherein

[000356] each of  $T^{3'}$  and  $T^{3''}$  is, independently, H, optionally substituted alkyl, optionally substituted alkoxy, or optionally substituted thioalkoxy, or the combination of  $T^{3'}$  and  $T^{3''}$  join together (e.g., as in  $T^3$ ) to form O (oxo), S (thio), or Se (seleno);

[000357] each  $V^4$  is, independently, O, S,  $N(R^{Vc})_{nv}$ , or  $C(R^{Vc})_{nv}$ , wherein  $nv$  is an integer from 0 to 2 and each  $R^{Vc}$  is, independently, H, halo, optionally substituted amino acid, optionally substituted alkyl, optionally substituted alkenyl, optionally substituted alkynyl, optionally substituted alkoxy, optionally substituted alkenyloxy, optionally substituted heterocyclyl, optionally substituted alkheterocyclyl, or optionally substituted alkynyloxy (e.g., optionally substituted with any substituent described herein, such as those selected from (1)-(21) for alkyl), wherein the combination of  $R^{13b}$  and  $R^{Vc}$  can be taken together to form optionally substituted heterocyclyl;

[000358] each  $V^5$  is, independently,  $N(R^{Vd})_{nv}$ , or  $C(R^{Vd})_{nv}$ , wherein  $nv$  is an integer from 0 to 2 and each  $R^{Vd}$  is, independently, H, halo, optionally substituted amino acid, optionally substituted alkyl, optionally substituted alkenyl, optionally substituted alkynyl, optionally substituted alkoxy, optionally substituted alkenyloxy, optionally substituted heterocyclyl, optionally substituted alkheterocyclyl, or optionally substituted alkynyloxy (e.g., optionally substituted with any substituent described herein, such as those selected from (1)-(21) for alkyl) (e.g.,  $V^5$  is -CH or N);

[000359] each of  $R^{13a}$  and  $R^{13b}$  is, independently, H, optionally substituted acyl, optionally substituted acyloxyalkyl, optionally substituted alkyl, or optionally substituted

alkoxy, wherein the combination of R<sup>13b</sup> and R<sup>14</sup> can be taken together to form optionally substituted heterocyclyl;

[000360] each R<sup>14</sup> is, independently, H, halo, hydroxy, thiol, optionally substituted acyl, optionally substituted amino acid, optionally substituted alkyl, optionally substituted haloalkyl, optionally substituted alkenyl, optionally substituted alkynyl, optionally substituted hydroxyalkyl (e.g., substituted with an *O*-protecting group), optionally substituted hydroxyalkenyl, optionally substituted hydroxyalkynyl, optionally substituted alkoxy, optionally substituted alkenyloxy, optionally substituted alkynyloxy, optionally substituted aminoalkoxy, optionally substituted alkoxyalkoxy, optionally substituted acyloxyalkyl, optionally substituted amino (e.g., -NHR, wherein R is H, alkyl, aryl, or phosphoryl), azido, optionally substituted aryl, optionally substituted heterocyclyl, optionally substituted alkheterocyclyl, optionally substituted aminoalkyl, optionally substituted aminoalkenyl, or optionally substituted aminoalkyl; and

[000361] each of R<sup>15</sup> and R<sup>16</sup> is, independently, H, optionally substituted alkyl, optionally substituted alkenyl, or optionally substituted alkynyl.

[000362] Further exemplary modified cytosines include those having Formula (b32)- (b35):

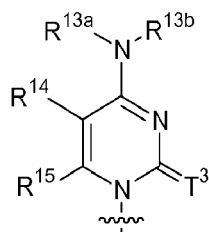

(b32),

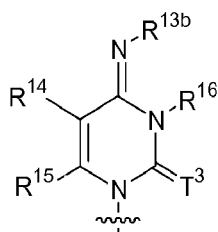

(b33),

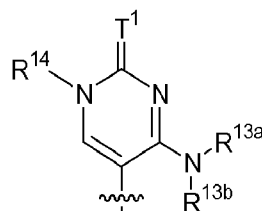

(b34), or

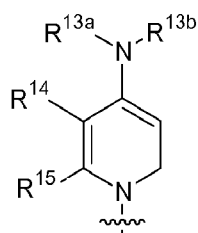

(b35), or a pharmaceutically acceptable salt or stereoisomer thereof,

[000363] wherein

[000364] each of T<sup>1</sup> and T<sup>3</sup> is, independently, O (oxo), S (thio), or Se (seleno);

[000365] each of R<sup>13a</sup> and R<sup>13b</sup> is, independently, H, optionally substituted acyl, optionally substituted acyloxyalkyl, optionally substituted alkyl, or optionally substituted

alkoxy, wherein the combination of R<sup>13b</sup> and R<sup>14</sup> can be taken together to form optionally substituted heterocyclyl;

[000366] each R<sup>14</sup> is, independently, H, halo, hydroxy, thiol, optionally substituted acyl, optionally substituted amino acid, optionally substituted alkyl, optionally substituted haloalkyl, optionally substituted alkenyl, optionally substituted alkynyl, optionally substituted hydroxyalkyl (e.g., substituted with an *O*-protecting group), optionally substituted hydroxyalkenyl, optionally substituted hydroxyalkynyl, optionally substituted alkoxy, optionally substituted alkenyloxy, optionally substituted alkynyloxy, optionally substituted aminoalkoxy, optionally substituted alkoxyalkoxy, optionally substituted acyloxyalkyl, optionally substituted amino (e.g., -NHR, wherein R is H, alkyl, aryl, or phosphoryl), azido, optionally substituted aryl, optionally substituted heterocyclyl, optionally substituted alkheterocyclyl, optionally substituted aminoalkyl (e.g., hydroxyalkyl, alkyl, alkenyl, or alkynyl), optionally substituted aminoalkenyl, or optionally substituted aminoalkynyl; and

[000367] each of R<sup>15</sup> and R<sup>16</sup> is, independently, H, optionally substituted alkyl, optionally substituted alkenyl, or optionally substituted alkynyl (e.g., R<sup>15</sup> is H, and R<sup>16</sup> is H or optionally substituted alkyl).

[000368] In some embodiments, R<sup>15</sup> is H, and R<sup>16</sup> is H or optionally substituted alkyl. In particular embodiments, R<sup>14</sup> is H, acyl, or hydroxyalkyl. In some embodiments, R<sup>14</sup> is halo. In some embodiments, both R<sup>14</sup> and R<sup>15</sup> are H. In some embodiments, both R<sup>15</sup> and R<sup>16</sup> are H. In some embodiments, each of R<sup>14</sup> and R<sup>15</sup> and R<sup>16</sup> is H. In further embodiments, each of R<sup>13a</sup> and R<sup>13b</sup> is independently, H or optionally substituted alkyl.

[000369] Further non-limiting examples of modified cytosines include compounds of Formula (b36):

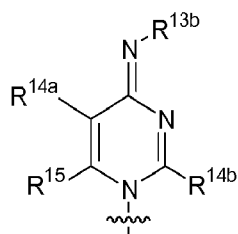

(b36) or a pharmaceutically acceptable salt or stereoisomer thereof,

[000370] wherein

[000371] each R<sup>13b</sup> is, independently, H, optionally substituted acyl, optionally substituted acyloxyalkyl, optionally substituted alkyl, or optionally substituted alkoxy,

wherein the combination of R<sup>13b</sup> and R<sup>14b</sup> can be taken together to form optionally substituted heterocyclyl;

[000372] each R<sup>14a</sup> and R<sup>14b</sup> is, independently, H, halo, hydroxy, thiol, optionally substituted acyl, optionally substituted amino acid, optionally substituted alkyl, optionally substituted haloalkyl, optionally substituted alkenyl, optionally substituted alkynyl, optionally substituted hydroxyalkyl (e.g., substituted with an *O*-protecting group), optionally substituted hydroxyalkenyl, optionally substituted alkoxy, optionally substituted alkenyloxy, optionally substituted alkynyloxy, optionally substituted aminoalkoxy, optionally substituted alkoxyalkoxy, optionally substituted acyloxyalkyl, optionally substituted amino (e.g., -NHR, wherein R is H, alkyl, aryl, phosphoryl, optionally substituted aminoalkyl, or optionally substituted carboxyalkyl), azido, optionally substituted aryl, optionally substituted heterocyclyl, optionally substituted alkheterocyclyl, optionally substituted ammoalkyl, optionally substituted aminoalkenyl, or optionally substituted aminoalkynyl; and

[000373] each of R<sup>15</sup> is, independently, H, optionally substituted alkyl, optionally substituted alkenyl, or optionally substituted alkynyl.

[000374] In particular embodiments, R<sup>14b</sup> is an optionally substituted amino acid (e.g., optionally substituted lysine). In some embodiments, R<sup>14a</sup> is H.

[000375] In some embodiments, B is a modified guanine. Exemplary modified guanines include compounds of Formula (b15)-(b17):

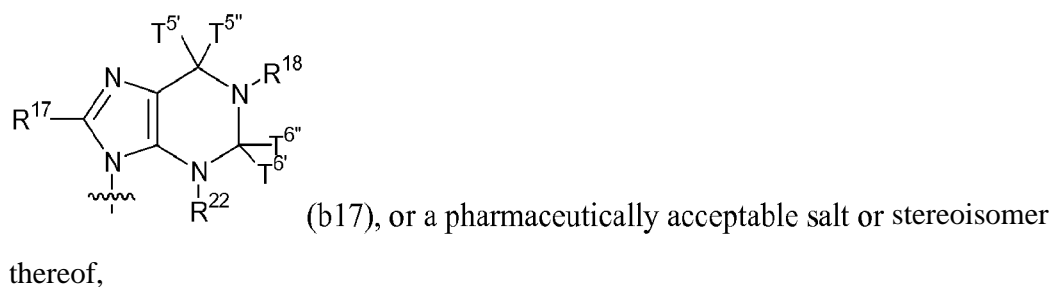
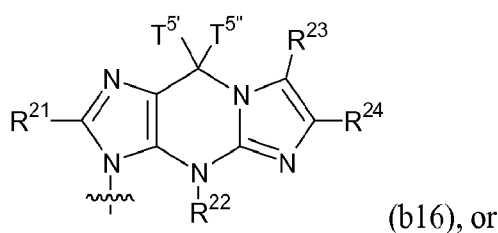
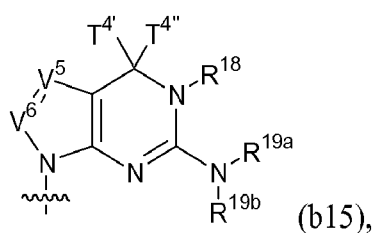

[000376] wherein

[000377] each of T<sup>4'</sup>, T<sup>4''</sup>, T<sup>5'</sup>, T<sup>5''</sup>, T<sup>6'</sup>, and T<sup>6''</sup> is, independently, H, optionally substituted alkyl, or optionally substituted alkoxy, and wherein the combination of T<sup>4'</sup> and T<sup>4''</sup> (e.g., as in T<sup>4</sup>) or the combination of T<sup>5'</sup> and T<sup>5''</sup> (e.g., as in T<sup>5</sup>) or the combination of T<sup>6'</sup> and T<sup>6''</sup> (e.g., as in T<sup>6</sup>) join together form O (oxo), S (thio), or Se (seleno);

[000378] each of V<sup>5</sup> and V<sup>6</sup> is, independently, O, S, N(R<sup>Vd</sup>)<sub>nv</sub>, or C(R<sup>Vd</sup>)<sub>nv</sub>, wherein nv is an integer from 0 to 2 and each R<sup>Vd</sup> is, independently, H, halo, thiol, optionally substituted amino acid, cyano, amidine, optionally substituted aminoalkyl, optionally substituted aminoalkenyl, optionally substituted aminoalkynyl, optionally substituted alkyl, optionally substituted alkenyl, optionally substituted alkynyl, optionally substituted alkoxy, optionally substituted alkenyloxy, or optionally substituted alkynyloxy (e.g., optionally substituted with any substituent described herein, such as those selected from (1)-(21) for alkyl), optionally substituted thioalkoxy, or optionally substituted amino; and

[000379] each of R<sup>17</sup>, R<sup>18</sup>, R<sup>19a</sup>, R<sup>19b</sup>, R<sup>21</sup>, R<sup>22</sup>, R<sup>23</sup>, and R<sup>24</sup> is, independently, H, halo, thiol, optionally substituted alkyl, optionally substituted alkenyl, optionally substituted alkynyl, optionally substituted thioalkoxy, optionally substituted amino, or optionally substituted amino acid.

[000380] Exemplary modified guanosines include compounds of Formula (b37)-(b40):

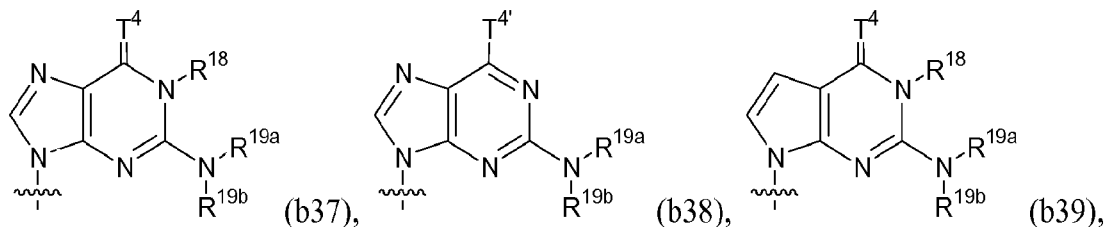

or

(b40), or a pharmaceutically acceptable salt or stereoisomer thereof,

[000381] wherein

[000382] each of T<sup>4'</sup> is, independently, H, optionally substituted alkyl, or optionally substituted alkoxy, and each T<sup>4</sup> is, independently, O (oxo), S (thio), or Se (seleno);



[000383] each of  $R^{18}$ ,  $R^{19a}$ ,  $R^{19b}$ , and  $R^{21}$  is, independently, H, halo, thiol, optionally substituted alkyl, optionally substituted alkenyl, optionally substituted alkynyl, optionally substituted thioalkoxy, optionally substituted amino, or optionally substituted amino acid.

[000384] In some embodiments,  $R^{18}$  is H or optionally substituted alkyl. In further embodiments,  $T^4$  is oxo. In some embodiments, each of  $R^{19a}$  and  $R^{19b}$  is, independently, H or optionally substituted alkyl.

[000385] In some embodiments, B is a modified adenine. Exemplary modified adenines include compounds of Formula (b18)-(b20):

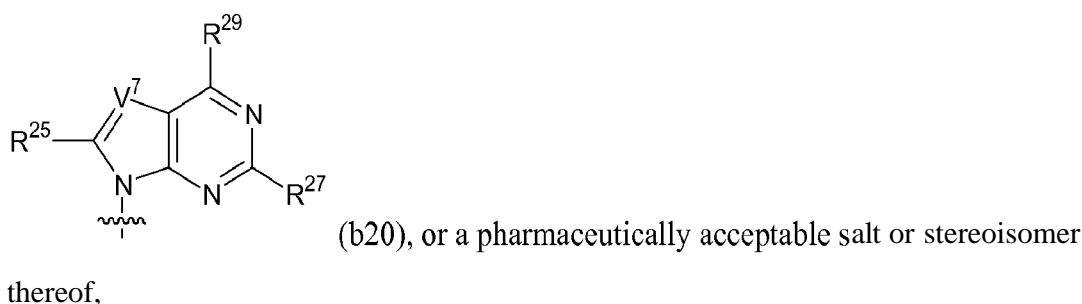
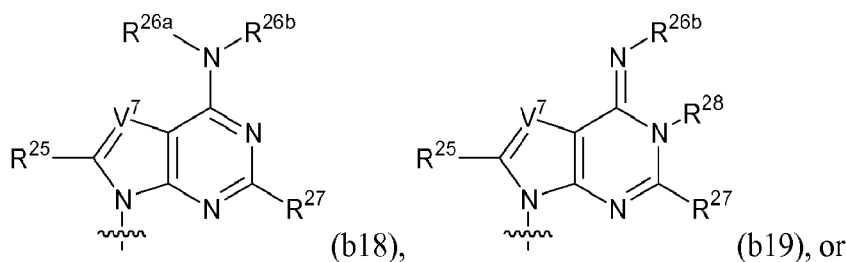

[000386] wherein

[000387] each  $V^7$  is, independently, O, S,  $N(R^{Ve})_{nv}$ , or  $C(R^{Ve})_{nv}$ , wherein  $nv$  is an integer from 0 to 2 and each  $R^{Ve}$  is, independently, H, halo, optionally substituted amino acid, optionally substituted alkyl, optionally substituted alkenyl, optionally substituted alkynyl, optionally substituted alkoxy, optionally substituted alkenyloxy, or optionally substituted alkynyloxy (e.g., optionally substituted with any substituent described herein, such as those selected from (1)-(21) for alkyl);

[000388] each  $R^{25}$  is, independently, H, halo, thiol, optionally substituted alkyl, optionally substituted alkenyl, optionally substituted alkynyl, optionally substituted thioalkoxy, or optionally substituted amino;

[000389] each of  $R^{26a}$  and  $R^{26b}$  is, independently, H, optionally substituted acyl, optionally substituted amino acid, optionally substituted carbamoylalkyl, optionally substituted alkyl, optionally substituted alkenyl, optionally substituted alkynyl, optionally

substituted hydroxyalkyl, optionally substituted hydroxyalkenyl, optionally substituted hydroxyalkynyl, optionally substituted alkoxy, or polyethylene glycol group (e.g.,  $-(\text{CH}_2)_{s_2}(\text{OCH}_2\text{CH}_2)_s(\text{CH}_2)_{s_3}\text{OR}'$ , wherein  $s_1$  is an integer from 1 to 10 (e.g., from 1 to 6 or from 1 to 4), each of  $s_2$  and  $s_3$ , independently, is an integer from 0 to 10 (e.g., from 0 to 4, from 0 to 6, from 1 to 4, from 1 to 6, or from 1 to 10), and  $\text{R}'$  is H or  $\text{C}_{1-20}$  alkyl); or an amino-polyethylene glycol group (e.g.,  $-\text{NR}^{\text{N}1}(\text{CH}_2)_{s_2}(\text{CH}_2\text{CH}_2\text{O})_{s_1}(\text{CH}_2)_{s_3}\text{NR}^{\text{N}1}$ , wherein  $s_1$  is an integer from 1 to 10 (e.g., from 1 to 6 or from 1 to 4), each of  $s_2$  and  $s_3$ , independently, is an integer from 0 to 10 (e.g., from 0 to 4, from 0 to 6, from 1 to 4, from 1 to 6, or from 1 to 10), and each  $\text{R}^{\text{N}1}$  is, independently, hydrogen or optionally substituted  $\text{C}_{1-6}$  alkyl);

[000390] each  $\text{R}^{27}$  is, independently, H, optionally substituted alkyl, optionally substituted alkenyl, optionally substituted alkynyl, optionally substituted alkoxy, optionally substituted thioalkoxy or optionally substituted amino;

[000391] each  $\text{R}^{28}$  is, independently, H, optionally substituted alkyl, optionally substituted alkenyl, or optionally substituted alkynyl; and

[000392] each  $\text{R}^{29}$  is, independently, H, optionally substituted acyl, optionally substituted amino acid, optionally substituted carbamoylalkyl, optionally substituted alkyl, optionally substituted alkenyl, optionally substituted alkynyl, optionally substituted hydroxyalkyl, optionally substituted hydroxyalkenyl, optionally substituted alkoxy, or optionally substituted amino.

[000393] Exemplary modified adenines include compounds of Formula (b41)-(b43):

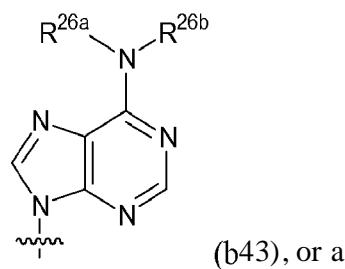
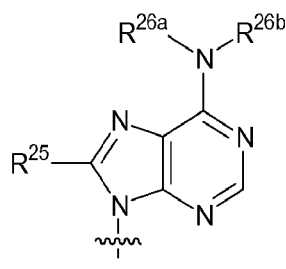
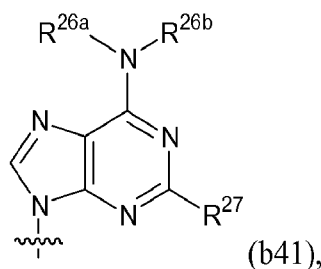

pharmaceutically acceptable salt or stereoisomer thereof,

[000394] wherein

[000395] each  $\text{R}^{25}$  is, independently, H, halo, thiol, optionally substituted alkyl, optionally substituted alkenyl, optionally substituted alkynyl, optionally substituted thioalkoxy, or optionally substituted amino;

[000396] each of  $R^{26a}$  and  $R^{26b}$  is, independently, H, optionally substituted acyl, optionally substituted amino acid, optionally substituted carbamoylalkyl, optionally substituted alkyl, optionally substituted alkenyl, optionally substituted alkynyl, optionally substituted hydroxyalkyl, optionally substituted hydroxyalkenyl, optionally substituted hydroxyalkynyl, optionally substituted alkoxy, or polyethylene glycol group (e.g.,  $-(CH_2)_{s2}(OCH_2CH_2)_{s1}(CH_2)_{s3}OR'$ , wherein  $s_i$  is an integer from 1 to 10 (e.g., from 1 to 6 or from 1 to 4), each of  $s_2$  and  $s_3$ , independently, is an integer from 0 to 10 (e.g., from 0 to 4, from 0 to 6, from 1 to 4, from 1 to 6, or from 1 to 10), and  $R'$  is H or  $C_{1-20}$  alkyl); or an amino-polyethylene glycol group (e.g.,  $-NR^{N1}(CH_2)_{s2}(CH_2CH_2O)_{si}(CH_2)_{s3}NR^{N1}$ , wherein  $s_i$  is an integer from 1 to 10 (e.g., from 1 to 6 or from 1 to 4), each of  $s_2$  and  $s_3$ , independently, is an integer from 0 to 10 (e.g., from 0 to 4, from 0 to 6, from 1 to 4, from 1 to 6, or from 1 to 10), and each  $R^{N1}$  is, independently, hydrogen or optionally substituted  $C_{1-6}$  alkyl); and

[000397] each  $R^{27}$  is, independently, H, optionally substituted alkyl, optionally substituted alkenyl, optionally substituted alkynyl, optionally substituted alkoxy, optionally substituted thioalkoxy, or optionally substituted amino.

[000398] In some embodiments,  $R^{26a}$  is H, and  $R^{26b}$  is optionally substituted alkyl. In some embodiments, each of  $R^{26a}$  and  $R^{26b}$  is, independently, optionally substituted alkyl. In particular embodiments,  $R^{27}$  is optionally substituted alkyl, optionally substituted alkoxy, or optionally substituted thioalkoxy. In other embodiments,  $R^{25}$  is optionally substituted alkyl, optionally substituted alkoxy, or optionally substituted thioalkoxy.

[000399] In particular embodiments, the optional substituent for  $R^{26a}$ ,  $R^{26b}$ , or  $R^{29}$  is a polyethylene glycol group (e.g.,  $-(CH_2)_{s2}(OCH_2CH_2)_{s1}(CH_2)_{s3}OR'$ , wherein  $s_i$  is an integer from 1 to 10 (e.g., from 1 to 6 or from 1 to 4), each of  $s_2$  and  $s_3$ , independently, is an integer from 0 to 10 (e.g., from 0 to 4, from 0 to 6, from 1 to 4, from 1 to 6, or from 1 to 10), and  $R'$  is H or  $C_{1-20}$  alkyl); or an amino-polyethylene glycol group (e.g.,  $-NR^{N1}(CH_2)_{s2}(CH_2CH_2O)_{si}(CH_2)_{s3}NR^{N1}$ , wherein  $s_i$  is an integer from 1 to 10 (e.g., from 1 to 6 or from 1 to 4), each of  $s_2$  and  $s_3$ , independently, is an integer from 0 to 10 (e.g., from 0 to 4, from 0 to 6, from 1 to 4, from 1 to 6, or from 1 to 10), and each  $R^{N1}$  is, independently, hydrogen or optionally substituted  $C_{1-6}$  alkyl).

[000400] In some embodiments, B may have Formula (b21):

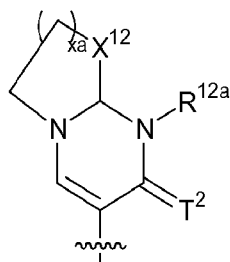

(b21), wherein  $X^{12}$  is, independently, 0, S, optionally substituted alkylene (e.g., methylene), or optionally substituted heteroalkylene,  $x_a$  is an integer from 0 to 3, and  $R^{12a}$  and  $T^2$  are as described herein.

[000401] In some embodiments, B may have Formula (b22):

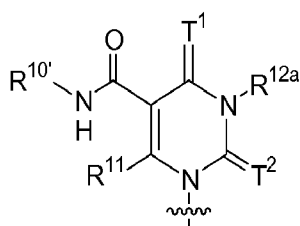

(b22), wherein  $R^{10'}$  is, independently, optionally substituted alkyl, optionally substituted alkenyl, optionally substituted alkynyl, optionally substituted aryl, optionally substituted heterocyclyl, optionally substituted aminoalkyl, optionally substituted aminoalkenyl, optionally substituted aminoalkynyl, optionally substituted alkoxy, optionally substituted alkoxy carbonylalkyl, optionally substituted alkoxy carbonylalkenyl, optionally substituted alkoxy carbonylalkynyl, optionally substituted alkoxy carbonylalkoxy, optionally substituted carboxyalkoxy, optionally substituted carboxyalkyl, or optionally substituted carbamoylalkyl, and  $R^{11}$ ,  $R^{12a}$ ,  $T^1$ , and  $T^2$  are as described herein.

[000402] In some embodiments, B may have Formula (b23):

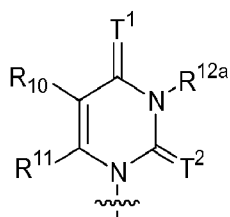

(b23), wherein  $R^{10}$  is optionally substituted heterocyclyl (e.g., optionally substituted furyl, optionally substituted thienyl, or optionally substituted pyrrolyl), optionally substituted aryl (e.g., optionally substituted phenyl or optionally substituted naphthyl), or any substituent described herein (e.g., for  $R^{10}$ ); and wherein  $R^{11}$  (e.g., H or any substituent described herein),  $R^{12a}$  (e.g., H or any substituent described herein),  $T^1$  (e.g., oxo or any substituent described herein), and  $T^2$  (e.g., oxo or any substituent described herein) are as described herein.

[000403] In some embodiments, B may have Formula (b24):

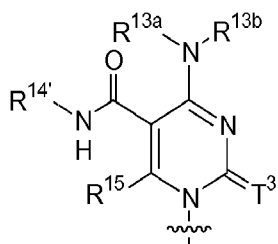

(b24), wherein R<sup>14'</sup> is, independently, optionally substituted alkyl, optionally substituted alkenyl, optionally substituted alkynyl, optionally substituted aryl, optionally substituted heterocyclyl, optionally substituted alkaryl, optionally substituted alkheterocyclyl, optionally substituted aminoalkyl, optionally substituted aminoalkenyl, optionally substituted aminoalkynyl, optionally substituted alkoxy, optionally substituted alkoxy-carbonylalkenyl, optionally substituted alkoxy-carbonylalkynyl, optionally substituted alkoxy-carbonylalkyl, optionally substituted alkoxy-carbonylalkoxy, optionally substituted carboxyalkoxy, optionally substituted carboxyalkyl, or optionally substituted carbamoylalkyl, and R<sup>13a</sup>, R<sup>13b</sup>, R<sup>15</sup>, and T<sup>3</sup> are as described herein.

[000404] In some embodiments, B may have Formula (b25):

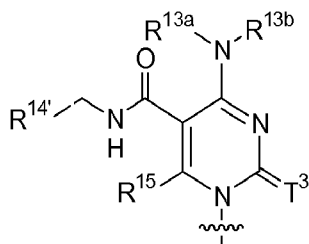

(b25), wherein R<sup>14'</sup> is optionally substituted heterocyclyl (e.g., optionally substituted furyl, optionally substituted thienyl, or optionally substituted pyrrolyl), optionally substituted aryl (e.g., optionally substituted phenyl or optionally substituted naphthyl), or any substituent described herein (e.g., for R<sup>14</sup> or R<sup>14'</sup>); and wherein R<sup>13a</sup> (e.g., H or any substituent described herein), R<sup>13b</sup> (e.g., H or any substituent described herein), R<sup>15</sup> (e.g., H or any substituent described herein), and T<sup>3</sup> (e.g., oxo or any substituent described herein) are as described herein.

[000405] In some embodiments, B is a nucleobase selected from the group consisting of cytosine, guanine, adenine, and uracil. In some embodiments, B may be:

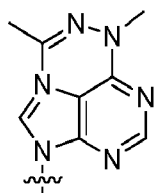

(b26) or

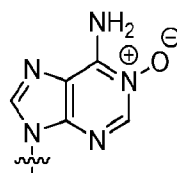

(b27).

[000406] In some embodiments, the modified nucleobase is a modified uracil. Exemplary nucleobases and nucleosides having a modified uracil include pseudouridine ( $\psi$ ), pyridin-4-one ribonucleoside, 5-aza-uridine, 6-aza-uridine, 2-thio-5-aza-uridine, 2-thio-uridine ( $s^2U$ ), 4-thio-uridine ( $s^4U$ ), 4-thio-pseudouridine, 2-thio-pseudouridine, 5-hydroxy-uridine ( $ho^5U$ ), 5-aminoallyl-uridine, 5-halo-uridine (e.g., 5-iodo-uridine or 5-bromo-uridine), 3-methyl-uridine ( $m^3U$ ), 5-methoxy-uridine ( $mo^5U$ ), uridine 5-oxyacetic acid ( $cmo^5U$ ), uridine 5-oxyacetic acid methyl ester ( $mcmo^5U$ ), 5-carboxymethyl-uridine ( $cm^5U$ ), 1-carboxymethyl-pseudouridine, 5-carboxyhydroxymethyl-uridine ( $chm^5U$ ), 5-carboxyhydroxymethyl-uridine methyl ester ( $mchm^5U$ ), 5-methoxycarbonylmethyl-uridine ( $mem^5U$ ), 5-methoxycarbonylmethyl-2-thio-uridine ( $mem^5s^2U$ ), 5-aminomethyl-2-thio-uridine ( $nm^5s^2U$ ), 5-methylaminomethyl-uridine ( $mnm^5U$ ), 5-methylaminomethyl-2-thio-uridine ( $mnm^5s^2U$ ), 5-methylaminomethyl-2-seleno-uridine ( $mnm^5se^2U$ ), 5-carbamoylmethyl-uridine ( $ncm^5U$ ), 5-carboxymethylaminomethyl-uridine ( $cmnm^5U$ ), 5-carboxymethylaminomethyl-2-thio-uridine ( $cmnm^5s^2U$ ), 5-propynyl-uridine, 1-propynyl-pseudouridine, 5-taurinomethyl-uridine ( $\tau m^5U$ ), 1-taurinomethyl-pseudouridine, 5-taurinomethyl-2-thio-uridine ( $\tau m^5s^2U$ ), 1-taurinomethyl-4-thio-pseudouridine, 5-methyl-uridine ( $m^5U$ , i.e., having the nucleobase deoxythymine), 1-methylpseudouridine ( $m^1\psi$ ), 5-methyl-2-thio-uridine ( $m^5VU$ ), 1-methyl-4-thio-pseudouridine ( $m^1s^4\psi$ ), 4-thio-1-methyl-pseudouridine, 3-methyl-pseudouridine ( $m^3\psi$ ), 2-thio-1-methyl-pseudouridine, 1-methyl-1-deaza-pseudouridine, 2-thio-1-methyl-1-deaza-pseudouridine, dihydrouridine (D), dihydropseudouridine, 5,6-dihydrouridine, 5-methyl-dihydrouridine ( $m^5D$ ), 2-thio-dihydrouridine, 2-thio-dihydropseudouridine, 2-methoxy-uridine, 2-methoxy-4-thio-uridine, 4-methoxy-pseudouridine, 4-methoxy-2-thio-pseudouridine, N 1-methyl-pseudouridine (also known as 1-methylpseudouridine ( $m^1\psi$ )), 3-(3-amino-3-carboxypropyl)uridine ( $acp^3U$ ), 1-methyl-3-(3-amino-3-carboxypropyl)pseudouridine ( $acp^3\psi$ ), 5-(isopentenylaminomethyl)uridine ( $inm^5U$ ), 5-(isopentenylaminomethyl)-2-thio-uridine ( $inm^5Vu$ ),  $\alpha$ -thio-uridine, 2'-O-methyl-uridine (Um), 5,2'-O-dimethyl-uridine ( $m^5Um$ ), 2'-O-methyl-pseudouridine ( $\psi m$ ), 2-thio-2'-O-methyl-uridine ( $s^2Um$ ), 5-methoxycarbonylmethyl-2'-O-methyl-uridine ( $mcm^5Um$ ), 5-carbamoylmethyl-2'-O-methyl-uridine ( $ncm^5Um$ ), 5-carboxymethylaminomethyl-2'-O-methyl-uridine ( $cmnm^5Um$ ), 3,2'-O-dimethyl-uridine ( $m^3Um$ ), 5-(isopentenylaminomethyl)-2'-O-

methyl-uridine (inm<sup>5</sup>Um), 1-thio-uridine, deoxythymidine, 2'-F-ara-uridine, 2'-F-uridine, 2'-OH-ara-uridine, 5-(2-carbomethoxyvinyl) uridine, and 5-[3-(1-E-propenylamino)uridine.

[000407] In some embodiments, the modified nucleobase is a modified cytosine. Exemplary nucleobases and nucleosides having a modified cytosine include 5-aza-cytidine, 6-aza-cytidine, pseudoisocytidine, 3-methyl-cytidine (m<sup>3</sup>C), N4-acetyl-cytidine (ac<sup>4</sup>C), 5-formyl-cytidine (f<sup>5</sup>C), N4-methyl-cytidine (m<sup>4</sup>C), 5-methyl-cytidine (m<sup>5</sup>C), 5-halo-cytidine (e.g., 5-iodo-cytidine), 5-hydroxymethyl-cytidine (hm<sup>5</sup>C), 1-methyl-pseudoisocytidine, pyrrolo-cytidine, pyrrolo-pseudoisocytidine, 2-thio-cytidine (s<sup>2</sup>C), 2-thio-5-methyl-cytidine, 4-thio-pseudoisocytidine, 4-thio-1-methyl-pseudoisocytidine, 4-thio-1-methyl-1-deaza-pseudoisocytidine, 1-methyl-1-deaza-pseudoisocytidine, zebularine, 5-aza-zebularine, 5-methyl-zebularine, 5-aza-2-thio-zebularine, 2-thio-zebularine, 2-methoxy-cytidine, 2-methoxy-5-methyl-cytidine, 4-methoxy-pseudoisocytidine, 4-methoxy-1-methyl-pseudoisocytidine, lysidine (k<sub>2</sub>C), a-thio-cytidine, 2'-O-methyl-cytidine (Cm), 5,2'-O-dimethyl-cytidine (m<sup>5</sup>Cm), N4-acetyl-2'-O-methyl-cytidine (ac<sup>4</sup>Cm), N4,2'-O-dimethyl-cytidine (m<sup>4</sup>Cm), 5-formyl-2'-O-methyl-cytidine (f<sup>5</sup>Cm), N4,N4,2'-O-trimethyl-cytidine (m<sup>4</sup><sub>2</sub>Cm), 1-thio-cytidine, 2'-F-ara-cytidine, 2'-F-cytidine, and 2'-OH-ara-cytidine.

[000408] In some embodiments, the modified nucleobase is a modified adenine. Exemplary nucleobases and nucleosides having a modified adenine include 2-amino-purine, 2,6-diaminopurine, 2-amino-6-halo-purine (e.g., 2-amino-6-chloro-purine), 6-halo-purine (e.g., 6-chloro-purine), 2-amino-6-methyl-purine, 8-azido-adenosine, 7-deaza-adenine, 7-deaza-8-aza-adenine, 7-deaza-2-amino-purine, 7-deaza-8-aza-2-amino-purine, 7-deaza-2,6-diaminopurine, 7-deaza-8-aza-2,6-diaminopurine, 1-methyl-adenosine (m<sup>1</sup>A), 2-methyl-adenine (m<sup>2</sup>A), N6-methyl-adenosine (m<sup>6</sup>A), 2-methylthio-N6-methyl-adenosine (ms<sup>2</sup>m<sup>6</sup>A), N6-isopentenyl-adenosine (i<sup>6</sup>A), 2-methylthio-N6-isopentenyl-adenosine (ms<sup>2</sup>i<sup>6</sup>A), N6-(cis-hydroxyisopentenyl)adenosine (io<sup>6</sup>A), 2-methylthio-N6-(cis-hydroxyisopentenyl)adenosine (ms<sup>2</sup>io<sup>6</sup>A), N6-glycylcarbamoyl-adenosine (g<sup>6</sup>A), N6-threonylcarbamoyl-adenosine (t<sup>6</sup>A), N6-methyl-N6-threonylcarbamoyl-adenosine (m<sup>6</sup>t<sup>6</sup>A), 2-methylthio-N6-threonylcarbamoyl-adenosine (ms<sup>2</sup>g<sup>6</sup>A), N6,N6-dimethyl-adenosine (m<sup>6</sup><sub>2</sub>A), N6-hydroxynorvalylcarbamoyl-adenosine

(hn<sup>6</sup>A), 2-methylthio-N6-hydroxynorvalylcarbamoyl-adenosine (ms<sup>2</sup>hn<sup>6</sup>A), N6-acetyl-adenosine (ac<sup>6</sup>A), 7-methyl-adenine, 2-methylthio-adenine, 2-methoxy-adenine, a-thio-adenosine, 2'-O-methyl-adenosine (Am), N6,2'-O-dimethyl-adenosine (m<sup>6</sup>Am), N6,N6,2'-O-trimethyl-adenosine (m<sup>6</sup><sub>2</sub>Am), 1,2'-O-dimethyl-adenosine (rr<sup>6</sup>Am), 2'-O-riboseadenosine (phosphate) (Ar(p)), 2-amino-N6-methyl-purine, 1-thio-adenosine, 8-azido-adenosine, 2'-F-ara-adenosine, 2'-F-adenosine, 2'-OH-ara-adenosine, and N6-(19-amino-pentaoxanonadecyl)-adenosine.

[000409] In some embodiments, the modified nucleobase is a modified guanine.

Exemplary nucleobases and nucleosides having a modified guanine include inosine (I), 1-methyl-inosine (m<sup>1</sup>I), wyosine (imG), methylwyosine (mimG), 4-demethyl-wyosine (imG-14), isowyosine (imG2), wybutosine (yW), peroxywybutosine (o<sub>2</sub>yW), hydroxywybutosine (OHyW), undermodified hydroxywybutosine (OHyW\*), 7-deaza-guanosine, queuosine (Q), epoxyqueuosine (oQ), galactosyl-queuosine (galQ), mannosyl-queuosine (manQ), 7-cyano-7-deaza-guanosine (preQo), 7-aminomethyl-7-deaza-guanosine (preQi), archaeosine (G<sup>+</sup>), 7-deaza-8-aza-guanosine, 6-thio-guanosine, 6-thio-7-deaza-guanosine, 6-thio-7-deaza-8-aza-guanosine, 7-methyl-guanosine (m<sup>7</sup>G), 6-thio-7-methyl-guanosine, 7-methyl-inosine, 6-methoxy-guanosine, 1-methyl-guanosine (rr<sup>6</sup>G), N2-methyl-guanosine (m<sup>2</sup>G), N2,N2-dimethyl-guanosine (m<sup>2</sup><sub>2</sub>G), N2,7-dimethyl-guanosine (m<sup>2,7</sup>G), N2, N2,7-dimethyl-guanosine (m<sup>ΣΣ7</sup>G), 8-oxo-guanosine, 7-methyl-8-oxo-guanosine, 1-methyl-6-thio-guanosine, N2-methyl-6-thio-guanosine, N2,N2-dimethyl-6-thio-guanosine, a-thio-guanosine, 2'-O-methyl-guanosine (Gm), N2-methyl-2'-O-methyl-guanosine (m<sup>2</sup>Gm), N2,N2-dimethyl-2'-O-methyl-guanosine (m<sup>2</sup><sub>2</sub>Gm), 1-methyl-2'-O-methyl-guanosine (rr<sup>6</sup>Gm), N2,7-dimethyl-2'-O-methyl-guanosine (m<sup>2,7</sup>Gm), 2'-O-methyl-inosine (Im), 1,2'-O-dimethyl-inosine (m<sup>1</sup>Im), and 2'-O-riboseylguanosine (phosphate) (Gr(p)).

[000410] The nucleobase of the nucleotide can be independently selected from a purine, a pyrimidine, a purine or pyrimidine analog. For example, the nucleobase can each be independently selected from adenine, cytosine, guanine, uracil, or hypoxanthine. In another embodiment, the nucleobase can also include, for example, naturally-occurring and synthetic derivatives of a base, including pyrazolo[3,4-d]pyrimidines, 5-methylcytosine (5-me-C), 5-hydroxymethyl cytosine, xanthine, hypoxanthine, 2-



aminoadenine, 6-methyl and other alkyl derivatives of adenine and guanine, 2-propyl and other alkyl derivatives of adenine and guanine, 2-thiouracil, 2-thiothymine and 2-thiocytosine, 5-propynyl uracil and cytosine, 6-azo uracil, cytosine and thymine, 5-uracil (pseudouracil), 4-thiouracil, 8-halo (*e.g.*, 8-bromo), 8-amino, 8-thiol, 8-thioalkyl, 8-hydroxyl and other 8-substituted adenines and guanines, 5-halo particularly 5-bromo, 5-trifluoromethyl and other 5-substituted uracils and cytosines, 7-methylguanine and 7-methyladenine, 8-azaguanine and 8-azaadenine, deazaguanine, 7-deazaguanine, 3-deazaguanine, deazaadenine, 7-deazaadenine, 3-deazaadenine, pyrazolo[3,4-d]pyrimidine, imidazo[1,5-a]1,3,5 triazinones, 9-deazapurines, imidazo[4,5-d]pyrazines, thiazolo[4,5-d]pyrimidines, pyrazin-2-ones, 1,2,4-triazine, pyridazine; and 1,3,5 triazine. When the nucleotides are depicted using the shorthand A, G, C, T or U, each letter refers to the representative base and/or derivatives thereof, *e.g.*, A includes adenine or adenine analogs, *e.g.*, 7-deaza adenine).

*Modifications on the Internucleoside Linkage*

[000411] The modified nucleotides, which may be incorporated into a polynucleotide, primary construct, or mmRNA molecule, can be modified on the internucleoside linkage (*e.g.*, phosphate backbone). Herein, in the context of the polynucleotide backbone, the phrases "phosphate" and "phosphodiester" are used interchangeably. Backbone phosphate groups can be modified by replacing one or more of the oxygen atoms with a different substituent. Further, the modified nucleosides and nucleotides can include the wholesale replacement of an unmodified phosphate moiety with another internucleoside linkage as described herein. Examples of modified phosphate groups include, but are not limited to, phosphorothioate, phosphoroselenates, boranophosphates, boranophosphate esters, hydrogen phosphonates, phosphoramidates, phosphorodiamidates, alkyl or aryl phosphonates, and phosphotriesters. Phosphorodithioates have both non-linking oxygens replaced by sulfur. The phosphate linker can also be modified by the replacement of a linking oxygen with nitrogen (bridged phosphoramidates), sulfur (bridged phosphorothioates), and carbon (bridged methylene-phosphonates).

[000412] The *a*-thio substituted phosphate moiety is provided to confer stability to RNA and DNA polymers through the unnatural phosphorothioate backbone linkages. Phosphorothioate DNA and RNA have increased nuclease resistance and subsequently a

longer half-life in a cellular environment. Phosphorothioate linked cosmetic polynucleotides, primary constructs, or mmRNA molecules are expected to also reduce the innate immune response through weaker binding/activation of cellular innate immune molecules.

[000413] In specific embodiments, a modified nucleoside includes an alpha-thio-nucleoside (e.g., 5'-0-(1-thiophosphate)-adenosine, 5'-0-(1-thiophosphate)-cytidine (alpha-thio-cytidine), 5'-0-(1-thiophosphate)-guanosine, 5'-0-(1-thiophosphate)-uridine, or 5'-0-(1-thiophosphate)-pseudouridine).

[000414] Other internucleoside linkages that may be employed according to the present invention, including internucleoside linkages which do not contain a phosphorous atom, are described herein below.

#### **Combinations of Modified Sugars, Nucleobases, and Internucleoside Linkages**

[000415] The cosmetic polynucleotides, primary constructs, and mmRNA of the invention can include a combination of modifications to the sugar, the nucleobase, and/or the internucleoside linkage. These combinations can include any one or more modifications described herein. For examples, any of the nucleotides described herein in Formulas (Ia), (Ia-1)-(Ia-3), (Ib)-(Ic), (Ha)-(Hb), (IIa)-(IIb), (IIb-1), (IIb-2), (IIc-1)-(IIc-2), (IIn-1), (IIn-2), (IVa)-(IVf), and (IXa)-(IXr) can be combined with any of the nucleobases described herein (e.g., in Formulas (b1)-(b43) or any other described herein).

#### **Synthesis of Cosmetic Polypeptides, Primary Constructs, and mmRNA Molecules**

[000416] The cosmetic polypeptides, cosmetic primary constructs, and cosmetic mmRNA molecules for use in accordance with the invention may be prepared according to any useful technique, as described herein. The modified nucleosides and nucleotides used in the synthesis of cosmetic polynucleotides, cosmetic primary constructs, and cosmetic mmRNA molecules disclosed herein can be prepared from readily available starting materials using the following general methods and procedures. Where typical or preferred process conditions (e.g., reaction temperatures, times, mole ratios of reactants, solvents, pressures, etc.) are provided, a skilled artisan would be able to optimize and develop additional process conditions. Optimum reaction conditions may vary with the particular reactants or solvent used, but such conditions can be determined by one skilled in the art by routine optimization procedures.

[000417] The processes described herein can be monitored according to any suitable method known in the art. For example, product formation can be monitored by spectroscopic means, such as nuclear magnetic resonance spectroscopy (e.g.,  $^1\text{H}$  or  $^{13}\text{C}$ ) infrared spectroscopy, spectrophotometry (e.g., UV-visible), or mass spectrometry, or by chromatography such as high performance liquid chromatography (HPLC) or thin layer chromatography.

[000418] Preparation of cosmetic polypeptides, cosmetic primary constructs, and cosmetic mmRNA molecules of the present invention can involve the protection and deprotection of various chemical groups. The need for protection and deprotection, and the selection of appropriate protecting groups can be readily determined by one skilled in the art. The chemistry of protecting groups can be found, for example, in Greene, et al, *Protective Groups in Organic Synthesis*, 2d. Ed., Wiley & Sons, 1991, which is incorporated herein by reference in its entirety.

[000419] The reactions of the processes described herein can be carried out in suitable solvents, which can be readily selected by one of skill in the art of organic synthesis. Suitable solvents can be substantially nonreactive with the starting materials (reactants), the intermediates, or products at the temperatures at which the reactions are carried out, i.e., temperatures which can range from the solvent's freezing temperature to the solvent's boiling temperature. A given reaction can be carried out in one solvent or a mixture of more than one solvent. Depending on the particular reaction step, suitable solvents for a particular reaction step can be selected.

[000420] Resolution of racemic mixtures of modified nucleosides and nucleotides can be carried out by any of numerous methods known in the art. An example method includes fractional recrystallization using a "chiral resolving acid" which is an optically active, salt-forming organic acid. Suitable resolving agents for fractional recrystallization methods are, for example, optically active acids, such as the D and L forms of tartaric acid, diacetyltartaric acid, dibenzoyltartaric acid, mandelic acid, malic acid, lactic acid or the various optically active camphorsulfonic acids. Resolution of racemic mixtures can also be carried out by elution on a column packed with an optically active resolving agent (e.g., dinitrobenzoylphenylglycine). Suitable elution solvent composition can be determined by one skilled in the art.

[000421] Modified nucleosides and nucleotides (e.g., building block molecules) can be prepared according to the synthetic methods described in Ogata et al., J. Org. Chem. 74:2585-2588 (2009); Purmal et al, Nucl. Acids Res. 22(1): 72-78, (1994); Fukuhara et al., Biochemistry, 1(4): 563-568 (1962); and Xu et al., Tetrahedron, 48(9): 1729-1740 (1992), each of which are incorporated by reference in their entirety.

[000422] The cosmetic polypeptides, cosmetic primary constructs, and cosmetic mmRNA of the invention may or may not be uniformly modified along the entire length of the molecule. For example, one or more or all types of nucleotide (e.g., purine or pyrimidine, or any one or more or all of A, G, U, C) may or may not be uniformly modified in a cosmetic polynucleotide of the invention, or in a given predetermined sequence region thereof (e.g. one or more of the sequence regions represented in Figure 1). In some embodiments, all nucleotides X in a cosmetic polynucleotide of the invention (or in a given sequence region thereof) are modified, wherein X may any one of nucleotides A, G, U, C, or any one of the combinations A+G, A+U, A+C, G+U, G+C, U+C, A+G+U, A+G+C, G+U+C or A+G+C.

[000423] Different sugar modifications, nucleotide modifications, and/or internucleoside linkages (e.g., backbone structures) may exist at various positions in the cosmetic polynucleotide, cosmetic primary construct, or cosmetic mmRNA. One of ordinary skill in the art will appreciate that the nucleotide analogs or other modification(s) may be located at any position(s) of a cosmetic polynucleotide, cosmetic primary construct, or cosmetic mmRNA such that the function of the cosmetic polynucleotide, cosmetic primary construct, or cosmetic mmRNA is not substantially decreased. A modification may also be a 5' or 3' terminal modification. The cosmetic polynucleotide, cosmetic primary construct, or cosmetic mmRNA may contain from about 1% to about 100% modified nucleotides (either in relation to overall nucleotide content, or in relation to one or more types of nucleotide, i.e. any one or more of A, G, U or C) or any intervening percentage (e.g., from 1% to 20%, from 1% to 25%, from 1% to 50%, from 1% to 60%, from 1% to 70%, from 1% to 80%, from 1% to 90%, from 1% to 95%, from 10% to 20%, from 10% to 25%, from 10% to 50%, from 10% to 60%, from 10% to 70%, from 10% to 80%, from 10% to 90%, from 10% to 95%, from 10% to 100%, from 20% to 25%, from 20% to 50%, from 20% to 60%, from 20% to 70%, from

20% to 80%, from 20% to 90%, from 20% to 95%, from 20% to 100%, from 50% to 60%, from 50% to 70%, from 50% to 80%, from 50% to 90%, from 50% to 95%, from 50% to 100%, from 70% to 80%, from 70% to 90%, from 70% to 95%, from 70% to 100%, from 80% to 90%, from 80% to 95%, from 80% to 100%, from 90% to 95%, from 90% to 100%, and from 95% to 100%).

**[000424]** In some embodiments, the cosmetic polynucleotide, cosmetic primary construct, or cosmetic mmRNA includes a modified pyrimidine (e.g., a modified uracil/uridine/U or modified cytosine/cytidine/C). In some embodiments, the uracil or uridine (generally: U) in the cosmetic polynucleotide, cosmetic primary construct, or cosmetic mmRNA molecule may be replaced with from about 1% to about 100% of a modified uracil or modified uridine (e.g., from 1% to 20%, from 1% to 25%, from 1% to 50%, from 1% to 60%, from 1% to 70%, from 1% to 80%, from 1% to 90%, from 1% to 95%, from 10% to 20%, from 10% to 25%, from 10% to 50%, from 10% to 60%, from 10% to 70%, from 10% to 80%, from 10% to 90%, from 10% to 95%, from 10% to 100%, from 20% to 25%, from 20% to 50%, from 20% to 60%, from 20% to 70%, from 20% to 80%, from 20% to 90%, from 20% to 95%, from 20% to 100%, from 50% to 60%, from 50% to 70%, from 50% to 80%, from 50% to 90%, from 50% to 95%, from 50% to 100%, from 70% to 80%, from 70% to 90%, from 70% to 95%, from 70% to 100%, from 80% to 90%, from 80% to 95%, from 80% to 100%, from 90% to 95%, from 90% to 100%), and from 95% to 100% of a modified uracil or modified uridine). The modified uracil or uridine can be replaced by a compound having a single unique structure or by a plurality of compounds having different structures (e.g., 2, 3, 4 or more unique structures, as described herein). In some embodiments, the cytosine or cytidine (generally: C) in the cosmetic polynucleotide, cosmetic primary construct, or cosmetic mmRNA molecule may be replaced with from about 1% to about 100% of a modified cytosine or modified cytidine (e.g., from 1% to 20%, from 1% to 25%, from 1% to 50%, from 1% to 60%, from 1% to 70%, from 1% to 80%, from 1% to 90%, from 1% to 95%, from 10% to 20%, from 10% to 25%, from 10% to 50%, from 10% to 60%, from 10% to 70%, from 10% to 80%, from 10% to 90%, from 10% to 95%, from 10% to 100%, from 20% to 25%, from 20% to 50%, from 20% to 60%, from 20% to 70%, from 20% to 80%, from 20% to 90%, from 20% to 95%, from 20% to 100%, from 50% to 60%, from 50%

to 70%, from 50% to 80%, from 50% to 90%, from 50% to 95%, from 50% to 100%, from 70% to 80%, from 70% to 90%, from 70% to 95%, from 70% to 100%, from 80% to 90%, from 80% to 95%, from 80% to 100%, from 90% to 95%, from 90% to 100%, and from 95% to 100% of a modified cytosine or modified cytidine). The modified cytosine or cytidine can be replaced by a compound having a single unique structure or by a plurality of compounds having different structures (e.g., 2, 3, 4 or more unique structures, as described herein).

[000425] In some embodiments, the present disclosure provides methods of synthesizing a cosmetic polynucleotide, cosmetic primary construct, or cosmetic mmRNA (e.g., the first region, first flanking region, or second flanking region) including n number of linked nucleosides having Formula (Ia-1):

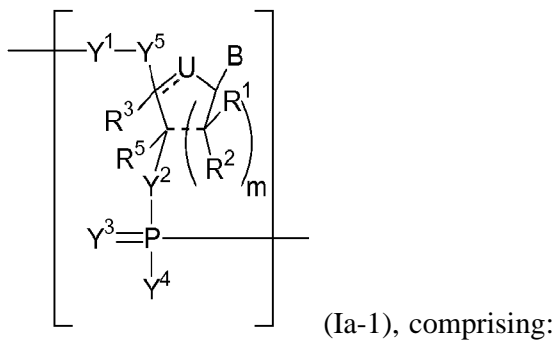

a) reacting a nucleotide of Formula (IV-1):

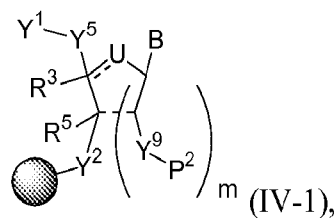

with a phosphoramidite compound of Formula (V-1):

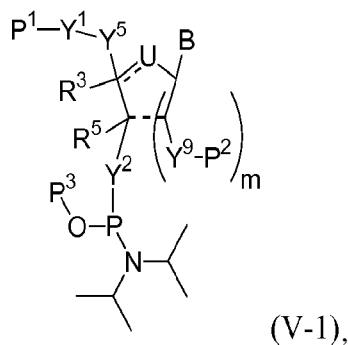

wherein Y<sup>9</sup> is H, hydroxy, phosphoryl, pyrophosphate, sulfate, amino, thiol, optionally substituted amino acid, or a peptide (e.g., including from 2 to 12 amino acids);

and each P<sup>1</sup>, P<sup>2</sup>, and P<sup>3</sup> is, independently, a suitable protecting group; and  denotes a solid support;

to provide a cosmetic polynucleotide, cosmetic primary construct, or cosmetic mmRNA of Formula (VI-1):

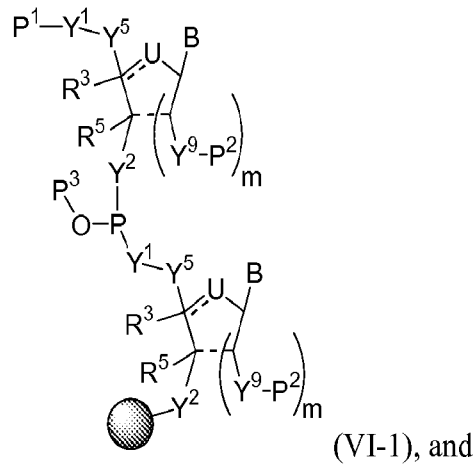

b) oxidizing or sulfurizing the cosmetic polynucleotide, cosmetic primary construct, or cosmetic mmRNA of Formula (V) to yield a cosmetic polynucleotide, cosmetic primary construct, or cosmetic mmRNA of Formula (VII-1):

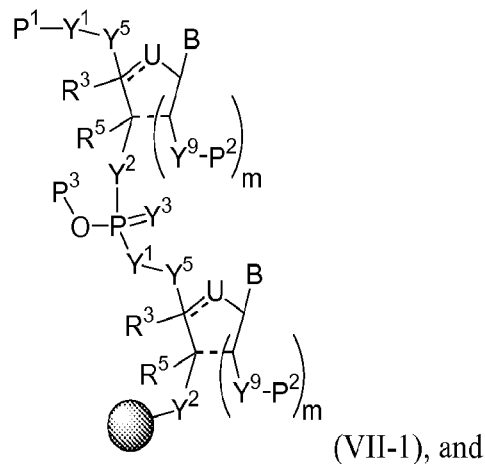

c) removing the protecting groups to yield the cosmetic polynucleotide, cosmetic primary construct, or cosmetic mmRNA of Formula (Ia).

[000426] In some embodiments, steps a) and b) are repeated from 1 to about 10,000 times. In some embodiments, the methods further comprise a nucleotide (e.g., mmRNA molecule) selected from the group consisting of A, C, G and U adenosine, cytosine, guanosine, and uracil. In some embodiments, the nucleobase may be a pyrimidine or derivative thereof. In some embodiments, the cosmetic polynucleotide, cosmetic primary construct, or cosmetic mmRNA is translatable.

[000427] Other components of cosmetic polynucleotides, cosmetic primary constructs, and cosmetic mmRNA are optional, and are beneficial in some embodiments. For example, a 5' untranslated region (UTR) and/or a 3'UTR are provided, wherein either or both may independently contain one or more different nucleotide modifications. In such embodiments, nucleotide modifications may also be present in the translatable region. Also provided are cosmetic polynucleotides, cosmetic primary constructs, and cosmetic mmRNA containing a Kozak sequence.

[000428] Exemplary syntheses of modified nucleotides, which are incorporated into a modified nucleic acid or mmRNA, e.g., RNA or mRNA, are provided below in Scheme 1 through Scheme 11. Scheme 1 provides a general method for phosphorylation of nucleosides, including modified nucleosides.

Scheme 1

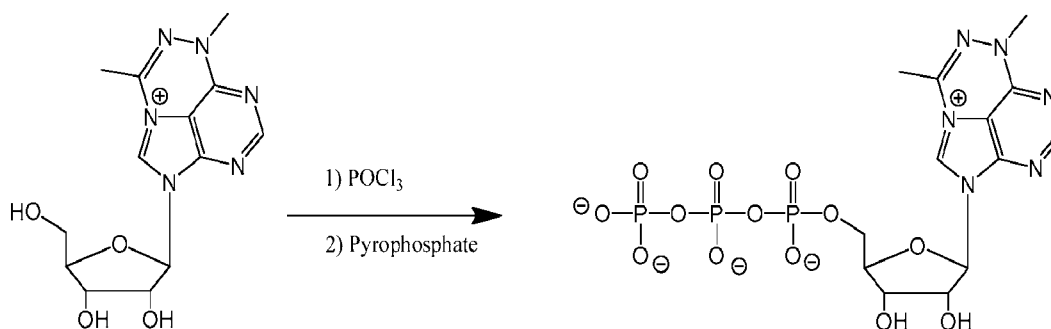

[000429] Various protecting groups may be used to control the reaction. For example, Scheme 2 provides the use of multiple protecting and deprotecting steps to promote phosphorylation at the 5' position of the sugar, rather than the 2' and 3' hydroxyl groups.

Scheme 2



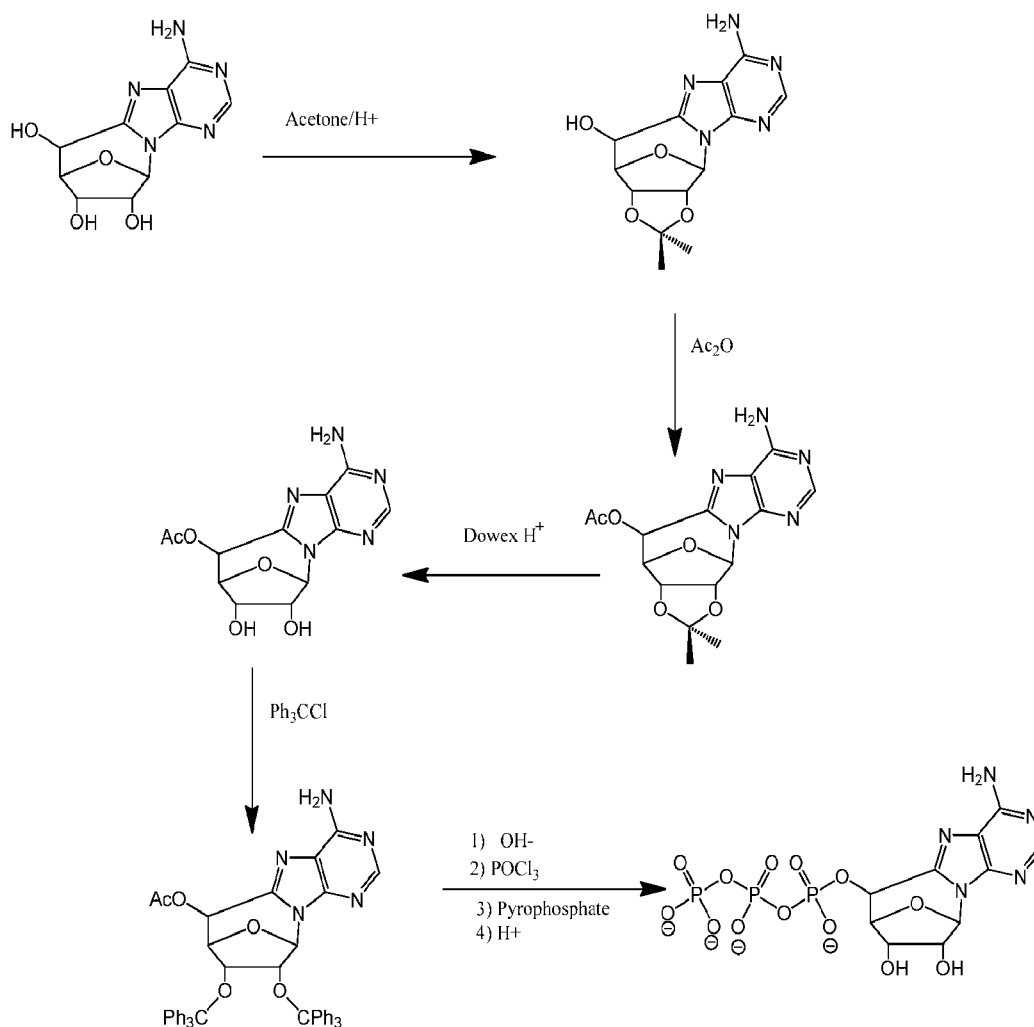

**[000430]** Modified nucleotides can be synthesized in any useful manner. Schemes 3, 4, and 7 provide exemplary methods for synthesizing modified nucleotides having a modified purine nucleobase; and Schemes 5 and 6 provide exemplary methods for synthesizing modified nucleotides having a modified pseudouridine or pseudoisocytidine, respectively.

Scheme 3

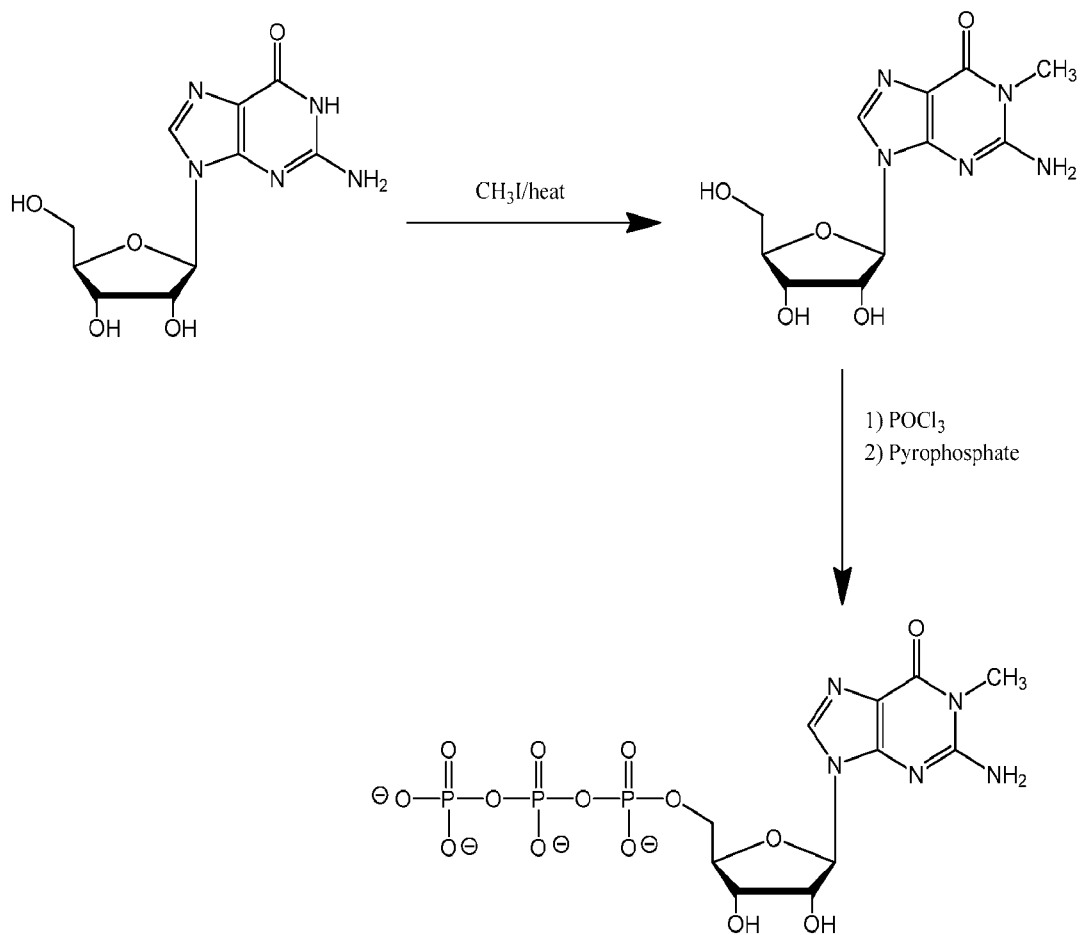

Scheme 4

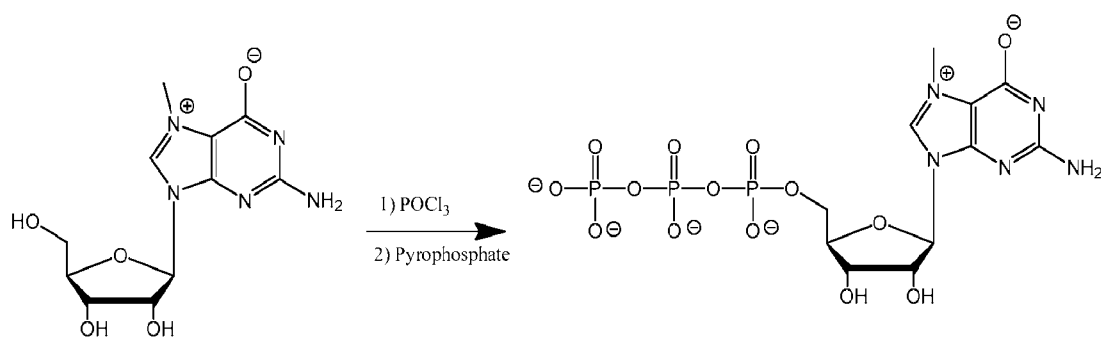

Scheme 5

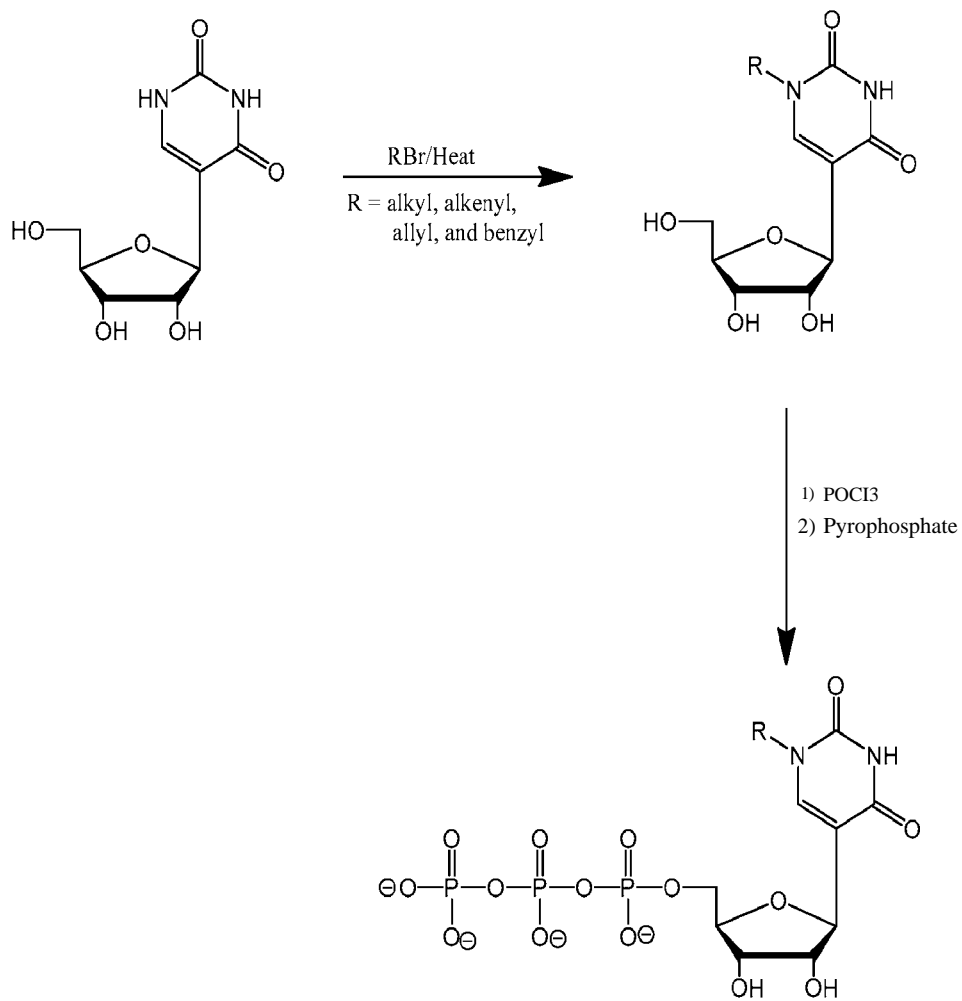

## Scheme 6

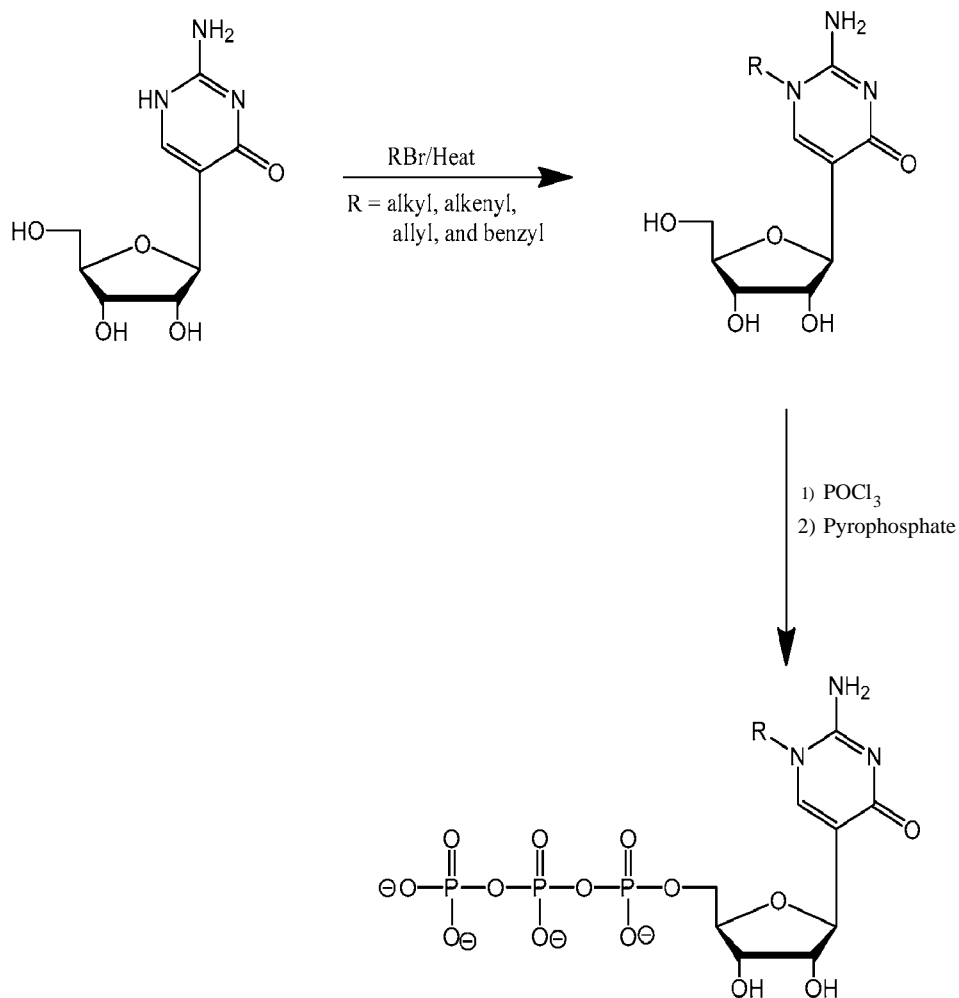

Scheme 7

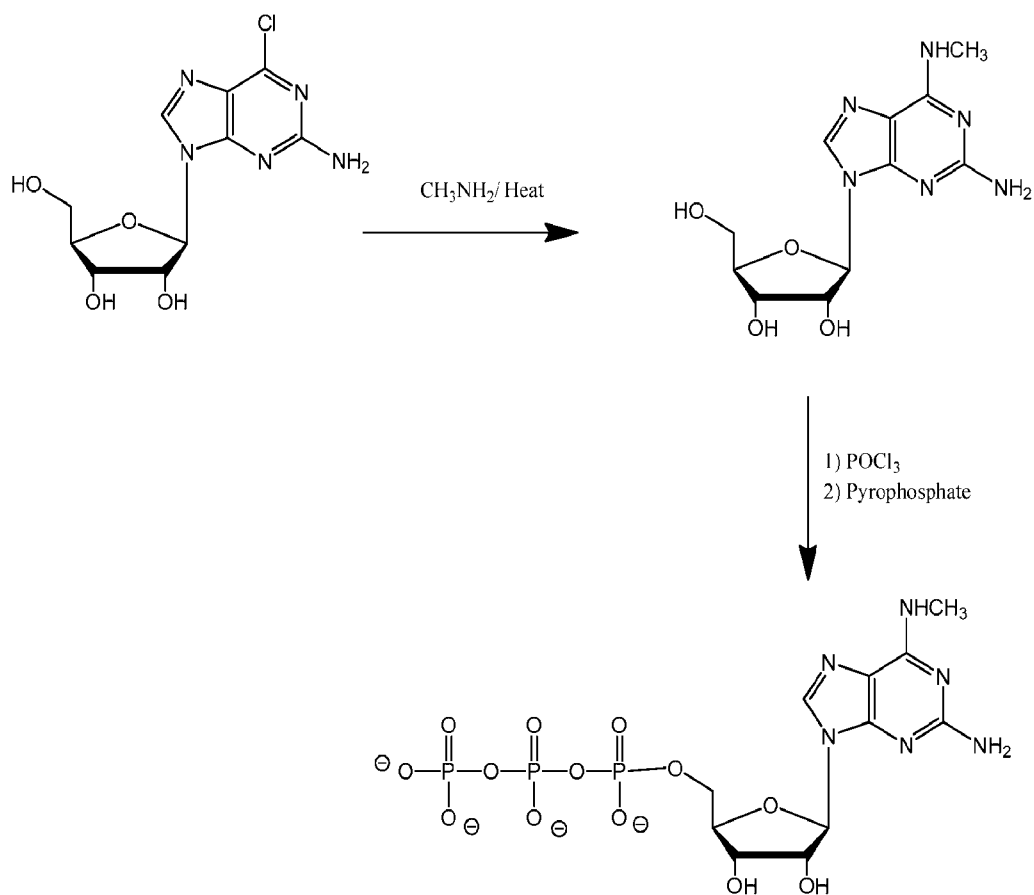

[000431] Schemes 8 and 9 provide exemplary syntheses of modified nucleotides. Scheme 10 provides a non-limiting biocatalytic method for producing nucleotides.

Scheme 8

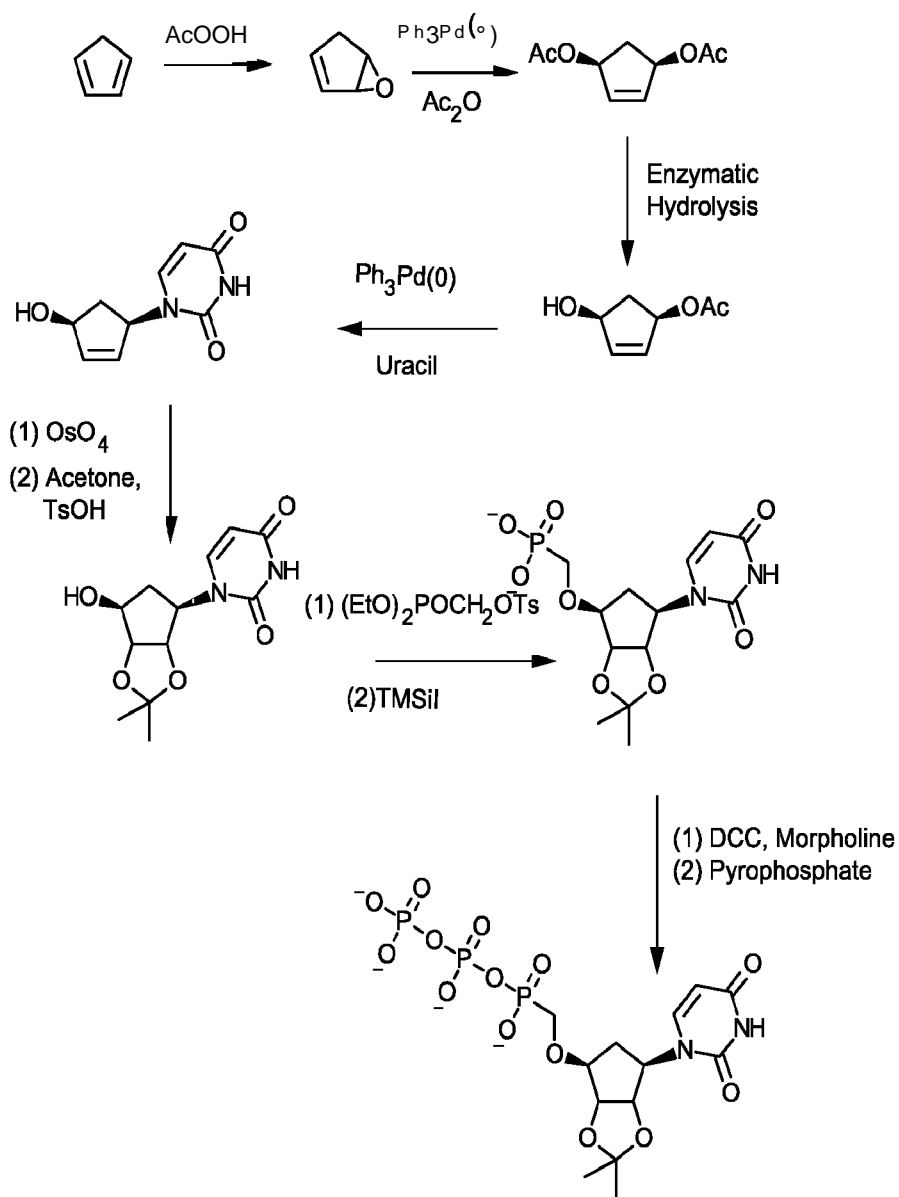

Scheme 9

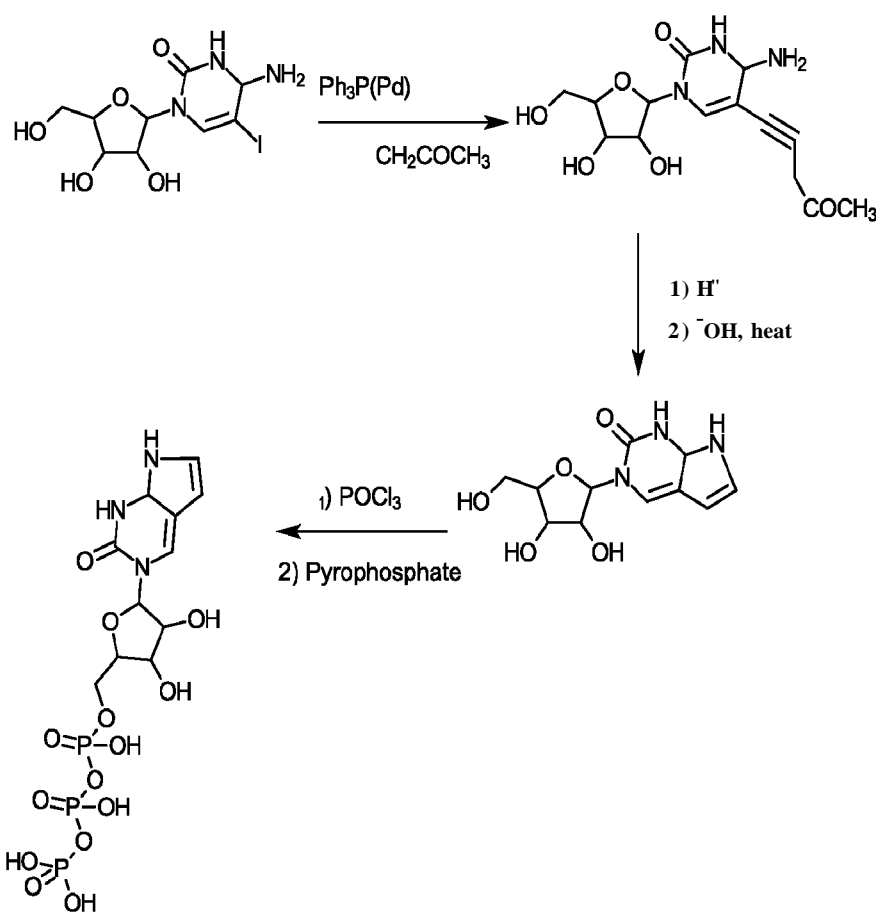

Scheme 10

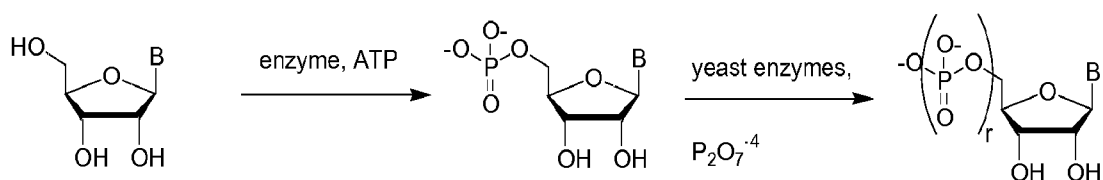

[000432] Scheme 11 provides an exemplary synthesis of a modified uracil, where the N1 position is modified with R12b, as provided elsewhere, and the 5'-position of ribose is phosphorylated. T1, T2, R12a, R12b, and r are as provided herein. This synthesis, as well as optimized versions thereof, can be used to modify other pyrimidine nucleobases and purine nucleobases (see e.g., Formulas (b1)-(b43)) and/or to install one or more phosphate groups (e.g., at the 5' position of the sugar). This alkylating reaction can also be used to include one or more optionally substituted alkyl group at any reactive group

(e.g., amino group) in any nucleobase described herein (e.g., the amino groups in the Watson-Crick base-pairing face for cytosine, uracil, adenine, and guanine).

Scheme 11

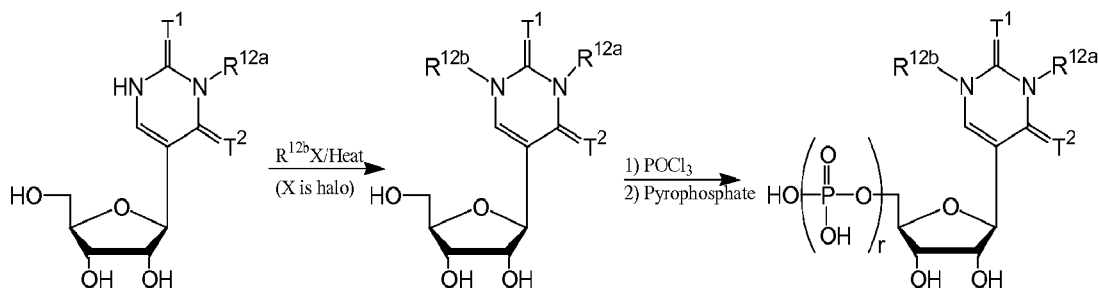

### Combinations of Nucleotides in mmRNA

**[000433]** Further examples of modified nucleotides and modified nucleotide combinations are provided below in Table 9. These combinations of modified nucleotides can be used to form the cosmetic polypeptides, cosmetic primary constructs, or cosmetic mmRNA of the invention.

**[000434]** Unless otherwise noted, the modified nucleotides may be completely substituted for the natural nucleotides of the modified nucleic acids or mmRNA of the invention. As a non-limiting example, the natural nucleotide uridine may be substituted with a modified nucleoside described herein. In another non-limiting example, the natural nucleotide uridine may be partially substituted (e.g., about 0.1%, 1%, 5%, 10%, 15%, 20%, 25%, 30%, 35%, 40%, 45%, 50%, 55%, 60%, 65%, 70%, 75%, 80%, 85%, 90%, 95% or 99.9%) with at least one of the modified nucleoside disclosed herein.

Table 9

Modified Nucleotide	Modified Nucleotide Combination
$\alpha$ -thio-cytidine	$\alpha$ -thio-cytidine/5-iodo-uridine
	$\alpha$ -thio-cytidine/N1-methyl-pseudouridine
	$\alpha$ -thio-cytidine/ $\alpha$ -thio-uridine
	$\alpha$ -thio-cytidine/5-methyl-uridine
	$\alpha$ -thio-cytidine/pseudo-uridine
	about 50% of the cytosines are $\alpha$ -thio-cytidine
pseudoisocytidine	pseudoisocytidine/5-iodo-uridine
	pseudoisocytidine/N1-methyl-pseudouridine
	pseudoisocytidine/ $\alpha$ -thio-uridine
	pseudoisocytidine/5-methyl-uridine
	pseudoisocytidine/pseudouridine
	about 25% of cytosines are pseudoisocytidine
	pseudoisocytidine/about 50% of uridines are N1-methyl-pseudouridine and about 50% of uridines are pseudouridine
pseudoisocytidine/about 25% of uridines are N1-methyl-	



	pseudouridine and about 25% of uridines are pseudouridine
pyrrolo-cytidine	pyrrolo-cytidine/5-iodo-uridine
	pyrrolo-cytidine/N1-methyl-pseudouridine
	pyrrolo-cytidine/a-thio-uridine
	pyrrolo-cytidine/5-methyl-uridine
	pyrrolo-cytidine/pseudouridine
	about 50% of the cytosines are pyrrolo-cytidine
5-methyl-cytidine	5-methyl-cytidine/5-iodo-uridine
	5-methyl-cytidine/N1-methyl-pseudouridine
	5-methyl-cytidine/a-thio-uridine
	5-methyl-cytidine/5-methyl-uridine
	5-methyl-cytidine/pseudouridine
	about 25% of cytosines are 5-methyl-cytidine
	about 50% of cytosines are 5-methyl-cytidine
	5-methyl-cytidine/5-methoxy-uridine
	5-methyl-cytidine/5-bromo-uridine
	5-methyl-cytidine/2-thio-uridine
	5-methyl-cytidine/about 50% of uridines are 2-thio-uridine
	about 50% of uridines are 5-methyl-cytidine/ about 50% of uridines are 2-thio-uridine
N4-acetyl-cytidine	N4-acetyl-cytidine /5-iodo-uridine
	N4-acetyl-cytidine /N1-methyl-pseudouridine
	N4-acetyl-cytidine /a-thio-uridine
	N4-acetyl-cytidine /5-methyl-uridine
	N4-acetyl-cytidine /pseudouridine
	about 50% of cytosines are N4-acetyl-cytidine
	about 25% of cytosines are N4-acetyl-cytidine
	N4-acetyl-cytidine /5-methoxy-uridine
	N4-acetyl-cytidine /5-bromo-uridine
	N4-acetyl-cytidine /2-thio-uridine
	about 50% of cytosines are N4-acetyl-cytidine/ about 50% of uridines are 2-thio-uridine

[000435] Further examples of modified nucleotide combinations are provided below in Table 10. These combinations of modified nucleotides can be used to form the polypeptides, primary constructs, or mmRNA of the invention.

Table 10

<u>Modified Nucleotide</u>	<u>Modified Nucleotide Combination</u>
modified cytidine having one or more nucleobases of Formula (b10)	modified cytidine with (b10)/pseudouridine
	modified cytidine with (b10)/N1-methyl-pseudouridine
	modified cytidine with (b10)/5-methoxy-uridine
	modified cytidine with (b10)/5-methyl-uridine
	modified cytidine with (b10)/5-bromo-uridine
	modified cytidine with (b10)/2-thio-uridine
	about 50% of cytidine substituted with modified cytidine (b10)/ about 50% of uridines are 2-thio-uridine
modified cytidine having one or more nucleobases of Formula (b32)	modified cytidine with (b32)/pseudouridine
	modified cytidine with (b32)/N1-methyl-pseudouridine
	modified cytidine with (b32)/5-methoxy-uridine
	modified cytidine with (b32)/5-methyl-uridine

	modified cytidine with (b32)/5-bromo-uridine
	modified cytidine with (b32)/2-thio-uridine
	about 50% of cytidine substituted with modified cytidine (b32)/ about 50% of uridines are 2-thio-uridine
modified uridine having one or more nucleobases of Formula (b1)	modified uridine with (b1)/ N4-acetyl-cytidine
	modified uridine with (b1)/ 5-methyl- cytidine
modified uridine having one or more nucleobases of Formula (b8)	modified uridine with (b8)/ N4-acetyl-cytidine
	modified uridine with (b8)/ 5-methyl-cytidine
modified uridine having one or more nucleobases of Formula (b28)	modified uridine with (b28)/ N4-acetyl-cytidine
	modified uridine with (b28)/ 5-methyl-cytidine
modified uridine having one or more nucleobases of Formula (b29)	modified uridine with (b29)/ N4-acetyl-cytidine
	modified uridine with (b29)/ 5-methyl-cytidine
modified uridine having one or more nucleobases of Formula (b30)	modified uridine with (b30)/ N4-acetyl-cytidine
	modified uridine with (b30)/ 5-methyl-cytidine

[000436] In some embodiments, at least 25% of the cytosines are replaced by a compound of Formula (M0)-(b14) (e.g., at least about 30%, at least about 35%, at least about 40%, at least about 45%, at least about 50%, at least about 55%, at least about 60%, at least about 65%, at least about 70%, at least about 75%, at least about 80%, at least about 85%, at least about 90%, at least about 95%, or about 100%).

[000437] In some embodiments, at least 25% of the uracils are replaced by a compound of Formula (b1)-(b9) (e.g., at least about 30%, at least about 35%, at least about 40%, at least about 45%, at least about 50%, at least about 55%, at least about 60%, at least about 65%, at least about 70%, at least about 75%, at least about 80%, at least about 85%, at least about 90%, at least about 95%, or about 100%).

[000438] In some embodiments, at least 25% of the cytosines are replaced by a compound of Formula (b10)-(b14), and at least 25% of the uracils are replaced by a compound of Formula (b1)-(b9) (e.g., at least about 30%, at least about 35%, at least about 40%, at least about 45%, at least about 50%, at least about 55%, at least about 60%, at least about 65%, at least about 70%, at least about 75%, at least about 80%, at least about 85%, at least about 90%, at least about 95%, or about 100%).

**IV. Pharmaceutical Compositions**

Formulation, Administration, Delivery and Dosing

[000439] The present invention provides cosmetic polynucleotides, cosmetic primary constructs and cosmetic mmRNA compositions and complexes in combination with one or more pharmaceutically acceptable excipients. Pharmaceutical compositions may optionally comprise one or more additional active substances, e.g. therapeutically and/or prophylactically active substances. General considerations in the formulation and/or manufacture of pharmaceutical agents may be found, for example, in *Remington: The Science and Practice of Pharmacy* 2<sup>1st</sup> ed., Lippincott Williams & Wilkins, 2005 (incorporated herein by reference).

[000440] In some embodiments, compositions are administered to humans, human patients or subjects. For the purposes of the present disclosure, the phrase "active ingredient" generally refers to cosmetic polynucleotides, cosmetic primary constructs and cosmetic mmRNA to be delivered as described herein.

[000441] Although the descriptions of pharmaceutical compositions provided herein are principally directed to pharmaceutical compositions which are suitable for administration to humans, it will be understood by the skilled artisan that such compositions are generally suitable for administration to any other animal, e.g., to non-human animals, e.g. non-human mammals. Modification of pharmaceutical compositions suitable for administration to humans in order to render the compositions suitable for administration to various animals is well understood, and the ordinarily skilled veterinary pharmacologist can design and/or perform such modification with merely ordinary, if any, experimentation. Subjects to which administration of the pharmaceutical compositions is contemplated include, but are not limited to, humans and/or other primates; mammals, including commercially relevant mammals such as cattle, pigs, horses, sheep, cats, dogs, mice, and/or rats; and/or birds, including commercially relevant birds such as poultry, chickens, ducks, geese, and/or turkeys.

[000442] Formulations of the pharmaceutical compositions described herein may be prepared by any method known or hereafter developed in the art of pharmacology. In general, such preparatory methods include the step of bringing the active ingredient into association with an excipient and/or one or more other accessory ingredients, and then, if necessary and/or desirable, dividing, shaping and/or packaging the product into a desired single- or multi-dose unit.

[000443] A pharmaceutical composition in accordance with the invention may be prepared, packaged, and/or sold in bulk, as a single unit dose, and/or as a plurality of single unit doses. As used herein, a "unit dose" is discrete amount of the pharmaceutical composition comprising a predetermined amount of the active ingredient. The amount of the active ingredient is generally equal to the dosage of the active ingredient which would be administered to a subject and/or a convenient fraction of such a dosage such as, for example, one-half or one-third of such a dosage.

[000444] Relative amounts of the active ingredient, the pharmaceutically acceptable excipient, and/or any additional ingredients in a pharmaceutical composition in accordance with the invention will vary, depending upon the identity, size, and/or condition of the subject treated and further depending upon the route by which the composition is to be administered. By way of example, the composition may comprise between 0.1% and 100%, e.g., between .5 and 50%, between 1-30%, between 5-80%, at least 80%, (w/w) active ingredient.

#### Formulations

[000445] The cosmetic polynucleotide, cosmetic primary construct, and cosmetic mmRNA of the invention can be formulated using one or more excipients to: (1) increase stability; (2) increase cell transfection; (3) permit the sustained or delayed release (e.g., from a depot formulation of the cosmetic polynucleotide, cosmetic primary construct, or mmRNA); (4) alter the biodistribution (e.g., target the cosmetic polynucleotide, cosmetic primary construct, or cosmetic mmRNA to specific tissues or cell types); (5) increase the translation of encoded protein *in vivo*; and/or (6) alter the release profile of encoded protein *in vivo*. In addition to traditional excipients such as any and all solvents, dispersion media, diluents, or other liquid vehicles, dispersion or suspension aids, surface active agents, isotonic agents, thickening or emulsifying agents, preservatives, excipients of the present invention can include, without limitation, lipidoids, liposomes, lipid nanoparticles, polymers, lipoplexes, core-shell nanoparticles, peptides, proteins, cells transfected with cosmetic polynucleotide, primary cosmetic construct, or cosmetic mmRNA (e.g., for transplantation into a subject), hyaluronidase, nanoparticle mimics and combinations thereof. Accordingly, the formulations of the invention can include one or more excipients, each in an amount that together increases

the stability of the cosmetic polynucleotide, cosmetic primary construct, or cosmetic mmRNA, increases cell transfection by the cosmetic polynucleotide, cosmetic primary construct, or cosmetic mmRNA, increases the expression of cosmetic polynucleotide, cosmetic primary construct, or cosmetic mmRNA encoded protein, and/or alters the release profile of cosmetic polynucleotide, cosmetic primary construct, or cosmetic mmRNA encoded proteins. Further, the cosmetic primary construct and cosmetic mmRNA of the present invention may be formulated using self-assembled nucleic acid nanoparticles.

[000446] Formulations of the pharmaceutical compositions described herein may be prepared by any method known or hereafter developed in the art of pharmacology. In general, such preparatory methods include the step of associating the active ingredient with an excipient and/or one or more other accessory ingredients.

[000447] A pharmaceutical composition in accordance with the present disclosure may be prepared, packaged, and/or sold in bulk, as a single unit dose, and/or as a plurality of single unit doses. As used herein, a "unit dose" refers to a discrete amount of the pharmaceutical composition comprising a predetermined amount of the active ingredient. The amount of the active ingredient may generally be equal to the dosage of the active ingredient which would be administered to a subject and/or a convenient fraction of such a dosage including, but not limited to, one-half or one-third of such a dosage.

[000448] Relative amounts of the active ingredient, the pharmaceutically acceptable excipient, and/or any additional ingredients in a pharmaceutical composition in accordance with the present disclosure may vary, depending upon the identity, size, and/or condition of the subject being treated and further depending upon the route by which the composition is to be administered. For example, the composition may comprise between 0.1% and 99% (w/w) of the active ingredient.

[000449] In some embodiments, the formulations described herein may contain at least one cosmetic mmRNA. As a non-limiting example, the formulations may contain 1, 2, 3, 4 or 5 cosmetic mmRNA. In one embodiment the formulation may contain modified mRNA encoding proteins selected from categories such as, cosmetic proteins. In one embodiment, the formulation contains at least three cosmetic modified mRNA encoding cosmetic proteins. In one embodiment, the formulation contains at least five cosmetic

modified mRNA encoding cosmetic proteins. Pharmaceutical formulations may additionally comprise a pharmaceutically acceptable excipient, which, as used herein, includes, but is not limited to, any and all solvents, dispersion media, diluents, or other liquid vehicles, dispersion or suspension aids, surface active agents, isotonic agents, thickening or emulsifying agents, preservatives, and the like, as suited to the particular dosage form desired. Various excipients for formulating pharmaceutical compositions and techniques for preparing the composition are known in the art (see Remington: The Science and Practice of Pharmacy, 21<sup>st</sup> Edition, A. R. Gennaro, Lippincott, Williams & Wilkins, Baltimore, MD, 2006; incorporated herein by reference in its entirety). The use of a conventional excipient medium may be contemplated within the scope of the present disclosure, except insofar as any conventional excipient medium may be incompatible with a substance or its derivatives, such as by producing any undesirable biological effect or otherwise interacting in a deleterious manner with any other component(s) of the pharmaceutical composition.

**[000450]** In some embodiments, the particle size of the lipid nanoparticle may be increased and/or decreased. The change in particle size may be able to help counter biological reaction such as, but not limited to, inflammation or may increase the biological effect of the cosmetic modified mRNA delivered to mammals.

**[000451]** Pharmaceutically acceptable excipients used in the manufacture of pharmaceutical compositions include, but are not limited to, inert diluents, surface active agents and/or emulsifiers, preservatives, buffering agents, lubricating agents, and/or oils. Such excipients may optionally be included in the pharmaceutical formulations of the invention.

#### *Lipidoids*

**[000452]** The synthesis of lipidoids has been extensively described and formulations containing these compounds are particularly suited for delivery of cosmetic polynucleotides, primary constructs or mmRNA (see Mahon et al., Bioconjug Chem. 2010 21:1448-1454; Schroeder et al, J Intern Med. 2010 267:9-21; Akinc et al, Nat Biotechnol. 2008 26:561-569; Love et al, Proc Natl Acad Sci U S A. 2010 107:1864-1869; Siegwart et al, Proc Natl Acad Sci U S A. 2011 108:12996-3001; all of which are incorporated herein in their entireties).

[000453] While these lipidoids have been used to effectively deliver double stranded small interfering RNA molecules in rodents and non-human primates (see Akinc et al., Nat Biotechnol. 2008 26:561-569; Frank-Kamenetsky et al, Proc Natl Acad Sci U S A. 2008 105:1 1915-1 1920; Akinc et al., Mol Ther. 2009 17:872-879; Love et al., Proc Natl Acad Sci U S A. 2010 107:1864-1869; Leuschner et al, Nat Biotechnol. 2011 29:1005-1010; all of which is incorporated herein in their entirety), the present disclosure describes their formulation and use in delivering single stranded cosmetic polynucleotides, primary constructs, or mmRNA. Complexes, micelles, liposomes or particles can be prepared containing these lipidoids and therefore, can result in an effective delivery of the cosmetic polynucleotide, primary construct, or mmRNA, as judged by the production of an encoded protein, following the injection of a lipidoid formulation via localized and/or systemic routes of administration. Lipidoid complexes of cosmetic polynucleotides, primary constructs, or mmRNA can be administered by various means including, but not limited to, intravenous, intramuscular, or subcutaneous routes.

[000454] *In vivo* delivery of nucleic acids may be affected by many parameters, including, but not limited to, the formulation composition, nature of particle PEGylation, degree of loading, oligonucleotide to lipid ratio, and biophysical parameters such as, but not limited to, particle size (Akinc et al., Mol Ther. 2009 17:872-879; herein incorporated by reference in its entirety). As an example, small changes in the anchor chain length of poly(ethylene glycol) (PEG) lipids may result in significant effects on *in vivo* efficacy. Formulations with the different lipidoids, including, but not limited to penta[3-(1-laurylamino propionyl)]-triethylenetetramine hydrochloride (TETA-5LAP; aka 98N12-5, see Murugaiah et al., Analytical Biochemistry, 401 :61 (2010); herein incorporated by reference in its entirety), C12-200 (including derivatives and variants), and MD1, can be tested for *in vivo* activity.

[000455] The lipidoid referred to herein as "98N12-5" is disclosed by Akinc et al, Mol Ther. 2009 17:872-879 and is incorporated by reference in its entirety. (See Figure 2)

[000456] The lipidoid referred to herein as "C12-200" is disclosed by Love et al, Proc Natl Acad Sci U S A. 2010 107:1864-1869 (see Figure 2) and Liu and Huang, Molecular Therapy. 2010 669-670 (see Figure 2); both of which are herein incorporated by

reference in their entirety. The lipidoid formulations can include particles comprising either 3 or 4 or more components in addition to cosmetic polynucleotide, primary construct, or mmRNA. As an example, formulations with certain lipidoids, include, but are not limited to, 98N12-5 and may contain 42% lipidoid, 48% cholesterol and 10% PEG (C14 alkyl chain length). As another example, formulations with certain lipidoids, include, but are not limited to, C12-200 and may contain 50% lipidoid, 10% distearylphosphatidyl choline, 38.5% cholesterol, and 1.5% PEG-DMG.

**[000457]** In one embodiment, a cosmetic polynucleotide, primary construct, or mmRNA formulated with a lipidoid for systemic intravenous administration can target the liver. For example, a final optimized intravenous formulation using a cosmetic polynucleotide, primary construct, or mmRNA, and comprising a lipid molar composition of 42% 98N12-5, 48% cholesterol, and 10% PEG-lipid with a final weight ratio of about 7.5 to 1 total lipid to cosmetic polynucleotide, primary construct, or mmRNA, and a C14 alkyl chain length on the PEG lipid, with a mean particle size of roughly 50-60 nm, can result in the distribution of the formulation to be greater than 90% to the liver.(see, Akinc et al, Mol Ther. 2009 17:872-879; herein incorporated by reference in its entirety). In another example, an intravenous formulation using a C12-200 (see US provisional application 61/175,770 and published international application WO2010129709, each of which is herein incorporated by reference in their entirety) lipidoid may have a molar ratio of 50/10/38.5/1.5 of C12-200/distearylphosphatidyl choline/cholesterol/PEG-DMG, with a weight ratio of 7 to 1 total lipid to cosmetic polynucleotide, primary construct, or mmRNA, and a mean particle size of 80 nm may be effective to deliver cosmetic polynucleotide, primary construct, or mmRNA to hepatocytes (see, Love et al., Proc Natl Acad Sci U S A. 2010 107:1864-1869 herein incorporated by reference in its entirety). In another embodiment, an MD1 lipidoid-containing formulation may be used to effectively deliver cosmetic polynucleotide, primary construct, or mmRNA to hepatocytes *in vivo*. The characteristics of optimized lipidoid formulations for intramuscular or subcutaneous routes may vary significantly depending on the target cell type and the ability of formulations to diffuse through the extracellular matrix into the blood stream. While a particle size of less than 150 nm may be desired for effective hepatocyte delivery due to the size of the endothelial fenestrae



(see, Akinc et al., Mol Ther. 2009 17:872-879 herein incorporated by reference in its entirety), use of a lipidoid-formulated cosmetic polynucleotide, primary construct, or mmRNA to deliver the formulation to other cells types including, but not limited to, endothelial cells, myeloid cells, and muscle cells may not be similarly size-limited. Use of lipidoid formulations to deliver siRNA in vivo to other non-hepatocyte cells such as myeloid cells and endothelium has been reported (see Akinc et al., Nat Biotechnol. 2008 26:561-569; Leuschner et al, Nat Biotechnol. 2011 29:1005-1010; Cho et al. Adv. Funct. Mater. 2009 19:31 12-31 18; 8<sup>th</sup> International Judah Folkman Conference, Cambridge, MA October 8-9, 2010; each of which is herein incorporated by reference in its entirety). Effective delivery to myeloid cells, such as monocytes, lipidoid formulations may have a similar component molar ratio. Different ratios of lipidoids and other components including, but not limited to, distearylphosphatidyl choline, cholesterol and PEG-DMG, may be used to optimize the formulation of the cosmetic polynucleotide, primary construct, or mmRNA for delivery to different cell types including, but not limited to, hepatocytes, myeloid cells, muscle cells, etc. For example, the component molar ratio may include, but is not limited to, 50% C12-200, 10% distearylphosphatidyl choline, 38.5% cholesterol, and %1.5 PEG-DMG (see Leuschner et al, Nat Biotechnol 2011 29:1005-1010; herein incorporated by reference in its entirety). The use of lipidoid formulations for the localized delivery of nucleic acids to cells (such as, but not limited to, adipose cells and muscle cells) via either subcutaneous or intramuscular delivery, may not require all of the formulation components desired for systemic delivery, and as such may comprise only the lipidoid and the cosmetic polynucleotide, primary construct, or mmRNA.

[000458] Combinations of different lipidoids may be used to improve the efficacy of cosmetic polynucleotide, primary construct, or mmRNA directed protein production as the lipidoids may be able to increase cell transfection by the cosmetic polynucleotide, primary construct, or mmRNA; and/or increase the translation of encoded protein (see Whitehead et al, Mol. Ther. 2011, 19: 1688-1694, herein incorporated by reference in its entirety).

*Liposomes, Lipoplexes, and Lipid Nanoparticles*

[000459] The cosmetic polynucleotide, primary construct, and mmRNA of the invention can be formulated using one or more liposomes, lipoplexes, or lipid nanoparticles. In one embodiment, pharmaceutical compositions of polynucleotide, primary construct, or mmRNA include liposomes. Liposomes are artificially-prepared vesicles which may primarily be composed of a lipid bilayer and may be used as a delivery vehicle for the administration of nutrients and pharmaceutical formulations. Liposomes can be of different sizes such as, but not limited to, a multilamellar vesicle (MLV) which may be hundreds of nanometers in diameter and may contain a series of concentric bilayers separated by narrow aqueous compartments, a small unicellular vesicle (SUV) which may be smaller than 50 nm in diameter, and a large unilamellar vesicle (LUV) which may be between 50 and 500 nm in diameter. Liposome design may include, but is not limited to, opsonins or ligands in order to improve the attachment of liposomes to unhealthy tissue or to activate events such as, but not limited to, endocytosis. Liposomes may contain a low or a high pH in order to improve the delivery of the pharmaceutical formulations.

[000460] The formation of liposomes may depend on the physicochemical characteristics such as, but not limited to, the pharmaceutical formulation entrapped and the liposomal ingredients, the nature of the medium in which the lipid vesicles are dispersed, the effective concentration of the entrapped substance and its potential toxicity, any additional processes involved during the application and/or delivery of the vesicles, the optimization size, polydispersity and the shelf-life of the vesicles for the intended application, and the batch-to-batch reproducibility and possibility of large-scale production of safe and efficient liposomal products.

[000461] In one embodiment, pharmaceutical compositions described herein may include, without limitation, liposomes such as those formed from 1,2-dioleoyloxy-*NN*-dimethylaminopropane (DODMA) liposomes, DiLa2 liposomes from Marina Biotech (Bothell, WA), 1,2-dilinoleoyloxy-3-dimethylaminopropane (DLin-DMA), 2,2-dilinoleyl-4-(2-dimethylaminoethyl)-[1,3]-dioxolane (DLin-KC2-DMA), and MC3 (US20 100324 120; herein incorporated by reference in its entirety) and liposomes which may deliver small molecule drugs such as, but not limited to, DOXIL® from Janssen Biotech, Inc. (Horsham, PA).

[000462] In one embodiment, pharmaceutical compositions described herein may include, without limitation, liposomes such as those formed from the synthesis of stabilized plasmid-lipid particles (SPLP) or stabilized nucleic acid lipid particle (SNALP) that have been previously described and shown to be suitable for oligonucleotide delivery in vitro and in vivo (see Wheeler et al. *Gene Therapy*. 1999 6:271-281; Zhang et al. *Gene Therapy*. 1999 6:1438-1447; Jeffs et al. *Pharm Res*. 2005 22:362-372; Morrissey et al, *Nat Biotechnol*. 2005 2:1002-1007; Zimmermann et al., *Nature*. 2006 441:11 1-1 14; Heyes et al. *J Contr Rel*. 2005 107:276-287; Semple et al. *Nature Biotech*. 2010 28:172-176; Judge et al. *J Clin Invest*. 2009 119:661-673; deFougerolles *Hum Gene Ther*. 2008 19:125-132; all of which are incorporated herein in their entirety). The original manufacture method by Wheeler et al. was a detergent dialysis method, which was later improved by Jeffs et al. and is referred to as the spontaneous vesicle formation method. The liposome formulations are composed of 3 to 4 lipid components in addition to the cosmetic polynucleotide, primary construct, or mmRNA. As an example a liposome can contain, but is not limited to, 55% cholesterol, 20% distearylphosphatidyl choline (DSPC), 10% PEG-S-DSG, and 15% 1,2-dioleoyloxy -*N,N*-dimethylaminopropane (DODMA), as described by Jeffs et al. As another example, certain liposome formulations may contain, but are not limited to, 48% cholesterol, 20% DSPC, 2% PEG-c-DMA, and 30% cationic lipid, where the cationic lipid can be 1,2-distearloxy -*N,N*-dimethylaminopropane (DSDMA), DODMA, DLin-DMA, or 1,2-dilinolenyloxy-3-dimethylaminopropane (DLenDMA), as described by Heyes et al.

[000463] In one embodiment, pharmaceutical compositions may include liposomes which may be formed to deliver mmRNA which may encode at least one immunogen. The mmRNA may be encapsulated by the liposome and/or it may be contained in an aqueous core which may then be encapsulated by the liposome (see International Pub. Nos. WO2012031046, WO2012031043, WO2012030901 and WO2012006378; each of which is herein incorporated by reference in their entirety). In another embodiment, the mmRNA which may encode an immunogen may be formulated in a cationic oil-in-water emulsion where the emulsion particle comprises an oil core and a cationic lipid which can interact with the mmRNA anchoring the molecule to the emulsion particle (see International Pub. No. WO2012006380; herein incorporated by reference in its entirety).

In yet another embodiment, the lipid formulation may include at least cationic lipid, a lipid which may enhance transfection and a least one lipid which contains a hydrophilic head group linked to a lipid moiety (International Pub. No. WO201 1076807 and U.S. Pub. No. 201 10200582; each of which is herein incorporated by reference in their entirety). In another embodiment, the cosmetic polynucleotides, primary constructs and/or mmRNA encoding an immunogen may be formulated in a lipid vesicle which may have crosslinks between functionalized lipid bilayers (see U.S. Pub. No. 20120177724, herein incorporated by reference in its entirety).

[000464] In one embodiment, the cosmetic polynucleotides, primary constructs and/or mmRNA may be formulated in a lipid vesicle which may have crosslinks between functionalized lipid bilayers.

[000465] In one embodiment, the cosmetic polynucleotides, primary constructs and/or mmRNA may be formulated in a liposome comprising a cationic lipid. The liposome may have a molar ratio of nitrogen atoms in the cationic lipid to the phosphates in the RNA (N:P ratio) of between 1:1 and 20:1 as described in International Publication No. WO2013006825, herein incorporated by reference in its entirety. In another embodiment, the liposome may have a N:P ratio of greater than 20: 1 or less than 1:1.

[000466] In one embodiment, the cosmetic polynucleotides, primary constructs and/or mmRNA may be formulated in a lipid-polycation complex. The formation of the lipid-polycation complex may be accomplished by methods known in the art and/or as described in U.S. Pub. No. 20120178702, herein incorporated by reference in its entirety. As a non-limiting example, the polycation may include a cationic peptide or a polypeptide such as, but not limited to, polylysine, polyomithine and/or polyarginine and the cationic peptides described in International Pub. No. WO2012013326; herein incorporated by reference in its entirety. In another embodiment, the cosmetic polynucleotides, primary constructs and/or mmRNA may be formulated in a lipid-polycation complex which may further include a neutral lipid such as, but not limited to, cholesterol or dioleoyl phosphatidylethanolamine (DOPE).

[000467] The liposome formulation may be influenced by, but not limited to, the selection of the cationic lipid component, the degree of cationic lipid saturation, the nature of the PEGylation, ratio of all components and biophysical parameters such as

size. In one example by Semple et al. (Semple et al. Nature Biotech. 2010 28:172-176; herein incorporated by reference in its entirety), the liposome formulation was composed of 57.1 % cationic lipid, 7.1% dipalmitoylphosphatidylcholine, 34.3 % cholesterol, and 1.4% PEG-c-DMA. As another example, changing the composition of the cationic lipid could more effectively deliver siRNA to various antigen presenting cells (Basha et al. Mol Ther. 2011 19:2186-2200; herein incorporated by reference in its entirety).

**[000468]** In some embodiments, the ratio of PEG in the lipid nanoparticle (LNP) formulations may be increased or decreased and/or the carbon chain length of the PEG lipid may be modified from C14 to C18 to alter the pharmacokinetics and/or biodistribution of the LNP formulations. As a non-limiting example, LNP formulations may contain 1-5% of the lipid molar ratio of PEG-c-DOMG as compared to the cationic lipid, DSPC and cholesterol. In another embodiment the PEG-c-DOMG may be replaced with a PEG lipid such as, but not limited to, PEG-DSG (1,2-Distearoyl-sn-glycerol, methoxypolyethylene glycol) or PEG-DPG (1,2-Dipalmitoyl-sn-glycerol, methoxypolyethylene glycol). The cationic lipid may be selected from any lipid known in the art such as, but not limited to, DLin-MC3-DMA, DLin-DMA, C12-200 and DLin-KC2-DMA.

**[000469]** In one embodiment, the cosmetic polynucleotides, primary constructs or mmPvNA may be formulated in a lipid nanoparticle such as those described in International Publication No. WO2012/170930, herein incorporated by reference in its entirety.

**[000470]** In one embodiment, the cationic lipid may be selected from, but not limited to, a cationic lipid described in International Publication Nos. WO2012/040184, WO2011/153120, WO2011/49733, WO2011/090965, WO2011/043913, WO2011/022460, WO2012/061259, WO2012/054365, WO2012/044638, WO2010/080724, WO2010/21865 and WO2008/103276, US Patent Nos. 7,893,302, 7,404,969 and 8,283,333 and US Patent Publication No. US2010/0036115 and US2012/0202871; each of which is herein incorporated by reference in their entirety. In another embodiment, the cationic lipid may be selected from, but not limited to, formula A described in International Publication Nos. WO2012/040184, WO2011/153120, WO2011/49733, WO2011/090965, WO2011/043913, WO2011/022460, WO2012/061259, WO2012/054365 and

WO2012044638; each of which is herein incorporated by reference in their entirety. In yet another embodiment, the cationic lipid may be selected from, but not limited to, formula CLI-CLXXIX of International Publication No. WO2008 103276, formula CLI-CLXXIX of US Patent No. 7,893,302, formula CLI-CLXXXXII of US Patent No. 7,404,969 and formula I-VI of US Patent Publication No. US201000361 15; each of which is herein incorporated by reference in their entirety. As a non-limiting example, the cationic lipid may be selected from (20Z,23Z)-N,N-dimethylnonacos-20,23-dien-10-amine, (17Z,20Z)-N,N-dimethylhexacos-17,20-dien-9-amine, (1Z,19Z)-N,N-dimethylpentacos-16,19-dien-8-amine, (13Z,16Z)-N,N-dimethyldocos-13,16-dien-5-amine, (12Z,15Z)-N,N-dimethylhenicos-12,15-dien-4-amine, (14Z,17Z)-N,N-dimethyltricos-14,17-dien-6-amine, (15Z,18Z)-N,N-dimethyltetracos-15,18-dien-7-amine, (18Z,21Z)-N,N-dimethylheptacos-18,21-dien-10-amine, (15Z,18Z)-N,N-dimethyltetracos-15,18-dien-5-amine, (14Z,17Z)-N,N-dimethyltricos-14,17-dien-4-amine, (19Z,22Z)-N,N-dimethyloctacos-19,22-dien-9-amine, (18Z,21Z)-N,N-dimethylheptacos-18,21-dien-8-amine, (17Z,20Z)-N,N-dimethylhexacos-17,20-dien-7-amine, (16Z,19Z)-N,N-dimethylpentacos-16,19-dien-6-amine, (22Z,25Z)-N,N-dimethylhentriacont-22,25-dien-10-amine, (21Z,24Z)-N,N-dimethyltriacont-21,24-dien-9-amine, (18Z)-N,N-dimethylheptacos-18-en-10-amine, (17Z)-N,N-dimethylhexacos-17-en-9-amine, (19Z,22Z)-N,N-dimethyloctacos-19,22-dien-7-amine, N,N-dimethylheptacos-10-amine, (20Z,23Z)-N-ethyl-N-methylnonacos-20,23-dien-10-amine, 1-[(11Z,14Z)-1-nonylicos-11,14-dien-1-yl]pyrrolidine, (20Z)-N,N-dimethylheptacos-20-en-10-amine, (15Z)-N,N-dimethylheptacos-15-en-10-amine, (14Z)-N,N-dimethylnonacos-14-en-10-amine, (17Z)-N,N-dimethylnonacos-17-en-10-amine, (24Z)-N,N-dimethyltritriacont-24-en-10-amine, (20Z)-N,N-dimethylnonacos-20-en-10-amine, (22Z)-N,N-dimethylhentriacont-22-en-10-amine, (16Z)-N,N-dimethylpentacos-16-en-8-amine, (12Z,15Z)-N,N-dimethyl-2-nonylhenicos-12,15-dien-1-amine, (13Z,16Z)-N,N-dimethyl-3-nonyldocos-13,16-dien-1-amine, N,N-dimethyl-1-[(1S,2R)-2-octylcyclopropyl]heptadecan-8-amine, 1-[(1S,2R)-2-hexylcyclopropyl]-N,N-dimethylnonadecan-10-amine, N,N-dimethyl-1-[(1S,2R)-2-octylcyclopropyl]nonadecan-10-amine, N,N-dimethyl-21-[(1S,2R)-2-octylcyclopropyl]henicosan-10-amine, N,N-dimethyl-1-[(1S,2S)-2-[(1R,2R)-2-pentylcyclopropyl]methyl]cyclopropyl]nonadecan-

10-amine, N,N-dimethyl-1-[(1S,2R)-2-octylcyclopropyl]hexadecan-8-amine, N,N-dimethyl-[(1R,2S)-2-undecylcyclopropyl]tetradecan-5-amine, N,N-dimethyl-3-{7-[(1S,2R)-2-octylcyclopropyl]heptyl} dodecan-1-amine, 1-[(1R,2S)-2-heptylcyclopropyl]-N,N-dimethyloctadecan-9-amine, 1-[(1S,2R)-2-decylcyclopropyl]-N,N-dimethylpentadecan-6-amine, N,N-dimethyl-1-[(1S,2R)-2-octylcyclopropyl]pentadecan-8-amine, R-N,N-dimethyl-1-[(9Z,12Z)-octadeca-9,12-dien-1-yloxy]-3-(octyloxy)propan-2-amine, S-N,N-dimethyl-1-[(9Z,12Z)-octadeca-9,12-dien-1-yloxy]-3-(octyloxy)propan-2-amine, 1-{2-[(9Z,12Z)-octadeca-9,12-dien-1-yloxy]-1-[(octyloxy)methyl]ethyl}pyrrolidine, (2S)-N,N-dimethyl-1-[(9Z,12Z)-octadeca-9,12-dien-1-yloxy]-3-[(5Z)-oct-5-en-1-yloxy]propan-2-amine, 1-{2-[(9Z,12Z)-octadeca-9,12-dien-1-yloxy]-1-[(octyloxy)methyl]ethyl}azetidine, (2S)-1-(hexyloxy)-N,N-dimethyl-3-[(9Z,12Z)-octadeca-9,12-dien-1-yloxy]propan-2-amine, (2S)-1-(heptyloxy)-N,N-dimethyl-3-[(9Z,12Z)-octadeca-9,12-dien-1-yloxy]propan-2-amine, N,N-dimethyl-1-(nonyloxy)-3-[(9Z,12Z)-octadeca-9,12-dien-1-yloxy]propan-2-amine, N,N-dimethyl-1-[(9Z)-octadec-9-en-1-yloxy]-3-(octyloxy)propan-2-amine; (2S)-N,N-dimethyl-1-[(6Z,9Z,12Z)-octadeca-6,9,12-trien-1-yloxy]-3-(octyloxy)propan-2-amine, (2S)-1-[(11Z,14Z)-icosa-11,14-dien-1-yloxy]-N,N-dimethyl-3-(pentyloxy)propan-2-amine, (2S)-1-(hexyloxy)-3-[(11Z,14Z)-icosa-11,14-dien-1-yloxy]-N,N-dimethylpropan-2-amine, 1-[(11Z,14Z)-icosa-11,14-dien-1-yloxy]-N,N-dimethyl-3-(octyloxy)propan-2-amine, 1-[(13Z,16Z)-docosa-13,16-dien-1-yloxy]-N,N-dimethyl-3-(octyloxy)propan-2-amine, (2S)-1-[(13Z,16Z)-docosa-13,16-dien-1-yloxy]-3-(hexyloxy)-N,N-dimethylpropan-2-amine, (2S)-1-[(13Z)-docos-13-en-1-yloxy]-3-(hexyloxy)-N,N-dimethylpropan-2-amine, 1-[(13Z)-docos-13-en-1-yloxy]-N,N-dimethyl-3-(octyloxy)propan-2-amine, 1-[(9Z)-hexadec-9-en-1-yloxy]-N,N-dimethyl-3-(octyloxy)propan-2-amine, (2R)-N,N-dimethyl-H(1-methoxyloxy)-3-[(9Z,12Z)-octadeca-9,12-dien-1-yloxy]propan-2-amine, (2R)-1-[(3,7-dimethyloctyl)oxy]-N,N-dimethyl-3-[(9Z,12Z)-octadeca-9,12-dien-1-yloxy]propan-2-amine, N,N-dimethyl-1-(octyloxy)-3-[(8-[(1S,2S)-2-[(1R,2R)-2-pentylcyclopropyl]methyl]cyclopropyl]octyl)oxy]propan-2-amine, N,N-dimethyl-1-[[8-(2-octylcyclopropyl)octyl]oxy]-3-(octyloxy)propan-2-amine and (11E,20Z,23Z)-N,N-dimethylnonacos-11,20,23-trien-10-amine or a pharmaceutically acceptable salt or stereoisomer thereof.

[000471] In one embodiment, the lipid may be a cleavable lipid such as those described in International Publication No. WO2012170889, herein incorporated by reference in its entirety.

[000472] In one embodiment, the cationic lipid may be synthesized by methods known in the art and/or as described in International Publication Nos. WO20 12040 184, WO201 1153 120, WO201 1149733, WO201 1090965, WO201 1043913, WO201 1022460, WO2012061259, WO2012054365, WO2012044638, WO2010080724 and WO20 102 1865; each of which is herein incorporated by reference in their entirety.

[000473] In one embodiment, the LNP formulations of the cosmetic polynucleotides, primary constructs and/or mmRNA may contain PEG-c-DOMG at 3% lipid molar ratio. In another embodiment, the LNP formulations polynucleotides, primary constructs and/or mmRNA may contain PEG-c-DOMG at 1.5% lipid molar ratio.

[000474] In one embodiment, the pharmaceutical compositions of the cosmetic polynucleotides, primary constructs and/or mmRNA may include at least one of the PEGylated lipids described in International Publication No. 2012099755, herein incorporated by reference.

[000475] In one embodiment, the LNP formulation may contain PEG-DMG 2000 (1,2-dimyristoyl-sn-glycero-3-phosphoethanolamine-N-[methoxy(polyethylene glycol)-2000]). In one embodiment, the LNP formulation may contain PEG-DMG 2000, a cationic lipid known in the art and at least one other component. In another embodiment, the LNP formulation may contain PEG-DMG 2000, a cationic lipid known in the art, DSPC and cholesterol. As a non-limiting example, the LNP formulation may contain PEG-DMG 2000, DLin-DMA, DSPC and cholesterol. As another non-limiting example the LNP formulation may contain PEG-DMG 2000, DLin-DMA, DSPC and cholesterol in a molar ratio of 2:40:10:48 (see e.g., Geall et al, Nonviral delivery of self-amplifying RNA vaccines, PNAS 2012; PMID: 22908294; herein incorporated by reference in its entirety). . As another non-limiting example, modified RNA described herein may be formulated in a nanoparticle to be delivered by a parenteral route as described in U.S. Pub. No. 20120207845; herein incorporated by reference in its entirety.

[000476] In one embodiment, the LNP formulation may be formulated by the methods described in International Publication Nos. WO201 1127255 or WO2008103276, each of



which is herein incorporated by reference in their entirety. As a non-limiting example, modified RNA described herein may be encapsulated in LNP formulations as described in WO201 1127255 and/or WO2008103276; each of which is herein incorporated by reference in their entirety.

[000477] In one embodiment, LNP formulations described herein may comprise a polycationic composition. As a non-limiting example, the polycationic composition may be selected from formula 1-60 of US Patent Publication No. US20050222064; herein incorporated by reference in its entirety. In another embodiment, the LNP formulations comprising a polycationic composition may be used for the delivery of the modified RNA described herein *in vivo* and/or *in vitro*.

[000478] In one embodiment, the LNP formulations described herein may additionally comprise a permeability enhancer molecule. Non-limiting permeability enhancer molecules are described in US Patent Publication No. US20050222064; herein incorporated by reference in its entirety.

[000479] In one embodiment, the pharmaceutical compositions may be formulated in liposomes such as, but not limited to, DiLa2 liposomes (Marina Biotech, Bothell, WA), SMARTICLES® (Marina Biotech, Bothell, WA), neutral DOPC (1,2-dioleoyl-sn-glycero-3-phosphocholine) based liposomes (e.g., siRNA delivery for ovarian cancer (Landen et al. Cancer Biology & Therapy 2006 5(12)1708-1713); herein incorporated by reference in its entirety) and hyaluronan-coated liposomes (Quiet Therapeutics, Israel).

[000480] The nanoparticle formulations may be a carbohydrate nanoparticle comprising a carbohydrate carrier and a modified nucleic acid molecule (e.g., mmRNA). As a non-limiting example, the carbohydrate carrier may include, but is not limited to, an anhydride-modified phytoglycogen or glycogen-type material, phytoglycogen octenyl succinate, phytoglycogen beta-dextrin, anhydride-modified phytoglycogen beta-dextrin. (See e.g., International Publication No. WO2012109121; herein incorporated by reference in its entirety).

[000481] Lipid nanoparticle formulations may be improved by replacing the cationic lipid with a biodegradable cationic lipid which is known as a rapidly eliminated lipid nanoparticle (reLNP). Ionizable cationic lipids, such as, but not limited to, DLinDMA, DLin-KC2-DMA, and DLin-MC3-DMA, have been shown to accumulate in plasma and

tissues over time and may be a potential source of toxicity. The rapid metabolism of the rapidly eliminated lipids can improve the tolerability and therapeutic index of the lipid nanoparticles by an order of magnitude from a 1 mg/kg dose to a 10 mg/kg dose in rat. Inclusion of an enzymatically degraded ester linkage can improve the degradation and metabolism profile of the cationic component, while still maintaining the activity of the reLNP formulation. The ester linkage can be internally located within the lipid chain or it may be terminally located at the terminal end of the lipid chain. The internal ester linkage may replace any carbon in the lipid chain.

[000482] In one embodiment, the internal ester linkage may be located on either side of the saturated carbon. Non-limiting examples of reLNPs include,

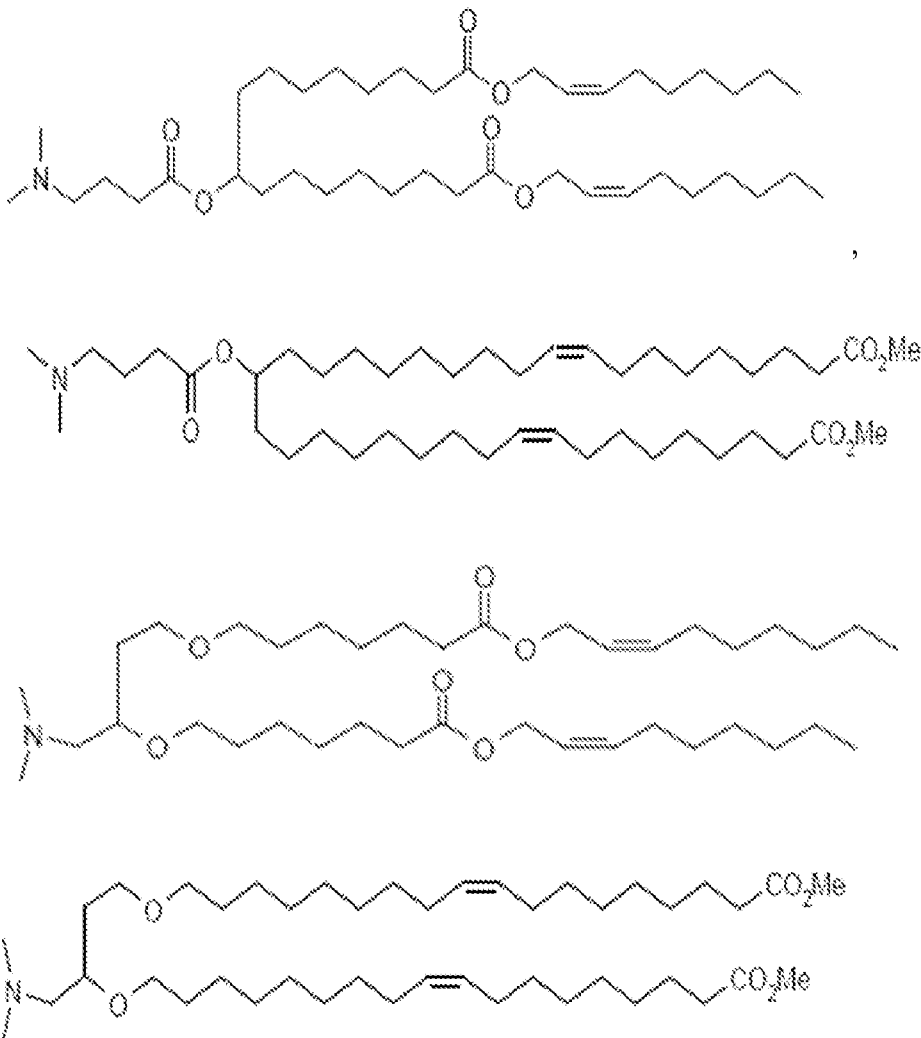

and

[000483] In one embodiment, an immune response may be elicited by delivering a lipid nanoparticle which may include a nanospecies, a polymer and an immunogen. (U.S.

Publication No. 20120189700 and International Publication No. WO2012099805; each of which is herein incorporated by reference in their entirety). The polymer may encapsulate the nanospecies or partially encapsulate the nanospecies. The immunogen may be a recombinant protein, a modified RNA and/or a primary construct described herein. In one embodiment, the lipid nanoparticle may be formulated for use in a vaccine such as, but not limited to, against a pathogen.

[000484] Lipid nanoparticles may be engineered to alter the surface properties of particles so the lipid nanoparticles may penetrate the mucosal barrier. Mucus is located on mucosal tissue such as, but not limited to, oral (e.g., the buccal and esophageal membranes and tonsil tissue), ophthalmic, gastrointestinal (e.g., stomach, small intestine, large intestine, colon, rectum), nasal, respiratory (e.g., nasal, pharyngeal, tracheal and bronchial membranes), genital (e.g., vaginal, cervical and urethral membranes). Nanoparticles larger than 10-200 nm which are preferred for higher drug encapsulation efficiency and the ability to provide the sustained delivery of a wide array of drugs have been thought to be too large to rapidly diffuse through mucosal barriers. Mucus is continuously secreted, shed, discarded or digested and recycled so most of the trapped particles may be removed from the mucosa tissue within seconds or within a few hours. Large polymeric nanoparticles (200nm -500nm in diameter) which have been coated densely with a low molecular weight polyethylene glycol (PEG) diffused through mucus only 4 to 6-fold lower than the same particles diffusing in water (Lai et al. PNAS 2007 104(5): 1482-487; Lai et al. Adv Drug Deliv Rev. 2009 61(2): 158-171; each of which is herein incorporated by reference in their entirety). The transport of nanoparticles may be determined using rates of permeation and/or fluorescent microscopy techniques including, but not limited to, fluorescence recovery after photobleaching (FRAP) and high resolution multiple particle tracking (MPT). As a non-limiting example, compositions which can penetrate a mucosal barrier may be made as described in U.S. Pat. No. 8,241,670, herein incorporated by reference in its entirety.

[000485] The lipid nanoparticle engineered to penetrate mucus may comprise a polymeric material (i.e. a polymeric core) and/or a polymer-vitamin conjugate and/or a tri-block co-polymer. The polymeric material may include, but is not limited to, polyamines, polyethers, polyamides, polyesters, polycarbamates, polyureas,

polycarbonates, poly(styrenes), polyimides, polysulfones, polyurethanes, polyacetylenes, polyethylenes, polyethyleneimines, polyisocyanates, polyacrylates, polymethacrylates, polyacrylonitriles, and polyarylates. The polymeric material may be biodegradable and/or biocompatible. The polymeric material may additionally be irradiated. As a non-limiting example, the polymeric material may be gamma irradiated (See e.g., International App. No. WO201282165, herein incorporated by reference in its entirety). Non-limiting examples of specific polymers include poly(caprolactone) (PCL), ethylene vinyl acetate polymer (EVA), poly(lactic acid) (PLA), poly(L-lactic acid) (PLLA), poly(glycolic acid) (PGA), poly(lactic acid-co-glycolic acid) (PLGA), poly(L-lactic acid-co-glycolic acid) (PLLGA), poly(D,L-lactide) (PDLA), poly(L-lactide) (PLLA), poly(D,L-lactide-co-caprolactone), poly(D,L-lactide-co-caprolactone-co-glycolide), poly(D,L-lactide-co-PEO-co-D,L-lactide), poly(D,L-lactide-co-PPO-co-D,L-lactide), polyalkyl cyanoacrylate, polyurethane, poly-L-lysine (PLL), hydroxypropyl methacrylate (HPMA), polyethyleneglycol, poly-L-glutamic acid, poly(hydroxy acids), polyanhydrides, polyorthoesters, poly(ester amides), polyamides, poly(ester ethers), polycarbonates, polyalkylenes such as polyethylene and polypropylene, polyalkylene glycols such as poly(ethylene glycol) (PEG), polyalkylene oxides (PEO), polyalkylene terephthalates such as poly(ethylene terephthalate), polyvinyl alcohols (PVA), polyvinyl ethers, polyvinyl esters such as polyvinyl acetate), polyvinyl halides such as polyvinyl chloride) (PVC), polyvinylpyrrolidone, polysiloxanes, polystyrene (PS), polyurethanes, derivatized celluloses such as alkyl celluloses, hydroxyalkyl celluloses, cellulose ethers, cellulose esters, nitro celluloses, hydroxypropylcellulose, carboxymethylcellulose, polymers of acrylic acids, such as poly(methyl(meth)acrylate) (PMMA), poly(ethyl(meth)acrylate), poly(butyl(meth)acrylate), poly(isobutyl(meth)acrylate), poly(hexyl(meth)acrylate), poly(isodecyl(meth)acrylate), poly(lauryl(meth)acrylate), poly(phenyl(meth)acrylate), poly(methyl acrylate), poly(isopropyl acrylate), poly(isobutyl acrylate), poly(octadecyl acrylate) and copolymers and mixtures thereof, polydioxanone and its copolymers, polyhydroxyalkanoates, polypropylene fumarate, polyoxymethylene, poloxamers, poly(ortho)esters, poly(butyric acid), poly(valeric acid), poly(lactide-co-caprolactone), and trimethylene carbonate, polyvinylpyrrolidone. The lipid nanoparticle may be coated or associated with a co-polymer such as, but not limited

to, a block co-polymer (such as a branched polyether-polyamide block copolymer described in International Publication No. WO2013012476, herein incorporated by reference in its entirety), and (poly(ethylene glycol))-(poly(propylene oxide))-(poly(ethylene glycol)) triblock copolymer (see e.g., US Publication 20120121718 and US Publication 20100003337 and U.S. Pat. No. 8,263,665; each of which is herein incorporated by reference in their entirety). The co-polymer may be a polymer that is generally regarded as safe (GRAS) and the formation of the lipid nanoparticle may be in such a way that no new chemical entities are created. For example, the lipid nanoparticle may comprise poloxamers coating PLGA nanoparticles without forming new chemical entities which are still able to rapidly penetrate human mucus (Yang et al. *Angew. Chem. Int. Ed.* 2011 50:2597-2600; herein incorporated by reference in its entirety).

[000486] The vitamin of the polymer-vitamin conjugate may be vitamin E. The vitamin portion of the conjugate may be substituted with other suitable components such as, but not limited to, vitamin A, vitamin E, other vitamins, cholesterol, a hydrophobic moiety, or a hydrophobic component of other surfactants (e.g., sterol chains, fatty acids, hydrocarbon chains and alkylene oxide chains).

[000487] The lipid nanoparticle engineered to penetrate mucus may include surface altering agents such as, but not limited to, mmRNA, anionic proteins (e.g., bovine serum albumin), surfactants (e.g., cationic surfactants such as for example dimethyldioctadecylammonium bromide), sugars or sugar derivatives (e.g., cyclodextrin), nucleic acids, polymers (e.g., heparin, polyethylene glycol and poloxamer), mucolytic agents (e.g., N-acetylcysteine, mugwort, bromelain, papain, clerodendrum, acetylcysteine, bromhexine, carbocysteine, eprazinone, mesna, ambroxol, sobrerol, domiodol, letosteine, stepronin, tiopronin, gelsolin, thymosin  $\beta_4$  dornase alfa, neltenexine, erdosteine) and various DNases including rhDNase. The surface altering agent may be embedded or enmeshed in the particle's surface or disposed (e.g., by coating, adsorption, covalent linkage, or other process) on the surface of the lipid nanoparticle. (see e.g., US Publication 20100215580 and US Publication 20080166414; each of which is herein incorporated by reference in their entirety).

[000488] The mucus penetrating lipid nanoparticles may comprise at least one mmRNA described herein. The mmRNA may be encapsulated in the lipid nanoparticle and/or

disposed on the surface of the particle. The mRNA may be covalently coupled to the lipid nanoparticle. Formulations of mucus penetrating lipid nanoparticles may comprise a plurality of nanoparticles. Further, the formulations may contain particles which may interact with the mucus and alter the structural and/or adhesive properties of the surrounding mucus to decrease mucoadhesion which may increase the delivery of the mucus penetrating lipid nanoparticles to the mucosal tissue.

[000489] In one embodiment, the cosmetic polynucleotide, primary construct, or mRNA is formulated as a lipoplex, such as, without limitation, the ATUPLEX™ system, the DACC system, the DBTC system and other siRNA-lipoplex technology from Silence Therapeutics (London, United Kingdom), STEMFECT™ from STEMGENT® (Cambridge, MA), and polyethylenimine (PEI) or protamine -based targeted and non-targeted delivery of nucleic acids (Aleku et al. *Cancer Res.* 2008 68:9788-9798; Strumberg et al. *Int J Clin Pharmacol Ther* 2012 50:76-78; Santel et al, *Gene Ther* 2006 13:1222-1234; Santel et al, *Gene Ther* 2006 13:1360-1370; Gutbier et al, *Pulm Pharmacol. Ther.* 2010 23:334-344; Kaufmann et al. *Microvasc Res* 2010 80:286-293; Weide et al. *J Immunother.* 2009 32:498-507; Weide et al. *J Immunother.* 2008 31:180-188; Pascolo *Expert Opin. Biol. Ther.* 4:1285-1294; Fotin-Mleczek et al., *J. Immunother.* 34:1-15; Song et al., *Nature Biotechnol.* 2005, 23:709-717; Peer et al, *Proc Natl Acad Sci U S A.* 2007 6;104:4095-4100; deFougerolles *Hum Gene Ther.* 2008 19:125-132; all of which are incorporated herein by reference in its entirety).

[000490] In one embodiment such formulations may also be constructed or compositions altered such that they passively or actively are directed to different cell types *in vivo*, including but not limited to hepatocytes, immune cells, tumor cells, endothelial cells, antigen presenting cells, and leukocytes (Akinc et al. *Mol Ther.* 2010 18:1357-1364; Song et al., *Nat Biotechnol.* 2005 23:709-717; Judge et al, *J Clin Invest.* 2009 119:661-673; Kaufmann et al, *Microvasc Res* 2010 80:286-293; Santel et al. *Gene Ther* 2006 13:1222-1234; Santel et al. *Gene Ther* 2006 13:1360-1370; Gutbier et al, *Pulm Pharmacol. Ther.* 2010 23:334-344; Basha et al, *Mol. Ther.* 2011 19:2186-2200; Fenske and Cullis, *Expert Opin Drug Deliv.* 2008 5:25-44; Peer et al. *Science.* 2008 319:627-630; Peer and Lieberman, *Gene Ther.* 2011 18:127-133; all of which are incorporated herein by reference in its entirety). One example of passive targeting of

formulations to liver cells includes the DLin-DMA, DLin-KC2-DMA and DLin-MC3-DMA-based lipid nanoparticle formulations which have been shown to bind to apolipoprotein E and promote binding and uptake of these formulations into hepatocytes in vivo (Akinc et al. *Mol Ther.* 2010 18:1357-1364; herein incorporated by reference in its entirety). Formulations can also be selectively targeted through expression of different ligands on their surface as exemplified by, but not limited by, folate, transferrin, N-acetylgalactosamine (GalNAc), and antibody targeted approaches (Kolhatkar et al, *Curr Drug Discov Technol.* 2011 8:197-206; Musacchio and Torchilin, *Front Biosci.* 2011 16:1388-1412; Yu et al., *Mol Membr Biol.* 2010 27:286-298; Patil et al., *Crit Rev Ther Drug Carrier Syst.* 2008 25:1-61; Benoit et al, *Biomacromolecules.* 2011 12:2708-2714; Zhao et al., *Expert Opin Drug Deliv.* 2008 5:309-319; Akinc et al, *Mol Ther.* 2010 18:1357-1364; Srinivasan et al., *Methods Mol Biol.* 2012 820:105-116; Ben-Arie et al, *Methods Mol Biol.* 2012 757:497-507; Peer 2010 *J Control Release.* 20:63-68; Peer et al, *Proc Natl Acad Sci U S A.* 2007 104:4095-4100; Kim et al, *Methods Mol Biol.* 2011 721:339-353; Subramanya et al, *Mol Ther.* 2010 18:2028-2037; Song et al, *Nat Biotechnol.* 2005 23:709-717; Peer et al. *Science.* 2008 319:627-630; Peer and Lieberman, *Gene Ther.* 2011 18:1127-1133; all of which are incorporated herein by reference in its entirety).

**[000491]** In one embodiment, the cosmetic polynucleotide, primary construct, or mmRNA is formulated as a solid lipid nanoparticle. A solid lipid nanoparticle (SLN) may be spherical with an average diameter between 10 to 1000 nm. SLN possess a solid lipid core matrix that can solubilize lipophilic molecules and may be stabilized with surfactants and/or emulsifiers. In a further embodiment, the lipid nanoparticle may be a self-assembly lipid-polymer nanoparticle (see Zhang et al, *ACS Nano*, 2008, 2 (8), pp 1696-1702; herein incorporated by reference in its entirety).

**[000492]** Liposomes, lipoplexes, or lipid nanoparticles may be used to improve the efficacy of polynucleotide, primary construct, or mmRNA directed protein production as these formulations may be able to increase cell transfection by the cosmetic polynucleotide, primary construct, or mmRNA; and/or increase the translation of encoded protein. One such example involves the use of lipid encapsulation to enable the effective systemic delivery of polyplex plasmid DNA (Heyes et al, *Mol Ther.* 2007 15:713-720;

herein incorporated by reference in its entirety). The liposomes, lipoplexes, or lipid nanoparticles may also be used to increase the stability of the cosmetic polynucleotide, primary construct, or mmRNA.

**[000493]** In one embodiment, the the polynucleotides, primary constructs, and/or the mmRNA of the present invention can be formulated for controlled release and/or targeted delivery. As used herein, "controlled release" refers to a pharmaceutical composition or compound release profile that conforms to a particular pattern of release to effect a therapeutic outcome. In one embodiment, the polynucleotides, primary constructs or the mmRNA may be encapsulated into a delivery agent described herein and/or known in the art for controlled release and/or targeted delivery. As used herein, the term "encapsulate" means to enclose, surround or encase. As it relates to the formulation of the compounds of the invention, encapsulation may be substantial, complete or partial. The term "substantially encapsulated" means that at least greater than 50, 60, 70, 80, 85, 90, 95, 96, 97, 98, 99, 99.9, 99.9 or greater than 99.999% of the pharmaceutical composition or compound of the invention may be enclosed, surrounded or encased within the delivery agent. "Partially encapsulation" means that less than 10, 10, 20, 30, 40 50 or less of the pharmaceutical composition or compound of the invention may be enclosed, surrounded or encased within the delivery agent. Advantageously, encapsulation may be determined by measuring the escape or the activity of the pharmaceutical composition or compound of the invention using fluorescence and/or electron micrograph. For example, at least 1, 5, 10, 20, 30, 40, 50, 60, 70, 80, 85, 90, 95, 96, 97, 98, 99, 99.9, 99.99 or greater than 99.99% of the pharmaceutical composition or compound of the invention are encapsulated in the delivery agent.

**[000494]** In one embodiment, the controlled release formulation may include, but is not limited to, tri-block co-polymers. As a non-limiting example, the formulation may include two different types of tri-block co-polymers (International Pub. No. WO201213 1104 and WO201213 1106; each of which is herein incorporated by reference in its entirety).

**[000495]** In another embodiment, the the polynucleotides, primary constructs, or the mmRNA may be encapsulated into a lipid nanoparticle or a rapidly eliminated lipid nanoparticle and the lipid nanoparticles or a rapidly eliminated lipid nanoparticle may



then be encapsulated into a polymer, hydrogel and/or surgical sealant described herein and/or known in the art. As a non-limiting example, the polymer, hydrogel or surgical sealant may be PLGA, ethylene vinyl acetate (EVAc), poloxamer, GELSITE® (Nanotherapeutics, Inc. Alachua, FL), HYLENEX® (Halozyme Therapeutics, San Diego CA), surgical sealants such as fibrinogen polymers (Ethicon Inc. Cornelia, GA), TISSELL® (Baxter International, Inc Deerfield, IL), PEG-based sealants, and COSEAL® (Baxter International, Inc Deerfield, IL).

**[000496]** In another embodiment, the lipid nanoparticle may be encapsulated into any polymer known in the art which may form a gel when injected into a subject. As another non-limiting example, the lipid nanoparticle may be encapsulated into a polymer matrix which may be biodegradable.

**[000497]** In one embodiment, the the cosmetic polynucleotide, primary construct, or mmRNA formulation for controlled release and/or targeted delivery may also include at least one controlled release coating. Controlled release coatings include, but are not limited to, OPADRY®, polyvinylpyrrolidone/vinyl acetate copolymer, polyvinylpyrrolidone, hydroxypropyl methylcellulose, hydroxypropyl cellulose, hydroxyethyl cellulose, EUDRAGIT RL®, EUDRAGIT RS® and cellulose derivatives such as ethylcellulose aqueous dispersions (AQUACOAT® and SURELEASE®).

**[000498]** In one embodiment, the controlled release and/or targeted delivery formulation may comprise at least one degradable polyester which may contain polycationic side chains. Degradable polyesters include, but are not limited to, poly(serine ester), poly(L-lactide-co-L-lysine), poly(4-hydroxy-L-proline ester), and combinations thereof. In another embodiment, the degradable polyesters may include a PEG conjugation to form a PEGylated polymer.

**[000499]** In one embodiment, the the polynucleotides, primary constructs, and/or the mmRNA of the present invention may be encapsulated in a therapeutic nanoparticle. Therapeutic nanoparticles may be formulated by methods described herein and known in the art such as, but not limited to, International Pub Nos. WO2010005740, WO2010030763, WO2010005721, WO2010005723, WO2012054923, US Pub. Nos. US20 110262491, US20 100 104645, US20100087337, US20100068285, US201 10274759, US20100068286 andUS20120288541 and US Pat No. 8,206,747,

8,293,276, 8,318,208 and 8,318,211 each of which is herein incorporated by reference in their entirety. In another embodiment, therapeutic polymer nanoparticles may be identified by the methods described in US Pub No. US20120140790, herein incorporated by reference in its entirety.

**[000500]** In one embodiment, the therapeutic nanoparticle may be formulated for sustained release. As used herein, "sustained release" refers to a pharmaceutical composition or compound that conforms to a release rate over a specific period of time. The period of time may include, but is not limited to, hours, days, weeks, months and years. As a non-limiting example, the sustained release nanoparticle may comprise a polymer and a therapeutic agent such as, but not limited to, the polynucleotides, primary constructs, and miRNA of the present invention (see International Pub No. 2010075072 and US Pub No. US20100216804, US20110217377 and US20120201859, each of which is herein incorporated by reference in their entirety).

**[000501]** In one embodiment, the therapeutic nanoparticles may be formulated to be target specific. As a non-limiting example, the therapeutic nanoparticles may include a corticosteroid (see International Pub. No. WO2011084518; herein incorporated by reference in its entirety). In one embodiment, the therapeutic nanoparticles may be formulated to be cancer specific. As a non-limiting example, the therapeutic nanoparticles may be formulated in nanoparticles described in International Pub No. WO2008121949, WO2010005726, WO2010005725, WO2011084521 and US Pub No. US20100069426, US20120004293 and US20100104655, each of which is herein incorporated by reference in their entirety.

**[000502]** In one embodiment, the nanoparticles of the present invention may comprise a polymeric matrix. As a non-limiting example, the nanoparticle may comprise two or more polymers such as, but not limited to, polyethylenes, polycarbonates, polyanhydrides, polyhydroxyacids, polypropylfumerates, polycaprolactones, polyamides, polyacetals, polyethers, polyesters, poly(orthoesters), polycyanoacrylates, polyvinyl alcohols, polyurethanes, polyphosphazenes, polyacrylates, polymethacrylates, polycyanoacrylates, polyureas, polystyrenes, polyamines, polylysine, poly(ethylene imine), poly(serine ester), poly(L-lactide-co-L-lysine), poly(4-hydroxy-L-proline ester) or combinations thereof.

[000503] In one embodiment, the therapeutic nanoparticle comprises a diblock copolymer. In one embodiment, the diblock copolymer may include PEG in combination with a polymer such as, but not limited to, polyethylenes, polycarbonates, polyanhydrides, polyhydroxyacids, polypropylfumerates, polycaprolactones, polyamides, polyacetals, polyethers, polyesters, poly(orthoesters), polycyanoacrylates, polyvinyl alcohols, polyurethanes, polyphosphazenes, polyacrylates, polymethacrylates, polycyanoacrylates, polyureas, polystyrenes, polyamines, polylysine, poly(ethylene imine), poly(serine ester), poly(L-lactide-co-L-lysine), poly(4-hydroxy-L-proline ester) or combinations thereof.

[000504] As a non-limiting example the therapeutic nanoparticle comprises a PLGA-PEG block copolymer (see US Pub. No. US20120004293 and US Pat No. 8,236,330, each of which is herein incorporated by reference in their entirety). In another non-limiting example, the therapeutic nanoparticle is a stealth nanoparticle comprising a diblock copolymer of PEG and PLA or PEG and PLGA (see US Pat No 8,246,968, and International Publication No. WO2012166923, each of which is herein incorporated by reference in its entirety).

[000505] In one embodiment, the therapeutic nanoparticle may comprise a multiblock copolymer (See e.g., U.S. Pat. No. 8,263,665 and 8,287,910; each of which is herein incorporated by reference in its entirety).

[000506] In one embodiment, the block copolymers described herein may be included in a polyion complex comprising a non-polymeric micelle and the block copolymer. (See e.g., U.S. Pub. No. 20120076836; herein incorporated by reference in its entirety).

[000507] In one embodiment, the therapeutic nanoparticle may comprise at least one acrylic polymer. Acrylic polymers include but are not limited to, acrylic acid, methacrylic acid, acrylic acid and methacrylic acid copolymers, methyl methacrylate copolymers, ethoxyethyl methacrylates, cyanoethyl methacrylate, amino alkyl methacrylate copolymer, poly(acrylic acid), poly(methacrylic acid), polycyanoacrylates and combinations thereof.

[000508] In one embodiment, the therapeutic nanoparticles may comprise at least one cationic polymer described herein and/or known in the art.

**[000509]** In one embodiment, the therapeutic nanoparticles may comprise at least one amine-containing polymer such as, but not limited to polylysine, polyethylene imine, poly(amidoamine) dendrimers, poly(beta-amino esters) (See e.g., U.S. Pat. No. 8,287,849; herein incorporated by reference in its entirety) and combinations thereof.

**[000510]** In one embodiment, the therapeutic nanoparticles may comprise at least one degradable polyester which may contain polycationic side chains. Degradable polyesters include, but are not limited to, poly(serine ester), poly(L-lactide-co-L-lysine), poly(4-hydroxy-L-proline ester), and combinations thereof. In another embodiment, the degradable polyesters may include a PEG conjugation to form a PEGylated polymer.

**[000511]** In another embodiment, the therapeutic nanoparticle may include a conjugation of at least one targeting ligand. The targeting ligand may be any ligand known in the art such as, but not limited to, a monoclonal antibody. (Kirpotin et al, Cancer Res. 2006 66:6732-6740; herein incorporated by reference in its entirety).

**[000512]** In one embodiment, the therapeutic nanoparticle may be formulated in an aqueous solution which may be used to target cancer (see International Pub No. WO201 1084513 and US Pub No. US201 10294717, each of which is herein incorporated by reference in their entirety).

**[000513]** In one embodiment, the polynucleotides, primary constructs, or mmRNA may be encapsulated in, linked to and/or associated with synthetic nanocarriers. Synthetic nanocarriers include, but are not limited to, those described in International Pub. Nos. WO2010005740, WO2010030763, WO201213501, WO2012149252, WO2012149255, WO2012149259, WO2012149265, WO2012149268, WO2012149282, WO2012149301, WO2012149393, WO2012149405, WO201214941 1 WO2012149454 and WO2013019669, and US Pub. Nos. US20 110262491, US20 100 104645, US20100087337 and US20 120244222, each of which is herein incorporated by reference in their entirety. The synthetic nanocarriers may be formulated using methods known in the art and/or described herein. As a non-limiting example, the synthetic nanocarriers may be formulated by the methods described in International Pub Nos. WO20 10005740, WO2010030763 and WO201213501 and US Pub. Nos. US20 110262491, US20 100 104645, US20100087337 and US20 12024422, each of which is herein incorporated by reference in their entirety. In another embodiment, the synthetic

nanocarrier formulations may be lyophilized by methods described in International Pub. No. WO201 1072218 and US Pat No. 8,21 1,473; each of which is herein incorporated by reference in their entirety.

**[000514]** In one embodiment, the synthetic nanocarriers may contain reactive groups to release the cosmetic polynucleotides, primary constructs and/or mmRNA described herein (see International Pub. No. WO20120952552 and US Pub No. US20120171229, each of which is herein incorporated by reference in their entirety).

**[000515]** In one embodiment, the synthetic nanocarriers may contain an immunostimulatory agent to enhance the immune response from delivery of the synthetic nanocarrier. As a non-limiting example, the synthetic nanocarrier may comprise a Th1 immunostimulatory agent which may enhance a Th1 -based response of the immune system (see International Pub No. WO2010123569 and US Pub. No. US201 10223201, each of which is herein incorporated by reference in its entirety).

**[000516]** In one embodiment, the synthetic nanocarriers may be formulated for targeted release. In one embodiment, the synthetic nanocarrier is formulated to release the cosmetic polynucleotides, primary constructs and/or mmRNA at a specified pH and/or after a desired time interval. As a non-limiting example, the synthetic nanoparticle may be formulated to release the cosmetic polynucleotides, primary constructs and/or mmRNA after 24 hours and/or at a pH of 4.5 (see International Pub. Nos. WO20 10138193 and WO20 10138194 and US Pub Nos. US20 110020388 and US201 10027217, each of which is herein incorporated by reference in their entireties).

**[000517]** In one embodiment, the synthetic nanocarriers may be formulated for controlled and/or sustained release of the cosmetic polynucleotides, primary constructs and/or mmRNA described herein. As a non-limiting example, the synthetic nanocarriers for sustained release may be formulated by methods known in the art, described herein and/or as described in International Pub No. WO2010138192 and US Pub No. 20100303850, each of which is herein incorporated by reference in their entirety.

**[000518]** In one embodiment, the synthetic nanocarrier may be formulated for use as a vaccine. In one embodiment, the synthetic nanocarrier may encapsulate at least one polynucleotide, primary construct and/or mmRNA which encode at least one antigen. As a non-limiting example, the synthetic nanocarrier may include at least one antigen and an

excipient for a vaccine dosage form (see International Pub No. WO201 1150264 and US Pub No. US201 10293723, each of which is herein incorporated by reference in their entirety). As another non-limiting example, a vaccine dosage form may include at least two synthetic nanocarriers with the same or different antigens and an excipient (see International Pub No. WO201 1150249 and US Pub No. US201 10293701, each of which is herein incorporated by reference in their entirety). The vaccine dosage form may be selected by methods described herein, known in the art and/or described in International Pub No. WO201 1150258 and US Pub No. US20120027806, each of which is herein incorporated by reference in their entirety).

**[000519]** In one embodiment, the synthetic nanocarrier may comprise at least one polynucleotide, primary construct and/or mmRNA which encodes at least one adjuvant. As non-limiting example, the adjuvant may comprise dimethyldioctadecylammonium-bromide, dimethyldioctadecylammonium-chloride, dimethyldioctadecylammonium-phosphate or dimethyldioctadecylammonium-acetate (DDA) and an apolar fraction or part of said apolar fraction of a total lipid extract of a mycobacterium (See e.g, U.S. Pat. No. 8,241,610; herein incorporated by reference in its entirety). In another embodiment, the synthetic nanocarrier may comprise at least one polynucleotide, primary construct and/or mmRNA and an adjuvant. As a non-limiting example, the synthetic nanocarrier comprising and adjuvant may be formulated by the methods described in International Pub No. WO201 1150240 and US Pub No. US201 10293700, each of which is herein incorporated by reference in its entirety.

**[000520]** In one embodiment, the synthetic nanocarrier may encapsulate at least one polynucleotide, primary construct and/or mmRNA which encodes a peptide, fragment or region from a virus. As a non-limiting example, the synthetic nanocarrier may include, but is not limited to, the nanocarriers described in International Pub No. WO20 12024621, WO201202629, WO2012024632 and US Pub No. US20 120064 110, US20120058153 and US20120058154, each of which is herein incorporated by reference in their entirety.

**[000521]** In one embodiment, the synthetic nanocarrier may be coupled to a cosmetic polynucleotide, primary construct or mmRNA which may be able to trigger a humoral and/or cytotoxic T lymphocyte (CTL) response (See e.g., International Publication No. WO2013019669, herein incorporated by reference in its entirety).

[000522] In one embodiment, the nanoparticle may be optimized for oral administration. The nanoparticle may comprise at least one cationic biopolymer such as, but not limited to, chitosan or a derivative thereof. As a non-limiting example, the nanoparticle may be formulated by the methods described in U.S. Pub. No. 20120282343; herein incorporated by reference in its entirety.

*Polymers, Biodegradable Nanoparticles, and Core-Shell Nanoparticles*

[000523] The cosmetic polynucleotide, primary construct, and mmRNA of the invention can be formulated using natural and/or synthetic polymers. Non-limiting examples of polymers which may be used for delivery include, but are not limited to, DYNAMIC POLYCONJUGATE® (Arrowhead Research Corp., Pasadena, CA) formulations from MIRUS® Bio (Madison, WI) and Roche Madison (Madison, WI), PHASERX® polymer formulations such as, without limitation, SMARTT POLYMER TECHNOLOGY™ (Seattle, WA), DMRI/DOPE, poloxamer, VAXFECTIN® adjuvant from Vical (San Diego, CA), chitosan, cyclodextrin from Calando Pharmaceuticals (Pasadena, CA), dendrimers and poly(lactic-co-glycolic acid) (PLGA) polymers. RONDEL™ (RNAi/Oligonucleotide Nanoparticle Delivery) polymers (Arrowhead Research Corporation, Pasadena, CA) and pH responsive co-block polymers such as, but not limited to, PHASERX® (Seattle, WA).

[000524] A non-limiting example of chitosan formulation includes a core of positively charged chitosan and an outer portion of negatively charged substrate (U.S. Pub. No. 20120258176; herein incorporated by reference in its entirety). Chitosan includes, but is not limited to N-trimethyl chitosan, mono-N-carboxymethyl chitosan (MCC), N-palmitoyl chitosan (NPCS), EDTA-chitosan, low molecular weight chitosan, chitosan derivatives, or combinations thereof.

[000525] In one embodiment, the polymers used in the present invention have undergone processing to reduce and/or inhibit the attachment of unwanted substances such as, but not limited to, bacteria, to the surface of the polymer. The polymer may be processed by methods known and/or described in the art and/or described in International Pub. No. WO2012150467, herein incorporated by reference in its entirety.

[000526] A non-limiting example of PLGA formulations include, but are not limited to, PLGA injectable depots (e.g., ELIGARD® which is formed by dissolving PLGA in 66%

N-methyl-2-pyrrolidone (NMP) and the remainder being aqueous solvent and leuprolide. Once injected, the PLGA and leuprolide peptide precipitates into the subcutaneous space).

[000527] Many of these polymer approaches have demonstrated efficacy in delivering oligonucleotides *in vivo* into the cell cytoplasm (reviewed in deFougerolles *Hum Gene Ther.* 2008 19:125-132; herein incorporated by reference in its entirety). Two polymer approaches that have yielded robust *in vivo* delivery of nucleic acids, in this case with small interfering RNA (siRNA), are dynamic polyconjugates and cyclodextrin-based nanoparticles. The first of these delivery approaches uses dynamic polyconjugates and has been shown *in vivo* in mice to effectively deliver siRNA and silence endogenous target mRNA in hepatocytes (Rozema et al, *Proc Natl Acad Sci U S A.* 2007 104: 12982-12887; herein incorporated by reference in its entirety). This particular approach is a multicomponent polymer system whose key features include a membrane-active polymer to which nucleic acid, in this case siRNA, is covalently coupled via a disulfide bond and where both PEG (for charge masking) and  $\alpha$ -acetylgalactosamine (for hepatocyte targeting) groups are linked via pH-sensitive bonds (Rozema et al, *Proc Natl Acad Sci U S A.* 2007 104:12982-12887; herein incorporated by reference in its entirety). On binding to the hepatocyte and entry into the endosome, the polymer complex disassembles in the low-pH environment, with the polymer exposing its positive charge, leading to endosomal escape and cytoplasmic release of the siRNA from the polymer. Through replacement of the  $\alpha$ -acetylgalactosamine group with a mannose group, it was shown one could alter targeting from asialoglycoprotein receptor-expressing hepatocytes to sinusoidal endothelium and Kupffer cells. Another polymer approach involves using transferrin-targeted cyclodextrin-containing polycation nanoparticles. These nanoparticles have demonstrated targeted silencing of the *EWS-FLII* gene product in transferrin receptor-expressing Ewing's sarcoma tumor cells (Hu-Lieskovan *et al*, *Cancer Res.* 2005 65: 8984-8982; herein incorporated by reference in its entirety) and siRNA formulated in these nanoparticles was well tolerated in non-human primates (Heidel *et al*, *Proc Natl Acad Sci USA* 2007 104:5715-21; herein incorporated by reference in its entirety). Both of these delivery strategies incorporate rational approaches using both targeted delivery and endosomal escape mechanisms.



**[000528]** The polymer formulation can permit the sustained or delayed release of polynucleotide, primary construct, or mmRNA (e.g., following intramuscular or subcutaneous injection). The altered release profile for the cosmetic polynucleotide, primary construct, or mmRNA can result in, for example, translation of an encoded protein over an extended period of time. The polymer formulation may also be used to increase the stability of the cosmetic polynucleotide, primary construct, or mmRNA. Biodegradable polymers have been previously used to protect nucleic acids other than mmRNA from degradation and been shown to result in sustained release of payloads in vivo (Rozema et al., *Proc Natl Acad Sci U S A.* 2007 104:12982-12887; Sullivan et al., *Expert Opin Drug Deliv.* 2010 7:1433-1446; Convertine et al, *Biomacromolecules.* 2010 Oct 1; Chu et al, *Acc Chem Res.* 2012 Jan 13; Manganiello et al, *Biomaterials.* 2012 33:2301-2309; Benoit et al., *Biomacromolecules.* 2011 12:2708-2714; Singha et al, *Nucleic Acid Ther.* 2011 2:133-147; deFougerolles *Hum Gene Ther.* 2008 19:125-132; Schaffert and Wagner, *Gene Ther.* 2008 16: 1131-1138; Chaturvedi et al, *Expert Opin Drug Deliv.* 2011 8:1455-1468; Davis, *Mol Pharm.* 2009 6:659-668; Davis, *Nature* 2010 464: 1067-1070; each of which is herein incorporated by reference in its entirety).

**[000529]** In one embodiment, the pharmaceutical compositions may be sustained release formulations. In a further embodiment, the sustained release formulations may be for subcutaneous delivery. Sustained release formulations may include, but are not limited to, PLGA microspheres, ethylene vinyl acetate (EVAc), poloxamer, GELSITE® (Nanotherapeutics, Inc. Alachua, FL), HYLENEX® (Halozyme Therapeutics, San Diego CA), surgical sealants such as fibrinogen polymers (Ethicon Inc. Cornelia, GA), TISSELL® (Baxter International, Inc Deerfield, IL), PEG-based sealants, and COSEAL® (Baxter International, Inc Deerfield, IL).

**[000530]** As a non-limiting example modified mRNA may be formulated in PLGA microspheres by preparing the PLGA microspheres with tunable release rates (e.g., days and weeks) and encapsulating the modified mRNA in the PLGA microspheres while maintaining the integrity of the modified mRNA during the encapsulation process. EVAc are non-biodegradable, biocompatible polymers which are used extensively in pre-clinical sustained release implant applications (e.g., extended release products Ocusert a pilocarpine ophthalmic insert for glaucoma or progestasert a sustained release

progesterone intrauterine device; transdermal delivery systems Testoderm, Duragesic and Selegiline; catheters). Poloxamer F-407 NF is a hydrophilic, non-ionic surfactant triblock copolymer of polyoxyethylene-polyoxypropylene-polyoxyethylene having a low viscosity at temperatures less than 5°C and forms a solid gel at temperatures greater than 15°C. PEG-based surgical sealants comprise two synthetic PEG components mixed in a delivery device which can be prepared in one minute, seals in 3 minutes and is reabsorbed within 30 days. GELSITE® and natural polymers are capable of in-situ gelation at the site of administration. They have been shown to interact with protein and peptide therapeutic candidates through ionic interaction to provide a stabilizing effect.

**[000531]** Polymer formulations can also be selectively targeted through expression of different ligands as exemplified by, but not limited by, folate, transferrin, and N-acetylgalactosamine (GalNAc) (Benoit et al, *Biomacromolecules*. 2011 12:2708-2714; Rozema et al, *Proc Natl Acad Sci U S A*. 2007 104:12982-12887; Davis, *Mol Pharm*. 2009 6:659-668; Davis, *Nature* 2010 464:1067-1070; each of which is herein incorporated by reference in its entirety).

**[000532]** The modified nucleic acid, and mRNA of the invention may be formulated with or in a polymeric compound. The polymer may include at least one polymer such as, but not limited to, polyethenes, polyethylene glycol (PEG), poly(L-lysine)(PLL), PEG grafted to PLL, cationic lipopolymer, biodegradable cationic lipopolymer, polyethyleneimine (PEI), cross-linked branched poly(alkylene imines), a polyamine derivative, a modified poloxamer, a biodegradable polymer, elastic biodegradable polymer, biodegradable block copolymer, biodegradable random copolymer, biodegradable polyester copolymer, biodegradable polyester block copolymer, biodegradable polyester block random copolymer, multiblock copolymers, linear biodegradable copolymer, poly[α-(4-aminobutyl)-L-glycolic acid] (PAGA), biodegradable cross-linked cationic multi-block copolymers, polycarbonates, polyanhydrides, polyhydroxyacids, polypropylfumerates, polycaprolactones, polyamides, polyacetals, polyethers, polyesters, poly(orthoesters), polycyanoacrylates, polyvinyl alcohols, polyurethanes, polyphosphazenes, polyacrylates, polymethacrylates, polycyanoacrylates, polyureas, polystyrenes, polyamines, polylysine, poly(ethylene imine), poly(serine ester), poly(L-lactide-co-L-lysine), poly(4-hydroxy-L-proline ester),

acrylic polymers, amine-containing polymers, dextran polymers, dextran polymer derivatives or or combinations thereof .

[000533] As a non-limiting example, the modified nucleic acid or mmRNA of the invention may be formulated with the polymeric compound of PEG grafted with PLL as described in U.S. Pat. No. 6,177,274; herein incorporated by reference in its entirety. The formulation may be used for transfecting cells *in vitro* or for *in vivo* delivery of the modified nucleic acid and mmRNA. In another example, the modified nucleic acid and mmRNA may be suspended in a solution or medium with a cationic polymer, in a dry pharmaceutical composition or in a solution that is capable of being dried as described in U.S. Pub. Nos. 20090042829 and 20090042825; each of which are herein incorporated by reference in their entireties.

[000534] As another non-limiting example the cosmetic polynucleotides, primary constructs or mmRNA of the invention may be formulated with a PLGA-PEG block copolymer (see US Pub. No. US20 120004293 and US Pat No. 8,236,330, herein incorporated by reference in their entireties) or PLGA-PEG-PLGA block copolymers (See U.S. Pat. No. 6,004,573, herein incorporated by reference in its entirety). As a non-limiting example, the cosmetic polynucleotides, primary constructs or mmRNA of the invention may be formulated with a diblock copolymer of PEG and PLA or PEG and PLGA (see US Pat No 8,246,968, herein incorporated by reference in its entirety).

[000535] A polyamine derivative may be used to deliver nucleic acids or to treat and/or prevent a disease or to be included in an implantable or injectable device (U.S. Pub. No. 20100260817 herein incorporated by reference in its entirety). As a non-limiting example, a pharmaceutical composition may include the modified nucleic acids and mmRNA and the polyamine derivative described in U.S. Pub. No. 20100260817 (the contents of which are incorporated herein by reference in its entirety. As a non-limiting example the cosmetic polynucleotides, primary constructs and mmRNA of the present invention may be delivered using a polyamide polymer such as, but not limited to, a polymer comprising a 1,3-dipolar addition polymer prepared by combining a carbohydrate diazide monomer with a dialkyne unit comprising oligoamines (U.S. Pat. No. 8,236,280; herein incorporated by reference in its entirety).

[000536] In one embodiment, the cosmetic polynucleotides, primary constructs or mmRNA of the present invention may be formulated with at least one polymer and/or derivatives thereof described in International Publication Nos. WO201 1115862, WO2012082574 and WO20 12068 187 and U.S. Pub. No. 20120283427, each of which are herein incorporated by reference in their entireties. In another embodiment, the modified nucleic acid or mmRNA of the present invention may be formulated with a polymer of formula Z as described in WO201 1115862, herein incorporated by reference in its entirety. In yet another embodiment, the modified nucleic acid or mmRNA may be formulated with a polymer of formula Z, Z' or Z'' as described in International Pub. Nos. WO2012082574 or WO20 12068 187 and U.S. Pub. No. 2012028342, each of which are herein incorporated by reference in their entireties. The polymers formulated with the modified RNA of the present invention may be synthesized by the methods described in International Pub. Nos. WO2012082574 or WO2012068187, each of which are herein incorporated by reference in their entireties.

[000537] The cosmetic polynucleotides, primary constructs or mmRNA of the invention may be formulated with at least one acrylic polymer. Acrylic polymers include but are not limited to, acrylic acid, methacrylic acid, acrylic acid and methacrylic acid copolymers, methyl methacrylate copolymers, ethoxyethyl methacrylates, cyanoethyl methacrylate, amino alkyl methacrylate copolymer, poly(acrylic acid), poly(methacrylic acid), polycyanoacrylates and combinations thereof.

[000538] Formulations of cosmetic polynucleotides, primary constructs or mmRNA of the invention may include at least one amine-containing polymer such as, but not limited to polylysine, polyethylene imine, poly(amidoamine) dendrimers or combinations thereof.

[000539] For example, the modified nucleic acid or mmRNA of the invention may be formulated in a pharmaceutical compound including a poly(alkylene imine), a biodegradable cationic lipopolymer, a biodegradable block copolymer, a biodegradable polymer, or a biodegradable random copolymer, a biodegradable polyester block copolymer, a biodegradable polyester polymer, a biodegradable polyester random copolymer, a linear biodegradable copolymer, PAGA, a biodegradable cross-linked cationic multi-block copolymer or combinations thereof. The biodegradable cationic

lipopolymer may be made by methods known in the art and/or described in U.S. Pat. No. 6,696,038, U.S. App. Nos. 20030073619 and 20040142474 each of which is herein incorporated by reference in their entireties. The poly(alkylene imine) may be made using methods known in the art and/or as described in U.S. Pub. No. 20100004315, herein incorporated by reference in its entirety. The biodegradable polymer, biodegradable block copolymer, the biodegradable random copolymer, biodegradable polyester block copolymer, biodegradable polyester polymer, or biodegradable polyester random copolymer may be made using methods known in the art and/or as described in U.S. Pat. Nos. 6,517,869 and 6,267,987, the contents of which are each incorporated herein by reference in their entirety. The linear biodegradable copolymer may be made using methods known in the art and/or as described in U.S. Pat. No. 6,652,886. The PAGA polymer may be made using methods known in the art and/or as described in U.S. Pat. No. 6,217,912 herein incorporated by reference in its entirety. The PAGA polymer may be copolymerized to form a copolymer or block copolymer with polymers such as but not limited to, poly-L-lysine, polyarginine, polyornithine, histones, avidin, protamines, polylactides and poly(lactide-co-glycolides). The biodegradable cross-linked cationic multi-block copolymers may be made my methods known in the art and/or as described in U.S. Pat. No. 8,057,821 or U.S. Pub. No. 2012009145 each of which are herein incorporated by reference in their entireties. For example, the multi-block copolymers may be synthesized using linear polyethyleneimine (LPEI) blocks which have distinct patterns as compared to branched polyethyleneimines. Further, the composition or pharmaceutical composition may be made by the methods known in the art, described herein, or as described in U.S. Pub. No. 20100004315 or U.S. Pat. Nos. 6,267,987 and 6,217,912 each of which are herein incorporated by reference in their entireties.

**[000540]** The polynucleotides, primary constructs, and mmRNA of the invention may be formulated with at least one degradable polyester which may contain polycationic side chains. Degradable polyesters include, but are not limited to, poly(serine ester), poly(L-lactide-co-L-lysine), poly(4-hydroxy-L-proline ester), and combinations thereof. In another embodiment, the degradable polyesters may include a PEG conjugation to form a PEGylated polymer.

[000541] The polynucleotides, primary construct, mmRNA of the invention may be formulated with at least one crosslinkable polyester. Crosslinkable polyesters include those known in the art and described in US Pub. No. 20120269761, herein incorporated by reference in its entirety.

[000542] In one embodiment, the polymers described herein may be conjugated to a lipid-terminating PEG. As a non-limiting example, PLGA may be conjugated to a lipid-terminating PEG forming PLGA-DSPE-PEG. As another non-limiting example, PEG conjugates for use with the present invention are described in International Publication No. WO2008 103276, herein incorporated by reference in its entirety. The polymers may be conjugated using a ligand conjugate such as, but not limited to, the conjugates described in U.S. Pat. No. 8,273,363, herein incorporated by reference in its entirety.

[000543] In one embodiment, the modified RNA described herein may be conjugated with another compound. Non-limiting examples of conjugates are described in US Patent Nos. 7,964,578 and 7,833,992, each of which are herein incorporated by reference in their entireties. In another embodiment, modified RNA of the present invention may be conjugated with conjugates of formula 1-122 as described in US Patent Nos. 7,964,578 and 7,833,992, each of which are herein incorporated by reference in their entireties. The cosmetic polynucleotides, primary constructs and/or mmRNA described herein may be conjugated with a metal such as, but not limited to, gold. (See e.g., Giljohann et al. *Journ. Amer. Chem. Soc.* 2009 131(6): 2072-2073; herein incorporated by reference in its entirety). In another embodiment, the cosmetic polynucleotides, primary constructs and/or mmRNA described herein may be conjugated and/or encapsulated in gold-nanoparticles. (International Pub. No. WO201216269 and U.S. Pub. No. 20120302940; each of which is herein incorporated by reference in its entirety).

[000544] As described in U.S. Pub. No. 201000043 13, herein incorporated by reference in its entirety, a gene delivery composition may include a nucleotide sequence and a poloxamer. For example, the modified nucleic acid and mmRNA of the present invention may be used in a gene delivery composition with the poloxamer described in U.S. Pub. No. 20100004313.

[000545] In one embodiment, the polymer formulation of the present invention may be stabilized by contacting the polymer formulation, which may include a cationic carrier,

with a cationic lipopolymer which may be covalently linked to cholesterol and polyethylene glycol groups. The polymer formulation may be contacted with a cationic lipopolymer using the methods described in U.S. Pub. No. 20090042829 herein incorporated by reference in its entirety. The cationic carrier may include, but is not limited to, polyethylenimine, poly(trimethylenimine), poly(tetramethylenimine), polypropylenimine, aminoglycoside-polyamine, dideoxy-diamino-b-cyclodextrin, spermine, spermidine, poly(2-dimethylamino)ethyl methacrylate, poly(lysine), poly(histidine), poly(arginine), cationized gelatin, dendrimers, chitosan, 1,2-Dioleoyl-3-Trimethylammonium-Propane(DOTAP), N-[1-(2,3-dioleoyloxy)propyl]-N,N,N-trimethylammonium chloride (DOTMA), 1-[2-(oleoyloxy)ethyl]-2-oleyl-3-(2-hydroxyethyl)imidazolium chloride (DOTIM), 2,3-dioleoyloxy-N-[2(sperminecarboxamido)ethyl]-N,N-dimethyl-1-propanaminium trifluoroacetate (DOSPA), 3B-[N—(N',N'-Dimethylaminoethane)-carbamoyl]Cholesterol Hydrochloride (DC-Cholesterol HCl) diheptadecylamidoglycyl spermidine (DOGS), N,N-distearyl-N,N-dimethylammonium bromide (DDAB), N-(1,2-dimyristyloxyprop-3-yl)-N,N-dimethyl-N-hydroxyethyl ammonium bromide (DMRIE), N,N-dioleoyl-N,N-dimethylammonium chloride DODAC) and combinations thereof.

**[000546]** The cosmetic polynucleotides, primary constructs and/or mmRNA of the invention may be formulated in a polyplex of one or more polymers (U.S. Pub. No. 20120237565 and 20120270927; each of which is herein incorporated by reference in its entirety). In one embodiment, the polyplex comprises two or more cationic polymers. The cationic polymer may comprise a poly(ethylene imine) (PEI) such as linear PEL

**[000547]** The cosmetic polynucleotide, primary construct, and mmRNA of the invention can also be formulated as a nanoparticle using a combination of polymers, lipids, and/or other biodegradable agents, such as, but not limited to, calcium phosphate. Components may be combined in a core-shell, hybrid, and/or layer-by-layer architecture, to allow for fine-tuning of the nanoparticle so to delivery of the polynucleotide, primary construct and mmRNA may be enhanced (Wang et al, Nat Mater. 2006 5:791-796; Fuller et al., Biomaterials. 2008 29:1526-1532; DeKoker et al., Adv Drug Deliv Rev. 2011 63:748-761; Endres et al, Biomaterials. 2011 32:7721-7731; Su et al., Mol Pharm. 2011 Jun 6;8(3):774-87; herein incorporated by reference in its entirety). As a non-

limiting example, the nanoparticle may comprise a plurality of polymers such as, but not limited to hydrophilic-hydrophobic polymers (e.g., PEG-PLGA), hydrophobic polymers (e.g., PEG) and/or hydrophilic polymers (International Pub. No. WO20120225129; herein incorporated by reference in its entirety).

[000548] Biodegradable calcium phosphate nanoparticles in combination with lipids and/or polymers have been shown to deliver polynucleotides, primary constructs and mmRNA *in vivo*. In one embodiment, a lipid coated calcium phosphate nanoparticle, which may also contain a targeting ligand such as anisamide, may be used to deliver the polynucleotide, primary construct and mmRNA of the present invention. For example, to effectively deliver siRNA in a mouse metastatic lung model a lipid coated calcium phosphate nanoparticle was used (Li et al, J Contr Rel. 2010 142: 416-421; Li et al., J Contr Rel. 2012 158:108-114; Yang et al, Mol Ther. 2012 20:609-615; herein incorporated by reference in its entirety). This delivery system combines both a targeted nanoparticle and a component to enhance the endosomal escape, calcium phosphate, in order to improve delivery of the siRNA.

[000549] In one embodiment, calcium phosphate with a PEG-polyanion block copolymer may be used to delivery polynucleotides, primary constructs and mmRNA (Kazikawa et al, J Contr Rel. 2004 97:345-356; Kazikawa et al., J Contr Rel. 2006 111:368-370; herein incorporated by reference in its entirety).

[000550] In one embodiment, a PEG-charge-conversional polymer (Pitella et al, Biomaterials. 2011 32:3 106-3 114) may be used to form a nanoparticle to deliver the cosmetic polynucleotides, primary constructs and mmRNA of the present invention. The PEG-charge-conversional polymer may improve upon the PEG-polyanion block copolymers by being cleaved into a polycation at acidic pH, thus enhancing endosomal escape.

[000551] The use of core-shell nanoparticles has additionally focused on a high-throughput approach to synthesize cationic cross-linked nanogel cores and various shells (Siegwart et al., Proc Natl Acad Sci U S A. 2011 108:12996-13001). The complexation, delivery, and internalization of the polymeric nanoparticles can be precisely controlled by altering the chemical composition in both the core and shell components of the



nanoparticle. For example, the core-shell nanoparticles may efficiently deliver siRNA to mouse hepatocytes after they covalently attach cholesterol to the nanoparticle.

[000552] In one embodiment, a hollow lipid core comprising a middle PLGA layer and an outer neutral lipid layer containing PEG may be used to delivery of the polynucleotide, primary construct and mmRNA of the present invention. As a non-limiting example, in mice bearing a luciferase-expressing tumor, it was determined that the lipid-polymer-lipid hybrid nanoparticle significantly suppressed luciferase expression, as compared to a conventional lipoplex (Shi et al, *Angew Chem Int Ed.* 2011 50:7027-7031; herein incorporated by reference in its entirety).

[000553] In one embodiment, the lipid nanoparticles may comprise a core of the modified nucleic acid molecules disclosed herein and a polymer shell. The polymer shell may be any of the polymers described herein and are known in the art. In an additional embodiment, the polymer shell may be used to protect the modified nucleic acids in the core.

[000554] Core-shell nanoparticles for use with the modified nucleic acid molecules of the present invention are described and may be formed by the methods described in U.S. Pat. No. 8,313,777 herein incorporated by reference in its entirety.

[000555] In one embodiment, the core-shell nanoparticles may comprise a core of the modified nucleic acid molecules disclosed herein and a polymer shell. The polymer shell may be any of the polymers described herein and are known in the art. In an additional embodiment, the polymer shell may be used to protect the modified nucleic acid molecules in the core. As a non-limiting example, the core-shell nanoparticle may be used to treat an eye disease or disorder (See e.g. US Publication No. 20120321719, herein incorporated by reference in its entirety).

[000556] In one embodiment, the polymer used with the formulations described herein may be a modified polymer (such as, but not limited to, a modified polyacetal) as described in International Publication No. WO2011120053, herein incorporated by reference in its entirety.

#### *Peptides and Proteins*

[000557] The cosmetic polynucleotide, primary construct, and mmRNA of the invention can be formulated with peptides and/or proteins in order to increase

transfection of cells by the cosmetic polynucleotide, primary construct, or mmRNA. In one embodiment, peptides such as, but not limited to, cell penetrating peptides and proteins and peptides that enable intracellular delivery may be used to deliver pharmaceutical formulations. A non-limiting example of a cell penetrating peptide which may be used with the pharmaceutical formulations of the present invention includes a cell-penetrating peptide sequence attached to polycations that facilitates delivery to the intracellular space, e.g., HIV-derived TAT peptide, penetratins, transportans, or hCT derived cell-penetrating peptides (see, e.g., Caron et al., *Mol. Ther.* 3(3):3 10-8 (2001); Langel, *Cell-Penetrating Peptides: Processes and Applications* (CRC Press, Boca Raton FL, 2002); El-Andaloussi et al., *Curr. Pharm. Des.* 11(28):3597-611 (2003); and Deshayes et al., *Cell. Mol. Life Sci.* 62(16): 1839-49 (2005), all of which are incorporated herein by reference in their entirety). The compositions can also be formulated to include a cell penetrating agent, e.g., liposomes, which enhance delivery of the compositions to the intracellular space. Polynucleotides, primary constructs, and mmRNA of the invention may be complexed to peptides and/or proteins such as, but not limited to, peptides and/or proteins from Aileron Therapeutics (Cambridge, MA) and Permeon Biologies (Cambridge, MA) in order to enable intracellular delivery (Cronican et al., *ACS Chem. Biol.* 2010 5:747-752; McNaughton et al, *Proc. Natl. Acad. Sci. USA* 2009 106:61 11-61 16; Sawyer, *Chem Biol Drug Des.* 2009 73:3-6; Verdine and Hilinski, *Methods Enzymol.* 2012;503:3-33; all of which are herein incorporated by reference in its entirety).

[000558] In one embodiment, the cell-penetrating polypeptide may comprise a first domain and a second domain. The first domain may comprise a supercharged polypeptide. The second domain may comprise a protein-binding partner. As used herein, "protein-binding partner" includes, but are not limited to, antibodies and functional fragments thereof, scaffold proteins, or peptides. The cell-penetrating polypeptide may further comprise an intracellular binding partner for the protein-binding partner. The cell-penetrating polypeptide may be capable of being secreted from a cell where the cosmetic polynucleotide, primary construct, or mmRNA may be introduced.

[000559] Formulations of the including peptides or proteins may be used to increase cell transfection by the cosmetic polynucleotide, primary construct, or mmRNA, alter the

biodistribution of the cosmetic polynucleotide, primary construct, or mmRNA (e.g., by targeting specific tissues or cell types), and/or increase the translation of encoded protein. (See e.g., International Pub. No. WO20121 10636; herein incorporated by reference in its entirety).

#### *Cells*

**[000560]** The cosmetic polynucleotide, primary construct, and mmRNA of the invention can be transfected *ex vivo* into cells, which are subsequently transplanted into a subject. As non-limiting examples, the pharmaceutical compositions may include red blood cells to deliver modified RNA to liver and myeloid cells, virosomes to deliver modified RNA in virus-like particles (VLPs), and electroporated cells such as, but not limited to, from MAXCYTE® (Gaithersburg, MD) and from ERYTECH® (Lyon, France) to deliver modified RNA. Examples of use of red blood cells, viral particles and electroporated cells to deliver payloads other than mmRNA have been documented (Godfrin et al, Expert Opin Biol Ther. 2012 12:127-133; Fang et al, Expert Opin Biol Ther. 2012 12:385-389; Hu et al., Proc Natl Acad Sci U S A. 201 1 108:10980-10985; Lund et al, Pharm Res. 2010 27:400-420; Huckriede et al, J Liposome Res. 2007;17:39-47; Cusi, Hum Vaccin. 2006 2:1-7; de Jonge et al, Gene Ther. 2006 13:400-41 1; all of which are herein incorporated by reference in its entirety).

**[000561]** The cosmetic polynucleotides, primary constructs and mmRNA may be delivered in synthetic VLPs synthesized by the methods described in International Pub No. WO201 1085231 and US Pub No. 201 10171248, each of which are herein incorporated by reference in their entireties.

**[000562]** Cell-based formulations of the cosmetic polynucleotide, primary construct, and mmRNA of the invention may be used to ensure cell transfection (e.g., in the cellular carrier), alter the biodistribution of the cosmetic polynucleotide, primary construct, or mmRNA (e.g., by targeting the cell carrier to specific tissues or cell types), and/or increase the translation of encoded protein.

**[000563]** A variety of methods are known in the art and suitable for introduction of nucleic acid into a cell, including viral and non-viral mediated techniques. Examples of typical non-viral mediated techniques include, but are not limited to, electroporation, calcium phosphate mediated transfer, nucleofection, sonoporation, heat shock,

magnetofection, liposome mediated transfer, microinjection, microprojectile mediated transfer (nanoparticles), cationic polymer mediated transfer (DEAE-dextran, polyethylenimine, polyethylene glycol (PEG) and the like) or cell fusion.

[000564] The technique of sonoporation, or cellular sonication, is the use of sound (e.g., ultrasonic frequencies) for modifying the permeability of the cell plasma membrane. Sonoporation methods are known to those in the art and are used to deliver nucleic acids *in vivo* (Yoon and Park, *Expert Opin Drug Deliv.* 2010 7:321-330; Postema and Gilja, *Curr Pharm Biotechnol.* 2007 8:355-361; Newman and Bettinger, *Gene Ther.* 2007 14:465-475; all herein incorporated by reference in their entirety). Sonoporation methods are known in the art and are also taught for example as it relates to bacteria in US Patent Publication 20100196983 and as it relates to other cell types in, for example, US Patent Publication 20100009424, each of which are incorporated herein by reference in their entirety.

[000565] Electroporation techniques are also well known in the art and are used to deliver nucleic acids *in vivo* and clinically (Andre et al., *Curr Gene Ther.* 2010 10:267-280; Chiarella et al, *Curr Gene Ther.* 2010 10:281-286; Hojman, *Curr Gene Ther.* 2010 10:128-138; all herein incorporated by reference in their entirety). In one embodiment, polynucleotides, primary constructs or mmRNA may be delivered by electroporation as described in Example 8.

#### *Hyaluronidase*

[000566] The intramuscular or subcutaneous localized injection of polynucleotide, primary construct, or mmRNA of the invention can include hyaluronidase, which catalyzes the hydrolysis of hyaluronan. By catalyzing the hydrolysis of hyaluronan, a constituent of the interstitial barrier, hyaluronidase lowers the viscosity of hyaluronan, thereby increasing tissue permeability (Frost, *Expert Opin. Drug Deliv.* (2007) 4:427-440; herein incorporated by reference in its entirety). It is useful to speed their dispersion and systemic distribution of encoded proteins produced by transfected cells. Alternatively, the hyaluronidase can be used to increase the number of cells exposed to a cosmetic polynucleotide, primary construct, or mmRNA of the invention administered intramuscularly or subcutaneously.

#### *Nanoparticle Mimics*

[000567] The polynucleotide, primary construct or mmRNA of the invention may be encapsulated within and/or absorbed to a nanoparticle mimic. A nanoparticle mimic can mimic the delivery function organisms or particles such as, but not limited to, pathogens, viruses, bacteria, fungus, parasites, prions and cells. As a non-limiting example the polynucleotide, primary construct or mmRNA of the invention may be encapsulated in a non-viron particle which can mimic the delivery function of a virus (see International Pub. No. WO20 120063 76 herein incorporated by reference in its entirety).

*Nanotubes*

[000568] The cosmetic polynucleotides, primary constructs or mmRNA of the invention can be attached or otherwise bound to at least one nanotube such as, but not limited to, rosette nanotubes, rosette nanotubes having twin bases with a linker, carbon nanotubes and/or single-walled carbon nanotubes, The cosmetic polynucleotides, primary constructs or mmRNA may be bound to the nanotubes through forces such as, but not limited to, steric, ionic, covalent and/or other forces.

[000569] In one embodiment, the nanotube can release one or more polynucleotides, primary constructs or mmRNA into cells. The size and/or the surface structure of at least one nanotube may be altered so as to govern the interaction of the nanotubes within the body and/or to attach or bind to the cosmetic polynucleotides, primary constructs or mmRNA disclosed herein. In one embodiment, the building block and/or the functional groups attached to the building block of the at least one nanotube may be altered to adjust the dimensions and/or properties of the nanotube. As a non-limiting example, the length of the nanotubes may be altered to hinder the nanotubes from passing through the holes in the walls of normal blood vessels but still small enough to pass through the larger holes in the blood vessels of tumor tissue.

[000570] In one embodiment, at least one nanotube may also be coated with delivery enhancing compounds including polymers, such as, but not limited to, polyethylene glycol. In another embodiment, at least one nanotube and/or the cosmetic polynucleotides, primary constructs or mmRNA may be mixed with pharmaceutically acceptable excipients and/or delivery vehicles.

[000571] In one embodiment, the cosmetic polynucleotides, primary constructs or mmRNA are attached and/or otherwise bound to at least one rosette nanotube. The

rosette nanotubes may be formed by a process known in the art and/or by the process described in International Publication No. WO20 12094304, herein incorporated by reference in its entirety. At least one polynucleotide, primary construct and/or mmRNA may be attached and/or otherwise bound to at least one rosette nanotube by a process as described in International Publication No. WO20 12094304, herein incorporated by reference in its entirety, where rosette nanotubes or modules forming rosette nanotubes are mixed in aqueous media with at least one polynucleotide, primary construct and/or mmRNA under conditions which may cause at least one polynucleotide, primary construct or mmRNA to attach or otherwise bind to the rosette nanotubes.

**[000572]** In one embodiment, the cosmetic polynucleotides, primary constructs or mmRNA may be attached to and/or otherwise bound to at least one carbon nanotube. As a non-limiting example, the cosmetic polynucleotides, primary constructs or mmRNA may be bound to a linking agent and the linked agent may be bound to the carbon nanotube (See e.g., U.S. Pat No. 8,246,995; herein incorporated by reference in its entirety). The carbon nanotube may be a single-walled nanotube (See e.g., U.S. Pat No. 8,246,995; herein incorporated by reference in its entirety).

#### *Conjugates*

**[000573]** The polynucleotides, primary constructs, and mmRNA of the invention include conjugates, such as a cosmetic polynucleotide, primary construct, or mmRNA covalently linked to a carrier or targeting group, or including two encoding regions that together produce a fusion protein (e.g., bearing a targeting group and therapeutic protein or peptide).

**[000574]** The conjugates of the invention include a naturally occurring substance, such as a protein (e.g., human serum albumin (HSA), low-density lipoprotein (LDL), high-density lipoprotein (HDL), or globulin); an carbohydrate (e.g., a dextran, pullulan, chitin, chitosan, inulin, cyclodextrin or hyaluronic acid); or a lipid. The ligand may also be a recombinant or synthetic molecule, such as a synthetic polymer, e.g., a synthetic polyamino acid, an oligonucleotide (e.g. an aptamer). Examples of polyamino acids include polyamino acid is a polylysine (PLL), poly L-aspartic acid, poly L-glutamic acid, styrene-maleic acid anhydride copolymer, poly(L-lactide-co-glycolide) copolymer, divinyl ether-maleic anhydride copolymer, N-(2-hydroxypropyl)methacrylamide

copolymer (HMPA), polyethylene glycol (PEG), polyvinyl alcohol (PVA), polyurethane, poly(2-ethylacrylic acid), N-isopropylacrylamide polymers, or polyphosphazine.

Example of polyamines include: polyethylenimine, polylysine (PLL), spermine, spermidine, polyamine, pseudopeptide-polyamine, peptidomimetic polyamine, dendrimer polyamine, arginine, amidine, protamine, cationic lipid, cationic porphyrin, quaternary salt of a polyamine, or an alpha helical peptide.

**[000575]** Representative U.S. patents that teach the preparation of polynucleotide conjugates, particularly to RNA, include, but are not limited to, U.S. Pat. Nos. 4,828,979; 4,948,882; 5,218,105; 5,525,465; 5,541,313; 5,545,730; 5,552,538; 5,578,717, 5,580,731; 5,591,584; 5,109,124; 5,118,802; 5,138,045; 5,414,077; 5,486,603; 5,512,439; 5,578,718; 5,608,046; 4,587,044; 4,605,735; 4,667,025; 4,762,779; 4,789,737; 4,824,941; 4,835,263; 4,876,335; 4,904,582; 4,958,013; 5,082,830; 5,112,963; 5,214,136; 5,082,830; 5,112,963; 5,214,136; 5,245,022; 5,254,469; 5,258,506; 5,262,536; 5,272,250; 5,292,873; 5,317,098; 5,371,241; 5,391,723; 5,416,203; 5,451,463; 5,510,475; 5,512,667; 5,514,785; 5,565,552; 5,567,810; 5,574,142; 5,585,481; 5,587,371; 5,595,726; 5,597,696; 5,599,923; 5,599,928 and 5,688,941; 6,294,664; 6,320,017; 6,576,752; 6,783,931; 6,900,297; 7,037,646; each of which is herein incorporated by reference in their entireties.

**[000576]** In one embodiment, the conjugate of the present invention may function as a carrier for the modified nucleic acids and mmRNA of the present invention. The conjugate may comprise a cationic polymer such as, but not limited to, polyamine, polylysine, polyalkylenimine, and polyethylenimine which may be grafted to with poly(ethylene glycol). As a non-limiting example, the conjugate may be similar to the polymeric conjugate and the method of synthesizing the polymeric conjugate described in U.S. Pat. No. 6,586,524 herein incorporated by reference in its entirety.

**[000577]** The conjugates can also include targeting groups, e.g., a cell or tissue targeting agent, e.g., a lectin, glycoprotein, lipid or protein, e.g., an antibody, that binds to a specified cell type such as a kidney cell. A targeting group can be a thyrotropin, melanotropin, lectin, glycoprotein, surfactant protein A, Mucin carbohydrate, multivalent lactose, multivalent galactose, N-acetyl-galactosamine, N-acetyl-gulucosamine multivalent mannose, multivalent fucose, glycosylated polyaminoacids, multivalent galactose, transferrin, bisphosphonate, polyglutamate, polyaspartate, a lipid, cholesterol,

a steroid, bile acid, folate, vitamin B12, biotin, an RGD peptide, an RGD peptide mimetic or an aptamer.

[000578] Targeting groups can be proteins, e.g., glycoproteins, or peptides, e.g., molecules having a specific affinity for a co-ligand, or antibodies e.g., an antibody, that binds to a specified cell type such as a cancer cell, endothelial cell, or bone cell.

Targeting groups may also include hormones and hormone receptors. They can also include non-peptidic species, such as lipids, lectins, carbohydrates, vitamins, cofactors, multivalent lactose, multivalent galactose, N-acetyl-galactosamine, N-acetyl-gulucosamine multivalent mannose, multivalent fucose, or aptamers. The ligand can be, for example, a lipopolysaccharide, or an activator of p38 MAP kinase.

[000579] The targeting group can be any ligand that is capable of targeting a specific receptor. Examples include, without limitation, folate, GalNAc, galactose, mannose, mannose-6P, aptamers, integrin receptor ligands, chemokine receptor ligands, transferrin, biotin, serotonin receptor ligands, PSMA, endothelin, GCPII, somatostatin, LDL, and HDL ligands. In particular embodiments, the targeting group is an aptamer. The aptamer can be unmodified or have any combination of modifications disclosed herein.

[000580] In one embodiment, pharmaceutical compositions of the present invention may include chemical modifications such as, but not limited to, modifications similar to locked nucleic acids.

[000581] Representative U.S. Patents that teach the preparation of locked nucleic acid (LNA) such as those from Santaris, include, but are not limited to, the following: U.S. Pat. Nos. 6,268,490; 6,670,461; 6,794,499; 6,998,484; 7,053,207; 7,084,125; and 7,399,845, each of which is herein incorporated by reference in its entirety.

[000582] Representative U.S. patents that teach the preparation of PNA compounds include, but are not limited to, U.S. Pat. Nos. 5,539,082; 5,714,331; and 5,719,262, each of which is herein incorporated by reference. Further teaching of PNA compounds can be found, for example, in Nielsen *et al*, Science, 1991, 254, 1497-1500.

[000583] Some embodiments featured in the invention include polynucleotides, primary constructs or mmRNA with phosphorothioate backbones and ohgonucleosides with other modified backbones, and in particular  $-\text{CH}_2-\text{NH}-\text{CH}_2-$ ,  $-\text{CH}_2-\text{N}(\text{CH}_3)-\text{O}-\text{CH}_2-$



[known as a methylene (methylimino) or MMI backbone],  $-\text{CH}_2-\text{O}-\text{N}(\text{C}\text{I}\text{I}\text{I})-\text{CH}_2-$ ,  $\sim\text{CH}_2-\text{N}(\text{CH}_3)-\text{N}(\text{CH}_3)-\text{CH}_2-$  and  $-\text{N}(\text{CH}_3)-\text{CH}_2-\text{CH}_2-$  [wherein the native phosphodiester backbone is represented as  $-\text{O}-\text{P}(\text{O})_2-\text{O}-\text{CH}_2-$ ] of the above-referenced U.S. Pat. No. 5,489,677, and the amide backbones of the above-referenced U.S. Pat. No. 5,602,240. In some embodiments, the polynucleotides featured herein have morpholino backbone structures of the above-referenced U.S. Pat. No. 5,034,506.

[000584] Modifications at the 2' position may also aid in delivery. Preferably, modifications at the 2' position are not located in a polypeptide-coding sequence, i.e., not in a translatable region. Modifications at the 2' position may be located in a 5'UTR, a 3'UTR and/or a tailing region. Modifications at the 2' position can include one of the following at the 2' position: H (i.e., 2'-deoxy); F; O-, S-, or N-alkyl; O-, S-, or N-alkenyl; O-, S- or N-alkynyl; or O-alkyl-O-alkyl, wherein the alkyl, alkenyl and alkynyl may be substituted or unsubstituted  $\text{C}_1$  to  $\text{C}_{10}$  alkyl or  $\text{C}_2$  to  $\text{C}_{10}$  alkenyl and alkynyl. Exemplary suitable modifications include  $\text{O}[(\text{CH}_2)_m, \text{O}]_n\text{CH}_3$ ,  $\text{O}(\text{CH}_2)_n\text{OCH}_3$ ,  $\text{O}(\text{CH}_2)_n\text{NH}_2$ ,  $\text{O}(\text{CH}_2)_n\text{CH}_3$ ,  $\text{O}(\text{CH}_2)_n\text{ONH}_2$ , and  $\text{O}(\text{CH}_2)_n\text{ON}[(\text{CH}_2)_m\text{CH}_3]_2$ , where n and m are from 1 to about 10. In other embodiments, the cosmetic polynucleotides, primary constructs or mmRNA include one of the following at the 2' position:  $\text{C}_1$  to  $\text{C}_{10}$  lower alkyl, substituted lower alkyl, alkaryl, aralkyl, O-alkaryl or O-aralkyl, SH, SCH<sub>3</sub>, OCN, Cl, Br, CN, CF<sub>3</sub>, OCF<sub>3</sub>, SOCH<sub>3</sub>, SO<sub>2</sub>CH<sub>3</sub>, ONO<sub>2</sub>, NO<sub>2</sub>, N<sub>3</sub>, NH<sub>2</sub>, heterocycloalkyl, heterocycloalkaryl, aminoalkylamino, polyalkylamino, substituted silyl, an RNA cleaving group, a reporter group, an intercalator, a group for improving the pharmacokinetic properties, or a group for improving the pharmacodynamic properties, and other substituents having similar properties. In some embodiments, the modification includes a 2'-methoxyethoxy (2'-O-CH<sub>2</sub>CH<sub>2</sub>OCH<sub>3</sub>, also known as 2'-O-(2-methoxyethyl) or 2'-MOE) (Martin *et al.*, *Helv. Chim. Acta*, 1995, 78:486-504) i.e., an alkoxy-alkoxy group. Another exemplary modification is 2'-dimethylaminoethoxy, i.e., a  $\text{O}(\text{CH}_2)_2\text{N}(\text{CH}_3)_2$  group, also known as 2'-DMAOE, as described in examples herein below, and 2'-dimethylaminoethoxyethoxy (also known in the art as 2'-O-dimethylaminoethoxyethyl or 2'-DMAEOE), i.e.,  $2^*\text{-O}-\text{CH}_2-\text{O}-\text{CH}_2-\text{N}(\text{CH}_2)_2$ , also described in examples herein below. Other modifications include 2'-methoxy (2'-OCH<sub>3</sub>), 2'-aminopropoxy (2'-OCH<sub>2</sub>CH<sub>2</sub>CH<sub>2</sub>NH<sub>2</sub>) and 2'-fluoro (2'-F). Similar modifications may also be made at other

positions, particularly the 3' position of the sugar on the 3' terminal nucleotide or in 2'-5' linked dsRNAs and the 5' position of 5' terminal nucleotide. Polynucleotides of the invention may also have sugar mimetics such as cyclobutyl moieties in place of the pentofuranosyl sugar. Representative U.S. patents that teach the preparation of such modified sugar structures include, but are not limited to, U.S. Pat. Nos. 4,981,957; 5,118,800; 5,319,080; 5,359,044; 5,393,878; 5,446,137; 5,466,786; 5,514,785; 5,519,134; 5,567,811; 5,576,427; 5,591,722; 5,597,909; 5,610,300; 5,627,053; 5,639,873; 5,646,265; 5,658,873; 5,670,633; and 5,700,920 and each of which is herein incorporated by reference.

**[000585]** In still other embodiments, the cosmetic polynucleotide, primary construct, or mmRNA is covalently conjugated to a cell penetrating polypeptide. The cell-penetrating peptide may also include a signal sequence. The conjugates of the invention can be designed to have increased stability; increased cell transfection; and/or altered the biodistribution (e.g., targeted to specific tissues or cell types).

**[000586]** In one embodiment, the cosmetic polynucleotides, primary constructs or mmRNA may be conjugated to an agent to enhance delivery. As a non-limiting example, the agent may be a monomer or polymer such as a targeting monomer or a polymer having targeting blocks as described in International Publication No. WO201 1062965, herein incorporated by reference in its entirety. In another non-limiting example, the agent may be a transport agent covalently coupled to the cosmetic polynucleotides, primary constructs or mmRNA of the present invention (See e.g., U.S. Pat. Nos. 6,835,393 and 7,374,778, each of which is herein incorporated by reference in its entirety). In yet another non-limiting example, the agent may be a membrane barrier transport enhancing agent such as those described in U.S. Pat. Nos. 7,737,108 and 8,003,129, each of which is herein incorporated by reference in its entirety.

**[000587]** In another embodiment, the cosmetic polynucleotides, primary constructs or mmRNA may be conjugated to SMARTT POLYMER TECHNOLOGY® (PHASERX®, Inc. Seattle, WA).

*Self-Assembled Nanoparticles*

*Nucleic Acid Self-Assembled Nanoparticles*

[000588] Self-assembled nanoparticles have a well-defined size which may be precisely controlled as the nucleic acid strands may be easily reprogrammable. For example, the optimal particle size for a cancer-targeting nanodelivery carrier is 20-100 nm as a diameter greater than 20 nm avoids renal clearance and enhances delivery to certain tumors through enhanced permeability and retention effect. Using self-assembled nucleic acid nanoparticles a single uniform population in size and shape having a precisely controlled spatial orientation and density of cancer-targeting ligands for enhanced delivery. As a non-limiting example, oligonucleotide nanoparticles were prepared using programmable self-assembly of short DNA fragments and therapeutic siRNAs. These nanoparticles are molecularly identical with controllable particle size and target ligand location and density. The DNA fragments and siRNAs self-assembled into a one-step reaction to generate DNA/siRNA tetrahedral nanoparticles for targeted *in vivo* delivery. (Lee et al, Nature Nanotechnology 2012 7:389-393; herein incorporated by reference in its entirety).

[000589] In one embodiment, the cosmetic polynucleotides, primary constructs and/or mmRNA disclosed herein may be formulated as self-assembled nanoparticles. As a non-limiting example, nucleic acids may be used to make nanoparticles which may be used in a delivery system for the cosmetic polynucleotides, primary constructs and/or mmRNA of the present invention (See e.g., International Pub. No. WO2012125987; herein incorporated by reference in its entirety).

[000590] In one embodiment, the nucleic acid self-assembled nanoparticles may comprise a core of the cosmetic polynucleotides, primary constructs or mmRNA disclosed herein and a polymer shell. The polymer shell may be any of the polymers described herein and are known in the art. In an additional embodiment, the polymer shell may be used to protect the polynucleotides, primary constructs and mmRNA in the core.

#### Polymer-Based Self-Assembled Nanoparticles

[000591] Polymers may be used to form sheets which self-assembled into nanoparticles. These nanoparticles may be used to deliver the cosmetic polynucleotides, primary constructs and mmRNA of the present invention. In one embodiment, these self-assembled nanoparticles may be microsponges formed of long polymers of RNA hairpins

which form into crystalline 'pleated' sheets before self-assembling into microsponges. These microsponges are densely-packed sponge like microparticles which may function as an efficient carrier and may be able to deliver cargo to a cell. The microsponges may be from 1  $\mu\text{m}$  to 300 nm in diameter. The microsponges may be complexed with other agents known in the art to form larger microsponges. As a non-limiting example, the microsp sponge may be complexed with an agent to form an outer layer to promote cellular uptake such as polycation polyethyleneimine (PEI). This complex can form a 250-nm diameter particle that can remain stable at high temperatures (150°C) (Grabow and Jaegar, Nature Materials 2012, 11:269-269; herein incorporated by reference in its entirety). Additionally these microsponges may be able to exhibit an extraordinary degree of protection from degradation by ribonucleases.

[000592] In another embodiment, the polymer-based self-assembled nanoparticles such as, but not limited to, microsponges, may be fully programmable nanoparticles. The geometry, size and stoichiometry of the nanoparticle may be precisely controlled to create the optimal nanoparticle for delivery of cargo such as, but not limited to, polynucleotides, primary constructs and/or mmRNA.

[000593] In one embodiment, the polymer based nanoparticles may comprise a core of the cosmetic polynucleotides, primary constructs and/or mmRNA disclosed herein and a polymer shell. The polymer shell may be any of the polymers described herein and are known in the art. In an additional embodiment, the polymer shell may be used to protect the polynucleotides, primary construct and/or mmRNA in the core.

[000594] In yet another embodiment, the polymer based nanoparticle may comprise a non-nucleic acid polymer comprising a plurality of heterogenous monomers such as those described in International Publication No. WO2013009736, herein incorporated by reference in its entirety.

#### *Inorganic Nanoparticles*

[000595] The cosmetic polynucleotides, primary constructs and/or mmRNAs of the present invention may be formulated in inorganic nanoparticles (U.S. Pat. No. 8,257,745, herein incorporated by reference in its entirety). The inorganic nanoparticles may include, but are not limited to, clay substances that are water swellable. As a non-limiting example, the inorganic nanoparticle may include synthetic smectite clays which

are made from simple silicates (See e.g., U.S. Pat. No. 5,585,108 and 8,257,745 each of which are herein incorporated by reference in their entirety).

[000596] In one embodiment, the inorganic nanoparticles may comprise a core of the modified nucleic acids disclosed herein and a polymer shell. The polymer shell may be any of the polymers described herein and are known in the art. In an additional embodiment, the polymer shell may be used to protect the modified nucleic acids in the core.

#### *Semi-conductive and Metallic Nanoparticles*

[000597] The cosmetic polynucleotides, primary constructs and/or mmRNAs of the present invention may be formulated in water-dispersible nanoparticle comprising a semiconductive or metallic material (U.S. Pub. No. 20120228565; herein incorporated by reference in its entirety) or formed in a magnetic nanoparticle (U.S. Pub. No. 20120265001 and 20120283503; each of which is herein incorporated by reference in its entirety). The water-dispersible nanoparticles may be hydrophobic nanoparticles or hydrophilic nanoparticles.

[000598] In one embodiment, the semi-conductive and/or metallic nanoparticles may comprise a core of the cosmetic polynucleotides, primary constructs and/or mmRNA disclosed herein and a polymer shell. The polymer shell may be any of the polymers described herein and are known in the art. In an additional embodiment, the polymer shell may be used to protect the cosmetic polynucleotides, primary constructs and/or mmRNA in the core.

#### *Gels and Hydrogels*

[000599] In one embodiment, the cosmetic polynucleotides, primary constructs and/or mmRNA disclosed herein may be encapsulated into any hydrogel known in the art which may form a gel when injected into a subject. Hydrogels are a network of polymer chains that are hydrophilic, and are sometimes found as a colloidal gel in which water is the dispersion medium. Hydrogels are highly absorbent (they can contain over 99% water) natural or synthetic polymers. Hydrogels also possess a degree of flexibility very similar to natural tissue, due to their significant water content. The hydrogel described herein may used to encapsulate lipid nanoparticles which are biocompatible, biodegradable and/or porous.

[000600] As a non-limiting example, the hydrogel may be an aptamer-functionalized hydrogel. The aptamer-functionalized hydrogel may be programmed to release one or more polynucleotides, primary constructs and/or mmRNA using nucleic acid hybridization. (Battig et al., J. Am. Chem. Society. 2012 134:12410-12413; herein incorporated by reference in its entirety).

[000601] As another non-limiting example, the hydrogel may be shaped as an inverted opal.

The opal hydrogels exhibit higher swelling ratios and the swelling kinetics is an order of magnitude faster as well. Methods of producing opal hydrogels and description of opal hydrogels are described in International Pub. No. WO2012148684, herein incorporated by reference in its entirety.

[000602] In yet another non-limiting example, the hydrogel may be an antibacterial hydrogel. The antibacterial hydrogel may comprise a pharmaceutical acceptable salt or organic material such as, but not limited to pharmaceutical grade and/or medical grade silver salt and aloe vera gel or extract. (International Pub. No. WO2012151438, herein incorporated by reference in its entirety).

[000603] In one embodiment, the modified mRNA may be encapsulated in a lipid nanoparticle and then the lipid nanoparticle may be encapsulated into a hydrogel.

[000604] In one embodiment, the cosmetic polynucleotides, primary constructs and/or mmRNA disclosed herein may be encapsulated into any gel known in the art. As a non-limiting example the gel may be a fluorouracil injectable gel or a fluorouracil injectable gel containing a chemical compound and/or drug known in the art. As another example, the cosmetic polynucleotides, primary constructs and/or mmRNA may be encapsulated in a fluorouracil gel containing epinephrine (See e.g., Smith et al. Cancer Chemotherapy and Pharmacology, 1999 44(4):267-274; herein incorporated by reference in its entirety).

[000605] In one embodiment, the cosmetic polynucleotides, primary constructs and/or mmRNA disclosed herein may be encapsulated into a fibrin gel, fibrin hydrogel or fibrin glue. In another embodiment, the cosmetic polynucleotides, primary constructs and/or mmRNA may be formulated in a lipid nanoparticle or a rapidly eliminated lipid nanoparticle prior to being encapsulated into a fibrin gel, fibrin hydrogel or a fibrin glue. In yet another embodiment, the cosmetic polynucleotides, primary constructs and/or

mmRNA may be formulated as a lipoplex prior to being encapsulated into a fibrin gel, hydrogel or a fibrin glue. Fibrin gels, hydrogels and glues comprise two components, a fibrinogen solution and a thrombin solution which is rich in calcium (See e.g., Spicer and Mikos, *Journal of Controlled Release* 2010. 148: 49-55; Kidd et al. *Journal of Controlled Release* 2012. 157:80-85; each of which is herein incorporated by reference in its entirety). The concentration of the components of the fibrin gel, hydrogel and/or glue can be altered to change the characteristics, the network mesh size, and/or the degradation characteristics of the gel, hydrogel and/or glue such as, but not limited to changing the release characteristics of the fibrin gel, hydrogel and/or glue. (See e.g., Spicer and Mikos, *Journal of Controlled Release* 2010. 148: 49-55; Kidd et al. *Journal of Controlled Release* 2012. 157:80-85; Catelas et al. *Tissue Engineering* 2008. 14:119-128; each of which is herein incorporated by reference in its entirety). This feature may be advantageous when used to deliver the modified mRNA disclosed herein. (See e.g., Kidd et al. *Journal of Controlled Release* 2012. 157:80-85; Catelas et al. *Tissue Engineering* 2008. 14: 119-128; each of which is herein incorporated by reference in its entirety).

#### *Cations and Anions*

[000606] Formulations of polynucleotides, primary constructs and/or mmRNA disclosed herein may include cations or anions. In one embodiment, the formulations include metal cations such as, but not limited to, Zn<sup>2+</sup>, Ca<sup>2+</sup>, Cu<sup>2+</sup>, Mg<sup>+</sup> and combinations thereof. As a non-limiting example, formulations may include polymers and a polynucleotides, primary constructs and/or mmRNA complexed with a metal cation (See e.g., U.S. Pat. Nos. 6,265,389 and 6,555,525, each of which is herein incorporated by reference in its entirety).

#### *Molded Nanoparticles and Microparticles*

[000607] The cosmetic polynucleotides, primary constructs and/or mmRNA disclosed herein may be formulated in nanoparticles and/or microparticles. These nanoparticles and/or microparticles may be molded into any size shape and chemistry. As an example, the nanoparticles and/or microparticles may be made using the PRINT® technology by LIQUIDA TECHNOLOGIES® (Morrisville, NC) (See e.g., International Pub. No. WO2007024323; herein incorporated by reference in its entirety).

[000608] In one embodiment, the molded nanoparticles may comprise a core of the cosmetic polynucleotides, primary constructs and/or mmRNA disclosed herein and a polymer shell. The polymer shell may be any of the polymers described herein and are known in the art. In an additional embodiment, the polymer shell may be used to protect the polynucleotides, primary construct and/or mmRNA in the core.

*NanoJackets and NanoLiposomes*

[000609] The cosmetic polynucleotides, primary constructs and/or mmRNA disclosed herein may be formulated in NanoJackets and NanoLiposomes by Keystone Nano (State College, PA). NanoJackets are made of compounds that are naturally found in the body including calcium, phosphate and may also include a small amount of silicates.

Nanojackets may range in size from 5 to 50 nm and may be used to deliver hydrophilic and hydrophobic compounds such as, but not limited to, polynucleotides, primary constructs and/or mmRNA.

[000610] NanoLiposomes are made of lipids such as, but not limited to, lipids which naturally occur in the body. NanoLiposomes may range in size from 60-80 nm and may be used to deliver hydrophilic and hydrophobic compounds such as, but not limited to, polynucleotides, primary constructs and/or mmRNA. In one aspect, the cosmetic polynucleotides, primary constructs and/or mmRNA disclosed herein are formulated in a NanoLiposome such as, but not limited to, Ceramide NanoLiposomes.

*Excipients*

[000611] Pharmaceutical formulations may additionally comprise a pharmaceutically acceptable excipient, which, as used herein, includes any and all solvents, dispersion media, diluents, or other liquid vehicles, dispersion or suspension aids, surface active agents, isotonic agents, thickening or emulsifying agents, preservatives, solid binders, lubricants and the like, as suited to the particular dosage form desired. Remington's *The Science and Practice of Pharmacy*, 21<sup>st</sup> Edition, A. R. Gennaro (Lippincott, Williams & Wilkins, Baltimore, MD, 2006; incorporated herein by reference in its entirety) discloses various excipients used in formulating pharmaceutical compositions and known techniques for the preparation thereof. Except insofar as any conventional excipient medium is incompatible with a substance or its derivatives, such as by producing any undesirable biological effect or otherwise interacting in a deleterious manner with any



other component(s) of the pharmaceutical composition, its use is contemplated to be within the scope of this invention.

**[000612]** In some embodiments, a pharmaceutically acceptable excipient is at least 95%, at least 96%, at least 97%, at least 98%, at least 99%, or 100% pure. In some embodiments, an excipient is approved for use in humans and for veterinary use. In some embodiments, an excipient is approved by United States Food and Drug Administration. In some embodiments, an excipient is pharmaceutical grade. In some embodiments, an excipient meets the standards of the United States Pharmacopoeia (USP), the European Pharmacopoeia (EP), the British Pharmacopoeia, and/or the International Pharmacopoeia.

**[000613]** Pharmaceutically acceptable excipients used in the manufacture of pharmaceutical compositions include, but are not limited to, inert diluents, dispersing and/or granulating agents, surface active agents and/or emulsifiers, disintegrating agents, binding agents, preservatives, buffering agents, lubricating agents, and/or oils. Such excipients may optionally be included in pharmaceutical compositions.

**[000614]** Exemplary diluents include, but are not limited to, calcium carbonate, sodium carbonate, calcium phosphate, dicalcium phosphate, calcium sulfate, calcium hydrogen phosphate, sodium phosphate lactose, sucrose, cellulose, microcrystalline cellulose, kaolin, mannitol, sorbitol, inositol, sodium chloride, dry starch, cornstarch, powdered sugar, *etc.*, and/or combinations thereof.

**[000615]** Exemplary granulating and/or dispersing agents include, but are not limited to, potato starch, corn starch, tapioca starch, sodium starch glycolate, clays, alginic acid, guar gum, citrus pulp, agar, bentonite, cellulose and wood products, natural sponge, cation-exchange resins, calcium carbonate, silicates, sodium carbonate, cross-linked poly(vinyl-pyrrolidone) (crospovidone), sodium carboxymethyl starch (sodium starch glycolate), carboxymethyl cellulose, cross-linked sodium carboxymethyl cellulose (croscarmellose), methylcellulose, pregelatinized starch (starch 1500), microcrystalline starch, water insoluble starch, calcium carboxymethyl cellulose, magnesium aluminum silicate (VEEGUM®), sodium lauryl sulfate, quaternary ammonium compounds, *etc.*, and/or combinations thereof

**[000616]** Exemplary surface active agents and/or emulsifiers include, but are not limited to, natural emulsifiers (e.g. acacia, agar, alginic acid, sodium alginate, tragacanth,

chondrux, cholesterol, xanthan, pectin, gelatin, egg yolk, casein, wool fat, cholesterol, wax, and lecithin), colloidal clays (e.g. bentonite [aluminum silicate] and VEEGUM<sup>®</sup> [magnesium aluminum silicate]), long chain amino acid derivatives, high molecular weight alcohols (e.g. stearyl alcohol, cetyl alcohol, oleyl alcohol, triacetin monostearate, ethylene glycol distearate, glyceryl monostearate, and propylene glycol monostearate, polyvinyl alcohol), carbomers (e.g. carboxy polymethylene, polyacrylic acid, acrylic acid polymer, and carboxyvinyl polymer), carrageenan, cellulosic derivatives (e.g. carboxymethylcellulose sodium, powdered cellulose, hydroxymethyl cellulose, hydroxypropyl cellulose, hydroxypropyl methylcellulose, methylcellulose), sorbitan fatty acid esters (e.g. polyoxyethylene sorbitan monolaurate [TWEEN<sup>®</sup>20], polyoxyethylene sorbitan [TWEEN<sup>®</sup>60], polyoxyethylene sorbitan monooleate [TWEEN<sup>®</sup>80], sorbitan monopalmitate [SPAN<sup>®</sup>40], sorbitan monostearate [SPAN<sup>®</sup>60], sorbitan tristearate [SPAN<sup>®</sup>65], glyceryl monooleate, sorbitan monooleate [SPAN<sup>®</sup>80]), polyoxyethylene esters (e.g. polyoxyethylene monostearate [MYRJ<sup>®</sup>45], polyoxyethylene hydrogenated castor oil, polyethoxylated castor oil, polyoxymethylene stearate, and SOLUTOL<sup>®</sup>), sucrose fatty acid esters, polyethylene glycol fatty acid esters (e.g. CREMOPHOR<sup>®</sup>), polyoxyethylene ethers, (e.g. polyoxyethylene lauryl ether [BRIJ<sup>®</sup>30]), poly(vinyl-pyrrolidone), diethylene glycol monolaurate, triethanolamine oleate, sodium oleate, potassium oleate, ethyl oleate, oleic acid, ethyl laurate, sodium lauryl sulfate, PLUORINC<sup>®</sup>F 68, POLOXAMER<sup>®</sup>188, cetrimonium bromide, cetylpyridinium chloride, benzalkonium chloride, docusate sodium, etc. and/or combinations thereof.

**[000617]** Exemplary binding agents include, but are not limited to, starch (*e.g.* cornstarch and starch paste); gelatin; sugars (*e.g.* sucrose, glucose, dextrose, dextrin, molasses, lactose, lactitol, mannitol,); natural and synthetic gums (*e.g.* acacia, sodium alginate, extract of Irish moss, panwar gum, ghatti gum, mucilage of isapol husks, carboxymethylcellulose, methylcellulose, ethylcellulose, hydroxyethylcellulose, hydroxypropyl cellulose, hydroxypropyl methylcellulose, microcrystalline cellulose, cellulose acetate, poly(vinyl-pyrrolidone), magnesium aluminum silicate (Veegum<sup>®</sup>), and larch arabogalactan); alginates; polyethylene oxide; polyethylene glycol; inorganic calcium salts; silicic acid; polymethacrylates; waxes; water; alcohol; *etc.*; and combinations thereof.

[000618] Exemplary preservatives may include, but are not limited to, antioxidants, chelating agents, antimicrobial preservatives, antifungal preservatives, alcohol preservatives, acidic preservatives, and/or other preservatives. Exemplary antioxidants include, but are not limited to, alpha tocopherol, ascorbic acid, acorbyl palmitate, butylated hydroxyanisole, butylated hydroxytoluene, monothioglycerol, potassium metabisulfite, propionic acid, propyl gallate, sodium ascorbate, sodium bisulfite, sodium metabisulfite, and/or sodium sulfite. Exemplary chelating agents include ethylenediaminetetraacetic acid (EDTA), citric acid monohydrate, disodium edetate, dipotassium edetate, edetic acid, fumaric acid, malic acid, phosphoric acid, sodium edetate, tartaric acid, and/or trisodium edetate. Exemplary antimicrobial preservatives include, but are not limited to, benzalkonium chloride, benzethonium chloride, benzyl alcohol, bronopol, cetrimide, cetylpyridinium chloride, chlorhexidine, chlorobutanol, chlorocresol, chloroxylenol, cresol, ethyl alcohol, glycerin, hexetidine, imidurea, phenol, phenoxyethanol, phenylethyl alcohol, phenylmercuric nitrate, propylene glycol, and/or thimerosal. Exemplary antifungal preservatives include, but are not limited to, butyl paraben, methyl paraben, ethyl paraben, propyl paraben, benzoic acid, hydroxybenzoic acid, potassium benzoate, potassium sorbate, sodium benzoate, sodium propionate, and/or sorbic acid. Exemplary alcohol preservatives include, but are not limited to, ethanol, polyethylene glycol, phenol, phenolic compounds, bisphenol, chlorobutanol, hydroxybenzoate, and/or phenylethyl alcohol. Exemplary acidic preservatives include, but are not limited to, vitamin A, vitamin C, vitamin E, beta-carotene, citric acid, acetic acid, dehydroacetic acid, ascorbic acid, sorbic acid, and/or phytic acid. Other preservatives include, but are not limited to, tocopherol, tocopherol acetate, deteroxime mesylate, cetrimide, butylated hydroxyanisole (BHA), butylated hydroxytoluene (BHT), ethylenediamine, sodium lauryl sulfate (SLS), sodium lauryl ether sulfate (SLES), sodium bisulfite, sodium metabisulfite, potassium sulfite, potassium metabisulfite, GLYDANT PLUS<sup>®</sup>, PHENONIP<sup>®</sup>, methylparaben, GERMALL<sup>®</sup> 115, GERMABEN<sup>®</sup> II, NEOLONE<sup>™</sup>, KATHON<sup>™</sup>, and/or EUXYL<sup>®</sup>.

[000619] Exemplary buffering agents include, but are not limited to, citrate buffer solutions, acetate buffer solutions, phosphate buffer solutions, ammonium chloride, calcium carbonate, calcium chloride, calcium citrate, calcium gluconate, calcium

gluceptate, calcium gluconate, D-gluconic acid, calcium glycerophosphate, calcium lactate, propanoic acid, calcium levulinate, pentanoic acid, dibasic calcium phosphate, phosphoric acid, tribasic calcium phosphate, calcium hydroxide phosphate, potassium acetate, potassium chloride, potassium gluconate, potassium mixtures, dibasic potassium phosphate, monobasic potassium phosphate, potassium phosphate mixtures, sodium acetate, sodium bicarbonate, sodium chloride, sodium citrate, sodium lactate, dibasic sodium phosphate, monobasic sodium phosphate, sodium phosphate mixtures, tromethamine, magnesium hydroxide, aluminum hydroxide, alginic acid, pyrogen-free water, isotonic saline, Ringer's solution, ethyl alcohol, *etc.*, and/or combinations thereof.

**[000620]** Exemplary lubricating agents include, but are not limited to, magnesium stearate, calcium stearate, stearic acid, silica, talc, malt, glyceryl behanate, hydrogenated vegetable oils, polyethylene glycol, sodium benzoate, sodium acetate, sodium chloride, leucine, magnesium lauryl sulfate, sodium lauryl sulfate, *etc.*, and combinations thereof.

**[000621]** Exemplary oils include, but are not limited to, almond, apricot kernel, avocado, babassu, bergamot, black current seed, borage, cade, camomile, canola, caraway, carnauba, castor, cinnamon, cocoa butter, coconut, cod liver, coffee, com, cotton seed, emu, eucalyptus, evening primrose, fish, flaxseed, geraniol, gourd, grape seed, hazel nut, hyssop, isopropyl myristate, jojoba, kukui nut, lavandin, lavender, lemon, litsea cubeba, macademia nut, mallow, mango seed, meadowfoam seed, mink, nutmeg, olive, orange, orange roughy, palm, palm kernel, peach kernel, peanut, poppy seed, pumpkin seed, rapeseed, rice bran, rosemary, safflower, sandalwood, sasquana, savoury, sea buckthorn, sesame, shea butter, silicone, soybean, sunflower, tea tree, thistle, tsubaki, vetiver, walnut, and wheat germ oils. Exemplary oils include, but are not limited to, butyl stearate, caprylic triglyceride, capric triglyceride, cyclomethicone, diethyl sebacate, dimethicone 360, isopropyl myristate, mineral oil, octyldodecanol, oleyl alcohol, silicone oil, and/or combinations thereof.

**[000622]** Excipients such as cocoa butter and suppository waxes, coloring agents, coating agents, sweetening, flavoring, and/or perfuming agents can be present in the composition, according to the judgment of the formulator.

#### Delivery

[000623] The present disclosure encompasses the delivery of cosmetic polynucleotides, primary constructs or mmRNA for any of therapeutic, pharmaceutical, diagnostic or imaging by any appropriate route taking into consideration likely advances in the sciences of drug delivery. Delivery may be naked or formulated.

*Naked Delivery*

[000624] The cosmetic polynucleotides, primary constructs or mmRNA of the present invention may be delivered to a cell naked. As used herein in, "naked" refers to delivering polynucleotides, primary constructs or mmRNA free from agents which promote transfection. For example, the cosmetic polynucleotides, primary constructs or mmRNA delivered to the cell may contain no modifications. The naked polynucleotides, primary constructs or mmRNA may be delivered to the cell using routes of administration known in the art and described herein.

*Formulated Delivery*

[000625] The cosmetic polynucleotides, primary constructs or mmRNA of the present invention may be formulated, using the methods described herein. The formulations may contain polynucleotides, primary constructs or mmRNA which may be modified and/or unmodified. The formulations may further include, but are not limited to, cell penetration agents, a pharmaceutically acceptable carrier, a delivery agent, a bioerodible or biocompatible polymer, a solvent, and a sustained-release delivery depot. The formulated polynucleotides, primary constructs or mmRNA may be delivered to the cell using routes of administration known in the art and described herein.

[000626] The compositions may also be formulated for direct delivery to an organ or tissue in any of several ways in the art including, but not limited to, direct soaking or bathing, via a catheter, by gels, powder, ointments, creams, gels, lotions, and/or drops, by using substrates such as fabric or biodegradable materials coated or impregnated with the compositions, and the like.

Administration

[000627] The cosmetic polynucleotides, primary constructs or mmRNA of the present invention may be administered by any route which results in a therapeutically effective outcome. These include, but are not limited to enteral, gastroenteral, epidural, oral, transdermal, epidural (peridural), intracerebral (into the cerebrum),

intracerebroventricular (into the cerebral ventricles), epicutaneous (application onto the skin), intradermal, (into the skin itself), subcutaneous (under the skin), nasal administration (through the nose), intravenous (into a vein), intraarterial (into an artery), intramuscular (into a muscle), intracardiac (into the heart), intraosseous infusion (into the bone marrow), intrathecal (into the spinal canal), intraperitoneal, (infusion or injection into the peritoneum), intravesical infusion, intravitreal, (through the eye), intracavernous injection, ( into the base of the penis), intravaginal administration, intrauterine, extra-amniotic administration, transdermal (diffusion through the intact skin for systemic distribution), transmucosal (diffusion through a mucous membrane), insufflation (snorting), sublingual, sublabial, enema, eye drops (onto the conjunctiva), or in ear drops. In specific embodiments, compositions may be administered in a way which allows them cross the blood-brain barrier, vascular barrier, or other epithelial barrier. Non-limiting routes of administration for the cosmetic polynucleotides, primary constructs or mmRNA of the present invention are described below.

*Parenteral and Injectable Administration*

[000628] Liquid dosage forms for parenteral administration include, but are not limited to, pharmaceutically acceptable emulsions, microemulsions, solutions, suspensions, syrups, and/or elixirs. In addition to active ingredients, liquid dosage forms may comprise inert diluents commonly used in the art such as, for example, water or other solvents, solubilizing agents and emulsifiers such as ethyl alcohol, isopropyl alcohol, ethyl carbonate, ethyl acetate, benzyl alcohol, benzyl benzoate, propylene glycol, 1,3-butylene glycol, dimethylformamide, oils (in particular, cottonseed, groundnut, corn, germ, olive, castor, and sesame oils), glycerol, tetrahydrofurfuryl alcohol, polyethylene glycols and fatty acid esters of sorbitan, and mixtures thereof. Besides inert diluents, oral compositions can include adjuvants such as wetting agents, emulsifying and suspending agents, sweetening, flavoring, and/or perfuming agents. In certain embodiments for parenteral administration, compositions are mixed with solubilizing agents such as CREMOPHOR<sup>®</sup>, alcohols, oils, modified oils, glycols, polysorbates, cyclodextrins, polymers, and/or combinations thereof.

[000629] Injectable preparations, for example, sterile injectable aqueous or oleaginous suspensions may be formulated according to the known art using suitable dispersing

agents, wetting agents, and/or suspending agents. Sterile injectable preparations may be sterile injectable solutions, suspensions, and/or emulsions in nontoxic parenterally acceptable diluents and/or solvents, for example, as a solution in 1,3-butanediol. Among the acceptable vehicles and solvents that may be employed are water, Ringer's solution, U.S.P., and isotonic sodium chloride solution. Sterile, fixed oils are conventionally employed as a solvent or suspending medium. For this purpose any bland fixed oil can be employed including synthetic mono- or diglycerides. Fatty acids such as oleic acid can be used in the preparation of injectables.

[000630] Injectable formulations can be sterilized, for example, by filtration through a bacterial-retaining filter, and/or by incorporating sterilizing agents in the form of sterile solid compositions which can be dissolved or dispersed in sterile water or other sterile injectable medium prior to use.

[000631] In order to prolong the effect of an active ingredient, it is often desirable to slow the absorption of the active ingredient from subcutaneous or intramuscular injection. This may be accomplished by the use of a liquid suspension of crystalline or amorphous material with poor water solubility. The rate of absorption of the drug then depends upon its rate of dissolution which, in turn, may depend upon crystal size and crystalline form. Alternatively, delayed absorption of a parenterally administered drug form is accomplished by dissolving or suspending the drug in an oil vehicle. Injectable depot forms are made by forming microcapsule matrices of the drug in biodegradable polymers such as polylactide-polyglycolide. Depending upon the ratio of drug to polymer and the nature of the particular polymer employed, the rate of drug release can be controlled. Examples of other biodegradable polymers include poly(orthoesters) and poly(anhydrides). Depot injectable formulations are prepared by entrapping the drug in liposomes or microemulsions which are compatible with body tissues.

#### *Rectal and Vaginal Administration*

[000632] Compositions for rectal or vaginal administration are typically suppositories which can be prepared by mixing compositions with suitable non-irritating excipients such as cocoa butter, polyethylene glycol or a suppository wax which are solid at ambient temperature but liquid at body temperature and therefore melt in the rectum or vaginal cavity and release the active ingredient.

*Oral Administration*

[000633] Liquid dosage forms for oral administration include, but are not limited to, pharmaceutically acceptable emulsions, microemulsions, solutions, suspensions, syrups, and/or elixirs. In addition to active ingredients, liquid dosage forms may comprise inert diluents commonly used in the art such as, for example, water or other solvents, solubilizing agents and emulsifiers such as ethyl alcohol, isopropyl alcohol, ethyl carbonate, ethyl acetate, benzyl alcohol, benzyl benzoate, propylene glycol, 1,3-butylene glycol, dimethylformamide, oils (in particular, cottonseed, groundnut, corn, germ, olive, castor, and sesame oils), glycerol, tetrahydrofurfuryl alcohol, polyethylene glycols and fatty acid esters of sorbitan, and mixtures thereof. Besides inert diluents, oral compositions can include adjuvants such as wetting agents, emulsifying and suspending agents, sweetening, flavoring, and/or perfuming agents. In certain embodiments for parenteral administration, compositions are mixed with solubilizing agents such as CREMOPHOR<sup>®</sup>, alcohols, oils, modified oils, glycols, polysorbates, cyclodextrins, polymers, and/or combinations thereof.

[000634] Solid dosage forms for oral administration include capsules, tablets, pills, powders, and granules. In such solid dosage forms, an active ingredient is mixed with at least one inert, pharmaceutically acceptable excipient such as sodium citrate or dicalcium phosphate and/or fillers or extenders (*e.g.* starches, lactose, sucrose, glucose, mannitol, and silicic acid), binders (*e.g.* carboxymethylcellulose, alginates, gelatin, polyvinylpyrrolidone, sucrose, and acacia), humectants (*e.g.* glycerol), disintegrating agents (*e.g.* agar, calcium carbonate, potato or tapioca starch, alginic acid, certain silicates, and sodium carbonate), solution retarding agents (*e.g.* paraffin), absorption accelerators (*e.g.* quaternary ammonium compounds), wetting agents (*e.g.* cetyl alcohol and glycerol monostearate), absorbents (*e.g.* kaolin and bentonite clay), and lubricants (*e.g.* talc, calcium stearate, magnesium stearate, solid polyethylene glycols, sodium lauryl sulfate), and mixtures thereof. In the case of capsules, tablets and pills, the dosage form may comprise buffering agents.

*Topical or Transdermal Administration*

[000635] As described herein, compositions containing the cosmetic polynucleotides, primary constructs or mmRNA of the invention may be formulated for administration



topically. The skin may be an ideal target site for delivery as it is readily accessible. Gene expression may be restricted not only to the skin, potentially avoiding nonspecific toxicity, but also to specific layers and cell types within the skin.

**[000636]** The site of cutaneous expression of the delivered compositions will depend on the route of nucleic acid delivery. Three routes are commonly considered to deliver polynucleotides, primary constructs or mmRNA to the skin: (i) topical application (e.g. for local/regional treatment and/or cosmetic applications); (ii) intradermal injection (e.g. for local/regional treatment and/or cosmetic applications); and (iii) systemic delivery (e.g. for treatment of dermatologic diseases that affect both cutaneous and extracutaneous regions). Polynucleotides, primary constructs or mmRNA can be delivered to the skin by several different approaches known in the art. Most topical delivery approaches have been shown to work for delivery of DNA, such as but not limited to, topical application of non-cationic liposome-DNA complex, cationic liposome-DNA complex, particle-mediated (gene gun), puncture-mediated gene transfections, and viral delivery approaches. After delivery of the nucleic acid, gene products have been detected in a number of different skin cell types, including, but not limited to, basal keratinocytes, sebaceous gland cells, dermal fibroblasts and dermal macrophages.

**[000637]** In one embodiment, the invention provides for a variety of dressings (e.g., wound dressings) or bandages (e.g., adhesive bandages) for conveniently and/or effectively carrying out methods of the present invention. Typically dressing or bandages may comprise sufficient amounts of pharmaceutical compositions and/or polynucleotides, primary constructs or mmRNA described herein to allow a user to perform multiple treatments of a subject(s).

**[000638]** In one embodiment, the invention provides for the cosmetic polynucleotides, primary constructs or mmRNA compositions to be delivered in more than one injection.

**[000639]** In one embodiment, before topical and/or transdermal administration at least one area of tissue, such as skin, may be subjected to a device and/or solution which may increase permeability. In one embodiment, the tissue may be subjected to an abrasion device to increase the permeability of the skin (see U.S. Patent Publication No. 20080275468, herein incorporated by reference in its entirety). In another embodiment, the tissue may be subjected to an ultrasound enhancement device. An ultrasound

enhancement device may include, but is not limited to, the devices described in U.S. Publication No. 20040236268 and U.S. Patent Nos. 6,491,657 and 6,234,990; each of which are herein incorporated by reference in their entireties. Methods of enhancing the permeability of tissue are described in U.S. Publication Nos. 20040171980 and 20040236268 and U.S. Pat. No. 6,190,315; each of which are herein incorporated by reference in their entireties.

**[000640]** In one embodiment, a device may be used to increase permeability of tissue before delivering formulations of modified mRNA described herein. The permeability of skin may be measured by methods known in the art and/or described in U.S. Patent No. 6,190,315, herein incorporated by reference in its entirety. As a non-limiting example, a modified mRNA formulation may be delivered by the drug delivery methods described in U.S. Patent No. 6,190,315, herein incorporated by reference in its entirety.

**[000641]** In another non-limiting example tissue may be treated with a eutectic mixture of local anesthetics (EMLA) cream before, during and/or after the tissue may be subjected to a device which may increase permeability. Katz et al. (Anesth Analg (2004); 98:371-76; herein incorporated by reference in its entirety) showed that using the EMLA cream in combination with a low energy, an onset of superficial cutaneous analgesia was seen as fast as 5 minutes after a pretreatment with a low energy ultrasound.

**[000642]** In one embodiment, enhancers may be applied to the tissue before, during, and/or after the tissue has been treated to increase permeability. Enhancers include, but are not limited to, transport enhancers, physical enhancers, and cavitation enhancers. Non-limiting examples of enhancers are described in U.S. Patent No. 6,190,315, herein incorporated by reference in its entirety.

**[000643]** In one embodiment, a device may be used to increase permeability of tissue before delivering formulations of modified mRNA described herein, which may further contain a substance that invokes an immune response. In another non-limiting example, a formulation containing a substance to invoke an immune response may be delivered by the methods described in U.S. Publication Nos. 20040171980 and 20040236268; each of which are herein incorporated by reference in their entireties.

**[000644]** Dosage forms for topical and/or transdermal administration of a composition may include ointments, pastes, creams, lotions, gels, powders, solutions, sprays, inhalants

and/or patches. Generally, an active ingredient is admixed under sterile conditions with a pharmaceutically acceptable excipient and/or any needed preservatives and/or buffers as may be required. Additionally, the present invention contemplates the use of transdermal patches, which often have the added advantage of providing controlled delivery of a compound to the body. Such dosage forms may be prepared, for example, by dissolving and/or dispensing the compound in the proper medium. Alternatively or additionally, rate may be controlled by either providing a rate controlling membrane and/or by dispersing the compound in a polymer matrix and/or gel.

[000645] Formulations suitable for topical administration include, but are not limited to, liquid and/or semi liquid preparations such as liniments, lotions, oil in water and/or water in oil emulsions such as creams, ointments and/or pastes, and/or solutions and/or suspensions. Topically-administrable formulations may, for example, comprise from about 0.1% to about 10% (w/w) active ingredient, although the concentration of active ingredient may be as high as the solubility limit of the active ingredient in the solvent. Formulations for topical administration may further comprise one or more of the additional ingredients described herein.

#### *Depot Administration*

[000646] As described herein, in some embodiments, the composition is formulated in depots for extended release. Generally, a specific organ or tissue (a "target tissue") is targeted for administration.

[000647] In some aspects of the invention, the cosmetic polynucleotides, primary constructs or mmRNA are spatially retained within or proximal to a target tissue. Provided are method of providing a composition to a target tissue of a mammalian subject by contacting the target tissue (which contains one or more target cells) with the composition under conditions such that the composition, in particular the nucleic acid component(s) of the composition, is substantially retained in the target tissue, meaning that at least 10, 20, 30, 40, 50, 60, 70, 80, 85, 90, 95, 96, 97, 98, 99, 99.9, 99.99 or greater than 99.99%, of the composition is retained in the target tissue. Advantageously, retention is determined by measuring the amount of the nucleic acid present in the composition that enters one or more target cells. For example, at least 1, 5, 10, 20, 30, 40, 50, 60, 70, 80, 85, 90, 95, 96, 97, 98, 99, 99.9, 99.99 or greater than 99.99% of the

nucleic acids administered to the subject are present intracellularly at a period of time following administration. For example, intramuscular injection to a mammalian subject is performed using an aqueous composition containing a ribonucleic acid and a transfection reagent, and retention of the composition is determined by measuring the amount of the ribonucleic acid present in the muscle cells.

**[000648]** Aspects of the invention are directed to methods of providing a composition to a target tissue of a mammalian subject, by contacting the target tissue (containing one or more target cells) with the composition under conditions such that the composition is substantially retained in the target tissue. The composition contains an effective amount of a polynucleotides, primary constructs or mmRNA such that the polypeptide of interest is produced in at least one target cell. The compositions generally contain a cell penetration agent, although "naked" nucleic acid (such as nucleic acids without a cell penetration agent or other agent) is also contemplated, and a pharmaceutically acceptable carrier.

**[000649]** In some circumstances, the amount of a protein produced by cells in a tissue is desirably increased. Preferably, this increase in protein production is spatially restricted to cells within the target tissue. Thus, provided are methods of increasing production of a protein of interest in a tissue of a mammalian subject. A composition is provided that contains polynucleotides, primary constructs or mmRNA characterized in that a unit quantity of composition has been determined to produce the polypeptide of interest in a substantial percentage of cells contained within a predetermined volume of the target tissue.

**[000650]** In some embodiments, the composition includes a plurality of different polynucleotides, primary constructs or mmRNA, where one or more than one of the cosmetic polynucleotides, primary constructs or mmRNA encodes a polypeptide of interest. Optionally, the composition also contains a cell penetration agent to assist in the intracellular delivery of the composition. A determination is made of the dose of the composition required to produce the polypeptide of interest in a substantial percentage of cells contained within the predetermined volume of the target tissue (generally, without inducing significant production of the polypeptide of interest in tissue adjacent to the

predetermined volume, or distally to the target tissue). Subsequent to this determination, the determined dose is introduced directly into the tissue of the mammalian subject.

[000651] In one embodiment, the invention provides for the cosmetic polynucleotides, primary constructs or mmRNA to be delivered in more than one injection or by split dose injections.

[000652] In one embodiment, the invention may be retained near target tissue using a small disposable drug reservoir, patch pump or osmotic pump. Non-limiting examples of patch pumps include those manufactured and/or sold by BD® (Franklin Lakes, NJ), Insulet Corporation (Bedford, MA), SteadyMed Therapeutics (San Francisco, CA), Medtronic (Minneapolis, MN) (e.g., MiniMed), UniLife (York, PA), Valeritas (Bridgewater, NJ), and SpringLeaf Therapeutics (Boston, MA). A non-limiting example of an osmotic pump include those manufactured by DURECT® (Cupertino, CA) (e.g., DUROS® and ALZET®).

#### *Pulmonary Administration*

[000653] A pharmaceutical composition may be prepared, packaged, and/or sold in a formulation suitable for pulmonary administration via the buccal cavity. Such a formulation may comprise dry particles which comprise the active ingredient and which have a diameter in the range from about 0.5 nm to about 7 nm or from about 1 nm to about 6 nm. Such compositions are suitably in the form of dry powders for administration using a device comprising a dry powder reservoir to which a stream of propellant may be directed to disperse the powder and/or using a self propelling solvent/powder dispensing container such as a device comprising the active ingredient dissolved and/or suspended in a low-boiling propellant in a sealed container. Such powders comprise particles wherein at least 98% of the particles by weight have a diameter greater than 0.5 nm and at least 95% of the particles by number have a diameter less than 7 nm. Alternatively, at least 95% of the particles by weight have a diameter greater than 1 nm and at least 90% of the particles by number have a diameter less than 6 nm. Dry powder compositions may include a solid fine powder diluent such as sugar and are conveniently provided in a unit dose form.

[000654] Low boiling propellants generally include liquid propellants having a boiling point of below 65 °F at atmospheric pressure. Generally the propellant may constitute

50% to 99.9% (w/w) of the composition, and active ingredient may constitute 0.1% to 20%, (w/w) of the composition. A propellant may further comprise additional ingredients such as a liquid non-ionic and/or solid anionic surfactant and/or a solid diluent (which may have a particle size of the same order as particles comprising the active ingredient).

[000655] As a non-limiting example, the cosmetic polynucleotides, primary constructs and/or mmRNA described herein may be formulated for pulmonary delivery by the methods described in U.S. Pat. No. 8,257,685; herein incorporated by reference in its entirety.

[000656] Pharmaceutical compositions formulated for pulmonary delivery may provide an active ingredient in the form of droplets of a solution and/or suspension. Such formulations may be prepared, packaged, and/or sold as aqueous and/or dilute alcoholic solutions and/or suspensions, optionally sterile, comprising active ingredient, and may conveniently be administered using any nebulization and/or atomization device. Such formulations may further comprise one or more additional ingredients including, but not limited to, a flavoring agent such as saccharin sodium, a volatile oil, a buffering agent, a surface active agent, and/or a preservative such as methylhydroxybenzoate. Droplets provided by this route of administration may have an average diameter in the range from about 0.1 nm to about 200 nm.

*Intranasal, nasal and buccal Administration*

[000657] Formulations described herein as being useful for pulmonary delivery are useful for intranasal delivery of a pharmaceutical composition. Another formulation suitable for intranasal administration is a coarse powder comprising the active ingredient and having an average particle from about 0.2  $\mu\text{m}$  to 500  $\mu\text{m}$ . Such a formulation is administered in the manner in which snuff is taken, *i.e.* by rapid inhalation through the nasal passage from a container of the powder held close to the nose.

[000658] Formulations suitable for nasal administration may, for example, comprise from about as little as 0.1% (w/w) and as much as 100% (w/w) of active ingredient, and may comprise one or more of the additional ingredients described herein. A pharmaceutical composition may be prepared, packaged, and/or sold in a formulation suitable for buccal administration. Such formulations may, for example, be in the form of tablets and/or lozenges made using conventional methods, and may, for example, 0.1%

to 20% (w/w) active ingredient, the balance comprising an orally dissolvable and/or degradable composition and, optionally, one or more of the additional ingredients described herein. Alternately, formulations suitable for buccal administration may comprise a powder and/or an aerosolized and/or atomized solution and/or suspension comprising active ingredient. Such powdered, aerosolized, and/or aerosolized formulations, when dispersed, may have an average particle and/or droplet size in the range from about 0.1 nm to about 200 nm, and may further comprise one or more of any additional ingredients described herein.

*Ophthalmic Administration*

[000659] A pharmaceutical composition may be prepared, packaged, and/or sold in a formulation suitable for ophthalmic administration. Such formulations may, for example, be in the form of eye drops including, for example, a 0.1/1.0% (w/w) solution and/or suspension of the active ingredient in an aqueous or oily liquid excipient. Such drops may further comprise buffering agents, salts, and/or one or more other of any additional ingredients described herein. Other ophthalmically-administrable formulations which are useful include those which comprise the active ingredient in microcrystalline form and/or in a liposomal preparation. Ear drops and/or eye drops are contemplated as being within the scope of this invention. A multilayer thin film device may be prepared to contain a pharmaceutical composition for delivery to the eye and/or surrounding tissue.

*Payload Administration: Detectable Agents and Therapeutic Agents*

[000660] The cosmetic polynucleotides, primary constructs or mmRNA described herein can be used in a number of different scenarios in which delivery of a substance (the "payload") to a biological target is desired, for example delivery of detectable substances for detection of the target, or delivery of a therapeutic agent. Detection methods can include, but are not limited to, both imaging *in vitro* and *in vivo* imaging methods, *e.g.*, immunohistochemistry, bioluminescence imaging (BLI), Magnetic Resonance Imaging (MRI), positron emission tomography (PET), electron microscopy, X-ray computed tomography, Raman imaging, optical coherence tomography, absorption imaging, thermal imaging, fluorescence reflectance imaging, fluorescence microscopy, fluorescence molecular tomographic imaging, nuclear magnetic resonance imaging, X-

ray imaging, ultrasound imaging, photoacoustic imaging, lab assays, or in any situation where tagging/staining/imaging is required.

[000661] The cosmetic polynucleotides, primary constructs or mmRNA can be designed to include both a linker and a payload in any useful orientation. For example, a linker having two ends is used to attach one end to the payload and the other end to the nucleobase, such as at the C-7 or C-8 positions of the deaza-adenosine or deaza-guanosine or to the N-3 or C-5 positions of cytosine or uracil. The polynucleotide of the invention can include more than one payload (e.g., a label and a transcription inhibitor), as well as a cleavable linker. In one embodiment, the modified nucleotide is a modified 7-deaza-adenosine triphosphate, where one end of a cleavable linker is attached to the C7 position of 7-deaza-adenine, the other end of the linker is attached to an inhibitor (e.g., to the C5 position of the nucleobase on a cytidine), and a label (e.g., Cy5) is attached to the center of the linker (see, e.g., compound 1 of A\*pCp C5 Parg Capless in Fig. 5 and columns 9 and 10 of U.S. Pat. No. 7,994,304, incorporated herein by reference). Upon incorporation of the modified 7-deaza-adenosine triphosphate to an encoding region, the resulting polynucleotide having a cleavable linker attached to a label and an inhibitor (e.g., a polymerase inhibitor). Upon cleavage of the linker (e.g., with reductive conditions to reduce a linker having a cleavable disulfide moiety), the label and inhibitor are released. Additional linkers and payloads (e.g., therapeutic agents, detectable labels, and cell penetrating payloads) are described herein.

[000662] Scheme 12 below depicts an exemplary modified nucleotide wherein the nucleobase, adenine, is attached to a linker at the C-7 carbon of 7-deaza adenine. In addition, Scheme 12 depicts the modified nucleotide with the linker and payload, e.g., a detectable agent, incorporated onto the 3' end of the mRNA. Disulfide cleavage and 1,2-addition of the thiol group onto the propargyl ester releases the detectable agent. The remaining structure (depicted, for example, as pApC5Parg in Scheme 12) is the inhibitor. The rationale for the structure of the modified nucleotides is that the tethered inhibitor sterically interferes with the ability of the polymerase to incorporate a second base. Thus, it is critical that the tether be long enough to affect this function and that the inhibitor be in a stereochemical orientation that inhibits or prohibits second and follow on nucleotides into the growing polynucleotide strand.



## Scheme 12

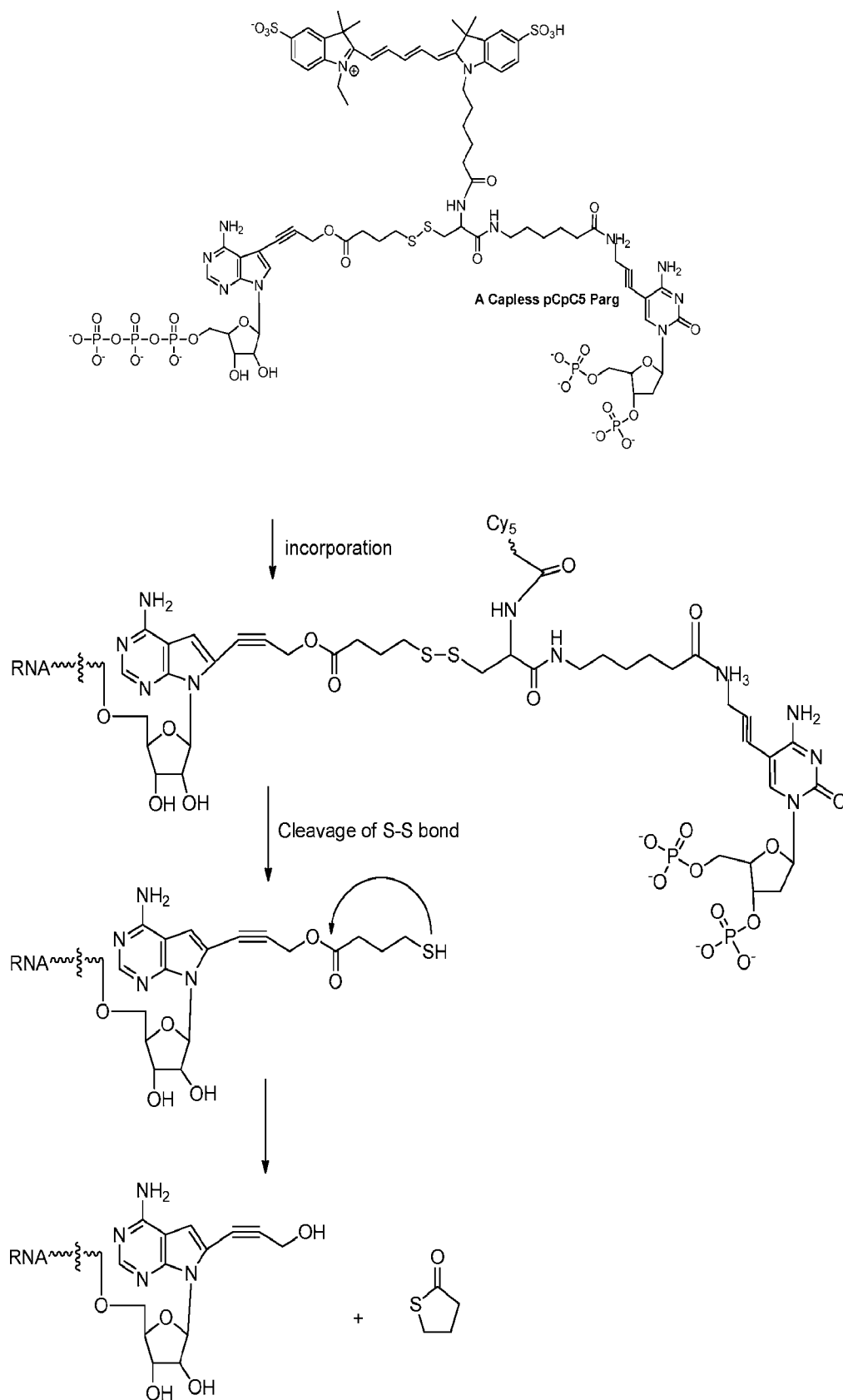

[000663] For example, the cosmetic polynucleotides, primary constructs or mmRNA described herein can be used in reprogramming induced pluripotent stem cells (iPS cells), which can directly track cells that are transfected compared to total cells in the cluster. In another example, a drug that may be attached to the cosmetic polynucleotides, primary constructs or mmRNA via a linker and may be fluorescently labeled can be used to track the drug *in vivo*, *e.g.* intracellularly. Other examples include, but are not limited to, the use of a polynucleotides, primary constructs or mmRNA in reversible drug delivery into cells.

[000664] The cosmetic polynucleotides, primary constructs or mmRNA described herein can be used in intracellular targeting of a payload, *e.g.*, detectable or therapeutic agent, to specific organelle. Exemplary intracellular targets can include, but are not limited to, the nuclear localization for advanced mRNA processing, or a nuclear localization sequence (NLS) linked to the mRNA containing an inhibitor.

[000665] In addition, the cosmetic polynucleotides, primary constructs or mmRNA described herein can be used to deliver therapeutic agents to cells or tissues, *e.g.*, in living animals. For example, the cosmetic polynucleotides, primary constructs or mmRNA described herein can be used to deliver highly polar chemotherapeutics agents to kill cancer cells. The cosmetic polynucleotides, primary constructs or mmRNA attached to the therapeutic agent through a linker can facilitate member permeation allowing the therapeutic agent to travel into a cell to reach an intracellular target.

[000666] In one example, the linker is attached at the 2'-position of the ribose ring and/or at the 3' and/or 5' position of the polynucleotides, primary constructs mmRNA (See *e.g.*, International Pub. No. WO2012030683, herein incorporated by reference in its entirety). The linker may be any linker disclosed herein, known in the art and/or disclosed in International Pub. No. WO2012030683, herein incorporated by reference in its entirety.

[000667] In another example, the cosmetic polynucleotides, primary constructs or mmRNA can be attached to the cosmetic polynucleotides, primary constructs or mmRNA a viral inhibitory peptide (VIP) through a cleavable linker. The cleavable linker can release the VIP and dye into the cell. In another example, the cosmetic polynucleotides, primary constructs or mmRNA can be attached through the linker to an ADP-ribosylate,

which is responsible for the actions of some bacterial toxins, such as cholera toxin, diphtheria toxin, and pertussis toxin. These toxin proteins are ADP-ribosyltransferases that modify target proteins in human cells. For example, cholera toxin ADP-ribosylates G proteins modifies human cells by causing massive fluid secretion from the lining of the small intestine, which results in life-threatening diarrhea.

**[000668]** In some embodiments, the payload may be a therapeutic agent such as a cytotoxin, radioactive ion, chemotherapeutic, or other therapeutic agent. A cytotoxin or cytotoxic agent includes any agent that may be detrimental to cells. Examples include, but are not limited to, taxol, cytochalasin B, gramicidin D, ethidium bromide, emetine, mitomycin, etoposide, teniposide, vincristine, vinblastine, colchicine, doxorubicin, daunorubicin, dihydroxyanthracenedione, mitoxantrone, mithramycin, actinomycin D, 1-dehydrotestosterone, glucocorticoids, procaine, tetracaine, lidocaine, propranolol, puromycin, maytansinoids, *e.g.*, maytansinol (see U.S. Pat. No. 5,208,020 incorporated herein in its entirety), rachelmycin (CC-1065, see U.S. Pat. Nos. 5,475,092, 5,585,499, and 5,846,545, all of which are incorporated herein by reference), and analogs or homologs thereof. Radioactive ions include, but are not limited to iodine (*e.g.*, iodine 125 or iodine 131), strontium 89, phosphorous, palladium, cesium, iridium, phosphate, cobalt, yttrium 90, samarium 153, and praseodymium. Other therapeutic agents include, but are not limited to, antimetabolites (*e.g.*, methotrexate, 6-mercaptopurine, 6-thioguanine, cytarabine, 5-fluorouracil decarbazine), alkylating agents (*e.g.*, mechlorethamine, thiotepa chlorambucil, rachelmycin (CC-1065), melphalan, carmustine (BSNU), lomustine (CCNU), cyclophosphamide, busulfan, dibromomannitol, streptozotocin, mitomycin C, and cis-dichlorodiamine platinum (II) (DDP) cisplatin), anthracyclines (*e.g.*, daunorubicin (formerly daunomycin) and doxorubicin), antibiotics (*e.g.*, dactinomycin (formerly actinomycin), bleomycin, mithramycin, and anthramycin (AMC)), and anti-mitotic agents (*e.g.*, vincristine, vinblastine, taxol and maytansinoids).

**[000669]** In some embodiments, the payload may be a detectable agent, such as various organic small molecules, inorganic compounds, nanoparticles, enzymes or enzyme substrates, fluorescent materials, luminescent materials (*e.g.*, luminol), bioluminescent materials (*e.g.*, luciferase, luciferin, and aequorin), chemiluminescent materials, radioactive materials (*e.g.*,  $^{18}\text{F}$ ,  $^{67}\text{Ga}$ ,  $^{81\text{m}}\text{Kr}$ ,  $^{82}\text{Rb}$ ,  $^{111}\text{In}$ ,  $^{123}\text{I}$ ,  $^{133}\text{Xe}$ ,  $^{201}\text{Tl}$ ,  $^{125}\text{I}$ ,

<sup>35</sup>S, <sup>14</sup>C, <sup>3</sup>H, or <sup>99m</sup>Tc (e.g., as pertechnetate (technetate(VII), Tc(V)), and contrast agents (e.g., gold (e.g., gold nanoparticles), gadolinium (e.g., chelated Gd), iron oxides (e.g., superparamagnetic iron oxide (SPIO), monocrystalline iron oxide nanoparticles (MIONs), and ultrasmall superparamagnetic iron oxide (USPIO)), manganese chelates (e.g., Mn-DPDP), barium sulfate, iodinated contrast media (iohexol), microbubbles, or perfluorocarbons). Such optically-detectable labels include for example, without limitation, 4-acetamido-4'-isothiocyanatostilbene-2,2'-disulfonic acid; acridine and derivatives (e.g., acridine and acridine isothiocyanate); 5-(2'-aminoethyl)aminonaphthalene-1-sulfonic acid (EDANS); 4-amino-N-[3-vinylsulfonyl]phenyl]naphthalimide-3,5-disulfonate; N-(4-anilino-1-naphthyl)maleimide; anthranilamide; BODIPY; Brilliant Yellow; coumarin and derivatives (e.g., coumarin, 7-amino-4-methylcoumarin (AMC, Coumarin 120), and 7-amino-4-trifluoromethylcoumarin (Coumarin 151)); cyanine dyes; cyanosine; 4',6-diaminidino-2-phenylindole (DAPI); 5',5''-dibromopyrogallol-sulfonaphthalein (Bromopyrogallol Red); 7-diethylamino-3-(4'-isothiocyanatophenyl)-4-methylcoumarin; diethylenetriamine pentaacetate; 4,4'-diisothiocyanatodihydro-stilbene-2,2'-disulfonic acid; 4,4'-diisothiocyanatostilbene-2,2'-disulfonic acid; 5-[dimethylamino]-naphthalene-1-sulfonyl chloride (DNS, dansylchloride); 4-dimethylaminophenylazophenyl-4'-isothiocyanate (DABITC); eosin and derivatives (e.g., eosin and eosin isothiocyanate); erythrosin and derivatives (e.g., erythrosin B and erythrosin isothiocyanate); ethidium; fluorescein and derivatives (e.g., 5-carboxyfluorescein (FAM), 5-(4,6-dichlorotriazin-2-yl)aminofluorescein (DTAF), 2',7'-dimethoxy-4'5'-dichloro-6-carboxyfluorescein, fluorescein, fluorescein isothiocyanate, X-rhodamine-5-(and-6)-isothiocyanate (QFITC or XRITC), and fluorescamine); 2-[2-[3-[[1,3-dihydro-1,1-dimethyl-3-(3-sulfopropyl)-2H-benz[e]indol-2-ylidene]ethylidene]-2-[4-(ethoxycarbonyl)-1-piperazinyl]-1-cyclopenten-1-yl]ethenyl]-1,1-dimethyl-3-(3-sulfopropyl)-1H-benz[e]indolium hydroxide, inner salt, compound with n,n-diethylethanamine(1:1) (IR144); 5-chloro-2-[2-[3-[(5-chloro-3-ethyl-2(3H)-benzothiazol-ylidene)ethylidene]-2-(diphenylamino)-1-cyclopenten-1-yl]ethenyl]-3-ethyl benzothiazolium perchlorate (IR140); Malachite Green isothiocyanate; 4-methylumbelliferone orthocresolphthalein; nitrotyrosine; pararosaniline; Phenol Red; B-phycoerythrin; o-phthalaldehyde; pyrene and

derivatives(e.g., pyrene, pyrene butyrate, and succinimidyl 1-pyrene); butyrate quantum dots; Reactive Red 4 (CIBACRON™ Brilliant Red 3B-A); rhodamine and derivatives (e.g., 6-carboxy-X-rhodamine (ROX), 6-carboxyrhodamine (R6G), lissamine rhodamine B sulfonyl chloride rhodamine (Rhod), rhodamine B, rhodamine 123, rhodamine X isothiocyanate, sulforhodamine B, sulforhodamine 101, sulfonyl chloride derivative of sulforhodamine 101 (Texas Red), N,N,N',N'-tetramethyl-6-carboxyrhodamine (TAMRA) tetramethyl rhodamine, and tetramethyl rhodamine isothiocyanate (TRITC)); riboflavin; rosolic acid; terbium chelate derivatives; Cyanine-3 (Cy3); Cyanine-5 (Cy5); cyanine-5.5 (Cy5.5), Cyanine-7 (Cy7); IRD 700; IRD 800; Alexa 647; La Jolla Blue; phthalocyanine; and naphthalocyanine.

**[000670]** In some embodiments, the detectable agent may be a non-detectable precursor that becomes detectable upon activation (e.g., fluorogenic tetrazine-fluorophore constructs (e.g., tetrazine-BODIPY FL, tetrazine-Oregon Green 488, or tetrazine-BODIPY TMR-X) or enzyme activatable fluorogenic agents (e.g., PROSENSE® (VisEn Medical))). In vitro assays in which the enzyme labeled compositions can be used include, but are not limited to, enzyme linked immunosorbent assays (ELISAs), immunoprecipitation assays, immunofluorescence, enzyme immunoassays (EIA), radioimmunoassays (RIA), and Western blot analysis.

#### *Combinations*

**[000671]** The cosmetic polynucleotides, primary constructs or mmiRNA may be used in combination with one or more other therapeutic, prophylactic, diagnostic, or imaging agents. By "in combination with," it is not intended to imply that the agents must be administered at the same time and/or formulated for delivery together, although these methods of delivery are within the scope of the present disclosure. Compositions can be administered concurrently with, prior to, or subsequent to, one or more other desired therapeutics or medical procedures. In general, each agent will be administered at a dose and/or on a time schedule determined for that agent. In some embodiments, the present disclosure encompasses the delivery of pharmaceutical, prophylactic, diagnostic, or imaging compositions in combination with agents that may improve their bioavailability, reduce and/or modify their metabolism, inhibit their excretion, and/or modify their distribution within the body. As a non-limiting example, the nucleic acids or mmRNA

may be used in combination with a pharmaceutical agent for the treatment of cancer or to control hyperproliferative cells. In U.S. Pat. No. 7,964,571, herein incorporated by reference in its entirety, a combination therapy for the treatment of solid primary or metastasized tumor is described using a pharmaceutical composition including a DNA plasmid encoding for interleukin-12 with a lipopolymer and also administering at least one anticancer agent or chemotherapeutic. Further, the nucleic acids and mmRNA of the present invention that encodes anti-proliferative molecules may be in a pharmaceutical composition with a lipopolymer (see e.g., U.S. Pub. No. 201 10218231, herein incorporated by reference in its entirety, claiming a pharmaceutical composition comprising a DNA plasmid encoding an anti-proliferative molecule and a lipopolymer) which may be administered with at least one chemotherapeutic or anticancer agent.

[000672] It will further be appreciated that therapeutically, prophylactically, diagnostically, or imaging active agents utilized in combination may be administered together in a single composition or administered separately in different compositions. In general, it is expected that agents utilized in combination will be utilized at levels that do not exceed the levels at which they are utilized individually. In some embodiments, the levels utilized in combination will be lower than those utilized individually. In one embodiment, the combinations, each or together may be administered according to the split dosing regimens described herein.

#### Dosing

[000673] The present invention provides methods comprising administering modified mRNAs and their encoded proteins or complexes in accordance with the invention to a subject in need thereof. Nucleic acids, proteins or complexes, or pharmaceutical, imaging, diagnostic, or prophylactic compositions thereof, may be administered to a subject using any amount and any route of administration effective for preventing, treating, diagnosing, or imaging a disease, disorder, and/or condition (e.g., a disease, disorder, and/or condition relating to working memory deficits). The exact amount required will vary from subject to subject, depending on the species, age, and general condition of the subject, the severity of the disease, the particular composition, its mode of administration, its mode of activity, and the like. Compositions in accordance with the invention are typically formulated in dosage unit form for ease of administration and

uniformity of dosage. It will be understood, however, that the total daily usage of the compositions of the present invention may be decided by the attending physician within the scope of sound medical judgment. The specific therapeutically effective, prophylactically effective, or appropriate imaging dose level for any particular patient will depend upon a variety of factors including the disorder being treated and the severity of the disorder; the activity of the specific compound employed; the specific composition employed; the age, body weight, general health, sex and diet of the patient; the time of administration, route of administration, and rate of excretion of the specific compound employed; the duration of the treatment; drugs used in combination or coincidental with the specific compound employed; and like factors well known in the medical arts.

[000674] In certain embodiments, compositions in accordance with the present invention may be administered at dosage levels sufficient to deliver from about 0.0001 mg/kg to about 100 mg/kg, from about 0.001 mg/kg to about 0.05 mg/kg, from about 0.005 mg/kg to about 0.05 mg/kg, from about 0.001 mg/kg to about 0.005 mg/kg, from about 0.05 mg/kg to about 0.5 mg/kg, from about 0.01 mg/kg to about 50 mg/kg, from about 0.1 mg/kg to about 40 mg/kg, from about 0.5 mg/kg to about 30 mg/kg, from about 0.01 mg/kg to about 10 mg/kg, from about 0.1 mg/kg to about 10 mg/kg, or from about 1 mg/kg to about 25 mg/kg, of subject body weight per day, one or more times a day, to obtain the desired therapeutic, diagnostic, prophylactic, or imaging effect. The desired dosage may be delivered three times a day, two times a day, once a day, every other day, every third day, every week, every two weeks, every three weeks, or every four weeks. In certain embodiments, the desired dosage may be delivered using multiple administrations (*e.g.*, two, three, four, five, six, seven, eight, nine, ten, eleven, twelve, thirteen, fourteen, or more administrations). When multiple administrations are employed, split dosing regimens such as those described herein may be used.

[000675] According to the present invention, it has been discovered that administration of mmRNA in split-dose regimens produce higher levels of proteins in mammalian subjects. As used herein, a "split dose" is the division of single unit dose or total daily dose into two or more doses, *e.g.*, two or more administrations of the single unit dose. As used herein, a "single unit dose" is a dose of any therapeutic administered in one dose/at one time/single route/single point of contact, *i.e.*, single administration event. As used

herein, a "total daily dose" is an amount given or prescribed in 24 hr period. It may be administered as a single unit dose. In one embodiment, the mmRNA of the present invention are administered to a subject in split doses. The mmRNA may be formulated in buffer only or in a formulation described herein.

#### Dosage Forms

[000676] A pharmaceutical composition described herein can be formulated into a dosage form described herein, such as a topical, intranasal, intratracheal, or injectable (e.g., intravenous, intraocular, intravitreal, intramuscular, intracardiac, intraperitoneal, subcutaneous).

#### *Liquid dosage forms*

[000677] Liquid dosage forms for parenteral administration include, but are not limited to, pharmaceutically acceptable emulsions, microemulsions, solutions, suspensions, syrups, and/or elixirs. In addition to active ingredients, liquid dosage forms may comprise inert diluents commonly used in the art including, but not limited to, water or other solvents, solubilizing agents and emulsifiers such as ethyl alcohol, isopropyl alcohol, ethyl carbonate, ethyl acetate, benzyl alcohol, benzyl benzoate, propylene glycol, 1,3-butylene glycol, dimethylformamide, oils (in particular, cottonseed, groundnut, corn, germ, olive, castor, and sesame oils), glycerol, tetrahydrofurfuryl alcohol, polyethylene glycols and fatty acid esters of sorbitan, and mixtures thereof. In certain embodiments for parenteral administration, compositions may be mixed with solubilizing agents such as CREMOPHOR<sup>®</sup>, alcohols, oils, modified oils, glycols, polysorbates, cyclodextrins, polymers, and/or combinations thereof.

#### *Injectable*

[000678] Injectable preparations, for example, sterile injectable aqueous or oleaginous suspensions may be formulated according to the known art and may include suitable dispersing agents, wetting agents, and/or suspending agents. Sterile injectable preparations may be sterile injectable solutions, suspensions, and/or emulsions in nontoxic parenterally acceptable diluents and/or solvents, for example, a solution in 1,3-butanediol. Among the acceptable vehicles and solvents that may be employed include, but are not limited to, water, Ringer's solution, U.S.P., and isotonic sodium chloride solution. Sterile, fixed oils are conventionally employed as a solvent or suspending



medium. For this purpose any bland fixed oil can be employed including synthetic mono- or diglycerides. Fatty acids such as oleic acid can be used in the preparation of injectables.

**[000679]** Injectable formulations can be sterilized, for example, by filtration through a bacterial-retaining filter, and/or by incorporating sterilizing agents in the form of sterile solid compositions which can be dissolved or dispersed in sterile water or other sterile injectable medium prior to use.

**[000680]** In order to prolong the effect of an active ingredient, it may be desirable to slow the absorption of the active ingredient from subcutaneous or intramuscular injection. This may be accomplished by the use of a liquid suspension of crystalline or amorphous material with poor water solubility. The rate of absorption of the polynucleotide, primary construct or mmRNA then depends upon its rate of dissolution which, in turn, may depend upon crystal size and crystalline form. Alternatively, delayed absorption of a parenterally administered polynucleotide, primary construct or mmRNA may be accomplished by dissolving or suspending the polynucleotide, primary construct or mmRNA in an oil vehicle. Injectable depot forms are made by forming microcapsule matrices of the polynucleotide, primary construct or mmRNA in biodegradable polymers such as polylactide-polyglycolide. Depending upon the ratio of polynucleotide, primary construct or mmRNA to polymer and the nature of the particular polymer employed, the rate of polynucleotide, primary construct or mmRNA release can be controlled. Examples of other biodegradable polymers include, but are not limited to, poly(orthoesters) and poly(anhydrides). Depot injectable formulations may be prepared by entrapping the polynucleotide, primary construct or mmRNA in liposomes or microemulsions which are compatible with body tissues.

#### *Pulmonary*

**[000681]** Formulations described herein as being useful for pulmonary delivery may also be used for intranasal delivery of a pharmaceutical composition. Another formulation suitable for intranasal administration may be a coarse powder comprising the active ingredient and having an average particle from about 0.2  $\mu\text{m}$  to 500  $\mu\text{m}$ . Such a formulation may be administered in the manner in which snuff is taken, i.e. by rapid

inhalation through the nasal passage from a container of the powder held close to the nose.

[000682] Formulations suitable for nasal administration may, for example, comprise from about as little as 0.1% (w/w) and as much as 100% (w/w) of active ingredient, and may comprise one or more of the additional ingredients described herein. A pharmaceutical composition may be prepared, packaged, and/or sold in a formulation suitable for buccal administration. Such formulations may, for example, be in the form of tablets and/or lozenges made using conventional methods, and may, for example, contain about 0.1% to 20% (w/w) active ingredient, where the balance may comprise an orally dissolvable and/or degradable composition and, optionally, one or more of the additional ingredients described herein. Alternately, formulations suitable for buccal administration may comprise a powder and/or an aerosolized and/or atomized solution and/or suspension comprising active ingredient. Such powdered, aerosolized, and/or aerosolized formulations, when dispersed, may have an average particle and/or droplet size in the range from about 0.1 nm to about 200 nm, and may further comprise one or more of any additional ingredients described herein.

[000683] General considerations in the formulation and/or manufacture of pharmaceutical agents may be found, for example, in Remington: The Science and Practice of Pharmacy 21<sup>st</sup> ed., Lippincott Williams & Wilkins, 2005 (incorporated herein by reference in its entirety).

#### *Coatings or Shells*

[000684] Solid dosage forms of tablets, dragees, capsules, pills, and granules can be prepared with coatings and shells such as enteric coatings and other coatings well known in the pharmaceutical formulating art. They may optionally comprise opacifying agents and can be of a composition that they release the active ingredient(s) only, or preferentially, in a certain part of the intestinal tract, optionally, in a delayed manner. Examples of embedding compositions which can be used include polymeric substances and waxes. Solid compositions of a similar type may be employed as fillers in soft and hard-filled gelatin capsules using such excipients as lactose or milk sugar as well as high molecular weight polyethylene glycols and the like.

Properties of Pharmaceutical Compositions

[000685] The pharmaceutical compositions described herein can be characterized by one or more of bioavailability, therapeutic window and/or volume of distribution.

*Bioavailability*

[000686] The cosmetic polynucleotides, primary constructs or mmRNA, when formulated into a composition with a delivery agent as described herein, can exhibit an increase in bioavailability as compared to a composition lacking a delivery agent as described herein. As used herein, the term "bioavailability" refers to the systemic availability of a given amount of cosmetic polynucleotides, primary constructs or mmRNA administered to a mammal. Bioavailability can be assessed by measuring the area under the curve (AUC) or the maximum serum or plasma concentration ( $C_{max}$ ) of the unchanged form of a compound following administration of the compound to a mammal. AUC is a determination of the area under the curve plotting the serum or plasma concentration of a compound along the ordinate (Y-axis) against time along the abscissa (X-axis). Generally, the AUC for a particular compound can be calculated using methods known to those of ordinary skill in the art and as described in G. S. Banker, *Modern Pharmaceutics, Drugs and the Pharmaceutical Sciences*, v. 72, Marcel Dekker, New York, Inc., 1996, herein incorporated by reference in its entirety.

[000687] The  $C_{max}$  value is the maximum concentration of the compound achieved in the serum or plasma of a mammal following administration of the compound to the mammal. The  $C_{max}$  value of a particular compound can be measured using methods known to those of ordinary skill in the art. The phrases "increasing bioavailability" or "improving the pharmacokinetics," as used herein mean that the systemic availability of a first polynucleotide, primary construct or mmRNA, measured as AUC,  $C_{max}$ , or  $C_{min}$  in a mammal is greater, when co-administered with a delivery agent as described herein, than when such co-administration does not take place. In some embodiments, the bioavailability of the polynucleotide, primary construct or mmRNA can increase by at least about 2%, at least about 5%, at least about 10%, at least about 15%, at least about 20%, at least about 25%, at least about 30%, at least about 35%, at least about 40%, at least about 45%, at least about 50%, at least about 55%, at least about 60%, at least about 65%, at least about 70%, at least about 75%, at least about 80%, at least about 85%, at least about 90%, at least about 95%», or about 100%».

*Therapeutic Window*

[000688] The cosmetic polynucleotides, primary constructs or mmRNA, when formulated into a composition with a delivery agent as described herein, can exhibit an increase in the therapeutic window of the administered polynucleotide, primary construct or mmRNA composition as compared to the therapeutic window of the administered polynucleotide, primary construct or mmRNA composition lacking a delivery agent as described herein. As used herein "therapeutic window" refers to the range of plasma concentrations, or the range of levels of therapeutically active substance at the site of action, with a high probability of eliciting a therapeutic effect. In some embodiments, the therapeutic window of the polynucleotide, primary construct or mmRNA when co-administered with a delivery agent as described herein can increase by at least about 2%, at least about 5%, at least about 10%, at least about 15%, at least about 20%, at least about 25%, at least about 30%, at least about 35%, at least about 40%, at least about 45%, at least about 50%, at least about 55%, at least about 60%, at least about 65%, at least about 70%, at least about 75%, at least about 80%, at least about 85%, at least about 90%, at least about 95%, or about 100%.

*Volume of Distribution*

[000689] The cosmetic polynucleotides, primary constructs or mmRNA, when formulated into a composition with a delivery agent as described herein, can exhibit an improved volume of distribution ( $V_{dist}$ ), e.g., reduced or targeted, relative to a composition lacking a delivery agent as described herein. The volume of distribution ( $V_{dist}$ ) relates the amount of the drug in the body to the concentration of the drug in the blood or plasma. As used herein, the term "volume of distribution" refers to the fluid volume that would be required to contain the total amount of the drug in the body at the same concentration as in the blood or plasma:  $V_{dist}$  equals the amount of drug in the body/concentration of drug in blood or plasma. For example, for a 10 mg dose and a plasma concentration of 10 mg/L, the volume of distribution would be 1 liter. The volume of distribution reflects the extent to which the drug is present in the extravascular tissue. A large volume of distribution reflects the tendency of a compound to bind to the tissue components compared with plasma protein binding. In a clinical setting,  $V_{dist}$  can be used to determine a loading dose to achieve a steady state concentration. In some

embodiments, the volume of distribution of the polynucleotide, primary construct or mmRNA when co-administered with a delivery agent as described herein can decrease at least about 2%, at least about 5%, at least about 10%, at least about 15%, at least about 20%, at least about 25%, at least about 30%, at least about 35%, at least about 40%, at least about 45%, at least about 50%, at least about 55%, at least about 60%, at least about 65%, at least about 70%.

#### *Biological Effect*

**[000690]** In one embodiment, the biological effect of the modified mRNA delivered to the animals may be categorized by analyzing the protein expression in the animals. The protein expression may be determined from analyzing a biological sample collected from a mammal administered the modified mRNA of the present invention. In one embodiment, the expression protein encoded by the modified mRNA administered to the mammal of at least 50 pg/ml may be preferred. For example, a protein expression of 50-200 pg/ml for the protein encoded by the modified mRNA delivered to the mammal may be seen as a therapeutically effective amount of protein in the mammal.

#### Detection of Modified Nucleic Acids by Mass Spectrometry

**[000691]** Mass spectrometry (MS) is an analytical technique that can provide structural and molecular mass/concentration information on molecules after their conversion to ions. The molecules are first ionized to acquire positive or negative charges and then they travel through the mass analyzer to arrive at different areas of the detector according to their mass/charge ( $m/z$ ) ratio.

**[000692]** Mass spectrometry is performed using a mass spectrometer which includes an ion source for ionizing the fractionated sample and creating charged molecules for further analysis. For example ionization of the sample may be performed by electrospray ionization (ESI), atmospheric pressure chemical ionization (APCI), photoionization, electron ionization, fast atom bombardment (FAB)/liquid secondary ionization (LSIMS), matrix assisted laser desorption/ionization (MALDI), field ionization, field desorption, thermospray/plasmaspray ionization, and particle beam ionization. The skilled artisan will understand that the choice of ionization method can be determined based on the analyte to be measured, type of sample, the type of detector, the choice of positive versus negative mode, etc.

[000693] After the sample has been ionized, the positively charged or negatively charged ions thereby created may be analyzed to determine a mass-to-charge ratio (i.e.,  $m/z$ ). Suitable analyzers for determining mass-to-charge ratios include quadropole analyzers, ion traps analyzers, and time-of-flight analyzers. The ions may be detected using several detection modes. For example, selected ions may be detected (i.e., using a selective ion monitoring mode (SIM)), or alternatively, ions may be detected using a scanning mode, e.g., multiple reaction monitoring (MRM) or selected reaction monitoring (SRM).

[000694] Liquid chromatography-multiple reaction monitoring (LC-MS/MRM) coupled with stable isotope labeled dilution of peptide standards has been shown to be an effective method for protein verification (e.g., Keshishian et al, Mol Cell Proteomics 2009 8: 2339-2349; Kuhn et al., Clin Chem 2009 55:1108-1 117; Lopez et al., Clin Chem 2010 56:281-290; each of which are herein incorporated by reference in its entirety). Unlike untargeted mass spectrometry frequently used in biomarker discovery studies, targeted MS methods are peptide sequence-based modes of MS that focus the full analytical capacity of the instrument on tens to hundreds of selected peptides in a complex mixture. By restricting detection and fragmentation to only those peptides derived from proteins of interest, sensitivity and reproducibility are improved dramatically compared to discovery-mode MS methods. This method of mass spectrometry-based multiple reaction monitoring (MRM) quantitation of proteins can dramatically impact the discovery and quantitation of biomarkers via rapid, targeted, multiplexed protein expression profiling of clinical samples.

[000695] In one embodiment, a biological sample which may contain at least one protein encoded by at least one modified mRNA of the present invention may be analyzed by the method of MRM-MS. The quantification of the biological sample may further include, but is not limited to, isotopically labeled peptides or proteins as internal standards.

[000696] According to the present invention, the biological sample, once obtained from the subject, may be subjected to enzyme digestion. As used herein, the term "digest" means to break apart into shorter peptides. As used herein, the phrase "treating a sample to digest proteins" means manipulating a sample in such a way as to break down proteins

in a sample. These enzymes include, but are not limited to, trypsin, endoproteinase Glu-C and chymotrypsin. In one embodiment, a biological sample which may contain at least one protein encoded by at least one modified mRNA of the present invention may be digested using enzymes.

[000697] In one embodiment, a biological sample which may contain protein encoded by modified mRNA of the present invention may be analyzed for protein using electrospray ionization. Electrospray ionization (ESI) mass spectrometry (ESIMS) uses electrical energy to aid in the transfer of ions from the solution to the gaseous phase before they are analyzed by mass spectrometry. Samples may be analyzed using methods known in the art (e.g., Ho et al., Clin Biochem Rev. 2003 24(1):3-12; herein incorporated by reference in its entirety). The ionic species contained in solution may be transferred into the gas phase by dispersing a fine spray of charge droplets, evaporating the solvent and ejecting the ions from the charged droplets to generate a mist of highly charged droplets. The mist of highly charged droplets may be analyzed using at least 1, at least 2, at least 3 or at least 4 mass analyzers such as, but not limited to, a quadropole mass analyzer. Further, the mass spectrometry method may include a purification step. As a non-limiting example, the first quadropole may be set to select a single m/z ratio so it may filter out other molecular ions having a different m/z ratio which may eliminate complicated and time-consuming sample purification procedures prior to MS analysis.

[000698] In one embodiment, a biological sample which may contain protein encoded by modified mRNA of the present invention may be analyzed for protein in a tandem ESIMS system (e.g., MS/MS). As non-limiting examples, the droplets may be analyzed using a product scan (or daughter scan) a precursor scan (parent scan) a neutral loss or a multiple reaction monitoring.

[000699] In one embodiment, a biological sample which may contain protein encoded by modified mRNA of the present invention may be analyzed using matrix-assisted laser desorption/ionization (MALDI) mass spectrometry (MALDIMS). MALDI provides for the nondestructive vaporization and ionization of both large and small molecules, such as proteins. In MALDI analysis, the analyte is first co-crystallized with a large molar excess of a matrix compound, which may also include, but is not limited to, an ultraviolet absorbing weak organic acid. Non-limiting examples of matrices used in MALDI are a-

cyano-4-hydroxycinnamic acid, 3,5-dimethoxy-4-hydroxycinnamic acid and 2,5-dihydroxybenzoic acid. Laser radiation of the analyte-matrix mixture may result in the vaporization of the matrix and the analyte. The laser induced desorption provides high ion yields of the intact analyte and allows for measurement of compounds with high accuracy. Samples may be analyzed using methods known in the art (e.g., Lewis, Wei and Siuzdak, Encyclopedia of Analytical Chemistry 2000:5880-5894; herein incorporated by reference in its entirety). As non-limiting examples, mass analyzers used in the MALDI analysis may include a linear time-of-flight (TOF), a TOF reflectron or a Fourier transform mass analyzer.

[000700] In one embodiment, the analyte-matrix mixture may be formed using the dried-droplet method. A biologic sample is mixed with a matrix to create a saturated matrix solution where the matrix-to-sample ratio is approximately 5000:1. An aliquot (approximately 0.5-2.0 uL) of the saturated matrix solution is then allowed to dry to form the analyte-matrix mixture.

[000701] In one embodiment, the analyte-matrix mixture may be formed using the thin-layer method. A matrix homogeneous film is first formed and then the sample is then applied and may be absorbed by the matrix to form the analyte-matrix mixture.

[000702] In one embodiment, the analyte-matrix mixture may be formed using the thick-layer method. A matrix homogeneous film is formed with a nitro-cellulose matrix additive. Once the uniform nitro-cellulose matrix layer is obtained the sample is applied and absorbed into the matrix to form the analyte-matrix mixture.

[000703] In one embodiment, the analyte-matrix mixture may be formed using the sandwich method. A thin layer of matrix crystals is prepared as in the thin-layer method followed by the addition of droplets of aqueous trifluoroacetic acid, the sample and matrix. The sample is then absorbed into the matrix to form the analyte-matrix mixture.

#### **V. Uses of cosmetic polynucleotides, primary constructs and mmRNA of the Invention**

[000704] The cosmetic polynucleotides, primary constructs and mmRNA of the present invention are designed, in preferred embodiments, to provide for avoidance or evasion of deleterious bio-responses such as the immune response and/or degradation pathways, overcoming the threshold of expression and/or improving protein production capacity,



improved expression rates or translation efficiency, improved drug or protein half life and/or protein concentrations, optimized protein localization, to improve one or more of the stability and/or clearance in tissues, receptor uptake and/or kinetics, cellular access by the compositions, engagement with translational machinery, secretion efficiency (when applicable), accessibility to circulation, and/or modulation of a cell's status, function and/or activity.

### Therapeutics

#### *Therapeutic Agents*

[000705] The cosmetic polynucleotides, primary constructs or mmRNA of the present invention, such as modified nucleic acids and modified RNAs, and the proteins translated from them described herein can be used as therapeutic or prophylactic agents. They are provided for use in medicine. For example, a polynucleotide, primary construct or mmRNA described herein can be administered to a subject, wherein the polynucleotide, primary construct or mmRNA is translated *in vivo* to produce a therapeutic or prophylactic polypeptide in the subject. Provided are compositions, methods, kits, and reagents for diagnosis, treatment or prevention of a disease or condition in humans and other mammals. The active therapeutic agents of the invention include polynucleotides, primary constructs or mmRNA, cells containing polynucleotides, primary constructs or mmRNA or polypeptides translated from the cosmetic polynucleotides, primary constructs or mmRNA.

[000706] In certain embodiments, provided herein are combination therapeutics containing one or more polynucleotide, primary construct or mmRNA containing translatable regions that encode for a protein or proteins that boost a mammalian subject's immunity along with a protein that induces antibody-dependent cellular toxicity. For example, provided herein are therapeutics containing one or more nucleic acids that encode trastuzumab and granulocyte-colony stimulating factor (G-CSF). In particular, such combination therapeutics are useful in Her2+ breast cancer patients who develop induced resistance to trastuzumab. (See, e.g., Albrecht, Immunotherapy. 2(6):795-8 (2010)).

[000707] Provided herein are methods of inducing translation of a recombinant polypeptide in a cell population using the polynucleotide, primary construct or mmRNA

described herein. Such translation can be *in vivo*, *ex vivo*, *in culture*, or *in vitro*. The cell population is contacted with an effective amount of a composition containing a nucleic acid that has at least one nucleoside modification, and a translatable region encoding the recombinant polypeptide. The population is contacted under conditions such that the nucleic acid is localized into one or more cells of the cell population and the recombinant polypeptide is translated in the cell from the nucleic acid.

[000708] An "effective amount" of the composition is provided based, at least in part, on the target tissue, target cell type, means of administration, physical characteristics of the nucleic acid (e.g., size, and extent of modified nucleosides), and other determinants. In general, an effective amount of the composition provides efficient protein production in the cell, preferably more efficient than a composition containing a corresponding unmodified nucleic acid. Increased efficiency may be demonstrated by increased cell transfection (i.e., the percentage of cells transfected with the nucleic acid), increased protein translation from the nucleic acid, decreased nucleic acid degradation (as demonstrated, e.g., by increased duration of protein translation from a modified nucleic acid), or reduced innate immune response of the host cell.

[000709] Aspects of the invention are directed to methods of inducing *in vivo* translation of a recombinant polypeptide in a mammalian subject in need thereof. Therein, an effective amount of a composition containing a nucleic acid that has at least one structural or chemical modification and a translatable region encoding the recombinant polypeptide is administered to the subject using the delivery methods described herein. The nucleic acid is provided in an amount and under other conditions such that the nucleic acid is localized into a cell of the subject and the recombinant polypeptide is translated in the cell from the nucleic acid. The cell in which the nucleic acid is localized, or the tissue in which the cell is present, may be targeted with one or more than one rounds of nucleic acid administration.

[000710] In certain embodiments, the administered polynucleotide, primary construct or mRNA directs production of one or more recombinant polypeptides that provide a functional activity which is substantially absent in the cell, tissue or organism in which the recombinant polypeptide is translated. For example, the missing functional activity may be enzymatic, structural, or gene regulatory in nature. In related embodiments, the

administered polynucleotide, primary construct or mmRNA directs production of one or more recombinant polypeptides that increases (e.g., synergistically) a functional activity which is present but substantially deficient in the cell in which the recombinant polypeptide is translated.

[000711] In other embodiments, the administered polynucleotide, primary construct or mmRNA directs production of one or more recombinant polypeptides that replace a polypeptide (or multiple polypeptides) that is substantially absent in the cell in which the recombinant polypeptide is translated. Such absence may be due to genetic mutation of the encoding gene or regulatory pathway thereof. In some embodiments, the recombinant polypeptide increases the level of an endogenous protein in the cell to a desirable level; such an increase may bring the level of the endogenous protein from a subnormal level to a normal level or from a normal level to a super-normal level.

[000712] Alternatively, the recombinant polypeptide functions to antagonize the activity of an endogenous protein present in, on the surface of, or secreted from the cell. Usually, the activity of the endogenous protein is deleterious to the subject; for example, due to mutation of the endogenous protein resulting in altered activity or localization. Additionally, the recombinant polypeptide antagonizes, directly or indirectly, the activity of a biological moiety present in, on the surface of, or secreted from the cell. Examples of antagonized biological moieties include lipids (e.g., cholesterol), a lipoprotein (e.g., low density lipoprotein), a nucleic acid, a carbohydrate, a protein toxin such as shiga and tetanus toxins, or a small molecule toxin such as botulinum, cholera, and diphtheria toxins. Additionally, the antagonized biological molecule may be an endogenous protein that exhibits an undesirable activity, such as a cytotoxic or cytostatic activity.

[000713] The recombinant proteins described herein may be engineered for localization within the cell, potentially within a specific compartment such as the nucleus, or are engineered for secretion from the cell or translocation to the plasma membrane of the cell.

[000714] In some embodiments, modified mRNAs and their encoded polypeptides in accordance with the present invention may be used for treatment of any of a variety of diseases, disorders, and/or conditions, including but not limited to one or more of the following: autoimmune disorders (e.g. diabetes, lupus, multiple sclerosis, psoriasis,

rheumatoid arthritis); inflammatory disorders (*e.g.* arthritis, pelvic inflammatory disease); infectious diseases (*e.g.* viral infections (*e.g.*, HIV, HCV, RSV), bacterial infections, fungal infections, sepsis); neurological disorders (*e.g.* Alzheimer's disease, Huntington's disease; autism; Duchenne muscular dystrophy); cardiovascular disorders (*e.g.* atherosclerosis, hypercholesterolemia, thrombosis, clotting disorders, angiogenic disorders such as macular degeneration); proliferative disorders (*e.g.* cancer, benign neoplasms); respiratory disorders (*e.g.* chronic obstructive pulmonary disease); digestive disorders (*e.g.* inflammatory bowel disease, ulcers); musculoskeletal disorders (*e.g.* fibromyalgia, arthritis); endocrine, metabolic, and nutritional disorders (*e.g.* diabetes, osteoporosis); urological disorders (*e.g.* renal disease); psychological disorders (*e.g.* depression, schizophrenia); skin disorders (*e.g.* wounds, eczema); blood and lymphatic disorders (*e.g.* anemia, hemophilia); *etc.*

**[000715]** Diseases characterized by dysfunctional or aberrant protein activity include cystic fibrosis, sickle cell anemia, epidermolysis bullosa, amyotrophic lateral sclerosis, and glucose-6-phosphate dehydrogenase deficiency. The present invention provides a method for treating such conditions or diseases in a subject by introducing nucleic acid or cell-based therapeutics containing the polynucleotide, primary construct or mmRNA provided herein, wherein the polynucleotide, primary construct or mmRNA encode for a protein that antagonizes or otherwise overcomes the aberrant protein activity present in the cell of the subject. Specific examples of a dysfunctional protein are the missense mutation variants of the cystic fibrosis transmembrane conductance regulator (CFTR) gene, which produce a dysfunctional protein variant of CFTR protein, which causes cystic fibrosis.

**[000716]** Diseases characterized by missing (or substantially diminished such that proper (normal or physiological protein function does not occur) protein activity include cystic fibrosis, Niemann-Pick type C,  $\beta$  thalassemia major, Duchenne muscular dystrophy, Hurler Syndrome, Hunter Syndrome, and Hemophilia A. Such proteins may not be present, or are essentially non-functional. The present invention provides a method for treating such conditions or diseases in a subject by introducing nucleic acid or cell-based therapeutics containing the polynucleotide, primary construct or mmRNA provided herein, wherein the polynucleotide, primary construct or mmRNA encode for a

protein that replaces the protein activity missing from the target cells of the subject.

Specific examples of a dysfunctional protein are the nonsense mutation variants of the cystic fibrosis transmembrane conductance regulator (CFTR) gene, which produce a nonfunctional protein variant of CFTR protein, which causes cystic fibrosis.

[000717] Thus, provided are methods of treating cystic fibrosis in a mammalian subject by contacting a cell of the subject with a polynucleotide, primary construct or mmRNA having a translatable region that encodes a functional CFTR polypeptide, under conditions such that an effective amount of the CFTR polypeptide is present in the cell. Preferred target cells are epithelial, endothelial and mesothelial cells, such as the lung, and methods of administration are determined in view of the target tissue; i.e., for lung delivery, the RNA molecules are formulated for administration by inhalation.

[000718] In another embodiment, the present invention provides a method for treating hyperlipidemia in a subject, by introducing into a cell population of the subject with a modified mRNA molecule encoding Sortilin, a protein recently characterized by genomic studies, thereby ameliorating the hyperlipidemia in a subject. The *SORT1* gene encodes a trans-Golgi network (TGN) transmembrane protein called Sortilin. Genetic studies have shown that one of five individuals has a single nucleotide polymorphism, rs12740374, in the *lpl3* locus of the *SORT1* gene that predisposes them to having low levels of low-density lipoprotein (LDL) and very-low-density lipoprotein (VLDL). Each copy of the minor allele, present in about 30% of people, alters LDL cholesterol by 8 mg/dL, while two copies of the minor allele, present in about 5% of the population, lowers LDL cholesterol 16 mg/dL. Carriers of the minor allele have also been shown to have a 40% decreased risk of myocardial infarction. Functional *in vivo* studies in mice describes that overexpression of *SORT1* in mouse liver tissue led to significantly lower LDL-cholesterol levels, as much as 80% lower, and that silencing *SORT1* increased LDL cholesterol approximately 200% (Musunuru K et al. From noncoding variant to phenotype via *SORT1* at the *lpl3* cholesterol locus. *Nature* 2010; 466: 714-721).

[000719] In another embodiment, the present invention provides a method for treating hematopoietic disorders, cardiovascular disease, oncology, diabetes, cystic fibrosis, neurological diseases, inborn errors of metabolism, skin and systemic disorders, and blindness. The identity of molecular targets to treat these specific diseases has been

described (Templeton ed., Gene and Cell Therapy: Therapeutic Mechanisms and Strategies, 3<sup>rd</sup> Edition, Boca Raton, FL: CRC Press; herein incorporated by reference in its entirety).

**[000720]** Provided herein, are methods to prevent infection and/or sepsis in a subject at risk of developing infection and/or sepsis, the method comprising administering to a subject in need of such prevention a composition comprising a polynucleotide, primary construct or mRNA precursor encoding an anti-microbial polypeptide (*e.g.*, an anti-bacterial polypeptide), or a partially or fully processed form thereof in an amount sufficient to prevent infection and/or sepsis. In certain embodiments, the subject at risk of developing infection and/or sepsis may be a cancer patient. In certain embodiments, the cancer patient may have undergone a conditioning regimen. In some embodiments, the conditioning regimen may include, but is not limited to, chemotherapy, radiation therapy, or both.

**[000721]** Further provided herein, are methods to treat infection and/or sepsis in a subject, the method comprising administering to a subject in need of such treatment a composition comprising a polynucleotide, primary construct or mRNA precursor encoding an anti-microbial polypeptide (*e.g.*, an anti-bacterial polypeptide), *e.g.*, an anti-microbial polypeptide described herein, or a partially or fully processed form thereof in an amount sufficient to treat an infection and/or sepsis. In certain embodiments, the subject in need of treatment is a cancer patient. In certain embodiments, the cancer patient has undergone a conditioning regimen. In some embodiments, the conditioning regimen may include, but is not limited to, chemotherapy, radiation therapy, or both.

**[000722]** In certain embodiments, the subject may exhibit acute or chronic microbial infections (*e.g.*, bacterial infections). In certain embodiments, the subject may have received or may be receiving a therapy. In certain embodiments, the therapy may include, but is not limited to, radiotherapy, chemotherapy, steroids, ultraviolet radiation, or a combination thereof. In certain embodiments, the patient may suffer from a microvascular disorder. In some embodiments, the microvascular disorder may be diabetes. In certain embodiments, the patient may have a wound. In some embodiments, the wound may be an ulcer. In a specific embodiment, the wound may be a diabetic foot ulcer. In certain embodiments, the subject may have one or more burn wounds. In

certain embodiments, the administration may be local or systemic. In certain embodiments, the administration may be subcutaneous. In certain embodiments, the administration may be intravenous. In certain embodiments, the administration may be oral. In certain embodiments, the administration may be topical. In certain embodiments, the administration may be by inhalation. In certain embodiments, the administration may be rectal. In certain embodiments, the administration may be vaginal.

[000723] Other aspects of the present disclosure relate to transplantation of cells containing polynucleotide, primary construct, or mmRNA to a mammalian subject. Administration of cells to mammalian subjects is known to those of ordinary skill in the art, and include, but is not limited to, local implantation (e.g., topical or subcutaneous administration), organ delivery or systemic injection (e.g., intravenous injection or inhalation), and the formulation of cells in pharmaceutically acceptable carrier. Such compositions containing polynucleotide, primary construct, or mmRNA can be formulated for administration intramuscularly, transarterially, intraperitoneally, intravenously, intranasally, subcutaneously, endoscopically, transdermally, or intrathecally. In some embodiments, the composition may be formulated for extended release.

[000724] The subject to whom the therapeutic agent may be administered suffers from or may be at risk of developing a disease, disorder, or deleterious condition. Provided are methods of identifying, diagnosing, and classifying subjects on these bases, which may include clinical diagnosis, biomarker levels, genome-wide association studies (GWAS), and other methods known in the art.

#### Wound Management

[000725] The cosmetic polynucleotides, primary constructs or mmRNA of the present invention may be used for wound treatment, *e.g.* of wounds exhibiting delayed healing. Provided herein are methods comprising the administration of polynucleotide, primary construct or mmRNA in order to manage the treatment of wounds. The methods herein may further comprise steps carried out either prior to, concurrent with or post administration of the polynucleotide, primary construct or mmRNA. For example, the wound bed may need to be cleaned and prepared in order to facilitate wound healing and hopefully obtain closure of the wound. Several strategies may be used in order to

promote wound healing and achieve wound closure including, but not limited to: (i) debridement, optionally repeated, sharp debridement (surgical removal of dead or infected tissue from a wound), optionally including chemical debriding agents, such as enzymes, to remove necrotic tissue; (ii) wound dressings to provide the wound with a moist, warm environment and to promote tissue repair and healing.

[000726] Examples of materials that are used in formulating wound dressings include, but are not limited to: hydrogels (*e.g.*, AQUASORB®; DUODERM®), hydrocolloids (*e.g.*, AQUACEL®; COMFEEL®), foams (*e.g.*, LYOFOAM®; SPYROSORB®), and alginates (*e.g.*, ALGISITE®; CURASORB®); (iii) additional growth factors to stimulate cell division and proliferation and to promote wound healing *e.g.* becaplermin (REGRANEX GEL®), a human recombinant platelet-derived growth factor that is approved by the FDA for the treatment of neuropathic foot ulcers; (iv) soft-tissue wound coverage, a skin graft may be necessary to obtain coverage of clean, non-healing wounds. Examples of skin grafts that may be used for soft-tissue coverage include, but are not limited to: autologous skin grafts, cadaveric skin graft, bioengineered skin substitutes (*e.g.*, APLIGRAF®; DERMAGRAFT®).

[000727] In certain embodiments, the polynucleotide, primary construct or mmRNA of the present invention may further include hydrogels (*e.g.*, AQUASORB®; DUODERM®), hydrocolloids (*e.g.*, AQUACEL®; COMFEEL®), foams (*e.g.*, LYOFOAM®; SPYROSORB®), and/or alginates (*e.g.*, ALGISITE®; CURASORB®). In certain embodiments, the polynucleotide, primary construct or mmRNA of the present invention may be used with skin grafts including, but not limited to, autologous skin grafts, cadaveric skin graft, or bioengineered skin substitutes (*e.g.*, APLIGRAF®; DERMAGRAFT®). In some embodiments, the polynucleotide, primary construct or mmRNA may be applied with wound dressing formulations and/or skin grafts or they may be applied separately but methods such as, but not limited to, soaking or spraying.

[000728] In some embodiments, compositions for wound management may comprise a polynucleotide, primary construct or mmRNA encoding for an anti-microbial polypeptide (*e.g.*, an anti-bacterial polypeptide) and/or an anti-viral polypeptide. A precursor or a partially or fully processed form of the anti-microbial polypeptide may be encoded. The composition may be formulated for administration using a bandage (*e.g.*, an adhesive



bandage). The anti-microbial polypeptide and/or the anti-viral polypeptide may be intermixed with the dressing compositions or may be applied separately, e.g., by soaking or spraying.

#### Production of Antibodies

[000729] In one embodiment of the invention, the cosmetic polynucleotides, primary constructs or mmRNA may encode antibodies and fragments of such antibodies. These may be produced by any one of the methods described herein. The antibodies may be of any of the different subclasses or isotypes of immunoglobulin such as, but not limited to, IgA, IgG, or IgM, or any of the other subclasses. Exemplary antibody molecules and fragments that may be prepared according to the invention include, but are not limited to, immunoglobulin molecules, substantially intact immunoglobulin molecules and those portions of an immunoglobulin molecule that may contain the paratope. Such portion of antibodies that contain the paratope include, but are not limited to Fab, Fab', F(ab')<sub>2</sub>, F(v) and those portions known in the art.

[000730] The polynucleotides of the invention may encode variant antibody polypeptides which may have a certain identity with a reference polypeptide sequence, or have a similar or dissimilar binding characteristic with the reference polypeptide sequence.

[000731] Antibodies obtained by the methods of the present invention may be chimeric antibodies comprising non-human antibody-derived variable region(s) sequences, derived from the immunized animals, and human antibody-derived constant region(s) sequences. In addition, they can also be humanized antibodies comprising complementary determining regions (CDRs) of non-human antibodies derived from the immunized animals and the framework regions (FRs) and constant regions derived from human antibodies. In another embodiment, the methods provided herein may be useful for enhancing antibody protein product yield in a cell culture process.

#### Managing Infection

[000732] In one embodiment, provided are methods for treating or preventing a microbial infection (*e.g.*, a bacterial infection) and/or a disease, disorder, or condition associated with a microbial or viral infection, or a symptom thereof, in a subject, by administering a polynucleotide, primary construct or mmRNA encoding an anti-microbial

polypeptide. Said administration may be in combination with an anti-microbial agent (*e.g.*, an anti-bacterial agent), *e.g.*, an anti-microbial polypeptide or a small molecule anti-microbial compound described herein. The anti-microbial agents include, but are not limited to, anti-bacterial agents, anti-viral agents, anti-fungal agents, anti-protozoal agents, anti-parasitic agents, and anti-prion agents.

[000733] The agents can be administered simultaneously, for example in a combined unit dose (*e.g.*, providing simultaneous delivery of both agents). The agents can also be administered at a specified time interval, such as, but not limited to, an interval of minutes, hours, days or weeks. Generally, the agents may be concurrently bioavailable, *e.g.*, detectable, in the subject. In some embodiments, the agents may be administered essentially simultaneously, for example two unit dosages administered at the same time, or a combined unit dosage of the two agents. In other embodiments, the agents may be delivered in separate unit dosages. The agents may be administered in any order, or as one or more preparations that includes two or more agents. In a preferred embodiment, at least one administration of one of the agents, *e.g.*, the first agent, may be made within minutes, one, two, three, or four hours, or even within one or two days of the other agent, *e.g.*, the second agent. In some embodiments, combinations can achieve synergistic results, *e.g.*, greater than additive results, *e.g.*, at least 25, 50, 75, 100, 200, 300, 400, or 500% greater than additive results.

*Conditions associated with bacterial infection*

[000734] Diseases, disorders, or conditions which may be associated with bacterial infections include, but are not limited to one or more of the following: abscesses, actinomycosis, acute prostatitis, aeromonas hydrophila, annual ryegrass toxicity, anthrax, bacillary peliosis, bacteremia, bacterial gastroenteritis, bacterial meningitis, bacterial pneumonia, bacterial vaginosis, bacterium-related cutaneous conditions, bartonellosis, BCG-oma, botryomycosis, botulism, Brazilian purpuric fever, Brodie abscess, brucellosis, Buruli ulcer, campylobacteriosis, caries, Carrion's disease, cat scratch disease, cellulitis, chlamydia infection, cholera, chronic bacterial prostatitis, chronic recurrent multifocal osteomyelitis, clostridial necrotizing enteritis, combined periodontic-endodontic lesions, contagious bovine pleuropneumonia, diphtheria, diphtheritic stomatitis, ehrlichiosis, erysipelas, piglottitis, erysipelas, Fitz-Hugh-Curtis syndrome,

flea-borne spotted fever, foot rot (infectious pododermatitis), Garre's sclerosing osteomyelitis, Gonorrhoea, Granuloma inguinale, human granulocytic anaplasmosis, human monocytotropic ehrlichiosis, hundred days' cough, impetigo, late congenital syphilitic ophthalmopathy, legionellosis, Lemierre's syndrome, leprosy (Hansen's Disease), leptospirosis, listeriosis, Lyme disease, lymphadenitis, melioidosis, meningococcal disease, meningococcal septicaemia, methicillin-resistant *Staphylococcus aureus* (MRSA) infection, mycobacterium avium-intracellulare (MAI), mycoplasma pneumonia, necrotizing fasciitis, nocardiosis, noma (cancrum oris or gangrenous stomatitis), omphalitis, orbital cellulitis, osteomyelitis, overwhelming post-splenectomy infection (OPSI), ovine brucellosis, pasteurellosis, periorbital cellulitis, pertussis (whooping cough), plague, pneumococcal pneumonia, Pott disease, proctitis, pseudomonas infection, psittacosis, pyaemia, pyomyositis, Q fever, relapsing fever (typhina), rheumatic fever, Rocky Mountain spotted fever (RMSF), rickettsiosis, salmonellosis, scarlet fever, sepsis, serratia infection, shigellosis, southern tick-associated rash illness, staphylococcal scalded skin syndrome, streptococcal pharyngitis, swimming pool granuloma, swine brucellosis, syphilis, syphilitic aortitis, tetanus, toxic shock syndrome (TSS), trachoma, trench fever, tropical ulcer, tuberculosis, tularemia, typhoid fever, typhus, urogenital tuberculosis, urinary tract infections, vancomycin-resistant *Staphylococcus aureus* infection, Waterhouse-Friderichsen syndrome, pseudotuberculosis (*Yersinia*) disease, and yersiniosis. Other diseases, disorders, and/or conditions associated with bacterial infections can include, for example, Alzheimer's disease, anorexia nervosa, asthma, atherosclerosis, attention deficit hyperactivity disorder, autism, autoimmune diseases, bipolar disorder, cancer (*e.g.*, colorectal cancer, gallbladder cancer, lung cancer, pancreatic cancer, and stomach cancer), chronic fatigue syndrome, chronic obstructive pulmonary disease, Crohn's disease, coronary heart disease, dementia, depression, Guillain-Barre syndrome, metabolic syndrome, multiple sclerosis, myocardial infarction, obesity, obsessive-compulsive disorder, panic disorder, psoriasis, rheumatoid arthritis, sarcoidosis, schizophrenia, stroke, thromboangiitis obliterans (Buerger's disease), and Tourette syndrome.

#### *Bacterial Pathogens*

[000735] The bacterium described herein can be a Gram-positive bacterium or a Gram-negative bacterium. Bacterial pathogens include, but are not limited to, *Acinetobacter baumannii*, *Bacillus anthracis*, *Bacillus subtilis*, *Bordetella pertussis*, *Borrelia burgdorferi*, *Brucella abortus*, *Brucella canis*, *Brucella melitensis*, *Brucella suis*, *Campylobacter jejuni*, *Chlamydia pneumoniae*, *Chlamydia trachomatis*, *Chlamydophila psittaci*, *Clostridium botulinum*, *Clostridium difficile*, *Clostridium perfringens*, *Clostridium tetani*, coagulase Negative *Staphylococcus*, *Corynebacterium diphtheria*, *Enterococcus faecalis*, *Enterococcus faecium*, *Escherichia coli*, enterotoxigenic *Escherichia coli* (ETEC), enteropathogenic *E. coli*, *E. coli* 0157:H7, *Enterobacter sp.*, *Francisella tularensis*, *Haemophilus influenzae*, *Helicobacter pylori*, *Klebsiella pneumoniae*, *Legionella pneumophila*, *Leptospira interrogans*, *Listeria monocytogenes*, *Moraxella catarrhalis*, *Mycobacterium leprae*, *Mycobacterium tuberculosis*, *Mycoplasma pneumoniae*, *Neisseria gonorrhoeae*, *Neisseria meningitides*, *Preteus mirabilis*, *Proteus sps.*, *Pseudomonas aeruginosa*, *Rickettsia rickettsii*, *Salmonella typhi*, *Salmonella typhimurium*, *Serratia marcescens*, *Shigella flexneri*, *Shigella sonnei*, *Staphylococcus aureus*, *Staphylococcus epidermidis*, *Staphylococcus saprophyticus*, *Streptococcus agalactiae*, *Streptococcus mutans*, *Streptococcus pneumoniae*, *Streptococcus pyogenes*, *Treponema pallidum*, *Vibrio cholerae*, and *Yersinia pestis*. Bacterial pathogens may also include bacteria that cause resistant bacterial infections, for example, clindamycin-resistant *Clostridium difficile*, fluoroquinolon-resistant *Clostridium difficile*, methicillin-resistant *Staphylococcus aureus* (MRSA), multidrug-resistant *Enterococcus faecalis*, multidrug-resistant *Enterococcus faecium*, multidrug-resistance *Pseudomonas aeruginosa*, multidrug-resistant *Acinetobacter baumannii*, and vancomycin-resistant *Staphylococcus aureus* (VRSA).

#### *Antibiotic Combinations*

[000736] In one embodiment, the modified mRNA of the present invention may be administered in conjunction with one or more antibiotics. These include, but are not limited to Aknilox, Ambisome, Amoxycillin, Ampicillin, Augmentin, Avelox, Azithromycin, Bactroban, Betadine, Betnovate, Blephamide, Cefaclor, Cefadroxil, Cefdinir, Cefepime, Cefix, Cefixime, Cefoxitin, Cefpodoxime, Cefprozil, Cefuroxime, Cefzil, Cephalexin, Cephazolin, Ceptaz, Chloramphenicol, Chlorhexidine,

Chloromycetin, Chlorsig, Ciprofloxacin, Clarithromycin, Clindagel, Clindamycin, Clindatech, Cloxacillin, Colistin, Co-trimoxazole, Demeclocycline, Diclocil, Dicloxacillin, Doxycycline, Duricef, Erythromycin, Flamazine, Floxin, Framycetin, Fucidin, Furadantin, Fusidic, Gatifloxacin, Gemifloxacin, Gemifloxacin, Ilosone, Iodine, Levaquin, Levofloxacin, Lomefloxacin, Maxaquin, Mefoxin, Meronem, Minocycline, Moxifloxacin, Myambutol, Mycostatin, Neosporin, Netromycin, Nitrofurantoin, Norfloxacin, Norilet, Ofloxacin, Omnicef, Ospamox, Oxytetracycline, Paraxin, Penicillin, Pneumovax, Polyfax, Povidone, Rifadin, Rifampin, Rifaximin, Rifinah, Rimactane, Rocephin, Roxithromycin, Seromycin, Soframycin, Sparfloxacin, Staphlex, Targocid, Tetracycline, Tetradox, Tetralysal, tobramycin, Tobramycin, Trecator, Tygacil, Vancocin, Velosef, Vibramycin, Xifaxan, Zagam, Zitrotek, Zoderm, Zymar, and Zyvox.

*Antibacterial agents*

[000737] Exemplary anti-bacterial agents include, but are not limited to, aminoglycosides (*e.g.*, amikacin (AMIKIN®), gentamicin (GARAMYCIN®), kanamycin (KANTREX®), neomycin (MYCIFRADIN®), netilmicin (NETROMYCIN®), tobramycin (NEBCIN®), Paromomycin (HUMATFN®)), ansamycins (*e.g.*, geldanamycin, herbimycin), carbacephem (*e.g.*, loracarbef (LORABID®), Carbapenems (*e.g.*, ertapenem (INVANZ®), doripenem (DORIBAX®), imipenem/cilastatin (PRIMAXIN®), meropenem (MERREM®), cephalosporins (first generation) (*e.g.*, cefadroxil (DURICEF®), cefazolin (ANCEF®), cefalotin or cefalothin (KEFLIN®), cefalexin (KEFLEX®), cephalosporins (second generation) (*e.g.*, cefaclor (CECLOR®), cefamandole (MANDOL®), cefoxitin (MEFOXIN®), cefprozil (CEFZIL®), cefuroxime (CEFTIN®, ZINNAT®)), cephalosporins (third generation) (*e.g.*, cefixime (SUPRAX®), cefdinir (OMNICEF®, CEFDIEL®), cefditoren (SPECTRACEF®), cefoperazone (CEFOBID®), cefotaxime (CLAFORAN®), cefpodoxime (VANTIN®), ceftazidime (FORTAZ®), ceftibuten (CEDAX®), ceftizoxime (CEFIZOX®), ceftriaxone (ROCEPHIN®)), cephalosporins (fourth generation) (*e.g.*, cefepime (MAXIPIME®)), cephalosporins (fifth generation) (*e.g.*, ceftobiprole (ZEFTERA®)), glycopeptides (*e.g.*, teicoplanin (TARGOCID®), vancomycin (VANCOCIN®), telavancin (VIBATIV®)), lincosamides (*e.g.*, clindamycin (CLEOCIN®), lincomycin (LINCOCIN®)), lipopeptide (*e.g.*, daptomycin (CUBICIN®)), macrolides (*e.g.*, azithromycin (ZITHROMAX®),

SUMAMED®), ZITROCIN®), clarithromycin (BIAXIN®), dirithromycin (DYNABAC®), erythromycin (ERYTHOCIN®, ERYTHROPED®), roxithromycin, troleandomycin (TAO®), telithromycin (KETEK®), spectinomycin (TROBICIN®), monobactams (*e.g.*, aztreonam (AZACTAM®)), nitrofurans (*e.g.*, furazolidone (FUROXONE®), nitrofurantoin (MACRODANTIN®, MACROBID®)), penicillins (*e.g.*, amoxicillin (NOVAMOX®, AMOXIL®), ampicillin (PRINCIPEN®), azlocillin, carbenicillin (GEOCILLIN®), cloxacillin (TEGOPEN®), dicloxacillin (DYNAPEN®), flucloxacillin (FLOXAPEN®), mezlocillin (MEZLIN®), methicillin (STAPHCILLIN®), nafcillin (UNIPEN®), oxacillin (PROSTAPHLIN®), penicillin G (PENTIDS®), penicillin V (PEN-VEE-K®), piperacillin (PIPRACIL®), temocillin (NEGABAN®), ticarcillin (TICAR®)), penicillin combinations (*e.g.*, amoxicillin/clavulanate (AUGMENTFN®), ampicillin/sulbactam (UNASYN®), piperacillin/tazobactam (ZOSYN®), ticarcillin/clavulanate (TIMENTIN®)), polypeptides (*e.g.*, bacitracin, colistin (COLY-MYCIN-S®), polymyxin B, quinolones (*e.g.*, ciprofloxacin (CIPRO®, CIPROXIN®, CIPROBAY®), enoxacin (PENETREX®), gatifloxacin (TEQUIN®), levofloxacin (LEVAQUIN®), lomefloxacin (MAXAQUIN®), moxifloxacin (AVELOX®), nalidixic acid (NEGGRAM®), norfloxacin (NOROXIN®), ofloxacin (FLOXIN®, OCUFLOX®), trovafloxacin (TROVAN®), grepafloxacin (RAXAR®), sparfloxacin (ZAGAM®), temafloxacin (OMNIFLOX®)), sulfonamides (*e.g.*, mafenide (SULFAMYLON®), sulfonamidochrysoidine (PRONTOSIL®), sulfacetamide (SULAMYD®, BLEPH-10®), sulfadiazine (MICRO-SULFON®), silver sulfadiazine (SILVADENE®), sulfamethizole (THIOSULFIL FORTE®), sulfamethoxazole (GANTANOL®), sulfanilimide, sulfasalazine (AZULFIDINE®), sulfisoxazole (GANTRISIN®), trimethoprim (PROLOPRIM®), TRIMPEX®), trimethoprim-sulfamethoxazole (co-trimoxazole) (TMP-SMX) (BACTRIM®, SEPTRA®)), tetracyclines (*e.g.*, demeclocycline (DECLOMYCIN®), doxycycline (VIBRAMYCIN®), minocycline (MINOCIN®), oxytetracycline (TERRAMYCIN®), tetracycline (SUMYCIN®, ACHROMYCIN® V, STECLIN®)), drugs against mycobacteria (*e.g.*, clofazimine (LAMPRENE®), dapsone (AVLOSULFON®), capreomycin (CAPASTAT®), cycloserine (SEROMYCIN®), ethambutol (MYAMBUTOL®), ethionamide (TRECATOR®), isoniazid (I.N.H.®), pyrazinamide (ALDINAMIDE®),

rifampin (RIFADIN®, RIMACTANE®), rifabutin (MYCOBUTIN®), rifapentine (PRIFTIN®), streptomycin, and others (*e.g.*, arsphenamine (SALVARSAN®), chloramphenicol (CHLOROMYCETIN®), fosfomycin (MONUROL®), fusidic acid (FUCIDIN®), linezolid (ZYVOX®), metronidazole (FLAGYL®), mupirocin (BACTROBAN®), platensimycin, quinupristin/dalfopristin (SYNERCID®), rifaximin (XIFAXAN®), thiamphenicol, tigecycline (TIGACYL®), tinidazole (TINDAMAX®, FASIGYN®)).

*Conditions associated with viral infection*

[000738] In another embodiment, provided are methods for treating or preventing a viral infection and/or a disease, disorder, or condition associated with a viral infection, or a symptom thereof, in a subject, by administering a polynucleotide, primary construct or mRNA encoding an anti-viral polypeptide, *e.g.*, an anti-viral polypeptide described herein in combination with an anti-viral agent, *e.g.*, an anti-viral polypeptide or a small molecule anti-viral agent described herein.

[000739] Diseases, disorders, or conditions associated with viral infections include, but are not limited to, acute febrile pharyngitis, pharyngoconjunctival fever, epidemic keratoconjunctivitis, infantile gastroenteritis, Coxsackie infections, infectious mononucleosis, Burkitt lymphoma, acute hepatitis, chronic hepatitis, hepatic cirrhosis, hepatocellular carcinoma, primary HSV-1 infection (*e.g.*, gingivostomatitis in children, tonsillitis and pharyngitis in adults, keratoconjunctivitis), latent HSV-1 infection (*e.g.*, herpes labialis and cold sores), primary HSV-2 infection, latent HSV-2 infection, aseptic meningitis, infectious mononucleosis, Cytomegalic inclusion disease, Kaposi sarcoma, multicentric Castleman disease, primary effusion lymphoma, AIDS, influenza, Reye syndrome, measles, postinfectious encephalomyelitis, Mumps, hyperplastic epithelial lesions (*e.g.*, common, flat, plantar and anogenital warts, laryngeal papillomas, epidermodysplasia verruciformis), cervical carcinoma, squamous cell carcinomas, croup, pneumonia, bronchiolitis, common cold, Poliomyelitis, Rabies, bronchiolitis, pneumonia, influenza-like syndrome, severe bronchiolitis with pneumonia, German measles, congenital rubella, Varicella, and herpes zoster.

*Viral pathogens*

[000740] Viral pathogens include, but are not limited to, adenovirus, coxsackievirus, dengue virus, encephalitis virus, Epstein-Barr virus, hepatitis A virus, hepatitis B virus, hepatitis C virus, herpes simplex virus type 1, herpes simplex virus type 2, cytomegalovirus, human herpesvirus type 8, human immunodeficiency virus, influenza virus, measles virus, mumps virus, human papillomavirus, parainfluenza virus, poliovirus, rabies virus, respiratory syncytial virus, rubella virus, varicella-zoster virus, West Nile virus, and yellow fever virus. Viral pathogens may also include viruses that cause resistant viral infections.

*Antiviral agents*

[000741] Exemplary anti-viral agents include, but are not limited to, abacavir (ZIAGEN®), abacavir/lamivudine/zidovudine (trizivir®), aciclovir or acyclovir (CYCLOVIR®, HERPEX®, ACIVIR®, ACIVIRAX®, ZOVIRAX®, ZOVIR®), adefovir (Preveon®, Hepsara®), amantadine (SYMMETREL®), amprenavir (AGENERASE®), ampligen, arbidol, atazanavir (REYATAZ®), boceprevir, cidofovir, darunavir (PREZISTA®), delavirdine (RESCRIPTOR®), didanosine (VIDEX®), docosanol (ABREVA®), edoxudine, efavirenz (SUSTIVA®, STOCRIN®), emtricitabine (EMTRIVA®), emtricitabine/tenofovir/efavirenz (ATRIPLA®), enfuvirtide (FUZEON®), entecavir (BARACLUDE®, ENTAVIR®), famciclovir (FAMVIR®), fomivirsen (VITRAVENE®), fosamprenavir (LEXIVA®, TELZIR®), foscarnet (FOSCAVIR®), fosfonet, ganciclovir (CYTOVENE®, CYMEVENE®, VITRASERT®), GS 9137 (ELVITEGRAVIR®), imiquimod (ALDARA®, ZYCLARA®, BESELNA®), indinavir (CRIXIVAN®), inosine, inosine pranobex (IMUNOVIR®), interferon type I, interferon type II, interferon type III, kutapressin (NEXAVIR®), lamivudine (ZEFFIX®, HEPTOVIR®, EPIVIR®), lamivudine/zidovudine (COMBIVIR®), lopinavir, loviride, maraviroc (SELZENTRY®, CELSENTRI®), methisazone, MK-2048, moroxydine, nelfmavir (VIRACEPT®), nevirapine (VIRAMUNE®), oseltamivir (TAMIFLU®), peginterferon alfa-2a (PEGASYS®), penciclovir (DENA VIR®), peramivir, pleconaril, podophyllotoxin (CONDYLOX®), raltegravir (ISENTRESS®), ribavirin (COPEGUS®, REBETOL®, RIBASPHERE®, VILONA® AND VIRAZOLE®), rimantadine (FLUMADINE®), ritonavir (NORVIR®), pyramidine, saquinavir (INVIRASE®, FORTOVASE®),



stavudine, tea tree oil (melaleuca oil), tenofovir (VIREAD®), tenofovir/emtricitabine (TRUVADA®), tipranavir (APTIVUS®), trifluridine (VIROPTIC®), tromantadine (VIRU-MERZ®), valaciclovir (VALTREX®), valganciclovir (VALCYTE®), vicriviroc, vidarabine, viramidine, zalcitabine, zanamivir (RELENZA®), and zidovudine (azidothymidine (AZT), RETROVIR®, RETROVIS®).

*Conditions associated with fungal infections*

[000742] Diseases, disorders, or conditions associated with fungal infections include, but are not limited to, aspergilloses, blastomycosis, candidiasis, coccidioidomycosis, cryptococcosis, histoplasmosis, mycetomas, paracoccidioidomycosis, and tinea pedis. Furthermore, persons with immuno-deficiencies are particularly susceptible to disease by fungal genera such as *Aspergillus*, *Candida*, *Cryptococcus*, *Histoplasma*, and *Pneumocystis*. Other fungi can attack eyes, nails, hair, and especially skin, the so-called dermatophytic fungi and keratinophilic fungi, and cause a variety of conditions, of which ringworms such as athlete's foot are common. Fungal spores are also a major cause of allergies, and a wide range of fungi from different taxonomic groups can evoke allergic reactions in some people.

*Fungal pathogens*

[000743] Fungal pathogens include, but are not limited to, Ascomycota (e.g., *Fusarium oxysporum*, *Pneumocystis jirovecii*, *Aspergillus* spp., *Coccidioides immitis/posadasii*, *Candida albicans*), Basidiomycota (e.g., *Filobasidiella neoformans*, *Trichosporon*), Microsporidia (e.g., *Encephalitozoon cuniculi*, *Enterocytozoon bieneusi*), and Mucoromycotina (e.g., *Mucor circinelloides*, *Rhizopus oryzae*, *Lichtheimia corymbifera*).

*Anti-fungal agents*

[000744] Exemplary anti-fungal agents include, but are not limited to, polyene antifungals (e.g., natamycin, rimocidin, filipin, nystatin, amphotericin B, candicin, hamycin), imidazole antifungals (e.g., miconazole (MICATIN®, DAKTARIN®), ketoconazole (NIZORAL®, FUNGORAL®, SEBIZOLE®), clotrimazole (LOTRIMIN®, LOTRIMIN® AF, CANESTEN®), econazole, omoconazole, bifonazole, butoconazole, fenticonazole, isoconazole, oxiconazole, sertaconazole (ERTACZO®), sulconazole, tioconazole), triazole antifungals (e.g., albaconazole, fluconazole,

itraconazole, isavuconazole, ravuconazole, posaconazole, voriconazole, terconazole), thiazole antifungals (*e.g.*, abafungin), allylamines (*e.g.*, terbinafme (LAMISIL®), naftifme (NAFTIN®), butenafme (LOTRIMIN® Ultra)), echinocandins (*e.g.*, anidulafungin, caspofungin, micafungin), and others (*e.g.*, polygodial, benzoic acid, ciclopirox, tolnaftate (TINACTIN®, DESENEX®, AFTATE®), undecylenic acid, flucytosine or 5-fluorocytosine, griseofulvin, haloprogin, sodium bicarbonate, allicin).

*Conditions associated with protozoal infection*

[000745] Diseases, disorders, or conditions associated with protozoal infections include, but are not limited to, amoebiasis, giardiasis, trichomoniasis, African Sleeping Sickness, American Sleeping Sickness, leishmaniasis (Kala-Azar), balantidiasis, toxoplasmosis, malaria, acanthamoeba keratitis, and babesiosis.

*Protozoan pathogens*

[000746] Protozoal pathogens include, but are not limited to, Entamoeba histolytica, Giardia lamblia, Trichomonas vaginalis, Trypanosoma brucei, T. cruzi, Leishmania donovani, Balantidium coli, Toxoplasma gondii, Plasmodium spp., and Babesia microti.

*Anti-protozoan agents*

[000747] Exemplary anti-protozoal agents include, but are not limited to, eflornithine, furazolidone (FUROXONE®, DEPENDAL-M®), melarsoprol, metronidazole (FLAGYL®), ornidazole, paromomycin sulfate (HUMATIN®), pentamidine, pyrimethamine (DARAPRIM®), and tinidazole (TINDAMAX®, FASIGYN®).

*Conditions associated with parasitic infection*

[000748] Diseases, disorders, or conditions associated with parasitic infections include, but are not limited to, acanthamoeba keratitis, amoebiasis, ascariasis, babesiosis, balantidiasis, baylisascariasis, chagas disease, clonorchiasis, cochliomyia, cryptosporidiosis, diphyllbothriasis, dracunculiasis, echinococcosis, elephantiasis, enterobiasis, fascioliasis, fasciolopsiasis, filariasis, giardiasis, gnathostomiasis, hymenolepiasis, isosporiasis, katayama fever, leishmaniasis, lyme disease, malaria, metagonimiasis, myiasis, onchocerciasis, pediculosis, scabies, schistosomiasis, sleeping sickness, strongyloidiasis, taeniasis, toxocariasis, toxoplasmosis, trichinosis, and trichuriasis.

*Parasitic pathogens*

[000749] Parasitic pathogens include, but are not limited to, Acanthamoeba, Anisakis, Ascaris lumbricoides, botfly, Balantidium coli, bedbug, Cestoda, chiggers, Cochliomyia hominivorax, Entamoeba histolytica, Fasciola hepatica, Giardia lamblia, hookworm, Leishmania, Linguatula serrata, liver fluke, Loa loa, Paragonimus, pinworm, Plasmodium falciparum, Schistosoma, Strongyloides stercoralis, mite, tapeworm, Toxoplasma gondii, Trypanosoma, whipworm, Wuchereria bancrofti.

*Anti-parasitic agents*

[000750] Exemplary anti-parasitic agents include, but are not limited to, antinematodes (e.g., mebendazole, pyrantel pamoate, thiabendazole, diethylcarbamazine, ivermectin), anticestodes (e.g., niclosamide, praziquantel, albendazole), antitremitodes (e.g., praziquantel), antiamoebics (e.g., rifampin, amphotericin B), and antiprotozoals (e.g., melarsoprol, eflornithine, metronidazole, tinidazole).

*Conditions associated with prion infection*

[000751] Diseases, disorders, or conditions associated with prion infections include, but are not limited to Creutzfeldt-Jakob disease (CJD), iatrogenic Creutzfeldt-Jakob disease (iCJD), variant Creutzfeldt-Jakob disease (vCJD), familial Creutzfeldt-Jakob disease (fCJD), sporadic Creutzfeldt-Jakob disease (sCJD), Gerstmann-Straussler-Scheinker syndrome (GSS), fatal familial insomnia (FFI), Kuru, Scrapie, bovine spongiform encephalopathy (BSE), mad cow disease, transmissible mink encephalopathy (TME), chronic wasting disease (CWD), feline spongiform encephalopathy (FSE), exotic ungulate encephalopathy (EUE), and spongiform encephalopathy.

*Anti-prion agents*

[000752] Exemplary anti-prion agents include, but are not limited to, flupirtine, pentosan polysphate, quinacrine, and tetracyclic compounds.

Modulation of the Immune Response*Avoidance of the immune response*

[000753] As described herein, a useful feature of the cosmetic polynucleotides, primary constructs or mmRNA of the invention is the capacity to reduce, evade or avoid the innate immune response of a cell. In one aspect, provided herein are polynucleotides, primary constructs or mmRNA encoding a polypeptide of interest which when delivered

to cells, results in a reduced immune response from the host as compared to the response triggered by a reference compound, e.g. an unmodified polynucleotide corresponding to a polynucleotide, primary construct or mmRNA of the invention, or a different polynucleotide, primary construct or mmRNA of the invention. As used herein, a "reference compound" is any molecule or substance which when administered to a mammal, results in an innate immune response having a known degree, level or amount of immune stimulation. A reference compound need not be a nucleic acid molecule and it need not be any of the cosmetic polynucleotides, primary constructs or mmRNA of the invention. Hence, the measure of a polynucleotides, primary constructs or mmRNA avoidance, evasion or failure to trigger an immune response can be expressed in terms relative to any compound or substance which is known to trigger such a response.

**[000754]** The term "innate immune response" includes a cellular response to exogenous single stranded nucleic acids, generally of viral or bacterial origin, which involves the induction of cytokine expression and release, particularly the interferons, and cell death. As used herein, the innate immune response or interferon response operates at the single cell level causing cytokine expression, cytokine release, global inhibition of protein synthesis, global destruction of cellular RNA, upregulation of major histocompatibility molecules, and/or induction of apoptotic death, induction of gene transcription of genes involved in apoptosis, anti-growth, and innate and adaptive immune cell activation. Some of the genes induced by type I IFNs include PKR, ADAR (adenosine deaminase acting on RNA), OAS (2',5'-oligoadenylate synthetase), RNase L, and Mx proteins. PKR and ADAR lead to inhibition of translation initiation and RNA editing, respectively. OAS is a dsRNA-dependent synthetase that activates the endoribonuclease RNase L to degrade ssRNA.

**[000755]** In some embodiments, the innate immune response comprises expression of a Type I or Type II interferon, and the expression of the Type I or Type II interferon is not increased more than two-fold compared to a reference from a cell which has not been contacted with a polynucleotide, primary construct or mmRNA of the invention.

**[000756]** In some embodiments, the innate immune response comprises expression of one or more IFN signature genes and where the expression of the one or more IFN signature genes is not increased more than three-fold compared to a reference from a cell

which has not been contacted with the polynucleotide, primary construct or mmRNA of the invention.

[000757] While in some circumstances, it might be advantageous to eliminate the innate immune response in a cell, the invention provides polynucleotides, primary constructs and mmRNA that upon administration result in a substantially reduced (significantly less) the immune response, including interferon signaling, without entirely eliminating such a response.

[000758] In some embodiments, the immune response is lower by 10%, 20%, 30%, 40%, 50%, 60%, 70%, 80%, 90%, 95%, 99%, 99.9%, or greater than 99.9% as compared to the immune response induced by a reference compound. The immune response itself may be measured by determining the expression or activity level of Type 1 interferons or the expression of interferon-regulated genes such as the toll-like receptors (e.g., TLR7 and TLR8). Reduction of innate immune response can also be measured by measuring the level of decreased cell death following one or more administrations to a cell population; e.g., cell death is 10%, 25%, 50%, 75%, 85%, 90%, 95%, or over 95% less than the cell death frequency observed with a reference compound. Moreover, cell death may affect fewer than 50%, 40%, 30%, 20%, 10%, 5%, 1%, 0.1%, 0.01% or fewer than 0.01% of cells contacted with the polynucleotide, primary construct or mmRNA.

[000759] In another embodiment, the polynucleotide, primary construct or mmRNA of the present invention is significantly less immunogenic than an unmodified in vitro-synthesized RNA molecule polynucleotide, or primary construct with the same sequence or a reference compound. As used herein, "significantly less immunogenic" refers to a detectable decrease in immunogenicity. In another embodiment, the term refers to a fold decrease in immunogenicity. In another embodiment, the term refers to a decrease such that an effective amount of the polynucleotide, primary construct or mmRNA can be administered without triggering a detectable immune response. In another embodiment, the term refers to a decrease such that the polynucleotide, primary construct or mmRNA can be repeatedly administered without eliciting an immune response sufficient to detectably reduce expression of the recombinant protein. In another embodiment, the decrease is such that the polynucleotide, primary construct or mmRNA can be repeatedly

administered without eliciting an immune response sufficient to eliminate detectable expression of the recombinant protein.

[000760] In another embodiment, the polynucleotide, primary construct or mmRNA is 2-fold less immunogenic than its unmodified counterpart or reference compound. In another embodiment, immunogenicity is reduced by a 3-fold factor. In another embodiment, immunogenicity is reduced by a 5-fold factor. In another embodiment, immunogenicity is reduced by a 7-fold factor. In another embodiment, immunogenicity is reduced by a 10-fold factor. In another embodiment, immunogenicity is reduced by a 15-fold factor. In another embodiment, immunogenicity is reduced by a fold factor. In another embodiment, immunogenicity is reduced by a 50-fold factor. In another embodiment, immunogenicity is reduced by a 100-fold factor. In another embodiment, immunogenicity is reduced by a 200-fold factor. In another embodiment, immunogenicity is reduced by a 500-fold factor. In another embodiment, immunogenicity is reduced by a 1000-fold factor. In another embodiment, immunogenicity is reduced by a 2000-fold factor. In another embodiment, immunogenicity is reduced by another fold difference.

[000761] Methods of determining immunogenicity are well known in the art, and include, e.g. measuring secretion of cytokines (e.g. IL-12, IFN $\alpha$ , TNF- $\alpha$ , RANTES, MIP-1  $\alpha$  or  $\beta$ , IL-6, IFN- $\beta$ , or IL-8), measuring expression of DC activation markers (e.g. CD83, HLA-DR, CD80 and CD86), or measuring ability to act as an adjuvant for an adaptive immune response.

[000762] The the polynucleotide, primary construct or mmRNA of the invention, including the combination of modifications taught herein may have superior properties making them more suitable as therapeutic modalities.

[000763] It has been determined that the "all or none" model in the art is sorely insufficient to describe the biological phenomena associated with the therapeutic utility of modified mRNA. The present inventors have determined that to improve protein production, one may consider the nature of the modification, or combination of modifications, the percent modification and survey more than one cytokine or metric to determine the efficacy and risk profile of a particular modified mRNA.

[000764] In one aspect of the invention, methods of determining the effectiveness of a modified mRNA as compared to unmodified involves the measure and analysis of one

or more cytokines whose expression is triggered by the administration of the exogenous nucleic acid of the invention. These values are compared to administration of an unmodified nucleic acid or to a standard metric such as cytokine response, PolyIC, R-848 or other standard known in the art.

[000765] One example of a standard metric developed herein is the measure of the ratio of the level or amount of encoded polypeptide (protein) produced in the cell, tissue or organism to the level or amount of one or more (or a panel) of cytokines whose expression is triggered in the cell, tissue or organism as a result of administration or contact with the modified nucleic acid. Such ratios are referred to herein as the Protein:Cytokine Ratio or "PC" Ratio. The higher the PC ratio, the more efficacious the modified nucleic acid (polynucleotide encoding the protein measured). Preferred PC Ratios, by cytokine, of the present invention may be greater than 1, greater than 10, greater than 100, greater than 1000, greater than 10,000 or more. Modified nucleic acids having higher PC Ratios than a modified nucleic acid of a different or unmodified construct are preferred.

[000766] The PC ratio may be further qualified by the percent modification present in the polynucleotide. For example, normalized to a 100% modified nucleic acid, the protein production as a function of cytokine (or risk) or cytokine profile can be determined.

[000767] In one embodiment, the present invention provides a method for determining, across chemistries, cytokines or percent modification, the relative efficacy of any particular modified the polynucleotide, primary construct or mmRNA by comparing the PC Ratio of the modified nucleic acid (polynucleotide, primary construct or mmRNA).

[000768] mmRNA containing varying levels of nucleobase substitutions could be produced that maintain increased protein production and decreased immunostimulatory potential. The relative percentage of any modified nucleotide to its naturally occurring nucleotide counterpart can be varied during the GvT reaction (for instance, 100, 50, 25, 10, 5, 2.5, 1, 0.1, 0.01% 5 methyl cytidine usage versus cytidine; 100, 50, 25, 10, 5, 2.5, 1, 0.1, 0.01% pseudouridine or NI-methyl-pseudouridine usage versus uridine). mmRNA can also be made that utilize different ratios using 2 or more different nucleotides to the same base (for instance, different ratios of pseudouridine and NI-

methyl-pseudouridine). mmRNA can also be made with mixed ratios at more than 1 "base" position, such as ratios of 5 methyl cytidine/cytidine and pseudouridine/N1-methyl-pseudouridine/uridine at the same time. Use of modified mRNA with altered ratios of modified nucleotides can be beneficial in reducing potential exposure to chemically modified nucleotides. Lastly, positional introduction of modified nucleotides into the mmRNA which modulate either protein production or immunostimulatory potential or both is also possible. The ability of such mmRNA to demonstrate these improved properties can be assessed in vitro (using assays such as the PBMC assay described herein), and can also be assessed in vivo through measurement of both mmRNA-encoded protein production and mediators of innate immune recognition such as cytokines.

**[000769]** In another embodiment, the relative immunogenicity of the polynucleotide, primary construct or mmRNA and its unmodified counterpart are determined by determining the quantity of the polynucleotide, primary construct or mmRNA required to elicit one of the above responses to the same degree as a given quantity of the unmodified nucleotide or reference compound. For example, if twice as much polynucleotide, primary construct or mmRNA is required to elicit the same response, than the polynucleotide, primary construct or mmRNA is two-fold less immunogenic than the unmodified nucleotide or the reference compound.

**[000770]** In another embodiment, the relative immunogenicity of the polynucleotide, primary construct or mmRNA and its unmodified counterpart are determined by determining the quantity of cytokine (e.g. IL-12, IFN $\alpha$ , TNF- $\alpha$ , RANTES, MIP-1 $\alpha$  or beta, IL-6, IFN-beta, or IL-8) secreted in response to administration of the polynucleotide, primary construct or mmRNA, relative to the same quantity of the unmodified nucleotide or reference compound. For example, if one-half as much cytokine is secreted, than the polynucleotide, primary construct or mmRNA is two-fold less immunogenic than the unmodified nucleotide. In another embodiment, background levels of stimulation are subtracted before calculating the immunogenicity in the above methods.

**[000771]** Provided herein are also methods for performing the titration, reduction or elimination of the immune response in a cell or a population of cells. In some



embodiments, the cell is contacted with varied doses of the same polynucleotides, primary constructs or mmRNA and dose response is evaluated. In some embodiments, a cell is contacted with a number of different polynucleotides, primary constructs or mmRNA at the same or different doses to determine the optimal composition for producing the desired effect. Regarding the immune response, the desired effect may be to avoid, evade or reduce the immune response of the cell. The desired effect may also be to alter the efficiency of protein production.

[000772] The cosmetic polynucleotides, primary constructs and/or mmRNA of the present invention may be used to reduce the immune response using the method described in International Publication No. WO2013003475, herein incorporated by reference in its entirety.

*Activation of the immune response: Vaccines*

[000773] Additionally, certain modified nucleosides, or combinations thereof, when introduced into the cosmetic polynucleotides, primary constructs or mmRNA of the invention will activate the innate immune response. Such activating molecules are useful as adjuvants when combined with polypeptides and/or other vaccines. In certain embodiments, the activating molecules contain a translatable region which encodes for a polypeptide sequence useful as a vaccine, thus providing the ability to be a self-adjuvant.

[000774] In one embodiment, the cosmetic polynucleotides, primary constructs and/or mmRNA of the invention may encode an immunogen. The delivery of the cosmetic polynucleotides, primary constructs and/or mmRNA encoding an immunogen may activate the immune response. As a non-limiting example, the cosmetic polynucleotides, primary constructs and/or mmRNA encoding an immunogen may be delivered to cells to trigger multiple innate response pathways (see International Pub. No. WO2012006377; herein incorporated by reference in its entirety). As another non-limiting example, the cosmetic polynucleotides, primary constructs and mmRNA of the present invention encoding an immunogen may be delivered to a vertebrate in a dose amount large enough to be immunogenic to the vertebrate (see International Pub. No. WO2012006372 and WO2012006369; each of which is herein incorporated by reference in their entirety).

[000775] The cosmetic polynucleotides, primary constructs or mmRNA of invention may encode a polypeptide sequence for a vaccine and may further comprise an inhibitor.

The inhibitor may impair antigen presentation and/or inhibit various pathways known in the art. As a non-limiting example, the cosmetic polynucleotides, primary constructs or mmRNA of the invention may be used for a vaccine in combination with an inhibitor which can impair antigen presentation (see International Pub. No. WO2012089225 and WO2012089338; each of which is herein incorporated by reference in their entirety).

[000776] In one embodiment, the cosmetic polynucleotides, primary constructs or mmRNA of the invention may be self-replicating RNA. Self-replicating RNA molecules can enhance efficiency of RNA delivery and expression of the enclosed gene product. In one embodiment, the cosmetic polynucleotides, primary constructs or mmRNA may comprise at least one modification described herein and/or known in the art. In one embodiment, the self-replicating RNA can be designed so that the self-replicating RNA does not induce production of infectious viral particles. As a non-limiting example the self-replicating RNA may be designed by the methods described in US Pub. No. US20110300205 and International Pub. Nos. WO2011005799, WO2013006838 and WO2013006842, each of which is herein incorporated by reference in their entirety.

[000777] In one embodiment, the self-replicating polynucleotides, primary constructs or mmRNA of the invention may encode a protein which may raise the immune response. As a non-limiting example, the cosmetic polynucleotides, primary constructs or mmRNA may be self-replicating mRNA may encode at least one antigen (see US Pub. No. US20110300205 and International Pub. No. WO2011005799; each of which is herein incorporated by reference in their entirety).

[000778] In one embodiment, the self-replicating polynucleotides, primary constructs or mmRNA of the invention may be formulated using methods described herein or known in the art. As a non-limiting example, the self-replicating RNA may be formulated for delivery by the methods described in Geall et al (Nonviral delivery of self-amplifying RNA vaccines, PNAS 2012; PMID: 22908294).

[000779] In one embodiment, the cosmetic polynucleotides, primary constructs or mmRNA of the present invention may encode amphipathic and/or immunogenic amphipathic peptides.

[000780] In one embodiment, a formulation of the cosmetic polynucleotides, primary constructs or mmRNA of the present invention may further comprise an amphipathic

and/or immunogenic amphipathic peptide. As a non-limiting example, the cosmetic polynucleotides, primary constructs or mmRNA comprising an amphipathic and/or immunogenic amphipathic peptide may be formulated as described in US. Pub. No. US201 10250237 and International Pub. Nos. WO2010009277 and WO2010009065; each of which is herein incorporated by reference in their entirety.

**[000781]** In one embodiment, the cosmetic polynucleotides, primary constructs or mmRNA of the present invention may be immunostimulatory. As a non-limiting example, the cosmetic polynucleotides, primary constructs or mmRNA may encode all or a part of a positive-sense or a negative-sense stranded RNA virus genome (see International Pub No. WO2012092569 and US Pub No. US20120177701, each of which is herein incorporated by reference in their entirety). In another non-limiting example, the immunostimulatory polynucleotides, primary constructs or mmRNA of the present invention may be formulated with an excipient for administration as described herein and/or known in the art (see International Pub No. WO2012068295 and US Pub No. US20120213812, each of which is herein incorporated by reference in their entirety).

**[000782]** In one embodiment, the response of the vaccine formulated by the methods described herein may be enhanced by the addition of various compounds to induce the therapeutic effect. As a non-limiting example, the vaccine formulation may include a MHC II binding peptide or a peptide having a similar sequence to a MHC II binding peptide (see International Pub Nos. WO2012027365, WO201 1031298 and US Pub No. US20120070493, US201 101 10965, each of which is herein incorporated by reference in their entirety). As another example, the vaccine formulations may comprise modified nicotinic compounds which may generate an antibody response to nicotine residue in a subject (see International Pub No. WO2012061717 and US Pub No. US201201 14677, each of which is herein incorporated by reference in their entirety).

#### Naturally Occurring Mutants

**[000783]** In another embodiment, the cosmetic polynucleotides, primary construct and/or mmRNA can be utilized to express variants of naturally occurring proteins that have an improved disease modifying activity, including increased biological activity, improved patient outcomes, or a protective function, etc. Many such modifier genes have been described in mammals (Nadeau, Current Opinion in Genetics & Development 2003

13:290-295; Hamilton and Yu, PLoS Genet. 2012;8:e1002644; Corder et al, Nature Genetics 1994 7:180 - 184; all herein incorporated by reference in their entireties). Examples in humans include Apo E2 protein, Apo A-I variant proteins (Apo A-I Milano, Apo A-I Paris), hyperactive Factor IX protein (Factor IX Padua Arg338Lys), transthyretin mutants (TTR Thr1 19Met). Expression of ApoE2 (cysl 12, cysl58) has been shown to confer protection relative to other ApoE isoforms (*ApoE3* (cysl 12, argl58), and *ApoE4* (argl 12, argl58)) by reducing susceptibility to Alzheimer's disease and possibly other conditions such as cardiovascular disease (Corder et al, Nature Genetics 1994 7:180 - 184; Seripa et al., Rejuvenation Res. 201 1 14:491-500; Liu et al. Nat Rev Neurol. 2013 9:106-1 18; all herein incorporated by reference in their entireties). Expression of Apo A-I variants has been associated with reduced cholesterol (deGoma and Rader, 201 1 Nature Rev Cardiol 8:266-271; Nissen et al, 2003 JAMA 290:2292-2300; all herein incorporated by reference in its entirety). The amino acid sequence of ApoA-I in certain populations has been changed to cysteine in Apo A-I Milano (Arg 173 changed to Cys) and in Apo A-I Paris (Arg 151 changed to Cys). Factor IX mutation at position R338L (FIX Padua) results in a Factor IX protein that has ~10-fold increased activity (Simioni et al., N Engl J Med. 2009 361:1671-1675; Finn et al, Blood. 2012 120:4521-4523; Cantore et al, Blood. 2012 120:4517-20; all herein incorporated by reference in their entireties). Mutation of transthyretin at positions 104 or 119 (Arg 104 His, Thr1 19Met) has been shown to provide protection to patients also harboring the disease causing VaBOMet mutations (Saraiva, Hum Mutat. 2001 17:493-503; DATA BASE ON TRANSTHYRETIN MUTATIONS <http://www.ibmc.up.pt/mjsaraiva/ttrmut.html>; all herein incorporated by reference in its entirety). Differences in clinical presentation and severity of symptoms among Portuguese and Japanese Met 30 patients carrying respectively the Met 119 and the His 104 mutations are observed with a clear protective effect exerted by the non pathogenic mutant (Coelho et al. 1996 Neuromuscular Disorders (Suppl) 6: S20; Terazaki et al. 1999. Biochem Biophys Res Commun 264: 365-370; all herein incorporated by reference in its entirety), which confer more stability to the molecule. A modified mRNA encoding these protective TTR alleles can be expressed in TTR amyloidosis patients, thereby reducing the effect of the pathogenic mutant TTR protein.

### Major Groove Interacting Partners

[000784] As described herein, the phrase "major groove interacting partner" refers to RNA recognition receptors that detect and respond to RNA ligands through interactions, *e.g.* binding, with the major groove face of a nucleotide or nucleic acid. As such, RNA ligands comprising modified nucleotides or nucleic acids such as the polynucleotide, primary construct or mmRNA as described herein decrease interactions with major groove binding partners, and therefore decrease an innate immune response.

[000785] Example major groove interacting, *e.g.* binding, partners include, but are not limited to the following nucleases and helicases. Within membranes, TLRs (Toll-like Receptors) 3, 7, and 8 can respond to single- and double-stranded RNAs. Within the cytoplasm, members of the superfamily 2 class of DEX(D/H) helicases and ATPases can sense RNAs to initiate antiviral responses. These helicases include the RIG-I (retinoic acid-inducible gene I) and MDA5 (melanoma differentiation-associated gene 5). Other examples include laboratory of genetics and physiology 2 (LGP2), HIN-200 domain containing proteins, or Helicase-domain containing proteins.

### Targeting of pathogenic organisms or diseased cells

[000786] Provided herein are methods for targeting pathogenic microorganisms, such as bacteria, yeast, protozoa, helminthes and the like, or diseased cells such as cancer cells using polynucleotides, primary constructs or mmRNA that encode cytostatic or cytotoxic polypeptides. Preferably the mRNA introduced contains modified nucleosides or other nucleic acid sequence modifications that are translated exclusively, or preferentially, in the target pathogenic organism, to reduce possible off-target effects of the therapeutic. Such methods are useful for removing pathogenic organisms or killing diseased cells found in any biological material, including blood, semen, eggs, and transplant materials including embryos, tissues, and organs.

### Bioprocessing

[000787] The methods provided herein may be useful for enhancing protein product yield in a cell culture process. In a cell culture containing a plurality of host cells, introduction of a polynucleotide, primary construct or mmRNA described herein results in increased protein production efficiency relative to a corresponding unmodified nucleic acid. Such increased protein production efficiency can be demonstrated, *e.g.*, by showing

increased cell transfection, increased protein translation from the polynucleotide, primary construct or mmRNA, decreased nucleic acid degradation, and/or reduced innate immune response of the host cell. Protein production can be measured by enzyme-linked immunosorbent assay (ELISA), and protein activity can be measured by various functional assays known in the art. The protein production may be generated in a continuous or a batch-fed mammalian process.

[000788] Additionally, it is useful to optimize the expression of a specific polypeptide in a cell line or collection of cell lines of potential interest, particularly a polypeptide of interest such as a protein variant of a reference protein having a known activity. In one embodiment, provided is a method of optimizing expression of a polypeptide of interest in a target cell, by providing a plurality of target cell types, and independently contacting with each of the plurality of target cell types a polynucleotide, primary construct or mmRNA encoding a polypeptide of interest. The cells may be transfected with two or more polynucleotide, primary construct or mmRNA simultaneously or sequentially.

[000789] In certain embodiments, multiple rounds of the methods described herein may be used to obtain cells with increased expression of one or more nucleic acids or proteins of interest. For example, cells may be transfected with one or more polynucleotide, primary construct or mmRNA that encode a nucleic acid or protein of interest. The cells may be isolated according to methods described herein before being subjected to further rounds of transfections with one or more other nucleic acids which encode a nucleic acid or protein of interest before being isolated again. This method may be useful for generating cells with increased expression of a complex of proteins, nucleic acids or proteins in the same or related biological pathway, nucleic acids or proteins that act upstream or downstream of each other, nucleic acids or proteins that have a modulating, activating or repressing function to each other, nucleic acids or proteins that are dependent on each other for function or activity, or nucleic acids or proteins that share homology.

[000790] Additionally, culture conditions may be altered to increase protein production efficiency. Subsequently, the presence and/or level of the polypeptide of interest in the plurality of target cell types is detected and/or quantitated, allowing for the optimization of a polypeptide's expression by selection of an efficient target cell and cell culture

conditions relating thereto. Such methods are particularly useful when the polypeptide contains one or more post-translational modifications or has substantial tertiary structure, situations which often complicate efficient protein production.

[000791] In one embodiment, the cells used in the methods of the present invention may be cultured. The cells may be cultured in suspension or as adherent cultures. The cells may be cultured in a varied of vessels including, but not limited to, bioreactors, cell bags, wave bags, culture plates, flasks and other vessels well known to those of ordinary skill in the art. Cells may be cultured in IMDM (Invitrogen, Catalog number 12440-53) or any other suitable media including, but not limited to, chemically defined media formulations. The ambient conditions which may be suitable for cell culture, such as temperature and atmospheric composition, are well known to those skilled in the art. The methods of the invention may be used with any cell that is suitable for use in protein production.

[000792] The invention provides for the repeated introduction (e.g., transfection) of modified nucleic acids into a target cell population, e.g., *in vitro*, *ex vivo*, *in situ*, or *in vivo*. For example, contacting the same cell population may be repeated one or more times (such as two, three, four, five or more than five times). In some embodiments, the step of contacting the cell population with the cosmetic polynucleotides, primary constructs or mmRNA is repeated a number of times sufficient such that a predetermined efficiency of protein translation in the cell population is achieved. Given the often reduced cytotoxicity of the target cell population provided by the nucleic acid modifications, repeated transfections are achievable in a diverse array of cell types and within a variety of tissues, as provided herein.

[000793] In one embodiment, the bioprocessing methods of the present invention may be used to produce antibodies or functional fragments thereof. The functional fragments may comprise a Fab, Fab', F(ab')<sub>2</sub>, an Fv domain, an scFv, or a diabody. They may be variable in any region including the complement determining region (CDR). In one embodiment, there is complete diversity in the CDR3 region. In another embodiment, the antibody is substantially conserved except in the CDR3 region.

[000794] Antibodies may be made which bind or associate with any biomolecule, whether human, pathogenic or non-human in origin. The pathogen may be present in a

non-human mammal, a clinical specimen or from a commercial product such as a cosmetic or pharmaceutical material. They may also bind to any specimen or sample including clinical specimens or tissue samples from any organism.

[000795] In some embodiments, the contacting step is repeated multiple times at a frequency selected from the group consisting of: 6 hour, 12 hour, 24 hour, 36 hour, 48 hour, 72 hour, 84 hour, 96 hour, and 108 hour and at concentrations of less than 20 nM, less than 50 nM, less than 80 nM or less than 100 nM. Compositions may also be administered at less than 1mM, less than 5mM, less than 10mM, less than 100mM or less than 500 mM.

[000796] In some embodiments, the cosmetic polynucleotides, primary constructs or mmRNA are added at an amount of 50 molecules per cell, 100 molecules/cell, 200 molecules/cell, 300 molecules/cell, 400 molecules/cell, 500 molecules/ cell, 600 molecules/cell, 700 molecules/ cell, 800 molecules/cell, 900 molecules/cell, 1000 molecules/cell, 2000 molecules/cell, or 5000 molecules/cell.

[000797] In other embodiments, the cosmetic polynucleotides, primary constructs or mmRNA are added at a concentration selected from the group consisting of: 0.01 fmol/10<sup>6</sup> cells, 0.1 fmol/10<sup>6</sup> cells, 0.5 fmol/10<sup>6</sup> cells, 0.75 fmol/10<sup>6</sup> cells, 1 fmol/10<sup>6</sup> cells, 2 fmol/10<sup>6</sup> cells, 5 fmol/10<sup>6</sup> cells, 10 fmol/10<sup>6</sup> cells, 20 fmol/10<sup>6</sup> cells, 30 fmol/10<sup>6</sup> cells, 40 fmol/10<sup>6</sup> cells, 50 fmol/10<sup>6</sup> cells, 60 fmol/10<sup>6</sup> cells, 100 fmol/10<sup>6</sup> cells, 200 fmol/10<sup>6</sup> cells, 300 fmol/10<sup>6</sup> cells, 400 fmol/10<sup>6</sup> cells, 500 fmol/10<sup>6</sup> cells, 700 fmol/10<sup>6</sup> cells, 800 fmol/10<sup>6</sup> cells, 900 fmol/10<sup>6</sup> cells, and 1 pmol/10<sup>6</sup> cells.

[000798] In some embodiments, the production of a biological product upon is detected by monitoring one or more measurable bioprocess parameters, such as a parameter selected from the group consisting of: cell density, pH, oxygen levels, glucose levels, lactic acid levels, temperature, and protein production. Protein production can be measured as specific productivity (SP) (the concentration of a product, such as a heterologously expressed polypeptide, in solution) and can be expressed as mg/L or g/L; in the alternative, specific productivity can be expressed as pg/cell/day. An increase in SP can refer to an absolute or relative increase in the concentration of a product produced under two defined set of conditions (e.g., when compared with controls not treated with modified mRNA(s)).



*Cells*

[000799] In one embodiment, the cells are selected from the group consisting of mammalian cells, bacterial cells, plant, microbial, algal and fungal cells. In some embodiments, the cells are mammalian cells, such as, but not limited to, human, mouse, rat, goat, horse, rabbit, hamster or cow cells. In a further embodiment, the cells may be from an established cell line, including, but not limited to, HeLa, NSO, SP2/0, KEK 293T, Vera, Caco, Caco-2, MDCK, COS-1, COS-7, K562, Jurkat, CHO-K1, DG44, CHOK1SV, CHO-S, Huvec, CV-1, Huh-7, NIH3T3, HEK293, 293, A549, HepG2, IMR-90, MCF-7, U-20S, Per.C6, SF9, SF21 or Chinese Hamster Ovary (CHO) cells.

[000800] In certain embodiments, the cells are fungal cells, such as, but not limited to, Chrysosporium cells, Aspergillus cells, Trichoderma cells, Dictyostelium cells, Candida cells, Saccharomyces cells, Schizosaccharomyces cells, and Penicillium cells.

[000801] In certain embodiments, the cells are bacterial cells such as, but not limited to, E. coli, B. subtilis, or BL21 cells. Primary and secondary cells to be transfected by the methods of the invention can be obtained from a variety of tissues and include, but are not limited to, all cell types which can be maintained in culture. For examples, primary and secondary cells which can be transfected by the methods of the invention include, but are not limited to, fibroblasts, keratinocytes, epithelial cells (e.g., mammary epithelial cells, intestinal epithelial cells), endothelial cells, glial cells, neural cells, formed elements of the blood (e.g., lymphocytes, bone marrow cells), muscle cells and precursors of these somatic cell types. Primary cells may also be obtained from a donor of the same species or from another species (e.g., mouse, rat, rabbit, cat, dog, pig, cow, bird, sheep, goat, horse).

*Purification and Isolation*

[000802] Those of ordinary skill in the art should be able to make a determination of the methods to use to purify or isolate of a protein of interest from cultured cells. Generally, this is done through a capture method using affinity binding or non-affinity purification. If the protein of interest is not secreted by the cultured cells, then a lysis of the cultured cells should be performed prior to purification or isolation. One may use unclarified cell culture fluid containing the protein of interest along with cell culture media components as well as cell culture additives, such as anti-foam compounds and other nutrients and

supplements, cells, cellular debris, host cell proteins, DNA, viruses and the like in the present invention. The process may be conducted in the bioreactor itself. The fluid may either be preconditioned to a desired stimulus such as pH, temperature or other stimulus characteristic or the fluid can be conditioned upon the addition of polymer(s) or the polymer(s) can be added to a carrier liquid that is properly conditioned to the required parameter for the stimulus condition required for that polymer to be solubilized in the fluid. The polymer may be allowed to circulate thoroughly with the fluid and then the stimulus may be applied (change in pH, temperature, salt concentration, etc) and the desired protein and polymer(s) precipitate can out of the solution. The polymer and the desired protein(s) can be separated from the rest of the fluid and optionally washed one or more times to remove any trapped or loosely bound contaminants. The desired protein may then be recovered from the polymer(s) by, for example, elution and the like. Preferably, the elution may be done under a set of conditions such that the polymer remains in its precipitated form and retains any impurities to it during the selected elution of the desired protein. The polymer and protein as well as any impurities may be solubilized in a new fluid such as water or a buffered solution and the protein may be recovered by a means such as affinity, ion exchanged, hydrophobic, or some other type of chromatography that has a preference and selectivity for the protein over that of the polymer or impurities. The eluted protein may then be recovered and may be subjected to additional processing steps, either batch like steps or continuous flow through steps if appropriate.

[000803] In another embodiment, it may be useful to optimize the expression of a specific polypeptide in a cell line or collection of cell lines of potential interest, particularly a polypeptide of interest such as a protein variant of a reference protein having a known activity. In one embodiment, provided is a method of optimizing expression of a polypeptide of interest in a target cell, by providing a plurality of target cell types, and independently contacting with each of the plurality of target cell types a modified mRNA encoding a polypeptide. Additionally, culture conditions may be altered to increase protein production efficiency. Subsequently, the presence and/or level of the polypeptide of interest in the plurality of target cell types is detected and/or quantitated, allowing for the optimization of a polypeptide of interest's expression by selection of an

efficient target cell and cell culture conditions relating thereto. Such methods may be useful when the polypeptide of interest contains one or more post-translational modifications or has substantial tertiary structure, which often complicate efficient protein production.

#### *Protein recovery*

[000804] The protein of interest may be preferably recovered from the culture medium as a secreted polypeptide, or it can be recovered from host cell lysates if expressed without a secretory signal. It may be necessary to purify the protein of interest from other recombinant proteins and host cell proteins in a way that substantially homogenous preparations of the protein of interest are obtained. The cells and/or particulate cell debris may be removed from the culture medium or lysate. The product of interest may then be purified from contaminant soluble proteins, polypeptides and nucleic acids by, for example, fractionation on immunoaffinity or ion-exchange columns, ethanol precipitation, reverse phase HPLC (RP-HPLC), SEPHADEX® chromatography, chromatography on silica or on a cation exchange resin such as DEAE. Methods of purifying a protein heterologous expressed by a host cell are well known in the art.

[000805] Methods and compositions described herein may be used to produce proteins which are capable of attenuating or blocking the endogenous agonist biological response and/or antagonizing a receptor or signaling molecule in a mammalian subject. For example, IL-12 and IL-23 receptor signaling may be enhanced in chronic autoimmune disorders such as multiple sclerosis and inflammatory diseases such as rheumatoid arthritis, psoriasis, lupus erythematosus, ankylosing spondylitis and Chron's disease (Kikly K, Liu L, Na S, Sedgwich JD (2006) Cur. Opin. Immunol. 18(6): 670-5). In another embodiment, a nucleic acid encodes an antagonist for chemokine receptors. Chemokine receptors CXCR-4 and CCR-5 are required for HIV entry into host cells (Arenzana-Seisdedos F et al, (1996) Nature. Oct 3; 383 (6599):400).

#### Gene Silencing

[000806] The cosmetic polynucleotides, primary constructs and mmRNA described herein are useful to silence (i.e., prevent or substantially reduce) expression of one or more target genes in a cell population. A polynucleotide, primary construct or mmRNA encoding a polypeptide of interest capable of directing sequence-specific histone H3

methylation is introduced into the cells in the population under conditions such that the polypeptide is translated and reduces gene transcription of a target gene via histone H3 methylation and subsequent heterochromatin formation. In some embodiments, the silencing mechanism is performed on a cell population present in a mammalian subject. By way of non-limiting example, a useful target gene is a mutated Janus Kinase-2 family member, wherein the mammalian subject expresses the mutant target gene suffers from a myeloproliferative disease resulting from aberrant kinase activity.

[000807] Co-administration of cosmetic polynucleotides, primary constructs and mmRNA and RNAi agents are also provided herein.

#### Modulation of Biological Pathways

[000808] The rapid translation polynucleotides, primary constructs and mmRNA introduced into cells provides a desirable mechanism of modulating target biological pathways. Such modulation includes antagonism or agonism of a given pathway. In one embodiment, a method is provided for antagonizing a biological pathway in a cell by contacting the cell with an effective amount of a composition comprising a polynucleotide, primary construct or mmRNA encoding a polypeptide of interest, under conditions such that the cosmetic polynucleotides, primary constructs and mmRNA is localized into the cell and the polypeptide is capable of being translated in the cell from the cosmetic polynucleotides, primary constructs and mmRNA, wherein the polypeptide inhibits the activity of a polypeptide functional in the biological pathway. Exemplary biological pathways are those defective in an autoimmune or inflammatory disorder such as multiple sclerosis, rheumatoid arthritis, psoriasis, lupus erythematosus, ankylosing spondylitis colitis, or Crohn's disease; in particular, antagonism of the IL-12 and IL-23 signaling pathways are of particular utility. (See Kikly K, Liu L, Na S, Sedgwick JD (2006) *Curr. Opin. Immunol.* 18 (6): 670-5).

[000809] Further, provided are polynucleotide, primary construct or mmRNA encoding an antagonist for chemokine receptors; chemokine receptors CXCR-4 and CCR-5 are required for, e.g., HIV entry into host cells (Arenzana-Seisdedos F et al, (1996) *Nature.* Oct 3;383(6599):400).

[000810] Alternatively, provided are methods of agonizing a biological pathway in a cell by contacting the cell with an effective amount of a polynucleotide, primary

construct or mmRNA encoding a recombinant polypeptide under conditions such that the nucleic acid is localized into the cell and the recombinant polypeptide is capable of being translated in the cell from the nucleic acid, and the recombinant polypeptide induces the activity of a polypeptide functional in the biological pathway. Exemplary agonized biological pathways include pathways that modulate cell fate determination. Such agonization is reversible or, alternatively, irreversible.

#### Expression of Ligand or Receptor on Cell Surface

**[000811]** In some aspects and embodiments of the aspects described herein, the cosmetic polynucleotides, primary constructs or mmRNA described herein can be used to express a ligand or ligand receptor on the surface of a cell (*e.g.*, a homing moiety). A ligand or ligand receptor moiety attached to a cell surface can permit the cell to have a desired biological interaction with a tissue or an agent *in vivo*. A ligand can be an antibody, an antibody fragment, an aptamer, a peptide, a vitamin, a carbohydrate, a protein or polypeptide, a receptor, *e.g.*, cell-surface receptor, an adhesion molecule, a glycoprotein, a sugar residue, a therapeutic agent, a drug, a glycosaminoglycan, or any combination thereof. For example, a ligand can be an antibody that recognizes a cancer-cell specific antigen, rendering the cell capable of preferentially interacting with tumor cells to permit tumor-specific localization of a modified cell. A ligand can confer the ability of a cell composition to accumulate in a tissue to be treated, since a preferred ligand may be capable of interacting with a target molecule on the external face of a tissue to be treated. Ligands having limited cross-reactivity to other tissues are generally preferred.

**[000812]** In some cases, a ligand can act as a homing moiety which permits the cell to target to a specific tissue or interact with a specific ligand. Such homing moieties can include, but are not limited to, any member of a specific binding pair, antibodies, monoclonal antibodies, or derivatives or analogs thereof, including without limitation: Fv fragments, single chain Fv (scFv) fragments, Fab' fragments, F(ab')<sub>2</sub> fragments, single domain antibodies, camelized antibodies and antibody fragments, humanized antibodies and antibody fragments, and multivalent versions of the foregoing; multivalent binding reagents including without limitation: monospecific or bispecific antibodies, such as disulfide stabilized Fv fragments, scFv tandems ((SCFV)<sub>2</sub> fragments), diabodies,

tribodies or tetrabodies, which typically are covalently linked or otherwise stabilized (*i.e.*, leucine zipper or helix stabilized) scFv fragments; and other homing moieties include for example, aptamers, receptors, and fusion proteins.

[000813] In some embodiments, the homing moiety may be a surface-bound antibody, which can permit tuning of cell targeting specificity. This is especially useful since highly specific antibodies can be raised against an epitope of interest for the desired targeting site. In one embodiment, multiple antibodies are expressed on the surface of a cell, and each antibody can have a different specificity for a desired target. Such approaches can increase the avidity and specificity of homing interactions.

[000814] A skilled artisan can select any homing moiety based on the desired localization or function of the cell, for example an estrogen receptor ligand, such as tamoxifen, can target cells to estrogen-dependent breast cancer cells that have an increased number of estrogen receptors on the cell surface. Other non-limiting examples of ligand/receptor interactions include CCRI (*e.g.*, for treatment of inflamed joint tissues or brain in rheumatoid arthritis, and/or multiple sclerosis), CCR7, CCR8 (*e.g.*, targeting to lymph node tissue), CCR6, CCR9, CCR10 (*e.g.*, to target to intestinal tissue), CCR4, CCR10 (*e.g.*, for targeting to skin), CXCR4 (*e.g.*, for general enhanced transmigration), HCELL (*e.g.*, for treatment of inflammation and inflammatory disorders, bone marrow), Alpha4beta7 (*e.g.*, for intestinal mucosa targeting), VLA-4/VCAM-1 (*e.g.*, targeting to endothelium). In general, any receptor involved in targeting (*e.g.*, cancer metastasis) can be harnessed for use in the methods and compositions described herein.

#### Modulation of Cell Lineage

[000815] Provided are methods of inducing an alteration in cell fate in a target mammalian cell. The target mammalian cell may be a precursor cell and the alteration may involve driving differentiation into a lineage, or blocking such differentiation. Alternatively, the target mammalian cell may be a differentiated cell, and the cell fate alteration includes driving de-differentiation into a pluripotent precursor cell, or blocking such de-differentiation, such as the dedifferentiation of cancer cells into cancer stem cells. In situations where a change in cell fate is desired, effective amounts of mRNAs encoding a cell fate inductive polypeptide is introduced into a target cell under conditions such that an alteration in cell fate is induced. In some embodiments, the modified

mRNAs are useful to reprogram a subpopulation of cells from a first phenotype to a second phenotype. Such a reprogramming may be temporary or permanent. Optionally, the reprogramming induces a target cell to adopt an intermediate phenotype.

[000816] Additionally, the methods of the present invention are particularly useful to generate induced pluripotent stem cells (iPS cells) because of the high efficiency of transfection, the ability to re-transfect cells, and the tenability of the amount of recombinant polypeptides produced in the target cells. Further, the use of iPS cells generated using the methods described herein is expected to have a reduced incidence of teratoma formation.

[000817] Also provided are methods of reducing cellular differentiation in a target cell population. For example, a target cell population containing one or more precursor cell types is contacted with a composition having an effective amount of a polynucleotides, primary constructs and mmRNA encoding a polypeptide, under conditions such that the polypeptide is translated and reduces the differentiation of the precursor cell. In non-limiting embodiments, the target cell population contains injured tissue in a mammalian subject or tissue affected by a surgical procedure. The precursor cell is, e.g., a stromal precursor cell, a neural precursor cell, or a mesenchymal precursor cell.

[000818] In a specific embodiment, provided are polynucleotide, primary construct or mmPvNA that encode one or more differentiation factors Gata4, Mef2c and Tbx4. These mRNA-generated factors are introduced into fibroblasts and drive the reprogramming into cardiomyocytes. Such a reprogramming can be performed *in vivo*, by contacting an mRNA-containing patch or other material to damaged cardiac tissue to facilitate cardiac regeneration. Such a process promotes cardiomyocyte genesis as opposed to fibrosis.

#### Mediation of cell death

[000819] In one embodiment, polynucleotides, primary constructs or mmRNA compositions can be used to induce apoptosis in a cell (*e.g.*, a cancer cell) by increasing the expression of a death receptor, a death receptor ligand or a combination thereof. This method can be used to induce cell death in any desired cell and has particular usefulness in the treatment of cancer where cells escape natural apoptotic signals.

[000820] Apoptosis can be induced by multiple independent signaling pathways that converge upon a final effector mechanism consisting of multiple interactions between

several "death receptors" and their ligands, which belong to the tumor necrosis factor (TNF) receptor/ligand superfamily. The best-characterized death receptors are CD95 ("Fas"), TNFR1 (p55), death receptor 3 (DR3 or Apo3/TRAMO), DR4 and DR5 (apo2-TRAIL-R2). The final effector mechanism of apoptosis may be the activation of a series of proteinases designated as caspases. The activation of these caspases results in the cleavage of a series of vital cellular proteins and cell death. The molecular mechanism of death receptors/ligands-induced apoptosis is well known in the art. For example, Fas/FasL-mediated apoptosis is induced by binding of three FasL molecules which induces trimerization of Fas receptor via C-terminus death domains (DDs), which in turn recruits an adapter protein FADD (Fas-associated protein with death domain) and Caspase-8. The oligomerization of this trimolecular complex, Fas/FAIDD/caspase-8, results in proteolytic cleavage of proenzyme caspase-8 into active caspase-8 that, in turn, initiates the apoptosis process by activating other downstream caspases through proteolysis, including caspase-3. Death ligands in general are apoptotic when formed into trimers or higher order of structures. As monomers, they may serve as antiapoptotic agents by competing with the trimers for binding to the death receptors.

[000821] In one embodiment, the cosmetic polynucleotides, primary constructs or mmRNA composition encodes for a death receptor (*e.g.*, Fas, TRAIL, TRAMO, TNFR, TLR etc). Cells made to express a death receptor by transfection of cosmetic polynucleotides, primary constructs and mmRNA become susceptible to death induced by the ligand that activates that receptor. Similarly, cells made to express a death ligand, *e.g.*, on their surface, will induce death of cells with the receptor when the transfected cell contacts the target cell. In another embodiment, the cosmetic polynucleotides, primary constructs and mmRNA composition encodes for a death receptor ligand (*e.g.*, FasL, TNF, etc). In another embodiment, the cosmetic polynucleotides, primary constructs and mmRNA composition encodes a caspase (*e.g.*, caspase 3, caspase 8, caspase 9 etc). Where cancer cells often exhibit a failure to properly differentiate to a non-proliferative or controlled proliferative form, in another embodiment, the synthetic, polynucleotides, primary constructs and mmRNA composition encodes for both a death receptor and its appropriate activating ligand. In another embodiment, the synthetic, polynucleotides, primary constructs and mmRNA composition encodes for a differentiation factor that



when expressed in the cancer cell, such as a cancer stem cell, will induce the cell to differentiate to a non-pathogenic or nonself-renewing phenotype (*e.g.*, reduced cell growth rate, reduced cell division etc) or to induce the cell to enter a dormant cell phase (*e.g.*, Goresting phase).

[000822] One of skill in the art will appreciate that the use of apoptosis-inducing techniques may require that the cosmetic polynucleotides, primary constructs or mmRNA are appropriately targeted to *e.g.*, tumor cells to prevent unwanted wide-spread cell death. Thus, one can use a delivery mechanism (*e.g.*, attached ligand or antibody, targeted liposome etc) that recognizes a cancer antigen such that the cosmetic polynucleotides, primary constructs or mmRNA are expressed only in cancer cells.

#### Cosmetic Applications

[000823] In one embodiment, the cosmetic polynucleotides, cosmetic primary constructs and/or cosmetic mmRNA may be used in the treatment, amelioration or prophylaxis of cosmetic diseases, disorders and conditions. Such disease, disorders and conditions include, but are not limited to, acne vulgaris, acne aestivalis, acne conglobata, acne cosmetic, acne fulminans, acne keloidalis nuchae, acne mechanica, acne medicamentosa, acne miliaris necrotica, acne necrotica, acne rosacea, actinic keratosis, acne vulgaris, acne aestivalis, acne conglobata, acne cosmetic, acne fulminans, acne keloidalis nuchae, acne mechanica, acne medicamentosa, acne miliaris necrotica, acne necrotica, acne rosacea, acute urticaria, allergic contact dermatitis, alopecia areata, angioedema, athlete's foot, atopic dermatitis, autoeczematization, baby acne, balding, bastomycosis, blackheads, birthmarks and other skin pigmentation problems, boils, bruises, bug bites and stings, burns, cellulitis, chiggers, chloracne, cholinergic or stress uricara, chronic urticara, cold type urticara, confluent and reticulated papillomatosis, corns, cysts, dandruff, dermatitis herpetiformis, dermatographism, dyshidrotic eczema, diaper rash, dry skin, dyshidrosis, ectodermal dysplasia such as, hyprohidrotic ectodermal dysplasia and X-linked hyprohidrotic ectodermal dysplasia, eczema, epidermaodysplasia verruciformis, erythema nodosum, excoriated acne, exercise-induced anaphylaxis folliculitis, excess skin oil, folliculitis, freckles, frostbite, fungal nails, hair density, hair growth rate, halogen acne, hair loss, heat rash, hematoma, herpes simplex infections (non-genital), hidradenitis suppurativa, hives, hyperhidrosis, hyperpigmentation,

hypohidrotic ectodermal dysplasia, hypopigmentation, impetigo, ingrown hair, heat type urticara, ingrown toenail, infantile acne or neonatal acne, itch, irritant contact dermatitis, jock itch, keloid, keratosis pilaris, lichen planus, lichen sclerosus, lupus miliaris disseminatus faciei, melasma, moles, molluscum contagiosum, nail growth rate, nail health, neurodermatitis, nummular eczema, occupational acne, oil acne, onychomycosis, physical urticara, pilonidal cyst, pityriasis rosea, pityriasis versicolor, poison ivy, pomade acne, pseudofolliculitis barbae or acne keloidalis nuchae, psoriasis, psoriatic arthritis, pressure or delayed pressure urticara, puncture wounds such as cuts and scrapes, rash, rare or water type urticara, rhinoplasty, ringworm, rosacea, rothmund-thomson syndrome, sagging of the skin, scabis, scars, seborrhea, seborrheic dermatitis, shingles, skin cancer, skin tag, solar type urticara, spider bite, stretch marks, sunburn, tar acne, tropical acne, thinning of skin, thrush, tinea versicolor, transient acantholytic dermatosis, tycoon's cap or acne necrotica miliaris, uneven skin tone, varicose veins, venous eczema, vibratory angioedema, vitiligo, warts, Weber-Christian disease, wrinkles, x-linked hypohidrotic ectodermal dysplasia, xerotic eczema, yeast infection and general signs of aging.

*Common Diseases, Disorders and Conditions*

*Dry Skin*

[000824] Dry skin often shows as patches of rough, red, and/or itchy areas of skin in places of the body including areas are often exposed to the environment such as, but not limited to, arms, hands and lower legs and other areas which tend to be protected from the environment such as, but not limited to, soles of the feet, thighs and the abdomen. Dry skin can lead to cracks and fissures in the skin which may be worsened in the winter because of low humidity. Dry skin may be hereditary (ichthyosis vulgaris), a result of aging when natural oils diminish, a result of medical conditions such as, but not limited to, asthma and thyroid disease, or a result of daily skin care habits.

[000825] Ichthyosis vulgaris (also known as autosomal dominant ichthyosis, ichthyosis simplex or common ichthyosis) is the most common form of the heterogeneous family of genetic skin disorders known as, ichthyosis. Ichthyosis vulgaris is mostly an autosomal dominant inherited skin disorder, but there is a rare non-heritable version called acquired ichthyosis, that causes dry, scaly skin affecting around 1 in 250 people. Many people with ichthyosis have associated conditions such as, but not limited to, problems with

sweating due to the build up of scales on the skin, cracking of the skin on the fingers or extremities that create bloody cuts, inflamed and/or tight skin that can be painful and other atopic diseases such as allergies, eczema, asthma, and keratosis pilaris.

[000826] A mutation to the gene encoding profilaggrin (a protein which is converted to filaggrin) is believed to cause ichthyosis vulgaris. In one embodiment, the cosmetic polynucleotides, cosmetic primary constructs and/or cosmetic mmRNA may be used in the treatment, amelioration or prophylaxis of dry skin and its associated diseases, disorders and/or conditions. In a further embodiment, the cosmetic polynucleotides, cosmetic primary constructs and/or cosmetic mmRNA encode a cosmetic polypeptide of interest such as, but not limited to, SEQ ID NO: 1298.

### Psoriasis

[000827] Psoriasis is an autoimmune disease that appears on the skin when the immune system mistakes the skin cells as a pathogen. The body then sends out signals to speed up the growth cycle of skin cells. Associated conditions with psoriasis include, but are not limited to, an increased risk of stroke, high blood lipid levels, psoriatic nail dystrophy causing small indentations, ridges, pits, discoloration or separation from the nail bed, inflammation of the joints known as psoriatic arthritis and psoriasis of the scalp where the scalp may have fine dry scaly skin or a heavily crusted plaque area.

[000828] Plaque psoriasis, the most common of the five types of psoriasis which affects 1-2% of the people in the United States, is when skin rapidly accumulates causing the skin to be inflamed, red, and covered with silvery scales. Patches of circular to oval shaped red plaques that itch or burn are typical and are can be found anywhere on the body but are common on the arms, legs, trunk or scalp. The occurrence and length of time psoriasis can be affected by environmental factors such as, but not limited to, smoking, injury to the skin, sun exposure, alcohol, certain drugs and medication, and infection such as HIV.

[000829] Guttate psoriasis is small, salmon-pink drops on the skin often triggered by a streptococcal infection but can be triggered by other infections such as, but not limited to, chickenpox or colds. Pustular psoriasis is clearly defined raised bumps on the skin that are filled with pus and the skin under and around these bumps can be reddish. Pustular is an uncommon form of psoriasis and can occur alone or in combination with plaque-type

psoriasis. Inverse psoriasis is bright red, smooth patches found in the folds of the skin usually in areas such as, but not limited to, under the breast, in the armpits, near the genital, under the buttocks or in abdominal folds. Erythrodermic psoriasis is the least common type of psoriasis but can be serious as a very large area of the body is bright red and inflamed. The body can appear covered in a red, peeling rash that usually itches and/or burns which increases blood flow and can put a strain on the heart.

[000830] There are nine locations, called psoriasis susceptibility 1 through 9 (PSORS1 - PSORS9), on different chromosomes that are associated with psoriasis. PSORS1 may be the major determinant of psoriasis and probably accounts for 35-50% of its heritability as it controls genes that affect the immune system or encode proteins that are found in the skin in greater amounts in psoriasis. PSORS1 is located in the major histocompatibility complex (MHC) on chromosome 6 which controls important immune functions. In the PSORS1 locus there are three genes that have a strong association with psoriasis vulgaris, major histocompatibility complex, class I, C (HLA-C) variant HLA-Cw6 which encodes a MHC class I protein, coiled-coil alpha-helical rod protein 1 (CCHR1) variant WWC which encodes a coiled protein that may be overexpressed in psoriatic epidermis and corneodesmosin (CDSN) variant allele 5 which may be expressed in the granular and cornified layers of the epidermis and may be upregulated in psoriasis. Studies have also suggested that a rare mutation on the gene encoding the caspase recruitment domain family, member 14 (CARD 14; also known as CARD-containing MAGUK protein 2) protein and an environmental trigger was able to cause plaque psoriasis. Currently, IL-12B on chromosome 5q which expresses interleukin-12B and IL-23R on chromosome 1p which expresses the interleukin-23 receptor are under investigation as they may be involved in T cell differentiation and T cells are involved in the inflammatory process that leads to psoriasis. Further, IL-12B and IL-23R are on the pathway that upregulates two genes involved in inflammation, tumor necrosis factor (TNF and TNF-alpha) and nuclear factor of kappa light polypeptide gene enhancer in B-cells.

[000831] In one embodiment, the cosmetic polynucleotides, cosmetic primary constructs and/or cosmetic mmRNA may be used in the treatment, amelioration or prophylaxis of the five types of psoriasis. In a further embodiment, the cosmetic polynucleotides, cosmetic primary constructs and/or cosmetic mmRNA encode a

cosmetic polypeptide of interest such as, but not limited to, SEQ ID NOs: 951, 952, 953, 954, 955, 956, 957, 958, 959, 960, 961, 962, 963, 964, 965, 966, 967, 968, 969, 970, 971, 972, 973, 974, 975, 976, 977, 978, 979, 980, 981, 982, 983, 984, 985, 986, 987, 988, 989, 990, 991, 992, 993, 994, 995, 996, 997, 998, 999, 1000, 1001, 1002, 1003, 1004, 1005, 1006, 1007, 1008, 1009, 1010, 1011, 1012, 1013, 1014, 1015, 1016, 1017, 1018, 1019, 1020, 1021, 1022, 1023, 1024, 1025, 1026, 1224, 1225, 1226, 1227, 1228, 1229, 1311, 1332, 1333, 1334, 1335, 1336, 1337, 1338, 1339, 1340, 1341, 1420, 1421, 1422, 1423, 1424, 1425, 1426, 1427, 1428, 1429, 1430, 1431, 1432, 1433, 1434, 1435, 1436, 1437, 1438, 1439, 1440, 1441, 1442, 1443, 1444, 1445, 1446, 1447, 1448, 1449, 1450, 1451, 1452, 1453, 1454, 1455, 1456, 1457, 1458, 1459, 1460, 1461, 1462, 1463, 1464, 1465, 1466, 1520, 1521, 1522, 1523, 1539, 1540, 1541, 1542, 1543, 1544, 1545, 1546, 1547, 1548, 1549, 1550, 1551, 1552, 1602, 1603, 1604, 1605, 1606, 1607 and 1608.

Eczema

[000832] Eczema, the general term for inflammation of the skin, is a disease that causes itchy, inflamed skin which can affect the insides of the elbows, backs of the knees, the face and can cover most of the body. Several other skin diseases, disorders and conditions that are also under the term eczema include, but are not limited to, atopic dermatitis, nummular eczema, dyshidrotic eczema, seborrheic dermatitis, irritant contact dermatitis, allergic contact dermatitis, dyshidrosis, venous eczema, dermatitis herpetiformis, neurodermatitis, autoeczematization and xerotic eczema. Flare-ups of eczema can be caused by triggers such as, but not limited to, dry skin, irritants, allergens, emotional stress, heat and sweating, and infections.

[000833] Inherited eczema and some related disorders are believed to be caused by the gene that produces the protein filaggrin. Further, three genetic variants, ovo-like 1 (OVOL1), actin-like 9 (ACTL9) and kinesin family member 3A (KIF3A) have been associated with eczema. Itching sensations which are a common symptom in eczema have recently been connected to the genes brain-derived neurotrophic factor (BDNF) and tachykinin, precursor 1 (TAC1)

[000834] In one embodiment, the cosmetic polynucleotides, cosmetic primary constructs and/or cosmetic mmRNA may be used in the treatment, amelioration or prophylaxis of eczema and its associated diseases, disorders and/or conditions. In a

further embodiment, the cosmetic polynucleotides, cosmetic primary constructs and/or cosmetic mmRNA encode a cosmetic polypeptide of interest such as, but not limited to, SEQ ID NOs: 913, 922, 923, 924, 925, 926, 927, 928, 929, 930, 931, 932, 933, 934, 935, 936, 937, 938, 939, 1408, 1409, 1410, 1411, 1524, 1594, 1595 and 1596.

Hives or Urticaria

[000835] Hives, or urticaria, is an outbreak of swollen, pale red bumps or plaques on the skin that appear suddenly which may be a result of the body's reaction to allergens, an acute viral infection, friction, pressure, temperature extremes, exercise and sunlight. Hives can cause itching but may also burn or sting and may appear anywhere on the skin such as the face, lips, tongue, throat, or ears. There are several types of hives such as, but not limited to, acute urticaria, chronic urticaria and angioedema, physical urticaria, pressure or delayed pressure urticaria, cholinergic or stress urticaria, cold type urticaria, heat type urticaria, solar type urticaria, rare or water type urticaria, vibratory angioedema, exercise-induced anaphylaxis and dermatographism.

[000836] People that have urticaria, such as cold urticaria, can have mutations in the gene phospholipase C, gamma 2 (PLCG-2) which is an enzyme involved in activating immune cells. The mutations (termed PLAID) will cause the PLCG-2 enzyme to function without shutting off causing excessive or deficient immune system reactions. Targeting the PLCG-2 enzyme may be a way to treat diseases, disorder and conditions associated with the PLAID mutation.

[000837] In one embodiment, the cosmetic polynucleotides, cosmetic primary constructs and/or cosmetic mmRNA may be used in the treatment, amelioration or prophylaxis of urticaria and its associated diseases, disorders and/or conditions. In a further embodiment, the cosmetic polynucleotides, cosmetic primary constructs and/or cosmetic mmRNA encode a cosmetic polypeptide of interest such as, but not limited to, SEQ ID NOs: 1525-1527.

Rosacea

[000838] Rosacea involves the swelling of the blood vessels just under the skin which cause symptoms such as, but not limited to, redness of the face, blushing or flushing, red nose, acne-like skin sores, a burning or stinging feeling in the face, irritated, bloodshot, or watery eyes or spider-like blood vessels (telangiectasia) of the face. There are four

subtypes of rosacea and subjects having rosacea may suffer from more than one subtype. Erthematotelangiectatic rosacea is permanent redness with a tendency to flush and blush easily. Subjects with papulopustular rosacea, often confused with acne, suffer from some permanent redness with red bumps with some bumps being pus filled. Phymatous rosacea causes thickening skin, irregular surface nodularities of the nose, chin, forehead, cheeks, eyelids and ears. Red, dry and irritated eyes and eyelids are referred to as ocular rosacea.

[000839] Subjects who have rosacea have elevated levels of cathelicidin antimicrobial peptide (CAMP) and/or kallikrein-related peptidase 5 (also known as stratum corneum tryptic enzyme (SCTE)). In one embodiment, the cosmetic polynucleotides, cosmetic primary constructs and/or cosmetic mmRNA may be used in the treatment, amelioration or prophylaxis of rosacea and its associated diseases, disorders and/or conditions. In a further embodiment, the cosmetic polynucleotides, cosmetic primary constructs and/or cosmetic mmRNA encode a cosmetic polypeptide of interest such as, but not limited to, SEQ ID NOs: 1405-1407.

#### Acne

[000840] Acne is a general term that is used for acneiform eruptions commonly known as a symptom for acne vulgaris but may also refer to acne aestivalis, acne conglobata, acne cosmetic, acne fulminans, acne keloidalis nuchae, acne mechanica, acne medicamentosa, acne miliaris necrotica, acne necrotica, acne rosacea, baby acne, blackheads, chloracne, excoriated acne, halogen acne, infantile acne or neonatal acne, lupus miliaris disseminatus faciei, occupational acne, oil acne, pomade acne, tar acne, tropical acne, tycoon's cap or acne necrotica miliaris, pseudofolliculitis barbae or acne keloidalis nuchae, and hidradenitis suppurativa. Acne may be caused by hormonal changes, genetic factors, psychological factors such as, but not limited to, stress, infections and diet.

[000841] Matrix metalloproteinases (MMP) have a predominant role in the inflammatory matrix remodeling and hyperproliferative skin disorders. Matrix metalloproteinase-1 (MMP-1 or interstitial collagenase), matrix metalloproteinase-9 (MMP-9), matrix metalloproteinase-13 (MMP-13), tissue inhibitors of MMP-1 (TIMP-1) and tissue inhibitors of MMP-2 (TIMP-2) were found to be highly expressed in skin from

an acne patient suggesting that MP and TIMP of epithelial origin controlling these genes may have therapeutic effects on acne.

[000842] In one embodiment, the cosmetic polynucleotides, cosmetic primary constructs and/or cosmetic mmRNA may be used in the treatment, amelioration or prophylaxis of acne and its associated diseases, disorders and/or conditions. In a further embodiment, the cosmetic polynucleotides, cosmetic primary constructs and/or cosmetic mmRNA encode a cosmetic polypeptide of interest such as, but not limited to the cosmetic targets disclosed herein.

Vitiligo

[000843] Vitiligo is a skin condition in which there is a loss of brown color or pigment from areas of the skin which results in irregular white patches. 1 out of every 100 people in the United States is affected by this autoimmune problem where the immune system destroys the cells that produce brown pigment (melanocytes). Vitiligo most often affects the face, elbows, knees, hands, feet and genitals. Vitiligo has been associated with other autoimmune diseases such as, but not limited to, Addison's disease, hyperthyroidism and pernicious anemia.

[000844] Mutations on the NLR family, pyrin domain containing 1 gene (NALP1) gene, located on chromosome 17 at 17p 13, may be a cause of vitiligo. NALP1 is expressed at high levels in T cells and Langerhan cells which are involved in skin autoimmunity. Caspase 1 and caspase 7 are inflammatory products of NALP1 which activate the inflammatory cytokine interleukin 1-beta (IL-1B) which is often expressed at high levels in patients with vitiligo. Inhibiting caspase and IL-1B may be useful therapeutics for vitiligo and its associated diseases.

[000845] In one embodiment, the cosmetic polynucleotides, cosmetic primary constructs and/or cosmetic mmRNA may be used in the treatment, amelioration or prophylaxis of vitiligo and its associated diseases, disorders and/or conditions. In a further embodiment, the cosmetic polynucleotides, cosmetic primary constructs and/or cosmetic mmRNA encode a cosmetic polypeptide of interest such as, but not limited to, SEQ ID NOs: 1512-1519.

*Hypohidrotic Ectodermal Dysplasia*



[000846] Subjects with hyprohidrotic ectodermal dysplasia (HED) have a reduced ability to sweat, sparse scalp and body hair and absent or malformed teeth. They may also have distinctive facial features such as, but not limited to, a prominent forehead, thick lips, flattened bridge of the nose, and thin, wrinkled and dark-color skin around the eyes. Common associated conditions with those who have HED include chronic skin problems such as atopic dermatitis and eczema, and a bad-smelling discharge from the nose.

[000847] Hyprohidrotic ectodermal dysplasia is caused by mutations in the ectodysplasin A gene (EDA), receptor (EDAR), and receptor associated death domain (EDARADD). Most cases are inherited in mutations on the EDA gene in an X-linked recessive pattern. Less common are mutations in the EDAR which have an autosomal dominant or autosomal recessive pattern of inheritance and mutations in the EDARADD with have an autosomal recessive pattern of inheritance.

[000848] In one embodiment, the cosmetic polynucleotides, cosmetic primary constructs and/or cosmetic mrnRNA may be used in the treatment, amelioration or prophylaxis of hyprohidrotic ectodermal dysplasia and its associated diseases, disorders and/or conditions. In a further embodiment, the cosmetic polynucleotides, cosmetic primary constructs and/or cosmetic mmRNA encode a cosmetic polypeptide of interest such as, but not limited to, SEQ ID NOs: 1233-1235 and 1242-1244.

#### Balding

[000849] Balding, or hair thinning, is the partial or complete loss of hair. Male pattern baldness, or androgenetic alopecia (AGA), may depend on a variant of the androgen receptor (AR) in order to develop. Further the ectodysplasin A2 receptor (EDA2R) has also been pointed out as a gene associated with AGA. Lysophosphatidic acid receptor 6 (P2RY5) has been connected to hair loss as it is linked to hair structure. Certain variants of P2RY5 have lead to baldness at birth and another variant caused wholly hair at birth.

[000850] In one embodiment, the cosmetic polynucleotides, cosmetic primary constructs and/or cosmetic mmRNA may be used in the treatment, amelioration or prophylaxis of hyprohidrotic ectodermal dysplasia and its associated diseases, disorders and/or conditions. In a further embodiment, the cosmetic polynucleotides, cosmetic primary constructs and/or cosmetic mmRNA encode a cosmetic polypeptide of interest

such as, but not limited to, SEQ ID NOs: 914, 915, 916, 917, 918, 1236, 1237, 1238, 1239, 1240, 1241, 1412 and 1413.

Scarring and Stretch Marks

**[000851]** Scars are areas of fibrous tissue that replace normal skin after injury. Scar tissue is the same protein (collagen) as the tissue that it replaces but the collagen cross-links and forms a pronounced alignment in a single direction instead of a random basketweave formation in normal tissue. The skin where scars tissue exists is less resistant to ultraviolet radiation and sweat glands and hair follicles do not grow back in the scar tissue.

**[000852]** Stretch marks, called striae, are a form of scarring that is caused when the skin is stretched rapidly, such as during pregnancy, weight gain, or growth spurts, or when skin is under tension during the healing process. Other forms of scarring include hypertrophic scars when the body over produces collagen causing the scar to be raised above the surrounding skin and atrophic scars which have a sunken recess in the skin caused when the underlying structures supporting the skin are lost.

**[000853]** Studies have suggested that collagen, ribosomal s6 kinase and secreted phosphoprotein 1 (also known as osteopontin) play important roles in the formation of scar tissue. Transforming growth factor beta 3 may also be used to have scar tissue more closely resemble normal tissue in appearance and structure.

**[000854]** In one embodiment, the cosmetic polynucleotides, cosmetic primary constructs and/or cosmetic mmRNA may be used in the treatment, amelioration or prophylaxis of scarring and stretch marks and its associated diseases, disorders and/or conditions. In a further embodiment, the cosmetic polynucleotides, cosmetic primary constructs and/or cosmetic mmRNA encode a cosmetic polypeptide of interest such as, but not limited to, SEQ ID NOs: 1027, 1028, 1029, 1030, 1031, 1032, 1033, 1034, 1035, 1036, 1037, 1038, 1039, 1040, 1041, 1042, 1043, 1044, 1045, 1046, 1047, 1048, 1049, 1050, 1051, 1052, 1053, 1054, 1055, 1056, 1057, 1058, 1059, 1060, 1061, 1062, 1063, 1064, 1065, 1066, 1067, 1068, 1069, 1070, 1071, 1072, 1073, 1074, 1075, 1076, 1077, 1078, 1079, 1080, 1081, 1082, 1083, 1084, 1085, 1086, 1087, 1088, 1089, 1090, 1091, 1092, 1093, 1094, 1095, 1096, 1097, 1098, 1099, 1100, 1101, 1102, 1103, 1104, 1105, 1106, 1107, 1108, 1109, 1110, 1111, 1112, 1113, 1114, 1115, 1116, 1117, 1118, 1119,

1120, 1121, 1122, 1123, 1124, 1125, 1126, 1127, 1128, 1129, 1130, 1131, 1132, 1133, 1134, 1135, 1136, 1137, 1138, 1139, 1140, 1141, 1142, 1143, 1144, 1145, 1146, 1147, 1148, 1149, 1150, 1151, 1152, 1153, 1154, 1155, 1156, 1157, 1158, 1159, 1160, 1161, 1162, 1163, 1164, 1165, 1166, 1167, 1168, 1169, 1170, 1171, 1172, 1173, 1174, 1175, 1176, 1177, 1178, 1179, 1180, 1181, 1182, 1183, 1184, 1185, 1186, 1187, 1188, 1189, 1190, 1191, 1192, 1193, 1194, 1195, 1196, 1197, 1198, 1199, 1200, 1201, 1202, 1203, 1204, 1205, 1206, 1207, 1208, 1209, 1210, 1211, 1212, 1213, 1214, 1215, 1216, 1217, 1218, 1219, 1220, 1221, 1222, 1223, 1469, 1553, 1554, 1555, 1556, 1557, 1558, 1559, 1560, 1561, 1562, 1563, 1564, 1565, 1566, 1567, 1568, 1569, 1570, 1571, 1572, 1573, 1574, 1575, 1576, 1577, 1578 and 1579..

*Epidermodysplasia Verruciformis*

[000855] Epidermodysplasia verruciformis (also known as Lutz-Lewandowsky epidermodysplasia) is an extremely rare autosomal recessive genetic hereditary skin disorder often associated with a high risk of skin cancer. The skin disorder is caused by a mutation in either transmembrane channel-like 6 (EVER1) or transmembrane channel-like 8 (EVER2) genes which are located adjacent to one another on chromosome 17. EVER1 and EVER2 help to regulate the distribution of zinc in the cell nucleus and thus the activity of these genes may restrict the access of viral proteins to cellular zinc stores which may limit cell growth.

[000856] In one embodiment, the cosmetic polynucleotides, cosmetic primary constructs and/or cosmetic mrnRNA may be used in the treatment, amelioration or prophylaxis of scarring and stretch marks and its associated diseases, disorders and/or conditions. In a further embodiment, the cosmetic polynucleotides, cosmetic primary constructs and/or cosmetic mmRNA encode a cosmetic polypeptide of interest such as, but not limited to, SEQ ID NOs: 1600-1601.

*Sagging skin, thinning of skin, wrinkles*

[000857] Skin may have an undesirable change such as sagging, thinning or wrinkling as a result of the substantial and steady decline in the expression of cosmetic proteins such as, but not limited to, collagen, elastin, fibroblast growth factor 7, TIMP metalloproteinase inhibitors, matrix metalloproteinases, superoxide dismutase and other extracellular matrix proteins and proteoglycans. Replacing these cosmetic proteins

and/or preventing the decline of these cosmetic proteins may be an effective strategy in maintaining and/or improving the appearance and health of the skin.

[000858] In one embodiment, the cosmetic polynucleotides, cosmetic primary constructs and/or cosmetic mmRNA may be used in the treatment, amelioration or prophylaxis of sagging skin, thinning skin and/or wrinkles. In a further embodiment, the cosmetic polynucleotides, cosmetic primary constructs and/or cosmetic mmRNA encode a cosmetic polypeptide of interest such as, but not limited to, SEQ ID NOs: 1030, 1031, 1032, 1033, 1034, 1035, 1036, 1037, 1469, 1038, 1039, 1040, 1041, 1042, 1043, 1044, 1045, 1046, 1047, 1048, 1049, 1050, 1051, 1052, 1053, 1063, 1064, 1065, 1066, 1576, 1067, 1068, 1069, 1070, 1027, 1028, 1071, 1072, 1073, 1074, 1075, 1076, 1077, 1078, 1079, 1080, 1081, 1082, 1083, 1054, 1055, 1056, 1057, 1058, 1059, 1060, 1061, 1062, 1084, 1085, 1086, 1087, 1088, 1089, 1090, 1091, 1092, 1093, 1094, 1095, 1096, 1097, 1098, 1099, 1100, 1101, 1102, 1103, 1104, 1105, 1106, 1107, 1108, 1109, 1110, 1111, 1112, 1113, 1114, 1115, 1116, 1117, 1118, 1119, 1120, 1121, 1122, 1123, 1124, 1125, 1126, 1127, 1128, 1129, 1130, 1131, 1132, 1133, 1134, 1135, 1136, 1137, 1138, 1139, 1140, 1141, 1142, 1143, 1144, 1145, 1146, 1147, 1148, 1149, 1150, 1151, 1152, 1153, 1154, 1155, 1156, 1157, 1158, 1159, 1160, 1161, 1162, 1163, 1164, 1165, 1166, 1167, 1168, 1169, 1170, 1171, 1172, 1173, 1174, 1175, 1176, 1177, 1178, 1179, 1180, 1181, 1182, 1183, 1186, 1187, 1188, 1189, 1190, 1191, 1192, 1193, 1184, 1185, 1194, 1195, 1196, 1197, 1198, 1199, 1200, 1201, 1202, 1203, 1204, 1205, 1206, 1207, 1208, 1209, 1210, 1029, 1211, 1212, 1213, 1214, 1215, 1216, 1217, 1218, 1219, 1220, 1221, 1222, 1223, 1592, 1590, 1589, 1588, 1591, 1254, 1259, 1255, 1251, 1258, 1256, 1252, 1245, 1253, 1246, 1249, 1250, 1247, 1248, 1257, 1401, 1399, 1403, 1404, 1400, 1402, 1494, 1493, 1492, 1467, 1468, 1471, 1470, 1474, 1473, 1472, 1475, 1476, 1478, 1480, 1477, 1479, 1481, 1482, 1484, 1483, 1485, 1486, 1487, 1489, 1490, 1491 and 1488.

#### *Repair and Maintenance of Tissue*

[000859] Skin cells express a variety of proteins and other factors that may be important to the repair and maintenance of the tissue. Proteins which may be important to the repair and maintenance of the tissue include, but are not limited to, transforming growth factor (TGF), insulin-like growth factor (IGF), platelet-derived growth factor (PDGF), epidermal growth factor (EGF), heparin-binding EGF-like growth factor, vascular

endothelial growth factor (VEGF), c-fos induced growth factor, colony stimulating factor 2, interleukins, fibroblast growth factor (FGF), connective tissue growth factor (CTGF), growth hormone, colony stimulating factor 1, colony stimulating factor 3, calponin, cysteine-rich, angiogenic inducer, thyroid stimulating hormone (TSH), hepatocyte growth factor (HGF), hypoxia inducible factor 1 (HIF-1) and actin.

**[000860]** In one embodiment, the cosmetic polynucleotides, cosmetic primary constructs and/or cosmetic mmRNA may be used in the treatment, amelioration or prophylaxis of cells which are important to the repair and maintenance of tissue. In a further embodiment, the cosmetic polynucleotides, cosmetic primary constructs and/or cosmetic mmRNA encode a cosmetic polypeptide of interest such as, but not limited to, SEQ ID NOs: 885, 886, 887, 888, 889, 890, 891, 892, 893, 894, 895, 896, 897, 898, 899, 900, 901, 902, 903, 904, 905, 906, 907, 908, 909, 910, 911, 912, 940, 941, 942, 943, 944, 945, 946, 947, 948, 949, 950, 1245, 1246, 1247, 1248, 1249, 1250, 1251, 1252, 1253, 1254, 1255, 1256, 1257, 1258, 1259, 1260, 1261, 1262, 1263, 1264, 1265, 1266, 1267, 1268, 1269, 1270, 1271, 1272, 1273, 1274, 1275, 1276, 1277, 1278, 1279, 1280, 1281, 1282, 1283, 1284, 1285, 1286, 1287, 1288, 1289, 1290, 1291, 1292, 1293, 1294, 1295, 1296, 1297, 1299, 1300, 1301, 1302, 1303, 1304, 1305, 1306, 1307, 1308, 1309, 1310, 1311, 1312, 1313, 1314, 1315, 1316, 1317, 1318, 1319, 1320, 1321, 1322, 1323, 1324, 1325, 1326, 1327, 1328, 1329, 1330, 1331, 1342, 1343, 1344, 1345, 1346, 1347, 1348, 1349, 1350, 1351, 1352, 1353, 1354, 1355, 1356, 1357, 1358, 1359, 1360, 1361, 1362, 1363, 1364, 1365, 1366, 1367, 1368, 1369, 1370, 1371, 1372, 1373, 1374, 1375, 1376, 1377, 1378, 1379, 1380, 1381, 1382, 1383, 1384, 1385, 1386, 1387, 1388, 1389, 1390, 1391, 1392, 1393, 1394, 1395, 1396, 1397, 1414, 1415, 1416, 1417, 1418, 1419, 1528, 1529, 1530, 1531, 1532, 1533, 1588, 1589, 1590, 1591, 1592, 1597 and 1598.

#### *Skin Tanning*

**[000861]** Tanning of the skin is a natural shield against skin cancer. In response to ultraviolet (UV) light from the sun, keratinocytes being pumping out melanocyte - stimulating hormone which binds to melanocyte-stimulating hormone receptors on melanocytes which leads to melanin production and ultimately a tan. Melanocyte-stimulating hormone is derived from pro-opiomelanocortin. As a non-limiting example,

by altering the levels of pro-opiomelanocortin in the body the ability of a subject to tan may be altered.

[000862] In one embodiment, the cosmetic polynucleotides, cosmetic primary constructs and/or cosmetic mmRNA may be used in the treatment, amelioration or prophylaxis of cells which are important to the tanning of skin. In a further embodiment, the cosmetic polynucleotides, cosmetic primary constructs and/or cosmetic mmRNA encode a cosmetic polypeptide of interest such as, but not limited to, SEQ ID NOs: 919, 920, 921, 1230, 1231, 1232, 1495, 1496, 1497, 1498, 1499, 1500, 1501, 1502, 1503, 1504, 1505, 1506, 1507, 1508, 1509, 1510, 1511, 1534, 1535, 1536, 1537, 1538, 1586, 1587, 1593, 1609, 1610 and 1611..

#### *Hair Pigmentation*

[000863] Hair color is determined by the levels of pigmentation in the hair follicles due to melanin, specifically eumelanin and pheomelanin. There are two types of eumelanin, black eumelanin and brown eumelanin. A pink to red pigmentation is given by pheomelanin. As a non-limiting example, red hair has a large amount of pheomelanin in the hair follicles.

[000864] In one embodiment, the cosmetic polynucleotides, cosmetic primary constructs and/or cosmetic mmRNA may be used in the treatment, amelioration or prophylaxis of cells which are important to the pigmentation of hair and hair follicles. In a further embodiment, the cosmetic polynucleotides, cosmetic primary constructs and/or cosmetic mmRNA encode a cosmetic polypeptide of interest such as, but not limited to, SEQ ID NOs: 1495, 1580, 1581, 1582, 1583, 1584, 1585, 1586, 1587 and 1593..

#### *Neurotoxins*

[000865] In one embodiment, neurotoxins are used in the cosmetic polynucleotides, cosmetic primary constructs and/or cosmetic mmRNA described herein for the treatment, amelioration or prophylaxis or various diseases, disorder and/or conditions. As used herein, "neurotoxin" refers to a substance that is capable of causing damage to nerves or nerve tissue. Categories of neurotoxins include, but are not limited to, sodium channel inhibitors (e.g., tetrodotoxin), potassium channel inhibitors (e.g., tetraethylammonium), chloride channel inhibitors (e.g., chlorotoxin and curare), calcium channel inhibitors

(e.g., conotoxin), synaptic vesicle release inhibitors (e.g., botulinum toxin and tetanus toxin) and blood brain barrier inhibitor (e.g., aluminum and mercury).

[000866] The neurotoxins described herein may be used as therapeutic agents in cosmetic and/or medical procedures such as, but not limited, treatment of strabismus ("crossed eyes"), blepharospasm ("uncontrollable blinking"), achalasia, sweating, muscle spasms, upper motor neuron syndrome, cervical dystonia, headaches and chronic migraines.

#### Tetanus Toxin

[000867] Tetanus toxin is a neurotoxin produced by *Clostridium tetani* which has two separate, distinct parts. In one part of the toxin is the cause of the toxic effects and tetanus symptoms. In the other part, called the carboxy-terminal domain, is non-toxic and is able to penetrate and affect the nervous system. The carboxy-terminal domain is able to inhibit serotonin from being transported through the synaptic membranes. This domain may be useful as a protectant against neurodegenerative and other muscle disorders such as Parkinson's disease as it can prevent the death of neurons when the neurons are faced with aggressive situations.

[000868] In one embodiment, the cosmetic polynucleotides, cosmetic primary constructs and/or cosmetic mmRNA may be used in the treatment, amelioration or prophylaxis of neurodegenerative and other muscle disorders. In a further embodiment, the cosmetic polynucleotides, cosmetic primary constructs and/or cosmetic mmRNA encode a cosmetic polypeptide of interest such as, but not limited to, the sequences described in Example 116 (See e.g., Table 178).

#### Botulinum Toxin

[000869] Botulinum toxin is a neurotoxin produced by *Clostridium botulinum*, which has seven immunologically distinct protein neurotoxins designated as serotypes A through G with a CI and C2 with a molecular weight of 150 kDa. The botulinum toxin has a disulfide bond between the 50 kDa N-terminal light chain and the 100 kDa C-terminal heavy chain to form the 150 kDa neurotoxin.

[000870] In one embodiment, the cosmetic polynucleotides, cosmetic primary constructs and/or cosmetic mmRNA may be used in the treatment, amelioration or prophylaxis of cosmetic diseases, disorders and/or conditions and other muscle disorders.

[000871] In one embodiment, the cosmetic polynucleotides, cosmetic primary constructs and/or cosmetic mmRNA encode a cosmetic polypeptide of interest such as, but not limited to, the sequences described in Example 116 (See e.g., Table 178).

[000872] In one embodiment, the cosmetic polynucleotides, cosmetic primary constructs and/or cosmetic mmRNA encode a light chain of a polypeptide of interest such as, but not limited to, the sequences described in Example 116 (See e.g., Table 178). A light chain of the polypeptide of interest may be produced by a method known in the art. As a non-limiting example, light chains of botulinum neurotoxin may be produced using the methods described in U.S. Pub. No. 2010027321 1 herein incorporated by reference in its entirety.

[000873] The botulinum toxins are released as protein aggregates by *Clostridia* which are designated as progenitor toxins or toxin complexes. Toxin complexes result from the noncovalent association of the neurotoxin with up to seven other proteins which are known as neurotoxin-associated proteins (NAPs). NAPs include, but are not limited to, nontoxic, non-hemagglutinin protein (NTNH), hemagglutination protein (HA) and other proteins possessing hemagglutination properties. Broadly there are three categories of HA proteins, having designations of HA-1, HA-2, HA-3 (HA-3a & HA-3b are also present in some complexes). The 150 kDa toxin is the active neurotoxin, while the bound NTNH and HA proteins that form the aggregate or complex provide protection or facilitate delivery of the active toxin. The aggregate or complex may be of three sizes designated 12S (300 kDa), 16S (500 kDa), and 19S (900 kDa). The type A serotype produces all three size complexes (12S, 16S, and 19S), type B, C, and D strains produce 12S and 16S complexes, strains E and F produce only 12S complexes, while the G strain only produces the 16S complex.

[000874] The 12S complex is botulinum toxin bound to the NTNH protein. All the complexes consist of this bound pair. The 16S aggregate is the addition of HA proteins bound to this core complex. The 19S is a dimer of the 16S aggregate. The HA proteins have specific nomenclature based on their molecular weight (HA-17 weights 17 kDa) and are HA-17, HA-17/15, HA-19/20, HA-26/21, HA-33, HA-33/35, HA-52, HA-55, HA-70. With the type A complex the HA proteins have been correlated as follows: HA-15/17 (HA-2), HA-33/35 (HA-1), and HA-70 (HA-3) that fragments into HA-19/20 (HA-3a)



and HA-52 (HA-3b). The C serotype complex is similar with the B and D complexes having only an HA-3 (and no HA-3a or -3b). The G complex is composed of the HA-2 and HA-3 proteins. Example 117 (see e.g., Table 179) describes a non-limiting listing of NAPs for the seven botulinum toxin serotypes.

**[000875]** Botulinum toxins may be used to treat various diseases, disorders and conditions such as, but not limited to, headaches, migraine headaches, tension headaches, sinus headaches, cervicogenic headaches, hormone headaches, sweating disorders, axillary hyperhidrosis, palmar hyperhidrosis, plantar hyperhidrosis, genital hyperhidrosis, Frey's syndrome, hyperkinetic skin lines, facial wrinkle, glabellar lines, crow's feet, marionette lines, a nasolabial fold, a skin disorder, achalasia, strabismus, chronic anal fissure, blepharospasm, musculoskeletal pain, fibromyalgia, pancreatitis, tachycardia, prostatic enlargement, prostatitis, urinary retention, urinary incontinence, overactive bladder, hemifacial spasm, tremors, myoclonus, gastrointestinal disorders, diabetes, sialorrhea, detrusor-sphincter dyssynergia, post stroke spasticity, wound healing, juvenile cerebral palsy, smooth muscle spasm, restenosis, a focal dystonia, epilepsy, cervical dystonia, thyroid disorder, hypercalcemia, an obsessive compulsive disorder, arthritic pain, Raynaud's syndrome, striae distensae, peritoneal adhesion, vasospasms, rhinorrhea, muscle contracture, an injured muscle, laryngeal dystonia, writer's cramp, carpal tunnel syndrome, movement disorders such as Parkinson's disease, tics, tourette's syndrome, sialorrhea in Parkinson's disease, bulbar amyotrophic lateral sclerosis, autonomic hypersecretory disorders, dystonia and other movement disorders, idiopathic and neurogenic detrusor overactivity, vaginismus, temporomandibular joint pain disorders, diabetic neuropathy, vocal cord dysfunction (VCD) including spasmodic dysphonia and tremor, reduction of the Masseter muscle for decreasing the apparent size of the lower jaw and benign prostatic hyperplasia. Botulinum toxin has also been used in clinical settings such as, for example, for the treatment of neuromuscular disorders characterized by hyperactive skeletal muscles.

**[000876]** Botulinum toxin type A has been approved by the U.S. Food and Drug Administration (FDA) for the treatment of essential blepharospasm, strabismus and hemifacial spasm in patients over the age of twelve, cervical dystonia, glabellar line

(facial) wrinkles and for treating hyperhidrosis. The FDA has also approved a botulinum toxin type B for the treatment of cervical dystonia.

*Treatment of Migraines and Headaches*

[000877] Botulinum toxin may be used to treat migraines and headaches such as, but not limited to, chronic migraines, cluster headaches, sinus headaches, tension headaches and cervicogenic headaches. Botulinum toxin may reduce hyperactivity along a neuromuscular pathway by preventing release of acetylcholine, thereby decreasing contractility of musculature and relieving migraine and/or headache pain. In addition, reduction of excess acetylcholine found at the neuromuscular junctions during migraines and headaches through botulinum toxin injection may further result in normalization of muscle activity and decreased pain. Botulinum toxin may further reduce pain by entering into the central nervous system and blocking neurotransmitter exocytosis and nociceptor signalling, thereby decreasing the signal pathway of pain during a migraine and/or headache.

[000878] Chronic migraines are neurological disorders characterized by moderate to severe headaches and nausea. Botulinum toxin may be injected into the head and neck to treat these chronic headaches. As a non-limiting example, botulinum toxin may be able to improve headache symptoms in subjects who may have pressure perceived from an outside source, who have had chronic migraines for less than 30 years and/or who may have chronic daily headache due to medication overuse.

[000879] Sinus headaches are conditions that arise from inflammation of the paranasal sinuses, often due to infection, allergy or autoimmune conditions, which may lead to chronic facial pain. Subcutaneous injection of botulinum toxin may be able to improve sinus related headache pain in subjects who have developed chronic facial pain as a result of a sinus infection. Injection of botulinum toxin may reduce pain syndromes associated with sinus headaches by impairing secretion of neuro-effectors from mast cells, sensory nerve tissue and blood vessel endothelium, showing an anti-inflammatory effect from botulinum toxin treatment.

[000880] Tension headaches are conditions that arise from muscle tension around the head and neck and may be the result of stress, sleep deprivation, hunger, eyestrain and bad posture. Tension headaches may occur as an isolated event, constantly, or daily and

pain may last for 30 minutes to 7 days. Direct injection of botulinum toxin at the site of pain or trigger points in facial muscles may be used as a preventative medication for tension headaches. Multiple injections may be required to relieve tension headache symptoms and relief may last for about 3 to 4 months.

**[000881]** Cervicogenic headaches are a chronic, hemicranial pain syndrome in which the sensation of pain originates in the cervical spine or soft tissues of the neck and are often precipitated by neck movement or sustained awkward head positioning.

Cervicogenic headaches will last on average between 2 weeks to 7 weeks. Injection of botulinum toxin, into pericranial and cervical muscles may effectively treat cervicogenic headaches. Injection of botulinum toxin may relax tense muscles in the head and neck, which cause cervicogenic headaches, and may result in pain relief.

**[000882]** Hormone headaches are pain syndromes often associated with changing hormone levels that occur during menstruation, pregnancy, and menopause in women. Chemically induced hormone changes may be induced by medications such as, but not limited to, birth control pills, may also trigger hormone headaches in women. Injection of botulinum toxin into the endocrine system may help reduce effects of pain associated with hormone headaches by blocking nerve signals carrying pain signals. The effects of botulinum toxin may wear off after 2 to 3 months and may require repeat injections to maintain desired effects.

#### *Treatment of Sweating Conditions*

**[000883]** Botulinum toxin may be used to treat hyperhidrosis such as, but not limited to, general sweating conditions, palmer hyperhidrosis, plantar hyperhidrosis, axillary hyperhidrosis and gustatory hyperhidrosis and genital hyperhidrosis. Injection of botulinum toxin at a desired site may prevent cellular exocytosis of acetylcholine and exert an inhibitory effect on secretory cells, resulting in a decrease in sweat production in or around an injected area. Treatment with botulinum toxin may further result in reduction in unpleasant body odor associated with hyperhidrosis by reducing moisture and secretions of sweat glands.

**[000884]** General sweating is a condition characterized by abnormally increased perspiration, in excess of that required to maintain a normal body temperature, of any part of the body. Type A botulmum toxin injections may be used as an effective treatment

for general sweating by blocking the secretion of acetylcholine, the chemical responsible for turning on sweat glands. Small injections of botulinum toxin to an affected area is a relatively simple procedure that should cause little pain to the subject, and a single treatment for excessive sweating may have a lasting effect from about 4 months to 12 months.

**[00885]** Palmer hyperhidrosis is a sweating condition specific to the hands. Injection of botulinum toxin type A or type B may be a long-lasting method to treat excessive sweating of the palms by blocking acetylcholine secretion in or around the site of injection into the palms. Treatment of botulinum toxin injections into the palms typically take less than a half of hour and a significant symptomatic improvement can be seen that may last up to 12 months.

Plantar hyperhidrosis is a sweating condition specific to the feet, with over 3% of the world's population having this condition. Direct injection of botulinum toxin may effectively be used to treat plantar hyperhidrosis by blocking acetylcholine at the site of injection and blocking sweat gland secretion. In order to increase the efficacy of botulinum toxin treatment for plantar hyperhidrosis repeated and multiple injections may be required as the feet have over 250,000 sweat glands which may be regulated to manage sweat secretion.

**[00886]** Axillary hyperhidrosis is a sweating condition specific to the armpits, causing profuse sweating under the armpits without the ability to control the rate of perspiration. Axillary hyperhidrosis may be caused by the sympathetic nervous system sending signals to the underarm sweat glands to keep producing sweat. Intradermal injection of botulinum toxin under the armpits may be used to treat axillary hyperhidrosis by inhibiting acetylcholine secretion which initiates sweat glands in the armpits. Treatment of axillary hyperhidrosis with botulinum toxin may last for about 3 weeks to about 17 weeks, thereafter repeated injections may be needed to continue to manage sweat secretion.

**[00887]** Gustatory hyperhidrosis or Frey's syndrome is a sweating condition specific to the forehead, upper lip, perioral region or sternum, often occurring a few moments after eating spicy foods, tomato sauce, chocolate, coffee, tea or hot soups. Frey's Syndrome may be congenital or may be acquired after parotid gland surgery or an injury

to the auricotemporal nerve (which carries sympathetic fibers to the sweat glands of the scalp and parasympathetic fibers to the parotid gland). Symptoms of Frey's syndrome include, but are not limited to, sweating on the cheek area adjacent to the ear. Injection of botulinum toxin type A may be an effective treatment for Frey's syndrome. In addition to inhibiting acetylcholine at the nerve endplates, thereby blocking signals to overactive muscles, neurotransmitters in sweat glands that depend on acetylcholine for their activation may remain suppressed in the presence of botulinum toxin. Treatment of Frey's Syndrome through intradermal injection of botulinum toxin in or around a condition site may help prevent sweating for about 17 weeks, thereafter repeated injections may be needed to manage sweat secretion.

[000888] Genital hyperhidrosis is excessive sweating of the genital area, including the groin, inner thighs and buttocks. Genital hyperhidrosis is considered a hereditary condition, but may also be caused by stress, change in hormones, anxiety, exercise levels and high levels of humidity. Intradermal injection of botulinum toxin may treat genital hyperhidrosis by inhibiting exocytosis of acetylcholine, thereby suppressing secretion of sweat from sweat glands in or around the intradermal injection site. Effects from injections may last for about 3 to 17 months before repeat injections may be desired to treat genital hyperhidrosis.

#### *Treatment of Cosmetic Conditions*

[000889] Injection of type A and type B botulinum toxin in small quantities may be effectively used to treat cosmetic conditions such as, but not limited to, facial wrinkles, hyperkinetic skin lines, glabellar lines, crow's feet, marionette lines, skin disorders, nasolabial folds, blepharospasm, strabismus, hemifacial spasms and wound healing. Injecting overactive facial muscles with minute quantities of botulinum toxin can result in a decrease in acetylcholine release at the neuromuscular junction, thereby temporarily rendering the muscles unable to contract, and temporarily ending, for instance, spasmodic winking found in blepharospasms. Injection of small quantities of botulinum toxin may have a lasting effect for cosmetic purposes on average for a period of about 4 to 6 months.

[000890] Facial wrinkles are a slight ridge, crumpling, creasing or puckering in the smoothness of the surface of skin. Facial wrinkles may occur for a variety of reasons

such as, but not limited to, aging, loss of elasticity in skin layers, muscle contraction, sun damage, smoking, dehydration and/or medication. Small doses of botulinum toxin may be injected into facial muscles to block the release of acetylcholine by nerve cells that signal muscle contraction. This interference results in a smoothing out of existing facial wrinkles thereby treating the wrinkles. Treatment of botulinum toxin on facial wrinkles usually takes about 48 to 72 hours to take effect and the results remain for about 3 months before additional injections may be necessary to continue treating the wrinkles.

[000891] Hyperkinetic skin lines are lines formed by hyperkinetic or overactive musculature, which are typically found along the cheeks around hyperkinetic muscles. Hyperkinetic skin lines are commonly associated with aging skin. Injection of small quantities of botulinum toxin to hyperkinetic muscles may reduce hyperkinetic skin lines by temporarily inhibiting contraction of hyperkinetic muscles through acetylcholine inhibition. Treatment of hyperkinetic skin lines with botulinum toxin may last for about 3 months before retreatment of additional injections may be desired.

[000892] Glabellar lines are vertical lines between the eyebrows, which are formed by repeated contraction of the glabellar muscles. Over time the skin between the eyebrows loses elasticity, resulting in deep wrinkles between the eyebrows, commonly known as frown lines. Glabellar lines may be part of the aging process and the FDA has currently approved the use of Botulinum toxin type A for the treatment of glabellar lines. Injection of Botulinum toxin at the site of the glabellar lines, may result in relaxation of the muscles which have been repetitively contracted to create the glabellar lines. Repeat treatment may be necessary. The effects of treatment with botulinum toxin may last for about 3 months depending on factors such as, but not limited to, age, severity, and number of previous treatments.

[000893] Crow's feet are small wrinkles radiating outward from the outer corner of the eye, often occurring as the result of age. Crow's feet may be caused by contraction of the muscles that run around the circumference of the eye, while other causes of crow's feet may include, but are not limited to, aging, thin skin, muscle degeneration, tendon degeneration and sun damage. Injection of botulinum toxin to the muscles around the circumference of the eye may treat crow's feet through the inhibition of acetylcholine which is necessary to induce muscle contraction. Botulinum toxin may be less effective

as a treatment for crow's feet which has been induced by conditions such as, but not limited to, age, thin skin, muscle degeneration, tendon degeneration and sun damage for instance, as these conditions are not related to underlying muscle activity around the eyes.

**[000894]** Marionette lines are vertical lines that laterally circumscribe the chin and may give the face an expression of being dissatisfied or grim. Marionette lines tend to appear as ligaments around the mouth and chin loosen and sag during the aging process. Botulinum toxin may be used around the chin and mouth to reduce or soften marionette lines caused by muscle contractions by inhibiting acetylcholine necessary for muscle contraction. Treatment of botulinum toxin for marionette lines may further include, but is not limited to, dermal fillers to have significant impact on deep marionette lines.

**[000895]** Skin disorders are abnormal conditions of the membranous tissue of the epidermis and dermis. Skin disorders may include, but are not limited to, dimples, warts, pimples, facial rashes, hives and xerosis. Botulinum toxin may be used to improve a variety of skin disorders as it may provide an anti-aging effect on the skin. Botulinum toxin is particularly useful for any skin disorder that may be caused by abnormal muscle contractions or related to sweat gland production. Dimples, for example, may be the result of overactivity of the mentalis muscle in the chin, which may be temporarily managed through botulinum toxin injections. In the chin area, special consideration to the dosing of botulinum toxin is important in order to prevent drooling or the drooping of muscles around the mouth.

**[000896]** Nasolabial folds are folds on the face that run from the corners of the nose to the mouth which become more pronounced with aging. Factors that may contribute to nasolabial folds include, but are not limited to, excess skin, skin thinning, excess cheek fat and ptosis of cheek fat. Injections of botulinum toxin may be used to treat nasolabial folds by relaxing the facial musculature. For example, injections of botulinum toxin may be at the lip elevator complex in the nasolabial fold and the levator labii superioris alaeque nasi muscle, one injection per side. Effects of treatment may last for up to 6 months before repeated injections may be desired.

**[000897]** Striae distensae are depressed lines or bands of thin reddened skin, which later become white, smooth, shiny and/or depressed. Striae distensae may occur in

response to changes in weight or muscle mass and skin tension and are commonly referred to as stretch marks. Injection of Botulinum toxin may relax tense and stretched muscles resulting in improved muscle elasticity and a decrease in striae distensae.

[000898] Wound healing is an intricate process in which the skin repairs itself after injury. In normal skin the epidermis and dermis form a protective barrier against the external environment. Once the protective barrier is broken the normal process of wound healing includes inflammation, proliferation and skin remodeling. Increased metabolic activity and inflammation during the healing process may induce muscle contractions around the edges of the skin wound and may cause microtraumas around the scar during the normal healing process. Botulinum toxin may be an effective treatment to aid in wound healing by decreasing muscle spasms during the healing process and may improve pain control, inflammation, blood flow and/or ischemia associated with wound healing.

*Treatment of Head and Neck Conditions*

[000899] Head and neck conditions such as but not limited to, achalasia, sialorrhea, rhinorrhea, cervical dystonia, focal dystonia, temporomandibular joint disorder, blepharospasms, strabismus, hemifacial spasm, vocal cord dysfunction, laryngeal dystonia, bulbar amyotrophic lateral sclerosis, masseter muscle reduction, epilepsy, obsessive-compulsive disorder. Injection of botulinum toxin at the site of head or neck pain may inhibit the release of the neurotransmitter acetylcholine at the neuromuscular junction thereby inhibiting muscle contractions, which are often the cause of pain. Besides reducing muscle tone, botulinum toxin tends to reduce pain in syndromes associated with muscle spasm and has been proposed as an analgesic, suggesting alternative non-cholinergic mechanisms of action that may affect head and neck conditions.

[000900] Achalasia is a condition of the esophagus, wherein the esophageal sphincter loses its contractile ability to normally prevent the back flow of food from the stomach to the esophagus. Achalasia may be caused by the degeneration of nerve cells that normally signal the brain to tell the esophageal sphincter to relax and continue contraction to keep the esophagus closed. Intrasphincteric injection of botulinum toxin may be used to paralyze the muscles of the esophageal sphincter so that the muscles relax



and continue to contract, which may be an effective therapy for several years after injection.

**[000901]** Sialorrhea is an excessive flow of saliva often resulting from neuromuscular dysfunction, hypersecretion, sensory dysfunction or anatomic dysfunction, resulting in poor oral and facial muscle control. Sialorrhea may be associated with a variety of conditions, including but not limited to acute inflammation of the mouth, mental retardation, mercurialism, pregnancy, teething, alcoholism, malnutrition and Parkinson's disease. Sialorrhea, as a result of Parkinson's disease, may occur because of a neuromuscular dysfunction that results in impaired or infrequent swallowing. Injection of botulinum toxin into the salivary glands of the head may block hypersecretion of saliva by inhibiting acetylcholine release from nerve endings in the salivary glands. Botulinum toxin injections to treat Siallorhea as a result of Parkinson's disease may relax neuromuscular conditions and improve voluntary control over swallowing. Improvements may be noticed within 1 week of an injection and last for about 3 months. Repeated injections may necessarily for continued treatment.

**[000902]** Rhinorrhea is a condition where the nasal cavity is significantly filled with mucous fluid. Rhinorrhea frequently occurs as a common symptom of conditions such as, but not limited to, allergies, colds and hay fever. Topical application of botulinum toxin may act as a cholinergic blocking agent to treat Rhinorrhea, and may significantly reduce neurally induced rhinorrhea. Injections of botulinum toxin into the ganglion muscles may be a treatment option to reduce cholinergically induced rhinorrhea.

**[000903]** Cervical dystonia is a chronic neurological movement disorder that causes the neck to involuntarily turn to the left, right, upwards, and/or downwards. Both agonist and antagonist muscles contract simultaneously during cervical dystonia movements, resulting in involuntary movements. Most subjects first experience symptoms of cervical dystonia midlife. Cervical dystonia may be an inherited or acquired condition from exposure to various toxins and/or other diseases. Injections of botulinum toxin may be used to treat cervical dystonia by disabling the movement of antagonist muscles while the agonist muscles are allowed to move freely, resulting in relief from involuntary neck movements. Botulinum toxin injections may provide relief for about 3 to 4 months

before repeat injections may be desired. Some preparations of botulinum toxin are approved by the FDA for clinical use in the United States for treating cervical dystonia.

[000904] Focal dystonia is a neurological condition which affects a muscle or group of muscles in a part of the body and causing an involuntary muscular contraction or twisting. Focal hand dystonia, for instance, results in fingers that either curl into the palm or extend outward without control. Injection of Botulinum toxin results in paralysis of striated muscle groups, which may treat involuntary muscle contractions in focal dystonia. The effects from treatment of botulinum toxin usually will be apparent about 2 weeks after injection and last for about 3 months before repeat injection may be desired.

[000905] Temporomandibular joint disorder is an umbrella term covering acute or chronic pain in the muscles of mastication and/or inflammation of the temporomandibular joint, which connect the mandible to the skull. Damage to the rotation or hinged action of the jawbone or the gliding actions of the mouth to open wide, for example, may be a cause of temporomandibular joint disorder. Temporomandibular joint disorder may result in significant pain combined with impairment of function. Symptoms of temporomandibular joint disorder may include, but are not limited to, difficulty biting and/or chewing, clicking, popping or grating sounds when opening and/or closing the mouth, dull aching pain in the face, earache, headache, and/or reduced ability to open and close the mouth. Injection of botulinum toxin to the orofacial musculature may result in weakening of hyperactive muscles that may cause temporomandibular joint disorder pain, and may also relieve head and neck pain resulting from temporomandibular joint disorder. Injections of botulinum toxin may need to be repeated about every 3 months to maintain relief of the symptoms.

[000906] Blepharospasms are spasms of the muscle of the eyelids, causing the eyes to shut tightly, which is often denoted by spasmodic winking. Injection of Botulinum toxin weakens the muscles of the eyelids by blocking nerve impulses transmitted from the nerve endings of the muscles. For example, botulinum toxin may be injected intramuscularly into several sites above and/or below the eyes with a fine needle. Typically, results are seen about 1 to 14 days after the injection of botulinum toxin to treat blepharospasms and last for about 3 to 4 months.

[000907] Strabismus is a condition in which the eyes are not properly aligned with each other. Strabismus typically involves a lack of coordination between the extraocular muscles, which prevents bringing the gaze of each eye to the same point in space and preventing binocular vision, which may adversely affect depth perception. Strabismus may be a disorder of the brain in coordinating the eyes, or a disorder of relevant muscles' direction of motion. Botulinum toxin may be used to treat strabismus through injection into the extraocular muscles, temporarily preventing muscle contractions around the eye for several months, allowing for the opposing muscle to change the eye's position and potentially provide an improved eye alignment. Botulinum toxin may also be used in conjunction with surgery as an effective treatment for strabismus.

[000908] Hemifacial spasm is an involuntary twitching or contraction of facial muscles on one side of the face. Hemifacial spasm may be caused by an injury to a facial nerve and/or a condition such as, but not limited to, a tumor or blood vessel compressing the nerve, or Bell's palsy. Hemifacial spasms affect about 8 out of every 100,000 people in the United States, with an average age of onset of around 44 years. Injection of botulinum toxin into facial muscles may block the release of acetylcholine into the muscles and may also prevent muscle contraction thereby preventing the involuntary twitching associated with hemifacial spasms. Typically 1 to 3 injections of botulinum toxin may be used to treat hemifacial spasms, with effects seen around 3 days and last for about 3 months before repeated injections may be necessary.

[000909] Vocal cord dysfunction is a condition characterized by an abnormal adduction of the vocal cords during a respiratory cycle that produces airflow obstruction at the level of the larynx. Vocal cord dysfunction may be triggered suddenly or gradually and may be caused by conditions such as, but not limited to, gastroesophageal reflux disease, extra-esophageal reflux, exposure to inhaled allergens, post nasal drip, exercise and/or neurological conditions. Symptoms of vocal cord dysfunction may include, but are not limited to, shortness of breath, wheezing, coughing, tightness in the throat, skin discoloration, and noise during inhalation. Injection of botulinum toxin into the larynx may result in paralysis of vocal cord muscles, making it impossible for the vocal cords to move during respiration and thereby relieving effects from vocal cord dysfunction.

Repeat injections of botulinum toxin may be required as the paralysis effect may wear off a few months after the injection.

[000910] Laryngeal dystonia is a voice disorder characterized by spasmodic contraction of laryngeal muscles, resulting in strained and strangle speech with break in rhythm. Laryngeal dysphonia may affect anyone, becomes most evident between the ages of 30 and 50, and is more prevalent in women than in men. Botulinum toxin injections of one or both of the voice box muscles may be an effective treatment to weaken the muscles that cause laryngeal dystonia. Injection dosages may depend on disease state and provide temporary relief from laryngeal dystonia for about 4 months.

[000911] Bulbar amyotrophic lateral sclerosis is a progressive neuromuscular weakening condition characterized by difficulty swallowing and chewing food, drooling, and facial tremors. Bulbar amyotrophic lateral sclerosis is the result of motor neurons that die and results in loss of muscle control by the brain nerves in the bulbar region of the brainstem, which control the throat, tongue, and jaw. Approximately 30,000 Americans have bulbar amyotrophic lateral sclerosis, which typically occurs midlife. Injection of botulinum toxin into an effected area may help relieve symptoms of bulbar amyotrophic lateral sclerosis by blocking acetylcholine release from nerve ending and treating one or more aspects of a condition. As a non-limiting example, injection of botulinum toxin into the parotid glands may be used to treat drooling conditions and/or Sialorrhea. Injection of botulinum toxin may result in a decrease in saliva production from the parotid glands providing temporary relief of bulbar amyotrophic lateral sclerosis symptoms for about 2 to 3 months.

[000912] Masseter muscle reduction is the reduction in the size of a thick rectangular muscle in the cheek that functions to close the jaw. Botulinum toxin injection of the Masseter muscle may be used for aesthetic purposes to relax the masseter muscle and reduce a prominent mandibular angle in the face, resulting from the thick rectangular Masseter muscle. 1 to 3 injections of Botulinum toxin at the inferior masseter border may be used for treatment. The maximum reduction of masseter muscle size may be seen in about 1 to 2 months after injection, and aesthetic results may continue for up to 12 months before further injections may be desired.

[000913] Epilepsy is a brain disorder in which a person has repeated seizures over time. Seizures are episodes of disturbed brain activity that cause changes in attention and/or behavior. Intracranial injection of botulinum toxin may help relieve epilepsy seizures by inhibiting acetylcholine release at nerve ending and blocking nerve signals from the brain which normally create an epileptic seizure.

[000914] Obsessive-compulsive disorder is an anxiety disorder in which people have unwanted and repeated thoughts, feelings, ideas, sensations or behaviors that cause repetitive behaviors, which may cause major distress or interfere with every day activity. Family history and chemical imbalances in the brain may contribute to obsessive-compulsive disorder, and chemical imbalances from the brain, possibly including secretion levels of serotonin, may contribute to obsessive-compulsive disorder. Injection of botulinum toxin to inhibit imbalanced chemical secretions, such as hypersecretion of serotonin, may result in improvements in the symptoms for chemically induced obsessive-compulsive disorders. Injection dosages and location may vary depending on the severity of obsessive-compulsive disorder in a patient.

*Treatment of Musculoskeletal Conditions of the Torso*

[000915] Musculoskeletal conditions, diseases and disorders are abnormal conditions of muscles and their associated ligaments, tendons, connective tissues and bones. Botulinum toxin may be used to treat musculoskeletal conditions of the torso, such as but not limited to, musculoskeletal condition, fibromyalgia, tremors, myoclonus, post stroke spasticity, juvenile cerebral palsy, smooth muscle spasms, arthritic pain, muscle contracture, muscle injury, writer's cramp, carpal tunnel syndrome, movement disorders, tics and tourette's syndrome. Botulinum toxin injection may be used to treat symptoms of musculoskeletal diseases, disorders and conditions by relaxing tense muscles, and inhibiting acetylcholine at nerve endings, thereby decreasing pain responses associated with musculoskeletal diseases, disorders and conditions.

[000916] Musculoskeletal conditions are pain that affects the muscles, ligaments and tendons, along with the bones. The causes of musculoskeletal conditions and pain may include, but are not limited to, wear and tear from daily activities, trauma to an area, auto accidents, falls, fractures, sprains, dislocations, direct blows to muscles, postural strain, repetitive movements, overuse and prolonged immobilization and disease related

conditions. Subjects with musculoskeletal pain may have symptoms of pain, fatigue and sleep disturbance. Botulinum toxin may be injected at the location of musculoskeletal pain to reduce muscle spasms. Temporary muscle paralysis, improved blood flow and release of fibers normally under compression with botulinum toxin treatment may result in significant pain relief of musculoskeletal pain.

[000917] Fibromyalgia is a common syndrome in which a person has long-term, body-wide pain and tenderness in the joints, muscles, tendons, and other soft tissues. Causes of fibromyalgia include, but are not limited to, fatigue, sleep problems, headaches, depression, and anxiety. Botulinum toxin, when injected in small quantities, may cause selective weakening and paralysis of muscles, thereby alleviating spasms and pain associated with fibromyalgia. Injection of botulinum toxin may take up to 3 weeks for relief to be noted, and injections may be repeated every 3 to 4 months if desired.

[000918] A tremor is an involuntary muscle contraction and relaxation involving to-and-fro movements of one or more body parts. Tremors are common involuntary movements, which may affect the hands, arms, eyes, face, head, vocal folds, trunk and legs and may be a symptom of a neurological disorder. Botulinum toxin injections may be used to treat tremors and may be particularly effective to treat tremors of the head and voice. Injection of botulinum toxin may affect muscle efferents and afferents and may alter sensory feedback to the central nervous system, thereby allowing control of involuntary muscle contractions, which may cause tremors.

[000919] Myoclonus is a brief, involuntary twitching of a muscle or a group of muscles that may be caused by rapid contraction and relaxation of the muscles and may be seen in children, adolescents, and adults. Myoclonus may develop in response to infection, head or spinal cord injury, stroke, stress, brain tumors, kidney or liver failure, lipid storage disease, chemical or drug poisoning, as a side effect of some drugs or other disorders. Injections of botulinum toxin may be used to treat myoclonus by inhibiting acetylcholine release at muscle junctions and preventing signals transmission, which result in involuntary muscle twitches in myoclonus.

[000920] Post stroke spasticity is a motor dysfunction arising from upper motor neuron lesions due to stroke. Post stroke spasticity often leaves subjects with recognizable antigravity postural patterns which may be characterized by shoulder

adduction, elbow and wrist flexion in the upper limb, hip adduction, knee extension and ankle plantar flexion in the lower limb, which is thought to result from increased motor neuron activity in the antigravity muscles. Injection of botulinum toxin in or around the site of post stroke spasticity may effectively reduce muscle spasms, thereby decreasing muscle tone and increasing range of motion in muscles. Dosages of botulinum toxin to treat post stroke spasticity may be generally adjusted according to factors such as the severity of spasticity, number of muscles involved, age, and number of prior botulinum toxin treatments, for optimal treatment effects.

**[000921]** Juvenile cerebral palsy is a group of non-progressive, non-contagious motor conditions that cause physical disability in juvenile development, particularly in areas of body movement. Resulting limits in movement and posture are often accompanied by disturbances of sensation, depth perception, other sight-based perceptual problems, communication problems and impairment in juvenile cognition. Juveniles with cerebral palsy often have spastic muscles in or around the foot and tight muscles in the thighs. Injections of botulinum toxin in juveniles with cerebral palsy may result in relaxation of spastic muscles and relaxation of thigh muscles, making it comfortable for a juvenile patient to walk and/or sit. In some countries botulinum toxin has been approved for treatment of some cerebral palsy conditions in juveniles.

**[000922]** Smooth muscle spasms are a sudden involuntary contraction of a muscle or group of muscles which often results in moderate to severe pain. Smooth muscles are typically found in hollow organs including the stomach, intestines, blood vessels and the bladder. Injection of botulinum toxin to spasmic smooth muscles may help loosen and relax the muscle and prevent pain to a patient. Injection of botulinum toxin to smooth muscles may take effect within three days from the date of injection and last for about three months before repeat injections may be desired.

**[000923]** Arthritic pain is inflammation of a joint usually accompanied by pain, swelling and stiffness, resulting in infection, trauma, degenerative changes, metabolic disturbances, aging and other causes. Common forms of arthritic pain are osteoarthritis and rheumatoid arthritis, with indications including pain or swelling of a joint. Injection of botulinum toxin at a specific muscle may result in blocking contraction of muscles at the area of injection, which may result in decreased pain in arthritic joints and an increase

in the range of motion, previously hindered by arthritic swelling. Treatment with botulinum toxin may reduce arthritic pain by about 50%.

[000924] Muscle contracture is shortening of the muscles and tendons, resulting in reduced flexibility, which may occur as a result of paralysis, muscular atrophy, spinal cord injury and some forms of muscular dystrophy, as a non-limiting example. Muscles contain receptors called spindles that monitor tension from the spinal cord to maintain muscle length. Injury to the spinal cord increases excitability of neural circuits that control muscle tension. Spastic muscles resulting from spinal cord injury resist muscle tension changes by contracting and lead to muscle contracture or shortening of the muscles. Injection of botulinum toxin to treat muscle contracture may relieve spasticity in muscles by blocking motor nerves and motorneurons that innervate muscles.

[000925] Muscle injury is damage that occurs by overstretched muscles or tendons which are pulled or torn. Botulinum toxin may help restore muscles and relieve pain from muscle injury by blocking motor and neural signals in the back which create spasms, injury and pain. Dosages of botulinum toxin for muscle injury may vary greatly, depending on the size and location of a muscle injury.

[000926] Writer's cramps are cramps or spasms that affect certain muscles of the hand and/or fingers. Symptoms of writer's cramp include loss of precision muscle coordination, camping pain with sustained use and muscle pain. Injection of botulinum toxin may be an effective treatment for writer's cramp. Injections in the forearm muscles may weaken cramped or spasmic muscles of the hand and/or fingers and result in temporary relief for writer's cramp, which may last for about 3 months.

[000927] Carpel tunnel syndrome is an entrapment of the median nerve traveling through the canal on the palmar side of the wrist connecting the forearm to the middle compartment of the palm, the carpel tunnel, which results in pain and numbness. The carpel tunnel is a narrow passageway with nine flexor tendons passing through it, if one or more flexor tendons swell, the narrowing canal often results in the median nerve becoming entrapped or compressed, resulting in pain. Injection of botulinum toxin into the carpel tunnel may relieve weakness and pain resulting from the compressed nerve in the tunnel, possibly by blocking the nerve signal, and be an effective treatment for about 3 months before further injections may be desired.



[000928] Movement disorders are a group of diseases and syndromes affecting the ability to produce and control movement. Examples of movement disorders include, but are not limited to, Parkinson's disease, Huntington's disease, Wilson's disease, tourette syndrome, dystonia, tic disorders, and restless leg syndrome. Movement is controlled through interaction of the brain centers, muscle reflexes, and neuronal signaling processes, injury or damage at any interaction point may cause a movement disorder. Treatment of movement disorders is disease specific, however, injection of Botulinum toxin may be a treatment for many movement disorders by inhibiting the release of neurotransmitters that cause muscle contraction. Treatment will typically last between about 3 to 4 months before repeated injections may be desired.

[000929] A tic is a condition in which a part of the body moves repeatedly, quickly, suddenly and uncontrollably. Tics can occur in any body part, such as the face, shoulders, hands or legs and can occur in children, adolescents and adults. Most tics are mild and hardly noticeable, however sometimes they may be chronic and do not go away.

Injection of botulinum toxin to muscles with tic syndrome may weaken the muscle and relieve tic symptoms for about 3 to 12 months, before repeated injections may be desired.

[000930] Tourette's syndrome is an inherited neurological disorder with onset in childhood, typically characterized by multiple physical tics and some vocal tics. Genetic and environmental factors play a role in the etiology of tourette's syndrome, though the exact causes are unknown. Injection of botulinum toxin around motor tics may treat tics associated with tourette syndrome by blocking acetylcholine at nerve ending and suppressing neuronal signals that may create Tourette syndrome related tics. Injection sites may be patient specific depending on the tic location and require repeat injection within 2 to 3 months.

[000931] *Treatment of Organ Conditions*

[000932] Organs, such as the heart, bladder, pancreas, sex organs and thyroid may have conditions resulting from inflammation, muscle hyperactivity, or neuronal misfiring, creating discomfort and sometimes life-threatening illnesses for a patient. Botulinum toxin may be used to treat organ conditions such as but not limited to, thyroid disorder, pancreatitis, tachycardia, urinary retention, urinary incontinence, overactive bladder, detrusor-sphincter dyssnergia, idiopathic and neurogenic detrusor overactivity,

vaginismus, prostatic enlargement, proctitis, benign prostatic hyperplasia, and autonomic hypersecretory disorders. Relief of organ conditions by injection of botulinum toxin may help ease pain and prevent recurrence of organ conditions through inhibition of acetylcholine release at neuromuscular junctures.

**[000933]** Thyroid disorder is a medical condition with impaired functioning of the thyroid, typically occurring as an overactive thyroid, hyperthyroidism, or an underactive thyroid, hypothyroidism. Imbalance in production of thyroid hormones arises from dysfunction of the thyroid gland, of the pituitary gland or of the hypothalamus. Botulinum toxin may be administered to a thyroid and reduce the effect of thyroid hormone on the thyroid. Injection, for instance, of botulinum toxin to the sympathetic ganglion that innervates the thyroid, may reduce the stimulatory effect of thyroid hormone secretion on the thyroid. Repeat injections of botulinum toxin to treat thyroid disorder may be desired about every 3 months.

**[000934]** Pancreatitis is a condition that occurs from inflammation of the pancreas. The pancreas is a gland located behind the stomach, which releases the hormones, insulin and glucagon, as well as digestive enzymes that aid in digestion and absorption of food. Botulinum toxin endoscopic injection into the pancreas may be an effective treatment for pancreatitis. Endoscopic injection of botulinum toxin into patients with recurrent pancreatitis may result in short-term relief for about 9 to 10 months and may also be used to determine if patients will benefit from other forms of endoscopic surgery such as pancreatic sphincter removal.

**[000935]** Tachycardia typically refers to a heart rate that exceeds the normal range of a resting heart rate, which may be dangerous depending on the speed and rhythm. Intraperitoneal or intracardiac injection of botulinum toxin to heart muscles may help control tachycardia conditions by temporarily managing muscle contractile activity.

**[000936]** Urinary retention is a condition that causes urine to remain in the bladder even after urination. While anyone may experience urinary retention, it is most common in men in their 50's and 60's, which may be the result of progressive obstruction of the urethra by an enlarging prostate. In some cases, even with the sensation of a full bladder, urination may be impossible, causing discomfort and possible infection. Injection of

botulinum toxin in the bladder may help relieve pain associated with muscle spasms found in patients with urinary retention.

[000937] Urinary incontinence is the unintentional loss of urine sufficient enough in frequency to cause physical and/or emotional discomfort. About 13 million Americans suffer from urinary incontinence, which may be caused by conditions including but not limited to: weakening of pelvic muscles during childbirth, hysterectomy or gynecological surgery, bladder dysfunction, menopause, neurological condition, and obesity. Injections of botulinum toxin to the urinary bladder may lead to relaxation of the bladder muscles and increase the bladders storage capacity, thereby decreasing urinary incontinence. The FDA has approved the use of botulinum toxin type A to treat urinary incontinence in people with some neurological conditions, such as spinal cord injury and multiple sclerosis, in which urinary incontinence may be a significant problem.

[000938] Overactive bladder is the strong, sudden need to urinate due to bladder spasms or contractions. Overactive bladders may result in leakage of urine because the bladder muscles contract at the wrong times. Causes of overactive bladder may include but are not limited to: bladder cancer, bladder inflammation, bladder outlet obstruction, bladder stones, infection and nervous system disease. Intravesical injection of botulinum toxin may be used to treat neurogenic and idiopathic overactive bladder in adults. To treat overactive bladder, 15 to 20 injections of botulinum toxin may be required, which may affect some of the nerves controlling the bladder, thereby providing an increased ability of a subject to squeeze the bladder to urinate when desired and less of a likelihood of the bladder squeezing when it should not.

[000939] Detrusor-sphincter dyssynergia is a condition in which there is a lack of coordination between the bladder and the external sphincter muscle, which creates a build-up of urinary pressure. Detrusor-sphincter dyssynergia may be caused by lesions between the brain stem and the lower part of the spinal cord, which results in damage to the nervous system. Botulinum toxin treatment into the external urethral sphincter may be an effective therapy for neurogenic disorders and bladder malfunction due to detrusor-sphincter dyssynergia. Dosages required for injection may vary depending on the severity of injury, with results that may range from about 2 months to 12 months.

**[000940]** Idiopathic and neurogenic detrusor overactivity is involuntary detrusor muscle contractions during the filling phase of the bladder, which may be spontaneous or provoked, and lead to involuntary bladder emptying. Idiopathic and neurogenic detrusor overactivity may lead to urinary incontinence or complete bladder emptying. Injection of botulinum toxin to the detrusor muscle of the bladder may result in weakening of the detrusor muscle and inhibit overactive contractions that push on and fill the bladder. Botulinum toxin treatment may result in less detrusor muscle pressure on the bladder and an increase in bladder compliance in cases where the baseline bladder compliance was abnormal prior to treatment. Treatments with Botulinum toxin for idiopathic and neurogenic detrusor activity may last for about 6 to 9 months.

**[000941]** Vaginismus is a condition that affects a women's ability to engage in any form of vaginal penetration. Vaginismus occurs as the result of a reflex by the pubococcygeus muscle that causes the vagina to tense suddenly, making vaginal penetration painful or impossible. Injection of botulinum toxin intravaginally may be an effective treatment of Vaginismus, to effectively paralyze the muscle causing intense muscle pain by blocking acetylcholine release in the innervated muscles and paralyzing nerve impulses. Tests to determine the areas of maximum reflex and resulting pain may be conducted prior to injection, for optimal treatment efficiency.

**[000942]** Prostatic enlargement is common as a man ages, as the prostate enlarges, the layer of tissue surrounding the prostate stops the prostate from expanding, causing the gland to press against the urethra like a clamp on a garden hose. The bladder wall becomes thicker and irritable. Intraprostatic injection of botulinum toxin may relax prostate muscles and reduce prostate volume for a period of up to about 18 months, wherein significant symptomatic improvement may be shown after treatment.

**[000943]** Prostatitis is an inflammation of the prostate gland, a common condition in adult males. Prostatitis is often caused by infection and may develop rapidly or slowly. Difficulties in urinating and pain from swelling may be symptoms of prosatitis. Injections of botulinum toxin to the prostate may be used to treat prostatitis. The inhibitory effect of botulinum toxin on motor end plates may result in prostate muscle relaxation, which may decrease inflammation and pain associated with prostatitis for a period of about 3 months, before repeat injections may be required.

[000944] Benign prostatic hyperplasia is an increase in size of the prostate, resulting from hyperplasia of prostatic cells, which form large discrete nodules in the prostate. These nodules may compress the urethral canal and cause partial or complete obstruction of the urethra, which interferes with the normal flow of urine. Symptoms such as urinary hesitancy, frequent urination, painful urination, urinary tract infection and urinary retention may be seen. Injection of botulinum toxin to the bladder may weaken tight muscles and block nerve signals, which may help improve urine flow and decrease residual urine left in the bladder in benign prostatic hyperplasia. Treatment of botulinum toxin may be an effective treatment for benign prostatic hyperplasia for about 3 months to 12 months, before repeat injections may be required.

[000945] Autonomic hypersecretory disorders are excessive production of a bodily fluid involuntarily, often controlled by the central nervous system. Autonomic hypersecretory disorders may occur anywhere in the body, including, but not limited to, excessive tears from tear glands, excessive sweating from sweat glands, and excessive gastric acid in the stomach. Injection of botulinum toxin at the site of a hypersecretory disorder may result in a decrease in hypersecretory activity by blocking acetylcholine release at nerve endings, which may be signaling the central nervous system to secrete excessively. Botulinum toxin has been shown to be an effective treatment for hypersecretory disorders, with improved symptoms typically lasting for about 3 months before repeat injections are required.

*Treatment of Gastrointestinal Conditions*

[000946] Gastrointestinal disorders are all diseases that pertain to the gastrointestinal tract including but not limited to disorders of the esophagus, stomach, first, second, and third part of the duodenum, jejunum, ileum, the ileo-cecal complex, large intestine (ascending, transverse, and descending colon), sigmoid colon, and rectum. Botulinum toxin may be an effective treatment for gastrointestinal disorders, such as but not limited to chronic anal fissure and peritoneal adhesion, as a potent neuromuscular blocking agent that inhibits acetylcholine release at nerve endings, thereby altering muscle function.

[000947] Chronic anal fissure is a painful tear or split in the distal anal canal, which persists for about 6 weeks. Botulinum toxin may be injected directly into the internal anal sphincter, which may inhibit the sphincter muscle from contraction for about a 3

month period, until the nerve ending regenerate. The 3 month period may allow fissures to heal and symptoms of chronic anal fissure to resolve. Repeated injections of Botulinum toxin may be made for a prolonged inhibitory effect on the sphincter, or may be followed by a sphincterotomy surgery.

[000948] Peritoneal adhesion is part of the healing process from inflammation of the peritoneum, the thin tissue that lines the inner wall of the abdomen and covers most of the abdominal organs. Peritoneal adhesions may, by contraction, cause partial obstruction of the intestine and chronic or intermittent pain. Injection of botulinum toxin in or around the site of a peritoneal adhesion may relax muscles and reduce muscle tension in the peritoneal adhesion, resulting in decreased pain and improved peritoneal healing.

*Treatment of Blood Conditions*

[000949] Botulinum toxin may be used to treat several blood conditions and blood vessel conditions, such as, but not limited to: diabetes, diabetes neuropathy, hypercalcaemia, restonosis, Raynaud's syndrome, and vasospasms. Injection of botulinum toxin may inhibit acetylcholine at nerve ending in the location of an injection, thereby effecting both nerve and muscle responses to the inhibited nerve endings, which may result in effective treatment for blood condition.

[000950] Diabetes is a group of metabolic diseases in which a person has high blood sugar because his/her body does not produce enough insulin or because cells are not responding to insulin that is produced. Symptoms of diabetes may include but are not limited to: frequent urination, increased hunger and increased thirst. Diabetic neuropathy is damage to nerves in the body that occurs due to high blood sugar levels from diabetes. About 50% of the people with diabetes will develop nerve damage, which is more likely to develop if blood sugar levels are not well controlled. Diabetic neuropathy nerve damage may affect any part of the body and are important for managing major vital organs including the heart, bladder, stomach and intestines. Injection of Botulinum toxin may have an inhibitory effect on biochemical mediators of neuropathic pain by modulating afferent sensory fiber firing, and may be used to treat nerve pain which is associated with diabetes.

[000951] Hypercalcaemia is an elevated calcium level in the blood, which may be due to excessive skeletal calcium release, increased intestinal calcium absorption,

overactivity of parathyroid glands or decreased renal calcium excretion. Symptoms of hypercalcaemia may include but are not limited to nausea, fatigue and muscle weakness. Injection of botulinum toxin to an overactive parathyroid gland may inhibit neural activity of the gland and result in reduction of hypercalcaemia induced from overactive parathyroid glands.

**[000952]** Restenosis is the reoccurrence of stenosis, the narrowing of blood vessels, which leads to restricted blood flow. Restenosis typically pertains to an artery or other large blood vessel that has become narrowed, leading to restricted blood flow. Injection of botulinum toxin to vessels may reduce or eliminate blood vessel damage by expanding the inner diameter of the blood vessel and thereby treating restenosis. Botulinum toxin may dilate blood vessels when injected into blood vessels and be useful following a cardiovascular procedure, where narrowing of blood vessels may occur.

**[000953]** Raynaud's syndrome is a vasospastic disorder causing discoloration of the fingers, toes and occasionally other areas, which may result in pain and discoloration. Raynaud's is believed to be the result of vasospasms that decrease blood supply to the regions of the body. People in their 30's are most likely to develop Raynaud's syndrome, with the occurrence in women more prevalent than in men. Injection of botulinum toxin at the site of Raynaud's syndrome, for instance at the metacarpophalangeal joint in the hands to treat Raynaud's syndrome in the fingers, may impact nerves carrying pain signals and result in significant decrease in pain associated with Raynaud's syndrome. In addition ulcers and other skin conditions associated with Raynaud's syndrome may be effectively reduced with botulinum toxin treatment.

**[000954]** Vasospasms refer to a condition in which blood vessel spasms lead to vessel vasoconstriction, which may result in death. Endothelial cells normally induce relaxation of the smooth muscle cells, however aggregating platelets may induce contraction of smooth muscle cells which may outweigh normally induced relaxation of cells, thereby causing vasospasms and vessel vasoconstriction. Injection of botulinum toxin may reduce pain that occurs after a vasospasm has occurred, by direct injection into the head area. Botulinum toxin may also be used as a pretreatment when conditions for vasoconstriction are known, as treatment with botulinum toxin may maintain normal

vessel diameters from constriction, possibly by inducing relaxation of smooth muscles surrounding vessel walls.

*Fungal Diseases, Disorders and Conditions*

[000955] The the cosmetic polynucleotides, cosmetic primary constructs and/or cosmetic mmRNA may be used in the treatment, amelioration or prophylaxis of the diseases, disorders and/or conditions caused by fungus. Fungal infections of the ingumentary system are common and include diseases, disorders and/or conditions such as, but not limited to athlete's foot, jock itch, ringworm of the body and/or scalp, bastomycosis, yeast infections, thrush, dandruff, seborrhoeic dermatitis, tinea versicolor, folliculitis, pityriasis versicolor, atopic dermatitis, psoriasis, confluent and reticulated papillomatosis, onychomycosis, and transient acantholytic dermatosis.

*Athlete 's Foot*

[000956] In one embodiment, the cosmetic polynucleotides, cosmetic primary constructs and/or cosmetic mmRNA may be used in the treatment, amelioration or prophylaxis of athlete's foot. Athlete's foot, or tinea pedis, is a fungal infection of the foot which causes peeling, redness, itching, burning, and sometimes blisters and sores. Athlete's foot is caused by a microscopic fungus that lives on dead tissue of the hair, toenails, and outer skin layers. There are at least four kinds of fungus that can cause athlete's foot the most common of which is trichophyton rubrum. Athlete's foot is usually treated with topical formulations, but in severe cases it may be treated using oral formulations.

[000957] There are three types of athlete's foot. The most common type is interdigital, also called toe web infection, and usually occurs between the two smallest toes. Common symptoms of this type of athlete's foot are itching, burning, and scaling and the infection can spread to the sole of the foot. Moccasin-type infection of athlete's foot can begin with a minor irritation, dryness, itching, or scaly skin which may involve the entire sole of the foot and extend onto the sides of the foot. The least common type of athlete's foot is vesicular. Usually the condition begins with a sudden outbreak of fluid-filled blisters under the skin, most often on the underside of the foot.

*Jock Itch*



[000958] In one embodiment, the cosmetic polynucleotides, cosmetic primary constructs and/or cosmetic mmRNA may be used in the treatment, amelioration or prophylaxis of jock itch. Jock itch, or tinea cruris, is a common skin infection that is caused by a type of fungus called tinea. Jock itch appears as a red, itchy rash that is often ring-shaped in warm, moist areas of the body. Jock itch is usually treated with topical formulations such as creams and/or sprays.

Ringworm of the Body

[000959] In one embodiment, the cosmetic polynucleotides, cosmetic primary constructs and/or cosmetic mmRNA may be used in the treatment, amelioration or prophylaxis of ringworm of the body. Ringworm of the body, or tinea corpora, is a fungal infection of the skin that looks like a circular, red, flat sore and may be accompanied by scaly skin. There are many types of ringworm of the body including, but not limited to, facial ringworm or tinea faciei, blackdot ringworm or tinea capitis, ringworm of the hands or tinea manuum, ringworm of the nail, and onychomycosis, or tinea unguium. Ringworm of the body is commonly treated with topical formulations and severe cases may be treated with oral formulations.

Blastomycosis

[000960] In one embodiment, the cosmetic polynucleotides, cosmetic primary constructs and/or cosmetic mmRNA may be used in the treatment, amelioration or prophylaxis of blastomycosis. Blastomycosis is caused by the fungus *Blastomyces dermatitidis* which grows in soil as a mold producing conidia that infects human subjects through the air. This fungus grows as a budding yeast in human tissues and may also include symptoms common with mild respiratory infections.

Ringworm of the Scalp

[000961] In one embodiment, the cosmetic polynucleotides, cosmetic primary constructs and/or cosmetic mmRNA may be used in the treatment, amelioration or prophylaxis of ringworm of the scalp. Ringworm of the scalp, or tinea capitis, is an infection of the scalp which is often seen in school children which is primarily caused by dermatophytes in the *Trichophyton* and *Microsporum* genera that invade the hair shaft. Ringworm of the scalp is commonly treated with oral formulations.

Yeast Infection

[000962] In one embodiment, the cosmetic polynucleotides, cosmetic primary constructs and/or cosmetic mmRNA may be used in the treatment, amelioration or prophylaxis of yeast infections. Yeast infections of the skin, or cutaneous candidiasis, are caused by yeast-like fungi called *Candida*. These infections occur when the yeast on the skin grow more actively and causes a red, scaling, itchy rash on the skin. *Candida* may also cause diaper rash in infants and cause infection of the nail. Treatment of yeast infection includes topical formulations, solutions and oral formulations.

#### Thrush

[000963] In one embodiment, the cosmetic polynucleotides, cosmetic primary constructs and/or cosmetic mmRNA may be used in the treatment, amelioration or prophylaxis of thrush. Thrush is an infection of the mouth cause by *Candida* often affecting babies, toddlers, older adults and people with weakened immune systems. Treatment of thrush includes the use of solutions and oral formulations.

#### Diseases, Disorders and Conditions related to *Malassezia* fungi

[000964] *Malassezia*, or *Pityrosporum*, is naturally found on the skin surface of many animals. There are numerous species of *malasserzia* fungus such as, but not limited to, *malasserzia furfur*, *malasserzia pachydermatis*, *malasserzia globosa*, *malasserzia restricta*, *malasserzia slooffiae*, *malasserzia sympodialis*, *malasserzia nana*, *malasserzia yamatoensis*, *malasserzia dermatis*, and *malasserzia obtuse*. Diseases, disorder and/or conditions caused by the *malassezia* fungus include, but are not limited to, dandruff, seborrhoeic dermatitis, tinea versicolor, folliculitis, pityriasis versicolor, atopic dermatitis, psoriasis, confluent and reticulated papillomatosis, onychomycosis, and transient acantholytic dermatosis. In one embodiment, the cosmetic polynucleotides, cosmetic primary constructs and/or cosmetic mmRNA may be used in the treatment, amelioration or prophylaxis of diseases, disorder and/or conditions caused by the *malassezia* fungus.

## VI. Kits and Devices

### Kits

[000965] The invention provides a variety of kits for conveniently and/or effectively carrying out methods of the present invention. Typically kits will comprise sufficient

amounts and/or numbers of components to allow a user to perform multiple treatments of a subject(s) and/or to perform multiple experiments.

[000966] In one aspect, the present invention provides kits comprising the molecules (polynucleotides, primary constructs or mmRNA) of the invention. In one embodiment, the kit comprises one or more functional antibodies or function fragments thereof.

[000967] Said kits can be for protein production, comprising a first polynucleotide, primary construct or mmRNA comprising a translatable region. The kit may further comprise packaging and instructions and/or a delivery agent to form a formulation composition. The delivery agent may comprise a saline, a buffered solution, a lipidoid or any delivery agent disclosed herein.

[000968] In one embodiment, the buffer solution may include sodium chloride, calcium chloride, phosphate and/or EDTA. In another embodiment, the buffer solution may include, but is not limited to, saline, saline with 2mM calcium, 5% sucrose, 5% sucrose with 2mM calcium, 5% Mannitol, 5% Mannitol with 2mM calcium, Ringer's lactate, sodium chloride, sodium chloride with 2mM calcium and mannose (See e.g., U.S. Pub. No. 20120258046; herein incorporated by reference in its entirety). In a further embodiment, the buffer solutions may be precipitated or it may be lyophilized. The amount of each component may be varied to enable consistent, reproducible higher concentration saline or simple buffer formulations. The components may also be varied in order to increase the stability of modified RNA in the buffer solution over a period of time and/or under a variety of conditions. In one aspect, the present invention provides kits for protein production, comprising: a polynucleotide, primary construct or mmRNA comprising a translatable region, provided in an amount effective to produce a desired amount of a protein encoded by the translatable region when introduced into a target cell; a second polynucleotide comprising an inhibitory nucleic acid, provided in an amount effective to substantially inhibit the innate immune response of the cell; and packaging and instructions.

[000969] In one aspect, the present invention provides kits for protein production, comprising a polynucleotide, primary construct or mmRNA comprising a translatable region, wherein the polynucleotide exhibits reduced degradation by a cellular nuclease, and packaging and instructions.

[000970] In one aspect, the present invention provides kits for protein production, comprising a polynucleotide, primary construct or mmRNA comprising a translatable region, wherein the polynucleotide exhibits reduced degradation by a cellular nuclease, and a mammalian cell suitable for translation of the translatable region of the first nucleic acid.

[000971] In one embodiment, the levels of Protein C may be measured by immunoassay. The assay may be purchased and is available from any number of suppliers including BioMerieux, Inc. (Durham, NC), Abbott Laboratories (Abbott Park, IL), Siemens Medical Solutions USA, Inc. (Malvern, PA), BIOPORTO® Diagnostics A/S (Gentofte, Denmark), USCN® Life Science Inc. (Houston, TX) or Roche Diagnostic Corporation (Indianapolis, IN). In this embodiment, the assay may be used to assess levels of Protein C or its activated form or a variant delivered as or in response to administration of a modified mRNA molecule.

#### Devices

[000972] The present invention provides for devices which may incorporate polynucleotides, primary constructs or mmRNA that encode polypeptides of interest. These devices contain in a stable formulation the reagents to synthesize a polynucleotide in a formulation available to be immediately delivered to a subject in need thereof, such as a human patient. Non-limiting examples of such a polypeptide of interest include a growth factor and/or angiogenesis stimulator for wound healing, a peptide antibiotic to facilitate infection control, and an antigen to rapidly stimulate an immune response to a newly identified virus.

[000973] Devices may also be used in conjunction with the present invention. In one embodiment, a device is used to assess levels of a protein which has been administered in the form of a modified mRNA. The device may comprise a blood, urine or other biofluidic test. It may be as large as to include an automated central lab platform or a small decentralized bench top device. It may be point of care or a handheld device. In this embodiment, for example, Protein C or APC may be quantitated before, during or after treatment with a modified mRNA encoding Protein C (its zymogen), APC or any variants thereof. Protein C, also known as autoprotease II and blood coagulation factor XIV is a zymogen, or precursor, of a serine protease which plays an important role in the

regulation of blood coagulation and generation of fibrinolytic activity in vivo. It is synthesized in the liver as a single-chain polypeptide but undergoes posttranslational processing to give rise to a two-chain intermediate. The intermediate form of Protein C is converted via thrombin-mediated cleavage of a 12-residue peptide from the amino-terminus of the heavy chain to of the molecule to the active form, known as "activated protein C" (APC). The device may be useful in drug discovery efforts as a companion diagnostic test associated with Protein C, or APC treatment such as for sepsis or severe sepsis. In early studies it was suggested that APC had the ability to reduce mortality in severe sepsis. Following this line of work, clinical studies lead to the FDA approval of one compound, activated drotrecogin alfa (recombinant protein C). However, in late 2011, the drug was withdrawn from sale in all markets following results of the PROWESS-SHOCK study, which showed the study did not meet the primary endpoint of a statistically significant reduction in 28-day all-cause mortality in patients with septic shock. The present invention provides modified mRNA molecules which may be used in the diagnosis and treatment of sepsis, severe sepsis and septicemia which overcome prior issues or problems associated with increasing protein expression efficiencies in mammals.

[000974] In some embodiments the device is self-contained, and is optionally capable of wireless remote access to obtain instructions for synthesis and/or analysis of the generated polynucleotide, primary construct or mmRNA. The device is capable of mobile synthesis of at least one polynucleotide, primary construct or mmRNA and preferably an unlimited number of different polynucleotides, primary constructs or mmRNA. In certain embodiments, the device is capable of being transported by one or a small number of individuals. In other embodiments, the device is scaled to fit on a benchtop or desk. In other embodiments, the device is scaled to fit into a suitcase, backpack or similarly sized object. In another embodiment, the device may be a point of care or handheld device. In further embodiments, the device is scaled to fit into a vehicle, such as a car, truck or ambulance, or a military vehicle such as a tank or personnel carrier. The information necessary to generate a modified mRNA encoding polypeptide of interest is present within a computer readable medium present in the device.

[000975] In one embodiment, a device may be used to assess levels of a protein which has been administered in the form of a polynucleotide, primary construct or mmRNA. The device may comprise a blood, urine or other biofluidic test.

[000976] In some embodiments, the device is capable of communication (e.g., wireless communication) with a database of nucleic acid and polypeptide sequences. The device contains at least one sample block for insertion of one or more sample vessels. Such sample vessels are capable of accepting in liquid or other form any number of materials such as template DNA, nucleotides, enzymes, buffers, and other reagents. The sample vessels are also capable of being heated and cooled by contact with the sample block. The sample block is generally in communication with a device base with one or more electronic control units for the at least one sample block. The sample block preferably contains a heating module, such heating molecule capable of heating and/or cooling the sample vessels and contents thereof to temperatures between about -20C and above +100C. The device base is in communication with a voltage supply such as a battery or external voltage supply. The device also contains means for storing and distributing the materials for RNA synthesis.

[000977] Optionally, the sample block contains a module for separating the synthesized nucleic acids. Alternatively, the device contains a separation module operably linked to the sample block. Preferably the device contains a means for analysis of the synthesized nucleic acid. Such analysis includes sequence identity (demonstrated such as by hybridization), absence of non-desired sequences, measurement of integrity of synthesized mRNA (such as by microfluidic viscometry combined with spectrophotometry), and concentration and/or potency of modified RNA (such as by spectrophotometry).

[000978] In certain embodiments, the device is combined with a means for detection of pathogens present in a biological material obtained from a subject, e.g., the IBIS PLEX-ID system (Abbott, Abbott Park, IL) for microbial identification.

[000979] Suitable devices for use in delivering intradermal pharmaceutical compositions described herein include short needle devices such as those described in U.S. Patents 4,886,499; 5,190,521; 5,328,483; 5,527,288; 4,270,537; 5,015,235; 5,141,496; and 5,417,662; each of which is herein incorporated by reference in their

entirety. Intradermal compositions may be administered by devices which limit the effective penetration length of a needle into the skin, such as those described in PCT publication WO 99/34850 (herein incorporated by reference in its entirety) and functional equivalents thereof. Jet injection devices which deliver liquid compositions to the dermis via a liquid jet injector and/or via a needle which pierces the stratum corneum and produces a jet which reaches the dermis are suitable. Jet injection devices are described, for example, in U.S. Patents 5,480,381; 5,599,302; 5,334,144; 5,993,412; 5,649,912; 5,569,189; 5,704,911; 5,383,851; 5,893,397; 5,466,220; 5,339,163; 5,312,335; 5,503,627; 5,064,413; 5,520,639; 4,596,556; 4,790,824; 4,941,880; 4,940,460; and PCT publications WO 97/37705 and WO 97/13537; each of which are herein incorporated by reference in their entirety. Ballistic powder/particle delivery devices which use compressed gas to accelerate vaccine in powder form through the outer layers of the skin to the dermis are suitable. Alternatively or additionally, conventional syringes may be used in the classical mantoux method of intradermal administration.

**[000980]** In some embodiments, the device may be a pump or comprise a catheter for administration of compounds or compositions of the invention across the blood brain barrier. Such devices include but are not limited to a pressurized olfactory delivery device, iontophoresis devices, multi-layered microfluidic devices, and the like. Such devices may be portable or stationary. They may be implantable or externally tethered to the body or combinations thereof.

**[000981]** Devices for administration may be employed to deliver the cosmetic polynucleotides, primary constructs or mmRNA of the present invention according to single, multi- or split-dosing regimens taught herein. Such devices are described below.

**[000982]** Method and devices known in the art for multi-administration to cells, organs and tissues are contemplated for use in conjunction with the methods and compositions disclosed herein as embodiments of the present invention. These include, for example, those methods and devices having multiple needles, hybrid devices employing for example lumens or catheters as well as devices utilizing heat, electric current or radiation driven mechanisms.

**[000983]** According to the present invention, these multi-administration devices may be utilized to deliver the single, multi- or split doses contemplated herein.

[000984] A method for delivering therapeutic agents to a solid tissue has been described by Bahrami et al. and is taught for example in US Patent Publication 201 10230839, the contents of which are incorporated herein by reference in their entirety. According to Bahrami, an array of needles is incorporated into a device which delivers a substantially equal amount of fluid at any location in said solid tissue along each needle's length.

[000985] A device for delivery of biological material across the biological tissue has been described by Kodgule et al. and is taught for example in US Patent Publication 201 10172610, the contents of which are incorporated herein by reference in their entirety. According to Kodgule, multiple hollow micro-needles made of one or more metals and having outer diameters from about 200 microns to about 350 microns and lengths of at least 100 microns are incorporated into the device which delivers peptides, proteins, carbohydrates, nucleic acid molecules, lipids and other pharmaceutically active ingredients or combinations thereof.

[000986] A delivery probe for delivering a therapeutic agent to a tissue has been described by Gunday et al. and is taught for example in US Patent Publication 201 10270184, the contents of each of which are incorporated herein by reference in their entirety. According to Gunday, multiple needles are incorporated into the device which moves the attached capsules between an activated position and an inactivated position to force the agent out of the capsules through the needles.

[000987] A multiple-injection medical apparatus has been described by Assaf and is taught for example in US Patent Publication 201 10218497, the contents of which are incorporated herein by reference in their entirety. According to Assaf, multiple needles are incorporated into the device which has a chamber connected to one or more of said needles and a means for continuously refilling the chamber with the medical fluid after each injection.

[000988] In one embodiment, the cosmetic polynucleotide, primary construct, or mmRNA is administered subcutaneously or intramuscularly via at least 3 needles to three different, optionally adjacent, sites simultaneously, or within a 60 minutes period (e.g., administration to 4, 5, 6, 7, 8, 9, or 10 sites simultaneously or within a 60 minute period). The split doses can be administered simultaneously to adjacent tissue using the devices



described in U.S. Patent Publication Nos. 201 10230839 and 201 10218497, each of which is incorporated herein by reference in their entirety.

**[000989]** An at least partially implantable system for injecting a substance into a patient's body, in particular a penis erection stimulation system has been described by Forsell and is taught for example in US Patent Publication 201 10196198, the contents of which are incorporated herein by reference in their entirety. According to Forsell, multiple needles are incorporated into the device which is implanted along with one or more housings adjacent the patient's left and right corpora cavernosa. A reservoir and a pump are also implanted to supply drugs through the needles.

**[000990]** A method for the transdermal delivery of a therapeutic effective amount of iron has been described by Berenson and is taught for example in US Patent Publication 20100130910, the contents of which are incorporated herein by reference in their entirety. According to Berenson, multiple needles may be used to create multiple micro channels in stratum corneum to enhance transdermal delivery of the ionic iron on an iontophoretic patch.

**[000991]** A method for delivery of biological material across the biological tissue has been described by Kodgule et al and is taught for example in US Patent Publication 201 10196308, the contents of which are incorporated herein by reference in their entirety. According to Kodgule, multiple biodegradable microneedles containing a therapeutic active ingredient are incorporated in a device which delivers proteins, carbohydrates, nucleic acid molecules, lipids and other pharmaceutically active ingredients or combinations thereof.

**[000992]** A transdermal patch comprising a botulinum toxin composition has been described by Donovan and is taught for example in US Patent Publication 20080220020, the contents of which are incorporated herein by reference in their entirety. According to Donovan, multiple needles are incorporated into the patch which delivers botulinum toxin under stratum corneum through said needles which project through the stratum corneum of the skin without rupturing a blood vessel.

**[000993]** A small, disposable drug reservoir, or patch pump, which can hold approximately 0.2 to 15 mL of liquid formulations can be placed on the skin and deliver the formulation continuously subcutaneously using a small bore needed (e.g., 26 to 34

gauge). As non-limiting examples, the patch pump may be 50 mm by 76 mm by 20 mm spring loaded having a 30 to 34 gauge needle (BD™ Microinfuser, Franklin Lakes NJ), 41 mm by 62 mm by 17 mm with a 2 mL reservoir used for drug delivery such as insulin (OMNIPOD®, Insulet Corporation Bedford, MA), or 43-60 mm diameter, 10 mm thick with a 0.5 to 10 mL reservoir (PATCHPUMP®, SteadyMed Therapeutics, San Francisco, CA). Further, the patch pump may be battery powered and/or rechargeable.

**[000994]** A cryoprobe for administration of an active agent to a location of cryogenic treatment has been described by Toubia and is taught for example in US Patent Publication 20080140061, the contents of which are incorporated herein by reference in their entirety. According to Toubia, multiple needles are incorporated into the probe which receives the active agent into a chamber and administers the agent to the tissue.

**[000995]** A method for treating or preventing inflammation or promoting healthy joints has been described by Stock et al and is taught for example in US Patent Publication 20090 155 186, the contents of which are incorporated herein by reference in their entirety. According to Stock, multiple needles are incorporated in a device which administers compositions containing signal transduction modulator compounds.

**[000996]** A multi-site injection system has been described by Kimmell et al. and is taught for example in US Patent Publication 20100256594, the contents of which are incorporated herein by reference in their entirety. According to Kimmell, multiple needles are incorporated into a device which delivers a medication into a stratum corneum through the needles.

**[000997]** A method for delivering interferons to the intradermal compartment has been described by Dekker et al. and is taught for example in US Patent Publication 20050181033, the contents of which are incorporated herein by reference in their entirety. According to Dekker, multiple needles having an outlet with an exposed height between 0 and 1 mm are incorporated into a device which improves pharmacokinetics and bioavailability by delivering the substance at a depth between 0.3 mm and 2 mm.

**[000998]** A method for delivering genes, enzymes and biological agents to tissue cells has described by Desai and is taught for example in US Patent Publication 20030073908, the contents of which are incorporated herein by reference in their entirety. According to

Desai, multiple needles are incorporated into a device which is inserted into a body and delivers a medication fluid through said needles.

**[000999]** A method for treating cardiac arrhythmias with fibroblast cells has been described by Lee et al and is taught for example in US Patent Publication 20040005295, the contents of which are incorporated herein by reference in their entirety. According to Lee, multiple needles are incorporated into the device which delivers fibroblast cells into the local region of the tissue.

**[0001000]** A method using a magnetically controlled pump for treating a brain tumor has been described by Shachar et al. and is taught for example in US Patent 7799012 (method) and 7799016 (device), the contents of which are incorporated herein by reference in their entirety. According Shachar, multiple needles were incorporated into the pump which pushes a medicating agent through the needles at a controlled rate.

**[0001001]** Methods of treating functional disorders of the bladder in mammalian females have been described by Versi et al. and are taught for example in US Patent 8,029,496, the contents of which are incorporated herein by reference in their entirety. According to Versi, an array of micro-needles is incorporated into a device which delivers a therapeutic agent through the needles directly into the trigone of the bladder.

**[0001002]** A micro-needle transdermal transport device has been described by Angel et al and is taught for example in US Patent 7,364,568, the contents of which are incorporated herein by reference in their entirety. According to Angel, multiple needles are incorporated into the device which transports a substance into a body surface through the needles which are inserted into the surface from different directions. The micro-needle transdermal transport device may be a solid micro-needle system or a hollow micro-needle system. As a non-limiting example, the solid micro-needle system may have up to a 0.5 mg capacity, with 300-1500 solid micro-needles per cm<sup>2</sup> about 150-700 µm tall coated with a drug. The micro-needles penetrate the stratum corneum and remain in the skin for short duration (e.g., 20 seconds to 15 minutes). In another example, the hollow micro-needle system has up to a 3 mL capacity to deliver liquid formulations using 15-20 microneedles per cm<sup>2</sup> being approximately 950 µm tall. The micro-needles penetrate the skin to allow the liquid formulations to flow from the device into the skin.

The hollow micro-needle system may be worn from 1 to 30 minutes depending on the formulation volume and viscosity.

**[0001003]** A device for subcutaneous infusion has been described by Dalton et al and is taught for example in US Patent 7,150,726, the contents of which are incorporated herein by reference in their entirety. According to Dalton, multiple needles are incorporated into the device which delivers fluid through the needles into a subcutaneous tissue.

**[0001004]** A device and a method for intradermal delivery of vaccines and gene therapeutic agents through microcannula have been described by Mikszta et al. and are taught for example in US Patent 7,473,247, the contents of which are incorporated herein by reference in their entirety. According to Mitszta, at least one hollow micro-needle is incorporated into the device which delivers the vaccines to the subject's skin to a depth of between 0.025 mm and 2 mm.

**[0001005]** A method of delivering insulin has been described by Pettis et al and is taught for example in US Patent 7,722,595, the contents of which are incorporated herein by reference in their entirety. According to Pettis, two needles are incorporated into a device wherein both needles insert essentially simultaneously into the skin with the first at a depth of less than 2.5 mm to deliver insulin to intradermal compartment and the second at a depth of greater than 2.5 mm and less than 5.0 mm to deliver insulin to subcutaneous compartment.

**[0001006]** Cutaneous injection delivery under suction has been described by Kochamba et al. and is taught for example in US Patent 6,896,666, the contents of which are incorporated herein by reference in their entirety. According to Kochamba, multiple needles in relative adjacency with each other are incorporated into a device which injects a fluid below the cutaneous layer.

**[0001007]** A device for withdrawing or delivering a substance through the skin has been described by Down et al and is taught for example in US Patent 6,607,513, the contents of which are incorporated herein by reference in their entirety. According to Down, multiple skin penetrating members which are incorporated into the device have lengths of about 100 microns to about 2000 microns and are about 30 to 50 gauge.

**[0001008]** A device for delivering a substance to the skin has been described by Palmer et al and is taught for example in US Patent 6,537,242, the contents of which are

incorporated herein by reference in their entirety. According to Palmer, an array of micro-needles is incorporated into the device which uses a stretching assembly to enhance the contact of the needles with the skin and provides a more uniform delivery of the substance.

**[0001009]** A perfusion device for localized drug delivery has been described by Zamoyski and is taught for example in US Patent 6,468,247, the contents of which are incorporated herein by reference in their entirety. According to Zamoyski, multiple hypodermic needles are incorporated into the device which injects the contents of the hypodermics into a tissue as said hypodermics are being retracted.

**[0001010]** A method for enhanced transport of drugs and biological molecules across tissue by improving the interaction between micro-needles and human skin has been described by Prausnitz et al. and is taught for example in US Patent 6,743,211, the contents of which are incorporated herein by reference in their entirety. According to Prausnitz, multiple micro-needles are incorporated into a device which is able to present a more rigid and less deformable surface to which the micro-needles are applied.

**[0001011]** A device for intraorgan administration of medicinal agents has been described by Ting et al and is taught for example in US Patent 6,077,251, the contents of which are incorporated herein by reference in their entirety. According to Ting, multiple needles having side openings for enhanced administration are incorporated into a device which by extending and retracting said needles from and into the needle chamber forces a medicinal agent from a reservoir into said needles and injects said medicinal agent into a target organ.

**[0001012]** A multiple needle holder and a subcutaneous multiple channel infusion port has been described by Brown and is taught for example in US Patent 4,695,273, the contents of which are incorporated herein by reference in their entirety. According to Brown, multiple needles on the needle holder are inserted through the septum of the infusion port and communicate with isolated chambers in said infusion port.

**[0001013]** A dual hypodermic syringe has been described by Horn and is taught for example in US Patent 3,552,394, the contents of which are incorporated herein by reference in their entirety. According to Horn, two needles incorporated into the device

are spaced apart less than 68 mm and may be of different styles and lengths, thus enabling injections to be made to different depths.

**[0001014]** A syringe with multiple needles and multiple fluid compartments has been described by Hershberg and is taught for example in US Patent 3,572,336, the contents of which are incorporated herein by reference in their entirety. According to Hershberg, multiple needles are incorporated into the syringe which has multiple fluid compartments and is capable of simultaneously administering incompatible drugs which are not able to be mixed for one injection.

**[0001015]** A surgical instrument for intradermal injection of fluids has been described by Eliscu et al. and is taught for example in US Patent 2,588,623, the contents of which are incorporated herein by reference in their entirety. According to Eliscu, multiple needles are incorporated into the instrument which injects fluids intradermally with a wider disperse.

**[0001016]** An apparatus for simultaneous delivery of a substance to multiple breast milk ducts has been described by Hung and is taught for example in EP 1818017, the contents of which are incorporated herein by reference in their entirety. According to Hung, multiple lumens are incorporated into the device which inserts through the orifices of the ductal networks and delivers a fluid to the ductal networks.

**[0001017]** A catheter for introduction of medications to the tissue of a heart or other organs has been described by Tkebuchava and is taught for example in WO2006138109, the contents of which are incorporated herein by reference in their entirety. According to Tkebuchava, two curved needles are incorporated which enter the organ wall in a flattened trajectory.

**[0001018]** Devices for delivering medical agents have been described by McKay et al. and are taught for example in WO2006118804, the content of which are incorporated herein by reference in their entirety. According to McKay, multiple needles with multiple orifices on each needle are incorporated into the devices to facilitate regional delivery to a tissue, such as the interior disc space of a spinal disc.

**[0001019]** A method for directly delivering an immunomodulatory substance into an intradermal space within a mammalian skin has been described by Pettis and is taught for example in WO2004020014, the contents of which are incorporated herein by reference

in their entirety. According to Pettis, multiple needles are incorporated into a device which delivers the substance through the needles to a depth between 0.3 mm and 2 mm.

[0001020] Methods and devices for administration of substances into at least two compartments in skin for systemic absorption and improved pharmacokinetics have been described by Pettis et al. and are taught for example in WO2003094995, the contents of which are incorporated herein by reference in their entirety. According to Pettis, multiple needles having lengths between about 300  $\mu\text{m}$  and about 5 mm are incorporated into a device which delivers to intradermal and subcutaneous tissue compartments simultaneously.

[0001021] A drug delivery device with needles and a roller has been described by Zimmerman et al. and is taught for example in WO2012006259, the contents of which are incorporated herein by reference in their entirety. According to Zimmerman, multiple hollow needles positioned in a roller are incorporated into the device which delivers the content in a reservoir through the needles as the roller rotates.

[0001022] A drug delivery device such as a stent is known in the art and is taught for example in U.S. Pat. No. 8,333,799, U.S. Pub. Nos. US20060020329, US20040172127 and US20100161032; the contents of each of which are herein incorporated by reference in their entirety. Formulations of the polynucleotides, primary constructs, mmRNA described herein may be delivered using stents. Additionally, stents used herein may be able to deliver multiple polynucleotides, primary constructs and/or mmRNA and/or formulations at the same or varied rates of delivery. Non-limiting examples of manufacturers of stents include CORDIS® (Miami, FL) (CYPHER®), Boston Scientific Corporation (Natick, MA) (TAXUS®), Medtronic (Minneapolis, MN) (ENDEAVOUR®) and Abbott (Abbott Park, IL) (XIENCE V®).

#### Methods and Devices utilizing catheters and/or lumens

[0001023] Methods and devices using catheters and lumens may be employed to administer the mmRNA of the present invention on a single, multi- or split dosing schedule. Such methods and devices are described below.

[0001024] A catheter-based delivery of skeletal myoblasts to the myocardium of damaged hearts has been described by Jacoby et al and is taught for example in US Patent Publication 20060263338, the contents of which are incorporated herein by reference in

their entirety. According to Jacoby, multiple needles are incorporated into the device at least part of which is inserted into a blood vessel and delivers the cell composition through the needles into the localized region of the subject's heart.

**[0001025]** An apparatus for treating asthma using neurotoxin has been described by Deem et al and is taught for example in US Patent Publication 20060225742, the contents of which are incorporated herein by reference in their entirety. According to Deem, multiple needles are incorporated into the device which delivers neurotoxin through the needles into the bronchial tissue.

**[0001026]** A method for administering multiple-component therapies has been described by Nayak and is taught for example in US Patent 7,699,803, the contents of which are incorporated herein by reference in their entirety. According to Nayak, multiple injection cannulas may be incorporated into a device wherein depth slots may be included for controlling the depth at which the therapeutic substance is delivered within the tissue.

**[0001027]** A surgical device for ablating a channel and delivering at least one therapeutic agent into a desired region of the tissue has been described by McIntyre et al and is taught for example in US Patent 8,012,096, the contents of which are incorporated herein by reference in their entirety. According to McIntyre, multiple needles are incorporated into the device which dispenses a therapeutic agent into a region of tissue surrounding the channel and is particularly well suited for transmyocardial revascularization operations.

**[0001028]** Methods of treating functional disorders of the bladder in mammalian females have been described by Versi et al and are taught for example in US Patent 8,029,496, the contents of which are incorporated herein by reference in their entirety. According to Versi, an array of micro-needles is incorporated into a device which delivers a therapeutic agent through the needles directly into the trigone of the bladder.

**[0001029]** A device and a method for delivering fluid into a flexible biological barrier have been described by Yeshurun et al. and are taught for example in US Patent 7,998,119 (device) and 8,007,466 (method), the contents of which are incorporated herein by reference in their entirety. According to Yeshurun, the micro-needles on the device penetrate and extend into the flexible biological barrier and fluid is injected through the bore of the hollow micro-needles.



**[0001030]** A method for epicardially injecting a substance into an area of tissue of a heart having an epicardial surface and disposed within a torso has been described by Bonner et al and is taught for example in US Patent 7,628,780, the contents of which are incorporated herein by reference in their entirety. According to Bonner, the devices have elongate shafts and distal injection heads for driving needles into tissue and injecting medical agents into the tissue through the needles.

**[0001031]** A device for sealing a puncture has been described by Nielsen et al and is taught for example in US Patent 7,972,358, the contents of which are incorporated herein by reference in their entirety. According to Nielsen, multiple needles are incorporated into the device which delivers a closure agent into the tissue surrounding the puncture tract.

**[0001032]** A method for myogenesis and angiogenesis has been described by Chiu et al. and is taught for example in US Patent 6,551,338, the contents of which are incorporated herein by reference in their entirety. According to Chiu, 5 to 15 needles having a maximum diameter of at least 1.25 mm and a length effective to provide a puncture depth of 6 to 20 mm are incorporated into a device which inserts into proximity with a myocardium and supplies an exogenous angiogenic or myogenic factor to said myocardium through the conduits which are in at least some of said needles.

**[0001033]** A method for the treatment of prostate tissue has been described by Bolmsj et al. and is taught for example in US Patent 6,524,270, the contents of which are incorporated herein by reference in their entirety. According to Bolmsj, a device comprising a catheter which is inserted through the urethra has at least one hollow tip extendible into the surrounding prostate tissue. An astringent and analgesic medicine is administered through said tip into said prostate tissue.

**[0001034]** A method for infusing fluids to an intraosseous site has been described by Findlay et al. and is taught for example in US Patent 6,761,726, the contents of which are incorporated herein by reference in their entirety. According to Findlay, multiple needles are incorporated into a device which is capable of penetrating a hard shell of material covered by a layer of soft material and delivers a fluid at a predetermined distance below said hard shell of material.

[0001035] A device for injecting medications into a vessel wall has been described by Vigil et al. and is taught for example in US Patent 5,713,863, the contents of which are incorporated herein by reference in their entirety. According to Vigil, multiple injectors are mounted on each of the flexible tubes in the device which introduces a medication fluid through a multi-lumen catheter, into said flexible tubes and out of said injectors for infusion into the vessel wall.

[0001036] A catheter for delivering therapeutic and/or diagnostic agents to the tissue surrounding a bodily passageway has been described by Faxon et al. and is taught for example in US Patent 5,464,395, the contents of which are incorporated herein by reference in their entirety. According to Faxon, at least one needle cannula is incorporated into the catheter which delivers the desired agents to the tissue through said needles which project outboard of the catheter.

[0001037] Balloon catheters for delivering therapeutic agents have been described by Orr and are taught for example in WO20 10024871, the contents of which are incorporated herein by reference in their entirety. According to Orr, multiple needles are incorporated into the devices which deliver the therapeutic agents to different depths within the tissue. In another aspect, drug-eluting balloons may be used to deliver the formulations described herein. The drug-eluting balloons may be used in target lesion applications such as, but are not limited to, in-stent restenosis, treating lesion in tortuous vessels, bifurcation lesions, femoral/popliteal lesions and below the knee lesions.

[0001038] A device for delivering therapeutic agents (e.g., cosmetic polynucleotides, primary constructs or mmRNA) to tissue disposed about a lumen has been described by Perry et al. and is taught for example in U.S. Pat. Pub. US20100125239, the contents of which are herein incorporated by reference in their entirety. According to Perry, the catheter has a balloon which may be coated with a therapeutic agent by methods known in the art and described in Perry. When the balloon expands, the therapeutic agent will contact the surrounding tissue. The device may additionally have a heat source to change the temperature of the coating on the balloon to release the therapeutic agent to the tissue.

Methods and Devices utilizing electrical current

[0001039] Methods and devices utilizing electric current may be employed to deliver the mmRNA of the present invention according to the single, multi- or split dosing regimens taught herein. Such methods and devices are described below.

[0001040] An electro collagen induction therapy device has been described by Marquez and is taught for example in US Patent Publication 20090137945, the contents of which are incorporated herein by reference in their entirety. According to Marquez, multiple needles are incorporated into the device which repeatedly pierce the skin and draw in the skin a portion of the substance which is applied to the skin first.

[0001041] An electrokinetic system has been described by Etheredge et al. and is taught for example in US Patent Publication 20070185432, the contents of which are incorporated herein by reference in their entirety. According to Etheredge, micro-needles are incorporated into a device which drives by an electrical current the medication through the needles into the targeted treatment site.

[0001042] An iontophoresis device has been described by Matsumura et al. and is taught for example in US Patent 7,437,189, the contents of which are incorporated herein by reference in their entirety. According to Matsumura, multiple needles are incorporated into the device which is capable of delivering ionizable drug into a living body at higher speed or with higher efficiency.

[0001043] Intradermal delivery of biologically active agents by needle-free injection and electroporation has been described by Hoffmann et al and is taught for example in US Patent 7,171,264, the contents of which are incorporated herein by reference in their entirety. According to Hoffmann, one or more needle-free injectors are incorporated into an electroporation device and the combination of needle-free injection and electroporation is sufficient to introduce the agent into cells in skin, muscle or mucosa.

[0001044] A method for electropermeabilization-mediated intracellular delivery has been described by Lundkvist et al. and is taught for example in US Patent 6,625,486, the contents of which are incorporated herein by reference in their entirety. According to Lundkvist, a pair of needle electrodes is incorporated into a catheter. Said catheter is positioned into a body lumen followed by extending said needle electrodes to penetrate into the tissue surrounding said lumen. Then the device introduces an agent through at least one of said needle electrodes and applies electric field by said pair of needle

electrodes to allow said agent pass through the cell membranes into the cells at the treatment site.

[0001045] A delivery system for transdermal immunization has been described by Levin et al. and is taught for example in WO2006003659, the contents of which are incorporated herein by reference in their entirety. According to Levin, multiple electrodes are incorporated into the device which applies electrical energy between the electrodes to generate micro channels in the skin to facilitate transdermal delivery.

[0001046] A method for delivering RF energy into skin has been described by Schomacker and is taught for example in WO201 1163264, the contents of which are incorporated herein by reference in their entirety. According to Schomacker, multiple needles are incorporated into a device which applies vacuum to draw skin into contact with a plate so that needles insert into skin through the holes on the plate and deliver RF energy.

## **VII. Definitions**

[0001047] At various places in the present specification, substituents of compounds of the present disclosure are disclosed in groups or in ranges. It is specifically intended that the present disclosure include each and every individual subcombination of the members of such groups and ranges. For example, the term "C<sub>1-6</sub> alkyl" is specifically intended to individually disclose methyl, ethyl, C<sub>3</sub> alkyl, C<sub>4</sub> alkyl, C<sub>5</sub> alkyl, and C<sub>6</sub> alkyl.

[0001048] *About*: As used herein, the term "about" means +/- 10% of the recited value.

[0001049] *Administered in combination*: As used herein, the term "administered in combination" or "combined administration" means that two or more agents are administered to a subject at the same time or within an interval such that there may be an overlap of an effect of each agent on the patient. In some embodiments, they are administered within about 60, 30, 15, 10, 5, or 1 minute of one another. In some embodiments, the administrations of the agents are spaced sufficiently closely together such that a combinatorial (*e.g.*, a synergistic) effect is achieved.

[0001050] *Aesthetic presentation*: As used herein, the phrase "aesthetic presentation" refers to an improved appearance relative to a previous appearance. For example, a change in aesthetic presentation may include the concealment of skin discoloration, scarring, and/or stretch marks.

**[0001051]** *Animal:* As used herein, the term "animal" refers to any member of the animal kingdom. In some embodiments, "animal" refers to humans at any stage of development. In some embodiments, "animal" refers to non-human animals at any stage of development. In certain embodiments, the non-human animal is a mammal (*e.g.*, a rodent, a mouse, a rat, a rabbit, a monkey, a dog, a cat, a sheep, cattle, a primate, or a pig). In some embodiments, animals include, but are not limited to, mammals, birds, reptiles, amphibians, fish, and worms. In some embodiments, the animal is a transgenic animal, genetically-engineered animal, or a clone.

**[0001052]** *Antigens of interest or desired antigens:* As used herein, the terms "antigens of interest" or "desired antigens" include those proteins and other biomolecules provided herein that are immunospecifically bound by the antibodies and fragments, mutants, variants, and alterations thereof described herein. Examples of antigens of interest include, but are not limited to, insulin, insulin-like growth factor, hGH, tPA, cytokines, such as interleukins (IL), *e.g.*, IL-1, IL-2, IL-3, IL-4, IL-5, IL-6, IL-7, IL-8, IL-9, IL-10, IL-11, IL-12, IL-13, IL-14, IL-15, IL-16, IL-17, IL-18, interferon (IFN) alpha, IFN beta, IFN gamma, IFN omega or IFN tau, tumor necrosis factor (TNF), such as TNF alpha and TNF beta, TNF gamma, TRAIL; G-CSF, GM-CSF, M-CSF, MCP-1 and VEGF.

**[0001053]** *Approximately:* As used herein, the term "approximately" or "about," as applied to one or more values of interest, refers to a value that is similar to a stated reference value. In certain embodiments, the term "approximately" or "about" refers to a range of values that fall within 25%, 20%, 19%, 18%, 17%, 16%, 15%, 14%, 13%, 12%, 11%, 10%, 9%, 8%, 7%, 6%, 5%, 4%, 3%, 2%, 1%, or less in either direction (greater than or less than) of the stated reference value unless otherwise stated or otherwise evident from the context (except where such number would exceed 100% of a possible value).

**[0001054]** *Associated with:* As used herein, the terms "associated with," "conjugated," "linked," "attached," and "tethered," when used with respect to two or more moieties, means that the moieties are physically associated or connected with one another, either directly or via one or more additional moieties that serves as a linking agent, to form a structure that is sufficiently stable so that the moieties remain physically associated under the conditions in which the structure is used, *e.g.*, physiological conditions. An

"association" need not be strictly through direct covalent chemical bonding. It may also suggest ionic or hydrogen bonding or a hybridization based connectivity sufficiently stable such that the "associated" entities remain physically associated.

**[0001055]** *Bifunctional*: As used herein, the term "bifunctional" refers to any substance, molecule or moiety which is capable of or maintains at least two functions. The functions may effect the same outcome or a different outcome. The structure that produces the function may be the same or different. For example, bifunctional modified RNAs of the present invention may encode a cytotoxic peptide (a first function) while those nucleosides which comprise the encoding RNA are, in and of themselves, cytotoxic (second function). In this example, delivery of the bifunctional modified RNA to a cancer cell would produce not only a peptide or protein molecule which may ameliorate or treat the cancer but would also deliver a cytotoxic payload of nucleosides to the cell should degradation, instead of translation of the modified RNA, occur.

**[0001056]** *Biocompatible*: As used herein, the term "biocompatible" means compatible with living cells, tissues, organs or systems posing little to no risk of injury, toxicity or rejection by the immune system.

**[0001057]** *Biodegradable*: As used herein, the term "biodegradable" means capable of being broken down into innocuous products by the action of living things.

**[0001058]** *Biologically active*: As used herein, the phrase "biologically active" refers to a characteristic of any substance that has activity in a biological system and/or organism. For instance, a substance that, when administered to an organism, has a biological effect on that organism, is considered to be biologically active. In particular embodiments, a cosmetic polynucleotide, cosmetic primary construct or cosmetic mmRNA of the present invention may be considered biologically active if even a portion of the cosmetic polynucleotide, cosmetic primary construct or cosmetic mmRNA is biologically active or mimics an activity considered biologically relevant.

**[0001059]** *Chemical terms*: The following provides the definition of various chemical terms from "acyl" to "thiol."

**[0001060]** The term "acyl," as used herein, represents a hydrogen or an alkyl group (e.g., a haloalkyl group), as defined herein, that is attached to the parent molecular group through a carbonyl group, as defined herein, and is exemplified by formyl (i.e., a

carboxyaldehyde group), acetyl, propionyl, butanoyl and the like. Exemplary unsubstituted acyl groups include from 1 to 7, from 1 to 11, or from 1 to 21 carbons. In some embodiments, the alkyl group is further substituted with 1, 2, 3, or 4 substituents as described herein.

**[0001061]** The term "acylamino," as used herein, represents an acyl group, as defined herein, attached to the parent molecular group through an amino group, as defined herein (i.e.,  $-N(R^{N1})-C(=O)-R$ , where R is H or an optionally substituted  $C_{1-6}$ ,  $C_{1-10}$ , or  $C_{1-20}$  alkyl group and  $R^{N1}$  is as defined herein). Exemplary unsubstituted acylamino groups include from 1 to 41 carbons (e.g., from 1 to 7, from 1 to 13, from 1 to 21, from 2 to 7, from 2 to 13, from 2 to 21, or from 2 to 41 carbons). In some embodiments, the alkyl group is further substituted with 1, 2, 3, or 4 substituents as described herein, and/or the amino group is  $-NH_2$  or  $-NHR^{N1}$ , wherein  $R^{N1}$  is, independently, OH,  $NO_2$ ,  $NH_2$ ,  $NR^{N2}_2$ ,  $SO_2OR^{N2}$ ,  $SO_2R^{N2}$ ,  $SOR^{N2}$ , alkyl, or aryl, and each  $R^{N2}$  can be H, alkyl, or aryl.

**[0001062]** The term "acyloxy," as used herein, represents an acyl group, as defined herein, attached to the parent molecular group through an oxygen atom (i.e.,  $-O-C(=O)-R$ , where R is H or an optionally substituted  $C_{1-6}$ ,  $C_{1-10}$ , or  $C_{1-20}$  alkyl group). Exemplary unsubstituted acyloxy groups include from 1 to 21 carbons (e.g., from 1 to 7 or from 1 to 11 carbons). In some embodiments, the alkyl group is further substituted with 1, 2, 3, or 4 substituents as described herein, and/or the amino group is  $-NH_2$  or  $-NHR^{N1}$ , wherein  $R^{N1}$  is, independently, OH,  $NO_2$ ,  $NH_2$ ,  $NR^{N2}_2$ ,  $SO_2OR^{N2}$ ,  $SO_2R^{N2}$ ,  $SOR^{N2}$ , alkyl, or aryl, and each  $R^{N2}$  can be H, alkyl, or aryl.

**[0001063]** The term "alkaryl," as used herein, represents an aryl group, as defined herein, attached to the parent molecular group through an alkylene group, as defined herein. Exemplary unsubstituted alkaryl groups are from 7 to 30 carbons (e.g., from 7 to 16 or from 7 to 20 carbons, such as  $C_{1-6}$  alk- $C_{6-10}$  aryl,  $C_{1-10}$  alk- $C_{6-10}$  aryl, or  $C_{1-20}$  alk- $C_{6-10}$  aryl). In some embodiments, the alkylene and the aryl each can be further substituted with 1, 2, 3, or 4 substituent groups as defined herein for the respective groups. Other groups preceded by the prefix "alk-" are defined in the same manner, where "alk" refers to a  $C_{1-6}$  alkylene, unless otherwise noted, and the attached chemical structure is as defined herein.

[0001064] The term "alkcycloalkyl" represents a cycloalkyl group, as defined herein, attached to the parent molecular group through an alkylene group, as defined herein (e.g., an alkylene group of from 1 to 4, from 1 to 6, from 1 to 10, or from 1 to 20 carbons). In some embodiments, the alkylene and the cycloalkyl each can be further substituted with 1, 2, 3, or 4 substituent groups as defined herein for the respective group.

[0001065] The term "alkenyl," as used herein, represents monovalent straight or branched chain groups of, unless otherwise specified, from 2 to 20 carbons (e.g., from 2 to 6 or from 2 to 10 carbons) containing one or more carbon-carbon double bonds and is exemplified by ethenyl, 1-propenyl, 2-propenyl, 2-methyl-1-propenyl, 1-butenyl, 2-butenyl, and the like. Alkenyls include both cis and trans isomers. Alkenyl groups may be optionally substituted with 1, 2, 3, or 4 substituent groups that are selected, independently, from amino, aryl, cycloalkyl, or heterocyclyl (e.g., heteroaryl), as defined herein, or any of the exemplary alkyl substituent groups described herein.

[0001066] The term "alkenyloxy" represents a chemical substituent of formula -OR, where R is a C<sub>2-20</sub> alkenyl group (e.g., C<sub>2-6</sub> or C<sub>2-10</sub> alkenyl), unless otherwise specified. Exemplary alkenyloxy groups include ethenyloxy, propenyloxy, and the like. In some embodiments, the alkenyl group can be further substituted with 1, 2, 3, or 4 substituent groups as defined herein (e.g., a hydroxy group).

[0001067] The term "alkheteroaryl" refers to a heteroaryl group, as defined herein, attached to the parent molecular group through an alkylene group, as defined herein. Exemplary unsubstituted alkheteroaryl groups are from 2 to 32 carbons (e.g., from 2 to 22, from 2 to 18, from 2 to 17, from 2 to 16, from 3 to 15, from 2 to 14, from 2 to 13, or from 2 to 12 carbons, such as C<sub>i-6</sub> alk-C<sub>1-12</sub> heteroaryl, C<sub>1-10</sub> alk-C<sub>1-12</sub> heteroaryl, or C<sub>1-20</sub> alk-C<sub>1-12</sub> heteroaryl). In some embodiments, the alkylene and the heteroaryl each can be further substituted with 1, 2, 3, or 4 substituent groups as defined herein for the respective group. Alkheteroaryl groups are a subset of alkheterocyclyl groups.

[0001068] The term "alkheterocyclyl" represents a heterocyclyl group, as defined herein, attached to the parent molecular group through an alkylene group, as defined herein. Exemplary unsubstituted alkheterocyclyl groups are from 2 to 32 carbons (e.g., from 2 to 22, from 2 to 18, from 2 to 17, from 2 to 16, from 3 to 15, from 2 to 14, from 2 to 13, or from 2 to 12 carbons, such as C<sub>i-6</sub> alk-C<sub>1-12</sub> heterocyclyl, C<sub>1-10</sub> alk-C<sub>i-12</sub> heterocyclyl, or



Ci<sub>20</sub> alk-C<sub>1-12</sub> heterocyclyl). In some embodiments, the alkylene and the heterocyclyl each can be further substituted with 1, 2, 3, or 4 substituent groups as defined herein for the respective group.

**[0001069]** The term "alkoxy" represents a chemical substituent of formula -OR, where R is a Ci<sub>20</sub> alkyl group (e.g., C<sub>1-6</sub> or C<sub>1-10</sub> alkyl), unless otherwise specified. Exemplary alkoxy groups include methoxy, ethoxy, propoxy (e.g., n-propoxy and isopropoxy), t-butoxy, and the like. In some embodiments, the alkyl group can be further substituted with 1, 2, 3, or 4 substituent groups as defined herein (e.g., hydroxy or alkoxy).

**[0001070]** The term "alkoxyalkoxy" represents an alkoxy group that is substituted with an alkoxy group. Exemplary unsubstituted alkoxyalkoxy groups include between 2 to 40 carbons (e.g., from 2 to 12 or from 2 to 20 carbons, such as C<sub>1-6</sub> alkoxy-Ci<sub>6</sub> alkoxy, C<sub>1-10</sub> alkoxy-Ci<sub>10</sub> alkoxy, or C<sub>1-20</sub> alkoxy-Ci<sub>20</sub> alkoxy). In some embodiments, the each alkoxy group can be further substituted with 1, 2, 3, or 4 substituent groups as defined herein.

**[0001071]** The term "alkoxyalkyl" represents an alkyl group that is substituted with an alkoxy group. Exemplary unsubstituted alkoxyalkyl groups include between 2 to 40 carbons (e.g., from 2 to 12 or from 2 to 20 carbons, such as C<sub>1-6</sub> alkoxy-Ci<sub>6</sub> alkyl, C<sub>1-10</sub> alkoxy-Ci<sub>10</sub> alkyl, or C<sup>o</sup> alkoxy-C<sub>1-20</sub> alkyl). In some embodiments, the alkyl and the alkoxy each can be further substituted with 1, 2, 3, or 4 substituent groups as defined herein for the respective group.

**[0001072]** The term "alkoxycarbonyl," as used herein, represents an alkoxy, as defined herein, attached to the parent molecular group through a carbonyl atom (e.g., -C(0)-OR, where R is H or an optionally substituted C<sub>1-6</sub>, C<sub>1-10</sub>, or Ci<sub>20</sub> alkyl group). Exemplary unsubstituted alkoxycarbonyl include from 1 to 21 carbons (e.g., from 1 to 11 or from 1 to 7 carbons). In some embodiments, the alkoxy group is further substituted with 1, 2, 3, or 4 substituents as described herein.

**[0001073]** The term "alkoxycarbonylalkoxy," as used herein, represents an alkoxy group, as defined herein, that is substituted with an alkoxycarbonyl group, as defined herein (e.g., -O-alkyl-C(0)-OR, where R is an optionally substituted C<sub>1-6</sub>, C<sub>1-10</sub>, or C<sub>1-20</sub> alkyl group). Exemplary unsubstituted alkoxycarbonylalkoxy include from 3 to 41 carbons (e.g., from 3 to 10, from 3 to 13, from 3 to 17, from 3 to 21, or from 3 to 31 carbons, such

as  $C_{1-6}$  alkoxy,  $C_{1-10}$  alkoxy,  $C_{1-20}$  alkoxy, or  $C_{1-6}$  alkoxy,  $C_{1-10}$  alkoxy, or  $C_{1-20}$  alkoxy). In some embodiments, each alkoxy group is further independently substituted with 1, 2, 3, or 4 substituents, as described herein (e.g., a hydroxy group).

[0001074] The term "alkoxycarbonylalkyl," as used herein, represents an alkyl group, as defined herein, that is substituted with an alkoxy group, as defined herein (e.g., -alkyl-C(=O)-OR, where R is an optionally substituted  $C_{1-20}$ ,  $C_{1-10}$ , or  $C_{1-6}$  alkyl group). Exemplary unsubstituted alkoxyalkyl include from 3 to 41 carbons (e.g., from 3 to 10, from 3 to 13, from 3 to 17, from 3 to 21, or from 3 to 31 carbons, such as  $C_{1-6}$  alkoxy,  $C_{1-10}$  alkoxy, or  $C_{1-20}$  alkoxy). In some embodiments, each alkyl and alkoxy group is further independently substituted with 1, 2, 3, or 4 substituents as described herein (e.g., a hydroxy group).

[0001075] The term "alkyl," as used herein, is inclusive of both straight chain and branched chain saturated groups from 1 to 20 carbons (e.g., from 1 to 10 or from 1 to 6), unless otherwise specified. Alkyl groups are exemplified by methyl, ethyl, n- and isopropyl, n-, sec-, iso- and tert-butyl, neopentyl, and the like, and may be optionally substituted with one, two, three, or, in the case of alkyl groups of two carbons or more, four substituents independently selected from the group consisting of: (1)  $C_{1-6}$  alkoxy; (2)  $C_{1-6}$  alkylsulfanyl; (3) amino, as defined herein (e.g., unsubstituted amino (i.e.,  $-NH_2$ ) or a substituted amino (i.e.,  $-N(R^{N1})_2$ , where  $R^{N1}$  is as defined for amino); (4)  $C_{6-10}$  aryl- $C_{1-6}$  alkoxy; (5) azido; (6) halo; (7) ( $C_{2-9}$  heterocycl)oxy; (8) hydroxy; (9) nitro; (10) oxo (e.g., carboxyaldehyde or acyl); (11)  $C_{1-7}$  spirocyclyl; (12) thioalkoxy; (13) thiol; (14)  $-C(=O)R^{A'}$ , where  $R^{A'}$  is selected from the group consisting of (a)  $C_{1-20}$  alkyl (e.g.,  $C_{1-6}$  alkyl), (b)  $C_{2-20}$  alkenyl (e.g.,  $C_{2-6}$  alkenyl), (c)  $C_{6-10}$  aryl, (d) hydrogen, (e)  $C_{1-6}$  alk- $C_{6-10}$  aryl, (f) amino- $C_{1-20}$  alkyl, (g) polyethylene glycol of  $-(CH_2)_{s2}(OCH_2CH_2)_{s3}i(CH_2)_{s3}OR'$ , wherein  $s_1$  is an integer from 1 to 10 (e.g., from 1 to 6 or from 1 to 4), each of  $s_2$  and  $s_3$ , independently, is an integer from 0 to 10 (e.g., from 0 to 4, from 0 to 6, from 1 to 4, from 1 to 6, or from 1 to 10), and  $R'$  is H or  $C_{1-20}$  alkyl, and (h) amino-polyethylene glycol of  $-NR^{N1}(CH_2)_{s2}(CH_2CH_2O)_{s3}i(CH_2)_{s3}NR^{N1}$ , wherein  $s_1$  is an integer from 1 to 10 (e.g., from 1 to 6 or from 1 to 4), each of  $s_2$  and  $s_3$ , independently, is an integer from 0 to 10 (e.g., from 0 to 4, from 0 to 6, from 1 to 4, from 1 to 6, or from 1 to 10), and each  $R^{N1}$  is,

independently, hydrogen or optionally substituted C<sub>1-6</sub> alkyl; (15) -C(O)NR<sup>B'</sup>R<sup>C'</sup>, where each of R<sup>B'</sup> and R<sup>C'</sup> is, independently, selected from the group consisting of (a) hydrogen, (b) C<sub>1-6</sub> alkyl, (c) C<sub>6-10</sub> aryl, and (d) C<sub>1-6</sub> alk-C<sub>6-10</sub> aryl; (16) -SC<sup>D'</sup>R<sup>D'</sup>, where R<sup>D'</sup> is selected from the group consisting of (a) C<sub>1-6</sub> alkyl, (b) C<sub>6-10</sub> aryl, (c) C<sub>1-6</sub> alk-C<sub>6-10</sub> aryl, and (d) hydroxy; (17) -SC<sub>2</sub>NR<sup>E'</sup>R<sup>F'</sup>, where each of R<sup>E'</sup> and R<sup>F'</sup> is, independently, selected from the group consisting of (a) hydrogen, (b) C<sub>1-6</sub> alkyl, (c) C<sub>6-10</sub> aryl and (d) C<sub>1-6</sub> alk-C<sub>6-10</sub> aryl; (18) -C(O)R<sup>G'</sup>, where R<sup>G'</sup> is selected from the group consisting of (a) C<sub>1-20</sub> alkyl (e.g., C<sub>1-6</sub> alkyl), (b) C<sub>2-20</sub> alkenyl (e.g., C<sub>2-6</sub> alkenyl), (c) C<sub>6-10</sub> aryl, (d) hydrogen, (e) C<sub>1-6</sub> alk-C<sub>6-10</sub> aryl, (f) amino-C<sub>1-20</sub> alkyl, (g) polyethylene glycol of -  
(CH<sub>2</sub>)<sub>s2</sub>(OCH<sub>2</sub>CH<sub>2</sub>)<sub>s1</sub>(CH<sub>2</sub>)<sub>s3</sub>OR', wherein s<sub>1</sub> is an integer from 1 to 10 (e.g., from 1 to 6 or from 1 to 4), each of s<sub>2</sub> and s<sub>3</sub>, independently, is an integer from 0 to 10 (e.g., from 0 to 4, from 0 to 6, from 1 to 4, from 1 to 6, or from 1 to 10), and R' is H or C<sub>1-20</sub> alkyl, and (h) amino-polyethylene glycol of -NR<sup>N1</sup>(CH<sub>2</sub>)<sub>s2</sub>(CH<sub>2</sub>CH<sub>2</sub>O)<sub>s1</sub>(CH<sub>2</sub>)<sub>s3</sub>NR<sup>N1</sup>, wherein s<sub>1</sub> is an integer from 1 to 10 (e.g., from 1 to 6 or from 1 to 4), each of s<sub>2</sub> and s<sub>3</sub>, independently, is an integer from 0 to 10 (e.g., from 0 to 4, from 0 to 6, from 1 to 4, from 1 to 6, or from 1 to 10), and each R<sup>N1</sup> is, independently, hydrogen or optionally substituted C<sub>1-6</sub> alkyl; (19) -NR<sup>H'</sup>C(O)R<sup>I'</sup>, wherein R<sup>H'</sup> is selected from the group consisting of (a1) hydrogen and (b1) C<sub>1-6</sub> alkyl, and R<sup>I'</sup> is selected from the group consisting of (a1) C<sub>1-20</sub> alkyl (e.g., C<sub>1-6</sub> alkyl), (b2) C<sub>2-20</sub> alkenyl (e.g., C<sub>2-6</sub> alkenyl), (c2) C<sub>6-10</sub> aryl, (d2) hydrogen, (e2) C<sub>1-6</sub> alk-C<sub>6-10</sub> aryl, (f2) amino-C<sub>1-20</sub> alkyl, (g2) polyethylene glycol of -(CH<sub>2</sub>)<sub>s2</sub>(OCH<sub>2</sub>CH<sub>2</sub>)<sub>s1</sub>(CH<sub>2</sub>)<sub>s3</sub>OR', wherein s<sub>1</sub> is an integer from 1 to 10 (e.g., from 1 to 6 or from 1 to 4), each of s<sub>2</sub> and s<sub>3</sub>, independently, is an integer from 0 to 10 (e.g., from 0 to 4, from 0 to 6, from 1 to 4, from 1 to 6, or from 1 to 10), and R' is H or C<sub>1-20</sub> alkyl, and (h2) amino-polyethylene glycol of -  
NR<sup>N1</sup>(CH<sub>2</sub>)<sub>s2</sub>(CH<sub>2</sub>CH<sub>2</sub>O)<sub>s1</sub>(CH<sub>2</sub>)<sub>s3</sub>NR<sup>N1</sup>, wherein s<sub>1</sub> is an integer from 1 to 10 (e.g., from 1 to 6 or from 1 to 4), each of s<sub>2</sub> and s<sub>3</sub>, independently, is an integer from 0 to 10 (e.g., from 0 to 4, from 0 to 6, from 1 to 4, from 1 to 6, or from 1 to 10), and each R<sup>N1</sup> is, independently, hydrogen or optionally substituted C<sub>1-6</sub> alkyl; (20) -NR<sup>J'</sup>C(O)OR<sup>K'</sup>, wherein R<sup>J'</sup> is selected from the group consisting of (a1) hydrogen and (b1) C<sub>1-6</sub> alkyl, and R<sup>K'</sup> is selected from the group consisting of (a2) C<sub>1-20</sub> alkyl (e.g., C<sub>1-6</sub> alkyl), (b2) C<sub>2-20</sub> alkenyl (e.g., C<sub>2-6</sub> alkenyl), (c2) C<sub>6-10</sub> aryl, (d2) hydrogen, (e2) C<sub>1-6</sub> alk-C<sub>6-10</sub> aryl, (f2)

amino-C<sub>1-20</sub> alkyl, (g2) polyethylene glycol of  $-(CH_2)_{s_2}(OCH_2CH_2)_{s_3}O R'$ , wherein  $s_1$  is an integer from 1 to 10 (e.g., from 1 to 6 or from 1 to 4), each of  $s_2$  and  $s_3$ , independently, is an integer from 0 to 10 (e.g., from 0 to 4, from 0 to 6, from 1 to 4, from 1 to 6, or from 1 to 10), and  $R'$  is H or C<sub>1-20</sub> alkyl, and (h2) amino-polyethylene glycol of  $-NR^{N_1}(CH_2)_{s_2}(CH_2CH_2)_{s_3}NR^{N_1}$ , wherein  $s_1$  is an integer from 1 to 10 (e.g., from 1 to 6 or from 1 to 4), each of  $s_2$  and  $s_3$ , independently, is an integer from 0 to 10 (e.g., from 0 to 4, from 0 to 6, from 1 to 4, from 1 to 6, or from 1 to 10), and each  $R^{N_1}$  is, independently, hydrogen or optionally substituted C<sub>1-6</sub> alkyl; and (21) amidine. In some embodiments, each of these groups can be further substituted as described herein. For example, the alkylene group of a Cpalkaryl can be further substituted with an oxo group to afford the respective aryloyl substituent.

**[0001076]** The term "alkylene" and the prefix "alk-," as used herein, represent a saturated divalent hydrocarbon group derived from a straight or branched chain saturated hydrocarbon by the removal of two hydrogen atoms, and is exemplified by methylene, ethylene, isopropylene, and the like. The term "C<sub>x-y</sub> alkylene" and the prefix "C<sub>x-y</sub> alk-" represent alkylene groups having between x and y carbons. Exemplary values for x are 1, 2, 3, 4, 5, and 6, and exemplary values for y are 2, 3, 4, 5, 6, 7, 8, 9, 10, 12, 14, 16, 18, or 20 (e.g., C<sub>1-6</sub>, C<sub>1-10</sub>, C<sub>2-20</sub>, C<sub>2-6</sub>, C<sub>2-10</sub>, or C<sub>2-20</sub> alkylene). In some embodiments, the alkylene can be further substituted with 1, 2, 3, or 4 substituent groups as defined herein for an alkyl group.

**[0001077]** The term "alkylsulfmlyl," as used herein, represents an alkyl group attached to the parent molecular group through an -S(O)- group. Exemplary unsubstituted alkylsulfmlyl groups are from 1 to 6, from 1 to 10, or from 1 to 20 carbons. In some embodiments, the alkyl group can be further substituted with 1, 2, 3, or 4 substituent groups as defined herein.

**[0001078]** The term "alkylsulfinylalkyl," as used herein, represents an alkyl group, as defined herein, substituted by an alkylsulfmlyl group. Exemplary unsubstituted alkylsulfinylalkyl groups are from 2 to 12, from 2 to 20, or from 2 to 40 carbons. In some embodiments, each alkyl group can be further substituted with 1, 2, 3, or 4 substituent groups as defined herein.

**[0001079]** The term "alkynyl," as used herein, represents monovalent straight or branched chain groups from 2 to 20 carbon atoms (e.g., from 2 to 4, from 2 to 6, or from 2 to 10 carbons) containing a carbon-carbon triple bond and is exemplified by ethynyl, 1-propynyl, and the like. Alkynyl groups may be optionally substituted with 1, 2, 3, or 4 substituent groups that are selected, independently, from aryl, cycloalkyl, or heterocyclyl (e.g., heteroaryl), as defined herein, or any of the exemplary alkyl substituent groups described herein.

**[0001080]** The term "alkynyloxy" represents a chemical substituent of formula -OR, where R is a C<sub>2-20</sub>alkynyl group (e.g., C<sub>2-6</sub> or C<sub>2-10</sub>alkynyl), unless otherwise specified. Exemplary alkynyloxy groups include ethynyloxy, propynyloxy, and the like. In some embodiments, the alkynyl group can be further substituted with 1, 2, 3, or 4 substituent groups as defined herein (e.g., a hydroxy group).

**[0001081]** The term "amidine," as used herein, represents a -C(=NH)NH<sub>2</sub> group.

**[0001082]** The term "amino," as used herein, represents -N(R<sup>N1</sup>)<sub>2</sub>, wherein each R<sup>N1</sup> is, independently, H, OH, NO<sub>2</sub>, N(R<sup>N2</sup>)<sub>2</sub>, SO<sub>2</sub>OR<sup>N2</sup>, SO<sub>2</sub>R<sup>N2</sup>, SOR<sup>N2</sup>, an *N*-protecting group, alkyl, alkenyl, alkynyl, alkoxy, aryl, alkaryl, cycloalkyl, alkycycloalkyl, carboxyalkyl, sulfoalkyl, heterocyclyl (e.g., heteroaryl), or alkheterocyclyl (e.g., alkheteroaryl), wherein each of these recited R<sup>N1</sup> groups can be optionally substituted, as defined herein for each group; or two R<sup>N1</sup> combine to form a heterocyclyl or an *N*-protecting group, and wherein each R<sup>N2</sup> is, independently, H, alkyl, or aryl. The amino groups of the invention can be an unsubstituted amino (i.e., -NH<sub>2</sub>) or a substituted amino (i.e., -N(R<sup>N1</sup>)<sub>2</sub>). In a preferred embodiment, amino is -NH<sub>2</sub> or -NHR<sup>N1</sup>, wherein R<sup>N1</sup> is, independently, OH, NO<sub>2</sub>, NH<sub>2</sub>, NR<sup>N2</sup><sub>2</sub>, SO<sub>2</sub>OR<sup>N2</sup>, SO<sub>2</sub>R<sup>N2</sup>, SOR<sup>N2</sup>, alkyl, carboxyalkyl, sulfoalkyl, or aryl, and each R<sup>N2</sup> can be H, C<sub>1-6</sub>alkyl (e.g., C<sub>1-6</sub>alkyl), or C<sub>6-10</sub>aryl.

**[0001083]** The term "amino acid," as described herein, refers to a molecule having a side chain, an amino group, and an acid group (e.g., a carboxy group of -CO<sub>2</sub>H or a sulfo group of -SO<sub>3</sub>H), wherein the amino acid is attached to the parent molecular group by the side chain, amino group, or acid group (e.g., the side chain). In some embodiments, the amino acid is attached to the parent molecular group by a carbonyl group, where the side chain or amino group is attached to the carbonyl group. Exemplary side chains include an optionally substituted alkyl, aryl, heterocyclyl, alkaryl, alkheterocyclyl, aminoalkyl,

carbamoylalkyl, and carboxyalkyl. Exemplary amino acids include alanine, arginine, asparagine, aspartic acid, cysteine, glutamic acid, glutamine, glycine, histidine, hydroxynorvaline, isoleucine, leucine, lysine, methionine, norvaline, ornithine, phenylalanine, proline, pyrrolysine, selenocysteine, serine, taurine, threonine, tryptophan, tyrosine, and valine. Amino acid groups may be optionally substituted with one, two, three, or, in the case of amino acid groups of two carbons or more, four substituents independently selected from the group consisting of: (1) C<sub>1-6</sub> alkoxy; (2) C<sub>1-6</sub> alkylsulfanyl; (3) amino, as defined herein (e.g., unsubstituted amino (i.e., -NH<sub>2</sub>) or a substituted amino (i.e., -N(R<sup>N1</sup>)<sub>2</sub>, where R<sup>N1</sup> is as defined for amino); (4) C<sub>6-10</sub> aryl-C<sub>1-6</sub> alkoxy; (5) azido; (6) halo; (7) (C<sub>2-9</sub> heterocyclyl)oxy; (8) hydroxy; (9) nitro; (10) oxo (e.g., carboxyaldehyde or acyl); (11) C<sub>1-7</sub> spirocyclyl; (12) thioalkoxy; (13) thiol; (14) -C(O)<sub>2</sub>R<sup>A'</sup>, where R<sup>A'</sup> is selected from the group consisting of (a) C<sup>o</sup> alkyl (e.g., C<sub>1-6</sub> alkyl), (b) C<sub>2-20</sub> alkenyl (e.g., C<sub>2-6</sub> alkenyl), (c) C<sub>6-10</sub> aryl, (d) hydrogen, (e) C<sub>1-6</sub> alk-C<sub>6-10</sub> aryl, (f) amino-C<sub>1-20</sub> alkyl, (g) polyethylene glycol of -(CH<sub>2</sub>)<sub>s2</sub>(OCH<sub>2</sub>CH<sub>2</sub>)<sub>s1</sub>(CH<sub>2</sub>)<sub>s3</sub>OR', wherein s<sub>1</sub> is an integer from 1 to 10 (e.g., from 1 to 6 or from 1 to 4), each of s<sub>2</sub> and s<sub>3</sub>, independently, is an integer from 0 to 10 (e.g., from 0 to 4, from 0 to 6, from 1 to 4, from 1 to 6, or from 1 to 10), and R' is H or C<sub>1-20</sub> alkyl, and (h) amino-polyethylene glycol of -NR<sup>N1</sup>(CH<sub>2</sub>)<sub>s2</sub>(CH<sub>2</sub>CH<sub>2</sub>O)<sub>s1</sub>(CH<sub>2</sub>)<sub>s3</sub>NR<sup>N1</sup>, wherein s<sub>1</sub> is an integer from 1 to 10 (e.g., from 1 to 6 or from 1 to 4), each of s<sub>2</sub> and s<sub>3</sub>, independently, is an integer from 0 to 10 (e.g., from 0 to 4, from 0 to 6, from 1 to 4, from 1 to 6, or from 1 to 10), and each R<sup>N1</sup> is, independently, hydrogen or optionally substituted C<sub>1-6</sub> alkyl; (15) -C(O)NR<sup>B'</sup>R<sup>C'</sup>, where each of R<sup>B'</sup> and R<sup>C'</sup> is, independently, selected from the group consisting of (a) hydrogen, (b) C<sub>1-6</sub> alkyl, (c) C<sub>6-10</sub> aryl, and (d) C<sub>1-6</sub> alk-C<sub>6-10</sub> aryl; (16) -SC>2R<sup>D'</sup>, where R<sup>D'</sup> is selected from the group consisting of (a) C<sub>1-6</sub> alkyl, (b) C<sub>6-10</sub> aryl, (c) C<sub>1-6</sub> alk-C<sub>6-10</sub> aryl, and (d) hydroxy; (17) -S(O)<sub>2</sub>NR<sup>E'</sup>R<sup>F'</sup>, where each of R<sup>E'</sup> and R<sup>F'</sup> is, independently, selected from the group consisting of (a) hydrogen, (b) C<sub>1-6</sub> alkyl, (c) C<sub>6-10</sub> aryl and (d) C<sub>1-6</sub> alk-C<sub>6-10</sub> aryl; (18) -C(O)R<sup>G'</sup>, where R<sup>G'</sup> is selected from the group consisting of (a) C<sub>1-20</sub> alkyl (e.g., C<sub>1-6</sub> alkyl), (b) C<sub>2-20</sub> alkenyl (e.g., C<sub>2-6</sub> alkenyl), (c) C<sub>6-10</sub> aryl, (d) hydrogen, (e) C<sub>1-6</sub> alk-C<sub>6-10</sub> aryl, (f) amino-C<sub>1-20</sub> alkyl, (g) polyethylene glycol of -(CH<sub>2</sub>)<sub>s2</sub>(OCH<sub>2</sub>CH<sub>2</sub>)<sub>s1</sub>(CH<sub>2</sub>)<sub>s3</sub>OR', wherein s<sub>1</sub> is an integer from 1 to 10 (e.g., from 1 to 6 or from 1 to 4), each of s<sub>2</sub> and s<sub>3</sub>, independently, is an integer from 0 to 10 (e.g., from 0

to 4, from 0 to 6, from 1 to 4, from 1 to 6, or from 1 to 10), and  $R'$  is H or  $C_{1-6}$  alkyl, and (h) amino-polyethylene glycol of  $-NR^{N1}(CH_2)_{s2}(CH_2CH_2O)_s(CH_2)_{s3}NR^{N1}$ , wherein  $s_1$  is an integer from 1 to 10 (e.g., from 1 to 6 or from 1 to 4), each of  $s_2$  and  $s_3$ , independently, is an integer from 0 to 10 (e.g., from 0 to 4, from 0 to 6, from 1 to 4, from 1 to 6, or from 1 to 10), and each  $R^{N1}$  is, independently, hydrogen or optionally substituted  $C_{1-6}$  alkyl; (19)  $-NR^{H'}C(O)R^{I'}$ , wherein  $R^{H'}$  is selected from the group consisting of (a1) hydrogen and (b1)  $C_{1-6}$  alkyl, and  $R^{I'}$  is selected from the group consisting of (a2)  $C_{1-20}$  alkyl (e.g.,  $C_{1-6}$  alkyl), (b2)  $C_{2-20}$  alkenyl (e.g.,  $C_{2-6}$  alkenyl), (c2)  $C_{6-10}$  aryl, (d2) hydrogen, (e2)  $C_{1-6}$  alk-C<sub>6-10</sub> aryl, (f2) amino- $C_{1-20}$  alkyl, (g2) polyethylene glycol of  $-(CH_2)_{s2}(OCH_2CH_2)_{s1}(CH_2)_{s3}OR'$ , wherein  $s_1$  is an integer from 1 to 10 (e.g., from 1 to 6 or from 1 to 4), each of  $s_2$  and  $s_3$ , independently, is an integer from 0 to 10 (e.g., from 0 to 4, from 0 to 6, from 1 to 4, from 1 to 6, or from 1 to 10), and  $R'$  is H or  $C_{1-20}$  alkyl, and (h2) amino-polyethylene glycol of  $-NR^{N1}(CH_2)_{s2}(CH_2CH_2O)_s(CH_2)_{s3}NR^{N1}$ , wherein  $s_1$  is an integer from 1 to 10 (e.g., from 1 to 6 or from 1 to 4), each of  $s_2$  and  $s_3$ , independently, is an integer from 0 to 10 (e.g., from 0 to 4, from 0 to 6, from 1 to 4, from 1 to 6, or from 1 to 10), and each  $R^{N1}$  is, independently, hydrogen or optionally substituted  $C_{1-6}$  alkyl; (20)  $-NR^{J'}C(O)OR^{K'}$ , wherein  $R^{J'}$  is selected from the group consisting of (a1) hydrogen and (b1)  $C_{1-6}$  alkyl, and  $R^{K'}$  is selected from the group consisting of (a1)  $C_{1-20}$  alkyl (e.g.,  $C_{1-6}$  alkyl), (b2)  $C_{2-20}$  alkenyl (e.g.,  $C_{2-6}$  alkenyl), (c2)  $C_{6-10}$  aryl, (d2) hydrogen, (e2)  $C_{1-6}$  alk-C<sub>6-10</sub> aryl, (f2) amino- $C_{1-20}$  alkyl, (g2) polyethylene glycol of  $-(CH_2)_{s2}(OCH_2CH_2)_{s1}(CH_2)_{s3}OR'$ , wherein  $s_1$  is an integer from 1 to 10 (e.g., from 1 to 6 or from 1 to 4), each of  $s_2$  and  $s_3$ , independently, is an integer from 0 to 10 (e.g., from 0 to 4, from 0 to 6, from 1 to 4, from 1 to 6, or from 1 to 10), and  $R'$  is H or  $C_{1-20}$  alkyl, and (h2) amino-polyethylene glycol of  $-NR^{N1}(CH_2)_{s2}(CH_2CH_2O)_s(CH_2)_{s3}NR^{N1}$ , wherein  $s_1$  is an integer from 1 to 10 (e.g., from 1 to 6 or from 1 to 4), each of  $s_2$  and  $s_3$ , independently, is an integer from 0 to 10 (e.g., from 0 to 4, from 0 to 6, from 1 to 4, from 1 to 6, or from 1 to 10), and each  $R^{N1}$  is, independently, hydrogen or optionally substituted  $C_{1-6}$  alkyl; and (21) amidine. In some embodiments, each of these groups can be further substituted as described herein.

[0001084] The term "aminoalkoxy," as used herein, represents an alkoxy group, as defined herein, substituted by an amino group, as defined herein. The alkyl and amino

each can be further substituted with 1, 2, 3, or 4 substituent groups as described herein for the respective group (e.g.,  $\text{C}_0\text{R}^{\text{A}'}$ , where  $\text{R}^{\text{A}'}$  is selected from the group consisting of (a)  $\text{C}_{1-6}$  alkyl, (b)  $\text{C}_{6-10}$  aryl, (c) hydrogen, and (d)  $\text{C}_{1-6}$  alk- $\text{C}_{6-10}$  aryl, e.g., carboxy).

[0001085] The term "aminoalkyl," as used herein, represents an alkyl group, as defined herein, substituted by an amino group, as defined herein. The alkyl and amino each can be further substituted with 1, 2, 3, or 4 substituent groups as described herein for the respective group (e.g.,  $\text{C}_0\text{R}^{\text{A}'}$ , where  $\text{R}^{\text{A}'}$  is selected from the group consisting of (a)  $\text{C}_{1-6}$  alkyl, (b)  $\text{C}_{6-10}$  aryl, (c) hydrogen, and (d)  $\text{C}_{1-6}$  alk- $\text{C}_{6-10}$  aryl, e.g., carboxy).

[0001086] The term "aryl," as used herein, represents a mono-, bicyclic, or multicyclic carbocyclic ring system having one or two aromatic rings and is exemplified by phenyl, naphthyl, 1,2-dihydronaphthyl, 1,2,3,4-tetrahydronaphthyl, anthracenyl, phenanthrenyl, fluorenyl, indanyl, indenyl, and the like, and may be optionally substituted with 1, 2, 3, 4, or 5 substituents independently selected from the group consisting of: (1)  $\text{C}_{1-7}$  acyl (e.g., carboxyaldehyde); (2)  $\text{C}_{1-20}$  alkyl (e.g.,  $\text{C}_{1-6}$  alkyl,  $\text{C}_{1-6}$  alkoxy- $\text{C}_{1-6}$  alkyl,  $\text{C}_{1-6}$  alkylsulfinyl- $\text{C}_{1-6}$  alkyl, amino- $\text{C}_{1-6}$  alkyl, azido- $\text{C}_{1-6}$  alkyl, (carboxyaldehyde)- $\text{C}_{1-6}$  alkyl, halo- $\text{C}_{1-6}$  alkyl (e.g., perfluoroalkyl), hydroxy- $\text{C}_{1-6}$  alkyl, nitro- $\text{C}_{1-6}$  alkyl, or  $\text{C}_{1-6}$  thioalkoxy- $\text{C}_{1-6}$  alkyl); (3)  $\text{C}_{1-20}$  alkoxy (e.g.,  $\text{C}_{1-6}$  alkoxy, such as perfluoroalkoxy); (4)  $\text{C}_{1-6}$  alkylsulfinyl; (5)  $\text{C}_{6-10}$  aryl; (6) amino; (7)  $\text{C}_{1-6}$  alk- $\text{C}_{6-10}$  aryl; (8) azido; (9)  $\text{C}_{3-8}$  cycloalkyl; (10)  $\text{C}_{1-6}$  alk- $\text{C}_{3-8}$  cycloalkyl; (11) halo; (12)  $\text{C}_{1-12}$  heterocyclyl (e.g.,  $\text{C}_{1-12}$  heteroaryl); (13) ( $\text{C}_{1-12}$  heterocyclyl)oxy; (14) hydroxy; (15) nitro; (16)  $\text{C}_{1-20}$  thioalkoxy (e.g.,  $\text{C}_{1-6}$  thioalkoxy); (17)  $-(\text{CH}_2)_q\text{C}_0\text{R}^{\text{A}'}$ , where q is an integer from zero to four, and  $\text{R}^{\text{A}'}$  is selected from the group consisting of (a)  $\text{C}_{1-6}$  alkyl, (b)  $\text{C}_{6-10}$  aryl, (c) hydrogen, and (d)  $\text{C}_{1-6}$  alk- $\text{C}_{6-10}$  aryl; (18)  $-(\text{CH}_2)_q\text{CONR}^{\text{B}'}\text{R}^{\text{C}'}$ , where q is an integer from zero to four and where  $\text{R}^{\text{B}'}$  and  $\text{R}^{\text{C}'}$  are independently selected from the group consisting of (a) hydrogen, (b)  $\text{C}_{1-6}$  alkyl, (c)  $\text{C}_{6-10}$  aryl, and (d)  $\text{C}_{1-6}$  alk- $\text{C}_{6-10}$  aryl; (19)  $-(\text{CH}_2)_q\text{S}_0\text{R}^{\text{D}'}$ , where q is an integer from zero to four and where  $\text{R}^{\text{D}'}$  is selected from the group consisting of (a) alkyl, (b)  $\text{C}_{6-10}$  aryl, and (c) alk- $\text{C}_{6-10}$  aryl; (20)  $-(\text{CH}_2)_q\text{S}_0\text{NR}^{\text{E}'}\text{R}^{\text{F}'}$ , where q is an integer from zero to four and where each of  $\text{R}^{\text{E}'}$  and  $\text{R}^{\text{F}'}$  is, independently, selected from the group consisting of (a) hydrogen, (b)  $\text{C}_{1-6}$  alkyl, (c)  $\text{C}_{6-10}$  aryl, and (d)  $\text{C}_{1-6}$  alk- $\text{C}_{6-10}$  aryl; (21) thiol; (22)  $\text{C}_{6-10}$  aryloxy; (23)  $\text{C}_{3-8}$  cycloalkoxy; (24)  $\text{C}_{6-10}$  aryl- $\text{C}_{1-6}$  alkoxy; (25)  $\text{C}_{1-6}$  alk- $\text{C}_{1-12}$  heterocyclyl (e.g.,  $\text{C}_{1-6}$  alk- $\text{C}_{1-12}$  heteroaryl); (26)  $\text{C}_{2-20}$



alkenyl; and (27) C<sub>2-20</sub> alkynyl. In some embodiments, each of these groups can be further substituted as described herein. For example, the alkylene group of a C<sub>i</sub>-alkaryl or a C<sub>i</sub>-alkheterocyclyl can be further substituted with an oxo group to afford the respective aryloyl and (heterocyclyl)oyl substituent group.

[0001087] The term "arylalkoxy," as used herein, represents an alkaryl group, as defined herein, attached to the parent molecular group through an oxygen atom. Exemplary unsubstituted alkoxyalkyl groups include from 7 to 30 carbons (e.g., from 7 to 16 or from 7 to 20 carbons, such as C<sub>6-10</sub> aryl-C<sup>^</sup> alkoxy, C<sub>6-io</sub> aryl-C<sub>i-io</sub> alkoxy, or C<sub>6-io</sub> aryl-C<sub>1-20</sub> alkoxy). In some embodiments, the arylalkoxy group can be substituted with 1, 2, 3, or 4 substituents as defined herein

[0001088] The term "aryloxy" represents a chemical substituent of formula -OR', where R' is an aryl group of 6 to 18 carbons, unless otherwise specified. In some embodiments, the aryl group can be substituted with 1, 2, 3, or 4 substituents as defined herein.

[0001089] The term "aryloyl," as used herein, represents an aryl group, as defined herein, that is attached to the parent molecular group through a carbonyl group. Exemplary unsubstituted aryloyl groups are of 7 to 11 carbons. In some embodiments, the aryl group can be substituted with 1, 2, 3, or 4 substituents as defined herein.

[0001090] The term "azido" represents an -N<sub>3</sub> group, which can also be represented as -N=N=N.

[0001091] The term "bicyclic," as used herein, refer to a structure having two rings, which may be aromatic or non-aromatic. Bicyclic structures include spirocyclyl groups, as defined herein, and two rings that share one or more bridges, where such bridges can include one atom or a chain including two, three, or more atoms. Exemplary bicyclic groups include a bicyclic carbocyclyl group, where the first and second rings are carbocyclyl groups, as defined herein; a bicyclic aryl groups, where the first and second rings are aryl groups, as defined herein; bicyclic heterocyclyl groups, where the first ring is a heterocyclyl group and the second ring is a carbocyclyl (e.g., aryl) or heterocyclyl (e.g., heteroaryl) group; and bicyclic heteroaryl groups, where the first ring is a heteroaryl group and the second ring is a carbocyclyl (e.g., aryl) or heterocyclyl (e.g., heteroaryl) group. In some embodiments, the bicyclic group can be substituted with 1, 2, 3, or 4 substituents as defined herein for cycloalkyl, heterocyclyl, and aryl groups.

[0001092] The terms "carbocyclic" and "carbocyclyl," as used herein, refer to an optionally substituted C<sub>3-2</sub> monocyclic, bicyclic, or tricyclic structure in which the rings, which may be aromatic or non-aromatic, are formed by carbon atoms. Carbocyclic structures include cycloalkyl, cycloalkenyl, and aryl groups.

[0001093] The term "carbamoyl," as used herein, represents -C(=O)-N(R<sup>N1</sup>)<sub>2</sub>, where the meaning of each R<sup>N1</sup> is found in the definition of "amino" provided herein.

[0001094] The term "carbamoylalkyl," as used herein, represents an alkyl group, as defined herein, substituted by a carbamoyl group, as defined herein. The alkyl group can be further substituted with 1, 2, 3, or 4 substituent groups as described herein.

[0001095] The term "carbamyl," as used herein, refers to a carbamate group having the structure

-NR<sup>N1</sup>C(=O)OR or -OC(=O)N(R<sup>N1</sup>)<sub>2</sub>, where the meaning of each R<sup>N1</sup> is found in the definition of "amino" provided herein, and R is alkyl, cycloalkyl, alkylcycloalkyl, aryl, alkaryl, heterocyclyl (e.g., heteroaryl), or alkheterocyclyl (e.g., alkheteroaryl), as defined herein.

[0001096] The term "carbonyl," as used herein, represents a C(=O) group, which can also be represented as C=O.

[0001097] The term "carboxyaldehyde" represents an acyl group having the structure -CHO.

[0001098] The term "carboxy," as used herein, means -CO<sub>2</sub>H.

[0001099] The term "carboxyalkoxy," as used herein, represents an alkoxy group, as defined herein, substituted by a carboxy group, as defined herein. The alkoxy group can be further substituted with 1, 2, 3, or 4 substituent groups as described herein for the alkyl group.

[0001100] The term "carboxyalkyl," as used herein, represents an alkyl group, as defined herein, substituted by a carboxy group, as defined herein. The alkyl group can be further substituted with 1, 2, 3, or 4 substituent groups as described herein.

[0001101] The term "cyano," as used herein, represents an -CN group.

[0001102] The term "cycloalkoxy" represents a chemical substituent of formula -OR, where R is a C<sub>3-8</sub> cycloalkyl group, as defined herein, unless otherwise specified. The cycloalkyl group can be further substituted with 1, 2, 3, or 4 substituent groups as

described herein. Exemplary unsubstituted cycloalkoxy groups are from 3 to 8 carbons. In some embodiment, the cycloalkyl group can be further substituted with 1, 2, 3, or 4 substituent groups as described herein.

[0001103] The term "cycloalkyl," as used herein represents a monovalent saturated or unsaturated non-aromatic cyclic hydrocarbon group from three to eight carbons, unless otherwise specified, and is exemplified by cyclopropyl, cyclobutyl, cyclopentyl, cyclohexyl, cycloheptyl, bicyclo[2.2.1]heptyl, and the like. When the cycloalkyl group includes one carbon-carbon double bond, the cycloalkyl group can be referred to as a "cycloalkenyl" group. Exemplary cycloalkenyl groups include cyclopentenyl, cyclohexenyl, and the like. The cycloalkyl groups of this invention can be optionally substituted with: (1) C<sub>1-7</sub> acyl (e.g., carboxyaldehyde); (2) C<sub>i-20</sub> alkyl (e.g., C<sub>1-6</sub> alkyl, C<sub>6-10</sub> alkoxy-C<sub>1-6</sub> alkyl, C<sub>1-6</sub> alkylsulfinyl-C<sub>1-6</sub> alkyl, amino-C<sub>1-6</sub> alkyl, azido-C<sub>1-6</sub> alkyl, (carboxyaldehyde)-C<sub>1-6</sub> alkyl, halo-C<sub>1-6</sub> alkyl (e.g., perfluoroalkyl), hydroxy-C<sub>1-6</sub> alkyl, nitro-C<sub>1-6</sub> alkyl, or C<sub>1-6</sub> thioalkoxy-C<sub>1-6</sub> alkyl); (3) C<sub>1-20</sub> alkoxy (e.g., C<sub>1-6</sub> alkoxy, such as perfluoroalkoxy); (4) C<sub>1-6</sub> alkylsulfinyl; (5) C<sub>6-10</sub> aryl; (6) amino; (7) C<sub>1-6</sub> alk-C<sub>6-10</sub> aryl; (8) azido; (9) C<sub>3-8</sub> cycloalkyl; (10) C<sub>1-6</sub> alk-C<sub>3-8</sub> cycloalkyl; (11) halo; (12) C<sub>1-12</sub> heterocyclyl (e.g., C<sub>1-12</sub> heteroaryl); (13) (C<sub>1-12</sub> heterocyclyl)oxy; (14) hydroxy; (15) nitro; (16) C<sub>1-6</sub> thioalkoxy (e.g., C<sub>1-6</sub> thioalkoxy); (17) -(CH<sub>2</sub>)<sub>q</sub>C(=O)<sub>2</sub>R<sup>A'</sup>, where q is an integer from zero to four, and R<sup>A'</sup> is selected from the group consisting of (a) C<sub>1-6</sub> alkyl, (b) C<sub>6-10</sub> aryl, (c) hydrogen, and (d) C<sub>1-6</sub> alk-C<sub>6-10</sub> aryl; (18) -(CH<sub>2</sub>)<sub>q</sub>CONR<sup>B'</sup>R<sup>C'</sup>, where q is an integer from zero to four and where R<sup>B'</sup> and R<sup>C'</sup> are independently selected from the group consisting of (a) hydrogen, (b) C<sub>6-10</sub> alkyl, (c) C<sub>6-10</sub> aryl, and (d) C<sub>1-6</sub> alk-C<sub>6-10</sub> aryl; (19) -(CH<sub>2</sub>)<sub>q</sub>S(=O)<sub>2</sub>R<sup>D'</sup>, where q is an integer from zero to four and where R<sup>D'</sup> is selected from the group consisting of (a) C<sub>6-10</sub> alkyl, (b) C<sub>6-10</sub> aryl, and (c) C<sub>1-6</sub> alk-C<sub>6-10</sub> aryl; (20) -(CH<sub>2</sub>)<sub>q</sub>S(=O)<sub>2</sub>NR<sup>E'</sup>R<sup>F'</sup>, where q is an integer from zero to four and where each of R<sup>E'</sup> and R<sup>F'</sup> is, independently, selected from the group consisting of (a) hydrogen, (b) C<sub>6-10</sub> alkyl, (c) C<sub>6-10</sub> aryl, and (d) C<sub>1-6</sub> alk-C<sub>6-10</sub> aryl; (21) thiol; (22) C<sub>6-10</sub> aryloxy; (23) C<sub>3-8</sub> cycloalkoxy; (24) C<sub>6-10</sub> aryl-C<sub>1-6</sub> alkoxy; (25) C<sub>1-6</sub> alk-C<sub>1-12</sub> heterocyclyl (e.g., C<sub>1-6</sub> alk-C<sub>1-12</sub> heteroaryl); (26) oxo; (27) C<sub>2-20</sub> alkenyl; and (28) C<sub>2-20</sub> alkynyl. In some embodiments, each of these groups can be further substituted as described herein. For example, the

alkylene group of a Ci-alkaryl or a Ci-alkheterocyclyl can be further substituted with an oxo group to afford the respective aryloyl and (heterocyclyl)oyl substituent group.

[0001104] The term "diastereomer," as used herein means stereoisomers that are not mirror images of one another and are non-superimposable on one another.

[0001105] The term "effective amount" of an agent, as used herein, is that amount sufficient to effect beneficial or desired results, for example, clinical results, and, as such, an "effective amount" depends upon the context in which it is being applied. For example, in the context of administering an agent that treats cancer, an effective amount of an agent is, for example, an amount sufficient to achieve treatment, as defined herein, of cancer, as compared to the response obtained without administration of the agent.

[0001106] The term "enantiomer," as used herein, means each individual optically active form of a compound of the invention, having an optical purity or enantiomeric excess (as determined by methods standard in the art) of at least 80% (i.e., at least 90% of one enantiomer and at most 10% of the other enantiomer), preferably at least 90% and more preferably at least 98%.

[0001107] The term "halo," as used herein, represents a halogen selected from bromine, chlorine, iodine, or fluorine.

[0001108] The term "haloalkoxy," as used herein, represents an alkoxy group, as defined herein, substituted by a halogen group (i.e., F, Cl, Br, or I). A haloalkoxy may be substituted with one, two, three, or, in the case of alkyl groups of two carbons or more, four halogens. Haloalkoxy groups include perfluoroalkoxys (e.g.,  $-\text{OCF}_3$ ),  $-\text{OCHF}_2$ ,  $-\text{OCH}_2\text{F}$ ,  $-\text{OCCl}_3$ ,  $-\text{OCH}_2\text{CH}_2\text{Br}$ ,  $-\text{OCH}_2\text{CH}(\text{CH}_2\text{CH}_2\text{Br})\text{CH}_3$ , and  $-\text{OCHICH}_3$ . In some embodiments, the haloalkoxy group can be further substituted with 1, 2, 3, or 4 substituent groups as described herein for alkyl groups.

[0001109] The term "haloalkyl," as used herein, represents an alkyl group, as defined herein, substituted by a halogen group (i.e., F, Cl, Br, or I). A haloalkyl may be substituted with one, two, three, or, in the case of alkyl groups of two carbons or more, four halogens. Haloalkyl groups include perfluoroalkyls (e.g.,  $-\text{CF}_3$ ),  $-\text{CHF}_2$ ,  $-\text{CH}_2\text{F}$ ,  $-\text{CCl}_3$ ,  $-\text{CH}_2\text{CH}_2\text{Br}$ ,  $-\text{CH}_2\text{CH}(\text{CH}_2\text{CH}_2\text{Br})\text{CH}_3$ , and  $-\text{CHICH}_3$ . In some embodiments, the haloalkyl group can be further substituted with 1, 2, 3, or 4 substituent groups as described herein for alkyl groups.

[0001110] The term "heteroalkylene," as used herein, refers to an alkylene group, as defined herein, in which one or two of the constituent carbon atoms have each been replaced by nitrogen, oxygen, or sulfur. In some embodiments, the heteroalkylene group can be further substituted with 1, 2, 3, or 4 substituent groups as described herein for alkylene groups.

[0001111] The term "heteroaryl," as used herein, represents that subset of heterocyclyls, as defined herein, which are aromatic: i.e., they contain  $4n+2$  pi electrons within the mono- or multicyclic ring system. Exemplary unsubstituted heteroaryl groups are of 1 to 12 (e.g., 1 to 11, 1 to 10, 1 to 9, 2 to 12, 2 to 11, 2 to 10, or 2 to 9) carbons. In some embodiment, the heteroaryl is substituted with 1, 2, 3, or 4 substituents groups as defined for a heterocyclyl group.

[0001112] The term "heterocyclyl," as used herein represents a 5-, 6- or 7-membered ring, unless otherwise specified, containing one, two, three, or four heteroatoms independently selected from the group consisting of nitrogen, oxygen, and sulfur. The 5-membered ring has zero to two double bonds, and the 6- and 7-membered rings have zero to three double bonds. Exemplary unsubstituted heterocyclyl groups are of 1 to 12 (e.g., 1 to 11, 1 to 10, 1 to 9, 2 to 12, 2 to 11, 2 to 10, or 2 to 9) carbons. The term "heterocyclyl" also represents a heterocyclic compound having a bridged multicyclic structure in which one or more carbons and/or heteroatoms bridges two non-adjacent members of a monocyclic ring, e.g., a quinuclidinyl group. The term "heterocyclyl" includes bicyclic, tricyclic, and tetracyclic groups in which any of the above heterocyclic rings is fused to one, two, or three carbocyclic rings, e.g., an aryl ring, a cyclohexane ring, a cyclohexene ring, a cyclopentane ring, a cyclopentene ring, or another monocyclic heterocyclic ring, such as indolyl, quinolyl, isoquinolyl, tetrahydroquinolyl, benzofuryl, benzothienyl and the like. Examples of fused heterocyclyls include tropanes and 1,2,3,5,8,8a-hexahydroindolizine. Heterocyclyls include pyrrolyl, pyrrolinyl, pyrrolidinyl, pyrazolyl, pyrazolinyl, pyrazolidinyl, imidazolyl, imidazoliny, imidazolidinyl, pyridyl, piperidinyl, homopiperidinyl, pyrazinyl, piperazinyl, pyrimidinyl, pyridazinyl, oxazolyl, oxazolidinyl, isoxazolyl, isoxazolidinyl, morpholmyl, thiomorpholinyl, thiazolyl, thiazolidinyl, isothiazolyl, isothiazolidinyl, indolyl, indazolyl, quinolyl, isoquinolyl, quinoxaliny, dihydroquinoxaliny, quinazoliny, cinnoliny,

phthalazinyl, benzimidazolyl, benzothiazolyl, benzoxazolyl, benzothiadiazolyl, furyl, thienyl, thiazolidinyl, isothiazolyl, triazolyl, tetrazolyl, oxadiazolyl (e.g., 1,2,3-oxadiazolyl), purinyl, thiadiazolyl (e.g., 1,2,3-thiadiazolyl), tetrahydrofuranyl, dihydrofuranyl, tetrahydrothienyl, dihydrothienyl, dihydroindolyl, dihydroquinolyl, tetrahydroquinolyl, tetrahydroisoquinolyl, dihydroisoquinolyl, pyranyl, dihydropyranyl, dithiazolyl, benzofuranyl, isobenzofuranyl, benzothienyl, and the like, including dihydro and tetrahydro forms thereof, where one or more double bonds are reduced and replaced with hydrogens. Still other exemplary heterocyclyls include: 2,3,4,5-tetrahydro-2-oxo-oxazolyl; 2,3-dihydro-2-oxo-1H-imidazolyl; 2,3,4,5-tetrahydro-5-oxo-1H-pyrazolyl (e.g., 2,3,4,5-tetrahydro-2-phenyl-5-oxo-1H-pyrazolyl); 2,3,4,5-tetrahydro-2,4-dioxo-1H-imidazolyl (e.g., 2,3,4,5-tetrahydro-2,4-dioxo-5-methyl-5-phenyl-1H-imidazolyl); 2,3-dihydro-2-thioxo-1,3,4-oxadiazolyl (e.g., 2,3-dihydro-2-thioxo-5-phenyl-1,3,4-oxadiazolyl); 4,5-dihydro-5-oxo-1H-triazolyl (e.g., 4,5-dihydro-3-methyl-4-amino-5-oxo-1H-triazolyl); 1,2,3,4-tetrahydro-2,4-dioxopyridinyl (e.g., 1,2,3,4-tetrahydro-2,4-dioxo-3,3-diethylpyridinyl); 2,6-dioxo-piperidinyl (e.g., 2,6-dioxo-3-ethyl-3-phenylpiperidinyl); 1,6-dihydro-6-oxopyrimidinyl; 1,6-dihydro-4-oxopyrimidinyl (e.g., 2-(methylthio)-1,6-dihydro-4-oxo-5-methylpyrimidin-1-yl); 1,2,3,4-tetrahydro-2,4-dioxopyrimidinyl (e.g., 1,2,3,4-tetrahydro-2,4-dioxo-3-ethylpyrimidinyl); 1,6-dihydro-6-oxo-pyridazinyl (e.g., 1,6-dihydro-6-oxo-3-ethylpyridazinyl); 1,6-dihydro-6-oxo-1,2,4-triazinyl (e.g., 1,6-dihydro-5-isopropyl-6-oxo-1,2,4-triazinyl); 2,3-dihydro-2-oxo-1H-indolyl (e.g., 3,3-dimethyl-2,3-dihydro-2-oxo-1H-indolyl and 2,3-dihydro-2-oxo-3,3'-spiropropane-1H-indol-1-yl); 1,3-dihydro-1-oxo-2H-iso-indolyl; 1,3-dihydro-1,3-dioxo-2H-iso-indolyl; 1H-benzopyrazolyl (e.g., 1-(ethoxycarbonyl)-1H-benzopyrazolyl); 2,3-dihydro-2-oxo-1H-benzimidazolyl (e.g., 3-ethyl-2,3-dihydro-2-oxo-1H-benzimidazolyl); 2,3-dihydro-2-oxo-benzoxazolyl (e.g., 5-chloro-2,3-dihydro-2-oxo-benzoxazolyl); 2,3-dihydro-2-oxo-benzoxazolyl; 2-oxo-2H-benzopyranyl; 1,4-benzodioxanyl; 1,3-benzodioxanyl; 2,3-dihydro-3-oxo-4H-1,3-benzothiazinyl; 3,4-dihydro-4-oxo-3H-quinazolinyl (e.g., 2-methyl-3,4-dihydro-4-oxo-3H-quinazolinyl); 1,2,3,4-tetrahydro-2,4-dioxo-3H-quinazolyl (e.g., 1-ethyl-1,2,3,4-tetrahydro-2,4-dioxo-3H-quinazolyl); 1,2,3,6-tetrahydro-2,6-dioxo-7H-purinyl (e.g., 1,2,3,6-tetrahydro-1,3-dimethyl-2,6-dioxo-7H-purinyl); 1,2,3,6-tetrahydro-2,6-dioxo-1H-purinyl (e.g., 1,2,3,6-tetrahydro-3,7-dimethyl-2,6-dioxo-1H-

purinyl); 2-oxobenz[c, J]indolyl; 1,1-dioxo-2H-naphth[1,8-c, J]isothiazolyl; and 1,8-naphthylenedicarboxamido. Additional heterocyclics include 3,3a,4,5,6,6a-hexahydro-pyrrolo[3,4-b]pyrrol-(2H)-yl, and 2,5-diazabicyclo[2.2.1]heptan-2-yl, homopiperazinyl (or diazepanyl), tetrahydropyranyl, dithiazolyl, benzofuranyl, benzothienyl, oxepanyl, thiepanyl, azocanyl, oxecanyl, and thiocanyl. Heterocyclic groups also include groups of the formula

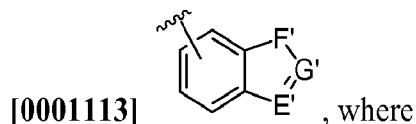

[0001114] E' is selected from the group consisting of -N- and -CH-; F' is selected from the group consisting of -N=CH-, -NH-CH<sub>2</sub>-, -NH-C(O)-, -NH-, -CH=N-, -CH<sub>2</sub>-NH-, -C(O)-NH-, -CH=CH-, -CH<sub>2</sub>-, -CH<sub>2</sub>CH<sub>2</sub>-, -CH<sub>2</sub>O-, -OCH<sub>2</sub>-, -O-, and -S-; and G' is selected from the group consisting of -CH- and -N-. Any of the heterocyclic groups mentioned herein may be optionally substituted with one, two, three, four or five substituents independently selected from the group consisting of: (1) C<sub>1-7</sub> acyl (e.g., carboxyaldehyde); (2) C<sub>1-20</sub> alkyl (e.g., C<sub>i-6</sub> alkyl, C<sub>1-6</sub> alkoxy-C<sub>i-6</sub> alkyl, C<sub>i-6</sub> alkylsulfanyl-C<sub>i-6</sub> alkyl, amino-C<sub>i-6</sub> alkyl, azido-C<sub>i-6</sub> alkyl, (carboxyaldehyde)-C<sub>i-6</sub> alkyl, halo-C<sub>i-6</sub> alkyl (e.g., perfluoroalkyl), hydroxy-C<sub>i-6</sub> alkyl, nitro-C<sub>i-6</sub> alkyl, or C<sub>1-6</sub> thioalkoxy-C<sub>i-6</sub> alkyl); (3) C<sub>1-20</sub> alkoxy (e.g., C<sub>1-6</sub> alkoxy, such as perfluoroalkoxy); (4) C<sub>i-6</sub> alkylsulfinyl; (5) C<sub>6-10</sub> aryl; (6) amino; (7) C<sub>i-6</sub> alk-C<sub>6-10</sub> aryl; (8) azido; (9) C<sub>3-8</sub> cycloalkyl; (10) C<sub>i-6</sub> alk-C<sub>3-8</sub> cycloalkyl; (11) halo; (12) C<sub>1-12</sub> heterocyclic (e.g., C<sub>2-12</sub> heteroaryl); (13) (C<sub>1-12</sub> heterocyclic)oxy; (14) hydroxy; (15) nitro; (16) C<sub>1-20</sub> thioalkoxy (e.g., C<sub>1-6</sub> thioalkoxy); (17) -(CH<sub>2</sub>)<sub>q</sub>C(O)<sub>2</sub>R<sup>A'</sup>, where q is an integer from zero to four, and R<sup>A'</sup> is selected from the group consisting of (a) C<sub>1-6</sub> alkyl, (b) C<sub>6-10</sub> aryl, (c) hydrogen, and (d) C<sub>1-6</sub> alk-C<sub>6-10</sub> aryl; (18) -(CH<sub>2</sub>)<sub>q</sub>CONR<sup>B'</sup>R<sup>C'</sup>, where q is an integer from zero to four and where R<sup>B'</sup> and R<sup>C'</sup> are independently selected from the group consisting of (a) hydrogen, (b) C<sub>1-6</sub> alkyl, (c) C<sub>6-10</sub> aryl, and (d) C<sub>1-6</sub> alk-C<sub>6-10</sub> aryl; (19) -(CH<sub>2</sub>)<sub>q</sub>S(O)<sub>2</sub>R<sup>D'</sup>, where q is an integer from zero to four and where R<sup>D'</sup> is selected from the group consisting of (a) C<sub>1-6</sub> alkyl, (b) C<sub>6-10</sub> aryl, and (c) C<sub>1-6</sub> alk-C<sub>6-10</sub> aryl; (20) -(CH<sub>2</sub>)<sub>q</sub>S(O)<sub>2</sub>NR<sup>E'</sup>R<sup>F'</sup>, where q is an integer from zero to four and where each of R<sup>E'</sup> and R<sup>F'</sup> is, independently, selected from the group consisting of (a) hydrogen, (b) C<sub>i-6</sub> alkyl, (c) C<sub>6-10</sub> aryl, and (d) C<sub>1-6</sub> alk-C<sub>6-10</sub> aryl; (21) thiol; (22) C<sub>6-10</sub> aryloxy; (23) C<sub>3-8</sub> cycloalkoxy;

(24) arylalkoxy; (25) C<sub>1-6</sub> alk-C<sub>1-12</sub> heterocyclyl (e.g., C<sub>1-6</sub> alk-C<sub>1-12</sub> heteroaryl); (26) oxo; (27) (C<sub>1-12</sub> heterocyclyl)imino; (28) C<sub>2-20</sub> alkenyl; and (29) C<sub>2-20</sub> alkynyl. In some embodiments, each of these groups can be further substituted as described herein. For example, the alkylene group of a Ci-alkaryl or a Ci-alkheterocyclyl can be further substituted with an oxo group to afford the respective aryloyl and (heterocyclyl)oyl substituent group.

**[0001115]** The term "(heterocyclyl)imino," as used herein, represents a heterocyclyl group, as defined herein, attached to the parent molecular group through an imino group. In some embodiments, the heterocyclyl group can be substituted with 1, 2, 3, or 4 substituent groups as defined herein.

**[0001116]** The term "(heterocyclyl)oxy," as used herein, represents a heterocyclyl group, as defined herein, attached to the parent molecular group through an oxygen atom. In some embodiments, the heterocyclyl group can be substituted with 1, 2, 3, or 4 substituent groups as defined herein.

**[0001117]** The term "(heterocyclyl)oyl," as used herein, represents a heterocyclyl group, as defined herein, attached to the parent molecular group through a carbonyl group. In some embodiments, the heterocyclyl group can be substituted with 1, 2, 3, or 4 substituent groups as defined herein.

**[0001118]** The term "hydrocarbon," as used herein, represents a group consisting only of carbon and hydrogen atoms.

**[0001119]** The term "hydroxy," as used herein, represents an -OH group.

**[0001120]** The term "hydroxyalkenyl," as used herein, represents an alkenyl group, as defined herein, substituted by one to three hydroxy groups, with the proviso that no more than one hydroxy group may be attached to a single carbon atom of the alkyl group, and is exemplified by dihydroxypropenyl, hydroxyisopentenyl, and the like.

**[0001121]** The term "hydroxyalkyl," as used herein, represents an alkyl group, as defined herein, substituted by one to three hydroxy groups, with the proviso that no more than one hydroxy group may be attached to a single carbon atom of the alkyl group, and is exemplified by hydroxymethyl, dihydroxypropyl, and the like.

**[0001122]** The term "isomer," as used herein, means any tautomer, stereoisomer, enantiomer, or diastereomer of any compound of the invention. It is recognized that the



compounds of the invention can have one or more chiral centers and/or double bonds and, therefore, exist as stereoisomers, such as double-bond isomers (i.e., geometric E/Z isomers) or diastereomers (e.g., enantiomers (i.e., (+) or (-)) or cis/trans isomers). According to the invention, the chemical structures depicted herein, and therefore the compounds of the invention, encompass all of the corresponding stereoisomers, that is, both the stereomerically pure form (e.g., geometrically pure, enantiomerically pure, or diastereomerically pure) and enantiomeric and stereoisomeric mixtures, e.g., racemates. Enantiomeric and stereoisomeric mixtures of compounds of the invention can typically be resolved into their component enantiomers or stereoisomers by well-known methods, such as chiral-phase gas chromatography, chiral-phase high performance liquid chromatography, crystallizing the compound as a chiral salt complex, or crystallizing the compound in a chiral solvent. Enantiomers and stereoisomers can also be obtained from stereomerically or enantiomerically pure intermediates, reagents, and catalysts by well-known asymmetric synthetic methods.

[0001123] The term "*N*-protected amino," as used herein, refers to an amino group, as defined herein, to which is attached one or two *N*-protecting groups, as defined herein.

[0001124] The term "*N*-protecting group," as used herein, represents those groups intended to protect an amino group against undesirable reactions during synthetic procedures. Commonly used *N*-protecting groups are disclosed in Greene, "Protective Groups in Organic Synthesis," 3<sup>rd</sup> Edition (John Wiley & Sons, New York, 1999), which is incorporated herein by reference. *N*-protecting groups include acyl, aryloyl, or carbamyl groups such as formyl, acetyl, propionyl, pivaloyl, *t*-butylacetyl, 2-chloroacetyl, 2-bromoacetyl, trifluoroacetyl, trichloroacetyl, phthalyl, *o*-nitrophenoxyacetyl, *a*-chlorobutyryl, benzoyl, 4-chlorobenzoyl, 4-bromobenzoyl, 4-nitrobenzoyl, and chiral auxiliaries such as protected or unprotected D, L or D, L-amino acids such as alanine, leucine, phenylalanine, and the like; sulfonyl-containing groups such as benzenesulfonyl, *p*-toluenesulfonyl, and the like; carbamate forming groups such as benzyloxycarbonyl, *p*-chlorobenzyloxycarbonyl, *p*-methoxybenzyloxycarbonyl, *p*-nitrobenzyloxycarbonyl, 2-nitrobenzyloxycarbonyl, *p*-bromobenzyloxycarbonyl, 3,4-dimethoxybenzyloxycarbonyl, 3,5-dimethoxybenzyloxycarbonyl, 2,4-dimethoxybenzyloxycarbonyl, 4-methoxybenzyloxycarbonyl, 2-nitro-4,5-dimethoxybenzyloxycarbonyl,

3,4,5-trimethoxybenzyloxycarbonyl, 1-(p-biphenyl)-1-methylethoxycarbonyl,  $\alpha,\alpha$ -dimethyl-3,5-dimethoxybenzyloxycarbonyl, benzhydryloxy carbonyl, t-butyloxycarbonyl, diisopropylmethoxycarbonyl, isopropylloxycarbonyl, ethoxycarbonyl, methoxycarbonyl, allyloxycarbonyl, 2,2,2,-trichloroethoxycarbonyl, phenoxy carbonyl, 4-nitrophenoxy carbonyl, fluorenyl-9-methoxycarbonyl, cyclopentylloxycarbonyl, adamantylloxycarbonyl, cyclohexylloxycarbonyl, phenylthiocarbonyl, and the like, alkaryl groups such as benzyl, triphenylmethyl, benzyloxymethyl, and the like and silyl groups, such as trimethylsilyl, and the like. Preferred *N*-protecting groups are formyl, acetyl, benzoyl, pivaloyl, t-butylacetyl, alanyl, phenylsulfonyl, benzyl, t-butyloxycarbonyl (Boc), and benzyloxycarbonyl (Cbz).

[0001125] The term "nitro," as used herein, represents an -NO<sub>2</sub> group.

[0001126] The term "oxo" as used herein, represents =O.

[0001127] The term "perfluoroalkyl," as used herein, represents an alkyl group, as defined herein, where each hydrogen radical bound to the alkyl group has been replaced by a fluoride radical. Perfluoroalkyl groups are exemplified by trifluoromethyl, pentafluoroethyl, and the like.

[0001128] The term "perfluoroalkoxy," as used herein, represents an alkoxy group, as defined herein, where each hydrogen radical bound to the alkoxy group has been replaced by a fluoride radical. Perfluoroalkoxy groups are exemplified by trifluoromethoxy, pentafluoroethoxy, and the like.

[0001129] The term "spirocyclyl," as used herein, represents a C<sub>2-7</sub> alkylene diradical, both ends of which are bonded to the same carbon atom of the parent group to form a spirocyclic group, and also a C<sub>i-6</sub> heteroalkylene diradical, both ends of which are bonded to the same atom. The heteroalkylene radical forming the spirocyclyl group can contain one, two, three, or four heteroatoms independently selected from the group consisting of nitrogen, oxygen, and sulfur. In some embodiments, the spirocyclyl group includes one to seven carbons, excluding the carbon atom to which the diradical is attached. The spirocyclyl groups of the invention may be optionally substituted with 1, 2, 3, or 4 substituents provided herein as optional substituents for cycloalkyl and/or heterocyclyl groups.

[0001130] The term "stereoisomer," as used herein, refers to all possible different isomeric as well as conformational forms which a compound may possess (e.g., a compound of any formula described herein), in particular all possible stereochemically and conformationally isomeric forms, all diastereomers, enantiomers and/or conformers of the basic molecular structure. Some compounds of the present invention may exist in different tautomeric forms, all of the latter being included within the scope of the present invention.

[0001131] The term "sulfoalkyl," as used herein, represents an alkyl group, as defined herein, substituted by a sulfo group of  $-SO_3H$ . In some embodiments, the alkyl group can be further substituted with 1, 2, 3, or 4 substituent groups as described herein.

[0001132] The term "sulfonyl," as used herein, represents an  $-S(O)_2-$  group.

[0001133] The term "thioalkaryl," as used herein, represents a chemical substituent of formula  $-SR$ , where R is an alkaryl group. In some embodiments, the alkaryl group can be further substituted with 1, 2, 3, or 4 substituent groups as described herein.

[0001134] The term "thioalkheterocyclyl," as used herein, represents a chemical substituent of formula  $-SR$ , where R is an alkheterocyclyl group. In some embodiments, the alkheterocyclyl group can be further substituted with 1, 2, 3, or 4 substituent groups as described herein.

[0001135] The term "thioalkoxy," as used herein, represents a chemical substituent of formula  $-SR$ , where R is an alkyl group, as defined herein. In some embodiments, the alkyl group can be further substituted with 1, 2, 3, or 4 substituent groups as described herein.

[0001136] The term "thiol" represents an  $-SH$  group.

[0001137] *Compound*: As used herein, the term "compound," is meant to include all stereoisomers, geometric isomers, tautomers, and isotopes of the structures depicted.

[0001138] The compounds described herein can be asymmetric (*e.g.*, having one or more stereocenters). All stereoisomers, such as enantiomers and diastereomers, are intended unless otherwise indicated. Compounds of the present disclosure that contain asymmetrically substituted carbon atoms can be isolated in optically active or racemic forms. Methods on how to prepare optically active forms from optically active starting materials are known in the art, such as by resolution of racemic mixtures or by

stereoselective synthesis. Many geometric isomers of olefins, C=N double bonds, and the like can also be present in the compounds described herein, and all such stable isomers are contemplated in the present disclosure. Cis and trans geometric isomers of the compounds of the present disclosure are described and may be isolated as a mixture of isomers or as separated isomeric forms.

**[0001139]** Compounds of the present disclosure also include tautomeric forms.

Tautomeric forms result from the swapping of a single bond with an adjacent double bond and the concomitant migration of a proton. Tautomeric forms include prototropic tautomers which are isomeric protonation states having the same empirical formula and total charge. Examples prototropic tautomers include ketone - enol pairs, amide - imidic acid pairs, lactam - lactim pairs, amide - imidic acid pairs, enamine - imine pairs, and annular forms where a proton can occupy two or more positions of a heterocyclic system, such as, 1H- and 3H-imidazole, 1H-, 2H- and 4H- 1,2,4-triazole, 1H- and 2H- isoindole, and 1H- and 2H-pyrazole. Tautomeric forms can be in equilibrium or sterically locked into one form by appropriate substitution.

**[0001140]** Compounds of the present disclosure also include all of the isotopes of the atoms occurring in the intermediate or final compounds. "Isotopes" refers to atoms having the same atomic number but different mass numbers resulting from a different number of neutrons in the nuclei. For example, isotopes of hydrogen include tritium and deuterium.

**[0001141]** The compounds and salts of the present disclosure can be prepared in combination with solvent or water molecules to form solvates and hydrates by routine methods.

**[0001142]** *Condition:* As used herein, the term "condition" refers to a disorder that presents with observable symptoms.

**[0001143]** *Conserved:* As used herein, the term "conserved" refers to nucleotides or amino acid residues of a polynucleotide sequence or polypeptide sequence, respectively, that are those that occur unaltered in the same position of two or more sequences being compared. Nucleotides or amino acids that are relatively conserved are those that are conserved amongst more related sequences than nucleotides or amino acids appearing elsewhere in the sequences.

[0001 144] In some embodiments, two or more sequences are said to be "completely conserved" if they are 100% identical to one another. In some embodiments, two or more sequences are said to be "highly conserved" if they are at least 70% identical, at least 80% identical, at least 90% identical, or at least 95% identical to one another. In some embodiments, two or more sequences are said to be "highly conserved" if they are about 70% identical, about 80% identical, about 90% identical, about 95%>, about 98%, or about 99% identical to one another. In some embodiments, two or more sequences are said to be "conserved" if they are at least 30%> identical, at least 40% identical, at least 50% identical, at least 60%> identical, at least 70% identical, at least 80%> identical, at least 90% identical, or at least 95% identical to one another. In some embodiments, two or more sequences are said to be "conserved" if they are about 30% identical, about 40% identical, about 50%o identical, about 60% identical, about 70% identical, about 80%o identical, about 90%o identical, about 95%o identical, about 98% identical, or about 99% identical to one another. Conservation of sequence may apply to the entire length of an oligonucleotide or polypeptide or may apply to a portion, region or feature thereof.

[0001 145] *Cosmetic*: As used herein, the term "cosmetic" refers to a substance which may be used to enhance, alter, modify and/or change the appearance of a cell, tissue and/or organism.

[0001 146] *Cosmetic polypeptide*: As used herein, a "cosmetic polypeptide" refers to a polypeptide that upon contact or administration enhances, alters, modifies and/or changes the phenotype or aesthetic presentation of a cell, tissue, system, and/or organism. A cosmetic polypeptide may be a therapeutic, e.g., it may comprise pharmaceutical compositions and/or formulations, or they may serve to provide only aesthetic benefits such as with lipsticks, fingernail and toenail polish, eye and facial make-up, cover-ups, concealers and the like.

[0001 147] *Cosmetic protein*: As used herein, a "cosmetic protein" refers to a protein which may be encoded by a cosmetic polypeptide, fragments and variants thereof.

[0001 148] *Cyclic or Cyclized*: As used herein, the term "cyclic" refers to the presence of a continuous loop. Cyclic molecules need not be circular, only joined to form an unbroken chain of subunits. Cyclic molecules such as the engineered RNA or mRNA of

the present invention may be single units or multimers or comprise one or more components of a complex or higher order structure.

[0001149] *Cytostatic*: As used herein, "cytostatic" refers to inhibiting, reducing, suppressing the growth, division, or multiplication of a cell (*e.g.*, a mammalian cell (*e.g.*, a human cell)), bacterium, virus, fungus, protozoan, parasite, prion, or a combination thereof.

[0001150] *Cytotoxic*: As used herein, "cytotoxic" refers to killing or causing injurious, toxic, or deadly effect on a cell (*e.g.*, a mammalian cell (*e.g.*, a human cell)), bacterium, virus, fungus, protozoan, parasite, prion, or a combination thereof.

[0001151] *Delivery*: As used herein, "delivery" refers to the act or manner of delivering a compound, substance, entity, moiety, cargo or payload.

[0001152] *Delivery Agent*: As used herein, "delivery agent" refers to any substance which facilitates, at least in part, the *in vivo* delivery of a cosmetic polynucleotide, cosmetic primary construct or cosmetic mmRNA to targeted cells.

[0001153] *Destabilized*: As used herein, the term "destable," "destabilize," or "destabilizing region" means a region or molecule that is less stable than a starting, wild-type or native form of the same region or molecule.

[0001154] *Detectable label*: As used herein, "detectable label" refers to one or more markers, signals, or moieties which are attached, incorporated or associated with another entity that is readily detected by methods known in the art including radiography, fluorescence, chemiluminescence, enzymatic activity, absorbance and the like. Detectable labels include radioisotopes, fluorophores, chromophores, enzymes, dyes, metal ions, ligands such as biotin, avidin, streptavidin and haptens, quantum dots, and the like. Detectable labels may be located at any position in the peptides or proteins disclosed herein. They may be within the amino acids, the peptides, or proteins, or located at the N- or C- termini.

[0001155] *Disease*: As used herein, the term "disease" refers to an abnormal condition affecting the body of an organism often showing specific bodily symptoms.

[0001156] *Disorder*: As used herein, the term "disorder," refers to a disruption of or an interference with normal functions or established systems of the body.

[0001157] *Digest*: As used herein, the term "digest" means to break apart into smaller pieces or components. When referring to polypeptides or proteins, digestion results in the production of peptides.

[0001158] *Distal*: As used herein, the term "distal" means situated away from the center or away from a point or region of interest.

[0001159] *Dosing regimen*: As used herein, a "dosing regimen" is a schedule of administration or physician determined regimen of treatment, prophylaxis, or palliative care.

[0001160] *Dose splitting factor (DSF)-ratio* of PUD of dose split treatment divided by PUD of total daily dose or single unit dose. The value is derived from comparison of dosing regimens groups.

[0001161] *Encoded protein cleavage signal*: As used herein, "encoded protein cleavage signal" refers to the nucleotide sequence which encodes a protein cleavage signal.

[0001162] *Engineered*: As used herein, embodiments of the invention are "engineered" when they are designed to have a feature or property, whether structural or chemical, that varies from a starting point, wild type or native molecule.

[0001163] *Exosome*: As used herein, "exosome" is a vesicle secreted by mammalian cells or a complex involved in RNA degradation.

[0001164] *Expression*: As used herein, "expression" of a nucleic acid sequence refers to one or more of the following events: (1) production of an RNA template from a DNA sequence (*e.g.*, by transcription); (2) processing of an RNA transcript (*e.g.*, by splicing, editing, 5' cap formation, and/or 3' end processing); (3) translation of an RNA into a polypeptide or protein; and (4) post-translational modification of a polypeptide or protein.

[0001165] *Feature*: As used herein, a "feature" refers to a characteristic, a property, or a distinctive element.

[0001166] *Formulation*: As used herein, a "formulation" includes at least a cosmetic polynucleotide, cosmetic primary construct or cosmetic mmRNA and a delivery agent.

[0001167] *Fragment*: A "fragment," as used herein, refers to a portion. For example, fragments of proteins may comprise polypeptides obtained by digesting full-length protein isolated from cultured cells.

**[0001168]** *Functional*: As used herein, a "functional" biological molecule is a biological molecule in a form in which it exhibits a property and/or activity by which it is characterized.

**[0001169]** *Heavy Chain*: As used herein, when referring to neurotoxins, the phrase "heavy chain" describes the larger of the N-terminal or C-terminal chains.

**[0001170]** *Homology*: As used herein, the term "homology" refers to the overall relatedness between polymeric molecules, *e.g.* between nucleic acid molecules (*e.g.* DNA molecules and/or RNA molecules) and/or between polypeptide molecules. In some embodiments, polymeric molecules are considered to be "homologous" to one another if their sequences are at least 25%, 30%, 35%, 40%, 45%, 50%, 55%, 60%, 65%, 70%, 75%, 80%, 85%, 90%, 95%, or 99% identical or similar. The term "homologous" necessarily refers to a comparison between at least two sequences (polynucleotide or polypeptide sequences). In accordance with the invention, two polynucleotide sequences are considered to be homologous if the polypeptides they encode are at least about 50%, 60%, 70%, 80%, 90%, 95%, or even 99% for at least one stretch of at least about 20 amino acids. In some embodiments, homologous polynucleotide sequences are characterized by the ability to encode a stretch of at least 4-5 uniquely specified amino acids. For polynucleotide sequences less than 60 nucleotides in length, homology is determined by the ability to encode a stretch of at least 4-5 uniquely specified amino acids. In accordance with the invention, two protein sequences are considered to be homologous if the proteins are at least about 50%, 60%, 70%, 80%, or 90% identical for at least one stretch of at least about 20 amino acids.

**[0001171]** *Identity*: As used herein, the term "identity" refers to the overall relatedness between polymeric molecules, *e.g.*, between oligonucleotide molecules (*e.g.* DNA molecules and/or RNA molecules) and/or between polypeptide molecules. Calculation of the percent identity of two polynucleotide sequences, for example, can be performed by aligning the two sequences for optimal comparison purposes (*e.g.*, gaps can be introduced in one or both of a first and a second nucleic acid sequences for optimal alignment and non-identical sequences can be disregarded for comparison purposes). In certain embodiments, the length of a sequence aligned for comparison purposes is at least 30%, at least 40%, at least 50%, at least 60%, at least 70%, at least 80%, at least 90%, at least



95%, or 100% of the length of the reference sequence. The nucleotides at corresponding nucleotide positions are then compared. When a position in the first sequence is occupied by the same nucleotide as the corresponding position in the second sequence, then the molecules are identical at that position. The percent identity between the two sequences is a function of the number of identical positions shared by the sequences, taking into account the number of gaps, and the length of each gap, which needs to be introduced for optimal alignment of the two sequences. The comparison of sequences and determination of percent identity between two sequences can be accomplished using a mathematical algorithm. For example, the percent identity between two nucleotide sequences can be determined using methods such as those described in *Computational Molecular Biology*, Lesk, A. M., ed., Oxford University Press, New York, 1988; *Biocomputing: Informatics and Genome Projects*, Smith, D. W., ed., Academic Press, New York, 1993; *Sequence Analysis in Molecular Biology* von Heinje, G., Academic Press, 1987; *Computer Analysis of Sequence Data, Part I*, Griffin, A. M., and Griffin, H. G., eds., Humana Press, New Jersey, 1994; and *Sequence Analysis Primer*, Gribskov, M. and Devereux, J., eds., M Stockton Press, New York, 1991; each of which is incorporated herein by reference. For example, the percent identity between two nucleotide sequences can be determined using the algorithm of Meyers and Miller (CABIOS, 1989, 4:11-17), which has been incorporated into the ALIGN program (version 2.0) using a PAM120 weight residue table, a gap length penalty of 12 and a gap penalty of 4. The percent identity between two nucleotide sequences can, alternatively, be determined using the GAP program in the GCG software package using an NWSgapdna.CMP matrix. Methods commonly employed to determine percent identity between sequences include, but are not limited to those disclosed in Carillo, H., and Lipman, D., *SIAM J Applied Math.*, 48:1073 (1988); incorporated herein by reference. Techniques for determining identity are codified in publicly available computer programs. Exemplary computer software to determine homology between two sequences include, but are not limited to, GCG program package, Devereux, J., *et al*, *Nucleic Acids Research*, 12(1), 387 (1984)), BLASTP, BLASTN, and FASTA Altschul, S. F. *et al*, *J. Molec. Biol.*, 215, 403 (1990)).

[0001172] *Inhibit expression of a gene*: As used herein, the phrase "inhibit expression of a gene" means to cause a reduction in the amount of an expression product of the gene.

The expression product can be an RNA transcribed from the gene (*e.g.*, an mRNA) or a polypeptide translated from an mRNA transcribed from the gene. Typically a reduction in the level of an mRNA results in a reduction in the level of a polypeptide translated therefrom. The level of expression may be determined using standard techniques for measuring mRNA or protein.

[0001173] *In vitro*: As used herein, the term "*in vitro*" refers to events that occur in an artificial environment, *e.g.*, in a test tube or reaction vessel, in cell culture, in a Petri dish, *etc.*, rather than within an organism (*e.g.*, animal, plant, or microbe).

[0001174] *In vivo*: As used herein, the term "*in vivo*" refers to events that occur within an organism (*e.g.*, animal, plant, or microbe or cell or tissue thereof).

[0001175] *Isolated*: As used herein, the term "isolated" refers to a substance or entity that has been separated from at least some of the components with which it was associated (whether in nature or in an experimental setting). Isolated substances may have varying levels of purity in reference to the substances from which they have been associated. Isolated substances and/or entities may be separated from at least about 10%, about 20%, about 30%, about 40%, about 50%, about 60%, about 70%, about 80%, about 90%, or more of the other components with which they were initially associated. In some embodiments, isolated agents are more than about 80%, about 85%, about 90%, about 91%, about 92%, about 93%, about 94%, about 95%, about 96%, about 97%, about 98%, about 99%, or more than about 99% pure. As used herein, a substance is "pure" if it is substantially free of other components. *Substantially isolated*: By "substantially isolated" is meant that the compound is substantially separated from the environment in which it was formed or detected. Partial separation can include, for example, a composition enriched in the compound of the present disclosure. Substantial separation can include compositions containing at least about 50%, at least about 60%, at least about 70%, at least about 80%, at least about 90%, at least about 95%, at least about 97%, or at least about 99% by weight of the compound of the present disclosure, or salt thereof. Methods for isolating compounds and their salts are routine in the art.

[0001176] *Light Chain*: As used herein, when referring to neurotoxins, the phrase "light chain" describes the smaller of the N-terminal or C-terminal chains.

[0001177] *Linker*: As used herein, a linker refers to a group of atoms, e.g., 10-1,000 atoms, and can be comprised of the atoms or groups such as, but not limited to, carbon, amino, alkylamino, oxygen, sulfur, sulfoxide, sulfonyl, carbonyl, and imine. The linker can be attached to a modified nucleoside or nucleotide on the nucleobase or sugar moiety at a first end, and to a payload, e.g., a detectable or therapeutic agent, at a second end. The linker may be of sufficient length as to not interfere with incorporation into a nucleic acid sequence. The linker can be used for any useful purpose, such as to form mmRNA multimers (e.g., through linkage of two or more cosmetic polynucleotides, cosmetic primary constructs, or cosmetic mmRNA molecules) or mmRNA conjugates, as well as to administer a payload, as described herein. Examples of chemical groups that can be incorporated into the linker include, but are not limited to, alkyl, alkenyl, alkynyl, amido, amino, ether, thioether, ester, alkylene, heteroalkylene, aryl, or heterocyclyl, each of which can be optionally substituted, as described herein. Examples of linkers include, but are not limited to, unsaturated alkanes, polyethylene glycols (e.g., ethylene or propylene glycol monomeric units, e.g., diethylene glycol, dipropylene glycol, triethylene glycol, tripropylene glycol, tetraethylene glycol, or tetraethylene glycol), and dextran polymers. Other examples include, but are not limited to, cleavable moieties within the linker, such as, for example, a disulfide bond (-S-S-) or an azo bond (-N=N-), which can be cleaved using a reducing agent or photolysis. Non-limiting examples of a selectively cleavable bond include an amido bond can be cleaved for example by the use of tris(2-carboxyethyl)phosphine (TCEP), or other reducing agents, and/or photolysis, as well as an ester bond can be cleaved for example by acidic or basic hydrolysis.

[0001178] *MicroRNA (miRNA) binding site*: As used herein, a microRNA (miRNA) binding site represents a nucleotide location or region of a nucleic acid transcript to which at least the "seed" region of a miRNA binds.

[0001179] *Modified*: As used herein "modified" refers to a changed state or structure of a molecule of the invention. Molecules may be modified in many ways including chemically, structurally, and functionally. In one embodiment, the mRNA molecules of the present invention are modified by the introduction of non-natural nucleosides and/or nucleotides, e.g., as it relates to the natural ribonucleotides A, U, G, and C. Noncanonical

nucleotides such as the cap structures are not considered "modified" although they differ from the chemical structure of the A, C, G, U ribonucleotides.

[0001180] *Mucus*: As used herein, "mucus" refers to the natural substance that is viscous and comprises mucin glycoproteins.

[0001181] *Naturally occurring*: As used herein, "naturally occurring" means existing in nature without artificial aid.

[0001182] *Non-human vertebrate*: As used herein, a "non human vertebrate" includes all vertebrates except *Homo sapiens*, including wild and domesticated species. Examples of non-human vertebrates include, but are not limited to, mammals, such as alpaca, banteng, bison, camel, cat, cattle, deer, dog, donkey, gayal, goat, guinea pig, horse, llama, mule, pig, rabbit, reindeer, sheep water buffalo, and yak.

[0001183] *Off-target*: As used herein, "off target" refers to any unintended effect on any one or more target, gene, or cellular transcript.

[0001184] *Open readingframe*: As used herein, "open reading frame" or "ORF" refers to a sequence which does not contain a stop codon in a given reading frame.

[0001185] *Operably linked*: As used herein, the phrase "operably linked" refers to a functional connection between two or more molecules, constructs, transcripts, entities, moieties or the like.

[0001186] *Paratope*: As used herein, a "paratope" refers to the antigen-binding site of an antibody.

[0001187] *Patient*: As used herein, "patient" refers to a subject who may seek or be in need of treatment, requires treatment, is receiving treatment, will receive treatment, or a subject who is under care by a trained professional for a particular disease or condition.

[0001188] *Optionally substituted*: Herein a phrase of the form "optionally substituted X" (*e.g.*, optionally substituted alkyl) is intended to be equivalent to "X, wherein X is optionally substituted" (*e.g.*, "alkyl, wherein said alkyl is optionally substituted"). It is not intended to mean that the feature "X" (*e.g.* alkyl) *per se* is optional.

[0001189] *Peptide*: As used herein, "peptide" is less than or equal to 50 amino acids long, *e.g.*, about 5, 10, 15, 20, 25, 30, 35, 40, 45, or 50 amino acids long.

[0001190] *Pharmaceutical composition*: The phrase "pharmaceutical composition" refers to a composition that alters the etiology of a disease, disorder and/or condition.

**[0001191]** *Pharmaceutically acceptable*: The phrase "pharmaceutically acceptable" is employed herein to refer to those compounds, materials, compositions, and/or dosage forms which are, within the scope of sound medical judgment, suitable for use in contact with the tissues of human beings and animals without excessive toxicity, irritation, allergic response, or other problem or complication, commensurate with a reasonable benefit/risk ratio.

**[0001192]** *Pharmaceutically acceptable excipients*: The phrase "pharmaceutically acceptable excipient," as used herein, refers any ingredient other than the compounds described herein (for example, a vehicle capable of suspending or dissolving the active compound) and having the properties of being substantially nontoxic and non-inflammatory in a patient. Excipients may include, for example: antiadherents, antioxidants, binders, coatings, compression aids, disintegrants, dyes (colors), emollients, emulsifiers, fillers (diluents), film formers or coatings, flavors, fragrances, glidants (flow enhancers), lubricants, preservatives, printing inks, sorbents, suspending or dispersing agents, sweeteners, and waters of hydration. Exemplary excipients include, but are not limited to: butylated hydroxytoluene (BHT), calcium carbonate, calcium phosphate (dibasic), calcium stearate, croscarmellose, crosslinked polyvinyl pyrrolidone, citric acid, crospovidone, cysteine, ethylcellulose, gelatin, hydroxypropyl cellulose, hydroxypropyl methylcellulose, lactose, magnesium stearate, maltitol, mannitol, methionine, methylcellulose, methyl paraben, microcrystalline cellulose, polyethylene glycol, polyvinyl pyrrolidone, povidone, pregelatinized starch, propyl paraben, retinyl palmitate, shellac, silicon dioxide, sodium carboxymethyl cellulose, sodium citrate, sodium starch glycolate, sorbitol, starch (corn), stearic acid, sucrose, talc, titanium dioxide, vitamin A, vitamin E, vitamin C, and xylitol.

**[0001193]** *Pharmaceutically acceptable salts*: The present disclosure also includes pharmaceutically acceptable salts of the compounds described herein. As used herein, "pharmaceutically acceptable salts" refers to derivatives of the disclosed compounds wherein the parent compound is modified by converting an existing acid or base moiety to its salt form (e.g., by reacting the free base group with a suitable organic acid). Examples of pharmaceutically acceptable salts include, but are not limited to, mineral or organic acid salts of basic residues such as amines; alkali or organic salts of acidic

residues such as carboxylic acids; and the like. Representative acid addition salts include acetate, adipate, alginate, ascorbate, aspartate, benzenesulfonate, benzoate, bisulfate, borate, butyrate, camphorate, camphorsulfonate, citrate, cyclopentanepropionate, digluconate, dodecylsulfate, ethanesulfonate, fumarate, glucoheptonate, glycerophosphate, hemisulfate, heptonate, hexanoate, hydrobromide, hydrochloride, hydroiodide, 2-hydroxy-ethanesulfonate, lactobionate, lactate, laurate, lauryl sulfate, malate, maleate, malonate, methanesulfonate, 2-naphthalenesulfonate, nicotinate, nitrate, oleate, oxalate, palmitate, pamoate, pectinate, persulfate, 3-phenylpropionate, phosphate, picrate, pivalate, propionate, stearate, succinate, sulfate, tartrate, thiocyanate, toluenesulfonate, undecanoate, valerate salts, and the like. Representative alkali or alkaline earth metal salts include sodium, lithium, potassium, calcium, magnesium, and the like, as well as nontoxic ammonium, quaternary ammonium, and amine cations, including, but not limited to ammonium, tetramethylammonium, tetraethylammonium, methylamine, dimethylamine, trimethylamine, triethylamine, ethylamine, and the like. The pharmaceutically acceptable salts of the present disclosure include the conventional non-toxic salts of the parent compound formed, for example, from non-toxic inorganic or organic acids. The pharmaceutically acceptable salts of the present disclosure can be synthesized from the parent compound which contains a basic or acidic moiety by conventional chemical methods. Generally, such salts can be prepared by reacting the free acid or base forms of these compounds with a stoichiometric amount of the appropriate base or acid in water or in an organic solvent, or in a mixture of the two; generally, nonaqueous media like ether, ethyl acetate, ethanol, isopropanol, or acetonitrile are preferred. Lists of suitable salts are found in *Remington's Pharmaceutical Sciences*, 17<sup>th</sup> ed., Mack Publishing Company, Easton, Pa., 1985, p. 1418, *Pharmaceutical Salts: Properties, Selection, and Use*, P.H. Stahl and C.G. Wermuth (eds.), Wiley-VCH, 2008, and Berge et al., *Journal of Pharmaceutical Science*, 66, 1-19 (1977), each of which is incorporated herein by reference in its entirety.

[0001194] *Pharmaceutically acceptable solvate*: The term "pharmaceutically acceptable solvate," as used herein, means a compound of the invention wherein molecules of a suitable solvent are incorporated in the crystal lattice. A suitable solvent is physiologically tolerable at the dosage administered. For example, solvates may be

prepared by crystallization, recrystallization, or precipitation from a solution that includes organic solvents, water, or a mixture thereof. Examples of suitable solvents are ethanol, water (for example, mono-, di-, and tri-hydrates), *N*-methylpyrrolidinone (NMP), dimethyl sulfoxide (DMSO), *N,N'*-dimethylformamide (DMF), *N,N'*-dimethylacetamide (DMAC), 1,3-dimethyl-2-imidazolidinone (DMEU), 1,3-dimethyl-3,4,5,6-tetrahydro-2-(1H)-pyrimidinone (DMPU), acetonitrile (ACN), propylene glycol, ethyl acetate, benzyl alcohol, 2-pyrrolidone, benzyl benzoate, and the like. When water is the solvent, the solvate is referred to as a "hydrate."

**[0001195]** *Pharmacokinetic*: As used herein, "pharmacokinetic" refers to any one or more properties of a molecule or compound as it relates to the determination of the fate of substances administered to a living organism. Pharmacokinetics is divided into several areas including the extent and rate of absorption, distribution, metabolism and excretion. This is commonly referred to as ADME where: (A) Absorption is the process of a substance entering the blood circulation; (D) Distribution is the dispersion or dissemination of substances throughout the fluids and tissues of the body; (M) Metabolism (or Biotransformation) is the irreversible transformation of parent compounds into daughter metabolites; and (E) Excretion (or Elimination) refers to the elimination of the substances from the body. In rare cases, some drugs irreversibly accumulate in body tissue.

**[0001196]** *Phenotype*: As used herein, "phenotype" refers to the set of observable characteristics of a subject, cell, tissue, organ and/or organism. For example, a change in phenotype may include the reduction of facial wrinkles, disappearance of age spots, disappearance of skin discoloration and the like.

**[0001197]** *Physicochemical*: As used herein, "physicochemical" means of or relating to a physical and/or chemical property.

**[0001198]** *Polypeptide per unit drug (PUD)*: As used herein, a PUD or product per unit drug, is defined as a subdivided portion of total daily dose, usually 1 mg, pg, kg, etc., of a product (such as a polypeptide) as measured in body fluid or tissue, usually defined in concentration such as pmol/mL, mmol/mL, etc divided by the measure in the body fluid.

**[0001199]** *Preventing*: As used herein, the term "preventing" refers to partially or completely delaying onset of an infection, disease, disorder and/or condition; partially or

completely delaying onset of one or more symptoms, features, or clinical manifestations of a particular infection, disease, disorder, and/or condition; partially or completely delaying onset of one or more symptoms, features, or manifestations of a particular infection, disease, disorder, and/or condition; partially or completely delaying progression from an infection, a particular disease, disorder and/or condition; and/or decreasing the risk of developing pathology associated with the infection, the disease, disorder, and/or condition.

**[0001200]** *Prodrug*: The present disclosure also includes prodrugs of the compounds described herein. As used herein, "prodrugs" refer to any substance, molecule or entity which is in a form predicate for that substance, molecule or entity to act as a therapeutic upon chemical or physical alteration. Prodrugs may be covalently bonded or sequestered in some way and which release or are converted into the active drug moiety prior to, upon or after administered to a mammalian subject. Prodrugs can be prepared by modifying functional groups present in the compounds in such a way that the modifications are cleaved, either in routine manipulation or *in vivo*, to the parent compounds. Prodrugs include compounds wherein hydroxyl, amino, sulfhydryl, or carboxyl groups are bonded to any group that, when administered to a mammalian subject, cleaves to form a free hydroxyl, amino, sulfhydryl, or carboxyl group respectively. Preparation and use of prodrugs is discussed in T. Higuchi and V. Stella, "Pro-drugs as Novel Delivery Systems," Vol. 14 of the A.C.S. Symposium Series, and in *Bioreversible Carriers in Drug Design*, ed. Edward B. Roche, American Pharmaceutical Association and Pergamon Press, 1987, both of which are hereby incorporated by reference in their entirety.

**[0001201]** *Proliferate*: As used herein, the term "proliferate" means to grow, expand or increase or cause to grow, expand or increase rapidly. "Proliferative" means having the ability to proliferate. "Anti-proliferative" means having properties counter to or inapposite to proliferative properties.

**[0001202]** *Protein cleavage site*: As used herein, "protein cleavage site" refers to a site where controlled cleavage of the amino acid chain can be accomplished by chemical, enzymatic or photochemical means.



[0001203] *Protein cleavage signal*: As used herein "protein cleavage signal" refers to at least one amino acid that flags or marks a polypeptide for cleavage.

[0001204] *Protein of interest*: As used herein, the terms "proteins of interest" or "desired proteins" include those provided herein and fragments, mutants, variants, and alterations thereof.

[0001205] *Proximal*: As used herein, the term "proximal" means situated nearer to the center or to a point or region of interest.

[0001206] *Pseudouridine*: As used herein, pseudouridine refers to the C-glycoside isomer of the nucleoside uridine. A "pseudouridine analog" is any modification, variant, isoform or derivative of pseudouridine. For example, pseudouridine analogs include but are not limited to 1-carboxymethyl-pseudouridine, 1-propynyl-pseudouridine, 1-taurinomethyl-pseudouridine, 1-taurinomethyl-4-thio-pseudouridine, 1-methylpseudouridine ( $m^1\psi$ ), 1-methyl-4-thio-pseudouridine ( $m^1s^4\psi$ ), 4-thio-1-methyl-pseudouridine, 3-methyl-pseudouridine ( $m^3\psi$ ), 2-thio-1-methyl-pseudouridine, 1-methyl-1-deaza-pseudouridine, 2-thio-1-methyl-1-deaza-pseudouridine, dihydropseudouridine, 2-thio-dihydropseudouridine, 2-methoxyuridine, 2-methoxy-4-thio-uridine, 4-methoxy-pseudouridine, 4-methoxy-2-thio-pseudouridine, N1-methyl-pseudouridine, 1-methyl-3-(3-amino-3-carboxypropyl)pseudouridine ( $acp^3\psi$ ), and 2'-**0**-methyl-pseudouridine ( $\psi m$ ).

[0001207] *Purified*: As used herein, "purify," "purified," "purification" means to make substantially pure or clear from unwanted components, material defilement, admixture or imperfection.

[0001208] *Sample*: As used herein, the term "sample" or "biological sample" refers to a subset of its tissues, cells or component parts (e.g. body fluids, including but not limited to blood, mucus, lymphatic fluid, synovial fluid, cerebrospinal fluid, saliva, amniotic fluid, amniotic cord blood, urine, vaginal fluid and semen). A sample further may include a homogenate, lysate or extract prepared from a whole organism or a subset of its tissues, cells or component parts, or a fraction or portion thereof, including but not limited to, for example, plasma, serum, spinal fluid, lymph fluid, the external sections of the skin, respiratory, intestinal, and genitourinary tracts, tears, saliva, milk, blood cells, tumors, organs. A sample further refers to a medium, such as a nutrient broth or gel, which may contain cellular components, such as proteins or nucleic acid molecule.

[0001209] *Signal Sequences*: As used herein, the phrase "signal sequences" refers to a sequence which can direct the transport or localization of a protein.

[0001210] *Single unit dose*: As used herein, a "single unit dose" is a dose of any therapeutic administered in one dose/at one time/single route/single point of contact, i.e., single administration event.

[0001211] *Similarity*: As used herein, the term "similarity" refers to the overall relatedness between polymeric molecules, e.g. between polynucleotide molecules (e.g. DNA molecules and/or RNA molecules) and/or between polypeptide molecules. Calculation of percent similarity of polymeric molecules to one another can be performed in the same manner as a calculation of percent identity, except that calculation of percent similarity takes into account conservative substitutions as is understood in the art.

[0001212] *Skin*: The term "skin" is the thin layer of tissue forming the natural outer covering of the body of a subject and includes the epidermis and the dermis. The dermis is the thick layer of living tissue below the epidermis which is the surface epithelium of the skin.

[0001213] *Split dose*: As used herein, a "split dose" is the division of single unit dose or total daily dose into two or more doses.

[0001214] *Stable*: As used herein "stable" refers to a compound that is sufficiently robust to survive isolation to a useful degree of purity from a reaction mixture, and preferably capable of formulation into an efficacious therapeutic agent.

[0001215] *Stabilized*: As used herein, the term "stabilize", "stabilized," "stabilized region" means to make or become stable.

[0001216] *Subject*: As used herein, the term "subject" or "patient" refers to any organism to which a composition in accordance with the invention may be administered, e.g., for experimental, diagnostic, prophylactic, and/or therapeutic purposes. Typical subjects include animals (e.g., mammals such as mice, rats, rabbits, non-human primates, and humans) and/or plants.

[0001217] *Substantially*: As used herein, the term "substantially" refers to the qualitative condition of exhibiting total or near-total extent or degree of a characteristic or property of interest. One of ordinary skill in the biological arts will understand that biological and chemical phenomena rarely, if ever, go to completion and/or proceed to completeness or

achieve or avoid an absolute result. The term "substantially" is therefore used herein to capture the potential lack of completeness inherent in many biological and chemical phenomena.

[0001218] *Substantially equal*: As used herein as it relates to time differences between doses, the term means plus/minus 2%.

[0001219] *Substantially simultaneously*: As used herein and as it relates to plurality of doses, the term means within 2 seconds.

[0001220] *Suffering from*: An individual who is "suffering from" a disease, disorder, and/or condition has been diagnosed with or displays one or more symptoms of a disease, disorder, and/or condition.

[0001221] *Susceptible to*: An individual who is "susceptible to" a disease, disorder, and/or condition has not been diagnosed with and/or may not exhibit symptoms of the disease, disorder, and/or condition but harbors a propensity to develop a disease or its symptoms. In some embodiments, an individual who is susceptible to a disease, disorder, and/or condition (for example, cancer) may be characterized by one or more of the following: (1) a genetic mutation associated with development of the disease, disorder, and/or condition; (2) a genetic polymorphism associated with development of the disease, disorder, and/or condition; (3) increased and/or decreased expression and/or activity of a protein and/or nucleic acid associated with the disease, disorder, and/or condition; (4) habits and/or lifestyles associated with development of the disease, disorder, and/or condition; (5) a family history of the disease, disorder, and/or condition; and (6) exposure to and/or infection with a microbe associated with development of the disease, disorder, and/or condition. In some embodiments, an individual who is susceptible to a disease, disorder, and/or condition will develop the disease, disorder, and/or condition. In some embodiments, an individual who is susceptible to a disease, disorder, and/or condition will not develop the disease, disorder, and/or condition.

[0001222] *Synthetic*: The term "synthetic" means produced, prepared, and/or manufactured by the hand of man. Synthesis of polynucleotides or polypeptides or other molecules of the present invention may be chemical or enzymatic.

[0001223] *Targeted Cells*: As used herein, "targeted cells" refers to any one or more cells of interest. The cells may be found *in vitro*, *in vivo*, *in situ* or in the tissue or organ

of an organism. The organism may be an animal, preferably a mammal, more preferably a human and most preferably a patient.

[0001224] *Therapeutic Agent*: The term "therapeutic agent" refers to any agent that, when administered to a subject, has a therapeutic, diagnostic, and/or prophylactic effect and/or elicits a desired biological and/or pharmacological effect.

[0001225] *Therapeutically effective amount*: As used herein, the term "therapeutically effective amount" means an amount of an agent to be delivered (*e.g.*, nucleic acid, drug, therapeutic agent, diagnostic agent, prophylactic agent, *etc.*) that is sufficient, when administered to a subject suffering from or susceptible to an infection, disease, disorder, and/or condition, to treat, improve symptoms of, diagnose, prevent, and/or delay the onset of the infection, disease, disorder, and/or condition.

[0001226] *Therapeutically effective outcome*: As used herein, the term "therapeutically effective outcome" means an outcome that is sufficient in a subject suffering from or susceptible to an infection, disease, disorder, and/or condition, to treat, improve symptoms of, diagnose, prevent, and/or delay the onset of the infection, disease, disorder, and/or condition.

[0001227] *Total daily dose*: As used herein, a "total daily dose" is an amount given or prescribed in 24 hr period. It may be administered as a single unit dose.

[0001228] *Transcription factor*: As used herein, the term "transcription factor" refers to a DNA-binding protein that regulates transcription of DNA into RNA, for example, by activation or repression of transcription. Some transcription factors effect regulation of transcription alone, while others act in concert with other proteins. Some transcription factor can both activate and repress transcription under certain conditions. In general, transcription factors bind a specific target sequence or sequences highly similar to a specific consensus sequence in a regulatory region of a target gene. Transcription factors may regulate transcription of a target gene alone or in a complex with other molecules.

[0001229] *Treating*: As used herein, the term "treating" refers to partially or completely alleviating, ameliorating, improving, relieving, delaying onset of, inhibiting progression of, reducing severity of, and/or reducing incidence of one or more symptoms or features of a particular infection, disease, disorder, and/or condition. For example, "treating" cancer may refer to inhibiting survival, growth, and/or spread of a tumor. Treatment may

be administered to a subject who does not exhibit signs of a disease, disorder, and/or condition and/or to a subject who exhibits only early signs of a disease, disorder, and/or condition for the purpose of decreasing the risk of developing pathology associated with the disease, disorder, and/or condition.

**[0001230]** *Unmodified:* As used herein, "unmodified" refers to any substance, compound or molecule prior to being changed in any way. Unmodified may, but does not always, refer to the wild type or native form of a biomolecule. Molecules may undergo a series of modifications whereby each modified molecule may serve as the "unmodified" starting molecule for a subsequent modification.

### **Equivalents and Scope**

**[0001231]** Those skilled in the art will recognize, or be able to ascertain using no more than routine experimentation, many equivalents to the specific embodiments in accordance with the invention described herein. The scope of the present invention is not intended to be limited to the above Description, but rather is as set forth in the appended claims.

**[0001232]** In the claims, articles such as "a," "an," and "the" may mean one or more than one unless indicated to the contrary or otherwise evident from the context. Claims or descriptions that include "or" between one or more members of a group are considered satisfied if one, more than one, or all of the group members are present in, employed in, or otherwise relevant to a given product or process unless indicated to the contrary or otherwise evident from the context. The invention includes embodiments in which exactly one member of the group is present in, employed in, or otherwise relevant to a given product or process. The invention includes embodiments in which more than one, or all of the group members are present in, employed in, or otherwise relevant to a given product or process.

**[0001233]** It is also noted that the term "comprising" is intended to be open and permits but does not require the inclusion of additional elements or steps. When the term "comprising" is used herein, the term "consisting of" is thus also encompassed and disclosed.

**[0001234]** Where ranges are given, endpoints are included. Furthermore, it is to be understood that unless otherwise indicated or otherwise evident from the context and

understanding of one of ordinary skill in the art, values that are expressed as ranges can assume any specific value or subrange within the stated ranges in different embodiments of the invention, to the tenth of the unit of the lower limit of the range, unless the context clearly dictates otherwise.

[0001235] In addition, it is to be understood that any particular embodiment of the present invention that falls within the prior art may be explicitly excluded from any one or more of the claims. Since such embodiments are deemed to be known to one of ordinary skill in the art, they may be excluded even if the exclusion is not set forth explicitly herein. Any particular embodiment of the compositions of the invention (*e.g.*, any nucleic acid or protein encoded thereby; any method of production; any method of use; *etc.*) can be excluded from any one or more claims, for any reason, whether or not related to the existence of prior art.

[0001236] All cited sources, for example, references, publications, databases, database entries, and art cited herein, are incorporated into this application by reference, even if not expressly stated in the citation. In case of conflicting statements of a cited source and the instant application, the statement in the instant application shall control.

[0001237] Section and table headings are not intended to be limiting.

## **EXAMPLES**

### **Example 1. Modified mRNA Production**

[0001238] Modified mRNAs (mmRNA) according to the invention may be made using standard laboratory methods and materials. The open reading frame (ORF) of the gene of interest may be flanked by a 5' untranslated region (UTR) which may contain a strong Kozak translational initiation signal and/or an alpha-globin 3' UTR which may include an oligo(dT) sequence for templated addition of a poly-A tail. The modified mRNAs may be modified to reduce the cellular innate immune response. The modifications to reduce the cellular response may include pseudouridine ( $\psi$ ) and 5-methyl-cytidine (5meC, 5mc or m<sup>5</sup>C). (See, Kariko K et al. *Immunity* 23:165-75 (2005), Kariko K et al. *Mol Ther* 16:1833-40 (2008), Anderson BR et al. *NAR* (2010); each of which are herein incorporated by reference in their entireties).

[0001239] The ORF may also include various upstream or downstream additions (such as, but not limited to,  $\beta$ -globin, tags, *etc.*) may be ordered from an optimization service

such as, but limited to, DNA2.0 (Menlo Park, CA) and may contain multiple cloning sites which may have XbaI recognition. Upon receipt of the construct, it may be reconstituted and transformed into chemically competent *E. coli*.

**[0001240]** The methods described herein to make modified mRNA may be used to produce molecules of all sizes including long molecules. Modified mRNA using the described methods has been made for different sized molecules including glucosidase, alpha; acid (GAA) (3.2 kb), cystic fibrosis transmembrane conductance regulator (CFTR) (4.7 kb), Factor VII (7.3 kb), lysosomal acid lipase (45.4kDa), glucocerebrosidase (59.7 kDa) and iduronate 2-sulfatase (76 kDa).

**[0001241]** For the present invention, NEB DH5-alpha Competent *E. coli* are used. Transformations are performed according to NEB instructions using 100 ng of plasmid. The protocol is as follows:

1. Thaw a tube of NEB 5-alpha Competent *E. coli* cells on ice for 10 minutes.
2. Add 1-5  $\mu$ l containing 1 pg-100 ng of plasmid DNA to the cell mixture. Carefully flick the tube 4-5 times to mix cells and DNA. Do not vortex.
3. Place the mixture on ice for 30 minutes. Do not mix.
4. Heat shock at 42°C for exactly 30 seconds. Do not mix.
5. Place on ice for 5 minutes. Do not mix.
6. Pipette 950  $\mu$ l of room temperature SOC into the mixture.
7. Place at 37°C for 60 minutes. Shake vigorously (250 rpm) or rotate.
8. Warm selection plates to 37°C.
9. Mix the cells thoroughly by flicking the tube and inverting.
10. Spread 50-100  $\mu$ l of each dilution onto a selection plate and incubate overnight at 37°C. Alternatively, incubate at 30°C for 24-36 hours or 25°C for 48 hours.

A single colony is then used to inoculate 5 ml of LB growth media using the appropriate antibiotic and then allowed to grow (250 RPM, 37° C) for 5 hours. This is then used to inoculate a 200 ml culture medium and allowed to grow overnight under the same conditions.

**[0001242]** To isolate the plasmid (up to 850  $\mu$ g), a maxi prep is performed using the Invitrogen PURELINK™ HiPure Maxiprep Kit (Carlsbad, CA), following the manufacturer's instructions.

[0001243] In order to generate cDNA for *In Vitro* Transcription (IVT), the plasmid (an Example of which is shown in Figure 3) is first linearized using a restriction enzyme such as XbaI. A typical restriction digest with XbaI will comprise the following: Plasmid 1.0 µg; 10x Buffer 1.0 µl; XbaI 1.5 µl; d340 up to 10 µl; incubated at 37° C for 1 hr. If performing at lab scale (< 5µg), the reaction is cleaned up using Invitrogen's PURELINK™ PCR Micro Kit (Carlsbad, CA) per manufacturer's instructions. Larger scale purifications may need to be done with a product that has a larger load capacity such as Invitrogen's standard PURELINK™ PCR Kit (Carlsbad, CA). Following the cleanup, the linearized vector is quantified using the NanoDrop and analyzed to confirm linearization using agarose gel electrophoresis.

[0001244] As a non-limiting example, G-CSF may represent the polypeptide of interest. Sequences used in the steps outlined in Examples 1-5 are shown in Table 10. It should be noted that the start codon (ATG) has been underlined in each sequence of Table 10.

**Table 10. G-CSF Sequences**

SEQ ID NO	Description
5652	cDNA sequence: <u>ATGGCTGGACCTGCCACCCAGAGCCCCATGAAGCTGATGGC</u> CCTGCAGCTGCTGCTGTGGCACAGTGCCTCTGGACAGTGCA GGAAGCCACCCCCCTGGGCCCTGCCAGCTCCCTGCCCCAGAG CTTCTGCTCAAGTGCTTAGAGCAAGTGAGGAAGATCCAGG GCGATGGCGCAGCGCTCCAGGAGAAGCTGTGTGCCACCTAC AAGCTGTGCCACCCCGAGGAGCTGGTGCTGCTCGGACACTCT CTGGGCATCCCCTGGGCTCCCCTGAGCAGCTGCCCCAGCCAG GCCCTGCAGCTGGCAGGCTGCTTGAGCCA ACTCCATAGCGGC CTTTTCTTACCAGGGGCTCCTGCAGGCCCTGGAAGGGATC TCCCCGAGTTGGGTCCCACCTTGGACACACTGCAGCTGGAC GTCGCCGACTTTGCCACCACCATCTGGCAGCAGATGGAAGA ACTGGGAATGGCCCCTGCCCTGCAGCCCACCCAGGGTGCCAT GCCGGCCTTCGCCTCTGCTTTCCAGCGCCGGGCAGGAGGGGT CCTGGTTGCCTCCCATCTGCAGAGCTTCTGGAGGTGTCGTA CCGCGTTCTACGCCACCTTGCCCAGCCCTGA
5653	cDNA having T7 polymerase site, AfeI and XbaI restriction site: TAATACGACTCACTATA GGGAAATAAGAGAGAAAAGAAGAGTAAGAAGAAATATAAG AGCCACC <u>ATGGCTGGACCTGCCACCCAGAGCCCCATGAAGCTGATGGC</u> CCTGCAGCTGCTGCTGTGGCACAGTGCCTCTGGACAGTGCA GGAAGCCACCCCCCTGGGCCCTGCCAGCTCCCTGCCCCAGAG CTTCTGCTCAAGTGCTTAGAGCAAGTGAGGAAGATCCAGG



	<p>GCGATGGCGCAGCGCTCCAGGAGAAGCTGTGTGCCACCTAC  AAGCTGTGCCACCCCGAGGAGCTGGTGCTGCTCGGACACTCT  CTGGGCATCCCCTGGGCTCCCCTGAGCAGCTGCCCCAGCCAG  GCCCTGCAGCTGGCAGGCTGCTTGAGCCAACTCCATAGCGGC  CTTTTCTCTACCAGGGGCTCCTGCAGGCCCTGGAAGGGATC  TCCCCGAGTTGGGTCCCACCTTGGACACACTGCAGCTGGAC  GTCGCCGACTTTGCCACCACCATCTGGCAGCAGATGGAAGA  ACTGGGAATGGCCCCTGCCCTGCAGCCCACCCAGGGTGCCAT  GCCGGCCTTCGCCTCTGCTTTCAGCGCCGGGCAGGAGGGGT  CCTGGTTGCCTCCCATCTGCAGAGCTTCCTGGAGGTGTCGTA  CCGCGTTCTACGCCACCTTGCCCAGCCCTGA  AGCGCTGCCTTCTGCGGGGCTTGCCTTCTGGCCATGCCCTTCT  TCTCTCCCTTGACCTGTACCTCTTGGTCTTTGAATAAAGCCT  GAGTAGGAAGGCGGCCGCTCGAGCATGCATCTAGA</p>
<p>5654</p>	<p>Optimized sequence; containing T7 polymerase site, Afel and Xba  restriction site  TAATACGACTCACTATA  GGGAAATAAGAGAGAAAAGAAGAGTAAGAAGAAATATAAG  AGCCACC  <u>ATGGCCGGTCCC</u>CGACCCAAAGCCCCATGAAACTTATGGC  CCTGCAGTTGCTGCTTTGGCACTCGGCCCTCTGGACAGTCCA  AGAAGCGACTCCTCTCGGACCTGCCTCATCGTTGCCGCAGTC  ATTCTTTTGAAGTGTCTGGAGCAGGTGCGAAAGATTCAGGG  CGATGGAGCCGCACTCCAAGAGAAGCTCTGCGCGACATACA  AACTTTGCCATCCCGAGGAGCTCGTACTGCTCGGGCACAGCT  TGGGGATTCCCTGGGCTCCTCTCTCGTCCTGTCCGTCGCAGG  CTTTGCAGTTGGCAGGGTGCCTTTCCCAGCTCCACTCCGGTTT  GTTCTTGTATCAGGGACTGCTGCAAGCCCTTGAGGGAATCTC  GCCAGAATTGGGCCCCGACGCTGGACACGTTGCAGCTCGACG  TGCGGATTTGCAACAACCATCTGGCAGCAGATGGAGGAA  CTGGGGATGGCACCCGCGCTGCAGCCCACGCAGGGGGCAAT  GCCGGCCTTTGCGTCCGCGTTTCAGCGCAGGGCGGGTGGAGT  CCTCGTAGCGAGCCACCTTCAATCATTTTTTGAAGTCTCGTA  CCGGGTGCTGAGACATCTTGCGCAGCCGTGA  AGCGCTGCCTTCTGCGGGGCTTGCCTTCTGGCCATGCCCTTCT  TCTCTCCCTTGACCTGTACCTCTTGGTCTTTGAATAAAGCCT  GAGTAGGAAGGCGGCCGCTCGAGCATGCATCTAGA</p>
<p>5655</p>	<p>mRNA sequence (transcribed)  GGGAAAU AAGAGAGAAAAGAAGAGUAAGAAGAAAUAUAA  GAGCCACC  <u>AUGGCCGGUCCC</u>CGACCCAAAGCCCCAUGAAACUUAUGG  CCCUGCAGUUGCUGCUUUGGCACUCGGCCCUCUGGACAGU  CCAAGAAGCGACUCCUCUCGGACCUGCCUCAUCGUUGCCGC  AGUCAUUCUUUGAAGUGUCUGGAGCAGGUGCGAAAGAU  UCAGGGCGAUGGAGCCGCACUCCAAGAGAAGCUCUGCGCG</p>

ACAUACAAACUUUGCCAUCCCGAGGAGCUCGUACUGCUCG GGCACAGCUUGGGGAUUCCUGGGCUCCUCUCUCGUCCUG UCCGUCGCAGGCUUUGCAGUUGGCAGGGUGCCUUUCCAG CUCCACUCCGGUUUGUUCUUGUAUCAGGGACUGCUGCAAG CCCUUGAGGGAAUCUCGCCAGAAUUGGGCCCGACGCUGGA CACGUUGCAGCUCGACGUGGCGGAUUUCGCAACAACCAUC UGGCAGCAGAUGGAGGAACUGGGGAUGGCACCCGCGCUCG AGCCACGCAGGGGGCAAUGCCGGCCUUUGCGUCCGCGUU UCAGCGCAGGGCGGGUGGAGUCCUCGUAGCGAGCCACCUU CAAUCAUUUUUGGAAGUCUCGUACCGGGUGCUGAGACAUC UUGCGCAGCCGUGA AGCGCUGCCUUCUGCGGGGCUUGCCUUCUGGCCAUGCCCU UCUUCUCUCCUUGCACCUGUACCUCUUGGUCUUUGAAUA AAGCCUGAGUAGGAAG
--

### **Example 2: PCR for cDNA Production**

[0001245] PCR procedures for the preparation of cDNA are performed using 2x KAPA HIFI™ HotStart ReadyMix by Kapa Biosystems (Woburn, MA). This system includes 2x KAPA ReadyMix 12.5 μl; Forward Primer (10 uM) 0.75 μl; Reverse Primer (10 uM) 0.75 μl; Template cDNA 100 ng; and d<sup>3</sup>/40 diluted to 25.0 μl. The reaction conditions are at 95° C for 5 min. and 25 cycles of 98° C for 20 sec, then 58° C for 15 sec, then 72° C for 45 sec, then 72° C for 5 min. then 4° C to termination.

[0001246] The reverse primer of the instant invention incorporates a poly-T<sup>n</sup> for a poly-A<sub>120</sub> in the mRNA. Other reverse primers with longer or shorter poly(T) tracts can be used to adjust the length of the poly(A) tail in the mRNA.

[0001247] The reaction is cleaned up using Invitrogen's PURELINK™ PCR Micro Kit (Carlsbad, CA) per manufacturer's instructions (up to 5 μg). Larger reactions will require a cleanup using a product with a larger capacity. Following the cleanup, the cDNA is quantified using the NANODROP™ and analyzed by agarose gel electrophoresis to confirm the cDNA is the expected size. The cDNA is then submitted for sequencing analysis before proceeding to the *in vitro* transcription reaction.

### **Example 3. *In vitro* Transcription (TVT)**

[0001248] The *in vitro* transcription reaction generates mRNA containing modified nucleotides or modified RNA. The input nucleotide triphosphate (NTP) mix is made in-house using natural and un-natural NTPs.

[0001249] A typical *in vitro* transcription reaction includes the following:

1. Template cDNA 1.0 µg
2. IOx transcription buffer (400 mM Tris-HCl pH 8.0, 190 mM MgCl<sub>2</sub>, 50 mM DTT, 10 mM Spermidine) 2.0 µl
3. Custom NTPs (25mM each) 7.2 µl
4. RNase Inhibitor 20 U
5. T7 RNA polymerase 3000 U
6. d<sup>3</sup>40 Up to 20.0 µl. and
7. Incubation at 37° C for 3 hr-5 hrs.

[0001250] The crude IVT mix may be stored at 4° C overnight for cleanup the next day. 1 U of RNase-free DNase is then used to digest the original template. After 15 minutes of incubation at 37° C, the mRNA is purified using Ambion's MEGACLEAR™ Kit (Austin, TX) following the manufacturer's instructions. This kit can purify up to 500 µg of RNA. Following the cleanup, the RNA is quantified using the NanoDrop and analyzed by agarose gel electrophoresis to confirm the RNA is the proper size and that no degradation of the RNA has occurred.

#### **Example 4. Enzymatic Capping of mRNA**

[0001251] Capping of the mRNA is performed as follows where the mixture includes: IVT RNA 60 µg-180 µg and dH<sub>2</sub>O up to 72 µl. The mixture is incubated at 65° C for 5 minutes to denature RNA, and then is transferred immediately to ice.

[0001252] The protocol then involves the mixing of IOx Capping Buffer (0.5 M Tris-HCl (pH 8.0), 60 mM KCl, 12.5 mM MgCl<sub>2</sub>) (10.0 µl); 20 mM GTP (5.0 µl); 20 mM S-Adenosyl Methionine (2.5 µl); RNase Inhibitor (100 U); 2'-O-Methyltransferase (400U); Vaccinia capping enzyme (Guanylyl transferase) (40 U); dH<sub>2</sub>O (Up to 28 µl); and incubation at 37° C for 30 minutes for 60 µg RNA or up to 2 hours for 180 µg of RNA.

[0001253] The mRNA is then purified using Ambion's MEGACLEAR™ Kit (Austin, TX) following the manufacturer's instructions. Following the cleanup, the RNA is quantified using the NANODROP™ (ThermoFisher, Waltham, MA) and analyzed by agarose gel electrophoresis to confirm the RNA is the proper size and that no degradation of the RNA has occurred. The RNA product may also be sequenced by running a reverse-transcription-PCR to generate the cDNA for sequencing.

**Example 5. PolyA Tailing Reaction**

[0001254] Without a poly-T in the cDNA, a poly-A tailing reaction must be performed before cleaning the final product. This is done by mixing Capped IVT RNA (100  $\mu\text{l}$ ); RNase Inhibitor (20 U); IOx Tailing Buffer (0.5 M Tris-HCl (pH 8.0), 2.5 M NaCl, 100 mM  $\text{MgCl}_2$ )(12.0  $\mu\text{l}$ ); 20 mM ATP (6.0  $\mu\text{l}$ ); Poly-A Polymerase (20 U);  $\text{dH}_2\text{O}$  up to 123.5  $\mu\text{l}$  and incubation at 37° C for 30 min. If the poly-A tail is already in the transcript, then the tailing reaction may be skipped and proceed directly to cleanup with Ambion's MEGACLEAR™ kit (Austin, TX) (up to 500  $\mu\text{g}$ ). Poly-A Polymerase is preferably a recombinant enzyme expressed in yeast.

[0001255] For studies performed and described herein, the poly-A tail is encoded in the IVT template to comprise 160 nucleotides in length. However, it should be understood that the processivity or integrity of the polyA tailing reaction may not always result in exactly 160 nucleotides. Hence polyA tails of approximately 160 nucleotides, e.g, about 150-165, 155, 156, 157, 158, 159, 160, 161, 162, 163, 164 or 165 are within the scope of the invention.

**Example 6. Natural 5' Caps and 5' Cap Analogues**

[0001256] 5'-capping of modified RNA may be completed concomitantly during the *in vitro* transcription reaction using the following chemical RNA cap analogs to generate the 5'-guanosine cap structure according to manufacturer protocols: 3'-0-Me-m7G(5')ppp(5') G [the ARCA cap]; G(5')ppp(5')A; G(5')ppp(5')G; m7G(5')ppp(5')A; m7G(5')ppp(5')G (New England BioLabs, Ipswich, MA). 5'-capping of modified RNA may be completed post-transcriptionally using a Vaccinia Virus Capping Enzyme to generate the "Cap 0" structure: m7G(5')ppp(5')G (New England BioLabs, Ipswich, MA). Cap 1 structure may be generated using both Vaccinia Virus Capping Enzyme and a 2'-0 methyl-transferase to generate: m7G(5')ppp(5')G-2'-0-methyl. Cap 2 structure may be generated from the Cap 1 structure followed by the 2'-0-methylation of the 5'-antepenultimate nucleotide using a 2'-0 methyl-transferase. Cap 3 structure may be generated from the Cap 2 structure followed by the 2'-0-methylation of the 5'-preantepenultimate nucleotide using a 2'-0 methyl-transferase. Enzymes are preferably derived from a recombinant source.

[0001257] When transfected into mammalian cells, the modified mRNAs have a stability of between 12-18 hours or more than 18 hours, e.g., 24, 36, 48, 60, 72 or greater than 72 hours.

### **Example 7. Capping**

#### **A. Protein Expression Assay**

[0001258] Synthetic mRNAs encoding human G-CSF (cDNA shown in SEQ ID NO: 5652; mRNA sequence fully modified with 5-methylcytosine at each cytosine and pseudouridine replacement at each uridine site shown in SEQ ID NO: 5655 with a polyA tail approximately 160 nucleotides in length not shown in sequence) containing the ARCA (3' 0-Me-m7G(5')ppp(5')G) cap analog or the Cap1 structure can be transfected into human primary keratinocytes at equal concentrations. 6, 12, 24 and 36 hours post-transfection the amount of G-CSF secreted into the culture medium can be assayed by ELISA. Synthetic mRNAs that secrete higher levels of G-CSF into the medium would correspond to a synthetic mRNA with a higher translationally-competent Cap structure.

#### **B. Purity Analysis Synthesis**

[0001259] Synthetic mRNAs encoding human G-CSF (cDNA shown in SEQ ID NO: 5652; mRNA sequence fully modified with 5-methylcytosine at each cytosine and pseudouridine replacement at each uridine site shown in SEQ ID NO: 5655 with a polyA tail approximately 160 nucleotides in length not shown in sequence) containing the ARCA cap analog or the Cap1 structure crude synthesis products can be compared for purity using denaturing Agarose-Urea gel electrophoresis or HPLC analysis. Synthetic mRNAs with a single, consolidated band by electrophoresis correspond to the higher purity product compared to a synthetic mRNA with multiple bands or streaking bands. Synthetic mRNAs with a single HPLC peak would also correspond to a higher purity product. The capping reaction with a higher efficiency would provide a more pure mRNA population.

#### **C. Cytokine Analysis**

[0001260] Synthetic mRNAs encoding human G-CSF (cDNA shown in SEQ ID NO: 5652; mRNA sequence fully modified with 5-methylcytosine at each cytosine and pseudouridine replacement at each uridine site shown in SEQ ID NO: 5655 with a polyA tail approximately 160 nucleotides in length not shown in sequence) containing the

ARCA cap analog or the Cap1 structure can be transfected into human primary keratinocytes at multiple concentrations. 6, 12, 24 and 36 hours post-transfection the amount of pro-inflammatory cytokines such as TNF-alpha and IFN-beta secreted into the culture medium can be assayed by ELISA. Synthetic mRNAs that secrete higher levels of pro-inflammatory cytokines into the medium would correspond to a synthetic mRNA containing an immune-activating cap structure.

#### D. Capping Reaction Efficiency

[0001261] Synthetic mRNAs encoding human G-CSF (cDNA shown in SEQ ID NO: 5652; mRNA sequence fully modified with 5-methylcytosine at each cytosine and pseudouridine replacement at each uridine site shown in SEQ ID NO: 5655 with a polyA tail approximately 160 nucleotides in length not shown in sequence) containing the ARCA cap analog or the Cap1 structure can be analyzed for capping reaction efficiency by LC-MS after capped mRNA nuclease treatment. Nuclease treatment of capped mRNAs would yield a mixture of free nucleotides and the capped 5'-5'-triphosphate cap structure detectable by LC-MS. The amount of capped product on the LC-MS spectra can be expressed as a percent of total mRNA from the reaction and would correspond to capping reaction efficiency. The cap structure with higher capping reaction efficiency would have a higher amount of capped product by LC-MS.

#### **Example 8. Agarose Gel Electrophoresis of Modified RNA or RT PCR Products**

[0001262] Individual modified RNAs (200-400 ng in a 20 µl volume) or reverse transcribed PCR products (200-400 ng) are loaded into a well on a non-denaturing 1.2% Agarose E-Gel (Invitrogen, Carlsbad, CA) and run for 12-15 minutes according to the manufacturer protocol.

#### **Example 9. Nanodrop Modified RNA Quantification and UV Spectral Data**

[0001263] Modified RNAs in TE buffer (1 µl) are used for Nanodrop UV absorbance readings to quantitate the yield of each modified RNA from an *in vitro* transcription reaction.

#### **Example 10. Formulation of Modified mRNA Using Lipidoids**

[0001264] Modified mRNAs (mmRNA) are formulated for *in vitro* experiments by mixing the mmRNA with the lipidoid at a set ratio prior to addition to cells. *In vivo* formulation may require the addition of extra ingredients to facilitate circulation

throughout the body. To test the ability of these lipidoids to form particles suitable for *in vivo* work, a standard formulation process used for siRNA-lipidoid formulations was used as a starting point. Initial mmRNA-lipidoid formulations may consist of particles composed of 42% lipidoid, 48% cholesterol and 10% PEG, with further optimization of ratios possible. After formation of the particle, mmRNA is added and allowed to integrate with the complex. The encapsulation efficiency is determined using a standard dye exclusion assays.

### **Materials and Methods for Examples 11-15**

#### A. Lipid Synthesis

[0001265] Six lipids, DLin-DMA, DLin-K-DMA, DLin-KC2-DMA, 98N12-5, C12-200 and DLin-MC3-DMA, were synthesized by methods outlined in the art in order to be formulated with modified RNA. DLin-DMA and precursors were synthesized as described in Heyes et. al, J. Control Release, 2005, 107, 276-287. DLin-K-DMA and DLin-KC2-DMA and precursors were synthesized as described in Semple et. al, Nature Biotechnology, 2010, 28, 172-176. 98N12-5 and precursor were synthesized as described in Akinc et. al, *Nature Biotechnology*, 2008, 26, 561-569.

[0001266] C12-200 and precursors were synthesized according to the method outlined in Love et. al, PNAS, 2010, 107, 1864-1869. 2-epoxydodecane (5.10 g, 27.7 mmol, 8.2 eq) was added to a vial containing Amine 200 (0.723 g, 3.36 mmol, 1 eq) and a stirring bar. The vial was sealed and warmed to 80°C. The reaction was stirred for 4 days at 80°C. Then the mixture was purified by silica gel chromatography using a gradient from pure dichloromethane (DCM) to DCM:MeOH 98:2. The target compound was further purified by RP-HPLC to afford the desired compound.

[0001267] DLin-MC3-DMA and precursors were synthesized according to procedures described in WO 2010054401 herein incorporated by reference in its entirety. A mixture of dimethyl methanol (1.5 g, 2.8 mmol, 1 eq), N,N-dimethylaminobutyric acid (1.5 g, 2.8 mmol, 1 eq), DIPEA (0.73 mL, 4.2 mmol, 1.5 eq) and TBTU (1.35 g, 4.2 mmol, 1.5 eq) in 10 mL of DMF was stirred for 10 h at room temperature. Then the reaction mixture was diluted in ether and washed with water. The organic layer was dried over anhydrous sodium sulfate, filtrated and concentrated under reduced pressure. The crude product was purified by silica gel chromatography using a gradient DCM to DCM:MeOH 98:2.

Subsequently the target compound was subjected to an additional RP-HPLC purification which was done using a YMC - Pack C4 column to afford the target compound.

B. Formulation of Modified RNA Nanoparticles

[0001268] Solutions of synthesized lipid, 1,2-distearoyl-3 -phosphatidylcholine (DSPC) (Avanti Polar Lipids, Alabaster, AL), cholesterol (Sigma-Aldrich, Taufkirchen, Germany), and a-[3'-(1,2-dimyristoyl-3-propanoxy)-carboxamide-propyl]-ro-methoxy-polyoxyethylene (PEG-c-DOMG) (NOF, Bouwelven, Belgium) were prepared at concentrations of 50 mM in ethanol and stored at -20°C. The lipids were combined to yield molar ratio of 50:10:38.5:1.5 (Lipid: DSPC: Cholesterol: PEG-c-DOMG) and diluted with ethanol to a final lipid concentration of 25 mM. Solutions of modified mRNA at a concentration of 1-2 mg/mL in water were diluted in 50 mM sodium citrate buffer at a pH of 3 to form a stock modified mRNA solution. Formulations of the lipid and modified mRNA were prepared by combining the synthesized lipid solution with the modified mRNA solution at total lipid to modified mRNA weight ratio of 10:1, 15:1, 20:1 and 30:1. The lipid ethanolic solution was rapidly injected into aqueous modified mRNA solution to afford a suspension containing 33% ethanol. The solutions were injected either manually (MI) or by the aid of a syringe pump (SP) (Harvard Pump 33 Dual Syringe Pump Harvard Apparatus Holliston, MA).

[0001269] To remove the ethanol and to achieve the buffer exchange, the formulations were dialyzed twice against phosphate buffered saline (PBS), pH 7.4 at volumes 200-times of the primary product using a Slide-A-Lyzer cassettes (Thermo Fisher Scientific Inc. Rockford, IL) with a molecular weight cutoff (MWCO) of 10 kD. The first dialysis was carried at room temperature for 3 hours and then the formulations were dialyzed overnight at 4°C. The resulting nanoparticle suspension was filtered through 0.2 µm sterile filter (Sarstedt, Numbrecht, Germany) into glass vials and sealed with a crimp closure.

C. Characterization of formulations

[0001270] A Zetasizer Nano ZS (Malvern Instruments Ltd, Malvern, Worcestershire, UK) was used to determine the particle size, the polydispersity index (PDI) and the zeta potential of the modified mRNA nanoparticles in IX PBS in determining particle size and 15 mM PBS in determining zeta potential.



[0001271] Ultraviolet-visible spectroscopy was used to determine the concentration of modified niRNA nanoparticle formulation. 100  $\mu\text{L}$  of the diluted formulation in IX PBS was added to 900  $\mu\text{L}$  of a 4:1 (v/v) mixture of methanol and chloroform. After mixing, the absorbance spectrum of the solution was recorded between 230 nm and 330 nm on a DU 800 spectrophotometer (Beckman Coulter, Beckman Coulter, Inc., Brea, CA). The modified RNA concentration in the nanoparticle formulation was calculated based on the extinction coefficient of the modified RNA used in the formulation and on the difference between the absorbance at a wavelength of 260 nm and the baseline value at a wavelength of 330 nm.

[0001272] QUANT-IT™ RIBOGREEN® RNA assay (Invitrogen Corporation Carlsbad, CA) was used to evaluate the encapsulation of modified RNA by the nanoparticle. The samples were diluted to a concentration of approximately 5  $\mu\text{g}/\text{mL}$  in TE buffer (10 mM Tris-HCl, 1 mM EDTA, pH 7.5). 50  $\mu\text{L}$  of the diluted samples were transferred to a polystyrene 96 well plate, then either 50  $\mu\text{L}$  of TE buffer or 50  $\mu\text{L}$  of a 2% Triton X-100 solution was added. The plate was incubated at a temperature of 37°C for 15 minutes. The RIBOGREEN® reagent was diluted 1:100 in TE buffer, 100  $\mu\text{L}$  of this solution was added to each well. The fluorescence intensity was measured using a fluorescence plate reader (Wallac Victor 1420 Multilabel Counter; Perkin Elmer, Waltham, MA) at an excitation wavelength of 480 nm and an emission wavelength of 520 nm. The fluorescence values of the reagent blank were subtracted from that of each of the samples and the percentage of free modified RNA was determined by dividing the fluorescence intensity of the intact sample (without addition of Triton X-100) by the fluorescence value of the disrupted sample (caused by the addition of Triton X-100).

#### D. In Vitro Incubation

[0001273] Human embryonic kidney epithelial (HEK293) and hepatocellular carcinoma epithelial (HepG2) cells (LGC standards GmbH, Wesel, Germany) were seeded on 96-well plates (Greiner Bio-one GmbH, Frickenhausen, Germany) and plates for HEK293 cells were precoated with collagen type I. HEK293 were seeded at a density of 30,000 and HepG2 were seeded at a density of 35,000 cells per well in 100  $\mu\text{L}$  cell culture medium. For HEK293 the cell culture medium was DMEM, 10% FCS, adding 2mM L-Glutamine, 1 mM Sodium pyruvate and 1x non-essential amino acids (Biochrom AG,

Berlin, Germany) and 1.2 mg/ml Sodiumbicarbonate (Sigma-Aldrich, Munich, Germany) and for HepG2 the culture medium was MEM (Gibco Life Technologies, Darmstadt, Germany), 10% FCS adding 2mM L-Glutamine, 1 mM Sodiumpyruvate and 1x non-essential amino acids (Biochrom AG, Berlin, Germany). Formulations containing mCherry mRNA (mRNA sequence shown in SEQ ID NO: 5656; polyA tail of approximately 160 nucleotides not shown in sequence; 5'cap, Cap1) were added in quadruplicates directly after seeding the cells and incubated. The mCherry cDNA with the T7 promoter, 5'untranslated region (UTR) and 3' UTR used in *in vitro* transcription (IVT) is given in SEQ ID NO: 5657. The mCherry mRNA was modified with a 5meC at each cytosine and pseudouridine replacement at each uridine site.

[0001274] Cells were harvested by transferring the culture media supernatants to a 96-well Pro-Bind U-bottom plate (Beckton Dickinson GmbH, Heidelberg, Germany). Cells were trypsinized with ½ volume Trypsin/EDTA (Biochrom AG, Berlin, Germany), pooled with respective supernatants and fixed by adding one volume PBS/2%FCS (both Biochrom AG, Berlin, Germany)/0.5% formaldehyde (Merck, Darmstadt, Germany). Samples then were submitted to a flow cytometer measurement with a 532nm excitation laser and the 610/20 filter for PE-Texas Red in a LSRII cytometer (Beckton Dickinson GmbH, Heidelberg, Germany). The mean fluorescence intensity (MFI) of all events and the standard deviation of four independent wells are presented in for samples analyzed.

#### **Example 11. Purification of Nanoparticle Formulations**

[0001275] Nanoparticle formulations of DLin-KC2-DMA and 98N12-5 in HEK293and HepG2 were tested to determine if the mean fluorescent intensity (MFI) was dependent on the lipid to modified RNA ratio and/or purification. Three formulations of DLin-KC2-DMA and two formulations of 98N12-5 were produced using a syringe pump to the specifications described in Table 11. Purified samples were purified by SEPHADEX™ G-25 DNA grade (GE Healthcare, Sweden). Each formulation before and after purification (aP) was tested at concentration of 250 ng modified RNA per well in a 24 well plate. The percentage of cells that are positive for the marker for FL4 channel (%FL4-positive) when analyzed by the flow cytometer for each formulation and the background sample, and the MFI of the marker for the FL4 channel for each formulation

and the background sample are shown in Table 12. The formulations which had been purified had a slightly higher MFI than those formulations tested before purification.

**Table 11. Formulations**

Formulation #	Lipid	Lipid/RNA wt/wt	Mean size (nm)
NPA-001-1	DLin-KC2-DMA	10	155 nm PDI: 0.08
NPA-001-1 aP	DLin-KC2-DMA	10	141 nm PDI: 0.14
NPA-002-1	DLin-KC2-DMA	15	140 nm PDI: 0.11
NPA-002-1 aP	DLin-KC2-DMA	15	125 nm PDI: 0.12
NPA-003-1	DLin-KC2-DMA	20	114 nm PDI: 0.08
NPA-003-1 aP	DLin-KC2-DMA	20	104 nm PDI: 0.06
NPA-005-1	98N12-5	15	127 nm PDI: 0.12
NPA-005-1 aP	98N12-5	15	134 nm PDI: 0.17
NPA-006-1	98N12	20	126 nm PDI: 0.08
NPA-006-1 aP	98N12	20	118 nm PDI: 0.13

**Table 12. HEK293 and HepG2, 24-well, 250 ng Modified RNA/well**

Formulation	%FL4-positive		FL4 MFI	
	HEK293	HepG2	HEK293	HepG2
Untreated	0.33	0.40	0.25	0.30
NPA-001-1	62.42	5.68	1.49	0.41
NPA-001-ap	87.32	9.02	3.23	0.53
NPA-002-1	91.28	9.90	4.43	0.59
NPA-002-ap	92.68	14.02	5.07	0.90
NPA-003-1	87.70	11.76	6.83	0.88
NPA-003-ap	88.88	15.46	8.73	1.06
NPA-005-1	50.60	4.75	1.83	0.46
NPA-005-ap	38.64	5.16	1.32	0.46
NPA-006-1	54.19	13.16	1.30	0.60
NPA-006-ap	49.97	13.74	1.27	0.61

**Example 12. Concentration Response Curve**

[0001276] Nanoparticle formulations of 98N12-5 (NPA-005) and DLin-KC2-DMA (NPA-003) were tested at varying concentrations to determine the MFI of FL4 or mCherry (mRNA sequence shown in SEQ ID NO: 5656; polyA tail of approximately 160

nucleotides not shown in sequence; 5'cap, CapI; fully modified with 5-methylcytosine and pseudouridine) over a range of doses. The formulations tested are outlined in Table 13. To determine the optimal concentration of nanoparticle formulations of 98N12-5, varying concentrations of formulated modified RNA (100 ng, 10 ng, 1.0 ng, 0.1 ng and 0.01 ng per well) were tested in a 24-well plate of HEK293, and the results of the FL4 MFI of each dose are shown in Table 14. Likewise, to determine the optimal concentration of nanoparticle formulations of DLin-KC2-DMA, varying concentrations of formulated modified RNA (250 ng 100 ng, 10 ng, 1.0 ng, 0.1 ng and 0.01 ng per well) were tested in a 24-well plate of HEK293, and the results of the FL4 MFI of each dose are shown in Table 15. Nanoparticle formulations of DLin-KC2-DMA were also tested at varying concentrations of formulated modified RNA (250 ng, 100 ng and 30 ng per well) in a 24 well plate of HEK293, and the results of the FL4 MFI of each dose are shown in Table 16. A dose of 1 ng/well for 98N12-5 and a dose of 10 ng/well for DLin-KC2-DMA were found to resemble the FL4 MFI of the background.

[0001277] To determine how close the concentrations resembled the background, we utilized a flow cytometer with optimized filter sets for detection of mCherry expression, and were able to obtain results with increased sensitivity relative to background levels. Doses of 25 ng/well, 0.25 ng/well, 0.025 ng/well and 0.0025 ng/well were analyzed for 98N12-5 (NPA-005) and DLin-KC2-DMA (NPA-003) to determine the MFI of mCherry. As shown in Table 17, the concentration of 0.025 ng/well and lesser concentrations are similar to the background MFI level of mCherry which is about 386.125.

**Table 13. Formulations**

Formulation #	NPA-003	NPA-005
Lipid	DLin-KC2-DMA	98N12-5
Lipid/RNA wt/wt	20	15
Mean size	114 nm PDI: 0.08	106 nm PDI: 0.12

**Table 14. HEK293, NPA-005, 24-well, n=4**

Formulation	FL4 MFI
Untreated control	0.246
NPA-005 100 ng	2.2175
NPA-005 10 ng	0.651

NPA-005 1.0 ng	0.28425
NPA-005 0.1 ng	0.27675
NPA-005 0.01 ng	0.2865

**Table 15. HEK293, NPA-003, 24-well, n=4**

Formulation	FL4 MFI
Untreated control	0.3225
NPA-003 250 ng	2.9575
NPA-003 100 ng	1.255
NPA-003 10 ng	0.40025
NPA-003 1 ng	0.33025
NPA-003 0.1 ng	0.34625
NPA-003 0.01 ng	0.3475

**Table 16. HEK293, NPA-003, 24-well, n=4**

Formulation	FL4 MFI
Untreated control	0.27425
NPA-003 250 ng	5.6075
NPA-003 100 ng	3.7825
NPA-003 30 ng	1.5525

**Table 17. Concentration and MFI**

Formulation	MFI mCherry	
	NPA-003	NPA-005
25 ng/well	11963.25	12256.75
0.25 ng/well	1349.75	2572.75
0.025 ng/well	459.50	534.75
0.0025 ng/well	310.75	471.75

**Example 13. Manual Injection and Syringe Pump Formulations**

[0001278] Two formulations of DLin-KC2-DMA and 98N12-5 were prepared by manual injection (MI) and syringe pump injection (SP) and analyzed along with a background sample to compare the MFI of mCherry (mRNA sequence shown in SEQ ID NO: 5656; polyA tail of approximately 160 nucleotides not shown in sequence; 5'cap, Cap1; fully modified with 5-methylcytosine and pseudouridine) of the different formulations. Table 18 shows that the syringe pump formulations had a higher MFI as compared to the manual injection formulations of the same lipid and lipid/RNA ratio.

**Table 18. Formulations and MFI**

Formulation #	Lipid	Lipid/RNA wt/wt	Mean size (nm)	Method of formulation	MFI
Untreated Control	N/A	N/A	N/A	N/A	674.67
NPA-002	DLin-KC2-DMA	15	140 nm PDI: 0.11	MI	10318.25
NPA-002-2	DLin-KC2-DMA	15	105 nm PDI: 0.04	SP	37054.75
NPA-003	DLin-KC2-DMA	20	114 nm PDI: 0.08	MI	22037.5
NPA-003-2	DLin-KC2-DMA	20	95 nm PDI: 0.02	SP	37868.75
NPA-005	98N12-5	15	127 nm PDI: 0.12	MI	11504.75
NPA-005-2	98N12-5	15	106 nm PDI: 0.07	SP	9343.75
NPA-006	98N12-5	20	126 nm PDI: 0.08	MI	11182.25
NPA-006-2	98N12-5	20	93 nm PDI: 0.08	SP	5167

#### **Example 14. Lipid Nanoparticle Formulations**

[0001279] Formulations of DLin-DMA, DLin-K-DMA, DLin-KC2-DMA, 98N12-5, C12-200 and DLin-MC3-DMA were incubated at a concentration of 60 ng/well or 62.5 ng/well in a plate of HEK293 and 62.5 ng/well in a plate of HepG2 cells for 24 hours to determine the MFI of mCherry (SEQ ID NO: 5656; polyA tail of approximately 160 nucleotides not shown in sequence; 5'cap, Cap1; fully modified with 5-methylcytosine and pseudouridine) for each formulation. The formulations tested are outlined in Table 19 below. As shown in Table 20 for the 60 ng/well and Tables 21, 22 and 23 for the 62.5 ng/well, the formulation of NPA-003 and NPA-018 have the highest mCherry MFI and the formulations of NPA-008, NPA-010 and NPA-013 are most similar to the background sample mCherry MFI value.

**Table 19. Formulations**

Formulation #	Lipid	Lipid/RNA wt/wt	Mean size (nm)
NPA-001	DLin-KC2-DMA	10	155 nm PDI: 0.08
NPA-002	DLin-KC2-DMA	15	140 nm PDI: 0.11
NPA-002-2	DLin-KC2-DMA	15	105 nm PDI: 0.04
NPA-003	DLin-KC2-DMA	20	114 nm PDI: 0.08

<b>NPA-003-2</b>	DLin-KC2-DMA	20	95 nm PDI: 0.02
<b>NPA-005</b>	98N12-5	15	127 nm PDI: 0.12
<b>NPA-006</b>	98N12-5	20	126 nm PDI: 0.08
<b>NPA-007</b>	DLin-DMA	15	148 nm PDI: 0.09
<b>NPA-008</b>	DLin-K-DMA	15	121 nm PDI: 0.08
<b>NPA-009</b>	C12-200	15	138 nm PDI: 0.15
<b>NPA-010</b>	DLin-MC3-DMA	15	126 nm PDI: 0.09
<b>NPA-012</b>	DLin-DMA	20	86 nm PDI: 0.08
<b>NPA-013</b>	DLin-K-DMA	20	104 nm PDI: 0.03
<b>NPA-014</b>	C12-200	20	101 nm PDI: 0.06
<b>NPA-015</b>	DLin-MC3-DMA	20	109 nm PDI: 0.07

**Table 20. HEK293, 96-well, 60 ng Modified RNA/well**

<b>Formulation</b>	<b>MFI mCherry</b>
Untreated	871.81
NPA-001	6407.25
NPA-002	14995
NPA-003	29499.5
NPA-005	3762
NPA-006	2676
NPA-007	9905.5
NPA-008	1648.75
NPA-009	2348.25
NPA-010	4426.75
NPA-012	11466
NPA-013	2098.25
NPA-014	3194.25
NPA-015	14524

**Table 21. HEK293, 62.5 ng /well**

<b>Formulation</b>	<b>MFI mCherry</b>
Untreated	871.81
NPA-001	6407.25
NPA-002	14995
NPA-003	29499.5
NPA-005	3762

NPA-006	2676
NPA-007	9905.5
NPA-008	1648.75
NPA-009	2348.25
NPA-010	4426.75
NPA-012	11466
NPA-013	2098.25
NPA-014	3194.25
NPA-015	14524

**Table 22. HEK293, 62.5 ng /well**

<b>Formulation</b>	<b>MFI mCherry</b>
Untreated	295
NPA-007	3504
NPA-012	8286
NPA-017	6128
NPA-003-2	17528
NPA-018	34142
NPA-010	1095
NPA-015	5859
NPA-019	3229

**Table 23. HepG2, 62.5 ng /well**

<b>Study 1</b>	
<b>Formulation</b>	<b>MFI mCherry</b>
Untreated	649.94
NPA-001	6006.25
NPA-002	8705
NPA-002-2	15860.25
NPA-003	15059.25
NPA-003-2	28881
NPA-005	1676
NPA-006	1473
NPA-007	15678
NPA-008	2976.25
NPA-009	961.75
NPA-010	3301.75
NPA-012	18333.25
NPA-013	5853
NPA-014	2257
NPA-015	16225.75
<b>Study 2</b>	
<b>Formulation</b>	<b>MFI mCherry</b>
Untreated control	656
NPA-007	16798



NPA-012	21993
NPA-017	20377
NPA-003-2	35651
NPA-018	40154
NPA-010	2496
NPA-015	19741
NPA-019	16373

**Example 15. *In vivo* formulation studies**

[0001280] Rodents (n=5) are administered intravenously, subcutaneously or intramuscularly a single dose of a formulation containing a modified mRNA and a lipid. The modified mRNA administered to the rodents is selected from G-CSF (mRNA sequence shown in SEQ ID NO: 5655; polyA tail of approximately 160 nucleotides not shown in sequence; 5'cap, Cap1), erythropoietin (EPO) (mRNA sequence shown in SEQ ID NO: 5658; polyA tail of approximately 160 nucleotides not shown in sequence; 5'cap, Cap1), Factor IX (mRNA sequence shown in SEQ ID NO: 5659; polyA tail of approximately 160 nucleotides not shown in sequence; 5'cap, Cap1) or mCherry (mRNA sequence shown in SEQ ID NO: 5656; polyA tail of approximately 160 nucleotides not shown in sequence; 5'cap, Cap1). The erythropoietin cDNA with the T7 promoter, 5'untranslated region (UTR) and 3' UTR used in *in vitro* transcription (IVT) is given in SEQ ID NO: 5660 and SEQ ID NO: 5661.

[0001281] Each formulation also contains a lipid which is selected from one of DLin-DMA, DLin-K-DMA, DLin-KC2-DMA, 98N12-5, C12-200, DLin-MC3-DMA, reLNP, ATUPLEX®, DACC and DBTC. The rodents are injected with 100ug, 10 ug or 1 ug of the formulated modified mRNA and samples are collected at specified time intervals.

[0001282] Serum from the rodents administered formulations containing human G-CSF modified mRNA are measured by specific G-CSF ELISA and serum from mice administered human factor IX modified RNA is analyzed by specific factor IX ELISA or chromogenic assay. The liver and spleen from the mice administered with mCherry modified mRNA are analyzed by immunohistochemistry (IHC) or fluorescence-activated cell sorting (FACS). As a control, a group of mice are not injected with any formulation and their serum and tissue are collected analyzed by ELISA, FACS and/or IHC.

A. Time Course

[0001283] The rodents are administered formulations containing at least one modified mRNA to study the time course of protein expression for the administered formulation. The rodents are bled at specified time intervals prior to and after administration of the modified mRNA formulations to determine protein expression and complete blood count. Samples are also collected from the site of administration of rodents administered modified mRNA formulations subcutaneously and intramuscularly to determine the protein expression in the tissue.

#### B. Dose Response

[0001284] The rodents are administered formulations containing at least one modified mRNA to determine dose response of each formulation. The rodents are bled at specified time intervals prior to and after administration of the modified mRNA formulations to determine protein expression and complete blood count. The rodents are also sacrificed to analyze the effect of the modified mRNA formulation on the internal tissue. Samples are also collected from the site of administration of rodents administered modified mRNA formulations subcutaneously and intramuscularly to determine the protein expression in the tissue.

#### C. Toxicity

[0001285] The rodents are administered formulations containing at least one modified mRNA to study toxicity of each formulation. The rodents are bled at specified time intervals prior to and after administration of the modified mRNA formulations to determine protein expression and complete blood count. The rodents are also sacrificed to analyze the effect of the modified mRNA formulation on the internal tissue. Samples are also collected from the site of administration of rodents administered modified mRNA formulations subcutaneously and intramuscularly to determine the protein expression in the tissue.

### **Example 16. PLGA Microsphere Formulations**

[0001286] Optimization of parameters used in the formulation of PLGA microspheres may allow for tunable release rates and high encapsulation efficiencies while maintaining the integrity of the modified RNA encapsulated in the microspheres. Parameters such as, but not limited to, particle size, recovery rates and encapsulation efficiency may be optimized to achieve the optimal formulation.

#### A. Synthesis of PLGA microspheres

[0001287] Polylactiglycolic acid (PLGA) microspheres were synthesized using the water/oil/water double emulsification methods known in the art using PLGA (Lactel, Cat# B6010-2, inherent viscosity 0.55-0.75, 50:50 LA:GA), polyvinylalcohol (PVA) (Sigma, Cat# 348406-25G, MW 13-23k) dichloromethane and water. Briefly, 0.1 ml of water (W1) was added to 2 ml of PLGA dissolved in dichloromethane (DCM) (O1) at concentrations ranging from 50 - 200 mg/ml of PLGA. The W1/O1 emulsion was homogenized (IKA Ultra-Turrax Homogenizer, T18) for 30 seconds at speed 4 (-15,000 rpm). The W1/O1 emulsion was then added to 100 to 200 ml of 0.3 to 1% PVA (W2) and homogenized for 1 minute at varied speeds. Formulations were left to stir for 3 hours and then washed by centrifugation (20-25 min, 4,000 rpm, 4°C). The supernatant was discarded and the PLGA pellets were resuspended in 5-10 ml of water, which was repeated 2x. Average particle size (represents 20 -30 particles) for each formulation was determined by microscopy after washing. Table 24 shows that an increase in the PLGA concentration led to larger sized microspheres. A PLGA concentration of 200 mg/mL gave an average particle size of 14.8  $\mu\text{m}$ , 100 mg/mL was 8.7  $\mu\text{m}$ , and 50 mg/mL of PLGA gave an average particle size of 4.0  $\mu\text{m}$ .

**Table 24. Varied PLGA Concentration**

Sample ID	O1 Volume (mL)	PLGA Concentration (mg/mL)	W2 Volume (mL)	PVA Concentration (%)	Speed	Average Size ( $\mu\text{m}$ )
1	2	200	100	0.3	5	14.8
2	2	100	100	0.3	5	8.7
3	2	50	100	0.3	5	4.0

[0001288] Table 25 shows that decreasing the homogenization speed from 5 (-20,000 rpm) to speed 4 (-15,000 rpm) led to an increase in particle size from 14.8  $\mu\text{m}$  to 29.7  $\mu\text{m}$ .

**Table 25. Varied Homogenization Speed**

Sample ID	O1 Volume (mL)	PLGA Concentration (mg/mL)	W2 Volume (mL)	PVA Concentration (%)	Speed	Average Size ( $\mu\text{m}$ )
1	2	200	100	0.3	5	14.8
4	2	200	100	0.3	4	29.7

[0001289] Table 26 shows that increasing the W2 volume (i.e. increasing the ratio of W2:O1 from 50:1 to 100:1), decreased average particle size slightly. Altering the PVA concentration from 0.3 to 1 wt% had little impact on PLGA microsphere size.

**Table 26. Varied W2 Volume and Concentration**

Sample ID	O1 Volume (mL)	PLGA Concentration (mg/mL)	W2 Volume (mL)	PVA Concentration (%)	Speed	Average Size (µm)
1	2	200	100	0.3	5	14.8
5	2	200	200	0.3	5	11.7
6	2	200	190	0.3	5	11.4
7	2	200	190	1.0	5	12.3

**B. Encapsulation of modified mRNA**

[0001290] Modified G-CSF mRNA (mRNA sequence shown in SEQ ID NO: 5655; polyA tail of approximately 160 nucleotides not shown in sequence; 5'cap, CapI; fully modified with 5-methylcytosine and pseudouridine) was dissolved in water at a concentration of 2 mg/ml (W3). Three batches of PLGA microsphere formulations were made as described above with the following parameters: 0.1 ml of W3 at 2 mg/ml, 1.6 ml of O1 at 200 mg/ml, 160 ml of W2 at 1%, and homogenized at a speed of 4 for the first emulsion (W3/O1) and homogenized at a speed of 5 for the second emulsion (W3/O1/W2). After washing by centrifugation, the formulations were frozen in liquid nitrogen and then lyophilized for 3 days. To test the encapsulation efficiency of the formulations, the lyophilized material was deformed in DCM for 6 hours followed by an overnight extraction in water. The modified RNA concentration in the samples was then determined by OD260. Encapsulation efficiency was calculated by taking the actual amount of modified RNA and dividing by the starting amount of modified RNA. In the three batches tested, there was an encapsulation efficiency of 59.2, 49.8 and 61.3.

**C. Integrity of modified mRNA encapsulated in PLGA microspheres**

[0001291] Modified Factor IX mRNA (mRNA sequence shown in SEQ ID NO: 5659; polyA tail of approximately 160 nucleotides not shown in sequence; 5'cap, CapI; fully modified with 5-methylcytosine and pseudouridine) was dissolved in water at varied concentrations (W4) to vary the weight percent loading in the formulation (mg modified RNA/mg PLGA \* 100) and to determine encapsulation efficiency. The parameters in Table 27 were used to make four different batches of PLGA microsphere formulations

with a homogenization speed of 4 for the first emulsion (W4/01) and a homogenization speed of 5 for the second emulsion (W4/01/W2).

**Table 27. Factor IX PLGA Microsphere Formulation Parameters**

ID	W4 Vol (uL)	Factor IX Conc (mg/ml)	Factor IX Amnt (ug)	O1 Vol (ml)	PLGA Conc (mg/ml)	W2 Vol (ml)	PVA Conc (%)	Weight% (wt%) Loading
A	100	2.0	200.0	2.0	200	200	1.0	0.05
B	100	4.0	400.0	2.0	200	200	1.0	0.10
C	400	2.0	800.0	2.0	200	200	1.0	0.20
D	400	4.0	1600.0	2.0	200	200	1.0	0.40

[0001292] After lyophilization, PLGA microspheres were weighed out in 2 ml eppendorf tubes to correspond to ~ 10 ug of modified RNA. Lyophilization was found to not destroy the overall structure of the PLGA microspheres. To increase weight percent loading (wt%) for the PLGA microspheres, increasing amounts of modified RNA were added to the samples. PLGA microspheres were deformed by adding 1.0 ml of DCM to each tube and then shaking the samples for 6 hours. For modified RNA extraction, 0.5 ml of water was added to each sample and the samples were shaken overnight before the concentration of modified RNA in the samples was determined by OD260. To determine the recovery of the extraction process, unformulated Factor IX modified RNA (SEQ ID NO: 5659; polyA tail of approximately 160 nucleotides not shown in sequence; 5'cap, Cap1; fully modified with 5-methylcytosine and pseudouridine) (deformulation control) was spiked into DCM and was subjected to the deformulation process. Table 28 shows the loading and encapsulation efficiency for the samples. All encapsulation efficiency samples were normalized to the deformulation control.

**Table 28. Weight Percent Loading and Encapsulation Efficiency**

ID	Theoretical modified RNA loading (wt%)	Actual modified RNA loading (wt%)	Encapsulation Efficiency (%)
A	0.05	0.06	97.1
B	0.10	0.10	85.7
C	0.20	0.18	77.6
D	0.40	0.31	68.1
Control	-	-	100.0

D. Release study of modified mRNA encapsulated in PLGA microspheres

[0001293] PLGA microspheres formulated with Factor IX modified RNA (SEQ ID NO: 5659; polyA tail of approximately 160 nucleotides not shown in sequence; 5'cap, CapI; fully modified with 5-methylcytosine and pseudouridine) were deformed as described above and the integrity of the extracted modified RNA was determined by automated electrophoresis (Bio-Rad Experion). The extracted modified mRNA was compared against unformulated modified mRNA and the deformation control in order to test the integrity of the encapsulated modified mRNA. As shown in Figure 4, the majority of modRNA was intact for batch ID A, B, C and D, for the deformed control (Deform control) and the unformulated control (Uniform control).

E. Protein Expression of modified mRNA encapsulated in PLGA microspheres

[0001294] PLGA microspheres formulated with Factor IX modified RNA (SEQ ID NO: 5659; polyA tail of approximately 160 nucleotides not shown in sequence; 5'cap, CapI; fully modified with 5-methylcytosine and pseudouridine) were deformed as described above and the protein expression of the extracted modified RNA was determined by an *in vitro* transfection assay. HEK293 cells were reverse transfected with 250 ng of Factor IX modified RNA complexed with RNAiMAX (Invitrogen) in triplicate.

[0001295] Factor IX modified RNA was diluted in nuclease-free water to a concentration of 25 ng/ $\mu$ l and RNAiMAX was diluted 13.3x in serum-free EMEM. Equal volumes of diluted modified RNA and diluted RNAiMAX were mixed together and were allowed to stand for 20 to 30 minutes at room temperature. Subsequently, 20  $\mu$ l of the transfection mix containing 250 ng of Factor IX modified RNA was added to 80  $\mu$ l of a cell suspension containing 30,000 cells. Cells were then incubated for 16h in a humidified 37°C/5% CO<sub>2</sub> cell culture incubator before harvesting the cell culture supernatant. Factor IX protein expression in the cell supernatant was analyzed by an ELISA kit specific for Factor IX (Molecular Innovations, Cat # HFIXKT-TOT) and the protein expression is shown in Table 29. In all PLGA microsphere batches tested, Factor IX modified RNA remained active and expressed Factor IX protein after formulation in PLGA microspheres and subsequent deformation.

**Table 29. Protein Expression**

Sample	Factor IX Protein Expression (ng/ml)
--------	--------------------------------------

Batch A	0.83
Batch B	1.83
Batch C	1.54
Batch D	2.52
Deformulated Control	4.34
Unformulated Control	3.35

F. Release study of modified mRNA encapsulated in PLGA microspheres  
**[0001296]** PLGA microspheres formulated with Factor IX modified RNA (SEQ ID NO: 5659; polyA tail of approximately 160 nucleotides not shown in sequence; 5'cap, Cap1; fully modified with 5-methylcytosine and pseudouridine) were resuspended in water to a PLGA microsphere concentration of 24 mg/ml. After resuspension, 150 ul of the PLGA microsphere suspension was aliquoted into eppendorf tubes. Samples were kept incubating and shaking at 37°C during the course of the study. Triplicate samples were pulled at 0.2, 1, 2, 8, 14, and 21 days. To determine the amount of modified RNA released from the PLGA microspheres, samples were centrifuged, the supernatant was removed, and the modified RNA concentration in the supernatant was determined by OD 260. The percent release, shown in Table 30, was calculated based on the total amount of modified RNA in each sample. After 31 days, 96% of the Factor IX modified RNA was released from the PLGA microsphere formulations.

**Table 30. Percent Release**

Time (days)	% Release
0	0.0
0.2	27.0
1	37.7
2	45.3
4	50.9
8	57.0
14	61.8
21	75.5
31	96.4

G. Particle size reproducibility of PLGA microspheres  
**[0001297]** Three batches of Factor IX modified RNA (SEQ ID NO: 5659 polyA tail of approximately 160 nucleotides not shown in sequence; 5'cap, Cap1; fully modified with 5-methylcytosine and pseudouridine) PLGA microspheres were made using the same

conditions described for Batch D, shown in Table 27, (0.4 ml of W4 at 4 mg/ml, 2.0 ml of 0 1 at 200 mg/ml, 200 ml of W2 at 1%, and homogenized at a speed of 5 for the W4/01/W2 emulsion). To improve the homogeneity of the PLGA microsphere suspension, filtration was incorporated prior to centrifugation. After stirring for 3 hours and before centrifuging, all formulated material was passed through a 100  $\mu\text{m}$  nylon mesh strainer (Fisherbrand Cell Strainer, Cat # 22-363-549) to remove larger aggregates. After washing and resuspension with water, 100-200  $\mu\text{l}$  of a PLGA microspheres sample was used to measure particle size of the formulations by laser diffraction (Malvern Mastersizer2000). The particle size of the samples is shown in Table 31.

**Table 31. Particle Size Summary**

ID	D10 ( $\mu\text{m}$ )	D50 ( $\mu\text{m}$ )	D90 ( $\mu\text{m}$ )	Volume Weighted Mean ( $\mu\text{m}$ )	Filtration
Control	19.2	62.5	722.4	223.1	No
A	9.8	31.6	65.5	35.2	Yes
B	10.5	32.3	66.9	36.1	Yes
C	10.8	35.7	79.8	41.4	Yes

[0001298] Results of the 3 PLGA microsphere batches using filtration were compared to a PLGA microsphere batch made under the same conditions without filtration. The inclusion of a filtration step before washing reduced the mean particle size and demonstrated a consistent particle size distribution between 3 PLGA microsphere batches.

#### H. Serum Stability of Factor IX PLGA Microspheres

[0001299] Factor IX mRNA RNA (SEQ ID NO: 5659 polyA tail of approximately 160 nucleotides not shown in sequence; 5'cap, Cap1; fully modified with 5-methylcytosine and pseudouridine) in buffer (TE) or 90% serum (Se), or Factor IX mRNA in PLGA in buffer, 90% serum or 1% serum was incubated in buffer, 90% serum or 1% serum at an mRNA concentration of 50 ng/ $\mu\text{l}$  in a total volume of 70  $\mu\text{l}$ . The samples were removed at 0, 30, 60 or 120 minutes. RNases were inactivated with proteinase K digestion for 20 minutes at 55°C by adding 25  $\mu\text{l}$  of 4x proteinase K buffer (0.4 ml 1M TRIS-HCl pH 7.5, 0.1 ml 0.5M EDTA, 0.12 ml 5M NaCl, and 0.4ml 10% SDS) and 8  $\mu\text{l}$  of proteinase K at 20 mg/ml. The Factor IX mRNA was precipitated (add 250  $\mu\text{l}$  95% ethanol for 1 hour,



centrifuge for 10 min at 13 k rpm and remove supernatant, add 200 ul 70% ethanol to the pellet, centrifuge again for 5 min at 13 k rpm and remove supernatant and resuspend the pellet in 70 ul water) or extracted from PLGA microspheres (centrifuge 5 min at 13k rpm and remove supernatant, wash pellet with 1 ml water, centrifuge 5 min at 13k rpm and remove supernatant, add 280 ul dichloromethane to the pellet and shake for 15 minutes, add 70 ul water and then shake for 2 hours and remove the aqueous phase) before being analyzed by bioanalyzer. PLGA microspheres protect Factor IX modified mRNA from degradation in 90% and 1% serum over 2 hours. Factor IX modified mRNA completely degrades in 90% serum at the initial time point.

**Example 17. Lipid nanoparticle *in vivo* studies**

[0001300] G-CSF (cDNA with the T7 promoter, 5' Untranslated region (UTR) and 3'UTR used in *in vitro* transcription is given in SEQ ID NO: 5654. mRNA sequence shown in SEQ ID NO: 5655; polyA tail of approximately 160 nucleotides not shown in sequence; 5'cap, Cap 1; fully modified with 5-methylcytosine and pseudouridine) and Factor IX (cDNA with the T7 promoter, 5' UTR and 3'UTR used in *in vitro* transcription is given in SEQ ID NO: 5662. mRNA sequence shown in SEQ ID NO: 5659; polyA tail of approximately 160 nucleotides not shown in sequence; 5'cap, Cap 1; fully modified with 5-methylcytosine and pseudouridine) modified mRNA were formulated as lipid nanoparticles (LNPs) using the syringe pump method. The LNPs were formulated at a 20:1 weight ratio of total lipid to modified mRNA with a final lipid molar ratio of 50:10:38.5:1.5 (DLin-KC2-DMA: DSPC: Cholesterol: PEG-c-DOMG). Formulations, listed in Table 32, were characterized by particle size, zeta potential, and encapsulation.

**Table 32. Formulations**

Formulation #	NPA-029-1	NPA-030-1
Modified mRNA	Factor IX	G-CSF
Mean size	91 nm PDI: 0.04	106 nm PDI: 0.06
Zeta at pH 7.4	1.8 mV	0.9 mV
Encaps. (RiboGr)	92%	100%

[0001301] LNP formulations were administered to mice (n=5) intravenously at a modified mRNA dose of 100, 10, or 1 ug. Mice were sacrificed at 8 hrs after dosing. Serum was collected by cardiac puncture from mice that were administered with G-CSF or Factor IX modified mRNA formulations. Protein expression was determined by ELISA.

[0001302] There was no significant body weight loss (<5%) in the G-CSF or Factor IX dose groups. Protein expression for G-CSF or Factor IX dose groups was determined by ELISA from a standard curve. Serum samples were diluted (about 20-2500x for G-CSF and about 10-250x for Factor IX) to ensure samples were within the linear range of the standard curve. As shown in Table 33, G-CSF protein expression determined by ELISA was approximately 17, 1200, and 4700 ng/ml for the 1, 10, and 100 ug dose groups, respectively. As shown in Table 34, Factor IX protein expression determined by ELISA was approximately 36, 380, and 3000-11000 ng/ml for the 1, 10, and 100 ug dose groups, respectively.

**Table 33. G-CSF Protein Expression**

Dose (ug)	Conc (ng/ml)	Dilution Factor	Sample Volume
1	17.73	20x	5 ul
10	1204.82	2500x	0.04 ul
100	4722.20	2500x	0.04 ul

**Table 34. Factor IX Protein Expression**

Dose (ug)	Conc (ng/ml)	Dilution Factor	Sample Volume
1	36.05	10x	5 ul
10	383.04	10x	5 ul
100*	3247.75	50x	1 ul
100*	11177.20	250x	0.2 ul

[0001303] As shown in Table 35, the LNP formulations described above have about a 10,000-100,000-fold increase in protein production compared to an administration of an intravenous (IV)-lipoplex formulation for the same dosage of modified mRNA and

intramuscular (IM) or subcutaneous (SC) administration of the same dose of modified mRNA in saline. As used in Table 35, the symbol "~" means about.

**Table 35. Protein Production**

G-CSF	Dose (ug)	Serum Concentration (pg/ml) 8-12 hours after administration
IM	100	~20-80
SC	100	~10-40
IV (Lipoplex)	100	~30
IV (LNP)	100	~5,000,000
IV (LNP)	10	~1,000,000
IV (LNP)	1	~20,000
Factor IX	Dose (ug)	Serum Concentration (ng/ml) 8-12 hours after administration
IM	2 x 100	~1.6 ng/ml
IV (LNP)	100	~3,000-10,000 ng/ml
IV (LNP)	10	~400 ng/ml
IV (LNP)	1	~40 ng/ml

**Materials and Methods for Examples 18-23**

[0001304] G-CSF (mRNA sequence shown in SEQ ID NO: 5655; polyA tail of approximately 160 nucleotides not shown in sequence; 5'cap, Cap 1; fully modified with 5-methylcytosine and pseudouridine) and EPO (mRNA sequence shown in SEQ ID NO: 5658; polyA tail of approximately 160 nucleotides not shown in sequence; 5'cap, Cap 1; fully modified with 5-methylcytosine and pseudouridine) modified mRNA were formulated as lipid nanoparticles (LNPs) using the syringe pump method. The LNPs were formulated at a 20: 1 weight ratio of total lipid to modified mRNA with a final lipid molar ratio of 50:10:38.5:1.5 (DLin-KC2-DMA: DSPC: Cholesterol: PEG-c-DOMG). Formulations, listed in Table 36, were characterized by particle size, zeta potential, and encapsulation.

**Table 36. Formulations**

Formulation #	NPA-030-2	NPA-060-1
Modified mRNA	G-CSF	EPO
Mean size	84 nm PDI: 0.04	85 nm PDI: 0.03
Zeta at pH 7.4	0.8 mV	1.5 mV
Encapsulation (RiboGreen)	95%	98%

**Example 18. Lipid nanoparticle *in vivo* studies with modified mRNA**

[0001305] LNP formulations, shown in Table 36 (above), were administered to rats (n=5) intravenously (IV), intramuscularly (IM) or subcutaneously (SC) at a single modified mRNA dose of 0.05 mg/kg. A control group of rats (n=4) was untreated. The rats were bled at 2 hours, 8 hours, 24 hours, 48 hours and 96 hours and after they were administered with G-CSF or EPO modified mRNA formulations to determine protein expression using ELISA. The rats administered EPO modified mRNA intravenously were also bled at 7 days.

[0001306] As shown in Table 37, EPO protein expression in the rats intravenously administered modified EPO mRNA was detectable out to 5 days. G-CSF in the rats intravenously administered modified G-CSF mRNA was detectable to 7 days.

Subcutaneous and intramuscular administration of EPO modified mRNA was detectable to at least 24 hours and G-CSF modified mRNA was detectable to at least 8 hours. In Table 37, "OSC" refers to values that were outside the standard curve and "NT" means not tested.

**Table 37. G-CSF and EPO Protein Expression**

Route	Time	EPO Serum Concentration (pg/ml)	G-CSF Serum Concentration (pg/ml)
IV	2 hours	36,981.0	31,331.9
IV	8 hours	62,053.3	70,532.4
IV	24 hours	42,077.0	5,738.6
IV	48 hours	5,561.5	233.8
IV	5 days	0.0	60.4
IV	7 days	0.0	NT
IM	2 hours	1395.4	1620.4
IM	8 hours	8974.6	7910.4
IM	24 hours	4678.3	893.3
IM	48 hours	NT	OSC
IM	5 days	NT	OSC
SC	2 hours	386.2	80.3
SC	8 hours	985.6	164.2
SC	24 hours	544.2	OSC
SC	48 hours	NT	OSC
SC	5 days	NT	OSC
Untreated	All bleeds	0	0

**Example 19. Time course *in vivo* study**

[0001307] LNP formulations, shown in Table 36 (above), were administered to mice (n=5) intravenously (IV) at a single modified mRNA dose of 0.5, 0.05 or 0.005 mg/kg. The mice were bled at 8 hours, 24 hours, 72 hours and 6 days after they were administered with G-CSF or EPO modified mRNA formulations to determine protein expression using ELISA.

[0001308] As shown in Table 38, EPO and G-CSF protein expression in the mice administered with the modified mRNA intravenously was detectable out to 72 hours for the mice dosed with 0.005 mg/kg and 0.05 mg/kg of modified mRNA and out to 6 days for the mice administered the EPO modified mRNA. In Table 38, ">" means greater than and "ND" means not detected.

**Table 38. Protein Expression**

Dose (mg/kg)	Time	EPO Serum Concentration (pg/ml)	G-CSF Serum Concentration (pg/ml)
0.005	8 hours	12,508.3	11,550.6
0.005	24 hours	6,803.0	5,068.9
0.005	72 hours	ND	ND
0.005	6 days	ND	ND
0.05	8 hours	92,139.9	462,312.5
0.05	24 hours	54,389.4	80,903.8
0.05	72 hours	ND	ND
0.05	6 days	ND	ND
0.5	8 hours	498,515.3	>1,250,000
0.5	24 hours	160,566.3	495,812.5
0.5	72 hours	3,492.5	1,325.6
0.5	6 days	21.2	ND

**Example 20. LNP formulations *in vivo* study in rodents****A. LNP Formulations in Mice**

[0001309] LNP formulations, shown in Table 36 (above), were administered to mice (n=4) intravenously (IV) at a single modified mRNA dose 0.05 mg/kg or 0.005 mg/kg. There was also 3 control groups of mice (n=4) that were untreated. The mice were bled at 2 hours, 8 hours, 24 hours, 48 hours and 72 hours after they were administered with G-CSF or EPO modified mRNA formulations to determine the protein expression. Protein expression of G-CSF and EPO were determined using ELISA.

[0001310] As shown in Table 39, EPO and G-CSF protein expression in the mice was detectable at least out to 48 hours for the mice that received a dose of 0.005 mg/kg modified RNA and 72 hours for the mice that received a dose of 0.05 mg/kg modified RNA. In Table 39, "OSC" refers to values that were outside the standard curve and "NT" means not tested.

**Table 39. Protein Expression in Mice**

Dose (mg/kg)	Time	EPO Serum Concentration (pg/ml)	G-CSF Serum Concentration (pg/ml)
0.005	2 hours	OSC	3,447.8
0.005	8 hours	1,632.8	11,454.0
0.005	24 hours	1,141.0	4,960.2
0.005	48 hours	137.4	686.4
0.005	72 hours	0	NT
0.05	2 hours	10,027.3	20,951.4
0.05	8 hours	56,547.2	70,012.8
0.05	24 hours	25,027.3	19,356.2
0.05	48 hours	1,432.3	1,963.0
0.05	72 hours	82.2	47.3

#### B. LNP Formulations in Rats

[0001311] LNP formulations, shown in Table 36 (above), are administered to rats (n=4) intravenously (IV) at a single modified mRNA dose 0.05 mg/kg. There is also a control group of rats (n=4) that are untreated. The rats are bled at 2 hours, 8 hours, 24 hours, 48 hours, 72 hours, 7 days and 14 days after they were administered with G-CSF or EPO modified mRNA formulations to determine the protein expression. Protein expression of G-CSF and EPO are determined using ELISA.

#### **Example 21. Early Time Course Study of LNPs**

[0001312] LNP formulations, shown in Table 36 (above), are administered to mammals intravenously (IV), intramuscularly (IM) or subcutaneously (SC) at a single modified mRNA dose of 0.5 mg/kg, 0.05 mg/kg or 0.005 mg/kg. A control group of mammals are not treated. The mammals are bled at 5 minutes, 10 minutes, 20 minutes, 30 minutes, 45 minutes, 1 hour, 1.5 hours and/or 2 hours after they are administered with the modified mRNA LNP formulations to determine protein expression using ELISA. The mammals are also bled to determine the complete blood count such as the granulocyte levels and red blood cell count.

**Example 22. Non-human primate *in vivo* study**

[0001313] LNP formulations, shown in Table 36 (above), were administered to non-human primates (NHP) (cynomolgus monkey) (n=2) as a bolus intravenous injection (IV) over approximately 30 seconds using a hypodermic needle, which may be attached to a syringe/abocath or butterfly if needed. The NHP were administered a single modified mRNA IV dose of 0.05mg/kg of EPO or G-CSF or 0.005 mg/kg of EPO in a dose volume of 0.5 mL/kg. The NHPs were bled 5-6 days before dosing with the modified mRNA LNP formulations to determine protein expression in the serum and a baseline complete blood count. After administration with the modified mRNA formulation the NHP were bled at 8, 24, 48 and 72 hours to determined protein expression. At 24 and 72 hours after administration the complete blood count of the NHP was also determined. Protein expression of G-CSF and EPO was determined by ELISA. Urine from the NHPs was collected over the course of the entire experiment and analyzed to evaluate clinical safety. Samples were collected from the NHPs after they were administered with G-CSF or EPO modified mRNA formulations to determine protein expression using ELISA. Clinical chemistry, hematology, urinalysis and cytokines of the non-human primates were also analyzed.

[0001314] As shown in Table 40, EPO protein expression in the NHPs administered 0.05 mg/kg is detectable out to 72 hours and the 0.005 mg/kg dosing of the EPO formulation is detectable out to 48 hours. In Table 40, the "<" means less than a given value. G-CSF protein expression was seen out to 24 hours after administration with the modified mRNA formulation. Preliminarily, there was an increase in granulocytes and reticulocytes levels seen in the NHP after administration with the modified mRNA formulations.

**Table 40. Protein Expression in Non-Human Primates**

Modified mRNA	Dose (mg/kg)	Time	Female NHP Serum Concentration (pg/ml)	Male NHP Serum Concentration (pg/ml)	Average Serum Concentration (pg/ml)
G-CSF	0.05	Pre-bleed	0	0	0
		8 hours	3289	1722	2,506
		24 hours	722	307	515
		48 hours	0	0	0

		72 hours	0	0	0
EPO	0.05	Pre-bleed	0	0	0
		8 hours	19,858	7,072	13,465
		24 hours	18,178	4,913	11,546
		48 hours	5,291	498	2,895
		72 hours	744	60	402
EPO	0.005	Pre-bleed	0	0	0
		8 hours	523	250	387
		24 hours	302	113	208
		48 hours	<7.8	<7.8	<7.8
		72 hours	0	0	0

**Example 23. Non-human primate *in vivo* study for G-CSF and EPO**

[0001315] LNP formulations, shown in Table 36 (above), were administered to non-human primates (NHP) (cynomolgus monkey) (n=2) as intravenous injection (IV). The NHP were administered a single modified mRNA IV dose of 0.5 mg/kg, 0.05mg/kg or 0.005 mg/kg of G-CSF or EPO in a dose volume of 0.5 mL/kg. The NHPs were bled before dosing with the modified mRNA LNP formulations to determine protein expression in the serum and a baseline complete blood count. After administration with the G-CSF modified mRNA formulation the NHP were bled at 8, 24, 48 and 72 hours to determined protein expression. After administration with the EPO modified mRNA formulation the NHP were bled at 8, 24, 48, 72 hours and 7 days to determined protein expression.

[0001316] Samples collected from the NHPs after they were admnistered with G-CSF or EPO modified mRNA formulations were analyzed by ELISA to determine protein expression. Neutrophil and reticulocyte count was also determined pre-dose, 24 hours, 3 days, 7 days, 14 days and 18 days after administration of the modified G-CSF or EPO formulation.

[0001317] As shown in Table 41, G-CSF protein expression was not detected beyond 72 hours. In Table 41, "<39" refers to a value below the lower limit of detection of 39 pg/ml.

**Table 41. G-CSF Protein Expression**

Modified mRNA	Dose (mg/kg)	Time	Female NHP Serum G-CSF Concentration (pg/ml)	Male NHP Serum G-CSF Concentration (pg/ml)
---------------	--------------	------	--	--



G-CSF	0.5	Pre-bleed	<39	<39
		8 hours	43,525	43,594
		24 hours	11,374	3,628
		48 hours	1,100	833
		72 hours	<39	306
G-CSF	0.05	Pre-bleed	<39	<39
		8 hours	3,289	1,722
		24 hours	722	307
		48 hours	<39	<39
		72 hours	<39	<39
G-CSF	0.005	Pre-bleed	<39	<39
		8 hours	559	700
		24 hours	155	<39
		48 hours	<39	<39
		72 hours	<39	<39

[0001318] As shown in Table 42, EPO protein expression was not detected beyond 7 days. In Table 42, "<7.8" refers to a value below the lower limit of detection of 7.8 pg/ml.

**Table 42. EPO Protein Expression**

Modified mRNA	Dose (mg/kg)	Time	Female NHP Serum EPO Concentration (pg/ml)	Male NHP Serum EPO Concentration (pg/ml)
EPO	0.5	Pre-bleed	<7.8	<7.8
		8 hours	158,771	119,086
		24 hours	133,978	85,825
		48 hours	45,250	64,793
		72 hours	15,097	20,407
		7 days	<7.8	<7.8
EPO	0.05	Pre-bleed	<7.8	<7.8
		8 hours	19,858	7,072
		24 hours	18,187	4,913
		48 hours	5,291	498
		72 hours	744	60
		7 days	<7.8	<7.8
EPO	0.005	Pre-bleed	<7.8	<7.8
		8 hours	523	250
		24 hours	302	113
		48 hours	11	29
		72 hours	<7.8	<7.8
		7 days	<7.8	<7.8

[0001319] As shown in Table 43, there was an increase in neutrophils in all G-CSF groups relative to pre-dose levels.

**Table 43. Pharmacologic Effect of G-CSF mRNA in NHP**

Dose (mg/kg)	Time	Male NHP (G-CSF) Neutrophils ( $10^9/L$ )	Female NHP (G-CSF) Neutrophils ( $10^9/L$ )	Male NHP (EPO) Neutrophils ( $10^9/L$ )	Female NHP (EPO) Neutrophils ( $10^9/L$ )
0.5	Pre-dose	1.53	1.27	9.72	1.82
	24 hours	14.92	13.96	7.5	11.85
	3 days	9.76	13.7	11.07	5.22
	7 days	2.74	3.81	11.8	2.85
	14/18 days	2.58	1.98	7.16	2.36
0.05	Pre-dose	13.74	3.05	0.97	2.15
	24 hours	19.92	29.91	2.51	2.63
	3 days	7.49	10.77	1.73	4.08
	7 days	4.13	3.8	1.23	2.77
	14/18 days	3.59	1.82	1.53	1.27
0.005	Pre-dose	1.52	2.54	5.46	5.96
	24 hours	16.44	8.6	5.37	2.59
	3 days	3.74	1.78	6.08	2.83
	7 days	7.28	2.27	3.51	2.23
	14/18 days	4.31	2.28	1.52	2.54

[0001320] As shown in Table 44, there was an increase in reticulocytes in all EPO groups 3 days to 14/18 days after dosing relative to reticulocyte levels 24 hours after dosing.

**Table 44. Pharmacologic Effect of EPO mRNA on Neutrophil Count**

Dose (mg/kg)	Time	Male NHP (G-CSF) Neutrophils ( $10^{12}/L$ )	Female NHP (G-CSF) Neutrophils ( $10^{12}/L$ )	Male NHP (EPO) Neutrophils ( $10^{12}/L$ )	Female NHP (EPO) Neutrophils ( $10^{12}/L$ )
0.5	Pre-dose	0.067	0.055	0.107	0.06
	24 hours	0.032	0.046	0.049	0.045
	3 days	0.041	0.017	0.09	0.064
	7 days	0.009	0.021	0.35	0.367
	14/18 days	0.029	0.071	0.066	0.071
0.05	Pre-dose	0.055	0.049	0.054	0.032
	24 hours	0.048	0.046	0.071	0.04
	3 days	0.101	0.061	0.102	0.105
	7 days	0.157	0.094	0.15	0.241
	14/18 days	0.107	0.06	0.067	0.055
0.005	Pre-dose	0.037	0.06	0.036	0.052
	24 hours	0.037	0.07	0.034	0.061
	3 days	0.037	0.054	0.079	0.118
	7 days	0.046	0.066	0.049	0.087
	14/18 days	0.069	0.057	0.037	0.06

[0001321] As shown in Tables 45-47, the administration of EPO modified RNA had an effect on other erythropoetic parameters including hemoglobin (HGB), hematocrit (HCT) and red blood cell (RBC) count.

**Table 45. Pharmacologic Effect of EPO mRNA on Hemoglobin**

Dose (mg/kg)	Time	Male NHP (G-CSF) HGB (g/L)	Female NHP (G-CSF) HGB (g/L)	Male NHP (EPO) HGB (g/L)	Female NHP (EPO) HGB (g/L)
0.5	Pre-dose	133	129	134	123
	24 hours	113	112	127	108
	3 days	118	114	126	120
	7 days	115	116	140	134
	14/18 days	98	113	146	133
0.05	Pre-dose	137	129	133	133
	24 hours	122	117	123	116
	3 days	126	115	116	120
	7 days	126	116	126	121
	14/18 days	134	123	133	129
0.005	Pre-dose	128	129	132	136
	24 hours	117	127	122	128
	3 days	116	127	125	130
	7 days	116	129	119	127
	14/18 days	118	129	128	129

**Table 46. Pharmacologic Effect of EPO mRNA on Hematocrit**

Dose (mg/kg)	Time	Male NHP (G-CSF) HCT (L/L)	Female NHP (G-CSF) HCT (L/L)	Male NHP (EPO) HCT (L/L)	Female NHP (EPO) HCT (L/L)
0.5	Pre-dose	0.46	0.43	0.44	0.4
	24 hours	0.37	0.38	0.4	0.36
	3 days	0.39	0.38	0.41	0.39
	7 days	0.39	0.38	0.45	0.45
	14/18 days	0.34	0.37	0.48	0.46
0.05	Pre-dose	0.44	0.44	0.45	0.43
	24 hours	0.39	0.4	0.43	0.39
	3 days	0.41	0.39	0.38	0.4
	7 days	0.42	0.4	0.45	0.41
	14/18 days	0.44	0.4	0.46	0.43
0.005	Pre-dose	0.42	0.42	0.48	0.45
	24 hours	0.4	0.42	0.42	0.43
	3 days	0.4	0.41	0.44	0.42
	7 days	0.39	0.42	0.41	0.42
	14/18 days	0.41	0.42	0.42	0.42

**Table 47. Pharmacologic Effect of EPO mRNA on Red Blood Cells**

Dose (mg/kg)	Time	Male NHP (G-CSF) RBC (10 <sup>12</sup> /L)	Female NHP (G-CSF) RBC (10 <sup>12</sup> /L)	Male NHP (EPO) RBC (10 <sup>12</sup> /L)	Female NHP (EPO) RBC (10 <sup>12</sup> /L)
0.5	Pre-dose	5.57	5.57	5.43	5.26
	24 hours	4.66	4.96	5.12	4.69

	3 days	4.91	4.97	5.13	5.15
	7 days	4.8	5.04	5.55	5.68
	14/18 days	4.21	4.92	5.83	5.72
0.05	Pre-dose	5.68	5.64	5.57	5.84
	24 hours	4.96	5.08	5.25	5.18
	3 days	5.13	5.04	4.81	5.16
	7 days	5.17	5.05	5.37	5.31
	14/18 days	5.43	5.26	5.57	5.57
0.005	Pre-dose	5.67	5.36	6.15	5.72
	24 hours	5.34	5.35	5.63	5.35
	3 days	5.32	5.24	5.77	5.42
	7 days	5.25	5.34	5.49	5.35
	14/18 days	5.37	5.34	5.67	5.36

[0001322] As shown in Tables 48 and 49, the administration of modified RNA had an effect on serum chemistry parameters including alanine transaminase (ALT) and aspartate transaminase (AST).

**Table 48. Pharmacologic Effect of EPO mRNA on Alanine Transaminase**

Dose (mg/kg)	Time	Male NHP (G-CSF) ALT (U/L)	Female NHP (G-CSF) ALT (U/L)	Male NHP (EPO) ALT (U/L)	Female NHP (EPO) ALT (U/L)
0.5	Pre-dose	29	216	50	31
	2 days	63	209	98	77
	4 days	70	98	94	87
	7 days	41	149	60	59
	14days	43	145	88	44
0.05	Pre-dose	58	53	56	160
	2 days	82	39	95	254
	4 days	88	56	70	200
	7 days	73	73	64	187
	14days	50	31	29	216
0.005	Pre-dose	43	51	45	45
	2 days	39	32	62	48
	4 days	48	58	48	50
	7 days	29	55	21	48
	14days	44	46	43	51

**Table 49. Pharmacologic Effect of EPO mRNA on Aspartate Transaminase**

Dose (mg/kg)	Time	Male NHP (G-CSF) AST (U/L)	Female NHP (G-CSF) AST (U/L)	Male NHP (EPO) AST (U/L)	Female NHP (EPO) AST (U/L)
0.5	Pre-dose	32	47	59	20
	2 days	196	294	125	141
	4 days	67	63	71	60
	7 days	53	68	56	47
	14days	47	67	82	44
0.05	Pre-dose	99	33	74	58
	2 days	95	34	61	80
	4 days	69	42	48	94

	7 days	62	52	53	78
	14days	59	20	32	47
0.005	Pre-dose	35	54	39	40
	2 days	70	34	29	25
	4 days	39	36	43	55
	7 days	28	31	55	31
	14days	39	20	35	54

[0001323] As shown in Table 50, the administration of lipid nanoparticle-formulated modified RNA at high doses (0.5 mg/kg) caused an increase in cytokines, interferon-alpha (IFN-alpha) after administration of modified mRNA.

**Table 50. Pharmacologic Effect of EPO mRNA on Alanine Transaminase**

Dose (mg/kg)	Time	Male NHP (G-CSF) IFN-alpha (pg/mL)	Female NHP (G-CSF) IFN-alpha (pg/mL)	Male NHP (EPO) IFN-alpha (pg/mL)	Female NHP (EPO) IFN-alpha (pg/mL)
0.5	Pre-dose	0	0	0	0
	Day 1 + 8 hr	503,8	529,2	16,79	217,5
	4 days	0	0	0	0
0.05	Pre-dose	0	0	0	0
	Day 1 + 8 hr	0	0	0	0
	4 days	0	0	0	0
0.005	Pre-dose	0	0	0	0
	Day 1 + 8 hr	0	0	0	0
	4 days	0	0	0	0

**Example 24. Study of Intramuscular and/or Subcutaneous Administration in Non-Human Primates**

[0001324] Formulations containing modified EPO mRNA (mRNA sequence shown in SEQ ID NO: 5658; polyA tail of approximately 160 nucleotides not shown in sequence; 5'cap, Cap1; fully modified with 5-methylcytosine and pseudouridine) or G-CSF mRNA (mRNA sequence shown in SEQ ID NO: 5655; polyA tail of approximately 160 nucleotides not shown in sequence; 5'cap, Cap1; fully modified with 5-methylcytosine and pseudouridine) in saline were administered to non-human primates (Cynomolgus monkey) (NHP) intramuscularly (IM) or subcutaneously (SC). The single modified mRNA dose of 0.05mg/kg or 0.005 mg/kg was in a dose volume of 0.5 mL/kg. The non-human primates are bled 5-6 days prior to dosing to determine serum protein concentration and a baseline complete blood count. After administration with the

modified mRNA formulation the NHP are bled at 8 hours, 24 hours, 48 hours, 72 hours, 7 days and 14 days to determined protein expression. Protein expression of G-CSF and EPO is determined by ELISA. At 24 hours, 72 hours, 7 days and 14 days after administration the complete blood count of the NHP is also determined. Urine from the NHPs is collected over the course of the entire experiment and analyzed to evaluate clinical safety. Tissue near the injection site is also collected and analyzed to determine protein expression.

**Example 25. Modified mRNA Trafficking**

[0001325] In order to determine localization and/or trafficking of the modified mRNA, studies may be performed as follows.

[0001326] LNP formulations of siRNA and modified mRNA are formulated according to methods known in the art and/or described herein. The LNP formulations may include at least one modified mRNA which may encode a protein such as G-CSF, EPO, Factor VII, and/or any protein described herein. The formulations may be administered locally into muscle of mammals using intramuscular or subcutaneous injection. The dose of modified mRNA and the size of the LNP may be varied to determine the effect on trafficking in the body of the mammal and/or to assess the impact on a biologic reaction such as, but not limited to, inflammation. The mammal may be bled at different time points to determine the expression of protein encoded by the modified mRNA administered present in the serum and/or to determine the complete blood count in the mammal.

[0001327] For example, modified mRNA encoding Factor VII, expressed in the liver and secreted into the serum, may be administered intramuscularly and/or subcutaneously. Coincident or prior to modified mRNA administration, siRNA is administered to knock out endogenous Factor VII. Factor VII arising from the intramuscular and/or subcutaneous injection of modified mRNA is administered is measured in the blood. Also, the levels of Factor VII is measured in the tissues near the injection site. If Factor VII is expressed in blood then there is trafficking of the modified mRNA. If Factor VII is expressed in tissue and not in the blood than there is only local expression of Factor VII.

**Example 26. Formulations of Multiple Modified mRNA**

[0001328] LNP formulations of modified mRNA are formulated according to methods known in the art and/or described herein or known in the art. The LNP formulations may include at least one modified mRNA which may encode a protein such as G-CSF, EPO, thrombopoietin and/or any protein described herein. The at least one modified mRNA may include 1, 2, 3, 4 or 5 modified mRNA molecules. The formulations containing at least one modified mRNA may be administered intravenously, intramuscularly or subcutaneously in a single or multiple dosing regimens. Biological samples such as, but not limited to, blood and/or serum may be collected and analyzed at different time points before and/or after administration of the at least one modified mRNA formulation. An expression of a protein in a biological sample of 50-200 pg/ml after the mammal has been administered a formulation containing at least one modified mRNA encoding said protein would be considered biologically effective.

**Example 27. Polyethylene Glycol Ratio Studies**

A. Formulation and Characterization of PEG LNPs

[0001329] Lipid nanoparticles (LNPs) were formulated using the syringe pump method. The LNPs were formulated at a 20: 1 weight ratio of total lipid to modified G-CSF mRNA (mRNA sequence shown in SEQ ID NO: 5655; polyA tail of approximately 160 nucleotides not shown in sequence; 5'cap, Cap1; fully modified with 5-methylcytosine and pseudouridine). The molar ratio ranges of the formulations are shown in Table 51.

**Table 51. Molar Ratios**

	<b>DLin-KC2-DMA</b>	<b>DSPC</b>	<b>Cholesterol</b>	<b>PEG-c-DOMG</b>
Mole Percent (mol%)	50.0	10.0	37-38.5	1.5-3

[0001330] Two types of PEG lipid, 1,2-Dimyristoyl-sn-glycerol, methoxypolyethylene Glycol (PEG-DMG, NOF Cat # SUNBRIGHT® GM-020) and 1,2-Distearoyl-sn-glycerol, methoxypolyethylene Glycol (PEG-DSG, NOF Cat # SUNBRIGHT® GS-020), were tested at 1.5 or 3.0 mol%. After the formation of the LNPs and the encapsulation of the modified G-CSF mRNA, the LNP formulations were characterized by particle size, zeta potential and encapsulation percentage and the results are shown in Table 52.

**Table 52. Characterization of LNP Formulations**

<b>Formulation No.</b>	<b>NPA-071-1</b>	<b>NPA-072-1</b>	<b>NPA-073-1</b>	<b>NPA-074-1</b>
------------------------	------------------	------------------	------------------	------------------

Lipid	PEG-DMG	PEG-DMG	PEG-DSA	PEG-DSA
	1.5%	3%	1.5%	3%
Mean Size	95 nm PDI: 0.01	85 nm PDI: 0.06	95 nm PDI: 0.08	75 nm PDI: 0.08
Zeta at pH 7.4	-1.1 mV	-2.6 mV	1.7 mV	0.7 mV
Encapsulation (RiboGreen)	88%	89%	98%	95%

B. *In Vivo* Screening of PEG LNPs

[0001331] Formulations of the PEG LNPs described in Table 52 were administered to mice (n=5) intravenously at a dose of 0.5 mg/kg. Serum was collected from the mice at 2 hours, 8 hours, 24 hours, 48 hours, 72 hours and 8 days after administration of the formulation. The serum was analyzed by ELISA to determine the protein expression of G-CSF and the expression levels are shown in Table 53. LNP formulations using PEG-DMG gave substantially higher levels of protein expression than LNP formulations with PEG-DSA.

**Table 53. Protein Expression**

Lipid	Formulation No.	Time	Protein Expression (pg/ml)
PEG-DMG, 1.5%	NPA-071-1	2 hours	114,102
		8 hours	357,944
		24 hours	104,832
		48 hours	6,697
		72 hours	980
		8 days	0
PEG-DMG, 3%	NPA-072-1	2 hours	154,079
		8 hours	354,994
		24 hours	164,311
		48 hours	13,048
		72 hours	1,182
		8 days	13
PEG-DSA, 1.5%	NPA-073-1	2 hours	3,193
		8 hours	6,162
		24 hours	446
		48 hours	197
		72 hours	124
		8 days	5
PEG-DSA, 3%	NPA-074-1	2 hours	259
		8 hours	567
		24 hours	258
		48 hours	160
		72 hours	328
		8 days	33



**Example 27. Cationic Lipid Formulation Studies****A. Formulation and Characterization of Cationic Lipid Nanoparticles**

[0001332] Lipid nanoparticles (LNPs) were formulated using the syringe pump method. The LNPs were formulated at a 20: 1 weight ratio of total lipid to modified mRNA. The final lipid molar ratio ranges of cationic lipid, DSPC, cholesterol and PEG-c-DOMG are outlined in Table 54.

**Table 54. Molar Ratios**

	<b>Cationic Lipid</b>	<b>DSPC</b>	<b>Cholesterol</b>	<b>PEG-c-DOMG</b>
Mole Percent (mol%)	50.0	10.0	38.5	1.5

[0001333] A 25 mM lipid solution in ethanol and modified RNA in 50mM citrate at a pH of 3 were mixed to create spontaneous vesicle formation. The vesicles were stabilized in ethanol before the ethanol was removed and there was a buffer exchange by dialysis. The LNPs were then characterized by particle size, zeta potential, and encapsulation percentage. Table 55 describes the characterization of LNPs encapsulating EPO modified mRNA (mRNA sequence shown in SEQ ID NO: 5658 polyA tail of approximately 160 nucleotides not shown in sequence; 5'cap, Cap1; fully modified with 5-methylcytosine and pseudouridine) or G-CSF modified mRNA (mRNA sequence shown in SEQ ID NO: 5655; polyA tail of approximately 160 nucleotides not shown in sequence; 5'cap, Cap1; fully modified with 5-methylcytosine and pseudouridine) using DLin-MC3-DMA, DLin-DMA or C12-200 as the cationic lipid.

**Table 55. Characterization of Cationic Lipid Formulations**

<b>Formulation No.</b>	<b>NPA-071-1</b>	<b>NPA-072-1</b>	<b>NPA-073-1</b>	<b>NPA-074-1</b>	<b>NPA-075-1</b>	<b>NPA-076-1</b>
<b>Lipid</b>	DLin-MC3-DMA	DLin-MC3-DMA	DLin-DMA	DLin-DMA	C12-200	C12-200
<b>Modified RNA</b>	EPO	G-CSF	EPO	G-CSF	EPO	G-CSF
<b>Mean Size</b>	89 nm PDI: 0.07	96 nm PDI: 0.08	70 nm PDI: 0.04	73 nm PDI: 0.06	97 nm PDI: 0.05	103 nm PDI: 0.09
<b>Zeta at pH 7.4</b>	-1.1 mV	-1.4 mV	-1.6 mV	-0.4 mV	1.4 mV	0.9 mV
<b>Encapsulation (RiboGreen)</b>	100%	100%	99%	100%	88%	98%

**B. *In Vivo* Screening of Cationic LNP Formulations**

[0001334] Formulations of the cationic lipid formulations described in Table 55 were administered to mice (n=5) intravenously at a dose of 0.5 mg/kg. Serum was collected from the mice at 2 hours, 24 hours, 72 hours and/or 7 days after administration of the formulation. The serum was analyzed by ELISA to determine the protein expression of EPO or G-CSF and the expression levels are shown in Table 56.

**Table 56. Protein Expression**

Modified mRNA	Formulation No.	Time	Protein Expression (pg/ml)
EPO	NPA-071-1	2 hours	304,190.0
		24 hours	166,811.5
		72 hours	1,356.1
		7 days	20.3
EPO	NPA-073-1	2 hours	73,852.0
		24 hours	75,559.7
		72 hours	130.8
EPO	NPA-075-1	2 hours	413,010.2
		24 hours	56,463.8
G-CSF	NPA-072-1	2 hours	62,113.1
		24 hours	53,206.6
G-CSF	NPA-074-1	24 hours	25,059.3
G-CSF	NPA-076-1	2 hours	219,198.1
		24 hours	8,470.0

[0001335] Toxicity was seen in the mice administered the LNPs formulations with the cationic lipid CI2-200 (NPA-075-1 and NPA-076-1) and they were sacrificed at 24 hours because they showed symptoms such as scrubby fur, cowering behavior and weight loss of greater than 10%. CI2-200 was expected to be more toxic but also had a high level of expression over a short period. The cationic lipid DLin-DMA (NPA-073-1 and NPA-074-1) had the lowest expression out of the three cationic lipids tested. DLin-MC3-DMA (NPA-071-1 and NPA-072-1) showed good expression up to day three and was above the background sample out to day 7 for EPO formulations.

**Example 29. Method of Screening for Protein Expression**

A. Electrospray Ionization

[0001336] A biological sample which may contain proteins encoded by modified RNA administered to the subject is prepared and analyzed according to the manufacturer protocol for electrospray ionization (ESI) using 1, 2, 3 or 4 mass analyzers. A biologic sample may also be analyzed using a tandem ESI mass spectrometry system.

[0001337] Patterns of protein fragments, or whole proteins, are compared to known controls for a given protein and identity is determined by comparison.

**B. Matrix-Assisted Laser Desorption/Ionization**

[0001338] A biological sample which may contain proteins encoded by modified RNA administered to the subject is prepared and analyzed according to the manufacturer protocol for matrix-assisted laser desorption/ionization (MALDI).

[0001339] Patterns of protein fragments, or whole proteins, are compared to known controls for a given protein and identity is determined by comparison.

**C. Liquid Chromatography-Mass spectrometry-Mass spectrometry**

[0001340] A biological sample, which may contain proteins encoded by modified RNA, may be treated with a trypsin enzyme to digest the proteins contained within. The resulting peptides are analyzed by liquid chromatography-mass spectrometry-mass spectrometry (LC/MS/MS). The peptides are fragmented in the mass spectrometer to yield diagnostic patterns that can be matched to protein sequence databases via computer algorithms. The digested sample may be diluted to achieve 1 ng or less starting material for a given protein. Biological samples containing a simple buffer background (e.g. water or volatile salts) are amenable to direct in-solution digest; more complex backgrounds (e.g. detergent, non-volatile salts, glycerol) require an additional clean-up step to facilitate the sample analysis.

[0001341] Patterns of protein fragments, or whole proteins, are compared to known controls for a given protein and identity is determined by comparison.

**Example 30. Lipid Nanoparticle *in vivo* studies**

[0001342] mCherry mRNA (mRNA sequence shown in SEQ ID NO: 5663; polyA tail of approximately 160 nucleotides not shown in sequence; 5'cap, Cap1; fully modified with 5-methylcytosine and pseudouridine) was formulated as a lipid nanoparticle (LNP) using the syringe pump method. The LNP was formulated at a 20: 1 weight ratio of total lipid to modified mRNA with a final lipid molar ratio of 50: 10:38.5 :1.5 (DLin-KC2-DMA: DSPC: Cholesterol: PEG-c-DOMG). The mCherry formulation, listed in Table 57, was characterized by particle size, zeta potential, and encapsulation.

**Table 57. mCherry Formulation**

<b>Formulation #</b>	<b>NPA-003-5</b>
Modified mRNA	mCherry

Mean size	105 nm PDI: 0.09
Zeta at pH 7.4	1.8 mV
Encaps. (RiboGr)	100%

[0001343] The LNP formulation was administered to mice (n=5) intravenously at a modified mRNA dose of 100 ug. Mice were sacrificed at 24 hrs after dosing. The liver and spleen from the mice administered with mCherry modified mRNA formulations were analyzed by immunohistochemistry (IHC), western blot, or fluorescence-activated cell sorting (FACS).

[0001344] Histology of the liver showed uniform mCherry expression throughout the section, while untreated animals did not express mCherry. Western blots were also used to confirm mCherry expression in the treated animals, whereas mCherry was not detected in the untreated animals. Tubulin was used as a control marker and was detected in both treated and untreated mice, indicating that normal protein expression in hepatocytes was unaffected.

[0001345] FACS and IHC were also performed on the spleens of mCherry and untreated mice. All leukocyte cell populations were negative for mCherry expression by FACS analysis. By IHC, there were also no observable differences in the spleen in the spleen between mCherry treated and untreated mice.

### **Example 31. Syringe Pump *in vivo* studies**

[0001346] mCherry modified mRNA (mRNA sequence shown in SEQ ID NO: 5656; polyA tail of approximately 160 nucleotides not shown in sequence; 5'cap, Cap1) is formulated as a lipid nanoparticle (LNP) using the syringe pump method. The LNP is formulated at a 20: 1 weight ratio of total lipid to modified mRNA with a final lipid molar ratio of 50:10:38.5:1.5 (DLin-KC2-DMA: DSPC: Cholesterol: PEG-c-DOMG). The mCherry formulation is characterized by particle size, zeta potential, and encapsulation.

[0001347] The LNP formulation is administered to mice (n=5) intravenously at a modified mRNA dose of 10 or 100 ug. Mice are sacrificed at 24 hrs after dosing. The liver and spleen from the mice administered with mCherry modified mRNA formulations

are analyzed by immunohistochemistry (IHC), western blot, and/or fluorescence-activated cell sorting (FACS).

**Example 32. *In vitro* and *in vivo* Expression**

A. *In vitro* Expression in Human Cells Using Lipidoid Formulations

[0001348] The ratio of mmRNA to lipidoid used to test for *in vitro* transfection is tested empirically at different lipidoid:mmRNA ratios. Previous work using siRNA and lipidoids have utilized 2.5:1, 5:1, 10:1, and 15:1 lipidoid :siRNA wt:wt ratios. Given the longer length of mmRNA relative to siRNA, a lower wt:wt ratio of lipidoid to mmRNA may be effective. In addition, for comparison mmRNA were also formulated using RNAIMAX™ (Invitrogen, Carlsbad, CA) or TRANSIT-mRNA (Mirus Bio, Madison, WI) cationic lipid delivery vehicles.

[0001349] The ability of lipidoid-formulated Luciferase (IVT cDNA sequence as shown in SEQ ID NO: 5664; mRNA sequence shown in SEQ ID NO: 5665, polyA tail of approximately 160 nucleotides not shown in sequence, 5'cap, Cap1, fully modified with 5-methylcytosine at each cytosine and pseudouridine replacement at each uridine site), green fluorescent protein (GFP) (IVT cDNA sequence as shown in SEQ ID NO: 5666; mRNA sequence shown in SEQ ID NO: 5667, polyA tail of approximately 160 nucleotides not shown in sequence, 5'cap, Cap1, fully modified with 5-methylcytosine at each cytosine and pseudouridine replacement at each uridine site), G-CSF mRNA (mRNA sequence shown in SEQ ID NO: 5655; polyA tail of approximately 160 nucleotides not shown in sequence; 5'cap, Cap1), and EPO mRNA (mRNA sequence shown in SEQ ID NO: 5658; polyA tail of approximately 160 nucleotides not shown in sequence; 5'cap, Cap1) to express the desired protein product can be confirmed by luminescence for luciferase expression, flow cytometry for GFP expression, and by ELISA for G-CSF and Erythropoietin (EPO) secretion.

B. *In vivo* Expression Following Intravenous Injection

[0001350] Systemic intravenous administration of the formulations are created using various different lipidoids including, but not limited to, 98N12-5, C12-200, and MD1.

[0001351] Lipidoid formulations containing mmRNA are injected intravenously into animals. The expression of the modified mRNA (mmRNA)-encoded proteins are assessed in blood and/or other organs samples such as, but not limited to, the liver and

spleen collected from the animal. Conducting single dose intravenous studies will also allow an assessment of the magnitude, dose responsiveness, and longevity of expression of the desired product.

**[0001352]** In one embodiment, lipidoid based formulations of 98N12-5, C12-200, MD1 and other lipidoids, are used to deliver luciferase, green fluorescent protein (GFP), mCherry fluorescent protein, secreted alkaline phosphatase (sAP), human G-CSF, human Factor IX, or human Erythropoietin (EPO) mmRNA into the animal. After formulating mmRNA with a lipid, as described previously, animals are divided into groups to receive either a saline formulation, or a lipidoid-formulation which contains one of a different mmRNA selected from luciferase, GFP, mCherry, sAP, human G-CSF, human Factor IX, and human EPO. Prior to injection into the animal, mmRNA-containing lipidoid formulations are diluted in PBS. Animals are then administered a single dose of formulated mmRNA ranging from a dose of 10 mg/kg to doses as low as 1 ng/kg, with a preferred range to be 10 mg/kg to 100 ng/kg, where the dose of mmRNA depends on the animal body weight such as a 20 gram mouse receiving a maximum formulation of 0.2 ml (dosing is based no mmRNA per kg body weight). After the administration of the mmRNA-lipidoid formulation, serum, tissues, and/or tissue lysates are obtained and the level of the mmRNA-encoded product is determined at a single and/or a range of time intervals. The ability of lipidoid-formulated Luciferase, GFP, mCherry, sAP, G-CSF, Factor IX, and EPO mmRNA to express the desired protein product is confirmed by luminescence for the expression of Luciferase, flow cytometry for the expression of GFP and mCherry expression, by enzymatic activity for sAP, or by ELISA for the section of G-CSF, Factor IX and/or EPO.

**[0001353]** Further studies for a multi-dose regimen are also performed to determine the maximal expression of mmRNA, to evaluate the saturability of the mmRNA-driven expression (by giving a control and active mmRNA formulation in parallel or in sequence), and to determine the feasibility of repeat drug administration (by giving mmRNA in doses separated by weeks or months and then determining whether expression level is affected by factors such as immunogenicity). An assessment of the physiological function of proteins such as G-CSF and EPO are also determined through analyzing samples from the animal tested and detecting increases in granulocyte and red

blood cell counts, respectively. . Activity of an expressed protein product such as Factor IX, in animals can also be assessed through analysis of Factor IX enzymatic activity (such as an activated partial thromboplastin time assay) and effect of clotting times.

C. In vitro Expression Following Intramuscular and/or Subcutaneous Injection

[0001354] The use of lipidoid formulations to deliver oligonucleotides, including mRNA, via an intramuscular route or a subcutaneous route of injection needs to be evaluated as it has not been previously reported. Intramuscular and/or subcutaneous injection of mmRNA are evaluated to determine if mmRNA-containing lipidoid formulations are capable to produce both localized and systemic expression of a desired portiens.

[0001355] Lipidoid formulations of 98N12-5, C12-200, and MDIcontaining mmRNA selected from luciferase, green fluorescent protein (GFP), mCherry fluorescent protein, secreted alkaline phosphatase (sAP), human G-CSF, human factor IX, or human Erythropoietin (EPO) mmRNA are injected intramuscularly and/or subcutaneously into animals. The expression of mmRNA-encoded proteins are assessed both within the muscle or subcutaneous tissue and systemically in blood and other organs such as the liver and spleen. Single dose studies allow an assessment of the magnitude, dose responsiveness, and longevity of expression of the desired product.

[0001356] Animals are divided into groups to receive either a saline formulation or a formulation containing modified mRNA. Prior to injection mmRNA-containing lipidoid formulations are diluted in PBS. Animals are administered a single intramuscular dose of formulated mmRNA ranging from 50 mg/kg to doses as low as 1 ng/kg with a preferred range to be 10 mg/kg to 100 ng/kg. A maximum dose for intramuscular administration, for a mouse, is roughly 1 mg mmRNA or as low as 0.02 ng mmRNA for an intramuscular injection into the hind limb of the mouse. For subcutaneous administration, the animals are administered a single subcutaneous dose of formulated mmRNA ranging from 400 mg/kg to doses as low as 1 ng/kg with a preferred range to be 80 mg/kg to 100 ng/kg. A maximum dose for subcutaneous administration, for a mouse, is roughly 8 mg mmRNA or as low as 0.02 ng mmRNA.

[0001357] For a 20 gram mouse the volume of a single intramuscular injection is maximally 0.025 ml and a single subcutaneous injection is maximally 0.2 ml. The

optimal dose of mmRNA administered is calculated from the body weight of the animal. At various points in time points following the administration of the mmRNA-lipidoid, serum, tissues, and tissue lysates is obtained and the level of the mmiRNA-encoded product is determined. The ability of lipidoid-formulated luciferase, green fluorescent protein (GFP), mCherry fluorescent protein, secreted alkaline phosphatase (sAP), human G-CSF, human factor IX, or human Erythropoietin (EPO) mmRNA to express the desired protein product is confirmed by luminescence for luciferase expression, flow cytometry for GFP and mCherry expression, by enzymatic activity for sAP, and by ELISA for G-CSF, Factor IX and Erythropoietin (EPO) secretion.

[0001358] Additional studies for a multi-dose regimen are also performed to determine the maximal expression using mmRNA, to evaluate the saturability of the mmRNA-driven expression (achieved by giving a control and active mmRNA formulation in parallel or in sequence), and to determine the feasibility of repeat drug administration (by giving mmRNA in doses separated by weeks or months and then determining whether expression level is affected by factors such as immunogenicity). Studies utilizing multiple subcutaneous or intramuscular injection sites at one time point, are also utilized to further increase mmRNA drug exposure and improve protein production. An assessment of the physiological function of proteins, such as GFP, mCherry, sAP, human G-CSF, human factor IX, and human EPO, are determined through analyzing samples from the tested animals and detecting a change in granulocyte and/or red blood cell counts. Activity of an expressed protein product such as Factor IX, in animals can also be assessed through analysis of Factor IX enzymatic activity (such as an activated partial thromboplastin time assay) and effect of clotting times.

### **Example 33. Bifunctional mmRNA**

[0001359] Using the teachings and synthesis methods described herein, modified RNAs are designed and synthesized to be bifunctional, thereby encoding one or more cytotoxic protein molecules as well as be synthesized using cytotoxic nucleosides.

[0001360] Administration of the bifunctional modified mRNAs is effected using either saline or a lipid carrier. Once administered, the bifunctional modified mRNA is translated to produce the encoded cytotoxic peptide. Upon degradation of the delivered modified



mRNA, the cytotoxic nucleosides are released which also effect therapeutic benefit to the subject.

### **Example 34. Modified mRNA Transfection**

#### **A. Reverse Transfection**

[0001361] For experiments performed in a 24-well collagen-coated tissue culture plate, Keratinocytes are seeded at a cell density of  $1 \times 10^5$ . For experiments performed in a 96-well collagen-coated tissue culture plate, Keratinocytes are seeded at a cell density of  $0.5 \times 10^5$ . For each modified mRNA (mmRNA) to be transfected, modified mRNA: RNAIMAX™ is prepared as described and mixed with the cells in the multi-well plate within a period of time, e.g., 6 hours, of cell seeding before cells had adhered to the tissue culture plate.

#### **B. Forward Transfection**

[0001362] In a 24-well collagen-coated tissue culture plate, Keratinocytes are seeded at a cell density of  $0.7 \times 10^5$ . For experiments performed in a 96-well collagen-coated tissue culture plate, Keratinocytes are seeded at a cell density of  $0.3 \times 10^5$ . Keratinocytes are grown to a confluency of >70% for over 24 hours. For each modified mRNA (mmRNA) to be transfected, modified mRNA: RNAIMAX™ is prepared as described and transfected onto the cells in the multi-well plate over 24 hours after cell seeding and adherence to the tissue culture plate.

#### **C. Modified mRNA Translation Screen: G-CSF ELISA**

[0001363] Keratinocytes are grown in EPILIFE medium with Supplement S7 from Invitrogen (Carlsbad, CA) at a confluence of >70%. One set of keratinocytes were reverse transfected with 300 ng of the chemically modified mRNA (mmRNA) complexed with RNAIMAX™ from Invitrogen. Another set of keratinocytes are forward transfected with 300 ng modified mRNA complexed with RNAIMAX™ from Invitrogen. The modified mRNA: RNAIMAX™ complex is formed by first incubating the RNA with Supplement-free EPILIFE® media in a 5X volumetric dilution for 10 minutes at room temperature.

[0001364] In a second vial, RNAIMAX™ reagent was incubated with Supplement-free EPILIFE® Media in 10X volumetric dilution for 10 minutes at room temperature. The RNA vial was then mixed with the RNAIMAX™ vial and incubated for 20-30 minutes at

room temperature before being added to the cells in a drop-wise fashion. Secreted human Granulocyte-Colony Stimulating Factor (G-CSF) concentration in the culture medium is measured at 18 hours post-transfection for each of the chemically modified mRNA in triplicate.

[0001365] Secretion of Human G-CSF from transfected human keratinocytes is quantified using an ELISA kit from Invitrogen or R&D Systems (Minneapolis, MN) following the manufacturers recommended instructions.

D. Modified mRNA Dose and Duration: G-CSF ELISA

[0001366] Keratinocytes are grown in EPILIFE® medium with Supplement S7 from Invitrogen at a confluence of >70%. Keratinocytes are reverse transfected with either Ong, 46.875ng, 93.75ng, 187.5ng, 375ng, 750ng, or 1500ng modified mRNA complexed with the RNAIMAX™ from Invitrogen (Carlsbad, CA). The modified mRNA :RNAIMAX™ complex is formed as described. Secreted human G-CSF concentration in the culture medium is measured at 0, 6, 12, 24, and 48 hours post-transfection for each concentration of each modified mRNA in triplicate. Secretion of human G-CSF from transfected human keratinocytes is quantified using an ELISA kit from Invitrogen or R&D Systems following the manufacturers recommended instructions.

**Example 35. Split dose studies**

[0001367] Studies utilizing multiple subcutaneous or intramuscular injection sites at one time point were designed and performed to investigate ways to increase mmRNA drug exposure and improve protein production. In addition to detection of the expressed protein product, an assessment of the physiological function of proteins was also determined through analyzing samples from the animal tested.

[0001368] Surprisingly, it has been determined that split dosing of mmRNA produces greater protein production and phenotypic responses than those produced by single unit dosing or multi-dosing schemes.

[0001369] The design of a single unit dose, multi-dose and split dose experiment involved using human erythropoietin (EPO) mmRNA (mRNA shown in SEQ ID NO: 5658; polyA tail of approximately 160 nucleotides not shown in sequence; 5'cap, Cap1) administered in buffer alone. The dosing vehicle (F. buffer) consisted of 150mM NaCl, 2

mM CaCl<sub>2</sub>, 2 mM Na<sup>+</sup>-phosphate (1.4mM monobasic sodium phosphate; 0.6mM dibasic sodium phosphate), and 0.5 mM EDTA, pH 6.5. The pH was adjusted using sodium hydroxide and the final solution was filter sterilized. The mmRNA was modified with 5meC at each cytosine and pseudouridine replacement at each uridine site.

[0001370] Animals (n=5) were injected IM (intramuscular) for the single unit dose of 100 ug. For multi-dosing, two schedules were used, 3 doses of 100 ug and 6 doses of 100 ug. For the split dosing scheme, two schedules were used, 3 doses at 33.3 ug and 6 doses of 16.5 ug mmRNA. Control dosing involved use of buffer only at 6 doses. Control mmRNA involved the use of luciferase mmRNA (IVT cDNA sequence shown in SEQ ID NO: 5664; mRNA sequence shown in SEQ ID NO: 5665, polyA tail of approximately 160 nucleotides not shown in sequence, 5'cap, Cap1, fully modified with 5-methylcytosine at each cytosine and pseudouridine replacement at each uridine site) dosed 6 times at 100 ug. Blood and muscle tissue were evaluated 13 hrs post injection.

[0001371] Human EPO protein was measured in mouse serum 13h post I.M. single, multi- or split dosing of the EPO mmRNA in buffer. Seven groups of mice (n=5 mice per group) were treated and evaluated. The results are shown in Table 58.

**Table 58. Split dose study**

Group	Treatment	Dose of mmRNA	Total Dose	Avg. pmol/m L human EPO	Polypeptide per unit drug (pmol/ug)	Dose Splitting Factor
1	Human EPO mmRNA	1 x 100 ug	100 ug	14.3	.14	1
2	Human EPO mmRNA	3 x 100 ug	300 ug	82.5	.28	2
3	Human EPO mmRNA	6 x 100 ug	600 ug	273.0	.46	3.3
4	Human EPO mmRNA	3 x 33.3 ug	100 ug	104.7	1.1	7.9
5	Human EPO mmRNA	6 x 16.5 ug	100 ug	127.9	1.3	9.3
6	Luciferase mmRNA	6 x 100 ug	600 ug	0	--	--
7	Buffer Alone	--	--	0	--	--

[0001372] The splitting factor is defined as the product per unit drug divided by the single dose product per unit drug (PUD). For example for treatment group 2 the value .28 or product (EPO) per unit drug (mmRNA) is divided by the single dose product per unit

drug of 0.14. The result is 2. Likewise, for treatment group 4, the value 1.1 or product (EPO) per unit drug (mmRNA) is divided by the single dose product per unit drug of 0.14. The result is 7.9. Consequently, the dose splitting factor (DSF) may be used as an indicator of the efficacy of a split dose regimen. For any single administration of a total daily dose, the DSF should be equal to 1. Therefore any DSF greater than this value in a split dose regimen is an indication of increased efficacy.

[0001373] To determine the dose response trends, impact of injection site and impact of injection timing, studies are performed. In these studies, varied doses of 1 ug, 5 ug, 10 ug, 25 ug, 50 ug, and values in between are used to determine dose response outcomes. Split dosing for a 100 ug total dose includes three or six doses of 1.6 ug, 4.2 ug, 8.3 ug, 16.6 ug, or values and total doses equal to administration of the total dose selected.

[0001374] Injection sites are chosen from the limbs or any body surface presenting enough area suitable for injection. This may also include a selection of injection depth to target the dermis (Intradermal), epidermis (Epidermal), subcutaneous tissue (SC) or muscle (IM). Injection angle will vary based on targeted delivery site with injections targeting the intradermal site to be 10-15 degree angles from the plane of the surface of the skin, between 20-45 degrees from the plane of the surface of the skin for subcutaneous injections and angles of between 60-90 degrees for injections substantially into the muscle.

### **Example 36. Quantification in Exosomes**

[0001375] The quantity and localization of the mmRNA of the present invention can be determined by measuring the amounts (initial, timecourse, or residual basis) in isolated exosomes. In this study, since the mmRNA are typically codon-optimized and distinct in sequence from endogenous mRNA, the levels of mmRNA are quantitated as compared to endogenous levels of native or wild type mRNA by using the methods of Gibbings, PCT/IB2009/005878, the contents of which are incorporated herein by reference in their entirety.

[0001376] In these studies, the method is performed by first isolating exosomes or vesicles preferably from a bodily fluid of a patient previously treated with a polynucleotide, primary construct or mmRNA of the invention, then measuring, in said exosomes, the polynucleotide, primary construct or mmRNA levels by one of mRNA

microarray, qRT-PCR, or other means for measuring RNA in the art including by suitable antibody or immunohistochemical methods.

**Example 37. Effect of Modified mRNA on Cellular Viability, Cytotoxicity and Apoptosis**

[0001377] This experiment demonstrates cellular viability, cytotoxicity and apoptosis for distinct modified mRNA *in-vitro* transfected Human Keratinocyte cells. Keratinocytes are grown in EPILIFE® medium with Human Keratinocyte Growth Supplement in the absence of hydrocortisone from Invitrogen (Carlsbad, CA) at a confluence of >70%. Keratinocytes are reverse transfected with Ong, 46.875ng, 93.75ng, 187.5ng, 375ng, 750ng, 1500ng, 3000ng, or 6000ng of modified mRNA complexed with RNAIMAX™ from Invitrogen. The modified mRNA:RNAIMAX™ complex is formed. Secreted human G-CSF concentration in the culture medium is measured at 0, 6, 12, 24, and 48 hours post-transfection for each concentration of each modified mRNA in triplicate. Secretion of human G-CSF from transfected human keratinocytes is quantified using an ELISA kit from Invitrogen or R&D Systems following the manufacturers recommended instructions.

[0001378] Cellular viability, cytotoxicity and apoptosis is measured at 0, 12, 48, 96, and 192 hours post-transfection using the APOTOX-GLO™ kit from Promega (Madison, WI) according to manufacturer instructions.

**Example 38. Detection of a Cellular Innate Immune Response to Modified mRNA Using an ELISA Assay**

[0001379] An enzyme-linked immunosorbent assay (ELISA) for Human Tumor Necrosis Factor- $\alpha$  (TNF- $\alpha$ ), Human Interferon- $\beta$  (IFN- $\beta$ ) and Human Granulocyte-Colony Stimulating Factor (G-CSF) secreted from *in vitro*-transfected Human Keratinocyte cells is tested for the detection of a cellular innate immune response. Keratinocytes are grown in EPILIFE® medium with Human Keratinocyte Growth Supplement in the absence of hydrocortisone from Invitrogen (Carlsbad, CA) at a confluence of >70%. Secreted TNF- $\alpha$  keratinocytes are reverse transfected with Ong, 93.75ng, 187.5ng, 375ng, 750ng, 1500ng or 3000ng of the chemically modified mRNA (mRNA) complexed with RNAIMAX™ from Invitrogen as described in triplicate. Secreted TNF- $\alpha$  in the culture

medium is measured 24 hours post-transfection for each of the chemically modified mRNA using an ELISA kit from Invitrogen according to the manufacturer protocols. [0001380] Secreted IFN- $\beta$  in the same culture medium is measured 24 hours post-transfection for each of the chemically modified mRNA using an ELISA kit from Invitrogen according to the manufacturer protocols. Secreted human G-CSF concentration in the same culture medium is measured at 24 hours post-transfection for each of the chemically modified mRNA. Secretion of human G-CSF from transfected human keratinocytes is quantified using an ELISA kit from Invitrogen or R&D Systems (Minneapolis, MN) following the manufacturers recommended instructions. These data indicate which modified mRNA (mmRNA) are capable eliciting a reduced cellular innate immune response in comparison to natural and other chemically modified polynucleotides or reference compounds by measuring exemplary type 1 cytokines TNF- $\alpha$  and IFN- $\beta$ .

**Example 39. Human Granulocyte -Colony Stimulating Factor (G-CSF) Modified mRNA-induced Cell Proliferation Assay**

[0001381] Human keratinocytes are grown in EPILIFE® medium with Supplement S7 from Invitrogen at a confluence of >70% in a 24-well collagen-coated TRANSWELL® (Corning, Lowell, MA) co-culture tissue culture plate. Keratinocytes are reverse transfected with 750ng of the indicated chemically modified mRNA (mmRNA) complexed with RNAiMAX from Invitrogen as described in triplicate. The modified mRNA:RNAiMAX complex is formed as described. Keratinocyte media is exchanged 6-8 hours post-transfection. 42-hours post-transfection, the 24-well TRANSWELL® plate insert with a 0.4  $\mu\text{m}$ -pore semi-permeable polyester membrane is placed into the human G-CSF modified mRNA-transfected keratinocyte containing culture plate

[0001382] Human myeloblast cells, Kasumi-1 cells or KG-1 ( $0.2 \times 10^5$  cells), are seeded into the insert well and cell proliferation is quantified 42 hours post-co-culture initiation using the CyQuant Direct Cell Proliferation Assay (Invitrogen, Carlsbad, CA) in a 100-120  $\mu\text{l}$  volume in a 96-well plate. Modified mRNA-encoding human G-CSF-induced myeloblast cell proliferation is expressed as a percent cell proliferation normalized to untransfected keratinocyte/myeloblast co-culture control wells. Secreted human G-CSF concentration in both the keratinocyte and myeloblast insert co-culture wells is measured

at 42 hours post-co-culture initiation for each modified mRNA in duplicate. Secretion of human G-CSF is quantified using an ELISA kit from Invitrogen following the manufacturer recommended instructions.

[0001383] Transfected human G-CSF modified mRNA in human keratinocyte feeder cells and untransfected human myeloblast cells are detected by RT-PCR. Total RNA from sample cells is extracted and lysed using RNEASY® kit (Qiagen, Valencia, CA) according to the manufacturer instructions. Extracted total RNA is submitted to RT-PCR for specific amplification of modified mRNA-G-CSF using PROSCRIPT® M-MuLV *Taq* RT-PCR kit (New England BioLabs, Ipswich, MA) according to the manufacturer instructions with human G-CSF-specific primers. RT-PCR products are visualized by 1.2% agarose gel electrophoresis.

#### **Example 40; Co-Culture Assay**

[0001384] Modified mRNA comprised of chemically-distinct modified nucleotides encoding human Granulocyte-Colony Stimulating Factor (G-CSF) may stimulate the cellular proliferation of a transfection incompetent cell in a co-culture environment. The co-culture includes a highly transfectable cell type such as a human keratinocyte and a transfection incompetent cell type such as a white blood cell (WBC). The modified mRNA encoding G-CSF are transfected into the highly transfectable cell allowing for the production and secretion of G-CSF protein into the extracellular environment where G-CSF acts in a paracrine-like manner to stimulate the white blood cell expressing the G-CSF receptor to proliferate. The expanded WBC population may be used to treat immune-compromised patients or partially reconstitute the WBC population of an immunosuppressed patient and thus reduce the risk of opportunistic infections.

[0001385] In another example, a highly transfectable cell such as a fibroblast are transfected with certain growth factors support and simulate the growth, maintenance, or differentiation of poorly transfectable embryonic stem cells or induced pluripotent stem cells.

#### **Example 41: Detection Assays of Human IgG Antibodies**

##### **A. ELISA Detection of Human IgG Antibodies**

[0001386] This example describes an ELISA for Human IgG from Chinese Hamster Ovary's (CHO) and Human Embryonic Kidney (HEK, HER-2 Negative) 293 cells

transfected with human IgG modified mRNA (mmRNA). The Human Embryonic Kidney (HEK) 293 are grown in CD 293 Medium with Supplement of L-Glutamine from Invitrogen until they reach a confluence of 80-90%. The CHO cells are grown in CD CHO Medium with Supplement of L-Glutamine, Hypoxanthine and Thymidine. In one aspect,  $2 \times 10^6$  cells are transfected with 24  $\mu\text{g}$  modified mRNA complexed with RNAIMAX™ from Invitrogen in a 75cm<sup>2</sup> culture flask from Corning in 7 ml of medium. In another aspect, 80,000 cells are transfected with 1  $\mu\text{g}$  modified mRNA complexed with RNAIMAX™ from Invitrogen in a 24-well plate. The modified mRNA:RNAIMAX™ complex is formed by incubating in a vial the mmRNA with either the CD 293 or CD CHO medium in a 5X volumetric dilution for 10 minutes at room temperature. In a second vial, RNAIMAX™ reagent is incubated with CD 293 medium or CD CHO medium in a 10X volumetric dilution for 10 minutes at room temperature. The mmRNA vial is then mixed with the RNAIMAX™ vial and incubated for 20-30 minutes at room temperature before it is added to the CHO or HEK cells in a drop-wise fashion. The culture supernatants are stored at 4 degrees Celsius. The concentration of the secreted human IgG in the culture medium in the 24  $\mu\text{g}$  mmRNA transfections is measured at 12, 24, 36 hours post-transfection and the 1  $\mu\text{g}$  mmRNA transfection is measured at 36 hours. Secretion of Trastuzumab from transfected HEK 293 cells is quantified using an ELISA kit from Abcam (Cambridge, MA) following the manufacturer's recommended instructions. The data shows that a Humanized IgG antibody (such as Trastuzumab) mmRNA is capable of being translated in HEK Cells and that Trastuzumab is secreted out of the cells and released into the extracellular environment. Furthermore, the data demonstrate that transfection of cells with mmRNA encoding Trastuzumab for the production of secreted protein can be scaled up to a bioreactor or large cell culture conditions.

B. Western Detection of Modified mRNA Produced Human IgG Antibody  
[0001387] A Western Blot of CHO-K1 cells is co-transfected with 1  $\mu\text{g}$  each of Heavy and Light Chain of Trastuzumab modified mRNA (mmRNA). CHO cells are grown using standard protocols in 24-well plates. The cell supernatants or cell lysates are collected 24 hours post-transfection, separated on a 12% SDS-Page gel and transferred onto a nitrocellulose membrane using the IBOT® by Invitrogen (Carlsbad, CA). The



cells are incubated with a first conjugation of a rabbit polyclonal antibody to Human IgG conjugated to DYLIGHT594 (ab96904, abeam, Cambridge, MA) and a second conjugation of a goat polyclonal antibody to Rb IgG which is conjugated to alkaline phosphatase. After incubation, the antibody is detected using Novex® alkaline phosphatase chromogenic substrate by Invitrogen (Carlsbad, CA).

C. Cell Immuno Staining of Modified mRNA Produced Trastuzumab and Rituximab

[0001388] CHO-K1 cells are co-transfected with 500 ng each of Heavy and Light Chain of either Trastuzumab or Rituximab. Cells are grown in F-12K Medium from GIBCO® (Grand Island, NY) and 10% FBS. Cells are fixed with 4% paraformaldehyde in PBS, permeabilized with 0.1% Triton X-100 in PBS for 5-10 minutes at room temperature and cells are washed 3 times with room temperature PBS. Trastuzumab and Rituximab staining is performed using rabbit polyclonal antibody to Human IgG conjugated to DYLIGHT®594 (ab96904, abeam, Cambridge, MA) according to the manufacture's recommended dilutions. Nuclear DNA staining is performed with DAPI dye from Invitrogen (Carlsbad, CA). The protein for Trastuzumab and Rituximab is translated and localized to the cytoplasm upon modified mRNA transfections. Pictures are taken 13 hours post-transfection.

D. Binding Immunoblot Assay for Modified mRNA Produced Trastuzumab and Rituximab

[0001389] Trastuzumab and Rituximab are detected using a binding immunoblot detection assay. Varying concentrations (100ng/ul to Ong/ul) of the ErbB2 peptide (ab40048, abeam, Cambridge, MA), antigen for Trastuzumab and the CD20 peptide (ab97360, abeam, Cambridge, MA), antigen for Rituximab are run on a 12% SDS-Page gel and transferred onto a membrane using the iBlot from Invitrogen. The membranes are incubated for 1 hour with their respective cell supernatants from CHO-K1 cells which are co-transfected with 500ng each of Heavy and Light Chain of either Trastuzumab or Rituximab. The membranes are blocked with 1% BSA and a secondary anti-human IgG antibody conjugated to alkaline phosphatase (abeam, Cambridge, MA) is added. Antibody detection is conducted using the NOVEX alkaline phosphatase chromogenic substrate by Invitrogen (Carlsbad, CA). The data shows that a humanized IgG antibodies

generated from modified mRNA is capable of recognizing and binding to their respective antigens.

E. Cell Proliferation Assay

[0001390] The SK-BR-3 cell line, an adherent cell line derived from a human breast adenocarcinoma, which overexpresses the HER2/neu receptor can be used to compare the anti-proliferative properties of modified mRNA (mmRNA) generated Trastuzumab. Varying concentrations of purified Trastuzumab generated from modified mRNA and trastuzumab are be added to cell cultures, and their effects on cell growth are be assessed in triplicate cytotoxicity and viability assays.

**Example 42: Bulk Transfection of Modified mRNA into Cell Culture**

A. Cationic Lipid Delivery Vehicles

[0001391] RNA transfections are carried out using RNAiMAX™ (Invitrogen, Carlsbad, CA) or TRANSIT-mRNA (Minis Bio, Madison, WI) cationic lipid delivery vehicles. RNA and reagent are first diluted in Opti-MEM basal media (Invitrogen, Carlsbad, CA). 100 ng/uL RNA is diluted 5x and 5 µL of RNAiMax per µg of RNA is diluted 10x. The diluted components are pooled and incubated 15 minutes at room temperature before they are dispensed to culture media. For TRANSIT-mRNA transfections, 100 ng/uL RNA is diluted 10x in Opti-MEM and BOOST reagent is added (at a concentration of 2 µL per µg of RNA), TRANSIT-mRNA is added (at a concentration of 2 µL per µg of RNA), and then the RNA-lipid complexes are delivered to the culture media after a 2-minute incubation at room temperature. RNA transfections are performed in Nutristem xenofree hES media (Stemgent, Cambridge, MA) for RiPS derivations, Dermal Cell Basal Medium plus Keratinocyte Growth Kit (ATCC) for keratinocyte experiments, and Opti-MEM plus 2% FBS for all other experiments. Successful introduction of a modified mRNA (mmRNA) into host cells can be monitored using various known methods, such as a fluorescent marker, such as Green Fluorescent Protein (GFP). Successful transfection of a modified mRNA can also be determined by measuring the protein expression level of the target polypeptide by e.g., Western Blotting or immunocytochemistry. Similar methods may be followed for large volume scale-up to multi-liter (5-10,000L) culture format following similar RNA-lipid complex ratios.

B. Electroporation Delivery of Exogenous Synthetic mRNA Transcripts

[0001392] Electroporation parameters are optimized by transfecting MRC-5 fibroblasts with in vitro synthetic modified mRNA (mmRNA) transcripts and measuring transfection efficiency by quantitative RT-PCR with primers designed to specifically detect the exogenous transcripts. Discharging a 150uF capacitor charged to F into  $2.5 \times 10^6$  cells suspended in 50  $\mu$ l of Opti-MEM (Invitrogen, Carlsbad, CA) in a standard electroporation cuvette with a 2mm gap is sufficient for repeated delivery in excess of 10,000 copies of modified mRNA transcripts per cell, as determined using the standard curve method, while maintaining high viability (>70%). Further experiments may reveal that the voltage required to efficiently transfect cells with mmRNA transcripts can depend on the cell density during electroporation. Cell density may vary from  $1 \times 10^6$  cell/50  $\mu$ l to a density of  $2.5 \times 10^6$  cells/50  $\mu$ l and require from 110V to 145V to transfect cells with similar efficiencies measured in transcript copies per cell. Large multi-liter (5-10,000 L) electroporation may be performed similar to large volume flow electroporation strategies similar to methods described with the above described constraints (Li et al, 2002; Geng et al., 2010).

**Example 43: In Vivo Delivery Using Lipoplexes**

A. Human EPO Modified RNA Lipoplex

[0001393] A formulation containing 100  $\mu$ g of modified human erythropoietin mRNA (mRNA shown in SEQ ID NO: 5658; polyA tail of approximately 160 nucleotides not shown in sequence; 5'cap, Cap1) (EPO; fully modified 5-methylcytosine; N1-methylpseudouridine) was lipoplexed with 30% by volume of RNAiMAX™ (Lipoplex-h-Epo-46; Generation 2 or Gen2) in 50-70 uL delivered intramuscularly to four C57/BL6 mice. Other groups consisted of mice receiving an injection of the lipoplexed modified luciferase mRNA (Lipoplex-luc) (IVT cDNA sequence shown in SEQ ID NO: 5664; mRNA sequence shown in SEQ ID NO: 5665, polyA tail of approximately 160 nucleotides not shown in sequence, 5'cap, Cap1, fully modified with 5-methylcytosine at each cytosine and pseudouridine replacement at each uridine site) which served as a control containing 100  $\mu$ g of modified luciferase mRNA was lipoplexed with 30% by volume of RNAiMAX™ or mice receiving an injection of the formulation buffer as negative control at a dose volume of 65ul. 13 hours after the intramuscular injection,

serum was collected from each mouse to measure the amount of human EPO protein in the mouse serum by human EPO ELISA and the results are shown in Table 59.

**Table 59. Human EPO Production (IM Injection Route)**

Formulation	Average
Lipoplex-h-Epo-46	251.95
Lipoplex-Luc	0
Formulation Buffer	0

**B. Human G-CSF Modified RNA Lipoplex**

[0001394] A formulation containing 100 µg of one of the two types of modified human G-CSF mRNA (mRNA sequence shown in SEQ ID NO: 5655; polyA tail of approximately 160 nucleotides not shown in sequence; 5'cap, Cap1) (G-CSF fully modified with 5-methylcytosine and pseudouridine (G-CSF) or G-CSF fully modified with 5-methylcytosine and N1-methyl-pseudouridine (G-CSF-N1) lipoplexed with 30% by volume of RNAIMAX™ and delivered in 150 uL intramuscularly (I.M), in 150 uL subcutaneously (S.C) and in 225uL intravenously (IV) to C57/BL6 mice. Three control groups were administered either 100 µg of modified luciferase mRNA (IVT cDNA sequence shown in SEQ ID NO: 5664; mRNA sequence shown in SEQ ID NO: 5665, polyA tail of approximately 160 nucleotides not shown in sequence, 5'cap, Cap1, fully modified with 5-methylcytosine at each cytosine and pseudouridine replacement at each uridine site) intramuscularly (Luc-unsp I.M.) or 150 µg of modified luciferase mRNA intravenously (Luc-unsp IV.) or 150 uL of the formulation buffer intramuscularly (Buffer I.M.). 6 hours after administration of a formulation, serum was collected from each mouse to measure the amount of human G-CSF protein in the mouse serum by human G-CSF ELISA and the results are shown in Table 60.

[0001395] These results demonstrate that both 5-methylcytosine/pseudouridine and 5-methylcytosine/N1-methyl-pseudouridine modified human G-CSF mRNA can result in specific human G-CSF protein expression in serum when delivered via IV . or I.M. route of administration in a lipoplex formulation.

**Table 60. Human G-CSF in Serum (I.M., I.V., S.C. Injection Route)**

Formulation	Route	G-CSF (pg/ml)
G-CSF	I.M.	85.6
G-CSF N1	I.M.	40.1

G-CSF	S.C.	3.9
G-CSF N1	S.C.	0.0
G-CSF	I.V.	31.0
G-CSF N1	I.V.	6.1
Luc-unsp	I.M.	0.0
Luc-unsp	I.V.	0.0
Buffer	I.M.	0.0

### C. Human G-CSF Modified RNA Lipoplex Comparison

[0001396] A formulation containing 100 µg of either modified human G-CSF mRNA lipoplexed with 30% by volume of RNAIMAX™ with a 5-methylcytosine (5mc) and a pseudouridine (ψ) modification (G-CSF-Gen1 -Lipoplex), modified human G-CSF mRNA with a 5mc and ψ modification in saline (G-CSF-Gen1 -Saline), modified human G-CSF mRNA with a N1-5-methylcytosine (N1-5mc) and a ψ modification lipoplexed with 30% by volume of RNAIMAX™ (G-CSF-Gen2-Lipoplex), modified human G-CSF mRNA with a N1-5mc and ψ modification in saline (G-CSF-Gen2-Saline), modified luciferase with a 5mc and ψ modification lipoplexed with 30% by volume of RNAIMAX™ (Luc-Lipoplex), or modified luciferase mRNA with a 5mc and ψ modification in saline (Luc-Saline) was delivered intramuscularly (I.M.) or subcutaneously (S.C.) and a control group for each method of administration was giving a dose of 80µL of the formulation buffer (F. Buffer) to C57/BL6 mice. 13 hours post injection serum and tissue from the site of injection were collected from each mouse and analyzed by G-CSF ELISA to compare human G-CSF protein levels. The results of the human G-CSF protein in mouse serum from the intramuscular administration, and the subcutaneous administration results are shown in Table 61.

[0001397] These results demonstrate that 5-methylcytosine/pseudouridine and 5-methylcytosine/N1-methyl-pseudouridine modified human G-CSF mRNA can result in specific human G-CSF protein expression in serum when delivered via I.M. or S.C. route of administration whether in a saline formulation or in a lipoplex formulation. As shown in Table 61, 5-methylcytosine/N1-methyl-pseudouridine modified human G-CSF mRNA generally demonstrates increased human G-CSF protein production relative to 5-methylcytosine/pseudouridine modified human G-CSF mRNA.

**Table 61. Human G-CSF Protein in Mouse Serum**

Formulation	G-CSF (pg/ml)	
	I.M. Injection Route	S.C. Injection Route
G-CSF-Gen1-Lipoplex	13.988	42.855
G-CSF-Gen1-saline	9.375	4.614
G-CSF-Gen2-lipoplex	75.572	32.107
G-CSF-Gen2-saline	20.190	45.024
Luc lipoplex	0	3.754
Luc saline	0.0748	0
F. Buffer	4.977	2.156

#### D. mCherry Modified RNA Lipoplex Comparison

##### *Intramuscular and Subcutaneous Administration*

[0001398] A formulation containing 100 µg of either modified mCherry mRNA (mRNA sequence shown in SEQ ID NO: 5656; polyA tail of approximately 160 nucleotides not shown in sequence; 5'cap, Cap1) lipoplexed with 30% by volume of RNAIMAX™ or modified mCherry mRNA in saline is delivered intramuscularly and subcutaneously to mice. A formulation buffer is also administered to a control group of mice either intramuscularly or subcutaneously. The site of injection on the mice may be collected 17 hours post injection for sectioning to determine the cell type(s) responsible for producing protein.

##### *Intravitreal Administration*

[0001399] A formulation containing 10 µg of either modified mCherry mRNA lipoplexed with RNAIMAX™, modified mCherry mRNA in a formulation buffer, modified luciferase mRNA lipoplexed with RNAMAX™, modified luciferase mRNA in a formulation buffer can be administered by intravitreal injection (IVT) in rats in a dose volume of 5 µl/eye. A formulation buffer is also administered by IVT to a control group of rats in a dose volume of 5 µl/eye. Eyes from treated rats can be collected after 18 hours post injection for sectioning and lysating to determine whether mRNA can be effectively delivered in vivo to the eye and result in protein production, and to also determine the cell type(s) responsible for producing protein *in vivo*.

##### *Intranasal Administration*

[0001400] A formulation containing 100 µg of either modified mCherry mRNA lipoplexed with 30% by volume of RNAIMAX™, modified mCherry mRNA in saline, modified luciferase mRNA lipoplexed with 30% by volume of RNAIMAX™ or

modified luciferase mRNA in saline is delivered intranasally. A formulation buffer is also administered to a control group intranasally. Lungs may be collected about 13 hours post instillation for sectioning (for those receiving mCherry mRNA) or homogenization (for those receiving luciferase mRNA). These samples will be used to determine whether mmRNA can be effectively delivered *in vivo* to the lungs and result in protein production, and to also determine the cell type(s) responsible for producing protein *in vivo*.

**Example 44: *In Vivo* Delivery Using Varying Lipid Ratios**

[0001401] Modified mRNA was delivered to C57/BL6 mice to evaluate varying lipid ratios and the resulting protein expression. Formulations of 100µg modified human EPO mRNA (mRNA shown in SEQ ID NO: 5658; polyA tail of approximately 160 nucleotides not shown in sequence; 5'cap, Cap1; fully modified with 5-methylcytosine and pseudouridine) lipoplexed with 10%, 30% or 50% RNAiMAX™, 100µg modified luciferase mRNA (IVT cDNA sequence shown in SEQ ID NO: 5664; mRNA sequence shown in SEQ ID NO: 5665, polyA tail of approximately 160 nucleotides not shown in sequence, 5'cap, Cap1, fully modified with 5-methylcytosine at each cytosine and pseudouridine replacement at each uridine site) lipoplexed with 10%, 30% or 50% RNAiMAX™ or a formulation buffer were administered intramuscularly to mice in a single 70 µl dose. Serum was collected 13 hours post injection to undergo a human EPO ELISA to determine the human EPO protein level in each mouse. The results of the human EPO ELISA, shown in Table 62, show that modified human EPO expressed in the muscle is secreted into the serum for each of the different percentage of RNAiMAX™.

**Table 62. Human EPO Protein in Mouse Serum (IM Injection Route)**

Formulation	EPO (pg/ml)
Epo + 10% RNAiMAX	11.4
Luc + 10% RNAiMAX	0
Epo + 30% RNAiMAX	27.1
Luc + 30% RNAiMAX	0
Epo + 50% RNAiMAX	19.7
Luc + 50% RNAiMAX	0
F. Buffer	0

**Example 45: Intramuscular and Subcutaneous *In Vivo* Delivery in Mammals**

[0001402] Modified human EPO mRNA (mRNA sequence shown in SEQ ID NO: 5658; polyA tail of approximately 160 nucleotides not shown in sequence; 5'cap, CapI; fully modified with 5-methylcytosine and pseudouridine) formulated in saline was delivered to either C57/BL6 mice or Sprague-Dawley rats to evaluate the dose dependency on human EPO production. Rats were intramuscularly injected with 50  $\mu$ l of the modified human EPO mRNA (h-EPO), modified luciferase mRNA (Luc) (IVT cDNA sequence shown in SEQ ID NO: 5664; mRNA sequence shown in SEQ ID NO: 5665, polyA tail of approximately 160 nucleotides not shown in sequence, 5'cap, CapI, fully modified with 5-methylcytosine at each cytosine and pseudouridine replacement at each uridine site) or the formulation buffer (F.Buffer) as described in the dosing chart Table 63.

[0001403] Mice were intramuscularly or subcutaneously injected with 50  $\mu$ l of the modified human EPO mRNA (h-EPO), modified luciferase mRNA (Luc) or the formulation buffer (F.Buffer) as described in the dosing chart Table 64. 13 hours post injection blood was collected and serum was analyzed to determine the amount human EPO for each mouse or rat. The average and geometric mean in pg/ml for the rat study are also shown in Table 63.

**Table 63. Rat Study**

	Group	Dose (ug)	Avg. pg/ml	Geometric -mean pg/ml
h-EPO	G#1	150	67.7	67.1
h-EPO	G#2	100	79.4	66.9
h-EPO	G#3	50	101.5	85.4
h-EPO	G#4	10	46.3	31.2
h-EPO	G#5	1	28.7	25.4
Luc	G#6	100	24.5	22.4
F.Buffer	G#7	-	18.7	18.5

**Table 64. Mouse Study**

Route	Treatment	Group	Dose	Average Level in serum pg/ml
IM	h-EPO	1	100 $\mu$ g	96.2
IM	h-EPO	2	50 $\mu$ g	63.5
IM	h-EPO	3	25 $\mu$ g	18.7
IM	h-EPO	4	10 $\mu$ g	25.9
IM	h-EPO	5	1 $\mu$ g	2.6
IM	Luc	6	100 $\mu$ g	0
IM	F.Buffer	7	-	1.0



SC	h-EPO	1	100 µg	72.0
SC	Luc	2	100 µg	26.7
SC	F.Buffer	3	--	17.4

**Example 46: Duration of Activity after Intramuscular *In Vivo* Delivery in Rats**

[0001404] Modified human EPO mRNA (mRNA sequence shown in SEQ ID NO: 5658; polyA tail of approximately 160 nucleotides not shown in sequence; 5'cap, CapI; fully modified with 5-methylcytosine and pseudouridine) formulated in formulation buffer was delivered to Sprague-Dawley rats to determine the duration of the dose response. Rats were intramuscularly injected with 50 µl of the modified human EPO mRNA (h-EPO), modified luciferase mRNA (IVT cDNA sequence shown in SEQ ID NO: 5664; mRNA sequence shown in SEQ ID NO: 5665, polyA tail of approximately 160 nucleotides not shown in sequence, 5'cap, CapI, fully modified with 5-methylcytosine at each cytosine and pseudouridine replacement at each uridine site) (Luc) or the formulation buffer (F.Buffer) as described in the dosing chart Table 65. The rats were bled 2, 6, 12, 24, 48 and 72 hours after the intramuscular injection to determine the concentration of human EPO in serum at a given time. The average and geometric mean in pg/ml for this study are also shown in Table 65.

**Table 65. Dosing Chart**

	Group	Dose (ug)	Avg. pg/ml	Geometric -mean (pg/ml)	
	h-EPO	2 hour	100	59.6	58.2
	h-EPO	6 hour	100	68.6	55.8
	h-EPO	12 hour	100	87.4	84.5
	h-EPO	24 hour	100	108.6	95.3
	h-EPO	48 hour	100	77.9	77.0
	h-EPO	72 hour	100	80.1	75.8
	Luc	24, 48 and 72 hour	100	37.2	29.2
	F.Buffer	24, 48 and 72 hour	-	48.9	10.4

**Example 47: Routes of Administration**

[0001405] Further studies were performed to investigate dosing using different routes of administration. Following the protocol outlined in Example 35, 4 mice per group were dosed intramuscularly (I.M.), intravenously (IV) or subcutaneously (S.C.) by the dosing chart outlined in Table 66. Serum was collected 13 hours post injection from all mice,

tissue was collected from the site of injection from the intramuscular and subcutaneous group and the spleen, liver and kidneys were collected from the intravenous group. The results from the intramuscular group and the subcutaneous group results are shown in Table 67.

**Table 66. Dosing Chart**

Group	Treatment	Route	Dose of mmRNA	Total Dose	Dosing Vehicle
1	Lipoplex-human EPO mmRNA	I.M.	4 x 100 ug + 30% Lipoplex	4x70 ul	Lipoplex
2	Lipoplex-human EPO mmRNA	I.M.	4 x 100 ug	4x70 ul	Buffer
3	Lipoplex-human EPO mmRNA	S.C.	4 x 100 ug + 30% Lipoplex	4x70 ul	Lipoplex
4	Lipoplex-human EPO mmRNA	S.C.	4 x 100 ug	4x70 ul	Buffer
5	Lipoplex-human EPO mmRNA	I.V.	200 ug + 30% Lipoplex	140 ul	Lipoplex
6	Lipoplexed-Luciferase mmRNA	I.M.	100 ug + 30% Lipoplex	4x70 ul	Lipoplex
7	Lipoplexed-Luciferase mmRNA	I.M.	100 ug	4x70 ul	Buffer
8	Lipoplexed-Luciferase mmRNA	S.C.	100 ug + 30% Lipoplex	4x70 ul	Lipoplex
9	Lipoplexed-Luciferase mmRNA	S.C.	100 ug	4x70 ul	Buffer
10	Lipoplexed-human EPO mmRNA	I.V.	200 ug + 30% Lipoplex	140 ul	Lipoplex
11	Formulation Buffer	I.M.	4x multi dosing	4x70 ul	Buffer

**Table 67. Human EPO Protein in Mouse Serum (I.M. Injection Route)**

Formulation	EPO (pg/ml)	
	I.M. Injection Route	S.C. Injection Route
Epo-Lipoplex	67.115	2.154
Luc-Lipoplex	0	0
Epo-Saline	100.891	11.37
Luc-Saline	0	0
Formulation Buffer	0	0

**Example 48. Rapidly Eliminated Lipid Nanoparticle (reLNP) Studies**

A. Formulation of Modified RNA reLNPs

[0001406] Solutions of synthesized lipid, 1,2-distearoyl-3-phosphatidylcholine (DSPC) (Avanti Polar Lipids, Alabaster, AL), cholesterol (Sigma-Aldrich, Taufkirchen,

Germany), and a-[3'-(1,2-dimyristoyl-3-propanoxy)-carboxamide-propyl]-ro-methoxy-polyoxyethylene (PEG-c-DOMG) (NOF, Bouwelven, Belgium) are prepared and stored at -20°C. The synthesized lipid is selected from DLin-DMA with an internal ester, DLin-DMA with a terminal ester, DLin-MC3-DMA-internal ester, and DLin-MC3-DMA with a terminal ester. The reLNPs are combined to yield a molar ratio of 50:10:38.5:1.5 (reLNP: DSPC: Cholesterol: PEG-c-DOMG). Formulations of the reLNPs and modified mRNA are prepared by combining the lipid solution with the modified mRNA solution at total lipid to modified mRNA weight ratio of 10:1, 15:1, 20:1 and 30:1.

#### B. Characterization of formulations

[0001407] A Zetasizer Nano ZS (Malvern Instruments Ltd, Malvern, Worcestershire, UK) is used to determine the particle size, the polydispersity index (PDI) and the zeta potential of the modified mRNA nanoparticles in IX PBS in determining particle size and 15 mM PBS in determining zeta potential.

[0001408] Ultraviolet-visible spectroscopy is used to determine the concentration of modified mRNA nanoparticle formulation. After mixing, the absorbance spectrum of the solution is recorded between 230 nm and 330 nm on a DU 800 spectrophotometer (Beckman Coulter, Beckman Coulter, Inc., Brea, CA). The modified RNA concentration in the nanoparticle formulation is calculated based on the extinction coefficient of the modified RNA used in the formulation and on the difference between the absorbance at a wavelength of 260 nm and the baseline value at a wavelength of 330 nm.

[0001409] QUANT-IT™ RIBOGREEN® RNA assay (Invitrogen Corporation Carlsbad, CA) is used to evaluate the encapsulation of modified RNA by the nanoparticle. The samples are diluted, transferred to a polystyrene 96 well plate, then either a TE buffer or a 2% Triton X-100 solution is added. The plate is incubated and the RIBOGREEN® reagent is diluted in TE buffer, and of this solution is added to each well. The fluorescence intensity is measured using a fluorescence plate reader (Wallac Victor 1420 Multilabel Counter; Perkin Elmer, Waltham, MA) The fluorescence values of the reagent blank are subtracted from each of the samples and the percentage of free modified RNA is determined by dividing the fluorescence intensity of the intact sample by the fluorescence value of the disrupted sample.

#### C. In Vitro Incubation

[0001410] Human embryonic kidney epithelial (HEK293) and hepatocellular carcinoma epithelial (HepG2) cells (LGC standards GmbH, Wesel, Germany) are seeded on 96-well plates (Greiner Bio-one GmbH, Frickenhausen, Germany) and plates for HEK293 cells are precoated with collagen type I. HEK293 are seeded at a density of about 30,000 and HepG2 are seeded at a density of about 35,000 cells per well in 100  $\mu$ l cell culture medium. Formulations containing mCherry mRNA (mRNA sequence shown in SEQ ID NO: 5656; polyA tail of approximately 160 nucleotides not shown in sequence; 5'cap, Cap1) are added directly after seeding the cells and incubated. The mCherry cDNA with the T7 promoter, 5'untranslated region (UTR) and 3' UTR used in *in vitro* transcription (IVT) is given in SEQ ID NO: 5657.

[0001411] Cells are harvested by transferring the culture media supernatants to a 96-well Pro-Bind U-bottom plate (Beckton Dickinson GmbH, Heidelberg, Germany). Cells are trypsinized with 1/2 volume Trypsin/EDTA (Biochrom AG, Berlin, Germany), pooled with respective supernatants and fixed by adding one volume PBS/2%FCS (both Biochrom AG, Berlin, Germany)/0.5% formaldehyde (Merck, Darmstadt, Germany). Samples are then submitted to a flow cytometer measurement with an excitation laser and a filter for PE-Texas Red in a LSRII cytometer (Beckton Dickinson GmbH, Heidelberg, Germany). The mean fluorescence intensity (MFI) of all events and the standard deviation of four independent wells are presented in for samples analyzed.

#### D. In Vivo Formulation Studies

[0001412] Mice are administered intravenously a single dose of a formulation containing a modified mRNA and a reLNP. The modified mRNA administered to the mice is selected from G-CSF (mRNA sequence shown in SEQ ID NO: 5655; polyA tail of approximately 160 nucleotides not shown in sequence; 5'cap, Cap1), Factor IX (mRNA shown in SEQ ID NO: 5659; polyA tail of approximately 160 nucleotides not shown in sequence; 5'cap, Cap1) or mCherry (mRNA sequence shown in SEQ ID NO: 5656; polyA tail of approximately 160 nucleotides not shown in sequence; 5'cap, Cap1).

[0001413] The mice are injected with 100ug, 10 ug or 1 ug of the formulated modified mRNA and are sacrificed 8 hours after they are administered the formulation. Serum from the mice administered formulations containing human G-CSF modified mRNA are measured by specific G-CSF ELISA and serum from mice administered human Factor IX

modified RNA is analyzed by specific factor IX ELISA or chromogenic assay. The liver and spleen from the mice administered with mCherry modified mRNA are analyzed by immunohistochemistry (IHC) or fluorescence-activated cell sorting (FACS). As a control, a group of mice are not injected with any formulation and their serum and tissue are collected analyzed by ELISA, FACS and/or IHC.

**Example 49. In Vitro Transfection of VEGF-A**

[0001414] Human vascular endothelial growth factor-isoform A (VEGF-A) modified mRNA (mRNA sequence shown in SEQ ID NO: 5668; polyA tail of approximately 160 nucleotides not shown in sequence; 5'cap, Cap1) was transfected via reverse transfection in Human Keratinocyte cells in 24 multi-well plates. Human Keratinocytes cells were grown in EPILIFE® medium with Supplement S7 from Invitrogen (Carlsbad, CA) until they reached a confluence of 50-70%. The cells were transfected with 0, 46.875, 93.75, 187.5, 375, 750, and 1500 ng of modified mRNA (mmRNA) encoding VEGF-A which had been complexed with RNAIMAX™ from Invitrogen (Carlsbad, CA). The RNA:RNAIMAX™ complex was formed by first incubating the RNA with Supplement-free EPILIFE® media in a 5X volumetric dilution for 10 minutes at room temperature. In a second vial, RNAIMAX™ reagent was incubated with Supplement-free EPILIFE® Media in a 10X volumetric dilution for 10 minutes at room temperature. The RNA vial was then mixed with the RNAIMAX™ vial and incubated for 20-30 minutes at room temperature before being added to the cells in a drop-wise fashion.

[0001415] The fully optimized mRNA encoding VEGF-A (mRNA sequence shown in SEQ ID NO: 5668; polyA tail of approximately 160 nucleotides not shown in sequence; 5'cap, Cap1) transfected with the Human Keratinocyte cells included modifications during translation such as natural nucleoside triphosphates (NTP), pseudouridine at each uridine site and 5-methylcytosine at each cytosine site (pseudo-U/5mC), and N1-methyl-pseudouridine at each uridine site and 5-methylcytosine at each cytosine site (N1-methyl-Pseudo-U/5mC). Cells were transfected with the mmRNA encoding VEGF-A and secreted VEGF-A concentration (pg/ml) in the culture medium was measured at 6, 12, 24, and 48 hours post-transfection for each of the concentrations using an ELISA kit from Invitrogen (Carlsbad, CA) following the manufacturers recommended instructions. These data, shown in Table 68, show that modified mRNA encoding VEGF-A is capable of

being translated in Human Keratocyte cells and that VEGF-A is transported out of the cells and released into the extracellular environment.

**Table 68. VEGF-A Dosing and Protein Secretion**

<b>VEGF-A Dose Containing Natural NTPs</b>				
<b>Dose (ng)</b>	<b>6 hours (pg/ml)</b>	<b>12 hours (pg/ml)</b>	<b>24 hours (pg/ml)</b>	<b>48 hours (pg/ml)</b>
<b>46.875</b>	10.37	18.07	33.90	67.02
<b>93.75</b>	9.79	20.54	41.95	65.75
<b>187.5</b>	14.07	24.56	45.25	64.39
<b>375</b>	19.16	37.53	53.61	88.28
<b>750</b>	21.51	38.90	51.44	61.79
<b>1500</b>	36.11	61.90	76.70	86.54
<b>VEGF-A Dose Containing Pseudo-U/5mC</b>				
<b>Dose (ng)</b>	<b>6 hours (pg/ml)</b>	<b>12 hours (pg/ml)</b>	<b>24 hours (pg/ml)</b>	<b>48 hours (pg/ml)</b>
<b>46.875</b>	10.13	16.67	33.99	72.88
<b>93.75</b>	11.00	20.00	46.47	145.61
<b>187.5</b>	16.04	34.07	83.00	120.77
<b>375</b>	69.15	188.10	448.50	392.44
<b>750</b>	133.95	304.30	524.02	526.58
<b>1500</b>	198.96	345.65	426.97	505.41
<b>VEGF-A Dose Containing N1-methyl-Pseudo-U/5mC</b>				
<b>Dose (ng)</b>	<b>6 hours (pg/ml)</b>	<b>12 hours (pg/ml)</b>	<b>24 hours (pg/ml)</b>	<b>48 hours (pg/ml)</b>
<b>46.875</b>	0.03	6.02	27.65	100.42
<b>93.75</b>	12.37	46.38	121.23	167.56
<b>187.5</b>	104.55	365.71	1025.41	1056.91
<b>375</b>	605.89	1201.23	1653.63	1889.23
<b>750</b>	445.41	1036.45	1522.86	1954.81
<b>1500</b>	261.61	714.68	1053.12	1513.39

**Example 50. In vivo studies of Factor IX**

[0001416] Human Factor IX mmRNA (GenI; fully modified 5-methylcytosine and pseudouridine) formulated in formulation buffer was delivered to mice via intramuscular injection. The results demonstrate that Factor IX protein was elevated in serum as measured 13 hours after administration.

[0001417] In this study, mice (N=5 for Factor IX, N=3 for Luciferase or Buffer controls) were intramuscularly injected with 50 µl of the Factor IX mmRNA (mRNA sequence shown in SEQ ID NO: 5659; polyA tail of approximately 160 nucleotides not shown in sequence; 5'cap, CapI), Luciferase (IVT cDNA sequence shown in SEQ ID NO: 5664; mRNA sequence shown in SEQ ID NO: 5665, polyA tail of approximately 160

nucleotides not shown in sequence, 5'cap, Cap1, fully modified with 5-methylcytosine at each cytosine and pseudouridine replacement at each uridine site) or the formulation buffer (F.Buffer) at 2x 100 ug/mouse. The mice were bled at 13 hours after the intramuscular injection to determine the concentration of human the polypeptide in serum in pg/mL. The results revealed that administration of Factor IX mmRNA resulted in levels of 1600 pg/mL at 13 hours as compared to less than 100 pg/mL of Factor IX for either Luciferase or buffer control administration.

**Example 51. Multi-site administration: Intramuscular and Subcutaneous**

[0001418] Human G-CSF modified mRNA (mRNA sequence shown in SEQ ID NO: 5655; polyA tail of approximately 160 nucleotides not shown in sequence; 5'cap, Cap1) modified as either Gen1 or Gen2 (5-methylcytosine (5mc) and a pseudouridine ( $\psi$ ) modification, G-CSF-Gen1; or N1-5-methylcytosine (N1-5mc) and a  $\psi$  modification, G-CSF-Gen2) and formulated in formulation buffer were delivered to mice via intramuscular (IM) or subcutaneous (SC) injection. Injection of four doses or 2x 50ug (two sites) daily for three days (24 hrs interval) was performed. The fourth dose was administered 6 hrs before blood collection and CBC analysis. Controls included Luciferase (IVT cDNA sequence shown in SEQ ID NO: 5664; mRNA sequence shown in SEQ ID NO: 5665, polyA tail of approximately 160 nucleotides not shown in sequence, 5'cap, Cap1, fully modified with 5-methylcytosine at each cytosine and pseudouridine replacement at each uridine site) or the formulation buffer (F.Buffer). The mice were bled at 72 hours after the first mRNA injection (6 hours after the last modified mRNA dose) to determine the effect of mRNA-encoded human G-CSF on the neutrophil count. The dosing regimen is shown in Table 69 as are the resulting neutrophil counts (thousands/uL). In Table 69, an asterisk^ indicates statistical significance at  $p < 0.05$ .

[0001419] For intramuscular administration, the data reveal a four fold increase in neutrophil count above control at day 3 for the Gen1 G-CSF mRNA and a two fold increase for the Gen2 G-CSF mmRNA. For subcutaneous administration, the data reveal a two fold increase in neutrophil count above control at day 3 for the Gen2 G-CSF mRNA.

[0001420] These data demonstrate that both 5-methylcytidine/pseudouridine and 5-methylcytidine/N1-methyl-pseudouridine -modified mRNA can be biologically active, as evidenced by specific increases in blood neutrophil counts.

**Table 69. Dosing Regimen**

Gr.	Treatment	Route	N=	Dose ( $\mu\text{g}/\text{mouse}$ )	Dose Vol. ( $\mu\text{l}/\text{mouse}$ )	Dosing Vehicle	Neutrophil Thous/uL
1	G-CSF (Gen1)	I.M	5	2x50ug (four doses)	50	F. buffer	840*
2	G-CSF (Gen1)	S.C	5	2x50ug (four doses)	50	F. buffer	430
3	G-CSF (Gen2)	I.M	5	2x50ug (four doses)	50	F. buffer	746*
4	G-CSF (Gen2)	S.C	5	2x50ug (four doses)	50	F. buffer	683
5	Luc (Gen1)	I.M.	5	2x50ug (four doses)	50	F. buffer	201
6	Luc (Gen1)	S.C.	5	2x50ug (four doses)	50	F. buffer	307
7	Luc (Gen2)	I.M	5	2x50ug (four doses)	50	F. buffer	336
8	Luc (Gen2)	S.C	5	2x50ug (four doses)	50	F. buffer	357
9	F. Buffer	I.M	4	0 (four doses)	50	F. buffer	245
10	F. Buffer	S.C.	4	0 (four doses)	50	F. buffer	509
11	Untreated	-	4			-	312

**Example 52. Intravenous administration**

[0001421] Human G-CSF modified mRNA (mRNA sequence shown in SEQ ID NO: 5655; polyA tail of approximately 160 nucleotides not shown in sequence; 5'cap, Cap1) modified with 5-methylcytosine (5mc) and a pseudouridine ( $\psi$ ) modification (Gen1); or having no modifications and formulated in 10% lipoplex (RNAiMax) were delivered to mice at a dose of 50 ug RNA and in a volume of 100 ul via intravenous (IV) injection at days 0, 2 and 4. Neutrophils were measured at days 1, 5 and 8. Controls included non-specific mammalian RNA or the formulation buffer alone (F.Buffer). The mice were bled at days 1, 5 and 8 to determine the effect of modified mRNA-encoded human G-CSF to increase neutrophil count. The dosing regimen is shown in Table 70 as are the resulting neutrophil counts (thousands/uL; K/uL).



[0001422] For intravenous administration, the data reveal a four to five fold increase in neutrophil count above control at day 5 with G-CSF modified mRNA but not with unmodified G-CSF mRNA or non-specific controls. Blood count returned to baseline four days after the final injection. No other changes in leukocyte populations were observed.

[0001423] In Table 70, an asterisk (\*) indicates statistical significance at  $p < 0.001$  compared to buffer.

[0001424] These data demonstrate that lipoplex-formulated 5-methylcytidine/pseudouridine-modified mRNA can be biologically active, when delivered through an I.V. route of administration as evidenced by specific increases in blood neutrophil counts. No other cell subsets were significantly altered. Unmodified G-CSF mRNA similarly administered showed no pharmacologic effect on neutrophil counts.

**Table 70. Dosing Regimen**

Gr.	Day	Treatment	N=	Dose Vol. (µl/mouse)	Dosing Vehicle	Neutrophil K/uL
1	1	G-CSF (Gen1)	5	100	10% lipoplex	2.91
2	5	G-CSF (Gen1)	5	100	10% lipoplex	5.32*
3	8	G-CSF (Gen1)	5	100	10% lipoplex	2.06
4	1	G-CSF (no modification)	5	100	10% lipoplex	1.88
5	5	G-CSF (no modification)	5	100	10% lipoplex	1.95
6	8	G-CSF (no modification)	5	100	10% lipoplex	2.09
7	1	RNA control	5	100	10% lipoplex	2.90
8	5	RNA control	5	100	10% lipoplex	1.68
9	8	RNA control	4	100	10% lipoplex	1.72
10	1	F. Buffer	4	100	10% lipoplex	2.51
11	5	F. Buffer	4	100	10% lipoplex	1.31
12	8	F. Buffer	4	100	10% lipoplex	1.92

**Example 53. Saline formulation: Intramuscular Administration**

[0001425] Human G-CSF modified mRNA (mRNA sequence shown in SEQ ID NO: 5655; polyA tail of approximately 160 nucleotides not shown in sequence; 5'cap, Cap1) and human EPO mmiRNA (mRNA sequence shown in SEQ ID NO: 5658; polyA tail of approximately 160 nucleotides not shown in sequence; 5'cap, Cap1); G-CSF modified mRNA (modified with 5-methylcytosine (5mc) and pseudouridine ( $\psi$ )) and EPO

modified mRNA (modified with NI-5-methylcytosine (NI-5mc) and  $\psi$  modification), were formulated in formulation buffer (150 mM sodium chloride, 2mM calcium chloride, 2mM phosphate, 0.5 mM EDTA at a pH of 6.5) and delivered to mice via intramuscular (IM) injection at a dose of 100 ug.

[0001426] Controls included Luciferase (IVT cDNA sequence shown in SEQ ID NO: 5664; mRNA sequence shown in SEQ ID NO: 5665, polyA tail of approximately 160 nucleotides not shown in sequence, 5'cap, Cap1, fully modified with 5-methylcytosine at each cytosine and pseudouridine replacement at each uridine site) or the formulation buffer (F.Buffer). The mice were bled at 13 hours after the injection to determine the concentration of the human polypeptide in serum in pg/mL. (G-CSF groups measured human G-CSF in mouse serum and EPO groups measured human EPO in mouse serum). The data are shown in Table 71.

**Table 71. Dosing Regimen**

Group	Treatment	N=	Dose Vol. ( $\mu$ l/mouse)	Dosing Vehicle	Average Protein Product pg/mL, serum
G-CSF	G-CSF	5	50	Saline	19.8
G-CSF	Luciferase	5	50	Saline	0.5
G-CSF	F. buffer	5	50	F. buffer	0.5
EPO	EPO	5	50	Saline	191.5
EPO	Luciferase	5	50	Saline	15.0
EPO	F. buffer			F. buffer	4.8

**B. Dose Response**

[0001427] Human EPO modified mRNA (mRNA sequence shown in SEQ ID NO: 5658; polyA tail of approximately 160 nucleotides not shown in sequence; 5'cap, Cap1; fully modified with 5-methylcytosine and pseudouridine) were formulated in formulation buffer and delivered to mice via intramuscular (IM) injection.

[0001428] Controls included Luciferase (mRNA sequence shown in SEQ ID NO: 5665, polyA tail of approximately 160 nucleotides not shown in sequence, 5'cap, Cap1, fully modified with 5-methylcytosine and pseudouridine) or the formulation buffer (F.Buffer). The mice were bled at 13 hours after the injection to determine the concentration of the human polypeptide in serum in pg/mL. The dose and expression are shown in Table 72.

**Table 72. Dosing Regimen and Expression**

Treatment	Dose Vol. (μl/mouse)	Average Protein Product pg/mL, serum
EPO	100	96.2
EPO	50	63.5
EPO	25	18.7
EPO	10	25.9
EPO	1	2.6
Luciferase	100	0.0
F. buffer	100	1.0

**Example 54. EPO multi-dose/multi-administration**

[0001429] Studies utilizing multiple intramuscular injection sites at one time point were designed and performed.

[0001430] The design of a single multi-dose experiment involved using human erythropoietin (EPO) mmRNA (mRNA sequence shown in SEQ ID NO: 5658; polyA tail of approximately 160 nucleotides not shown in sequence; 5'cap, Cap1) or G-CSF mmRNA (mRNA sequence shown in SEQ ID NO: 5655; polyA tail of approximately 160 nucleotides not shown in sequence; 5'cap, Cap1) administered in formulation buffer. The dosing vehicle (F. buffer) was used as a control. The EPO and G-CSF modified mRNA were modified with 5-methylcytosine at each cytosine and pseudouridine replacement at each uridine site.

[0001431] Animals (n=5), Sprague-Dawley rats, were injected IM (intramuscular) for the single unit dose of 100 ug (delivered to one thigh). For multi-dosing 6 doses of 100 ug (delivered to two thighs) were used for both EPO and G-CSF mmRNA. Control dosing involved use of buffer at a single dose. Human EPO blood levels were evaluated 13 hrs post injection.

[0001432] Human EPO protein was measured in rat serum 13 hrs post intramuscular injection. Five groups of rats were treated and evaluated. The results are shown in Table 73.

**Table 73. Multi-dose study**

Group	Treatment	Dose of mmRNA	Total Dose	Avg. Pg/mL human EPO,

				serum
1	Human EPO mmRNA	1 x 100 ug	100 ug	143
2	Human EPO mmRNA	6 x 100 ug	600 ug	256
3	G-CSF mmRNA	1 x 100 ug	100 ug	43
4	G-CSF mmRNA	6 x 100 ug	600 ug	58
5	Buffer Alone	-	-	20

### **Example 55. Signal Sequence Exchange Study**

[0001433] Several variants of mmRNAs encoding human Granulocyte colony stimulating factor (G-CSF) (mRNA sequence shown in SEQ ID NO: 5655; polyA tail of approximately 160 nucleotides not shown in sequence; 5'cap, Cap1) were synthesized using modified nucleotides pseudouridine and 5-methylcytosine (pseudo-U/5mC). These variants included the G-CSF constructs encoding either the wild-type N terminal secretory signal peptide sequence (MAGPATQSPMKLMALQLLLWHSALWTVQEA; SEQ ID NO: 95), no secretory signal peptide sequence, or secretory signal peptide sequences taken from other mRNAs. These included sequences where the wild type G-CSF signal peptide sequence was replaced with the signal peptide sequence of either: human  $\alpha$ -1-anti trypsin (AAT) (MMPSSVSWGILLLAGLCCLVPVSLA; SEQ ID NO: 94), human Factor IX (FIX)

(MQRVNMIMAESPSLITICLLGYLLSAECTVFLDHENANKILNRPKR; SEQ ID NO: 96), human Prolactin (Prolac) (MKGSLLLLLVSNLLLCQSVAP; SEQ ID NO: 97), or human Albumin (Alb) (MKWVTFISLLFLFSSAYSRGVFRR; SEQ ID NO: 98).

[0001434] 250ng of modified mRNA encoding each G-CSF variant was transfected into HEK293A (293A in the table), mouse myoblast (MM in the table) (C2C12, CRL-1772, ATCC) and rat myoblast (RM in the table) (L6 line, CRL-1458, ATCC) cell lines in a 24 well plate using 1 ul of Lipofectamine 2000 (Life Technologies), each well containing 300,000 cells. The supernatants were harvested after 24 hrs and the secreted G-CSF protein was analyzed by ELISA using the Human G-CSF ELISA kit (Life Technologies). The data shown in Table 74 reveal that cells transfected with G-CSF mmRNA encoding the Albumin signal peptide secrete at least 12 fold more G-CSF protein than its wild type counterpart.

**Table 74. Signal Peptide Exchange**

Signal peptides	293A (pg/ml)	MM (pg/ml)	RM (pg/ml)
G-CSF Natural	9650	3450	6050
a-1-anti trypsin	9950	5000	8475
Factor IX	11675	6175	11675
Prolactin	7875	1525	9800
Albumin	122050	81050	173300
No Signal peptide	0	0	0

### **Example 56. Cytokine Study: PBMC**

#### PBMC isolation and Culture

[0001435] 50 mL of human blood from two donors was received from Research Blood Components (lots KP30928 and KP3093 1) in sodium heparin tubes. For each donor, the blood was pooled and diluted to 70 mL with DPBS (SAFC Bioscience 5933 1C, lot 071M8408) and split evenly between two 50 mL conical tubes. 10 mL of Ficoll Paque (GE Healthcare 17-5442-03, lot 10074400) was gently dispensed below the blood layer. The tubes were centrifuged at 2000 rpm for 30 minutes with low acceleration and braking. The tubes were removed and the buffy coat PBMC layers were gently transferred to a fresh 50 mL conical and washed with DPBS. The tubes were centrifuged at 1450 rpm for 10 minutes.

[0001436] The supernatant was aspirated and the PBMC pellets were resuspended and washed in 50 mL of DPBS. The tubes were centrifuged at 1250 rpm for 10 minutes. This wash step was repeated, and the PBMC pellets were resuspended in 19 mL of Optimem I (Gibco 11058, lot 1072088) and counted. The cell suspensions were adjusted to a concentration of  $3.0 \times 10^6$  cells / mL live cells.

[0001437] These cells were then plated on five 96 well tissue culture treated round bottom plates (Costar 3799) per donor at 50 uL per well. Within 30 minutes, transfection mixtures were added to each well at a volume of 50 uL per well. After 4 hours post transfection, the media was supplemented with 10 uL of Fetal Bovine Serum (Gibco 10082, lot 1012368)

#### Transfection Preparation

[0001438] mmRNA encoding human G-CSF (mRNA sequence shown in SEQ ID NO: 5655; polyA tail of approximately 160 nucleotides not shown in sequence; 5'cap, Cap1)

(containing either (1) natural NTPs, (2) 100% substitution with 5-methyl cytidine and pseudouridine, or (3) 100% substitution with 5-methyl cytidine and N1-methyl pseudouridine; mmRNA encoding luciferase (IVT cDNA sequence shown in SEQ ID NO: 5665; mRNA sequence shown in SEQ ID NO: 5665, polyA tail of approximately 160 nucleotides not shown in sequence, 5'cap, Cap1, fully modified with 5-methylcytosine at each cytosine and pseudouridine replacement at each uridine site) (containing either (1) natural NTPs or (2) 100% substitution with 5-methyl cytidine and pseudouridine) and TLR agonist R848 (Invivogen tlr1-r848) were diluted to 38.4 ng/ uL in a final volume of 2500 uL Optimem I.

**[0001439]** Separately, 432 uL of Lipofectamine 2000 (Invitrogen 11668-027, lot 1070962) was diluted with 13.1 mL Optimem I. In a 96 well plate nine aliquots of 135 uL of each mmRNA, positive control (R-848) or negative control (Optimem I) was added to 135 uL of the diluted Lipofectamine 2000. The plate containing the material to be transfected was incubated for 20 minutes. The transfection mixtures were then transferred to each of the human PBMC plates at 50 uL per well. The plates were then incubated at 37 C. At 2, 4, 8, 20, and 44 hours each plate was removed from the incubator, and the supernatants were frozen.

**[0001440]** After the last plate was removed, the supernatants were assayed using a human G-CSF ELISA kit (Invitrogen KHC2032) and human IFN-alpha ELISA kit (Thermo Scientific 41105-2). Each condition was done in duplicate.

#### Results :

**[0001441]** The ability of unmodified and modified mRNA (mmRNAs) to produce the encoded protein was assessed (G-CSF production) over time as was the ability of the mRNA to trigger innate immune recognition as measured by interferon-alpha production. Use of *in vitro* PBMC cultures is an accepted way to measure the immunostimulatory potential of oligonucleotides (Robbins et al., Oligonucleotides 2009 19:89-102; herein incorporated by reference in its entirety).

**[0001442]** Results were interpolated against the standard curve of each ELISA plate using a four parameter logistic curve fit. Shown in Tables 75 and 76 are the average from 2 separate PBMC donors of the G-CSF and IFN-alpha production over time as measured by specific ELISA.

[0001443] In the G-CSF ELISA, background signal from the Lipofectamine 2000 untreated condition was subtracted at each timepoint. The data demonstrated specific production of human G-CSF protein by human peripheral blood mononuclear is seen with G-CSF mRNA containing natural NTPs, 100% substitution with 5-methyl cytidine and pseudouridine, or 100% substitution with 5-methyl cytidine and N1-methyl pseudouridine. Production of G-CSF was significantly increased through the use of modified mRNA relative to unmodified mRNA, with the 5-methyl cytidine and N1-methyl pseudouridine containing G-CSF mmRNA showing the highest level of G-CSF production. With regards to innate immune recognition, unmodified mRNA resulted in substantial IFN-alpha production, while the modified mRNA largely prevented interferon-alpha production. G-CSF mRNA fully modified with 5-methyl cytidine and N1-methyl-pseudouridine did not significantly increase cytokines whereas G-CSF mRNA fully modified with 5-methyl cytidine and pseudouridine induced IFN-alpha, TNF-alpha and IP10. Many other cytokines were not affected by either modification.

**Table 75. G-CSF Signal**

<b>G-CSF signal - 2 Donor Average</b>					
<b>pg / mL</b>	<b>2 Hr</b>	<b>4 Hr</b>	<b>8 Hr</b>	<b>20 Hr</b>	<b>44 Hr</b>
G-CSF (5mC/pseudouridine)	120.3	136.8	421.0	346.1	431.8
G-CSF (5mC/N1-methyl pseudouridine)	256.3	273.7	919.3	1603.3	1843.3
G-CSF(Natural-no modification)	63.5	92.6	129.6	258.3	242.4
Luciferase (5mC/pseudouridine)	4.5	153.7	33.0	186.5	58.0

**Table 76. IFN-alpha signal**

<b>IFN-alpha signal - 2 donor average</b>					
<b>pg / mL</b>	<b>2 Hr</b>	<b>4 Hr</b>	<b>8 Hr</b>	<b>20 Hr</b>	<b>44 Hr</b>
G-CSF (5mC/pseudouridine)	21.1	2.9	3.7	22.7	4.3
G-CSF (5mC/N1-methyl pseudouridine)	0.5	0.4	3.0	2.3	2.1
G-CSF(Natural)	0.0	2.1	23.3	74.9	119.7
Luciferase (5mC/pseudouridine)	0.4	0.4	4.7	1.0	2.4
R-848	39.1	151.3	278.4	362.2	208.1
Lpf. 2000 control	0.8	17.2	16.5	0.7	3.1

**Example 57. Chemical modification ranges of modified mRNA**

[0001444] Modified nucleotides such as, but not limited to, the chemical modifications 5-methylcytosine and pseudouridine have been shown to lower the innate immune

response and increase expression of RNA in mammalian cells. Surprisingly, and not previously known, the effects manifested by the chemical modifications can be titrated when the amount of chemical modification is less than 100%. Previously, it was believed that full modification was necessary and sufficient to elicit the beneficial effects of the chemical modifications and that less than 100% modification of an mRNA had little effect. However, it has now been shown that the benefits of chemical modification can be derived using less than complete modification and that the effects are target, concentration and modification dependent.

A. Modified RNA transfected in PBMC  
[0001445] 960 ng of G-CSF mRNA modified with 5-methylcytosine (5mC) and pseudouridine (pseudoU) or unmodified G-CSF mRNA was transfected with 0.8 uL of Lipofectamine 2000 into peripheral blood mononuclear cells (PBMC) from three normal blood donors (D1, D2, D3). The G-CSF mRNA (mRNA sequence shown in SEQ ID NO: 5655; polyA tail of approximately 160 nucleotides not shown in sequence; 5'cap, Cap1) was completely modified with 5mC and pseudoU (100% modification), not modified with 5mC and pseudoU (0% modification) or was partially modified with 5mC and pseudoU so the mRNA would contain 50% modification, 25% modification, 10% modification, %5 modification, 1% modification or 0.1 % modification. A control sample of Luciferase (mRNA sequence shown in SEQ ID NO: 5665; polyA tail of approximately 160 nucleotides not shown in sequence; 5'cap, Cap1; fully modified 5meC and pseudoU) was also analyzed for G-CSF expression. For TNF-alpha and IFN-alpha control samples of Lipofectamine2000, LPS, R-848, Luciferase (mRNA sequence shown in SEQ ID NO: 5665; polyA tail of approximately 160 nucleotides not shown in sequence; 5'cap, Cap1; fully modified 5mC and pseudo), and P(I)P(C) were also analyzed. The supernatant was harvested and run by ELISA 22 hours after transfection to determine the protein expression. The expression of G-CSF is shown in Table 77 and the expression of IFN-alpha and TNF-alpha is shown in Table 78. The expression of IFN-alpha and TNF-alpha may be a secondary effect from the transfection of the G-CSF mRNA. Tables 77 and 78 show that the amount of chemical modification of G-CSF, IFN-alpha and TNF-alpha is titratable when the mRNA is not fully modified and the titratable trend is not the same for each target.



**Table 77. G-CSF Expression**

	G-CSF Expression (pg/ml)		
	D1	D2	D3
100% modification	270.3	151.6	162.2
50% modification	45.6	19.8	26.3
25% modification	23.6	10.8	8.9
10% modification	39.4	12.9	12.9
5% modification	70.9	26.8	26.3
1 % modification	70.3	26.9	66.9
0.1% modification	67.5	25.2	28.7
Luciferase	14.5	3.1	10.0

**Table 78. IFN-alpha and TNF-alpha Expression**

	IFN-alpha Expression (pg/ml)			TNF-alpha Expression (pg/ml)		
	D1	D2	D3	D1	D2	D3
100% modification	76.8	6.8	15.1	5.6	1.4	21.4
50% modification	22.0	5.5	257.3	4.7	1.7	12.1
25% modification	64.1	14.9	549.7	3.9	0.7	10.1
10% modification	150.2	18.8	787.8	6.6	0.9	13.4
5% modification	143.9	41.3	1009.6	2.5	1.8	12.0
1 % modification	189.1	40.5	375.2	9.1	1.2	25.7
0.1% modification	261.2	37.8	392.8	9.0	2.	13.7
0% modification	230.3	45.1	558.3	10.9	1.4	10.9
LF 200	0	0	1.5	45.8	2.8	53.6
LPS	0	0	1.0	114.5	70.0	227.0
R-848	39.5	11.9	183.5	389.3	256.6	410.6
Luciferase	9.1	0	3.9	4.5	2.7	13.6
P(I)P(C)	1498.1	216.8	238.8	61.2	4.4	69.1

**B. Modified RNA transfected in HEK293**

[0001446] Human embryonic kidney epithelial (HEK293) cells were seeded on 96-well plates at a density of 30,000 cells per well in 100 ul cell culture medium. 250 ng of

modified G-CSF mRNA (mRNA sequence shown in SEQ ID NO: 5655; polyA tail of approximately 160 nucleotides not shown in sequence; 5'cap, Cap1) formulated with RNAiMAX™ (Invitrogen, Carlsbad, CA) was added to a well. The G-CSF was completely modified with 5mC and pseudoU (100% modification), not modified with 5mC and pseudoU (0% modification) or was partially modified with 5mC and pseudoU so the mRNA would contain 75% modification, 50% modification or 25% modification. Control samples (AK 5/2, mCherry (SEQ ID NO: 5656; polyA tail of approximately 160 nucleotides not shown in sequence; 5'cap, Cap1; fully modified 5mC and pseudoU) and untreated) were also analyzed. The half-life of G-CSF mRNA fully modified with 5-methylcytosine and pseudouridine is approximately 8-10 hours. The supernatants were harvested after 16 hours and the secreted G-CSF protein was analyzed by ELISA. Table 79 shows that the amount of chemical modification of G-CSF is titratable when the mRNA is not fully modified.

**Table 79. G-CSF Expression**

	G-CSF Expression (ng/ml)
100% modification	118.4
75% modification	101.9
50% modification	105.7
25% modification	231.1
0% modification	270.9
AK 5/2	166.8
mCherry	0
Untreated	0

**Example 58; *In Vivo* Delivery of Modified mRNA (mm RNA)**

[0001447] Modified RNA was delivered to C57/BL6 mice intramuscularly, subcutaneously, or intravenously to evaluate the bio-distribution of modified RNA using luciferase. A formulation buffer used with all delivery methods contained 150mM sodium chloride, 2mM calcium chloride, 2 mM Na<sup>+</sup>-phosphate which included 1.4mM monobasic sodium phosphate and 0.6 mM of dibasic sodium phosphate, and 0.5 mM ethylenediaminetetraacetic acid (EDTA) was adjusted using sodium hydroxide to reach a final pH of 6.5 before being filtered and sterilized. A IX concentration was used as the delivery buffer. To create the lipoplexed solution delivered to the mice, in one vial 50 µg

of RNA was equilibrated for 10 minutes at room temperature in the delivery buffer and in a second vial 10  $\mu\text{l}$  RNAiMAX™ was equilibrated for 10 minutes at room temperature in the delivery buffer. After equilibrium, the vials were combined and delivery buffer was added to reach a final volume of 100  $\mu\text{l}$  which was then incubated for 20 minutes at room temperature. Luciferin was administered by intraperitoneal injection (IP) at 150 mg/kg to each mouse prior to imaging during the plateau phase of the luciferin exposure curve which was between 15 and 30 minutes. To create luciferin, 1 g of D-luciferin potassium or sodium salt was dissolved in 66.6 ml of distilled phosphate buffer solution (DPBS), not containing  $\text{Mg}^{2+}$  or  $\text{Ca}^{2+}$ , to make a 15 mg/ml solution. The solution was gently mixed and passed through a 0.2  $\mu\text{m}$  syringe filter, before being purged with nitrogen, aliquoted and frozen at  $-80^{\circ}\text{C}$  while being protected from light as much as possible. The solution was thawed using a waterbath if luciferin was not dissolved, gently mixed and kept on ice on the day of dosing.

[0001448] Whole body images were taken of each mouse 2, 8 and 24 hours after dosing. Tissue images and serum was collected from each mouse 24 hours after dosing. Mice administered doses intravenously had their liver, spleen, kidneys, lungs, heart, peri-renal adipose tissue and thymus imaged. Mice administered doses intramuscularly or subcutaneously had their liver, spleen, kidneys, lungs, peri-renal adipose tissue, and muscle at the injection site. From the whole body images the bioluminescence was measured in photon per second for each route of administration and dosing regimen.

#### A. Intramuscular Administration

[0001449] Mice were intramuscularly (I.M.) administered either modified luciferase mRNA fully modified with 5-methylcytosine and pseudouridine (Naked-Luc), lipoplexed modified luciferase mRNA fully modified with 5-methylcytosine and pseudouridine (Lipoplex-luc) (IVT cDNA sequence shown in SEQ ID NO: 5664; mRNA sequence shown in SEQ ID NO: 5665, polyA tail of approximately 160 nucleotides not shown in sequence, 5'cap, Cap1, fully modified with 5-methylcytosine at each cytosine and pseudouridine replacement at each uridine site), lipoplexed modified granulocyte colony-stimulating factor (G-CSF) mRNA (mRNA sequence shown in SEQ ID NO: 5655; polyA tail of approximately 160 nucleotides not shown in sequence; 5'cap, Cap1; fully modified with 5-methylcytosine and pseudouridine) (Lipoplex-Cytokine) or the formation buffer at

a single dose of 50 µg of modified RNA in an injection volume of 50µl for each formulation in the right hind limb and a single dose of 5 µg of modified RNA in an injection volume of 50 µl in the left hind limb. The bioluminescence average for the luciferase expression signals for each group at 2, 8 and 24 hours after dosing are shown in Table 80. The bioluminescence showed a positive signal at the injection site of the 5 µg and 50 µg modified RNA formulations containing and not containing lipoplex.

**Table 80. *In vivo* Biophotonic Imaging (I.M. Injection Route)**

Formulation	Dose (ug)	Bioluminescence (photon/sec)		
		2 hours	8 hours	24 hours
Naked-Luc	5	224,000	683,000	927,000
Lipoplex-Luc	5	579,000	639,000	186,000
Lipoplex-G-CSF	5	64,600	85,600	75,100
Formulation Buffer	5	102,000	86,000	90,700
Naked-Luc	50	446,000	766,000	509,000
Lipoplex-Luc	50	374,000	501,000	332,000
Lipoplex-G-CSF	50	49,400	74,800	74,200
Formulation Buffer	50	59,300	69,200	63,600

**B. Subcutaneous Administration**

[0001450] Mice were subcutaneously (S.C.) administered either modified luciferase mRNA (Naked-Luc), lipoplexed modified luciferase mRNA (Lipoplex-luc), lipoplexed modified G-CSF mRNA (Lipoplex-G-CSF) or the formation buffer at a single dose of 50 µg of modified mRNA in an injection volume of 100 µl for each formulation. The bioluminescence average for the luciferase expression signals for each group at 2, 8 and 24 hours after dosing are shown in Table 81. The bioluminescence showed a positive signal at the injection site of the 50 µg modified mRNA formulations containing and not containing lipoplex.

**Table 81. *In vivo* Biophotonic Imaging (S.C. Injection Route)**

Formulation	Bioluminescence (photon/sec)		
	2 hours	8 hours	24 hours
Naked-Luc	3,700,000	8,060,000	2,080,000
Lipoplex-Luc	3,960,000	1,700,000	1,290,000
Lipoplex-G-CSF	123,000	121,000	117,000
Formulation Buffer	116,000	127,000	123,000

**C. Intravenous Administration**

[0001451] Mice were intravenously (I.V.) administered either modified luciferase mRNA (Naked-Luc), lipoplexed modified luciferase mRNA (Lipoplex-luc), lipoplexed modified G-CSF mRNA (Lipoplex-G-CSF) or the formation buffer at a single dose of 50 µg of modified mRNA in an injection volume of 100 µl for each formulation. The bioluminescence average for the luciferase expression signal in the spleen from each group at 2 hours after dosing is shown in Table 82. The bioluminescence showed a positive signal in the spleen of the 50 µg modified mRNA formulations containing lipoplex.

**Table 82. *In vivo* Biophotonic Imaging (I.V. Injection Route)**

<b>Formulation</b>	<b>Bioluminescence (photon/sec) of the Spleen</b>
Naked-Luc	58,400
Lipoplex-Luc	65,000
Lipoplex-G-CSF	57,100
Formulation Buffer	58,300

**Example 59. Buffer Formulation Studies**

[0001452] G-CSF modified mRNA (mRNA sequence shown in SEQ ID NO: 5655; polyA tail of approximately 160 nucleotides not shown in sequence; 5'cap, Cap1; fully modified with NI-pseudouridine and 5-methylcytosine) or Factor IX modified mRNA (mRNA sequence shown in SEQ ID NO: 5659; polyA tail of approximately 160 nucleotides not shown in sequence; 5'cap, Cap1; fully modified with NI-pseudouridine and 5-methylcytosine) in a buffer solution is administered intramuscularly to rats in an injection volume of 50 µl (n=5) at a modified mRNA dose of 200 µg per rat as described in Table 83. The modified mRNA is lyophilized in water for 1-2 days. It is then reconstituted in the buffers listed below to a target concentration of 6 mg/ml. Concentration is determined by OD 260. Samples are diluted to 4 mg/ml in the appropriate buffer before dosing.

[0001453] To precipitate the modified mRNA, 3M sodium acetate, pH 5.5 and pure ethanol are added at 1/10<sup>th</sup> the total volume and 4 times the total volume of modified mRNA, respectively. The material is placed at -80C for a minimum of 1 hour. The material is then centrifuged for 30 minutes at 4000 rpm, 4C. The supernatant is removed

and the pellet is centrifuged and washed 3x with 75% ethanol. Finally, the pellet is reconstituted with buffer to a target concentration of 6 mg/ml. Concentration is determined by OD 260. Samples are diluted to 4 mg/ml in the appropriate buffer before dosing. All samples are prepared by lyophilization unless noted below.

**Table 83. Buffer Dosing Groups**

Group	Treatment	Buffer	Dose (ug/rat)
1	G-CSF	0.9% Saline	200
	Factor IX	0.9% Saline	200
2	G-CSF	0.9% Saline + 2mM Calcium	200
	Factor IX	0.9% Saline + 2mM Calcium	200
3	G-CSF	Lactated Ringer's	200
	Factor IX	Lactated Ringer's	200
4	G-CSF	5% Sucrose	200
	Factor IX	5% Sucrose	200
5	G-CSF	5% Sucrose + 2mM Calcium	200
	Factor IX	5% Sucrose + 2mM Calcium	200
6	G-CSF	5% Mannitol	200
	Factor IX	5% Mannitol	200
7	G-CSF	5% Mannitol + 2mM Calcium	200
	Factor IX	5% Mannitol + 2mM Calcium	200
8	G-CSF	0.9% saline (precipitation)	200
	Factor IX	0.9% saline (precipitation)	200

[0001454] Serum samples are collected from the rats at various time intervals and analyzed for G-CSF or Factor IX protein expression using G-CSF or Factor IX ELISA.

**Example 60. Multi-Dose Study**

[0001455] Sprague-Dawley rats (n=8) are injected intravenously eight times (twice a week) over 28 days. The rats are injected with 0.5 mg/kg, 0.05 mg/kg, 0.005 mg/kg or 0.0005 mg/kg of human G-CSF modified mRNA of luciferase modified mRNA formulated in a lipid nanoparticle, 0.5 mg/kg of human G-CSF modified mRNA in saline, 0.2 mg/kg of the human G-CSF protein Neupogen or non-translatable human G-CSF modified mRNA formulated in a lipid nanoparticle. Serum is collected during pre-determined time intervals to evaluate G-CSF protein expression (8, 24 and 72 hours after the first dose of the week), complete blood count and white blood count (24 and 72 hours

after the first dose of the week) and clinical chemistry (24 and 72 hours after the first dose of the week). The rats are sacrificed at day 29, 4 days after the final dosing, to determine the complete blood count, white blood count, clinical chemistry, protein expression and to evaluate the effect on the major organs by histopathology and necropsy. Further, an antibody assay is performed on the rats on day 29.

**Example 61. LNP *in vivo* study**

[0001456] Luciferase modified mRNA (mRNA sequence shown in SEQ ID NO: 5665; polyA tail of approximately 160 nucleotides not shown in sequence, 5' cap, Cap1; fully modified with 5-methylcytosine and pseudouridine was formulated as a lipid nanoparticle (LNP) using the syringe pump method. The LNP was formulated at a 20: 1 weight ratio of total lipid to modified mRNA with a final lipid molar ratio of 50:10:38.5:1.5 (DLin-KC2-DMA: DSPC: Cholesterol: PEG-DMG). As shown in Table 84, the luciferase LNP formulation was characterized by particle size, zeta potential, and encapsulation.

**Table 84. Luciferase Formulation**

Formulation	NPA-098-1
Modified mRNA	Luciferase
Mean size	135 nm
	PDI: 0.08
Zeta at pH 7.4	-0.6 mV
Encaps. (RiboGr)	91 %

[0001457] As outlined in Table 85, the luciferase LNP formulation was administered to Balb-C mice (n=3) intramuscularly, intravenously and subcutaneously and a luciferase modified RNA formulated in PBS was administered to mice intravenously.

**Table 85. Luciferase Formulations**

Formulation	Vehicle	Route	Concentration (mg/ml)	Injection Volume (ul)	Amount of modified RNA (ug)	Dose (mg/kg)
Luc-LNP	PBS	IV	0.20	50	10	0.50
Luc-LNP	PBS	IM	0.20	50	10	0.50
Luc-LNP	PBS	SC	0.20	50	10	0.50
Luc-PBS	PBS	IV	0.20	50	10	0.50

[0001458] The mice administered the luciferase LNP formulation intravenously and intramuscularly were imaged at 2, 8, 24, 48, 120 and 192 hours and the mice administered the luciferase LNP formulation subcutaneously were imaged at 2, 8, 24, 48

and 120 hours to determine the luciferase expression as shown in Table 86. In Table 86, "NT" means not tested. Twenty minutes prior to imaging, mice were injected intraperitoneally with a D-luciferin solution at 150 mg/kg. Animals were then anesthetized and images were acquired with an IVIS Lumina II imaging system (Perkin Elmer). Bioluminescence was measured as total flux (photons/second) of the entire mouse.

**Table 86. Luciferase Expression**

Formulation	Route of Admin	Average Expression (photon/second)					
		2 hours	8 hours	24 hours	48 hours	120 hours	192 hours
Luc-LNP	IV	1.62E+08	3.00E+09	7.77E+08	4.98E+08	1.89E+08	6.08E+07
Luc-LNP	IM	4.85E+07	4.92E+08	9.02E+07	3.17E+07	1.22E+07	2.38E+06
Luc-LNP	SC	1.85E+07	9.79E+08	3.09E+08	4.94E+07	1.98E+06	NT
Luc-PBS	IV	3.61E+05	5.64E+05	3.19E+05	NT	NT	NT

[0001459] One mouse administered the LNP formulation intravenously was sacrificed at 8 hours to determine the luciferase expression in the liver and spleen. Also, one mouse administered the LNP formulation intramuscular was sacrificed at 8 hours to determine the luciferase expression of the muscle around the injection site and in the liver and spleen. As shown in Table 87, expression was seen in the both the liver and spleen after intravenous and intramuscular administration and in the muscle around the intramuscular injection site.

**Table 87. Luciferase Expression in Tissue**

<b>Luciferase LNP: IV Administration</b>	Expression (photon/second)
Liver	7.984E+08
Spleen	3.951E+08
<b>Luciferase LNP: IM Administration</b>	Expression (photon/second)
Muscle around the injection site	3.688E+07
Liver	1.507E+08
Spleen	1.096E+07

**Example 62. Cytokine Study: PBMC**

A. PBMC isolation and Culture

[0001460] 50 mL of human blood from two donors was received from Research Blood Components (lots KP30928 and KP3093 1) in sodium heparin tubes. For each donor, the



blood was pooled and diluted to 70 mL with DPBS (SAFC Bioscience 5933 1C, lot 071M8408) and split evenly between two 50 mL conical tubes. 10 mL of Ficoll Paque (GE Healthcare 17-5442-03, lot 10074400) was gently dispensed below the blood layer. The tubes were centrifuged at 2000 rpm for 30 minutes with low acceleration and braking. The tubes were removed and the buffy coat PBMC layers were gently transferred to a fresh 50 mL conical and washed with DPBS. The tubes were centrifuged at 1450 rpm for 10 minutes.

[0001461] The supernatant was aspirated and the PBMC pellets were resuspended and washed in 50 mL of DPBS. The tubes were centrifuged at 1250 rpm for 10 minutes. This wash step was repeated, and the PBMC pellets were resuspended in 19 mL of OptiMem I (Gibco 11058, lot 1072088) and counted. The cell suspensions were adjusted to a concentration of  $3.0 \times 10^6$  cells / mL live cells.

[0001462] These cells were then plated on five 96 well tissue culture treated round bottom plates (Costar 3799) per donor at 50 uL per well. Within 30 minutes, transfection mixtures were added to each well at a volume of 50 uL per well. After 4 hours post transfection, the media was supplemented with 10 uL of Fetal Bovine Serum (Gibco 10082, lot 1012368).

#### B. Transfection Preparation

[0001463] Modified mRNA encoding human G-CSF (mRNA sequence shown in SEQ ID NO: 5655; polyA tail of approximately 160 nucleotides not shown in sequence; 5'cap, Cap1) (containing either (1) natural NTPs, (2) 100% substitution with 5-methyl cytidine and pseudouridine, or (3) 100% substitution with 5-methyl cytidine and N1-methyl pseudouridine; mRNA encoding luciferase (IVT cDNA sequence shown in SEQ ID NO: 5654; mRNA sequence shown in SEQ ID NO: 5665, polyA tail of approximately 160 nucleotides not shown in sequence, 5'cap, Cap1, fully modified with 5-methylcytosine at each cytosine and pseudouridine replacement at each uridine site) (containing either (1) natural NTPs or (2) 100% substitution with 5-methyl cytidine and pseudouridine) and TLR agonist R848 (Invivogen tlr1-r848) were diluted to 38.4 ng / uL in a final volume of 2500 uL OptiMem I.

[0001464] Separately, 110 uL of Lipofectamine 2000 (Invitrogen 11668-027, lot 1070962) was diluted with 6.76 mL OptiMem I. In a 96 well plate nine aliquots of 135 uL

of each mRNA, positive control (R-848) or negative control (Optimem I) was added to 135 uL of the diluted Lipofectamine 2000. The plate containing the material to be transfected was incubated for 20 minutes. The transfection mixtures were then transferred to each of the human PBMC plates at 50 uL per well. The plates were then incubated at 37°C. At 2, 4, 8, 20, and 44 hours each plate was removed from the incubator, and the supernatants were frozen.

[0001465] After the last plate was removed, the supernatants were assayed using a human G-CSF ELISA kit (Invitrogen KHC2032) and human IFN-alpha ELISA kit (Thermo Scientific 41105-2). Each condition was done in duplicate.

### C. Protein and Innate Immune Response Analysis

[0001466] The ability of unmodified and modified mRNA to produce the encoded protein was assessed (G-CSF production) over time as was the ability of the mRNA to trigger innate immune recognition as measured by interferon-alpha production. Use of *in vitro* PBMC cultures is an accepted way to measure the immunostimulatory potential of oligonucleotides (Robbins et al, Oligonucleotides 2009 19:89-102).

[0001467] Results were interpolated against the standard curve of each ELISA plate using a four parameter logistic curve fit. Shown in Tables 88 and 89 are the average from 3 separate PBMC donors of the G-CSF, interferon-alpha (IFN-alpha) and tumor necrosis factor alpha (TNF-alpha) production over time as measured by specific ELISA.

[0001468] In the G-CSF ELISA, background signal from the Lipofectamine 2000 (LF2000) untreated condition was subtracted at each time point. The data demonstrated specific production of human G-CSF protein by human peripheral blood mononuclear is seen with G-CSF mRNA containing natural NTPs, 100% substitution with 5-methyl cytidine and pseudouridine, or 100% substitution with 5-methyl cytidine and N1-methyl pseudouridine. Production of G-CSF was significantly increased through the use of 5-methyl cytidine and N1-methyl pseudouridine modified mRNA relative to 5-methyl cytidine and pseudouridine modified mRNA.

[0001469] With regards to innate immune recognition, while both modified mRNA chemistries largely prevented IFN-alpha and TNF-alpha production relative to positive controls (R848, p(I)p(C)), significant differences did exist between the chemistries. 5-methyl cytidine and pseudouridine modified mRNA resulted in low but detectable levels

of IFN-alpha and TNF-alpha production, while 5-methyl cytidine and N1-methyl pseudouridine modified mRNA resulted in no detectable IFN-alpha and TNF-alpha production.

[0001470] Consequently, it has been determined that, in addition to the need to review more than one cytokine marker of the activation of the innate immune response, it has surprisingly been found that combinations of modifications provide differing levels of cellular response (protein production and immune activation). The modification, N1-methyl pseudouridine, in this study has been shown to convey added protection over the standard combination of 5-methylcytidine/pseudouridine explored by others resulting in twice as much protein and almost 150 fold reduction in immune activation (TNF-alpha).

[0001471] Given that PBMC contain a large array of innate immune RNA recognition sensors and are also capable of protein translation, it offers a useful system to test the interdependency of these two pathways. It is known that mRNA translation can be negatively affected by activation of such innate immune pathways (Kariko et al. Immunity (2005) 23:165-175; Warren et al. Cell Stem Cell (2010) 7:618-630). Using PBMC as an in vitro assay system it is possible to establish a correlation between translation (in this case G-CSF protein production) and cytokine production (in this case exemplified by IFN-alpha and TNF-alpha protein production). Better protein production is correlated with lower induction of innate immune activation pathway, and new chemistries can be judged favorably based on this ratio (Table 90).

[0001472] In this study, the PC Ratio for the two chemical modifications, pseudouridine and N1-methyl pseudouridine, both with 5-methyl cytosine was 4742/141=34 as compared to 9944/1=9944 for the cytokine IFN-alpha. For the cytokine, TNF-alpha, the two chemistries had PC Ratios of 153 and 1243, respectively suggesting that for either cytokine, the N1-methyl-pseudouridine is the superior modification. In Tables 88 and 89, "NT" means not tested.

Table 88. G-CSF

G-CSF: 3 Donor Average (pg/ml)	
G-CSF 5-methyl cytosine/ pseudouridine	4742
G-CSF 5-methylcytosine/	9944

N 1-methyl-pseudouridine	
Luciferase	18
LF2000	16

**Table 89. IFN-alpha and TNF-alpha**

	IFN-alpha: 3 Donor Average (pg/ml)	TNF-alpha: 3 Donor Average (pg/ml)
G-CSF 5-methyl cytosine/ pseudouridine	141	31
G-CSF 5-methylcytosine/ N1-methyl-pseudouridine	1	8
P(I)P(C)	1104	NT
R-848	NT	1477
LF2000	17	25

**Table 90. G-CSF to Cytokine Ratios**

	G-CSF/ IFN-alpha (ratio)		G-CSF/TNF-alpha (ratio)	
	5-methyl cytosine/ pseudouridine	5-methylcytosine/ N1-methyl- pseudouridine	5-methyl cytosine/ pseudouridine	5-methylcytosine/ N1-methyl- pseudouridine
PC Ratio	34	9944	153	1243

**Example 63. In Vitro PBMC Studies: Percent modification**

[0001473] 480 ng of G-CSF mRNA modified with 5-methylcytosine (5mC) and pseudouridine (pseudoU) or unmodified G-CSF mRNA was transfected with 0.4 uL of Lipofectamine 2000 into peripheral blood mononuclear cells (PBMC) from three normal blood donors (D1, D2, and D3). The G-CSF mRNA (mRNA sequence shown in SEQ ID NO: 5655; polyA tail of approximately 160 nucleotides not shown in sequence; 5'cap, Cap1) was completely modified with 5mC and pseudoU (100% modification), not modified with 5mC and pseudoU (0% modification) or was partially modified with 5mC and pseudoU so the mRNA would contain 75% modification, 50% modification or 25% modification. A control sample of Luciferase (mRNA sequence shown in SEQ ID NO: 5665; polyA tail of approximately 160 nucleotides not shown in sequence; 5'cap, Cap1; fully modified 5meC and pseudoU) was also analyzed for G-CSF expression. For TNF-alpha and IFN-alpha control samples of Lipofectamine2000, LPS, R-848, Luciferase (mRNA sequence shown in SEQ ID NO: 5665; polyA tail of approximately 160

nucleotides not shown in sequence; 5'cap, Cap1; fully modified 5mC and pseudo), and P(I)P(C) were also analyzed. The supernatant was harvested and run by ELISA 22 hours after transfection to determine the protein expression. The expression of G-CSF is shown in Table 91 and the expression of IFN-alpha and TNF-alpha is shown in Table 92. The expression of IFN-alpha and TNF-alpha may be a secondary effect from the transfection of the G-CSF mRNA. Tables 91 and 92 show that the amount of chemical modification of G-CSF, interferon alpha (IFN-alpha) and tumor necrosis factor-alpha (TNF-alpha) is titratable when the mRNA is not fully modified and the titratable trend is not the same for each target.

[0001474] By using PBMC as an *in vitro* assay system it is possible to establish a correlation between translation (in this case G-CSF protein production) and cytokine production (in this case exemplified by IFN-alpha protein production). Better protein production is correlated with lower induction of innate immune activation pathway, and the percentage modification of a chemistry can be judged favorably based on this ratio (Table 93). As calculated from Tables 91 and 92 and shown in Table 93, full modification with 5-methylcytidine and pseudouridine shows a much better ratio of protein/cytokine production than without any modification (natural G-CSF mRNA) (100-fold for IFN-alpha and 27-fold for TNF-alpha). Partial modification shows a linear relationship with increasingly less modification resulting in a lower protein/cytokine ratio.

**Table 91. G-CSF Expression**

	G-CSF Expression (pg/ml)		
	D1	D2	D3
100% modification	1968.9	2595.6	2835.7
75% modification	566.7	631.4	659.5
50% modification	188.9	187.2	191.9
25% modification	139.3	126.9	102.0
0% modification	194.8	182.0	183.3
Luciferase	90.2	0.0	22.1

**Table 92. IFN-alpha and TNF-alpha Expression**

	IFN-alpha Expression (pg/ml)			TNF-alpha Expression (pg/ml)		
	D1	D2	D3	D1	D2	D3
100% modification	336.5	78.0	46.4	115.0	15.0	11.1
75% modification	339.6	107.6	160.9	107.4	21.7	11.8
50% modification	478.9	261.1	389.7	49.6	24.1	10.4

25% modification	564.3	400.4	670.7	85.6	26.6	19.8
0% modification	1421.6	810.5	1260.5	154.6	96.8	45.9
LPS	0.0	0.6	0.0	0.0	12.6	4.3
R-848	0.5	3.0	14.1	655.2	989.9	420.4
Pd)P(C)	130.8	297.1	585.2	765.8	2362.7	1874.4
Lipid only	1952.2	866.6	855.8	248.5	82.0	60.7

**Table 93. PC Ratio and Effect of Percentage of Modification**

% Modification	Average G-CSF (pg/ml)	Average IFN-a (pg/ml)	Average TNF-a (pg/ml)	G-CSF/ IFN-alpha (PC ratio)	G-CSF/TNF-alpha (PC ratio)
100	2466	153	47	16	52
75	619	202	47	3.1	13
50	189	376	28	0.5	6.8
25	122	545	44	0.2	2.8
0	186	1164	99	0.16	1.9

**Example 64. Modified RNA transfected in PBMC**

[0001475] 500 ng of G-CSF mRNA modified with 5-methylcytosine (5mC) and pseudouridine (pseudoU) or unmodified G-CSF mRNA was transfected with 0.4 uL of Lipofectamine 2000 into peripheral blood mononuclear cells (PBMC) from three normal blood donors (D1, D2, and D3). The G-CSF mRNA (mRNA sequence shown in SEQ ID NO: 5655; polyA tail of approximately 160 nucleotides not shown in sequence; 5'cap, Cap1) was completely modified with 5mC and pseudoU (100% modification), not modified with 5mC and pseudoU (0% modification) or was partially modified with 5mC and pseudoU so the mRNA would contain 50% modification, 25% modification, 10% modification, 5% modification, 1% modification or 0.1% modification. A control sample of mCherry (mRNA sequence shown in SEQ ID NO: 5656; polyA tail of approximately 160 nucleotides not shown in sequence; 5'cap, Cap1; fully modified 5mC and pseudouridine), G-CSF fully modified with 5-methylcytosine and pseudouridine (Control G-CSF) and an untreated control was also analyzed for expression of G-CSF, tumor necrosis factor-alpha (TNF-alpha) and interferon-alpha (IFN-alpha). The supernatant was harvested 6 hours and 18 hours after transfection and run by ELISA to determine the protein expression. The expression of G-CSF, IFN-alpha, and TNF-alpha for Donor 1 is shown in Table 94, Donor 2 is shown in Table 95 and Donor 3 is shown in Table 96.

[0001476] Full 100% modification with 5-methylcytidine and pseudouridine resulted in the most protein translation (G-CSF) and the least amount of cytokine produced across all three human PBMC donors. Decreasing amounts of modification results in more cytokine production (IFN-alpha and TNF-alpha), thus further highlighting the importance of fully modification to reduce cytokines and to improve protein translation (as evidenced here by G-CSF production).

**Table 94. Donor 1**

	G-CSF (pg/mL)		IFN-alpha (pg/mL)		TNF-alpha (pg/mL)	
	6 hours	18 hours	6 hours	18 hours	6 hours	18 hours
100% Mod	1815	2224	1	13	0	0
75% Mod	591	614	0	89	0	0
50% Mod	172	147	0	193	0	0
25% Mod	111	92	2	219	0	0
10% Mod	138	138	7	536	18	0
1% Mod	199	214	9	660	18	3
0.1% Mod	222	208	10	597	0	6
0 % Mod	273	299	10	501	10	0
Control G-CSF	957	1274	3	123	18633	1620
mCherry	0	0	0	10	0	0
Untreated	N/A	N/A	0	0	1	1

**Table 95. Donor 2**

	G-CSF (pg/mL)		IFN-alpha (pg/mL)		TNF-alpha (pg/mL)	
	6 hours	18 hours	6 hours	18 hours	6 hours	18 hours
100% Mod	2184	2432	0	7	0	11
75% Mod	935	958	3	130	0	0
50% Mod	192	253	2	625	7	23
25% Mod	153	158	7	464	6	6
10% Mod	203	223	25	700	22	39
1% Mod	288	275	27	962	51	66
0.1% Mod	318	288	33	635	28	5
0 % Mod	389	413	26	748	1	253
Control G-CSF	1461	1634	1	59	481	814
mCherry	0	7	0	1	0	0
Untreated	N/A	N/A	1	0	0	0

**Table 96. Donor 3**

	G-CSF (pg/mL)		IFN-alpha (pg/mL)		TNF-alpha (pg/mL)	
	6 hours	18 hours	6 hours	18 hours	6 hours	18 hours
100% Mod	6086	7549	7	658	11	11
75% Mod	2479	2378	23	752	4	35
50% Mod	667	774	24	896	22	18

25% Mod	480	541	57	1557	43	115
10% Mod	838	956	159	2755	144	123
1% Mod	1108	1197	235	3415	88	270
0.1% Mod	1338	1177	191	2873	37	363
0 % Mod	1463	1666	215	3793	74	429
Control G-CSF	3272	3603	16	1557	731	9066
mCherry	0	0	2	645	0	0
Untreated	N/A	N/A	1	1	0	8

### **Example 65. Innate Immune Response Study in BJ Fibroblasts**

#### **A. Single Transfection**

[0001477] Human primary foreskin fibroblasts (BJ fibroblasts) were obtained from American Type Culture Collection (ATCC) (catalog # CRL-2522) and grown in Eagle's Minimum Essential Medium (ATCC, catalog # 30-2003) supplemented with 10% fetal bovine serum at 37°C, under 5% CO<sub>2</sub>. BJ fibroblasts were seeded on a 24-well plate at a density of 300,000 cells per well in 0.5 ml of culture medium. 250 ng of modified G-CSF mRNA (mRNA sequence shown in SEQ ID NO: 5655; polyA tail of approximately 140 nucleotides not shown in sequence; 5'cap, Cap1) fully modified with 5-methylcytosine and pseudouridine (Gen1) or fully modified with 5-methylcytosine and NI-methyl-pseudouridine (Gen2) having Cap0, Cap1 or no cap was transfected using Lipofectamine 2000 (Invitrogen, catalog # 11668-019), following manufacturer's protocol. Control samples of poly I:C (PIC), Lipofectamine 2000 (Lipo), natural luciferase mRNA (mRNA sequence shown in SEQ ID NO: 5665; polyA tail of approximately 160 nucleotides not shown in sequence; 5'cap, Cap1) and natural G-CSF mRNA were also transfected. The cells were harvested after 18 hours, the total RNA was isolated and DNASE® treated using the RNeasy micro kit (catalog #74004) following the manufacturer's protocol. 100 ng of total RNA was used for cDNA synthesis using High Capacity cDNA Reverse Transcription kit (catalog #4368814) following the manufacturer's protocol. The cDNA was then analyzed for the expression of innate immune response genes by quantitative real time PCR using SybrGreen in a Biorad CFX 384 instrument following manufacturer's protocol. Table 97 shows the expression level of innate immune response transcripts relative to house-keeping gene HPRT (hypoxanthine phosphoribosyltransferase) and is expressed as fold-induction relative to HPRT. In the table, the panel of standard metrics includes: RIG-I is retinoic acid



inducible gene 1, IL6 is interleukin-6, OAS-1 is oligoadenylate synthetase 1, IFN $\beta$  is interferon-beta, AIM2 is absent in melanoma-2, IFIT-1 is interferon-induced protein with tetratricopeptide repeats 1, PKR is protein kinase R, TNF $\alpha$  is tumor necrosis factor alpha and IFN $\alpha$  is interferon alpha.

**Table 97. Innate Immune Response Transcript Levels**

Formulation	RIG-I	IL6	OAS-1	IFN $\beta$	AIM2	IFIT-1	PKR	TNF $\alpha$	IFN $\alpha$
Natural Luciferase	71.5	20.6	20.778	11.404	0.251	151.218	16.001	0.526	0.067
Natural G-CSF	73.3	47.1	19.359	13.615	0.264	142.011	11.667	1.185	0.153
PIC	30.0	2.8	8.628	1.523	0.100	71.914	10.326	0.264	0.063
G-CSF Gen1-UC	0.81	0.22	0.080	0.009	0.008	2.220	1.592	0.090	0.027
G-CSF Gen1-Cap0	0.54	0.26	0.042	0.005	0.008	1.314	1.568	0.088	0.038
G-CSF Gen1-Cap1	0.58	0.30	0.035	0.007	0.006	1.510	1.371	0.090	0.040
G-CSF Gen2-UC	0.21	0.20	0.002	0.007	0.007	0.603	0.969	0.129	0.005
G-CSF Gen2-Cap0	0.23	0.21	0.002	0.0014	0.007	0.648	1.547	0.121	0.035
G-CSF Gen2-Cap1	0.27	0.26	0.011	0.004	0.005	0.678	1.557	0.099	0.037
Lipo	0.27	0.53	0.001	0	0.007	0.954	1.536	0.158	0.064

**B. Repeat Transfection**

[0001478] Human primary foreskin fibroblasts (BJ fibroblasts) were obtained from American Type Culture Collection (ATCC) (catalog # CRL-2522) and grown in Eagle's Minimum Essential Medium (ATCC, catalog # 30-2003) supplemented with 10% fetal bovine serum at 37°C, under 5% CO<sub>2</sub>. BJ fibroblasts were seeded on a 24-well plate at a density of 300,000 cells per well in 0.5 ml of culture medium. 250 ng of modified G-CSF mRNA (mRNA sequence shown in SEQ ID NO: 5655; polyA tail of approximately 140 nucleotides not shown in sequence; 5'cap, Cap1) unmodified, fully modified with 5-methylcytosine and pseudouridine (Gen1) or fully modified with 5-methylcytosine and NI-methyl-pseudouridine (Gen2) was transfected daily for 5 days following manufacturer's protocol. Control samples of Lipofectamine 2000 (L2000) and mCherry mRNA (mRNA sequence shown in SEQ ID NO: 5656; polyA tail of approximately 160 nucleotides not shown in sequence; 5'cap, Cap1; fully modified with 5-methylcytidine

and pseudouridine) were also transfected daily for 5 days. The results are shown in Table 98.

[0001479] Unmodified mRNA showed a cytokine response in interferon-beta (IFN-beta) and interleukin-6 (IL-6) after one day. mRNA modified with at least pseudouridine showed a cytokine response after 2-3 days whereas mRNA modified with 5-methylcytosine and NI-methyl-pseudouridine showed a reduced response after 3-5 days.

**Table 98. Cytokine Response**

Formulation	Transfection	IFN-beta (pg/ml)	IL-6 (pg/ml)
G-CSF unmodified	6 hours	0	3596
	Day 1	1363	15207
	Day 2	238	12415
	Day 3	225	5017
	Day 4	363	4267
	Day 5	225	3094
G-CSF Gen 1	6 hours	0	3396
	Day 1	38	3870
	Day 2	1125	16341
	Day 3	100	25983
	Day 4	75	18922
	Day 5	213	15928
G-CSF Gen 2	6 hours	0	3337
	Day 1	0	3733
	Day 2	150	974
	Day 3	213	4972
	Day 4	1400	4122
	Day 5	350	2906
mCherry	6 hours	0	3278
	Day 1	238	3893
	Day 2	113	1833
	Day 3	413	25539
	Day 4	413	29233
	Day 5	213	20178
L2000	6 hours	0	3270
	Day 1	13	3933
	Day 2	388	567
	Day 3	338	1517
	Day 4	475	1594
	Day 5	263	1561

**Example 66. In vivo detection of Innate Immune Response**

[0001480] In an effort to distinguish the importance of different chemical modification of mRNA on *in vivo* protein production and cytokine response *in vivo*, female BALB/C mice (n=5) are injected intramuscularly with G-CSF mRNA (G-CSF mRNA unmod) (mRNA sequence shown in SEQ ID NO: 5655; polyA tail of approximately 160

nucleotides not shown in sequence;) with a 5' cap of Cap1, G-CSF mRNA fully modified with 5-methylcytosine and pseudouridine (G-CSF mRNA 5mc/pU), G-CSF mRNA fully modified with 5-methylcytosine and N1-methyl-pseudouridine with (G-CSF mRNA 5mc/N1pU) or without a 5' cap (G-CSF mRNA 5mc/N1 pU no cap) or a control of either R848 or 5% sucrose as described in Table 99.

**Table 99. Dosing Chart**

Formulation	Route	Dose (ug/mouse)	Dose (ul)
G-CSF mRNA unmod	I.M.	200	50
G-CSF mRNA 5mc/pU	I.M.	200	50
G-CSF mRNA 5mc/N1pU	I.M.	200	50
G-CSF mRNA 5mc/N1pU no cap	I.M.	200	50
R848	I.M.	75	50
5% sucrose	I.M.	-	50
Untreated	I.M.	-	-

[0001481] Blood is collected at 8 hours after dosing. Using ELISA the protein levels of G-CSF, TNF-alpha and IFN-alpha is determined by ELISA. 8 hours after dosing, muscle is collected from the injection site and quantitative real time polymerase chain reaction (QPCR) is used to determine the mRNA levels of RIG-I, PKR, AIM-2, IFIT-1, OAS-2, MDA-5, IFN-beta, TNF-alpha, IL-6, G-CSF, CD45 in the muscle.

**Example 67. In vivo detection of Innate Immune Response Study**

[0001482] Female BALB/C mice (n=5) were injected intramuscularly with G-CSF mRNA (G-CSF mRNA unmod) (mRNA sequence shown in SEQ ID NO: 5655; polyA tail of approximately 160 nucleotides not shown in sequence;) with a 5' cap of Cap1, G-CSF mRNA fully modified with 5-methylcytosine and pseudouridine (G-CSF mRNA 5mc/pU), G-CSF mRNA fully modified with 5-methylcytosine and N1-methyl-pseudouridine with (G-CSF mRNA 5mc/N1pU) or without a 5' cap (G-CSF mRNA 5mc/N1 pU no cap) or a control of either R848 or 5% sucrose as described in Table 100. Blood is collected at 8 hours after dosing and using ELISA the protein levels of G-CSF and interferon-alpha (IFN-alpha) is determined by ELISA and are shown in Table 100.

[0001483] As shown in Table 100, unmodified, 5mc/pU, and 5mc/N1pU modified G-CSF mRNA resulted in human G-CSF expression in mouse serum. The uncapped

5mC/NlpU modified G-CSF mRNA showed no human G-CSF expression in serum, highlighting the importance of having a 5' cap structure for protein translation.

[0001484] As expected, no human G-CSF protein was expressed in the R848, 5% sucrose only, and untreated groups. Importantly, significant differences were seen in cytokine production as measured by mouse IFN-alpha in the serum. As expected, unmodified G-CSF mRNA demonstrated a robust cytokine response *in vivo* (greater than the R848 positive control). The 5mc/pU modified G-CSF mRNA did show a low but detectable cytokine response *in vivo*, while the 5mc/NlpU modified mRNA showed no detectable IFN-alpha in the serum (and same as vehicle or untreated animals).

[0001485] Also, the response of 5mc/NlpU modified mRNA was the same regardless of whether it was capped or not. These *in vivo* results reinforce the conclusion that 1) that unmodified mRNA produce a robust innate immune response, 2) that this is reduced, but not abolished, through 100% incorporation of 5mc/pU modification, and 3) that incorporation of 5mc/NlpU modifications results in no detectable cytokine response.

[0001486] Lastly, given that these injections are in 5% sucrose (which has no effect by itself), these result should accurately reflect the immunostimulatory potential of these modifications.

[0001487] From the data it is evident that NlpU modified molecules produce more protein while concomitantly having little or no effect on IFN-alpha expression. It is also evident that capping is required for protein production for this chemical modification. The Protein: Cytokine Ratio of 748 as compared to the PC Ratio for the unmodified mRNA (PC=9) means that this chemical modification is far superior as related to the effects or biological implications associated with IFN-alpha.

**Table 100. Human G-CSF and Mouse IFN-alpha in serum**

Formulation	Route	Dose (ug/mouse)	Dose (ul)	G-CSF protein (pg/ml)	IFN-alpha expression (pg/ml)	PC Ratio
G-CSF mRNA unmod	I.M.	200	50	605.6	67.01	9
G-CSF mRNA 5mc/pU	I.M.	200	50	356.5	8.87	40
G-CSF mRNA5mc/NlpU	I.M.	200	50	748.1	0	748
G-CSF mRNA5mc/NlpU no cap	I.M.	200	50	6.5	0	6.5
R848	I.M.	75	50	3.4	40.97	.08
5% sucrose	I.M.	-	50	0	1.49	0
Untreated	I.M.	-	-	0	0	0

**Example 68; *In Vivo* Delivery of Modified RNA**

[0001488] Protein production of modified mRNA was evaluated by delivering modified G-CSF mRNA or modified Factor IX mRNA to female Sprague Dawley rats (n=6). Rats were injected with 400 ug in 100 ul of G-CSF mRNA (mRNA sequence shown in SEQ ID NO: 5655; polyA tail of approximately 160 nucleotides not shown in sequence; 5'cap, Cap1) fully modified with 5-methylcytosine and pseudouridine (G-CSF Gen1), G-CSF mRNA fully modified with 5-methylcytosine and N1-methyl-pseudouridine (G-CSF Gen2) or Factor IX mRNA (mRNA sequence shown in SEQ ID NO: 5659; polyA tail of approximately 160 nucleotides not shown in sequence; 5'cap, Cap1) fully modified with 5-methylcytosine and pseudouridine (Factor IX Gen1) reconstituted from the lyophilized form in 5% sucrose. Blood was collected 8 hours after injection and the G-CSF protein level in serum was measured by ELISA. Table 101 shows the G-CSF protein levels in serum after 8 hours.

[0001489] These results demonstrate that both G-CSF Gen 1 and G-CSF Gen 2 modified mRNA can produce human G-CSF protein in a rat following a single intramuscular injection, and that human G-CSF protein production is improved when using Gen 2 chemistry over Gen 1 chemistry.

**Table 101. G-CSF Protein in Rat Serum (I.M. Injection Route)**

Formulation	G-CSF protein (pg/ml)
G-CSF Gen1	19.37
G-CSF Gen2	64.72
Factor IX Gen 1	2.25

**Example 69. Chemical Modification: *In vitro* studies****A. *In vitro* Screening in PBMC**

[0001490] 500 ng of G-CSF (mRNA sequence shown in SEQ ID NO: 5655; polyA tail of approximately 160 nucleotides not shown in sequence; 5'cap, Cap1) mRNA fully modified with the chemical modification outlined Tables 104 and 105 was transfected with 0.4 uL Lipofectamine 2000 into peripheral blood mononuclear cells (PBMC) from three normal blood donors. Control samples of LPS, R848, P(I)P(C) and mCherry (mRNA sequence shown in SEQ ID NO: 5656; polyA tail of approximately 160 nucleotides not shown in sequence, 5'cap, Cap1; fully modified with 5-methylcytosine

and pseudouridine) were also analyzed. The supernatant was harvested and stored frozen until analyzed by ELISA to determine the G-CSF protein expression, and the induction of the cytokines interferon-alpha (IFN-a) and tumor necrosis factor alpha (TNF-a). The protein expression of G-CSF is shown in Table 102, the expression of IFN-a and TNF-a is shown in Table 103.

[0001491] The data in Table 102 demonstrates that many, but not all, chemical modifications can be used to productively produce human G-CSF in PBMC. Of note, 100% N1-methyl-pseudouridine substitution demonstrates the highest level of human G-CSF production (almost 10-fold higher than pseudouridine itself). When N1-methyl-pseudouridine is used in combination with 5-methylcytidine a high level of human G-CSF protein is also produced (this is also higher than when pseudouridine is used in combination with 5 methylcytidine).

[0001492] Given the inverse relationship between protein production and cytokine production in PBMC, a similar trend is also seen in Table 103, where 100% substitution with N1-methyl-pseudouridine results no cytokine induction (similar to transfection only controls) and pseudouridine shows detectable cytokine induction which is above background.

[0001493] Other modifications such as N6-methyladenosine and a-thiocytidine appear to increase cytokine stimulation.

**Table 102. Chemical Modifications and G-CSF Protein Expression**

Chemical Modifications	G-CSF Protein Expression (pg/ml)		
	Donor 1	Donor 2	Donor 3
Pseudouridine	2477	1,909	1,498
5-methyluridine	318	359	345
N1-methyl-pseudouridine	21,495	16,550	12,441
2-thiouridine	932	1,000	600
4-thiouridine	5	391	218
5-methoxyuridine	2,964	1,832	1,800
5-methylcytosine and pseudouridine (1 <sup>st</sup> set)	2,632	1,955	1,373
5-methylcytosine and N1-methyl-pseudouridine (1 <sup>st</sup> set)	10,232	7,245	6,214
2'Fluoroguanosine	59	186	177
2'Fluorouridine	118	209	191
5-methylcytosine and pseudouridine (2 <sup>nd</sup> set)	1,682	1,382	1,036
5-methylcytosine and N1-methyl-pseudouridine	9,564	8,509	7,141

(2 <sup>nd</sup> set)			
5-bromouridine	314	482	291
5-(2-carbomethoxyvinyl)uridine	77	286	177
5-[3(1-E-propenylamino)uridine	541	491	550
$\alpha$ -thiocytidine	105	264	245
5-methylcytosine and pseudouridine (3 <sup>rd</sup> set)	1,595	1,432	955
N1-methyladenosine	182	177	191
N6-methyladenosine	100	168	200
5-methylcytidine	291	277	359
N4-acetylcytidine	50	136	36
5-formylcytidine	18	205	23
5-methylcytosine and pseudouridine (4 <sup>th</sup> set)	264	350	182
5-methylcytosine and N1-methyl-pseudouridine (4 <sup>th</sup> set)	9,505	6,927	5,405
LPS	1,209	786	636
mCherry	5	168	164
R848	709	732	636
P(I)P(C)	5	186	182

Table 103. Chemical Modifications and Cytokine Expression

Chemical Modifications	IFN- $\alpha$ Expression (pg/ml)			TNF- $\alpha$ Expression (pg/ml)		
	Donor 1	Donor 2	Donor 3	Donor 1	Donor 2	Donor 3
Pseudouridine	120	77	171	36	81	126
5-methyluridine	245	135	334	94	100	157
N1-methyl-pseudouridine	26	75	138	101	106	134
2-thiouridine	100	108	154	133	133	141
4-thiouridine	463	258	659	169	126	254
5-methoxyuridine	0	64	133	39	74	111
5-methylcytosine and pseudouridine (1 <sup>st</sup> set)	88	94	148	64	89	121
5-methylcytosine and N1-methyl-pseudouridine (1 <sup>st</sup> set)	0	60	136	54	79	126
2'Fluoroguanosine	107	97	194	91	94	141
2'Fluorouridine	158	103	178	164	121	156
5-methylcytosine and pseudouridine (2 <sup>nd</sup> set)	133	92	167	99	111	150
5-methylcytosine and N1-methyl-pseudouridine (2 <sup>nd</sup> set)	0	66	140	54	97	149
5-bromouridine	95	86	181	87	106	157
5-(2-carbomethoxyvinyl)uridine	0	61	130	40	81	116
5-[3(1-E-propenylamino)uridine	0	58	132	71	90	119
$\alpha$ -thiocytidine	1,138	565	695	300	273	277

5-methylcytosine and pseudouridine (3 <sup>rd</sup> set)	88	75	150	84	89	130
N1-methyladenosine	322	255	377	256	157	294
N6-methyladenosine	1,935	1,065	1,492	1,080	630	857
5-methylcytidine	643	359	529	176	136	193
N4-acetylcytidine	789	593	431	263	67	207
5-formylcytidine	180	93	88	136	30	40
5-methylcytosine and pseudouridine (4 <sup>th</sup> set)	131	28	18	53	24	29
5-methylcytosine and N1-methyl-pseudouridine (4 <sup>th</sup> set)	0	0	0	36	14	13
LPS	0	67	146	7,004	3,974	4,020
mCherry	100	75	143	67	100	133
R848	674	619	562	11,179	8,546	9,907
P(I)P(C)	470	117	362	249	177	197

### B. *In vitro* Screening in HeLa Cells

[0001494] The day before transfection, 20,000 HeLa cells (ATCC no. CCL-2; Manassas, VA) were harvested by treatment with Trypsin-EDTA solution (LifeTechnologies, Grand Island, NY) and seeded in a total volume of 100ul EMEM medium (supplemented with 10%FCS and 1x Glutamax) per well in a 96-well cell culture plate (Corning, Manassas, VA). The cells were grown at 37oG in 5% CO2 atmosphere overnight. Next day, 83 ng of Luciferase modified RNA (mRNA sequence shown in SEQ ID NO: 5665; polyA tail of approximately 160 nucleotides not shown in sequence; 5'cap, Cap1) with the chemical modification described in Table 104, were diluted in 10ul final volume of OPTI-MEM (LifeTechnologies, Grand Island, NY). Lipofectamine 2000 (LifeTechnologies, Grand Island, NY) was used as transfection reagent and 0.2 ul were diluted in 10 ul final volume of OPTI-MEM. After 5 minutes of incubation at room temperature, both solutions were combined and incubated an additional 15 minute at room temperature. Then the 20ul combined solution was added to the 100ul cell culture medium containing the HeLa cells and incubated at room temperature.

[0001495] After 18 to 22 hours of incubation cells expressing luciferase were lysed with 100 ul of Passive Lysis Buffer (Promega, Madison, WI) according to manufacturer instructions. Aliquots of the lysates were transferred to white opaque polystyrene 96-well plates (Corning, Manassas, VA) and combined with 100 ul complete luciferase assay solution (Promega, Madison, WI). The lysate volumes were adjusted or diluted until no



more than 2 mio relative light units (RLU) per well were detected for the strongest signal producing samples and the RLUs for each chemistry tested are shown in Table 104. The plate reader was a BioTek Synergy HI (BioTek, Winooski, VT). The background signal of the plates without reagent was about 200 relative light units per well.

[0001496] These results demonstrate that many, but not all, chemical modifications can be used to productively produce human G-CSF in HeLa cells. Of note, 100% N1-methyl-pseudouridine substitution demonstrates the highest level of human G-CSF production.

**Table 104. Relative Light Units of Luciferase**

Chemical Modification	RLU
N6-methyladenosine (m6a)	534
5-methylcytidine (m5c)	138,428
N4-acetylcytidine (ac4c)	235,412
5-formylcytidine (f5c)	436
5-methylcytosine/pseudouridine, test A1	48,659
5-methylcytosine/N1-methyl-pseudouridine, test A1	190,924
Pseudouridine	655,632
1-methylpseudouridine (m1u)	1,517,998
2-thiouridine (s2u)	3387
5-methoxyuridine (mo5u)	253,719
5-methylcytosine/pseudouridine, test B1	317,744
5-methylcytosine/N1-methyl-pseudouridine, test B1	265,871
5-Bromo-uridine	43,276
5 (2 carbovinyl) uridine	531
5 (3-1E propenyl Amino) uridine	446
5-methylcytosine/pseudouridine, test A2	295,824
5-methylcytosine/N1-methyl-pseudouridine, test A2	233,921
5-methyluridine	50,932
$\alpha$ -Thio-cytidine	26,358
5-methylcytosine/pseudouridine, test B2	481,477
5-methylcytosine/N1-methyl-pseudouridine, test B2	271,989
5-methylcytosine/pseudouridine, test A3	438,831
5-methylcytosine/N1-methyl-pseudouridine, test A3	277,499
Unmodified Luciferase	234,802

C. In vitro Screening in Rabbit Reticulocyte Lysates

[0001497] Luciferase mRNA (mRNA sequence shown in SEQ ID NO: 5665; polyA tail of approximately 160 nucleotides not shown in sequence; 5'cap, Cap1) was modified with the chemical modification listed in Table 105 and were diluted in sterile nuclease-free water to a final amount of 250 ng in 10 ul. The diluted luciferase was added to 40 ul of freshly prepared Rabbit Reticulocyte Lysate and the *in vitro* translation reaction was done in a standard 1.5 mL polypropylene reaction tube (Thermo Fisher Scientific, Waltham, MA) at 30°C in a dry heating block. The translation assay was done with the Rabbit Reticulocyte Lysate (nuclease-treated) kit (Promega, Madison, WI) according to the manufacturer's instructions. The reaction buffer was supplemented with a one-to-one blend of provided amino acid stock solutions devoid of either Leucine or Methionine resulting in a reaction mix containing sufficient amounts of both amino acids to allow effective *in vitro* translation.

[0001498] After 60 minutes of incubation, the reaction was stopped by placing the reaction tubes on ice. Aliquots of the *in vitro* translation reaction containing luciferase modified RNA were transferred to white opaque polystyrene 96-well plates (Corning, Manassas, VA) and combined with 100ul complete luciferase assay solution (Promega, Madison, WI). The volumes of the *in vitro* translation reactions were adjusted or diluted until no more than 2 mio relative light units (RLUs) per well were detected for the strongest signal producing samples and the RLUs for each chemistry tested are shown in Table 105. The plate reader was a BioTek Synergy HI (BioTek, Winooski, VT). The background signal of the plates without reagent was about 200 relative light units per well.

[0001499] These cell-free translation results very nicely correlate with the protein production results in HeLa, with the same modifications generally working or not working in both systems. One notable exception is 5-formylcytidine modified luciferase mRNA which worked in the cell-free translation system, but not in the HeLa cell-based transfection system. A similar difference between the two assays was also seen with 5-formylcytidine modified G-CSF mRNA.

**Table 105. Relative Light Units of Luciferase**

Chemical Modification	RLU
N6-methyladenosine (m6a)	398

5-methylcytidine (m5c)	152,989
N4-acetylcytidine (ac4c)	60,879
5-formylcytidine (f5c)	55,208
5-methylcytosine/pseudouridine, test A1	349,398
5-methylcytosine/N1-methyl-pseudouridine, test A1	205,465
Pseudouridine	587,795
1-methyl-pseudouridine (mlu)	589,758
2-thiouridine (s2u)	708
5-methoxyuridine (mo5u)	288,647
5-methylcytosine/pseudouridine, test B1	454,662
5-methylcytosine/N1-methyl-pseudouridine, test B1	223,732
5-Bromo-uridine	221,879
5 (2 carbovinyl) uridine	225
5 (3- IE propenyl Amino) uridine	211
5-methylcytosine/pseudouridine, test A2	558,779
5-methylcytosine/N1-methyl-pseudouridine, test A2	333,082
5-methyluridine	214,680
a-Thio-cytidine	123,878
5-methylcytosine/pseudouridine, test B2	487,805
5-methylcytosine/N1-methyl-pseudouridine, test B2	154,096
5-methylcytosine/pseudouridine, test A3	413,535
5-methylcytosine/N1-methyl-pseudouridine, test A3	292,954
Unmodified Luciferase	225,986

**Example 70. Chemical Modification: *In vivo* studies**

A. *In vivo* Screening of G-CSF Modified mRNA

[0001500] Balb-C mice (n=4) are intramuscularly injected in each leg with modified G-CSF mRNA (mRNA sequence shown in SEQ ID NO: 5655; polyA tail of approximately 160 nucleotides not shown in sequence; 5'cap, Cap1), fully modified with the chemical modifications outlined in Table 106, is formulated in 1xPBS. A control of luciferase modified mRNA (mRNA sequence shown in SEQ ID NO: 5665; polyA tail of approximately 160 nucleotides not shown in sequence; 5'cap, Cap1; fully modified with pseudouridine and 5-methylcytosine) and a control of PBS are also tested. After 8 hours serum is collected to determine G-CSF protein levels cytokine levels by ELISA.

**Table 106. G-CSF**

mRNA	Chemical Modifications
------	------------------------

G-CSF	Pseudouridine
G-CSF	5-methyluridine
G-CSF	2-thiouridine
G-CSF	4-thiouridine
G-CSF	5-methoxyuridine
G-CSF	2'-fluorouridine
G-CSF	5-bromouridine
G-CSF	5-[3(1-E-propenylamino)uridine)
G-CSF	alpha-thio-cytidine
G-CSF	5-methylcytidine
G-CSF	N4-acetylcytidine
G-CSF	Pseudouridine and 5-methylcytosine
G-CSF	N1-methyl-pseudouridine and 5-methylcytosine
Luciferase	Pseudouridine and 5-methylcytosine
PBS	None

B. *In vivo* Screening of Luciferase Modified mRNA

[0001501] Balb-C mice (n=4) were subcutaneously injected with 200ul containing 42 to 103 ug of modified luciferase mRNA (mRNA sequence shown in SEQ ID NO: 5665; polyA tail of approximately 160 nucleotides not shown in sequence; 5'cap, Cap1), fully modified with the chemical modifications outlined in Table 107, was formulated in 1xPBS. A control of PBS was also tested. The dosages of the modified luciferase mRNA is also outlined in Table 107. 8 hours after dosing the mice were imaged to determine luciferase expression. Twenty minutes prior to imaging, mice were injected intraperitoneally with a D-luciferin solution at 150 mg/kg. Animals were then anesthetized and images were acquired with an IVIS Lumina II imaging system (Perkin Elmer). Bioluminescence was measured as total flux (photons/second) of the entire mouse.

[0001502] As demonstrated in Table 107, all luciferase mRNA modified chemistries demonstrated *in vivo* activity, with the exception of 2'-fluorouridine. In addition 1-methyl-pseudouridine modified mRNA demonstrated very high expression of luciferase (5-fold greater expression than pseudouridine containing mRNA).

**Table 107. Luciferase Screening**

mRNA	Chemical Modifications	Dose (ug) of mRNA	Dose volume (ml)	Luciferase expression (photon/second)
Luciferase	5-methylcytidine	83	0.72	1.94E+07
Luciferase	N4-acetylcytidine	76	0.72	1.11E07
Luciferase	Pseudouridine	95	1.20	1.36E+07

Luciferase	1-methylpseudouridine	103	0.72	7.40E+07
Luciferase	5-methoxyuridine	95	1.22	3.32+07
Luciferase	5-methyluridine	94	0.86	7.42E+06
Luciferase	5-bromouridine	89	1.49	3.75E+07
Luciferase	2'-fluoroguanosine	42	0.72	5.88E+05
Luciferase	2'-fluorocytidine	47	0.72	4.21E+05
Luciferase	2'-flurorouridine	59	0.72	3.47E+05
PBS	None	-	0.72	3.16E+05

### **Example 71. *In vivo* Screening of Combination Luciferase Modified mRNA**

[0001503] Balb-C mice (n=4) were subcutaneously injected with 200ul of 100 ug of modified luciferase mRNA (mRNA sequence shown in SEQ ID NO: 5665; polyA tail of approximately 160 nucleotides not shown in sequence; 5'cap, Cap1), fully modified with the chemical modifications outlined in Table 108, was formulated in 1x PBS. A control of PBS was also tested. 8 hours after dosing the mice were imaged to determine luciferase expression. Twenty minutes prior to imaging, mice were injected intraperitoneally with a D-luciferin solution at 150 mg/kg. Animals were then anesthetized and images were acquired with an IVIS Lumina II imaging system (Perkin Elmer). Bioluminescence was measured as total flux (photons/second) of the entire mouse.

[0001504] As demonstrated in Table 108, all luciferase mRNA modified chemistries (in combination) demonstrated *in vivo* activity. In addition the presence of N1-methyl-pseudouridine in the modified mRNA (with N4-acetylcytidine or 5 methylcytidine) demonstrated higher expression than when the same combinations were tested using with pseudouridine. Taken together, these data demonstrate that N1-methyl-pseudouridine containing luciferase mRNA results in improved protein expression *in vivo* whether used alone (Table 107) or when used in combination with other modified nucleotides (Table 108).

**Table 108. Luciferase Screening Combinations**

mRNA	Chemical Modifications	Luciferase expression (photon/second)
Luciferase	N4-acetylcytidine/pseudouridine	4.18E+06
Luciferase	N4-acetylcytidine/N1-methyl-pseudouridine	2.88E+07
Luciferase	5-methylcytidine/5-methoxyuridine	3.48E+07
Luciferase	5-methylcytidine/5-methyluridine	1.44E+07
Luciferase	5-methylcytidine/where 50% of the uridine is replaced with 2-thiouridine	2.39E+06

Luciferase	5-methylcytidine/pseudouridine	2.36E+07
Luciferase	5-methylcytidine/N1-methyl-pseudouridine	4.15E+07
PBS	None	3.59E+05

### **Example 72. Innate Immune Response in BJ Fibroblasts**

[0001505] Human primary foreskin fibroblasts (BJ fibroblasts) are obtained from American Type Culture Collection (ATCC) (catalog #CRL-2522) and grown in Eagle's Minimum Essential Medium (ATCC, cat# 30-2003) supplemented with 10% fetal bovine serum at 37°C, under 5% CO<sub>2</sub>. BJ fibroblasts are seeded on a 24-well plate at a density of 130,000 cells per well in 0.5 ml of culture medium. 250 ng of modified G-CSF mRNA (mRNA sequence shown in SEQ ID NO: 5655; polyA tail of approximately 160 nucleotides not shown in sequence; 5'cap, Cap1) fully modified with 5-methylcytosine and pseudouridine (Gen1) or fully modified with 5-methylcytosine and N1-methyl-pseudouridine (Gen2) is transfected using Lipofectamine 2000 (Invitrogen, cat# 11668-019), following manufacturer's protocol. Control samples of Lipofectamine 2000 and unmodified G-CSF mRNA (natural G-CSF) are also transfected. The cells are transfected for five consecutive days. The transfection complexes are removed four hours after each round of transfection.

[0001506] The culture supernatant is assayed for secreted G-CSF (R&D Systems, catalog #DCS50), tumor necrosis factor-alpha (TNF-alpha) and interferon alpha (IFN-alpha) by ELISA every day after transfection following manufacturer's protocols. The cells are analyzed for viability using CELL TITER GLO® (Promega, catalog #G7570) 6 hrs and 18 hrs after the first round of transfection and every alternate day following that. At the same time from the harvested cells, total RNA is isolated and treated with DNASE® using the RNAEASY micro kit (catalog #74004) following the manufacturer's protocol. 100 ng of total RNA is used for cDNA synthesis using the High Capacity cDNA Reverse Transcription kit (Applied Biosystems, cat #4368814) following the manufacturer's protocol. The cDNA is then analyzed for the expression of innate immune response genes by quantitative real time PCR using SybrGreen in a Biorad CFX 384 instrument following the manufacturer's protocol.

### **Example 73. In vitro Transcription with wild-type T7 polymerase**

[0001507] Luciferase mRNA (mRNA sequence shown in SEQ ID NO: 5665; polyA tail of approximately 160 nucleotides not shown in sequence; 5'cap, Cap1) and G-CSF mRNA (mRNA sequence shown in SEQ ID NO: 5655; polyA tail of approximately 160 nucleotides not shown in sequence; 5'cap, Cap1) were fully modified with different chemistries and chemistry combinations listed in Tables 109-112 using wild-type T7 polymerase as previously described.

[0001508] The yield of the translation reactions was determined by spectrophotometric measurement (OD260) and the yield for Luciferase is shown in Table 109 and G-CSF is shown in Table 111.

[0001509] The luciferase and G-CSF modified mRNA were also subjected to an enzymatic capping reaction and each modified mRNA capping reaction was evaluated for yield by spectrophotometric measurement (OD260) and correct size assessed using bioanalyzer. The yield from the capping reaction for luciferase is shown in Table 110 and G-CSF is shown in Table 112.

**Table 109. *In vitro* transcription chemistry for Luciferase**

<b>Chemical Modification</b>	<b>Yield (mg)</b>
N6-methyladenosine	0.99
5-methylcytidine	1.29
N4-acetylcytidine	1.0
5-formylcytidine	0.55
Pseudouridine	2.0
N1-methyl-pseudouridine	1.43
2-thiouridine	1.56
5-methoxyuridine	2.35
5-methyluridine	1.01
$\alpha$ -Thio-cytidine	0.83
5-Br-uridine (5Bru)	1.96
5 (2 carbomethoxyvinyl) uridine	0.89
5 (3-1E propenyl Amino) uridine	2.01
N4-acetylcytidine/pseudouridine	1.34
N4-acetylcytidine/N1-methyl-pseudouridine	1.26
5-methylcytidine/5-methoxyuridine	1.38
5-methylcytidine/5-bromouridine	0.12
5-methylcytidine/5-methyluridine	2.97
5-methylcytidine/ half of the uridines are modified with 2-thiouridine	1.59
5-methylcytidine/2-thiouridine	0.90
5-methylcytidine/pseudouridine	1.83
5-methylcytidine/N1 methyl pseudouridine	1.33

**Table 110. Capping chemistry and yield for Luciferase modified mRNA**

<b>Chemical Modification</b>	<b>Yield (mg)</b>
5-methylcytidine	1.02
N4-acetylcytidine	0.93
5-formylecytidine	0.55
Pseudouridine	2.07
N1-methyl-pseudouridine	1.27
2-thiouridine	1.44
5-methoxyuridine	2
5-methyluridine	0.8
$\alpha$ -Thio-cytidine	0.74
5-Br-uridine (5Bru)	1.29
5 (2 carbomethoxyvinyl) uridine	0.54
5 (3-IE propenyl Amino) uridine	1.39
N4-acetylcytidine/pseudouridine	0.99
N4-acetylcytidine/N1-methyl-pseudouridine	1.08
5-methylcytidine/5-methoxyuridine	1.13
5-methylcytidine/5-methyluridine	1.08
5-methylcytidine/ half of the uridines are modified with 2-thiouridine	1.2
5-methylcytidine/2-thiouridine	1.27
5-methylcytidine/pseudouridine	1.19
5-methylcytidine/N1 methyl pseudouridine	1.04

**Table 111. *In vitro* transcription chemistry and yield for G-CSF modified mRNA**

<b>Chemical Modification</b>	<b>Yield (mg)</b>
N6-methyladenosine	1.57
5-methylcytidine	2.05
N4-acetylcytidine	3.13
5-formylecytidine	1.41
Pseudouridine	4.1
N1-methyl-pseudouridine	3.24
2-thiouridine	3.46
5-methoxyuridine	2.57
5-methyluridine	4.27
4-thiouridine	1.45
2'-F-uridine	0.96
$\alpha$ -Thio-cytidine	2.29
2'-F-guanosine	0.6
N-1-methyladenosine	0.63
5-Br-uridine (5Bru)	1.08



5 (2 carbomethoxyvinyl) uridine	1.8
5 (3-IE propenyl Amino) uridine	2.09
N4-acetylcytidine/pseudouridine	1.72
N4-acetylcytidine/N 1-methyl-pseudouridine	1.37
5-methylcytidine/5 -methoxyuridine	1.85
5-methylcytidine/5 -methyluridine	1.56
5-methylcytidine/ half of the uridines are modified with 2-thiouridine	1.84
5-methylcytidine/2-thiouridine	2.53
5-methylcytidine/pseudouridine	0.63
N4-acetylcytidine/2-thiouridine	1.3
N4-acetylcytidine/5-bromouridine	1.37
5-methylcytidine/N1 methyl pseudouridine	1.25
N4-acetylcytidine/pseudouridine	2.24

**Table 112. Capping chemistry and yield for G-CSF modified mRNA**

Chemical Modification	Yield (mg)
N6-methyladenosine	1.04
5-methylcytidine	1.08
N4-acetylcytidine	2.73
5-formylcytidine	0.95
Pseudouridine	3.88
N 1-methyl-pseudouridine	2.58
2-thiouridine	2.57
5-methoxyuridine	2.05
5-methyluridine	3.56
4-thiouridine	0.91
2'-F-uridine	0.54
a-Thio-cytidine	1.79
2'-F-guanosine	0.14
5-Br-uridine (5Bru)	0.79
5 (2 carbomethoxyvinyl) uridine	1.28
5 (3-IE propenyl Amino) uridine	1.78
N4-acetylcytidine/pseudouridine	0.29
N4-acetylcytidine/N 1-methyl-pseudouridine	0.33
5-methylcytidine/ 5-methoxyuridine	0.91
5-methylcytidine/ 5-methyluridine	0.61
5-methylcytidine/ half of the uridines are modified with 2-thiouridine	1.24
5-methylcytidine/pseudouridine	1.08
N4-acetylcytidine/2-thiouridine	1.34
N4-acetylcytidine/5-bromouridine	1.22
5-methylcytidine/N1 methyl pseudouridine	1.56

**Example 74. *In vitro* Transcription with mutant T7 polymerase**

[0001510] Luciferase mRNA (mRNA sequence shown in SEQ ID NO: 5665; polyA tail of approximately 160 nucleotides not shown in sequence; 5'cap, Cap1) and G-CSF

mRNA (mRNA sequence shown in SEQ ID NO: 5655; polyA tail of approximately 160 nucleotides not shown in sequence; 5'cap, Cap1) were fully modified with different chemistries and chemistry combinations listed in Tables 113-116 using a mutant T7 polymerase (Durascribe® T7 Transcription kit (Cat. No. DSO 10925) (Epicentre®, Madison, WI).

[0001511] The yield of the translation reactions was determined by spectrophotometric measurement (OD260) and the yield for Luciferase is shown in Table 113 and G-CSF is shown in Table 115.

[0001512] The luciferase and G-CSF modified mRNA were also subjected to an enzymatic capping reaction and each modified mRNA capping reaction was evaluated for yield by spectrophotometric measurement (OD260) and correct size assessed using bioanalyzer. The yield from the capping reaction for luciferase is shown in Table 114 and G-CSF is shown in Table 115.

**Table 113. *In vitro* transcription chemistry and yield for Luciferase modified mRNA**

Chemical Modification	Yield (ug)
2'Fluorocytosine	71.4
2'Fluorouridine	57.5
5-methylcytosine/pseudouridine, test A	26.4
5-methylcytosine/N1-methyl-pseudouridine, test A	73.3
N1-acetylcytidine/2-fluorouridine	202.2
5-methylcytidine/2-fluorouridine	131.9
2-fluorocytosine/pseudouridine	119.3
2-fluorocytosine/N1-methyl-pseudouridine	107.0
2-fluorocytosine/2-thiouridine	34.7
2-fluorocytosine/5-bromouridine	81.0
2-fluorocytosine/2-fluorouridine	80.4
2-fluoroguanine/5-methylcytosine	61.2
2-fluoroguanine/5-methylcytosine/pseudouridine	65.0
2-fluoroguanine/5-methylcytidine/N1-methyl-pseudouridine	41.2
2-fluoroguanine/pseudouridine	79.1
2-fluoroguanine/N1-methyl-pseudouridine	74.6
5-methylcytidine/pseudouridine, test B	91.8
5-methylcytidine/N1-methyl-pseudouridine, test B	72.4
2'fluoroadenosine	190.98

**Table 114. Capping chemistry and yield for Luciferase modified mRNA**

Chemical Modification	Yield (ug)
2'Fluorocytosine	19.2
2'Fluorouridine	16.7
5-methylcytosine/pseudouridine, test A	7.0
5-methylcytosine/N1-methyl-pseudouridine, test A	21.5
N1-acetylcytidine/2-fluorouridine	47.5
5-methylcytidine/2-fluorouridine	53.2
2-fluorocytosine/pseudouridine	58.4
2-fluorocytosine/N1-methyl-pseudouridine	26.2
2-fluorocytosine/2-thiouridine	12.9
2-fluorocytosine/5-bromouridine	26.5
2-fluorocytosine/2-fluorouridine	35.7
2-fluoroguanine/5-methylcytosine	24.7
2-fluoroguanine/5-methylcytosine/pseudouridine	32,3
2-fluoroguanine/5-methylcytidine/ N1-methyl-pseudouridine	31.3
2-fluoroguanine/pseudouridine	20.9
2-fluoroguanine/N1-methyl-pseudouridine	29.8
5-methylcytidine/pseudouridine, test B	58.2
5-methylcytidine/N1-methyl-pseudouridine, test B	44.4

**Table 115. *In vitro* transcription chemistry and yield for G-CSF modified mRNA**

Chemical Modification	Yield (ug)
2'Fluorocytosine	56.5
2'Fluorouridine	79.4
5-methylcytosine/pseudouridine, test A	21.2
5-methylcytosine/N1-methyl-pseudouridine, test A	77.1
N1-acetylcytidine/2-fluorouridine	168.6
5-methylcytidine/2-fluorouridine	134.7
2-fluorocytosine/pseudouridine	97.8
2-fluorocytosine/N1-methyl-pseudouridine	103.1
2-fluorocytosine/2-thiouridine	58.8
2-fluorocytosine/5-bromouridine	88.8
2-fluorocytosine/2-fluorouridine	93.9
2-fluoroguanine/5-methylcytosine	97.3
2-fluoroguanine/5-methylcytosine/pseudouridine	96.0
2-fluoroguanine/5-methylcytidine/N1-methyl-pseudouridine	82.0
2-fluoroguanine/pseudouridine	68.0
2-fluoroguanine/N1-methyl-pseudouridine	59.3
5-methylcytidine/pseudouridine, test B	58,7
5-methylcytidine/N1-methyl-pseudouridine, test B	78.0

**Table 116. Capping chemistry and yield for G-CSF modified mRNA**

Chemical Modification	Yield (ug)
2'Fluorocytosine	16.9
2'Fluorouridine	17.0
5-methylcytosine/pseudouridine, test A	10.6
5-methylcytosine/N1-methyl-pseudouridine, test A	22.7
N1-acetylcytidine/2-fluorouridine	19.9
5-methylcytidine/2-fluorouridine	21.3
2-fluorocytosine/pseudouridine	65.2
2-fluorocytosine/N1-methyl-pseudouridine	58.9
2-fluorocytosine/2-thiouridine	41.2
2-fluorocytosine/5-bromouridine	35.8
2-fluorocytosine/2-fluorouridine	36.7
2-fluoroguanine/5-methylcytosine	36.6
2-fluoroguanine/5-methylcytosine/pseudouridine	37.3
2-fluoroguanine/5-methylcytidine/TSil-methyl-pseudouridine	30.7
2-fluoroguanine/pseudouridine	29.0
2-fluoroguanine/N1-methyl-pseudouridine	22.7
5-methylcytidine/pseudouridine, test B	60.4
5-methylcytidine/N1-methyl-pseudouridine, test B	33.0

#### **Example 75. 2'-O-methyl and 2'Fluoro compounds**

[0001513] Luciferase mRNA (mRNA sequence shown in SEQ ID NO: 5665; polyA tail of approximately 160 nucleotides not shown in sequence; 5'cap, Cap1) were produced as fully modified versions with the chemistries in Table 117 and transcribed using mutant T7 polymerase (Durascribe® T7 Transcription kit (Cat. No. DS010925) (Epicentre®, Madison, WI). 2' fluoro-containing mRNA were made using Durascribe T7, however, 2'Omethyl-containing mRNA could not be transcribed using Durascribe T7.

[0001514] Incorporation of 2'Omethyl modified mRNA might possibly be accomplished using other mutant T7 polymerases (Nat Biotechnol. (2004) 22:1 155-1 160; Nucleic Acids Res. (2002) 30:e138) or US Patent 7,309,570, the contents of each of which are incorporated herein by reference in their entirety. Alternatively, 2'OMe modifications could be introduced post-transcriptionally using enzymatic means.

[0001515] Introduction of modifications on the 2' group of the sugar has many potential advantages. 2'OMe substitutions, like 2' fluoro substitutions are known to protect against nucleases and also have been shown to abolish innate immune recognition when incorporated into other nucleic acids such as siRNA and anti-sense (incorporated in its entirety, Crooke, ed. Antisense Drug Technology, 2<sup>nd</sup> edition; Boca Raton: CRC press).

[0001516] The 2'Fluoro-modified mRNA were then transfected into HeLa cells to assess protein production in a cell context and the same mRNA were also assessed in a cell-free rabbit reticulocyte system. A control of unmodified luciferase (natural luciferase) was used for both transcription experiments, a control of untreated and mock transfected (Lipofectamine 2000 alone) were also analyzed for the HeLa transfection and a control of no RNA was analyzed for the rabbit reticulysates.

[0001517] For the HeLa transfection experiments, the day before transfection, 20,000 HeLa cells (ATCC no. CCL-2; Manassas, VA) were harvested by treatment with Trypsin-EDTA solution (LifeTechnologies, Grand Island, NY) and seeded in a total volume of 100ul EMEM medium (supplemented with 10%FCS and 1x Glutamax) per well in a 96-well cell culture plate (Corning, Manassas, VA). The cells were grown at 37oG in 5% CO<sub>2</sub> atmosphere overnight. Next day, 83 ng of the 2'fluoro-containing luciferase modified RNA (mRNA sequence shown in SEQ ID NO: 5665; polyA tail of approximately 160 nucleotides not shown in sequence; 5'cap, Cap1) with the chemical modification described in Table 117, were diluted in 100ul final volume of OPTI-MEM (LifeTechnologies, Grand Island, NY). Lipofectamine 2000 (LifeTechnologies, Grand Island, NY) was used as transfection reagent and 0.2 ul were diluted in 10 ul final volume of OPTI-MEM. After 5 minutes of incubation at room temperature, both solutions were combined and incubated an additional 15 minute at room temperature. Then the 20ul combined solution was added to the 100ul cell culture medium containing the HeLa cells and incubated at room temperature. After 18 to 22 hours of incubation cells expressing luciferase were lysed with 100 ul of Passive Lysis Buffer (Promega, Madison, WI) according to manufacturer instructions. Aliquots of the lysates were transferred to white opaque polystyrene 96-well plates (Corning, Manassas, VA) and combined with 100 ul complete luciferase assay solution (Promega, Madison, WI). The lysate volumes were adjusted or diluted until no more than 2 mio relative light units (RLU) per well were detected for the strongest signal producing samples and the RLUs for each chemistry tested are shown in Table 117. The plate reader was a BioTek Synergy HI (BioTek, Winooski, VT).The background signal of the plates without reagent was about 200 relative light units per well.

[0001518] For the rabbit reticulocyte lysate assay, 2'-fluoro-containing luciferase mRNA were diluted in sterile nuclease-free water to a final amount of 250 ng in 10 ul and added to 40 ul of freshly prepared Rabbit Reticulocyte Lysate and the *in vitro* translation reaction was done in a standard 1.5 mL polypropylene reaction tube (Thermo Fisher Scientific, Waltham, MA) at 30°C in a dry heating block. The translation assay was done with the Rabbit Reticulocyte Lysate (nuclease-treated) kit (Promega, Madison, WI) according to the manufacturer's instructions. The reaction buffer was supplemented with a one-to-one blend of provided amino acid stock solutions devoid of either Leucine or Methionine resulting in a reaction mix containing sufficient amounts of both amino acids to allow effective *in vitro* translation. After 60 minutes of incubation, the reaction was stopped by placing the reaction tubes on ice.

[0001519] Aliquots of the *in vitro* translation reaction containing luciferase modified RNA were transferred to white opaque polystyrene 96-well plates (Corning, Manassas, VA) and combined with 100ul complete luciferase assay solution (Promega, Madison, WI). The volumes of the *in vitro* translation reactions were adjusted or diluted until no more than 2 mio relative light units (RLUs) per well were detected for the strongest signal producing samples and the RLUs for each chemistry tested are shown in Table 118. The plate reader was a BioTek Synergy HI (BioTek, Winooski, VT). The background signal of the plates without reagent was about 160 relative light units per well.

[0001520] As can be seen in Table 117 and 118, multiple 2'Fluoro-containing compounds are active in vitro and produce luciferase protein.

**Table 117. HeLa Cells**

Chemical Modification	Concentration (ug/ml)	Volume (ul)	Yield (ug)	RLU
2'Fluoroadenosine	381.96	500	190.98	388.5
2'Fluorocytosine	654.56	500	327.28	2420
2'Fluoroguanine	541,795	500	270.90	11,705.5
2'Fluorouridine	944.005	500	472.00	6767.5
Natural luciferase	N/A	N/A	N/A	133,853.5
Mock	N/A	N/A	N/A	340
Untreated	N/A	N/A	N/A	238

**Table 118. Rabbit Reticulysates**

Chemical Modification	RLU
2'Fluoroadenosine	162

2'Fluorocytosine	208
2'Fluoroguanine	371,509
2'Fluorouridine	258
Natural luciferase	2,159,968
No RNA	156

**Example 76. Luciferase in HeLa Cells using a combination of modifications**

[0001521] To evaluate using of 2'fluoro-modified mRNA in combination with other modification a series of mRNA were transcribed using either wild-type T7 polymerase (non-fluoro-containing compounds) or using mutant T7 polymerases (fluyoro-containing compounds) as described in Example 75. All modified mRNA were tested by in vitro transfection in HeLa cells.

[0001522] The day before transfection, 20,000 HeLa cells (ATCC no. CCL-2; Manassas, VA) were harvested by treatment with Trypsin-EDTA solution (LifeTechnologies, Grand Island, NY) and seeded in a total volume of 100ul EMEM medium (supplemented with 10%FCS and 1x Glutamax) per well in a 96-well cell culture plate (Corning, Manassas, VA). The cells were grown at 37oG in 5% CO<sub>2</sub> atmosphere overnight. Next day, 83 ng of Luciferase modified RNA (mRNA sequence shown in SEQ ID NO: 5665; polyA tail of approximately 160 nucleotides not shown in sequence; 5'cap, Cap1) with the chemical modification described in Table 119, were diluted in 10ul final volume of OPTI-MEM (LifeTechnologies, Grand Island, NY). Lipofectamine 2000 (LifeTechnologies, Grand Island, NY) was used as transfection reagent and 0.2 ul were diluted in 10 ul final volume of OPTI-MEM. After 5 minutes of incubation at room temperature, both solutions were combined and incubated an additional 15 minute at room temperature. Then the 20ul combined solution was added to the 100ul cell culture medium containing the HeLa cells and incubated at room temperature.

[0001523] After 18 to 22 hours of incubation cells expressing luciferase were lysed with 100 ul of Passive Lysis Buffer (Promega, Madison, WI) according to manufacturer instructions. Aliquots of the lysates were transferred to white opaque polystyrene 96-well plates (Coming, Manassas, VA) and combined with 100 ul complete luciferase assay solution (Promega, Madison, WI). The lysate volumes were adjusted or diluted until no more than 2 mio relative light units (RLU) per well were detected for the strongest signal producing samples and the RLUs for each chemistry tested are shown in Table 119. The

plate reader was a BioTek Synergy HI (BioTek, Winooski, VT). The background signal of the plates without reagent was about 200 relative light units per well.

[0001524] As evidenced in Table 119, most combinations of modifications resulted in mRNA which produced functional luciferase protein, including all the non-fluoro containing compounds and many of the combinations containing 2' fluoro modifications.

**Table 119. Luciferase**

<b>Chemical Modification</b>	<b>RLU</b>
N4-acetylcytidine/pseudouridine	113,796
N4-acetylcytidine/N1-methyl-pseudouridine	316,326
5-methylcytidine/5-methoxyuridine	24,948
5-methylcytidine/5-methyluridine	43,675
5-methylcytidine/half of the uridines modified with 50% 2-thiouridine	41,601
5-methylcytidine/2-thiouridine	1,102
5-methylcytidine/pseudouridine	51,035
5-methylcytidine/N1 methyl pseudouridine	152,151
N4-acetylcytidine/2'Fluorouridine triphosphate	288
5-methylcytidine/2'Fluorouridine triphosphate	269
2'Fluorocytosine triphosphate /pseudouridine	260
2'Fluorocytosine triphosphate /N1-methyl-pseudouridine	412
2'Fluorocytosine triphosphate/2-thiouridine	427
2'Fluorocytosine triphosphate/5-bromouridine	253
2'Fluorocytosine triphosphate /2'Fluorouridine triphosphate	184
2'Fluoroguanine triphosphate/5-methylcytidine	321
2'Fluoroguanine triphosphate/5-methylcytidine/Pseudouridine	207
2'Fluoroguanine /5-methylcytidine/N1 methylpsuedouridine	235
2'Fluoroguanine/pseudouridine	218
2'Fluoroguanine/N1-methylpsuedouridine	247
5-methylcytidine/pseudouridine, test A	13,833
5-methylcytidine/N-methyl-pseudouridine, test A	598
2'Fluorocytosine triphosphate	201
2'F luorouridine triphosphate	305
5-methylcytidine/pseudouridine, test B	115,401
5-methylcytidine/N-methyl-pseudouridine, test B	21,034
Natural luciferase	30,801
Untreated	344
Mock	262

**Example 77. G-CSF *In Vitro* Transcription**

[0001525] To assess the activity of all our different chemical modifications in the context of a second open reading frame, we replicated experiments previously conducted using luciferase mRNA, with human G-CSF mRNA. G-CSF mRNA (mRNA sequence shown



in SEQ ID NO: 5655; polyA tail of approximately 160 nucleotides not shown in sequence; 5'cap, Cap1) were fully modified with the chemistries in Tables 120 and 121 using wild-type T7 polymerase (for all non-fluoro-containing compounds) or mutant T7 polymerase (for all fluoro-containing compounds). The mutant T7 polymerase was obtained commercially (Durascribe® T7 Transcription kit (Cat. No. DS010925) (Epicentre®, Madison, WI).

[0001526] The modified RNA in Tables 120 and 121 were transfected *in vitro* in HeLa cells or added to rabbit reticulysates (250ng of modified mRNA) as indicated. A control of untreated, mock transfected (transfection reagent alone), G-CSF fully modified with 5-methylcytosine and N1-methyl-pseudouridine or luciferase control (mRNA sequence shown in SEQ ID NO: 5665; polyA tail of approximately 160 nucleotides not shown in sequence; 5'cap, Cap1) fully modified with 5-methylcytosine and N1-methyl-pseudouridine were also analyzed. The expression of G-CSF protein was determined by ELISA and the values are shown in Tables 120 and 121. In Table 120, "NT" means not tested.

[0001527] As shown in Table 120, many, but not all, chemical modifications resulted in human G-CSF protein production. These results from cell-based and cell-free translation systems correlate very nicely with the same modifications generally working or not working in both systems. One notable exception is 5-formylcytidine modified G-CSF mRNA which worked in the cell-free translation system, but not in the HeLa cell-based transfection system. A similar difference between the two assays was also seen with 5-formylcytidine modified luciferase mRNA.

[0001528] As demonstrated in Table 121, many, but not all, G-CSF mRNA modified chemistries (when used in combination) demonstrated *in vivo* activity. In addition the presence of N1-methyl-pseudouridine in the modified mRNA (with N4-acetylcytidine or 5 methylcytidine) demonstrated higher expression than when the same combinations were tested using with pseudouridine. Taken together, these data demonstrate that N1-methyl-pseudouridine containing G-CSF mRNA results in improved protein expression *in vitro*.

**Table 120. G-CSF Expression**

Chemical Modification	G-CSF protein	G-CSF protein
-----------------------	---------------	---------------

	(pg/ml) HeLa cells	(pg/ml) Rabbit reticulysates cells
Pseudouridine	1,150,909	147,875
5-methyluridine	347,045	147,250
2-thiouridine	417,273	18,375
N1-methyl-pseudouridine	NT	230,000
4-thiouridine	107,273	52,375
5-methoxyuridine	1,715,909	201,750
5-methylcytosine/pseudouridine, Test A	609,545	119,750
5-methylcytosine/N1-methyl-pseudouridine , Test A	1,534,318	110,500
2'-Fluoro-guanosine	11,818	0
2'-Fluoro-uridine	60,455	0
5-methylcytosine/pseudouridine, Test B	358,182	57,875
5-methylcytosine/N1-methyl-pseudouridine , Test B	1,568,636	76,750
5-Bromo-uridine	186,591	72,000
5-(2-carbomethoxyvinyl) uridine	1,364	0
5-[3(1-E-propenylamino) uridine	27,955	32,625
a-thio-cytidine	120,455	42,625
5-methylcytosine/pseudouridine, Test C	882,500	49,250
N1-methyl-adenosine	4,773	0
N6-methyl-adenosine	1,591	0
5-methyl-cytidine	646,591	79,375
N4-acetylcytidine	39,545	8,000
5-formyl-cytidine	0	24,000
5-methylcytosine/pseudouridine, Test D	87,045	47,750
5-methylcytosine/N1-methyl-pseudouridine , Test D	1,168,864	97,125
Mock	909	682
Untreated	0	0
5-methylcytosine/N1-methyl-pseudouridine , Control	1,106,591	NT
Luciferase control	NT	0

Table 121. Combination Chemistries in HeLa cells

Chemical Modification	G-CSF protein (pg/ml) HeLa cells
N4-acetylcytidine/pseudouridine	537,273
N4-acetylcytidine/N1-methyl-pseudouridine	1,091,818
5-methylcytidine/5-methoxyuridine	516,136
5-methylcytidine/5-bromouridine	48,864
5-methylcytidine/5-methyluridine	207,500

5-methylcytidine/2-thiouridine	33,409
N4-acetylcytidine/5-bromouridine	2 11,591
N4-acetylcytidine/2-thiouridine	46,136
5-methylcytosine/pseudouridine	301,364
5-methylcytosine/N 1-methyl-pseudouridine	1,017,727
N4-acetylcytidine/2'Fluorouridine triphosphate	62,273
5-methylcytidine/2'Fluorouridine triphosphate	49,318
2'Fluorocytosine triphosphate/pseudouridine	7,955
2'Fluorocytosine triphosphate/N 1-methyl-pseudouridine	1,364
2'Fluorocytosine triphosphate/2-thiouridine	0
2'Fluorocytosine triphosphate/5-bromouridine	1,818
2'Fluorocytosine triphosphate/2'Fluorouridine triphosphate	909
2'Fluoroguanine triphosphate/5-methylcytidine	0
2'Fluoroguanine triphosphate/5-methylcytidine/pseudouridine	0
2'Fluoroguanine triphosphate /5-methylcytidine/N 1 methyl-pseudouridine	1,818
2'Fluoroguanine triphosphate/pseudouridine	1,136
2'Fluoroguanine triphosphate/2 'Fluorocytosine triphosphate/N 1-methyl-pseudouridine	0
5-methylcytidine/pseudouridine	617,727
5-methylcytidine/N 1-methyl-pseudouridine	747,045
5-methylcytidine/pseudouridine	475,455
5-methylcytidine/N 1-methyl-pseudouridine	689,091
5-methylcytosine/N 1-methyl-pseudouridine, Control 1	848,409
5-methylcytosine/N 1-methyl-pseudouridine, Control 2	581,818
Mock	682
Untreated	0
Luciferase 2'Fluorocytosine triphosphate	0
Luciferase 2'Fluorouridine triphosphate	0

### **Example 78. Screening of Chemistries**

[0001529] The tables listed in below (Tables 122-124) summarize much of the *in vitro* and *in vitro* screening data with the different compounds presented in the previous examples. A good correlation exists between cell-based and cell-free translation assays. The same chemistry substitutions generally show good concordance whether tested in the context of luciferase or G-CSF mRNA. Lastly, N1-methyl-pseudouridine containing mRNA show a very high level of protein expression with little to no detectable cytokine stimulation *in vitro* and *in vivo*, and is superior to mRNA containing pseudouridine both *in vitro* and *in vivo*.

[0001530] Luciferase mRNA (mRNA sequence shown in SEQ ID NO: 5665; polyA tail of approximately 160 nucleotides not shown in sequence; 5'cap, Cap1) and G-CSF mRNA (mRNA sequence shown in SEQ ID NO: 5655; polyA tail of approximately 160

nucleotides not shown in sequence; 5'cap, Cap1) were modified with naturally and non-naturally occurring chemistries described in Tables 122 and 123 or combination chemistries described in Table 124 and tested using methods described herein.

[0001531] In Tables 122 and 123, "\*" refers to *in vitro* transcription reaction using a mutant T7 polymerase (Durascribe® T7 Transcription kit (Cat. No. DSO 10925) (Epicentre®, Madison, WI); "\*\*\*" refers to the second result *in vitro* transcription reaction using a mutant T7 polymerase (Durascribe® T7 Transcription kit (Cat. No. DS010925) (Epicentre®, Madison, WI); "\*\*\*\*" refers to production seen in cell free translations (rabbit reticulocyte lysates); the protein production of HeLa is judged by "+," "+/-" and "-"; when referring to G-CSF PBMC "++++" means greater than 6,000 pg/ml G-CSF, "+++" means greater than 3,000 pg/ml G-CSF, "++" means greater than 1,500 pg/ml G-CSF, "+" means greater than 300 pg/ml G-CSF, "+/-" means 150-300 pg/ml G-CSF and the background was about 110 pg/ml; when referring to cytokine PBMC "++++" means greater than 1,000 pg/ml interferon-alpha (IFN-alpha), "+++" means greater than 600 pg/ml IFN-alpha, "++" means greater than 300 pg/ml IFN-alpha, "+" means greater than 100 pg/ml IFN-alpha, "-" means less than 100 pg/ml and the background was about 70 pg/ml; and "NT" means not tested. In Table 123, the protein production was evaluated using a mutant T7 polymerase (Durascribe® T7 Transcription kit (Cat. No. DS010925) (Epicentre®, Madison, WI).

**Table 122. Naturally Occurring**

Common Name (symbol)	IVT (Luc)	IVT (G-CSF)	Protein (Luc; HeLa)	Protein (G-CSF; HeLa)	Protein (G-CSF; PBMC)	Cytokines (G-CSF; PBMC)	In Vivo Protein (Luc)	In Vivo Protein (G-CSF)
1-methyladenosine (m <sup>1</sup> A)	Fail	Pass	NT	-	+/-	++	NT	NT
N <sup>6</sup> -methyladenosine (m <sup>6</sup> A)	Pass	Pass	-	-	+/-	++++	NT	NT
2'-O-methyladenosine (Am)	Fail*	Not Done	NT	NT	NT	NT	NT	NT
5-methylcytidine (m <sup>5</sup> C)	Pass	Pass	+	+	+	++	+	NT
2'-O-methylcytidine (Cm)	Fail*	Not Done	NT	NT	NT	NT	NT	NT
2-thiocytidine (s <sup>2</sup> C)	Fail	Fail	NT	NT	NT	NT	NT	NT
N <sup>4</sup> -acetylcytidine	Pass	Pass	+	+	+/-	+++	+	NT

(ac <sup>4</sup> C)									
5-formylcytidine (f <sup>5</sup> C)	Pass	Pass	***	***	-	+	NT	NT	
2'-O-methylguanosine (Gm)	Fail*	Not Done	NT	NT	NT	NT	NT	NT	
inosine (I)	Fail	Fail	NT	NT	NT	NT	NT	NT	
pseudouridine (Y)	Pass	Pass	+	+	++	+	+	NT	
5-methyluridine (m <sup>5</sup> U)	Pass	Pass	+	+	+/-	+	NT	NT	
2'-O-methyluridine (Um)	Fail*	Not Done	NT	NT	NT	NT	NT	NT	
1-methylpseudouridine (m <sup>1</sup> Y)	Pass	Pass	+	Not Done	++++	-	+	NT	
2-thiouridine (s <sup>2</sup> U)	Pass	Pass	-	+	+	+	NT	NT	
4-thiouridine (s <sup>4</sup> U)	Fail	Pass		+	+/-	++	NT	NT	
5-methoxyuridine (mo <sup>5</sup> U)	Pass	Pass	+	+	++	-	+	NT	
3-methyluridine (m <sup>3</sup> U)	Fail	Fail	NT	NT	NT	NT	NT	NT	

Table 123. Non-Naturally Occurring

Common Name	IVT (Luc)	IVT (G-CSF)	Protein (Luc; HeLa)	Protein (G-CSF; HeLa)	Protein (G-CSF; PBMC)	Cytokines (G-CSF; PBMC)	In Vivo Protein (Luc)	In Vivo Protein (G-CSF)
2'-F-ara-guanosine	Fail	Fail	NT	NT	NT	NT	NT	NT
2'-F-ara-adenosine	Fail	Fail	NT	NT	NT	NT	NT	NT
2'-F-ara-cytidine	Fail	Fail	NT	NT	NT	NT	NT	NT
2'-F-ara-uridine	Fail	Fail	NT	NT	NT	NT	NT	NT
2'-F-guanosine	Fail/Pass**	Pass/Fail**	***	+/-	-	+	+	NT
2'-F-adenosine	Fail/Pass**	Fail/Fail**	***	NT	NT	NT	NT	NT
2'-F-cytidine	Fail/Pass**	Fail/Pass**	***	NT	NT	NT	+	NT
2'-F-uridine	Fail/Pass**	Pass/Pass**	***	+	+/-	+	-	NT
2'-OH-ara-guanosine	Fail	Fail	NT	NT	NT	NT	NT	NT
2'-OH-ara-adenosine	Not Done	Not Done	NT	NT	NT	NT	NT	NT
2'-OH-ara-cytidine	Fail	Fail	NT	NT	NT	NT	NT	NT
2'-OH-ara-uridine	Fail	Fail	NT	NT	NT	NT	NT	NT
5-Br-Uridine	Pass	Pass	+	+	+	+	+	
5-(2-carbomethoxyvinyl)	Pass	Pass	-	-	+/-	-		

Uridine								
5-[3-(1-E-Propenylamino) Uridine (aka Chem 5)]	Pass	Pass	-	+	+	-		
N6-(19-Amino-pentaoxanonadecyl) A	Fail	Fail	NT	NT	NT	NT	NT	NT
2-Dimethylamino guanosine	Fail	Fail	NT	NT	NT	NT	NT	NT
6-Aza-cytidine	Fail	Fail	NT	NT	NT	NT	NT	NT
$\alpha$ -Thio-cytidine	Pass	Pass	+	+	+/-	+++	NT	NT
Pseudo-isocytidine	NT	NT	NT	NT	NT	NT	NT	NT
5-Iodo-uridine	NT	NT	NT	NT	NT	NT	NT	NT
$\alpha$ -Thio-uridine	NT	NT	NT	NT	NT	NT	NT	NT
6-Aza-uridine	NT	NT	NT	NT	NT	NT	NT	NT
Deoxy-thymidine	NT	NT	NT	NT	NT	NT	NT	NT
$\alpha$ -Thio guanosine	NT	NT	NT	NT	NT	NT	NT	NT
8-Oxo-guanosine	NT	NT	NT	NT	NT	NT	NT	NT
O6-Methyl-guanosine	NT	NT	NT	NT	NT	NT	NT	NT
7-Deaza-guanosine	NT	NT	NT	NT	NT	NT	NT	NT
6-Chloro-purine	NT	NT	NT	NT	NT	NT	NT	NT
$\alpha$ -Thio-adenosine	NT	NT	NT	NT	NT	NT	NT	NT
7-Deaza-adenosine	NT	NT	NT	NT	NT	NT	NT	NT
5-iodo-cytidine	NT	NT	NT	NT	NT	NT	NT	NT

In Table 124, the protein production of HeLa is judged by "+," "+/-" and "-"; when referring to G-CSF PBMC "++++" means greater than 6,000 pg/ml G-CSF, "+++" means greater than 3,000 pg/ml G-CSF, "++" means greater than 1,500 pg/ml G-CSF, "+" means greater than 300 pg/ml G-CSF, "+/-" means 150-300 pg/ml G-CSF and the background was about 110 pg/ml; when referring to cytokine PBMC "++++" means greater than 1,000 pg/ml interferon-alpha (IFN-alpha), "+++" means greater than 600 pg/ml IFN-alpha, "++" means greater than 300 pg/ml IFN-alpha, "+" means greater than 100 pg/ml IFN-alpha, "-" means less than 100 pg/ml and the background was about 70 pg/ml; "WT" refers to the wild type T7 polymerase, "MT" refers to mutant T7 polymerase (Durascribe® T7 Transcription kit (Cat. No. DSO 10925) (Epicentre®, Madison, WI) and "NT" means not tested.

**Table 124. Combination Chemistry**

Cytidine analog	Uridine analog	Purine	IVT Luc	IVT (G-CSF)	Protein (Luc; HeLa)	Protein (G-CSF; HeLa)	Protein (G-CSF; PBMC)	Cytokines (G-CSF; PBMC)	In Vivo Protein (Luc)
N4-acetylcytidine	pseudouridi	A,G	Pass	Pass	+	+	NT	NT	+

	ne		WT	WT					
N4-acetylcytidine	N1-methylpseudouridine	A,G	Pass WT	Pass WT	+	+	NT	NT	+
5-methylcytidine	5-methoxyuridine	A,G	Pass WT	Pass WT	+	+	NT	NT	+
5-methylcytidine	5-bromouridine	A,G	Pass WT	Pass WT	Not Done	+	NT	NT	
5-methylcytidine	5-methyluridine	A,G	Pass WT	Pass WT	+	+	NT	NT	+
5-methylcytidine	50% 2-thiouridine; 50% uridine	A,G	Pass WT	Pass WT	+	NT	NT	NT	+
5-methylcytidine	100% 2-thiouridine	A,G	Pass WT	Pass WT	-	+	NT	NT	
5-methylcytidine	pseudouridine	A,G	Pass WT	Pass WT	+	+	++	+	+
5-methylcytidine	N1-methylpseudouridine	A,G	Pass WT	Pass WT	+	+	++++	-	+
N4-acetylcytidine	2-thiouridine	A,G	Not Done	Pass WT	Not Done	+	NT	NT	NT
N4-acetylcytidine	5-bromouridine	A, G	Not Done	Pass WT	Not Done	+	NT	NT	NT
N4-acetylcytidine	2-Fluorouridine triphosphate	A,G	Pass	Pass	-	+	NT	NT	NT
5-methylcytidine	2-Fluorouridine triphosphate	A,G	Pass	Pass	-	+	NT	NT	NT
2 Fluorocytosine triphosphate	pseudouridine	A,G	Pass	Pass	-	+	NT	NT	NT
2 Fluorocytosine triphosphate	N1-methylpseudouridine	A,G	Pass	Pass	-	+/-	NT	NT	NT
2 Fluorocytosine triphosphate	2-thiouridine	A,G	Pass	Pass	-	-	NT	NT	NT
2 Fluorocytosine triphosphate	5-bromouridine	A,G	Pass	Pass	-	+/-	NT	NT	NT
2 Fluorocytosine triphosphate	2-Fluorouridine triphosphate	A,G	Pass	Pass	-	+/-	NT	NT	NT
5-methylcytidine	uridine	A,2 Fluoro	Pass	Pass	-	-	NT	NT	NT
5-methylcytidine	pseudouridine	A,2 Fluoro	Pass	Pass	-	-	NT	NT	NT

		GTP							
5-methylcytidine	N1-methyl-pseudouridine	A,2 Fluoro GTP	Pass	Pass	-	+/-	NT	NT	NT
2 Fluorocytosine triphosphate	pseudouridine	A,2 Fluoro GTP	Pass	Pass	-	+/-	NT	NT	NT
2 Fluorocytosine triphosphate	N1-methyl-pseudouridine	A,2 Fluoro GTP	Pass	Pass	-	-	NT	NT	NT

### **Example 79. 2'Fluoro Chemistries in PBMC**

[0001532] The ability of G-CSF modified mRNA (mRNA sequence shown in SEQ ID NO: 5655; polyA tail of approximately 160 nucleotides not shown in sequence; 5'cap, Cap1) to trigger innate an immune response was determined by measuring interferon-alpha (IFN-alpha) and tumor necrosis factor-alpha (TNF-alpha) production. Use of *in vitro* PBMC cultures is an accepted way to measure the immunostimulatory potential of oligonucleotides (Robbins et al, Oligonucleotides 2009 19:89-102) and transfection methods are described herein. Shown in Table 125 are the average from 2 or 3 separate PBMC donors of the interferon-alpha (IFN-alpha) and tumor necrosis factor alpha (TNF-alpha) production over time as measured by specific ELISA. Controls of R848, P(I)P(C), LPS and Lipofectamine 2000 (L2000) were also analyzed.

[0001533] With regards to innate immune recognition, while both modified mRNA chemistries largely prevented IFN-alpha and TNF-alpha production relative to positive controls (R848, P(I)P(C)), 2'fluoro compounds reduce IFN-alpha and TNF-alpha production even lower than other combinations and N4-acetylcytidine combinations raised the cytokine profile.

**Table 125. IFN-alpha and TNF-alpha**

	<b>IFN-alpha: 3 Donor Average (pg/ml)</b>	<b>TNF-alpha: 2 Donor Average (pg/ml)</b>
L2000	1	361
P(I)P(C)	482	544
R848	45	8,235
LPS	0	6,889
N4-acetylcytidine/pseudouridine	694	528
N4-acetylcytidine/N1-methyl-pseudouridine	307	283
5-methylcytidine/5-methoxyuridine	0	411
5-methylcytidine/5-bromouridine	0	270
5-methylcytidine/5-methyluridine	456	428



5-methylcytidine/2-thiouridine	274	277
N4-acetylcytidine/2-thiouridine	0	285
N4-acetylcytidine/5-bromouridine	44	403
5-methylcytidine/pseudouridine	73	332
5-methylcytidine/N1-methyl-pseudouridine	31	280
N4-acetylcytidine/2 'fluorouridine triphosphate	35	32
5-methylcytidine <i>IT</i> fluorouridine triphosphate	24	0
2'fluorocytidine triphosphate/N 1-methyl-pseudouridine	0	11
2'fluorocytidine triphosphate/2 -thiouridine	0	0
2'fluorocytidine/ triphosphates -bromouridine	12	2
2'fluorocytidine triphosphate/2 'fluorouridine triphosphate	11	0
2'fluorocytidine triphosphate/5 -methylcytidine	14	23
2'fluorocytidine triphosphate/5-methylcytidine/pseudouridine	6	21
2'fluorocytidine triphosphate/5-methylcytidine/N 1-methyl-pseudouridine	3	15
2'fluorocytidine triphosphate/pseudouridine	0	4
2'fluorocytidine triphosphate/TSil -methyl-pseudouridine	6	20
5-methylcytidine/pseudouridine	82	18
5-methylcytidine/N1 -methyl-pseudouridine	35	3

### **Example 80. Modified mRNA with a Tobacco Etch Virus 5'UTR**

[0001534] A 5' untranslated region (UTR) may be provided as a flanking region.

Multiple 5' UTRs may be included in the flanking region and may be the same or of different sequences. Any portion of the flanking regions, including none, may be codon optimized and any may independently contain one or more different structural or chemical modifications, before and/or after codon optimization.

[0001535] The 5' UTR may comprise the 5'UTR from the tobacco etch virus (TEV).

Variants of 5' UTRs may be utilized wherein one or more nucleotides are added or removed to the termini, including A, T, C or G.

### **Example 81. Expression of PLGA Formulated mRNA**

#### A. Synthesis and Characterization of Luciferase PLGA Microspheres

[0001536] Luciferase mRNA (mRNA sequence shown in SEQ ID NO: 5655; polyA tail of approximately 140 nucleotides not shown in sequence; 5'cap, Cap1) fully modified with 5-methylcytosine and N1-methyl pseudouridine, modified with 25% of uridine replaced with 2-thiouridine and 25% of cytosine replaced with 5-methylcytosine, fully modified with N1-methyl pseudouridine, or fully modified with pseudouridine was

reconstituted in 1x TE buffer and then formulated in PLGA microspheres. PLGA microspheres were synthesized using the water/oil/water double emulsification methods known in the art using PLGA-ester cap (Lactel, Cat# B6010-2, inherent viscosity 0.55-0.75, 50:50 LA:GA), polyvinylalcohol (PVA) (Sigma, Cat# 348406-25G, MW 13-23k) dichloromethane and water. Briefly, 0.4 ml of mRNA in TE buffer at 4 mg/ml (W1) was added to 2 ml of PLGA dissolved in dichloromethane (DCM) (01) at a concentration of 200 mg/ml of PLGA. The W1/O1 emulsion was homogenized (IKA Ultra-Turrax Homogenizer, T18) for 30 seconds at speed 5 (-19,000 rpm). The W1/O1 emulsion was then added to 250 ml 1% PVA (W2) and homogenized for 1 minute at speed 5 (-19,000 rpm). Formulations were left to stir for 3 hours, then passed through a 100 µm nylon mesh strainer (Fisherbrand Cell Strainer, Cat # 22-363-549) to remove larger aggregates, and finally washed by centrifugation (10 min, 9,250 rpm, 4°C). The supernatant was discarded and the PLGA pellets were resuspended in 5-10 ml of water, which was repeated 2x. After washing and resuspension with water, 100-200 µl of a PLGA microspheres sample was used to measure particle size of the formulations by laser diffraction (Malvern Mastersizer2000). The washed formulations were frozen in liquid nitrogen and then lyophilized for 2-3 days.

[0001537] After lyophilization, -10 mg of PLGA MS were weighed out in 2 ml eppendorf tubes and deformed by adding 1 ml of DCM and letting the samples shake for 2-6 hrs. The mRNA was extracted from the deformed PLGA microspheres by adding 0.5 ml of water and shaking the sample overnight. Unformulated luciferase mRNA in TE buffer (unformulated control) was spiked into DCM and went through the deformation process (deformation control) to be used as controls in the transfection assay. The encapsulation efficiency, weight percent loading and particle size are shown in Table 126. Encapsulation efficiency was calculated as mg of mRNA from deformation of PLGA microspheres divided by the initial amount of mRNA added to the formulation. Weight percent loading in the formulation was calculated as mg of mRNA from deformation of PLGA microspheres divided by the initial amount of PLGA added to the formulation.

**Table 126. PLGA Characteristics**

Chemical Modifications	Sample ID	Encapsulation Efficiency (%)	Theoretical mRNA	Actual mRNA	Particle Size (D50,
------------------------	-----------	------------------------------	------------------	-------------	---------------------

			Loading (wt %)	Loading (wt %)	um
Fully modified with 5-methylcytosine and N1-methyl pseudouridine	43-66A	45.8	0.4	0.18	33.4
	43-66B	29.6		0.12	27.7
	43-66C	25.5		0.10	27.1
25% of uridine replaced with 2-thiouridine and 25% of cytosine replaced with 5-methylcytosine	43-67A	34.6	0.4	0.14	29.9
	43-67B	22.8		0.09	30.2
	43-67C	23.9		0.10	25.1
Fully modified with N1-methyl pseudouridine	43-69A	55.8	0.4	0.22	40.5
	43-69B	31.2		0.12	41.1
	43-69C	24.9		0.10	46.1
Fully modified with pseudouridine	43-68-1	49.3	0.4	0.20	34.8
	43-68-2	37.4		0.15	35.9
	43-68-3	45.0		0.18	36.5

#### B. Protein Expression of modified mRNA Encapsulated in PLGA Microspheres

**[0001538]** The day before transfection, 20,000 HeLa cells (ATCC no. CCL-2; Manassas, VA) were harvested by treatment with Trypsin-EDTA solution (LifeTechnologies, Grand Island, NY) and seeded in a total volume of 100ul EMEM medium (supplemented with 10%FCS and 1x Glutamax) per well in a 96-well cell culture plate (Corning, Manassas, VA). The cells were grown at 37oC in a 5% CO<sub>2</sub> atmosphere overnight. The next day, 83 ng of the deformed luciferase mRNA PLGA microsphere samples, deformed luciferase mRNA control (Deform control), or unformulated luciferase mRNA control (Unformul control) was diluted in a 10ul final volume of OPTI-MEM (LifeTechnologies, Grand Island, NY). Lipofectamine 2000 (LifeTechnologies, Grand Island, NY) was used as a transfection reagent and 0.2ul was diluted in a 10ul final volume of OPTI-MEM. After 5min of incubation at room temperature, both solutions were combined and incubated an additional 15min at room temperature. Then 20ul of the combined solution was added to 100ul of cell culture medium containing the HeLa cells. The plates were then incubated as described before.

**[0001539]** After an 18 to 22 hour incubation, cells expressing luciferase were lysed with 100ul Passive Lysis Buffer (Promega, Madison, WI) according to manufacturer instructions. Aliquots of the lysates were transferred to white opaque polystyrene 96-well plates (Coming, Manassas, VA) and combined with 100ul complete luciferase assay solution (Promega, Madison, WI). The background signal of the plates without reagent was about 200 relative light units per well. The plate reader was a BioTek Synergy HI (BioTek, Winooski, VT).

Cells were harvested and the bioluminescence (in relative light units, RLU) for each sample is shown in Table 127. Transfection of these samples confirmed that the varied chemistries of luciferase mRNA is still able to express luciferase protein after PLGA microsphere formulation.

**Table 127. Chemical Modifications**

<b>Chemical Modifications</b>	<b>Sample ID</b>	<b>Biolum. (RLU)</b>
Fully modified with 5-methylcytosine and N1-methyl pseudouridine	Deform control	164266.5
	Unformul control	113714
	43-66A	25174
	43-66B	25359
	43-66C	20060
25% of uridine replaced with 2-thiouridine and 25% of cytosine replaced with 5-methylcytosine	Deform control	90816.5
	Unformul control	129806
	43-67A	38329.5
	43-67B	8471.5
	43-67C	10991.5
Fully modified with N1-methyl pseudouridine	Deform control	928093.5
	Unformul control	1512273.5
	43-69A	1240299.5
	43-69B	748667.5
	43-69C	1193314
Fully modified with pseudouridine	Deform control	154168
	Unformul control	151581
	43-68-1	120974.5
	43-68-2	107669
	43-68-3	97226

**Example 82. In vitro studies of Factor IX**

**A. Serum-Free Media**

[0001540] Human Factor IX mRNA (mRNA sequence shown in SEQ ID NO: 5659; polyA tail of approximately 160 nucleotides not shown in sequence; 5'cap, CapI; fully modified with 5-methylcytosine and pseudouridine) was transfected in serum-free media. The cell culture supernatant was collected and subjected to trypsin digestion before undergoing 2-dimensional HPLC separation of the peptides. Matrix-assisted laser desorption/ionization was used to detect the peptides. 8 peptides were detected and 7 of

the detected peptides are unique to Factor IX. These results indicate that the mRNA transfected in the serum-free media was able to express full-length Factor IX protein.

**B. Human Embryonic Kidney (HEK) 293A Cells**

[0001541] 250 ng of codon optimized Human Factor IX mRNA (mRNA sequence shown in SEQ ID NO: 5659; fully modified with 5-methylcytosine and pseudouridine; polyA tail of approximately 160 nucleotides not shown in sequence; 5'cap, Cap1) was transfected into HEK 293A cells (150, 000 cells/well) using Lipofectamine 2000 in DMEM in presence of 10% FBS. The transfection complexes were removed 3 hours after transfection. Cells were harvested at 3, 6, 9, 12, 24, 48 and 72 hours after transfection. Total RNA was isolated and used for cDNA synthesis. The cDNA was subjected to analysis by quantitative Real-Time PCR using codon optimized Factor IX specific primer set. Human hypoxanthine phosphoribosyltransferase 1 (HPRT) level was used for normalization. The data is plotted as a percent of detectable mRNA considering the mRNA level as 100% at the 3 hour time point. The half-life of Factor IX modified mRNA fully modified with 5-methylcytosine and pseudouridine in human embryonic kidney 293 (HEK293) cells is about 8-10 hours.

**Example 83. Saline formulation: Subcutaneous Administration**

[0001542] Human G-CSF modified mRNA (mRNA sequence shown in SEQ ID NO: 5655; polyA tail of approximately 160 nucleotides not shown in sequence; 5'cap, Cap1; fully modified with 5-methylcytosine and pseudouridine) and human EPO modified mRNA (mRNA sequence shown in SEQ ID NO: 5658; polyA tail of approximately 160 nucleotides not shown in sequence; 5'cap, Cap1; fully modified with 5-methylcytosine and pseudouridine), were formulated in saline and delivered to mice via intramuscular (IM) injection at a dose of 100 ug.

[0001543] Controls included Luciferase (mRNA sequence shown in SEQ ID NO: 5665; polyA tail of approximately 160 nucleotides not shown in sequence; 5'cap, Cap1; fully modified with 5-methylcytosine and pseudouridine) or the formulation buffer (F.Buffer). The mice were bled at 13 hours after the injection to determine the concentration of the human polypeptide in serum in pg/mL. (G-CSF groups measured human G-CSF in mouse serum and EPO groups measured human EPO in mouse serum). The data are shown in Table 128.

[0001544] mRNA degrades rapidly in serum in the absence of formulation suggesting the best method to deliver mRNA to last longer in the system is by formulating the mRNA. As shown in Table 128, mRNA can be delivered subcutaneously using only a buffer formulation.

**Table 128. Dosing Regimen**

Group	Treatment	Dose Vol. (µl/mouse)	Dosing Vehicle	Average Protein Product pg/mL, serum
G-CSF	G-CSF	100	F. buffer	45
G-CSF	Luciferase	100	F. buffer	0
G-CSF	F. buffer	100	F. buffer	2.2
EPO	EPO	100	F. buffer	72.03
EPO	Luciferase	100	F. buffer	26.7
EPO	F. buffer	100	F. buffer	13.05

**Example 84. Intravitreal Delivery**

[0001545] mCherry modified mRNA (mRNA sequence shown in SEQ ID NO: 5656; polyA tail of approximately 160 nucleotides not shown in sequence; 5'cap, Cap1; fully modified with 5-methylcytosine and pseudouridine) and luciferase modified mRNA (mRNA sequence shown in SEQ ID NO: 5665; polyA tail of approximately 160 nucleotides not shown in sequence; 5'cap, Cap1; fully modified with 5-methylcytosine and pseudouridine) formulated in saline was delivered intravitreally in rats as described in Table 129. The sample was compared against a control of saline only delivered intravitreally.

**Table 129. Dosing Chart**

Group No.	Dose Level (µg modified RNA/eye)	Dose volume (µL/eye)	Treatment	
			Right Eye (OD)	Left Eye (OS)
Control	0	5	Delivery buffer only	Delivery buffer only
Modified RNA in delivery buffer	10	5	mCherry	Luciferase

[0001546] The formulation will be administered to the left or right eye of each animal on day 1 while the animal is anesthetized. On the day prior to administration gentamicin

ophthalmic ointment or solution was applied to both eyes twice. The gentamicin ophthalmic ointment or solution was also applied immediately following the injection and on the day following the injection. Prior to dosing, mydriatic drops (1% tropicamide and/or 2.5% phenylephrine) are applied to each eye.

[0001547] 18 hours post dosing the eyes receiving the dose of mCherry and delivery buffer are enucleated and each eye was separately placed in a tube containing 10 mL 4% paraformaldehyde at room temperature for overnight tissue fixation. The following day, eyes will be separately transferred to tubes containing 10 mL of 30% sucrose and stored at 21°C until they were processed and sectioned. The slides prepared from different sections were evaluated under F-microscopy. Positive expression was seen in the slides prepared with the eyes administered mCherry modified mRNA and the control showed no expression.

**Example 85. In Vivo Cytokine Expression Study**

[0001548] Mice were injected intramuscularly with 200 ug of G-CSF modified mRNA (mRNA sequence shown in SEQ ID NO: 5655; polyA tail of approximately 160 nucleotides not shown in sequence) which was unmodified with a 5'cap, Cap1 (unmodified), fully modified with 5-methylcytosine and pseudouridine and a 5'cap, Cap1 (Gen1) or fully modified with 5-methylcytosine and N1-methyl-pseudouridine and a 5'cap, Cap1 (Gen2 cap) or no cap (Gen2 uncapped). Controls of R-848, 5% sucrose and untreated mice were also analyzed. After 8 hours serum was collected from the mice and analyzed for interferon-alpha (IFN-alpha) expression. The results are shown in Table 130.

**Table 130. IFN-alpha Expression**

<b><u>Formulation</u></b>	<b><u>IFN-alpha (pg/ml)</u></b>
G-CSF unmodified	67.012
G-CSF Gen1	8.867
G-CSF Gen2 cap	0
G-CSF Gen2 uncapped	0
R-848	40.971
5% sucrose	1.493
Untreated	0

**Example 86. In vitro expression of VEGF modified mRNA**

[0001549] HEK293 cells were transfected with modified mRNA (mmRNA) VEGF-A (mRNA sequence shown in SEQ ID NO: 5668; polyA tail of approximately 160 nucleotides not shown in sequence; 5'cap, Cap1; fully modified with 5-methylcytosine and pseudouridine) which had been complexed with Lipofectamine2000 from Invitrogen (Carlsbad, CA) at the concentration shown in Table 131. The protein expression was detected by ELISA and the protein (pg/ml) is shown in Table 131.

**Table 131. Protein Expression**

Amount Transfected	10 ng	2.5 ng	625 pg	156 pg	39 pg	10 pg	2 pg	610 fg
Protein (pg/ml)	10495	10038	2321.23	189.6	0	0	0	0

**Example 87. In vitro Screening in HeLa Cells of GFP**

[0001550] The day before transfection, 20,000 HeLa cells (ATCC no. CCL-2; Manassas, VA) were harvested by treatment with Trypsin-EDTA solution (LifeTechnologies, Grand Island, NY) and seeded in a total volume of 100ul EMEM medium (supplemented with 10%FCS and 1x Glutamax) per well in a 96-well cell culture plate (Corning, Manassas, VA). The cells were grown at 37°C in 5% CO<sub>2</sub> atmosphere overnight. Next day, 37.5 ng or 75 ng of Green Fluorescent protein (GFP) modified RNA (mRNA sequence shown in SEQ ID NO: 5667; polyA tail of approximately 160 nucleotides not shown in sequence; 5'cap, Cap1) with the chemical modification described in Table 132, were diluted in 10ul final volume of OPTI-MEM (LifeTechnologies, Grand Island, NY). Lipofectamine 2000 (LifeTechnologies, Grand Island, NY) was used as transfection reagent and 0.2 ul were diluted in 10 ul final volume of OPTI-MEM. After 5 minutes of incubation at room temperature, both solutions were combined and incubated an additional 15 minute at room temperature. Then the 20ul combined solution was added to the 100ul cell culture medium containing the HeLa cells and incubated at room temperature.

[0001551] After an 18 to 22 hour incubation cells expressing luciferase were lysed with 100 ul of Passive Lysis Buffer (Promega, Madison, WI) according to manufacturer instructions. Aliquots of the lysates were transferred to white opaque polystyrene 96-well plates (Corning, Manassas, VA) and combined with 100 ul complete luciferase assay



solution (Promega, Madison, WI). The median fluorescence intensity (MFI) was determined for each chemistry and is shown in Table 132.

[0001552] These results demonstrate that GFP fully modified with N1-methyl-pseudouridine and 5-methylcytosine produces more protein in HeLa cells compared to the other chemistry. Additionally the higher dose of GFP administered to the cells resulted in the highest MFI value.

**Table 132. Mean Fluorescence Intensity**

Chemistry	37.5 ng	75 ng
	MFI	MFI
No modifications	97400	89500
5-methylcytosine/pseudouridine	324000	715000
5-methylcytosine/N1-methyl-pseudouridine	643000	1990000

**Example 88. Homogenization**

[0001553] Different luciferase mRNA solutions (as described in Table 132 where "X" refers to the solution containing that component) (mRNA sequence shown in SEQ ID NO: 5665; polyA tail of approximately 160 nucleotides not shown in sequence; 5'cap, Cap1; fully modified with 5-methylcytosine and pseudouridine) were evaluated to test the percent yield of the different solutions, the integrity of the mRNA by bioanalyzer, and the protein expression of the mRNA by in vitro transfection. The mRNA solutions were prepared in water, 1x TE buffer at 4 mg/ml as indicated in Table 133, and added to either dichloromethane (DCM) or DCM containing 200 mg/ml of poly(lactic-co-glycolic acid) (PLGA) (Lactel, Cat# B6010-2, inherent viscosity 0.55-0.75, 50:50 LA:GA) to achieve a final mRNA concentration of 0.8 mg/ml. The solutions requiring homogenization were homogenized for 30 seconds at speed 5 (approximately 19,000 rpm) (IKA Ultra-Turrax Homogenizer, T18). The mRNA samples in water, dichloromethane and poly(lactic-co-glycolic acid) (PLGA) were not recoverable (NR). All samples, except the NR samples, maintained integrity of the mRNA as determined by bioanalyzer (Bio-rad Experion).

[0001554] The day before transfection, 20,000 HeLa cells (ATCC no. CCL-2; Manassas, VA) were harvested by treatment with Trypsin-EDTA solution (LifeTechnologies, Grand Island, NY) and seeded in a total volume of 100ul EMEM medium (supplemented with 10%FCS and 1x Glutamax) per well in a 96-well cell culture plate (Corning, Manassas, VA). The cells were grown at 37oC in a 5% CO2 atmosphere overnight. The next day,

250 ng of luciferase mRNA from the recoverable samples was diluted in a 100ul final volume of OPTI-MEM (LifeTechnologies, Grand Island, NY). Lipofectamine 2000 (LifeTechnologies, Grand Island, NY) was used as a transfection reagent and 0.2ul was diluted in a 100ul final volume of OPTI-MEM. After 5 minutes of incubation at room temperature, both solutions were combined and incubated an additional 15 minutes at room temperature. Then 20ul of the combined solution was added to 100ul of cell culture medium containing the HeLa cells. The plates were then incubated as described before. Controls luciferase mRNA (luciferase mRNA formulated in saline) (Control) and untreated cells (Untreat.) were also evaluated. Cells were harvested and the bioluminescence average (in photons/second) (biolum. (p/s)) for each signal is also shown in Table 133. The recoverable samples all showed activity of luciferase mRNA when analyzed.

**[0001555]** After an 18 to 22 hour incubation, cells expressing luciferase were lysed with 100ul Passive Lysis Buffer (Promega, Madison, WI) according to manufacturer instructions. Aliquots of the lysates were transferred to white opaque polystyrene 96-well plates (Coming, Manassas, VA) and combined with 100ul complete luciferase assay solution (Promega, Madison, WI). The background signal of the plates without reagent was about 200 relative light units per well. The plate reader was a BioTek Synergy HI (BioTek, Winooski, VT).

**[0001556]** Cells were harvested and the bioluminescence average (in relative light units, RLU) (biolum. (RLU)) for each signal is also shown in Table 133. The recoverable samples all showed activity of luciferase mRNA when analyzed.

**Table 133. Solutions**

Solution No.	Water	1x TE Buffer	DCM	DCM/PLGA	Homogenizer	Yield (%)	Biolum. (RLU)
1	X					96	5423780
2		X			X	95	4911950
3	X				X	92	2367230
4		X			X	90	4349410
5	X		X		X	66	4145340
6		X	X		X	71	3834440
7	X			X	X	NR	n/a
8		X		X	X	24	3182080
9	X			X		NR	n/a
10		X		X		79	3276800
11	X		X			79	5563550
12		X	X			79	4919100

Control							2158060
Untreat.							3530

### **Example 89. TE Buffer and Water Evaluation**

[0001557] Luciferase mRNA (mRNA sequence shown in SEQ ID NO: 5665; polyA tail of approximately 160 nucleotides not shown in sequence; 5'cap, Cap1; fully modified with 5-methylcytosine and pseudouridine) was reconstituted in water or TE buffer as outlined in Table 134 and then formulated in PLGA microspheres. PLGA microspheres were synthesized using the water/oil/water double emulsification methods known in the art using PLGA (Lactel, Cat# B6010-2, inherent viscosity 0.55-0.75, 50:50 LA:GA), polyvinylalcohol (PVA) (Sigma, Cat# 348406-25G, MW 13-23k) dichloromethane and water. Briefly, 0.2 to 0.6 ml of mRNA in water or TE buffer at a concentration of 2 to 6 mg/ml (W1) was added to 2 ml of PLGA dissolved in dichloromethane (DCM) (01) at a concentration of 100 mg/ml of PLGA. The W1/O1 emulsion was homogenized (IKA Ultra-Turrax Homogenizer, T18) for 30 seconds at speed 5 (-19,000 rpm). The W1/O1 emulsion was then added to 250 ml 1% PVA (W2) and homogenized for 1 minute at speed 5 (-19,000 rpm). Formulations were left to stir for 3 hours, then passed through a 100 µm nylon mesh strainer (Fisherbrand Cell Strainer, Cat # 22-363-549) to remove larger aggregates, and finally washed by centrifugation (10 min, 9,250 rpm, 4°C). The supernatant was discarded and the PLGA pellets were resuspended in 5-10 ml of water, which was repeated 2x. The washed formulations were frozen in liquid nitrogen and then lyophilized for 2-3 days. After lyophilization, ~10 mg of PLGA MS were weighed out in 2 ml eppendorf tubes and deformed by adding 1 ml of DCM and letting the samples shake for 2-6 hrs. mRNA was extracted from the deformed PLGA microspheres by adding 0.5 ml of water and shaking the sample overnight.

Unformulated luciferase mRNA in water or TE buffer (deformation controls) was spiked into DCM and went through the deformation process to be used as controls in the transfection assay.

[0001558] The day before transfection, 20,000 HeLa cells (ATCC no. CCL-2; Manassas, VA) were harvested by treatment with Trypsin-EDTA solution (LifeTechnologies, Grand Island, NY) and seeded in a total volume of 100µl EMEM medium (supplemented with 10%FCS and 1x Glutamax) per well in a 96-well cell culture plate (Corning, Manassas,

VA). The cells were grown at 37°C in a 5% CO<sub>2</sub> atmosphere overnight. The next day, 100 ng of the deformed luciferase mRNA samples was diluted in a 100 µl final volume of OPTI-MEM (Life Technologies, Grand Island, NY). Lipofectamine 2000 (Life Technologies, Grand Island, NY) was used as a transfection reagent and 0.2 µl was diluted in a 100 µl final volume of OPTI-MEM. After 5 minutes of incubation at room temperature, both solutions were combined and incubated an additional 15 minutes at room temperature. Then 20 µl of the combined solution was added to 100 µl of cell culture medium containing the HeLa cells. The plates were then incubated as described before. [0001559] After 18 to 22 hour incubation, cells expressing luciferase were lysed with 100 µl Passive Lysis Buffer (Promega, Madison, WI) according to manufacturer instructions. Aliquots of the lysates were transferred to white opaque polystyrene 96-well plates (Corning, Manassas, VA) and combined with 100 µl complete luciferase assay solution (Promega, Madison, WI). The background signal of the plates without reagent was about 200 relative light units per well. The plate reader was a BioTek Synergy HI (BioTek, Winooski, VT). To determine the activity of the luciferase mRNA from each formulation, the relative light units (RLU) for each formulation was divided by the RLU of the appropriate mRNA deformation control (mRNA in water or TE buffer). Table 134 shows the activity of the luciferase mRNA. The activity of the luciferase mRNA in the PLGA microsphere formulations (Form.) was substantially improved by formulating in TE buffer versus water.

**Table 134. Formulations**

Form.	mRNA conc. (mg/ml)	W1 Solvent volume (ul)	Total mRNA (ug)	Theoretical mRNA Loading (wt%)	Actual mRNA Loading (wt%)	W1 Solvent	Activity (% of deformation control)
PLGA A	4	400	1600	0.80	0.14	Water	12.5%
PLGA B	4	200	800	0.40	0.13	Water	1.3%
PLGA C	4	600	2400	1.20	0.13	Water	12.1%
PLGA D	2	400	800	0.40	0.07	Water	1.3%
PLGA E	6	400	2400	1.20	0.18	TE Buffer	38.9%
PLGA F	4	400	1600	0.80	0.16	TE Buffer	39.7%
PLGA G	4	400	1600	0.80	0.10	TE Buffer	26.6%

**Example 90. Chemical Modifications on mRNA**

[0001560] The day before transfection, 20,000 HeLa cells (ATCC no. CCL-2; Manassas, VA) were harvested by treatment with Trypsin-EDTA solution (Life Technologies, Grand Island, NY) and seeded in a total volume of 100ul EMEM medium (supplemented with 10%FCS and 1x Glutamax) per well in a 96-well cell culture plate (Corning, Manassas, VA). The cells were grown at 37°C in 5% CO<sub>2</sub> atmosphere overnight. The next day, 83 ng of Luciferase modified RNA (mRNA sequence shown SEQ ID NO: 5665; polyA tail of approximately 140 nucleotides not shown in sequence; 5'cap, Cap1) with the chemical modification described in Table 135, were diluted in 10ul final volume of OPTI-MEM (LifeTechnologies, Grand Island, NY). Lipofectamine 2000 (LifeTechnologies, Grand Island, NY) was used as transfection reagent and 0.2 ul were diluted in 10 ul final volume of OPTI-MEM. After 5 minutes of incubation at room temperature, both solutions were combined and incubated an additional 15 minute at room temperature. Then the 20ul combined solution was added to the 100ul cell culture medium containing the HeLa cells and incubated at room temperature.

[0001561] After 18 to 22 hours of incubation cells expressing luciferase were lysed with 100 ul of Passive Lysis Buffer (Promega, Madison, WI) according to manufacturer instructions. Aliquots of the lysates were transferred to white opaque polystyrene 96-well plates (Coming, Manassas, VA) and combined with 100 ul complete luciferase assay solution (Promega, Madison, WI). The lysate volumes were adjusted or diluted until no more than 2 mio relative light units (RLU) per well were detected for the strongest signal producing samples and the RLUs for each chemistry tested are shown in Table 135. The plate reader was a BioTek Synergy HI (BioTek, Winooski, VT).The background signal of the plates without reagent was about 200 relative light units per well.

**Table 135. Chemical Modifications**

<b>Sample</b>	<b>RLU</b>
Untreated	336
Unmodified Luciferase	33980
5-methylcytosine and pseudouridine	1601234
5-methylcytosine and N1-methyl-pseudouridine	421189
25% cytosines replaced with 5-methylcytosine and 25% of	222114

uridines replaced with 2-thiouridine	
N1-methyl-pseudouridine	3068261
Pseudouridine	140234
N4-Acetylcytidine	1073251
5-methoxyuridine	219657
5-Bromouridine	6787
N4-Acetylcytidine and N1-methyl-pseudouridine	976219
5-methylcytosine and 5-methoxyuridine	66621
5-methylcytosine and 2'fluorouridine	11333

**Example 91. Intramuscular and Subcutaneous Administration of Modified mRNA**

[0001562] Luciferase modified mRNA (mRNA sequence shown in SEQ ID NO: 5665; polyA tail of approximately 140 nucleotides not shown in sequence; 5'cap, Cap1) fully modified with 5-methylcytosine and pseudouridine (5mC/pU), fully modified with 5-methylcytosine and N1-methyl-pseudouridine (5mC/N1mpU), fully modified with pseudouridine (pU), fully modified with N1-methyl-pseudouridine (N1mpU) or modified where 25% of the cytosines replaced with 5-methylcytosine and 25% of the uridines replaced with 2-thiouridine (5mC/s2U) formulated in PBS (pH 7.4) was administered to Balb-C mice intramuscularly or subcutaneously at a dose of 2.5 mg/kg. The mice were imaged at 2 hours, 8 hours, 24 hours, 48 hours, 72 hours, 96 hours, 120 hours and 144 hours for intramuscular delivery and 2 hours, 8 hours, 24 hours, 48 hours, 72 hours, 96 hours and 120 hours for subcutaneous delivery. Twenty minutes prior to imaging, mice were injected intraperitoneally with a D-luciferin solution at 150 mg/kg. Animals were then anesthetized and images were acquired with an IVIS Lumina II imaging system (Perkin Elmer). Bioluminescence was measured as total flux (photons/second) of the entire mouse. The average total flux (photons/second) for intramuscular administration is shown in Table 136 and the average total flux (photons/second) for subcutaneous administration is shown in Table 137. The background signal was 3.79E+05 (p/s). The peak expression for intramuscular administration was seen between 24 and 48 hours for all chemistry and expression was still detected at 144 hours. For subcutaneous delivery the peak expression was seen at 2-8 hours and expression was detected at 72 hours.

**Table 136. Intramuscular Administration**

	5mC/pU	5mC/N1mpU	5mC/s2U	pU	N1mpU
	Flux (p/s)	Flux (p/s)	Flux (p/s)	Flux (p/s)	Flux (p/s)

2 hours	1.98E+07	4.65E+06	4.68E+06	2.33E+06	3.66E+07
8 hours	1.42E+07	3.64E+06	3.78E+06	8.07E+06	7.21E+07
24 hours	2.92E+07	1.22E+07	3.35E+07	1.01E+07	1.75E+08
48 hours	2.64E+07	1.01E+07	5.06E+07	7.46E+06	3.42E+08
72 hours	2.18E+07	8.59E+06	3.42E+07	4.08E+06	5.83E+07
96 hours	2.75E+07	2.70E+06	2.38E+07	4.35E+06	7.15E+07
120 hours	2.19E+07	1.60E+06	1.54E+07	1.25E+06	3.87E+07
144 hours	9.17E+06	2.19E+06	1.14E+07	1.86E+06	5.04E+07

**Table 137. Subcutaneous Administration**

	5mC/pU	5mC/NImpU	5mC/s2U	pU	NImpU
	Flux (p/s)	Flux (p/s)	Flux (p/s)	Flux (p/s)	Flux (p/s)
2 hours	5.26E+06	4.54E+06	9.34E+06	2.43E+06	2.80E+07
8 hours	2.32E+06	8.75E+05	8.15E+06	2.12E+06	3.09E+07
24 hours	2.67E+06	5.49E+06	3.80E+06	2.24E+06	1.48E+07
48 hours	1.22E+06	1.77E+06	3.07E+06	1.58E+06	1.24E+07
72 hours	1.12E+06	8.00E+05	8.53E+05	4.80E+05	2.29E+06
96 hours	5.16E+05	5.33E+05	4.30E+05	4.30E+05	6.62E+05
120 hours	3.80E+05	4.09E+05	3.21E+05	6.82E+05	5.05E+05

**Example 92. Osmotic Pump Study**

[0001563] Prior to implantation, an osmotic pump (ALZET® Osmotic Pump 2001D, DURECT Corp. Cupertino, CA) is loaded with the 0.2 ml of IX PBS (pH 7.4) (PBS loaded pump) or 0.2 ml of luciferase modified mRNA (mRNA sequence shown in SEQ ID NO: 5665; polyA tail of approximately 140 nucleotides not shown in sequence; 5'cap, Cap1; fully modified with 5-methylcytosine and N1-methyl-pseudouridine) at 1 mg/ml in 1x PBS (pH 7.4) (Luciferase loaded pump) and incubated overnight in 1x PBS (pH 7.4) at 37°C.

[0001564] Balb-C mice (n=3) are implanted subcutaneously with either the PBS loaded pump or the luciferase loaded pump and imaged at 2 hours, 8 hours and 24 hours. As a control a PBS loaded pump is implanted subcutaneously and the mice are injected subcutaneously with luciferase modified mRNA in 1x PBS (PBS loaded pump; SC Luciferase) or an osmotic pump is not implanted and the mice are injected subcutaneously with luciferase modified mRNA in 1x PBS (SC Luciferase). The luciferase formulations are outlined in Table 138.

**Table 138. Luciferase Formulations**

Group	Vehicle	Conc (mg/ml)	Inj. Vol. (ul)	Amt (ug)	Dose (mg/kg)
PBS loaded pump; SC Luciferase	PBS	1.00	50	50	2.5
Luciferase loaded pump	PBS	1.00	-	200	10.0
PBS loaded pump	PBS	-	-	-	-
SC Luciferase	PBS	1.00	50	50	2.5

### **Example 93. External Osmotic Pump Study**

**[0001565]** An external osmotic pump (ALZET® Osmotic Pump 2001D, DURECT Corp. Cupertino, CA) is loaded with the 0.2 ml of 1x PBS (pH 7.4) (PBS loaded pump) or 0.2 ml of luciferase modified mRNA (mRNA sequence shown in SEQ ID NO: 5665; polyA tail of approximately 140 nucleotides not shown in sequence; 5'cap, CapI; fully modified with 5-methylcytosine and N1-methyl-pseudouridine) at 1 mg/ml in 1x PBS (pH 7.4) (luciferase loaded pump) and incubated overnight in 1x PBS (pH 7.4) at 37°C.

**[0001566]** Using a catheter connected to the external PBS loaded pump or the luciferase loaded pump Balb-C mice (n=3) are administered the formulation. The mice are imaged at 2 hours, 8 hours and 24 hours. As a control an external PBS loaded pump is used and the mice are injected subcutaneously with luciferase modified mRNA in 1x PBS (PBS loaded pump; SC Luciferase) or the external pump is not used and the mice are only injected subcutaneously with luciferase modified mRNA in 1x PBS (SC Luciferase). Twenty minutes prior to imaging, mice are injected intraperitoneally with a D-luciferin solution at 150 mg/kg. Animals are then anesthetized and images are acquired with an IVIS Lumina II imaging system (Perkin Elmer). Bioluminescence is measured as total flux (photons/second) of the entire mouse. The luciferase formulations are outlined in Table 139 and the average total flux (photons/second).

**Table 139. Luciferase Formulations**

Group	Vehicle	Conc (mg/ml)	Inj. Vol. (ul)	Amt (ug)	Dose (mg/kg)
PBS loaded pump; SC Luciferase	PBS	1.00	50	50	2.5
Luciferase loaded pump	PBS	1.00	-	200	10.0
PBS loaded pump	PBS	-	-	-	-
SC Luciferase	PBS	1.00	50	50	2.5

### **Example 94. Fibrin Sealant Study**



[0001567] Fibrin sealant, such as Tisseel (Baxter Healthcare Corp., Deerfield, IL), is composed of fibrinogen and thrombin in a dual-barreled syringe. Upon mixing, fibrinogen is converted to fibrin to form a fibrin clot in about 10 to 30 seconds. This clot can mimic the natural clotting mechanism of the body. Additionally a fibrin hydrogel is a three dimensional structure that can potentially be used in sustained release delivery. Currently, fibrin sealant is approved for application in hemostasis and sealing to replace conventional surgical techniques such as suture, ligature and cautery.

[0001568] The thrombin and fibrinogen components were loaded separately into a dual barreled syringe. Balb-C mice (n=3) were injected subcutaneously with 50 ul of fibrinogen, 50 ul of thrombin and they were also injected at the same site with modified luciferase mRNA (mRNA sequence shown in SEQ ID NO: 5665; polyA tail of approximately 140 nucleotides not shown in sequence; 5'cap, Cap1; fully modified with 5-methylcytosine and N1-methyl-pseudouridine) (Tisseel+Luciferase), 50 ul of fibrinogen and 50 ul thrombin (Tisseel) or modified luciferase mRNA (Luciferase). The injection of fibrinogen and thrombin was done simultaneously using the dual-barreled syringe. The SC injection of luciferase was done 15 minutes after the fibrinogen/thrombin injection to allow the fibrin hydrogel to polymerize (Tisseel + Luciferase group). A control group of untreated mice were also evaluated. The mice were imaged at 5 hours and 24 hours. Twenty minutes prior to imaging, mice were injected intraperitoneally with a D-luciferin solution at 150 mg/kg. Animals were then anesthetized and images were acquired with an IVIS Lumina II imaging system (Perkin Elmer). Bioluminescence was measured as total flux (photons/second) of the entire mouse. The luciferase formulations are outlined in Table 140 and the average total flux (photons/second) is shown in Table 141. The fibrin sealant was found to not interfere with imaging and the injection of luciferase and Tisseel showed expression of luciferase.

**Table 140. Luciferase Formulations**

Group	Vehicle	Conc (mg/ml)	Inj. Vol. (ul)	Amt (ug)	Dose (mg/kg)
Tisseel+Luciferase	PBS	1.00	50	50	2.5
Tisseel	-	-	-	-	-
Luciferase	PBS	1.00	50	50	2.5
Untreated	-	-	-	-	-

**Table 141. Total Flux**

Group	5 Hours	24 Hours
	Flux (p/s)	Flux (p/s)
Tisseel+Luciferase	4.59E+05	3.39E+05
Tisseel	1.99E+06	1.06E+06
Luciferase	9.94E+05	7.44E+05
Untreated	3.90E+05	3.79E+05

**Example 95. Fibrin Containing mRNA Sealant Study****A. Modified mRNA and Calcium Chloride**

**[0001569]** Prior to reconstitution, luciferase mRNA (mRNA sequence shown in SEQ ID NO: 5665; polyA tail of approximately 140 nucleotides not shown in sequence; 5'cap, Cap1) fully modified with 5-methylcytosine andNI-methyl-pseudouridine or fully modified with NI-methyl-pseudouridine is added to calcium chloride. The calcium chloride is then used to reconstitute thrombin. Fibrinogen is reconstituted with fibrinolysis inhibitor solution per the manufacturer's instructions. The reconstituted thrombin containing modified mRNA and fibrinogen is loaded into a dual barreled syringe. Mice are injected subcutaneously with 50 ul of fibrinogen and50 ul of thrombin containing modified mRNA or they were injected with 50 ul of PBS containing an equivalent dose of modified luciferase mRNA. A control group of untreated mice is also evaluated. The mice are imaged at predetermined intervals to determine the average total flux (photons/second).

**B. Lipid Nanoparticle Formulated Modified mRNA and Calcium Chloride**

**[0001570]** Prior to reconstitution, luciferase mRNA (mRNA sequence shown in SEQ ID NO: 5665; polyA tail of approximately 140 nucleotides not shown in sequence; 5'cap, Cap1) fully modified with 5-methylcytosine andNI-methyl-pseudouridine or fully modified with NI-methyl-pseudouridine is formulated in a lipid nanoparticle is added to calcium chloride. The calcium chloride is then used to reconstitute thrombin. Fibrinogen is reconstituted with fibrinolysis inhibitor solution per the manufacturer's instructions. The reconstituted thrombin containing modified mRNA and fibrinogen is loaded into a dual barreled syringe. Mice are injected subcutaneously with 50 ul of fibrinogen and50 ul of thrombin containing modified mRNA or they were injected with 50 ul of PBS containing an equivalent dose of modified luciferase mRNA. A control group of

untreated mice is also evaluated. The mice are imaged at predetermined intervals to determine the average total flux (photons/second).

C. Modified mRNA and Fibrinogen

[0001571] Prior to reconstitution, luciferase mRNA (mRNA sequence shown in SEQ ID NO: 5665; polyA tail of approximately 140 nucleotides not shown in sequence; 5'cap, Cap1) fully modified with 5-methylcytosine and N1-methyl-pseudouridine or fully modified with N1-methyl-pseudouridine is added to the fibrinolysis inhibitor solution. The fibrinolysis inhibitor solution is then used to reconstitute fibrinogen. Thrombin is reconstituted with the calcium chloride solution per the manufacturer's instructions. The reconstituted fibrinogen containing modified mRNA and thrombin is loaded into a dual barreled syringe. Mice are injected subcutaneously with 50 ul of thrombin and 50 ul of fibrinogen containing modified mRNA or they were injected with 50 ul of PBS containing an equivalent dose of modified luciferase mRNA. A control group of untreated mice is also evaluated. The mice are imaged at predetermined intervals to determine the average total flux (photons/second).

D. Lipid Nanoparticle Formualted Modified mRNA and Fibrinogen

[0001572] Prior to reconstitution, luciferase mRNA (mRNA sequence shown in SEQ ID NO: 5665; polyA tail of approximately 140 nucleotides not shown in sequence; 5'cap, Cap1) fully modified with 5-methylcytosine and N1-methyl-pseudouridine or fully modified with N1-methyl-pseudouridine is formulated in a lipid nanoparticle is added to the fibrinolysis inhibitor solution. The fibrinolysis inhibitor solution is then used to reconstitute fibrinogen. Thrombin is reconstituted with the calcium chloride solution per the manufacturer's instructions. The reconstituted fibrinogen containing modified mRNA and thrombin is loaded into a dual barreled syringe. Mice are injected subcutaneously with 50 ul of thrombin and 50 ul of fibrinogen containing modified mRNA or they were injected with 50 ul of PBS containing an equivalent dose of modified luciferase mRNA. A control group of untreated mice is also evaluated. The mice are imaged at predetermined intervals to determine the average total flux (photons/second).

E. Modified mRNA and Thrombin

[0001573] Prior to reconstitution, luciferase mRNA (mRNA sequence shown in SEQ ID NO: 5665; polyA tail of approximately 140 nucleotides not shown in sequence; 5'cap,

Cap1) fully modified with 5-methylcytosine and NI-methyl-pseudouridine or fully modified with NI-methyl-pseudouridine is added to the reconstituted thrombin after it is reconstituted with the calcium chloride per the manufacturer's instructions. The fibrinolysis inhibitor solution is then used to reconstitute fibrinogen per the manufacturer's instructions. The reconstituted fibrinogen and thrombin containing modified mRNA is loaded into a dual barreled syringe. Mice are injected subcutaneously with 50 ul of thrombin containing modified mRNA and 50 ul of fibrinogen or they were injected with 50 ul of PBS containing an equivalent dose of modified luciferase mRNA. A control group of untreated mice is also evaluated. The mice are imaged at predetermined intervals to determine the average total flux (photons/second).

F. Lipid Nanoparticle Formualted Modified mRNA and Thrombin  
[0001574] Prior to reconstitution, luciferase mRNA (mRNA sequence shown in SEQ ID NO: 5665; polyA tail of approximately 140 nucleotides not shown in sequence; 5'cap, Cap1) fully modified with 5-methylcytosine and NI-methyl-pseudouridine or fully modified with NI-methyl-pseudouridine is formulated in a lipid nanoparticle is added to the reconstituted thrombin after it is reconstituted with the calcium chloride per the manufacturer's instructions. The fibrinolysis inhibitor solution is then used to reconstitute fibrinogen per the manufacturer's instructions. The reconstituted fibrinogen and thrombin containing modified mRNA is loaded into a dual barreled syringe. Mice are injected subcutaneously with 50 ul of thrombin containing modified mRNA and 50 ul of fibrinogen or they were injected with 50 ul of PBS containing an equivalent dose of modified luciferase mRNA. A control group of untreated mice is also evaluated. The mice are imaged at predetermined intervals to determine the average total flux (photons/second).

**Example 96. Cationic Lipid Formulation of 5-Methylcytosine and NI-Methyl-pseudouridine Modified mRNA**

[0001575] Luciferase mRNA (mRNA sequence shown in SEQ ID NO: 5665; polyA tail of approximately 140 nucleotides not shown in sequence; 5'cap, Cap1) fully modified with 5-methylcytosine and NI-methyl-pseudouridine was formulated in the cationic

lipids described in Table 142. The formulations were administered intravenously (I.V.), intramuscularly (I.M.) or subcutaneously (S.C.) to Balb-C mice at a dose of 0.05 mg/kg.

**Table 142. Cationic Lipid Formulations**

Formulation	NPA-126-1	NPA-127-1	NPA-128-1	NPA-129-1	111612-B
Lipid	DLin-MC3-DMA	DLin-KC2-DMA	C12-200	DLinDMA	DODMA
Lipid/mRNA ratio (wt/wt)	20:1	20:1	20:1	20:1	20:1
Mean Size	122 nm PDI: 0.13	114 nm PDI: 0.10	153 nm PDI: 0.17	137 nm PDI: 0.09	223.2 nm PDI: 0.142
Zeta at pH 7.4	-1.4 mV	-0.5 mV	-1.4 mV	2.0 mV	-3.09 mV
Encaps. (RiboGr)	95%	77%	69%	80%	64%

[0001576] Twenty minutes prior to imaging, mice were injected intraperitoneally with a D-luciferin solution at 150 mg/kg. Animals were then anesthetized and images were acquired with an IVIS Lumina II imaging system (Perkin Elmer). Bioluminescence was measured as total flux (photons/second) of the entire mouse. The mice were imaged at 2 hours, 8 hours and 24 hours after dosing and the average total flux (photons/second) was measured for each route of administration and cationic lipid formulation. The background flux was about 4.17E+05 p/s. The results of the imaging are shown in Table 143. In Table 143, "NT" means not tested.

**Table 143. Flux**

Route	Time Point	DLin-MC3-DMA	DLin-KC2-DMA	C12-200	DLinDMA	DODMA
		Flux (p/s)	Flux (p/s)	Flux (p/s)	Flux (p/s)	Flux (p/s)
I.V.	2 hrs	1.92E+08	2.91E+08	1.08E+08	2.53E+07	8.40E+06
I.V.	8 hrs	1.47E+08	2.13E+08	3.72E+07	3.82E+07	5.62E+06
I.V.	24 hrs	1.32E+07	2.41E+07	5.35E+06	4.20E+06	8.97E+05
I.M.	2 hrs	8.29E+06	2.37E+07	1.80E+07	1.51E+06	NT
I.M.	8 hrs	5.83E+07	2.12E+08	2.60E+07	1.99E+07	NT
I.M.	24 hrs	4.30E+06	2.64E+07	3.01E+06	9.46E+05	NT
S.C.	2 hrs	1.90E+07	5.16E+07	8.91E+07	4.66E+06	9.61E+06
S.C.	8 hrs	7.74E+07	2.00E+08	4.58E+07	9.67E+07	1.90E+07
S.C.	24 hrs	7.49E+07	2.47E+07	6.96E+06	6.50E+06	1.28E+06

**Example 97. Lipid Nanoparticle Intravenous Study**

[0001577] Luciferase mRNA (mRNA sequence shown in SEQ ID NO: 5665; polyA tail of approximately 160 nucleotides not shown in sequence; 5'cap, Cap1; fully modified with 5-methylcytosine and pseudouridine) was formulated in a lipid nanoparticle containing 50% DLin-MC3-DMA OR DLin-KC2-DMA as described in Table 144, 38.5% cholesterol, 10% DSPC and 1.5% PEG. The formulation was administered intravenously (IN.) to Balb-C mice at a dose of 0.5 mg/kg, 0.05 mg/kg, 0.005 mg/kg or 0.0005 mg/kg. Twenty minutes prior to imaging, mice were injected intraperitoneally with a D-luciferin solution at 150 mg/kg. Animals were then anesthetized and images were acquired with an IVIS Lumina II imaging system (Perkin Elmer). Bioluminescence was measured as total flux (photons/second) of the entire mouse.

**Table 144. Formulations**

Formulation	NPA-098-1	NPA-100-1
Lipid	DLin-KC2-DMA	DLin-MC3-DMA
Lipid/mRNA ratio (wt/wt)	20:1	20:1
Mean Size	135 nm PDI: 0.08	152 nm PDI: 0.08
Zeta at pH 7.4	-0.6 mV	-1.2 mV
Encaps. (RiboGr)	91%	94%

[0001578] For DLin-KC2-DMA the mice were imaged at 2 hours, 8 hours, 24 hours, 72 hours, 96 hours and 168 hours after dosing and the average total flux (photons/second) was measured for each route of administration and cationic lipid formulation. The background flux was about 3.66E+05 p/s. The results of the imaging are shown in Table 145. Organs were imaged at 8 hours and the average total flux (photons/second) was measured for the liver, spleen, lung and kidney. A control for each organ was also analyzed. The results are shown in Table 146. The peak signal for all dose levels was at 8 hours after administration. Also, distribution to the various organs (liver, spleen, lung, and kidney) may be able to be controlled by increasing or decreasing the LNP dose.

**Table 145. Flux**

Time Point	0.5 mg/kg	0.05 mg/kg	0.005 mg/kg	0.0005 mg/kg
	Flux (p/s)	Flux (p/s)	Flux (p/s)	Flux (p/s)
2 hrs	3.54E+08	1.75E+07	2.30E+06	4.09E+05
8 hrs	1.67E+09	1.71E+08	9.81E+06	7.84E+05
24 hrs	2.05E+08	2.67E+07	2.49E+06	5.51E+05
72 hrs	8.17E+07	1.43E+07	1.01E+06	3.75E+05
96 hrs	4.10E+07	9.15E+06	9.58E+05	4.29E+05

168 hrs	3.42E+07	9.15E+06	1.47E+06	5.29E+05
---------	----------	----------	----------	----------

**Table 146. Organ Flux**

	Liver	Spleen	Lung	Kidney
	Flux (p/s)	Flux (p/s)	Flux (p/s)	Flux (p/s)
0.5 mg/kg	1.42E+08	4.86E+07	1.90E+05	3.20E+05
0.05 mg/kg	7.45E+06	4.62E+05	6.86E+04	9.11E+04
0.005 mg/kg	3.32E+05	2.97E+04	1.42E+04	1.15E+04
0.0005 mg/kg	2.34E+04	1.08E+04	1.87E+04	9.78E+03
Untreated	1.88E+04	1.02E+04	1.41E+04	9.20E+03

[0001579] For DLin-MC3-DMA the mice were imaged at 2 hours, 8 hours, 24 hours, 48 hours, 72 hours and 144 hours after dosing and the average total flux (photons/second) was measured for each route of administration and cationic lipid formulation. The background flux was about  $4.5 \times 10^5$  p/s. The results of the imaging are shown in Table 147. Organs were imaged at 8 hours and the average total flux (photons/second) was measured for the liver, spleen, lung and kidney. A control for each organ was also analyzed. The results are shown in Table 148. The peak signal for all dose levels was at 8 hours after administration. Also, distribution to the various organs (liver, spleen, lung, and kidney) may be able to be controlled by increasing or decreasing the LNP dose.

**Table 147. Flux**

Time Point	0.5 mg/kg	0.05 mg/kg	0.005 mg/kg	0.0005 mg/kg
	Flux (p/s)	Flux (p/s)	Flux (p/s)	Flux (p/s)
2 hrs	1.23E+08	7.76E+06	7.66E+05	4.88E+05
8 hrs	1.05E+09	6.79E+07	2.75E+06	5.61E+05
24 hrs	4.44E+07	1.00E+07	1.06E+06	5.71E+05
48 hrs	2.12E+07	4.27E+06	7.42E+05	4.84E+05
72 hrs	1.34E+07	5.84E+06	6.90E+05	4.38E+05
144 hrs	4.26E+06	2.25E+06	4.58E+05	3.99E+05

**Table 148. Organ Flux**

	Liver	Spleen	Lung	Kidney
	Flux (p/s)	Flux (p/s)	Flux (p/s)	Flux (p/s)
0.5 mg/kg	1.19E+08	9.66E+07	1.19E+06	1.85E+05
0.05 mg/kg	1.10E+07	1.79E+06	7.23E+04	5.82E+04
0.005 mg/kg	3.58E+05	6.04E+04	1.33E+04	1.33E+04
0.0005 mg/kg	2.25E+04	1.88E+04	2.05E+04	1.65E+04
Untreated	1.91E+04	1.66E+04	2.63E+04	2.14E+04

**Example 98. Lipid Nanoparticle Subcutaneous Study**

[0001580] Luciferase mRNA (mRNA sequence shown in SEQ ID NO: 5665; polyA tail of approximately 160 nucleotides not shown in sequence; 5'cap, Cap1; fully modified with 5-methylcytosine and pseudouridine) was formulated in a lipid nanoparticle containing 50% DLin-KC2-DMA as described in Table 149, 385% cholesterol, 10% DSPC and 1.5% PEG. The formulation was administered subcutaneously (S.C.) to Balb-C mice at a dose of 0.5 mg/kg, 0.05 mg/kg or 0.005 mg/kg.

**Table 149. DLin-KC2-DMA Formulation**

Formulation	NPA-098-1
Lipid	DLin-KC2-DMA
Lipid/mRNA ratio (wt/wt)	20:1
Mean Size	135 nm PDI: 0.08
Zeta at pH 7.4	-0.6 mV
Encaps. (RiboGr)	91%

[0001581] Twenty minutes prior to imaging, mice were injected intraperitoneally with a D-luciferin solution at 150 mg/kg. Animals were then anesthetized and images were acquired with an IVIS Lumina II imaging system (Perkin Elmer). Bioluminescence was measured as total flux (photons/second) of the entire mouse. The mice were imaged at 2 hours, 8 hours, 24 hours, 48 hours, 72 hours and 144 hours after dosing and the average total flux (photons/second) was measured for each route of administration and cationic lipid formulation. The lower limit of detection was about 3E+05 p/s. The results of the imaging are shown in Table 150. Organs were imaged at 8 hours and the average total flux (photons/second) was measured for the liver, spleen, lung and kidney. A control for each organ was also analyzed. The results are shown in Table 151. The peak signal for all dose levels was at 8 hours after administration. Also, distribution to the various organs (liver, spleen, lung, and kidney) may be able to be controlled by increasing or decreasing the LNP dose. At high doses, the LNP formulations migrates outside of the subcutaneous injection site, as high levels of luciferase expression are detected in the liver, spleen, lung, and kidney.

**Table 150. Flux**

Time Point	0.5 mg/kg	0.05 mg/kg	0.005 mg/kg
	Flux (p/s)	Flux (p/s)	Flux (p/s)



2 hrs	3.18E+07	7.46E+06	8.94E+05
8 hrs	5.15E+08	2.18E+08	1.34E+07
24 hrs	1.56E+08	5.30E+07	7.16E+06
48 hrs	5.22E+07	8.75E+06	9.06E+05
72 hrs	8.87E+06	1.50E+06	2.98E+05
144 hrs	4.55E+05	3.51E+05	2.87E+05

**Table 151. Organ Flux**

	Liver	Spleen	Lung	Kidney
	Flux (p/s)	Flux (p/s)	Flux (p/s)	Flux (p/s)
0.5 mg/kg	1.01E+07	7.43E+05	9.75E+04	1.75E+05
0.05 mg/kg	1.61E+05	3.94E+04	4.04E+04	3.29E+04
0.005 mg/kg	2.84E+04	2.94E+04	2.42E+04	9.79E+04
Untreated	1.88E+04	1.02E+04	1.41E+04	9.20E+03

**Example 99. Cationic Lipid Nanoparticle Subcutaneous Study**

[0001582] Luciferase mRNA (mRNA sequence shown in SEQ ID NO: 5665; polyA tail of approximately 160 nucleotides not shown in sequence; 5'cap, Cap1; fully modified with 5-methylcytosine and pseudouridine) is formulated in a lipid nanoparticle containing 50% DLin-MC3-DMA, 38.5% cholesterol, 10% DSPC and 1.5% PEG. The formulation is administered subcutaneously (S.C.) to Balb-C mice at a dose of 0.5 mg/kg, 0.05 mg/kg or 0.005 mg/kg.

[0001583] The mice are imaged at 2 hours, 8 hours, 24 hours, 48 hours, 72 hours and 144 hours after dosing and the average total flux (photons/second) was measured for each route of administration and cationic lipid formulation. Organs are imaged at 8 hours and the average total flux (photons/second) is measured for the liver, spleen, lung and kidney. A control for each organ is also analyzed.

**Example 100. Luciferase Lipoplex Study**

[0001584] Lipoplexed luciferase mRNA (mRNA sequence shown in SEQ ID NO: 5665; polyA tail of approximately 140 nucleotides not shown in sequence; 5'cap, Cap1) fully modified with 5-methylcytosine and pseudouridine (5mC/pU), fully modified with 5-methylcytosine and N1-methyl-pseudouridine (5mC/N1mpU) or modified where 25% of the cytosines replaced with 5-methylcytosine and 25% of the uridines replaced with 2-thiouridine (5mC/s2U). The formulation was administered intravenously (I.V.), intramuscularly (I.M.) or subcutaneously (S.C.) to Balb-C mice at a dose of 0.10 mg/kg.

[0001585] Twenty minutes prior to imaging, mice were injected intraperitoneally with a D-luciferin solution at 150 mg/kg. Animals were then anesthetized and images were acquired with an IVIS Lumina II imaging system (Perkin Elmer). Bioluminescence was measured as total flux (photons/second) of the entire mouse. The mice were imaged at 8 hours, 24 hours and 48 hours after dosing and the average total flux (photons/second) was measured for each route of administration and chemical modification. The background signal was about 3.91E+05 p/s. The results of the imaging are shown in Table 152. Organs were imaged at 6 hours and the average total flux (photons/second) was measured for the liver, spleen, lung and kidney. A control for each organ was also analyzed. The results are shown in Table 153.

**Table 152. Flux**

Route	Time Point	5mC/pU	5mC/N1mpU	5mC/s2U
		Flux (p/s)	Flux (p/s)	Flux (p/s)
I.V.	8 hrs	5.76E+06	1.78E+06	1.88E+06
I.V.	24 hrs	1.02E+06	7.13E+05	5.28E+05
I.V.	48 hrs	4.53E+05	3.76E+05	4.14E+05
I.M.	8 hrs	1.90E+06	2.53E+06	1.29E+06
I.M.	24 hrs	9.33E+05	7.84E+05	6.48E+05
I.M.	48 hrs	8.51E+05	6.59E+05	5.49E+05
S.C.	8 hrs	2.85E+06	6.48E+06	1.14E+06
S.C.	24 hrs	6.66E+05	7.15E+06	3.93E+05
S.C.	48 hrs	3.24E+05	3.20E+06	5.45E+05

**Table 153. Organ Flux**

Route	Chemistry	Liver	Spleen	Lung	Kidney	Inj. Site
		Flux (p/s)	Flux (p/s)	Flux (p/s)	Flux (p/s)	Flux (p/s)
I.V.	5mC/pU	5.26E+05	2.04E+07	4.28E+06	1.77E+04	n/a
I.V.	5mC/N1mpU	1.48E+05	5.00E+06	1.93E+06	1.77E+04	n/a
I.V.	5mC/s2U	2.14E+04	3.29E+06	5.48E+05	2.16E+04	n/a
I.M.	5mC/pU	2.46E+04	1.38E+04	1.50E+04	1.44E+04	1.15E+06
I.M.	5mC/N1mpU	1.72E+04	1.76E+04	1.99E+04	1.56E+04	1.20E+06
I.M.	5mC/s2U	1.28E+04	1.36E+04	1.33E+04	1.07E+04	7.60E+05
S.C.	5mC/pU	1.55E+04	1.67E+04	1.45E+04	1.69E+04	4.46E+04
S.C.	5mC/N1mpU	1.20E+04	1.46E+04	1.38E+04	1.14E+04	8.29E+04
S.C.	5mC/s2U	1.22E+04	1.31E+04	1.45E+04	1.08E+04	5.62E+04
	Untreated	2.59E+04	1.34E+04	1.26E+04	1.22E+04	n/a

**Example 101. Cationic Lipid Formulation of Modified mRNA**

[0001586] Luciferase mRNA (mRNA sequence shown in SEQ ID NO: 5665; polyA tail of approximately 140 nucleotides not shown in sequence; 5'cap, Cap1) modified where 25% of the cytosines replaced with 5-methylcytosine and 25% of the uridines replaced with 2-thiouridine (5mC/s2U) was formulated in the cationic lipids described in Table 154. The formulations were administered intravenously (IV.), intramuscularly (I.M.) or subcutaneously (S.C.) to Balb-C mice at a dose of 0.05 mg/kg.

**Table 154. Cationic Lipid Formulations**

Formulation	NPA-130-1	NPA-131-1	NPA-132-1	NPA-133-1	111612-C
Lipid	DLin-MC3-DMA	DLin-KC2-DMA	C12-200	DLinDMA	DODMA
Lipid/mRNA ratio (wt/wt)	20:1	20:1	20:1	20:1	20:1
Mean Size	120 nm PDI: 0.10	105 nm PDI: 0.11	122 nm PDI: 0.13	105 nm PDI: 0.14	221.3 nm PDI: 0.063
Zeta at pH 7.4	0.2 mV	-0.6 mV	-0.5 mV	-0.3 mV	-3.10 mV
Encaps. (RiboGr)	100%	100%	93%	93%	60%

[0001587] Twenty minutes prior to imaging, mice were injected intraperitoneally with a D-luciferin solution at 150 mg/kg. Animals were then anesthetized and images were acquired with an IVIS Lumina II imaging system (Perkin Elmer). Bioluminescence was measured as total flux (photons/second) of the entire mouse. The mice were imaged at 2 hours, 8 hours and 24 hours after dosing and the average total flux (photons/second) was measured for each route of administration and cationic lipid formulation. The background flux was about 3.3 1E+05 p/s. The results of the imaging are shown in Table 155. In Table 155, "NT" means not tested. Untreated mice showed an average flux of 3.14E+05 at 2 hours, 3.33E+05 at 8 hours and 3.46E+05 at 24 hours. Peak expression was seen for all three routes tested at 8 hours. DLin-KC2-DMA has better expression than DLin-MC3-DMA and DODMA showed expression for all routes evaluated.

**Table 155. Flux**

Route	Time Point	DLin-MC3-DMA	DLin-KC2-DMA	C12-200	DLinDMA	DODMA
		Flux (p/s)	Flux (p/s)	Flux (p/s)	Flux (p/s)	Flux (p/s)

I.V.	2 hrs	9.88E+06	6.98E+07	9.18E+06	3.98E+06	5.79E+06
I.V.	8 hrs	1.21E+07	1.23E+08	1.02E+07	5.98E+06	6.14E+06
I.V.	24 hrs	2.02E+06	1.05E+07	1.25E+06	1.35E+06	5.72E+05
I.M.	2 hrs	6.72E+05	3.66E+06	3.25E+06	7.34E+05	4.42E+05
I.M.	8 hrs	7.78E+06	2.85E+07	4.29E+06	2.22E+06	1.38E+05
I.M.	24 hrs	4.22E+05	8.79E+05	5.95E+05	8.48E+05	4.80E+05
S.C.	2 hrs	2.37E+06	4.77E+06	4.44E+06	1.07E+06	1.05E+06
S.C.	8 hrs	3.65E+07	1.17E+08	3.71E+06	9.33E+06	2.57E+06
S.C.	24 hrs	4.47E+06	1.28E+07	6.39E+05	8.89E+05	4.27E+05

### **Example 102. Formulation of 5-Methylcytosine and NI-Methyl-pseudouridine**

#### **Modified mRNA**

[0001588] Luciferase mRNA (mRNA sequence shown in SEQ ID NO: 5665; polyA tail of approximately 140 nucleotides not shown in sequence; 5'cap, Cap1) fully modified with 5-methylcytosine and NI-methyl-pseudouridine was formulated in PBS (pH of 7.4). The formulations were administered intramuscularly (I.M.) or subcutaneously (S.C.) to Balb-C mice at a dose of 2.5 mg/kg.

[0001589] Twenty minutes prior to imaging, mice were injected intraperitoneally with a D-luciferin solution at 150 mg/kg. Animals were then anesthetized and images were acquired with an IVIS Lumina II imaging system (Perkin Elmer). Bioluminescence was measured as total flux (photons/second) of the entire mouse. The mice were imaged at 5 minutes, 30 minutes, 60 minutes and 120 minutes after dosing and the average total flux (photons/second) was measured for each route of administration and cationic lipid formulation. The background flux was about 3.78E+05 p/s. The results of the imaging are shown in Table 156. Expression of luciferase was already seen at 30 minutes with both routes of delivery. Peak expression from subcutaneous administration appears between 30 to 60 minutes. Intramuscular expression was still increasing at 120 minutes.

**Table 156. Flux**

Route	Time Point	PBS (pH 7.4)
		Flux (p/s)
I.M.	5 min	4.38E+05
I.M.	30 min	1.09E+06
I.M.	60 min	1.18E+06
I.M.	120 min	2.86E+06
S.C.	5 min	4.19E+05
S.C.	30 min	6.38E+06
S.C.	60 min	5.61E+06
S.C.	120 min	2.66E+06

**Example 103. Intramuscular and Subcutaneous Administration of Chemically Modified mRNA**

[0001590] Luciferase modified mRNA (mRNA sequence shown in SEQ ID NO: 5665; polyA tail of approximately 140 nucleotides not shown in sequence; 5'cap, Cap1) fully modified with N4-acetylcytidine, fully modified with 5-methoxyuridine, fully modified with N4-acetylcytidine and N1-methyl-pseudouridine or fully modified 5-methylcytosine and 5-methoxyuridine formulated in PBS (pH 7.4) was administered to Balb-C mice intramuscularly or subcutaneously at a dose of 2.5 mg/kg. Twenty minutes prior to imaging, mice were injected intraperitoneally with a D-luciferin solution at 150 mg/kg. Animals were then anesthetized and images were acquired with an IVIS Lumina II imaging system (Perkin Elmer). Bioluminescence was measured as total flux (photons/second) of the entire mouse. The mice were imaged at 2 hours, 8 hours and 24 hours. The average total flux (photons/second) for intramuscular administration is shown in Table 157\_ and the average total flux (photons/second) for subcutaneous administration is shown in Table 158. The background signal was 3.84E+05 (p/s). The peak expression for intramuscular administration was seen between 24 and 48 hours for all chemistry and expression was still detected at 120 hours. For subcutaneous delivery the peak expression was seen at 2-8 hours and expression was detected at 72 hours.

**Table 157. Intramuscular Administration**

	2 hours	8 hours	24 hours
	Flux (p/s)	Flux (p/s)	Flux (p/s)
N4-acetylcytidine	1.32E+07	2.15E+07	4.01E+07
5-methoxyuridine	4.93E+06	1.80E+07	4.53E+07
N4-acetylcytidine/ N1-methyl-pseudouridine	2.02E+07	1.93E+07	1.63E+08
5-methylcytosine/5- methoxyuridine	6.79E+06	4.55E+07	3.44E+07

**Table 158. Subcutaneous Administration**

	2 hours	8 hours	24 hours
	Flux (p/s)	Flux (p/s)	Flux (p/s)
N4-acetylcytidine	3.07E+07	1.23E+07	1.28E+07
5-methoxyuridine	7.10E+06	9.38E+06	1.32E+07
N4-acetylcytidine/ N1-methyl-pseudouridine	7.12E+06	3.07E+06	1.03E+07

5-methylcytosine/5 - methoxyuridine	7.15E+06	1.25E+07	1.1 1E+07
--	----------	----------	-----------

**Example 104. *In vivo* study**

[0001591] Luciferase modified mRNA containing at least one chemical modification is formulated as a lipid nanoparticle (LNP) using the syringe pump method and characterized by particle size, zeta potential, and encapsulation.

[0001592] As outlined in Table 159, the luciferase LNP formulation is administered to Balb-C mice intramuscularly (I.M.), intravenously (I.V.) and subcutaneously (S.C.). As a control luciferase modified RNA formulated in PBS is administered intravenously to mice.

**Table 159. Luciferase Formulations**

Formulation	Vehicle	Route	Concentration (mg/ml)	Injection Volume (ul)	Amount of modified RNA (ug)	Dose (mg/kg)
Luc-LNP	PBS	S.C.	0.2000	50	10	0.5000
Luc-LNP	PBS	S.C.	0.0200	50	1	0.0500
Luc-LNP	PBS	S.C.	0.0020	50	0.1	0.0050
Luc-LNP	PBS	S.C.	0.0002	50	0.01	0.0005
Luc-LNP	PBS	I.V.	0.2000	50	10	0.5000
Luc-LNP	PBS	I.V.	0.0200	50	1	0.0500
Luc-LNP	PBS	I.V.	0.0020	50	0.1	0.0050
Luc-LNP	PBS	I.V.	0.0002	50	0.01	0.0005
Luc-LNP	PBS	I.M.	0.2000	50	10	0.5000
Luc-LNP	PBS	I.M.	0.0200	50	1	0.0500
Luc-LNP	PBS	I.M.	0.0020	50	0.1	0.0050
Luc-LNP	PBS	I.M.	0.0002	50	0.01	0.0005
Luc-PBS	PBS	I.V.	0.20	50	10	0.50

[0001593] The mice are imaged at 2, 8, 24, 48, 120 and 192 hours to determine the bioluminescence (measured as total flux (photons/second) of the entire mouse). At 8 hours or 192 hours the liver, spleen, kidney and injection site for subcutaneous and intramuscular administration are imaged to determine the bioluminescence.

**Example 105. Cationic Lipid Formulation Studies of Chemically Modified mRNA**

[0001594] Luciferase mRNA (mRNA sequence shown in SEQ ID NO: 5665; polyA tail of approximately 140 nucleotides not shown in sequence; 5'cap, Cap1) fully modified with 5-methylcytosine and pseudouridine (5mC/pU), pseudouridine (pU) or NI-methyl-pseudouridine (NImpU) was formulated in the cationic lipids described in Table 160.

The formulations were administered intravenously (I.V.), intramuscularly (I.M.) or subcutaneously (S.C.) to Balb-C mice at a dose of 0.05 mg/kg.

**Table 160. Cationic Lipid Formulations**

Formulation	NPA-137-1	NPA-134-1	NPA-135-1	NPA-136-1	111612-A
Lipid	DLin-MC3-DMA	DLin-MC3-DMA	DLin-KC2-DMA	C12-200	DODMA
Lipid/mRNA ratio (wt/wt)	20:1	20:1	20:1	20:1	20:1
Mean Size	111 nm PDI: 0.15	104 nm PDI: 0.13	95 nm PDI: 0.11	143 nm PDI: 0.12	223.2 nm PDI: 0.142
Zeta at pH 7.4	-4.1 mV	-1.9 mV	-1.0 mV	0.2 mV	-3.09 mV
Encaps. (RiboGr)	97%	100%	100%	78%	64%
Chemistry	pU	N1mpU	N1mpU	N1mpU	5mC/pU

[0001595] Twenty minutes prior to imaging, mice were injected intraperitoneally with a D-luciferin solution at 150 mg/kg. Animals were then anesthetized and images were acquired with an IVIS Lumina II imaging system (Perkin Elmer). Bioluminescence was measured as total flux (photons/second) of the entire mouse. The mice were imaged at 2 hours, 8 hours and 24 hours after dosing and the average total flux (photons/second) was measured for each route of administration and cationic lipid formulation. The background flux was about  $4.11 \times 10^5$  p/s. The results of the imaging are shown in Table 161. Peak expression was seen for all three routes tested at 8 hours.

**Table 161. Flux**

Route	Time Point	DLin-MC3-DMA (pU)	DLin-MC3-DMA (N1mpU)	DLin-KC2-DMA (N1mpU)	C12-200 (N1mpU)	DODMA (5mC/pU)
		Flux (p/s)	Flux (p/s)	Flux (p/s)	Flux (p/s)	Flux (p/s)
I.V.	2 hrs	3.21E+08	1.24E+09	1.01E+09	9.00E+08	3.90E+07
I.V.	8 hrs	1.60E+09	3.22E+09	2.38E+09	1.11E+09	1.17E+07
I.V.	24 hrs	1.41E+08	3.68E+08	3.93E+08	8.06E+07	1.11E+07
I.M.	2 hrs	2.09E+07	3.29E+07	8.32E+07	9.43E+07	4.66E+06
I.M.	8 hrs	2.16E+08	6.14E+08	1.00E+09	8.77E+07	7.05E+06
I.M.	24 hrs	1.23E+07	1.40E+08	5.09E+08	1.36E+07	1.14E+06
S.C.	2 hrs	2.32E+07	3.60E+07	2.14E+08	1.01E+08	3.11E+07
S.C.	8 hrs	5.55E+08	9.80E+08	4.93E+09	1.01E+09	8.04E+07
S.C.	24 hrs	1.81E+08	2.74E+08	2.12E+09	4.74E+07	1.34E+07

**Example 106. Studies of Chemical Modified mRNA**

[0001596] Luciferase mRNA (mRNA sequence shown in SEQ ID NO: 5665; polyA tail of approximately 140 nucleotides not shown in sequence; 5'cap, Cap1) fully modified with N4-acetylcytidine (N4-acetyl), fully modified with 5-methoxyuridine (5meth), fully modified with N4-acetylcytidine and N1-methyl-pseudouridine (N4-acetyl/N1mpU) or fully modified with 5-methylcytosine and 5-methoxyuridine (5mC/5-meth) was formulated in DLin-MC3-DMA as described in Table 162. The formulations were administered intravenously (TV.), intramuscularly (I.M.) or subcutaneously (S.C.) to Balb-C mice at a dose of 0.05 mg/kg.

**Table 162. Cationic Lipid Formulations**

Formulation	NPA-141-1	NPA-142-1	NPA-143-1	NPA-144-1
Lipid	DLin-MC3-DMA	DLin-MC3-DMA	DLin-MC3-DMA	DLin-MC3-DMA
Lipid/mRNA ratio (wt/wt)	20:1	20:1	20:1	20:1
Mean Size	138 nm PDI: 0.16	116 nm PDI: 0.15	144 nm PDI: 0.15	131 nm PDI: 0.15
Zeta at pH 7.4	-2.8 mV	-2.8 mV	-4.3 mV	-5.0 mV
Encaps. (RiboGr)	97%	100%	75%	72%
Chemistry	N4-acetyl	5meth	N4-acetyl/ N1mpU	5mC/5-meth

[0001597] Twenty minutes prior to imaging, mice were injected intraperitoneally with a D-luciferin solution at 150 mg/kg. Animals were then anesthetized and images were acquired with an IVIS Lumina II imaging system (Perkin Elmer). Bioluminescence was measured as total flux (photons/second) of the entire mouse. The mice were imaged at 2 hours, 6 hours and 24 hours after dosing and the average total flux (photons/second) was measured for each route of administration and cationic lipid formulation. The background flux was about 2.70E+05 p/s. The results of the imaging are shown in Table 163.

**Table 163. Flux**

Route	Time Point	N4-acetyl	5meth	N4-acetyl/ N1mpU	5mC/5-meth



		Flux (p/s)	Flux (p/s)	Flux (p/s)	Flux (p/s)
I.V.	2 hrs	9.17E+07	3.19E+06	4.21E+07	1.88E+06
I.V.	6 hrs	7.70E+08	9.28E+06	2.34E+08	7.75E+06
I.V.	24 hrs	6.84E+07	1.04E+06	3.55E+07	3.21E+06
I.M.	2 hrs	8.59E+06	7.86E+05	5.30E+06	5.11E+05
I.M.	6 hrs	1.27E+08	8.88E+06	3.82E+07	3.17E+06
I.M.	24 hrs	4.46E+07	1.38E+06	2.00E+07	1.39E+06
S.C.	2 hrs	1.83E+07	9.67E+05	4.45E+06	1.01E+06
S.C.	6 hrs	2.89E+08	1.78E+07	8.91E+07	1.29E+07
S.C.	24 hrs	6.09E+07	6.40E+06	2.08E+08	6.63E+06

**Example 107. Lipid Nanoparticle Containing A Plurality of Modified mRNAs**

[0001598] EPO mRNA (mRNA sequence shown in SEQ ID NO: 5658; polyA tail of approximately 140 nucleotides not shown in sequence; 5'cap, Cap1; fully modified with 5-methylcytosine andNI-methyl-pseudouridine), G-CSF mRNA (mRNA sequence shown in SEQ ID NO: 5655; polyA tail of approximately 140 nucleotides not shown in sequence; 5'cap, Cap1; fully modified with 5-methylcytosine andNI-methyl-pseudouridine) and Factor IX mRNA (mRNA sequence shown in SEQ ID NO: 5659; polyA tail of approximately 140 nucleotides not shown in sequence; 5'cap, Cap1; fully modified with 5-methylcytosine and NI-methyl-pseudouridine), is formulated in DLin-MC3-DMA as described in Table 164. The formulations are administered intravenously (I.V.), intramuscularly (I.M.) or subcutaneously (S.C.) to Balb-C mice at a dose of 0.05 mg/kg. Control LNP formulations containing only one mRNA are also administered at an equivalent dose.

**Table 164. DLin-MC3-DMA Formulation**

Formulation	NPA-157-1
Lipid	DLin-MC3- DMA
Lipid/mRNA ratio (wt/wt)	20:1
Mean Size	89 nm PDI: 0.08
Zeta at pH 7.4	1.1 mV
Encaps. (RiboGr)	97%

[0001599] Serum is collected from the mice at 8 hours, 24 hours, 72 hours and/or 7 days after administration of the formulation. The serum is analyzed by ELISA to determine the protein expression of EPO, G-CSF, and Factor IX.

**Example 108. Cationic Lipid Formulation Studies of of 5-Methylcytosine and NI-Methyl-pseudouridine Modified mRNA**

[0001600] EPO mRNA (mRNA sequence shown in SEQ ID NO: 5658; polyA tail of approximately 140 nucleotides not shown in sequence; 5'cap, CapI; fully modified with 5-methylcytosine and NI-methyl-pseudouridine) or G-CSF mRNA (mRNA sequence shown in SEQ ID NO: 5655; polyA tail of approximately 140 nucleotides not shown in sequence; 5'cap, CapI; fully modified with 5-methylcytosine and NI-methyl-pseudouridine) is formulated in DLin-MC3-DMA and DLin-KC2-DMA as described in Table 165. The formulations are administered intravenously (I.V) , intramuscularly (I.M.) or subcutaneously (S.C.) to Balb-C mice at a dose of 0.05 mg/kg.

**Table 165. DLin-MC3-DMA and DLin-KC2-DMA Formulations**

Formulation	NPA-147-1	NPA-148-1	NPA-150-1	NPA-151-1
mRNA	EPO	EPO	G-CSF	G-CSF
Lipid	DLin-MC3-DMA	DLin-KC2-DMA	DLin-MC3-DMA	DLin-KC2-DMA
Lipid/mRNA ratio (wt/wt)	20:1	20:1	20:1	20:1
Mean Size	117 nm PDI: 0.14	82 nm PDI: 0.08	119 nm PDI: 0.13	88 nm PDI: 0.08
Zeta at pH 7.4	-1.7 mV	0.6 mV	3.6 mV	2.2 mV
Encaps. (RiboGr)	100%	96%	100%	100%

[0001601] Serum is collected from the mice at 8 hours, 24 hours, 72 hours and/or 7 days after administration of the formulation. The serum is analyzed by ELISA to determine the protein expression of EPO and G-CSF.

**Example 109. In Vitro VEGF PBMC Study**

[0001602] 500 ng of VEGF mRNA (mRNA sequence shown in SEQ ID NO: 5668 polyA tail of approximately 160 nucleotides not shown in sequence; 5'cap, CapI) fully modified with 5-methylcytosine and pseudouridine (VEGF 5mC/pU), fully modified with 5-methylcytosine and NI-methyl-pseudouridine (VEGF 5mC/NImpU) or unmodified (VEGF unmod) was transfected with 0.4 uL of Lipofectamine 2000 into peripheral blood mononuclear cells (PBMC) from three normal blood donors (D1, D2, and D3). Cells were also untreated for each donor as a control. The supernatant was harvested and run

by ELISA 22 hours after transfection to determine the protein expression and cytokine induction. The expression of VEGF and IFN-alpha induction is shown in Table 166.

**Table 166. Protein and Cytokine levels**

	VEGF Expression (pg/ml)			IFN-alpha Induction (pg/ml)		
	D1	D2	D3	D1	D2	D3
VEGF unmod	2	0	0	5400	3537	4946
VEGF 5mC/pU	424	871	429	145	294	106
VEGF 5mC/N1mpU	5088	10331	6183	205	165	6

**Example 110. *In vitro* expression of modified mRNA**

HEK293 cells were transfected with VEGF-A modified mRNA (mRNA sequence shown in SEQ ID NO: 5668; polyA tail of approximately 160 nucleotides not shown in sequence; 5'cap, Cap1; fully modified with 5-methylcytosine and pseudouridine) or EPO modified mRNA (mRNA sequence shown in SEQ ID NO: 5658; polyA tail of approximately 160 nucleotides not shown in sequence; 5'cap, Cap1; fully modified with 5-methylcytosine and pseudouridine), HeLa cells were forward transfected with Transforming growth factor beta (TGF-beta) modified mRNA (mRNA sequence shown in SEQ ID NO 5669; poly A tail of approximately 160 nucleotides not shown in sequence; 5'cap, Cap1; fully modified with 5-methylcytosine and pseudouridine) and HepG2 cells were transfected with bactericidal/permeability-increasing protein (rBPI-21) modified mRNA (mRNA sequence shown in SEQ ID NO 5670; poly A tail of approximately 160 nucleotides not shown in sequence; 5'cap, Cap1; fully modified with 5-methylcytosine and pseudouridine) which had been complexed with Lipofectamine2000 from Invitrogen (Carlsbad, CA) at the concentrations shown in Table 167, 168, and 169 using the procedures described herein. The protein expression was detected by ELISA and the protein (pg/ml) is also shown in Table 167, 168, and 169. In Table 167, ">" means greater than. For TGF-beta a control of untreated cells and a mock transfection of Lipofectamine2000 was also tested.

**Table 167. EPO Protein Expression**

<b>Amount Transfected</b>	5 ng	1 ng	200 pg	40 pg	8 pg	1.6 pg	320 fg	64 fg
<b>Protein (pg/ml)</b>	>2000	609.486	114.676	0	0	0	0	0

**Table 168. TGF-beta Protein Expression**

<b>Amount Transfected</b>	750 ng	250 ng	83 ng	Mock	Untreated
<b>Protein (pg/ml)</b>	5058	4325	3210	2	0

**Table 169. rBPI-21 Protein Expression**

<b>Amount Transfected</b>	2 ug	400 ng	80 ng	16 ng	3.2 ng	640 pg	128 pg	26 pg
<b>Protein (pg/ml)</b>	20.683	9.269	4.768	0	0	0	0	0

**Example 111. Bicistronic modified mRNA**

[0001603] Human embryonic kidney epithelial (HEK293) were seeded on 96-well plates (Greiner Bio-one GmbH, Frickenhausen, Germany) HEK293 were seeded at a density of 30,000 in 100  $\mu$ l cell culture medium (DMEM, 10% FCS, adding 2mM L-Glutamine, 1 mM Sodiumpyruvate and 1x non-essential amino acids (Biochrom AG, Berlin, Germany) and 1.2 mg/ml Sodiumbicarbonate (Sigma-Aldrich, Munich, Germany)) 75 ng of the bicistronic modified mRNA (mCherry-2A-GFP) (mRNA sequence shown in SEQ ID NO 5671; polyA tail of approximately 160 nucleotides not shown in sequence; 5'cap, Cap1; fully modified with 5-methylcytosine and pseudouridine), mCherry modified mRNA (mRNA SEQ ID NO: 5657; polyA tail of approximately 160 nucleotides not shown in sequence; 5'cap, Cap1; fully modified with 5-methylcytosine and pseudouridine) or green fluorescent protein (GFP) modified mRNA (mRNA sequence shown in SEQ ID NO: 5667; polyA tail of approximately 160 nucleotides not shown in sequence; 5'cap, Cap1; fully modified with 5-methylcytosine and pseudouridine) were added after seeding the cells and incubated. A control of untreated cells was also evaluated. mCherry-2A-GFP refers to a modified mRNA sequence comprising the coding region of mCherry, the 2A peptide and the coding region of GFP.

[0001604] Cells were harvested by transferring the culture media supernatants to a 96-well Pro-Bind U-bottom plate (Beckton Dickinson GmbH, Heidelberg, Germany). Cells were trypsinized with 1/2 volume Trypsin/EDTA (Biochrom AG, Berlin, Germany), pooled with respective supernatants and fixed by adding one volume PBS/2%FCS (both Biochrom AG, Berlin, Germany)/0.5% formaldehyde (Merck, Darmstadt, Germany).

Samples then were submitted to a flow cytometer measurement with a 532nm excitation laser and the 610/20 filter for PE-Texas Red in a LSRII cytometer (Beckton Dickinson GmbH, Heidelberg, Germany). The mean fluorescence intensity (MFI) of all events is shown in Table 170. Cells transfected with the bi-cistronic modified mRNA were able to express both mCherry and GFP.

**Table 170. MFI of Modified mRNA**

Modified mRNA	mCherry MFI	GFP MFI
mCherry	17746	427
GFP	427	20019
mCherry-2A-GFP	5742	6783
Untreated	427	219

**Example 112. Cationic Lipid Formulation Studies of of 5-Methylcytosine and NI-Methyl-pseudouridine Modified mRNA to Produce an Antibody**

Herceptin heavy chain (HC) mRNA (mRNA sequence shown in SEQ ID NO 5672 ; polyA tail of approximately 140 nucleotides not shown in sequence; 5'cap, Cap1; fully modified with 5-methylcytosine and NI-methyl-pseudouridine) and Herceptin light chain (LC) modified mRNA (mRNA sequence shown in SEQ ID NO 5673 ; polyA tail of approximately 140 nucleotides not shown in sequence; 5'cap, Cap1; fully modified with 5-methylcytosine and NI-methyl-pseudouridine) are formulated in DLin-MC3-DMA and DLin-KC2-DMA as described in Table 171. The formulations are administered intravenously (I.V) to Balb-C mice at a dose of 0.500, 0.050, and 0.005 mg/kg.

**Table 171. DLin-MC3-DMA and DLin-KC2-DMA Formulations**

Formulation	NPA-158-1	NPA-159-1
Herceptin HC:LC Ratio (wt/wt)	2:1	2:1
Lipid	DLin-MC3-DMA	DLin-KC2-DMA
Lipid/Total mRNA ratio (wt/wt)	20:1	20:1
Mean Size	129 nm PDI: 0.14	100 nm PDI: 0.10

Zeta at pH 7.4	0.9 mV	1.9 mV
Encaps. (RiboGr)	100%	100%

Serum was collected from the mice at 8 hours, 24 hours, 72 hours and/or 7 days after administration of the formulation. The serum was analyzed by ELISA to determine the protein expression of Herceptin.

**Example 113. Directed SAR of Pseudouridine and N1-methyl PseudoUridine**

[0001605] With the recent focus on the pyrimidine nucleoside pseudouridine, a series of structure-activity studies were designed to investigate mRNA containing modifications to pseudouridine or N1-methyl-pseudouridine.

[0001606] The study was designed to explore the effect of chain length, increased lipophilicity, presence of ring structures, and alteration of hydrophobic or hydrophilic interactions when modifications were made at the N1 position, C6 position, the 2-position, the 4-position and on the phosphate backbone. Stability is also investigated.

[0001607] To this end, modifications involving alkylation, cycloalkylation, alkyl-cycloalkylation, arylation, alkyl-arylation, alkylation moieties with amino groups, alkylation moieties with carboxylic acid groups, and alkylation moieties containing amino acid charged moieties are investigated. The degree of alkylation is generally Cr C<sub>6</sub>. Examples of the chemistry modifications include those listed in Table 172 and Table 173.

**Table 172. Pseudouridine and N1-methyl Pseudo Uridine SAR**

Chemistry Modification	Compound #	Naturally occurring
<b>N1-Modifications</b>		
N1-Ethyl-pseudo-UTP	1	N
N1-Propyl-pseudo-UTP	2	N
N1- <i>iso</i> -propyl-pseudo-UTP	3	N
N1-(2,2,2-Trifluoroethyl)-pseudo-UTP	4	N
N1-Cyclopropyl-pseudo-UTP	5	N
N1-Cyclopropylmethyl-pseudo-UTP	6	N
N1-Phenyl-pseudo-UTP	7	N
N1-Benzyl-pseudo-UTP	8	N
N1-Aminomethyl-pseudo-UTP	9	N
P pseudo-UTP-N1-2-ethanoic acid	10	N
N 1-(3-Amino-3-carboxypropyl)pseudo-UTP	11	N

N1-Methyl-3-(3-amino-3-carboxypropyl)pseudo-UTP	12	Y
<b>C-6 Modifications</b>		
6-Methyl-pseudo-UTP	13	N
6-Trifluoromethyl-pseudo-UTP	14	N
6-Methoxy-pseudo-UTP	15	N
6-Phenyl-pseudo-UTP	16	N
6-Iodo-pseudo-UTP	17	N
6-Bromo-pseudo-UTP	18	N
6-Chloro-pseudo-UTP	19	N
6-Fluoro-pseudo-UTP	20	N
<b>2- or 4-position Modifications</b>		
4-Thio-pseudo-UTP	21	N
2-Thio-pseudo-UTP	22	N
<b>Phosphate backbone Modifications</b>		
Alpha-thio-pseudo-UTP	23	N
N1-Me-alpha-thio-pseudo-UTP	24	N

Table 173. Pseudouridine and N1-methyl Pseudo Uridine SAR

Chemistry Modification	Compound #	Naturally occurring
N1-Methyl-pseudo-UTP	1	Y
N1-Butyl-pseudo-UTP	2	N
N1- <i>tert</i> -Butyl-pseudo-UTP	3	N
N1-Pentyl-pseudo-UTP	4	N
N1-Hexyl-pseudo-UTP	5	N
N1-Trifluoromethyl-pseudo-UTP	6	Y
N1-Cyclobutyl-pseudo-UTP	7	N
N1-Cyclopentyl-pseudo-UTP	8	N
N1-Cyclohexyl-pseudo-UTP	9	N
N1-Cycloheptyl-pseudo-UTP	10	N
N1-Cyclooctyl-pseudo-UTP	11	N
N1-Cyclobutylmethyl-pseudo-UTP	12	N
N1-Cyclopentylmethyl-pseudo-UTP	13	N
N1-Cyclohexylmethyl-pseudo-UTP	14	N
N1-Cycloheptylmethyl-pseudo-UTP	15	N
N1-Cyclooctylmethyl-pseudo-UTP	16	N
N1- <i>p</i> -tolyl-pseudo-UTP	17	N
N1-(2,4,6-Trimethyl-phenyl)pseudo-UTP	18	N
N1-(4-Methoxy-phenyl)pseudo-UTP	19	N
N1-(4-Amino-phenyl)pseudo-UTP	20	N

N 1-(4-Nitro-phenyl)pseudo-UTP	21	N
Pseudo-UTP-N 1-p-benzoic acid	22	N
N 1-(4-Methyl-benzyl)pseudo-UTP	24	N
N 1-(2,4,6-Trimethyl-benzyl)pseudo-UTP	23	N
N 1-(4-Methoxy-benzyl)pseudo-UTP	25	N
N 1-(4-Amino-benzyl)pseudo-UTP	26	N
N 1-(4-Nitro-benzyl)pseudo-UTP	27	N
Pseudo-UTP-N 1-methyl-p-benzoic acid	28	N
N 1-(2-Amino-ethyl)pseudo-UTP	29	N
N 1-(3-Amino-propyl)pseudo-UTP	30	N
N 1-(4-Amino-butyl)pseudo-UTP	31	N
N 1-(5-Amino-pentyl)pseudo-UTP	32	N
N 1-(6-Amino-hexyl)pseudo-UTP	33	N
Pseudo-UTP-N 1-3-propionic acid	34	N
Pseudo-UTP-N 1-4-butanoic acid	35	N
Pseudo-UTP-N 1-5-pentanoic acid	36	N
Pseudo-UTP-N 1-6-hexanoic acid	37	N
Pseudo-UTP-N 1-7-heptanoic acid	38	N
N 1-(2-Amino-2-carboxyethyl)pseudo-UTP	39	N
N 1-(4-Amino-4-carboxybutyl)pseudo-UTP	40	N
N3-Alkyl-pseudo-UTP	41	N
6-Ethyl-pseudo-UTP	42	N
6-Propyl-pseudo-UTP	43	N
6-iso-Propyl-pseudo-UTP	44	N
6-Butyl-pseudo-UTP	45	N
6-tert-Butyl-pseudo-UTP	46	N
6-(2,2,2-Trifluoroethyl)-pseudo-UTP	47	N
6-Ethoxy-pseudo-UTP	48	N
6-Trifluoromethoxy-pseudo-UTP	49	N
6-Phenyl-pseudo-UTP	50	N
6-(Substituted-Phenyl)-pseudo-UTP	51	N
6-Cyano-pseudo-UTP	52	N
6-Azido-pseudo-UTP	53	N
6-Amino-pseudo-UTP	54	N
6-Ethylcarboxylate-pseudo-UTP	54b	N
6-Hydroxy-pseudo-UTP	55	N
6-Methylamino-pseudo-UTP	55b	N
6-Dimethylamino-pseudo-UTP	57	N
6-Hydroxyamino-pseudo-UTP	59	N
6-Formyl-pseudo-UTP	60	N



6-(4-Morpholino)-pseudo-UTP	61	N
6-(4-Thiomorpholino)-pseudo-UTP	62	N
N 1-Me-4-thio-pseudo-UTP	63	N
N 1-Me-2-thio-pseudo-UTP	64	N
1,6-Dimethyl-pseudo-UTP	65	N
1-Methyl-6-trifluoromethyl-pseudo-UTP	66	N
1-Methyl-6-ethyl-pseudo-UTP	67	N
1-Methyl-6-propyl-pseudo-UTP	68	N
1-Methyl-6-iso-propyl-pseudo-UTP	69	N
1-Methyl-6-butyl-pseudo-UTP	70	N
1-Methyl-6-tert-butyl-pseudo-UTP	71	N
1-Methyl-6-(2,2,2-Trifluoroethyl)pseudo-UTP	72	N
1-Methyl-6-iodo-pseudo-UTP	73	N
1-Methyl-6-bromo-pseudo-UTP	74	N
1-Methyl-6-chloro-pseudo-UTP	75	N
1-Methyl-6-fluoro-pseudo-UTP	76	N
1-Methyl-6-methoxy-pseudo-UTP	77	N
1-Methyl-6-ethoxy-pseudo-UTP	78	N
1-Methyl-6-trifluoromethoxy-pseudo-UTP	79	N
1-Methyl-6-phenyl-pseudo-UTP	80	N
1-Methyl-6-(substituted phenyl)pseudo-UTP	81	N
1-Methyl-6-cyano-pseudo-UTP	82	N
1-Methyl-6-azido-pseudo-UTP	83	N
1-Methyl-6-amino-pseudo-UTP	84	N
1-Methyl-6-ethylcarboxylate-pseudo-UTP	85	N
1-Methyl-6-hydroxy-pseudo-UTP	86	N
1-Methyl-6-methylamino-pseudo-UTP	87	N
1-Methyl-6-dimethylamino-pseudo-UTP	88	N
1-Methyl-6-hydroxyamino-pseudo-UTP	89	N
1-Methyl-6-formyl-pseudo-UTP	90	N
1-Methyl-6-(4-morpholino)-pseudo-UTP	91	N
1-Methyl-6-(4-thiomorpholino)-pseudo-UTP	92	N
1-Alkyl-6-vinyl-pseudo-UTP	93	N
1-Alkyl-6-allyl-pseudo-UTP	94	N
1-Alkyl-6-homoallyl-pseudo-UTP	95	N

1-Alkyl-6-ethynyl-pseudo-UTP	96	N
1-Alkyl-6-(2-propynyl)-pseudo-UTP	97	N
1-Alkyl-6-(1-propynyl)-pseudo-UTP	98	N

**Example 114. Incorporation of naturally and non-naturally occurring nucleosides**

[0001608] Naturally and non-naturally occurring nucleosides are incorporated into mRNA encoding a polypeptide of interest. Examples of these are given in Tables 174 and 175. Certain commercially available nucleoside triphosphates (NTPs) are investigated in the polynucleotides of the invention. A selection of these are given in Table 175. The resultant mRNA are then examined for their ability to produce protein, induce cytokines, and/or produce a therapeutic outcome.

**Table 174. Naturally and non-naturally occurring nucleosides**

Chemistry Modification	Compound #	Naturally occurring
N4-Methyl-Cytosine	1	Y
N4,N4-Dimethyl-2'-OMe-Cytosine	2	Y
5-Oxyacetic acid-methyl ester-Uridine	3	Y
N3-Methyl-pseudo-Uridine	4	Y
5-Hydroxymethyl-Cytosine	5	Y
5-Trifluoromethyl-Cytosine	6	N
5-Trifluoromethyl-Uridine	7	N
5-Methyl-amino-methyl-Uridine	8	Y
5-Carboxy-methyl-amino-methyl-Uridine	9	Y
5-Carboxymethylaminomethyl-2'-OMe-Uridine	10	Y
5-Carboxymethylaminomethyl-2-thio-Uridine	11	Y
5-Methylaminomethyl-2-thio-Uridine	12	Y
5-Methoxy-carbonyl-methyl-Uridine	13	Y
5-Methoxy-carbonyl-methyl-2'-OMe-Uridine	14	Y
5-Oxyacetic acid-Uridine	15	Y
3-(3-Amino-3-carboxypropyl)-Uridine	16	Y
5-(carboxyhydroxymethyl)uridine methyl ester	17	Y
5-(carboxyhydroxymethyl)uridine	18	Y

**Table 175. Non-naturally occurring nucleoside triphosphates**

Chemistry Modification	Compound #	Naturally occurring
N1-Me-GTP	1	N
2'-OMe-2-Amino-ATP	2	N
2'-OMe-pseudo-UTP	3	Y
2'-OMe-6-Me-UTP	4	N
2'-Azido-2'-deoxy-ATP	5	N
2'-Azido-2'-deoxy-GTP	6	N
2'-Azido-2'-deoxy-UTP	7	N
2'-Azido-2'-deoxy-CTP	8	N
2'-Amino-2'-deoxy-ATP	9	N
2'-Amino-2'-deoxy-GTP	10	N
2'-Amino-2'-deoxy-UTP	11	N
2'-Amino-2'-deoxy-CTP	12	N
2-Amino-ATP	13	N
8-Aza-ATP	14	N
Xanthosine-5'-TP	15	N
5-Bromo-CTP	16	N
2'-F-5-Methyl-2'-deoxy-UTP	17	N
5-Aminoallyl-CTP	18	N
2-Amino-riboside-TP	19	N

**Example 115. Incorporation of modifications to the nucleobase and carbohydrate (sugar)**

[0001609] Naturally and non-naturally occurring nucleosides are incorporated into mRNA encoding a polypeptide of interest. Commercially available nucleosides and NTPs having modifications to both the nucleobase and carbohydrate (sugar) are examined for their ability to be incorporated into mRNA and to produce protein, induce cytokines, and/or produce a therapeutic outcome. Examples of these nucleosides are given in Tables 176 and 177.

**Table 176. Combination modifications**

Chemistry Modification	Compound #
5-iodo-2'-fluoro-deoxyuridine	1
5-iodo-cytidine	6
2'-bromo-deoxyuridine	7
8-bromo-adenosine	8
8-bromo-guanosine	9
2,2'-anhydro-cytidine hydrochloride	10

2,2'-anhydro-uridine	11
2'-Azido-deoxyuridine	12
2-amino-adenosine	13
N4-Benzoyl-cytidine	14
N4-Amino-cytidine	15
2'-O-Methyl-N4-Acetyl-cytidine	16
2'Fluoro-N4-Acetyl-cytidine	17
2'Fluor-N4-Bz-cytidine	18
2'O-methyl-N4-Bz-cytidine	19
2O-methyl-N6-Bz-deoxyadenosine	20
2'Fluoro-N6-Bz-deoxyadenosine	21
N2-isobutyl-guanosine	22
2'Fluro-N2-isobutyl-guanosine	23
2O-methyl-N2-isobutyl-guanosine	24

Table 177. Naturally occurring combinations

Name	Compound #	Naturally occurring
5-Methoxycarbonylmethyl-2-thiouridine TP	1	Y
5-Methylaminomethyl-2-thiouridine TP	2	Y
5-Crbamoylmethyluridine TP	3	Y
5-Carbamoylmethyl-2'-O-methyluridine TP	4	Y
1-Methyl-3-(3-amino-3-carboxypropyl) pseudouridine TP	5	Y
5-Methylaminomethyl-2-selenouridine TP	6	Y
5-Carboxymethyluridine TP	7	Y
5-Methyldihydrouridine TP	8	Y
lysidine TP	9	Y
5-Taurinomethyluridine TP	10	Y
5-Taurinomethyl-2-thiouridine TP	11	Y
5-( <i>iso</i> -Pentenylaminomethyl)uridine TP	12	Y
5-( <i>iso</i> -Pentenylaminomethyl)- 2-thiouridine TP	13	Y
5-( <i>iso</i> -Pentenylaminomethyl)-2'-O-methyluridine TP	14	Y
N4-Acetyl-2'-O-methylcytidine TP	15	Y
N4,2'-O-Dimethylcytidine TP	16	Y
5-Formyl-2'-O-methylcytidine TP	17	Y
2'-O-Methylpseudouridine TP	18	Y
2-Thio-2'-O-methyluridine TP	19	Y
3,2'-O-Dimethyluridine TP	20	Y

In the tables "UTP" stands for uridine triphosphate, "GTP" stands for guanosine triphosphate, "ATP" stands for adenosine triphosphate, "CTP" stands for cytosine triphosphate, "TP" stands for triphosphate and "Bz" stands for benzyl.

**Example 116. Additional Cosmetic Polypeptides of Interest**

[0001610] The cosmetic polypeptide of interest may be a toxin such as but not limited to botulinum toxin and/or tetanus toxin. Shown in Table 178, in addition to the name and description of the gene encoding the cosmetic polypeptide of interest is the NCBI Accession ID for the nucleotide (NCBI Nucleotide) or protein sequence (NCBI Protein). For any particular gene there may exist one or more variants or isoforms. Where these exist, they are shown in the tables as well. It will be appreciated by those of skill in the art that disclosed in the Tables are potential flanking regions. These are encoded in each ENST transcript or NCBI nucleotide sequence either to the 5' (upstream) or 3' (downstream) of the ORF or coding region. The coding region is definitively and specifically disclosed by teaching the ENSP protein or NCBI protein sequence. Consequently, the sequences taught flanking that encoding the protein are considered flanking regions. It is also possible to further characterize the 5' and 3' flanking regions by utilizing one or more available databases or algorithms. Databases have annotated the features contained in the flanking regions of the ENST transcripts, NCBI nucleotide sequences and these are available in the art.

**Table 178. Cosmetic Targets**

Target	Target Description	NCBI Nucleotide	SEQ ID NO	NCBI Protein	SEQ ID NO
729	botulinum toxin type A	GQ168376.1	5674	ACS52168.1	5691
730	botulinum toxin type A light chain	N/A	5675	N/A	5692
731	botulinum toxin type B	AB665558.1	5676	YP_001693307.1	5693
732	botulinum toxin type B light chain	N/A	5677	N/A	5694
733	botulinum toxin type C1	AB200359.1	5678	P18640.2	5695
734	botulinum toxin type C1 light chain	N/A	5679	N/A	5696
735	botulinum toxin type C2 component I	AB465554.1	5680	BAH29485.1	5697
736	botulinum toxin type C2 component	AB465554.1	5681	BAH29486.1	5698

	II				
737	botulinum toxin type D	S49407.1	5682	P19321.1	5699
738	botulinum toxin type D light chain	N/A	5683	N/A	5700
739	botulinum toxin type E	AM695761.1	5684	CAQ03495.1	5701
740	botulinum toxin type E light chain	N/A	5685	N/A	5702
741	botulinum toxin type F	M92906.1	5686	P30996.1	5703
742	botulinum toxin type F light chain	N/A	5687	N/A	5704
743	botulinum toxin type G	X74162.1	5688	Q60393.2	5705
744	botulinum toxin type G light chain	N/A	5689	N/A	5706
745	tetanus toxin	X06214.1	5690	P04958.2	5707

#### A. Tetanus Toxin

[0001611] The cosmetic polynucleotides, cosmetic primary constructs and/or cosmetic mmRNA may be used in the treatment, amelioration or prophylaxis of neurodegenerative and other muscle disorders. The cosmetic polynucleotides, cosmetic primary constructs and/or cosmetic mmRNA of the present invention can encode a cosmetic polypeptide of interest such as, but not limited to, SEQ ID NOs: 5707.

#### B. Botulinum Toxin

[0001612] The cosmetic polynucleotides, cosmetic primary constructs and/or cosmetic mmRNA may be used in the treatment, amelioration or prophylaxis of cosmetic diseases, disorders and/or conditions and other muscle disorders. The cosmetic polynucleotides, cosmetic primary constructs and/or cosmetic mmRNA can encode a cosmetic polypeptide of interest, a light chain of a cosmetic polypeptide of interest such as, but not limited to, SEQ ID NOs: 5691-5706. The light chain of the polypeptide of interest may be produced by a method known in the art.

#### **Example 117. Protein Complexes Associated with Neurotoxins**

[0001613] The cosmetic polynucleotides, cosmetic primary construct and/or cosmetic mmRNA can encode and/or form toxin complexes from the noncovalent association of the neurotoxin with up to seven other proteins which are known as neurotoxin-associated proteins (NAPs). Table 179 describes a non-limiting listing of NAPs for the seven botulinum toxin serotypes.

**Table 179. Neurotoxin-Associated Proteins**

<b>Botulinum Toxin Serotype</b>	<b>Neurotoxin-associated protein (NAP)</b>	<b>SEQ ID NO</b>
A	NTNH	5708
A	NTNH	5709
A	NTNH	5710
A	NTNH	5711
A	NTNH	5712
A	NTNH	5713
A	NTNH	5714
A	NTNH	5715
A	NTNH	5716
A	HA-17/15	5717
A	HA-33/35	5718
A	HA-33/35	5719
A	HA-33/35	5720
A	HA-19/20	
A	HA-70	5721
A	HA-70	5722
B	NTNH	5723
B	NTNH	5724
B	NTNH	5725
B	NTNH	5726
B	NTNH	5727
B	HA-17	5728
B	HA-33/35	5729
B	HA-33/35	5730
B	HA-33/35	5731
B	HA-70	5732
B	HA-70	5733
C	NTNH	5734
C	NTNH	5735
C	HA-17	5736
C	HA-17	5737
C	HA-26/21	
C	HA-33	5738
C	HA-33	5739
C	HA-33	5740
C	HA-70	5741
C	HA-70	5742
D	NTNH	5743
D	NTNH	5744

D	HA-17	5745
D	HA-33	5746
D	HA-33	5747
D	HA-70	5748
E	NTNH	5749
F	NTNH	5750
F	NTNH	5751
F	NTNH	5752
G	NTNH	5753
G	HA-70 (partial sequence)	5754
G	HA-17	

**Example 118. Dose response and injection site selection and timing**

[0001614] To determine the dose response trends, impact of injection site and impact of injection timing, studies are performed following the protocol outlined in Example 35. In these studies, varied doses of 1 µg, 5 µg, 10 µg, 25 µg, 50 µg, and values in between are used to determine dose response outcomes. Split dosing for a 100 µg total dose includes three or six doses of 1.6 µg, 4.2 µg, 8.3 µg, 16.6 µg, or values and total doses equal to administration of the total dose selected.

[0001615] Injection sites are chosen from the limbs or any body surface presenting enough area suitable for injection. This may also include a selection of injection depth to target the dermis (Intradermal), epidermis (Epidermal), subcutaneous tissue (SC) or muscle (IM). Injection angle will vary based on targeted delivery site with injections targeting the intradermal site to be 10-15 degree angles from the plane of the surface of the skin, between 20-45 degrees from the plane of the surface of the skin for subcutaneous injections and angles of between 60-90 degrees for injections substantially into the muscle.

**Example 119. Intranasal Lung Delivery of 1-methylpseudouridine or 5-methylcytosine and 1-methylpseudouridine Modified Luciferase mRNA Formulated in Cationic Lipid Nanoparticle**

[0001616] Luciferase modified mRNA (mRNA sequence shown in SEQ ID NO: 5665; polyA tail of approximately 140 nucleotides not shown in sequence; 5'cap, Cap1) fully modified with 1-methylpseudouridine (Luc-G5-LNP-KC2) or fully modified with 1-



methylpseudouridine and 5-methylcytosine (Luc-G2-LNP-KC2) were formulated in the cationic Lipid Nanoparticle (LNP-KC2) as described in Table 180.

**Table 180. Formulation**

Formulation	NPA-127-1	NPA-135-1
Lipid	DLin-KC2-DMA	DLin-KC2-DMA
Lipid/mRNA ratio (wt/wt)	20:1	20:1
Mean Size	114 nm PDI: 0.10	95 nm PDI: 0.11
Zeta at pH 7.4	-0.5 mV	-1.0 mV
Encaps. (RiboGr)	77%	100%

[0001617] The formulations were administered intranasally (I.N.) to Balb-C mice at a dose of 0.3 mg/kg. Twenty minutes prior to imaging, mice were injected intraperitoneally with a D-luciferin solution at 150 mg/kg. Animals were then anesthetized and images were acquired with an IVIS Lumina II imaging system (Perkin Elmer). Bioluminescence was measured as total flux (photons/second) of the entire mouse. The mice were imaged at 2 hours, 8 hours, 48, and 72 hours after dosing and the average total flux (photons/second) was measured. The background flux was about  $6.3 \times 10^5$  p/s. The results of the imaging of Luc-G5-LNP-KC2 or Luc-G5-LNP-KC2 vs. Vehicle are shown in the Table 181, "NT" means not tested.

**Table 181. Luciferase expression after intranasal dosing**

Route	Time Point	Luc-G5-LNP-KC2	Luc-G2-LNP-KC2	Vehicle (PBS)
		Flux (p/s)	Flux (p/s)	Flux (p/s)
I.N.	2 hrs	1.53E+06	5.81E+05	3.87E+05
I.N.	8 hrs	1.09E+07	9.35E+05	5.57E+05
I.N.	24 hrs	5.93E+06	5.33E+05	4.89E+05
I.N.	28 hrs	1.22E+06	7.63E+05	8.81E+05
I.N.	72 hrs	8.43E+05	NT	8.17E+05

**Example 120. Intranasal Lung Delivery of l-methylpseudouridine or 5-methylcytosine and l-methylpseudouridine Modified Luciferase mRNA lipoplexed in Lipofectamine 2000**

[0001618] Luciferase modified mRNA (mRNA sequence shown in SEQ ID NO: 5665; polyA tail of approximately 140 nucleotides not shown in sequence; 5'cap, Cap1) fully modified with l-methylpseudouridine (Luc-G5-Lipoplex) or fully modified with l-methylpseudouridine and 5-methylcytosine (Luc-G2-Lipoplex) were lipoplexed in two

steps, first step was the dilution of 16.6ul from 3mg/ml of 1-methylpseudouridine or 1-methylpseudouridine and 5-methylcytosine modified luciferase mRNA in 108.5 ul DMEM and the second step was the dilution of 100ul LF2000 in 25ul DMEM then both mixed together gently to make 250ul total mixer which incubated 5-10 min at RT to form a Lipid-mRNA complex before injection. The lipoplex from both Luciferase mRNA fully modified with 1-methylpseudouridine or 1-methylpseudouridine and 5-methylcytosine were administered intranasally (I.N.) to Balb-C mice at a dose of 0.5 mg/kg.

[0001619] Twenty minutes prior to imaging, mice were injected intraperitoneally with a D-luciferin solution at 150 mg/kg. Animals were then anesthetized and images were acquired with an IVIS Lumina II imaging system (Perkin Elmer). Bioluminescence was measured as total flux (photons/second) of the entire mouse. The mice were imaged at 2 hours, 8 hours and 24 hours after dosing and the average total flux (photons/second) was measured. The background signal was about  $4.8 \times 10^5$  p/s. The background flux was about  $6.3 \times 10^5$  p/s. The results of the imaging of Luc-G5-Lipoplex or Luc-G2-Lipoplex vs. Vehicle are shown in the Table 182.

**Table 182. Luciferase expression after intranasal dosing**

Route	Time Point	Luc-G5-Lipoplex	Luc-G2-Lipoplex	Vehicle (PBS)
		Flux (p/s)	Flux (p/s)	Flux (p/s)
I.N.	2 hrs	$8.37 \times 10^5$	$9.58 \times 10^5$	$3.87 \times 10^5$
I.N.	8 hrs	$8.42 \times 10^5$	$7.11 \times 10^5$	$5.57 \times 10^5$
I.N.	24 hrs	$5.74 \times 10^5$	$5.53 \times 10^5$	$4.89 \times 10^5$

**Example 121. Intranasal Lung Delivery of 1-methylpseudouridine or 5-methylcytosine and 1-methylpseudouridine Modified Luciferase mRNA formulated in PBS**

[0001620] Luciferase modified mRNA (mRNA sequence shown in SEQ ID NO: 5665; polyA tail of approximately 140 nucleotides not shown in sequence; 5'cap, Cap1) fully modified with 1-methylpseudouridine (Luc-G5-Buffer(PBS)) or fully modified with 1-methylpseudouridine and 5-methylcytosine (Luc-G2-Buffer(PBS)) formulated in PBS (pH 7.4) were administered intranasally (I.N.) to Balb-C mice at a dose of 7.5 mg/kg.

[0001621] Twenty minutes prior to imaging, mice were injected intraperitoneally with a D-luciferin solution at 150 mg/kg. Animals were then anesthetized and images were acquired with an IVIS Lumina II imaging system (Perkin Elmer). Bioluminescence was measured as total flux (photons/second) of the entire mouse. The mice were imaged at 2 hours, 8 hours and 24 hours after dosing and the average total flux (photons/second) was measured. The background flux was about  $4.8 \times 10^5$  p/s. The background flux was about  $6.3 \times 10^5$  p/s. The results of the imaging of Luc-G5-in Buffer vs. Vehicle are shown in the Table 183.

**Table 183. Luciferase expression after intranasal dosing**

Route	Time Point	Luc-G5-in Buffer (PBS)	Luc-G2-in Buffer (PBS)	Vehicle (PBS)
		Flux [p/s]	Flux [p/s]	Flux (p/s)
I.N.	2 hrs	$4.50 \times 10^5$	$9.58 \times 10^5$	$3.87 \times 10^5$
I.N.	8 hrs	$7.12 \times 10^5$	$7.11 \times 10^5$	$5.57 \times 10^5$
I.N.	24 hrs	$4.47 \times 10^5$	$5.53 \times 10^5$	$4.89 \times 10^5$

It is to be understood that the words which have been used are words of description rather than limitation, and that changes may be made within the purview of the appended claims without departing from the true scope and spirit of the invention in its broader aspects.

While the present invention has been described at some length and with some particularity with respect to the several described embodiments, it is not intended that it should be limited to any such particulars or embodiments or any particular embodiment, but it is to be construed with references to the appended claims so as to provide the broadest possible interpretation of such claims in view of the prior art and, therefore, to effectively encompass the intended scope of the invention.

All publications, patent applications, patents, and other references mentioned herein are incorporated by reference in their entirety. In case of conflict, the present specification, including definitions, will control. In addition, section headings, the materials, methods, and examples are illustrative only and not intended to be limiting.

## Claims

We claim:

1. A method of treating a disease, disorder and/or condition in a subject in need thereof by increasing a level of a cosmetic polypeptide of interest comprising administering to said subject an isolated polynucleotide comprising:
  - (a) a first region of linked nucleosides, said first region encoding the cosmetic polypeptide of interest selected from the group consisting of SEQ ID NOs: 884-1611 and 5691-5707;
  - (b) a first flanking region located at the 5' terminus of said first region comprising;
    - (i) a sequence of linked nucleosides selected from the group consisting of the native 5' untranslated region (UTR) of any of the nucleic acids that encode any of SEQ ID NOs: 884-1611 and 5691-5707, SEQ ID NO: 1-4 and functional variants thereof;
  - (c) a second flanking region located at the 3' terminus of said first region comprising;
    - (i') a sequence of linked nucleosides selected from the group consisting of the native 3' UTR of any of the nucleic acids that encode any of SEQ ID NOs: 884-1611 and 5691-5707, SEQ ID NOs 5-21 and functional variants thereof; and
    - (ii') a 3' tailing sequence of linked nucleosides.
2. A method of altering, modifying or changing the appearance of a member of the integumentary system of a subject comprising contacting said member with an isolated polynucleotide comprising:
  - (a) a first region of linked nucleosides, said first region encoding the cosmetic polypeptide of interest selected from the group consisting of SEQ ID NOs: 884-1611 and 5691-5707;
  - (b) a first flanking region located at the 5' terminus of said first region comprising;

- (ii) a sequence of linked nucleosides selected from the group consisting of the native 5' untranslated region (UTR) of any of the nucleic acids that encode any of SEQ ID NOs: 884-161 1 and 5691-5707, SEQ ID NO: 1-4 and functional variants thereof;
- (c) a second flanking region located at the 3' terminus of said first region comprising;
- (i') a sequence of linked nucleosides selected from the group consisting of the native 3' UTR of any of the nucleic acids that encode any of SEQ ID NOs: 884-161 1 and 5691-5707, SEQ ID NOs 5-21 and functional variants thereof; and
  - (ir) a 3' tailing sequence of linked nucleosides.
3. The method of claim 1 or 2, wherein the first region further comprises two stop codons.
4. The method of claim 1 or 2, wherein the first region further comprises a first stop codon "TGA" and a second stop codon selected from the group consisting of "TAA," "TGA" and "TAG."
5. The method of claim 1 or 2, wherein the 3' tailing sequence of linked nucleosides is selected from the group consisting of a poly-A tail of approximately 160 nucleotides and a poly A-G quartet.
6. The method of claim 1 or 2, wherein the first flanking region further comprises at least one 5'terminal cap.
7. The method of claim 6, wherein the at least one 5' terminal cap is selected from the group consisting of CapO, CapI, ARCA, inosine, N1-methyl-guanosine, 2'fluoro-guanosine, 7-deaza-guanosine, 8-oxo-guanosine, 2-amino-guanosine, LNA-guanosine, and 2-azido-guanosine.

8. The method of claim 1 or 2, wherein the isolated polynucleotide is substantially purified.
9. The method of claim 1 or 2, wherein the nucleotides comprise at least two modifications and a translatable region.
10. The method of claim 9, wherein the modifications are located on one or more of a nucleoside and/or the backbone of said nucleotides.
11. The method of claim 10, where the modifications are located on both a nucleoside and a backbone linkage.
12. The method of claim 10, where the modifications are located on the backbone linkage.
13. The method of claim 12, where the backbone linkage is modified by replacement of one or more oxygen atoms.
14. The method of claim 12, where the modifications comprise replacing at least one phosphodiester linkage with a phosphorothioate linkage.
15. The method of claim 10, where the modifications are located on a nucleoside.
16. The method of claim 15, where the modifications are on a sugar of the nucleoside.
17. The method of claim 15, where the modifications are selected from the group consisting of pyridin-4-one ribonucleoside, 5-aza-uridine, 2-thio-5-aza-uridine, 2-thiouridine, 4-thio-pseudouridine, 2-thio-pseudouridine, 5-hydroxyuridine, 3-methyluridine, 5-carboxymethyl-uridine, 1-carboxymethyl-pseudouridine, 5-propynyl-uridine, 1-propynyl-pseudouridine, 5-taurinomethyluridine, 1-taurinomethyl-pseudouridine, 5-taurinomethyl-2-thio-uridine, 1-taurinomethyl-4-

thio-uridine, 5-methyl-uridine, 1-methyl-pseudouridine, 4-thio-1-methyl-pseudouridine, 2-thio-1-methyl-pseudouridine, 1-methyl-1-deaza-pseudouridine, 2-thio-1-methyl-1-deaza-pseudouridine, dihydrouridine, dihydropseudouridine, 2-thio-dihydrouridine, 2-thio-dihydropseudouridine, 2-methoxyuridine, 2-methoxy-4-thio-uridine, 4-methoxy-pseudouridine, 4-methoxy-2-thio-pseudouridine, 5-azacytidine, pseudoisocytidine, 3-methyl-cytidine, N4-acetylcytidine, 5-formylcytidine, N4-methylcytidine, 5-hydroxymethylcytidine, 1-methyl-pseudoisocytidine, pyrrolo-cytidine, pyrrolo-pseudoisocytidine, 2-thio-cytidine, 2-thio-5-methyl-cytidine, 4-thio-pseudoisocytidine, 4-thio-1-methyl-pseudoisocytidine, 4-thio-1-methyl-1-deaza-pseudoisocytidine, 1-methyl-1-deaza-pseudoisocytidine, zebularine, 5-aza-zebularine, 5-methyl-zebularine, 5-aza-2-thio-zebularine, 2-thio-zebularine, 2-methoxy-cytidine, 2-methoxy-5-methyl-cytidine, 4-methoxy-pseudoisocytidine, 4-methoxy-1-methyl-pseudoisocytidine, 2-aminopurine, 2,6-diaminopurine, 7-deaza-adenine, 7-deaza-8-aza-adenine, 7-deaza-2-aminopurine, 7-deaza-8-aza-2-aminopurine, 7-deaza-2,6-diaminopurine, 7-deaza-8-aza-2,6-diaminopurine, 1-methyladenosine, N6-methyladenosine, N6-isopentenyladenosine, N6-(cis-hydroxyisopentenyl)adenosine, 2-methylthio-N6-(cis-hydroxyisopentenyl)adenosine, N6-glycinylocarbonyladenosine, N6-threonylocarbonyladenosine, 2-methylthio-N6-threonyl carbonyladenosine, N6,N6-dimethyladenosine, 7-methyladenine, 2-methylthio-adenine, 2-methoxy-adenine, inosine, 1-methyl-inosine, wyosine, wybutosine, 7-deaza-guanosine, 7-deaza-8-aza-guanosine, 6-thio-guanosine, 6-thio-7-deaza-guanosine, 6-thio-7-deaza-8-aza-guanosine, 7-methyl-guanosine, 6-thio-7-methyl-guanosine, 7-methylinosine, 6-methoxy-guanosine, 1-methyl-guanosine, N2-methyl-guanosine, N2,N2-dimethyl-guanosine, 8-oxo-guanosine, 7-methyl-8-oxo-guanosine, 1-methyl-6-thio-guanosine, N2-methyl-6-thio-guanosine, and N2,N2-dimethyl-6-thio-guanosine.

18. The method of claim 10, where the modifications are located on a nucleobase.

19. The method of claim 18, where the nucleobase modified is selected from the group consisting of cytosine, guanine, adenine, thymine and uracil.
20. The method of claim 2 where the member is selected from the group consisting of skin, hair and nails.
21. The method of claim 20 wherein the subject suffers from at least one disease, disorder and/or condition.
22. The method of claim 1 wherein the disease, disorder and/or condition is selected from the group consisting of acne vulgaris, acne aestivalis, acne conglobata, acne cosmetic, acne fulminans, acne keloidalis nuchae, acne mechanica, acne medicamentosa, acne miliaris necrotica, acne necrotica, acne rosacea, actinic keratosis, acne vulgaris, acne aestivalis, acne conglobata, acne cosmetic, acne fulminans, acne keloidalis nuchae, acne mechanica, acne medicamentosa, acne miliaris necrotica, acne necrotica, acne rosacea, acute urticaria, allergic contact dermatitis, alopecia areata, angioedema, athlete's foot, atopic dermatitis, autoeczematization, baby acne, balding, blastomycosis, blackheads, birthmarks and other skin pigmentation problems, boils, bruises, bug bites and stings, burns, cellulitis, chiggers, chloracne, cholinergic or stress urticaria, chronic urticaria, cold type urticaria, confluent and reticulated papillomatosis, corns, cysts, dandruff, dermatitis herpetiformis, dermatographism, dyshidrotic eczema, diaper rash, dry skin, dyshidrosis, ectodermal dysplasia such as, hypohidrotic ectodermal dysplasia and X-linked hypohidrotic ectodermal dysplasia, eczema, epidermodysplasia verruciformis, erythema nodosum, excoriated acne, exercise-induced anaphylaxis folliculitis, excess skin oil, folliculitis, freckles, frostbite, fungal nails, hair density, hair growth rate, halogen acne, hair loss, heat rash, hematoma, herpes simplex infections (non-genital), hidradenitis suppurativa, hives, hyperhidrosis, hyperpigmentation, hypohidrotic ectodermal dysplasia, hypopigmentation, impetigo, ingrown hair, heat type urticaria, ingrown toenail, infantile acne or neonatal acne, itch, irritant contact dermatitis, jock itch, keloid,



- keratosis pilaris, lichen planus, lichen sclerosus, lupus miliaris disseminatus faciei, melasma, moles, molluscum contagiosum, nail growth rate, nail health, neurodermatitis, nummular eczema, occupational acne, oil acne, onychomycosis, physical urticaria, pilonidal cyst, pityriasis rosea, pityriasis versicolor, poison ivy, pomade acne, pseudofolliculitis barbae or acne keloidalis nuchae, psoriasis, psoriatic arthritis, pressure or delayed pressure urticaria, puncture wounds such as cuts and scrapes, rash, rare or water type urticaria, rhinoplasty, ringworm, rosacea, rothmund-thomson syndrome, sagging of the skin, scabies, scars, seborrhea, seborrheic dermatitis, shingles, skin cancer, skin tag, solar type urticaria, spider bite, stretch marks, sunburn, tar acne, tropical acne, thinning of skin, thrush, tinea versicolor, transient acantholytic dermatosis, tycoon's cap or acne necrotica miliaris, uneven skin tone, varicose veins, venous eczema, vibratory angioedema, vitiligo, warts, Weber-Christian disease, wrinkles, x-linked hypohidrotic ectodermal dysplasia, xerotic eczema, yeast infection and general signs of aging.
23. The method of claim 1 or 2, wherein the isolated polynucleotide is formulated.
24. The method of claim 23, wherein the formulation comprises a lipid which is selected from one of DLin-DMA, DLin-K-DMA, DLin-KC2-DMA, 98N 12-5, C12-200, DLin-MC3-DMA, PLGA, PEG, PEG-DMA and PEGylated lipids and mixtures thereof.
25. The method of claim 24, wherein the isolated polynucleotide is administered at a total daily dose of between 1 ug and 150 ug.
26. The method of claim 25, wherein administration is by injection, topical administration, ophthalmic administration and intranasal administration.
27. The method of claim 26, wherein administration is by injection and said injection is selected from the group consisting of intradermal, subcutaneous and intramuscular.

28. The method of claim 26, wherein administration is topical administration and said topical administration is selected from the group consisting of cream, lotion, ointment, gel, spray, solution and the like.
29. The method of claim 28 wherein the topical administration further comprises a penetration enhancer.
30. The method of claim 28 where the penetration enhancer is selected from the group consisting of surfactants, fatty acids, bile salts, chelating agents, non-chelating non-surfactants, polyoxyethylene-9-lauryl ether, polyoxyethylene-20-cetyl ether, fatty acids and/or salts in combination with bile acids and/or salts, sodium salt in combination with lauric acid, capric acid and UDCA, and the like.
31. The method of claim 30, further comprising a fragrance, a colorant, a sunscreen, an antibacterial and/or a moisturizer.
32. The method of claim 26, wherein the isolated polynucleotide is administered to at least one site selected from the group consisting of forehead, scalp, hair follicles, hair, upper eyelids, lower eyelids, eyebrows, eyelashes, infraorbital area, periorbital areas, temple, nose, nose bridge, cheeks, tongue, nasolabial folds, lips, periobicular areas, jaw line, ears, neck, breast, forearm, upper arm, palm, hand, finger, nails, back, abdomen, sides, buttocks, thigh, calf, feet, toes and the like.
33. A cosmetic composition comprising an isolated polynucleotide comprising:
- (a) a first region of linked nucleosides, said first region encoding a cosmetic polypeptide of interest selected from the group consisting of SEQ ID NOs: 884-1611 and 5691-5707;
  - (b) a first flanking region located at the 5' terminus of said first region comprising;

- (iii) a sequence of linked nucleosides selected from the group consisting of the native 5' untranslated region (UTR) of any of the nucleic acids that encode any of SEQ ID NOs: 884-161 1 and 5691-5707, SEQ ID NO: 1-4 and functional variants thereof;
- (c) a second flanking region located at the 3' terminus of said first region comprising;
- (i') a sequence of linked nucleosides selected from the group consisting of the native 3' UTR of any of the nucleic acids that encode any of SEQ ID NOs: 884-161 1 and 5691-5707, SEQ ID NOs 5-21 and functional variants thereof; and
  - (ir) a 3' tailing sequence of linked nucleosides.
34. The cosmetic composition of claim 33 wherein the first region of linked nucleosides comprises at least an open reading frame of a nucleic acid sequence, wherein the nucleic acid sequence is selected from the group consisting of SEQ ID NOs: 1991-5640.
35. The cosmetic composition of claim 33, wherein the first region further comprises two stop codons.
36. The cosmetic composition of claim 33, wherein the first region further comprises a first stop codon "TGA" and a second stop codon selected from the group consisting of "TAA," "TGA" and "TAG."
37. The cosmetic composition of claim 33, wherein the 3' tailing sequence of linked nucleosides is selected from the group consisting of a poly-A tail of approximately 160 nucleotides and a poly A-G quartet.
38. The cosmetic composition of claim 33, wherein the first flanking region further comprises at least one 5'terminal cap.

39. The cosmetic composition of claim 38, wherein the at least one 5' terminal cap is selected from the group consisting of CapO, CapI, ARCA, inosine, NI-methyl-guanosine, 2'fluoro-guanosine, 7-deaza-guanosine, 8-oxo-guanosine, 2-amino-guanosine, LNA-guanosine, and 2-azido-guanosine.
40. The cosmetic composition of any of claims 33-39 where the isolated polynucleotide is substantially purified.
41. The cosmetic composition of any one of claims 33-39, wherein said nucleotides comprise at least two modifications and a translatable region.
42. The cosmetic composition of claim 41, wherein the modifications are located on one or more of a nucleoside and/or the backbone of said nucleotides.
43. The cosmetic composition of claim 42, where the modifications are located on both a nucleoside and a backbone linkage.
44. The cosmetic composition of claim 42, where the modifications are located on the backbone linkage.
45. The cosmetic composition of claim 44, where the backbone linkage is modified by replacement of one or more oxygen atoms.
46. The cosmetic composition of claim 44, where the modifications comprises replacing at least one phosphodiester linkage with a phosphorothioate linkage.
47. The cosmetic composition of claim 42, where the modifications are located on a nucleoside.

48. The cosmetic composition of claim 44, where the modifications are on a sugar of the nucleoside.
49. The cosmetic composition of claim 47, where the modifications are selected from the group consisting of pyridin-4-one ribonucleoside, 5-aza-uridine, 2-thio-5-aza-uridine, 2-thiouridine, 4-thio-pseudouridine, 2-thio-pseudouridine, 5-hydroxyuridine, 3-methyluridine, 5-carboxymethyl-uridine, 1-carboxymethyl-pseudouridine, 5-propynyl-uridine, 1-propynyl-pseudouridine, 5-taurinomethyluridine, 1-taurinomethyl-pseudouridine, 5-taurinomethyl-2-thio-uridine, 1-taurinomethyl-4-thio-uridine, 5-methyl-uridine, 1-methyl-pseudouridine, 4-thio-1-methyl-pseudouridine, 2-thio-1-methyl-pseudouridine, 1-methyl-1-deaza-pseudouridine, 2-thio-1-methyl-1-deaza-pseudouridine, dihydrouridine, dihydropseudouridine, 2-thio-dihydrouridine, 2-thio-dihydropseudouridine, 2-methoxyuridine, 2-methoxy-4-thio-uridine, 4-methoxy-pseudouridine, 4-methoxy-2-thio-pseudouridine, 5-aza-cytidine, pseudoisocytidine, 3-methyl-cytidine, N4-acetylcytidine, 5-formylcytidine, N4-methylcytidine, 5-hydroxymethylcytidine, 1-methyl-pseudoisocytidine, pyrrolo-cytidine, pyrrolo-pseudoisocytidine, 2-thio-cytidine, 2-thio-5-methyl-cytidine, 4-thio-pseudoisocytidine, 4-thio-1-methyl-pseudoisocytidine, 4-thio-1-methyl-1-deaza-pseudoisocytidine, 1-methyl-1-deaza-pseudoisocytidine, zebularine, 5-aza-zebularine, 5-methyl-zebularine, 5-aza-2-thio-zebularine, 2-thio-zebularine, 2-methoxy-cytidine, 2-methoxy-5-methyl-cytidine, 4-methoxy-pseudoisocytidine, 4-methoxy-1-methyl-pseudoisocytidine, 2-aminopurine, 2,6-diaminopurine, 7-deaza-adenine, 7-deaza-8-aza-adenine, 7-deaza-2-aminopurine, 7-deaza-8-aza-2-aminopurine, 7-deaza-2,6-diaminopurine, 7-deaza-8-aza-2,6-diaminopurine, 1-methyladenosine, N6-methyladenosine, N6-isopentenyladenosine, N6-(cis-hydroxyisopentenyl)adenosine, 2-methylthio-N6-(cis-hydroxyisopentenyl)adenosine, N6-glycylcarbamoyladenosine, N6-threonylcarbamoyladenosine, 2-methylthio-N6-threonyl carbamoyladenosine, N6,N6-dimethyladenosine, 7-methyladenine, 2-methylthio-adenine, 2-methoxy-adenine, inosine, 1-methyl-inosine, wyosine, wybutosine, 7-deaza-guanosine, 7-deaza-8-aza-guanosine, 6-

- thio-guanosine, 6-thio-7-deaza-guanosine, 6-thio-7-deaza-8-aza-guanosine, 7-methyl-guanosine, 6-thio-7-methyl-guanosine, 7-methylinosine, 6-methoxy-guanosine, 1-methylguanosine, N2-methylguanosine, N2,N2-dimethylguanosine, 8-oxo-guanosine, 7-methyl-8-oxo-guanosine, 1-methyl-6-thio-guanosine, N2-methyl-6-thio-guanosine, and N2,N2-dimethyl-6-thio-guanosine.
50. The cosmetic composition of claim 42, where the modifications are located on a nucleobase.
51. The cosmetic composition of claim 50, where the modifications on the nucleobase are selected from the group consisting of cytosine, guanine, adenine, thymine and uracil.
52. The cosmetic composition of claim 34 further comprising a pharmaceutical acceptable excipient.
53. The cosmetic composition of claim 52, wherein the pharmaceutical acceptable excipient is selected from the group consisting of a solvent, aqueous solvent, non-aqueous solvent, dispersion media, diluent, dispersion, suspension aid, surface active agent, isotonic agent, thickening or emulsifying agent, preservative, lipid, lipidoids liposome, lipid nanoparticle, core-shell nanoparticles, polymer, lipoplex, peptide, protein, cell, hyaluronidase, and mixtures thereof.
54. The cosmetic composition of claim 53, where the cosmetic composition further comprises a lipid and wherein said lipid is selected from DLin-DMA, DLin-K-DMA, DLin-KC2-DMA, 98N12-5, C 12-200, DLin-MC3-DMA, PLGA, PEG, PEG-DMA and PEGylated lipids and mixtures thereof.

Figure 1

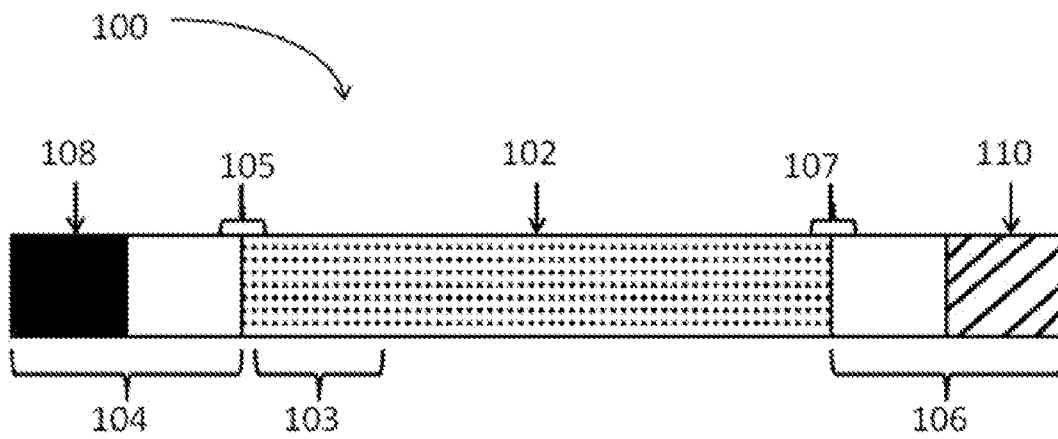
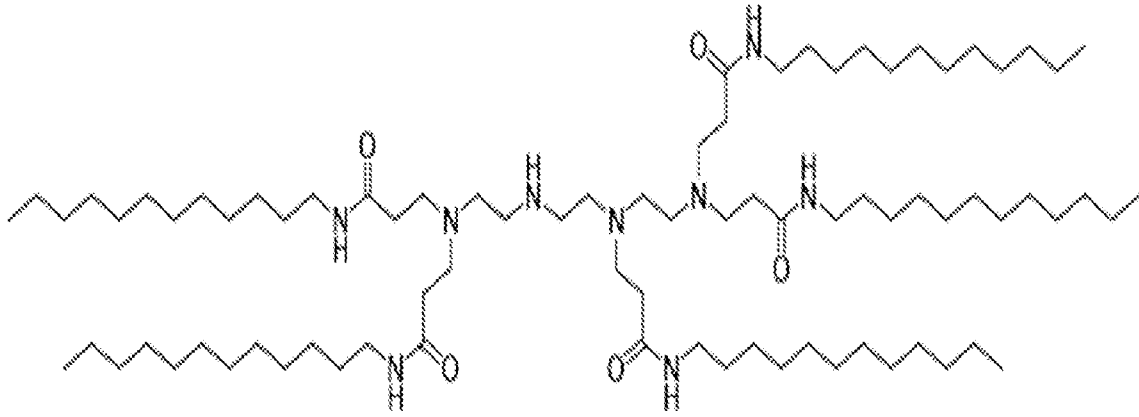
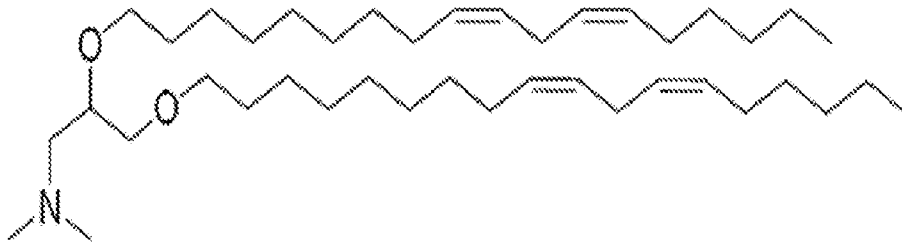

FIGURE 2

98N12-5 (TETA5-LAP)



DLin-DMA



DLin-K-DMA (2,2-Dilinoleyl-4-dimethylaminomethyl-[1,3]-dioxolane)

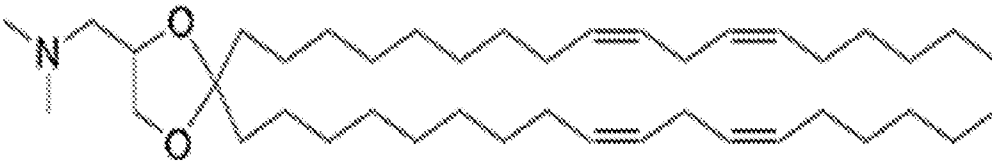

DLin-KC2-DMA

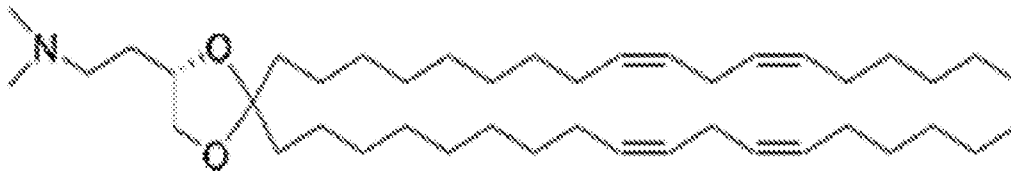

PRIOR ART



## FIGURE 2 CONT.

## DLin-MC3-DMA

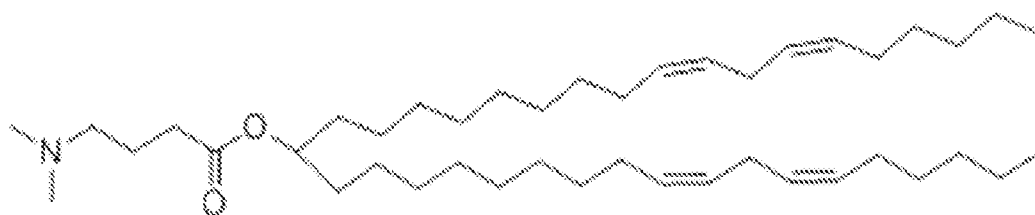

## C12-200

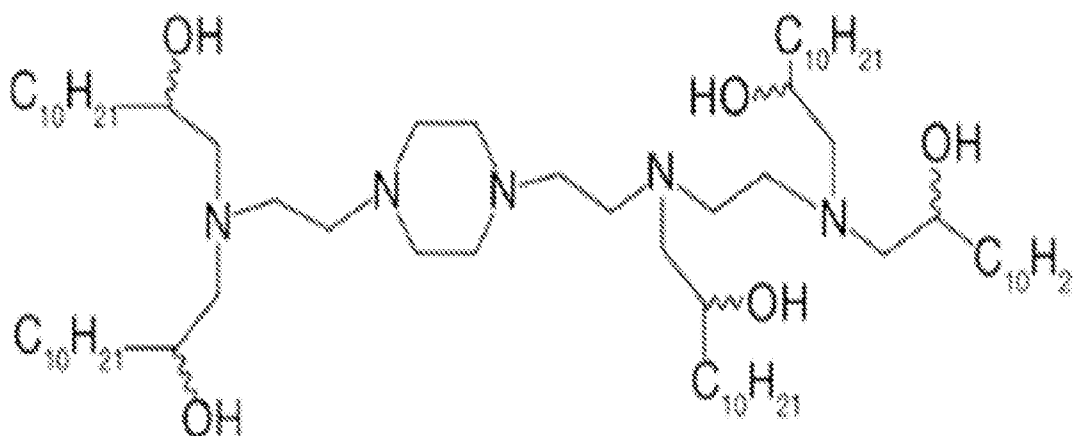

PRIOR ART

FIGURE 3

Only single cutters are shown in the map.

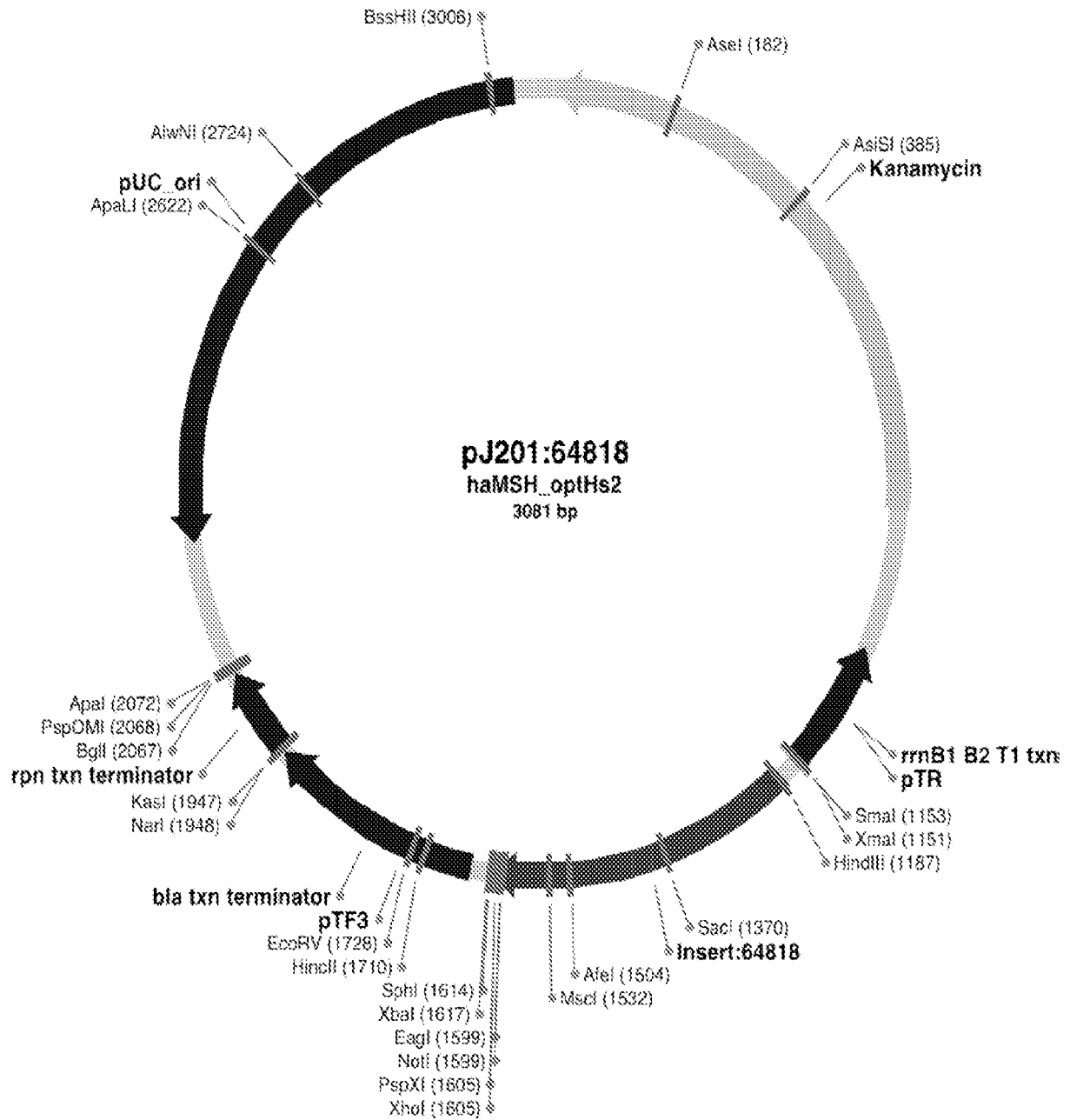

PRIOR ART

FIGURE 4

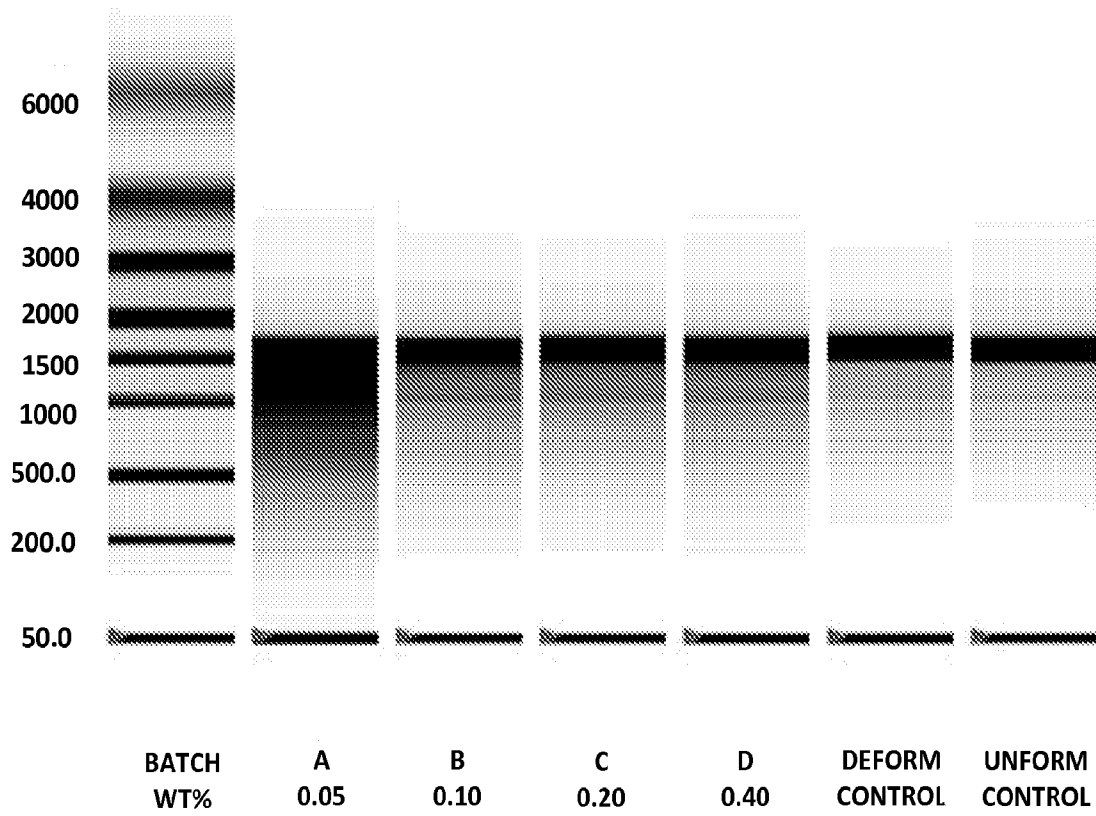

**INTERNATIONAL SEARCH REPORT**

International application No.  
PCT/US201 3/030068

<p><b>A. CLASSIFICATION OF SUBJECT MATTER</b>  <b>IPC(8) - A61 K 31/71 15 (201 3.01)</b>  <b>USPC - 514/44R</b></p> <p>According to International Patent Classification (IPC) or to both national classification and IPC</p>																	
<p><b>B. FIELDS SEARCHED</b></p> <p>Minimum documentation searched (classification system followed by classification symbols)                  IPC(8) - A61K 31/7105, 31/71 1, 31/71 15, 31/7125; A61P 17/00; A61Q 7/00; C07H 21/00, 21/02; C12P 19/34 (2013.01)                  USPC - 132/202; 435/91 .3; 514/44R; 536/23.1, 23.2, 23.5</p> <p>Documentation searched other than minimum documentation to the extent that such documents are included in the fields searched                  CPC Class/Subclass(es): A61K 38/00, 48/00; A61Q 5/02; C12P 19/34 (2013.01)</p> <p>Electronic data base consulted during the international search (name of data base and, where practicable, search terms used)                  Orbit.com, Google Scholar, Google Patents</p>																	
<p><b>C. DOCUMENTS CONSIDERED TO BE RELEVANT</b></p> <table border="1" style="width:100%; border-collapse: collapse;"> <thead> <tr> <th style="width:10%;">Category*</th> <th style="width:70%;">Citation of document, with indication, where appropriate, of the relevant passages</th> <th style="width:20%;">Relevant to claim No.</th> </tr> </thead> <tbody> <tr> <td align="center">Y</td> <td>US 2009/0286852 A1 (KARIKO et al) 19 November 2009 (19.11.2009) entire document</td> <td align="center">1-33, 35-54</td> </tr> <tr> <td align="center">Y</td> <td>US 2009/0144839 A1 (INANA et al) 04 June 2009 (04.06.2009) entire document</td> <td align="center">1-33, 35-54</td> </tr> <tr> <td align="center">Y</td> <td>US 2007/0224635 A1 (BOUQUIN) 27 September 2007 (27.09.2007) entire document</td> <td align="center">3, 4, 35, 36</td> </tr> <tr> <td align="center">Y</td> <td>US 2010/0261231 A1 (KORE et al) 14 October 2010 (14.10.2010) entire document</td> <td align="center">7, 39</td> </tr> </tbody> </table>			Category*	Citation of document, with indication, where appropriate, of the relevant passages	Relevant to claim No.	Y	US 2009/0286852 A1 (KARIKO et al) 19 November 2009 (19.11.2009) entire document	1-33, 35-54	Y	US 2009/0144839 A1 (INANA et al) 04 June 2009 (04.06.2009) entire document	1-33, 35-54	Y	US 2007/0224635 A1 (BOUQUIN) 27 September 2007 (27.09.2007) entire document	3, 4, 35, 36	Y	US 2010/0261231 A1 (KORE et al) 14 October 2010 (14.10.2010) entire document	7, 39
Category*	Citation of document, with indication, where appropriate, of the relevant passages	Relevant to claim No.															
Y	US 2009/0286852 A1 (KARIKO et al) 19 November 2009 (19.11.2009) entire document	1-33, 35-54															
Y	US 2009/0144839 A1 (INANA et al) 04 June 2009 (04.06.2009) entire document	1-33, 35-54															
Y	US 2007/0224635 A1 (BOUQUIN) 27 September 2007 (27.09.2007) entire document	3, 4, 35, 36															
Y	US 2010/0261231 A1 (KORE et al) 14 October 2010 (14.10.2010) entire document	7, 39															
<p> Further documents are listed in the continuation of Box C. </p>																	
<table style="width:100%;"> <tr> <td style="width:50%;">                 * Special categories of cited documents;                  "A" document defining the general state of the art which is not considered to be of particular relevance                  "E" earlier application or patent but published on or after the international filing date                  "L" document which may throw doubts on priority claim(s) or which is cited to establish the publication date of another citation or other special reason (as specified)                  "O" document referring to an oral disclosure, use, exhibition or other means                  "P" document published prior to the international filing date but later than the priority date claimed             </td> <td style="width:50%;">                 "T" later document published after the international filing date or priority date and not in conflict with the application but cited to understand the principle or theory underlying the invention                  "X" document of particular relevance; the claimed invention cannot be considered novel or cannot be considered to involve an inventive step when the document is taken alone                  "Y" document of particular relevance; the claimed invention cannot be considered to involve an inventive step when the document is combined with one or more other such documents, such combination being obvious to a person skilled in the art                  "&amp;" document member of the same patent family             </td> </tr> </table>			* Special categories of cited documents; "A" document defining the general state of the art which is not considered to be of particular relevance "E" earlier application or patent but published on or after the international filing date "L" document which may throw doubts on priority claim(s) or which is cited to establish the publication date of another citation or other special reason (as specified) "O" document referring to an oral disclosure, use, exhibition or other means "P" document published prior to the international filing date but later than the priority date claimed	"T" later document published after the international filing date or priority date and not in conflict with the application but cited to understand the principle or theory underlying the invention "X" document of particular relevance; the claimed invention cannot be considered novel or cannot be considered to involve an inventive step when the document is taken alone "Y" document of particular relevance; the claimed invention cannot be considered to involve an inventive step when the document is combined with one or more other such documents, such combination being obvious to a person skilled in the art "&" document member of the same patent family													
* Special categories of cited documents; "A" document defining the general state of the art which is not considered to be of particular relevance "E" earlier application or patent but published on or after the international filing date "L" document which may throw doubts on priority claim(s) or which is cited to establish the publication date of another citation or other special reason (as specified) "O" document referring to an oral disclosure, use, exhibition or other means "P" document published prior to the international filing date but later than the priority date claimed	"T" later document published after the international filing date or priority date and not in conflict with the application but cited to understand the principle or theory underlying the invention "X" document of particular relevance; the claimed invention cannot be considered novel or cannot be considered to involve an inventive step when the document is taken alone "Y" document of particular relevance; the claimed invention cannot be considered to involve an inventive step when the document is combined with one or more other such documents, such combination being obvious to a person skilled in the art "&" document member of the same patent family																
Date of the actual completion of the international search 21 June 2013		Date of mailing of the international search report <p align="center"><b>0 8 JUL 2013</b></p>															
Name and mailing address of the ISA/US Mail Stop PCT, Attn: ISA/US, Commissioner for Patents P.O. Box 1450, Alexandria, Virginia 22313-1450 Facsimile No. 571-273-3201		Authorized officer; Blaine R. Copenhaver PCT Helpdesk: 571-272-4300 PCT OSP: 571-272-7774															

INTERNATIONAL SEARCH REPORT

International application No.

PCT/US2013/030068

Box No. I Nucleotide and/or amino acid sequence(s) (Continuation of item I.c. of the first sheet)

1. With regard to any nucleotide and/or amino acid sequence disclosed in the international application, the international search was carried out on the basis of a sequence listing filed or furnished:

a. (means)

on paper

in electronic form

b. (time)

in the international application as filed

together with the international application in electronic form

subsequently to this Authority for the purposes of search

2.  In addition, in the case that more than one version or copy of a sequence listing has been filed or furnished, the required statements that the information in the subsequent or additional copies is identical to that in the application as filed or does not go beyond the application as filed, as appropriate, were furnished.

3. Additional comments:

Specifically, SEQ ID NO: 884 was searched.

INTERNATIONAL SEARCH REPORT

International application No.

PCT/US201 3/030068

**Box No. II Observations where certain claims were found unsearchable (Continuation of item 2 of first sheet)**

This international search report has not been established in respect of certain claims under Article 17(2)(a) for the following reasons:

1.  Claims Nos.:  
because they relate to subject matter not required to be searched by this Authority, namely:
  
2.  Claims Nos.:  
because they relate to parts of the international application that do not comply with the prescribed requirements to such an extent that no meaningful international search can be carried out, specifically:
  
3.  Claims Nos.:  
because they are dependent claims and are not drafted in accordance with the second and third sentences of Rule 6.4(a).

**Box No. III Observations where unity of invention is lacking (Continuation of item 3 of first sheet)**

This International Searching Authority found multiple inventions in this international application, as follows:

**See Extra Sheets**

1.  As all required additional search fees were timely paid by the applicant, this international search report covers all searchable claims.
2.  As all searchable claims could be searched without effort justifying additional fees, this Authority did not invite payment of additional fees.
3.  As only some of the required additional search fees were timely paid by the applicant, this international search report covers only those claims for which fees were paid, specifically claims Nos.:
  
4.  No required additional search fees were timely paid by the applicant. Consequently, this international search report is restricted to the invention first mentioned in the claims; it is covered by claims Nos.:  
**1-54, limited to cosmetic polypeptide of interest selected to be SEQ ID NO: 884.**

**Remark on Protest**

- The additional search fees were accompanied by the applicant's protest and, where applicable, the payment of a protest fee.
- The additional search fees were accompanied by the applicant's protest but the applicable protest fee was not paid within the time limit specified in the invitation.
- No protest accompanied the payment of additional search fees.

## INTERNATIONAL SEARCH REPORT

Information on patent family members

International application No.

PCT/US201 3/030068

This application contains the following inventions or groups of inventions which are not so linked as to form a single general inventive concept under PCT Rule 13.1. In order for all inventions to be examined, the appropriate additional examination fees need to be paid.

Group I+: claims 1-54 are drawn to a method of treating a disease, disorder and/or condition in a subject in need thereof by increasing a level of a cosmetic polypeptide of interest and a method of altering, modifying or changing the appearance of a member of the integumentary system of a subject, said methods comprising administering to said subject an isolated polynucleotide; and a composition comprising the same; wherein the isolated polynucleotide comprises: (a) a first region of linked nucleosides, said first region encoding the cosmetic polypeptide of interest selected from the group consisting of SEQ ID NOs: 884-161 1 and 5691-5707; (b) a first flanking region located at the 5' terminus of said first region comprising; (i) a sequence of linked nucleosides selected from the group consisting of the native 5' untranslated region (UTR) of any of the nucleic acids that encode any of SEQ ID NOs: 884-161 1 and 5691-5707, SEQ ID NO: 1-4 and functional variants thereof; (c) a second flanking region located at the 3' terminus of said first region comprising; (i') a sequence of linked nucleosides selected from the group consisting of the native 3' UTR of any of the nucleic acids that encode any of SEQ ID NOs: 884-161 1 and 5691-5707, SEQ ID NOs: 5-21 and functional variants thereof; and (v') a 3' tailing sequence of linked nucleosides.

The first invention of Group I+ is restricted to a method of treating a disease, disorder and/or condition in a subject in need thereof by increasing a level of a cosmetic polypeptide of interest; a method of altering, modifying or changing the appearance of a member of the integumentary system of a subject, said methods comprising administering to said subject an isolated polynucleotide; and a composition comprising the same; wherein the isolated polynucleotide comprises: (a) a first region of linked nucleosides, said first region encoding the cosmetic polypeptide of interest selected to be SEQ ID NO: 884; (b) a first flanking region located at the 5' terminus of said first region comprising; (i) a sequence of linked nucleosides selected to be the native 5' untranslated region (UTR) of the nucleic acid sequence of SEQ ID NO: 884; (c) a second flanking region located at the 3' terminus of said first region comprising; (i') a sequence of linked nucleosides selected to be the native 3' UTR of the nucleic acid sequence of SEQ ID NO: 884; and (v') a 3' tailing sequence of linked nucleosides. It is believed that claims 1-54 read on this first named invention and thus these claims will be searched without fee to the extent that they read on SEQ ID NO:884.

Applicant is invited to elect additional polypeptides of interest with specified SEQ ID NOs and/or 5' UTRs with specified SEQ ID NO and/or 3' UTRs with specified SEQ ID NO for each isolated polynucleotide to be searched in a specific combination by paying additional fee for each set of election.

An exemplary election would be a method of treating a disease, disorder and/or condition in a subject in need thereof by increasing a level of a cosmetic polypeptide of interest; a method of altering, modifying or changing the appearance of a member of the integumentary system of a subject, said methods comprising administering to said subject an isolated polynucleotide; and a composition comprising the same; wherein the isolated polynucleotide comprises: (a) a first region of linked nucleosides, said first region encoding the cosmetic polypeptide of interest selected to be SEQ ID NO: 885; (b) a first flanking region located at the 5' terminus of said first region comprising; (i) a sequence of linked nucleosides selected to be the native 5' untranslated region (UTR) of the nucleic acid sequence of SEQ ID NO: 885; (c) a second flanking region located at the 3' terminus of said first region comprising; (i') a sequence of linked nucleosides selected to be the native 3' UTR of the nucleic acid sequence of SEQ ID NO: 885; and (v') a 3' tailing sequence of linked nucleosides. Additional isolated polynucleotides will be searched upon the payment of additional fees. Applicants must specify the claims that read on any additional elected inventions. Applicants must further indicate, if applicable, the claims which read on the first named invention if different than what was indicated above for this group. Failure to clearly identify how any paid additional invention fees are to be applied to the "+" group(s) will result in only the first claimed invention to be searched/examined.

The inventions listed in Groups I+ do not relate to a single general inventive concept under PCT Rule 13.1, because under PCT Rule 13.2 they lack the same or corresponding special technical features for the following reasons:

The Group I+ formulas do not share a significant structural element, requiring the selection of alternatives for isolated polynucleotide "a first region of linked nucleosides, said first region encoding the polypeptide of interest selected from the group consisting of SEQ ID NOs: 884-161 1 and 5691-5707" and "a sequence of linked nucleosides selected from the group consisting of the native 5' untranslated region (UTR) of any of the nucleic acids that encode any of SEQ ID NOs: 884-161 1 and 5691- 5707, SEQ ID NOs: 1-4 and functional variants thereof" and "a sequence of linked nucleosides selected from the group consisting of the native 3' UTR of any of the nucleic acids that encode any of SEQ ID NOs: 884-161 1 and 5691-5707, SEQ ID NOs: 5-21 and functional variants thereof."

The Group I+ shares the technical features of a method of treating a disease, disorder and/or condition in a subject in need thereof by increasing a level of a cosmetic polypeptide of interest; a method of altering, modifying or changing the appearance of a member of the integumentary system of a subject, said methods comprising administering to said subject an isolated polynucleotide; and a composition comprising the same; wherein the isolated polynucleotide comprises (a) a first region of linked nucleosides, said first region encoding a polypeptide of interest; (b) a first flanking region located at the 5' terminus of said first region comprising; a sequence of linked nucleosides and at least one 5' terminal cap; (c) a second flanking region located at the 3' terminus of said first region comprising a sequence of linked nucleosides and a 3' tailing sequence of linked nucleosides. However, these shared technical features do not represent a contribution over the prior art.

Specifically, US 2009/0286852 A1 to Kariko et al. discloses a method of treating a disease, disorder and/or condition in a subject in need thereof by increasing a level of a cosmetic polypeptide of interest (a method for increasing a hair growth from a hair follicle is a scalp of a subject, comprising contacting a cell of the scalp with an in vitro-synthesized RNA molecule, the in vitro-synthesized RNA molecule encoding a telomerase (cosmetic polypeptide)... thereby increasing hair growth from a hair follicle, Para. [0015]; (enzyme) expression correlated quantitatively with the amount of injected RNA, Para. [0242]; a variety of disorders may be treated by employing methods of the present invention including, inter alia, monogenic disorders, infectious diseases, acquired disorders, cancer, and the like, Para. [01 00]); a method of altering, modifying or changing the appearance of a member of the integumentary system of a subject (a method for increasing a hair growth from a hair follicle is a scalp of a subject, comprising contacting a cell of the scalp with an in vitro-synthesized RNA molecule, the in vitro-synthesized RNA molecule encoding a telomerase (cosmetic polypeptide)... thereby increasing hair growth from a hair follicle, Para. [0015]), said methods comprising administering to said subject an isolated polynucleotide (further comprises administering the RNA, oligoribonucleotide, or polyribonucleotide molecule, Para. [0093]; the present invention provides a method for introducing a recombinant protein into a cell of a subject, comprising contacting the subject with an in vitro-transcribed RNA molecule encoding the recombinant protein, Para. [0146]); and a composition comprising the same (an in vitro-transcribed RNA molecule of methods and compositions of the present invention, Para. [0045]); wherein the isolated polynucleotide comprises (a) a first region of linked nucleosides, said first region encoding a polypeptide of interest (one embodiment, the present invention provides a messenger RNA... the messenger RNA encodes a protein of interest, Para. [0039]); (b) a first flanking region located at the 5' terminus of said first region comprising a sequence of linked nucleosides and at least one 5' terminal cap (firefly luciferase-encoding mRNAs were synthesized that contained combinations of the following modifications: 1) a unique 5' untranslated sequence, 2) cap, Para. [0230]; mRNAs that had 5' cap, Para. [0033]); (c) a second flanking region located at the 3' terminus of said first region comprising; a sequence of linked nucleosides and a 3' tailing sequence of linked nucleosides (mRNAs containing... 3'UTRs with long poly(A) tails, Para. [0256]).

The inventions listed in Groups I+ therefore lack unity under Rule 13 because they do not share a same or corresponding special technical features.