



(51) International Patent Classification:	61/618,873	2 April 2012 (02.04.2012)	US
A61K 48/00 (2006.01)	61/618,878	2 April 2012 (02.04.2012)	u s
(21) International Application Number:	61/618,885	2 April 2012 (02.04.2012)	u s
PCT/US2013/030062	61/618,896	2 April 2012 (02.04.2012)	u s
(22) International Filing Date:	61/618,911	2 April 2012 (02.04.2012)	u s
9 March 2013 (09.03.2013)	61/618,922	2 April 2012 (02.04.2012)	u s
(25) Filing Language:	61/618,953	2 April 2012 (02.04.2012)	u s
English	61/618,961	2 April 2012 (02.04.2012)	u s
(26) Publication Language:	61/618,957	2 April 2012 (02.04.2012)	u s
English	61/618,945	2 April 2012 (02.04.2012)	u s
(30) Priority Data:	61/648,286	17 May 2012 (17.05.2012)	u s
61/618,862	61/648,244	17 May 2012 (17.05.2012)	u s
2 April 2012 (02.04.2012)	61/668,157	5 July 2012 (05.07.2012)	u s
61/618,866	61/681,648	10 August 2012 (10.08.2012)	u s
2 April 2012 (02.04.2012)	61/681,675	10 August 2012 (10.08.2012)	u s
61/618,868	61/681,654	10 August 2012 (10.08.2012)	u s
2 April 2012 (02.04.2012)			

[Continued on nextpage]

(54) Title: MODIFIED POLYNUCLEOTIDES FOR THE PRODUCTION OF BIOLOGICS AND PROTEINS ASSOCIATED WITH HUMAN DISEASE

(57) Abstract: The invention relates to compositions and methods for the preparation, manufacture and therapeutic use of polynucleotides, primary transcripts and mmRNA molecules.

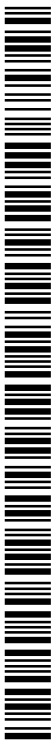

WO 2013/151666 A2

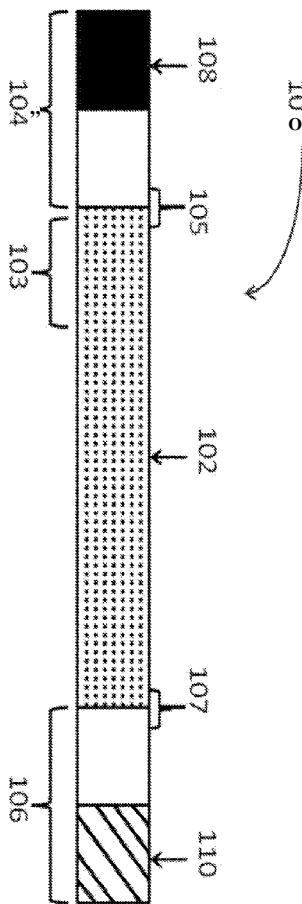

FIGURE i

61/681,687	10 August 2012 (10.08.2012)	US
61/681,696	10 August 2012 (10.08.2012)	u s
61/681,647	10 August 2012 (10.08.2012)	u s
61/681,704	10 August 2012 (10.08.2012)	u s
61/681,720	10 August 2012 (10.08.2012)	u s
61/681,742	10 August 2012 (10.08.2012)	u s
61/681,658	10 August 2012 (10.08.2012)	u s
61/681,649	10 August 2012 (10.08.2012)	u s
61/681,645	10 August 2012 (10.08.2012)	u s
61/681,661	10 August 2012 (10.08.2012)	u s
61/681,712	10 August 2012 (10.08.2012)	u s
61/681,650	10 August 2012 (10.08.2012)	u s
61/681,667	10 August 2012 (10.08.2012)	u s
61/696,381	4 September 2012 (04.09.2012)	u s
61/709,303	3 October 2012 (03.10.2012)	u s
61/712,490	11 October 2012 (11.10.2012)	u s
61/737,203	14 December 2012 (14.12.2012)	u s
61/737,168	14 December 2012 (14.12.2012)	u s
61/737,213	14 December 2012 (14.12.2012)	u s
61/737,155	14 December 2012 (14.12.2012)	u s
61/737,134	14 December 2012 (14.12.2012)	u s
61/737,139	14 December 2012 (14.12.2012)	u s
61/737,152	14 December 2012 (14.12.2012)	u s
61/737,184	14 December 2012 (14.12.2012)	u s
61/737,160	14 December 2012 (14.12.2012)	u s
61/737,191	14 December 2012 (14.12.2012)	u s
61/737,174	14 December 2012 (14.12.2012)	u s
61/737,135	14 December 2012 (14.12.2012)	u s
61/737,130	14 December 2012 (14.12.2012)	u s
61/737,147	14 December 2012 (14.12.2012)	u s

- (71) **Applicant:** MODERNA THERAPEUTICS [US/US]; 161 First Street, First Floor, Cambridge, Massachusetts 02142 (US).
- (72) **Inventors:** **BANCEL, Stephane;** 68 Pinckney Road, Boston, Massachusetts 02114 (US). **CHAKRABORTY, Tirtha;** 153 Woburn Street, Medford, Massachusetts 02155 (US). **DE FOUGEROLLES, Antonin;** 66 Summit Avenue, Brookline, Massachusetts 02446 (US). **EL-BASHIR, Sayda M.;** 149 Grove Street, Cambridge, Massachusetts 02138 (US). **JOHN, Matthias;** 338 Harvard St. #5, Cambridge, Massachusetts 02138 (US). **ROY, Atanu;** 115 Hill Street #9, Stoneham, Massachusetts

02180 (US). **WHORISKEY, Susan;** 47 Louise Road, Belmont, Massachusetts 02478 (US). **WOOD, Kristy M.;** 501 Huron Ave, Unit 2, Cambridge, Massachusetts 02138 (US). **HATALA, Paul;** 26 Monument Street #1, Charlestown, Massachusetts 02124 (US). **SCHRUM, Jason P.;** 4601 Flat Rock Road, Apt. 417, Philadelphia, Pennsylvania 19127 (US). **EJEBE, Kenechi;** 208 Pearl Street, Apt. 1, Cambridge, Massachusetts 02139 (US). **ELLSWORTH, Jeff Lynn;** 23 Meriam Street, Lexington, Massachusetts 02420 (US). **GUILD, Justin;** 495 Edgell Rd, Framingham, Massachusetts 01701 (US).

- (74) **Agent:** **WARD, Donna T.;** Dt Ward, P.C., 142A Main Street, Groton, Massachusetts 01450 (US).
- (81) **Designated States** (unless otherwise indicated, for every kind of national protection available): AE, AG, AL, AM, AO, AT, AU, AZ, BA, BB, BG, BH, BN, BR, BW, BY, BZ, CA, CH, CL, CN, CO, CR, CU, CZ, DE, DK, DM, DO, DZ, EC, EE, EG, ES, FI, GB, GD, GE, GH, GM, GT, HN, HR, HU, ID, IL, IN, IS, JP, KE, KG, KM, KN, KP, KR, KZ, LA, LC, LK, LR, LS, LT, LU, LY, MA, MD, ME, MG, MK, MN, MW, MX, MY, MZ, NA, NG, NI, NO, NZ, OM, PA, PE, PG, PH, PL, PT, QA, RO, RS, RU, RW, SC, SD, SE, SG, SK, SL, SM, ST, SV, SY, TH, TJ, TM, TN, TR, TT, TZ, UA, UG, US, UZ, VC, VN, ZA, ZM, ZW.

- (84) **Designated States** (unless otherwise indicated, for every kind of regional protection available): ARIPO (BW, GH, GM, KE, LR, LS, MW, MZ, NA, RW, SD, SL, SZ, TZ, UG, ZM, ZW), Eurasian (AM, AZ, BY, KG, KZ, RU, TJ, TM), European (AL, AT, BE, BG, CH, CY, CZ, DE, DK, EE, ES, FI, FR, GB, GR, HR, HU, IE, IS, IT, LT, LU, LV, MC, MK, MT, NL, NO, PL, PT, RO, RS, SE, SI, SK, SM, TR), OAPI (BF, BJ, CF, CG, CI, CM, GA, GN, GQ, GW, ML, MR, NE, SN, TD, TG).

- Published:**
- without international search report and to be republished upon receipt of that report (Rule 48.2(g))
 - with sequence listing part of description (Rule 5.2(a))

**MODIFIED POLYNUCLEOTIDES FOR THE PRODUCTION OF BIOLOGICS
AND PROTEINS ASSOCIATED WITH HUMAN DISEASE**

REFERENCE TO SEQUENCE LISTING

[0001] The present application is being filed along with a Sequence Listing in electronic format. The Sequence Listing file entitled M300PCTSQLST.txt, was created on March 9, 2013 and is 49,417,315 bytes in size. The information in electronic format of the Sequence Listing is incorporated herein by reference in its entirety.

CROSS REFERENCE TO RELATED APPLICATIONS

[0002] This application claims priority to U.S. Provisional Patent Application No 61/681,742, filed, August 10, 2012, entitled Modified Polynucleotides for the Production of Oncology-Related Proteins and Peptides, U.S. Provisional Patent Application No 61/737,224, filed December 14, 2012, entitled Terminally Optimized Modified RNAs, International Application No PCT/US2012/069610, filed December 14, 2012, entitled Modified Nucleoside, Nucleotide, and Nucleic Acid Compositions, U.S. Provisional Patent Application No 61/618,862, filed April 2, 2012, entitled Modified Polynucleotides for the Production of Biologies, U.S. Provisional Patent Application No 61/681,645, filed August 10, 2012, entitled Modified Polynucleotides for the Production of Biologies, U.S. Provisional Patent Application No 61/737,130, filed December 14, 2012, entitled Modified Polynucleotides for the Production of Biologies, U.S. Provisional Patent Application No 61/618,866, filed April 2, 2012, entitled Modified Polynucleotides for the Production of Antibodies, U.S. Provisional Patent Application No 61/681,647, filed August 10, 2012, entitled Modified Polynucleotides for the Production of Antibodies, U.S. Provisional Patent Application No 61/737,134, filed December 14, 2012, entitled Modified Polynucleotides for the Production of Antibodies, U.S. Provisional Patent Application No 61/618,868, filed April 2, 2012, entitled Modified Polynucleotides for the Production of Vaccines, U.S. Provisional Patent Application No 61/681,648, filed August 10, 2012, entitled Modified Polynucleotides for the Production of Vaccines, U.S. Provisional Patent Application No 61/737,135, filed December 14, 2012, entitled Modified Polynucleotides for the Production of Vaccines, U.S. Provisional Patent Application No 61/618,870, filed April 2, 2012, entitled Modified Polynucleotides for the Production of Therapeutic Proteins and Peptides, U.S. Provisional Patent Application No

61/681,649, filed August 10, 2012, entitled Modified Polynucleotides for the Production of Therapeutic Proteins and Peptides, U.S. Provisional Patent Application No 61/737,139, filed December 14, 2012, Modified Polynucleotides for the Production of Therapeutic Proteins and Peptides, U.S. Provisional Patent Application No 61/618,873, filed April 2, 2012, entitled Modified Polynucleotides for the Production of Secreted Proteins, U.S. Provisional Patent Application No 61/681,650, filed August 10, 2012, entitled Modified Polynucleotides for the Production of Secreted Proteins, U.S. Provisional Patent Application No 61/737,147, filed December 14, 2012, entitled Modified Polynucleotides for the Production of Secreted Proteins, U.S. Provisional Patent Application No 61/618,878, filed April 2, 2012, entitled Modified Polynucleotides for the Production of Plasma Membrane Proteins, U.S. Provisional Patent Application No 61/681,654, filed August 10, 2012, entitled Modified Polynucleotides for the Production of Plasma Membrane Proteins, U.S. Provisional Patent Application No 61/737,152, filed December 14, 2012, entitled Modified Polynucleotides for the Production of Plasma Membrane Proteins, U.S. Provisional Patent Application No 61/618,885, filed April 2, 2012, entitled Modified Polynucleotides for the Production of Cytoplasmic and Cytoskeletal Proteins, U.S. Provisional Patent Application No 61/681,658, filed August 10, 2012, entitled Modified Polynucleotides for the Production of Cytoplasmic and Cytoskeletal Proteins, U.S. Provisional Patent Application No 61/737,155, filed December 14, 2012, entitled Modified Polynucleotides for the Production of Cytoplasmic and Cytoskeletal Proteins, U.S. Provisional Patent Application No 61/618,896, filed April 2, 2012, entitled Modified Polynucleotides for the Production of Intracellular Membrane Bound Proteins, U.S. Provisional Patent Application No 61/668,157, filed July 5, 2012, entitled Modified Polynucleotides for the Production of Intracellular Membrane Bound Proteins, U.S. Provisional Patent Application No 61/681,661, filed August 10, 2012, entitled Modified Polynucleotides for the Production of Intracellular Membrane Bound Proteins, U.S. Provisional Patent Application No 61/737,160, filed December 14, 2012, entitled Modified Polynucleotides for the Production of Intracellular Membrane Bound Proteins, U.S. Provisional Patent Application No 61/618,911, filed April 2, 2012, entitled Modified Polynucleotides for the Production of Nuclear Proteins, U.S. Provisional Patent Application No 61/681,667, filed August 10, 2012, entitled Modified Polynucleotides for

the Production of Nuclear Proteins, U.S. Provisional Patent Application No 61/737,168, filed December 14, 2012, entitled Modified Polynucleotides for the Production of Nuclear Proteins, U.S. Provisional Patent Application No 61/618,922, filed April 2, 2012, entitled Modified Polynucleotides for the Production of Proteins, U.S. Provisional Patent Application No 61/681,675, filed August 10, 2012, entitled Modified Polynucleotides for the Production of Proteins, U.S. Provisional Patent Application No 61/737,174, filed December 14, 2012, entitled Modified Polynucleotides for the Production of Proteins, U.S. Provisional Patent Application No 61/618,935, filed April 2, 2012, entitled Modified Polynucleotides for the Production of Proteins Associated with Human Disease, U.S. Provisional Patent Application No 61/681,687, filed August 10, 2012, entitled Modified Polynucleotides for the Production of Proteins Associated with Human Disease, U.S. Provisional Patent Application No 61/737,184, filed December 14, 2012, entitled Modified Polynucleotides for the Production of Proteins Associated with Human Disease, U.S. Provisional Patent Application No 61/618,945, filed April 2, 2012, entitled Modified Polynucleotides for the Production of Proteins Associated with Human Disease, U.S. Provisional Patent Application No 61/681,696, filed August 10, 2012, entitled Modified Polynucleotides for the Production of Proteins Associated with Human Disease, U.S. Provisional Patent Application No 61/737,191, filed December 14, 2012, entitled Modified Polynucleotides for the Production of Proteins Associated with Human Disease, U.S. Provisional Patent Application No 61/618,953, filed April 2, 2012, entitled Modified Polynucleotides for the Production of Proteins Associated with Human Disease, U.S. Provisional Patent Application No 61/681,704, filed August 10, 2012, entitled Modified Polynucleotides for the Production of Proteins Associated with Human Disease, U.S. Provisional Patent Application No 61/737,203, filed December 14, 2012, entitled Modified Polynucleotides for the Production of Proteins Associated with Human Disease, U.S. Provisional Patent Application No 61/618,961, filed April 2, 2012, entitled Dosing Methods for Modified mRNA, U.S. Provisional Patent Application No 61/648,286, filed May 17, 2012, entitled Dosing Methods for Modified mRNA, the contents of each of which are herein incorporated by reference in its entirety.

[0003] This application is also related to International Publication No. PCT/US2012/58519, filed October 3, 2012, entitled Modified Nucleosides, Nucleotides,

and Nucleic Acids, and Uses Thereof and International Publication No.

PCT/US2012/69610, filed December 14, 2012, entitled Modified Nucleoside, Nucleotide, and Nucleic Acid Compositions.

[0004] The instant application is also related to co-pending applications, each filed concurrently herewith on March 9, 2013 and having Attorney Docket Number M301.20, (PCT/US 13/XXXXXX) entitled Modified Polynucleotides; Attorney Docket Number M304.20 (PCT/US 13/XXXXXX), entitled Modified Polynucleotides for the Production of Secreted Proteins; Attorney Docket Number M305.20 (PCT/US 13/XXXXXX), entitled Modified Polynucleotides for the Production of Membrane Proteins; Attorney Docket Number M306.20 (PCT/US 13/XXXXXX), entitled Modified Polynucleotides for the Production of Cytoplasmic and Cytoskeletal Proteins; Attorney Docket Number M308.20 (PCT/US 13/XXXXXX), entitled Modified Polynucleotides for the Production of Nuclear Proteins; Attorney Docket Number M309.20 (PCT/US 13/XXXXXX), entitled Modified Polynucleotides for the Production of Proteins; Attorney Docket Number M310.20 (PCT/US 13/XXXXXX), entitled Modified Polynucleotides for the Production of Proteins Associated with Human Disease; Attorney Docket Number MNC1.20 (PCT/US 13/XXXXXX), entitled Modified Polynucleotides for the Production of Cosmetic Proteins and Peptides and Attorney Docket Number MNC2.20 (PCT/US 13/XXXXXX), entitled Modified Polynucleotides for the Production of Oncology-Related Proteins and Peptides, the contents of each of which are herein incorporated by reference in its entirety.

FIELD OF THE INVENTION

[0005] The invention relates to compositions, methods, processes, kits and devices for the design, preparation, manufacture and/or formulation of polynucleotides, primary constructs and modified mRNA molecules (mmRNA).

BACKGROUND OF THE INVENTION

[0006] There are multiple problems with prior methodologies of effecting protein expression. For example, introduced DNA can integrate into host cell genomic DNA at some frequency, resulting in alterations and/or damage to the host cell genomic DNA. Alternatively, the heterologous deoxyribonucleic acid (DNA) introduced into a cell can be inherited by daughter cells (whether or not the heterologous DNA has integrated into

the chromosome) or by offspring. In addition, assuming proper delivery and no damage or integration into the host genome, there are multiple steps which must occur before the encoded protein is made. Once inside the cell, DNA must be transported into the nucleus where it is transcribed into RNA. The RNA transcribed from DNA must then enter the cytoplasm where it is translated into protein. Not only do the multiple processing steps from administered DNA to protein create lag times before the generation of the functional protein, each step represents an opportunity for error and damage to the cell. Further, it is known to be difficult to obtain DNA expression in cells as DNA frequently enters a cell but is not expressed or not expressed at reasonable rates or concentrations. This can be a particular problem when DNA is introduced into primary cells or modified cell lines.

[0007] In the early 1990's Bloom and colleagues successfully rescued vasopressin-deficient rats by injecting in vitro-transcribed vasopressin mRNA into the hypothalamus (Science 255: 996-998; 1992). However, the low levels of translation and the immunogenicity of the molecules hampered the development of mRNA as a therapeutic and efforts have since focused on alternative applications that could instead exploit these pitfalls, i.e. immunization with mRNAs coding for cancer antigens.

[0008] Others have investigated the use of mRNA to deliver a polypeptide of interest and shown that certain chemical modifications of mRNA molecules, particularly pseudouridine and 5-methyl-cytosine, have reduced immunostimulatory effect.

[0009] These studies are disclosed in, for example, Ribostem Limited in United Kingdom patent application serial number 0316089.2 filed on July 9, 2003 now abandoned, PCT application number PCT/GB2004/002981 filed on July 9, 2004 published as WO2005005622, United States patent application national phase entry serial number 10/563,897 filed on June 8, 2006 published as US20060247195 now abandoned, and European patent application national phase entry serial number EP2004743322 filed on July 9, 2004 published as EP 16467 14 now withdrawn; Novozymes, Inc. in PCT application number PCT/US2007/88060 filed on December 19, 2007 published as WO2008140615, United States patent application national phase entry serial number 12/520,072 filed on July 2, 2009 published as US20 100028943 and European patent application national phase entry serial number EP2007874376 filed on July 7, 2009

published as EP2 104739; University of Rochester in PCT application number PCT/US2006/46120 filed on December 4, 2006 published as WO2007064952 and United States patent application serial number 11/606,995 filed on December 1, 2006 published as US20070141030; BioNTech AG in European patent application serial number EP2007024312 filed December 14, 2007 now abandoned, PCT application number PCT/EP2008/01059 filed on December 12, 2008 published as WO2009077134, European patent application national phase entry serial number EP2008861423 filed on June 2, 2010 published as EP2240572, United States patent application national phase entry serial number 12/735,060 filed November 24, 2010 published as US201 10065103, German patent application serial number DE 10 2005 046 490 filed September 28, 2005, PCT application PCT/EP2006/0448 filed September 28, 2006 published as WO2007036366, national phase European patent EP1934345 published March, 21, 2012 and national phase US patent application serial number 11/992,638 filed August 14, 2009 published as 20100129877; Immune Disease Institute Inc. in United States patent application serial number 13/088,009 filed April 15, 2011 published as US20120046346 and PCT application PCT/US201 1/32679 filed April 15, 2011 published as WO201 10130624; Shire Human Genetic Therapeutics in United States patent application serial number 12/957,340 filed on November 20, 2010 published as US201 10244026; Sequitur Inc. in PCT application PCT/US 1998/019492 filed on September 18, 1998 published as WO1999014346; The Scripps Research Institute in PCT application number PCT/US20 10/00567 filed on February 24, 2010 published as WO20 10098861, and United States patent application national phase entry serial number 13/203,229 filed November 3, 2011 published as US20 120053333; Ludwig-Maximilians University in PCT application number PCT/EP20 10/004681 filed on July 30, 2010 published as WO201 1012316; Cellscript Inc. in United States patent number 8,039,214 filed June 30, 2008 and granted October 18, 2011, United States patent application serial numbers 12/962,498 filed on December 7, 2010 published as US201 10143436, 12/962,468 filed on December 7, 2010 published as US201 10143397, 13/237,451 filed on September 20, 2011 published as US20120009649, and PCT applications PCT/US20 10/59305 filed December 7, 2010 published as WO201 1071931 and PCT/US2010/59317 filed on December 7, 2010 published as WO201 1071936; The Trustees of the University of

Pennsylvania in PCT application number PCT/US2006/32372 filed on August 21, 2006 published as WO2007024708, and United States patent application national phase entry serial number 11/990,646 filed on March 27, 2009 published as US20090286852; Curevac GMBH in German patent application serial numbers DE10 2001 027 283.9 filed June 5, 2001, DE10 2001 062 480.8 filed December 19, 2001, and DE 20 2006 051 516 filed October 31, 2006 all abandoned, European patent numbers EP1392341 granted March 30, 2005 and EP1458410 granted January 2, 2008, PCT application numbers PCT/EP2002/06180 filed June 5, 2002 published as WO2002098443, PCT/EP2002/14577 filed on December 19, 2002 published as WO2003051401, PCT/EP2007/09469 filed on December 31, 2007 published as WO2008052770, PCT/EP2008/03033 filed on April 16, 2008 published as WO2009127230, PCT/EP2006/004784 filed on May 19, 2005 published as WO2006122828, PCT/EP2008/00081 filed on January 9, 2007 published as WO2008083949, and United States patent application serial numbers 10/729,830 filed on December 5, 2003 published as US20050032730, 10/870,110 filed on June 18, 2004 published as US20050059624, 11/914,945 filed on July 7, 2008 published as US20080267873, 12/446,912 filed on October 27, 2009 published as US20 10047261 now abandoned, 12/522,214 filed on January 4, 2010 published as US20 100 189729, 12/787,566 filed on May 26, 2010 published as US201 10077287, 12/787,755 filed on May 26, 2010 published as US20 100239608, 13/185,119 filed on July 18, 2011 published as US20 110269950, and 13/106,548 filed on May 12, 2011 published as US201 1031 1472 all of which are herein incorporated by reference in their entirety.

[00010] Notwithstanding these reports which are limited to a selection of chemical modifications including pseudouridine and 5-methyl-cytosine, there remains a need in the art for therapeutic modalities to address the myriad of barriers surrounding the efficacious modulation of intracellular translation and processing of nucleic acids encoding polypeptides or fragments thereof.

[00011] To this end, the inventors have shown that certain modified mRNA sequences have the potential as therapeutics with benefits beyond just evading, avoiding or diminishing the immune response. Such studies are detailed in published co-pending applications International Application PCT/US201 1/046861 filed August 5, 2011 and

PCT/US2011/054636 filed October 3, 2011, International Application number PCT/US2011/054617 filed October 3, 2011, the contents of which are incorporated herein by reference in their entirety.

[00012] The present invention addresses this need by providing nucleic acid based compounds or polynucleotides which encode a polypeptide of interest (e.g., modified mRNA or mmRNA) and which have structural and/or chemical features that avoid one or more of the problems in the art, for example, features which are useful for optimizing formulation and delivery of nucleic acid-based therapeutics while retaining structural and functional integrity, overcoming the threshold of expression, improving expression rates, half life and/or protein concentrations, optimizing protein localization, and avoiding deleterious bio-responses such as the immune response and/or degradation pathways.

SUMMARY OF THE INVENTION

[00013] Described herein are compositions, methods, processes, kits and devices for the design, preparation, manufacture and/or formulation of modified mRNA (mmRNA) molecules.

[00014] The details of various embodiments of the invention are set forth in the description below. Other features, objects, and advantages of the invention will be apparent from the description and the drawings, and from the claims.

BRIEF DESCRIPTION OF THE DRAWINGS

[00015] The foregoing and other objects, features and advantages will be apparent from the following description of particular embodiments of the invention, as illustrated in the accompanying drawings in which like reference characters refer to the same parts throughout the different views. The drawings are not necessarily to scale, emphasis instead being placed upon illustrating the principles of various embodiments of the invention.

[00016] FIG. 1 is a schematic of a primary construct of the present invention.

[00017] FIG. 2 illustrates lipid structures in the prior art useful in the present invention. Shown are the structures for 98N12-5 (TETA5-LAP), DLin-DMA, DLin-K-DMA (2,2-Dilinoleyl-4-dimethylaminomethyl-[1,3]-dioxolane), DLin-KC2-DMA, DLin-MC3-DMA and C12-200.

[00018] FIG. 3 is a representative plasmid useful in the IVT reactions taught herein. The plasmid contains Insert 64818, designed by the instant inventors.

[00019] FIG. 4 is a gel profile of modified mRNA encapsulated in PLGA microspheres.

[00020] FIG. 5 is a histogram of Factor IX protein production PLGA formulation Factor IX modified mRNA.

[00021] FIG. 6 is a histogram showing VEGF protein production in human keratinocyte cells after transfection of modified mRNA at a range of doses. Figure 6A shows protein production after transfection of modified mRNA comprising natural nucleoside triphosphate (NTP). Figure 6B shows protein production after transfection of modified mRNA fully modified with pseudouridine (Pseudo-U) and 5-methylcytosine (5mC). Figure 6C shows protein production after transfection of modified mRNA fully modified with NI-methyl-pseudouridine (NI-methyl-Pseudo-U) and 5-methylcytosine (5mC).

[00022] FIG. 7 is a histogram of VEGF protein production in HEK293 cells.

[00023] FIG. 8 is a histogram of VEGF expression and IFN-alpha induction after transfection of VEGF modified mRNA in peripheral blood mononuclear cells (PBMC). Figure 8A shows VEGF expression. Figure 8B shows IFN-alpha induction.

[00024] FIG. 9 is a histogram of VEGF protein production in HeLa cells from VEGF modified mRNA.

[00025] FIG. 10 is a histogram of VEGF protein production from lipoplexed VEGF modified mRNA in mice.

[00026] FIG. 11 is a histogram of G-CSF protein production in HeLa cells from G-CSF modified mRNA.

[00027] FIG. 12 is a histogram of G-CSF protein production in mice from lipoplexed G-CSF modified mRNA.

[00028] FIG. 13 is a histogram of Factor IX protein production in HeLa cell supernatant from Factor IX modified mRNA.

[00029] FIG. 14 is a histogram of APOA1 protein production in HeLa cells from APOA1 wild-type modified mRNA, APOA1 Milano modified mRNA or APOA1 Paris modified mRNA.

[00030] FIG. 15 is a gel profile of APOA1 protein from APOA1 wild-type modified mRNA.

[00031] FIG. 16 is a gel profile of APOA1 protein from APOA1 Paris modified mRNA.

[00032] FIG. 17 is a gel profile of APOA1 protein from APOA1 Milano modified mRNA.

[00033] FIG. 18 is a gel profile of Fibrinogen alpha (FGA) protein from FGA modified mRNA.

[00034] FIG. 19 is a histogram of Plasminogen protein production in HeLa cell supernatant from Plasminogen modified mRNA.

[00035] FIG. 20 is a gel profile of Plasminogen protein from Plasminogen modified mRNA.

[00036] FIG. 21 is a gel profile of galactose-1-phosphate uridylyltransferase (GALT) protein from GALT modified mRNA.

[00037] FIG. 22 is a gel profile of argininosuccinate lyase (ASL) protein from ASL modified mRNA.

[00038] FIG. 23 is a gel profile of tyrosine aminotransferase (TAT) protein from TAT modified mRNA.

[00039] FIG. 24 is a gel profile of glucan (1,4-alpha-), branching enzyme 1 (GBE1) protein from GBE1 modified mRNA.

[00040] FIG. 25 is a histogram of Prothrombin protein production in HeLa cell supernatant from Prothrombin modified mRNA.

[00041] FIG. 26 is a histogram of Prothrombin protein production in HeLa cell supernatant from Prothrombin modified mRNA.

[00042] FIG. 27 is a gel profile of ceruloplasmin (CP or CLP) protein from CP modified mRNA.

[00043] FIG. 28 is a histogram of transforming growth factor beta 1 (TGF-beta1) protein production in HeLa cell supernatant from TGF-beta1 modified mRNA.

[00044] FIG. 29 is a gel profile of ornithine carbamoyltransferase (OTC) protein from OTC modified mRNA.

[00045] FIG. 30 is a flow cytometry plot of low density lipoprotein receptor (LDLR) modified mRNA.

[00046] FIG. 31 is a gel profile of UDP glucuronosyltransferase 1 family, polypeptide A1 (UGT1A1) protein from UGT1A1 modified mRNA.

[00047] FIG. 32 is a histogram of Factor XI protein production in HEK293 cells.

[00048] FIG. 33 is a gel profile of Aquaporin-5 protein from Aquaporin-5 modified mRNA.

[00049] FIG. 34 is a histogram of Factor VII protein production in HeLa cells from Factor VII modified mRNA.

[00050] FIG. 35 is a histogram of Insulin Glargine protein production in HeLa cells from Insulin Glargine modified mRNA.

[00051] FIG. 36 is a histogram of Tissue Factor protein production in HeLa cells from Tissue Factor modified mRNA.

[00052] FIG. 37 is a histogram of Factor XI protein production in HeLa cells from Factor XI modified mRNA.

[00053] FIG. 38 is a histogram of Factor XI protein production in HeLa cell supernatant from Factor XI modified mRNA.

[00054] FIG. 39 is a histogram of Insulin Aspart protein production in HeLa cells from Insulin Aspart modified mRNA.

[00055] FIG. 40 is a histogram of Insulin Lispro protein production in HeLa cells from Insulin Lispro modified mRNA.

[00056] FIG. 41 is a histogram of Insulin Glulisine protein production in HeLa cells from Insulin Glulisine modified mRNA.

[00057] FIG. 42 is a histogram of human growth hormone protein production in HeLa cells from human growth hormone modified mRNA.

[00058] FIG. 43 is a gel profile of tumor protein 53 (p53) protein from p53 modified mRNA. Figure 43A shows the expected size of p53. Figure 43B shows the expected size of p53.

[00059] FIG. 44 is a gel profile of tuftelin (TUFT1) protein from TUFT1 modified mRNA.

- [00060] FIG. 45 is a gel profile of galactokinase 1 (GALK1) protein from GALK1 modified mRNA. Figure 45A shows the expected size of GALK1. Figure 45B shows the expected size of GALK1.
- [00061] FIG. 46 is a gel profile of defensin, beta 103A (DEFB103A) protein from DEFB103A modified mRNA.
- [00062] FIG. 47 is a flow cytometry plot of LDLR modified mRNA.
- [00063] FIG. 48 is a histogram of vascular endothelial growth factor expression in HeLa.
- [00064] FIG. 49 is a histogram of the cell vitality of HeLa cells transfected with vascular endothelial growth factor mRNA.
- [00065] FIG. 50 is a histogram of Insulin Aspart protein expression.
- [00066] FIG. 51 is a histogram of Insulin Glargine protein expression.
- [00067] FIG. 52 is a histogram of Insulin Glulisine protein expression.
- [00068] FIG. 53 is a histogram of Interleukin 7 (IL-7) protein expression.
- [00069] FIG. 54 is a histogram of Erythropoietin (EPO) protein expression.
- [00070] FIG. 55 is a gel profile of Lysosomal Acid Lipase protein from Lysosomal Acid Lipase modified mRNA.
- [00071] FIG. 56 is a gel profile of Glucocerebrosidase protein from Glucocerebrosidase modified mRNA.
- [00072] FIG. 57 is a gel profile of Iduronate 2-Sulfatase protein from Iduronate 2-Sulfatase modified mRNA.
- [00073] FIG. 58 is a gel profile of Luciferase protein from Luciferase modified mRNA.
- [00074] FIG. 59 is a histogram of IgG concentration after administration with formulated Herceptin modified mRNA in mammals.
- [00075] FIG. 60 is a histogram of IgG concentration (in ng/ml) after transfection with Herceptin modified mRNA.
- [00076] FIG. 61 is a gel profile of Herceptin protein from Herceptin modified mRNA.
- [00077] FIG. 62 is a histogram of Glucocerebrosidase enzyme activity.
- [00078] FIG. 63 is a histogram of Lysosomal Acid Lipase enzyme activity.
- [00079] FIG. 64 is a histogram of Factor VIII protein expression.

- [00080] FIG. 65 is a histogram of Factor VIII Chromogenic Activity.
- [00081] FIG. 66 is a graph of LDLR Expression. Figure 66A shows LDL Receptor Expression of cells compared to LDLR mRNA added. Figure 66B shows LDL Receptor Expression of cells post transfection. Figure 66C shows the saturation of BODIPY® labeled LRL. Figure 66D shows the binding affinity of BODIPY-LDL to cells.
- [00082] FIG. 67 is a graph showing the percent positive cells for UGT1A1 Expression.
- [00083] FIG. 68 is a graph showing UGT1A1 protein accumulation.
- [00084] FIG. 69 is a gel profile of UGT1A1 protein and OTC from either UGT1A1 or OTC modified mRNA.
- [00085] FIG. 70 is a flow cytometry plot of HEK293 cells transfected with PAh or UGT1A1.
- [00086] FIG. 71 is a gel profile of UGT1A1 protein from UGT1A1 modified mRNA.
- [00087] FIG. 72 is a gel profile of microsomal extracts of mice treated with LNPs containing UGT1A1.

DETAILED DESCRIPTION

[00088] It is of great interest in the fields of therapeutics, diagnostics, reagents and for biological assays to be able to deliver a nucleic acid, e.g., a ribonucleic acid (RNA) inside a cell, whether *in vitro*, *in vivo*, *in situ* or *ex vivo*, such as to cause intracellular translation of the nucleic acid and production of an encoded polypeptide of interest. Of particular importance is the delivery and function of a non-integrative polynucleotide.

[00089] Described herein are compositions (including pharmaceutical compositions) and methods for the design, preparation, manufacture and/or formulation of polynucleotides encoding one or more polypeptides of interest. Also provided are systems, processes, devices and kits for the selection, design and/or utilization of the polynucleotides encoding the polypeptides of interest described herein.

[00090] According to the present invention, these polynucleotides are preferably modified as to avoid the deficiencies of other polypeptide-encoding molecules of the art. Hence these polynucleotides are referred to as modified mRNA or mmRNA.

[00091] The use of modified polynucleotides in the fields of antibodies, viruses, veterinary applications and a variety of *in vivo* settings has been explored by the

inventors and these studies are disclosed in for example, co-pending and co-owned United States provisional patent application serial numbers 61/470,451 filed March 31, 2011 teaching in vivo applications of mmRNA; 61/517,784 filed on April 26, 2011 teaching engineered nucleic acids for the production of antibody polypeptides; 61/519,158 filed May 17, 2011 teaching veterinary applications of mmRNA technology; 61/533,537 filed on September 12, 2011 teaching antimicrobial applications of mmRNA technology; 61/533,554 filed on September 12, 2011 teaching viral applications of mmRNA technology, 61/542,533 filed on October 3, 2011 teaching various chemical modifications for use in mmRNA technology; 61/570,690 filed on December 14, 2011 teaching mobile devices for use in making or using mmRNA technology; 61/570,708 filed on December 14, 2011 teaching the use of mmRNA in acute care situations; 61/576,651 filed on December 16, 2011 teaching terminal modification architecture for mmRNA; 61/576,705 filed on December 16, 2011 teaching delivery methods using lipidoids for mmRNA; 61/578,271 filed on December 21, 2011 teaching methods to increase the viability of organs or tissues using mmRNA; 61/581,322 filed on December 29, 2011 teaching mmRNA encoding cell penetrating peptides; 61/581,352 filed on December 29, 2011 teaching the incorporation of cytotoxic nucleosides in mmRNA and 61/631,729 filed on January 10, 2012 teaching methods of using mmRNA for crossing the blood brain barrier; all of which are herein incorporated by reference in their entirety.

[00092] Provided herein, in part, are polynucleotides, primary constructs and/or mmRNA encoding polypeptides of interest which have been designed to improve one or more of the stability and/or clearance in tissues, receptor uptake and/or kinetics, cellular access by the compositions, engagement with translational machinery, mRNA half-life, translation efficiency, immune evasion, protein production capacity, secretion efficiency (when applicable), accessibility to circulation, protein half-life and/or modulation of a cell's status, function and/or activity.

I. Compositions of the Invention (mmRNA)

[00093] The present invention provides nucleic acid molecules, specifically polynucleotides, primary constructs and/or mmRNA which encode one or more polypeptides of interest. The term "nucleic acid," in its broadest sense, includes any compound and/or substance that comprise a polymer of nucleotides. These polymers are

often referred to as polynucleotides. Exemplary nucleic acids or polynucleotides of the invention include, but are not limited to, ribonucleic acids (RNAs), deoxyribonucleic acids (DNAs), threose nucleic acids (TNAs), glycol nucleic acids (GNAs), peptide nucleic acids (PNAs), locked nucleic acids (LNAs, including LNA having a β -D-ribo configuration, α -LNA having an α -L-ribo configuration (a diastereomer of LNA), 2'-amino-LNA having a 2'-amino functionalization, and 2'-amino- α -LNA having a 2'-amino functionalization) or hybrids thereof.

[00094] In preferred embodiments, the nucleic acid molecule is a messenger RNA (mRNA). As used herein, the term "messenger RNA" (mRNA) refers to any polynucleotide which encodes a polypeptide of interest and which is capable of being translated to produce the encoded polypeptide of interest *in vitro*, *in vivo*, *in situ* or *ex vivo*.

[00095] Traditionally, the basic components of an mRNA molecule include at least a coding region, a 5'UTR, a 3'UTR, a 5' cap and a poly-A tail. Building on this wild type modular structure, the present invention expands the scope of functionality of traditional mRNA molecules by providing polynucleotides or primary RNA constructs which maintain a modular organization, but which comprise one or more structural and/or chemical modifications or alterations which impart useful properties to the polynucleotide including, in some embodiments, the lack of a substantial induction of the innate immune response of a cell into which the polynucleotide is introduced. As such, modified mRNA molecules of the present invention are termed "mmRNA." As used herein, a "structural" feature or modification is one in which two or more linked nucleotides are inserted, deleted, duplicated, inverted or randomized in a polynucleotide, primary construct or mmRNA without significant chemical modification to the nucleotides themselves. Because chemical bonds will necessarily be broken and reformed to effect a structural modification, structural modifications are of a chemical nature and hence are chemical modifications. However, structural modifications will result in a different sequence of nucleotides. For example, the polynucleotide "ATCG" may be chemically modified to "AT-5meC-G". The same polynucleotide may be structurally modified from "ATCG" to "ATCCCG". Here, the dinucleotide "CC" has been inserted, resulting in a structural modification to the polynucleotide.

mmRNA Architecture

[00096] The mmRNA of the present invention are distinguished from wild type mRNA in their functional and/or structural design features which serve to, as evidenced herein, overcome existing problems of effective polypeptide production using nucleic acid-based therapeutics.

[00097] Figure 1 shows a representative polynucleotide primary construct **100** of the present invention. As used herein, the term "primary construct" or "primary mRNA construct" refers to a polynucleotide transcript which encodes one or more polypeptides of interest and which retains sufficient structural and/or chemical features to allow the polypeptide of interest encoded therein to be translated. Primary constructs may be polynucleotides of the invention. When structurally or chemically modified, the primary construct may be referred to as an mmRNA.

[00098] Returning to FIG. 1, the primary construct **100** here contains a first region of linked nucleotides **102** that is flanked by a first flanking region **104** and a second flanking region **106**. As used herein, the "first region" may be referred to as a "coding region" or "region encoding" or simply the "first region." This first region may include, but is not limited to, the encoded polypeptide of interest. The polypeptide of interest may comprise at its 5' terminus one or more signal sequences encoded by a signal sequence region **103**. The flanking region **104** may comprise a region of linked nucleotides comprising one or more complete or incomplete 5' UTRs sequences. The flanking region **104** may also comprise a 5' terminal cap **108**. The second flanking region **106** may comprise a region of linked nucleotides comprising one or more complete or incomplete 3' UTRs. The flanking region **106** may also comprise a 3' tailing sequence **110**.

[00099] Bridging the 5' terminus of the first region **102** and the first flanking region **104** is a first operational region **105**. Traditionally this operational region comprises a Start codon. The operational region may alternatively comprise any translation initiation sequence or signal including a Start codon.

[00100] Bridging the 3' terminus of the first region **102** and the second flanking region **106** is a second operational region **107**. Traditionally this operational region comprises a Stop codon. The operational region may alternatively comprise any translation initiation

sequence or signal including a Stop codon. According to the present invention, multiple serial stop codons may also be used.

[000101] Generally, the shortest length of the first region of the primary construct of the present invention can be the length of a nucleic acid sequence that is sufficient to encode for a dipeptide, a tripeptide, a tetrapeptide, a pentapeptide, a hexapeptide, a heptapeptide, an octapeptide, a nonapeptide, or a decapeptide. In another embodiment, the length may be sufficient to encode a peptide of 2-30 amino acids, e.g. 5-30, 10-30, 2-25, 5-25, 10-25, or 10-20 amino acids. The length may be sufficient to encode for a peptide of at least 11, 12, 13, 14, 15, 17, 20, 25 or 30 amino acids, or a peptide that is no longer than 40 amino acids, e.g. no longer than 35, 30, 25, 20, 17, 15, 14, 13, 12, 11 or 10 amino acids.

Examples of dipeptides that the polynucleotide sequences can encode or include, but are not limited to, carnosine and anserine.

[000102] Generally, the length of the first region encoding the polypeptide of interest of the present invention is greater than about 30 nucleotides in length (e.g., at least or greater than about 35, 40, 45, 50, 55, 60, 70, 80, 90, 100, 120, 140, 160, 180, 200, 250, 300, 350, 400, 450, 500, 600, 700, 800, 900, 1,000, 1,100, 1,200, 1,300, 1,400, 1,500, 1,600, 1,700, 1,800, 1,900, 2,000, 2,500, and 3,000, 4,000, 5,000, 6,000, 7,000, 8,000, 9,000, 10,000, 20,000, 30,000, 40,000, 50,000, 60,000, 70,000, 80,000, 90,000 or up to and including 100,000 nucleotides). As used herein, the "first region" may be referred to as a "coding region" or "region encoding" or simply the "first region."

[000103] In some embodiments, the polynucleotide, primary construct, or mmRNA includes from about 30 to about 100,000 nucleotides (e.g., from 30 to 50, from 30 to 100, from 30 to 250, from 30 to 500, from 30 to 1,000, from 30 to 1,500, from 30 to 3,000, from 30 to 5,000, from 30 to 7,000, from 30 to 10,000, from 30 to 25,000, from 30 to 50,000, from 30 to 70,000, from 100 to 250, from 100 to 500, from 100 to 1,000, from 100 to 1,500, from 100 to 3,000, from 100 to 5,000, from 100 to 7,000, from 100 to 10,000, from 100 to 25,000, from 100 to 50,000, from 100 to 70,000, from 100 to 100,000, from 500 to 1,000, from 500 to 1,500, from 500 to 2,000, from 500 to 3,000, from 500 to 5,000, from 500 to 7,000, from 500 to 10,000, from 500 to 25,000, from 500 to 50,000, from 500 to 70,000, from 500 to 100,000, from 1,000 to 1,500, from 1,000 to 2,000, from 1,000 to 3,000, from 1,000 to 5,000, from 1,000 to 7,000, from 1,000 to

10,000, from 1,000 to 25,000, from 1,000 to 50,000, from 1,000 to 70,000, from 1,000 to 100,000, from 1,500 to 3,000, from 1,500 to 5,000, from 1,500 to 7,000, from 1,500 to 10,000, from 1,500 to 25,000, from 1,500 to 50,000, from 1,500 to 70,000, from 1,500 to 100,000, from 2,000 to 3,000, from 2,000 to 5,000, from 2,000 to 7,000, from 2,000 to 10,000, from 2,000 to 25,000, from 2,000 to 50,000, from 2,000 to 70,000, and from 2,000 to 100,000).

[000104] According to the present invention, the first and second flanking regions may range independently from 15-1,000 nucleotides in length (e.g., greater than 30, 40, 45, 50, 55, 60, 70, 80, 90, 100, 120, 140, 160, 180, 200, 250, 300, 350, 400, 450, 500, 600, 700, 800, and 900 nucleotides or at least 30, 40, 45, 50, 55, 60, 70, 80, 90, 100, 120, 140, 160, 180, 200, 250, 300, 350, 400, 450, 500, 600, 700, 800, 900, and 1,000 nucleotides).

[000105] According to the present invention, the tailing sequence may range from absent to 500 nucleotides in length (e.g., at least 60, 70, 80, 90, 120, 140, 160, 180, 200, 250, 300, 350, 400, 450, or 500 nucleotides). Where the tailing region is a polyA tail, the length may be determined in units of or as a function of polyA Binding Protein binding. In this embodiment, the polyA tail is long enough to bind at least 4 monomers of PolyA Binding Protein. PolyA Binding Protein monomers bind to stretches of approximately 38 nucleotides. As such, it has been observed that polyA tails of about 80 nucleotides and 160 nucleotides are functional.

[000106] According to the present invention, the capping region may comprise a single cap or a series of nucleotides forming the cap. In this embodiment the capping region may be from 1 to 10, e.g. 2-9, 3-8, 4-7, 1-5, 5-10, or at least 2, or 10 or fewer nucleotides in length. In some embodiments, the cap is absent.

[000107] According to the present invention, the first and second operational regions may range from 3 to 40, e.g., 5-30, 10-20, 15, or at least 4, or 30 or fewer nucleotides in length and may comprise, in addition to a Start and/or Stop codon, one or more signal and/or restriction sequences.

Cyclic mmRNA

[000108] According to the present invention, a primary construct or mmRNA may be cyclized, or concatemerized, to generate a translation competent molecule to assist interactions between poly-A binding proteins and 5'-end binding proteins. The

mechanism of cyclization or concatemerization may occur through at least 3 different routes: 1) chemical, 2) enzymatic, and 3) ribozyme catalyzed. The newly formed 5'-/3'-linkage may be intramolecular or intermolecular.

[000109] In the first route, the 5'-end and the 3'-end of the nucleic acid contain chemically reactive groups that, when close together, form a new covalent linkage between the 5'-end and the 3'-end of the molecule. The 5'-end may contain an NHS-ester reactive group and the 3'-end may contain a 3'-amino-terminated nucleotide such that in an organic solvent the 3'-amino-terminated nucleotide on the 3'-end of a synthetic mRNA molecule will undergo a nucleophilic attack on the 5'-NHS-ester moiety forming a new 5'-/3'-amide bond.

[000110] In the second route, T4 RNA ligase may be used to enzymatically link a 5'-phosphorylated nucleic acid molecule to the 3'-hydroxyl group of a nucleic acid forming a new phosphodiester linkage. In an example reaction, 1 μ g of a nucleic acid molecule is incubated at 37°C for 1 hour with 1-10 units of T4 RNA ligase (New England Biolabs, Ipswich, MA) according to the manufacturer's protocol. The ligation reaction may occur in the presence of a split oligonucleotide capable of base-pairing with both the 5'- and 3'-region in juxtaposition to assist the enzymatic ligation reaction.

[000111] In the third route, either the 5'-or 3'-end of the cDNA template encodes a ligase ribozyme sequence such that during *in vitro* transcription, the resultant nucleic acid molecule can contain an active ribozyme sequence capable of ligating the 5'-end of a nucleic acid molecule to the 3'-end of a nucleic acid molecule. The ligase ribozyme may be derived from the Group I Intron, Group I Intron, Hepatitis Delta Virus, Hairpin ribozyme or may be selected by SELEX (systematic evolution of ligands by exponential enrichment). The ribozyme ligase reaction may take 1 to 24 hours at temperatures between 0 and 37°C.

mmRNA Multimers

[000112] According to the present invention, multiple distinct polynucleotides, primary constructs or mmRNA may be linked together through the 3'-end using nucleotides which are modified at the 3'-terminus. Chemical conjugation may be used to control the stoichiometry of delivery into cells. For example, the glyoxylate cycle enzymes, isocitrate lyase and malate synthase, may be supplied into HepG2 cells at a 1:1 ratio to

alter cellular fatty acid metabolism. This ratio may be controlled by chemically linking polynucleotides, primary constructs or mmRNA using a 3'-azido terminated nucleotide on one polynucleotide, primary construct or mmRNA species and a C5-ethynyl or alkynyl-containing nucleotide on the opposite polynucleotide, primary construct or mmRNA species. The modified nucleotide is added post-transcriptionally using terminal transferase (New England Biolabs, Ipswich, MA) according to the manufacturer's protocol. After the addition of the 3'-modified nucleotide, the two polynucleotide, primary construct or mmRNA species may be combined in an aqueous solution, in the presence or absence of copper, to form a new covalent linkage via a click chemistry mechanism as described in the literature.

[000113] In another example, more than two polynucleotides may be linked together using a functionalized linker molecule. For example, a functionalized saccharide molecule may be chemically modified to contain multiple chemical reactive groups (SH-, NH₂-, N₃, etc. .) to react with the cognate moiety on a 3'-functionalized mRNA molecule (i.e., a 3'-maleimide ester, 3'-NHS-ester, alkynyl). The number of reactive groups on the modified saccharide can be controlled in a stoichiometric fashion to directly control the stoichiometric ratio of conjugated polynucleotide, primary construct or mmRNA.

mmRNA Conjugates and Combinations

[000114] In order to further enhance protein production, primary constructs or mmRNA of the present invention can be designed to be conjugated to other polynucleotides, dyes, intercalating agents (*e.g.* acridines), cross-linkers (*e.g.* psoralene, mitomycin C), porphyrins (TPPC4, texaphyrin, Sapphyrin), polycyclic aromatic hydrocarbons (*e.g.*, phenazine, dihydrophenazine), artificial endonucleases (*e.g.* EDTA), alkylating agents, phosphate, amino, mercapto, PEG (*e.g.*, PEG-40K), MPEG, [MPEG]₂, polyamino, alkyl, substituted alkyl, radiolabeled markers, enzymes, haptens (*e.g.* biotin), transport/absorption facilitators (*e.g.*, aspirin, vitamin E, folic acid), synthetic ribonucleases, proteins, *e.g.*, glycoproteins, or peptides, *e.g.*, molecules having a specific affinity for a co-ligand, or antibodies *e.g.*, an antibody, that binds to a specified cell type such as a cancer cell, endothelial cell, or bone cell, hormones and hormone receptors, non-peptidic species, such as lipids, lectins, carbohydrates, vitamins, cofactors, or a drug.

[000115] Conjugation may result in increased stability and/or half life and may be particularly useful in targeting the polynucleotides, primary constructs or mmRNA to specific sites in the cell, tissue or organism.

[000116] According to the present invention, the mmRNA or primary constructs may be administered with, or further encode one or more of RNAi agents, siRNAs, shRNAs, miRNAs, miRNA binding sites, antisense RNAs, ribozymes, catalytic DNA, tRNA, RNAs that induce triple helix formation, aptamers or vectors, and the like.

Bifunctional mmRNA

[000117] In one embodiment of the invention are bifunctional polynucleotides (e.g., bifunctional primary constructs or bifunctional mmRNA). As the name implies, bifunctional polynucleotides are those having or capable of at least two functions. These molecules may also by convention be referred to as multi-functional.

[000118] The multiple functionalities of bifunctional polynucleotides may be encoded by the RNA (the function may not manifest until the encoded product is translated) or may be a property of the polynucleotide itself. It may be structural or chemical. Bifunctional modified polynucleotides may comprise a function that is covalently or electrostatically associated with the polynucleotides. Further, the two functions may be provided in the context of a complex of a mmRNA and another molecule.

[000119] Bifunctional polynucleotides may encode peptides which are anti-proliferative. These peptides may be linear, cyclic, constrained or random coil. They may function as aptamers, signaling molecules, ligands or mimics or mimetics thereof. Anti-proliferative peptides may, as translated, be from 3 to 50 amino acids in length. They may be 5-40, 10-30, or approximately 15 amino acids long. They may be single chain, multichain or branched and may form complexes, aggregates or any multi-unit structure once translated.

Noncoding polynucleotides and primary constructs

[000120] As described herein, provided are polynucleotides and primary constructs having sequences that are partially or substantially not translatable, e.g., having a noncoding region. Such noncoding region may be the "first region" of the primary construct. Alternatively, the noncoding region may be a region other than the first region. Such molecules are generally not translated, but can exert an effect on protein production

by one or more of binding to and sequestering one or more translational machinery components such as a ribosomal protein or a transfer RNA (tRNA), thereby effectively reducing protein expression in the cell or modulating one or more pathways or cascades in a cell which in turn alters protein levels. The polynucleotide or primary construct may contain or encode one or more long noncoding RNA (lncRNA, or lincRNA) or portion thereof, a small nucleolar RNA (sno-RNA), micro RNA (miRNA), small interfering RNA (siRNA) or Piwi-interacting RNA (piRNA).

Polypeptides of interest

[000121] According to the present invention, the primary construct is designed to encode one or more polypeptides of interest or fragments thereof. A polypeptide of interest may include, but is not limited to, whole polypeptides, a plurality of polypeptides or fragments of polypeptides, which independently may be encoded by one or more nucleic acids, a plurality of nucleic acids, fragments of nucleic acids or variants of any of the aforementioned. As used herein, the term "polypeptides of interest" refer to any polypeptide which is selected to be encoded in the primary construct of the present invention. As used herein, "polypeptide" means a polymer of amino acid residues (natural or unnatural) linked together most often by peptide bonds. The term, as used herein, refers to proteins, polypeptides, and peptides of any size, structure, or function. In some instances the polypeptide encoded is smaller than about 50 amino acids and the polypeptide is then termed a peptide. If the polypeptide is a peptide, it will be at least about 2, 3, 4, or at least 5 amino acid residues long. Thus, polypeptides include gene products, naturally occurring polypeptides, synthetic polypeptides, homologs, orthologs, paralog, fragments and other equivalents, variants, and analogs of the foregoing. A polypeptide may be a single molecule or may be a multi-molecular complex such as a dimer, trimer or tetramer. They may also comprise single chain or multichain polypeptides such as antibodies or insulin and may be associated or linked. Most commonly disulfide linkages are found in multichain polypeptides. The term polypeptide may also apply to amino acid polymers in which one or more amino acid residues are an artificial chemical analogue of a corresponding naturally occurring amino acid.

[000122] The term "polypeptide variant" refers to molecules which differ in their amino acid sequence from a native or reference sequence. The amino acid sequence variants

may possess substitutions, deletions, and/or insertions at certain positions within the amino acid sequence, as compared to a native or reference sequence. Ordinarily, variants will possess at least about 50% identity (homology) to a native or reference sequence, and preferably, they will be at least about 80%, more preferably at least about 90% identical (homologous) to a native or reference sequence.

[000123] In some embodiments "variant mimics" are provided. As used herein, the term "variant mimic" is one which contains one or more amino acids which would mimic an activated sequence. For example, glutamate may serve as a mimic for phospho-threonine and/or phospho-serine. Alternatively, variant mimics may result in deactivation or in an inactivated product containing the mimic, e.g., phenylalanine may act as an inactivating substitution for tyrosine; or alanine may act as an inactivating substitution for serine.

[000124] "Homology" as it applies to amino acid sequences is defined as the percentage of residues in the candidate amino acid sequence that are identical with the residues in the amino acid sequence of a second sequence after aligning the sequences and introducing gaps, if necessary, to achieve the maximum percent homology. Methods and computer programs for the alignment are well known in the art. It is understood that homology depends on a calculation of percent identity but may differ in value due to gaps and penalties introduced in the calculation.

[000125] By "homologs" as it applies to polypeptide sequences means the corresponding sequence of other species having substantial identity to a second sequence of a second species.

[000126] "Analog" is meant to include polypeptide variants which differ by one or more amino acid alterations, e.g., substitutions, additions or deletions of amino acid residues that still maintain one or more of the properties of the parent or starting polypeptide.

[000127] The present invention contemplates several types of compositions which are polypeptide based including variants and derivatives. These include substitutional, insertional, deletion and covalent variants and derivatives. The term "derivative" is used synonymously with the term "variant" but generally refers to a molecule that has been modified and/or changed in any way relative to a reference molecule or starting molecule.

[000128] As such, mRNA encoding polypeptides containing substitutions, insertions and/or additions, deletions and covalent modifications with respect to reference sequences, in particular the polypeptide sequences disclosed herein, are included within the scope of this invention. For example, sequence tags or amino acids, such as one or more lysines, can be added to the peptide sequences of the invention (e.g., at the N-terminal or C-terminal ends). Sequence tags can be used for peptide purification or localization. Lysines can be used to increase peptide solubility or to allow for biotinylation. Alternatively, amino acid residues located at the carboxy and amino terminal regions of the amino acid sequence of a peptide or protein may optionally be deleted providing for truncated sequences. Certain amino acids (e.g., C-terminal or N-terminal residues) may alternatively be deleted depending on the use of the sequence, as for example, expression of the sequence as part of a larger sequence which is soluble, or linked to a solid support.

[000129] "Substitutional variants" when referring to polypeptides are those that have at least one amino acid residue in a native or starting sequence removed and a different amino acid inserted in its place at the same position. The substitutions may be single, where only one amino acid in the molecule has been substituted, or they may be multiple, where two or more amino acids have been substituted in the same molecule.

[000130] As used herein the term "conservative amino acid substitution" refers to the substitution of an amino acid that is normally present in the sequence with a different amino acid of similar size, charge, or polarity. Examples of conservative substitutions include the substitution of a non-polar (hydrophobic) residue such as isoleucine, valine and leucine for another non-polar residue. Likewise, examples of conservative substitutions include the substitution of one polar (hydrophilic) residue for another such as between arginine and lysine, between glutamine and asparagine, and between glycine and serine. Additionally, the substitution of a basic residue such as lysine, arginine or histidine for another, or the substitution of one acidic residue such as aspartic acid or glutamic acid for another acidic residue are additional examples of conservative substitutions. Examples of non-conservative substitutions include the substitution of a non-polar (hydrophobic) amino acid residue such as isoleucine, valine, leucine, alanine,

methionine for a polar (hydrophilic) residue such as cysteine, glutamine, glutamic acid or lysine and/or a polar residue for a non-polar residue.

[000131] "Insertional variants" when referring to polypeptides are those with one or more amino acids inserted immediately adjacent to an amino acid at a particular position in a native or starting sequence. "Immediately adjacent" to an amino acid means connected to either the alpha-carboxy or alpha-amino functional group of the amino acid.

[000132] "Deletional variants" when referring to polypeptides are those with one or more amino acids in the native or starting amino acid sequence removed. Ordinarily, deletional variants will have one or more amino acids deleted in a particular region of the molecule.

[000133] "Covalent derivatives" when referring to polypeptides include modifications of a native or starting protein with an organic proteinaceous or non-proteinaceous derivatizing agent, and/or post-translational modifications. Covalent modifications are traditionally introduced by reacting targeted amino acid residues of the protein with an organic derivatizing agent that is capable of reacting with selected side-chains or terminal residues, or by harnessing mechanisms of post-translational modifications that function in selected recombinant host cells. The resultant covalent derivatives are useful in programs directed at identifying residues important for biological activity, for immunoassays, or for the preparation of anti-protein antibodies for immunoaffinity purification of the recombinant glycoprotein. Such modifications are within the ordinary skill in the art and are performed without undue experimentation.

[000134] Certain post-translational modifications are the result of the action of recombinant host cells on the expressed polypeptide. Glutaminyl and asparaginyl residues are frequently post-translationally deamidated to the corresponding glutamyl and aspartyl residues. Alternatively, these residues are deamidated under mildly acidic conditions. Either form of these residues may be present in the polypeptides produced in accordance with the present invention.

[000135] Other post-translational modifications include hydroxylation of proline and lysine, phosphorylation of hydroxyl groups of seryl or threonyl residues, methylation of the alpha-amino groups of lysine, arginine, and histidine side chains (T. E. Creighton,

Proteins: Structure and Molecular Properties, W.H. Freeman & Co., San Francisco, pp. 79-86 (1983)).

[000136] "Features" when referring to polypeptides are defined as distinct amino acid sequence-based components of a molecule. Features of the polypeptides encoded by the mmRNA of the present invention include surface manifestations, local conformational shape, folds, loops, half-loops, domains, half-domains, sites, termini or any combination thereof.

[000137] As used herein when referring to polypeptides the term "surface manifestation" refers to a polypeptide based component of a protein appearing on an outermost surface.

[000138] As used herein when referring to polypeptides the term "local conformational shape" means a polypeptide based structural manifestation of a protein which is located within a definable space of the protein.

[000139] As used herein when referring to polypeptides the term "fold" refers to the resultant conformation of an amino acid sequence upon energy minimization. A fold may occur at the secondary or tertiary level of the folding process. Examples of secondary level folds include beta sheets and alpha helices. Examples of tertiary folds include domains and regions formed due to aggregation or separation of energetic forces. Regions formed in this way include hydrophobic and hydrophilic pockets, and the like.

[000140] As used herein the term "turn" as it relates to protein conformation means a bend which alters the direction of the backbone of a peptide or polypeptide and may involve one, two, three or more amino acid residues.

[000141] As used herein when referring to polypeptides the term "loop" refers to a structural feature of a polypeptide which may serve to reverse the direction of the backbone of a peptide or polypeptide. Where the loop is found in a polypeptide and only alters the direction of the backbone, it may comprise four or more amino acid residues. Oliva et al. have identified at least 5 classes of protein loops (J. Mol Biol 266 (4): 814-830; 1997). Loops may be open or closed. Closed loops or "cyclic" loops may comprise 2, 3, 4, 5, 6, 7, 8, 9, 10 or more amino acids between the bridging moieties. Such bridging moieties may comprise a cysteine-cysteine bridge (Cys-Cys) typical in polypeptides

having disulfide bridges or alternatively bridging moieties may be non-protein based such as the dibromozylyl agents used herein.

[000142] As used herein when referring to polypeptides the term "half-loop" refers to a portion of an identified loop having at least half the number of amino acid residues as the loop from which it is derived. It is understood that loops may not always contain an even number of amino acid residues. Therefore, in those cases where a loop contains or is identified to comprise an odd number of amino acids, a half-loop of the odd-numbered loop will comprise the whole number portion or next whole number portion of the loop (number of amino acids of the loop/2+/-0.5 amino acids). For example, a loop identified as a 7 amino acid loop could produce half-loops of 3 amino acids or 4 amino acids ($7/2=3.5+/-0.5$ being 3 or 4).

[000143] As used herein when referring to polypeptides the term "domain" refers to a motif of a polypeptide having one or more identifiable structural or functional characteristics or properties (e.g., binding capacity, serving as a site for protein-protein interactions).

[000144] As used herein when referring to polypeptides the term "half-domain" means a portion of an identified domain having at least half the number of amino acid residues as the domain from which it is derived. It is understood that domains may not always contain an even number of amino acid residues. Therefore, in those cases where a domain contains or is identified to comprise an odd number of amino acids, a half-domain of the odd-numbered domain will comprise the whole number portion or next whole number portion of the domain (number of amino acids of the domain/2+/-0.5 amino acids). For example, a domain identified as a 7 amino acid domain could produce half-domains of 3 amino acids or 4 amino acids ($7/2=3.5+/-0.5$ being 3 or 4). It is also understood that sub-domains may be identified within domains or half-domains, these subdomains possessing less than all of the structural or functional properties identified in the domains or half domains from which they were derived. It is also understood that the amino acids that comprise any of the domain types herein need not be contiguous along the backbone of the polypeptide (i.e., nonadjacent amino acids may fold structurally to produce a domain, half-domain or subdomain).

[000145] As used herein when referring to polypeptides the terms "site" as it pertains to amino acid based embodiments is used synonymously with "amino acid residue" and "amino acid side chain." A site represents a position within a peptide or polypeptide that may be modified, manipulated, altered, derivatized or varied within the polypeptide based molecules of the present invention.

[000146] As used herein the terms "termini" or "terminus" when referring to polypeptides refers to an extremity of a peptide or polypeptide. Such extremity is not limited only to the first or final site of the peptide or polypeptide but may include additional amino acids in the terminal regions. The polypeptide based molecules of the present invention may be characterized as having both an N-terminus (terminated by an amino acid with a free amino group (NH₂)) and a C-terminus (terminated by an amino acid with a free carboxyl group (COOH)). Proteins of the invention are in some cases made up of multiple polypeptide chains brought together by disulfide bonds or by non-covalent forces (multimers, oligomers). These sorts of proteins will have multiple N- and C-termini. Alternatively, the termini of the polypeptides may be modified such that they begin or end, as the case may be, with a non-polypeptide based moiety such as an organic conjugate.

[000147] Once any of the features have been identified or defined as a desired component of a polypeptide to be encoded by the primary construct or mRNA of the invention, any of several manipulations and/or modifications of these features may be performed by moving, swapping, inverting, deleting, randomizing or duplicating. Furthermore, it is understood that manipulation of features may result in the same outcome as a modification to the molecules of the invention. For example, a manipulation which involved deleting a domain would result in the alteration of the length of a molecule just as modification of a nucleic acid to encode less than a full length molecule would.

[000148] Modifications and manipulations can be accomplished by methods known in the art such as, but not limited to, site directed mutagenesis. The resulting modified molecules may then be tested for activity using *in vitro* or *in vivo* assays such as those described herein or any other suitable screening assay known in the art.

[000149] According to the present invention, the polypeptides may comprise a consensus sequence which is discovered through rounds of experimentation. As used herein a "consensus" sequence is a single sequence which represents a collective population of sequences allowing for variability at one or more sites.

[000150] As recognized by those skilled in the art, protein fragments, functional protein domains, and homologous proteins are also considered to be within the scope of polypeptides of interest of this invention. For example, provided herein is any protein fragment (meaning a polypeptide sequence at least one amino acid residue shorter than a reference polypeptide sequence but otherwise identical) of a reference protein 10, 20, 30, 40, 50, 60, 70, 80, 90, 100 or greater than 100 amino acids in length. In another example, any protein that includes a stretch of about 20, about 30, about 40, about 50, or about 100 amino acids which are about 40%, about 50%, about 60%, about 70%, about 80%, about 90%, about 95%, or about 100% identical to any of the sequences described herein can be utilized in accordance with the invention. In certain embodiments, a polypeptide to be utilized in accordance with the invention includes 2, 3, 4, 5, 6, 7, 8, 9, 10, or more mutations as shown in any of the sequences provided or referenced herein.

Encoded Polypeptides

[000151] The primary constructs or mmRNA of the present invention may be designed to encode polypeptides of interest selected from any of several target categories including, but not limited to, biologics, antibodies, vaccines, therapeutic proteins or peptides, cell penetrating peptides, secreted proteins, plasma membrane proteins, cytoplasmic or cytoskeletal proteins, intracellular membrane bound proteins, nuclear proteins, proteins associated with human disease, targeting moieties or those proteins encoded by the human genome for which no therapeutic indication has been identified but which nonetheless have utility in areas of research and discovery.

[000152] In one embodiment primary constructs or mmRNA may encode variant polypeptides which have a certain identity with a reference polypeptide sequence. As used herein, a "reference polypeptide sequence" refers to a starting polypeptide sequence. Reference sequences may be wild type sequences or any sequence to which reference is made in the design of another sequence. A "reference polypeptide sequence" may, e.g., be any one of SEQ ID NOs: 769-1392 as disclosed herein, e.g., any of SEQ ID NOs 769,

770, 771, 772, 773, 774, 775, 776, 777, 778, 779, 780, 781, 782, 783, 784, 785, 786, 787, 788, 789, 790, 791, 792, 793, 794, 795, 796, 797, 798, 799, 800, 801, 802, 803, 804, 805, 806, 807, 808, 809, 810, 811, 812, 813, 814, 815, 816, 817, 818, 819, 820, 821, 822, 823, 824, 825, 826, 827, 828, 829, 830, 831, 832, 833, 834, 835, 836, 837, 838, 839, 840, 841, 842, 843, 844, 845, 846, 847, 848, 849, 850, 851, 852, 853, 854, 855, 856, 857, 858, 859, 860, 861, 862, 863, 864, 865, 866, 867, 868, 869, 870, 871, 872, 873, 874, 875, 876, 877, 878, 879, 880, 881, 882, 883, 884, 885, 886, 887, 888, 889, 890, 891, 892, 893, 894, 895, 896, 897, 898, 899, 900, 901, 902, 903, 904, 905, 906, 907, 908, 909, 910, 911, 912, 913, 914, 915, 916, 917, 918, 919, 920, 921, 922, 923, 924, 925, 926, 927, 928, 929, 930, 931, 932, 933, 934, 935, 936, 937, 938, 939, 940, 941, 942, 943, 944, 945, 946, 947, 948, 949, 950, 951, 952, 953, 954, 955, 956, 957, 958, 959, 960, 961, 962, 963, 964, 965, 966, 967, 968, 969, 970, 971, 972, 973, 974, 975, 976, 977, 978, 979, 980, 981, 982, 983, 984, 985, 986, 987, 988, 989, 990, 991, 992, 993, 994, 995, 996, 997, 998, 999, 1000, 1001, 1002, 1003, 1004, 1005, 1006, 1007, 1008, 1009, 1010, 1011, 1012, 1013, 1014, 1015, 1016, 1017, 1018, 1019, 1020, 1021, 1022, 1023, 1024, 1025, 1026, 1027, 1028, 1029, 1030, 1031, 1032, 1033, 1034, 1035, 1036, 1037, 1038, 1039, 1040, 1041, 1042, 1043, 1044, 1045, 1046, 1047, 1048, 1049, 1050, 1051, 1052, 1053, 1054, 1055, 1056, 1057, 1058, 1059, 1060, 1061, 1062, 1063, 1064, 1065, 1066, 1067, 1068, 1069, 1070, 1071, 1072, 1073, 1074, 1075, 1076, 1077, 1078, 1079, 1080, 1081, 1082, 1083, 1084, 1085, 1086, 1087, 1088, 1089, 1090, 1091, 1092, 1093, 1094, 1095, 1096, 1097, 1098, 1099, 1100, 1101, 1102, 1103, 1104, 1105, 1106, 1107, 1108, 1109, 1110, 1111, 1112, 1113, 1114, 1115, 1116, 1117, 1118, 1119, 1120, 1121, 1122, 1123, 1124, 1125, 1126, 1127, 1128, 1129, 1130, 1131, 1132, 1133, 1134, 1135, 1136, 1137, 1138, 1139, 1140, 1141, 1142, 1143, 1144, 1145, 1146, 1147, 1148, 1149, 1150, 1151, 1152, 1153, 1154, 1155, 1156, 1157, 1158, 1159, 1160, 1161, 1162, 1163, 1164, 1165, 1166, 1167, 1168, 1169, 1170, 1171, 1172, 1173, 1174, 1175, 1176, 1177, 1178, 1179, 1180, 1181, 1182, 1183, 1184, 1185, 1186, 1187, 1188, 1189, 1190, 1191, 1192, 1193, 1194, 1195, 1196, 1197, 1198, 1199, 1200, 1201, 1202, 1203, 1204, 1205, 1206, 1207, 1208, 1209, 1210, 1211, 1212, 1213, 1214, 1215, 1216, 1217, 1218, 1219, 1220, 1221, 1222, 1223, 1224, 1225, 1226, 1227, 1228, 1229, 1230, 1231, 1232, 1233, 1234, 1235, 1236, 1237, 1238, 1239, 1240, 1241, 1242, 1243, 1244, 1245, 1246, 1247, 1248, 1249, 1250, 1251, 1252, 1253, 1254,

1255, 1256, 1257, 1258, 1259, 1260, 1261, 1262, 1263, 1264, 1265, 1266, 1267, 1268, 1269, 1270, 1271, 1272, 1273, 1274, 1275, 1276, 1277, 1278, 1279, 1280, 1281, 1282, 1283, 1284, 1285, 1286, 1287, 1288, 1289, 1290, 1291, 1292, 1293, 1294, 1295, 1296, 1297, 1298, 1299, 1300, 1301, 1302, 1303, 1304, 1305, 1306, 1307, 1308, 1309, 1310, 1311, 1312, 1313, 1314, 1315, 1316, 1317, 1318, 1319, 1320, 1321, 1322, 1323, 1324, 1325, 1326, 1327, 1328, 1329, 1330, 1331, 1332, 1333, 1334, 1335, 1336, 1337, 1338, 1339, 1340, 1341, 1342, 1343, 1344, 1345, 1346, 1347, 1348, 1349, 1350, 1351, 1352, 1353, 1354, 1355, 1356, 1357, 1358, 1359, 1360, 1361, 1362, 1363, 1364, 1365, 1366, 1367, 1368, 1369, 1370, 1371, 1372, 1373, 1374, 1375, 1376, 1377, 1378, 1379, 1380, 1381, 1382, 1383, 1384, 1385, 1386, 1387, 1388, 1389, 1390, 1391, 1392.

[000153] The term "identity" as known in the art, refers to a relationship between the sequences of two or more peptides, as determined by comparing the sequences. In the art, identity also means the degree of sequence relatedness between peptides, as determined by the number of matches between strings of two or more amino acid residues. Identity measures the percent of identical matches between the smaller of two or more sequences with gap alignments (if any) addressed by a particular mathematical model or computer program (i.e., "algorithms"). Identity of related peptides can be readily calculated by known methods. Such methods include, but are not limited to, those described in Computational Molecular Biology, Lesk, A. M., ed., Oxford University Press, New York, 1988; Biocomputing: Informatics and Genome Projects, Smith, D. W., ed., Academic Press, New York, 1993; Computer Analysis of Sequence Data, Part 1, Griffin, A. M., and Griffin, H. G., eds., Humana Press, New Jersey, 1994; Sequence Analysis in Molecular Biology, von Heinje, G., Academic Press, 1987; Sequence Analysis Primer, Gribskov, M. and Devereux, J., eds., M. Stockton Press, New York, 1991; and Carillo et al, SIAM J. Applied Math. 48, 1073 (1988).

[000154] In some embodiments, the polypeptide variant may have the same or a similar activity as the reference polypeptide. Alternatively, the variant may have an altered activity (e.g., increased or decreased) relative to a reference polypeptide. Generally, variants of a particular polynucleotide or polypeptide of the invention will have at least about 40%, 45%, 50%, 55%, 60%, 65%, 70%, 75%, 80%, 85%, 90%, 91%, 92%, 93%, 94%, 95%, 96%, 97%, 98%, 99% but less than 100% sequence identity to that particular

reference polynucleotide or polypeptide as determined by sequence alignment programs and parameters described herein and known to those skilled in the art. Such tools for alignment include those of the BLAST suite (Stephen F. Altschul, Thomas L. Madden, Alejandro A. Schaffer, Jinghui Zhang, Zheng Zhang, Webb Miller, and David J. Lipman (1997), "Gapped BLAST and PSI-BLAST: a new generation of protein database search programs", *Nucleic Acids Res.* 25:3389-3402.) Other tools are described herein, specifically in the definition of "Identity."

[000155] Default parameters in the BLAST algorithm include, for example, an expect threshold of 10, Word size of 28, Match/Mismatch Scores 1, -2, Gap costs Linear. Any filter can be applied as well as a selection for species specific repeats, e.g., *Homo sapiens*.

Biologies

[000156] The polynucleotides, primary constructs or mmRNA disclosed herein, may encode one or more biologics. As used herein, a "biologic" is a polypeptide-based molecule produced by the methods provided herein and which may be used to treat, cure, mitigate, prevent, or diagnose a serious or life-threatening disease or medical condition. Biologies, according to the present invention include, but are not limited to, allergenic extracts (e.g. for allergy shots and tests), blood components, gene therapy products, human tissue or cellular products used in transplantation, vaccines, monoclonal antibodies, cytokines, growth factors, enzymes, thrombolytics, and immunomodulators, among others.

[000157] According to the present invention, one or more biologics currently being marketed or in development may be encoded by the polynucleotides, primary constructs or mmRNA of the present invention. While not wishing to be bound by theory, it is believed that incorporation of the encoding polynucleotides of a known biologic into the primary constructs or mmRNA of the invention will result in improved therapeutic efficacy due at least in part to the specificity, purity and/or selectivity of the construct designs.

Antibodies

[000158] The primary constructs or mmRNA disclosed herein, may encode one or more antibodies or fragments thereof. The term "antibody" includes monoclonal antibodies (including full length antibodies which have an immunoglobulin Fc region), antibody

compositions with polyepitopic specificity, multispecific antibodies (e.g., bispecific antibodies, diabodies, and single-chain molecules), as well as antibody fragments. The term "immunoglobulin" (Ig) is used interchangeably with "antibody" herein. As used herein, the term "monoclonal antibody" refers to an antibody obtained from a population of substantially homogeneous antibodies, i.e., the individual antibodies comprising the population are identical except for possible naturally occurring mutations and/or post-translation modifications (e.g., isomerizations, amidations) that may be present in minor amounts. Monoclonal antibodies are highly specific, being directed against a single antigenic site.

[000159] The monoclonal antibodies herein specifically include "chimeric" antibodies (immunoglobulins) in which a portion of the heavy and/or light chain is identical with or homologous to corresponding sequences in antibodies derived from a particular species or belonging to a particular antibody class or subclass, while the remainder of the chain(s) is(are) identical with or homologous to corresponding sequences in antibodies derived from another species or belonging to another antibody class or subclass, as well as fragments of such antibodies, so long as they exhibit the desired biological activity. Chimeric antibodies of interest herein include, but are not limited to, "primatized" antibodies comprising variable domain antigen-binding sequences derived from a non-human primate (e.g., Old World Monkey, Ape etc.) and human constant region sequences.

[000160] An "antibody fragment" comprises a portion of an intact antibody, preferably the antigen binding and/or the variable region of the intact antibody. Examples of antibody fragments include Fab, Fab', F(ab')₂ and Fv fragments; diabodies; linear antibodies; nanobodies; single-chain antibody molecules and multispecific antibodies formed from antibody fragments.

[000161] Any of the five classes of immunoglobulins, IgA, IgD, IgE, IgG and IgM, may be encoded by the mmRNA of the invention, including the heavy chains designated alpha, delta, epsilon, gamma and mu, respectively. Also included are polynucleotide sequences encoding the subclasses, gamma and mu. Hence any of the subclasses of antibodies may be encoded in part or in whole and include the following subclasses: IgG1, IgG2, IgG3, IgG4, IgA1 and IgA2.

[000162] According to the present invention, one or more antibodies or fragments currently being marketed or in development may be encoded by the polynucleotides, primary constructs or mmRNA of the present invention. While not wishing to be bound by theory, it is believed that incorporation into the primary constructs of the invention will result in improved therapeutic efficacy due at least in part to the specificity, purity and selectivity of the mmRNA designs.

[000163] Antibodies encoded in the polynucleotides, primary constructs or mmRNA of the invention may be utilized to treat conditions or diseases in many therapeutic areas such as, but not limited to, blood, cardiovascular, CNS, poisoning (including antivenoms), dermatology, endocrinology, gastrointestinal, medical imaging, musculoskeletal, oncology, immunology, respiratory, sensory and anti-infective.

[000164] In one embodiment, primary constructs or mmRNA disclosed herein may encode monoclonal antibodies and/or variants thereof. Variants of antibodies may also include, but are not limited to, substitutional variants, conservative amino acid substitution, insertional variants, deletional variants and/or covalent derivatives. In one embodiment, the primary construct and/or mmRNA disclosed herein may encode an immunoglobulin Fc region. In another embodiment, the primary constructs and/or mmRNA may encode a variant immunoglobulin Fc region. As a non-limiting example, the primary constructs and/or mmRNA may encode an antibody having a variant immunoglobulin Fc region as described in U.S. Pat. No. 8,217,147 herein incorporated by reference in its entirety.

Vaccines

[000165] The primary constructs or mmRNA disclosed herein, may encode one or more vaccines. As used herein, a "vaccine" is a biological preparation that improves immunity to a particular disease or infectious agent. According to the present invention, one or more vaccines currently being marketed or in development may be encoded by the polynucleotides, primary constructs or mmRNA of the present invention. While not wishing to be bound by theory, it is believed that incorporation into the primary constructs or mmRNA of the invention will result in improved therapeutic efficacy due at least in part to the specificity, purity and selectivity of the construct designs.

[000166] Vaccines encoded in the polynucleotides, primary constructs or mmRNA of the invention may be utilized to treat conditions or diseases in many therapeutic areas such as, but not limited to, cardiovascular, CNS, dermatology, endocrinology, oncology, immunology, respiratory, and anti-infective.

Therapeutic proteins or peptides

[000167] The primary constructs or mmRNA disclosed herein, may encode one or more validated or "in testing" therapeutic proteins or peptides.

[000168] According to the present invention, one or more therapeutic proteins or peptides currently being marketed or in development may be encoded by the polynucleotides, primary constructs or mmRNA of the present invention. While not wishing to be bound by theory, it is believed that incorporation into the primary constructs or mmRNA of the invention will result in improved therapeutic efficacy due at least in part to the specificity, purity and selectivity of the construct designs.

[000169] Therapeutic proteins and peptides encoded in the polynucleotides, primary constructs or mmRNA of the invention may be utilized to treat conditions or diseases in many therapeutic areas such as, but not limited to, blood, cardiovascular, CNS, poisoning (including antivenoms), dermatology, endocrinology, genetic, genitourinary, gastrointestinal, musculoskeletal, oncology, and immunology, respiratory, sensory and anti-infective.

Cell-Penetrating Polypeptides

[000170] The primary constructs or mmRNA disclosed herein, may encode one or more cell-penetrating polypeptides. As used herein, "cell-penetrating polypeptide" or CPP refers to a polypeptide which may facilitate the cellular uptake of molecules. A cell-penetrating polypeptide of the present invention may contain one or more detectable labels. The polypeptides may be partially labeled or completely labeled throughout. The polynucleotide, primary construct or mmRNA may encode the detectable label completely, partially or not at all. The cell-penetrating peptide may also include a signal sequence. As used herein, a "signal sequence" refers to a sequence of amino acid residues bound at the amino terminus of a nascent protein during protein translation. The signal sequence may be used to signal the secretion of the cell-penetrating polypeptide.

[000171] In one embodiment, the polynucleotides, primary constructs or mmRNA may also encode a fusion protein. The fusion protein may be created by operably linking a charged protein to a therapeutic protein. As used herein, "operably linked" refers to the therapeutic protein and the charged protein being connected in such a way to permit the expression of the complex when introduced into the cell. As used herein, "charged protein" refers to a protein that carries a positive, negative or overall neutral electrical charge. Preferably, the therapeutic protein may be covalently linked to the charged protein in the formation of the fusion protein. The ratio of surface charge to total or surface amino acids may be approximately 0.1, 0.2, 0.3, 0.4, 0.5, 0.6, 0.7, 0.8 or 0.9.

[000172] The cell-penetrating polypeptide encoded by the polynucleotides, primary constructs or mmRNA may form a complex after being translated. The complex may comprise a charged protein linked, e.g. covalently linked, to the cell-penetrating polypeptide. "Therapeutic protein" refers to a protein that, when administered to a cell has a therapeutic, diagnostic, and/or prophylactic effect and/or elicits a desired biological and/or pharmacological effect.

[000173] In one embodiment, the cell-penetrating polypeptide may comprise a first domain and a second domain. The first domain may comprise a supercharged polypeptide. The second domain may comprise a protein-binding partner. As used herein, "protein-binding partner" includes, but is not limited to, antibodies and functional fragments thereof, scaffold proteins, or peptides. The cell-penetrating polypeptide may further comprise an intracellular binding partner for the protein-binding partner. The cell-penetrating polypeptide may be capable of being secreted from a cell where the polynucleotide, primary construct or mmRNA may be introduced. The cell-penetrating polypeptide may also be capable of penetrating the first cell.

[000174] In a further embodiment, the cell-penetrating polypeptide is capable of penetrating a second cell. The second cell may be from the same area as the first cell, or it may be from a different area. The area may include, but is not limited to, tissues and organs. The second cell may also be proximal or distal to the first cell.

[000175] In one embodiment, the polynucleotides, primary constructs or mmRNA may encode a cell-penetrating polypeptide which may comprise a protein-binding partner. The protein binding partner may include, but is not limited to, an antibody, a

supercharged antibody or a functional fragment. The polynucleotides, primary constructs or mmRNA may be introduced into the cell where a cell-penetrating polypeptide comprising the protein-binding partner is introduced.

Secreted proteins

[000176] Human and other eukaryotic cells are subdivided by membranes into many functionally distinct compartments. Each membrane-bounded compartment, or organelle, contains different proteins essential for the function of the organelle. The cell uses "sorting signals," which are amino acid motifs located within the protein, to target proteins to particular cellular organelles.

[000177] One type of sorting signal, called a signal sequence, a signal peptide, or a leader sequence, directs a class of proteins to an organelle called the endoplasmic reticulum (ER).

[000178] Proteins targeted to the ER by a signal sequence can be released into the extracellular space as a secreted protein. Similarly, proteins residing on the cell membrane can also be secreted into the extracellular space by proteolytic cleavage of a "linker" holding the protein to the membrane. While not wishing to be bound by theory, the molecules of the present invention may be used to exploit the cellular trafficking described above. As such, in some embodiments of the invention, polynucleotides, primary constructs or mmRNA are provided to express a secreted protein. The secreted proteins may be selected from those described herein or those in US Patent Publication, 20100255574, the contents of which are incorporated herein by reference in their entirety.

[000179] In one embodiment, these may be used in the manufacture of large quantities of valuable human gene products.

Plasma membrane proteins

[000180] In some embodiments of the invention, polynucleotides, primary constructs or mmRNA are provided to express a protein of the plasma membrane.

Cytoplasmic or cytoskeletal proteins

[000181] In some embodiments of the invention, polynucleotides, primary constructs or mmRNA are provided to express a cytoplasmic or cytoskeletal protein.

Intracellular membrane bound proteins

[000182] In some embodiments of the invention, polynucleotides, primary constructs or mmRNA are provided to express an intracellular membrane bound protein.

Nuclear proteins

[000183] In some embodiments of the invention, polynucleotides, primary constructs or mmRNA are provided to express a nuclear protein.

Proteins associated with human disease

[000184] In some embodiments of the invention, polynucleotides, primary constructs or mmRNA are provided to express a protein associated with human disease.

Miscellaneous proteins

[000185] In some embodiments of the invention, polynucleotides, primary constructs or mmRNA are provided to express a protein with a presently unknown therapeutic function.

Targeting Moieties

[000186] In some embodiments of the invention, polynucleotides, primary constructs or mmRNA are provided to express a targeting moiety. These include a protein-binding partner or a receptor on the surface of the cell, which functions to target the cell to a specific tissue space or to interact with a specific moiety, either *in vivo* or *in vitro*.

Suitable protein-binding partners include, but are not limited to, antibodies and functional fragments thereof, scaffold proteins, or peptides. Additionally, polynucleotide, primary construct or mmRNA can be employed to direct the synthesis and extracellular localization of lipids, carbohydrates, or other biological moieties or biomolecules.

Polypeptide Libraries

[000187] In one embodiment, the polynucleotides, primary constructs or mmRNA may be used to produce polypeptide libraries. These libraries may arise from the production of a population of polynucleotides, primary constructs or mmRNA, each containing various structural or chemical modification designs. In this embodiment, a population of polynucleotides, primary constructs or mmRNA may comprise a plurality of encoded polypeptides, including but not limited to, an antibody or antibody fragment, protein binding partner, scaffold protein, and other polypeptides taught herein or known in the art. In a preferred embodiment, the polynucleotides are primary constructs of the present

invention, including mmRNA which may be suitable for direct introduction into a target cell or culture which in turn may synthesize the encoded polypeptides.

[000188] In certain embodiments, multiple variants of a protein, each with different amino acid modification(s), may be produced and tested to determine the best variant in terms of pharmacokinetics, stability, biocompatibility, and/or biological activity, or a biophysical property such as expression level. Such a library may contain 10 , 10^2 , 10^3 , 10^4 , 10^5 , 10^6 , 10^7 , 10^8 , 10^9 , or over 10^9 possible variants (including, but not limited to, substitutions, deletions of one or more residues, and insertion of one or more residues).

Anti-Microbial and Anti-viral Polypeptides

[000189] The polynucleotides, primary constructs and mmRNA of the present invention may be designed to encode one or more antimicrobial peptides (AMP) or antiviral peptides (AVP). AMPs and AVPs have been isolated and described from a wide range of animals such as, but not limited to, microorganisms, invertebrates, plants, amphibians, birds, fish, and mammals (Wang *et al.*, *Nucleic Acids Res.* 2009; 37 (Database issue):D933-7). For example, anti-microbial polypeptides are described in Antimicrobial Peptide Database (<http://aps.unmc.edu/AP/main.php>; Wang *et al.*, *Nucleic Acids Res.* 2009; 37 (Database issue):D933-7), CAMP: Collection of Anti-Microbial Peptides (<http://www.bicnirrh.res.in/antimicrobial/>); Thomas *et al.*, *Nucleic Acids Res.* 2010; 38 (Database issue):D774-80), US 5221732, US 5447914, US 5519115, US 5607914, US 5714577, US 5734015, US 5798336, US 5821224, US 5849490, US 5856127, US 5905187, US 5994308, US 5998374, US 6107460, US 6191254, US 6211148, US 6300489, US 6329504, US 6399370, US 6476189, US 6478825, US 6492328, US 6514701, US 6573361, US 6573361, US 6576755, US 6605698, US 6624140, US 6638531, US 6642203, US 6653280, US 6696238, US 6727066, US 6730659, US 6743598, US 6743769, US 6747007, US 6790833, US 6794490, US 6818407, US 6835536, US 6835713, US 6838435, US 6872705, US 6875907, US 6884776, US 6887847, US 6906035, US 6911524, US 6936432, US 7001924, US 7071293, US 7078380, US 7091185, US 7094759, US 7166769, US 7244710, US 7314858, and US 7582301, the contents of which are incorporated by reference in their entirety.

[000190] The anti-microbial polypeptides described herein may block cell fusion and/or viral entry by one or more enveloped viruses (*e.g.*, HIV, HCV). For example, the anti-

microbial polypeptide can comprise or consist of a synthetic peptide corresponding to a region, *e.g.*, a consecutive sequence of at least about 5, 10, 15, 20, 25, 30, 35, 40, 45, 50, 55, or 60 amino acids of the transmembrane subunit of a viral envelope protein, *e.g.*, HIV-1 gp120 or gp41. The amino acid and nucleotide sequences of HIV-1 gp120 or gp41 are described in, *e.g.*, Kuiken *et al.*, (2008). "*HIV Sequence Compendium*," Los Alamos National Laboratory.

[000191] In some embodiments, the anti-microbial polypeptide may have at least about 75%, 80%, 85%, 90%, 95%, 100% sequence homology to the corresponding viral protein sequence. In some embodiments, the anti-microbial polypeptide may have at least about 75%, 80%, 85%, 90%, 95%, or 100% sequence homology to the corresponding viral protein sequence.

[000192] In other embodiments, the anti-microbial polypeptide may comprise or consist of a synthetic peptide corresponding to a region, *e.g.*, a consecutive sequence of at least about 5, 10, 15, 20, 25, 30, 35, 40, 45, 50, 55, or 60 amino acids of the binding domain of a capsid binding protein. In some embodiments, the anti-microbial polypeptide may have at least about 75%, 80%, 85%, 90%, 95%, or 100% sequence homology to the corresponding sequence of the capsid binding protein.

[000193] The anti-microbial polypeptides described herein may block protease dimerization and inhibit cleavage of viral proproteins (*e.g.*, HIV Gag-pol processing) into functional proteins thereby preventing release of one or more enveloped viruses (*e.g.*, HIV, HCV). In some embodiments, the anti-microbial polypeptide may have at least about 75%, 80%, 85%, 90%, 95%, 100% sequence homology to the corresponding viral protein sequence.

[000194] In other embodiments, the anti-microbial polypeptide can comprise or consist of a synthetic peptide corresponding to a region, *e.g.*, a consecutive sequence of at least about 5, 10, 15, 20, 25, 30, 35, 40, 45, 50, 55, or 60 amino acids of the binding domain of a protease binding protein. In some embodiments, the anti-microbial polypeptide may have at least about 75%, 80%, 85%, 90%, 95%, 100% sequence homology to the corresponding sequence of the protease binding protein.

[000195] The anti-microbial polypeptides described herein can include an *in vitro*-evolved polypeptide directed against a viral pathogen.

Anti-Microbial Polypeptides

[000196] Anti-microbial polypeptides (AMPs) are small peptides of variable length, sequence and structure with broad spectrum activity against a wide range of microorganisms including, but not limited to, bacteria, viruses, fungi, protozoa, parasites, prions, and tumor/cancer cells. (See, *e.g.*, Zaiou, J Mol Med, 2007; 85:317; herein incorporated by reference in its entirety). It has been shown that AMPs have broad-spectrum of rapid onset of killing activities, with potentially low levels of induced resistance and concomitant broad anti-inflammatory effects.

[000197] In some embodiments, the anti-microbial polypeptide (*e.g.*, an anti-bacterial polypeptide) may be under 10kDa, *e.g.*, under 8kDa, 6kDa, 4kDa, 2kDa, or 1kDa. In some embodiments, the anti-microbial polypeptide (*e.g.*, an anti-bacterial polypeptide) consists of from about 6 to about 100 amino acids, *e.g.*, from about 6 to about 75 amino acids, about 6 to about 50 amino acids, about 6 to about 25 amino acids, about 25 to about 100 amino acids, about 50 to about 100 amino acids, or about 75 to about 100 amino acids. In certain embodiments, the anti-microbial polypeptide (*e.g.*, an anti-bacterial polypeptide) may consist of from about 15 to about 45 amino acids. In some embodiments, the anti-microbial polypeptide (*e.g.*, an anti-bacterial polypeptide) is substantially cationic.

[000198] In some embodiments, the anti-microbial polypeptide (*e.g.*, an anti-bacterial polypeptide) may be substantially amphipathic. In certain embodiments, the anti-microbial polypeptide (*e.g.*, an anti-bacterial polypeptide) may be substantially cationic and amphipathic. In some embodiments, the anti-microbial polypeptide (*e.g.*, an anti-bacterial polypeptide) may be cytostatic to a Gram-positive bacterium. In some embodiments, the anti-microbial polypeptide (*e.g.*, an anti-bacterial polypeptide) may be cytotoxic to a Gram-positive bacterium. In some embodiments, the anti-microbial polypeptide (*e.g.*, an anti-bacterial polypeptide) may be cytostatic and cytotoxic to a Gram-positive bacterium. In some embodiments, the anti-microbial polypeptide (*e.g.*, an anti-bacterial polypeptide) may be cytostatic to a Gram-negative bacterium. In some embodiments, the anti-microbial polypeptide (*e.g.*, an anti-bacterial polypeptide) may be cytotoxic to a Gram-negative bacterium. In some embodiments, the anti-microbial polypeptide (*e.g.*, an anti-bacterial polypeptide) may be cytostatic and cytotoxic to a

Gram-positive bacterium. In some embodiments, the anti-microbial polypeptide may be cytostatic to a virus, fungus, protozoan, parasite, prion, or a combination thereof. In some embodiments, the anti-microbial polypeptide may be cytotoxic to a virus, fungus, protozoan, parasite, prion, or a combination thereof. In certain embodiments, the anti-microbial polypeptide may be cytostatic and cytotoxic to a virus, fungus, protozoan, parasite, prion, or a combination thereof. In some embodiments, the anti-microbial polypeptide may be cytotoxic to a tumor or cancer cell (*e.g.*, a human tumor and/or cancer cell). In some embodiments, the anti-microbial polypeptide may be cytostatic to a tumor or cancer cell (*e.g.*, a human tumor and/or cancer cell). In certain embodiments, the anti-microbial polypeptide may be cytotoxic and cytostatic to a tumor or cancer cell (*e.g.*, a human tumor or cancer cell). In some embodiments, the anti-microbial polypeptide (*e.g.*, an anti-bacterial polypeptide) may be a secreted polypeptide.

[000199] In some embodiments, the anti-microbial polypeptide comprises or consists of a defensin. Exemplary defensins include, but are not limited to, α -defensins (*e.g.*, neutrophil defensin 1, defensin alpha 1, neutrophil defensin 3, neutrophil defensin 4, defensin 5, defensin 6), β -defensins (*e.g.*, beta-defensin 1, beta-defensin 2, beta-defensin 103, beta-defensin 107, beta-defensin 110, beta-defensin 136), and θ -defensins. In other embodiments, the anti-microbial polypeptide comprises or consists of a cathelicidin (*e.g.*, hCAP18).

Anti-Viral Polypeptides

[000200] Anti-viral polypeptides (AVPs) are small peptides of variable length, sequence and structure with broad spectrum activity against a wide range of viruses. See, *e.g.*, Zaiou, J Mol Med, 2007; 85:317. It has been shown that AVPs have a broad-spectrum of rapid onset of killing activities, with potentially low levels of induced resistance and concomitant broad anti-inflammatory effects. In some embodiments, the anti-viral polypeptide is under 10kDa, *e.g.*, under 8kDa, 6kDa, 4kDa, 2kDa, or 1kDa. In some embodiments, the anti-viral polypeptide comprises or consists of from about 6 to about 100 amino acids, *e.g.*, from about 6 to about 75 amino acids, about 6 to about 50 amino acids, about 6 to about 25 amino acids, about 25 to about 100 amino acids, about 50 to about 100 amino acids, or about 75 to about 100 amino acids. In certain embodiments, the anti-viral polypeptide comprises or consists of from about 15 to about

45 amino acids. In some embodiments, the anti-viral polypeptide is substantially cationic. In some embodiments, the anti-viral polypeptide is substantially amphipathic. In certain embodiments, the anti-viral polypeptide is substantially cationic and amphipathic. In some embodiments, the anti-viral polypeptide is cytostatic to a virus. In some embodiments, the anti-viral polypeptide is cytotoxic to a virus. In some embodiments, the anti-viral polypeptide is cytostatic and cytotoxic to a virus. In some embodiments, the anti-viral polypeptide is cytostatic to a bacterium, fungus, protozoan, parasite, prion, or a combination thereof. In some embodiments, the anti-viral polypeptide is cytotoxic to a bacterium, fungus, protozoan, parasite, prion or a combination thereof. In certain embodiments, the anti-viral polypeptide is cytostatic and cytotoxic to a bacterium, fungus, protozoan, parasite, prion, or a combination thereof. In some embodiments, the anti-viral polypeptide is cytotoxic to a tumor or cancer cell (*e.g.*, a human cancer cell). In some embodiments, the anti-viral polypeptide is cytostatic to a tumor or cancer cell (*e.g.*, a human cancer cell). In certain embodiments, the anti-viral polypeptide is cytotoxic and cytostatic to a tumor or cancer cell (*e.g.*, a human cancer cell). In some embodiments, the anti-viral polypeptide is a secreted polypeptide.

Cytotoxic Nucleosides

[000201] In one embodiment, the polynucleotides, primary constructs or mmRNA of the present invention may incorporate one or more cytotoxic nucleosides. For example, cytotoxic nucleosides may be incorporated into polynucleotides, primary constructs or mmRNA such as bifunctional modified RNAs or mRNAs. Cytotoxic nucleoside anti-cancer agents include, but are not limited to, adenosine arabinoside, cytarabine, cytosine arabinoside, 5-fluorouracil, fludarabine, floxuridine, FTORAFUR® (a combination of tegafur and uracil), tegafur ((RS)-5-fluoro-1-(tetrahydrofuran-2-yl)pyrimidine-2,4(1H,3H)-dione), and 6-mercaptopurine.

[000202] A number of cytotoxic nucleoside analogues are in clinical use, or have been the subject of clinical trials, as anticancer agents. Examples of such analogues include, but are not limited to, cytarabine, gemcitabine, troxacitabine, decitabine, tezacitabine, 2'-deoxy-2'-methylidene-cytidine (DMDC), cladribine, clofarabine, 5-azacytidine, 4'-thioaracytidine, cyclopentenylcytosine and 1-(2-C-cyano-2-deoxy-beta-D-arabino-pentofuranosyl)-cytosine. Another example of such a compound is fludarabine

phosphate. These compounds may be administered systemically and may have side effects which are typical of cytotoxic agents such as, but not limited to, little or no specificity for tumor cells over proliferating normal cells.

[000203] A number of prodrugs of cytotoxic nucleoside analogues are also reported in the art. Examples include, but are not limited to, N4-behenoyl-1-beta-D-arabinofuranosylcytosine, N4-octadecyl-1-beta-D-arabinofuranosylcytosine, N4-palmitoyl-1-(2-C-cyano-2-deoxy-beta-D-arabino-pentofuranosyl) cytosine, and P-4055 (cytarabine 5'-elaidic acid ester). In general, these prodrugs may be converted into the active drugs mainly in the liver and systemic circulation and display little or no selective release of active drug in the tumor tissue. For example, capecitabine, a prodrug of 5'-deoxy-5-fluorocytidine (and eventually of 5-fluorouracil), is metabolized both in the liver and in the tumor tissue. A series of capecitabine analogues containing "an easily hydrolysable radical under physiological conditions" has been claimed by Fujiu et al. (U.S. Pat. No. 4,966,891) and is herein incorporated by reference. The series described by Fujiu includes N4 alkyl and aralkyl carbamates of 5'-deoxy-5-fluorocytidine and the implication that these compounds will be activated by hydrolysis under normal physiological conditions to provide 5'-deoxy-5-fluorocytidine.

[000204] A series of cytarabine N4-carbamates has been reported by Fadl et al (Pharmazie. 1995, 50, 382-7, herein incorporated by reference) in which compounds were designed to convert into cytarabine in the liver and plasma. WO 2004/041203, herein incorporated by reference, discloses prodrugs of gemcitabine, where some of the prodrugs are N4-carbamates. These compounds were designed to overcome the gastrointestinal toxicity of gemcitabine and were intended to provide gemcitabine by hydrolytic release in the liver and plasma after absorption of the intact prodrug from the gastrointestinal tract. Nomura et al (Bioorg Med. Chem. 2003, 11, 2453-61, herein incorporated by reference) have described acetal derivatives of 1-(3-C-ethynyl -P-D-ribo-pentofuranosyl) cytosine which, on bioreduction, produced an intermediate that required further hydrolysis under acidic conditions to produce a cytotoxic nucleoside compound.

[000205] Cytotoxic nucleotides which may be chemotherapeutic also include, but are not limited to, pyrazolo [3,4-D]-pyrimidines, allopurinol, azathioprine, capecitabine, cytosine arabinoside, fluorouracil, mercaptopurine, 6-thioguanine, acyclovir, ara-

adenosine, ribavirin, 7-deaza-adenosine, 7-deaza-guanosine, 6-aza-uracil, 6-aza-cytidine, thymidine ribonucleotide, 5-bromodeoxyuridine, 2-chloro-purine, and inosine, or combinations thereof.

Flanking Regions: Untranslated Regions (UTRs)

[000206] Untranslated regions (UTRs) of a gene are transcribed but not translated. The 5'UTR starts at the transcription start site and continues to the start codon but does not include the start codon; whereas, the 3'UTR starts immediately following the stop codon and continues until the transcriptional termination signal. There is growing body of evidence about the regulatory roles played by the UTRs in terms of stability of the nucleic acid molecule and translation. The regulatory features of a UTR can be incorporated into the polynucleotides, primary constructs and/or mmRNA of the present invention to enhance the stability of the molecule. The specific features can also be incorporated to ensure controlled down-regulation of the transcript in case they are misdirected to undesired organs sites.

5' UTR and Translation Initiation

[000207] Natural 5'UTRs bear features which play roles in for translation initiation. They harbor signatures like Kozak sequences which are commonly known to be involved in the process by which the ribosome initiates translation of many genes. Kozak sequences have the consensus CCR(A/G)CCAUGG, where R is a purine (adenine or guanine) three bases upstream of the start codon (AUG), which is followed by another 'G'. 5'UTR also have been known to form secondary structures which are involved in elongation factor binding.

[000208] By engineering the features typically found in abundantly expressed genes of specific target organs, one can enhance the stability and protein production of the polynucleotides, primary constructs or mmRNA of the invention. For example, introduction of 5' UTR of liver-expressed mRNA, such as albumin, serum amyloid A, Apolipoprotein A/B/E, transferrin, alpha fetoprotein, erythropoietin, or Factor VIII, could be used to enhance expression of a nucleic acid molecule, such as a mmRNA, in hepatic cell lines or liver. Likewise, use of 5' UTR from other tissue-specific mRNA to improve expression in that tissue is possible for muscle (MyoD, Myosin, Myoglobin, Myogenin, Herculin), for endothelial cells (Tie-1, CD36), for myeloid cells (C/EBP, AML1, G-CSF,

GM-CSF, CD1 lb, MSR, Fr-1, i-NOS), for leukocytes (CD45, CD18), for adipose tissue (CD36, GLUT4, ACRP30, adiponectin) and for lung epithelial cells (SP-A/B/C/D).

[000209] Other non-UTR sequences may be incorporated into the 5' (or 3' UTR) UTRs. For example, introns or portions of introns sequences may be incorporated into the flanking regions of the polynucleotides, primary constructs or mmRNA of the invention. Incorporation of intronic sequences may increase protein production as well as mRNA levels.

3' UTR and the AU Rich Elements

[000210] 3' UTRs are known to have stretches of Adenosines and Uridines embedded in them. These AU rich signatures are particularly prevalent in genes with high rates of turnover. Based on their sequence features and functional properties, the AU rich elements (AREs) can be separated into three classes (Chen et al, 1995): Class I AREs contain several dispersed copies of an AUUUA motif within U-rich regions. C-Myc and MyoD contain class I AREs. Class II AREs possess two or more overlapping UUAUUUA(U/A)(U/A) nonamers. Molecules containing this type of AREs include GM-CSF and TNF-a. Class III AREs are less well defined. These U rich regions do not contain an AUUUA motif. c-Jun and Myogenin are two well-studied examples of this class. Most proteins binding to the AREs are known to destabilize the messenger, whereas members of the ELAV family, most notably HuR, have been documented to increase the stability of mRNA. HuR binds to AREs of all the three classes. Engineering the HuR specific binding sites into the 3' UTR of nucleic acid molecules will lead to HuR binding and thus, stabilization of the message *in vivo*.

[000211] Introduction, removal or modification of 3' UTR AU rich elements (AREs) can be used to modulate the stability of polynucleotides, primary constructs or mmRNA of the invention. When engineering specific polynucleotides, primary constructs or mmRNA, one or more copies of an ARE can be introduced to make polynucleotides, primary constructs or mmRNA of the invention less stable and thereby curtail translation and decrease production of the resultant protein. Likewise, AREs can be identified and removed or mutated to increase the intracellular stability and thus increase translation and production of the resultant protein. Transfection experiments can be conducted in relevant cell lines, using polynucleotides, primary constructs or mmRNA of the invention

and protein production can be assayed at various time points post-transfection. For example, cells can be transfected with different ARE-engineering molecules and by using an ELISA kit to the relevant protein and assaying protein produced at 6 hour, 12 hour, 24 hour, 48 hour, and 7 days post-transfection.

Incorporating microRNA Binding Sites

[000212] microRNAs (or miRNA) are 19-25 nucleotide long noncoding RNAs that bind to the 3'UTR of nucleic acid molecules and down-regulate gene expression either by reducing nucleic acid molecule stability or by inhibiting translation. The polynucleotides, primary constructs or mmRNA of the invention may comprise one or more microRNA target sequences, microRNA sequences, or microRNA seeds. Such sequences may correspond to any known microRNA such as those taught in US Publication US2005/0261218 and US Publication US2005/0059005, the contents of which are incorporated herein by reference in their entirety.

[000213] A microRNA sequence comprises a "seed" region, i.e., a sequence in the region of positions 2-8 of the mature microRNA, which sequence has perfect Watson-Crick complementarity to the miRNA target sequence. A microRNA seed may comprise positions 2-8 or 2-7 of the mature microRNA. In some embodiments, a microRNA seed may comprise 7 nucleotides (e.g., nucleotides 2-8 of the mature microRNA), wherein the seed-complementary site in the corresponding miRNA target is flanked by an adenine (A) opposed to microRNA position 1. In some embodiments, a microRNA seed may comprise 6 nucleotides (e.g., nucleotides 2-7 of the mature microRNA), wherein the seed-complementary site in the corresponding miRNA target is flanked by an adenine (A) opposed to microRNA position 1. See for example, Grimson A, Farh KK, Johnston WK, Garrett-Engle P, Lim LP, Barcel DP; Mol Cell. 2007 Jul 6;27(1):91-105; each of which is herein incorporated by reference in their entirety. The bases of the microRNA seed have complete complementarity with the target sequence. By engineering microRNA target sequences into the 3'UTR of polynucleotides, primary constructs or mmRNA of the invention one can target the molecule for degradation or reduced translation, provided the microRNA in question is available. This process will reduce the hazard of off target effects upon nucleic acid molecule delivery. Identification of microRNA, microRNA target regions, and their expression patterns and role in biology have been reported

(Bonauer et al., *Curr Drug Targets* 2010 11:943-949; Anand and Cheresh *Curr Opin Hematol* 2011 18:171-176; Contreras and Rao *Leukemia* 2012 26:404-413 (2011 Dec 20. doi: 10.1038/leu.2011.356); Bartel *Cell* 2009 136:215-233; Landgraf et al, *Cell*, 2007 129:1401-1414; each of which is herein incorporated by reference in its entirety).

[000214] For example, if the nucleic acid molecule is an mRNA and is not intended to be delivered to the liver but ends up there, then miR-122, a microRNA abundant in liver, can inhibit the expression of the gene of interest if one or multiple target sites of miR-122 are engineered into the 3' UTR of the polynucleotides, primary constructs or mmRNA. Introduction of one or multiple binding sites for different microRNA can be engineered to further decrease the longevity, stability, and protein translation of a polynucleotides, primary constructs or mmRNA.

[000215] As used herein, the term "microRNA site" refers to a microRNA target site or a microRNA recognition site, or any nucleotide sequence to which a microRNA binds or associates. It should be understood that "binding" may follow traditional Watson-Crick hybridization rules or may reflect any stable association of the microRNA with the target sequence at or adjacent to the microRNA site.

[000216] Conversely, for the purposes of the polynucleotides, primary constructs or mmRNA of the present invention, microRNA binding sites can be engineered out of (i.e. removed from) sequences in which they naturally occur in order to increase protein expression in specific tissues. For example, miR-122 binding sites may be removed to improve protein expression in the liver. Regulation of expression in multiple tissues can be accomplished through introduction or removal of one or several microRNA binding sites.

[000217] Examples of tissues where microRNA are known to regulate mRNA, and thereby protein expression, include, but are not limited to, liver (miR-122), muscle (miR-133, miR-206, miR-208), endothelial cells (miR-17-92, miR-126), myeloid cells (miR-142-3p, miR-142-5p, miR-16, miR-21, miR-223, miR-24, miR-27), adipose tissue (let-7, miR-30c), heart (miR-149), kidney (miR-192, miR-194, miR-204), and lung epithelial cells (let-7, miR-133, miR-126). MicroRNA can also regulate complex biological processes such as angiogenesis (miR-132) (Anand and Cheresh *Curr Opin Hematol* 2011 18:171-176; herein incorporated by reference in its entirety). In the

polynucleotides, primary constructs or mmRNA of the present invention, binding sites for microRNAs that are involved in such processes may be removed or introduced, in order to tailor the expression of the polynucleotides, primary constructs or mmRNA expression to biologically relevant cell types or to the context of relevant biological processes. A listing of MicroRNA, miR sequences and miR binding sites is listed in Table 9 of U.S. Provisional Application No. 61/753,661 filed January 17, 2013, in Table 9 of U.S. Provisional Application No. 61/754,159 filed January 18, 2013, and in Table 7 of U.S. Provisional Application No. 61/758,921 filed January 31, 2013, each of which are herein incorporated by reference in their entireties.

[000218] Lastly, through an understanding of the expression patterns of microRNA in different cell types, polynucleotides, primary constructs or mmRNA can be engineered for more targeted expression in specific cell types or only under specific biological conditions. Through introduction of tissue-specific microRNA binding sites, polynucleotides, primary constructs or mmRNA could be designed that would be optimal for protein expression in a tissue or in the context of a biological condition. Examples of use of microRNA to drive tissue or disease-specific gene expression are listed (Getner and Naldini, *Tissue Antigens*. 2012, 80:393-403; herein incorporated by reference in its entirety). In addition, microRNA seed sites can be incorporated into mRNA to decrease expression in certain cells which results in a biological improvement. An example of this is incorporation of miR-142 sites into a UGT1A1-expressing lentiviral vector. The presence of miR-142 seed sites reduced expression in hematopoietic cells, and as a consequence reduced expression in antigen-presenting cells, leading to the absence of an immune response against the virally expressed UGT1A1 (Schmitt et al., *Gastroenterology* 2010; 139:999-1007; Gonzalez-Asequinolaza et al. *Gastroenterology* 2010, 139:726-729; both herein incorporated by reference in its entirety). Incorporation of miR-142 sites into modified mRNA could not only reduce expression of the encoded protein in hematopoietic cells, but could also reduce or abolish immune responses to the mRNA-encoded protein. Incorporation of miR-142 seed sites (one or multiple) into mRNA would be important in the case of treatment of patients with complete protein deficiencies (UGT1A1 type I, LDLR-deficient patients, CRIM-negative Pompe patients, etc.) .

[000219] Transfection experiments can be conducted in relevant cell lines, using engineered polynucleotides, primary constructs or mmRNA and protein production can be assayed at various time points post-transfection. For example, cells can be transfected with different microRNA binding site-engineering polynucleotides, primary constructs or mmRNA and by using an ELISA kit to the relevant protein and assaying protein produced at 6 hour, 12 hour, 24 hour, 48 hour, 72 hour and 7 days post-transfection. *In vivo* experiments can also be conducted using microRNA-binding site-engineered molecules to examine changes in tissue-specific expression of formulated polynucleotides, primary constructs or mmRNA.

5' Capping

[000220] The 5' cap structure of an mRNA is involved in nuclear export, increasing mRNA stability and binds the mRNA Cap Binding Protein (CBP), which is responsible for mRNA stability in the cell and translation competency through the association of CBP with poly(A) binding protein to form the mature cyclic mRNA species. The cap further assists the removal of 5' proximal introns removal during mRNA splicing.

[000221] Endogenous mRNA molecules may be 5'-end capped generating a 5'-ppp-5'-triphosphate linkage between a terminal guanosine cap residue and the 5'-terminal transcribed sense nucleotide of the mRNA molecule. This 5'-guanylate cap may then be methylated to generate an N7-methyl-guanylate residue. The ribose sugars of the terminal and/or antiterminal transcribed nucleotides of the 5' end of the mRNA may optionally also be 2'-O-methylated. 5'-decapping through hydrolysis and cleavage of the guanylate cap structure may target a nucleic acid molecule, such as an mRNA molecule, for degradation.

[000222] Modifications to the polynucleotides, primary constructs, and mmRNA of the present invention may generate a non-hydrolyzable cap structure preventing decapping and thus increasing mRNA half-life. Because cap structure hydrolysis requires cleavage of 5'-ppp-5' phosphodiester linkages, modified nucleotides may be used during the capping reaction. For example, a Vaccinia Capping Enzyme from New England Biolabs (Ipswich, MA) may be used with a-thio-guanosine nucleotides according to the manufacturer's instructions to create a phosphorothioate linkage in the 5'-ppp-5' cap.

Additional modified guanosine nucleotides may be used such as a-methyl-phosphonate and seleno-phosphate nucleotides.

[000223] Additional modifications include, but are not limited to, 2'-O-methylation of the ribose sugars of 5'-terminal and/or 5'-antiterminal nucleotides of the mRNA (as mentioned above) on the 2'-hydroxyl group of the sugar ring. Multiple distinct 5'-cap structures can be used to generate the 5'-cap of a nucleic acid molecule, such as an mRNA molecule.

[000224] Cap analogs, which herein are also referred to as synthetic cap analogs, chemical caps, chemical cap analogs, or structural or functional cap analogs, differ from natural (i.e. endogenous, wild-type or physiological) 5'-caps in their chemical structure, while retaining cap function. Cap analogs may be chemically (i.e. non-enzymatically) or enzymatically synthesized and/or linked to a nucleic acid molecule.

[000225] For example, the Anti-Reverse Cap Analog (ARCA) cap contains two guanines linked by a 5'-5'-triphosphate group, wherein one guanine contains an N7 methyl group as well as a 3'-O-methyl group (i.e., N7,3'-O-dimethyl-guanosine-5'-triphosphate-5'-guanosine (m^7G -3'mppp-G; which may equivalently be designated 3' O-Me- $m^7G(5')$ ppp(5')G). The 3'-O atom of the other, unmodified, guanine becomes linked to the 5'-terminal nucleotide of the capped nucleic acid molecule (e.g. an mRNA or mmRNA). The N7- and 3'-O-methylated guanine provides the terminal moiety of the capped nucleic acid molecule (e.g. mRNA or mmRNA).

[000226] Another exemplary cap is mCAP, which is similar to ARCA but has a 2'-O-methyl group on guanosine (i.e., N7,2'-O-dimethyl-guanosine-5'-triphosphate-5'-guanosine, m^7Gm -ppp-G).

[000227] While cap analogs allow for the concomitant capping of a nucleic acid molecule in an in vitro transcription reaction, up to 20% of transcripts can remain uncapped. This, as well as the structural differences of a cap analog from an endogenous 5'-cap structures of nucleic acids produced by the endogenous, cellular transcription machinery, may lead to reduced translational competency and reduced cellular stability.

[000228] Polynucleotides, primary constructs and mmRNA of the invention may also be capped post-transcriptionally, using enzymes, in order to generate more authentic 5'-cap structures. As used herein, the phrase "more authentic" refers to a feature that

closely mirrors or mimics, either structurally or functionally, an endogenous or wild type feature. That is, a "more authentic" feature is better representative of an endogenous, wild-type, natural or physiological cellular function and/or structure as compared to synthetic features or analogs, etc., of the prior art, or which outperforms the corresponding endogenous, wild-type, natural or physiological feature in one or more respects. Non-limiting examples of more authentic 5'cap structures of the present invention are those which, among other things, have enhanced binding of cap binding proteins, increased half life, reduced susceptibility to 5' endonucleases and/or reduced 5'decapping, as compared to synthetic 5'cap structures known in the art (or to a wild-type, natural or physiological 5'cap structure). For example, recombinant Vaccinia Virus Capping Enzyme and recombinant 2'-O-methyltransferase enzyme can create a canonical 5'-5'-triphosphate linkage between the 5'-terminal nucleotide of an mRNA and a guanine cap nucleotide wherein the cap guanine contains an N7 methylation and the 5'-terminal nucleotide of the mRNA contains a 2'-O-methyl. Such a structure is termed the Cap1 structure. This cap results in a higher translational-competency and cellular stability and a reduced activation of cellular pro-inflammatory cytokines, as compared, e.g., to other 5'cap analog structures known in the art. Cap structures include, but are not limited to, 7mG(5')ppp(5')N,pN2p (cap 0), 7mG(5')ppp(5')N1mpNp (cap 1), and 7mG(5')-ppp(5')N1mpN2mp (cap 2).

[000229] Because the polynucleotides, primary constructs or mmRNA may be capped post-transcriptionally, and because this process is more efficient, nearly 100% of the polynucleotides, primary constructs or mmRNA may be capped. This is in contrast to ~80% when a cap analog is linked to an mRNA in the course of an in vitro transcription reaction.

[000230] According to the present invention, 5' terminal caps may include endogenous caps or cap analogs. According to the present invention, a 5' terminal cap may comprise a guanine analog. Useful guanine analogs include, but are not limited to, inosine, N1-methyl-guanosine, 2'fluoro-guanosine, 7-deaza-guanosine, 8-oxo-guanosine, 2-amino-guanosine, LNA-guanosine, and 2-azido-guanosine.

Viral Sequences

[000231] Additional viral sequences such as, but not limited to, the translation enhancer sequence of the barley yellow dwarf virus (BYDV-PAV), the Jaagsiekte sheep retrovirus (JSRV) and/or the Enzootic nasal tumor virus (See e.g., International Pub. No. WO2012129648; herein incorporated by reference in its entirety) can be engineered and inserted in the 3' UTR of the polynucleotides, primary constructs or mmRNA of the invention and can stimulate the translation of the construct *in vitro* and *in vivo*. Transfection experiments can be conducted in relevant cell lines and protein production can be assayed by ELISA at 12hr, 24hr, 48hr, 72 hr and day 7 post-transfection.

IRES Sequences

[000232] Further, provided are polynucleotides, primary constructs or mmRNA which may contain an internal ribosome entry site (IRES). First identified as a feature Picorna virus RNA, IRES plays an important role in initiating protein synthesis in absence of the 5' cap structure. An IRES may act as the sole ribosome binding site, or may serve as one of multiple ribosome binding sites of an mRNA. Polynucleotides, primary constructs or mmRNA containing more than one functional ribosome binding site may encode several peptides or polypeptides that are translated independently by the ribosomes ("multicistronic nucleic acid molecules"). When polynucleotides, primary constructs or mmRNA are provided with an IRES, further optionally provided is a second translatable region. Examples of IRES sequences that can be used according to the invention include without limitation, those from picornaviruses (e.g. FMDV), pest viruses (CFFV), polio viruses (PV), encephalomyocarditis viruses (ECMV), foot-and-mouth disease viruses (FMDV), hepatitis C viruses (HCV), classical swine fever viruses (CSFV), murine leukemia virus (MLV), simian immune deficiency viruses (SIV) or cricket paralysis viruses (CrPV).

Poly-A tails

[000233] During RNA processing, a long chain of adenine nucleotides (poly-A tail) may be added to a polynucleotide such as an mRNA molecules in order to increase stability. Immediately after transcription, the 3' end of the transcript may be cleaved to free a 3' hydroxyl. Then poly-A polymerase adds a chain of adenine nucleotides to the

RNA. The process, called polyadenylation, adds a poly-A tail that can be between, for example, approximately 100 and 250 residues long.

[000234] It has been discovered that unique poly-A tail lengths provide certain advantages to the polynucleotides, primary constructs or mmRNA of the present invention.

[000235] Generally, the length of a poly-A tail of the present invention is greater than 30 nucleotides in length. In another embodiment, the poly-A tail is greater than 35 nucleotides in length (e.g., at least or greater than about 35, 40, 45, 50, 55, 60, 70, 80, 90, 100, 120, 140, 160, 180, 200, 250, 300, 350, 400, 450, 500, 600, 700, 800, 900, 1,000, 1,100, 1,200, 1,300, 1,400, 1,500, 1,600, 1,700, 1,800, 1,900, 2,000, 2,500, and 3,000 nucleotides). In some embodiments, the polynucleotide, primary construct, or mmRNA includes from about 30 to about 3,000 nucleotides (e.g., from 30 to 50, from 30 to 100, from 30 to 250, from 30 to 500, from 30 to 750, from 30 to 1,000, from 30 to 1,500, from 30 to 2,000, from 30 to 2,500, from 50 to 100, from 50 to 250, from 50 to 500, from 50 to 750, from 50 to 1,000, from 50 to 1,500, from 50 to 2,000, from 50 to 2,500, from 50 to 3,000, from 100 to 500, from 100 to 750, from 100 to 1,000, from 100 to 1,500, from 100 to 2,000, from 100 to 2,500, from 100 to 3,000, from 500 to 750, from 500 to 1,000, from 500 to 1,500, from 500 to 2,000, from 500 to 2,500, from 500 to 3,000, from 1,000 to 1,500, from 1,000 to 2,000, from 1,000 to 2,500, from 1,000 to 3,000, from 1,500 to 2,000, from 1,500 to 2,500, from 1,500 to 3,000, from 2,000 to 3,000, from 2,000 to 2,500, and from 2,500 to 3,000).

[000236] In one embodiment, the poly-A tail is designed relative to the length of the overall polynucleotides, primary constructs or mmRNA. This design may be based on the length of the coding region, the length of a particular feature or region (such as the first or flanking regions), or based on the length of the ultimate product expressed from the polynucleotides, primary constructs or mmRNA.

[000237] In this context the poly-A tail may be 10, 20, 30, 40, 50, 60, 70, 80, 90, or 100% greater in length than the polynucleotides, primary constructs or mmRNA or feature thereof. The poly-A tail may also be designed as a fraction of polynucleotides, primary constructs or mmRNA to which it belongs. In this context, the poly-A tail may be 10, 20, 30, 40, 50, 60, 70, 80, or 90% or more of the total length of the construct or the

total length of the construct minus the poly-A tail. Further, engineered binding sites and conjugation of polynucleotides, primary constructs or mmRNA for Poly-A binding protein may enhance expression.

[000238] Additionally, multiple distinct polynucleotides, primary constructs or mmRNA may be linked together to the PABP (Poly-A binding protein) through the 3'-end using modified nucleotides at the 3'-terminus of the poly-A tail. Transfection experiments can be conducted in relevant cell lines and protein production can be assayed by ELISA at 12hr, 24hr, 48hr, 72 hr and day 7 post-transfection.

[000239] In one embodiment, the polynucleotide primary constructs of the present invention are designed to include a polyA-G Quartet. The G-quartet is a cyclic hydrogen bonded array of four guanine nucleotides that can be formed by G-rich sequences in both DNA and RNA. In this embodiment, the G-quartet is incorporated at the end of the poly-A tail. The resultant mmRNA construct is assayed for stability, protein production and other parameters including half-life at various time points. It has been discovered that the polyA-G quartet results in protein production equivalent to at least 75% of that seen using a poly-A tail of 120 nucleotides alone.

Quantification

[000240] In one embodiment, the polynucleotides, primary constructs or mmRNA of the present invention may be quantified in exosomes derived from one or more bodily fluid. As used herein "bodily fluids" include peripheral blood, serum, plasma, ascites, urine, cerebrospinal fluid (CSF), sputum, saliva, bone marrow, synovial fluid, aqueous humor, amniotic fluid, cerumen, breast milk, bronchoalveolar lavage fluid, semen, prostatic fluid, cowper's fluid or pre-ejaculatory fluid, sweat, fecal matter, hair, tears, cyst fluid, pleural and peritoneal fluid, pericardial fluid, lymph, chyme, chyle, bile, interstitial fluid, menses, pus, sebum, vomit, vaginal secretions, mucosal secretion, stool water, pancreatic juice, lavage fluids from sinus cavities, bronchopulmonary aspirates, blastocyl cavity fluid, and umbilical cord blood. Alternatively, exosomes may be retrieved from an organ selected from the group consisting of lung, heart, pancreas, stomach, intestine, bladder, kidney, ovary, testis, skin, colon, breast, prostate, brain, esophagus, liver, and placenta.

[000241] In the quantification method, a sample of not more than 2mL is obtained from the subject and the exosomes isolated by size exclusion chromatography, density gradient centrifugation, differential centrifugation, nanomembrane ultrafiltration, immunoabsorbent capture, affinity purification, microfluidic separation, or combinations thereof. In the analysis, the level or concentration of a polynucleotide, primary construct or mmRNA may be an expression level, presence, absence, truncation or alteration of the administered construct. It is advantageous to correlate the level with one or more clinical phenotypes or with an assay for a human disease biomarker. The assay may be performed using construct specific probes, cytometry, qRT-PCR, real-time PCR, PCR, flow cytometry, electrophoresis, mass spectrometry, or combinations thereof while the exosomes may be isolated using immunohistochemical methods such as enzyme linked immunosorbent assay (ELISA) methods. Exosomes may also be isolated by size exclusion chromatography, density gradient centrifugation, differential centrifugation, nanomembrane ultrafiltration, immunoabsorbent capture, affinity purification, microfluidic separation, or combinations thereof.

[000242] These methods afford the investigator the ability to monitor, in real time, the level of polynucleotides, primary constructs or mmRNA remaining or delivered. This is possible because the polynucleotides, primary constructs or mmRNA of the present invention differ from the endogenous forms due to the structural or chemical modifications.

II. Design and synthesis of mmRNA

[000243] Polynucleotides, primary constructs or mmRNA for use in accordance with the invention may be prepared according to any available technique including, but not limited to chemical synthesis, enzymatic synthesis, which is generally termed *in vitro* transcription (IVT) or enzymatic or chemical cleavage of a longer precursor, etc.

Methods of synthesizing RNAs are known in the art (see, *e.g.*, Gait, M.J. (ed.)

Oligonucleotide synthesis: a practical approach, Oxford [Oxfordshire], Washington, DC: IRL Press, 1984; and Herdewijn, P. (ed.) *Oligonucleotide synthesis: methods and applications*, Methods in Molecular Biology, v. 288 (Clifton, N.J.) Totowa, N.J.: Humana Press, 2005; both of which are incorporated herein by reference).

[000244] The process of design and synthesis of the primary constructs of the invention generally includes the steps of gene construction, mRNA production (either with or without modifications) and purification. In the enzymatic synthesis method, a target polynucleotide sequence encoding the polypeptide of interest is first selected for incorporation into a vector which will be amplified to produce a cDNA template. Optionally, the target polynucleotide sequence and/or any flanking sequences may be codon optimized. The cDNA template is then used to produce mRNA through *in vitro* transcription (IVT). After production, the mRNA may undergo purification and clean-up processes. The steps of which are provided in more detail below.

Gene Construction

[000245] The step of gene construction may include, but is not limited to gene synthesis, vector amplification, plasmid purification, plasmid linearization and clean-up, and cDNA template synthesis and clean-up.

Gene Synthesis

[000246] Once a polypeptide of interest, or target, is selected for production, a primary construct is designed. Within the primary construct, a first region of linked nucleosides encoding the polypeptide of interest may be constructed using an open reading frame (ORF) of a selected nucleic acid (DNA or RNA) transcript. The ORF may comprise the wild type ORF, an isoform, variant or a fragment thereof. As used herein, an "open reading frame" or "ORF" is meant to refer to a nucleic acid sequence (DNA or RNA) which is capable of encoding a polypeptide of interest. ORFs often begin with the start codon, ATG and end with a nonsense or termination codon or signal.

[000247] Further, the nucleotide sequence of the first region may be codon optimized. Codon optimization methods are known in the art and may be useful in efforts to achieve one or more of several goals. These goals include to match codon frequencies in target and host organisms to ensure proper folding, bias GC content to increase mRNA stability or reduce secondary structures, minimize tandem repeat codons or base runs that may impair gene construction or expression, customize transcriptional and translational control regions, insert or remove protein trafficking sequences, remove/add post translation modification sites in encoded protein (e.g. glycosylation sites), add, remove or shuffle protein domains, insert or delete restriction sites, modify ribosome binding sites

and mRNA degradation sites, to adjust translational rates to allow the various domains of the protein to fold properly, or to reduce or eliminate problem secondary structures within the mRNA. Codon optimization tools, algorithms and services are known in the art, non-limiting examples include services from GeneArt (Life Technologies), DNA2.0 (Menlo Park CA) and/or proprietary methods. In one embodiment, the ORF sequence is optimized using optimization algorithms. Codon options for each amino acid are given in Table 1.

Table 1. Codon Options

Amino Acid	Single Letter Code	Codon Options
Isoleucine	I	ATT, ATC, ATA
Leucine	L	CTT, CTC, CTA, CTG, TTA, TTG
Valine	V	GTT, GTC, GTA, GTG
Phenylalanine	F	TTT, TTC
Methionine	M	ATG
Cysteine	C	TGT, TGC
Alanine	A	GCT, GCC, GCA, GCG
Glycine	G	GGT, GGC, GGA, GGG
Proline	P	CCT, CCC, CCA, CCG
Threonine	T	ACT, ACC, ACA, ACG
Serine	S	TCT, TCC, TCA, TCG, AGT, AGC
Tyrosine	Y	TAT, TAC
Tryptophan	W	TGG
Glutamine	Q	CAA, CAG
Asparagine	N	AAT, AAC
Histidine	H	CAT, CAC
Glutamic acid	E	GAA, GAG
Aspartic acid	D	GAT, GAC
Lysine	K	AAA, AAG
Arginine	R	CGT, CGC, CGA, CGG, AGA, AGG
Selenocysteine	Sec	UGA in mRNA in presence of Selenocystein insertion element (SECIS)
Stop codons	Stop	TAA, TAG, TGA

[000248] Features, which may be considered beneficial in some embodiments of the present invention, may be encoded by the primary construct and may flank the ORF as a first or second flanking region. The flanking regions may be incorporated into the primary construct before and/or after optimization of the ORF. It is not required that a primary construct contain both a 5' and 3' flanking region. Examples of such features include, but are not limited to, untranslated regions (UTRs), Kozak sequences, an

oligo(dT) sequence, and detectable tags and may include multiple cloning sites which may have XbaI recognition.

[000249] In some embodiments, a 5' UTR and/or a 3' UTR may be provided as flanking regions. Multiple 5' or 3' UTRs may be included in the flanking regions and may be the same or of different sequences. Any portion of the flanking regions, including none, may be codon optimized and any may independently contain one or more different structural or chemical modifications, before and/or after codon optimization. Combinations of features may be included in the first and second flanking regions and may be contained within other features. For example, the ORF may be flanked by a 5' UTR which may contain a strong Kozak translational initiation signal and/or a 3' UTR which may include an oligo(dT) sequence for templated addition of a poly-A tail. 5'UTR may comprise a first polynucleotide fragment and a second polynucleotide fragment from the same and/or different genes such as the 5'UTRs described in US Patent Application Publication No. 20100293625, herein incorporated by reference in its entirety.

[000250] Tables 2 and 3 provide a listing of exemplary UTRs which may be utilized in the primary construct of the present invention as flanking regions. Shown in Table 2 is a listing of a 5'-untranslated region of the invention. Variants of 5' UTRs may be utilized wherein one or more nucleotides are added or removed to the termini, including A, T, C or G.

Table 2. 5'-Untranslated Regions

5' UTR Identifier	Name/Description	Sequence	SEQ ID NO.
5UTR-001	Upstream UTR	GGGAAATAAGAGAGAAAAGAAGAGTA AGAAGAAATATAAGAGCCACC	1
5UTR-002	Upstream UTR	GGGAGATCAGAGAGAAAAGAAGAGTA AGAAGAAATATAAGAGCCACC	2
5UTR-003	Upstream UTR	GGAATAAAAGTCTCAACACAACATATA CAAAACAAACGAATCTCAAGCAATCAA GCATTCTACTTCTATTGCAGCAATTTAA ATCATTCTTTTAAAGCAAAAGCAATTT TCTGAAAATTTTCACCATTACGAACGA TAGCAAC	3
5UTR-004	Upstream UTR	GGGAGACAAGCUUGGCAUCCGGUAC UGUUGGUAAGCCACC	4

[000251] Shown in Table 3 is a representative listing of 3'-untranslated regions of the invention. Variants of 3' UTRs may be utilized wherein one or more nucleotides are added or removed to the termini, including A, T, C or G.

Table 3. 3'-Untranslated Regions

3' UTR Identifier	Name/Description	Sequence	SEQ ID NO.
3UTR-001	Creatine Kinase	GCGCCTGCCACCTGCCACCGACTGCTGGA ACCCAGCCAGTGGGAGGGCCTGGCCCACC AGAGTCCTGCTCCCTCACTCCTCGCCCCGC CCCCTGTCCCAGAGTCCCACCTGGGGGCTC TCTCCACCCTTCTCAGAGTTCCAGTTTCAAC CAGAGTTCCAACCAATGGGCTCCATCCTCT GGATTCTGGCCAATGAAATATCTCCCTGGC AGGGTCTCTTCTTTTCCCAGAGCTCCACCC CAACCAGGAGCTCTAGTTAATGGAGAGCTC CCAGCACACTCGGAGCTTGTGCTTTGTCTC CACGCAAAGCGATAAATAAAAGCATTGGT GGCCTTTGGTCTTTGAATAAAGCCTGAGTA GGAAGTCTAGA	5
3UTR-002	Myoglobin	GCCCCTGCCGCTCCCACCCCCACCCATCTG GGCCCCGGGTTCAAGAGAGAGCGGGGTCT GATCTCGTGTAGCCATATAGAGTTTGCTTC TGAGTGTCTGCTTTGTTTAGTAGAGGTGGG CAGGAGGAGCTGAGGGGCTGGGGCTGGGG TGTTGAAGTTGGCTTTGCATGCCAGCGAT GCGCCTCCCTGTGGGATGTCATCACCCCTGG GAACCGGGAGTGGCCCTTGGCTCACTGTGT TCTGCATGGTTTGGATCTGAATTAATTGTCC TTTCTTCTAAATCCAACCGAACTTCTTCCA ACCTCCAAACTGGCTGTAACCCCAAATCCA AGCCATTAACTACACCTGACAGTAGCAATT GTCTGATTAATCACTGGCCCCTTGAAGACA GCAGAATGTCCCTTTGCAATGAGGAGGAG ATCTGGGCTGGGCGGGCCAGCTGGGGAAG CATTTGACTATCTGGAACCTTGTGTGTGCCTC CTCAGGTATGGCAGTGAATCACCTGGTTTT AATAAAACAACCTGCAACATCTCATGGTCT TTGAATAAAGCCTGAGTAGGAAGTCTAGA	6
3UTR-003	α -actin	ACACACTCCACCTCCAGCACGCGACTTCTC AGGACGACGAATCTTCTCAATGGGGGGGC GGCTGAGCTCCAGCCACCCCGCAGTCACTT TCTTTGTAACAACCTCCGTTGCTGCCATCGT AAACCTGACACAGTGTTTATAACGTGTACAT ACATTAACCTATTACCTCATTTTGTATTTT TCGAAACAAAGCCCTGTGGAAGAAAATGG AAAACTTGAAGAAGCATTAAAGTCATTCTG TTAAGCTGCGTAAATGGTCTTTGAATAAAG	7

		CCTGAGTAGGAAGTCTAGA	
3UTR-004	Albumin	CATCACATTTAAAGCATCTCAGCCTACCA TGAGAATAAGAGAAAGAAAATGAAGATCA AAAGCTTATTCATCTGTTTTCTTTTCGTT GGTGTAAGCCAACACCCTGTCTAAAAAAC ATAAATTTCTTTAATCATTTTGCCCTTTTC TCTGTGCTTCAATTAATAAAAAATGGAAAG AATCTAATAGAGTGGTACAGCACTGTTATT TTTCAAAGATGTGTTGCTATCCTGAAAATT CTGTAGGTTCTGTGGAAGTCCAGTGTCT CTCTTATTCCACTTCGGTAGAGGATTTCTAG TTTCTTGTGGGCTAATTAATAAATCATT ATACTCTTCTAATGGTCTTTGAATAAAGCC TGAGTAGGAAGTCTAGA	8
3UTR-005	α -globin	GCTGCCTTCTGCGGGGCTTGCCTTCTGGCC ATGCCCTTCTTCTCCTTGCACCTGTACC TCTTGGTCTTTGAATAAAGCCTGAGTAGGA AGGCGGCCGCTCGAGCATGCATCTAGA	9
3UTR-006	G-CSF	GCCAAGCCCTCCCATCCCATGTATTTATCT CTATTTAATATTTATGTCTATTTAAGCCTCA TATTTAAAGACAGGGAAGAGCAGAACGGA GCCCCAGGCCTCTGTGTCCTTCCCTGCATTT CTGAGTTTCATTCTCCTGCCTGTAGCAGTG AGAAAAAGCTCCTGTCCTCCCATCCCCTGG ACTGGGAGGTAGATAGGTAAATACCAAGT ATTTATTAATGACTGCTCCCCAGCCCTG GCTCTGCAATGGGCACTGGGATGAGCCGCT GTGAGCCCCTGGTCTGAGGGTCCCCACCT GGGACCCTTGAGAGTATCAGGTCTCCCACG TGGGAGACAAGAAATCCCTGTTTAATATTT AAACAGCAGTGTTCCCATCTGGGTCTTG CACCCCTCACTCTGGCCTCAGCCGACTGCA CAGCGGCCCTGCATCCCCTTGGCTGTGAG GCCCCTGGACAAGCAGAGGTGGCCAGAGC TGGGAGGCATGGCCCTGGGGTCCCACGAAT TTGCTGGGGAATCTCGTTTTTCTTCTTAAGA CTTTTGGGACATGGTTTGACTCCCGAACAT CACCGACGCGTCTCCTGTTTTTCTGGGTGG CCTCGGGACACCTGCCCTGCCCCACGAGG GTCAGGACTGTGACTCTTTTTAGGGCCAGG CAGGTGCCTGGACATTTGCCTTGCTGGACG GGGACTGGGGATGTGGGAGGGAGCAGACA GGAGGAATCATGTCAGGCCTGTGTGTGAAA GGAAGCTCCACTGTCACCCTCCACCTCTTC ACCCCCACTCACCAGTGTCCCCTCCACTG TCACATTGTAAGTGAATTCAGGATAATAA AGTGTTTGCCTCCATGGTCTTTGAATAAAG CCTGAGTAGGAAGGCGGCCGCTCGAGCAT GCATCTAGA	10
3UTR-007	Colla2;	ACTCAATCTAAATTAATAAAGAAAGAAAT	11

	<p>collagen, type I, alpha 2</p>	<p>TTGAAAAA ACTTTCTCTTTGCCATTTCTTCT TCTTCTTTTTTA ACTGAAAGCTGAATCCTTC CATTTCTTCTGCACATCTACTTGCTTAAATT GTGGGCAAAAGAGAAAAAGAAGGATTGAT CAGAGCATTGTGCAATACAGTTTCATTAAC TCCTTCCCCCGCTCCCCAAAAATTTGAATT TTTTTTTCAACTCTTACACCTGTTATGGA AAATGTCAACCTTTGTAAGAAAACCAAAT AAAAATTGAAAAATAAAAACCATAAACAT TTGCACCACTTGTGGCTTTTGAATATCTTCC ACAGAGGGAAGTTTAAAACCCAACTTCC AAAGGTTTAAACTACCTCAAACACTTTCC CATGAGTGTGATCCACATTGTTAGGTGCTG ACCTAGACAGAGATGAACTGAGGTCCTTGT TTTGT TTTGTT CATAATACAAAGGTGCTAAT TAATAGTATTT CAGATACTTGAAGAATGTT GATGGTGCTAGAAGAATTTGAGAAGAAAT ACTCCTGTATTGAGTTGTATCGTGTGGTGT ATTTTTTAAAAAATTTGATTTAGCATTCATA TTTTCCATCTTATTCCCAATTAAAAGTATGC AGATTATTTGCCCAAATCTTCTTCAGATTCA GCATTTGTTCTTTGCCAGTCTCATTTCATC TTCTTCCATGGTTCCACAGAAGCTTTGTTTC TTGGGCAAGCAGAAAAATTA AATTGTACCT ATTTTGTATATGTGAGATGTTTAAATAAAT TGTGAAAAAATGAAATAAAGCATGTTTG GTTTTCCAAAAGAACATAT</p>	
<p>3UTR-008</p>	<p>Col6a2; collagen, type VI, alpha 2</p>	<p>CGCCGCCGCCCGGGCCCCGCAGTCGAGGGT CGTGAGCCCACCCCGTCCATGGTGCTAAGC GGGCCCGGGTCCCACACGGCCAGCACCGCT GCTCACTCGGACGACGCCCTGGGCCTGCAC CTCTCCAGCTCCTCCCACGGGGTCCCCGTA GCCCCGGCCCCCGCCAGCCCCAGGTCTCC CCAGGCCCTCCGCAGGCTGCCCGGCCTCCC TCCCCCTGCAGCCATCCCAAGGCTCCTGAC CTACCTGGCCCCCTGAGCTCTGGAGCAAGCC CTGACCCAATAAAGGCTTTGAACCCAT</p>	<p>12</p>
<p>3UTR-009</p>	<p>RPN1; ribophorin I</p>	<p>GGGGCTAGAGCCCTCTCCGCACAGCGTGGA GACGGGGCAAGGAGGGGGTTATTAGGAT TGGTGGTTTTGTTTTGCTTTGTTTAAAGCCG TGGGAAAATGGCACA ACTTTACCTCTGTGG GAGATGCAACACTGAGAGCCAAGGGGTGG GAGTTGGGATAATTTTTATATAAAAAGAAGT TTTTCCACTTTGAATTGCTAAAAGTGGCATT TTTCCTATGTGCAGTCACTCCTCTCATTTCT AAAATAGGGACGTGGCCAGGCACGGTGGC TCATGCCTGTAATCCCAGCACTTTGGGAGG CCGAGGCAGGCGGCTCACGAGGTCAGGAG ATCGAGACTATCCTGGCTAACACGGTAAAA CCCTGTCTCTACTAAAAGTACAAAAAATTA GCTGGGCGTGGTGGTGGGCACCTGTAGTCC</p>	<p>13</p>

		CAGCTACTCGGGAGGCTGAGGCAGGAGAA AGGCATGAATCCAAGAGGCAGAGCTTGCA GTGAGCTGAGATCACGCCATTGCACTCCAG CCTGGGCAACAGTGTTAAGACTCTGTCTCA AATATAAATAAATAAATAAATAAATAAAT AAATAAATAAAAAATAAAGCGAGATGTTGC CCTCAA	
3UTR-010	LRP1; low density lipoprotein receptor-related protein 1	GGCCCTGCCCCGTCGGACTGCCCCAGAAA GCCTCCTGCCCCCTGCCAGTGAAGTCCTTC AGTGAGCCCCTCCCCAGCCAGCCCTTCCCT GGCCCCGCCGGATGTATAAATGTAAAAATG AAGGAATTACATTTTATATGTGAGCGAGCA AGCCGGCAAGCGAGCACAGTATTATTTCTC CATCCCCTCCCTGCCTGCTCCTTGGCACCCC CATGCTGCCTTCAGGGAGACAGGCAGGGA GGGCTTGGGGCTGCACCTCCTACCCTCCA CCAGAACGCACCCCCTGGGAGAGCTGGT GGTGCAGCCTTCCCCTCCCTGTATAAGACA CTTTGCCAAGGCTCTCCCCTCTCGCCCCATC CCTGCTTGCCCGCTCCCACAGCTTCCCTGAG GGCTAATTCTGGGAAGGGAGAGTTCTTTGC TGCCCCTGTCTGGAAGACGTGGCTCTGGGT GAGGTAGGCGGAAAGGATGGAGTGTTTT AGTTCTTGGGGGAGGCCACCCCAAACCCCA GCCCCAACTCCAGGGGCACCTATGAGATGG CCATGCTCAACCCCCCTCCCAGACAGGCC TCCCTGTCTCCAGGGCCCCCACCGAGGTT CCAGGGCTGGAGACTTCTCTGGTAAACAT TCCTCCAGCCTCCCCTCCCCTGGGGACGCC AAGGAGGTGGGCCACACCCAGGAAGGGAA AGCGGGCAGCCCCGTTTTTGGGGACGTGAAC GTTTTAATAATTTTTGCTGAATTCCTTTACA ACTAAATAACACAGATATTGTTATAAATAA AATTGT	14
3UTR-011	Nnt1; cardiotrophin-like cytokine factor 1	ATATTAAGGATCAAGCTGTTAGCTAATAAT GCCACCTCTGCAGTTTTTGGGAACAGGCAA TAAAGTATCAGTATACATGGTGATGTACAT CTGTAGCAAAGCTCTTGGAGAAAATGAAG ACTGAAGAAAGCAAAGCAAAAAGTGTATA GAGAGATTTTTCAAAGCAGTAATCCCTCA ATTTTAAAAAAGGATTGAAAATTCTAAATG TCTTTCTGTGCATATTTTTTGTGTTAGGAAT CAAAGTATTTTATAAAAGGAGAAAGAAC AGCCTCATTTTAGATGTAGTCTGTTGGATT TTTTATGCCTCCTCAGTAACCAGAAATGTTT TAAAAAACTAAGTGTTTAGGATTTCAAGAC AACATTATACATGGCTCTGAAATATCTGAC ACAATGTAAACATTGCAGGCACCTGCATTT TATGTTTTTTTTTCAACAAATGTGACTAAT TTGAAACTTTTATGAACTTCTGAGCTGTCCC CTTGCAATTCAACCGCAGTTTGAATTAATC	15

	<p>ATATCAAATCAGTTTTAATTTTTTAAATTGT ACTTCAGAGTCTATATTTCAAGGGCACATT TTCTCACTACTATTTTAATACATTAAAGGA CTAAATAATCTTTCAGAGATGCTGGAAACA AATCATTTGCTTTATATGTTTCATTAGAATA CCAATGAAACATACAACTTGAAAATTAGTA ATAGTATTTTTGAAGATCCCATTTCTAATTG GAGATCTCTTTAATTTTCGATCAACTTATAAT GTGTAGTACTATATTAAGTGCACCTGAGTG GAATTC AACATTTGACTAATAAAAATGAGTT CATCATGTTGGCAAGTGATGTGGCAATTAT CTCTGGTGACAAAAGAGTAAAATCAAATAT TTCTGCCTGTTACAAATATCAAGGAAGACC TGCTACTATGAAATAGATGACATTAATCTG TCTTCACTGTTTATAATACGGATGGATTTTT TTTCAAATCAGTGTGTGTTTTGAGGTCTTAT GTAATTGATGACATTTGAGAGAAATGGTGG CTTTTTTAGCTACCTCTTTGTTCAATTAAG CACCAGTAAAGATCATGTCTTTTTATAGAA GTGTAGATTTTCTTTGTGACTTTGCTATCGT GCCTAAAGCTCTAAATATAGGTGAATGTGT GATGAATACTCAGATTATTTGTCTCTCTATA TAATTAGTTTGGTACTAAGTTTCTCAAAAA ATTATTAACACATGAAAGACAATCTCTAAA CCAGAAAAAGAAGTAGTACAAATTTTGTTA CTGTAATGCTCGCGTTTAGTGAGTTTAAAA CACACAGTATCTTTTGGTTTTATAATCAGTT TCTATTTTGCTGTGCCTGAGATTAAGATCTG TGTATGTGTGTGTGTGTGTGTGTGCGTTTGT GTGTTAAAGCAGAAAAGACTTTTTTAAAAG TTTTAAGTGATAAATGCAATTTGTTAATTG ATCTTAGATCACTAGTAAACTCAGGGCTGA ATTATACCATGTATATTCTATTAGAAGAAA GTAAACACCATCTTTATTCCTGCCCTTTTTC TTCTCTCAAAGTAGTTGTAGTTATATCTAG AAAGAAGCAATTTTGATTTCTTGAAAAGGT AGTTCCTGCACTCAGTTTAAACTAAAAATA ATCATACTTGGATTTTATTTATTTTTGT CATAGTAAAAATTTTAATTTATATATATTTTAT TTAGTATTATCTTATTCTTTGCTATTTGCCA ATCCTTTGTCATCAATTGTGTTAAATGAATT GAAAATTCATGCCCTGTTCAATTTTATTTTAC TTTATTGGTTAGGATATTTAAAGGATTTTTG TATATATAATTTCTTAAATTAATATTCCAAA AGGTTAGTGGACTTAGATTATAAATTATGG CAAAAATCTAAAAACAACAAAAATGATTTT TATACATTCTATTTCAATTTCTCTTTTTCC AATAAGTCATACAATTGGTAGATATGACTT ATTTTATTTTGTATTATTCATATATCTTT ATGATATTTAAGTATAAATAATTAATAAAA TTTATTGTACCTTATAGTCTGTACCAAAA</p>	
--	---	--

		<p>AAAAAAAAATTATCTGTAGGTAGTGAAATGC TAATGTTGATTTGTCTTTAAGGGCTTGTTAA CTATCCTTTATTTTCTCATTGTCTTAAATT AGGAGTTTGTGTTTAAATTAATCATCTAAG CAAAAATGTATATAAATCCCATTACTGGG TATATACCAAAGGATTATAAATCATGCTG CTATAAAGACACATGCACACGTATGTTTAT TGCAGCACTATTCACAATAGCAAAGACTTG GAACCAACCAAATGTCCATCAATGATAGA CTTGATTAAGAAAATGTGCACATATACACC ATGGAATACTATGCAGCCATAAAAAAGGA TGAGTTCATGTCCTTTGTAGGGACATGGAT AAAGCTGGAACCATCATTCTGAGCAAAC ATTGCAAGGACAGAAAACCAAACACTGCA TGTTCCTCACTCATAGGTGGGAATTGAACAA TGAGAACACTTGGACACAAGGTGGGGAAC ACCACACACCAGGGCCTGTCATGGGGTGG GGGGAGTGGGGAGGGATAGCATTAGGAGA TATACCTAATGTAAATGATGAGTTAATGGG TGCAGCACACCAACATGGCACATGTATACA TATGTAGCAAACCTGCACGTTGTGCACATG TACCCTAGAACTTAAAGTATAATTAAAAAA AAAAAGAAAACAGAAGCTATTTATAAAGA AGTTATTTGCTGAAATAAATGTGATCTTTC CCATTAATAAATAAAGAAATTTTGGGGTA AAAAACACAATATATTGTATTCTTGAAAA ATTCTAAGAGAGTGGATGTGAAGTGTCTC ACCACAAAAGTGATAACTAATTGAGGTAAT GCACATATTAATTAGAAAGATTTTGTCAAT CCACAATGTATATACTTAAAAATATGTT ATACACAATAAATACATACATTAATAAATA AGTAAATGTA</p>	
<p>3UTR-012</p>	<p>Col6a1; collagen, type VI, alpha 1</p>	<p>CCCACCCTGCACGCCGGCACCAAACCCTGT CCTCCCACCCCTCCCCACTCATCTAAAC AGAGTAAAATGTGATGCGAATTTTCCCGAC CAACCTGATTCGCTAGATTTTTTTTAAGGA AAAGCTTGGAAAGCCAGGACACAACGCTG CTGCCTGCTTTGTGCAGGGTCCCTCCGGGGC TCAGCCCTGAGTTGGCATCACCTGCGCAGG GCCCTCTGGGGCTCAGCCCTGAGCTAGTGT CACCTGCACAGGGCCCTCTGAGGCTCAGCC CTGAGCTGGCGTCACCTGTGCAGGGCCCTC TGGGGCTCAGCCCTGAGCTGGCCTCACCTG GGTTCCCCACCCGGGCTCTCCTGCCCTGC CCTCCTGCCC GCCCTCCCTCCTGCCTGCGCA GCTCCTTCCCTAGGCACCTCTGTGCTGCATC CCACCAGCCTGAGCAAGACGCCCTCTCGGG GCCTGTGCCGCACTAGCCTCCCTCTCCTCTG TCCCCATAGCTGGTTTTTCCCACCAATCCTC ACCTAACAGTTACTTTACAATTAACCTCAA AGCAAGCTCTTCTCCTCAGCTTGGGGCAGC</p>	<p>16</p>

		<p>CATTGGCCTCTGTCTCGTTTTGGGAAACCA AGGTCAGGAGGCCGTTGCAGACATAAATCT CGGCGACTCGGCCCGTCTCCTGAGGGTCC TGCTGGTGACCGGCCTGGACCTTGGCCCTA CAGCCCTGGAGGCCGCTGCTGACCAGCACT GACCCCGACCTCAGAGAGTACTCGCAGGG GCGCTGGCTGCACTCAAGACCCTCGAGATT AACGGTGCTAACCCCGTCTGCTCCTCCCTC CCGCAGAGACTGGGGCCTGGACTGGACAT GAGAGCCCCTTGGTGCCACAGAGGGCTGTG TCTTACTAGAAACAACGCAAACCTCTCCTT CCTCAGAATAGTGATGTGTTGACGTTTTA TCAAAGGCCCCCTTTCTATGTTTCATGTTAGT TTTGCTCCTTCTGTGTTTTTTTTCTGAACCAT ATCCATGTTGCTGACTTTTCCAAATAAAGG TTTTCACTCCTCTC</p>	
<p>3UTR-013</p>	<p>Calr; calreticulin</p>	<p>AGAGGCCTGCCTCCAGGGCTGGACTGAGG CCTGAGCGCTCCTGCCGCAGAGCTGGCCGC GCCAAATAATGTCTCTGTGAGACTCGAGAA CTTTCATTTTTTTCCAGGCTGGTTCGGATTT GGGGTGGATTTTGGTTTTTGTCCCTCCTCC ACTCTCCCCACCCCTCCCCGCCCTTTTTT TTTTTTTTTTTAAACTGGTATTTATCTTTG ATTCTCCTTCAGCCCTCACCCCTGGTTCTCA TCTTTCTTGATCAACATCTTTTCTTGCCTCT GTCCCTTCTCTCATCTCTTAGCTCCCTCC AACCTGGGGGGCAGTGGTGTGGAGAAGCC ACAGGCCTGAGATTTTCATCTGCTCTCCTTCC TGGAGCCCAGAGGAGGGCAGCAGAAGGGG GTGGTGTCTCCAACCCCCAGCACTGAGGA AGAACGGGGCTTTCTCATTTACCCCTCC CTTTCTCCCCTGCCCCAGGACTGGGCCAC TTCTGGGTGGGGCAGTGGTCCCAGATTGG CTCACACTGAGAATGTAAGAATAACAAC AAAATTTCTATTAAATTAATTTTGTGTCTC C</p>	<p>17</p>
<p>3UTR-014</p>	<p>Collal; collagen, type I, alpha 1</p>	<p>CTCCCTCCATCCCAACCTGGCTCCCTCCAC CCAACCAACTTTCCCCCAACCCGGAAACA GACAAGCAACCCAAACTGAACCCCTCAA AAGCCAAAAAATGGGAGACAATTCACAT GGACTTTGGAAAATATTTTTTCTTTGTCAT TCATCTCTCAAACCTAGTTTTTATCTTTGAC CAACCGAACATGACCAAAAACCAAAAGTG CATTCAACCTTACCAAAAAAAAAAAAAAAAA AAAAGAATAAATAAATAACTTTTTAAAAA AGGAAGCTTGGTCCACTTGCTTGAAGACCC ATGCGGGGGTAAGTCCCTTTCTGCCCGTTG GGCTTATGAAACCCCAATGCTGCCCTTTCT GCTCCTTTCTCCACACCCCTTGGGGCCTC CCCTCCACTCCTTCCCAAATCTGTCTCCCA GAAGACACAGGAAACAATGTATTGTCTGCC</p>	<p>18</p>

		<p> CAGCAATCAAAGGCAATGCTCAAACACCC AAGTGGCCCCCACCCTCAGCCCGCTCCTGC CCGCCAGCACCCCCAGGCCCTGGGGGACC TGGGGTTCTCAGACTGCCAAAGAAGCCTTG CCATCTGGCGCTCCCATGGCTCTTGCAACA TCTCCCCTTCGTTTTTGAGGGGGTTCATGCCG GGGGAGCCACCAGCCCCTCACTGGGTTCGG AGGAGAGTCAGGAAGGGCCACGACAAAGC AGAAACATCGGATTTGGGGAACGCGTGTG AATCCCTTGTGCCGCAGGGCTGGGCGGGAG AGACTGTTCTGTTCCCTTGTGTAAGTGTGTTG CTGAAAGACTACCTCGTTCCTTGTCTTGATGT GTCACCGGGGCAACTGCCTGGGGGCGGGG ATGGGGGCAGGGTGAAGCGGCTCCCCAT TTTATACCAAAGGTGCTACATCTATGTGAT GGGTGGGGTGGGGAGGGAATCACTGGTGC TATAGAAATTGAGATGCCCCCCCAGGCCAG CAAATGTTCCCTTTTTGTTCAAAGTCTATTTT TATTCCTTGATATTTTTCTTTTTTTTTTTTT TTTTTGTGGATGGGGACTTGTGAATTTTTCT AAAGGTGCTATTTAACATGGGAGGAGAGC GTGTGCGGCTCCAGCCCAGCCCGCTGCTCA CTTTCCACCCTCTCTCCACCCTGCCTCTGGCT TCTCAGGCCTCTGCTCTCCGACCTCTCTCCT CTGAAACCCTCCTCCACAGCTGCAGCCCAT CCTCCCGCTCCCTCCTAGTCTGTCTGCGT CCTCTGTCCCCGGGTTTCAGAGACAACCTC CCAAAGCACAAAGCAGTTTTTCCCCTAGG GGTGGGAGGAAGCAAAAGACTCTGTACCT ATTTTGTATGTGTATAATAATTTGAGATGTT TTTAATTATTTTGATTGCTGGAATAAAGCA TGTGAAATGACCCAAACATAATCCGCAGT GGCCTCCTAATTTCTTTCTTTGGAGTTGGGG GAGGGGTAGACATGGGGAAGGGGCTTTGG GGTGATGGGCTTGCCTTCCATTCTGCCCTT TCCCTCCCCACTATTCTCTTCTAGATCCCTC CATAACCCCACTCCCCTTTCTCTCACCTTC TTATACCGCAAACCTTTCTACTTCTCTTTT ATTTTCTATTCTTGCAATTTCTTGCACCTT TTCAAATCCTCTTCTCCCCTGCAATACCAT ACAGGCAATCCACGTGCACAACACACACA CACTCTTACATCTGGGGTTGTCAAAC CTCATAACCACTCCCCTTCAAGCCCATCCA CTCTCCACCCCTGGATGCCCTGCACTTGG TGGCGGTGGGATGCTCATGGATACTGGGAG GGTGAGGGGAGTGGAACCCGTGAGGAGGA CCTGGGGGCCTCTCCTTGAAGTACTGACATGAA GGGTCATCTGGCCTCTGCTCCCTTCTCACCC ACGCTGACCTCCTGCCGAAGGAGCAACGC AACAGGAGAGGGGTCTGCTGAGCCTGGCG AGGGTCTGGGAGGGACCAGGAGGAAGGCG </p>	
--	--	---	--

		TGCTCCCTGCTCGCTGTCCTGGCCCTGGGG GAGTGAGGGAGACAGACACCTGGGAGAGC TGTGGGGAAGGCACTCGCACCGTGCTCTTG GGAAGGAAGGAGACCTGGCCCTGCTCACC ACGGAAGGGTGCCTCGACCTCCTGAATCC CCAGAACACAACCCCCCTGGGCTGGGGTG GTCTGGGGAACCATCGTGCCCCCGCCTCCC GCCTACTCCTTTTTAAGCTT	
3UTR-015	Plodl; procollagen- lysine, 2- oxoglutarate 5- dioxygenase 1	TTGGCCAGGCCTGACCCTCTTGGACCTTTCT TCTTTGCCGACAACCACTGCCCAGCAGCCT CTGGGACCTCGGGGTCCCAGGGAACCCAGT CCAGCCTCCTGGCTGTTGACTTCCCATTGCT CTTGGAGCCACCAATCAAAGAGATTCAAA GAGATTCTGCAGGCCAGAGGCGGAACAC ACCTTTATGGCTGGGGCTCTCCGTGGTGTT CTGGACCCAGCCCCTGGAGACACCATTAC TTTTACTGCTTTGTAGTACTCGTGCTCTCC AACCTGTCTTCCTGAAAAACCAAGGCCCCC TCCCCCACCTCTTCCATGGGGTGAGACTT GAGCAGAACAGGGGCTTCCCCAAGTTGCC AGAAAGACTGTCTGGGTGAGAAGCCATGG CCAGAGCTTCTCCAGGCACAGGTGTTGCA CCAGGGACTTCTGCTTCAAGTTTTGGGGTA AAGACACCTGGATCAGACTCCAAGGGCTG CCCTGAGTCTGGGACTTCTGCCTCCATGGC TGGTCATGAGAGCAAACCGTAGTCCCCTGG AGACAGCGACTCCAGAGAACCTCTTGGGA GACAGAAGAGGCATCTGTGCACAGCTCGA TCTTCTACTTGCCTGTGGGGAGGGGAGTGA CAGGTCCACACACCACACTGGGTCACCCTG TCCTGGATGCCTCTGAAGAGAGGGACAGA CCGTCAGAAACTGGAGAGTTTCTATTAAG GTCATTTAACA	19
3UTR-016	Nucbl; nucleobindi n 1	TCCTCCGGGACCCCAGCCCTCAGGATTCT GATGCTCCAAGGCGACTGATGGGCGCTGG ATGAAGTGGCACAGTCAGCTTCCCTGGGGG CTGGTGTCATGTTGGGCTCCTGGGGCGGGG GCACGGCCTGGCATTTCACGCATTGCTGCC ACCCAGGTCCACCTGTCTCCACTTTCACA GCCTCCAAGTCTGTGGCTCTTCCCTTCTGTC CTCCGAGGGGCTTGCCTTCTCTCGTGTCCA GTGAGGTGCTCAGTGATCGGCTTAACTTAG AGAAGCCC GCCCCTCCCCTTCTCCGTCTG TCCAAGAGGGTCTGCTCTGAGCCTGCGTT CCTAGGTGGCTCGGCCTCAGCTGCCTGGGT TGTGGCCGCCCTAGCATCCTGTATGCCAC AGCTACTGGAATCCCCGCTGCTGCTCCGGG CCAAGCTTCTGGTTGATTAATGAGGGCATG GGGTGGTCCCCTCAAGACCTTCCCCTACCTT TTGTGGAACCAAGTATGCCTCAAAGACAGT GTCCCCTCCACAGCTGGGTGCCAGGGGCG	20

		GGGATCCTCAGTATAGCCGGTGAACCCTGA TACCAGGAGCCTGGGCCTCCCTGAACCCCT GGCTTCCAGCCATCTCATCGCCAGCCTCCT CCTGGACCTCTTGGCCCCCAGCCCCTTCCC CACACAGCCCCAGAAGGGTCCCAGAGCTG ACCCCACTCCAGGACCTAGGCCAGCCCCT CAGCCTCATCTGGAGCCCCTGAAGACCAGT CCCACCCACCTTTCTGGCCTCATCTGACACT GCTCCGCATCCTGCTGTGTGTCCTGTTCCAT GTTCCGGTTCATCCAAATACACTTTCTGG AACAAA	
3UTR-017	α -globin	GCTGGAGCCTCGGTGGCCATGCTTCTTGCC CCTTGGGCCTCCCCCAGCCCCTCCTCCCCT TCCTGCACCCGTACCCCGTGGTCTTTGAA TAAAGTCTGAGTGGGCGGC	21

[000252] It should be understood that those listed in the previous tables are examples and that any UTR from any gene may be incorporated into the respective first or second flanking region of the primary construct. Furthermore, multiple wild-type UTRs of any known gene may be utilized. It is also within the scope of the present invention to provide artificial UTRs which are not variants of wild type genes. These UTRs or portions thereof may be placed in the same orientation as in the transcript from which they were selected or may be altered in orientation or location. Hence a 5' or 3' UTR may be inverted, shortened, lengthened, made chimeric with one or more other 5' UTRs or 3' UTRs. As used herein, the term "altered" as it relates to a UTR sequence, means that the UTR has been changed in some way in relation to a reference sequence. For example, a 3' or 5' UTR may be altered relative to a wild type or native UTR by the change in orientation or location as taught above or may be altered by the inclusion of additional nucleotides, deletion of nucleotides, swapping or transposition of nucleotides. Any of these changes producing an "altered" UTR (whether 3' or 5') comprise a variant UTR.

[000253] In one embodiment, a double, triple or quadruple UTR such as a 5' or 3' UTR may be used. As used herein, a "double" UTR is one in which two copies of the same UTR are encoded either in series or substantially in series. For example, a double beta-globin 3' UTR may be used as described in US Patent publication 20100129877, the contents of which are incorporated herein by reference in its entirety.

[000254] It is also within the scope of the present invention to have patterned UTRs. As used herein "patterned UTRs" are those UTRs which reflect a repeating or alternating pattern, such as ABABAB or AABBAABBAABB or ABCABCABC or variants thereof repeated once, twice, or more than 3 times. In these patterns, each letter, A, B, or C represent a different UTR at the nucleotide level.

[000255] In one embodiment, flanking regions are selected from a family of transcripts whose proteins share a common function, structure, feature of property. For example, polypeptides of interest may belong to a family of proteins which are expressed in a particular cell, tissue or at some time during development. The UTRs from any of these genes may be swapped for any other UTR of the same or different family of proteins to create a new chimeric primary transcript. As used herein, a "family of proteins" is used in the broadest sense to refer to a group of two or more polypeptides of interest which share at least one function, structure, feature, localization, origin, or expression pattern.

[000256] After optimization (if desired), the primary construct components are reconstituted and transformed into a vector such as, but not limited to, plasmids, viruses, cosmids, and artificial chromosomes. For example, the optimized construct may be reconstituted and transformed into chemically competent *E. coli*, yeast, neurospora, maize, drosophila, etc. where high copy plasmid-like or chromosome structures occur by methods described herein.

[000257] The untranslated region may also include translation enhancer elements (TEE). As a non-limiting example, the TEE may include those described in US Application No. 20090226470, herein incorporated by reference in its entirety, and those known in the art.

Stop Codons

[000258] In one embodiment, the primary constructs of the present invention may include at least two stop codons before the 3' untranslated region (UTR). The stop codon may be selected from TGA, TAA and TAG. In one embodiment, the primary constructs of the present invention include the stop codon TGA and one additional stop codon. In a further embodiment the addition stop codon may be TAA. In another embodiment, the primary constructs of the present invention include three stop codons.

Vector Amplification

[000259] The vector containing the primary construct is then amplified and the plasmid isolated and purified using methods known in the art such as, but not limited to, a maxi prep using the Invitrogen PURELINK™ HiPure Maxiprep Kit (Carlsbad, CA).

Plasmid Linearization

[000260] The plasmid may then be linearized using methods known in the art such as, but not limited to, the use of restriction enzymes and buffers. The linearization reaction may be purified using methods including, for example Invitrogen's PURELINK™ PCR Micro Kit (Carlsbad, CA), and HPLC based purification methods such as, but not limited to, strong anion exchange HPLC, weak anion exchange HPLC, reverse phase HPLC (RP-HPLC), and hydrophobic interaction HPLC (HIC-HPLC) and Invitrogen's standard PURELINK™ PCR Kit (Carlsbad, CA). The purification method may be modified depending on the size of the linearization reaction which was conducted. The linearized plasmid is then used to generate cDNA for *in vitro* transcription (IVT) reactions.

cDNA Template Synthesis

[000261] A cDNA template may be synthesized by having a linearized plasmid undergo polymerase chain reaction (PCR). Table 4 is a listing of primers and probes that may be usefully in the PCR reactions of the present invention. It should be understood that the listing is not exhaustive and that primer-probe design for any amplification is within the skill of those in the art. Probes may also contain chemically modified bases to increase base-pairing fidelity to the target molecule and base-pairing strength. Such modifications may include 5-methyl-Cytidine, 2, 6-di-amino-purine, 2'-fluoro, phosphoro-thioate, or locked nucleic acids.

Table 4. Primers and Probes

Primer/ Probe Identifier	Sequence (5'-3')	Hybridization target	SEQ ID NO.
UFP	TTGGACCCTCGTACAGAAGCTAA TACG	cDNA Template	22
URP	T _{x160} CTTCCTACTCAGGCTTTATTC AAAGACCA	cDNA Template	23
GBA1	CCTTGACCTTCTGGAAGCTTC	Acid glucocerebrosidase	24
GBA2	CCAAGCACTGAAACGGATAT	Acid glucocerebrosidase	25
LUC1	GATGAAAAGTGCTCCAAGGA	Luciferase	26

LUC2	AACCGTGATGAAAAGGTACC	Luciferase	27
LUC3	TCATGCAGATTGGAAAGGTC	Luciferase	28
GCSF1	CTTCTTGGACTGTCCAGAGG	G-CSF	29
GCSF2	GCAGTCCCTGATACAAGAAC	G-CSF	30
GCSF3	GATTGAAGGTGGCTCGCTAC	G-CSF	31

*UFP is universal forward primer; URP is universal reverse primer.

[000262] In one embodiment, the cDNA may be submitted for sequencing analysis before undergoing transcription.

mRNA Production

[000263] The process of mRNA or mmRNA production may include, but is not limited to, *in vitro* transcription, cDNA template removal and RNA clean-up, and mRNA capping and/or tailing reactions.

In Vitro Transcription

[000264] The cDNA produced in the previous step may be transcribed using an *in vitro* transcription (IVT) system. The system typically comprises a transcription buffer, nucleotide triphosphates (NTPs), an RNase inhibitor and a polymerase. The NTPs may be manufactured in house, may be selected from a supplier, or may be synthesized as described herein. The NTPs may be selected from, but are not limited to, those described herein including natural and unnatural (modified) NTPs. The polymerase may be selected from, but is not limited to, T7 RNA polymerase, T3 RNA polymerase and mutant polymerases such as, but not limited to, polymerases able to incorporate modified nucleic acids.

RNA Polymerases

[000265] Any number of RNA polymerases or variants may be used in the design of the primary constructs of the present invention.

[000266] RNA polymerases may be modified by inserting or deleting amino acids of the RNA polymerase sequence. As a non-limiting example, the RNA polymerase may be modified to exhibit an increased ability to incorporate a 2'-modified nucleotide triphosphate compared to an unmodified RNA polymerase (see International Publication

WO2008078180 and U.S. Patent 8,101,385; herein incorporated by reference in their entireties).

[000267] Variants may be obtained by evolving an RNA polymerase, optimizing the RNA polymerase amino acid and/or nucleic acid sequence and/or by using other methods known in the art. As a non-limiting example, T7 RNA polymerase variants may be evolved using the continuous directed evolution system set out by Esvelt *et al.* (Nature (2011) 472(7344):499-503; herein incorporated by reference in its entirety) where clones of T7 RNA polymerase may encode at least one mutation such as, but not limited to, lysine at position 93 substituted for threonine (K93T), I4M, A7T, E63V, V64D, A65E, D66Y, T76N, C125R, S128R, A136T, N165S, G175R, H176L, Y178H, F182L, L196F, G198V, D208Y, E222K, S228A, Q239R, T243N, G259D, M267I, G280C, H300R, D351A, A354S, E356D, L360P, A383V, Y385C, D388Y, S397R, M401T, N410S, K450R, P451T, G452V, E484A, H523L, H524N, G542V, E565K, K577E, K577M, N601S, S684Y, L699I, K713E, N748D, Q754R, E775K, A827V, D851N or L864F. As another non-limiting example, T7 RNA polymerase variants may encode at least one mutation as described in U.S. Pub. Nos. 20100120024 and 20070117112; herein incorporated by reference in their entireties. Variants of RNA polymerase may also include, but are not limited to, substitutional variants, conservative amino acid substitution, insertional variants, deletional variants and/or covalent derivatives.

[000268] In one embodiment, the primary construct may be designed to be recognized by the wild type or variant RNA polymerases. In doing so, the primary construct may be modified to contain sites or regions of sequence changes from the wild type or parent primary construct.

[000269] In one embodiment, the primary construct may be designed to include at least one substitution and/or insertion upstream of an RNA polymerase binding or recognition site, downstream of the RNA polymerase binding or recognition site, upstream of the TATA box sequence, downstream of the TATA box sequence of the primary construct but upstream of the coding region of the primary construct, within the 5'UTR, before the 5'UTR and/or after the 5'UTR.

[000270] In one embodiment, the 5'UTR of the primary construct may be replaced by the insertion of at least one region and/or string of nucleotides of the same base. The

region and/or string of nucleotides may include, but is not limited to, at least 3, at least 4, at least 5, at least 6, at least 7 or at least 8 nucleotides and the nucleotides may be natural and/or unnatural. As a non-limiting example, the group of nucleotides may include 5-8 adenine, cytosine, thymine, a string of any of the other nucleotides disclosed herein and/or combinations thereof.

[000271] In one embodiment, the 5'UTR of the primary construct may be replaced by the insertion of at least two regions and/or strings of nucleotides of two different bases such as, but not limited to, adenine, cytosine, thymine, any of the other nucleotides disclosed herein and/or combinations thereof. For example, the 5'UTR may be replaced by inserting 5-8 adenine bases followed by the insertion of 5-8 cytosine bases. In another example, the 5'UTR may be replaced by inserting 5-8 cytosine bases followed by the insertion of 5-8 adenine bases.

[000272] In one embodiment, the primary construct may include at least one substitution and/or insertion downstream of the transcription start site which may be recognized by an RNA polymerase. As a non-limiting example, at least one substitution and/or insertion may occur downstream the transcription start site by substituting at least one nucleic acid in the region just downstream of the transcription start site (such as, but not limited to, +1 to +6). Changes to region of nucleotides just downstream of the transcription start site may affect initiation rates, increase apparent nucleotide triphosphate (NTP) reaction constant values, and increase the dissociation of short transcripts from the transcription complex during initial transcription (Briebe et al, *Biochemistry* (2002) 41: 5 144-5 149; herein incorporated by reference in its entirety). The modification, substitution and/or insertion of at least one nucleic acid may cause a silent mutation of the nucleic acid sequence or may cause a mutation in the amino acid sequence.

[000273] In one embodiment, the primary construct may include the substitution of at least 1, at least 2, at least 3, at least 4, at least 5, at least 6, at least 7, at least 8, at least 9, at least 10, at least 11, at least 12 or at least 13 guanine bases downstream of the transcription start site.

[000274] In one embodiment, the primary construct may include the substitution of at least 1, at least 2, at least 3, at least 4, at least 5 or at least 6 guanine bases in the region

just downstream of the transcription start site. As a non-limiting example, if the nucleotides in the region are GGGAGA the guanine bases may be substituted by at least 1, at least 2, at least 3 or at least 4 adenine nucleotides. In another non-limiting example, if the nucleotides in the region are GGGAGA the guanine bases may be substituted by at least 1, at least 2, at least 3 or at least 4 cytosine bases. In another non-limiting example, if the nucleotides in the region are GGGAGA the guanine bases may be substituted by at least 1, at least 2, at least 3 or at least 4 thymine, and/or any of the nucleotides described herein.

[000275] In one embodiment, the primary construct may include at least one substitution and/or insertion upstream of the start codon. For the purpose of clarity, one of skill in the art would appreciate that the start codon is the first codon of the protein coding region whereas the transcription start site is the site where transcription begins. The primary construct may include, but is not limited to, at least 1, at least 2, at least 3, at least 4, at least 5, at least 6, at least 7 or at least 8 substitutions and/or insertions of nucleotide bases. The nucleotide bases may be inserted or substituted at 1, at least 1, at least 2, at least 3, at least 4 or at least 5 locations upstream of the start codon. The nucleotides inserted and/or substituted may be the same base (e.g., all A or all C or all T or all G), two different bases (e.g., A and C, A and T, or C and T), three different bases (e.g., A, C and T or A, C and T) or at least four different bases. As a non-limiting example, the guanine base upstream of the coding region in the primary construct may be substituted with adenine, cytosine, thymine, or any of the nucleotides described herein. In another non-limiting example the substitution of guanine bases in the primary construct may be designed so as to leave one guanine base in the region downstream of the transcription start site and before the start codon (see Esvelt *et al.* Nature (2011) 472(7344):499-503; herein incorporated by reference in its entirety). As a non-limiting example, at least 5 nucleotides may be inserted at 1 location downstream of the transcription start site but upstream of the start codon and the at least 5 nucleotides may be the same base type.

cDNA Template Removal and Clean-Up

[000276] The cDNA template may be removed using methods known in the art such as, but not limited to, treatment with Deoxyribonuclease I (DNase I). RNA clean-up may

also include a purification method such as, but not limited to, AGENCOURT® CLEANSEQ® system from Beckman Coulter (Danvers, MA), HPLC based purification methods such as, but not limited to, strong anion exchange HPLC, weak anion exchange HPLC, reverse phase HPLC (RP-HPLC), and hydrophobic interaction HPLC (HIC-HPLC) .

Capping and/or Tailing Reactions

[000277] The primary construct or mmRNA may also undergo capping and/or tailing reactions. A capping reaction may be performed by methods known in the art to add a 5' cap to the 5' end of the primary construct. Methods for capping include, but are not limited to, using a Vaccinia Capping enzyme (New England Biolabs, Ipswich, MA).

[000278] A poly-A tailing reaction may be performed by methods known in the art, such as, but not limited to, 2' O-methyltransferase and by methods as described herein. If the primary construct generated from cDNA does not include a poly-T, it may be beneficial to perform the poly-A-tailing reaction before the primary construct is cleaned.

mRNA Purification

[000279] Primary construct or mmRNA purification may include, but is not limited to, mRNA or mmRNA clean-up, quality assurance and quality control. mRNA or mmRNA clean-up may be performed by methods known in the arts such as, but not limited to, AGENCOURT® beads (Beckman Coulter Genomics, Danvers, MA), poly-T beads, LNA™ oligo-T capture probes (EXIQON® Inc, Vedbaek, Denmark) or HPLC based purification methods such as, but not limited to, strong anion exchange HPLC, weak anion exchange HPLC, reverse phase HPLC (RP-HPLC), and hydrophobic interaction HPLC (HIC-HPLC). The term "purified" when used in relation to a polynucleotide such as a "purified mRNA or mmRNA" refers to one that is separated from at least one contaminant. As used herein, a "contaminant" is any substance which makes another unfit, impure or inferior. Thus, a purified polynucleotide (e.g., DNA and RNA) is present in a form or setting different from that in which it is found in nature, or a form or setting different from that which existed prior to subjecting it to a treatment or purification method.

[000280] A quality assurance and/or quality control check may be conducted using methods such as, but not limited to, gel electrophoresis, UV absorbance, or analytical HPLC.

[000281] In another embodiment, the mRNA or mmRNA may be sequenced by methods including, but not limited to reverse-transcriptase-PCR.

[000282] In one embodiment, the mRNA or mmRNA may be quantified using methods such as, but not limited to, ultraviolet visible spectroscopy (UV/Vis). A non-limiting example of a UV/Vis spectrometer is a NANODROP® spectrometer (ThermoFisher, Waltham, MA). The quantified mRNA or mmRNA may be analyzed in order to determine if the mRNA or mmRNA may be of proper size, check that no degradation of the mRNA or mmRNA has occurred. Degradation of the mRNA and/or mmRNA may be checked by methods such as, but not limited to, agarose gel electrophoresis, HPLC based purification methods such as, but not limited to, strong anion exchange HPLC, weak anion exchange HPLC, reverse phase HPLC (RP-HPLC), and hydrophobic interaction HPLC (HIC-HPLC), liquid chromatography-mass spectrometry (LCMS), capillary electrophoresis (CE) and capillary gel electrophoresis (CGE).

Signal Sequences

[000283] The primary constructs or mmRNA may also encode additional features which facilitate trafficking of the polypeptides to therapeutically relevant sites. One such feature which aids in protein trafficking is the signal sequence. As used herein, a "signal sequence" or "signal peptide" is a polynucleotide or polypeptide, respectively, which is from about 9 to 200 nucleotides (3-60 amino acids) in length which is incorporated at the 5' (or N-terminus) of the coding region or polypeptide encoded, respectively. Addition of these sequences result in trafficking of the encoded polypeptide to the endoplasmic reticulum through one or more secretory pathways. Some signal peptides are cleaved from the protein by signal peptidase after the proteins are transported.

[000284] Table 5 is a representative listing of protein signal sequences which may be incorporated for encoding by the polynucleotides, primary constructs or mmRNA of the invention.

Table 5. Signal Sequences

ID	Description	NUCLEOTIDE SEQUENCE (5'-3')	SEQ ID NO.	ENCODED PEPTIDE	SEQ ID NO.
SS-001	a-1- antitrypsin	ATGATGCCATCCTCAGTCTCA TGGGGTATTTTGTCTTTGGCG GGTCTGTGCTGTCTCGTGCCG GTGTCGCTCGCA	32	MMPSSVSWGIL LAGLCCCLVP VSLA	94
SS-002	G-CSF	ATGGCCGACCGGCGACTCAG TCGCCATGAACTCATGGCC CTGCAGTTGTTGCTTTGGCAC TCAGCCCTCTGGACCGTCCAA GAGGCG	33	MAGPATQSPM KLMALQLLLW HSALWTVQEA	95
SS-003	Factor IX	ATGCAGAGAGTGAACATGATT ATGGCCGAGTCCCATCGCTC ATCACAATCTGCCTGCTTGGT ACCTGCTTCCGCCGAATGCA CTGTCTTTCTGGATCACGAGA ATGCGAATAAGATCTTGAACC GACCCAAACGG	34	MQRVNMIMAE SPSLITICLLGY LLSAECTVFLD HENANKILNRP KR	96
SS-004	Prolactin	ATGAAAGGATCATTGCTGTTG CTCCTCGTGTGCGAACCTTCTG CTTTGCCAGTCCGTAGCCCCC	35	MKGSLLLLLV SNLLLCQSVAP	97
SS-005	Albumin	ATGAAATGGGTGACGTTTCATC TCACTGTTGTTTTTGTTCCTCGT CCGCCTACTCCAGGGGAGTAT TCCGCCGA	36	MKWVTFISLLF LFSSAYSRG VFRR	98
SS-006	HMMSP38	ATGTGGTGGCGGCTCTGGTGG CTGCTCCTGTTGCTCCTTTCG TGTGGCCCATGGTGTGGGCA	37	MWWRLWLL LLLLLPMWA	99
MLS- 001	ornithine carbamoyltransferase	TGCTCTTAACTCCGCATCCT GTTGAATAACGCTGCGTTCCG AAATGGGCATAACTTCATGGT ACGCAACTTCAGATGCGGCCA GCCACTCCAG	38	MLFNLRILLNN AAFRNGHNF VRNFRCGQPL Q	100
MLS- 002	Cytochrome C Oxidase subunit 8A	ATGTCCGTCTTGACACCCTG CTCTTGAGAGGGCTGACGGGG TCCGCTAGACGCCTGCCGGTA CCGCGAGCGAAGATCCACTCC CTG	39	MSVLTPLLLRG LTGSARRLPVP RAKIHSL	101
MLS- 003	Cytochrome C Oxidase subunit 8A	ATGAGCGTGCTCACTCCGTTG CTTCTTCGAGGGCTTACGGGA TCGGCTCGGAGGTTGCCCGTC CCGAGAGCGAAGATCCATTCTG TTG	40	MSVLTPLLLRG LTGSARRLPVP RAKIHSL	102
SS-007	Type III, bacterial	TGACAAAAATAACTTTATCTC CCCAGAATTTTAGAATCCAAA AACAGGAAACCACTACTA AAAGAAAAATCAACCGAGAA AAATTCTTAGCAAAAAGTAT	41	MVTKITLSPQN FRIKQETLL KEKSTEKNSLA KSILAVKNHFI ELRSKLSERFIS	103

		TCTCGCAGTAAAAATCACTTC ATCGAATTAAGGTCAAATA TCGGAACGTTTTATTTTCGCAT AAGAACA		HKNT	
SS-008	Viral	ATGCTGAGCTTTGTGGATAACC CGCACCTGCTGCTGCTGGCG GTGACCAGCTGCCTGGCGACC TGCCAG	42	MLSFVDTRTLL LLAVTSLATC Q	104
SS-009	viral	ATGGGCAGCAGCCAGGCGCC GCGCATGGGCAGCGTGGGCG GCCATGGCCTGATGGCGCTGC TGATGGCGGGCCTGATTCTGC CGGGCATTCTGGCG	43	MGSSQAPRMG SVGGHGLMAL LMAGLILPGIL A	105
SS-010	Viral	ATGGCGGGCATTTTTTATTTTC TGTTTAGCTTTCTGTTTGGCAT TTGCGAT	44	MAGIFYFLFSF LFGICD	106
SS-01 1	Viral	ATGGAAAACCGCCTGCTGCGC GTGTTTCTGGTGTGGGCGGCG CTGACCATGGATGGCGCGAGC GCG	45	MENRLLRVFL VWAALTMDG ASA	107
SS-012	Viral	ATGGCGCGCCAGGGCTGCTTT GGCAGCTATCAGGTGATTAGC CTGTTTACCTTTGCGATTGGC GTGAACCTGTGCCTGGGC	46	MARQCGFGSY QVISLFTFAIGV NLCLG	108
SS-013	<i>Bacillus</i>	ATGAGCCGCCTGCCGGTGCTG CTGCTGCTGCAGCTGCTGGTG CGCCGGGCCTGCAG	47	MSRLPVLLLQ LLVRPGLQ	109
SS-014	<i>Bacillus</i>	ATGAAACAGCAGAAACGCCT GTATGCGCGCCTGCTGACCCT GCTGTTTGCCTGATTTTTCTG CTGCCGCATAGCAGCGCGAGC GCG	48	MKQQKRLYAR LLTLLFALIFLL PHSSASA	110
SS-015	Secretion signal	ATGGCGACCGCTGCCTCCG CCCTCCCCGCGGCACCTGCGG CTGCTGCGGCTGCTGCTCTCC GCCCTCGTCCTCGGC	49	MATPLPPPSR HLRLLRLLLSG	111
SS-016	Secretion signal	ATGAAGGCTCCGGGTCGGCTC GTGCTCATCATCTGTGCTCC GTGGTCTTCTCT	50	MKAPGRLVLII LCSVVFS	112
SS-017	Secretion signal	ATGCTTCAGCTTTGGAACTT GTTCTCCTGTGCGGCGTGCTC ACT	51	MLQLWKLLCG VLT	113
SS-018	Secretion signal	ATGCTTTATCTCCAGGGTTGG AGCATGCCTGCTGTGGCA	52	MLYLQGWSM PAVA	114
SS-019	Secretion signal	ATGGATAACGTGCAGCCGAA AATAAAACATCGCCCTTCTG CTTCAGTGTGAAAGGCCACGT GAAGATGCTGCGGCTGGATAT TATCAACTCACTGGTAACAAC AGTATTCATGCTCATCGTATC	53	MDNVQPKIKH RPFCSVKGHV KMLRLDIINSL VTVFMLIVSV LALIP	115

		TGTGTTGGCACTGATACCA			
SS-020	Secretion signal	ATGCCCTGCCTAGACCAACAG CTCACTGTTTCATGCCCTACCCT GCCCTGCCAGCCCTCCTCTC TGGCCTTCTGCCAAGTGGGGT TCTTAACAGCA	54	MPCLDQQLTV HALPCPAQPSS L AFCQVGFLT A	116
SS-021	Secretion signal	ATGAAAACCTTGTTCAATCCA GCCCCTGCCATTGCTGACCTG GATCCCCAGTTCTACACCCTC TCAGATGTGTTCTGCTGCAAT GAAAGTGAGGCTGAGATTTTA ACTGGCCTCACGGTGGGCAGC GCTGCAGATGCT	55	MKTLFNPAPAI ADLDPQFYTLS DVFCCNESEAE ILTGLTVGSAA DA	117
SS-022	Secretion signal	ATGAAGCCTCTCCTTGTTGTG TTTGTCTTTCTTTTCCTTTGGG ATCCAGTGCTGGCA	56	MKPLL VVFVF LFLWDPVLA	118
SS-023	Secretion signal	ATGTCCTGTTCCCTAAAGTTT ACTTTGATIGTAATTTTTTTTT ACTGTTGGCTTTCATCCAGC	57	MSCSLKFTLIVI FFTCTLSSS	119
SS-024	Secretion signal	ATGGTTCCTACTAAACCTCTTC AAAGAAATGGCAGCATGATG AGCTTTGAAAATGTGAAAGAA AAGAGCAGAGAAGGAGGGCC CCATGCACACACCCCGAAGA AGAATTGTGTTTCGTGGTAAC ACACTACCCTCAGGTCAGAC CACACTCAACCTGTTTTTCCAT ATATTCAAGGTTCTTACTCAA CCACTTTCCTTCTGTGGGGT	58	MVLTKPLQRN GSMMSFENVK EKSREGGPHA HTPEEELCFVV THTPQVQTTL NLFFHIFKVL T QPLSLLWG	120
SS-025	Secretion signal	ATGGCCACCCCGCCATTCCGG CTGATAAGGAAGATGTTTTCC TTCAAGGTGAGCAGATGGATG GGGCTTGCCTGCTTCCGGTCC CTGGCGGCATCC	59	MATPPFRLIRK MFSFKVSRWM GLACFRSLAAS	121
SS-026	Secretion signal	ATGAGCTTTTTCCAACCTCCTG ATGAAAAGGAAGGAACCTCAT TCCCTTGGTGGTGTTTCATGAC TGTGGCGGCGGGTGGAGCCTC ATCT	60	MSFFQLLMKR KELIPLVVFMT VAAGGASS	122
SS-027	Secretion signal	ATGGTCTCAGCTCTGCGGGGA GCACCCCTGATCAGGGTGCAC TCAAGCCCTGTTTCTTCTCCTT CTGTGAGTGGACCACGGAGGC TGGTGAGCTGCCTGTCATCCC AAAGCTCAGCTCTGAGC	61	MVSALRGAPLI RVHSSPVSSPS VSGPAALVSL SSQSSALS	123
SS-028	Secretion signal	ATGATGGGGTCCCCAGTGAGT CATCTGCTGGCCGGCTTCTGT GTGTGGGTCGTCTTGGGC	62	MMGSPVSHLL AGFCVWVVLG	124
SS-029	Secretion signal	ATGGCAAGCATGGCTGCCGTG CTCACCTGGGCTCTGGCTCTT	63	MASMAAVLT WALALLSAFS	125

		CTTTCAGCGTTTTTCGGCCACC CAGGCA		ATQA	
SS-030	Secretion signal	ATGGTGCTCATGTGGACCACT GGTGACGCCTTCAAGACGGCC TACTTCCTGCTGAAGGGTGCC CCTCTGCAGTTCTCCGTGTGC GGCCTGCTGCAGGTGCTGGTG GACCTGGCCATCCTGGGGCAG GCCTACGCC	64	MVLMWTSGD AFKTAYFLLK GAPLQFSVCGL LQVLVDLAILG QATA	126
SS-031	Secretion signal	ATGGATTTTGTGCGCTGGAGCC ATCGGAGGCGTCTGCGGTGTT GCTGTGGGCTACCCCTGGAC ACGGTGAAGGTCAGGATCCA GACGGAGCCAAAGTACACAG GCATCTGGCACTGCGTCCGGG ATACGTATCACCGAGAGCGCG TGTGGG GCTTCTACCGGGGCCTCTCGC TGCCCGTGTGCACGGTGTCCC TGGTATCTTCC	65	MDFVAGAIGG VCGVAVGYPL DTVKVRIQTEP LYTGIWHCVR DTYHRERVWG FYRGLSLPCT VSLVSS	127
SS-032	Secretion signal	ATGGAGAAGCCCCTCTTCCCA TLAGTGCCTTTGCATTGGTTTG GCTTTGGCTACACAGCACTGG TTGTTTCTGGTGGGATCGTTG GCTATGTA AAAACAGGCAGC GTGCCGTCCCTGGCTGCAGGG CTGCTCTTCGGCAGTCTAGCC	66	MEKPLFPLVPL HWFQFGYTAL VVS GGIVGYV KTGSVPSLAA GLLFGSLA	128
SS-033	Secretion signal	ATGGGTCTGCTCCTTCCCCTG GCACTCTGCATCCTAGTCCTG TGC	67	MGLLLPLALCI LVLC	129
SS-034	Secretion signal	ATGGGGATCCAGACGAGCCCC GTCCTGCTGGCCTCCCTGGGG GTGGGGCTGGTCACTCTGCTC GGCCTGGCTGTGGGC	68	MGIQTSPVLLA SLGVGLVTLL GLAVG	130
SS-035	Secretion signal	ATGTCGGACCTGCTACTACTG GGCCTGATTGGGGGCCTGACT CTCTTACTGCTGCTGACGCTG CTAGCCTTTGCC	69	MSDLLLLGLIG GLTLLLLLTLL AFA	131
SS-036	Secretion signal	ATGGAGACTGTGGTGATTGTT GCCATAGGTGTGCTGGCCACC ATGTTTCTGGCTTCGTTTGCAG CCTTGGTGCTGGTTTGCAGGC AG	70	METVVIVAIGV LATIFLASFAA LVLVCRQ	132
SS-037	Secretion signal	ATGCGCGGCTCTGTGGAGTGC ACCTGGGGTTGGGGGCACTGT GCCCCAGCCCCCTGCTCCTT TGGACTCTACTTCTGTTTGCA GCCCCATTTGGCCTGCTGGGG	71	MAGSVECTWG WGHCAPSPLL LWTLFFF AAFP GLLG	133
SS-038	Secretion signal	ATGATGCCGTCCCGTACCAAC CTGGCTACTGGAATCCCCAGT	72	MMP SRTNLAT GIPSSKVKYSR	134

		AGTAAAGTGAAATATTCAAGG CTCTCCAGCACAGACGATGGC TACATTGACCTTCAGTTTAAG AAAACCCCTCCTAAGATCCCT TATAAGGCCATCGCACTTGCC ACTGTGCTGTTTTTGATTGGC GCC		LSSTDDGYIDL QFKKTPPKIPY KAIALATVLF IGA	
SS-039	Secretion signal	ATGGCCCTGCCCCAGATGTGT GACGGGAGCCACTTGGCCTCC ACCCTCCGCTATTGCATGACA GTCAGCGGCACAGTGGTTCTG GTGGCCGGGACGCTCTGCTTC GCT	73	MALPQMCDGS HLASTLRYCM TVSGTVVLVA GTLCA	135
SS-041	Vrg-6	TGAAAAAGTGGTTCGTTGCTG CCGGCATCGGCGCTGCCGGAC TCATGCTCTCCAGCGCCGCCA	74	MKKWFVAAGI GAGLLMLSSA A	136
SS-042	PhoA	ATGAAACAGAGCACCATTGCG CTGGCGCTGCTGCCGCTGCTG TTTACCCCGGTGACCAAAGCG	75	MKQSTIALALL PLLFTPVTKA	137
SS-043	OmpA	ATGAAAAAAACCGCGATTGC GATTGCGGTGGCGCTGGCGGG CTTTGCGACCGTGGCGCAGGC G	76	MKKTAIAIAV ALAGFATVAQ A	138
SS-044	STI	ATGAAAAAACTGATGCTGGCG ATTTTTTTTAGCGTGCTGAGCT TTCCGAGCTTTAGCCAGAGC	77	MKKLMLAIFFS VLSFSPFSQS	139
SS-045	STII	ATGAAAAAAAACATTGCGTTT CTGCTGGCGAGCATGTTTGTG TTTAGCATTGCGACCAACGCG TATGCG	78	MKKNIAFLAS MFVFSIATNAY A	140
SS-046	Amylase	ATGTTTGCGAAACGCTTTAAA ACCAGCCTGCTGCCGCTGTTT GCGGGCTTTCTGCTGCTGTTTC ATCTGGTGCTGGCGGGCCCGG CGGCGGCGAGC	79	MFAKRFKTSL LPLFAGFLLLF HLVLAGPAAA S	141
SS-047	Alpha Factor	ATGCGCTTTCCGAGCATTTTT ACCGCGGTGCTGTTTGC GGCG AGCAGCGCGCTGGCG	80	MRFPSIFTAVL FAASSALA	142
SS-048	Alpha Factor	ATGCGCTTTCCGAGCATTTTT ACCACCGTGCTGTTTGC GGCG AGCAGCGCGCTGGCG	81	MRFPSIFTTVL FAASSALA	143
SS-049	Alpha Factor	ATGCGCTTTCCGAGCATTTTT ACCAGCGTGCTGTTTGC GGCG AGCAGCGCGCTGGCG	82	MRFPSIFTSVLF AASSALA	144
SS-050	Alpha Factor	ATGCGCTTTCCGAGCATTTTT ACCCATGTGCTGTTTGC GGCG AGCAGCGCGCTGGCG	83	MRFPSIFTHVL FAASSALA	145
SS-051	Alpha Factor	ATGCGCTTTCCGAGCATTTTT ACCATTGTGCTGTTTGC GGCG AGCAGCGCGCTGGCG	84	MRFPSIFTIVLF AASSALA	146

SS-052	Alpha Factor	ATGCGCTTTCCGAGCATTTTT ACCTTTGTGCTGTTTGCGGCG AGCAGCGCGCTGGCG	85	MRFPSIFTFVLF AASSALA	147
SS-053	Alpha Factor	ATGCGCTTTCCGAGCATTTTT ACCGAAGTGCTGTTTGCGGCG AGCAGCGCGCTGGCG	86	MRFPSIFTEVL FAASSALA	148
SS-054	Alpha Factor	ATGCGCTTTCCGAGCATTTTT ACCGGCGTGCTGTTTGCGGCG AGCAGCGCGCTGGCG	87	MRFPSIFTGVL FAASSALA	149
SS-055	Endoglucanase V	ATGCGTTCCTCCCCCTCCTCC GCTCCGCCGTTGTGGCCGCC TGCCGGTGTGGCCCTTGCC	88	MRSSPLLSAV VAALPVLALA	150
SS-056	Secretion signal	ATGGGCGCGGCGGCCGTGCGC TGGCACTTGTGCGTGCTGCTG GCCCTGGGCACACGCGGGCG GCTG	89	MGAAAVRWH LCVLLALGTR GRL	151
SS-057	Fungal	ATGAGGAGCTCCCTTGTGCTG TTCTTTGTCTCTGCGTGGACG GCCTTGGCCAG	90	MRSSLVLFVS AWTALA	152
SS-058	Fibronectin	ATGCTCAGGGGTCCGGGACCC GGGCGGCTGCTGCTGCTAGCA GTCCTGTGCCTGGGGACATCG GTGCGCTGCACCGAAACCGGG AAGAGCAAGAGG	91	MLRGP GPGRLL LLAVLCLGTS VRCTETGKSK R	153
SS-059	Fibronectin	ATGCTTAGGGGTCCGGGGCCC GGGCTGCTGCTGCTGGCCGTC CAGCTGGGGACAGCGGTGCC TCCACG	92	MLRGP GPGLL LLAVQCLGTA VPSTGA	154
SS-060	Fibronectin	ATGCGCCGGGGGGCCCTGACC GGGCTGCTCCTGGTCCTGTGC CTGAGTGTGTGCTACGTGCA GCCCCCTCTGCAACAAGCAAG AAGCGCAGG	93	MRRGALTGLL LVLCLSVVLR AAPSATSKKR R	155

[000285] In the table, SS is secretion signal and MLS is mitochondrial leader signal. The primary constructs or mmRNA of the present invention may be designed to encode any of the signal sequences of SEQ ID NOs 94-155, or fragments or variants thereof. These sequences may be included at the beginning of the polypeptide coding region, in the middle or at the terminus or alternatively into a flanking region. Further, any of the polynucleotide primary constructs of the present invention may also comprise one or more of the sequences defined by SEQ ID NOs 32-93. These may be in the first region or either flanking region.

[000286] Additional signal sequences which may be utilized in the present invention include those taught in, for example, databases such as those found at

<http://www.signalpeptide.de/> or <http://proline.bic.nus.edu.sg/spdb/>. Those described in US Patents 8,124,379; 7,413,875 and 7,385,034 are also within the scope of the invention and the contents of each are incorporated herein by reference in their entirety.

Target Selection

[000287] According to the present invention, the primary constructs comprise at least a first region of linked nucleosides encoding at least one polypeptide of interest. The polypeptides of interest or "Targets" of the present invention are listed in Table 6. Shown in Table 6, in addition to the name and description of the gene encoding the polypeptide of interest are the ENSEMBL Transcript ID (ENST), the ENSEMBL Protein ID (ENSP) and when available the optimized transcript sequence ID (Optim Trans SEQ ID) or optimized open reading frame sequence ID (Optim ORF SEQ ID). For any particular gene there may exist one or more variants or isoforms. Where these exist, they are shown in the table as well. It will be appreciated by those of skill in the art that disclosed in the Table are potential flanking regions. These are encoded in each ENST transcript either to the 5' (upstream) or 3' (downstream) of the ORF or coding region. The coding region is definitively and specifically disclosed by teaching the ENSP sequence. Consequently, the sequences taught flanking that encoding the protein are considered flanking regions. It is also possible to further characterize the 5' and 3' flanking regions by utilizing one or more available databases or algorithms. Databases have annotated the features contained in the flanking regions of the ENST transcripts and these are available in the art.

Table 6. Targets

Target No.	Target Description	ENST	Trans SEQ ID NO	ENSP	Peptide SEQ ID NO	Optim ORF SEQ ID	Optim Trans SEQ ID NO
1	4-hydroxyphenylpyruvate dioxygenase	289004	156	289004	769	1673, 2293, 2913, 3533, 4153, 5433-5519	
2	4-hydroxyphenylpyruvate dioxygenase	543163	157	441677	770	1674, 2294, 2914, 3534, 4154	
3	4-hydroxyphenylpyruvate dioxygenase	545969	158	437419	771	1675, 2295, 2915, 3535, 4155	
4	6-pyruvoyltetrahydropterin synthase	280362	159	280362	772	1676, 2296, 2916, 3536, 4156, 4773, 5103, 5520-	1609

						5606	
5	A disintegrin and metalloproteinase with thrombospondin motifs 13 isoform 1 preproprotein	563979	160	4561 86	773	1677, 2297, 2917, 3537, 4157, 4774, 5104, 5607-5693	1609
6	activity-dependent neuroprotector homeobox	349014	161	342905	774	1678, 2298, 2918, 3538, 4158, 4775, 5105, 5694-5780	
7	activity-dependent neuroprotector homeobox	371602	162	360662	775	1679, 2299, 2919, 3539, 4159, 4776, 5106	
8	activity-dependent neuroprotector homeobox	396029	163	379346	776	1680, 2300, 2920, 3540, 4160, 4777, 5107	
9	activity-dependent neuroprotector homeobox	396032	164	379349	777	1681, 2301, 2921, 3541, 4161, 4778, 5108	
10	activity-dependent neuroprotector homeobox	534467	165	4361 81	778	1682, 2302, 2922, 3542, 4162, 4779, 5109	
11	ADAM metalloproteinase with thrombospondin type 1 motif, 13	33835 1	166	345 120	779	1683, 2303, 2923, 3543, 4163, 4780, 5110	
12	ADAM metalloproteinase with thrombospondin type 1 motif, 13	355699	167	347927	780	1393, 1684, 2304, 2924, 3544, 4164, 4781, 5111	
13	ADAM metalloproteinase with thrombospondin type 1 motif, 13	356589	168	348997	781	1394, 1685, 2305, 2925, 3545, 4165, 4782, 5112	
14	ADAM metalloproteinase with thrombospondin type 1 motif, 13	371910	169	360978	782	1395, 1686, 2306, 2926, 3546, 4166, 4783, 5113	
15	ADAM metalloproteinase with thrombospondin	37191 1	170	360979	783	1396, 1687, 2307, 2927, 3547, 4167, 4784, 5114	

	type 1 motif, 13						
16	ADAM metalloproteinase with thrombospondin type 1 motif, 13	371916	171	360984	784	1397, 1688, 2308, 2928, 3548, 4168, 4785, 5115	
17	ADAM metalloproteinase with thrombospondin type 1 motif, 13	371929	172	360997	785	1398, 1689, 2309, 2929, 3549, 4169, 4786, 5116	1610
18	ADAM metalloproteinase with thrombospondin type 1 motif, 13	536611	173	444504	786	1399, 1690, 2310, 2930, 3550, 4170, 4787, 5117	
19	AIFsh						
20	Albiglutide; albiglutide						
21	aldolase A fructose-bisphosphate	563060	174	455800	787	1691, 2311, 2931, 3551, 4171	
22	aldolase A fructose-bisphosphate	564546	175	455917	788	1692, 2312, 2932, 3552, 4172	
23	aldolase A fructose-bisphosphate	564595	176	457468	789	1693, 2313, 2933, 3553, 4173	
24	aldolase A, fructose-bisphosphate	338110	177	336927	790	1694, 2314, 2934, 3554, 4174	
25	aldolase A, fructose-bisphosphate	395240	178	378661	791	1695, 2315, 2935, 3555, 4175	
26	aldolase A, fructose-bisphosphate	395248	179	378669	792	1696, 2316, 2936, 3556, 4176, 5781-5867	
27	aldolase A, fructose-bisphosphate	412304	180	400452	793	1697, 2317, 2937, 3557, 4177	
28	ameloblastin (enamel matrix protein)	322937	181	313809	794	1698, 2318, 2938, 3558, 4178, 4788, 5118, 5868-5954	1611
29	ameloblastin (enamel matrix protein)	449493	182	391234	795	1699, 2319, 2939, 3559, 4179, 4789, 5119	1611
30	ameloblastin (enamel matrix protein)	538728	183	445605	796	1700, 2320, 2940, 3560, 4180, 4790,	1611

						5 120	
31	amelogenin, X-linked	348912	184	3353 12	797	1701, 2321, 2941, 3561, 4 181, 4791, 5 121	
32	amelogenin, X-linked	380712	185	370088	798	1702, 2322, 2942, 3562, 4 182, 4792, 5 122, 5955-6041	
33	amelogenin, X-linked	380714	186	370090	799	1703, 2323, 2943, 3563, 4 183, 4793, 5 123	
34	amelogenin, Y-linked	215479	187	215479	800	1704, 2324, 2944, 3564, 4 184	1612
35	amelogenin, Y-linked	383036	188	372505	801	1705, 2325, 2945, 3565, 4 185	1612
36	amelogenin, Y-linked	383037	189	372506	802	1706, 2326, 2946, 3566, 4 186	1612
37	amylo-alpha-1, 6-glucosidase, 4-alpha-glucanotransferase	294724	190	294724	803	1707, 2327, 2947, 3567, 4 187	
38	amylo-alpha-1, 6-glucosidase, 4-alpha-glucanotransferase	361302	191	354971	804	1708, 2328, 2948, 3568, 4 188	
39	amylo-alpha-1, 6-glucosidase, 4-alpha-glucanotransferase	361522	192	354635	805	1709, 2329, 2949, 3569, 4 189	
40	amylo-alpha-1, 6-glucosidase, 4-alpha-glucanotransferase	361915	193	355 106	806	1710, 2330, 2950, 3570, 4190, 6042-6128	
41	amylo-alpha-1, 6-glucosidase, 4-alpha-glucanotransferase	370161	194	3591 80	807	171 1, 233 1, 295 1, 3571, 4191	
42	amylo-alpha-1, 6-glucosidase, 4-alpha-glucanotransferase	370163	195	3591 82	808	1712, 2332, 2952, 3572, 4192	
43	amylo-alpha-1, 6-glucosidase, 4-alpha-glucanotransferase	370165	196	3591 84	809	1713, 2333, 2953, 3573, 4193	
44	amyloid P component, serum	255040	197	255040	810	1714, 2334, 2954, 3574,	

						4194, 6129-6215	
45	angiotensin I converting enzyme (peptidyl-dipeptidase A) 2	252519	198	252519	811	1715, 2335, 2955, 3575, 4195, 6216-6302	
46	angiotensin I converting enzyme (peptidyl-dipeptidase A) 2	427411	199	389326	812	1716, 2336, 2956, 3576, 4196	
47	Anti-TNFalpha (TNFRFusion; Enbrel)						
48	APOA1 Milano; apo A-I(R173C)Milano , ETC-216				813	1400, 1717, 2337, 2957, 3577, 4197, 4794, 5124	1613
49	APOA1 Paris; apo A-I(R151C)Paris				814	1401, 1718, 2338, 2958, 3578, 4198, 4795, 5125	
50	ApoA-a optimized mRNA						1614
51	apolipoprotein A-I	236850	200	236850	815	1402, 1719, 2339, 2959, 3579, 4199, 4796, 5126, 6303-5363	1615
52	apolipoprotein A-I	359492	201	352471	816	1720, 2340, 2960, 3580, 4200, 4797, 5127	1615
53	apolipoprotein A-I	375320	202	364469	817	1721, 2341, 2961, 3581, 4201, 4798, 5128	1615
54	apolipoprotein A-I	375323	203	364472	818	1722, 2342, 2962, 3582, 4202, 4799, 5129	1615
55	apolipoprotein B (including Ag(x) antigen)	233242	204	233242	819	1723, 2343, 2963, 3583, 4203	
56	apolipoprotein B (including Ag(x) antigen)	535079	205	439731	820	1724, 2344, 2964, 3584, 4204	
57	aquaporin 5	293599	206	293599	821	1725, 2345, 2965, 3585, 4205, 4800, 5130, 6564-6650	1616
58	arginase, liver	356962	207	349446	822	1726, 2346, 2966, 3586, 4206,	

59	arginase, liver	368087	208	357066	823	1727, 2347, 2967, 3587, 4207, 6651- 6737	
60	arginase, liver	476845	209	417694	824	1728, 2348, 2968, 3588, 4208	
61	argininosuccinate lyase	304874	210	307188	825	1729, 2349, 2969, 3589, 4209, 6738- 6876	
62	argininosuccinate lyase	380839	211	370219	826	1730, 2350, 2970, 3590, 4210	
63	argininosuccinate lyase	395331	212	378740	827	1731, 2351, 2971, 3591, 4211	
64	argininosuccinate lyase	395332	213	378741	828	1732, 2352, 2972, 3592, 4212	
65	argininosuccinate lyase	502022	214	441778	829	1733, 2353, 2973, 3593, 4213	
66	argininosuccinate synthase 1	334909	215	361470	830	1403, 1734, 2354, 2974, 3594, 4214	
67	argininosuccinate synthase 1	352480	216	253004	831	1735, 2355, 2975, 3595, 4215, 6877- 6963	
68	argininosuccinate synthase 1	372386	217	361461	832	1404, 1736, 2356, 2976, 3596, 4216	
69	argininosuccinate synthase 1	372393	218	361469	833	1737, 2357, 2977, 3597, 4217	
70	argininosuccinate synthase 1	372394	219	361471	834	1738, 2358, 2978, 3598, 4218	
71	argininosuccinate synthase 1	422569	220	394212	835	1405, 1739, 2359, 2979, 3599, 4219	
72	argininosuccinate synthase 1	443588	221	397785	836	1406, 1740, 2360, 2980, 3600, 4220	
73	artemin	372354	222	361429	837	1741, 2361, 2981, 3601, 4221, 4801, 5131, 6964- 7050	
74	artemin	372359	223	361434	838	1742, 2362, 2982, 3602, 4222, 4802, 5132	

75	artemin	414809	224	387435	839	1743, 2363, 2983, 3603, 4223, 4803, 5 133	
76	artemin	471394	225	435804	840	1744, 2364, 2984, 3604, 4224, 4804, 5 134	
77	artemin	474592	226	434856	841	1745, 2365, 2985, 3605, 4225, 4805, 5 135	
78	artemin	477048	227	434784	842	1746, 2366, 2986, 3606, 4226, 4806, 5 136	
79	artemin	491 846	228	436149	843	1747, 2367, 2987, 3607, 4227, 4807, 5 137	
80	artemin	498139	229	436727	844	1748, 2368, 2988, 3608, 4228, 4808, 5 138	
81	arylsulfatase B	264914	230	264914	845	1749, 2369, 2989, 3609, 4229, 4809, 5 139, 705 1- 7137	1617
82	arylsulfatase B	264914	231	264914	846	1750, 2370, 2990, 3610, 4230, 4810, 5 140	1617
83	arylsulfatase B	39615 1	232	379455	847	175 1, 2371, 2991, 361 1, 423 1, 481 1, 5 141	1617
84	arylsulfatase B	521 117	233	42861 1	848	1752, 2372, 2992, 3612, 4232, 4812, 5 142	1617
85	asparaginase homolog (S. cerevisiae)	299234	234	299234	849	1753, 2373, 2993, 3613, 4233, 4813, 5 143	
86	asparaginase homolog (S. cerevisiae)	455920	235	389003	850	1754, 2374, 2994, 3614, 4234, 4814, 5 144	
87	asparaginase homolog (S. cerevisiae)	550583	236	446856	85 1	1755, 2375, 2995, 3615, 4235, 4815, 5 145	

88	asparaginase homolog (S. cerevisiae)	551177	237	450040	852	1756, 2376, 2996, 3616, 4236, 4816, 5146	
89	aspartoacylase	263080	238	263080	853	1757, 2377, 2997, 3617, 4237	
90	aspartoacylase	456349	239	409976	854	1758, 2378, 2998, 3618, 4238, 7138-7224	
91	ATPase, aminophospholipid transporter, class I, type 8B, member 1	283684	240	283684	855	1407, 1759, 2379, 2999, 3619, 4239, 7225-7398	
92	ATPase, aminophospholipid transporter, class I, type 8B, member 1	536015	241	445359	856	1760, 2380, 3000, 3620, 4240	
93	ATPase, Cu ⁺⁺ transporting, beta polypeptide	242839	242	242839	857	1761, 2381, 3001, 3621, 4241, 4817, 5147, 7399-7485	1618
94	ATPase, Cu ⁺⁺ transporting, beta polypeptide	344297	243	342559	858	1762, 2382, 3002, 3622, 4242, 4818, 5148	1618
95	ATPase, Cu ⁺⁺ transporting, beta polypeptide	400366	244	383217	859	1763, 2383, 3003, 3623, 4243, 4819, 5149	1618
96	ATPase, Cu ⁺⁺ transporting, beta polypeptide	400370	245	383221	860	1764, 2384, 3004, 3624, 4244, 4820, 5150	1618
97	ATPase, Cu ⁺⁺ transporting, beta polypeptide	417240	246	390360	861	1765, 2385, 3005, 3625, 4245, 4821, 5151	
98	ATPase, Cu ⁺⁺ transporting, beta polypeptide	418097	247	393343	862	1766, 2386, 3006, 3626, 4246, 4822, 5152	1618
99	ATPase, Cu ⁺⁺ transporting, beta polypeptide	448424	248	416738	863	1767, 2387, 3007, 3627, 4247, 4823, 5153	1618
100	ATPase, Cu ⁺⁺ transporting, beta polypeptide	542656	249	443128	864	1768, 2388, 3008, 3628, 4248, 4824, 5154	

101	ATP-binding cassette, sub-family B (MDR/TAP), member 11	263817	250	263817	865	1408, 1769, 2389, 3009, 3629, 4249	
102	ATP-binding cassette, sub-family B (MDR/TAP), member 4	265723	251	265723	866	1409, 1770, 2390, 3010, 3630, 4250, 7486-7659	
103	ATP-binding cassette, sub-family B (MDR/TAP), member 4	358400	252	351172	867	1410, 1771, 2391, 3011, 3631, 4251	
104	ATP-binding cassette, sub-family B (MDR/TAP), member 4	359206	253	352135	868	1411, 1772, 2392, 3012, 3632, 4252	
105	ATP-binding cassette, sub-family B (MDR/TAP), member 4	417608	254	394511	869	1412, 1773, 2393, 3013, 3633, 4253	
106	ATP-binding cassette, sub-family B (MDR/TAP), member 4	453593	255	392983	870	1774, 2394, 3014, 3634, 4254	
107	ATP-binding cassette, sub-family B (MDR/TAP), member 4	545634	256	437465	871	1775, 2395, 3015, 3635, 4255	
108	bactericidal/permeability-increasing protein	262865	257	262865	872	1776, 2396, 3016, 3636, 4256, 7660-7746	
109	basic helix-loop-helix family, member e41	242728	258	242728	873	1413, 1777, 2397, 3017, 3637, 4257, 7747-7833	
110	basic helix-loop-helix family, member e41	540731	259	437369	874	1778, 2398, 3018, 3638, 4258	
111	bone morphogenetic protein 2	378827	260	368104	875	1414, 1779, 2399, 3019, 3639, 4259, 7834-7920	
112	bone morphogenetic protein 7	395863	261	379204	876	1415, 1780, 2400, 3020, 3640, 4260, 4825, 5155, 7921-8007	

113	bone morphogenetic protein 7	395864	262	379205	877	1416, 1781, 2401, 3021, 3641, 4261, 4826, 5156	
114	Cap18						
115	carbamoyl-phosphate synthase 1, mitochondrial	233072	263	233072	878	1417, 1782, 2402, 3022, 3642, 4262	
116	carbamoyl-phosphate synthase 1, mitochondrial	417946	264	388496	879	1418, 1783, 2403, 3023, 3643, 4263	
117	carbamoyl-phosphate synthase 1, mitochondrial	430249	265	402608	880	1419, 1784, 2404, 3024, 3644, 4264, 8008-8146	
118	carbamoyl-phosphate synthase 1, mitochondrial	451903	266	406136	881	1420, 1785, 2405, 3025, 3645, 4265	
119	carbamoyl-phosphate synthase 1, mitochondrial	518043	267	430697	882	1786, 2406, 3026, 3646, 4266,	
120	carbamoyl-phosphate synthase 1, mitochondrial	536125	268	445539	883	1787, 2407, 3027, 3647, 4267	
121	carbamoyl-phosphate synthase 1, mitochondrial	539150	269	444139	884	1788, 2408, 3028, 3648, 4268	
122	carbamoyl-phosphate synthase 1, mitochondrial	544169	270	442790	885	1789, 2409, 3029, 3649, 4269	
123	cardiotrophin 1	279804	271	279804	886	1790, 2410, 3030, 3650, 4270, 8147-8233	
124	cardiotrophin 1	395019	272	378465	887	1791, 2411, 3031, 3651, 4271	
125	cathelicidin antimicrobial peptide	296435	273	296435	888	1792, 2412, 3032, 3652, 4272, 4827, 5157, 8234-8407	1619
126	cathelicidin antimicrobial peptide	576243	274	458149	889	1793, 2413, 3033, 3653, 4273, 4828, 5158	

127	Cbp/p300-interacting transactivator, with Glu/Asp-rich carboxy-terminal domain, 4	372638	275	361721	890	1421, 1794, 2414, 3034, 3654, 4274, 8408-8494	
128	ceruloplasmin (ferroxidase)	264613	276	264613	891	1422, 1795, 2415, 3035, 3655, 4275, 4829, 5159, 8495-8581	1620
129	Cheetah Program 2; hyaluronidase (human); insulin lispro						
130	ciliary neurotrophic factor	361987	277	355370	892	1796, 2416, 3036, 3656, 4276	
131	coagulation factor II (thrombin)	311907	278	308541	893	1423, 1797, 2417, 3037, 3657, 4277, 4830, 5160, 8582-8668	
132	coagulation factor II (thrombin)	446804	279	406403	894	1798, 2418, 3038, 3658, 4278, 4831, 5161	
133	coagulation factor II (thrombin)	530231	280	433907	895	1424, 1799, 2419, 3039, 3659, 4279, 4832, 5162	
134	coagulation factor III (thromboplastin, tissue factor)	334047	281	334145	896	1425, 1800, 2420, 3040, 3660, 4280, 8669-8755	
135	coagulation factor III (thromboplastin, tissue factor)	370207	282	359226	897	1426, 1801, 2421, 3041, 3661, 4281, 8756-8842	
136	coagulation factor IX	218099	283	218099	898	1427, 1802, 2422, 3042, 3662, 4282, 8843-9016	1621
137	coagulation factor IX	394090	284	377650	899	1428, 1803, 2423, 3043, 3663, 4283, 4833, 5163	1621
138	coagulation factor V (proaccelerin, labile factor)	367796	285	356770	900	1429, 1804, 2424, 3044, 3664, 4284	
139	coagulation factor V (proaccelerin, labile factor)	367797	286	356771	901	1430, 1805, 2425, 3045, 3665, 4285, 9017-9155	

140	coagulation factor V (proaccelerin, labile factor)	546081	287	439664	902	1431, 1806, 2426, 3046, 3666, 4286	
141	coagulation factor VII (serum prothrombin conversion accelerator)	346342	288	329546	903	1432, 1807, 2427, 3047, 3667, 4287, 4834, 5164	1622
142	coagulation factor VII (serum prothrombin conversion accelerator)	375581	289	364731	904	1433, 1808, 2428, 3048, 3668, 4288, 4835, 5165, 9156-9242	1622
143	coagulation factor VII (serum prothrombin conversion accelerator)	541084	290	442051	905	1434, 1809, 2429, 3049, 3669, 4289, 4836, 5166	1622
144	coagulation factor VIII procoagulant component	330287	291	327895	906	1810, 2430, 3050, 3670, 4290, 4837, 5167	
145	coagulation factor VIII, procoagulant component	360256	292	353393	907	1435, 1811, 2431, 3051, 3671, 4291, 4838, 5168	1623
146	coagulation factor X	375551	293	364701	908	1436, 1812, 2432, 3052, 3672, 4292, 4839, 5169	
147	coagulation factor X	375559	294	364709	909	1437, 1813, 2433, 3053, 3673, 4293, 4840, 5170, 9243-9381	
148	coagulation factor X	409306	295	387092	910	1438, 1814, 2434, 3054, 3674, 4294, 4841, 5171	
149	coagulation factor XI	264692	296	264692	911	1439, 1815, 2435, 3055, 3675, 4295, 4842, 5172	1624
150	coagulation factor XI	403665	297	384957	912	1440, 1816, 2436, 3056, 3676, 4296, 4843, 5173, 9382-9468	1624
151	coagulation factor XI	452239	298	397401	913	1441, 1817, 2437, 3057, 3677, 4297, 4844, 5174,	
152	coagulation factor XIII, A1 polypeptide	264870	299	264870	914	1442, 1818, 2438, 3058, 3678, 4298,	

						9469-9555	
153	coagulation factor XIII, A1 polypeptide	414279	300	413334	915	1443, 1819, 2439, 3059, 3679, 4299	
154	coagulation factor XIII, A1 polypeptide	441301	301	416127	916	1820, 2440, 3060, 3680, 4300	
155	collagen, type VII, alpha 1	328333	302	332371	917	1821, 2441, 3061, 3681, 4301, 4845, 5175, 9556-9642	1625
156	collagen, type VII, alpha 1	454817	303	412569	918	1822, 2442, 3062, 3682, 4302, 4846, 5176,	
157	colony stimulating factor 2 (granulocyte-macrophage)	296871	304	296871	919	1823, 2443, 3063, 3683, 4303, 4847, 5177, 9643-9781	1626
158	colony stimulating factor 3 (granulocyte)	225474	305	225474	920	1824, 2444, 3064, 3684, 4304, 9782-9868	1627
159	colony stimulating factor 3 (granulocyte)	331769	306	327766	921	1825, 2445, 3065, 3685, 4305, 4848, 5178, 9869-9955	
160	colony stimulating factor 3 (granulocyte)	394148	307	377704	922	1826, 2446, 3066, 3686, 4306, 4849, 5179,	1627
161	colony stimulating factor 3 (granulocyte)	394149	308	377705	923	1827, 2447, 3067, 3687, 4307, 4850, 5180, 9956-10042	1627
162	complement factor H	367429	309	356399	924	1444, 1828, 2448, 3068, 3688, 4308, 4851, 5181	1627
163	complement factor H	391986	310	375846	925	1829, 2449, 3069, 3689, 4309, 4852, 5182	
164	complement factor H	439155	311	402656	926	1445, 1830, 2450, 3070, 3690, 4310, 4853, 5183	
165	copper metabolism (Murr1) domain	311832	312	308236	927	1446, 1831, 2451, 3071,	

	containing 1					3691, 4311, 10043-10129	
166	copper metabolism (Murr1) domain containing 1	427417	313	413207	928	1447, 1832, 2452, 3072, 3692, 4312	
167	copper metabolism (Murr1) domain containing 1	444166	314	410050	929	1448, 1833, 2453, 3073, 3693, 4313	
168	copper metabolism (Murr1) domain containing 1	458337	315	401236	930	1834, 2454, 3074, 3694, 4314	
169	copper metabolism (Murr1) domain containing 1	538736	316	438961	931	1449, 1835, 2455, 3075, 3695, 4315	
170	corticotropin releasing hormone	276571	317	276571	932	1836, 2456, 3076, 3696, 4316, 4854, 5184	
171	CTLA4-Ig (Orencia)						
172	cystic fibrosis transmembrane conductance regulator (ATP-binding cassette sub-family C, member 7)	3084	318	3084	933	1450, 1837, 2457, 3077, 3697, 4317, 4855, 5185, 10130-10216	1628
173	cystic fibrosis transmembrane conductance regulator (ATP-binding cassette sub-family C, member 7)	426809	319	389119	934	1451, 1838, 2458, 3078, 3698, 4318, 4856, 5186	
174	cystic fibrosis transmembrane conductance regulator (ATP-binding cassette sub-family C, member 7)	454343	320	403677	935	1452, 1839, 2459, 3079, 3699, 4319, 4857, 5187	1628
175	cystic fibrosis transmembrane conductance regulator (ATP-binding cassette sub-family C, member 7)	468795	321	419254	936	1453, 1840, 2460, 3080, 3700, 4320, 4858, 5188	
176	cystinosis lysosomal cystine transporter	381870	322	371294	937	1841, 2461, 3081, 3701, 4321	

177	cystinosis, lysosomal cystine transporter	46640	323	46640	938	1454, 1842, 2462, 3082, 3702, 4322, 4859, 5 189, 10217-10355	
178	cystinosis, lysosomal cystine transporter	414524	324	395471	939	1455, 1843, 2463, 3083, 3703, 4323	
179	cystinosis, lysosomal cystine transporter	441220	325	4 11465	940	1456, 1844, 2464, 3084, 3704, 4324	
180	cystinosis, lysosomal cystine transporter	4521 11	326	408652	941	1457, 1845, 2465, 3085, 3705, 4325	
181	defensin, beta 103A	3 14357	327	320951	942	1846, 2466, 3086, 3706, 4326, 4860, 5 190	1629
182	defensin, beta 103B	3 18124	328	324633	943	1847, 2467, 3087, 3707, 4327, 4861, 5 191, 10356-10442	1630
183	defensin, beta 4A	302247	329	303532	944	1848, 2468, 3088, 3708, 4328, 4862, 5 192, 10443-10529	163 1
184	defensin, beta 4B	3 18157	330	424598	945	1849, 2469, 3089, 3709, 4329, 4863, 5 193	1632
185	DegludecPlus; insulin aspart; insulin degludec						
186	deoxyribonuclease I	246949	33 1	246949	946	1850, 2470, 3090, 3710, 4330, 4864, 5 194, 10530-10616	1633
187	deoxyribonuclease I	407479	332	385905	947	185 1, 2471, 3091, 371 1, 433 1, 4865, 5 195	1633
188	deoxyribonuclease I	4141 10	333	416699	948	1852, 2472, 3092, 3712, 4332, 4866, 5 196	
189	dysferlin, limb girdle muscular dystrophy 2B (autosomal recessive)	258104	334	258104	949	1458, 1853, 2473, 3093, 3713, 4333, 4867, 5 197	

190	dysferlin, limb girdle muscular dystrophy 2B (autosomal recessive)	394120	335	377678	950	1459, 1854, 2474, 3094, 3714, 4334, 4868, 5198, 10617-10703	1634
191	dysferlin, limb girdle muscular dystrophy 2B (autosomal recessive)	409366	336	386512	951	1460, 1855, 2475, 3095, 3715, 4335, 4869, 5199	
192	dysferlin, limb girdle muscular dystrophy 2B (autosomal recessive)	409582	337	386547	952	1461, 1856, 2476, 3096, 3716, 4336, 4870, 5200	
193	dysferlin, limb girdle muscular dystrophy 2B (autosomal recessive)	409651	338	386683	953	1462, 1857, 2477, 3097, 3717, 4337, 4871, 5201	
194	dysferlin, limb girdle muscular dystrophy 2B (autosomal recessive)	409744	339	386285	954	1463, 1858, 2478, 3098, 3718, 4338, 4872, 5202	
195	dysferlin, limb girdle muscular dystrophy 2B (autosomal recessive)	409762	340	387137	955	1464, 1859, 2479, 3099, 3719, 4339, 4873, 5203	
196	dysferlin, limb girdle muscular dystrophy 2B (autosomal recessive)	410020	341	386881	956	1465, 1860, 2480, 3100, 3720, 4340, 4874, 5204	
197	dysferlin, limb girdle muscular dystrophy 2B (autosomal recessive)	410041	342	386617	957	1466, 1861, 2481, 3101, 3721, 4341, 4875, 5205	
198	dysferlin, limb girdle muscular dystrophy 2B (autosomal recessive)	413539	343	407046	958	1467, 1862, 2482, 3102, 3722, 4342, 4876, 5206	
199	dysferlin, limb girdle muscular dystrophy 2B (autosomal recessive)	429174	344	398305	959	1468, 1863, 2483, 3103, 3723, 4343, 4877, 5207	
200	ectodysplasin A	338901	345	340611	960	1864, 2484, 3104, 3724, 4344, 4878, 5208	

201	ectodysplasin A	374552	346	363680	961	1865, 2485, 3105, 3725, 4345, 4879, 5209	
202	ectodysplasin A	374553	347	363681	962	1866, 2486, 3106, 3726, 4346, 4880, 5210, 10704- 10790	1635
203	ectodysplasin A	525810	348	434195	963	1867, 2487, 3107, 3727, 4347, 4881, 5211	
204	ectodysplasin A	524573	349	432585	964	1868, 2488, 3108, 3728, 4348, 4882, 5212	
205	ectodysplasin A	527388	350	434861	965	1869, 2489, 3109, 3729, 4349, 4883, 5213	
206	enamelin	396073	351	379383	966	1870, 2490, 3110, 3730, 4350, 4884, 5214	1636
207	erythropoietin	252723	352	252723	967	1871, 2491, 3111, 3731, 4351, 4885, 5215, 10791- 11051	1637
208	Exenatide				968	1872, 2492, 3112, 3732, 4352, 4886, 5216	
209	family with sequence similarity 98, member C	252530	353	252530	969	1873, 2493, 3113, 3733, 4353	
210	family with sequence similarity 98, member C	343358	354	340348	970	1874, 2494, 3114, 3734, 4354	
211	fibrinogen alpha chain	302053	355	306361	971	1469, 1875, 2495, 3115, 3735, 4355, 11052-11190	
212	fibrinogen alpha chain	403106	356	385981	972	1470, 1876, 2496, 3116, 3736, 4356	
213	fibrinogen alpha chain	457487	357	407891	973	1877, 2497, 3117, 3737, 4357	
214	fibrinogen beta chain	302068	358	306099	974	1471, 1878, 2498, 3118, 3738, 4358,	

						11191-11329	
215	fibrinogen beta chain	537843	359	437727	975	1879, 2499, 3119, 3739, 4359	
216	fibrinogen gamma chain	336098	360	336829	976	1472, 1880, 2500, 3120, 3740, 4360, 11330-11468	
217	fibrinogen gamma chain	404648	361	384860	977	1473, 1881, 2501, 3121, 3741, 4361	
218	fibroblast growth factor 21	222157	362	222157	978	1474, 1882, 2502, 3122, 3742, 4362	
219	fibroblast growth factor 21	593756	363	471477	979	1883, 2503, 3123, 3743, 4363, 11469-11555	
220	fibronectin type III domain containing 5	373470	364	362569	980	1884, 2504, 3124, 3744, 4364,	
221	fibronectin type III domain containing 5	373471	365	362570	981	1885, 2505, 3125, 3745, 4365, 11556-11642	
222	follicle stimulating hormone, beta polypeptide	254122	366	254122	982	1886, 2506, 3126, 3746, 4366, 4887, 5217, 11643-11729	
223	follicle stimulating hormone, beta polypeptide	417547	367	416606	983	1887, 2507, 3127, 3747, 4367, 4888, 5218	
224	follicle stimulating hormone, beta polypeptide	533718	368	433424	984	1888, 2508, 3128, 3748, 4368, 4889, 5219	
225	fumarylacetoacetate hydrolase (fumarylacetoacetase)	261755	369	261755	985	1475, 1889, 2509, 3129, 3749, 4369	
226	fumarylacetoacetate hydrolase (fumarylacetoacetase)	407106	370	385080	986	1890, 2510, 3130, 3750, 4370, 11730-11868	
227	fumarylacetoacetate hydrolase (fumarylacetoacetase)	561421	371	453347	987	1891, 2511, 3131, 3751, 4371	
228	galactokinase 1	225614	372	225614	988	1892, 2512, 3132, 3752, 4372	

229	galactokinase 1	375188	373	364334	989	1893, 2513, 3133, 3753, 4373	
230	galactokinase 1	437911	374	406305	990	1894, 2514, 3134, 3754, 4374	
231	galactokinase 1	588479	375	465930	991	1895, 2515, 3135, 3755, 4375, 11869- 11955	
232	galactosamine (N-acetyl)-6-sulfate sulfatase	268695	376	268695	992	1476, 1896, 2516, 3136, 3756, 4376, 4890, 5220, 11956-12042	1638
233	galactosamine (N-acetyl)-6-sulfate sulfatase	439266	377	402127	993	1897, 2517, 3137, 3757, 4377, 4891, 5221	
234	galactosamine (N-acetyl)-6-sulfate sulfatase	542788	378	438197	994	1477, 1898, 2518, 3138, 3758, 4378, 4892, 5222	
235	galactose-1-phosphate uridylyltransferase	378842	379	368119	995	1899, 2519, 3139, 3759, 4379, 12043- 12181	
236	galactose-1-phosphate uridylyltransferase	450095	380	401956	996	1900, 2520, 3140, 3760, 4380	
237	galactose-1-phosphate uridylyltransferase	554550	381	451435	997	1901, 2521, 3141, 3761, 4381	
238	galactosidase, alpha	218516	382	218516	998	1902, 2522, 3142, 3762, 4382, 12182- 12268	1639
239	Galectin 3 inhibitor (A9)		383		999		1640
240	Galectin 3 inhibitor (C12)		384		1000		1641
241	glial cell derived neurotrophic factor	326524	385	317145	1001	1903, 2523, 3143, 3763, 4383, 4893, 5223	
242	glial cell derived neurotrophic factor	344622	386	339703	1002	1904, 2524, 3144, 3764, 4384, 4894, 5224	
243	glial cell derived neurotrophic factor	427982	387	409007	1003	1905, 2525, 3145, 3765, 4385, 4895, 5225, 12269- 12355	1642

244	glial cell derived neurotrophic factor	502572	388	423557	1004	1906, 2526, 3146, 3766, 4386, 4896, 5226	
245	glial cell derived neurotrophic factor	510177	389	424592	1005	1907, 2527, 3147, 3767, 4387, 4897, 5227	
246	glial cell derived neurotrophic factor	515058	390	425928	1006	1908, 2528, 3148, 3768, 4388, 4898, 5228	
247	glial cell derived neurotrophic factor	381826	391	371248	1007	1909, 2529, 3149, 3769, 4389, 4899, 5229	
248	GLP-1 Fc; dulaglutide						
249	glucagon	375497	392	364647	1008	1910, 2530, 3150, 3770, 4390, 4900, 5230	1643
250	glucagon	418842	393	387662	1009	1911, 2531, 3151, 3771, 4391, 4901, 5231, 12356-12703	1643
251	glucan (1,4-alpha-), branching enzyme 1	264326	394	264326	1010	1912, 2532, 3152, 3772, 4392	
252	glucan (1,4-alpha-), branching enzyme 1	429644	395	410833	1011	1478, 1913, 2533, 3153, 3773, 4393, 12704-12842	
253	glucan (1,4-alpha-), branching enzyme 1	536832	396	445365	1012	1914, 2534, 3154, 3774, 4394	
254	glucose-6-phosphatase, catalytic subunit	253801	397	253801	1013	1915, 2535, 3155, 3775, 4395, 12843-12981	
255	glucosidase, alpha; acid	302262	398	305692	1014	1916, 2536, 3156, 3776, 4396, 4902, 5232, 12982-13155	1644
256	glucosidase, alpha; acid	390015	399	374665	1015	1917, 2537, 3157, 3777, 4397, 4903, 5233	1644
257	glucosidase, beta; acid	327247	400	314508	1016	1918, 2538, 3158, 3778, 4398, 4904, 5234	1645

258	glucosidase, beta, acid	368373	401	357357	1017	1919, 2539, 3159, 3779, 4399, 4905, 5235	1645
259	glucosidase, beta, acid	402928	402	385813	1018	1920, 2540, 3160, 3780, 4400, 4906, 5236	1645
260	glucosidase, beta, acid	427500	403	402577	1019	1921, 2541, 3161, 3781, 4401, 4907, 5237	1645
261	glucosidase, beta, acid	428024	404	397986	1020	1922, 2542, 3162, 3782, 4402, 4908, 5238	1645
262	glucosidase, beta, acid	536555	405	446457	1021	1923, 2543, 3163, 3783, 4403, 4909, 5239	1645
263	glucosidase, beta, acid	536770	406	445560	1022	1924, 2544, 3164, 3784, 4404, 4910, 5240	1645
264	glycogen synthase 2 (liver)	261195	407	261195	1023	1925, 2545, 3165, 3785, 4405, 13156-13242	
265	glycoprotein hormones, alpha polypeptide	369582	408	358595	1024	1926, 2546, 3166, 3786, 4406, 4911, 5241, 13243-13329	1646
266	GP2013; rituximab						
267	Granulysin 9 kDa (non-secreted)					1479	
268	Granulysin 9 kDa (secreted)					1480	
269	growth hormone 1	323322	409	312673	1025	1927, 2547, 3167, 3787, 4407, 4912, 5242, 13330-13416	1647
270	growth hormone 1	342364	410	339278	1026	1928, 2548, 3168, 3788, 4408, 4913, 5243	1647
271	growth hormone 1	351388	411	343791	1027	1929, 2549, 3169, 3789, 4409, 4914, 5244	1647
272	growth hormone 1	458650	412	408486	1028	1930, 2550, 3170, 3790, 4410, 4915,	1647

						5245	
273	growth hormone 2	332800	413	333 157	1029	193 1, 255 1, 3 171, 3791, 441 1, 4916, 5246	
274	growth hormone 2	423893	414	409294	1030	1932, 2552, 3 172, 3792, 4412, 4917, 5247	
275	growth hormone 2	449787	415	410618	103 1	1933, 2553, 3 173, 3793, 4413, 491 8, 5248	
276	growth hormone 2	456543	416	394122	1032	1934, 2554, 3 174, 3794, 4414, 4919, 5249	
277	GTP cyclohydrolase 1	3955 14	417	378890	1033	1935, 2555, 3 175, 3795, 4415, 4920, 5250, 13417- 13503	1648
278	GTP cyclohydrolase 1	395524	4 18	378895	1034	1936, 2556, 3 176, 3796, 4416, 4921, 525 1	
279	GTP cyclohydrolase 1	491895	419	419045	1035	1937, 2557, 3 177, 3797, 4417, 4922, 5252	1649
280	GTP cyclohydrolase 1	536224	420	445246	1036	1938, 2558, 3 178, 3798, 441 8, 4923, 5253	
281	GTP cyclohydrolase 1	543643	421	44401 1	1037	1939, 2559, 3 179, 3799, 4419, 4924, 5254	
282	hemochromatosis	309234	422	3 11698	1038	1940, 2560, 3 180, 3800, 4420	
283	hemochromatosis	3 17896	423	3 13776	1039	1941, 2561, 3 181, 3801, 4421	
284	hemochromatosis	336625	424	337819	1040	1942, 2562, 3 182, 3802, 4422	
285	hemochromatosis	349999	425	259699	1041	1943, 2563, 3 183, 3803, 4423	
286	hemochromatosis	352392	426	3 15936	1042	1944, 2564, 3 184, 3804, 4424	

287	hemochromatosis	353147	427	312342	1043	1945, 2565, 3185, 3805, 4425	
288	hemochromatosis	357618	428	417404	1044	1946, 2566, 3186, 3806, 4426	
289	hemochromatosis	397022	429	380217	1045	1947, 2567, 3187, 3807, 4427	
290	hemochromatosis	461397	430	420802	1046	1948, 2568, 3188, 3808, 4428	
291	hemochromatosis	470149	431	419725	1047	1949, 2569, 3189, 3809, 4429	
292	hemochromatosis	488199	432	420559	1048	1950, 2570, 3190, 3810, 4430	
293	hemochromatosis	535098	433	445872	1049	1951, 2571, 3191, 3811, 4431	
294	hemochromatosis	539147	434	445098	1050	1952, 2572, 3192, 3812, 4432	
295	hemochromatosis type 2 (juvenile)	336751	435	337014	1051	1481, 1953, 2573, 3193, 3813, 4433, 4925, 5255, 13504-13590	
296	hemochromatosis type 2 (juvenile)	357836	436	350495	1052	1482, 1954, 2574, 3194, 3814, 4434, 4926, 5256	
297	hemochromatosis type 2 (juvenile)	421822	437	411863	1053	1483, 1955, 2575, 3195, 3815, 4435, 4927, 5257	
298	hemochromatosis type 2 (juvenile)	475797	438	425716	1054	1484, 1956, 2576, 3196, 3816, 4436, 4928, 5258	
299	hemochromatosis type 2 (juvenile)	497365	439	421820	1055	1957, 2577, 3197, 3817, 4437, 4929, 5259	
300	hemochromatosis type 2 (juvenile)	577520	440	463276	1056	1958, 2578, 3198, 3818, 4438	
301	hemochromatosis type 2 (juvenile)	580693	441	464413	1057	1959, 2579, 3199, 3819, 4439	
302	hepatocyte growth factor (hepapoietin A; scatter factor)	222390	442	222390	1058	1960, 2580, 3200, 3820, 4440, 13591- 13677	

303	hepatocyte growth factor (hepapoietin A; scatter factor)	354224	443	346164	1059	1961, 2581, 3201, 3821, 4441	
304	hepatocyte growth factor (hepapoietin A; scatter factor)	394769	444	378250	1060	1962, 2582, 3202, 3822, 4442	
305	hepatocyte growth factor (hepapoietin A; scatter factor)	412881	445	396307	1061	1963, 2583, 3203, 3823, 4443	
306	hepatocyte growth factor (hepapoietin A; scatter factor)	421558	446	388592	1062	1964, 2584, 3204, 3824, 4444	
307	hepatocyte growth factor (hepapoietin A; scatter factor)	423064	447	413829	1063	1965, 2585, 3205, 3825, 4445	
308	hepatocyte growth factor (hepapoietin A; scatter factor)	444829	448	389854	1064	1966, 2586, 3206, 3826, 4446	
309	hepatocyte growth factor (hepapoietin A; scatter factor)	453411	449	408270	1065	1967, 2587, 3207, 3827, 4447	
310	hepatocyte growth factor (hepapoietin A; scatter factor)	457544	450	391238	1066	1968, 2588, 3208, 3828, 4448	
311	hepcidin antimicrobial peptide	222304	451	222304	1067	1485 1969, 2589, 3209, 3829, 4449	
312	hepcidin antimicrobial peptide	598398	452	471 894	1068	1970, 2590, 3210, 3830, 4450, 13678-13764	
313	Herceptin Heavy Chain				1069	1971, 2591, 3211, 3831, 4451, 4930, 5260	
314	Herceptin Light Chain				1070	1972, 2592, 3212, 3832, 4452, 4931, 5261	
315	hypoxanthine phosphoribosyltransferase 1	298556	453	298556	1071	1486, 1973, 2593, 3213, 3833, 4453, 4932, 5262, 13765-13851	1650
316	hypoxanthine phosphoribosyltransferase 1	370796	454	359832	1072	1974, 2594, 3214, 3834, 4454, 4933, 5263	
317	IDegLira; insulin degludec; liraglutide						
318	iduronate 2-sulfatase	340855	455	339801	1073	1975, 2595, 3215, 3835, 4455, 4934, 5264	1651

319	iduronate 2-sulfatase	370441	456	359470	1074	1976, 2596, 3216, 3836, 4456, 4935, 5265	165 1
320	iduronate 2-sulfatase	370443	457	359472	1075	1977, 2597, 3217, 3837, 4457, 4936, 5266	165 1
321	iduronate 2-sulfatase	428056	458	390241	1076	1978, 2598, 3218, 3838, 4458, 4937, 5267	165 1
322	iduronate 2-sulfatase	521702	459	429745	1077	1979, 2599, 3219, 3839, 4459, 4938, 5268	165 1
323	iduronate 2-sulfatase	537071	460	440324	1078	1980, 2600, 3220, 3840, 4460, 4939, 5269	165 1
324	iduronate 2-sulfatase	541269	461	441261	1079	1981, 2601, 3221, 3841, 4461, 4940, 5270	165 1
325	iduronidase, alpha-L-	247933	462	247933	1080	1982, 2602, 3222, 3842, 4462, 4941, 5271, 13852-13938	1652
326	iduronidase, alpha-L-	453894	463	396458	1081	1983, 2603, 3223, 3843, 4463, 4942, 5272	1652
327	IgM Heavy						
328	IgM Light						
329	INS-IGF2 readthrough	397270	464	380440	1082	1984, 2604, 3224, 3844, 4464, 4943, 5273	
330	insulin	250971	465	250971	1083	1985, 2605, 3225, 3845, 4465, 4944, 5274, 13939-14286	1653
331	insulin	381330	466	37073 1	1084	1986, 2606, 3226, 3846, 4466, 4945, 5275	1653
332	insulin	397262	467	380432	1085	1987, 2607, 3227, 3847, 4467, 4946, 5276, 14287-14373	1653

333	insulin	512523	468	424008	1086	1988, 2608, 3228, 3848, 4468, 4947, 5277	
334	Insulin Aspart				1087	1989, 2609, 3229, 3849, 4469, 4948, 5278	
335	Insulin Glargine				1088	1990, 2610, 3230, 3850, 4470, 4949, 5279	
336	Insulin Glulisine				1089	1991, 2611, 3231, 3851, 4471, 4950, 5280	
337	Insulin Lispro				1090	1992, 2612, 3232, 3852, 4472, 4951, 5281	
338	interferon, alpha 10	357374	469	369566	1091	1993, 2613, 3233, 3853, 4473, 4952, 5282	
339	interferon, alpha 13	449498	470	394494	1092	1994, 2614, 3234, 3854, 4474, 4953, 5283	
340	interferon, alpha 14	380222	471	369571	1093	1995, 2615, 3235, 3855, 4475, 4954, 5284	
341	interferon, alpha 16	380216	472	369564	1094	1996, 2616, 3236, 3856, 4476, 4955, 5285	
342	interferon, alpha 17	413767	473	411940	1095	1997, 2617, 3237, 3857, 4477, 4956, 5286	
343	interferon, alpha 2	380206	474	369554	1096	1998, 2618, 3238, 3858, 4478, 4957, 5287, 14374- 14460	1654
344	interferon, alpha 21	380225	475	369574	1097	1999, 2619, 3239, 3859, 4479, 4958, 5288	
345	interferon, alpha 4	421715	476	412897	1098	2000, 2620, 3240, 3860, 4480, 4959, 5289	

346	interferon, alpha 5	259555	477	259555	1099	2001, 2621, 3241, 3861, 4481, 4960, 5290	
347	interferon, alpha 6	380210	478	369558	1100	2002, 2622, 3242, 3862, 4482, 4961, 5291	
348	interferon, alpha 7	239347	479	239347	1101	2003, 2623, 3243, 3863, 4483, 4962, 5292	
349	interferon, alpha 8	380205	480	369553	1102	2004, 2624, 3244, 3864, 4484, 4963, 5293	
350	interferon, beta 1, fibroblast	380232	481	369581	1103	2005, 2625, 3245, 3865, 4485, 4964, 5294, 14461- 14547	1655
351	interleukin 10	423557	482	412237	1104	1487, 2006, 2626, 3246, 3866, 4486, 14548-14634	
352	interleukin 21	264497	483	264497	1105	2007, 2627, 3247, 3867, 4487, 14635- 14721	
353	interleukin 7	263851	484	263851	1106	1488, 2008, 2628, 3248, 3868, 4488, 4965, 5295, 14722-14860	1656
354	interleukin 7	379113	485	368408	1107	1489, 2009, 2629, 3249, 3869, 4489, 4966, 5296	1656
355	interleukin 7	379114	486	368409	1108	2010, 2630, 3250, 3870, 4490, 4967, 5297	
356	interleukin 7	518982	487	430272	1109	2011, 2631, 3251, 3871, 4491, 4968, 5298	
357	interleukin 7	520215	488	428364	1110	1490, 2012, 2632, 3252, 3872, 4492, 4969, 5299	
358	interleukin 7	520269	489	427750	1111	1491, 2013, 2633, 3253, 3873, 4493, 4970, 5300	

359	interleukin 7	520317	490	427800	1112	2014, 2634, 3254, 3874, 4494, 4971, 5301	
360	interleukin 7	541183	491	438922	1113	1492, 2015, 2635, 3255, 3875, 4495, 4972, 5302	
361	KIT ligand	228280	492	228280	1114	2016, 2636, 3256, 3876, 4496, 14861- 14947	
362	KIT ligand	347404	493	54216	1115	2017, 2637, 3257, 3877, 4497	
363	KIT ligand	537835	494	438889	1116	2018, 2638, 3258, 3878, 4498	
364	klotho	380099	495	369442	1117	1493, 2019, 2639, 3259, 3879, 4499, 14948-15347	
365	klotho	426690	496	399513	1118	14942020, 2640, 3260, 3880, 4500	
366	Kruppel-like factor 4 (gut)	374672	497	363804	1119	2021, 2641, 3261, 3881, 4501	
367	Kruppel-like factor 4 (gut)	411706	498	399921	1120	2022, 2642, 3262, 3882, 4502	
368	Kruppel-like factor 4 (gut)	420475	499	404922	1121	2023, 2643, 3263, 3883, 4503	
369	Kruppel-like factor 4 (gut)	439281	500	396294	1122	2024, 2644, 3264, 3884, 4504	
370	lecithin- cholesterol acyltransferase	264005	501	264005	1123	1495, 2025, 2645, 3265, 3885, 4505, 15348-15434	
371	lectin, galactoside- binding, soluble, 3	254301	502	254301	1124	2026, 2646, 3266, 3886, 4506, 15435- 15521	
372	lin-28 homolog A (C. elegans)	254231	503	254231	1125	2027, 2647, 3267, 3887, 4507	
373	lin-28 homolog A (C. elegans)	326279	504	363314	1126	2028, 2648, 3268, 3888, 4508, 15522- 15608	
374	lipase A, lysosomal acid, cholesterol	282673	505	282673	1127	1496, 2029, 2649, 3269, 3889, 4509,	

	esterase					4973, 5303	
375	lipase A, lysosomal acid, cholesterol esterase	336233	506	337354	1128	1497, 2030, 2650, 3270, 3890, 4510, 4974, 5304, 15609-15782	1657
376	lipase A, lysosomal acid, cholesterol esterase	354621	507	360895	1129	2031, 2651, 3271, 3891, 4511, 4975, 5305	
377	lipase A, lysosomal acid, cholesterol esterase	371829	508	360894	1130	2032, 2652, 3272, 3892, 4512, 4976, 5306	1657
378	lipase A, lysosomal acid, cholesterol esterase	371837	509	360903	1131	1498, 2033, 2653, 3273, 3893, 4513, 4977, 5307	
379	lipase A, lysosomal acid, cholesterol esterase	425287	510	392037	1132	1499, 2034, 2654, 3274, 3894, 4514, 4978, 5308	
380	lipase A, lysosomal acid, cholesterol esterase	428800	511	388415	1133	1500, 2035, 2655, 3275, 3895, 4515, 4979, 5309	1657
381	lipase A, lysosomal acid, cholesterol esterase	456827	512	413019	1134	2036, 2656, 3276, 3896, 4516, 4980, 5310	1657
382	lipase A, lysosomal acid, cholesterol esterase	540050	513	439727	1135	2037, 2657, 3277, 3897, 4517, 4981, 5311	
383	lipase A, lysosomal acid, cholesterol esterase	541980	514	438127	1136	2038, 2658, 3278, 3898, 4518, 4982, 5312	1657
384	lipase A, lysosomal acid, cholesterol esterase	542307	515	437564	1137	1501, 2039, 2659, 3279, 3899, 4519, 4983, 5313	1657
385	lipoprotein lipase	311322	516	309757	1138	1502, 2040, 2660, 3280, 3900, 4520, 4984, 5314, 15783-15869	
386	lipoprotein lipase	520959	517	428496	1139	1503, 2041, 2661, 3281, 3901, 4521, 4985, 5315	
387	lipoprotein lipase	522701	518	428557	1140	1504, 2042, 2662, 3282,	

						3902, 4522, 4986, 5316	
388	lipoprotein lipase	524029	519	428237	1141	1505, 2043, 2663, 3283, 3903, 4523, 4987, 5317	
389	lipoprotein lipase	535763	520	438606	1142	2044, 2664, 3284, 3904, 4524, 4988, 5318	
390	lipoprotein lipase	538071	521	439407	1143	2045, 2665, 3285, 3905, 4525, 4989, 5319	
391	liraglutide native 7-37					1506	
392	liraglutide native 7-37-A8G					1507	
393	liraglutide native 7-37-A8G-10X					1508	
394	liraglutide; GLP1; Victoza					1509	
395	LL-37; Cathelicidin anti- microbial peptide				1144		1620
396	low density lipoprotein receptor	455727	522	397829	1145	1510, 2046, 2666, 3286, 3906, 4526	
397	low density lipoprotein receptor	535915	523	440520	1146	1511, 2047, 2667, 3287, 3907, 4527	
398	low density lipoprotein receptor	545707	524	437639	1147	1512, 2048, 2668, 3288, 3908, 4528	
399	low density lipoprotein receptor	558013	525	453346	1148	1513, 2049, 2669, 3289, 3909, 4529	
400	low density lipoprotein receptor	558518	526	454071	1149	1514, 2050, 2670, 3290, 3910, 4530, 15870-16478	
401	low density lipoprotein receptor	561343	527	454147	1150	2051, 2671, 3291, 3911, 4531	
402	low density lipoprotein receptor	252444	528	252444	1151	2052, 2672, 3292, 3912, 4532	
403	luteinizing hormone beta polypeptide	221421	529	221421	1152	2053, 2673, 3293, 3913, 4533	
404	luteinizing hormone beta polypeptide	391870	530	375743	1153	2054, 2674, 3294, 3914, 4534, 4990, 5320,	

405	LY2963016; insulin glargine						
406	Ly6/neurotoxin 1	317543	531	319846	1154	2055, 2675, 3295, 3915, 4535	
407	MabThera SC; rituximab						
408	mannosidase alpha class 2B member 1	221363	532	221363	1155	2056, 2676, 3296, 3916, 4536	
409	mannosidase, alpha, class 2B, member 1	433513	533	390583	1156	1515, 2057, 2677, 3297, 3917, 4537	
410	mannosidase, alpha, class 2B, member 1	456935	534	395473	1157	1516, 2058, 2678, 3298, 3918, 4538, 16479-16565	
411	mannosidase, alpha, class 2B, member 1	536796	535	438266	1158	2059, 2679, 3299, 3919, 4539	
412	meteorin glial cell differentiation regulator	568223	536	455068	1159	2060, 2680, 3300, 3920, 4540, 16566- 16652	
413	meteorin, glial cell differentiation regulator	219542	537	219542	1160	2061, 2681, 3301, 3921, 4541	
414	methylmalonyl CoA mutase	274813	538	274813	1161	1517, 2062, 2682, 3302, 3922, 4542, 4991, 5321, 16653-16739	1658
415	methylmalonyl CoA mutase	540138	539	445535	1162	2063, 2683, 3303, 3923, 4543, 4992, 5322,	
416	microsomal triglyceride transfer protein	265517	540	265517	1163	1518, 2064, 2684, 3304, 3924, 4544, 16740-16878	
417	microsomal triglyceride transfer protein	457717	541	400821	1164	2065, 2685, 3305, 3925, 4545	
418	microsomal triglyceride transfer protein	506883	542	426755	1165	1519, 2066, 2686, 3306, 3926, 4546	
419	microsomal triglyceride transfer protein	538053	543	437358	1166	2067, 2687, 3307, 3927, 4547	
420	N- acetylglucosamine -1-phosphate transferase, alpha and beta subunits	299314	544	299314	1167	1520, 2068, 2688, 3308, 3928, 4548, 16879-17017	

421	N-acetylglucosamine-1-phosphate transferase, alpha and beta subunits	549940	545	449150	1168	1521, 2069, 2689, 3309, 3929, 4549	
422	N-acetylglutamate synthase	293404	546	293404	1169	2070, 2690, 3310, 3930, 4550, 17018-17156	
423	N-acetylglutamate synthase	541745	547	441262	1170	2071, 2691, 3311, 3931, 4551	
424	N-acylsphingosine amidohydrolase (acid ceramidase) 1	262097	548	262097	1171	1522, 2072, 2692, 3312, 3932, 455217157-17295	
425	N-acylsphingosine amidohydrolase (acid ceramidase) 1	314146	549	326970	1172	1523, 2073, 2693, 3313, 3933, 4553	
426	N-acylsphingosine amidohydrolase (acid ceramidase) 1	381733	550	371152	1173	1524, 2074, 2694, 3314, 3934, 4554	
427	N-acylsphingosine amidohydrolase (acid ceramidase) 1	417108	551	394125	1174	1525, 2075, 2695, 3315, 3935, 4555	
428	N-acylsphingosine amidohydrolase (acid ceramidase) 1	520781	552	427751	1175	1526, 2076, 2696, 3316, 3936, 4556	
429	natriuretic peptide B	376468	553	365651	1176	2077, 2697, 3317, 3937, 4557, 4993, 5323,	
430	nerve growth factor (beta polypeptide)	369512	554	358525	1177	2078, 2698, 3318, 3938, 4558, 4994, 5324, 17296-17382	
431	neuregulin 1	287840	555	287840	1178	2079, 2699, 3319, 3939, 4559	
432	neuregulin 1	287842	556	287842	1179	2080, 2700, 3320, 3940, 4560, 17383-17469	
433	neuregulin 1	287845	557	287845	1180	2081, 2701, 3321, 3941, 4561	
434	neuregulin 1	338921	558	343395	1181	2082, 2702, 3322, 3942, 4562	

435	neuregulin 1	341377	559	340497	1182	2083, 2703, 3323, 3943, 4563	
436	neuregulin 1	356819	560	349275	1183	2084, 2704, 3324, 3944, 4564	
437	neuregulin 1	405005	561	384620	1184	2085, 2705, 3325, 3945, 4565	
438	neuregulin 1	519301	562	429582	1185	2086, 2706, 3326, 3946, 4566	
439	neuregulin 1	520407	563	434640	1186	2087, 2707, 3327, 3947, 4567, 17470- 17556	
440	neuregulin 1	520502	564	433289	1187	2088, 2708, 3328, 3948, 4568	
441	neuregulin 1	521670	565	428828	1188	2089, 2709, 3329, 3949, 4569	
442	neuregulin 1	539990	566	439276	1189	2090, 2710, 3330, 3950, 4570	
443	neuregulin 1	523079	567	430120	1190	2091, 2711, 3331, 3951, 4571	
444	OMOMYC				1191	1527, 17557- 17643	
445	OMOMYC90 (90AA truncated domain)					1528, 17644- 17784	
446	Orencia S.C.; abatacept						
447	ornithine carbamoyltransfer ase	39007	568	39007	1192	1529, 2092, 2712, 3332, 3952, 4572, 4995, 5325, 17785-17871	1659
448	parathyroid hormone	282091	569	282091	1193	2093, 2713, 3333, 3953, 4573, 4996, 5326	
449	parathyroid hormone	529816	570	433208	1194	2094, 2714, 3334, 3954, 4574, 4997, 5327	
450	PBO-326; rituximab						
451	phenylalanine hydroxylase	546844	571	446658	1195	1530, 2095, 2715, 3335, 3955, 4575, 4998, 5328	

452	phenylalanine hydroxylase	551337	572	447620	1196	1531, 2096, 2716, 3336, 3956, 4576, 4999, 5329	
453	phenylalanine hydroxylase	553106	573	448059	1197	1532, 2097, 2717, 3337, 3957, 4577, 5000, 5330, 17872-17958	1660
454	phosphorylase kinase beta	566044	574	456729	1198	2098, 2718, 3338, 3958, 4578	
455	phosphorylase kinase gamma 2 (testis)	563588	575	455607	1199	2099, 2719, 3339, 3959, 4579, 17959-18045	
456	phosphorylase kinase, alpha 2 (liver)	379942	576	369274	1200	2100, 2720, 3340, 3960, 4580, 18046-18132	
457	phosphorylase kinase, beta	299167	577	299167	1201	2101, 2721, 3341, 3961, 4581	
458	phosphorylase kinase, beta	323584	578	313504	1202	2102, 2722, 3342, 3962, 4582, 18133-18219	
459	phosphorylase kinase, beta	455779	579	414345	1203	2103, 2723, 3343, 3963, 4583	
460	phosphorylase kinase, gamma 2 (testis)	328273	580	329968	1204	2104, 2724, 3344, 3964, 4584	
461	phosphorylase kinase, gamma 2 (testis)	424889	581	388571	1205	2105, 2725, 3345, 3965, 4585	
462	phosphorylase, glycogen, liver	216392	582	216392	1206	2106, 2726, 3346, 3966, 4586	
463	phosphorylase, glycogen, liver	544180	583	443787	1207	2107, 2727, 3347, 3967, 4587	
464	plasminogen	308192	584	308938	1208	1533, 2108, 2728, 3348, 3968, 4588, 18220-18271	
465	plasminogen	316325	585	321466	1209	2109, 2729, 3349, 3969, 4589	
466	plasminogen	366924	586	355891	1210	1534, 2110, 2730, 3350, 3970, 4590	
467	plasminogen activator, tissue	220809	587	220809	1211	1535, 2111, 2731, 3351, 3971, 4591,	1661

						18272-18358	
468	plasminogen activator, tissue	270189	588	270189	1212	1536, 2112, 2732, 3352, 3972, 4592, 5001, 5331	1661
469	plasminogen activator, tissue	352041	589	270188	1213	1537, 2113, 2733, 3353, 3973, 4593, 5002, 5332	1661
470	plasminogen activator, tissue	429089	590	392045	1214	2114, 2734, 3354, 3974, 4594, 5003, 5333	1661
471	plasminogen activator, tissue	429710	591	407861	1215	1538, 2115, 2735, 3355, 3975, 4595, 5004, 5334	
472	plasminogen activator, tissue	519510	592	428886	1216	1539, 2116, 2736, 3356, 3976, 4596, 5005, 5335	
473	plasminogen activator, tissue	520523	593	428797	1217	1540, 2117, 2737, 3357, 3977, 4597, 5006, 5336	1661
474	plasminogen activator, tissue	521694	594	429801	1218	1541, 2118, 2738, 3358, 3978, 4598, 5007, 5337	1661
475	plasminogen activator, tissue	524009	595	429401	1219	1542, 2119, 2739, 3359, 3979, 4599, 5008, 5338	
476	POU class 5 homeobox 1	259915	596	259915	1220	2120, 2740, 3360, 3980, 4600	
477	POU class 5 homeobox 1	376243	597	365419	1221	2121, 2741, 3361, 3981, 4601	
478	POU class 5 homeobox 1	383524	598	373016	1222	2122, 2742, 3362, 3982, 4602	
479	POU class 5 homeobox 1	412166	599	387646	1223	2123, 2743, 3363, 3983, 4603	
480	POU class 5 homeobox 1	419095	600	413622	1224	2124, 2744, 3364, 3984, 4604	
481	POU class 5 homeobox 1	429603	601	392877	1225	2125, 2745, 3365, 3985, 4605	
482	POU class 5 homeobox 1	433063	602	405041	1226	2126, 2746, 3366, 3986,	

						4606	
483	POU class 5 homeobox 1	433348	603	412665	1227	2127, 2747, 3367, 3987, 4607	
484	POU class 5 homeobox 1	434616	604	388842	1228	2128, 2748, 3368, 3988, 4608, 18359- 18445	
485	POU class 5 homeobox 1	448657	605	416165	1229	2129, 2749, 3369, 3989, 4609	
486	POU class 5 homeobox 1	451077	606	391507	1230	2130, 2750, 3370, 3990, 4610	
487	POU class 5 homeobox 1	454714	607	400047	1231	2131, 2751, 3371, 3991, 4611	
488	POU class 5 homeobox 1	546505	608	448154	1232	2132, 2752, 3372, 3992, 4612	
489	POU class 5 homeobox 1	547234	609	449442	1233	2133, 2753, 3373, 3993, 4613	
490	POU class 5 homeobox 1	547658	610	446962	1234	2134, 2754, 3374, 3994, 4614	
491	POU class 5 homeobox 1	548682	611	446815	1235	2135, 2755, 3375, 3995, 4615	
492	POU class 5 homeobox 1	550059	612	447874	1236	2136, 2756, 3376, 3996, 4616	
493	POU class 5 homeobox 1	550521	613	447969	1237	2137, 2757, 3377, 3997, 4617	
494	POU class 5 homeobox 1	550572	614	448254	1238	2138, 2758, 3378, 3998, 4618	
495	POU class 5 homeobox 1	553069	615	448231	1239	2139, 2759, 3379, 3999, 4619	
496	POU class 5 homeobox 1	553206	616	446757	1240	2140, 2760, 3380, 4000, 4620	
497	proprotein convertase subtilisin/kexin type 9	302118	617	303208	1241	2141, 2761, 3381, 4001, 4621	
498	proprotein convertase subtilisin/kexin type 9	452118	618	401598	1242	2142, 2762, 3382, 4002, 4622	

499	proprotein convertase subtilisin/kexin type 9	543384	619	441859	1243	2143, 2763, 3383, 4003, 4623	
500	protein C (inactivator of coagulation factors Va and VIIIa)	234071	620	234071	1244	2144, 2764, 3384, 4004, 4624	
501	protein C (inactivator of coagulation factors Va and VIIIa)	409048	621	386679	1245	2145, 2765, 3385, 4005, 4625, 5009, 5339	
502	protein C (inactivator of coagulation factors Va and VIIIa)	422777	622	409543	1246	2146, 2766, 3386, 4006, 4626, 5010, 5340	
503	protein C (inactivator of coagulation factors Va and VIIIa)	427769	623	406295	1247	2147, 2767, 3387, 4007, 4627, 5011, 5341	
504	protein C (inactivator of coagulation factors Va and VIIIa)	429925	624	412697	1248	2148, 2768, 3388, 4008, 4628, 5012, 5342	
505	protein C (inactivator of coagulation factors Va and VIIIa)	453608	625	404030	1249	2149, 2769, 3389, 4009, 4629, 5013, 5343	
506	protein C (inactivator of coagulation factors Va and VIIIa)	537436	626	442106	1250	2150, 2770, 3390, 4010, 4630, 5014, 5344	
507	relaxin 2	308420	627	308018	1251	2151, 2771, 3391, 4011, 4631	
508	relaxin 2	381627	628	371040	1252	2152, 2772, 3392, 4012, 4632, 18446-18532	
509	Reverse Caspase 3 (cleavable)					1543	
510	Reverse Caspase 3 (non-cleavable)					1544	
511	Reverse Caspase 6					1545	
512	rhodopsin	296271	629	296271	1253	2153, 2773, 3393, 4013, 4633, 5015, 5345, 18533-18619	
513	Rituximab; rituximab						
514	serpin peptidase inhibitor, clade A (alpha-1 antiproteinase,	355814	630	348068	1254	2154, 2774, 3394, 4014, 4634, 5016, 5346, 18620-	1662

	antitrypsin), member 1					18706	
515	serpin peptidase inhibitor, clade A (alpha-1 antiproteinase, antitrypsin), member 1	393087	631	376802	1255	2155, 2775, 3395, 4015, 4635, 5017, 5347	1662
516	serpin peptidase inhibitor, clade A (alpha-1 antiproteinase, antitrypsin), member 1	393088	632	376803	1256	2156, 2776, 3396, 4016, 4636, 5018, 5348	1662
517	serpin peptidase inhibitor, clade A (alpha-1 antiproteinase, antitrypsin), member 1	402629	633	386094	1257	2157, 2777, 3397, 4017, 4637, 5019, 5349	
518	serpin peptidase inhibitor, clade A (alpha-1 antiproteinase, antitrypsin), member 1	404814	634	385960	1258	2158, 2778, 3398, 4018, 4638, 5020, 5350	1662
519	serpin peptidase inhibitor, clade A (alpha-1 antiproteinase, antitrypsin), member 1	437397	635	408474	1259	2159, 2779, 3399, 4019, 4639, 5021, 5351	1662
520	serpin peptidase inhibitor, clade A (alpha-1 antiproteinase, antitrypsin), member 1	440909	636	390299	1260	2160, 2780, 3400, 4020, 4640, 5022, 5352	1662
521	serpin peptidase inhibitor, clade A (alpha-1 antiproteinase, antitrypsin), member 1	448921	637	416066	1261	2161, 2781, 3401, 4021, 4641, 5023, 5353	1662
522	serpin peptidase inhibitor, clade A (alpha-1 antiproteinase, antitrypsin), member 1	449399	638	416354	1262	2162, 2782, 3402, 4022, 4642, 5024, 5354	1662

523	serpin peptidase inhibitor, clade A (alpha-1 antiproteinase, antitrypsin), member 1	553327	639	452480	1263	2163, 2783, 3403, 4023, 4643, 5025, 5355, 18707-18793	
524	serpin peptidase inhibitor, clade A (alpha-1 antiproteinase, antitrypsin), member 1	556091	640	452169	1264	2164, 2784, 3404, 4024, 4644, 5026, 5356	
525	serpin peptidase inhibitor, clade A (alpha-1 antiproteinase, antitrypsin), member 1	556955	641	451098	1265	2165, 2785, 3405, 4025, 4645, 5027, 5357	
526	serpin peptidase inhibitor, clade A (alpha-1 antiproteinase, antitrypsin), member 1	557118	642	451826	1266	2166, 2786, 3406, 4026, 4646, 5028, 5358	
527	serpin peptidase inhibitor, clade A (alpha-1 antiproteinase, antitrypsin), member 1	557492	643	452452	1267	2167, 2787, 3407, 4027, 4647, 5029, 5359	
528	serpin peptidase inhibitor, clade C (antithrombin), member 1	351522	644	307953	1268	2168, 2788, 3408, 4028, 4648, 5030, 5360	
529	serpin peptidase inhibitor, clade C (antithrombin), member 1	367698	645	356671	1269	1546, 2169, 2789, 3409, 4029, 4649, 5031, 5361, 18794-18932	
530	serpin peptidase inhibitor, clade F (alpha-2 antiplasmin, pigment epithelium derived factor), member 2	324015	646	321853	1270	1547, 2170, 2790, 3410, 4030, 4650	
531	serpin peptidase inhibitor, clade F (alpha-2 antiplasmin, pigment epithelium derived factor), member 2	382061	647	371493	1271	2171, 2791, 3411, 4031, 4651, 18933-19071	
532	serpin peptidase inhibitor, clade F	450523	648	403877	1272	1548, 2172, 2792, 3412,	

	(alpha-2 antiplasmin, pigment epithelium derived factor), member 2					4032, 4652	
533	serpin peptidase inhibitor, clade F (alpha-2 antiplasmin, pigment epithelium derived factor), member 2	453066	649	402286	1273	1549, 2173, 2793, 3413, 4033, 4653	
534	serpin peptidase inhibitor, clade G (C1 inhibitor), member 1	278407	650	278407	1274	1550, 2174, 2794, 3414, 4034, 4654, 5032, 5362, 19072-19210	
535	serpin peptidase inhibitor, clade G (C1 inhibitor), member 1	378323	651	367574	1275	1551, 2175, 2795, 3415, 4035, 4655, 5033, 5363	
536	serpin peptidase inhibitor, clade G (C1 inhibitor), member 1	378324	652	367575	1276	1552, 2176, 2796, 3416, 4036, 4656, 5034, 5364	
537	serpin peptidase inhibitor, clade G (C1 inhibitor), member 1	405496	653	384561	1277	1553, 2177, 2797, 3417, 4037, 4657, 5035, 5365	
538	serpin peptidase inhibitor, clade G (C1 inhibitor), member 1	433668	654	399800	1278	2178, 2798, 3418, 4038, 4658, 5036, 5366	
539	sirtuin 1	212015	655	212015	1279	1554, 2179, 2799, 3419, 4039, 4659, 19211-19297	1663
540	sirtuin 1	403579	656	384063	1280	1555, 2180, 2800, 3420, 4040, 4660, 5037, 5367	
541	sirtuin 1	406900	657	384508	1281	2181, 2801, 3421, 4041, 4661, 5038, 5368	
542	sirtuin 1	432464	658	409208	1282	1556, 2182, 2802, 3422, 4042, 4662, 5039, 5369	1664
543	sirtuin 6	305232	659	305310	1283	1557, 2183, 2803, 3423, 4043, 4663, 5040, 5370	

544	sirtuin 6	337491	660	337332	1284	1558, 2184, 2804, 3424, 4044, 4664, 5041, 5371, 19298-19384	1665
545	sirtuin 6	381935	661	371360	1285	1559, 2185, 2805, 3425, 4045, 4665, 5042, 5372	
546	solute carrier family 2 (facilitated glucose transporter), member 2	314251	662	323568	1286	1560, 2186, 2806, 3426, 4046, 4666, 19385-19523	
547	solute carrier family 2 (facilitated glucose transporter), member 2	382808	663	372258	1287	1561, 2187, 2807, 3427, 4047, 4667	
548	solute carrier family 37 (glucose-6- phosphate transporter) member 4	577093	664	461344	1288	2188, 2808, 3428, 4048, 4668,, 19524- 19610	
549	solute carrier family 37 (glucose-6- phosphate transporter) member 4	590663	665	464769	1289	2189, 2809, 3429, 4049, 4669	
550	solute carrier family 40 (iron- regulated transporter), member 1	261024	666	261024	1290	2190, 2810, 3430, 4050, 4670	
551	solute carrier family 40 (iron- regulated transporter), member 1	427241	667	390005	1291	2191, 2811, 3431, 4051, 4671	
552	solute carrier family 40 (iron- regulated transporter), member 1	427419	668	392730	1292	2192, 2812, 3432, 4052, 4672	
553	solute carrier family 40 (iron- regulated transporter), member 1	440626	669	396134	1293	2193, 2813, 3433, 4053, 4673	
554	solute carrier family 40 (iron- regulated transporter),	455320	670	413549	1294	2194, 2814, 3434, 4054, 4674	

	member 1						
555	solute carrier family 40 (iron-regulated transporter), member 1	481497	671	446069	1295	2195, 2815, 3435, 4055, 4675	
556	solute carrier family 40 (iron-regulated transporter), member 1	544056	672	444582	1296	2196, 2816, 3436, 4056, 4676	
557	sortilin 1	256637	673	256637	1297	1562, 2197, 2817, 3437, 4057, 4677, 5043, 5373	
558	sortilin 1	538502	674	438597	1298	1563, 2198, 2818, 3438, 4058, 4678, 5044, 5374, 19611-19697	
559	sperm adhesion molecule 1 (PH-20 hyaluronidase, zona pellucida binding)	223028	675	223028	1299	2199, 2819, 3439, 4059, 4679	
560	sperm adhesion molecule 1 (PH-20 hyaluronidase, zona pellucida binding)	340011	676	345849	1300	2200, 2820, 3440, 4060, 4680, 5045, 5375	
561	sperm adhesion molecule 1 (PH-20 hyaluronidase, zona pellucida binding)	402183	677	386028	1301	2201, 2821, 3441, 4061, 4681, 5046, 5376	
562	sperm adhesion molecule 1 (PH-20 hyaluronidase, zona pellucida binding)	413927	678	391491	1302	2202, 2822, 3442, 4062, 4682, 5047, 5377	
563	sperm adhesion molecule 1 (PH-20 hyaluronidase, zona pellucida binding)	439500	679	402123	1303	2203, 2823, 3443, 4063, 4683, 5048, 5378	
564	sperm adhesion molecule 1 (PH-20 hyaluronidase, zona pellucida binding)	460182	680	417934	1304	2204, 2824, 3444, 4064, 4684, 5049, 5379	
565	sphingomyelin phosphodiesterase 1, acid lysosomal	299397	681	299397	1305	1564, 2205, 2825, 3445, 4065, 4685,	

						5050, 5380,	
566	sphingomyelin phosphodiesterase 1, acid lysosomal	342245	682	340409	1306	1565, 2206, 2826, 3446, 4066, 4686, 5051, 5381, 19698-19784	1666
567	sphingomyelin phosphodiesterase 1, acid lysosomal	356761	683	349203	1307	1566, 2207, 2827, 3447, 4067, 4687, 5052, 5382	
568	sphingomyelin phosphodiesterase 1, acid lysosomal	527275	684	435350	1308	1567, 2208, 2828, 3448, 4068, 4688, 5053, 5383	
569	sphingomyelin phosphodiesterase 1, acid lysosomal	533123	685	435950	1309	1568, 2209, 2829, 3449, 4069, 4689, 5054, 5384	
570	sphingomyelin phosphodiesterase 1, acid lysosomal	534405	686	434353	1310	1569, 2210, 2830, 3450, 4070, 4690, 5055, 5385	
571	SRY (sex determining region Y)-box 2	325404	687	323588	1311	2211, 2831, 3451, 4071, 4691	
572	SRY (sex determining region Y)-box 2	431565	688	439111	1312	2212, 2832, 3452, 4072, 4692, 19785-19871	
573	Subcutaneous Herceptin; trastuzumab						
574	surfactant protein B	393822	689	377409	1313	2213, 2833, 3453, 4073, 4693	
575	surfactant protein B	409383	690	386346	1314	2214, 2834, 3454, 4074, 4694	
576	surfactant protein B	441838	691	395757	1315	2215, 2835, 3455, 4075, 4695	
577	surfactant protein B	519937	692	428719	1316	2216, 2836, 3456, 4076, 4696	
578	Synagis						
579	thrombomodulin	377103	693	366307	1317	1570, 2217, 2837, 3457, 4077, 4697, 19872-19958	
580	thrombomodulin	503590	694	440119	1318	2218, 2838, 3458, 4078, 4698	

581	thrombopoietin	204615	695	204615	1319	1571, 2219, 2839, 3459, 4079, 4699, 5056, 5386, 19959-20045	1667
582	thrombopoietin	353488	696	341335	1320	2220, 2840, 3460, 4080, 4700, 5057, 5387	
583	thrombopoietin	421442	697	411704	1321	1572, 2221, 2841, 3461, 4081, 4701, 5058, 5388	
584	thrombopoietin	445696	698	410763	1322	1573, 2222, 2842, 3462, 4082, 4702, 5059, 5389	
585	TL011; rituximab						
586	transferrin receptor 2	223051	699	223051	1323	2223, 2843, 3463, 4083, 4703	
587	transferrin receptor 2	431692	700	413905	1324	2224, 2844, 3464, 4084, 4704	
588	transferrin receptor 2	462107	701	420525	1325	2225, 2845, 3465, 4085, 4705	
589	transferrin receptor 2	544242	702	443656	1326	2226, 2846, 3466, 4086, 4706	
590	transforming growth factor, beta 1	221930	703	221930	1327	2227, 2847, 3467, 4087, 4707, 20046- 20132	1668
591	transforming growth factor, beta 2	366929	704	355896	1328	2228, 2848, 3468, 4088, 4708	
592	transforming growth factor, beta 2	366930	705	355897	1329	2229, 2849, 3469, 4089, 4709	
593	transforming growth factor, beta 3	238682	706	238682	1330	2230, 2850, 3470, 4090, 4710, 5060, 5390, 20133- 20219	
594	transforming growth factor, beta 3	556285	707	451110	1331	2231, 2851, 3471, 4091, 4711, 5061, 5391	
595	transthyretin	237014	708	237014	1332	2232, 2852, 3472, 4092, 4712, 20220- 20358	

596	transthyretin	432547	709	396762	1333	2233, 2853, 3473, 4093, 4713	
597	transthyretin	541025	710	442134	1334	2234, 2854, 3474, 4094, 4714	
598	tuftelin 1	353024	711	343781	1335	2235, 2855, 3475, 4095, 4715, 5062, 5392	1669
599	tuftelin 1	368848	712	357841	1336	2236, 2856, 3476, 4096, 4716, 5063, 5393	1669
600	tuftelin 1	368849	713	357842	1337	2237, 2857, 3477, 4097, 4717, 5064, 5394, 20359- 20445	1669
601	tuftelin 1	507671	714	443643	1338	2238, 2858, 3478, 4098, 4718, 5065, 5395	1669
602	tuftelin 1	538902	715	437997	1339	2239, 2859, 3479, 4099, 4719, 5066, 5396	
603	tuftelin 1	544350	716	441557	1340	2240, 2860, 3480, 4100, 4720, 5067, 5397	1669
604	tumor protein p53	269305	717	269305	1341	1574, 2241, 2861, 3481, 4101, 4721, 5068, 5398, 20446-20532	1670
605	tumor protein p53	359597	718	352610	1342	1575, 2242, 2862, 3482, 4102, 4722, 5069, 5399	
606	tumor protein p53	396473	719	379735	1343	2243, 2863, 3483, 4103, 4723, 5070, 5400	
607	tumor protein p53	413465	720	410739	1344	1576, 2244, 2864, 3484, 4104, 4724, 5071, 5401	
608	tumor protein p53	414315	721	394195	1345	2245, 2865, 3485, 4105, 4725, 5072, 5402	
609	tumor protein p53	419024	722	402130	1346	2246, 2866, 3486, 4106, 4726, 5073,	

						5403	
610	tumor protein p53	420246	723	391127	1347	1577, 2247, 2867, 3487, 4107, 4727, 5074, 5404	
611	tumor protein p53	445888	724	391478	1348	2248, 2868, 3488, 4108, 4728, 5075, 5405	1670
612	tumor protein p53	455263	725	398846	1349	1578, 2249, 2869, 3489, 4109, 4729, 5076, 5406	
613	tumor protein p53	503591	726	426252	1350	1579, 2250, 2870, 3490, 4110, 4730, 5077, 5407	
614	tumor protein p53	508793	727	424104	1351	1580, 2251, 2871, 3491, 4111, 4731, 5078, 5408	
615	tumor protein p53	509690	728	425104	1352	1581, 2252, 2872, 3492, 4112, 4732, 5079, 5409	
616	tumor protein p53	514944	729	423862	1353	1582, 2253, 2873, 3493, 4113, 4733, 5080, 5410	
617	tumor protein p53	545858	730	437792	1354	2254, 2874, 3494, 4114, 4734, 5081, 5411	
618	tyrosinase (oculocutaneous albinism IA)	263321	731	263321	1355	2255, 2875, 3495, 4115, 4735, , , 20533- 20619	
619	tyrosine aminotransferase	355962	732	348234	1356	1583, 2256, 2876, 3496, 4116, 4736, , , 20620-20758	
620	UDP glucuronosyltransf erase 1 family, polypeptide A1	305208	733	304845	1357	1584, 2257, 2877, 3497, 4117, 4737, , , 20759-20845	
621	UDP glucuronosyltransf erase 1 family, polypeptide A1	360418	734	353593	1358	1585, 2258, 2878, 3498, 4118, 4738	
622	UDP glucuronosyltransf erase 1 family, polypeptide A10	344644	735	343838	1359	2259, 2879, 3499, 4119, 4739	

623	UDP glucuronosyltransf erase 1 family, polypeptide A3	482026	736	418532	1360	2260, 2880, 3500, 4120, 4740	
624	UDP glycosyltransferas e 3 family polypeptide A2	513300	737	427404	1361	2261, 2881, 3501, 4121, 4741, 5082, 5412	
625	UDP glycosyltransferas e 3 family, polypeptide A2	282507	738	282507	1362	2262, 2882, 3502, 4122, 4742, 5083, 5413	1671
626	UDP glycosyltransferas e 3 family, polypeptide A2	515131	739	420865	1363	2263, 2883, 3503, 4123, 4743, 5084, 5414	
627	UDP glycosyltransferas e 3 family, polypeptide A2	545528	740	445367	1364	2264, 2884, 3504, 4124, 4744, 5085, 5415	
628	vascular endothelial growth factor A	230480	741	230480	1365	1586, 2265, 2885, 3505, 4125, 4745	
629	vascular endothelial growth factor A	324450	742	317598	1366	1587, 2266, 2886, 3506, 4126, 4746, 5086, 5416	
630	vascular endothelial growth factor A	372055	743	361125	1367	1588, 2267, 2887, 3507, 4127, 4747, 5087, 5417	
631	vascular endothelial growth factor A	372064	744	361134	1368	1589, 2268, 2888, 3508, 4128, 4748, 5088, 5418	
632	vascular endothelial growth factor A	372067	745	361137	1369	1590, 2269, 2889, 3509, 4129, 4749, 5089, 5419, 20846-20932	1672
633	vascular endothelial growth factor A	372077	746	361148	1370	1591, 2270, 2890, 3510, 4130, 4750, 5090, 5420	
634	vascular endothelial growth factor A	413642	747	389864	1371	1592, 2271, 2891, 3511, 4131, 4751, 5091, 5421	
635	vascular endothelial growth factor A	417285	748	388663	1372	1593, 2272, 2892, 3512, 4132, 4752, 5092, 5422	
636	vascular endothelial growth factor A	425836	749	388465	1373	1594, 2273, 2893, 3513, 4133, 4753,	

						5093, 5423	
637	vascular endothelial growth factor A	457104	750	409911	1374	1595, 2274, 2894, 3514, 4134, 4754, 5094, 5424	
638	vascular endothelial growth factor A	482630	751	421561	1375	1596, 2275, 2895, 3515, 4135, 4755, 5095, 5425	
639	vascular endothelial growth factor A	518689	752	430829	1376	1597, 2276, 2896, 3516, 4136, 4756, 5096, 5426	
640	vascular endothelial growth factor A	518824	753	430002	1377	1598, 2277, 2897, 3517, 4137, 4757, 5097, 5427	
641	vascular endothelial growth factor A	519767	754	430594	1378	1599, 2278, 2898, 3518, 4138, 4758, 5098, 5428	
642	vascular endothelial growth factor A	520948	755	428321	1379	1600, 2279, 2899, 3519, 4139, 4759, 5099, 5429	
643	vascular endothelial growth factor A	523125	756	429008	1380	1601, 2280, 2900, 3520, 4140, 4760, 5100, 5430	
644	vascular endothelial growth factor A	523873	757	430479	1381	1602, 2281, 2901, 3521, 4141, 4761, 5101, 5431	
645	vascular endothelial growth factor A	523950	758	429643	1382	1603, 2282, 2902, 3522, 4142, 4762, 5102, 5432	
646	vascular endothelial growth factor C	280193	759	280193	1383	1604, 2283, 2903, 3523, 4143, 4763, 20933-21019	
647	vasoactive intestinal peptide	367243	760	356212	1384	1605, 2284, 2904, 3524, 4144, 4764	
648	vasoactive intestinal peptide	367244	761	356213	1385	1606, 2285, 2905, 3525, 4145, 4765, 21020-21106	
649	vasoactive intestinal peptide	431366	762	410356	1386	1607, 2286, 2906, 3526, 4146, 4766	
650	v-myc myelocytomatosis	259523	763	259523	1387	2287, 2907, 3527, 4147,	

	viral oncogene homolog (avian)					4767	
651	v-myc myelocytomatosis viral oncogene homolog (avian)	377970	764	367207	1388	2288, 2908, 3528, 4148, 4768, 21107-21110	
652	v-myc myelocytomatosis viral oncogene homolog (avian)	454617	765	405312	1389	2289, 2909, 3529, 4149, 4769	
653	v-myc myelocytomatosis viral oncogene homolog (avian)	524013	766	430235	1390	2290, 2910, 3530, 4150, 4770, 21111-21284	
654	von Willebrand factor	261405	767	261405	1391	1608, 2291, 2911, 3531, 4151, 4771, 21285-21423	
655	zinc finger, GATA-like protein 1	403903	768	384434	1392	2292, 2912, 3532, 4152, 4772	

Protein Cleavage Signals and Sites

[000288] In one embodiment, the polypeptides of the present invention may include at least one protein cleavage signal containing at least one protein cleavage site. The protein cleavage site may be located at the N-terminus, the C-terminus, at any space between the N- and the C-termini such as, but not limited to, half-way between the N- and C-termini, between the N-terminus and the half way point, between the half way point and the C-terminus, and combinations thereof.

[000289] The polypeptides of the present invention may include, but is not limited to, a proprotein convertase (or prohormone convertase), thrombin or Factor Xa protein cleavage signal. Proprotein convertases are a family of nine proteinases, comprising seven basic amino acid-specific subtilisin-like serine proteinases related to yeast kexin, known as prohormone convertase 1/3 (PC1/3), PC2, furin, PC4, PC5/6, paired basic amino-acid cleaving enzyme 4 (PACE4) and PC7, and two other subtilases that cleave at non-basic residues, called subtilisin kexin isozyme 1 (SKI-1) and proprotein convertase subtilisin kexin 9 (PCSK9). Non-limiting examples of protein cleavage signal amino acid sequences are listing in Table 7. In Table 7, "X" refers to any amino acid, "n" may be 0, 2, 4 or 6 amino acids and "*" refers to the protein cleavage site. In Table 7, SEQ ID NO: 21426 refers to when n=4 and SEQ ID NO: 21427 refers to when n=6.

Table 7. Protein Cleavage Site Sequences

Protein Cleavage Signal	Amino Acid Cleavage Sequence	SEQ ID NO
Proprotein convertase	R-X-X-R*	21424
	R-X-K/R-R*	21425
	K/R-X _n -K/R*	21426 or 21427
Thrombin	L-V-P-R*-G-S	21428
	L-V-P-R*	21429
	A/F/G/I/L/T/V/M-A/F/G/I/L/T/V/W-P-R*	21430
Factor Xa	I-E-G-R*	21431
	I-D-G-R*	21432
	A-E-G-R*	21433
	A/F/G/I/L/T/V/M-D/E-G-R*	21434

[000290] In one embodiment, the primary constructs and the mmRNA of the present invention may be engineered such that the primary construct or mmRNA contains at least one encoded protein cleavage signal. The encoded protein cleavage signal may be located before the start codon, after the start codon, before the coding region, within the coding region such as, but not limited to, half way in the coding region, between the start codon and the half way point, between the half way point and the stop codon, after the coding region, before the stop codon, between two stop codons, after the stop codon and combinations thereof.

[000291] In one embodiment, the primary constructs or mmRNA of the present invention may include at least one encoded protein cleavage signal containing at least one protein cleavage site. The encoded protein cleavage signal may include, but is not limited to, a proprotein convertase (or prohormone convertase), thrombin and/or Factor Xa protein cleavage signal. One of skill in the art may use Table 1 above or other known methods to determine the appropriate encoded protein cleavage signal to include in the primary constructs or mmRNA of the present invention. For example, starting with the signal of Table 7 and considering the codons of Table 1 one can design a signal for the primary construct which can produce a protein signal in the resulting polypeptide.

[000292] In one embodiment, the polypeptides of the present invention include at least one protein cleavage signal and/or site.

[000293] As a non-limiting example, U.S. Pat. No. 7,374,930 and U.S. Pub. No. 20090227660, herein incorporated by reference in their entireties, use a furin cleavage site to cleave the N-terminal methionine of GLP-1 in the expression product from the Golgi apparatus of the cells. In one embodiment, the polypeptides of the present invention include at least one protein cleavage signal and/or site with the proviso that the polypeptide is not GLP-1.

[000294] In one embodiment, the primary constructs or mmRNA of the present invention includes at least one encoded protein cleavage signal and/or site.

[000295] In one embodiment, the primary constructs or mmRNA of the present invention includes at least one encoded protein cleavage signal and/or site with the proviso that the primary construct or mmRNA does not encode GLP-1 .

[000296] In one embodiment, the primary constructs or mmRNA of the present invention may include more than one coding region. Where multiple coding regions are present in the primary construct or mmRNA of the present invention, the multiple coding regions may be separated by encoded protein cleavage sites. As a non-limiting example, the primary construct or mmRNA may be signed in an ordered pattern. On such pattern follows AXBY form where A and B are coding regions which may be the same or different coding regions and/or may encode the same or different polypeptides, and X and Y are encoded protein cleavage signals which may encode the same or different protein cleavage signals. A second such pattern follows the form AXYBZ where A and B are coding regions which may be the same or different coding regions and/or may encode the same or different polypeptides, and X, Y and Z are encoded protein cleavage signals which may encode the same or different protein cleavage signals. A third pattern follows the form ABXCY where A, B and C are coding regions which may be the same or different coding regions and/or may encode the same or different polypeptides, and X and Y are encoded protein cleavage signals which may encode the same or different protein cleavage signals.

[000297] In one embodiment, the polypeptides, primary constructs and mmRNA can also contain sequences that encode protein cleavage sites so that the polypeptides, primary constructs and mmRNA can be released from a carrier region or a fusion partner by treatment with a specific protease for said protein cleavage site.

[000298] In one embodiment, the polypeptides, primary constructs and mmRNA of the present invention may include a sequence encoding the 2A peptide. In one embodiment, this sequence may be used to separate the coding region of two or more polypeptides of interest. As a non-limiting example, the sequence encoding the 2A peptide may be between coding region A and coding region B (A-2Apep-B). The presence of the 2A peptide would result in the cleavage of one long protein into protein A, protein B and the 2A peptide. Protein A and protein B may be the same or different polypeptides of interest. In another embodiment, the 2A peptide may be used in the polynucleotides, primary constructs and/or mmRNA of the present invention to produce two, three, four, five, six, seven, eight, nine, ten or more proteins.

Incorporating Post Transcriptional Control Modulators

[000299] In one embodiment, the polynucleotides, primary constructs and/or mmRNA of the present invention may include at least one post transcriptional control modulator. These post transcriptional control modulators may be, but are not limited to, small molecules, compounds and regulatory sequences. As a non-limiting example, post transcriptional control may be achieved using small molecules identified by PTC Therapeutics Inc. (South Plainfield, NJ) using their GEMS™ (Gene Expression Modulation by Small-Moleclues) screening technology.

[000300] The post transcriptional control modulator may be a gene expression modulator which is screened by the method detailed in or a gene expression modulator described in International Publication No. WO2006022712, herein incorporated by reference in its entirety. Methods identifying RNA regulatory sequences involved in translational control are described in International Publication No. WO2004067728, herein incorporated by reference in its entirety; methods identifying compounds that modulate untranslated region dependent expression of a gene are described in International Publication No. WO2004065561, herein incorporated by reference in its entirety.

[000301] In one embodiment, the polynucleotides, primary constructs and/or mmRNA of the present invention may include at least one post transcriptional control modulator is located in the 5' and/or the 3' untranslated region of the polynucleotides, primary constructs and/or mmRNA of the present invention

[000302] In another embodiment, the polynucleotides, primary constructs and/or mmRNA of the present invention may include at least one post transcription control modulator to modulate premature translation termination. The post transcription control modulators may be compounds described in or a compound found by methods outlined in International Publication Nso. WO2004010106, WO2006044456, WO2006044682, WO2006044503 and WO2006044505, each of which is herein incorporated by reference in its entirety. As a non-limiting example, the compound may bind to a region of the 28S ribosomal RNA in order to modulate premature translation termination (See e.g., WO2004010106, herein incorporated by reference in its entirety).

[000303] In one embodiment, polynucleotides, primary constructs and/or mmRNA of the present invention may include at least one post transcription control modulator to alter protein expression. As a non-limiting example, the expression of VEGF may be regulated using the compounds described in or a compound found by the methods described in International Publication Nos. WO20051 18857, WO2006065480, WO2006065479 and WO2006058088, each of which is herein incorporated by reference in its entirety.

[000304] The polynucleotides, primary constructs and/or mmRNA of the present invention may include at least one post transcription control modulator to control translation. In one embodiment, the post transcription control modulator may be a RNA regulatory sequence. As a non-limiting example, the RNA regulatory sequence may be identified by the methods described in International Publication No. WO2006071903, herein incorporated by reference in its entirety.

III. Modifications

[000305] Herein, in a polynucleotide (such as a primary construct or an mRNA molecule), the terms "modification" or, as appropriate, "modified" refer to modification with respect to A, G, U or C ribonucleotides. Generally, herein, these terms are not intended to refer to the ribonucleotide modifications in naturally occurring 5'-terminal mRNA cap moieties. In a polypeptide, the term "modification" refers to a modification as compared to the canonical set of 20 amino acids, moiety)

[000306] The modifications may be various distinct modifications. In some embodiments, the coding region, the flanking regions and/or the terminal regions may contain one, two, or more (optionally different) nucleoside or nucleotide modifications. In some embodiments, a modified polynucleotide, primary construct, or mmRNA introduced to a cell may exhibit reduced degradation in the cell, as compared to an unmodified polynucleotide, primary construct, or mmRNA.

[000307] The polynucleotides, primary constructs, and mmRNA can include any useful modification, such as to the sugar, the nucleobase, or the internucleoside linkage (*e.g.* to a linking phosphate / to a phosphodiester linkage / to the phosphodiester backbone). One or more atoms of a pyrimidine nucleobase may be replaced or substituted with optionally substituted amino, optionally substituted thiol, optionally substituted alkyl (*e.g.*, methyl or ethyl), or halo (*e.g.*, chloro or fluoro). In certain embodiments, modifications (*e.g.*, one or more modifications) are present in each of the sugar and the internucleoside linkage. Modifications according to the present invention may be modifications of ribonucleic acids (RNAs) to deoxyribonucleic acids (DNAs), threose nucleic acids (TNAs), glycol nucleic acids (GNAs), peptide nucleic acids (PNAs), locked nucleic acids (LNAs) or hybrids thereof). Additional modifications are described herein.

[000308] As described herein, the polynucleotides, primary constructs, and mmRNA of the invention do not substantially induce an innate immune response of a cell into which the mRNA is introduced. Features of an induced innate immune response include 1) increased expression of pro-inflammatory cytokines, 2) activation of intracellular PRRs (RIG-I, MDA5, etc, and/or 3) termination or reduction in protein translation.

[000309] In certain embodiments, it may be desirable to intracellularly degrade a modified nucleic acid molecule introduced into the cell. For example, degradation of a modified nucleic acid molecule may be preferable if precise timing of protein production is desired. Thus, in some embodiments, the invention provides a modified nucleic acid molecule containing a degradation domain, which is capable of being acted on in a directed manner within a cell. In another aspect, the present disclosure provides polynucleotides comprising a nucleoside or nucleotide that can disrupt the binding of a major groove interacting, *e.g.* binding, partner with the polynucleotide (*e.g.*, where the

modified nucleotide has decreased binding affinity to major groove interacting partner, as compared to an unmodified nucleotide).

[000310] The polynucleotides, primary constructs, and mmRNA can optionally include other agents (e.g., RNAi-inducing agents, RNAi agents, siRNAs, shRNAs, miRNAs, antisense RNAs, ribozymes, catalytic DNA, tRNA, RNAs that induce triple helix formation, aptamers, vectors, etc.). In some embodiments, the polynucleotides, primary constructs, or mmRNA may include one or more messenger RNAs (mRNAs) and one or more modified nucleoside or nucleotides (e.g., mmRNA molecules). Details for these polynucleotides, primary constructs, and mmRNA follow.

Polynucleotides and Primary Constructs

[000311] The polynucleotides, primary constructs, and mmRNA of the invention includes a first region of linked nucleosides encoding a polypeptide of interest, a first flanking region located at the 5' terminus of the first region, and a second flanking region located at the 3' terminus of the first region.

[000312] In some embodiments, the polynucleotide, primary construct, or mmRNA (e.g., the first region, first flanking region, or second flanking region) includes n number of linked nucleosides having Formula (Ia) or Formula (Ia-1):

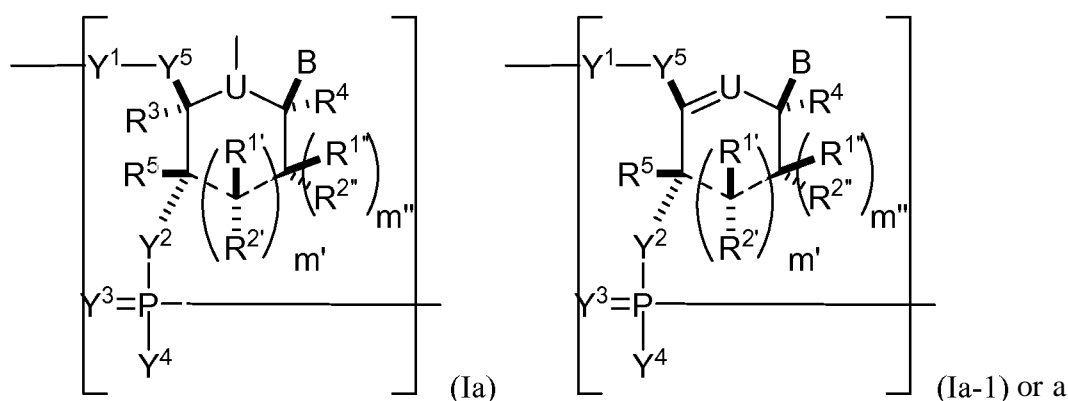

pharmaceutically acceptable salt or stereoisomer thereof,

[000313] wherein

[000314] U is O, S, N(R^u)_{nu}, or C(R^u)_{nu}, wherein nu is an integer from 0 to 2 and each R^u is, independently, H, halo, or optionally substituted alkyl;

[000315] — is a single bond or absent;

[000316] each of R^{1'}, R^{2'}, R^{1''}, R^{2''}, R¹, R², R³, R⁴, and R⁵ is, independently, if present, H, halo, hydroxy, thiol, optionally substituted alkyl, optionally substituted alkoxy,

optionally substituted alkenyloxy, optionally substituted alkynyloxy, optionally substituted aminoalkoxy, optionally substituted alkoxyalkoxy, optionally substituted hydroxyalkoxy, optionally substituted amino, azido, optionally substituted aryl, optionally substituted aminoalkyl, optionally substituted aminoalkenyl, optionally substituted aminoalkynyl, or absent; wherein the combination of R³ with one or more of R^{1'}, R^{1''}, R^{2'}, R^{2''}, or R⁵ (e.g., the combination of R^{1'} and R³, the combination of R^{1''} and R³, the combination of R^{2'} and R³, the combination of R^{2''} and R³, or the combination of R⁵ and R³) can join together to form optionally substituted alkylene or optionally substituted heteroalkylene and, taken together with the carbons to which they are attached, provide an optionally substituted heterocyclyl (e.g., a bicyclic, tricyclic, or tetracyclic heterocyclyl); wherein the combination of R⁵ with one or more of R^{1'}, R^{1''}, R^{2'}, or R^{2''} (e.g., the combination of R^{1'} and R⁵, the combination of R^{1''} and R⁵, the combination of R^{2'} and R⁵, or the combination of R^{2''} and R⁵) can join together to form optionally substituted alkylene or optionally substituted heteroalkylene and, taken together with the carbons to which they are attached, provide an optionally substituted heterocyclyl (e.g., a bicyclic, tricyclic, or tetracyclic heterocyclyl); and wherein the combination of R⁴ and one or more of R^{1'}, R^{1''}, R^{2'}, R^{2''}, R³, or R⁵ can join together to form optionally substituted alkylene or optionally substituted heteroalkylene and, taken together with the carbons to which they are attached, provide an optionally substituted heterocyclyl (e.g., a bicyclic, tricyclic, or tetracyclic heterocyclyl); each of m' and m'' is, independently, an integer from 0 to 3 (e.g., from 0 to 2, from 0 to 1, from 1 to 3, or from 1 to 2);

[000317] each of Y¹, Y², and Y³, is, independently, O, S, Se, -NR^{N1}-, optionally substituted alkylene, or optionally substituted heteroalkylene, wherein R^{N1} is H, optionally substituted alkyl, optionally substituted alkenyl, optionally substituted alkynyl, optionally substituted aryl, or absent;

[000318] each Y⁴ is, independently, H, hydroxy, thiol, boranyl, optionally substituted alkyl, optionally substituted alkenyl, optionally substituted alkynyl, optionally substituted alkoxy, optionally substituted alkenyloxy, optionally substituted alkynyloxy, optionally substituted thioalkoxy, optionally substituted alkoxyalkoxy, or optionally substituted amino;

[000319] each Y⁵ is, independently, O, S, Se, optionally substituted alkylene (e.g., methylene), or optionally substituted heteroalkylene;

[000320] n is an integer from 1 to 100,000; and

[000321] B is a nucleobase (e.g., a purine, a pyrimidine, or derivatives thereof), wherein the combination of B and R^{1'}, the combination of B and R^{2'}, the combination of B and R^{1''}, or the combination of B and R^{2''} can, taken together with the carbons to which they are attached, optionally form a bicyclic group (e.g., a bicyclic heterocyclyl) or wherein the combination of B, R^{1'}, and R³ or the combination of B, R^{2'}, and R³ can optionally form a tricyclic or tetracyclic group (e.g., a tricyclic or tetracyclic heterocyclyl, such as in Formula (IIo)-(IIp) herein). In some embodiments, the polynucleotide, primary construct, or mmRNA includes a modified ribose. In some embodiments, the polynucleotide, primary construct, or mmRNA (e.g., the first region, the first flanking region, or the second flanking region) includes n number of linked nucleosides having Formula (Ia-2)-(Ia-5) or a pharmaceutically acceptable salt or stereoisomer thereof.

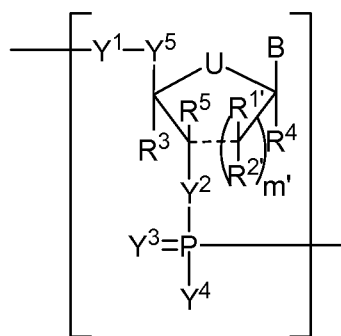

(Ia-2)

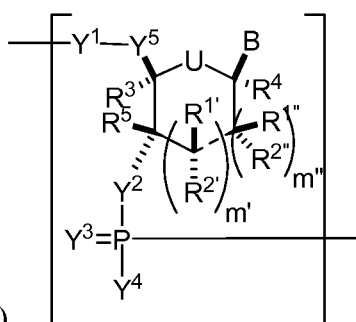

(Ia-3)

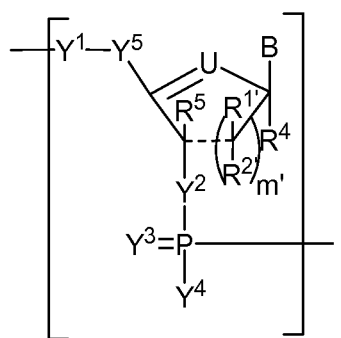

(Ia-4),

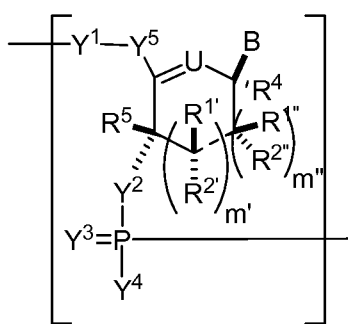

(Ia-5).

[000322] In some embodiments, the polynucleotide, primary construct, or mmRNA (e.g., the first region, the first flanking region, or the second flanking region) includes n number of linked nucleosides having Formula (Ib) or Formula (Ib-1):

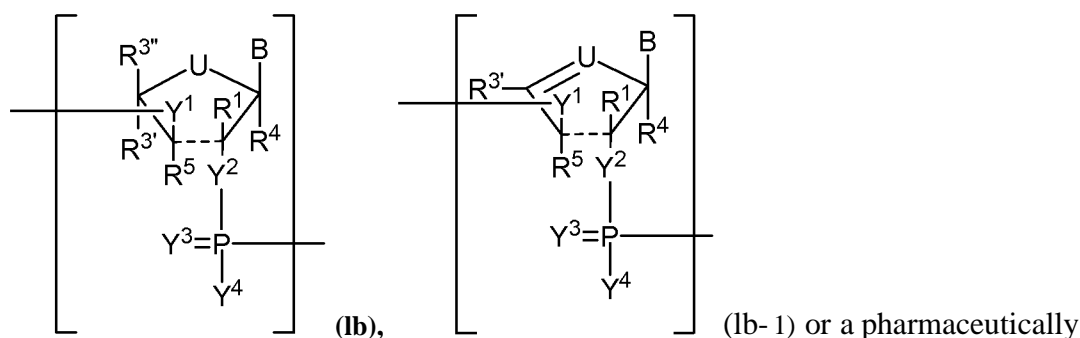

acceptable salt or stereoisomer thereof,

[000323] wherein

[000324] U is O, S, N(R^u)_{nu}, or C(R^u)_{nu}, wherein nu is an integer from 0 to 2 and each R^u is, independently, H, halo, or optionally substituted alkyl;

[000325] — is a single bond or absent;

[000326] each of R¹, R^{3'}, R^{3''}, and R⁴ is, independently, H, halo, hydroxy, optionally substituted alkyl, optionally substituted alkoxy, optionally substituted alkenyloxy, optionally substituted alkynyloxy, optionally substituted aminoalkoxy, optionally substituted alkoxyalkoxy, optionally substituted hydroxyalkoxy, optionally substituted amino, azido, optionally substituted aryl, optionally substituted aminoalkyl, optionally substituted aminoalkenyl, optionally substituted aminoalkynyl, or absent; and wherein the combination of R¹ and R^{3'} or the combination of R¹ and R^{3''} can be taken together to form optionally substituted alkylene or optionally substituted heteroalkylene (e.g., to produce a locked nucleic acid);

[000327] each R⁵ is, independently, H, halo, hydroxy, optionally substituted alkyl, optionally substituted alkoxy, optionally substituted alkenyloxy, optionally substituted alkynyloxy, optionally substituted aminoalkoxy, optionally substituted alkoxyalkoxy, or absent;

[000328] each of Y¹, Y², and Y³ is, independently, O, S, Se, -NR^{N1}-, optionally substituted alkylene, or optionally substituted heteroalkylene, wherein R^{N1} is H, optionally substituted alkyl, optionally substituted alkenyl, optionally substituted alkynyl, or optionally substituted aryl;

[000329] each Y⁴ is, independently, H, hydroxy, thiol, boranyl, optionally substituted alkyl, optionally substituted alkenyl, optionally substituted alkynyl, optionally substituted

alkoxy, optionally substituted alkenyloxy, optionally substituted alkynyloxy, optionally substituted alkoxyalkoxy, or optionally substituted amino;

[000330] n is an integer from 1 to 100,000; and

[000331] B is a nucleobase.

[000332] In some embodiments, the polynucleotide, primary construct, or mmRNA (e.g., the first region, first flanking region, or second flanking region) includes n number of linked nucleosides having Formula (Ic):

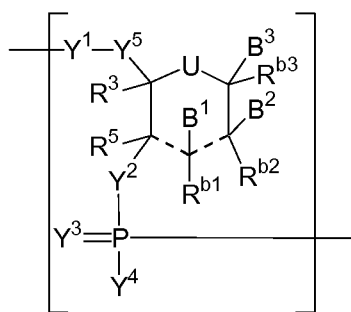

(Ic), or a pharmaceutically acceptable salt or stereoisomer

thereof,

[000333] wherein

[000334] U is O, S, N(R^u)_{nu}, or C(R^u)_{nu}, wherein nu is an integer from 0 to 2 and each R^u is, independently, H, halo, or optionally substituted alkyl;

[000335] — is a single bond or absent;

[000336] each of B¹, B², and B³ is, independently, a nucleobase (e.g., a purine, a pyrimidine, or derivatives thereof, as described herein), H, halo, hydroxy, thiol, optionally substituted alkyl, optionally substituted alkoxy, optionally substituted alkenyloxy, optionally substituted alkynyloxy, optionally substituted aminoalkoxy, optionally substituted alkoxyalkoxy, optionally substituted hydroxyalkoxy, optionally substituted amino, azido, optionally substituted aryl, optionally substituted aminoalkyl, optionally substituted aminoalkenyl, or optionally substituted aminoalkynyl, wherein one and only one of B¹, B², and B³ is a nucleobase;

[000337] each of R^{b1}, R^{b2}, R^{b3}, R³, and R⁵ is, independently, H, halo, hydroxy, thiol, optionally substituted alkyl, optionally substituted alkoxy, optionally substituted alkenyloxy, optionally substituted alkynyloxy, optionally substituted aminoalkoxy, optionally substituted alkoxyalkoxy, optionally substituted hydroxyalkoxy, optionally

substituted amino, azido, optionally substituted aryl, optionally substituted aminoalkyl, optionally substituted aminoalkenyl or optionally substituted aminoalkynyl;

[000338] each of Y^1 , Y^2 , and Y^3 , is, independently, O, S, Se, $-NR^{N1}$ -, optionally substituted alkylene, or optionally substituted heteroalkylene, wherein R^{N1} is H, optionally substituted alkyl, optionally substituted alkenyl, optionally substituted alkynyl, or optionally substituted aryl;

[000339] each Y^4 is, independently, H, hydroxy, thiol, boranyl, optionally substituted alkyl, optionally substituted alkenyl, optionally substituted alkynyl, optionally substituted alkoxy, optionally substituted alkenyloxy, optionally substituted alkynyloxy, optionally substituted thioalkoxy, optionally substituted alkoxyalkoxy, or optionally substituted amino;

[000340] each Y^5 is, independently, O, S, Se, optionally substituted alkylene (e.g., methylene), or optionally substituted heteroalkylene;

[000341] n is an integer from 1 to 100,000; and

[000342] wherein the ring including U can include one or more double bonds.

[000343] In particular embodiments, the ring including U does not have a double bond between $U-CB^3R^{b3}$ or between $CB^3R^{b3}-C^{B2}R^{b2}$.

[000344] In some embodiments, the polynucleotide, primary construct, or mmRNA (e.g., the first region, first flanking region, or second flanking region) includes n number of linked nucleosides having Formula (Id):

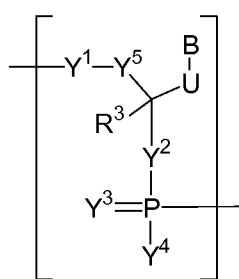

(Id), or a pharmaceutically acceptable salt or stereoisomer thereof,

[000345] wherein

[000346] U is O, S, $N(R^u)_{n_u}$, or $C(R^u)_{n_u}$, wherein n_u is an integer from 0 to 2 and each R^u is, independently, H, halo, or optionally substituted alkyl;

[000347] each R^3 is, independently, H, halo, hydroxy, thiol, optionally substituted alkyl, optionally substituted alkoxy, optionally substituted alkenyloxy, optionally substituted alkynyloxy, optionally substituted aminoalkoxy, optionally substituted alkoxyalkoxy,

optionally substituted hydroxyalkoxy, optionally substituted amino, azido, optionally substituted aryl, optionally substituted aminoalkyl, optionally substituted aminoalkenyl, or optionally substituted aminoalkynyl;

[000348] each of Y^1 , Y^2 , and Y^3 , is, independently, O, S, Se, $-NR^{N1}$ -, optionally substituted alkylene, or optionally substituted heteroalkylene, wherein R^{N1} is H, optionally substituted alkyl, optionally substituted alkenyl, optionally substituted alkynyl, or optionally substituted aryl;

[000349] each Y^4 is, independently, H, hydroxy, thiol, boranyl, optionally substituted alkyl, optionally substituted alkenyl, optionally substituted alkynyl, optionally substituted alkoxy, optionally substituted alkenyloxy, optionally substituted alkynyloxy, optionally substituted thioalkoxy, optionally substituted alkoxyalkoxy, or optionally substituted amino;

[000350] each Y^5 is, independently, O, S, optionally substituted alkylene (e.g., methylene), or optionally substituted heteroalkylene;

[000351] n is an integer from 1 to 100,000; and

[000352] B is a nucleobase (e.g., a purine, a pyrimidine, or derivatives thereof).

[000353] In some embodiments, the polynucleotide, primary construct, or mmRNA (e.g., the first region, first flanking region, or second flanking region) includes n number of linked nucleosides having Formula (Ie):

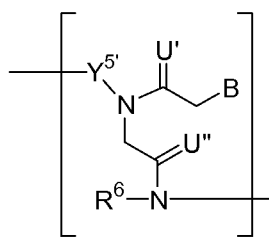

(Ie), or a pharmaceutically acceptable salt or stereoisomer thereof,

[000354] wherein

[000355] each of U' and U'' is, independently, O, S, $N(R^u)_{n_u}$, or $C(R^u)_{n_u}$, wherein n_u is an integer from 0 to 2 and each R^u is, independently, H, halo, or optionally substituted alkyl;

[000356] each R^6 is, independently, H, halo, hydroxy, thiol, optionally substituted alkyl, optionally substituted alkoxy, optionally substituted alkenyloxy, optionally substituted alkynyloxy, optionally substituted aminoalkoxy, optionally substituted alkoxyalkoxy,

optionally substituted hydroxyalkoxy, optionally substituted amino, azido, optionally substituted aryl, optionally substituted aminoalkyl, optionally substituted aminoalkenyl, or optionally substituted aminoalkynyl;

[000357] each Y^5 is, independently, O, S, optionally substituted alkylene (e.g., methylene or ethylene), or optionally substituted heteroalkylene;

[000358] n is an integer from 1 to 100,000; and

[000359] B is a nucleobase (e.g., a purine, a pyrimidine, or derivatives thereof).

[000360] In some embodiments, the polynucleotide, primary construct, or mmRNA (e.g., the first region, first flanking region, or second flanking region) includes n number of linked nucleosides having Formula (If) or (If-1):

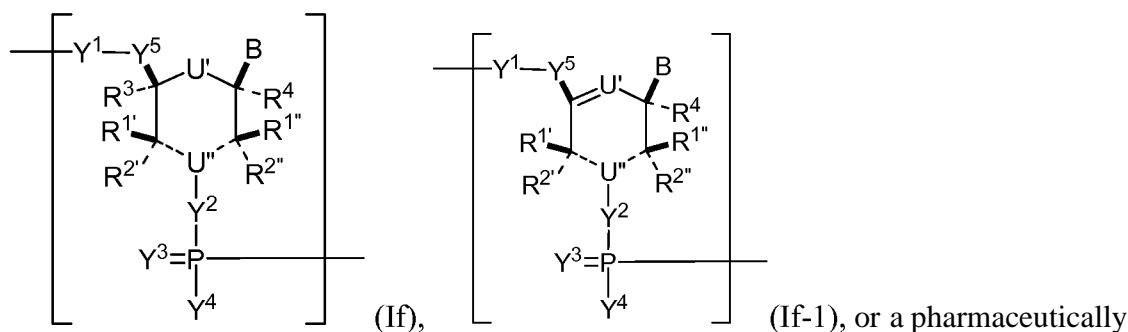

acceptable salt or stereoisomer thereof,

[000361] wherein

[000362] each of U' and U'' is, independently, O, S, N, $N(R^u)_{n_u}$, or $C(R^u)_{n_u}$, wherein n_u is an integer from 0 to 2 and each R^u is, independently, H, halo, or optionally substituted alkyl (e.g., U' is O and U'' is N);

[000363] — is a single bond or absent;

[000364] each of $R^{1'}$, $R^{2'}$, $R^{1''}$, $R^{2''}$, R^3 , and R^4 is, independently, H, halo, hydroxy, thiol, optionally substituted alkyl, optionally substituted alkoxy, optionally substituted alkenyloxy, optionally substituted alkynyloxy, optionally substituted aminoalkoxy, optionally substituted alkoxyalkoxy, optionally substituted hydroxyalkoxy, optionally substituted amino, azido, optionally substituted aryl, optionally substituted aminoalkyl, optionally substituted aminoalkenyl, optionally substituted aminoalkynyl, or absent; and wherein the combination of $R^{1'}$ and R^3 , the combination of $R^{1''}$ and R^3 , the combination of $R^{2'}$ and R^3 , or the combination of $R^{2''}$ and R^3 can be taken together to form optionally substituted alkylene or optionally substituted heteroalkylene (e.g., to produce a locked

nucleic acid); each of m' and m'' is, independently, an integer from 0 to 3 (e.g., from 0 to 2, from 0 to 1, from 1 to 3, or from 1 to 2);

[000365] each of Y^1 , Y^2 , and Y^3 , is, independently, O, S, Se, $-NR^{N1}$ -, optionally substituted alkylene, or optionally substituted heteroalkylene, wherein R^{N1} is H, optionally substituted alkyl, optionally substituted alkenyl, optionally substituted alkynyl, optionally substituted aryl, or absent;

[000366] each Y^4 is, independently, H, hydroxy, thiol, boranyl, optionally substituted alkyl, optionally substituted alkenyl, optionally substituted alkynyl, optionally substituted alkoxy, optionally substituted alkenyloxy, optionally substituted alkynyloxy, optionally substituted thioalkoxy, optionally substituted alkoxyalkoxy, or optionally substituted amino;

[000367] each Y^5 is, independently, O, S, Se, optionally substituted alkylene (e.g., methylene), or optionally substituted heteroalkylene;

[000368] n is an integer from 1 to 100,000; and

[000369] B is a nucleobase (e.g., a purine, a pyrimidine, or derivatives thereof).

[000370] In some embodiments of the polynucleotides, primary constructs, or mmRNA (e.g., Formulas (Ia), (Ia-1)-(Ia-3), (Ib)-(Ib-1), and (IIa)-(IIp)), the ring including U has one or two double bonds.

[000371] In some embodiments of the polynucleotides, primary constructs, or mmRNA (e.g., Formulas (Ia)-(Ia-5), (Ib)-(Ib-1), (IIa)-(IIp), (IIb-1), (IIb-2), (IIc-1)-(IIc-2), (IIn-1), (IIn-2), (IVa)-(IVl), and (IXa)-(IXr)), each of R^1 , $R^{1'}$, and $R^{1''}$, if present, is H. In further embodiments, each of R^2 , $R^{2'}$, and $R^{2''}$, if present, is, independently, H, halo (e.g., fluoro), hydroxy, optionally substituted alkoxy (e.g., methoxy or ethoxy), or optionally substituted alkoxyalkoxy. In particular embodiments, alkoxyalkoxy is -

$(CH_2)_{s_2}(OCH_2CH_2)_{s_1}(CH_2)_{s_3}OR'$, wherein s_1 is an integer from 1 to 10 (e.g., from 1 to 6 or from 1 to 4), each of s_2 and s_3 , independently, is an integer from 0 to 10 (e.g., from 0 to 4, from 0 to 6, from 1 to 4, from 1 to 6, or from 1 to 10), and R' is H or C_{1-6} alkyl). In some embodiments, s_2 is 0, s_1 is 1 or 2, s_3 is 0 or 1, and R' is C_{1-6} alkyl.

[000372] In some embodiments of the polynucleotides, primary constructs, or mmRNA (e.g., Formulas (Ia)-(Ia-5), (Ib)-(Ib-1), (IIa)-(IIp), (IIb-1), (IIb-2), (IIc-1)-(IIc-2), (IIn-1), (IIn-2), (IVa)-(IVl), and (IXa)-(IXr)), each of R^2 , $R^{2'}$, and $R^{2''}$, if present, is H. In further

embodiments, each of R^1 , $R^{1'}$, and $R^{1''}$, if present, is, independently, H, halo (e.g., fluoro), hydroxy, optionally substituted alkoxy (e.g., methoxy or ethoxy), or optionally substituted alkoxyalkoxy. In particular embodiments, alkoxyalkoxy is -
 $(CH_2)_{s2}(OCH_2CH_2)_{si}(CH_2)_{s3}OR'$, wherein si is an integer from 1 to 10 (e.g., from 1 to 6 or from 1 to 4), each of $s2$ and $s3$, independently, is an integer from 0 to 10 (e.g., from 0 to 4, from 0 to 6, from 1 to 4, from 1 to 6, or from 1 to 10), and R' is H or Ci_{20} alkyl). In some embodiments, $s2$ is 0, si is 1 or 2, $s3$ is 0 or 1, and R' is Ci_6 alkyl.

[000373] In some embodiments of the polynucleotides, primary constructs, or mmRNA (e.g., Formulas (Ia)-(Ia-5), (Ib)-(If-1), (IIa)-(IIp), (IIb-1), (IIb-2), (IIc-1)-(IIc-2), (IIn-1), (IIn-2), (IVa)-(IVl), and (IXa)-(IXr)), each of R^3 , R^4 , and R^5 is, independently, H, halo (e.g., fluoro), hydroxy, optionally substituted alkyl, optionally substituted alkoxy (e.g., methoxy or ethoxy), or optionally substituted alkoxyalkoxy. In particular embodiments, R^3 is H, R^4 is H, R^5 is H, or R^3 , R^4 , and R^5 are all H. In particular embodiments, R^3 is Ci_6 alkyl, R^4 is Ci_6 alkyl, R^5 is Ci_6 alkyl, or R^3 , R^4 , and R^5 are all Ci_6 alkyl. In particular embodiments, R^3 and R^4 are both H, and R^5 is Ci_6 alkyl.

[000374] In some embodiments of the polynucleotides, primary constructs, or mmRNA (e.g., Formulas (Ia)-(Ia-5), (Ib)-(If-1), (IIa)-(IIp), (IIb-1), (IIb-2), (IIc-1)-(IIc-2), (IIn-1), (IIn-2), (IVa)-(IVl), and (IXa)-(IXr)), R^3 and R^5 join together to form optionally substituted alkylene or optionally substituted heteroalkylene and, taken together with the carbons to which they are attached, provide an optionally substituted heterocyclyl (e.g., a bicyclic, tricyclic, or tetracyclic heterocyclyl, such as trans-3',4' analogs, wherein R^3 and R^5 join together to form heteroalkylene (e.g., $-(CH_2)_{b1}O(CH_2)_{b2}O(CF_2)_{b3}-$, wherein each of $b1$, $b2$, and $b3$ are, independently, an integer from 0 to 3).

[000375] In some embodiments of the polynucleotides, primary constructs, or mmRNA (e.g., Formulas (Ia)-(Ia-5), (Ib)-(If-1), (IIa)-(IIp), (IIb-1), (IIb-2), (IIc-1)-(IIc-2), (IIn-1), (IIn-2), (IVa)-(IVl), and (IXa)-(IXr)), R^3 and one or more of $R^{1'}$, $R^{1''}$, $R^{2'}$, $R^{2''}$, or R^5 join together to form optionally substituted alkylene or optionally substituted heteroalkylene and, taken together with the carbons to which they are attached, provide an optionally substituted heterocyclyl (e.g., a bicyclic, tricyclic, or tetracyclic heterocyclyl, R^3 and one or more of $R^{1'}$, $R^{1''}$, $R^{2'}$, $R^{2''}$, or R^5 join together to form heteroalkylene (e.g., -

$(\text{CH}_2)_b\text{iO}(\text{CH}_2)_{b2}\text{O}(\text{CH}_2)_{b3}$ -, wherein each of b_1 , b_2 , and b_3 are, independently, an integer from 0 to 3).

[000376] In some embodiments of the polynucleotides, primary constructs, or mmRNA (e.g., Formulas (Ia)-(Ia-5), (Ib)-(If-1), (IIa)-(IIp), (IIb-1), (IIb-2), (IIc-1)-(IIc-2), (IIn-1), (IIn-2), (IVa)-(IVl), and (IXa)-(IXr)), R^5 and one or more of $R^{1'}$, $R^{1''}$, $R^{2'}$, or $R^{2''}$ join together to form optionally substituted alkylene or optionally substituted heteroalkylene and, taken together with the carbons to which they are attached, provide an optionally substituted heterocyclyl (e.g., a bicyclic, tricyclic, or tetracyclic heterocyclyl, R^5 and one or more of $R^{1'}$, $R^{1''}$, $R^{2'}$, or $R^{2''}$ join together to form heteroalkylene (e.g., -

$(\text{CH}_2)_{b1}\text{O}(\text{CH}_2)_{b2}\text{O}(\text{CH}_2)_{b3}$ -, wherein each of b_1 , b_2 , and b_3 are, independently, an integer from 0 to 3).

[000377] In some embodiments of the polynucleotides, primary constructs, or mmRNA (e.g., Formulas (Ia)-(Ia-5), (Ib)-(If-1), (IIa)-(IIp), (IIb-1), (IIb-2), (IIc-1)-(IIc-2), (IIn-1), (IIn-2), (IVa)-(IVl), and (IXa)-(IXr)), each Y^2 is, independently, O, S, or $-\text{NR}^{\text{N}1}$ -, wherein $R^{\text{N}1}$ is H, optionally substituted alkyl, optionally substituted alkenyl, optionally substituted alkynyl, or optionally substituted aryl. In particular embodiments, Y^2 is $\text{NR}^{\text{N}1}$ -, wherein $R^{\text{N}1}$ is H or optionally substituted alkyl (e.g., C_{1-6} alkyl, such as methyl, ethyl, isopropyl, or n-propyl).

[000378] In some embodiments of the polynucleotides, primary constructs, or mmRNA (e.g., Formulas (Ia)-(Ia-5), (Ib)-(If-1), (IIa)-(IIp), (IIb-1), (IIb-2), (IIc-1)-(IIc-2), (IIn-1), (IIn-2), (IVa)-(IVl), and (IXa)-(IXr)), each Y^3 is, independently, O or S.

[000379] In some embodiments of the polynucleotides, primary constructs, or mmRNA (e.g., Formulas (Ia)-(Ia-5), (Ib)-(If-1), (IIa)-(IIp), (IIb-1), (IIb-2), (IIc-1)-(IIc-2), (IIn-1), (IIn-2), (IVa)-(IVl), and (IXa)-(IXr)), R^1 is H; each R^2 is, independently, H, halo (e.g., fluoro), hydroxy, optionally substituted alkoxy (e.g., methoxy or ethoxy), or optionally substituted alkoxyalkoxy (e.g., $-(\text{CH}_2)_{s2}(\text{OCH}_2\text{CH}_2)_s(\text{CH}_2)_{s3}\text{OR}'$, wherein s_i is an integer from 1 to 10 (e.g., from 1 to 6 or from 1 to 4), each of s_2 and s_3 , independently, is an integer from 0 to 10 (e.g., from 0 to 4, from 0 to 6, from 1 to 4, from 1 to 6, or from 1 to 10), and R' is H or C_{1-6} alkyl, such as wherein s_2 is 0, s_3 is 1 or 2, s_3 is 0 or 1, and R' is C_{1-6} alkyl); each Y^2 is, independently, O or $-\text{NR}^{\text{N}1}$ -, wherein $R^{\text{N}1}$ is H, optionally substituted alkyl, optionally substituted alkenyl, optionally substituted alkynyl, or

optionally substituted aryl (e.g., wherein R^{N1} is H or optionally substituted alkyl (e.g., Ci_6 alkyl, such as methyl, ethyl, isopropyl, or n-propyl)); and each Y^3 is, independently, O or S (e.g., S). In further embodiments, R^3 is H, halo (e.g., fluoro), hydroxy, optionally substituted alkyl, optionally substituted alkoxy (e.g., methoxy or ethoxy), or optionally substituted alkoxyalkoxy. In yet further embodiments, each Y^1 is, independently, O or $-NR^{N1}$ -, wherein R^{N1} is H, optionally substituted alkyl, optionally substituted alkenyl, optionally substituted alkynyl, or optionally substituted aryl (e.g., wherein R^{N1} is H or optionally substituted alkyl (e.g., Ci_6 alkyl, such as methyl, ethyl, isopropyl, or n-propyl)); and each Y^4 is, independently, H, hydroxy, thiol, optionally substituted alkyl, optionally substituted alkoxy, optionally substituted thioalkoxy, optionally substituted alkoxyalkoxy, or optionally substituted amino.

[000380] In some embodiments of the polynucleotides, primary constructs, or mmRNA (e.g., Formulas (Ia)-(Ia-5), (Ib)-(If-1), (IIa)-(IIp), (IIb-1), (IIb-2), (IIc-1)-(IIc-2), (IIn-1), (IIn-2), (IVa)-(IVl), and (IXa)-(IXr)), each R^1 is, independently, H, halo (e.g., fluoro), hydroxy, optionally substituted alkoxy (e.g., methoxy or ethoxy), or optionally substituted alkoxyalkoxy (e.g., $-(CH_2)_{s2}(OCH_2CH_2)_s(CH_2)_{s3}OR'$, wherein s_i is an integer from 1 to 10 (e.g., from 1 to 6 or from 1 to 4), each of s_2 and s_3 , independently, is an integer from 0 to 10 (e.g., from 0 to 4, from 0 to 6, from 1 to 4, from 1 to 6, or from 1 to 10), and R' is H or Ci_{20} alkyl, such as wherein s_2 is 0, s_i is 1 or 2, s_3 is 0 or 1, and R' is Ci_6 alkyl); R^2 is H; each Y^2 is, independently, O or $-NR^{N1}$ -, wherein R^{N1} is H, optionally substituted alkyl, optionally substituted alkenyl, optionally substituted alkynyl, or optionally substituted aryl (e.g., wherein R^{N1} is H or optionally substituted alkyl (e.g., Ci_6 alkyl, such as methyl, ethyl, isopropyl, or n-propyl)); and each Y^3 is, independently, O or S (e.g., S). In further embodiments, R^3 is H, halo (e.g., fluoro), hydroxy, optionally substituted alkyl, optionally substituted alkoxy (e.g., methoxy or ethoxy), or optionally substituted alkoxyalkoxy. In yet further embodiments, each Y^1 is, independently, O or $-NR^{N1}$ -, wherein R^{N1} is H, optionally substituted alkyl, optionally substituted alkenyl, optionally substituted alkynyl, or optionally substituted aryl (e.g., wherein R^{N1} is H or optionally substituted alkyl (e.g., Ci_6 alkyl, such as methyl, ethyl, isopropyl, or n-propyl)); and each Y^4 is, independently, H, hydroxy, thiol, optionally substituted alkyl,

optionally substituted alkoxy, optionally substituted thioalkoxy, optionally substituted alkoxyalkoxy, or optionally substituted amino.

[000381] In some embodiments of the polynucleotides, primary constructs, or mmRNA (e.g., Formulas (Ia)-(Ia-5), (Ib)-(If-1), (IIa)-(IIp), (IIb-1), (IIb-2), (IIc-1)-(IIc-2), (IIn-1), (IIn-2), (IVa)-(IVl), and (IXa)-(IXr)), the ring including U is in the β -D (e.g., β -D-ribo) configuration.

[000382] In some embodiments of the polynucleotides, primary constructs, or mmRNA (e.g., Formulas (Ia)-(Ia-5), (Ib)-(If-1), (IIa)-(IIp), (IIb-1), (IIb-2), (IIc-1)-(IIc-2), (IIn-1), (IIn-2), (IVa)-(IVl), and (IXa)-(IXr)), the ring including U is in the α -L (e.g., α -L-ribo) configuration.

[000383] In some embodiments of the polynucleotides, primary constructs, or mmRNA (e.g., Formulas (Ia)-(Ia-5), (Ib)-(If-1), (IIa)-(IIp), (IIb-1), (IIb-2), (IIc-1)-(IIc-2), (IIn-1), (IIn-2), (IVa)-(IVl), and (IXa)-(IXr)), one or more B is not pseudouridine (ψ) or 5-methyl-cytidine (m^5C). In some embodiments, about 10% to about 100% of n number of B nucleobases is not ψ or m^5C (e.g., from 10% to 20%, from 10% to 35%, from 10% to 50%, from 10% to 60%, from 10% to 75%, from 10% to 90%, from 10% to 95%, from 10% to 98%, from 10% to 99%, from 20% to 35%, from 20% to 50%, from 20% to 60%, from 20% to 75%, from 20% to 90%, from 20% to 95%, from 20% to 98%, from 20% to 99%, from 20% to 100%, from 50% to 60%, from 50% to 75%, from 50% to 90%, from 50% to 95%, from 50% to 98%, from 50% to 99%, from 50% to 100%, from 75% to 90%, from 75% to 95%, from 75% to 98%, from 75% to 99%, and from 75% to 100% of n number of B is not ψ or m^5C). In some embodiments, B is not ψ or m^5C .

[000384] In some embodiments of the polynucleotides, primary constructs, or mmRNA (e.g., Formulas (Ia)-(Ia-5), (Ib)-(If-1), (IIa)-(IIp), (IIb-1), (IIb-2), (IIc-1)-(IIc-2), (IIn-1), (IIn-2), (IVa)-(IVl), and (IXa)-(IXr)), when B is an unmodified nucleobase selected from cytosine, guanine, uracil and adenine, then at least one of Y^1 , Y^2 , or Y^3 is not O.

[000385] In some embodiments, the polynucleotide, primary construct, or mmRNA includes a modified ribose. In some embodiments, the polynucleotide, primary construct, or mmRNA (e.g., the first region, the first flanking region, or the second flanking region) includes n number of linked nucleosides having Formula (IIa)-(IIc):

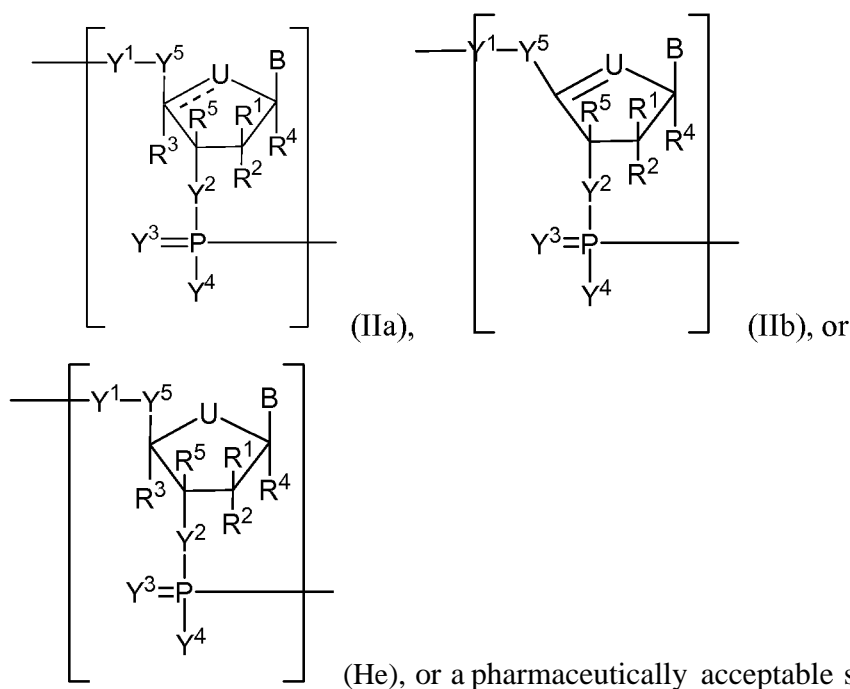

thereof. In particular embodiments, U is O or C(R^U)_{nu}, wherein nu is an integer from 0 to 2 and each R^u is, independently, H, halo, or optionally substituted alkyl (e.g., U is -CH₂- or -CH-). In other embodiments, each of R¹, R², R³, R⁴, and R⁵ is, independently, H, halo, hydroxy, thiol, optionally substituted alkyl, optionally substituted alkoxy, optionally substituted alkenyloxy, optionally substituted alkynyloxy, optionally substituted aminoalkoxy, optionally substituted alkoxyalkoxy, optionally substituted hydroxyalkoxy, optionally substituted amino, azido, optionally substituted aryl, optionally substituted aminoalkyl, optionally substituted aminoalkenyl, optionally substituted aminoalkynyl, or absent (e.g., each R¹ and R² is, independently, H, halo, hydroxy, optionally substituted alkyl, or optionally substituted alkoxy; each R³ and R⁴ is, independently, H or optionally substituted alkyl; and R⁵ is H or hydroxy), and --- is a single bond or double bond.

[000386] In particular embodiments, the polynucleotides or mmRNA includes n number of linked nucleosides having Formula (Ib-1)-(Ib-2):

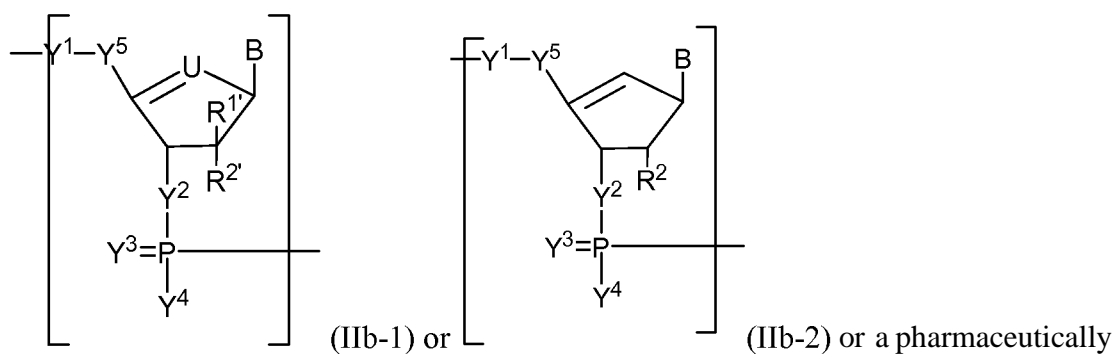

acceptable salt or stereoisomer thereof. In some embodiments, U is O or $C(R^U)_{n_u}$, wherein n_u is an integer from 0 to 2 and each R^u is, independently, H, halo, or optionally substituted alkyl (e.g., U is $-CH_2-$ or $-CH-$). In other embodiments, each of R^1 and R^2 is, independently, H, halo, hydroxy, thiol, optionally substituted alkyl, optionally substituted alkoxy, optionally substituted alkenyloxy, optionally substituted alkynyloxy, optionally substituted aminoalkoxy, optionally substituted alkoxyalkoxy, optionally substituted hydroxyalkoxy, optionally substituted amino, azido, optionally substituted aryl, optionally substituted aminoalkyl, optionally substituted aminoalkenyl, optionally substituted aminoalkynyl, or absent (e.g., each R^1 and R^2 is, independently, H, halo, hydroxy, optionally substituted alkyl, or optionally substituted alkoxy, e.g., H, halo, hydroxy, alkyl, or alkoxy). In particular embodiments, R^2 is hydroxy or optionally substituted alkoxy (e.g., methoxy, ethoxy, or any described herein).

[000387] In particular embodiments, the polynucleotide, primary construct, or mmRNA includes n number of linked nucleosides having Formula (IIc-1)-(IIc-4):

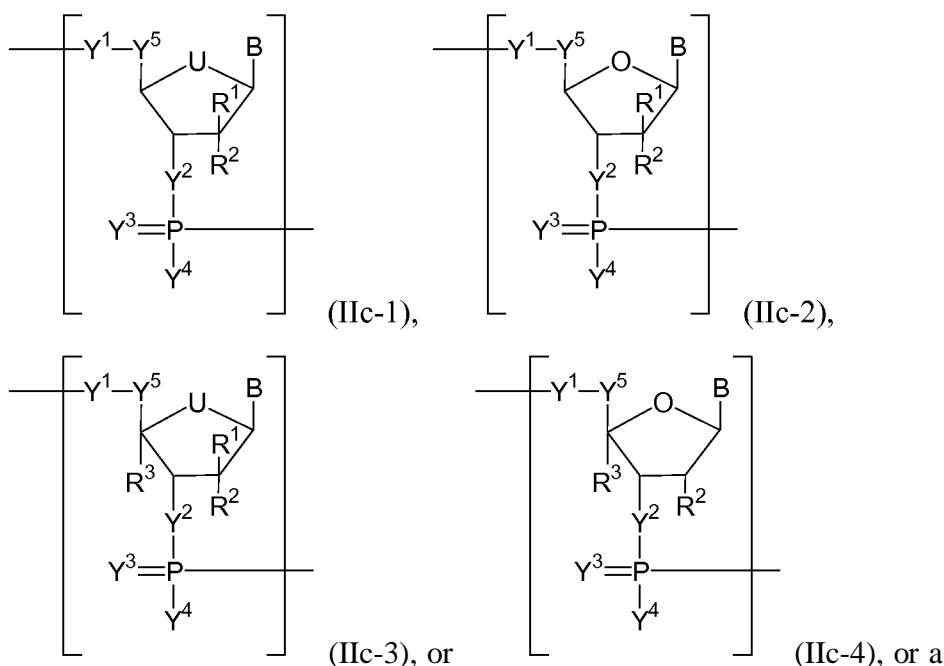

pharmaceutically acceptable salt or stereoisomer thereof. In some embodiments, U is O or C(R^u)_{nu}, wherein nu is an integer from 0 to 2 and each R^u is, independently, H, halo, or optionally substituted alkyl (e.g., U is -CH₂- or -CH-). In some embodiments, each of R¹, R², and R³ is, independently, H, halo, hydroxy, thiol, optionally substituted alkyl, optionally substituted alkoxy, optionally substituted alkenyloxy, optionally substituted alkynyloxy, optionally substituted aminoalkoxy, optionally substituted alkoxyalkoxy, optionally substituted hydroxyalkoxy, optionally substituted amino, azido, optionally substituted aryl, optionally substituted aminoalkyl, optionally substituted aminoalkenyl, optionally substituted aminoalkynyl, or absent (e.g., each R¹ and R² is, independently, H, halo, hydroxy, optionally substituted alkyl, or optionally substituted alkoxy, e.g., H, halo, hydroxy, alkyl, or alkoxy; and each R³ is, independently, H or optionally substituted alkyl)). In particular embodiments, R² is optionally substituted alkoxy (e.g., methoxy or ethoxy, or any described herein). In particular embodiments, R¹ is optionally substituted alkyl, and R² is hydroxy. In other embodiments, R¹ is hydroxy, and R² is optionally substituted alkyl. In further embodiments, R³ is optionally substituted alkyl.

[000388] In some embodiments, the polynucleotide, primary construct, or mmRNA includes an acyclic modified ribose. In some embodiments, the polynucleotide, primary construct, or mmRNA (e.g., the first region, the first flanking region, or the second flanking region) includes n number of linked nucleosides having Formula (IId)-(IIf):

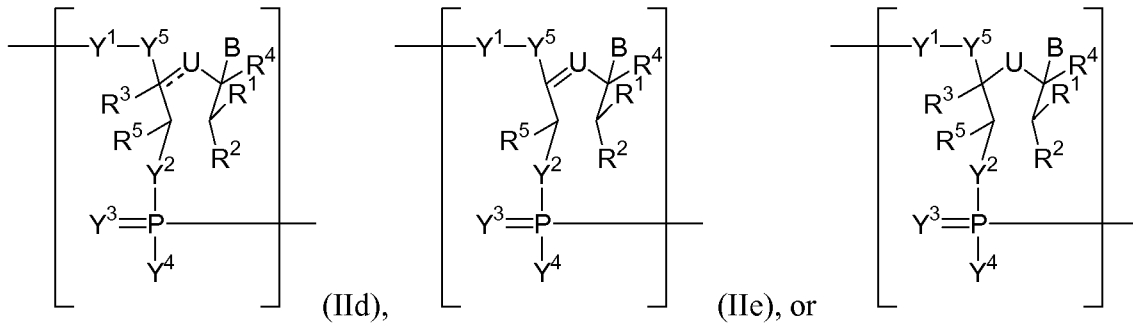

(IIe), or a pharmaceutically acceptable salt or stereoisomer thereof.

[000389] In some embodiments, the polynucleotide, primary construct, or mmRNA includes an acyclic modified hexitol. In some embodiments, the polynucleotide, primary construct, or mmRNA (e.g., the first region, the first flanking region, or the second flanking region) includes n number of linked nucleosides Formula (IIg)-(IIj):

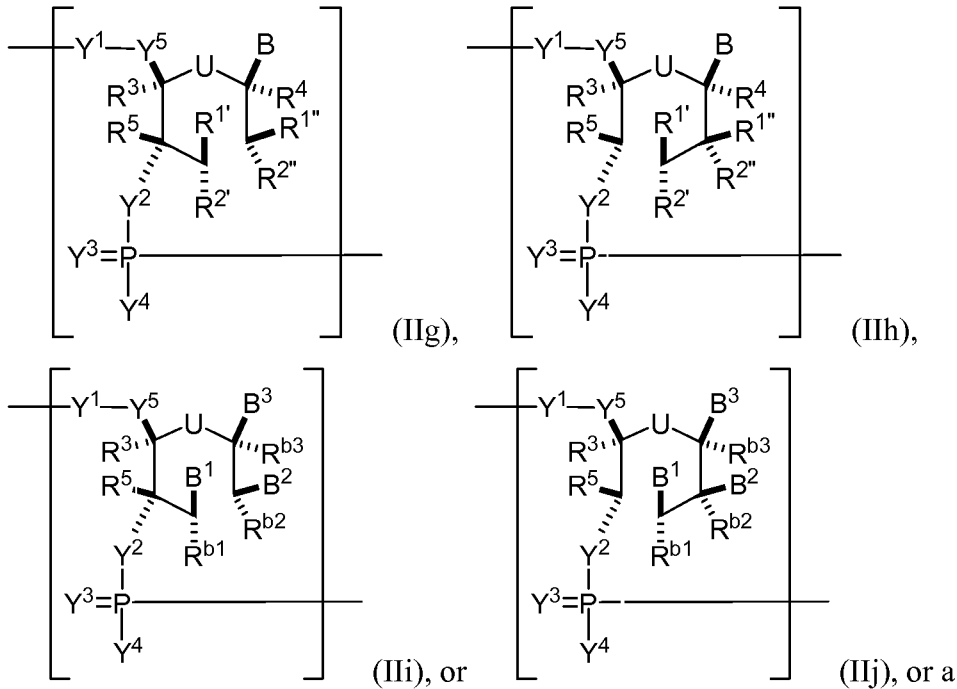

pharmaceutically acceptable salt or stereoisomer thereof.

[000390] In some embodiments, the polynucleotide, primary construct, or mmRNA includes a sugar moiety having a contracted or an expanded ribose ring. In some embodiments, the polynucleotide, primary construct, or mmRNA (e.g., the first region, the first flanking region, or the second flanking region) includes n number of linked nucleosides having Formula (IIk)-(IIm):

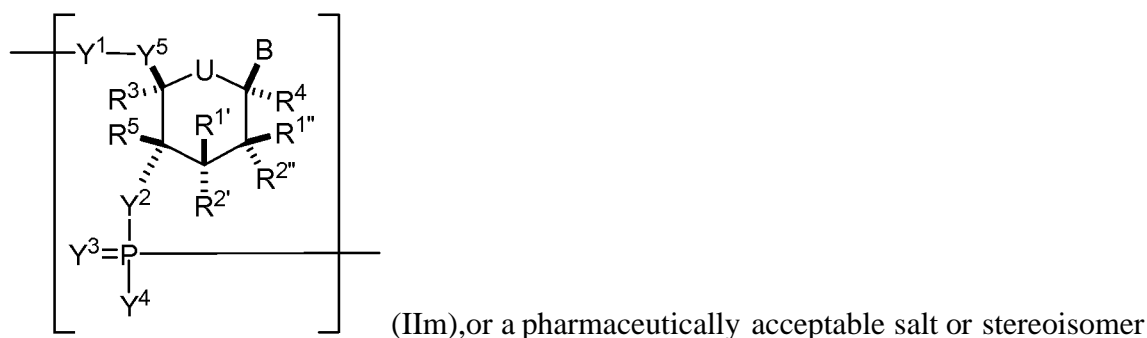
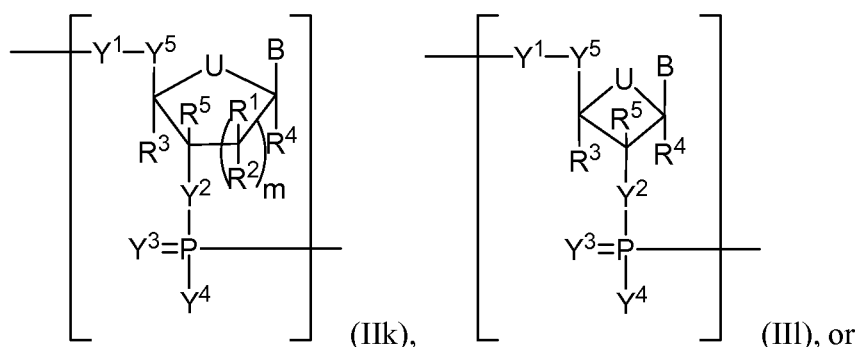

thereof, wherein each of R^1 , $R^{1'}$, $R^{1''}$, $R^{2'}$, and $R^{2''}$ is, independently, H, halo, hydroxy, optionally substituted alkyl, optionally substituted alkoxy, optionally substituted alkenyloxy, optionally substituted alkynyloxy, optionally substituted aminoalkoxy, optionally substituted alkoxyalkoxy, or absent; and wherein the combination of $R^{2'}$ and R^3 or the combination of $R^{2''}$ and R^3 can be taken together to form optionally substituted alkylene or optionally substituted heteroalkylene.

[000391] In some embodiments, the polynucleotide, primary construct, or mmRNA includes a locked modified ribose. In some embodiments, the polynucleotide, primary construct, or mmRNA (e.g., the first region, the first flanking region, or the second flanking region) includes n number of linked nucleosides having Formula (II_n):

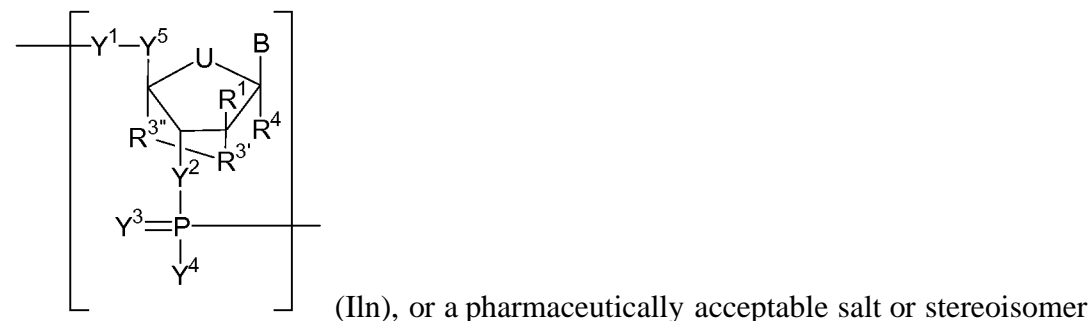

thereof, wherein $R^{3'}$ is O, S, or $-NR^{N1}$, wherein R^{N1} is H, optionally substituted alkyl, optionally substituted alkenyl, optionally substituted alkynyl, or optionally substituted

aryl and $R^{3''}$ is optionally substituted alkylene (e.g., $-\text{CH}_2-$, $-\text{CH}_2\text{CH}_2-$, or $-\text{CH}_2\text{CH}_2\text{CH}_2-$) or optionally substituted heteroalkylene (e.g., $-\text{CH}_2\text{NH}-$, $-\text{CH}_2\text{CH}_2\text{NH}-$, $-\text{CH}_2\text{OCH}_2-$, or $-\text{CH}_2\text{CH}_2\text{OCH}_2-$) (e.g., $R^{3'}$ is O and $R^{3''}$ is optionally substituted alkylene (e.g., $-\text{CH}_2-$, $-\text{CH}_2\text{CH}_2-$, or $-\text{CH}_2\text{CH}_2\text{CH}_2-$)).

[000392] In some embodiments, the polynucleotide, primary construct, or mmRNA includes n number of linked nucleosides having Formula (II-n1)-(II-n2):

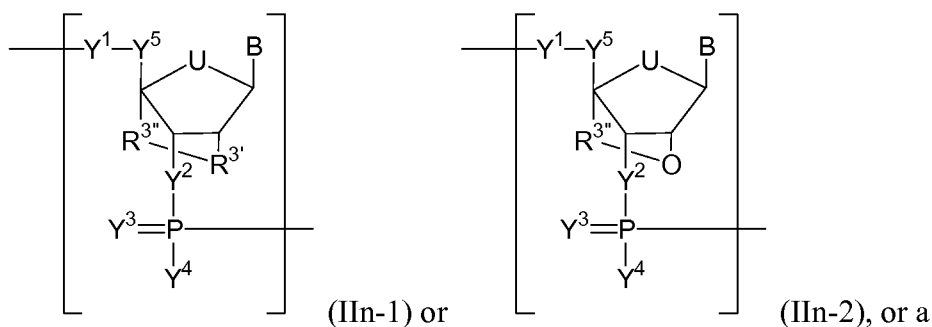

pharmaceutically acceptable salt or stereoisomer thereof, wherein $R^{3'}$ is O, S, or $-\text{NR}^{\text{N}1-}$, wherein $R^{\text{N}1}$ is H, optionally substituted alkyl, optionally substituted alkenyl, optionally substituted alkynyl, or optionally substituted aryl and $R^{3''}$ is optionally substituted alkylene (e.g., $-\text{CH}_2-$, $-\text{CH}_2\text{CH}_2-$, or $-\text{CH}_2\text{CH}_2\text{CH}_2-$) or optionally substituted heteroalkylene (e.g., $-\text{CH}_2\text{NH}-$, $-\text{CH}_2\text{CH}_2\text{NH}-$, $-\text{CH}_2\text{OCH}_2-$, or $-\text{CH}_2\text{CH}_2\text{OCH}_2-$) (e.g., $R^{3'}$ is O and $R^{3''}$ is optionally substituted alkylene (e.g., $-\text{CH}_2-$, $-\text{CH}_2\text{CH}_2-$, or $-\text{CH}_2\text{CH}_2\text{CH}_2-$)).

[000393] In some embodiments, the polynucleotide, primary construct, or mmRNA includes a locked modified ribose that forms a tetracyclic heterocyclyl. In some embodiments, the polynucleotide, primary construct, or mmRNA (e.g., the first region, the first flanking region, or the second flanking region) includes n number of linked nucleosides having Formula (Ho):

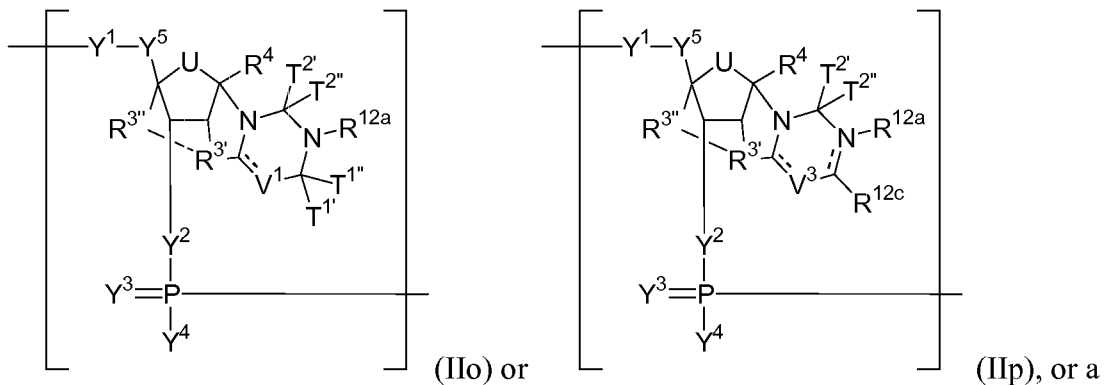

pharmaceutically acceptable salt or stereoisomer thereof, wherein R^{12a} , R^{12c} , $T^{1'}$, $T^{1''}$, $T^{2'}$, $T^{2''}$, V^1 , and V^3 are as described herein.

[000394] Any of the formulas for the polynucleotides, primary constructs, or mmRNA can include one or more nucleobases described herein (e.g., Formulas (bl)-(b43)).

[000395] In one embodiment, the present invention provides methods of preparing a polynucleotide, primary construct, or mmRNA, wherein the polynucleotide comprises n number of nucleosides having Formula (Ia), as defined herein:

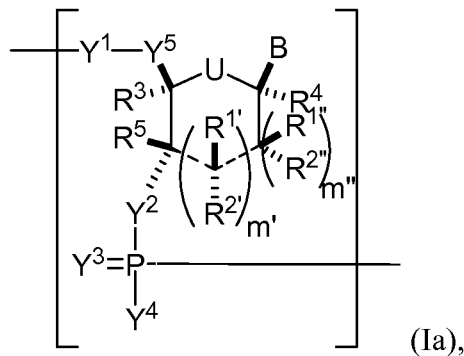

the method comprising reacting a compound of Formula (IIIa), as defined herein:

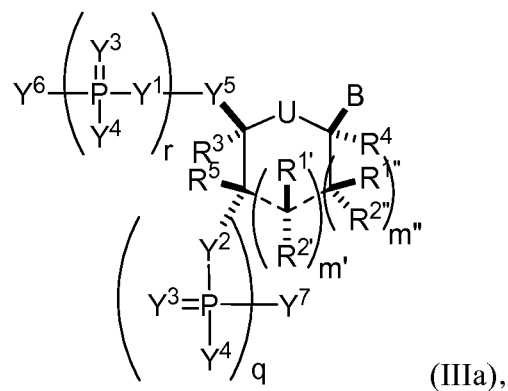

with an RNA polymerase, and a cDNA template.

[000396] In a further embodiment, the present invention provides methods of amplifying a polynucleotide, primary construct, or mmRNA comprising at least one nucleotide (e.g., mmRNA molecule), the method comprising: reacting a compound of Formula (IIa), as defined herein, with a primer, a cDNA template, and an RNA polymerase.

[000397] In one embodiment, the present invention provides methods of preparing a polynucleotide, primary construct, or mmRNA comprising at least one nucleotide (e.g., mmRNA molecule), wherein the polynucleotide comprises n number of nucleosides having Formula (Ia), as defined herein:

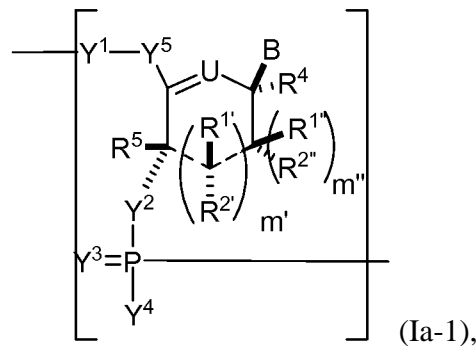

the method comprising reacting a compound of Formula (IIIa-1), as defined herein:

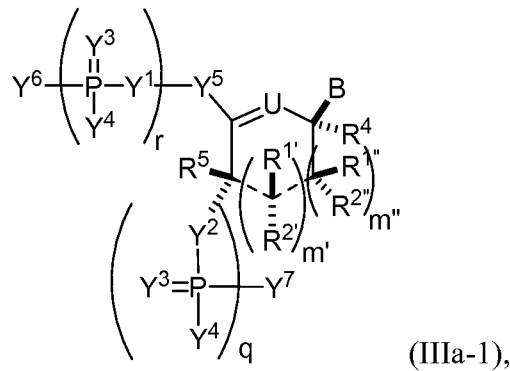

with an RNA polymerase, and a cDNA template.

[000398] In a further embodiment, the present invention provides methods of amplifying a polynucleotide, primary construct, or mmRNA comprising at least one nucleotide (e.g., mmRNA molecule), the method comprising:

[000399] reacting a compound of Formula (IIIa-1), as defined herein, with a primer, a cDNA template, and an RNA polymerase.

[000400] In one embodiment, the present invention provides methods of preparing a modified mRNA comprising at least one nucleotide (e.g., mmRNA molecule), wherein the polynucleotide comprises n number of nucleosides having Formula (Ia-2), as defined herein:

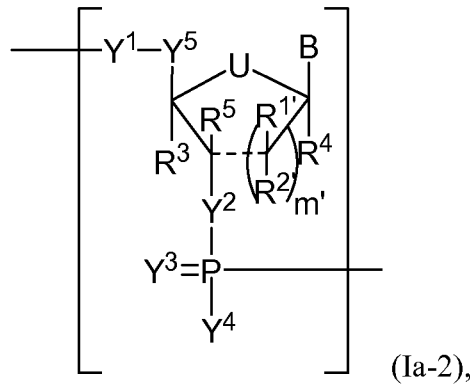

the method comprising reacting a compound of Formula (IIIa-2), as defined herein:

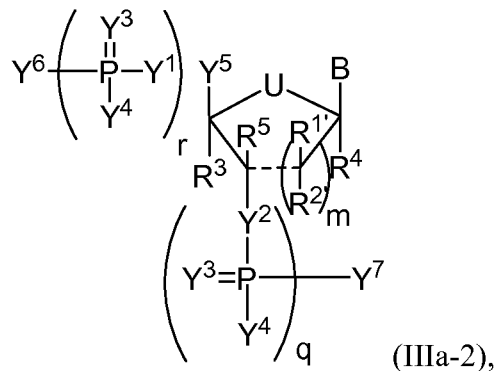

with an RNA polymerase, and a cDNA template.

[000401] In a further embodiment, the present invention provides methods of amplifying a modified mRNA comprising at least one nucleotide (e.g., mmRNA molecule), the method comprising:

[000402] reacting a compound of Formula (IIIa-2), as defined herein, with a primer, a cDNA template, and an RNA polymerase.

[000403] In some embodiments, the reaction may be repeated from 1 to about 7,000 times. In any of the embodiments herein, B may be a nucleobase of Formula (b1)-(b43).

[000404] The polynucleotides, primary constructs, and mmRNA can optionally include 5' and/or 3' flanking regions, which are described herein.

Modified RNA (mmRNA) Molecules

[000405] The present invention also includes building blocks, e.g., modified ribonucleosides, modified ribonucleotides, of modified RNA (mmRNA) molecules. For example, these building blocks can be useful for preparing the polynucleotides, primary constructs, or mmRNA of the invention.

In some embodiments, the building block molecule has Formula (IIia) or (IIIa-1):

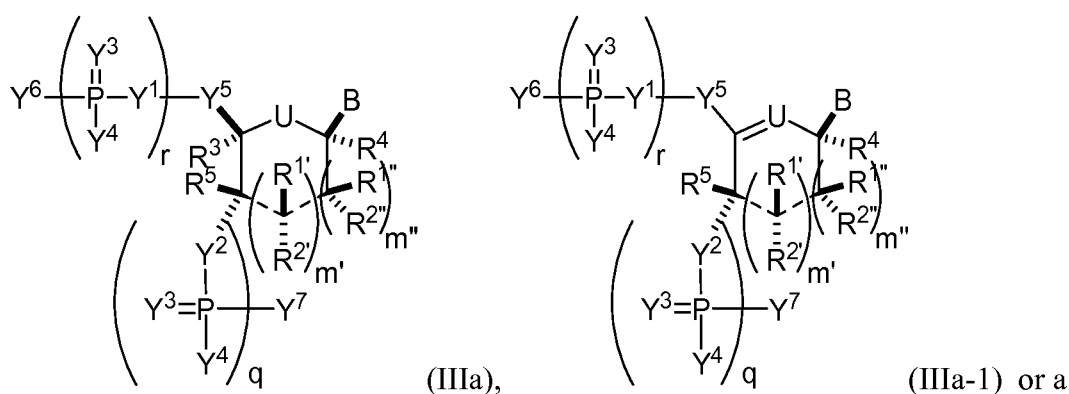

pharmaceutically acceptable salt or stereoisomer thereof, wherein the substituents are as described herein (e.g., for Formula (Ia) and (Ia-1)), and wherein when B is an unmodified nucleobase selected from cytosine, guanine, uracil and adenine, then at least one of Y¹, Y², or Y³ is not O.

[000406] In some embodiments, the building block molecule, which may be incorporated into a polynucleotide, primary construct, or mmRNA, has Formula (IVa)-(IVb):

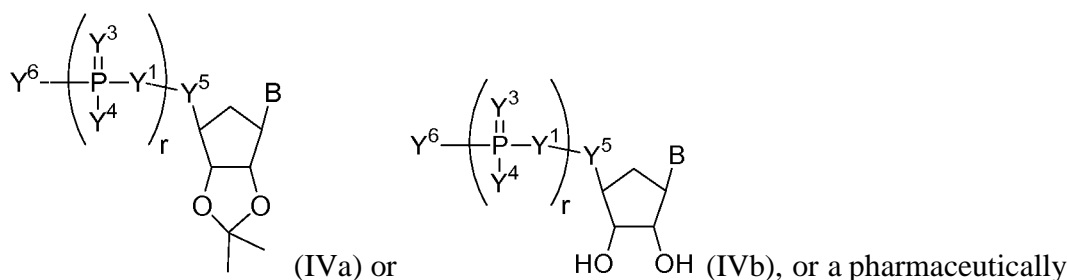

acceptable salt or stereoisomer thereof, wherein B is as described herein (e.g., any one of (bl)-(b43)). In particular embodiments, Formula (IVa) or (IVb) is combined with a modified uracil (e.g., any one of formulas (bl)-(b9), (b21)-(b23), and (b28)-(b31), such as formula (bl), (b8), (b28), (b29), or (b30)). In particular embodiments, Formula (IVa) or (IVb) is combined with a modified cytosine (e.g., any one of formulas (bl0)-(bl4),

(b24), (b25), and (b32)-(b36), such as formula (b10) or (b32). In particular embodiments, Formula (IVa) or (IVb) is combined with a modified guanine (e.g., any one of formulas (b15)-(b17) and (b37)-(b40)). In particular embodiments, Formula (IVa) or (IVb) is combined with a modified adenine (e.g., any one of formulas (M8)-(b20) and (b41)-(b43)).

[000407] In some embodiments, the building block molecule, which may be incorporated into a polynucleotide, primary construct, or mmRNA, has Formula (IVc)-(IVk):

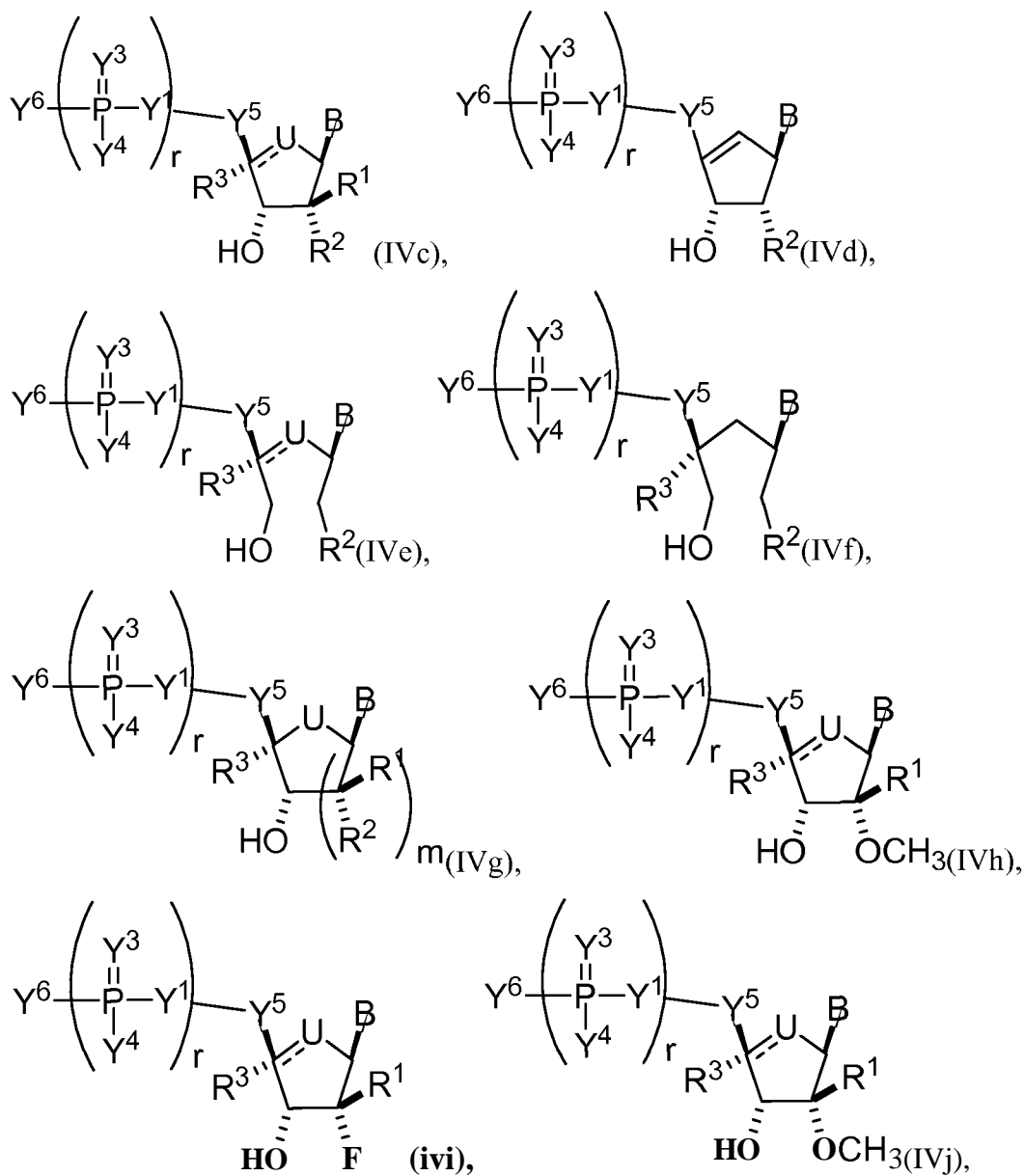

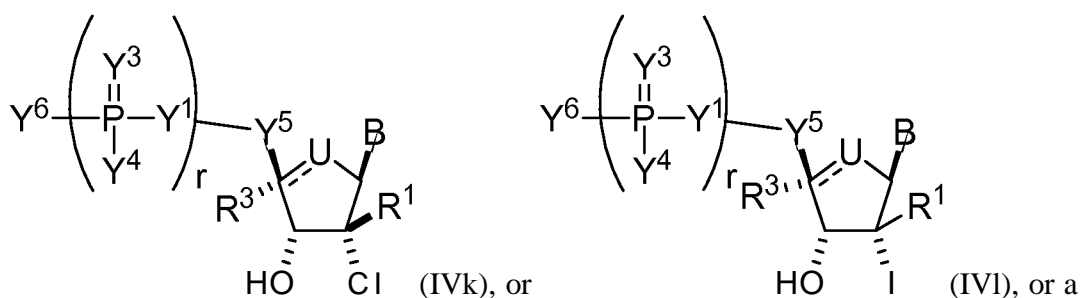

pharmaceutically acceptable salt or stereoisomer thereof, wherein B is as described herein (e.g., any one of (b1)-(b43)). In particular embodiments, one of Formulas (IVc)-(IVk) is combined with a modified uracil (e.g., any one of formulas (b1)-(b9), (b21)-(b23), and (b28)-(b31), such as formula (b1), (b8), (b28), (b29), or (b30)). In particular embodiments, one of Formulas (IVc)-(IVk) is combined with a modified cytosine (e.g., any one of formulas (M0)-(b14), (b24), (b25), and (b32)-(b36), such as formula (b10) or (b32)). In particular embodiments, one of Formulas (IVc)-(IVk) is combined with a modified guanine (e.g., any one of formulas (b15)-(b17) and (b37)-(b40)). In particular embodiments, one of Formulas (IVc)-(IVk) is combined with a modified adenine (e.g., any one of formulas (M8)-(b20) and (b41)-(b43)).

[000408] In other embodiments, the building block molecule, which may be incorporated into a polynucleotide, primary construct, or mmRNA, has Formula (Va) or (Vb):

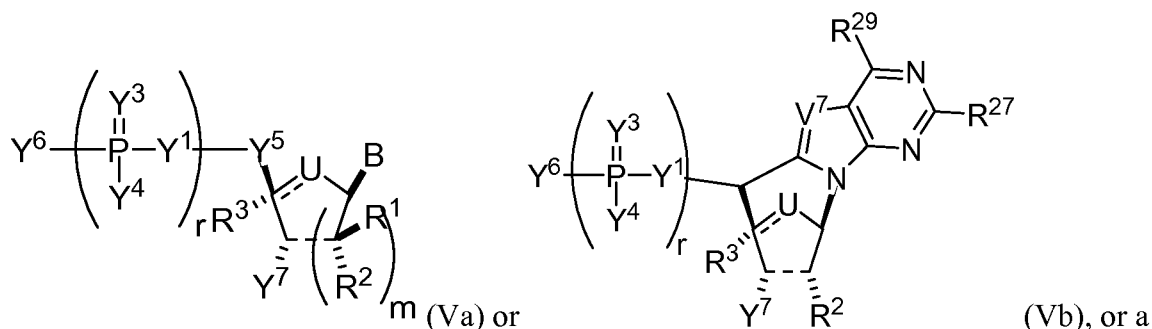

pharmaceutically acceptable salt or stereoisomer thereof, wherein B is as described herein (e.g., any one of (b1)-(b43)).

[000409] In other embodiments, the building block molecule, which may be incorporated into a polynucleotide, primary construct, or mmRNA, has Formula (IXa)-(IXd):

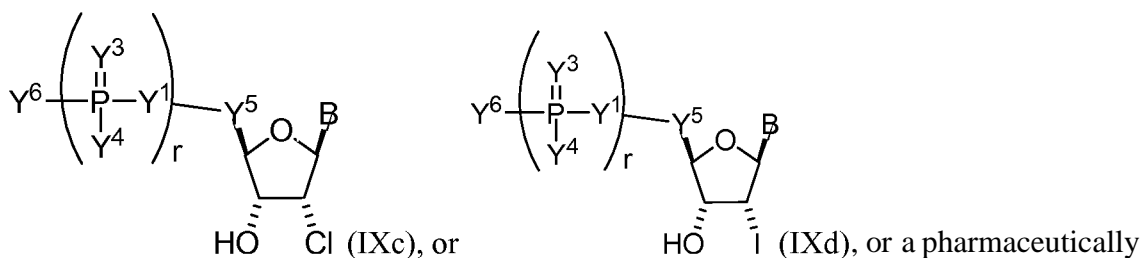
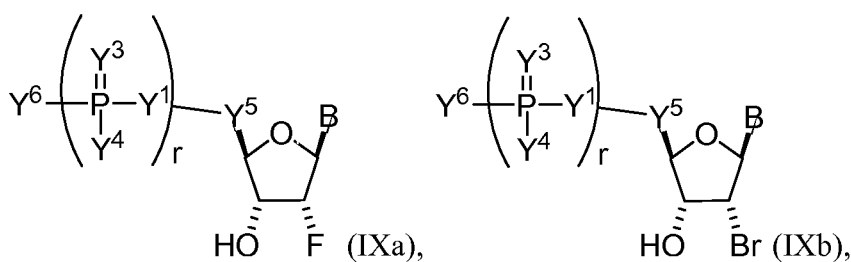

acceptable salt or stereoisomer thereof, wherein B is as described herein (e.g., any one of (b1)-(b43)). In particular embodiments, one of Formulas (IXa)-(IXd) is combined with a modified uracil (e.g., any one of formulas (b1)-(b9), (b21)-(b23), and (b28)-(b31), such as formula (b1), (b8), (b28), (b29), or (b30)). In particular embodiments, one of Formulas (IXa)-(IXd) is combined with a modified cytosine (e.g., any one of formulas (M0)-(b14), (b24), (b25), and (b32)-(b36), such as formula (b10) or (b32)). In particular embodiments, one of Formulas (IXa)-(IXd) is combined with a modified guanine (e.g., any one of formulas (b15)-(b17) and (b37)-(b40)). In particular embodiments, one of Formulas (IXa)-(IXd) is combined with a modified adenine (e.g., any one of formulas (M8)-(b20) and (b41)-(b43)).

[000410] In other embodiments, the building block molecule, which may be incorporated into a polynucleotide, primary construct, or mmRNA, has Formula (IXe)-(IXg):

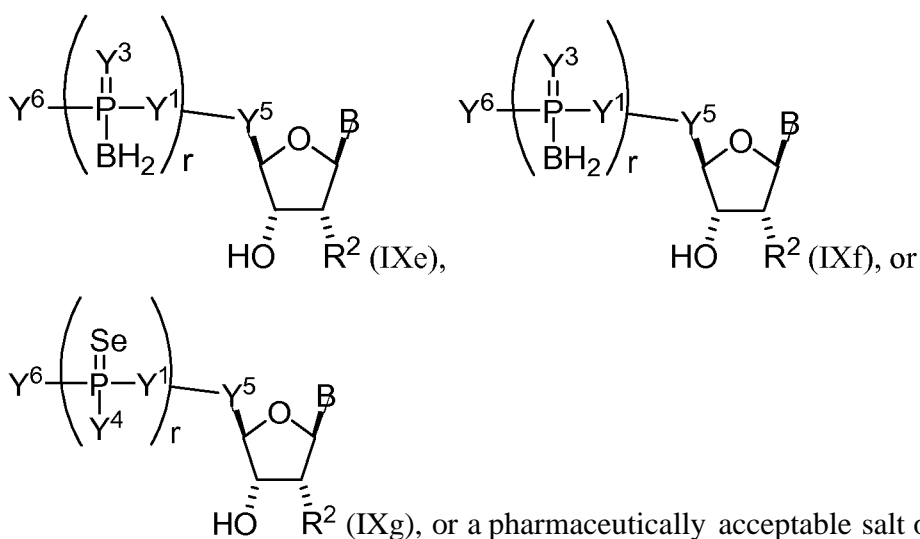

or a pharmaceutically acceptable salt or stereoisomer thereof, wherein B is as described herein (e.g., any one of (b1)-(b43)). In particular embodiments, one of Formulas (IXe)-(IXg) is combined with a modified uracil (e.g., any one of formulas (b1)-(b9), (b21)-(b23), and (b28)-(b31), such as formula (b1), (b8), (b28), (b29), or (b30)). In particular embodiments, one of Formulas (IXe)-(IXg) is combined with a modified cytosine (e.g., any one of formulas (M0)-(b14), (b24), (b25), and (b32)-(b36), such as formula (b10) or (b32)). In particular embodiments, one of Formulas (IXe)-(IXg) is combined with a modified guanine (e.g., any one of formulas (b15)-(b17) and (b37)-(b40)). In particular embodiments, one of Formulas (IXe)-(IXg) is combined with a modified adenine (e.g., any one of formulas (M8)-(b20) and (b41)-(b43)).

[000411] In other embodiments, the building block molecule, which may be incorporated into a polynucleotide, primary construct, or mmRNA, has Formula (IXh)-(IXk):

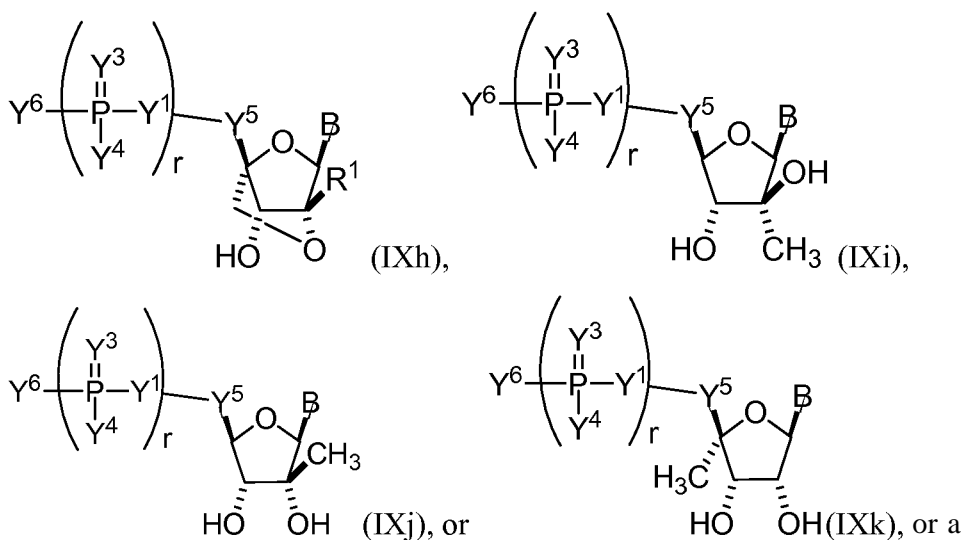

pharmaceutically acceptable salt or stereoisomer thereof, wherein B is as described herein (e.g., any one of (b1)-(b43)). In particular embodiments, one of Formulas (IXh)-(IXk) is combined with a modified uracil (e.g., any one of formulas (b1)-(b9), (b21)-(b23), and (b28)-(b31), such as formula (b1), (b8), (b28), (b29), or (b30)). In particular embodiments, one of Formulas (IXh)-(IXk) is combined with a modified cytosine (e.g., any one of formulas (M0)-(b14), (b24), (b25), and (b32)-(b36), such as formula (b10) or (b32)). In particular embodiments, one of Formulas (IXh)-(IXk) is combined with a modified guanine (e.g., any one of formulas (b15)-(b17) and (b37)-(b40)). In particular embodiments, one of Formulas (IXh)-(IXk) is combined with a modified adenine (e.g., any one of formulas (M8)-(b20) and (b41)-(b43)).

[000412] In other embodiments, the building block molecule, which may be incorporated into a polynucleotide, primary construct, or mmRNA, has Formula (IX1)-(IXr):

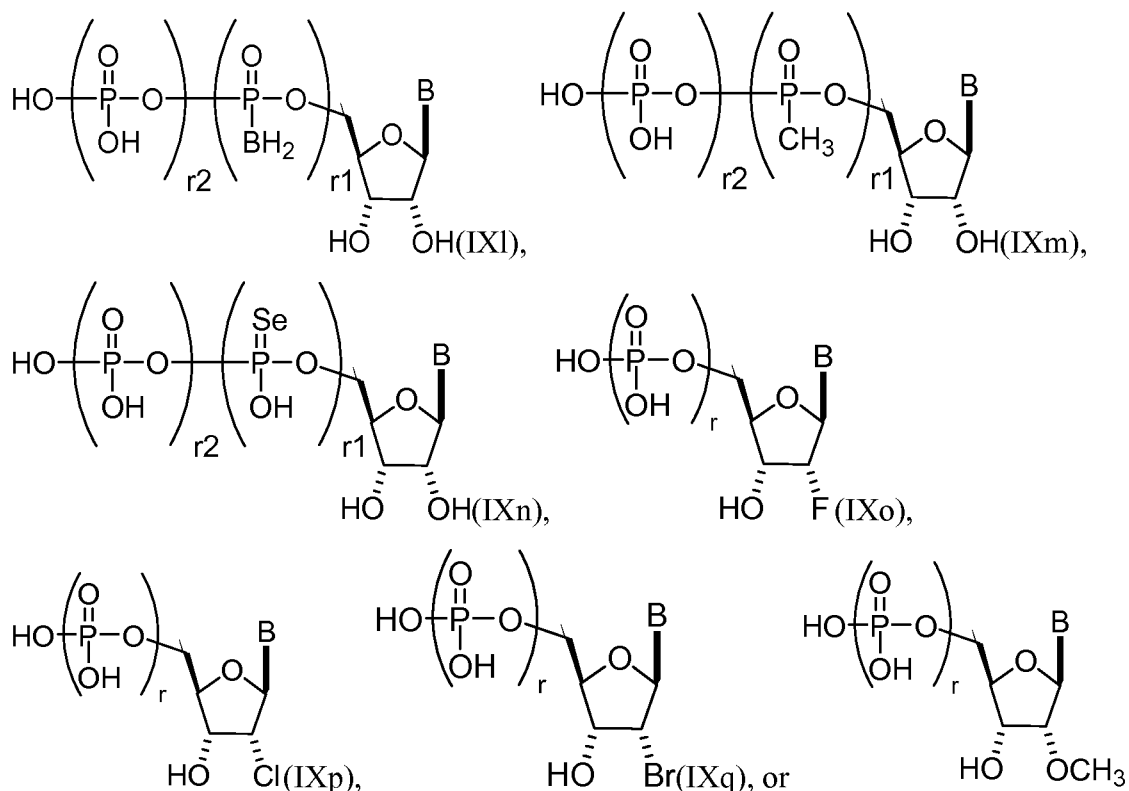

(IXr) or a pharmaceutically acceptable salt or stereoisomer thereof, wherein each r1 and r2 is, independently, an integer from 0 to 5 (e.g., from 0 to 3, from 1 to 3, or from 1 to 5) and B is as described herein (e.g., any one of (b1)-(b43)). In particular embodiments, one of Formulas (IXl)-(IXr) is combined with a modified uracil (e.g., any one of formulas (b1)-(b9), (b21)-(b23), and (b28)-(b31), such as formula (b1), (b8), (b28), (b29), or (b30)). In particular embodiments, one of Formulas (IXl)-(IXr) is combined with a modified cytosine (e.g., any one of formulas (M0)-(b14), (b24), (b25), and (b32)-(b36), such as formula (b10) or (b32)). In particular embodiments, one of Formulas (IXl)-(IXr) is combined with a modified guanine (e.g., any one of formulas (b15)-(b17) and (b37)-(b40)). In particular embodiments, one of Formulas (IXl)-(IXr) is combined with a modified adenine (e.g., any one of formulas (M8)-(b20) and (b41)-(b43)).

[000413] In some embodiments, the building block molecule, which may be incorporated into a polynucleotide, primary construct, or mmRNA, can be selected from the group consisting of:

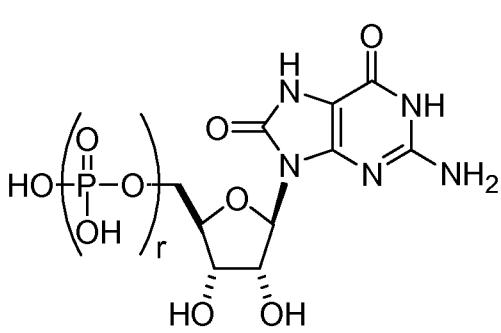
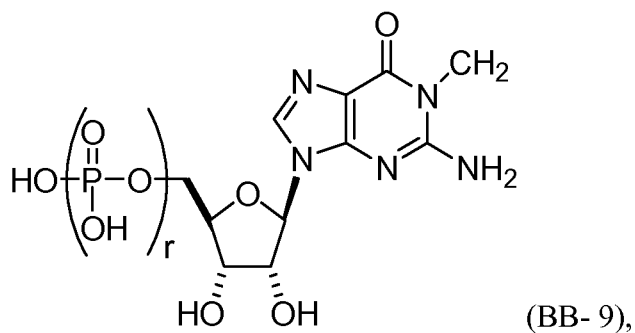
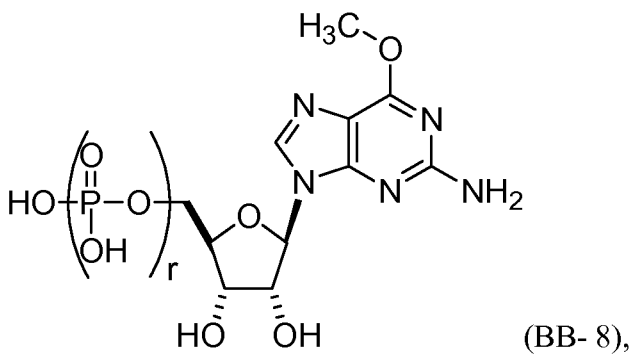
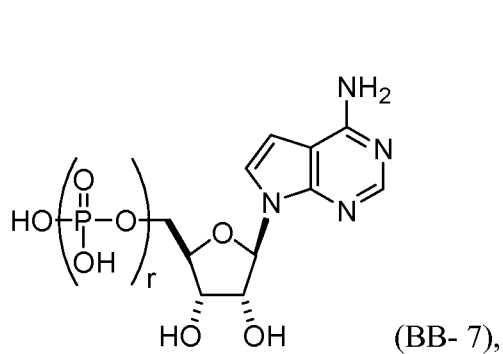
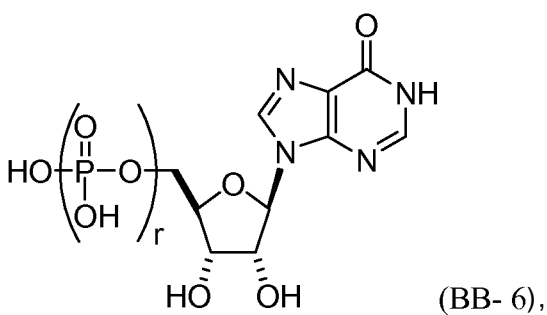
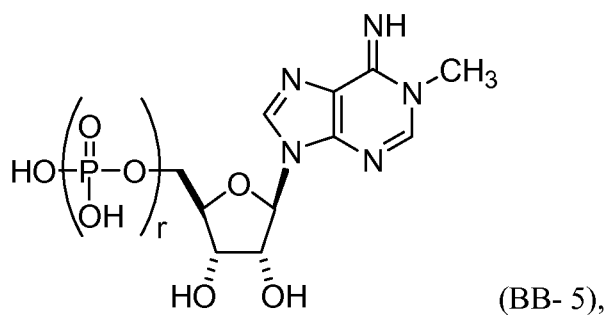
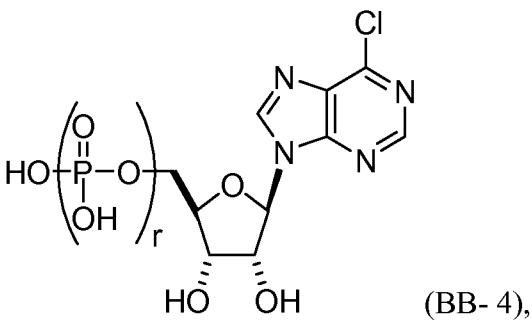
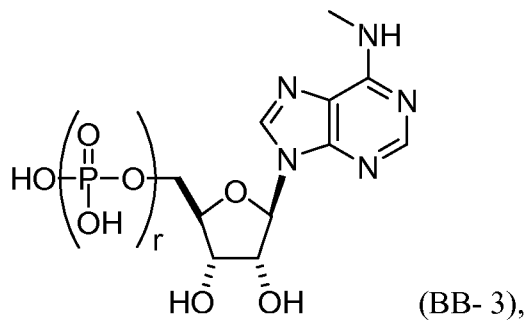
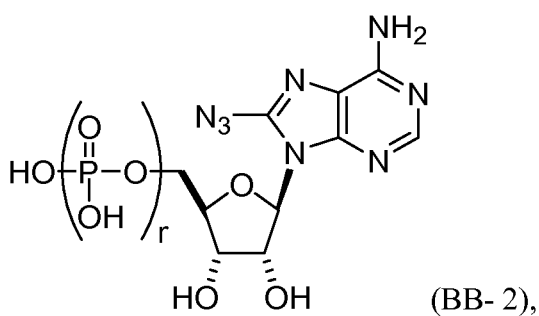
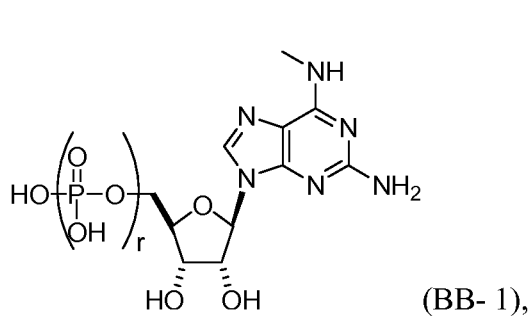

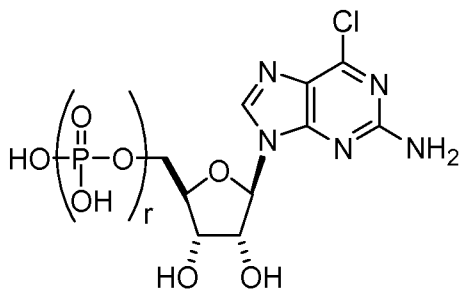

(BB- 10),

(BB- 11), and

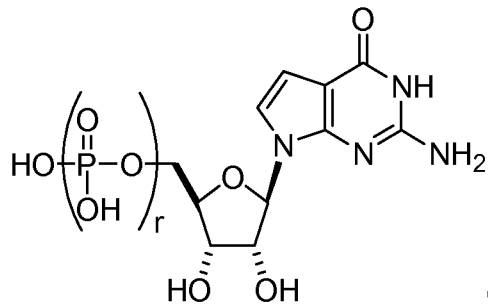

(BB- 12), or a pharmaceutically acceptable salt or

stereoisomer thereof, wherein each r is, independently, an integer from 0 to 5 (e.g., from 0 to 3, from 1 to 3, or from 1 to 5).

[000414] In some embodiments, the building block molecule, which may be incorporated into a polynucleotide, primary construct, or mmRNA, can be selected from the group consisting of:

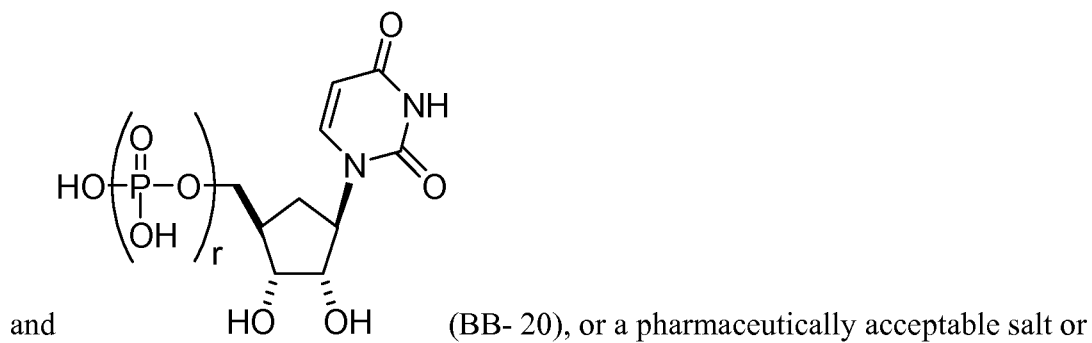
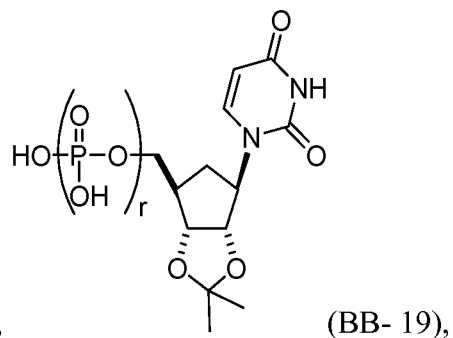
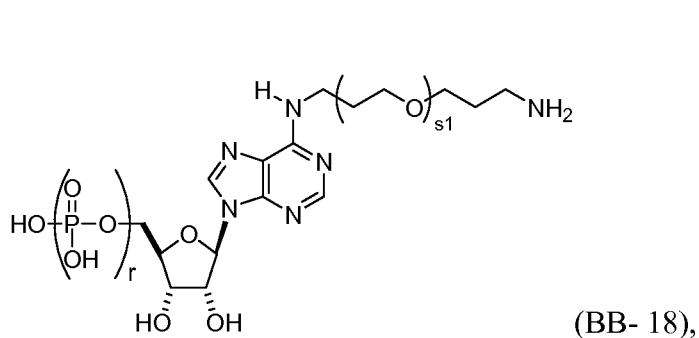
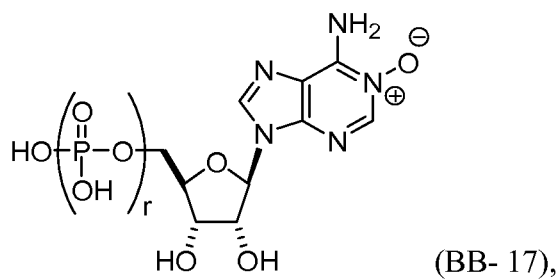
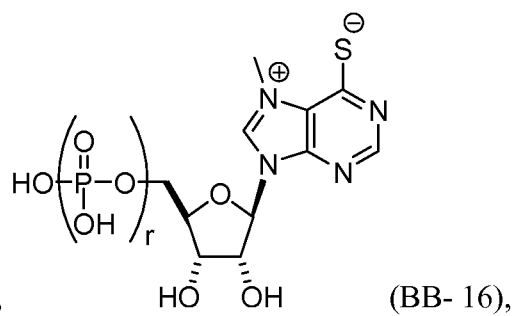
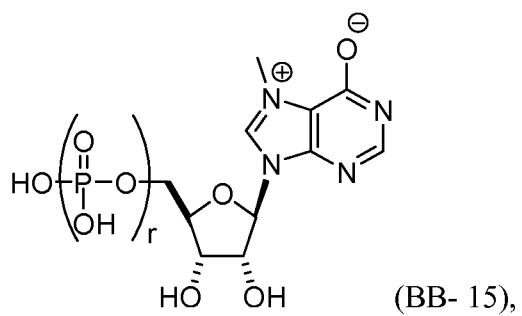
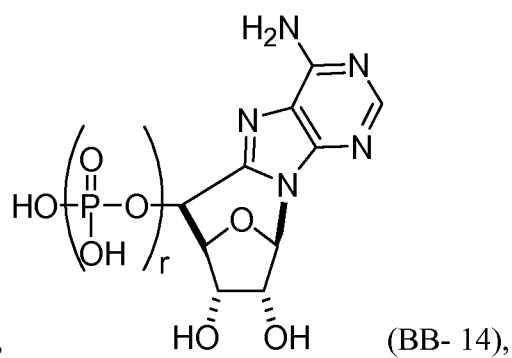
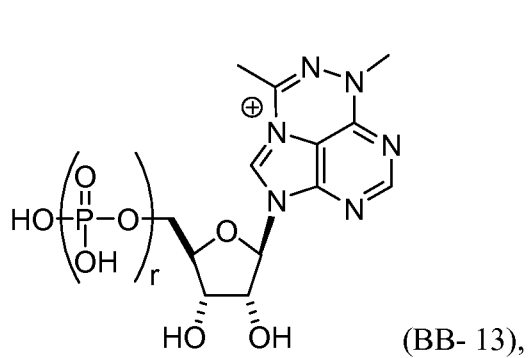

stereoisomer thereof, wherein each r is, independently, an integer from 0 to 5 (e.g., from 0 to 3, from 1 to 3, or from 1 to 5) and s_i is as described herein.

[000415] In some embodiments, the building block molecule, which may be incorporated into a nucleic acid (e.g., RNA, mRNA, polynucleotide, primary construct, or mmRNA), is a modified uridine (e.g., selected from the group consisting of:

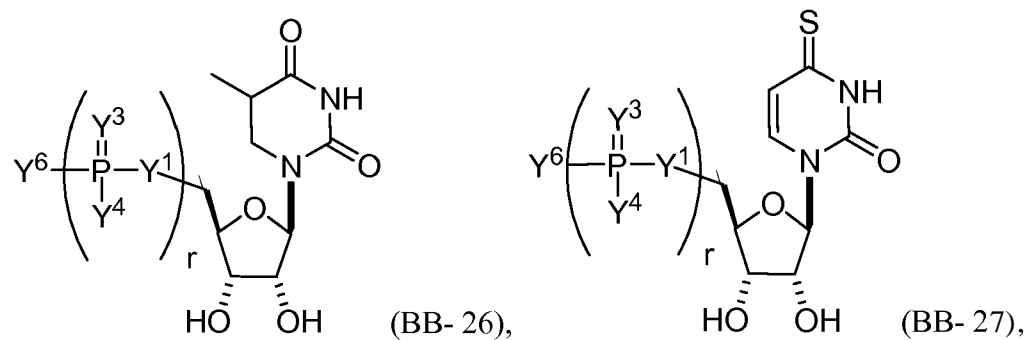
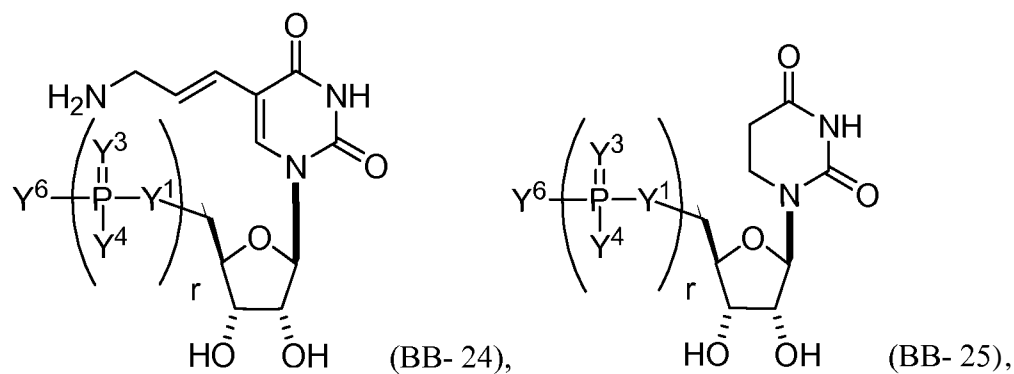
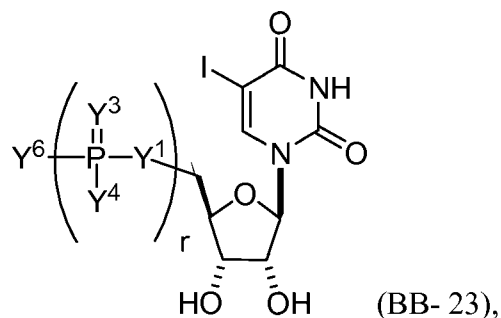
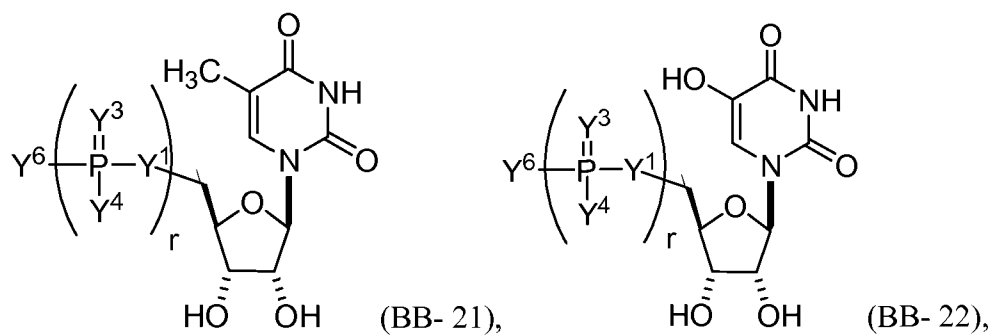

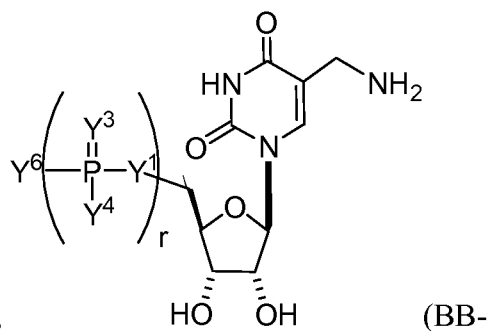
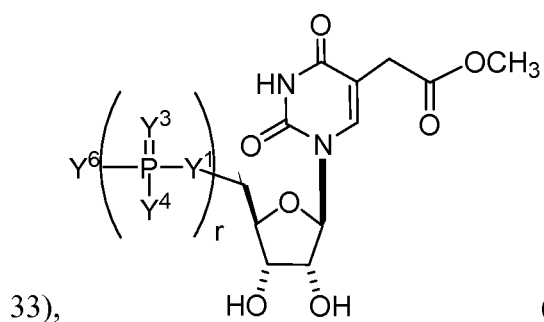
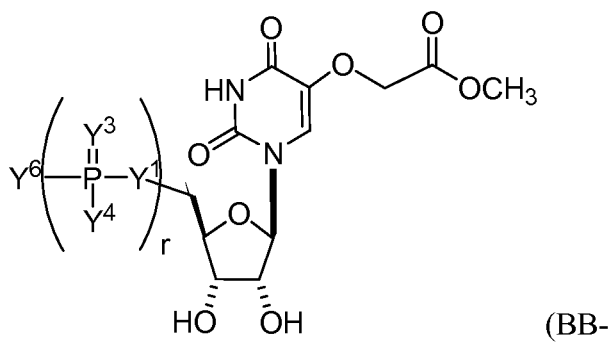
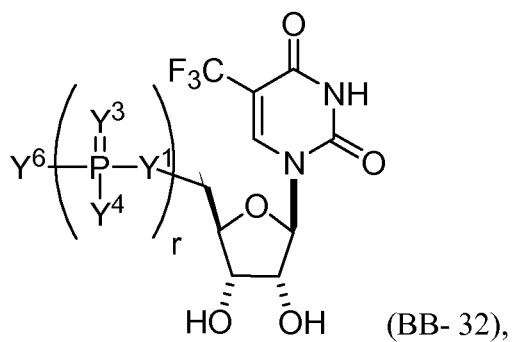
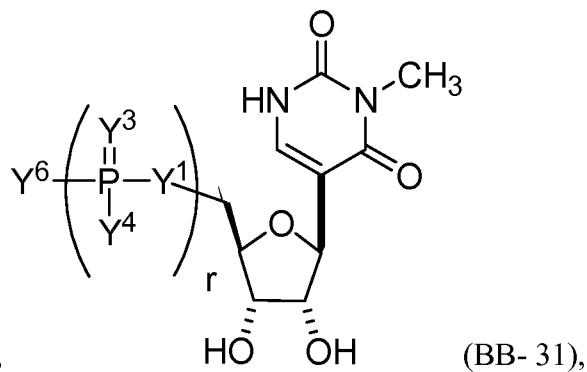
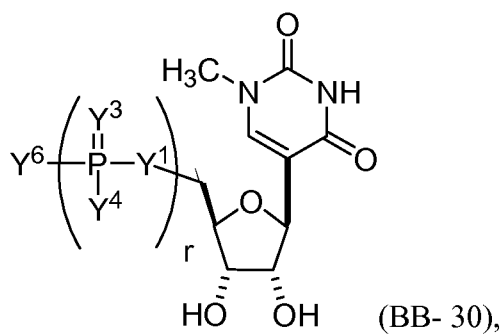
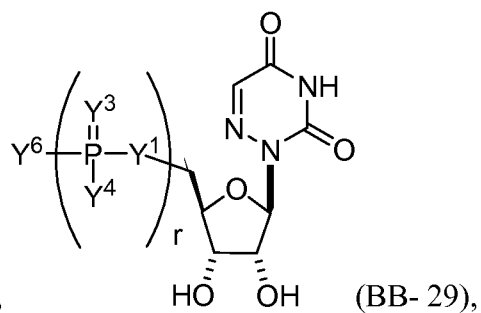
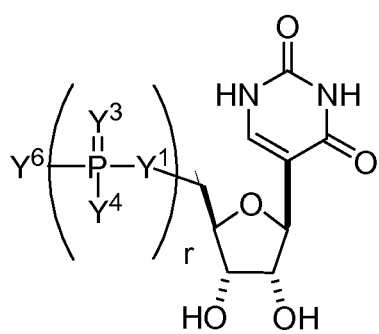

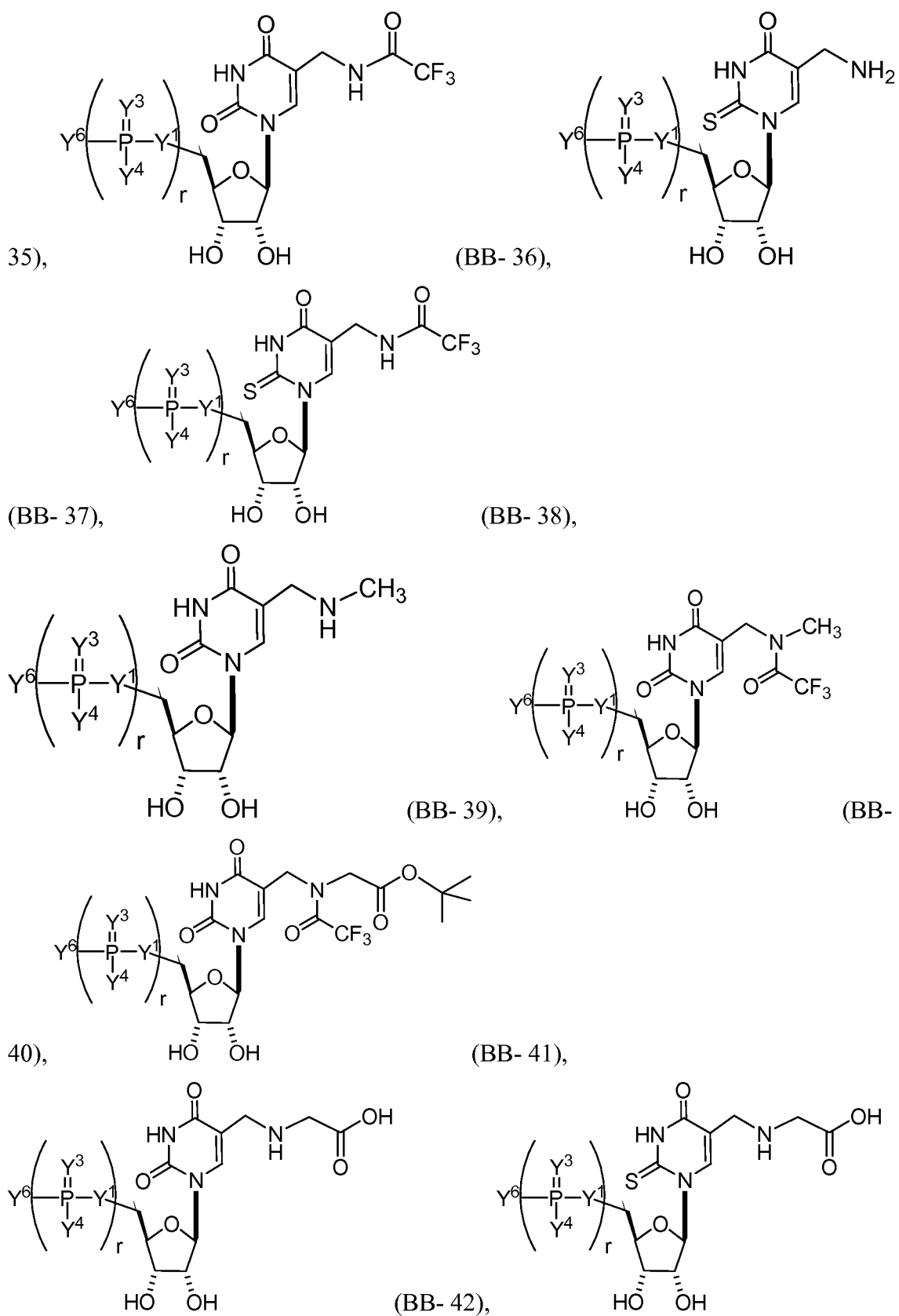

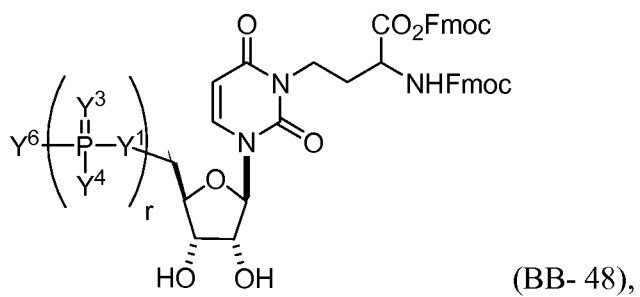
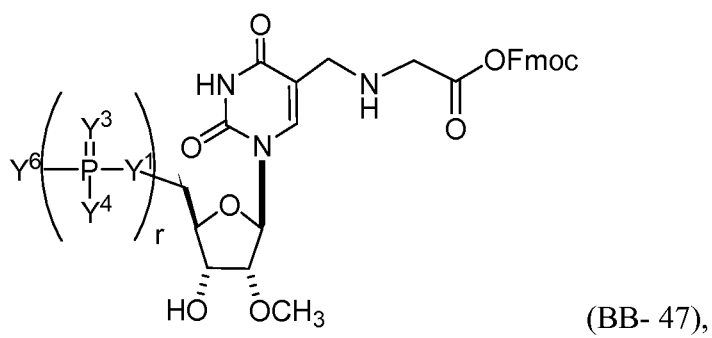
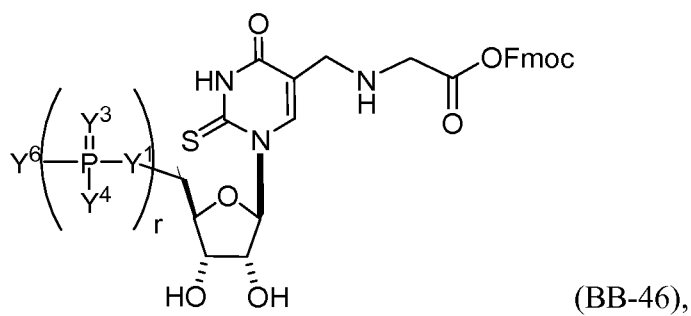
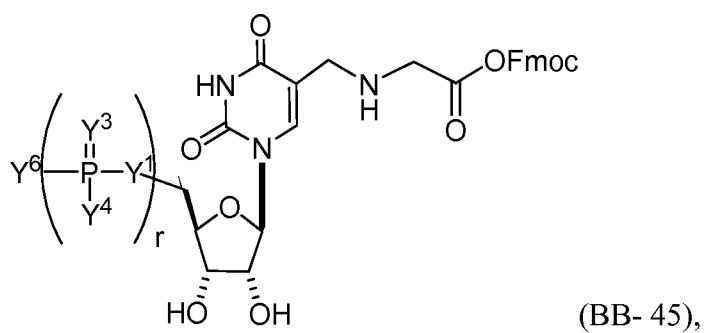
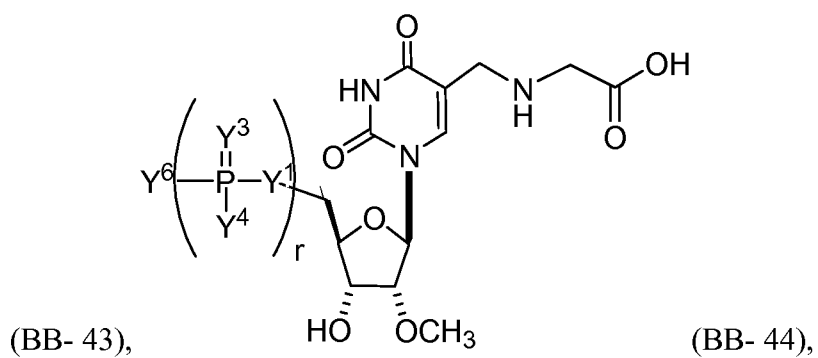

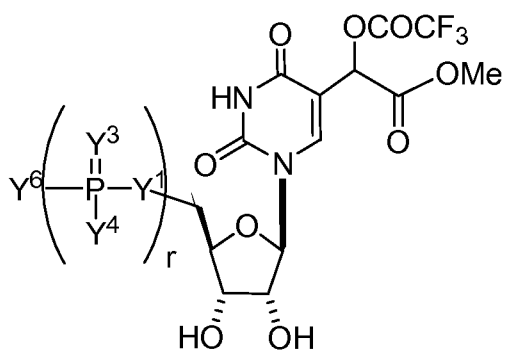
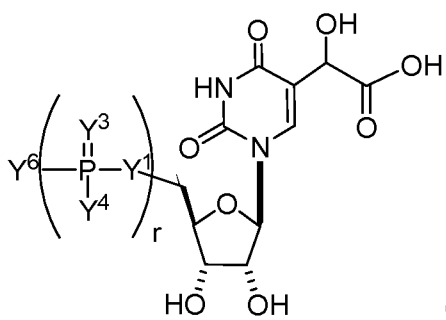
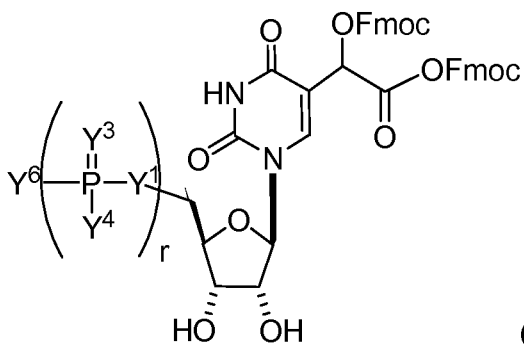
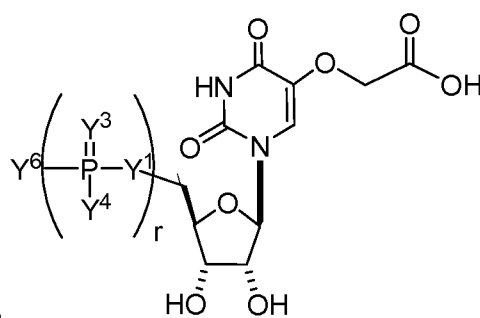
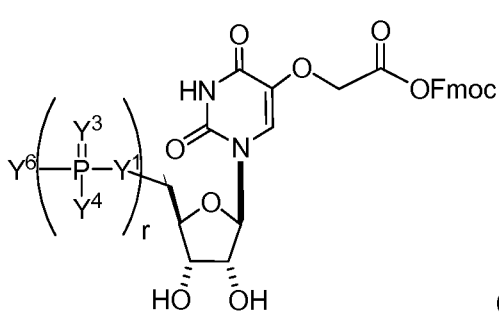
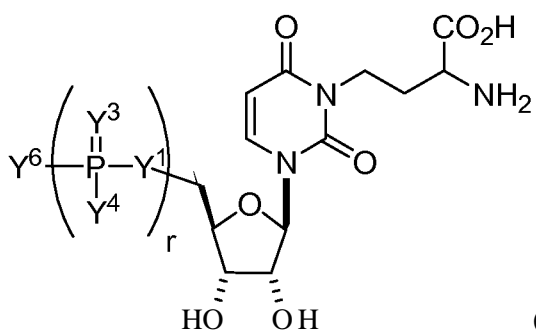

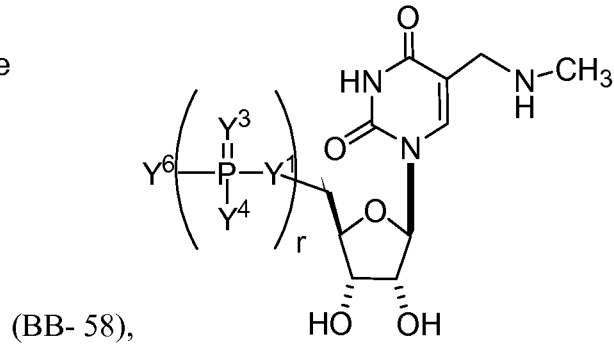
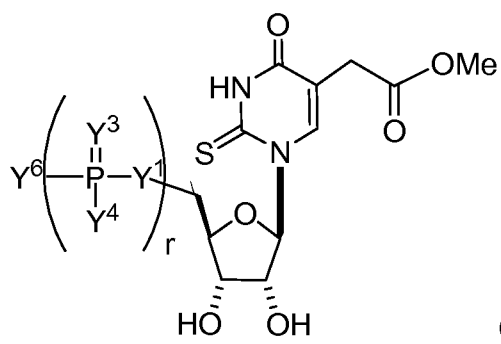
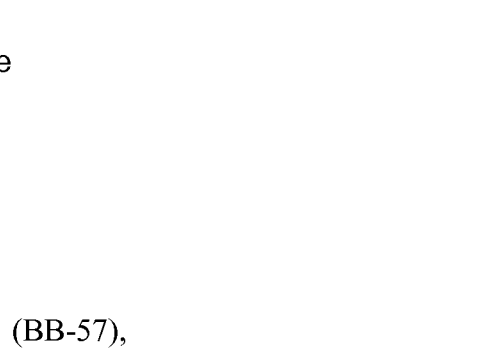
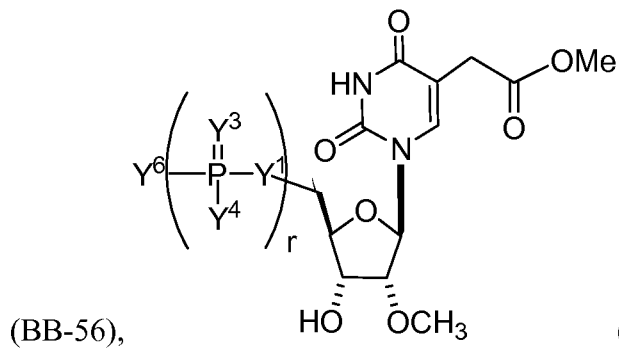
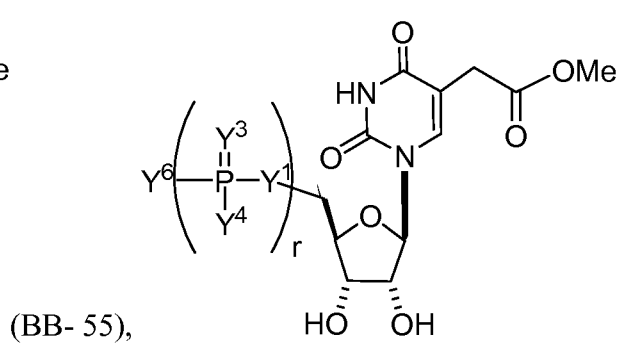
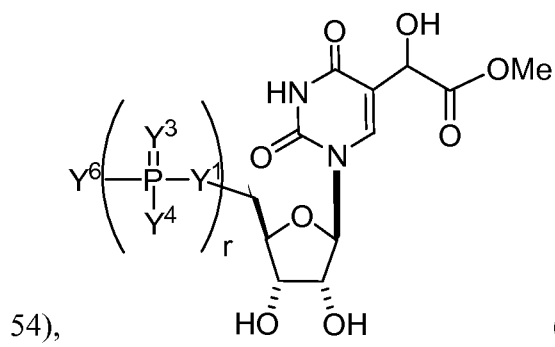

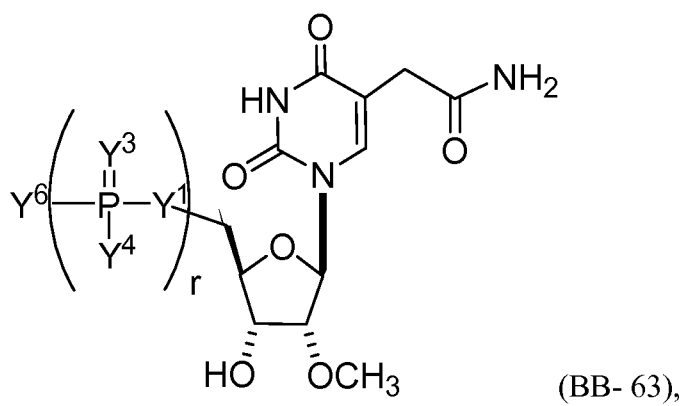
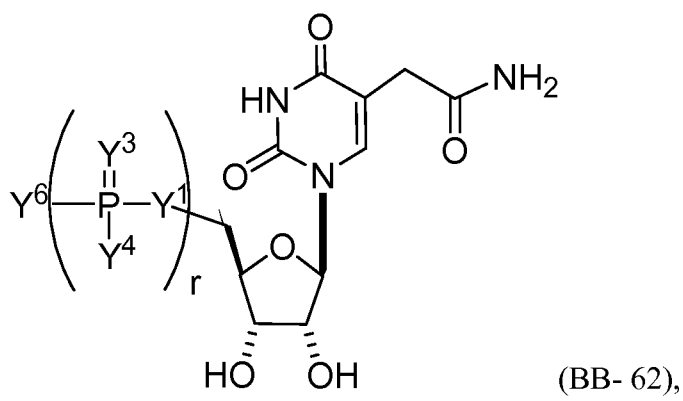
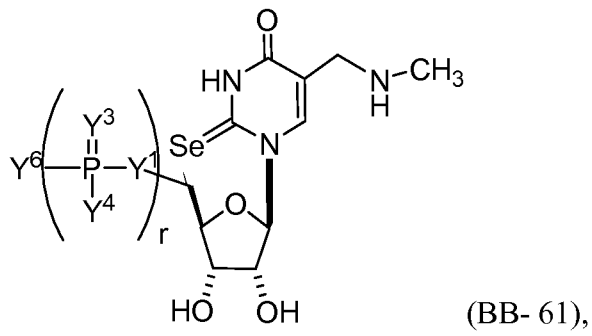
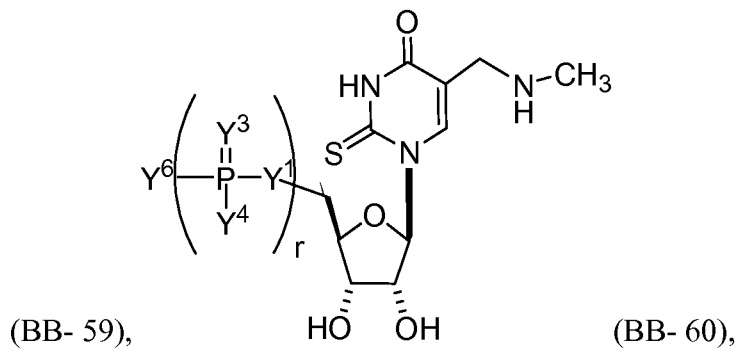

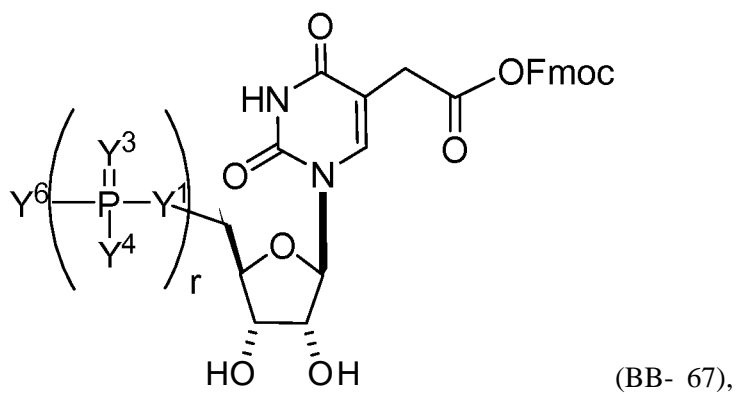
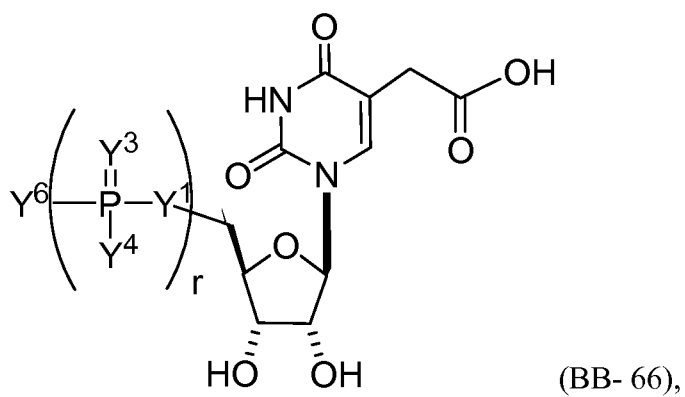
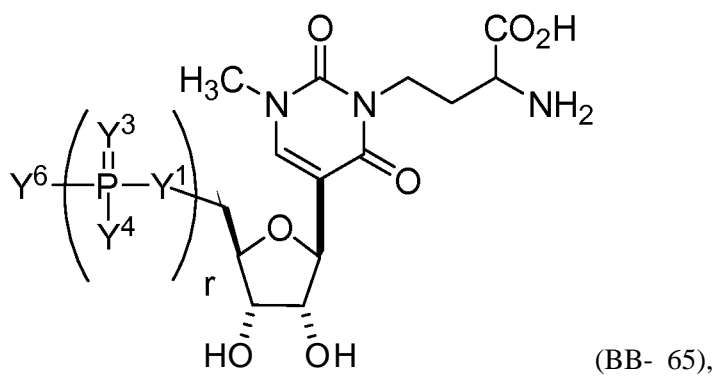
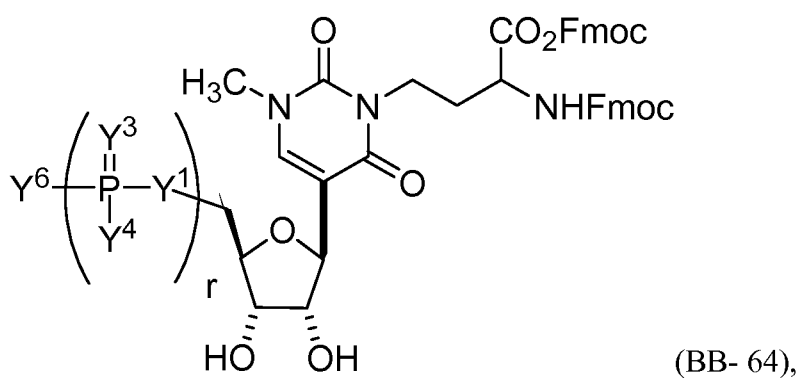

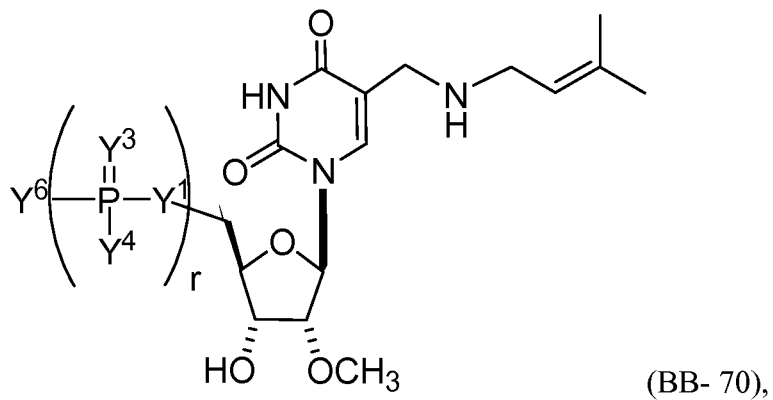
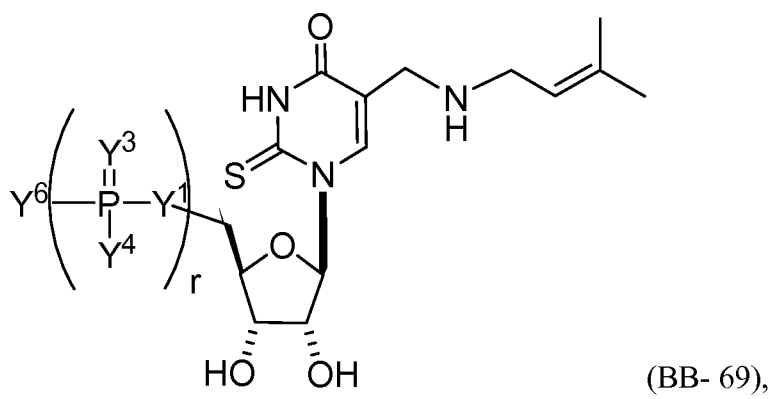
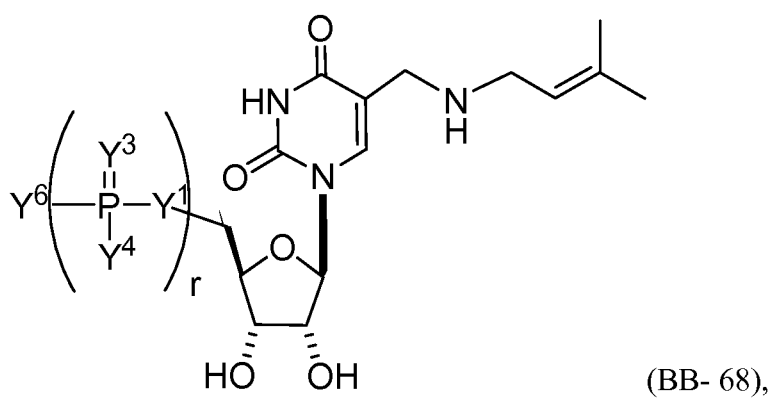

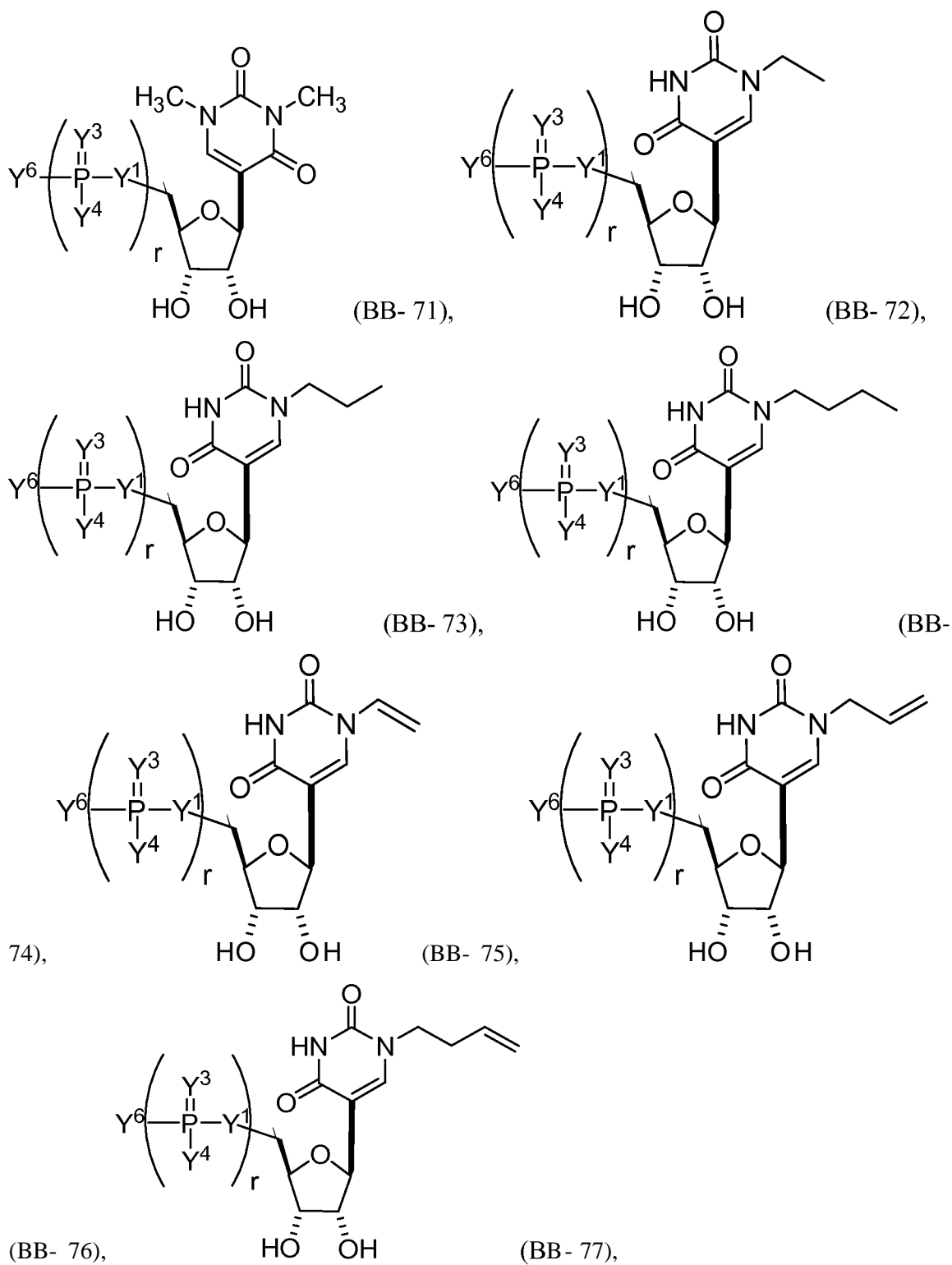

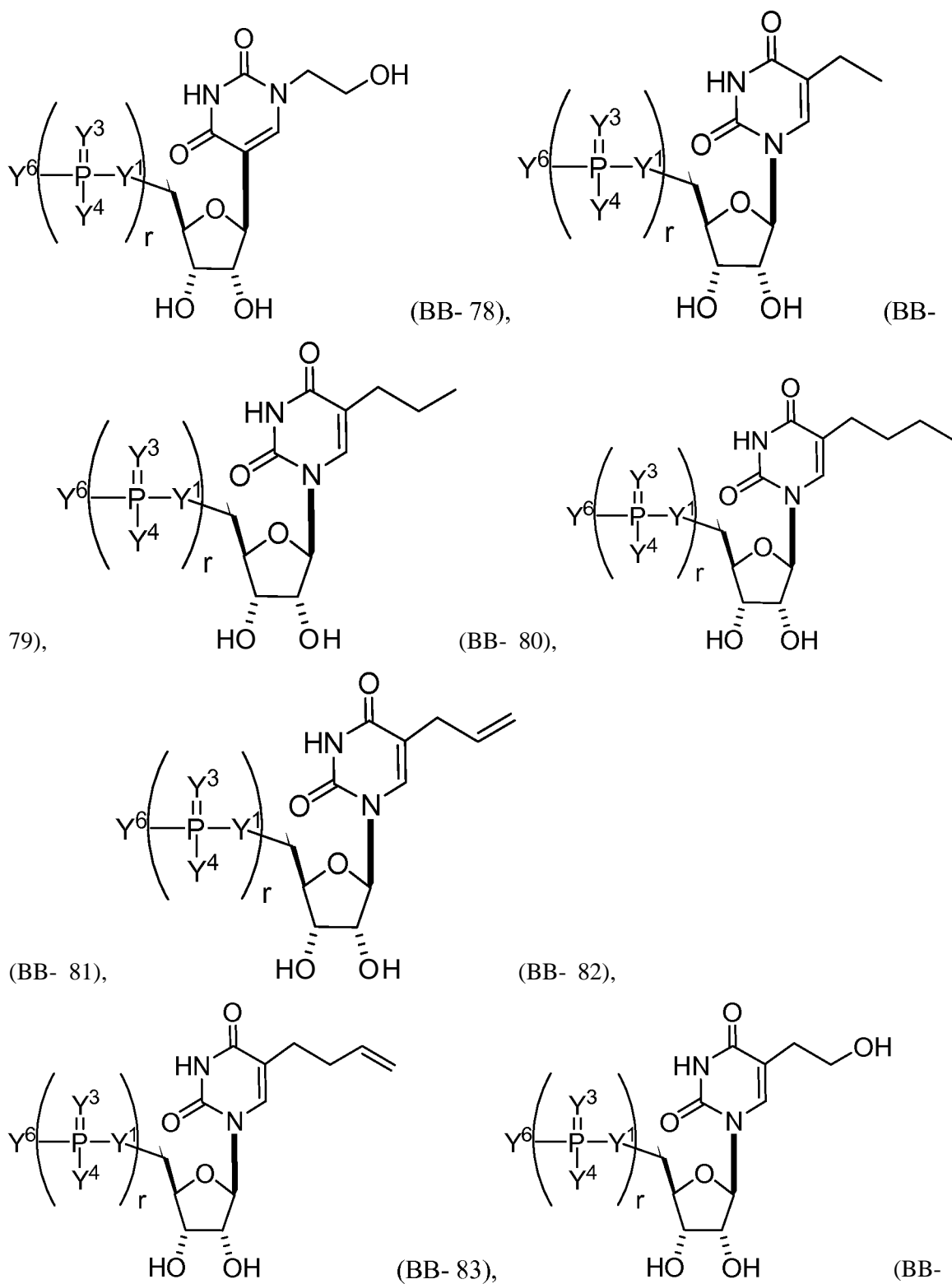

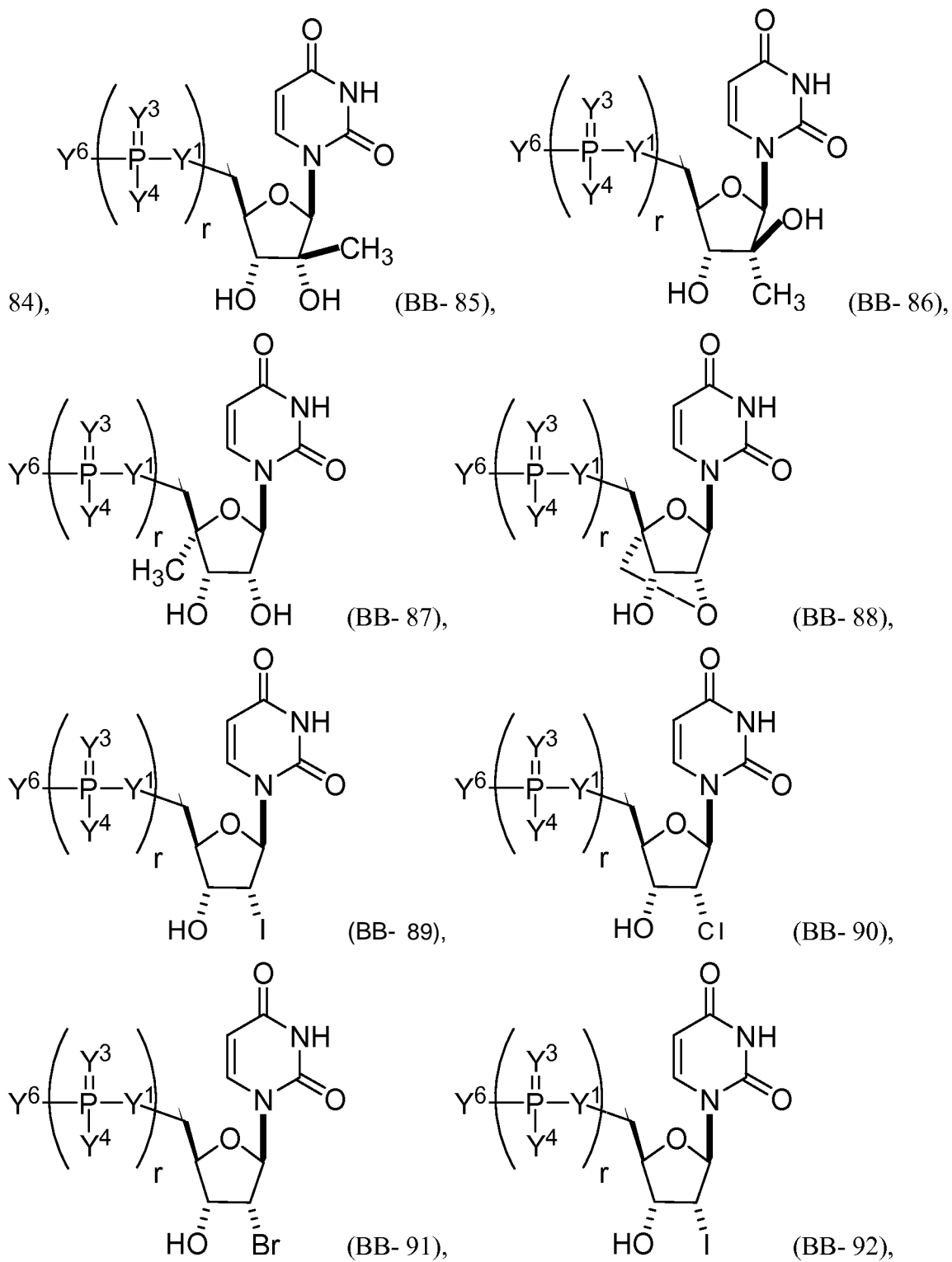

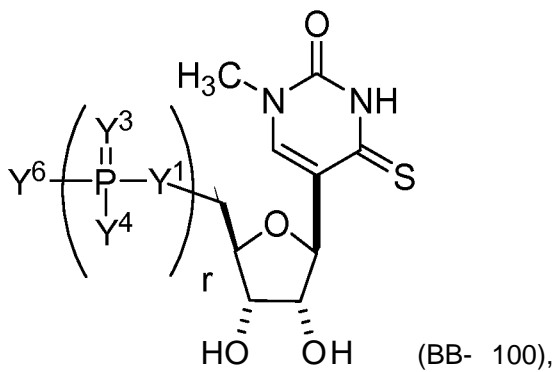
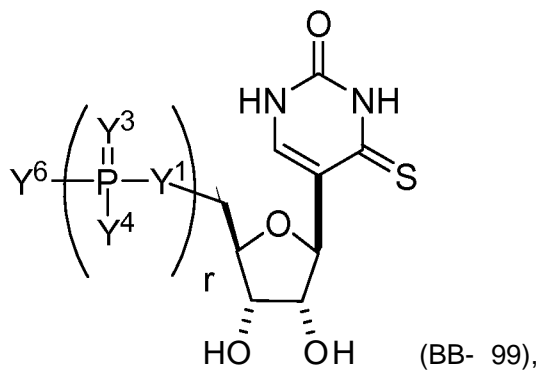
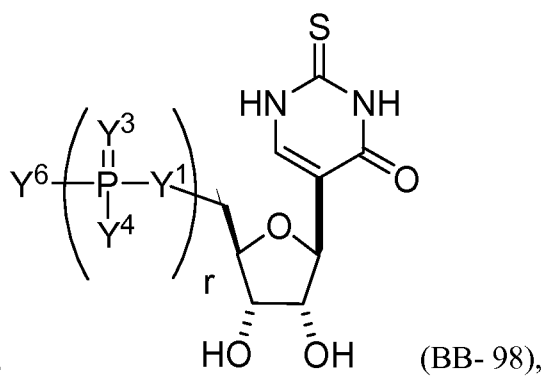
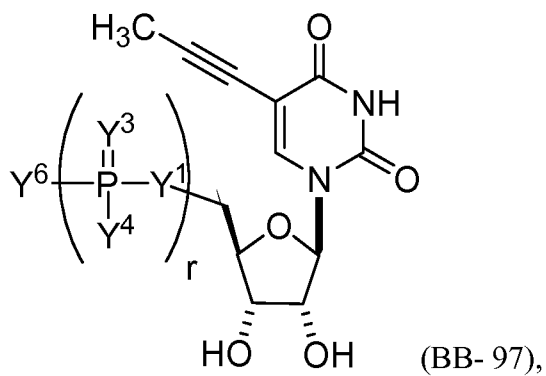
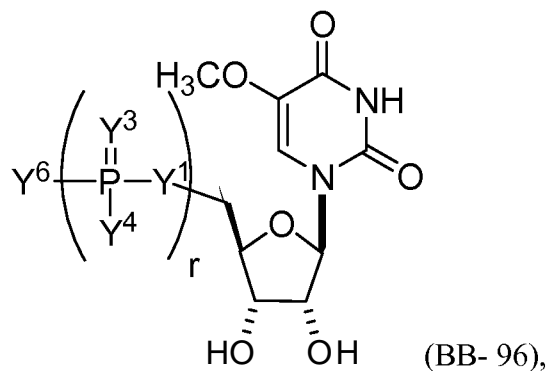
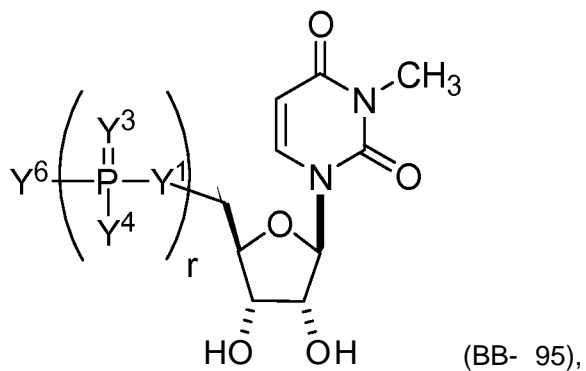
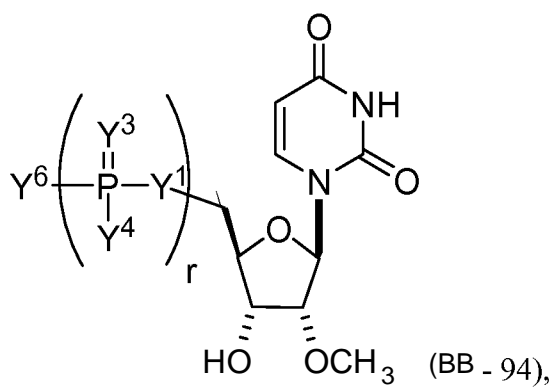
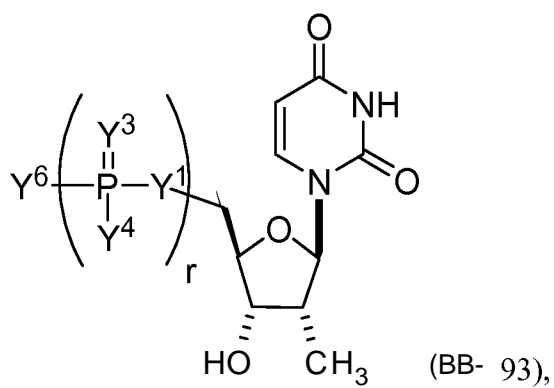

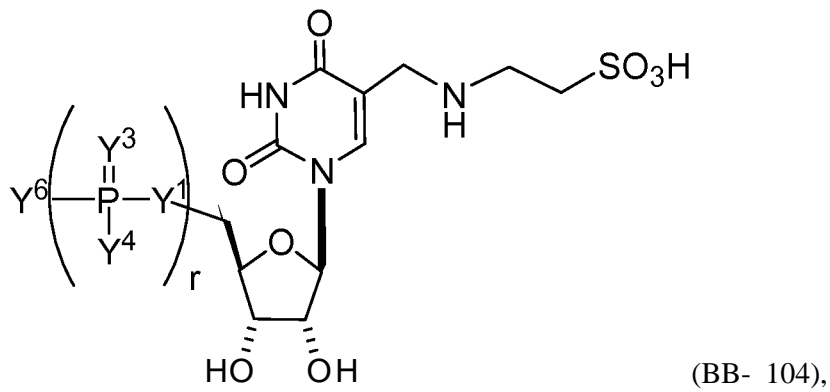
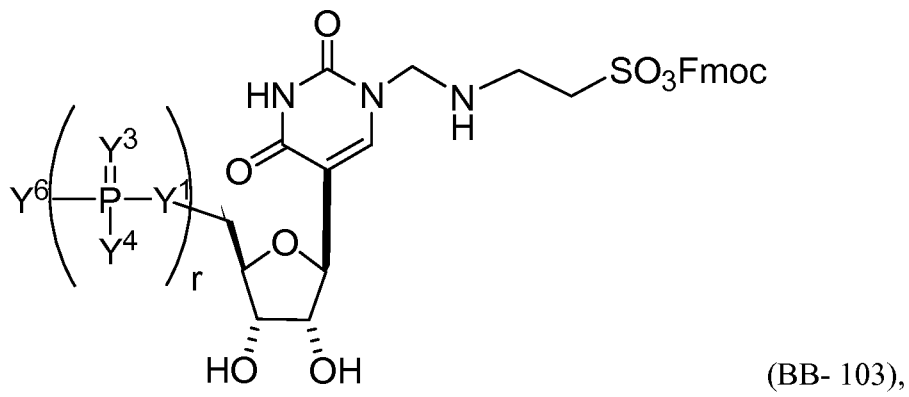
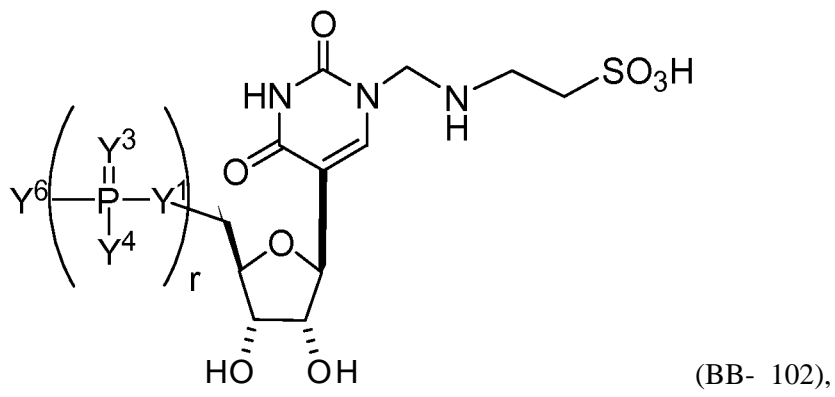
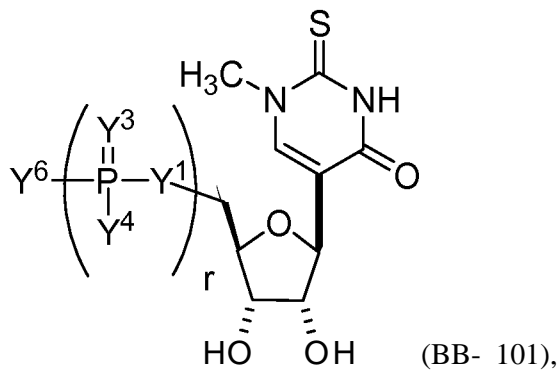

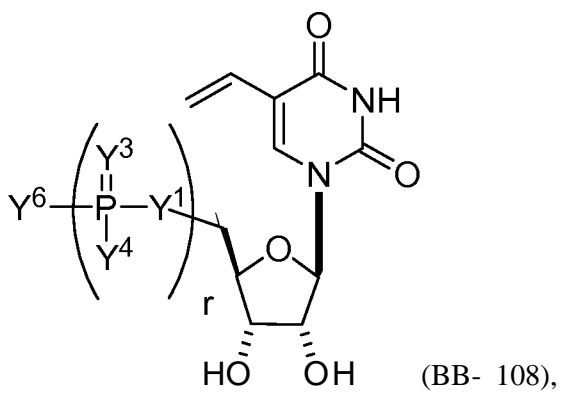
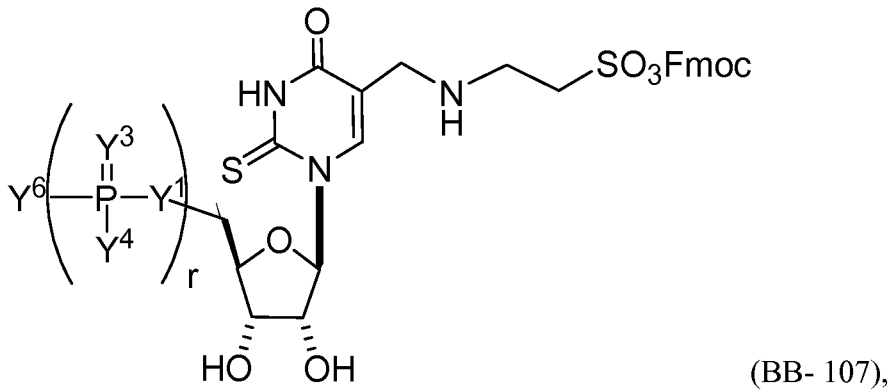
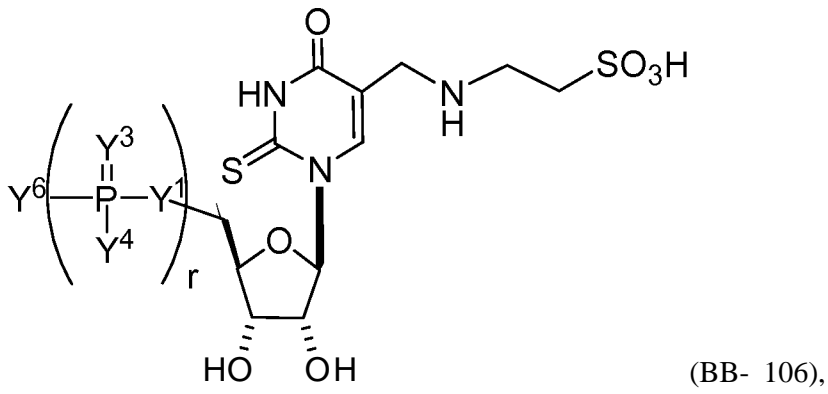
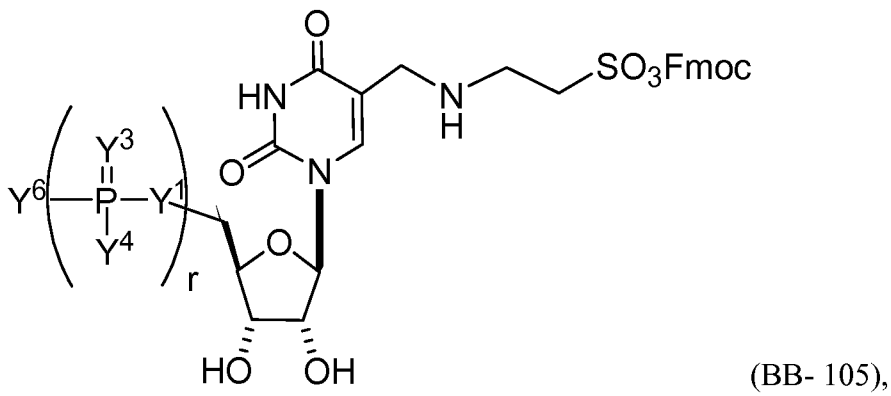

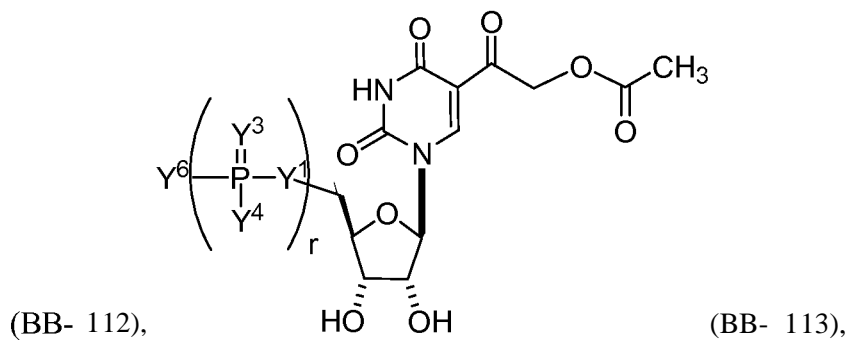
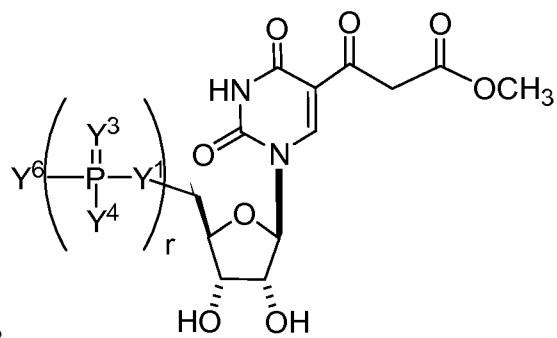
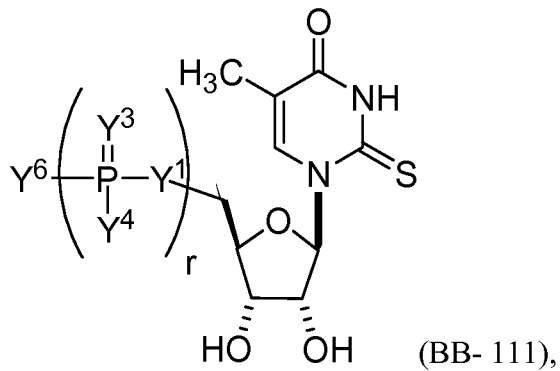
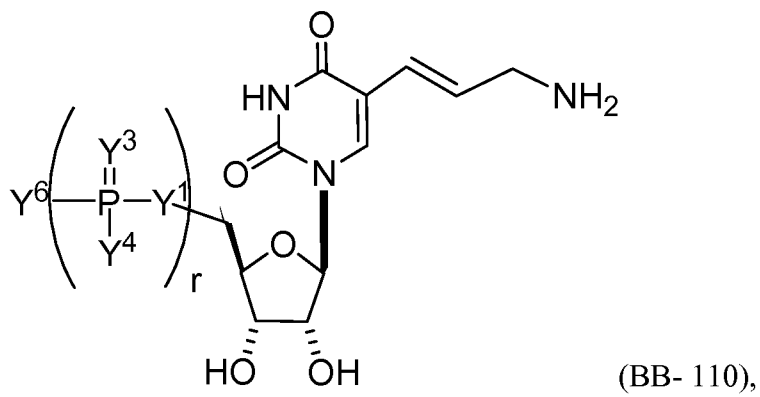
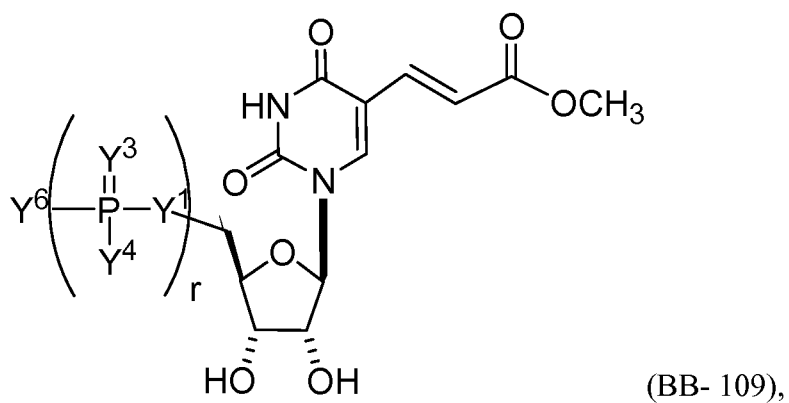

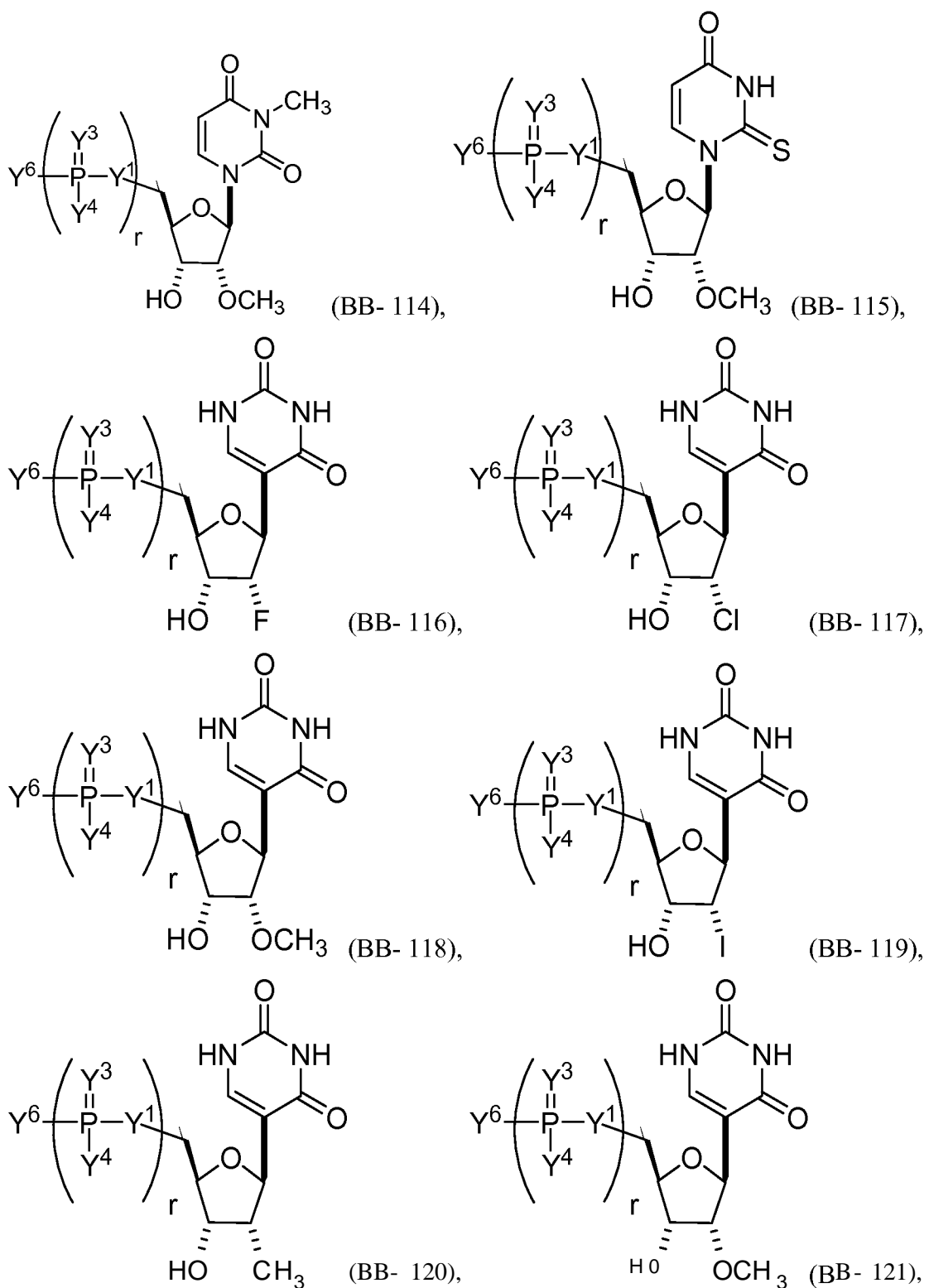

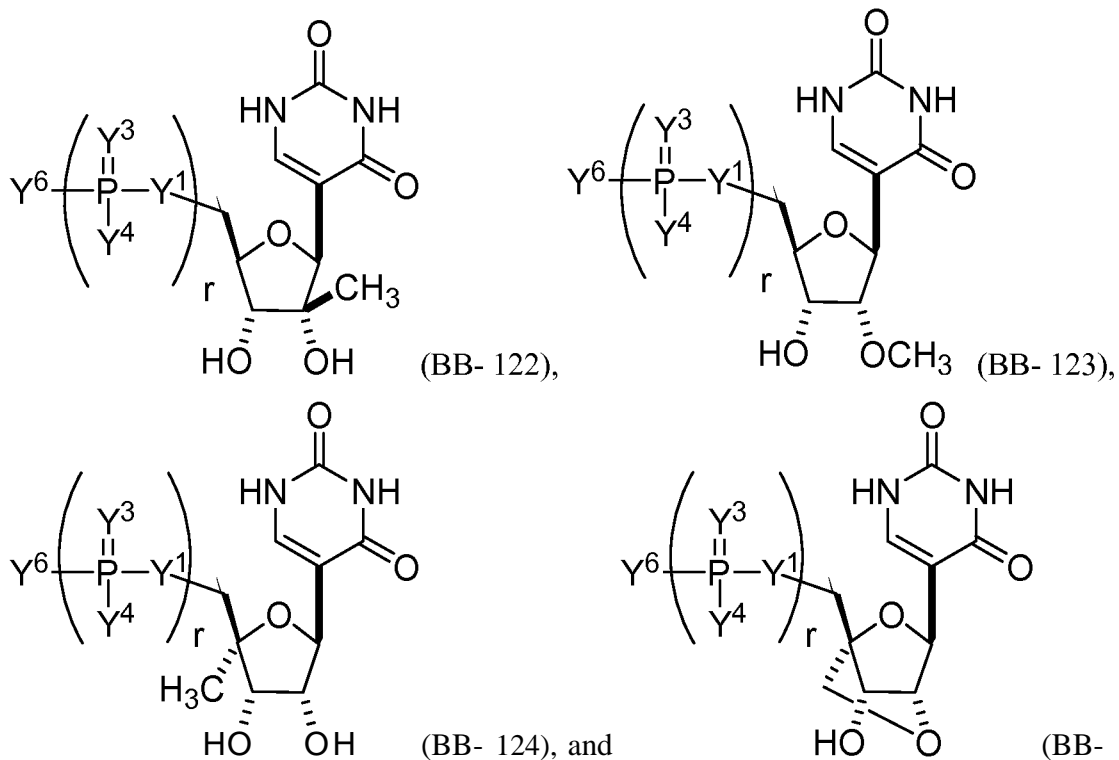

or a pharmaceutically acceptable salt or stereoisomer thereof, wherein Y^1 , Y^3 , Y^4 , Y^6 , and r are as described herein (e.g., each r is, independently, an integer from 0 to 5, such as from 0 to 3, from 1 to 3, or from 1 to 5)).

[000416] In some embodiments, the building block molecule, which may be incorporated into a polynucleotide, primary construct, or mmRNA, is a modified cytidine (e.g., selected from the group consisting of:

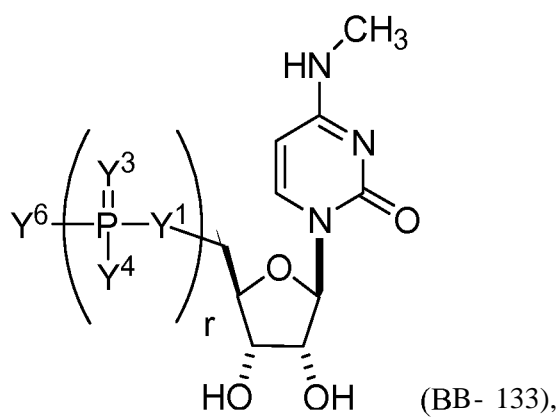
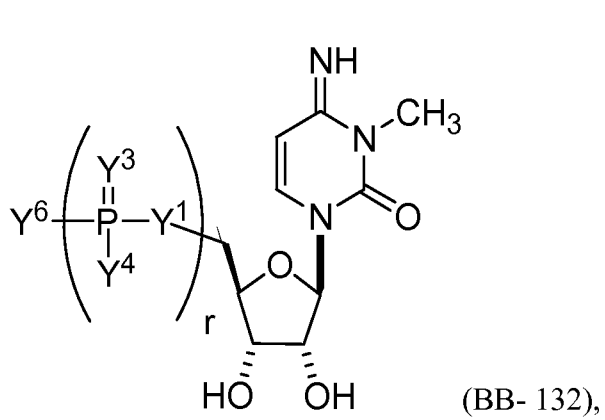
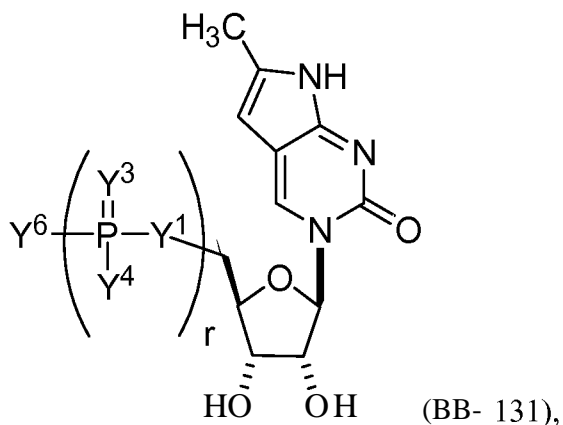
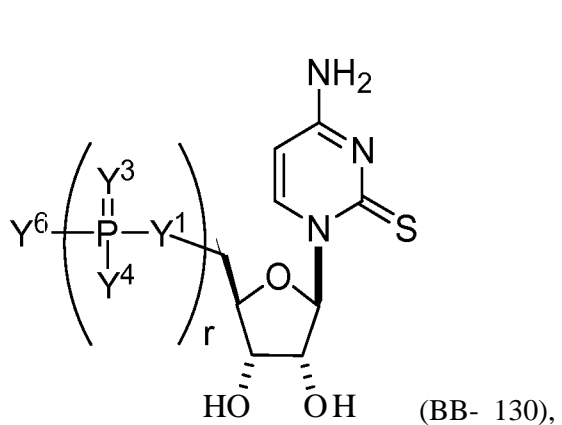
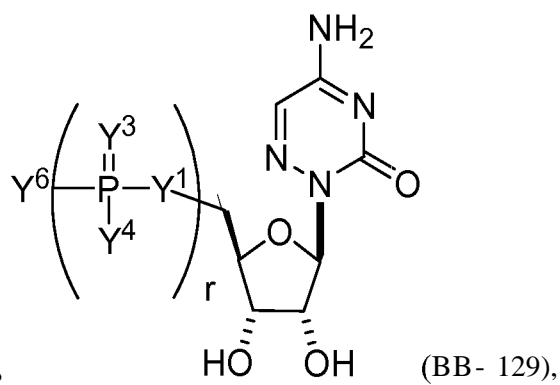
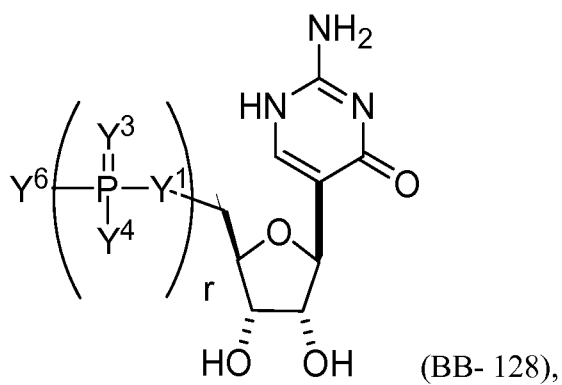
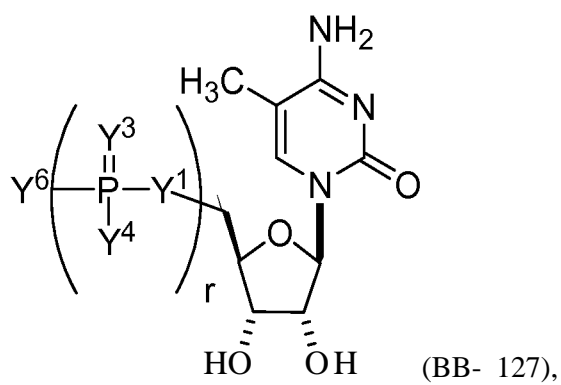
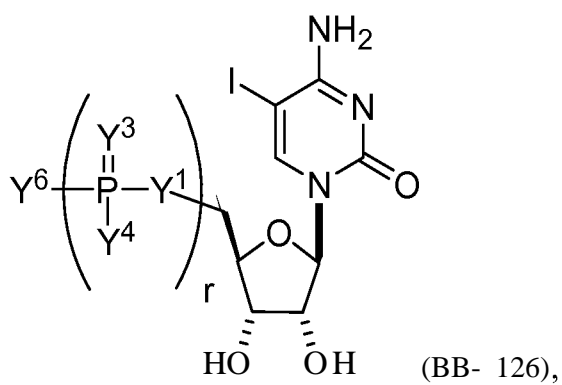

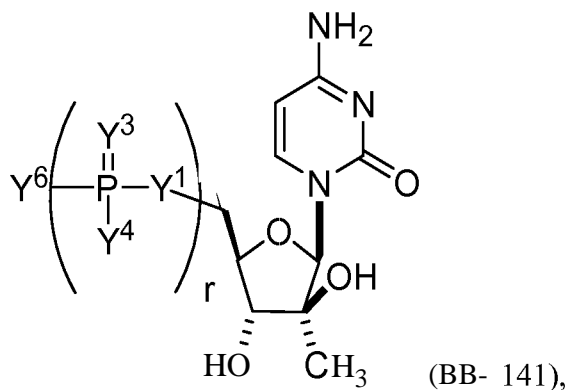
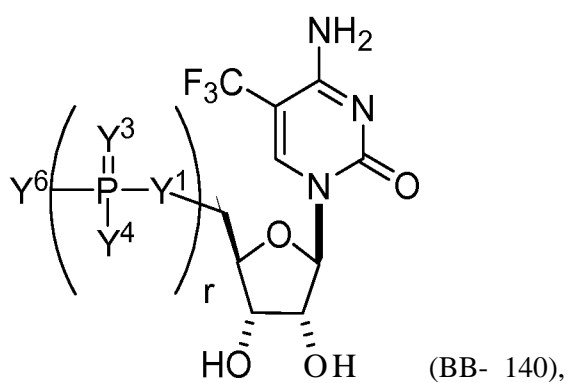
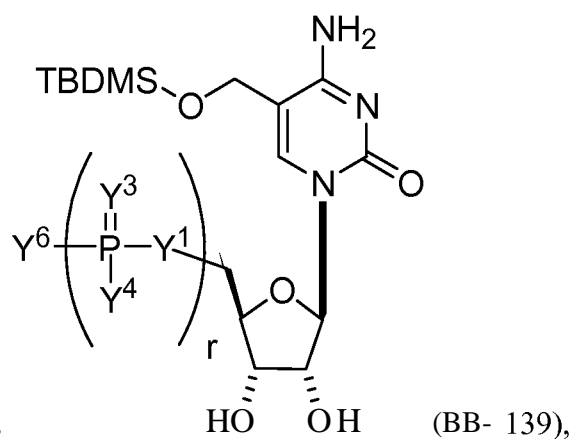
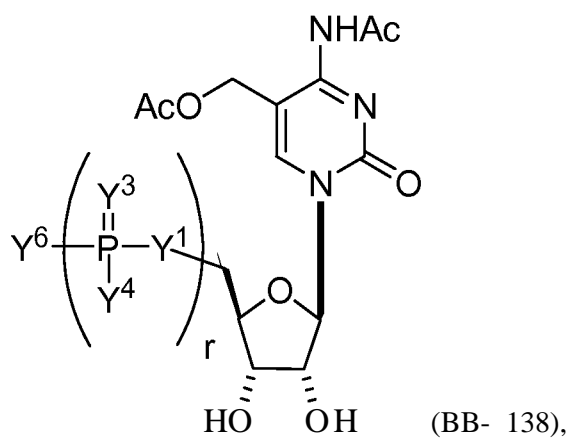
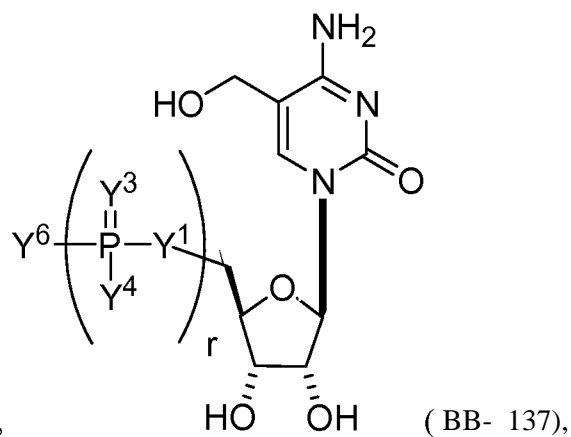
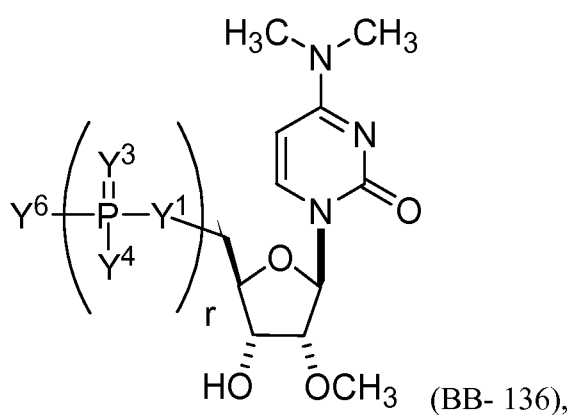
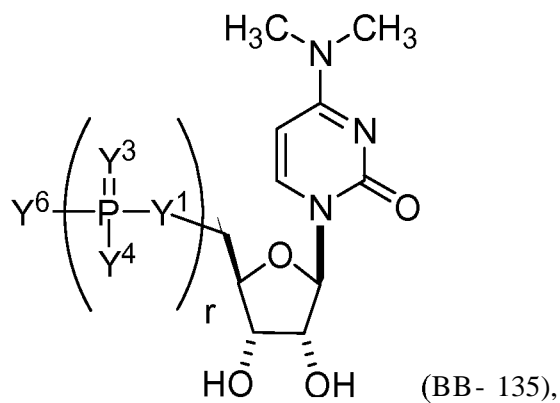
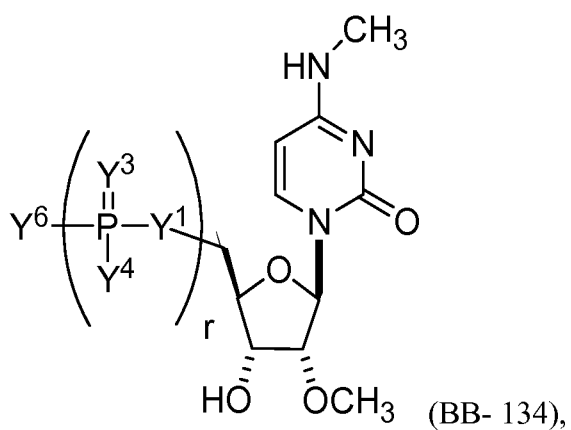

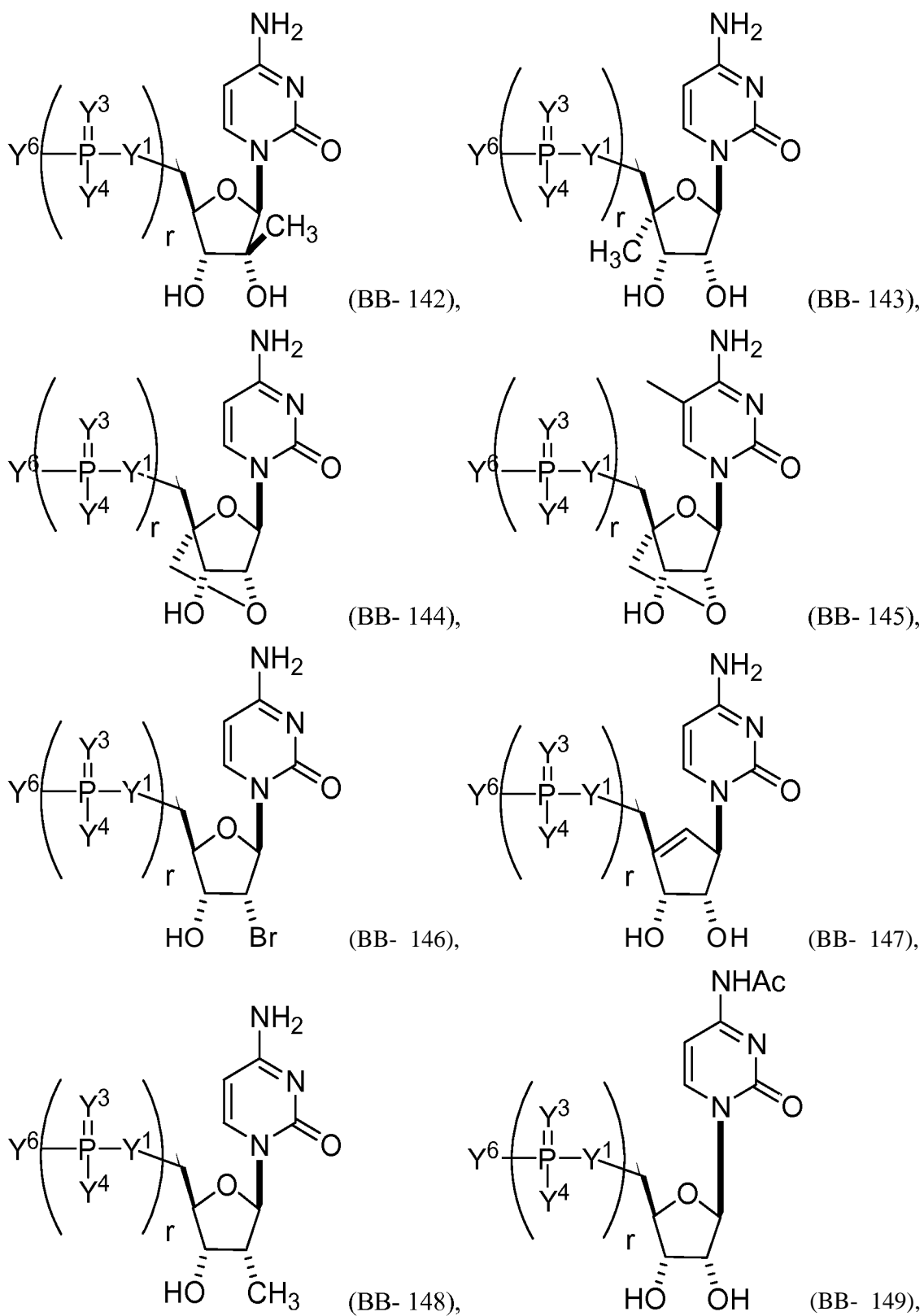

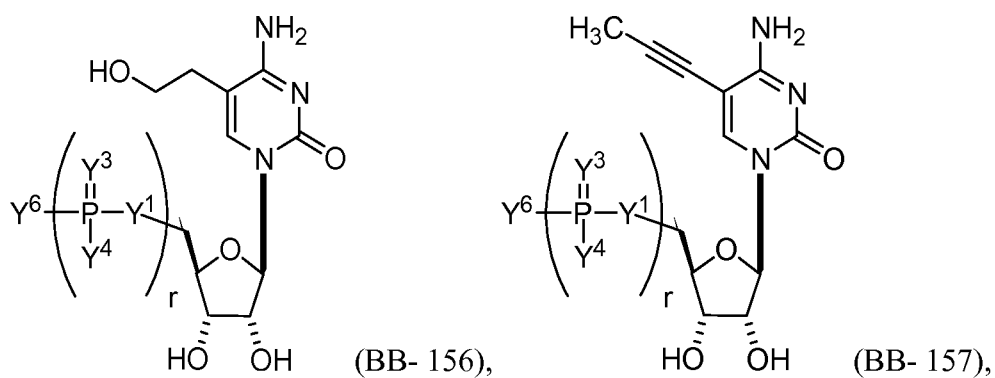
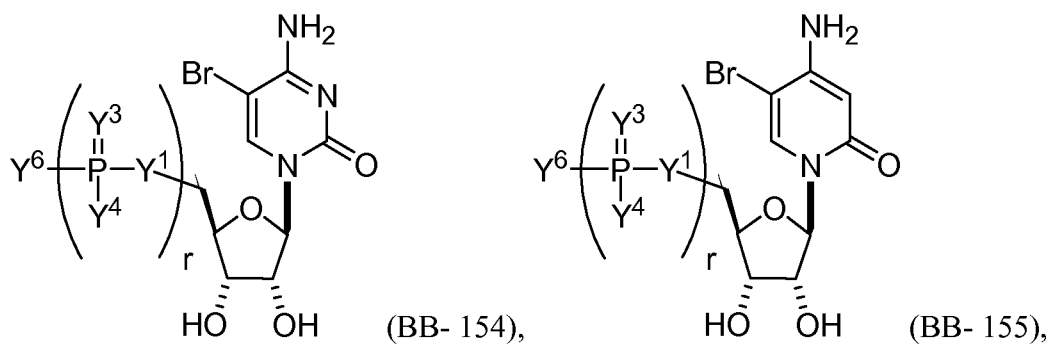
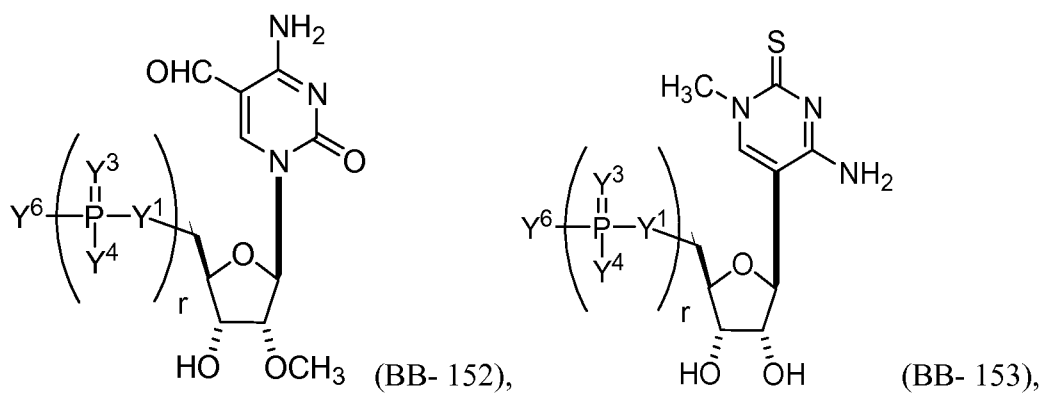
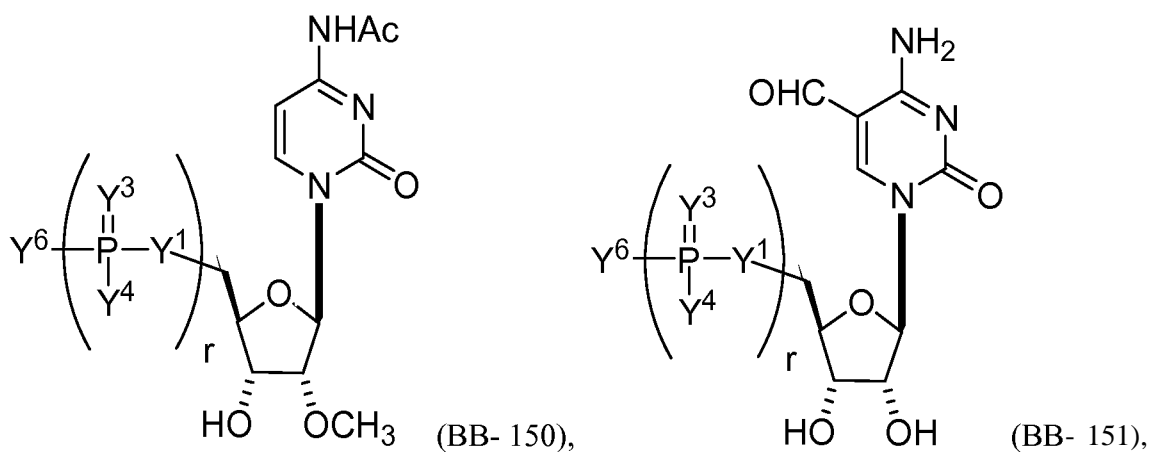

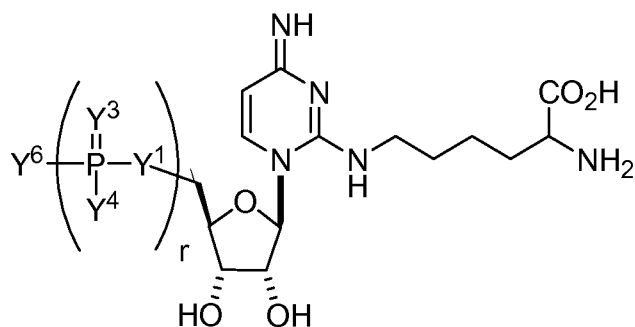
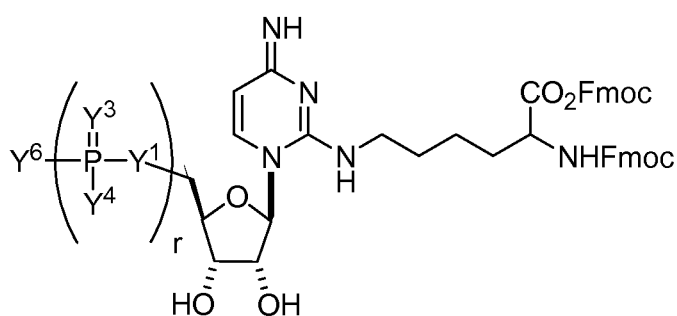

acceptable salt or stereoisomer thereof, wherein Y¹, Y³, Y⁴, Y⁶, and r are as described herein (e.g., each r is, independently, an integer from 0 to 5, such as from 0 to 3, from 1 to 3, or from 1 to 5)). For example, the building block molecule, which may be incorporated into a polynucleotide, primary construct, or mmRNA, can be:

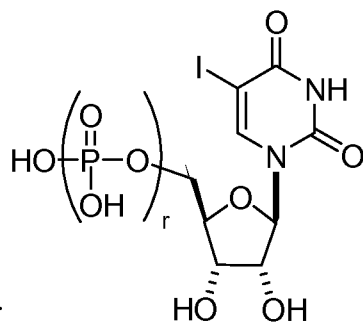
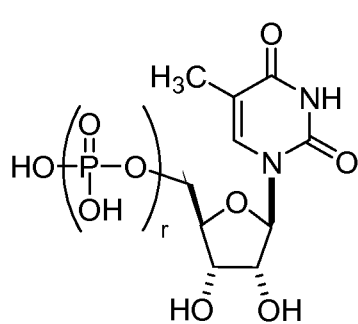

pharmaceutically acceptable salt or stereoisomer thereof, wherein each r is, independently, an integer from 0 to 5 (e.g., from 0 to 3, from 1 to 3, or from 1 to 5).

[000417] In some embodiments, the building block molecule, which may be incorporated into a polynucleotide, primary construct, or mmRNA, is a modified adenosine (e.g., selected from the group consisting of:

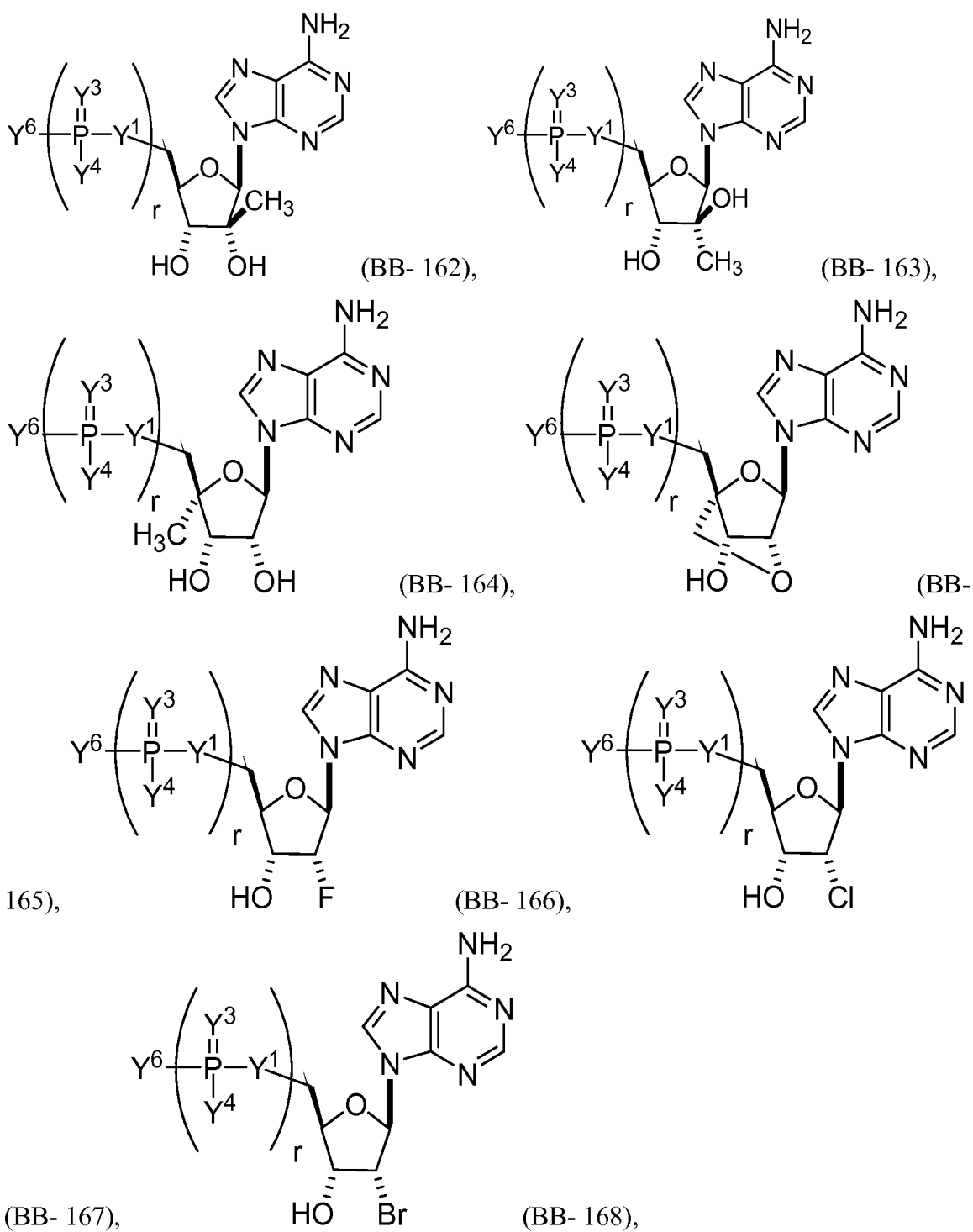

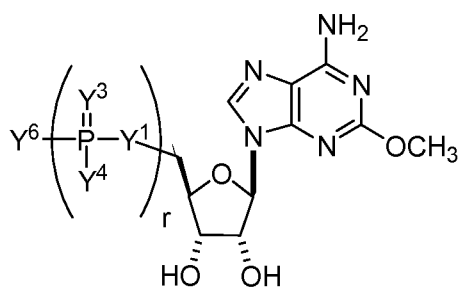
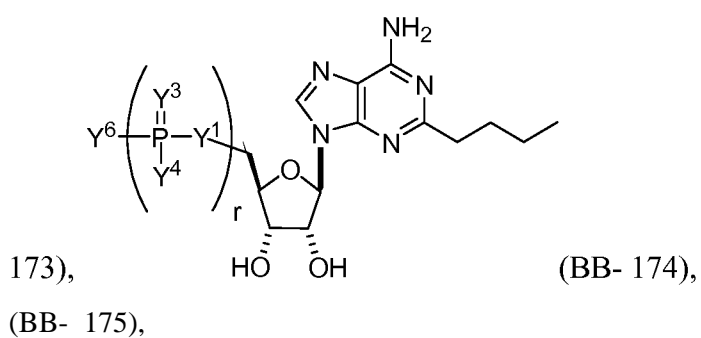
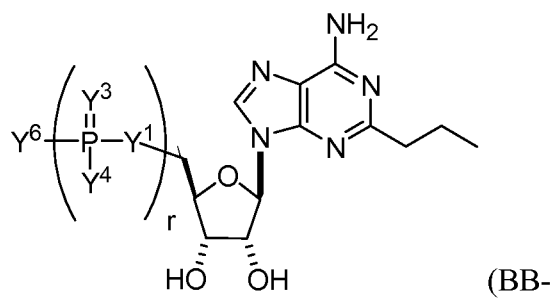
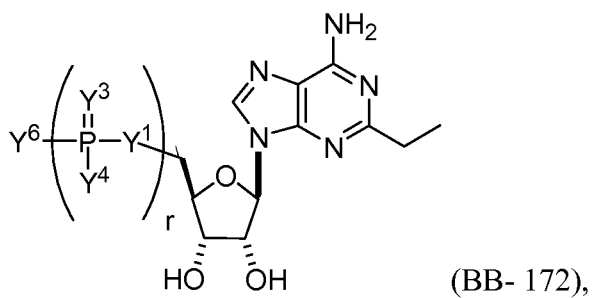
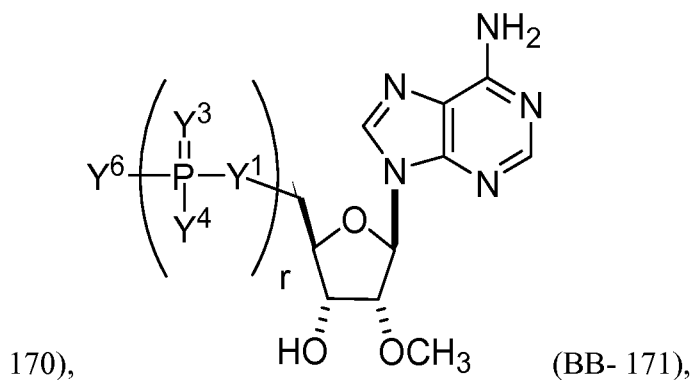
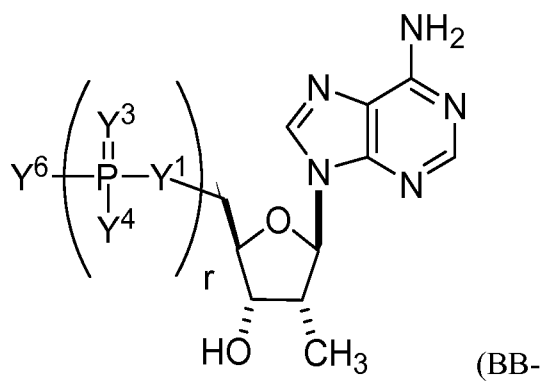
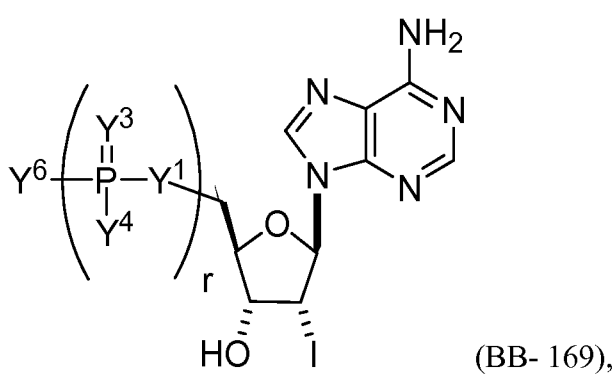

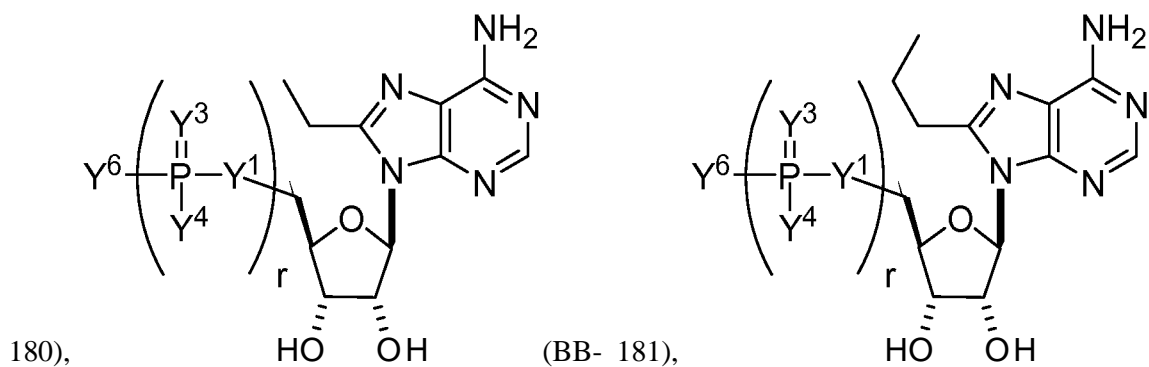
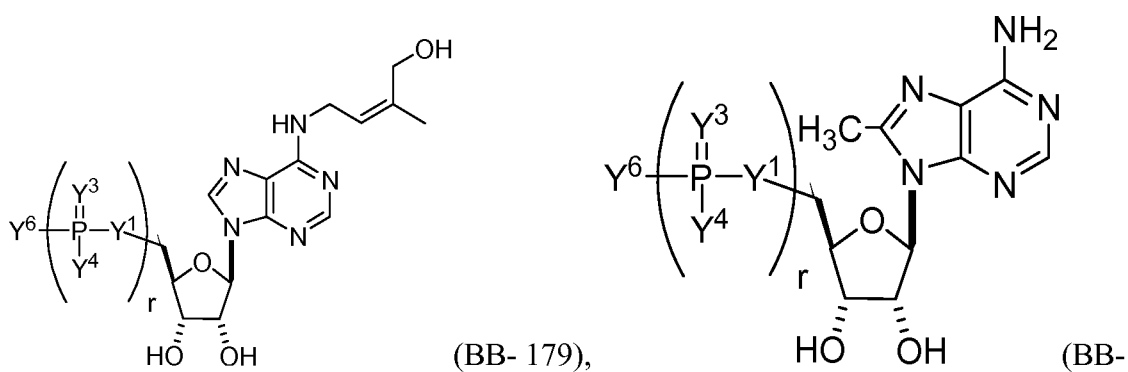
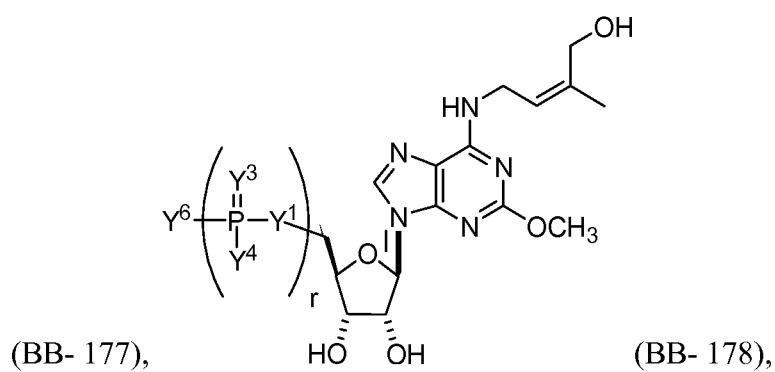
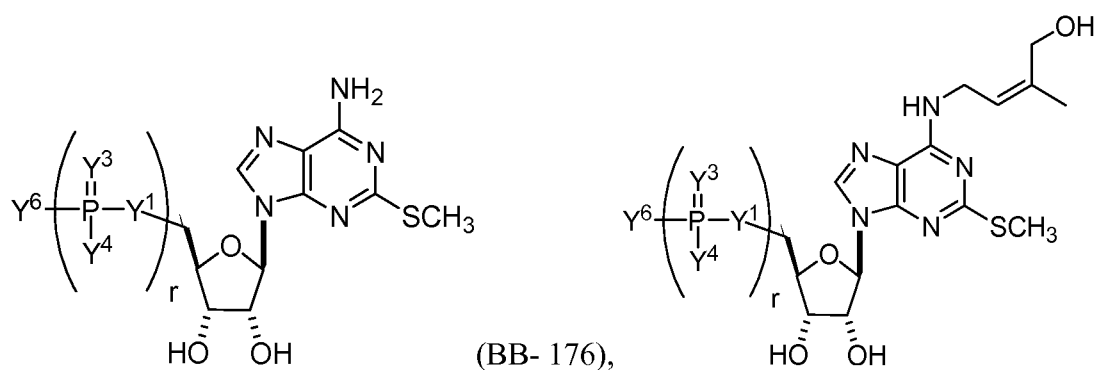

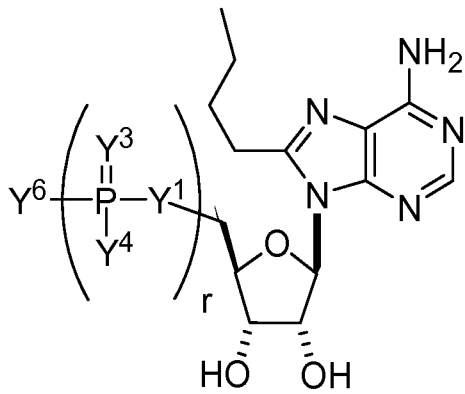

(BB- 182),

(BB- 183),

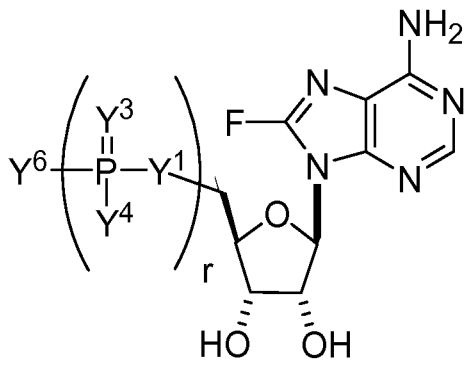

(BB- 184),

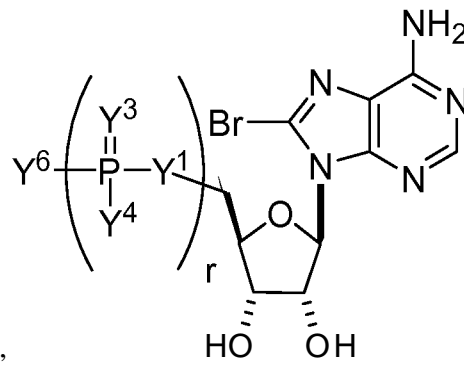

(BB- 185),

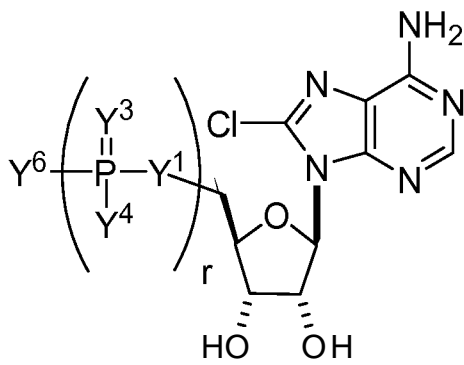

(BB- 186),

(BB- 186),

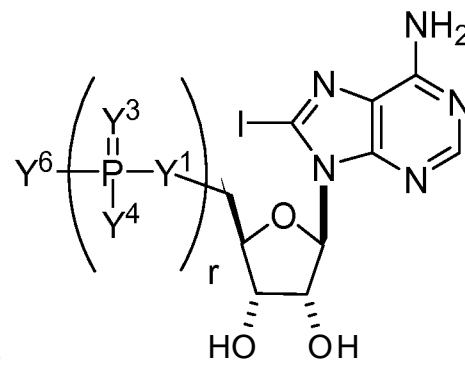

(BB- 187),

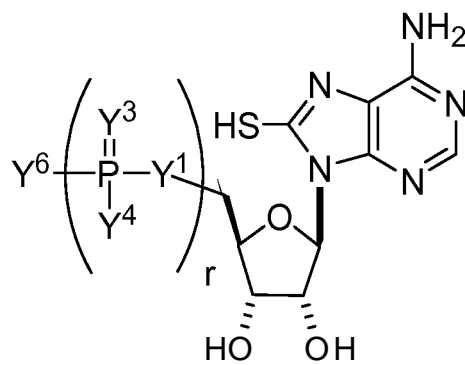

(BB- 188),

(BB- 188),

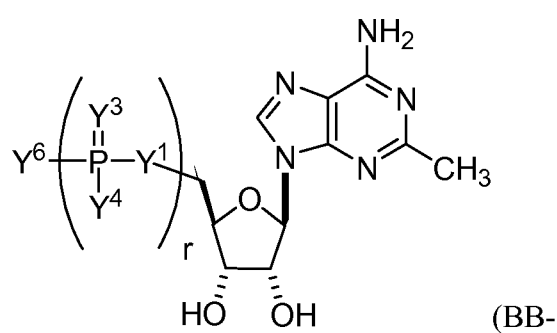
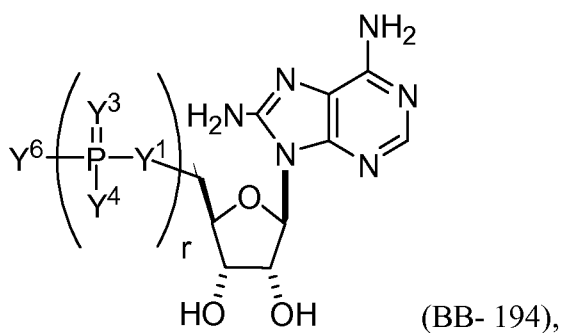
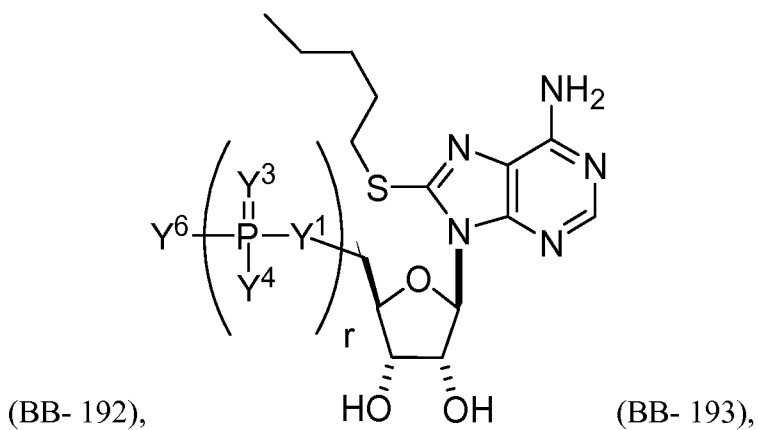
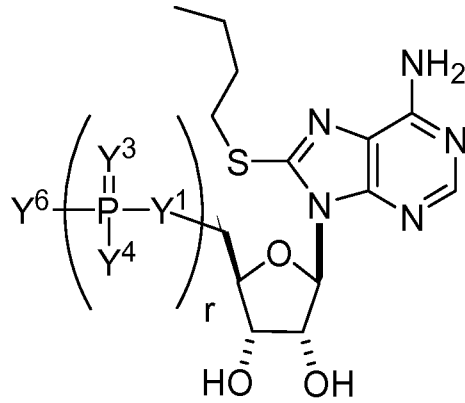
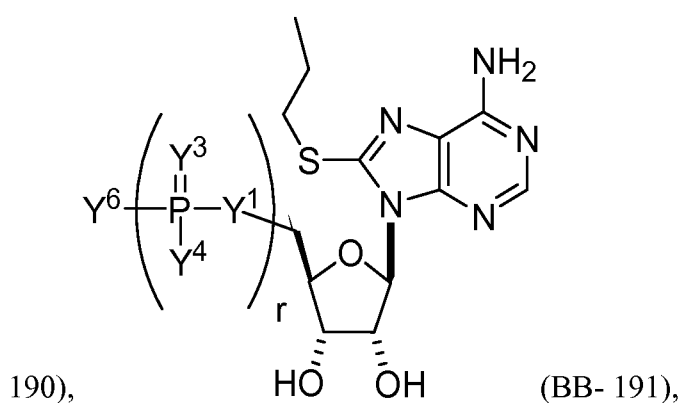
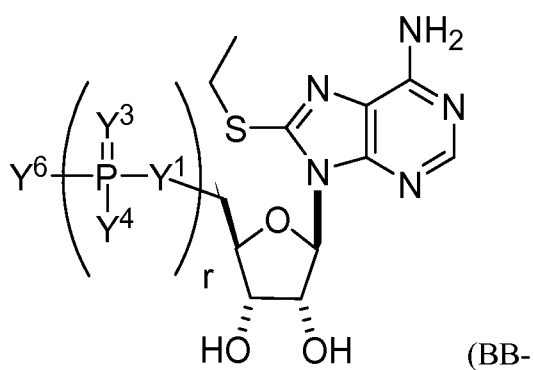
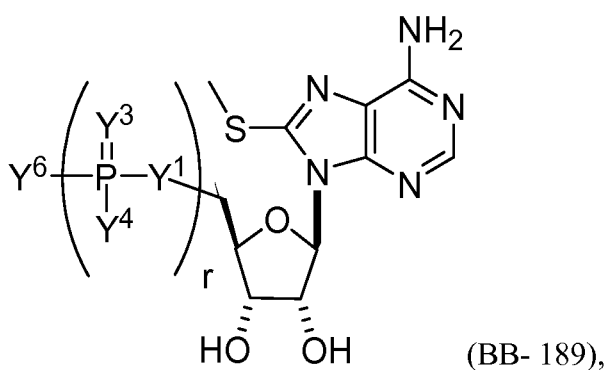

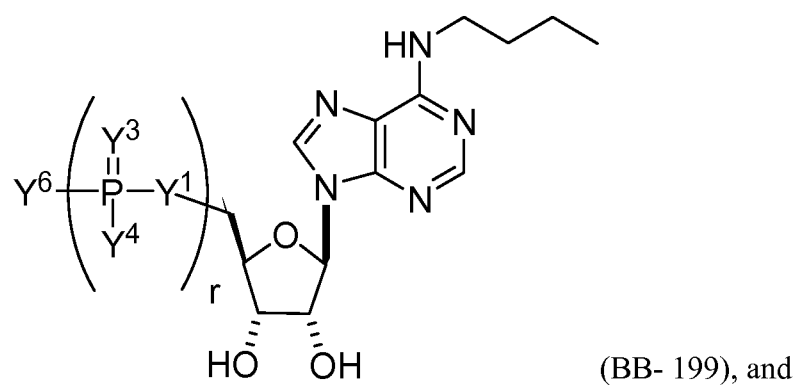
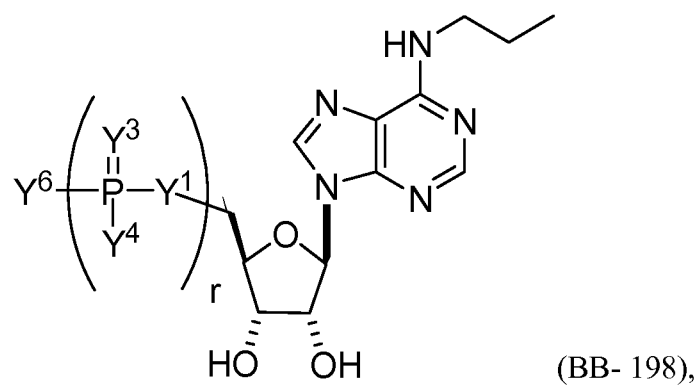
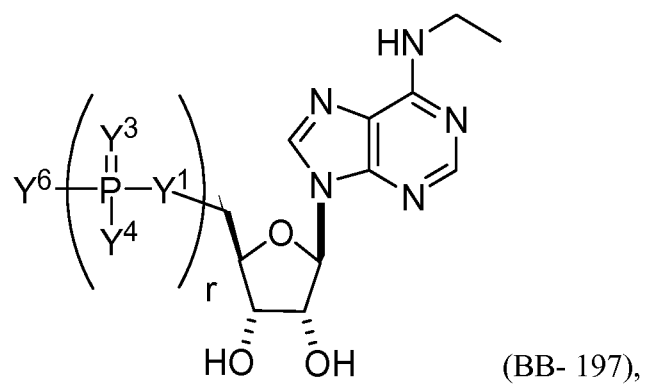
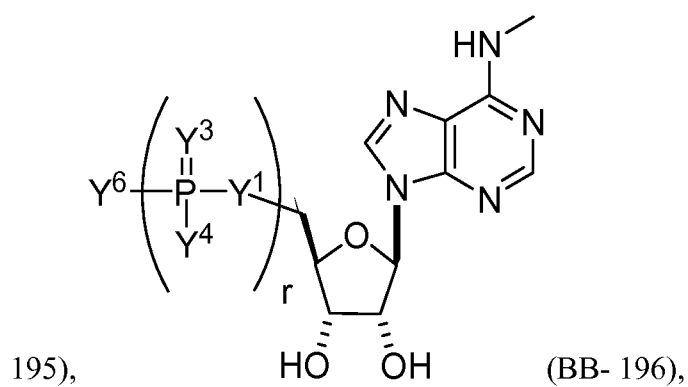

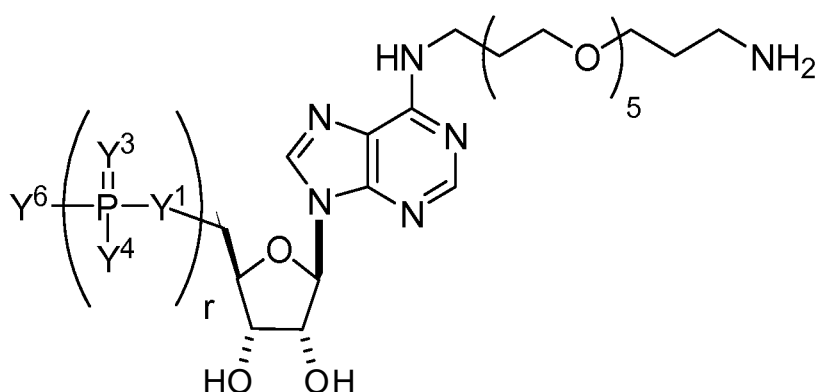

pharmaceutically acceptable salt or stereoisomer thereof, wherein Y^1 , Y^3 , Y^4 , Y^6 , and r are as described herein (e.g., each r is, independently, an integer from 0 to 5, such as from 0 to 3, from 1 to 3, or from 1 to 5)).

[000418] In some embodiments, the building block molecule, which may be incorporated into a polynucleotide, primary construct, or mmRNA, is a modified guanosine (e.g., selected from the group consisting of:

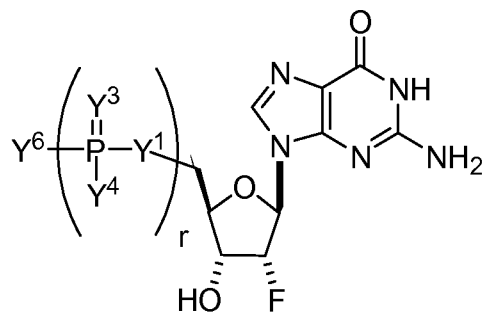
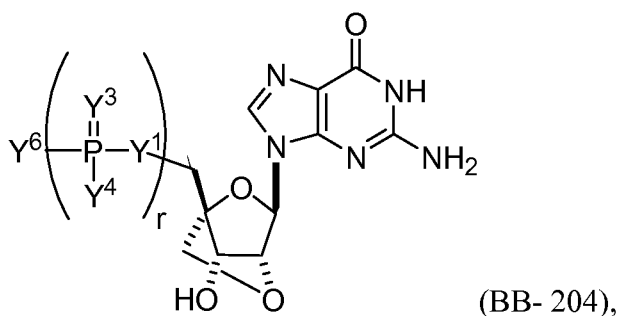
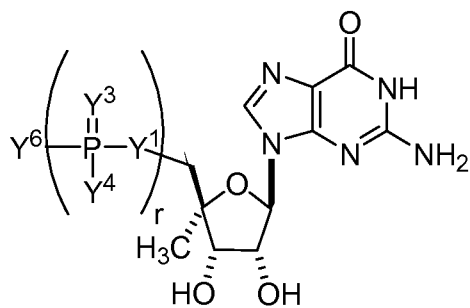
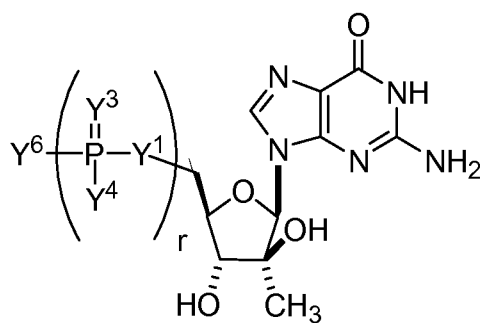
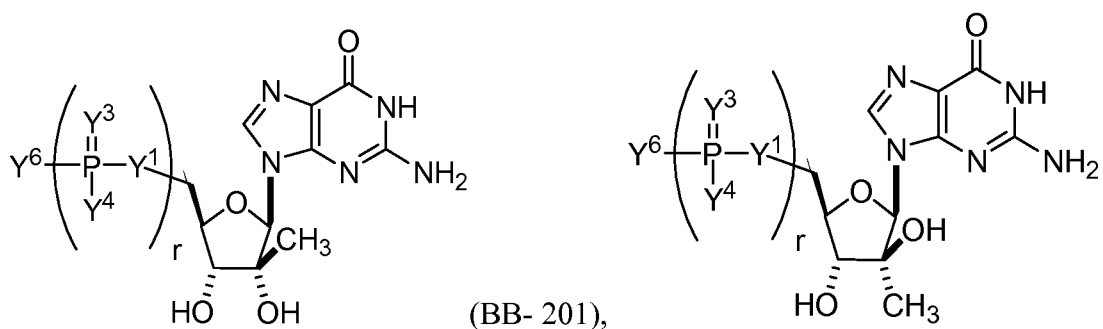

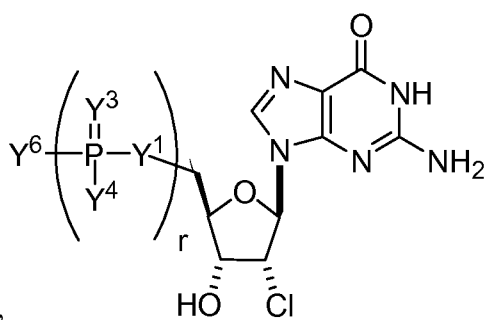

(BB-206),

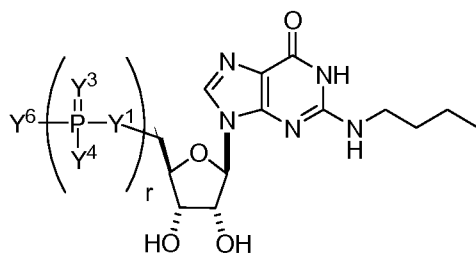
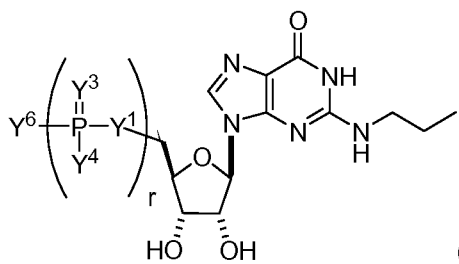
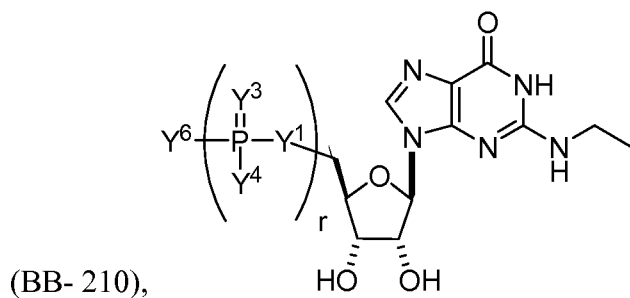
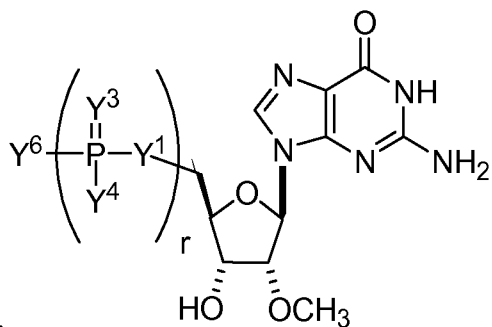
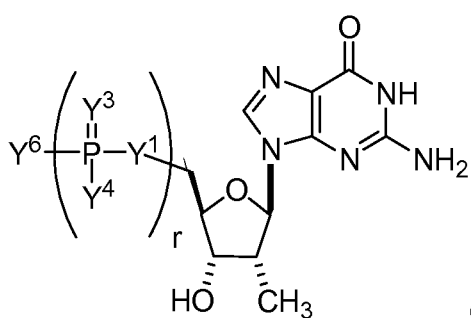
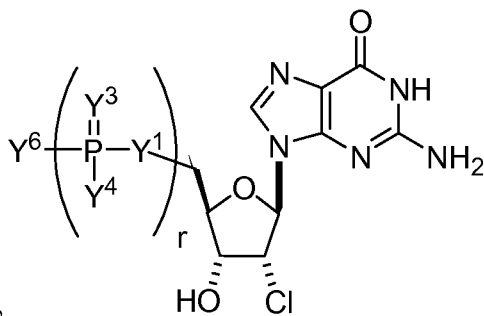
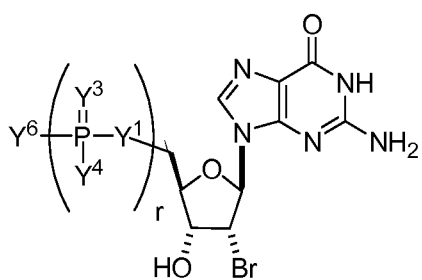

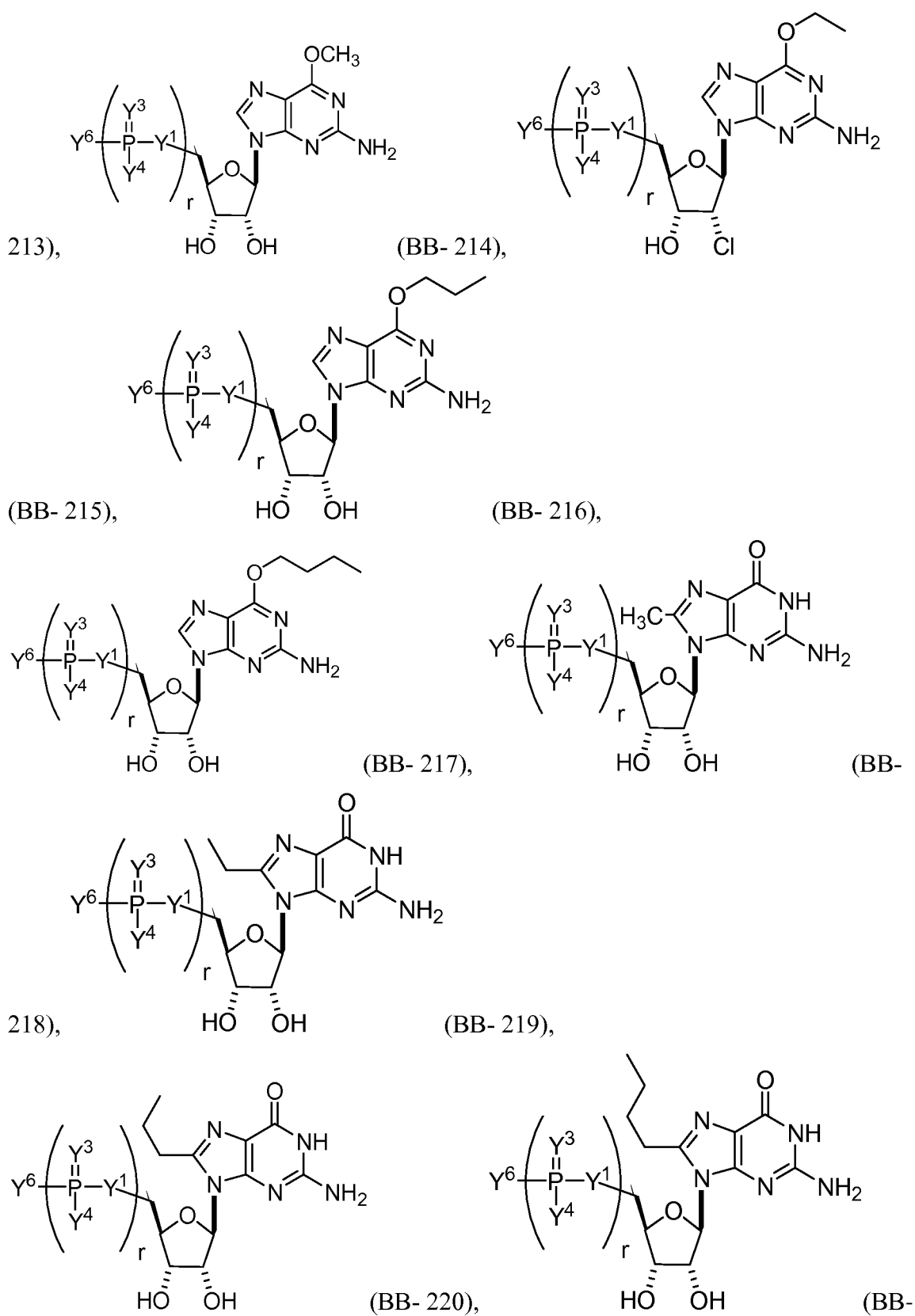

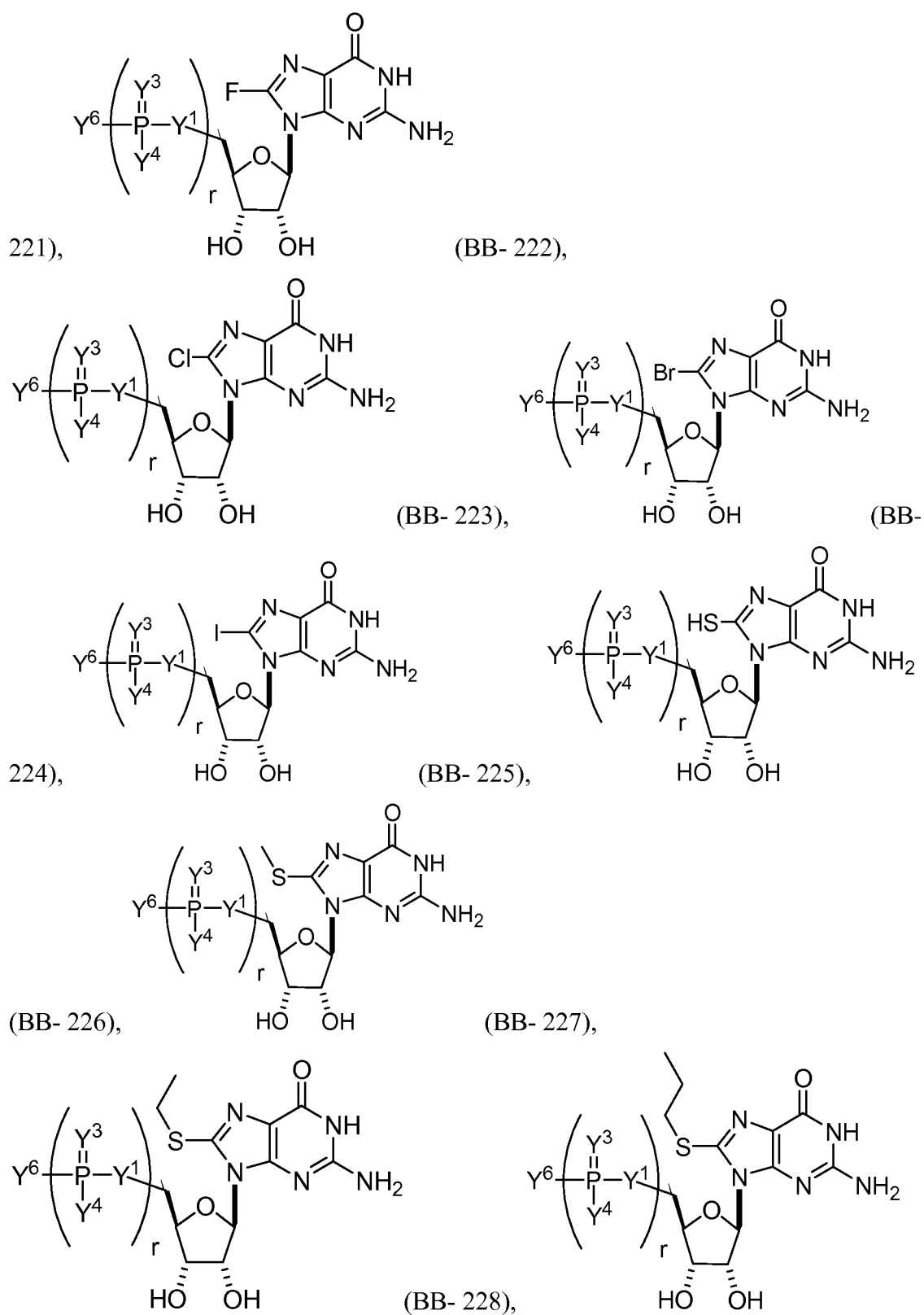

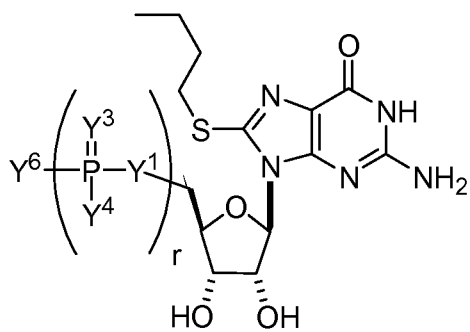

(BB- 230),

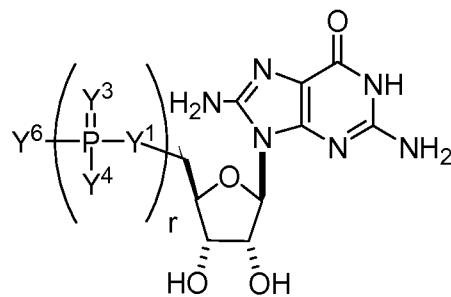
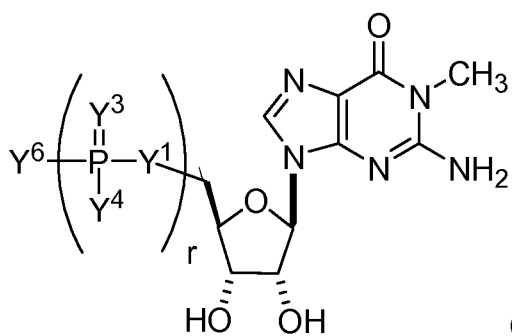
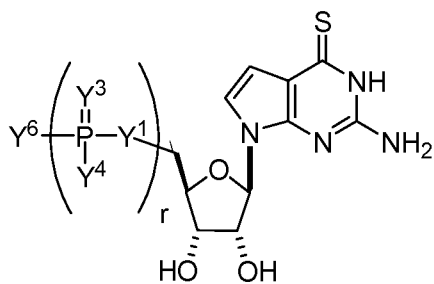
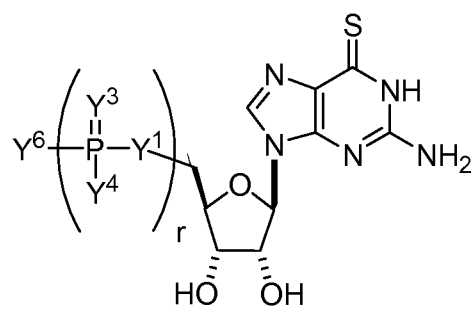
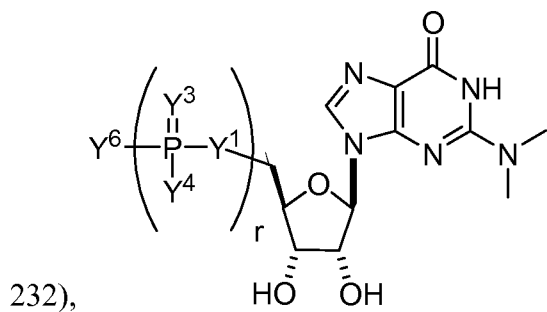
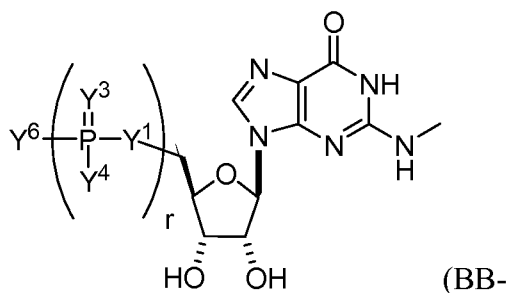
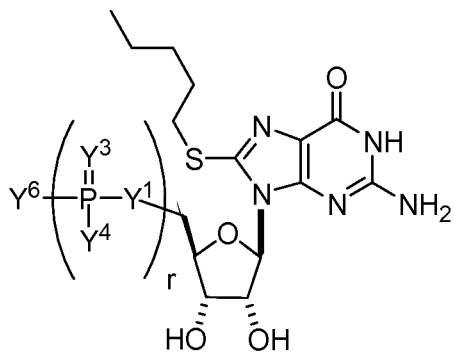

or a pharmaceutically acceptable salt or stereoisomer thereof, wherein Y¹, Y³,

Y⁴, Y⁶, and r are as described herein (e.g., each r is, independently, an integer from 0 to 5, such as from 0 to 3, from 1 to 3, or from 1 to 5)).

[000419] In some embodiments, the chemical modification can include replacement of C group at C-5 of the ring (e.g., for a pyrimidine nucleoside, such as cytosine or uracil) with N (e.g., replacement of the >CH group at C-5 with >NR^{N1} group, wherein R^{N1} is H or optionally substituted alkyl). For example, the building block molecule, which may be incorporated into a polynucleotide, primary construct, or mmRNA, can be:

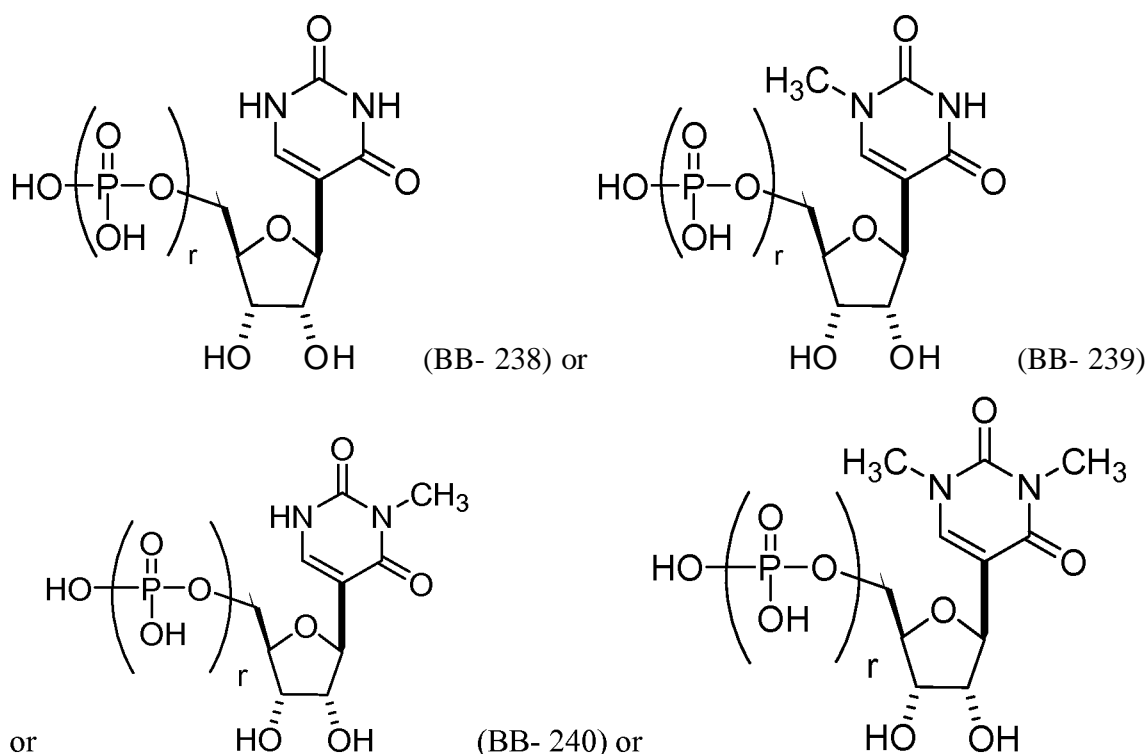

(BB- 241), or a pharmaceutically acceptable salt or stereoisomer thereof, wherein each r is, independently, an integer from 0 to 5 (e.g., from 0 to 3, from 1 to 3, or from 1 to 5).

[000420] In another embodiment, the chemical modification can include replacement of the hydrogen at C-5 of cytosine with halo (e.g., Br, Cl, F, or I) or optionally substituted alkyl (e.g., methyl). For example, the building block molecule, which may be incorporated into a polynucleotide, primary construct, or mmRNA, can be:

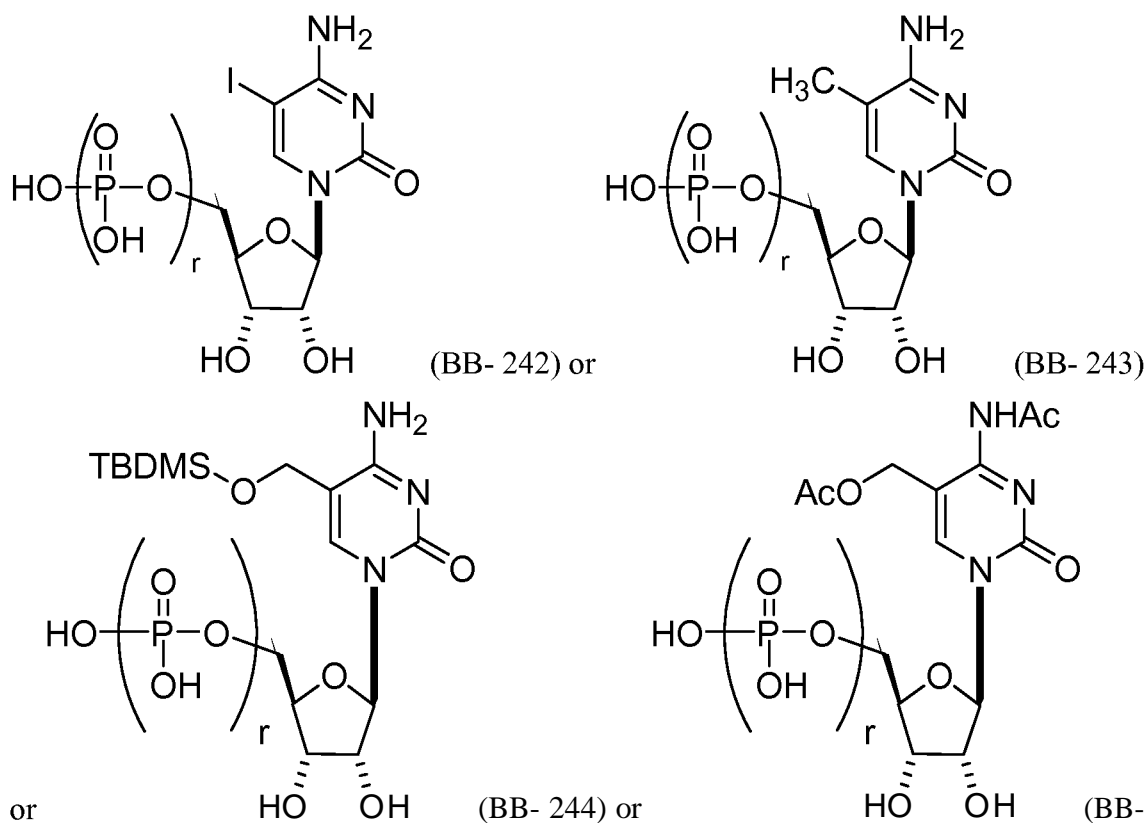

or a pharmaceutically acceptable salt or stereoisomer thereof, wherein each r is, independently, an integer from 0 to 5 (e.g., from 0 to 3, from 1 to 3, or from 1 to 5).

[000421] In yet a further embodiment, the chemical modification can include a fused ring that is formed by the NH_2 at the C-4 position and the carbon atom at the C-5 position. For example, the building block molecule, which may be incorporated into a polynucleotide, primary construct, or mmRNA, can be:

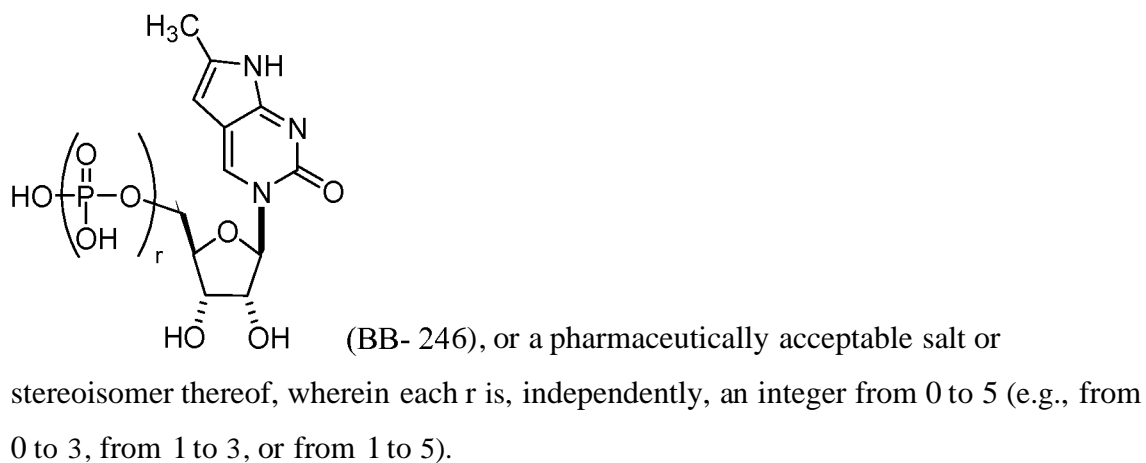

Modifications on the Sugar

[000422] The modified nucleosides and nucleotides (e.g., building block molecules), which may be incorporated into a polynucleotide, primary construct, or mmRNA (e.g., RNA or mRNA, as described herein), can be modified on the sugar of the ribonucleic acid. For example, the 2' hydroxyl group (OH) can be modified or replaced with a number of different substituents. Exemplary substitutions at the 2'-position include, but are not limited to, H, halo, optionally substituted C_{i-6} alkyl; optionally substituted C_{i-6} alkoxy; optionally substituted C_{6-10} aryloxy; optionally substituted C3-8 cycloalkyl; optionally substituted C3-8 cycloalkoxy; optionally substituted C_{6-10} aryloxy; optionally substituted C_{6-10} aryl- C_{i-6} alkoxy, optionally substituted C_{1-12} (heterocycl)oxy; a sugar (e.g., ribose, pentose, or any described herein); a polyethyleneglycol (PEG), $-O(CH_2CH_2O)_nCH_2CH_2OR$, where R is H or optionally substituted alkyl, and n is an integer from 0 to 20 (e.g., from 0 to 4, from 0 to 8, from 0 to 10, from 0 to 16, from 1 to 4, from 1 to 8, from 1 to 10, from 1 to 16, from 1 to 20, from 2 to 4, from 2 to 8, from 2 to 10, from 2 to 16, from 2 to 20, from 4 to 8, from 4 to 10, from 4 to 16, and from 4 to 20); "locked" nucleic acids (LNA) in which the 2'-hydroxyl is connected by a C_{i-6} alkylene or C_{i-6} heteroalkylene bridge to the 4'-carbon of the same ribose sugar, where exemplary bridges included methylene, propylene, ether, or amino bridges; aminoalkyl, as defined herein; aminoalkoxy, as defined herein; amino as defined herein; and amino acid, as defined herein

Generally, RNA includes the sugar group ribose, which is a 5-membered ring having an oxygen. Exemplary, non-limiting modified nucleotides include replacement of the oxygen in ribose (e.g., with S, Se, or alkylene, such as methylene or ethylene); addition of a double bond (e.g., to replace ribose with cyclopentenyl or cyclohexenyl); ring contraction of ribose (e.g., to form a 4-membered ring of cyclobutane or oxetane); ring expansion of ribose (e.g., to form a 6- or 7-membered ring having an additional carbon or heteroatom, such as for anhydrohexitol, altritol, mannitol, cyclohexanyl, cyclohexenyl, and morpholino that also has a phosphoramidate backbone); multicyclic forms (e.g., tricyclo; and "unlocked" forms, such as glycol nucleic acid (GNA) (e.g., R-GNA or S-GNA, where ribose is replaced by glycol units attached to phosphodiester bonds), threose nucleic acid (TNA, where ribose is replaced with α -L-threofuranosyl-(3' \rightarrow 2')) , and peptide nucleic acid (PNA, where 2-amino-ethyl-glycine linkages replace the ribose and

phosphodiester backbone). The sugar group can also contain one or more carbons that possess the opposite stereochemical configuration than that of the corresponding carbon in ribose. Thus, a polynucleotide, primary construct, or mmRNA molecule can include nucleotides containing, e.g., arabinose, as the sugar.

Modifications on the Nucleobase

[000423] The present disclosure provides for modified nucleosides and nucleotides. As described herein "nucleoside" is defined as a compound containing a sugar molecule (e.g., a pentose or ribose) or a derivative thereof in combination with an organic base (e.g., a purine or pyrimidine) or a derivative thereof (also referred to herein as "nucleobase"). As described herein, "nucleotide" is defined as a nucleoside including a phosphate group. The modified nucleotides may be synthesized by any useful method, as described herein (e.g., chemically, enzymatically, or recombinantly to include one or more modified or non-natural nucleosides).

[000424] The modified nucleotide base pairing encompasses not only the standard adenosine-thymine, adenosine-uracil, or guanosine-cytosine base pairs, but also base pairs formed between nucleotides and/or modified nucleotides comprising non-standard or modified bases, wherein the arrangement of hydrogen bond donors and hydrogen bond acceptors permits hydrogen bonding between a non-standard base and a standard base or between two complementary non-standard base structures. One example of such non-standard base pairing is the base pairing between the modified nucleotide inosine and adenine, cytosine or uracil.

[000425] The modified nucleosides and nucleotides can include a modified nucleobase. Examples of nucleobases found in RNA include, but are not limited to, adenine, guanine, cytosine, and uracil. Examples of nucleobase found in DNA include, but are not limited to, adenine, guanine, cytosine, and thymine. These nucleobases can be modified or wholly replaced to provide polynucleotides, primary constructs, or mmRNA molecules having enhanced properties, e.g., resistance to nucleases through disruption of the binding of a major groove binding partner. Table 8 below identifies the chemical faces of each canonical nucleotide. Circles identify the atoms comprising the respective chemical regions.

Table 8

	Major Groove Face	Minor Groove Face	Watson-Crick Base-pairing Face
Pyrimidines	Cytidine:		
	Uridine:		
Purines	Adenosine:		
	Guanosine:		

[000426] In some embodiments, B is a modified uracil. Exemplary modified uracils include those having Formula (b1)-(b5):

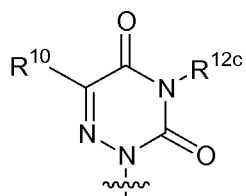
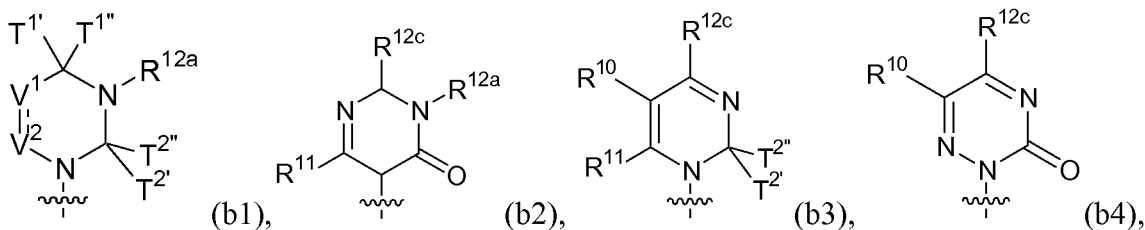

or (b5), or a pharmaceutically acceptable salt or stereoisomer thereof,

[000427] wherein

[000428] is a single or double bond;

[000429] each of T^{1'}, T^{1''}, T^{2'}, and T^{2''} is, independently, H, optionally substituted alkyl, optionally substituted alkoxy, or optionally substituted thioalkoxy, or the combination of T^{1'} and T^{1''} or the combination of T^{2'} and T^{2''} join together (e.g., as in T²) to form O (oxo), S (thio), or Se (seleno);

[000430] each of V¹ and V² is, independently, O, S, N(R^{Vb})_{nv}, or C(R^{Vb})_{nv}, wherein nv is an integer from 0 to 2 and each R^{Vb} is, independently, H, halo, optionally substituted amino acid, optionally substituted alkyl, optionally substituted haloalkyl, optionally substituted alkenyl, optionally substituted alkynyl, optionally substituted alkoxy, optionally substituted alkenyloxy, optionally substituted alkynyloxy, optionally substituted hydroxyalkyl, optionally substituted hydroxyalkenyl, optionally substituted hydroxyalkynyl, optionally substituted aminoalkyl (e.g., substituted with an N-protecting group, such as any described herein, e.g., trifluoroacetyl), optionally substituted aminoalkenyl, optionally substituted aminoalkynyl, optionally substituted acylaminoalkyl (e.g., substituted with an N-protecting group, such as any described herein, e.g., trifluoroacetyl), optionally substituted alkoxycarbonylalkyl, optionally substituted alkoxycarbonylalkenyl, optionally substituted alkoxycarbonylalkynyl, or optionally substituted alkynyloxy (e.g., optionally substituted with any substituent described herein, such as those selected from (1)-(21) for alkyl);

[000431] R¹⁰ is H, halo, optionally substituted amino acid, hydroxy, optionally substituted alkyl, optionally substituted alkenyl, optionally substituted alkynyl, optionally substituted aminoalkyl, optionally substituted hydroxyalkyl, optionally substituted hydroxyalkenyl, optionally substituted hydroxyalkynyl, optionally substituted aminoalkenyl, optionally substituted aminoalkynyl, optionally substituted alkoxy, optionally substituted alkoxycarbonylalkyl, optionally substituted alkoxycarbonylalkenyl, optionally substituted alkoxycarbonylalkynyl, optionally substituted alkoxycarbonylalkoxy, optionally substituted carboxyalkoxy, optionally substituted carboxyalkyl, or optionally substituted carbamoylalkyl;

[000432] R¹¹ is H or optionally substituted alkyl;

[000433] R^{12a} is H, optionally substituted alkyl, optionally substituted hydroxyalkyl, optionally substituted hydroxyalkenyl, optionally substituted hydroxyalkynyl, optionally substituted aminoalkyl, optionally substituted aminoalkenyl, or optionally substituted

aminoalkynyl, optionally substituted carboxyalkyl (e.g., optionally substituted with hydroxy), optionally substituted carboxyalkoxy, optionally substituted carboxyaminoalkyl, or optionally substituted carbamoylalkyl; and

[000434] R^{12c} is H, halo, optionally substituted alkyl, optionally substituted alkoxy, optionally substituted thioalkoxy, optionally substituted amino, optionally substituted hydroxyalkyl, optionally substituted hydroxyalkenyl, optionally substituted hydroxyalkynyl, optionally substituted aminoalkyl, optionally substituted aminoalkenyl, or optionally substituted aminoalkynyl.

[000435] Other exemplary modified uracils include those having Formula (b6)-(b9):

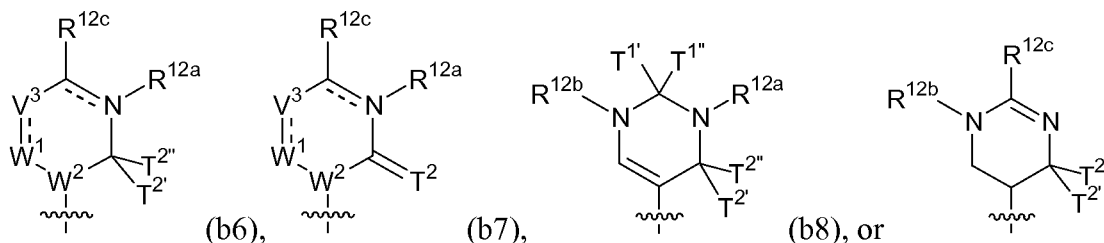

(b9), or a pharmaceutically acceptable salt or stereoisomer thereof,

[000436] wherein

[000437] \equiv is a single or double bond;

[000438] each of T^1 , $T^{1''}$, $T^{2'}$, and $T^{2''}$ is, independently, H, optionally substituted alkyl, optionally substituted alkoxy, or optionally substituted thioalkoxy, or the combination of T^1 and $T^{1''}$ join together (e.g., as in T^1) or the combination of $T^{2'}$ and $T^{2''}$ join together (e.g., as in T^2) to form O (oxo), S (thio), or Se (seleno), or each T^1 and T^2 is, independently, O (oxo), S (thio), or Se (seleno);

[000439] each of W^1 and W^2 is, independently, $N(R^{Wa})_{nw}$ or $C(R^{Wa})_{nw}$, wherein nw is an integer from 0 to 2 and each R^{Wa} is, independently, H, optionally substituted alkyl, or optionally substituted alkoxy;

[000440] each V^3 is, independently, O, S, $N(R^{Va})_{nv}$, or $C(R^{Va})_{nv}$, wherein nv is an integer from 0 to 2 and each R^{Va} is, independently, H, halo, optionally substituted amino acid, optionally substituted alkyl, optionally substituted hydroxyalkyl, optionally substituted hydroxyalkenyl, optionally substituted hydroxyalkynyl, optionally substituted alkenyl, optionally substituted alkynyl, optionally substituted heterocyclyl, optionally substituted alkheterocyclyl, optionally substituted alkoxy, optionally substituted

alkenyloxy, or optionally substituted alkynyloxy, optionally substituted aminoalkyl (e.g., substituted with an N-protecting group, such as any described herein, e.g., trifluoroacetyl, or sulfoalkyl), optionally substituted aminoalkenyl, optionally substituted aminoalkynyl, optionally substituted acylaminoalkyl (e.g., substituted with an N-protecting group, such as any described herein, e.g., trifluoroacetyl), optionally substituted alkoxyacetylalkyl, optionally substituted alkoxyacetylalkenyl, optionally substituted alkoxyacetylalkynyl, optionally substituted alkoxyacetylacyl, optionally substituted alkoxyacetylalkoxy, optionally substituted carboxyalkyl (e.g., optionally substituted with hydroxy and/or an O-protecting group), optionally substituted carboxyalkoxy, optionally substituted carboxyaminoalkyl, or optionally substituted carbamoylalkyl (e.g., optionally substituted with any substituent described herein, such as those selected from (1)-(21) for alkyl), and wherein R^{Va} and R^{12c} taken together with the carbon atoms to which they are attached can form optionally substituted cycloalkyl, optionally substituted aryl, or optionally substituted heterocyclyl (e.g., a 5- or 6-membered ring);

[000441] R^{12a} is H, optionally substituted alkyl, optionally substituted hydroxyalkyl, optionally substituted hydroxyalkenyl, optionally substituted hydroxyalkynyl, optionally substituted aminoalkyl, optionally substituted aminoalkenyl, optionally substituted aminoalkynyl, optionally substituted carboxyalkyl (e.g., optionally substituted with hydroxy and/or an O-protecting group), optionally substituted carboxyalkoxy, optionally substituted carboxyaminoalkyl, optionally substituted carbamoylalkyl, or absent;

[000442] R^{12b} is H, optionally substituted alkyl, optionally substituted alkenyl, optionally substituted alkynyl, optionally substituted hydroxyalkyl, optionally substituted hydroxyalkenyl, optionally substituted hydroxyalkynyl, optionally substituted aminoalkyl, optionally substituted aminoalkenyl, optionally substituted aminoalkynyl, optionally substituted alkaryl, optionally substituted heterocyclyl, optionally substituted alkheterocyclyl, optionally substituted amino acid, optionally substituted alkoxyacetylacyl, optionally substituted alkoxyacetylalkoxy, optionally substituted alkoxyacetylalkyl, optionally substituted alkoxyacetylalkenyl, optionally substituted alkoxyacetylalkynyl, optionally substituted alkoxyacetylalkoxy, optionally substituted carboxyalkyl (e.g., optionally substituted with hydroxy and/or an O-protecting

group), optionally substituted carboxyalkoxy, optionally substituted carboxyaminoalkyl, or optionally substituted carbamoylalkyl,

[000443] wherein the combination of R^{12b} and T^1 or the combination of R^{12b} and R^{12c} can join together to form optionally substituted heterocyclyl; and

[000444] R^{12c} is H, halo, optionally substituted alkyl, optionally substituted alkoxy, optionally substituted thioalkoxy, optionally substituted amino, optionally substituted aminoalkyl, optionally substituted aminoalkenyl, or optionally substituted aminoalkynyl.

[000445] Further exemplary modified uracils include those having Formula (b28)-(b31):

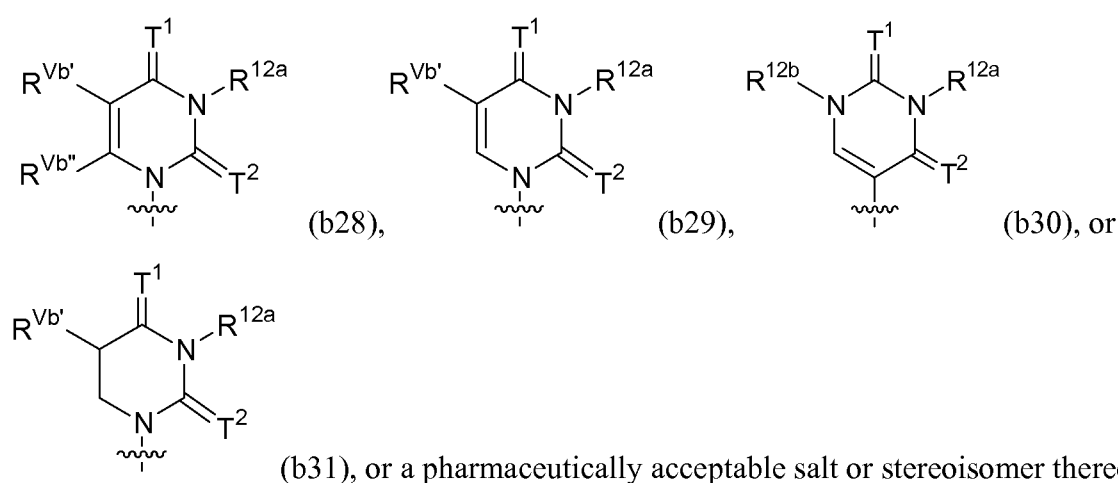

[000446] wherein

[000447] each of T^1 and T^2 is, independently, O (oxo), S (thio), or Se (seleno);

[000448] each $R^{Vb'}$ and $R^{Vb''}$ is, independently, H, halo, optionally substituted amino acid, optionally substituted alkyl, optionally substituted haloalkyl, optionally substituted hydroxyalkyl, optionally substituted hydroxyalkenyl, optionally substituted hydroxyalkynyl, optionally substituted alkenyl, optionally substituted alkynyl, optionally substituted alkoxy, optionally substituted alkenyloxy, optionally substituted alkynyloxy, optionally substituted aminoalkyl (e.g., substituted with an N-protecting group, such as any described herein, e.g., trifluoroacetyl, or sulfoalkyl), optionally substituted aminoalkenyl, optionally substituted aminoalkynyl, optionally substituted acylaminoalkyl (e.g., substituted with an N-protecting group, such as any described herein, e.g., trifluoroacetyl), optionally substituted alkoxyalkenyl, optionally substituted alkoxyalkynyl, optionally substituted alkoxyalkenyl, optionally substituted alkoxyalkynyl, optionally

substituted alkoxyacetyl, optionally substituted alkoxyacetylalkoxy, optionally substituted carboxyalkyl (e.g., optionally substituted with hydroxy and/or an O-protecting group), optionally substituted carboxyalkoxy, optionally substituted carboxyaminoalkyl, or optionally substituted carbamoylalkyl (e.g., optionally substituted with any substituent described herein, such as those selected from (1)-(21) for alkyl) (e.g., $R^{Vb'}$ is optionally substituted alkyl, optionally substituted alkenyl, or optionally substituted aminoalkyl, e.g., substituted with an N-protecting group, such as any described herein, e.g., trifluoroacetyl, or sulfoalkyl);

[000449] R^{12a} is H, optionally substituted alkyl, optionally substituted carboxyaminoalkyl, optionally substituted aminoalkyl (e.g., e.g., substituted with an N-protecting group, such as any described herein, e.g., trifluoroacetyl, or sulfoalkyl), optionally substituted aminoalkenyl, or optionally substituted aminoalkynyl; and

[000450] R^{12b} is H, optionally substituted alkyl, optionally substituted alkenyl, optionally substituted alkynyl, optionally substituted hydroxyalkyl, optionally substituted hydroxyalkenyl, optionally substituted hydroxyalkynyl, optionally substituted aminoalkyl, optionally substituted aminoalkenyl, optionally substituted aminoalkynyl (e.g., e.g., substituted with an N-protecting group, such as any described herein, e.g., trifluoroacetyl, or sulfoalkyl),

[000451] optionally substituted alkoxyacetyl, optionally substituted alkoxyacetylalkoxy, optionally substituted alkoxyacetylalkyl, optionally substituted alkoxyacetylalkenyl, optionally substituted alkoxyacetylalkynyl, optionally substituted alkoxyacetylalkoxy, optionally substituted carboxyalkoxy, optionally substituted carboxyalkyl, or optionally substituted carbamoylalkyl.

[000452] In particular embodiments, T^1 is O (oxo), and T^2 is S (thio) or Se (seleno). In other embodiments, T^1 is S (thio), and T^2 is O (oxo) or Se (seleno). In some embodiments, $R^{Vb'}$ is H, optionally substituted alkyl, or optionally substituted alkoxy.

[000453] In other embodiments, each R^{12a} and R^{12b} is, independently, H, optionally substituted alkyl, optionally substituted alkenyl, optionally substituted alkynyl, or optionally substituted hydroxyalkyl. In particular embodiments, R^{12a} is H. In other embodiments, both R^{12a} and R^{12b} are H.

[000454] In some embodiments, each $R^{Vb'}$ of R^{12b} is, independently, optionally substituted aminoalkyl (e.g., substituted with an N-protecting group, such as any described herein, e.g., trifluoroacetyl, or sulfoalkyl), optionally substituted aminoalkenyl, optionally substituted aminoalkynyl, or optionally substituted acylaminoalkyl (e.g., substituted with an N-protecting group, such as any described herein, e.g., trifluoroacetyl). In some embodiments, the amino and/or alkyl of the optionally substituted aminoalkyl is substituted with one or more of optionally substituted alkyl, optionally substituted alkenyl, optionally substituted sulfoalkyl, optionally substituted carboxy (e.g., substituted with an O-protecting group), optionally substituted hydroxy (e.g., substituted with an O-protecting group), optionally substituted carboxyalkyl (e.g., substituted with an O-protecting group), optionally substituted alkoxy carbonylalkyl (e.g., substituted with an O-protecting group), or *N*-protecting group. In some embodiments, optionally substituted aminoalkyl is substituted with an optionally substituted sulfoalkyl or optionally substituted alkenyl. In particular embodiments, R^{12a} and $R^{Vb''}$ are both H. In particular embodiments, T^1 is O (oxo), and T^2 is S (thio) or Se (seleno).

[000455] In some embodiments, $R^{Vb'}$ is optionally substituted alkoxy carbonylalkyl or optionally substituted carbamoylalkyl.

[000456] In particular embodiments, the optional substituent for R^{12a} , R^{12b} , R^{12c} , or R^{Va} is a polyethylene glycol group (e.g., $-(CH_2)_{s2}(OCH_2CH_2)_s(CH_2)_{s3}OR'$, wherein s_i is an integer from 1 to 10 (e.g., from 1 to 6 or from 1 to 4), each of s_2 and s_3 , independently, is an integer from 0 to 10 (e.g., from 0 to 4, from 0 to 6, from 1 to 4, from 1 to 6, or from 1 to 10), and R' is H or C_{1-20} alkyl); or an amino-polyethylene glycol group (e.g., $-NR^{N1}(CH_2)_{s2}(CH_2CH_2O)_s(CH_2)_{s3}NR^{N1}$, wherein s_i is an integer from 1 to 10 (e.g., from 1 to 6 or from 1 to 4), each of s_2 and s_3 , independently, is an integer from 0 to 10 (e.g., from 0 to 4, from 0 to 6, from 1 to 4, from 1 to 6, or from 1 to 10), and each R^{N1} is, independently, hydrogen or optionally substituted C_{1-6} alkyl).

[000457] In some embodiments, B is a modified cytosine. Exemplary modified cytosines include compounds of Formula (bl0)-(bl4):

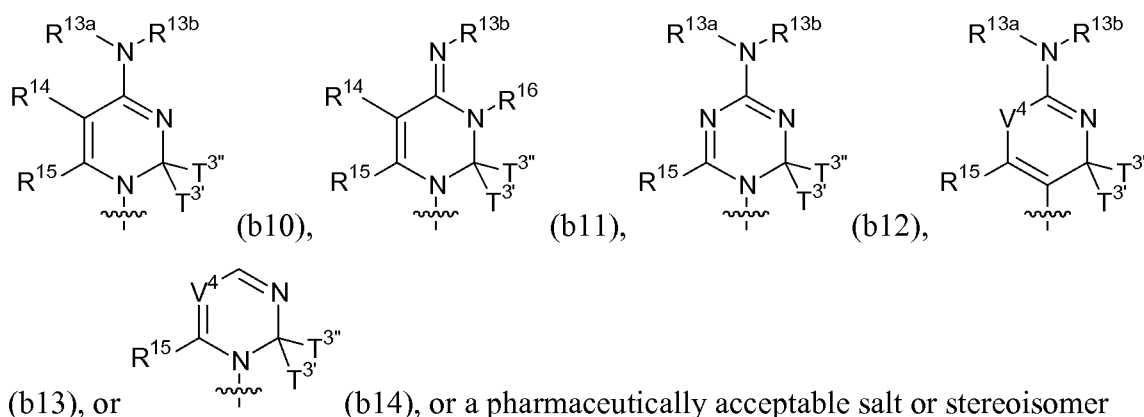

wherein

[000458] each of T^{3'} and T^{3''} is, independently, H, optionally substituted alkyl, optionally substituted alkoxy, or optionally substituted thioalkoxy, or the combination of T^{3'} and T^{3''} join together (e.g., as in T³) to form O (oxo), S (thio), or Se (seleno);

[000459] each V⁴ is, independently, O, S, N(R^{Vc})_{nv}, or C(R^{Vc})_{nv}, wherein nv is an integer from 0 to 2 and each R^{Vc} is, independently, H, halo, optionally substituted amino acid, optionally substituted alkyl, optionally substituted alkenyl, optionally substituted alkynyl, optionally substituted alkoxy, optionally substituted alkenyloxy, optionally substituted heterocyclyl, optionally substituted alkheterocyclyl, or optionally substituted alkynyloxy (e.g., optionally substituted with any substituent described herein, such as those selected from (1)-(21) for alkyl), wherein the combination of R^{13b} and R^{Vc} can be taken together to form optionally substituted heterocyclyl;

[000460] each V⁵ is, independently, N(R^{Vd})_{nv}, or C(R^{Vd})_{nv}, wherein nv is an integer from 0 to 2 and each R^{Vd} is, independently, H, halo, optionally substituted amino acid, optionally substituted alkyl, optionally substituted alkenyl, optionally substituted alkynyl, optionally substituted alkoxy, optionally substituted alkenyloxy, optionally substituted heterocyclyl, optionally substituted alkheterocyclyl, or optionally substituted alkynyloxy (e.g., optionally substituted with any substituent described herein, such as those selected from (1)-(21) for alkyl) (e.g., V⁵ is -CH or N);

[000461] each of R^{13a} and R^{13b} is, independently, H, optionally substituted acyl, optionally substituted acyloxyalkyl, optionally substituted alkyl, or optionally substituted

alkoxy, wherein the combination of R^{13b} and R¹⁴ can be taken together to form optionally substituted heterocyclyl;

[000462] each R¹⁴ is, independently, H, halo, hydroxy, thiol, optionally substituted acyl, optionally substituted amino acid, optionally substituted alkyl, optionally substituted haloalkyl, optionally substituted alkenyl, optionally substituted alkynyl, optionally substituted hydroxyalkyl (e.g., substituted with an O-protecting group), optionally substituted hydroxyalkenyl, optionally substituted hydroxyalkynyl, optionally substituted alkoxy, optionally substituted alkenyloxy, optionally substituted alkynyloxy, optionally substituted aminoalkoxy, optionally substituted alkoxyalkoxy, optionally substituted acyloxyalkyl, optionally substituted amino (e.g., -NHR, wherein R is H, alkyl, aryl, or phosphoryl), azido, optionally substituted aryl, optionally substituted heterocyclyl, optionally substituted alkheterocyclyl, optionally substituted aminoalkyl, optionally substituted aminoalkenyl, or optionally substituted aminoalkyl; and

[000463] each of R¹⁵ and R¹⁶ is, independently, H, optionally substituted alkyl, optionally substituted alkenyl, or optionally substituted alkynyl.

[000464] Further exemplary modified cytosines include those having Formula (b32)-(b35):

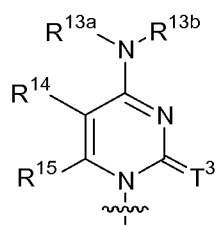

(b32),

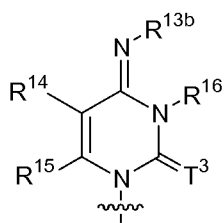

(b33),

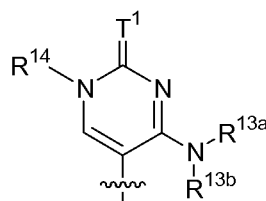

(b34), or

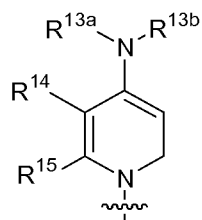

(b35), or a pharmaceutically acceptable salt or stereoisomer thereof,

[000465] wherein

[000466] each of T¹ and T³ is, independently, O (oxo), S (thio), or Se (seleno);

[000467] each of R^{13a} and R^{13b} is, independently, H, optionally substituted acyl, optionally substituted acyloxyalkyl, optionally substituted alkyl, or optionally substituted

alkoxy, wherein the combination of R^{13b} and R¹⁴ can be taken together to form optionally substituted heterocyclyl;

[000468] each R¹⁴ is, independently, H, halo, hydroxy, thiol, optionally substituted acyl, optionally substituted amino acid, optionally substituted alkyl, optionally substituted haloalkyl, optionally substituted alkenyl, optionally substituted alkynyl, optionally substituted hydroxyalkyl (e.g., substituted with an O-protecting group), optionally substituted hydroxyalkenyl, optionally substituted hydroxyalkynyl, optionally substituted alkoxy, optionally substituted alkenyloxy, optionally substituted alkynyloxy, optionally substituted aminoalkoxy, optionally substituted alkoxyalkoxy, optionally substituted acyloxyalkyl, optionally substituted amino (e.g., -NHR, wherein R is H, alkyl, aryl, or phosphoryl), azido, optionally substituted aryl, optionally substituted heterocyclyl, optionally substituted alkheterocyclyl, optionally substituted aminoalkyl (e.g., hydroxyalkyl, alkyl, alkenyl, or alkynyl), optionally substituted aminoalkenyl, or optionally substituted aminoalkynyl; and

[000469] each of R¹⁵ and R¹⁶ is, independently, H, optionally substituted alkyl, optionally substituted alkenyl, or optionally substituted alkynyl (e.g., R¹⁵ is H, and R¹⁶ is H or optionally substituted alkyl).

[000470] In some embodiments, R¹⁵ is H, and R¹⁶ is H or optionally substituted alkyl. In particular embodiments, R¹⁴ is H, acyl, or hydroxyalkyl. In some embodiments, R¹⁴ is halo. In some embodiments, both R¹⁴ and R¹⁵ are H. In some embodiments, both R¹⁵ and R¹⁶ are H. In some embodiments, each of R¹⁴ and R¹⁵ and R¹⁶ is H. In further embodiments, each of R^{13a} and R^{13b} is independently, H or optionally substituted alkyl.

[000471] Further non-limiting examples of modified cytosines include compounds of Formula (b36):

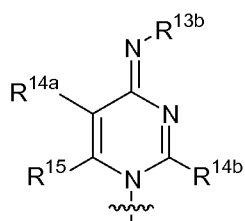

(b36) or a pharmaceutically acceptable salt or stereoisomer thereof,

[000472] wherein

[000473] each R^{13b} is, independently, H, optionally substituted acyl, optionally substituted acyloxyalkyl, optionally substituted alkyl, or optionally substituted alkoxy,

wherein the combination of R^{13b} and R^{14b} can be taken together to form optionally substituted heterocyclyl;

[000474] each R^{14a} and R^{14b} is, independently, H, halo, hydroxy, thiol, optionally substituted acyl, optionally substituted amino acid, optionally substituted alkyl, optionally substituted haloalkyl, optionally substituted alkenyl, optionally substituted alkynyl, optionally substituted hydroxyalkyl (e.g., substituted with an O-protecting group), optionally substituted hydroxyalkenyl, optionally substituted alkoxy, optionally substituted alkenyloxy, optionally substituted alkynyloxy, optionally substituted aminoalkoxy, optionally substituted alkoxyalkoxy, optionally substituted acyloxyalkyl, optionally substituted amino (e.g., -NHR, wherein R is H, alkyl, aryl, phosphoryl, optionally substituted aminoalkyl, or optionally substituted carboxyalkyl), azido, optionally substituted aryl, optionally substituted heterocyclyl, optionally substituted alkheterocyclyl, optionally substituted aminoalkyl, optionally substituted aminoalkenyl, or optionally substituted aminoalkynyl; and

[000475] each of R¹⁵ is, independently, H, optionally substituted alkyl, optionally substituted alkenyl, or optionally substituted alkynyl.

[000476] In particular embodiments, R^{14b} is an optionally substituted amino acid (e.g., optionally substituted lysine). In some embodiments, R^{14a} is H.

[000477] In some embodiments, B is a modified guanine. Exemplary modified guanines include compounds of Formula (b15)-(b17):

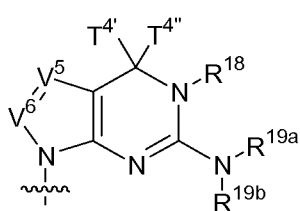

(b15),

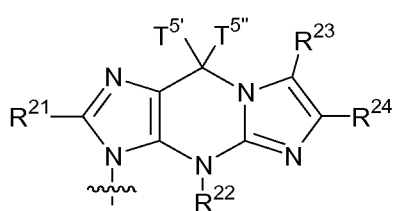

(b16), or

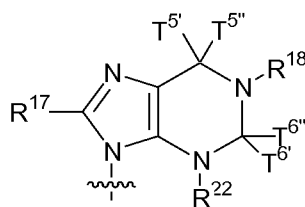

(b17), or a pharmaceutically acceptable salt or stereoisomer

thereof,

[000478] wherein

[000479] each of T^{4'}, T^{4''}, T^{5'}, T^{5''}, T^{6'}, and T^{6''} is, independently, H, optionally substituted alkyl, or optionally substituted alkoxy, and wherein the combination of T^{4'} and T^{4''} (e.g., as in T⁴) or the combination of T^{5'} and T^{5''} (e.g., as in T⁵) or the combination of T^{6'} and T^{6''} (e.g., as in T⁶) join together form O (oxo), S (thio), or Se (seleno);

[000480] each of V⁵ and V⁶ is, independently, O, S, N(R^{Vd})_{nv}, or C(R^{Vd})_{nv}, wherein nv is an integer from 0 to 2 and each R^{Vd} is, independently, H, halo, thiol, optionally substituted amino acid, cyano, amidine, optionally substituted aminoalkyl, optionally substituted aminoalkenyl, optionally substituted aminoalkynyl, optionally substituted alkyl, optionally substituted alkenyl, optionally substituted alkynyl, optionally substituted alkoxy, optionally substituted alkenyloxy, or optionally substituted alkynyloxy (e.g., optionally substituted with any substituent described herein, such as those selected from (1)-(21) for alkyl), optionally substituted thioalkoxy, or optionally substituted amino; and

[000481] each of R¹⁷, R¹⁸, R^{19a}, R^{19b}, R²¹, R²², R²³, and R²⁴ is, independently, H, halo, thiol, optionally substituted alkyl, optionally substituted alkenyl, optionally substituted alkynyl, optionally substituted thioalkoxy, optionally substituted amino, or optionally substituted amino acid.

[000482] Exemplary modified guanosines include compounds of Formula (b37)-(b40):

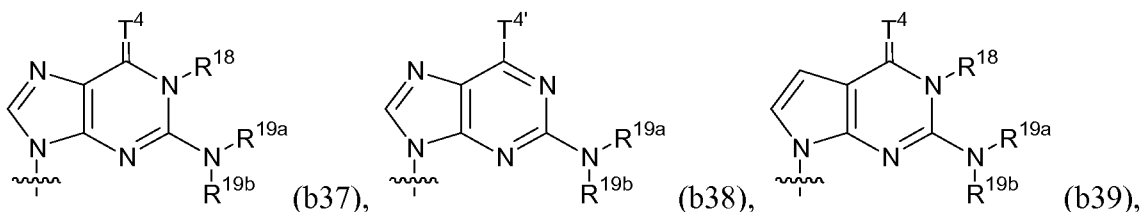

or

(b40), or a pharmaceutically acceptable salt or stereoisomer thereof,

[000483] wherein

[000484] each of T^{4'} is, independently, H, optionally substituted alkyl, or optionally substituted alkoxy, and each T⁴ is, independently, O (oxo), S (thio), or Se (seleno);

[000485] each of R^{18} , R^{19a} , R^{19b} , and R^{21} is, independently, H, halo, thiol, optionally substituted alkyl, optionally substituted alkenyl, optionally substituted alkynyl, optionally substituted thioalkoxy, optionally substituted amino, or optionally substituted amino acid.

[000486] In some embodiments, R^{18} is H or optionally substituted alkyl. In further embodiments, T^4 is oxo. In some embodiments, each of R^{19a} and R^{19b} is, independently, H or optionally substituted alkyl.

[000487] In some embodiments, B is a modified adenine. Exemplary modified adenines include compounds of Formula (M8)-(b20):

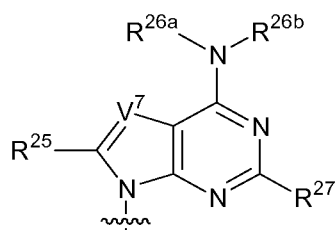

(b18),

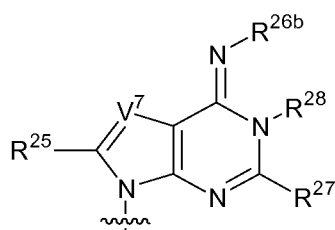

(b19), or

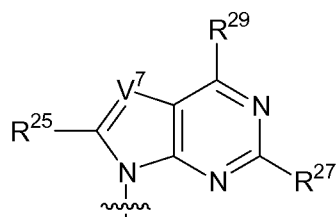

(b20), or a pharmaceutically acceptable salt or stereoisomer

thereof,

[000488] wherein

[000489] each V^7 is, independently, O, S, $N(R^{Ve})_{nv}$, or $C(R^{Ve})_{nv}$, wherein nv is an integer from 0 to 2 and each R^{Ve} is, independently, H, halo, optionally substituted amino acid, optionally substituted alkyl, optionally substituted alkenyl, optionally substituted alkynyl, optionally substituted alkoxy, optionally substituted alkenyloxy, or optionally substituted alkynyloxy (e.g., optionally substituted with any substituent described herein, such as those selected from (1)-(21) for alkyl);

[000490] each R^{25} is, independently, H, halo, thiol, optionally substituted alkyl, optionally substituted alkenyl, optionally substituted alkynyl, optionally substituted thioalkoxy, or optionally substituted amino;

[000491] each of R^{26a} and R^{26b} is, independently, H, optionally substituted acyl, optionally substituted amino acid, optionally substituted carbamoylalkyl, optionally substituted alkyl, optionally substituted alkenyl, optionally substituted alkynyl, optionally

substituted hydroxyalkyl, optionally substituted hydroxyalkenyl, optionally substituted hydroxyalkynyl, optionally substituted alkoxy, or polyethylene glycol group (e.g., $-(CH_2)_{s_2}(OCH_2CH_2)_{s_3}si(CH_2)_{s_3}R'$, wherein si is an integer from 1 to 10 (e.g., from 1 to 6 or from 1 to 4), each of s_2 and s_3 , independently, is an integer from 0 to 10 (e.g., from 0 to 4, from 0 to 6, from 1 to 4, from 1 to 6, or from 1 to 10), and R' is H or C_{1-20} alkyl); or an amino-polyethylene glycol group (e.g., $-NR^{N1}(CH_2)_{s_2}(CH_2CH_2O)_{s_3}i(CH_2)_{s_3}NR^{N1}$, wherein si is an integer from 1 to 10 (e.g., from 1 to 6 or from 1 to 4), each of s_2 and s_3 , independently, is an integer from 0 to 10 (e.g., from 0 to 4, from 0 to 6, from 1 to 4, from 1 to 6, or from 1 to 10), and each R^{N1} is, independently, hydrogen or optionally substituted C_{1-6} alkyl);

[000492] each R^{27} is, independently, H, optionally substituted alkyl, optionally substituted alkenyl, optionally substituted alkynyl, optionally substituted alkoxy, optionally substituted thioalkoxy or optionally substituted amino;

[000493] each R^{28} is, independently, H, optionally substituted alkyl, optionally substituted alkenyl, or optionally substituted alkynyl; and

[000494] each R^{29} is, independently, H, optionally substituted acyl, optionally substituted amino acid, optionally substituted carbamoylalkyl, optionally substituted alkyl, optionally substituted alkenyl, optionally substituted alkynyl, optionally substituted hydroxyalkyl, optionally substituted hydroxyalkenyl, optionally substituted alkoxy, or optionally substituted amino.

[000495] Exemplary modified adenines include compounds of Formula (b41)-(b43):

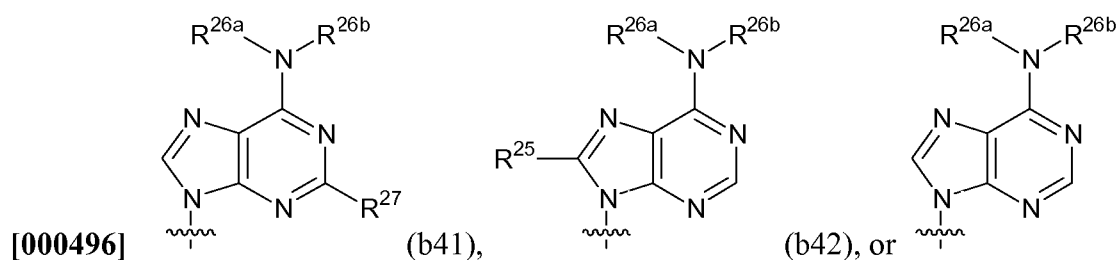

(b43), or a pharmaceutically acceptable salt or stereoisomer thereof,

[000497] wherein

[000498] each R^{25} is, independently, H, halo, thiol, optionally substituted alkyl, optionally substituted alkenyl, optionally substituted alkynyl, optionally substituted thioalkoxy, or optionally substituted amino;

[000499] each of R^{26a} and R^{26b} is, independently, H, optionally substituted acyl, optionally substituted amino acid, optionally substituted carbamoylalkyl, optionally substituted alkyl, optionally substituted alkenyl, optionally substituted alkynyl, optionally substituted hydroxyalkyl, optionally substituted hydroxyalkenyl, optionally substituted hydroxyalkynyl, optionally substituted alkoxy, or polyethylene glycol group (e.g., $-(CH_2)_{s2}(OCH_2CH_2)_s i(CH_2)_{s3}OR'$, wherein s_i is an integer from 1 to 10 (e.g., from 1 to 6 or from 1 to 4), each of s_2 and s_3 , independently, is an integer from 0 to 10 (e.g., from 0 to 4, from 0 to 6, from 1 to 4, from 1 to 6, or from 1 to 10), and R' is H or C_{1-20} alkyl); or an amino-polyethylene glycol group (e.g., $-NR^{N1}(CH_2)_{s2}(CH_2CH_2O)_s i(CH_2)_{s3}NR^{N1}$, wherein s_i is an integer from 1 to 10 (e.g., from 1 to 6 or from 1 to 4), each of s_2 and s_3 , independently, is an integer from 0 to 10 (e.g., from 0 to 4, from 0 to 6, from 1 to 4, from 1 to 6, or from 1 to 10), and each R^{N1} is, independently, hydrogen or optionally substituted C_{1-6} alkyl); and

[000500] each R^{27} is, independently, H, optionally substituted alkyl, optionally substituted alkenyl, optionally substituted alkynyl, optionally substituted alkoxy, optionally substituted thioalkoxy, or optionally substituted amino.

[000501] In some embodiments, R^{26a} is H, and R^{26b} is optionally substituted alkyl. In some embodiments, each of R^{26a} and R^{26b} is, independently, optionally substituted alkyl. In particular embodiments, R^{27} is optionally substituted alkyl, optionally substituted alkoxy, or optionally substituted thioalkoxy. In other embodiments, R^{25} is optionally substituted alkyl, optionally substituted alkoxy, or optionally substituted thioalkoxy.

[000502] In particular embodiments, the optional substituent for R^{26a} , R^{26b} , or R^{29} is a polyethylene glycol group (e.g., $-(CH_2)_{s2}(OCH_2CH_2)_s i(CH_2)_{s3}OR'$, wherein s_i is an integer from 1 to 10 (e.g., from 1 to 6 or from 1 to 4), each of s_2 and s_3 , independently, is an integer from 0 to 10 (e.g., from 0 to 4, from 0 to 6, from 1 to 4, from 1 to 6, or from 1 to 10), and R' is H or C_{1-20} alkyl); or an amino-polyethylene glycol group (e.g., $-NR^{N1}(CH_2)_{s2}(CH_2CH_2O)_s i(CH_2)_{s3}NR^{N1}$, wherein s_i is an integer from 1 to 10 (e.g., from 1 to 6 or from 1 to 4), each of s_2 and s_3 , independently, is an integer from 0 to 10 (e.g., from 0 to 4, from 0 to 6, from 1 to 4, from 1 to 6, or from 1 to 10), and each R^{N1} is, independently, hydrogen or optionally substituted C_{1-6} alkyl).

[000503] In some embodiments, B may have Formula (b21):

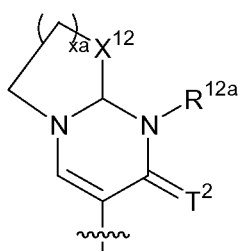

(b21), wherein X^{12} is, independently, O, S, optionally substituted alkylene (e.g., methylene), or optionally substituted heteroalkylene, x_a is an integer from 0 to 3, and R^{12a} and T^2 are as described herein.

[000504] In some embodiments, B may have Formula (b22):

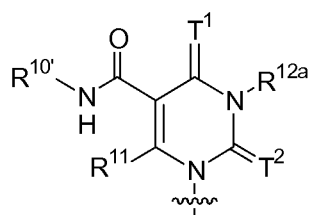

(b22), wherein $R^{10'}$ is, independently, optionally substituted alkyl, optionally substituted alkenyl, optionally substituted alkynyl, optionally substituted aryl, optionally substituted heterocyclyl, optionally substituted aminoalkyl, optionally substituted aminoalkenyl, optionally substituted aminoalkynyl, optionally substituted alkoxy, optionally substituted alkoxy carbonylalkyl, optionally substituted alkoxy carbonylalkenyl, optionally substituted alkoxy carbonylalkynyl, optionally substituted alkoxy carbonylalkoxy, optionally substituted carboxyalkoxy, optionally substituted carboxyalkyl, or optionally substituted carbamoylalkyl, and R^{11} , R^{12a} , T^1 , and T^2 are as described herein.

[000505] In some embodiments, B may have Formula (b23):

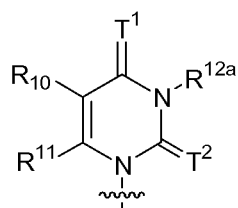

(b23), wherein R^{10} is optionally substituted heterocyclyl (e.g., optionally substituted furyl, optionally substituted thienyl, or optionally substituted pyrrolyl), optionally substituted aryl (e.g., optionally substituted phenyl or optionally substituted naphthyl), or any substituent described herein (e.g., for R^{10}); and wherein R^{11} (e.g., H or any substituent described herein), R^{12a} (e.g., H or any substituent described

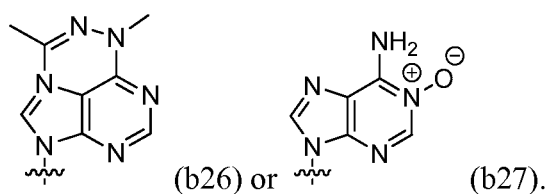

[000508] In some embodiments, the modified nucleobase is a modified uracil. Exemplary nucleobases and nucleosides having a modified uracil include pseudouridine (ψ), pyridin-4-one ribonucleoside, 5-aza-uridine, 6-aza-uridine, 2-thio-5-aza-uridine, 2-thio-uridine (s^2U), 4-thio-uridine (s^4U), 4-thio-pseudouridine, 2-thio-pseudouridine, 5-hydroxy-uridine (ho^5U), 5-aminoallyl-uridine, 5-halo-uridine (e.g., 5-iodo-uridine or 5-bromo-uridine), 3-methyl-uridine (m^3U), 5-methoxy-uridine (mo^5U), uridine 5-oxyacetic acid (cmo^5U), uridine 5-oxyacetic acid methyl ester ($mcmo^5U$), 5-carboxymethyl-uridine (cm^5U), 1-carboxymethyl-pseudouridine, 5-carboxyhydroxymethyl-uridine (chm^5U), 5-carboxyhydroxymethyl-uridine methyl ester ($mchm^5U$), 5-methoxycarbonylmethyl-uridine (mcm^5U), 5-methoxycarbonylmethyl-2-thio-uridine (mcm^5s^2U), 5-aminomethyl-2-thio-uridine (**nm ψ U**), 5-methylaminomethyl-uridine (mnm^5U), 5-methylaminomethyl-2-thio-uridine (mnm^5s^2U), 5-methylaminomethyl-2-seleno-uridine (mnm^5se^2U), 5-carbamoylmethyl-uridine (ncm^5U), 5-carboxymethylaminomethyl-uridine ($cmnm^5U$), 5-carboxymethylaminomethyl-2-thio-uridine ($cmnm^5s^2U$), 5-propynyl-uridine, 1-propynyl-pseudouridine, 5-taurinomethyl-uridine (**τm^5U**), 1-taurinomethyl-pseudouridine, 5-taurinomethyl-2-thio-uridine (**τm^5s^2U**), 1-taurinomethyl-4-thio-pseudouridine, 5-methyl-uridine (m^5U , i.e., having the nucleobase deoxythymine), 1-methylpseudouridine (m^\wedge), 5-methyl-2-thio-uridine (m^5s^2U), 1-methyl-4-thio-pseudouridine (**$m^V \psi$**), 4-thio-1-methyl-pseudouridine, 3-methyl-pseudouridine ($m^3\psi$), 2-thio-1-methyl-pseudouridine, 1-methyl-1-deaza-pseudouridine, 2-thio-1-methyl-1-deaza-pseudouridine, dihydrouridine (D), dihydropseudouridine, 5,6-dihydrouridine, 5-methyl-dihydrouridine (m^5D), 2-thio-dihydrouridine, 2-thio-dihydropseudouridine, 2-methoxy-uridine, 2-methoxy-4-thio-uridine, 4-methoxy-pseudouridine, 4-methoxy-2-thio-pseudouridine, N1-methyl-pseudouridine (also known as 1-methylpseudouridine (m^\wedge)), 3-(3-amino-3-carboxypropyl)uridine (acp^3U), 1-methyl-3-(3-amino-3-carboxypropyl)pseudouridine ($acp^3\psi$), 5-(isopentenylaminomethyl)uridine (inm^5U), 5-(isopentenylaminomethyl)-2-thio-uridine (inm^5s^2U), a-thio-uridine, 2'-O-methyl-uridine (Um), 5,2'-O-dimethyl-

uridine (m^5U), 2'-O-methyl-pseudouridine ($\psi\eta$), 2-thio-2'-O-methyl-uridine (s^2U), 5-methoxycarbonylmethyl-2'-O-methyl-uridine (mcm^5U), 5-carbamoylmethyl-2'-O-methyl-uridine (ncm^5U), 5-carboxymethylaminomethyl-2'-O-methyl-uridine ($cmnm^5U$), 3,2'-O-dimethyl-uridine (m^3U), 5-(isopentenylaminomethyl)-2'-O-methyl-uridine (inm^5U), 1-thio-uridine, deoxythymidine, 2'-F-ara-uridine, 2'-F-uridine, 2'-OH-ara-uridine, 5-(2-carbomethoxyvinyl) uridine, and 5-[3-(1-E-propenylamino)uridine.

[000509] In some embodiments, the modified nucleobase is a modified cytosine. Exemplary nucleobases and nucleosides having a modified cytosine include 5-aza-cytidine, 6-aza-cytidine, pseudoisocytidine, 3-methyl-cytidine (m^3C), N4-acetyl-cytidine (ac^4C), 5-formyl-cytidine (f^5C), N4-methyl-cytidine (m^4C), 5-methyl-cytidine (m^5C), 5-halo-cytidine (e.g., 5-iodo-cytidine), 5-hydroxymethyl-cytidine (hm^5C), 1-methyl-pseudoisocytidine, pyrrolo-cytidine, pyrrolo-pseudoisocytidine, 2-thio-cytidine (s^2C), 2-thio-5-methyl-cytidine, 4-thio-pseudoisocytidine, 4-thio-1-methyl-pseudoisocytidine, 4-thio-1-methyl-1-deaza-pseudoisocytidine, 1-methyl-1-deaza-pseudoisocytidine, zebularine, 5-aza-zebularine, 5-methyl-zebularine, 5-aza-2-thio-zebularine, 2-thio-zebularine, 2-methoxy-cytidine, 2-methoxy-5-methyl-cytidine, 4-methoxy-pseudoisocytidine, 4-methoxy-1-methyl-pseudoisocytidine, lysidine (k_2C), a-thio-cytidine, 2'-O-methyl-cytidine (Cm), 5,2'-O-dimethyl-cytidine (m^5Cm), N4-acetyl-2'-O-methyl-cytidine (ac^4Cm), N4,2'-O-dimethyl-cytidine (m^4Cm), 5-formyl-2'-O-methyl-cytidine (f^5Cm), N4,N4,2'-O-trimethyl-cytidine (m^4_2Cm), 1-thio-cytidine, 2'-F-ara-cytidine, 2'-F-cytidine, and 2'-OH-ara-cytidine.

[000510] In some embodiments, the modified nucleobase is a modified adenine. Exemplary nucleobases and nucleosides having a modified adenine include 2-amino-purine, 2,6-diaminopurine, 2-amino-6-halo-purine (e.g., 2-amino-6-chloro-purine), 6-halo-purine (e.g., 6-chloro-purine), 2-amino-6-methyl-purine, 8-azido-adenosine, 7-deaza-adenine, 7-deaza-8-aza-adenine, 7-deaza-2-amino-purine, 7-deaza-8-aza-2-amino-purine, 7-deaza-2,6-diaminopurine, 7-deaza-8-aza-2,6-diaminopurine, 1-methyl-adenosine (m^1A), 2-methyl-adenine (m^2A), N6-methyl-adenosine (m^6A), 2-methylthio-N6-methyl-adenosine (ms^2m^6A), N6-isopentenyl-adenosine (i^6A), 2-methylthio-N6-isopentenyl-adenosine (ms^2i^6A), N6-(cis-hydroxyisopentenyl)adenosine (io^6A), 2-

methylthio-N6-(cis-hydroxyisopentenyl)adenosine (ms^2io^6A), N6-glycinylocarbamoyl-adenosine (g^6A), N6-threonylocarbamoyl-adenosine (t^6A), N6-methyl-N6-threonylocarbamoyl-adenosine (m^6t^6A), 2-methylthio-N6-threonylocarbamoyl-adenosine (ms^2g^6A), N6,N6-dimethyl-adenosine (m^6_2A), N6-hydroxynorvalylcarbamoyl-adenosine (hn^6A), 2-methylthio-N6-hydroxynorvalylcarbamoyl-adenosine (ms^2hn^6A), N6-acetyl-adenosine (ac^6A), 7-methyl-adenine, 2-methylthio-adenine, 2-methoxy-adenine, a-thio-adenosine, 2'-0-methyl-adenosine (Am), N6,2'-0-dimethyl-adenosine (m^6Am), N6,N6,2'-0-trimethyl-adenosine (m^6_2Am), 1,2'-0-dimethyl-adenosine (rr^6Am), 2'-0-ribosyladenosine (phosphate) (Ar(p)), 2-amino-N6-methyl-purine, 1-thio-adenosine, 8-azido-adenosine, 2'-F-ara-adenosine, 2'-F-adenosine, 2'-OH-ara-adenosine, and N6-(19-amino-pentaoxonadecyl)-adenosine.

[000511] In some embodiments, the modified nucleobase is a modified guanine.

Exemplary nucleobases and nucleosides having a modified guanine include inosine (I), 1-methyl-inosine (m^1I), wyosine (imG), methylwyosine (mimG), 4-demethyl-wyosine (imG-14), isowyosine (imG2), wybutosine (yW), peroxywybutosine (o_2yW), hydroxywybutosine (OHyW), undermodified hydroxywybutosine (OHyW*), 7-deaza-guanosine, queuosine (Q), epoxyqueuosine (oQ), galactosyl-queuosine (galQ), mannosyl-queuosine (manQ), 7-cyano-7-deaza-guanosine (preQo), 7-aminomethyl-7-deaza-guanosine (preQi), archaeosine (G^+), 7-deaza-8-aza-guanosine, 6-thio-guanosine, 6-thio-7-deaza-guanosine, 6-thio-7-deaza-8-aza-guanosine, 7-methyl-guanosine (m^7G), 6-thio-7-methyl-guanosine, 7-methyl-inosine, 6-methoxy-guanosine, 1-methyl-guanosine (n^6G), N2-methyl-guanosine (m^2G), N2,N2-dimethyl-guanosine (m^2_2G), N2,7-dimethyl-guanosine ($m^{2,7}G$), N2, N2,7-dimethyl-guanosine ($m^{2,2,7}G$), 8-oxo-guanosine, 7-methyl-8-oxo-guanosine, 1-methyl-6-thio-guanosine, N2-methyl-6-thio-guanosine, N2,N2-dimethyl-6-thio-guanosine, a-thio-guanosine, 2'-0-methyl-guanosine (Gm), N2-methyl-2'-0-methyl-guanosine (m^2Gm), N2,N2-dimethyl-2'-0-methyl-guanosine (m^2_2Gm), 1-methyl-2'-0-methyl-guanosine (m^1m), N2,7-dimethyl-2'-0-methyl-guanosine ($m^{2,7}Gm$), 2'-0-methyl-inosine (Im), 1,2'-0-dimethyl-inosine (m^1m), and 2'-0-ribosylguanosine (phosphate) (Gr(p)).

[000512] The nucleobase of the nucleotide can be independently selected from a purine, a pyrimidine, a purine or pyrimidine analog. For example, the nucleobase can each be

independently selected from adenine, cytosine, guanine, uracil, or hypoxanthine. In another embodiment, the nucleobase can also include, for example, naturally-occurring and synthetic derivatives of a base, including pyrazolo[3,4-d]pyrimidines, 5-methylcytosine (5-me-C), 5-hydroxymethyl cytosine, xanthine, hypoxanthine, 2-aminoadenine, 6-methyl and other alkyl derivatives of adenine and guanine, 2-propyl and other alkyl derivatives of adenine and guanine, 2-thiouracil, 2-thiothymine and 2-thiocytosine, 5-propynyl uracil and cytosine, 6-azo uracil, cytosine and thymine, 5-uracil (pseudouracil), 4-thiouracil, 8-halo (*e.g.*, 8-bromo), 8-amino, 8-thiol, 8-thioalkyl, 8-hydroxyl and other 8-substituted adenines and guanines, 5-halo particularly 5-bromo, 5-trifluoromethyl and other 5-substituted uracils and cytosines, 7-methylguanine and 7-methyladenine, 8-azaguanine and 8-azaadenine, deazaguanine, 7-deazaguanine, 3-deazaguanine, deazaadenine, 7-deazaadenine, 3-deazaadenine, pyrazolo[3,4-d]pyrimidine, imidazo[1,5-a],3,5 triazinones, 9-deazapurines, imidazo[4,5-d]pyrazines, thiazolo[4,5-d]pyrimidines, pyrazin-2-ones, 1,2,4-triazine, pyridazine; and 1,3,5 triazine. When the nucleotides are depicted using the shorthand A, G, C, T or U, each letter refers to the representative base and/or derivatives thereof, *e.g.*, A includes adenine or adenine analogs, *e.g.*, 7-deaza adenine).

Modifications on the Internucleoside Linkage

[000513] The modified nucleotides, which may be incorporated into a polynucleotide, primary construct, or mmRNA molecule, can be modified on the internucleoside linkage (*e.g.*, phosphate backbone). Herein, in the context of the polynucleotide backbone, the phrases "phosphate" and "phosphodiester" are used interchangeably. Backbone phosphate groups can be modified by replacing one or more of the oxygen atoms with a different substituent. Further, the modified nucleosides and nucleotides can include the wholesale replacement of an unmodified phosphate moiety with another internucleoside linkage as described herein. Examples of modified phosphate groups include, but are not limited to, phosphorothioate, phosphoroselenates, boranophosphates, boranophosphate esters, hydrogen phosphonates, phosphoramidates, phosphorodiamidates, alkyl or aryl phosphonates, and phosphotriesters. Phosphorodithioates have both non-linking oxygens replaced by sulfur. The phosphate linker can also be modified by the replacement of a

linking oxygen with nitrogen (bridged phosphoramidates), sulfur (bridged phosphorothioates), and carbon (bridged methylene -phosphonates).

[000514] The a-thio substituted phosphate moiety is provided to confer stability to RNA and DNA polymers through the unnatural phosphorothioate backbone linkages. Phosphorothioate DNA and RNA have increased nuclease resistance and subsequently a longer half-life in a cellular environment. Phosphorothioate linked polynucleotides, primary constructs, or mmRNA molecules are expected to also reduce the innate immune response through weaker binding/activation of cellular innate immune molecules.

[000515] In specific embodiments, a modified nucleoside includes an alpha-thio-nucleoside (e.g., 5'-0-(1-thiophosphate)-adenosine, 5'-0-(1-thiophosphate)-cytidine (a-thio-cytidine), 5'-0-(1-thiophosphate)-guanosine, 5'-0-(1-thiophosphate)-uridine, or 5'-0-(1-thiophosphate)-pseudouridine).

[000516] Other internucleoside linkages that may be employed according to the present invention, including internucleoside linkages which do not contain a phosphorous atom, are described herein below.

Combinations of Modified Sugars, Nucleobases, and Internucleoside Linkages

[000517] The polynucleotides, primary constructs, and mmRNA of the invention can include a combination of modifications to the sugar, the nucleobase, and/or the internucleoside linkage. These combinations can include any one or more modifications described herein. For examples, any of the nucleotides described herein in Formulas (Ia), (Ia-1)-(Ia-3), (Ib)-(If), (IIa)-(IIp), (IIb-1), (IIb-2), (IIc-1)-(IIc-2), (IIIn-1), (IIIn-2), (IVa)-(IV1), and (IXa)-(IXr) can be combined with any of the nucleobases described herein (e.g., in Formulas (bl)-(b43) or any other described herein).

Synthesis of Polypeptides., Primary Constructs, and mmRNA Molecules

[000518] The polypeptides, primary constructs, and mmRNA molecules for use in accordance with the invention may be prepared according to any useful technique, as described herein. The modified nucleosides and nucleotides used in the synthesis of polynucleotides, primary constructs, and mmRNA molecules disclosed herein can be prepared from readily available starting materials using the following general methods and procedures. Where typical or preferred process conditions (e.g., reaction temperatures, times, mole ratios of reactants, solvents, pressures, etc.) are provided, a

skilled artisan would be able to optimize and develop additional process conditions. Optimum reaction conditions may vary with the particular reactants or solvent used, but such conditions can be determined by one skilled in the art by routine optimization procedures.

[000519] The processes described herein can be monitored according to any suitable method known in the art. For example, product formation can be monitored by spectroscopic means, such as nuclear magnetic resonance spectroscopy (e.g., ^1H or ^{13}C) infrared spectroscopy, spectrophotometry (e.g., UV-visible), or mass spectrometry, or by chromatography such as high performance liquid chromatography (HPLC) or thin layer chromatography.

[000520] Preparation of polypeptides, primary constructs, and mmRNA molecules of the present invention can involve the protection and deprotection of various chemical groups. The need for protection and deprotection, and the selection of appropriate protecting groups can be readily determined by one skilled in the art. The chemistry of protecting groups can be found, for example, in Greene, et al, *Protective Groups in Organic Synthesis*, 2d. Ed., Wiley & Sons, 1991, which is incorporated herein by reference in its entirety.

[000521] The reactions of the processes described herein can be carried out in suitable solvents, which can be readily selected by one of skill in the art of organic synthesis. Suitable solvents can be substantially nonreactive with the starting materials (reactants), the intermediates, or products at the temperatures at which the reactions are carried out, i.e., temperatures which can range from the solvent's freezing temperature to the solvent's boiling temperature. A given reaction can be carried out in one solvent or a mixture of more than one solvent. Depending on the particular reaction step, suitable solvents for a particular reaction step can be selected.

[000522] Resolution of racemic mixtures of modified nucleosides and nucleotides can be carried out by any of numerous methods known in the art. An example method includes fractional recrystallization using a "chiral resolving acid" which is an optically active, salt-forming organic acid. Suitable resolving agents for fractional recrystallization methods are, for example, optically active acids, such as the D and L forms of tartaric acid, diacetyltartaric acid, dibenzoyltartaric acid, mandelic acid, malic acid, lactic acid or

the various optically active camphorsulfonic acids. Resolution of racemic mixtures can also be carried out by elution on a column packed with an optically active resolving agent (*e.g.*, dinitrobenzoylphenylglycine). Suitable elution solvent composition can be determined by one skilled in the art.

Modified nucleosides and nucleotides (*e.g.*, building block molecules) can be prepared according to the synthetic methods described in Ogata et al, *J. Org. Chem.* 74:2585-2588 (2009); Purmal et al, *Nucl. Acids Res.* 22(1): 72-78, (1994); Fukuhara et al, *Biochemistry*, 1(4): 563-568 (1962); and Xu et al, *Tetrahedron*, 48(9): 1729-1740 (1992), each of which are incorporated by reference in their entirety.

[000523] The polypeptides, primary constructs, and mmRNA of the invention may or may not be uniformly modified along the entire length of the molecule. For example, one or more or all types of nucleotide (*e.g.*, purine or pyrimidine, or any one or more or all of A, G, U, C) may or may not be uniformly modified in a polynucleotide of the invention, or in a given predetermined sequence region thereof (*e.g.* one or more of the sequence regions represented in Figure 1). In some embodiments, all nucleotides X in a polynucleotide of the invention (or in a given sequence region thereof) are modified, wherein X may any one of nucleotides A, G, U, C, or any one of the combinations A+G, A+U, A+C, G+U, G+C, U+C, A+G+U, A+G+C, G+U+C or A+G+C.

[000524] Different sugar modifications, nucleotide modifications, and/or internucleoside linkages (*e.g.*, backbone structures) may exist at various positions in the polynucleotide, primary construct, or mmRNA. One of ordinary skill in the art will appreciate that the nucleotide analogs or other modification(s) may be located at any position(s) of a polynucleotide, primary construct, or mmRNA such that the function of the polynucleotide, primary construct, or mmRNA is not substantially decreased. A modification may also be a 5' or 3' terminal modification. The polynucleotide, primary construct, or mmRNA may contain from about 1% to about 100% modified nucleotides (either in relation to overall nucleotide content, or in relation to one or more types of nucleotide, *i.e.* any one or more of A, G, U or C) or any intervening percentage (*e.g.*, from 1% to 20%, from 1% to 25%, from 1% to 50%, from 1% to 60%, from 1% to 70%, from 1% to 80%, from 1% to 90%, from 1% to 95%, from 10% to 20%, from 10% to 25%, from 10% to 50%, from 10% to 60%, from 10% to 70%, from 10% to 80%, from

10% to 90%, from 10% to 95%, from 10% to 100%, from 20% to 25%, from 20% to 50%, from 20% to 60%, from 20% to 70%, from 20% to 80%, from 20% to 90%, from 20% to 95%, from 20% to 100%, from 50% to 60%, from 50% to 70%, from 50% to 80%, from 50% to 90%, from 50% to 95%, from 50% to 100%, from 70% to 80%, from 70% to 90%, from 70% to 95%, from 70% to 100%, from 80% to 90%, from 80% to 95%, from 80% to 100%, from 90% to 95%, from 90% to 100%, and from 95% to 100%).

[000525] In some embodiments, the polynucleotide, primary construct, or mmRNA includes a modified pyrimidine (e.g., a modified uracil/uridine/U or modified cytosine/cytidine/C). In some embodiments, the uracil or uridine (generally: U) in the polynucleotide, primary construct, or mmRNA molecule may be replaced with from about 1%, to about 100% of a modified uracil or modified uridine (e.g., from 1% to 20%>, from 1% to 25%, from 1% to 50%, from 1% to 60%, from 1% to 70%, from 1% to 80%, from 1% to 90%, from 1% to 95%, from 10% to 20%, from 10% to 25%, from 10% to 50%, from 10% to 60%, from 10% to 70%, from 10% to 80%, from 10% to 90%, from 10% to 95%, from 10% to 100%, from 20% to 25%, from 20% to 50%, from 20% to 60%, from 20% to 70%, from 20% to 80%, from 20% to 90%, from 20% to 95%, from 20% to 100%, from 50% to 60%, from 50% to 70%, from 50% to 80%, from 50% to 90%, from 50% to 95%, from 50% to 100%, from 70% to 80%, from 70% to 90%, from 70% to 95%, from 70% to 100%, from 80% to 90%, from 80% to 95%, from 80% to 100%, from 90% to 95%, from 90% to 100%, and from 95% to 100% of a modified uracil or modified uridine). The modified uracil or uridine can be replaced by a compound having a single unique structure or by a plurality of compounds having different structures (e.g., 2, 3, 4 or more unique structures, as described herein). In some embodiments, the cytosine or cytidine (generally: C) in the polynucleotide, primary construct, or mmRNA molecule may be replaced with from about 1% to about 100% of a modified cytosine or modified cytidine (e.g., from 1% to 20%>, from 1% to 25%, from 1% to 50%, from 1% to 60%, from 1% to 70%, from 1% to 80%, from 1% to 90%, from 1% to 95%, from 10% to 20%, from 10% to 25%, from 10% to 50%, from 10% to 60%, from 10% to 70%, from 10% to 80%, from 10% to 90%, from 10% to 95%, from 10% to 100%, from 20% to 25%, from 20% to 50%, from 20% to 60%, from 20% to 70%, from

20% to 80%, from 20% to 90%, from 20% to 95%, from 20% to 100%, from 50% to 60%, from 50% to 70%, from 50% to 80%, from 50% to 90%, from 50% to 95%, from 50% to 100%, from 70% to 80%, from 70% to 90%, from 70% to 95%, from 70% to 100%, from 80% to 90%, from 80% to 95%, from 80% to 100%, from 90% to 95%, from 90% to 100%, and from 95% to 100%, of a modified cytosine or modified cytidine). The modified cytosine or cytidine can be replaced by a compound having a single unique structure or by a plurality of compounds having different structures (e.g., 2, 3, 4 or more unique structures, as described herein).

In some embodiments, the present disclosure provides methods of synthesizing a polynucleotide, primary construct, or mmRNA (e.g., the first region, first flanking region, or second flanking region) including n number of linked nucleosides having Formula (Ia-1):

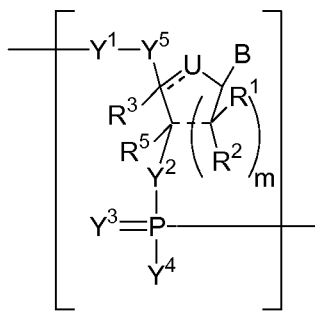

(Ia-1), comprising:

a) reacting a nucleotide of Formula (IV-1):

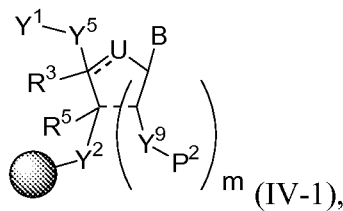

with a phosphoramidite compound of Formula (V-1):

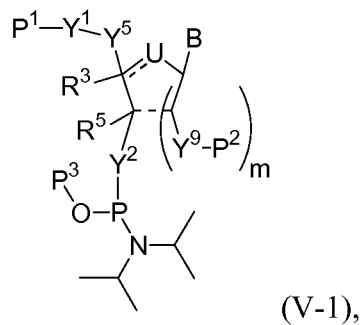

wherein Y^9 is H, hydroxy, phosphoryl, pyrophosphate, sulfate, amino, thiol, optionally substituted amino acid, or a peptide (e.g., including from 2 to 12 amino acids); and each P^1 , P^2 , and P^3 is, independently, a suitable protecting group; and ● denotes a solid support;

to provide a polynucleotide, primary construct, or mmRNA of Formula (VI-1):

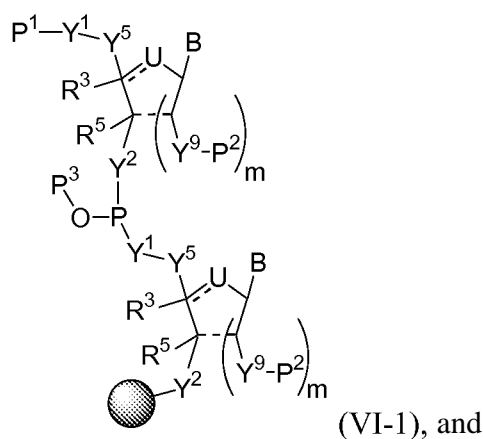

b) oxidizing or sulfurizing the polynucleotide, primary construct, or mmRNA of Formula (V) to yield a polynucleotide, primary construct, or mmRNA of Formula (VII-1):

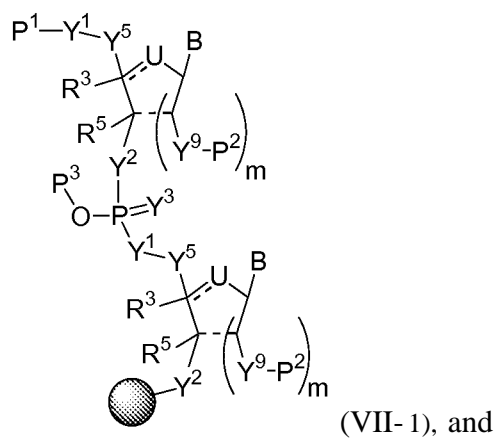

c) removing the protecting groups to yield the polynucleotide, primary construct, or mmRNA of Formula (Ia).

[000526] In some embodiments, steps a) and b) are repeated from 1 to about 10,000 times. In some embodiments, the methods further comprise a nucleotide (e.g., mmRNA molecule) selected from the group consisting of A, C, G and U adenosine, cytosine, guanosine, and uracil. In some embodiments, the nucleobase may be a pyrimidine or derivative thereof. In some embodiments, the polynucleotide, primary construct, or mmRNA is translatable.

[000527] Other components of polynucleotides, primary constructs, and mmRNA are optional, and are beneficial in some embodiments. For example, a 5' untranslated region (UTR) and/or a 3'UTR are provided, wherein either or both may independently contain one or more different nucleotide modifications. In such embodiments, nucleotide modifications may also be present in the translatable region. Also provided are polynucleotides, primary constructs, and mmRNA containing a Kozak sequence.

[000528] Exemplary syntheses of modified nucleotides, which are incorporated into a modified nucleic acid or mmRNA, e.g., RNA or mRNA, are provided below in Scheme 1 through Scheme 11. Scheme 1 provides a general method for phosphorylation of nucleosides, including modified nucleosides.

Scheme 1

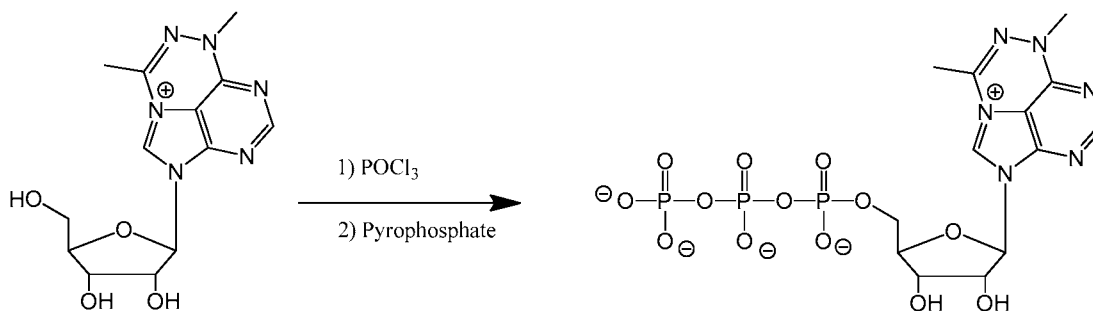

[000529] Various protecting groups may be used to control the reaction. For example, Scheme 2 provides the use of multiple protecting and deprotecting steps to promote phosphorylation at the 5' position of the sugar, rather than the 2' and 3' hydroxyl groups.

Scheme 2

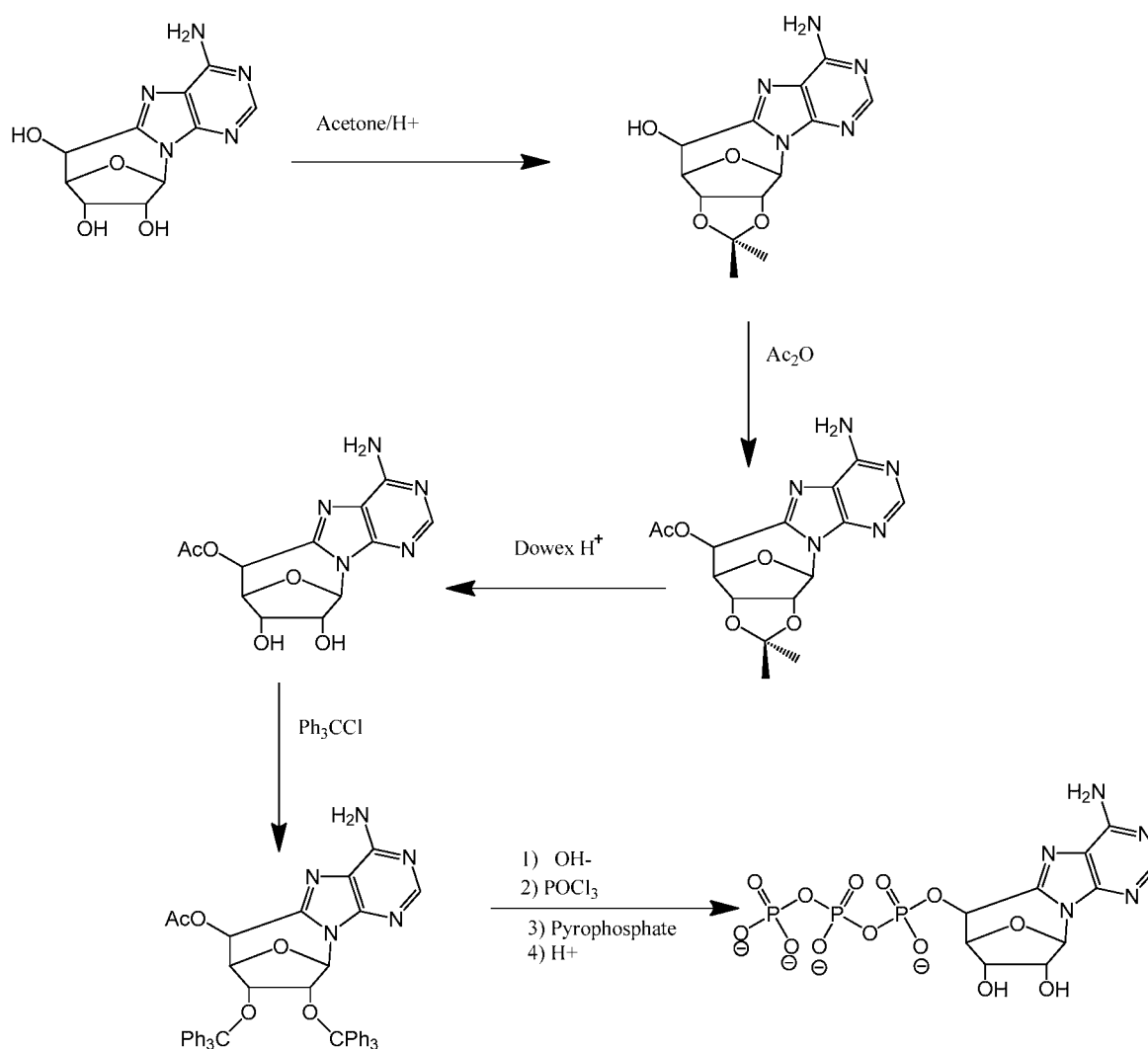

[000530] Modified nucleotides can be synthesized in any useful manner. Schemes 3, 4, and 7 provide exemplary methods for synthesizing modified nucleotides having a modified purine nucleobase; and Schemes 5 and 6 provide exemplary methods for synthesizing modified nucleotides having a modified pseudouridine or pseudoisocytidine, respectively.

Scheme 3

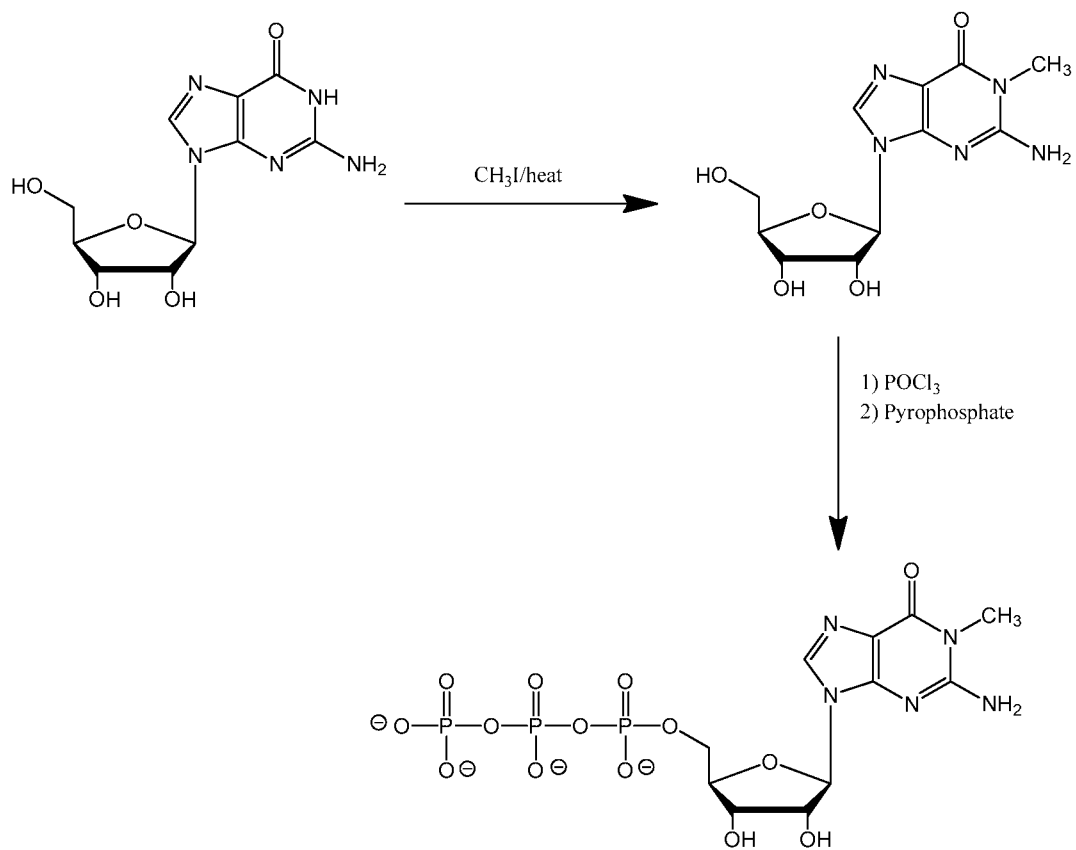

Scheme 4

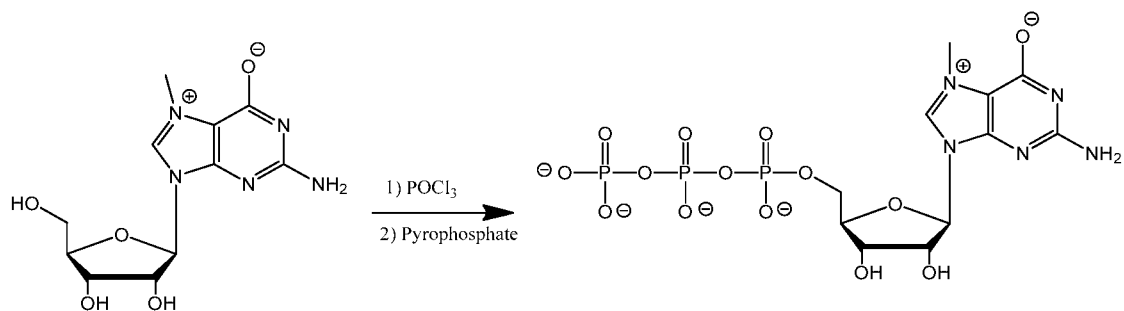

Scheme 5

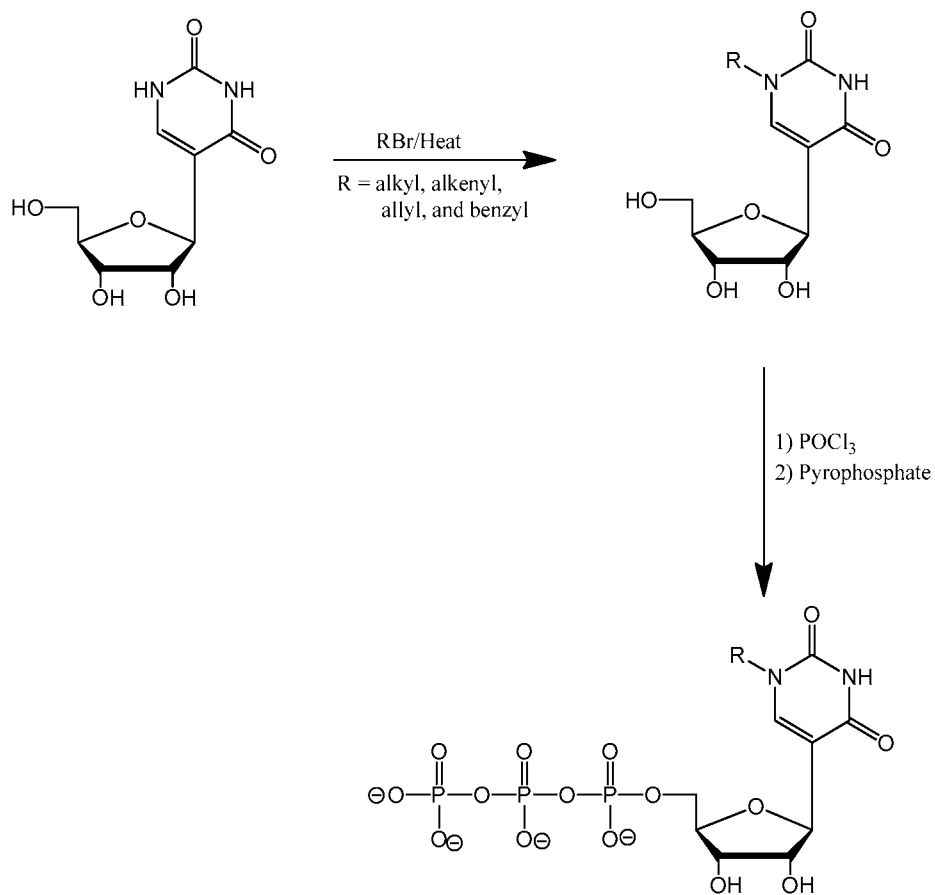

Scheme 6

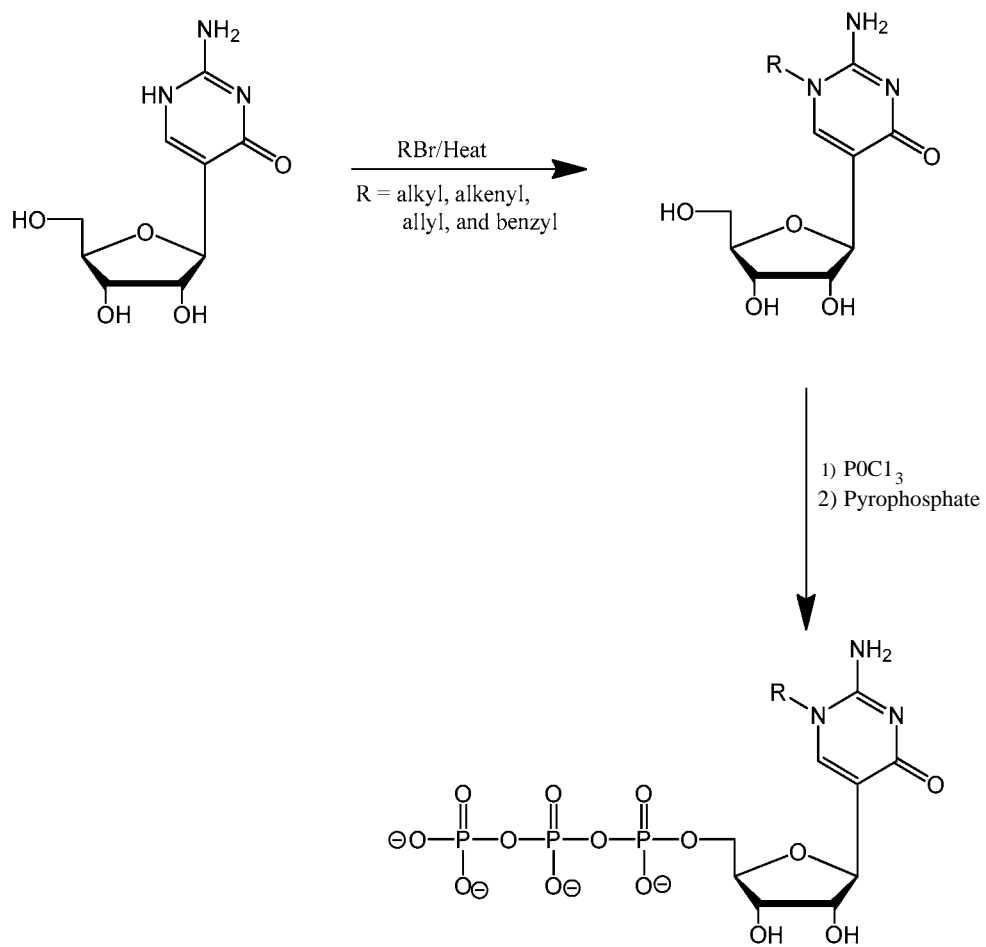

Scheme 7

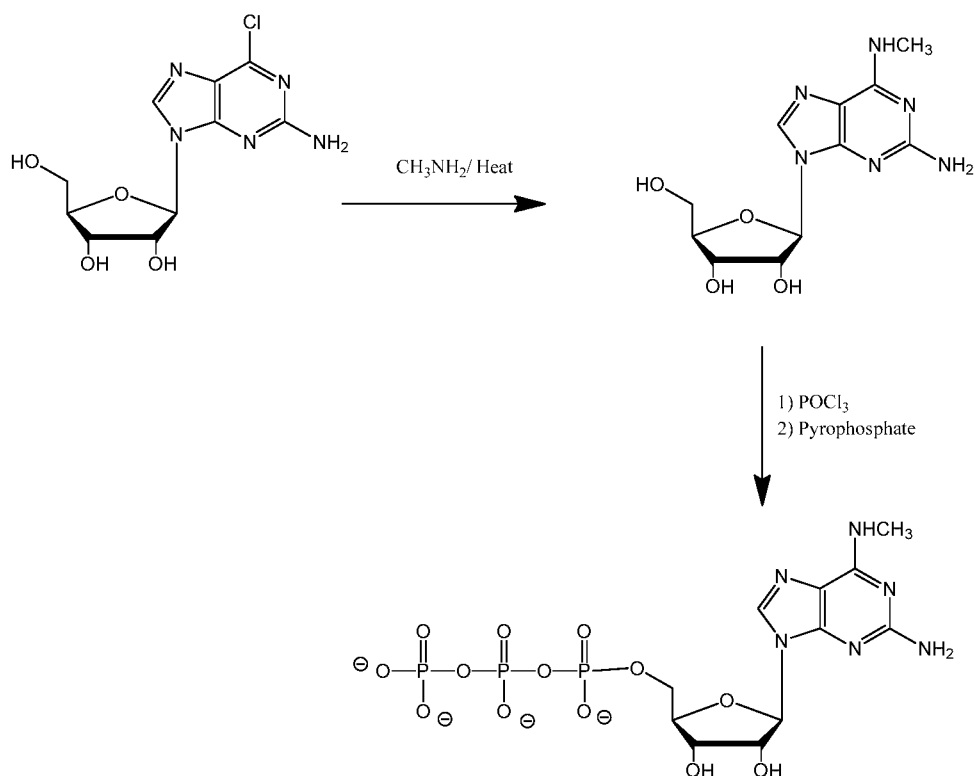

[000531] Schemes 8 and 9 provide exemplary syntheses of modified nucleotides. Scheme 10 provides a non-limiting biocatalytic method for producing nucleotides.

Scheme 8

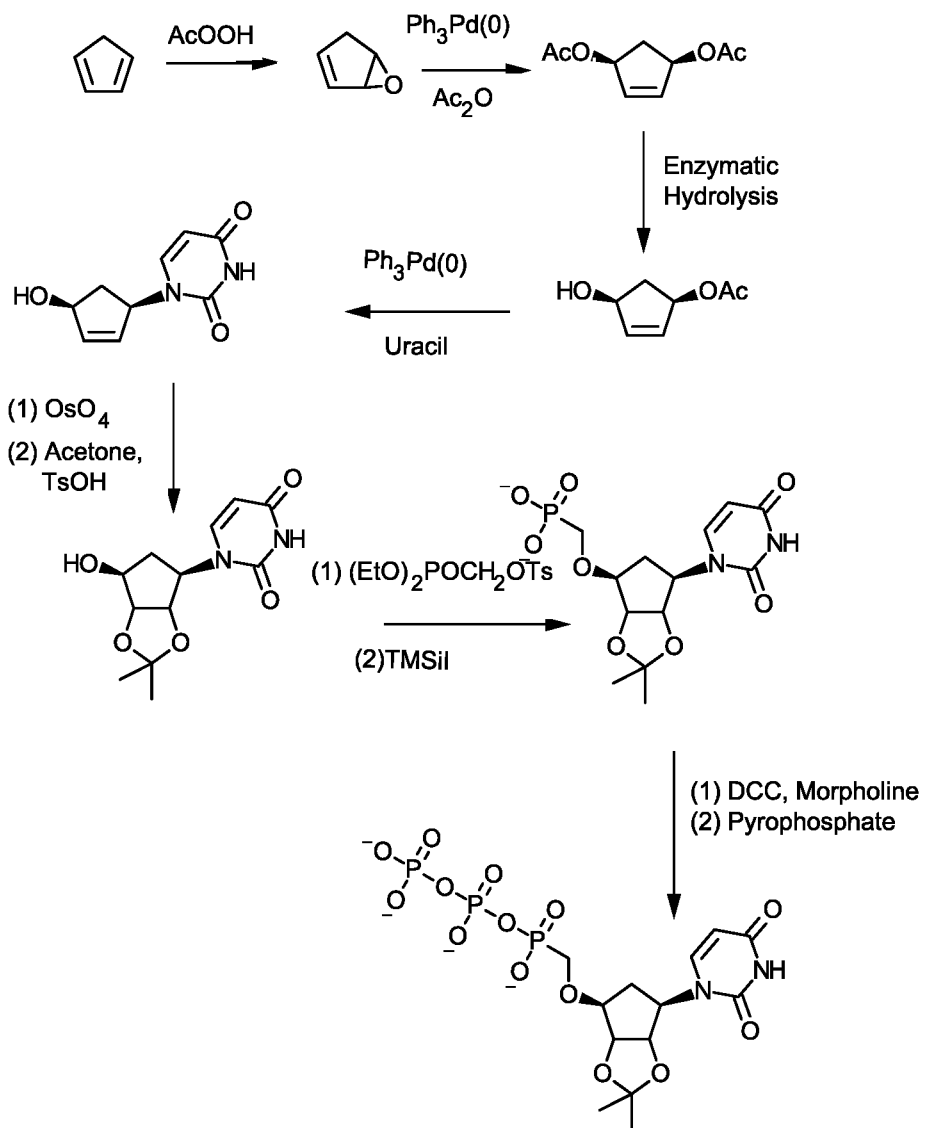

Scheme 9

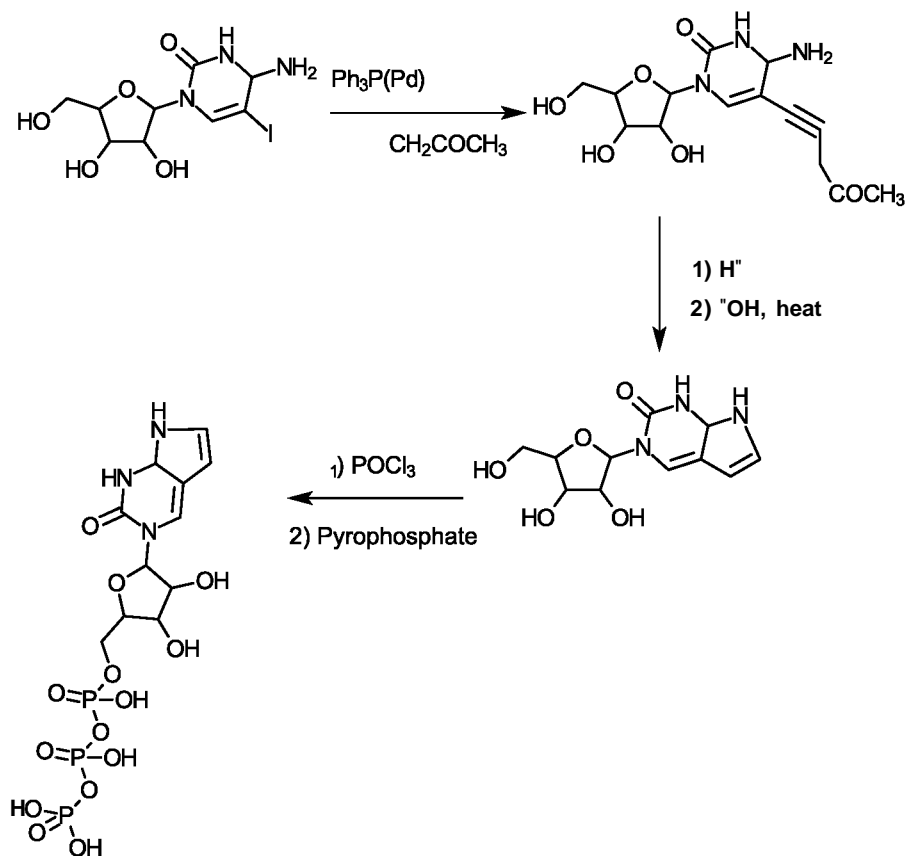

Scheme 10

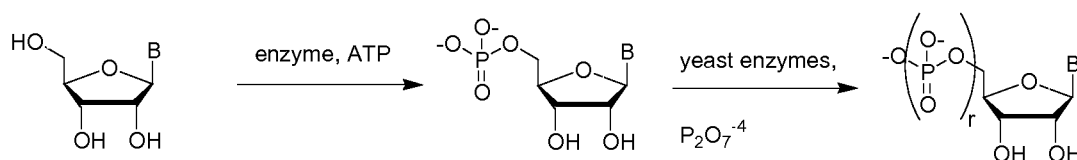

[000532] Scheme 11 provides an exemplary synthesis of a modified uracil, where the N1 position is modified with R^{12b} , as provided elsewhere, and the 5'-position of ribose is phosphorylated. T^1 , T^2 , R^{12a} , R^{12b} , and r are as provided herein. This synthesis, as well as optimized versions thereof, can be used to modify other pyrimidine nucleobases and purine nucleobases (see e.g., Formulas (b1)-(b43)) and/or to install one or more phosphate groups (e.g., at the 5' position of the sugar). This alkylating reaction can also be used to include one or more optionally substituted alkyl group at any reactive group

(e.g., amino group) in any nucleobase described herein (e.g., the amino groups in the Watson-Crick base-pairing face for cytosine, uracil, adenine, and guanine).

Scheme 11

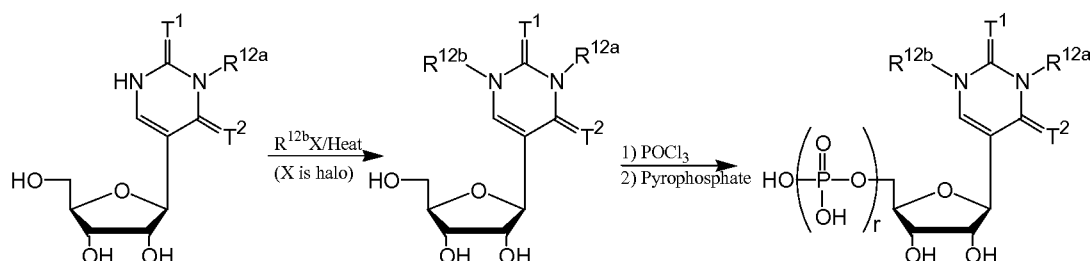

Combinations of Nucleotides in mmRNA

[000533] Further examples of modified nucleotides and modified nucleotide combinations are provided below in Table 9. These combinations of modified nucleotides can be used to form the polypeptides, primary constructs, or mmRNA of the invention. Unless otherwise noted, the modified nucleotides may be completely substituted for the natural nucleotides of the modified nucleic acids or mmRNA of the invention. As a non-limiting example, the natural nucleotide uridine may be substituted with a modified nucleoside described herein. In another non-limiting example, the natural nucleotide uridine may be partially substituted (e.g., about 0.1%, 1%, 5%, 10%, 15%, 20%, 25%, 30%, 35%, 40%, 45%, 50%, 55%, 60%, 65%, 70%, 75%, 80%, 85%, 90%, 95% or 99.9%) with at least one of the modified nucleoside disclosed herein.

Table 9

Modified Nucleotide	Modified Nucleotide Combination
α -thio-cytidine	α -thio-cytidine/5-iodo-uridine
	α -thio-cytidine/N1-methyl-pseudouridine
	α -thio-cytidine/ α -thio-uridine
	α -thio-cytidine/5-methyl-uridine
	α -thio-cytidine/pseudo-uridine
	about 50% of the cytosines are α -thio-cytidine
pseudoisocytidine	pseudoisocytidine/5-iodo-uridine
	pseudoisocytidine/N1-methyl-pseudouridine
	pseudoisocytidine/ α -thio-uridine
	pseudoisocytidine/5-methyl-uridine
	pseudoisocytidine/pseudouridine
	about 25% of cytosines are pseudoisocytidine
	pseudoisocytidine/about 50% of uridines are N1-methyl-pseudouridine and about 50% of uridines are pseudouridine

	pseudoisocytidine/about 25% of uridines are N1-methyl-pseudouridine and about 25% of uridines are pseudouridine
pyrrolo-cytidine	pyrrolo-cytidine/5-iodo-uridine
	pyrrolo-cytidine/N1-methyl-pseudouridine
	pyrrolo-cytidine/a-thio-uridine
	pyrrolo-cytidine/5-methyl-uridine
	pyrrolo-cytidine/pseudouridine
	about 50% of the cytosines are pyrrolo-cytidine
5-methyl-cytidine	5-methyl-cytidine/5-iodo-uridine
	5-methyl-cytidine/N1-methyl-pseudouridine
	5-methyl-cytidine/a-thio-uridine
	5-methyl-cytidine/5-methyl-uridine
	5-methyl-cytidine/pseudouridine
	about 25% of cytosines are 5-methyl-cytidine
	about 50% of cytosines are 5-methyl-cytidine
	5-methyl-cytidine/5-methoxy-uridine
	5-methyl-cytidine/5-bromo-uridine
	5-methyl-cytidine/2-thio-uridine
	5-methyl-cytidine/about 50% of uridines are 2-thio-uridine
	about 50% of uridines are 5-methyl-cytidine/ about 50% of uridines are 2-thio-uridine
N4-acetyl-cytidine	N4-acetyl-cytidine /5-iodo-uridine
	N4-acetyl-cytidine /N1-methyl-pseudouridine
	N4-acetyl-cytidine /a-thio-uridine
	N4-acetyl-cytidine /5-methyl-uridine
	N4-acetyl-cytidine /pseudouridine
	about 50% of cytosines are N4-acetyl-cytidine
	about 25% of cytosines are N4-acetyl-cytidine
	N4-acetyl-cytidine /5-methoxy-uridine
	N4-acetyl-cytidine /5-bromo-uridine
	N4-acetyl-cytidine /2-thio-uridine
about 50% of cytosines are N4-acetyl-cytidine/ about 50% of uridines are 2-thio-uridine	

[000534] Further examples of modified nucleotide combinations are provided below in Table 10. These combinations of modified nucleotides can be used to form the polypeptides, primary constructs, or mmRNA of the invention.

Table 10

Modified Nucleotide	Modified Nucleotide Combination
modified cytidine having one or more nucleobases of Formula (b10)	modified cytidine with (b10)/pseudouridine
	modified cytidine with (b10)/N1-methyl-pseudouridine
	modified cytidine with (b10)/5-methoxy-uridine
	modified cytidine with (b10)/5-methyl-uridine

	modified cytidine with (b10)/5-bromo-uridine
	modified cytidine with (b10)/2-thio-uridine
	about 50% of cytidine substituted with modified cytidine (b10)/ about 50% of uridines are 2-thio-uridine
modified cytidine having one or more nucleobases of Formula (b32)	modified cytidine with (b32)/pseudouridine
	modified cytidine with (b32)/N1-methyl-pseudouridine
	modified cytidine with (b32)/5-methoxy-uridine
	modified cytidine with (b32)/5-methyl-uridine
	modified cytidine with (b32)/5-bromo-uridine
	modified cytidine with (b32)/2-thio-uridine
	about 50% of cytidine substituted with modified cytidine (b32)/ about 50% of uridines are 2-thio-uridine
modified uridine having one or more nucleobases of Formula (b1)	modified uridine with (b1)/ N4-acetyl-cytidine
	modified uridine with (b1)/ 5-methyl-cytidine
modified uridine having one or more nucleobases of Formula (b8)	modified uridine with (b8)/ N4-acetyl-cytidine
	modified uridine with (b8)/ 5-methyl-cytidine
modified uridine having one or more nucleobases of Formula (b28)	modified uridine with (b28)/ N4-acetyl-cytidine
	modified uridine with (b28)/ 5-methyl-cytidine
modified uridine having one or more nucleobases of Formula (b29)	modified uridine with (b29)/ N4-acetyl-cytidine
	modified uridine with (b29)/ 5-methyl-cytidine
modified uridine having one or more nucleobases of Formula (b30)	modified uridine with (b30)/ N4-acetyl-cytidine
	modified uridine with (b30)/ 5-methyl-cytidine

[000535] In some embodiments, at least 25% of the cytosines are replaced by a compound of Formula (M0)-(b14) (e.g., at least about 30%, at least about 35%, at least about 40%, at least about 45%, at least about 50%, at least about 55%, at least about 60%, at least about 65%, at least about 70%, at least about 75%, at least about 80%, at least about 85%, at least about 90%, at least about 95%, or about 100%).

[000536] In some embodiments, at least 25% of the uracils are replaced by a compound of Formula (b1)-(b9) (e.g., at least about 30%, at least about 35%, at least about 40%, at least about 45%, at least about 50%, at least about 55%, at least about 60%, at least about 65%, at least about 70%, at least about 75%, at least about 80%, at least about 85%, at least about 90%, at least about 95%, or about 100%).

[000537] In some embodiments, at least 25% of the cytosines are replaced by a compound of Formula (M0)-(b14), and at least 25% of the uracils are replaced by a compound of Formula (b1)-(b9) (e.g., at least about 30%, at least about 35%, at least about 40%, at least about 45%, at least about 50%, at least about 55%, at least about 60%, at least about 65%, at least about 70%, at least about 75%, at least about 80%, at least about 85%, at least about 90%, at least about 95%, or about 100%).

IV. Pharmaceutical Compositions

Formulation, Administration, Delivery and Dosing

[000538] The present invention provides polynucleotides, primary constructs and mmRNA compositions and complexes in combination with one or more pharmaceutically acceptable excipients. Pharmaceutical compositions may optionally comprise one or more additional active substances, e.g. therapeutically and/or prophylactically active substances. General considerations in the formulation and/or manufacture of pharmaceutical agents may be found, for example, in *Remington: The Science and Practice of Pharmacy* 2^{1st} ed., Lippincott Williams & Wilkins, 2005 (incorporated herein by reference).

[000539] In some embodiments, compositions are administered to humans, human patients or subjects. For the purposes of the present disclosure, the phrase "active ingredient" generally refers to polynucleotides, primary constructs and mmRNA to be delivered as described herein.

[000540] Although the descriptions of pharmaceutical compositions provided herein are principally directed to pharmaceutical compositions which are suitable for administration to humans, it will be understood by the skilled artisan that such compositions are generally suitable for administration to any other animal, e.g., to non-human animals, e.g. non-human mammals. Modification of pharmaceutical compositions suitable for administration to humans in order to render the compositions suitable for administration to various animals is well understood, and the ordinarily skilled veterinary pharmacologist can design and/or perform such modification with merely ordinary, if any, experimentation. Subjects to which administration of the pharmaceutical compositions is contemplated include, but are not limited to, humans and/or other primates; mammals, including commercially relevant mammals such as cattle, pigs,

horses, sheep, cats, dogs, mice, and/or rats; and/or birds, including commercially relevant birds such as poultry, chickens, ducks, geese, and/or turkeys.

[000541] Formulations of the pharmaceutical compositions described herein may be prepared by any method known or hereafter developed in the art of pharmacology. In general, such preparatory methods include the step of bringing the active ingredient into association with an excipient and/or one or more other accessory ingredients, and then, if necessary and/or desirable, dividing, shaping and/or packaging the product into a desired single- or multi-dose unit.

[000542] A pharmaceutical composition in accordance with the invention may be prepared, packaged, and/or sold in bulk, as a single unit dose, and/or as a plurality of single unit doses. As used herein, a "unit dose" is discrete amount of the pharmaceutical composition comprising a predetermined amount of the active ingredient. The amount of the active ingredient is generally equal to the dosage of the active ingredient which would be administered to a subject and/or a convenient fraction of such a dosage such as, for example, one-half or one-third of such a dosage.

[000543] Relative amounts of the active ingredient, the pharmaceutically acceptable excipient, and/or any additional ingredients in a pharmaceutical composition in accordance with the invention will vary, depending upon the identity, size, and/or condition of the subject treated and further depending upon the route by which the composition is to be administered. By way of example, the composition may comprise between 0.1% and 100%, e.g., between .5 and 50%, between 1-30%, between 5-80%, at least 80%, (w/w) active ingredient.

Formulations

[000544] The polynucleotide, primary construct, and mmRNA of the invention can be formulated using one or more excipients to: (1) increase stability; (2) increase cell transfection; (3) permit the sustained or delayed release (e.g., from a depot formulation of the polynucleotide, primary construct, or mmRNA); (4) alter the biodistribution (e.g., target the polynucleotide, primary construct, or mmRNA to specific tissues or cell types); (5) increase the translation of encoded protein *in vivo*; and/or (6) alter the release profile of encoded protein *in vivo*. In addition to traditional excipients such as any and all solvents, dispersion media, diluents, or other liquid vehicles, dispersion or suspension

aids, surface active agents, isotonic agents, thickening or emulsifying agents, preservatives, excipients of the present invention can include, without limitation, lipidoids, liposomes, lipid nanoparticles, polymers, lipoplexes, core-shell nanoparticles, peptides, proteins, cells transfected with polynucleotide, primary construct, or mmRNA (e.g., for transplantation into a subject), hyaluronidase, nanoparticle mimics and combinations thereof. Accordingly, the formulations of the invention can include one or more excipients, each in an amount that together increases the stability of the polynucleotide, primary construct, or mmRNA, increases cell transfection by the polynucleotide, primary construct, or mmRNA, increases the expression of polynucleotide, primary construct, or mmRNA encoded protein, and/or alters the release profile of polynucleotide, primary construct, or mmRNA encoded proteins. Further, the primary construct and mmRNA of the present invention may be formulated using self-assembled nucleic acid nanoparticles.

[000545] Formulations of the pharmaceutical compositions described herein may be prepared by any method known or hereafter developed in the art of pharmacology. In general, such preparatory methods include the step of associating the active ingredient with an excipient and/or one or more other accessory ingredients.

[000546] A pharmaceutical composition in accordance with the present disclosure may be prepared, packaged, and/or sold in bulk, as a single unit dose, and/or as a plurality of single unit doses. As used herein, a "unit dose" refers to a discrete amount of the pharmaceutical composition comprising a predetermined amount of the active ingredient. The amount of the active ingredient may generally be equal to the dosage of the active ingredient which would be administered to a subject and/or a convenient fraction of such a dosage including, but not limited to, one-half or one-third of such a dosage.

[000547] Relative amounts of the active ingredient, the pharmaceutically acceptable excipient, and/or any additional ingredients in a pharmaceutical composition in accordance with the present disclosure may vary, depending upon the identity, size, and/or condition of the subject being treated and further depending upon the route by which the composition is to be administered. For example, the composition may comprise between 0.1% and 99% (w/w) of the active ingredient.

[000548] In some embodiments, the formulations described herein may contain at least one mmRNA. As a non-limiting example, the formulations may contain 1, 2, 3, 4 or 5 mmRNA. In one embodiment the formulation may contain modified mRNA encoding proteins selected from categories such as, but not limited to, human proteins, veterinary proteins, bacterial proteins, biological proteins, antibodies, immunogenic proteins, therapeutic peptides and proteins, secreted proteins, plasma membrane proteins, cytoplasmic and cytoskeletal proteins, intracellular membrane bound proteins, nuclear proteins, proteins associated with human disease and/or proteins associated with non-human diseases. In one embodiment, the formulation contains at least three modified mRNA encoding proteins. In one embodiment, the formulation contains at least five modified mRNA encoding proteins.

[000549] Pharmaceutical formulations may additionally comprise a pharmaceutically acceptable excipient, which, as used herein, includes, but is not limited to, any and all solvents, dispersion media, diluents, or other liquid vehicles, dispersion or suspension aids, surface active agents, isotonic agents, thickening or emulsifying agents, preservatives, and the like, as suited to the particular dosage form desired. Various excipients for formulating pharmaceutical compositions and techniques for preparing the composition are known in the art (see Remington: The Science and Practice of Pharmacy, 21st Edition, A. R. Gennaro, Lippincott, Williams & Wilkins, Baltimore, MD, 2006; incorporated herein by reference in its entirety). The use of a conventional excipient medium may be contemplated within the scope of the present disclosure, except insofar as any conventional excipient medium may be incompatible with a substance or its derivatives, such as by producing any undesirable biological effect or otherwise interacting in a deleterious manner with any other component(s) of the pharmaceutical composition.

[000550] In some embodiments, the particle size of the lipid nanoparticle may be increased and/or decreased. The change in particle size may be able to help counter biological reaction such as, but not limited to, inflammation or may increase the biological effect of the modified mRNA delivered to mammals.

[000551] Pharmaceutically acceptable excipients used in the manufacture of pharmaceutical compositions include, but are not limited to, inert diluents, surface active

agents and/or emulsifiers, preservatives, buffering agents, lubricating agents, and/or oils. Such excipients may optionally be included in the pharmaceutical formulations of the invention.

Lipidoids

[000552] The synthesis of lipidoids has been extensively described and formulations containing these compounds are particularly suited for delivery of polynucleotides, primary constructs or mmRNA (see Mahon et al., *Bioconjug Chem.* 2010 21:1448-1454; Schroeder et al, *J Intern Med.* 2010 267:9-21; Akinc et al, *Nat Biotechnol.* 2008 26:561-569; Love et al, *Proc Natl Acad Sci U S A.* 2010 107:1864-1869; Siegwart et al, *Proc Natl Acad Sci U S A.* 2011 108:12996-3001; all of which are incorporated herein in their entireties).

[000553] While these lipidoids have been used to effectively deliver double stranded small interfering RNA molecules in rodents and non-human primates (see Akinc et al., *Nat Biotechnol.* 2008 26:561-569; Frank-Kamenetsky et al, *Proc Natl Acad Sci U S A.* 2008 105:1915-1920; Akinc et al, *Mol Ther.* 2009 17:872-879; Love et al, *Proc Natl Acad Sci U S A.* 2010 107:1864-1869; Leuschner et al, *Nat Biotechnol.* 2011 29:1005-1010; all of which is incorporated herein in their entirety), the present disclosure describes their formulation and use in delivering single stranded polynucleotides, primary constructs, or mmRNA. Complexes, micelles, liposomes or particles can be prepared containing these lipidoids and therefore, can result in an effective delivery of the polynucleotide, primary construct, or mmRNA, as judged by the production of an encoded protein, following the injection of a lipidoid formulation via localized and/or systemic routes of administration. Lipidoid complexes of polynucleotides, primary constructs, or mmRNA can be administered by various means including, but not limited to, intravenous, intramuscular, or subcutaneous routes.

[000554] *In vivo* delivery of nucleic acids may be affected by many parameters, including, but not limited to, the formulation composition, nature of particle PEGylation, degree of loading, oligonucleotide to lipid ratio, and biophysical parameters such as, but not limited to, particle size (Akinc et al., *Mol Ther.* 2009 17:872-879; herein incorporated by reference in its entirety). As an example, small changes in the anchor chain length of poly(ethylene glycol) (PEG) lipids may result in significant effects on *in vivo* efficacy.

Formulations with the different lipidoids, including, but not limited to penta[3-(1-laurylamino propionyl)]-triethylenetetramine hydrochloride (TETA-5LAP; aka 98N12-5, see Murugaiah et al., Analytical Biochemistry, 401 :61 (2010); herein incorporated by reference in its entirety), CI2-200 (including derivatives and variants), and MD1, can be tested for *in vivo* activity.

[000555] The lipidoid referred to herein as "98N12-5" is disclosed by Akinc et al, Mol Ther. 2009 17:872-879 and is incorporated by reference in its entirety. (See Figure 2)

[000556] The lipidoid referred to herein as "CI 2-200" is disclosed by Love et al, Proc Natl Acad Sci U S A. 2010 107:1864-1869 (see Figure 2) and Liu and Huang, Molecular Therapy. 2010 669-670 (see Figure 2); both of which are herein incorporated by reference in their entirety. The lipidoid formulations can include particles comprising either 3 or 4 or more components in addition to polynucleotide, primary construct, or mmRNA. As an example, formulations with certain lipidoids, include, but are not limited to, 98N12-5 and may contain 42% lipidoid, 48% cholesterol and 10% PEG (CI 4 alkyl chain length). As another example, formulations with certain lipidoids, include, but are not limited to, C12-200 and may contain 50% lipidoid, 10% disteoylphosphatidyl choline, 38.5% cholesterol, and 1.5% PEG-DMG.

[000557] In one embodiment, a polynucleotide, primary construct, or mmRNA formulated with a lipidoid for systemic intravenous administration can target the liver. For example, a final optimized intravenous formulation using polynucleotide, primary construct, or mmRNA, and comprising a lipid molar composition of 42% 98N12-5, 48% cholesterol, and 10% PEG-lipid with a final weight ratio of about 7.5 to 1 total lipid to polynucleotide, primary construct, or mmRNA, and a C14 alkyl chain length on the PEG lipid, with a mean particle size of roughly 50-60 nm, can result in the distribution of the formulation to be greater than 90% to the liver.(see, Akinc et al, Mol Ther. 2009 17:872-879; herein incorporated by reference in its entirety). In another example, an intravenous formulation using a C12-200 (see US provisional application 61/175,770 and published international application WO20 10 129709, each of which is herein incorporated by reference in their entirety) lipidoid may have a molar ratio of 50/10/38.5/1.5 of C12-200/disteoylphosphatidyl choline/cholesterol/PEG-DMG, with a weight ratio of 7 to 1 total lipid to polynucleotide, primary construct, or mmRNA, and a mean particle size of

80 nm may be effective to deliver polynucleotide, primary construct, or mmRNA to hepatocytes (see, Love et al, Proc Natl Acad Sci U S A. 2010 107:1864-1869 herein incorporated by reference in its entirety). In another embodiment, an MD1 lipidoid-containing formulation may be used to effectively deliver polynucleotide, primary construct, or mmRNA to hepatocytes *in vivo*. The characteristics of optimized lipidoid formulations for intramuscular or subcutaneous routes may vary significantly depending on the target cell type and the ability of formulations to diffuse through the extracellular matrix into the blood stream. While a particle size of less than 150 nm may be desired for effective hepatocyte delivery due to the size of the endothelial fenestrae (see, Akinc et al., Mol Ther. 2009 17:872-879 herein incorporated by reference in its entirety), use of a lipidoid-formulated polynucleotide, primary construct, or mmRNA to deliver the formulation to other cells types including, but not limited to, endothelial cells, myeloid cells, and muscle cells may not be similarly size-limited. Use of lipidoid formulations to deliver siRNA *in vivo* to other non-hepatocyte cells such as myeloid cells and endothelium has been reported (see Akinc et al., Nat Biotechnol. 2008 26:561-569; Leuschner et al, Nat Biotechnol. 2011 29:1005-1010; Cho et al. Adv. Funct. Mater. 2009 19:3112-3118; 8th International Judah Folkman Conference, Cambridge, MA October 8-9, 2010; each of which is herein incorporated by reference in its entirety). Effective delivery to myeloid cells, such as monocytes, lipidoid formulations may have a similar component molar ratio. Different ratios of lipidoids and other components including, but not limited to, distearylphosphatidyl choline, cholesterol and PEG-DMG, may be used to optimize the formulation of the polynucleotide, primary construct, or mmRNA for delivery to different cell types including, but not limited to, hepatocytes, myeloid cells, muscle cells, etc. For example, the component molar ratio may include, but is not limited to, 50% C12-200, 10% distearylphosphatidyl choline, 38.5% cholesterol, and 1.5% PEG-DMG (see Leuschner et al., Nat Biotechnol 2011 29:1005-1010; herein incorporated by reference in its entirety). The use of lipidoid formulations for the localized delivery of nucleic acids to cells (such as, but not limited to, adipose cells and muscle cells) via either subcutaneous or intramuscular delivery, may not require all of the formulation components desired for systemic delivery, and as such may comprise only the lipidoid and the polynucleotide, primary construct, or mmRNA.

[000558] Combinations of different lipidoids may be used to improve the efficacy of polynucleotide, primary construct, or mmRNA directed protein production as the lipidoids may be able to increase cell transfection by the polynucleotide, primary construct, or mmRNA; and/or increase the translation of encoded protein (see Whitehead et al., Mol. Ther. 2011, 19:1688-1694, herein incorporated by reference in its entirety).

Liposomes, Lipoplexes, and Lipid Nanoparticles

[000559] The polynucleotide, primary construct, and mmRNA of the invention can be formulated using one or more liposomes, lipoplexes, or lipid nanoparticles. In one embodiment, pharmaceutical compositions of polynucleotide, primary construct, or mmRNA include liposomes. Liposomes are artificially-prepared vesicles which may primarily be composed of a lipid bilayer and may be used as a delivery vehicle for the administration of nutrients and pharmaceutical formulations. Liposomes can be of different sizes such as, but not limited to, a multilamellar vesicle (MLV) which may be hundreds of nanometers in diameter and may contain a series of concentric bilayers separated by narrow aqueous compartments, a small unicellular vesicle (SUV) which may be smaller than 50 nm in diameter, and a large unilamellar vesicle (LUV) which may be between 50 and 500 nm in diameter. Liposome design may include, but is not limited to, opsonins or ligands in order to improve the attachment of liposomes to unhealthy tissue or to activate events such as, but not limited to, endocytosis. Liposomes may contain a low or a high pH in order to improve the delivery of the pharmaceutical formulations.

[000560] The formation of liposomes may depend on the physicochemical characteristics such as, but not limited to, the pharmaceutical formulation entrapped and the liposomal ingredients, the nature of the medium in which the lipid vesicles are dispersed, the effective concentration of the entrapped substance and its potential toxicity, any additional processes involved during the application and/or delivery of the vesicles, the optimization size, polydispersity and the shelf-life of the vesicles for the intended application, and the batch-to-batch reproducibility and possibility of large-scale production of safe and efficient liposomal products.

[000561] In one embodiment, pharmaceutical compositions described herein may include, without limitation, liposomes such as those formed from 1,2-dioleoyloxy-*NN*-

dimethylaminopropane (DODMA) liposomes, DiLa2 liposomes from Marina Biotech (Bothell, WA), 1,2-dilinoleyloxy-3 -dimethylaminopropane (DLin-DMA), 2,2-dilinoleyloxy-4-(2-dimethylaminoethyl)-[1,3]-dioxolane (DLin-KC2-DMA), and MC3 (US20 100324 120; herein incorporated by reference in its entirety) and liposomes which may deliver small molecule drugs such as, but not limited to, DOXIL® from Janssen Biotech, Inc. (Horsham, PA).

[000562] In one embodiment, pharmaceutical compositions described herein may include, without limitation, liposomes such as those formed from the synthesis of stabilized plasmid-lipid particles (SPLP) or stabilized nucleic acid lipid particle (SNALP) that have been previously described and shown to be suitable for oligonucleotide delivery in vitro and in vivo (see Wheeler et al. *Gene Therapy*. 1999 6:271-281; Zhang et al. *Gene Therapy*. 1999 6:1438-1447; Jeffs et al. *Pharm Res*. 2005 22:362-372; Morrissey et al, *Nat Biotechnol*. 2005 2:1002-1007; Zimmermann et al, *Nature*. 2006 441:11-14; Heyes et al. *J Contr Rel*. 2005 107:276-287; Semple et al. *Nature Biotech*. 2010 28:172-176; Judge et al. *J Clin Invest*. 2009 119:661-673; deFougerolles *Hum Gene Ther*. 2008 19: 125-132; all of which are incorporated herein in their entireties). The original manufacture method by Wheeler et al. was a detergent dialysis method, which was later improved by Jeffs et al. and is referred to as the spontaneous vesicle formation method. The liposome formulations are composed of 3 to 4 lipid components in addition to the polynucleotide, primary construct, or mmRNA. As an example a liposome can contain, but is not limited to, 55% cholesterol, 20% distearylphosphatidyl choline (DSPC), 10% PEG-S-DSG, and 15% 1,2-dioleyloxy -*N,N*-dimethylaminopropane (DODMA), as described by Jeffs et al. As another example, certain liposome formulations may contain, but are not limited to, 48% cholesterol, 20% DSPC, 2% PEG-c-DMA, and 30% cationic lipid, where the cationic lipid can be 1,2-distearloxy -*N,N*-dimethylaminopropane (DSDMA), DODMA, DLin-DMA, or 1,2-dilinolenyloxy-3 -dimethylaminopropane (DLinDMA), as described by Heyes et al.

[000563] In one embodiment, pharmaceutical compositions may include liposomes which may be formed to deliver mmRNA which may encode at least one immunogen. The mmRNA may be encapsulated by the liposome and/or it may be contained in an aqueous core which may then be encapsulated by the liposome (see International Pub.

Nos. WO2012031046, WO2012031043, WO2012030901 and WO2012006378; each of which is herein incorporated by reference in their entirety). In another embodiment, the mmRNA which may encode an immunogen may be formulated in a cationic oil-in-water emulsion where the emulsion particle comprises an oil core and a cationic lipid which can interact with the mmRNA anchoring the molecule to the emulsion particle (see International Pub. No. WO2012006380; herein incorporated by reference in its entirety). In yet another embodiment, the lipid formulation may include at least cationic lipid, a lipid which may enhance transfection and a least one lipid which contains a hydrophilic head group linked to a lipid moiety (International Pub. No. WO201 1076807 and U.S. Pub. No. 201 10200582; each of which is herein incorporated by reference in their entirety). In another embodiment, the polynucleotides, primary constructs and/or mmRNA encoding an immunogen may be formulated in a lipid vesicle which may have crosslinks between functionalized lipid bilayers (see U.S. Pub. No. 20120177724, herein incorporated by reference in its entirety).

[000564] In one embodiment, the polynucleotides, primary constructs and/or mmRNA may be formulated in a lipid vesicle which may have crosslinks between functionalized lipid bilayers.

[000565] In one embodiment, the polynucleotides, primary constructs and/or mmRNA may be formulated in a liposome comprising a cationic lipid. The liposome may have a molar ratio of nitrogen atoms in the cationic lipid to the phosphates in the RNA (N:P ratio) of between 1:1 and 20:1 as described in International Publication No. WO2013006825, herein incorporated by reference in its entirety. In another embodiment, the liposome may have a N:P ratio of greater than 20: 1 or less than 1:1.

[000566] In one embodiment, the polynucleotides, primary constructs and/or mmRNA may be formulated in a lipid-polycation complex. The formation of the lipid-polycation complex may be accomplished by methods known in the art and/or as described in U.S. Pub. No. 20120178702, herein incorporated by reference in its entirety. As a non-limiting example, the polycation may include a cationic peptide or a polypeptide such as, but not limited to, polylysine, polyornithine and/or polyarginine and the cationic peptides described in International Pub. No. WO2012013326; herein incorporated by reference in its entirety. In another embodiment, the polynucleotides, primary constructs and/or

mmRNA may be formulated in a lipid-polycation complex which may further include a neutral lipid such as, but not limited to, cholesterol or dioleoyl phosphatidylethanolamine (DOPE).

[000567] The liposome formulation may be influenced by, but not limited to, the selection of the cationic lipid component, the degree of cationic lipid saturation, the nature of the PEGylation, ratio of all components and biophysical parameters such as size. In one example by Semple et al. (Semple et al. Nature Biotech. 2010 28:172-176; herein incorporated by reference in its entirety), the liposome formulation was composed of 57.1 % cationic lipid, 7.1% dipalmitoylphosphatidylcholine, 34.3 % cholesterol, and 1.4% PEG-c-DMA. As another example, changing the composition of the cationic lipid could more effectively deliver siRNA to various antigen presenting cells (Basha et al. Mol Ther. 2011 19:2186-2200; herein incorporated by reference in its entirety).

[000568] In some embodiments, the ratio of PEG in the lipid nanoparticle (LNP) formulations may be increased or decreased and/or the carbon chain length of the PEG lipid may be modified from C14 to C18 to alter the pharmacokinetics and/or biodistribution of the LNP formulations. As a non-limiting example, LNP formulations may contain 1-5% of the lipid molar ratio of PEG-c-DOMG as compared to the cationic lipid, DSPC and cholesterol. In another embodiment the PEG-c-DOMG may be replaced with a PEG lipid such as, but not limited to, PEG-DSG (1,2-Distearoyl-sn-glycerol, methoxypoly ethylene glycol) or PEG-DPG (1,2-Dipalmitoyl-sn-glycerol, methoxypolyethylene glycol). The cationic lipid may be selected from any lipid known in the art such as, but not limited to, DLin-MC3-DMA, DLin-DMA, C12-200 and DLin-KC2-DMA.

[000569] In one embodiment, the polynucleotides, primary constructs or mmRNA may be formulated in a lipid nanoparticle such as those described in International Publication No. WO2012170930, herein incorporated by reference in its entirety.

[000570] In one embodiment, the cationic lipid may be selected from, but not limited to, a cationic lipid described in International Publication Nos. WO2012040184, WO2011153120, WO2011149733, WO2011090965, WO2011043913, WO2011022460, WO2012061259, WO2012054365, WO2012044638, WO2010080724, WO201021865 and WO2008103276, US Patent Nos. 7,893,302, 7,404,969 and 8,283,333 and US Patent

Publication No. US201000361 15 and US20 120202871; each of which is herein incorporated by reference in their entirety. In another embodiment, the cationic lipid may be selected from, but not limited to, formula A described in International Publication Nos. WO2012040184, WO201 1153120, WO201 1149733, WO201 1090965, WO201 1043913, WO201 1022460, WO2012061259, WO2012054365 and WO2012044638; each of which is herein incorporated by reference in their entirety. In yet another embodiment, the cationic lipid may be selected from, but not limited to, formula CLI-CLXXIX of International Publication No. WO2008 103276, formula CLI-CLXXIX of US Patent No. 7,893,302, formula CLI-CLXXXII of US Patent No. 7,404,969 and formula I-VI of US Patent Publication No. US201000361 15; each of which is herein incorporated by reference in their entirety. As a non-limiting example, the cationic lipid may be selected from (20Z,23Z)-N,N-dimethylnonacos-20,23-dien-10-amine, (17Z,20Z)-N,N-dimethylhexacos-17,20-dien-9-amine, (1Z,19Z)-N,N-dimethylpentacos-16,19-dien-8-amine, (13Z,16Z)-N,N-dimethyldocos-13,16-dien-5-amine, (12Z,15Z)-N,N-dimethylhenicos-12,15-dien-4-amine, (14Z,17Z)-N,N-dimethyltricos-14,17-dien-6-amine, (15Z,18Z)-N,N-dimethyltetracos-15,18-dien-7-amine, (18Z,21Z)-N,N-dimethylheptacos-18,21-dien-10-amine, (15Z,18Z)-N,N-dimethyltetracos-15,18-dien-5-amine, (14Z,17Z)-N,N-dimethyltricos-14,17-dien-4-amine, (19Z,22Z)-N,N-dimethyloctacos-19,22-dien-9-amine, (18Z,21Z)-N,N-dimethylheptacos-18,21-dien-8-amine, (17Z,20Z)-N,N-dimethylhexacos-17,20-dien-7-amine, (16Z,19Z)-N,N-dimethylpentacos-16,19-dien-6-amine, (22Z,25Z)-N,N-dimethylhentriacont-22,25-dien-10-amine, (21Z,24Z)-N,N-dimethyltriacont-21,24-dien-9-amine, (18Z)-N,N-dimethylheptacos-18-en-10-amine, (17Z)-N,N-dimethylhexacos-17-en-9-amine, (19Z,22Z)-N,N-dimethyloctacos-19,22-dien-7-amine, N,N-dimethylheptacos-10-amine, (20Z,23Z)-N-ethyl-N-methylnonacos-20,23-dien-10-amine, 1-[(1Z,14Z)-1-nonylicos-1,14-dien-1-yl] pyrrolidine, (20Z)-N,N-dimethylheptacos-20-en-10-amine, (15Z)-N,N-dimethylheptacos-15-en-10-amine, (14Z)-N,N-dimethylnonacos-14-en-10-amine, (17Z)-N,N-dimethylnonacos-17-en-10-amine, (24Z)-N,N-dimethyltriacont-24-en-10-amine, (20Z)-N,N-dimethylnonacos-20-en-10-amine, (22Z)-N,N-dimethylhentriacont-22-en-10-amine, (16Z)-N,N-dimethylpentacos-16-en-8-amine, (12Z,15Z)-N,N-dimethyl-2-nonylhenicos-12,15-dien-1-amine, (13Z,16Z)-

N,N-dimethyl-3-nonyldocosa-13,16-dien-1-amine, N,N-dimethyl-1-[(1S,2R)-2-octylcyclopropyl] eptadecan-8-amine, 1-[(1S,2R)-2-hexylcyclopropyl]-N,N-dimethylnonadecan-10-amine, N,N-dimethyl-1-[(1S,2R)-2-octylcyclopropyl]nonadecan-10-amine, N,N-dimethyl-2-1-[(1S,2R)-2-octylcyclopropyl]hencicosan-10-amine, N,N-dimethyl-1-[(1S,2S)-2-[(1R,2R)-2-pentylcyclopropyl]methyl]cyclopropyl]nonadecan-10-amine, N,N-dimethyl-1-[(1S,2R)-2-octylcyclopropyl]hexadecan-8-amine, N,N-dimethyl-[(1R,2S)-2-undecylcyclopropyl]tetradecan-5-amine, N,N-dimethyl-3-{7-[(1S,2R)-2-octylcyclopropyl]heptyl} dodecan-1-amine, 1-[(1R,2S)-2-heptylcyclopropyl]-N,N-dimethyloctadecan-9-amine, 1-[(1S,2R)-2-decylcyclopropyl]-N,N-dimethylpentadecan-6-amine, N,N-dimethyl-1-[(1S,2R)-2-octylcyclopropyl]pentadecan-8-amine, R-N,N-dimethyl-1-[(9Z,12Z)-octadeca-9,12-dien-1-yloxy]-3-(octyloxy)propan-2-amine, S-N,N-dimethyl-1-[(9Z,12Z)-octadeca-9,12-dien-1-yloxy]-3-(octyloxy)propan-2-amine, 1-{2-[(9Z,12Z)-octadeca-9,12-dien-1-yloxy]-1-[(octyloxy)methyl]ethyl}pyrrolidine, (2S)-N,N-dimethyl-1-[(9Z,12Z)-octadeca-9,12-dien-1-yloxy]-3-[(5Z)-oct-5-en-1-yloxy]propan-2-amine, 1-{2-[(9Z,12Z)-octadeca-9,12-dien-1-yloxy]-1-[(octyloxy)methyl]ethyl} azetidina, (2S)-1-(hexyloxy)-N,N-dimethyl-3-[(9Z,12Z)-octadeca-9,12-dien-1-yloxy]propan-2-amine, (2S)-1-(heptyloxy)-N,N-dimethyl-3-[(9Z,12Z)-octadeca-9,12-dien-1-yloxy]propan-2-amine, N,N-dimethyl-1-(nonyloxy)-3-[(9Z,12Z)-octadeca-9,12-dien-1-yloxy]propan-2-amine, N,N-dimethyl-1-[(9Z)-octadec-9-en-1-yloxy]-3-(octyloxy)propan-2-amine; (2S)-N,N-dimethyl-1-[(6Z,9Z,12Z)-octadeca-6,9,12-trien-1-yloxy]-3-(octyloxy)propan-2-amine, (2S)-1-[(11Z,14Z)-icosa-11,14-dien-1-yloxy]-N,N-dimethyl-3-(pentyloxy)propan-2-amine, (2S)-1-(hexyloxy)-3-[(11Z,14Z)-icosa-11,14-dien-1-yloxy]-N,N-dimethylpropan-2-amine, 1-[(11Z,14Z)-icosa-11,14-dien-1-yloxy]-N,N-dimethyl-3-(octyloxy)propan-2-amine, 1-[(13Z,16Z)-docosa-13,16-dien-1-yloxy]-N,N-dimethyl-3-(octyloxy)propan-2-amine, (2S)-1-[(13Z,16Z)-docosa-13,16-dien-1-yloxy]-3-(hexyloxy)-N,N-dimethylpropan-2-amine, (2S)-1-[(13Z)-docos-13-en-1-yloxy]-3-(hexyloxy)-N,N-dimethylpropan-2-amine, 1-[(13Z)-docos-13-en-1-yloxy]-N,N-dimethyl-3-(octyloxy)propan-2-amine, 1-[(9Z)-hexadec-9-en-1-yloxy]-N,N-dimethyl-3-(octyloxy)propan-2-amine, (2R)-N,N-dimethyl-H(1-metoyloctyl)oxy]-3-[(9Z,12Z)-octadeca-9,12-dien-1-yloxy]propan-2-amine, (2R)-1-[(3,7-dimethyloctyl)oxy]-N,N-dimethyl-3-[(9Z,12Z)-octadeca-9,12-dien-1-yloxy]propan-

2-amine, N,N-dimethyl- 1-(octyloxy)-3-({8-[(1S,2S)-2- {[(1R,2R)-2-pentylcyclopropyl]methyl} cyclopropyl]octyl } oxy)propan-2-amine, N,N-dimethyl- 1- {[8-(2-octylcyclopropyl)octyl]oxy}-3-(octyloxy)propan-2-amine and (11E,20Z,23Z)-N,N-dimethylnonacosyl,20,2-trien-10-amine or a pharmaceutically acceptable salt or stereoisomer thereof.

[000571] In one embodiment, the lipid may be a cleavable lipid such as those described in International Publication No. WO2012170889, herein incorporated by reference in its entirety.

[000572] In one embodiment, the cationic lipid may be synthesized by methods known in the art and/or as described in International Publication Nos. WO2012040184, WO2011153120, WO2011149733, WO2011090965, WO2011043913, WO2011022460, WO2012061259, WO2012054365, WO2012044638, WO2010080724 and WO201021865; each of which is herein incorporated by reference in their entirety.

[000573] In one embodiment, the LNP formulations of the polynucleotides, primary constructs and/or mRNA may contain PEG-c-DOMG at 3% lipid molar ratio. In another embodiment, the LNP formulations polynucleotides, primary constructs and/or mRNA may contain PEG-c-DOMG at 1.5% lipid molar ratio.

[000574] In one embodiment, the pharmaceutical compositions of the polynucleotides, primary constructs and/or mRNA may include at least one of the PEGylated lipids described in International Publication No. 2012099755, herein incorporated by reference.

[000575] In one embodiment, the LNP formulation may contain PEG-DMG 2000 (1,2-dimyristoyl-sn-glycero-3-phosphoethanolamine-N-[methoxy(poly ethylene glycol)-2000]). In one embodiment, the LNP formulation may contain PEG-DMG 2000, a cationic lipid known in the art and at least one other component. In another embodiment, the LNP formulation may contain PEG-DMG 2000, a cationic lipid known in the art, DSPC and cholesterol. As a non-limiting example, the LNP formulation may contain PEG-DMG 2000, DLin-DMA, DSPC and cholesterol. As another non-limiting example the LNP formulation may contain PEG-DMG 2000, DLin-DMA, DSPC and cholesterol in a molar ratio of 2:40:10:48 (see e.g., Geall et al., Nonviral delivery of self-amplifying RNA vaccines, PNAS 2012; PMID: 22908294; herein incorporated by reference in its entirety). . As another non-limiting example, modified RNA described herein may be formulated

in a nanoparticle to be delivered by a parenteral route as described in U.S. Pub. No. 20120207845; herein incorporated by reference in its entirety.

In one embodiment, the LNP formulation may be formulated by the methods described in International Publication Nos. WO201 1127255 or WO2008103276, each of which is herein incorporated by reference in their entirety. As a non-limiting example, modified RNA described herein may be encapsulated in LNP formulations as described in WO201 1127255 and/or WO2008103276; each of which is herein incorporated by reference in their entirety.

In one embodiment, LNP formulations described herein may comprise a polycationic composition. As a non-limiting example, the polycationic composition may be selected from formula 1-60 of US Patent Publication No. US20050222064; herein incorporated by reference in its entirety. In another embodiment, the LNP formulations comprising a polycationic composition may be used for the delivery of the modified RNA described herein *in vivo* and/or *in vitro*.

[000576] In one embodiment, the LNP formulations described herein may additionally comprise a permeability enhancer molecule. Non-limiting permeability enhancer molecules are described in US Patent Publication No. US20050222064; herein incorporated by reference in its entirety.

[000577] In one embodiment, the pharmaceutical compositions may be formulated in liposomes such as, but not limited to, DiLa2 liposomes (Marina Biotech, Bothell, WA), SMARTICLES® (Marina Biotech, Bothell, WA), neutral DOPC (1,2-dioleoyl-sn-glycero-3-phosphocholine) based liposomes (e.g., siRNA delivery for ovarian cancer (Landen et al. Cancer Biology & Therapy 2006 5(12)1708-1713); herein incorporated by reference in its entirety) and hyaluronan-coated liposomes (Quiet Therapeutics, Israel).

[000578] The nanoparticle formulations may be a carbohydrate nanoparticle comprising a carbohydrate carrier and a modified nucleic acid molecule (e.g., mmRNA). As a non-limiting example, the carbohydrate carrier may include, but is not limited to, an anhydride-modified phytoglycogen or glycogen-type material, phytoglycogen octenyl succinate, phytoglycogen beta-dextrin, anhydride-modified phytoglycogen beta-dextrin. (See e.g., International Publication No. WO2012109121; herein incorporated by reference in its entirety).

[000579] Lipid nanoparticle formulations may be improved by replacing the cationic lipid with a biodegradable cationic lipid which is known as a rapidly eliminated lipid nanoparticle (reLNP). Ionizable cationic lipids, such as, but not limited to, DLinDMA, DLin-KC2-DMA, and DLin-MC3-DMA, have been shown to accumulate in plasma and tissues over time and may be a potential source of toxicity. The rapid metabolism of the rapidly eliminated lipids can improve the tolerability and therapeutic index of the lipid nanoparticles by an order of magnitude from a 1 mg/kg dose to a 10 mg/kg dose in rat. Inclusion of an enzymatically degraded ester linkage can improve the degradation and metabolism profile of the cationic component, while still maintaining the activity of the reLNP formulation. The ester linkage can be internally located within the lipid chain or it may be terminally located at the terminal end of the lipid chain. The internal ester linkage may replace any carbon in the lipid chain.

[000580] In one embodiment, the internal ester linkage may be located on either side of the saturated carbon. Non-limiting examples of reLNPs include,

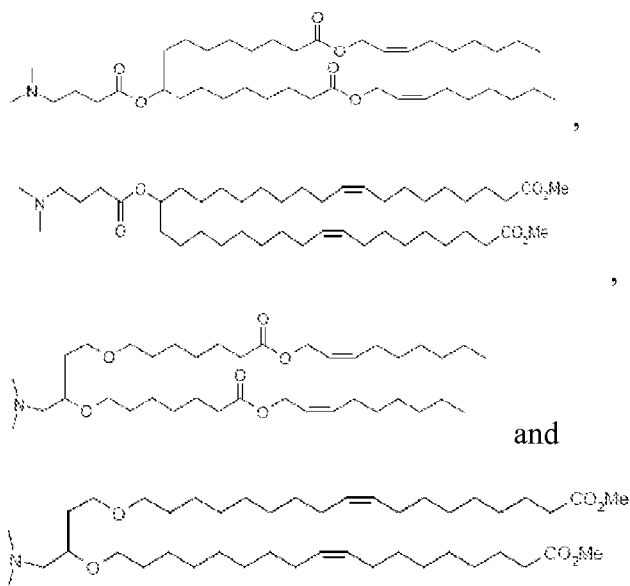

[000581] In one embodiment, an immune response may be elicited by delivering a lipid nanoparticle which may include a nanospecies, a polymer and an immunogen. (U.S. Publication No. 20120189700 and International Publication No. WO2012099805; each of which is herein incorporated by reference in their entirety). The polymer may encapsulate the nanospecies or partially encapsulate the nanospecies. The immunogen may be a recombinant protein, a modified RNA and/or a primary construct described

herein. In one embodiment, the lipid nanoparticle may be formulated for use in a vaccine such as, but not limited to, against a pathogen.

[000582] Lipid nanoparticles may be engineered to alter the surface properties of particles so the lipid nanoparticles may penetrate the mucosal barrier. Mucus is located on mucosal tissue such as, but not limited to, oral (e.g., the buccal and esophageal membranes and tonsil tissue), ophthalmic, gastrointestinal (e.g., stomach, small intestine, large intestine, colon, rectum), nasal, respiratory (e.g., nasal, pharyngeal, tracheal and bronchial membranes), genital (e.g., vaginal, cervical and urethral membranes).

Nanoparticles larger than 10-200 nm which are preferred for higher drug encapsulation efficiency and the ability to provide the sustained delivery of a wide array of drugs have been thought to be too large to rapidly diffuse through mucosal barriers. Mucus is continuously secreted, shed, discarded or digested and recycled so most of the trapped particles may be removed from the mucosa tissue within seconds or within a few hours. Large polymeric nanoparticles (200nm -500nm in diameter) which have been coated densely with a low molecular weight polyethylene glycol (PEG) diffused through mucus only 4 to 6-fold lower than the same particles diffusing in water (Lai et al. PNAS 2007 104(5): 1482-487; Lai et al. Adv Drug Deliv Rev. 2009 61(2): 158-171; each of which is herein incorporated by reference in their entirety). The transport of nanoparticles may be determined using rates of permeation and/or fluorescent microscopy techniques including, but not limited to, fluorescence recovery after photobleaching (FRAP) and high resolution multiple particle tracking (MPT). As a non-limiting example, compositions which can penetrate a mucosal barrier may be made as described in U.S. Pat. No. 8,241,670, herein incorporated by reference in its entirety.

[000583] The lipid nanoparticle engineered to penetrate mucus may comprise a polymeric material (i.e. a polymeric core) and/or a polymer-vitamin conjugate and/or a tri-block co-polymer. The polymeric material may include, but is not limited to, polyamines, polyethers, polyamides, polyesters, polycarbamates, polyureas, polycarbonates, poly(styrenes), polyimides, polysulfones, polyurethanes, polyacetylenes, polyethylenes, polyethyleneimines, polyisocyanates, polyacrylates, polymethacrylates, polyacrylonitriles, and polyarylates. The polymeric material may be biodegradable and/or biocompatible. The polymeric material may additionally be irradiated. As a non-limiting

example, the polymeric material may be gamma irradiated (See e.g., International App. No. WO201282165, herein incorporated by reference in its entirety). Non-limiting examples of specific polymers include poly(caprolactone) (PCL), ethylene vinyl acetate polymer (EVA), poly(lactic acid) (PLA), poly(L-lactic acid) (PLLA), poly(glycolic acid) (PGA), poly(lactic acid-co-glycolic acid) (PLGA), poly(L-lactic acid-co-glycolic acid) (PLLGA), poly(D,L-lactide) (PDLA), poly(L-lactide) (PLLA), poly(D,L-lactide-co-caprolactone), poly(D,L-lactide-co-caprolactone-co-glycolide), poly(D,L-lactide-co-PEO-co-D,L-lactide), poly(D,L-lactide-co-PPO-co-D,L-lactide), polyalkyl cyanoacralate, polyurethane, poly-L-lysine (PLL), hydroxypropyl methacrylate (HPMA), polyethyleneglycol, poly-L-glutamic acid, poly(hydroxy acids), polyanhydrides, polyorthoesters, poly(ester amides), polyamides, poly(ester ethers), polycarbonates, polyalkylenes such as polyethylene and polypropylene, polyalkylene glycols such as poly(ethylene glycol) (PEG), polyalkylene oxides (PEO), polyalkylene terephthalates such as poly(ethylene terephthalate), polyvinyl alcohols (PVA), polyvinyl ethers, polyvinyl esters such as poly(vinyl acetate), polyvinyl halides such as poly(vinyl chloride) (PVC), polyvinylpyrrolidone, polysiloxanes, polystyrene (PS), polyurethanes, derivatized celluloses such as alkyl celluloses, hydroxyalkyl celluloses, cellulose ethers, cellulose esters, nitro celluloses, hydroxypropylcellulose, carboxymethylcellulose, polymers of acrylic acids, such as poly(methyl(meth)acrylate) (PMMA), poly(ethyl(meth)acrylate), poly(butyl(meth)acrylate), poly(isobutyl(meth)acrylate), poly(hexyl(meth)acrylate), poly(isodecyl(meth)acrylate), poly(lauryl(meth)acrylate), poly(phenyl(meth)acrylate), poly(methyl acrylate), poly(isopropyl acrylate), poly(isobutyl acrylate), poly(octadecyl acrylate) and copolymers and mixtures thereof, polydioxanone and its copolymers, polyhydroxyalkanoates, polypropylene fumarate, polyoxymethylene, poloxamers, poly(ortho)esters, poly(butyric acid), poly(valeric acid), poly(lactide-co-caprolactone), and trimethylene carbonate, polyvinylpyrrolidone. The lipid nanoparticle may be coated or associated with a co-polymer such as, but not limited to, a block co-polymer (such as a branched polyether-polyamide block copolymer described in International Publication No. WO2013012476, herein incorporated by reference in its entirety), and (poly(ethylene glycol))-(poly(propylene oxide))- (poly(ethylene glycol)) triblock copolymer (see e.g., US Publication 20120121718 and

US Publication 20100003337 and U.S. Pat. No. 8,263,665; each of which is herein incorporated by reference in their entirety). The co-polymer may be a polymer that is generally regarded as safe (GRAS) and the formation of the lipid nanoparticle may be in such a way that no new chemical entities are created. For example, the lipid nanoparticle may comprise poloxamers coating PLGA nanoparticles without forming new chemical entities which are still able to rapidly penetrate human mucus (Yang et al. *Angew. Chem. Int. Ed.* 2011 50:2597-2600; herein incorporated by reference in its entirety).

[000584] The vitamin of the polymer-vitamin conjugate may be vitamin E. The vitamin portion of the conjugate may be substituted with other suitable components such as, but not limited to, vitamin A, vitamin E, other vitamins, cholesterol, a hydrophobic moiety, or a hydrophobic component of other surfactants (e.g., sterol chains, fatty acids, hydrocarbon chains and alkylene oxide chains).

[000585] The lipid nanoparticle engineered to penetrate mucus may include surface altering agents such as, but not limited to, mmRNA, anionic proteins (e.g., bovine serum albumin), surfactants (e.g., cationic surfactants such as for example dimethyldioctadecylammonium bromide), sugars or sugar derivatives (e.g., cyclodextrin), nucleic acids, polymers (e.g., heparin, polyethylene glycol and poloxamer), mucolytic agents (e.g., N-acetylcysteine, mugwort, bromelain, papain, clerodendrum, acetylcysteine, bromhexine, carbocysteine, eprazinone, mesna, ambroxol, sobrerol, domiodol, letosteine, stepronin, tiopronin, gelsolin, thymosin β 4 dornase alfa, neltexine, erdosteine) and various DNases including rhDNase.. The surface altering agent may be embedded or enmeshed in the particle's surface or disposed (e.g., by coating, adsorption, covalent linkage, or other process) on the surface of the lipid nanoparticle. (see e.g., US Publication 20100215580 and US Publication 20080166414; each of which is herein incorporated by reference in their entirety).

[000586] The mucus penetrating lipid nanoparticles may comprise at least one mmRNA described herein. The mmRNA may be encapsulated in the lipid nanoparticle and/or disposed on the surface of the particle. The mmRNA may be covalently coupled to the lipid nanoparticle. Formulations of mucus penetrating lipid nanoparticles may comprise a plurality of nanoparticles. Further, the formulations may contain particles which may interact with the mucus and alter the structural and/or adhesive properties of the

surrounding mucus to decrease mucoadhesion which may increase the delivery of the mucus penetrating lipid nanoparticles to the mucosal tissue.

[000587] In one embodiment, the polynucleotide, primary construct, or mmRNA is formulated as a lipoplex, such as, without limitation, the ATUPLEX™ system, the DACC system, the DBTC system and other siRNA-lipoplex technology from Silence Therapeutics (London, United Kingdom), STEMFECT™ from STEMGENT® (Cambridge, MA), and polyethylenimine (PEI) or protamine -based targeted and non-targeted delivery of nucleic acids (Aleku et al. *Cancer Res.* 2008 68:9788-9798; Strumberg et al. *Int J Clin Pharmacol Ther* 2012 50:76-78; Santel et al, *Gene Ther* 2006 13:1222-1234; Santel et al, *Gene Ther* 2006 13:1360-1370; Gutbier et al, *Pulm Pharmacol. Ther.* 2010 23:334-344; Kaufmann et al. *Microvasc Res* 2010 80:286-293; Weide et al. *J Immunother.* 2009 32:498-507; Weide et al. *J Immunother.* 2008 31:180-188; Pascolo *Expert Opin. Biol. Ther.* 4:1285-1294; Fotin-Mleczek et al, 2011 *J. Immunother.* 34:1-15; Song et al, *Nature Biotechnol.* 2005, 23:709-717; Peer et al, *Proc Natl Acad Sci U S A.* 2007 6;104:4095-4100; deFougerolles *Hum Gene Ther.* 2008 19:125-132; all of which are incorporated herein by reference in its entirety).

[000588] In one embodiment such formulations may also be constructed or compositions altered such that they passively or actively are directed to different cell types *in vivo*, including but not limited to hepatocytes, immune cells, tumor cells, endothelial cells, antigen presenting cells, and leukocytes (Akinc et al. *Mol Ther.* 2010 18:1357-1364; Song et al, *Nat Biotechnol.* 2005 23:709-717; Judge et al, *J Clin Invest.* 2009 119:661-673; Kaufmann et al, *Microvasc Res* 2010 80:286-293; Santel et al, *Gene Ther* 2006 13:1222-1234; Santel et al, *Gene Ther* 2006 13:1360-1370; Gutbier et al, *Pulm Pharmacol. Ther.* 2010 23:334-344; Basha et al, *Mol. Ther.* 2011 19:2186-2200; Fenske and Cullis, *Expert Opin Drug Deliv.* 2008 5:25-44; Peer et al, *Science.* 2008 319:627-630; Peer and Lieberman, *Gene Ther.* 2011 18:127-133; all of which are incorporated herein by reference in its entirety). One example of passive targeting of formulations to liver cells includes the DLin-DMA, DLin-KC2-DMA and DLin-MC3-DMA-based lipid nanoparticle formulations which have been shown to bind to apolipoprotein E and promote binding and uptake of these formulations into hepatocytes *in vivo* (Akinc et al. *Mol Ther.* 2010 18:1357-1364; herein incorporated by reference in

its entirety). Formulations can also be selectively targeted through expression of different ligands on their surface as exemplified by, but not limited by, folate, transferrin, N-acetylgalactosamine (GalNAc), and antibody targeted approaches (Kolhatkar et al., *Curr Drug Discov Technol.* 2011 8:197-206; Musacchio and Torchilin, *Front Biosci.* 2011 16:1388-1412; Yu et al, *Mol Membr Biol.* 2010 27:286-298; Patil et al, *Crit Rev Ther Drug Carrier Syst.* 2008 25:1-61; Benoit et al, *Biomacromolecules.* 2011 12:2708-2714; Zhao et al, *Expert Opin Drug Deliv.* 2008 5:309-319; Akinc et al, *Mol Ther.* 2010 18:1357-1364; Srinivasan et al, *Methods Mol Biol.* 2012 820:105-116; Ben-Arie et al, *Methods Mol Biol.* 2012 757:497-507; Peer 2010 *J Control Release.* 20:63-68; Peer et al, *Proc Natl Acad Sci U S A.* 2007 104:4095-4100; Kim et al, *Methods Mol Biol.* 2011 721:339-353; Subramanya et al, *Mol Ther.* 2010 18:2028-2037; Song et al, *Nat Biotechnol.* 2005 23:709-717; Peer et al, *Science.* 2008 319:627-630; Peer and Lieberman, *Gene Ther.* 2011 18:1127-1133; all of which are incorporated herein by reference in its entirety)..

[000589] In one embodiment, the polynucleotide, primary construct, or mmRNA is formulated as a solid lipid nanoparticle. A solid lipid nanoparticle (SLN) may be spherical with an average diameter between 10 to 1000 nm. SLN possess a solid lipid core matrix that can solubilize lipophilic molecules and may be stabilized with surfactants and/or emulsifiers. In a further embodiment, the lipid nanoparticle may be a self-assembly lipid-polymer nanoparticle (see Zhang et al, *ACS Nano*, 2008, 2 (8), pp 1696-1702; herein incorporated by reference in its entirety).

[000590] Liposomes, lipoplexes, or lipid nanoparticles may be used to improve the efficacy of polynucleotide, primary construct, or mmRNA directed protein production as these formulations may be able to increase cell transfection by the polynucleotide, primary construct, or mmRNA; and/or increase the translation of encoded protein. One such example involves the use of lipid encapsulation to enable the effective systemic delivery of polyplex plasmid DNA (Heyes et al, *Mol Ther.* 2007 15:713-720; herein incorporated by reference in its entirety). The liposomes, lipoplexes, or lipid nanoparticles may also be used to increase the stability of the polynucleotide, primary construct, or mmRNA.

[000591] In one embodiment, the the polynucleotides, primary constructs, and/or the mmRNA of the present invention can be formulated for controlled release and/or targeted delivery. As used herein, "controlled release" refers to a pharmaceutical composition or compound release profile that conforms to a particular pattern of release to effect a therapeutic outcome. In one embodiment, the polynucleotides, primary constructs or the mmRNA may be encapsulated into a delivery agent described herein and/or known in the art for controlled release and/or targeted delivery. As used herein, the term "encapsulate" means to enclose, surround or encase. As it relates to the formulation of the compounds of the invention, encapsulation may be substantial, complete or partial. The term "substantially encapsulated" means that at least greater than 50, 60, 70, 80, 85, 90, 95, 96, 97, 98, 99, 99.9, 99.9 or greater than 99.999% of the pharmaceutical composition or compound of the invention may be enclosed, surrounded or encased within the delivery agent. "Partially encapsulation" means that less than 10, 10, 20, 30, 40 50 or less of the pharmaceutical composition or compound of the invention may be enclosed, surrounded or encased within the delivery agent. Advantageously, encapsulation may be determined by measuring the escape or the activity of the pharmaceutical composition or compound of the invention using fluorescence and/or electron micrograph. For example, at least 1, 5, 10, 20, 30, 40, 50, 60, 70, 80, 85, 90, 95, 96, 97, 98, 99, 99.9, 99.99 or greater than 99.99% of the pharmaceutical composition or compound of the invention are encapsulated in the delivery agent.

[000592] In one embodiment, the controlled release formulation may include, but is not limited to, tri-block co-polymers. As a non-limiting example, the formulation may include two different types of tri-block co-polymers (International Pub. No. WO201213 1104 and WO201213 1106; each of which is herein incorporated by reference in its entirety).

[000593] In another embodiment, the the polynucleotides, primary constructs, or the mmRNA may be encapsulated into a lipid nanoparticle or a rapidly eliminated lipid nanoparticle and the lipid nanoparticles or a rapidly eliminated lipid nanoparticle may then be encapsulated into a polymer, hydrogel and/or surgical sealant described herein and/or known in the art. As a non-limiting example, the polymer, hydrogel or surgical sealant may be PLGA, ethylene vinyl acetate (EVAc), poloxamer, GELSITE®

(Nanotherapeutics, Inc. Alachua, FL), HYLENEX® (Halozyme Therapeutics, San Diego CA), surgical sealants such as fibrinogen polymers (Ethicon Inc. Cornelia, GA), TISSELL® (Baxter International, Inc Deerfield, IL), PEG-based sealants, and COSEAL® (Baxter International, Inc Deerfield, IL).

[000594] In another embodiment, the lipid nanoparticle may be encapsulated into any polymer known in the art which may form a gel when injected into a subject. As another non-limiting example, the lipid nanoparticle may be encapsulated into a polymer matrix which may be biodegradable.

[000595] In one embodiment, the the polynucleotide, primary construct, or mmRNA formulation for controlled release and/or targeted delivery may also include at least one controlled release coating. Controlled release coatings include, but are not limited to, OPADRY®, polyvinylpyrrolidone/vinyl acetate copolymer, polyvinylpyrrolidone, hydroxypropyl methylcellulose, hydroxypropyl cellulose, hydroxyethyl cellulose, EUDRAGIT RL®, EUDRAGIT RS® and cellulose derivatives such as ethylcellulose aqueous dispersions (AQUACOAT® and SURELEASE®).

[000596] In one embodiment, the controlled release and/or targeted delivery formulation may comprise at least one degradable polyester which may contain polycationic side chains. Degradable polyesters include, but are not limited to, poly(serine ester), poly(L-lactide-co-L-lysine), poly(4-hydroxy-L-proline ester), and combinations thereof. In another embodiment, the degradable polyesters may include a PEG conjugation to form a PEGylated polymer.

[000597] In one embodiment, the the polynucleotides, primary constructs, and/or the mmRNA of the present invention may be encapsulated in a therapeutic nanoparticle. Therapeutic nanoparticles may be formulated by methods described herein and known in the art such as, but not limited to, International Pub Nos. WO20 10005740, WO2010030763, WO2010005721, WO2010005723, WO2012054923, US Pub. Nos. US201 10262491, US20100104645, US20100087337, US20100068285, US20 110274759, US20100068286 and US20120288541 and US Pat No. 8,206,747, 8,293,276, 8,318,208 and 8,318,21 1 each of which is herein incorporated by reference in their entirety. In another embodiment, therapeutic polymer nanoparticles may be

identified by the methods described in US Pub No. US20120140790, herein incorporated by reference in its entirety.

[000598] In one embodiment, the therapeutic nanoparticle may be formulated for sustained release. As used herein, "sustained release" refers to a pharmaceutical composition or compound that conforms to a release rate over a specific period of time. The period of time may include, but is not limited to, hours, days, weeks, months and years. As a non-limiting example, the sustained release nanoparticle may comprise a polymer and a therapeutic agent such as, but not limited to, the the polynucleotides, primary constructs, and mmRNA of the present invention (see International Pub No. 2010075072 and US Pub No. US20 1002 16804, US201 10217377 and US20120201859, each of which is herein incorporated by reference in their entirety).

[000599] In one embodiment, the therapeutic nanoparticles may be formulated to be target specific. As a non-limiting example, the thereapeutic nanoparticles may include a corticosteroid (see International Pub. No. WO201 1084518; herein incorporated by reference in its entirety). In one embodiment, the therapeutic nanoparticles may be formulated to be cancer specific. As a non-limiting example, the therapeutic nanoparticles may be formulated in nanoparticles described in International Pub No. WO2008121949, WO2010005726, WO2010005725, WO201 1084521 and US Pub No. US20 100069426, US20120004293 and US20100104655, each of which is herein incorporated by reference in their entirety.

[000600] In one embodiment, the nanoparticles of the present invention may comprise a polymeric matrix. As a non-limiting example, the nanoparticle may comprise two or more polymers such as, but not limited to, polyethylenes, polycarbonates, polyanhydrides, polyhydroxyacids, polypropylfumerates, polycaprolactones, polyamides, polyacetals, polyethers, polyesters, poly(orthoesters), polycyanoacrylates, polyvinyl alcohols, polyurethanes, polyphosphazenes, polyacrylates, polymethacrylates, polycyanoacrylates, polyureas, polystyrenes, polyamines, polylysine, poly(ethylene imine), poly(serine ester), poly(L-lactide-co-L-lysine), poly(4-hydroxy-L-proline ester) or combinations thereof.

[000601] In one embodiment, the therapeutic nanoparticle comprises a diblock copolymer. In one embodiment, the diblock copolymer may include PEG in combination

with a polymer such as, but not limited to, polyethylenes, polycarbonates, polyhydrides, polyhydroxyacids, polypropylfumerates, polycaprolactones, polyamides, polyacetals, polyethers, polyesters, poly(orthoesters), polycyanoacrylates, polyvinyl alcohols, polyurethanes, polyphosphazenes, polyacrylates, polymethacrylates, polycyanoacrylates, polyureas, polystyrenes, polyamines, polylysine, poly(ethylene imine), poly(serine ester), poly(L-lactide-co-L-lysine), poly(4-hydroxy-L-proline ester) or combinations thereof.

[000602] As a non-limiting example the therapeutic nanoparticle comprises a PLGA-PEG block copolymer (see US Pub. No. US20120004293 and US Pat No. 8,236,330, each of which is herein incorporated by reference in their entirety). In another non-limiting example, the therapeutic nanoparticle is a stealth nanoparticle comprising a diblock copolymer of PEG and PLA or PEG and PLGA (see US Pat No 8,246,968 and International Publication No. WO20 12 166923, each of which is herein incorporated by reference in its entirety).

[000603] In one embodiment, the therapeutic nanoparticle may comprise a multiblock copolymer (See e.g., U.S. Pat. No. 8,263,665 and 8,287,910; each of which is herein incorporated by reference in its entirety).

[000604] In one embodiment, the block copolymers described herein may be included in a polyion complex comprising a non-polymeric micelle and the block copolymer. (See e.g., U.S. Pub. No. 20120076836; herein incorporated by reference in its entirety).

[000605] In one embodiment, the therapeutic nanoparticle may comprise at least one acrylic polymer. Acrylic polymers include but are not limited to, acrylic acid, methacrylic acid, acrylic acid and methacrylic acid copolymers, methyl methacrylate copolymers, ethoxyethyl methacrylates, cyanoethyl methacrylate, amino alkyl methacrylate copolymer, poly(acrylic acid), poly(methacrylic acid), polycyanoacrylates and combinations thereof.

[000606] In one embodiment, the therapeutic nanoparticles may comprise at least one cationic polymer described herein and/or known in the art.

[000607] In one embodiment, the therapeutic nanoparticles may comprise at least one amine-containing polymer such as, but not limited to polylysine, polyethylene imine,

poly(amidoamine) dendrimers, poly(beta-amino esters) (See e.g., U.S. Pat. No. 8,287,849; herein incorporated by reference in its entirety) and combinations thereof.

[000608] In one embodiment, the therapeutic nanoparticles may comprise at least one degradable polyester which may contain polycationic side chains. Degradable polyesters include, but are not limited to, poly(serine ester), poly(L-lactide-co-L-lysine), poly(4-hydroxy-L-proline ester), and combinations thereof. In another embodiment, the degradable polyesters may include a PEG conjugation to form a PEGylated polymer.

[000609] In another embodiment, the therapeutic nanoparticle may include a conjugation of at least one targeting ligand. The targeting ligand may be any ligand known in the art such as, but not limited to, a monoclonal antibody. (Kirpotin et al, Cancer Res. 2006 66:6732-6740; herein incorporated by reference in its entirety).

[000610] In one embodiment, the therapeutic nanoparticle may be formulated in an aqueous solution which may be used to target cancer (see International Pub No. WO201 1084513 and US Pub No. US201 10294717, each of which is herein incorporated by reference in their entirety).

[000611] In one embodiment, the polynucleotides, primary constructs, or mmRNA may be encapsulated in, linked to and/or associated with synthetic nanocarriers. Synthetic nanocarriers include, but are not limited to, those described in International Pub. Nos. WO2010005740, WO2010030763, WO201213501, WO2012149252, WO2012149255, WO2012149259, WO2012149265, WO2012149268, WO2012149282, WO2012149301, WO2012149393, WO2012149405, WO201214941 1, WO2012149454 and WO20 130 19669, and US Pub. Nos. US20 110262491, US20 100 104645, US20 100087337 and US20 120244222, each of which is herein incorporated by reference in their entirety. The synthetic nanocarriers may be formulated using methods known in the art and/or described herein. As a non-limiting example, the synthetic nanocarriers may be formulated by the methods described in International Pub Nos. WO20 10005740, WO20 10030763 and WO20 12 1350 1 and US Pub. Nos. US20 11026249 1, US20100104645, US20100087337 and US2012024422, each of which is herein incorporated by reference in their entirety. In another embodiment, the synthetic nanocarrier formulations may be lyophilized by methods described in International Pub.

No. WO201 1072218 and US Pat No. 8,21 1,473; each of which is herein incorporated by reference in their entirety.

[000612] In one embodiment, the synthetic nanocarriers may contain reactive groups to release the polynucleotides, primary constructs and/or mmRNA described herein (see International Pub. No. WO20120952552 and US Pub No. US20120171229, each of which is herein incorporated by reference in their entirety).

[000613] In one embodiment, the synthetic nanocarriers may contain an immunostimulatory agent to enhance the immune response from delivery of the synthetic nanocarrier. As a non-limiting example, the synthetic nanocarrier may comprise a Th1 immunostimulatory agent which may enhance a Th1 -based response of the immune system (see International Pub No. WO2010123569 and US Pub. No. US201 10223201, each of which is herein incorporated by reference in its entirety).

[000614] In one embodiment, the synthetic nanocarriers may be formulated for targeted release. In one embodiment, the synthetic nanocarrier is formulated to release the polynucleotides, primary constructs and/or mmRNA at a specified pH and/or after a desired time interval. As a non-limiting example, the synthetic nanoparticle may be formulated to release the polynucleotides, primary constructs and/or mmRNA after 24 hours and/or at a pH of 4.5 (see International Pub. Nos. WO2010138193 and WO2010138194 and US Pub Nos. US201 10020388 and US20 110027217, each of which is herein incorporated by reference in their entireties).

[000615] In one embodiment, the synthetic nanocarriers may be formulated for controlled and/or sustained release of the polynucleotides, primary constructs and/or mmRNA described herein. As a non-limiting example, the synthetic nanocarriers for sustained release may be formulated by methods known in the art, described herein and/or as described in International Pub No. WO2010138192 and US Pub No. 20100303850, each of which is herein incorporated by reference in their entirety.

[000616] In one embodiment, the synthetic nanocarrier may be formulated for use as a vaccine. In one embodiment, the synthetic nanocarrier may encapsulate at least one polynucleotide, primary construct and/or mmRNA which encode at least one antigen. As a non-limiting example, the synthetic nanocarrier may include at least one antigen and an excipient for a vaccine dosage form (see International Pub No. WO201 1150264 and US

Pub No. US201 10293723, each of which is herein incorporated by reference in their entirety). As another non-limiting example, a vaccine dosage form may include at least two synthetic nanocarriers with the same or different antigens and an excipient (see International Pub No. WO201 1150249 and US Pub No. US201 10293701, each of which is herein incorporated by reference in their entirety). The vaccine dosage form may be selected by methods described herein, known in the art and/or described in International Pub No. WO201 1150258 and US Pub No. US20120027806, each of which is herein incorporated by reference in their entirety).

[000617] In one embodiment, the synthetic nanocarrier may comprise at least one polynucleotide, primary construct and/or mmRNA which encodes at least one adjuvant. As non-limiting example, the adjuvant may comprise dimethyldioctadecylammonium-bromide, dimethyldioctadecylammonium-chloride, dimethyldioctadecylammonium-phosphate or dimethyldioctadecylammonium-acetate (DDA) and an apolar fraction or part of said apolar fraction of a total lipid extract of a mycobacterium (See e.g., U.S. Pat. No. 8,241,610; herein incorporated by reference in its entirety). In another embodiment, the synthetic nanocarrier may comprise at least one polynucleotide, primary construct and/or mmRNA and an adjuvant. As a non-limiting example, the synthetic nanocarrier comprising and adjuvant may be formulated by the methods described in International Pub No. WO201 1150240 and US Pub No. US201 10293700, each of which is herein incorporated by reference in its entirety.

[000618] In one embodiment, the synthetic nanocarrier may encapsulate at least one polynucleotide, primary construct and/or mmRNA which encodes a peptide, fragment or region from a virus. As a non-limiting example, the synthetic nanocarrier may include, but is not limited to, the nanocarriers described in International Pub No. WO2012024621, WO201202629, WO2012024632 and US Pub No. US201200641 10, US20120058153 and US20120058154, each of which is herein incorporated by reference in their entirety.

[000619] In one embodiment, the synthetic nanocarrier may be coupled to a polynucleotide, primary construct or mmRNA which may be able to trigger a humoral and/or cytotoxic T lymphocyte (CTL) response (See e.g., International Publication No. WO20 130 19669, herein incorporated by reference in its entirety).

[000620] In one embodiment, the nanoparticle may be optimized for oral administration. The nanoparticle may comprise at least one cationic biopolymer such as, but not limited to, chitosan or a derivative thereof. As a non-limiting example, the nanoparticle may be formulated by the methods described in U.S. Pub. No. 20120282343; herein incorporated by reference in its entirety.

Polymers, Biodegradable Nanoparticles, and Core-Shell Nanoparticles

[000621] The polynucleotide, primary construct, and mmRNA of the invention can be formulated using natural and/or synthetic polymers. Non-limiting examples of polymers which may be used for delivery include, but are not limited to, DYNAMIC POLYCONJUGATE® (Arrowhead Research Corp., Pasadena, CA) formulations from MIRUS® Bio (Madison, WI) and Roche Madison (Madison, WI), PHASERX™ polymer formulations such as, without limitation, SMARTT POLYMER TECHNOLOGY™ (PHASERX®, Seattle, WA), DMRI/DOPE, poloxamer, VAXFECTIN® adjuvant from Vical (San Diego, CA), chitosan, cyclodextrin from Calando Pharmaceuticals (Pasadena, CA), dendrimers and poly(lactic-co-glycolic acid) (PLGA) polymers. RONDEL™ (RNAi/Oligonucleotide Nanoparticle Delivery) polymers (Arrowhead Research Corporation, Pasadena, CA) and pH responsive co-block polymers such as, but not limited to, PHASERX® (Seattle, WA).

[000622] A non-limiting example of chitosan formulation includes a core of positively charged chitosan and an outer portion of negatively charged substrate (U.S. Pub. No. 20120258176; herein incorporated by reference in its entirety). Chitosan includes, but is not limited to N-trimethyl chitosan, mono-N-carboxymethyl chitosan (MCC), N-palmitoyl chitosan (NPCS), EDTA-chitosan, low molecular weight chitosan, chitosan derivatives, or combinations thereof.

[000623] In one embodiment, the polymers used in the present invention have undergone processing to reduce and/or inhibit the attachment of unwanted substances such as, but not limited to, bacteria, to the surface of the polymer. The polymer may be processed by methods known and/or described in the art and/or described in International Pub. No. WO2012150467, herein incorporated by reference in its entirety.

[000624] A non-limiting example of PLGA formulations include, but are not limited to, PLGA injectable depots (e.g., ELIGARD® which is formed by dissolving PLGA in 66%

N-methyl-2-pyrrolidone (NMP) and the remainder being aqueous solvent and leuprolide. Once injected, the PLGA and leuprolide peptide precipitates into the subcutaneous space).

[000625] Many of these polymer approaches have demonstrated efficacy in delivering oligonucleotides *in vivo* into the cell cytoplasm (reviewed in deFougerolles *Hum Gene Ther.* 2008 19:125-132; herein incorporated by reference in its entirety). Two polymer approaches that have yielded robust *in vivo* delivery of nucleic acids, in this case with small interfering RNA (siRNA), are dynamic polyconjugates and cyclodextrin-based nanoparticles. The first of these delivery approaches uses dynamic polyconjugates and has been shown *in vivo* in mice to effectively deliver siRNA and silence endogenous target mRNA in hepatocytes (Rozema et al, *Proc Natl Acad Sci U S A.* 2007 104:12982-12887; herein incorporated by reference in its entirety). This particular approach is a multicomponent polymer system whose key features include a membrane-active polymer to which nucleic acid, in this case siRNA, is covalently coupled via a disulfide bond and where both PEG (for charge masking) and α -acetylgalactosamine (for hepatocyte targeting) groups are linked via pH-sensitive bonds (Rozema et al., *Proc Natl Acad Sci U S A.* 2007 104:12982-12887; herein incorporated by reference in its entirety). On binding to the hepatocyte and entry into the endosome, the polymer complex disassembles in the low-pH environment, with the polymer exposing its positive charge, leading to endosomal escape and cytoplasmic release of the siRNA from the polymer. Through replacement of the α -acetylgalactosamine group with a mannose group, it was shown one could alter targeting from asialoglycoprotein receptor-expressing hepatocytes to sinusoidal endothelium and Kupffer cells. Another polymer approach involves using transferrin-targeted cyclodextrin-containing polycation nanoparticles. These nanoparticles have demonstrated targeted silencing of the *EWS-FLII* gene product in transferrin receptor-expressing Ewing's sarcoma tumor cells (Hu-Lieskovan *et al.*, *Cancer Res.* 2005 65: 8984-8982; herein incorporated by reference in its entirety) and siRNA formulated in these nanoparticles was well tolerated in non-human primates (Heidel *et al.*, *Proc Natl Acad Sci USA* 2007 104:5715-21; herein incorporated by reference in its entirety). Both of these delivery strategies incorporate rational approaches using both targeted delivery and endosomal escape mechanisms.

[000626] The polymer formulation can permit the sustained or delayed release of polynucleotide, primary construct, or mmRNA (e.g., following intramuscular or subcutaneous injection). The altered release profile for the polynucleotide, primary construct, or mmRNA can result in, for example, translation of an encoded protein over an extended period of time. The polymer formulation may also be used to increase the stability of the polynucleotide, primary construct, or mmRNA. Biodegradable polymers have been previously used to protect nucleic acids other than mmRNA from degradation and been shown to result in sustained release of payloads in vivo (Rozema et al., Proc Natl Acad Sci U S A. 2007 104:12982-12887; Sullivan et al, Expert Opin Drug Deliv. 2010 7:1433-1446; Convertine et al, Biomacromolecules. 2010 Oct 1; Chu et al, Acc Chem Res. 2012 Jan 13; Manganiello et al., Biomaterials. 2012 33:2301-2309; Benoit et al., Biomacromolecules. 2011 12:2708-2714; Singha et al., Nucleic Acid Ther. 2011 2:133-147; deFougerolles Hum Gene Ther. 2008 19:125-132; Schaffert and Wagner, Gene Ther. 2008 16:1131-1138; Chaturvedi et al, Expert Opin Drug Deliv. 2011 8:1455-1468; Davis, Mol Pharm. 2009 6:659-668; Davis, Nature 2010 464:1067-1070; each of which is herein incorporated by reference in its entirety).

[000627] In one embodiment, the pharmaceutical compositions may be sustained release formulations. In a further embodiment, the sustained release formulations may be for subcutaneous delivery. Sustained release formulations may include, but are not limited to, PLGA microspheres, ethylene vinyl acetate (EVAc), poloxamer, GELSITE® (Nanotherapeutics, Inc. Alachua, FL), HYLENEX® (Halozyme Therapeutics, San Diego CA), surgical sealants such as fibrinogen polymers (Ethicon Inc. Cornelia, GA), TISSELL® (Baxter International, Inc Deerfield, IL), PEG-based sealants, and COSEAL® (Baxter International, Inc Deerfield, IL).

[000628] As a non-limiting example modified mRNA may be formulated in PLGA microspheres by preparing the PLGA microspheres with tunable release rates (e.g., days and weeks) and encapsulating the modified mRNA in the PLGA microspheres while maintaining the integrity of the modified mRNA during the encapsulation process. EVAc are non-biodegradable, biocompatible polymers which are used extensively in pre-clinical sustained release implant applications (e.g., extended release products Ocusert a pilocarpine ophthalmic insert for glaucoma or progestasert a sustained release

progesterone intrauterine device; transdermal delivery systems Testoderm, Duragesic and Selegiline; catheters). Poloxamer F-407 NF is a hydrophilic, non-ionic surfactant triblock copolymer of polyoxyethylene-polyoxypropylene-polyoxyethylene having a low viscosity at temperatures less than 5°C and forms a solid gel at temperatures greater than 15°C. PEG-based surgical sealants comprise two synthetic PEG components mixed in a delivery device which can be prepared in one minute, seals in 3 minutes and is reabsorbed within 30 days. GELSITE® and natural polymers are capable of in-situ gelation at the site of administration. They have been shown to interact with protein and peptide therapeutic candidates through ionic interaction to provide a stabilizing effect.

[000629] Polymer formulations can also be selectively targeted through expression of different ligands as exemplified by, but not limited by, folate, transferrin, and N-acetylgalactosamine (GalNAc) (Benoit et al., *Biomacromolecules*. 2011 12:2708-2714; Rozema et al, *Proc Natl Acad Sci U S A*. 2007 104:12982-12887; Davis, *Mol Pharm*. 2009 6:659-668; Davis, *Nature* 2010 464:1067-1070; each of which is herein incorporated by reference in its entirety).

[000630] The modified nucleic acid, and mmRNA of the invention may be formulated with or in a polymeric compound. The polymer may include at least one polymer such as, but not limited to, polyethenes, polyethylene glycol (PEG), poly(L-lysine)(PLL), PEG grafted to PLL, cationic lipopolymer, biodegradable cationic lipopolymer, polyethyleneimine (PEI), cross-linked branched poly(alkylene imines), a polyamine derivative, a modified poloxamer, a biodegradable polymer, elastic biodegradable polymer, biodegradable block copolymer, biodegradable random copolymer, biodegradable polyester copolymer, biodegradable polyester block copolymer, biodegradable polyester block random copolymer, multiblock copolymers, linear biodegradable copolymer, poly[α-(4-aminobutyl)-L-glycolic acid] (PAGA), biodegradable cross-linked cationic multi-block copolymers, polycarbonates, polyanhydrides, polyhydroxyacids, polypropylfumerates, polycaprolactones, polyamides, polyacetals, polyethers, polyesters, poly(orthoesters), polycyanoacrylates, polyvinyl alcohols, polyurethanes, polyphosphazenes, polyacrylates, polymethacrylates, polycyanoacrylates, polyureas, polystyrenes, polyamines, polylysine, poly(ethylene imine), poly(serine ester), poly(L-lactide-co-L-lysine), poly(4-hydroxy-L-proline ester),

acrylic polymers, amine-containing polymers, dextran polymers, dextran polymer derivatives or or combinations thereof .

[000631] As a non-limiting example, the modified nucleic acid or mmRNA of the invention may be formulated with the polymeric compound of PEG grafted with PLL as described in U.S. Pat. No. 6,177,274; herein incorporated by reference in its entirety. The formulation may be used for transfecting cells *in vitro* or for *in vivo* delivery of the modified nucleic acid and mmRNA. In another example, the modified nucleic acid and mmRNA may be suspended in a solution or medium with a cationic polymer, in a dry pharmaceutical composition or in a solution that is capable of being dried as described in U.S. Pub. Nos. 20090042829 and 20090042825; each of which are herein incorporated by reference in their entireties.

[000632] As another non-limiting example the polynucleotides, primary constructs or mmRNA of the invention may be formulated with a PLGA-PEG block copolymer (see US Pub. No. US20120004293 and US Pat No. 8,236,330, herein incorporated by reference in their entireties) or PLGA-PEG-PLGA block copolymers (See U.S. Pat. No. 6,004,573, herein incorporated by reference in its entirety). As a non-limiting example, the polynucleotides, primary constructs or mmRNA of the invention may be formulated with a diblock copolymer of PEG and PLA or PEG and PLGA (see US Pat No 8,246,968, herein incorporated by reference in its entirety).

[000633] A polyamine derivative may be used to deliver nucleic acids or to treat and/or prevent a disease or to be included in an implantable or injectable device (U.S. Pub. No. 20100260817 herein incorporated by reference in its entirety). As a non-limiting example, a pharmaceutical composition may include the modified nucleic acids and mmRNA and the polyamine derivative described in U.S. Pub. No. 20100260817 (the contents of which are incorporated herein by reference in its entirety). As a non-limiting example the polynucleotides, primary constructs and mmRNA of the present invention may be delivered using a polyamide polymer such as, but not limited to, a polymer comprising a 1,3-dipolar addition polymer prepared by combining a carbohydrate diazide monomer with a dialkyne unit comprising oligoamines (U.S. Pat. No. 8,236,280; herein incorporated by reference in its entirety).

[000634] In one embodiment, the polynucleotides, primary constructs or mmRNA of the present invention may be formulated with at least one polymer and/or derivatives thereof described in International Publication Nos. WO201 1115862, WO2012082574 and WO2012068187 and U.S. Pub. No. 20120283427, each of which are herein incorporated by reference in their entireties. In another embodiment, the modified nucleic acid or mmRNA of the present invention may be formulated with a polymer of formula Z as described in WO201 1115862, herein incorporated by reference in its entirety. In yet another embodiment, the modified nucleic acid or mmRNA may be formulated with a polymer of formula Z, Z' or Z" as described in International Pub. Nos. WO2012082574 or WO2012068187 and U.S. Pub. No. 2012028342, each of which are herein incorporated by reference in their entireties. The polymers formulated with the modified RNA of the present invention may be synthesized by the methods described in International Pub. Nos. WO2012082574 or WO2012068187, each of which are herein incorporated by reference in their entireties.

[000635] The polynucleotides, primary constructs or mmRNA of the invention may be formulated with at least one acrylic polymer. Acrylic polymers include but are not limited to, acrylic acid, methacrylic acid, acrylic acid and methacrylic acid copolymers, methyl methacrylate copolymers, ethoxyethyl methacrylates, cyanoethyl methacrylate, amino alkyl methacrylate copolymer, poly(acrylic acid), poly(methacrylic acid), polycyanoacrylates and combinations thereof.

[000636] Formulations of polynucleotides, primary constructs or mmRNA of the invention may include at least one amine-containing polymer such as, but not limited to polylysine, polyethylene imine, poly(amidoamine) dendrimers or combinations thereof.

[000637] For example, the modified nucleic acid or mmRNA of the invention may be formulated in a pharmaceutical compound including a poly(alkylene imine), a biodegradable cationic lipopolymer, a biodegradable block copolymer, a biodegradable polymer, or a biodegradable random copolymer, a biodegradable polyester block copolymer, a biodegradable polyester polymer, a biodegradable polyester random copolymer, a linear biodegradable copolymer, PAGA, a biodegradable cross-linked cationic multi-block copolymer or combinations thereof. The biodegradable cationic lipopolymer may be made by methods known in the art and/or described in U.S. Pat. No.

6,696,038, U.S. App. Nos. 20030073619 and 20040142474 each of which is herein incorporated by reference in their entireties. The poly(alkylene imine) may be made using methods known in the art and/or as described in U.S. Pub. No. 20100004315, herein incorporated by reference in its entirety. The biodegradable polymer, biodegradable block copolymer, the biodegradable random copolymer, biodegradable polyester block copolymer, biodegradable polyester polymer, or biodegradable polyester random copolymer may be made using methods known in the art and/or as described in U.S. Pat. Nos. 6,517,869 and 6,267,987, the contents of which are each incorporated herein by reference in their entirety. The linear biodegradable copolymer may be made using methods known in the art and/or as described in U.S. Pat. No. 6,652,886. The PAGA polymer may be made using methods known in the art and/or as described in U.S. Pat. No. 6,217,912 herein incorporated by reference in its entirety. The PAGA polymer may be copolymerized to form a copolymer or block copolymer with polymers such as but not limited to, poly-L-lysine, polyarginine, polyornithine, histones, avidin, protamines, polylactides and poly(lactide-co-glycolides). The biodegradable cross-linked cationic multi-block copolymers may be made by methods known in the art and/or as described in U.S. Pat. No. 8,057,821 or U.S. Pub. No. 2012009145 each of which are herein incorporated by reference in their entireties. For example, the multi-block copolymers may be synthesized using linear polyethyleneimine (LPEI) blocks which have distinct patterns as compared to branched polyethyleneimines. Further, the composition or pharmaceutical composition may be made by the methods known in the art, described herein, or as described in U.S. Pub. No. 20100004315 or U.S. Pat. Nos. 6,267,987 and 6,217,912 each of which are herein incorporated by reference in their entireties.

[000638] The polynucleotides, primary constructs, and mmRNA of the invention may be formulated with at least one degradable polyester which may contain polycationic side chains. Degradable polyesters include, but are not limited to, poly(serine ester), poly(L-lactide-co-L-lysine), poly(4-hydroxy-L-proline ester), and combinations thereof. In another embodiment, the degradable polyesters may include a PEG conjugation to form a PEGylated polymer.

[000639] The polynucleotides, primary construct, mmRNA of the invention may be formulated with at least one crosslinkable polyester. Crosslinkable polyesters include

those known in the art and described in US Pub. No. 20120269761, herein incorporated by reference in its entirety.

[000640] In one embodiment, the polymers described herein may be conjugated to a lipid-terminating PEG. As a non-limiting example, PLGA may be conjugated to a lipid-terminating PEG forming PLGA-DSPE-PEG. As another non-limiting example, PEG conjugates for use with the present invention are described in International Publication No. WO2008 103276, herein incorporated by reference in its entirety. The polymers may be conjugated using a ligand conjugate such as, but not limited to, the conjugates described in U.S. Pat. No. 8,273,363, herein incorporated by reference in its entirety.

[000641] In one embodiment, the modified RNA described herein may be conjugated with another compound. Non-limiting examples of conjugates are described in US Patent Nos. 7,964,578 and 7,833,992, each of which are herein incorporated by reference in their entireties. In another embodiment, modified RNA of the present invention may be conjugated with conjugates of formula 1-122 as described in US Patent Nos. 7,964,578 and 7,833,992, each of which are herein incorporated by reference in their entireties. The polynucleotides, primary constructs and/or mmRNA described herein may be conjugated with a metal such as, but not limited to, gold. (See e.g., Giljohann et al. *Journ. Amer. Chem. Soc.* 2009 131(6): 2072-2073; herein incorporated by reference in its entirety). In another embodiment, the polynucleotides, primary constructs and/or mmRNA described herein may be conjugated and/or encapsulated in gold-nanoparticles. (International Pub. No. WO201216269 and U.S. Pub. No. 20120302940; each of which is herein incorporated by reference in its entirety).

[000642] As described in U.S. Pub. No. 201000043 13, herein incorporated by reference in its entirety, a gene delivery composition may include a nucleotide sequence and a poloxamer. For example, the modified nucleic acid and mmRNA of the present invention may be used in a gene delivery composition with the poloxamer described in U.S. Pub. No. 20100004313.

[000643] In one embodiment, the polymer formulation of the present invention may be stabilized by contacting the polymer formulation, which may include a cationic carrier, with a cationic lipopolymer which may be covalently linked to cholesterol and polyethylene glycol groups. The polymer formulation may be contacted with a cationic

lipopolymer using the methods described in U.S. Pub. No. 20090042829 herein incorporated by reference in its entirety. The cationic carrier may include, but is not limited to, polyethylenimine, poly(trimethylenimine), poly(tetramethylenimine), polypropylenimine, aminoglycoside-polyamine, dideoxy-diamino-b-cyclodextrin, spermine, spermidine, poly(2-dimethylamino)ethyl methacrylate, poly(lysine), poly(histidine), poly(arginine), cationized gelatin, dendrimers, chitosan, 1,2-Dioleoyl-3-Trimethylammonium-Propane(DOTAP), N-[1-(2,3-dioleoyloxy)propyl]-N,N,N-trimethylammonium chloride (DOTMA), 1-[2-(oleoyloxy)ethyl]-2-oleyl-3-(2-hydroxyethyl)imidazolium chloride (DOTIM), 2,3-dioleoyloxy-N-[2(sperminocarboxamido)ethyl]-N,N-dimethyl-1-propanaminium trifluoroacetate (DOSPA), 3B-[N—(N',N'-Dimethylaminoethane)-carbonyl]Cholesterol Hydrochloride (DC-Cholesterol HCl) diheptadecylamidoglycyl spermidine (DOGS), N,N-distearyl-N,N-dimethylammonium bromide (DDAB), N-(1,2-dimyristyloxyprop-3-yl)-N,N-dimethyl-N-hydroxyethyl ammonium bromide (DMRIE), N,N-dioleoyl-N,N-dimethylammonium chloride (DODAC) and combinations thereof.

[000644] The polynucleotides, primary constructs and/or mmRNA of the invention may be formulated in a polyplex of one or more polymers (U.S. Pub. No. 20120237565 and 20120270927; each of which is herein incorporated by reference in its entirety). In one embodiment, the polyplex comprises two or more cationic polymers. The cationic polymer may comprise a poly(ethylene imine) (PEI) such as linear PEI

[000645] The polynucleotide, primary construct, and mmRNA of the invention can also be formulated as a nanoparticle using a combination of polymers, lipids, and/or other biodegradable agents, such as, but not limited to, calcium phosphate. Components may be combined in a core-shell, hybrid, and/or layer-by-layer architecture, to allow for fine-tuning of the nanoparticle so to delivery of the polynucleotide, primary construct and mmRNA may be enhanced (Wang et al, Nat Mater. 2006 5:791-796; Fuller et al, Biomaterials. 2008 29:1526-1532; DeKoker et al, Adv Drug Deliv Rev. 2011 63:748-761; Endres et al, Biomaterials. 2011 32:7721-7731; Su et al, Mol Pharm. 2011 Jun 6;8(3):774-87; herein incorporated by reference in its entirety). As a non-limiting example, the nanoparticle may comprise a plurality of polymers such as, but not limited to hydrophilic-hydrophobic polymers (e.g., PEG-PLGA), hydrophobic polymers (e.g.,

PEG) and/or hydrophilic polymers (International Pub. No. WO20120225129; herein incorporated by reference in its entirety).

[000646] Biodegradable calcium phosphate nanoparticles in combination with lipids and/or polymers have been shown to deliver polynucleotides, primary constructs and mmRNA *in vivo*. In one embodiment, a lipid coated calcium phosphate nanoparticle, which may also contain a targeting ligand such as anisamide, may be used to deliver the polynucleotide, primary construct and mmRNA of the present invention. For example, to effectively deliver siRNA in a mouse metastatic lung model a lipid coated calcium phosphate nanoparticle was used (Li et al, J Contr Rel. 2010 142: 416-421; Li et al., J Contr Rel. 2012 158:108-114; Yang et al, Mol Ther. 2012 20:609-615; herein incorporated by reference in its entirety). This delivery system combines both a targeted nanoparticle and a component to enhance the endosomal escape, calcium phosphate, in order to improve delivery of the siRNA.

[000647] In one embodiment, calcium phosphate with a PEG-polyanion block copolymer may be used to delivery polynucleotides, primary constructs and mmRNA (Kazikawa et al, J Contr Rel. 2004 97:345-356; Kazikawa et al, J Contr Rel. 2006 111:368-370; herein incorporated by reference in its entirety).

[000648] In one embodiment, a PEG-charge-conversional polymer (Pitella et al., Biomaterials. 2011 32:3106-3114) may be used to form a nanoparticle to deliver the polynucleotides, primary constructs and mmRNA of the present invention. The PEG-charge-conversional polymer may improve upon the PEG-polyanion block copolymers by being cleaved into a polycation at acidic pH, thus enhancing endosomal escape.

[000649] The use of core-shell nanoparticles has additionally focused on a high-throughput approach to synthesize cationic cross-linked nanogel cores and various shells (Siegwart et al, Proc Natl Acad Sci U S A. 2011 108:12996-13001). The complexation, delivery, and internalization of the polymeric nanoparticles can be precisely controlled by altering the chemical composition in both the core and shell components of the nanoparticle. For example, the core-shell nanoparticles may efficiently deliver siRNA to mouse hepatocytes after they covalently attach cholesterol to the nanoparticle.

[000650] In one embodiment, a hollow lipid core comprising a middle PLGA layer and an outer neutral lipid layer containing PEG may be used to delivery of the polynucleotide,

primary construct and mmRNA of the present invention. As a non-limiting example, in mice bearing a luciferase-expressing tumor, it was determined that the lipid-polymer-lipid hybrid nanoparticle significantly suppressed luciferase expression, as compared to a conventional lipoplex (Shi et al, Angew Chem Int Ed. 2011 50:7027-7031; herein incorporated by reference in its entirety).

[000651] In one embodiment, the lipid nanoparticles may comprise a core of the modified nucleic acid molecules disclosed herein and a polymer shell. The polymer shell may be any of the polymers described herein and are known in the art. In an additional embodiment, the polymer shell may be used to protect the modified nucleic acids in the core.

[000652] Core-shell nanoparticles for use with the modified nucleic acid molecules of the present invention are described and may be formed by the methods described in U.S. Pat. No. 8,313,777 herein incorporated by reference in its entirety.

[000653] In one embodiment, the core-shell nanoparticles may comprise a core of the modified nucleic acid molecules disclosed herein and a polymer shell. The polymer shell may be any of the polymers described herein and are known in the art. In an additional embodiment, the polymer shell may be used to protect the modified nucleic acid molecules in the core. As a non-limiting example, the core-shell nanoparticle may be used to treat an eye disease or disorder (See e.g. US Publication No. 20120321719, herein incorporated by reference in its entirety).

[000654] In one embodiment, the polymer used with the formulations described herein may be a modified polymer (such as, but not limited to, a modified polyacetal) as described in International Publication No. WO2011120053, herein incorporated by reference in its entirety.

Peptides and Proteins

[000655] The polynucleotide, primary construct, and mmRNA of the invention can be formulated with peptides and/or proteins in order to increase transfection of cells by the polynucleotide, primary construct, or mmRNA. In one embodiment, peptides such as, but not limited to, cell penetrating peptides and proteins and peptides that enable intracellular delivery may be used to deliver pharmaceutical formulations. A non-limiting example of a cell penetrating peptide which may be used with the pharmaceutical formulations of the

present invention includes a cell-penetrating peptide sequence attached to polycations that facilitates delivery to the intracellular space, e.g., HIV-derived TAT peptide, penetratins, transportans, or hCT derived cell-penetrating peptides (see, e.g., Caron et al, Mol. Ther. 3(3):310-8 (2001); Langel, Cell-Penetrating Peptides: Processes and Applications (CRC Press, Boca Raton FL, 2002); El-Andaloussi et al., Curr. Pharm. Des. 11(28):3597-611 (2003); and Deshayes et al, Cell. Mol. Life Sci. 62(16):1839-49 (2005), all of which are incorporated herein by reference in their entirety). The compositions can also be formulated to include a cell penetrating agent, e.g., liposomes, which enhance delivery of the compositions to the intracellular space. Polynucleotides, primary constructs, and mmRNA of the invention may be complexed to peptides and/or proteins such as, but not limited to, peptides and/or proteins from Aileron Therapeutics (Cambridge, MA) and Permeon Biologies (Cambridge, MA) in order to enable intracellular delivery (Cronican et al, ACS Chem. Biol. 2010 5:747-752; McNaughton et al, Proc. Natl. Acad. Sci. USA 2009 106:6111-6116; Sawyer, Chem Biol Drug Des. 2009 73:3-6; Verdine and Hilinski, Methods Enzymol. 2012;503:3-33; all of which are herein incorporated by reference in its entirety).

[000656] In one embodiment, the cell-penetrating polypeptide may comprise a first domain and a second domain. The first domain may comprise a supercharged polypeptide. The second domain may comprise a protein-binding partner. As used herein, "protein-binding partner" includes, but are not limited to, antibodies and functional fragments thereof, scaffold proteins, or peptides. The cell-penetrating polypeptide may further comprise an intracellular binding partner for the protein-binding partner. The cell-penetrating polypeptide may be capable of being secreted from a cell where the polynucleotide, primary construct, or mmRNA may be introduced.

[000657] Formulations of the including peptides or proteins may be used to increase cell transfection by the polynucleotide, primary construct, or mmRNA, alter the biodistribution of the polynucleotide, primary construct, or mmRNA (e.g., by targeting specific tissues or cell types), and/or increase the translation of encoded protein. (See e.g., International Pub. No. WO2012/110636; herein incorporated by reference in its entirety).

Cells

[000658] The polynucleotide, primary construct, and mmRNA of the invention can be transfected *ex vivo* into cells, which are subsequently transplanted into a subject. As non-limiting examples, the pharmaceutical compositions may include red blood cells to deliver modified RNA to liver and myeloid cells, virosomes to deliver modified RNA in virus-like particles (VLPs), and electroporated cells such as, but not limited to, from MAXCYTE® (Gaithersburg, MD) and from ERYTECH® (Lyon, France) to deliver modified RNA. Examples of use of red blood cells, viral particles and electroporated cells to deliver payloads other than mmRNA have been documented (Godfrin et al., *Expert Opin Biol Ther.* 2012 12:127-133; Fang et al., *Expert Opin Biol Ther.* 2012 12:385-389; Hu et al, *Proc Natl Acad Sci U S A.* 201 1 108:10980-10985; Lund et al, *Pharm Res.* 2010 27:400-420; Huckriede et al, *J Liposome Res.* 2007;17:39-47; Cusi, *Hum Vaccin.* 2006 2:1-7; de Jonge et al, *Gene Ther.* 2006 13:400-41 1; all of which are herein incorporated by reference in its entirety).

[000659] The polynucleotides, primary constructs and mmRNA may be delivered in synthetic VLPs synthesized by the methods described in International Pub No. WO201 1085231 and US Pub No. 201 10171248, each of which are herein incorporated by reference in their entirety.

[000660] Cell-based formulations of the polynucleotide, primary construct, and mmRNA of the invention may be used to ensure cell transfection (e.g., in the cellular carrier), alter the biodistribution of the polynucleotide, primary construct, or mmRNA (e.g., by targeting the cell carrier to specific tissues or cell types), and/or increase the translation of encoded protein.

[000661] A variety of methods are known in the art and suitable for introduction of nucleic acid into a cell, including viral and non-viral mediated techniques. Examples of typical non-viral mediated techniques include, but are not limited to, electroporation, calcium phosphate mediated transfer, nucleofection, sonoporation, heat shock, magnetofection, liposome mediated transfer, microinjection, microprojectile mediated transfer (nanoparticles), cationic polymer mediated transfer (DEAE-dextran, polyethylenimine, polyethylene glycol (PEG) and the like) or cell fusion.

[000662] The technique of sonoporation, or cellular sonication, is the use of sound (e.g., ultrasonic frequencies) for modifying the permeability of the cell plasma membrane. Sonoporation methods are known to those in the art and are used to deliver nucleic acids *in vivo* (Yoon and Park, *Expert Opin Drug Deliv.* 2010 7:321-330; Postema and Gilja, *Curr Pharm Biotechnol.* 2007 8:355-361; Newman and Bettinger, *Gene Ther.* 2007 14:465-475; all herein incorporated by reference in their entirety). Sonoporation methods are known in the art and are also taught for example as it relates to bacteria in US Patent Publication 20100196983 and as it relates to other cell types in, for example, US Patent Publication 20100009424, each of which are incorporated herein by reference in their entirety.

[000663] Electroporation techniques are also well known in the art and are used to deliver nucleic acids *in vivo* and clinically (Andre et al., *Curr Gene Ther.* 2010 10:267-280; Chiarella et al, *Curr Gene Ther.* 2010 10:281-286; Hojman, *Curr Gene Ther.* 2010 10:128-138; all herein incorporated by reference in their entirety). In one embodiment, polynucleotides, primary constructs or mmRNA may be delivered by electroporation as described in Example 8.

Hyaluronidase

[000664] The intramuscular or subcutaneous localized injection of polynucleotide, primary construct, or mmRNA of the invention can include hyaluronidase, which catalyzes the hydrolysis of hyaluronan. By catalyzing the hydrolysis of hyaluronan, a constituent of the interstitial barrier, hyaluronidase lowers the viscosity of hyaluronan, thereby increasing tissue permeability (Frost, *Expert Opin. Drug Deliv.* (2007) 4:427-440; herein incorporated by reference in its entirety). It is useful to speed their dispersion and systemic distribution of encoded proteins produced by transfected cells. Alternatively, the hyaluronidase can be used to increase the number of cells exposed to a polynucleotide, primary construct, or mmRNA of the invention administered intramuscularly or subcutaneously.

Nanoparticle Mimics

[000665] The polynucleotide, primary construct or mmRNA of the invention may be encapsulated within and/or absorbed to a nanoparticle mimic. A nanoparticle mimic can mimic the delivery function organisms or particles such as, but not limited to, pathogens,

viruses, bacteria, fungus, parasites, prions and cells. As a non-limiting example the polynucleotide, primary construct or mmRNA of the invention may be encapsulated in a non-viron particle which can mimic the delivery function of a virus (see International Pub. No. WO2012006376 herein incorporated by reference in its entirety).

Nanotubes

[000666] The polynucleotides, primary constructs or mmRNA of the invention can be attached or otherwise bound to at least one nanotube such as, but not limited to, rosette nanotubes, rosette nanotubes having twin bases with a linker, carbon nanotubes and/or single-walled carbon nanotubes, The polynucleotides, primary constructs or mmRNA may be bound to the nanotubes through forces such as, but not limited to, steric, ionic, covalent and/or other forces.

[000667] In one embodiment, the nanotube can release one or more polynucleotides, primary constructs or mmRNA into cells. The size and/or the surface structure of at least one nanotube may be altered so as to govern the interaction of the nanotubes within the body and/or to attach or bind to the polynucleotides, primary constructs or mmRNA disclosed herein. In one embodiment, the building block and/or the functional groups attached to the building block of the at least one nanotube may be altered to adjust the dimensions and/or properties of the nanotube. As a non-limiting example, the length of the nanotubes may be altered to hinder the nanotubes from passing through the holes in the walls of normal blood vessels but still small enough to pass through the larger holes in the blood vessels of tumor tissue.

[000668] In one embodiment, at least one nanotube may also be coated with delivery enhancing compounds including polymers, such as, but not limited to, polyethylene glycol. In another embodiment, at least one nanotube and/or the polynucleotides, primary constructs or mmRNA may be mixed with pharmaceutically acceptable excipients and/or delivery vehicles.

[000669] In one embodiment, the polynucleotides, primary constructs or mmRNA are attached and/or otherwise bound to at least one rosette nanotube. The rosette nanotubes may be formed by a process known in the art and/or by the process described in International Publication No. WO2012094304, herein incorporated by reference in its entirety. At least one polynucleotide, primary construct and/or mmRNA may be attached

and/or otherwise bound to at least one rosette nanotube by a process as described in International Publication No. WO2012094304, herein incorporated by reference in its entirety, where rosette nanotubes or modules forming rosette nanotubes are mixed in aqueous media with at least one polynucleotide, primary construct and/or mmRNA under conditions which may cause at least one polynucleotide, primary construct or mmRNA to attach or otherwise bind to the rosette nanotubes.

[000670] In one embodiment, the polynucleotides, primary constructs or mmRNA may be attached to and/or otherwise bound to at least one carbon nanotube. As a non-limiting example, the polynucleotides, primary constructs or mmRNA may be bound to a linking agent and the linked agent may be bound to the carbon nanotube (See e.g., U.S. Pat No. 8,246,995; herein incorporated by reference in its entirety). The carbon nanotube may be a single-walled nanotube (See e.g., U.S. Pat No. 8,246,995; herein incorporated by reference in its entirety).

Conjugates

[000671] The polynucleotides, primary constructs, and mmRNA of the invention include conjugates, such as a polynucleotide, primary construct, or mmRNA covalently linked to a carrier or targeting group, or including two encoding regions that together produce a fusion protein (e.g., bearing a targeting group and therapeutic protein or peptide).

[000672] The conjugates of the invention include a naturally occurring substance, such as a protein (e.g., human serum albumin (HSA), low-density lipoprotein (LDL), high-density lipoprotein (HDL), or globulin); an carbohydrate (e.g., a dextran, pullulan, chitin, chitosan, inulin, cyclodextrin or hyaluronic acid); or a lipid. The ligand may also be a recombinant or synthetic molecule, such as a synthetic polymer, e.g., a synthetic polyamino acid, an oligonucleotide (e.g. an aptamer). Examples of polyamino acids include polyamino acid is a polylysine (PLL), poly L-aspartic acid, poly L-glutamic acid, styrene-maleic acid anhydride copolymer, poly(L-lactide-co-glycolid) copolymer, divinyl ether-maleic anhydride copolymer, N-(2-hydroxypropyl)methacrylamide copolymer (HMPA), polyethylene glycol (PEG), polyvinyl alcohol (PVA), polyurethane, poly(2-ethylacrylic acid), N-isopropylacrylamide polymers, or polyphosphazine. Example of polyamines include: polyethylenimine, polylysine (PLL), spermine,

spermidine, polyamine, pseudopeptide-polyamine, peptidomimetic polyamine, dendrimer polyamine, arginine, amidine, protamine, cationic lipid, cationic porphyrin, quaternary salt of a polyamine, or an alpha helical peptide.

[000673] Representative U.S. patents that teach the preparation of polynucleotide conjugates, particularly to RNA, include, but are not limited to, U.S. Pat. Nos. 4,828,979; 4,948,882; 5,218,105; 5,525,465; 5,541,313; 5,545,730; 5,552,538; 5,578,717; 5,580,731; 5,591,584; 5,109,124; 5,118,802; 5,138,045; 5,414,077; 5,486,603; 5,512,439; 5,578,718; 5,608,046; 4,587,044; 4,605,735; 4,667,025; 4,762,779; 4,789,737; 4,824,941; 4,835,263; 4,876,335; 4,904,582; 4,958,013; 5,082,830; 5,112,963; 5,214,136; 5,082,830; 5,112,963; 5,214,136; 5,245,022; 5,254,469; 5,258,506; 5,262,536; 5,272,250; 5,292,873; 5,317,098; 5,371,241; 5,391,723; 5,416,203; 5,451,463; 5,510,475; 5,512,667; 5,514,785; 5,565,552; 5,567,810; 5,574,142; 5,585,481; 5,587,371; 5,595,726; 5,597,696; 5,599,923; 5,599,928 and 5,688,941; 6,294,664; 6,320,017; 6,576,752; 6,783,931; 6,900,297; 7,037,646; each of which is herein incorporated by reference in their entireties.

[000674] In one embodiment, the conjugate of the present invention may function as a carrier for the modified nucleic acids and mmRNA of the present invention. The conjugate may comprise a cationic polymer such as, but not limited to, polyamine, polylysine, polyalkylenimine, and polyethylenimine which may be grafted to with poly(ethylene glycol). As a non-limiting example, the conjugate may be similar to the polymeric conjugate and the method of synthesizing the polymeric conjugate described in U.S. Pat. No. 6,586,524 herein incorporated by reference in its entirety.

[000675] The conjugates can also include targeting groups, e.g., a cell or tissue targeting agent, e.g., a lectin, glycoprotein, lipid or protein, e.g., an antibody, that binds to a specified cell type such as a kidney cell. A targeting group can be a thyrotropin, melanotropin, lectin, glycoprotein, surfactant protein A, Mucin carbohydrate, multivalent lactose, multivalent galactose, N-acetyl-galactosamine, N-acetyl-gulucosamine multivalent mannose, multivalent fucose, glycosylated polyaminoacids, multivalent galactose, transferrin, bisphosphonate, polyglutamate, polyaspartate, a lipid, cholesterol, a steroid, bile acid, folate, vitamin B12, biotin, an RGD peptide, an RGD peptide mimetic or an aptamer.

[000676] Targeting groups can be proteins, e.g., glycoproteins, or peptides, e.g., molecules having a specific affinity for a co-ligand, or antibodies e.g., an antibody, that binds to a specified cell type such as a cancer cell, endothelial cell, or bone cell. Targeting groups may also include hormones and hormone receptors. They can also include non-peptidic species, such as lipids, lectins, carbohydrates, vitamins, cofactors, multivalent lactose, multivalent galactose, N-acetyl-galactosamine, N-acetyl-gulucosamine multivalent mannose, multivalent fucose, or aptamers. The ligand can be, for example, a lipopolysaccharide, or an activator of p38 MAP kinase.

[000677] The targeting group can be any ligand that is capable of targeting a specific receptor. Examples include, without limitation, folate, GalNAc, galactose, mannose, mannose-6P, aptamers, integrin receptor ligands, chemokine receptor ligands, transferrin, biotin, serotonin receptor ligands, PSMA, endothelin, GCPII, somatostatin, LDL, and HDL ligands. In particular embodiments, the targeting group is an aptamer. The aptamer can be unmodified or have any combination of modifications disclosed herein.

[000678] In one embodiment, pharmaceutical compositions of the present invention may include chemical modifications such as, but not limited to, modifications similar to locked nucleic acids.

[000679] Representative U.S. Patents that teach the preparation of locked nucleic acid (LNA) such as those from Santaris, include, but are not limited to, the following: U.S. Pat. Nos. 6,268,490; 6,670,461; 6,794,499; 6,998,484; 7,053,207; 7,084,125; and 7,399,845, each of which is herein incorporated by reference in its entirety.

[000680] Representative U.S. patents that teach the preparation of PNA compounds include, but are not limited to, U.S. Pat. Nos. 5,539,082; 5,714,331; and 5,719,262, each of which is herein incorporated by reference. Further teaching of PNA compounds can be found, for example, in Nielsen *et al.*, *Science*, 1991, 254, 1497-1500.

[000681] Some embodiments featured in the invention include polynucleotides, primary constructs or mmRNA with phosphorothioate backbones and oligonucleosides with other modified backbones, and in particular $-\text{CH}_2-\text{NH}-\text{CH}_2-$, $-\text{CH}_2-\text{N}(\text{CH}_3)-\text{O}-\text{CH}_2-$ [known as a methylene (methylimino) or MMI backbone], $-\text{CH}_2-\text{O}-\text{N}(\text{CH}_3)-\text{CH}_2-$, $-\text{CH}_2-\text{N}(\text{CH}_3)-\text{N}(\text{CH}_3)-\text{CH}_2-$ and $-\text{N}(\text{CH}_3)-\text{CH}_2-\text{CH}_2-$ [wherein the native

phosphodiester backbone is represented as $-\text{O}-\text{P}(\text{O})_2-\text{O}-\text{CH}_2-$ of the above-referenced U.S. Pat. No. 5,489,677, and the amide backbones of the above-referenced U.S. Pat. No. 5,602,240. In some embodiments, the polynucleotides featured herein have morpholino backbone structures of the above-referenced U.S. Pat. No. 5,034,506.

[000682] Modifications at the 2' position may also aid in delivery. Preferably, modifications at the 2' position are not located in a polypeptide-coding sequence, i.e., not in a translatable region. Modifications at the 2' position may be located in a 5'UTR, a 3'UTR and/or a tailing region. Modifications at the 2' position can include one of the following at the 2' position: H (i.e., 2'-deoxy); F; O-, S-, or N-alkyl; O-, S-, or N-alkenyl; O-, S- or N-alkynyl; or O-alkyl-O-alkyl, wherein the alkyl, alkenyl and alkynyl may be substituted or unsubstituted C_1 to C_{10} alkyl or C_2 to C_{10} alkenyl and alkynyl. Exemplary suitable modifications include $0[(\text{CH}_2)_n\text{O}]_m\text{CH}_3$, $0(\text{CH}_2)_n\text{OCH}_3$, $0(\text{CH}_2)_n\text{NH}_2$, $0(\text{CH}_2)_n\text{CH}_3$, $0(\text{CH}_2)_n\text{ONH}_2$, and $0(\text{CH}_2)_n\text{ON}[(\text{CH}_2)_n\text{CH}_3]_2$, where n and m are from 1 to about 10. In other embodiments, the polynucleotides, primary constructs or mRNA include one of the following at the 2' position: C_1 to C_{10} lower alkyl, substituted lower alkyl, aralkyl, O-alkaryl or O-aralkyl, SH, SCH_3 , OCN, Cl, Br, CN, CF_3 , OCF_3 , SOCH_3 , SO_2CH_3 , ONO_2 , NO_2 , N_3 , NH_2 , heterocycloalkyl, heterocycloalkaryl, aminoalkylamino, polyalkylamino, substituted silyl, an RNA cleaving group, a reporter group, an intercalator, a group for improving the pharmacokinetic properties, or a group for improving the pharmacodynamic properties, and other substituents having similar properties. In some embodiments, the modification includes a 2'-methoxyethoxy (2'- $-\text{O}-\text{CH}_2\text{CH}_2\text{OCH}_3$, also known as 2'-O-(2-methoxy ethyl) or 2'-MOE) (Martin *et al*, *Helv. Chim. Acta*, 1995, 78:486-504) i.e., an alkoxy-alkoxy group. Another exemplary modification is 2'-dimethylaminoethoxy, i.e., a $0(\text{CH}_2)_2\text{ON}(\text{CH}_3)_2$ group, also known as 2'-DMAOE, as described in examples herein below, and 2'-dimethylaminoethoxyethoxy (also known in the art as 2'-O-dimethylaminoethoxyethyl or 2'-DMAEOE), i.e., 2'- $-\text{O}-\text{CH}_2-\text{O}-\text{CH}_2-\text{N}(\text{CH}_3)_2$, also described in examples herein below. Other modifications include 2'-methoxy (2'- OCH_3), 2'-aminopropoxy (2'- $\text{OCH}_2\text{CH}_2\text{CH}_2\text{NH}_2$) and 2'-fluoro (2'-F). Similar modifications may also be made at other positions, particularly the 3' position of the sugar on the 3' terminal nucleotide or in 2'-5' linked dsRNAs and the 5' position of 5' terminal nucleotide. Polynucleotides of the

invention may also have sugar mimetics such as cyclobutyl moieties in place of the pentofuranosyl sugar. Representative U.S. patents that teach the preparation of such modified sugar structures include, but are not limited to, U.S. Pat. Nos. 4,981,957; 5,118,800; 5,319,080; 5,359,044; 5,393,878; 5,446,137; 5,466,786; 5,514,785; 5,519,134; 5,567,811; 5,576,427; 5,591,722; 5,597,909; 5,610,300; 5,627,053; 5,639,873; 5,646,265; 5,658,873; 5,670,633; and 5,700,920 and each of which is herein incorporated by reference.

[000683] In still other embodiments, the polynucleotide, primary construct, or mmRNA is covalently conjugated to a cell penetrating polypeptide. The cell-penetrating peptide may also include a signal sequence. The conjugates of the invention can be designed to have increased stability; increased cell transfection; and/or altered the biodistribution (e.g., targeted to specific tissues or cell types).

[000684] In one embodiment, the polynucleotides, primary constructs or mmRNA may be conjugated to an agent to enhance delivery. As a non-limiting example, the agent may be a monomer or polymer such as a targeting monomer or a polymer having targeting blocks as described in International Publication No. WO2011062965, herein incorporated by reference in its entirety. In another non-limiting example, the agent may be a transport agent covalently coupled to the polynucleotides, primary constructs or mmRNA of the present invention (See e.g., U.S. Pat. Nos. 6,835,393 and 7,374,778, each of which is herein incorporated by reference in its entirety). In yet another non-limiting example, the agent may be a membrane barrier transport enhancing agent such as those described in U.S. Pat. Nos. 7,737,108 and 8,003,129, each of which is herein incorporated by reference in its entirety.

[000685] In another embodiment, polynucleotides, primary constructs or mmRNA may be conjugated to SMARTT POLYMER TECHNOLOGY® (PHASERX®, Inc. Seattle, WA).

Self-Assembled Nanoparticles

Nucleic Acid Self-Assembled Nanoparticles

[000686] Self-assembled nanoparticles have a well-defined size which may be precisely controlled as the nucleic acid strands may be easily reprogrammable. For example, the optimal particle size for a cancer-targeting nanodelivery carrier is 20-100 nm as a

diameter greater than 20 nm avoids renal clearance and enhances delivery to certain tumors through enhanced permeability and retention effect. Using self-assembled nucleic acid nanoparticles a single uniform population in size and shape having a precisely controlled spatial orientation and density of cancer-targeting ligands for enhanced delivery. As a non-limiting example, oligonucleotide nanoparticles were prepared using programmable self-assembly of short DNA fragments and therapeutic siRNAs. These nanoparticles are molecularly identical with controllable particle size and target ligand location and density. The DNA fragments and siRNAs self-assembled into a one-step reaction to generate DNA/siRNA tetrahedral nanoparticles for targeted *in vivo* delivery. (Lee et al, Nature Nanotechnology 2012 7:389-393; herein incorporated by reference in its entirety).

[000687] In one embodiment, the polynucleotides, primary constructs and/or mmRNA disclosed herein may be formulated as self-assembled nanoparticles. As a non-limiting example, nucleic acids may be used to make nanoparticles which may be used in a delivery system for the polynucleotides, primary constructs and/or mmRNA of the present invention (See e.g., International Pub. No. WO2012125987; herein incorporated by reference in its entirety).

[000688] In one embodiment, the nucleic acid self-assembled nanoparticles may comprise a core of the polynucleotides, primary constructs or mmRNA disclosed herein and a polymer shell. The polymer shell may be any of the polymers described herein and are known in the art. In an additional embodiment, the polymer shell may be used to protect the polynucleotides, primary constructs and mmRNA in the core.

Polymer-Based Self-Assembled Nanoparticles

[000689] Polymers may be used to form sheets which self-assembled into nanoparticles. These nanoparticles may be used to deliver the polynucleotides, primary constructs and mmRNA of the present invention. In one embodiment, these self-assembled nanoparticles may be microsponges formed of long polymers of RNA hairpins which form into crystalline 'pleated' sheets before self-assembling into microsponges. These microsponges are densely-packed sponge like microparticles which may function as an efficient carrier and may be able to deliver cargo to a cell. The microsponges may be from 100 nm to 300 nm in diameter. The microsponges may be complexed with other

agents known in the art to form larger microsponges. As a non-limiting example, the micro sponge may be complexed with an agent to form an outer layer to promote cellular uptake such as polycation polyethyleneimine (PEI). This complex can form a 250-nm diameter particle that can remain stable at high temperatures (150°C) (Grabow and Jaegar, *Nature Materials* 2012, 11:269-269; herein incorporated by reference in its entirety). Additionally these microsponges may be able to exhibit an extraordinary degree of protection from degradation by ribonucleases.

[000690] In another embodiment, the polymer-based self-assembled nanoparticles such as, but not limited to, microsponges, may be fully programmable nanoparticles. The geometry, size and stoichiometry of the nanoparticle may be precisely controlled to create the optimal nanoparticle for delivery of cargo such as, but not limited to, polynucleotides, primary constructs and/or mmRNA.

[000691] In one embodiment, the polymer based nanoparticles may comprise a core of the polynucleotides, primary constructs and/or mmRNA disclosed herein and a polymer shell. The polymer shell may be any of the polymers described herein and are known in the art. In an additional embodiment, the polymer shell may be used to protect the polynucleotides, primary construct and/or mmRNA in the core.

[000692] In yet another embodiment, the polymer based nanoparticle may comprise a non-nucleic acid polymer comprising a plurality of heterogenous monomers such as those described in Interantional Publication No. WO20 13009736, herein incorporated by reference in its entirety.

Inorganic Nanoparticles

[000693] The polynucleotides, primary constructs and/or mmRNAs of the present invention may be formulated in inorganic nanoparticles (U.S. Pat. No. 8,257,745, herein incorporated by reference in its entirety). The inorganic nanoparticles may include, but are not limited to, clay substances that are water swellable. As a non-limiting example, the inorganic nanoparticle may include synthetic smectite clays which are made from simple silicates (See e.g., U.S. Pat. No. 5,585,108 and 8,257,745 each of which are herein incorporated by reference in their entirety).

[000694] In one embodiment, the inorganic nanoparticles may comprise a core of the modified nucleic acids disclosed herein and a polymer shell. The polymer shell may be

any of the polymers described herein and are known in the art. In an additional embodiment, the polymer shell may be used to protect the modified nucleic acids in the core.

Semi-conductive and Metallic Nanoparticles

[000695] The polynucleotides, primary constructs and/or mmRNAs of the present invention may be formulated in water-dispersible nanoparticle comprising a semiconductive or metallic material (U.S. Pub. No. 20120228565; herein incorporated by reference in its entirety) or formed in a magnetic nanoparticle (U.S. Pub. No. 20120265001 and 20120283503; each of which is herein incorporated by reference in its entirety). The water-dispersible nanoparticles may be hydrophobic nanoparticles or hydrophilic nanoparticles.

[000696] In one embodiment, the semi-conductive and/or metallic nanoparticles may comprise a core of the polynucleotides, primary constructs and/or mmRNA disclosed herein and a polymer shell. The polymer shell may be any of the polymers described herein and are known in the art. In an additional embodiment, the polymer shell may be used to protect the polynucleotides, primary constructs and/or mmRNA in the core.

Gels and Hydrogels

[000697] In one embodiment, the polynucleotides, primary constructs and/or mmRNA disclosed herein may be encapsulated into any hydrogel known in the art which may form a gel when injected into a subject. Hydrogels are a network of polymer chains that are hydrophilic, and are sometimes found as a colloidal gel in which water is the dispersion medium. Hydrogels are highly absorbent (they can contain over 99% water) natural or synthetic polymers. Hydrogels also possess a degree of flexibility very similar to natural tissue, due to their significant water content. The hydrogel described herein may be used to encapsulate lipid nanoparticles which are biocompatible, biodegradable and/or porous.

[000698] As a non-limiting example, the hydrogel may be an aptamer-functionalized hydrogel. The aptamer-functionalized hydrogel may be programmed to release one or more polynucleotides, primary constructs and/or mmRNA using nucleic acid hybridization. (Battig et al, J. Am. Chem. Society. 2012 134:12410-12413; herein incorporated by reference in its entirety).

[000699] As another non-limiting example, the hydrogel may be shaped as an inverted opal.

The opal hydrogels exhibit higher swelling ratios and the swelling kinetics is an order of magnitude faster as well. Methods of producing opal hydrogels and description of opal hydrogels are described in International Pub. No. WO2012148684, herein incorporated by reference in its entirety.

[000700] In yet another non-limiting example, the hydrogel may be an antibacterial hydrogel. The antibacterial hydrogel may comprise a pharmaceutical acceptable salt or organic material such as, but not limited to pharmaceutical grade and/or medical grade silver salt and aloe vera gel or extract. (International Pub. No. WO2012151438, herein incorporated by reference in its entirety).

[000701] In one embodiment, the modified mRNA may be encapsulated in a lipid nanoparticle and then the lipid nanoparticle may be encapsulated into a hydrogel.

[000702] In one embodiment, the polynucleotides, primary constructs and/or mRNA disclosed herein may be encapsulated into any gel known in the art. As a non-limiting example the gel may be a fluorouracil injectable gel or a fluorouracil injectable gel containing a chemical compound and/or drug known in the art. As another example, the polynucleotides, primary constructs and/or mRNA may be encapsulated in a fluorouracil gel containing epinephrine (See e.g., Smith et al. Cancer Chemotherapy and Pharmacology, 1999 44(4):267-274; herein incorporated by reference in its entirety).

[000703] In one embodiment, the polynucleotides, primary constructs and/or mRNA disclosed herein may be encapsulated into a fibrin gel, fibrin hydrogel or fibrin glue. In another embodiment, the polynucleotides, primary constructs and/or mRNA may be formulated in a lipid nanoparticle or a rapidly eliminated lipid nanoparticle prior to being encapsulated into a fibrin gel, fibrin hydrogel or a fibrin glue. In yet another embodiment, the polynucleotides, primary constructs and/or mRNA may be formulated as a lipoplex prior to being encapsulated into a fibrin gel, hydrogel or a fibrin glue.

Fibrin gels, hydrogels and glues comprise two components, a fibrinogen solution and a thrombin solution which is rich in calcium (See e.g., Spicer and Mikos, Journal of Controlled Release 2010. 148: 49-55; Kidd et al. Journal of Controlled Release 2012. 157:80-85; each of which is herein incorporated by reference in its entirety). The

concentration of the components of the fibrin gel, hydrogel and/or glue can be altered to change the characteristics, the network mesh size, and/or the degradation characteristics of the gel, hydrogel and/or glue such as, but not limited to changing the release characteristics of the fibrin gel, hydrogel and/or glue. (See e.g., Spicer and Mikos, *Journal of Controlled Release* 2010. 148: 49-55; Kidd et al. *Journal of Controlled Release* 2012. 157:80-85; Catelas et al. *Tissue Engineering* 2008. 14:1 19-128; each of which is herein incorporated by reference in its entirety). This feature may be advantageous when used to deliver the modified mRNA disclosed herein. (See e.g., Kidd et al. *Journal of Controlled Release* 2012. 157:80-85; Catelas et al. *Tissue Engineering* 2008. 14:1 19-128; each of which is herein incorporated by reference in its entirety).

Cations and Anions

[000704] Formulations of polynucleotides, primary constructs and/or mmRNA disclosed herein may include cations or anions. In one embodiment, the formulations include metal cations such as, but not limited to, Zn²⁺, Ca²⁺, Cu²⁺, Mg⁺ and combinations thereof. As a non-limiting example, formulations may include polymers and a polynucleotides, primary constructs and/or mmRNA complexed with a metal cation (See e.g., U.S. Pat. Nos. 6,265,389 and 6,555,525, each of which is herein incorporated by reference in its entirety).

Molded Nanoparticles and Microparticles

[000705] The polynucleotides, primary constructs and/or mmRNA disclosed herein may be formulated in nanoparticles and/or microparticles. These nanoparticles and/or microparticles may be molded into any size shape and chemistry. As an example, the nanoparticles and/or microparticles may be made using the PRINT® technology by LIQUIDA TECHNOLOGIES® (Morrisville, NC) (See e.g., International Pub. No. WO2007024323; herein incorporated by reference in its entirety).

[000706] In one embodiment, the molded nanoparticles may comprise a core of the polynucleotides, primary constructs and/or mmRNA disclosed herein and a polymer shell. The polymer shell may be any of the polymers described herein and are known in the art. In an additional embodiment, the polymer shell may be used to protect the polynucleotides, primary construct and/or mmRNA in the core.

NanoJackets and NanoLiposomes

[000707] The polynucleotides, primary constructs and/or mmRNA disclosed herein may be formulated in NanoJackets and NanoLiposomes by Keystone Nano (State College, PA). NanoJackets are made of compounds that are naturally found in the body including calcium, phosphate and may also include a small amount of silicates. Nanojackets may range in size from 5 to 50 nm and may be used to deliver hydrophilic and hydrophobic compounds such as, but not limited to, polynucleotides, primary constructs and/or mmRNA.

[000708] NanoLiposomes are made of lipids such as, but not limited to, lipids which naturally occur in the body. NanoLiposomes may range in size from 60-80 nm and may be used to deliver hydrophilic and hydrophobic compounds such as, but not limited to, polynucleotides, primary constructs and/or mmRNA. In one aspect, the polynucleotides, primary constructs and/or mmRNA disclosed herein are formulated in a NanoLiposome such as, but not limited to, Ceramide NanoLiposomes.

Excipients

[000709] Pharmaceutical formulations may additionally comprise a pharmaceutically acceptable excipient, which, as used herein, includes any and all solvents, dispersion media, diluents, or other liquid vehicles, dispersion or suspension aids, surface active agents, isotonic agents, thickening or emulsifying agents, preservatives, solid binders, lubricants and the like, as suited to the particular dosage form desired. Remington's *The Science and Practice of Pharmacy*, 21st Edition, A. R. Gennaro (Lippincott, Williams & Wilkins, Baltimore, MD, 2006; incorporated herein by reference in its entirety) discloses various excipients used in formulating pharmaceutical compositions and known techniques for the preparation thereof. Except insofar as any conventional excipient medium is incompatible with a substance or its derivatives, such as by producing any undesirable biological effect or otherwise interacting in a deleterious manner with any other component(s) of the pharmaceutical composition, its use is contemplated to be within the scope of this invention.

[000710] In some embodiments, a pharmaceutically acceptable excipient is at least 95%, at least 96%, at least 97%, at least 98%, at least 99%, or 100% pure. In some embodiments, an excipient is approved for use in humans and for veterinary use. In some embodiments, an excipient is approved by United States Food and Drug Administration.

In some embodiments, an excipient is pharmaceutical grade. In some embodiments, an excipient meets the standards of the United States Pharmacopoeia (USP), the European Pharmacopoeia (EP), the British Pharmacopoeia, and/or the International Pharmacopoeia.

[000711] Pharmaceutically acceptable excipients used in the manufacture of pharmaceutical compositions include, but are not limited to, inert diluents, dispersing and/or granulating agents, surface active agents and/or emulsifiers, disintegrating agents, binding agents, preservatives, buffering agents, lubricating agents, and/or oils. Such excipients may optionally be included in pharmaceutical compositions.

[000712] Exemplary diluents include, but are not limited to, calcium carbonate, sodium carbonate, calcium phosphate, dicalcium phosphate, calcium sulfate, calcium hydrogen phosphate, sodium phosphate lactose, sucrose, cellulose, microcrystalline cellulose, kaolin, mannitol, sorbitol, inositol, sodium chloride, dry starch, cornstarch, powdered sugar, *etc.*, and/or combinations thereof.

[000713] Exemplary granulating and/or dispersing agents include, but are not limited to, potato starch, corn starch, tapioca starch, sodium starch glycolate, clays, alginic acid, guar gum, citrus pulp, agar, bentonite, cellulose and wood products, natural sponge, cation-exchange resins, calcium carbonate, silicates, sodium carbonate, cross-linked poly(vinyl-pyrrolidone) (crospovidone), sodium carboxymethyl starch (sodium starch glycolate), carboxymethyl cellulose, cross-linked sodium carboxymethyl cellulose (croscarmellose), methylcellulose, pregelatinized starch (starch 1500), microcrystalline starch, water insoluble starch, calcium carboxymethyl cellulose, magnesium aluminum silicate (VEEGUM[®]), sodium lauryl sulfate, quaternary ammonium compounds, *etc.*, and/or combinations thereof.

[000714] Exemplary surface active agents and/or emulsifiers include, but are not limited to, natural emulsifiers (e.g. acacia, agar, alginic acid, sodium alginate, tragacanth, chondrux, cholesterol, xanthan, pectin, gelatin, egg yolk, casein, wool fat, cholesterol, wax, and lecithin), colloidal clays (e.g. bentonite [aluminum silicate] and VEEGUM[®] [magnesium aluminum silicate]), long chain amino acid derivatives, high molecular weight alcohols (e.g. stearyl alcohol, cetyl alcohol, oleyl alcohol, triacetin monostearate, ethylene glycol distearate, glyceryl monostearate, and propylene glycol monostearate, polyvinyl alcohol), carbomers (e.g. carboxy polymethylene, polyacrylic acid, acrylic acid

polymer, and carboxyvinyl polymer), carrageenan, cellulosic derivatives (e.g. carboxymethylcellulose sodium, powdered cellulose, hydroxymethyl cellulose, hydroxypropyl cellulose, hydroxypropyl methylcellulose, methylcellulose), sorbitan fatty acid esters (e.g. polyoxyethylene sorbitan monolaurate [TWEEN[®]20], polyoxyethylene sorbitan [TWEENn[®]60], polyoxyethylene sorbitan monooleate [TWEEN[®]80], sorbitan monopalmitate [SPAN[®]40], sorbitan monostearate [SPAN[®]60], sorbitan tristearate [SPAN[®]65], glyceryl monooleate, sorbitan monooleate [SPAN[®]80]), polyoxyethylene esters (e.g. polyoxyethylene monostearate [MYRJ[®]45], polyoxyethylene hydrogenated castor oil, polyethoxylated castor oil, polyoxymethylene stearate, and SOLUTOL[®]), sucrose fatty acid esters, polyethylene glycol fatty acid esters (e.g. CREMOPHOR[®]), polyoxyethylene ethers, (e.g. polyoxyethylene lauryl ether [BRIJ[®]30]), poly(vinyl-pyrrolidone), diethylene glycol monolaurate, triethanolamine oleate, sodium oleate, potassium oleate, ethyl oleate, oleic acid, ethyl laurate, sodium lauryl sulfate, PLUORINC[®]F 68, POLOXAMER[®]188, cetrimonium bromide, cetylpyridinium chloride, benzalkonium chloride, docusate sodium, etc. and/or combinations thereof.

[000715] Exemplary binding agents include, but are not limited to, starch (*e.g.* cornstarch and starch paste); gelatin; sugars (*e.g.* sucrose, glucose, dextrose, dextrin, molasses, lactose, lactitol, mannitol,); natural and synthetic gums (*e.g.* acacia, sodium alginate, extract of Irish moss, panwar gum, ghatti gum, mucilage of isapol husks, carboxymethylcellulose, methylcellulose, ethylcellulose, hydroxyethylcellulose, hydroxypropyl cellulose, hydroxypropyl methylcellulose, microcrystalline cellulose, cellulose acetate, poly(vinyl-pyrrolidone), magnesium aluminum silicate (Veegum[®]), and larch arabogalactan); alginates; polyethylene oxide; polyethylene glycol; inorganic calcium salts; silicic acid; polymethacrylates; waxes; water; alcohol; *etc.*; and combinations thereof.

[000716] Exemplary preservatives may include, but are not limited to, antioxidants, chelating agents, antimicrobial preservatives, antifungal preservatives, alcohol preservatives, acidic preservatives, and/or other preservatives. Exemplary antioxidants include, but are not limited to, alpha tocopherol, ascorbic acid, acorbyl palmitate, butylated hydroxyanisole, butylated hydroxytoluene, monothioglycerol, potassium metabisulfite, propionic acid, propyl gallate, sodium ascorbate, sodium bisulfite, sodium

metabisulfite, and/or sodium sulfite. Exemplary chelating agents include ethylenediaminetetraacetic acid (EDTA), citric acid monohydrate, disodium edetate, dipotassium edetate, edetic acid, fumaric acid, malic acid, phosphoric acid, sodium edetate, tartaric acid, and/or trisodium edetate. Exemplary antimicrobial preservatives include, but are not limited to, benzalkonium chloride, benzethonium chloride, benzyl alcohol, bronopol, cetrimide, cetylpyridinium chloride, chlorhexidine, chlorobutanol, chlorocresol, chloroxylenol, cresol, ethyl alcohol, glycerin, hexetidine, imidurea, phenol, phenoxyethanol, phenylethyl alcohol, phenylmercuric nitrate, propylene glycol, and/or thimerosal. Exemplary antifungal preservatives include, but are not limited to, butyl paraben, methyl paraben, ethyl paraben, propyl paraben, benzoic acid, hydroxybenzoic acid, potassium benzoate, potassium sorbate, sodium benzoate, sodium propionate, and/or sorbic acid. Exemplary alcohol preservatives include, but are not limited to, ethanol, polyethylene glycol, phenol, phenolic compounds, bisphenol, chlorobutanol, hydroxybenzoate, and/or phenylethyl alcohol. Exemplary acidic preservatives include, but are not limited to, vitamin A, vitamin C, vitamin E, beta-carotene, citric acid, acetic acid, dehydroacetic acid, ascorbic acid, sorbic acid, and/or phytic acid. Other preservatives include, but are not limited to, tocopherol, tocopherol acetate, dextroxime mesylate, cetrimide, butylated hydroxyanisole (BHA), butylated hydroxytoluene (BHT), ethylenediamine, sodium lauryl sulfate (SLS), sodium lauryl ether sulfate (SLES), sodium bisulfite, sodium metabisulfite, potassium sulfite, potassium metabisulfite, GLYDANT PLUS[®], PHENONIP[®], methylparaben, GERMALL[®] 115, GERMABEN[®] II, NEOLONE[™], KATHON[™], and/or EUXYL[®].

[000717] Exemplary buffering agents include, but are not limited to, citrate buffer solutions, acetate buffer solutions, phosphate buffer solutions, ammonium chloride, calcium carbonate, calcium chloride, calcium citrate, calcium gluconate, calcium gluceptate, calcium gluconate, D-gluconic acid, calcium glycerophosphate, calcium lactate, propanoic acid, calcium levulinate, pentanoic acid, dibasic calcium phosphate, phosphoric acid, tribasic calcium phosphate, calcium hydroxide phosphate, potassium acetate, potassium chloride, potassium gluconate, potassium mixtures, dibasic potassium phosphate, monobasic potassium phosphate, potassium phosphate mixtures, sodium acetate, sodium bicarbonate, sodium chloride, sodium citrate, sodium lactate, dibasic

sodium phosphate, monobasic sodium phosphate, sodium phosphate mixtures, tromethamine, magnesium hydroxide, aluminum hydroxide, alginic acid, pyrogen-free water, isotonic saline, Ringer's solution, ethyl alcohol, *etc.*, and/or combinations thereof.

[000718] Exemplary lubricating agents include, but are not limited to, magnesium stearate, calcium stearate, stearic acid, silica, talc, malt, glyceryl behanate, hydrogenated vegetable oils, polyethylene glycol, sodium benzoate, sodium acetate, sodium chloride, leucine, magnesium lauryl sulfate, sodium lauryl sulfate, *etc.*, and combinations thereof.

[000719] Exemplary oils include, but are not limited to, almond, apricot kernel, avocado, babassu, bergamot, black current seed, borage, cade, camomile, canola, caraway, carnauba, castor, cinnamon, cocoa butter, coconut, cod liver, coffee, corn, cotton seed, emu, eucalyptus, evening primrose, fish, flaxseed, geraniol, gourd, grape seed, hazel nut, hyssop, isopropyl myristate, jojoba, kukui nut, lavandin, lavender, lemon, litsea cubeba, macademia nut, mallow, mango seed, meadowfoam seed, mink, nutmeg, olive, orange, orange roughy, palm, palm kernel, peach kernel, peanut, poppy seed, pumpkin seed, rapeseed, rice bran, rosemary, safflower, sandalwood, sasquana, savoury, sea buckthorn, sesame, shea butter, silicone, soybean, sunflower, tea tree, thistle, tsubaki, vetiver, walnut, and wheat germ oils. Exemplary oils include, but are not limited to, butyl stearate, caprylic triglyceride, capric triglyceride, cyclomethicone, diethyl sebacate, dimethicone 360, isopropyl myristate, mineral oil, octyldodecanol, oleyl alcohol, silicone oil, and/or combinations thereof.

[000720] Excipients such as cocoa butter and suppository waxes, coloring agents, coating agents, sweetening, flavoring, and/or perfuming agents can be present in the composition, according to the judgment of the formulator.

Delivery

[000721] The present disclosure encompasses the delivery of polynucleotides, primary constructs or mmRNA for any of therapeutic, pharmaceutical, diagnostic or imaging by any appropriate route taking into consideration likely advances in the sciences of drug delivery. Delivery may be naked or formulated.

Naked Delivery

[000722] The polynucleotides, primary constructs or mmRNA of the present invention may be delivered to a cell naked. As used herein in, "naked" refers to delivering

polynucleotides, primary constructs or mmRNA free from agents which promote transfection. For example, the polynucleotides, primary constructs or mmRNA delivered to the cell may contain no modifications. The naked polynucleotides, primary constructs or mmRNA may be delivered to the cell using routes of administration known in the art and described herein.

Formulated Delivery

[000723] The polynucleotides, primary constructs or mmRNA of the present invention may be formulated, using the methods described herein. The formulations may contain polynucleotides, primary constructs or mmRNA which may be modified and/or unmodified. The formulations may further include, but are not limited to, cell penetration agents, a pharmaceutically acceptable carrier, a delivery agent, a bioerodible or biocompatible polymer, a solvent, and a sustained-release delivery depot. The formulated polynucleotides, primary constructs or mmRNA may be delivered to the cell using routes of administration known in the art and described herein.

[000724] The compositions may also be formulated for direct delivery to an organ or tissue in any of several ways in the art including, but not limited to, direct soaking or bathing, via a catheter, by gels, powder, ointments, creams, gels, lotions, and/or drops, by using substrates such as fabric or biodegradable materials coated or impregnated with the compositions, and the like.

Administration

[000725] The polynucleotides, primary constructs or mmRNA of the present invention may be administered by any route which results in a therapeutically effective outcome. These include, but are not limited to enteral, gastroenteral, epidural, oral, transdermal, epidural (peridural), intracerebral (into the cerebrum), intracerebroventricular (into the cerebral ventricles), epicutaneous (application onto the skin), intradermal, (into the skin itself), subcutaneous (under the skin), nasal administration (through the nose), intravenous (into a vein), intraarterial (into an artery), intramuscular (into a muscle), intracardiac (into the heart), intraosseous infusion (into the bone marrow), intrathecal (into the spinal canal), intraperitoneal, (infusion or injection into the peritoneum), intravesical infusion, intravitreal, (through the eye), intracavernous injection, (into the base of the penis), intravaginal administration, intrauterine, extra-amniotic

administration, transdermal (diffusion through the intact skin for systemic distribution), transmucosal (diffusion through a mucous membrane), insufflation (snorting), sublingual, sublabial, enema, eye drops (onto the conjunctiva), or in ear drops. In specific embodiments, compositions may be administered in a way which allows them cross the blood-brain barrier, vascular barrier, or other epithelial barrier. Non-limiting routes of administration for the polynucleotides, primary constructs or mmRNA of the present invention are described below.

Parenteral and Injectable Administration

[000726] Liquid dosage forms for parenteral administration include, but are not limited to, pharmaceutically acceptable emulsions, microemulsions, solutions, suspensions, syrups, and/or elixirs. In addition to active ingredients, liquid dosage forms may comprise inert diluents commonly used in the art such as, for example, water or other solvents, solubilizing agents and emulsifiers such as ethyl alcohol, isopropyl alcohol, ethyl carbonate, ethyl acetate, benzyl alcohol, benzyl benzoate, propylene glycol, 1,3-butylene glycol, dimethylformamide, oils (in particular, cottonseed, groundnut, corn, germ, olive, castor, and sesame oils), glycerol, tetrahydrofurfuryl alcohol, polyethylene glycols and fatty acid esters of sorbitan, and mixtures thereof. Besides inert diluents, oral compositions can include adjuvants such as wetting agents, emulsifying and suspending agents, sweetening, flavoring, and/or perfuming agents. In certain embodiments for parenteral administration, compositions are mixed with solubilizing agents such as CREMOPHOR[®], alcohols, oils, modified oils, glycols, polysorbates, cyclodextrins, polymers, and/or combinations thereof.

[000727] Injectable preparations, for example, sterile injectable aqueous or oleaginous suspensions may be formulated according to the known art using suitable dispersing agents, wetting agents, and/or suspending agents. Sterile injectable preparations may be sterile injectable solutions, suspensions, and/or emulsions in nontoxic parenterally acceptable diluents and/or solvents, for example, as a solution in 1,3-butanediol. Among the acceptable vehicles and solvents that may be employed are water, Ringer's solution, U.S.P., and isotonic sodium chloride solution. Sterile, fixed oils are conventionally employed as a solvent or suspending medium. For this purpose any bland fixed oil can

be employed including synthetic mono- or diglycerides. Fatty acids such as oleic acid can be used in the preparation of injectables.

[000728] Injectable formulations can be sterilized, for example, by filtration through a bacterial-retaining filter, and/or by incorporating sterilizing agents in the form of sterile solid compositions which can be dissolved or dispersed in sterile water or other sterile injectable medium prior to use.

[000729] In order to prolong the effect of an active ingredient, it is often desirable to slow the absorption of the active ingredient from subcutaneous or intramuscular injection. This may be accomplished by the use of a liquid suspension of crystalline or amorphous material with poor water solubility. The rate of absorption of the drug then depends upon its rate of dissolution which, in turn, may depend upon crystal size and crystalline form. Alternatively, delayed absorption of a parenterally administered drug form is accomplished by dissolving or suspending the drug in an oil vehicle. Injectable depot forms are made by forming microcapsule matrices of the drug in biodegradable polymers such as polylactide-polyglycolide. Depending upon the ratio of drug to polymer and the nature of the particular polymer employed, the rate of drug release can be controlled. Examples of other biodegradable polymers include poly(orthoesters) and poly(anhydrides). Depot injectable formulations are prepared by entrapping the drug in liposomes or microemulsions which are compatible with body tissues.

Rectal and Vaginal Administration

[000730] Compositions for rectal or vaginal administration are typically suppositories which can be prepared by mixing compositions with suitable non-irritating excipients such as cocoa butter, polyethylene glycol or a suppository wax which are solid at ambient temperature but liquid at body temperature and therefore melt in the rectum or vaginal cavity and release the active ingredient.

Oral Administration

[000731] Liquid dosage forms for oral administration include, but are not limited to, pharmaceutically acceptable emulsions, microemulsions, solutions, suspensions, syrups, and/or elixirs. In addition to active ingredients, liquid dosage forms may comprise inert diluents commonly used in the art such as, for example, water or other solvents, solubilizing agents and emulsifiers such as ethyl alcohol, isopropyl alcohol, ethyl

carbonate, ethyl acetate, benzyl alcohol, benzyl benzoate, propylene glycol, 1,3-butylene glycol, dimethylformamide, oils (in particular, cottonseed, groundnut, corn, germ, olive, castor, and sesame oils), glycerol, tetrahydrofurfuryl alcohol, polyethylene glycols and fatty acid esters of sorbitan, and mixtures thereof. Besides inert diluents, oral compositions can include adjuvants such as wetting agents, emulsifying and suspending agents, sweetening, flavoring, and/or perfuming agents. In certain embodiments for parenteral administration, compositions are mixed with solubilizing agents such as CREMOPHOR[®], alcohols, oils, modified oils, glycols, polysorbates, cyclodextrins, polymers, and/or combinations thereof.

[000732] Solid dosage forms for oral administration include capsules, tablets, pills, powders, and granules. In such solid dosage forms, an active ingredient is mixed with at least one inert, pharmaceutically acceptable excipient such as sodium citrate or dicalcium phosphate and/or fillers or extenders (*e.g.* starches, lactose, sucrose, glucose, mannitol, and silicic acid), binders (*e.g.* carboxymethylcellulose, alginates, gelatin, polyvinylpyrrolidone, sucrose, and acacia), humectants (*e.g.* glycerol), disintegrating agents (*e.g.* agar, calcium carbonate, potato or tapioca starch, alginic acid, certain silicates, and sodium carbonate), solution retarding agents (*e.g.* paraffin), absorption accelerators (*e.g.* quaternary ammonium compounds), wetting agents (*e.g.* cetyl alcohol and glycerol monostearate), absorbents (*e.g.* kaolin and bentonite clay), and lubricants (*e.g.* talc, calcium stearate, magnesium stearate, solid polyethylene glycols, sodium lauryl sulfate), and mixtures thereof. In the case of capsules, tablets and pills, the dosage form may comprise buffering agents.

Topical or Transdermal Administration

[000733] As described herein, compositions containing the polynucleotides, primary constructs or mmRNA of the invention may be formulated for administration topically. The skin may be an ideal target site for delivery as it is readily accessible. Gene expression may be restricted not only to the skin, potentially avoiding nonspecific toxicity, but also to specific layers and cell types within the skin.

[000734] The site of cutaneous expression of the delivered compositions will depend on the route of nucleic acid delivery. Three routes are commonly considered to deliver polynucleotides, primary constructs or mmRNA to the skin: (i) topical application (*e.g.*

for local/regional treatment and/or cosmetic applications); (ii) intradermal injection (e.g. for local/regional treatment and/or cosmetic applications); and (iii) systemic delivery (e.g. for treatment of dermatologic diseases that affect both cutaneous and extracutaneous regions). Polynucleotides, primary constructs or mmRNA can be delivered to the skin by several different approaches known in the art. Most topical delivery approaches have been shown to work for delivery of DNA, such as but not limited to, topical application of non-cationic liposome-DNA complex, cationic liposome-DNA complex, particle-mediated (gene gun), puncture-mediated gene transfections, and viral delivery approaches. After delivery of the nucleic acid, gene products have been detected in a number of different skin cell types, including, but not limited to, basal keratinocytes, sebaceous gland cells, dermal fibroblasts and dermal macrophages.

[000735] In one embodiment, the invention provides for a variety of dressings (e.g., wound dressings) or bandages (e.g., adhesive bandages) for conveniently and/or effectively carrying out methods of the present invention. Typically dressing or bandages may comprise sufficient amounts of pharmaceutical compositions and/or polynucleotides, primary constructs or mmRNA described herein to allow a user to perform multiple treatments of a subject(s).

[000736] In one embodiment, the invention provides for the polynucleotides, primary constructs or mmRNA compositions to be delivered in more than one injection.

[000737] In one embodiment, before topical and/or transdermal administration at least one area of tissue, such as skin, may be subjected to a device and/or solution which may increase permeability. In one embodiment, the tissue may be subjected to an abrasion device to increase the permeability of the skin (see U.S. Patent Publication No. 20080275468, herein incorporated by reference in its entirety). In another embodiment, the tissue may be subjected to an ultrasound enhancement device. An ultrasound enhancement device may include, but is not limited to, the devices described in U.S. Publication No. 20040236268 and U.S. Patent Nos. 6,491,657 and 6,234,990; each of which are herein incorporated by reference in their entireties. Methods of enhancing the permeability of tissue are described in U.S. Publication Nos. 20040171980 and 20040236268 and U.S. Pat. No. 6,190,315; each of which are herein incorporated by reference in their entireties.

[000738] In one embodiment, a device may be used to increase permeability of tissue before delivering formulations of modified mRNA described herein. The permeability of skin may be measured by methods known in the art and/or described in U.S. Patent No. 6,190,315, herein incorporated by reference in its entirety. As a non-limiting example, a modified mRNA formulation may be delivered by the drug delivery methods described in U.S. Patent No. 6,190,315, herein incorporated by reference in its entirety.

[000739] In another non-limiting example tissue may be treated with a eutectic mixture of local anesthetics (EMLA) cream before, during and/or after the tissue may be subjected to a device which may increase permeability. Katz et al. (Anesth Analg (2004); 98:371-76; herein incorporated by reference in its entirety) showed that using the EMLA cream in combination with a low energy, an onset of superficial cutaneous analgesia was seen as fast as 5 minutes after a pretreatment with a low energy ultrasound.

[000740] In one embodiment, enhancers may be applied to the tissue before, during, and/or after the tissue has been treated to increase permeability. Enhancers include, but are not limited to, transport enhancers, physical enhancers, and cavitation enhancers. Non-limiting examples of enhancers are described in U.S. Patent No. 6,190,315, herein incorporated by reference in its entirety.

[000741] In one embodiment, a device may be used to increase permeability of tissue before delivering formulations of modified mRNA described herein, which may further contain a substance that invokes an immune response. In another non-limiting example, a formulation containing a substance to invoke an immune response may be delivered by the methods described in U.S. Publication Nos. 20040171980 and 20040236268; each of which are herein incorporated by reference in their entireties.

[000742] Dosage forms for topical and/or transdermal administration of a composition may include ointments, pastes, creams, lotions, gels, powders, solutions, sprays, inhalants and/or patches. Generally, an active ingredient is admixed under sterile conditions with a pharmaceutically acceptable excipient and/or any needed preservatives and/or buffers as may be required.

[000743] Additionally, the present invention contemplates the use of transdermal patches, which often have the added advantage of providing controlled delivery of a compound to the body. Such dosage forms may be prepared, for example, by dissolving

and/or dispensing the compound in the proper medium. Alternatively or additionally, rate may be controlled by either providing a rate controlling membrane and/or by dispersing the compound in a polymer matrix and/or gel.

[000744] Formulations suitable for topical administration include, but are not limited to, liquid and/or semi liquid preparations such as liniments, lotions, oil in water and/or water in oil emulsions such as creams, ointments and/or pastes, and/or solutions and/or suspensions.

[000745] Topically-administrable formulations may, for example, comprise from about 0.1% to about 10% (w/w) active ingredient, although the concentration of active ingredient may be as high as the solubility limit of the active ingredient in the solvent. Formulations for topical administration may further comprise one or more of the additional ingredients described herein.

Depot Administration

[000746] As described herein, in some embodiments, the composition is formulated in depots for extended release. Generally, a specific organ or tissue (a "target tissue") is targeted for administration.

[000747] In some aspects of the invention, the polynucleotides, primary constructs or mmRNA are spatially retained within or proximal to a target tissue. Provided are method of providing a composition to a target tissue of a mammalian subject by contacting the target tissue (which contains one or more target cells) with the composition under conditions such that the composition, in particular the nucleic acid component(s) of the composition, is substantially retained in the target tissue, meaning that at least 10, 20, 30, 40, 50, 60, 70, 80, 85, 90, 95, 96, 97, 98, 99, 99.9, 99.99 or greater than 99.99% of the composition is retained in the target tissue. Advantageously, retention is determined by measuring the amount of the nucleic acid present in the composition that enters one or more target cells. For example, at least 1, 5, 10, 20, 30, 40, 50, 60, 70, 80, 85, 90, 95, 96, 97, 98, 99, 99.9, 99.99 or greater than 99.99% of the nucleic acids administered to the subject are present intracellularly at a period of time following administration. For example, intramuscular injection to a mammalian subject is performed using an aqueous composition containing a ribonucleic acid and a transfection reagent, and retention of the

composition is determined by measuring the amount of the ribonucleic acid present in the muscle cells.

[000748] Aspects of the invention are directed to methods of providing a composition to a target tissue of a mammalian subject, by contacting the target tissue (containing one or more target cells) with the composition under conditions such that the composition is substantially retained in the target tissue. The composition contains an effective amount of a polynucleotides, primary constructs or mmRNA such that the polypeptide of interest is produced in at least one target cell. The compositions generally contain a cell penetration agent, although "naked" nucleic acid (such as nucleic acids without a cell penetration agent or other agent) is also contemplated, and a pharmaceutically acceptable carrier.

[000749] In some circumstances, the amount of a protein produced by cells in a tissue is desirably increased. Preferably, this increase in protein production is spatially restricted to cells within the target tissue. Thus, provided are methods of increasing production of a protein of interest in a tissue of a mammalian subject. A composition is provided that contains polynucleotides, primary constructs or mmRNA characterized in that a unit quantity of composition has been determined to produce the polypeptide of interest in a substantial percentage of cells contained within a predetermined volume of the target tissue.

[000750] In some embodiments, the composition includes a plurality of different polynucleotides, primary constructs or mmRNA, where one or more than one of the polynucleotides, primary constructs or mmRNA encodes a polypeptide of interest. Optionally, the composition also contains a cell penetration agent to assist in the intracellular delivery of the composition. A determination is made of the dose of the composition required to produce the polypeptide of interest in a substantial percentage of cells contained within the predetermined volume of the target tissue (generally, without inducing significant production of the polypeptide of interest in tissue adjacent to the predetermined volume, or distally to the target tissue). Subsequent to this determination, the determined dose is introduced directly into the tissue of the mammalian subject.

[000751] In one embodiment, the invention provides for the polynucleotides, primary constructs or mmRNA to be delivered in more than one injection or by split dose injections.

[000752] In one embodiment, the invention may be retained near target tissue using a small disposable drug reservoir, patch pump or osmotic pump. Non-limiting examples of patch pumps include those manufactured and/or sold by BD® (Franklin Lakes, NJ), Insulet Corporation (Bedford, MA), SteadyMed Therapeutics (San Francisco, CA), Medtronic (Minneapolis, MN) (e.g., MiniMed), UniLife (York, PA), Valeritas (Bridgewater, NJ), and SpringLeaf Therapeutics (Boston, MA). A non-limiting example of an osmotic pump include those manufactured by DURECT® (Cupertino, CA) (e.g., DUROS® and ALZET®).

Pulmonary Administration

[000753] A pharmaceutical composition may be prepared, packaged, and/or sold in a formulation suitable for pulmonary administration via the buccal cavity. Such a formulation may comprise dry particles which comprise the active ingredient and which have a diameter in the range from about 0.5 nm to about 7 nm or from about 1 nm to about 6 nm. Such compositions are suitably in the form of dry powders for administration using a device comprising a dry powder reservoir to which a stream of propellant may be directed to disperse the powder and/or using a self propelling solvent/powder dispensing container such as a device comprising the active ingredient dissolved and/or suspended in a low-boiling propellant in a sealed container. Such powders comprise particles wherein at least 98% of the particles by weight have a diameter greater than 0.5 nm and at least 95% of the particles by number have a diameter less than 7 nm. Alternatively, at least 95% of the particles by weight have a diameter greater than 1 nm and at least 90% of the particles by number have a diameter less than 6 nm. Dry powder compositions may include a solid fine powder diluent such as sugar and are conveniently provided in a unit dose form.

[000754] Low boiling propellants generally include liquid propellants having a boiling point of below 65 °F at atmospheric pressure. Generally the propellant may constitute 50% to 99.9% (w/w) of the composition, and active ingredient may constitute 0.1% to 20% (w/w) of the composition. A propellant may further comprise additional ingredients

such as a liquid non-ionic and/or solid anionic surfactant and/or a solid diluent (which may have a particle size of the same order as particles comprising the active ingredient).

[000755] As a non-limiting example, the polynucleotides, primary constructs and/or mmRNA described herein may be formulated for pulmonary delivery by the methods described in U.S. Pat. No. 8,257,685; herein incorporated by reference in its entirety.

[000756] Pharmaceutical compositions formulated for pulmonary delivery may provide an active ingredient in the form of droplets of a solution and/or suspension. Such formulations may be prepared, packaged, and/or sold as aqueous and/or dilute alcoholic solutions and/or suspensions, optionally sterile, comprising active ingredient, and may conveniently be administered using any nebulization and/or atomization device. Such formulations may further comprise one or more additional ingredients including, but not limited to, a flavoring agent such as saccharin sodium, a volatile oil, a buffering agent, a surface active agent, and/or a preservative such as methylhydroxybenzoate. Droplets provided by this route of administration may have an average diameter in the range from about 0.1 nm to about 200 nm.

Intranasal, nasal and buccal Administration

[000757] Formulations described herein as being useful for pulmonary delivery are useful for intranasal delivery of a pharmaceutical composition. Another formulation suitable for intranasal administration is a coarse powder comprising the active ingredient and having an average particle from about 0.2 μm to 500 μm . Such a formulation is administered in the manner in which snuff is taken, *i.e.* by rapid inhalation through the nasal passage from a container of the powder held close to the nose.

[000758] Formulations suitable for nasal administration may, for example, comprise from about as little as 0.1% (w/w) and as much as 100% (w/w) of active ingredient, and may comprise one or more of the additional ingredients described herein. A pharmaceutical composition may be prepared, packaged, and/or sold in a formulation suitable for buccal administration. Such formulations may, for example, be in the form of tablets and/or lozenges made using conventional methods, and may, for example, 0.1% to 20% (w/w) active ingredient, the balance comprising an orally dissolvable and/or degradable composition and, optionally, one or more of the additional ingredients described herein. Alternately, formulations suitable for buccal administration may

comprise a powder and/or an aerosolized and/or atomized solution and/or suspension comprising active ingredient. Such powdered, aerosolized, and/or aerosolized formulations, when dispersed, may have an average particle and/or droplet size in the range from about 0.1 nm to about 200 nm, and may further comprise one or more of any additional ingredients described herein.

Ophthalmic Administration

[000759] A pharmaceutical composition may be prepared, packaged, and/or sold in a formulation suitable for ophthalmic administration. Such formulations may, for example, be in the form of eye drops including, for example, a 0.1/1.0% (w/w) solution and/or suspension of the active ingredient in an aqueous or oily liquid excipient. Such drops may further comprise buffering agents, salts, and/or one or more other of any additional ingredients described herein. Other ophthalmically-administrable formulations which are useful include those which comprise the active ingredient in microcrystalline form and/or in a liposomal preparation. Ear drops and/or eye drops are contemplated as being within the scope of this invention. A multilayer thin film device may be prepared to contain a pharmaceutical composition for delivery to the eye and/or surrounding tissue.

Payload Administration: Detectable Agents and Therapeutic Agents

[000760] The polynucleotides, primary constructs or mmRNA described herein can be used in a number of different scenarios in which delivery of a substance (the "payload") to a biological target is desired, for example delivery of detectable substances for detection of the target, or delivery of a therapeutic agent. Detection methods can include, but are not limited to, both imaging *in vitro* and *in vivo* imaging methods, *e.g.*, immunohistochemistry, bioluminescence imaging (BLI), Magnetic Resonance Imaging (MRI), positron emission tomography (PET), electron microscopy, X-ray computed tomography, Raman imaging, optical coherence tomography, absorption imaging, thermal imaging, fluorescence reflectance imaging, fluorescence microscopy, fluorescence molecular tomographic imaging, nuclear magnetic resonance imaging, X-ray imaging, ultrasound imaging, photoacoustic imaging, lab assays, or in any situation where tagging/staining/imaging is required.

[000761] The polynucleotides, primary constructs or mmRNA can be designed to include both a linker and a payload in any useful orientation. For example, a linker

having two ends is used to attach one end to the payload and the other end to the nucleobase, such as at the C-7 or C-8 positions of the deaza-adenosine or deaza-guanosine or to the N-3 or C-5 positions of cytosine or uracil. The polynucleotide of the invention can include more than one payload (e.g., a label and a transcription inhibitor), as well as a cleavable linker. In one embodiment, the modified nucleotide is a modified 7-deaza-adenosine triphosphate, where one end of a cleavable linker is attached to the C7 position of 7-deaza-adenine, the other end of the linker is attached to an inhibitor (e.g., to the C5 position of the nucleobase on a cytidine), and a label (e.g., Cy5) is attached to the center of the linker (see, e.g., compound 1 of A*pCp C5 Parg Capless in Fig. 5 and columns 9 and 10 of U.S. Pat. No. 7,994,304, incorporated herein by reference). Upon incorporation of the modified 7-deaza-adenosine triphosphate to an encoding region, the resulting polynucleotide having a cleavable linker attached to a label and an inhibitor (e.g., a polymerase inhibitor). Upon cleavage of the linker (e.g., with reductive conditions to reduce a linker having a cleavable disulfide moiety), the label and inhibitor are released. Additional linkers and payloads (e.g., therapeutic agents, detectable labels, and cell penetrating payloads) are described herein.

[000762] Scheme 12 below depicts an exemplary modified nucleotide wherein the nucleobase, adenine, is attached to a linker at the C-7 carbon of 7-deaza adenine. In addition, Scheme 12 depicts the modified nucleotide with the linker and payload, e.g., a detectable agent, incorporated onto the 3' end of the mRNA. Disulfide cleavage and 1,2-addition of the thiol group onto the propargyl ester releases the detectable agent. The remaining structure (depicted, for example, as pApC5Parg in Scheme 12) is the inhibitor. The rationale for the structure of the modified nucleotides is that the tethered inhibitor sterically interferes with the ability of the polymerase to incorporate a second base. Thus, it is critical that the tether be long enough to affect this function and that the inhibitor be in a stereochemical orientation that inhibits or prohibits second and follow on nucleotides into the growing polynucleotide strand.

Scheme 12

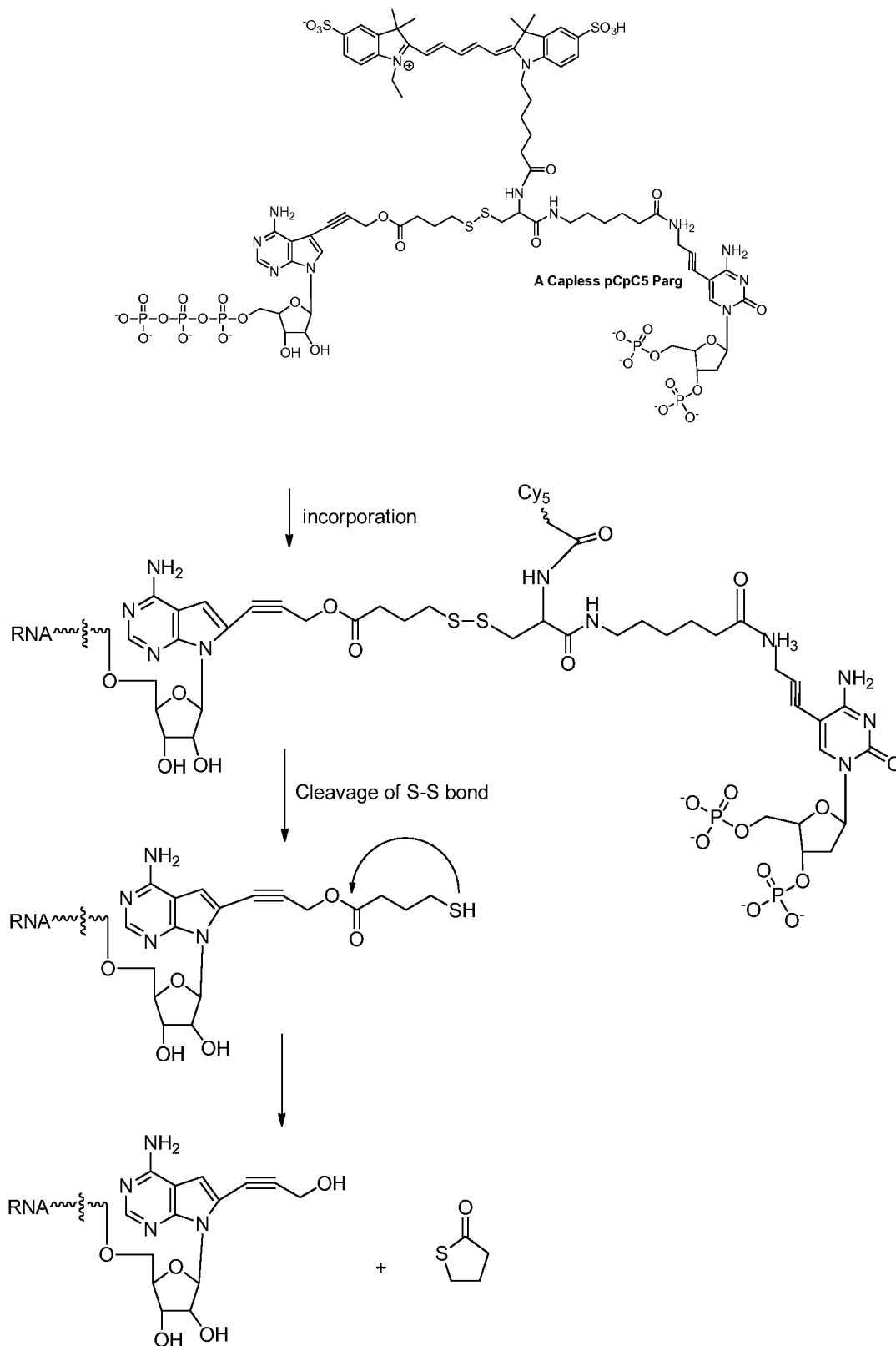

[000763] For example, the polynucleotides, primary constructs or mmRNA described herein can be used in reprogramming induced pluripotent stem cells (iPS cells), which

can directly track cells that are transfected compared to total cells in the cluster. In another example, a drug that may be attached to the polynucleotides, primary constructs or mmRNA via a linker and may be fluorescently labeled can be used to track the drug *in vivo*, *e.g.* intracellularly. Other examples include, but are not limited to, the use of a polynucleotides, primary constructs or mmRNA in reversible drug delivery into cells.

[000764] The polynucleotides, primary constructs or mmRNA described herein can be used in intracellular targeting of a payload, *e.g.*, detectable or therapeutic agent, to specific organelle. Exemplary intracellular targets can include, but are not limited to, the nuclear localization for advanced mRNA processing, or a nuclear localization sequence (NLS) linked to the mRNA containing an inhibitor.

[000765] In addition, the polynucleotides, primary constructs or mmRNA described herein can be used to deliver therapeutic agents to cells or tissues, *e.g.*, in living animals. For example, the polynucleotides, primary constructs or mmRNA described herein can be used to deliver highly polar chemotherapeutics agents to kill cancer cells. The polynucleotides, primary constructs or mmRNA attached to the therapeutic agent through a linker can facilitate member permeation allowing the therapeutic agent to travel into a cell to reach an intracellular target.

[000766] In one example, the linker is attached at the 2'-position of the ribose ring and/or at the 3' and/or 5' position of the polynucleotides, primary constructs mmRNA (See *e.g.*, International Pub. No. WO2012030683, herein incorporated by reference in its entirety). The linker may be any linker disclosed herein, known in the art and/or disclosed in International Pub. No. WO2012030683, herein incorporated by reference in its entirety.

[000767] In another example, the polynucleotides, primary constructs or mmRNA can be attached to the polynucleotides, primary constructs or mmRNA a viral inhibitory peptide (VIP) through a cleavable linker. The cleavable linker can release the VIP and dye into the cell. In another example, the polynucleotides, primary constructs or mmRNA can be attached through the linker to an ADP-ribosylate, which is responsible for the actions of some bacterial toxins, such as cholera toxin, diphtheria toxin, and pertussis toxin. These toxin proteins are ADP-ribosyltransferases that modify target proteins in human cells. For example, cholera toxin ADP-ribosylates G proteins modifies

human cells by causing massive fluid secretion from the lining of the small intestine, which results in life-threatening diarrhea.

[000768] In some embodiments, the payload may be a therapeutic agent such as a cytotoxin, radioactive ion, chemotherapeutic, or other therapeutic agent. A cytotoxin or cytotoxic agent includes any agent that may be detrimental to cells. Examples include, but are not limited to, taxol, cytochalasin B, gramicidin D, ethidium bromide, emetine, mitomycin, etoposide, teniposide, vincristine, vinblastine, colchicine, doxorubicin, daunorubicin, dihydroxyanthracenedione, mitoxantrone, mithramycin, actinomycin D, 1-dehydrotestosterone, glucocorticoids, procaine, tetracaine, lidocaine, propranolol, puromycin, maytansinoids, *e.g.*, maytansinol (see U.S. Pat. No. 5,208,020 incorporated herein in its entirety), rachelmycin (CC-1065, see U.S. Pat. Nos. 5,475,092, 5,585,499, and 5,846,545, all of which are incorporated herein by reference), and analogs or homologs thereof. Radioactive ions include, but are not limited to iodine (*e.g.*, iodine 125 or iodine 131), strontium 89, phosphorous, palladium, cesium, iridium, phosphate, cobalt, yttrium 90, samarium 153, and praseodymium. Other therapeutic agents include, but are not limited to, antimetabolites (*e.g.*, methotrexate, 6-mercaptopurine, 6-thioguanine, cytarabine, 5-fluorouracil decarbazine), alkylating agents (*e.g.*, mechlorethamine, thiotepa chlorambucil, rachelmycin (CC-1065), melphalan, carmustine (BSNU), lomustine (CCNU), cyclophosphamide, busulfan, dibromomannitol, streptozotocin, mitomycin C, and cis-dichlorodiamine platinum (II) (DDP) cisplatin), anthracyclines (*e.g.*, daunorubicin (formerly daunomycin) and doxorubicin), antibiotics (*e.g.*, dactinomycin (formerly actinomycin), bleomycin, mithramycin, and anthramycin (AMC)), and anti-mitotic agents (*e.g.*, vincristine, vinblastine, taxol and maytansinoids).

[000769] In some embodiments, the payload may be a detectable agent, such as various organic small molecules, inorganic compounds, nanoparticles, enzymes or enzyme substrates, fluorescent materials, luminescent materials (*e.g.*, luminol), bioluminescent materials (*e.g.*, luciferase, luciferin, and aequorin), chemiluminescent materials, radioactive materials (*e.g.*, ^{18}F , ^{67}Ga , $^{81\text{m}}\text{Kr}$, ^{82}Rb , ^{111}In , ^{123}I , ^{133}Xe , ^{201}Tl , ^{125}I , ^{35}S , ^{14}C , ^3H , or $^{99\text{m}}\text{Tc}$ (*e.g.*, as pertechnetate (technetate(VII), TcO_4^-)), and contrast agents (*e.g.*, gold (*e.g.*, gold nanoparticles), gadolinium (*e.g.*, chelated Gd), iron oxides (*e.g.*, superparamagnetic iron oxide (SPIO), monocrystalline iron oxide nanoparticles

(MIONs), and ultrasmall superparamagnetic iron oxide (USPIO)), manganese chelates (e.g., Mn-DPDP), barium sulfate, iodinated contrast media (iohexol), microbubbles, or perfluorocarbons). Such optically-detectable labels include for example, without limitation, 4-acetamido-4'-isothiocyanatostilbene-2,2'-disulfonic acid; acridine and derivatives (e.g., acridine and acridine isothiocyanate); 5-(2'-aminoethyl)aminonaphthalene-1-sulfonic acid (EDANS); 4-amino-N-[3-vinylsulfonyl]phenyl]naphthalimide-3,5-disulfonate; N-(4-anilino-1-naphthyl)maleimide; anthranilamide; BODIPY; Brilliant Yellow; coumarin and derivatives (e.g., coumarin, 7-amino-4-methylcoumarin (AMC, Coumarin 120), and 7-amino-4-trifluoromethylcoumarin (Coumarin 151)); cyanine dyes; cyanosine; 4',6-diaminidino-2-phenylindole (DAPI); 5'-5''-dibromopyrogallol-sulfonaphthalein (Bromopyrogallol Red); 7-diethylamino-3-(4'-isothiocyanatophenyl)-4-methylcoumarin; diethylenetriamine pentaacetate; 4,4'-diisothiocyanatodihydro-stilbene-2,2'-disulfonic acid; 4,4'-diisothiocyanatostilbene-2,2'-disulfonic acid; 5-[dimethylamino]-naphthalene-1-sulfonyl chloride (DNS, dansylchloride); 4-dimethylaminophenylazophenyl-4'-isothiocyanate (DABITC); eosin and derivatives (e.g., eosin and eosin isothiocyanate); erythrosin and derivatives (e.g., erythrosin B and erythrosin isothiocyanate); ethidium; fluorescein and derivatives (e.g., 5-carboxyfluorescein (FAM), 5-(4,6-dichlorotriazin-2-yl)amino fluorescein (DTAF), 2',7'-dimethoxy-4',5'-dichloro-6-carboxyfluorescein, fluorescein, fluorescein isothiocyanate, X-rhodamine-5-(and-6)-isothiocyanate (QFITC or XRITC), and fluorescamine); 2-[2-[3-[[1,3-dihydro-1,1-dimethyl-3-(3-sulfo-propyl)-2H-benz[e]indol-2-ylidene]ethylidene]-2-[4-(ethoxycarbonyl)-1-piperazinyl]-1-cyclopenten-1-yl]ethenyl]-1,1-dimethyl-3-(3-sulforpropyl)-1H-benz[e]indolium hydroxide, inner salt, compound with n,n-diethylethanamine(1:1) (IR144); 5-chloro-2-[2-[3-[(5-chloro-3-ethyl-2(3H)-benzothiazol-ylidene)ethylidene]-2-(diphenylamino)-1-cyclopenten-1-yl]ethenyl]-3-ethyl benzothiazolium perchlorate (IR140); Malachite Green isothiocyanate; 4-methylumbelliferone orthocresolphthalein; nitrotyrosine; pararosaniline; Phenol Red; B-phycoerythrin; o-phthaldialdehyde; pyrene and derivatives (e.g., pyrene, pyrene butyrate, and succinimidyl 1-pyrene); butyrate quantum dots; Reactive Red 4 (CIBACRON™ Brilliant Red 3B-A); rhodamine and derivatives (e.g., 6-carboxy-X-rhodamine (ROX), 6-carboxyrhodamine (R6G), lissamine rhodamine

B sulfonyl chloride rhodamine (Rhod), rhodamine B, rhodamine 123, rhodamine X isothiocyanate, sulforhodamine B, sulforhodamine 101, sulfonyl chloride derivative of sulforhodamine 101 (Texas Red), N,N,N',N' tetramethyl-6-carboxyrhodamine (TAMRA) tetramethyl rhodamine, and tetramethyl rhodamine isothiocyanate (TRITC)); riboflavin; rosolic acid; terbium chelate derivatives; Cyanine-3 (Cy3); Cyanine-5 (Cy5); cyanine-5.5 (Cy5.5), Cyanine-7 (Cy7); IRD 700; IRD 800; Alexa 647; La Jolla Blue; phthalocyanine; and naphthalocyanine.

[000770] In some embodiments, the detectable agent may be a non-detectable precursor that becomes detectable upon activation (e.g., fluorogenic tetrazine-fluorophore constructs (e.g., tetrazine-BODIPY FL, tetrazine-Oregon Green 488, or tetrazine-BODIPY TMR-X) or enzyme activatable fluorogenic agents (e.g., PROSENSE® (VisEn Medical))). In vitro assays in which the enzyme labeled compositions can be used include, but are not limited to, enzyme linked immunosorbent assays (ELISAs), immunoprecipitation assays, immunofluorescence, enzyme immunoassays (EIA), radioimmunoassays (RIA), and Western blot analysis.

Combinations

[000771] The polynucleotides, primary constructs or mmRNA may be used in combination with one or more other therapeutic, prophylactic, diagnostic, or imaging agents. By "in combination with," it is not intended to imply that the agents must be administered at the same time and/or formulated for delivery together, although these methods of delivery are within the scope of the present disclosure. Compositions can be administered concurrently with, prior to, or subsequent to, one or more other desired therapeutics or medical procedures. In general, each agent will be administered at a dose and/or on a time schedule determined for that agent. In some embodiments, the present disclosure encompasses the delivery of pharmaceutical, prophylactic, diagnostic, or imaging compositions in combination with agents that may improve their bioavailability, reduce and/or modify their metabolism, inhibit their excretion, and/or modify their distribution within the body. As a non-limiting example, the nucleic acids or mmRNA may be used in combination with a pharmaceutical agent for the treatment of cancer or to control hyperproliferative cells. In U.S. Pat. No. 7,964,571, herein incorporated by reference in its entirety, a combination therapy for the treatment of solid primary or

metastasized tumor is described using a pharmaceutical composition including a DNA plasmid encoding for interleukin-12 with a lipopolymer and also administering at least one anticancer agent or chemotherapeutic. Further, the nucleic acids and mmRNA of the present invention that encodes anti-proliferative molecules may be in a pharmaceutical composition with a lipopolymer (see e.g., U.S. Pub. No. 201 10218231, herein incorporated by reference in its entirety, claiming a pharmaceutical composition comprising a DNA plasmid encoding an anti-proliferative molecule and a lipopolymer) which may be administered with at least one chemotherapeutic or anticancer agent.

[000772] It will further be appreciated that therapeutically, prophylactically, diagnostically, or imaging active agents utilized in combination may be administered together in a single composition or administered separately in different compositions. In general, it is expected that agents utilized in combination will be utilized at levels that do not exceed the levels at which they are utilized individually. In some embodiments, the levels utilized in combination will be lower than those utilized individually. In one embodiment, the combinations, each or together may be administered according to the split dosing regimens described herein.

Dosing

[000773] The present invention provides methods comprising administering modified mRNAs and their encoded proteins or complexes in accordance with the invention to a subject in need thereof. Nucleic acids, proteins or complexes, or pharmaceutical, imaging, diagnostic, or prophylactic compositions thereof, may be administered to a subject using any amount and any route of administration effective for preventing, treating, diagnosing, or imaging a disease, disorder, and/or condition (*e.g.*, a disease, disorder, and/or condition relating to working memory deficits). The exact amount required will vary from subject to subject, depending on the species, age, and general condition of the subject, the severity of the disease, the particular composition, its mode of administration, its mode of activity, and the like. Compositions in accordance with the invention are typically formulated in dosage unit form for ease of administration and uniformity of dosage. It will be understood, however, that the total daily usage of the compositions of the present invention may be decided by the attending physician within the scope of sound medical judgment. The specific therapeutically effective,

prophylactically effective, or appropriate imaging dose level for any particular patient will depend upon a variety of factors including the disorder being treated and the severity of the disorder; the activity of the specific compound employed; the specific composition employed; the age, body weight, general health, sex and diet of the patient; the time of administration, route of administration, and rate of excretion of the specific compound employed; the duration of the treatment; drugs used in combination or coincidental with the specific compound employed; and like factors well known in the medical arts.

[000774] In certain embodiments, compositions in accordance with the present invention may be administered at dosage levels sufficient to deliver from about 0.0001 mg/kg to about 100 mg/kg, from about 0.001 mg/kg to about 0.05 mg/kg, from about 0.005 mg/kg to about 0.05 mg/kg, from about 0.001 mg/kg to about 0.005 mg/kg, from about 0.05 mg/kg to about 0.5 mg/kg, from about 0.01 mg/kg to about 50 mg/kg, from about 0.1 mg/kg to about 40 mg/kg, from about 0.5 mg/kg to about 30 mg/kg, from about 0.01 mg/kg to about 10 mg/kg, from about 0.1 mg/kg to about 10 mg/kg, or from about 1 mg/kg to about 25 mg/kg, of subject body weight per day, one or more times a day, to obtain the desired therapeutic, diagnostic, prophylactic, or imaging effect. The desired dosage may be delivered three times a day, two times a day, once a day, every other day, every third day, every week, every two weeks, every three weeks, or every four weeks. In certain embodiments, the desired dosage may be delivered using multiple administrations (*e.g.*, two, three, four, five, six, seven, eight, nine, ten, eleven, twelve, thirteen, fourteen, or more administrations). When multiple administrations are employed, split dosing regimens such as those described herein may be used.

[000775] According to the present invention, it has been discovered that administration of mmRNA in split-dose regimens produce higher levels of proteins in mammalian subjects. As used herein, a "split dose" is the division of single unit dose or total daily dose into two or more doses, *e.g.*, two or more administrations of the single unit dose. As used herein, a "single unit dose" is a dose of any therapeutic administered in one dose/at one time/single route/single point of contact, *i.e.*, single administration event. As used herein, a "total daily dose" is an amount given or prescribed in 24 hr period. It may be administered as a single unit dose. In one embodiment, the mmRNA of the present

invention are administered to a subject in split doses. The mmRNA may be formulated in buffer only or in a formulation described herein.

Dosage Forms

[000776] A pharmaceutical composition described herein can be formulated into a dosage form described herein, such as a topical, intranasal, intratracheal, or injectable (e.g., intravenous, intraocular, intravitreal, intramuscular, intracardiac, intraperitoneal, subcutaneous).

Liquid dosage forms

[000777] Liquid dosage forms for parenteral administration include, but are not limited to, pharmaceutically acceptable emulsions, microemulsions, solutions, suspensions, syrups, and/or elixirs. In addition to active ingredients, liquid dosage forms may comprise inert diluents commonly used in the art including, but not limited to, water or other solvents, solubilizing agents and emulsifiers such as ethyl alcohol, isopropyl alcohol, ethyl carbonate, ethyl acetate, benzyl alcohol, benzyl benzoate, propylene glycol, 1,3-butylene glycol, dimethylformamide, oils (in particular, cottonseed, groundnut, corn, germ, olive, castor, and sesame oils), glycerol, tetrahydrofurfuryl alcohol, polyethylene glycols and fatty acid esters of sorbitan, and mixtures thereof. In certain embodiments for parenteral administration, compositions may be mixed with solubilizing agents such as CREMOPHOR[®], alcohols, oils, modified oils, glycols, polysorbates, cyclodextrins, polymers, and/or combinations thereof.

Injectable

[000778] Injectable preparations, for example, sterile injectable aqueous or oleaginous suspensions may be formulated according to the known art and may include suitable dispersing agents, wetting agents, and/or suspending agents. Sterile injectable preparations may be sterile injectable solutions, suspensions, and/or emulsions in nontoxic parenterally acceptable diluents and/or solvents, for example, a solution in 1,3-butanediol. Among the acceptable vehicles and solvents that may be employed include, but are not limited to, water, Ringer's solution, U.S.P., and isotonic sodium chloride solution. Sterile, fixed oils are conventionally employed as a solvent or suspending medium. For this purpose any bland fixed oil can be employed including synthetic mono-

or diglycerides. Fatty acids such as oleic acid can be used in the preparation of injectables.

Injectable formulations can be sterilized, for example, by filtration through a bacterial-retaining filter, and/or by incorporating sterilizing agents in the form of sterile solid compositions which can be dissolved or dispersed in sterile water or other sterile injectable medium prior to use.

In order to prolong the effect of an active ingredient, it may be desirable to slow the absorption of the active ingredient from subcutaneous or intramuscular injection. This may be accomplished by the use of a liquid suspension of crystalline or amorphous material with poor water solubility. The rate of absorption of the polynucleotide, primary construct or mmRNA then depends upon its rate of dissolution which, in turn, may depend upon crystal size and crystalline form. Alternatively, delayed absorption of a parenterally administered polynucleotide, primary construct or mmRNA may be accomplished by dissolving or suspending the polynucleotide, primary construct or mmRNA in an oil vehicle. Injectable depot forms are made by forming microcapsule matrices of the polynucleotide, primary construct or mmRNA in biodegradable polymers such as polylactide-polyglycolide. Depending upon the ratio of polynucleotide, primary construct or mmRNA to polymer and the nature of the particular polymer employed, the rate of polynucleotide, primary construct or mmRNA release can be controlled. Examples of other biodegradable polymers include, but are not limited to, poly(orthoesters) and poly(anhydrides). Depot injectable formulations may be prepared by entrapping the polynucleotide, primary construct or mmRNA in liposomes or microemulsions which are compatible with body tissues.

Pulmonary

[000779] Formulations described herein as being useful for pulmonary delivery may also be used for intranasal delivery of a pharmaceutical composition. Another formulation suitable for intranasal administration may be a coarse powder comprising the active ingredient and having an average particle from about 0.2 μm to 500 μm . Such a formulation may be administered in the manner in which snuff is taken, i.e. by rapid inhalation through the nasal passage from a container of the powder held close to the nose.

[000780] Formulations suitable for nasal administration may, for example, comprise from about as little as 0.1% (w/w) and as much as 100% (w/w) of active ingredient, and may comprise one or more of the additional ingredients described herein. A pharmaceutical composition may be prepared, packaged, and/or sold in a formulation suitable for buccal administration. Such formulations may, for example, be in the form of tablets and/or lozenges made using conventional methods, and may, for example, contain about 0.1% to 20% (w/w) active ingredient, where the balance may comprise an orally dissolvable and/or degradable composition and, optionally, one or more of the additional ingredients described herein. Alternately, formulations suitable for buccal administration may comprise a powder and/or an aerosolized and/or atomized solution and/or suspension comprising active ingredient. Such powdered, aerosolized, and/or aerosolized formulations, when dispersed, may have an average particle and/or droplet size in the range from about 0.1 nm to about 200 nm, and may further comprise one or more of any additional ingredients described herein.

[000781] General considerations in the formulation and/or manufacture of pharmaceutical agents may be found, for example, in Remington: The Science and Practice of Pharmacy 21st ed., Lippincott Williams & Wilkins, 2005 (incorporated herein by reference in its entirety).

Coatings or Shells

[000782] Solid dosage forms of tablets, dragees, capsules, pills, and granules can be prepared with coatings and shells such as enteric coatings and other coatings well known in the pharmaceutical formulating art. They may optionally comprise opacifying agents and can be of a composition that they release the active ingredient(s) only, or preferentially, in a certain part of the intestinal tract, optionally, in a delayed manner. Examples of embedding compositions which can be used include polymeric substances and waxes. Solid compositions of a similar type may be employed as fillers in soft and hard-filled gelatin capsules using such excipients as lactose or milk sugar as well as high molecular weight polyethylene glycols and the like.

Properties of Pharmaceutical Compositions

[000783] The pharmaceutical compositions described herein can be characterized by one or more of bioavailability, therapeutic window and/or volume of distribution.

Bioavailability

[000784] The polynucleotides, primary constructs or mmRNA, when formulated into a composition with a delivery agent as described herein, can exhibit an increase in bioavailability as compared to a composition lacking a delivery agent as described herein. As used herein, the term "bioavailability" refers to the systemic availability of a given amount of polynucleotides, primary constructs or mmRNA administered to a mammal. Bioavailability can be assessed by measuring the area under the curve (AUC) or the maximum serum or plasma concentration (C_{\max}) of the unchanged form of a compound following administration of the compound to a mammal. AUC is a determination of the area under the curve plotting the serum or plasma concentration of a compound along the ordinate (Y-axis) against time along the abscissa (X-axis). Generally, the AUC for a particular compound can be calculated using methods known to those of ordinary skill in the art and as described in G. S. Banker, *Modern Pharmaceutics, Drugs and the Pharmaceutical Sciences*, v. 72, Marcel Dekker, New York, Inc., 1996, herein incorporated by reference in its entirety.

[000785] The C_{\max} value is the maximum concentration of the compound achieved in the serum or plasma of a mammal following administration of the compound to the mammal. The C_{\max} value of a particular compound can be measured using methods known to those of ordinary skill in the art. The phrases "increasing bioavailability" or "improving the pharmacokinetics," as used herein mean that the systemic availability of a first polynucleotide, primary construct or mmRNA, measured as AUC, C_{\max} , or C_{\min} in a mammal is greater, when co-administered with a delivery agent as described herein, than when such co-administration does not take place. In some embodiments, the bioavailability of the polynucleotide, primary construct or mmRNA can increase by at least about 2%, at least about 5%, at least about 10%, at least about 15%, at least about 20%, at least about 25%, at least about 30%>, at least about 35%, at least about 40%>, at least about 45%, at least about 50%>, at least about 55%, at least about 60%, at least about 65%o, at least about 70%, at least about 75%, at least about 80%, at least about 85%, at least about 90%, at least about 95%, or about 100%.

Therapeutic Window

[000786] The polynucleotides, primary constructs or mmRNA, when formulated into a composition with a delivery agent as described herein, can exhibit an increase in the therapeutic window of the administered polynucleotide, primary construct or mmRNA composition as compared to the therapeutic window of the administered polynucleotide, primary construct or mmRNA composition lacking a delivery agent as described herein. As used herein "therapeutic window" refers to the range of plasma concentrations, or the range of levels of therapeutically active substance at the site of action, with a high probability of eliciting a therapeutic effect. In some embodiments, the therapeutic window of the polynucleotide, primary construct or mmRNA when co-administered with a delivery agent as described herein can increase by at least about 2%, at least about 5%, at least about 10%, at least about 15%, at least about 20%, at least about 25%, at least about 30%, at least about 35%, at least about 40%, at least about 45%, at least about 50%, at least about 55%, at least about 60%, at least about 65%, at least about 70%, at least about 75%, at least about 80%, at least about 85%, at least about 90%, at least about 95%, or about 100%.

Volume of Distribution

[000787] The polynucleotides, primary constructs or mmRNA, when formulated into a composition with a delivery agent as described herein, can exhibit an improved volume of distribution (V_{dist}), e.g., reduced or targeted, relative to a composition lacking a delivery agent as described herein. The volume of distribution (V_{dist}) relates the amount of the drug in the body to the concentration of the drug in the blood or plasma. As used herein, the term "volume of distribution" refers to the fluid volume that would be required to contain the total amount of the drug in the body at the same concentration as in the blood or plasma: V_{dist} equals the amount of drug in the body/concentration of drug in blood or plasma. For example, for a 10 mg dose and a plasma concentration of 10 mg/L, the volume of distribution would be 1 liter. The volume of distribution reflects the extent to which the drug is present in the extravascular tissue. A large volume of distribution reflects the tendency of a compound to bind to the tissue components compared with plasma protein binding. In a clinical setting, V_{dist} can be used to determine a loading dose to achieve a steady state concentration. In some embodiments, the volume of distribution of the polynucleotide, primary construct or mmRNA when co-

administered with a delivery agent as described herein can decrease at least about 2%, at least about 5%, at least about 10%, at least about 15%, at least about 20%, at least about 25%, at least about 30%, at least about 35%, at least about 40%, at least about 45%, at least about 50%, at least about 55%, at least about 60%, at least about 65%, at least about 70%.

Biological Effect

[000788] In one embodiment, the biological effect of the modified mRNA delivered to the animals may be categorized by analyzing the protein expression in the animals. The protein expression may be determined from analyzing a biological sample collected from a mammal administered the modified mRNA of the present invention. In one embodiment, the expression protein encoded by the modified mRNA administered to the mammal of at least 50 pg/ml may be preferred. For example, a protein expression of 50-200 pg/ml for the protein encoded by the modified mRNA delivered to the mammal may be seen as a therapeutically effective amount of protein in the mammal.

Detection of Modified Nucleic Acids by Mass Spectrometry

[000789] Mass spectrometry (MS) is an analytical technique that can provide structural and molecular mass/concentration information on molecules after their conversion to ions. The molecules are first ionized to acquire positive or negative charges and then they travel through the mass analyzer to arrive at different areas of the detector according to their mass/charge (m/z) ratio.

[000790] Mass spectrometry is performed using a mass spectrometer which includes an ion source for ionizing the fractionated sample and creating charged molecules for further analysis. For example ionization of the sample may be performed by electrospray ionization (ESI), atmospheric pressure chemical ionization (APCI), photoionization, electron ionization, fast atom bombardment (FAB)/liquid secondary ionization (LSIMS), matrix assisted laser desorption/ionization (MALDI), field ionization, field desorption, thermospray/plasmaspray ionization, and particle beam ionization. The skilled artisan will understand that the choice of ionization method can be determined based on the analyte to be measured, type of sample, the type of detector, the choice of positive versus negative mode, etc.

[000791] After the sample has been ionized, the positively charged or negatively charged ions thereby created may be analyzed to determine a mass-to-charge ratio (i.e., m/z). Suitable analyzers for determining mass-to-charge ratios include quadrupole analyzers, ion traps analyzers, and time-of-flight analyzers. The ions may be detected using several detection modes. For example, selected ions may be detected (i.e., using a selective ion monitoring mode (SIM)), or alternatively, ions may be detected using a scanning mode, e.g., multiple reaction monitoring (MRM) or selected reaction monitoring (SRM).

[000792] Liquid chromatography-multiple reaction monitoring (LC-MS/MRM) coupled with stable isotope labeled dilution of peptide standards has been shown to be an effective method for protein verification (e.g., Keshishian et al., *Mol Cell Proteomics* 2009 8: 2339-2349; Kuhn et al, *Clin Chem* 2009 55:1 108-1 117; Lopez et al, *Clin Chem* 2010 56:281-290; each of which are herein incorporated by reference in its entirety). Unlike untargeted mass spectrometry frequently used in biomarker discovery studies, targeted MS methods are peptide sequence-based modes of MS that focus the full analytical capacity of the instrument on tens to hundreds of selected peptides in a complex mixture. By restricting detection and fragmentation to only those peptides derived from proteins of interest, sensitivity and reproducibility are improved dramatically compared to discovery-mode MS methods. This method of mass spectrometry-based multiple reaction monitoring (MRM) quantitation of proteins can dramatically impact the discovery and quantitation of biomarkers via rapid, targeted, multiplexed protein expression profiling of clinical samples.

[000793] In one embodiment, a biological sample which may contain at least one protein encoded by at least one modified mRNA of the present invention may be analyzed by the method of MRM-MS. The quantification of the biological sample may further include, but is not limited to, isotopically labeled peptides or proteins as internal standards.

[000794] According to the present invention, the biological sample, once obtained from the subject, may be subjected to enzyme digestion. As used herein, the term "digest" means to break apart into shorter peptides. As used herein, the phrase "treating a sample to digest proteins" means manipulating a sample in such a way as to break down proteins

in a sample. These enzymes include, but are not limited to, trypsin, endoproteinase Glu-C and chymotrypsin. In one embodiment, a biological sample which may contain at least one protein encoded by at least one modified mRNA of the present invention may be digested using enzymes.

[000795] In one embodiment, a biological sample which may contain protein encoded by modified mRNA of the present invention may be analyzed for protein using electrospray ionization. Electrospray ionization (ESI) mass spectrometry (ESIMS) uses electrical energy to aid in the transfer of ions from the solution to the gaseous phase before they are analyzed by mass spectrometry. Samples may be analyzed using methods known in the art (e.g., Ho et al., Clin Biochem Rev. 2003 24(1):3-12; herein incorporated by reference in its entirety). The ionic species contained in solution may be transferred into the gas phase by dispersing a fine spray of charge droplets, evaporating the solvent and ejecting the ions from the charged droplets to generate a mist of highly charged droplets. The mist of highly charged droplets may be analyzed using at least 1, at least 2, at least 3 or at least 4 mass analyzers such as, but not limited to, a quadropole mass analyzer. Further, the mass spectrometry method may include a purification step. As a non-limiting example, the first quadropole may be set to select a single m/z ratio so it may filter out other molecular ions having a different m/z ratio which may eliminate complicated and time-consuming sample purification procedures prior to MS analysis.

[000796] In one embodiment, a biological sample which may contain protein encoded by modified mRNA of the present invention may be analyzed for protein in a tandem ESIMS system (e.g., MS/MS). As non-limiting examples, the droplets may be analyzed using a product scan (or daughter scan) a precursor scan (parent scan) a neutral loss or a multiple reaction monitoring.

[000797] In one embodiment, a biological sample which may contain protein encoded by modified mRNA of the present invention may be analyzed using matrix-assisted laser desorption/ionization (MALDI) mass spectrometry (MALDIMS). MALDI provides for the nondestructive vaporization and ionization of both large and small molecules, such as proteins. In MALDI analysis, the analyte is first co-crystallized with a large molar excess of a matrix compound, which may also include, but is not limited to, an ultraviolet absorbing weak organic acid. Non-limiting examples of matrices used in MALDI are a-

cyano-4-hydroxycinnamic acid, 3,5-dimethoxy-4-hydroxycinnamic acid and 2,5-dihydroxybenzoic acid. Laser radiation of the analyte-matrix mixture may result in the vaporization of the matrix and the analyte. The laser induced desorption provides high ion yields of the intact analyte and allows for measurement of compounds with high accuracy. Samples may be analyzed using methods known in the art (e.g., Lewis, Wei and Siuzdak, Encyclopedia of Analytical Chemistry 2000:5880-5894; herein incorporated by reference in its entirety). As non-limiting examples, mass analyzers used in the MALDI analysis may include a linear time-of-flight (TOF), a TOF reflectron or a Fourier transform mass analyzer.

[000798] In one embodiment, the analyte-matrix mixture may be formed using the dried-droplet method. A biologic sample is mixed with a matrix to create a saturated matrix solution where the matrix-to-sample ratio is approximately 5000: 1. An aliquot (approximately 0.5-2.0 uL) of the saturated matrix solution is then allowed to dry to form the analyte-matrix mixture.

[000799] In one embodiment, the analyte-matrix mixture may be formed using the thin-layer method. A matrix homogeneous film is first formed and then the sample is then applied and may be absorbed by the matrix to form the analyte-matrix mixture.

[000800] In one embodiment, the analyte-matrix mixture may be formed using the thick-layer method. A matrix homogeneous film is formed with a nitro-cellulose matrix additive. Once the uniform nitro-cellulose matrix layer is obtained the sample is applied and absorbed into the matrix to form the analyte-matrix mixture.

[000801] In one embodiment, the analyte-matrix mixture may be formed using the sandwich method. A thin layer of matrix crystals is prepared as in the thin-layer method followed by the addition of droplets of aqueous trifluoroacetic acid, the sample and matrix. The sample is then absorbed into the matrix to form the analyte-matrix mixture.

V. Uses of Polynucleotides, primary constructs and mmRNA of the Invention

[000802] The polynucleotides, primary constructs and mmRNA of the present invention are designed, in preferred embodiments, to provide for avoidance or evasion of deleterious bio-responses such as the immune response and/or degradation pathways, overcoming the threshold of expression and/or improving protein production capacity, improved expression rates or translation efficiency, improved drug or protein half life

and/or protein concentrations, optimized protein localization, to improve one or more of the stability and/or clearance in tissues, receptor uptake and/or kinetics, cellular access by the compositions, engagement with translational machinery, secretion efficiency (when applicable), accessibility to circulation, and/or modulation of a cell's status, function and/or activity.

Therapeutics

Therapeutic Agents

[000803] The polynucleotides, primary constructs or mmRNA of the present invention, such as modified nucleic acids and modified RNAs, and the proteins translated from them described herein can be used as therapeutic or prophylactic agents. They are provided for use in medicine. For example, a polynucleotide, primary construct or mmRNA described herein can be administered to a subject, wherein the polynucleotide, primary construct or mmRNA is translated *in vivo* to produce a therapeutic or prophylactic polypeptide in the subject. Provided are compositions, methods, kits, and reagents for diagnosis, treatment or prevention of a disease or condition in humans and other mammals. The active therapeutic agents of the invention include polynucleotides, primary constructs or mmRNA, cells containing polynucleotides, primary constructs or mmRNA or polypeptides translated from the polynucleotides, primary constructs or mmRNA.

[000804] In certain embodiments, provided herein are combination therapeutics containing one or more polynucleotide, primary construct or mmRNA containing translatable regions that encode for a protein or proteins that boost a mammalian subject's immunity along with a protein that induces antibody-dependent cellular toxicity. For example, provided herein are therapeutics containing one or more nucleic acids that encode trastuzumab and granulocyte-colony stimulating factor (G-CSF). In particular, such combination therapeutics are useful in Her2+ breast cancer patients who develop induced resistance to trastuzumab. (See, e.g., Albrecht, *Immunotherapy*. 2(6):795-8 (2010)).

[000805] Provided herein are methods of inducing translation of a recombinant polypeptide in a cell population using the polynucleotide, primary construct or mmRNA described herein. Such translation can be *in vivo*, *ex vivo*, *in culture*, or *in vitro*. The cell population is contacted with an effective amount of a composition containing a nucleic

acid that has at least one nucleoside modification, and a translatable region encoding the recombinant polypeptide. The population is contacted under conditions such that the nucleic acid is localized into one or more cells of the cell population and the recombinant polypeptide is translated in the cell from the nucleic acid.

[000806] An "effective amount" of the composition is provided based, at least in part, on the target tissue, target cell type, means of administration, physical characteristics of the nucleic acid (e.g., size, and extent of modified nucleosides), and other determinants. In general, an effective amount of the composition provides efficient protein production in the cell, preferably more efficient than a composition containing a corresponding unmodified nucleic acid. Increased efficiency may be demonstrated by increased cell transfection (i.e., the percentage of cells transfected with the nucleic acid), increased protein translation from the nucleic acid, decreased nucleic acid degradation (as demonstrated, e.g., by increased duration of protein translation from a modified nucleic acid), or reduced innate immune response of the host cell.

[000807] Aspects of the invention are directed to methods of inducing *in vivo* translation of a recombinant polypeptide in a mammalian subject in need thereof. Therein, an effective amount of a composition containing a nucleic acid that has at least one structural or chemical modification and a translatable region encoding the recombinant polypeptide is administered to the subject using the delivery methods described herein. The nucleic acid is provided in an amount and under other conditions such that the nucleic acid is localized into a cell of the subject and the recombinant polypeptide is translated in the cell from the nucleic acid. The cell in which the nucleic acid is localized, or the tissue in which the cell is present, may be targeted with one or more than one rounds of nucleic acid administration.

[000808] In certain embodiments, the administered polynucleotide, primary construct or mRNA directs production of one or more recombinant polypeptides that provide a functional activity which is substantially absent in the cell, tissue or organism in which the recombinant polypeptide is translated. For example, the missing functional activity may be enzymatic, structural, or gene regulatory in nature. In related embodiments, the administered polynucleotide, primary construct or mRNA directs production of one or more recombinant polypeptides that increases (e.g., synergistically) a functional activity

which is present but substantially deficient in the cell in which the recombinant polypeptide is translated.

[000809] In other embodiments, the administered polynucleotide, primary construct or mmRNA directs production of one or more recombinant polypeptides that replace a polypeptide (or multiple polypeptides) that is substantially absent in the cell in which the recombinant polypeptide is translated. Such absence may be due to genetic mutation of the encoding gene or regulatory pathway thereof. In some embodiments, the recombinant polypeptide increases the level of an endogenous protein in the cell to a desirable level; such an increase may bring the level of the endogenous protein from a subnormal level to a normal level or from a normal level to a super-normal level.

[000810] Alternatively, the recombinant polypeptide functions to antagonize the activity of an endogenous protein present in, on the surface of, or secreted from the cell. Usually, the activity of the endogenous protein is deleterious to the subject; for example, due to mutation of the endogenous protein resulting in altered activity or localization. Additionally, the recombinant polypeptide antagonizes, directly or indirectly, the activity of a biological moiety present in, on the surface of, or secreted from the cell. Examples of antagonized biological moieties include lipids (e.g., cholesterol), a lipoprotein (e.g., low density lipoprotein), a nucleic acid, a carbohydrate, a protein toxin such as shiga and tetanus toxins, or a small molecule toxin such as botulinum, cholera, and diphtheria toxins. Additionally, the antagonized biological molecule may be an endogenous protein that exhibits an undesirable activity, such as a cytotoxic or cytostatic activity.

[000811] The recombinant proteins described herein may be engineered for localization within the cell, potentially within a specific compartment such as the nucleus, or are engineered for secretion from the cell or translocation to the plasma membrane of the cell.

[000812] In some embodiments, modified mRNAs and their encoded polypeptides in accordance with the present invention may be used for treatment of any of a variety of diseases, disorders, and/or conditions, including but not limited to one or more of the following: autoimmune disorders (*e.g.* diabetes, lupus, multiple sclerosis, psoriasis, rheumatoid arthritis); inflammatory disorders (*e.g.* arthritis, pelvic inflammatory disease); infectious diseases (*e.g.* viral infections (*e.g.* , HIV, HCV, RSV), bacterial infections,

fungal infections, sepsis); neurological disorders (*e.g.* Alzheimer's disease, Huntington's disease; autism; Duchenne muscular dystrophy); cardiovascular disorders (*e.g.* atherosclerosis, hypercholesterolemia, thrombosis, clotting disorders, angiogenic disorders such as macular degeneration); proliferative disorders (*e.g.* cancer, benign neoplasms); respiratory disorders (*e.g.* chronic obstructive pulmonary disease); digestive disorders (*e.g.* inflammatory bowel disease, ulcers); musculoskeletal disorders (*e.g.* fibromyalgia, arthritis); endocrine, metabolic, and nutritional disorders (*e.g.* diabetes, osteoporosis); urological disorders (*e.g.* renal disease); psychological disorders (*e.g.* depression, schizophrenia); skin disorders (*e.g.* wounds, eczema); blood and lymphatic disorders (*e.g.* anemia, hemophilia); *etc.*

[000813] Diseases characterized by dysfunctional or aberrant protein activity include cystic fibrosis, sickle cell anemia, epidermolysis bullosa, amyotrophic lateral sclerosis, and glucose-6-phosphate dehydrogenase deficiency. The present invention provides a method for treating such conditions or diseases in a subject by introducing nucleic acid or cell-based therapeutics containing the polynucleotide, primary construct or mmRNA provided herein, wherein the polynucleotide, primary construct or mmRNA encode for a protein that antagonizes or otherwise overcomes the aberrant protein activity present in the cell of the subject. Specific examples of a dysfunctional protein are the missense mutation variants of the cystic fibrosis transmembrane conductance regulator (CFTR) gene, which produce a dysfunctional protein variant of CFTR protein, which causes cystic fibrosis.

[000814] Diseases characterized by missing (or substantially diminished such that proper (normal or physiological protein function does not occur) protein activity include cystic fibrosis, Niemann-Pick type C, β thalassemia major, Duchenne muscular dystrophy, Hurler Syndrome, Hunter Syndrome, and Hemophilia A. Such proteins may not be present, or are essentially non-functional. The present invention provides a method for treating such conditions or diseases in a subject by introducing nucleic acid or cell-based therapeutics containing the polynucleotide, primary construct or mmRNA provided herein, wherein the polynucleotide, primary construct or mmRNA encode for a protein that replaces the protein activity missing from the target cells of the subject. Specific examples of a dysfunctional protein are the nonsense mutation variants of the

cystic fibrosis transmembrane conductance regulator (CFTR) gene, which produce a nonfunctional protein variant of CFTR protein, which causes cystic fibrosis.

[000815] Thus, provided are methods of treating cystic fibrosis in a mammalian subject by contacting a cell of the subject with a polynucleotide, primary construct or mmRNA having a translatable region that encodes a functional CFTR polypeptide, under conditions such that an effective amount of the CFTR polypeptide is present in the cell. Preferred target cells are epithelial, endothelial and mesothelial cells, such as the lung, and methods of administration are determined in view of the target tissue; i.e., for lung delivery, the RNA molecules are formulated for administration by inhalation.

[000816] In another embodiment, the present invention provides a method for treating hyperlipidemia in a subject, by introducing into a cell population of the subject with a modified mRNA molecule encoding Sortilin, a protein recently characterized by genomic studies, thereby ameliorating the hyperlipidemia in a subject. The *SORTI* gene encodes a trans-Golgi network (TGN) transmembrane protein called Sortilin. Genetic studies have shown that one of five individuals has a single nucleotide polymorphism, rs12740374, in the *lpl3* locus of the *SORTI* gene that predisposes them to having low levels of low-density lipoprotein (LDL) and very-low-density lipoprotein (VLDL). Each copy of the minor allele, present in about 30% of people, alters LDL cholesterol by 8 mg/dL, while two copies of the minor allele, present in about 5% of the population, lowers LDL cholesterol 16 mg/dL. Carriers of the minor allele have also been shown to have a 40% decreased risk of myocardial infarction. Functional *in vivo* studies in mice describes that overexpression of *SORTI* in mouse liver tissue led to significantly lower LDL-cholesterol levels, as much as 80% lower, and that silencing *SORTI* increased LDL cholesterol approximately 200% (Musunuru K et al. From noncoding variant to phenotype via *SORTI* at the *lpl3* cholesterol locus. *Nature* 2010; 466: 714-721).

[000817] In another embodiment, the present invention provides a method for treating hematopoietic disorders, cardiovascular disease, oncology, diabetes, cystic fibrosis, neurological diseases, inborn errors of metabolism, skin and systemic disorders, and blindness. The identity of molecular targets to treat these specific diseases has been described (Templeton ed., *Gene and Cell Therapy: Therapeutic Mechanisms and*

Strategies, 3rd Edition, Boca Raton, FL: CRC Press; herein incorporated by reference in its entirety).

[000818] Provided herein, are methods to prevent infection and/or sepsis in a subject at risk of developing infection and/or sepsis, the method comprising administering to a subject in need of such prevention a composition comprising a polynucleotide, primary construct or mrnRNA precursor encoding an anti-microbial polypeptide (*e.g.*, an anti-bacterial polypeptide), or a partially or fully processed form thereof in an amount sufficient to prevent infection and/or sepsis. In certain embodiments, the subject at risk of developing infection and/or sepsis may be a cancer patient. In certain embodiments, the cancer patient may have undergone a conditioning regimen. In some embodiments, the conditioning regimen may include, but is not limited to, chemotherapy, radiation therapy, or both. As a non-limiting example, a polynucleotide, primary construct or mrnRNA can encode Protein C, its zymogen or prepro-protein, the activated form of Protein C (APC) or variants of Protein C which are known in the art. The polynucleotides, primary constructs or mrnRNA may be chemically modified and delivered to cells. Non-limiting examples of polypeptides which may be encoded within the chemically modified mRNAs of the present invention include those taught in US Patents 7,226,999; 7,498,305; 6,630,138 each of which is incorporated herein by reference in its entirety. These patents teach Protein C like molecules, variants and derivatives, any of which may be encoded within the chemically modified molecules of the present invention.

[000819] Further provided herein, are methods to treat infection and/or sepsis in a subject, the method comprising administering to a subject in need of such treatment a composition comprising a polynucleotide, primary construct or mrnRNA precursor encoding an anti-microbial polypeptide (*e.g.*, an anti-bacterial polypeptide), *e.g.*, an anti-microbial polypeptide described herein, or a partially or fully processed form thereof in an amount sufficient to treat an infection and/or sepsis. In certain embodiments, the subject in need of treatment is a cancer patient. In certain embodiments, the cancer patient has undergone a conditioning regimen. In some embodiments, the conditioning regimen may include, but is not limited to, chemotherapy, radiation therapy, or both.

[000820] In certain embodiments, the subject may exhibit acute or chronic microbial infections (*e.g.*, bacterial infections). In certain embodiments, the subject may have received or may be receiving a therapy. In certain embodiments, the therapy may include, but is not limited to, radiotherapy, chemotherapy, steroids, ultraviolet radiation, or a combination thereof. In certain embodiments, the patient may suffer from a microvascular disorder. In some embodiments, the microvascular disorder may be diabetes. In certain embodiments, the patient may have a wound. In some embodiments, the wound may be an ulcer. In a specific embodiment, the wound may be a diabetic foot ulcer. In certain embodiments, the subject may have one or more burn wounds. In certain embodiments, the administration may be local or systemic. In certain embodiments, the administration may be subcutaneous. In certain embodiments, the administration may be intravenous. In certain embodiments, the administration may be oral. In certain embodiments, the administration may be topical. In certain embodiments, the administration may be by inhalation. In certain embodiments, the administration may be rectal. In certain embodiments, the administration may be vaginal.

[000821] Other aspects of the present disclosure relate to transplantation of cells containing polynucleotide, primary construct, or mmRNA to a mammalian subject. Administration of cells to mammalian subjects is known to those of ordinary skill in the art, and include, but is not limited to, local implantation (*e.g.*, topical or subcutaneous administration), organ delivery or systemic injection (*e.g.*, intravenous injection or inhalation), and the formulation of cells in pharmaceutically acceptable carrier. Such compositions containing polynucleotide, primary construct, or mmRNA can be formulated for administration intramuscularly, transarterially, intraperitoneally, intravenously, intranasally, subcutaneously, endoscopically, transdermally, or intrathecally. In some embodiments, the composition may be formulated for extended release.

[000822] The subject to whom the therapeutic agent may be administered suffers from or may be at risk of developing a disease, disorder, or deleterious condition. Provided are methods of identifying, diagnosing, and classifying subjects on these bases, which may include clinical diagnosis, biomarker levels, genome-wide association studies (GWAS), and other methods known in the art.

Rare Liver Diseases or Disorders*Progressive Familial Intrahepatic Cholestasis (PFIC)*

[000823] In one embodiment, the rare liver disease or disorder polynucleotide, primary construct, or mmRNA of the present invention may be used to treat progressive familial intrahepatic cholestasis (PFIC). The term "progressive familial intrahepatic cholestasis" or "PFIC" as used herein refers to a liver disorder that can lead to liver failure. PFIC is characterized by autosomal recessive defects in bile formation and hepatocellular cholestasis. As used herein, "hepatocellular" is a term used to describe something that affects or pertains to liver cells (also referred to as hepatocytes). As used herein, the term "cholestasis" refers to a condition characterized by slowed or disrupted flow of bile from the liver. As used herein, the term "bile" refers to a liquid substance produced by the liver comprising water, bile salts, mucus, fats inorganic salts and cholesterol, which aids in the emulsification and digestion of dietary fats.

[000824] There are three known types of PFIC (PFIC-1, PFIC-2 and PFIC-3), and they have been traced to mutations in genes encoding proteins involved in the hepatocellular transport system and in the formation of bile.

[000825] PFIC-1 and PFIC-2 are typically diagnosed in infancy but diagnosis may occur during the prenatal period or the neonatal period. As used herein, the term "prenatal" refers to the period of time in the life of an organism that occurs before birth. As used herein, the term "neonatal" refers to a period of time in the life of an organism that occurs after birth. In humans, the neonatal period may include a period of time from birth to about 1 month, to about 3 months or to about 6 months after birth. As used herein, the term "infancy" refers to a period in the life of an organism that occurs between birth and childhood. In humans, infancy may include the period of time from birth to about 1 year of life, to about 2 years of life, to about 3 years of life or to about 4 years of life.

[000826] PFIC-3 may be diagnosed during the prenatal period, during the neonatal period or during infancy. In some cases, PFIC-3 may be able evade diagnosis until childhood or young adulthood. As used herein, the term "childhood" refers to the period of time in the life of an organism that occurs after infancy and before young adulthood. In humans, childhood may include the period of time from about 2 years of age to about 10

years of age, from about 3 years of age to about 11 years of age, from about 4 years of age to about 12 years of age or from about 5 years of age to about 13 years of age. As used herein, the term "young adulthood" refers to the period of time in the life of an organism between childhood and adulthood. In humans, young adulthood may include the periods of time from about 10 years of age to about 16 years of age, from about 11 years of age to about 17 years of age, from about 12 years of age to about 18 years of age, from about 13 years of age to about 19 years of age and from about 14 years of age to about 20 years of age.

[000827] Clinical manifestations of PFIC include, but are not limited to pruritus, cholestasis and jaundice. As used herein, the term "pruritus" refers to an uncomfortable sensation that leads to the urge to scratch or rub an afflicted part of the body. As used herein, the term "jaundice" refers to a condition characterized by yellow skin, eyes and/or mucus membranes resulting from the buildup of bilirubin.

[000828] Most patients with PFIC develop fibrosis and suffer from liver failure prior to adulthood. Individuals afflicted with PFIC may be diagnosed through observation of clinical manifestations, cholangiography, liver ultrasonography, liver histology and genetic testing. Additional tests may be conducted to exclude other disorders resulting in childhood cholestasis.

[000829] Dysfunction in one of three different cellular transporters causes each of PFIC types 1, 2 and 3. Each is involved in lipid transport and each plays a vital role in the secretion of bile from the liver. PFIC type 1 is caused by genetic mutations that lead to dysfunction of ATPase aminophospholipid transporter, class I, type 8B, member 1 (ATP8B1). ATP8B1 functions to translocate phosphatidylserine and phosphatidylethanolamine from one side of a phospholipid bilayer to the other. Both PFIC-2 and PFIC-3 are caused by mutations affecting the function of ATP-binding cassette (ABC) transporters. ABC, subfamily B, member 11 (ABCB1 1) transporters support bile production through the transport of taurocholate as well as other cholate-linked compounds from hepatocytes into the bile. Defective ABCB1 1 function leads to PFIC-2. ABC subfamily B, member 4 (ABCB4) transports phospholipids, preferably phosphatidyl choline, across hepatocellular membranes for incorporation into bile. Gene mutations that lead to dysfunction of ABCB4 are responsible for PFIC-3. (Davit-Spraul,

A. et al., *Progressive familial intrahepatic cholestasis*. Orphanet J Rare Dis. 2009 Jan 8;4:1; Degiorgio, D. et al., *Molecular characterization and structural implications of 25 new ABCB4 mutations in progressive familial intrahepatic cholestasis type 3 (PFIC3)*. Eur J Hum Genet. 2007 Dec;15(12):1230-8; each of which are herein incorporated by reference in their entireties).

[000830] In one embodiment, patients with PFIC may be administered a composition comprising at least one rare liver disease or disorder polynucleotide, primary construct or mmRNA of the present invention. The rare liver disease or disorder polynucleotide, primary construct or mmRNA may encode a peptide, protein or fragment thereof such as, but not limited to, ATP-binding cassette, sub-family (MDR/TAP), member 4 (ABCB4), ATP-binding cassette, sub-family (MDR/TAP, member 11 (ABCB1 1) and ATPase, aminophospholipid transporter, class I, type 8B, member 1 (ATP8B1).

[000831] In one embodiment, PFIC-1 may be treated by administering a composition of the present invention comprising at least one rare liver disease or disorder polynucleotide, primary construct or mmRNA encoding a peptide, protein or fragment thereof of ATP8B1. In another embodiment, PFIC-1 may be treated by administering a composition of the present invention comprising at least one rare liver disease or disorder polynucleotide, primary construct or mmRNA encoding a peptide, protein or fragment thereof comprising SEQ ID NO: 855 or 856.

[000832] In one embodiment, PFIC-2 may be treated by administering a composition of the present invention comprising at least one rare liver disease or disorder polynucleotide, primary construct or mmRNA encoding a peptide, protein or fragment thereof of ABCB1 1. In another embodiment, PFIC-2 may be treated by administering a composition of the present invention comprising at least one rare liver disease or disorder polynucleotide, primary construct or mmRNA encoding a peptide, protein or fragment thereof comprising SEQ ID NO: 865.

[000833] In one embodiment, PFIC-3 may be treated by administering a composition of the present invention comprising at least one rare liver disease or disorder polynucleotide, primary construct or mmRNA encoding a peptide, protein or fragment thereof of ABCB4. In another embodiment, PFIC-3 may be treated by administering a composition of the present invention comprising at least one rare liver disease or disorder

polynucleotide, primary construct or mmRNA encoding a peptide, protein or fragment thereof comprising SEQ ID NO: 866-871.

Familial Hypercholesterolemia

[000834] In one embodiment, the rare liver disease or disorder polynucleotide, primary construct, or mmRNA of the present invention may be used to treat familial hypercholesterolemia (FH). As used herein, the term "familial hypercholesterolemia" or "FH" refers to an inherited disorder characterized by elevated levels of low density lipoprotein (LDL)-associated cholesterol in the plasma. Patients or subjects with FH may have an increased risk for cardiovascular disease at a young age. In some embodiments, high levels of LDL in the blood of these individuals may be the result of mutations in the gene encoding the LDL receptor. It is believed, and is no means limiting, that the LDL receptor binds LDL in the circulation and facilitates endocytosis of LDL into the cell that the receptor is expressed on. When this receptor is dysfunctional, LDL levels remain elevated in the circulation and promote the development of atherosclerosis. Individuals with FH may be heterozygous or homozygous for FH-related gene mutations. Symptoms in homozygous individuals can be more severe. Diagnosis is possible during childhood or young adulthood by methods known in the art including, but not limited to, a physical exam that reveals xanthomas (fatty skin growths). Earlier diagnosis of FH may be made through an analysis of family history and genetics. (Sjouke, B. et al, *Familial hypercholesterolemia: present and future management*. Curr Cardiol Rep. 2011 Dec;13(6):527-36; Avis, H.J. et al., *A systematic review and meta-analysis of statin therapy in children with familial hypercholesterolemia*. Arterioscler Thromb Vase Biol. 2007 Aug;27(8):1803-10; each of which are herein incorporated by reference in their entireties).

[000835] In one embodiment, patients with FH may be administered a composition comprising at least one rare liver disease or disorder polynucleotide, primary construct or mmRNA of the present invention. The rare liver disease or disorder polynucleotide, primary construct or mmRNA may encode a peptide, protein or fragment thereof such as, but not limited to, low density lipoprotein receptor (LDLR), apolipoprotein B (APOB), and proprotein convertase subtilisin/kexin type 9 (PCSK9).

[000836] In one embodiment, FH may be treated by administering a composition of the present invention comprising at least one rare liver disease or disorder polynucleotide, primary construct or mmRNA encoding a peptide, protein or fragment thereof of LDLR. In another embodiment, FH may be treated by administering a composition of the present invention comprising at least one rare liver disease or disorder polynucleotide, primary construct or mmRNA encoding a peptide, protein or fragment thereof comprising SEQ ID NO: 1145-1 151.

[000837] In one embodiment, FH may be treated by administering a composition of the present invention comprising at least one rare liver disease or disorder polynucleotide, primary construct or mmRNA encoding a peptide, protein or fragment thereof of APOB. In another embodiment, FH may be treated by administering a composition of the present invention comprising at least one rare liver disease or disorder polynucleotide, primary construct or mmRNA encoding a peptide, protein or fragment thereof comprising SEQ ID NO: 819 or 819.

[000838] In one embodiment, FH may be treated by administering a composition of the present invention comprising at least one rare liver disease or disorder polynucleotide, primary construct or mmRNA encoding a peptide, protein or fragment thereof of PCSK9. In another embodiment, FH may be treated by administering a composition of the present invention comprising at least one rare liver disease or disorder polynucleotide, primary construct or mmRNA encoding a peptide, protein or fragment thereof comprising SEQ ID NO: 1241-1243.

Ornithine transcarbamylase Deficiency

[000839] In one embodiment, the rare liver disease or disorder polynucleotide, primary construct, or mmRNA of the present invention may be used to treat ornithine transcarbamylase deficiency (OTCD). As used herein, the term "ornithine transcarbamylase deficiency" or "OTCD" refers to an inherited disorder in the synthesis of urea resulting from mutations in the gene encoding the enzyme ornithine transcarbamylase (OTC). These mutations can lead to hyperammonemia, neurological problems and an increased rate of death. OTC is an important component of the urea cycle, catalyzing the formation of citrulline from carbamoyl phosphate and ornithine. This process is critical to the removal of excess ammonia from the body. The gene for

OTC is carried on the X chromosome making OTCD an X-linked disorder. As with most X-linked disorders, OTCD primarily affects males, while females are carriers. The severity of OTCD depends upon the nature of the mutation in the gene. Gene mutations in individuals that result in non-functional OTC typically lead to the death of those individuals within the first month of life. Such mutations may be discovered by genetic analysis in an individual suspected of suffering from OTCD. Individuals with gene mutations that lead to varying degrees of enzyme function may survive longer and respond to treatments to reduce the effects of the disease. Diagnosis of OTCD may occur after the observation of symptoms and the detection of high levels of ammonia and orotic acid in the urine. (Brunetti-Pierri, N. et al., *Phenotypic correction of ornithine transcarbamylase deficiency using low dose helper-dependent adenoviral vectors*. J Gene Med. 2008 Aug;10(8):890-6; Wilmslow, U.K., *Ornithine transcarbamylase deficiency: a urea cycle defect*. Eur J Paediatr Neurol. 2003;7(3):1 15-21; each of which are herein incorporated by reference in their entireties).

[000840] In one embodiment, patients with OTC may be administered a composition comprising at least one rare liver disease or disorder polynucleotide, primary construct or mmRNA of the present invention. The rare liver disease or disorder polynucleotide, primary construct or mmRNA may encode a peptide, protein or fragment thereof such as, but not limited to, ornithine carbamoyltransferase (OTC).

[000841] In one embodiment, OTCD may be treated by administering a composition of the present invention comprising at least one rare liver disease or disorder polynucleotide, primary construct or mmRNA encoding a peptide, protein or fragment thereof of OTC. In another embodiment, OTCD may be treated by administering a composition of the present invention comprising at least one rare liver disease or disorder polynucleotide, primary construct or mmRNA encoding a peptide, protein or fragment thereof comprising SEQ ID NO: 1192.

Crigler-Najjar Syndrome

[000842] In one embodiment, the rare liver disease or disorder polynucleotide, primary construct, or mmRNA of the present invention may be used to treat Crigler-Najjar syndrome. As used herein, the term "Crigler-Najjar syndrome" refers to an inborn error affecting the function of the 1A1 isoform of the enzyme bilirubin-uridine diphosphate

glucuronosyltransferase (UGT1A1). UGT1A1 is critical in the detoxification of hydrophobic bilirubin, a toxic byproduct of heme degradation. It is believed that UGT1A1 functions by linking hydrophobic bilirubin to glucuronic acid for excretion into the bile. Individuals suffering from Crigler-Najjar syndrome can experience unconjugated hyperbilirubinemia (or excess hydrophobic bilirubin in the circulation), leading to neurological impairment and the requirement for regular phototherapy that becomes less and less effective as the patients age. Diagnosis of Crigler-Najjar syndrome typically begins with the observation of jaundice in infants and then enzyme function may be evaluated by enzyme and liver assays known in the art. (Lysy, P.A. et al., *Liver cell transplantation for Crigler-Najjar syndrome type I: update and perspectives*. World J Gastroenterol. 2008 Jun 14;14(22):3464-70; Sugatani, J., *Function, genetic polymorphism, and transcriptional regulation of human UDP-glucuronosyltransferase (UGT) 1A1*. Drug Metab Pharmacokinet. 2012 Oct 23. [Epub ahead of print]; each of which are herein incorporated by reference in their entireties).

[000843] In one embodiment, patients with Crigler-Najjar syndrome may be administered a composition comprising at least one rare liver disease or disorder polynucleotide, primary construct or mmRNA of the present invention. The rare liver disease or disorder polynucleotide, primary construct or mmRNA may encode a peptide, protein or fragment thereof such as, but not limited to, UGT1A1 .

[000844] In one embodiment, Crigler-Najjar syndrome may be treated by administering a composition of the present invention comprising at least one rare liver disease or disorder polynucleotide, primary construct or mmRNA encoding a peptide, protein or fragment thereof of UGT1A1. In another embodiment, Crigler-Najjar syndrome may be treated by administering a composition of the present invention comprising at least one rare liver disease or disorder polynucleotide, primary construct or mmRNA encoding a peptide, protein or fragment thereof comprising SEQ ID NO: 1357 or 1358.

Aceruloplasminemia

[000845] In one embodiment, the rare liver disease or disorder polynucleotide, primary construct, or mmRNA of the present invention may be used to treat Aceruloplasminemia. As used herein, the term "aceruloplasminemia" refers to a disease in which ceruloplasmin (CP) may be defective and/or dysfunctional due to a gene mutation in the CP gene. It is

believed that CP is a transport protein responsible for transporting iron from cells into capillaries. Once in the capillaries, iron can bind to ferritin and enters the blood stream. In the absence of functional CP, iron accumulates within cells and serum ferritin levels become elevated. (Ogimoto, M. et al., *Criteria for early identification of aceruloplasminemia*. Intern Med. 2011;50(13): 1415-8; Miyajima, H., *Aceruloplasminemia*. GeneReviews [Internet]. Seattle (WA): University of Washington, Seattle; 2003 Aug 12 [updated 2011 Feb 17]; each of which are herein incorporated by reference in its entirety).

[000846] Iron accumulation may be especially severe in the liver as well as in the eye, brain and pancreas. Aceruloplasminemia, arising from genetic defects in the CP gene, is an autosomal recessive disorder. As used herein, the term "autosomal recessive" refers to a disease, disorder, trait or phenotype that can affect those who are homozygous for a responsible gene. Symptoms of the disease typically manifest between the ages of 25 and 60 years old. Diagnosis of individuals believed to be suffering from the disease may occur by way of serum analysis for ceruloplasmin and iron levels or through MRI analysis of the brain to look for iron accumulation.

[000847] In one embodiment, patients with Aceruloplasminemia may be administered a composition comprising at least one rare liver disease or disorder polynucleotide, primary construct or mmRNA of the present invention. The rare liver disease or disorder polynucleotide, primary construct or mmRNA may encode a peptide, protein or fragment thereof such as, but not limited to, CP.

[000848] In one embodiment, Aceruloplasminemia may be treated by administering a composition of the present invention comprising at least one rare liver disease or disorder polynucleotide, primary construct or mmRNA encoding a peptide, protein or fragment thereof of CP. In another embodiment, Aceruloplasminemia may be treated by administering a composition of the present invention comprising at least one rare liver disease or disorder polynucleotide, primary construct or mmRNA encoding a peptide, protein or fragment thereof comprising SEQ ID NO: 891.

Alpha-Mannosidosis

[000849] In one embodiment, the rare liver disease or disorder polynucleotide, primary construct, or mmRNA of the present invention may be used to treat alpha-mannosidosis.

As used herein, the term "alpha-mannosidosis" refers to a disorder caused by defective and/or dysfunctional alpha-D-mannosidase enzyme activity resulting in lysosomal storage disorder. Alpha-mannosidosis, arising from genetic defects in the MAN2B1 gene (encoding alpha-D-mannosidase), is an autosomal recessive disorder. Characteristics of those suffering from alpha-mannosidosis include, but are not limited to immunodeficiency, abnormalities of the face and skeleton, impaired hearing and intellectual impairment. Diagnosis may occur as early as during infancy using methods known in the art including, but not limited to, analysis of phenotypic characteristics as well as liver and spleen dysfunction. Milder forms of the disease may remain undiagnosed through childhood and young adulthood. Diagnosis of the disease is typically confirmed by measurement of alpha-D-mannosidase enzymatic activity in white blood cells. (Malm, D. et al, *Alpha-mannosidosis*. Orphanet J Rare Dis. 2008 Jul 23;3:21; herein incorporated by reference in its entirety).

[000850] In one embodiment, patients with alpha-mannosidosis may be administered a composition comprising at least one rare liver disease or disorder polynucleotide, primary construct or mmRNA of the present invention. The rare liver disease or disorder polynucleotide, primary construct or mmRNA may encode a peptide, protein or fragment thereof such as, but not limited to, MAN2B1.

[000851] In one embodiment, alpha-mannosidosis may be treated by administering a composition of the present invention comprising at least one rare liver disease or disorder polynucleotide, primary construct or mmRNA encoding a peptide, protein or fragment thereof of MAN2B1. In another embodiment, alpha-mannosidosis may be treated by administering a composition of the present invention comprising at least one rare liver disease or disorder polynucleotide, primary construct or mmRNA encoding a peptide, protein or fragment thereof comprising SEQ ID NO: 1156-1158.

Tyrosinemia

[000852] In one embodiment, the rare liver disease or disorder polynucleotide, primary construct, or mmRNA of the present invention may be used to treat tyrosinemia. As used herein, the term "tyrosinemia" refers to a disorder and/or condition characterized by elevated levels of tyrosine and/or tyrosine byproducts in the blood. In some embodiments, tyrosinemia is caused by a genetic mutation resulting in a defective and/or

dysfunctional enzyme necessary for tyrosine degradation. Symptoms include, but are not limited to failure to thrive, diarrhea, vomiting, jaundice, an increased tendency for nosebleeds, microcephaly, tremor, ataxia, self-mutilating behavior, fine motor coordination disturbances, language deficits, convulsions and/or a cabbage-like odor. (Nakamura, K. et al, *Animal models of tyrosinemia*. J Nutr. 2007 Jun; 137(6 Suppl 1): 1556S-1560S; discussion 1573S-1575S; Bergeron, A. et al, *Hereditary tyrosinemia: an endoplasmic reticulum stress disorder?* Med Sci (Paris). 2003 Oct;19(10):976-80; Mehere, P. et al, *Tyrosine aminotransferase: biochemical and structural properties and molecular dynamics simulations*. Protein Cell. 2010 Nov;l(1 1): 1023-32; each of which is herein incorporated by reference in its entirety).

[000853] Type-1 tyrosinemia refers to a form of the disorder caused by a lack of fumarylacetoacetate hydrolase (FAH) activity. The lack of FAH activity in tyrosinemia type-1 leads to an accumulation of the metabolite fumarylacetoacetate, triggering cellular activities such as apoptosis, mutagenesis, aneuploidy and mitogenesis.

[000854] Tyrosinemia type-2 refers to a form of the disorder caused by a lack of tyrosine aminotransferase (TAT) activity. TAT is responsible for the reversible transamination of tyrosine as well as other aromatic amino acids including, but not limited to p-hydroxyphenylpyruvate (pHPP).

[000855] In one embodiment, patients with tyrosinemia may be administered a composition comprising at least one rare liver disease or disorder polynucleotide, primary construct or mmRNA of the present invention. The rare liver disease or disorder polynucleotide, primary construct or mmRNA may encode a peptide, protein or fragment thereof such as, but not limited to, FAH or TAT.

[000856] In one embodiment, tyrosinemia type-1 may be treated by administering a composition of the present invention comprising at least one rare liver disease or disorder polynucleotide, primary construct or mmRNA encoding a peptide, protein or fragment thereof of FAH. In another embodiment, tyrosinemia type-1 may be treated by administering a composition of the present invention comprising at least one rare liver disease or disorder polynucleotide, primary construct or mmRNA encoding a peptide, protein or fragment thereof comprising SEQ ID NO: 985-987.

[000857] In one embodiment, tyrosinemia type-2 may be treated by administering a composition of the present invention comprising at least one rare liver disease or disorder polynucleotide, primary construct or mmRNA encoding a peptide, protein or fragment thereof of TAT. In another embodiment, tyrosinemia type-2 may be treated by administering a composition of the present invention comprising at least one rare liver disease or disorder polynucleotide, primary construct or mmRNA encoding a peptide, protein or fragment thereof comprising SEQ ID NO: 1356.

Hemochromatosis

[000858] In one embodiment, the rare liver disease or disorder polynucleotide, primary construct, or mmRNA of the present invention may be used to treat hemochromatosis. As used herein, the term "hemochromatosis" refers to a disorder or condition characterized by iron overload that may result from a genetic defect. Symptoms of hemochromatosis include, but are not limited to hepatic cirrhosis, hyperpigmentation, decreased pituitary function, diabetes and/or arthritis. The genetic defect associated with hemochromatosis is used to characterize the form of the disease. Hemochromatosis type 1 is caused by a genetic mutation in the HFE gene. Types 2A and 2B are the result of mutations in the HFE2 and HAMP genes, respectively. While symptoms for hemochromatosis type 1 do not typically present until adulthood, symptoms for hemochromatosis types 2A and 2B typically present during childhood. (Papanikolaou, G. et al., *Hepcidin in iron overload disorders*. Blood. 2005 May 15; 105(10): 4103-5; Nandar, W. et al, *HFE gene variants affect iron in the brain*. J Nutr. 2011 Apr 1;141(4):729S-739S; Wallace, D.F. et al, *Non-HFE haemochromatosis*. World J Gastroenterol. 2007 Sep 21;13(35):4690-8; each of which is herein incorporated by reference in its entirety).

[000859] In one embodiment, patients with hemochromatosis may be administered a composition comprising at least one rare liver disease or disorder polynucleotide, primary construct or mmRNA of the present invention. The rare liver disease or disorder polynucleotide, primary construct or mmRNA may encode a peptide, protein or fragment thereof such as, but not limited to, HFE2, HAMP, solute carrier family 40, member 1 (SLC40A1) and transferrin receptor 2 (TFR2).

[000860] In one embodiment, hemochromatosis type-1 may be treated by administering a composition of the present invention comprising at least one rare liver disease or disorder polynucleotide, primary construct or mmRNA encoding a peptide, protein or fragment thereof of HFE. In another embodiment, hemochromatosis type-1 may be treated by administering a composition of the present invention comprising at least one rare liver disease or disorder polynucleotide, primary construct or mmRNA encoding a peptide, protein or fragment thereof comprising SEQ ID NO: 1038-1050.

[000861] In one embodiment, hemochromatosis type-2 may be treated by administering a composition of the present invention comprising at least one rare liver disease or disorder polynucleotide, primary construct or mmRNA encoding a peptide, protein or fragment thereof of HFE2 or HAMP. In another embodiment, hemochromatosis type-2 may be treated by administering a composition of the present invention comprising at least one rare liver disease or disorder polynucleotide, primary construct or mmRNA encoding a peptide, protein or fragment thereof comprising SEQ ID NO: 1051-1057, 1067 or 1068.

[000862] In one embodiment, hemochromatosis may be treated by administering a composition of the present invention comprising at least one rare liver disease or disorder polynucleotide, primary construct or mmRNA encoding a peptide, protein or fragment thereof of TFR2 or SLC40A1. In another embodiment, hemochromatosis may be treated by administering a composition of the present invention comprising at least one rare liver disease or disorder polynucleotide, primary construct or mmRNA encoding a peptide, protein or fragment thereof comprising SEQ ID NO: 1290-1296 or 1323-1326.

Glycogen Storage Disease

[000863] In one embodiment, the rare liver disease or disorder polynucleotide, primary construct, or mmRNA of the present invention may be used to treat glycogen storage disease IV. As used herein, the terms "glycogen storage disease" or "GSD" refer to a disorder in an organism characterized by defective synthesis and/or breakdown of glycogen. In some embodiments, GSD includes, but is not limited to GSD type 4 also known as Andersen disease, Brancher deficiency, amylopectinosis and glycogen branching enzyme deficiency. GSD type IV results from a deficiency in glycogen branching enzyme (GBE), encoded by the GBE1 gene, leading to the formation of

abnormal glycogens that may be cytotoxic. Although variations exist due to the expression of tissue-specific isoforms, patients with classical hepatic GSD type IV appear healthy at birth; however, cirrhosis of the liver occurs early in life, typically leading to liver failure before the 5th year of life. (Ozen, H., Glycogen storage diseases: new perspectives. World J Gastroenterol. 2007 May 14;13(18):2541-53; herein incorporated by reference in its entirety).

[000864] In one embodiment, patients with GSD may be administered a composition comprising at least one rare liver disease or disorder polynucleotide, primary construct or mmRNA of the present invention. The rare liver disease or disorder polynucleotide, primary construct or mmRNA may encode a peptide, protein or fragment thereof such as, but not limited to, glucan (1,4-alpha-), branching enzyme 1 (GBE1).

[000865] In one embodiment, GSD type IV may be treated by administering a composition of the present invention comprising at least one rare liver disease or disorder polynucleotide, primary construct or mmRNA encoding a peptide, protein or fragment thereof of GBE1. In another embodiment, GSD IV may be treated by administering a composition of the present invention comprising at least one rare liver disease or disorder polynucleotide, primary construct or mmRNA encoding a peptide, protein or fragment thereof comprising SEQ ID NO: 1010-1012.

Fanconi Cystinosis

[000866] In one embodiment, the rare liver disease or disorder polynucleotide, primary construct, or mmRNA of the present invention may be used to treat fanconi cystinosis. As used herein, the term "cystinosis" refers to a disease characterized by the abnormal accumulation of cystine within lysosomes. It is the most common cause of Fanconi syndrome, a kidney disease that prevents reabsorption of metabolites into the blood stream, causing them to instead be passed in the urine. Cystine is formed through a disulfide bond between two cysteine residues. Lysosomes are sites of hydrolytic protein digestion and cystine accumulating within lysosomes relies on carrier-mediated transport for its release. Cystinosin, encoded by the CTNS gene, is a seven transmembrane protein that binds cystine in lysosomes and facilitates its removal from lysosomes in collaboration with other proteins. Individuals with severe defects in cystinosin function are affected between 6 and 12 months of age and present with fluid and electrolyte loss as

well as other renal and metabolic complications. Renal failure typically occurs by the age of 10. Current treatment is with the drug cysteamine which is capable of cleaving cystine molecules, allowing them to be cleared from lysosomes. (Kalatzis, V. et al, Cystinosis: from gene to disease. Nephrol Dial Transplant. 2002 Nov;17(11): 1883-6; herein incorporated by reference in its entirety).

[000867] In one embodiment, patients with hemochromatosis may be administered a composition comprising at least one rare liver disease or disorder polynucleotide, primary construct or mmRNA of the present invention. The rare liver disease or disorder polynucleotide, primary construct or mmRNA may encode a peptide, protein or fragment thereof such as, but not limited to, cystinosis, lysosomal cysteine transporter (CTNS).

[000868] In one embodiment, fanconi cystinosis may be treated by administering a composition of the present invention comprising at least one rare liver disease or disorder polynucleotide, primary construct or mmRNA encoding a peptide, protein or fragment thereof of CTNS. In another embodiment, fanconi cystinosis may be treated by administering a composition of the present invention comprising at least one rare liver disease or disorder polynucleotide, primary construct or mmRNA encoding a peptide, protein or fragment thereof comprising SEQ ID NO: 938-941.

Farber Lipogranulomatosis

[000869] In one embodiment, the rare liver disease or disorder polynucleotide, primary construct, or mmRNA of the present invention may be used to treat farber lipogranulomatosis. As used herein, the terms "Farber lipogranulomatosis," "Farber's lipogranulomatosis" or "Farber disease" refers to a lysosomal storage disorder identified by Sidney Farber in 1957. The disease is caused by a defect in the enzyme acid ceramidase, encoded by the N-acylsphingosine amidohydrolase (acid ceramidase) 1 (ASAH1) gene. Deficiency of this enzyme prevents the normal breakdown of intracellular ceramide into sphingosine and fatty acid and causes the abnormal accumulation ceramide that leads to disease symptoms. Symptoms are typically present in early infancy, but may also occur in later life. In the classic form of the disease, symptoms develop within the first few weeks of life and may include deformity of the joints, the presence of subcutaneous nodules and hoarseness. Patients may also suffer neurological impairment, typically leading to death in infancy. Patients with mild

neurological impairment may survive into their fourth decade. Currently, there are no treatments available for Farber lipogranulomatosis. (Ekici, B. et al., Farber disease: A clinical diagnosis. *J Pediatr Neurosci.* 2012 May;7(2): 154-5; Farber, S. et al, Lipogranulomatosis; a new lipo-glycoprotein storage disease. *J Mt Sinai Hosp N Y.* 1957 Nov-Dec;24(6):816-37; each of which is herein incorporated by reference in its entirety).

[000870] In one embodiment, patients with hemochromatosis may be administered a composition comprising at least one rare liver disease or disorder polynucleotide, primary construct or mmRNA of the present invention. The rare liver disease or disorder polynucleotide, primary construct or mmRNA may encode a peptide, protein or fragment thereof such as, but not limited to, N-acylsphingosine amidohydrolase (acid ceramidase) 1 (ASAHI).

[000871] In one embodiment, farber lipogranulomatosis may be treated by administering a composition of the present invention comprising at least one rare liver disease or disorder polynucleotide, primary construct or mmRNA encoding a peptide, protein or fragment thereof of ASAHI. In another embodiment, fanconi cystinosis may be treated by administering a composition of the present invention comprising at least one rare liver disease or disorder polynucleotide, primary construct or mmRNA encoding a peptide, protein or fragment thereof comprising SEQ ID NO: 1171-1 175.

Wound Management

[000872] The polynucleotides, primary constructs or mmRNA of the present invention may be used for wound treatment, *e.g.* of wounds exhibiting delayed healing. Provided herein are methods comprising the administration of polynucleotide, primary construct or mmRNA in order to manage the treatment of wounds. The methods herein may further comprise steps carried out either prior to, concurrent with or post administration of the polynucleotide, primary construct or mmRNA. For example, the wound bed may need to be cleaned and prepared in order to facilitate wound healing and hopefully obtain closure of the wound. Several strategies may be used in order to promote wound healing and achieve wound closure including, but not limited to: (i) debridement, optionally repeated, sharp debridement (surgical removal of dead or infected tissue from a wound), optionally including chemical debriding agents, such as enzymes, to remove necrotic tissue; (ii)

wound dressings to provide the wound with a moist, warm environment and to promote tissue repair and healing.

[000873] Examples of materials that are used in formulating wound dressings include, but are not limited to: hydrogels (*e.g.*, AQUASORB®; DUODERM®), hydrocolloids (*e.g.*, AQUACEL®; COMFEEL®), foams (*e.g.*, LYOFOAM®; SPYROSORB®), and alginates (*e.g.*, ALGISITE®; CURASORB®); (iii) additional growth factors to stimulate cell division and proliferation and to promote wound healing *e.g.* becaplermin (REGRANEX GEL®), a human recombinant platelet-derived growth factor that is approved by the FDA for the treatment of neuropathic foot ulcers; (iv) soft-tissue wound coverage, a skin graft may be necessary to obtain coverage of clean, non-healing wounds. Examples of skin grafts that may be used for soft-tissue coverage include, but are not limited to: autologous skin grafts, cadaveric skin graft, bioengineered skin substitutes (*e.g.*, APLIGRAF®; DERMAGRAFT®).

[000874] In certain embodiments, the polynucleotide, primary construct or mmRNA of the present invention may further include hydrogels (*e.g.*, AQUASORB®; DUODERM®), hydrocolloids (*e.g.*, AQUACEL®; COMFEEL®), foams (*e.g.*, LYOFOAM®; SPYROSORB®), and/or alginates (*e.g.*, ALGISITE®; CURASORB®). In certain embodiments, the polynucleotide, primary construct or mmRNA of the present invention may be used with skin grafts including, but not limited to, autologous skin grafts, cadaveric skin graft, or bioengineered skin substitutes (*e.g.*, APLIGRAF®; DERMAGRAFT®). In some embodiments, the polynucleotide, primary construct or mmRNA may be applied with wound dressing formulations and/or skin grafts or they may be applied separately but methods such as, but not limited to, soaking or spraying.

[000875] In some embodiments, compositions for wound management may comprise a polynucleotide, primary construct or mmRNA encoding for an anti-microbial polypeptide (*e.g.*, an anti-bacterial polypeptide) and/or an anti-viral polypeptide. A precursor or a partially or fully processed form of the anti-microbial polypeptide may be encoded. The composition may be formulated for administration using a bandage (*e.g.*, an adhesive bandage). The anti-microbial polypeptide and/or the anti-viral polypeptide may be intermixed with the dressing compositions or may be applied separately, *e.g.*, by soaking or spraying.

Production of Antibodies

[000876] In one embodiment of the invention, the polynucleotides, primary constructs or mmRNA may encode antibodies and fragments of such antibodies. These may be produced by any one of the methods described herein. The antibodies may be of any of the different subclasses or isotypes of immunoglobulin such as, but not limited to, IgA, IgG, or IgM, or any of the other subclasses. Exemplary antibody molecules and fragments that may be prepared according to the invention include, but are not limited to, immunoglobulin molecules, substantially intact immunoglobulin molecules and those portions of an immunoglobulin molecule that may contain the paratope. Such portion of antibodies that contain the paratope include, but are not limited to Fab, Fab', F(ab')₂, F(v) and those portions known in the art.

[000877] The polynucleotides of the invention may encode variant antibody polypeptides which may have a certain identity with a reference polypeptide sequence, or have a similar or dissimilar binding characteristic with the reference polypeptide sequence.

[000878] Antibodies obtained by the methods of the present invention may be chimeric antibodies comprising non-human antibody-derived variable region(s) sequences, derived from the immunized animals, and human antibody-derived constant region(s) sequences. In addition, they can also be humanized antibodies comprising complementary determining regions (CDRs) of non-human antibodies derived from the immunized animals and the framework regions (FRs) and constant regions derived from human antibodies. In another embodiment, the methods provided herein may be useful for enhancing antibody protein product yield in a cell culture process.

Managing Infection

[000879] In one embodiment, provided are methods for treating or preventing a microbial infection (*e.g.*, a bacterial infection) and/or a disease, disorder, or condition associated with a microbial or viral infection, or a symptom thereof, in a subject, by administering a polynucleotide, primary construct or mmRNA encoding an anti-microbial polypeptide. Said administration may be in combination with an anti-microbial agent (*e.g.*, an anti-bacterial agent), *e.g.*, an anti-microbial polypeptide or a small molecule anti-microbial compound described herein. The anti-microbial agents include, but are not

limited to, anti-bacterial agents, anti-viral agents, anti-fungal agents, anti-protozoal agents, anti-parasitic agents, and anti-prion agents.

[000880] The agents can be administered simultaneously, for example in a combined unit dose (*e.g.*, providing simultaneous delivery of both agents). The agents can also be administered at a specified time interval, such as, but not limited to, an interval of minutes, hours, days or weeks. Generally, the agents may be concurrently bioavailable, *e.g.*, detectable, in the subject. In some embodiments, the agents may be administered essentially simultaneously, for example two unit dosages administered at the same time, or a combined unit dosage of the two agents. In other embodiments, the agents may be delivered in separate unit dosages. The agents may be administered in any order, or as one or more preparations that includes two or more agents. In a preferred embodiment, at least one administration of one of the agents, *e.g.*, the first agent, may be made within minutes, one, two, three, or four hours, or even within one or two days of the other agent, *e.g.*, the second agent. In some embodiments, combinations can achieve synergistic results, *e.g.*, greater than additive results, *e.g.*, at least 25, 50, 75, 100, 200, 300, 400, or 500% greater than additive results.

Conditions associated with bacterial infection

[000881] Diseases, disorders, or conditions which may be associated with bacterial infections include, but are not limited to one or more of the following: abscesses, actinomycosis, acute prostatitis, aeromonas hydrophila, annual ryegrass toxicity, anthrax, bacillary peliosis, bacteremia, bacterial gastroenteritis, bacterial meningitis, bacterial pneumonia, bacterial vaginosis, bacterium-related cutaneous conditions, bartonellosis, BCG-oma, botryomycosis, botulism, Brazilian purpuric fever, Brodie abscess, brucellosis, Buruli ulcer, campylobacteriosis, caries, Carrion's disease, cat scratch disease, cellulitis, chlamydia infection, cholera, chronic bacterial prostatitis, chronic recurrent multifocal osteomyelitis, clostridial necrotizing enteritis, combined periodontic-endodontic lesions, contagious bovine pleuropneumonia, diphtheria, diphtheritic stomatitis, ehrlichiosis, erysipelas, piglottitis, erysipelas, Fitz-Hugh-Curtis syndrome, flea-borne spotted fever, foot rot (infectious pododermatitis), Garre's sclerosing osteomyelitis, Gonorrhea, Granuloma inguinale, human granulocytic anaplasmosis, human monocytotropic ehrlichiosis, hundred days' cough, impetigo, late congenital

syphilitic oculopathy, legionellosis, Lemierre's syndrome, leprosy (Hansen's Disease), leptospirosis, listeriosis, Lyme disease, lymphadenitis, melioidosis, meningococcal disease, meningococcal septicaemia, methicillin-resistant *Staphylococcus aureus* (MRSA) infection, mycobacterium avium-intracellulare (MAI), mycoplasma pneumonia, necrotizing fasciitis, nocardiosis, noma (cancrum oris or gangrenous stomatitis), omphalitis, orbital cellulitis, osteomyelitis, overwhelming post-splenectomy infection (OPSI), ovine brucellosis, pasteurellosis, periorbital cellulitis, pertussis (whooping cough), plague, pneumococcal pneumonia, Pott disease, proctitis, pseudomonas infection, psittacosis, pyaemia, pyomyositis, Q fever, relapsing fever (typhina), rheumatic fever, Rocky Mountain spotted fever (RMSF), rickettsiosis, salmonellosis, scarlet fever, sepsis, serratia infection, shigellosis, southern tick-associated rash illness, staphylococcal scalded skin syndrome, streptococcal pharyngitis, swimming pool granuloma, swine brucellosis, syphilis, syphilitic aortitis, tetanus, toxic shock syndrome (TSS), trachoma, trench fever, tropical ulcer, tuberculosis, tularemia, typhoid fever, typhus, urogenital tuberculosis, urinary tract infections, vancomycin-resistant *Staphylococcus aureus* infection, Waterhouse-Friderichsen syndrome, pseudotuberculosis (*Yersinia*) disease, and yersiniosis. Other diseases, disorders, and/or conditions associated with bacterial infections can include, for example, Alzheimer's disease, anorexia nervosa, asthma, atherosclerosis, attention deficit hyperactivity disorder, autism, autoimmune diseases, bipolar disorder, cancer (e.g., colorectal cancer, gallbladder cancer, lung cancer, pancreatic cancer, and stomach cancer), chronic fatigue syndrome, chronic obstructive pulmonary disease, Crohn's disease, coronary heart disease, dementia, depression, Guillain-Barre syndrome, metabolic syndrome, multiple sclerosis, myocardial infarction, obesity, obsessive-compulsive disorder, panic disorder, psoriasis, rheumatoid arthritis, sarcoidosis, schizophrenia, stroke, thromboangiitis obliterans (Buerger's disease), and Tourette syndrome.

Bacterial Pathogens

[000882] The bacterium described herein can be a Gram-positive bacterium or a Gram-negative bacterium. Bacterial pathogens include, but are not limited to, *Acinetobacter baumannii*, *Bacillus anthracis*, *Bacillus subtilis*, *Bordetella pertussis*, *Borrelia burgdorferi*, *Brucella abortus*, *Brucella canis*, *Brucella melitensis*, *Brucella suis*,

Campylobacter jejuni, *Chlamydia pneumoniae*, *Chlamydia trachomatis*, *Chlamydophila psittaci*, *Clostridium botulinum*, *Clostridium difficile*, *Clostridium perfringens*, *Clostridium tetani*, coagulase Negative *Staphylococcus*, *Corynebacterium diphtheria*, *Enterococcus faecalis*, *Enterococcus faecium*, *Escherichia coli*, enterotoxigenic *Escherichia coli* (ETEC), enteropathogenic *E. coli*, *E. coli* 0157:H7, *Enterobacter sp.*, *Francisella tularensis*, *Haemophilus influenzae*, *Helicobacter pylori*, *Klebsiella pneumoniae*, *Legionella pneumophila*, *Leptospira interrogans*, *Listeria monocytogenes*, *Moraxella catarrhalis*, *Mycobacterium leprae*, *Mycobacterium tuberculosis*, *Mycoplasma pneumoniae*, *Neisseria gonorrhoeae*, *Neisseria meningitides*, *Preteus mirabilis*, *Proteus sps.*, *Pseudomonas aeruginosa*, *Rickettsia rickettsii*, *Salmonella typhi*, *Salmonella typhimurium*, *Serratia marcescens*, *Shigella flexneri*, *Shigella sonnei*, *Staphylococcus aureus*, *Staphylococcus epidermidis*, *Staphylococcus saprophyticus*, *Streptococcus agalactiae*, *Streptococcus mutans*, *Streptococcus pneumoniae*, *Streptococcus pyogenes*, *Treponema pallidum*, *Vibrio cholerae*, and *Yersinia pestis*. Bacterial pathogens may also include bacteria that cause resistant bacterial infections, for example, clindamycin-resistant *Clostridium difficile*, fluoroquinolon-resistant *Clostridium difficile*, methicillin-resistant *Staphylococcus aureus* (MRSA), multidrug-resistant *Enterococcus faecalis*, multidrug-resistant *Enterococcus faecium*, multidrug-resistance *Pseudomonas aeruginosa*, multidrug-resistant *Acinetobacter baumannii*, and vancomycin-resistant *Staphylococcus aureus* (VRSA).

Antibiotic Combinations

[000883] In one embodiment, the modified mRNA of the present invention may be administered in conjunction with one or more antibiotics. These include, but are not limited to Aknilox , Ambisome, Amoxicillin, Ampicillin, Augmentin, Avelox, Azithromycin, Bactroban, Betadine, Betnovate, Blephamide, Cefaclor, Cefadroxil, Cefdinir, Cefepime, Cefix, Cefixime, Cefoxitin, Cefpodoxime, Cefprozil, Cefuroxime, Cefzil, Cephalexin, Cephazolin, Ceptaz, Chloramphenicol, Chlorhexidine, Chloromycetin, Chlorsig, Ciprofloxacin, Clarithromycin, Clindagel, Clindamycin, Clindatech, Cloxacillin, Colistin, Co-trimoxazole, Demeclocycline, Diclocil, Dicloxacillin, Doxycycline, Duricef, Erythromycin, Flamazine, Floxin, Framycetin, Fucidin, Furadantin, Fusidic, Gatifloxacin, Gemifloxacin, Gemifloxacin, Ilosone, Iodine,

Levaquin, Levofloxacin, Lomefloxacin, Maxaquin, Mefoxin, Meronem, Minocycline, Moxifloxacin, Myambutol, Mycostatin, Neosporin, Netromycin, Nitrofurantoin, Norfloxacin, Norilet, Ofloxacin, Omnicef, Ospamox, Oxytetracycline, Paraxin, Penicillin, Pneumovax, Polyfax, Povidone, Rifadin, Rifampin, Rifaximin, Rifinah, Rimactane, Rocephin, Roxithromycin, Seromycin, Soframycin, Sparfloxacin, Staphlex, Targocid, Tetracycline, Tetradox, Tetralysal, tobramycin, Tobramycin, Trecator, Tygacil, Vancocin, Velosef, Vibramycin, Xifaxan, Zagam, Zitrotek, Zoderm, Zymar, and Zyvox.

Antibacterial agents

[000884] Exemplary anti-bacterial agents include, but are not limited to, aminoglycosides *{e.g., amikacin (AMIKIN®), gentamicin (GARAMYCIN®), kanamycin (KANTREX®), neomycin (MYCIFRADIN®), netilmicin (NETROMYCIN®), tobramycin (NEBCIN®), Paromomycin (HUMATIN®) }* , ansamycins *{e.g., geldanamycin, herbimycin}* , carbacephem *{e.g., loracarbef (LORABID®), Carbapenems {e.g., ertapenem (INVANZ®), doripenem (DORIBAX®), imipenem/cilastatin (PRIMAXIN®), meropenem (MERREM®), cephalosporins (first generation) {e.g., cefadroxil (DURICEF®), cefazolin (ANCEF®), cefalotin or cefalothin (KEFLIN®), cefalexin (KEFLEX®), cephalosporins (second generation) {e.g., cefaclor (CECLOR®), cefamandole (MANDOL®), cefoxitin (MEFOXIN®), cefprozil (CEFZIL®), cefuroxime (CEFTIN®, ZINNAT®)}, cephalosporins (third generation) {e.g., cefixime (SUPRAX®), cefdinir (OMNICEF®, CEFDIEL®), cefditoren (SPECTRACEF®), cefoperazone (CEFOBID®), cefotaxime (CLAFORAN®), cefpodoxime (VANTIN®), ceftazidime (FORTAZ®), ceftibuten (CEDAX®), ceftizoxime (CEFIZOX®), ceftriaxone (ROCEPHIN®)}, cephalosporins (fourth generation) {e.g., cefepime (MAXIPIME®)}, cephalosporins (fifth generation) {e.g., ceftobiprole (ZEFTERA®)}, glycopeptides {e.g., teicoplanin (TARGOCID®), vancomycin (VANCOCIN®), telavancin (VIBATIV®)}, lincosamides {e.g., clindamycin (CLEOCIN®), lincomycin (LINCOCIN®)}, lipopeptide {e.g., daptomycin (CUBICIN®)}, macrolides {e.g., azithromycin (ZITHROMAX®, SUMAMED®, ZITROCIN®), clarithromycin (BIAXIN®), dirithromycin (DYNABAC®), erythromycin (ERYTHOCIN®, ERYTHROPED®), roxithromycin, troleandomycin (TAO®), telithromycin (KETEK®), spectinomycin (TROBICIN®)}, monobactams {e.g., aztreonam (AZACTAM®)}, nitrofurans {e.g., furazolidone*

(FUROXONE®), nitrofurantoin (MACRODANTIN®, MACROBID®), penicillins (*e.g.*, amoxicillin (NOVAMOX®, AMOXIL®), ampicillin (PRINCIPEN®), azlocillin, carbenicillin (GEOCILLIN®), cloxacillin (TEGOPEN®), dicloxacillin (DYNAPEN®), flucloxacillin (FLOXAPEN®), mezlocillin (MEZLIN®), methicillin (STAPHCILLIN®), nafcillin (UNIPEN®), oxacillin (PROSTAPHLIN®), penicillin G (PENTIDS®), penicillin V (PEN-VEE-K®), piperacillin (PIPRACIL®), temocillin (NEGABAN®), ticarcillin (TICAR®)), penicillin combinations (*e.g.*, amoxicillin/clavulanate (AUGMENTIN®), ampicillin/sulbactam (UNASYN®), piperacillin/tazobactam (ZOSYN®), ticarcillin/clavulanate (TIMENTIN®)), polypeptides (*e.g.*, bacitracin, colistin (COLY-MYCIN-S®), polymyxin B, quinolones (*e.g.*, ciprofloxacin (CIPRO®, CIPROXIN®, CIPROBAY®), enoxacin (PENETREX®), gatifloxacin (TEQUIN®), levofloxacin (LEVAQUIN®), lomefloxacin (MAXAQUIN®), moxifloxacin (AVELOX®), nalidixic acid (NEGGRAM®), norfloxacin (NOROXIN®), ofloxacin (FLOXIN®, OCUFLOX®), trovafloxacin (TROVAN®), grepafloxacin (RAXAR®), sparfloxacin (ZAGAM®), temafloxacin (OMNIFLOX®)), sulfonamides (*e.g.*, mafenide (SULFAMYLON®), sulfonamidochrysoidine (PRONTOSIL®), sulfacetamide (SULAMYD®, BLEPH-10®), sulfadiazine (MICRO-SULFON®), silver sulfadiazine (SILVADENE®), sulfamethizole (THIOSULFIL FORTE®), sulfamethoxazole (GANTANOL®), sulfanilimide, sulfasalazine (AZULFIDINE®), sulfisoxazole (GANTRISIN®), trimethoprim (PROLOPRIM®), TRIMPEX®), trimethoprim-sulfamethoxazole (co-trimoxazole) (TMP-SMX) (BACTRIM®, SEPTRA®)), tetracyclines (*e.g.*, demeclocycline (DECLOMYCIN®), doxycycline (VIBRAMYCIN®), minocycline (MINOCIN®), oxytetracycline (TERRAMYCIN®), tetracycline (SUMYCIN®, ACHROMYCIN® V, STECLIN®)), drugs against mycobacteria (*e.g.*, clofazimine (LAMPRENE®), dapsone (AVLOSULFON®), capreomycin (CAPASTAT®), cycloserine (SEROMYCIN®), ethambutol (MYAMBUTOL®), ethionamide (TRECATOR®), isoniazid (I.N.H.®), pyrazinamide (ALDINAMIDE®), rifampin (RIFADIN®, RIMACTANE®), rifabutin (MYCOBUTIN®), rifapentine (PRIFTIN®), streptomycin), and others (*e.g.*, arsphenamine (SALVARSAN®), chloramphenicol (CHLOROMYCETIN®), fosfomycin (MONUROL®), fusidic acid (FUCIDIN®), linezolid (ZYVOX®), metronidazole (FLAGYL®), mupirocin

(BACTROBAN®), platensimycin, quinupristin/dalfopristin (SYNERCID®), rifaximin (XIFAXAN®), thiamphenicol, tigecycline (TIGACYL®), tinidazole (TINDAMAX®, FASIGYN®)).

Conditions associated with viral infection

[000885] In another embodiment, provided are methods for treating or preventing a viral infection and/or a disease, disorder, or condition associated with a viral infection, or a symptom thereof, in a subject, by administering a polynucleotide, primary construct or mmRNA encoding an anti-viral polypeptide, *e.g.*, an anti-viral polypeptide described herein in combination with an anti-viral agent, *e.g.*, an anti-viral polypeptide or a small molecule anti-viral agent described herein.

[000886] Diseases, disorders, or conditions associated with viral infections include, but are not limited to, acute febrile pharyngitis, pharyngoconjunctival fever, epidemic keratoconjunctivitis, infantile gastroenteritis, Coxsackie infections, infectious mononucleosis, Burkitt lymphoma, acute hepatitis, chronic hepatitis, hepatic cirrhosis, hepatocellular carcinoma, primary HSV-1 infection (*e.g.*, gingivostomatitis in children, tonsillitis and pharyngitis in adults, keratoconjunctivitis), latent HSV-1 infection (*e.g.*, herpes labialis and cold sores), primary HSV-2 infection, latent HSV-2 infection, aseptic meningitis, infectious mononucleosis, Cytomegalic inclusion disease, Kaposi sarcoma, multicentric Castleman disease, primary effusion lymphoma, AIDS, influenza, Reye syndrome, measles, postinfectious encephalomyelitis, Mumps, hyperplastic epithelial lesions (*e.g.*, common, flat, plantar and anogenital warts, laryngeal papillomas, epidermodysplasia verruciformis), cervical carcinoma, squamous cell carcinomas, croup, pneumonia, bronchiolitis, common cold, Poliomyelitis, Rabies, bronchiolitis, pneumonia, influenza-like syndrome, severe bronchiolitis with pneumonia, German measles, congenital rubella, Varicella, and herpes zoster.

Viral pathogens

[000887] Viral pathogens include, but are not limited to, adenovirus, coxsackievirus, dengue virus, encephalitis virus, Epstein-Barr virus, hepatitis A virus, hepatitis B virus, hepatitis C virus, herpes simplex virus type 1, herpes simplex virus type 2, cytomegalovirus, human herpesvirus type 8, human immunodeficiency virus, influenza virus, measles virus, mumps virus, human papillomavirus, parainfluenza virus,

poliovirus, rabies virus, respiratory syncytial virus, rubella virus, varicella-zoster virus, West Nile virus, and yellow fever virus. Viral pathogens may also include viruses that cause resistant viral infections.

Antiviral agents

[000888] Exemplary anti-viral agents include, but are not limited to, abacavir (ZIAGEN®), abacavir/lamivudine/zidovudine (trizivir®), aciclovir or acyclovir (CYCLOVIR®, HERPEX®, ACIVIR®, ACIVIRAX®, ZOVIRAX®, ZOVIR®), adefovir (Preveon®, Hepsera®), amantadine (SYMMETREL®), amprenavir (AGENERASE®), ampligen, arbidol, atazanavir (REYATAZ®), boceprevir, cidofovir, darunavir (PREZISTA®), delavirdine (RESCRIPTOR®), didanosine (VIDEX®), docosanol (ABREVA®), edoxudine, efavirenz (SUSTIVA®, STOCRIN®), emtricitabine (EMTRIVA®), emtricitabine/tenofovir/efavirenz (ATRIPLA®), enfuvirtide (FUZEON®), entecavir (BARACLUDGE®, ENTAVIR®), famciclovir (FAMVIR®), fomivirsen (VITRAVENE®), fosamprenavir (LEXIVA®, TELZIR®), foscarnet (FOSCAVIR®), fosfonet, ganciclovir (CYTOVENE®, CYMEVENE®, VITRASERT®), GS 9137 (ELVITEGRAVIR®), imiquimod (ALDARA®, ZYCLARA®, BESELNA®), indinavir (CRIXIVAN®), inosine, inosine pranobex (IMUNOVIR®), interferon type I, interferon type II, interferon type III, kutapressin (NEXAVIR®), lamivudine (ZEFFIX®, HEPTOVIR®, EPIVIR®), lamivudine/zidovudine (COMBIVIR®), lopinavir, loviride, maraviroc (SELZENTRY®, CELSENTRI®), methisazone, MK-2048, moroxydine, nelfmavir (VIRACEPT®), nevirapine (VIRAMUNE®), oseltamivir (TAMIFLU®), peginterferon alfa-2a (PEGASYS®), penciclovir (DENA VIR®), peramivir, pleconaril, podophyllotoxin (CONDYLOX®), raltegravir (ISENTRESS®), ribavirin (COPEGUS®, REBETOL®, RIBASPHERE®, VILONA® AND VIRAZOLE®), rimantadine (FLUMADINE®), ritonavir (NORVIR®), pyrimidine, saquinavir (INVIRASE®, FORTOVASE®), stavudine, tea tree oil (melaleuca oil), tenofovir (VIREAD®), tenofovir/emtricitabine (TRUVADA®), tipranavir (APTIVUS®), trifluridine (VIROPTIC®), tromantadine (VIRU-MERZ®), valaciclovir (VALTREX®), valganciclovir (VALCYTE®), vicriviroc, vidarabine, viramidine, zalcitabine, zanamivir (RELENZA®), and zidovudine (azidothymidine (AZT), RETROVIR®, RETROVIS®).

Conditions associated with fungal infections

[000889] Diseases, disorders, or conditions associated with fungal infections include, but are not limited to, aspergilloses, blastomycosis, candidiasis, coccidioidomycosis, cryptococcosis, histoplasmosis, mycetomas, paracoccidioidomycosis, and tinea pedis. Furthermore, persons with immuno-deficiencies are particularly susceptible to disease by fungal genera such as *Aspergillus*, *Candida*, *Cryptococcus*, *Histoplasma*, and *Pneumocystis*. Other fungi can attack eyes, nails, hair, and especially skin, the so-called dermatophyte fungi and keratinophilic fungi, and cause a variety of conditions, of which ringworms such as athlete's foot are common. Fungal spores are also a major cause of allergies, and a wide range of fungi from different taxonomic groups can evoke allergic reactions in some people.

Fungal pathogens

[000890] Fungal pathogens include, but are not limited to, Ascomycota (e.g., *Fusarium oxysporum*, *Pneumocystis jirovecii*, *Aspergillus* spp., *Coccidioides immitis/posadasii*, *Candida albicans*), Basidiomycota (e.g., *Filobasidiella neoformans*, *Trichosporon*), Microsporidia (e.g., *Encephalitozoon cuniculi*, *Enterocytozoon bieneusi*), and Mucoromycotina (e.g., *Mucor circinelloides*, *Rhizopus oryzae*, *Lichtheimia corymbifera*).

Anti-fungal agents

[000891] Exemplary anti-fungal agents include, but are not limited to, polyene antifungals {e.g., natamycin, rimocidin, filipin, nystatin, amphotericin B, candicin, hamycin}, imidazole antifungals {e.g., miconazole (MICATIN®, DAKTARIN®), ketoconazole (NIZORAL®, FUNGORAL®, SEBIZOLE®), clotrimazole (LOTRIMIN®, LOTRIMIN® AF, CANESTEN®), econazole, omoconazole, bifonazole, butoconazole, fenticonazole, isoconazole, oxiconazole, sertaconazole (ERTACZO®), sulconazole, tioconazole}, triazole antifungals {e.g., albaconazole fluconazole, itraconazole, isavuconazole, ravuconazole, posaconazole, voriconazole, terconazole}, thiazole antifungals {e.g., abafungin}, allylamines {e.g., terbinafme (LAMISIL®), naftifme (NAFTIN®), butenafme (LOTRIMIN® Ultra)}, echinocandins {e.g., anidulafungin, caspofungin, micafungin}, and others {e.g., polygodial, benzoic acid,

ciclopirox, tolnaftate (TINACTIN®, DESENEKX®, AFTATE®), undecylenic acid, flucytosine or 5-fluorocytosine, griseofulvin, haloprogin, sodium bicarbonate, allicin).

Conditions associated with protozoal infection

[000892] Diseases, disorders, or conditions associated with protozoal infections include, but are not limited to, amoebiasis, giardiasis, trichomoniasis, African Sleeping Sickness, American Sleeping Sickness, leishmaniasis (Kala-Azar), balantidiasis, toxoplasmosis, malaria, acanthamoeba keratitis, and babesiosis.

Protozoan pathogens

[000893] Protozoal pathogens include, but are not limited to, Entamoeba histolytica, Giardia lamblia, Trichomonas vaginalis, Trypanosoma brucei, T. cruzi, Leishmania donovani, Balantidium coli, Toxoplasma gondii, Plasmodium spp., and Babesia microti.

Anti-protozoan agents

[000894] Exemplary anti-protozoal agents include, but are not limited to, eflornithine, furazolidone (FUROXONE®, DEPENDAL-M®), melarsoprol, metronidazole (FLAGYL®), ornidazole, paromomycin sulfate (HUMATIN®), pentamidine, pyrimethamine (DARAPRIM®), and imidazole (TINDAMAX®, FASIGYN®).

Conditions associated with parasitic infection

[000895] Diseases, disorders, or conditions associated with parasitic infections include, but are not limited to, acanthamoeba keratitis, amoebiasis, ascariasis, babesiosis, balantidiasis, baylisascariasis, chagas disease, clonorchiasis, cochliomyia, cryptosporidiosis, diphyllbothriasis, dracunculiasis, echinococcosis, elephantiasis, enterobiasis, fascioliasis, fasciolopsiasis, filariasis, giardiasis, gnathostomiasis, hymenolepiasis, isosporiasis, katayama fever, leishmaniasis, lyme disease, malaria, metagonimiasis, myiasis, onchocerciasis, pediculosis, scabies, schistosomiasis, sleeping sickness, strongyloidiasis, taeniasis, toxocariasis, toxoplasmosis, trichinosis, and trichuriasis.

Parasitic pathogens

[000896] Parasitic pathogens include, but are not limited to, Acanthamoeba, Anisakis, Ascaris lumbricoides, botfly, Balantidium coli, bedbug, Cestoda, chiggers, Cochliomyia hominivorax, Entamoeba histolytica, Fasciola hepatica, Giardia lamblia, hookworm, Leishmania, Linguatula serrata, liver fluke, Loa loa, Paragonimus, pinworm, Plasmodium

falciparum, Schistosoma, Strongyloides stercoralis, mite, tapeworm, Toxoplasma gondii, Trypanosoma, whipworm, Wuchereria bancrofti.

Anti-parasitic agents

[000897] Exemplary anti-parasitic agents include, but are not limited to, antinematodes (*e.g.*, mebendazole, pyrantel pamoate, thiabendazole, diethylcarbamazine, ivermectin), anticestodes (*e.g.*, niclosamide, praziquantel, albendazole), antitrepatodes (*e.g.*, praziquantel), antiamoebics (*e.g.*, rifampin, amphotericin B), and antiprotozoals (*e.g.*, melarsoprol, eflornithine, metronidazole, imidazole).

Conditions associated with prion infection

[000898] Diseases, disorders, or conditions associated with prion infections include, but are not limited to Creutzfeldt-Jakob disease (CJD), iatrogenic Creutzfeldt-Jakob disease (iCJD), variant Creutzfeldt-Jakob disease (vCJD), familial Creutzfeldt-Jakob disease (fCJD), sporadic Creutzfeldt-Jakob disease (sCJD), Gerstmann-Straussler-Scheinker syndrome (GSS), fatal familial insomnia (FFI), Kuru, Scrapie, bovine spongiform encephalopathy (BSE), mad cow disease, transmissible mink encephalopathy (TME), chronic wasting disease (CWD), feline spongiform encephalopathy (FSE), exotic ungulate encephalopathy (EUE), and spongiform encephalopathy.

Anti-prion agents

[000899] Exemplary anti-prion agents include, but are not limited to, flupirtine, pentosan polysuphate, quinacrine, and tetracyclic compounds.

Modulation of the Immune Response

Avoidance of the immune response

[000900] As described herein, a useful feature of the polynucleotides, primary constructs or mmRNA of the invention is the capacity to reduce, evade or avoid the innate immune response of a cell. In one aspect, provided herein are polynucleotides, primary constructs or mmRNA encoding a polypeptide of interest which when delivered to cells, results in a reduced immune response from the host as compared to the response triggered by a reference compound, *e.g.* an unmodified polynucleotide corresponding to a polynucleotide, primary construct or mmRNA of the invention, or a different polynucleotide, primary construct or mmRNA of the invention. As used herein, a "reference compound" is any molecule or substance which when administered to a

mammal, results in an innate immune response having a known degree, level or amount of immune stimulation. A reference compound need not be a nucleic acid molecule and it need not be any of the polynucleotides, primary constructs or mmRNA of the invention. Hence, the measure of a polynucleotides, primary constructs or mmRNA avoidance, evasion or failure to trigger an immune response can be expressed in terms relative to any compound or substance which is known to trigger such a response.

[000901] The term "innate immune response" includes a cellular response to exogenous single stranded nucleic acids, generally of viral or bacterial origin, which involves the induction of cytokine expression and release, particularly the interferons, and cell death. As used herein, the innate immune response or interferon response operates at the single cell level causing cytokine expression, cytokine release, global inhibition of protein synthesis, global destruction of cellular RNA, upregulation of major histocompatibility molecules, and/or induction of apoptotic death, induction of gene transcription of genes involved in apoptosis, anti-growth, and innate and adaptive immune cell activation. Some of the genes induced by type I IFNs include PKR, ADAR (adenosine deaminase acting on RNA), OAS (2',5'-oligoadenylate synthetase), RNase L, and Mx proteins. PKR and ADAR lead to inhibition of translation initiation and RNA editing, respectively. OAS is a dsRNA-dependent synthetase that activates the endoribonuclease RNase L to degrade ssRNA.

[000902] In some embodiments, the innate immune response comprises expression of a Type I or Type II interferon, and the expression of the Type I or Type II interferon is not increased more than two-fold compared to a reference from a cell which has not been contacted with a polynucleotide, primary construct or mmRNA of the invention.

[000903] In some embodiments, the innate immune response comprises expression of one or more IFN signature genes and where the expression of the one or more IFN signature genes is not increased more than three-fold compared to a reference from a cell which has not been contacted with the polynucleotide, primary construct or mmRNA of the invention.

[000904] While in some circumstances, it might be advantageous to eliminate the innate immune response in a cell, the invention provides polynucleotides, primary constructs and mmRNA that upon administration result in a substantially reduced (significantly less)

the immune response, including interferon signaling, without entirely eliminating such a response.

[000905] In some embodiments, the immune response is lower by 10%, 20%, 30%, 40%, 50%, 60%, 70%, 80%, 90%, 95%, 99%, 99.9%, or greater than 99.9% as compared to the immune response induced by a reference compound. The immune response itself may be measured by determining the expression or activity level of Type 1 interferons or the expression of interferon-regulated genes such as the toll-like receptors (e.g., TLR7 and TLR8). Reduction of innate immune response can also be measured by measuring the level of decreased cell death following one or more administrations to a cell population; e.g., cell death is 10%, 25%, 50%, 75%, 85%, 90%, 95%, or over 95% less than the cell death frequency observed with a reference compound. Moreover, cell death may affect fewer than 50%, 40%, 30%, 20%, 10%, 5%, 1%, 0.1%, 0.01% or fewer than 0.01% of cells contacted with the polynucleotide, primary construct or mmRNA.

[000906] In another embodiment, the polynucleotide, primary construct or mmRNA of the present invention is significantly less immunogenic than an unmodified in vitro-synthesized RNA molecule polynucleotide, or primary construct with the same sequence or a reference compound. As used herein, "significantly less immunogenic" refers to a detectable decrease in immunogenicity. In another embodiment, the term refers to a fold decrease in immunogenicity. In another embodiment, the term refers to a decrease such that an effective amount of the polynucleotide, primary construct or mmRNA can be administered without triggering a detectable immune response. In another embodiment, the term refers to a decrease such that the polynucleotide, primary construct or mmRNA can be repeatedly administered without eliciting an immune response sufficient to detectably reduce expression of the recombinant protein. In another embodiment, the decrease is such that the polynucleotide, primary construct or mmRNA can be repeatedly administered without eliciting an immune response sufficient to eliminate detectable expression of the recombinant protein.

[000907] In another embodiment, the polynucleotide, primary construct or mmRNA is 2-fold less immunogenic than its unmodified counterpart or reference compound. In another embodiment, immunogenicity is reduced by a 3-fold factor. In another embodiment, immunogenicity is reduced by a 5-fold factor. In another embodiment,

immunogenicity is reduced by a 7-fold factor. In another embodiment, immunogenicity is reduced by a 10-fold factor. In another embodiment, immunogenicity is reduced by a 15-fold factor. In another embodiment, immunogenicity is reduced by a fold factor. In another embodiment, immunogenicity is reduced by a 50-fold factor. In another embodiment, immunogenicity is reduced by a 100-fold factor. In another embodiment, immunogenicity is reduced by a 200-fold factor. In another embodiment, immunogenicity is reduced by a 500-fold factor. In another embodiment, immunogenicity is reduced by a 1000-fold factor. In another embodiment, immunogenicity is reduced by a 2000-fold factor. In another embodiment, immunogenicity is reduced by another fold difference.

[000908] Methods of determining immunogenicity are well known in the art, and include, e.g. measuring secretion of cytokines (e.g. IL-12, IFNalpha, TNF-alpha, RANTES, MIP-1 alpha or beta, IL-6, IFN-beta, or IL-8), measuring expression of DC activation markers (e.g. CD83, HLA-DR, CD80 and CD86), or measuring ability to act as an adjuvant for an adaptive immune response.

[000909] The the polynucleotide, primary construct or mmRNA of the invention, including the combination of modifications taught herein may have superior properties making them more suitable as therapeutic modalities.

[000910] It has been determined that the "all or none" model in the art is sorely insufficient to describe the biological phenomena associated with the therapeutic utility of modified mRNA. The present inventors have determined that to improve protein production, one may consider the nature of the modification, or combination of modifications, the percent modification and survey more than one cytokine or metric to determine the efficacy and risk profile of a particular modified mRNA.

[000911] In one aspect of the invention, methods of determining the effectiveness of a modified mRNA as compared to unmodified involves the measure and analysis of one or more cytokines whose expression is triggered by the administration of the exogenous nucleic acid of the invention. These values are compared to administration of an unmodified nucleic acid or to a standard metric such as cytokine response, PolyIC, R-848 or other standard known in the art.

[000912] One example of a standard metric developed herein is the measure of the ratio of the level or amount of encoded polypeptide (protein) produced in the cell, tissue or

organism to the level or amount of one or more (or a panel) of cytokines whose expression is triggered in the cell, tissue or organism as a result of administration or contact with the modified nucleic acid. Such ratios are referred to herein as the Protein:Cytokine Ratio or "PC" Ratio. The higher the PC ratio, the more efficacious the modified nucleic acid (polynucleotide encoding the protein measured). Preferred PC Ratios, by cytokine, of the present invention may be greater than 1, greater than 10, greater than 100, greater than 1000, greater than 10,000 or more. Modified nucleic acids having higher PC Ratios than a modified nucleic acid of a different or unmodified construct are preferred.

[000913] The PC ratio may be further qualified by the percent modification present in the polynucleotide. For example, normalized to a 100% modified nucleic acid, the protein production as a function of cytokine (or risk) or cytokine profile can be determined.

[000914] In one embodiment, the present invention provides a method for determining, across chemistries, cytokines or percent modification, the relative efficacy of any particular modified the polynucleotide, primary construct or mmRNA by comparing the PC Ratio of the modified nucleic acid (polynucleotide, primary construct or mmRNA).

[000915] mmRNA containing varying levels of nucleobase substitutions could be produced that maintain increased protein production and decreased immunostimulatory potential. The relative percentage of any modified nucleotide to its naturally occurring nucleotide counterpart can be varied during the IVT reaction (for instance, 100, 50, 25, 10, 5, 2.5, 1, 0.1, 0.01% 5 methyl cytidine usage versus cytidine; 100, 50, 25, 10, 5, 2.5, 1, 0.1, 0.01% pseudouridine or NI-methyl-pseudouridine usage versus uridine). mmRNA can also be made that utilize different ratios using 2 or more different nucleotides to the same base (for instance, different ratios of pseudouridine and NI-methyl-pseudouridine). mmRNA can also be made with mixed ratios at more than 1 "base" position, such as ratios of 5 methyl cytidine/cytidine and pseudouridine/NI-methyl-pseudouridine/uridine at the same time. Use of modified mRNA with altered ratios of modified nucleotides can be beneficial in reducing potential exposure to chemically modified nucleotides. Lastly, positional introduction of modified nucleotides into the mmRNA which modulate either protein production or immunostimulatory

potential or both is also possible. The ability of such mmRNA to demonstrate these improved properties can be assessed in vitro (using assays such as the PBMC assay described herein), and can also be assessed in vivo through measurement of both mmRNA-encoded protein production and mediators of innate immune recognition such as cytokines.

[000916] In another embodiment, the relative immunogenicity of the polynucleotide, primary construct or mmRNA and its unmodified counterpart are determined by determining the quantity of the polynucleotide, primary construct or mmRNA required to elicit one of the above responses to the same degree as a given quantity of the unmodified nucleotide or reference compound. For example, if twice as much polynucleotide, primary construct or mmRNA is required to elicit the same response, than the polynucleotide, primary construct or mmRNA is two-fold less immunogenic than the unmodified nucleotide or the reference compound.

[000917] In another embodiment, the relative immunogenicity of the polynucleotide, primary construct or mmRNA and its unmodified counterpart are determined by determining the quantity of cytokine (e.g. IL-12, IFN α , TNF- α , RANTES, MIP-1 α or beta, IL-6, IFN-beta, or IL-8) secreted in response to administration of the polynucleotide, primary construct or mmRNA, relative to the same quantity of the unmodified nucleotide or reference compound. For example, if one-half as much cytokine is secreted, than the polynucleotide, primary construct or mmRNA is two-fold less immunogenic than the unmodified nucleotide. In another embodiment, background levels of stimulation are subtracted before calculating the immunogenicity in the above methods.

[000918] Provided herein are also methods for performing the titration, reduction or elimination of the immune response in a cell or a population of cells. In some embodiments, the cell is contacted with varied doses of the same polynucleotides, primary constructs or mmRNA and dose response is evaluated. In some embodiments, a cell is contacted with a number of different polynucleotides, primary constructs or mmRNA at the same or different doses to determine the optimal composition for producing the desired effect. Regarding the immune response, the desired effect may be

to avoid, evade or reduce the immune response of the cell. The desired effect may also be to alter the efficiency of protein production.

[000919] The polynucleotides, primary constructs and/or mmRNA of the present invention may be used to reduce the immune response using the method described in International Publication No. WO2013003475, herein incorporated by reference in its entirety.

Activation of the immune response: Vaccines

[000920] Additionally, certain modified nucleosides, or combinations thereof, when introduced into the polynucleotides, primary constructs or mmRNA of the invention will activate the innate immune response. Such activating molecules are useful as adjuvants when combined with polypeptides and/or other vaccines. In certain embodiments, the activating molecules contain a translatable region which encodes for a polypeptide sequence useful as a vaccine, thus providing the ability to be a self-adjuvant.

[000921] In one embodiment, the polynucleotides, primary constructs and/or mmRNA of the invention may encode an immunogen. The delivery of the polynucleotides, primary constructs and/or mmRNA encoding an immunogen may activate the immune response. As a non-limiting example, the polynucleotides, primary constructs and/or mmRNA encoding an immunogen may be delivered to cells to trigger multiple innate response pathways (see International Pub. No. WO2012006377; herein incorporated by reference in its entirety). As another non-limiting example, the polynucleotides, primary constructs and mmRNA of the present invention encoding an immunogen may be delivered to a vertebrate in a dose amount large enough to be immunogenic to the vertebrate (see International Pub. No. WO2012006372 and WO2012006369; each of which is herein incorporated by reference in their entirety).

[000922] The polynucleotides, primary constructs or mmRNA of invention may encode a polypeptide sequence for a vaccine and may further comprise an inhibitor. The inhibitor may impair antigen presentation and/or inhibit various pathways known in the art. As a non-limiting example, the polynucleotides, primary constructs or mmRNA of the invention may be used for a vaccine in combination with an inhibitor which can impair antigen presentation (see International Pub. No. WO2012089225 and WO2012089338; each of which is herein incorporated by reference in their entirety).

[000923] In one embodiment, the polynucleotides, primary constructs or mmRNA of the invention may be self-replicating RNA. Self-replicating RNA molecules can enhance efficiency of RNA delivery and expression of the enclosed gene product. In one embodiment, the polynucleotides, primary constructs or mmRNA may comprise at least one modification described herein and/or known in the art. In one embodiment, the self-replicating RNA can be designed so that the self-replicating RNA does not induce production of infectious viral particles. As a non-limiting example the self-replicating RNA may be designed by the methods described in US Pub. No. US201 10300205 and International Pub. No. WO201 1005799, each of which is herein incorporated by reference in their entirety.

[000924] In one embodiment, the self-replicating polynucleotides, primary constructs or mmRNA of the invention may encode a protein which may raise the immune response. As a non-limiting example, the polynucleotides, primary constructs or mmRNA may be self-replicating mRNA may encode at least one antigen (see US Pub. No. US201 10300205 and International Pub. Nos. WO201 1005799, WO2013006838 and WO20 13006842; each of which is herein incorporated by reference in their entirety).

[000925] In one embodiment, the self-replicating polynucleotides, primary constructs or mmRNA of the invention may be formulated using methods described herein or known in the art. As a non-limiting example, the self-replicating RNA may be formulated for delivery by the methods described in Geall et al (Nonviral delivery of self-amplifying RNA vaccines, PNAS 2012; PMID: 22908294).

[000926] In one embodiment, the polynucleotides, primary constructs or mmRNA of the present invention may encode amphipathic and/or immunogenic amphipathic peptides.

[000927] In on embodiment, a formulation of the polynucleotides, primary constructs or mmRNA of the present invention may further comprise an amphipathic and/or immunogenic amphipathic peptide. As a non-limiting example, the polynucleotides, primary constructs or mmRNA comprising an amphipathic and/or immunogenic amphipathic peptide may be formulated as described in US. Pub. No. US201 10250237 and International Pub. Nos. WO2010009277 and WO2010009065; each of which is herein incorporated by reference in their entirety.

[000928] In one embodiment, the polynucleotides, primary constructs or mmRNA of the present invention may be immunostimulatory. As a non-limiting example, the polynucleotides, primary constructs or mmRNA may encode all or a part of a positive-sense or a negative-sense stranded RNA virus genome (see International Pub No. WO2012092569 and US Pub No. US20120177701, each of which is herein incorporated by reference in their entirety). In another non-limiting example, the immunostimulatory polynucleotides, primary constructs or mmRNA of the present invention may be formulated with an excipient for administration as described herein and/or known in the art (see International Pub No. WO2012068295 and US Pub No. US20120213812, each of which is herein incorporated by reference in their entirety).

[000929] In one embodiment, the response of the vaccine formulated by the methods described herein may be enhanced by the addition of various compounds to induce the therapeutic effect. As a non-limiting example, the vaccine formulation may include a MHC II binding peptide or a peptide having a similar sequence to a MHC II binding peptide (see International Pub Nos. WO2012027365, WO201 1031298 and US Pub No. US20 120070493, US201 101 10965, each of which is herein incorporated by reference in their entirety). As another example, the vaccine formulations may comprise modified nicotinic compounds which may generate an antibody response to nicotine residue in a subject (see International Pub No. WO2012061717 and US Pub No. US201201 14677, each of which is herein incorporated by reference in their entirety).

Naturally Occurring Mutants

[000930] In another embodiment, the polynucleotides, primary construct and/or mmRNA can be utilized to express variants of naturally occurring proteins that have an improved disease modifying activity, including increased biological activity, improved patient outcomes, or a protective function, etc. Many such modifier genes have been described in mammals (Nadeau, Current Opinion in Genetics & Development 2003 13:290-295; Hamilton and Yu, PLoS Genet. 2012;8:e1002644; Corder et al, Nature Genetics 1994 7:180 - 184; all herein incorporated by reference in their entirety). Examples in humans include Apo E2 protein, Apo A-I variant proteins (Apo A-I Milano, Apo A-I Paris), hyperactive Factor IX protein (Factor IX Padua Arg338Lys), transthyretin mutants (TTR Thr19Met). Expression of ApoE2 (cys12, cys158) has

been shown to confer protection relative to other ApoE isoforms (*ApoE3* (cys12, arg158), and *ApoE4* (arg12, arg158)) by reducing susceptibility to Alzheimer's disease and possibly other conditions such as cardiovascular disease (Corder et al, Nature Genetics 1994 7:180 - 184; Seripa et al, Rejuvenation Res. 2011 14:491-500; Liu et al. Nat Rev Neurol. 2013 9:106-118; all herein incorporated by reference in their entirety). Expression of Apo A-I variants has been associated with reduced cholesterol (deGoma and Rader, 2011 Nature Rev Cardiol 8:266-271; Nissen et al, 2003 JAMA 290:2292-2300; all herein incorporated by reference in its entirety). The amino acid sequence of ApoA-I in certain populations has been changed to cysteine in Apo A-I Milano (Arg 173 changed to Cys) and in Apo A-I Paris (Arg 151 changed to Cys). Factor IX mutation at position R338L (FIX Padua) results in a Factor IX protein that has ~10-fold increased activity (Simioni et al, N Engl J Med. 2009 361:1671-1675; Finn et al, Blood. 2012 120:4521-4523; Cantore et al, Blood. 2012 120:4517-20; all herein incorporated by reference in their entirety). Mutation of transthyretin at positions 104 or 119 (Arg 104 His, Thr119Met) has been shown to provide protection to patients also harboring the disease causing VaBOMet mutations (Saraiva, Hum Mutat. 2001 17:493-503; DATA BASE ON TRANSTHYRETIN MUTATIONS

<http://www.ibmc.up.pt/mjsaraiva/ttrmut.html>; all herein incorporated by reference in its entirety). Differences in clinical presentation and severity of symptoms among Portuguese and Japanese Met 30 patients carrying respectively the Met 119 and the His 104 mutations are observed with a clear protective effect exerted by the non pathogenic mutant (Coelho et al. 1996 Neuromuscular Disorders (Suppl) 6: S20; Terazaki et al. 1999. Biochem Biophys Res Commun 264: 365-370; all herein incorporated by reference in its entirety), which confer more stability to the molecule. A modified mRNA encoding these protective TTR alleles can be expressed in TTR amyloidosis patients, thereby reducing the effect of the pathogenic mutant TTR protein.

Major Groove Interacting Partners

[000931] As described herein, the phrase "major groove interacting partner" refers to RNA recognition receptors that detect and respond to RNA ligands through interactions, *e.g.* binding, with the major groove face of a nucleotide or nucleic acid. As such, RNA ligands comprising modified nucleotides or nucleic acids such as the polynucleotide,

primary construct or mmRNA as described herein decrease interactions with major groove binding partners, and therefore decrease an innate immune response.

[000932] Example major groove interacting, *e.g.* binding, partners include, but are not limited to the following nucleases and helicases. Within membranes, TLRs (Toll-like Receptors) 3, 7, and 8 can respond to single- and double-stranded RNAs. Within the cytoplasm, members of the superfamily 2 class of DEX(D/H) helicases and ATPases can sense RNAs to initiate antiviral responses. These helicases include the RIG-I (retinoic acid-inducible gene I) and MDA5 (melanoma differentiation-associated gene 5). Other examples include laboratory of genetics and physiology 2 (LGP2), HFN-200 domain containing proteins, or Helicase-domain containing proteins.

Targeting of pathogenic organisms or diseased cells

[000933] Provided herein are methods for targeting pathogenic microorganisms, such as bacteria, yeast, protozoa, helminthes and the like, or diseased cells such as cancer cells using polynucleotides, primary constructs or mmRNA that encode cytostatic or cytotoxic polypeptides. Preferably the mRNA introduced contains modified nucleosides or other nucleic acid sequence modifications that are translated exclusively, or preferentially, in the target pathogenic organism, to reduce possible off-target effects of the therapeutic. Such methods are useful for removing pathogenic organisms or killing diseased cells found in any biological material, including blood, semen, eggs, and transplant materials including embryos, tissues, and organs.

Bioprocessing

[000934] The methods provided herein may be useful for enhancing protein product yield in a cell culture process. In a cell culture containing a plurality of host cells, introduction of a polynucleotide, primary construct or mmRNA described herein results in increased protein production efficiency relative to a corresponding unmodified nucleic acid. Such increased protein production efficiency can be demonstrated, *e.g.*, by showing increased cell transfection, increased protein translation from the polynucleotide, primary construct or mmRNA, decreased nucleic acid degradation, and/or reduced innate immune response of the host cell. Protein production can be measured by enzyme-linked immunosorbent assay (ELISA), and protein activity can be measured by various

functional assays known in the art. The protein production may be generated in a continuous or a batch-fed mammalian process.

[000935] Additionally, it is useful to optimize the expression of a specific polypeptide in a cell line or collection of cell lines of potential interest, particularly a polypeptide of interest such as a protein variant of a reference protein having a known activity. In one embodiment, provided is a method of optimizing expression of a polypeptide of interest in a target cell, by providing a plurality of target cell types, and independently contacting with each of the plurality of target cell types a polynucleotide, primary construct or mmRNA encoding a polypeptide of interest. The cells may be transfected with two or more polynucleotide, primary construct or mmRNA simultaneously or sequentially.

[000936] In certain embodiments, multiple rounds of the methods described herein may be used to obtain cells with increased expression of one or more nucleic acids or proteins of interest. For example, cells may be transfected with one or more polynucleotide, primary construct or mmRNA that encode a nucleic acid or protein of interest. The cells may be isolated according to methods described herein before being subjected to further rounds of transfections with one or more other nucleic acids which encode a nucleic acid or protein of interest before being isolated again. This method may be useful for generating cells with increased expression of a complex of proteins, nucleic acids or proteins in the same or related biological pathway, nucleic acids or proteins that act upstream or downstream of each other, nucleic acids or proteins that have a modulating, activating or repressing function to each other, nucleic acids or proteins that are dependent on each other for function or activity, or nucleic acids or proteins that share homology.

[000937] Additionally, culture conditions may be altered to increase protein production efficiency. Subsequently, the presence and/or level of the polypeptide of interest in the plurality of target cell types is detected and/or quantitated, allowing for the optimization of a polypeptide's expression by selection of an efficient target cell and cell culture conditions relating thereto. Such methods are particularly useful when the polypeptide contains one or more post-translational modifications or has substantial tertiary structure, situations which often complicate efficient protein production.

[000938] In one embodiment, the cells used in the methods of the present invention may be cultured. The cells may be cultured in suspension or as adherent cultures. The cells may be cultured in a varied of vessels including, but not limited to, bioreactors, cell bags, wave bags, culture plates, flasks and other vessels well known to those of ordinary skill in the art. Cells may be cultured in IMDM (Invitrogen, Catalog number 12440-53) or any other suitable media including, but not limited to, chemically defined media formulations. The ambient conditions which may be suitable for cell culture, such as temperature and atmospheric composition, are well known to those skilled in the art. The methods of the invention may be used with any cell that is suitable for use in protein production.

[000939] The invention provides for the repeated introduction (e.g., transfection) of modified nucleic acids into a target cell population, e.g., *in vitro*, *ex vivo*, *in situ*, or *in vivo*. For example, contacting the same cell population may be repeated one or more times (such as two, three, four, five or more than five times). In some embodiments, the step of contacting the cell population with the polynucleotides, primary constructs or mmRNA is repeated a number of times sufficient such that a predetermined efficiency of protein translation in the cell population is achieved. Given the often reduced cytotoxicity of the target cell population provided by the nucleic acid modifications, repeated transfections are achievable in a diverse array of cell types and within a variety of tissues, as provided herein.

[000940] In one embodiment, the bioprocessing methods of the present invention may be used to produce antibodies or functional fragments thereof. The functional fragments may comprise a Fab, Fab', F(ab')₂, an Fv domain, an scFv, or a diabody. They may be variable in any region including the complement determining region (CDR). In one embodiment, there is complete diversity in the CDR3 region. In another embodiment, the antibody is substantially conserved except in the CDR3 region.

[000941] Antibodies may be made which bind or associate with any biomolecule, whether human, pathogenic or non-human in origin. The pathogen may be present in a non-human mammal, a clinical specimen or from a commercial product such as a cosmetic or pharmaceutical material. They may also bind to any specimen or sample including clinical specimens or tissue samples from any organism.

[000942] In some embodiments, the contacting step is repeated multiple times at a frequency selected from the group consisting of: 6 hour, 12 hour, 24 hour, 36 hour, 48 hour, 72 hour, 84 hour, 96 hour, and 108 hour and at concentrations of less than 20 nM, less than 50 nM, less than 80 nM or less than 100 nM. Compositions may also be administered at less than 1mM, less than 5mM, less than 10mM, less than 100mM or less than 500 mM.

[000943] In some embodiments, the polynucleotides, primary constructs or mmRNA are added at an amount of 50 molecules per cell, 100 molecules/cell, 200 molecules/cell, 300 molecules/cell, 400 molecules/cell, 500 molecules/ cell, 600 molecules/cell, 700 molecules/ cell, 800 molecules/cell, 900 molecules/cell, 1000 molecules/cell, 2000 molecules/cell, or 5000 molecules/cell.

[000944] In other embodiments, the polynucleotides, primary constructs or mmRNA are added at a concentration selected from the group consisting of: 0.01 fmol/10⁶ cells, 0.1 fmol/10⁶ cells, 0.5 fmol/10⁶ cells, 0.75 fmol/10⁶ cells, 1 fmol/10⁶ cells, 2 fmol/10⁶ cells, 5 fmol/10⁶ cells, 10 fmol/10⁶ cells, 20 fmol/10⁶ cells, 30 fmol/10⁶ cells, 40 fmol/10⁶ cells, 50 fmol/10⁶ cells, 60 fmol/10⁶ cells, 100 fmol/10⁶ cells, 200 fmol/10⁶ cells, 300 fmol/10⁶ cells, 400 fmol/10⁶ cells, 500 fmol/10⁶ cells, 700 fmol/10⁶ cells, 800 fmol/10⁶ cells, 900 fmol/10⁶ cells, and 1 pmol/10⁶ cells.

[000945] In some embodiments, the production of a biological product upon is detected by monitoring one or more measurable bioprocess parameters, such as a parameter selected from the group consisting of: cell density, pH, oxygen levels, glucose levels, lactic acid levels, temperature, and protein production. Protein production can be measured as specific productivity (SP) (the concentration of a product, such as a heterologously expressed polypeptide, in solution) and can be expressed as mg/L or g/L; in the alternative, specific productivity can be expressed as pg/cell/day. An increase in SP can refer to an absolute or relative increase in the concentration of a product produced under two defined set of conditions (e.g., when compared with controls not treated with modified mRNA(s)).

Cells

[000946] In one embodiment, the cells are selected from the group consisting of mammalian cells, bacterial cells, plant, microbial, algal and fungal cells. In some

embodiments, the cells are mammalian cells, such as, but not limited to, human, mouse, rat, goat, horse, rabbit, hamster or cow cells. In a further embodiment, the cells may be from an established cell line, including, but not limited to, HeLa, NSO, SP2/0, KEK 293T, Vero, Caco, Caco-2, MDCK, COS-1, COS-7, K562, Jurkat, CHO-K1, DG44, CHOK1SV, CHO-S, Huvec, CV-1, Huh-7, NIH3T3, HEK293, 293, A549, HepG2, IMR-90, MCF-7, U-20S, Per.C6, SF9, SF21 or Chinese Hamster Ovary (CHO) cells.

[000947] In certain embodiments, the cells are fungal cells, such as, but not limited to, Chrysosporium cells, Aspergillus cells, Trichoderma cells, Dictyostelium cells, Candida cells, Saccharomyces cells, Schizosaccharomyces cells, and Penicillium cells.

[000948] In certain embodiments, the cells are bacterial cells such as, but not limited to, E. coli, B. subtilis, or BL21 cells. Primary and secondary cells to be transfected by the methods of the invention can be obtained from a variety of tissues and include, but are not limited to, all cell types which can be maintained in culture. For examples, primary and secondary cells which can be transfected by the methods of the invention include, but are not limited to, fibroblasts, keratinocytes, epithelial cells (e.g., mammary epithelial cells, intestinal epithelial cells), endothelial cells, glial cells, neural cells, formed elements of the blood (e.g., lymphocytes, bone marrow cells), muscle cells and precursors of these somatic cell types. Primary cells may also be obtained from a donor of the same species or from another species (e.g., mouse, rat, rabbit, cat, dog, pig, cow, bird, sheep, goat, horse).

Purification and Isolation

[000949] Those of ordinary skill in the art should be able to make a determination of the methods to use to purify or isolate of a protein of interest from cultured cells. Generally, this is done through a capture method using affinity binding or non-affinity purification. If the protein of interest is not secreted by the cultured cells, then a lysis of the cultured cells should be performed prior to purification or isolation. One may use unclarified cell culture fluid containing the protein of interest along with cell culture media components as well as cell culture additives, such as anti-foam compounds and other nutrients and supplements, cells, cellular debris, host cell proteins, DNA, viruses and the like in the present invention. The process may be conducted in the bioreactor itself. The fluid may either be preconditioned to a desired stimulus such as pH, temperature or other stimulus

characteristic or the fluid can be conditioned upon the addition of polymer(s) or the polymer(s) can be added to a carrier liquid that is properly conditioned to the required parameter for the stimulus condition required for that polymer to be solubilized in the fluid. The polymer may be allowed to circulate thoroughly with the fluid and then the stimulus may be applied (change in pH, temperature, salt concentration, etc) and the desired protein and polymer(s) precipitate can out of the solution. The polymer and the desired protein(s) can be separated from the rest of the fluid and optionally washed one or more times to remove any trapped or loosely bound contaminants. The desired protein may then be recovered from the polymer(s) by, for example, elution and the like. Preferably, the elution may be done under a set of conditions such that the polymer remains in its precipitated form and retains any impurities to it during the selected elution of the desired protein. The polymer and protein as well as any impurities may be solubilized in a new fluid such as water or a buffered solution and the protein may be recovered by a means such as affinity, ion exchanged, hydrophobic, or some other type of chromatography that has a preference and selectivity for the protein over that of the polymer or impurities. The eluted protein may then be recovered and may be subjected to additional processing steps, either batch like steps or continuous flow through steps if appropriate.

[000950] In another embodiment, it may be useful to optimize the expression of a specific polypeptide in a cell line or collection of cell lines of potential interest, particularly a polypeptide of interest such as a protein variant of a reference protein having a known activity. In one embodiment, provided is a method of optimizing expression of a polypeptide of interest in a target cell, by providing a plurality of target cell types, and independently contacting with each of the plurality of target cell types a modified mRNA encoding a polypeptide. Additionally, culture conditions may be altered to increase protein production efficiency. Subsequently, the presence and/or level of the polypeptide of interest in the plurality of target cell types is detected and/or quantitated, allowing for the optimization of a polypeptide of interest's expression by selection of an efficient target cell and cell culture conditions relating thereto. Such methods may be useful when the polypeptide of interest contains one or more post-translational

modifications or has substantial tertiary structure, which often complicate efficient protein production.

Protein recovery

[000951] The protein of interest may be preferably recovered from the culture medium as a secreted polypeptide, or it can be recovered from host cell lysates if expressed without a secretory signal. It may be necessary to purify the protein of interest from other recombinant proteins and host cell proteins in a way that substantially homogenous preparations of the protein of interest are obtained. The cells and/or particulate cell debris may be removed from the culture medium or lysate. The product of interest may then be purified from contaminant soluble proteins, polypeptides and nucleic acids by, for example, fractionation on immunoaffinity or ion-exchange columns, ethanol precipitation, reverse phase HPLC (RP-HPLC), SEPHADEX® chromatography, chromatography on silica or on a cation exchange resin such as DEAE. Methods of purifying a protein heterologous expressed by a host cell are well known in the art.

[000952] Methods and compositions described herein may be used to produce proteins which are capable of attenuating or blocking the endogenous agonist biological response and/or antagonizing a receptor or signaling molecule in a mammalian subject. For example, IL-12 and IL-23 receptor signaling may be enhanced in chronic autoimmune disorders such as multiple sclerosis and inflammatory diseases such as rheumatoid arthritis, psoriasis, lupus erythematosus, ankylosing spondylitis and Chron's disease (Kikly K, Liu L, Na S, Sedgwich JD (2006) Cur. Opin. Immunol. 18(6): 670-5). In another embodiment, a nucleic acid encodes an antagonist for chemokine receptors. Chemokine receptors CXCR-4 and CCR-5 are required for HIV entry into host cells (Arenzana-Seisdedos F et al, (1996) Nature. Oct 3; 383 (6599):400).

Gene Silencing

[000953] The polynucleotides, primary constructs and mmRNA described herein are useful to silence (i.e., prevent or substantially reduce) expression of one or more target genes in a cell population. A polynucleotide, primary construct or mmRNA encoding a polypeptide of interest capable of directing sequence-specific histone H3 methylation is introduced into the cells in the population under conditions such that the polypeptide is translated and reduces gene transcription of a target gene via histone H3 methylation and

subsequent heterochromatin formation. In some embodiments, the silencing mechanism is performed on a cell population present in a mammalian subject. By way of non-limiting example, a useful target gene is a mutated Janus Kinase-2 family member, wherein the mammalian subject expresses the mutant target gene suffers from a myeloproliferative disease resulting from aberrant kinase activity.

[000954] Co-administration of polynucleotides, primary constructs and mmRNA and RNAi agents are also provided herein.

Modulation of Biological Pathways

[000955] The rapid translation polynucleotides, primary constructs and mmRNA introduced into cells provides a desirable mechanism of modulating target biological pathways. Such modulation includes antagonism or agonism of a given pathway. In one embodiment, a method is provided for antagonizing a biological pathway in a cell by contacting the cell with an effective amount of a composition comprising a polynucleotide, primary construct or mmRNA encoding a polypeptide of interest, under conditions such that the polynucleotides, primary constructs and mmRNA is localized into the cell and the polypeptide is capable of being translated in the cell from the polynucleotides, primary constructs and mmRNA, wherein the polypeptide inhibits the activity of a polypeptide functional in the biological pathway. Exemplary biological pathways are those defective in an autoimmune or inflammatory disorder such as multiple sclerosis, rheumatoid arthritis, psoriasis, lupus erythematosus, ankylosing spondylitis colitis, or Crohn's disease; in particular, antagonism of the IL-12 and IL-23 signaling pathways are of particular utility. (See Kikly K, Liu L, Na S, Sedgwick JD (2006) *Curr. Opin. Immunol.* 18 (6): 670-5).

[000956] Further, provided are polynucleotide, primary construct or mmRNA encoding an antagonist for chemokine receptors; chemokine receptors CXCR-4 and CCR-5 are required for, e.g., HIV entry into host cells (Arenzana-Seisdedos F et al, (1996) *Nature.* Oct 3;383(6599):400).

[000957] Alternatively, provided are methods of agonizing a biological pathway in a cell by contacting the cell with an effective amount of a polynucleotide, primary construct or mmRNA encoding a recombinant polypeptide under conditions such that the nucleic acid is localized into the cell and the recombinant polypeptide is capable of being

translated in the cell from the nucleic acid, and the recombinant polypeptide induces the activity of a polypeptide functional in the biological pathway. Exemplary agonized biological pathways include pathways that modulate cell fate determination. Such agonization is reversible or, alternatively, irreversible.

Expression of Ligand or Receptor on Cell Surface

[000958] In some aspects and embodiments of the aspects described herein, the polynucleotides, primary constructs or mRNA described herein can be used to express a ligand or ligand receptor on the surface of a cell (*e.g.*, a homing moiety). A ligand or ligand receptor moiety attached to a cell surface can permit the cell to have a desired biological interaction with a tissue or an agent *in vivo*. A ligand can be an antibody, an antibody fragment, an aptamer, a peptide, a vitamin, a carbohydrate, a protein or polypeptide, a receptor, *e.g.*, cell-surface receptor, an adhesion molecule, a glycoprotein, a sugar residue, a therapeutic agent, a drug, a glycosaminoglycan, or any combination thereof. For example, a ligand can be an antibody that recognizes a cancer-cell specific antigen, rendering the cell capable of preferentially interacting with tumor cells to permit tumor-specific localization of a modified cell. A ligand can confer the ability of a cell composition to accumulate in a tissue to be treated, since a preferred ligand may be capable of interacting with a target molecule on the external face of a tissue to be treated. Ligands having limited cross-reactivity to other tissues are generally preferred.

[000959] In some cases, a ligand can act as a homing moiety which permits the cell to target to a specific tissue or interact with a specific ligand. Such homing moieties can include, but are not limited to, any member of a specific binding pair, antibodies, monoclonal antibodies, or derivatives or analogs thereof, including without limitation: Fv fragments, single chain Fv (scFv) fragments, Fab' fragments, F(ab')₂ fragments, single domain antibodies, camelized antibodies and antibody fragments, humanized antibodies and antibody fragments, and multivalent versions of the foregoing; multivalent binding reagents including without limitation: monospecific or bispecific antibodies, such as disulfide stabilized Fv fragments, scFv tandems ((SCFV)₂ fragments), diabodies, tribodies or tetrabodies, which typically are covalently linked or otherwise stabilized (*i.e.*, leucine zipper or helix stabilized) scFv fragments; and other homing moieties include for example, aptamers, receptors, and fusion proteins.

[000960] In some embodiments, the homing moiety may be a surface-bound antibody, which can permit tuning of cell targeting specificity. This is especially useful since highly specific antibodies can be raised against an epitope of interest for the desired targeting site. In one embodiment, multiple antibodies are expressed on the surface of a cell, and each antibody can have a different specificity for a desired target. Such approaches can increase the avidity and specificity of homing interactions.

[000961] A skilled artisan can select any homing moiety based on the desired localization or function of the cell, for example an estrogen receptor ligand, such as tamoxifen, can target cells to estrogen-dependent breast cancer cells that have an increased number of estrogen receptors on the cell surface. Other non-limiting examples of ligand/receptor interactions include CCRI (*e.g.*, for treatment of inflamed joint tissues or brain in rheumatoid arthritis, and/or multiple sclerosis), CCR7, CCR8 (*e.g.*, targeting to lymph node tissue), CCR6, CCR9, CCR10 (*e.g.*, to target to intestinal tissue), CCR4, CCR10 (*e.g.*, for targeting to skin), CXCR4 (*e.g.*, for general enhanced transmigration), HCELL (*e.g.*, for treatment of inflammation and inflammatory disorders, bone marrow), Alpha4beta7 (*e.g.*, for intestinal mucosa targeting), VLA-4/VCAM-1 (*e.g.*, targeting to endothelium). In general, any receptor involved in targeting (*e.g.*, cancer metastasis) can be harnessed for use in the methods and compositions described herein.

Modulation of Cell Lineage

[000962] Provided are methods of inducing an alteration in cell fate in a target mammalian cell. The target mammalian cell may be a precursor cell and the alteration may involve driving differentiation into a lineage, or blocking such differentiation. Alternatively, the target mammalian cell may be a differentiated cell, and the cell fate alteration includes driving de-differentiation into a pluripotent precursor cell, or blocking such de-differentiation, such as the dedifferentiation of cancer cells into cancer stem cells. In situations where a change in cell fate is desired, effective amounts of mRNAs encoding a cell fate inductive polypeptide is introduced into a target cell under conditions such that an alteration in cell fate is induced. In some embodiments, the modified mRNAs are useful to reprogram a subpopulation of cells from a first phenotype to a second phenotype. Such a reprogramming may be temporary or permanent.

Optionally, the reprogramming induces a target cell to adopt an intermediate phenotype.

[000963] Additionally, the methods of the present invention are particularly useful to generate induced pluripotent stem cells (iPS cells) because of the high efficiency of transfection, the ability to re-transfect cells, and the tenability of the amount of recombinant polypeptides produced in the target cells. Further, the use of iPS cells generated using the methods described herein is expected to have a reduced incidence of teratoma formation.

[000964] Also provided are methods of reducing cellular differentiation in a target cell population. For example, a target cell population containing one or more precursor cell types is contacted with a composition having an effective amount of a polynucleotides, primary constructs and mmRNA encoding a polypeptide, under conditions such that the polypeptide is translated and reduces the differentiation of the precursor cell. In non-limiting embodiments, the target cell population contains injured tissue in a mammalian subject or tissue affected by a surgical procedure. The precursor cell is, e.g., a stromal precursor cell, a neural precursor cell, or a mesenchymal precursor cell.

[000965] In a specific embodiment, provided are polynucleotide, primary construct or mmRNA that encode one or more differentiation factors Gata4, Mef2c and Tbx4. These mRNA-generated factors are introduced into fibroblasts and drive the reprogramming into cardiomyocytes. Such a reprogramming can be performed *in vivo*, by contacting an mRNA-containing patch or other material to damaged cardiac tissue to facilitate cardiac regeneration. Such a process promotes cardiomyocyte genesis as opposed to fibrosis.

Mediation of cell death

[000966] In one embodiment, polynucleotides, primary constructs or mmRNA compositions can be used to induce apoptosis in a cell (*e.g.*, a cancer cell) by increasing the expression of a death receptor, a death receptor ligand or a combination thereof. This method can be used to induce cell death in any desired cell and has particular usefulness in the treatment of cancer where cells escape natural apoptotic signals.

[000967] Apoptosis can be induced by multiple independent signaling pathways that converge upon a final effector mechanism consisting of multiple interactions between several "death receptors" and their ligands, which belong to the tumor necrosis factor

(TNF) receptor/ligand superfamily. The best-characterized death receptors are CD95 ("Fas"), TNFRI (p55), death receptor 3 (DR3 or Apo3/TRAMO), DR4 and DR5 (apo2-TRAIL-R2). The final effector mechanism of apoptosis may be the activation of a series of proteinases designated as caspases. The activation of these caspases results in the cleavage of a series of vital cellular proteins and cell death. The molecular mechanism of death receptors/ligands-induced apoptosis is well known in the art. For example, Fas/FasL-mediated apoptosis is induced by binding of three FasL molecules which induces trimerization of Fas receptor via C-terminus death domains (DDs), which in turn recruits an adapter protein FADD (Fas-associated protein with death domain) and Caspase-8. The oligomerization of this trimolecular complex, Fas/FAIDD/caspase-8, results in proteolytic cleavage of proenzyme caspase-8 into active caspase-8 that, in turn, initiates the apoptosis process by activating other downstream caspases through proteolysis, including caspase-3. Death ligands in general are apoptotic when formed into trimers or higher order of structures. As monomers, they may serve as antiapoptotic agents by competing with the trimers for binding to the death receptors.

[000968] In one embodiment, the polynucleotides, primary constructs or mmRNA composition encodes for a death receptor (*e.g.*, Fas, TRAIL, TRAMO, TNFR, TLR etc). Cells made to express a death receptor by transfection of polynucleotides, primary constructs and mmRNA become susceptible to death induced by the ligand that activates that receptor. Similarly, cells made to express a death ligand, *e.g.*, on their surface, will induce death of cells with the receptor when the transfected cell contacts the target cell. In another embodiment, the polynucleotides, primary constructs and mmRNA composition encodes for a death receptor ligand (*e.g.*, FasL, TNF, etc). In another embodiment, the polynucleotides, primary constructs and mmRNA composition encodes a caspase (*e.g.*, caspase 3, caspase 8, caspase 9 etc). Where cancer cells often exhibit a failure to properly differentiate to a non-proliferative or controlled proliferative form, in another embodiment, the synthetic, polynucleotides, primary constructs and mmRNA composition encodes for both a death receptor and its appropriate activating ligand. In another embodiment, the synthetic, polynucleotides, primary constructs and mmRNA composition encodes for a differentiation factor that when expressed in the cancer cell, such as a cancer stem cell, will induce the cell to differentiate to a non-pathogenic or

nonself-renewing phenotype (*e.g.*, reduced cell growth rate, reduced cell division etc) or to induce the cell to enter a dormant cell phase (*e.g.*, G₀resting phase).

[000969] One of skill in the art will appreciate that the use of apoptosis-inducing techniques may require that the polynucleotides, primary constructs or mmRNA are appropriately targeted to *e.g.*, tumor cells to prevent unwanted wide-spread cell death. Thus, one can use a delivery mechanism (*e.g.*, attached ligand or antibody, targeted liposome etc) that recognizes a cancer antigen such that the polynucleotides, primary constructs or mmRNA are expressed only in cancer cells.

Cosmetic Applications

[000970] In one embodiment, the polynucleotides, primary constructs and/or mmRNA may be used in the treatment, amelioration or prophylaxis of cosmetic conditions. Such conditions include acne, rosacea, scarring, wrinkles, eczema, shingles, psoriasis, age spots, birth marks, dry skin, calluses, rash (*e.g.*, diaper, heat), scabies, hives, warts, insect bites, vitiligo, dandruff, freckles, and general signs of aging.

VI. Kits and Devices

Kits

[000971] The invention provides a variety of kits for conveniently and/or effectively carrying out methods of the present invention. Typically kits will comprise sufficient amounts and/or numbers of components to allow a user to perform multiple treatments of a subject(s) and/or to perform multiple experiments.

[000972] In one aspect, the present invention provides kits comprising the molecules (polynucleotides, primary constructs or mmRNA) of the invention. In one embodiment, the kit comprises one or more functional antibodies or function fragments thereof.

[000973] Said kits can be for protein production, comprising a first polynucleotide, primary construct or mmRNA comprising a translatable region. The kit may further comprise packaging and instructions and/or a delivery agent to form a formulation composition. The delivery agent may comprise a saline, a buffered solution, a lipidoid or any delivery agent disclosed herein.

[000974] In one embodiment, the buffer solution may include sodium chloride, calcium chloride, phosphate and/or EDTA. In another embodiment, the buffer solution may include, but is not limited to, saline, saline with 2mM calcium, 5% sucrose, 5% sucrose

with 2mM calcium, 5% Mannitol, 5% Mannitol with 2mM calcium, Ringer's lactate, sodium chloride, sodium chloride with 2mM calcium and mannose (See e.g., U.S. Pub. No. 20120258046; herein incorporated by reference in its entirety). In a further embodiment, the buffer solutions may be precipitated or it may be lyophilized. The amount of each component may be varied to enable consistent, reproducible higher concentration saline or simple buffer formulations. The components may also be varied in order to increase the stability of modified RNA in the buffer solution over a period of time and/or under a variety of conditions. In one aspect, the present invention provides kits for protein production, comprising: a polynucleotide, primary construct or mmRNA comprising a translatable region, provided in an amount effective to produce a desired amount of a protein encoded by the translatable region when introduced into a target cell; a second polynucleotide comprising an inhibitory nucleic acid, provided in an amount effective to substantially inhibit the innate immune response of the cell; and packaging and instructions.

[000975] In one aspect, the present invention provides kits for protein production, comprising a polynucleotide, primary construct or mmRNA comprising a translatable region, wherein the polynucleotide exhibits reduced degradation by a cellular nuclease, and packaging and instructions.

[000976] In one aspect, the present invention provides kits for protein production, comprising a polynucleotide, primary construct or mmRNA comprising a translatable region, wherein the polynucleotide exhibits reduced degradation by a cellular nuclease, and a mammalian cell suitable for translation of the translatable region of the first nucleic acid.

[000977] In one embodiment, the levels of Protein C may be measured by immunoassay. The assay may be purchased and is available from any number of suppliers including BioMerieux, Inc. (Durham, NC), Abbott Laboratories (Abbott Park, IL), Siemens Medical Solutions USA, Inc. (Malvern, PA), BIOPORTO® Diagnostics A/S (Gentofte, Denmark), USCN® Life Science Inc. (Houston, TX) or Roche Diagnostic Corporation (Indianapolis, IN). In this embodiment, the assay may be used to assess levels of Protein C or its activated form or a variant delivered as or in response to administration of a modified mRNA molecule.

Devices

[000978] The present invention provides for devices which may incorporate polynucleotides, primary constructs or mmRNA that encode polypeptides of interest. These devices contain in a stable formulation the reagents to synthesize a polynucleotide in a formulation available to be immediately delivered to a subject in need thereof, such as a human patient. Non-limiting examples of such a polypeptide of interest include a growth factor and/or angiogenesis stimulator for wound healing, a peptide antibiotic to facilitate infection control, and an antigen to rapidly stimulate an immune response to a newly identified virus.

[000979] Devices may also be used in conjunction with the present invention. In one embodiment, a device is used to assess levels of a protein which has been administered in the form of a modified mRNA. The device may comprise a blood, urine or other biofluidic test. It may be as large as to include an automated central lab platform or a small decentralized bench top device. It may be point of care or a handheld device. In this embodiment, for example, Protein C or APC may be quantitated before, during or after treatment with a modified mRNA encoding Protein C (its zymogen), APC or any variants thereof. Protein C, also known as autoprotease II and blood coagulation factor XIV is a zymogen, or precursor, of a serine protease which plays an important role in the regulation of blood coagulation and generation of fibrinolytic activity in vivo. It is synthesized in the liver as a single-chain polypeptide but undergoes posttranslational processing to give rise to a two-chain intermediate. The intermediate form of Protein C is converted via thrombin-mediated cleavage of a 12-residue peptide from the amino-terminus of the heavy chain to of the molecule to the active form, known as "activated protein C" (APC). The device may be useful in drug discovery efforts as a companion diagnostic test associated with Protein C, or APC treatment such as for sepsis or severe sepsis. In early studies it was suggested that APC had the ability to reduce mortality in severe sepsis. Following this line of work, clinical studies lead to the FDA approval of one compound, activated drotrecogin alfa (recombinant protein C). However, in late 2011, the drug was withdrawn from sale in all markets following results of the PROWESS-SHOCK study, which showed the study did not meet the primary endpoint of a statistically significant reduction in 28-day all-cause mortality in patients with septic

shock. The present invention provides modified mRNA molecules which may be used in the diagnosis and treatment of sepsis, severe sepsis and septicemia which overcome prior issues or problems associated with increasing protein expression efficiencies in mammals.

[000980] In some embodiments the device is self-contained, and is optionally capable of wireless remote access to obtain instructions for synthesis and/or analysis of the generated polynucleotide, primary construct or mmRNA. The device is capable of mobile synthesis of at least one polynucleotide, primary construct or mmRNA and preferably an unlimited number of different polynucleotides, primary constructs or mmRNA. In certain embodiments, the device is capable of being transported by one or a small number of individuals. In other embodiments, the device is scaled to fit on a benchtop or desk. In other embodiments, the device is scaled to fit into a suitcase, backpack or similarly sized object. In another embodiment, the device may be a point of care or handheld device. In further embodiments, the device is scaled to fit into a vehicle, such as a car, truck or ambulance, or a military vehicle such as a tank or personnel carrier. The information necessary to generate a modified mRNA encoding polypeptide of interest is present within a computer readable medium present in the device.

[000981] In one embodiment, a device may be used to assess levels of a protein which has been administered in the form of a polynucleotide, primary construct or mmRNA. The device may comprise a blood, urine or other biofluidic test.

[000982] In some embodiments, the device is capable of communication (e.g., wireless communication) with a database of nucleic acid and polypeptide sequences. The device contains at least one sample block for insertion of one or more sample vessels. Such sample vessels are capable of accepting in liquid or other form any number of materials such as template DNA, nucleotides, enzymes, buffers, and other reagents. The sample vessels are also capable of being heated and cooled by contact with the sample block. The sample block is generally in communication with a device base with one or more electronic control units for the at least one sample block. The sample block preferably contains a heating module, such heating molecule capable of heating and/or cooling the sample vessels and contents thereof to temperatures between about -20C and above +100C. The device base is in communication with a voltage supply such as a battery or

external voltage supply. The device also contains means for storing and distributing the materials for RNA synthesis.

[000983] Optionally, the sample block contains a module for separating the synthesized nucleic acids. Alternatively, the device contains a separation module operably linked to the sample block. Preferably the device contains a means for analysis of the synthesized nucleic acid. Such analysis includes sequence identity (demonstrated such as by hybridization), absence of non-desired sequences, measurement of integrity of synthesized mRNA (such as by microfluidic viscometry combined with spectrophotometry), and concentration and/or potency of modified RNA (such as by spectrophotometry).

[000984] In certain embodiments, the device is combined with a means for detection of pathogens present in a biological material obtained from a subject, e.g., the IBIS PLEX-ID system (Abbott, Abbott Park, IL) for microbial identification.

[000985] Suitable devices for use in delivering intradermal pharmaceutical compositions described herein include short needle devices such as those described in U.S. Patents 4,886,499; 5,190,521; 5,328,483; 5,527,288; 4,270,537; 5,015,235; 5,141,496; and 5,417,662; each of which is herein incorporated by reference in their entirety. Intradermal compositions may be administered by devices which limit the effective penetration length of a needle into the skin, such as those described in PCT publication WO 99/34850 (herein incorporated by reference in its entirety) and functional equivalents thereof. Jet injection devices which deliver liquid compositions to the dermis via a liquid jet injector and/or via a needle which pierces the stratum corneum and produces a jet which reaches the dermis are suitable. Jet injection devices are described, for example, in U.S. Patents 5,480,381; 5,599,302; 5,334,144; 5,993,412; 5,649,912; 5,569,189; 5,704,911; 5,383,851; 5,893,397; 5,466,220; 5,339,163; 5,312,335; 5,503,627; 5,064,413; 5,520,639; 4,596,556; 4,790,824; 4,941,880; 4,940,460; and PCT publications WO 97/37705 and WO 97/13537; each of which are herein incorporated by reference in their entirety. Ballistic powder/particle delivery devices which use compressed gas to accelerate vaccine in powder form through the outer layers of the skin to the dermis are suitable. Alternatively or additionally, conventional syringes may be used in the classical mantoux method of intradermal administration.

[000986] In some embodiments, the device may be a pump or comprise a catheter for administration of compounds or compositions of the invention across the blood brain barrier. Such devices include but are not limited to a pressurized olfactory delivery device, iontophoresis devices, multi-layered microfluidic devices, and the like. Such devices may be portable or stationary. They may be implantable or externally tethered to the body or combinations thereof.

[000987] Devices for administration may be employed to deliver the polynucleotides, primary constructs or mmRNA of the present invention according to single, multi- or split-dosing regimens taught herein. Such devices are described below.

[000988] Method and devices known in the art for multi-administration to cells, organs and tissues are contemplated for use in conjunction with the methods and compositions disclosed herein as embodiments of the present invention. These include, for example, those methods and devices having multiple needles, hybrid devices employing for example lumens or catheters as well as devices utilizing heat, electric current or radiation driven mechanisms.

[000989] According to the present invention, these multi-administration devices may be utilized to deliver the single, multi- or split doses contemplated herein.

[000990] A method for delivering therapeutic agents to a solid tissue has been described by Bahrami et al. and is taught for example in US Patent Publication 201 10230839, the contents of which are incorporated herein by reference in their entirety. According to Bahrami, an array of needles is incorporated into a device which delivers a substantially equal amount of fluid at any location in said solid tissue along each needle's length.

[000991] A device for delivery of biological material across the biological tissue has been described by Kodgule et al. and is taught for example in US Patent Publication 201 10172610, the contents of which are incorporated herein by reference in their entirety. According to Kodgule, multiple hollow micro-needles made of one or more metals and having outer diameters from about 200 microns to about 350 microns and lengths of at least 100 microns are incorporated into the device which delivers peptides, proteins, carbohydrates, nucleic acid molecules, lipids and other pharmaceutically active ingredients or combinations thereof.

[000992] A delivery probe for delivering a therapeutic agent to a tissue has been described by Gunday et al. and is taught for example in US Patent Publication 201 10270184, the contents of each of which are incorporated herein by reference in their entirety. According to Gunday, multiple needles are incorporated into the device which moves the attached capsules between an activated position and an inactivated position to force the agent out of the capsules through the needles.

[000993] A multiple-injection medical apparatus has been described by Assaf and is taught for example in US Patent Publication 201 10218497, the contents of which are incorporated herein by reference in their entirety. According to Assaf, multiple needles are incorporated into the device which has a chamber connected to one or more of said needles and a means for continuously refilling the chamber with the medical fluid after each injection.

[000994] In one embodiment, the polynucleotide, primary construct, or mmRNA is administered subcutaneously or intramuscularly via at least 3 needles to three different, optionally adjacent, sites simultaneously, or within a 60 minutes period (e.g., administration to 4, 5, 6, 7, 8, 9, or 10 sites simultaneously or within a 60 minute period). The split doses can be administered simultaneously to adjacent tissue using the devices described in U.S. Patent Publication Nos. 201 10230839 and 201 10218497, each of which is incorporated herein by reference in their entirety.

[000995] An at least partially implantable system for injecting a substance into a patient's body, in particular a penis erection stimulation system has been described by Forsell and is taught for example in US Patent Publication 201 10196198, the contents of which are incorporated herein by reference in their entirety. According to Forsell, multiple needles are incorporated into the device which is implanted along with one or more housings adjacent the patient's left and right corpora cavernosa. A reservoir and a pump are also implanted to supply drugs through the needles.

[000996] A method for the transdermal delivery of a therapeutic effective amount of iron has been described by Berenson and is taught for example in US Patent Publication 20100130910, the contents of which are incorporated herein by reference in their entirety. According to Berenson, multiple needles may be used to create multiple micro channels

in stratum corneum to enhance transdermal delivery of the ionic iron on an iontophoretic patch.

[000997] A method for delivery of biological material across the biological tissue has been described by Kodgule et al and is taught for example in US Patent Publication 201 10196308, the contents of which are incorporated herein by reference in their entirety. According to Kodgule, multiple biodegradable microneedles containing a therapeutic active ingredient are incorporated in a device which delivers proteins, carbohydrates, nucleic acid molecules, lipids and other pharmaceutically active ingredients or combinations thereof.

[000998] A transdermal patch comprising a botulinum toxin composition has been described by Donovan and is taught for example in US Patent Publication 20080220020, the contents of which are incorporated herein by reference in their entirety. According to Donovan, multiple needles are incorporated into the patch which delivers botulinum toxin under stratum corneum through said needles which project through the stratum corneum of the skin without rupturing a blood vessel.

[000999] A small, disposable drug reservoir, or patch pump, which can hold approximately 0.2 to 15 mL of liquid formulations can be placed on the skin and deliver the formulation continuously subcutaneously using a small bore needle (e.g., 26 to 34 gauge). As non-limiting examples, the patch pump may be 50 mm by 76 mm by 20 mm spring loaded having a 30 to 34 gauge needle (BD™ Microinfuser, Franklin Lakes NJ), 41 mm by 62 mm by 17 mm with a 2 mL reservoir used for drug delivery such as insulin (OMNIPOD®, Insulet Corporation Bedford, MA), or 43-60 mm diameter, 10 mm thick with a 0.5 to 10 mL reservoir (PATCHPUMP®, SteadyMed Therapeutics, San Francisco, CA). Further, the patch pump may be battery powered and/or rechargeable.

[0001000] A cryoprobe for administration of an active agent to a location of cryogenic treatment has been described by Toubia and is taught for example in US Patent Publication 20080140061, the contents of which are incorporated herein by reference in their entirety. According to Toubia, multiple needles are incorporated into the probe which receives the active agent into a chamber and administers the agent to the tissue.

[0001001] A method for treating or preventing inflammation or promoting healthy joints has been described by Stock et al and is taught for example in US Patent Publication

20090155186, the contents of which are incorporated herein by reference in their entirety. According to Stock, multiple needles are incorporated in a device which administers compositions containing signal transduction modulator compounds.

[0001002] A multi-site injection system has been described by Kimmell et al. and is taught for example in US Patent Publication 20100256594, the contents of which are incorporated herein by reference in their entirety. According to Kimmell, multiple needles are incorporated into a device which delivers a medication into a stratum corneum through the needles.

[0001003] A method for delivering interferons to the intradermal compartment has been described by Dekker et al. and is taught for example in US Patent Publication 20050181033, the contents of which are incorporated herein by reference in their entirety. According to Dekker, multiple needles having an outlet with an exposed height between 0 and 1 mm are incorporated into a device which improves pharmacokinetics and bioavailability by delivering the substance at a depth between 0.3 mm and 2 mm.

[0001004] A method for delivering genes, enzymes and biological agents to tissue cells has described by Desai and is taught for example in US Patent Publication 20030073908, the contents of which are incorporated herein by reference in their entirety. According to Desai, multiple needles are incorporated into a device which is inserted into a body and delivers a medication fluid through said needles.

[0001005] A method for treating cardiac arrhythmias with fibroblast cells has been described by Lee et al and is taught for example in US Patent Publication 20040005295, the contents of which are incorporated herein by reference in their entirety. According to Lee, multiple needles are incorporated into the device which delivers fibroblast cells into the local region of the tissue.

[0001006] A method using a magnetically controlled pump for treating a brain tumor has been described by Shachar et al. and is taught for example in US Patent 7799012 (method) and 7799016 (device), the contents of which are incorporated herein by reference in their entirety. According Shachar, multiple needles were incorporated into the pump which pushes a medicating agent through the needles at a controlled rate.

[0001007] Methods of treating functional disorders of the bladder in mammalian females have been described by Versi et al. and are taught for example in US Patent 8,029,496,

the contents of which are incorporated herein by reference in their entirety. According to Versi, an array of micro-needles is incorporated into a device which delivers a therapeutic agent through the needles directly into the trigone of the bladder.

[0001008] A micro-needle transdermal transport device has been described by Angel et al and is taught for example in US Patent 7,364,568, the contents of which are incorporated herein by reference in their entirety. According to Angel, multiple needles are incorporated into the device which transports a substance into a body surface through the needles which are inserted into the surface from different directions. The micro-needle transdermal transport device may be a solid micro-needle system or a hollow micro-needle system. As a non-limiting example, the solid micro-needle system may have up to a 0.5 mg capacity, with 300-1500 solid micro-needles per cm² about 150-700 μm tall coated with a drug. The micro-needles penetrate the stratum corneum and remain in the skin for short duration (e.g., 20 seconds to 15 minutes). In another example, the hollow micro-needle system has up to a 3 mL capacity to deliver liquid formulations using 15-20 microneedles per cm² being approximately 950 μm tall. The micro-needles penetrate the skin to allow the liquid formulations to flow from the device into the skin. The hollow micro-needle system may be worn from 1 to 30 minutes depending on the formulation volume and viscosity.

[0001009] A device for subcutaneous infusion has been described by Dalton et al and is taught for example in US Patent 7,150,726, the contents of which are incorporated herein by reference in their entirety. According to Dalton, multiple needles are incorporated into the device which delivers fluid through the needles into a subcutaneous tissue.

[0001010] A device and a method for intradermal delivery of vaccines and gene therapeutic agents through microcannula have been described by Mikszta et al. and are taught for example in US Patent 7,473,247, the contents of which are incorporated herein by reference in their entirety. According to Mikszta, at least one hollow micro-needle is incorporated into the device which delivers the vaccines to the subject's skin to a depth of between 0.025 mm and 2 mm.

[0001011] A method of delivering insulin has been described by Pettis et al and is taught for example in US Patent 7,722,595, the contents of which are incorporated herein by reference in their entirety. According to Pettis, two needles are incorporated into a device

wherein both needles insert essentially simultaneously into the skin with the first at a depth of less than 2.5 mm to deliver insulin to intradermal compartment and the second at a depth of greater than 2.5 mm and less than 5.0 mm to deliver insulin to subcutaneous compartment.

[0001012] Cutaneous injection delivery under suction has been described by Kochamba et al. and is taught for example in US Patent 6,896,666, the contents of which are incorporated herein by reference in their entirety. According to Kochamba, multiple needles in relative adjacency with each other are incorporated into a device which injects a fluid below the cutaneous layer.

[0001013] A device for withdrawing or delivering a substance through the skin has been described by Down et al and is taught for example in US Patent 6,607,513, the contents of which are incorporated herein by reference in their entirety. According to Down, multiple skin penetrating members which are incorporated into the device have lengths of about 100 microns to about 2000 microns and are about 30 to 50 gauge.

[0001014] A device for delivering a substance to the skin has been described by Palmer et al and is taught for example in US Patent 6,537,242, the contents of which are incorporated herein by reference in their entirety. According to Palmer, an array of micro-needles is incorporated into the device which uses a stretching assembly to enhance the contact of the needles with the skin and provides a more uniform delivery of the substance.

[0001015] A perfusion device for localized drug delivery has been described by Zamoyski and is taught for example in US Patent 6,468,247, the contents of which are incorporated herein by reference in their entirety. According to Zamoyski, multiple hypodermic needles are incorporated into the device which injects the contents of the hypodermics into a tissue as said hypodermics are being retracted.

[0001016] A method for enhanced transport of drugs and biological molecules across tissue by improving the interaction between micro-needles and human skin has been described by Prausnitz et al. and is taught for example in US Patent 6,743,211, the contents of which are incorporated herein by reference in their entirety. According to Prausnitz, multiple micro-needles are incorporated into a device which is able to present a more rigid and less deformable surface to which the micro-needles are applied.

[0001017] A device for intraorgan administration of medicinal agents has been described by Ting et al and is taught for example in US Patent 6,077,251, the contents of which are incorporated herein by reference in their entirety. According to Ting, multiple needles having side openings for enhanced administration are incorporated into a device which by extending and retracting said needles from and into the needle chamber forces a medicinal agent from a reservoir into said needles and injects said medicinal agent into a target organ.

[0001018] A multiple needle holder and a subcutaneous multiple channel infusion port has been described by Brown and is taught for example in US Patent 4,695,273, the contents of which are incorporated herein by reference in their entirety. According to Brown, multiple needles on the needle holder are inserted through the septum of the infusion port and communicate with isolated chambers in said infusion port.

[0001019] A dual hypodermic syringe has been described by Horn and is taught for example in US Patent 3,552,394, the contents of which are incorporated herein by reference in their entirety. According to Horn, two needles incorporated into the device are spaced apart less than 68 mm and may be of different styles and lengths, thus enabling injections to be made to different depths.

[0001020] A syringe with multiple needles and multiple fluid compartments has been described by Hershberg and is taught for example in US Patent 3,572,336, the contents of which are incorporated herein by reference in their entirety. According to Hershberg, multiple needles are incorporated into the syringe which has multiple fluid compartments and is capable of simultaneously administering incompatible drugs which are not able to be mixed for one injection.

[0001021] A surgical instrument for intradermal injection of fluids has been described by Eliscu et al. and is taught for example in US Patent 2,588,623, the contents of which are incorporated herein by reference in their entirety. According to Eliscu, multiple needles are incorporated into the instrument which injects fluids intradermally with a wider disperse.

[0001022] An apparatus for simultaneous delivery of a substance to multiple breast milk ducts has been described by Hung and is taught for example in EP 1818017, the contents of which are incorporated herein by reference in their entirety. According to Hung,

multiple lumens are incorporated into the device which inserts through the orifices of the ductal networks and delivers a fluid to the ductal networks.

[0001023] A catheter for introduction of medications to the tissue of a heart or other organs has been described by Tkebuchava and is taught for example in WO2006138109, the contents of which are incorporated herein by reference in their entirety. According to Tkebuchava, two curved needles are incorporated which enter the organ wall in a flattened trajectory.

[0001024] Devices for delivering medical agents have been described by Mckay et al. and are taught for example in WO20061 18804, the content of which are incorporated herein by reference in their entirety. According to Mckay, multiple needles with multiple orifices on each needle are incorporated into the devices to facilitate regional delivery to a tissue, such as the interior disc space of a spinal disc.

[0001025] A method for directly delivering an immunomodulatory substance into an intradermal space within a mammalian skin has been described by Pettis and is taught for example in WO2004020014, the contents of which are incorporated herein by reference in their entirety. According to Pettis, multiple needles are incorporated into a device which delivers the substance through the needles to a depth between 0.3 mm and 2 mm.

[0001026] Methods and devices for administration of substances into at least two compartments in skin for systemic absorption and improved pharmacokinetics have been described by Pettis et al. and are taught for example in WO2003094995, the contents of which are incorporated herein by reference in their entirety. According to Pettis, multiple needles having lengths between about 300 μm and about 5 mm are incorporated into a device which delivers to intradermal and subcutaneous tissue compartments simultaneously.

[0001027] A drug delivery device with needles and a roller has been described by Zimmerman et al. and is taught for example in WO2012006259, the contents of which are incorporated herein by reference in their entirety. According to Zimmerman, multiple hollow needles positioned in a roller are incorporated into the device which delivers the content in a reservoir through the needles as the roller rotates.

[0001028] A drug delivery device such as a stent is known in the art and is taught for example in U.S. Pat. No. 8,333,799, U.S. Pub. Nos. US20060020329, US20040172127

and US20100161032; the contents of each of which are herein incorporated by reference in their entirety. Formulations of the polynucleotides, primary constructs, mmRNA described herein may be delivered using stents. Additionally, stents used herein may be able to deliver multiple polynucleotides, primary constructs and/or mmRNA and/or formulations at the same or varied rates of delivery. Non-limiting examples of manufacturers of stents include CORDIS® (Miami, FL) (CYPHER®), Boston Scientific Corporation (Natick, MA) (TAXUS®), Medtronic (Minneapolis, MN) (ENDEAVOUR®) and Abbott (Abbott Park, IL) (XIENCE V®).

Methods and Devices utilizing catheters and/or lumens

[0001029] Methods and devices using catheters and lumens may be employed to administer the mmRNA of the present invention on a single, multi- or split dosing schedule. Such methods and devices are described below.

[0001030] A catheter-based delivery of skeletal myoblasts to the myocardium of damaged hearts has been described by Jacoby et al and is taught for example in US Patent Publication 20060263338, the contents of which are incorporated herein by reference in their entirety. According to Jacoby, multiple needles are incorporated into the device at least part of which is inserted into a blood vessel and delivers the cell composition through the needles into the localized region of the subject's heart.

[0001031] An apparatus for treating asthma using neurotoxin has been described by Deem et al and is taught for example in US Patent Publication 20060225742, the contents of which are incorporated herein by reference in their entirety. According to Deem, multiple needles are incorporated into the device which delivers neurotoxin through the needles into the bronchial tissue.

[0001032] A method for administering multiple-component therapies has been described by Nayak and is taught for example in US Patent 7,699,803, the contents of which are incorporated herein by reference in their entirety. According to Nayak, multiple injection cannulas may be incorporated into a device wherein depth slots may be included for controlling the depth at which the therapeutic substance is delivered within the tissue.

[0001033] A surgical device for ablating a channel and delivering at least one therapeutic agent into a desired region of the tissue has been described by McIntyre et al and is taught for example in US Patent 8,012,096, the contents of which are incorporated herein

by reference in their entirety. According to McIntyre, multiple needles are incorporated into the device which dispenses a therapeutic agent into a region of tissue surrounding the channel and is particularly well suited for transmural revascularization operations.

[0001034] Methods of treating functional disorders of the bladder in mammalian females have been described by Versi et al and are taught for example in US Patent 8,029,496, the contents of which are incorporated herein by reference in their entirety. According to Versi, an array of micro-needles is incorporated into a device which delivers a therapeutic agent through the needles directly into the trigone of the bladder.

[0001035] A device and a method for delivering fluid into a flexible biological barrier have been described by Yeshurun et al. and are taught for example in US Patent 7,998,119 (device) and 8,007,466 (method), the contents of which are incorporated herein by reference in their entirety. According to Yeshurun, the micro-needles on the device penetrate and extend into the flexible biological barrier and fluid is injected through the bore of the hollow micro-needles.

[0001036] A method for epicardially injecting a substance into an area of tissue of a heart having an epicardial surface and disposed within a torso has been described by Bonner et al and is taught for example in US Patent 7,628,780, the contents of which are incorporated herein by reference in their entirety. According to Bonner, the devices have elongate shafts and distal injection heads for driving needles into tissue and injecting medical agents into the tissue through the needles.

[0001037] A device for sealing a puncture has been described by Nielsen et al and is taught for example in US Patent 7,972,358, the contents of which are incorporated herein by reference in their entirety. According to Nielsen, multiple needles are incorporated into the device which delivers a closure agent into the tissue surrounding the puncture tract.

[0001038] A method for myogenesis and angiogenesis has been described by Chiu et al. and is taught for example in US Patent 6,551,338, the contents of which are incorporated herein by reference in their entirety. According to Chiu, 5 to 15 needles having a maximum diameter of at least 1.25 mm and a length effective to provide a puncture depth of 6 to 20 mm are incorporated into a device which inserts into proximity with a

myocardium and supplies an exogenous angiogenic or myogenic factor to said myocardium through the conduits which are in at least some of said needles.

[0001039] A method for the treatment of prostate tissue has been described by Bolmsj et al. and is taught for example in US Patent 6,524,270, the contents of which are incorporated herein by reference in their entirety. According to Bolmsj, a device comprising a catheter which is inserted through the urethra has at least one hollow tip extendible into the surrounding prostate tissue. An astringent and analgesic medicine is administered through said tip into said prostate tissue.

[0001040] A method for infusing fluids to an intraosseous site has been described by Findlay et al. and is taught for example in US Patent 6,761,726, the contents of which are incorporated herein by reference in their entirety. According to Findlay, multiple needles are incorporated into a device which is capable of penetrating a hard shell of material covered by a layer of soft material and delivers a fluid at a predetermined distance below said hard shell of material.

[0001041] A device for injecting medications into a vessel wall has been described by Vigil et al. and is taught for example in US Patent 5,713,863, the contents of which are incorporated herein by reference in their entirety. According to Vigil, multiple injectors are mounted on each of the flexible tubes in the device which introduces a medication fluid through a multi-lumen catheter, into said flexible tubes and out of said injectors for infusion into the vessel wall.

[0001042] A catheter for delivering therapeutic and/or diagnostic agents to the tissue surrounding a bodily passageway has been described by Faxon et al. and is taught for example in US Patent 5,464,395, the contents of which are incorporated herein by reference in their entirety. According to Faxon, at least one needle cannula is incorporated into the catheter which delivers the desired agents to the tissue through said needles which project outboard of the catheter.

[0001043] Balloon catheters for delivering therapeutic agents have been described by Orr and are taught for example in WO20 10024871, the contents of which are incorporated herein by reference in their entirety. According to Orr, multiple needles are incorporated into the devices which deliver the therapeutic agents to different depths within the tissue. In another aspect, drug-eluting balloons may be used to deliver the formulations

described herein. The drug-eluting balloons may be used in target lesion applications such as, but are not limited to, in-stent restenosis, treating lesion in tortuous vessels, bifurcation lesions, femoral/popliteal lesions and below the knee lesions.

[0001044] A device for delivering therapeutic agents (e.g., polynucleotides, primary constructs or mmRNA) to tissue disposed about a lumen has been described by Perry et al. and is taught for example in U.S. Pat. Pub. US20100125239, the contents of which are herein incorporated by reference in their entirety. According to Perry, the catheter has a balloon which may be coated with a therapeutic agent by methods known in the art and described in Perry. When the balloon expands, the therapeutic agent will contact the surrounding tissue. The device may additionally have a heat source to change the temperature of the coating on the balloon to release the therapeutic agent to the tissue.

Methods and Devices utilizing electrical current

[0001045] Methods and devices utilizing electric current may be employed to deliver the mmRNA of the present invention according to the single, multi- or split dosing regimens taught herein. Such methods and devices are described below.

[0001046] An electro collagen induction therapy device has been described by Marquez and is taught for example in US Patent Publication 20090137945, the contents of which are incorporated herein by reference in their entirety. According to Marquez, multiple needles are incorporated into the device which repeatedly pierce the skin and draw in the skin a portion of the substance which is applied to the skin first.

[0001047] An electrokinetic system has been described by Etheredge et al. and is taught for example in US Patent Publication 20070185432, the contents of which are incorporated herein by reference in their entirety. According to Etheredge, micro-needles are incorporated into a device which drives by an electrical current the medication through the needles into the targeted treatment site.

[0001048] An iontophoresis device has been described by Matsumura et al. and is taught for example in US Patent 7,437,189, the contents of which are incorporated herein by reference in their entirety. According to Matsumura, multiple needles are incorporated into the device which is capable of delivering ionizable drug into a living body at higher speed or with higher efficiency.

[0001049] Intradermal delivery of biologically active agents by needle-free injection and electroporation has been described by Hoffmann et al and is taught for example in US Patent 7,171,264, the contents of which are incorporated herein by reference in their entirety. According to Hoffmann, one or more needle-free injectors are incorporated into an electroporation device and the combination of needle-free injection and electroporation is sufficient to introduce the agent into cells in skin, muscle or mucosa.

[0001050] A method for electropermeabilization-mediated intracellular delivery has been described by Lundkvist et al. and is taught for example in US Patent 6,625,486, the contents of which are incorporated herein by reference in their entirety. According to Lundkvist, a pair of needle electrodes is incorporated into a catheter. Said catheter is positioned into a body lumen followed by extending said needle electrodes to penetrate into the tissue surrounding said lumen. Then the device introduces an agent through at least one of said needle electrodes and applies electric field by said pair of needle electrodes to allow said agent pass through the cell membranes into the cells at the treatment site.

[0001051] A delivery system for transdermal immunization has been described by Levin et al. and is taught for example in WO2006003659, the contents of which are incorporated herein by reference in their entirety. According to Levin, multiple electrodes are incorporated into the device which applies electrical energy between the electrodes to generate micro channels in the skin to facilitate transdermal delivery.

[0001052] A method for delivering RF energy into skin has been described by Schomacker and is taught for example in WO201 1163264, the contents of which are incorporated herein by reference in their entirety. According to Schomacker, multiple needles are incorporated into a device which applies vacuum to draw skin into contact with a plate so that needles insert into skin through the holes on the plate and deliver RF energy.

VII. Definitions

[0001053] At various places in the present specification, substituents of compounds of the present disclosure are disclosed in groups or in ranges. It is specifically intended that the present disclosure include each and every individual subcombination of the members

of such groups and ranges. For example, the term "C_{i-6} alkyl" is specifically intended to individually disclose methyl, ethyl, C₃ alkyl, C₄ alkyl, C₅ alkyl, and C₆ alkyl.

[0001054] *About:* As used herein, the term "about" means +/- 10% of the recited value.

[0001055] *Administered in combination:* As used herein, the term "administered in combination" or "combined administration" means that two or more agents are administered to a subject at the same time or within an interval such that there may be an overlap of an effect of each agent on the patient. In some embodiments, they are administered within about 60, 30, 15, 10, 5, or 1 minute of one another. In some embodiments, the administrations of the agents are spaced sufficiently closely together such that a combinatorial (*e.g.*, a synergistic) effect is achieved.

[0001056] *Animal:* As used herein, the term "animal" refers to any member of the animal kingdom. In some embodiments, "animal" refers to humans at any stage of development. In some embodiments, "animal" refers to non-human animals at any stage of development. In certain embodiments, the non-human animal is a mammal (*e.g.*, a rodent, a mouse, a rat, a rabbit, a monkey, a dog, a cat, a sheep, cattle, a primate, or a pig). In some embodiments, animals include, but are not limited to, mammals, birds, reptiles, amphibians, fish, and worms. In some embodiments, the animal is a transgenic animal, genetically-engineered animal, or a clone.

[0001057] *Antigens of interest or desired antigens:* As used herein, the terms "antigens of interest" or "desired antigens" include those proteins and other biomolecules provided herein that are immunospecifically bound by the antibodies and fragments, mutants, variants, and alterations thereof described herein. Examples of antigens of interest include, but are not limited to, insulin, insulin-like growth factor, hGH, tPA, cytokines, such as interleukins (IL), *e.g.*, IL-1, IL-2, IL-3, IL-4, IL-5, IL-6, IL-7, IL-8, IL-9, IL-10, IL-11, IL-12, IL-13, IL-14, IL-15, IL-16, IL-17, IL-18, interferon (IFN) alpha, IFN beta, IFN gamma, IFN omega or IFN tau, tumor necrosis factor (TNF), such as TNF alpha and TNF beta, TNF gamma, TRAIL; G-CSF, GM-CSF, M-CSF, MCP-1 and VEGF.

[0001058] *Approximately:* As used herein, the term "approximately" or "about," as applied to one or more values of interest, refers to a value that is similar to a stated reference value. In certain embodiments, the term "approximately" or "about" refers to a range of values that fall within 25%, 20%, 19%, 18%, 17%, 16%, 15%, 14%, 13%, 12%,

11%, 10%, 9%, 8%, 7%, 6%, 5%, 4%, 3%, 2%, 1%, or less in either direction (greater than or less than) of the stated reference value unless otherwise stated or otherwise evident from the context (except where such number would exceed 100% of a possible value).

[0001059] *Associated with:* As used herein, the terms "associated with," "conjugated," "linked," "attached," and "tethered," when used with respect to two or more moieties, means that the moieties are physically associated or connected with one another, either directly or via one or more additional moieties that serves as a linking agent, to form a structure that is sufficiently stable so that the moieties remain physically associated under the conditions in which the structure is used, *e.g.*, physiological conditions. An "association" need not be strictly through direct covalent chemical bonding. It may also suggest ionic or hydrogen bonding or a hybridization based connectivity sufficiently stable such that the "associated" entities remain physically associated.

[0001060] *Bifunctional:* As used herein, the term "bifunctional" refers to any substance, molecule or moiety which is capable of or maintains at least two functions. The functions may effect the same outcome or a different outcome. The structure that produces the function may be the same or different. For example, bifunctional modified RNAs of the present invention may encode a cytotoxic peptide (a first function) while those nucleosides which comprise the encoding RNA are, in and of themselves, cytotoxic (second function). In this example, delivery of the bifunctional modified RNA to a cancer cell would produce not only a peptide or protein molecule which may ameliorate or treat the cancer but would also deliver a cytotoxic payload of nucleosides to the cell should degradation, instead of translation of the modified RNA, occur.

[0001061] *Biocompatible:* As used herein, the term "biocompatible" means compatible with living cells, tissues, organs or systems posing little to no risk of injury, toxicity or rejection by the immune system.

[0001062] *Biodegradable:* As used herein, the term "biodegradable" means capable of being broken down into innocuous products by the action of living things.

[0001063] *Biologically active:* As used herein, the phrase "biologically active" refers to a characteristic of any substance that has activity in a biological system and/or organism. For instance, a substance that, when administered to an organism, has a biological effect

on that organism, is considered to be biologically active. In particular embodiments, a polynucleotide, primary construct or mmRNA of the present invention may be considered biologically active if even a portion of the polynucleotide, primary construct or mmRNA is biologically active or mimics an activity considered biologically relevant.

[0001064] *Chemical terms:* The following provides the definition of various chemical terms from "acyl" to "thiol."

[0001065] The term "acyl," as used herein, represents a hydrogen or an alkyl group (e.g., a haloalkyl group), as defined herein, that is attached to the parent molecular group through a carbonyl group, as defined herein, and is exemplified by formyl (i.e., a carboxyaldehyde group), acetyl, propionyl, butanoyl and the like. Exemplary unsubstituted acyl groups include from 1 to 7, from 1 to 11, or from 1 to 21 carbons. In some embodiments, the alkyl group is further substituted with 1, 2, 3, or 4 substituents as described herein.

[0001066] The term "acylamino," as used herein, represents an acyl group, as defined herein, attached to the parent molecular group through an amino group, as defined herein (i.e., $-N(R^{N1})-C(=O)-R$, where R is H or an optionally substituted C_{1-6} , C_{1-10} , or C_{1-20} alkyl group and R^{N1} is as defined herein). Exemplary unsubstituted acylamino groups include from 1 to 41 carbons (e.g., from 1 to 7, from 1 to 13, from 1 to 21, from 2 to 7, from 2 to 13, from 2 to 21, or from 2 to 41 carbons). In some embodiments, the alkyl group is further substituted with 1, 2, 3, or 4 substituents as described herein, and/or the amino group is $-NH_2$ or $-NHR^{N1}$, wherein R^{N1} is, independently, OH, NO_2 , NH_2 , NR^{N2}_2 , SO_2OR^{N2} , SO_2R^{N2} , SOR^{N2} , alkyl, or aryl, and each R^{N2} can be H, alkyl, or aryl.

[0001067] The term "acyloxy," as used herein, represents an acyl group, as defined herein, attached to the parent molecular group through an oxygen atom (i.e., $-O-C(=O)-R$, where R is H or an optionally substituted C_{1-6} , C_{1-10} , or C_{1-20} alkyl group). Exemplary unsubstituted acyloxy groups include from 1 to 21 carbons (e.g., from 1 to 7 or from 1 to 11 carbons). In some embodiments, the alkyl group is further substituted with 1, 2, 3, or 4 substituents as described herein, and/or the amino group is $-NH_2$ or $-NHR^{N1}$, wherein R^{N1} is, independently, OH, NO_2 , NH_2 , NR^{N2}_2 , SO_2OR^{N2} , SO_2R^{N2} , SOR^{N2} , alkyl, or aryl, and each R^{N2} can be H, alkyl, or aryl.

[0001068] The term "alkaryl," as used herein, represents an aryl group, as defined herein, attached to the parent molecular group through an alkylene group, as defined herein. Exemplary unsubstituted alkaryl groups are from 7 to 30 carbons (e.g., from 7 to 16 or from 7 to 20 carbons, such as C_{1-6} alk- C_{6-10} aryl, C_{1-10} alk- C_{6-10} aryl, or C_{1-20} alk- C_{6-10} aryl). In some embodiments, the alkylene and the aryl each can be further substituted with 1, 2, 3, or 4 substituent groups as defined herein for the respective groups. Other groups preceded by the prefix "alk-" are defined in the same manner, where "alk" refers to a C_{1-6} alkylene, unless otherwise noted, and the attached chemical structure is as defined herein.

[0001069] The term "alkcycloalkyl" represents a cycloalkyl group, as defined herein, attached to the parent molecular group through an alkylene group, as defined herein (e.g., an alkylene group of from 1 to 4, from 1 to 6, from 1 to 10, or from 1 to 20 carbons). In some embodiments, the alkylene and the cycloalkyl each can be further substituted with 1, 2, 3, or 4 substituent groups as defined herein for the respective group.

[0001070] The term "alkenyl," as used herein, represents monovalent straight or branched chain groups of, unless otherwise specified, from 2 to 20 carbons (e.g., from 2 to 6 or from 2 to 10 carbons) containing one or more carbon-carbon double bonds and is exemplified by ethenyl, 1-propenyl, 2-propenyl, 2-methyl-1-propenyl, 1-butenyl, 2-butenyl, and the like. Alkenyls include both cis and trans isomers. Alkenyl groups may be optionally substituted with 1, 2, 3, or 4 substituent groups that are selected, independently, from amino, aryl, cycloalkyl, or heterocyclyl (e.g., heteroaryl), as defined herein, or any of the exemplary alkyl substituent groups described herein.

[0001071] The term "alkenyloxy" represents a chemical substituent of formula -OR, where R is a C_{2-20} alkenyl group (e.g., C_{2-6} or C_{2-10} alkenyl), unless otherwise specified. Exemplary alkenyloxy groups include ethenyloxy, propenyloxy, and the like. In some embodiments, the alkenyl group can be further substituted with 1, 2, 3, or 4 substituent groups as defined herein (e.g., a hydroxy group).

[0001072] The term "alkheteroaryl" refers to a heteroaryl group, as defined herein, attached to the parent molecular group through an alkylene group, as defined herein. Exemplary unsubstituted alkheteroaryl groups are from 2 to 32 carbons (e.g., from 2 to 22, from 2 to 18, from 2 to 17, from 2 to 16, from 3 to 15, from 2 to 14, from 2 to 13, or

from 2 to 12 carbons, such as C_{i-6} **alk-Ci_i₂** heteroaryl, C_{1-10} **alk-Ci_i₂** heteroaryl, or C_{i-20} **alk-Ci_i₂** heteroaryl). In some embodiments, the alkylene and the heteroaryl each can be further substituted with 1, 2, 3, or 4 substituent groups as defined herein for the respective group. Alkheteroaryl groups are a subset of alkheterocyclyl groups.

[0001073] The term "alkheterocyclyl" represents a heterocyclyl group, as defined herein, attached to the parent molecular group through an alkylene group, as defined herein.

Exemplary unsubstituted alkheterocyclyl groups are from 2 to 32 carbons (e.g., from 2 to 22, from 2 to 18, from 2 to 17, from 2 to 16, from 3 to 15, from 2 to 14, from 2 to 13, or from 2 to 12 carbons, such as C_{i-6} **alk-Ci_i₂** heterocyclyl, C_{1-10} **alk-Ci_i₂** heterocyclyl, or C_{i-20} **alk-Ci_i₂** heterocyclyl). In some embodiments, the alkylene and the heterocyclyl each can be further substituted with 1, 2, 3, or 4 substituent groups as defined herein for the respective group.

[0001074] The term "alkoxy" represents a chemical substituent of formula -OR, where R is a C_{i-20} alkyl group (e.g., C_{i-6} or C_{1-10} alkyl), unless otherwise specified. Exemplary alkoxy groups include methoxy, ethoxy, propoxy (e.g., n-propoxy and isopropoxy), t-butoxy, and the like. In some embodiments, the alkyl group can be further substituted with 1, 2, 3, or 4 substituent groups as defined herein (e.g., hydroxy or alkoxy).

[0001075] The term "alkoxyalkoxy" represents an alkoxy group that is substituted with an alkoxy group. Exemplary unsubstituted alkoxyalkoxy groups include between 2 to 40 carbons (e.g., from 2 to 12 or from 2 to 20 carbons, such as C_{i-6} **alkoxy-Ci_i₆** alkoxy, C_{1-10} **alkoxy-Ci_i₁₀** alkoxy, or C_{i-20} **alkoxy-Ci_i₂₀** alkoxy). In some embodiments, the each alkoxy group can be further substituted with 1, 2, 3, or 4 substituent groups as defined herein.

[0001076] The term "alkoxyalkyl" represents an alkyl group that is substituted with an alkoxy group. Exemplary unsubstituted alkoxyalkyl groups include between 2 to 40 carbons (e.g., from 2 to 12 or from 2 to 20 carbons, such as C_{i-6} **alkoxy-Ci_i₆** alkyl, C_{1-10} **alkoxy-Ci_i₁₀** alkyl, or C_{i-20} **alkoxy-Ci_i₂₀** alkyl). In some embodiments, the alkyl and the alkoxy each can be further substituted with 1, 2, 3, or 4 substituent groups as defined herein for the respective group.

[0001077] The term "alkoxycarbonyl," as used herein, represents an alkoxy, as defined herein, attached to the parent molecular group through a carbonyl atom (e.g., -C(=O)-OR,

where R is H or an optionally substituted C_{1-6} , C_{1-10} , or C_{1-20} alkyl group). Exemplary unsubstituted alkoxy carbonyl include from 1 to 21 carbons (e.g., from 1 to 11 or from 1 to 7 carbons). In some embodiments, the alkoxy group is further substituted with 1, 2, 3, or 4 substituents as described herein.

[0001078] The term "alkoxy carbonyl alkoxy," as used herein, represents an alkoxy group, as defined herein, that is substituted with an alkoxy carbonyl group, as defined herein (e.g., -O-alkyl-C(=O)-OR, where R is an optionally substituted C_{1-6} , C_{1-10} , or C_{1-20} alkyl group). Exemplary unsubstituted alkoxy carbonyl alkoxy include from 3 to 41 carbons (e.g., from 3 to 10, from 3 to 13, from 3 to 17, from 3 to 21, or from 3 to 31 carbons, such as C_{1-6} alkoxy carbonyl- C_{1-6} alkoxy, C_{1-10} alkoxy carbonyl- C_{1-10} alkoxy, or C_{1-20} alkoxy carbonyl- C_{1-20} alkoxy). In some embodiments, each alkoxy group is further independently substituted with 1, 2, 3, or 4 substituents, as described herein (e.g., a hydroxy group).

[0001079] The term "alkoxy carbonyl alkyl," as used herein, represents an alkyl group, as defined herein, that is substituted with an alkoxy carbonyl group, as defined herein (e.g., -alkyl-C(=O)-OR, where R is an optionally substituted C_{1-20} , C_{1-10} , or C_{1-6} alkyl group). Exemplary unsubstituted alkoxy carbonyl alkyl include from 3 to 41 carbons (e.g., from 3 to 10, from 3 to 13, from 3 to 17, from 3 to 21, or from 3 to 31 carbons, such as C_{1-6} alkoxy carbonyl- C_{1-6} alkyl, C_{1-10} alkoxy carbonyl- C_{1-10} alkyl, or C_{1-20} alkoxy carbonyl- C_{1-20} alkyl). In some embodiments, each alkyl and alkoxy group is further independently substituted with 1, 2, 3, or 4 substituents as described herein (e.g., a hydroxy group).

[0001080] The term "alkyl," as used herein, is inclusive of both straight chain and branched chain saturated groups from 1 to 20 carbons (e.g., from 1 to 10 or from 1 to 6), unless otherwise specified. Alkyl groups are exemplified by methyl, ethyl, n- and iso-propyl, n-, sec-, iso- and tert-butyl, neopentyl, and the like, and may be optionally substituted with one, two, three, or, in the case of alkyl groups of two carbons or more, four substituents independently selected from the group consisting of: (1) C_{1-6} alkoxy; (2) C_{1-6} alkylsulfinyl; (3) amino, as defined herein (e.g., unsubstituted amino (i.e., $-NH_2$) or a substituted amino (i.e., $-N(R^{N1})_2$, where R^{N1} is as defined for amino); (4) C_{6-10} aryl- C_{1-6} alkoxy; (5) azido; (6) halo; (7) (C_{2-9} heterocycl)oxy; (8) hydroxy; (9) nitro; (10) oxo (e.g., carboxyaldehyde or acyl); (11) C_{1-7} spirocyclyl; (12) thioalkoxy; (13) thiol; (14) -

C_0R^A , where R^A is selected from the group consisting of (a) C_{1-20} alkyl (e.g., C_{1-6} alkyl), (b) C_{2-20} alkenyl (e.g., C_{2-6} alkenyl), (c) C_{6-10} aryl, (d) hydrogen, (e) C_{1-6} alk- C_{6-10} aryl, (f) amino- C_{1-20} alkyl, (g) polyethylene glycol of $-(CH_2)_{s_2}(OCH_2CH_2)_{s_3}i(CH_2)_{s_3}OR'$, wherein s_1 is an integer from 1 to 10 (e.g., from 1 to 6 or from 1 to 4), each of s_2 and s_3 , independently, is an integer from 0 to 10 (e.g., from 0 to 4, from 0 to 6, from 1 to 4, from 1 to 6, or from 1 to 10), and R' is H or C_{1-20} alkyl, and (h) amino-polyethylene glycol of $-NR^{N1}(CH_2)_{s_2}(CH_2CH_2O)_{s_3}i(CH_2)_{s_3}NR^{N1}$, wherein s_1 is an integer from 1 to 10 (e.g., from 1 to 6 or from 1 to 4), each of s_2 and s_3 , independently, is an integer from 0 to 10 (e.g., from 0 to 4, from 0 to 6, from 1 to 4, from 1 to 6, or from 1 to 10), and each R^{N1} is, independently, hydrogen or optionally substituted C_{1-6} alkyl; (15) $-C(0)NR^B R^C$, where each of R^B and R^C is, independently, selected from the group consisting of (a) hydrogen, (b) C_{1-6} alkyl, (c) C_{6-10} aryl, and (d) C_{1-6} alk- C_{6-10} aryl; (16) $-SO_2R^D$, where R^D is selected from the group consisting of (a) C_{1-6} alkyl, (b) C_{6-10} aryl, (c) C_{1-6} alk- C_{6-10} aryl, and (d) hydroxy; (17) $-SO_2NR^E R^F$, where each of R^E and R^F is, independently, selected from the group consisting of (a) hydrogen, (b) C_{1-6} alkyl, (c) C_{6-10} aryl and (d) C_{1-6} alk- C_{6-10} aryl; (18) $-C(0)R^G$, where R^G is selected from the group consisting of (a) C_{1-20} alkyl (e.g., C_{1-6} alkyl), (b) C_{2-20} alkenyl (e.g., C_{2-6} alkenyl), (c) C_{6-10} aryl, (d) hydrogen, (e) C_{1-6} alk- C_{6-10} aryl, (f) amino- C_{1-20} alkyl, (g) polyethylene glycol of $-(CH_2)_{s_2}(OCH_2CH_2)_{s_3}i(CH_2)_{s_3}OR'$, wherein s_1 is an integer from 1 to 10 (e.g., from 1 to 6 or from 1 to 4), each of s_2 and s_3 , independently, is an integer from 0 to 10 (e.g., from 0 to 4, from 0 to 6, from 1 to 4, from 1 to 6, or from 1 to 10), and R' is H or C_{1-20} alkyl, and (h) amino-polyethylene glycol of $-NR^{N1}(CH_2)_{s_2}(CH_2CH_2O)_{s_3}i(CH_2)_{s_3}NR^{N1}$, wherein s_1 is an integer from 1 to 10 (e.g., from 1 to 6 or from 1 to 4), each of s_2 and s_3 , independently, is an integer from 0 to 10 (e.g., from 0 to 4, from 0 to 6, from 1 to 4, from 1 to 6, or from 1 to 10), and each R^{N1} is, independently, hydrogen or optionally substituted C_{1-6} alkyl; (19) $-NR^H C(0)R^I$, wherein R^H is selected from the group consisting of (a) hydrogen and (b) C_{1-6} alkyl, and R^I is selected from the group consisting of (a2) C_{1-20} alkyl (e.g., C_{1-6} alkyl), (b2) C_{2-20} alkenyl (e.g., C_{2-6} alkenyl), (c2) C_{6-10} aryl, (d2) hydrogen, (e2) C_{1-6} alk- C_{6-10} aryl, (f2) amino- C_{1-20} alkyl, (g2) polyethylene glycol of $-(CH_2)_{s_2}(OCH_2CH_2)_{s_3}i(CH_2)_{s_3}OR'$, wherein s_1 is an integer from 1 to 10 (e.g., from 1 to 6 or from 1 to 4), each of s_2 and s_3 , independently, is an integer

from 0 to 10 (e.g., from 0 to 4, from 0 to 6, from 1 to 4, from 1 to 6, or from 1 to 10), and R' is H or C₁₋₂₀ alkyl, and (hi) amino-poly ethylene glycol of -NR^{N1}(CH₂)_{s2}(CH₂CH₂O)_si(CH₂)_{s3}NR^{N1}, wherein si is an integer from 1 to 10 (e.g., from 1 to 6 or from 1 to 4), each of s2 and s3, independently, is an integer from 0 to 10 (e.g., from 0 to 4, from 0 to 6, from 1 to 4, from 1 to 6, or from 1 to 10), and each R^{N1} is, independently, hydrogen or optionally substituted C₁₋₆ alkyl; (20) -NR^JC(O)OR^K, wherein R^J is selected from the group consisting of (a1) hydrogen and (b1) C₁₋₆ alkyl, and R^K is selected from the group consisting of (a2) C₁₋₂₀ alkyl (e.g., C₁₋₆ alkyl), (b2) C₂₋₂₀ alkenyl (e.g., C₂₋₆ alkenyl), (c2) C₆₋₁₀ aryl, (d2) hydrogen, (e2) C₁₋₆ alk-C₆₋₁₀ aryl, (f2) amino-C₁₋₂₀ alkyl, (g2) polyethylene glycol of -(CH₂)_{s2}(OCH₂CH₂)_si(CH₂)_{s3}OR^{N1}, wherein si is an integer from 1 to 10 (e.g., from 1 to 6 or from 1 to 4), each of s2 and s3, independently, is an integer from 0 to 10 (e.g., from 0 to 4, from 0 to 6, from 1 to 4, from 1 to 6, or from 1 to 10), and R' is H or C₁₋₂₀ alkyl, and (h2) amino-polyethylene glycol of -NR^{N1}(CH₂)_{s2}(CH₂CH₂O)_si(CH₂)_{s3}NR^{N1}, wherein si is an integer from 1 to 10 (e.g., from 1 to 6 or from 1 to 4), each of s2 and s3, independently, is an integer from 0 to 10 (e.g., from 0 to 4, from 0 to 6, from 1 to 4, from 1 to 6, or from 1 to 10), and each R^{N1} is, independently, hydrogen or optionally substituted C₁₋₆ alkyl; and (21) amidine. In some embodiments, each of these groups can be further substituted as described herein. For example, the alkylene group of a C_i-alkaryl can be further substituted with an oxo group to afford the respective aryloxy substituent.

[0001081] The term "alkylene" and the prefix "alk-," as used herein, represent a saturated divalent hydrocarbon group derived from a straight or branched chain saturated hydrocarbon by the removal of two hydrogen atoms, and is exemplified by methylene, ethylene, isopropylene, and the like. The term "C_{x-y} alkylene" and the prefix "C_{x-y} alk-" represent alkylene groups having between x and y carbons. Exemplary values for x are 1, 2, 3, 4, 5, and 6, and exemplary values for y are 2, 3, 4, 5, 6, 7, 8, 9, 10, 12, 14, 16, 18, or 20 (e.g., C₁₋₆, C₁₋₁₀, C₂₋₂₀, C₂₋₆, C₂₋₁₀, or C₂₋₂₀ alkylene). In some embodiments, the alkylene can be further substituted with 1, 2, 3, or 4 substituent groups as defined herein for an alkyl group.

[0001082] The term "alkylsulfanyl," as used herein, represents an alkyl group attached to the parent molecular group through an -S(O)- group. Exemplary unsubstituted

alkylsulfonyl groups are from 1 to 6, from 1 to 10, or from 1 to 20 carbons. In some embodiments, the alkyl group can be further substituted with 1, 2, 3, or 4 substituent groups as defined herein.

[0001083] The term "alkylsulfinylalkyl," as used herein, represents an alkyl group, as defined herein, substituted by an alkylsulfonyl group. Exemplary unsubstituted alkylsulfinylalkyl groups are from 2 to 12, from 2 to 20, or from 2 to 40 carbons. In some embodiments, each alkyl group can be further substituted with 1, 2, 3, or 4 substituent groups as defined herein.

[0001084] The term "alkynyl," as used herein, represents monovalent straight or branched chain groups from 2 to 20 carbon atoms (e.g., from 2 to 4, from 2 to 6, or from 2 to 10 carbons) containing a carbon-carbon triple bond and is exemplified by ethynyl, 1-propynyl, and the like. Alkynyl groups may be optionally substituted with 1, 2, 3, or 4 substituent groups that are selected, independently, from aryl, cycloalkyl, or heterocyclyl (e.g., heteroaryl), as defined herein, or any of the exemplary alkyl substituent groups described herein.

[0001085] The term "alkynyloxy" represents a chemical substituent of formula -OR, where R is a C₂₋₂₀ alkynyl group (e.g., C₂₋₆ or C₂₋₁₀ alkynyl), unless otherwise specified. Exemplary alkynyloxy groups include ethynyloxy, propynyloxy, and the like. In some embodiments, the alkynyl group can be further substituted with 1, 2, 3, or 4 substituent groups as defined herein (e.g., a hydroxy group).

[0001086] The term "amidine," as used herein, represents a -C(=NH)NH₂ group.

[0001087] The term "amino," as used herein, represents -N(R^{N1})₂, wherein each R^{N1} is, independently, H, OH, NO₂, N(R^{N2})₂, SO₂OR^{N2}, SO₂R^{N2}, SOR^{N2}, an *N*-protecting group, alkyl, alkenyl, alkynyl, alkoxy, aryl, alkaryl, cycloalkyl, alkylcycloalkyl, carboxyalkyl, sulfoalkyl, heterocyclyl (e.g., heteroaryl), or alkheterocyclyl (e.g., alkheteroaryl), wherein each of these recited R^{N1} groups can be optionally substituted, as defined herein for each group; or two R^{N1} combine to form a heterocyclyl or an *N*-protecting group, and wherein each R^{N2} is, independently, H, alkyl, or aryl. The amino groups of the invention can be an unsubstituted amino (i.e., -NH₂) or a substituted amino (i.e., -N(R^{N1})₂). In a preferred embodiment, amino is -NH₂ or -NHR^{N1}, wherein R^{N1} is, independently, OH, NO₂, NH₂,

$\text{NR}^{\text{N}2}$, $\text{SO}_2\text{OR}^{\text{N}2}$, $\text{SO}_2\text{R}^{\text{N}2}$, $\text{SOR}^{\text{N}2}$, alkyl, carboxyalkyl, sulfoalkyl, or aryl, and each $\text{R}^{\text{N}2}$ can be H, C_{1-6} alkyl (e.g., C_{1-6} alkyl), or C_{6-10} aryl.

[0001088] The term "amino acid," as described herein, refers to a molecule having a side chain, an amino group, and an acid group (e.g., a carboxy group of $-\text{CO}_2\text{H}$ or a sulfo group of $-\text{SO}_3\text{H}$), wherein the amino acid is attached to the parent molecular group by the side chain, amino group, or acid group (e.g., the side chain). In some embodiments, the amino acid is attached to the parent molecular group by a carbonyl group, where the side chain or amino group is attached to the carbonyl group. Exemplary side chains include an optionally substituted alkyl, aryl, heterocyclyl, alkaryl, alkheterocyclyl, aminoalkyl, carbamoylalkyl, and carboxyalkyl. Exemplary amino acids include alanine, arginine, asparagine, aspartic acid, cysteine, glutamic acid, glutamine, glycine, histidine, hydroxynorvaline, isoleucine, leucine, lysine, methionine, norvaline, ornithine, phenylalanine, proline, pyrrolysine, selenocysteine, serine, taurine, threonine, tryptophan, tyrosine, and valine. Amino acid groups may be optionally substituted with one, two, three, or, in the case of amino acid groups of two carbons or more, four substituents independently selected from the group consisting of: (1) C_{1-6} alkoxy; (2) C_{1-6} alkylsulfinyl; (3) amino, as defined herein (e.g., unsubstituted amino (i.e., $-\text{NH}_2$) or a substituted amino (i.e., $-\text{N}(\text{R}^{\text{N}1})_2$, where $\text{R}^{\text{N}1}$ is as defined for amino); (4) C_{6-10} aryl- C_{1-6} alkoxy; (5) azido; (6) halo; (7) $(\text{C}_{2-9}$ heterocyclyl)oxy; (8) hydroxy; (9) nitro; (10) oxo (e.g., carboxyaldehyde or acyl); (11) C_{1-7} spirocyclyl; (12) thioalkoxy; (13) thiol; (14) $-\text{C}(\text{O})_2\text{R}^{\text{A}}$, where R^{A} is selected from the group consisting of (a) C_{1-20} alkyl (e.g., C_{1-6} alkyl), (b) C_{2-20} alkenyl (e.g., C_{2-6} alkenyl), (c) C_{6-10} aryl, (d) hydrogen, (e) C_{1-6} alkyl- C_{6-10} aryl, (f) amino- C_{1-20} alkyl, (g) polyethylene glycol of $-(\text{CH}_2)_{s2}(\text{OCH}_2\text{CH}_2)_{s3}(\text{CH}_2)_{s3}\text{OR}'$, wherein s_i is an integer from 1 to 10 (e.g., from 1 to 6 or from 1 to 4), each of s_2 and s_3 , independently, is an integer from 0 to 10 (e.g., from 0 to 4, from 0 to 6, from 1 to 4, from 1 to 6, or from 1 to 10), and R' is H or C_{1-6} alkyl, and (h) amino-polyethylene glycol of $-\text{NR}^{\text{N}1}(\text{CH}_2)_{s2}(\text{CH}_2\text{CH}_2\text{O})_{s3}(\text{CH}_2)_{s3}\text{NR}^{\text{N}1}$, wherein s_i is an integer from 1 to 10 (e.g., from 1 to 6 or from 1 to 4), each of s_2 and s_3 , independently, is an integer from 0 to 10 (e.g., from 0 to 4, from 0 to 6, from 1 to 4, from 1 to 6, or from 1 to 10), and each $\text{R}^{\text{N}1}$ is, independently, hydrogen or optionally substituted C_{1-6} alkyl; (15) $-\text{C}(\text{O})\text{NR}^{\text{B}'}\text{R}^{\text{C}'}$, where each of $\text{R}^{\text{B}'}$ and $\text{R}^{\text{C}'}$ is, independently, selected from the group consisting of (a) hydrogen,

(b) C₁₋₆ alkyl, (c) C₆₋₁₀ aryl, and (d) C₁₋₆ alk-C₆₋₁₀ aryl; (16) -SO₂R^{D'}, where R^{D'} is selected from the group consisting of (a) C₁₋₆ alkyl, (b) C₆₋₁₀ aryl, (c) C₁₋₆ alk-C₆₋₁₀ aryl, and (d) hydroxy; (17) -SO₂NR^{E'}R^{F'}, where each of R^{E'} and R^{F'} is, independently, selected from the group consisting of (a) hydrogen, (b) C₁₋₆ alkyl, (c) C₆₋₁₀ aryl and (d) C₁₋₆ alk-C₆₋₁₀ aryl; (18) -C(0)R^{G'}, where R^{G'} is selected from the group consisting of (a) C₁₋₆ alkyl (e.g., C₁₋₆ alkyl), (b) C₂₋₆ alkenyl (e.g., C₂₋₆ alkenyl), (c) C₆₋₁₀ aryl, (d) hydrogen, (e) C₁₋₆ alk-C₆₋₁₀ aryl, (f) amino-C₁₋₆ alkyl, (g) polyethylene glycol of -(CH₂)_{s2}(OCH₂CH₂)_{s3}(CH₂)_{s3}OR', wherein s₁ is an integer from 1 to 10 (e.g., from 1 to 6 or from 1 to 4), each of s₂ and s₃, independently, is an integer from 0 to 10 (e.g., from 0 to 4, from 0 to 6, from 1 to 4, from 1 to 6, or from 1 to 10), and R' is H or C₁₋₆ alkyl, and (h) amino-polyethylene glycol of -NR^{N1}(CH₂)_{s2}(CH₂CH₂)_{s3}(CH₂)_{s3}NR^{N1}, wherein s₁ is an integer from 1 to 10 (e.g., from 1 to 6 or from 1 to 4), each of s₂ and s₃, independently, is an integer from 0 to 10 (e.g., from 0 to 4, from 0 to 6, from 1 to 4, from 1 to 6, or from 1 to 10), and each R^{N1} is, independently, hydrogen or optionally substituted C₁₋₆ alkyl; (19) -NR^{H'}C(0)R^{I'}, wherein R^{H'} is selected from the group consisting of (a1) hydrogen and (b1) C₁₋₆ alkyl, and R^{I'} is selected from the group consisting of (a2) C₁₋₆ alkyl (e.g., C₁₋₆ alkyl), (b2) C₂₋₆ alkenyl (e.g., C₂₋₆ alkenyl), (c2) C₆₋₁₀ aryl, (d2) hydrogen, (e2) C₁₋₆ alk-C₆₋₁₀ aryl, (f2) amino-C₁₋₆ alkyl, (g2) polyethylene glycol of -(CH₂)_{s2}(OCH₂CH₂)_{s3}(CH₂)_{s3}OR', wherein s₁ is an integer from 1 to 10 (e.g., from 1 to 6 or from 1 to 4), each of s₂ and s₃, independently, is an integer from 0 to 10 (e.g., from 0 to 4, from 0 to 6, from 1 to 4, from 1 to 6, or from 1 to 10), and R' is H or C₁₋₆ alkyl, and (h2) amino-polyethylene glycol of -NR^{N1}(CH₂)_{s2}(CH₂CH₂)_{s3}(CH₂)_{s3}NR^{N1}, wherein s₁ is an integer from 1 to 10 (e.g., from 1 to 6 or from 1 to 4), each of s₂ and s₃, independently, is an integer from 0 to 10 (e.g., from 0 to 4, from 0 to 6, from 1 to 4, from 1 to 6, or from 1 to 10), and each R^{N1} is, independently, hydrogen or optionally substituted C₁₋₆ alkyl; (20) -NR^{J'}C(0)OR^{K'}, wherein R^{J'} is selected from the group consisting of (a1) hydrogen and (b1) C₁₋₆ alkyl, and R^{K'} is selected from the group consisting of (a2) C₁₋₆ alkyl (e.g., C₁₋₆ alkyl), (b2) C₂₋₆ alkenyl (e.g., C₂₋₆ alkenyl), (c2) C₆₋₁₀ aryl, (d2) hydrogen, (e2) C₁₋₆ alk-C₆₋₁₀ aryl, (f2) amino-C₁₋₆ alkyl, (g2) polyethylene glycol of -(CH₂)_{s2}(OCH₂CH₂)_{s3}(CH₂)_{s3}OR', wherein s₁ is an integer from 1 to 10 (e.g., from 1 to 6 or from 1 to 4), each of s₂ and s₃,

independently, is an integer from 0 to 10 (e.g., from 0 to 4, from 0 to 6, from 1 to 4, from 1 to 6, or from 1 to 10), and R' is H or C₁₋₂₀ alkyl, and (hi) amino-polyethylene glycol of -NR^{N1}(CH₂)_{s2}(CH₂CH₂O)_si(CH₂)_{s3}NR^{N1}, wherein si is an integer from 1 to 10 (e.g., from 1 to 6 or from 1 to 4), each of s2 and s3, independently, is an integer from 0 to 10 (e.g., from 0 to 4, from 0 to 6, from 1 to 4, from 1 to 6, or from 1 to 10), and each R^{N1} is, independently, hydrogen or optionally substituted C₁₋₆ alkyl; and (21) amidine. In some embodiments, each of these groups can be further substituted as described herein.

[0001089] The term "aminoalkoxy," as used herein, represents an alkoxy group, as defined herein, substituted by an amino group, as defined herein. The alkyl and amino each can be further substituted with 1, 2, 3, or 4 substituent groups as described herein for the respective group (e.g., C₀₋₂R^{A'}, where R^{A'} is selected from the group consisting of (a) C₁₋₆ alkyl, (b) C₆₋₁₀ aryl, (c) hydrogen, and (d) C₁₋₆ alk-C₆₋₁₀ aryl, e.g., carboxy).

[0001090] The term "aminoalkyl," as used herein, represents an alkyl group, as defined herein, substituted by an amino group, as defined herein. The alkyl and amino each can be further substituted with 1, 2, 3, or 4 substituent groups as described herein for the respective group (e.g., C₀₋₂R^{A'}, where R^{A'} is selected from the group consisting of (a) C₁₋₆ alkyl, (b) C₆₋₁₀ aryl, (c) hydrogen, and (d) C₁₋₆ alk-C₆₋₁₀ aryl, e.g., carboxy).

[0001091] The term "aryl," as used herein, represents a mono-, bicyclic, or multicyclic carbocyclic ring system having one or two aromatic rings and is exemplified by phenyl, naphthyl, 1,2-dihydronaphthyl, 1,2,3,4-tetrahydronaphthyl, anthracenyl, phenanthrenyl, fluorenyl, indanyl, indenyl, and the like, and may be optionally substituted with 1, 2, 3, 4, or 5 substituents independently selected from the group consisting of: (1) C₁₋₇ acyl (e.g., carboxyaldehyde); (2) C₁₋₂₀ alkyl (e.g., C₁₋₆ alkyl, C₁₋₆ alkoxy-C₁₋₆ alkyl, C₁₋₆ alkylsulfmethyl-C₁₋₆ alkyl, amino-C₁₋₆ alkyl, azido-C₁₋₆ alkyl, (carboxyaldehyde)-C₁₋₆ alkyl, halo-C₁₋₆ alkyl (e.g., perfluoroalkyl), hydroxy-C₁₋₆ alkyl, nitro-C₁₋₆ alkyl, or C₁₋₆ thioalkoxy-C₁₋₆ alkyl); (3) C₁₋₂₀ alkoxy (e.g., C₁₋₆ alkoxy, such as perfluoroalkoxy); (4) C₁₋₆ alkylsulfmethyl; (5) C₆₋₁₀ aryl; (6) amino; (7) C₁₋₆ alk-C₆₋₁₀ aryl; (8) azido; (9) C₃₋₈ cycloalkyl; (10) C₁₋₆ alk-C₃₋₈ cycloalkyl; (11) halo; (12) C₁₋₁₂ heterocyclyl (e.g., C₁₋₁₂ heteroaryl); (13) (C₁₋₁₂ heterocyclyl)oxy; (14) hydroxy; (15) nitro; (16) C₁₋₂₀ thioalkoxy (e.g., C₁₋₆ thioalkoxy); (17) -(CH₂)_qC₀₋₂R^{A'}, where q is an integer from zero to four, and R^{A'} is selected from the group consisting of (a) C₁₋₆ alkyl, (b) C₆₋₁₀ aryl, (c) hydrogen,

and (d) C_{i-6} alk- C_{6-i_0} aryl; (18) $-(CH_2)_qCONR^{B'}R^{C'}$, where q is an integer from zero to four and where $R^{B'}$ and $R^{C'}$ are independently selected from the group consisting of (a) hydrogen, (b) C_{i-6} alkyl, (c) C_{6-i_0} aryl, and (d) C_{i-6} alk- C_{6-i_0} aryl; (19) $-(CH_2)_qSO_2R^{D'}$, where q is an integer from zero to four and where $R^{D'}$ is selected from the group consisting of (a) alkyl, (b) C_{6-i_0} aryl, and (c) alk- C_{6-i_0} aryl; (20) $-(CH_2)_qSO_2NR^{E'}R^{F'}$, where q is an integer from zero to four and where each of $R^{E'}$ and $R^{F'}$ is, independently, selected from the group consisting of (a) hydrogen, (b) C_{i-6} alkyl, (c) C_{6-i_0} aryl, and (d) C_{i-6} alk- C_{6-i_0} aryl; (21) thiol; (22) C_{6-i_0} aryloxy; (23) C_{3-8} cycloalkoxy; (24) C_{6-i_0} aryl- C_{i-6} alkoxy; (25) C_{i-6} alk- C_{i-i_2} heterocyclyl (e.g., C_{i-6} alk- C_{i-i_2} heteroaryl); (26) C_{2-20} alkenyl; and (27) C_{2-20} alkynyl. In some embodiments, each of these groups can be further substituted as described herein. For example, the alkylene group of a Ci-alkaryl or a Ci-alkheterocyclyl can be further substituted with an oxo group to afford the respective aryloyl and (heterocyclyl)oyl substituent group.

[0001092] The term "arylalkoxy," as used herein, represents an alkaryl group, as defined herein, attached to the parent molecular group through an oxygen atom. Exemplary unsubstituted alkoxyalkyl groups include from 7 to 30 carbons (e.g., from 7 to 16 or from 7 to 20 carbons, such as C_{6-i_0} aryl- C_{i-6} alkoxy, C_{6-i_0} aryl- C_{i-i_0} alkoxy, or C_{6-i_0} aryl- C_{i-20} alkoxy). In some embodiments, the arylalkoxy group can be substituted with 1, 2, 3, or 4 substituents as defined herein

[0001093] The term "aryloxy" represents a chemical substituent of formula $-OR'$, where R' is an aryl group of 6 to 18 carbons, unless otherwise specified. In some embodiments, the aryl group can be substituted with 1, 2, 3, or 4 substituents as defined herein.

[0001094] The term "aryloyl," as used herein, represents an aryl group, as defined herein, that is attached to the parent molecular group through a carbonyl group. Exemplary unsubstituted aryloyl groups are of 7 to 11 carbons. In some embodiments, the aryl group can be substituted with 1, 2, 3, or 4 substituents as defined herein.

[0001095] The term "azido" represents an $-N_3$ group, which can also be represented as $-N=N=N$.

[0001096] The term "bicyclic," as used herein, refer to a structure having two rings, which may be aromatic or non-aromatic. Bicyclic structures include spirocyclyl groups, as defined herein, and two rings that share one or more bridges, where such bridges can

include one atom or a chain including two, three, or more atoms. Exemplary bicyclic groups include a bicyclic carbocyclyl group, where the first and second rings are carbocyclyl groups, as defined herein; a bicyclic aryl groups, where the first and second rings are aryl groups, as defined herein; bicyclic heterocyclyl groups, where the first ring is a heterocyclyl group and the second ring is a carbocyclyl (e.g., aryl) or heterocyclyl (e.g., heteroaryl) group; and bicyclic heteroaryl groups, where the first ring is a heteroaryl group and the second ring is a carbocyclyl (e.g., aryl) or heterocyclyl (e.g., heteroaryl) group. In some embodiments, the bicyclic group can be substituted with 1, 2, 3, or 4 substituents as defined herein for cycloalkyl, heterocyclyl, and aryl groups.

[0001097] The terms "carbocyclic" and "carbocyclyl," as used herein, refer to an optionally substituted C_{3-12} monocyclic, bicyclic, or tricyclic structure in which the rings, which may be aromatic or non-aromatic, are formed by carbon atoms. Carbocyclic structures include cycloalkyl, cycloalkenyl, and aryl groups.

[0001098] The term "carbamoyl," as used herein, represents $-C(=O)-N(R^{N1})_2$, where the meaning of each R^{N1} is found in the definition of "amino" provided herein.

[0001099] The term "carbamoylalkyl," as used herein, represents an alkyl group, as defined herein, substituted by a carbamoyl group, as defined herein. The alkyl group can be further substituted with 1, 2, 3, or 4 substituent groups as described herein.

[0001100] The term "carbamyl," as used herein, refers to a carbamate group having the structure

$-NR^{N1}C(=O)OR$ or $-OC(=O)N(R^{N1})_2$, where the meaning of each R^{N1} is found in the definition of "amino" provided herein, and R is alkyl, cycloalkyl, alkylcycloalkyl, aryl, alkaryl, heterocyclyl (e.g., heteroaryl), or alkheterocyclyl (e.g., alkheteroaryl), as defined herein.

[0001101] The term "carbonyl," as used herein, represents a $C(O)$ group, which can also be represented as $C=O$.

[0001102] The term "carboxyaldehyde" represents an acyl group having the structure -CHO.

[0001103] The term "carboxy," as used herein, means $-CO_2H$.

[0001104] The term "carboxyalkoxy," as used herein, represents an alkoxy group, as defined herein, substituted by a carboxy group, as defined herein. The alkoxy group can

be further substituted with 1, 2, 3, or 4 substituent groups as described herein for the alkyl group.

[0001105] The term "carboxyalkyl," as used herein, represents an alkyl group, as defined herein, substituted by a carboxy group, as defined herein. The alkyl group can be further substituted with 1, 2, 3, or 4 substituent groups as described herein.

[0001106] The term "cyano," as used herein, represents an -CN group.

[0001107] The term "cycloalkoxy" represents a chemical substituent of formula -OR, where R is a C₃₋₈ cycloalkyl group, as defined herein, unless otherwise specified. The cycloalkyl group can be further substituted with 1, 2, 3, or 4 substituent groups as described herein. Exemplary unsubstituted cycloalkoxy groups are from 3 to 8 carbons. In some embodiment, the cycloalkyl group can be further substituted with 1, 2, 3, or 4 substituent groups as described herein.

[0001108] The term "cycloalkyl," as used herein represents a monovalent saturated or unsaturated non-aromatic cyclic hydrocarbon group from three to eight carbons, unless otherwise specified, and is exemplified by cyclopropyl, cyclobutyl, cyclopentyl, cyclohexyl, cycloheptyl, bicyclo[2.2.1]heptyl, and the like. When the cycloalkyl group includes one carbon-carbon double bond, the cycloalkyl group can be referred to as a "cycloalkenyl" group. Exemplary cycloalkenyl groups include cyclopentenyl, cyclohexenyl, and the like. The cycloalkyl groups of this invention can be optionally substituted with: (1) C₁₋₇ acyl (e.g., carboxyaldehyde); (2) C₁₋₂₀ alkyl (e.g., C₁₋₆ alkyl, C₁₋₆ alkoxy-C₁₋₆ alkyl, C₁₋₆ alkylsulfmlyl-C₁₋₆ alkyl, amino-C₁₋₆ alkyl, azido-C₁₋₆ alkyl, (carboxyaldehyde)-C₁₋₆ alkyl, halo-C₁₋₆ alkyl (e.g., perfluoroalkyl), hydroxy-C₁₋₆ alkyl, nitro-C₁₋₆ alkyl, or C₁₋₆ thioalkoxy -C₁₋₆ alkyl); (3) C₁₋₂₀ alkoxy (e.g., C₁₋₆ alkoxy, such as perfluoroalkoxy); (4) C₁₋₆ alkylsulfmlyl; (5) C₆₋₁₀ aryl; (6) amino; (7) C₁₋₆ alk-C₆₋₁₀ aryl; (8) azido; (9) C₃₋₈ cycloalkyl; (10) C₁₋₆ alk-C₃₋₈ cycloalkyl; (11) halo; (12) C₁₋₁₂ heterocyclyl (e.g., C₁₋₁₂ heteroaryl); (13) (C₁₋₁₂ heterocyclyl)oxy; (14) hydroxy; (15) nitro; (16) C₁₋₂₀ thioalkoxy (e.g., C₁₋₆ thioalkoxy); (17) -(CH₂)_qC₀₋₂R^{A'}, where q is an integer from zero to four, and R^{A'} is selected from the group consisting of (a) C₁₋₆ alkyl, (b) C₆₋₁₀ aryl, (c) hydrogen, and (d) C₁₋₆ alk-C₆₋₁₀ aryl; (18) -(CH₂)_qCONR^{B'}R^{C'}, where q is an integer from zero to four and where R^{B'} and R^{C'} are independently selected from the group consisting of (a) hydrogen, (b) C₆₋₁₀ alkyl, (c) C₆₋₁₀ aryl, and (d) C₁₋₆ alk-C₆₋₁₀ aryl;

(19) $-(\text{CH}_2)_q\text{SO}_2\text{R}^{\text{D}'}$, where q is an integer from zero to four and where $\text{R}^{\text{D}'}$ is selected from the group consisting of (a) C_{6-10} alkyl, (b) C_{6-10} aryl, and (c) C_{1-6} alk- C_{6-10} aryl; (20) $-(\text{CH}_2)_q\text{SO}_2\text{NR}^{\text{E}'}\text{R}^{\text{F}'}$, where q is an integer from zero to four and where each of $\text{R}^{\text{E}'}$ and $\text{R}^{\text{F}'}$ is, independently, selected from the group consisting of (a) hydrogen, (b) C_{6-10} alkyl, (c) C_{6-10} aryl, and (d) C_{1-6} alk- C_{6-10} aryl; (21) thiol; (22) C_{6-10} aryloxy; (23) C_{3-8} cycloalkoxy; (24) C_{6-10} aryl- C_{1-6} alkoxy; (25) C_{1-6} alk- C_{1-2} heterocyclyl (e.g., C_{1-6} alk- C_{1-2} heteroaryl); (26) oxo; (27) C_{2-20} alkenyl; and (28) C_{2-20} alkynyl. In some embodiments, each of these groups can be further substituted as described herein. For example, the alkylene group of a C_i -alkaryl or a C_i -alkheterocyclyl can be further substituted with an oxo group to afford the respective aryloyl and (heterocyclyl)oyl substituent group.

[0001109] The term "diastereomer," as used herein means stereoisomers that are not mirror images of one another and are non-superimposable on one another.

[0001110] The term "effective amount" of an agent, as used herein, is that amount sufficient to effect beneficial or desired results, for example, clinical results, and, as such, an "effective amount" depends upon the context in which it is being applied. For example, in the context of administering an agent that treats cancer, an effective amount of an agent is, for example, an amount sufficient to achieve treatment, as defined herein, of cancer, as compared to the response obtained without administration of the agent.

[0001111] The term "enantiomer," as used herein, means each individual optically active form of a compound of the invention, having an optical purity or enantiomeric excess (as determined by methods standard in the art) of at least 80% (i.e., at least 90% of one enantiomer and at most 10% of the other enantiomer), preferably at least 90% and more preferably at least 98%.

[0001112] The term "halo," as used herein, represents a halogen selected from bromine, chlorine, iodine, or fluorine.

[0001113] The term "haloalkoxy," as used herein, represents an alkoxy group, as defined herein, substituted by a halogen group (i.e., F, Cl, Br, or I). A haloalkoxy may be substituted with one, two, three, or, in the case of alkyl groups of two carbons or more, four halogens. Haloalkoxy groups include perfluoroalkoxys (e.g., $-\text{OCF}_3$), $-\text{OCHF}_2$, $-\text{OCH}_2\text{F}$, $-\text{OCCl}_3$, $-\text{OCH}_2\text{CH}_2\text{Br}$, $-\text{OCH}_2\text{CH}(\text{CH}_2\text{CH}_2\text{Br})\text{CH}_3$, and $-\text{OCHICH}_3$. In some

embodiments, the haloalkoxy group can be further substituted with 1, 2, 3, or 4 substituent groups as described herein for alkyl groups.

[0001114] The term "haloalkyl," as used herein, represents an alkyl group, as defined herein, substituted by a halogen group (i.e., F, Cl, Br, or I). A haloalkyl may be substituted with one, two, three, or, in the case of alkyl groups of two carbons or more, four halogens. Haloalkyl groups include perfluoroalkyls (e.g., $-\text{CF}_3$), $-\text{CHF}_2$, $-\text{CH}_2\text{F}$, $-\text{CCl}_3$, $-\text{CH}_2\text{CH}_2\text{Br}$, $-\text{CH}_2\text{CH}(\text{CH}_2\text{CH}_2\text{Br})\text{CH}_3$, and $-\text{CHICH}_3$. In some embodiments, the haloalkyl group can be further substituted with 1, 2, 3, or 4 substituent groups as described herein for alkyl groups.

[0001115] The term "heteroalkylene," as used herein, refers to an alkylene group, as defined herein, in which one or two of the constituent carbon atoms have each been replaced by nitrogen, oxygen, or sulfur. In some embodiments, the heteroalkylene group can be further substituted with 1, 2, 3, or 4 substituent groups as described herein for alkylene groups.

[0001116] The term "heteroaryl," as used herein, represents that subset of heterocyclyls, as defined herein, which are aromatic: i.e., they contain $4n+2$ pi electrons within the mono- or multicyclic ring system. Exemplary unsubstituted heteroaryl groups are of 1 to 12 (e.g., 1 to 11, 1 to 10, 1 to 9, 2 to 12, 2 to 11, 2 to 10, or 2 to 9) carbons. In some embodiment, the heteroaryl is substituted with 1, 2, 3, or 4 substituents groups as defined for a heterocyclyl group.

[0001117] The term "heterocyclyl," as used herein represents a 5-, 6- or 7-membered ring, unless otherwise specified, containing one, two, three, or four heteroatoms independently selected from the group consisting of nitrogen, oxygen, and sulfur. The 5-membered ring has zero to two double bonds, and the 6- and 7-membered rings have zero to three double bonds. Exemplary unsubstituted heterocyclyl groups are of 1 to 12 (e.g., 1 to 11, 1 to 10, 1 to 9, 2 to 12, 2 to 11, 2 to 10, or 2 to 9) carbons. The term "heterocyclyl" also represents a heterocyclic compound having a bridged multicyclic structure in which one or more carbons and/or heteroatoms bridges two non-adjacent members of a monocyclic ring, e.g., a quinuclidinyl group. The term "heterocyclyl" includes bicyclic, tricyclic, and tetracyclic groups in which any of the above heterocyclic rings is fused to one, two, or three carbocyclic rings, e.g., an aryl ring, a cyclohexane

ring, a cyclohexene ring, a cyclopentane ring, a cyclopentene ring, or another monocyclic heterocyclic ring, such as indolyl, quinolyl, isoquinolyl, tetrahydroquinolyl, benzofuryl, benzothienyl and the like. Examples of fused heterocyclyls include tropanes and 1,2,3,5,8,8a-hexahydroindolizine. Heterocyclics include pyrrolyl, pyrrolinyl, pyrrolidinyl, pyrazolyl, pyrazolinyl, pyrazolidinyl, imidazolyl, imidazolynyl, imidazolidinyl, pyridyl, piperidinyl, homopiperidinyl, pyrazinyl, piperazinyl, pyrimidinyl, pyridazinyl, oxazolyl, oxazolidinyl, isoxazolyl, isoxazolidinyl, morpholinyl, thiomorpholinyl, thiazolyl, thiazolidinyl, isothiazolyl, isothiazolidinyl, indolyl, indazolyl, quinolyl, isoquinolyl, quinoxalynyl, dihydroquinoxalynyl, quinazolynyl, cinnolynyl, phthalazinyl, benzimidazolyl, benzothiazolyl, benzoxazolyl, benzothiadiazolyl, furyl, thienyl, thiazolidinyl, isothiazolyl, triazolyl, tetrazolyl, oxadiazolyl (e.g., 1,2,3-oxadiazolyl), purinyl, thiadiazolyl (e.g., 1,2,3-thiadiazolyl), tetrahydrofuranyl, dihydrofuranyl, tetrahydrothienyl, dihydrothienyl, dihydroindolyl, dihydroquinolyl, tetrahydroquinolyl, tetrahydroisoquinolyl, dihydroisoquinolyl, pyranyl, dihydropyranyl, dithiazolyl, benzofuranyl, isobenzofuranyl, benzothienyl, and the like, including dihydro and tetrahydro forms thereof, where one or more double bonds are reduced and replaced with hydrogens. Still other exemplary heterocyclyls include: 2,3,4,5-tetrahydro-2-oxo-oxazolyl; 2,3-dihydro-2-oxo-1H-imidazolyl; 2,3,4,5-tetrahydro-5-oxo-1H-pyrazolyl (e.g., 2,3,4,5-tetrahydro-2-phenyl-5-oxo-1H-pyrazolyl); 2,3,4,5-tetrahydro-2,4-dioxo-1H-imidazolyl (e.g., 2,3,4,5-tetrahydro-2,4-dioxo-5-methyl-5-phenyl-1H-imidazolyl); 2,3-dihydro-2-thioxo-1,3,4-oxadiazolyl (e.g., 2,3-dihydro-2-thioxo-5-phenyl-1,3,4-oxadiazolyl); 4,5-dihydro-5-oxo-1H-triazolyl (e.g., 4,5-dihydro-3-methyl-4-amino 5-oxo-1H-triazolyl); 1,2,3,4-tetrahydro-2,4-dioxopyridinyl (e.g., 1,2,3,4-tetrahydro-2,4-dioxo-3,3-diethylpyridinyl); 2,6-dioxo-piperidinyl (e.g., 2,6-dioxo-3-ethyl-3-phenylpiperidinyl); 1,6-dihydro-6-oxopyridinyl; 1,6-dihydro-4-oxopyrimidinyl (e.g., 2-(methylthio)-1,6-dihydro-4-oxo-5-methylpyrimidin-1-yl); 1,2,3,4-tetrahydro-2,4-dioxopyrimidinyl (e.g., 1,2,3,4-tetrahydro-2,4-dioxo-3-ethylpyrimidinyl); 1,6-dihydro-6-oxo-pyridazinyl (e.g., 1,6-dihydro-6-oxo-3-ethylpyridazinyl); 1,6-dihydro-6-oxo-1,2,4-triazinyl (e.g., 1,6-dihydro-5-isopropyl-6-oxo-1,2,4-triazinyl); 2,3-dihydro-2-oxo-1H-indolyl (e.g., 3,3-dimethyl-2,3-dihydro-2-oxo-1H-indolyl and 2,3-dihydro-2-oxo-3,3'-spiropropane-1H-indol-1-yl); 1,3-dihydro-1-oxo-2H-iso-indolyl; 1,3-dihydro-1,3-dioxo-2H-iso-indolyl;

1*H*-benzopyrazolyl (e.g., 1-(ethoxycarbonyl)- 1*H*-benzopyrazolyl); 2,3-dihydro-2-oxo-1*H*-benzimidazolyl (e.g., 3-ethyl-2,3-dihydro-2-oxo-1 *H*-benzimidazolyl); 2,3-dihydro-2-oxo-benzoxazolyl (e.g., 5-chloro-2,3-dihydro-2-oxo-benzoxazolyl); 2,3-dihydro-2-oxo-benzoxazolyl; 2-oxo-2*H*-benzopyranyl; 1,4-benzodioxanyl; 1,3-benzodioxanyl; 2,3-dihydro-3-oxo,4*H*-1,3-benzothiazinyl; 3,4-dihydro-4-oxo-3 *H*-quinazolinyll (e.g., 2-methyl-3,4-dihydro-4-oxo-3 *H*-quinazolinyll); 1,2,3,4-tetrahydro-2,4-dioxo-3 *H*-quinazolyl (e.g., 1-ethyl-1,2,3,4-tetrahydro-2,4-dioxo-3 *H*-quinazolyl); 1,2,3,6-tetrahydro-2,6-dioxo-7*H*-purinyl (e.g., 1,2,3,6-tetrahydro-1,3-dimethyl-2, 6-dioxo-7 *H* -purinyl); 1,2,3,6-tetrahydro-2,6-dioxo-1 *H* -purinyl (e.g., 1,2,3,6-tetrahydro-3,7-dimethyl-2,6-dioxo-1 *H* -purinyl); 2-oxobenz[*c,d*]indolyl; 1,1-dioxo-2*H*-naphth[1,8-*c,d*]isothiazolyl; and 1,8-naphthylenedicarboxamido. Additional heterocyclics include 3,3*a*,4,5,6,6*a*-hexahydro-pyrrolo[3,4-*b*]pyrrol-(2*H*)-yl, and 2,5-diazabicyclo[2.2.1]heptan-2-yl, homopiperazinyl (or diazepanyl), tetrahydropyranyl, dithiazolyl, benzofuranyl, benzothienyl, oxepanyl, thiepanyl, azocanyl, oxecanyl, and thiocanyl. Heterocyclic groups also include groups of the formula

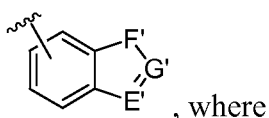

[0001118] **E'** is selected from the group consisting of **-N-** and **-CH-**; **F'** is selected from the group consisting of **-N=CH-**, **-NH-CH₂-**, **-NH-C(O)-**, **-NH-**, **-CH=N-**, **-CH₂-NH-**, **-C(O)-NH-**, **-CH=CH-**, **-CH₂-**, **-CH₂CH₂-**, **-CH₂O-**, **-OCH₂-**, **-O-**, and **-S-**; and **G'** is selected from the group consisting of **-CH-** and **-N-**. Any of the heterocyclyl groups mentioned herein may be optionally substituted with one, two, three, four or five substituents independently selected from the group consisting of: (1) **C₁₋₇** acyl (e.g., carboxyaldehyde); (2) **C₁₋₂₀** alkyl (e.g., **C₁₋₆** alkyl, **C₁₋₆** alkoxy-**C₁₋₆** alkyl, **C₁₋₆** alkylsulfmnyl-**C₁₋₆** alkyl, **amino-C₁₋₆** alkyl, **azido-C₁₋₆** alkyl, (carboxyaldehyde)-**C₁₋₆** alkyl, halo-**C₁₋₆** alkyl (e.g., perfluoroalkyl), hydroxy-**C₁₋₆** alkyl, nitro-**C₁₋₆** alkyl, or **C₁₋₆** thioalkoxy-**C₁₋₆** alkyl); (3) **C₁₋₂₀** alkoxy (e.g., **C₁₋₆** alkoxy, such as perfluoroalkoxy); (4) **C₁₋₆** alkylsulfinyll; (5) **C₆₋₁₀** aryl; (6) amino; (7) **C₁₋₆** alk-C₆₋₁₀ aryl; (8) azido; (9) **C₃₋₈** cycloalkyl; (10) **C₁₋₆** alk-C₃₋₈ cycloalkyl; (11) halo; (12) **C₁₋₁₂** heterocyclyl (e.g., **C₂₋₁₂** heteroaryl); (13) (**C₁₋₁₂** heterocyclyl)oxy; (14) hydroxy; (15) nitro; (16) **C₁₋₂₀** thioalkoxy (e.g., **C₁₋₆** thioalkoxy); (17) **-(CH₂)_qC₀₋₂R^{A'}**, where **q** is an integer from zero to four, and

$R^{A'}$ is selected from the group consisting of (a) C_{1-6} alkyl, (b) C_{6-10} aryl, (c) hydrogen, and (d) C_{1-6} alk- C_{6-10} aryl; (18) $-(CH_2)_qCONR^{B'}R^{C'}$, where q is an integer from zero to four and where $R^{B'}$ and $R^{C'}$ are independently selected from the group consisting of (a) hydrogen, (b) C_{1-6} alkyl, (c) C_{6-10} aryl, and (d) C_{1-6} alk- C_{6-10} aryl; (19) $-(CH_2)_qSO_2R^{D'}$, where q is an integer from zero to four and where $R^{D'}$ is selected from the group consisting of (a) C_{1-6} alkyl, (b) C_{6-10} aryl, and (c) C_{1-6} alk- C_{6-10} aryl; (20) $-(CH_2)_qSO_2NR^{E'}R^{F'}$, where q is an integer from zero to four and where each of $R^{E'}$ and $R^{F'}$ is, independently, selected from the group consisting of (a) hydrogen, (b) C_{1-6} alkyl, (c) C_{6-10} aryl, and (d) C_{1-6} alk- C_{6-10} aryl; (21) thiol; (22) C_{6-10} aryloxy; (23) C_{3-8} cycloalkoxy; (24) arylalkoxy; (25) C_{1-6} alk- C_{1-2} heterocyclyl (e.g., C_{1-6} alk- C_{1-2} heteroaryl); (26) oxo; (27) (C_{1-2} heterocyclyl)imino; (28) C_{2-2o} alkenyl; and (29) C_{2-2o} alkynyl. In some embodiments, each of these groups can be further substituted as described herein. For example, the alkylene group of a C_i -alkaryl or a C_i -alkheterocyclyl can be further substituted with an oxo group to afford the respective aryloyl and (heterocyclyl)oyl substituent group.

[0001119] The term "(heterocyclyl)imino," as used herein, represents a heterocyclyl group, as defined herein, attached to the parent molecular group through an imino group. In some embodiments, the heterocyclyl group can be substituted with 1, 2, 3, or 4 substituent groups as defined herein.

[0001120] The term "(heterocyclyl)oxy," as used herein, represents a heterocyclyl group, as defined herein, attached to the parent molecular group through an oxygen atom. In some embodiments, the heterocyclyl group can be substituted with 1, 2, 3, or 4 substituent groups as defined herein.

[0001121] The term "(heterocyclyl)oyl," as used herein, represents a heterocyclyl group, as defined herein, attached to the parent molecular group through a carbonyl group. In some embodiments, the heterocyclyl group can be substituted with 1, 2, 3, or 4 substituent groups as defined herein.

[0001122] The term "hydrocarbon," as used herein, represents a group consisting only of carbon and hydrogen atoms.

[0001123] The term "hydroxy," as used herein, represents an -OH group.

[0001124] The term "hydroxyalkenyl," as used herein, represents an alkenyl group, as defined herein, substituted by one to three hydroxy groups, with the proviso that no more than one hydroxy group may be attached to a single carbon atom of the alkyl group, and is exemplified by dihydroxypropenyl, hydroxyisopentenyl, and the like.

[0001125] The term "hydroxyalkyl," as used herein, represents an alkyl group, as defined herein, substituted by one to three hydroxy groups, with the proviso that no more than one hydroxy group may be attached to a single carbon atom of the alkyl group, and is exemplified by hydroxymethyl, dihydroxypropyl, and the like.

[0001126] The term "isomer," as used herein, means any tautomer, stereoisomer, enantiomer, or diastereomer of any compound of the invention. It is recognized that the compounds of the invention can have one or more chiral centers and/or double bonds and, therefore, exist as stereoisomers, such as double-bond isomers (i.e., geometric E/Z isomers) or diastereomers (e.g., enantiomers (i.e., (+) or (-)) or cis/trans isomers).

According to the invention, the chemical structures depicted herein, and therefore the compounds of the invention, encompass all of the corresponding stereoisomers, that is, both the stereomerically pure form (e.g., geometrically pure, enantiomerically pure, or diastereomerically pure) and enantiomeric and stereoisomeric mixtures, e.g., racemates. Enantiomeric and stereoisomeric mixtures of compounds of the invention can typically be resolved into their component enantiomers or stereoisomers by well-known methods, such as chiral-phase gas chromatography, chiral-phase high performance liquid chromatography, crystallizing the compound as a chiral salt complex, or crystallizing the compound in a chiral solvent. Enantiomers and stereoisomers can also be obtained from stereomerically or enantiomerically pure intermediates, reagents, and catalysts by well-known asymmetric synthetic methods.

[0001127] The term "*N*-protected amino," as used herein, refers to an amino group, as defined herein, to which is attached one or two *N*-protecting groups, as defined herein.

[0001128] The term "*N*-protecting group," as used herein, represents those groups intended to protect an amino group against undesirable reactions during synthetic procedures. Commonly used *N*-protecting groups are disclosed in Greene, "Protective Groups in Organic Synthesis," 3rd Edition (John Wiley & Sons, New York, 1999), which is incorporated herein by reference. *N*-protecting groups include acyl, aryloyl, or

carbonyl groups such as formyl, acetyl, propionyl, pivaloyl, t-butylacetyl, 2-chloroacetyl, 2-bromoacetyl, trifluoroacetyl, trichloroacetyl, phthalyl, o-nitrophenoxyacetyl, a-chlorobutyryl, benzoyl, 4-chlorobenzoyl, 4-bromobenzoyl, 4-nitrobenzoyl, and chiral auxiliaries such as protected or unprotected D, L or D, L-amino acids such as alanine, leucine, phenylalanine, and the like; sulfonyl-containing groups such as benzenesulfonyl, p-toluenesulfonyl, and the like; carbamate forming groups such as benzyloxycarbonyl, p-chlorobenzyloxycarbonyl, p-methoxybenzyloxycarbonyl, p-nitrobenzyloxycarbonyl, 2-nitrobenzyloxycarbonyl, p-bromobenzyloxycarbonyl, 3,4-dimethoxybenzyloxycarbonyl, 3,5-dimethoxybenzyloxycarbonyl, 2,4-dimethoxybenzyloxycarbonyl, 4-methoxybenzyloxycarbonyl, 2-nitro-4,5-dimethoxybenzyloxycarbonyl, 3,4,5-trimethoxybenzyloxycarbonyl, 1-(p-biphenyl)-1-methylethoxycarbonyl, α,α -dimethyl-3,5-dimethoxybenzyloxycarbonyl, benzhydryloxy carbonyl, t-butylloxycarbonyl, diisopropylmethoxycarbonyl, isopropylloxycarbonyl, ethoxycarbonyl, methoxycarbonyl, allyloxycarbonyl, 2,2,2-trichloroethoxycarbonyl, phenoxycarbonyl, 4-nitrophenoxy carbonyl, fluorenyl-9-methoxycarbonyl, cyclopentylloxycarbonyl, adamantylloxycarbonyl, cyclohexylloxycarbonyl, phenylthiocarbonyl, and the like, alkaryl groups such as benzyl, triphenylmethyl, benzyloxymethyl, and the like and silyl groups, such as trimethylsilyl, and the like. Preferred *N*-protecting groups are formyl, acetyl, benzoyl, pivaloyl, t-butylacetyl, alanyl, phenylsulfonyl, benzyl, t-butylloxycarbonyl (Boc), and benzyloxycarbonyl (Cbz).

[0001129] The term "nitro," as used herein, represents an $-\text{NO}_2$ group.

[0001130] The term "oxo" as used herein, represents $=\text{O}$.

[0001131] The term "perfluoroalkyl," as used herein, represents an alkyl group, as defined herein, where each hydrogen radical bound to the alkyl group has been replaced by a fluoride radical. Perfluoroalkyl groups are exemplified by trifluoromethyl, pentafluoroethyl, and the like.

[0001132] The term "perfluoroalkoxy," as used herein, represents an alkoxy group, as defined herein, where each hydrogen radical bound to the alkoxy group has been replaced by a fluoride radical. Perfluoroalkoxy groups are exemplified by trifluoromethoxy, pentafluoroethoxy, and the like.

[0001133] The term "spirocyclyl," as used herein, represents a C_{2-7} alkylene diradical, both ends of which are bonded to the same carbon atom of the parent group to form a spirocyclic group, and also a Ci_6 heteroalkylene diradical, both ends of which are bonded to the same atom. The heteroalkylene radical forming the spirocyclyl group can contain one, two, three, or four heteroatoms independently selected from the group consisting of nitrogen, oxygen, and sulfur. In some embodiments, the spirocyclyl group includes one to seven carbons, excluding the carbon atom to which the diradical is attached. The spirocyclyl groups of the invention may be optionally substituted with 1, 2, 3, or 4 substituents provided herein as optional substituents for cycloalkyl and/or heterocyclyl groups.

[0001134] The term "stereoisomer," as used herein, refers to all possible different isomeric as well as conformational forms which a compound may possess (e.g., a compound of any formula described herein), in particular all possible stereochemically and conformationally isomeric forms, all diastereomers, enantiomers and/or conformers of the basic molecular structure. Some compounds of the present invention may exist in different tautomeric forms, all of the latter being included within the scope of the present invention.

[0001135] The term "sulfoalkyl," as used herein, represents an alkyl group, as defined herein, substituted by a sulfo group of $-SO_3H$. In some embodiments, the alkyl group can be further substituted with 1, 2, 3, or 4 substituent groups as described herein.

[0001136] The term "sulfonyl," as used herein, represents an $-S(O)_2-$ group.

[0001137] The term "thioalkaryl," as used herein, represents a chemical substituent of formula $-SR$, where R is an alkaryl group. In some embodiments, the alkaryl group can be further substituted with 1, 2, 3, or 4 substituent groups as described herein.

[0001138] The term "thioalkheterocyclyl," as used herein, represents a chemical substituent of formula $-SR$, where R is an alkheterocyclyl group. In some embodiments, the alkheterocyclyl group can be further substituted with 1, 2, 3, or 4 substituent groups as described herein.

[0001139] The term "thioalkoxy," as used herein, represents a chemical substituent of formula $-SR$, where R is an alkyl group, as defined herein. In some embodiments, the

alkyl group can be further substituted with 1, 2, 3, or 4 substituent groups as described herein.

[0001140] The term "thiol" represents an -SH group.

[0001141] *Compound:* As used herein, the term "compound," is meant to include all stereoisomers, geometric isomers, tautomers, and isotopes of the structures depicted.

[0001142] The compounds described herein can be asymmetric (*e.g.*, having one or more stereocenters). All stereoisomers, such as enantiomers and diastereomers, are intended unless otherwise indicated. Compounds of the present disclosure that contain asymmetrically substituted carbon atoms can be isolated in optically active or racemic forms. Methods on how to prepare optically active forms from optically active starting materials are known in the art, such as by resolution of racemic mixtures or by stereoselective synthesis. Many geometric isomers of olefins, C=N double bonds, and the like can also be present in the compounds described herein, and all such stable isomers are contemplated in the present disclosure. Cis and trans geometric isomers of the compounds of the present disclosure are described and may be isolated as a mixture of isomers or as separated isomeric forms.

[0001143] Compounds of the present disclosure also include tautomeric forms.

Tautomeric forms result from the swapping of a single bond with an adjacent double bond and the concomitant migration of a proton. Tautomeric forms include prototropic tautomers which are isomeric protonation states having the same empirical formula and total charge. Examples prototropic tautomers include ketone - enol pairs, amide - imidic acid pairs, lactam - lactim pairs, amide - imidic acid pairs, enamine - imine pairs, and annular forms where a proton can occupy two or more positions of a heterocyclic system, such as, 1H- and 3H-imidazole, 1H-, 2H- and 4H- 1,2,4-triazole, 1H- and 2H- isoindole, and 1H- and 2H-pyrazole. Tautomeric forms can be in equilibrium or sterically locked into one form by appropriate substitution.

[0001144] Compounds of the present disclosure also include all of the isotopes of the atoms occurring in the intermediate or final compounds. "Isotopes" refers to atoms having the same atomic number but different mass numbers resulting from a different number of neutrons in the nuclei. For example, isotopes of hydrogen include tritium and deuterium.

[0001145] The compounds and salts of the present disclosure can be prepared in combination with solvent or water molecules to form solvates and hydrates by routine methods.

[0001146] *Conserved:* As used herein, the term "conserved" refers to nucleotides or amino acid residues of a polynucleotide sequence or polypeptide sequence, respectively, that are those that occur unaltered in the same position of two or more sequences being compared. Nucleotides or amino acids that are relatively conserved are those that are conserved amongst more related sequences than nucleotides or amino acids appearing elsewhere in the sequences.

[0001147] In some embodiments, two or more sequences are said to be "completely conserved" if they are 100% identical to one another. In some embodiments, two or more sequences are said to be "highly conserved" if they are at least 70% identical, at least 80% identical, at least 90% identical, or at least 95% identical to one another. In some embodiments, two or more sequences are said to be "highly conserved" if they are about 70% identical, about 80% identical, about 90% identical, about 95%, about 98%, or about 99% identical to one another. In some embodiments, two or more sequences are said to be "conserved" if they are at least 30% identical, at least 40% identical, at least 50% identical, at least 60% identical, at least 70% identical, at least 80% identical, at least 90% identical, or at least 95% identical to one another. In some embodiments, two or more sequences are said to be "conserved" if they are about 30% identical, about 40% identical, about 50% identical, about 60% identical, about 70% identical, about 80% identical, about 90% identical, about 95% identical, about 98% identical, or about 99% identical to one another. Conservation of sequence may apply to the entire length of an oligonucleotide or polypeptide or may apply to a portion, region or feature thereof.

[0001148] *Controlled Release:* As used herein, the term "controlled release" refers to a pharmaceutical composition or compound release profile that conforms to a particular pattern of release to effect a therapeutic outcome.

[0001149] *Cyclic or Cyclized:* As used herein, the term "cyclic" refers to the presence of a continuous loop. Cyclic molecules need not be circular, only joined to form an unbroken chain of subunits. Cyclic molecules such as the engineered RNA or mRNA of

the present invention may be single units or multimers or comprise one or more components of a complex or higher order structure.

[0001150] *Cytostatic*: As used herein, "cytostatic" refers to inhibiting, reducing, suppressing the growth, division, or multiplication of a cell (*e.g.*, a mammalian cell (*e.g.*, a human cell)), bacterium, virus, fungus, protozoan, parasite, prion, or a combination thereof.

[0001151] *Cytotoxic*: As used herein, "cytotoxic" refers to killing or causing injurious, toxic, or deadly effect on a cell (*e.g.*, a mammalian cell (*e.g.*, a human cell)), bacterium, virus, fungus, protozoan, parasite, prion, or a combination thereof.

[0001152] *Delivery*: As used herein, "delivery" refers to the act or manner of delivering a compound, substance, entity, moiety, cargo or payload.

[0001153] *Delivery Agent*: As used herein, "delivery agent" refers to any substance which facilitates, at least in part, the *in vivo* delivery of a polynucleotide, primary construct or mmRNA to targeted cells.

[0001154] *Destabilized*: As used herein, the term "destable," "destabilize," or "destabilizing region" means a region or molecule that is less stable than a starting, wild-type or native form of the same region or molecule.

[0001155] *Detectable label*: As used herein, "detectable label" refers to one or more markers, signals, or moieties which are attached, incorporated or associated with another entity that is readily detected by methods known in the art including radiography, fluorescence, chemiluminescence, enzymatic activity, absorbance and the like. Detectable labels include radioisotopes, fluorophores, chromophores, enzymes, dyes, metal ions, ligands such as biotin, avidin, streptavidin and haptens, quantum dots, and the like. Detectable labels may be located at any position in the peptides or proteins disclosed herein. They may be within the amino acids, the peptides, or proteins, or located at the N- or C- termini.

[0001156] *Digest*: As used herein, the term "digest" means to break apart into smaller pieces or components. When referring to polypeptides or proteins, digestion results in the production of peptides.

[0001157] *Distal*: As used herein, the term "distal" means situated away from the center or away from a point or region of interest.

[0001158] *Dosing regimen*: As used herein, a "dosing regimen" is a schedule of administration or physician determined regimen of treatment, prophylaxis, or palliative care.

[0001159] *Dose splitting factor (DSF)*- $\frac{\text{PUD of dose split treatment}}{\text{PUD of total daily dose or single unit dose}}$. The value is derived from comparison of dosing regimens groups.

[0001160] *Encapsulate*: As used herein, the term "encapsulate" means to enclose, surround or encase.

[0001161] *Encoded protein cleavage signal*: As used herein, "encoded protein cleavage signal" refers to the nucleotide sequence which encodes a protein cleavage signal.

[0001162] *Engineered*: As used herein, embodiments of the invention are "engineered" when they are designed to have a feature or property, whether structural or chemical, that varies from a starting point, wild type or native molecule.

[0001163] *Exosome*: As used herein, "exosome" is a vesicle secreted by mammalian cells or a complex involved in RNA degradation.

[0001164] *Expression*: As used herein, "expression" of a nucleic acid sequence refers to one or more of the following events: (1) production of an RNA template from a DNA sequence (*e.g.*, by transcription); (2) processing of an RNA transcript (*e.g.*, by splicing, editing, 5' cap formation, and/or 3' end processing); (3) translation of an RNA into a polypeptide or protein; and (4) post-translational modification of a polypeptide or protein.

[0001165] *Feature*: As used herein, a "feature" refers to a characteristic, a property, or a distinctive element.

[0001166] *Formulation*: As used herein, a "formulation" includes at least a polynucleotide, primary construct or mmRNA and a delivery agent.

[0001167] *Fragment*: A "fragment," as used herein, refers to a portion. For example, fragments of proteins may comprise polypeptides obtained by digesting full-length protein isolated from cultured cells.

[0001168] *Functional*: As used herein, a "functional" biological molecule is a biological molecule in a form in which it exhibits a property and/or activity by which it is characterized.

[0001169] *Homology*: As used herein, the term "homology" refers to the overall relatedness between polymeric molecules, *e.g.* between nucleic acid molecules (*e.g.* DNA molecules and/or RNA molecules) and/or between polypeptide molecules. In some embodiments, polymeric molecules are considered to be "homologous" to one another if their sequences are at least 25%, 30%, 35%, 40%, 45%, 50%, 55%, 60%, 65%, 70%, 75%, 80%, 85%, 90%, 95%, or 99% identical or similar. The term "homologous" necessarily refers to a comparison between at least two sequences (polynucleotide or polypeptide sequences). In accordance with the invention, two polynucleotide sequences are considered to be homologous if the polypeptides they encode are at least about 50%>, 60%, 70%, 80%, 90%, 95%, or even 99% for at least one stretch of at least about 20 amino acids. In some embodiments, homologous polynucleotide sequences are characterized by the ability to encode a stretch of at least 4-5 uniquely specified amino acids. For polynucleotide sequences less than 60 nucleotides in length, homology is determined by the ability to encode a stretch of at least 4-5 uniquely specified amino acids. In accordance with the invention, two protein sequences are considered to be homologous if the proteins are at least about 50%>, 60%>, 70%>, 80%>, or 90%> identical for at least one stretch of at least about 20 amino acids.

[0001170] *Identity*: As used herein, the term "identity" refers to the overall relatedness between polymeric molecules, *e.g.*, between oligonucleotide molecules (*e.g.* DNA molecules and/or RNA molecules) and/or between polypeptide molecules. Calculation of the percent identity of two polynucleotide sequences, for example, can be performed by aligning the two sequences for optimal comparison purposes (*e.g.*, gaps can be introduced in one or both of a first and a second nucleic acid sequences for optimal alignment and non-identical sequences can be disregarded for comparison purposes). In certain embodiments, the length of a sequence aligned for comparison purposes is at least 30%>, at least 40%, at least 50%, at least 60%, at least 70%, at least 80%, at least 90%, at least 95%, or 100% of the length of the reference sequence. The nucleotides at corresponding nucleotide positions are then compared. When a position in the first sequence is occupied by the same nucleotide as the corresponding position in the second sequence, then the molecules are identical at that position. The percent identity between the two sequences is a function of the number of identical positions shared by the sequences,

taking into account the number of gaps, and the length of each gap, which needs to be introduced for optimal alignment of the two sequences. The comparison of sequences and determination of percent identity between two sequences can be accomplished using a mathematical algorithm. For example, the percent identity between two nucleotide sequences can be determined using methods such as those described in Computational Molecular Biology, Lesk, A. M., ed., Oxford University Press, New York, 1988; Biocomputing: Informatics and Genome Projects, Smith, D. W., ed., Academic Press, New York, 1993; Sequence Analysis in Molecular Biology, von Heinje, G., Academic Press, 1987; Computer Analysis of Sequence Data, Part I, Griffin, A. M., and Griffin, H. G., eds., Humana Press, New Jersey, 1994; and Sequence Analysis Primer, Gribskov, M. and Devereux, J., eds., M Stockton Press, New York, 1991; each of which is incorporated herein by reference. For example, the percent identity between two nucleotide sequences can be determined using the algorithm of Meyers and Miller (CABIOS, 1989, 4:1 1-17), which has been incorporated into the ALIGN program (version 2.0) using a PAM120 weight residue table, a gap length penalty of 12 and a gap penalty of 4. The percent identity between two nucleotide sequences can, alternatively, be determined using the GAP program in the GCG software package using an NWSgapdna.CMP matrix. Methods commonly employed to determine percent identity between sequences include, but are not limited to those disclosed in Carillo, H., and Lipman, D., SIAM J Applied Math., 48:1073 (1988); incorporated herein by reference. Techniques for determining identity are codified in publicly available computer programs. Exemplary computer software to determine homology between two sequences include, but are not limited to, GCG program package, Devereux, J., *et al.*, *Nucleic Acids Research*, 12(1), 387 (1984)), BLASTP, BLASTN, and FASTA Altschul, S. F. *et al.*, *J. Molec. Biol.*, 215, 403 (1990)).

[0001171] *Inhibit expression of a gene:* As used herein, the phrase "inhibit expression of a gene" means to cause a reduction in the amount of an expression product of the gene. The expression product can be an RNA transcribed from the gene (*e.g.*, an mRNA) or a polypeptide translated from an mRNA transcribed from the gene. Typically a reduction in the level of an mRNA results in a reduction in the level of a polypeptide translated therefrom. The level of expression may be determined using standard techniques for measuring mRNA or protein.

[0001172] *In vitro*: As used herein, the term "*in vitro*" refers to events that occur in an artificial environment, *e.g.*, in a test tube or reaction vessel, in cell culture, in a Petri dish, *etc.*, rather than within an organism (*e.g.*, animal, plant, or microbe).

[0001173] *In vivo*: As used herein, the term "*in vivo*" refers to events that occur within an organism (*e.g.*, animal, plant, or microbe or cell or tissue thereof).

[0001174] *Isolated*: As used herein, the term "isolated" refers to a substance or entity that has been separated from at least some of the components with which it was associated (whether in nature or in an experimental setting). Isolated substances may have varying levels of purity in reference to the substances from which they have been associated. Isolated substances and/or entities may be separated from at least about 10%, about 20%, about 30%, about 40%, about 50%, about 60%, about 70%, about 80%, about 90%, or more of the other components with which they were initially associated. In some embodiments, isolated agents are more than about 80%>, about 85%, about 90%>, about 91%, about 92%, about 93%, about 94%, about 95%, about 96%, about 97%, about 98%, about 99%, or more than about 99% pure. As used herein, a substance is "pure" if it is substantially free of other components. *Substantially isolated*: By "substantially isolated" is meant that the compound is substantially separated from the environment in which it was formed or detected. Partial separation can include, for example, a composition enriched in the compound of the present disclosure. Substantial separation can include compositions containing at least about 50%, at least about 60%, at least about 70%, at least about 80%, at least about 90%, at least about 95%, at least about 97%, or at least about 99% by weight of the compound of the present disclosure, or salt thereof. Methods for isolating compounds and their salts are routine in the art.

[0001175] *Linker*: As used herein, a linker refers to a group of atoms, *e.g.*, 10-1,000 atoms, and can be comprised of the atoms or groups such as, but not limited to, carbon, amino, alkylamino, oxygen, sulfur, sulfoxide, sulfonyl, carbonyl, and imine. The linker can be attached to a modified nucleoside or nucleotide on the nucleobase or sugar moiety at a first end, and to a payload, *e.g.*, a detectable or therapeutic agent, at a second end. The linker may be of sufficient length as to not interfere with incorporation into a nucleic acid sequence. The linker can be used for any useful purpose, such as to form mmRNA multimers (*e.g.*, through linkage of two or more polynucleotides, primary constructs, or

mmRNA molecules) or mmRNA conjugates, as well as to administer a payload, as described herein. Examples of chemical groups that can be incorporated into the linker include, but are not limited to, alkyl, alkenyl, alkynyl, amido, amino, ether, thioether, ester, alkylene, heteroalkylene, aryl, or heterocyclyl, each of which can be optionally substituted, as described herein. Examples of linkers include, but are not limited to, unsaturated alkanes, polyethylene glycols (e.g., ethylene or propylene glycol monomeric units, e.g., diethylene glycol, dipropylene glycol, triethylene glycol, tripropylene glycol, tetraethylene glycol, or tetraethylene glycol), and dextran polymers and derivatives thereof. Other examples include, but are not limited to, cleavable moieties within the linker, such as, for example, a disulfide bond (-S-S-) or an azo bond (-N=N-), which can be cleaved using a reducing agent or photolysis. Non-limiting examples of a selectively cleavable bond include an amido bond can be cleaved for example by the use of tris(2-carboxyethyl)phosphine (TCEP), or other reducing agents, and/or photolysis, as well as an ester bond can be cleaved for example by acidic or basic hydrolysis.

[0001176] *MicroRNA (miRNA) binding site*: As used herein, a microRNA (miRNA) binding site represents a nucleotide location or region of a nucleic acid transcript to which at least the "seed" region of a miRNA binds.

[0001177] *Modified*: As used herein "modified" refers to a changed state or structure of a molecule of the invention. Molecules may be modified in many ways including chemically, structurally, and functionally. In one embodiment, the mRNA molecules of the present invention are modified by the introduction of non-natural nucleosides and/or nucleotides, e.g., as it relates to the natural ribonucleotides A, U, G, and C. Noncanonical nucleotides such as the cap structures are not considered "modified" although they differ from the chemical structure of the A, C, G, U ribonucleotides.

[0001178] *Mucus*: As used herein, "mucus" refers to the natural substance that is viscous and comprises mucin glycoproteins.

[0001179] *Naturally occurring*: As used herein, "naturally occurring" means existing in nature without artificial aid.

[0001180] *Non-human vertebrate*: As used herein, a "non human vertebrate" includes all vertebrates except *Homo sapiens*, including wild and domesticated species. Examples of non-human vertebrates include, but are not limited to, mammals, such as alpaca, banteng,

bison, camel, cat, cattle, deer, dog, donkey, gayal, goat, guinea pig, horse, llama, mule, pig, rabbit, reindeer, sheep water buffalo, and yak.

[0001181] *Off-target*: As used herein, "off target" refers to any unintended effect on any one or more target, gene, or cellular transcript.

[0001182] *Open readingframe*: As used herein, "open reading frame" or "ORF" refers to a sequence which does not contain a stop codon in a given reading frame.

[0001183] *Operably linked*: As used herein, the phrase "operably linked" refers to a functional connection between two or more molecules, constructs, transcripts, entities, moieties or the like.

[0001184] *Optionally substituted*: Herein a phrase of the form "optionally substituted X" (*e.g.*, optionally substituted alkyl) is intended to be equivalent to "X, wherein X is optionally substituted" (*e.g.*, "alkyl, wherein said alkyl is optionally substituted"). It is not intended to mean that the feature "X" (*e.g.* alkyl) *per se* is optional.

[0001185] *Peptide*: As used herein, "peptide" is less than or equal to 50 amino acids long, *e.g.*, about 5, 10, 15, 20, 25, 30, 35, 40, 45, or 50 amino acids long.

[0001186] *Paratope*: As used herein, a "paratope" refers to the antigen-binding site of an antibody.

[0001187] *Patient*: As used herein, "patient" refers to a subject who may seek or be in need of treatment, requires treatment, is receiving treatment, will receive treatment, or a subject who is under care by a trained professional for a particular disease or condition.

[0001188] *Pharmaceutically acceptable*: The phrase "pharmaceutically acceptable" is employed herein to refer to those compounds, materials, compositions, and/or dosage forms which are, within the scope of sound medical judgment, suitable for use in contact with the tissues of human beings and animals without excessive toxicity, irritation, allergic response, or other problem or complication, commensurate with a reasonable benefit/risk ratio.

[0001189] *Pharmaceutically acceptable excipients*: The phrase "pharmaceutically acceptable excipient," as used herein, refers any ingredient other than the compounds described herein (for example, a vehicle capable of suspending or dissolving the active compound) and having the properties of being substantially nontoxic and non-inflammatory in a patient. Excipients may include, for example: antiadherents,

antioxidants, binders, coatings, compression aids, disintegrants, dyes (colors), emollients, emulsifiers, fillers (diluent), film formers or coatings, flavors, fragrances, glidants (flow enhancers), lubricants, preservatives, printing inks, sorbents, suspending or dispersing agents, sweeteners, and waters of hydration. Exemplary excipients include, but are not limited to: butylated hydroxytoluene (BHT), calcium carbonate, calcium phosphate (dibasic), calcium stearate, croscarmellose, crosslinked polyvinyl pyrrolidone, citric acid, crospovidone, cysteine, ethylcellulose, gelatin, hydroxypropyl cellulose, hydroxypropyl methylcellulose, lactose, magnesium stearate, maltitol, mannitol, methionine, methylcellulose, methyl paraben, microcrystalline cellulose, polyethylene glycol, polyvinyl pyrrolidone, povidone, pregelatinized starch, propyl paraben, retinyl palmitate, shellac, silicon dioxide, sodium carboxymethyl cellulose, sodium citrate, sodium starch glycolate, sorbitol, starch (corn), stearic acid, sucrose, talc, titanium dioxide, vitamin A, vitamin E, vitamin C, and xylitol.

[0001190] *Pharmaceutically acceptable salts*: The present disclosure also includes pharmaceutically acceptable salts of the compounds described herein. As used herein, "pharmaceutically acceptable salts" refers to derivatives of the disclosed compounds wherein the parent compound is modified by converting an existing acid or base moiety to its salt form (e.g., by reacting the free base group with a suitable organic acid). Examples of pharmaceutically acceptable salts include, but are not limited to, mineral or organic acid salts of basic residues such as amines; alkali or organic salts of acidic residues such as carboxylic acids; and the like. Representative acid addition salts include acetate, adipate, alginate, ascorbate, aspartate, benzenesulfonate, benzoate, bisulfate, borate, butyrate, camphorate, camphorsulfonate, citrate, cyclopentanepropionate, digluconate, dodecylsulfate, ethanesulfonate, fumarate, glucoheptonate, glycerophosphate, hemisulfate, heptonate, hexanoate, hydrobromide, hydrochloride, hydroiodide, 2-hydroxy-ethanesulfonate, lactobionate, lactate, laurate, lauryl sulfate, malate, maleate, malonate, methanesulfonate, 2-naphthalenesulfonate, nicotinate, nitrate, oleate, oxalate, palmitate, pamoate, pectinate, persulfate, 3-phenylpropionate, phosphate, picrate, pivalate, propionate, stearate, succinate, sulfate, tartrate, thiocyanate, toluenesulfonate, undecanoate, valerate salts, and the like. Representative alkali or alkaline earth metal salts include sodium, lithium, potassium, calcium, magnesium, and

the like, as well as nontoxic ammonium, quaternary ammonium, and amine cations, including, but not limited to ammonium, tetramethylammonium, tetraethylammonium, methylamine, dimethylamine, trimethylamine, triethylamine, ethylamine, and the like. The pharmaceutically acceptable salts of the present disclosure include the conventional non-toxic salts of the parent compound formed, for example, from non-toxic inorganic or organic acids. The pharmaceutically acceptable salts of the present disclosure can be synthesized from the parent compound which contains a basic or acidic moiety by conventional chemical methods. Generally, such salts can be prepared by reacting the free acid or base forms of these compounds with a stoichiometric amount of the appropriate base or acid in water or in an organic solvent, or in a mixture of the two; generally, nonaqueous media like ether, ethyl acetate, ethanol, isopropanol, or acetonitrile are preferred. Lists of suitable salts are found in *Remington's Pharmaceutical Sciences*, 17th ed., Mack Publishing Company, Easton, Pa., 1985, p. 1418, *Pharmaceutical Salts: Properties, Selection, and Use*, P.H. Stahl and C.G. Wermuth (eds.), Wiley-VCH, 2008, and Berge et al., *Journal of Pharmaceutical Science*, 66, 1-19 (1977), each of which is incorporated herein by reference in its entirety.

[0001191] *Pharmaceutically acceptable solvate*: The term "pharmaceutically acceptable solvate," as used herein, means a compound of the invention wherein molecules of a suitable solvent are incorporated in the crystal lattice. A suitable solvent is physiologically tolerable at the dosage administered. For example, solvates may be prepared by crystallization, recrystallization, or precipitation from a solution that includes organic solvents, water, or a mixture thereof. Examples of suitable solvents are ethanol, water (for example, mono-, di-, and tri-hydrates), *N*-methylpyrrolidinone (NMP), dimethyl sulfoxide (DMSO), *N,N'*-dimethylformamide (DMF), *N,N'*-dimethylacetamide (DMAC), 1,3-dimethyl-2-imidazolidinone (DMEU), 1,3-dimethyl-3,4,5,6-tetrahydro-2-(1H)-pyrimidinone (DMPU), acetonitrile (ACN), propylene glycol, ethyl acetate, benzyl alcohol, 2-pyrrolidone, benzyl benzoate, and the like. When water is the solvent, the solvate is referred to as a "hydrate."

[0001192] *Pharmacokinetic*: As used herein, "pharmacokinetic" refers to any one or more properties of a molecule or compound as it relates to the determination of the fate of substances administered to a living organism. Pharmacokinetics is divided into several

areas including the extent and rate of absorption, distribution, metabolism and excretion. This is commonly referred to as ADME where: (A) Absorption is the process of a substance entering the blood circulation; (D) Distribution is the dispersion or dissemination of substances throughout the fluids and tissues of the body; (M) Metabolism (or Biotransformation) is the irreversible transformation of parent compounds into daughter metabolites; and (E) Excretion (or Elimination) refers to the elimination of the substances from the body. In rare cases, some drugs irreversibly accumulate in body tissue.

[0001193] *Physicochemical*: As used herein, "physicochemical" means of or relating to a physical and/or chemical property.

[0001194] *Polypeptide per unit drug (PUD)*: As used herein, a PUD or product per unit drug, is defined as a subdivided portion of total daily dose, usually 1 mg, pg, kg, etc., of a product (such as a polypeptide) as measured in body fluid or tissue, usually defined in concentration such as pmol/mL, mmol/mL, etc divided by the measure in the body fluid.

[0001195] *Preventing*: As used herein, the term "preventing" refers to partially or completely delaying onset of an infection, disease, disorder and/or condition; partially or completely delaying onset of one or more symptoms, features, or clinical manifestations of a particular infection, disease, disorder, and/or condition; partially or completely delaying onset of one or more symptoms, features, or manifestations of a particular infection, disease, disorder, and/or condition; partially or completely delaying progression from an infection, a particular disease, disorder and/or condition; and/or decreasing the risk of developing pathology associated with the infection, the disease, disorder, and/or condition.

[0001196] *Prodrug*: The present disclosure also includes prodrugs of the compounds described herein. As used herein, "prodrugs" refer to any substance, molecule or entity which is in a form predicate for that substance, molecule or entity to act as a therapeutic upon chemical or physical alteration. Prodrugs may be covalently bonded or sequestered in some way and which release or are converted into the active drug moiety prior to, upon or after administered to a mammalian subject. Prodrugs can be prepared by modifying functional groups present in the compounds in such a way that the modifications are cleaved, either in routine manipulation or *in vivo*, to the parent compounds. Prodrugs

include compounds wherein hydroxyl, amino, sulfhydryl, or carboxyl groups are bonded to any group that, when administered to a mammalian subject, cleaves to form a free hydroxyl, amino, sulfhydryl, or carboxyl group respectively. Preparation and use of prodrugs is discussed in T. Higuchi and V. Stella, "Pro-drugs as Novel Delivery Systems," Vol. 14 of the A.C.S. Symposium Series, and in *Bioreversible Carriers in Drug Design*, ed. Edward B. Roche, American Pharmaceutical Association and Pergamon Press, 1987, both of which are hereby incorporated by reference in their entirety.

[0001197] *Proliferate*: As used herein, the term "proliferate" means to grow, expand or increase or cause to grow, expand or increase rapidly. "Proliferative" means having the ability to proliferate. "Anti-proliferative" means having properties counter to or inapposite to proliferative properties.

[0001198] *Protein cleavage site*: As used herein, "protein cleavage site" refers to a site where controlled cleavage of the amino acid chain can be accomplished by chemical, enzymatic or photochemical means.

[0001199] *Protein cleavage signal*: As used herein "protein cleavage signal" refers to at least one amino acid that flags or marks a polypeptide for cleavage.

[0001200] *Protein of interest*: As used herein, the terms "proteins of interest" or "desired proteins" include those provided herein and fragments, mutants, variants, and alterations thereof.

[0001201] *Proximal*: As used herein, the term "proximal" means situated nearer to the center or to a point or region of interest.

[0001202] *Pseudouridine*: As used herein, pseudouridine refers to the C-glycoside isomer of the nucleoside uridine. A "pseudouridine analog" is any modification, variant, isoform or derivative of pseudouridine. For example, pseudouridine analogs include but are not limited to 1-carboxymethyl-pseudouridine, 1-propynyl-pseudouridine, 1-taurinomethyl-pseudouridine, 1-taurinomethyl-4-thio-pseudouridine, 1-methylpseudouridine ($m^1\psi$), 1-methyl-4-thio-pseudouridine ($m^1s^4\psi$), 4-thio-1-methyl-pseudouridine, 3-methyl-pseudouridine ($m^3\psi$), 2-thio-1-methyl-pseudouridine, 1-methyl-1-deaza-pseudouridine, 2-thio-1-methyl-1-deaza-pseudouridine, dihydropseudouridine, 2-thio-dihydropseudouridine, 2-methoxyuridine, 2-methoxy-4-thio-uridine, 4-methoxy-

pseudouridine, 4-methoxy-2-thio-pseudouridine, NI-methyl-pseudouridine, 1-methyl-3-(3-amino-3-carboxypropyl)pseudouridine (acp³ψ), and 2'-O-methyl-pseudouridine (ψηι).

[0001203] *Purified*: As used herein, "purify," "purified," "purification" means to make substantially pure or clear from unwanted components, material defilement, admixture or imperfection.

[0001204] *Sample*: As used herein, the term "sample" or "biological sample" refers to a subset of its tissues, cells or component parts (e.g. body fluids, including but not limited to blood, mucus, lymphatic fluid, synovial fluid, cerebrospinal fluid, saliva, amniotic fluid, amniotic cord blood, urine, vaginal fluid and semen). A sample further may include a homogenate, lysate or extract prepared from a whole organism or a subset of its tissues, cells or component parts, or a fraction or portion thereof, including but not limited to, for example, plasma, serum, spinal fluid, lymph fluid, the external sections of the skin, respiratory, intestinal, and genitourinary tracts, tears, saliva, milk, blood cells, tumors, organs. A sample further refers to a medium, such as a nutrient broth or gel, which may contain cellular components, such as proteins or nucleic acid molecule.

[0001205] *Signal Sequences*: As used herein, the phrase "signal sequences" refers to a sequence which can direct the transport or localization of a protein.

[0001206] *Single unit dose*: As used herein, a "single unit dose" is a dose of any therapeutic administered in one dose/at one time/single route/single point of contact, i.e., single administration event.

[0001207] *Similarity*: As used herein, the term "similarity" refers to the overall relatedness between polymeric molecules, e.g. between polynucleotide molecules (e.g. DNA molecules and/or RNA molecules) and/or between polypeptide molecules. Calculation of percent similarity of polymeric molecules to one another can be performed in the same manner as a calculation of percent identity, except that calculation of percent similarity takes into account conservative substitutions as is understood in the art.

[0001208] *Split dose*: As used herein, a "split dose" is the division of single unit dose or total daily dose into two or more doses.

[0001209] *Stable*: As used herein "stable" refers to a compound that is sufficiently robust to survive isolation to a useful degree of purity from a reaction mixture, and preferably capable of formulation into an efficacious therapeutic agent.

[0001210] *Stabilized*: As used herein, the term "stabilize", "stabilized," "stabilized region" means to make or become stable.

[0001211] *Subject*: As used herein, the term "subject" or "patient" refers to any organism to which a composition in accordance with the invention may be administered, *e.g.*, for experimental, diagnostic, prophylactic, and/or therapeutic purposes. Typical subjects include animals (*e.g.*, mammals such as mice, rats, rabbits, non-human primates, and humans) and/or plants.

[0001212] *Substantially*: As used herein, the term "substantially" refers to the qualitative condition of exhibiting total or near-total extent or degree of a characteristic or property of interest. One of ordinary skill in the biological arts will understand that biological and chemical phenomena rarely, if ever, go to completion and/or proceed to completeness or achieve or avoid an absolute result. The term "substantially" is therefore used herein to capture the potential lack of completeness inherent in many biological and chemical phenomena.

[0001213] *Substantially equal*: As used herein as it relates to time differences between doses, the term means plus/minus 2%.

[0001214] *Substantially simultaneously*: As used herein and as it relates to plurality of doses, the term means within 2 seconds.

[0001215] *Suffering from*: An individual who is "suffering from" a disease, disorder, and/or condition has been diagnosed with or displays one or more symptoms of a disease, disorder, and/or condition.

[0001216] *Susceptible to*: An individual who is "susceptible to" a disease, disorder, and/or condition has not been diagnosed with and/or may not exhibit symptoms of the disease, disorder, and/or condition but harbors a propensity to develop a disease or its symptoms. In some embodiments, an individual who is susceptible to a disease, disorder, and/or condition (for example, cancer) may be characterized by one or more of the following: (1) a genetic mutation associated with development of the disease, disorder, and/or condition; (2) a genetic polymorphism associated with development of the disease, disorder, and/or condition; (3) increased and/or decreased expression and/or activity of a protein and/or nucleic acid associated with the disease, disorder, and/or condition; (4) habits and/or lifestyles associated with development of the disease, disorder, and/or

condition; (5) a family history of the disease, disorder, and/or condition; and (6) exposure to and/or infection with a microbe associated with development of the disease, disorder, and/or condition. In some embodiments, an individual who is susceptible to a disease, disorder, and/or condition will develop the disease, disorder, and/or condition. In some embodiments, an individual who is susceptible to a disease, disorder, and/or condition will not develop the disease, disorder, and/or condition.

[0001217] *Sustained release*: As used herein, the term "sustained release" refers to a pharmaceutical composition or compound release profile that conforms to a release rate over a specific period of time.

[0001218] *Synthetic*: The term "synthetic" means produced, prepared, and/or manufactured by the hand of man. Synthesis of polynucleotides or polypeptides or other molecules of the present invention may be chemical or enzymatic.

[0001219] *Targeted Cells*: As used herein, "targeted cells" refers to any one or more cells of interest. The cells may be found *in vitro*, *in vivo*, *in situ* or in the tissue or organ of an organism. The organism may be an animal, preferably a mammal, more preferably a human and most preferably a patient.

[0001220] *Therapeutic Agent*: The term "therapeutic agent" refers to any agent that, when administered to a subject, has a therapeutic, diagnostic, and/or prophylactic effect and/or elicits a desired biological and/or pharmacological effect.

[0001221] *Therapeutically effective amount*: As used herein, the term "therapeutically effective amount" means an amount of an agent to be delivered (*e.g.*, nucleic acid, drug, therapeutic agent, diagnostic agent, prophylactic agent, *etc.*) that is sufficient, when administered to a subject suffering from or susceptible to an infection, disease, disorder, and/or condition, to treat, improve symptoms of, diagnose, prevent, and/or delay the onset of the infection, disease, disorder, and/or condition.

[0001222] *Therapeutically effective outcome*: As used herein, the term "therapeutically effective outcome" means an outcome that is sufficient in a subject suffering from or susceptible to an infection, disease, disorder, and/or condition, to treat, improve symptoms of, diagnose, prevent, and/or delay the onset of the infection, disease, disorder, and/or condition.

[0001223] *Total daily dose*: As used herein, a "total daily dose" is an amount given or prescribed in 24 hr period. It may be administered as a single unit dose.

[0001224] *Transcription factor*: As used herein, the term "transcription factor" refers to a DNA-binding protein that regulates transcription of DNA into RNA, for example, by activation or repression of transcription. Some transcription factors effect regulation of transcription alone, while others act in concert with other proteins. Some transcription factor can both activate and repress transcription under certain conditions. In general, transcription factors bind a specific target sequence or sequences highly similar to a specific consensus sequence in a regulatory region of a target gene. Transcription factors may regulate transcription of a target gene alone or in a complex with other molecules.

[0001225] *Treating*: As used herein, the term "treating" refers to partially or completely alleviating, ameliorating, improving, relieving, delaying onset of, inhibiting progression of, reducing severity of, and/or reducing incidence of one or more symptoms or features of a particular infection, disease, disorder, and/or condition. For example, "treating" cancer may refer to inhibiting survival, growth, and/or spread of a tumor. Treatment may be administered to a subject who does not exhibit signs of a disease, disorder, and/or condition and/or to a subject who exhibits only early signs of a disease, disorder, and/or condition for the purpose of decreasing the risk of developing pathology associated with the disease, disorder, and/or condition.

[0001226] *Unmodified*: As used herein, "unmodified" refers to any substance, compound or molecule prior to being changed in any way. Unmodified may, but does not always, refer to the wild type or native form of a biomolecule. Molecules may undergo a series of modifications whereby each modified molecule may serve as the "unmodified" starting molecule for a subsequent modification.

Equivalents and Scope

[0001227] Those skilled in the art will recognize, or be able to ascertain using no more than routine experimentation, many equivalents to the specific embodiments in accordance with the invention described herein. The scope of the present invention is not intended to be limited to the above Description, but rather is as set forth in the appended claims.

[0001228] In the claims, articles such as "a," "an," and "the" may mean one or more than one unless indicated to the contrary or otherwise evident from the context. Claims or descriptions that include "or" between one or more members of a group are considered satisfied if one, more than one, or all of the group members are present in, employed in, or otherwise relevant to a given product or process unless indicated to the contrary or otherwise evident from the context. The invention includes embodiments in which exactly one member of the group is present in, employed in, or otherwise relevant to a given product or process. The invention includes embodiments in which more than one, or all of the group members are present in, employed in, or otherwise relevant to a given product or process.

[0001229] It is also noted that the term "comprising" is intended to be open and permits but does not require the inclusion of additional elements or steps. When the term "comprising" is used herein, the term "consisting of" is thus also encompassed and disclosed.

[0001230] Where ranges are given, endpoints are included. Furthermore, it is to be understood that unless otherwise indicated or otherwise evident from the context and understanding of one of ordinary skill in the art, values that are expressed as ranges can assume any specific value or subrange within the stated ranges in different embodiments of the invention, to the tenth of the unit of the lower limit of the range, unless the context clearly dictates otherwise.

[0001231] In addition, it is to be understood that any particular embodiment of the present invention that falls within the prior art may be explicitly excluded from any one or more of the claims. Since such embodiments are deemed to be known to one of ordinary skill in the art, they may be excluded even if the exclusion is not set forth explicitly herein. Any particular embodiment of the compositions of the invention (*e.g.*, any nucleic acid or protein encoded thereby; any method of production; any method of use; *etc.*) can be excluded from any one or more claims, for any reason, whether or not related to the existence of prior art.

[0001232] All cited sources, for example, references, publications, databases, database entries, and art cited herein, are incorporated into this application by reference, even if

not expressly stated in the citation. In case of conflicting statements of a cited source and the instant application, the statement in the instant application shall control.

[0001233] Section and table headings are not intended to be limiting.

EXAMPLES

Example 1. Modified mRNA Production

[0001234] Modified mRNAs (mmRNA) according to the invention may be made using standard laboratory methods and materials. The open reading frame (ORF) of the gene of interest may be flanked by a 5' untranslated region (UTR) which may contain a strong Kozak translational initiation signal and/or an alpha-globin 3' UTR which may include an oligo(dT) sequence for templated addition of a poly-A tail. The modified mRNAs may be modified to reduce the cellular innate immune response. The modifications to reduce the cellular response may include pseudouridine (ψ) and 5-methyl-cytidine (5meC, 5mc or m⁵C). (See, Kariko K et al. *Immunity* 23: 165-75 (2005), Kariko K et al. *Mol Ther* 16:1833-40 (2008), Anderson BR et al. *NAR* (2010); each of which are herein incorporated by reference in their entireties).

[0001235] The ORF may also include various upstream or downstream additions (such as, but not limited to, β -globin, tags, etc.) may be ordered from an optimization service such as, but limited to, DNA2.0 (Menlo Park, CA) and may contain multiple cloning sites which may have XbaI recognition. Upon receipt of the construct, it may be reconstituted and transformed into chemically competent *E. coli*.

[0001236] For the present invention, NEB DH5-alpha Competent *E. coli* are used. Transformations are performed according to NEB instructions using 100 ng of plasmid. The protocol is as follows:

- 1 Thaw a tube of NEB 5-alpha Competent *E. coli* cells on ice for 10 minutes.
- 2 Add 1-5 μ l containing 1 pg-100 ng of plasmid DNA to the cell mixture. Carefully flick the tube 4-5 times to mix cells and DNA. Do not vortex.
- 3 Place the mixture on ice for 30 minutes. Do not mix.
- 4 Heat shock at 42°C for exactly 30 seconds. Do not mix.
- 5 Place on ice for 5 minutes. Do not mix.
- 6 Pipette 950 μ l of room temperature SOC into the mixture.
- 7 Place at 37°C for 60 minutes. Shake vigorously (250 rpm) or rotate.

8 Warm selection plates to 37°C.

9 Mix the cells thoroughly by flicking the tube and inverting.

[0001237] Spread 50-100 μ l of each dilution onto a selection plate and incubate overnight at 37°C. Alternatively, incubate at 30°C for 24-36 hours or 25°C for 48 hours.

[0001238] A single colony is then used to inoculate 5 ml of LB growth media using the appropriate antibiotic and then allowed to grow (250 RPM, 37° C) for 5 hours. This is then used to inoculate a 200 ml culture medium and allowed to grow overnight under the same conditions.

[0001239] To isolate the plasmid (up to 850 μ g), a maxi prep is performed using the Invitrogen PURELINK™ HiPure Maxiprep Kit (Carlsbad, CA), following the manufacturer's instructions.

[0001240] In order to generate cDNA for *In Vitro* Transcription (IVT), the plasmid (an Example of which is shown in Figure 3) is first linearized using a restriction enzyme such as XbaI. A typical restriction digest with XbaI will comprise the following: Plasmid 1.0 μ g; IOx Buffer 1.0 μ l; XbaI 1.5 μ l; dH₂O up to 10 μ l; incubated at 37° C for 1 hr. If performing at lab scale (< 5 μ g), the reaction is cleaned up using Invitrogen's PURELINK™ PCR Micro Kit (Carlsbad, CA) per manufacturer's instructions. Larger scale purifications may need to be done with a product that has a larger load capacity such as Invitrogen's standard PURELINK™ PCR Kit (Carlsbad, CA). Following the cleanup, the linearized vector is quantified using the NanoDrop and analyzed to confirm linearization using agarose gel electrophoresis.

[0001241] The methods described herein to make modified mRNA may be used to produce molecules of all sizes including long molecules. Modified mRNA using the described methods has been made for different sized molecules including glucosidase, alpha; acid (GAA) (3.2 kb), cystic fibrosis transmembrane conductance regulator (CFTR) (4.7 kb), Factor VII (7.3 kb), lysosomal acid lipase (45.4kDa), glucocerebrosidase (59.7 kDa) and iduronate 2-sulfatase (76 kDa).

[0001242] As a non-limiting example, G-CSF may represent the polypeptide of interest. Sequences used in the steps outlined in Examples 1-5 are shown in Table 11. It should be noted that the start codon (ATG) has been underlined in each sequence of Table 11.

Table 11. G-CSF Sequences

SEQ ID NO	Description
21435	cDNA sequence: <u>ATGGCTGGACCTGCCACCCAGAGCCCCATGAAGCTGATGGCCCTGCAG</u> CTGCTGCTGTGGCACAGTGCCTCTGGACAGTGCAGGAAGCCACCCCC CTGGGCCCTGCCAGCTCCCTGCCCCAGAGCTTCCTGCTCAAGTGCTTA GAGCAAGTGAGGAAGATCCAGGGCGATGGCGCAGCGCTCCAGGAGAA GCTGTGTGCCACCTACAAGCTGTGCCACCCCGAGGAGCTGGTGCTGCT CGGACACTCTCTGGGCATCCCCCTGGGCTCCCCTGAGCAGCTGCCCCAG CCAGGCCCTGCAGCTGGCAGGCTGCTTGAGCCAACTCCATAGCGGCCT TTTCTCTACCAGGGGCTCCTGCAGGCCCTGGAAGGGATCTCCCCCGA GTTGGGTCCCACCTTGGACACACTGCAGCTGGACGTCGCCGACTTTGC CACCACCATCTGGCAGCAGATGGAAGAAGTGGGAATGGCCCCTGCC TGCAGCCCACCCAGGGTGCCATGCCGGCCTTCGCCTCTGCTTTCCAGC GCCGGGCAGGAGGGGTCTGGTTGCCTCCCATCTGCAGAGCTTCCTGG AGGTGTTCGTACCGCGTTCTACGCCACCTTGCCCAGCCCTGA
21436	cDNA having T7 polymerase site, Afel and Xba restriction site: TAATACGACTCACTATA GGGAAATAAGAGAGAAAAGAAGAGTAAGAAGAAATATAAGAGCCAC C <u>ATGGCTGGACCTGCCACCCAGAGCCCCATGAAGCTGATGGCCCTGCAG</u> CTGCTGCTGTGGCACAGTGCCTCTGGACAGTGCAGGAAGCCACCCCC CTGGGCCCTGCCAGCTCCCTGCCCCAGAGCTTCCTGCTCAAGTGCTTA GAGCAAGTGAGGAAGATCCAGGGCGATGGCGCAGCGCTCCAGGAGAA GCTGTGTGCCACCTACAAGCTGTGCCACCCCGAGGAGCTGGTGCTGCT CGGACACTCTCTGGGCATCCCCCTGGGCTCCCCTGAGCAGCTGCCCCAG CCAGGCCCTGCAGCTGGCAGGCTGCTTGAGCCAACTCCATAGCGGCCT TTTCTCTACCAGGGGCTCCTGCAGGCCCTGGAAGGGATCTCCCCCGA GTTGGGTCCCACCTTGGACACACTGCAGCTGGACGTCGCCGACTTTGC CACCACCATCTGGCAGCAGATGGAAGAAGTGGGAATGGCCCCTGCC TGCAGCCCACCCAGGGTGCCATGCCGGCCTTCGCCTCTGCTTTCCAGC GCCGGGCAGGAGGGGTCTGGTTGCCTCCCATCTGCAGAGCTTCCTGG AGGTGTTCGTACCGCGTTCTACGCCACCTTGCCCAGCCCTGA AGCGCTGCCTTCTGCGGGGCTTGCCTTCTGGCCATGCCCTTCTTCTC CCTTGCACCTGTACCTCTTGGTCTTTGAATAAAGCCTGAGTAGGAAGG CGGCCGCTCGAGCATGCATCTAGA
21437	Optimized sequence; containing T7 polymerase site, Afel and Xba restriction site TAATACGACTCACTATA GGGAAATAAGAGAGAAAAGAAGAGTAAGAAGAAATATAAGAGCCAC C <u>ATGGCCGGTCCCGCGACCCAAAGCCCCATGAAACTTATGGCCCTGCAG</u> TTGCTGCTTTGGCACTCGGCCCTCTGGACAGTCCAAGAAGCGACTCCT CTCGGACCTGCCTCATCGTTGCCGCAGTCATTCCTTTTGAAGTGTCTGG AGCAGGTGCGAAAGATTAGGGCGATGGAGCCGCACTCCAAGAGAAG CTCTGCGCGACATAAACTTTGCCATCCCGAGGAGCTCGTACTGCTC GGGCACAGCTTGGGGATTCCCTGGGCTCCTCTCTCGTCCTGTCCGTCGC AGGCTTTGCAGTTGGCAGGGTGCCTTTCCAGCTCCACTCCGGTTTGT

	<p>CTTGTATCAGGGACTGCTGCAAGCCCTTGAGGGAATCTCGCCAGAATT GGGCCCGACGCTGGACACGTTGCAGCTCGACGTGGCGGATTTTCGCAAC AACCATCTGGCAGCAGATGGAGGAACTGGGGATGGCACCCGCGCTGC AGCCACGCAGGGGGCAATGCCGGCCTTTGCGTCCGCGTTTCAGCGCA GGGCGGGTGGAGTCCTCGTAGCGAGCCACCTTCAATCATTTTTTGAAG TCTCGTACCGGGTGTGAGACATCTTGCGCAGCCGTGA AGCGCTGCCTTCTGCGGGGCTTGCCTTCTGGCCATGCCCTTCTTCTCTC CCTTGCACCTGTACCTCTTGGTCTTTGAATAAAGCCTGAGTAGGAAGG CGGCCGCTCGAGCATGCATCTAGA</p>
<p>21438</p>	<p>mRNA sequence (transcribed) GGGAAAUAAAGAGAGAAAAGAAGAGUAAGAAGAAAUAUAAGAGCCA CC <u>AUGGCCGGUCCCGCGACCCAAAGCCCAUGAAACUUAUGGCCCU</u>GCA GUUGCUGCUUUGGCACUCGGCCUCUGGACAGUCCAAGAAGCGACU CCUCUCGGACCUGCCUCAUCGUUGCCGCAGUCAUCCUUUGAAGU GUCUGGAGCAGGUGCGAAAGAUUCAGGGCGAUGGAGCCGCACUCCA AGAGAAGCUCUGCGGACAUACAAACUUGCCAUCCCGAGGAGCUC GUACUGCUCGGGCACAGCUUGGGGAUUCCUGGGCUCCUCUCUGU CCUGUCCGUCGCAGGCUUUGCAGUUGGCAGGGUGCCUUUCCAGCU CCACUCCGGUUUGUUCUUGUAUCAGGGACUGCUGCAAGCCCUUGAG GGAAUCUCGCCAGAAUUGGGCCCGACGCUGGACACGUUGCAGCUCG ACGUGGCGGAUUUCGCAACAACCAUCUGGCAGCAGAUGGAGGAACU GGGGAUGGCACCCGCGCUGCAGCCCACGCAGGGGGCAAUGCCGGCC UUUGCGUCCGCGUUUCAGCGCAGGGCGGGUGGAGUCCUCGUAGCGA GCCACCUCAAUCAUUUUUGGAAGUCUCGUACCGGGUGCUGAGACA UCUUGCGCAGCCGUGA AGCGCUGCCUUCUGCGGGGCUUGCCUUCUGGCCAUGCCCUUCUUCUC UCCCUUGCACCUGUACCUCUUGGUCUUUGAAUAAAGCCUGAGUAGG AAG</p>

Example 2: PCR for cDNA Production

[0001243] PCR procedures for the preparation of cDNA are performed using 2x KAPA HIFI™ HotStart Ready Mix by Kapa Biosystems (Woburn, MA). This system includes 2x KAPA ReadyMix12.5 μl; Forward Primer (10 uM) 0.75 μl; Reverse Primer (10 uM) 0.75 μl; Template cDNA 100 ng; and dH₂O diluted to 25.0 μl. The reaction conditions are at 95° C for 5 min. and 25 cycles of 98° C for 20 sec, then 58° C for 15 sec, then 72° C for 45 sec, then 72° C for 5 min. then 4° C to termination.

[0001244] The reverse primer of the instant invention incorporates a poly-Ti₂₀ for a poly-Ai₂₀ in the mRNA. Other reverse primers with longer or shorter poly(T) tracts can be used to adjust the length of the poly(A) tail in the mRNA.

[0001245] The reaction is cleaned up using Invitrogen's PURELINK™ PCR Micro Kit (Carlsbad, CA) per manufacturer's instructions (up to 5 µg). Larger reactions will require a cleanup using a product with a larger capacity. Following the cleanup, the cDNA is quantified using the NANODROP™ and analyzed by agarose gel electrophoresis to confirm the cDNA is the expected size. The cDNA is then submitted for sequencing analysis before proceeding to the *in vitro* transcription reaction.

Example 3. *In vitro* Transcription (IVT)

[0001246] The *in vitro* transcription reaction generates mRNA containing modified nucleotides or modified RNA. The input nucleotide triphosphate (NTP) mix is made in-house using natural and un-natural NTPs.

[0001247] A typical *in vitro* transcription reaction includes the following:

- 1 Template cDNA 1.0 µg
- 2 10x transcription buffer (400 mM Tris-HCl pH 8.0, 190 mM MgCl₂, 50 mM DTT, 10 mM Spermidine) 2.0 µl
- 3 Custom NTPs (25mM each) 7.2 µl
- 4 RNase Inhibitor 20 U
- 5 T7 RNA polymerase 3000 U
- 6 dH₂O Up to 20.0 µl. and
- 7 Incubation at 37° C for 3 hr-5 hrs.

[0001248] The crude IVT mix may be stored at 4° C overnight for cleanup the next day. 1 U of RNase-free DNase is then used to digest the original template. After 15 minutes of incubation at 37° C, the mRNA is purified using Ambion's MEGACLEAR™ Kit (Austin, TX) following the manufacturer's instructions. This kit can purify up to 500 µg of RNA. Following the cleanup, the RNA is quantified using the NanoDrop and analyzed by agarose gel electrophoresis to confirm the RNA is the proper size and that no degradation of the RNA has occurred.

Example 4. Enzymatic Capping of mRNA

[0001249] Capping of the mRNA is performed as follows where the mixture includes: IVT RNA 60 µg-180µg and dH₂O up to 72 µl. The mixture is incubated at 65° C for 5 minutes to denature RNA, and then is transferred immediately to ice.

[0001250] The protocol then involves the mixing of IOx Capping Buffer (0.5 M Tris-HCl (pH 8.0), 60 mM KCl, 12.5 mM MgCl₂) (10.0 μl); 20 mM GTP (5.0 μl); 20 mM S-Adenosyl Methionine (2.5 μl); RNase Inhibitor (100 U); 2'-O-Methyltransferase (400U); Vaccinia capping enzyme (Guanylyl transferase) (40 U); dH₂O (Up to 28 μl); and incubation at 37° C for 30 minutes for 60 μg RNA or up to 2 hours for 180 μg of RNA.

[0001251] The mRNA is then purified using Ambion's MEGACLEAR™ Kit (Austin, TX) following the manufacturer's instructions. Following the cleanup, the RNA is quantified using the NANODROP™ (ThermoFisher, Waltham, MA) and analyzed by agarose gel electrophoresis to confirm the RNA is the proper size and that no degradation of the RNA has occurred. The RNA product may also be sequenced by running a reverse-transcription-PCR to generate the cDNA for sequencing.

Example 5. PolyA Tailing Reaction

[0001252] Without a poly-T in the cDNA, a poly-A tailing reaction must be performed before cleaning the final product. This is done by mixing Capped IVT RNA (100 μl); RNase Inhibitor (20 U); IOx Tailing Buffer (0.5 M Tris-HCl (pH 8.0), 2.5 M NaCl, 100 mM MgCl₂) (12.0 μl); 20 mM ATP (6.0 μl); Poly-A Polymerase (20 U); dH₂O up to 123.5 μl and incubation at 37° C for 30 min. If the poly-A tail is already in the transcript, then the tailing reaction may be skipped and proceed directly to cleanup with Ambion's MEGACLEAR™ kit (Austin, TX) (up to 500 μg). Poly-A Polymerase is preferably a recombinant enzyme expressed in yeast.

[0001253] For studies performed and described herein, the poly-A tail is encoded in the IVT template to comprise 160 nucleotides in length. However, it should be understood that the processivity or integrity of the polyA tailing reaction may not always result in exactly 160 nucleotides. Hence polyA tails of approximately 160 nucleotides, e.g, about 150-165, 155, 156, 157, 158, 159, 160, 161, 162, 163, 164 or 165 are within the scope of the invention.

Example 6. Natural 5' Caps and 5' Cap Analogues

[0001254] 5'-capping of modified RNA may be completed concomitantly during the *in vitro* transcription reaction using the following chemical RNA cap analogs to generate the 5'-guanosine cap structure according to manufacturer protocols: 3'-O-Me-m⁷G(5*)ppp(5*)G [the ARCA cap]; G(5*)ppp(5*)A; G(5*)ppp(5*)G; m⁷G(5*)ppp(5*)A;

m7G(5')ppp(5')G (New England BioLabs, Ipswich, MA). 5'-capping of modified RNA may be completed post-transcriptionally using a Vaccinia Virus Capping Enzyme to generate the "Cap 0" structure: m7G(5')ppp(5')G (New England BioLabs, Ipswich, MA). Cap 1 structure may be generated using both Vaccinia Virus Capping Enzyme and a 2'-O methyl-transferase to generate: m7G(5')ppp(5')G-2'-O-methyl. Cap 2 structure may be generated from the Cap 1 structure followed by the 2'-O-methylation of the 5'-antepenultimate nucleotide using a 2'-O methyl-transferase. Cap 3 structure may be generated from the Cap 2 structure followed by the 2'-O-methylation of the 5'-preantepenultimate nucleotide using a 2'-O methyl-transferase. Enzymes are preferably derived from a recombinant source.

[0001255] When transfected into mammalian cells, the modified mRNAs have a stability of between 12-18 hours or more than 18 hours, e.g., 24, 36, 48, 60, 72 or greater than 72 hours.

Example 7. Capping

A. Protein Expression Assay

[0001256] Synthetic mRNAs encoding human G-CSF (cDNA shown in SEQ ID NO: 21435; mRNA sequence fully modified with 5-methylcytosine at each cytosine and pseudouridine replacement at each uridine site shown in SEQ ID NO: 21438 with a polyA tail approximately 160 nucleotides in length not shown in sequence) containing the ARCA (3' 0-Me-m7G(5')ppp(5')G) cap analog or the Cap1 structure can be transfected into human primary keratinocytes at equal concentrations. 6, 12, 24 and 36 hours post-transfection the amount of G-CSF secreted into the culture medium can be assayed by ELISA. Synthetic mRNAs that secrete higher levels of G-CSF into the medium would correspond to a synthetic mRNA with a higher translationally-competent Cap structure.

B. Purity Analysis Synthesis

[0001257] Synthetic mRNAs encoding human G-CSF (cDNA shown in SEQ ID NO: 21435; mRNA sequence fully modified with 5-methylcytosine at each cytosine and pseudouridine replacement at each uridine site shown in SEQ ID NO: 21438 with a polyA tail approximately 160 nucleotides in length not shown in sequence) containing the ARCA cap analog or the Cap1 structure crude synthesis products can be compared for purity using denaturing Agarose-Urea gel electrophoresis or HPLC analysis. Synthetic

mRNAs with a single, consolidated band by electrophoresis correspond to the higher purity product compared to a synthetic mRNA with multiple bands or streaking bands. Synthetic mRNAs with a single HPLC peak would also correspond to a higher purity product. The capping reaction with a higher efficiency would provide a more pure mRNA population.

C. Cytokine Analysis

[0001258] Synthetic mRNAs encoding human G-CSF (cDNA shown in SEQ ID NO: 21435; mRNA sequence fully modified with 5-methylcytosine at each cytosine and pseudouridine replacement at each uridine site shown in SEQ ID NO: 21438 with a polyA tail approximately 160 nucleotides in length not shown in sequence) containing the ARCA cap analog or the Cap1 structure can be transfected into human primary keratinocytes at multiple concentrations. 6, 12, 24 and 36 hours post-transfection the amount of pro-inflammatory cytokines such as TNF-alpha and IFN-beta secreted into the culture medium can be assayed by ELISA. Synthetic mRNAs that secrete higher levels of pro-inflammatory cytokines into the medium would correspond to a synthetic mRNA containing an immune-activating cap structure.

D. Capping Reaction Efficiency

[0001259] Synthetic mRNAs encoding human G-CSF (cDNA shown in SEQ ID NO: 21435; mRNA sequence fully modified with 5-methylcytosine at each cytosine and pseudouridine replacement at each uridine site shown in SEQ ID NO: 21438 with a polyA tail approximately 160 nucleotides in length not shown in sequence) containing the ARCA cap analog or the Cap1 structure can be analyzed for capping reaction efficiency by LC-MS after capped mRNA nuclease treatment. Nuclease treatment of capped mRNAs would yield a mixture of free nucleotides and the capped 5'-5'-triphosphate cap structure detectable by LC-MS. The amount of capped product on the LC-MS spectra can be expressed as a percent of total mRNA from the reaction and would correspond to capping reaction efficiency. The cap structure with higher capping reaction efficiency would have a higher amount of capped product by LC-MS.

Example 8. Agarose Gel Electrophoresis of Modified RNA or RT PCR Products

[0001260] Individual modified RNAs (200-400 ng in a 20 μ l volume) or reverse transcribed PCR products (200-400 ng) are loaded into a well on a non-denaturing 1.2%

Agarose E-Gel (Invitrogen, Carlsbad, CA) and run for 12-15 minutes according to the manufacturer protocol.

Example 9. Nanodrop Modified RNA Quantification and UV Spectral Data

[0001261] Modified RNAs in TE buffer (1 μ i) are used for Nanodrop UV absorbance readings to quantitate the yield of each modified RNA from an *in vitro* transcription reaction.

Example 10. Formulation of Modified mRNA Using Lipidoids

[0001262] Modified mRNAs (mmRNA) are formulated for *in vitro* experiments by mixing the mmRNA with the lipidoid at a set ratio prior to addition to cells. *In vivo* formulation may require the addition of extra ingredients to facilitate circulation throughout the body. To test the ability of these lipidoids to form particles suitable for *in vivo* work, a standard formulation process used for siRNA-lipidoid formulations was used as a starting point. Initial mmRNA-lipidoid formulations may consist of particles composed of 42% lipidoid, 48% cholesterol and 10% PEG, with further optimization of ratios possible. After formation of the particle, mmRNA is added and allowed to integrate with the complex. The encapsulation efficiency is determined using a standard dye exclusion assays.

Materials and Methods for Examples 11-15

A. Lipid Synthesis

[0001263] Six lipids, DLin-DMA, DLin-K-DMA, DLin-KC2-DMA, 98N12-5, C12-200 and DLin-MC3-DMA, were synthesized by methods outlined in the art in order to be formulated with modified RNA. DLin-DMA and precursors were synthesized as described in Heyes et. al, J. Control Release, 2005, 107, 276-287. DLin-K-DMA and DLin-KC2-DMA and precursors were synthesized as described in Semple et. al, Nature Biotechnology, 2010, 28, 172-176. 98N12-5 and precursor were synthesized as described in Akinc et. al, *Nature Biotechnology*, 2008, 26, 561-569.

[0001264] C12-200 and precursors were synthesized according to the method outlined in Love et. al, PNAS, 2010, 107, 1864-1869. 2-epoxydodecane (5.10 g, 27.7 mmol, 8.2 eq) was added to a vial containing Amine 200 (0.723 g, 3.36 mmol, 1 eq) and a stirring bar. The vial was sealed and warmed to 80°C. The reaction was stirred for 4 days at 80°C. Then the mixture was purified by silica gel chromatography using a gradient from pure

dichloromethane (DCM) to DCM:MeOH 98:2. The target compound was further purified by RP-HPLC to afford the desired compound.

[0001265] DLin-MC3-DMA and precursors were synthesized according to procedures described in WO 2010054401 herein incorporated by reference in its entirety. A mixture of dilinoleyl methanol (1.5 g, 2.8 mmol, 1 eq), N,N-dimethylaminobutyric acid (1.5 g, 2.8 mmol, 1 eq), DIPEA (0.73 mL, 4.2 mmol, 1.5 eq) and TBTU (1.35 g, 4.2 mmol, 1.5 eq) in 10 mL of DMF was stirred for 10 h at room temperature. Then the reaction mixture was diluted in ether and washed with water. The organic layer was dried over anhydrous sodium sulfate, filtrated and concentrated under reduced pressure. The crude product was purified by silica gel chromatography using a gradient DCM to DCM:MeOH 98:2. Subsequently the target compound was subjected to an additional RP-HPLC purification which was done using a YMC - Pack C4 column to afford the target compound.

B. Formulation of Modified RNA Nanoparticles

[0001266] Solutions of synthesized lipid, 1,2-distearoyl-3-phosphatidylcholine (DSPC) (Avanti Polar Lipids, Alabaster, AL), cholesterol (Sigma-Aldrich, Taufkirchen, Germany), and a-[3'-(1,2-dimyristoyl-3-propanoxy)-carboxamide-propyl]-ro-methoxy-polyoxyethylene (PEG-c-DOMG) (NOF, Bouwelven, Belgium) were prepared at concentrations of 50 mM in ethanol and stored at -20°C. The lipids were combined to yield molar ratio of 50:10:38.5:1.5 (Lipid: DSPC: Cholesterol: PEG-c-DOMG) and diluted with ethanol to a final lipid concentration of 25 mM. Solutions of modified mRNA at a concentration of 1-2 mg/mL in water were diluted in 50 mM sodium citrate buffer at a pH of 3 to form a stock modified mRNA solution. Formulations of the lipid and modified mRNA were prepared by combining the synthesized lipid solution with the modified mRNA solution at total lipid to modified mRNA weight ratio of 10:1, 15:1, 20:1 and 30:1. The lipid ethanolic solution was rapidly injected into aqueous modified mRNA solution to afford a suspension containing 33% ethanol. The solutions were injected either manually (MI) or by the aid of a syringe pump (SP) (Harvard Pump 33 Dual Syringe Pump Harvard Apparatus Holliston, MA).

[0001267] To remove the ethanol and to achieve the buffer exchange, the formulations were dialyzed twice against phosphate buffered saline (PBS), pH 7.4 at volumes 200-times of the primary product using a Slide-A-Lyzer cassettes (Thermo Fisher Scientific

Inc. Rockford, IL) with a molecular weight cutoff (MWCO) of 10 kD. The first dialysis was carried at room temperature for 3 hours and then the formulations were dialyzed overnight at 4°C. The resulting nanoparticle suspension was filtered through 0.2 µm sterile filter (Sarstedt, Numbrecht, Germany) into glass vials and sealed with a crimp closure.

C. Characterization of formulations

[0001268] A Zetasizer Nano ZS (Malvern Instruments Ltd, Malvern, Worcestershire, UK) was used to determine the particle size, the polydispersity index (PDI) and the zeta potential of the modified mRNA nanoparticles in IX PBS in determining particle size and 15 mM PBS in determining zeta potential.

[0001269] Ultraviolet-visible spectroscopy was used to determine the concentration of modified mRNA nanoparticle formulation. 100 µL of the diluted formulation in IX PBS was added to 900 µL of a 4:1 (v/v) mixture of methanol and chloroform. After mixing, the absorbance spectrum of the solution was recorded between 230 nm and 330 nm on a DU 800 spectrophotometer (Beckman Coulter, Beckman Coulter, Inc., Brea, CA). The modified RNA concentration in the nanoparticle formulation was calculated based on the extinction coefficient of the modified RNA used in the formulation and on the difference between the absorbance at a wavelength of 260 nm and the baseline value at a wavelength of 330 nm.

[0001270] QUANT-IT™ RIBOGREEN® RNA assay (Invitrogen Corporation Carlsbad, CA) was used to evaluate the encapsulation of modified RNA by the nanoparticle. The samples were diluted to a concentration of approximately 5 µg/mL in TE buffer (10 mM Tris-HCl, 1 mM EDTA, pH 7.5). 50 µL of the diluted samples were transferred to a polystyrene 96 well plate, then either 50 µL of TE buffer or 50 µL of a 2% Triton X-100 solution was added. The plate was incubated at a temperature of 37°C for 15 minutes. The RIBOGREEN® reagent was diluted 1:100 in TE buffer, 100 µL of this solution was added to each well. The fluorescence intensity was measured using a fluorescence plate reader (Wallac Victor 1420 Multilabel Counter; Perkin Elmer, Waltham, MA) at an excitation wavelength of 480 nm and an emission wavelength of 520 nm. The fluorescence values of the reagent blank were subtracted from that of each of the samples and the percentage of free modified RNA was determined by dividing the fluorescence

intensity of the intact sample (without addition of Triton X-100) by the fluorescence value of the disrupted sample (caused by the addition of Triton X-100).

D. *In Vitro* Incubation

[0001271] Human embryonic kidney epithelial (HEK293) and hepatocellular carcinoma epithelial (HepG2) cells (LGC standards GmbH, Wesel, Germany) were seeded on 96-well plates (Greiner Bio-one GmbH, Frickenhausen, Germany) and plates for HEK293 cells were precoated with collagen type I. HEK293 were seeded at a density of 30,000 and HepG2 were seeded at a density of 35,000 cells per well in 100 μ l cell culture medium. For HEK293 the cell culture medium was DMEM, 10% FCS, adding 2mM L-Glutamine, 1 mM Sodium pyruvate and 1x non-essential amino acids (Biochrom AG, Berlin, Germany) and 1.2 mg/ml Sodium bicarbonate (Sigma-Aldrich, Munich, Germany) and for HepG2 the culture medium was MEM (Gibco Life Technologies, Darmstadt, Germany), 10% FCS adding 2mM L-Glutamine, 1 mM Sodium pyruvate and 1x non-essential amino acids (Biochrom AG, Berlin, Germany). Formulations containing mCherry mRNA (mRNA sequence shown in SEQ ID NO: 21439; polyA tail of approximately 160 nucleotides not shown in sequence; 5'cap, Cap1) were added in quadruplicates directly after seeding the cells and incubated. The mCherry cDNA with the T7 promoter, 5'untranslated region (UTR) and 3' UTR used in *in vitro* transcription (IVT) is given in SEQ ID NO: 21440. The mCherry mRNA was modified with a 5meC at each cytosine and pseudouridine replacement at each uridine site.

[0001272] Cells were harvested by transferring the culture media supernatants to a 96-well Pro-Bind U-bottom plate (Beckton Dickinson GmbH, Heidelberg, Germany). Cells were trypsinized with 1/2 volume Trypsin/EDTA (Biochrom AG, Berlin, Germany), pooled with respective supernatants and fixed by adding one volume PBS/2% FCS (both Biochrom AG, Berlin, Germany)/0.5% formaldehyde (Merck, Darmstadt, Germany). Samples then were submitted to a flow cytometer measurement with a 532nm excitation laser and the 610/20 filter for PE-Texas Red in a LSRII cytometer (Beckton Dickinson GmbH, Heidelberg, Germany). The mean fluorescence intensity (MFI) of all events and the standard deviation of four independent wells are presented in for samples analyzed.

Example 11. Purification of Nanoparticle Formulations

[0001273] Nanoparticle formulations of DLin-KC2-DMA and 98N12-5 in HEK293 and HepG2 were tested to determine if the mean fluorescent intensity (MFI) was dependent on the lipid to modified RNA ratio and/or purification. Three formulations of DLin-KC2-DMA and two formulations of 98N12-5 were produced using a syringe pump to the specifications described in Table 12. Purified samples were purified by SEPHADEX™ G-25 DNA grade (GE Healthcare, Sweden). Each formulation before and after purification (aP) was tested at concentration of 250 ng modified RNA per well in a 24 well plate. The percentage of cells that are positive for the marker for FL4 channel (%FL4-positive) when analyzed by the flow cytometer for each formulation and the background sample, and the MFI of the marker for the FL4 channel for each formulation and the background sample are shown in Table 13. The formulations which had been purified had a slightly higher MFI than those formulations tested before purification.

Table 12. Formulations

Formulation #	Lipid	Lipid/RNA wt/wt	Mean size (nm)
NPA-001-1	DLin-KC2-DMA	10	155 nm PDI: 0.08
NPA-001-1 aP	DLin-KC2-DMA	10	141 nm PDI: 0.14
NPA-002-1	DLin-KC2-DMA	15	140 nm PDI: 0.11
NPA-002-1 aP	DLin-KC2-DMA	15	125 nm PDI: 0.12
NPA-003-1	DLin-KC2-DMA	20	114 nm PDI: 0.08
NPA-003-1 aP	DLin-KC2-DMA	20	104 nm PDI: 0.06
NPA-005-1	98N12-5	15	127 nm PDI: 0.12
NPA-005-1 aP	98N12-5	15	134 nm PDI: 0.17
NPA-006-1	98N12	20	126 nm PDI: 0.08
NPA-006-1 aP	98N12	20	118 nm PDI: 0.13

Table 13. HEK293 and HepG2, 24-well, 250 ng Modified RNA/well

Formulation	%FL4-positive		FL4 MFI	
	HEK293	HepG2	HEK293	HepG2
Untreated	0.33	0.40	0.25	0.30
NPA-001-1	62.42	5.68	1.49	0.41
NPA-001-ap	87.32	9.02	3.23	0.53

NPA-002-1	91.28	9.90	4.43	0.59
NPA-002-ap	92.68	14.02	5.07	0.90
NPA-003- 1	87.70	11.76	6.83	0.88
NPA-003-ap	88.88	15.46	8.73	1.06
NPA-005- 1	50.60	4.75	1.83	0.46
NPA-005-ap	38.64	5.16	1.32	0.46
NPA-006-1	54.19	13.16	1.30	0.60
NPA-006-ap	49.97	13.74	1.27	0.61

Example 12. Concentration Response Curve

[0001274] Nanoparticle formulations of 98N12-5 (NPA-005) and DLin-KC2-DMA (NPA-003) were tested at varying concentrations to determine the MFI of FL4 or mCherry (mRNA sequence shown in SEQ ID NO: 21439; polyA tail of approximately 160 nucleotides not shown in sequence; 5'cap, Cap1; fully modified with 5-methylcytosine and pseudouridine) over a range of doses. The formulations tested are outlined in Table 14. To determine the optimal concentration of nanoparticle formulations of 98N12-5, varying concentrations of formulated modified RNA (100 ng, 10 ng, 1.0 ng, 0.1 ng and 0.01 ng per well) were tested in a 24-well plate of HEK293, and the results of the FL4 MFI of each dose are shown in Table 15. Likewise, to determine the optimal concentration of nanoparticle formulations of DLin-KC2-DMA, varying concentrations of formulated modified RNA (250 ng 100 ng, 10 ng, 1.0 ng, 0.1 ng and 0.01 ng per well) were tested in a 24-well plate of HEK293, and the results of the FL4 MFI of each dose are shown in Table 16. Nanoparticle formulations of DLin-KC2-DMA were also tested at varying concentrations of formulated modified RNA (250 ng, 100 ng and 30 ng per well) in a 24 well plate of HEK293, and the results of the FL4 MFI of each dose are shown in Table 17. A dose of 1 ng/well for 98N12-5 and a dose of 10 ng/well for DLin-KC2-DMA were found to resemble the FL4 MFI of the background.

[0001275] To determine how close the concentrations resembled the background, we utilized a flow cytometer with optimized filter sets for detection of mCherry expression, and were able to obtain results with increased sensitivity relative to background levels. Doses of 25 ng/well, 0.25 ng/well, 0.025 ng/well and 0.0025 ng/well were analyzed for 98N12-5 (NPA-005) and DLin-KC2-DMA (NPA-003) to determine the MFI of mCherry. As shown in Table 18, the concentration of 0.025 ng/well and lesser concentrations are similar to the background MFI level of mCherry which is about 386.125.

Table 14. Formulations

Formulation #	NPA-003	NPA-005
Lipid	DLin-KC2-DMA	98N12-5
Lipid/RNA wt/wt	20	15
Mean size	114 nm PDI: 0.08	106 nm PDI: 0.12

Table 15. HEK293, NPA-005, 24-well, n=4

Formulation	FL4 MFI
Untreated control	0.246
NPA-005 100 ng	2.2175
NPA-005 10 ng	0.651
NPA-005 1.0 ng	0.28425
NPA-005 0.1 ng	0.27675
NPA-005 0.01 ng	0.2865

Table 16. HEK293, NPA-003, 24-well, n=4

Formulation	FL4 MFI
Untreated control	0.3225
NPA-003 250 ng	2.9575
NPA-003 100 ng	1.255
NPA-003 10 ng	0.40025
NPA-003 1 ng	0.33025
NPA-003 0.1 ng	0.34625
NPA-003 0.01 ng	0.3475

Table 17. HEK293, NPA-003, 24-well, n=4

Formulation	FL4 MFI
Untreated control	0.27425
NPA-003 250 ng	5.6075
NPA-003 100 ng	3.7825
NPA-003 30 ng	1.5525

Table 18. Concentration and MFI

Formulation	MFI mCherry	
	NPA-003	NPA-005
25 ng/well	11963.25	12256.75
0.25 ng/well	1349.75	2572.75
0.025 ng/well	459.50	534.75
0.0025 ng/well	310.75	471.75

Example 13. Manual Injection and Syringe Pump Formulations

[0001276] Two formulations of DLin-KC2-DMA and 98N12-5 were prepared by manual injection (MI) and syringe pump injection (SP) and analyzed along with a background sample to compare the MFI of mCherry (mRNA sequence shown in SEQ ID NO: 21439; polyA tail of approximately 160 nucleotides not shown in sequence; 5'cap, Cap1; fully modified with 5-methylcytosine and pseudouridine) of the different formulations. Table 19 shows that the syringe pump formulations had a higher MFI as compared to the manual injection formulations of the same lipid and lipid/RNA ratio.

Table 19. Formulations and MFI

Formulation #	Lipid	Lipid/RNA wt/wt	Mean size (nm)	Method of formulation	MFI
Untreated Control	N/A	N/A	N/A	N/A	674.67
NPA-002	DLin-KC2-DMA	15	140 nm PDI: 0.11	MI	10318.25
NPA-002-2	DLin-KC2-DMA	15	105 nm PDI: 0.04	SP	37054.75
NPA-003	DLin-KC2-DMA	20	114 nm PDI: 0.08	MI	22037.5
NPA-003-2	DLin-KC2-DMA	20	95 nm PDI: 0.02	SP	37868.75
NPA-005	98N12-5	15	127 nm PDI: 0.12	MI	11504.75
NPA-005-2	98N12-5	15	106 nm PDI: 0.07	SP	9343.75
NPA-006	98N12-5	20	126 nm PDI: 0.08	MI	11182.25
NPA-006-2	98N12-5	20	93 nm PDI: 0.08	SP	5167

Example 14. Lipid Nanoparticle Formulations

[0001277] Formulations of DLin-DMA, DLin-K-DMA, DLin-KC2-DMA, 98N12-5, C12-200 and DLin-MC3-DMA were incubated at a concentration of 60 ng/well or 62.5 ng/well in a plate of HEK293 and 62.5 ng/well in a plate of HepG2 cells for 24 hours to determine the MFI of mCherry (SEQ ID NO: 21439; polyA tail of approximately 160 nucleotides not shown in sequence; 5'cap, Cap1; fully modified with 5-methylcytosine and pseudouridine) for each formulation. The formulations tested are outlined in Table 20 below. As shown in Table 21 for the 60 ng/well and Tables 22, 23, 24 and 25 for the 62.5 ng/well, the formulation of NPA-003 and NPA-018 have the highest mCherry MFI

and the formulations of NPA-008, NPA-010 and NPA-013 are most the similar to the background sample mCherry MFI value.

Table 20. Formulations

Formulation #	Lipid	Lipid/RNA wt/wt	Mean size (nm)
NPA-001	DLin-KC2-DMA	10	155 nm PDI: 0.08
NPA-002	DLin-KC2-DMA	15	140 nm PDI: 0.11
NPA-002-2	DLin-KC2-DMA	15	105 nm PDI: 0.04
NPA-003	DLin-KC2-DMA	20	114 nm PDI: 0.08
NPA-003-2	DLin-KC2-DMA	20	95 nm PDI: 0.02
NPA-005	98N12-5	15	127 nm PDI: 0.12
NPA-006	98N12-5	20	126 nm PDI: 0.08
NPA-007	DLin-DMA	15	148 nm PDI: 0.09
NPA-008	DLin-K-DMA	15	121 nm PDI: 0.08
NPA-009	C12-200	15	138 nm PDI: 0.15
NPA-010	DLin-MC3-DMA	15	126 nm PDI: 0.09
NPA-012	DLin-DMA	20	86 nm PDI: 0.08
NPA-013	DLin-K-DMA	20	104 nm PDI: 0.03
NPA-014	C12-200	20	101 nm PDI: 0.06
NPA-015	DLin-MC3-DMA	20	109 nm PDI: 0.07

Table 21. HEK293, 96-well, 60 ng Modified RNA/well

Formulation	MFI mCherry
Untreated	871.81
NPA-001	6407.25
NPA-002	14995
NPA-003	29499.5
NPA-005	3762
NPA-006	2676
NPA-007	9905.5
NPA-008	1648.75
NPA-009	2348.25
NPA-010	4426.75
NPA-012	11466

NPA-013	2098.25
NPA-014	3194.25
NPA-015	14524

Table 22. HEK293, 62.5 ng /well

Formulation	MFI mCherry
Untreated	871.81
NPA-001	6407.25
NPA-002	14995
NPA-003	29499.5
NPA-005	3762
NPA-006	2676
NPA-007	9905.5
NPA-008	1648.75
NPA-009	2348.25
NPA-010	4426.75
NPA-012	11466
NPA-013	2098.25
NPA-014	3194.25
NPA-015	14524

Table 23. HEK293, 62.5 ng /well

Formulation	MFI mCherry
Untreated	295
NPA-007	3504
NPA-012	8286
NPA-017	6128
NPA-003 -2	17528
NPA-018	34142
NPA-010	1095
NPA-015	5859
NPA-019	3229

Table 24. HepG2, 62.5 ng /well

Formulation	MFI mCherry
Untreated	649.94
NPA-001	6006.25
NPA-002	8705
NPA-002-2	15860.25
NPA-003	15059.25
NPA-003 -2	28881
NPA-005	1676
NPA-006	1473

NPA-007	15678
NPA-008	2976.25
NPA-009	961.75
NPA-010	3301.75
NPA-012	18333.25
NPA-013	5853
NPA-014	2257
NPA-015	16225.75

Table 25. HepG2, 62.5 ng /well

Formulation	MFI mCherry
Untreated control	656
NPA-007	16798
NPA-012	21993
NPA-017	20377
NPA-003-2	35651
NPA-018	40154
NPA-010	2496
NPA-015	19741
NPA-019	16373

Example 15. *In vivo* formulation studies

[0001278] Rodents (n=5) are administered intravenously, subcutaneously or intramuscularly a single dose of a formulation containing a modified mRNA and a lipid. The modified mRNA administered to the rodents is selected from G-CSF (mRNA sequence shown in SEQ ID NO: 21438; polyA tail of approximately 160 nucleotides not shown in sequence; 5'cap, Cap1), erythropoietin (EPO) (mRNA sequence shown in SEQ ID NO: 1638; polyA tail of approximately 160 nucleotides not shown in sequence; 5'cap, Cap1), Factor IX (mRNA sequence shown in SEQ ID NO: 1622; polyA tail of approximately 160 nucleotides not shown in sequence; 5'cap, Cap1) or mCherry (mRNA sequence shown in SEQ ID NO: 21439; polyA tail of approximately 160 nucleotides not shown in sequence; 5'cap, Cap1). The erythropoietin cDNA with the T7 promoter, 5'untranslated region (UTR) and 3' UTR used in *in vitro* transcription (IVT) is given in SEQ ID NO: 21441 and SEQ ID NO: 21442.

[0001279] Each formulation also contains a lipid which is selected from one of DLin-DMA, DLin-K-DMA, DLin-KC2-DMA, 98N12-5, C12-200, DLin-MC3-DMA, reLNP,

ATUPLEX®, DACC and DBTC. The rodents are injected with 100ug, 10 ug or 1 ug of the formulated modified mRNA and samples are collected at specified time intervals.

[0001280] Serum from the rodents administered formulations containing human G-CSF modified mRNA are measured by specific G-CSF ELISA and serum from mice administered human factor IX modified RNA is analyzed by specific factor IX ELISA or chromogenic assay. The liver and spleen from the mice administered with mCherry modified mRNA are analyzed by immunohistochemistry (IHC) or fluorescence-activated cell sorting (FACS). As a control, a group of mice are not injected with any formulation and their serum and tissue are collected analyzed by ELISA, FACS and/or IHC.

A. Time Course

[0001281] The rodents are administered formulations containing at least one modified mRNA to study the time course of protein expression for the administered formulation. The rodents are bled at specified time intervals prior to and after administration of the modified mRNA formulations to determine protein expression and complete blood count. Samples are also collected from the site of administration of rodents administered modified mRNA formulations subcutaneously and intramuscularly to determine the protein expression in the tissue.

B. Dose Response

[0001282] The rodents are administered formulations containing at least one modified mRNA to determine dose response of each formulation. The rodents are bled at specified time intervals prior to and after administration of the modified mRNA formulations to determine protein expression and complete blood count. The rodents are also sacrificed to analyze the effect of the modified mRNA formulation on the internal tissue. Samples are also collected from the site of administration of rodents administered modified mRNA formulations subcutaneously and intramuscularly to determine the protein expression in the tissue.

C. Toxicity

[0001283] The rodents are administered formulations containing at least one modified mRNA to study toxicity of each formulation. The rodents are bled at specified time intervals prior to and after administration of the modified mRNA formulations to determine protein expression and complete blood count. The rodents are also sacrificed to analyze the effect of the modified mRNA formulation on the internal tissue. Samples are

also collected from the site of administration of rodents administered modified mRNA formulations subcutaneously and intramuscularly to determine the protein expression in the tissue.

Example 16. PLGA Microsphere Formulations

[0001284] Optimization of parameters used in the formulation of PLGA microspheres may allow for tunable release rates and high encapsulation efficiencies while maintaining the integrity of the modified RNA encapsulated in the microspheres. Parameters such as, but not limited to, particle size, recovery rates and encapsulation efficiency may be optimized to achieve the optimal formulation.

A. Synthesis of PLGA microspheres

[0001285] Polylactideglycolic acid (PLGA) microspheres were synthesized using the water/oil/water double emulsification methods known in the art using PLGA (Lactel, Cat# B6010-2, inherent viscosity 0.55-0.75, 50:50 LA:GA), polyvinylalcohol (PVA) (Sigma, Cat# 348406-25G, MW 13-23k) dichloromethane and water. Briefly, 0.1 ml of water (W1) was added to 2 ml of PLGA dissolved in dichloromethane (DCM) (O1) at concentrations ranging from 50 - 200 mg/ml of PLGA. The W1/O1 emulsion was homogenized (IKA Ultra-Turrax Homogenizer, T18) for 30 seconds at speed 4 (-15,000 rpm). The W1/O1 emulsion was then added to 100 to 200 ml of 0.3 to 1% PVA (W2) and homogenized for 1 minute at varied speeds. Formulations were left to stir for 3 hours and then washed by centrifugation (20-25 min, 4,000 rpm, 4°C). The supernatant was discarded and the PLGA pellets were resuspended in 5-10 ml of water, which was repeated 2x. Average particle size (represents 20 -30 particles) for each formulation was determined by microscopy after washing. Table 26 shows that an increase in the PLGA concentration led to larger sized microspheres. A PLGA concentration of 200 mg/mL gave an average particle size of 14.8 μm , 100 mg/mL was 8.7 μm , and 50 mg/mL of PLGA gave an average particle size of 4.0 μm .

Table 26. Varied PLGA Concentration

Sample ID	O1 Volume (mL)	PLGA Concentration (mg/mL)	W2 Volume (mL)	PVA Concentration (%)	Speed	Average Size (μm)
1	2	200	100	0.3	5	14.8
2	2	100	100	0.3	5	8.7
3	2	50	100	0.3	5	4.0

[0001286] Table 27 shows that decreasing the homogenization speed from 5 (-20,000 rpm) to speed 4 (-15,000 rpm) led to an increase in particle size from 14.8 μm to 29.7 μm .

Table 27. Varied Homogenization Speed

Sample ID	O1 Volume (mL)	PLGA Concentration (mg/mL)	W2 Volume (mL)	PVA Concentration (%)	Speed	Average Size (μm)
1	2	200	100	0.3	5	14.8
4	2	200	100	0.3	4	29.7

[0001287] Table 28 shows that increasing the W2 volume (i.e. increasing the ratio of W2:O1 from 50:1 to 100:1), decreased average particle size slightly. Altering the PVA concentration from 0.3 to 1 wt% had little impact on PLGA microsphere size.

Table 28. Varied W2 Volume and Concentration

Sample ID	O1 Volume (mL)	PLGA Concentration (mg/mL)	W2 Volume (mL)	PVA Concentration (%)	Speed	Average Size (μm)
1	2	200	100	0.3	5	14.8
5	2	200	200	0.3	5	11.7
6	2	200	190	0.3	5	11.4
7	2	200	190	1.0	5	12.3

B. Encapsulation of modified mRNA

[0001288] Modified G-CSF mRNA (mRNA sequence shown in SEQ ID NO: 21438; polyA tail of approximately 160 nucleotides not shown in sequence; 5'cap, Cap1; fully modified with 5-methylcytosine and pseudouridine) was dissolved in water at a concentration of 2 mg/ml (W3). Three batches of PLGA microsphere formulations were made as described above with the following parameters: 0.1 ml of W3 at 2 mg/ml, 1.6 ml of O1 at 200 mg/ml, 160 ml of W2 at 1%, and homogenized at a speed of 4 for the first emulsion (W3/O1) and homogenized at a speed of 5 for the second emulsion (W3/O1/W2). After washing by centrifugation, the formulations were frozen in liquid nitrogen and then lyophilized for 3 days. To test the encapsulation efficiency of the formulations, the lyophilized material was de formulated in DCM for 6 hours followed by an overnight extraction in water. The modified RNA concentration in the samples was

then determined by OD260. Encapsulation efficiency was calculated by taking the actual amount of modified RNA and dividing by the starting amount of modified RNA. In the three batches tested, there was an encapsulation efficiency of 59.2, 49.8 and 61.3.

C. Integrity of modified mRNA encapsulated in PLGA microspheres
[0001289] Modified Factor IX mRNA (mRNA sequence shown in SEQ ID NO: 1622; polyA tail of approximately 160 nucleotides not shown in sequence; 5'cap, Cap1; fully modified with 5-methylcytosine and pseudouridine) was dissolved in water at varied concentrations (W4) to vary the weight percent loading in the formulation (mg modified RNA/mg PLGA * 100) and to determine encapsulation efficiency. The parameters in Table 29 were used to make four different batches of PLGA microsphere formulations with a homogenization speed of 4 for the first emulsion (W4/01) and a homogenization speed of 5 for the second emulsion (W4/01/W2).

Table 29. Factor IX PLGA Microsphere Formulation Parameters

ID	W4 Vol. (uL)	Factor IX Conc. (mg/ml)	Factor IX Amount (ug)	O1 Vol. (ml)	PLGA Conc. (mg/ml)	W2 Vol. (ml)	PVA Conc. (%)	Weight% (wt%) Loading
A	100	2.0	200.0	2.0	200	200	1.0	0.05
B	100	4.0	400.0	2.0	200	200	1.0	0.10
C	400	2.0	800.0	2.0	200	200	1.0	0.20
D	400	4.0	1600.0	2.0	200	200	1.0	0.40

[0001290] After lyophilization, PLGA microspheres were weighed out in 2 ml eppendorf tubes to correspond to ~ 10 ug of modified RNA. Lyophilization was found to not destroy the overall structure of the PLGA microspheres. To increase weight percent loading (wt%) for the PLGA microspheres, increasing amounts of modified RNA were added to the samples. PLGA microspheres were deformed by adding 1.0 ml of DCM to each tube and then shaking the samples for 6 hours. For modified RNA extraction, 0.5 ml of water was added to each sample and the samples were shaken overnight before the concentration of modified RNA in the samples was determined by OD260. To determine the recovery of the extraction process, unformulated Factor IX modified RNA (mRNA sequence shown in SEQ ID NO: 1622; polyA tail of approximately 160 nucleotides not shown in sequence; 5'cap, Cap1; fully modified with 5-methylcytosine and pseudouridine) (deformulation control) was spiked into DCM and was subjected to the

deformulation process. Table 30 shows the loading and encapsulation efficiency for the samples. All encapsulation efficiency samples were normalized to the deformulation control.

Table 30. Weight Percent Loading and Encapsulation Efficiency

ID	Theoretical modified RNA loading (wt%)	Actual modified RNA loading (wt%)	Encapsulation Efficiency (%)
A	0.05	0.06	97.1
B	0.10	0.10	85.7
C	0.20	0.18	77.6
D	0.40	0.31	68.1
Control	-	-	100.0

D. Release study of modified mRNA encapsulated in PLGA microspheres [0001291] PLGA microspheres formulated with Factor IX modified RNA (mRNA sequence shown in SEQ ID NO: 1622; polyA tail of approximately 160 nucleotides not shown in sequence; 5'cap, Cap1; fully modified with 5-methylcytosine and pseudouridine) were deformulated as described above and the integrity of the extracted modified RNA was determined by automated electrophoresis (Bio-Rad Experion). The extracted modified mRNA was compared against unformulated modified mRNA and the deformulation control in order to test the integrity of the encapsulated modified mRNA. As shown in Figure 4, the majority of modRNA was intact for batch ID A, B, C and D, for the deformulated control (Deform control) and the unformulated control (Unform control).

E. Protein Expression of modified mRNA encapsulated in PLGA microspheres [0001292] PLGA microspheres formulated with Factor IX modified RNA (mRNA sequence shown in SEQ ID NO: 1622; polyA tail of approximately 160 nucleotides not shown in sequence; 5'cap, Cap1; fully modified with 5-methylcytosine and pseudouridine) were deformulated as described above and the protein expression of the extracted modified RNA was determined by an *in vitro* transfection assay. HEK293 cells were reverse transfected with 250 ng of Factor IX modified RNA complexed with RNAiMAX (Invitrogen) in triplicate.

[0001293] Factor IX modified RNA was diluted in nuclease-free water to a concentration of 25 ng/ μ l and RNAiMAX was diluted 13.3x in serum-free EMEM. Equal volumes of diluted modified RNA and diluted RNAiMAX were mixed together and were allowed to stand for 20 to 30 minutes at room temperature. Subsequently, 20 μ l of the transfection mix containing 250 ng of Factor IX modified RNA was added to 80 μ l of a cell suspension containing 30,000 cells. Cells were then incubated for 16h in a humidified 37°C/5% CO₂ cell culture incubator before harvesting the cell culture supernatant. Factor IX protein expression in the cell supernatant was analyzed by an ELISA kit specific for Factor IX (Molecular Innovations, Cat # HFIXKT-TOT) and the protein expression is shown in Table 31 and Figure 5. In all PLGA microsphere batches tested, Factor IX modified RNA remained active and expressed Factor IX protein after formulation in PLGA microspheres and subsequent deformation.

Table 31. Protein Expression

Sample	Factor IX Protein Expression (ng/ml)
Batch A	0.83
Batch B	1.83
Batch C	1.54
Batch D	2.52
Deformulated Control	4.34
Unformulated Control	3.35

F. Release study of modified mRNA encapsulated in PLGA microspheres

[0001294] PLGA microspheres formulated with Factor IX modified RNA (mRNA sequence shown in SEQ ID NO: 1622; polyA tail of approximately 160 nucleotides not shown in sequence; 5'cap, Cap1; fully modified with 5-methylcytosine and pseudouridine) were resuspended in water to a PLGA microsphere concentration of 24 mg/ml. After resuspension, 150 μ l of the PLGA microsphere suspension was aliquoted into eppendorf tubes. Samples were kept incubating and shaking at 37°C during the course of the study. Triplicate samples were pulled at 0.2, 1, 2, 8, 14, and 21 days. To determine the amount of modified RNA released from the PLGA microspheres, samples were centrifuged, the supernatant was removed, and the modified RNA concentration in the supernatant was determined by OD 260. The percent release, shown in Table 32, was calculated based on the total amount of modified RNA in each sample. After 31 days,

96% of the Factor IX modified RNA was released from the PLGA microsphere formulations.

Table 32. Percent Release

Time (days)	% Release
0	0.0
0.2	27.0
1	37.7
2	45.3
4	50.9
8	57.0
14	61.8
21	75.5
31	96.4

G. Particle size reproducibility of PLGA microspheres

[0001295] Three batches of Factor IX modified RNA (mRNA sequence shown in SEQ ID NO: 1622 polyA tail of approximately 160 nucleotides not shown in sequence; 5'cap, Cap1; fully modified with 5-methylcytosine and pseudouridine) PLGA microspheres were made using the same conditions described for Batch D, shown in Table 29, (0.4 ml of W4 at 4 mg/ml, 2.0 ml of 0 1 at 200 mg/ml, 200 ml of W2 at 1%, and homogenized at a speed of 5 for the W4/01/W2 emulsion). To improve the homogeneity of the PLGA microsphere suspension, filtration was incorporated prior to centrifugation. After stirring for 3 hours and before centrifuging, all formulated material was passed through a 100 µm nylon mesh strainer (Fisherbrand Cell Strainer, Cat # 22-363-549) to remove larger aggregates. After washing and resuspension with water, 100-200 µm of a PLGA microspheres sample was used to measure particle size of the formulations by laser diffraction (Malvern Mastersizer2000). The particle size of the samples is shown in Table 33.

Table 33. Particle Size Summary

ID	D10 (µm)	D50 (µm)	D90 (µm)	Volume Weighted Mean (µm)	Filtration
Control	19.2	62.5	722.4	223.1	No
A	9.8	31.6	65.5	35.2	Yes
B	10.5	32.3	66.9	36.1	Yes

c	10.8	35.7	79.8	41.4	Yes
---	------	------	------	------	-----

[0001296] Results of the 3 PLGA microsphere batches using filtration were compared to a PLGA microsphere batch made under the same conditions without filtration. The inclusion of a filtration step before washing reduced the mean particle size and demonstrated a consistent particle size distribution between 3 PLGA microsphere batches.

H. Serum Stability of Factor IX PLGA Microspheres

[0001297] Factor IX mRNA RNA (mRNA sequence shown in SEQ ID NO: 1622 polyA tail of approximately 160 nucleotides not shown in sequence; 5'cap, Cap1; fully modified with 5-methylcytosine and pseudouridine) in buffer (TE) or 90% serum (Se), or Factor IX mRNA in PLGA in buffer, 90% serum or 1% serum was incubated in buffer, 90% serum or 1% serum at an mRNA concentration of 50 ng/ul in a total volume of 70 ul. The samples were removed at 0, 30, 60 or 120 minutes. RNases were inactivated with proteinase K digestion for 20 minutes at 55°C by adding 25 ul of 4x proteinase K buffer (0.4 ml 1M TRIS-HCl pH 7.5, 0.1 ml 0.5M EDTA, 0.12 ml 5M NaCl, and 0.4ml 10% SDS) and 8 ul of proteinase K at 20 mg/ml. The Factor IX mRNA was precipitated (add 250 ul 95% ethanol for 1 hour, centrifuge for 10 min at 13 k rpm and remove supernatant, add 200 ul 70% ethanol to the pellet, centrifuge again for 5 min at 13 k rpm and remove supernatant and resuspend the pellet in 70 ul water) or extracted from PLGA microspheres (centrifuge 5 min at 13k rpm and remove supernatant, wash pellet with 1 ml water, centrifuge 5 min at 13k rpm and remove supernatant, add 280 ul dichloromethane to the pellet and shake for 15 minutes, add 70 ul water and then shake for 2 hours and remove the aqueous phase) before being analyzed by bioanalyzer. PLGA microspheres protect Factor IX modified mRNA from degradation in 90% and 1% serum over 2 hours. Factor IX modified mRNA completely degrades in 90% serum at the initial time point.

Example 17. Lipid nanoparticle *in vivo* studies

[0001298] G-CSF (cDNA with the T7 promoter, 5' Untranslated region (UTR) and 3'UTR used in in vitro transcription is given in SEQ ID NO: 21437. mRNA sequence shown in SEQ ID NO: 21438; polyA tail of approximately 160 nucleotides not shown in

sequence; 5'cap, Cap 1; fully modified with 5-methylcytosine and pseudouridine) and Factor IX (cDNA with the T7 promoter, 5' UTR and 3'UTR used in in vitro transcription is given in SEQ ID NO: 21443. mRNA sequence shown in SEQ ID NO: 1622; polyA tail of approximately 160 nucleotides not shown in sequence; 5'cap, Cap 1; fully modified with 5-methylcytosine and pseudouridine) modified mRNA were formulated as lipid nanoparticles (LNPs) using the syringe pump method. The LNPs were formulated at a 20:1 weight ratio of total lipid to modified mRNA with a final lipid molar ratio of 50:10:38.5:1.5 (DLin-KC2-DMA: DSPC: Cholesterol: PEG-c-DOMG). Formulations, listed in Table 34, were characterized by particle size, zeta potential, and encapsulation.

Table 34. Formulations

Formulation #	NPA-029-1	NPA-030-1
Modified mRNA	Factor IX	G-CSF
Mean size	91 nm PDI: 0.04	106 nm PDI: 0.06
Zeta at pH 7.4	1.8 mV	0.9 mV
Encaps. (RiboGr)	92%	100%

[0001299] LNP formulations were administered to mice (n=5) intravenously at a modified mRNA dose of 100, 10, or 1 ug. Mice were sacrificed at 8 hrs after dosing. Serum was collected by cardiac puncture from mice that were administered with G-CSF or Factor IX modified mRNA formulations. Protein expression was determined by ELISA.

[0001300] There was no significant body weight loss (<5%) in the G-CSF or Factor IX dose groups. Protein expression for G-CSF or Factor IX dose groups was determined by ELISA from a standard curve. Serum samples were diluted (about 20-2500x for G-CSF and about 10-250x for Factor IX) to ensure samples were within the linear range of the standard curve. As shown in Table 35, G-CSF protein expression determined by ELISA was approximately 17, 1200, and 4700 ng/ml for the 1, 10, and 100 ug dose groups, respectively. As shown in Table 36, Factor IX protein expression determined by ELISA

was approximately 36, 380, and 3000-1 1000 ng/ml for the 1, 10, and 100 ug dose groups, respectively.

Table 35. G-CSF Protein Expression

Dose (ug)	Conc (ng/ml)	Dilution Factor	Sample Volume
1	17.73	20x	5 ul
10	1204.82	2500x	0.04 ul
100	4722.20	2500x	0.04 ul

Table 36. Factor IX Protein Expression

Dose (ug)	Conc (ng/ml)	Dilution Factor	Sample Volume
1	36.05	10x	5 ul
10	383.04	10x	5 ul
100*	3247.75	50x	1 ul
100*	11177.20	250x	0.2 ul

[0001301] As shown in Table 37, the LNP formulations described above have about a 10,000-100,000-fold increase in protein production compared to an administration of an intravenous (IV)-lipoplex formulation for the same dosage of modified mRNA and intramuscular (IM) or subcutaneous (SC) administration of the same dose of modified mRNA in saline. As used in Table 37, the symbol "~" means about.

Table 37. Protein Production

G-CSF	Dose (ug)	Serum Concentration (pg/ml) 8-12 hours after administration
IM	100	~20-80
SC	100	~10-40
IV (Lipoplex)	100	~30
IV (LNP)	100	~5,000,000
IV (LNP)	10	~1,000,000
IV (LNP)	1	~20,000
Factor IX	Dose (ug)	Serum Concentration (ng/ml) 8-12 hours after administration
IM	2 x 100	~1.6 ng/ml
IV (LNP)	100	~3,000-10,000 ng/ml
IV (LNP)	10	~400 ng/ml
IV (LNP)	1	~40 ng/ml

Materials and Methods for Examples 18-23

[0001302] G-CSF (mRNA sequence shown in SEQ ID NO: 21438; polyA tail of approximately 160 nucleotides not shown in sequence; 5'cap, Cap 1; fully modified with 5-methylcytosine and pseudouridine) and EPO (mRNA sequence shown in SEQ ID NO: 1638; polyA tail of approximately 160 nucleotides not shown in sequence; 5'cap, Cap 1; fully modified with 5-methylcytosine and pseudouridine) modified mRNA were formulated as lipid nanoparticles (LNPs) using the syringe pump method. The LNPs were formulated at a 20: 1 weight ratio of total lipid to modified mRNA with a final lipid molar ratio of 50:10:38.5:1.5 (DLin-KC2-DMA: DSPC: Cholesterol: PEG-c-DOMG). Formulations, listed in Table 38, were characterized by particle size, zeta potential, and encapsulation.

Table 38. Formulations

Formulation #	NPA-030-2	NPA-060-1
Modified mRNA	G-CSF	EPO
Mean size	84 nm PDI: 0.04	85 nm PDI: 0.03
Zeta at pH 7.4	0.8 mV	1.5 mV
Encapsulation (RiboGreen)	95%	98%

Example 18. Lipid nanoparticle *in vivo* studies with modified mRNA

[0001303] LNP formulations, shown in Table 38 (above), were administered to rats (n=5) intravenously (IV), intramuscularly (IM) or subcutaneously (SC) at a single modified mRNA dose of 0.05 mg/kg. A control group of rats (n=4) was untreated. The rats were bled at 2 hours, 8 hours, 24 hours, 48 hours and 96 hours and after they were administered with G-CSF or EPO modified mRNA formulations to determine protein expression using ELISA. The rats administered EPO modified mRNA intravenously were also bled at 7 days.

[0001304] As shown in Table 39, EPO protein expression in the rats intravenously administered modified EPO mRNA was detectable out to 5 days. G-CSF in the rats intravenously administered modified G-CSF mRNA was detectable to 7 days. Subcutaneous and intramuscular administration of EPO modified mRNA was detectable to at least 24 hours and G-CSF modified mRNA was detectable to at least 8 hours. In

Table 39, "OSC" refers to values that were outside the standard curve and "NT" means not tested.

Table 39. G-CSF and EPO Protein Expression

Route	Time	EPO Serum Concentration (pg/ml)	G-CSF Serum Concentration (pg/ml)
IV	2 hours	36,981.0	31,331.9
IV	8 hours	62,053.3	70,532.4
IV	24 hours	42,077.0	5,738.6
IV	48 hours	5,561.5	233.8
IV	5 days	0.0	60.4
IV	7 days	0.0	NT
IM	2 hours	1395.4	1620.4
IM	8 hours	8974.6	7910.4
IM	24 hours	4678.3	893.3
IM	48 hours	NT	OSC
IM	5 days	NT	OSC
SC	2 hours	386.2	80.3
SC	8 hours	985.6	164.2
SC	24 hours	544.2	OSC
SC	48 hours	NT	OSC
SC	5 days	NT	OSC
Untreated	All bleeds	0	0

Example 19. Time course *in vivo* study

[0001305] LNP formulations, shown in Table 38 (above), were administered to mice (n=5) intravenously (IV) at a single modified mRNA dose of 0.5, 0.05 or 0.005 mg/kg. The mice were bled at 8 hours, 24 hours, 72 hours and 6 days after they were administered with G-CSF or EPO modified mRNA formulations to determine protein expression using ELISA.

[0001306] As shown in Table 40, EPO and G-CSF protein expression in the mice administered with the modified mRNA intravenously was detectable out to 72 hours for the mice dosed with 0.005 mg/kg and 0.05 mg/kg of modified mRNA and out to 6 days for the mice administered the EPO modified mRNA. In Table 40, ">" means greater than and "ND" means not detected.

Table 40. Protein Expression

Dose (mg/kg)	Time	EPO Serum Concentration (pg/ml)	G-CSF Serum Concentration (pg/ml)
0.005	8 hours	12,508.3	11,550.6
0.005	24 hours	6,803.0	5,068.9
0.005	72 hours	ND	ND
0.005	6 days	ND	ND
0.05	8 hours	92,139.9	462,312.5
0.05	24 hours	54,389.4	80,903.8
0.05	72 hours	ND	ND
0.05	6 days	ND	ND
0.5	8 hours	498,515.3	>1,250,000
0.5	24 hours	160,566.3	495,812.5
0.5	72 hours	3,492.5	1,325.6
0.5	6 days	21.2	ND

Example 20. LNP formulations *in vivo* study in rodents**A. LNP Formulations in Mice**

[0001307] LNP formulations, shown in Table 38 (above), were administered to mice (n=4) intravenously (IV) at a single modified mRNA dose 0.05 mg/kg or 0.005 mg/kg. There was also 3 control groups of mice (n=4) that were untreated. The mice were bled at 2 hours, 8 hours, 24 hours, 48 hours and 72 hours after they were administered with G-CSF or EPO modified mRNA formulations to determine the protein expression. Protein expression of G-CSF and EPO were determined using ELISA.

[0001308] As shown in Table 41, EPO and G-CSF protein expression in the mice was detectable at least out to 48 hours for the mice that received a dose of 0.005 mg/kg modified RNA and 72 hours for the mice that received a dose of 0.05 mg/kg modified RNA. In Table 41, "OSC" refers to values that were outside the standard curve and "NT" means not tested.

Table 41. Protein Expression in Mice

Dose (mg/kg)	Time	EPO Serum Concentration (pg/ml)	G-CSF Serum Concentration (pg/ml)
0.005	2 hours	OSC	3,447.8
0.005	8 hours	1,632.8	11,454.0

0.005	24 hours	1,141.0	4,960.2
0.005	48 hours	137.4	686.4
0.005	72 hours	0	NT
0.05	2 hours	10,027.3	20,951.4
0.05	8 hours	56,547.2	70,012.8
0.05	24 hours	25,027.3	19,356.2
0.05	48 hours	1,432.3	1,963.0
0.05	72 hours	82.2	47.3

B. LNP Formulations in Rodents

[0001309] LNP formulations, shown in Table 38 (above), are administered to rats (n=4) intravenously (IV) at a single modified mRNA dose 0.05 mg/kg. There is also a control group of rats (n=4) that are untreated. The rats are bled at 2 hours, 8 hours, 24 hours, 48 hours, 72 hours, 7 days and 14 days after they were administered with G-CSF or EPO modified mRNA formulations to determine the protein expression. Protein expression of G-CSF and EPO are determined using ELISA.

Example 21. Early Time Course Study of LNPs

[0001310] LNP formulations, shown in Table 38 (above), are administered to mammals intravenously (IV), intramuscularly (IM) or subcutaneously (SC) at a single modified mRNA dose of 0.5 mg/kg, 0.05 mg/kg or 0.005 mg/kg. A control group of mammals are not treated. The mammals are bled at 5 minutes, 10 minutes, 20 minutes, 30 minutes, 45 minutes, 1 hour, 1.5 hours and/or 2 hours after they are administered with the modified mRNA LNP formulations to determine protein expression using ELISA. The mammals are also bled to determine the complete blood count such as the granulocyte levels and red blood cell count.

Example 22. Non-human primate *in vivo* study

[0001311] LNP formulations, shown in Table 38 (above), were administered to non-human primates (NHP) (cynomolgus monkey) (n=2) as a bolus intravenous injection (IV) over approximately 30 seconds using a hypodermic needle, which may be attached to a

syringe/abocath or butterfly if needed. The NHP were administered a single modified mRNA IV dose of 0.05mg/kg of EPO or G-CSF or 0.005 mg/kg of EPO in a dose volume of 0.5 mL/kg. The NHPs were bled 5-6 days before dosing with the modified mRNA LNP formulations to determine protein expression in the serum and a baseline complete blood count. After administration with the modified mRNA formulation the NHP were bled at 8, 24, 48 and 72 hours to determined protein expression. At 24 and 72 hours after administration the complete blood count of the NHP was also determined. Protein expression of G-CSF and EPO was determined by ELISA. Urine from the NHPs was collected over the course of the entire experiment and analyzed to evaluate clinical safety. Samples were collected from the NHPs after they were administered with G-CSF or EPO modified mRNA formulations to determine protein expression using ELISA. Clinical chemistry, hematology, urinalysis and cytokines of the non-human primates were also analyzed.

[0001312] As shown in Table 42, EPO protein expression in the NHPs administered 0.05 mg/kg is detectable out to 72 hours and the 0.005 mg/kg dosing of the EPO formulation is detectable out to 48 hours. In Table 42, the "<" means less than a given value. G-CSF protein expression was seen out to 24 hours after administration with the modified mRNA formulation. Preliminarily, there was an increase in granulocytes and reticulocytes levels seen in the NHP after administration with the modified mRNA formulations.

Table 42. Protein Expression in Non-Human Primates

Modified mRNA	Dose (mg/kg)	Time	Female NHP Serum Concentration (pg/ml)	Male NHP Serum Concentration (pg/ml)	Average Serum Concentration (pg/ml)
G-CSF	0.05	Pre-bleed	0	0	0
		8 hours	3289	1722	2,506
		24 hours	722	307	515
		48 hours	0	0	0
		72 hours	0	0	0

EPO	0.05	Pre-bleed	0	0	0
		8 hours	19,858	7,072	13,465
		24 hours	18,178	4,913	11,546
		48 hours	5,291	498	2,895
		72 hours	744	60	402
EPO	0.005	Pre-bleed	0	0	0
		8 hours	523	250	387
		24 hours	302	113	208
		48 hours	<7.8	<7.8	<7.8
		72 hours	0	0	0

Example 23. Non-human primate *in vivo* study for G-CSF and EPO

[0001313] LNP formulations, shown in Table 38 (above), were administered to non-human primates (NHP) (cynomolgus monkey) (n=2) as intravenous injection (IV). The NHP were administered a single modified mRNA IV dose of 0.5 mg/kg, 0.05mg/kg or 0.005 mg/kg of G-CSF or EPO in a dose volume of 0.5 mL/kg. The NHPs were bled before dosing with the modified mRNA LNP formulations to determine protein expression in the serum and a baseline complete blood count. After administration with the G-CSF modified mRNA formulation the NHP were bled at 8, 24, 48 and 72 hours to determined protein expression. After administration with the EPO modified mRNA formulation the NHP were bled at 8, 24, 48, 72 hours and 7 days to determined protein expression.

[0001314] Samples collected from the NHPs after they were administered with G-CSF or EPO modified mRNA formulations were analyzed by ELISA to determine protein expression. Neutrophil and reticulocyte count was also determined pre-dose, 24 hours, 3 days, 7 days, 14 days and 18 days after administration of the modified G-CSF or EPO formulation.

[0001315] As shown in Table 43, G-CSF protein expression was not detected beyond 72 hours. In Table 43, "<39" refers to a value below the lower limit of detection of 39 pg/ml.

Table 43. G-CSF Protein Expression

Modified mRNA	Dose (mg/kg)	Time	Female NHP Serum G-CSF Concentration (pg/ml)	Male NHP Serum G-CSF Concentration (pg/ml)
G-CSF	0.5	Pre-bleed	<39	<39
		8 hours	43,525	43,594
		24 hours	11,374	3,628
		48 hours	1,100	833
		72 hours	<39	306
G-CSF	0.05	Pre-bleed	<39	<39
		8 hours	3,289	1,722
		24 hours	722	307
		48 hours	<39	<39
		72 hours	<39	<39
G-CSF	0.005	Pre-bleed	<39	<39
		8 hours	559	700
		24 hours	155	<39
		48 hours	<39	<39
		72 hours	<39	<39

[0001316] As shown in Table 44, EPO protein expression was not detected beyond 7 days. In Table 44, "<7.8" refers to a value below the lower limit of detection of 7.8 pg/ml.

Table 44. EPO Protein Expression

Modified mRNA	Dose (mg/kg)	Time	Female NHP Serum EPO Concentration (pg/ml)	Male NHP Serum EPO Concentration (pg/ml)
EPO	0.5	Pre-bleed	<7.8	<7.8
		8 hours	158,771	119,086
		24 hours	133,978	85,825
		48 hours	45,250	64,793
		72 hours	15,097	20,407
		7 days	<7.8	<7.8

EPO	0.05	Pre-bleed	<7.8	<7.8
		8 hours	19,858	7,072
		24 hours	18,187	4,913
		48 hours	5,291	498
		72 hours	744	60
		7 days	<7.8	<7.8
EPO	0.005	Pre-bleed	<7.8	<7.8
		8 hours	523	250
		24 hours	302	113
		48 hours	11	29
		72 hours	<7.8	<7.8
		7 days	<7.8	<7.8

[0001317] As shown in Table 45, there was an increase in neutrophils in all G-CSF groups relative to pre-dose levels.

Table 45. Pharmacologic Effect of G-CSF mRNA in NHP

Dose (mg/kg)	Time	Male NHP (G-CSF) Neutrophils ($10^9/L$)	Female NHP (G-CSF) Neutrophils ($10^9/L$)	Male NHP (EPO) Neutrophils ($10^9/L$)	Female NHP (EPO) Neutrophils ($10^9/L$)
0.5	Pre-dose	1.53	1.27	9.72	1.82
	24 hours	14.92	13.96	7.5	11.85
	3 days	9.76	13.7	11.07	5.22
	7 days	2.74	3.81	11.8	2.85
	14/18 days	2.58	1.98	7.16	2.36
0.05	Pre-dose	13.74	3.05	0.97	2.15
	24 hours	19.92	29.91	2.51	2.63
	3 days	7.49	10.77	1.73	4.08
	7 days	4.13	3.8	1.23	2.77
	14/18 days	3.59	1.82	1.53	1.27
0.005	Pre-dose	1.52	2.54	5.46	5.96
	24 hours	16.44	8.6	5.37	2.59
	3 days	3.74	1.78	6.08	2.83

	7 days	7.28	2.27	3.51	2.23
	14/18 days	4.31	2.28	1.52	2.54

[0001318] As shown in Table 46, there was an increase in reticulocytes in all EPO groups 3 days to 14/18 days after dosing relative to reticulocyte levels 24 hours after dosing.

Table 46. Pharmacologic Effect of EPO mRNA on Neutrophil Count

Dose (mg/kg)	Time	Male NHP (G-CSF) Neutrophils (10 ¹² /L)	Female NHP (G-CSF) Neutrophils (10 ¹² /L)	Male NHP (EPO) Neutrophils (10 ¹² /L)	Female NHP (EPO) Neutrophils (10 ¹² /L)
0.5	Pre-dose	0.067	0.055	0.107	0.06
	24 hours	0.032	0.046	0.049	0.045
	3 days	0.041	0.017	0.09	0.064
	7 days	0.009	0.021	0.35	0.367
	14/18 days	0.029	0.071	0.066	0.071
0.05	Pre-dose	0.055	0.049	0.054	0.032
	24 hours	0.048	0.046	0.071	0.04
	3 days	0.101	0.061	0.102	0.105
	7 days	0.157	0.094	0.15	0.241
	14/18 days	0.107	0.06	0.067	0.055
0.005	Pre-dose	0.037	0.06	0.036	0.052
	24 hours	0.037	0.07	0.034	0.061
	3 days	0.037	0.054	0.079	0.118
	7 days	0.046	0.066	0.049	0.087
	14/18 days	0.069	0.057	0.037	0.06

[0001319] As shown in Tables 47-49, the administration of EPO modified RNA had an effect on other erythropoetic parameters including hemoglobin (HGB), hematocrit (HCT) and red blood cell (RBC) count.

Table 47. Pharmacologic Effect of EPO mRNA on Hemoglobin

Dose (mg/kg)	Time	Male NHP (G-CSF) HGB (g/L)	Female NHP (G-CSF) HGB (g/L)	Male NHP (EPO) HGB (g/L)	Female NHP (EPO) HGB
--------------	------	----------------------------	------------------------------	--------------------------	----------------------

					(g/L)
0.5	Pre-dose	133	129	134	123
	24 hours	113	112	127	108
	3 days	118	114	126	120
	7 days	115	116	140	134
	14/1 8 days	98	113	146	133
0.05	Pre-dose	137	129	133	133
	24 hours	122	117	123	116
	3 days	126	115	116	120
	7 days	126	116	126	121
	14/1 8 days	134	123	133	129
0.005	Pre-dose	128	129	132	136
	24 hours	117	127	122	128
	3 days	116	127	125	130
	7 days	116	129	119	127
	14/1 8 days	118	129	128	129

Table 48. Pharmacologic Effect of EPO mRNA on Hematocrit

Dose (mg/kg)	Time	Male NHP (G-CSF) HCT (L/L)	Female NHP (G-CSF) HCT (L/L)	Male NHP (EPO) HCT (L/L)	Female NHP (EPO) HCT (L/L)
0.5	Pre-dose	0.46	0.43	0.44	0.4
	24 hours	0.37	0.38	0.4	0.36
	3 days	0.39	0.38	0.41	0.39
	7 days	0.39	0.38	0.45	0.45
	14/18 days	0.34	0.37	0.48	0.46
0.05	Pre-dose	0.44	0.44	0.45	0.43
	24 hours	0.39	0.4	0.43	0.39
	3 days	0.41	0.39	0.38	0.4
	7 days	0.42	0.4	0.45	0.41
	14/18 days	0.44	0.4	0.46	0.43
0.005	Pre-dose	0.42	0.42	0.48	0.45
	24 hours	0.4	0.42	0.42	0.43
	3 days	0.4	0.41	0.44	0.42

	7 days	0.39	0.42	0.41	0.42
	14/18 days	0.41	0.42	0.42	0.42

Table 49. Pharmacologic Effect of EPO mRNA on Red Blood Cells

Dose (mg/kg)	Time	Male NHP (G-CSF) RBC (10 ¹² /L)	Female NHP (G-CSF) RBC (10 ¹² /L)	Male NHP (EPO) RBC (10 ¹² /L)	Female NHP (EPO) RBC (10 ¹² /L)
0.5	Pre-dose	5.57	5.57	5.43	5.26
	24 hours	4.66	4.96	5.12	4.69
	3 days	4.91	4.97	5.13	5.15
	7 days	4.8	5.04	5.55	5.68
	14/18 days	4.21	4.92	5.83	5.72
0.05	Pre-dose	5.68	5.64	5.57	5.84
	24 hours	4.96	5.08	5.25	5.18
	3 days	5.13	5.04	4.81	5.16
	7 days	5.17	5.05	5.37	5.31
	14/18 days	5.43	5.26	5.57	5.57
0.005	Pre-dose	5.67	5.36	6.15	5.72
	24 hours	5.34	5.35	5.63	5.35
	3 days	5.32	5.24	5.77	5.42
	7 days	5.25	5.34	5.49	5.35
	14/18 days	5.37	5.34	5.67	5.36

[0001320] As shown in Tables 50 and 51, the administration of modified RNA had an effect on serum chemistry parameters including alanine transaminase (ALT) and aspartate transaminase (AST).

Table 50. Pharmacologic Effect of EPO mRNA on Alanine Transaminase

Dose (mg/kg)	Time	Male NHP (G-CSF) ALT (U/L)	Female NHP (G-CSF) ALT (U/L)	Male NHP (EPO) ALT (U/L)	Female NHP (EPO) ALT (U/L)
0.5	Pre-dose	29	216	50	31
	2 days	63	209	98	77
	4 days	70	98	94	87
	7 days	41	149	60	59
	14days	43	145	88	44

0.05	Pre-dose	58	53	56	160
	2 days	82	39	95	254
	4 days	88	56	70	200
	7 days	73	73	64	187
	14days	50	31	29	216
0.005	Pre-dose	43	51	45	45
	2 days	39	32	62	48
	4 days	48	58	48	50
	7 days	29	55	21	48
	14days	44	46	43	51

Table 51. Pharmacologic Effect of EPO mRNA on Aspartate Transaminase

Dose (mg/kg)	Time	Male NHP (G-CSF) AST (U/L)	Female NHP (G-CSF) AST (U/L)	Male NHP (EPO) AST (U/L)	Female NHP (EPO) AST (U/L)
0.5	Pre-dose	32	47	59	20
	2 days	196	294	125	141
	4 days	67	63	71	60
	7 days	53	68	56	47
	14days	47	67	82	44
0.05	Pre-dose	99	33	74	58
	2 days	95	34	61	80
	4 days	69	42	48	94
	7 days	62	52	53	78
	14days	59	20	32	47
0.005	Pre-dose	35	54	39	40
	2 days	70	34	29	25
	4 days	39	36	43	55
	7 days	28	31	55	31
	14days	39	20	35	54

[0001321] As shown in Table 52, the administration of lipid nanoparticle-formulated modified RNA at high doses (0.5 mg/kg) caused an increase in cytokines, interferon-alpha (IFN-alpha) after administration of modified mRNA.

Table 52. Pharmacologic Effect of EPO mRNA on Alanine Transaminase

Dose (mg/kg)	Time	Male NHP (G-CSF) IFN-alpha (pg/mL)	Female NHP (G-CSF) IFN-alpha (pg/mL)	Male NHP (EPO) IFN-alpha (pg/mL)	Female NHP (EPO) IFN-alpha (pg/mL)
0.5	Pre-dose	0	0	0	0
	Day 1 + 8 hr	503.8	529.2	16.79	217.5
	4 days	0	0	0	0
0.05	Pre-dose	0	0	0	0
	Day 1 + 8 hr	0	0	0	0
	4 days	0	0	0	0
0.005	Pre-dose	0	0	0	0
	Day 1 + 8 hr	0	0	0	0
	4 days	0	0	0	0

Example 24. Study of Intramuscular and/or Subcutaneous Administration in Non-Human Primates

[0001322] Formulations containing modified EPO mRNA (mRNA sequence shown in SEQ ID NO: 1638; polyA tail of approximately 160 nucleotides not shown in sequence; 5'cap, CapI; fully modified with 5-methylcytosine and pseudouridine) or G-CSF mRNA (mRNA sequence shown in SEQ ID NO: 21438; polyA tail of approximately 160 nucleotides not shown in sequence; 5'cap, CapI; fully modified with 5-methylcytosine and pseudouridine) in saline were administered to non-human primates (Cynomolgus monkey) (NHP) intramuscularly (IM) or subcutaneously (SC). The single modified mRNA dose of 0.05mg/kg or 0.005 mg/kg was in a dose volume of 0.5 mL/kg. The non-human primates are bled 5-6 days prior to dosing to determine serum protein concentration and a baseline complete blood count. After administration with the modified mRNA formulation the NHP are bled at 8 hours, 24 hours, 48 hours, 72 hours, 7 days and 14 days to determined protein expression. Protein expression of G-CSF and EPO is determined by ELISA. At 24 hours, 72 hours, 7 days and 14 days after administration the complete blood count of the NHP is also determined. Urine from the NHPs is collected over the course of the entire experiment and analyzed to evaluate clinical safety. Tissue near the injection site is also collected and analyzed to determine protein expression.

Example 25. Modified mRNA Trafficking

[0001323] In order to determine localization and/or trafficking of the modified mRNA, studies may be performed as follows.

[0001324] LNP formulations of siRNA and modified mRNA are formulated according to methods known in the art and/or described herein. The LNP formulations may include at least one modified mRNA which may encode a protein such as G-CSF, EPO, Factor VII, and/or any protein described herein. The formulations may be administered locally into muscle of mammals using intramuscular or subcutaneous injection. The dose of modified mRNA and the size of the LNP may be varied to determine the effect on trafficking in the body of the mammal and/or to assess the impact on a biologic reaction such as, but not limited to, inflammation. The mammal may be bled at different time points to determine the expression of protein encoded by the modified mRNA administered present in the serum and/or to determine the complete blood count in the mammal.

[0001325] For example, modified mRNA encoding Factor VII, expressed in the liver and secreted into the serum, may be administered intramuscularly and/or subcutaneously. Coincident or prior to modified mRNA administration, siRNA is administered to knock out endogenous Factor VII. Factor VII arising from the intramuscular and/or subcutaneous injection of modified mRNA is administered is measured in the blood. Also, the levels of Factor VII is measured in the tissues near the injection site. If Factor VII is expressed in blood then there is trafficking of the modified mRNA. If Factor VII is expressed in tissue and not in the blood than there is only local expression of Factor VII.

Example 26. Formulations of Multiple Modified mRNA

[0001326] LNP formulations of modified mRNA are formulated according to methods known in the art and/or described herein or known in the art. The LNP formulations may include at least one modified mRNA which may encode a protein such as G-CSF, EPO, thrombopoietin and/or any protein described herein. The at least one modified mRNA may include 1, 2, 3, 4 or 5 modified mRNA molecules. The formulations containing at least one modified mRNA may be administered intravenously, intramuscularly or subcutaneously in a single or multiple dosing regimens. Biological samples such as, but not limited to, blood and/or serum may be collected and analyzed at different time points

before and/or after administration of the at least one modified mRNA formulation. An expression of a protein in a biological sample of 50-200 pg/ml after the mammal has been administered a formulation containing at least one modified mRNA encoding said protein would be considered biologically effective.

Example 27. Polyethylene Glycol Ratio Studies

A. Formulation and Characterization of PEG LNPs

[0001327] Lipid nanoparticles (LNPs) were formulated using the syringe pump method. The LNPs were formulated at a 20: 1 weight ratio of total lipid to modified G-CSF mRNA (mRNA sequence shown in SEQ ID NO: 21438; polyA tail of approximately 160 nucleotides not shown in sequence; 5'cap, Cap1; fully modified with 5-methylcytosine and pseudouridine). The molar ratio ranges of the formulations are shown in Table 53.

Table 53. Molar Ratios

	DLin-KC2-DMA	DSPC	Cholesterol	PEG-c-DMG
Mole Percent (mol%)	50.0	10.0	37-38.5	1.5-3

[0001328] Two types of PEG lipid, 1,2-Dimyristoyl-sn-glycerol, methoxypolyethylene Glycol (PEG-DMG, NOF Cat # SUNBRIGHT® GM-020) and 1,2-Distearoyl-sn-glycerol, methoxypolyethylene Glycol (PEG-DSG, NOF Cat # SUNBRIGHT® GS-020), were tested at 1.5 or 3.0 mol%. After the formation of the LNPs and the encapsulation of the modified G-CSF mRNA, the LNP formulations were characterized by particle size, zeta potential and encapsulation percentage and the results are shown in Table 54.

Table 54. Characterization of LNP Formulations

Formulation No.	NPA-071-1	NPA-072-1	NPA-073-1	NPA-074-1
Lipid	PEG-DMG 1.5%	PEG-DMG 3%	PEG-DSA 1.5%	PEG-DSA 3%
Mean Size	95 nm PDI: 0.01	85 nm PDI: 0.06	95 nm PDI: 0.08	75 nm PDI: 0.08
Zeta at pH 7.4	-1.1 mV	-2.6 mV	1.7 mV	0.7 mV
Encapsulation (RiboGreen)	88%	89%	98%	95%

B. In Vivo Screening of PEG LNPs

[0001329] Formulations of the PEG LNPs described in Table 55 were administered to mice (n=5) intravenously at a dose of 0.5 mg/kg. Serum was collected from the mice at 2

hours, 8 hours, 24 hours, 48 hours, 72 hours and 8 days after administration of the formulation. The serum was analyzed by ELISA to determine the protein expression of G-CSF and the expression levels are shown in Table 55. LNP formulations using PEG-DMG gave substantially higher levels of protein expression than LNP formulations with PEG-DSA.

Table 55. Protein Expression

Lipid	Formulation No.	Time	Protein Expression (pg/ml)
PEG-DMG, 1.5%	NPA-071-1	2 hours	114,102
		8 hours	357,944
		24 hours	104,832
		48 hours	6,697
		72 hours	980
		8 days	0
PEG-DMG, 3%	NPA-072-1	2 hours	154,079
		8 hours	354,994
		24 hours	164,311
		48 hours	13,048
		72 hours	1,182
		8 days	13
PEG-DSA, 1.5%	NPA-073-1	2 hours	3,193
		8 hours	6,162
		24 hours	446
		48 hours	197
		72 hours	124
		8 days	5
PEG-DSA, 3%	NPA-074-1	2 hours	259
		8 hours	567
		24 hours	258
		48 hours	160
		72 hours	328
		8 days	33

Example 28. Cationic Lipid Formulation Studies

A. Formulation and Characterization of Cationic Lipid Nanoparticles

[0001330] Lipid nanoparticles (LNPs) were formulated using the syringe pump method. The LNPs were formulated at a 20: 1 weight ratio of total lipid to modified mRNA. The final lipid molar ratio ranges of cationic lipid, DSPC, cholesterol and PEG-c-DOMG are outlined in Table 56.

Table 56. Molar Ratios

	Cationic Lipid	DSPC	Cholesterol	PEG-c-DOMG
Mole Percent (mol%)	50.0	10.0	38.5	1.5

[0001331] A 25 mM lipid solution in ethanol and modified RNA in 50mM citrate at a pH of 3 were mixed to create spontaneous vesicle formation. The vesicles were stabilized in ethanol before the ethanol was removed and there was a buffer exchange by dialysis. The LNPs were then characterized by particle size, zeta potential, and encapsulation percentage. Table 57 describes the characterization of LNPs encapsulating EPO modified mRNA (mRNA sequence shown in SEQ ID NO: 1638 polyA tail of approximately 160 nucleotides not shown in sequence; 5'cap, Cap1; fully modified with 5-methylcytosine and pseudouridine) or G-CSF modified mRNA (mRNA sequence shown in SEQ ID NO: 21438; polyA tail of approximately 160 nucleotides not shown in sequence; 5'cap, Cap1; fully modified with 5-methylcytosine and pseudouridine) using DLin-MC3-DMA, DLin-DMA or CI2-200 as the cationic lipid.

Table 57. Characterization of Cationic Lipid Formulations

Formulation No.	NPA-071-1	NPA-072-1	NPA-073-1	NPA-074-1	NPA-075-1	NPA-076-1
Lipid	DLin-MC3-DMA	DLin-MC3-DMA	DLin-DMA	DLin-DMA	C12-200	C12-200
Modified RNA	EPO	G-CSF	EPO	G-CSF	EPO	G-CSF
Mean Size	89 nm PDI: 0.07	96 nm PDI: 0.08	70 nm PDI: 0.04	73 nm PDI: 0.06	97 nm PDI: 0.05	103 nm PDI: 0.09
Zeta at pH 7.4	-1.1 mV	-1.4 mV	-1.6 mV	-0.4 mV	1.4 mV	0.9 mV
Encapsulation (RiboGreen)	100%	100%	99%	100%	88%	98%

B. In Vivo Screening of Cationic LNP Formulations

[0001332] Formulations of the cationic lipid formulations described in Table 57 were administered to mice (n=5) intravenously at a dose of 0.5 mg/kg. Serum was collected from the mice at 2 hours, 24 hours, 72 hours and/or 7 days after administration of the formulation. The serum was analyzed by ELISA to determine the protein expression of EPO or G-CSF and the expression levels are shown in Table 58.

Table 58. Protein Expression

Modified mRNA	Formulation No.	Time	Protein Expression (pg/ml)
EPO	NPA-071-1	2 hours	304,190.0
		24 hours	166,811.5
		72 hours	1,356.1
		7 days	20.3
EPO	NPA-073-1	2 hours	73,852.0
		24 hours	75,559.7
		72 hours	130.8
EPO	NPA-075-1	2 hours	413,010.2
		24 hours	56,463.8
G-CSF	NPA-072-1	2 hours	62,113.1
		24 hours	53,206.6
G-CSF	NPA-074-1	24 hours	25,059.3
G-CSF	NPA-076-1	2 hours	219,198.1
		24 hours	8,470.0

[0001333] Toxicity was seen in the mice administered the LNPs formulations with the cationic lipid CI2-200 (NPA-075-1 and NPA-076-1) and they were sacrificed at 24 hours because they showed symptoms such as scrubby fur, covering behavior and weight loss of greater than 10%. CI2-200 was expected to be more toxic but also had a high level of expression over a short period. The cationic lipid DLin-DMA (NPA-073-1 and NPA-074-1) had the lowest expression out of the three cationic lipids tested. DLin-MC3-DMA (NPA-071-1 and NPA-072-1) showed good expression up to day three and was above the background sample out to day 7 for EPO formulations.

Example 29. Method of Screening for Protein Expression

A. Electrospray Ionization

[0001334] A biological sample which may contain proteins encoded by modified RNA administered to the subject is prepared and analyzed according to the manufacturer protocol for electrospray ionization (ESI) using 1, 2, 3 or 4 mass analyzers. A biologic sample may also be analyzed using a tandem ESI mass spectrometry system.

Patterns of protein fragments, or whole proteins, are compared to known controls for a given protein and identity is determined by comparison.

B. Matrix-Assisted Laser Desorption/Ionization

[0001335] A biological sample which may contain proteins encoded by modified RNA administered to the subject is prepared and analyzed according to the manufacturer protocol for matrix-assisted laser desorption/ionization (MALDI).

[0001336] Patterns of protein fragments, or whole proteins, are compared to known controls for a given protein and identity is determined by comparison.

C. Liquid Chromatography-Mass spectrometry-Mass spectrometry

[0001337] A biological sample, which may contain proteins encoded by modified RNA, may be treated with a trypsin enzyme to digest the proteins contained within. The resulting peptides are analyzed by liquid chromatography-mass spectrometry-mass spectrometry (LC/MS/MS). The peptides are fragmented in the mass spectrometer to yield diagnostic patterns that can be matched to protein sequence databases via computer algorithms. The digested sample may be diluted to achieve 1 ng or less starting material for a given protein. Biological samples containing a simple buffer background (e.g. water or volatile salts) are amenable to direct in-solution digest; more complex backgrounds (e.g. detergent, non-volatile salts, glycerol) require an additional clean-up step to facilitate the sample analysis.

[0001338] Patterns of protein fragments, or whole proteins, are compared to known controls for a given protein and identity is determined by comparison.

Example 30. Lipid Nanoparticle *in vivo* studies

[0001339] mCherry niRNA (niRNA sequence shown in SEQ ID NO: 21444; polyA tail of approximately 160 nucleotides not shown in sequence; 5'cap, Cap1; fully modified with 5-methylcytosine and pseudouridine) was formulated as a lipid nanoparticle (LNP) using the syringe pump method. The LNP was formulated at a 20: 1 weight ratio of total lipid to modified mRNA with a final lipid molar ratio of 50:10:38.5:1.5 (DLin-KC2-DMA: DSPC: Cholesterol: PEG-c-DOMG). The mCherry formulation, listed in Table 59, was characterized by particle size, zeta potential, and encapsulation.

Table 59. mCherry Formulation

Formulation #	NPA-003-5
Modified mRNA	mCherry

Mean size	105 nm PDI: 0.09
Zeta at pH 7.4	1.8 mV
Encaps. (RiboGr)	100%

[0001340] The LNP formulation was administered to mice (n=5) intravenously at a modified mRNA dose of 100 ug. Mice were sacrificed at 24 hrs after dosing. The liver and spleen from the mice administered with mCherry modified mRNA formulations were analyzed by immunohistochemistry (IHC), western blot, or fluorescence-activated cell sorting (FACS).

[0001341] Histology of the liver showed uniform mCherry expression throughout the section, while untreated animals did not express mCherry. Western blots were also used to confirm mCherry expression in the treated animals, whereas mCherry was not detected in the untreated animals. Tubulin was used as a control marker and was detected in both treated and untreated mice, indicating that normal protein expression in hepatocytes was unaffected.

[0001342] FACS and IHC were also performed on the spleens of mCherry and untreated mice. All leukocyte cell populations were negative for mCherry expression by FACS analysis. By IHC, there were also no observable differences in the spleen in the spleen between mCherry treated and untreated mice.

Example 31. Syringe Pump *in vivo* studies

[0001343] mCherry modified mRNA (mRNA sequence shown in SEQ ID NO: 21439; polyA tail of approximately 160 nucleotides not shown in sequence; 5'cap, Cap1) is formulated as a lipid nanoparticle (LNP) using the syringe pump method. The LNP is formulated at a 20: 1 weight ratio of total lipid to modified mRNA with a final lipid molar ratio of 50:10:38.5:1.5 (DLin-KC2-DMA: DSPC: Cholesterol: PEG-c-DOMG). The mCherry formulation is characterized by particle size, zeta potential, and encapsulation.

[0001344] The LNP formulation is administered to mice (n=5) intravenously at a modified mRNA dose of 10 or 100 ug. Mice are sacrificed at 24 hrs after dosing. The liver and spleen from the mice administered with mCherry modified mRNA formulations

are analyzed by immunohistochemistry (IHC), western blot, and/or fluorescence-activated cell sorting (FACS).

Example 32. *In vitro* and *in vivo* Expression

A. *In vitro* Expression in Human Cells Using Lipidoid Formulations

[0001345] The ratio of mmRNA to lipidoid used to test for *in vitro* transfection is tested empirically at different lipidoid:mmRNA ratios. Previous work using siRNA and lipidoids have utilized 2.5:1, 5:1, 10:1, and 15:1 lipidoid :siRNA wt:wt ratios. Given the longer length of mmRNA relative to siRNA, a lower wtwt ratio of lipidoid to mmRNA may be effective. In addition, for comparison mmRNA were also formulated using RNAIMAX™ (Invitrogen, Carlsbad, CA) or TRANSIT-mRNA (Minis Bio, Madison, WI) cationic lipid delivery vehicles.

[0001346] The ability of lipidoid-formulated Luciferase (IVT cDNA sequence as shown in SEQ ID NO: 21445; mRNA sequence shown in SEQ ID NO: 21446, polyA tail of approximately 160 nucleotides not shown in sequence, 5'cap, Cap1, fully modified with 5-methylcytosine at each cytosine and pseudouridine replacement at each uridine site), green fluorescent protein (GFP) (IVT cDNA sequence as shown in SEQ ID NO: 21447; mRNA sequence shown in SEQ ID NO: 21448, polyA tail of approximately 160 nucleotides not shown in sequence, 5'cap, Cap1, fully modified with 5-methylcytosine at each cytosine and pseudouridine replacement at each uridine site), G-CSF mRNA (mRNA sequence shown in SEQ ID NO: 21439; polyA tail of approximately 160 nucleotides not shown in sequence; 5'cap, Cap1), and EPO mRNA (mRNA sequence shown in SEQ ID NO: 1638; polyA tail of approximately 160 nucleotides not shown in sequence; 5'cap, Cap1) to express the desired protein product can be confirmed by luminescence for luciferase expression, flow cytometry for GFP expression, and by ELISA for G-CSF and Erythropoietin (EPO) secretion.

B. *In vivo* Expression Following Intravenous Injection

[0001347] Systemic intravenous administration of the formulations are created using various different lipidoids including, but not limited to, 98N12-5, C12-200, and MD1.

[0001348] Lipidoid formulations containing mmRNA are injected intravenously into animals. The expression of the modified mRNA (mmRNA)-encoded proteins are assessed in blood and/or other organs samples such as, but not limited to, the liver and

spleen collected from the animal. Conducting single dose intravenous studies will also allow an assessment of the magnitude, dose responsiveness, and longevity of expression of the desired product.

[0001349] In one embodiment, lipidoid based formulations of 98N12-5, C12-200, MD1 and other lipidoids, are used to deliver luciferase, green fluorescent protein (GFP), mCherry fluorescent protein, secreted alkaline phosphatase (sAP), human G-CSF, human Factor IX, or human Erythropoietin (EPO) mmRNA into the animal. After formulating mmRNA with a lipid, as described previously, animals are divided into groups to receive either a saline formulation, or a lipidoid-formulation which contains one of a different mmRNA selected from luciferase, GFP, mCherry, sAP, human G-CSF, human Factor IX, and human EPO. Prior to injection into the animal, mmRNA-containing lipidoid formulations are diluted in PBS. Animals are then administered a single dose of formulated mmRNA ranging from a dose of 10 mg/kg to doses as low as 1 ng/kg, with a preferred range to be 10 mg/kg to 100 ng/kg, where the dose of mmRNA depends on the animal body weight such as a 20 gram mouse receiving a maximum formulation of 0.2 ml (dosing is based no mmRNA per kg body weight). After the administration of the mmRNA-lipidoid formulation, serum, tissues, and/or tissue lysates are obtained and the level of the mmRNA-encoded product is determined at a single and/or a range of time intervals. The ability of lipidoid-formulated Luciferase, GFP, mCherry, sAP, G-CSF, Factor IX, and EPO mmRNA to express the desired protein product is confirmed by luminescence for the expression of Luciferase, flow cytometry for the expression of GFP and mCherry expression, by enzymatic activity for sAP, or by ELISA for the section of G-CSF, Factor IX and/or EPO.

[0001350] Further studies for a multi-dose regimen are also performed to determine the maximal expression of mmRNA, to evaluate the saturability of the mmRNA-driven expression (by giving a control and active mmRNA formulation in parallel or in sequence), and to determine the feasibility of repeat drug administration (by giving mmRNA in doses separated by weeks or months and then determining whether expression level is affected by factors such as immunogenicity). An assessment of the physiological function of proteins such as G-CSF and EPO are also determined through analyzing samples from the animal tested and detecting increases in granulocyte and red

blood cell counts, respectively. . Activity of an expressed protein product such as Factor IX, in animals can also be assessed through analysis of Factor IX enzymatic activity (such as an activated partial thromboplastin time assay) and effect of clotting times.

C. *In vitro* Expression Following Intramuscular and/or Subcutaneous Injection

[0001351] The use of lipidoid formulations to deliver oligonucleotides, including mRNA, via an intramuscular route or a subcutaneous route of injection needs to be evaluated as it has not been previously reported. Intramuscular and/or subcutaneous injection of mmRNA are evaluated to determine if mmRNA-containing lipidoid formulations are capable to produce both localized and systemic expression of a desired proteins.

[0001352] Lipidoid formulations of 98N12-5, C12-200, and MDI-containing mmRNA selected from luciferase, green fluorescent protein (GFP), mCherry fluorescent protein, secreted alkaline phosphatase (sAP), human G-CSF, human factor IX, or human Erythropoietin (EPO) mmRNA are injected intramuscularly and/or subcutaneously into animals. The expression of mmRNA-encoded proteins are assessed both within the muscle or subcutaneous tissue and systemically in blood and other organs such as the liver and spleen. Single dose studies allow an assessment of the magnitude, dose responsiveness, and longevity of expression of the desired product.

[0001353] Animals are divided into groups to receive either a saline formulation or a formulation containing modified mRNA. Prior to injection mmRNA-containing lipidoid formulations are diluted in PBS. Animals are administered a single intramuscular dose of formulated mmRNA ranging from 50 mg/kg to doses as low as 1 ng/kg with a preferred range to be 10 mg/kg to 100 ng/kg. A maximum dose for intramuscular administration, for a mouse, is roughly 1 mg mmRNA or as low as 0.02 ng mmRNA for an intramuscular injection into the hind limb of the mouse. For subcutaneous administration, the animals are administered a single subcutaneous dose of formulated mmRNA ranging from 400 mg/kg to doses as low as 1 ng/kg with a preferred range to be 80 mg/kg to 100 ng/kg. A maximum dose for subcutaneous administration, for a mouse, is roughly 8 mg mmRNA or as low as 0.02 ng mmRNA.

[0001354] For a 20 gram mouse the volume of a single intramuscular injection is maximally 0.025 ml and a single subcutaneous injection is maximally 0.2 ml. The

optimal dose of mmRNA administered is calculated from the body weight of the animal. At various points in time points following the administration of the mmRNA-lipidoid, serum, tissues, and tissue lysates is obtained and the level of the mmRNA-encoded product is determined. The ability of lipidoid-formulated luciferase, green fluorescent protein (GFP), mCherry fluorescent protein, secreted alkaline phosphatase (sAP), human G-CSF, human factor IX, or human Erythropoietin (EPO) mmRNA to express the desired protein product is confirmed by luminescence for luciferase expression, flow cytometry for GFP and mCherry expression, by enzymatic activity for sAP, and by ELISA for G-CSF, Factor IX and Erythropoietin (EPO) secretion.

[0001355] Additional studies for a multi-dose regimen are also performed to determine the maximal expression using mmRNA, to evaluate the saturability of the mmRNA-driven expression (achieved by giving a control and active mmRNA formulation in parallel or in sequence), and to determine the feasibility of repeat drug administration (by giving mmRNA in doses separated by weeks or months and then determining whether expression level is affected by factors such as immunogenicity). Studies utilizing multiple subcutaneous or intramuscular injection sites at one time point, are also utilized to further increase mmRNA drug exposure and improve protein production. An assessment of the physiological function of proteins, such as GFP, mCherry, sAP, human G-CSF, human factor IX, and human EPO, are determined through analyzing samples from the tested animals and detecting a change in granulocyte and/or red blood cell counts. Activity of an expressed protein product such as Factor IX, in animals can also be assessed through analysis of Factor IX enzymatic activity (such as an activated partial thromboplastin time assay) and effect of clotting times.

Example 33. Bifunctional mmRNA

[0001356] Using the teachings and synthesis methods described herein, modified RNAs are designed and synthesized to be bifunctional, thereby encoding one or more cytotoxic protein molecules as well as be synthesized using cytotoxic nucleosides.

[0001357] Administration of the bifunctional modified mRNAs is effected using either saline or a lipid carrier. Once administered, the bifunctional modified mRNA is translated to produce the encoded cytotoxic peptide. Upon degradation of the delivered modified

mRNA, the cytotoxic nucleosides are released which also effect therapeutic benefit to the subject.

Example 34. Modified mRNA Transfection

A. Reverse Transfection

[0001358] For experiments performed in a 24-well collagen-coated tissue culture plate, Keratinocytes are seeded at a cell density of 1×10^5 . For experiments performed in a 96-well collagen-coated tissue culture plate, Keratinocytes are seeded at a cell density of 0.5×10^5 . For each modified mRNA (mmRNA) to be transfected, modified mRNA: RNAIMAX™ is prepared as described and mixed with the cells in the multi-well plate within a period of time, e.g., 6 hours, of cell seeding before cells had adhered to the tissue culture plate.

B. Forward Transfection

In a 24-well collagen-coated tissue culture plate, Keratinocytes are seeded at a cell density of 0.7×10^5 . For experiments performed in a 96-well collagen-coated tissue culture plate, Keratinocytes are seeded at a cell density of 0.3×10^5 . Keratinocytes are grown to a confluency of >70% for over 24 hours. For each modified mRNA (mmRNA) to be transfected, modified mRNA: RNAIMAX™ is prepared as described and transfected onto the cells in the multi-well plate over 24 hours after cell seeding and adherence to the tissue culture plate.

C. Modified mRNA Translation Screen: G-CSF ELISA

[0001359] Keratinocytes are grown in EPILIFE medium with Supplement S7 from Invitrogen (Carlsbad, CA) at a confluence of >70%. One set of keratinocytes were reverse transfected with 300 ng of the chemically modified mRNA (mmRNA) complexed with RNAIMAX™ from Invitrogen. Another set of keratinocytes are forward transfected with 300 ng modified mRNA complexed with RNAIMAX™ from Invitrogen. The modified mRNA: RNAIMAX™ complex is formed by first incubating the RNA with Supplement-free EPILIFE® media in a 5X volumetric dilution for 10 minutes at room temperature.

[0001360] In a second vial, RNAIMAX™ reagent was incubated with Supplement-free EPILIFE® Media in 10X volumetric dilution for 10 minutes at room temperature. The RNA vial was then mixed with the RNAIMAX™ vial and incubated for 20-30 minutes at

room temperature before being added to the cells in a drop-wise fashion. Secreted human Granulocyte-Colony Stimulating Factor (G-CSF) concentration in the culture medium is measured at 18 hours post-transfection for each of the chemically modified mRNA in triplicate.

[0001361] Secretion of Human G-CSF from transfected human keratinocytes is quantified using an ELISA kit from Invitrogen or R&D Systems (Minneapolis, MN) following the manufacturers recommended instructions.

D. Modified mRNA Dose and Duration: G-CSF ELISA

[0001362] Keratinocytes are grown in EPILIFE® medium with Supplement S7 from Invitrogen at a confluence of >70%. Keratinocytes are reverse transfected with either Ong, 46.875ng, 93.75ng, 187.5ng, 375ng, 750ng, or 1500ng modified mRNA complexed with the RNAIMAX™ from Invitrogen (Carlsbad, CA). The modified mRNA:RNAIMAX™ complex is formed as described. Secreted human G-CSF concentration in the culture medium is measured at 0, 6, 12, 24, and 48 hours post-transfection for each concentration of each modified mRNA in triplicate. Secretion of human G-CSF from transfected human keratinocytes is quantified using an ELISA kit from Invitrogen or R&D Systems following the manufacturers recommended instructions.

Example 35. Split dose studies

[0001363] Studies utilizing multiple subcutaneous or intramuscular injection sites at one time point were designed and performed to investigate ways to increase mmRNA drug exposure and improve protein production. In addition to detection of the expressed protein product, an assessment of the physiological function of proteins was also determined through analyzing samples from the animal tested.

[0001364] Surprisingly, it has been determined that split dosing of mmRNA produces greater protein production and phenotypic responses than those produced by single unit dosing or multi-dosing schemes.

[0001365] The design of a single unit dose, multi-dose and split dose experiment involved using human erythropoietin (EPO) mmRNA (mRNA shown in SEQ ID NO: 1638; polyA tail of approximately 160 nucleotides not shown in sequence; 5'cap, Cap1) administered in buffer alone. The dosing vehicle (F. buffer) consisted of 150mM NaCl, 2

mM CaCl₂, 2 mM Na⁺-phosphate (1.4mM monobasic sodium phosphate; 0.6mM dibasic sodium phosphate), and 0.5 mM EDTA, pH 6.5. The pH was adjusted using sodium hydroxide and the final solution was filter sterilized. The mmRNA was modified with 5meC at each cytosine and pseudouridine replacement at each uridine site.

[0001366] Animals (n=5) were injected IM (intramuscular) for the single unit dose of 100 ug. For multi-dosing, two schedules were used, 3 doses of 100 ug and 6 doses of 100 ug. For the split dosing scheme, two schedules were used, 3 doses at 33.3 ug and 6 doses of 16.5 ug mmRNA. Control dosing involved use of buffer only at 6 doses. Control mmRNA involved the use of luciferase mmRNA (IVT cDNA sequence shown in SEQ ID NO: 21445; mRNA sequence shown in SEQ ID NO: 21446, polyA tail of approximately 160 nucleotides not shown in sequence, 5'cap, Cap1, fully modified with 5-methylcytosine at each cytosine and pseudouridine replacement at each uridine site) dosed 6 times at 100 ug. Blood and muscle tissue were evaluated 13 hrs post injection.

[0001367] Human EPO protein was measured in mouse serum 13h post I.M. single, multi- or split dosing of the EPO mmRNA in buffer. Seven groups of mice (n=5 mice per group) were treated and evaluated. The results are shown in Table 60.

Table 60. Split dose study

Group	Treatment	Dose of mmRNA	Total Dose	Avg. pmol/mL human EPO	Polypeptide per unit drug (pmol/ug)	Dose Splitting Factor
1	Human EPO mmRNA	1 x 100 ug	100 ug	14.3	.14	1
2	Human EPO mmRNA	3 x 100 ug	300 ug	82.5	.28	2
3	Human EPO mmRNA	6 x 100 ug	600 ug	273.0	.46	3.3
4	Human EPO mmRNA	3 x 33.3 ug	100 ug	104.7	1.1	7.9
5	Human EPO mmRNA	6 x 16.5 ug	100 ug	127.9	1.3	9.3
6	Luciferase mmRNA	6 x 100 ug	600 ug	0	--	--
7	Buffer Alone	--	--	0	--	--

[0001368] The splitting factor is defined as the product per unit drug divided by the single dose product per unit drug (PUD). For example for treatment group 2 the value .28

or product (EPO) per unit drug (mmRNA) is divided by the single dose product per unit drug of 0.14. The result is 2. Likewise, for treatment group 4, the value 1.1 or product (EPO) per unit drug (mmRNA) is divided by the single dose product per unit drug of 0.14. The result is 7.9. Consequently, the dose splitting factor (DSF) may be used as an indicator of the efficacy of a split dose regimen. For any single administration of a total daily dose, the DSF should be equal to 1. Therefore any DSF greater than this value in a split dose regimen is an indication of increased efficacy.

[0001369] To determine the dose response trends, impact of injection site and impact of injection timing, studies are performed. In these studies, varied doses of 1ug, 5ug, 10 ug, 25 ug, 50 ug, and values in between are used to determine dose response outcomes. Split dosing for a 100 ug total dose includes three or six doses of 1.6 ug, 4.2 ug, 8.3 ug, 16.6 ug, or values and total doses equal to administration of the total dose selected.

[0001370] Injection sites are chosen from the limbs or any body surface presenting enough area suitable for injection. This may also include a selection of injection depth to target the dermis (Intradermal), epidermis (Epidermal), subcutaneous tissue (SC) or muscle (IM). Injection angle will vary based on targeted delivery site with injections targeting the intradermal site to be 10-15 degree angles from the plane of the surface of the skin, between 20-45 degrees from the plane of the surface of the skin for subcutaneous injections and angles of between 60-90 degrees for injections substantially into the muscle.

Example 36. Quantification in Exosomes

[0001371] The quantity and localization of the mmRNA of the present invention can be determined by measuring the amounts (initial, timecourse, or residual basis) in isolated exosomes. In this study, since the mmRNA are typically codon-optimized and distinct in sequence from endogenous mRNA, the levels of mmRNA are quantitated as compared to endogenous levels of native or wild type mRNA by using the methods of Gibbings, PCT/IB2009/005878, the contents of which are incorporated herein by reference in their entirety.

[0001372] In these studies, the method is performed by first isolating exosomes or vesicles preferably from a bodily fluid of a patient previously treated with a polynucleotide, primary construct or mmRNA of the invention, then measuring, in said

exosomes, the polynucleotide, primary construct or mmRNA levels by one of mRNA microarray, qRT-PCR, or other means for measuring RNA in the art including by suitable antibody or immunohistochemical methods.

Example 37. Effect of Modified mRNA on Cellular Viability, Cytotoxicity and Apoptosis

[0001373] This experiment demonstrates cellular viability, cytotoxicity and apoptosis for distinct modified mRNA *in-vitro* transfected Human Keratinocyte cells. Keratinocytes are grown in EPILIFE® medium with Human Keratinocyte Growth Supplement in the absence of hydrocortisone from Invitrogen (Carlsbad, CA) at a confluence of >70%. Keratinocytes are reverse transfected with Ong, 46.875ng, 93.75ng, 187.5ng, 375ng, 750ng, 1500ng, 3000ng, or 6000ng of modified mRNA complexed with RNAIMAX™ from Invitrogen. The modified mRNA:RNAIMAX™ complex is formed. Secreted human G-CSF concentration in the culture medium is measured at 0, 6, 12, 24, and 48 hours post-transfection for each concentration of each modified m RNA in triplicate. Secretion of human G-CSF from transfected human keratinocytes is quantified using an ELISA kit from Invitrogen or R&D Systems following the manufacturers recommended instructions.

[0001374] Cellular viability, cytotoxicity and apoptosis is measured at 0, 12, 48, 96, and 192 hours post-transfection using the APOTOX-GLO™ kit from Promega (Madison, WI) according to manufacturer instructions.

Example 38. Detection of a Cellular Innate Immune Response to Modified mRNA Using an ELISA Assay

[0001375] An enzyme-linked immunosorbent assay (ELISA) for Human Tumor Necrosis Factor- α (TNF- α), Human Interferon- β (IFN- β) and Human Granulocyte-Colony Stimulating Factor (G-CSF) secreted from *in vitro*-transfected Human Keratinocyte cells is tested for the detection of a cellular innate immune response. Keratinocytes are grown in EPILIFE® medium with Human Keratinocyte Growth Supplement in the absence of hydrocortisone from Invitrogen (Carlsbad, CA) at a confluence of >70%. Secreted TNF- α keratinocytes are reverse transfected with Ong, 93.75ng, 187.5ng, 375ng, 750ng, 1500ng or 3000ng of the chemically modified mRNA (mmRNA) complexed with RNAIMAX™ from Invitrogen as described in triplicate. Secreted TNF- α in the culture

medium is measured 24 hours post-transfection for each of the chemically modified mRNA using an ELISA kit from Invitrogen according to the manufacturer protocols. [0001376] Secreted IFN- β in the same culture medium is measured 24 hours post-transfection for each of the chemically modified mRNA using an ELISA kit from Invitrogen according to the manufacturer protocols. Secreted human G-CSF concentration in the same culture medium is measured at 24 hours post-transfection for each of the chemically modified mRNA. Secretion of human G-CSF from transfected human keratinocytes is quantified using an ELISA kit from Invitrogen or R&D Systems (Minneapolis, MN) following the manufacturers recommended instructions. These data indicate which modified mRNA (mmRNA) are capable eliciting a reduced cellular innate immune response in comparison to natural and other chemically modified polynucleotides or reference compounds by measuring exemplary type 1 cytokines TNF- α and IFN- β .

Example 39. Human Granulocyte -Colony Stimulating Factor (G-CSF) Modified mRNA-induced Cell Proliferation Assay

[0001377] Human keratinocytes are grown in EPILIFE® medium with Supplement S7 from Invitrogen at a confluence of >70% in a 24-well collagen-coated TRANSWELL® (Coming, Lowell, MA) co-culture tissue culture plate. Keratinocytes are reverse transfected with 750ng of the indicated chemically modified mRNA (mmRNA) complexed with RNAIMAX from Invitrogen as described in triplicate. The modified mRNA:RNAIMAX complex is formed as described. Keratinocyte media is exchanged 6-8 hours post-transfection. 42-hours post-transfection, the 24-well TRANSWELL® plate insert with a 0.4 μ m-pore semi-permeable polyester membrane is placed into the human G-CSF modified mRNA-transfected keratinocyte containing culture plate

[0001378] Human myeloblast cells, Kasumi-1 cells or KG-1 (0.2×10^5 cells), are seeded into the insert well and cell proliferation is quantified 42 hours post-co-culture initiation using the CyQuant Direct Cell Proliferation Assay (Invitrogen, Carlsbad, CA) in a 100-120 μ l volume in a 96-well plate. Modified siRNA-encoding human G-CSF-induced myeloblast cell proliferation is expressed as a percent cell proliferation normalized to untransfected keratinocyte/myeloblast co-culture control wells. Secreted human G-CSF concentration in both the keratinocyte and myeloblast insert co-culture wells is measured

at 42 hours post-co-culture initiation for each modified mRNA in duplicate. Secretion of human G-CSF is quantified using an ELISA kit from Invitrogen following the manufacturer recommended instructions.

[0001379] Transfected human G-CSF modified mRNA in human keratinocyte feeder cells and untransfected human myeloblast cells are detected by RT-PCR. Total RNA from sample cells is extracted and lysed using RNEASY® kit (Qiagen, Valencia, CA) according to the manufacturer instructions. Extracted total RNA is submitted to RT-PCR for specific amplification of modified mRNA-G-CSF using PROTOSCRIPT® M-MuLV *Taq* RT-PCR kit (New England BioLabs, Ipswich, MA) according to the manufacturer instructions with human G-CSF-specific primers. RT-PCR products are visualized by 1.2% agarose gel electrophoresis.

Example 40: Co-Culture Assay

Modified mRNA comprised of chemically-distinct modified nucleotides encoding human Granulocyte-Colony Stimulating Factor (G-CSF) may stimulate the cellular proliferation of a transfection incompetent cell in a co-culture environment. The co-culture includes a highly transfectable cell type such as a human keratinocyte and a transfection incompetent cell type such as a white blood cell (WBC). The modified mRNA encoding G-CSF are transfected into the highly transfectable cell allowing for the production and secretion of G-CSF protein into the extracellular environment where G-CSF acts in a paracrine-like manner to stimulate the white blood cell expressing the G-CSF receptor to proliferate. The expanded WBC population may be used to treat immune-compromised patients or partially reconstitute the WBC population of an immunosuppressed patient and thus reduce the risk of opportunistic infections.

In another example, a highly transfectable cell such as a fibroblast are transfected with certain growth factors support and simulate the growth, maintenance, or differentiation of poorly transfectable embryonic stem cells or induced pluripotent stem cells.

Example 41: Detection Assays of Human IgG Antibodies

A. ELISA Detection of Human IgG Antibodies

[0001380] This example describes an ELISA for Human IgG from Chinese Hamster Ovary's (CHO) and Human Embryonic Kidney (HEK, HER-2 Negative) 293 cells transfected with human IgG modified mRNA (mmRNA). The Human Embryonic

Embryonic Kidney (HEK) 293 are grown in CD 293 Medium with Supplement of L-Glutamine from Invitrogen until they reach a confluence of 80-90%. The CHO cells are grown in CD CHO Medium with Supplement of L-Glutamine, Hypoxanthine and Thymidine. In one aspect, 2×10^6 cells are transfected with $24 \mu\text{g}$ modified mRNA complexed with RNAIMAX™ from Invitrogen in a 75cm^2 culture flask from Corning in 7 ml of medium. In another aspect, 80,000 cells are transfected with $1 \mu\text{g}$ modified mRNA complexed with RNAIMAX™ from Invitrogen in a 24-well plate. The modified mRNA:RNAIMAX™ complex is formed by incubating in a vial the mmRNA with either the CD 293 or CD CHO medium in a 5X volumetric dilution for 10 minutes at room temperature. In a second vial, RNAIMAX™ reagent is incubated with CD 293 medium or CD CHO medium in a 10X volumetric dilution for 10 minutes at room temperature. The mmRNA vial is then mixed with the RNAIMAX™ vial and incubated for 20-30 minutes at room temperature before it is added to the CHO or HEK cells in a drop-wise fashion. The culture supernatants are stored at 4 degrees Celsius. The concentration of the secreted human IgG in the culture medium in the $24 \mu\text{g}$ mmRNA transfections is measured at 12, 24, 36 hours post-transfection and the $1 \mu\text{g}$ mmRNA transfection is measured at 36 hours. Secretion of Trastuzumab from transfected HEK 293 cells is quantified using an ELISA kit from Abcam (Cambridge, MA) following the manufacturers recommended instructions. The data shows that a Humanized IgG antibody (such as Trastuzumab) mmRNA is capable of being translated in HEK Cells and that Trastuzumab is secreted out of the cells and released into the extracellular environment. Furthermore, the data demonstrate that transfection of cells with mmRNA encoding Trastuzumab for the production of secreted protein can be scaled up to a bioreactor or large cell culture conditions.

B. Western Detection of Modified mRNA Produced Human IgG Antibody

[0001381] A Western Blot of CHO-K1 cells is co-transfected with $1 \mu\text{g}$ each of Heavy and Light Chain of Trastuzumab modified mRNA (mmRNA). CHO cells are grown using standard protocols in 24-well plates. The cell supernatants or cell lysates are collected 24 hours post-transfection, separated on a 12% SDS-Page gel and transferred onto a nitrocellulose membrane using the IBOT® by Invitrogen (Carlsbad, CA). The cells are incubated with a first conjugation of a rabbit polyclonal antibody to Human IgG

conjugated to DYLIGHT594 (ab96904, abeam, Cambridge, MA) and a second conjugation of a goat polyclonal antibody to Rb IgG which is conjugated to alkaline phosphatase. After incubation, the antibody is detected using Novex® alkaline phosphatase chromogenic substrate by Invitrogen (Carlsbad, CA).

C. Cell Immuno Staining of Modified mRNA Produced Trastuzumab and Rituximab
[0001382] CHO-K1 cells are co-transfected with 500 ng each of Heavy and Light Chain of either Trastuzumab or Rituximab. Cells are grown in F-12K Medium from GIBCO® (Grand Island, NY) and 10% FBS. Cells are fixed with 4% paraformaldehyde in PBS, permeabilized with 0.1% Triton X-100 in PBS for 5-10 minutes at room temperature and cells are washed 3 times with room temperature PBS. Trastuzumab and Rituximab staining is performed using rabbit polyclonal antibody to Human IgG conjugated to DYLIGHT®594 (ab96904, abeam, Cambridge, MA) according to the manufacture's recommended dilutions. Nuclear DNA staining is performed with DAPI dye from Invitrogen (Carlsbad, CA). The protein for Trastuzumab and Rituximab is translated and localized to the cytoplasm upon modified mRNA transfections. Pictures are taken 13 hours post-transfection.

D. Binding Immunoblot Assay for Modified mRNA Produced Trastuzumab and Rituximab
[0001383] Trastuzumab and Rituximab are detected using a binding immunoblot detection assay. Varying concentrations (100ng/ul to Ong/ul) of the ErB2 peptide (ab40048, abeam, Cambridge, MA), antigen for Trastuzumab and the CD20 peptide (ab97360, abeam, Cambridge, MA), antigen for Rituximab are run on a 12% SDS-Page gel and transferred onto a membrane using the iBlot from Invitrogen. The membranes are incubated for 1 hour with their respective cell supernatants from CHO-K1 cells which are co-transfected with 500ng each of Heavy and Light Chain of either Trastuzumab or Rituximab. The membranes are blocked with 1% BSA and a secondary anti-human IgG antibody conjugated to alkaline phosphatase (abeam, Cambridge, MA) is added. Antibody detection is conducted using the NOVEX alkaline phosphatase chromogenic substrate by Invitrogen (Carlsbad, CA). The data shows that a humanized IgG antibodies generated from modified mRNA is capable of recognizing and binding to their respective antigens.

E. Cell Proliferation Assay

[0001384] The SK-BR-3 cell line, an adherent cell line derived from a human breast adenocarcinoma, which overexpresses the HER2/neu receptor can be used to compare the anti-proliferative properties of modified mRNA (mmRNA) generated Trastuzumab. Varying concentrations of purified Trastuzumab generated from modified mRNA and trastuzumab are be added to cell cultures, and their effects on cell growth are be assessed in triplicate cytotoxicity and viability assays.

Example 42: Bulk Transfection of Modified mRNA into Cell Culture

A. Cationic Lipid Delivery Vehicles

[0001385] RNA transfections are carried out using RNAiMAX™ (Invitrogen, Carlsbad, CA) or TRANSIT-mRNA (Minis Bio, Madison, WI) cationic lipid delivery vehicles. RNA and reagent are first diluted in Opti-MEM basal media (Invitrogen, Carlsbad, CA). 100 ng/uL RNA is diluted 5x and 5 μL of RNAiMax per μg of RNA is diluted 10x. The diluted components are pooled and incubated 15 minutes at room temperature before they are dispensed to culture media. For TRANSIT-mRNA transfections, 100 ng/uL RNA is diluted 10x in Opti-MEM and BOOST reagent is added (at a concentration of 2 μL per μg of RNA), TRANSIT-mRNA is added (at a concentration of 2 μL per μg of RNA), and then the RNA-lipid complexes are delivered to the culture media after a 2-minute incubation at room temperature. RNA transfections are performed in Nutristem xenofree hES media (Stemgent, Cambridge, MA) for RiPS derivations, Dermal Cell Basal Medium plus Keratinocyte Growth Kit (ATCC) for keratinocyte experiments, and Opti-MEM plus 2% FBS for all other experiments. Successful introduction of a modified mRNA (mmRNA) into host cells can be monitored using various known methods, such as a fluorescent marker, such as Green Fluorescent Protein (GFP). Successful transfection of a modified mRNA can also be determined by measuring the protein expression level of the target polypeptide by e.g., Western Blotting or immunocytochemistry. Similar methods may be followed for large volume scale-up to multi-liter (5-10,000L) culture format following similar RNA-lipid complex ratios.

B. Electroporation Delivery of Exogenous Synthetic mRNA Transcripts

[0001386] Electroporation parameters are optimized by transfecting MRC-5 fibroblasts with in vitro synthetic modified mRNA (mmRNA) transcripts and measuring transfection

efficiency by quantitative RT-PCR with primers designed to specifically detect the exogenous transcripts. Discharging a 150 μ F capacitor charged to F into 2.5 $\times 10^6$ cells suspended in 50 μ l of Opti-MEM (Invitrogen, Carlsbad, CA) in a standard electroporation cuvette with a 2mm gap is sufficient for repeated delivery in excess of 10,000 copies of modified mRNA transcripts per cell, as determined using the standard curve method, while maintaining high viability (>70%). Further experiments may reveal that the voltage required to efficiently transfect cells with mRNA transcripts can depend on the cell density during electroporation. Cell density may vary from 1 $\times 10^6$ cell/50 μ l to a density of 2.5 $\times 10^6$ cells/50 μ l and require from 110V to 145V to transfect cells with similar efficiencies measured in transcript copies per cell. Large multi-liter (5-10,000 L) electroporation may be performed similar to large volume flow electroporation strategies similar to methods described with the above described constraints (Li et al, 2002; Geng et al, 2010).

Example 43: *In Vivo* Delivery Using Lipoplexes

A. Human EPO Modified RNA Lipoplex

[0001387] A formulation containing 100 μ g of modified human erythropoietin mRNA (mRNA shown in SEQ ID NO: 1638; polyA tail of approximately 160 nucleotides not shown in sequence; 5'cap, Cap1) (EPO; fully modified 5-methylcytosine; N1-methylpseudouridine) was lipoplexed with 30% by volume of RNAiMAX™ (Lipoplex-h-Epo-46; Generation 2 or Gen2) in 50-70 μ l delivered intramuscularly to four C57/BL6 mice. Other groups consisted of mice receiving an injection of the lipoplexed modified luciferase mRNA (Lipoplex-luc) (IVT cDNA sequence shown in SEQ ID NO: 21445; mRNA sequence shown in SEQ ID NO: 21446, polyA tail of approximately 160 nucleotides not shown in sequence, 5'cap, Cap1, fully modified with 5-methylcytosine at each cytosine and pseudouridine replacement at each uridine site) which served as a control containing 100 μ g of modified luciferase mRNA was lipoplexed with 30% by volume of RNAiMAX™ or mice receiving an injection of the formulation buffer as negative control at a dose volume of 65 μ l. 13 hours after the intramuscular injection, serum was collected from each mouse to measure the amount of human EPO protein in the mouse serum by human EPO ELISA and the results are shown in Table 61.

Table 61. Human EPO Production (IM Injection Route)

Formulation	Average
Lipoplex-h-Epo-46	251.95
Lipoplex-Luc	0
Formulation Buffer	0

B. Human G-CSF Modified RNA Lipoplex

[0001388] A formulation containing 100 µg of one of two versions of modified human G-CSF mRNA (mRNA sequence shown in SEQ ID NO: 21438; polyA tail of approximately 160 nucleotides not shown in sequence; 5'cap, Cap1) (G-CSF fully modified with 5-methylcytosine and pseudouridine (G-CSF) or G-CSF fully modified with 5-methylcytosine and N1-methyl-pseudouridine (G-CSF-N1) lipoplexed with 30% by volume of RNAIMAX™ and delivered in 150 uL intramuscularly (I.M.), in 150 uL subcutaneously (S.C) and in 225uL intravenously (I.V) to C57/BL6 mice.

[0001389] Three control groups were administered either 100 µg of modified luciferase mRNA (IVT cDNA sequence shown in SEQ ID NO: 21445; mRNA sequence shown in SEQ ID NO: 21446, polyA tail of approximately 160 nucleotides not shown in sequence, 5'cap, Cap1, fully modified with 5-methylcytosine at each cytosine and pseudouridine replacement at each uridine site) intramuscularly (Luc-unsp I.M.) or 150 µg of modified luciferase mRNA intravenously (Luc-unsp I.V.) or 150 uL of the formulation buffer intramuscularly (Buffer I.M.). 6 hours after administration of a formulation, serum was collected from each mouse to measure the amount of human G-CSF protein in the mouse serum by human G-CSF ELISA and the results are shown in Table 62.

[0001390] These results demonstrate that both 5-methylcytosine/pseudouridine and 5-methylcytosine/N1-methyl-pseudouridine modified human G-CSF mRNA can result in specific human G-CSF protein expression in serum when delivered via I.V. or I.M. route of administration in a lipoplex formulation.

Table 62. Human G-CSF in Serum (I.M., I.V., S.C. Injection Route)

Formulation	Route	G-CSF (pg/ml)
G-CSF	I.M.	85.6
G-CSF N1	I.M.	40.1
G-CSF	S.C.	3.9
G-CSF N1	S.C.	0.0
G-CSF	I.V.	31.0
G-CSF N1	I.V.	6.1
Luc-unsp	I.M.	0.0

Luc-unsp	I.V.	0.0
Buffer	I.M.	0.0

C. Human G-CSF Modified RNA Lipoplex Comparison

[0001391] A formulation containing 100 µg of either modified human G-CSF mRNA lipoplexed with 30% by volume of RNAIMAX™ with a 5-methylcytosine (5mc) and a pseudouridine (ψ) modification (G-CSF-Gen1 -Lipoplex), modified human G-CSF mRNA with a 5mc and ψ modification in saline (G-CSF-Gen1 -Saline), modified human G-CSF mRNA with a NI-5-methylcytosine (NI-5mc) and a ψ modification lipoplexed with 30% by volume of RNAIMAX™ (G-CSF-Gen2-Lipoplex), modified human G-CSF mRNA with a NI-5mc and ψ modification in saline (G-CSF-Gen2-Saline), modified luciferase with a 5mc and ψ modification lipoplexed with 30% by volume of RNAIMAX™ (Luc-Lipoplex), or modified luciferase mRNA with a a 5mc and ψ modification in saline (Luc-Saline) was delivered intramuscularly (I.M.) or subcutaneously (S.C.) and a control group for each method of administration was giving a dose of 80µL of the formulation buffer (F. Buffer) to C57/BL6 mice. 13 hours post injection serum and tissue from the site of injection were collected from each mouse and analyzed by G-CSF ELISA to compare human G-CSF protein levels. The results of the human G-CSF protein in mouse serum from the intramuscular administration, and the subcutaneous administration results are shown in Table 63.

[0001392] These results demonstrate that 5-methylcytosine/pseudouridine and 5-methylcytosine/NI-methyl-pseudouridine modified human G-CSF mRNA can result in specific human G-CSF protein expression in serum when delivered via I.M. or S.C. route of administration whether in a saline formulation or in a lipoplex formulation. As shown in Table 63, 5-methylcytosine/NI-methyl-pseudouridine modified human G-CSF mRNA generally demonstrates increased human G-CSF protein production relative to 5-methylcytosine/pseudouridine modified human G-CSF mRNA.

Table 63. Human G-CSF Protein in Mouse Serum

Formulation	G-CSF (pg/ml)	
	I.M. Injection Route	S.C. Injention Route
G-CSF-Gen1-Lipoplex	13.988	42.855
G-CSF-Gen1-saline	9.375	4.614
G-CSF-Gen2-lipoplex	75.572	32.107

G-CSF-Gen2-saline	20.190	45.024
Luc lipoplex	0	3.754
Luc saline	0.0748	0
F. Buffer	4.977	2.156

D. mCherry Modified RNA Lipoplex Comparison

Intramuscular and Subcutaneous Administration

[0001393] A formulation containing 100 µg of either modified mCherry mRNA (mRNA sequence shown in SEQ ID NO: 21439; polyA tail of approximately 160 nucleotides not shown in sequence; 5'cap, Cap1) lipoplexed with 30% by volume of RNAIMAX™ or modified mCherry mRNA in saline is delivered intramuscularly and subcutaneously to mice. A formulation buffer is also administered to a control group of mice either intramuscularly or subcutaneously. The site of injection on the mice may be collected 17 hours post injection for sectioning to determine the cell type(s) responsible for producing protein.

Intravitreal Administration

[0001394] A formulation containing 10 µg of either modified mCherry mRNA lipoplexed with RNAIMAX™, modified mCherry mRNA in a formulation buffer, modified luciferase mRNA lipoplexed with RNAMAX™, modified luciferase mRNA in a formulation buffer can be administered by intravitreal injection (IVT) in rats in a dose volume of 5 µl/eye. A formulation buffer is also administered by IVT to a control group of rats in a dose volume of 5 µl/eye. Eyes from treated rats can be collected after 18 hours post injection for sectioning and lysating to determine whether mRNA can be effectively delivered *in vivo* to the eye and result in protein production, and to also determine the cell type(s) responsible for producing protein *in vivo*.

Intranasal Administration

[0001395] A formulation containing 100 µg of either modified mCherry mRNA lipoplexed with 30% by volume of RNAIMAX™, modified mCherry mRNA in saline, modified luciferase mRNA lipoplexed with 30% by volume of RNAIMAX™ or modified luciferase mRNA in saline is delivered intranasally. A formulation buffer is also administered to a control group intranasally. Lungs may be collected about 13 hours post instillation for sectioning (for those receiving mCherry mRNA) or homogenization

(for those receiving luciferase mRNA). These samples will be used to determine whether mmRNA can be effectively delivered *in vivo* to the lungs and result in protein production, and to also determine the cell type(s) responsible for producing protein *in vivo*.

Example 44: *In Vivo* Delivery Using Varying Lipid Ratios

[0001396] Modified mRNA was delivered to C57/BL6 mice to evaluate varying lipid ratios and the resulting protein expression. Formulations of 10^μg modified human EPO mRNA (mRNA shown in SEQ ID NO: 1638; polyA tail of approximately 160 nucleotides not shown in sequence; 5'cap, Cap1; fully modified with 5-methylcytosine and pseudouridine) lipoplexed with 10%, 30% or 50% RNAiMAX™, 100μg modified luciferase mRNA (IVT cDNA sequence shown in SEQ ID NO: 21445; mRNA sequence shown in SEQ ID NO: 21446, polyA tail of approximately 160 nucleotides not shown in sequence, 5'cap, Cap1, fully modified with 5-methylcytosine at each cytosine and pseudouridine replacement at each uridine site) lipoplexed with 10%>, 30%> or 50%> RNAiMAX™ or a formulation buffer were administered intramuscularly to mice in a single 70 μl dose. Serum was collected 13 hours post injection to undergo a human EPO ELISA to determine the human EPO protein level in each mouse. The results of the human EPO ELISA, shown in Table 64, show that modified human EPO expressed in the muscle is secreted into the serum for each of the different percentage of RNAiMAX™.

Table 64. Human EPO Protein in Mouse Serum (IM Injection Route)

Formulation	EPO (pg/ml)
Epo + 10% RNAiMAX	11.4
Luc + 10% RNAiMAX	0
Epo + 30% RNAiMAX	27.1
Luc + 30% RNAiMAX	0
Epo + 50% RNAiMAX	19.7
Luc + 50% RNAiMAX	0
F. Buffer	0

Example 45: Intramuscular and Subcutaneous *In Vivo* Delivery in Mammals

[0001397] Modified human EPO mRNA (mRNA sequence shown in SEQ ID NO: 1638; polyA tail of approximately 160 nucleotides not shown in sequence; 5'cap, Cap1; fully modified with 5-methylcytosine and pseudouridine) formulated in formulation buffer was

delivered to either C57/BL6 mice or Sprague-Dawley rats to evaluate the dose dependency on human EPO production. Rats were intramuscularly injected with 50 µl of the modified human EPO mRNA (h-EPO), modified luciferase mRNA (Luc) (IVT cDNA sequence shown in SEQ ID NO: 21445; mRNA sequence shown in SEQ ID NO: 21446, polyA tail of approximately 160 nucleotides not shown in sequence, 5'cap, Capl, fully modified with 5-methylcytosine at each cytosine and pseudouridine replacement at each uridine site) or the formulation buffer (F.Buffer) as described in the dosing chart Table 65.

[0001398] Mice were intramuscularly or subcutaneously injected with 50 µl of the modified human EPO mRNA (h-EPO), modified luciferase mRNA (Luc) or the formulation buffer (F.Buffer) as described in the dosing chart Table 66. 13 hours post injection blood was collected and serum was analyzed to determine the amount human EPO for each mouse or rat. The average and geometric mean in pg/ml for the rat study are also shown in Table 65.

Table 65. Rat Study

	Group	Dose (ug)	Avg. pg/ml	Geometric-mean pg/ml
h-EPO	G#1	150	67.7	67.1
h-EPO	G#2	100	79.4	66.9
h-EPO	G#3	50	101.5	85.4
h-EPO	G#4	10	46.3	31.2
h-EPO	G#5	1	28.7	25.4
Luc	G#6	100	24.5	22.4
F.Buffer	G#7	-	18.7	18.5

Table 66. Mouse Study

Route	Treatment	Group	Dose	Average Level in serum pg/ml
IM	h-EPO	1	100 µg	96.2
IM	h-EPO	2	50 µg	63.5
IM	h-EPO	3	25 µg	18.7
IM	h-EPO	4	10 µg	25.9
IM	h-EPO	5	1 µg	2.6
IM	Luc	6	100 µg	0
IM	F.Buffer	7	-	1.0
SC	h-EPO	1	100 µg	72.0
SC	Luc	2	100 µg	26.7
SC	F.Buffer	3	--	17.4

Example 46: Duration of Activity after Intramuscular *In Vivo* Delivery

[0001399] Modified human EPO mRNA (mRNA sequence shown in SEQ ID NO: 1638; polyA tail of approximately 160 nucleotides not shown in sequence; 5'cap, Cap1; fully modified with 5-methylcytosine and pseudouridine) formulated in formulation buffer was delivered to Sprague-Dawley rats to determine the duration of the dose response. Rats were intramuscularly injected with 50 μ l of the modified human EPO mRNA (h-EPO), modified luciferase mRNA (IVT cDNA sequence shown in SEQ ID NO: 21445; mRNA sequence shown in SEQ ID NO: 21446, polyA tail of approximately 160 nucleotides not shown in sequence, 5'cap, Cap1, fully modified with 5-methylcytosine at each cytosine and pseudouridine replacement at each uridine site) (Luc) or the formulation buffer (F.Buffer) as described in the dosing chart Table 67. The rats were bled 2, 6, 12, 24, 48 and 72 hours after the intramuscular injection to determine the concentration of human EPO in serum at a given time. The average and geometric mean in pg/ml for this study are also shown in Table 67.

Table 67. Dosing Chart

	Group	Dose (ug)	Avg. pg/ml	Geometric-mean (pg/ml)
h-EPO	2 hour	100	59.6	58.2
h-EPO	6 hour	100	68.6	55.8
h-EPO	12 hour	100	87.4	84.5
h-EPO	24 hour	100	108.6	95.3
h-EPO	48 hour	100	77.9	77.0
h-EPO	72 hour	100	80.1	75.8
Luc	24, 48 and 72 hour	100	37.2	29.2
F.Buffer	24, 48 and 72 hour	-	48.9	10.4

Example 47: Routes of Administration

[0001400] Further studies were performed to investigate dosing using different routes of administration. Following the protocol outlined in Example 35, 4 mice per group were dosed intramuscularly (I.M.), intravenously (IV) or subcutaneously (S.C.) by the dosing chart outlined in Table 68. Serum was collected 13 hours post injection from all mice, tissue was collected from the site of injection from the intramuscular and subcutaneous group and the spleen, liver and kidneys were collected from the intravenous group. The results from the intramuscular group and the subcutaneous group results are shown in Table 69.

Table 68. Dosing Chart

Group	Treatment	Route	Dose of mmRNA	Total Dose	Dosing Vehicle
1	Lipoplex-human EPO mmRNA	I.M.	4 x 100 ug + 30% Lipoplex	4x70 ul	Lipoplex
2	Lipoplex-human EPO mmRNA	I.M.	4 x 100 ug	4x70 ul	Buffer
3	Lipoplex-human EPO mmRNA	S.C.	4 x 100 ug + 30% Lipoplex	4x70 ul	Lipoplex
4	Lipoplex-human EPO mmRNA	S.C.	4 x 100 ug	4x70 ul	Buffer
5	Lipoplex-human EPO mmRNA	I.V.	200 ug + 30% Lipoplex	140 ul	Lipoplex
6	Lipoplexed-Luciferase mmRNA	I.M.	100 ug + 30% Lipoplex	4x70 ul	Lipoplex
7	Lipoplexed-Luciferase mmRNA	I.M.	100 ug	4x70 ul	Buffer
8	Lipoplexed-Luciferase mmRNA	S.C.	100 ug + 30% Lipoplex	4x70 ul	Lipoplex
9	Lipoplexed-Luciferase mmRNA	S.C.	100 ug	4x70 ul	Buffer
10	Lipoplexed-human EPO mmRNA	I.V.	200 ug + 30% Lipoplex	140 ul	Lipoplex
11	Formulation Buffer	I.M.	4x multi dosing	4x70 ul	Buffer

Table 69. Human EPO Protein in Mouse Serum (I.M. Injection Route)

Formulation	EPO (pg/ml)	
	I.M. Injection Route	S.C. Injection Route
Epo-Lipoplex	67.115	2.154
Luc-Lipoplex	0	0
Epo-Saline	100.891	11.37
Luc-Saline	0	0
Formulation Buffer	0	0

Example 48. Rapidly eliminated Lipid Nanoparticle (reLNP) Studies**A. Formulation of Modified RNA reLNPs**

[0001401] Solutions of synthesized lipid, 1,2-distearoyl-3-phosphatidylcholine (DSPC) (Avanti Polar Lipids, Alabaster, AL), cholesterol (Sigma-Aldrich, Taufkirchen, Germany), and a-[3'-(1,2-dimyristoyl-3-propanoxy)-carboxamide-propyl]-ro-methoxy-polyoxyethylene (PEG-c-DOMG) (NOF, Bouwvelven, Belgium) are prepared and stored at -20°C. The synthesized lipid is selected from DLin-DMA with an internal ester, DLin-DMA with a terminal ester, DLin-MC3-DMA-internal ester, and DLin-MC3-DMA with

a terminal ester. The reLNPs are combined to yield a molar ratio of 50:10:38.5:1.5 (reLNP: DSPC: Cholesterol: PEG-c-DOMG). Formulations of the reLNPs and modified mRNA are prepared by combining the lipid solution with the modified mRNA solution at total lipid to modified mRNA weight ratio of 10:1, 15:1, 20:1 and 30:1.

B. Characterization of formulations

[0001402] A Zetasizer Nano ZS (Malvern Instruments Ltd, Malvern, Worcestershire, UK) is used to determine the particle size, the polydispersity index (PDI) and the zeta potential of the modified mRNA nanoparticles in IX PBS in determining particle size and 15 mM PBS in determining zeta potential.

[0001403] Ultraviolet-visible spectroscopy is used to determine the concentration of modified mRNA nanoparticle formulation. After mixing, the absorbance spectrum of the solution is recorded between 230 nm and 330 nm on a DU 800 spectrophotometer (Beckman Coulter, Beckman Coulter, Inc., Brea, CA). The modified RNA concentration in the nanoparticle formulation is calculated based on the extinction coefficient of the modified RNA used in the formulation and on the difference between the absorbance at a wavelength of 260 nm and the baseline value at a wavelength of 330 nm.

[0001404] QUANT-IT™ RIBOGREEN® RNA assay (Invitrogen Corporation Carlsbad, CA) is used to evaluate the encapsulation of modified RNA by the nanoparticle. The samples are diluted, transferred to a polystyrene 96 well plate, then either a TE buffer or a 2% Triton X-100 solution is added. The plate is incubated and the RIBOGREEN® reagent is diluted in TE buffer, and of this solution is added to each well. The fluorescence intensity is measured using a fluorescence plate reader (Wallac Victor 1420 Multilabel Counter; Perkin Elmer, Waltham, MA) The fluorescence values of the reagent blank are subtracted from each of the samples and the percentage of free modified RNA is determined by dividing the fluorescence intensity of the intact sample by the fluorescence value of the disrupted sample.

C. In Vitro Incubation

[0001405] Human embryonic kidney epithelial (HEK293) and hepatocellular carcinoma epithelial (HepG2) cells (LGC standards GmbH, Wesel, Germany) are seeded on 96-well plates (Greiner Bio-one GmbH, Frickenhausen, Germany) and plates for HEK293 cells are precoated with collagen typel . HEK293 are seeded at a density of about 30,000 and HepG2 are seeded at a density of about 35,000 cells per well in 100 µl cell culture

medium. Formulations containing mCherry mRNA (mRNA sequence shown in SEQ ID NO: 21439; polyA tail of approximately 160 nucleotides not shown in sequence; 5'cap, Cap1) are added directly after seeding the cells and incubated. The mCherry cDNA with the T7 promoter, 5'untranslated region (UTR) and 3' UTR used in *in vitro* transcription (IVT) is given in SEQ ID NO: 21440.

[0001406] Cells are harvested by transferring the culture media supernatants to a 96-well Pro-Bind U-bottom plate (Beckton Dickinson GmbH, Heidelberg, Germany). Cells are trypsinized with ½ volume Trypsin/EDTA (Biochrom AG, Berlin, Germany), pooled with respective supernatants and fixed by adding one volume PBS/2%FCS (both Biochrom AG, Berlin, Germany)/0.5% formaldehyde (Merck, Darmstadt, Germany). Samples are then submitted to a flow cytometer measurement with an excitation laser and a filter for PE-Texas Red in a LSRII cytometer (Beckton Dickinson GmbH, Heidelberg, Germany). The mean fluorescence intensity (MFI) of all events and the standard deviation of four independent wells are presented in for samples analyzed.

D. In Vivo Formulation Studies

[0001407] Mice are administered intravenously a single dose of a formulation containing a modified mRNA and a reLNP. The modified mRNA administered to the mice is selected from G-CSF (mRNA sequence shown in SEQ ID NO: 21438; polyA tail of approximately 160 nucleotides not shown in sequence; 5'cap, Cap1), Factor IX (mRNA shown in SEQ ID NO: 1622; polyA tail of approximately 160 nucleotides not shown in sequence; 5'cap, Cap1) or mCherry (mRNA sequence shown in SEQ ID NO:21439; polyA tail of approximately 160 nucleotides not shown in sequence; 5'cap, Cap1).

[0001408] The mice are injected with 100ug, 10 ug or 1 ug of the formulated modified mRNA and are sacrificed 8 hours after they are administered the formulation. Serum from the mice administered formulations containing human G-CSF modified mRNA are measured by specific G-CSF ELISA and serum from mice administered human Factor IX modified RNA is analyzed by specific factor IX ELISA or chromogenic assay. The liver and spleen from the mice administered with mCherry modified mRNA are analyzed by immunohistochemistry (IHC) or fluorescence-activated cell sorting (FACS). As a control, a group of mice are not injected with any formulation and their serum and tissue are collected analyzed by ELISA, FACS and/or IHC.

Example 49. In Vitro Transfection of VEGF-A

[0001409] Human vascular endothelial growth factor-isoform A (VEGF-A) modified mRNA (mRNA sequence shown in SEQ ID NO: 1672; polyA tail of approximately 160 nucleotides not shown in sequence; 5'cap, Cap1) was transfected via reverse transfection in Human Keratinocyte cells in 24 multi-well plates. Human Keratinocytes cells were grown in EPILIFE® medium with Supplement S7 from Invitrogen (Carlsbad, CA) until they reached a confluence of 50-70%. The cells were transfected with 0, 46.875, 93.75, 187.5, 375, 750, and 1500 ng of modified mRNA (mmRNA) encoding VEGF-A which had been complexed with RNAIMAX™ from Invitrogen (Carlsbad, CA). The RNA:RNAIMAX™ complex was formed by first incubating the RNA with Supplement-free EPILIFE® media in a 5X volumetric dilution for 10 minutes at room temperature. In a second vial, RNAIMAX™ reagent was incubated with Supplement-free EPILIFE® Media in a 10X volumetric dilution for 10 minutes at room temperature. The RNA vial was then mixed with the RNAIMAX™ vial and incubated for 20-30 minutes at room temperature before being added to the cells in a drop-wise fashion.

[0001410] The fully optimized mRNA encoding VEGF-A (mRNA sequence shown in SEQ ID NO: 1672; polyA tail of approximately 160 nucleotides not shown in sequence; 5'cap, Cap1) transfected with the Human Keratinocyte cells included modifications during translation such as natural nucleoside triphosphates (NTP), pseudouridine at each uridine site and 5-methylcytosine at each cytosine site (pseudo-U/5mC), and NI-methyl-pseudouridine at each uridine site and 5-methylcytosine at each cytosine site (NI-methyl-Pseudo-U/5mC). Cells were transfected with the mmRNA encoding VEGF-A and secreted VEGF-A concentration (pg/ml) in the culture medium was measured at 6, 12, 24, and 48 hours post-transfection for each of the concentrations using an ELISA kit from Invitrogen (Carlsbad, CA) following the manufacturers recommended instructions. These data, shown in Table 70 and Figures 6A, 6B and 6C, show that modified mRNA encoding VEGF-A is capable of being translated in Human Keratinocyte cells and that VEGF-A is transported out of the cells and released into the extracellular environment.

Table 70. VEGF-A Dosing and Protein Secretion

VEGF-A Dose Containing Natural NTPs				
Dose (ng)	6 hours (pg/ml)	12 hours (pg/ml)	24 hours (pg/ml)	48 hours (pg/ml)

46.875	10.37	18.07	33.90	67.02
93.75	9.79	20.54	41.95	65.75
187.5	14.07	24.56	45.25	64.39
375	19.16	37.53	53.61	88.28
750	21.51	38.90	51.44	61.79
1500	36.11	61.90	76.70	86.54
VEGF-A Dose Containing Pseudo-U/5mC				
Dose (ng)	6 hours (pg/ml)	12 hours (pg/ml)	24 hours (pg/ml)	48 hours (pg/ml)
46.875	10.13	16.67	33.99	72.88
93.75	11.00	20.00	46.47	145.61
187.5	16.04	34.07	83.00	120.77
375	69.15	188.10	448.50	392.44
750	133.95	304.30	524.02	526.58
1500	198.96	345.65	426.97	505.41
VEGF-A Dose Containing NI-methyl-Pseudo-U/5mC				
Dose (ng)	6 hours (pg/ml)	12 hours (pg/ml)	24 hours (pg/ml)	48 hours (pg/ml)
46.875	0.03	6.02	27.65	100.42
93.75	12.37	46.38	121.23	167.56
187.5	104.55	365.71	1025.41	1056.91
375	605.89	1201.23	1653.63	1889.23
750	445.41	1036.45	1522.86	1954.81
1500	261.61	714.68	1053.12	1513.39

Example 50. In vivo studies of Factor IX

[0001411] Human Factor IX mmRNA (GenI; fully modified 5-methylcytosine and pseudouridine) formulated in formulation buffer was delivered to mice via intramuscular injection. The results demonstrate that Factor IX protein was elevated in serum as measured 13 hours after administration.

[0001412] In this study, mice (N=5 for Factor IX, N=3 for Luciferase or Buffer controls) were intramuscularly injected with 50 µl of the Factor IX mmRNA (mRNA sequence shown in SEQ ID NO: 1622; polyA tail of approximately 160 nucleotides not shown in sequence; 5'cap, CapI), Luciferase (IVT cDNA sequence shown in SEQ ID NO: 21445; mRNA sequence shown in SEQ ID NO: 21446, polyA tail of approximately 160 nucleotides not shown in sequence, 5'cap, CapI, fully modified with 5-methylcytosine at each cytosine and pseudouridine replacement at each uridine site) or the formulation buffer (F.Buffer) at 2x 100 ug/mouse. The mice were bled at 13 hours after the intramuscular injection to determine the concentration of human the polypeptide in serum in pg/mL. The results revealed that administration of Factor IX mmRNA resulted in

levels of 1600 pg/mL at 13 hours as compared to less than 100 pg/mL of Factor IX for either Luciferase or buffer control administration.

Example 51. Multi-site administration: Intramuscular and Subcutaneous

[0001413] Human G-CSF modified mRNA (mRNA sequence shown in SEQ ID NO: 21438; polyA tail of approximately 160 nucleotides not shown in sequence; 5'cap, Cap1) modified as either Gen1 or Gen2 (5-methylcytosine (5mc) and a pseudouridine (ψ) modification, G-CSF-Gen1; or N1-5-methylcytosine (N1-5mc) and a ψ modification, G-CSF-Gen2) and formulated in formulation buffer were delivered to mice via intramuscular (IM) or subcutaneous (SC) injection. Injection of four doses or 2x 50ug (two sites) daily for three days (24 hrs interval) was performed. The fourth dose was administered 6 hrs before blood collection and CBC analysis. Controls included Luciferase (IVT cDNA sequence shown in SEQ ID NO: 21445; mRNA sequence shown in SEQ ID NO: 21446, polyA tail of approximately 160 nucleotides not shown in sequence, 5'cap, Cap1, fully modified with 5-methylcytosine at each cytosine and pseudouridine replacement at each uridine site) or the formulation buffer (F.Buffer). The mice were bled at 72 hours after the first mRNA injection (6 hours after the last modified mRNA dose) to determine the effect of mRNA-encoded human G-CSF on the neutrophil count. The dosing regimen is shown in Table 71 as are the resulting neutrophil counts (thousands/uL). In Table 71, an asterisk^ indicates statistical significance at $p < 0.05$.

[0001414] For intramuscular administration, the data reveal a four fold increase in neutrophil count above control at day 3 for the Gen1 G-CSF mRNA and a two fold increase for the Gen2 G-CSF mRNA. For subcutaneous administration, the data reveal a two fold increase in neutrophil count above control at day 3 for the Gen2 G-CSF mRNA.

[0001415] These data demonstrate that both 5-methylcytidine/pseudouridine and 5-methylcytidine/N1-methyl-pseudouridine -modified mRNA can be biologically active, as evidenced by specific increases in blood neutrophil counts.

Table 71. Dosing Regimen

Gr.	Treatment	Route	N=	Dose ($\mu\text{g}/\text{mouse}$)	Dose Vol. ($\mu\text{l}/\text{mouse}$)	Dosing Vehicle	Neutrophil Thous/uL
1	G-CSF (Gen1)	I.M	5	2x50ug (four doses)	50	F. buffer	840*

2	G-CSF (Gen1)	S.C	5	2x5 Oug (four doses)	50	F. buffer	430
3	G-CSF (Gen2)	I.M	5	2x5 Oug (four doses)	50	F. buffer	746*
4	G-CSF (Gen2)	S.C	5	2x5 Oug (four doses)	50	F. buffer	683
5	Luc (Gen1)	I.M.	5	2x5 Oug (four doses)	50	F. buffer	201
6	Luc (Gen1)	S.C.	5	2x5 Oug (four doses)	50	F. buffer	307
7	Luc (Gen2)	I.M	5	2x5 Oug (four doses)	50	F. buffer	336
8	Luc (Gen2)	S.C	5	2x5 Oug (four doses)	50	F. buffer	357
9	F. Buffer	I.M	4	0 (four doses)	50	F. buffer	245
10	F. Buffer	S.C.	4	0 (four doses)	50	F. buffer	509
11	Untreated	-	4			-	312

Example 52. Intravenous administration

[0001416] Human G-CSF modified mRNA (mRNA sequence shown in SEQ ID NO: 21438; polyA tail of approximately 160 nucleotides not shown in sequence; 5'cap, Cap1) modified with 5-methylcytosine (5mc) and a pseudouridine (ψ) modification (Gen 1); or having no modifications and formulated in 10% lipoplex (RNAiMax) were delivered to mice at a dose of 50 ug RNA and in a volume of 100 ul via intravenous (IV) injection at days 0, 2 and 4. Neutrophils were measured at days 1, 5 and 8. Controls included non-specific mammalian RNA or the formulation buffer alone (F.Buffer). The mice were bled at days 1, 5 and 8 to determine the effect of modified mRNA-encoded human G-CSF to increase neutrophil count. The dosing regimen is shown in Table 72 as are the resulting neutrophil counts (thousands/uL; K/uL).

[0001417] For intravenous administration, the data reveal a four to five fold increase in neutrophil count above control at day 5 with G-CSF modified mRNA but not with unmodified G-CSF mRNA or non-specific controls. Blood count returned to baseline four days after the final injection. No other changes in leukocyte populations were observed.

[0001418] In Table 72, an asterisk^{^*}) indicates statistical significance at $p < 0.001$ compared to buffer.

[0001419] These data demonstrate that lipoplex-formulated 5-methylcytidine/pseudouridine-modified mRNA can be biologically active, when delivered through an I.V. route of administration as evidenced by specific increases in blood neutrophil counts. No other cell subsets were significantly altered. Unmodified G-CSF mRNA similarly administered showed no pharmacologic effect on neutrophil counts.

Table 72. Dosing Regimen

Gr.	Day	Treatment	N=	Dose Vol. (µl/mouse)	Dosing Vehicle	Neutrophil K/uL
1	1	G-CSF (Gen1)	5	100	10% lipoplex	2.91
2	5	G-CSF (Gen1)	5	100	10% lipoplex	5.32*
3	8	G-CSF (Gen1)	5	100	10% lipoplex	2.06
4	1	G-CSF (no modification)	5	100	10% lipoplex	1.88
5	5	G-CSF (no modification)	5	100	10% lipoplex	1.95
6	8	G-CSF (no modification)	5	100	10% lipoplex	2.09
7	1	RNA control	5	100	10% lipoplex	2.90
8	5	RNA control	5	100	10% lipoplex	1.68
9	8	RNA control	4	100	10% lipoplex	1.72
10	1	F. Buffer	4	100	10% lipoplex	2.51
11	5	F. Buffer	4	100	10% lipoplex	1.31
12	8	F. Buffer	4	100	10% lipoplex	1.92

Example 53. Saline formulation: Intramuscular Administration

A. Protein Expression

[0001420] Human G-CSF modified mRNA (mRNA sequence shown in SEQ ID NO: 21438; polyA tail of approximately 160 nucleotides not shown in sequence; 5'cap, CapI) and human EPO mmRNA (mRNA sequence shown in SEQ ID NO: 1638; polyA tail of approximately 160 nucleotides not shown in sequence; 5'cap, CapI); G-CSF modified mRNA (modified with 5-methylcytosine (5mc) and pseudouridine (ψ)) and EPO modified mRNA (modified with N1-5-methylcytosine (N1-5mc) and ψ modification), were formulated in formulation buffer (150 mM sodium chloride, 2mM calcium chloride, 2mM phosphate, 0.5 mM EDTA at a pH of 6.5) and delivered to mice via intramuscular (IM) injection at a dose of 100 ug.

[0001421] Controls included Luciferase (IVT cDNA sequence shown in SEQ ID NO: 21445; mRNA sequence shown in SEQ ID NO: 21446, polyA tail of approximately 160

nucleotides not shown in sequence, 5'cap, Capl, fully modified with 5-methylcytosine at each cytosine and pseudouridine replacement at each uridine site) or the formulation buffer (F.Buffer). The mice were bled at 13 hours after the injection to determine the concentration of the human polypeptide in serum in pg/mL. (G-CSF groups measured human G-CSF in mouse serum and EPO groups measured human EPO in mouse serum). The data are shown in Table 73.

Table 73. Dosing Regimen

Group	Treatment	N=	Dose Vol. (µl/mouse)	Dosing Vehicle	Average Protein Product pg/mL, serum
G-CSF	G-CSF	5	50	Saline	19.8
G-CSF	Luciferase	5	50	Saline	0.5
G-CSF	F. buffer	5	50	F. buffer	0.5
EPO	EPO	5	50	Saline	191.5
EPO	Luciferase	5	50	Saline	15.0
EPO	F. buffer			F. buffer	4.8

B. Dose Response

[0001422] Human EPO modified mRNA (mRNA sequence shown in SEQ ID NO: 1638; polyA tail of approximately 160 nucleotides not shown in sequence; 5'cap, Capl; fully modified with 5-methylcytosine and pseudouridine) were formulated in formulation buffer and delivered to mice via intramuscular (IM) injection.

[0001423] Controls included Luciferase (mRNA sequence shown in SEQ ID NO: 21446, polyA tail of approximately 160 nucleotides not shown in sequence, 5'cap, Capl, fully modified with 5-methylcytosine and pseudouridine) or the formulation buffer (F.Buffer). The mice were bled at 13 hours after the injection to determine the concentration of the human polypeptide in serum in pg/mL. The dose and expression are shown in Table 74.

Table 74. Dosing Regimen and Expression

Treatment	Dose Vol. (µl/mouse)	Average Protein Product pg/mL, serum
EPO	100	96.2
EPO	50	63.5
EPO	25	18.7

EPO	10	25.9
EPO	1	2.6
Luciferase	100	0.0
F. buffer	100	1.0

Example 54. EPO multi-dose/multi-administration

[0001424] Studies utilizing multiple intramuscular injection sites at one time point were designed and performed.

[0001425] The design of a single multi-dose experiment involved using human erythropoietin (EPO) mmRNA (mRNA sequence shown in SEQ ID NO: 1638; polyA tail of approximately 160 nucleotides not shown in sequence; 5'cap, Cap1) or G-CSF mmRNA (mRNA sequence shown in SEQ ID NO: 21438; polyA tail of approximately 160 nucleotides not shown in sequence; 5'cap, Cap1) administered in formulation buffer. The dosing vehicle (F. buffer) was used as a control. The EPO and G-CSF modified mRNA were modified with 5-methylcytosine at each cytosine and pseudouridine replacement at each uridine site.

[0001426] Animals (n=5), Sprague-Dawley rats, were injected IM (intramuscular) for the single unit dose of 100 ug (delivered to one thigh). For multi-dosing 6 doses of 100 ug (delivered to two thighs) were used for both EPO and G-CSF mmRNA. Control dosing involved use of buffer at a single dose. Human EPO blood levels were evaluated 13 hrs post injection.

[0001427] Human EPO protein was measured in rat serum 13 hrs post intramuscular injection. Five groups of rats were treated and evaluated. The results are shown in Table 75.

Table 75. Multi-dose study

Group	Treatment	Dose of mmRNA	Total Dose	Avg. Pg/mL human EPO, serum
1	Human EPO mmRNA	1 x 100 ug	100 ug	143
2	Human EPO mmRNA	6 x 100 ug	600 ug	256
3	G-CSF mmRNA	1 x 100 ug	100 ug	43
4	G-CSF mmRNA	6 x 100 ug	600 ug	58
5	Buffer Alone	--	--	20

Example 55. Signal Sequence Exchange Study

[0001428] Several variants of mmRNAs encoding human Granulocyte colony stimulating factor (G-CSF) (mRNA sequence shown in SEQ ID NO: 21438; polyA tail of approximately 160 nucleotides not shown in sequence; 5'cap, Cap1) were synthesized using modified nucleotides pseudouridine and 5-methylcytosine (pseudo-U/5mC). These variants included the G-CSF constructs encoding either the wild-type N terminal secretory signal peptide sequence (MAGPATQSPMKLMALQLLWHSALWTVQEA; SEQ ID NO: 95), no secretory signal peptide sequence, or secretory signal peptide sequences taken from other mRNAs. These included sequences where the wild type G-CSF signal peptide sequence was replaced with the signal peptide sequence of either: human α -1-anti trypsin (AAT) (MMPSSVSWGILLLAGLCCLVPVSLA; SEQ ID NO: 94), human Factor IX (FIX) (MQRVNMIMAESPLITICLLGYLLSAECTVFLDHENANKILNRPKR; SEQ ID NO: 96), human Prolactin (Prolac) (MKGSLLLLLVSNLLLCQSVAP; SEQ ID NO: 97), or human Albumin (Alb) (MKWVTFISLLFLFSSAYSARGVFRR; SEQ ID NO: 98).

[0001429] 250ng of modified mRNA encoding each G-CSF variant was transfected into HEK293A (293A in the table), mouse myoblast (MM in the table) (C2C12, CRL-1772, ATCC) and rat myoblast (RM in the table) (L6 line, CRL-1458, ATCC) cell lines in a 24 well plate using 1 ul of Lipofectamine 2000 (Life Technologies), each well containing 300,000 cells. The supernatants were harvested after 24 hrs and the secreted G-CSF protein was analyzed by ELISA using the Human G-CSF ELISA kit (Life Technologies). The data shown in Table 76 reveal that cells transfected with G-CSF mmRNA encoding the Albumin signal peptide secrete at least 12 fold more G-CSF protein than its wild type counterpart.

Table 76. Signal Peptide Exchange

Signal peptides	293A (pg/ml)	MM (pg/ml)	RM (pg/ml)
G-CSF Natural	9650	3450	6050
α -1-anti trypsin	9950	5000	8475
Factor IX	11675	6175	11675
Prolactin	7875	1525	9800
Albumin	122050	81050	173300
No Signal peptide	0	0	0

Example 56. Cytokine Study: PBMC**A. PBMC isolation and Culture**

[0001430] 50 mL of human blood from two donors was received from Research Blood Components (lots KP30928 and KP30931) in sodium heparin tubes. For each donor, the blood was pooled and diluted to 70 mL with DPBS (SAFC Bioscience 5933 1C, lot 071M8408) and split evenly between two 50 mL conical tubes. 10 mL of Ficoll Paque (GE Healthcare 17-5442-03, lot 10074400) was gently dispensed below the blood layer. The tubes were centrifuged at 2000 rpm for 30 minutes with low acceleration and braking. The tubes were removed and the buffy coat PBMC layers were gently transferred to a fresh 50 mL conical and washed with DPBS. The tubes were centrifuged at 1450 rpm for 10 minutes.

[0001431] The supernatant was aspirated and the PBMC pellets were resuspended and washed in 50 mL of DPBS. The tubes were centrifuged at 1250 rpm for 10 minutes. This wash step was repeated, and the PBMC pellets were resuspended in 19 mL of Optimem I (Gibco 11058, lot 1072088) and counted. The cell suspensions were adjusted to a concentration of 3.0×10^6 cells / mL live cells.

[0001432] These cells were then plated on five 96 well tissue culture treated round bottom plates (Costar 3799) per donor at 50 uL per well. Within 30 minutes, transfection mixtures were added to each well at a volume of 50 uL per well. After 4 hours post transfection, the media was supplemented with 10 uL of Fetal Bovine Serum (Gibco 10082, lot 1012368)

B. Transfection Preparation

[0001433] mmRNA encoding human G-CSF (mRNA sequence shown in SEQ ID NO: 21438; polyA tail of approximately 160 nucleotides not shown in sequence; 5'cap, Cap1) (containing either (1) natural NTPs, (2) 100% substitution with 5-methyl cytidine and pseudouridine, or (3) 100% substitution with 5-methyl cytidine and NI-methyl-pseudouridine; mmRNA encoding luciferase (IVT cDNA sequence shown in SEQ ID NO: 21445; mRNA sequence shown in SEQ ID NO: 21446, polyA tail of approximately 160 nucleotides not shown in sequence, 5'cap, Cap1, fully modified with 5-methylcytosine at each cytosine and pseudouridine replacement at each uridine site)

(containing either (1) natural NTPs or (2) 100% substitution with 5-methyl cytidine and pseudouridine) and TLR agonist R848 (Invivogen tlr-r848) were diluted to 38.4 ng / uL in a final volume of 2500 uL Optimem I.

[0001434] Separately, 432 uL of Lipofectamine 2000 (Invitrogen 11668-027, lot 1070962) was diluted with 13.1 mL Optimem I. In a 96 well plate nine aliquots of 135 uL of each mmRNA, positive control (R-848) or negative control (Optimem I) was added to 135 uL of the diluted Lipofectamine 2000. The plate containing the material to be transfected was incubated for 20 minutes. The transfection mixtures were then transferred to each of the human PBMC plates at 50 uL per well. The plates were then incubated at 37 C. At 2, 4, 8, 20, and 44 hours each plate was removed from the incubator, and the supernatants were frozen.

[0001435] After the last plate was removed, the supernatants were assayed using a human G-CSF ELISA kit (Invitrogen KHC2032) and human IFN-alpha ELISA kit (Thermo Scientific 41105-2). Each condition was done in duplicate.

C. Results

[0001436] The ability of unmodified and modified mRNA (mmRNAs) to produce the encoded protein was assessed (G-CSF production) over time as was the ability of the mRNA to trigger innate immune recognition as measured by interferon-alpha production. Use of *in vitro* PBMC cultures is an accepted way to measure the immunostimulatory potential of oligonucleotides (Robbins et al, Oligonucleotides 2009 19:89-102; herein incorporated by reference in its entirety).

[0001437] Results were interpolated against the standard curve of each ELISA plate using a four parameter logistic curve fit. Shown in Tables 77 and 78 are the average from 2 separate PBMC donors of the G-CSF and IFN-alpha production over time as measured by specific ELISA.

[0001438] In the G-CSF ELISA, background signal from the Lipofectamine 2000 untreated condition was subtracted at each timepoint. The data demonstrated specific production of human G-CSF protein by human peripheral blood mononuclear is seen with G-CSF mRNA containing natural NTPs, 100% substitution with 5-methyl cytidine and pseudouridine, or 100% substitution with 5-methyl cytidine and NI-methyl-pseudouridine. Production of G-CSF was significantly increased through the use of

modified mRNA relative to unmodified mRNA, with the 5-methyl cytidine and NI-methyl-pseudouridine containing G-CSF mmRNA showing the highest level of G-CSF production. With regards to innate immune recognition, unmodified mRNA resulted in substantial IFN-alpha production, while the modified mRNA largely prevented interferon-alpha production. G-CSF mRNA fully modified with 5-methyl cytidine and NI-methyl-pseudouridine did not significantly increase cytokines whereas G-CSF mRNA fully modified with 5-methyl cytidine and pseudouridine induced IFN-alpha, TNF-alpha and IP 10. Many other cytokines were not affected by either modification.

Table 77. G-CSF Signal

G-CSF signal - 2 Donor Average					
pg / mL	2 Hr	4 Hr	8 Hr	20 Hr	44 Hr
G-CSF (5mC/pseudouridine)	120.3	136.8	421.0	346.1	431.8
G-CSF (5mC/NI-methyl-pseudouridine)	256.3	273.7	919.3	1603.3	1843.3
G-CSF(Natural-no modification)	63.5	92.6	129.6	258.3	242.4
Luciferase (5mC/pseudouridine)	4.5	153.7	33.0	186.5	58.0

Table 78. IFN-alpha signal

IFN-alpha signal - 2 donor average					
pg / mL	2 Hr	4 Hr	8 Hr	20 Hr	44 Hr
G-CSF (5mC/pseudouridine)	21.1	2.9	3.7	22.7	4.3
G-CSF (5mC/NI-methyl-pseudouridine)	0.5	0.4	3.0	2.3	2.1
G-CSF(Natural)	0.0	2.1	23.3	74.9	119.7
Luciferase (5mC/pseudouridine)	0.4	0.4	4.7	1.0	2.4
R-848	39.1	151.3	278.4	362.2	208.1
Lpf. 2000 control	0.8	17.2	16.5	0.7	3.1

Example 57. Chemical modification ranges of modified mRNA

[0001439] Modified nucleotides such as, but not limited to, the chemical modifications 5-methylcytosine and pseudouridine have been shown to lower the innate immune response and increase expression of RNA in mammalian cells. Surprisingly, and not previously known, the effects manifested by the chemical modifications can be titrated when the amount of chemical modification is less than 100%. Previously, it was believed that full modification was necessary and sufficient to elicit the beneficial effects of the

chemical modifications and that less than 100% modification of an mRNA had little effect. However, it has now been shown that the benefits of chemical modification can be derived using less than complete modification and that the effects are target, concentration and modification dependent.

A. Modified RNA transfected in PBMC

[0001440] 960 ng of G-CSF mRNA modified with 5-methylcytosine (5mC) and pseudouridine (pseudoU) or unmodified G-CSF mRNA was transfected with 0.8 uL of Lipofectamine 2000 into peripheral blood mononuclear cells (PBMC) from three normal blood donors (D1, D2, D3). The G-CSF mRNA (mRNA sequence shown in SEQ ID NO: 21438; polyA tail of approximately 160 nucleotides not shown in sequence; 5'cap, Cap1) was completely modified with 5mC and pseudoU (100% modification), not modified with 5mC and pseudoU (0% modification) or was partially modified with 5mC and pseudoU so the mRNA would contain 50% modification, 25% modification, 10% modification, 5% modification, 1% modification or 0.1% modification. A control sample of Luciferase (mRNA sequence shown in SEQ ID NO: 21446; polyA tail of approximately 160 nucleotides not shown in sequence; 5'cap, Cap1; fully modified 5mC and pseudoU) was also analyzed for G-CSF expression. For TNF-alpha and IFN-alpha control samples of Lipofectamine2000, LPS, R-848, Luciferase (mRNA sequence shown in SEQ ID NO: 21446; polyA tail of approximately 160 nucleotides not shown in sequence; 5'cap, Cap1; fully modified 5mC and pseudo), and P(I)P(C) were also analyzed. The supernatant was harvested and run by ELISA 22 hours after transfection to determine the protein expression. The expression of G-CSF is shown in Table 79 and the expression of IFN-alpha and TNF-alpha is shown in Table 80. The expression of IFN-alpha and TNF-alpha may be a secondary effect from the transfection of the G-CSF mRNA. Tables 79 and 80 show that the amount of chemical modification of G-CSF, IFN-alpha and TNF-alpha is titratable when the mRNA is not fully modified and the titratable trend is not the same for each target.

Table 79. G-CSF Expression

	G-CSF Expression (pg/ml)		
	D1	D2	D3
100% modification	270.3	151.6	162.2
50% modification	45.6	19.8	26.3
25% modification	23.6	10.8	8.9

10% modification	39.4	12.9	12.9
5% modification	70.9	26.8	26.3
1 % modification	70.3	26.9	66.9
0.1% modification	67.5	25.2	28.7
Luciferase	14.5	3.1	10.0

Table 80. IFN-alpha and TNF-alpha Expression

	IFN-alpha Expression (pg/ml)			TNF-alpha Expression (pg/ml)		
	D1	D2	D3	D1	D2	D3
100% modification	76.8	6.8	15.1	5.6	1.4	21.4
50% modification	22.0	5.5	257.3	4.7	1.7	12.1
25% modification	64.1	14.9	549.7	3.9	0.7	10.1
10% modification	150.2	18.8	787.8	6.6	0.9	13.4
5% modification	143.9	41.3	1009.6	2.5	1.8	12.0
1 % modification	189.1	40.5	375.2	9.1	1.2	25.7
0.1% modification	261.2	37.8	392.8	9.0	2.	13.7
0% modification	230.3	45.1	558.3	10.9	1.4	10.9
LF 200	0	0	1.5	45.8	2.8	53.6
LPS	0	0	1.0	114.5	70.0	227.0
R-848	39.5	11.9	183.5	389.3	256.6	410.6
Luciferase	9.1	0	3.9	4.5	2.7	13.6
P(I)P(C)	1498.1	216.8	238.8	61.2	4.4	69.1

B. Modified RNA transfected in HEK293

[0001441] Human embryonic kidney epithelial (HEK293) cells were seeded on 96-well plates at a density of 30,000 cells per well in 100 ul cell culture medium. 250 ng of modified G-CSF mRNA (mRNA sequence shown in SEQ ID NO: 21438; polyA tail of approximately 160 nucleotides not shown in sequence; 5'cap, Cap1) formulated with RNAiMAX™ (Invitrogen, Carlsbad, CA) was added to a well. The G-CSF was completely modified with 5mC and pseudoU (100% modification), not modified with 5mC and pseudoU (0% modification) or was partially modified with 5mC and pseudoU so the mRNA would contain 75% modification, 50% modification or 25% modification. Control samples (AK 5/2, mCherry (SEQ ID NO: 21439; polyA tail of approximately 160 nucleotides not shown in sequence; 5'cap, Cap1; fully modified 5mC and pseudoU)

and untreated) were also analyzed. The half-life of G-CSF mRNA fully modified with 5-methylcytosine and pseudouridine is approximately 8-10 hours. The supernatants were harvested after 16 hours and the secreted G-CSF protein was analyzed by ELISA. Table 81 shows that the amount of chemical modification of G-CSF is titratable when the mRNA is not fully modified.

Table 81. G-CSF Expression

	G-CSF Expression (ng/ml)
100% modification	118.4
75% modification	101.9
50% modification	105.7
25% modification	231.1
0% modification	270.9
AK 5/2	166.8
mCherry	0
Untreated	0

Example 58: *In Vivo* Delivery of Modified mRNA (mniRNA)

[0001442] Modified RNA was delivered to C57/BL6 mice intramuscularly, subcutaneously, or intravenously to evaluate the bio-distribution of modified RNA using luciferase. A formulation buffer used with all delivery methods contained 150mM sodium chloride, 2mM calcium chloride, 2 mM Na⁺-phosphate which included 1.4mM monobasic sodium phosphate and 0.6 mM of dibasic sodium phosphate, and 0.5 mM ethylenediaminetetraacetic acid (EDTA) was adjusted using sodium hydroxide to reach a final pH of 6.5 before being filtered and sterilized. A IX concentration was used as the delivery buffer. To create the lipoplexed solution delivered to the mice, in one vial 50 µg of RNA was equilibrated for 10 minutes at room temperature in the delivery buffer and in a second vial 10 µl RNAiMAX™ was equilibrated for 10 minutes at room temperature in the delivery buffer. After equilibrium, the vials were combined and delivery buffer was added to reach a final volume of 100 µl which was then incubated for 20 minutes at room temperature. Luciferin was administered by intraperitoneal injection (IP) at 150 mg/kg to each mouse prior to imaging during the plateau phase of the luciferin exposure curve which was between 15 and 30 minutes. To create luciferin, 1 g of D-luciferin potassium or sodium salt was dissolved in 66.6 ml of distilled phosphate buffer solution (DPBS), not containing Mg²⁺ or Ca²⁺, to make a 15 mg/ml solution. The solution was gently

mixed and passed through a 0.2 μm syringe filter, before being purged with nitrogen, aliquoted and frozen at -80°C while being protected from light as much as possible. The solution was thawed using a waterbath if luciferin was not dissolved, gently mixed and kept on ice on the day of dosing.

[0001443] Whole body images were taken of each mouse 2, 8 and 24 hours after dosing. Tissue images and serum was collected from each mouse 24 hours after dosing. Mice administered doses intravenously had their liver, spleen, kidneys, lungs, heart, peri-renal adipose tissue and thymus imaged. Mice administered doses intramuscularly or subcutaneously had their liver, spleen, kidneys, lungs, peri-renal adipose tissue, and muscle at the injection site. From the whole body images the bioluminescence was measured in photon per second for each route of administration and dosing regimen.

A. Intramuscular Administration

[0001444] Mice were intramuscularly (I.M.) administered either modified luciferase mRNA fully modified with 5-methylcytosine and pseudouridine (Naked-Luc), lipoplexed modified luciferase mRNA fully modified with 5-methylcytosine and pseudouridine (Lipoplex-luc) (IVT cDNA sequence shown in SEQ ID NO: 21445; mRNA sequence shown in SEQ ID NO: 21446, polyA tail of approximately 160 nucleotides not shown in sequence, 5'cap, Cap1, fully modified with 5-methylcytosine at each cytosine and pseudouridine replacement at each uridine site), lipoplexed modified granulocyte colony-stimulating factor (G-CSF) mRNA (mRNA sequence shown in SEQ ID NO: 21438; polyA tail of approximately 160 nucleotides not shown in sequence; 5'cap, Cap1; fully modified with 5-methylcytosine and pseudouridine) (Lipoplex-Cytokine) or the formation buffer at a single dose of 50 μg of modified RNA in an injection volume of 50 μl for each formulation in the right hind limb and a single dose of 5 μg of modified RNA in an injection volume of 50 μl in the left hind limb. The bioluminescence average for the luciferase expression signals for each group at 2, 8 and 24 hours after dosing are shown in Table 82. The bioluminescence showed a positive signal at the injection site of the 5 μg and 50 μg modified RNA formulations containing and not containing lipoplex.

Table 82. *In vivo* Biophotonic Imaging (I.M. Injection Route)

Formulation	Dose (ug)	Bioluminescence (photon/sec)		
		2 hours	8 hours	24 hours
Naked-Luc	5	224,000	683,000	927,000

Lipoplex-Luc	5	579,000	639,000	186,000
Lipoplex-G-CSF	5	64,600	85,600	75,100
Formulation Buffer	5	102,000	86,000	90,700
Naked-Luc	50	446,000	766,000	509,000
Lipoplex-Luc	50	374,000	501,000	332,000
Lipoplex-G-CSF	50	49,400	74,800	74,200
Formulation Buffer	50	59,300	69,200	63,600

B. Subcutaneous Administration

[0001445] Mice were subcutaneously (S.C.) administered either modified luciferase mRNA (Naked-Luc), lipoplexed modified luciferase mRNA (Lipoplex-luc), lipoplexed modified G-CSF mRNA (Lipoplex-G-CSF) or the formation buffer at a single dose of 50 μg of modified mRNA in an injection volume of 100 μl for each formulation. The bioluminescence average for the luciferase expression signals for each group at 2, 8 and 24 hours after dosing are shown in Table 83. The bioluminescence showed a positive signal at the injection site of the 50 μg modified mRNA formulations containing and not containing lipoplex.

Table 83. *In vivo* Biophotonic Imaging (S.C. Injection Route)

Formulation	Bioluminescence (photon/sec)		
	2 hours	8 hours	24 hours
Naked-Luc	3,700,000	8,060,000	2,080,000
Lipoplex-Luc	3,960,000	1,700,000	1,290,000
Lipoplex-G-CSF	123,000	121,000	117,000
Formulation Buffer	116,000	127,000	123,000

C. Intravenous Administration

[0001446] Mice were intravenously (I.V.) administered either modified luciferase mRNA (Naked-Luc), lipoplexed modified luciferase mRNA (Lipoplex-luc), lipoplexed modified G-CSF mRNA (Lipoplex-G-CSF) or the formation buffer at a single dose of 50 μg of modified mRNA in an injection volume of 100 μl for each formulation. The bioluminescence average for the luciferase expression signal in the spleen from each group at 2 hours after dosing is shown in Table 84. The bioluminescence showed a positive signal in the spleen of the 50 μg modified mRNA formulations containing lipoplex.

Table 84. *In vivo* Biophotonic Imaging (I.V. Injection Route)

Formulation	Bioluminescence (photon/sec) of the Spleen
Naked-Luc	58,400
Lipoplex-Luc	65,000
Lipoplex-G-CSF	57,100
Formulation Buffer	58,300

Example 59. Buffer Formulation Studies

[0001447] G-CSF modified mRNA (mRNA sequence shown in SEQ ID NO: 21438; polyA tail of approximately 160 nucleotides not shown in sequence; 5'cap, Cap1; fully modified with NI-pseudouridine and 5-methylcytosine) or Factor IX modified mRNA (mRNA sequence shown in SEQ ID NO: 1622; polyA tail of approximately 160 nucleotides not shown in sequence; 5'cap, Cap1; fully modified with NI-pseudouridine and 5-methylcytosine) in a buffer solution is administered intramuscularly to rats in an injection volume of 50 μ l (n=5) at a modified mRNA dose of 200 ug per rat as described in Table 85. The modified mRNA is lyophilized in water for 1-2 days. It is then reconstituted in the buffers listed below to a target concentration of 6 mg/ml. Concentration is determined by OD 260. Samples are diluted to 4 mg/ml in the appropriate buffer before dosing.

[0001448] To precipitate the modified mRNA, 3M sodium acetate, pH 5.5 and pure ethanol are added at 1/10th the total volume and 4 times the total volume of modified mRNA, respectively. The material is placed at -80C for a minimum of 1 hour. The material is then centrifuged for 30 minutes at 4000 rpm, 4C. The supernatant is removed and the pellet is centrifuged and washed 3x with 75% ethanol. Finally, the pellet is reconstituted with buffer to a target concentration of 6 mg/ml. Concentration is determined by OD 260. Samples are diluted to 4 mg/ml in the appropriate buffer before dosing. All samples are prepared by lyophilization unless noted below.

Table 85. Buffer Dosing Groups

Group	Treatment	Buffer	Dose (ug/rat)
1	G-CSF	0.9% Saline	200
	Factor IX	0.9% Saline	200
2	G-CSF	0.9% Saline + 2mM Calcium	200
	Factor IX	0.9% Saline + 2mM Calcium	200

3	G-CSF	Lactated Ringer's	200
	Factor IX	Lactated Ringer's	200
4	G-CSF	5% Sucrose	200
	Factor IX	5% Sucrose	200
5	G-CSF	5% Sucrose + 2mM Calcium	200
	Factor IX	5% Sucrose + 2mM Calcium	200
6	G-CSF	5% Mannitol	200
	Factor IX	5% Mannitol	200
7	G-CSF	5% Mannitol + 2mM Calcium	200
	Factor IX	5% Mannitol + 2mM Calcium	200
8	G-CSF	0.9% saline (precipitation)	200
	Factor IX	0.9% saline (precipitation)	200

[0001449] Serum samples are collected from the rats at various time intervals and analyzed for G-CSF or Factor IX protein expression using G-CSF or Factor IX ELISA.

Example 60. Multi-Dose Study

[0001450] Sprague-Dawley rats (n=8) are injected intravenously eight times (twice a week) over 28 days. The rats are injected with 0.5 mg/kg, 0.05 mg/kg, 0.005 mg/kg or 0.0005 mg/kg of human G-CSF modified mRNA of luciferase modified mRNA formulated in a lipid nanoparticle, 0.5 mg/kg of human G-CSF modified mRNA in saline, 0.2 mg/kg of the human G-CSF protein Neupogen or non-translatable human G-CSF modified mRNA formulated in a lipid nanoparticle. Serum is collected during pre-determined time intervals to evaluate G-CSF protein expression (8, 24 and 72 hours after the first dose of the week), complete blood count and white blood count (24 and 72 hours after the first dose of the week) and clinical chemistry (24 and 72 hours after the first dose of the week). The rats are sacrificed at day 29, 4 days after the final dosing, to determine the complete blood count, white blood count, clinical chemistry, protein expression and to evaluate the effect on the major organs by histopathology and necropsy. Further, an antibody assay is performed on the rats on day 29.

Example 61. LNP *in vivo* study

[0001451] Luciferase modified mRNA (mRNA sequence shown in SEQ ID NO: 21446; polyA tail of approximately 160 nucleotides not shown in sequence, 5' cap, Cap1; fully modified with 5-methylcytosine and pseudouridine) was formulated as a lipid nanoparticle

(LNP) using the syringe pump method. The LNP was formulated at a 20: 1 weight ratio of total lipid to modified mRNA with a final lipid molar ratio of 50:10:38.5:1.5 (DLin-KC2-DMA: DSPC: Cholesterol: PEG-DMG). As shown in Table 86, the luciferase LNP formulation was characterized by particle size, zeta potential, and encapsulation.

Table 86. Luciferase Formulation

Formulation	NPA-098-1
Modified mRNA	Luciferase
Mean size	135 nm
	PDI: 0.08
Zeta at pH 7.4	-0.6 mV
Encaps. (RiboGr)	91 %

[0001452] As outlined in Table 87, the luciferase LNP formulation was administered to Balb-C mice (n=3) intramuscularly, intravenously and subcutaneously and a luciferase modified RNA formulated in PBS was administered to mice intravenously.

Table 87. Luciferase Formulations

Formulation	Vehicle	Route	Concentration (mg/ml)	Injection Volume (ul)	Amount of modified RNA (ug)	Dose (mg/kg)
Luc-LNP	PBS	IV	0.20	50	10	0.50
Luc-LNP	PBS	IM	0.20	50	10	0.50
Luc-LNP	PBS	SC	0.20	50	10	0.50
Luc-PBS	PBS	IV	0.20	50	10	0.50

[0001453] The mice administered the luciferase LNP formulation intravenously and intramuscularly were imaged at 2, 8, 24, 48, 120 and 192 hours and the mice administered the luciferase LNP formulation subcutaneously were imaged at 2, 8, 24, 48 and 120 hours to determine the luciferase expression as shown in Table 88. In Table 88, "NT" means not tested. Twenty minutes prior to imaging, mice were injected intraperitoneally with a D-luciferin solution at 150 mg/kg. Animals were then anesthetized and images were acquired with an IVIS Lumina II imaging system (Perkin Elmer). Bioluminescence was measured as total flux (photons/second) of the entire mouse.

Table 88. Luciferase Expression

Form.	Route of Administration	Average Expression (photon/second)					
		2 hours	8 hours	24 hours	48 hours	120 hours	192 hours

Luc-LNP	IV	1.62E+08	3.00E+09	7.77E+08	4.98E+08	1.89E+08	6.08E+07
Luc-LNP	IM	4.85E+07	4.92E+08	9.02E+07	3.17E+07	1.22E+07	2.38E+06
Luc-LNP	SC	1.85E+07	9.79E+08	3.09E+08	4.94E+07	1.98E+06	NT
Luc-PBS	IV	3.61E+05	5.64E+05	3.19E+05	NT	NT	NT

[0001454] One mouse administered the LNP formulation intravenously was sacrificed at 8 hours to determine the luciferase expression in the liver and spleen. Also, one mouse administered the LNP formulation intramuscular was sacrificed at 8 hours to determine the luciferase expression of the muscle around the injection site and in the liver and spleen. As shown in Table 89, expression was seen in the both the liver and spleen after intravenous and intramuscular administration and in the muscle around the intramuscular injection site.

Table 89. Luciferase Expression in Tissue

Luciferase LNP: IV Administration	Expression (photon/second)
Liver	7.984E+08
Spleen	3.951E+08
Luciferase LNP: IM Administration	Expression (photon/second)
Muscle around the injection site	3.688E+07
Liver	1.507E+08
Spleen	1.096E+07

Example 62. Cytokine Study: PBMC

A. PBMC isolation and Culture

[0001455] 50 mL of human blood from two donors was received from Research Blood Components (lots KP30928 and KP30931) in sodium heparin tubes. For each donor, the blood was pooled and diluted to 70 mL with DPBS (SAFC Bioscience 5933 1C, lot 071M8408) and split evenly between two 50 mL conical tubes. 10 mL of Ficoll Paque (GE Healthcare 17-5442-03, lot 10074400) was gently dispensed below the blood layer. The tubes were centrifuged at 2000 rpm for 30 minutes with low acceleration and braking. The tubes were removed and the buffy coat PBMC layers were gently

transferred to a fresh 50 mL conical and washed with DPBS. The tubes were centrifuged at 1450 rpm for 10 minutes.

[0001456] The supernatant was aspirated and the PBMC pellets were resuspended and washed in 50 mL of DPBS. The tubes were centrifuged at 1250 rpm for 10 minutes. This wash step was repeated, and the PBMC pellets were resuspended in 19 mL of Optimem I (Gibco 11058, lot 1072088) and counted. The cell suspensions were adjusted to a concentration of 3.0×10^6 cells / mL live cells.

[0001457] These cells were then plated on five 96 well tissue culture treated round bottom plates (Costar 3799) per donor at 50 uL per well. Within 30 minutes, transfection mixtures were added to each well at a volume of 50 uL per well. After 4 hours post transfection, the media was supplemented with 10 uL of Fetal Bovine Serum (Gibco 10082, lot 1012368).

B. Transfection Preparation

[0001458] Modified mRNA encoding human G-CSF (mRNA sequence shown in SEQ ID NO: 21438; polyA tail of approximately 160 nucleotides not shown in sequence; 5'cap, Cap1) (containing either (1) natural NTPs, (2) 100% substitution with 5-methyl cytidine and pseudouridine, or (3) 100% substitution with 5-methyl cytidine and NI-methyl-pseudouridine; mRNA encoding luciferase (IVT cDNA sequence shown in SEQ ID NO: 21445; mRNA sequence shown in SEQ ID NO: 21446, polyA tail of approximately 160 nucleotides not shown in sequence, 5'cap, Cap1, fully modified with 5-methylcytosine at each cytosine and pseudouridine replacement at each uridine site) (containing either (1) natural NTPs or (2) 100% substitution with 5-methyl cytidine and pseudouridine) and TLR agonist R848 (Invivogen tlr1-r848) were diluted to 38.4 ng / uL in a final volume of 2500 uL Optimem I.

[0001459] Separately, 110 uL of Lipofectamine 2000 (Invitrogen 11668-027, lot 1070962) was diluted with 6.76 mL Optimem I. In a 96 well plate nine aliquots of 135 uL of each mRNA, positive control (R-848) or negative control (Optimem I) was added to 135 uL of the diluted Lipofectamine 2000. The plate containing the material to be transfected was incubated for 20 minutes. The transfection mixtures were then transferred to each of the human PBMC plates at 50 uL per well. The plates were then incubated at

37°C. At 2, 4, 8, 20, and 44 hours each plate was removed from the incubator, and the supernatants were frozen.

[0001460] After the last plate was removed, the supernatants were assayed using a human G-CSF ELISA kit (Invitrogen KHC2032) and human IFN-alpha ELISA kit (Thermo Scientific 41105-2). Each condition was done in duplicate.

C. Protein and Innate Immune Response Analysis

[0001461] The ability of unmodified and modified mRNA to produce the encoded protein was assessed (G-CSF production) over time as was the ability of the mRNA to trigger innate immune recognition as measured by interferon-alpha production. Use of *in vitro* PBMC cultures is an accepted way to measure the immunostimulatory potential of oligonucleotides (Robbins et al, Oligonucleotides 2009 19:89-102).

[0001462] Results were interpolated against the standard curve of each ELISA plate using a four parameter logistic curve fit. Shown in Tables 90 and 91 are the average from 3 separate PBMC donors of the G-CSF, interferon-alpha (IFN-alpha) and tumor necrosis factor alpha (TNF-alpha) production over time as measured by specific ELISA.

[0001463] In the G-CSF ELISA, background signal from the Lipofectamine 2000 (LF2000) untreated condition was subtracted at each time point. The data demonstrated specific production of human G-CSF protein by human peripheral blood mononuclear is seen with G-CSF mRNA containing natural NTPs, 100% substitution with 5-methyl cytidine and pseudouridine, or 100% substitution with 5-methyl cytidine and N1-methyl-pseudouridine. Production of G-CSF was significantly increased through the use of 5-methyl cytidine and N1-methyl-pseudouridine modified mRNA relative to 5-methyl cytidine and pseudouridine modified mRNA.

[0001464] With regards to innate immune recognition, while both modified mRNA chemistries largely prevented IFN-alpha and TNF-alpha production relative to positive controls (R848, p(I)p(C)), significant differences did exist between the chemistries. 5-methyl cytidine and pseudouridine modified mRNA resulted in low but detectable levels of IFN-alpha and TNF-alpha production, while 5-methyl cytidine and N1-methyl-pseudouridine modified mRNA resulted in no detectable IFN-alpha and TNF-alpha production.

[0001465] Consequently, it has been determined that, in addition to the need to review more than one cytokine marker of the activation of the innate immune response, it has surprisingly been found that combinations of modifications provide differing levels of cellular response (protein production and immune activation). The modification, NI-methyl-pseudouridine, in this study has been shown to convey added protection over the standard combination of 5-methylcytosine/pseudouridine explored by others resulting in twice as much protein and almost 150 fold reduction in immune activation (TNF-alpha).

[0001466] Given that PBMC contain a large array of innate immune RNA recognition sensors and are also capable of protein translation, it offers a useful system to test the interdependency of these two pathways. It is known that mRNA translation can be negatively affected by activation of such innate immune pathways (Kariko et al. Immunity (2005) 23:165-175; Warren et al. Cell Stem Cell (2010) 7:618-630). Using PBMC as an in vitro assay system it is possible to establish a correlation between translation (in this case G-CSF protein production) and cytokine production (in this case exemplified by IFN-alpha and TNF-alpha protein production). Better protein production is correlated with lower induction of innate immune activation pathway, and new chemistries can be judged favorably based on this ratio (Table 92).

[0001467] In this study, the PC Ratio for the two chemical modifications, pseudouridine and NI-methyl-pseudouridine, both with 5-methyl cytosine was $4742/141=34$ as compared to $9944/1=9944$ for the cytokine IFN-alpha. For the cytokine, TNF-alpha, the two chemistries had PC Ratios of 153 and 1243, respectively suggesting that for either cytokine, the NI-methyl-pseudouridine is the superior modification. In Tables 90 and 91, "NT" means not tested.

Table 90. G-CSF

G-CSF: 3 Donor Average (pg/ml)	
G-CSF 5-methylcytosine/ pseudouridine	4742
G-CSF 5-methylcytosine/ NI-methyl-pseudouridine	9944
Luciferase	18
LF2000	16

Table 91. IFN-alpha and TNF-alpha

	IFN-alpha: 3 Donor Average (pg/ml)	TNF-alpha: 3 Donor Average (pg/ml)
G-CSF 5-methylcytosine/pseudouridine	141	31
G-CSF 5-methylcytosine/ N1-methyl-pseudouridine	1	8
P(I)P(C)	1104	NT
R-848	NT	1477
LF2000	17	25

Table 92. G-CSF to Cytokine Ratios

	G-CSF/ IFN-alpha (ratio)		G-CSF/TNF-alpha (ratio)	
	5-methyl cytosine/ pseudouridine	5-methylcytosine/ N1-methyl-pseudouridine	5-methyl cytosine/ pseudouridine	5-methylcytosine/ N1-methyl-pseudouridine
PC Ratio	34	9944	153	1243

Example 63. In Vitro PBMC Studies: Percent modification

[0001468] 480 ng of G-CSF mRNA modified with 5-methylcytosine (5mC) and pseudouridine (pseudoU) or unmodified G-CSF mRNA was transfected with 0.4 uL of Lipofectamine 2000 into peripheral blood mononuclear cells (PBMC) from three normal blood donors (D1, D2, and D3). The G-CSF mRNA (mRNA sequence shown in SEQ ID NO: 21438; polyA tail of approximately 160 nucleotides not shown in sequence; 5'cap, Cap1) was completely modified with 5mC and pseudoU (100% modification), not modified with 5mC and pseudoU (0% modification) or was partially modified with 5mC and pseudoU so the mRNA would contain 75% modification, 50% modification or 25% modification. A control sample of Luciferase (mRNA sequence shown in SEQ ID NO: 21446; polyA tail of approximately 160 nucleotides not shown in sequence; 5'cap, Cap1; fully modified 5mC and pseudoU) was also analyzed for G-CSF expression. For TNF-alpha and IFN-alpha control samples of Lipofectamine2000, LPS, R-848, Luciferase (mRNA sequence shown in SEQ ID NO: 21446; polyA tail of approximately 160 nucleotides not shown in sequence; 5'cap, Cap1; fully modified 5mC and pseudo), and P(I)P(C) were also analyzed. The supernatant was harvested and run by ELISA 22 hours after transfection to determine the protein expression. The expression of G-CSF is shown

in Table 93 and the expression of IFN-alpha and TNF-alpha is shown in Table 94. The expression of IFN-alpha and TNF-alpha may be a secondary effect from the transfection of the G-CSF mRNA. Tables 93 and 94 show that the amount of chemical modification of G-CSF, interferon alpha (IFN-alpha) and tumor necrosis factor-alpha (TNF-alpha) is titratable when the mRNA is not fully modified and the titratable trend is not the same for each target.

[0001469] By using PBMC as an *in vitro* assay system it is possible to establish a correlation between translation (in this case G-CSF protein production) and cytokine production (in this case exemplified by IFN-alpha protein production). Better protein production is correlated with lower induction of innate immune activation pathway, and the percentage modification of a chemistry can be judged favorably based on this ratio (Table 95). As calculated from Tables 93 and 94 and shown in Table 95, full modification with 5-methylcytidine and pseudouridine shows a much better ratio of protein/cytokine production than without any modification (natural G-CSF mRNA) (100-fold for IFN-alpha and 27-fold for TNF-alpha). Partial modification shows a linear relationship with increasingly less modification resulting in a lower protein/cytokine ratio.

Table 93. G-CSF Expression

	G-CSF Expression (pg/ml)		
	D1	D2	D3
100% modification	1968.9	2595.6	2835.7
75% modification	566.7	631.4	659.5
50% modification	188.9	187.2	191.9
25% modification	139.3	126.9	102.0
0% modification	194.8	182.0	183.3
Luciferase	90.2	0.0	22.1

Table 94. IFN-alpha and TNF-alpha Expression

	IFN-alpha Expression (pg/ml)			TNF-alpha Expression (pg/ml)		
	D1	D2	D3	D1	D2	D3
100% modification	336.5	78.0	46.4	115.0	15.0	11.1
75% modification	339.6	107.6	160.9	107.4	21.7	11.8
50% modification	478.9	261.1	389.7	49.6	24.1	10.4
25% modification	564.3	400.4	670.7	85.6	26.6	19.8
0% modification	1421.6	810.5	1260.5	154.6	96.8	45.9
LPS	0.0	0.6	0.0	0.0	12.6	4.3
R-848	0.5	3.0	14.1	655.2	989.9	420.4

P(D)P(C)	130.8	297.1	585.2	765.8	2362.7	1874.4
Lipid_only	1952.2	866.6	855.8	248.5	82.0	60.7

Table 95. PC Ratio and Effect of Percentage of Modification

% Modification	Average G-CSF (pg/ml)	Average IFN-a (pg/ml)	Average TNF-a (pg/ml)	G-CSF/ IFN-alpha (PC ratio)	G-CSF/TNF-alpha (PC ratio)
100	2466	153	47	16	52
75	619	202	47	3.1	13
50	189	376	28	0.5	6.8
25	122	545	44	0.2	2.8
0	186	1164	99	0.16	1.9

Example 64. Modified RNA transfected in PBMC

[0001470] 500 ng of G-CSF mRNA modified with 5-methylcytosine (5mC) and pseudouridine (pseudoU) or unmodified G-CSF mRNA was transfected with 0.4 uL of Lipofectamine 2000 into peripheral blood mononuclear cells (PBMC) from three normal blood donors (D1, D2, and D3). The G-CSF mRNA (mRNA sequence shown in SEQ ID NO: 21438; polyA tail of approximately 160 nucleotides not shown in sequence; 5'cap, Cap1) was completely modified with 5mC and pseudoU (100% modification), not modified with 5mC and pseudoU (0% modification) or was partially modified with 5mC and pseudoU so the mRNA would contain 50% modification, 25% modification, 10%> modification, %5 modification, 1% modification or 0.1% modification. A control sample of mCherry (mRNA sequence shown in SEQ ID NO: 21439; polyA tail of approximately 160 nucleotides not shown in sequence; 5'cap, Cap1; fully modified 5meC and pseudouridine), G-CSF fully modified with 5-methylcytosine and pseudouridine (Control G-CSF) and an untreated control was also analyzed for expression of G-CSF, tumor necrosis factor-alpha (TNF-alpha) and interferon-alpha (IFN-alpha). The supernatant was harvested 6 hours and 18 hours after transfection and run by ELISA to determine the protein expression. The expression of G-CSF, IFN-alpha, and TNF-alpha for Donor 1 is shown in Table 96, Donor 2 is shown in Table 97 and Donor 3 is shown in Table 98.

[0001471] Full 100% modification with 5-methylcytidine and pseudouridine resulted in the most protein translation (G-CSF) and the least amount of cytokine produced across all three human PBMC donors. Decreasing amounts of modification results in more cytokine

production (IFN-alpha and TNF-alpha), thus further highlighting the importance of fully modification to reduce cytokines and to improve protein translation (as evidenced here by G-CSF production).

Table 96. Donor 1

	G-CSF (pg/mL)		IFN-alpha (pg/mL)		TNF-alpha (pg/mL)	
	6 hours	18 hours	6 hours	18 hours	6 hours	18 hours
100% Mod	1815	2224	1	13	0	0
75% Mod	591	614	0	89	0	0
50% Mod	172	147	0	193	0	0
25% Mod	111	92	2	219	0	0
10% Mod	138	138	7	536	18	0
1% Mod	199	214	9	660	18	3
0.1% Mod	222	208	10	597	0	6
0 % Mod	273	299	10	501	10	0
Control G-CSF	957	1274	3	123	18633	1620
mCherry	0	0	0	10	0	0
Untreated	N/A	N/A	0	0	1	1

Table 97. Donor 2

	G-CSF (pg/mL)		IFN-alpha (pg/mL)		TNF-alpha (pg/mL)	
	6 hours	18 hours	6 hours	18 hours	6 hours	18 hours
100% Mod	2184	2432	0	7	0	11
75% Mod	935	958	3	130	0	0
50% Mod	192	253	2	625	7	23
25% Mod	153	158	7	464	6	6
10% Mod	203	223	25	700	22	39
1% Mod	288	275	27	962	51	66
0.1% Mod	318	288	33	635	28	5
0 % Mod	389	413	26	748	1	253
Control G-CSF	1461	1634	1	59	481	814
mCherry	0	7	0	1	0	0
Untreated	N/A	N/A	1	0	0	0

Table 98. Donor 3

	G-CSF (pg/mL)		IFN-alpha (pg/mL)		TNF-alpha (pg/mL)	
	6 hours	18 hours	6 hours	18 hours	6 hours	18 hours
100% Mod	6086	7549	7	658	11	11
75% Mod	2479	2378	23	752	4	35
50% Mod	667	774	24	896	22	18
25% Mod	480	541	57	1557	43	115
10% Mod	838	956	159	2755	144	123
1% Mod	1108	1197	235	3415	88	270
0.1% Mod	1338	1177	191	2873	37	363

0 % Mod	1463	1666	215	3793	74	429
Control G-CSF	3272	3603	16	1557	731	9066
mCherry	0	0	2	645	0	0
Untreated	N/A	N/A	1	1	0	8

Example 65. Innate Immune Response Study in BJ Fibroblasts

A. Single Transfection

[0001472] Human primary foreskin fibroblasts (BJ fibroblasts) were obtained from American Type Culture Collection (ATCC) (catalog # CRL-2522) and grown in Eagle's Minimum Essential Medium (ATCC, catalog # 30-2003) supplemented with 10% fetal bovine serum at 37°C, under 5% CO₂. BJ fibroblasts were seeded on a 24-well plate at a density of 300,000 cells per well in 0.5 ml of culture medium. 250 ng of modified G-CSF mRNA (mRNA sequence shown in SEQ ID NO: 21438; polyA tail of approximately 140 nucleotides not shown in sequence; 5'cap, Cap1) fully modified with 5-methylcytosine and pseudouridine (Gen1) or fully modified with 5-methylcytosine and N1-methyl-pseudouridine (Gen2) having CapO, Cap1 or no cap was transfected using Lipofectamine 2000 (Invitrogen, catalog # 11668-019), following manufacturer's protocol. Control samples of poly I:C (PIC), Lipofectamine 2000 (Lipo), natural luciferase mRNA (mRNA sequence shown in SEQ ID NO: 21446; polyA tail of approximately 160 nucleotides not shown in sequence; 5'cap, Cap1) and natural G-CSF mRNA were also transfected. The cells were harvested after 18 hours, the total RNA was isolated and DNASE® treated using the RNeasy micro kit (catalog #74004) following the manufacturer's protocol. 100 ng of total RNA was used for cDNA synthesis using High Capacity cDNA Reverse Transcription kit (catalog #4368814) following the manufacturer's protocol. The cDNA was then analyzed for the expression of innate immune response genes by quantitative real time PCR using SybrGreen in a Biorad CFX 384 instrument following manufacturer's protocol. Table 99 shows the expression level of innate immune response transcripts relative to house-keeping gene HPRT (hypoxanthine phosphoribosyltransferase) and is expressed as fold-induction relative to HPRT. In the table, the panel of standard metrics includes: RIG-I is retinoic acid inducible gene 1, IL6 is interleukin-6, OAS-1 is oligoadenylate synthetase 1, IFN β is interferon-beta, AIM2 is absent in melanoma-2, IFIT-1 is interferon-induced protein with

tetratricopeptide repeats 1, PKR is protein kinase R, TNFa is tumor necrosis factor alpha and IFNa is interferon alpha.

Table 99. Innate Immune Response Transcript Levels

Form.	RIG-I	IL6	OAS-1	IFNb	AIM2	IFIT-1	PKR	TNFa	IFNa
Natural Luciferase	71.5	20.6	20.778	11.404	0.251	151.218	16.001	0.526	0.067
Natural G-CSF	73.3	47.1	19.359	13.615	0.264	142.011	11.667	1.185	0.153
PIC	30.0	2.8	8.628	1.523	0.100	71.914	10.326	0.264	0.063
G-CSF Gen1-UC	0.81	0.22	0.080	0.009	0.008	2.220	1.592	0.090	0.027
G-CSF Gen1-Cap0	0.54	0.26	0.042	0.005	0.008	1.314	1.568	0.088	0.038
G-CSF Gen1-Cap1	0.58	0.30	0.035	0.007	0.006	1.510	1.371	0.090	0.040
G-CSF Gen2-UC	0.21	0.20	0.002	0.007	0.007	0.603	0.969	0.129	0.005
G-CSF Gen2-Cap0	0.23	0.21	0.002	0.0014	0.007	0.648	1.547	0.121	0.035
G-CSF Gen2-Cap1	0.27	0.26	0.011	0.004	0.005	0.678	1.557	0.099	0.037
Lipo	0.27	0.53	0.001	0	0.007	0.954	1.536	0.158	0.064

B. Repeat Transfection

[0001473] Human primary foreskin fibroblasts (BJ fibroblasts) were obtained from American Type Culture Collection (ATCC) (catalog # CRL-2522) and grown in Eagle's Minimum Essential Medium (ATCC, catalog # 30-2003) supplemented with 10% fetal bovine serum at 37°C, under 5% CO₂. BJ fibroblasts were seeded on a 24-well plate at a density of 300,000 cells per well in 0.5 ml of culture medium. 250 ng of modified G-CSF mRNA (mRNA sequence shown in SEQ ID NO: 21438; polyA tail of approximately 140 nucleotides not shown in sequence; 5'cap, Cap1) unmodified, fully modified with 5-methylcytosine and pseudouridine (Gen1) or fully modified with 5-methylcytosine and N1-methyl-pseudouridine (Gen2) was transfected daily for 5 days following manufacturer's protocol. Control samples of Lipofectamine 2000 (L2000) and mCherry mRNA (mRNA sequence shown in SEQ ID NO: 21439; polyA tail of

approximately 160 nucleotides not shown in sequence; 5'cap, Cap1; fully modified with 5-methylcytidine and pseudouridine) were also transfected daily for 5 days. The results are shown in Table 100.

[0001474] Unmodified mRNA showed a cytokine response in interferon-beta (IFN-beta) and interleukin-6 (IL-6) after one day. mRNA modified with at least pseudouridine showed a cytokine response after 2-3 days whereas mRNA modified with 5-methylcytosine and N1-methyl-pseudouridine showed a reduced response after 3-5 days.

Table 100. Cytokine Response

Formulation	Transfection	IFN-beta (pg/ml)	IL-6 (pg/ml)
G-CSF unmodified	6 hours	0	3596
	Day 1	1363	15207
	Day 2	238	12415
	Day 3	225	5017
	Day 4	363	4267
	Day 5	225	3094
G-CSF Gen 1	6 hours	0	3396
	Day 1	38	3870
	Day 2	1125	16341
	Day 3	100	25983
	Day 4	75	18922
	Day 5	213	15928
G-CSF Gen 2	6 hours	0	3337
	Day 1	0	3733
	Day 2	150	974
	Day 3	213	4972
	Day 4	1400	4122
	Day 5	350	2906
mCherry	6 hours	0	3278
	Day 1	238	3893
	Day 2	113	1833
	Day 3	413	25539
	Day 4	413	29233
	Day 5	213	20178
L2000	6 hours	0	3270
	Day 1	13	3933
	Day 2	388	567
	Day 3	338	1517
	Day 4	475	1594
	Day 5	263	1561

Example 66. *In vivo* detection of Innate Immune Response

[0001475] In an effort to distinguish the importance of different chemical modification of mRNA on *in vivo* protein production and cytokine response *in vivo*, female BALB/C mice (n=5) are injected intramuscularly with G-CSF mRNA (G-CSF mRNA unmod)

(mRNA sequence shown in SEQ ID NO: 21438; polyA tail of approximately 160 nucleotides not shown in sequence;) with a 5'cap of Cap1 , G-CSF mRNA fully modified with 5-methylcytosine and pseudouridine (G-CSF mRNA 5mc/pU), G-CSF mRNA fully modified with 5-methylcytosine and NI-methyl-pseudouridine with (G-CSF mRNA 5mc/N1pU) or without a 5' cap (G-CSF mRNA 5mc/N1 pU no cap) or a control of either R848 or 5% sucrose as described in Table 101.

Table 101. Dosing Chart

Formulation	Route	Dose (ug/mouse)	Dose (ul)
G-CSF mRNA unmod	I.M.	200	50
G-CSF mRNA 5mc/pU	I.M.	200	50
G-CSF mRNA 5mc/N1pU	I.M.	200	50
G-CSF mRNA 5mc/N1pU no cap	I.M.	200	50
R848	I.M.	75	50
5% sucrose	I.M.	-	50
Untreated	I.M.	-	-

[0001476] Blood is collected at 8 hours after dosing. Using ELISA the protein levels of G-CSF, TNF-alpha and IFN-alpha is determined by ELISA. 8 hours after dosing, muscle is collected from the injection site and quantitative real time polymerase chain reaction (QPCR) is used to determine the mRNA levels of RIG-I, PKR, AIM-2, IFIT-1, OAS-2, MDA-5, IFN-beta, TNF-alpha, IL-6, G-CSF, CD45 in the muscle.

Example 67. In vivo detection of Innate Immune Response Study

[0001477] Female BALB/C mice (n=5) were injected intramuscularly with G-CSF mRNA (G-CSF mRNA unmod) (mRNA sequence shown in SEQ ID NO: 21438; polyA tail of approximately 160 nucleotides not shown in sequence;) with a 5'cap of Cap1 , G-CSF mRNA fully modified with 5-methylcytosine and pseudouridine (G-CSF mRNA 5mc/pU), G-CSF mRNA fully modified with 5-methylcytosine and NI-methyl-pseudouridine with (G-CSF mRNA 5mc/N1pU) or without a 5' cap (G-CSF mRNA 5mc/N1 pU no cap) or a control of either R848 or 5% sucrose as described in Table 102. Blood is collected at 8 hours after dosing and using ELISA the protein levels of G-CSF and interferon-alpha (IFN-alpha) is determined by ELISA and are shown in Table 102.

[0001478] As shown in Table 102, unmodified, 5mc/pU, and 5mc/NlpU modified G-CSF mRNA resulted in human G-CSF expression in mouse serum. The uncapped 5mC/NlpU modified G-CSF mRNA showed no human G-CSF expression in serum, highlighting the importance of having a 5' cap structure for protein translation.

[0001479] As expected, no human G-CSF protein was expressed in the R848, 5% sucrose only, and untreated groups. Importantly, significant differences were seen in cytokine production as measured by mouse IFN-alpha in the serum. As expected, unmodified G-CSF mRNA demonstrated a robust cytokine response *in vivo* (greater than the R848 positive control). The 5mc/pU modified G-CSF mRNA did show a low but detectable cytokine response *in vivo*, while the 5mc/NlpU modified mRNA showed no detectable IFN-alpha in the serum (and same as vehicle or untreated animals).

[0001480] Also, the response of 5mc/NlpU modified mRNA was the same regardless of whether it was capped or not. These *in vivo* results reinforce the conclusion that 1) that unmodified mRNA produce a robust innate immune response, 2) that this is reduced, but not abolished, through 100% incorporation of 5mc/pU modification, and 3) that incorporation of 5mc/NlpU modifications results in no detectable cytokine response.

[0001481] Lastly, given that these injections are in 5% sucrose (which has no effect by itself), these result should accurately reflect the immunostimulatory potential of these modifications.

[0001482] From the data it is evident that NlpU modified molecules produce more protein while concomitantly having little or no effect on IFN-alpha expression. It is also evident that capping is required for protein production for this chemical modification. The Protein: Cytokine Ratio of 748 as compared to the PC Ratio for the unmodified mRNA (PC=9) means that this chemical modification is far superior as related to the effects or biological implications associated with IFN-alpha.

Table 102. Human G-CSF and Mouse IFN-alpha in serum

Formulation	Route	Dose (ug/mouse)	Dose (ul)	G-CSF protein (pg/ml)	IFN-alpha expression (pg/ml)	PC Ratio
G-CSF mRNA unmod	I.M.	200	50	605.6	67.01	9
G-CSF mRNA 5mc/pU	I.M.	200	50	356.5	8.87	40
G-CSF mRNA 5mc/NlpU	I.M.	200	50	748.1	0	748
G-CSF mRNA 5mc/NlpU no cap	I.M.	200	50	6.5	0	6.5

R848	I.M.	75	50	3.4	40.97	.08
5% sucrose	I.M.	-	50	0	1.49	0
Untreated	I.M.	-	-	0	0	0

Example 68: In Vivo Delivery of Modified RNA

[0001483] Protein production of modified mRNA was evaluated by delivering modified G-CSF mRNA or modified Factor IX mRNA to female Sprague Dawley rats (n=6). Rats were injected with 400 ug in 100 ul of G-CSF mRNA (mRNA sequence shown in SEQ ID NO: 21438; polyA tail of approximately 160 nucleotides not shown in sequence; 5'cap, Cap1) fully modified with 5-methylcytosine and pseudouridine (G-CSF Gen1), G-CSF mRNA fully modified with 5-methylcytosine and N1-methyl-pseudouridine (G-CSF Gen2) or Factor IX mRNA (mRNA sequence shown in SEQ ID NO: 1622; polyA tail of approximately 160 nucleotides not shown in sequence; 5'cap, Cap1) fully modified with 5-methylcytosine and pseudouridine (Factor IX Gen1) reconstituted from the lyophilized form in 5% sucrose. Blood was collected 8 hours after injection and the G-CSF protein level in serum was measured by ELISA. Table 103 shows the G-CSF protein levels in serum after 8 hours.

[0001484] These results demonstrate that both G-CSF Gen 1 and G-CSF Gen 2 modified mRNA can produce human G-CSF protein in a rat following a single intramuscular injection, and that human G-CSF protein production is improved when using Gen 2 chemistry over Gen 1 chemistry.

Table 103. G-CSF Protein in Rat Serum (I.M. Injection Route)

Formulation	G-CSF protein (pg/ml)
G-CSF Gen1	19.37
G-CSF Gen2	64.72
Factor IX Gen 1	2.25

Example 69. Chemical Modification: In vitro studies

A. In vitro Screening in PBMC

[0001485] 500 ng of G-CSF (mRNA sequence shown in SEQ ID NO: 21438; polyA tail of approximately 160 nucleotides not shown in sequence; 5'cap, Cap1) mRNA fully modified with the chemical modification outlined Tables 104 and 105 was transfected with 0.4 uL Lipofectamine 2000 into peripheral blood mononuclear cells (PBMC) from three normal blood donors. Control samples of LPS, R848, P(I)P(C) and mCherry

(mRNA sequence shown in SEQ ID NO: 21439; polyA tail of approximately 160 nucleotides not shown in sequence, 5'cap, Cap1; fully modified with 5-methylcytosine and pseudouridine) were also analyzed. The supernatant was harvested and stored frozen until analyzed by ELISA to determine the G-CSF protein expression, and the induction of the cytokines interferon-alpha (IFN-a) and tumor necrosis factor alpha (TNF-a). The protein expression of G-CSF is shown in Table 104, the expression of IFN-a and TNF-a is shown in Table 105.

[0001486] The data in Table 104 demonstrates that many, but not all, chemical modifications can be used to productively produce human G-CSF in PBMC. Of note, 100% N1-methyl-pseudouridine substitution demonstrates the highest level of human G-CSF production (almost 10-fold higher than pseudouridine itself). When N1-methyl-pseudouridine is used in combination with 5-methylcytosine a high level of human G-CSF protein is also produced (this is also higher than when pseudouridine is used in combination with 5 methylcytosine).

[0001487] Given the inverse relationship between protein production and cytokine production in PBMC, a similar trend is also seen in Table 105, where 100% substitution with N1-methyl-pseudouridine results no cytokine induction (similar to transfection only controls) and pseudouridine shows detectable cytokine induction which is above background.

[0001488] Other modifications such as N6-methyladenosine and alpha-thiocytidine appear to increase cytokine stimulation.

Table 104. Chemical Modifications and G-CSF Protein Expression

Chemical Modifications	G-CSF Protein Expression (pg/ml)		
	Donor 1	Donor 2	Donor 3
Pseudouridine	2477	1,909	1,498
5-methyluridine	318	359	345
N1-methyl-pseudouridine	21,495	16,550	12,441
2-thiouridine	932	1,000	600
4-thiouridine	5	391	218
5-methoxyuridine	2,964	1,832	1,800
5-methylcytosine and pseudouridine (1 st set)	2,632	1,955	1,373
5-methylcytosine and N1-methyl-pseudouridine (1 st set)	10,232	7,245	6,214
2'Fluoroguanosine	59	186	177

2'Fluorouridine	118	209	191
5-methylcytosine and pseudouridine (2 nd set)	1,682	1,382	1,036
5-methylcytosine and N1-methyl-pseudouridine (2 nd set)	9,564	8,509	7,141
5-bromouridine	314	482	291
5-(2-carbomethoxyvinyl)uridine	77	286	177
5-[3(1-E-propenylamino)uridine	541	491	550
α -thiocytidine	105	264	245
5-methylcytosine and pseudouridine (3 rd set)	1,595	1,432	955
N1-methyladenosine	182	177	191
N6-methyladenosine	100	168	200
5-methylcytidine	291	277	359
N4-acetylcytidine	50	136	36
5-formylcytidine	18	205	23
5-methylcytosine and pseudouridine (4 th set)	264	350	182
5-methylcytosine and N1-methyl-pseudouridine (4 th set)	9,505	6,927	5,405
LPS	1,209	786	636
mCherry	5	168	164
R848	709	732	636
P(I)P(C)	5	186	182

Table 105. Chemical Modifications and Cytokine Expression

Chemical Modifications	IFN- α Expression (pg/ml)			TNF- α Expression (pg/ml)		
	Donor 1	Donor 2	Donor 3	Donor 1	Donor 2	Donor 3
Pseudouridine	120	77	171	36	81	126
5-methyluridine	245	135	334	94	100	157
N1-methyl-pseudouridine	26	75	138	101	106	134
2-thiouridine	100	108	154	133	133	141
4-thiouridine	463	258	659	169	126	254
5-methoxyuridine	0	64	133	39	74	111
5-methylcytosine and pseudouridine (1 st set)	88	94	148	64	89	121
5-methylcytosine and N1-methyl-pseudouridine (1 st set)	0	60	136	54	79	126
2'Fluoroguanosine	107	97	194	91	94	141
2'Fluorouridine	158	103	178	164	121	156
5-methylcytosine and pseudouridine (2 nd set)	133	92	167	99	111	150
5-methylcytosine and N1-methyl-pseudouridine (2 nd set)	0	66	140	54	97	149

set)						
5-bromouridine	95	86	181	87	106	157
5-(2-carbomethoxyvinyl)uridine	0	61	130	40	81	116
5-[3(1-E-propenylamino)uridine	0	58	132	71	90	119
α -thiocytidine	1,138	565	695	300	273	277
5-methylcytosine and pseudouridine (3 rd set)	88	75	150	84	89	130
N1-methyladenosine	322	255	377	256	157	294
N6-methyladenosine	1,935	1,065	1,492	1,080	630	857
5-methylcytidine	643	359	529	176	136	193
N4-acetylcytidine	789	593	431	263	67	207
5-formylcytidine	180	93	88	136	30	40
5-methylcytosine and pseudouridine (4 th set)	131	28	18	53	24	29
5-methylcytosine and N1-methyl-pseudouridine (4 th set)	0	0	0	36	14	13
LPS	0	67	146	7,004	3,974	4,020
mCherry	100	75	143	67	100	133
R848	674	619	562	11,179	8,546	9,907
P(I)P(C)	470	117	362	249	177	197

B. *In vitro* Screening in HeLa Cells

[0001489] The day before transfection, 20,000 HeLa cells (ATCC no. CCL-2; Manassas, VA) were harvested by treatment with Trypsin-EDTA solution (LifeTechnologies, Grand Island, NY) and seeded in a total volume of 100ul EMEM medium (supplemented with 10%FCS and 1x Glutamax) per well in a 96-well cell culture plate (Corning, Manassas, VA). The cells were grown at 37oG in 5% CO₂ atmosphere overnight. Next day, 83 ng of Luciferase modified RNA (mRNA sequence shown in SEQ ID NO: 21446; polyA tail of approximately 160 nucleotides not shown in sequence; 5'cap, Cap1) with the chemical modification described in Table 106, were diluted in 10ul final volume of OPTI-MEM (LifeTechnologies, Grand Island, NY).

[0001490] Lipofectamine 2000 (LifeTechnologies, Grand Island, NY) was used as transfection reagent and 0.2 ul were diluted in 10 ul final volume of OPTI-MEM. After 5 minutes of incubation at room temperature, both solutions were combined and incubated

an additional 15 minute at room temperature. Then the 20ul combined solution was added to the 100ul cell culture medium containing the HeLa cells and incubated at room temperature.

[0001491] After 18 to 22 hours of incubation cells expressing luciferase were lysed with 100 ul of Passive Lysis Buffer (Promega, Madison, WI) according to manufacturer instructions. Aliquots of the lysates were transferred to white opaque polystyrene 96-well plates (Corning, Manassas, VA) and combined with 100 ul complete luciferase assay solution (Promega, Madison, WI). The lysate volumes were adjusted or diluted until no more than 2 mio relative light units (RLU) per well were detected for the strongest signal producing samples and the RLUs for each chemistry tested are shown in Table 106. The plate reader was a BioTek Synergy HI (BioTek, Winooski, VT). The background signal of the plates without reagent was about 200 relative light units per well.

[0001492] These results demonstrate that many, but not all, chemical modifications can be used to productively produce human G-CSF in HeLa cells. Of note, 100% N1-methyl-pseudouridine substitution demonstrates the highest level of human G-CSF production.

Table 106. Relative Light Units of Luciferase

Chemical Modification	RLU
N6-methyladenosine (m6a)	534
5-methylcytidine (m5c)	138,428
N4-acetylcytidine (ac4c)	235,412
5-formyleytidine (f5c)	436
5-methylcytosine/pseudouridine, test A1	48,659
5-methylcytosine/N1-methyl-pseudouridine, test A1	190,924
Pseudouridine	655,632
1-methylpseudouridine (m1u)	1,517,998
2-thiouridine (s2u)	3387
5-methoxyuridine (mo5u)	253,719
5-methylcytosine/pseudouridine, test B1	317,744
5-methylcytosine/N1-methyl-pseudouridine, test B1	265,871
5-Bromo-uridine	43,276
5 (2 carbovinyl) uridine	531
5 (3-1E propenyl Amino) uridine	446
5-methylcytosine/pseudouridine, test A2	295,824
5-methylcytosine/N1-methyl-pseudouridine, test A2	233,921

5-methyluridine	50,932
α -Thio-cytidine	26,358
5-methylcytosine/pseudouridine, test B2	481,477
5-methylcytosine/N1-methyl-pseudouridine, test B2	271,989
5-methylcytosine/pseudouridine, test A3	438,831
5-methylcytosine/N1-methyl-pseudouridine, test A3	277,499
Unmodified Luciferase	234,802

C. In vitro Screening in Rabbit Reticulocyte Lysates

[0001493] Luciferase mRNA (mRNA sequence shown in SEQ ID NO: 21446; polyA tail of approximately 160 nucleotides not shown in sequence; 5'cap, Cap1) was modified with the chemical modification listed in Table 107 and were diluted in sterile nuclease-free water to a final amount of 250 ng in 10 μ l. The diluted luciferase was added to 40 μ l of freshly prepared Rabbit Reticulocyte Lysate and the *in vitro* translation reaction was done in a standard 1.5 mL polypropylene reaction tube (Thermo Fisher Scientific, Waltham, MA) at 30°C in a dry heating block. The translation assay was done with the Rabbit Reticulocyte Lysate (nuclease-treated) kit (Promega, Madison, WI) according to the manufacturer's instructions. The reaction buffer was supplemented with a one-to-one blend of provided amino acid stock solutions devoid of either Leucine or Methionine resulting in a reaction mix containing sufficient amounts of both amino acids to allow effective *in vitro* translation.

[0001494] After 60 minutes of incubation, the reaction was stopped by placing the reaction tubes on ice. Aliquots of the *in vitro* translation reaction containing luciferase modified RNA were transferred to white opaque polystyrene 96-well plates (Corning, Manassas, VA) and combined with 100 μ l complete luciferase assay solution (Promega, Madison, WI). The volumes of the *in vitro* translation reactions were adjusted or diluted until no more than 2 mio relative light units (RLUs) per well were detected for the strongest signal producing samples and the RLUs for each chemistry tested are shown in Table 107. The plate reader was a BioTek Synergy HI (BioTek, Winooski, VT). The background signal of the plates without reagent was about 200 relative light units per well.

[0001495] These cell-free translation results very nicely correlate with the protein production results in HeLa, with the same modifications generally working or not

working in both systems. One notable exception is 5-formylcytidine modified luciferase mRNA which worked in the cell-free translation system, but not in the HeLa cell-based transfection system. A similar difference between the two assays was also seen with 5-formylcytidine modified G-CSF mRNA.

Table 107. Relative Light Units of Luciferase

Chemical Modification	RLU
N6-methyladenosine (m6a)	398
5-methylcytidine (m5c)	152,989
N4-acetylcytidine (ac4c)	60,879
5-formylcytidine (f5c)	55,208
5-methylcytosine/pseudouridine, test A1	349,398
5-methylcytosine/N1-methyl-pseudouridine, test A1	205,465
Pseudouridine	587,795
1-methylpseudouridine (m1u)	589,758
2-thiouridine (s2u)	708
5-methoxyuridine (mo5u)	288,647
5-methylcytosine/pseudouridine, test B1	454,662
5-methylcytosine/N1-methyl-pseudouridine, test B1	223,732
5-Bromo-uridine	221,879
5 (2 carbovinyl) uridine	225
5 (3-IE propenyl Amino) uridine	211
5-methylcytosine/pseudouridine, test A2	558,779
5-methylcytosine/N1-methyl-pseudouridine, test A2	333,082
5-methyluridine	214,680
α -Thio-cytidine	123,878
5-methylcytosine/pseudouridine, test B2	487,805
5-methylcytosine/N1-methyl-pseudouridine, test B2	154,096
5-methylcytosine/pseudouridine, test A3	413,535
5-methylcytosine/N1-methyl-pseudouridine, test A3	292,954
Unmodified Luciferase	225,986

Example 70. Chemical Modification: *In vivo* studies

A. *In vivo* Screening of G-CSF Modified mRNA
[0001496] Balb-C mice (n=4) are intramuscularly injected in each leg with modified G-CSF mRNA (mRNA sequence shown in SEQ ID NO: 21438; polyA tail of approximately 160 nucleotides not shown in sequence; 5'cap, Cap1), fully modified with

the chemical modifications outlined in Table 108, is formulated in IxPBS. A control of luciferase modified mRNA (mRNA sequence shown in SEQ ID NO: 21446; polyA tail of approximately 160 nucleotides not shown in sequence; 5'cap, Cap1; fully modified with pseudouridine and 5-methylcytosine) and a control of PBS are also tested. After 8 hours serum is collected to determine G-CSF protein levels cytokine levels by ELISA.

Table 108. G-CSF

mRNA	Chemical Modifications
G-CSF	Pseudouridine
G-CSF	5-methyluridine
G-CSF	2-thiouridine
G-CSF	4-thiouridine
G-CSF	5-methoxyuridine
G-CSF	2'-fluorouridine
G-CSF	5-bromouridine
G-CSF	5-[3(1-E-propenylamino)uridine)
G-CSF	alpha-thio-cytidine
G-CSF	5-methylcytidine
G-CSF	N4-acetylcytidine
G-CSF	Pseudouridine and 5-methylcytosine
G-CSF	N1-methyl-pseudouridine and 5-methylcytosine
Luciferase	Pseudouridine and 5-methylcytosine
PBS	None

B. *In vivo* Screening of Luciferase Modified mRNA

[0001497] Balb-C mice (n=4) were subcutaneously injected with 200ul containing 42 to 103 ug of modified luciferase mRNA (mRNA sequence shown in SEQ ID NO: 21446; polyA tail of approximately 160 nucleotides not shown in sequence; 5'cap, Cap1), fully modified with the chemical modifications outlined in Table 109, was formulated in IxPBS. A control of PBS was also tested. The dosages of the modified luciferase mRNA is also outlined in Table 109. 8 hours after dosing the mice were imaged to determine luciferase expression. Twenty minutes prior to imaging, mice were injected intraperitoneally with a D-luciferin solution at 150 mg/kg. Animals were then anesthetized and images were acquired with an IVIS Lumina II imaging system (Perkin Elmer). Bioluminescence was measured as total flux (photons/second) of the entire mouse.

[0001498] As demonstrated in Table 109, all luciferase mRNA modified chemistries demonstrated *in vivo* activity, with the exception of 2'-fluorouridine. In addition 1-

methylpseudouridine modified mRNA demonstrated very high expression of luciferase (5-fold greater expression than pseudouridine containing mRNA).

Table 109. Luciferase Screening

mRNA	Chemical Modifications	Dose (ug) of mRNA	Dose volume (ml)	Luciferase expression (photon/second)
Luciferase	5-methylcytidine	83	0.72	1.94E+07
Luciferase	N4-acetylcytidine	76	0.72	1.11E07
Luciferase	Pseudouridine	95	1.20	1.36E+07
Luciferase	1-methylpseudouridine	103	0.72	7.40E+07
Luciferase	5-methoxyuridine	95	1.22	3.32+07
Luciferase	5-methyluridine	94	0.86	7.42E+06
Luciferase	5-bromouridine	89	1.49	3.75E+07
Luciferase	2'-fluoroguanosine	42	0.72	5.88E+05
Luciferase	2'-fluorocytidine	47	0.72	4.21E+05
Luciferase	2'-flurorouridine	59	0.72	3.47E+05
PBS	None	-	0.72	3.16E+05

Example 71. In vivo Screening of Combination Luciferase Modified mRNA

[0001499] Balb-C mice (n=4) were subcutaneously injected with 200ul of 100 ug of modified luciferase mRNA (mRNA sequence shown in SEQ ID NO: 21446; polyA tail of approximately 160 nucleotides not shown in sequence; 5'cap, Cap1), fully modified with the chemical modifications outlined in Table 110, was formulated in 1x PBS. A control of PBS was also tested. 8 hours after dosing the mice were imaged to determine luciferase expression. Twenty minutes prior to imaging, mice were injected intraperitoneally with a D-luciferin solution at 150 mg/kg. Animals were then anesthetized and images were acquired with an IVIS Lumina II imaging system (Perkin Elmer). Bioluminescence was measured as total flux (photons/second) of the entire mouse.

[0001500] As demonstrated in Table 110, all luciferase mRNA modified chemistries (in combination) demonstrated *in vivo* activity. In addition the presence of N1-methyl-pseudouridine in the modified mRNA (with N4-acetylcytidine or 5 methylcytidine) demonstrated higher expression than when the same combinations were tested using with pseudouridine. Taken together, these data demonstrate that N1-methyl-pseudouridine containing luciferase mRNA results in improved protein expression in

vivo whether used alone (Table 109) or when used in combination with other modified nucleotides (Table 110).

Table 110. Luciferase Screening Combinations

mRNA	Chemical Modifications	Luciferase expression (photon/second)
Luciferase	N4-acetylcytidine/pseudouridine	4.18E+06
Luciferase	N4-acetylcytidine/N1-methyl-pseudouridine	2.88E+07
Luciferase	5-methylcytidine/5-methoxyuridine	3.48E+07
Luciferase	5-methylcytidine/5-methyluridine	1.44E+07
Luciferase	5-methylcytidine/where 50% of the uridine is replaced with 2-thiouridine	2.39E+06
Luciferase	5-methylcytidine/pseudouridine	2.36E+07
Luciferase	5-methylcytidine/N1-methyl-pseudouridine	4.15E+07
PBS	None	3.59E+05

Example 72. Innate Immune Response in BJ Fibroblasts

[0001501] Human primary foreskin fibroblasts (BJ fibroblasts) are obtained from American Type Culture Collection (ATCC) (catalog #CRL-2522) and grown in Eagle's Minimum Essential Medium (ATCC, cat# 30-2003) supplemented with 10% fetal bovine serum at 37°C, under 5% CO₂. BJ fibroblasts are seeded on a 24-well plate at a density of 130,000 cells per well in 0.5 ml of culture medium. 250 ng of modified G-CSF mRNA (mRNA sequence shown in SEQ ID NO: 21438; polyA tail of approximately 160 nucleotides not shown in sequence; 5'cap, Cap1) fully modified with 5-methylcytosine and pseudouridine (Gen1) or fully modified with 5-methylcytosine and N1-methyl-pseudouridine (Gen2) is transfected using Lipofectamine 2000 (Invitrogen, cat# 11668-019), following manufacturer's protocol. Control samples of Lipofectamine 2000 and unmodified G-CSF mRNA (natural G-CSF) are also transfected. The cells are transfected for five consecutive days. The transfection complexes are removed four hours after each round of transfection.

[0001502] The culture supernatant is assayed for secreted G-CSF (R&D Systems, catalog #DCS50), tumor necrosis factor-alpha (TNF-alpha) and interferon alpha (IFN-alpha) by ELISA every day after transfection following manufacturer's protocols. The cells are analyzed for viability using CELL TITER GLO® (Promega, catalog #G7570) 6 hrs and 18 hrs after the first round of transfection and every alternate day following that. At the

same time from the harvested cells, total RNA is isolated and treated with DNASE® using the RNAEASY micro kit (catalog #74004) following the manufacturer's protocol. 100 ng of total RNA is used for cDNA synthesis using the High Capacity cDNA Reverse Transcription kit (Applied Biosystems, cat #4368814) following the manufacturer's protocol. The cDNA is then analyzed for the expression of innate immune response genes by quantitative real time PCR using SybrGreen in a Biorad CFX 384 instrument following the manufacturer's protocol.

Example 73. *In vitro* Transcription with wild-type T7 polymerase

[0001503] Luciferase mRNA (mRNA sequence shown in SEQ ID NO: 21446; polyA tail of approximately 160 nucleotides not shown in sequence; 5'cap, Cap1) and G-CSF mRNA (mRNA sequence shown in SEQ ID NO: 21438; polyA tail of approximately 160 nucleotides not shown in sequence; 5'cap, Cap1) were fully modified with different chemistries and chemistry combinations listed in Tables 111-114 using wild-type T7 polymerase as previously described.

[0001504] The yield of the translation reactions was determined by spectrophometric measurement (OD260) and the yield for Luciferase is shown in Table 111 and G-CSF is shown in Table 113.

[0001505] The luciferase and G-CSF modified mRNA were also subjected to an enzymatic capping reaction and each modified mRNA capping reaction was evaluated for yield by spectrophometric measurement (OD260) and correct size assessed using bioanalyzer. The yield from the capping reaction for luciferase is shown in Table 112 and G-CSF is shown in Table 114.

Table 111. *In vitro* transcription chemistry for Luciferase

Chemical Modification	Yield (mg)
N6-methyladenosine	0.99
5-methylcytidine	1.29
N4-acetylcytidine	1.0
5-formylcytidine	0.55
Pseudouridine	2.0
N1-methyl-pseudouridine	1.43
2-thiouridine	1.56
5-methoxyuridine	2.35
5-methyluridine	1.01

α -Thio-cytidine	0.83
5-Br-uridine (5Bru)	1.96
5 (2 carbomethoxyvinyl) uridine	0.89
5 (3-IE propenyl Amino) uridine	2.01
N4-acetylcytidine/pseudouridine	1.34
N4-acetylcytidine/N 1-methyl-pseudouridine	1.26
5-methylcytidine/ 5-methoxyuridine	1.38
5-methylcytidine/ 5-bromouridine	0.12
5-methylcytidine/ 5-methyluridine	2.97
5-methylcytidine/ half of the uridines are modified with 2-thiouridine	1.59
5-methylcytidine/2-thiouridine	0.90
5-methylcytidine/pseudouridine	1.83
5-methylcytidine/N 1-methyl-pseudouridine	1.33

Table 112. Capping chemistry and yield for Luciferase modified mRNA

Chemical Modification	Yield (mg)
5-methylcytidine	1.02
N4-acetylcytidine	0.93
5-formylcytidine	0.55
Pseudouridine	2.07
N1-methyl-pseudouridine	1.27
2-thiouridine	1.44
5-methoxyuridine	2
5-methyluridine	0.8
α -Thio-cytidine	0.74
5-Br-uridine (5Bru)	1.29
5 (2 carbomethoxyvinyl) uridine	0.54
5 (3-1E propenyl Amino) uridine	1.39
N4-acetylcytidine/pseudouridine	0.99
N4-acetylcytidine/N1-methyl-pseudouridine	1.08
5-methylcytidine/5-methoxyuridine	1.13
5-methylcytidine/5-methyluridine	1.08
5-methylcytidine/ half of the uridines are modified with 2-thiouridine	1.2
5-methylcytidine/2-thiouridine	1.27
5-methylcytidine/pseudouridine	1.19
5-methylcytidine/N1-methyl-pseudouridine	1.04

Table 113. *In vitro* transcription chemistry and yield for G-CSF modified mRNA

Chemical Modification	Yield (mg)
N6-methyladenosine	1.57
5-methylcytidine	2.05

N4-acetylcytidine	3.13
5-formylcytidine	1.41
Pseudouridine	4.1
N 1-methyl-pseudouridine	3.24
2-thiouridine	3.46
5-methoxyuridine	2.57
5-methyluridine	4.27
4-thiouridine	1.45
2'-F-uridine	0.96
a-Thio-cytidine	2.29
2'-F-guanosine	0.6
N - 1-methyladenosine	0.63
5-Br-uridine (5Bru)	1.08
5 (2 carbomethoxyvinyl) uridine	1.8
5 (3-IE propenyl Amino) uridine	2.09
N4-acetylcytidine/pseudouridine	1.72
N4-acetylcytidine/N 1-methyl-pseudouridine	1.37
5-methylcytidine/ 5-methoxyuridine	1.85
5-methylcytidine/ 5-methyluridine	1.56
5-methylcytidine/ half of the uridines are modified with 2-thiouridine	1.84
5-methylcytidine/2-thiouridine	2.53
5-methylcytidine/pseudouridine	0.63
N4-acetylcytidine/2-thiouridine	1.3
N4-acetylcytidine/5-bromouridine	1.37
5-methylcytidine/N 1-methyl-pseudouridine	1.25
N4-acetylcytidine/pseudouridine	2.24

Table 114. Capping chemistry and yield for G-CSF modified mRNA

Chemical Modification	Yield (mg)
N6-methyladenosine	1.04
5-methylcytidine	1.08
N4-acetylcytidine	2.73
5-formylcytidine	0.95
Pseudouridine	3.88
N 1-methyl-pseudouridine	2.58
2-thiouridine	2.57
5-methoxyuridine	2.05
5-methyluridine	3.56
4-thiouridine	0.91
2'-F-uridine	0.54
a-Thio-cytidine	1.79
2'-F-guanosine	0.14
5-Br-uridine (5Bru)	0.79
5 (2 carbomethoxyvinyl) uridine	1.28
5 (3-IE propenyl Amino) uridine	1.78
N4-acetylcytidine/pseudouridine	0.29

N4-acetylcytidine/N ₁ -methyl-pseudouridine	0.33
5-methylcytidine/ 5-methoxyuridine	0.91
5-methylcytidine/ 5-methyluridine	0.61
5-methylcytidine/ half of the uridines are modified with 2-thiouridine	1.24
5-methylcytidine/pseudouridine	1.08
N4-acetylcytidine/2-thiouridine	1.34
N4-acetylcytidine/5-bromouridine	1.22
5-methylcytidine/N ₁ -methyl-pseudouridine	1.56

Example 74. *In vitro* Transcription with mutant T7 polymerase

[0001506] Luciferase mRNA (mRNA sequence shown in SEQ ID NO: 21446; polyA tail of approximately 160 nucleotides not shown in sequence; 5'cap, Cap1) and G-CSF mRNA (mRNA sequence shown in SEQ ID NO: 21438; polyA tail of approximately 160 nucleotides not shown in sequence; 5'cap, Cap1) were fully modified with different chemistries and chemistry combinations listed in Tables 115-118 using a mutant T7 polymerase (Durascribe® T7 Transcription kit (Cat. No. DS0 10925) (Epicentre®, Madison, WI).

[0001507] The yield of the translation reactions was determined by spectrophometric measurement (OD260) and the yield for Luciferase is shown in Tables 115 and G-CSF is shown in Tables 117.

[0001508] The luciferase and G-CSF modified mRNA were also subjected to an enzymatic capping reaction and each modified mRNA capping reaction was evaluated for yield by spectrophometric measurement (OD260) and correct size assessed using bioanalyzer. The yield from the capping reaction for luciferase is shown in Table 116 and G-CSF is shown in Table 118.

Table 115. *In vitro* transcription chemistry and yield for Luciferase modified mRNA

Chemical Modification	Yield (ug)
2'Fluorocytosine	71.4
2'Fluorouridine	57.5
5-methylcytosine/pseudouridine, test A	26.4
5-methylcytosine/N ₁ -methyl-pseudouridine, test A	73.3
N ₁ -acetylcytidine/2-fluorouridine	202.2
5-methylcytidine/2-fluorouridine	131.9
2-fluorocytosine/pseudouridine	119.3
2-fluorocytosine/N ₁ -methyl-pseudouridine	107.0
2-fluorocytosine/2-thiouridine	34.7
2-fluorocytosine/5-bromouridine	81.0

2-fluorocytosine/2-fluorouridine	80.4
2-fluoroguanine/5-methylcytosine	61.2
2-fluoroguanine/5-methylcytosine/pseudouridine	65.0
2-fluoroguanine/5-methylcytidine/N1-methyl-pseudouridine	41.2
2-fluoroguanine/pseudouridine	79.1
2-fluoroguanine/N1-methyl-pseudouridine	74.6
5-methylcytidine/pseudouridine, test B	91.8
5-methylcytidine/N1-methyl-pseudouridine, test B	72.4
2'fluoroadenosine	190.98

Table 116. Capping chemistry and yield for Luciferase modified mRNA

Chemical Modification	Yield (ug)
2'Fluorocytosine	19.2
2'Fluorouridine	16.7
5-methylcytosine/pseudouridine, test A	7.0
5-methylcytosine/N1-methyl-pseudouridine, test A	21.5
N1-acetylcytidine/2-fluorouridine	47.5
5-methylcytidine/2-fluorouridine	53.2
2-fluorocytosine/pseudouridine	58.4
2-fluorocytosine/N1-methyl-pseudouridine	26.2
2-fluorocytosine/2-thiouridine	12.9
2-fluorocytosine/5-bromouridine	26.5
2-fluorocytosine/2-fluorouridine	35.7
2-fluoroguanine/5-methylcytosine	24.7
2-fluoroguanine/5-methylcytosine/pseudouridine	32.3
2-fluoroguanine/5-methylcytidine/N1-methyl-pseudouridine	31.3
2-fluoroguanine/pseudouridine	20.9
2-fluoroguanine/N1-methyl-pseudouridine	29.8
5-methylcytidine/pseudouridine, test B	58.2
5-methylcytidine/N1-methyl-pseudouridine, test B	44.4

Table 117. *In vitro* transcription chemistry and yield for G-CSF modified mRNA

Chemical Modification	Yield (ug)
2'Fluorocytosine	56.5
2'Fluorouridine	79.4
5-methylcytosine/pseudouridine, test A	21.2
5-methylcytosine/N1-methyl-pseudouridine, test A	77.1
N1-acetylcytidine/2-fluorouridine	168.6
5-methylcytidine/2-fluorouridine	134.7
2-fluorocytosine/pseudouridine	97.8
2-fluorocytosine/N1-methyl-pseudouridine	103.1
2-fluorocytosine/2-thiouridine	58.8

2-fluorocytosine/5-bromouridine	88.8
2-fluorocytosine/2-fluorouridine	93.9
2-fluoroguanine/5-methylcytosine	97.3
2-fluoroguanine/5-methylcytosine/pseudouridine	96.0
2-fluoroguanine/5-methylcytidine/N1-methyl-pseudouridine	82.0
2-fluoroguanine/pseudouridine	68.0
2-fluoroguanine/N1-methyl-pseudouridine	59.3
5-methylcytidine/pseudouridine, test B	58.7
5-methylcytidine/N1-methyl-pseudouridine, test B	78.0

Table 118. Capping chemistry and yield for G-CSF modified mRNA

Chemical Modification	Yield (ug)
2'Fluorocytosine	16.9
2'Fluorouridine	17.0
5-methylcytosine/pseudouridine, test A	10.6
5-methylcytosine/N1-methyl-pseudouridine, test A	22.7
N1-acetylcytidine/2-fluorouridine	19.9
5-methylcytidine/2-fluorouridine	21.3
2-fluorocytosine/pseudouridine	65.2
2-fluorocytosine/N1-methyl-pseudouridine	58.9
2-fluorocytosine/2-thiouridine	41.2
2-fluorocytosine/5-bromouridine	35.8
2-fluorocytosine/2-fluorouridine	36.7
2-fluoroguanine/5-methylcytosine	36.6
2-fluoroguanine/5-methylcytosine/pseudouridine	37.3
2-fluoroguanine/5-methylcytidine/N1-methyl-pseudouridine	30.7
2-fluoroguanine/pseudouridine	29.0
2-fluoroguanine/N1-methyl-pseudouridine	22.7
5-methylcytidine/pseudouridine, test B	60.4
5-methylcytidine/N1-methyl-pseudouridine, test B	33.0

Example 75. 2'O-methyl and 2'Fluoro compounds

[0001509] Luciferase mRNA (mRNA sequence shown in SEQ ID NO: 21446; polyA tail of approximately 160 nucleotides not shown in sequence; 5'cap, Cap1) were produced as fully modified versions with the chemistries in Table 119 and transcribed using mutant T7 polymerase (Durascribe® T7 Transcription kit (Cat. No. DS0 10925) (Epicentre®, Madison, WI). 2' fluoro-containing mRNA were made using Durascribe T7, however, 2'O-methyl-containing mRNA could not be transcribed using Durascribe T7.

[0001510] Incorporation of 2'O-methyl modified mRNA might possibly be accomplished using other mutant T7 polymerases (Nat Biotechnol. (2004) 22:1 155-1 160; Nucleic Acids Res. (2002) 30:e138) or US Patent 7,309,570, the contents of each of which are incorporated herein by reference in their entirety. Alternatively, 2'OMe modifications could be introduced post-transcriptionally using enzymatic means.

[0001511] Introduction of modifications on the 2' group of the sugar has many potential advantages. 2'OMe substitutions, like 2' fluoro substitutions are known to protect against nucleases and also have been shown to abolish innate immune recognition when incorporated into other nucleic acids such as siRNA and anti-sense (incorporated in its entirety, Crooke, ed. Antisense Drug Technology, 2nd edition; Boca Raton: CRC press).

[0001512] The 2'Fluoro-modified mRNA were then transfected into HeLa cells to assess protein production in a cell context and the same mRNA were also assessed in a cell-free rabbit reticulocyte system. A control of unmodified luciferase (natural luciferase) was used for both transcription experiments, a control of untreated and mock transfected (Lipofectamine 2000 alone) were also analyzed for the HeLa transfection and a control of no RNA was analyzed for the rabbit reticulocytes.

[0001513] For the HeLa transfection experiments, the day before transfection, 20,000 HeLa cells (ATCC no. CCL-2; Manassas, VA) were harvested by treatment with Trypsin-EDTA solution (LifeTechnologies, Grand Island, NY) and seeded in a total volume of 100ul EMEM medium (supplemented with 10%FCS and 1x Glutamax) per well in a 96-well cell culture plate (Corning, Manassas, VA). The cells were grown at 37°C in 5% CO₂ atmosphere overnight. Next day, 83 ng of the 2'fluoro-containing luciferase modified RNA (mRNA sequence shown in SEQ ID NO: 21446; polyA tail of approximately 160 nucleotides not shown in sequence; 5'cap, Cap1) with the chemical modification described in Table 119, were diluted in 10ul final volume of OPTI-MEM (LifeTechnologies, Grand Island, NY). Lipofectamine 2000 (LifeTechnologies, Grand Island, NY) was used as transfection reagent and 0.2 ul were diluted in 10 ul final volume of OPTI-MEM. After 5 minutes of incubation at room temperature, both solutions were combined and incubated an additional 15 minute at room temperature. Then the 20ul combined solution was added to the 100ul cell culture medium containing the HeLa cells and incubated at room temperature. After 18 to 22 hours of incubation cells expressing

luciferase were lysed with 100 ul of Passive Lysis Buffer (Promega, Madison, WI) according to manufacturer instructions. Aliquots of the lysates were transferred to white opaque polystyrene 96-well plates (Corning, Manassas, VA) and combined with 100 ul complete luciferase assay solution (Promega, Madison, WI). The lysate volumes were adjusted or diluted until no more than 2 mio relative light units (RLU) per well were detected for the strongest signal producing samples and the RLUs for each chemistry tested are shown in Table 119. The plate reader was a BioTek Synergy HI (BioTek, Winooski, VT). The background signal of the plates without reagent was about 200 relative light units per well.

[0001514] For the rabbit reticulocyte lysate assay, 2'-fluoro-containing luciferase mRNA were diluted in sterile nuclease-free water to a final amount of 250 ng in 10 ul and added to 40 ul of freshly prepared Rabbit Reticulocyte Lysate and the *in vitro* translation reaction was done in a standard 1.5 mL polypropylene reaction tube (Thermo Fisher Scientific, Waltham, MA) at 30°C in a dry heating block. The translation assay was done with the Rabbit Reticulocyte Lysate (nuclease-treated) kit (Promega, Madison, WI) according to the manufacturer's instructions. The reaction buffer was supplemented with a one-to-one blend of provided amino acid stock solutions devoid of either Leucine or Methionine resulting in a reaction mix containing sufficient amounts of both amino acids to allow effective *in vitro* translation. After 60 minutes of incubation, the reaction was stopped by placing the reaction tubes on ice.

[0001515] Aliquots of the *in vitro* translation reaction containing luciferase modified RNA were transferred to white opaque polystyrene 96-well plates (Corning, Manassas, VA) and combined with 100ul complete luciferase assay solution (Promega, Madison, WI). The volumes of the *in vitro* translation reactions were adjusted or diluted until no more than 2 mio relative light units (RLUs) per well were detected for the strongest signal producing samples and the RLUs for each chemistry tested are shown in Table 120. The plate reader was a BioTek Synergy HI (BioTek, Winooski, VT). The background signal of the plates without reagent was about 160 relative light units per well.

[0001516] As can be seen in Table 119 and 120, multiple 2'Fluoro-containing compounds are active *in vitro* and produce luciferase protein.

Table 119. HeLa Cells

Chemical Modification	Concentration (ug/ml)	Volume (ul)	Yield (ug)	RLU
2'Fluoroadenosine	381.96	500	190.98	388.5
2'Fluorocytosine	654.56	500	327.28	2420
2'Fluoroguanine	541,795	500	270.90	11,705.5
2'Flurorouridine	944.005	500	472.00	6767.5
Natural luciferase	N/A	N/A	N/A	133,853.5
Mock	N/A	N/A	N/A	340
Untreated	N/A	N/A	N/A	238

Table 120. Rabbit Reticulysates

Chemical Modification	RLU
2'Fluoroadenosine	162
2'Fluorocytosine	208
2'Fluoroguanine	371,509
2'Flurorouridine	258
Natural luciferase	2,159,968
No RNA	156

Example 76. Luciferase in HeLa Cells using a combination of modifications

[0001517] To evaluate using of 2'fluoro-modified mRNA in combination with other modification a series of mRNA were transcribed using either wild-type T7 polymerase (non-fluoro-containing compounds) or using mutant T7 polymerases (fluoro-containing compounds) as described in Example 75. All modified mRNA were tested by in vitro transfection in HeLa cells.

[0001518] The day before transfection, 20,000 HeLa cells (ATCC no. CCL-2; Manassas, VA) were harvested by treatment with Trypsin-EDTA solution (LifeTechnologies, Grand Island, NY) and seeded in a total volume of 100ul EMEM medium (supplemented with 10%FCS and 1x Glutamax) per well in a 96-well cell culture plate (Corning, Manassas, VA). The cells were grown at 37oG in 5% CO₂ atmosphere overnight. Next day, 83 ng of Luciferase modified RNA (mRNA sequence shown in SEQ ID NO: 21446; polyA tail of approximately 160 nucleotides not shown in sequence; 5'cap, Cap1) with the chemical modification described in Table 121, were diluted in 10ul final volume of OPTI-MEM (LifeTechnologies, Grand Island, NY). Lipofectamine 2000 (LifeTechnologies, Grand Island, NY) was used as transfection reagent and 0.2 ul were diluted in 10 ul final volume of OPTI-MEM. After 5 minutes of incubation at room temperature, both solutions were combined and incubated an additional 15 minute at room temperature. Then the 20ul

combined solution was added to the 100ul cell culture medium containing the HeLa cells and incubated at room temperature.

[0001519] After 18 to 22 hours of incubation cells expressing luciferase were lysed with 100 ul of Passive Lysis Buffer (Promega, Madison, WI) according to manufacturer instructions. Aliquots of the lysates were transferred to white opaque polystyrene 96-well plates (Corning, Manassas, VA) and combined with 100 ul complete luciferase assay solution (Promega, Madison, WI). The lysate volumes were adjusted or diluted until no more than 2 mio relative light units (RLU) per well were detected for the strongest signal producing samples and the RLUs for each chemistry tested are shown in Table 121. The plate reader was a BioTek Synergy HI (BioTek, Winooski, VT). The background signal of the plates without reagent was about 200 relative light units per well.

[0001520] As evidenced in Table 121, most combinations of modifications resulted in mRNA which produced functional luciferase protein, including all the non-fluoro containing compounds and many of the combinations containing 2'fluoro modifications.

Table 121. Luciferase

Chemical Modification	RLU
N4-acetylcytidine/pseudouridine	113,796
N4-acetylcytidine/N1-methyl-pseudouridine	316,326
5-methylcytidine/5-methoxyuridine	24,948
5-methylcytidine/5-methyluridine	43,675
5-methylcytidine/half of the uridines modified with 50% 2-thiouridine	41,601
5-methylcytidine/2-thiouridine	1,102
5-methylcytidine/pseudouridine	51,035
5-methylcytidine/N1-methyl-pseudouridine	152,151
N4-acetylcytidine/2'Fluorouridine triphosphate	288
5-methylcytidine/2'Fluorouridine triphosphate	269
2'Fluorocytosine triphosphate /pseudouridine	260
2'Fluorocytosine triphosphate /N1-methyl-pseudouridine	412
2'Fluorocytosine triphosphate/2-thiouridine	427
2'Fluorocytosine triphosphate/5-bromouridine	253
2'Fluorocytosine triphosphate /2'Fluorouridine triphosphate	184
2'Fluoroguanine triphosphate/5-methylcytidine	321
2'Fluoroguanine triphosphate/5-methylcytidine/Pseudouridine	207
2'Fluoroguanine /5-methylcytidine/N1-methyl-psuedouridine	235
2'Fluoroguanine/pseudouridine	218
2'Fluoroguanine/N1-methyl-psuedouridine	247
5-methylcytidine/pseudouridine, test A	13,833
5-methylcytidine/N1-methyl-pseudouridine, test A	598
2'Fluorocytosine triphosphate	201

2'F fluorouridine triphosphate	305
5-methylcytidine/pseudouridine, test B	115,401
5-methylcytidine/N1-methyl-pseudouridine, test B	21,034
Natural luciferase	30,801
Untreated	344
Mock	262

Example 77. G-CSF *In Vitro* Transcription

[0001521] To assess the activity of all our different chemical modifications in the context of a second open reading frame, we replicated experiments previously conducted using luciferase mRNA, with human G-CSF mRNA. G-CSF mRNA (mRNA sequence shown in SEQ ID NO: 21438; polyA tail of approximately 160 nucleotides not shown in sequence; 5'cap, Cap1) were fully modified with the chemistries in Tables 122 and 123 using wild-type T7 polymerase (for all non-fluoro-containing compounds) or mutant T7 polymerase (for all fluoro-containing compounds). The mutant T7 polymerase was obtained commercially (Durascribe® T7 Transcription kit (Cat. No. DS010925) (Epicentre®, Madison, WI).

[0001522] The modified RNA in Tables 122 and 123 were transfected *in vitro* in HeLa cells or added to rabbit reticulocytes (250ng of modified mRNA) as indicated. A control of untreated, mock transfected (transfection reagent alone), G-CSF fully modified with 5-methylcytosine and N1-methyl-pseudouridine or luciferase control (mRNA sequence shown in SEQ ID NO: 21446; polyA tail of approximately 160 nucleotides not shown in sequence; 5'cap, Cap1) fully modified with 5-methylcytosine and N1-methyl-pseudouridine were also analyzed. The expression of G-CSF protein was determined by ELISA and the values are shown in Tables 122 and 123. In Table 122, "NT" means not tested.

[0001523] As shown in Table 123, many, but not all, chemical modifications resulted in human G-CSF protein production. These results from cell-based and cell-free translation systems correlate very nicely with the same modifications generally working or not working in both systems. One notable exception is 5-formylcytidine modified G-CSF mRNA which worked in the cell-free translation system, but not in the HeLa cell-based transfection system. A similar difference between the two assays was also seen with 5-formylcytidine modified luciferase mRNA.

[0001524] As demonstrated in Table 123, many, but not all, G-CSF mRNA modified chemistries (when used in combination) demonstrated *in vivo* activity. In addition the presence of N1-methyl-pseudouridine in the modified mRNA (with N4-acetylcytidine or 5 methylcytidine) demonstrated higher expression than when the same combinations were tested using with pseudouridine. Taken together, these data demonstrate that N1-methyl-pseudouridine containing G-CSF mRNA results in improved protein expression *in vitro*.

Table 122. G-CSF Expression

Chemical Modification	G-CSF protein (pg/ml) HeLa cells	G-CSF protein (pg/ml) Rabbit reticulysates cells
Pseudouridine	1,150,909	147,875
5-methyluridine	347,045	147,250
2-thiouridine	417,273	18,375
N1-methyl-pseudouridine	NT	230,000
4-thiouridine	107,273	52,375
5-methoxyuridine	1,715,909	201,750
5-methylcytosine/pseudouridine, Test A	609,545	119,750
5-methylcytosine/N1-methyl-pseudouridine , Test A	1,534,318	110,500
2'-Fluoro-guanosine	11,818	0
2'-Fluoro-uridine	60,455	0
5-methylcytosine/pseudouridine, Test B	358,182	57,875
5-methylcytosine/N1-methyl-pseudouridine , Test B	1,568,636	76,750
5-Bromo-uridine	186,591	72,000
5-(2carbomethoxyvinyl) uridine	1,364	0
5-[3(1-E-propenylamino) uridine	27,955	32,625
α -thio-cytidine	120,455	42,625
5-methylcytosine/pseudouridine, Test C	882,500	49,250
N1-methyl-adenosine	4,773	0
N6-methyl-adenosine	1,591	0
5-methyl-cytidine	646,591	79,375
N4-acetylcytidine	39,545	8,000
5-formyl-cytidine	0	24,000
5-methylcytosine/pseudouridine, Test D	87,045	47,750
5-methylcytosine/N1-methyl-pseudouridine , Test D	1,168,864	97,125
Mock	909	682
Untreated	0	0
5-methylcytosine/N1-methyl-pseudouridine , Control	1,106,591	NT
Luciferase control	NT	0

Table 123. Combination Chemistries in HeLa cells

Chemical Modification	G-CSF protein (pg/ml) HeLa cells
N4-acetylcytidine/pseudouridine	537,273
N4-acetylcytidine/N1-methyl-pseudouridine	1,091,818
5-methylcytidine/5-methoxyuridine	516,136
5-methylcytidine/5-bromouridine	48,864
5-methylcytidine/5-methyluridine	207,500
5-methylcytidine/2-thiouridine	33,409
N4-acetylcytidine/5-bromouridine	211,591
N4-acetylcytidine/2-thiouridine	46,136
5-methylcytosine/pseudouridine	301,364
5-methylcytosine/N1-methyl-pseudouridine	1,017,727
N4-acetylcytidine/2'Fluorouridine triphosphate	62,273
5-methylcytidine/2'Fluorouridine triphosphate	49,318
2'Fluorocytosine triphosphate/pseudouridine	7,955
2'Fluorocytosine triphosphate/N1-methyl-pseudouridine	1,364
2'Fluorocytosine triphosphate/2-thiouridine	0
2'Fluorocytosine triphosphate/5-bromouridine	1,818
2'Fluorocytosine triphosphate/2'Fluorouridine triphosphate	909
2'Fluoroguanine triphosphate/5-methylcytidine	0
2'Fluoroguanine triphosphate/5-methylcytidine/pseudouridine	0
2'Fluoroguanine triphosphate /5-methylcytidine/N1 methylpseudouridine	1,818
2'Fluoroguanine triphosphate/pseudouridine	1,136
2'Fluoroguanine triphosphate/2'Fluorocytosine triphosphate/N1-methyl-pseudouridine	0
5-methylcytidine/pseudouridine	617,727
5-methylcytidine/N1-methyl-pseudouridine	747,045
5-methylcytidine/pseudouridine	475,455
5-methylcytidine/N1-methyl-pseudouridine	689,091
5-methylcytosine/N1-methyl-pseudouridine, Control 1	848,409
5-methylcytosine/N1-methyl-pseudouridine, Control 2	581,818
Mock	682
Untreated	0
Luciferase 2'Fluorocytosine triphosphate	0
Luciferase 2'Fluorouridine triphosphate	0

Example 78. Screening of Chemistries

[0001525] The tables listed in below (Tables 124-126) summarize much of the *in vitro* and *in vitro* screening data with the different compounds presented in the previous examples. A good correlation exists between cell-based and cell-free translation assays. The same chemistry substitutions generally show good concordance whether tested in the

context of luciferase or G-CSF mRNA. Lastly, NI-methyl-pseudouridine containing mRNA show a very high level of protein expression with little to no detectable cytokine stimulation *in vitro* and *in vivo*, and is superior to mRNA containing pseudouridine both *in vitro* and *in vivo*.

[0001526] Luciferase mRNA (mRNA sequence shown in SEQ ID NO: 21446; polyA tail of approximately 160 nucleotides not shown in sequence; 5'cap, Cap1) and G-CSF mRNA (mRNA sequence shown in SEQ ID NO: 21438; polyA tail of approximately 160 nucleotides not shown in sequence; 5'cap, Cap1) were modified with naturally and non-naturally occurring chemistries described in Tables 124 and 125 or combination chemistries described in Table 126 and tested using methods described herein.

[0001527] In Tables 125 and 126, "*" refers to *in vitro* transcription reaction using a mutant T7 polymerase (Durascribe® T7 Transcription kit (Cat. No. DS0 10925) (Epicentre®, Madison, WI); "***" refers to the second result *in vitro* transcription reaction using a mutant T7 polymerase (Durascribe® T7 Transcription kit (Cat. No. DS0 10925) (Epicentre®, Madison, WI); "****" refers to production seen in cell free translations (rabbit reticulocyte lysates); the protein production of HeLa is judged by "+," "+/-" and "-"; when referring to G-CSF PBMC "++++" means greater than 6,000 pg/ml G-CSF, "+++ " means greater than 3,000 pg/ml G-CSF, "++" means greater than 1,500 pg/ml G-CSF, "+" means greater than 300 pg/ml G-CSF, "+/-" means 150-300 pg/ml G-CSF and the background was about 110 pg/ml; when referring to cytokine PBMC "++++" means greater than 1,000 pg/ml interferon-alpha (IFN-alpha), "+++ " means greater than 600 pg/ml IFN-alpha, "++" means greater than 300 pg/ml IFN-alpha, "+" means greater than 100 pg/ml IFN-alpha, "-" means less than 100 pg/ml and the background was about 70 pg/ml; and "NT" means not tested. In Table 125, the protein production was evaluated using a mutant T7 polymerase (Durascribe® T7 Transcription kit (Cat. No. DS0 10925) (Epicentre®, Madison, WI).

Table 124. Naturally Occurring

Common Name (symbol)	IVT (Luc)	IVT (G-CSF)	Protein (Luc; HeLa)	Protein (G-CSF; HeLa)	Protein (G-CSF; PBMC)	Cytokines (G-CSF; PBMC)	In Vivo Protein (Luc)	In Vivo Protein (G-CSF)
----------------------	-----------	-------------	---------------------	-----------------------	-----------------------	-------------------------	-----------------------	-------------------------

1-methyladenosine (m ¹ A)	Fail	Pass	NT	-	+/-	++	NT	NT
N ⁶ -methyladenosine (m ⁶ A)	Pass	Pass	-	-	+/-	++++	NT	NT
2'-O-methyladenosine (Am)	Fail*	Not Done	NT	NT	NT	NT	NT	NT
5-methylcytidine (m ⁵ C)	Pass	Pass	+	+	+	++	+	NT
2'-O-methylcytidine (Cm)	Fail*	Not Done	NT	NT	NT	NT	NT	NT
2-thiocytidine (s ² C)	Fail	Fail	NT	NT	NT	NT	NT	NT
N ⁴ -acetylcytidine (ac ⁴ C)	Pass	Pass	+	+	+/-	+++	+	NT
5-formylcytidine (f ⁵ C)	Pass	Pass	-***	-***	-	+	NT	NT
2'-O-methylguanosine (Gm)	Fail*	Not Done	NT	NT	NT	NT	NT	NT
inosine (I)	Fail	Fail	NT	NT	NT	NT	NT	NT
pseudouridine (Y)	Pass	Pass	+	+	++	+	+	NT
5-methyluridine (m ⁵ U)	Pass	Pass	+	+	+/-	+	NT	NT
2'-O-methyluridine (Um)	Fail*	Not Done	NT	NT	NT	NT	NT	NT
1-methylpseudouridine (m ¹ Y)	Pass	Pass	+	Not Done	++++	-	+	NT
2-thiouridine (s ² U)	Pass	Pass	-	+	+	+	NT	NT
4-thiouridine (s ⁴ U)	Fail	Pass		+	+/-	++	NT	NT
5-methoxyuridine (mo ⁵ U)	Pass	Pass	+	+	++	-	+	NT
3-methyluridine (m ³ U)	Fail	Fail	NT	NT	NT	NT	NT	NT

Table 125. Non-Naturally Occurring

Common Name	IVT (Luc)	IVT (G-CSF)	Protein (Luc; HeLa)	Protein (G-CSF; HeLa)	Protein (G-CSF; PBMC)	Cytokines (G-CSF; PBMC)	In Vivo Protein (Luc)	In Vivo Protein (G-CSF)
2'-F-ara-guanosine	Fail	Fail	NT	NT	NT	NT	NT	NT
2'-F-ara-adenosine	Fail	Fail	NT	NT	NT	NT	NT	NT

2'-F-ara-cytidine	Fail	Fail	NT	NT	NT	NT	NT	NT
2'-F-ara-uridine	Fail	Fail	NT	NT	NT	NT	NT	NT
2'-F-guanosine	Fail/Pass*	Pass/Fail**	+**	+/-	-	+	+	NT
2'-F-adenosine	Fail/Pass*	Fail/Fail**	-**	NT	NT	NT	NT	NT
2'-F-cytidine	Fail/Pass*	Fail/Pass**	+**	NT	NT	NT	+	NT
2'-F-uridine	Fail/Pass*	Pass/Pass**	+**	+	+/-	+	-	NT
2'-OH-ara-guanosine	Fail	Fail	NT	NT	NT	NT	NT	NT
2'-OH-ara-adenosine	Not Done	Not Done	NT	NT	NT	NT	NT	NT
2'-OH-ara-cytidine	Fail	Fail	NT	NT	NT	NT	NT	NT
2'-OH-ara-uridine	Fail	Fail	NT	NT	NT	NT	NT	NT
5-Br-Uridine	Pass	Pass	+	+	+	+	+	
5-(2-carbomethoxyvinyl) Uridine	Pass	Pass	-	-	+/-	-		
5-[3-(1-E-Propenylamino) Uridine (aka Chem 5)	Pass	Pass	-	+	+	-		
N6-(19-Aminopentaodecyl) A	Fail	Fail	NT	NT	NT	NT	NT	NT
2-Dimethylamino guanosine	Fail	Fail	NT	NT	NT	NT	NT	NT
6-Aza-cytidine	Fail	Fail	NT	NT	NT	NT	NT	NT
α-Thio-cytidine	Pass	Pass	+	+	+/-	+++	NT	NT
Pseudo-isocytidine	NT	NT	NT	NT	NT	NT	NT	NT
5-Iodo-uridine	NT	NT	NT	NT	NT	NT	NT	NT
α-Thio-uridine	NT	NT	NT	NT	NT	NT	NT	NT

6-Aza-uridine	NT	NT	NT	NT	NT	NT	NT	NT
Deoxy-thymidine	NT	NT	NT	NT	NT	NT	NT	NT
a-Thio guanosine	NT	NT	NT	NT	NT	NT	NT	NT
8-Oxo-guanosine	NT	NT	NT	NT	NT	NT	NT	NT
06-Methyl-guanosine	NT	NT	NT	NT	NT	NT	NT	NT
7-Deaza-guanosine	NT	NT	NT	NT	NT	NT	NT	NT
6-Chloro-purine	NT	NT	NT	NT	NT	NT	NT	NT
a-Thio-adenosine	NT	NT	NT	NT	NT	NT	NT	NT
7-Deaza-adenosine	NT	NT	NT	NT	NT	NT	NT	NT
5-iodo-cytidine	NT	NT	NT	NT	NT	NT	NT	NT

[0001528] In Table 126, the protein production of HeLa is judged by "+," "+/-" and "-"; when referring to G-CSF PBMC "++++" means greater than 6,000 pg/ml G-CSF, "+++" means greater than 3,000 pg/ml G-CSF, "++" means greater than 1,500 pg/ml G-CSF, "+" means greater than 300 pg/ml G-CSF, "+/-" means 150-300 pg/ml G-CSF and the background was about 110 pg/ml; when referring to cytokine PBMC "++++" means greater than 1,000 pg/ml interferon-alpha (IFN-alpha), "+++" means greater than 600 pg/ml IFN-alpha, "++" means greater than 300 pg/ml IFN-alpha, "+" means greater than 100 pg/ml IFN-alpha, "-" means less than 100 pg/ml and the background was about 70 pg/ml; "WT" refers to the wild type T7 polymerase, "MT" refers to mutant T7 polymerase (Durascribe® T7 Transcription kit (Cat. No. DSO 10925) (Epicentre®, Madison, WI) and "NT" means not tested.

Table 126. Combination Chemistry

Cytidine analog	Uridine analog	Purine	IVT Luc	IVT (G-CSF)	Protein (Luc; HeLa)	Protein (G-CSF; HeLa)	Protein (G-CSF; PBMC)	Cytokines (G-CSF; PBMC)	In Vivo Protein (Luc)
N4-acetylcytidine	pseudouridine	A,G	Pass WT	Pass WT	+	+	NT	NT	+
N4-acetylcytidine	N1-methyl-	A,G	Pass WT	Pass WT	+	+	NT	NT	+

ine	pseudouridine								
5-methylcytidine	5-methoxyuridine	A,G	Pass WT	Pass WT	+	+	NT	NT	+
5-methylcytidine	5-bromouridine	A,G	Pass WT	Pass WT	Not Done	+	NT	NT	
5-methylcytidine	5-methyluridine	A,G	Pass WT	Pass WT	+	+	NT	NT	+
5-methylcytidine	50% 2-thiouridine; 50% uridine	A,G	Pass WT	Pass WT	+	NT	NT	NT	+
5-methylcytidine	100% 2-thiouridine	A,G	Pass WT	Pass WT	-	+	NT	NT	
5-methylcytidine	pseudouridine	A,G	Pass WT	Pass WT	+	+	++	+	+
5-methylcytidine	N1-methylpseudouridine	A,G	Pass WT	Pass WT	+	+	++++	-	+
N4-acetylcytidine	2-thiouridine	A,G	Not Done	Pass WT	Not Done	+	NT	NT	NT
N4-acetylcytidine	5-bromouridine	A, G	Not Done	Pass WT	Not Done	+	NT	NT	NT
N4-acetylcytidine	2 Fluorouridine triphosphate	A,G	Pass	Pass	-	+	NT	NT	NT
5-methylcytidine	2 Fluorouridine triphosphate	A,G	Pass	Pass	-	+	NT	NT	NT
2 Fluorocytosine triphosphate	pseudouridine	A,G	Pass	Pass	-	+	NT	NT	NT
2 Fluorocytosine triphosphate	N1-methylpseudouridine	A,G	Pass	Pass	-	+/-	NT	NT	NT
2 Fluorocytosine triphosphate	2-thiouridine	A,G	Pass	Pass	-	-	NT	NT	NT

e									
2 Fluorocytosine triphosphate	5- bromouridine	A,G	Pass	Pass	-	+/-	NT	NT	NT
2 Fluorocytosine triphosphate	2 Fluorouridine triphosphate	A,G	Pass	Pass	-	+/-	NT	NT	NT
5- methylcytidine	uridine	A,2 Fluoro GTP	Pass	Pass	-	-	NT	NT	NT
5- methylcytidine	pseudouridine	A,2 Fluoro GTP	Pass	Pass	-	-	NT	NT	NT
5- methylcytidine	N1- methyl- pseudouridine	A,2 Fluoro GTP	Pass	Pass	-	+/-	NT	NT	NT
2 Fluorocytosine triphosphate	pseudouridine	A,2 Fluoro GTP	Pass	Pass	-	+/-	NT	NT	NT
2 Fluorocytosine triphosphate	N1- methyl- pseudouridine	A,2 Fluoro GTP	Pass	Pass	-	-	NT	NT	NT

Example 79. 2'Fluoro Chemistries in PBMC

[0001529] The ability of G-CSF modified mRNA (mRNA sequence shown in SEQ ID NO: 21438; polyA tail of approximately 160 nucleotides not shown in sequence; 5'cap, Cap1) to trigger innate an immune response was determined by measuring interferon-alpha (IFN-alpha) and tumor necrosis factor-alpha (TNF-alpha) production. Use of *in vitro* PBMC cultures is an accepted way to measure the immunostimulatory potential of oligonucleotides (Robbins et al, Oligonucleotides 2009 19:89-102) and transfection methods are described herein. Shown in Table 127 are the average from 2 or 3 separate PBMC donors of the interferon-alpha (IFN-alpha) and tumor necrosis factor alpha (TNF-alpha) production over time as measured by specific ELISA. Controls of R848, P(I)P(C), LPS and Lipofectamine 2000 (L2000) were also analyzed.

[0001530] With regards to innate immune recognition, while both modified mRNA chemistries largely prevented IFN-alpha and TNF-alpha production relative to positive

controls (R848, P(I)P(C)), 2'fluoro compounds reduce IFN-alpha and TNF-alpha production even lower than other combinations and N4-acetylcytidine combinations raised the cytokine profile.

Table 127. IFN-alpha and TNF-alpha

	IFN-alpha: 3 Donor Average (pg/ml)	TNF-alpha: 2 Donor Average (pg/ml)
L2000	1	361
P(I)P(C)	482	544
R848	45	8,235
LPS	0	6,889
N4-acetylcytidine/pseudouridine	694	528
N4-acetylcytidine/N1-methyl-pseudouridine	307	283
5-methylcytidine/5-methoxyuridine	0	411
5-methylcytidine/5-bromouridine	0	270
5-methylcytidine/5-methyluridine	456	428
5-methylcytidine/2-thiouridine	274	277
N4-acetylcytidine/2-thiouridine	0	285
N4-acetylcytidine/5-bromouridine	44	403
5-methylcytidine/pseudouridine	73	332
5-methylcytidine/N1-methyl-pseudouridine	31	280
N4-acetylcytidine/2'fluorouridine triphosphate	35	32
5-methylcytidine /2'fluorouridine triphosphate	24	0
2'fluorocytidine triphosphate/N1-methyl-pseudouridine	0	11
2'fluorocytidine triphosphate/2-thiouridine	0	0
2'fluorocytidine/ triphosphate5-bromouridine	12	2
2'fluorocytidine triphosphate/2'fluorouridine triphosphate	11	0
2'fluorocytidine triphosphate/5-methylcytidine	14	23
2'fluorocytidine triphosphate/5-methylcytidine/pseudouridine	6	21
2'fluorocytidine triphosphate/5-methylcytidine/N1-methyl-pseudouridine	3	15
2'fluorocytidine triphosphate/pseudouridine	0	4
2'fluorocytidine triphosphate/N1-methyl-pseudouridine	6	20
5-methylcytidine/pseudouridine	82	18
5-methylcytidine/N1-methyl-pseudouridine	35	3

Example 80. Modified mRNA with a Tobacco Etch Virus 5'UTR

[0001531] A 5' untranslated region (UTR) may be provided as a flanking region.

Multiple 5' UTRs may be included in the flanking region and may be the same or of different sequences. Any portion of the flanking regions, including none, may be codon

optimized and any may independently contain one or more different structural or chemical modifications, before and/or after codon optimization.

[0001532] The 5' UTR may comprise the 5'UTR from the tobacco etch virus (TEV). Variants of 5' UTRs may be utilized wherein one or more nucleotides are added or removed to the termini, including A, T, C or G.

Example 81. Expression of PLGA Formulated mRNA

A. Synthesis and Characterization of Luciferase PLGA Microspheres

[0001533] Luciferase mRNA (mRNA sequence shown in SEQ ID NO: 21446; polyA tail of approximately 140 nucleotides not shown in sequence; 5'cap, Cap1) fully modified with 5-methylcytosine and NI-methyl-pseudouridine, modified with 25% of uridine replaced with 2-thiouridine and 25% of cytosine replaced with 5-methylcytosine, fully modified with NI-methyl-pseudouridine, or fully modified with pseudouridine was reconstituted in 1x TE buffer and then formulated in PLGA microspheres. PLGA microspheres were synthesized using the water/oil/water double emulsification methods known in the art using PLGA-ester cap (Lactel, Cat# B6010-2, inherent viscosity 0.55-0.75, 50:50 LA:GA), polyvinylalcohol (PVA) (Sigma, Cat# 348406-25G, MW 13-23k) dichloromethane and water. Briefly, 0.4 ml of mRNA in TE buffer at 4 mg/ml (W1) was added to 2 ml of PLGA dissolved in dichloromethane (DCM) (O1) at a concentration of 200 mg/ml of PLGA. The W1/O1 emulsion was homogenized (IKA Ultra-Turrax Homogenizer, T18) for 30 seconds at speed 5 (-19,000 rpm). The W1/O1 emulsion was then added to 250 ml 1% PVA (W2) and homogenized for 1 minute at speed 5 (-19,000 rpm). Formulations were left to stir for 3 hours, then passed through a 100 μ m nylon mesh strainer (Fisherbrand Cell Strainer, Cat # 22-363-549) to remove larger aggregates, and finally washed by centrifugation (10 min, 9,250 rpm, 4°C). The supernatant was discarded and the PLGA pellets were resuspended in 5-10 ml of water, which was repeated 2x. After washing and resuspension with water, 100-200 μ l of a PLGA microspheres sample was used to measure particle size of the formulations by laser diffraction (Malvern Mastersizer2000). The washed formulations were frozen in liquid nitrogen and then lyophilized for 2-3 days.

[0001534] After lyophilization, -10 mg of PLGA MS were weighed out in 2 ml eppendorf tubes and deformed by adding 1 ml of DCM and letting the samples shake

for 2-6 hrs. The mRNA was extracted from the deformed PLGA microspheres by adding 0.5 ml of water and shaking the sample overnight. Unformulated luciferase mRNA in TE buffer (unformulated control) was spiked into DCM and went through the deformation process (deformation control) to be used as controls in the transfection assay. The encapsulation efficiency, weight percent loading and particle size are shown in Table 128. Encapsulation efficiency was calculated as mg of mRNA from deformation of PLGA microspheres divided by the initial amount of mRNA added to the formulation. Weight percent loading in the formulation was calculated as mg of mRNA from deformation of PLGA microspheres divided by the initial amount of PLGA added to the formulation.

Table 128. PLGA Characteristics

Chemical Modifications	Sample ID	Encapsulation Efficiency (%)	Theoretical mRNA Loading (wt %)	Actual mRNA Loading (wt %)	Particle Size (D50, μm)
Fully modified with 5-methylcytosine and N1-methyl-pseudouridine	43-66A	45.8	0.4	0.18	33.4
	43-66B	29.6		0.12	27.7
	43-66C	25.5		0.10	27.1
25% of uridine replaced with 2-thiouridine and 25% of cytosine replaced with 5-methylcytosine	43-67A	34.6	0.4	0.14	29.9
	43-67B	22.8		0.09	30.2
	43-67C	23.9		0.10	25.1
Fully modified with N1-methyl-pseudouridine	43-69A	55.8	0.4	0.22	40.5
	43-69B	31.2		0.12	41.1
	43-69C	24.9		0.10	46.1
Fully modified with pseudouridine	43-68-1	49.3	0.4	0.20	34.8
	43-68-2	37.4		0.15	35.9
	43-68-3	45.0		0.18	36.5

B. Protein Expression of modified mRNA Encapsulated in PLGA Microspheres [0001535] The day before transfection, 20,000 HeLa cells (ATCC no. CCL-2; Manassas, VA) were harvested by treatment with Trypsin-EDTA solution (LifeTechnologies, Grand Island, NY) and seeded in a total volume of 100 μl EMEM medium (supplemented with 10%FCS and 1x Glutamax) per well in a 96-well cell culture plate (Corning, Manassas, VA). The cells were grown at 37 $^{\circ}\text{C}$ in a 5% CO₂ atmosphere overnight. The next day, 83 ng of the deformed luciferase mRNA PLGA microsphere samples, deformed

luciferase mRNA control (Deform control), or unformulated luciferase mRNA control (Unformul control) was diluted in a 10ul final volume of OPTI-MEM (LifeTechnologies, Grand Island, NY). Lipofectamine 2000 (LifeTechnologies, Grand Island, NY) was used as a transfection reagent and 0.2ul was diluted in a 10ul final volume of OPTI-MEM. After 5min of incubation at room temperature, both solutions were combined and incubated an additional 15min at room temperature. Then 20ul of the combined solution was added to 100ul of cell culture medium containing the HeLa cells. The plates were then incubated as described before.

[0001536] After an 18 to 22 hour incubation, cells expressing luciferase were lysed with 100ul Passive Lysis Buffer (Promega, Madison, WI) according to manufacturer instructions. Aliquots of the lysates were transferred to white opaque polystyrene 96-well plates (Corning, Manassas, VA) and combined with 100ul complete luciferase assay solution (Promega, Madison, WI). The background signal of the plates without reagent was about 200 relative light units per well. The plate reader was a BioTek Synergy HI (BioTek, Winooski, VT).

[0001537] Cells were harvested and the bioluminescence (in relative light units, RLU) for each sample is shown in Table 129. Transfection of these samples confirmed that the varied chemistries of luciferase mRNA is still able to express luciferase protein after PLGA microsphere formulation.

Table 129. Chemical Modifications

Chemical Modifications	Sample ID	Biolum. (RLU)
Fully modified with 5-methylcytosine and N1-methyl-pseudouridine	Deform contol	164266.5
	Unformul control	113714
	43-66A	25174
	43-66B	25359
25% of uridine replaced with 2-thiouridine and 25% of cytosine replaced with 5-methylcytosine	43-66C	20060
	Deform contol	90816.5
	Unformul control	129806
	43-67A	38329.5
Fully modified with N1-methyl-	43-67B	8471.5
	43-67C	10991.5
	Deform contol	928093.5
	Unformul control	1512273.5

pseudouridine	43-69A	1240299.5
	43-69B	748667.5
	43-69C	1193314
Fully modified with pseudouridine	Deform control	154168
	Unformul control	151581
	43-68-1	120974.5
	43-68-2	107669
	43-68-3	97226

Example 82. In vitro studies of Factor IX

A. Serum-Free Media

[0001538] Human Factor IX mRNA (mRNA sequence shown in SEQ ID NO: 1622; polyA tail of approximately 160 nucleotides not shown in sequence; 5'cap, Cap1; fully modified with 5-methylcytosine and pseudouridine) was transfected in serum-free media. The cell culture supernatant was collected and subjected to trypsin digestion before undergoing 2-dimensional HPLC separation of the peptides. Matrix-assisted laser desorption/ionization was used to detect the peptides. 8 peptides were detected and 7 of the detected peptides are unique to Factor IX. These results indicate that the mRNA transfected in the serum-free media was able to express full-length Factor IX protein.

B. Human Embryonic Kidney (HEK) 293A Cells

[0001539] 250 ng of codon optimized Human Factor IX mRNA (mRNA sequence shown in SEQ ID NO: 1622; fully modified with 5-methylcytosine and pseudouridine; polyA tail of approximately 160 nucleotides not shown in sequence; 5'cap, Cap1) was transfected into HEK 293A cells (150,000 cells/well) using Lipofectamine 2000 in DMEM in presence of 10% FBS. The transfection complexes were removed 3 hours after transfection. Cells were harvested at 3, 6, 9, 12, 24, 48 and 72 hours after transfection. Total RNA was isolated and used for cDNA synthesis. The cDNA was subjected to analysis by quantitative Real-Time PCR using codon optimized Factor IX specific primer set. Human hypoxanthine phosphoribosyltransferase 1 (HPRT) level was used for normalization. The data is plotted as a percent of detectable mRNA considering the mRNA level as 100% at the 3 hour time point. The half-life of Factor IX modified mRNA fully modified with 5-methylcytosine and pseudouridine in human embryonic kidney 293 (HEK293) cells is about 8-10 hours.

Example 83. Saline formulation: Subcutaneous Administration

[0001540] Human G-CSF modified mRNA (mRNA sequence shown in SEQ ID NO: 21438; polyA tail of approximately 160 nucleotides not shown in sequence; 5'cap, CapI; fully modified with 5-methylcytosine and pseudouridine) and human EPO modified mRNA (mRNA sequence shown in SEQ ID NO: 1638; polyA tail of approximately 160 nucleotides not shown in sequence; 5'cap, CapI; fully modified with 5-methylcytosine and pseudouridine), were formulated in saline and delivered to mice via intramuscular (IM) injection at a dose of 100 ug.

[0001541] Controls included Luciferase (mRNA sequence shown in SEQ ID NO: 21446; polyA tail of approximately 160 nucleotides not shown in sequence; 5'cap, CapI; fully modified with 5-methylcytosine and pseudouridine) or the formulation buffer (F.Buffer). The mice were bled at 13 hours after the injection to determine the concentration of the human polypeptide in serum in pg/mL. (G-CSF groups measured human G-CSF in mouse serum and EPO groups measured human EPO in mouse serum). The data are shown in Table 130.

[0001542] mRNA degrades rapidly in serum in the absence of formulation suggesting the best method to deliver mRNA to last longer in the system is by formulating the mRNA. As shown in Table 130, mRNA can be delivered subcutaneously using only a buffer formulation.

Table 130. Dosing Regimen

Group	Treatment	Dose Vol. (µl/mouse)	Dosing Vehicle	Average Protein Product pg/mL, serum
G-CSF	G-CSF	100	F. buffer	45
G-CSF	Luciferase	100	F. buffer	0
G-CSF	F. buffer	100	F. buffer	2.2
EPO	EPO	100	F. buffer	72.03
EPO	Luciferase	100	F. buffer	26.7
EPO	F. buffer	100	F. buffer	13.05

Example 84. Intravitreal Delivery

[0001543] mCherry modified mRNA (mRNA sequence shown in SEQ ID NO: 21439; polyA tail of approximately 160 nucleotides not shown in sequence; 5'cap, CapI; fully modified with 5-methylcytosine and pseudouridine) and luciferase modified mRNA

(mRNA sequence shown in SEQ ID NO: 21446; polyA tail of approximately 160 nucleotides not shown in sequence; 5'cap, Cap1; fully modified with 5-methylcytosine and pseudouridine) formulated in saline was delivered intravitreally in rats as described in Table 131. The sample was compared against a control of saline only delivered intravitreally.

Table 131. Dosing Chart

Group No.	Dose Level (μ g modified RNA/eye)	Dose volume (μ L/eye)	Treatment	
			Right Eye (OD)	Left Eye (OS)
Control	0	5	Delivery buffer only	Delivery buffer only
Modified RNA in delivery buffer	10	5	mCherry	Luciferase

[0001544] The formulation will be administered to the left or right eye of each animal on day 1 while the animal is anesthetized. On the day prior to administration gentamicin ophthalmic ointment or solution was applied to both eyes twice. The gentamicin ophthalmic ointment or solution was also applied immediately following the injection and on the day following the injection. Prior to dosing, mydriatic drops (1% tropicamide and/or 2.5% phenylephrine) are applied to each eye.

[0001545] 18 hours post dosing the eyes receiving the dose of mCherry and delivery buffer are enucleated and each eye was separately placed in a tube containing 10 mL 4% paraformaldehyde at room temperature for overnight tissue fixation. The following day, eyes will be separately transferred to tubes containing 10 mL of 30% sucrose and stored at 21°C until they were processed and sectioned. The slides prepared from different sections were evaluated under F-microscopy. Positive expression was seen in the slides prepared with the eyes administered mCherry modified mRNA and the control showed no expression.

Example 85. In Vivo Cytokine Expression Study

[0001546] Mice were injected intramuscularly with 200 μ g of G-CSF modified mRNA (mRNA sequence shown in SEQ ID NO: 21438; polyA tail of approximately 160 nucleotides not shown in sequence) which was unmodified with a 5'cap, Cap1 (unmodified), fully modified with 5-methylcytosine and pseudouridine and a 5'cap, Cap1

(Gen1) or fully modified with 5-methylcytosine and N1-methyl-pseudouridine and a 5'cap, Cap1 (Gen2 cap) or no cap (Gen2 uncapped). Controls of R-848, 5% sucrose and untreated mice were also analyzed. After 8 hours serum was collected from the mice and analyzed for interferon-alpha (IFN-alpha) expression. The results are shown in Table 132.

Table 132. IFN-alpha Expression

Formulation	IFN-alpha (pg/ml)
G-CSF unmodified	67.012
G-CSF Gen1	8.867
G-CSF Gen2 cap	0
G-CSF Gen2 uncapped	0
R-848	40.971
5% sucrose	1.493
Untreated	0

Example 86. In vitro expression of VEGF modified mRNA

[0001547] HEK293 cells were transfected with modified mRNA (mmRNA) VEGF-A (mRNA sequence shown in SEQ ID NO: 1672; polyA tail of approximately 160 nucleotides not shown in sequence; 5'cap, Cap1; fully modified with 5-methylcytosine and pseudouridine) which had been complexed with Lipofectamine2000 from Invitrogen (Carlsbad, CA) at the concentration shown in Table 133. The protein expression was detected by ELISA and the protein (pg/ml) is shown in Table 133 and Figure 7.

Table 133. Protein Expression

Amount Transfected	10 ng	2.5 ng	625 pg	156 pg	39 pg	10 pg	2 pg	610 fg
Protein (pg/ml)	10495	10038	2321.23	189.6	0	0	0	0

Example 87. In vitro Screening in HeLa Cells of GFP

[0001548] The day before transfection, 20,000 HeLa cells (ATCC no. CCL-2; Manassas, VA) were harvested by treatment with Trypsin-EDTA solution (LifeTechnologies, Grand Island, NY) and seeded in a total volume of 100ul EMEM medium (supplemented with 10%FCS and 1x Glutamax) per well in a 96-well cell culture plate (Corning, Manassas, VA). The cells were grown at 37°C in 5% CO₂ atmosphere overnight. Next day, 37.5 ng or 75 ng of Green Fluorescent protein (GFP) modified RNA (mRNA sequence shown in SEQ ID NO: 21448; polyA tail of approximately 160 nucleotides not shown in sequence;

5'cap, CapI) with the chemical modification described in Table 134, were diluted in 10ul final volume of OPTI-MEM (LifeTechnologies, Grand Island, NY). Lipofectamine 2000 (LifeTechnologies, Grand Island, NY) was used as transfection reagent and 0.2 ul were diluted in 10 ul final volume of OPTI-MEM. After 5 minutes of incubation at room temperature, both solutions were combined and incubated an additional 15 minute at room temperature. Then the 20ul combined solution was added to the 100ul cell culture medium containing the HeLa cells and incubated at room temperature.

[0001549] After an 18 to 22 hour incubation cells expressing luciferase were lysed with 100 ul of Passive Lysis Buffer (Promega, Madison, WI) according to manufacturer instructions. Aliquots of the lysates were transferred to white opaque polystyrene 96-well plates (Corning, Manassas, VA) and combined with 100 ul complete luciferase assay solution (Promega, Madison, WI). The median fluorescence intensity (MFI) was determined for each chemistry and is shown in Table 134.

[0001550] These results demonstrate that GFP fully modified with N1-methyl-pseudouridine and 5-methylcytosine produces more protein in HeLa cells compared to the other chemistry. Additionally the higher dose of GFP administered to the cells resulted in the highest MFI value.

Table 134. Mean Fluorescence Intensity

Chemistry	37.5 ng	75 ng
	MFI	MFI
No modifications	97400	89500
5-methylcytosine/pseudouridine	324000	715000
5-methylcytosine/N1-methyl-pseudouridine	643000	1990000

Example 88. Homogenization

[0001551] Different luciferase mRNA solutions (as described in Table 135 where "X" refers to the solution containing that component) (mRNA sequence shown in SEQ ID NO: 21446; polyA tail of approximately 160 nucleotides not shown in sequence; 5'cap, CapI; fully modified with 5-methylcytosine and pseudouridine) were evaluated to test the percent yield of the different solutions, the integrity of the mRNA by bioanalyzer, and the protein expression of the mRNA by in vitro transfection. The mRNA solutions were prepared in water, 1x TE buffer at 4 mg/ml as indicated in Table 135, and added to either

dichloromethane (DCM) or DCM containing 200 mg/ml of poly(lactic-co-glycolic acid) (PLGA) (Lactel, Cat# B6010-2, inherent viscosity 0.55-0.75, 50:50 LA:GA) to achieve a final mRNA concentration of 0.8 mg/ml. The solutions requiring homogenization were homogenized for 30 seconds at speed 5 (approximately 19,000 rpm) (IKA Ultra-Turrax Homogenizer, T18). The mRNA samples in water, dichloromethane and poly(lactic-co-glycolic acid) (PLGA) were not recoverable (NR). All samples, except the NR samples, maintained integrity of the mRNA as determined by bioanalyzer (Bio-rad Experion).

[0001552] The day before transfection, 20,000 HeLa cells (ATCC no. CCL-2; Manassas, VA) were harvested by treatment with Trypsin-EDTA solution (LifeTechnologies, Grand Island, NY) and seeded in a total volume of 100ul EMEM medium (supplemented with 10%FCS and 1x Glutamax) per well in a 96-well cell culture plate (Corning, Manassas, VA). The cells were grown at 37oC in a 5% CO₂ atmosphere overnight. The next day, 250 ng of luciferase mRNA from the recoverable samples was diluted in a 10ul final volume of OPTI-MEM (LifeTechnologies, Grand Island, NY). Lipofectamine 2000 (LifeTechnologies, Grand Island, NY) was used as a transfection reagent and 0.2ul was diluted in a 10ul final volume of OPTI-MEM. After 5 minutes of incubation at room temperature, both solutions were combined and incubated an additional 15 minutes at room temperature. Then 20ul of the combined solution was added to 100ul of cell culture medium containing the HeLa cells. The plates were then incubated as described before. Controls luciferase mRNA (luciferase mRNA formulated in saline) (Control) and untreated cells (Untreat.) were also evaluated. Cells were harvested and the bioluminescence average (in photons/second) (biolum. (p/s)) for each signal is also shown in Table 135. The recoverable samples all showed activity of luciferase mRNA when analyzed.

[0001553] After an 18 to 22 hour incubation, cells expressing luciferase were lysed with 100ul Passive Lysis Buffer (Promega, Madison, WI) according to manufacturer instructions. Aliquots of the lysates were transferred to white opaque polystyrene 96-well plates (Corning, Manassas, VA) and combined with 100ul complete luciferase assay solution (Promega, Madison, WI). The background signal of the plates without reagent was about 200 relative light units per well. The plate reader was a BioTek Synergy HI (BioTek, Winooski, VT).

[0001554] Cells were harvested and the bioluminescence average (in relative light units, RLU) (biolum. (RLU)) for each signal is also shown in Table 135. The recoverable samples all showed activity of luciferase mRNA when analyzed.

Table 135. Solutions

Solution No.	Water	1x TE Buffer	DCM	DCM/PLGA	Homogenizer	Yield (%)	Biolum. (RLU)
1	X					96	5423780
2		X			X	95	4911950
3	X				X	92	2367230
4		X			X	90	4349410
5	X		X		X	66	4145340
6		X	X		X	71	3834440
7	X			X	X	NR	n/a
8		X		X	X	24	3182080
9	X			X		NR	n/a
10		X		X		79	3276800
11	X		X			79	5563550
12		X	X			79	4919100
Control							2158060
Untreat.							3530

Example 89. TE Buffer and Water Evaluation

[0001555] Luciferase mRNA (mRNA sequence shown in SEQ ID NO: 21446; polyA tail of approximately 160 nucleotides not shown in sequence; 5'cap, CapI; fully modified with 5-methylcytosine and pseudouridine) was reconstituted in water or TE buffer as outlined in Table 136 and then formulated in PLGA microspheres. PLGA microspheres were synthesized using the water/oil/water double emulsification methods known in the art using PLGA (Lactel, Cat# B6010-2, inherent viscosity 0.55-0.75, 50:50 LA:GA), polyvinylalcohol (PVA) (Sigma, Cat# 348406-25G, MW 13-23k) dichloromethane and water. Briefly, 0.2 to 0.6 ml of mRNA in water or TE buffer at a concentration of 2 to 6 mg/ml (W1) was added to 2 ml of PLGA dissolved in dichloromethane (DCM) (O1) at a concentration of 100 mg/ml of PLGA. The W1/O1 emulsion was homogenized (IKA Ultra-Turrax Homogenizer, T18) for 30 seconds at speed 5 (-19,000 rpm). The W1/O1 emulsion was then added to 250 ml 1% PVA (W2) and homogenized for 1 minute at speed 5 (-19,000 rpm).

[0001556] Formulations were left to stir for 3 hours, then passed through a 100 μ m nylon mesh strainer (Fisherbrand Cell Strainer, Cat # 22-363-549) to remove larger aggregates, and finally washed by centrifugation (10 min, 9,250 rpm, 4°C). The

supernatant was discarded and the PLGA pellets were resuspended in 5-10 ml of water, which was repeated 2x. The washed formulations were frozen in liquid nitrogen and then lyophilized for 2-3 days. After lyophilization, ~10 mg of PLGA MS were weighed out in 2 ml eppendorf tubes and deformed by adding 1 ml of DCM and letting the samples shake for 2-6 hrs. mRNA was extracted from the deformed PLGA microspheres by adding 0.5 ml of water and shaking the sample overnight. Unformulated luciferase mRNA in water or TE buffer (deformation controls) was spiked into DCM and went through the deformation process to be used as controls in the transfection assay.

[0001557] The day before transfection, 20,000 HeLa cells (ATCC no. CCL-2; Manassas, VA) were harvested by treatment with Trypsin-EDTA solution (LifeTechnologies, Grand Island, NY) and seeded in a total volume of 100ul EMEM medium (supplemented with 10%FCS and 1x Glutamax) per well in a 96-well cell culture plate (Corning, Manassas, VA). The cells were grown at 37oC in a 5% CO₂ atmosphere overnight. The next day, 100 ng of the deformed luciferase mRNA samples was diluted in a 10ul final volume of OPTI-MEM (LifeTechnologies, Grand Island, NY). Lipofectamine 2000 (LifeTechnologies, Grand Island, NY) was used as a transfection reagent and 0.2ul was diluted in a 10ul final volume of OPTI-MEM. After 5 minutes of incubation at room temperature, both solutions were combined and incubated an additional 15 minutes at room temperature. Then 20ul of the combined solution was added to 100ul of cell culture medium containing the HeLa cells. The plates were then incubated as described before.

[0001558] After 18 to 22 hour incubation, cells expressing luciferase were lysed with 100ul Passive Lysis Buffer (Promega, Madison, WI) according to manufacturer instructions. Aliquots of the lysates were transferred to white opaque polystyrene 96-well plates (Corning, Manassas, VA) and combined with 100ul complete luciferase assay solution (Promega, Madison, WI). The background signal of the plates without reagent was about 200 relative light units per well. The plate reader was a BioTek Synergy HI (BioTek, Winooski, VT). To determine the activity of the luciferase mRNA from each formulation, the relative light units (RLU) for each formulation was divided by the RLU of the appropriate mRNA deformation control (mRNA in water or TE buffer). Table 136 shows the activity of the luciferase mRNA. The activity of the luciferase mRNA in

the PLGA microsphere formulations (Form.) was substantially improved by formulating in TE buffer versus water.

Table 136. Formulations

Form.	mRNA conc. (mg/ml)	W1 Solvent volume (ul)	Total mRNA (ug)	Theoretical mRNA Loading (wt%)	Actual mRNA Loading (wt%)	W1 Solvent	Activity (% of deform. control)
PLGA A	4	400	1600	0.80	0.14	Water	12.5%
PLGA B	4	200	800	0.40	0.13	Water	1.3%
PLGA C	4	600	2400	1.20	0.13	Water	12.1%
PLGA D	2	400	800	0.40	0.07	Water	1.3%
PLGA E	6	400	2400	1.20	0.18	TE Buffer	38.9%
PLGA F	4	400	1600	0.80	0.16	TE Buffer	39.7%
PLGA G	4	400	1600	0.80	0.10	TE Buffer	26.6%

Example 90. Chemical Modifications on mRNA

[0001559] The day before transfection, 20,000 HeLa cells (ATCC no. CCL-2; Manassas, VA) were harvested by treatment with Trypsin-EDTA solution (Life Technologies, Grand Island, NY) and seeded in a total volume of 100ul EMEM medium (supplemented with 10%FCS and 1x Glutamax) per well in a 96-well cell culture plate (Corning, Manassas, VA). The cells were grown at 37°C in 5% CO₂ atmosphere overnight. The next day, 83 ng of Luciferase modified RNA (mRNA sequence shown SEQ ID NO: 21446; polyA tail of approximately 140 nucleotides not shown in sequence; 5'cap, Cap1) with the chemical modification described in Table 137, were diluted in 10ul final volume of OPTI-MEM (LifeTechnologies, Grand Island, NY). Lipofectamine 2000 (LifeTechnologies, Grand Island, NY) was used as transfection reagent and 0.2 ul were diluted in 10 ul final volume of OPTI-MEM. After 5 minutes of incubation at room temperature, both solutions were combined and incubated an additional 15 minute at room temperature. Then the 20ul combined solution was added to the 100ul cell culture medium containing the HeLa cells and incubated at room temperature.

[0001560] After 18 to 22 hours of incubation cells expressing luciferase were lysed with 100 ul of Passive Lysis Buffer (Promega, Madison, WI) according to manufacturer instructions. Aliquots of the lysates were transferred to white opaque polystyrene 96-well plates (Corning, Manassas, VA) and combined with 100 ul complete luciferase assay solution (Promega, Madison, WI). The lysate volumes were adjusted or diluted until no

more than 2 mio relative light units (RLU) per well were detected for the strongest signal producing samples and the RLUs for each chemistry tested are shown in Table 137. The plate reader was a BioTek Synergy HI (BioTek, Winooski, VT). The background signal of the plates without reagent was about 200 relative light units per well.

Table 137. Chemical Modifications

Sample	RLU
Untreated	336
Unmodified Luciferase	33980
5-methylcytosine and pseudouridine	1601234
5-methylcytosine and N1-methyl-pseudouridine	421189
25% cytosines replaced with 5-methylcytosine and 25% of uridines replaced with 2-thiouridine	222114
N1-methyl-pseudouridine	3068261
Pseudouridine	140234
N4-Acetylcytidine	1073251
5-methoxyuridine	219657
5-Bromouridine	6787
N4-Acetylcytidine and N1-methyl-pseudouridine	976219
5-methylcytosine and 5-methoxyuridine	66621
5-methylcytosine and 2' fluorouridine	11333

Example 91. Intramuscular and Subcutaneous Administration of Modified mRNA

[0001561] Luciferase modified mRNA (mRNA sequence shown in SEQ ID NO: 21446; polyA tail of approximately 140 nucleotides not shown in sequence; 5'cap, Cap1) fully modified with 5-methylcytosine and pseudouridine (5mC/pU), fully modified with 5-methylcytosine and N1-methyl-pseudouridine (5mC/N1mpU), fully modified with pseudouridine (pU), fully modified with N1-methyl-pseudouridine (N1mpU) or modified where 25% of the cytosines replaced with 5-methylcytosine and 25% of the uridines replaced with 2-thiouridine (5mC/s2U) formulated in PBS (pH 7.4) was administered to Balb-C mice intramuscularly or subcutaneously at a dose of 2.5 mg/kg. The mice were imaged at 2 hours, 8 hours, 24 hours, 48 hours, 72 hours, 96 hours, 120 hours and 144 hours for intramuscular delivery and 2 hours, 8 hours, 24 hours, 48 hours, 72 hours, 96 hours and 120 hours for subcutaneous delivery. Twenty minutes prior to imaging, mice were injected intraperitoneally with a D-luciferin solution at 150 mg/kg. Animals were then anesthetized and images were acquired with an IVIS Lumina II imaging system

(Perkin Elmer). Bioluminescence was measured as total flux (photons/second) of the entire mouse. The average total flux (photons/second) for intramuscular administration is shown in Table 138 and the average total flux (photons/second) for subcutaneous administration is shown in Table 139. The background signal was 3.79E+05 (p/s). The peak expression for intramuscular administration was seen between 24 and 48 hours for all chemistry and expression was still detected at 144 hours. For subcutaneous delivery the peak expression was seen at 2-8 hours and expression was detected at 72 hours.

Table 138. Intramuscular Administration

	5mC/pU	5mC/N1mpU	5mC/s2U	pU	N1mpU
	Flux (p/s)	Flux (p/s)	Flux (p/s)	Flux (p/s)	Flux (p/s)
2 hours	1.98E+07	4.65E+06	4.68E+06	2.33E+06	3.66E+07
8 hours	1.42E+07	3.64E+06	3.78E+06	8.07E+06	7.21E+07
24 hours	2.92E+07	1.22E+07	3.35E+07	1.01E+07	1.75E+08
48 hours	2.64E+07	1.01E+07	5.06E+07	7.46E+06	3.42E+08
72 hours	2.18E+07	8.59E+06	3.42E+07	4.08E+06	5.83E+07
96 hours	2.75E+07	2.70E+06	2.38E+07	4.35E+06	7.15E+07
120 hours	2.19E+07	1.60E+06	1.54E+07	1.25E+06	3.87E+07
144 hours	9.17E+06	2.19E+06	1.14E+07	1.86E+06	5.04E+07

Table 139. Subcutaneous Administration

	5mC/pU	5mC/N1mpU	5mC/s2U	pU	N1mpU
	Flux (p/s)	Flux (p/s)	Flux (p/s)	Flux (p/s)	Flux (p/s)
2 hours	5.26E+06	4.54E+06	9.34E+06	2.43E+06	2.80E+07
8 hours	2.32E+06	8.75E+05	8.15E+06	2.12E+06	3.09E+07
24 hours	2.67E+06	5.49E+06	3.80E+06	2.24E+06	1.48E+07
48 hours	1.22E+06	1.77E+06	3.07E+06	1.58E+06	1.24E+07
72 hours	1.12E+06	8.00E+05	8.53E+05	4.80E+05	2.29E+06
96 hours	5.16E+05	5.33E+05	4.30E+05	4.30E+05	6.62E+05
120 hours	3.80E+05	4.09E+05	3.21E+05	6.82E+05	5.05E+05

Example 92. Osmotic Pump Study

[0001562] Prior to implantation, an osmotic pump (ALZET® Osmotic Pump 2001D, DURECT Corp. Cupertino, CA) is loaded with the 0.2 ml of IX PBS (pH 7.4) (PBS loaded pump) or 0.2 ml of luciferase modified mRNA (mRNA sequence shown in SEQ ID NO: 21446; polyA tail of approximately 140 nucleotides not shown in sequence;

5'cap, CapI; fully modified with 5-methylcytosine andNI-methyl-pseudouridine) at 1 mg/ml in 1x PBS (pH 7.4) (Luciferase loaded pump) and incubated overnight in 1x PBS (pH 7.4) at 37°C.

[0001563] Balb-C mice (n=3) are implanted subcutaneously with either the PBS loaded pump or the luciferase loaded pump and imaged at 2 hours, 8 hours and 24 hours. As a control a PBS loaded pump is implanted subcutaneously and the mice are injected subcutaneously with luciferase modified mRNA in 1x PBS (PBS loaded pump; SC Luciferase) or an osmotic pump is not implanted and the mice are injected subcutaneously with luciferase modified mRNA in 1x PBS (SC Luciferase). The luciferase formulations are outlined in Table 140.

Table 140. Luciferase Formulations

Group	Vehicle	Conc (mg/ml)	Inj. Vol. (ul)	Amt (ug)	Dose (mg/kg)
PBS loaded pump; SC Luciferase	PBS	1.00	50	50	2.5
Luciferase loaded pump	PBS	1.00	-	200	10.0
PBS loaded pump	PBS	-	-	-	-
SC Luciferase	PBS	1.00	50	50	2.5

Example 93. External Osmotic Pump Study

[0001564] An external osmotic pump (ALZET® Osmotic Pump 2001D, DURECT Corp. Cupertino, CA) is loaded with the 0.2 ml of 1x PBS (pH 7.4) (PBS loaded pump) or 0.2 ml of luciferase modified mRNA (mRNA sequence shown in SEQ ID NO: 21446; polyA tail of approximately 140 nucleotides not shown in sequence; 5'cap, CapI; fully modified with 5-methylcytosine andNI-methyl-pseudouridine) at 1 mg/ml in 1x PBS (pH 7.4) (luciferase loaded pump) and incubated overnight in 1x PBS (pH 7.4) at 37°C.

[0001565] Using a catheter connected to the external PBS loaded pump or the luciferase loaded pump Balb-C mice (n=3) are administered the formulation. The mice are imaged at 2 hours, 8 hours and 24 hours. As a control an external PBS loaded pump is used and the mice are injected subcutaneously with luciferase modified mRNA in 1x PBS (PBS loaded pump; SC Luciferase) or the external pump is not used and the mice are only injected subcutaneously with luciferase modified mRNA in 1x PBS (SC Luciferase). Twenty minutes prior to imaging, mice are injected intraperitoneally with a D-luciferin

solution at 150 mg/kg. Animals are then anesthetized and images are acquired with an IVIS Lumina II imaging system (Perkin Elmer). Bioluminescence is measured as total flux (photons/second) of the entire mouse. The luciferase formulations are outlined in Table 141 and the average total flux (photons/second).

Table 141. Luciferase Formulations

Group	Vehicle	Conc (mg/ml)	Inj. Vol. (ul)	Amt (ug)	Dose (mg/kg)
PBS loaded pump; SC Luciferase	PBS	1.00	50	50	2.5
Luciferase loaded pump	PBS	1.00	-	200	10.0
PBS loaded pump	PBS	-	-	-	-
SC Luciferase	PBS	1.00	50	50	2.5

Example 94. Fibrin Sealant Study

[0001566] Fibrin sealant, such as Tisseel (Baxter Healthcare Corp., Deerfield, IL), is composed of fibrinogen and thrombin in a dual-barreled syringe. Upon mixing, fibrinogen is converted to fibrin to form a fibrin clot in about 10 to 30 seconds. This clot can mimic the natural clotting mechanism of the body. Additionally a fibrin hydrogel is a three dimensional structure that can potentially be used in sustained release delivery. Currently, fibrin sealant is approved for application in hemostasis and sealing to replace conventional surgical techniques such as suture, ligature and cautery.

[0001567] The thrombin and fibrinogen components were loaded separately into a dual barreled syringe. Balb-C mice (n=3) were injected subcutaneously with 50 ul of fibrinogen, 50 ul of thrombin and they were also injected at the same site with modified luciferase mRNA (mRNA sequence shown in SEQ ID NO: 21446; polyA tail of approximately 140 nucleotides not shown in sequence; 5'cap, Cap1; fully modified with 5-methylcytosine and N1-methyl-pseudouridine) (Tisseel+Luciferase), 50 ul of fibrinogen and 50 ul thrombin (Tisseel) or modified luciferase mRNA (Luciferase). The injection of fibrinogen and thrombin was done simultaneously using the dual-barreled syringe. The SC injection of luciferase was done 15 minutes after the fibrinogen/thrombin injection to allow the fibrin hydrogel to polymerize (Tisseel + Luciferase group). A control group of untreated mice were also evaluated. The mice were imaged at 5 hours and 24 hours. Twenty minutes prior to imaging, mice were

injected intraperitoneally with a D-luciferin solution at 150 mg/kg. Animals were then anesthetized and images were acquired with an IVIS Lumina II imaging system (Perkin Elmer). Bioluminescence was measured as total flux (photons/second) of the entire mouse. The luciferase formulations are outlined in Table 142 and the average total flux (photons/second) is shown in Table 143. The fibrin sealant was found to not interfere with imaging and the injection of luciferase and Tisseel showed expression of luciferase.

Table 142. Luciferase Formulations

Group	Vehicle	Conc (mg/ml)	Inj. Vol. (ul)	Amt (ug)	Dose (mg/kg)
Tisseel+Luciferase	PBS	1.00	50	50	2.5
Tisseel	-	-	-	-	-
Luciferase	PBS	1.00	50	50	2.5
Untreated	-	-	-	-	-

Table 143. Total Flux

Group	5 Hours	24 Hours
	Flux (p/s)	Flux (p/s)
Tisseel+Luciferase	4.59E+05	3.39E+05
Tisseel	1.99E+06	1.06E+06
Luciferase	9.94E+05	7.44E+05
Untreated	3.90E+05	3.79E+05

Example 95. Fibrin Containing mRNA Sealant Study

A. Modified mRNA and Calcium Chloride
[0001568] Prior to reconstitution, luciferase mRNA (mRNA sequence shown in SEQ ID NO: 21446; polyA tail of approximately 140 nucleotides not shown in sequence; 5'cap, Cap1) fully modified with 5-methylcytosine and N1-methyl-pseudouridine or fully modified with N1-methyl-pseudouridine is added to calcium chloride. The calcium chloride is then used to reconstitute thrombin. Fibrinogen is reconstituted with fibrinolysis inhibitor solution per the manufacturer's instructions. The reconstituted thrombin containing modified mRNA and fibrinogen is loaded into a dual barreled syringe. Mice are injected subcutaneously with 50 ul of fibrinogen and 50 ul of thrombin containing modified mRNA or they were injected with 50 ul of PBS containing an equivalent dose of modified luciferase mRNA. A control group of untreated mice is also

evaluated. The mice are imaged at predetermined intervals to determine the average total flux (photons/second).

B. Lipid Nanoparticle Formulated Modified mRNA and Calcium Chloride
[0001569] Prior to reconstitution, luciferase mRNA (mRNA sequence shown in SEQ ID NO: 21446; polyA tail of approximately 140 nucleotides not shown in sequence; 5'cap, Cap1) fully modified with 5-methylcytosine and NI-methyl-pseudouridine or fully modified with NI-methyl-pseudouridine is formulated in a lipid nanoparticle is added to calcium chloride. The calcium chloride is then used to reconstitute thrombin. Fibrinogen is reconstituted with fibrinolysis inhibitor solution per the manufacturer's instructions. The reconstituted thrombin containing modified mRNA and fibrinogen is loaded into a dual barreled syringe. Mice are injected subcutaneously with 50 ul of fibrinogen and 50 ul of thrombin containing modified mRNA or they were injected with 50 ul of PBS containing an equivalent dose of modified luciferase mRNA. A control group of untreated mice is also evaluated. The mice are imaged at predetermined intervals to determine the average total flux (photons/second).

C. Modified mRNA and Fibrinogen
[0001570] Prior to reconstitution, luciferase mRNA (mRNA sequence shown in SEQ ID NO: 21446; polyA tail of approximately 140 nucleotides not shown in sequence; 5'cap, Cap1) fully modified with 5-methylcytosine and NI-methyl-pseudouridine or fully modified with NI-methyl-pseudouridine is added to the fibrinolysis inhibitor solution. The fibrinolysis inhibitor solution is then used to reconstitute fibrinogen. Thrombin is reconstituted with the calcium chloride solution per the manufacturer's instructions. The reconstituted fibrinogen containing modified mRNA and thrombin is loaded into a dual barreled syringe. Mice are injected subcutaneously with 50 ul of thrombin and 50 ul of fibrinogen containing modified mRNA or they were injected with 50 ul of PBS containing an equivalent dose of modified luciferase mRNA. A control group of untreated mice is also evaluated. The mice are imaged at predetermined intervals to determine the average total flux (photons/second).

D. Lipid Nanoparticle Formulated Modified mRNA and Fibrinogen
[0001571] Prior to reconstitution, luciferase mRNA (mRNA sequence shown in SEQ ID NO: 21446; polyA tail of approximately 140 nucleotides not shown in sequence; 5'cap, Cap1) fully modified with 5-methylcytosine and NI-methyl-pseudouridine or fully

modified with NI-methyl-pseudouridine is formulated in a lipid nanoparticle is added to the fibrinolysis inhibitor solution. The fibrinolysis inhibitor solution is then used to reconstitute fibrinogen. Thrombin is reconstituted with the calcium chloride solution per the manufacturer's instructions. The reconstituted fibrinogen containing modified mRNA and thrombin is loaded into a dual barreled syringe. Mice are injected subcutaneously with 50 ul of thrombin and 50 ul of fibrinogen containing modified mRNA or they were injected with 50 ul of PBS containing an equivalent dose of modified luciferase mRNA. A control group of untreated mice is also evaluated. The mice are imaged at predetermined intervals to determine the average total flux (photons/second).

E. Modified mRNA and Thrombin

[0001572] Prior to reconstitution, luciferase mRNA (mRNA sequence shown in SEQ ID NO: 21446; polyA tail of approximately 140 nucleotides not shown in sequence; 5'cap, Cap1) fully modified with 5-methylcytosine and NI-methyl-pseudouridine or fully modified with NI-methyl-pseudouridine is added to the reconstituted thrombin after it is reconstituted with the calcium chloride per the manufacturer's instructions. The fibrinolysis inhibitor solution is then used to reconstitute fibrinogen per the manufacturer's instructions. The reconstituted fibrinogen and thrombin containing modified mRNA is loaded into a dual barreled syringe. Mice are injected subcutaneously with 50 ul of thrombin containing modified mRNA and 50 ul of fibrinogen or they were injected with 50 ul of PBS containing an equivalent dose of modified luciferase mRNA. A control group of untreated mice is also evaluated. The mice are imaged at predetermined intervals to determine the average total flux (photons/second).

F. Lipid Nanoparticle Formualted Modified mRNA and Thrombin

[0001573] Prior to reconstitution, luciferase mRNA (mRNA sequence shown in SEQ ID NO: 21446; polyA tail of approximately 140 nucleotides not shown in sequence; 5'cap, Cap1) fully modified with 5-methylcytosine and NI-methyl-pseudouridine or fully modified with NI-methyl-pseudouridine is formulated in a lipid nanoparticle is added to the reconstituted thrombin after it is reconstituted with the calcium chloride per the manufacturer's instructions. The fibrinolysis inhibitor solution is then used to reconstitute fibrinogen per the manufacturer's instructions. The reconstituted fibrinogen and

thrombin containing modified mRNA is loaded into a dual barreled syringe. Mice are injected subcutaneously with 50 ul of thrombin containing modified mRNA and 50 ul of fibrinogen or they were injected with 50 ul of PBS containing an equivalent dose of modified luciferase mRNA. A control group of untreated mice is also evaluated. The mice are imaged at predetermined intervals to determine the average total flux (photons/second).

Example 96. Cationic Lipid Formulation of 5-Methylcytosine and NI-Methyl-pseudouridine Modified mRNA

[0001574] Luciferase mRNA (mRNA sequence shown in SEQ ID NO: 21446; polyA tail of approximately 140 nucleotides not shown in sequence; 5'cap, Cap1) fully modified with 5-methylcytosine and NI-methyl-pseudouridine was formulated in the cationic lipids described in Table 144. The formulations were administered intravenously (I.V.), intramuscularly (I.M.) or subcutaneously (S.C.) to Balb-C mice at a dose of 0.05 mg/kg.

Table 144. Cationic Lipid Formulations

Formulation	NPA-126-1	NPA-127-1	NPA-128-1	NPA-129-1	111612-B
Lipid	DLin-MC3-DMA	DLin-KC2-DMA	C12-200	DLinDMA	DODMA
Lipid/mRNA ratio (wt/wt)	20:1	20:1	20:1	20:1	20:1
Mean Size	122 nm PDI: 0.13	114 nm PDI: 0.10	153 nm PDI: 0.17	137 nm PDI: 0.09	223.2 nm PDI: 0.142
Zeta at pH 7.4	-1.4 mV	-0.5 mV	-1.4 mV	2.0 mV	-3.09 mV
Encaps. (RiboGr)	95%	77%	69%	80%	64%

[0001575] Twenty minutes prior to imaging, mice were injected intraperitoneally with a D-luciferin solution at 150 mg/kg. Animals were then anesthetized and images were acquired with an IVIS Lumina II imaging system (Perkin Elmer). Bioluminescence was measured as total flux (photons/second) of the entire mouse. The mice were imaged at 2 hours, 8 hours and 24 hours after dosing and the average total flux (photons/second) was measured for each route of administration and cationic lipid formulation. The

background flux was about 4.17E+05 p/s. The results of the imaging are shown in Table 145. In Table 145, "NT" means not tested.

Table 145. Flux

Route	Time Point	DLin-MC3-DMA	DLin-KC2-DMA	C12-200	DLinDMA	DODMA
		Flux (p/s)	Flux (p/s)	Flux (p/s)	Flux (p/s)	Flux (p/s)
I.V.	2 hrs	1.92E+08	2.91E+08	1.08E+08	2.53E+07	8.40E+06
I.V.	8 hrs	1.47E+08	2.13E+08	3.72E+07	3.82E+07	5.62E+06
I.V.	24 hrs	1.32E+07	2.41E+07	5.35E+06	4.20E+06	8.97E+05
I.M.	2 hrs	8.29E+06	2.37E+07	1.80E+07	1.51E+06	NT
I.M.	8 hrs	5.83E+07	2.12E+08	2.60E+07	1.99E+07	NT
I.M.	24 hrs	4.30E+06	2.64E+07	3.01E+06	9.46E+05	NT
S.C.	2 hrs	1.90E+07	5.16E+07	8.91E+07	4.66E+06	9.61E+06
S.C.	8 hrs	7.74E+07	2.00E+08	4.58E+07	9.67E+07	1.90E+07
S.C.	24 hrs	7.49E+07	2.47E+07	6.96E+06	6.50E+06	1.28E+06

Example 97. Lipid Nanoparticle Intravenous Study

[0001576] Luciferase mRNA (mRNA sequence shown in SEQ ID NO: 21446; polyA tail of approximately 160 nucleotides not shown in sequence; 5'cap, Cap1; fully modified with 5-methylcytosine and pseudouridine) was formulated in a lipid nanoparticle containing 50% DLin-MC3-DMA OR DLin-KC2-DMA as described in Table 146, 38.5% cholesterol, 10% DSPC and 1.5% PEG. The formulation was administered intravenously (I.V.) to Balb-C mice at a dose of 0.5 mg/kg, 0.05 mg/kg, 0.005 mg/kg or 0.0005 mg/kg. Twenty minutes prior to imaging, mice were injected intraperitoneally with a D-luciferin solution at 150 mg/kg. Animals were then anesthetized and images were acquired with an IVIS Lumina II imaging system (Perkin Elmer). Bioluminescence was measured as total flux (photons/second) of the entire mouse.

Table 146. Formulations

Formulation	NPA-098-1	NPA-100-1
Lipid	DLin-KC2-DMA	DLin-MC3-DMA
Lipid/mRNA ratio (wt/wt)	20:1	20:1
Mean Size	135 nm PDI: 0.08	152 nm PDI: 0.08
Zeta at pH 7.4	-0.6 mV	-1.2 mV
Encaps. (RiboGr)	91%	94%

[0001577] For DLin-KC2-DMA the mice were imaged at 2 hours, 8 hours, 24 hours, 72 hours, 96 hours and 168 hours after dosing and the average total flux (photons/second) was measured for each route of administration and cationic lipid formulation. The background flux was about 3.66E+05 p/s. The results of the imaging are shown in Table 147. Organs were imaged at 8 hours and the average total flux (photons/second) was measured for the liver, spleen, lung and kidney. A control for each organ was also analyzed. The results are shown in Table 148. The peak signal for all dose levels was at 8 hours after administration. Also, distribution to the various organs (liver, spleen, lung, and kidney) may be able to be controlled by increasing or decreasing the LNP dose.

Table 147. Flux

Time Point	0.5 mg/kg	0.05 mg/kg	0.005 mg/kg	0.0005 mg/kg
	Flux (p/s)	Flux (p/s)	Flux (p/s)	Flux (p/s)
2 hrs	3.54E+08	1.75E+07	2.30E+06	4.09E+05
8 hrs	1.67E+09	1.71E+08	9.81E+06	7.84E+05
24 hrs	2.05E+08	2.67E+07	2.49E+06	5.51E+05
72 hrs	8.17E+07	1.43E+07	1.01E+06	3.75E+05
96 hrs	4.10E+07	9.15E+06	9.58E+05	4.29E+05
168 hrs	3.42E+07	9.15E+06	1.47E+06	5.29E+05

Table 148. Organ Flux

	Liver	Spleen	Lung	Kidney
	Flux (p/s)	Flux (p/s)	Flux (p/s)	Flux (p/s)
0.5 mg/kg	1.42E+08	4.86E+07	1.90E+05	3.20E+05
0.05 mg/kg	7.45E+06	4.62E+05	6.86E+04	9.11E+04
0.005 mg/kg	3.32E+05	2.97E+04	1.42E+04	1.15E+04
0.0005 mg/kg	2.34E+04	1.08E+04	1.87E+04	9.78E+03
Untreated	1.88E+04	1.02E+04	1.41E+04	9.20E+03

[0001578] For DLin-MC3-DMA the mice were imaged at 2 hours, 8 hours, 24 hours, 48 hours, 72 hours and 144 hours after dosing and the average total flux (photons/second) was measured for each route of administration and cationic lipid formulation. The background flux was about 4.51E+05 p/s. The results of the imaging are shown in Table 149. Organs were imaged at 8 hours and the average total flux (photons/second) was measured for the liver, spleen, lung and kidney. A control for each organ was also analyzed. The results are shown in Table 150. The peak signal for all dose levels was at 8 hours after administration. Also, distribution to the various organs (liver, spleen, lung, and kidney) may be able to be controlled by increasing or decreasing the LNP dose.

Table 149. Flux

Time Point	0.5 mg/kg	0.05 mg/kg	0.005 mg/kg	0.0005 mg/kg
	Flux (p/s)	Flux (p/s)	Flux (p/s)	Flux (p/s)
2 hrs	1.23E+08	7.76E+06	7.66E+05	4.88E+05
8 hrs	1.05E+09	6.79E+07	2.75E+06	5.61E+05
24 hrs	4.44E+07	1.00E+07	1.06E+06	5.71E+05
48 hrs	2.12E+07	4.27E+06	7.42E+05	4.84E+05
72 hrs	1.34E+07	5.84E+06	6.90E+05	4.38E+05
144 hrs	4.26E+06	2.25E+06	4.58E+05	3.99E+05

Table 150. Organ Flux

	Liver	Spleen	Lung	Kidney
	Flux (p/s)	Flux (p/s)	Flux (p/s)	Flux (p/s)
0.5 mg/kg	1.19E+08	9.66E+07	1.19E+06	1.85E+05
0.05 mg/kg	1.10E+07	1.79E+06	7.23E+04	5.82E+04
0.005 mg/kg	3.58E+05	6.04E+04	1.33E+04	1.33E+04
0.0005 mg/kg	2.25E+04	1.88E+04	2.05E+04	1.65E+04
Untreated	1.91E+04	1.66E+04	2.63E+04	2.14E+04

Example 98. Lipid Nanoparticle Subcutaneous Study

[0001579] Luciferase mRNA (mRNA sequence shown in SEQ ID NO: 21446; polyA tail of approximately 160 nucleotides not shown in sequence; 5'cap, Cap1; fully modified with 5-methylcytosine and pseudouridine) was formulated in a lipid nanoparticle containing 50% DLin-KC2-DMA as described in Table 151, 385% cholesterol, 10% DSPC and 1.5% PEG. The formulation was administered subcutaneously (S.C.) to Balb-C mice at a dose of 0.5 mg/kg, 0.05 mg/kg or 0.005 mg/kg.

Table 151. DLin-KC2-DMA Formulation

Formulation	NPA-098-1
Lipid	DLin-KC2-DMA
Lipid/mRNA ratio (wt/wt)	20:1
Mean Size	135 nm PDI: 0.08
Zeta at pH 7.4	-0.6 mV
Encaps. (RiboGr)	91%

[0001580] Twenty minutes prior to imaging, mice were injected intraperitoneally with a D-luciferin solution at 150 mg/kg. Animals were then anesthetized and images were acquired with an IVIS Lumina II imaging system (Perkin Elmer). Bioluminescence was measured as total flux (photons/second) of the entire mouse. The mice were imaged at 2

hours, 8 hours, 24 hours, 48 hours, 72 hours and 144 hours after dosing and the average total flux (photons/second) was measured for each route of administration and cationic lipid formulation. The lower limit of detection was about $3E+05$ p/s. The results of the imaging are shown in Table 152. Organs were imaged at 8 hours and the average total flux (photons/second) was measured for the liver, spleen, lung and kidney. A control for each organ was also analyzed. The results are shown in Table 153. The peak signal for all dose levels was at 8 hours after administration. Also, distribution to the various organs (liver, spleen, lung, and kidney) may be able to be controlled by increasing or decreasing the LNP dose. At high doses, the LNP formulations migrates outside of the subcutaneous injection site, as high levels of luciferase expression are detected in the liver, spleen, lung, and kidney.

Table 152. Flux

Time Point	0.5 mg/kg	0.05 mg/kg	0.005 mg/kg
	Flux (p/s)	Flux (p/s)	Flux (p/s)
2 hrs	3.18E+07	7.46E+06	8.94E+05
8 hrs	5.15E+08	2.18E+08	1.34E+07
24 hrs	1.56E+08	5.30E+07	7.16E+06
48 hrs	5.22E+07	8.75E+06	9.06E+05
72 hrs	8.87E+06	1.50E+06	2.98E+05
144 hrs	4.55E+05	3.51E+05	2.87E+05

Table 153. Organ Flux

	Liver	Spleen	Lung	Kidney
	Flux (p/s)	Flux (p/s)	Flux (p/s)	Flux (p/s)
0.5 mg/kg	1.01E+07	7.43E+05	9.75E+04	1.75E+05
0.05 mg/kg	1.61E+05	3.94E+04	4.04E+04	3.29E+04
0.005 mg/kg	2.84E+04	2.94E+04	2.42E+04	9.79E+04
Untreated	1.88E+04	1.02E+04	1.41E+04	9.20E+03

Example 99. Cationic Lipid Nanoparticle Subcutaneous Study

[0001581] Luciferase mRNA (mRNA sequence shown in SEQ ID NO: 21446; polyA tail of approximately 160 nucleotides not shown in sequence; 5'cap, CapI; fully modified with 5-methylcytosine and pseudouridine) is formulated in a lipid nanoparticle containing 50% DLin-MC3-DMA, 38.5% cholesterol, 10% DSPC and 1.5% PEG. The formulation is administered subcutaneously (S.C.) to Balb-C mice at a dose of 0.5 mg/kg, 0.05 mg/kg or 0.005 mg/kg.

[0001582] The mice are imaged at 2 hours, 8 hours, 24 hours, 48 hours, 72 hours and 144 hours after dosing and the average total flux (photons/second) was measured for each route of administration and cationic lipid formulation. Organs are imaged at 8 hours and the average total flux (photons/second) is measured for the liver, spleen, lung and kidney. A control for each organ is also analyzed.

Example 100. Luciferase Lipoplex Study

[0001583] Lipoplexed luciferase mRNA (mRNA sequence shown in SEQ ID NO: 21446; polyA tail of approximately 140 nucleotides not shown in sequence; 5'cap, Cap1) fully modified with 5-methylcytosine and pseudouridine (5mC/pU), fully modified with 5-methylcytosine and N1-methyl-pseudouridine (5mC/N1mpU) or modified where 25% of the cytosines replaced with 5-methylcytosine and 25% of the uridines replaced with 2-thiouridine (5mC/s2U). The formulation was administered intravenously (I.V.), intramuscularly (I.M.) or subcutaneously (S.C.) to Balb-C mice at a dose of 0.10 mg/kg.

[0001584] Twenty minutes prior to imaging, mice were injected intraperitoneally with a D-luciferin solution at 150 mg/kg. Animals were then anesthetized and images were acquired with an IVIS Lumina II imaging system (Perkin Elmer). Bioluminescence was measured as total flux (photons/second) of the entire mouse. The mice were imaged at 8 hours, 24 hours and 48 hours after dosing and the average total flux (photons/second) was measured for each route of administration and chemical modification. The background signal was about 3.91E+05 p/s. The results of the imaging are shown in Table 154. Organs were imaged at 6 hours and the average total flux (photons/second) was measured for the liver, spleen, lung and kidney. A control for each organ was also analyzed. The results are shown in Table 155.

Table 154. Flux

Route	Time Point	5mC/pU	5mC/N1mpU	5mC/s2U
		Flux (p/s)	Flux (p/s)	Flux (p/s)
I.V.	8 hrs	5.76E+06	1.78E+06	1.88E+06
I.V.	24 hrs	1.02E+06	7.13E+05	5.28E+05
I.V.	48 hrs	4.53E+05	3.76E+05	4.14E+05
I.M.	8 hrs	1.90E+06	2.53E+06	1.29E+06
I.M.	24 hrs	9.33E+05	7.84E+05	6.48E+05
I.M.	48 hrs	8.51E+05	6.59E+05	5.49E+05
S.C.	8 hrs	2.85E+06	6.48E+06	1.14E+06
S.C.	24 hrs	6.66E+05	7.15E+06	3.93E+05
S.C.	48 hrs	3.24E+05	3.20E+06	5.45E+05

Table 155. Organ Flux

Route	Chemistry	Liver	Spleen	Lung	Kidney	Inj. Site
		Flux (p/s)	Flux (p/s)	Flux (p/s)	Flux (p/s)	Flux (p/s)
I.V.	5mC/pU	5.26E+05	2.04E+07	4.28E+06	1.77E+04	n/a
I.V.	5mC/N1mpU	1.48E+05	5.00E+06	1.93E+06	1.77E+04	n/a
I.V.	5mC/s2U	2.14E+04	3.29E+06	5.48E+05	2.16E+04	n/a
I.M.	5mC/pU	2.46E+04	1.38E+04	1.50E+04	1.44E+04	1.15E+06
I.M.	5mC/N1mpU	1.72E+04	1.76E+04	1.99E+04	1.56E+04	1.20E+06
I.M.	5mC/s2U	1.28E+04	1.36E+04	1.33E+04	1.07E+04	7.60E+05
S.C.	5mC/pU	1.55E+04	1.67E+04	1.45E+04	1.69E+04	4.46E+04
S.C.	5mC/N1mpU	1.20E+04	1.46E+04	1.38E+04	1.14E+04	8.29E+04
S.C.	5mC/s2U	1.22E+04	1.31E+04	1.45E+04	1.08E+04	5.62E+04
	Untreated	2.59E+04	1.34E+04	1.26E+04	1.22E+04	n/a

Example 101. Cationic Lipid Formulation of Modified mRNA

[0001585] Luciferase mRNA (mRNA sequence shown in SEQ ID NO: 21446; polyA tail of approximately 140 nucleotides not shown in sequence; 5'cap, CapI) modified where 25% of the cytosines replaced with 5-methylcytosine and 25% of the uridines replaced with 2-thiouridine (5mC/s2U) was formulated in the cationic lipids described in Table 156. The formulations were administered intravenously (I.V.), intramuscularly (I.M.) or subcutaneously (S.C.) to Balb-C mice at a dose of 0.05 mg/kg.

Table 156. Cationic Lipid Formulations

Formulation	NPA-130-1	NPA-131-1	NPA-132-1	NPA-133-1	111612-C
Lipid	DLin-MC3-DMA	DLin-KC2-DMA	C12-200	DLinDMA	DODMA
Lipid/mRNA ratio (wt/wt)	20:1	20:1	20:1	20:1	20:1
Mean Size	120 nm PDI: 0.10	105 nm PDI: 0.11	122 nm PDI: 0.13	105 nm PDI: 0.14	221.3 nm PDI: 0.063
Zeta at pH 7.4	0.2 mV	-0.6 mV	-0.5 mV	-0.3 mV	-3.10 mV
Encaps. (RiboGr)	100%	100%	93%	93%	60%

[0001586] Twenty minutes prior to imaging, mice were injected intraperitoneally with a D-luciferin solution at 150 mg/kg. Animals were then anesthetized and images were acquired with an IVIS Lumina II imaging system (Perkin Elmer). Bioluminescence was measured as total flux (photons/second) of the entire mouse. The mice were imaged at 2

hours, 8 hours and 24 hours after dosing and the average total flux (photons/second) was measured for each route of administration and cationic lipid formulation. The background flux was about 3.31E+05 p/s. The results of the imaging are shown in Table 157. In Table 157, "NT" means not tested. Untreated mice showed an average flux of 3.14E+05 at 2 hours, 3.33E+05 at 8 hours and 3.46E+05 at 24 hours. Peak expression was seen for all three routes tested at 8 hours. DLin-KC2-DMA has better expression than DLin-MC3-DMA and DODMA showed expression for all routes evaluated.

Table 157. Flux

Route	Time Point	DLin-MC3-DMA	DLin-KC2-DMA	C12-200	DLinDMA	DODMA
		Flux (p/s)	Flux (p/s)	Flux (p/s)	Flux (p/s)	Flux (p/s)
I.V.	2 hrs	9.88E+06	6.98E+07	9.18E+06	3.98E+06	5.79E+06
I.V.	8 hrs	1.21E+07	1.23E+08	1.02E+07	5.98E+06	6.14E+06
I.V.	24 hrs	2.02E+06	1.05E+07	1.25E+06	1.35E+06	5.72E+05
I.M.	2 hrs	6.72E+05	3.66E+06	3.25E+06	7.34E+05	4.42E+05
I.M.	8 hrs	7.78E+06	2.85E+07	4.29E+06	2.22E+06	1.38E+05
I.M.	24 hrs	4.22E+05	8.79E+05	5.95E+05	8.48E+05	4.80E+05
S.C.	2 hrs	2.37E+06	4.77E+06	4.44E+06	1.07E+06	1.05E+06
S.C.	8 hrs	3.65E+07	1.17E+08	3.71E+06	9.33E+06	2.57E+06
S.C.	24 hrs	4.47E+06	1.28E+07	6.39E+05	8.89E+05	4.27E+05

Example 102. Formulation of 5-Methylcytosine and NI-Methyl-pseudouridine

Modified mRNA

[0001587] Luciferase mRNA (mRNA sequence shown in SEQ ID NO: 21446; polyA tail of approximately 140 nucleotides not shown in sequence; 5'cap, CapI) fully modified with 5-methylcytosine and NI-methyl-pseudouridine was formulated in PBS (pH of 7.4). The formulations were administered intramuscularly (I.M.) or subcutaneously (S.C.) to Balb-C mice at a dose of 2.5 mg/kg.

[0001588] Twenty minutes prior to imaging, mice were injected intraperitoneally with a D-luciferin solution at 150 mg/kg. Animals were then anesthetized and images were acquired with an IVIS Lumina II imaging system (Perkin Elmer). Bioluminescence was measured as total flux (photons/second) of the entire mouse. The mice were imaged at 5 minutes, 30 minutes, 60 minutes and 120 minutes after dosing and the average total flux (photons/second) was measured for each route of administration and cationic lipid formulation. The background flux was about 3.78E+05 p/s. The results of the imaging

are shown in Table 158. Expression of luciferase was already seen at 30 minutes with both routes of delivery. Peak expression from subcutaneous administration appears between 30 to 60 minutes. Intramuscular expression was still increasing at 120 minutes.

Table 158. Flux

Route	Time Point	PBS (pH 7.4)
		Flux (p/s)
I.M.	5 min	4.38E+05
I.M.	30 min	1.09E+06
I.M.	60 min	1.18E+06
I.M.	120 min	2.86E+06
S.C.	5 min	4.19E+05
S.C.	30 min	6.38E+06
S.C.	60 min	5.61E+06
S.C.	120 min	2.66E+06

Example 103. Intramuscular and Subcutaneous Administration of Chemically Modified mRNA

[0001589] Luciferase modified mRNA (mRNA sequence shown in SEQ ID NO: 21446; polyA tail of approximately 140 nucleotides not shown in sequence; 5'cap, Cap1) fully modified with N4-acetylcytidine, fully modified with 5-methoxyuridine, fully modified with N4-acetylcytidine and N1-methyl-pseudouridine or fully modified 5-methylcytosine and 5-methoxyuridine formulated in PBS (pH 7.4) was administered to Balb-C mice intramuscularly or subcutaneously at a dose of 2.5 mg/kg. Twenty minutes prior to imaging, mice were injected intraperitoneally with a D-luciferin solution at 150 mg/kg. Animals were then anesthetized and images were acquired with an IVIS Lumina II imaging system (Perkin Elmer). Bioluminescence was measured as total flux (photons/second) of the entire mouse. The mice were imaged at 2 hours, 8 hours and 24 hours. The average total flux (photons/second) for intramuscular administration is shown in Table 159 and the average total flux (photons/second) for subcutaneous administration is shown in Table 160. The background signal was 3.84E+05 (p/s). The peak expression for intramuscular administration was seen between 24 and 48 hours for all chemistry and expression was still detected at 120 hours. For subcutaneous delivery the peak expression was seen at 2-8 hours and expression was detected at 72 hours.

Table 159. Intramuscular Administration

	2 hours	8 hours	24 hours
	Flux (p/s)	Flux (p/s)	Flux (p/s)

N4-acetylcytidine	1.32E+07	2.15E+07	4.01E+07
5-methoxyuridine	4.93E+06	1.80E+07	4.53E+07
N4-acetylcytidine/ N 1-methyl-pseudouridine	2.02E+07	1.93E+07	1.63E+08
5-methylcytosine/ 5- methoxyuridine	6.79E+06	4.55E+07	3.44E+07

Table 160. Subcutaneous Administration

	2 hours	8 hours	24 hours
	Flux (p/s)	Flux (p/s)	Flux (p/s)
N4-acetylcytidine	3.07E+07	1.23E+07	1.28E+07
5-methoxyuridine	7.10E+06	9.38E+06	1.32E+07
N4-acetylcytidine/ N 1-methyl-pseudouridine	7.12E+06	3.07E+06	1.03E+07
5-methylcytosine/ 5- methoxyuridine	7.15E+06	1.25E+07	1.1 1E+07

Example 104. *In vivo* study

[0001590] Luciferase modified mRNA containing at least one chemical modification is formulated as a lipid nanoparticle (LNP) using the syringe pump method and characterized by particle size, zeta potential, and encapsulation.

[0001591] As outlined in Table 161, the luciferase LNP formulation is administered to Balb-C mice intramuscularly (I.M.), intravenously (I.V.) and subcutaneously (S.C.). As a control luciferase modified RNA formulated in PBS is administered intravenously to mice.

Table 161. Luciferase Formulations

Formulation	Vehicle	Route	Concentration (mg/ml)	Injection Volume (ul)	Amount of modified RNA (ug)	Dose (mg/kg)
Luc-LNP	PBS	S.C.	0.2000	50	10	0.5000
Luc-LNP	PBS	S.C.	0.0200	50	1	0.0500
Luc-LNP	PBS	S.C.	0.0020	50	0.1	0.0050
Luc-LNP	PBS	S.C.	0.0002	50	0.01	0.0005
Luc-LNP	PBS	I.V.	0.2000	50	10	0.5000
Luc-LNP	PBS	I.V.	0.0200	50	1	0.0500
Luc-LNP	PBS	I.V.	0.0020	50	0.1	0.0050
Luc-LNP	PBS	I.V.	0.0002	50	0.01	0.0005
Luc-LNP	PBS	I.M.	0.2000	50	10	0.5000
Luc-LNP	PBS	I.M.	0.0200	50	1	0.0500
Luc-LNP	PBS	I.M.	0.0020	50	0.1	0.0050
Luc-LNP	PBS	I.M.	0.0002	50	0.01	0.0005

Luc-PBS	PBS	I.V.	0.20	50	10	0.50
---------	-----	------	------	----	----	------

[0001592] The mice are imaged at 2, 8, 24, 48, 120 and 192 hours to determine the bioluminescence (measured as total flux (photons/second) of the entire mouse). At 8 hours or 192 hours the liver, spleen, kidney and injection site for subcutaneous and intramuscular administration are imaged to determine the bioluminescence.

Example 105. Cationic Lipid Formulation Studies of Chemically Modified mRNA

[0001593] Luciferase mRNA (mRNA sequence shown in SEQ ID NO: 21446; polyA tail of approximately 140 nucleotides not shown in sequence; 5'cap, Cap1) fully modified with 5-methylcytosine and pseudouridine (5mC/pU), pseudouridine (pU) or N1-methyl-pseudouridine (N1mpU) was formulated in the cationic lipids described in Table 162. The formulations were administered intravenously (I.V.), intramuscularly (I.M.) or subcutaneously (S.C.) to Balb-C mice at a dose of 0.05 mg/kg.

Table 162. Cationic Lipid Formulations

Formulation	NPA-137-1	NPA-134-1	NPA-135-1	NPA-136-1	111612-A
Lipid	DLin-MC3-DMA	DLin-MC3-DMA	DLin-KC2-DMA	C12-200	DODMA
Lipid/mRNA ratio (wt/wt)	20:1	20:1	20:1	20:1	20:1
Mean Size	111 nm PDI: 0.15	104 nm PDI: 0.13	95 nm PDI: 0.11	143 nm PDI: 0.12	223.2 nm PDI: 0.142
Zeta at pH 7.4	-4.1 mV	-1.9 mV	-1.0 mV	0.2 mV	-3.09 mV
Encaps. (RiboGr)	97%	100%	100%	78%	64%
Chemistry	pU	N1mpU	N1mpU	N1mpU	5mC/pU

[0001594] Twenty minutes prior to imaging, mice were injected intraperitoneally with a D-luciferin solution at 150 mg/kg. Animals were then anesthetized and images were acquired with an IVIS Lumina II imaging system (Perkin Elmer). Bioluminescence was measured as total flux (photons/second) of the entire mouse. The mice were imaged at 2 hours, 8 hours and 24 hours after dosing and the average total flux (photons/second) was measured for each route of administration and cationic lipid formulation. The background flux was about 4.11E+05 p/s. The results of the imaging are shown in Table 163. Peak expression was seen for all three routes tested at 8 hours.

Table 163. Flux

Route	Time Point	DLin-MC3-DMA (pU)	DLin-MC3-DMA (N1mpU)	DLin-KC2-DMA (N1mpU)	C12-200 (N1mpU)	DODMA (5mC/pU)
		Flux (p/s)	Flux (p/s)	Flux (p/s)	Flux (p/s)	Flux (p/s)
I.V.	2 hrs	3.21E+08	1.24E+09	1.01E+09	9.00E+08	3.90E+07
I.V.	8 hrs	1.60E+09	3.22E+09	2.38E+09	1.11E+09	1.17E+07
I.V.	24 hrs	1.41E+08	3.68E+08	3.93E+08	8.06E+07	1.11E+07
I.M.	2 hrs	2.09E+07	3.29E+07	8.32E+07	9.43E+07	4.66E+06
I.M.	8 hrs	2.16E+08	6.14E+08	1.00E+09	8.77E+07	7.05E+06
I.M.	24 hrs	1.23E+07	1.40E+08	5.09E+08	1.36E+07	1.14E+06
S.C.	2 hrs	2.32E+07	3.60E+07	2.14E+08	1.01E+08	3.11E+07
S.C.	8 hrs	5.55E+08	9.80E+08	4.93E+09	1.01E+09	8.04E+07
S.C.	24 hrs	1.81E+08	2.74E+08	2.12E+09	4.74E+07	1.34E+07

Example 106. Studies of Chemical Modified mRNA

[0001595] Luciferase mRNA (mRNA sequence shown in SEQ ID NO: 21446; polyA tail of approximately 140 nucleotides not shown in sequence; 5'cap, Cap1) fully modified with N4-acetylcytidine (N4-acetyl), fully modified with 5-methoxyuridine (5meth), fully modified with N4-acetylcytidine and N1-methyl-pseudouridine (N4-acetyl/N1mpU) or fully modified with 5-methylcytosine and 5-methoxyuridine (5mC/5-meth) was formulated in DLin-MC3-DMA as described in Table 164.

[0001596] The formulations were administered intravenously (I.V.), intramuscularly (I.M.) or subcutaneously (S.C.) to Balb-C mice at a dose of 0.05 mg/kg.

Table 164. Cationic Lipid Formulations

Formulation	NPA-141-1	NPA-142-1	NPA-143-1	NPA-144-1
Lipid	DLin-MC3-DMA	DLin-MC3-DMA	DLin-MC3-DMA	DLin-MC3-DMA
Lipid/mRNA ratio (wt/wt)	20:1	20:1	20:1	20:1
Mean Size	138 nm PDI: 0.16	116 nm PDI: 0.15	144 nm PDI: 0.15	131 nm PDI: 0.15
Zeta at pH 7.4	-2.8 mV	-2.8 mV	-4.3 mV	-5.0 mV
Encaps. (RiboGr)	97%	100%	75%	72%
Chemistry	N4-acetyl	5meth	N4-acetyl/ N1mpU	5mC/5-meth

[0001597] Twenty minutes prior to imaging, mice were injected intraperitoneally with a D-luciferin solution at 150 mg/kg. Animals were then anesthetized and images were acquired with an IVIS Lumina II imaging system (Perkin Elmer). Bioluminescence was measured as total flux (photons/second) of the entire mouse. The mice were imaged at 2 hours, 6 hours and 24 hours after dosing and the average total flux (photons/second) was measured for each route of administration and cationic lipid formulation. The background flux was about 2.70E+05 p/s. The results of the imaging are shown in Table 165.

Table 165. Flux

Route	Time Point	N4-acetyl	5meth	N4-acetyl/ N1mpU	5mC/5- meth
		Flux (p/s)	Flux (p/s)	Flux (p/s)	Flux (p/s)
I.V.	2 hrs	9.17E+07	3.19E+06	4.21E+07	1.88E+06
I.V.	6 hrs	7.70E+08	9.28E+06	2.34E+08	7.75E+06
I.V.	24 hrs	6.84E+07	1.04E+06	3.55E+07	3.21E+06
I.M.	2 hrs	8.59E+06	7.86E+05	5.30E+06	5.11E+05
I.M.	6 hrs	1.27E+08	8.88E+06	3.82E+07	3.17E+06
I.M.	24 hrs	4.46E+07	1.38E+06	2.00E+07	1.39E+06
S.C.	2 hrs	1.83E+07	9.67E+05	4.45E+06	1.01E+06
S.C.	6 hrs	2.89E+08	1.78E+07	8.91E+07	1.29E+07
S.C.	24 hrs	6.09E+07	6.40E+06	2.08E+08	6.63E+06

Example 107. Lipid Nanoparticle Containing A Plurality of Modified mRNAs

[0001598] EPO mRNA (mRNA sequence shown in SEQ ID NO: 1638; polyA tail of approximately 140 nucleotides not shown in sequence; 5'cap, Cap1; fully modified with 5-methylcytosine and N1-methyl-pseudouridine), G-CSF mRNA (mRNA sequence shown in SEQ ID NO: 21438; polyA tail of approximately 140 nucleotides not shown in sequence; 5'cap, Cap1; fully modified with 5-methylcytosine and N1-methyl-pseudouridine) and Factor IX mRNA (mRNA sequence shown in SEQ ID NO: 1622; polyA tail of approximately 140 nucleotides not shown in sequence; 5'cap, Cap1; fully modified with 5-methylcytosine and N1-methyl-pseudouridine), is formulated in DLin-MC3-DMA as described in Table 166. The formulations are administered intravenously (I.V.), intramuscularly (I.M.) or subcutaneously (S.C.) to Balb-C mice at a dose of 0.05 mg/kg. Control LNP formulations containing only one mRNA are also administered at an equivalent dose.

Table 166. DLin-MC3-DMA Formulation

Formulation	NPA-157-1
Lipid	DLin-MC3- DMA
Lipid/mRNA ratio (wt/wt)	20:1
Mean Size	89 nm PDI: 0.08
Zeta at pH 7.4	1.1 mV
Encaps. (RiboGr)	97%

[0001599] Serum is collected from the mice at 8 hours, 24 hours, 72 hours and/or 7 days after administration of the formulation. The serum is analyzed by ELISA to determine the protein expression of EPO, G-CSF, and Factor IX.

Example 108. Cationic Lipid Formulation Studies of of 5-Methylcytosine and NI-Methyl-pseudouridine Modified mRNA

[0001600] EPO mRNA (mRNA sequence shown in SEQ ID NO: 1638; polyA tail of approximately 140 nucleotides not shown in sequence; 5'cap, Cap1; fully modified with 5-methylcytosine and NI-methyl-pseudouridine) or G-CSF mRNA (mRNA sequence shown in SEQ ID NO: 21438; polyA tail of approximately 140 nucleotides not shown in sequence; 5'cap, Cap1; fully modified with 5-methylcytosine and NI-methyl-pseudouridine) is formulated in DLin-MC3-DMA and DLin-KC2-DMA as described in Table 167. The formulations are administered intravenously (I.V) , intramuscularly (I.M.) or subcutaneously (S.C.) to Balb-C mice at a dose of 0.05 mg/kg.

Table 167. DLin-MC3-DMA and DLin-KC2-DMA Formulations

Formulation	NPA-147-1	NPA-148-1	NPA-150-1	NPA-151-1
mRNA	EPO	EPO	G-CSF	G-CSF
Lipid	DLin-MC3- DMA	DLin-KC2- DMA	DLin-MC3- DMA	DLin-KC2- DMA
Lipid/mRNA ratio (wt/wt)	20:1	20:1	20:1	20:1
Mean Size	117 nm PDI: 0.14	82 nm PDI: 0.08	119 nm PDI: 0.13	88 nm PDI: 0.08
Zeta at pH 7.4	-1.7 mV	0.6 mV	3.6 mV	2.2 mV
Encaps. (RiboGr)	100%	96%	100%	100%

[0001601] Serum is collected from the mice at 8 hours, 24 hours, 72 hours and/or 7 days after administration of the formulation. The serum is analyzed by ELISA to determine the protein expression of EPO and G-CSF.

Example 109. In Vitro VEGF PBMC Study

[0001602] 500 ng of VEGF mRNA (mPvNA sequence shown in SEQ ID NO: 1672 polyA tail of approximately 160 nucleotides not shown in sequence; 5'cap, Cap1) fully modified with 5-methylcytosine and pseudouridine (VEGF 5mC/pU), fully modified with 5-methylcytosine and N1-methyl-pseudouridine (VEGF 5mC/N1mpU) or unmodified (VEGF unmod) was transfected with 0.4 uL of Lipofectamine 2000 into peripheral blood mononuclear cells (PBMC) from three normal blood donors (D1, D2, and D3). Cells were also untreated for each donor as a control. The supernatant was harvested and run by ELISA 22 hours after transfection to determine the protein expression and cytokine induction. The expression of VEGF and IFN-alpha induction is shown in Table 168 and Figures 8A and 8B.

Table 168. Protein and Cytokine levels

	VEGF Expression (pg/ml)			IFN-alpha Induction (pg/ml)		
	D1	D2	D3	D1	D2	D3
VEGF unmod	2	0	0	5400	3537	4946
VEGF 5mC/pU	424	871	429	145	294	106
VEGF 5mC/N1mpU	5088	10331	6183	205	165	6

Example 110. In vitro expression of modified mRNA

[0001603] HEK293 cells were transfected EPO modified mRNA (mRNA sequence shown in SEQ ID NO: 1638; polyA tail of approximately 160 nucleotides not shown in sequence; 5'cap, Cap1; fully modified with 5-methylcytosine and pseudouridine), HeLa cells were forward transfected with Transforming growth factor beta (TGF-beta) modified mRNA (mRNA sequence shown in SEQ ID NO: 1668; poly A tail of approximately 160 nucleotides not shown in sequence; 5'cap, Cap1; fully modified with 5-methylcytosine and pseudouridine) and HepG2 cells were transfected with bactericidal/permeability-increasing protein (rBPI-21) modified mRNA (SEQ ID NO: 21449; poly A tail of approximately 160 nucleotides not shown in sequence; 5'cap, Cap1; fully modified with 5-methylcytosine and pseudouridine) which had been complexed

with Lipofectamine2000 from Invitrogen (Carlsbad, CA) at the concentrations shown in Table 169, 170 and 171 using the procedures described herein. The protein expression was detected by ELISA and the protein (pg/ml) is also shown in Table 169, 170 and 171. In Table 169, ">" means greater than. For TGF-beta a control of untreated cells and a mock transfection of Lipofectamine2000 was also tested.

Table 169. EPO Protein Expression

Amount Transfected	5 ng	1 ng	200 pg	40 pg	8 pg	1.6 pg	320 fg	64 fg
Protein (pg/ml)	>2000	609.486	114.676	0	0	0	0	0

Table 170. TGF-beta Protein Expression

Amount Transfected	750 ng	250 ng	83 ng	Mock	Untreated
Protein (pg/ml)	5058	4325	3210	2	0

Table 171. rBPI-21 Protein Expression

Amount Transfected	2 ug	400 ng	80 ng	16 ng	3.2 ng	640 pg	128 pg	26 pg
Protein (pg/ml)	20.683	9.269	4.768	0	0	0	0	0

Example 111. Bicistronic modified mRNA

[0001604] Human embryonic kidney epithelial (HEK293) were seeded on 96-well plates (Greiner Bio-one GmbH, Frickenhausen, Germany) HEK293 were seeded at a density of 30,000 in 100 μ l cell culture medium (DMEM, 10% FCS, adding 2mM L-Glutamine, 1 mM Sodiumpyruvate and 1x non-essential amino acids (Biochrom AG, Berlin, Germany) and 1.2 mg/ml Sodiumbicarbonate (Sigma-Aldrich, Munich, Germany)) 75 ng of the bicistronic modified mRNA (mCherry-2A-GFP) (SEQ ID NO: 21450; polyA tail of approximately 160 nucleotides not shown in sequence; 5'cap, Cap1; fully modified with 5-methylcytosine and pseudouridine), mCherry modified mRNA (mRNA SEQ ID NO: 21439; polyA tail of approximately 160 nucleotides not shown in sequence; 5'cap, Cap1; fully modified with 5-methylcytosine and pseudouridine) or green fluorescent protein (GFP) modified mRNA (mRNA sequence shown in SEQ ID NO: 21448; polyA tail of

approximately 160 nucleotides not shown in sequence; 5'cap, Cap1; fully modified with 5-methylcytosine and pseudouridine) were added after seeding the cells and incubated. A control of untreated cells was also evaluated. mCherry-2A-GFP refers to a modified mRNA sequence comprising the coding region of mCherry, the 2A peptide and the coding region of GFP.

[0001605] Cells were harvested by transferring the culture media supernatants to a 96-well Pro-Bind U-bottom plate (Beckton Dickinson GmbH, Heidelberg, Germany). Cells were trypsinized with ½ volume Trypsin/EDTA (Biochrom AG, Berlin, Germany), pooled with respective supernatants and fixed by adding one volume PBS/2%FCS (both Biochrom AG, Berlin, Germany)/0.5% formaldehyde (Merck, Darmstadt, Germany). Samples then were submitted to a flow cytometer measurement with a 532nm excitation laser and the 610/20 filter for PE-Texas Red in a LSRII cytometer (Beckton Dickinson GmbH, Heidelberg, Germany). The mean fluorescence intensity (MFI) of all events is shown in Table 172. Cells transfected with the bi-cistronic modified mRNA were able to express both mCherry and GFP.

Table 172. MFI of Modified mRNA

Modified mRNA	mCherry MFI	GFP MFI
mCherry	17746	427
GFP	427	20019
mCherry-2A-GFP	5742	6783
Untreated	427	219

Example 112. Cationic Lipid Formulation Studies of of 5-Methylcytosine and N1-Methyl-pseudouridine Modified mRNA to Produce an Antibody

[0001606] Herceptin heavy chain (HC) mRNA (mRNA sequence shown in SEQ ID NO: 21451; polyA tail of approximately 140 nucleotides not shown in sequence; 5'cap, Cap1; fully modified with 5-methylcytosine and N1-methyl-pseudouridine) and Herceptin light chain (LC) (mRNA sequence shown in SEQ ID NO: 21452; polyA tail of approximately 140 nucleotides not shown in sequence; 5'cap, Cap1; fully modified with 5-methylcytosine and N1-methyl-pseudouridine) are formulated in DLin-MC3-DMA and

DLin-KC2-DMA as described in Table 173. The formulations are administered intravenously (I.V) to Balb-C mice at a dose of 0.500, 0.050, and 0.005 mg/kg.

Table 173. DLin-MC3-DMA and DLin-KC2-DMA Formulations

Formulation	NPA-158-1	NPA-159-1
Herceptin HC:LC Ratio (wt/wt)	2:1	2:1
Lipid	DLin-MC3-DMA	DLin-KC2-DMA
Lipid/Total mRNA ratio (wt/wt)	20:1	20:1
Mean Size	129 nm PDI: 0.14	100 nm PDI: 0.10
Zeta at pH 7.4	0.9 mV	1.9 mV
Encaps. (RiboGr)	100%	100%

[0001607] Serum was collected from the mice at 8 hours, 24 hours, 72 hours and/or 7 days after administration of the formulation. The serum was analyzed by ELISA to determine the protein expression of Herceptin.

Example 113. Directed SAR of Pseudouridine and N1-methyl-Pseudouridine

[0001608] With the recent focus on the pyrimidine nucleoside pseudouridine, a series of structure-activity studies were designed to investigate mRNA containing modifications to pseudouridine or N1-methyl-pseudouridine.

[0001609] The study was designed to explore the effect of chain length, increased lipophilicity, presence of ring structures, and alteration of hydrophobic or hydrophilic interactions when modifications were made at the N1 position, C6 position, the 2-position, the 4-position and on the phosphate backbone. Stability is also investigated.

[0001610] To this end, modifications involving alkylation, cycloalkylation, alkyl-cycloalkylation, arylation, alkyl-arylation, alkylation moieties with amino groups, alkylation moieties with carboxylic acid groups, and alkylation moieties containing amino acid charged moieties are investigated. The degree of alkylation is generally C₁-C₆. Examples of the chemistry modifications include those listed in Table 174 and Table 175.

Table 174. Pseudouridine and N1-methylPseudouridine SAR

Chemistry Modification	Compound #	Naturally occurring
N1-Modifications		
N1-Ethyl-pseudo-UTP	1	N
N1-Propyl-pseudo-UTP	2	N
N1- <i>iso</i> -propyl-pseudo-UTP	3	N
N1-(2,2,2-Trifluoroethyl)-pseudo-UTP	4	N
N1-Cyclopropyl-pseudo-UTP	5	N
N1-Cyclopropylmethyl-pseudo-UTP	6	N
N1-Phenyl-pseudo-UTP	7	N
N1-Benzyl-pseudo-UTP	8	N
N1-Aminomethyl-pseudo-UTP	9	N
P pseudo-UTP-N1-2-ethanoic acid	10	N
N 1-(3-Amino-3-carboxypropyl)pseudo-UTP	11	N
N1-Methyl-3-(3-amino-3-carboxypropyl)pseudo-UTP	12	Y
C-6 Modifications		
6-Methyl-pseudo-UTP	13	N
6-Trifluoromethyl-pseudo-UTP	14	N
6-Methoxy-pseudo-UTP	15	N
6-Phenyl-pseudo-UTP	16	N
6-Iodo-pseudo-UTP	17	N
6-Bromo-pseudo-UTP	18	N
6-Chloro-pseudo-UTP	19	N
6-Fluoro-pseudo-UTP	20	N
2- or 4-position Modifications		
4-Thio-pseudo-UTP	21	N
2-Thio-pseudo-UTP	22	N
Phosphate backbone Modifications		
Alpha-thio-pseudo-UTP	23	N
N1-Me-alpha-thio-pseudo-UTP	24	N

Table 175. Pseudouridine and N1-methyl-Pseudouridine SAR

Chemistry Modification	Compound #	Naturally occurring
N 1-Methyl-pseudo-UTP	1	Y
N1-Butyl-pseudo-UTP	2	N
N 1- <i>tert</i> -Butyl-pseudo-UTP	3	N
N 1-Pentyl-pseudo-UTP	4	N
N1-Hexyl-pseudo-UTP	5	N
N 1-Trifluoromethyl-pseudo-UTP	6	Y
N 1-Cyclobutyl-pseudo-UTP	7	N

N 1-Cyclopentyl-pseudo-UTP	8	N
N 1-Cyclohexyl-pseudo-UTP	9	N
N 1-Cycloheptyl-pseudo-UTP	10	N
N 1-Cyclooctyl-pseudo-UTP	11	N
N 1-Cyclobutylmethyl-pseudo-UTP	12	N
N 1-Cyclopentylmethyl-pseudo-UTP	13	N
N 1-Cyclohexylmethyl-pseudo-UTP	14	N
N 1-Cycloheptylmethyl-pseudo-UTP	15	N
N 1-Cyclooctylmethyl-pseudo-UTP	16	N
N 1-p-tolyl-pseudo-UTP	17	N
N 1-(2,4,6-Trimethyl-phenyl)pseudo-UTP	18	N
N 1-(4-Methoxy-phenyl)pseudo-UTP	19	N
N 1-(4-Amino-phenyl)pseudo-UTP	20	N
N 1-(4-Nitro-phenyl)pseudo-UTP	21	N
Pseudo-UTP-N 1-/?-benzoic acid	22	N
N 1-(4-Methyl-benzyl)pseudo-UTP	24	N
N 1-(2,4,6-Trimethyl-benzyl)pseudo-UTP	23	N
N 1-(4-Methoxy-benzyl)pseudo-UTP	25	N
N 1-(4-Amino-benzyl)pseudo-UTP	26	N
N 1-(4-Nitro-benzyl)pseudo-UTP	27	N
Pseudo-UTP-N 1-methyl-p-benzoic acid	28	N
N 1-(2-Amino-ethyl)pseudo-UTP	29	N
N 1-(3-Amino-propyl)pseudo-UTP	30	N
N 1-(4-Amino-butyl)pseudo-UTP	31	N
N 1-(5-Amino-pentyl)pseudo-UTP	32	N
N 1-(6-Amino-hexyl)pseudo-UTP	33	N
Pseudo-UTP-N 1-3-propionic acid	34	N
Pseudo-UTP-N 1-4-butanoic acid	35	N
Pseudo-UTP-N 1-5-pentanoic acid	36	N
Pseudo-UTP-N 1-6-hexanoic acid	37	N
Pseudo-UTP-N 1-7-heptanoic acid	38	N
N 1-(2-Amino-2-carboxyethyl)pseudo-UTP	39	N
N 1-(4-Amino-4-carboxybutyl)pseudo-UTP	40	N
N 3-Alkyl-pseudo-UTP	41	N
6-Ethyl-pseudo-UTP	42	N
6-Propyl-pseudo-UTP	43	N
6-iso-Propyl-pseudo-UTP	44	N
6-Butyl-pseudo-UTP	45	N
6-tert-Butyl-pseudo-UTP	46	N
6-(2,2,2-Trifluoroethyl)-pseudo-UTP	47	N
6-Ethoxy-pseudo-UTP	48	N
6-Trifluoromethoxy-pseudo-UTP	49	N
6-Phenyl-pseudo-UTP	50	N

6-(Substituted-Phenyl)-pseudo-UTP	51	N
6-Cyano-pseudo-UTP	52	N
6-Azido-pseudo-UTP	53	N
6-Amino-pseudo-UTP	54	N
6-Ethylcarboxylate-pseudo-UTP	54b	N
6-Hydroxy-pseudo-UTP	55	N
6-Methylamino-pseudo-UTP	55b	N
6-Dimethylamino-pseudo-UTP	57	N
6-Hydroxyamino-pseudo-UTP	59	N
6-Formyl-pseudo-UTP	60	N
6-(4-Morpholino)-pseudo-UTP	61	N
6-(4-Thiomorpholino)-pseudo-UTP	62	N
N 1-Me-4-thio-pseudo-UTP	63	N
N 1-Me-2-thio-pseudo-UTP	64	N
1,6-Dimethyl-pseudo-UTP	65	N
1-Methyl-6-trifluoromethyl-pseudo-UTP	66	N
1-Methyl-6-ethyl-pseudo-UTP	67	N
1-Methyl-6-propyl-pseudo-UTP	68	N
1-Methyl-6-iso-propyl-pseudo-UTP	69	N
1-Methyl-6-butyl-pseudo-UTP	70	N
1-Methyl-6-tert-butyl-pseudo-UTP	71	N
1-Methyl-6-(2,2,2-Trifluoroethyl)pseudo-UTP	72	N
1-Methyl-6-iodo-pseudo-UTP	73	N
1-Methyl-6-bromo-pseudo-UTP	74	N
1-Methyl-6-chloro-pseudo-UTP	75	N
1-Methyl-6-fluoro-pseudo-UTP	76	N
1-Methyl-6-methoxy-pseudo-UTP	77	N
1-Methyl-6-ethoxy-pseudo-UTP	78	N
1-Methyl-6-trifluoromethoxy-pseudo-UTP	79	N
1-Methyl-6-phenyl-pseudo-UTP	80	N
1-Methyl-6-(substituted phenyl)pseudo-UTP	81	N
1-Methyl-6-cyano-pseudo-UTP	82	N
1-Methyl-6-azido-pseudo-UTP	83	N
1-Methyl-6-amino-pseudo-UTP	84	N
1-Methyl-6-ethylcarboxylate-pseudo-UTP	85	N
1-Methyl-6-hydroxy-pseudo-UTP	86	N
1-Methyl-6-methylamino-pseudo-UTP	87	N
1-Methyl-6-dimethylamino-pseudo-UTP	88	N
1-Methyl-6-hydroxyamino-pseudo-UTP	89	N
1-Methyl-6-formyl-pseudo-UTP	90	N
1-Methyl-6-(4-morpholino)-pseudo-UTP	91	N
1-Methyl-6-(4-thiomorpholino)-pseudo-UTP	92	N
1-Alkyl-6-vinyl-pseudo-UTP	93	N

1-Alkyl-6-allyl-pseudo-UTP	94	N
1-Alkyl-6-homoallyl-pseudo-UTP	95	N
1-Alkyl-6-ethynyl-pseudo-UTP	96	N
1-Alkyl-6-(2-propynyl)-pseudo-UTP	97	N
1-Alkyl-6-(1-propynyl)-pseudo-UTP	98	N

Example 114. Incorporation of naturally and non-naturally occurring nucleosides

[0001611] Naturally and non-naturally occurring nucleosides are incorporated into mRNA encoding a polypeptide of interest. Examples of these are given in Tables 176 and 177. Certain commercially available nucleoside triphosphates (NTPs) are investigated in the polynucleotides of the invention. A selection of these are given in Table 176. The resultant mRNA are then examined for their ability to produce protein, induce cytokines, and/or produce a therapeutic outcome.

Table 176. Naturally and non-naturally occurring nucleosides

Chemistry Modification	Compound #	Naturally occurring
N4-Methyl-Cytosine	1	Y
N4,N4-Dimethyl-2'-OMe-Cytosine	2	Y
5-Oxyacetic acid-methyl ester-Uridine	3	Y
N3-Methyl-pseudo-Uridine	4	Y
5-Hydroxymethyl-Cytosine	5	Y
5-Trifluoromethyl-Cytosine	6	N
5-Trifluoromethyl-Uridine	7	N
5-Methyl-amino-methyl-Uridine	8	Y
5-Carboxy-methyl-amino-methyl-Uridine	9	Y
5-Carboxymethylaminomethyl-2'-OMe-Uridine	10	Y
5-Carboxymethylaminomethyl-2-thio-Uridine	11	Y
5-Methylaminomethyl-2-thio-Uridine	12	Y
5-Methoxy-carbonyl-methyl-Uridine	13	Y
5-Methoxy-carbonyl-methyl-2'-OMe-Uridine	14	Y
5-Oxyacetic acid-Uridine	15	Y
3-(3-Amino-3-carboxypropyl)-Uridine	16	Y
5-(carboxyhydroxymethyl)uridine methyl ester	17	Y
5-(carboxyhydroxymethyl)uridine	18	Y

Table 177. Non-naturally occurring nucleoside triphosphates

Chemistry Modification	Compound #	Naturally occurring
N1-Me-GTP	1	N
2'-OMe-2-Amino-ATP	2	N

2'-OMe-pseudo-UTP	3	Y
2'-OMe-6-Me-UTP	4	N
2'-Azido-2'-deoxy-ATP	5	N
2'-Azido-2'-deoxy-GTP	6	N
2'-Azido-2'-deoxy-UTP	7	N
2'-Azido-2'-deoxy-CTP	8	N
2'-Amino-2'-deoxy-ATP	9	N
2'-Amino-2'-deoxy-GTP	10	N
2'-Amino-2'-deoxy-UTP	11	N
2'-Amino-2'-deoxy-CTP	12	N
2-Amino-ATP	13	N
8-Aza-ATP	14	N
Xanthosine-5'-TP	15	N
5-Bromo-CTP	16	N
2'-F-5-Methyl-2'-deoxy-UTP	17	N
5-Aminoallyl-CTP	18	N
2-Amino-riboside-TP	19	N

Example 115. Incorporation of modifications to the nucleobase and carbohydrate (sugar)

[0001612] Naturally and non-naturally occurring nucleosides are incorporated into mRNA encoding a polypeptide of interest. Commercially available nucleosides and NTPs having modifications to both the nucleobase and carbohydrate (sugar) are examined for their ability to be incorporated into mRNA and to produce protein, induce cytokines, and/or produce a therapeutic outcome. Examples of these nucleosides are given in Tables 178 and 179.

Table 178. Combination modifications

Chemistry Modification	Compound #
5-iodo-2'-fluoro-deoxyuridine	1
5-iodo-cytidine	6
2'-bromo-deoxyuridine	7
8-bromo-adenosine	8
8-bromo-guanosine	9
2,2'-anhydro-cytidine hydrochloride	10
2,2'-anhydro-uridine	11
2'-Azido-deoxyuridine	12
2-amino-adenosine	13
N4-Benzoyl-cytidine	14

N4-Amino-cytidine	15
2'-O-Methyl-N4- Acetyl-cytidine	16
2'Fluoro-N4-Acetyl-cytidine	17
2'Fluor-N4-Bz-cytidine	18
2'0-methyl-N4-Bz-cytidine	19
2'0-methyl-N6-Bz-deoxyadenosine	20
2'Fluoro-N6-Bz-deoxyadenosine	21
N2-isobutyl-guanosine	22
2'Fluro-N2-isobutyl-guanosine	23
2'0-methyl-N2-isobutyl-guanosine	24

Table 179. Naturally occurring combinations

Name	Compound #	Naturally occurring
5-Methoxycarbonylmethyl-2-thiouridine TP	1	Y
5-Methylaminomethyl-2-thiouridine TP	2	Y
5-Crbamoylmethyluridine TP	3	Y
5-Carbamoylmethyl-2'-O-methyluridine TP	4	Y
1-Methyl-3-(3-amino-3-carboxypropyl) pseudouridine TP	5	Y
5-Methylaminomethyl-2-selenouridine TP	6	Y
5-Carboxymethyluridine TP	7	Y
5-Methyldihydrouridine TP	8	Y
lysidine TP	9	Y
5-Taurinomethyluridine TP	10	Y
5-Taurinomethyl-2-thiouridine TP	11	Y
5-(<i>iso</i> -Pentenylaminomethyl)uridine TP	12	Y
5-(<i>iso</i> -Pentenylaminomethyl)- 2-thiouridine TP	13	Y
5-(<i>iso</i> -Pentenylaminomethyl)-2'-O-methyluridine TP	14	Y
N4-Acetyl-2'-O-methylcytidine TP	15	Y
N4,2'-O-Dimethylcytidine TP	16	Y
5-Formyl-2'-O-methylcytidine TP	17	Y
2'-O-Methylpseudouridine TP	18	Y
2-Thio-2'-O-methyluridine TP	19	Y
3,2'-O-Dimethyluridine TP	20	Y

[0001613] In the tables "UTP" stands for uridine triphosphate, "GTP" stands for guanosine triphosphate, "ATP" stands for adenosine triphosphate, "CTP" stands for cytosine triphosphate, "TP" stands for triphosphate and "Bz" stands for benzyl.

Example 116. Protein Production of Vascular Endothelial Growth Factor in HeLa Cells

[0001614] The day before transfection, 20,000 HeLa cells (ATCC no. CCL-2; Manassas, VA) were harvested by treatment with Trypsin-EDTA solution (LifeTechnologies, Grand Island, NY) and seeded in a total volume of 100ul EMEM medium (supplemented with 10%FCS and 1x Glutamax) per well in a 96-well cell culture plate (Corning, Manassas, VA). The cells were grown at 37°C in 5% CO₂ atmosphere overnight. The next day, 250 ng of vascular endothelial growth factor (VEGF) modified RNA (mRNA sequence shown in SEQ ID NO: 1672; polyA tail of approximately 160 nucleotides not shown in sequence; 5'cap, Cap1) with the chemical modification described in Table 180, was diluted in 10ul final volume of OPTI-MEM (LifeTechnologies, Grand Island, NY). Lipofectamine 2000 (LifeTechnologies, Grand Island, NY) was used as transfection reagent and 0.2 ul of lipofectamine 2000 was diluted to 10 ul final volume of OPTI-MEM. After 5 minutes of incubation at room temperature, both solutions were combined and incubated an additional 15 minute at room temperature. Then the 20ul combined solution was added to the 100ul cell culture medium containing the HeLa cells and incubated at room temperature. A second set of HeLa cells was also evaluated with the VEGF mRNA according to the procedure set out above. A control of untreated cells and cells treated with just lipofecatamine 2000 was also analyzed for the first set of HeLa cells.

[0001615] After an 18 to 22 hour incubation cell culture supernatants of cells expressing VEGF were collected and centrifuged at 10,000rcf for 2 minutes. The cleared supernatants were then analyzed with a VEGF-specific ELISA kit (R & D Systems, Minneapolis, MN) according to the manufacturer instructions. All samples were diluted until the determined values were within the linear range of the ELISA standard curve. The amount of protein produced is shown in Table 180.

[0001616] These results demonstrate that VEGF fully modified with 1-methylpseudouridine produced more protein in HeLa cells compared to the other chemistry.

Table 180. Protein Production

Sample	VEGF set 1 (pg/ml)	VEGF set 2 (pg/ml)
5-methylcytosine and pseudouridine (5mC and pU)	25,455	50,341

5-methylcytosine and 1-methylpseudouridine (5mC and 1mpU)	5,795	8,523
25% of uridine modified with 2-thiouridine and 25% of cytosine modified with 5-methylcytosine (s2U and 5mC)	27,045	27,045
Pseudouridine (pU)	216,023	345,114
1-methylpseudouridine (1mpU)	32,614	38,523
Unmodified	409,318	447,273
Lipofectamine 2000 (L2000)	0	N/A
Untreated	0	N/A

Example 117. Comparison of Protein Production of Chemically Modified Vascular Endothelial Growth Factor in HeLa Cells

[0001617] The day before transfection, 20,000 HeLa cells (ATCC no. CCL-2; Manassas, VA) were harvested by treatment with Trypsin-EDTA solution (LifeTechnologies, Grand Island, NY) and seeded in a total volume of 100ul EMEM medium (supplemented with 10%FCS and 1x Glutamax) per well in a 96-well cell culture plate (Corning, Manassas, VA). The cells were grown at 37°C in 5% CO₂ atmosphere overnight. Next day, 250 ng of vascular endothelial growth factor (VEGF) modified RNA (mRNA sequence shown in SEQ ID NO: 1672; polyA tail of approximately 160 nucleotides not shown in sequence; 5'cap, Cap1) with the chemical modification described in Table 181, were diluted in 10ul final volume of OPTI-MEM (LifeTechnologies, Grand Island, NY). Lipofectamine 2000 (LifeTechnologies, Grand Island, NY) was used as transfection reagent and 0.2 ul of lipofectamine 2000 was diluted to 10 ul final volume of OPTI-MEM. After 5 minutes of incubation at room temperature, both solutions were combined and incubated an additional 15 minute at room temperature. Then the 20ul combined solution was added to the 100ul cell culture medium containing the HeLa cells and incubated at room temperature. A control of untreated cells was also analyzed.

[0001618] After an 18 to 22 hour incubation cell culture supernatants of cells expressing VEGF were collected and centrifuged at 10,000rcf for 2 minutes. The cleared supernatants were then analyzed with a VEGF-specific ELISA kit (R & D Systems, Minneapolis, MN) according to the manufacturer instructions. All samples were diluted until the determined values were within the linear range of the ELISA standard curve. The amount of protein produced is shown in Table 181 and Figure 9.

[0001619] These results demonstrate that VEGF fully modified with 1-methylpseudouridine produced more protein in HeLa cells compared to the other chemistry.

Table 181. Protein Production

Sample	VEGF (pg/ml)
Unmodified	121,176
5-methylcytosine and 1-methylpseudouridine (5mC and 1mpU)	760,000
1-methylpseudouridine (1mpU)	1,393,824
Untreated	0

Example 118. Production of Vascular Endothelial Growth Factor Protein in Mammals

[0001620] Lipoplexed vascular endothelial growth factor (VEGF) mRNA (mRNA sequence shown in SEQ ID NO: 1672; polyA tail of approximately 160 nucleotides not shown in sequence; 5'cap, Cap1) unmodified, fully modified with 5-methylcytosine and pseudouridine (5mC/pU), fully modified with 5-methylcytosine and 1-methylpseudouridine (5mC/1mpU), modified where 25% of the cytosines replaced with 5-methylcytosine and 25% of the uridines replaced with 2-thiouridine (5mC/s2U), fully modified with 1-methylpseudouridine (1mpU) or fully modified with pseudouridine (pU). The formulation was administered intravenously to mice at a dose of 2 ug of mRNA per mouse. As a control, a group of mice were untreated. Serum from the mice is measured by specific VEGF ELISA 3 hours after administration for VEGF protein expression. The results are shown in Table 182 and Figure 10.

Table 182. Protein Production

Sample	VEGF (pg/ml)
Unmodified	34
5-methylcytosine and pseudouridine (5mC and pU)	40
5-methylcytosine and 1-methylpseudouridine (5mC and 1mpU)	11
25% of uridine modified with 2-thiouridine and 25% of cytosine modified with 5-methylcytosine (s2U and 5mC)	53
Pseudouridine (pU)	86
1-methyl-pseudouridine (1mpU)	51
Untreated	0

Example 119. Protein Production of Granulocyte Colony Stimulating Factor in HeLa Cells

[0001621] The day before transfection, 20,000 HeLa cells (ATCC no. CCL-2; Manassas, VA) were harvested by treatment with Trypsin-EDTA solution (LifeTechnologies, Grand Island, NY) and seeded in a total volume of 100ul EMEM medium (supplemented with 10%FCS and 1x Glutamax) per well in a 96-well cell culture plate (Corning, Manassas, VA). The cells were grown at 37°C in 5% CO₂ atmosphere overnight. The next day, 250 ng of granulocyte colony stimulating factor (G-CSF) modified RNA (mRNA sequence shown in SEQ ID NO: 21438; polyA tail of approximately 160 nucleotides not shown in sequence; 5'cap, Cap1) with the chemical modification described in Table 183, was diluted in 10ul final volume of OPTI-MEM (LifeTechnologies, Grand Island, NY). Lipofectamine 2000 (LifeTechnologies, Grand Island, NY) was used as transfection reagent and 0.2 ul of lipofectamine 2000 was diluted to 10 ul final volume of OPTI-MEM. After 5 minutes of incubation at room temperature, both solutions were combined and incubated an additional 15 minute at room temperature. Then the 20ul combined solution was added to the 100ul cell culture medium containing the HeLa cells and incubated at room temperature. A control of untreated cells and cells treated with just lipofecatamine 2000 was also analyzed.

[0001622] After an 18 to 22 hour incubation cell culture supernatants of cells expressing G-CSF were collected and centrifuged at 10,000rcf for 2 minutes. The cleared supernatants were then analyzed with a G-CSF-specific ELISA kit (R & D Systems, Minneapolis, MN) according to the manufacturer instructions. All samples were diluted until the determined values were within the linear range of the ELISA standard curve. The amount of protein produced is shown in Table 183 and Figure 11.

Table 183. Protein Production

Sample	G-CSF (pg/ml)
5-methylcytosine and pseudouridine (5mC and pU)	704,250
5-methylcytosine and 1-methylpsudouridine (5mC and 1mpU)	1,523,750
25% of uridine modified with 2-thiouridine and 25% of	89,000

cytosine modified with 5-methylcytosine (s2U and 5mC)	
Pseudouridine (pU)	408,250
1-methylpseudouridine (ImpU)	1,391,250
Lipofectamine 2000 (L2000)	0
Untreated	0

Example 120. Production of Granulocyte Colony Stimulating Factor Protein in Mammals

[0001623] Granulocyte colony stimulating factor (G-CSF) mRNA (mRNA sequence shown in SEQ ID NO: 21438; polyA tail of approximately 160 nucleotides not shown in sequence; 5'cap, Cap1) fully modified with 5-methylcytosine and pseudouridine (5mC/pU), fully modified with 5-methylcytosine and 1-methylpseudouridine (5mC/ImpU), modified where 25% of the cytosines replaced with 5-methylcytosine and 25% of the uridines replaced with 2-thiouridine (5mC/s2U), fully modified with 1-methylpseudouridine (ImpU) or fully modified with pseudouridine (pU). The formulation was administered intravenously to mice (CD1) (n=3) at a dose of 2 ug of mRNA and 2 ul of lipofectamine 2000 (L2000) per mouse. As a control, a group of mice were untreated. Serum from the mice is measured by specific G-CSF ELISA 6 hours after administration for G-CSF protein expression. The results are shown in Table 184 and Figure 12.

Table 184. Protein Production

Sample	G-CSF (pg/ml)
5-methylcytosine and pseudouridine (5mC and pU)	3,800
5-methylcytosine and 1-methylpseudouridine (5mC and ImpU)	22,868
25% of uridine modified with 2-thiouridine and 25% of cytosine modified with 5-methylcytosine (s2U and 5mC)	1,386
Pseudouridine (pU)	7,579
1-methylpseudouridine (ImpU)	25,882
Untreated	0

Example 121. Protein Production of Chemically Modified Factor IX in HeLa Cell Supernatant

[0001624] The day before transfection, 15,000 HeLa cells (ATCC no. CCL-2; Manassas, VA) were harvested by treatment with Trypsin- Ethylenediammetetraacetic acid (EDTA)

solution (LifeTechnologies, Grand Island, NY) and seeded in a total volume of 100ul Eagle's minimal essential medium (EMEM) (supplemented with 10% fetal calf serum (FCS) and 1x Glutamax) per well in a 24-well cell culture plate (Corning, Manassas, VA). The cells were grown at 37°C in 5% CO₂ atmosphere overnight. Next day, 250 ng of factor IX modified RNA (mRNA sequence shown in SEQ ID NO: 1622; polyA tail of approximately 140 nucleotides not shown in sequence; 5'cap, Cap1) fully modified with 5-methylcytosine and pseudouridine (5mC/pU), fully modified with 5-methylcytosine and 1-methylpseudouridine (5mC/1mpU), modified where 25% of the cytosines replaced with 5-methylcytosine and 25% of the uridines replaced with 2-thiouridine (s2U/5mC), fully modified with 1-methylpseudouridine (ImpU) or fully modified with pseudouridine (pU) were diluted in 10 ul final volume of OPTI-MEM® (LifeTechnologies, Grand Island, NY). Lipofectamine 2000 (LifeTechnologies, Grand Island, NY) was used as transfection reagent and 0.2 ul of lipofectamine 2000 was diluted to 10 ul final volume of OPTI-MEM®. After 5 minutes of incubation at room temperature, both solutions were combined and incubated an additional 15 minute at room temperature. Then the 20ul combined solution was added to the 100ul cell culture medium containing the HeLa cells and incubated at room temperature. A control of untreated was also analyzed.

[0001625] After an 18 hour incubation cell culture supernatants of cells expressing factor IX were collected by lysing cells with immuno-precipitation (IP) buffer from Pierce Biotechnology (Thermo Scientific, Rockford, IL) and centrifuged at 10,000rcf for 2 minutes. The cleared supernatants were diluted 1:2 (1 ml lysate/2 wells/24 well plate) or 1:5 (1 ml lysate/5 wells/24 well plate) then analyzed with a factor IX-specific ELISA kit according to the manufacturer instructions. All samples were diluted until the determined values were within the linear range of the ELISA standard curve. The amount of protein produced in both studies is shown in Table 185 and Figure 13.

Table 185. Protein Production

Sample	Factor IX (ng/ml)
5-methylcytosine and pseudouridine (5mC/pU)	45.8
5-methylcytosine and 1-methylpseudouridine (5mC/1mpU)	147.1
25% of the cytosines replaced with 5-methylcytosine and 25% of the uridines replaced with 2-thiouridine (s2U/5mC)	7.4
Pseudouridine (pU)	17.0

1-methylpseudouridine (ImpU)	32.0
Untreated	0

Example 122. Protein Production of Apolipoprotein A-I in HeLa Cells

[0001626] The day before transfection, 20,000 HeLa cells (ATCC no. CCL-2; Manassas, VA) were harvested by treatment with Trypsin- Ethylenediammetetraacetic acid (EDTA) solution (LifeTechnologies, Grand Island, NY) and seeded in a total volume of 100ul Eagle's minimal essential medium (EMEM) (supplemented with 10% fetal calf serum (FCS) and 1x Glutamax) per well in a 24-well cell culture plate (Corning, Manassas, VA). The cells were grown at 37°C in 5% CO₂ atmosphere overnight. Next day, 250 ng of apolipoprotein A-I wild-type(APOA1wt) modified RNA (mRNA sequence shown in SEQ ID NO: 21453; polyA tail of approximately 160 nucleotides not shown in sequence; 5'cap, Cap1) fully modified with 5-methylcytosine and pseudouridine, apolipoprotein A1 Paris (APOA1 Paris) modified RNA (mRNA sequence shown in SEQ ID NO: 21454; polyA tail of approximately 160 nucleotides not shown in sequence; 5'cap, Cap1) fully modified with 5-methylcytosine and pseudouridine or apolipoprotein A1 Milano (APOA1 Milano) modified RNA (mRNA sequence shown in SEQ ID NO: 21455; polyA tail of approximately 160 nucleotides not shown in sequence; 5'cap, Cap1) fully modified with 5-methylcytosine and pseudouridine were diluted in 10ul final volume of OPTI-MEM® (LifeTechnologies, Grand Island, NY). Lipofectamine 2000 (LifeTechnologies, Grand Island, NY) was used as transfection reagent and 0.2 ul of lipofectamine 2000 was diluted to 10 ul final volume of OPTI-MEM®. After 5 minutes of incubation at room temperature, both solutions were combined and incubated an additional 15 minute at room temperature. Then the 20ul combined solution was added to the 100ul cell culture medium containing the HeLa cells and incubated at room temperature. A control of cells treated with just lipofecatamine 2000 was also analyzed.

[0001627] After an 18 hour incubation cell culture supernatants of cells expressing APOA1wt, APOA1 Paris or APOA1 Milano were collected by lysing cells with immunoprecipitation (IP) buffer from Pierce Biotechnology (Thermo Scientific, Rockford, IL) and centrifuged at 10.000rcf for 2 minutes. The cleared supernatants were diluted 1:2 (1 ml lysate/2 wells/24 well plate) or 1:5 (1 ml lysate/5 wells/24 well plate) then analyzed with an APOA1 -specific ELISA kit according to the manufacturer instructions. All

samples were diluted until the determined values were within the linear range of the ELISA standard curve. The study was repeated and the amount of protein produced in both studies is shown in Table 186 and Figure 14.

Table 186. Protein Production

Sample	Protein (ng/ml)
APOA1wt 1:2 Dilution	8
APOA1wt 1:2 Dilution Repeat	6
APOA1 Milano 1:2 Dilution	7
APOA1 Milano 1:2 Dilution Repeat	7
APOA1 Paris 1:2 Dilution	10
APOA1 Paris 1:2 Dilution Repeat	10
APOA1wt 1:5 Dilution	9
APOA1wt 1:5 Dilution Repeat	9
APOA1 Milano 1:5 Dilution	8
APOA1 Milano 1:5 Dilution Repeat	6
APOA1 Paris 1:5 Dilution	12
APOA1 Paris 1:5 Dilution Repeat	11
Control 1:2 Dilution	0
Control 1:2 Dilution Repeat	0
Control 1:5 Dilution	0
Control 1:5 Dilution Repeat	0

Example 123. Detection of Apolipoprotein A-I Wild-Type Protein: Western Blot

[0001628] The day before transfection, 750,000 HeLa cells (ATCC no. CCL-2; Manassas, VA) were harvested by treatment with Trypsin- Ethylenediaminetetraacetic acid (EDTA) solution (LifeTechnologies, Grand Island, NY) and seeded in a total volume of 3ml Eagle's minimal essential medium (EMEM) (supplemented with 10% fetal calf serum (FCS) and 1x Glutamax) per well in a 6-well cell culture plate (Corning, Manassas, VA). The cells were grown at 37°C in 5% CO₂ atmosphere overnight. Next day, 1250ng of Apolipoprotein A-I (APOA1) wild-type mRNA (mRNA sequence shown in SEQ ID NO: 21453; polyA tail of approximately 160 nucleotides not shown in sequence; 5'cap, Cap1) fully modified with 5-methylcytosine and pseudouridine (5mC/pU), fully modified with 5-methylcytosine and 1-methylpseudouridine (5mC/ImpU), modified where 25% of the cytosines replaced with 5-methylcytosine and 25% of the uridines replaced with 2-thiouridine (s2U/5mC), fully modified with 1-methylpseudouridine (ImpU) or fully modified with pseudouridine (pU) was diluted in

250ul final volume of OPTI-MEM® (LifeTechnologies, Grand Island, NY).

Lipofectamine 2000 (LifeTechnologies, Grand Island, NY) was used as transfection reagent and 5.5ul were diluted in 250ul final volume of OPTI-MEM®. After 5 minutes of incubation at room temperature, both solutions were combined and incubated an additional 15 minutes at room temperature. Then 500 ul of the combined solution was added to the 3 ml cell culture medium containing the HeLa cells. The plates were then incubated as described before.

[0001629] After an 16-18 hour incubation, the medium was removed and the cells were washed with 1ml PBS. After complete removal of the PBS, 500ul of fresh PBS was added. Cells were harvested by scraping with a cell scraper. Harvested cells receiving the same mRNA were then combined in one 1.5ml Eppendorf tube.

[0001630] Cells were pelleted by centrifugation at 3,000 rpm for 2 minutes. The PBS was removed and cells lysed in 250ul radio immunoprecipitatin assay (RIPA) buffer (containing PMSF and eukaryotic protease inhibitor mix) (all from BostonBioProducts, Ashland, MA) by gentle pipetting. Lysates were cleared by centrifugation at 10,000 rpm at 4°G for 10 minutes. Cleared lysates were transferred to Amicon filters with 10,000 kd molecular cutoff (Waters, Milford, MA) and spun at 12,000 rpm and 4°G for 20 minutes. The concentrated protein lysate was recovered by placing the inverted filter in a fresh 1.5ml Eppendorf tube and spinning at 3,000rpm for 1 minute. The final volume of the lysate is between 25-40 ul.

[0001631] Protein concentration was determined using the BCA kit for microtiter-plates from Pierce (Thermo Fisher, Rockford, IL). The standard proteins of the titration curve were dissolved in RIPA buffer (as described for cell lysate generation) and not in dilution buffer.

[0001632] Protein lysates were loaded onNuPage SDS-PAGE system (chambers and power supply) with 1.5mm ready-to-use Bis-Tris gels and 4-12% acrylamide gradient with MOPS-buffer as running aid (all from Life Technologies, Grand Island, NY). Each lysate sample was prepared to 40ul final volume. This sample contained 25ug protein lysate in variable volume, RIPA buffer to make up volume to 26ul, 4ul of 10x reducing agent and 10ul 4x SDS loading buffer (both from Life Technologies, Grand Island, NY). Samples were heated at 95°C for 5 minutes and loaded on the gel. Standard settings were

chosen by the manufacturer, 200V, 120mA and maximum 25W. Run time was 60 minutes, but no longer than running dye reaching the lower end of the gel.

[0001633] After the run was terminated, the plastic case was cracked and the encased gel transferred to a ready-to-use nitrocellulose membrane kit and power supply (iBLOT; LifeTechnologies, Grand Island, NY). Using default settings, the protein lysate was transferred by high Ampere electricity from the gel to the membrane.

[0001634] After the transfer, the membranes were incubated in 5% bovine serum albumin (BSA) in IX tris buffered saline (TBS) for 15 minutes then in 5% BSA in IX TBS + 0.1 % Tween for another 15 minutes. ApoA1 rabbit polyclonal antibody (Abeam, Cambridge, MA) against APOA1 were applied in 3ml of 5% BSA in IX TBS solution at a 1:500 to 1:2000 dilution for 3 hours at room temperature and gentle agitation on an orbital shaker. Membranes are washed 3 times with IX TBS/0.1 % Tween, 5 minutes each time with gentle agitation. Goat anti-rabbit HRP conjugate (Abeam, Cambridge, MA) was conjugated to horse radish peroxidase and binds to the ApoA1 rabbit polyclonal antibody. The conjugated antibody was diluted of 1:1000 to 1:5000 in 5% BSA in IX TBS and incubated for 3 hours at room temperature. The Western Blot detection of APOA1 protein from APOA1 wild-type mRNA containing various chemical modifications in HeLa cell lysates is shown in Figure 15.

Example 124. Detection of Apolipoprotein A-I Paris Protein: Western Blot

[0001635] The day before transfection, 750,000 HeLa cells (ATCC no. CCL-2; Manassas, VA) were harvested by treatment with Trypsin- Ethylenediaminetetraacetic acid (EDTA) solution (LifeTechnologies, Grand Island, NY) and seeded in a total volume of 3ml Eagle's minimal essential medium (EMEM) (supplemented with 10% fetal calf serum (FCS) and 1x Glutamax) per well in a 6-well cell culture plate (Corning, Manassas, VA). The cells were grown at 37°C in 5% CO₂ atmosphere overnight. Next day, 1250ng of Apolipoprotein A-I (APOA1) Paris mRNA (mRNA sequence shown in SEQ ID NO: 21454; polyA tail of approximately 160 nucleotides not shown in sequence; 5'cap, Cap1) fully modified with 5-methylcytosine and pseudouridine (5mC/pU), fully modified with 5-methylcytosine and 1-methylpseudouridine (5mC/1mpU), modified where 25% of the cytosines replaced with 5-methylcytosine and 25% of the uridines replaced with 2-thiouridine (s2U/5mC), fully modified with 1-methylpseudouridine

(ImpU) or fully modified with pseudouridine (pU) was diluted in 250ul final volume of OPTI-MEM® (LifeTechnologies, Grand Island, NY). Lipofectamine 2000 (LifeTechnologies, Grand Island, NY) was used as transfection reagent and 5.5ul were diluted in 250ul final volume of OPTI-MEM®. After 5 minutes of incubation at room temperature, both solutions were combined and incubated an additional 15 minutes at room temperature. Then 500 ul of the combined solution was added to the 3 ml cell culture medium containing the HeLa cells. The plates were then incubated as described before.

[0001636] After an 16-18 hour incubation, the medium was removed and the cells were washed with 1ml PBS. After complete removal of the PBS, 500ul of fresh PBS was added. Cells were harvested by scraping with a cell scraper. Harvested cells receiving the same mRNA were then combined in one 1.5ml Eppendorf tube.

[0001637] Cells were pelleted by centrifugation at 3,000 rpm for 2 minutes. The PBS was removed and cells lysed in 250ul radio immunoprecipitation assay (RIPA) buffer (containing PMSF and eukaryotic protease inhibitor mix) (all from BostonBioProducts, Ashland, MA) by gentle pipetting. Lysates were cleared by centrifugation at 10,000 rpm at 4°C for 10 minutes. Cleared lysates were transferred to Amicon filters with 10,000 kd molecular cutoff (Waters, Milford, MA) and spun at 12,000 rpm and 4°C for 20 minutes. The concentrated protein lysate was recovered by placing the inverted filter in a fresh 1.5ml Eppendorf tube and spinning at 3,000rpm for 1 minute. The final volume of the lysate is between 25-40 ul.

[0001638] Protein concentration was determined using the BCA kit for microtiter-plates from Pierce (Thermo Fisher, Rockford, IL). The standard proteins of the titration curve were dissolved in RIPA buffer (as described for cell lysate generation) and not in dilution buffer.

[0001639] Protein lysates were loaded onNuPage SDS-PAGE system (chambers and power supply) with 1.5mm ready-to-use Bis-Tris gels and 4-12% acrylamide gradient with MOPS-buffer as running aid (all from Life Technologies, Grand Island, NY). Each lysate sample was prepared to 40ul final volume. This sample contained 25ug protein lysate in variable volume, RIPA buffer to make up volume to 26ul, 4ul of 10x reducing agent and 10ul 4x SDS loading buffer (both from Life Technologies, Grand Island, NY).

Samples were heated at 95°C for 5 minutes and loaded on the gel. Standard settings were chosen by the manufacturer, 200V, 120mA and maximum 25W. Run time was 60 minutes, but no longer than running dye reaching the lower end of the gel.

[0001640] After the run was terminated, the plastic case was cracked and the encased gel transferred to a ready-to-use nitrocellulose membrane kit and power supply (iBLOT; LifeTechnologies, Grand Island, NY). Using default settings, the protein lysate was transferred by high Ampere electricity from the gel to the membrane.

[0001641] After the transfer, the membranes were incubated in 5% bovine serum albumin (BSA) in IX tris buffered saline (TBS) for 15 minutes then in 5% BSA in IX TBS + 0.1 % Tween for another 15 minutes. ApoA1 rabbit polyclonal antibody (Abeam, Cambridge, MA) against APOA1 were applied in 3ml of 5% BSA in IX TBS solution at a 1:500 to 1:2000 dilution for 3 hours at room temperature and gentle agitation on an orbital shaker. Membranes are washed 3 times with IX TBS/0.1 % Tween, 5 minutes each time with gentle agitation. Goat anti-rabbit HRP conjugate (Abeam, Cambridge, MA) was conjugated to horse radish peroxidase and binds to the ApoA1 rabbit polyclonal antibody. The conjugated antibody was diluted of 1:1000 to 1:5000 in 5% BSA in IX TBS and incubated for 3 hours at room temperature. The Western Blot detection of APOA1 protein from APOA1 Paris mRNA containing various chemical modifications in HeLa cell lysates is shown in Figure 16.

Example 125. Detection of Apolipoprotein A-I Milano Protein: Western Blot

[0001642] The day before transfection, 750,000 HeLa cells (ATCC no. CCL-2; Manassas, VA) were harvested by treatment with Trypsin- Ethylenediaminetetraacetic acid (EDTA) solution (LifeTechnologies, Grand Island, NY) and seeded in a total volume of 3ml Eagle's minimal essential medium (EMEM) (supplemented with 10% fetal calf serum (FCS) and 1x Glutamax) per well in a 6-well cell culture plate (Corning, Manassas, VA). The cells were grown at 37°C in 5% CO₂ atmosphere overnight. Next day, 1250ng of Apolipoprotein A-I (APOA1) Milano mRNA (mRNA sequence shown in SEQ ID NO: 21455; polyA tail of approximately 160 nucleotides not shown in sequence; 5'cap, Cap1) fully modified with 5-methylcytosine and pseudouridine (5mC/pU), fully modified with 5-methylcytosine and 1-methylpseudouridine (5mC/ImpU), modified where 25% of the cytosines replaced with 5-methylcytosine and

25% of the uridines replaced with 2-thiouridine (s2U/5mC), fully modified with 1-methylpseudouridine (ImpU) or fully modified with pseudouridine (pU) was diluted in 250ul final volume of OPTI-MEM® (LifeTechnologies, Grand Island, NY).

Lipofectamine 2000 (LifeTechnologies, Grand Island, NY) was used as transfection reagent and 5.5ul were diluted in 250ul final volume of OPTI-MEM®. After 5 minutes of incubation at room temperature, both solutions were combined and incubated an additional 15 minutes at room temperature. Then 500 ul of the combined solution was added to the 3 ml cell culture medium containing the HeLa cells. The plates were then incubated as described before.

[0001643] After an 16-18 hour incubation, the medium was removed and the cells were washed with 1ml PBS. After complete removal of the PBS, 500ul of fresh PBS was added. Cells were harvested by scraping with a cell scraper. Harvested cells receiving the same mRNA were then combined in one 1.5ml Eppendorf tube.

[0001644] Cells were pelleted by centrifugation at 3,000 rpm for 2 minutes. The PBS was removed and cells lysed in 250ul radio immunoprecipitoin assay (RIPA) buffer (containing PMSF and eukaryotic protease inhibitor mix) (all from BostonBioProducts, Ashland, MA) by gentle pipetting. Lysates were cleared by centrifugation at 10,000 rpm at 4°G for 10 minutes. Cleared lysates were transferred to Amicon filters with 10,000 kd molecular cutoff (Waters, Milford, MA) and spun at 12,000 rpm and 4°G for 20 minutes. The concentrated protein lysate was recovered by placing the inverted filter in a fresh 1.5ml Eppendorf tube and spinning at 3,000rpm for 1 minute. The final volume of the lysate is between 25-40 ul.

[0001645] Protein concentration was determined using the BCA kit for microtiter-plates from Pierce (Thermo Fisher, Rockford, IL). The standard proteins of the titration curve were dissolved in RIPA buffer (as described for cell lysate generation) and not in dilution buffer.

[0001646] Protein lysates were loaded onNuPage SDS-PAGE system (chambers and power supply) with 1.5mm ready-to-use Bis-Tris gels and 4-12% acrylamide gradient with MOPS-buffer as running aid (all from Life Technologies, Grand Island, NY). Each lysate sample was prepared to 40ul final volume. This sample contained 25ug protein lysate in variable volume, RIPA buffer to make up volume to 26ul, 4ul of 10x reducing

agent and 10ul 4x SDS loading buffer (both from Life Technologies, Grand Island, NY). Samples were heated at 95°C for 5 minutes and loaded on the gel. Standard settings were chosen by the manufacturer, 200V, 120mA and maximum 25W. Run time was 60 minutes, but no longer than running dye reaching the lower end of the gel.

[0001647] After the run was terminated, the plastic case was cracked and the encased gel transferred to a ready-to-use nitrocellulose membrane kit and power supply (iBLOT; LifeTechnologies, Grand Island, NY). Using default settings, the protein lysate was transferred by high Ampere electricity from the gel to the membrane.

[0001648] After the transfer, the membranes were incubated in 5% bovine serum albumin (BSA) in IX tris buffered saline (TBS) for 15 minutes then in 5% BSA in IX TBS + 0.1 % Tween for another 15 minutes. ApoA1 rabbit polyclonal antibody (Abeam, Cambridge, MA) against APOA1 were applied in 3ml of 5% BSA in IX TBS solution at a 1:500 to 1:2000 dilution for 3 hours at room temperature and gentle agitation on an orbital shaker. Membranes are washed 3 times with IX TBS/0.1 % Tween, 5 minutes each time with gentle agitation. Goat anti-rabbit HRP conjugate (Abeam, Cambridge, MA) was conjugated to horse radish peroxidase and binds to the ApoA1 rabbit polyclonal antibody. The conjugated antibody was diluted of 1:1000 to 1:5000 in 5% BSA in IX TBS and incubated for 3 hours at room temperature. The Western Blot detection of APOA1 protein from APOA1 Milano mRNA containing various chemical modifications in HeLa cell lysates is shown in Figure 17.

Example 126. Detection of Fibrinogen A Protein: Western Blot

[0001649] The day before transfection, 750,000 HeLa cells (ATCC no. CCL-2; Manassas, VA) were harvested by treatment with Trypsin- Ethylenediaminetetraacetic acid (EDTA) solution (LifeTechnologies, Grand Island, NY) and seeded in a total volume of 3ml Eagle's minimal essential medium (EMEM) (supplemented with 10% fetal calf serum (FCS) and 1x Glutamax) per well in a 6-well cell culture plate (Corning, Manassas, VA). The cells were grown at 37°C in 5% CO₂ atmosphere overnight. Next day, 1250ng of Fibrinogen A (FGA) mRNA (mRNA sequence shown in SEQ ID NO: 21456; polyA tail of approximately 160 nucleotides not shown in sequence; 5'cap, Cap1) fully modified with 5-methylcytosine and 1-methylpseudouridine (5mC/ImpU) was diluted in 250ul final volume of OPTI-MEM® (LifeTechnologies, Grand Island, NY).

Lipofectamine 2000 (LifeTechnologies, Grand Island, NY) was used as transfection reagent and 5.5ul were diluted in 250ul final volume of OPTI-MEM®. After 5 minutes of incubation at room temperature, both solutions were combined and incubated an additional 15 minutes at room temperature. Then 500 ul of the combined solution was added to the 3 ml cell culture medium containing the HeLa cells. The plates were then incubated as described before.

[0001650] After an 16-18 hour incubation, the medium was removed and the cells were washed with 1ml PBS. After complete removal of the PBS, 500ul of fresh PBS was added. Cells were harvested by scraping with a cell scraper. Harvested cells receiving the same mRNA were then combined in one 1.5ml Eppendorf tube.

[0001651] Cells were pelleted by centrifugation at 3,000 rpm for 2 minutes. The PBS was removed and cells lysed in 250ul radio immunoprecipitatin assay (RIPA) buffer (containing PMSF and eukaryotic protease inhibitor mix) (all from BostonBioProducts, Ashland, MA) by gentle pipetting. Lysates were cleared by centrifugation at 10,000 rpm at 4°G for 10 minutes. Cleared lysates were transferred to Amicon filters with 10,000 kd molecular cutoff (Waters, Milford, MA) and spun at 12,000 rpm and 4°G for 20 minutes. The concentrated protein lysate was recovered by placing the inverted filter in a fresh 1.5ml Eppendorf tube and spinning at 3,000rpm for 1 minute. The final volume of the lysate is between 25-40 ul.

[0001652] Protein concentration was determined using the BCA kit for microtiter-plates from Pierce (Thermo Fisher, Rockford, IL). The standard proteins of the titration curve were dissolved in RIPA buffer (as described for cell lysate generation) and not in dilution buffer.

[0001653] Protein lysates were loaded onNuPage SDS-PAGE system (chambers and power supply) with 1.5mm ready-to-use Bis-Tris gels and 4-12% acrylamide gradient with MOPS-buffer as running aid (all from Life Technologies, Grand Island, NY). Each lysate sample was prepared to 40ul final volume. This sample contained 25ug protein lysate in variable volume, RIPA buffer to make up volume to 26ul, 4ul of 10x reducing agent and 10ul 4x SDS loading buffer (both from Life Technologies, Grand Island, NY). Samples were heated at 95°C for 5 minutes and loaded on the gel. Standard settings were

chosen by the manufacturer, 200V, 120mA and maximum 25W. Run time was 60 minutes, but no longer than running dye reaching the lower end of the gel.

[0001654] After the run was terminated, the plastic case was cracked and the encased gel transferred to a ready-to-use nitrocellulose membrane kit and power supply (iBLOT; LifeTechnoIogies, Grand Island, NY). Using default settings, the protein lysate was transferred by high Ampere electricity from the gel to the membrane.

[0001655] After the transfer, the membranes were incubated in 5% bovine serum albumin (BSA) in IX tris buffered saline (TBS) for 15 minutes then in 5% BSA in IX TBS + 0.1 % Tween for another 15 minutes. Fibrinogen A goat polyclonal antibody (Abeam, Cambridge, MA) against fibrinogen A were applied in 3ml of 5% BSA in IX TBS solution at a 1:500 to 1:2000 dilution for 3 hours at room temperature and gentle agitation on an orbital shaker. Membranes are washed 3 times with IX TBS/0.1 % Tween, 5 minutes each time with gentle agitation. Donkey anti-goat HRP conjugate (Abeam, Cambridge, MA) was conjugated to horse radish peroxidase and binds to the fibrinogen A goat polyclonal antibody. The conjugated antibody was diluted of 1:1000 to 1:5000 in 5% BSA in IX TBS and incubated for 3 hours at room temperature. As shown with the box in Figure 18 the Western Blot detection of fibrinogen A was close to the expected size of 95 kd.

Example 127. Protein Production of Chemically Modified Plasminogen in HeLa Cell Supernatant

[0001656] The day before transfection, 20,000 HeLa cells (ATCC no. CCL-2; Manassas, VA) were harvested by treatment with Trypsin-EDTA solution (LifeTechnoIogies, Grand Island, NY) and seeded in a total volume of 100ul EMEM medium (supplemented with 10%FCS and 1x Glutamax) per well in a 96-well cell culture plate (Corning, Manassas, VA). The cells were grown at 37°C in 5% CO₂ atmosphere overnight. Next day, 250 ng of plasminogen modified RNA (mRNA sequence shown in SEQ ID NO: 21457; polyA tail of approximately 160 nucleotides not shown in sequence; 5'cap, CapI) fully modified with 5-methylcytosine and 1-methylpseudouridine, was diluted in 10ul final volume of OPTI-MEM (LifeTechnoIogies, Grand Island, NY). Lipofectamine 2000 (LifeTechnoIogies, Grand Island, NY) was used as transfection reagent and 0.2 ul of lipofectamine 2000 was diluted to 10 ul final volume of OPTI-MEM. After 5 minutes of incubation at room temperature, both solutions were combined and incubated an

additional 15 minute at room temperature. Then the 20ul combined solution was added to the 100ul cell culture medium containing the HeLa cells and incubated at room temperature. A control of erythropoietin (EPO) modified mRNA (mRNA sequence shown in SEQ ID NO: 1638; polyA tail of approximately 160 nucleotides not shown in sequence; 5'cap, Cap1, fully modified with 5-methylcytosine and pseudouridine) and untreated cells were also analyzed.

[0001657] After an 18 to 22 hour incubation cell culture supernatants of cells expressing plasminogen was collected and centrifuged at 10,000rcf for 2 minutes. The cleared supernatants were then analyzed with a plasminogen-specific ELISA kit (R & D Systems, Minneapolis, MN) according to the manufacturer instructions. All samples were diluted until the determined values were within the linear range of the ELISA standard curve. The amount of protein produced is shown in Table 187 and Figure 19.

Table 187. Protein Production

Sample	Plasminogen (ng/ml)
Plasminogen	10
EPO	1.1
Untreated	0.8

Example 128. Detection of Plasminogen Protein: Western Blot

[0001658] The day before transfection, 750,000 HeLa cells (ATCC no. CCL-2; Manassas, VA) were harvested by treatment with Trypsin- Ethylenediaminetetraacetic acid (EDTA) solution (LifeTechnologies, Grand Island, NY) and seeded in a total volume of 3ml Eagle's minimal essential medium (EMEM) (supplemented with 10% fetal calf serum (FCS) and 1x Glutamax) per well in a 6-well cell culture plate (Corning, Manassas, VA). The cells were grown at 37°C in 5% CO₂ atmosphere overnight. Next day, 1250ng of Plasminogen mRNA (mRNA sequence shown in SEQ ID NO: 21457; polyA tail of approximately 160 nucleotides not shown in sequence; 5'cap, Cap1) fully modified with 5-methylcytosine and 1-methylpseudouridine (5mC/1mpU) was diluted in 250ul final volume of OPTI-MEM® (LifeTechnologies, Grand Island, NY). Lipofectamine 2000 (LifeTechnologies, Grand Island, NY) was used as transfection reagent and 5.5ul were diluted in 250ul final volume of OPTI-MEM®. After 5 minutes of

incubation at room temperature, both solutions were combined and incubated an additional 15 minutes at room temperature. Then 500 ul of the combined solution was added to the 3 ml cell culture medium containing the HeLa cells. The plates were then incubated as described before.

[0001659] After an 16-18 hour incubation, the medium was removed and the cells were washed with 1ml PBS. After complete removal of the PBS, 500ul of fresh PBS was added. Cells were harvested by scraping with a cell scraper. Harvested cells receiving the same mRNA were then combined in one 1.5ml Eppendorf tube.

[0001660] Cells were pelleted by centrifugation at 3,000 rpm for 2 minutes. The PBS was removed and cells lysed in 250ul radio immunoprecipitation assay (RIPA) buffer (containing PMSF and eukaryotic protease inhibitor mix) (all from BostonBioProducts, Ashland, MA) by gentle pipetting. Lysates were cleared by centrifugation at 10,000 rpm at 4°C for 10 minutes. Cleared lysates were transferred to Amicon filters with 10,000 kd molecular cutoff (Waters, Milford, MA) and spun at 12,000 rpm and 4°C for 20 minutes. The concentrated protein lysate was recovered by placing the inverted filter in a fresh 1.5ml Eppendorf tube and spinning at 3,000rpm for 1 minute. The final volume of the lysate is between 25-40 ul.

[0001661] Protein concentration was determined using the BCA kit for microtiter-plates from Pierce (Thermo Fisher, Rockford, IL). The standard proteins of the titration curve were dissolved in RIPA buffer (as described for cell lysate generation) and not in dilution buffer.

[0001662] Protein lysates were loaded on NuPage SDS-PAGE system (chambers and power supply) with 1.5mm ready-to-use Bis-Tris gels and 4-12% acrylamide gradient with MOPS-buffer as running aid (all from Life Technologies, Grand Island, NY). Each lysate sample was prepared to 40ul final volume. This sample contained 25ug protein lysate in variable volume, RIPA buffer to make up volume to 26ul, 4ul of 10x reducing agent and 10ul 4x SDS loading buffer (both from Life Technologies, Grand Island, NY). Samples were heated at 95°C for 5 minutes and loaded on the gel. Standard settings were chosen by the manufacturer, 200V, 120mA and maximum 25W. Run time was 60 minutes, but no longer than running dye reaching the lower end of the gel.

[0001663] After the run was terminated, the plastic case was cracked and the encased gel transferred to a ready-to-use nitrocellulose membrane kit and power supply (iBLOT; LifeTechnologies, Grand Island, NY). Using default settings, the protein lysate was transferred by high Ampere electricity from the gel to the membrane.

[0001664] After the transfer, the membranes were incubated in 5% bovine serum albumin (BSA) in IX tris buffered saline (TBS) for 15 minutes then in 5% BSA in IX TBS + 0.1 % Tween for another 15 minutes. Plasminogen goat polyclonal antibody (Abeam, Cambridge, MA) against plasminogen were applied in 3ml of 5% BSA in IX TBS solution at a 1:500 to 1:2000 dilution for 3 hours at room temperature and gentle agitation on an orbital shaker. Membranes are washed 3 times with IX TBS/0.1 % Tween, 5 minutes each time with gentle agitation. Donkey anti-goat HRP conjugate (Abeam, Cambridge, MA) was conjugated to horse radish peroxidase and binds to the plasminogen goat polyclonal antibody. The conjugated antibody was diluted of 1:1000 to 1:5000 in 5% BSA in IX TBS and incubated for 3 hours at room temperature. Figure 20 shows that Plasminogen was detected close to the expected size of 95 kd.

Example 129. Detection of Galactose-1-phosphate Uridyltransferase Protein:

Western Blot

[0001665] The day before transfection, 750,000 HeLa cells (ATCC no. CCL-2; Manassas, VA) were harvested by treatment with Trypsin- Ethylenediaminetetraacetic acid (EDTA) solution (LifeTechnologies, Grand Island, NY) and seeded in a total volume of 3ml Eagle's minimal essential medium (EMEM) (supplemented with 10% fetal calf serum (FCS) and 1x Glutamax) per well in a 6-well cell culture plate (Corning, Manassas, VA). The cells were grown at 37°C in 5% CO₂ atmosphere overnight. Next day, 1250ng of galactose-1-phosphate uridyltransferase (GALT) mRNA (mRNA sequence shown in SEQ ID NO: 21458; polyA tail of approximately 160 nucleotides not shown in sequence; 5'cap, Cap1) fully modified with 5-methylcytosine and pseudouridine (5mC/pU) was diluted in 250ul final volume of OPTI-MEM® (LifeTechnologies, Grand Island, NY). Lipofectamine 2000 (LifeTechnologies, Grand Island, NY) was used as transfection reagent and 5.5ul were diluted in 250ul final volume of OPTI-MEM®. After 5 minutes of incubation at room temperature, both solutions were combined and incubated an additional 15 minutes at room temperature. Then 500 ul of

the combined solution was added to the 3 ml cell culture medium containing the HeLa cells. The plates were then incubated as described before.

[0001666] After an 16-18 hour incubation, the medium was removed and the cells were washed with 1ml PBS. After complete removal of the PBS, 500ul of fresh PBS was added. Cells were harvested by scraping with a cell scraper. Harvested cells receiving the same mRNA were then combined in one 1.5ml Eppendorf tube.

[0001667] Cells were pelleted by centrifugation at 3,000 rpm for 2 minutes. The PBS was removed and cells lysed in 250ul radio immunoprecipitation assay (RIPA) buffer (containing PMSF and eukaryotic protease inhibitor mix) (all from BostonBioProducts, Ashland, MA) by gentle pipetting. Lysates were cleared by centrifugation at 10,000 rpm at 4°C for 10 minutes. Cleared lysates were transferred to Amicon filters with 10,000 kd molecular cutoff (Waters, Milford, MA) and spun at 12,000 rpm and 4°C for 20 minutes. The concentrated protein lysate was recovered by placing the inverted filter in a fresh 1.5ml Eppendorf tube and spinning at 3,000rpm for 1 minute. The final volume of the lysate is between 25-40 ul.

[0001668] Protein concentration was determined using the BCA kit for microtiter-plates from Pierce (Thermo Fisher, Rockford, IL). The standard proteins of the titration curve were dissolved in RIPA buffer (as described for cell lysate generation) and not in dilution buffer.

[0001669] Protein lysates were loaded on NuPage SDS-PAGE system (chambers and power supply) with 1.5mm ready-to-use Bis-Tris gels and 4-12% acrylamide gradient with MOPS-buffer as running aid (all from Life Technologies, Grand Island, NY). Each lysate sample was prepared to 40ul final volume. This sample contained 25ug protein lysate in variable volume, RIPA buffer to make up volume to 26ul, 4ul of 10x reducing agent and 10ul 4x SDS loading buffer (both from Life Technologies, Grand Island, NY). Samples were heated at 95°C for 5 minutes and loaded on the gel. Standard settings were chosen by the manufacturer, 200V, 120mA and maximum 25W. Run time was 60 minutes, but no longer than running dye reaching the lower end of the gel.

[0001670] After the run was terminated, the plastic case was cracked and the encased gel transferred to a ready-to-use nitrocellulose membrane kit and power supply (iBLOT;

LifeTechnologies, Grand Island, NY). Using default settings, the protein lysate was transferred by high Ampere electricity from the gel to the membrane.

[0001671] After the transfer, the membranes were incubated in 5% bovine serum albumin (BSA) in IX tris buffered saline (TBS) for 15 minutes then in 5% BSA in IX TBS + 0.1 % Tween for another 15 minutes. GALT mouse monoclonal antibody (Novus biological, Littleton CO) against GALT were applied in 3ml of 5% BSA in IX TBS solution at a 1:500 to 1:2000 dilution for 3 hours at room temperature and gentle agitation on an orbital shaker. Membranes are washed 3 times with IX TBS/0.1 % Tween, 5 minutes each time with gentle agitation. Donkey anti-mouse HRP conjugate (Abeam, Cambridge, MA) was conjugated to horse radish peroxidase and binds to the GALT mouse monoclonal antibody. The conjugated antibody was diluted of 1:1000 to 1:5000 in 5% BSA in IX TBS and incubated for 3 hours at room temperature. As shown with the box in Figure 21, the Western Blot detection of GALT was about 42 kd.

Example 130. Detection of Argininosuccinase Acid Lyase Protein: Western Blot

[0001672] The day before transfection, 750,000 HeLa cells (ATCC no. CCL-2; Manassas, VA) were harvested by treatment with Trypsin- Ethylenediaminetetraacetic acid (EDTA) solution (LifeTechnologies, Grand Island, NY) and seeded in a total volume of 3ml Eagle's minimal essential medium (EMEM) (supplemented with 10% fetal calf serum (FCS) and 1x Glutamax) per well in a 6-well cell culture plate (Corning, Manassas, VA). The cells were grown at 37°C in 5% CO₂ atmosphere overnight. Next day, 1250ng of argininosuccinase acid lyase (ASL) mRNA (mRNA sequence shown in SEQ ID NO: 21459; polyA tail of approximately 160 nucleotides not shown in sequence; 5'cap, Cap1) fully modified with 5-methylcytosine and pseudouridine (5mC/pU) was diluted in 250ul final volume of OPTI-MEM® (LifeTechnologies, Grand Island, NY). Lipofectamine 2000 (LifeTechnologies, Grand Island, NY) was used as transfection reagent and 5.5ul were diluted in 250ul final volume of OPTI-MEM®. After 5 minutes of incubation at room temperature, both solutions were combined and incubated an additional 15 minutes at room temperature. Then 500 ul of the combined solution was added to the 3 ml cell culture medium containing the HeLa cells. The plates were then incubated as described before.

[0001673] After an 16-18 hour incubation, the medium was removed and the cells were washed with 1ml PBS. After complete removal of the PBS, 500ul of fresh PBS was added. Cells were harvested by scraping with a cell scraper. Harvested cells receiving the same mRNA were then combined in one 1.5ml Eppendorf tube.

[0001674] Cells were pelleted by centrifugation at 3,000 rpm for 2 minutes. The PBS was removed and cells lysed in 250ul radio immunoprecipitation assay (RIPA) buffer (containing PMSF and eukaryotic protease inhibitor mix) (all from BostonBioProducts, Ashland, MA) by gentle pipetting. Lysates were cleared by centrifugation at 10,000 rpm at 4°C for 10 minutes. Cleared lysates were transferred to Amicon filters with 10,000 kd molecular cutoff (Waters, Milford, MA) and spun at 12,000 rpm and 4°C for 20 minutes. The concentrated protein lysate was recovered by placing the inverted filter in a fresh 1.5ml Eppendorf tube and spinning at 3,000rpm for 1 minute. The final volume of the lysate is between 25-40 ul.

[0001675] Protein concentration was determined using the BCA kit for microtiter-plates from Pierce (Thermo Fisher, Rockford, IL). The standard proteins of the titration curve were dissolved in RIPA buffer (as described for cell lysate generation) and not in dilution buffer.

[0001676] Protein lysates were loaded onNuPage SDS-PAGE system (chambers and power supply) with 1.5mm ready-to-use Bis-Tris gels and 4-12% acrylamide gradient with MOPS-buffer as running aid (all from Life Technologies, Grand Island, NY). Each lysate sample was prepared to 40ul final volume. This sample contained 25ug protein lysate in variable volume, RIPA buffer to make up volume to 26ul, 4ul of 10x reducing agent and 10ul 4x SDS loading buffer (both from Life Technologies, Grand Island, NY). Samples were heated at 95°C for 5 minutes and loaded on the gel. Standard settings were chosen by the manufacturer, 200V, 120mA and maximum 25W. Run time was 60 minutes, but no longer than running dye reaching the lower end of the gel.

[0001677] After the run was terminated, the plastic case was cracked and the encased gel transferred to a ready-to-use nitrocellulose membrane kit and power supply (iBLOT; LifeTechnologies, Grand Island, NY). Using default settings, the protein lysate was transferred by high Ampere electricity from the gel to the membrane.

[0001678] After the transfer, the membranes were incubated in 5% bovine serum albumin (BSA) in IX tris buffered saline (TBS) for 15 minutes then in 5% BSA in IX TBS + 0.1 % Tween for another 15 minutes. ASL mouse monoclonal antibody (Novus biological, Littleton, CO) against ASL were applied in 3ml of 5% BSA in IX TBS solution at a 1:500 to 1:2000 dilution for 3 hours at room temperature and gentle agitation on an orbital shaker. Membranes are washed 3 times with IX TBS/0.1 % Tween, 5 minutes each time with gentle agitation. Donkey anti-mouse HRP conjugate (Abeam, Cambridge, MA) was conjugated to horse radish peroxidase and binds to the ASL mouse monoclonal antibody. The conjugated antibody was diluted of 1:1000 to 1:5000 in 5% BSA in IX TBS and incubated for 3 hours at room temperature. As shown with the box in Figure 22 the Western Blot detection of ASL was about 50 kd.

Example 131. Detection of Tyrosine Aminotransferase Protein: Western Blot

[0001679] The day before transfection, 750,000 HeLa cells (ATCC no. CCL-2; Manassas, VA) were harvested by treatment with Trypsin- Ethylenediaminetetraacetic acid (EDTA) solution (LifeTechnologies, Grand Island, NY) and seeded in a total volume of 3ml Eagle's minimal essential medium (EMEM) (supplemented with 10% fetal calf serum (FCS) and 1x Glutamax) per well in a 6-well cell culture plate (Corning, Manassas, VA). The cells were grown at 37°C in 5% CO₂ atmosphere overnight. Next day, 1250ng of tyrosine aminotransferase (TAT) mRNA (mRNA sequence shown in SEQ ID NO: 21460; polyA tail of approximately 160 nucleotides not shown in sequence; 5'cap, Cap1) fully modified with 5-methylcytosine and 1-methylpseudouridine (5mC/ImpU) was diluted in 250 ul final volume of OPTI-MEM® (LifeTechnologies, Grand Island, NY). Lipofectamine 2000 (LifeTechnologies, Grand Island, NY) was used as transfection reagent and 5.5 ul were diluted in 250 ul final volume of OPTI-MEM®. After 5 minutes of incubation at room temperature, both solutions were combined and incubated an additional 15 minutes at room temperature. Then 500 ul of the combined solution was added to the 3 ml cell culture medium containing the HeLa cells. The plates were then incubated as described before.

[0001680] After an 16-18 hour incubation, the medium was removed and the cells were washed with 1ml PBS. After complete removal of the PBS, 500ul of fresh PBS was

added. Cells were harvested by scraping with a cell scraper. Harvested cells receiving the same mRNA were then combined in one 1.5ml Eppendorf tube.

[0001681] Cells were pelleted by centrifugation at 3,000 rpm for 2 minutes. The PBS was removed and cells lysed in 250ul radio immunoprecipitation assay (RIPA) buffer (containing PMSF and eukaryotic protease inhibitor mix) (all from BostonBioProducts, Ashland, MA) by gentle pipetting. Lysates were cleared by centrifugation at 10,000 rpm at 4°C for 10 minutes. Cleared lysates were transferred to Amicon filters with 10,000 kd molecular cutoff (Waters, Milford, MA) and spun at 12,000 rpm and 4°C for 20 minutes. The concentrated protein lysate was recovered by placing the inverted filter in a fresh 1.5ml Eppendorf tube and spinning at 3,000rpm for 1 minute. The final volume of the lysate is between 25-40 ul.

[0001682] Protein concentration was determined using the BCA kit for microtiter-plates from Pierce (Thermo Fisher, Rockford, IL). The standard proteins of the titration curve were dissolved in RIPA buffer (as described for cell lysate generation) and not in dilution buffer.

[0001683] Protein lysates were loaded on NuPage SDS-PAGE system (chambers and power supply) with 1.5mm ready-to-use Bis-Tris gels and 4-12% acrylamide gradient with MOPS-buffer as running aid (all from Life Technologies, Grand Island, NY). Each lysate sample was prepared to 40ul final volume. This sample contained 25ug protein lysate in variable volume, RIPA buffer to make up volume to 26ul, 4ul of 10x reducing agent and 10ul 4x SDS loading buffer (both from Life Technologies, Grand Island, NY). Samples were heated at 95°C for 5 minutes and loaded on the gel. Standard settings were chosen by the manufacturer, 200V, 120mA and maximum 25W. Run time was 60 minutes, but no longer than running dye reaching the lower end of the gel.

[0001684] After the run was terminated, the plastic case was cracked and the encased gel transferred to a ready-to-use nitrocellulose membrane kit and power supply (iBLOT; LifeTechnologies, Grand Island, NY). Using default settings, the protein lysate was transferred by high Ampere electricity from the gel to the membrane.

[0001685] After the transfer, the membranes were incubated in 5% bovine serum albumin (BSA) in IX tris buffered saline (TBS) for 15 minutes then in 5% BSA in IX TBS + 0.1 % Tween for another 15 minutes. TAT rabbit polyclonal antibody (Novus

biologicals) against TAT were applied in 3ml of 5% BSA in IX TBS solution at a 1:500 to 1:2000 dilution for 3 hours at room temperature and gentle agitation on an orbital shaker. Membranes are washed 3 times with IX TBS/0.1 % Tween, 5 minutes each time with gentle agitation. Goat anti-rabbit HRP conjugate (Abeam, Cambridge, MA) was conjugated to horse radish peroxidase and binds to the TAT rabbit polyclonal antibody. The conjugated antibody was diluted of 1:1000 to 1:5000 in 5% BSA in IX TBS and incubated for 3 hours at room temperature. As shown with the box in Figure 23 the Western Blot detection of TAT was about 50 kd with the chemoluminescence band shown in white.

Example 132. Detection of 1,4-alpha-glucan-branching enzyme Protein: Western Blot

[0001686] The day before transfection, 750,000 HeLa cells (ATCC no. CCL-2; Manassas, VA) were harvested by treatment with Trypsin- Ethylenediaminetetraacetic acid (EDTA) solution (LifeTechnologies, Grand Island, NY) and seeded in a total volume of 3ml Eagle's minimal essential medium (EMEM) (supplemented with 10% fetal calf serum (FCS) and 1x Glutamax) per well in a 6-well cell culture plate (Corning, Manassas, VA). The cells were grown at 37°C in 5% CO₂ atmosphere overnight. Next day, 1250ng of 1,4-alpha-glucan-branching enzyme (GBE1) mRNA (mRNA sequence shown in SEQ ID NO: 21461; polyA tail of approximately 160 nucleotides not shown in sequence; 5'cap, Cap1) fully modified with 5-methylcytosine and 1-methylpseudouridine (5mC/ImpU) was diluted in 250 ul final volume of OPTI-MEM® (LifeTechnologies, Grand Island, NY). Lipofectamine 2000 (LifeTechnologies, Grand Island, NY) was used as transfection reagent and 5.5 ul were diluted in 250 ul final volume of OPTI-MEM®. After 5 minutes of incubation at room temperature, both solutions were combined and incubated an additional 15 minutes at room temperature. Then 500 ul of the combined solution was added to the 3 ml cell culture medium containing the HeLa cells. The plates were then incubated as described before.

[0001687] After an 16-18 hour incubation, the medium was removed and the cells were washed with 1ml PBS. After complete removal of the PBS, 500ul of fresh PBS was added. Cells were harvested by scraping with a cell scraper. Harvested cells receiving the same mRNA were then combined in one 1.5ml Eppendorf tube.

[0001688] Cells were pelleted by centrifugation at 3,000 rpm for 2 minutes. The PBS was removed and cells lysed in 250ul radio immunoprecipitatin assay (RIPA) buffer (containing PMSF and eukaryotic protease inhibitor mix) (all from BostonBioProducts, Ashland, MA) by gentle pipetting. Lysates were cleared by centrifugation at 10,000 rpm at 4°G for 10 minutes. Cleared lysates were transferred to Amicon filters with 10,000 kd molecular cutoff (Waters, Milford, MA) and spun at 12,000 rpm and 4°G for 20 minutes. The concentrated protein lysate was recovered by placing the inverted filter in a fresh 1.5ml Eppendorf tube and spinning at 3,000rpm for 1 minute. The final volume of the lysate is between 25-40 ul.

[0001689] Protein concentration was determined using the BCA kit for microtiter-plates from Pierce (Thermo Fisher, Rockford, IL). The standard proteins of the titration curve were dissolved in RIPA buffer (as described for cell lysate generation) and not in dilution buffer.

[0001690] Protein lysates were loaded onNuPage SDS-PAGE system (chambers and power supply) with 1.5mm ready-to-use Bis-Tris gels and 4-12% acrylamide gradient with MOPS-buffer as running aid (all from Life Technologies, Grand Island, NY). Each lysate sample was prepared to 40ul final volume. This sample contained 25ug protein lysate in variable volume, RIPA buffer to make up volume to 26ul, 4ul of 10x reducing agent and 10ul 4x SDS loading buffer (both from Life Technologies, Grand Island, NY). Samples were heated at 95°C for 5 minutes and loaded on the gel. Standard settings were chosen by the manufacturer, 200V, 120mA and maximum 25W. Run time was 60 minutes, but no longer than running dye reaching the lower end of the gel.

[0001691] After the run was terminated, the plastic case was cracked and the encased gel transferred to a ready-to-use nitrocellulose membrane kit and power supply (iBLOT; LifeTechnologies, Grand Island, NY). Using default settings, the protein lysate was transferred by high Ampere electricity from the gel to the membrane.

[0001692] After the transfer, the membranes were incubated in 5% bovine serum albumin (BSA) in IX tris buffered saline (TBS) for 15 minutes then in 5% BSA in IX TBS + 0.1 % Tween for another 15 minutes. GBE1 rabbit polyclonal antibody (Novus biological, Littleton, CO)) against GBE1 were applied in 3ml of 5% BSA in IX TBS solution at a 1:500 to 1:2000 dilution for 3 hours at room temperature and gentle agitation

on an orbital shaker. Membranes are washed 3 times with IX TBS/0.1 % Tween, 5 minutes each time with gentle agitation. Goat anti-rabbit HRP conjugate (Abeam, Cambridge, MA) was conjugated to horse radish peroxidase and binds to the GBEI rabbit polyclonal antibody. The conjugated antibody was diluted of 1:1000 to 1:5000 in 5% BSA in IX TBS and incubated for 3 hours at room temperature. As shown with the box in Figure 24 the Western Blot detection of GBEI was about the expected size of 70 kd.

Example 133. Protein Production of Prothrombin in HeLa Cell Supernatant

[0001693] The day before transfection, 20,000 HeLa cells (ATCC no. CCL-2; Manassas, VA) were harvested by treatment with Trypsin-EDTA solution (LifeTechnologies, Grand Island, NY) and seeded in a total volume of 100ul EMEM medium (supplemented with 10%FCS and 1x Glutamax) per well in a 96-well cell culture plate (Corning, Manassas, VA). The cells were grown at 37°C in 5% CO₂ atmosphere overnight. Next day, 250 ng of prothrombin modified RNA (mRNA sequence shown in SEQ ID NO: 21462; polyA tail of approximately 160 nucleotides not shown in sequence; 5'cap, Cap1) fully modified with 5-methylcytosine and 1-methylpseudouridine, was diluted in 10ul final volume of OPTI-MEM (LifeTechnologies, Grand Island, NY). Lipofectamine 2000 (LifeTechnologies, Grand Island, NY) was used as transfection reagent and 0.2 ul of lipofectamine 2000 was diluted to 10 ul final volume of OPTI-MEM. After 5 minutes of incubation at room temperature, both solutions were combined and incubated an additional 15 minute at room temperature. Then the 20ul combined solution was added to the 100ul cell culture medium containing the HeLa cells and incubated at room temperature. A control of erythropoietin (EPO) modified mRNA (mRNA sequence shown in SEQ ID NO: 1638; polyA tail of approximately 160 nucleotides not shown in sequence; 5'cap, Cap1, fully modified with 5-methylcytosine and pseudouridine) and untreated cells were also analyzed.

[0001694] After an 18 to 22 hour incubation cell culture supernatants of cells expressing plasminogen was collected and centrifuged at 10,000rcf for 2 minutes. The cleared supernatants were then analyzed with a prothrombin-specific ELISA kit (R & D Systems, Minneapolis, MN) according to the manufacturer instructions. All samples were diluted until the determined values were within the linear range of the ELISA standard curve. The amount of protein produced is shown in Table 188 and Figure 25.

Table 188. Protein Production

Sample	Prothrombin (ng/ml)
Prothrombin	31
EPO	2.5
Untreated	2

Example 134. Protein Production of Chemically Modified Prothrombin in HeLa Cell Supernatant

[0001695] The day before transfection, 15,000 HeLa cells (ATCC no. CCL-2; Manassas, VA) were harvested by treatment with Trypsin- Ethylenediammetetraacetic acid (EDTA) solution (LifeTechnologies, Grand Island, NY) and seeded in a total volume of 100ul Eagle's minimal essential medium (EMEM) (supplemented with 10% fetal calf serum (FCS) and 1x Glutamax) per well in a 24-well cell culture plate (Corning, Manassas, VA). The cells were grown at 37°C in 5% CO₂ atmosphere overnight. Next day, 250 ng of prothrombin modified RNA (mRNA sequence shown in SEQ ID NO: 21462; polyA tail of approximately 140 nucleotides not shown in sequence; 5'cap, Cap1) fully modified with 5-methylcytosine and pseudouridine (5mC/pU), fully modified with 5-methylcytosine and 1-methylpseudouridine (5mC/ImpU), modified where 25% of the cytosines replaced with 5-methylcytosine and 25% of the uridines replaced with 2-thiouridine (s2U/5mC), fully modified with 1-methylpseudouridine (ImpU) or fully modified with pseudouridine (pU) were diluted in 10 ul final volume of OPTI-MEM® (LifeTechnologies, Grand Island, NY). Lipofectamine 2000 (LifeTechnologies, Grand Island, NY) was used as transfection reagent and 0.2 ul of lipofectamine 2000 was diluted to 10 ul final volume of OPTI-MEM®. After 5 minutes of incubation at room temperature, both solutions were combined and incubated an additional 15 minute at room temperature. Then the 20ul combined solution was added to the 100ul cell culture medium containing the HeLa cells and incubated at room temperature. A control of untreated was also analyzed.

[0001696] After an 18 hour incubation cell culture supernatants of cells expressing prothrombin were collected by lysing cells with immuno-precipitation (IP) buffer from Pierce Biotechnology (Thermo Scientific, Rockford, IL) and centrifuged at 10.000rcf for

2 minutes. The cleared supernatants were diluted 1:2 (1 ml lysate/2 wells/24 well plate) or 1:5 (1 ml lysate/5 wells/24 well plate) then analyzed with a prothrombin-specific ELISA kit according to the manufacturer instructions. All samples were diluted until the determined values were within the linear range of the ELISA standard curve. The amount of protein produced in both studies is shown in Table 189 and Figure 26.

Table 189. Protein Production

Sample	Prothrombin (ng/ml)
5-methylcytosine and pseudouridine (5mC/pU)	68
5-methylcytosine and 1-methylpseudouridine (5mC/1mpU)	210
25% of the cytosines replaced with 5-methylcytosine and 25% of the uridines replaced with 2-thiouridine (s2U/5mC)	25
1-methylpseudouridine (1mpU)	277
pseudouridine (pU)	30
Untreated	7.5

Example 135. Detection of Ceruloplasmin Protein: Western Blot

[0001697] The day before transfection, 750,000 HeLa cells (ATCC no. CCL-2; Manassas, VA) were harvested by treatment with Trypsin- Ethylenediaminetetraacetic acid (EDTA) solution (LifeTechnologies, Grand Island, NY) and seeded in a total volume of 3ml Eagle's minimal essential medium (EMEM) (supplemented with 10% fetal calf serum (FCS) and 1x Glutamax) per well in a 6-well cell culture plate (Corning, Manassas, VA). The cells were grown at 37°C in 5% CO₂ atmosphere overnight. Next day, 1250ng of ceruloplasmin (CP or CLP) mRNA (mRNA sequence shown in SEQ ID NO: 1621; polyA tail of approximately 160 nucleotides not shown in sequence; 5'cap, Cap1) fully modified with 5-methylcytosine and 1-methylpseudouridine (5mC/1mpU) was diluted in 250 ul final volume of OPTI-MEM® (LifeTechnologies, Grand Island, NY). Lipofectamine 2000 (LifeTechnologies, Grand Island, NY) was used as transfection reagent and 5.5 ul were diluted in 250 ul final volume of OPTI-MEM®. After 5 minutes of incubation at room temperature, both solutions were combined and incubated an additional 15 minutes at room temperature. Then 500 ul of the combined solution was added to the 3 ml cell culture medium containing the HeLa cells. The plates were then incubated as described before.

[0001698] After an 16-18 hour incubation, the medium was removed and the cells were washed with 1ml PBS. After complete removal of the PBS, 500ul of fresh PBS was added. Cells were harvested by scraping with a cell scraper. Harvested cells receiving the same mRNA were then combined in one 1.5ml Eppendorf tube.

[0001699] Cells were pelleted by centrifugation at 3,000 rpm for 2 minutes. The PBS was removed and cells lysed in 250ul radio immunoprecipitation assay (RIPA) buffer (containing PMSF and eukaryotic protease inhibitor mix) (all from BostonBioProducts, Ashland, MA) by gentle pipetting. Lysates were cleared by centrifugation at 10,000 rpm at 4°C for 10 minutes. Cleared lysates were transferred to Amicon filters with 10,000 kd molecular cutoff (Waters, Milford, MA) and spun at 12,000 rpm and 4°C for 20 minutes. The concentrated protein lysate was recovered by placing the inverted filter in a fresh 1.5ml Eppendorf tube and spinning at 3,000rpm for 1 minute. The final volume of the lysate is between 25-40 ul.

[0001700] Protein concentration was determined using the BCA kit for microtiter-plates from Pierce (Thermo Fisher, Rockford, IL). The standard proteins of the titration curve were dissolved in RIPA buffer (as described for cell lysate generation) and not in dilution buffer.

[0001701] Protein lysates were loaded on NuPage SDS-PAGE system (chambers and power supply) with 1.5mm ready-to-use Bis-Tris gels and 4-12% acrylamide gradient with MOPS-buffer as running aid (all from Life Technologies, Grand Island, NY). Each lysate sample was prepared to 40ul final volume. This sample contained 25ug protein lysate in variable volume, RIPA buffer to make up volume to 26ul, 4ul of 10x reducing agent and 10ul 4x SDS loading buffer (both from Life Technologies, Grand Island, NY). Samples were heated at 95°C for 5 minutes and loaded on the gel. Standard settings were chosen by the manufacturer, 200V, 120mA and maximum 25W. Run time was 60 minutes, but no longer than running dye reaching the lower end of the gel.

[0001702] After the run was terminated, the plastic case was cracked and the encased gel transferred to a ready-to-use nitrocellulose membrane kit and power supply (iBLOT; LifeTechnologies, Grand Island, NY). Using default settings, the protein lysate was transferred by high Ampere electricity from the gel to the membrane.

[0001703] After the transfer, the membranes were incubated in 5% bovine serum albumin (BSA) in IX tris buffered saline (TBS) for 15 minutes then in 5% BSA in IX TBS + 0.1 % Tween for another 15 minutes. Ceruloplasmin rabbit polyclonal antibody (Novus biological, Littleton, CO) against CP proteins were applied in 3ml of 5% BSA in IX TBS solution at a 1:500 to 1:2000 dilution for 3 hours at room temperature and gentle agitation on an orbital shaker. Membranes are washed 3 times with IX TBS/0.1 % Tween, 5 minutes each time with gentle agitation. Goat anti-rabbit HRP conjugate (Abeam, Cambridge, MA) was conjugated to horse radish peroxidase and binds to the Ceruloplasmin rabbit polyclonal antibody. The conjugated antibody was diluted of 1:1000 to 1:5000 in 5% BSA in IX TBS and incubated for 3 hours at room temperature. As shown with the box in Figure 27 the Western Blot detection of ceruloplasmin (CLP) was about 148 kd.

Example 136. Protein Production of Transforming Growth Factor Beta 1 in HeLa Cell Supernatant

[0001704] The day before transfection, 20,000 HeLa cells (ATCC no. CCL-2; Manassas, VA) were harvested by treatment with Trypsin-EDTA solution (LifeTechnologies, Grand Island, NY) and seeded in a total volume of 100ul EMEM medium (supplemented with 10%FCS and 1x Glutamax) per well in a 96-well cell culture plate (Corning, Manassas, VA). The cells were grown at 37°C in 5% CO₂ atmosphere overnight. Next day, 83 ng, 250 ng or 750 ng of transforming growth factor beta 1 (TGF-beta1) modified RNA (mRNA sequence shown in SEQ ID NO: 1668; polyA tail of approximately 160 nucleotides not shown in sequence; 5'cap, Cap1) fully modified with 5-methylcytosine and pseudouridine, was diluted in 10ul final volume of OPTI-MEM (LifeTechnologies, Grand Island, NY). Lipofectamine 2000 (LifeTechnologies, Grand Island, NY) was used as transfection reagent and 0.2 ul of lipofectamine 2000 was diluted to 10 ul final volume of OPTI-MEM. After 5 minutes of incubation at room temperature, both solutions were combined and incubated an additional 15 minute at room temperature. Then the 20ul combined solution was added to the 100ul cell culture medium containing the HeLa cells and incubated at room temperature. A control of lipofecatmine 2000 treated cells (L2000) and untreated cells was also analyzed.

[0001705] After an 18 to 22 hour incubation cell culture supernatants of cells expressing TGF-beta1 was collected and centrifuged at 10,000rcf for 2 minutes. The cleared supernatants were then analyzed with a TGF-beta1 -specific ELISA kit (R & D Systems, Minneapolis, MN) according to the manufacturer instructions. All samples were diluted until the determined values were within the linear range of the ELISA standard curve. The amount of protein produced is shown in Table 190 and Figure 28.

Table 190. Protein Production

Sample	TGF-beta1 (pg/ml)
TGF-beta1 (83 ng)	3210
TGF-beta1 (250 ng)	4325
TGF-beta1 (750 ng)	5058
L2000	2
Untreated	0

Example 137. Detection of Ornithine Transcarbamoylase Protein: Western Blot

[0001706] The day before transfection, 750,000 HeLa cells (ATCC no. CCL-2; Manassas, VA) were harvested by treatment with Trypsin- Ethylenediaminetetraacetic acid (EDTA) solution (LifeTechnologies, Grand Island, NY) and seeded in a total volume of 3ml Eagle's minimal essential medium (EMEM) (supplemented with 10% fetal calf serum (FCS) and 1x Glutamax) per well in a 6-well cell culture plate (Coming, Manassas, VA). The cells were grown at 37°C in 5% CO₂ atmosphere overnight. Next day, 1250ng of ornithine transcarbamoylase (OTC) mRNA (mRNA sequence shown in SEQ ID NO: 1659; polyA tail of approximately 160 nucleotides not shown in sequence; 5'cap, Cap1) fully modified with 5-methylcytosine and pseudouridine (5mC/pU) was diluted in 250 ul final volume of OPTI-MEM® (LifeTechnologies, Grand Island, NY). Lipofectamine 2000 (LifeTechnologies, Grand Island, NY) was used as transfection reagent and 5.5 ul were diluted in 250 ul final volume of OPTI-MEM®. After 5 minutes of incubation at room temperature, both solutions were combined and incubated an additional 15 minutes at room temperature. Then 500 ul of the combined solution was added to the 3 ml cell culture medium containing the HeLa cells. The plates were then incubated as described before.

[0001707] After an 16-18 hour incubation, the medium was removed and the cells were washed with 1ml PBS. After complete removal of the PBS, 500ul of fresh PBS was added. Cells were harvested by scraping with a cell scraper. Harvested cells receiving the same mRNA were then combined in one 1.5ml Eppendorf tube.

[0001708] Cells were pelleted by centrifugation at 3,000 rpm for 2 minutes. The PBS was removed and cells lysed in 250ul radio immunoprecipitation assay (RIPA) buffer (containing PMSF and eukaryotic protease inhibitor mix) (all from BostonBioProducts, Ashland, MA) by gentle pipetting. Lysates were cleared by centrifugation at 10,000 rpm at 4°C for 10 minutes. Cleared lysates were transferred to Amicon filters with 10,000 kd molecular cutoff (Waters, Milford, MA) and spun at 12,000 rpm and 4°C for 20 minutes. The concentrated protein lysate was recovered by placing the inverted filter in a fresh 1.5ml Eppendorf tube and spinning at 3,000rpm for 1 minute. The final volume of the lysate is between 25-40 ul.

[0001709] Protein concentration was determined using the BCA kit for microtiter-plates from Pierce (Thermo Fisher, Rockford, IL). The standard proteins of the titration curve were dissolved in RIPA buffer (as described for cell lysate generation) and not in dilution buffer.

[0001710] Protein lysates were loaded onNuPage SDS-PAGE system (chambers and power supply) with 1.5mm ready-to-use Bis-Tris gels and 4-12% acrylamide gradient with MOPS-buffer as running aid (all from Life Technologies, Grand Island, NY). Each lysate sample was prepared to 40ul final volume. This sample contained 25ug protein lysate in variable volume, RIPA buffer to make up volume to 26ul, 4ul of 10x reducing agent and 10ul 4x SDS loading buffer (both from Life Technologies, Grand Island, NY). Samples were heated at 95°C for 5 minutes and loaded on the gel. Standard settings were chosen by the manufacturer, 200V, 120mA and maximum 25W. Run time was 60 minutes, but no longer than running dye reaching the lower end of the gel.

[0001711] After the run was terminated, the plastic case was cracked and the encased gel transferred to a ready-to-use nitrocellulose membrane kit and power supply (iBLOT; LifeTechnologies, Grand Island, NY). Using default settings, the protein lysate was transferred by high Ampere electricity from the gel to the membrane.

[0001712] After the transfer, the membranes were incubated in 5% bovine serum albumin (BSA) in IX tris buffered saline (TBS) for 15 minutes then in 5% BSA in IX TBS + 0.1 % Tween for another 15 minutes. OTC rabbit polyclonal antibody (Novus biological, Littleton, CO) against OTC proteins were applied in 3ml of 5% BSA in IX TBS solution at a 1:500 to 1:2000 dilution for 3 hours at room temperature and gentle agitation on an orbital shaker. Membranes are washed 3 times with IX TBS/0.1 % Tween, 5 minutes each time with gentle agitation. Goat anti-rabbit HRP conjugate (Abeam, Cambridge, MA) was conjugated to horse radish peroxidase and binds to the OTC rabbit polyclonal antibody. The conjugated antibody was diluted of 1:1000 to 1:5000 in 5% BSA in IX TBS and incubated for 3 hours at room temperature. As shown with the box in Figure 29 the Western Blot detection of OTC was about the expected size of 40 kd.

Example 138. LDLR *In Vivo* Study in Mammals

[0001713] Low density lipoprotein (LDL) receptor (LDLR) mRNA (mRNA shown in SEQ ID NO: 21463; fully modified with 5-methylcytosine and pseudouridine; 5'cap, CapI; polyA tail of 160 nucleotides not shown in the sequence) was complexed with Lipofectamine 2000 by mixing 8.0 µg mRNA with Dulbecco's modified Eagle's medium (DMEM) to a final volume of 0.2 mL.

[0001714] Lipofectamine 2000 was diluted 12.5-fold with DMEM and mixed with an equivalent volume of the diluted LDL receptor mRNA solution. The samples were incubated 5 minutes at room temperature and a 0.1 mL volume of the complexed mRNA mixture was injected into the tail vein of each of three C57BL/6 mice. Each animal received a total dose of 2.0 µg of LDL receptor mRNA. After 6 hours, the animals were sacrificed and the spleens were removed. Splenocytes were isolated according to standard procedures (with no prior lysis of red blood cells) and stained with equivalent amounts of either IgG specific for the human LDL receptor or non-immune IgG as a control.

[0001715] The expression of the LDL receptors was assessed by flow cytometry with gating on the CD11b⁺ splenocyte population. As shown in Figure 30, the expression of LDL receptors in the CD11b⁺ splenocyte population *in vivo* was evident in each of three separate mice by the presence of rightward shifted peaks that were stained with LDL

receptor IgG (LDLR IgG) as compared to cells stained with non-immune IgG (non-immune IgG).

[0001716] For mice treated with Lipofectamine alone, no LDL receptor specific peak was observed and staining was similar to that observed with non-immune IgG.

Example 139. Modified UGT1A1 mRNA Study

[0001717] HEK293 cells were seeded at density of 500,000 cells per 6-well plate in DMEM containing 10% fetal bovine serum and cells were grown overnight according to standard procedures. The next day 800 ng of UDP glucuronosyltransferase 1 family, polypeptide A1 (UGT1A1) mRNA (mRNA shown in SEQ ID NO: 21464; fully modified with 5-methylcytosine and pseudouridine; 5'cap, Cap1; polyA tail of 160 nucleotides not shown in the sequence) was diluted into 0.3 mL of Optimum buffer, a 4.0 µL sample of Lipofectamine 2000 was also diluted to 0.3 mL of Optimum buffer, and the mRNA was complexed to Lipofectamine 2000 by mixing the two solutions.

[0001718] After incubation at room temperature for 15 minutes, cells were transfected with the UGT1A1 mRNA/lipofectamine 2000 mixture. After incubation for 18 hours at 37°C, the media were aspirated and the cells were washed with PBS. Cells were harvested by scraping with a cell lifter and the cells were centrifuged at 3000 rpm for 3 minutes. The cell pellet was washed with PBS, centrifuged as described and the cell pellets were lysed by the addition of 0.25 mL of RIPA buffer supplemented with a protease inhibitor cocktail. Cell extracts were centrifuged for 10 minutes at 12,210 rpm and the supernatant fractions (lysates) were frozen at -80°C.

[0001719] Western blotting was conducted using the Simple Simon Western capillary electrophoresis apparatus using antibodies specific for human UGT1A1. A 0.005 mg sample of lysate was run in triplicate. As shown in Figure 31, UGT1A1 was detected as a single band of approximately 60 kDa. In contrast, no bands were detected using lysates from control cells transfected with an unrelated mRNA.

Example 140. In vivo expression of LDLR in mice

[0001720] LDLR ^{-/-} mice are used to test the in vivo expression of LDLR mRNA. LDL mRNA is administered to LDLR ^{-/-} mice by injection. Tissues from the mice are examined for LDLR expression. Western blot analysis of mouse tissues is carried out to

look for LDLR protein expression as a result of LDLR mRNA administration. Real time RT-PCR is carried out on mouse tissues to look for LDLR gene expression.

Example 141. Production of LDLR in Mammals

[0001721] Ornithine transcarbamoylase (OTC) is a mitochondrial protein encoded in the nuclear genome. Defects in OTC are characterized by toxic accumulation of ammonia and lead to urea cycle disorders.

[0001722] Modified mRNA encoding OTC are administered to the mice described in Example 140. Serum, tissue and/or organs are collected at various time points in order to determine protein expression.

[0001723] Further studies where LDLR modified mRNA are administered to the mice of Example 140 are also conducted. Serum, tissue and/or organs are collected at various time points in order to determine protein expression.

Example 142. Production of Chemically Modified Factor XI in HEK293 Cells

[0001724] Human embryonic kidney epithelial (HEK293) (LGC standards GmbH, Wesel, Germany) are seeded on 24-well plates (Greiner Bio-one GmbH, Frickenhausen, Germany) precoated with collagen type I. HEK293 are seeded at a density of about 100,000 cells per well in 100 μ i cell culture medium. Formulations containing 350 ng or 750 of Factor XI mRNA (modRNA FXI) (mRNA sequence shown in SEQ ID NO: 1625; polyA tail of approximately 160 nucleotides not shown in sequence; 5'cap, Cap1) are added directly after seeding the cells and incubated. A control of untreated cells was also evaluated.

[0001725] Cells are harvested by transferring the culture media supernatants to a 96-well Pro-Bind U-bottom plate (Beckton Dickinson GmbH, Heidelberg, Germany). Cells are trypsinized with 1/2 volume Trypsin/EDTA (Biochrom AG, Berlin, Germany), pooled with respective supernatants and fixed by adding one volume PBS/2%FCS (both Biochrom AG, Berlin, Germany)/0.5% formaldehyde (Merck, Darmstadt, Germany). After a 12 hour incubation, cell culture supernatants of cells expressing Factor XI were collected and centrifuged at 10,000rcf for 2 minutes. The cleared supernatants were then analyzed with a Factor XI-specific ELISA kit (Innovative Research, Novi, MI) according to the manufacturer instructions. The amount of protein produced is shown in Figure 32.

Example 143. Detection of Aquaporin-5 Protein: Western Blot

[0001726] The day before transfection, 750,000 HeLa cells (ATCC no. CCL-2; Manassas, VA) were harvested by treatment with Trypsin- Ethylenediaminetetraacetic acid (EDTA) solution (LifeTechnologies, Grand Island, NY) and seeded in a total volume of 3ml Eagle's minimal essential medium (EMEM) (supplemented with 10% fetal calf serum (FCS) and 1x Glutamax) per well in a 6-well cell culture plate (Corning, Manassas, VA). The cells were grown at 37°C in 5% CO₂ atmosphere overnight. Next day, 1250ng of aquaporin-5 mRNA (mRNA sequence shown in SEQ ID NO: 1617; polyA tail of approximately 160 nucleotides not shown in sequence; 5'cap, Cap1) fully modified with 5-methylcytosine and pseudouridine (5mC/pU), fully modified with 5-methylcytosine and 1-methylpseudouridine (5mC/ImpU), 25% of uridine modified with 2-thiouridine and 25% of cytosine modified with 5-methylcytosine (s2U and 5mC), fully modified with pseudouridine (pU) or fully modified with 1-methylpseudouridine (ImpU) was diluted in 250 ul final volume of OPTI-MEM® (LifeTechnologies, Grand Island, NY). Lipofectamine 2000 (LifeTechnologies, Grand Island, NY) was used as transfection reagent and 5.5 ul were diluted in 250 ul final volume of OPTI-MEM®. After 5 minutes of incubation at room temperature, both solutions were combined and incubated an additional 15 minutes at room temperature. Then 500 ul of the combined solution was added to the 3 ml cell culture medium containing the HeLa cells. The plates were then incubated as described before. A control of untreated cells was also evaluated.

[0001727] After an 16-18 hour incubation, the medium was removed and the cells were washed with 1ml PBS. After complete removal of the PBS, 500ul of fresh PBS was added. Cells were harvested by scraping with a cell scraper. Harvested cells receiving the same mRNA were then combined in one 1.5ml Eppendorf tube.

[0001728] Cells were pelleted by centrifugation at 3,000 rpm for 2 minutes. The PBS was removed and cells lysed in 250ul radio immunoprecipitation assay (RIPA) buffer (containing PMSF and eukaryotic protease inhibitor mix) (all from BostonBioProducts, Ashland, MA) by gentle pipetting. Lysates were cleared by centrifugation at 10,000 rpm at 4°C for 10 minutes. Cleared lysates were transferred to Amicon filters with 10,000 kd molecular cutoff (Waters, Milford, MA) and spun at 12,000 rpm and 4°C for 20 minutes. The concentrated protein lysate was recovered by placing the inverted filter in a fresh

1.5ml Eppendorf tube and spinning at 3,000rpm for 1 minute. The final volume of the lysate is between 25-40 ul.

[0001729] Protein concentration was determined using the BCA kit for microtiter-plates from Pierce (Thermo Fisher, Rockford, IL). The standard proteins of the titration curve were dissolved in RIPA buffer (as described for cell lysate generation) and not in dilution buffer.

[0001730] Protein lysates were loaded on NuPage SDS-PAGE system (chambers and power supply) with 1.5mm ready-to-use Bis-Tris gels and 4-12% acrylamide gradient with MOPS-buffer as running aid (all from Life Technologies, Grand Island, NY). Each lysate sample was prepared to 40ul final volume. This sample contained 25ug protein lysate in variable volume, RIPA buffer to make up volume to 26ul, 4ul of 10x reducing agent and 10ul 4x SDS loading buffer (both from Life Technologies, Grand Island, NY). Samples were heated at 95°C for 5 minutes and loaded on the gel. Standard settings were chosen by the manufacturer, 200V, 120mA and maximum 25W. Run time was 60 minutes, but no longer than running dye reaching the lower end of the gel.

[0001731] After the run was terminated, the plastic case was cracked and the encased gel transferred to a ready-to-use nitrocellulose membrane kit and power supply (iBLOT; LifeTechnologies, Grand Island, NY). Using default settings, the protein lysate was transferred by high Ampere electricity from the gel to the membrane.

[0001732] After the transfer, the membranes were incubated in 5% bovine serum albumin (BSA) in IX tris buffered saline (TBS) for 15 minutes then in 5% BSA in IX TBS + 0.1 % Tween for another 15 minutes. Aquaporin-5 rabbit polyclonal antibody (Abeam, Cambridge, MA) against aquaporin-5 proteins were applied in 3ml of 5% BSA in IX TBS solution at a 1:500 to 1:2000 dilution for 3 hours at room temperature and gentle agitation on an orbital shaker. Membranes are washed 3 times with IX TBS/0.1 % Tween, 5 minutes each time with gentle agitation. Goat anti-rabbit conjugate (Abeam, Cambridge, MA) was conjugated to horse radish peroxidase and binds to the Aquaporin-5 rabbit polyclonal antibody. The conjugated antibody was diluted of 1:1000 to 1:5000 in 5% BSA in IX TBS and incubated for 3 hours at room temperature. As shown with the box in Figure 33 the Western Blot detected protein in each of the chemistries evaluated.

Example 144. Protein Production of Factor VII in HeLa Cells

[0001733] The day before transfection, 15,000 HeLa cells (ATCC no. CCL-2; Manassas, VA) were harvested by treatment with Trypsin-EDTA solution (LifeTechnologies, Grand Island, NY) and seeded in a total volume of 100ul EMEM medium (supplemented with 10%FCS and 1x Glutamax) per well in a 96-well cell culture plate (Corning, Manassas, VA). The cells were grown at 37°C in 5% CO₂ atmosphere overnight. The next day, 250 ng of Factor VII modified RNA (mRNA sequence shown in SEQ ID NO: 1623; polyA tail of approximately 140 nucleotides not shown in sequence; 5'cap, Cap1) with the chemical modification described in Table 191, was diluted in 10ul final volume of OPTI-MEM (LifeTechnologies, Grand Island, NY). Lipofectamine 2000 (LifeTechnologies, Grand Island, NY) was used as transfection reagent and 0.2 ul of lipofectamine 2000 was diluted to 10 ul final volume of OPTI-MEM. After 5 minutes of incubation at room temperature, both solutions were combined and incubated an additional 15 minute at room temperature. Then the 20ul combined solution was added to the 100ul cell culture medium containing the HeLa cells and incubated at room temperature. A control of untreated cells was also analyzed.

[0001734] After an 18 to 22 hour incubation cell culture supernatants of cells expressing factor VII were collected and centrifuged at 10,000rcf for 2 minutes. The cleared supernatants were then analyzed with a Hyphen Biomed Chromogenic kit (Aniara, West Chester OH) according to the manufacturer instructions. All samples were diluted until the determined values were within the linear range of the ELISA standard curve. The amount of protein produced compared to the untreated samples is shown in Table 191 and Figure 34.

Table 191. Protein Production

Sample	Increase over untreated (pg/ml)
5-methylcytosine and pseudouridine (5mC and pU)	1.236
5-methylcytosine and 1-methylpseudouridine (5mC and 1mpU)	1.270
25% of uridine modified with 2-thiouridine and 25% of cytosine modified with 5-methylcytosine (s2U and 5mC)	1.299
Pseudouridine (pU)	1.276
1-methylpseudouridine (1mpU)	1.224
Untreated	1

Example 145. Protein Production of Chemically Modified Insulin Glargine in HeLa Cell Supernatant

[0001735] The day before transfection, 15,000 HeLa cells (ATCC no. CCL-2; Manassas, VA) were harvested by treatment with Trypsin- Ethylenediammetetraacetic acid (EDTA) solution (LifeTechnologies, Grand Island, NY) and seeded in a total volume of 100ul Eagle's minimal essential medium (EMEM) (supplemented with 10% fetal calf serum (FCS) and 1x Glutamax) per well in a 24-well cell culture plate (Corning, Manassas, VA). The cells were grown at 37°C in 5% CO₂ atmosphere overnight. Next day, 250 ng of insulin glargine modified RNA (mRNA sequence shown in SEQ ID NO: 21465; polyA tail of approximately 140 nucleotides not shown in sequence; 5'cap, Cap1) fully modified with 5-methylcytosine and pseudouridine (5mC/pU), fully modified with 5-methylcytosine and 1-methylpseudouridine (5mC/ImpU), modified where 25% of the cytosines replaced with 5-methylcytosine and 25% of the uridines replaced with 2-thiouridine (s2U/5mC), fully modified with 1-methylpseudouridine (ImpU) or fully modified with pseudouridine (pU) were diluted in 10 ul final volume of OPTI-MEM® (LifeTechnologies, Grand Island, NY). Lipofectamine 2000 (LifeTechnologies, Grand Island, NY) was used as transfection reagent and 0.2 ul of lipofectamine 2000 was diluted to 10 ul final volume of OPTI-MEM®. After 5 minutes of incubation at room temperature, both solutions were combined and incubated an additional 15 minute at room temperature. Then the 20ul combined solution was added to the 100ul cell culture medium containing the HeLa cells and incubated at room temperature. A control of untreated was also analyzed.

[0001736] After an 18 hour incubation cell culture supernatants of cells expressing insulin glargine were collected by lysing cells with immuno-precipitation (IP) buffer from Pierce Biotechnology (Thermo Scientific, Rockford, IL) and centrifuged at 10,000rcf for 2 minutes. The cleared supernatants were diluted 1:2 (1 ml lysate/2 wells/24 well plate) or 1:5 (1 ml lysate/5 wells/24 well plate) then analyzed with an insulin-specific ELISA kit (Mercodia AB, Uppsala, Sweden) according to the manufacturer instructions. All samples were diluted until the determined values were within the linear range of the ELISA standard curve. The amount of protein produced in both studies is shown in Table 192 and Figure 35. In Table 192, ">" means greater than.

Table 192. Protein Production

Sample	Insulin Glargine (mIU/ml)
5-methylcytosine and pseudouridine (5mC/pU)	22.7
5-methylcytosine and 1-methylpseudouridine (5mC/1mpU)	85.3
25% of the cytosines replaced with 5-methylcytosine and 25% of the uridines replaced with 2-thiouridine (s2U/5mC)	44.2
pseudouridine (pU)	42.0
1-methylpseudouridine (1mpU)	>105
Untreated	0

Example 146. Protein Production of Tissue Factor (Factor 3) in HeLa Cells

[0001737] The day before transfection, 15,000 HeLa cells (ATCC no. CCL-2; Manassas, VA) were harvested by treatment with Trypsin-EDTA solution (LifeTechnologies, Grand Island, NY) and seeded in a total volume of 100ul EMEM medium (supplemented with 10%FCS and 1x Glutamax) per well in a 96-well cell culture plate (Corning, Manassas, VA). The cells were grown at 37°C in 5% CO₂ atmosphere overnight. The next day, 250 ng of Tissue Factor (Factor 3) modified RNA (mRNA sequence shown in SEQ ID NO: 21466; polyA tail of approximately 160 nucleotides not shown in sequence; 5'cap, Cap1) with the chemical modification described in Table 193, was diluted in 10ul final volume of OPTI-MEM (LifeTechnologies, Grand Island, NY). Lipofectamine 2000 (LifeTechnologies, Grand Island, NY) was used as transfection reagent and 0.2 ul of lipofectamine 2000 was diluted to 10 ul final volume of OPTI-MEM. After 5 minutes of incubation at room temperature, both solutions were combined and incubated an additional 15 minute at room temperature. Then the 20ul combined solution was added to the 100ul cell culture medium containing the HeLa cells and incubated at room temperature. A control of untreated cells was also analyzed.

[0001738] After an 18 to 22 hour incubation cell culture supernatants of cells expressing tissue factor were collected and centrifuged at 10,000rcf for 2 minutes. The cleared supernatants were then analyzed with a Hyphen Biomed Chromogenic kit (Aniara, West Chester OH) according to the manufacturer instructions. All samples were diluted until the determined values were within the linear range of the ELISA standard curve. The amount of protein produced compared to the untreated samples is shown in Table 193 and Figure 36. In Table 193, ">" means greater than.

Table 193. Protein Production

Sample	Tissue Factor Protein (pg/ml)
5-methylcytosine and pseudouridine (5mC and pU)	> 2,500
5-methylcytosine and 1-methylpseudouridine (5mC and 1mpU)	> 2,500
25% of uridine modified with 2-thiouridine and 25% of cytosine modified with 5-methylcytosine (s2U and 5mC)	669
Pseudouridine (pU)	> 2,500
1-methylpseudouridine (1mpU)	> 2,500
Untreated	3.1

Example 147. Protein Production of Chemically Modified Factor XI in HeLa Cells

[0001739] The day before transfection, 15,000 HeLa cells (ATCC no. CCL-2; Manassas, VA) were harvested by treatment with Trypsin-EDTA solution (LifeTechnologies, Grand Island, NY) and seeded in a total volume of 100ul EMEM medium (supplemented with 10%FCS and 1x Glutamax) per well in a 96-well cell culture plate (Corning, Manassas, VA). The cells were grown at 37°C in 5% CO₂ atmosphere overnight. The next day, 250 ng of Factor XI modified RNA (mRNA sequence shown in SEQ ID NO: 1625; polyA tail of approximately 140 nucleotides not shown in sequence; 5'cap, Cap1) with the chemical modification described in Table 194, was diluted in 10ul final volume of OPTI-MEM (LifeTechnologies, Grand Island, NY). Lipofectamine 2000 (LifeTechnologies, Grand Island, NY) was used as transfection reagent and 0.2 ul of lipofectamine 2000 was diluted to 10 ul final volume of OPTI-MEM. After 5 minutes of incubation at room temperature, both solutions were combined and incubated an additional 15 minute at room temperature. Then the 20ul combined solution was added to the 100ul cell culture medium containing the HeLa cells and incubated at room temperature. A control of untreated cells was also analyzed.

[0001740] After an 18 to 22 hour incubation cell culture supernatants of cells expressing factor XI were collected and centrifuged at 10,000rcf for 2 minutes. The cleared supernatants were then analyzed with a analyzed with a Factor XI-specific ELISA kit (Innovative Research, Novi, MI) according to the manufacturer instructions. All samples were diluted until the determined values were within the linear range of the ELISA standard curve. The amount of protein produced compared to the untreated samples is shown in Table 194 and Figure 37. In Table 194, ">" means greater than.

Table 194. Protein Production

Sample	Factor XI Protein (ng/ml)
5-methylcytosine and pseudouridine (5mC and pU)	> 500
5-methylcytosine and 1-methylpseudouridine (5mC and 1mpU)	> 500
25% of uridine modified with 2-thiouridine and 25% of cytosine modified with 5-methylcytosine (s2U and 5mC)	42
Pseudouridine (pU)	> 500
1-methylpseudouridine (1mpU)	> 500
Untreated	9

Example 148. Protein Production of Factor XI in HeLa Cell Supernatant

[0001741] The day before transfection, 20,000 HeLa cells (ATCC no. CCL-2; Manassas, VA) were harvested by treatment with Trypsin-EDTA solution (LifeTechnologies, Grand Island, NY) and seeded in a total volume of 100ul EMEM medium (supplemented with 10%FCS and 1x Glutamax) per well in a 96-well cell culture plate (Corning, Manassas, VA). The cells were grown at 37°C in 5% CO₂ atmosphere overnight. Next day, 250 ng of Factor XI modified RNA (mRNA sequence shown in SEQ ID NO: 1625; polyA tail of approximately 140 nucleotides not shown in sequence; 5'cap, Cap1) fully modified with 5-methylcytosine and 1-methylpseudouridine, was diluted in 10ul final volume of OPTI-MEM (LifeTechnologies, Grand Island, NY). Lipofectamine 2000 (LifeTechnologies, Grand Island, NY) was used as transfection reagent and 0.2 ul of lipofectamine 2000 was diluted to 10 ul final volume of OPTI-MEM. After 5 minutes of incubation at room temperature, both solutions were combined and incubated an additional 15 minute at room temperature. Then the 20ul combined solution was added to the 100ul cell culture medium containing the HeLa cells and incubated at room temperature. A control of erythropoietin (EPO) modified mRNA (mRNA sequence shown in SEQ ID NO: 1638; polyA tail of approximately 160 nucleotides not shown in sequence; cap, Cap1, fully modified with 5-methylcytosine and pseudouridine) and untreated cells was also analyzed.

[0001742] After an 18 to 22 hour incubation cell culture supernatants of cells expressing plasminogen was collected and centrifuged at 10.000rcf for 2 minutes. The cleared supernatants were then analyzed with a Factor XI-specific ELISA kit (Innovative

Research, Novi, MI) according to the manufacturer instructions. All samples were diluted until the determined values were within the linear range of the ELISA standard curve.

The amount of protein produced is shown in Table 195 and Figure 38.

Table 195. Protein Production

Sample	Factor XI Protein (ng/ml)
Factor XI	105
EPO	0.3
Untreated	1.2

Example 149. Protein Production of Insulin Aspart in HeLa Cells

[0001743] The day before transfection, 15,000 HeLa cells (ATCC no. CCL-2; Manassas, VA) were harvested by treatment with Trypsin-EDTA solution (LifeTechnologies, Grand Island, NY) and seeded in a total volume of 100ul EMEM medium (supplemented with 10%FCS and 1x Glutamax) per well in a 96-well cell culture plate (Corning, Manassas, VA). The cells were grown at 37°C in 5% CO₂ atmosphere overnight. The next day, 250 ng of Insulin Aspart modified RNA (mRNA sequence shown in SEQ ID NO: 21467; polyA tail of approximately 160 nucleotides not shown in sequence; 5'cap, Cap1) with the chemical modification described in Table 196, was diluted in 10ul final volume of OPTI-MEM (LifeTechnologies, Grand Island, NY). Lipofectamine 2000 (LifeTechnologies, Grand Island, NY) was used as transfection reagent and 0.2 ul of lipofectamine 2000 was diluted to 10 ul final volume of OPTI-MEM. After 5 minutes of incubation at room temperature, both solutions were combined and incubated an additional 15 minute at room temperature. Then the 20ul combined solution was added to the 100ul cell culture medium containing the HeLa cells and incubated at room temperature. A control of untreated cells was also analyzed.

[0001744] After an 18 to 22 hour incubation cell culture supernatants of cells expressing Insulin Apart were collected and centrifuged at 10.000rcf for 2 minutes. The cleared supernatants were then analyzed with an Insulin-specific ELISA kit (Mercodia AB, Uppsala, Sweden) according to the manufacturer instructions. All samples were diluted until the determined values were within the linear range of the ELISA standard curve.

The amount of protein produced compared to the untreated samples is shown in Table 196 and Figure 39. In Table 196, ">" means greater than.

Table 196. Protein Production

Sample	Insulin Aspart (mIU/ml)
5-methylcytosine and pseudouridine (5mC and pU)	> 500
5-methylcytosine and 1-methylpseudouridine (5mC and 1mpU)	> 500
25% of uridine modified with 2-thiouridine and 25% of cytosine modified with 5-methylcytosine (s2U and 5mC)	> 500
Pseudouridine (pU)	> 500
1-methylpseudouridine (1mpU)	> 500
Untreated	0

Example 150. Protein Production of Insulin Lispro in HeLa Cells

[0001745] The day before transfection, 15,000 HeLa cells (ATCC no. CCL-2; Manassas, VA) were harvested by treatment with Trypsin-EDTA solution (LifeTechnologies, Grand Island, NY) and seeded in a total volume of 100ul EMEM medium (supplemented with 10%FCS and 1x Glutamax) per well in a 96-well cell culture plate (Corning, Manassas, VA). The cells were grown at 37°C in 5% CO₂ atmosphere overnight. The next day, 250 ng of Insulin Lispro modified RNA (mRNA sequence shown in SEQ ID NO: 21468; polyA tail of approximately 160 nucleotides not shown in sequence; 5'cap, Cap1) with the chemical modification described in Table 197, was diluted in 10ul final volume of OPTI-MEM (LifeTechnologies, Grand Island, NY). Lipofectamine 2000 (LifeTechnologies, Grand Island, NY) was used as transfection reagent and 0.2 ul of lipofectamine 2000 was diluted to 10 ul final volume of OPTI-MEM. After 5 minutes of incubation at room temperature, both solutions were combined and incubated an additional 15 minute at room temperature. Then the 20ul combined solution was added to the 100ul cell culture medium containing the HeLa cells and incubated at room temperature. A control of untreated cells was also analyzed.

[0001746] After an 18 to 22 hour incubation cell culture supernatants of cells expressing Insulin Lispro were collected and centrifuged at 10,000rcf for 2 minutes. The cleared supernatants were then analyzed with an insulin-specific ELISA kit (MercoDia AB, Uppsala, Sweden) according to the manufacturer instructions. All samples were diluted

until the determined values were within the linear range of the ELISA standard curve. The amount of protein produced compared to the untreated samples is shown in Table 197 and Figure 40. In Table 197, ">" means greater than.

Table 197. Protein Production

Sample	Insulin Aspart (mIU/ml)
5-methylcytosine and pseudouridine (5mC and pU)	> 500
5-methylcytosine and 1-methylpseudouridine (5mC and 1mpU)	> 500
25% of uridine modified with 2-thiouridine and 25% of cytosine modified with 5-methylcytosine (s2U and 5mC)	> 500
Pseudouridine (pU)	> 500
1-methylpseudouridine (1mpU)	> 500
Untreated	0

Example 151. Protein Production of Insulin Glulisine in HeLa Cells

[0001747] The day before transfection, 15,000 HeLa cells (ATCC no. CCL-2; Manassas, VA) were harvested by treatment with Trypsin-EDTA solution (LifeTechnologies, Grand Island, NY) and seeded in a total volume of 100ul EMEM medium (supplemented with 10%FCS and 1x Glutamax) per well in a 96-well cell culture plate (Corning, Manassas, VA). The cells were grown at 37°C in 5% CO₂ atmosphere overnight. The next day, 250 ng of Insulin Glulisine modified RNA (mRNA sequence shown in SEQ ID NO: 21469; polyA tail of approximately 160 nucleotides not shown in sequence; 5'cap, Cap1) with the chemical modification described in Table 198, was diluted in 10ul final volume of OPTI-MEM (LifeTechnologies, Grand Island, NY). Lipofectamine 2000 (LifeTechnologies, Grand Island, NY) was used as transfection reagent and 0.2 ul of lipofectamine 2000 was diluted to 10 ul final volume of OPTI-MEM. After 5 minutes of incubation at room temperature, both solutions were combined and incubated an additional 15 minute at room temperature. Then the 20ul combined solution was added to the 100ul cell culture medium containing the HeLa cells and incubated at room temperature. A control of untreated cells was also analyzed.

[0001748] After an 18 to 22 hour incubation cell culture supernatants of cells expressing Insulin Lispro were collected and centrifuged at 10,000rcf for 2 minutes. The cleared supernatants were then analyzed with an insulin-specific ELISA kit (Merckodia AB,

Uppsala, Sweden) according to the manufacturer instructions. All samples were diluted until the determined values were within the linear range of the ELISA standard curve. The amount of protein produced compared to the untreated samples is shown in Table 198 and Figure 41. In Table 198, ">" means greater than.

Table 198. Protein Production

Sample	Insulin (mIU/ml)
5-methylcytosine and pseudouridine (5mC and pU)	> 500
5-methylcytosine and 1-methylpseudouridine (5mC and 1mpU)	> 500
25% of uridine modified with 2-thiouridine and 25% of cytosine modified with 5-methylcytosine (s2U and 5mC)	> 500
Pseudouridine (pU)	> 500
1-methylpseudouridine (1mpU)	> 500
Untreated	0

Example 152. Protein Production of Human Growth Hormone in HeLa Cells

[0001749] The day before transfection, 15,000 HeLa cells (ATCC no. CCL-2; Manassas, VA) were harvested by treatment with Trypsin-EDTA solution (LifeTechnologies, Grand Island, NY) and seeded in a total volume of 100ul EMEM medium (supplemented with 10%FCS and 1x Glutamax) per well in a 96-well cell culture plate (Corning, Manassas, VA). The cells were grown at 37°C in 5% CO₂ atmosphere overnight. The next day, 250 ng of human growth hormone (hGH) modified RNA (mRNA sequence shown in SEQ ID NO: 1648; polyA tail of approximately 160 nucleotides not shown in sequence; 5'cap, Cap1) with the chemical modification described in Table 199, was diluted in 10ul final volume of OPTI-MEM (LifeTechnologies, Grand Island, NY). Lipofectamine 2000 (LifeTechnologies, Grand Island, NY) was used as transfection reagent and 0.2 ul of lipofectamine 2000 was diluted to 10 ul final volume of OPTI-MEM. After 5 minutes of incubation at room temperature, both solutions were combined and incubated an additional 15 minute at room temperature. Then the 20ul combined solution was added to the 100ul cell culture medium containing the HeLa cells and incubated at room temperature. A control of untreated cells was also analyzed.

[0001750] After an 18 to 22 hour incubation cell culture supernatants of cells expressing human growth hormone were collected and centrifuged at 10.000rcf for 2 minutes. The

cleared supernatants were then analyzed with a human growth hormone ELISA kit (Cat. No. DGH00; R&D SYSTEMS®, Minneapolis, MN) according to the manufacturer instructions. All samples were diluted until the determined values were within the linear range of the ELISA standard curve. The amount of protein produced compared to the untreated samples is shown in Table 199 and Figure 42. In Table 199, ">" means greater than.

Table 199. Protein Production

Sample	hGH (pg/ml)
5-methylcytosine and pseudouridine (5mC and pU)	> 8,000
5-methylcytosine and 1-methylpseudouridine (5mC and 1mpU)	> 8,000
25% of uridine modified with 2-thiouridine and 25% of cytosine modified with 5-methylcytosine (s2U and 5mC)	> 8,000
Pseudouridine (pU)	> 8,000
1-methylpseudouridine (1mpU)	> 8,000
Untreated	0

Example 153. Detection of tumor protein 53 Protein: Western Blot

[0001751] CD1 mice (Harlan Laboratories, South Easton, MA) were administered intravenously lipoplexed tumor protein 53 (TP53 or p53) mRNA (mRNA sequence shown in SEQ ID NO: 1670; polyA tail of approximately 140 nucleotides not shown in sequence; 5'cap, Cap1) fully modified with 5-methylcytosine and pseudouridine (5mC/pU), fully modified with 5-methylcytosine and 1-methylpseudouridine (5mC/1mpU), 25% of uridine modified with 2-thiouridine and 25% of cytosine modified with 5-methylcytosine (s2U and 5mC), fully modified with pseudouridine (pU) or fully modified with 1-methylpseudouridine (1mpU). The mice were administered a dose of 2 ug of mRNA complexed with 2ul Lipofectamine 2000 (LifeTechnologies, Grand Island, NY) in 100ul sterile basal DMEM medium (w/o additives, LifeTechnologies, Grand Island, NY).

[0001752] After 6 hours, the animals were sacrificed and serum & spleen are taken. Spleens were transferred to 6-well plates and kept on ice in presence of 1ml PBS. One spleen was cut with a scalpel several times and with a rubber cell scraper splenocytes were squeezed out until the PBS turns turbid due to cell release.

[0001753] Leaving fibrous components behind, the cells were transferred to a 100um cell strainer (BD Biosciences, San Jose, CA) sitting on a 12-well cell culture plate. By gravity the cells passed through the cell strainer and were collected beneath in the 12-well culture dish. 1 ml of PBS was transferred with the free-floating splenocytes to an Eppendorf tube and spun for 5 min at 2000 rpm. The PBS was discarded and the cell pellet combined with 500 ul fresh PBS. The splenocytes were resuspended by brief vortexing for 5 mins at 2000 rpm. The PBS was discarded and 1ml BD Pharmlyse was added to the cell pellet. The splenocytes were resuspended by brief vortexing. The cells were incubated at room temperature for 3 minutes and then spun at 200 rpm for 5 minutes. The cells were washed twice with 500 ul PBS and spun as described above. The cells were resuspended with 500 ul of PBS and spun as described.

[0001754] 250 ul of splenocytes were combined with 1x Pharmlyse buffer and vortexed briefly or resuspended with a pipet and then spun for 2 minutes at 2000 rpm.

[0001755] In one tube, resuspend cell pellet in 500ul RIPA buffer with protease inhibitor cocktail for mammalian cells (BostonBioproducts, Ashland, MA) and freeze lysate or continue with BCA assay immediately. In a second tube, add 250ul FACS staining kit fixation solution (4% formaldehyde; R and D Systems, Minneapolis, MN) and then incubate for 10 minutes at room temperature. The cells were washed twice with 500 ul PBS and spun as described above. The cell pellet was resuspended in 500 PBS and stored at 4°C.

[0001756] Protein lysates were loaded on NuPage SDS-PAGE system (chambers and power supply) with 1.5mm ready-to-use Bis-Tris gels and 4-12% acrylamide gradient with MOPS-buffer as running aid (all Life Technologies, Grand Island, NY). Each lysate sample was prepared to 40ul final volume. This sample contained 25ug protein lysate in variable volume, RIPA buffer to make up volume to 26ul, 4ul of 10x reducing agent and 10ul 4x SDS loading buffer (both from Life Technologies, Grand Island, NY). Samples were heated at 95oC for 5min and loaded on the gel. Standard settings were chosen by the manufacturer, 200V, 120mA and max. 25W. Run time was 60min, but no longer than running dye reaching the lower end of the gel.

[0001757] After the run was terminated, the plastic case was cracked and the encased gel transferred to a ready-to-use nitrocellulose membrane kit and power supply (iBLOT;

LifeTechnologies, Grand Island, NY). Using default settings, the protein lysate was transferred by high Ampere electricity from the gel to the membrane.

[0001758] After the transfer, the membranes were incubated in 5% BSA in IX TBS for 15 minutes then in 5% BSA in IX TBS + 0.1 % Tween for another 15 minutes. Primary antibodies against target proteins were applied in 3ml of 5% BSA in IX TBS solution at a 1:500 to 1:2000 dilution for 3 hours at room temperature and gentle agitation on an orbital shaker. Membranes are washed 3 times with IX TBS/0.1 % Tween, 5 minutes each time with gentle agitation. The secondary antibody [[which antibodies??]] was conjugated to horse radish peroxidase and binds to the primary antibody antibodies [[which antibodies??]] . The secondary antibody was diluted of 1:1000 to 1:5000 in 5% BSA in IX TBS and incubated for 3 hrs at RT. Primary and secondary antibodies were purchased from Abeam (Cambridge, MA), Novus Biologicals (Littleton, CO), Thermo Fisher (Rockford, IL), Millipore (Billerica, MA) or R and D systems (Minneapolis, MD).

[0001759] At the end of incubation time, the membranes were washed 3 times with IX TBS/0.1 % Tween, 5 minutes each time with gentle agitation. The membranes were developed in 5ml Pierce WestPico Chemiluminescent Substrate (Thermo Fisher, Rockford, IL) as directed.

[0001760] As shown with the box in Figures 43A and 43B the Western Blot detected protein around the expected size of 53 kd for each of the 2 samples evaluated for each chemistry.

Example 154. Detection of Tuftelin 1 Protein: Western Blot

[0001761] Human embryonic kidney epithelial (HEK293) were seeded on 96-well plates (Greiner Bio-one GmbH, Frickenhausen, Germany) and plates for HEK293 cells were precoated with collagen typel . HEK293 were seeded at a density of 35,000 in 100 µl cell culture medium (DMEM, 10% FCS, adding 2mM L-Glutamine, 1 mM Sodiumpyruvate and 1x non-essential amino acids (Biochrom AG, Berlin, Germany) and 1.2 mg/ml Sodiumbicarbonate (Sigma-Aldrich, Munich, Germany)).

[0001762] Transfected cells were lysed with 20 µl Sample buffer (20% Glycerol, 4% SDS, 100mM Tris-HCl pH 6.8, 0,2% Bromphenolblue, 5 % beta-Mercaptoethanol) per well. Supernatants were precipitated with 4 volumes ice-cold acetone and dissolved in

sample buffer. Samples were heated to 95°C for 5 minutes and run on SDS-polyacrylamide gels containing 10% acrylamide.

[0001763] Proteins were transferred to a nitrocellulose membrane by semidry blotting. Membranes were blocked with 5% skim milk powder in TBS and subsequently incubated with TUFT1 rabbit polyclonal antibodies (Novus Biologicals, Cat # NBP 1-87446) at a dilution of 1:500. Signals were detected using Donkey anti-rabbit HRP-conjugated secondary antibodies (St.Cruz Biotech, Heidelberg, Germany) and Super Signal West Pico detection reagent (Pierce). As shown in Figure 44 the Western Blot detected protein in the 2 ug (lane 2) and 200 ng (lane 3) samples. In Figure 44, lane 1 is the marker.

Example 155. Detection of Galactokinase 1 Protein: Western Blot

[0001764] CD1 mice (Harlan Laboratories, South Easton, MA) were administered intravenously lipoplexed galactokinase 1 (GALK1) mRNA (mRNA sequence shown in SEQ ID NO: 21470; polyA tail of approximately 140 nucleotides not shown in sequence; 5'cap, Cap1) fully modified with 5-methylcytosine and pseudouridine (5mC/pU), fully modified with 5-methylcytosine and 1-methylpseudouridine (5mC/ImpU), 25% of uridine modified with 2-thiouridine and 25% of cytosine modified with 5-methylcytosine (s2U and 5mC), fully modified with pseudouridine (pU) or fully modified with 1-methylpseudouridine (ImpU). The mice were administered a dose of 2 ug of mRNA complexed with 2ul Lipofectamine 2000 (LifeTechnologies, Grand Island, NY) in 100ul sterile basal DMEM medium (w/o additives, LifeTechnologies, Grand Island, NY).

[0001765] After 6 hours, the animals were sacrificed and serum & spleen are taken. Spleens were transferred to 6-well plates and kept on ice in presence of 1ml PBS. One spleen was cut with a scalpel several times and with a rubber cell scraper splenocytes were squeezed out until the PBS turns turbid due to cell release.

[0001766] Leaving fibrous components behind, the cells were transferred to a 100um cell strainer (BD Biosciences, San Jose, CA) sitting on a 12-well cell culture plate. By gravity the cells passed through the cell strainer and were collected beneath in the 12-well culture dish. 1 ml of PBS was transferred with the free-floating splenocytes to an Eppendorf tube and spun for 5 min at 2000 rpm. The PBS was discarded and the cell pellet combined with 500 ul fresh PBS. The splenocytes were resuspended by brief vortexing for 5 mins at 2000 rpm. The PBS was discarded and 1ml BD Pharmlyse was added to the

cell pellet. The splenocytes were resuspended by brief vortexing. The cells were incubated at room temperature for 3 minutes and then spun at 200 rpm for 5 minutes. The cells were washed twice with 500 ul PBS and spun as described above. The cells were resuspended with 500 ul of PBS and spun as described.

[0001767] 250 ul of splenocytes were combined with 1x Pharmlyse buffer and vortexed briefly or resuspended with a pipet and then spun for 2 minutes at 2000 rpm.

[0001768] In one tube, resuspend cell pellet in 500ul RIPA buffer with protease inhibitor cocktail for mammalian cells (BostonBioproducts, Ashland, MA) and freeze lysate or continue with BCA assay immediately. In a second tube, add 250ul FACS staining kit fixation solution (4% formaldehyde; R and D Systems, Minneapolis, MN) and then incubate for 10 minutes at room temperature. The cells were washed twice with 500 ul PBS and spun as described above. The cell pellet was resuspended in 500 PBS and stored at 4°C.

[0001769] Protein lysates were loaded on NuPage SDS-PAGE system (chambers and power supply) with 1.5mm ready-to-use Bis-Tris gels and 4-12% acrylamide gradient with MOPS-buffer as running aid (all Life Technologies, Grand Island, NY). Each lysate sample was prepared to 40ul final volume. This sample contained 25ug protein lysate in variable volume, RIPA buffer to make up volume to 26ul, 4ul of 10x reducing agent and 10ul 4x SDS loading buffer (both from Life Technologies, Grand Island, NY). Samples were heated at 95°C for 5min and loaded on the gel. Standard settings were chosen by the manufacturer, 200V, 120mA and max. 25W. Run time was 60min, but no longer than running dye reaching the lower end of the gel.

[0001770] After the run was terminated, the plastic case was cracked and the encased gel transferred to a ready-to-use nitrocellulose membrane kit and power supply (iBLOT; LifeTechnologies, Grand Island, NY). Using default settings, the protein lysate was transferred by high Ampere electricity from the gel to the membrane.

[0001771] After the transfer, the membranes were incubated in 5% BSA in IX TBS for 15 minutes then in 5% BSA in IX TBS + 0.1 % Tween for another 15 minutes. GALK1 rabbit polyclonal antibody (Abeam, Cambridge, MA) against GALK1 proteins were applied in 3ml of 5% BSA in IX TBS solution at a 1:500 to 1:2000 dilution for 3 hours at room temperature and gentle agitation on an orbital shaker. Membranes are washed 3

times with IX TBS/0.1 % Tween, 5 minutes each time with gentle agitation. The Goat anti-rabbit HRP conjugate (Abeam, Cambridge MA) was conjugated to horse radish peroxidase and binds to the GALK1 rabbit polyclonal antibody. The conjugated antibody was diluted of 1:1000 to 1:5000 in 5% BSA in IX TBS and incubated for 3 hrs at RT. Primary and secondary antibodies were purchased from Abeam (Cambridge, MA), Novus Biologicals (Littleton, CO), Thermo Fisher (Rockford, IL), Millipore (Billerica, MA) or R and D systems (Minneapolis, MD).

[0001772] At the end of incubation time, the membranes were washed 3 times with IX TBS/0.1 % Tween, 5 minutes each time with gentle agitation. The membranes were developed in 5ml Pierce WestPico Chemiluminescent Substrate (Thermo Fisher, Rockford, IL) as directed.

[0001773] As shown with the box in Figures 45A and 45B the Western Blot detected protein around the expected size of 30 and 42 kd for each of the 2 samples evaluated for each chemistry.

Example 156. Detection of defensin, beta 103A Protein: Western Blot

[0001774] The day before transfection, 750,000 HeLa cells (ATCC no. CCL-2; Manassas, VA) were harvested by treatment with Trypsin- Ethylenediaminetetraacetic acid (EDTA) solution (LifeTechnologies, Grand Island, NY) and seeded in a total volume of 3ml Eagle's minimal essential medium (EMEM) (supplemented with 10% fetal calf serum (FCS) and 1x Glutamax) per well in a 6-well cell culture plate (Corning, Manassas, VA). The cells were grown at 37°C in 5% CO₂ atmosphere overnight. Next day, 1250ng of defensin, beta 103A (DEFB103A) mRNA (mRNA sequence shown in SEQ ID NO: 1631; polyA tail of approximately 140 nucleotides not shown in sequence; 5'cap, Cap1) fully modified with 5-methylcytosine and pseudouridine (5mC/pU) was diluted in 250 ul final volume of OPTI-MEM® (LifeTechnologies, Grand Island, NY). Lipofectamine 2000 (LifeTechnologies, Grand Island, NY) was used as transfection reagent and 5.5 ul were diluted in 250 ul final volume of OPTI-MEM®. After 5 minutes of incubation at room temperature, both solutions were combined and incubated an additional 15 minutes at room temperature. Then 500 ul of the combined solution was added to the 3 ml cell culture medium containing the HeLa cells. The plates were then incubated as described before. A control of untreated cells was also evaluated.

[0001775] After an 16-18 hour incubation, the medium was removed and the cells were washed with 1ml PBS. After complete removal of the PBS, 500ul of fresh PBS was added. Cells were harvested by scraping with a cell scraper. Harvested cells receiving the same mRNA were then combined in one 1.5ml Eppendorf tube.

[0001776] Cells were pelleted by centrifugation at 3,000 rpm for 2 minutes. The PBS was removed and cells lysed in 250ul radio immunoprecipitation assay (RIPA) buffer (containing PMSF and eukaryotic protease inhibitor mix) (all from BostonBioProducts, Ashland, MA) by gentle pipetting. Lysates were cleared by centrifugation at 10,000 rpm at 4°C for 10 minutes. Cleared lysates were transferred to Amicon filters with 10,000 kd molecular cutoff (Waters, Milford, MA) and spun at 12,000 rpm and 4°C for 20 minutes. The concentrated protein lysate was recovered by placing the inverted filter in a fresh 1.5ml Eppendorf tube and spinning at 3,000rpm for 1 minute. The final volume of the lysate is between 25-40 ul.

[0001777] Protein concentration was determined using the BCA kit for microtiter-plates from Pierce (Thermo Fisher, Rockford, IL). The standard proteins of the titration curve were dissolved in RIPA buffer (as described for cell lysate generation) and not in dilution buffer.

[0001778] Protein lysates were loaded onNuPage SDS-PAGE system (chambers and power supply) with 1.5mm ready-to-use Bis-Tris gels and 4-12% acrylamide gradient with MOPS-buffer as running aid (all from Life Technologies, Grand Island, NY). Each lysate sample was prepared to 40ul final volume. This sample contained 25ug protein lysate in variable volume, RIPA buffer to make up volume to 26ul, 4ul of 10x reducing agent and 10ul 4x SDS loading buffer (both from Life Technologies, Grand Island, NY). Samples were heated at 95°C for 5 minutes and loaded on the gel. Standard settings were chosen by the manufacturer, 200V, 120mA and maximum 25W. Run time was 60 minutes, but no longer than running dye reaching the lower end of the gel.

[0001779] After the run was terminated, the plastic case was cracked and the encased gel transferred to a ready-to-use nitrocellulose membrane kit and power supply (iBLOT; LifeTechnologies, Grand Island, NY). Using default settings, the protein lysate was transferred by high Ampere electricity from the gel to the membrane.

[0001780] After the transfer, the membranes were incubated in 5% bovine serum albumin (BSA) in IX tris buffered saline (TBS) for 15 minutes then in 5% BSA in IX TBS + 0.1 % Tween for another 15 minutes. DEFB103A rabbit polyclonal antibody (Abeam, Cambridge MA) against DEFB103A proteins were applied in 3ml of 5% BSA in IX TBS solution at a 1:500 to 1:2000 dilution for 3 hours at room temperature and gentle agitation on an orbital shaker. Membranes are washed 3 times with IX TBS/0.1 % Tween, 5 minutes each time with gentle agitation. The Donkey anti-rabbit NL557 conjugate (R&D Systems, Minneapolis, MN) was conjugated to horse radish peroxidase and binds to the DEFB103A rabbit polyclonal antibody. The conjugated antibody was diluted of 1:1000 to 1:5000 in 5% BSA in IX TBS and incubated for 3 hours at room temperature. As shown with the box in Figure 46 the Western Blot detected protein in each of the chemistries evaluated.

Example 157. Confirmation of Peptide Identity

[0001781] Proteins can be evaluated using liquid chromatography-mass spectrometry in tandem with mass spectrometry (LC-MS/MS) with quantitative LC-multiple reaction monitoring (MRM) in order to confirm the identity of the peptide.

[0001782] The identity of any protein target described herein can be evaluated using the liquid chromatography-mass spectrometry in tandem with mass spectrometry (LC-MS/MS) with quantitative LC-multiple reaction monitoring (MRM) Assay (Biognosys AG, Schlieren Switzerland). HeLa cell lysates containing protein expressed from modified mRNA are evaluated using LC-MS/MS with quantitative LC-MRM Assay (Biognosys, Schlieren Switzerland) in order to confirm the identity of the peptides in the cell lysates. The identified peptide fragments are compared against known proteins including isoforms using methods known and/or described in the art.

A. Sample Preparation

[0001783] Protein in each sample in lysis buffer is reduced by incubation for 1 hour at 37°C with 5 mM tris(2-carboxyethyl)phosphine (TCEP). Alkylation is carried out using 10 mM iodoacetamide for 30 minutes in the dark at room temperature. Proteins are digested to peptides using trypsin (sequence grade, Promega Corporation, Madison, WI) at a protease: protein ratio of 1:50. Digestion is carried out overnight at 37°C (total digestion time is 12 hours). Peptides are cleaned up for mass spectrometric analysis using CI8 spin columns (The Nest Group, Southborough, MA) according to the manufacturer's

instructions. Peptides are dried down to complete dryness and resuspended in LC solvent A (1% acetonitrile, 0.1% formic acid (FA)). All solvents are HPLC-grade from SIGMA-ALDRICH® (St. Louis, MO) and all chemicals, where not stated otherwise, are obtained from SIGMA-ALDRICH® (St. Louis, MO).

B. LC-MS/MS and LC-MRM

[0001784] Peptides are injected to a packed C18 column (Magic AQ, 3 um particle size, 200 Å pore size, Michrom Bioresources, Inc (Auburn, CA); 11 cm column length, 75 um inner diameter, New Objective (Woburn, MA)) on a Proxeon Easy nLC nano-liquid chromatography system for all mass spectrometric analysis. LC solvents are A: 1 % acetonitrile in water with 0.1% FA; B: 3% water in acetonitrile with 0.1% FA. The LC gradient for shotgun analysis is 5-35% solvent B in 120 minutes followed by 35-100 % solvent B in 2 minutes and 100 % solvent B for 8 minutes (total gradient length is 130 minutes). LC-MS/MS shotgun runs for peptide discovery are carried out on a Thermo Scientific (Thermo Fisher Scientific) (Billerica, MA) Q Exactive mass spectrometer equipped with a standard nano-electrospray source. The LC gradient for LC-MRM is 5-35%, solvent B in 30 minutes followed by 35-100% solvent B in 2 minutes and 100% solvent B for 8 minutes (total gradient length is 40 minutes). The Thermo Scientific (Thermo Fisher Scientific) (Billerica, MA) TSQ Vantage triple quadrupole mass spectrometer is equipped with a standard nano-electrospray source. In unscheduled MRM mode for recalibration it is operated at a dwell time of 20 ms per transition. For relative quantification of the peptides across samples, the TSQ Vantage is operated in scheduled MRM mode with an acquisition window length of 4 minutes. The LC eluent is electrosprayed at 1.9 kV and MRM analysis is performed using a Q1 peak width of 0.7 Da. Collision energies are calculated for the TSQ Vantage by a linear regression according to the vendor's specifications.

C. Assay Design, Data Processing and Analysis

[0001785] For the generation of LC-MRM assays, the 12 most intense fragment ions from LC-MS/MS analysis are measured in scheduled LC-MRM mode and data were processed using MQUEST® (Clueteq, Karlsruhe, Germany), the scoring part of mProphet (Reiter et al, mProphet: Automated data processing and statistical validation for large-scale SRM experiments, Nature Methods, 2011 (8), 430-435; the contents of which are herein incorporated by reference). Assays were validated manually, exact

fragment intensities are determined and iRTs (indexed retention times) are assigned relative to Biognosys's iRT-peptides (Escher et al. Using iRT, a normalized retention time for more targeted measurement of peptides, *Proteomics*, 2012 (12), 1111-1121; the contents of which are herein incorporated by reference).

[0001786] For the relative quantification of the peptides across the sample series the 8 most intense transitions of each assay are measured across the sample series. Data analysis is carried out using SpectroDive™ (Biognosys, Schlieren Switzerland). Total peak areas are compared for the selected peptides and a false discover rate of 0.05 is applied. Peptides with a Qvalue below 0.05 are excluded and considered not detected in the respective sample.

Example 158. Confirmation of Peptide Identity from Modified mRNA Containing Chemical Modifications

[0001787] Cell lysates containing protein produced from low density lipoprotein receptor (LDLR) modified mRNA (mRNA sequence shown in SEQ ID NO: 21463; polyA tail of approximately 140 nucleotides not shown in sequence; 5'cap, Cap1; fully modified with 5-methylcytosine and pseudouridine), ornithine carbamoyltransferase (OTC) modified mRNA (mRNA sequence shown in SEQ ID NO: 1659; polyA tail of approximately 160 nucleotides not shown in sequence; 5'cap, Cap1; fully modified with 5-methylcytosine and pseudouridine), wild-type apolipoprotein A-I (APOA1wt) modified mRNA (mRNA sequence shown in SEQ ID NO: 21453; polyA tail of approximately 160 nucleotides not shown in sequence; 5'cap, Cap1; fully modified with 5-methylcytosine and pseudouridine), Hepcidin (HEPC) modified mRNA (mRNA sequence shown in SEQ ID NO: 21471; polyA tail of approximately 160 nucleotides not shown in sequence; 5'cap, Cap1; fully modified with 5-methylcytosine and 1-methylpseudouridine), hemochromatosis type 2 (HFE2) modified mRNA (mRNA sequence shown in SEQ ID NO: 21472; polyA tail of approximately 160 nucleotides not shown in sequence; 5'cap, Cap1; fully modified with 5-methylcytosine and 1-methylpseudouridine) or fumarylacetoacetate hydrolase (FAH) modified mRNA (mRNA sequence shown in SEQ ID NO: 21473; polyA tail of approximately 160 nucleotides not shown in sequence; 5'cap, Cap1; fully modified with 5-methylcytosine and 1-methylpseudouridine) were evaluated using the LC-MS/MS with quantitative LC-MRM as described in Example 157. Peptide fragments identified for the evaluated proteins are shown in Table 200. All

peptides were specific for parent protein and LDLR and HFE2 was specific for the parent protein and its isoforms. In Table 200, "Uniprot ID" refers to the protein identifier from the UniProt database when the peptide fragment sequences were blasted against all review proteins in the database. Housekeeping proteins used to evaluate the protein in the cell lysates are shown in Table 201.

Table 200. Protein and Peptide Fragment Sequences

<u>Protein</u>	<u>Peptide Fragment Sequence</u>	<u>Peptide Fragment SEQ ID NO</u>	<u>Uniprot ID</u>
APOA1	LLDNWDSVTSTFSK	21474	P02647
APOA1	WQEEMELYR	21475	P02647
APOA1	LHELQEK	21476	P02647
APOA1	VQPYLDDFQK	21477	P02647
FAH	ASSVVVSGTPIR	21478	P16930
FAH	GEGMSQAATICK	21479	P16930
FAH	HLFTGPVLSK	21480	P16930
FAH	IGVAIGDQILDLSIIK	21481	P16930
FAH	LGPEPIISK	21482	P16930
FAH	VFLQNLLSVSQAR	21483	P16930
FAH	WEYVPLGPFLGK	21484	P16930
FAH	AHEHIFGMVLMNDWSAR	21485	P16930
FAH	GTKPIDLGNGQTR	21486	P16930
FAH	HQDVFNQPTLNSFMGLGQAAWK	21487	P16930
FAH	QHATNVGIMFR	21488	P16930
HEPC	ASWMPMFQR	21489	P81172
HEPC	DTHFPICIFCCGCCHR	21490	P81172
LDLR	MICSTQLDR	21491	P01130, P01130-4, P01130-3, P01130-2
LDLR	LAHPFSLAVFEDK	21492	P01130, P01130-4, P01130-3, P01130-2
LDLR	NVVALDTEVASNR	21493	P01130, P01130-4, P01130-3, P01130-2
LDLR	TCSQDEFR	21494	P01130, P01130-4
OTC	FGMHLQAATPK	21495	P00480

OTC	KPEEVDDEVFYSR	21496	P00480
OTC	LAEQYAK	21497	P00480
OTC	LQAFQGYQVTMK	21498	P00480
OTC	SLGMIFEK	21499	P00480
OTC	VAASDWTFHLCLPR	21500	P00480
OTC	GEYLPLLQ GK	21501	P00480
OTC	GLTLSWIGDGNILHSIMMSAAK	21502	P00480
OTC	LLLTNDPLEAAHGGNVLITDTWISM GQEEEK	21503	P00480
OTC	LSTETGFALLGGHPCGLTTQDIHLG VNESLT	21504	P00480
OTC	YMLWLSADLK	21505	P00480
HFE2	CNAEYVSSTLSLR	21506	Q6ZVN8
HFE2	GGVGSGGLCR	21507	Q6ZVN8
HFE2	GPALPGAGSGLPAPDPCDYEGR	21508	Q6ZVN8, Q6ZVN8- 2
HFE2	AFLPDLEK	21509	Q6ZVN8, Q6ZVN8- 2, Q6ZVN8- 3
HFE2	LHGRPPGFLHCASFDPHVR	21510	Q6ZVN8, Q6ZVN8- 2
HFE2	NMQECIDQK	21511	Q6ZVN8, Q6ZVN8- 2

Table 201. Housekeeping Proteins

<u>Protein</u>	<u>Peptide Fragment Sequence</u>	<u>Peptide Fragment SEQ ID NO</u>	<u>Uniprot ID</u>
Beta-actin (ACTB)	VAPEEHPVLLTEAPLNPK	21512	P60709
Glyceraldehyde-3- phosphate dehydrogenase (G3P)	VVDLMAHMASK	21513	P04406
Heat shock protein HSP 90-beta (HS90B)	HLEINPDHPIVETLR	21514	P08238
Heat shock protein	YIDQEELNK	21515	P08238

HSP 90-beta (HS90B)			
L-lactate dehydrogenase A chain (LDHA)	DQLIYNLLK	21516	P00338
L-lactate dehydrogenase A chain (LDHA)	GEMMDLQHGSLFLR	21517	P00338
Phosphoglycerate kinase 1 (PGK1)	ALESPERPFLAILGGAK	21518	P00558
Phosphoglycerate kinase 1 (PGK1)	LGDVYVNDAFGTAHR	21519	P00558
60S acidic ribosomal protein P0 (RLA0)	IIQLLDDYPK	21520	P05388

Example 159. Confirmation and of Peptide Identity from Chemically Modified mRNA

[0001788] Cell lysates containing protein produced from cytotoxic T-lymphocyte-associated protein 4 (CTLA4) modified mRNA (mRNA sequence shown in SEQ ID NO: 21521; polyA tail of approximately 140 nucleotides not shown in sequence; 5'cap, Cap1), serpin peptidase inhibitor, clade A (alpha-1 antiproteinase, antitrypsin), member 1 (SERPINA1) modified mRNA (mRNA sequence shown in SEQ ID NO: 21522; polyA tail of approximately 140 nucleotides not shown in sequence; 5'cap, Cap1), sphingomyelin phosphodiesterase 1 (SMPD1) modified mRNA (mRNA sequence shown in SEQ ID NO: 21523; polyA tail of approximately 140 nucleotides not shown in sequence; 5'cap, Cap1), hypoxanthine-guanine phosphoribosyltransferase (HPRT1) modified mRNA (mRNA sequence shown in SEQ ID NO: 21524; polyA tail of approximately 140 nucleotides not shown in sequence; 5'cap, Cap1), 4-hydroxyphenylpyruvate dioxygenase (HPD) modified mRNA (mRNA sequence shown in SEQ ID NO: 21525; polyA tail of approximately 140 nucleotides not shown in sequence; 5'cap, Cap1), bone morphogenic protein-7 (BMP7) modified mRNA (mRNA sequence shown in SEQ ID NO: 21526; polyA tail of approximately 140 nucleotides not shown in sequence; 5'cap, Cap1), lecithin-cholesterol acyltransferase (LCAT) modified mRNA (mRNA sequence shown in SEQ ID NO: 21527; polyA tail of approximately 140 nucleotides not shown in sequence; 5'cap, Cap1), apoptosis-inducing factor short isoform

1 (AIFsh) modified mRNA (mRNA sequence shown in SEQ ID NO: 21528; polyA tail of approximately 140 nucleotides not shown in sequence; 5'cap, Cap1), tumor protein 53 (TP53 or P53) modified mRNA (mRNA sequence shown in SEQ ID NO: 1670; polyA tail of approximately 140 nucleotides not shown in sequence; 5'cap, Cap1), argininosuccinate synthetase (ASS1) modified mRNA (mRNA sequence shown in SEQ ID NO: 21529; polyA tail of approximately 160 nucleotides not shown in sequence; 5'cap, Cap1), KIT ligand/stem cell factor (KITLG) modified mRNA (mRNA sequence shown in SEQ ID NO: 21530; polyA tail of approximately 140 nucleotides not shown in sequence; 5'cap, Cap1), neuregulin 1, P2a isoform (NRG1) modified mRNA (cDNA sequence shown in SEQ ID NO: 21531; the T7 promoter, 5'untranslated region (UTR) and 3' UTR used in *in vitro* transcription (IVT) shown in the sequence), vasoactive intestinal peptide (VIP) modified mRNA (mRNA sequence shown in SEQ ID NO: 21532; polyA tail of approximately 140 nucleotides not shown in sequence; 5'cap, Cap1), arylsulfatase B (ARSB) modified mRNA (mRNA sequence shown in SEQ ID NO: 1618; polyA tail of approximately 140 nucleotides not shown in sequence; 5'cap, Cap1), 6-pyrovoyltetrahydropterin synthase (PTS) modified mRNA (mRNA sequence shown in SEQ ID NO: 1609; polyA tail of approximately 140 nucleotides not shown in sequence; 5'cap, Cap1), fibronectin type III domain-containing protein 5 (FNDC5 or Irisin) modified mRNA (cDNA sequence shown in SEQ ID NO: 21533; the T7 promoter, 5'untranslated region (UTR) and 3' UTR used in *in vitro* transcription (IVT) shown in the sequence), amelogenin (AMELY) modified mRNA (mRNA sequence shown in SEQ ID NO: 1613; polyA tail of approximately 140 nucleotides not shown in sequence; 5'cap, Cap1), aldolase A (ALDOA) modified mRNA (mRNA sequence shown in SEQ ID NO: 21534; polyA tail of approximately 140 nucleotides not shown in sequence; 5'cap, Cap1), nerve growth factor (NGF) modified mRNA (mRNA sequence shown in SEQ ID NO: 21535; polyA tail of approximately 140 nucleotides not shown in sequence; 5'cap, Cap1), glycogen synthase 2 (GYS2) modified mRNA (mRNA sequence shown in SEQ ID NO: 21536; polyA tail of approximately 140 nucleotides not shown in sequence; 5'cap, Cap1), GTP cyclohydrolase 1 (GCHI) modified mRNA (mRNA sequence shown in SEQ ID NO: 1649; polyA tail of approximately 140 nucleotides not shown in sequence; 5'cap, Cap1), hepatocyte growth factor (HGF) modified mRNA (mRNA

sequence shown in SEQ ID NO: 21537; polyA tail of approximately 140 nucleotides not shown in sequence; 5'cap, Cap1), ectodysplasin-A (EDA) modified mRNA (mRNA sequence shown in SEQ ID NO: 1636; polyA tail of approximately 140 nucleotides not shown in sequence; 5'cap, Cap1), arginase (ARG1) modified mRNA (mRNA sequence shown in SEQ ID NO: 21538; polyA tail of approximately 140 nucleotides not shown in sequence; 5'cap, Cap1), serum amyloid P (APCS) modified mRNA (mRNA sequence shown in SEQ ID NO: 21539; polyA tail of approximately 140 nucleotides not shown in sequence; 5'cap, Cap1), phosphorylase kinase, gamma 2 (PHKG2) modified mRNA (mRNA sequence shown in SEQ ID NO: 21540; polyA tail of approximately 140 nucleotides not shown in sequence; 5'cap, Cap1), 685eoxyribonuclease I (DNASE1) modified mRNA (mRNA sequence shown in SEQ ID NO: 1632; polyA tail of approximately 140 nucleotides not shown in sequence; 5'cap, Cap1), Exenatide modified mRNA (mRNA sequence shown in SEQ ID NO: 21541; polyA tail of approximately 140 nucleotides not shown in sequence; 5'cap, Cap1), glycogenin-1 (PYGL) modified mRNA (mRNA sequence shown in SEQ ID NO: 21542; polyA tail of approximately 140 nucleotides not shown in sequence; 5'cap, Cap1), alpha-galactosidase (GLA) modified mRNA (mRNA sequence shown in SEQ ID NO: 1640; polyA tail of approximately 140 nucleotides not shown in sequence; 5'cap, Cap1), alpha-L-iduronidase (IDUA) modified mRNA (mRNA sequence shown in SEQ ID NO: 1652; polyA tail of approximately 140 nucleotides not shown in sequence; 5'cap, Cap1), galactokinase-1 (GALK1) modified mRNA (mRNA sequence shown in SEQ ID NO: 21470; polyA tail of approximately 140 nucleotides not shown in sequence; 5'cap, Cap1) fully modified with 5-methylcytosine and pseudouridine (5mC and pU), fully modified with 5-methylcytosine and 1-methylpseudouridine (5mC and ImpU), modified where 25% of uridine modified with 2-thiouridine and 25% of cytosine modified with 5-methylcytosine (s2U and 5mC), fully modified with pseudouridine (pU), or fully modified with 1-methylpseudouridine (ImpU) were evaluated using the LC-MS/MS with quantitative LC-MRM as described in Example 157. Peptide fragments identified for the evaluated proteins are shown in Table 202.

Table 202. Proteins and Peptide Fragment Sequences

	<u>Peptide Fragment SEQ ID NO</u>	<u>5mC and pU</u>	<u>5mC and 1mpU</u>	<u>s2U and 5mC</u>	<u>pU</u>	<u>1mpU</u>
CTLA4						
AMDTGLYICK	21543	YES	-	YES	-	YES
GIASFVCEYASP GK	21544	-	-	YES	-	-
SERPINA1						
ITPNLAFAFSLY R	21545	-	YES	-	YES	YES
LSITGTYDLK	21546	-	YES	-	-	-
SMPD1						
IGGFYALSPYPG	21547	-	YES	-	YES	YES
HPRT1						
DLNHVCVISETG	21548	YES	YES	YES	YES	YES
EMGGHHIVALC	21549	YES	-	-	YES	YES
HPD						
AEEEEQNLNR	21550	YES	YES	YES	YES	YES
EMGDHLVK	21551	-	YES	-	-	YES
EVVSHVIK	21552	-	YES	YES	-	YES
BMP7						
ATEVHFR	21553	YES	YES	-	YES	YES
ESDLFLLDSR	21554	-	-	-	-	YES
IPEGEAVTAAEF	21555	YES	YES	YES	YES	YES
LCAT						
LDKPDVVNWMC	21556	-	YES	-	-	YES
LEPGQQUEEYR	21557	-	YES	-	YES	YES
SSGLVSNAPGVQ	21558	-	YES	YES	YES	YES
AIFsh						
DGEQHEDLNEV	21559	-	-	-	-	YES
TGGLEIDSDFGG	21560	YES	-	-	YES	YES
P53						
ELNEALELK	21561	-	-	-	-	YES
SVTCTYSPALNK	21562	-	-	-	YES	YES
TCPVQLWVDSTP	21563	-	-	-	-	YES
ASS1						
APNTPDILEIEFK	21564	YES	YES	-	-	YES
FAELVYTGFWHS	21565	YES	YES	-	YES	YES
FELSCYSLAPQIK	21566	YES	YES	YES	YES	YES
KITLG						
AVENIQINEEDN	21567	YES	YES	-	YES	YES
LFTPEEFFR	21568	YES	YES	-	YES	YES

LVANLPK	21569	YES	YES	-	-	-
NRG1						
ASLADSGEYMC	21570	YES	YES	YES	-	YES
VIP						
HADGVFTSDFSK	21571	YES	YES	YES	YES	YES
HSDAVFTDNYTR	21572	YES	YES	YES	YES	YES
ARSB						
ELIHISDWLPTLV	21573	-	YES	YES	YES	YES
GVGFWASPLLK	21574	-	YES	YES	YES	-
HSVPVYFPAQDP	21575	-	YES	YES	YES	YES
PTS						
FLSDEENLK	21576	YES	YES	YES	YES	YES
VYETDNNIVVYK	21577	YES	YES	-	YES	YES
YMEEAIMQPLD	21578	YES	YES	-	YES	YES
FNDC5						
SASETSTPEHQG	21579	-	YES	-	YES	YES
AMELY						
IALVLTPLK	21580	YES	-	-	YES	YES
ALDOA						
ALANSLACQGK	21581	YES	YES	YES	YES	YES
ALQASALK	21582	YES	YES	YES	YES	YES
GILAADESTGSIA	21583	YES	YES	YES	YES	YES
NGF						
LQHSLDTALR	21584	-	YES	-	-	YES
GYS2						
TQVEQCEPVND	21585	-	-	-	-	YES
GCH1						
AASAMQFFTK	21586	YES	YES	YES	YES	YES
IVEIYSR	21587	YES	YES	YES	YES	YES
VHIGYLPNK	21588	YES	YES	YES	YES	YES
HGF						
GEEGGPWCFTSN	21589	YES	YES	-	YES	YES
HIFWEPDASK	21590	-	-	-	-	YES
NPDGSESPWCFT	21591	-	YES	-	-	YES
EDA						
NDLSGGVLNDW	21592	-	-	YES	YES	YES
ARG1						
GGVEEGPTVLR	21593	YES	YES	YES	YES	YES
TIGIIGAPFSK	21594	YES	YES	YES	YES	YES
YFSMTEVDR	21595	YES	YES	YES	YES	YES
APCS						

IVLGQEQDSYGG	21596	YES	YES	-	YES	YES
QGYFVEAQPK	21597	YES	YES	-	-	YES
VEYSLYIGR	2158	YES	YES	-	YES	YES
PHKG2						
IMEVTAER	21599	YES	YES	YES	YES	YES
LLQVDPEAR	21600	-	YES	-	YES	YES
LSPEQLEEVR	21601	YES	YES	YES	YES	YES
DNASE1						
IAAFNIQTFGETK	21602	YES	YES	YES	YES	YES
IVVAGMLLR	21603	YES	-	-	YES	YES
YDIALVQEVV	21604	YES	YES	YES	YES	YES
Exenatide						
LFIEWLK	21605	YES	YES	YES	-	YES
PYGL						
APNDFNLR	21606	YES	YES	YES	YES	YES
DYYFALAHTVR	21607	YES	YES	YES	YES	YES
VLYPNDNFEGK	21608	YES	YES	YES	YES	YES
GLA						
FDGCYCDSLENL	21609	YES	YES	YES	YES	YES
NFADIDDSWK	21610	YES	YES	YES	YES	YES
SILDWTSFNQER	21611	YES	YES	YES	YES	YES
IDUA						
LDYISLHR	21612	YES	YES	YES	YES	YES
SPLSWGLLR	21613	YES	YES	YES	YES	YES
THWLLELVTR	21614	YES	YES	YES	YES	YES
GALK1						
GHALLIDCR	21615	YES	YES	YES	YES	YES
LAVLITNSNVR	21616	YES	YES	YES	YES	YES
LQFPLPTAQR	21617	YES	YES	YES	YES	YES

Example 160. Confirmation of Peptide Identity and Comparison to Recombinant Protein

[0001789] Liquid chromatography (LC)-mass spectrometry (MS) analysis, LC-MS/MS tryptic peptide mapping/sequencing analysis and 2-dimensional fluorescence differential gel electrophoresis (2-D DIGE) were conducted to confirm the expression of ornithine carbamoyltransferase (OTC) modified mRNA (mRNA sequence shown in SEQ ID NO: 1659; polyA tail of approximately 140 nucleotides not shown in sequence; 5'cap, Cap1) fully modified with 5-methylcytosine and pseudouridine or UDP glucuronosyltransferase 1 family, polypeptide A1 (UGT1A1) modified mRNA (mRNA sequence shown in SEQ

ID NO: 21464; polyA tail of approximately 140 nucleotides not shown in sequence; 5'cap, Cap1) fully modified with 5-methylcytosine and 1-methylpseudouridine in HeLa cells transfected with either transcript. The following materials were used: HPLC grade water (EMD Chemicals Inc., Gibbstown, NJ); formic acid (90%) (J.T.Baker, Phillipsburg, NJ); iodoacetamide (Sigma Aldrich, St. Louis, MO); methanol (EMD Chemicals Inc., Gibbstown, NJ); Tris(2-carboxyethyl)phosphine hydrochloride solution (TCEP), 0.5 M (Sigma Aldrich, St. Louis, MO); Tris(hydroxymethyl)aminomethane buffer substance (Tris buffer), pH 8.0 (Fluka-Sigma Aldrich, St. Louis, MO); calcium chloride dehydrated ACS reagent (CaCl_2) (Sigma Aldrich, St. Louis, MO); OTC reference protein [purified recombinant full length human OTC protein, (Abeam, Cambridge, MA)]; UGT1A1 reference protein [purified recombinant human UGT1A1 protein (OriGene Technologies, Rockville, MD)].

[0001790] HeLa cells were transfected with mRNA encoding OTC and UGT1A1. After transfection, cells were lysed and centrifuged to form a cell pellet. The total protein concentration of each sample was determined by bicinchoninic acid assay (BCA assay). The cellular pellet from untransfected HeLa cells had a total protein concentration of 1707 $\mu\text{g/mL}$ while cellular pellets from OTC and UGT1A1 transfected HeLa cells had total protein concentrations of 3947 $\mu\text{g/mL}$ and 2609 $\mu\text{g/mL}$, respectively.

[0001791] For tryptic peptide mapping/sequencing, recombinant proteins as well as cellular pellets were subjected to trypsin digestion. Recombinant OTC and UGT1A1 were prepared in 100 mM Tris buffer with 3 mM calcium chloride. The proteins (5 μg each) were reduced with 2 mM TCEP then denatured at 100°C for five minutes. The samples were cooled to room temperature then alkylated with 2 mM iodoacetamide. The alkylated samples were further reduced with 0.5 mM TCEP. The samples were treated with trypsin overnight at 37°C in a water bath. The digested samples were removed from the water bath and quenched with 2% formic acid in water. Cell pellets were prepared in 100 mM Tris buffer with 3 mM calcium chloride, pH 8.0. The reconstituted cell pellets and supernatant samples (50 μg each) were reduced with 2 mM TCEP then denatured at 100°C for five minutes. The samples were cooled to room temperature then alkylated with 100 mM iodoacetamide. The alkylated samples were further reduced with 0.5 mM TCEP. The samples were treated with trypsin overnight at 37°C in a water bath. The

digested samples were removed from the water bath and quenched with 2% formic acid in water.

[0001792] The tryptic peptides of recombinant proteins, cell pellets, and supernatant samples were injected onto a 150 x 2.1 mm Xbridge BEH300 C18 column. The column heater was set at 35 °C. Mobile Phase A was 0.1% formic acid in water. Mobile Phase B was 0.1% formic acid in 90/10 acetonitrile/water (v/v). The mass spectra of the digestion products were acquired with an ABSciex API QSTAR ELITE quadrupole time-of-flight mass spectrometer (AB Sciex, Foster City, CA). Data were acquired in time-of-flight (TOF) MS and MS/MS modes using positive electrospray ionization (ESI). The Turbo IonSpray interface was set at 500°C and maintained at a turbospray voltage of 5.0 kV with a declustering potential of 35 V. Ionization was assisted with a nebulizer and ionspray gas (nitrogen) set at 40 and 35 (arbitrary units) respectively. The data were acquired and processed using Analyst QS 2.0 software (AB Sciex, Foster City, CA).

[0001793] The LC-MS data were compared against the predicted/theoretical tryptic digestion products of OTC and UGT1A1 proteins using BioAnalyst software (AB Sciex, Foster City, CA). The digestion products of the recombinant proteins were used as reference peptides for peptide matching in the digested cell pellets and supernatant. The LC-MS and LC-MS/MS data were also mapped and sequenced to specific tryptic digestion products of the HeLa cell derived proteins. The peptide sequence of tryptic peptides were confirmed based on the LC-MS/MS product ion spectra.

[0001794] OTC protein was present in the cell pellet of the HeLa cells transfected with the OTC mRNA. Peptide mapping identified sixteen OTC peptides in the tryptic digest of the cell pellet. The product ion spectra of the cell derived peptides matched well with those of the recombinant protein. A database search of human proteins indicated the sequences of the thirteen unmodified peptides were specific only to human OTC.

UGT1A1 protein was expressed by the HeLa cells transfected with the UGT1A1 mRNA. Seven UGT1A1 peptides were identified in the tryptic digest of the cell pellet based on exact mass assignment and retention time match to the recombinant UGT1A1 protein. The identities of the matched peptides were confirmed by LC-MS/MS. Based on a search of human proteins, four of the seven observed tryptic peptides was specific to human UGT1A proteins while one of the seven observed tryptic peptides was specific only for

UGT1A1. Table 203 shows the peptides identified from the HeLa cell lysates for UGT1A1 modified mRNA and Table 204 shows the peptides identified from OTC modified mRNA.

Table 203. UGT1A1 Peptide Fragments

Peptide Fragment Sequence	SEQ ID NO
AMAIADALGKIPQTVLWR	21618
WLPQNDLLGHPMTR	21619
IPQTVLWR	21620
TYPVPFQR	21621
AMAIADALGK	21622
ENIMR	21623
SDFVK	21624

Table 204. OTC Peptide Fragments

Peptide Fragment Sequence	SEQ ID NO
QKGEYLPLLQGK	21625
VLSSMADAVLAR	21626
FGMHLQAATPK	21627
SLVFPEAENR	21628
GEYLPLLQGK	21629
GYEPDASVTK	21630
ILLNNAAFR	21631
QSDLDTLAK	21632
NFTGEEIK	21633
SLGMIFEK	21634
GRDLLTLK	21635
LAEQYAK	21636
DLLTLK	21637

[0001795] The protein profiles of the cell pellet samples were further characterized by two-dimensional fluorescence differential gel electrophoresis. The test samples were treated with different fluorescent dyes. The contents of the samples were resolved using isoelectric focusing (IEF) in the first dimension and sodium dodecyl sulfate polyacrylamide gel electrophoresis (SDS-PAGE) in the second dimension. The protein profiles of the OTC and UGT1A1 cell pellets were compared. DeCyder Differential Analysis Software (GE Healthcare, Buckinghamshire, UK) was used for data analysis. The presence of OTC and UGT1A1 in the HeLa cells was confirmed by the results of the analysis.

Example 161. Confirmation of Peptide Identity from Modified mRNA Containing Chemical Modifications

[0001796] Cell lysates containing protein produced from cathelicidin antimicrobial peptide (CAMP) modified mRNA (mRNA sequence shown in SEQ ID NO: 1621; polyA tail of approximately 140 nucleotides not shown in sequence; 5'cap, Cap1), CAP18 modified mRNA (mRNA sequence shown in SEQ ID NO: 21638; polyA tail of approximately 140 nucleotides not shown in sequence; 5'cap, Cap1), ciliary neurotrophic factor (CNTF) modified mRNA (mRNA sequence shown in SEQ ID NO: 21639; polyA tail of approximately 140 nucleotides not shown in sequence; 5'cap, Cap1), follicle stimulating hormone, beta polypeptide (FSHB) modified mRNA (mRNA sequence shown in SEQ ID NO: 21640; polyA tail of approximately 140 nucleotides not shown in sequence; 5'cap, Cap1), interferon, alpha 2 (IFNA2) modified mRNA (mRNA sequence shown in SEQ ID NO: 1654; polyA tail of approximately 140 nucleotides not shown in sequence; 5'cap, Cap1), interferon, beta 1, fibroblast (IFNB1) modified mRNA (mRNA sequence shown in SEQ ID NO: 1655; polyA tail of approximately 140 nucleotides not shown in sequence; 5'cap, Cap1), methylmalonyl-CoA mutase, mitochondrial (MUTA) modified mRNA (mRNA sequence shown in SEQ ID NO: 1658; polyA tail of approximately 140 nucleotides not shown in sequence; 5'cap, Cap1), galectin 3 (LEG3) modified mRNA (mRNA sequence shown in SEQ ID NO: 21641; poly A tail of approximately 140 nucleotides not shown in sequence; 5'cap, Cap1), transforming growth factor beta-3 (TGFB3) modified mRNA (mRNA sequence shown in SEQ ID NO: 21642; polyA tail of approximately 140 nucleotides not shown in sequence; 5'cap, Cap1), or tuftelin (TUFT1) modified mRNA (mRNA sequence shown in SEQ ID NO: 1669; polyA tail of approximately 140 nucleotides not shown in sequence; 5'cap, Cap1) fully modified with 5-methylcytosine and pseudouridine (5mC and pU), fully modified with 5-methylcytosine and 1-methylpseudouridine (5mC and ImpU), modified where 25% of uridine modified with 2-thiouridine and 25% of cytosine modified with 5-methylcytosine (s2U and 5mC), fully modified with pseudouridine (pU), or fully modified with 1-methylpseudouridine (ImpU) were evaluated using the LC-MS/MS with quantitative LC-MRM as described in Example 157. Peptide fragments identified for the evaluated proteins are shown in Table 205. In Table 205, "Uniprot ID" refers to the protein

identifier from the UniProt database when the peptide fragment sequences were blasted against all review proteins in the database.

Table 205. Protein and Peptide Fragment Sequences

	<u>Peptide Fragme nt SEQ ID NO</u>	<u>5mC and pU</u>	<u>5mC and 1mpU</u>	<u>s2U and 5m C</u>	<u>pU</u>	<u>1mp U</u>	<u>Uniprot ID</u>
CAMP							
CMGTVTLNQA R	21643	-	Yes	Yes	Yes	Yes	P49913
FALLGDFFR	21644	-	Yes	Yes	Yes	Yes	P49913
TTQQSPEDCDF K	21645	Yes	Yes	Yes	Yes	Yes	P49913
CAP18							
CVGTVILNQAR	21646	Yes	Yes	Yes	Yes	Yes	NA
SSDANLYR	21647	Yes	Yes	Yes	Yes	Yes	P49913
CNTF							
LQENLQAYR	21648	Yes	Yes	Yes	Yes	Yes	P26441
TFHVLLAR	21649	Yes	Yes	Yes	Yes	Yes	P26441
VLQELSQWTV	21650	Yes	Yes	Yes	Yes	Yes	P26441
FSHB							
CSDSDTDCTVR	21651	Yes	Yes	Yes	Yes	Yes	P01225
ELVYETVR	21652	-	-	Yes	-	Yes	P01225
VPGCAHHADSL YTYPVATQCHC	21653	Yes	Yes	Yes	Yes	Yes	P01225
IFNA2							
SFSLSTNLQESL	21654	-	Yes	-	Yes	Yes	P01563
TLMLLAQMR	21655	-	Yes	-	Yes	Yes	P01563
YSPCAWEVVR	21656	-	-	-	-	Yes	P01563
IFNB1							
LLWQLNGR	21657	-	Yes	-	Yes	Yes	P01574
LMSSLHLK	21658	-	-	-	Yes	Yes	P01574
LEG3							
GNDVAFHFNPR	21659	Yes	Yes	Yes	Yes	Yes	P17931
IQVLVEPDHFK	21660	Yes	Yes	Yes	Yes	Yes	P17931
MLITILGTVKPN	21661	Yes	Yes	Yes	Yes	Yes	P17931
MUTA							
LINEIEEMGGM	21662	Yes	Yes	Yes	Yes	Yes	P22033
NTQIIIQEEGIP	21663	Yes	Yes	Yes	Yes	Yes	P22033
TGLQAGLTIDE	21664	Yes	Yes	Yes	Yes	Yes	P22033
TGFB3							

ALDTNYCFR	21665	Yes	Yes	Yes	Yes	Yes	PI0600
GYANFCSGPC	21666	Yes	Yes	-	Yes	Yes	PI0600
VEQLSNMVVK	21667	Yes	Yes	Yes	Yes	Yes	P10600
TUFT1							
EAEQSNVALQR	21668	Yes	Yes	Yes	Yes	Yes	Q9NNX1
IAYLEAENLEM	21669	-	Yes	Yes	Yes	Yes	Q9NNX1
SEVQYIQEAR	21670	Yes	Yes	Yes	Yes	Yes	Q9NNX1

Example 162. Detection of Low Density Lipoprotein Receptor Expression in Cell Culture

A. HeLa cell transfection

[0001797] HeLa cells were plated into 24-well dishes (Corning Life Sciences, Tewksbury, MA) (7.5×10^4 cells/well) in Eagles Minimal Essential Medium (EMEM, Life Technologies, Grand Island, NY) supplemented with 10% fetal calf serum (FCS, Life Technologies, Grand Island, NY) and IX glutamax reagent (Life Technologies, Grand Island, NY) cultured overnight under standard cell culture conditions. Transfection solutions were prepared for each well to be treated by combining 250 ng of low density lipoprotein receptor (LDLR) modified mRNA (mRNA sequence shown in SEQ ID NO: 21463; polyA tail of approximately 140 nucleotides not shown in sequence; 5'cap, Cap1) fully modified with 5-methylcytosine and pseudouridine, mCherry modified mRNA (mRNA sequence shown in SEQ ID NO: 21439; polyA tail of approximately 160 nucleotides not shown in sequence; 5'cap, Cap1; fully modified with 5-methylcytosine and pseudouridine) or luciferase modified mRNA (mRNA sequence shown in SEQ ID NO: 21446; polyA tail of approximately 160 nucleotides not shown in sequence; 5'cap, Cap1; fully modified with 5-methylcytosine and pseudouridine) with 50 μl Opti-MEM reagent (Life Technologies, Grand Island, NY) in a first tube and 1 μl of L2000 transfection reagent (Life Technologies, Grand Island, NY) in 50 μl of Opti-MEM in a second tube. After preparation, first and second tubes were incubated at room temperature for 5 minutes before combining the contents of each. Combined transfection solutions were incubated for 15 minutes at room temperature. 100 μl of transfection solution was then added to each well. Cells were cultured for an additional 16 hours before continued analysis.

B. LDLR detection by flow cytometry

[0001798] After transfection, medium were removed from cells and 60 μl of 0.25% trypsin (Life Technologies, Grand Island, NY) was added to each well. Cells were trypsinized for 2 minutes before the addition of 240 μl /well of trypsin inhibitor (Life Technologies, Grand Island, NY). Resulting cell solutions were transferred to 96 well plates (Corning Life Sciences, Tewksbury, MA), cells were pelleted by centrifugation (800 x gravity for 5 minutes) and supernatants were discarded. Cell pellets were washed with PBS and resuspended in Foxp3 Fixation/Permeabilization solution (eBioscience, San Diego, CA) for 45 minutes. Cells were pelleted again by centrifugation (800 x gravity for 5 minutes) and resuspended in permeabilization buffer (eBiosciences, San Diego, CA) for 10 minutes. Cells were pelleted again by centrifugation (800 x gravity for 5 minutes) and washed in permeabilization buffer. Cells were then treated with primary antibodies directed toward LDLR, followed by phycoerythrin-labeled secondary antibodies. Labeled cells were then combined with FACS buffer (PBS with 1% bovine serum albumin and 0.1% sodium azide) and transferred to cluster tubes. As shown in Figure 47, labeled cells were then analyzed by flow cytometry using a BD Accuri (BD Biosciences, San Jose, CA).

C. LDLR detection by immunofluorescence

[0001799] Transfected cells were washed with PBS, and treated with fixation solution (PBS with 4% formaldehyde) for 20 minutes at room temperature. Cells were then washed with PBS and treated with permeabilization/blocking solution (Tris buffered saline with 5% bovine serum albumin with 0.1% Tween-20). Cells were incubated for 2 hours at room temperature with gentle agitation before washing 3 times with PBS containing 0.05% Tween-20. Cells were then treated with or without primary antibodies (goat anti-LDLR, R&D Systems, Minneapolis, MN) or normal IgG controls for 2 hours at room temperature, washed 3 times with PBS containing 0.05% Tween-20 and treated with secondary antibody solutions containing a 1:200 dilution of donkey anti-goat IgG with fluorescent label (R&D Systems, Minneapolis, MN). Cells were again washed with PBS containing 0.05% Tween-20 and examined by fluorescence microscopy imaging. Cells transiently expressing luciferase or mCherry were examined by fluorescence microscopy without fluorescent immunostaining.

Example 163. Detection of defensin, beta 103A by immunofluorescence

A. HeLa cell transfection

[0001800] HeLa cells are plated into 24-well dishes (Corning Life Sciences, Tewksbury, MA) (7.5×10^4 cells/well) in Eagles Minimal Essential Medium (EMEM, Life Technologies, Grand Island, NY) supplemented with 10% fetal calf serum (FCS, Life Technologies, Grand Island, NY) and IX glutamax reagent (Life Technologies, Grand Island, NY) cultured overnight under standard cell culture conditions. Transfection solutions are prepared for each well to be treated by combining 250 ng defensin, beta 103A (DEFB 103A) modified mRNA (mRNA sequence shown in SEQ ID NO: 1631; polyA tail of approximately 140 nucleotides not shown in sequence; 5'cap, Cap1) or mCherry modified mRNA (mRNA sequence shown in SEQ ID NO: 21439; polyA tail of approximately 160 nucleotides not shown in sequence; 5'cap, Cap1) with 50 μ l Opti-MEM reagent (Life Technologies, Grand Island, NY) in a first tube and 1 μ l of L2000 transfection reagent (Life Technologies, Grand Island, NY) in 50 μ l of Opti-MEM in a second tube. After preparation, first and second tubes are incubated at room temperature for 5 minutes before combining the contents of each. Combined transfection solutions are incubated for 15 minutes at room temperature. 100 μ l of transfection solution is then added to each well. Cells are cultured for an additional 16 hours before continued analysis.

B. DEFB103A detection by immunofluorescence

[0001801] Transfected cells are washed with PBS, and treated with fixation solution (PBS with 4% formaldehyde) for 20 minutes at room temperature. Cells are then washed with PBS and treated with permeabilization/b locking solution (Tris buffered saline with 5% bovine serum albumin with 0.1% Tween-20). Cells are incubated for 2 hours at room temperature with gentle agitation before washing 3 times with PBS containing 0.05% Tween-20. Cells are then left untreated with primary antibody, treated with anti-DEFB103A primary antibody (Rabbit anti-DEFB103A, Abeam, Cambridge, MA) or treated with normal IgG control antibody for 2 hours at room temperature, washed 3 times with PBS containing 0.05% Tween-20 and treated with secondary antibody solutions containing a 1:200 dilution of donkey anti-rabbit IgG with red fluorescent label (R&D Systems, Minneapolis, MN). Cells are again washed with PBS containing 0.05% Tween-20 and examined by fluorescence microscopy imaging. Cells transfected with modified mRNA encoding mCherry are visualized without immunofluorescent staining.

Example 164. Confirmation of Protein Expression

[0001802] Modified mRNA fully modified with 5-methylcytosine and pseudouridine (5mC/pU), fully modified with 5-methylcytosine and 1-methylpseudouridine (5mC/1mpU), modified where 25% of the cytosines replaced with 5-methylcytosine and 25% of the uridines replaced with 2-thiouridine (s2U/5mC), fully modified with 1-methylpseudouridine (1mpU) or fully modified with pseudouridine (pU) encoding the proteins described in Table 205 were analyzed by fluorescence and/or western blot in order to confirm the expression of protein and the length of the protein expressed. Table 205 describes the sequence of the modified mRNA (polyA tail of approximately 140 nucleotides not shown in sequence; 5'cap, Cap1) or the cDNA (the T7 promoter, 5'untranslated region (UTR) and 3' UTR used in *in vitro* transcription (IVT) shown in the sequence) the chemical modification evaluated and the length (in base pairs), if known.

Table 205. Protein and Expression

Protein	Modified mRNA SEQ ID NO	5mC/pU	5mC /1mpU	s2U/5mC	pU	1mpU
Luciferase	21446	Yes	Yes	Yes	Yes	Yes
Tumor protein 53 (P53 or TP53)	1670	Yes 1468 bp	Yes 1468 bp	-	-	Yes 1468 bp
Phenylalanine hydroxylase (PAH)	1660	Yes 1645 bp	Yes 1645 bp	Yes 1645 bp	-	Yes 1645 bp
Factor VII (F7)	1623	Yes 1687 bp	Yes 1687 bp	Yes 1687 bp	-	Yes 1687 bp
Defensin, beta 103A (DEFB103A)	1631	Yes 490 bp	Yes 490 bp	Yes 490 bp	Yes 490 bp	Yes 490 bp
6-pyruvoyltetrahydr opterin synthase (PTS)	1609	Yes 724 bp	Yes 724 bp	Yes 724 bp	Yes 724 bp	Yes 724 bp
Serpina 1	21522	Yes 1543 bp	Yes 1543 bp	-	-	Yes 1543 bp
Sphingomyelin phosphodiesterase 1, acid lysosomal (SMPD1)	21523	Yes 2176 bp	Yes 2176 bp	-	-	Yes 2176 bp
Herceptin Light	21452	Yes	Yes	Yes	Yes	Yes

Chain		1042 bp	1042 bp	1042 bp	1042 bp	1042 bp
Herceptin Heavy Chain	21451	Yes 1753 bp	Yes 1753 bp	Yes 1753 bp	Yes 1753 bp	Yes 1753 bp
Glial cell derived neurotrophic factor (GDNF)	21671	Yes 922 bp	Yes 922 bp	Yes 922 bp	-	Yes 922 bp
Rhodopsin (RHO)	21672	Yes 985 bp	Yes 985 bp	-	-	Yes 985 bp
Tissue Plasminogen Activator (PLAT)	1661	Yes 1975 bp	Yes 1975 bp	Yes 1975 bp	-	Yes 1975 bp
Argininosuccinate synthase 1 (ASS1)	21529	Yes 1525 bp	Yes 1525 bp	-	-	Yes 1525 bp
UDP glucuronosyltransferase 1 family, polypeptide A1 (UGT1A1)	21464	Yes 1888 bp	Yes 1888 bp	-	-	Yes 1888 bp
Sirtuin 6 (SIRT6)	1665	Yes 1354 bp	Yes 1354 bp	Yes 1354 bp	-	Yes 1354 bp
Thrombopoietin (THPO)	1667	Yes 3088 bp	Yes 3088 bp	Yes 3088 bp	-	Yes 3088 bp
Hypoxanthine phosphoribosyltransferase 1 (HPRT1)	21524	Yes 943 bp	Yes 943 bp	-	-	Yes 943 bp
Thrombomodulin (THBD)	21673	Yes 2014 bp	Yes 2014 bp	-	-	Yes 2014 bp
Factor XII (F12)	21674	Yes 2134 bp	Yes 2134 bp	Yes 2134 bp	-	Yes 2134 bp
Relaxin 2 (RLN2)	21675	Yes 844 bp	Yes 844 bp	Yes 844 bp	Yes 844 bp	Yes 844 bp
Vasoactive Intestinal Peptide (VIP)	21532	Yes 799 bp	Yes 799 bp	Yes 799 bp	Yes 799 bp	Yes 799 bp
Lecithin-cholesterol acyltransferase (LCAT)	21527	Yes 1609 bp	Yes 1609 bp	Yes 1609 bp	-	Yes 1609 bp
Fibroblast growth factor 21	21676	Yes 916 bp	Yes 916 bp	Yes 916 bp	-	Yes 916 bp
OMOMYC	21677	Yes	Yes	-	-	Yes

		1623 bp	1623 bp			1623 bp
Apoptosis-inducing factor pro-apoptotic isoform (AIFsh)	21528	Yes 1089 bp	Yes 1089 bp	-	-	Yes 1089 bp
Erythropoietin (EPO)	1638	Yes 868 bp	-	-	-	-
Human Growth Hormone (hGH)	1648	Yes 940 bp	Yes 940 bp	Yes 940 bp	Yes 940 bp	Yes 940 bp
Glactosidase, alpha (GLA)	1640	-	Yes 1576 bp	Yes 1576 bp	Yes 1576 bp	-
Arylsulfatase B	1618	-	Yes 1888 bp	Yes 1888 bp	Yes 1888 bp	-
Iduronidase, alpha-L- (IDUA)	1652	-	Yes 2248 bp	Yes 2248 bp	Yes 2248 bp	-
interferon, beta 1, fibroblast (IFNB)	1655	Yes 850 bp	-	-	-	-
CTLA4-Ig	21521	-	Yes 958 bp	Yes 958 bp	Yes 958 bp	-
Interferon alpha 2 (IFNA2)	1654	Yes 853 bp	-	-	-	-
Factor IX (F9)	1622	Yes 1672 bp	Yes 1672 bp	Yes 1672 bp	-	Yes 1672 bp
APOA1 Milano	21455	Yes 1090 bp	Yes 1090 bp	Yes 1090 bp	Yes 1090 bp	Yes 1090 bp
Factor XI (F11)	1625	Yes 2164 bp	Yes 2164 bp	Yes 2164 bp	-	Yes 2164 bp
CAP18	21638	Yes 796 bp	-	-	-	-
Aquaporin 5	1617	Yes 1084 bp	Yes 1084 bp	Yes 1084 bp	Yes 1084 bp	Yes 1084 bp
APOA1 Paris	21454	Yes 1090 bp	Yes 1090 bp	Yes 1090 bp	Yes 1090 bp	Yes 1090 bp
APOA1	21453	Yes 1090 bp	Yes 1090 bp	Yes 1090 bp	Yes 1090 bp	Yes 1090 bp
follicle stimulating	21640	Yes 673 bp	-	-	-	-

hormone beta (FSH beta)						
Prothrombin	21462	Yes 2155 bp	Yes 2155 bp	Yes 2155 bp	Yes 2155 bp	Yes 2155 bp
Tissue Factor (Factor 3)	21466	Yes 1174 bp	Yes 1174 bp	Yes 1174 bp	Yes 1174 bp	Yes 1174 bp
galactokinase 1 (GALK1)	21470	-	Yes 1465 bp	-	Yes 1465 bp	Yes 1465 bp
4-hydroxyphenylpyruvate dioxigenase (HPD)	21525	-	-	Yes 1468 bp	Yes 1468 bp	Yes 1468 bp
bone morphogenic protein-7 (BMP7)	21526	-	Yes 1582 bp	Yes 1582 bp	Yes 1582 bp	-
KIT ligand/stem cell factor (KITLG)	21530	-	Yes 1108 bp	Yes 1108 bp	Yes 1108 bp	-
Insulin Glulisine	21469	Yes 619 bp	Yes 619 bp	Yes 619 bp	Yes 619 bp	Yes 619 bp
Insulin Lispro	21468	Yes 619 bp	Yes 619 bp	Yes 619 bp	Yes 619 bp	Yes 619 bp
Insulin Aspart	21467	Yes 619 bp	Yes 619 bp	Yes 619 bp	Yes 619 bp	Yes 619 bp
Insulin Glargine	21465	Yes 619 bp	Yes 619 bp	Yes 619 bp	Yes 619 bp	Yes 619 bp
LL-37	1621	Yes 796 bp	-	-	-	-
Methylmalonyl-CoA mutase, mitochondrial (MUTA)	1658	Yes 2539 bp	-	-	-	-
Ceruloplasmin (CP)	1620	Yes 3481 bp	-	-	-	-
Protein	cDNA SEQ ID NO	5mC/ pU	5mC /1mpU	s2U/5mC	pU	1mpU

Irisin	21532	Yes 925 bp	Yes 925 bp	Yes 925 bp	-	Yes 925 bp
--------	-------	---------------	---------------	---------------	---	---------------

Example 165. Vascular Endothelial Growth Factor Expression and Cell Vitality

[0001803] The day before transfection, 100,000 HeLa cells (ATCC no. CCL-2; Manassas, VA) were harvested by treatment with Trypsin-EDTA solution (LifeTechnologies, Grand Island, NY) and seeded in a total volume of 100 μ l EMEM medium (supplemented with 10%FCS and 1x Glutamax) per well in a 24-well cell culture plate (Corning, Manassas, VA). The cells were grown at 37°C in 5% CO₂ atmosphere overnight. The next day, 62 ng, 250 ng, 750 ng or 1500 ng of vascular endothelial growth factor (VEGF) modified RNA (mRNA sequence shown in SEQ ID NO: 1672; polyA tail of approximately 160 nucleotides not shown in sequence; 5'cap, Cap1) fully modified with 5-methylcytosine and pseudouridine (5mC/pU), fully modified with 5-methylcytosine and 1-methylpseudouridine (5mC/ImpU), fully modified with 1-methylpseudouridine (ImpU) or containing no modifications (unmodified) was mixed with 2 μ l Lipofectamine 2000 (LifeTechnologies, Grand Island, NY) as transfection aid and added to the cells in duplicate.

A. Vascular Endothelial Growth Factor Protein Expression

[0001804] After an incubation of 24 hours cell culture supernatants of cells expressing VEGF were collected and centrifuged at 10,000rcf for 2 minutes. The cleared supernatants were then analyzed with a VEGF-specific ELISA kit (R & D Systems, Minneapolis, MN) according to the manufacturer instructions. All samples were diluted until the determined values were within the linear range of the ELISA standard curve. A control of untreated cells, cells treated in duplicate with 62 ng or 750 ng of green fluorescent protein (GFP) modified mRNA (mRNA sequence shown in SEQ ID NO: 1672; polyA tail of approximately 160 nucleotides not shown in sequence; 5'cap, Cap1) fully modified with 5-methylcytosine and pseudouridine (5mC/pU), fully modified with 5-methylcytosine and 1-methylpseudouridine (5mC/ImpU), fully modified with 1-methylpseudouridine (ImpU) or containing no modifications (unmodified) and a control of 250ng of mCherry modified mRNA (mRNA sequence shown in SEQ ID NO: 21439; polyA tail of approximately 160 nucleotides not shown in sequence; 5'cap, Cap1) was

also analyzed. The amount of VEGF produced in pg/ml is shown in Table 206 and in Figure 48. In Figure 48, "eGFP" refers to the green fluorescent protein modified mRNA, "MC" refers to the mCherry modified mRNA, "UNT-1" refers to the untreated cells, "GO" means the modified mRNA contains no modifications, "G1" means fully modified with 5-methylcytosine and pseudouridine, "G1" means fully modified with 5-methylcytosine and 1-methyl pseudouridine and "G5" means fully modified with 1-methylpseudouridine.

[0001805] Cells transfected with VEGF modified mRNA fully modified with 5-methylcytosine and 1-methylpseudouridine or fully modified with 1-methylpseudouridine showed the highest expression of VEGF.

Table 206. VEGF Protein Production (pg/ml)

		5mC/pU	5mC/1mpU	1mpU	Unmodified
VEGF	62 ng	220500	327409	325500	156545
	250 ng	322636	283500	168955	45818
	750 ng	1264773	2486591	3085091	107864
	1500 ng	2231727	3874500	3465955	238636
GFP	62 ng	NA	0	3818	955
	750 ng	NA	11455	1909	6682
Untreated		4773			
mCherry		0			

B. Vascular Endothelial Growth Factor

[0001806] After an incubation of 24 hours the medium was removed and cells lysed with 200ul per well of the Cell Titer Glo (CTG) assay reagent (Promega Corporation, Madison, WI). After 15 minutes of incubation at room temperature, two sets of 100ul of each lysate were transferred into white opaque polystyrene 96-well plates (Corning, Tewksbury, MA). Again 100ul of Cell Titer Glo assay reagent was added to each aliquot of cell lysate. The total volume of 110ul reagent mix was analyzed on a BioTek Synergy HI plate reader with a general luminescence program. The mean of duplicate measures were plotted in a graph with untreated HeLa cells as reference (1.0 = 100% vitality). A control of untreated cells in duplicate and cells treated with 250ng of mCherry modified mRNA (mRNA sequence shown in SEQ ID NO: 1672; polyA tail of approximately 160 nucleotides not shown in sequence; 5'cap, Cap1) was also evaluated. The normalized ATP abundance / cell viability is shown in Table 207 and Figure 49. In Figure 49, "MC"

refers to the mCherry modified mRNA, "UNT-1" and "UNT-2" refers to the untreated cells, "GO" means the modified mRNA contains no modifications, "G1" means fully modified with 5-methylcytosine and pseudouridine, "G1" means fully modified with 5-methylcytosine and 1-methyl pseudouridine, "G5" means fully modified with 1-methylpseudouridine and "*" means only one data point was obtained.

[0001807] Decreased luminescence activity, which is indicative of loss of cell vitality, was seen in cells transfected with VEGF modified mRNA fully modified with 5-methylcytosine and pseudouridine or unmodified. There was no decrease in cell vitality for cells transfected with VEGF modified mRNA fully modified with 5-methylcytosine and 1-methylpseudouridine or fully modified with 1-methylpseudouridine.

Table 207. Normalized ATP abundance/Cell Vitality

	5mC/pU	5mC/1mpU	1mpU	Unmodified
62 ng	1.12	1.19	1.20	1.59
250 ng	0.80	1.11	1.14	0.86
750 ng	0.64	1.01	1.04	0.38
1500 ng	0.48	0.99	0.98	0.48
Untreated	0.94			
mCherry	1.04			

Example 166. Protein Production of Erythropoietin in HeLa Cell Supernatant

[0001808] The day before transfection, 100,000 HeLa cells (ATCC no. CCL-2; Manassas, VA) were harvested by treatment with Trypsin-EDTA solution (LifeTechnologies, Grand Island, NY) and seeded in a total volume of 100ul EMEM medium (supplemented with 10%FCS and 1x Glutamax) per well in a 96-well cell culture plate (Corning, Manassas, VA). The cells were grown at 37°C in 5% CO₂ atmosphere overnight. Next day, 250 ng of erythropoietin (EPO) modified RNA (mRNA sequence shown in SEQ ID NO: 1638; polyA tail of approximately 160 nucleotides not shown in sequence; 5'cap, Cap1) fully modified with 5-methylcytosine and pseudouridine (5mC/pU), fully modified with 5-methylcytosine and 1-methylpseudouridine (5mC/1mpU), modified where 25% of uridine modified with 2-thiouridine and 25% of cytosine modified with 5-methylcytosine (s2U and 5mC), fully modified with pseudouridine (pU), or fully modified with 1-methylpseudouridine (ImpU), was diluted in 10ul final volume of OPTI-MEM (LifeTechnologies, Grand

Island, NY). Lipofectamine 2000 (LifeTechnologies, Grand Island, NY) was used as transfection reagent and 0.2 ul of lipofectamine 2000 was diluted to 10 ul final volume of OPTI-MEM. After 5 minutes of incubation at room temperature, both solutions were combined and incubated an additional 15 minute at room temperature. Then the 20ul combined solution was added to the 100ul cell culture medium containing the HeLa cells and incubated at room temperature. A control of lipofecatmine 2000 treated cells (L2000) and untreated cells was also analyzed.

[0001809] After an 18 to 22 hour incubation cell culture supernatants of cells expressing EPO was collected and centrifuged at 10,000rcf for 2 minutes. The cleared supernatants were then analyzed with an EPO ELISA kit (Stem Cell Technologies, Vancouver Canada) according to the manufacturer instructions. All samples were diluted until the determined values were within the linear range of the ELISA standard curve. The amount of protein produced is shown in Table 208.

Table 208. Protein Production

Sample	EPO (pg/ml)
5-methylcytosine and pseudouridine (5mC and pU)	17,900
5-methylcytosine and 1-methylpsudouridine (5mC and 1mpU)	81,146
25% of uridine modified with 2-thiouridine and 25% of cytosine modified with 5-methylcytosine (s2U and 5mC)	224,195
Pseudouridine (pU)	226,283
1-methylpseudouridine (1mpU)	522,375
L2000	597
Untreated	0

Example 167. In vitro expression of Insulin Aspart modified mRNA

[0001810] The cells were transfected with Insulin Aspart modified mRNA (mRNA sequence shown in SEQ ID NO: 21468; polyA tail of approximately 160 nucleotides not shown in sequence; 5'cap, Cap1) fully modified with 5-methylcytosine and pseudouridine (5mC/pU), fully modified with 5-methylcytosine and 1-methylpseudouridine (5mC/1mpU), modified where 25% of uridine modified with 2-thiouridine and 25% of cytosine modified with 5-methylcytosine (s2U and 5mC), fully modified with pseudouridine (pU), or fully modified with 1-methylpseudouridine (ImpU) which had been complexed with Lipofectamine2000 from Invitrogen (Carlsbad, CA) at

the concentration shown in Table 209. The total volume of transfection mix per 96-well was 50 μ l, split in two aliquots 25 μ l each. One 25 μ l aliquot contained 1 μ l of respective mmRNA and 24 μ l Opti-MEM, the other 25 μ l aliquot contained 0.4 μ l Lipofectamine2000 and 24.6 μ l Opti-MEM. Where needed, the aliquot containing modified mRNA and Opti-MEM was serially diluted in Opti-MEM. Both aliquots were incubated separately for 15 min at room temperature. Subsequently, both aliquots were mixed together and incubated for another 20 min at room temperature before finally transferring the total 50 μ l transfection mix to a 96-well containing 100 μ l cell culture medium plus 35000 HEK293 cells. Cells were then incubated for 24h in a humidified 37°C/5% CO₂ cell culture incubator before harvesting the cell culture supernatant or preparing cell lysate. The protein expression was detected by ELISA and the protein (pg/ml) is shown in Figure 50 and in Table 209. In Table 209, ">" means greater than.

Table 209. Protein Expression

Amount Transfected	2 ug	400 ng	80 ng	16 ng	3.2 ng	640 pg	128 pg	26 pg
Protein (mU/I)	>100	>100	>100	103.0	11.4	1.3	0	0

Example 168. *In vitro* expression of Insulin Glargine modified mRNA

[0001811] The cells were transfected with Insulin Glargine modified mRNA (mRNA sequence shown in SEQ ID NO: 21465; polyA tail of approximately 160 nucleotides not shown in sequence; 5'cap, Cap1) fully modified with 5-methylcytosine and pseudouridine (5mC/pU), fully modified with 5-methylcytosine and 1-methylpseudouridine (5mC/ImpU), modified where 25% of uridine modified with 2-thiouridine and 25% of cytosine modified with 5-methylcytosine (s2U and 5mC), fully modified with pseudouridine (pU), or fully modified with 1-methylpseudouridine (ImpU) which had been complexed with Lipofectamine2000 from Invitrogen (Carlsbad, CA) at the concentration shown in Table 210. The total volume of transfection mix per 96-well was 50 μ l, split in two aliquots 25 μ l each. One 25 μ l aliquot contained 1 μ l of respective mmRNA and 24 μ l Opti-MEM, the other 25 μ l aliquot contained 0.4 μ l Lipofectamine2000 and 24.6 μ l Opti-MEM. Where needed, the aliquot containing modified mRNA and Opti-MEM was serially diluted in Opti-MEM. Both aliquots were incubated separately for 15

min at room temperature. Subsequently, both aliquots were mixed together and incubated for another 20 min at room temperature before finally transferring the total 50 μ l transfection mix to a 96-well containing 100 μ l cell culture medium plus 35000 HEK293 cells. Cells were then incubated for 24h in a humidified 37°C/5% CO₂ cell culture incubator before harvesting the cell culture supernatant or preparing cell lysate. The protein expression was detected by ELISA and the protein (pg/ml) is shown in Figure 51 and in Table 210.

Table 210. Protein Expression

Amount Transfected	2 ug	400 ng	80 ng	16 ng	3.2 ng	640 pg	128 pg	26 pg
Protein (mU/I)	16.7	21.8	16.4	4.7	0	0	0	0

Example 169. *In vitro* expression of Insulin Glulisine modified mRNA

[0001812] The cells were transfected with Insulin Glulisine modified mRNA (mRNA sequence shown in SEQ ID NO: 21469; polyA tail of approximately 160 nucleotides not shown in sequence; 5'cap, Cap) fully modified with 5-methylcytosine and pseudouridine (5mC/pU), fully modified with 5-methylcytosine and 1-methylpseudouridine (5mC/ImpU), modified where 25% of uridine modified with 2-thiouridine and 25% of cytosine modified with 5-methylcytosine (s2U and 5mC), fully modified with pseudouridine (pU), or fully modified with 1-methylpseudouridine (ImpU) which had been complexed with Lipofectamine2000 from Invitrogen (Carlsbad, CA) at the concentration shown in Table 211. The total volume of transfection mix per 96-well was 50 μ l, split in two aliquots 25 μ l each. One 25 μ l aliquot contained 1 μ l of respective mmRNA and 24 μ l Opti-MEM, the other 25 μ l aliquot contained 0.4 μ l Lipofectamine2000 and 24.6 μ l Opti-MEM. Where needed, the aliquot containing modified mRNA and Opti-MEM was serially diluted in Opti-MEM. Both aliquots were incubated separately for 15 min at room temperature. Subsequently, both aliquots were mixed together and incubated for another 20 min at room temperature before finally transferring the total 50 μ l transfection mix to a 96-well containing 100 μ l cell culture medium plus 35000 HEK293 cells. Cells were then incubated for 24h in a humidified 37°C/5% CO₂ cell culture incubator before harvesting the cell culture supernatant or preparing cell lysate. The

protein expression was detected by ELISA and the protein (pg/ml) is shown in Figure 52 and in Table 211. In Table 211, ">" means greater than.

Table 211. Protein Expression

Amount Transfected	2 ug	400 ng	80 ng	16 ng	3.2 ng	640 pg	128 pg	26 pg
Protein (mU/I)	>100	>100	>100	95.9	13.1	0	0	0

Example 170. Dose response and injection site selection and timing

[0001813] To determine the dose response trends, impact of injection site and impact of injection timing, studies are performed following the protocol outlined in Example 35. In these studies, varied doses of 1ug, 5ug, 10 ug, 25 ug, 50 ug, and values in between are used to determine dose response outcomes. Split dosing for a 100 ug total dose includes three or six doses of 1.6 ug, 4.2 ug, 8.3 ug, 16.6 ug, or values and total doses equal to administration of the total dose selected.

[0001814] Injection sites are chosen from the limbs or any body surface presenting enough area suitable for injection. This may also include a selection of injection depth to target the dermis (Intradermal), epidermis (Epidermal), subcutaneous tissue (SC) or muscle (IM). Injection angle will vary based on targeted delivery site with injections targeting the intradermal site to be 10-15 degree angles from the plane of the surface of the skin, between 20-45 degrees from the plane of the surface of the skin for subcutaneous injections and angles of between 60-90 degrees for injections substantially into the muscle.

Example 171. Protein Production of Transforming Growth Factor Beta 1 in HeLa Cell Supernatant

[0001815] The day before transfection, 100,000 HeLa cells (ATCC no. CCL-2; Manassas, VA) were harvested by treatment with Trypsin-EDTA solution (LifeTechnologies, Grand Island, NY) and seeded in a total volume of 100ul EMEM medium (supplemented with 10%FCS and 1x Glutamax) per well in a 96-well cell culture plate (Corning, Manassas, VA). The cells were grown at 37°C in 5% CO₂ atmosphere overnight. Next day, 250 ng of transforming growth factor beta 1 (TGFB1) modified RNA (mRNA sequence shown in SEQ ID NO: 1668; polyA tail of approximately 140 nucleotides not shown in sequence; 5'cap, Cap1) fully modified with

5-methylcytosine and pseudouridine (5mC/pU), fully modified with 5-methylcytosine and 1-methylpseudouridine (5mC/1mpU), modified where 25% of uridine modified with 2-thiouridine and 25% of cytosine modified with 5-methylcytosine (s2U and 5mC), fully modified with pseudouridine (pU), or fully modified with 1-methylpseudouridine (1mpU), was diluted in 100ul final volume of OPTI-MEM (LifeTechnologies, Grand Island, NY). Lipofectamine 2000 (LifeTechnologies, Grand Island, NY) was used as transfection reagent and 0.2 ul of lipofectamine 2000 was diluted to 10 ul final volume of OPTI-MEM. After 5 minutes of incubation at room temperature, both solutions were combined and incubated an additional 15 minute at room temperature. Then the 20ul combined solution was added to the 100ul cell culture medium containing the HeLa cells and incubated at room temperature. A control of lipofecatmine 2000 treated cells (L2000) and untreated cells was also analyzed.

[0001816] After an 18 to 22 hour incubation cell culture supernatants of cells expressing TGFBI was collected and centrifuged at 10,000rcf for 2 minutes. The cleared supernatants were then analyzed with an TGFBI ELISA kit (R & D Systems, Minneapolis, MN) according to the manufacturer instructions. All samples were diluted until the determined values were within the linear range of the ELISA standard curve. The amount of protein produced is shown in Table 212.

Table 212. Protein Production

Sample	TGFBI (pg/ml)
5-methylcytosine and pseudouridine (5mC and pU)	704
5-methylcytosine and 1-methylpsudouridine (5mC and 1mpU)	1800
25% of uridine modified with 2-thiouridine and 25% of cytosine modified with 5-methylcytosine (s2U and 5mC)	57
Pseudouridine (pU)	743
1-methylpseudouridine (1mpU)	2279
L2000	4
Untreated	0

Example 172. Protein Production of Transforming Growth Factor Beta 1 in HeLa Cell Supernatant

[0001817] The day before transfection, 100,000 HeLa cells (ATCC no. CCL-2; Manassas, VA) were harvested by treatment with Trypsin-EDTA solution

(LifeTechnologies, Grand Island, NY) and seeded in a total volume of 100ul EMEM medium (supplemented with 10%FCS and 1x Glutamax) per well in a 96-well cell culture plate (Corning, Manassas, VA). The cells were grown at 37°C in 5% CO₂ atmosphere overnight. Next day, 250 ng of transforming growth factor beta 1 (TGFB1) modified RNA (mRNA sequence shown in SEQ ID NO: 1668; polyA tail of approximately 140 nucleotides not shown in sequence; 5'cap, Cap1) fully modified with 5-methylcytosine and pseudouridine (5mC/pU), fully modified with 5-methylcytosine and 1-methylpseudouridine (5mC/1mpU), modified where 25% of uridine modified with 2-thiouridine and 25% of cytosine modified with 5-methylcytosine (s2U and 5mC), fully modified with pseudouridine (pU), or fully modified with 1-methylpseudouridine (1mpU), was diluted in 10ul final volume of OPTI-MEM (LifeTechnologies, Grand Island, NY). Lipofectamine 2000 (LifeTechnologies, Grand Island, NY) was used as transfection reagent and 0.2 ul of lipofectamine 2000 was diluted to 10 ul final volume of OPTI-MEM. After 5 minutes of incubation at room temperature, both solutions were combined and incubated an additional 15 minute at room temperature. Then the 20ul combined solution was added to the 100ul cell culture medium containing the HeLa cells and incubated at room temperature. A control of lipofecatmine 2000 treated cells (L2000) and untreated cells was also analyzed.

[0001818] After an 18 to 22 hour incubation cell culture lysates of cells expressing TGFB1 was collected and centrifuged at 10,000rcf for 2 minutes. The cell lysates (7ug per ELISA) were then analyzed with an TGFB1 ELISA kit (R & D Systems, Minneapolis, MN) according to the manufacturer instructions. All samples were diluted until the determined values were within the linear range of the ELISA standard curve. The amount of protein produced is shown in Table 213.

Table 213. Protein Production

Sample	TGFB1 (pg/ml)
5-methylcytosine and pseudouridine (5mC and pU)	6214
5-methylcytosine and 1-methylpsudouridine (5mC and 1mpU)	9257
25% of uridine modified with 2-thiouridine and 25% of cytosine modified with 5-methylcytosine (s2U and 5mC)	5929
Pseudouridine (pU)	5157
1-methylpseudouridine (1mpU)	10857

L2000	0
Untreated	1043

Example 173. Confirmation of Peptide Identity from Modified mRNA

[0001819] Cell lysates containing protein produced from angiotensin-converting enzyme 2 (ACE2) modified mRNA (mRNA sequence shown in SEQ ID NO: 21678; polyA tail of approximately 140 nucleotides not shown in sequence; 5'cap, Cap1), activity-dependent neuroprotector (ADNP) modified mRNA (mRNA sequence shown in SEQ ID NO: 21679; polyA tail of approximately 140 nucleotides not shown in sequence; 5'cap, Cap1), Septin-4 (ARTS) modified mRNA (mRNA sequence shown in SEQ ID NO: 21680; polyA tail of approximately 140 nucleotides not shown in sequence; 5'cap, Cap1), bone morphogenetic protein 2 (BMP2) modified mRNA (mRNA sequence shown in SEQ ID NO: 21681; polyA tail of approximately 140 nucleotides not shown in sequence; 5'cap, Cap1), ceruloplasmin (CP) modified mRNA (mRNA sequence shown in SEQ ID NO: 1620; polyA tail of approximately 160 nucleotides not shown in sequence; 5'cap, Cap1), COMM domain-containing protein 1 (COMMD1) modified mRNA (mRNA sequence shown in SEQ ID NO: 21682; polyA tail of approximately 160 nucleotides not shown in sequence; 5'cap, Cap1), diablo, IAP-binding mitochondrial protein (DIABLO or SMAC) modified mRNA (mRNA sequence shown in SEQ ID NO: 21683; polyA tail of approximately 160 nucleotides not shown in sequence; 5'cap, Cap1), coagulation factor XIII alpha (F13A1) modified mRNA (mRNA sequence shown in SEQ ID NO: 21684; polyA tail of approximately 160 nucleotides not shown in sequence; 5'cap, Cap1), Heparin-binding epidermal growth factor-like molecule 1 (HBEGF) modified mRNA (mRNA sequence shown in SEQ ID NO: 21471; polyA tail of approximately 160 nucleotides not shown in sequence; 5'cap, Cap1), IgM Heavy Chain modified mRNA (mRNA sequence shown in SEQ ID NO: 21685; polyA tail of approximately 160 nucleotides not shown in sequence; 5'cap, Cap1), Interleukin-21 (IL21) modified mRNA (mRNA sequence shown in SEQ ID NO: 21686; polyA tail of approximately 160 nucleotides not shown in sequence; 5'cap, Cap1), N-acetylglutamate synthase (NAGS) modified mRNA (mRNA sequence shown in SEQ ID NO: 21687; polyA tail of approximately 160 nucleotides not shown in sequence; 5'cap, Cap1) or E3ubiquitin-protein ligase (XIAP) modified mRNA (mRNA sequence shown in SEQ ID NO: 21688; polyA tail of approximately 160 nucleotides not shown in sequence; 5'cap,

Cap1), fully modified with 5-methylcytosine and pseudouridine (5mC and pU), fully modified with 5-methylcytosine and 1-methylpseudouridine (5mC and ImpU), modified where 25% of uridine modified with 2-thiouridine and 25% of cytosine modified with 5-methylcytosine (s2U and 5mC), fully modified with pseudouridine (pU), or fully modified with 1-methylpseudouridine (ImpU) were evaluated using the LC-MS/MS with quantitative LC-MRM as described in Example 157. Peptide fragments identified for the evaluated proteins are shown in Table 214

Table 214. Protein and Peptide Fragment Sequences

	<u>Peptide Fragment SEQ ID NO</u>	<u>5mC and pU</u>	<u>5mC and 1mpU</u>	<u>s2U and 5mC</u>	<u>pU</u>	<u>1mpU</u>
ACE2						
ISFNFFVTAPK	21689	-	Yes	-	Yes	Yes
LWAWESWR	21690	-	Yes	Yes	Yes	Yes
SEPWTLALENVVG AK	21691	-	Yes	Yes	Yes	Yes
ADNP						
NVHSEDFENR	21692	-	-	-	-	Yes
ARTS						
ESGTDFFPIPAVPPGT DPETEK	21693	Yes	Yes	Yes	Yes	Yes
FLEDTTDDGELSK	21694	Yes	Yes	Yes	Yes	Yes
HAVDIEEK	21695	Yes	Yes	Yes	Yes	Yes
BMP2						
NYQDMVVEGCGC R	21696	-	Yes	Yes	Yes	Yes
SFHHEESLEELPETS GK	21697	-	Yes	Yes	Yes	Yes
WESFDVTPAVMR	21698	Yes	Yes	Yes	Yes	Yes
CP						
ALYLQYTDETFR	21699					
DIASGLIGPLICK	21700					
GAYPLSIEPIGVR	21701					
COMMD1						
ESLMNQSR	21702	Yes	Yes	Yes	Yes	Yes
HSAQIHTPVAIIELE LGK	21703	-	-	Yes	Yes	Yes
WNSGLR	21704	-	Yes	Yes	Yes	Yes
DIABLO						
AVYTLTSLYR	21705	Yes	Yes	Yes	Yes	Yes

LAEAQIEELR	21706	Yes	Yes	Yes	Yes	Yes
NHIQLVK	21707	Yes	Yes	Yes	Yes	Yes
F13A1						
MYVAVWTPYGVLR	21708	Yes	Yes	Yes	Yes	Yes
STVLTIPETIIK	21709	-	Yes	Yes	Yes	Yes
VEYVIGR	21710	-	-	Yes	Yes	Yes
HEPC						
DTHFPIBIFBBGBBHR	21711	Yes	Yes	Yes	Yes	Yes
IgM Heavy Chain						
TSTSPIVK	21712	-	Yes	-	Yes	Yes
WIYDTSK	21713	-	Yes	Yes	Yes	Yes
WKIDGSR	21714	Yes	Yes	Yes	Yes	Yes
IL21						
IINVSIK	21715	Yes	Yes	-	Yes	Yes
LTPSBDSYEK	21716	Yes	Yes	Yes	Yes	Yes
QLIDIVDQLK	21717	Yes	Yes	Yes	Yes	Yes
NAGS						
DLQTLFWR	21718	-	-	-	-	Yes
DSYELVNHAK	21719	Yes	Yes	Yes	Yes	Yes
HNAAAAPFFGGGSVLR	21720	Yes	Yes	Yes	Yes	Yes
XIAP						
AGFLYTGEEDTVR	21721	Yes	Yes	Yes	Yes	Yes
DHFALDRPSETHADYLLR	21722	Yes	-	-	Yes	Yes
IFTFGTWIYSV NK	21723	Yes	Yes	Yes	Yes	Yes

Example 174. Protein Expression Confirmation

[0001820] Modified mRNA fully modified with 5-methylcytosine and pseudouridine (5mC/pU), fully modified with 5-methylcytosine and 1-methylpseudouridine (5mC/ImpU), modified where 25% of the cytosines replaced with 5-methylcytosine and 25% of the uridines replaced with 2-thiouridine (s2U/5mC), fully modified with 1-methylpseudouridine (ImpU) or fully modified with pseudouridine (pU) encoding the proteins described in Table 215 were analyzed by fluorescence and/or western blot in order to confirm the expression of protein and the length of the protein expressed. Table 215 describes the sequence of the modified mRNA (polyA tail of approximately 140 nucleotides not shown in sequence; 5'cap, Cap1), the chemical modification evaluated and the length (in base pairs), if known.

Table 215. Protein and Expression

Protein	Modified mRNA SEQ ID NO	5mC/pU	5mC/1mpU	s2U/5mC	pU	1mpU
Glucagon (GLP1)	21724	-	Yes 451 bp	Yes 451 bp	Yes 451 bp	-
Glycoprotein hormones, alpha polypeptide (FSH-alpha)	21725	-	Yes 634 bp	Yes 634 bp	Yes 634 bp	-
Surfactant protein B (SFTPB)	21726	Yes 1432 bp	-	-	-	-
Anti-tumor necrosis factor alpha	21727	-	Yes 1684 bp	Yes 1684 bp	Yes 1684 bp	-
Sortilin 1 (SORT1)	21728	Yes 2782 bp	-	-	-	-
ImG Light Chain	21729	Yes 982 bp	-	-	-	-
Sirtuin 1 (SIRT1)	21730	Yes 2530 bp	-	-	-	-
galactosamine (N-acetyl)-6-sulfate sulfatase (GALNS)	21731	-	Yes 1855 bp	Yes 1855 bp	Yes 1855 bp	Yes 1855 bp
Complement factor H (CFH)	21732	Yes 3982 bp	-	-	-	-
colony stimulating factor 2 (granulocyte-macrophage) (GM-CSF)	21733	Yes 854 bp	-	-	-	-
Klotho (KL)	21734	Yes 1933 bp	-	-	-	-
coagulation factor XIII alpha (F13A1)	21684	Yes 2485 bp	-	-	-	-
Phosphorylase kinase, alpha 2 (PHKA2)	21735	Yes 3994 bp	-	-	-	-
Phosphorylase kinase, beta	21736	Yes 3568 bp	-	-	-	-

Tyrosinase (TYR)	21737	-	Yes 1876 bp	-	Yes 1876 bp	-
angiotensin-converting enzyme 2 (ACE2)	21678	Yes 2704 bp	-	-	-	-
neuregulin 1	21738	-	Yes 2209 bp	Yes 2209 bp	Yes 2209 bp	-
activity-dependent neuroprotector (ADNP)	21679	Yes 3595 bp	-	-	-	-
Interleukin-21 (IL21)	21686	Yes 754 bp	-	-	-	-
COMM domain-containing protein 1 (COMMD1)	21682	Yes 859 bp	-	-	-	-

Example 175. Intranasal Lung Delivery of 1-methylpseudouridine or 5-methylcytosine and 1-methylpseudouridine Modified Luciferase mRNA Formulated in Cationic Lipid Nanoparticle

[0001821] Luciferase modified mRNA (mRNA sequence shown in SEQ ID NO: 21446; polyA tail of approximately 140 nucleotides not shown in sequence; 5'cap, Cap1) fully modified with 1-methylpseudouridine (Luc-G5-LNP-KC2) or fully modified with 1-methylpseudouridine and 5-methylcytosine (Luc-G2-LNP-KC2) were formulated in the cationic Lipid Nanoparticle (LNP-KC2) as described in Table 216.

Table 216. Formulation

Formulation	NPA-127-1	NPA-135-1
Lipid	DLin-KC2-DMA	DLin-KC2-DMA
Lipid/mRNA ratio (wt/wt)	20:1	20:1
Mean Size	114 nm PDI: 0.10	95 nm PDI: 0.11
Zeta at pH 7.4	-0.5 mV	-1.0 mV
Encaps. (RiboGr)	77%	100%

[0001822] The formulations were administered intranasally (I.N.) to Balb-C mice at a dose of 0.3 mg/kg. Twenty minutes prior to imaging, mice were injected intraperitoneally

with a D-luciferin solution at 150 mg/kg. Animals were then anesthetized and images were acquired with an IVIS Lumina II imaging system (Perkin Elmer). Bioluminescence was measured as total flux (photons/second) of the entire mouse. The mice were imaged at 2 hours, 8 hours, 48, and 72 hours after dosing and the average total flux (photons/second) was measured and shown in Table 217. The background flux was about 6.3×10^5 p/s. The results of the imaging of Luc-G5-LNP-KC2 or Luc-G5-LNP-KC2 vs. Vehicle are shown in the Table 217, "NT" means not tested.

Table 217. Luciferase expression after intranasal dosing

Route	Time Point	Luc-G5-LNP-KC2	Luc-G2-LNP-KC2	Vehicle (PBS)
		Flux (p/s)	Flux (p/s)	Flux (p/s)
I.N.	2 hrs	1.53E+06	5.81E+05	3.87E+05
I.N.	8 hrs	1.09E+07	9.35E+05	5.57E+05
I.N.	24 hrs	5.93E+06	5.33E+05	4.89E+05
I.N.	28 hrs	1.22E+06	7.63E+05	8.81E+05
I.N.	72 hrs	8.43E+05	NT	8.17E+05

Example 176. Intranasal Lung Delivery of 1-methylpseudouridine or 5-methylcytosine and 1-methylpseudouridine Modified Luciferase mRNA lipoplexed in Lipofectamine 2000

[0001823] Luciferase modified mRNA (mRNA sequence shown in SEQ ID NO: 21446; polyA tail of approximately 140 nucleotides not shown in sequence; 5'cap, Cap1) fully modified with 1-methylpseudouridine (Luc-G5-Lipoplex) or fully modified with 1-methylpseudouridine and 5-methylcytosine (Luc-G2-Lipoplex) were lipoplexed in two steps, first step was the dilution of 16.6ul from 3mg/ml of G5 or G2 modified luciferase mRNA in 108.5 ul DMEM and the second step was the dilution of 100ul LF2000 in 25ul DMEM then both mixed together gently to make 250ul total mixer which incubated 5-10 min at RT to form a Lipid-mRNA complex before injection. The lipoplex from both Luciferase mRNA fully modified with 1-methylpseudouridine or 1-methylpseudouridine and 5-methylcytosine were administered intranasally (I.N.) to Balb-C mice at a dose of 0.5 mg/kg.

[0001824] Twenty minutes prior to imaging, mice were injected intraperitoneally with a D-luciferin solution at 150 mg/kg. Animals were then anesthetized and images were acquired with an IVIS Lumina II imaging system (Perkin Elmer). Bioluminescence was measured as total flux (photons/second) of the entire mouse. The mice were imaged at 2 hours, 8 hours and 24 hours after dosing and the average total flux (photons/second) was measured and is shown in Table 218. The background signal was about 4.8×10^5 p/s. The background flux was about 6.3×10^5 p/s. The results of the imaging of Luc-G5-Lipoplex or Luc-G2-Lipoplex vs. Vehicle are shown in the Table 218.

Table 218. Luciferase expression after intranasal dosing

Route	Time Point	Luc-G5-Lipoplex	Luc-G2-Lipoplex	Vehicle (PBS)
		Flux (p/s)	Flux (p/s)	Flux (p/s)
I.N.	2 hrs	8.37E+05	9.58E+05	3.87E+05
I.N.	8 hrs	8.42E+05	7.11E+05	5.57E+05
I.N.	24 hrs	5.74E+05	5.53E+05	4.89E+05

Example 177. Intranasal Lung Delivery of 1-methylpseudouridine or 5-methylcytosine and 1-methylpseudouridine Modified Luciferase mRNA formulated in PBS

[0001825] Luciferase modified mRNA (mRNA sequence shown in SEQ ID NO: 21446; polyA tail of approximately 140 nucleotides not shown in sequence; 5'cap, Cap1) fully modified with 1-methylpseudouridine (Luc-G5-Buffer(PBS)) or fully modified with 1-methylpseudouridine and 5-methylcytosine (Luc-G2-Buffer(PBS)) formulated in PBS (pH 7.4) were administered intranasally (I.N.) to Balb-C mice at a dose of 7.5 mg/kg.

[0001826] Twenty minutes prior to imaging, mice were injected intraperitoneally with a D-luciferin solution at 150 mg/kg. Animals were then anesthetized and images were acquired with an IVIS Lumina II imaging system (Perkin Elmer). Bioluminescence was measured as total flux (photons/second) of the entire mouse. The mice were imaged at 2 hours, 8 hours and 24 hours after dosing and the average total flux (photons/second) was measured and is shown in Table 219. The background flux was about 4.8×10^5 p/s. The background flux was about 6.3×10^5 p/s. The results of the imaging of Luc-G5-in Buffer vs. Vehicle are shown in the Table 219.

Table 219. Luciferase expression after intranasal dosing

Route	Time Point	Luc-G5-in Buffer (PBS)	Luc-G2-in Buffer (PBS)	Vehicle (PBS)
		Flux [p/s]	Flux [p/s]	Flux (p/s)
I.N.	2 hrs	4.50E+05	9.58E+05	3.87E+05
I.N.	8 hrs	7.12E+05	7.11E+05	5.57E+05
I.N.	24 hrs	4.47E+05	5.53E+05	4.89E+05

Example 178. *In Vitro* Transfection of Interleukin 7

[0001827] Interleukin 7 (IL7) modified mRNA (mRNA sequence shown in SEQ ID NO: 1656; polyA tail of approximately 160 nucleotides not shown in sequence; 5'cap, Cap1) was transfected via reverse transfection in Human Keratinocyte cells in 24 multi-well plates. Human Keratinocytes cells were grown in EPILIFE® medium with Supplement S7 from Invitrogen (Carlsbad, CA) until they reached a confluence of 50-70%. The cells were transfected with 0, 46.875, 93.75, 187.5, 375 and 750, ng of modified mRNA (mmRNA) encoding IL-7 which had been complexed with RNAIMAX™ from Invitrogen (Carlsbad, CA). The RNA:RNAIMAX™ complex was formed by first incubating the RNA with Supplement-free EPILIFE® media in a 5X volumetric dilution for 10 minutes at room temperature. In a second vial, RNAIMAX™ reagent was incubated with Supplement-free EPILIFE® Media in a 10X volumetric dilution for 10 minutes at room temperature. The RNA vial was then mixed with the RNAIMAX™ vial and incubated for 20-30 minutes at room temperature before being added to the cells in a drop-wise fashion.

[0001828] The fully optimized mRNA encoding IL-7 (mRNA sequence shown in SEQ ID NO: 1656; polyA tail of approximately 160 nucleotides not shown in sequence; 5'cap, Cap1) was fully modified with 5-methylcytosine and pseudouridine. Cells were transfected with the mmRNA encoding IL-7 and IL-7 concentration (pg/ml) in the culture medium was measured at 6 and 12 hours post-transfection for each of the concentrations using an ELISA kit from Invitrogen (Carlsbad, CA) following the manufacturers recommended instructions. These data, shown in Figure 53, show that modified mRNA encoding IL-7 is capable of being translated in Human Keratinocyte cells at the 375 and 750 ng doses.

Example 179. *In Vitro* Transfection of Erythropoietin

[0001829] Erythropoietin (EPO) modified mRNA (mRNA sequence shown in SEQ ID NO: 1638; polyA tail of approximately 160 nucleotides not shown in sequence; 5'cap, Cap1) was transfected via reverse transfection in Human Keratinocyte cells in 24 multi-well plates. Human Keratinocytes cells were grown in EPILIFE® medium with Supplement S7 from Invitrogen (Carlsbad, CA) until they reached a confluence of 50-70%. The cells were transfected with 46.875, 93.75, 187.5, 375 and 750, ng of modified mRNA (mmRNA) encoding EPO which had been complexed with RNAIMAX™ from Invitrogen (Carlsbad, CA). The RNA:RNAIMAX™ complex was formed by first incubating the RNA with Supplement-free EPILIFE® media in a 5X volumetric dilution for 10 minutes at room temperature. In a second vial, RNAIMAX™ reagent was incubated with Supplement-free EPILIFE® Media in a 10X volumetric dilution for 10 minutes at room temperature. The RNA vial was then mixed with the RNAIMAX™ vial and incubated for 20-30 minutes at room temperature before being added to the cells in a drop-wise fashion.

[0001830] The fully optimized mRNA encoding EPO (mRNA sequence shown in SEQ ID NO: 1638; polyA tail of approximately 160 nucleotides not shown in sequence; 5'cap, Cap1) was fully modified with 5-methylcytosine and pseudouridine. Cells were transfected with the mmRNA encoding EPO and EPO concentration (pg/ml) in the culture medium was measured at 6 and 12 hours post-transfection for each of the concentrations using an ELISA kit from Invitrogen (Carlsbad, CA) following the manufacturers recommended instructions. These data, shown in Figure 54, show that modified mRNA encoding EPO is capable of being translated in Human Keratinocyte cells.

Example 180. Detection of Lysosomal Acid Lipase Protein: Western Blot

[0001831] The day before transfection, 750,000 HeLa cells (ATCC no. CCL-2; Manassas, VA) were harvested by treatment with Trypsin- Ethylenediaminetetraacetic acid (EDTA) solution (LifeTechnologies, Grand Island, NY) and seeded in a total volume of 3ml Eagle's minimal essential medium (EMEM) (supplemented with 10% fetal calf serum (FCS) and 1x Glutamax) per well in a 6-well cell culture plate (Corning, Manassas, VA). The cells were grown at 37°C in 5% CO₂ atmosphere overnight. Next day, 750 ng of lysosomal acid lipase (LAL) mRNA (mRNA sequence shown in SEQ ID

NO: 1657; polyA tail of approximately 160 nucleotides not shown in sequence; 5'cap, Cap1) fully modified with 5-methylcytosine and pseudouridine) was diluted in 250ul final volume of OPTI-MEM® (LifeTechnologies, Grand Island, NY). Lipofectamine 2000 (LifeTechnologies, Grand Island, NY) was used as transfection reagent and 5.5ul were diluted in 250ul final volume of OPTI-MEM®. After 5 minutes of incubation at room temperature, both solutions were combined and incubated an additional 15 minutes at room temperature. Then 500 ul of the combined solution was added to the 3 ml cell culture medium containing the HeLa cells. The plates were then incubated as described before.

[0001832] After an 16-18 hour incubation, the medium was removed and the cells were washed with 1ml PBS. After complete removal of the PBS, 500ul of fresh PBS was added. Cells were harvested by scraping with a cell scraper. Harvested cells receiving the same mRNA were then combined in one 1.5ml Eppendorf tube.

[0001833] Cells were pelleted by centrifugation at 3,000 rpm for 2 minutes. The PBS was removed and cells lysed in 250ul radio immunoprecipitoin assay (RIPA) buffer (containing PMSF and eukaryotic protease inhibitor mix) (all from BostonBioProducts, Ashland, MA) by gentle pipetting. Lysates were cleared by centrifugation at 10,000 rpm at 4°G for 10 minutes. Cleared lysates were transferred to Amicon filters with 10,000 kd molecular cutoff (Waters, Milford, MA) and spun at 12,000 rpm and 4°G for 20 minutes. The concentrated protein lysate was recovered by placing the inverted filter in a fresh 1.5ml Eppendorf tube and spinning at 3,000rpm for 1 minute. The final volume of the lysate is between 25-40 ul.

[0001834] Protein concentration was determined using the BCA kit for microtiter-plates from Pierce (Thermo Fisher, Rockford, IL). The standard proteins of the titration curve were dissolved in RIPA buffer (as described for cell lysate generation) and not in dilution buffer.

[0001835] Protein lysates were loaded onNuPage SDS-PAGE system (chambers and power supply) with 1.5mm ready-to-use Bis-Tris gels and 4-12% acrylamide gradient with MOPS-buffer as running aid (all from Life Technologies, Grand Island, NY). Each lysate sample was prepared to 40ul final volume. This sample contained 25ug protein lysate in variable volume, RIPA buffer to make up volume to 26ul, 4ul of 10x reducing

agent and 10ul 4x SDS loading buffer (both from Life Technologies, Grand Island, NY). Samples were heated at 95°C for 5 minutes and loaded on the gel. Standard settings were chosen by the manufacturer, 200V, 120mA and maximum 25W. Run time was 60 minutes, but no longer than running dye reaching the lower end of the gel.

[0001836] After the run was terminated, the plastic case was cracked and the encased gel transferred to a ready-to-use nitrocellulose membrane kit and power supply (iBLOT; LifeTechnologies, Grand Island, NY). Using default settings, the protein lysate was transferred by high Ampere electricity from the gel to the membrane.

[0001837] After the transfer, the membranes were incubated in 5% bovine serum albumin (BSA) in IX tris buffered saline (TBS) for 15 minutes then in 5% BSA in IX TBS + 0.1 % Tween for another 15 minutes. Primary antibody anti-lysosomal acid lipase antibody; Abeam Cat No. ab89771) against the target protein was applied in 3ml of 5% BSA in IX TBS solution at a 1:500 to 1:2000 dilution for 3 hours at room temperature and gentle agitation on an orbital shaker. Membranes are washed 3 times with IX TBS/0.1 % Tween, 5 minutes each time with gentle agitation. The secondary antibody ((Western Breeze, Invitrogen) was conjugated to horse radish peroxidase and binds to the primary antibody. The secondary antibody was diluted of 1:1000 to 1:5000 in 5% BSA in IX TBS and incubated for 3 hours at room temperature. As shown in Figure 55 the western blot detection of LAL was close to 45.4 kDa. In Figure 55, lanes 1 and 2 show the modified mRNA and lanes 3 and 4 show the dosing vehicle only.

Example 181. Detection of Glucocerebrosidase Protein: Western Blot

[0001838] The day before transfection, 750,000 HeLa cells (ATCC no. CCL-2; Manassas, VA) were harvested by treatment with Trypsin- Ethylenediaminetetraacetic acid (EDTA) solution (LifeTechnologies, Grand Island, NY) and seeded in a total volume of 3ml Eagle's minimal essential medium (EMEM) (supplemented with 10% fetal calf serum (FCS) and 1x Glutamax) per well in a 6-well cell culture plate (Corning, Manassas, VA). The cells were grown at 37°C in 5% CO₂ atmosphere overnight. Next day, 750 ng of glucocerebrosidase mRNA (mRNA sequence shown in SEQ ID NO: 1645; polyA tail of approximately 160 nucleotides not shown in sequence; 5'cap, Cap1) fully modified with 5-methylcytosine and pseudouridine was diluted in 250ul final volume of OPTI-MEM® (LifeTechnologies, Grand Island, NY). Lipofectamine 2000

(LifeTechnologies, Grand Island, NY) was used as transfection reagent and 5.5ul were diluted in 250ul final volume of OPTI-MEM®. After 5 minutes of incubation at room temperature, both solutions were combined and incubated an additional 15 minutes at room temperature. Then 500 ul of the combined solution was added to the 3 ml cell culture medium containing the HeLa cells. The plates were then incubated as described before.

[0001839] After an 16-18 hour incubation, the medium was removed and the cells were washed with 1ml PBS. After complete removal of the PBS, 500ul of fresh PBS was added. Cells were harvested by scraping with a cell scraper. Harvested cells receiving the same mRNA were then combined in one 1.5ml Eppendorf tube.

[0001840] Cells were pelleted by centrifugation at 3,000 rpm for 2 minutes. The PBS was removed and cells lysed in 250ul radio immunoprecipitatin assay (RIPA) buffer (containing PMSF and eukaryotic protease inhibitor mix) (all from BostonBioProducts, Ashland, MA) by gentle pipetting. Lysates were cleared by centrifugation at 10,000 rpm at 4°G for 10 minutes. Cleared lysates were transferred to Amicon filters with 10,000 kd molecular cutoff (Waters, Milford, MA) and spun at 12,000 rpm and 4°G for 20 minutes. The concentrated protein lysate was recovered by placing the inverted filter in a fresh 1.5ml Eppendorf tube and spinning at 3,000rpm for 1 minute. The final volume of the lysate is between 25-40 ul.

[0001841] Protein concentration was determined using the BCA kit for microtiter-plates from Pierce (Thermo Fisher, Rockford, IL). The standard proteins of the titration curve were dissolved in RIPA buffer (as described for cell lysate generation) and not in dilution buffer.

[0001842] Protein lysates were loaded onNuPage SDS-PAGE system (chambers and power supply) with 1.5mm ready-to-use Bis-Tris gels and 4-12% acrylamide gradient with MOPS-buffer as running aid (all from Life Technologies, Grand Island, NY). Each lysate sample was prepared to 40ul final volume. This sample contained 25ug protein lysate in variable volume, RIPA buffer to make up volume to 26ul, 4ul of 10x reducing agent and 10ul 4x SDS loading buffer (both from Life Technologies, Grand Island, NY). Samples were heated at 95°C for 5 minutes and loaded on the gel. Standard settings were

chosen by the manufacturer, 200V, 120mA and maximum 25W. Run time was 60 minutes, but no longer than running dye reaching the lower end of the gel.

[0001843] After the run was terminated, the plastic case was cracked and the encased gel transferred to a ready-to-use nitrocellulose membrane kit and power supply (iBLOT; LifeTechnologies, Grand Island, NY). Using default settings, the protein lysate was transferred by high Ampere electricity from the gel to the membrane.

[0001844] After the transfer, the membranes were incubated in 5% bovine serum albumin (BSA) in IX tris buffered saline (TBS) for 15 minutes then in 5% BSA in IX TBS + 0.1 % Tween for another 15 minutes. Primary antibody (Anti-GBA antibody; Abeam Cat No. ab55080 and Sigma Cat No. G4046) against the target protein were applied in 3ml of 5% BSA in IX TBS solution at a 1:500 to 1:2000 dilution for 3 hours at room temperature and gentle agitation on an orbital shaker. Membranes are washed 3 times with IX TBS/0.1 % Tween, 5 minutes each time with gentle agitation. The secondary antibody (Western Breeze, Invitrogen) was conjugated to horse radish peroxidase and binds to the primary antibody. The secondary antibody was diluted of 1:1000 to 1:5000 in 5% BSA in IX TBS and incubated for 3 hours at room temperature. As shown in Figure 56 the western blot detection of glucocerebrosidase was close to 59.7 kDa. In Figure 56, lanes 1 and 2 show the modified mRNA and lanes 3 and 4 show the dosing vehicle only.

Example 182. Detection of Iduronate 2-Sulfatase Protein: Western Blot

[0001845] The day before transfection, 750,000 HeLa cells (ATCC no. CCL-2; Manassas, VA) were harvested by treatment with Trypsin- Ethylenediaminetetraacetic acid (EDTA) solution (LifeTechnologies, Grand Island, NY) and seeded in a total volume of 3ml Eagle's minimal essential medium (EMEM) (supplemented with 10% fetal calf serum (FCS) and 1x Glutamax) per well in a 6-well cell culture plate (Corning, Manassas, VA). The cells were grown at 37°C in 5% CO₂ atmosphere overnight. Next day, 750 ng of iduronate 2-sulfatase mRNA (mRNA sequence shown in SEQ ID NO: 1652; polyA tail of approximately 160 nucleotides not shown in sequence; 5'cap, Cap1) fully modified with 5-methylcytosine and pseudouridine) was diluted in 250ul final volume of OPTI-MEM® (LifeTechnologies, Grand Island, NY). Lipofectamine 2000 (LifeTechnologies, Grand Island, NY) was used as transfection reagent and 5.5ul were

diluted in 250ul final volume of OPTI-MEM®. After 5 minutes of incubation at room temperature, both solutions were combined and incubated an additional 15 minutes at room temperature. Then 500 ul of the combined solution was added to the 3 ml cell culture medium containing the HeLa cells. The plates were then incubated as described before.

[0001846] After an 16-18 hour incubation, the medium was removed and the cells were washed with 1ml PBS. After complete removal of the PBS, 500ul of fresh PBS was added. Cells were harvested by scraping with a cell scraper. Harvested cells receiving the same mRNA were then combined in one 1.5ml Eppendorf tube.

[0001847] Cells were pelleted by centrifugation at 3,000 rpm for 2 minutes. The PBS was removed and cells lysed in 250ul radio immunoprecipitation assay (RIPA) buffer (containing PMSF and eukaryotic protease inhibitor mix) (all from BostonBioProducts, Ashland, MA) by gentle pipetting. Lysates were cleared by centrifugation at 10,000 rpm at 4°C for 10 minutes. Cleared lysates were transferred to Amicon filters with 10,000 kd molecular cutoff (Waters, Milford, MA) and spun at 12,000 rpm and 4°C for 20 minutes. The concentrated protein lysate was recovered by placing the inverted filter in a fresh 1.5ml Eppendorf tube and spinning at 3,000rpm for 1 minute. The final volume of the lysate is between 25-40 ul.

[0001848] Protein concentration was determined using the BCA kit for microtiter-plates from Pierce (Thermo Fisher, Rockford, IL). The standard proteins of the titration curve were dissolved in RIPA buffer (as described for cell lysate generation) and not in dilution buffer.

[0001849] Protein lysates were loaded on NuPage SDS-PAGE system (chambers and power supply) with 1.5mm ready-to-use Bis-Tris gels and 4-12% acrylamide gradient with MOPS-buffer as running aid (all from Life Technologies, Grand Island, NY). Each lysate sample was prepared to 40ul final volume. This sample contained 25ug protein lysate in variable volume, RIPA buffer to make up volume to 26ul, 4ul of 10x reducing agent and 10ul 4x SDS loading buffer (both from Life Technologies, Grand Island, NY). Samples were heated at 95°C for 5 minutes and loaded on the gel. Standard settings were chosen by the manufacturer, 200V, 120mA and maximum 25W. Run time was 60 minutes, but no longer than running dye reaching the lower end of the gel.

[0001850] After the run was terminated, the plastic case was cracked and the encased gel transferred to a ready-to-use nitrocellulose membrane kit and power supply (iBLOT; LifeTechnologies, Grand Island, NY). Using default settings, the protein lysate was transferred by high Ampere electricity from the gel to the membrane.

[0001851] After the transfer, the membranes were incubated in 5% bovine serum albumin (BSA) in IX tris buffered saline (TBS) for 15 minutes then in 5% BSA in IX TBS + 0.1 % Tween for another 15 minutes. Primary antibodies (anti-iduronate 2 sulfatase antibody; Abeam Cat No. ab 70025 and R&D Systems Cat No. AF2449) against the target protein were applied in 3ml of 5% BSA in IX TBS solution at a 1:500 to 1:2000 dilution for 3 hours at room temperature and gentle agitation on an orbital shaker. Membranes are washed 3 times with IX TBS/0.1 % Tween, 5 minutes each time with gentle agitation. The secondary antibody (Western Breeze, Invitrogen) was conjugated to horse radish peroxidase and binds to the primary antibody. The secondary antibody was diluted of 1:1000 to 1:5000 in 5% BSA in IX TBS and incubated for 3 hours at room temperature. As shown in Figure 57 the western blot detection of iduronate 2-sulfatase was close to 76 kDa. In Figure 57, lanes 1 and 2 show the modified mRNA and lanes 3 and 4 show the dosing vehicle only.

Example 183. Detection of Luciferase Protein: Western Blot

[0001852] The day before transfection, 750,000 HeLa cells (ATCC no. CCL-2; Manassas, VA) were harvested by treatment with Trypsin- Ethylenediaminetetraacetic acid (EDTA) solution (LifeTechnologies, Grand Island, NY) and seeded in a total volume of 3ml Eagle's minimal essential medium (EMEM) (supplemented with 10% fetal calf serum (FCS) and 1x Glutamax) per well in a 6-well cell culture plate (Corning, Manassas, VA). The cells were grown at 37°C in 5% CO₂ atmosphere overnight. Next day, 750 ng of luciferase mRNA (mRNA sequence shown in SEQ ID NO: 21446; polyA tail of approximately 160 nucleotides not shown in sequence; 5'cap, Cap1) fully modified with 5-methylcytosine and pseudouridine) was diluted in 250ul final volume of OPTI-MEM® (LifeTechnologies, Grand Island, NY). Lipofectamine 2000 (LifeTechnologies, Grand Island, NY) was used as transfection reagent and 5.5ul were diluted in 250ul final volume of OPTI-MEM®. After 5 minutes of incubation at room temperature, both solutions were combined and incubated an additional 15 minutes at room temperature.

Then 500 ul of the combined solution was added to the 3 ml cell culture medium containing the HeLa cells. The plates were then incubated as described before.

[0001853] After an 16-18 hour incubation, the medium was removed and the cells were washed with 1ml PBS. After complete removal of the PBS, 500ul of fresh PBS was added. Cells were harvested by scraping with a cell scraper. Harvested cells receiving the same mRNA were then combined in one 1.5ml Eppendorf tube.

[0001854] Cells were pelleted by centrifugation at 3,000 rpm for 2 minutes. The PBS was removed and cells lysed in 250ul radio immunoprecipitation assay (RIPA) buffer (containing PMSF and eukaryotic protease inhibitor mix) (all from BostonBioProducts, Ashland, MA) by gentle pipetting. Lysates were cleared by centrifugation at 10,000 rpm at 4°C for 10 minutes. Cleared lysates were transferred to Amicon filters with 10,000 kd molecular cutoff (Waters, Milford, MA) and spun at 12,000 rpm and 4°C for 20 minutes. The concentrated protein lysate was recovered by placing the inverted filter in a fresh 1.5ml Eppendorf tube and spinning at 3,000rpm for 1 minute. The final volume of the lysate is between 25-40 ul.

[0001855] Protein concentration was determined using the BCA kit for microtiter-plates from Pierce (Thermo Fisher, Rockford, IL). The standard proteins of the titration curve were dissolved in RIPA buffer (as described for cell lysate generation) and not in dilution buffer.

[0001856] Protein lysates were loaded on NuPage SDS-PAGE system (chambers and power supply) with 1.5mm ready-to-use Bis-Tris gels and 4-12% acrylamide gradient with MOPS-buffer as running aid (all from Life Technologies, Grand Island, NY). Each lysate sample was prepared to 40ul final volume. This sample contained 25ug protein lysate in variable volume, RIPA buffer to make up volume to 26ul, 4ul of 10x reducing agent and 10ul 4x SDS loading buffer (both from Life Technologies, Grand Island, NY). Samples were heated at 95°C for 5 minutes and loaded on the gel. Standard settings were chosen by the manufacturer, 200V, 120mA and maximum 25W. Run time was 60 minutes, but no longer than running dye reaching the lower end of the gel.

[0001857] After the run was terminated, the plastic case was cracked and the encased gel transferred to a ready-to-use nitrocellulose membrane kit and power supply (iBLOT;

LifeTechnologies, Grand Island, NY). Using default settings, the protein lysate was transferred by high Ampere electricity from the gel to the membrane.

[0001858] After the transfer, the membranes were incubated in 5% bovine serum albumin (BSA) in IX tris buffered saline (TBS) for 15 minutes then in 5% BSA in IX TBS + 0.1 % Tween for another 15 minutes. Primary antibody (anti-luciferase, AbCam Cat No. ab21 176) against the target protein was applied in 3ml of 5% BSA in IX TBS solution at a 1:500 to 1:2000 dilution for 3 hours at room temperature and gentle agitation on an orbital shaker. Membranes are washed 3 times with IX TBS/0.1 % Tween, 5 minutes each time with gentle agitation. The secondary antibody (Western Breeze, Invitrogen) was conjugated to horse radish peroxidase and binds to the primary antibody. The secondary antibody was diluted of 1:1000 to 1:5000 in 5% BSA in IX TBS and incubated for 3 hours at room temperature. As shown in Figure 58 the western blot detection of luciferase was close to 60.7 kDa. In Figure 58, lanes 1 and 2 show the modified mRNA and lanes 3 and 4 show the dosing vehicle only.

Example 184. Herceptin *in vivo* studies

[0001859] Herceptin heavy chain (HC) modified mRNA (SEQ ID NO: 21451; polyA tail of approximately 140 nucleotides not shown in sequence; 5'cap, CapI; fully modified with 5-methylcytosine and 1-methylpseudouridine) and Herceptin light chain (LC) modified mRNA (SEQ ID NO: 21452; polyA tail of approximately 140 nucleotides not shown in sequence; 5'cap, CapI; fully modified with 5-methylcytosine and 1-methylpseudouridine) were formulated in DLin-MC3-DMA and DLin-KC2-DMA as described in Table 220.

Table 220. DLin-MC3-DMA and DLin-KC2-DMA Formulations

Formulation	NPA-159-1
Herceptin HC:LC Ratio (wt/wt)	2:1
Lipid	DLin-KC2-DMA
Lipid/Total mRNA ratio (wt/wt)	20:1
Mean Size	100 nm PDI: 0.10
Zeta at pH 7.4	1.9 mV

Encaps. (RiboGr) 100%

[0001860] The Herceptin formulations described in Table XI were administered intravenously to mice (CD1) at a dose of 0.5 mgs/kg. A control of Luciferase mRNA was also evaluated (Luc in Figure 59). The mice were bled at 8 hours, 24 hours, 48 hours, 96 hours, 168 hours (7 days), 336 hours (14 days), 504 hours (21 days) after the administration of Herceptin to determine the serum IgG concentration by ELISA (total human IgG detection kit by ABCAM®, Cambridge MA). The control Luciferase injected animals were bled at only 8 hr time point. The results are shown in Table 222 and Figure 59.

Table 222. Herceptin Formulations

mRNA	Route	Injection Volume (ul)	Amount of modified RNA (ug)	Dose (mg/kg)	Post dose collection (Hrs)	Human IgG (ng/ml)
Herceptin (LC+HC)	IV	100	10	0.5	8	39.4
Herceptin (LC+HC)	IV	100	10	0.5	24	56.1
Herceptin (LC+HC)	IV	100	10	0.5	48	43.8
Herceptin (LC+HC)	IV	100	10	0.5	96	56.7
Herceptin (LC+HC)	IV	100	10	0.5	168	31.7
Herceptin (LC+HC)	IV	100	10	0.5	336	17.6
Herceptin (LC+HC)	IV	100	10	0.5	504	3
Luciferase	IV	100	10	0.5	8	0.57

Example 185. Herceptin *in vitro* studies

[0001861] The day before transfection, 15,000 HeLa cells (ATCC no. CCL-2; Manassas, VA) were harvested by treatment with Trypsin-EDTA solution (LifeTechnologies, Grand Island, NY) and seeded in a total volume of 100ul EMEM medium (supplemented with 10%FCS and 1x Glutamax) per well in a 96-well cell culture plate (Corning, Manassas, VA). The cells were grown at 37°C in 5% CO₂ atmosphere overnight. The next day, 150ng of the herceptin heavy chain (HC) mRNA (SEQ ID NO: 21451; polyA tail of approximately 140 nucleotides not shown in sequence; 5'cap, Cap1; fully modified with 5-methylcytosine and 1-methylpsuedouridine) or 75ng Herceptin light chain (LC) (SEQ ID NO: 21452; polyA tail of approximately 140 nucleotides not shown in sequence; 5'cap, Cap1; fully modified with 5-methylcytosine and 1-methylpsuedouridine) or 500 ng of the Herceptin HC and 250 ng of Herceptin LC together was diluted in 10ul final volume of OPTI-MEM (LifeTechnologies, Grand Island, NY). Lipofectamine 2000 (LifeTechnologies, Grand Island, NY) was used as transfection reagent and 0.2 ul of

lipofectamine 2000 was diluted to 10 ul final volume of OPTI-MEM. After 5 minutes of incubation at room temperature, both solutions were combined and incubated an additional 15 minute at room temperature. Then the 20ul combined solution was added to the 100ul cell culture medium containing the HeLa cells and incubated at room temperature. As controls, Recombinant human IgG (Hu IgG Ctrl), assay buffer and culture medium from untreated wells in the presence absence of assay buffer (Assay buffer + Control Media) were also analyzed.

[0001862] After an 18 to 22 hour incubation cell culture supernatants of cells expressing Herceptin heavy or light chains were collected and analyzed with the total human IgG ELISA kit (ABCAM®, Cambridge MA) according to the manufacturer instructions. The amount of IgG produced is shown in Table 223 and Figure 60. In Table X3, "OTC" means off the chart.

Table 223. Herceptin Study

Sample	IgG (ng/ml)
Recombinant Human IgG	OTC
Herceptin Heavy Chain	12
Herceptin Light Chain	0
Herceptin Heavy + Light Chain	348
Assay buffer	9
Assay buffer + Control Media	12

Example 186. Herceptin *in vitro* studies: Confirmation of antibody production *in vitro* by immunoblotting

[0001863] HeLa cells were transfected *in vitro* in absence of serum using the Herceptin heavy and light chain mRNAs (herceptin heavy chain (HC) mRNA (SEQ ID NO: 21451; polyA tail of approximately 140 nucleotides not shown in sequence; 5'cap, Cap1; fully modified with 5-methylcytosine and 1-methylpsuedouridine), Herceptin light chain (LC) (SEQ ID NO: 21452; polyA tail of approximately 140 nucleotides not shown in sequence; 5'cap, Cap1; fully modified with 5-methylcytosine and 1-methylpsuedouridine) or Herceptin HC and LC together (H&L)) described in Example 185. 24 hours after transfection, supernatants were collected, concentrated and 4ug of protein was loaded, in presence (Lanes 1-5 in Figure 61) and absence (Lanes 6-10 in Figure 61) of reducing agents, into each lane of a 4-12% MOPS NuPAGE gel for

electrophoretic separation. The proteins were then transferred onto a PVDF membrane and probed using an antibody for simultaneous detection of heavy and light Ig chains. [0001864] As shown in Figure 61, In the lanes where supernatants from the only light chain transfected cells were run, light chain bands were detected under both reducing and non-reducing conditions. In the non-reducing condition a larger band was also detected at ~50 kDa. This corroborates well with the fact that light chain alone is secretory. The lanes containing supernatants from only heavy chain mRNA transfected cells had no signal in presence or absence of reducing agents, confirming lack of secretion of the heavy chain alone. Supernatants from cells transfected with both heavy and light chain mRNA had two bands in presence or absence of reducing agents. In both conditions there was a light chain specific band. This represented light chain from denatured Ig molecule under the reducing condition and free light chain protein under the non-reducing condition. Under the reducing condition, the heavy chain, which was only secreted in association with the light chain, was visible at 55 kDa whereas, under the non-reducing condition, no individual heavy chain band was apparent as expected. In that lane, a 160 kDa the total Ig band was clearly detectable. This confirms the molecular identity of the light and heavy chain proteins produced when the chemically modified mRNAs encoding these proteins were transfected in HeLa cells.

[0001865] In Figure 61, "MWM" represents molecular weight marker, "LC" represents Herceptin light chain, "HC" represents Herceptin heavy chain, and "Media" represents culture media alone.

Example 187. Enzymatic Activity Assay

A. Glucocerebrosidase Enzyme Activity

[0001866] HEK293 cells were transfected with 0, 625, 125, 250, 500, 1000 or 2000 ng of glucocerebrosidase modified mRNA (mRNA sequence shown in SEQ ID NO: 1645; polyA tail of approximately 160 nucleotides not shown in sequence; 5'cap, Cap1) fully modified with 5-methylcytosine and pseudouridine) complexed with RNAiMAX (Invitrogen). The cells were washed with PBS at 6 hours, 12 hours, 24 hours and 48 hours after transfection. The cells were then lysed in 100 mM citrate-phosphate buffer (pH 5.4) containing 0.54% sodium taurodeoxycholate with 1% Triton X-100. The cell lysate was then incubated in the presence of 0.5 mM of 4-Methylumbelliferyl β -D-

Galactopyranoside (4-MUG) substrate for 1 hour at 37 °C. After an hour the reaction was stopped with an equivalent volume of 200 mM sodium hydroxide. The conversion of 4-MU was measured in the plate reader (Ex= 370nm; Em = 460 nm). Figure 62 shows the enzymatic activity expressed as a percentage normalized against the mRNA control transfection (iduronate 2-sulfatase (mRNA sequence shown in SEQ ID NO: 1652; polyA tail of approximately 160 nucleotides not shown in sequence; 5'cap, Cap1) fully modified with 5-methylcytosine and pseudouridine) complexed with RNAiMAX (Invitrogen).

B. Lysosomal Acid Lipase Enzyme Activity

HEK293 cells were transfected with 0, 625, 125, 250, 500, 1000 or 2000 ng of lysosomal acid lipase modified mRNA (mRNA sequence shown in SEQ ID NO: 1657; polyA tail of approximately 160 nucleotides not shown in sequence; 5'cap, Cap1) fully modified with 5-methylcytosine and pseudouridine) complexed with RNAiMAX (Invitrogen). The cells were washed with PBS at 6 hours, 12 hours, 24 hours and 48 hours after transfection. The cells were then lysed in 100 mM citrate-phosphate buffer (pH 5.4) containing 0.54% sodium taurodeoxycholate with 1% Triton X-100. The cell lysate was then incubated in the presence of 0.5 mM of 4-Methylumbelliferyl β -D-Galactopyranoside (4-MUG) substrate for 1 hour at 37 °C. After an hour the reaction was stopped with an equivalent volume of 200 mM sodium hydroxide. The conversion of 4-MU was measured in the plate reader (Ex= 370nm; Em = 460 nm). Figure 63 shows the enzymatic activity expressed as a percentage normalized against the mRNA control transfection (iduronate 2-sulfatase (mRNA sequence shown in SEQ ID NO: 1652; polyA tail of approximately 160 nucleotides not shown in sequence; 5'cap, Cap1) fully modified with 5-methylcytosine and pseudouridine) complexed with RNAiMAX (Invitrogen).

Example 188. In Vitro Transfection of Factor VIII: Protein Detection

[0001867] Factor VIII modified mRNA (mRNA sequence shown in SEQ ID NO: 1623; polyA tail of approximately 160 nucleotides not shown in sequence; 5'cap, Cap1) was transfected via reverse transfection in HepG2 cells in 24 multi-well plates. HepG2 cells were grown in EPILIFE® medium with Supplement S7 from Invitrogen (Carlsbad, CA) until they reached a confluence of 50-70%. The cells were transfected with 0, 250 ng, 500 ng, 750 ng, 1000 ng of modified mRNA (mmRNA) encoding Factor VIII which had been complexed with RNAiMAX™ from Invitrogen (Carlsbad, CA). The

RNA:RNAIMAX™ complex was formed by first incubating the RNA with Supplement-free EPILIFE® media in a 5X volumetric dilution for 10 minutes at room temperature. In a second vial, RNAIMAX™ reagent was incubated with Supplement-free EPILIFE® Media in a 10X volumetric dilution for 10 minutes at room temperature. The RNA vial was then mixed with the RNAIMAX™ vial and incubated for 20-30 minutes at room temperature before being added to the cells in a drop-wise fashion.

[0001868] The fully optimized mRNA encoding Factor VIII (mRNA sequence shown in SEQ ID NO: 1623; polyA tail of approximately 160 nucleotides not shown in sequence; 5'cap, Cap1) transfected with the HepG2 cells included modifications during translation such as natural nucleoside triphosphates (NTP), pseudouridine at each uridine site and 5-methylcytosine at each cytosine site (pseudo-U/5mC), and N1-methyl-pseudouridine at each uridine site and 5-methylcytosine at each cytosine site (N1-methy-Pseudo-U/5mC). Cells were transfected with the mmRNA encoding Factor VIII and secreted Factor VIII concentration (pg/ml) in the culture medium was measured at 18 hours post-transfection for each of the concentrations using an ELISA kit from Invitrogen (Carlsbad, CA) following the manufacturers recommended instructions. These data, shown in Table 224 and Figures 64, show that modified mRNA encoding Factor VIII is capable of being translated in HepG2 cells.

Table 224. Factor VIII Dosing and Protein Secretion

Factor VIII Dose Containing Natural NTPs	
Dose (ng)	18 hours (IU/ml)
0	0
250	0
500	0.4
750	1.9
1000	2.1
Factor VIII Dose Containing Pseudo-U/5mC	
Dose (ng)	18 hours (IU/ml)
0	0
250	7.8
500	8.1
750	6.1
1000	7.8
Factor VIII Dose Containing N1-methy-Pseudo-U/5mC	
Dose (ng)	18 hours (IU/ml)
0	0
250	3.5
500	4.6

750	6.2
1000	6.0

Example 189. In Vitro Transfection of Factor VIII: Chromogenic Activity

[0001869] Factor VIII modified mRNA (mRNA sequence shown in SEQ ID NO: 1623; polyA tail of approximately 160 nucleotides not shown in sequence; 5'cap, Cap1) was transfected via reverse transfection in HepG2 cells in 24 multi-well plates. HepG2 cells were grown in EPILIFE® medium with Supplement S7 from Invitrogen (Carlsbad, CA) until they reached a confluence of 50-70%. The cells were transfected with 0, 250 ng, 500 ng, 750 ng, 1000 ng of modified mRNA (mmRNA) encoding Factor VIII which had been complexed with RNAIMAX™ from Invitrogen (Carlsbad, CA). The RNA:RNAIMAX™ complex was formed by first incubating the RNA with Supplement-free EPILIFE® media in a 5X volumetric dilution for 10 minutes at room temperature. In a second vial, RNAIMAX™ reagent was incubated with Supplement-free EPILIFE® Media in a 10X volumetric dilution for 10 minutes at room temperature. The RNA vial was then mixed with the RNAIMAX™ vial and incubated for 20-30 minutes at room temperature before being added to the cells in a drop-wise fashion.

[0001870] The fully optimized mRNA encoding Factor VIII (mRNA sequence shown in SEQ ID NO: 1623; polyA tail of approximately 160 nucleotides not shown in sequence; 5'cap, Cap1) transfected with the HepG2 cells included modifications during translation such pseudouridine at each uridine site and 5-methylcytosine at each cytosine site (pseudo-U/5mC), and NI-methy-pseudouridine at each uridine site and 5-methylcytosine at each cytosine site (NI-methyl-Pseudo-U/5mC). Cells were transfected with the mmRNA encoding Factor VIII. When activated by thrombin, Factor VIII forms an enzymatic complex with Factor IXa, phospholipids and Calcium, which activates Factor X to Factor Xa which activates Factor X, supplied in the assay at a constant concentration and in excess, to Factor Xa. This activity is directly related to the amount of Factor VIII.

[0001871] Generated Factor Xa was measured at 18 hours post-transfection by its activity on a specific Factor Xa chromogenic substrate (SXa-1 1), measured by the amount of pNA released, determined by color development at 405nm in order to determine the activity of Factor VIII.

[0001872] The Factor VIII activity was normalized to 25-30% Factor VIII concentrate control standard (% Activity). These data, shown in Table 225 and Figure 65, show that modified mRNA encoding Factor VIII is capable of being translated in HepG2 cells.

Table 225. Factor VIII Dosing and Protein Secretion

Factor VIII Dose Containing Pseudo-U/5mC	
Dose (ng)	18 hours (% Activity)
0	0
250	31.7
500	29.2
750	26.7
1000	20.4
Factor VIII Dose Containing N1-methy-Pseudo-U/5mC	
Dose (ng)	18 hours (IU/ml)
0	0
250	25.8
500	30.4
750	30.0
1000	26.7

Example 190. Low Density Lipoprotein Receptor (LDLR) Expression

A. In Vitro LDLR expression

[0001873] Human embryonic kidney epithelial (HEK293) cells (LGC standards GmbH, Wesel, Germany) are seeded on 6-well plates (BD Biosciences, San Jose, USA). HEK293 are seeded at a density of about 500,000 cells per well in 3 mL cell culture medium. Formulations containing LDLR mRNA (mRNA shown in SEQ ID NO: 21463; fully modified with 5-methylcytosine and 1-methylpseudouridine; 5'cap, cap 1, polyA tail of approximately 160 nucleotides (not shown in sequence)) or a control of G-CSF mRNA (mRNA shown in SEQ ID NO: 21438; fully modified with 5-methylcytosine and pseudouridine; 5'cap, cap1; polyA tail of approximately 160 nucleotides not shown in sequence) are added directly after seeding the cells at quantities of 4000, 800, 400, 40, and 4 ng per well and incubated. G-CSF mRNA transfected cells were treated with anti-LDLR antibody and one set of LDLR transfected cells were treated with normal goat IgG as controls. Bound primary antibodies were detected by FACS analysis following treatment with a PE-labeled secondary antibody.

[0001874] As shown in Figure 66A, results of the FACS analyses shows 74.8% of all gated live cells were detected to express LDLR at the 800 ng dose of LDLR mRNA. At the 40 ng dose of LDLR mRNA, 11.6% of all gated live cells were detected to express

LDLR. No staining was observed in LDLR siRNA treated cells stained with the control nonimmune IgG. No LDLR positive cells were detected in cells transfected with G-CSF siRNA.

B. Protein Accumulation

[0001875] Human embryonic kidney epithelial (HEK293) cells (LGC standards GmbH, Wesel, Germany) are seeded on 6-well plates (BD Biosciences, San Jose, USA).

HEK293 are seeded at a density of about 500,000 cells per well in 3 mL cell culture medium. Formulations containing LDLR mRNA (mRNA shown in SEQ ID NO: 21463; fully modified with 5-methylcytosine and 1-methylpseudouridine; 5'cap, cap 1, polyA tail of approximately 160 nucleotides (not shown in sequence)) or a control of G-CSF mRNA (mRNA shown in SEQ ID NO: 21438; fully modified with 5-methylcytosine and pseudouridine; 5'cap, cap1; polyA tail of approximately 160 nucleotides not shown in sequence) are added directly after seeding the cells per well and incubated. Fifteen hours later the transfection media is replaced with complete media. Transfected cells are harvested at 0, 2, 4, 8, 24, 48, and 72 hours after media replacement. Transfected cells were treated with anti-LDLR antibody conjugated to Phycoerythrin (PE) and one set of LDLR transfected cells were treated with normal goat IgG conjugated to PE as controls. Bound primary antibodies were detected by FACS analysis as described above.

[0001876] As shown in Figure 66B, the FACS analysis shows ~65% of all gated live cells were detected to express LDLR at the 0.0-h time point (15.0-h after transfection) after washing away the transfection media. The percent positive cells declined with time at 37°C, such that by 24h post-removal of the transfection media, LDLR was not detected.

C. BODIPY®-Labeled LDLR

[0001877] To evaluate whether the expressed LDLR were functional, BODIPY®-labeled LDL was used. HEK293 cells were transfected overnight with either LDLR modified mRNA (mRNA shown in SEQ ID NO: 21463; fully modified with 5-methylcytosine and 1-methylpseudouridine; 5'cap, cap 1, polyA tail of approximately 16 nucleotides (not shown in sequence)) or G-CSF modified mRNA (mRNA shown in SEQ ID NO: 21438; fully modified with 5-methylcytosine and pseudouridine; 5'cap, cap1; polyA tail of approximately 60 nucleotides not shown in sequence), the cells were washed and

incubated with increasing amounts of BODIPY-LDL. Following incubation for 1.0-h at 37°C, the cells were washed and the binding of BODIPY-LDL was assessed by FACS. Binding of BODIPY-LDL to LDLR mRNA transfected cells was high affinity (Kd -60 ng/mL) and saturable as shown in Figure 66C.

[0001878] In competition studies, binding of BODIPY-LDL could be reduced in a dose-dependent manner by unlabeled LDL (Figure 66D). These data show that binding of BODIPY-LDL to cells expressing LDLR mRNA is saturable, specific, and of high affinity.

Example 191. UDP glucuronosyltransferase 1 family, polypeptide A1 (UGT1A1)

Expression

A. In Vitro UGT1A1 expression

[0001879] Human embryonic kidney epithelial (HEK293) cells (LGC standards GmbH, Wesel, Germany) are seeded on 6-well plates (BD Biosciences, San Jose, USA). HEK293 are seeded at a density of about 500,000 cells per well in 3 mL cell culture medium. Formulations containing UDP glucuronosyltransferase 1 family, polypeptide A1 (UGT1A1) mRNA (mRNA shown in SEQ ID NO: 21463; fully modified with 5-methylcytosine and 1-methylpseudouridine; 5'cap, cap 1, polyA tail of approximately 160 nucleotides (not shown in sequence) or a control of G-CSF mRNA (mRNA shown in SEQ ID NO: 21438; fully modified with 5-methylcytosine and pseudouridine; 5'cap, cap1; polyA tail of approximately 160 nucleotides not shown in sequence) are added directly after seeding the cells at quantities of 4000, 800, 400, 40, and 4 ng per well and incubated. G-CSF mRNA transfected cells were treated with anti-UGT1A1 antibody and one set of UGT1A1 transfected cells were treated with normal goat IgG as controls. Bound primary antibodies were detected by FACS analysis following treatment with a PE-labeled secondary antibody.

[0001880] As is shown in Figure 67 the percent positive cells measured by FACS increased with the amount of UGT1A1 mRNA transfected into the HEK293 cells and reached a maximum at 74.8% of all gated live cells at the 800 ng dose of UGT1A1 mRNA. No further increase in percent positive cells was observed at the highest dose tested (4000 ng). These data demonstrate that the mRNA delivery and/or expression in mammalian cells are saturable. No staining was observed in UGT1A1 mRNA treated

cells stained with the control nonimmune IgG and no UGT1A1 positive cells were detected in cells transfected with G-CSF mRNA .

B. In Vitro UGT1A1 expression - protein accumulation

[0001881] Human embryonic kidney epithelial (HEK293) cells (LGC standards GmbH, Wesel, Germany) are seeded on 6-well plates (BD Biosciences, San Jose, USA). HEK293 are seeded at a density of about 500,000 cells per well in 3 mL cell culture medium. Formulations containing UGT1A1 mRNA (mRNA shown in SEQ ID NO: 2146; fully modified with 5-methylcytosine and 1-methylpseudouridine; 5'cap, cap 1, polyA tail of approximately 160 nucleotides (not shown in sequence) or a control of G-CSF mRNA (mRNA shown in SEQ ID NO: 21438; fully modified with 5-methylcytosine and pseudouridine; 5'cap, cap1; polyA tail of approximately 160 nucleotides not shown in sequence) are added directly after seeding the cells per well and incubated. Fifteen hours later the transfection media is replaced with complete media. Transfected cells are harvested at 0, 2, 4, 8, 24, 48, and 72 hours after media replacement. Transfected cells were treated with anti-UGT1A1 antibody conjugated to Phycoerythrin (PE) and one set of UGT1A1 transfected cells were treated with normal goat IgG conjugated to PE as controls. Bound primary antibodies were detected by FACS analysis as described above.

[0001882] As is shown in Figure 68, UGT1A1 protein accumulation in the UGT1A1 mRNA transfected cells increased with time of incubation after media replacement to a maximum at 24 hours and then declined to baseline values by 72 hours. Under these conditions, the apparent half-life of UGT1A1 mRNA was approximately 40.0-h.

Example 192. Detection of UGT1A1 and OTC by Western blot

[0001883] HEK293 Human embryonic kidney epithelial (HEK293) cells (LGC standards GmbH, Wesel, Germany) are seeded on 6-well plates (BD Biosciences, San Jose, USA). HEK293 are seeded at a density of about 500,000 cells per well in 2.4 mL cell culture medium. Formulations containing UGT1A1 mRNA (mRNA shown in SEQ ID NO: 21464; fully modified with 5-methylcytosine and 1-methylpseudouridine; 5'cap, cap 1, polyA tail of approximately 160 nucleotides (not shown in sequence) or OTC mRNA (mRNA shown in SEQ ID NO: 1659; fully modified with 5-methylcytosine and 1-methylpseudouridine; 5'cap, cap1; polyA tail of approximately 160 nucleotides not shown in sequence) are added directly after seeding the cells at quantities of 800 ng per well and

incubated for 16 hours. Cells were washed with 500 μ L PBS and harvested through cell scraping into 500 μ L PBS. Cells were centrifuged at 200 xg for 5 minutes and resuspended in 250 μ L RIPA buffer supplemented with protease inhibitors. The tubes were centrifuged for ten minutes at 14,000 xg. The supernatants were transferred to centrificon concentration columns and centrifuged for 30 minutes at 14,000 xg to concentrate the lysate. Lysate was quantified through BCA protein assay (Thermo Fisher Scientific Inc, Rockford, USA).

[0001884] Protein lysates were loaded on NuPage SDS-PAGE system (chambers and power supply) with 1.5mm ready-to-use Bis-Tris gels and 4-12% acrylamide gradient with MOPS-buffer as running aid (all from Life Technologies, Grand Island, NY). Each lysate sample was prepared to 40ul final volume. This sample contained 25ug protein lysate in variable volume, RIPA buffer to make up volume to 26 μ l, 4 μ l of 10 \times reducing agent and 10ul 4 \times SDS loading buffer (both from Life Technologies, Grand Island, NY). Samples were heated at 95 $^{\circ}$ C for 5 minutes and loaded on the gel. Standard settings were chosen by the manufacturer, 200V, 120mA and maximum 25W. Run time was 60 minutes, but no longer than running dye reaching the lower end of the gel.

[0001885] After the run was terminated, the plastic case was cracked and the encased gel transferred to a ready-to-use nitrocellulose membrane kit and power supply (iBLOT; Life Technologies, Grand Island, NY). Using default settings, the protein lysate was transferred by high Ampere electricity from the gel to the membrane.

[0001886] After the transfer, the membranes were incubated in 5% bovine serum albumin (BSA) in IX tris buffered saline (TBS) for 15 minutes then in 5% BSA in IX TBS + 0.1 % Tween for another 15 minutes. Primary antibodies, goat anti-human UGT1A1 (R&D systems) and rabbit anti-human OTC (NBPI) were applied in 3ml of 5% BSA in IX TBS solution at a 1:500 dilution for 3 hours at room temperature and gentle agitation on an orbital shaker. The OTC primary antibodies were detected with the WesternBreeze Chromogenic Kit-Anti-Rabbit according to the manufacturing protocol, and the UGT1A1 primary antibodies were detected with the WesternBreeze Chromogenic Kit-Anti-Goat (Invitrogen, Grand Island, NY) according to the manufacturing protocol.

[0001887] As is shown in Figure 69, UGT1A1 was detected as a ~60 kDa band by anti-UGT1A1 IgG in lysates of cells transfected with UGT1A1 mRNA (lane 4) but not in cells transfected with OTC mRNA (lane 3). Using the same lysates, OTC was detected as a ~39 kDa band by anti-OTC IgG in lysates of cells transfected with OTC mRNA (lane 7) but not in cells transfected with UGT1A1 mRNA (lane 8). These data establish that exogenous UGT1A1 and OTC mRNAs can direct the synthesis of their cognate proteins in mammalian cells.

Example 193. PAH and UGT1A1 Expression and Detection

A. HEK293, mouse and rat myoblast cell transfection with

[0001888] HEK293 (LGC standards GmbH, Wesel, Germany), C2C12 mouse myoblast (ATCC) and L6 rat myoblast (ATCC) cell lines were plated into 24-well dishes (BD Biosciences, San Jose, USA) (1.5×10^5 cells/well) in DMEM (ATCC) supplemented with 10% fetal calf serum (ATCC).

[0001889] Transfection solutions were prepared for each well to be treated by combining 250 ng of PAH modified mRNA (SEQ ID NO: 1660; polyA tail of approximately 160 nucleotides not shown in sequence; 5'cap, Cap1) fully modified with 5-methylcytosine and pseudouridine, UGT1A1 modified mRNA (SEQ ID NO: 21464; polyA tail of approximately 160 nucleotides not shown in sequence; 5'cap, Cap1; fully modified with 5-methylcytosine and pseudouridine or G-CSF modified mRNA (SEQ ID NO: 21438; polyA tail of approximately 160 nucleotides not shown in sequence; 5'cap, Cap1; fully modified with 5-methylcytosine and pseudouridine with 50 μ i Opti-MEM reagent (Life Technologies, Grand Island, NY) in a first tube and 1 μ i of L2000 transfection reagent (Life Technologies, Grand Island, NY) in 50 μ i of Opti-MEM in a second tube. After preparation, first and second tubes were incubated at room temperature for 5 minutes before combining the contents of each. Combined transfection solutions were incubated for 15 minutes at room temperature. 100 μ i of transfection solution was then added to each well. Cells were cultured for an additional 14 hours before continued analysis.

B. PAH, UGT1A1 detection by flow cytometry

[0001890] After transfection, medium were removed from cells and 60 μ i of 0.25% trypsin (Life Technologies, Grand Island, NY) was added to each well. Cells were trypsinized for 2 minutes before the addition of 240 μ i/well of trypsin inhibitor (Life Technologies, Grand Island, NY). Resulting cell solutions were transferred to 96 well

plates (Corning Life Sciences, Tewksbury, MA), cells were pelleted by centrifugation (800 x gravity for 5 minutes) and supernatants were discarded. Cell pellets were washed with PBS and resuspended in Foxp3 Fixation/Permeabilization solution (eBioscience, San Diego, CA) for 45 minutes. Cells were pelleted again by centrifugation (800 x gravity for 5 minutes) and resuspended in permeabilization buffer (eBiosciences, San Diego, CA) for 10 minutes. Cells were pelleted again by centrifugation (800 x gravity for 5 minutes) and washed in permeabilization buffer. PAH transfected cells were treated with anti-PAH antibody conjugated to Phycoerythrin (PE). One set of PAH transfected cells were treated with normal goat IgG conjugated to PE as staining controls. One set of G-CSF transfected cells was treated with anti-PAH antibody conjugated to Phycoerythrin (PE) as a transfection control. Bound primary antibodies were detected by FACS analysis as described above. Labeled cells were then combined with FACS buffer (PBS with 1% bovine serum albumin and 0.1% sodium azide) and transferred to cluster tubes and labeled cells were then analyzed by flow cytometry using a BD Accuri (BD Biosciences, San Jose, CA). As is shown in Figure 70, 11.9% of HEK293 cells transfected with PAH were detected to express PAH, and 58.6% of HEK293 cells transfected with UGT1A1 were detected to express UGT1A1. For each mRNA, the percent positive cells were similar to the results obtained with HEK293 cells when rat or mouse myoblast cells were used.

Example 194. Expression of UGT1A1 in HEK293 cells using direct capture capillary electrophoresis

[0001891] HEK293 cells were transfected with UGT1A1 mRNA and cell lysates were prepared as described above. Western analysis was performed using the Simple Simon Western system (Protein Simple). As is shown in Figure 71, UGT1A1 (-60 kDa band) was detected in lysates of cells transfected with UGT1A1 mRNA by the anti-UGT1A1 IgG (lanes 1, 4, and 6) but not by an identical concentration of nonimmune IgG (lanes 2 and 5). Similarly, no UGT1A1 was detected in using an identical amount of cell lysate of non-transfected Hep3b cells (lane 3) or in lysates from HEK293 cells transfected with OTC mRNA (lane 7).

[0001892] Normal C57BL6 mice were given a single intravenous injection of LNP containing UGT1A1 mRNA at a dose of 0.5 mg/kg. Twenty four hours later the mice

were sacrificed and the livers were isolated from each mouse. Microsomal membrane extracts were prepared from each liver by homogenization in ice-cold 5.0 mL of phosphate buffered saline (pH 7.4) containing protease inhibitors, using a Polytron homogenizer. The tissue homogenate was mixed with 40 ml of ice-cold microsome buffer (2.62mM KH₂P₀₄, 1.38mM K₂HP₀₄, 2% glycerol, and 0.5mM dithiothreitol) and centrifuged at 12,000 xg for 20 min at 4°C. The supernatant fraction was then centrifuged at 100,000 xg for 60 min at 4°C. The microsomal pellet was resuspended in microsome buffer and the protein concentration was determined by the Bradford method. Microsomal extracts were characterized by detection of a calnexin band by Western blotting using anti-calnexin antibody (Assay Designs, Ann Arbor, MI). Approximately 2-5 µg of microsomal extract was applied to the capillaries and electrophoresis and protein immobilization was performed as described by the manufacturer. As is shown in Figure 72 UGT1A1 was detected in microsomal extracts of mice treated with LNPs containing UGT1A1 mPvNA using an antibody specific (described above) for UGT1A1 (lane 2) but not with a non-specific antibody (lane 4). The molecular weight of the UGT1A1 in mouse liver was the same as that observed with extracts of HEK293 cells transfected with UGT1A1 mRNA and probed with the anti-UGT1A1 IgG (lane 3). No UGT1A1 band was detected in extracts of HEK293 cells transfected with OTC mRNA (lane 5). These data demonstrate expression of UGT1A1 mRNA in vivo in mice injected with LNPs containing UGT1A1 mRNA.

[0001893] It is to be understood that the words which have been used are words of description rather than limitation, and that changes may be made within the purview of the appended claims without departing from the true scope and spirit of the invention in its broader aspects.

[0001894] While the present invention has been described at some length and with some particularity with respect to the several described embodiments, it is not intended that it should be limited to any such particulars or embodiments or any particular embodiment, but it is to be construed with references to the appended claims so as to provide the broadest possible interpretation of such claims in view of the prior art and, therefore, to effectively encompass the intended scope of the invention.

[0001895] All publications, patent applications, patents, and other references mentioned herein are incorporated by reference in their entirety. In case of conflict, the present specification, including definitions, will control. In addition, section headings, the materials, methods, and examples are illustrative only and not intended to be limiting.

Claims

We claim:

1. An isolated polynucleotide comprising;
 - (a) a first region of linked nucleosides, said first region encoding a polypeptide of interest, said polypeptide of interest selected from the group consisting of SEQ ID NOs 769-1392;
 - (b) a first flanking region located at the 5' terminus of said first region comprising;
 - (i) a sequence of linked nucleosides selected from the group consisting of the native 5' UTR of any of the nucleic acids that encode any of SEQ ID NOs 769-1392, SEQ ID NOs: 1-4 and functional variants thereof; and
 - (ii) at least one 5' terminal cap;
 - (c) a second flanking region located at the 3' terminus of said first region comprising;
 - (i') a sequence of linked nucleosides selected from the group consisting of the native 3' UTR of any of the nucleic acids that encode any of SEQ ID NOs 769-1392, SEQ ID NOs 5-21 and functional variants thereof; and
 - (ii') a 3' tailing sequence of linked nucleosides.

2. The isolated polynucleotide of claim 1 wherein the first region of linked nucleosides comprises at least an open reading frame of a nucleic acid sequence, wherein the nucleic acid sequence selected from the group consisting of SEQ ID NOs: 1393-21423, 21435-21438, 21442-21443, 21449, 21451-21473, 21521-21542, 21639-21642, 21671-21679, 21681, 21682, 21684, 21686, 21687, 21724-21726, 21728 and 21730-21738.

3. The isolated polynucleotide of claim 1, wherein the 3'tailing sequence of linked nucleosides is selected from the group consisting of a poly-A tail of approximately 160 nucleotides and a polyA-G quartet.

alkenyloxy, optionally substituted alkynyloxy, optionally substituted aminoalkoxy, optionally substituted alkoxyalkoxy, optionally substituted hydroxyalkoxy, optionally substituted amino, azido, optionally substituted aryl, optionally substituted aminoalkyl, or absent; wherein the combination of R³ with one or more of R^{1''}, R^{2'}, R^{2''}, or R⁵ can join together to form optionally substituted alkylene or optionally substituted heteroalkylene and, taken together with the carbons to which they are attached, provide an optionally substituted heterocyclyl; wherein the combination of R⁵ with one or more of R^{1'}, R^{1''}, R^{2'}, or R^{2''} can join together to form optionally substituted alkylene or optionally substituted heteroalkylene and, taken together with the carbons to which they are attached, provide an optionally substituted heterocyclyl; and wherein the combination of R⁴ and one or more of R^{1'}, R^{1''}, R^{2'}, R^{2''}, R³, or R⁵ can join together to form optionally substituted alkylene or optionally substituted heteroalkylene and, taken together with the carbons to which they are attached, provide an optionally substituted heterocyclyl;

each of Y¹, Y², and Y³, is, independently, O, S, -NR^{N1}-, optionally substituted alkylene, or optionally substituted heteroalkylene, wherein R^{N1} is H, optionally substituted alkyl, optionally substituted alkenyl, optionally substituted alkynyl, optionally substituted aryl, or absent;

each Y⁴ is, independently, H, hydroxy, thiol, optionally substituted alkyl, optionally substituted alkenyl, optionally substituted alkynyl, optionally substituted alkoxy, optionally substituted alkenyloxy, optionally substituted alkynyloxy, optionally substituted thioalkoxy, optionally substituted alkoxyalkoxy, or optionally substituted amino;

each Y⁵ is, independently, O, S, optionally substituted alkylene, or optionally substituted heteroalkylene;

n is an integer from 1 to 100,000; and

B is a nucleobase, wherein the combination of B and R^{1'}, the combination of B and R^{2'}, the combination of B and R^{1''}, or the combination of B and R^{2''} can, taken together with the carbons to which they are attached, optionally form a bicyclic group or wherein the combination of B, R^{1''}, and R³ or the combination of B, R^{2''}, and R³ can optionally form a tricyclic or tetracyclic group.

9. The isolated polynucleotide of claim 8, wherein B is not pseudouridine (ψ) or 5-methyl-cytidine (m^5C).
10. The isolated polynucleotide of any one of claims 8-9, wherein
U is O or $C(R^u)_{n_u}$, wherein n_u is an integer from 1 to 2 and each R^u is,
independently, H, halo, or optionally substituted alkyl;
each of $R^1, R^{1'}, R^{1''}, R^2, R^{2'},$ and $R^{2''}$, if present, is, independently, H, halo,
hydroxy, optionally substituted alkyl, optionally substituted alkoxy, optionally substituted
alkenyloxy, optionally substituted alkynyloxy, optionally substituted aminoalkoxy,
optionally substituted alkoxyalkoxy, optionally substituted amino, azido, optionally
substituted aryl, or optionally substituted aminoalkyl;
each of R^3 and R^4 is, independently, H, halo, hydroxy, optionally substituted
alkyl, or optionally substituted alkoxyalkoxy;
each of $Y^1, Y^2,$ and Y^3 , is, independently, O, S, $-NR^{N1-}$, optionally substituted
alkylene, or optionally substituted heteroalkylene, wherein R^{N1} is H, optionally
substituted alkyl, optionally substituted alkenyl, or optionally substituted alkynyl;
each Y^4 is, independently, H, hydroxy, thiol, optionally substituted alkyl,
optionally substituted alkenyl, optionally substituted alkynyl, optionally substituted
alkoxy, optionally substituted alkenyloxy, optionally substituted alkynyloxy, optionally
substituted thioalkoxy, or optionally substituted amino;
each Y^5 is, independently, O or optionally substituted alkylene; and
 n is an integer from 10 to 10,000.
11. The isolated polynucleotide of claim 10, wherein each of $R^1, R^{1'},$ and $R^{1''}$, if
present, is H.
12. The isolated polynucleotide of claim 11, wherein each of $R^2, R^{2'},$ and $R^{2''}$, if
present, is, independently, H, halo, hydroxy, optionally substituted alkoxy, or optionally
substituted alkoxyalkoxy.

13. The isolated polynucleotide of claim 10, wherein each of R², R^{2'}, and R^{2''}, if present, is H.

14. The isolated polynucleotide of claim 13, wherein each of R¹, R^{1'}, and R^{1''}, if present, is, independently, H, halo, hydroxy, optionally substituted alkoxy, or optionally substituted alkoxyalkoxy.

15. The isolated polynucleotide of claim 8, wherein said first region comprises n number of linked nucleotides having Formula (Ha):

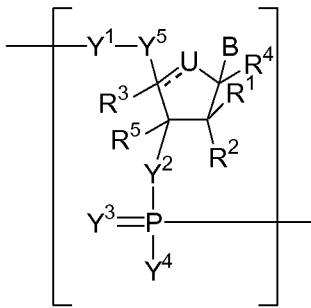

(IIa), or a pharmaceutically acceptable salt or stereoisomer thereof.

16. isolated The polypeptide of claim 15, wherein said first region comprises n number of linked nucleosides having Formula (lib) or (He), or a pharmaceutically acceptable salt thereof.

17. The isolated polynucleotide of claim 8, wherein said first region comprises n number of linked nucleosides having Formula (IId):

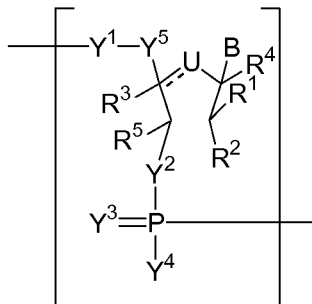

(IId), or a pharmaceutically acceptable salt or stereoisomer thereof.

18. The isolated polypeptide of claim 17, wherein said first region comprises n number of linked nucleosides having Formula (He) or (IIf), or a pharmaceutically acceptable salt thereof.

19. The isolated polynucleotide of claim 8, wherein said first region comprises n number of linked nucleotides, each of said linked nucleotides independently having one of Formulas (IIg)-(IIj):

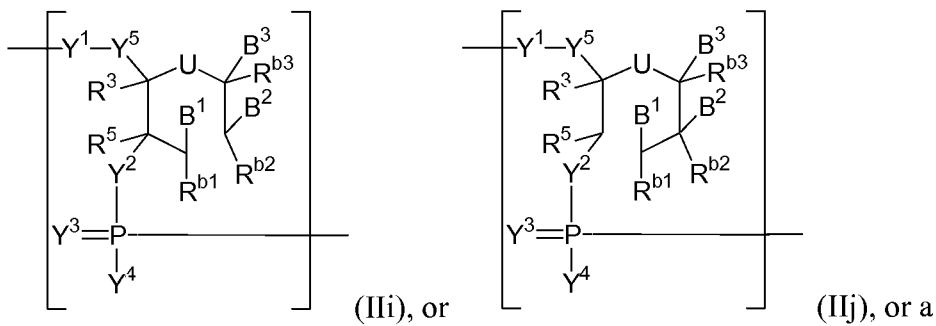
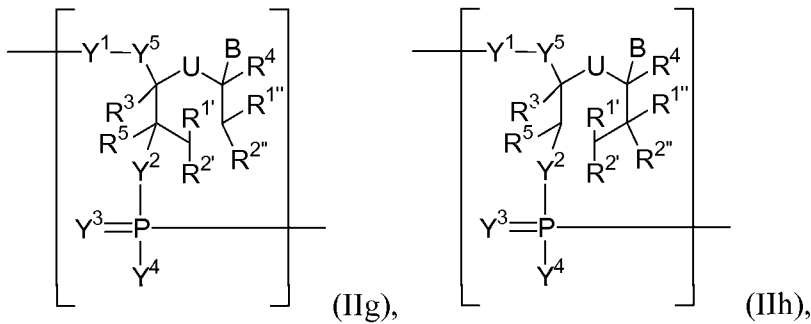

pharmaceutically acceptable salt or stereoisomer thereof.

20. The isolated polynucleotide of claim 8, wherein said first region comprises n number of linked nucleosides having Formula (IIk):

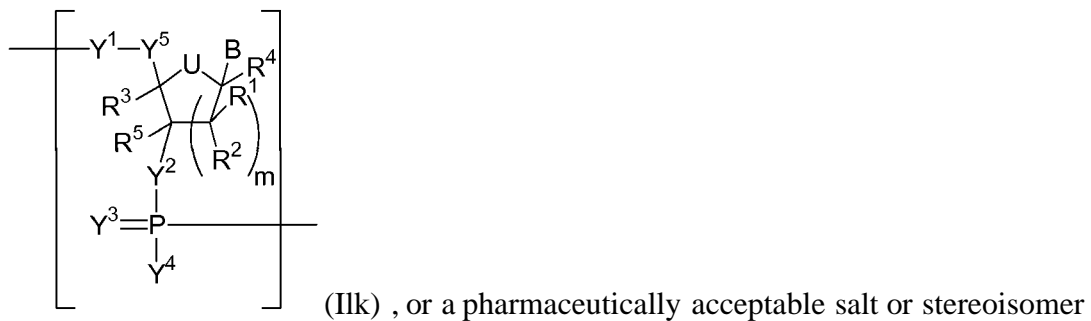

thereof.

21. The isolated polynucleotide of claim 20, wherein said first region comprises n number of linked nucleosides having Formula (III):

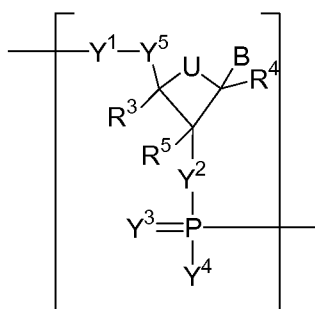

(III), or a pharmaceutically acceptable salt or stereoisomer

thereof.

22. The isolated polynucleotide of claim 20, wherein said first region comprises n number of linked nucleosides having Formula (Urn):

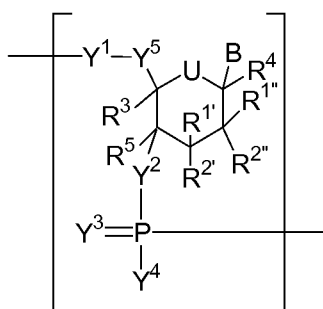

(Urn), or a pharmaceutically acceptable salt or stereoisomer

thereof,

wherein

each of R^1 , $R^{1''}$, $R^{2'}$, and $R^{2''}$ is, independently, H, halo, hydroxy, optionally substituted alkyl, optionally substituted alkoxy, optionally substituted alkenyloxy, optionally substituted alkynyloxy, optionally substituted aminoalkoxy, optionally substituted alkoxyalkoxy, or absent; and wherein the combination of $R^{2'}$ and R^3 or the combination of $R^{2''}$ and R^3 can be taken together to form optionally substituted alkylene or optionally substituted heteroalkylene.

23. The isolated polynucleotide of any one of claims 11-22, wherein

U is O or $C(R^u)_{n_u}$, wherein n_u is an integer from 1 to 2 and each R^u is, independently, H, halo, or optionally substituted alkyl;

each of R^1 and R^2 is, independently, H, halo, hydroxy, optionally substituted alkyl, optionally substituted alkoxy, optionally substituted alkenyloxy, optionally substituted alkynyloxy, optionally substituted aminoalkoxy, optionally substituted alkoxyalkoxy, optionally substituted amino, azido, optionally substituted aryl, or optionally substituted aminoalkyl;

each of R^3 and R^4 is, independently, H or optionally substituted alkyl;

each of Y^1 , Y^2 , and Y^3 , is, independently, O, S, $-NR^{N1}$ -, optionally substituted alkylene, or optionally substituted heteroalkylene, wherein R^{N1} is H, optionally substituted alkyl, optionally substituted alkenyl, or optionally substituted alkynyl;

each Y^4 is, independently, H, hydroxy, thiol, optionally substituted alkyl, optionally substituted alkenyl, optionally substituted alkynyl, optionally substituted alkoxy, optionally substituted alkenyloxy, optionally substituted alkynyloxy, optionally substituted thioalkoxy, or optionally substituted amino;

each Y^5 is, independently, O or optionally substituted alkylene; and

n is an integer from 10 to 10,000.

24. The isolated polynucleotide of claim 8, wherein said first region comprises n number of linked nucleosides having Formula (II n):

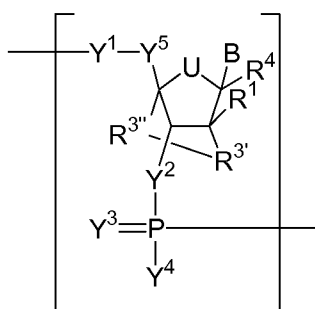

(II n), or a pharmaceutically acceptable salt or stereoisomer thereof,

thereof,

wherein

U is O or $C(R^u)_{n_u}$, wherein n_u is an integer from 1 to 2 and each R^u is, independently, H, halo, or optionally substituted alkyl;

each of R^1 and R^4 is, independently, H, halo, hydroxy, optionally substituted alkyl, optionally substituted alkoxy, optionally substituted alkenyloxy, optionally substituted alkynyloxy, optionally substituted aminoalkoxy, optionally substituted

alkoxyalkoxy, optionally substituted amino, azido, optionally substituted aryl, or optionally substituted aminoalkyl;

$R^{3'}$ is O, S, or $-NR^{N1-}$, wherein R^{N1} is H, optionally substituted alkyl, optionally substituted alkenyl, optionally substituted alkynyl, or optionally substituted aryl;

$R^{3''}$ is optionally substituted alkylene or optionally substituted heteroalkylene;

each of Y^1 , Y^2 , and Y^3 , is, independently, O, S, $-NR^{N1-}$, optionally substituted alkylene, or optionally substituted heteroalkylene, wherein R^{N1} is H, optionally substituted alkyl, optionally substituted alkenyl, or optionally substituted alkynyl;

each Y^4 is, independently, H, hydroxy, thiol, optionally substituted alkyl, optionally substituted alkenyl, optionally substituted alkynyl, optionally substituted alkoxy, optionally substituted alkenyloxy, optionally substituted alkynyloxy, optionally substituted thioalkoxy, or optionally substituted amino;

each Y^5 is, independently, O, S, optionally substituted alkylene (e.g., methylene), or optionally substituted heteroalkylene; and

n is an integer from 10 to 10,000.

25. The isolated polynucleotide of any one of claims 8-24, wherein in said n number of B has, each B independently has a formula selected from Formula (b1)-(b5):

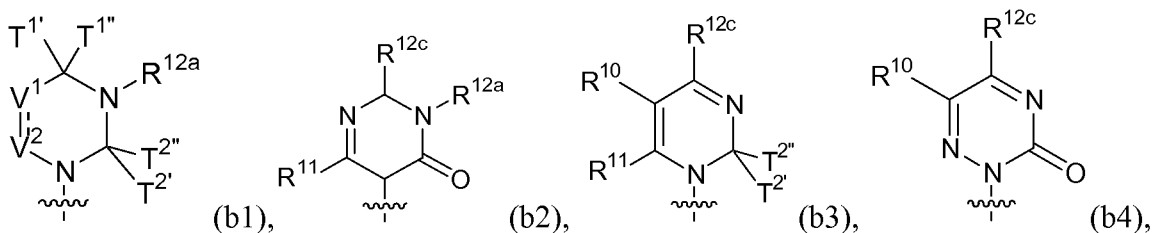

or

(b5), or a pharmaceutically acceptable salt or stereoisomer thereof,

wherein

\equiv connecting V^1 and V^2 in formula (b1) is a single or double bond;

each of T^1 , $T^{1'}$, $T^{2'}$, and $T^{2''}$ is, independently, H, optionally substituted alkyl, optionally substituted alkoxy, or optionally substituted thioalkoxy, or the combination of T^1 and $T^{1'}$ or the combination of $T^{2'}$ and $T^{2''}$ join together to form O (oxo), S (thio), or Se (seleno);

each of V^1 and V^2 is, independently, O, S, $N(R^{Vb})_{nv}$, or $C(R^{Vb})_{nv}$, wherein nv is an integer from 0 to 2 and each R^{Vb} is, independently, H, halo, optionally substituted amino acid, optionally substituted alkyl, optionally substituted alkenyl, optionally substituted alkynyl, optionally substituted alkoxy, optionally substituted alkenyloxy, or optionally substituted alkynyloxy;

R^{10} is H, halo, optionally substituted amino acid, hydroxy, optionally substituted alkyl, optionally substituted alkenyl, optionally substituted alkynyl, optionally substituted aminoalkyl, optionally substituted alkoxy, optionally substituted alkoxyalkyl, optionally substituted alkoxyalkoxy, optionally substituted carboxyalkoxy, optionally substituted carboxyalkyl, or optionally substituted carbamoylalkyl;

R^{11} is H or optionally substituted alkyl;

R^{12a} is H, optionally substituted alkyl, or optionally substituted aminoalkyl; and

R^{12c} is H, halo, optionally substituted alkyl, optionally substituted alkoxy, optionally substituted thioalkoxy, optionally substituted amino, or optionally substituted aminoalkyl.

26. The isolated polynucleotide of any one of claims 8-25, wherein n number of B has Formula (b6)-(b9):

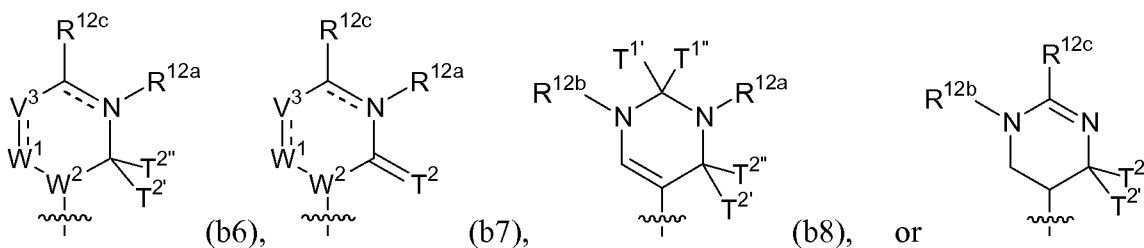

or a pharmaceutically acceptable salt or stereoisomer thereof,

wherein

is a single or double bond;

each of T^{1'}, T^{1''}, T^{2'}, and T^{2''} is, independently, H, optionally substituted alkyl, optionally substituted alkoxy, or optionally substituted thioalkoxy, or the combination of T^{1'} and T^{1''} or the combination of T^{2'} and T^{2''} join together to form O (oxo), S (thio), or Se (seleno);

each of W¹ and W² is, independently, N(R^{Wa})_{n_w} or C(R^{Wa})_{n_w}, wherein n_w is an integer from 0 to 2 and each R^{Wa} is, independently, H, optionally substituted alkyl, or optionally substituted alkoxy;

each V³ is, independently, O, S, N(R^{Va})_{n_v}, or C(R^{Va})_{n_v}, wherein n_v is an integer from 0 to 2 and each R^{Va} is, independently, H, halo, optionally substituted amino acid, optionally substituted alkyl, optionally substituted alkenyl, optionally substituted alkynyl, optionally substituted heterocyclyl, optionally substituted alkheterocyclyl, optionally substituted alkoxy, optionally substituted alkenyloxy, or optionally substituted alkynyloxy, and wherein R^{Va} and R^{12c} taken together with the carbon atoms to which they are attached can form optionally substituted cycloalkyl, optionally substituted aryl, or optionally substituted heterocyclyl;

R^{12a} is H, optionally substituted alkyl, optionally substituted aminoalkyl, or absent;

R^{12b} is H, optionally substituted alkyl, optionally substituted alkenyl, optionally substituted alkynyl, optionally substituted alkaryl, optionally substituted heterocyclyl, optionally substituted alkheterocyclyl, or optionally substituted amino acid, wherein the combination of R^{12b} and T^{1'} or the combination of R^{12b} and R^{12c} can join together to form optionally substituted heterocyclyl; and

R^{12c} is H, halo, optionally substituted alkyl, optionally substituted alkoxy, optionally substituted thioalkoxy, optionally substituted amino, or optionally substituted aminoalkyl.

27. The isolated polynucleotide of claim 26, wherein R^{12a}, R^{12b}, R^{12c}, or R^{Va} is substituted with -(CH₂)_{s2}(OCH₂CH₂)si(CH₂)_{s3}OR', wherein si is an integer from 1 to 10, each of s2 and s3, independently, is an integer from 0 to 10, and R' is H or C₁₋₂₀ alkyl); or -NR^{N1}(CH₂)_{s2}(CH₂CH₂O)_si(CH₂)_{s3}NR^{N1}, wherein si is an integer from 1 to 10, each of s2

and s_3 , independently, is an integer from 0 to 10, and each R^{N1} is, independently, hydrogen or optionally substituted C_{1-6} alkyl.

28. The isolated polynucleotide of any one of claims 8-27, wherein n number of B has Formula (b10)-(b14):

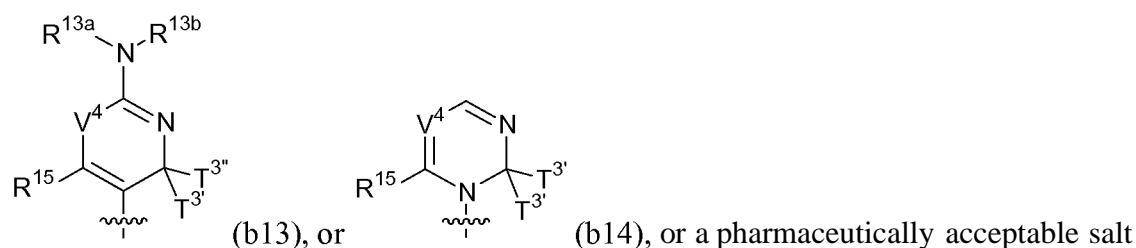
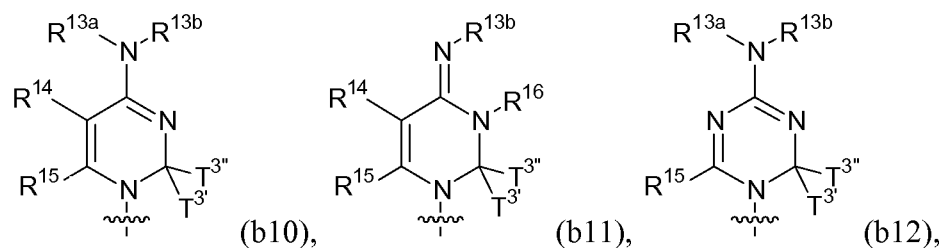

or stereoisomer thereof,

wherein

each of $T^{3'}$ and $T^{3''}$ is, independently, H, optionally substituted alkyl, optionally substituted alkoxy, or optionally substituted thioalkoxy, or the combination of $T^{3'}$ and $T^{3''}$ join together to form O (oxo), S (thio), or Se (seleno);

each V^4 is, independently, O, S, N(R^{Vc})_{nv}, or C(R^{Vc})_{nv}, wherein nv is an integer from 0 to 2 and each R^{Vc} is, independently, H, halo, optionally substituted amino acid, optionally substituted alkyl, optionally substituted alkenyl, optionally substituted alkynyl, optionally substituted alkoxy, optionally substituted alkenyloxy, optionally substituted heterocyclyl, optionally substituted alkheterocyclyl, or optionally substituted alkynyloxy, wherein the combination of R^{13b} and R^{Vc} can be taken together to form optionally substituted heterocyclyl;

each of R^{13a} and R^{13b} is, independently, H, optionally substituted acyl, optionally substituted alkyl, or optionally substituted alkoxy, wherein the combination of R^{13b} and R^{14} can be taken together to form optionally substituted heterocyclyl;

each R^{14} is, independently, H, halo, hydroxy, thiol, optionally substituted acyl, optionally substituted amino acid, optionally substituted alkyl, optionally substituted alkenyl, optionally substituted alkynyl, optionally substituted hydroxyalkyl, optionally substituted alkoxy, optionally substituted alkenyloxy, optionally substituted alkynyloxy, optionally substituted aminoalkoxy, optionally substituted alkoxyalkoxy, optionally substituted amino, azido, optionally substituted aryl, optionally substituted heterocyclyl, optionally substituted alkheterocyclyl, or optionally substituted aminoalkyl; and

each of R^{15} and R^{16} is, independently, H, optionally substituted alkyl, optionally substituted alkenyl, or optionally substituted alkynyl.

29. The isolated polynucleotide of any one of claims 7-27, wherein n number of B has Formula (b15)-(b 17):

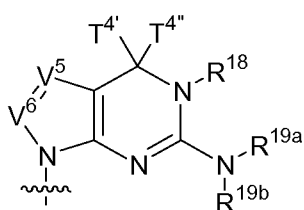

(b15),

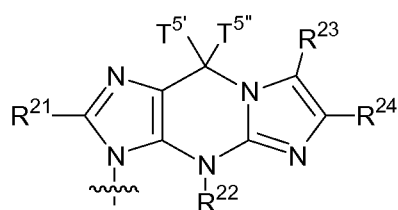

(b16), or

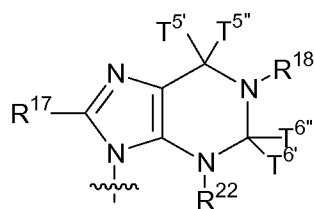

(b17), or a pharmaceutically acceptable salt or stereoisomer

thereof,

wherein

each of $T^{4'}$, $T^{4''}$, $T^{5'}$, $T^{5''}$, $T^{6'}$, and $T^{6''}$ is, independently, H, optionally substituted alkyl, or optionally substituted alkoxy, and wherein the combination of $T^{4'}$ and $T^{4''}$ or the combination of $T^{5'}$ and $T^{5''}$ or the combination of $T^{6'}$ and $T^{6''}$ together form O, S, or Se;

each of V^5 and V^6 is, independently, O, S, $N(R^{Vd})_{nv}$, or $C(R^{Vd})_{nv}$, wherein nv is an integer from 0 to 2 and each R^{Vd} is, independently, H, halo, optionally substituted amino acid, cyano, amidine, optionally substituted aminoalkyl, optionally substituted alkyl, optionally substituted alkenyl, optionally substituted alkynyl, optionally substituted alkoxy, optionally substituted alkenyloxy, or optionally substituted alkynyloxy; and

each of R^{17} , R^{18} , R^{19a} , R^{19b} , R^{21} , R^{22} , R^{23} , and R^{24} is, independently, H, optionally substituted alkyl, optionally substituted alkenyl, optionally substituted alkynyl, or optionally substituted amino acid.

30. The polynucleotide of any one of claims 8-29, wherein n number of B has Formula (b18)-(b20):

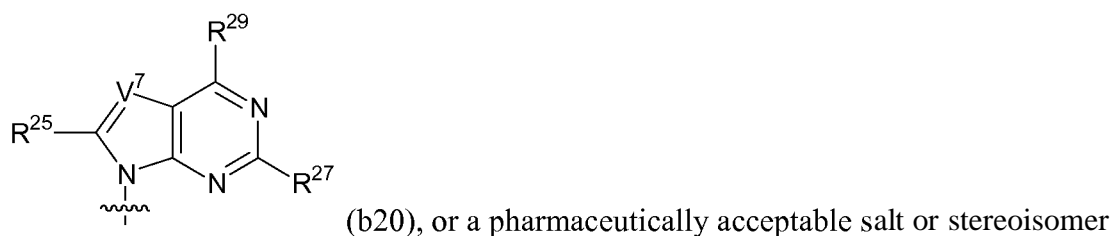
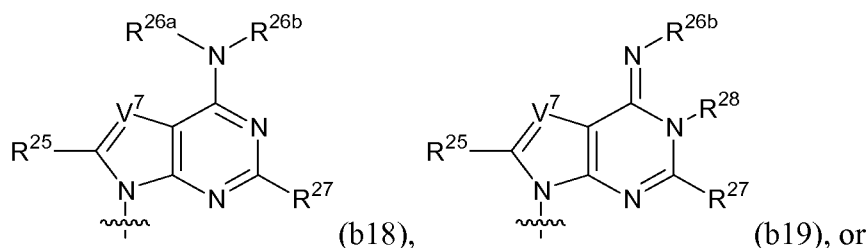

thereof,

wherein

each V^7 is, independently, O, S, $N(R^{Ve})_{nv}$, or $C(R^{Ve})_{nv}$, wherein nv is an integer from 0 to 2 and each R^{Ve} is, independently, H, halo, optionally substituted amino acid, optionally substituted alkyl, optionally substituted alkenyl, optionally substituted alkynyl, optionally substituted alkoxy, optionally substituted alkenyloxy, or optionally substituted alkynyloxy;

each R^{25} is, independently, H, optionally substituted alkyl, optionally substituted alkenyl, or optionally substituted alkynyl;

each of R^{26a} and R^{26b} is, independently, H, optionally substituted acyl, optionally substituted amino acid, optionally substituted carbamoylalkyl, optionally substituted alkyl, optionally substituted alkenyl, optionally substituted alkynyl, optionally substituted hydroxyalkyl, optionally substituted hydroxyalkenyl, or optionally substituted alkoxy;

each R^{27} is, independently, H, optionally substituted alkyl, optionally substituted alkenyl, optionally substituted alkynyl, optionally substituted alkoxy, or optionally substituted amino;

each R²⁸ is, independently, H, optionally substituted alkyl, optionally substituted alkenyl, or optionally substituted alkynyl; and

each R²⁹ is, independently, H, optionally substituted acyl, optionally substituted amino acid, optionally substituted carbamoylalkyl, optionally substituted alkyl, optionally substituted alkenyl, optionally substituted alkynyl, optionally substituted hydroxyalkyl, optionally substituted hydroxyalkenyl, optionally substituted alkoxy, or optionally substituted amino.

31. The isolated polynucleotide of claim 30, wherein R^{26a}, R^{26b}, or R²⁹ is substituted with $-(\text{CH}_2)_{s_2}(\text{OCH}_2\text{CH}_2)_i(\text{CH}_2)_{s_3}\text{R}'$, wherein s_1 is an integer from 1 to 10, each of s_2 and s_3 , independently, is an integer from 0 to 10, and R' is H or C_{i-20} alkyl; or $\text{NR}^{\text{N}1}(\text{CH}_2)_{s_2}(\text{CH}_2\text{CH}_2\text{O})_i(\text{CH}_2)_{s_3}\text{NR}^{\text{N}1}$, wherein s_1 is an integer from 1 to 10, each of s_2 and s_3 , independently, is an integer from 0 to 10, and each R^{N1} is, independently, hydrogen or optionally substituted C_{i-6} alkyl.

32. The isolated polynucleotide of any one of claims 8-31, wherein n number of B has Formula (b21):

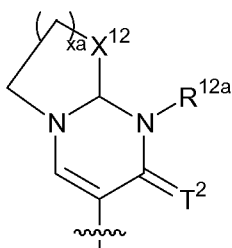

(b21), or a pharmaceutically acceptable salt or stereoisomer thereof,

polyaspartate, a lipid, cholesterol, a steroid, bile acid, folate, vitamin B12, biotin, an RGD peptide, an RGD peptide mimetic, or an aptamer.

38. A pharmaceutical composition comprising the isolated polynucleotide of any one of claims 1-37.

39. A pharmaceutical composition comprising the isolated polynucleotide of any one of claims 1-37 and a pharmaceutically acceptable excipient.

40. The pharmaceutical composition of claim 39, wherein the excipient is selected from a solvent, aqueous solvent, non-aqueous solvent, dispersion media, diluent, dispersion, suspension aid, surface active agent, isotonic agent, thickening or emulsifying agent, preservative, lipid, lipidoids liposome, lipid nanoparticle, core-shell nanoparticles, polymer, lipoplexe peptide, protein, cell, hyaluronidase, and mixtures thereof.

41. The pharmaceutical composition of claim 40, where the pharmaceutical composition comprises a lipid and wherein said lipid is selected from DLin-DMA, DLin-K-DMA, DLin-KC2-DMA, 98N12-5, C12-200, DLin-MC3-DMA, DODMA, DSDMA, DLenDMA, reLNPs, PLGA and PEGylated lipids and mixtures thereof.

42. A method of producing a polypeptide of interest in a mammalian cell, tissue or organism comprising administering to said cell, tissue or organism the isolated polynucleotide of any one of claims 1-37 or the pharmaceutical composition of any of claims 38-41.

43. The method of claim 42, wherein the isolated polynucleotide is formulated.

44. The method of claim 43, wherein the formulation comprises a lipid which is selected from one of DLin-DMA, DLin-K-DMA, DLin-KC2-DMA, 98N12-5, C12-200, DLin-MC3-DMA, DODMA, DSDMA, DLenDMA, reLNPs, PLGA, PEGylated lipids and mixtures or combinations thereof.

45. The method of claim 44, wherein the isolated polynucleotide is administered at a total daily dose of between 1 ug and 150 ug.
46. The method of claim 45, wherein administration is by injection.
47. The method of claim 46, wherein administration is intradermal or subcutaneous or intramuscular or intravitreal.
48. The method of claim 45, wherein levels of the polypeptide of interest in the serum of the mammal are at least 50 pg/mL at least two hours after administration.
49. The method of claim 45, wherein the levels of the polypeptide of interest in the serum of the mammal remain above 50 pg/mL for at least 72 hours after administration.
50. The method of claim 49, wherein the levels of the polypeptide of interest in the serum of the mammal remain above 60 pg/mL for at least 72 hours after administration.
51. The method of claim 44, wherein the resulting polynucleotide formulation has a mean particle size of 80 nm-160 nm, a PDI of between 0.02 and 0.20 and a lipid to polynucleotide ratio (wt/wt) of between 10-20.
52. A method for producing an increased level of a polypeptide of interest selected from the group consisting of SEQ ID NOs 769-1392 in a mammalian cell, tissue or organism, comprising administering to said cell, tissue or organism a total daily dose of the isolated polynucleotide of any one of claims 4-37 or the pharmaceutical composition of any one of claims 38-41 in two or more equal or unequal split doses.
53. The method of claim 52, wherein the level of the polypeptide produced in response to said administration is greater than the levels produced by administering the same total daily dose of the isolated polynucleotide or pharmaceutical composition as a

single administration.

54. The method of claim 52, wherein the mammalian organism is a human patient in need of an increased level of the polypeptide of interest.

55. The method of claim 54, wherein the increased level of the polypeptide of interest is detectable in a bodily fluid of said patient.

56. The method of claim 55, wherein the bodily fluid is selected from the group consisting of peripheral blood, serum, plasma, ascites, urine, cerebrospinal fluid (CSF), sputum, saliva, bone marrow, synovial fluid, aqueous humor, amniotic fluid, cerumen, breast milk, bronchoalveolar lavage fluid, semen, prostatic fluid, cowper's fluid or pre-ejaculatory fluid, sweat, fecal matter, hair, tears, cyst fluid, pleural and peritoneal fluid, pericardial fluid, lymph, chyme, chyle, bile, interstitial fluid, menses, pus, sebum, vomit, vaginal secretions, mucosal secretion, stool water, pancreatic juice, lavage fluids from sinus cavities, bronchopulmonary aspirates, blastocyl cavity fluid, and umbilical cord blood.

57. The method of claim 56, wherein the bodily fluid is serum and the polypeptide per unit drug (PUD) is greater than 1.

58. The method of claim 57, wherein the dose splitting factor (DSF) is greater than 4.

59. The method of claim 55, wherein administration is transdermal.

60. The method of claim 59, wherein transdermal administration comprises utilization of one or more members selected from the group consisting of a patch, cream, ointment, mechanical device, needle, sponge, depot and fabric.

61. The method of claim 59, wherein administration is according to a dosing regimen which occurs over the course of hours, days, weeks, months, or years.

62. The method of claim 52, wherein said two or more split doses comprise a first dose of the polynucleotide or pharmaceutical composition administered at a time T1 followed by a second dose of the polynucleotide or pharmaceutical composition administered at a time T2, wherein said time T1 and said time T2 are separated by no more than 1 minute and wherein said first dose and said second dose are administered in amounts that result in higher levels of the polypeptide of interest in said subject than if the amounts of polynucleotide or pharmaceutical composition were administered together in a single unit dose.

63. The method of claim 62, further comprising administering a plurality of doses of said polynucleotide or pharmaceutical composition, Nx at times Tn , wherein x and n are independently selected from 3 to about 1000 and where the time between Tn and $Tn+1$ is separated by increments of no more than 10 seconds.

64. The method of claim 63, wherein administration occurs by direct injection.

65. The method of claim 64, wherein direct injection is selected from the group consisting of intravenous, intradermal, subcutaneous, intramuscular and intravitreal.

66. The method of claim 64, wherein said first dose is administered proximal to said second or plurality of doses.

67. The method of claim 64, wherein said first dose is administered distal to said second or plurality of doses.

68. The method of claim 64, wherein the distance between the site of injection of said first dose and the site of injection of any second or plurality of doses is from about 1mm to about 10 cm.

69. The method of claim 64, wherein injection is made at a depth of from 0.1mm to about 1cm.

70. The method of claim 65, wherein direct injection is achieved by using one or more devices selected from multineedle injection systems, catheter or lumen systems, and ultrasound, electrical or radiation based systems.

71. The method of claim 63, wherein the amount polynucleotide or pharmaceutical composition administered in any dose is substantially equal.

72. The method of claim 63, wherein time T1 and time T2 are separated by no more than 30 seconds.

73. The method of claim 63, wherein time T1 and time T2 are separated by no more than 10 seconds.

74. The method of claim 63, wherein the first dose, the second dose and any of a plurality of doses are administered at substantially the same time.

75. The method of claim 63, wherein the single unit dose is between about 10 mg/kg and about 500 mg/kg.

76. The method of claim 63, wherein the single unit dose is between about 1.0 mg/kg and about 10 mg/kg.

77. The method of claim 63, wherein the single unit dose is between about 0.001 mg/kg and about 1.0 mg/kg.

78. A method of preparing a lipid nanoparticle formulation of a polynucleotide encoding a polypeptide of interest comprising rapidly injecting a first ethanolic solution into a second aqueous solution wherein,

(a) said first ethanolic solution comprises a mixture of lipid:DSPC: Cholesterol: PEG-c-DOMG to yield a molar ratio of 50:10:38.5:1.5 and having a final lipid concentration of approximately 25mM, and

(b) said second aqueous solution comprises a sodium citrate buffered solution of the polynucleotide encoding the polypeptide of interest having a concentration of 1-2 mg/mL and a pH of approximately 3,

wherein the rapid injection results in a suspension containing 33% ethanol and a total lipid to polynucleotide weight ratio of at least 10:1.

79. The method of claim 78, wherein the rapid injection is performed either manually (MI) or by the aid of a syringe pump (SP).

80. The method of claim 79, further comprising dialyzing the resultant suspension against phosphate buffered saline (PBS) at pH 7.4.

81. The method of claim 80, wherein dialysis is performed more than once.

82. The method of claim 81, further comprising filtering the dialyzed suspension through a 0.2 μ m sterile filter.

83. The method of any of claims 78-82, wherein the lipid is selected from the group consisting of DLin-DMA, DLin-K-DMA, DLin-KC2-DMA, 98N12-5, CI2-200, DLin-MC3-DMA, DODMA, DSDMA, DLenDMA, reLNPs, PLGA and PEGylated lipids.

84. The method of any of claims 78-83, wherein the polynucleotide is selected from the polynucleotide of any of claims 1-37.

85. A lipid nanoparticle formulation of a polynucleotide encoding a polypeptide of interest produced by the method of any of claims 78-84 and having a particle size of 80 nm-160 nm, a PDI of between 0.02 and 0.20 and a lipid to polynucleotide ratio (wt/wt) of between 10-30.

86. A lipid nanoparticle formulation of claim 85, wherein the polynucleotide is selected from the polynucleotide of any of claims 1-37.
87. A reLNP formulation of a polynucleotide said polynucleotide encoding a polypeptide of interest.
88. A reLNP formulation of claim 87, wherein the polynucleotide is selected from the polynucleotide of any of claims 1-36.
89. A sustained release formulation of a polynucleotide said polynucleotide encoding a polypeptide of interest.
90. A sustained release formulation of claim 89, wherein the polynucleotide is selected from the polynucleotide of any of claims 1-36.
91. A polynucleotide encoding a fusion protein said fusion protein comprising a first polypeptide and a second polypeptide.
92. The polynucleotide of claim 91 where the first polypeptide is selected from the group consisting of Fc receptor, Fab fragment, Fab' fragment, F(ab')₂ fragment, Fv fragment, IgA domain, IgD domain, IgE domain, IgD domain, IgM domain, IgV domain, IgC1 domain, IgC2 domain and Ig1 domain and the second polypeptide is a polypeptide of interest.

FIGURE 1

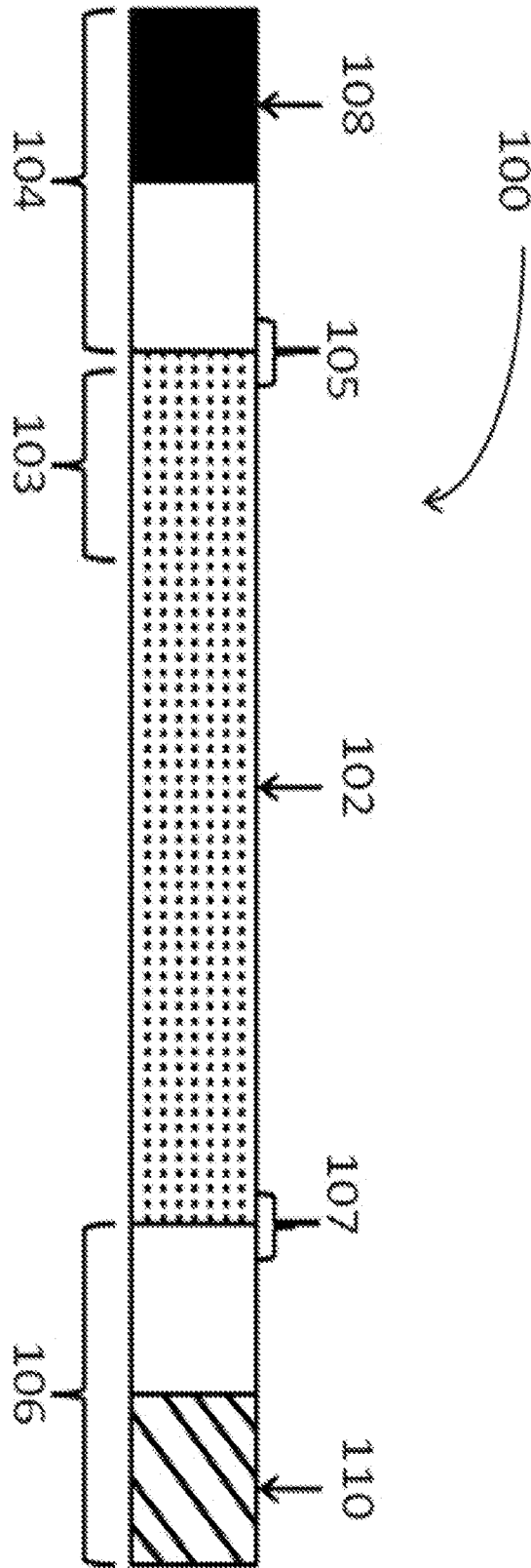
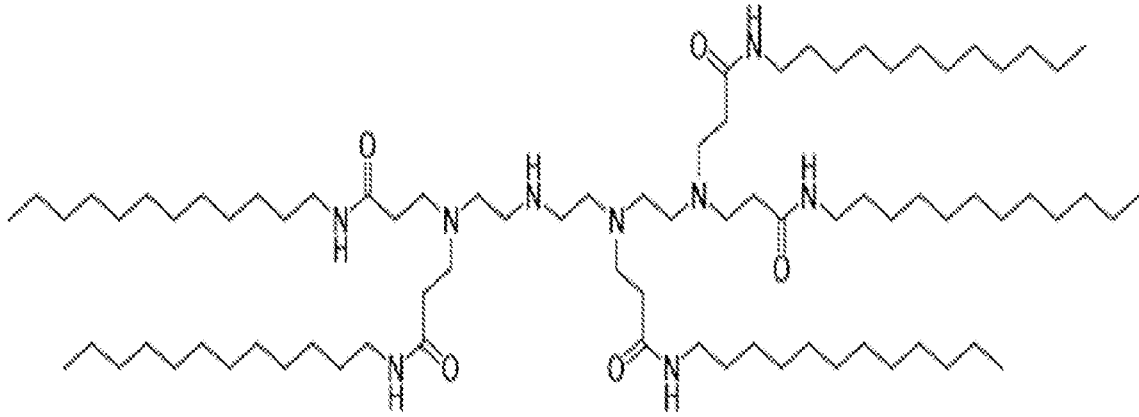
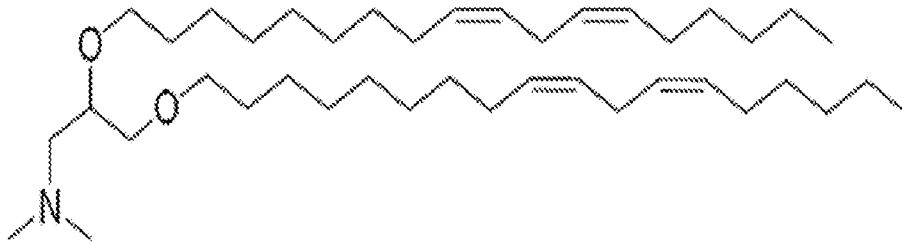

FIGURE 2

98N12-5 (TETA5-LAP)



DLin-DMA



DLin-K-DMA (2,2-Dilinoleyl-4-dimethylaminomethyl-[1,3]-dioxolane)

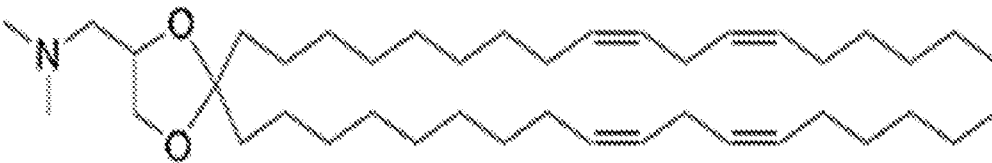

DLin-KC2-DMA

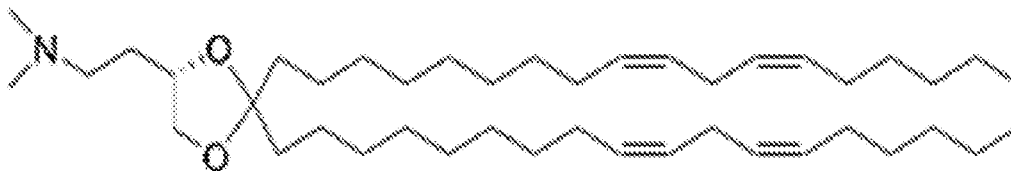

PRIOR ART

FIGURE 2 CONT.

DLin-MC3-DMA

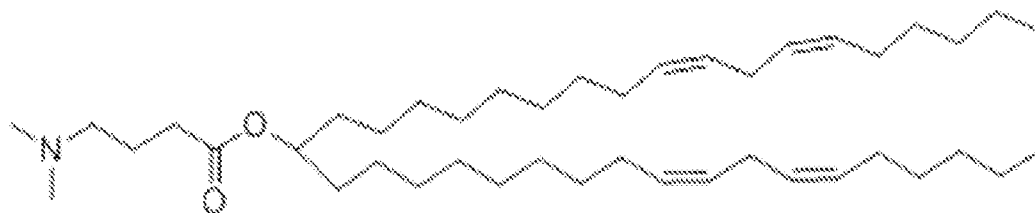

C12-200

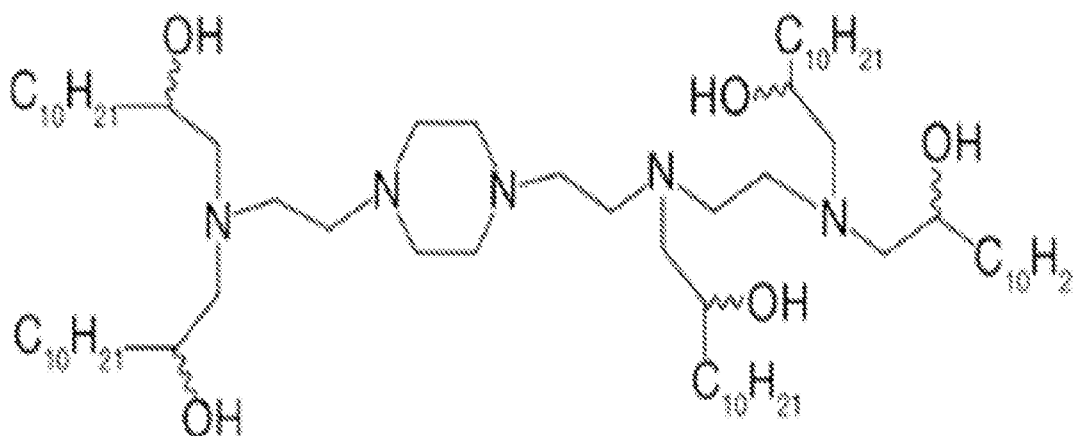

PRIOR ART

FIGURE 3

Only single cutters are shown in the map.

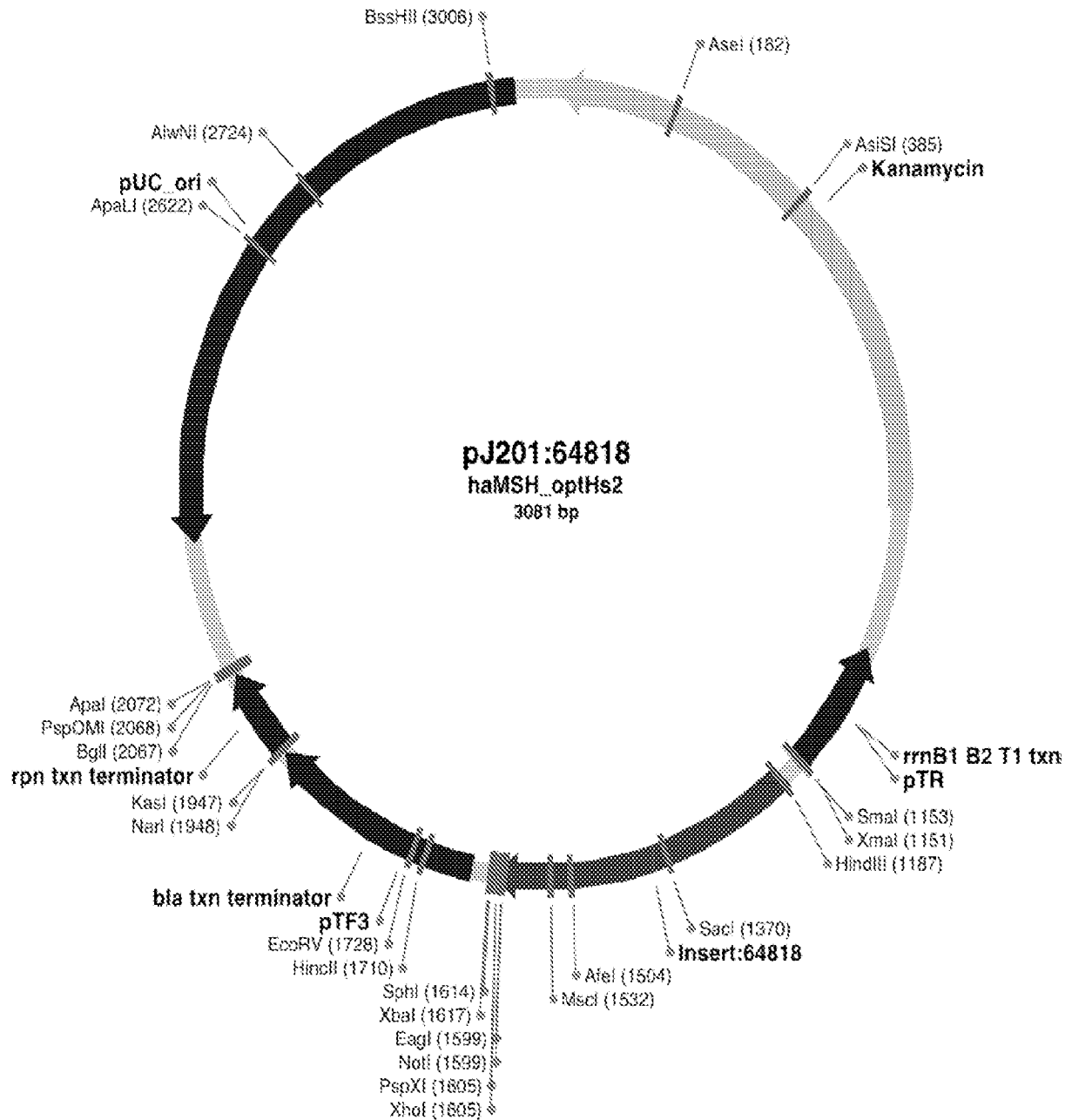

PRIOR ART

FIGURE 4

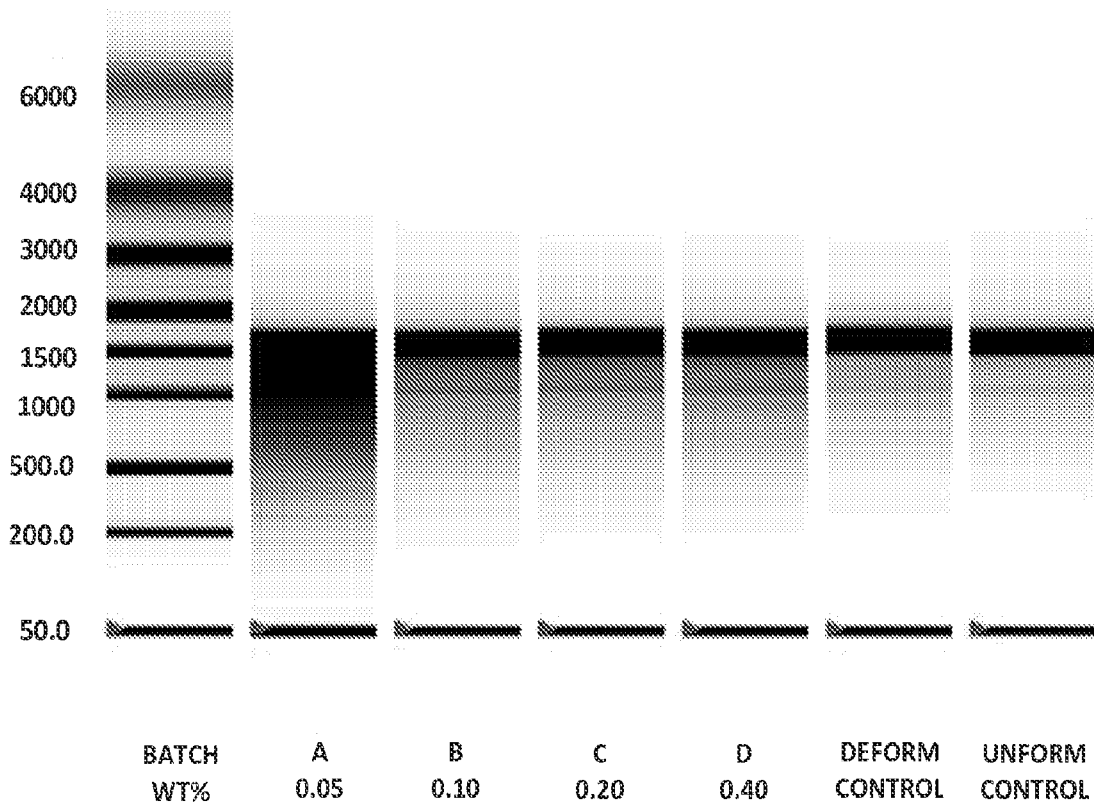

FIGURE 5

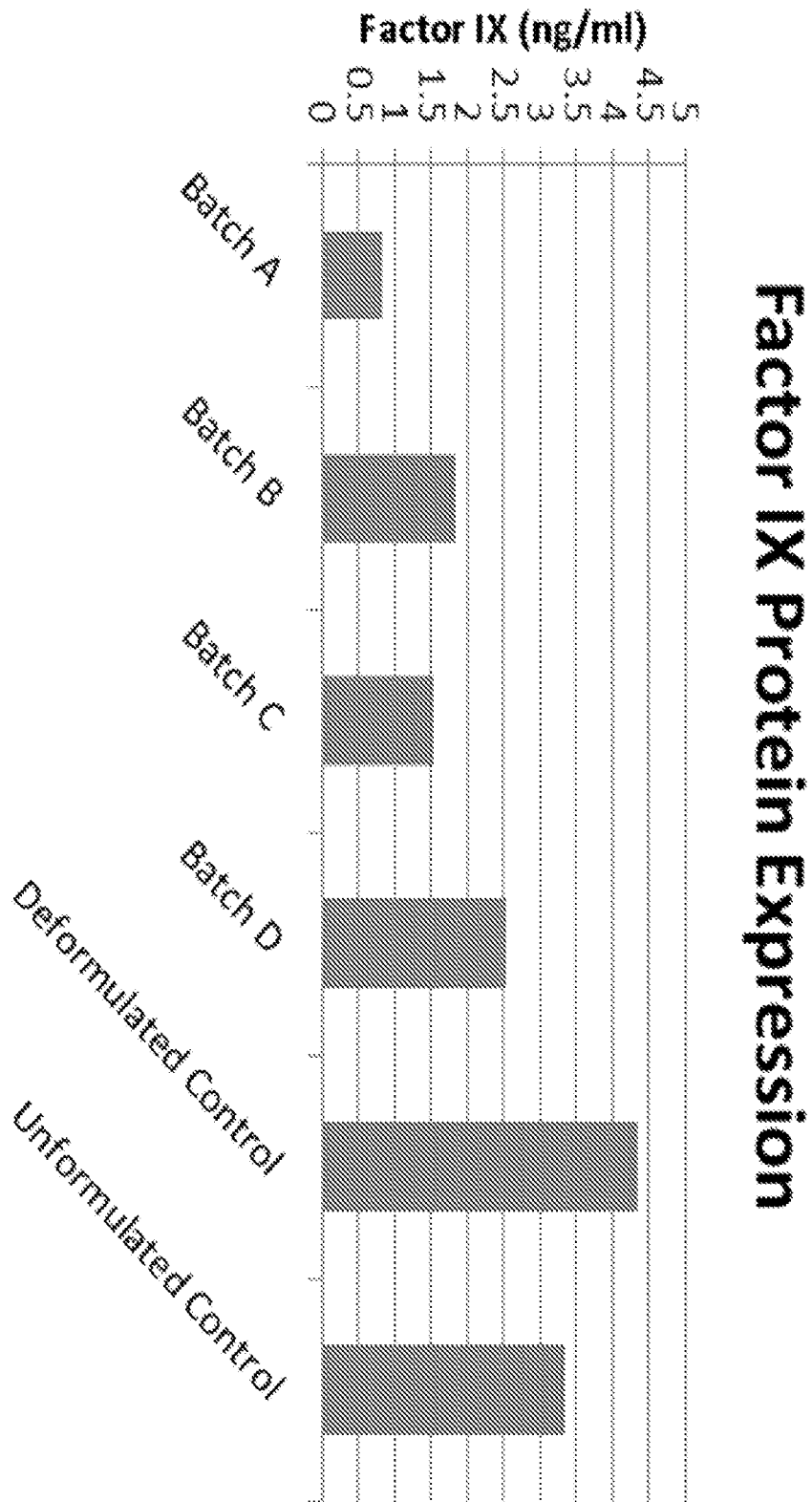

FIGURE 6

A.

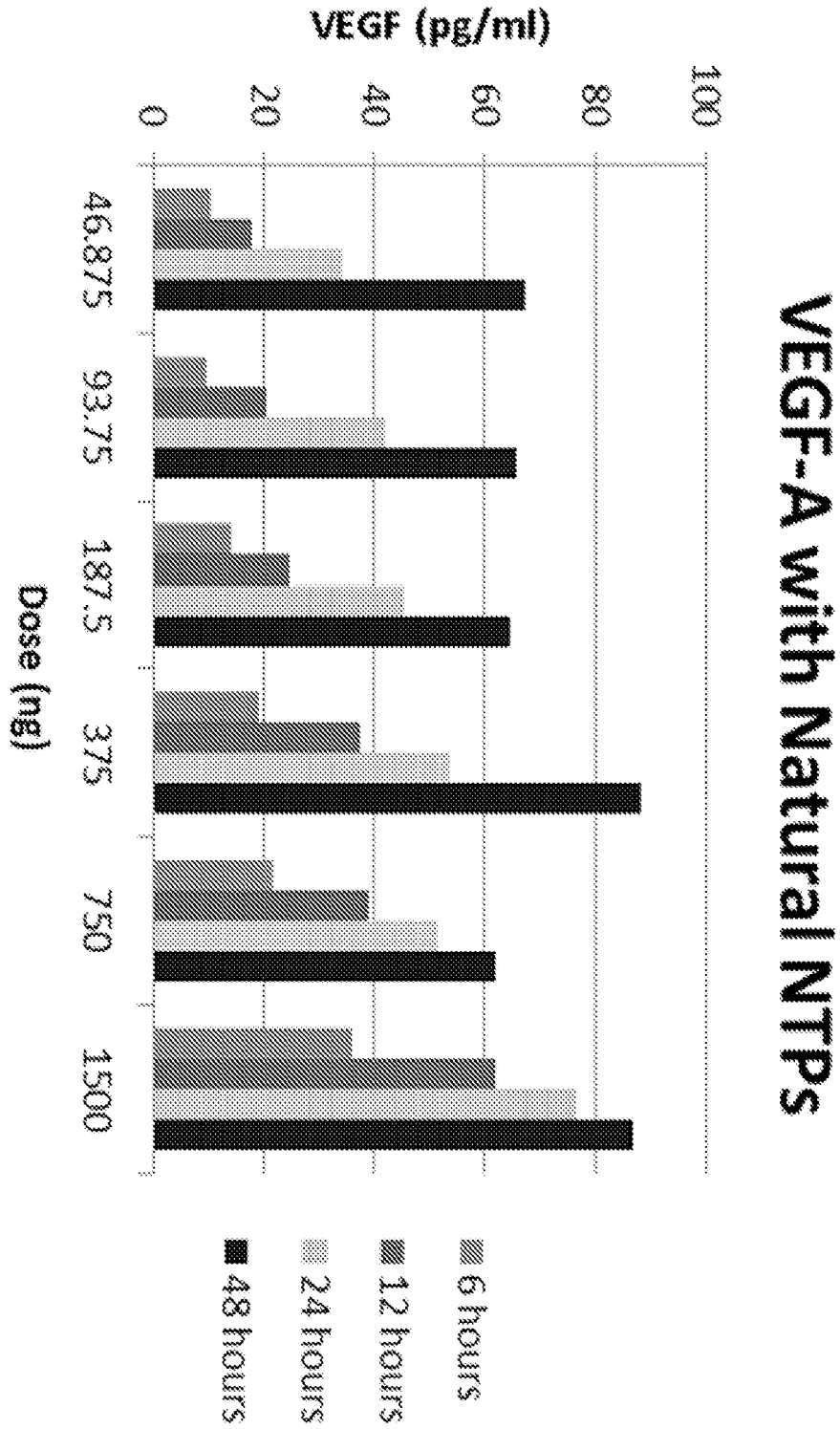

FIGURE 6 CONT.

B.

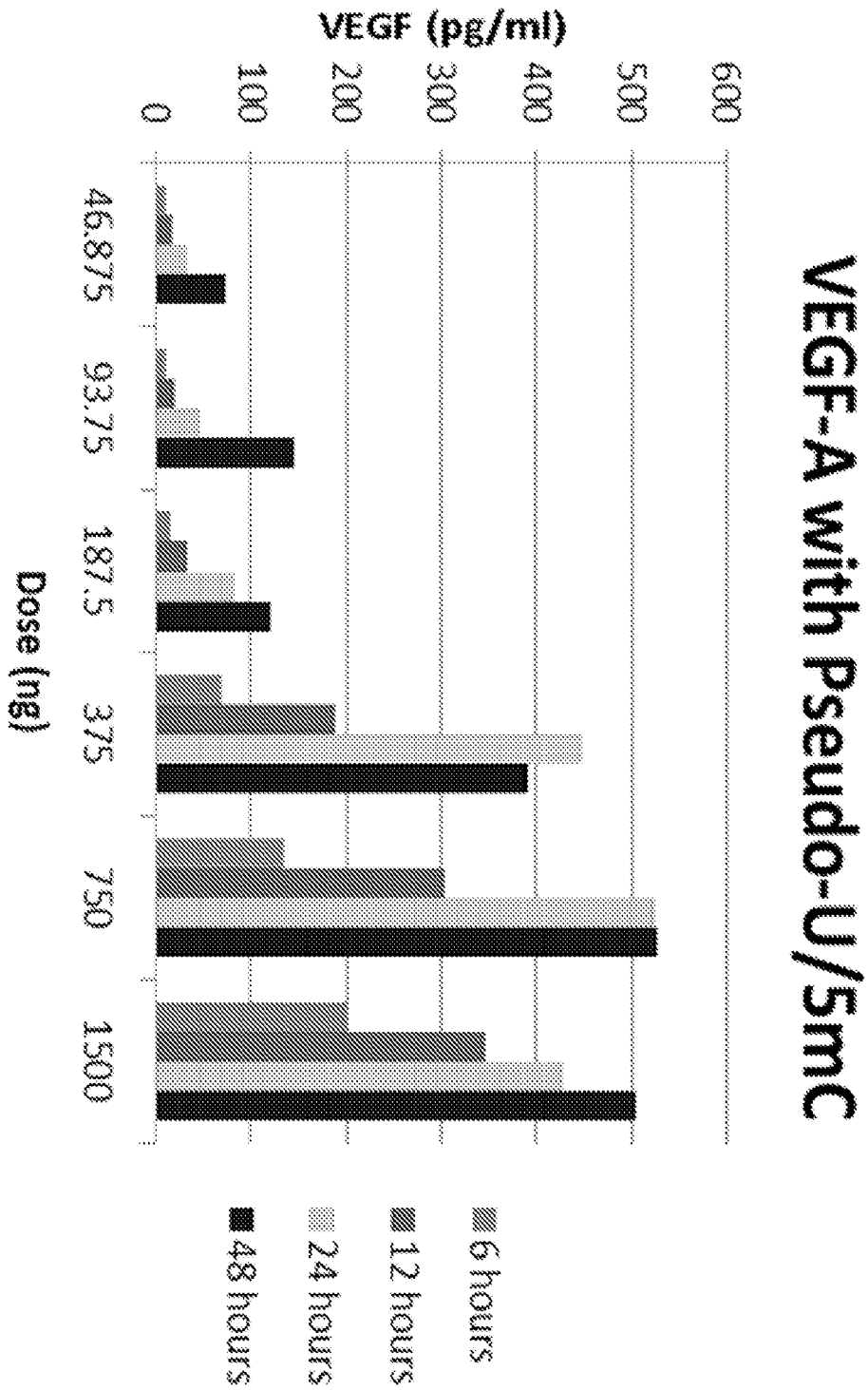

FIGURE 6 CONT.

c.

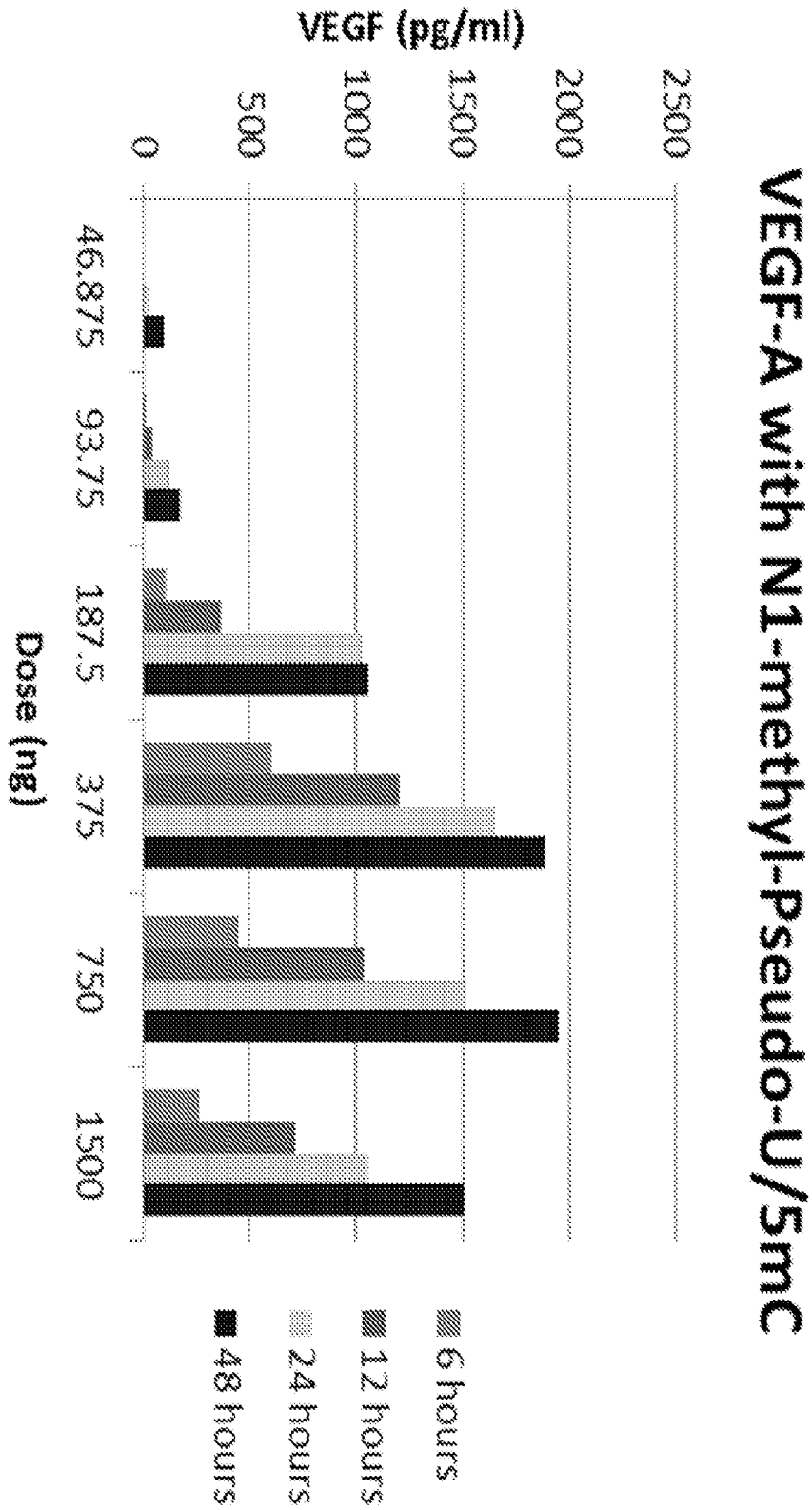

FIGURE 7

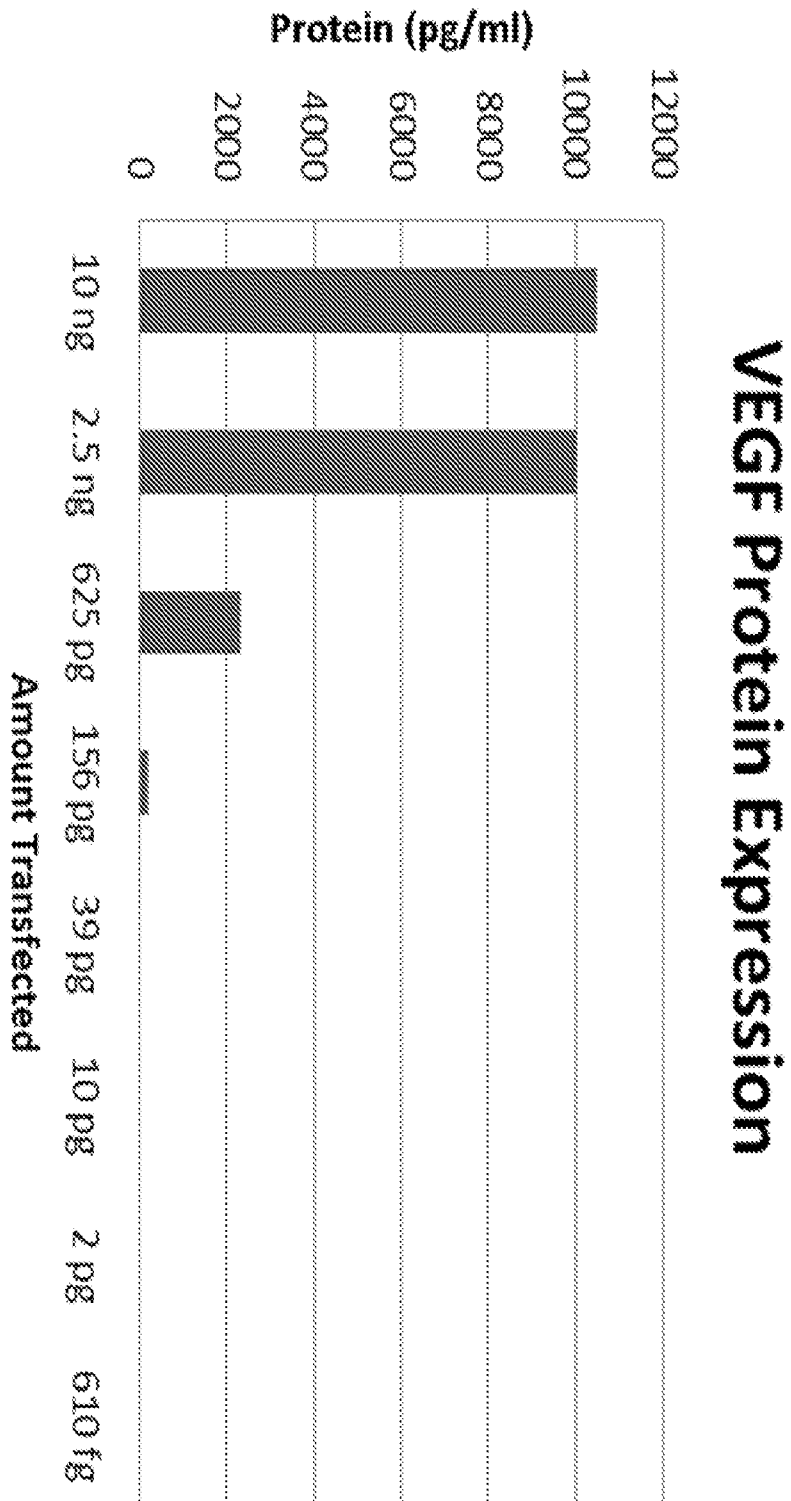

FIGURE 8

A.

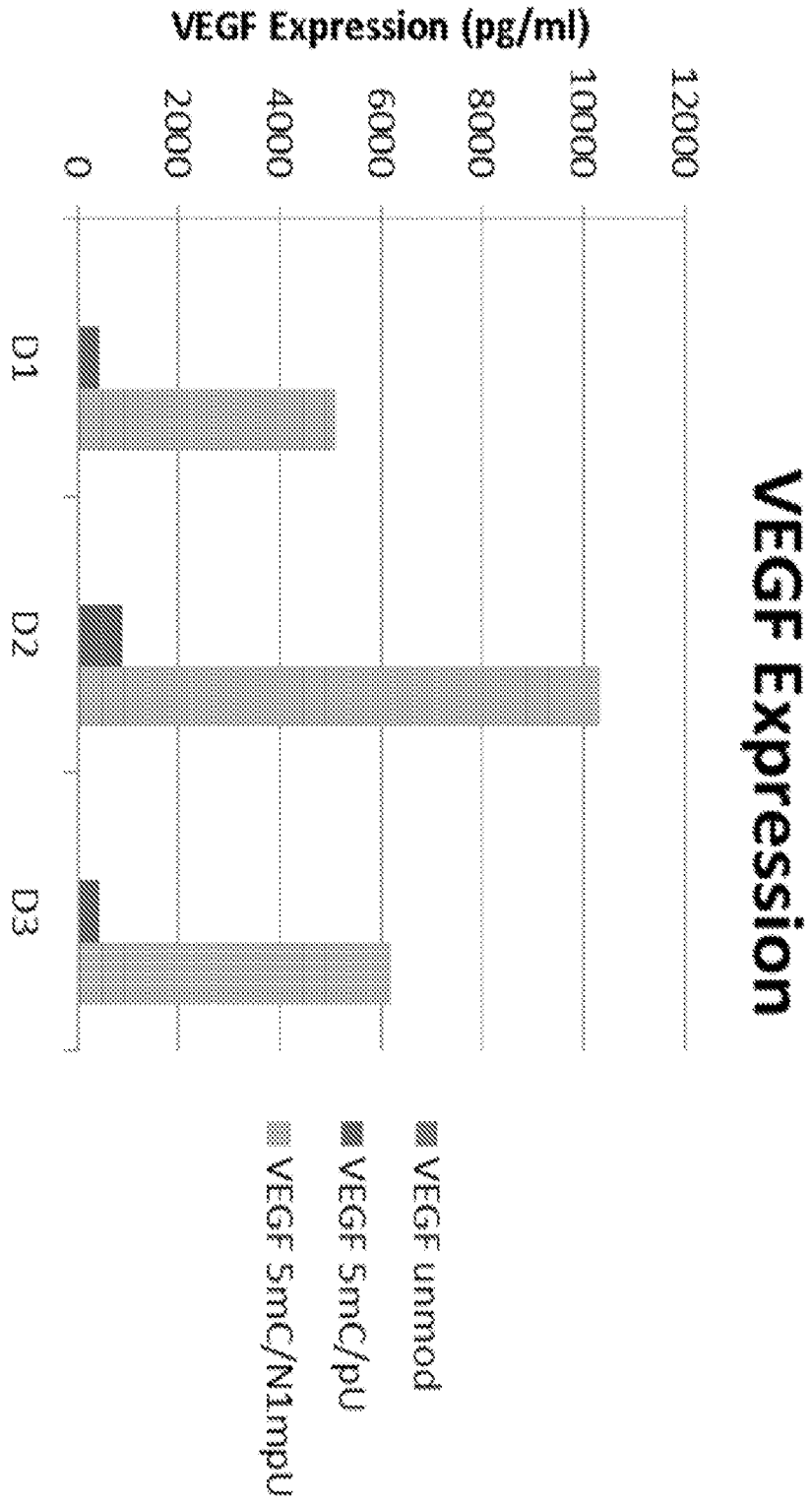

FIGURE 8 CONT.

B.

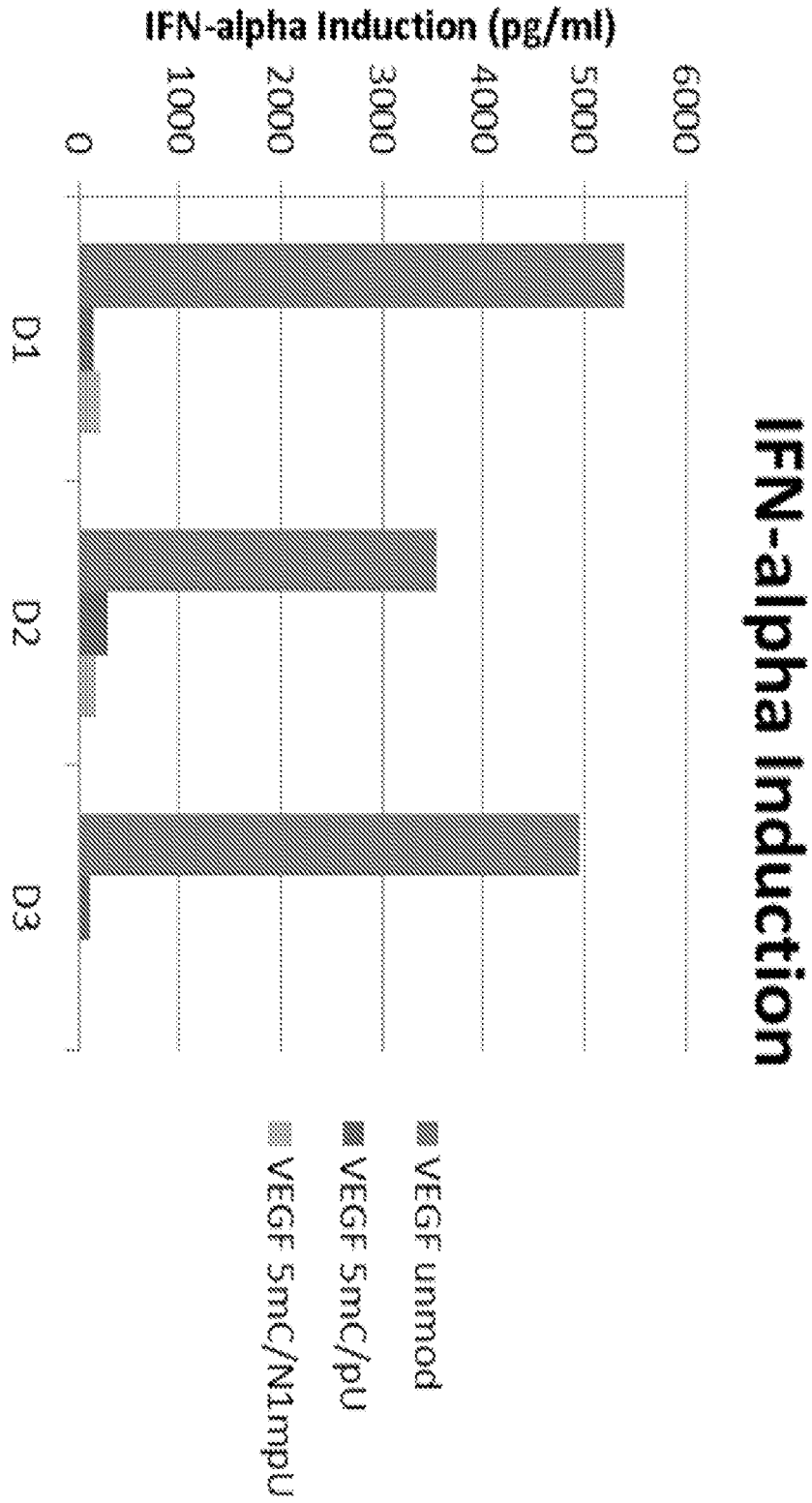

FIGURE 9

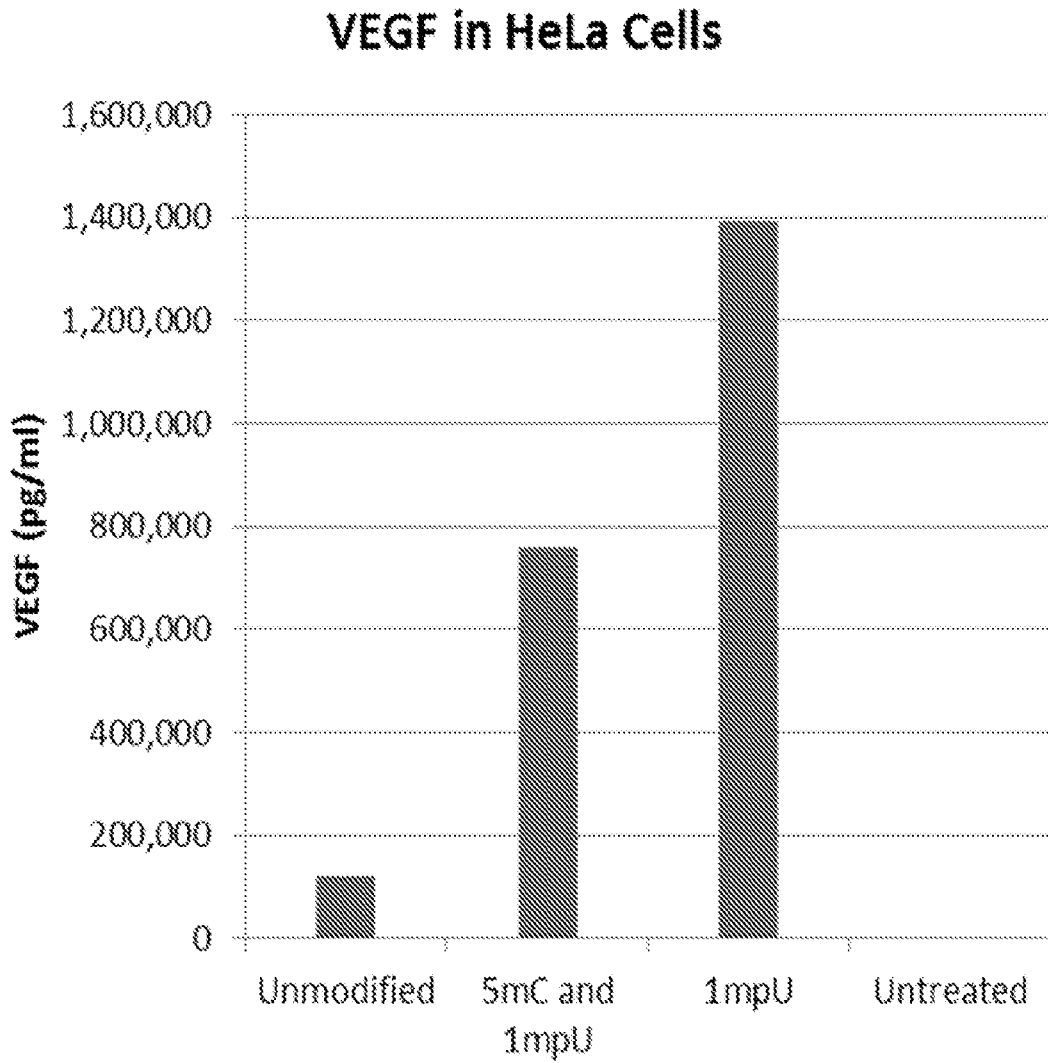

FIGURE 10

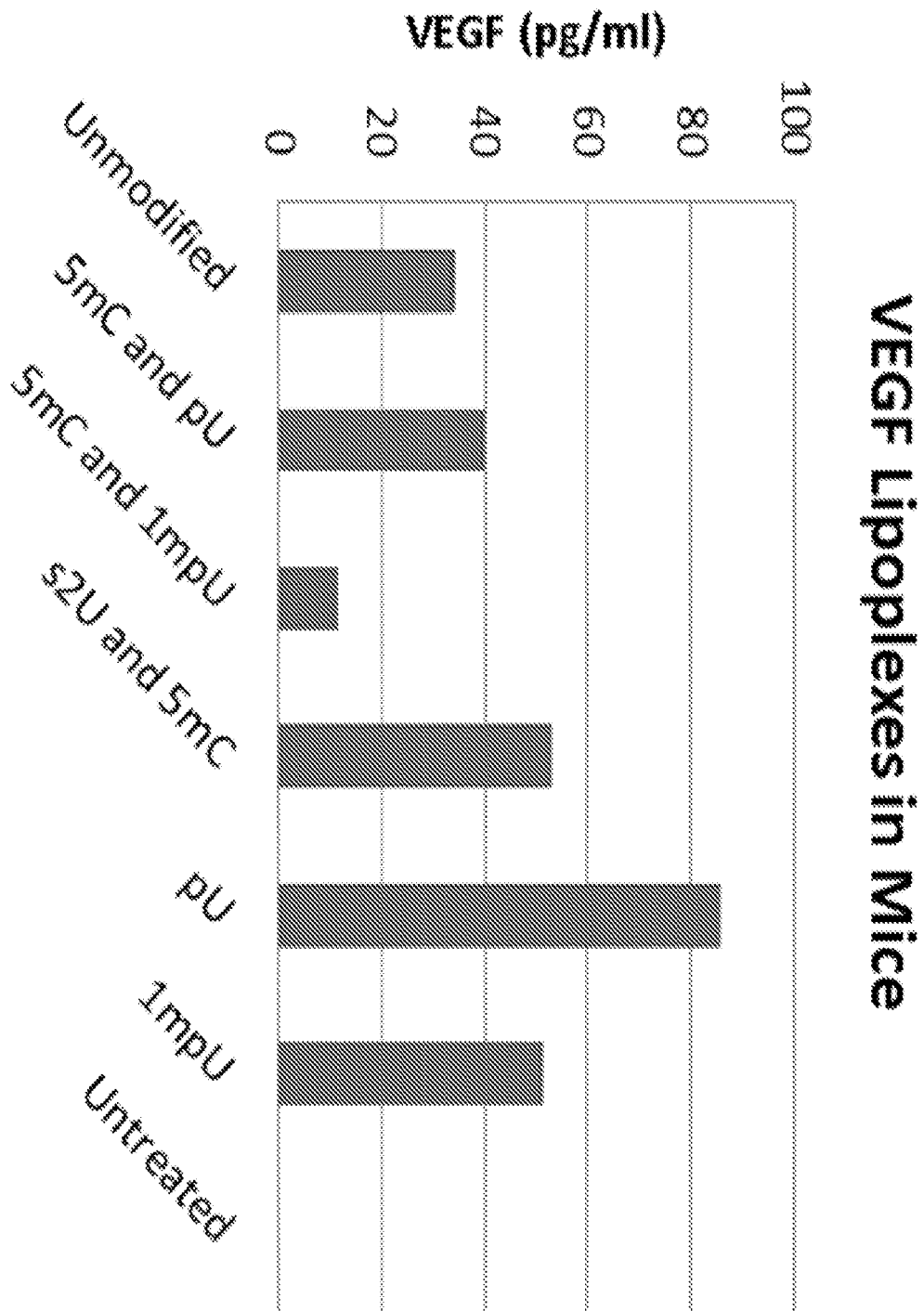

FIGURE 11

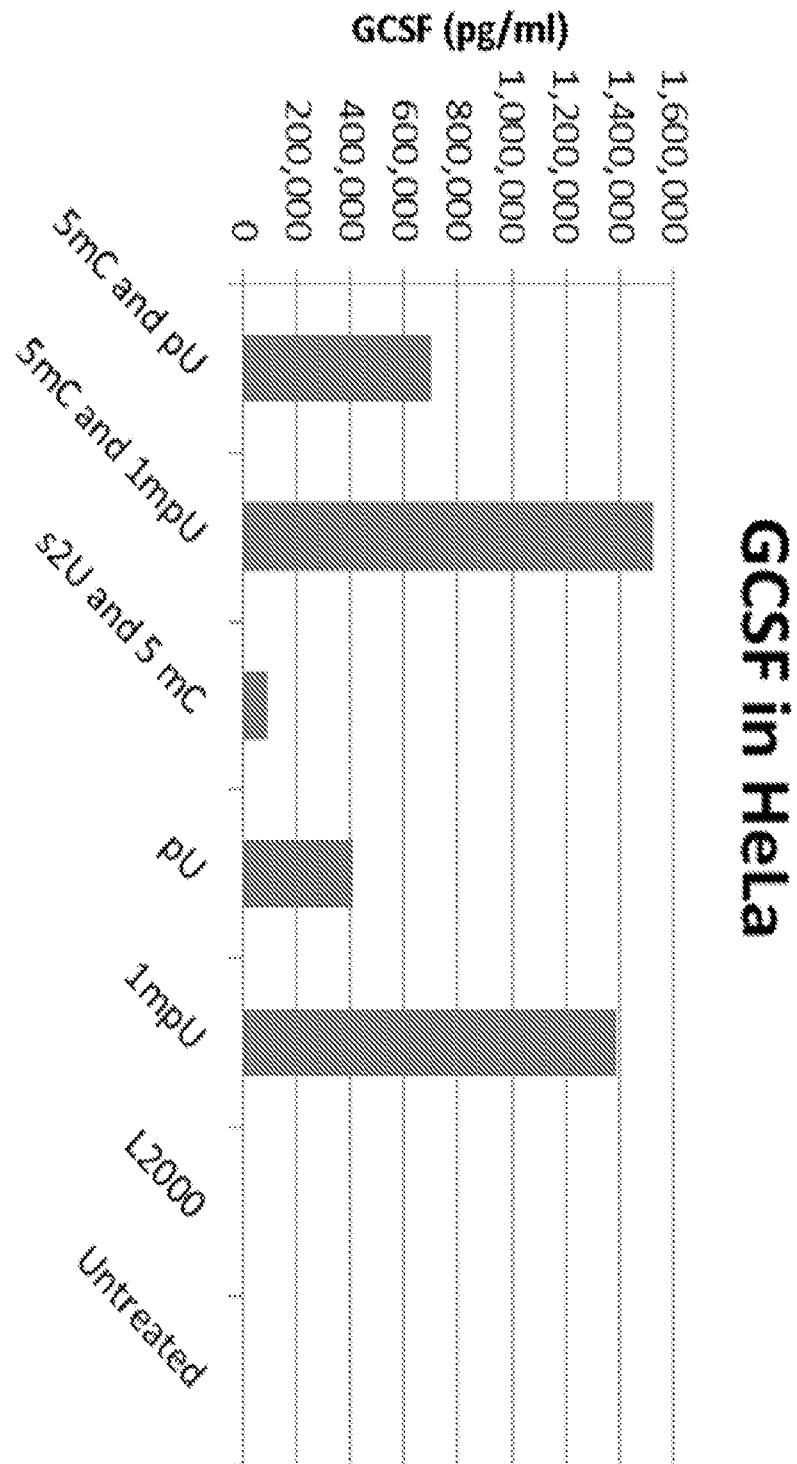

FIGURE 12

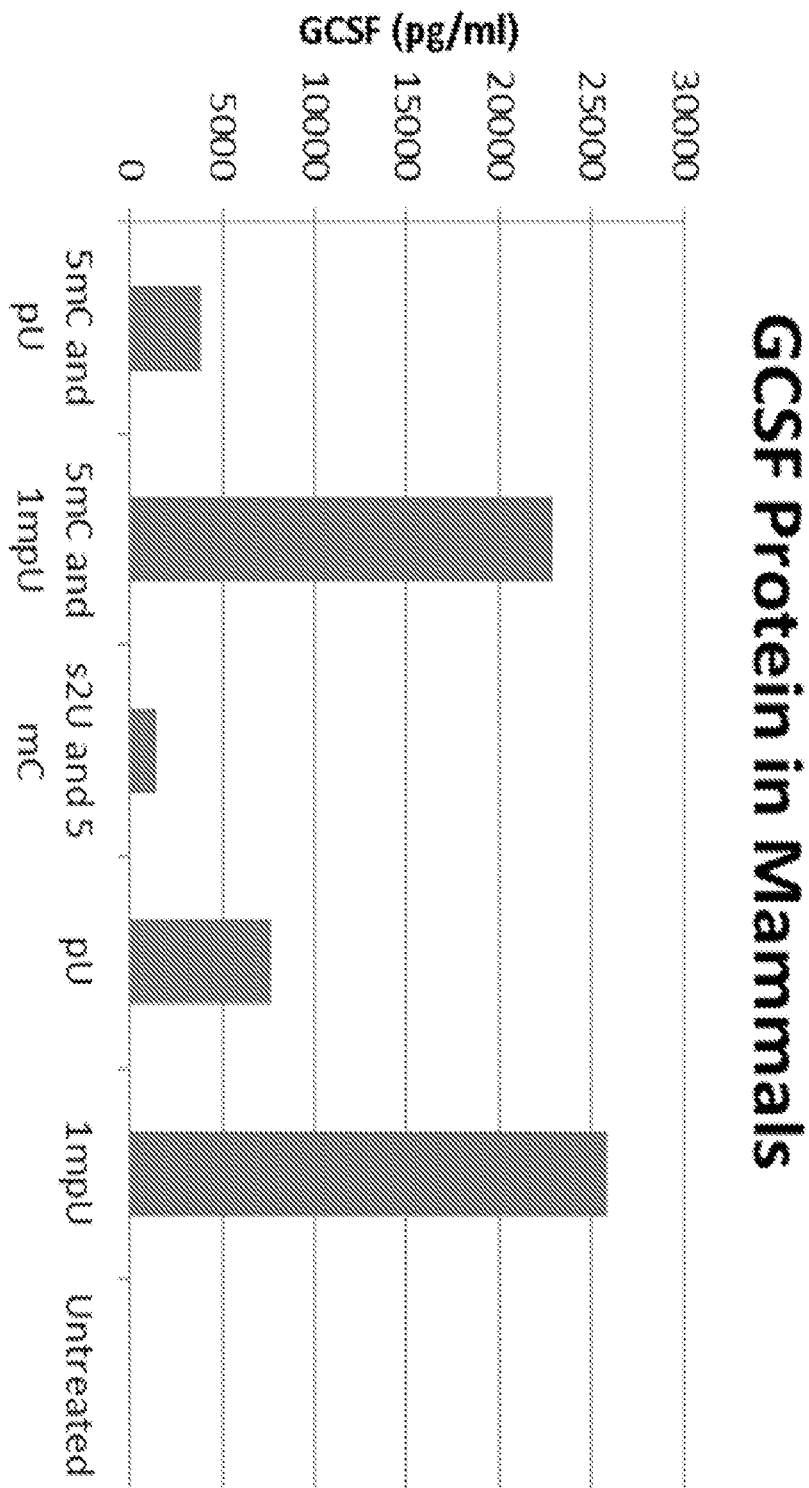

FIGURE 13

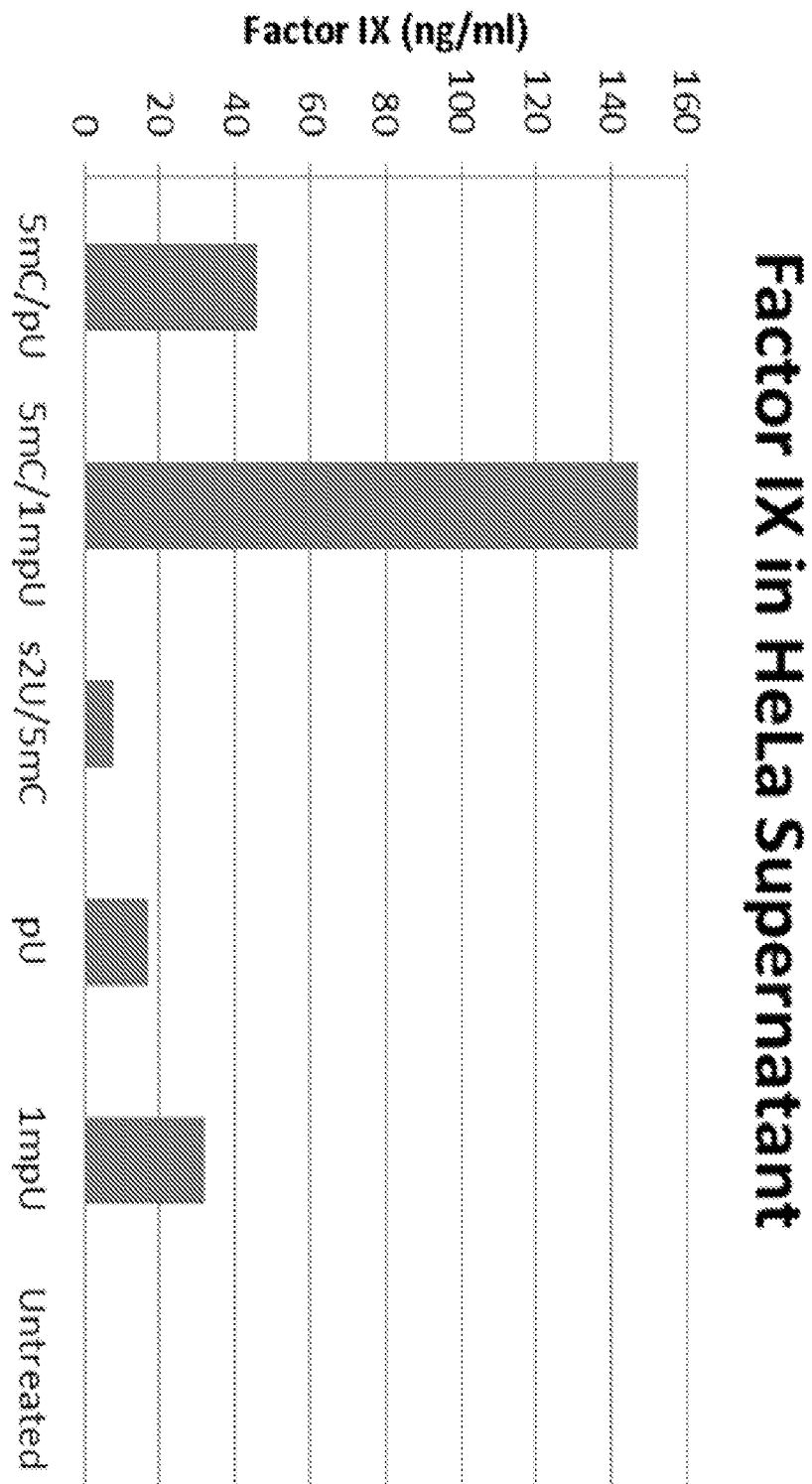

FIGURE 14

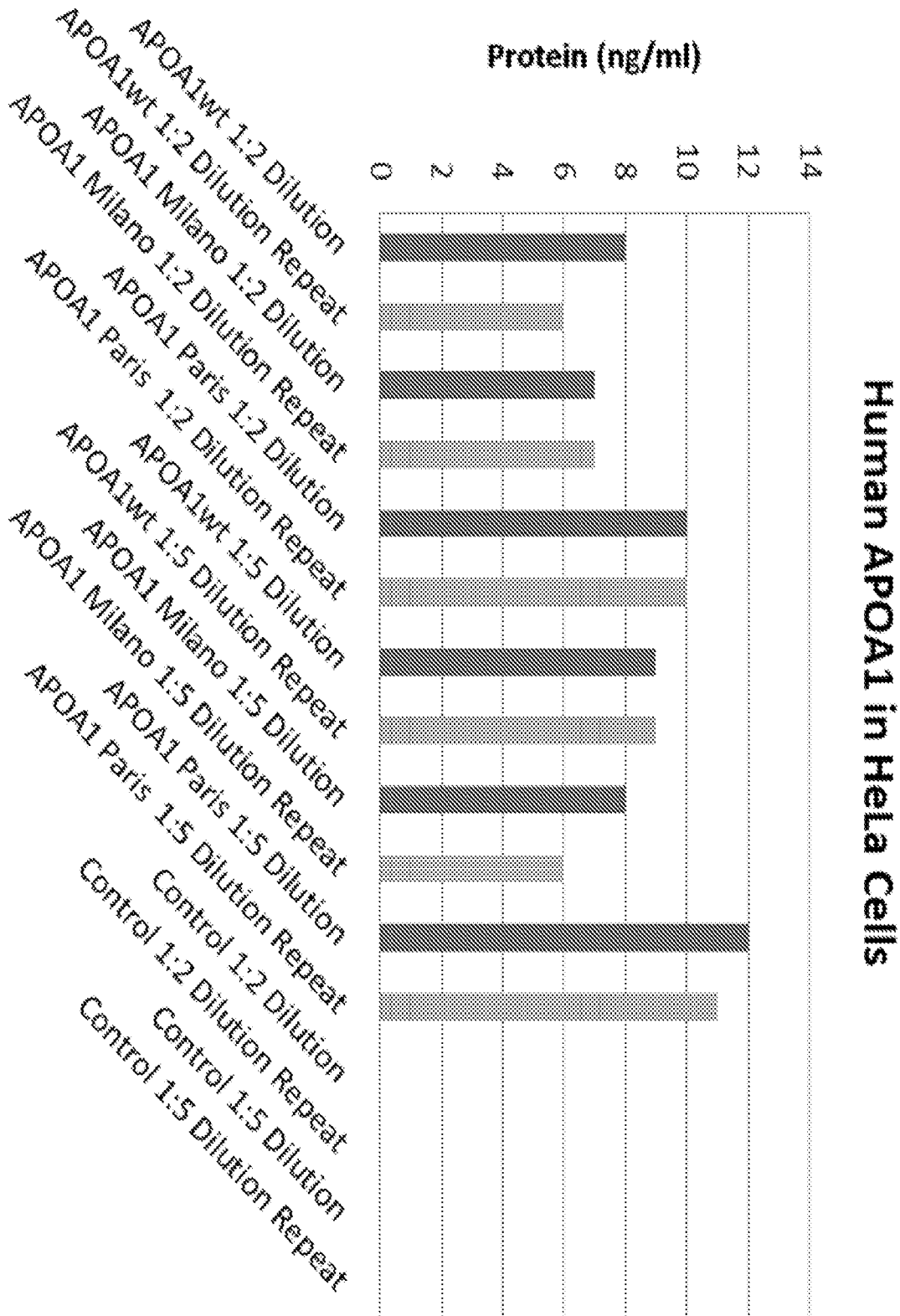

FIGURE 15

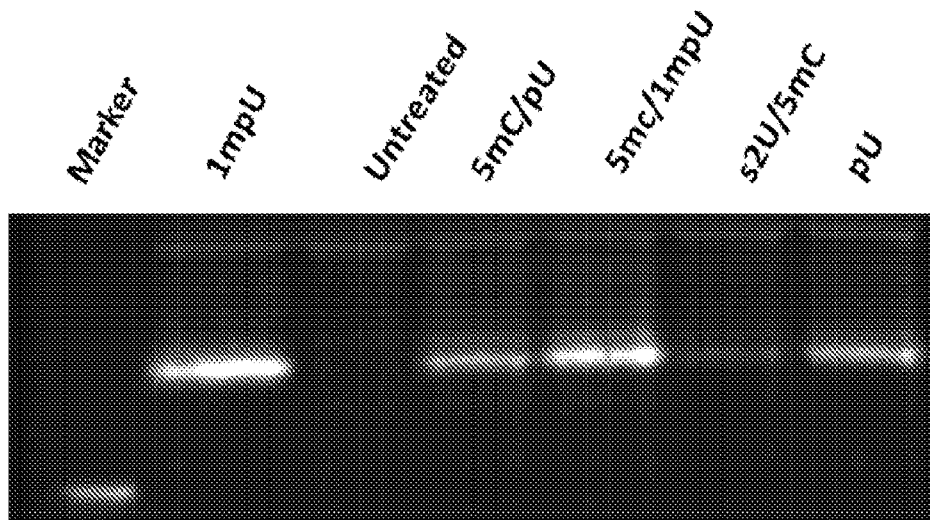

FIGURE 16

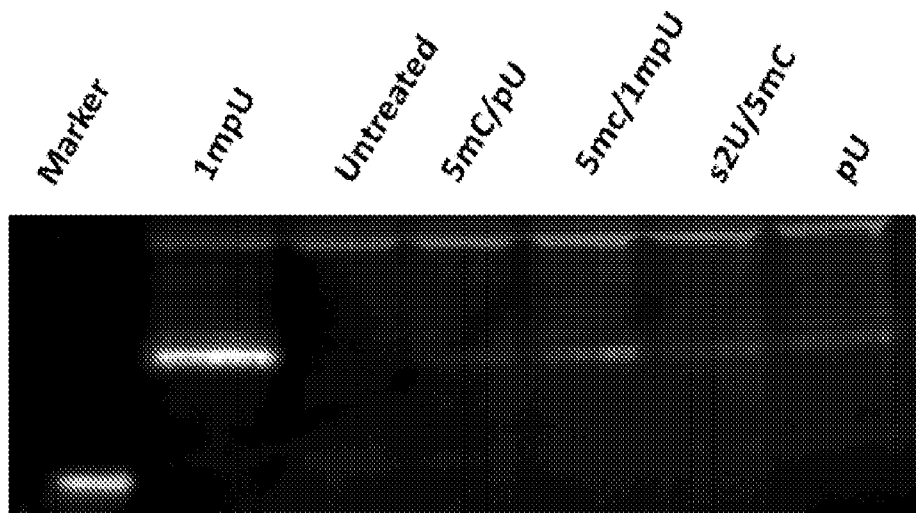

FIGURE 17

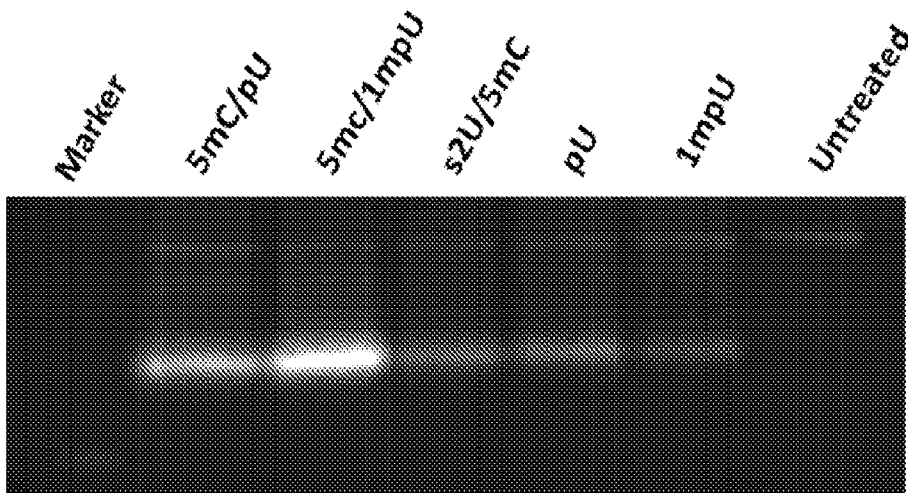

FIGURE 18

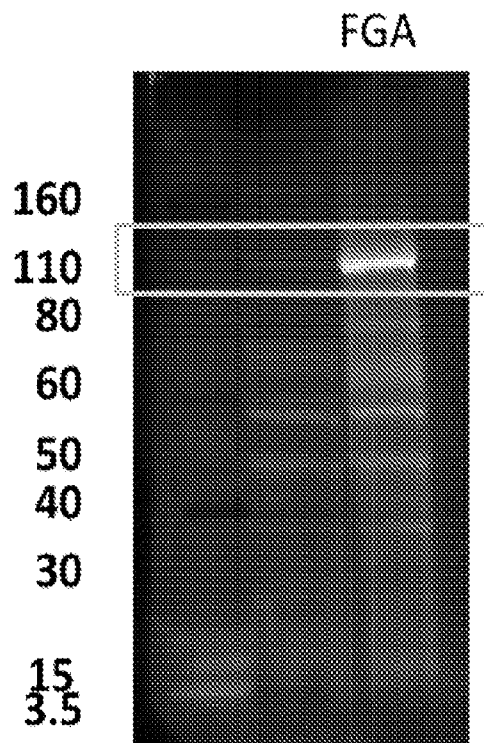

FIGURE 19

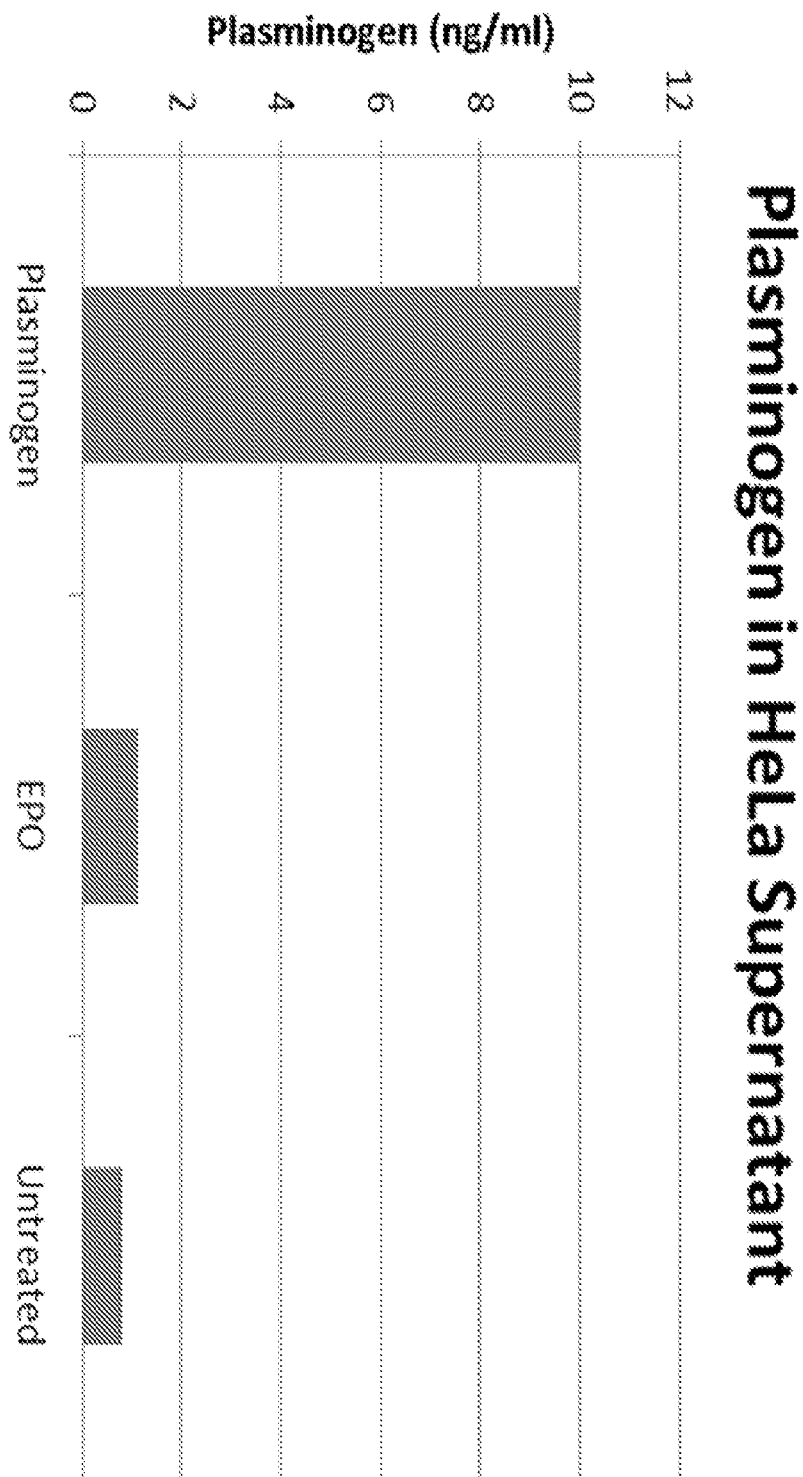

FIGURE 20

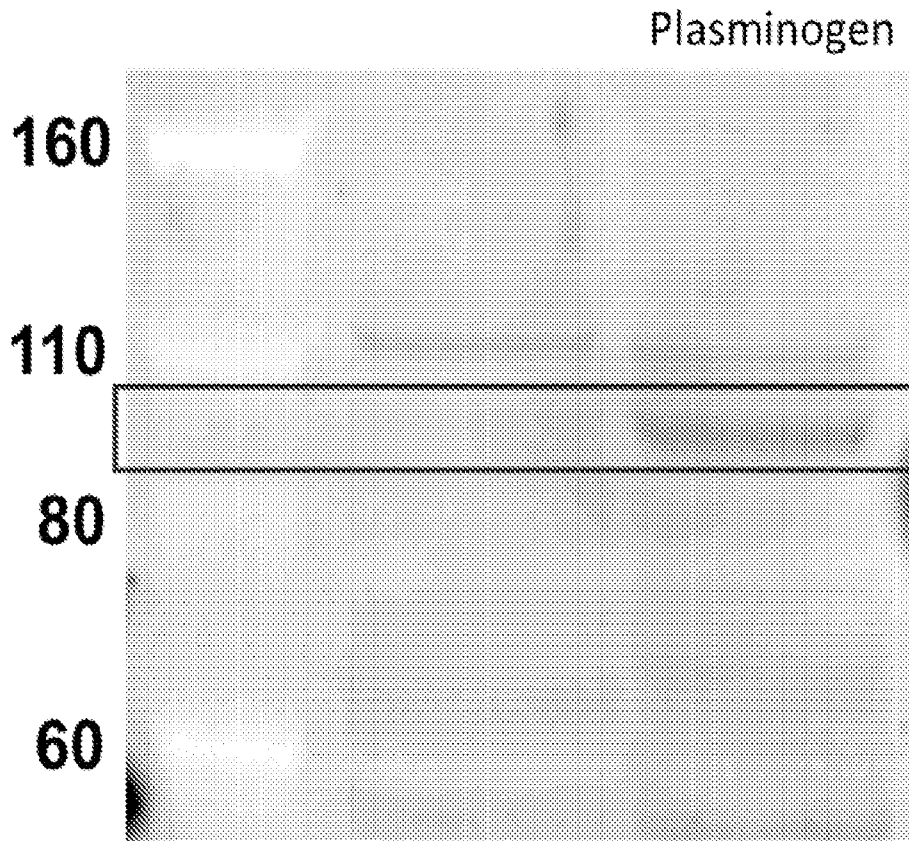

FIGURE 21

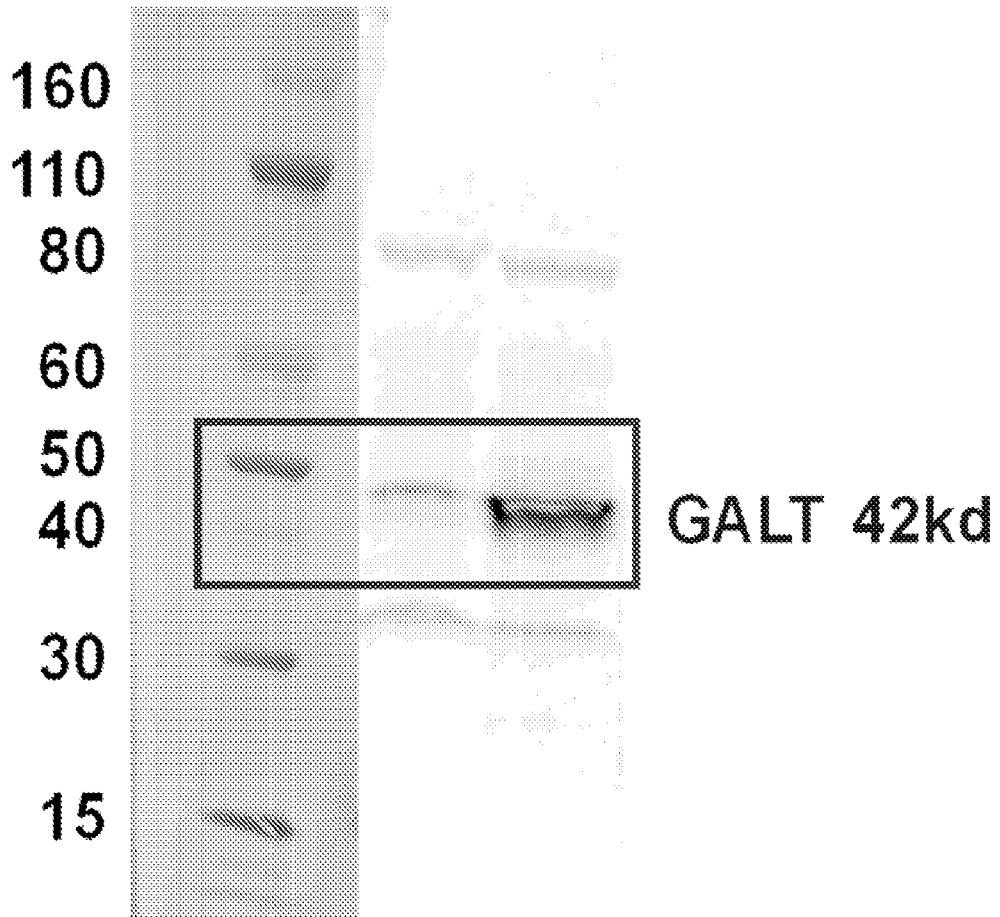

FIGURE 22

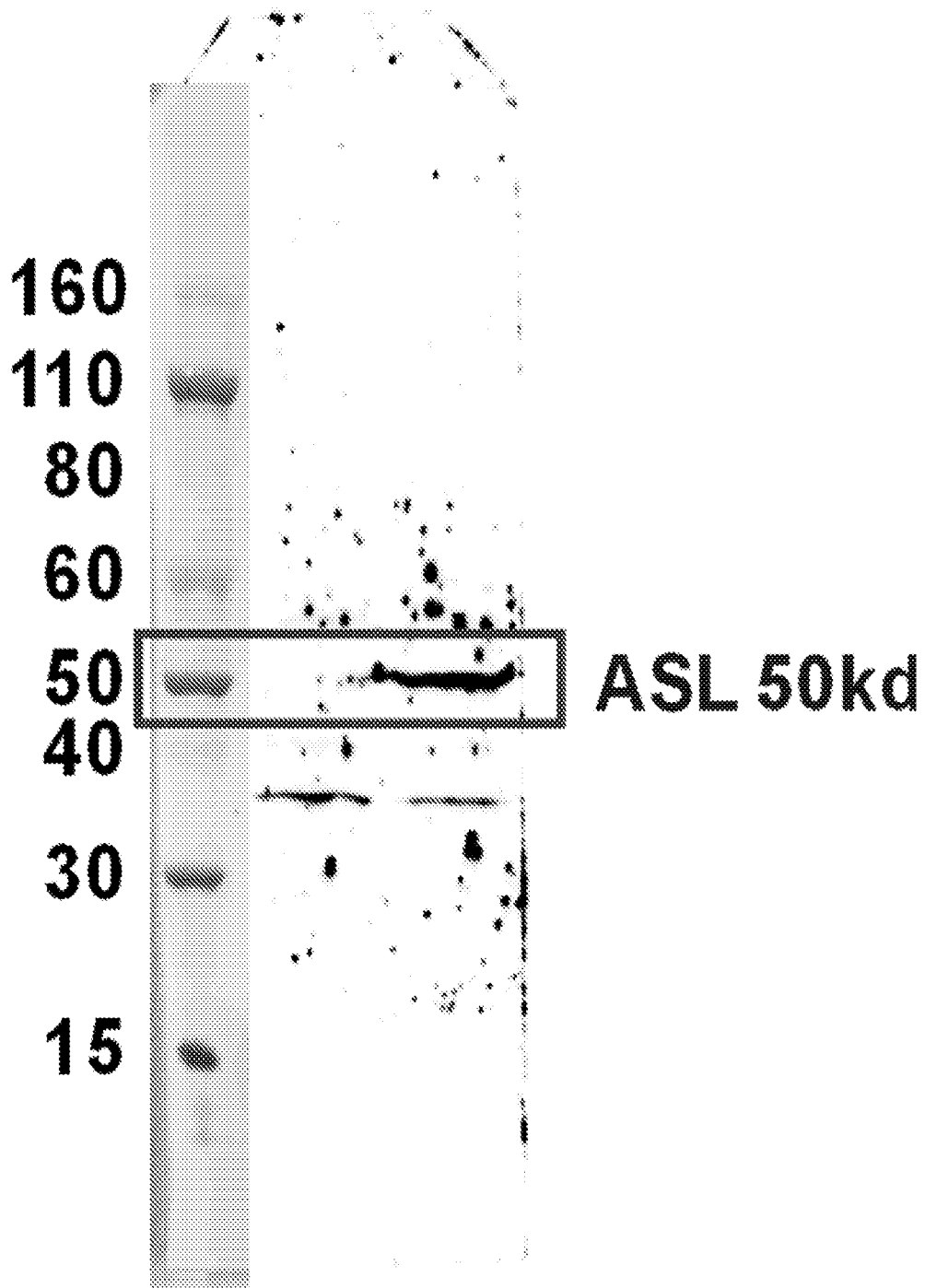

FIGURE 23



FIGURE 24

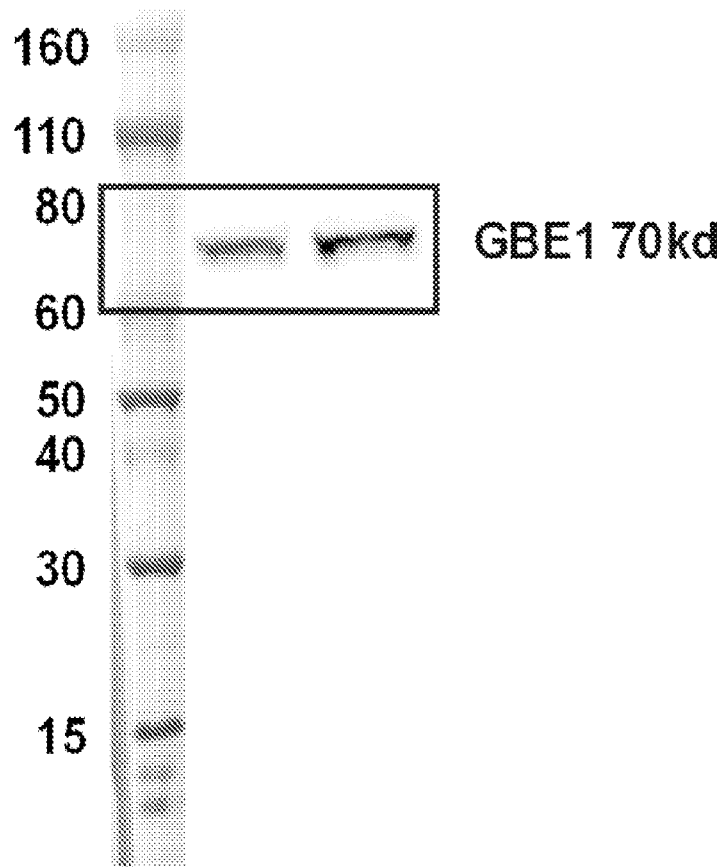

FIGURE 25

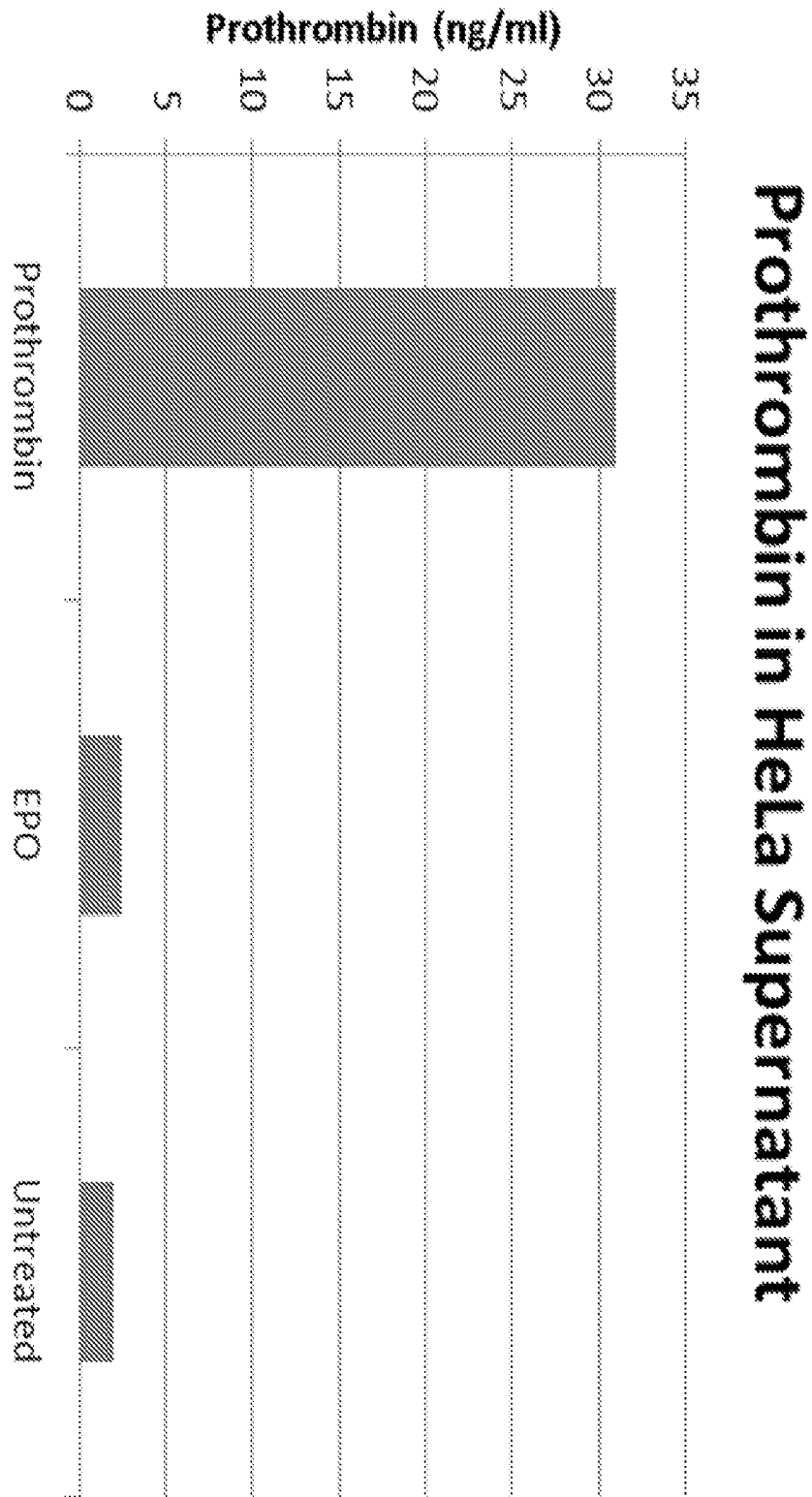

FIGURE 26

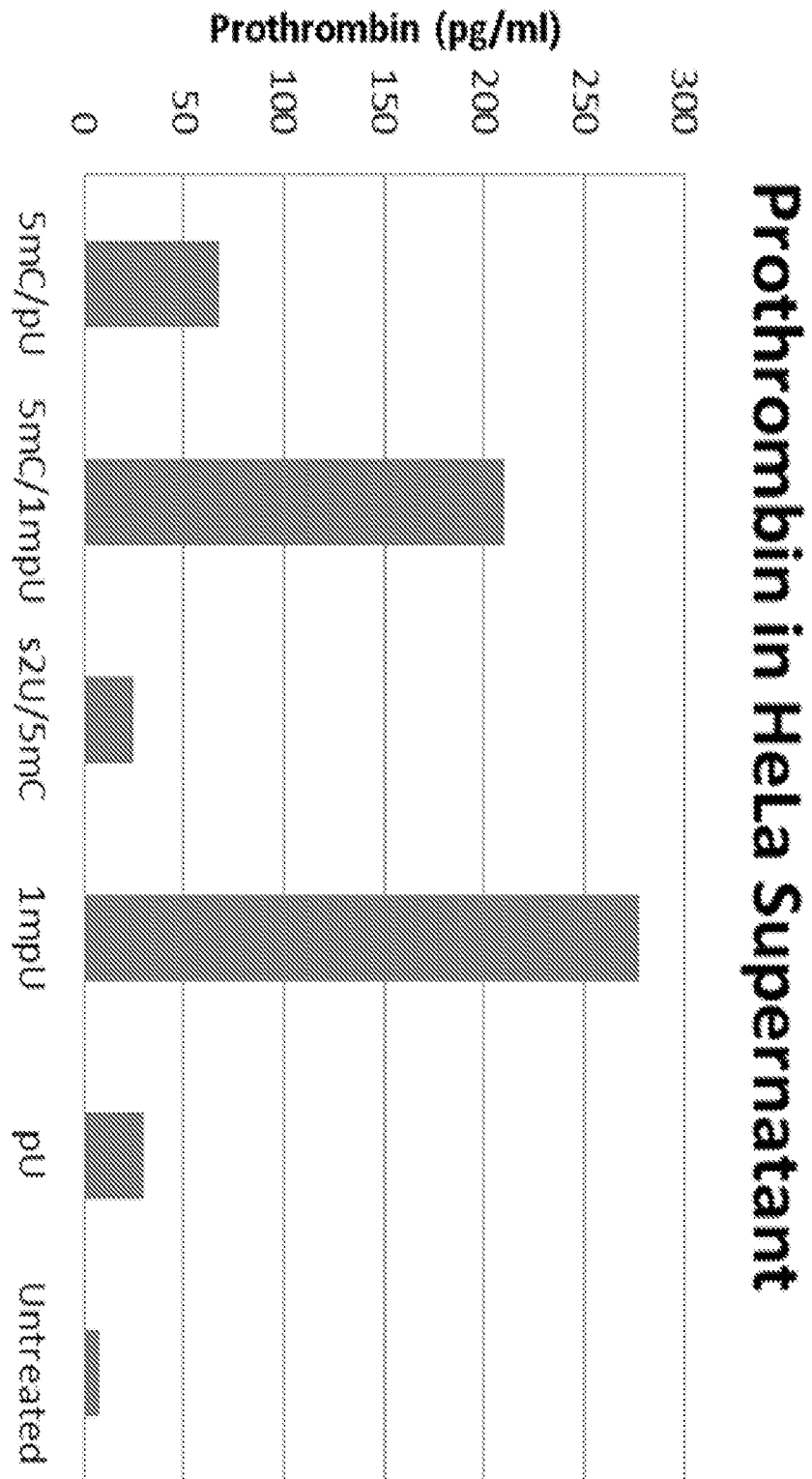

FIGURE 27

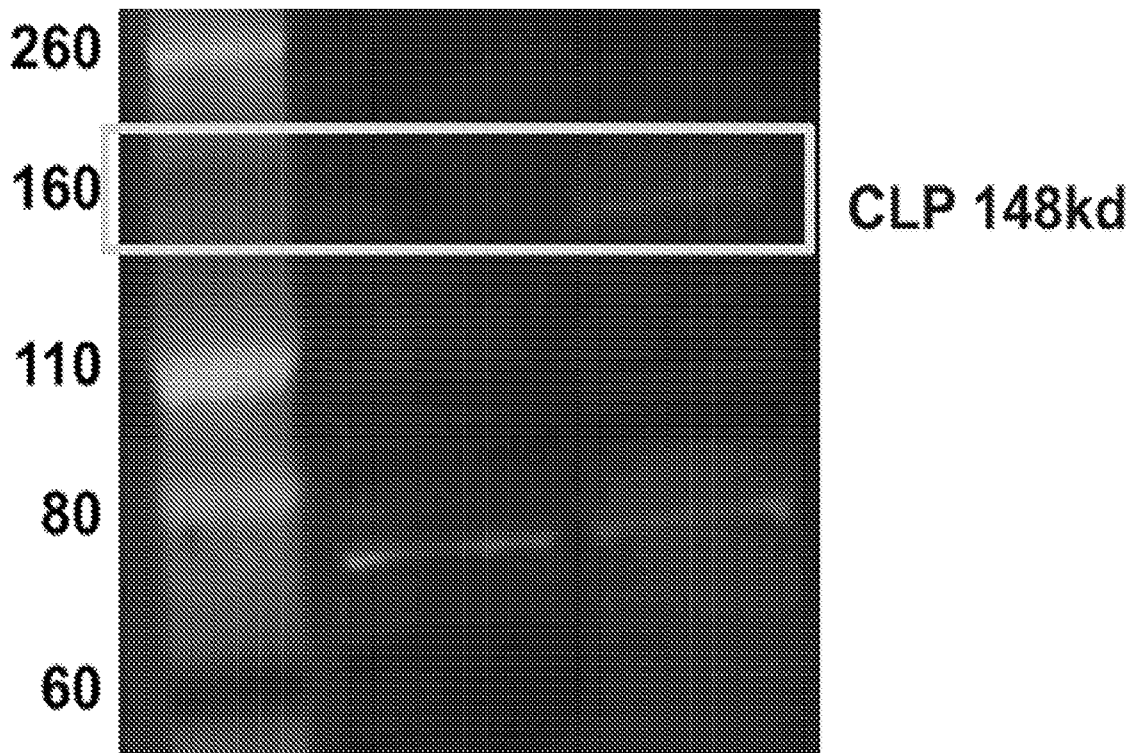

FIGURE 28

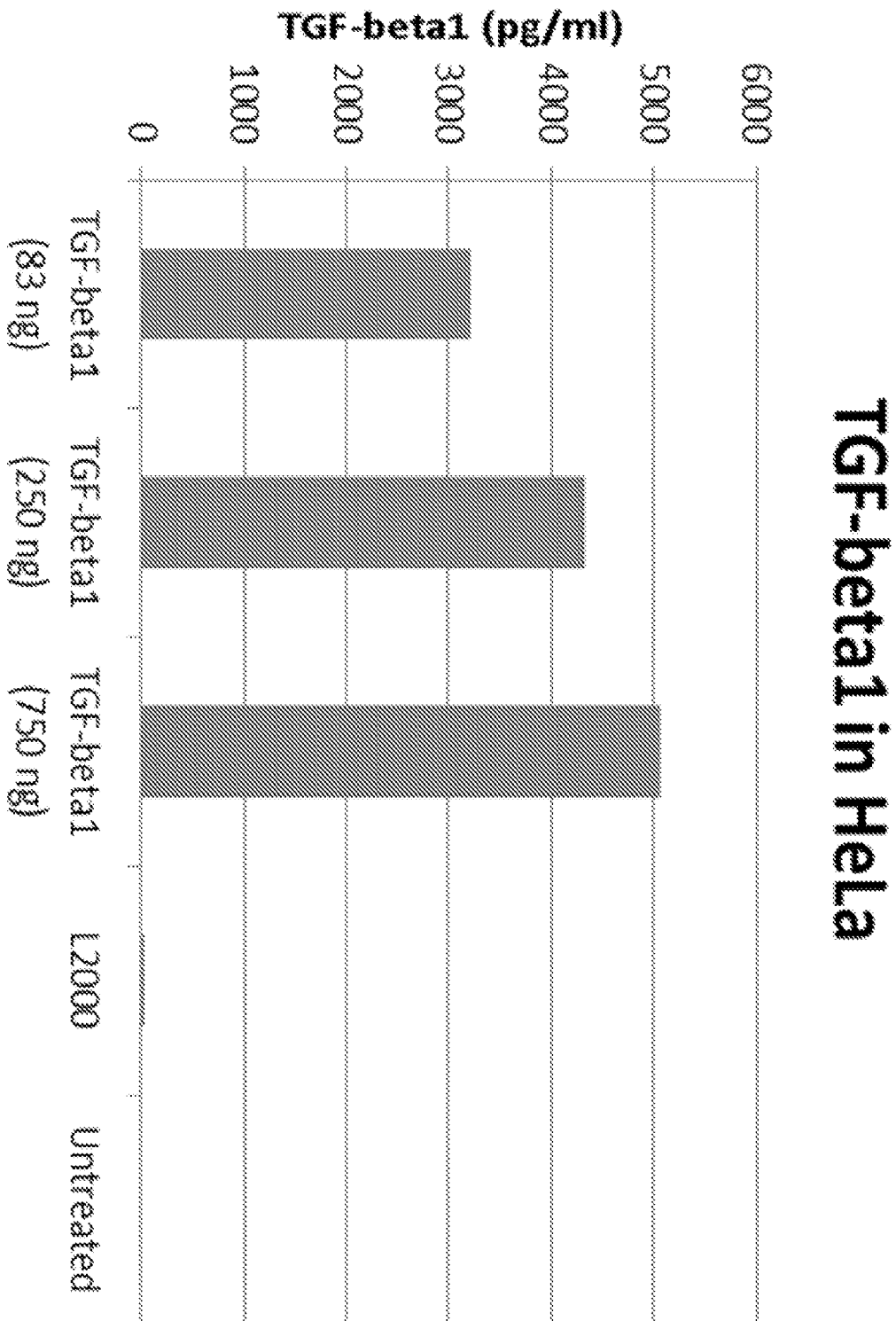

FIGURE 29

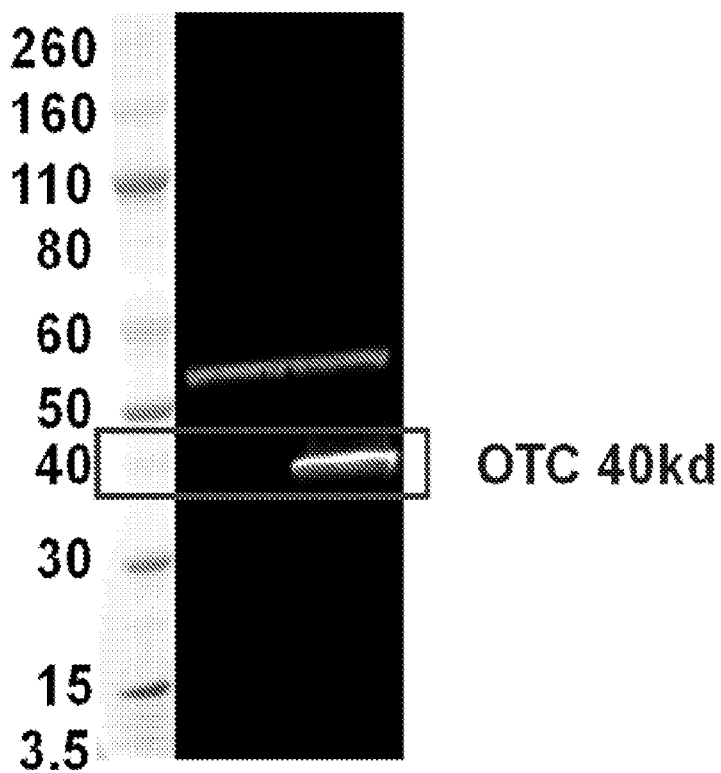

FIGURE 30

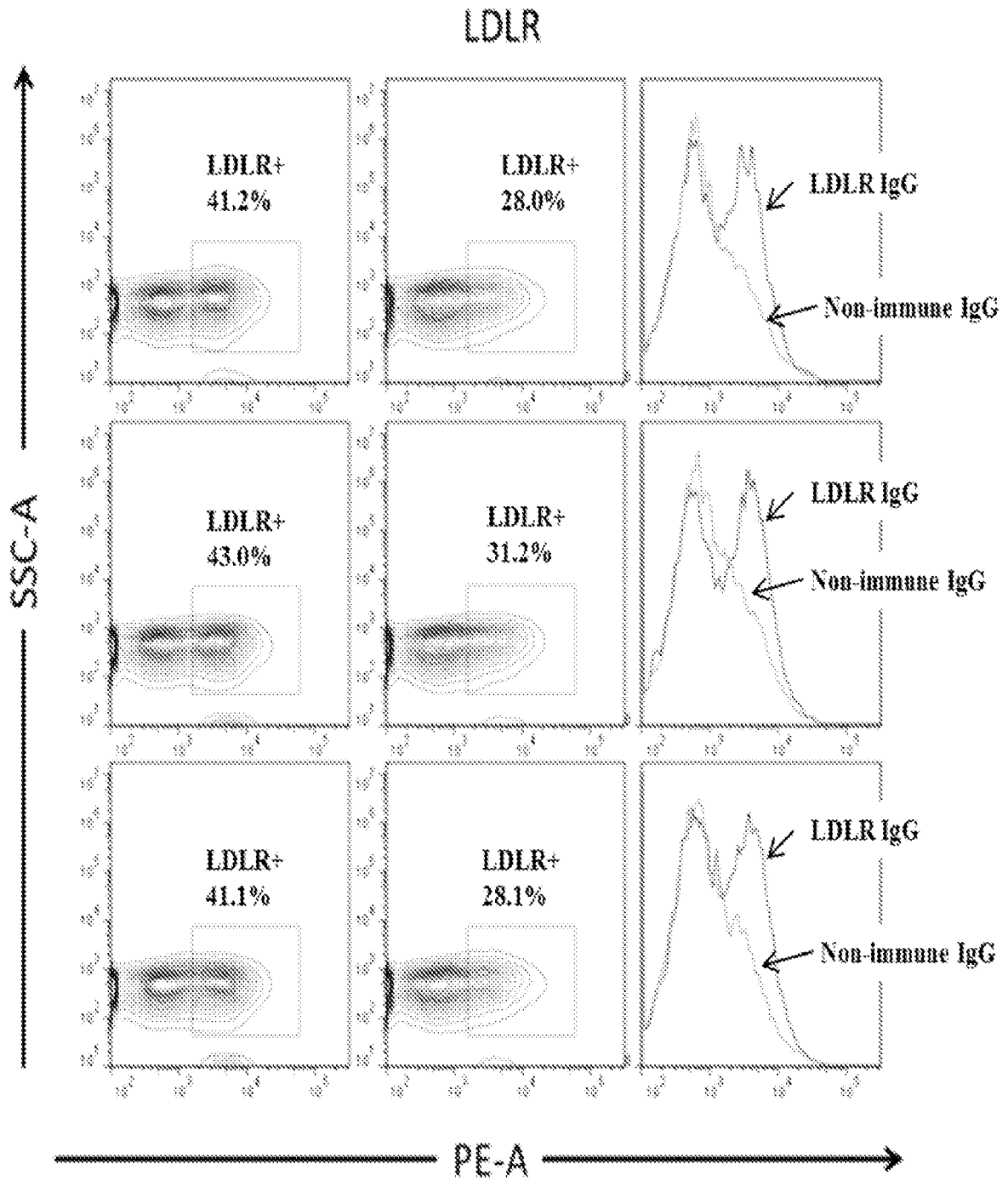

FIGURE 31

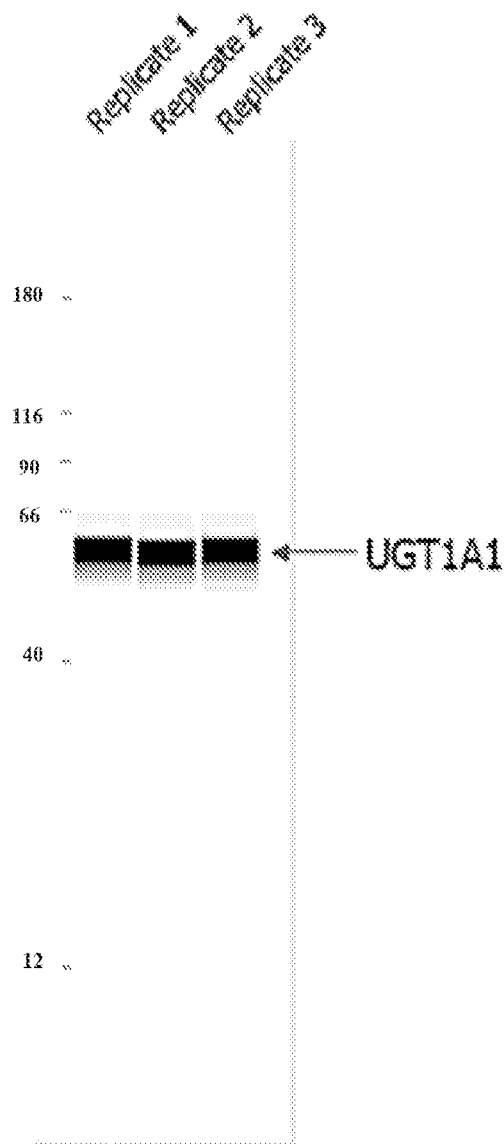

FIGURE 32

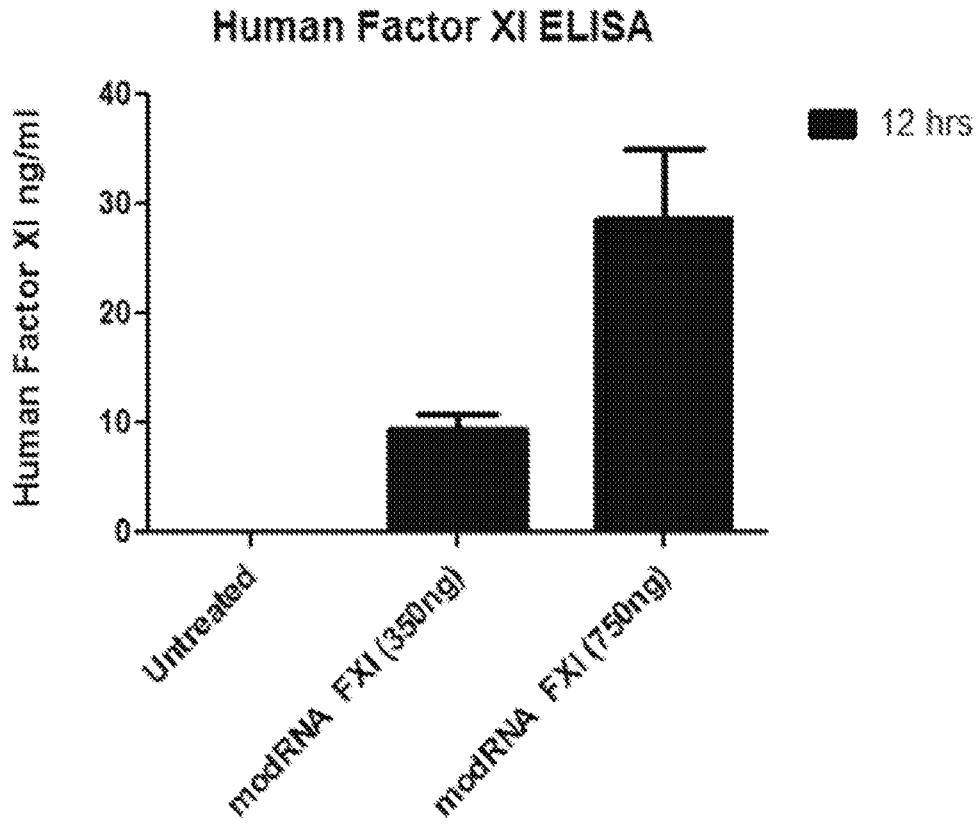

FIGURE 33

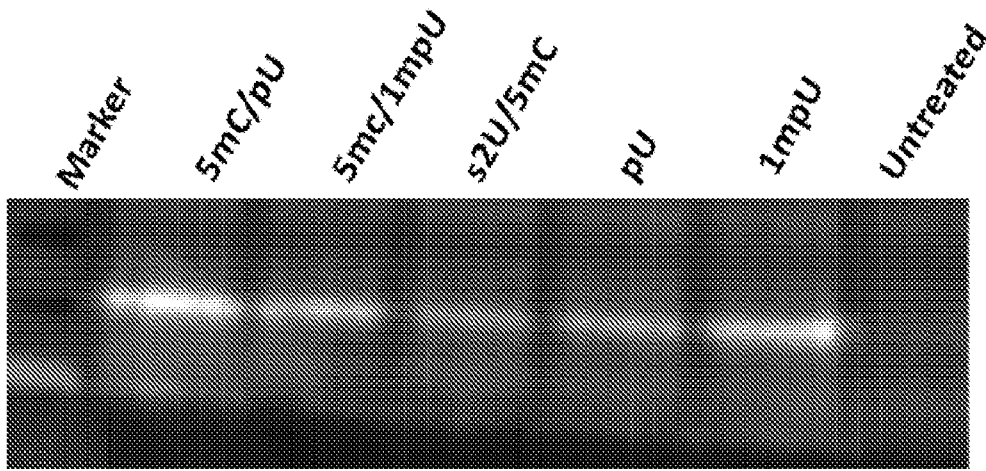

FIGURE 34

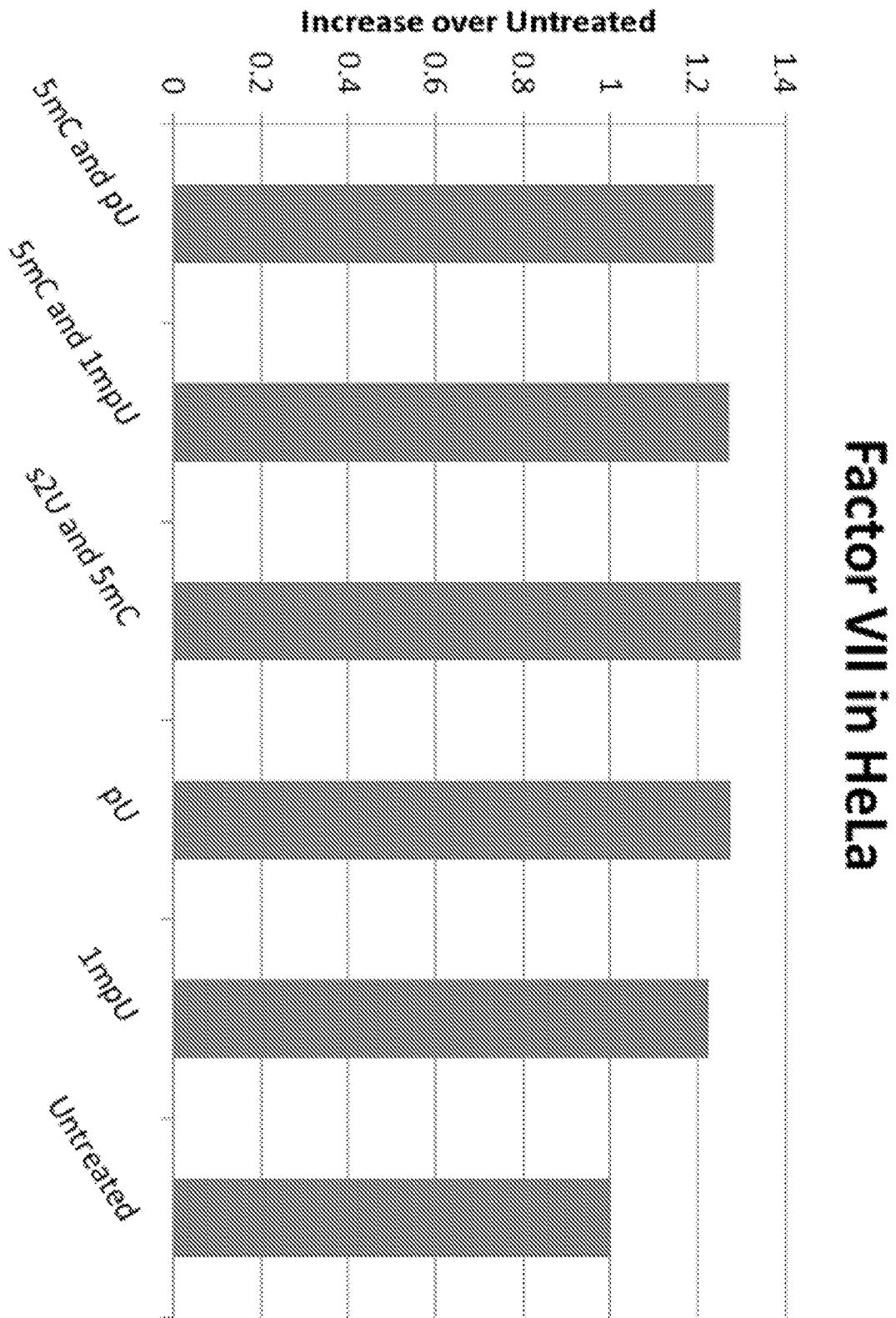

FIGURE 35

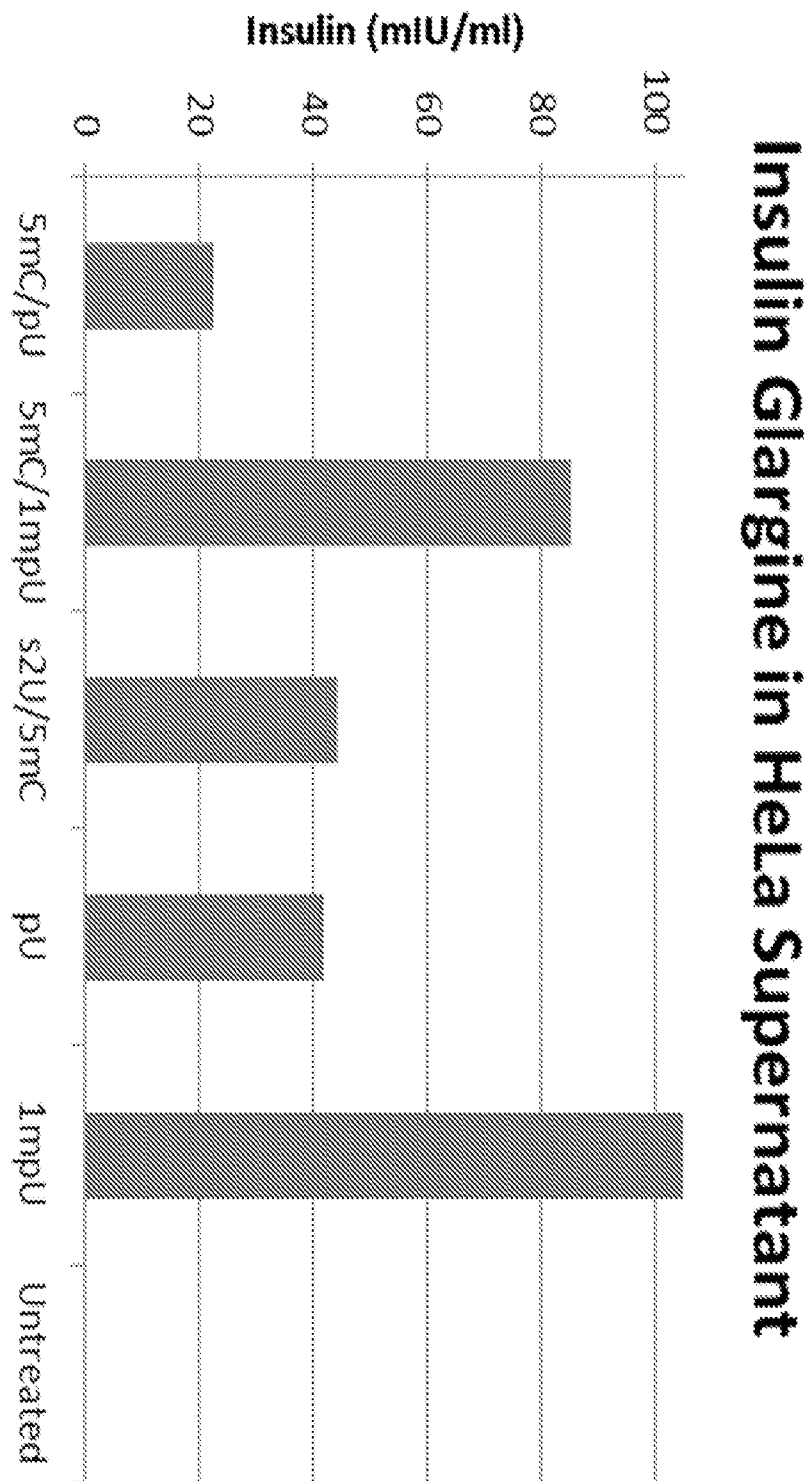

FIGURE 36

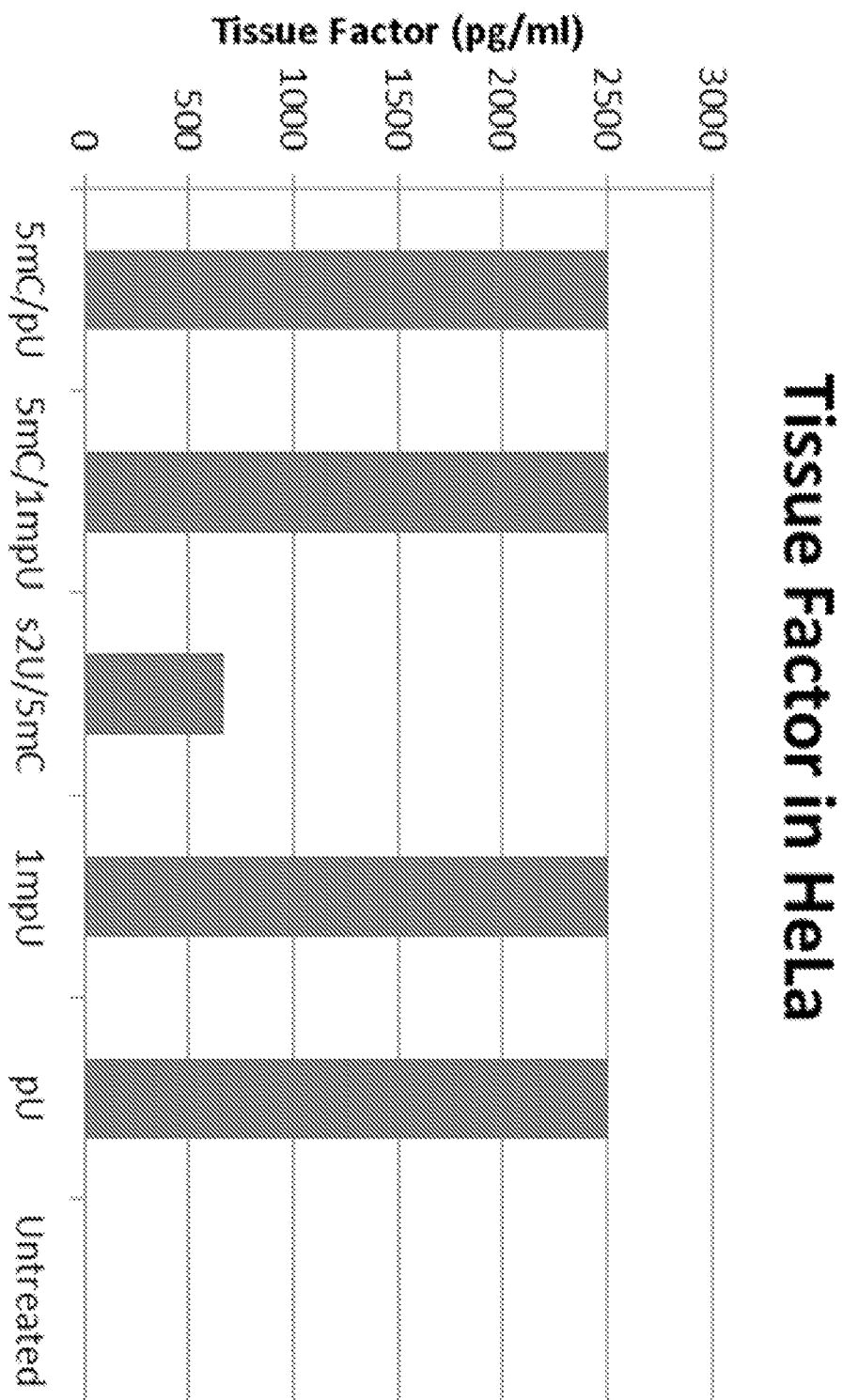
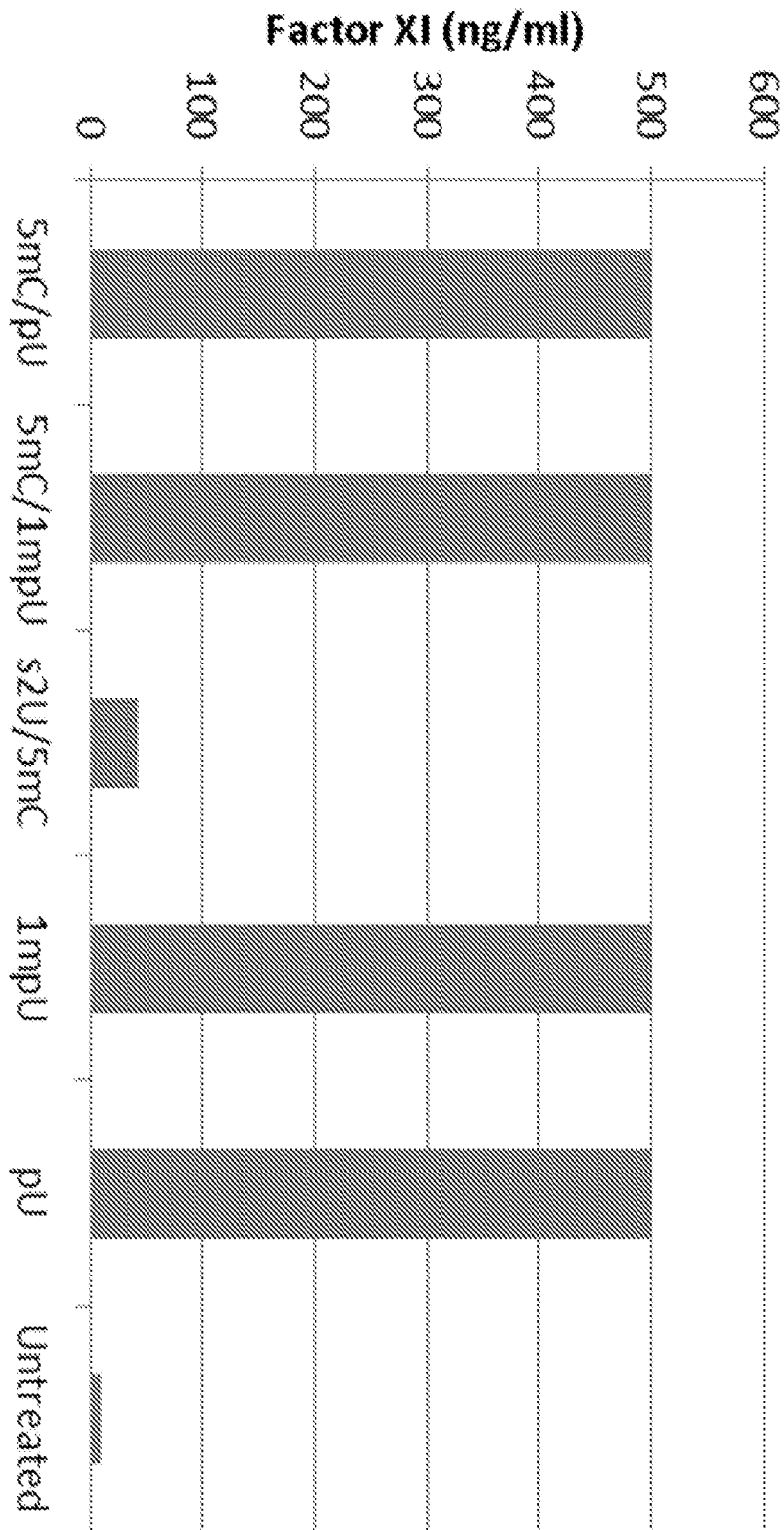

FIGURE 37



Factor XI in HeLa

FIGURE 38

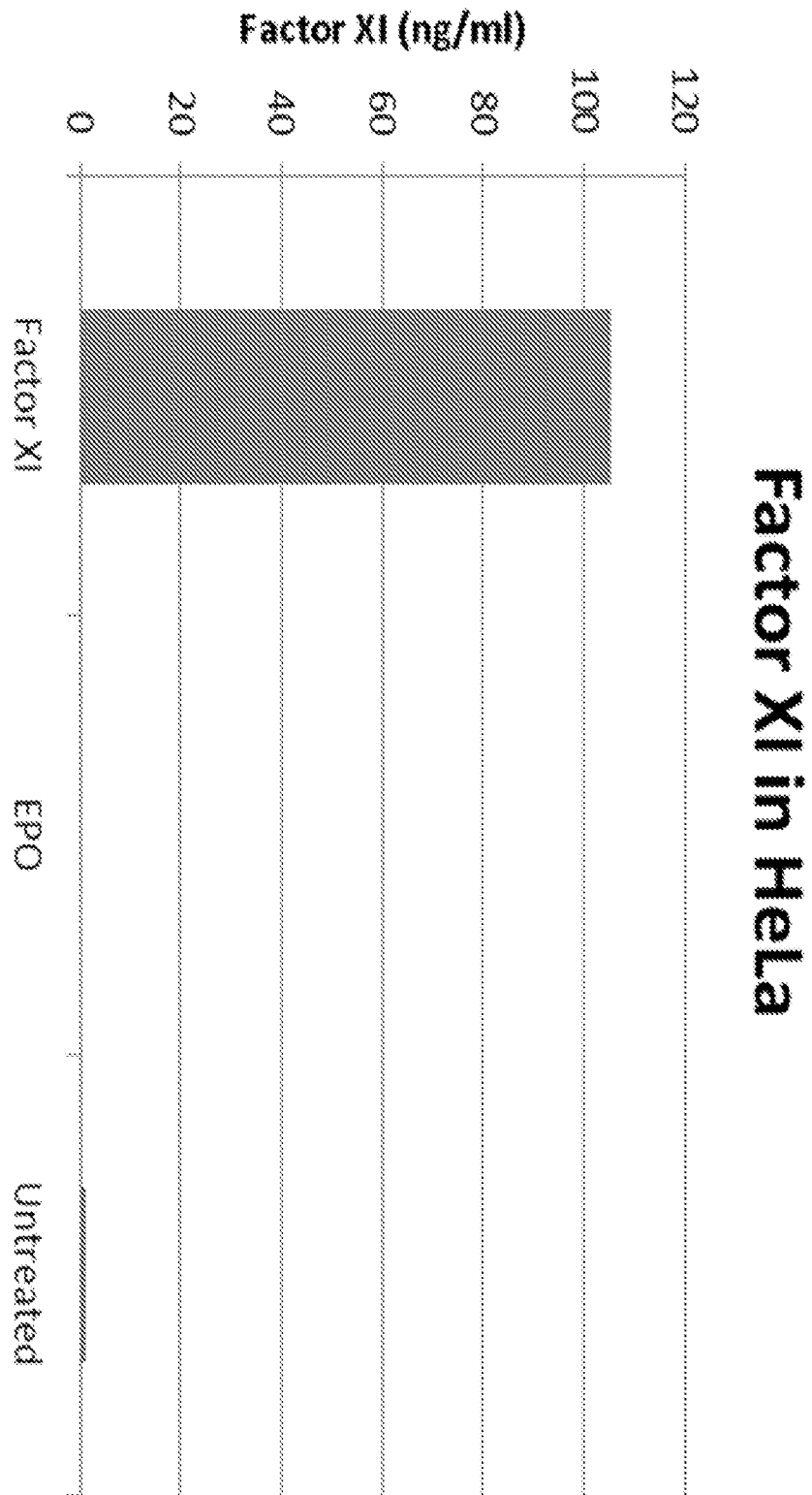

FIGURE 39

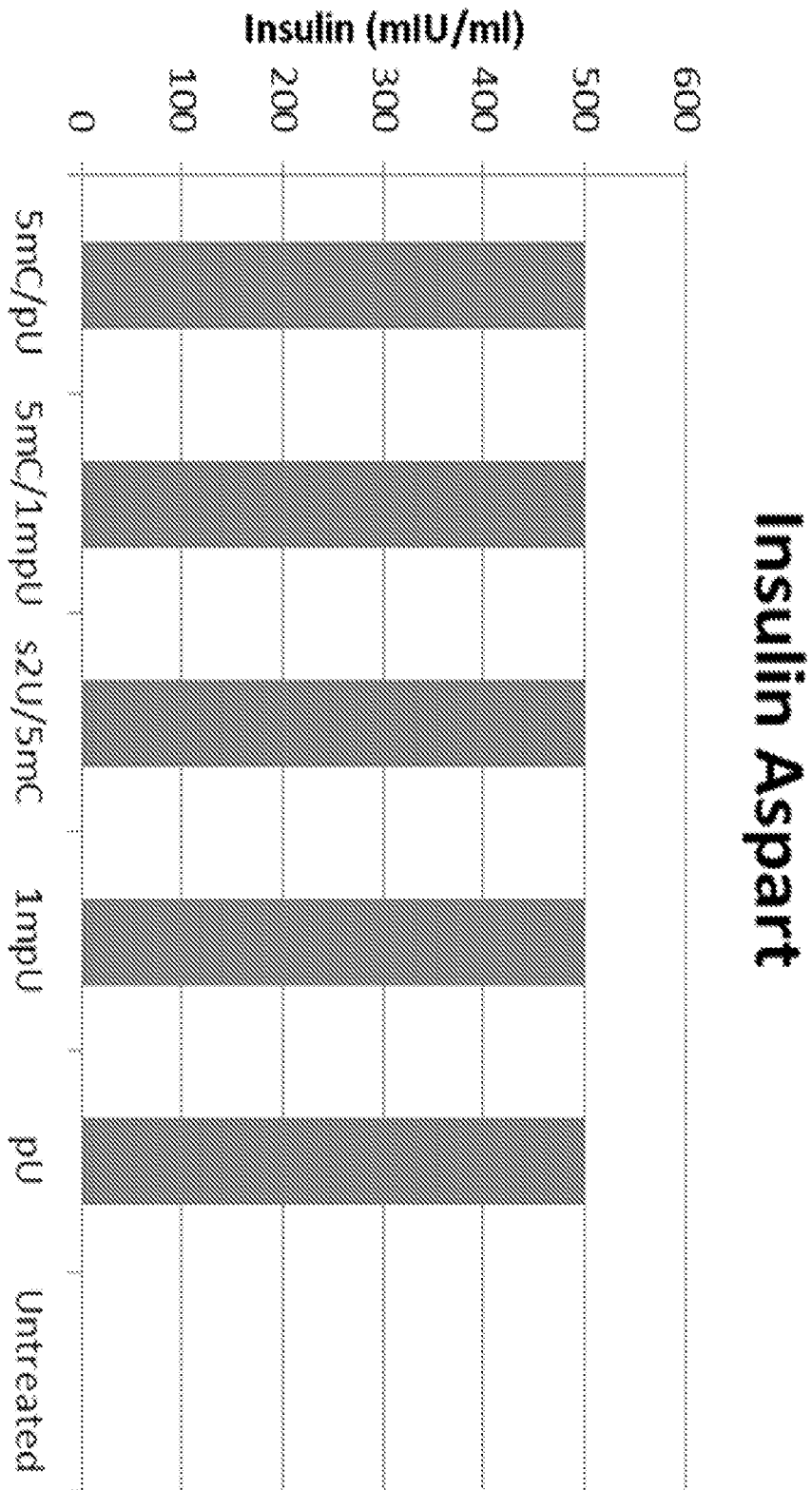

FIGURE 40

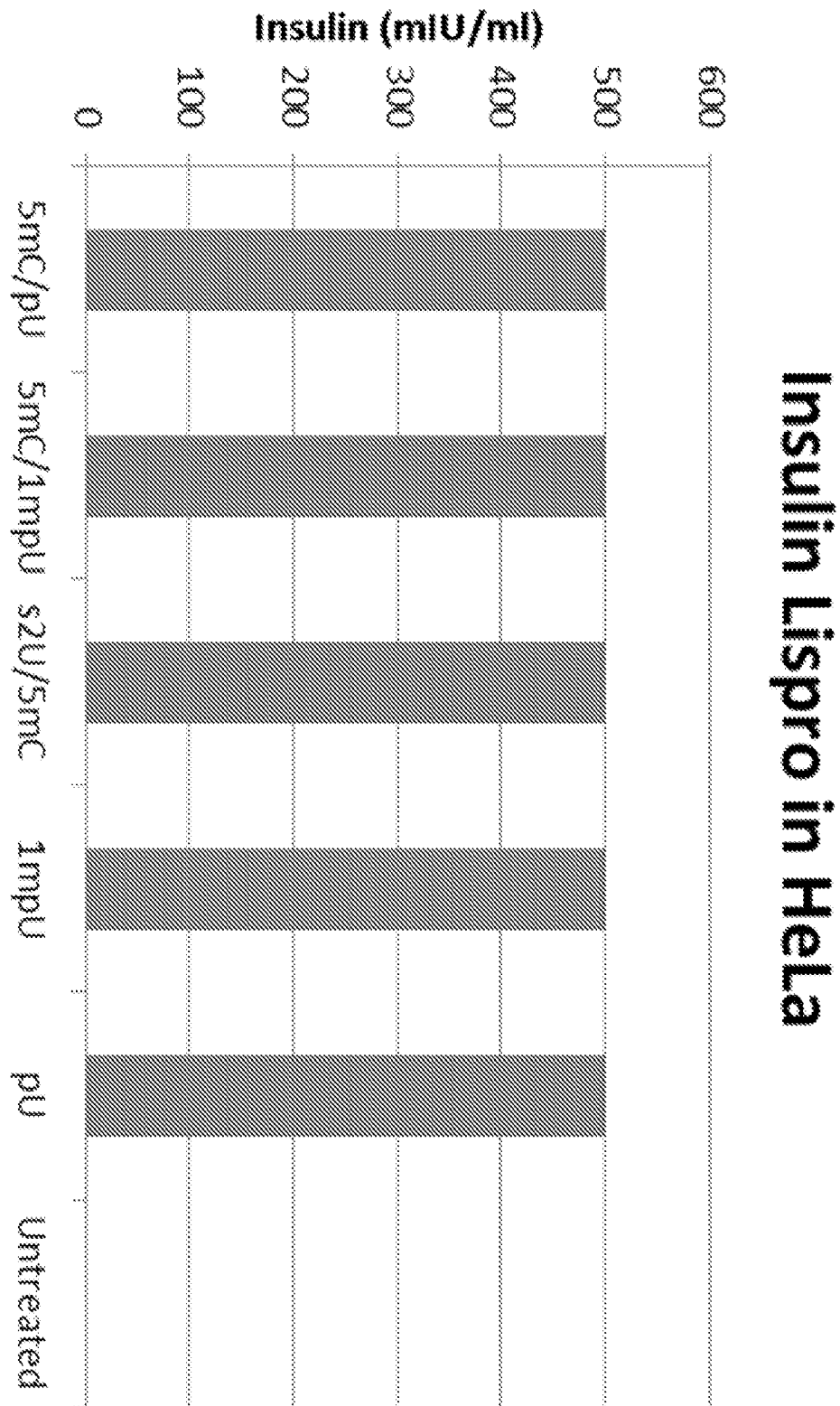

FIGURE 41

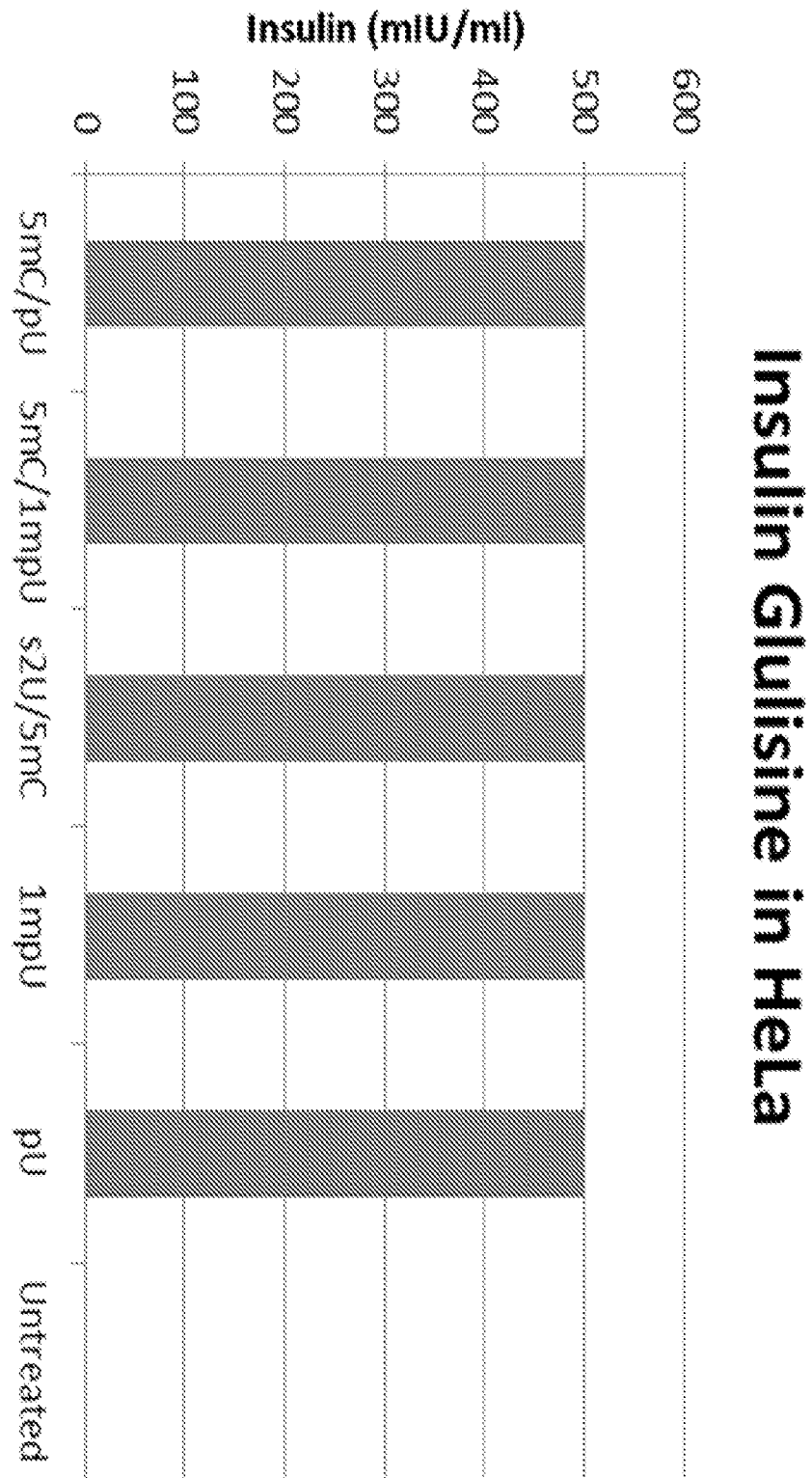

FIGURE 42

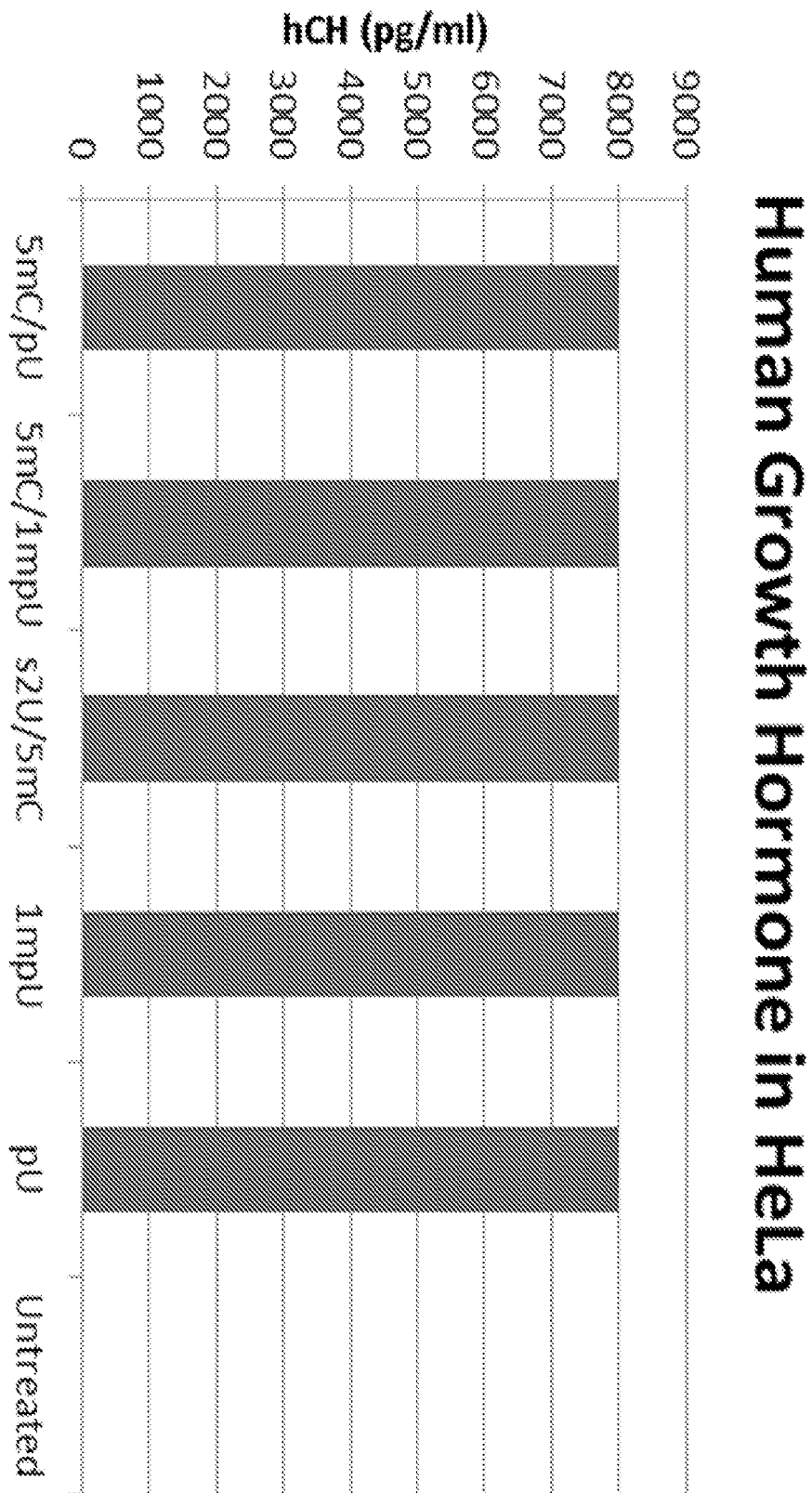
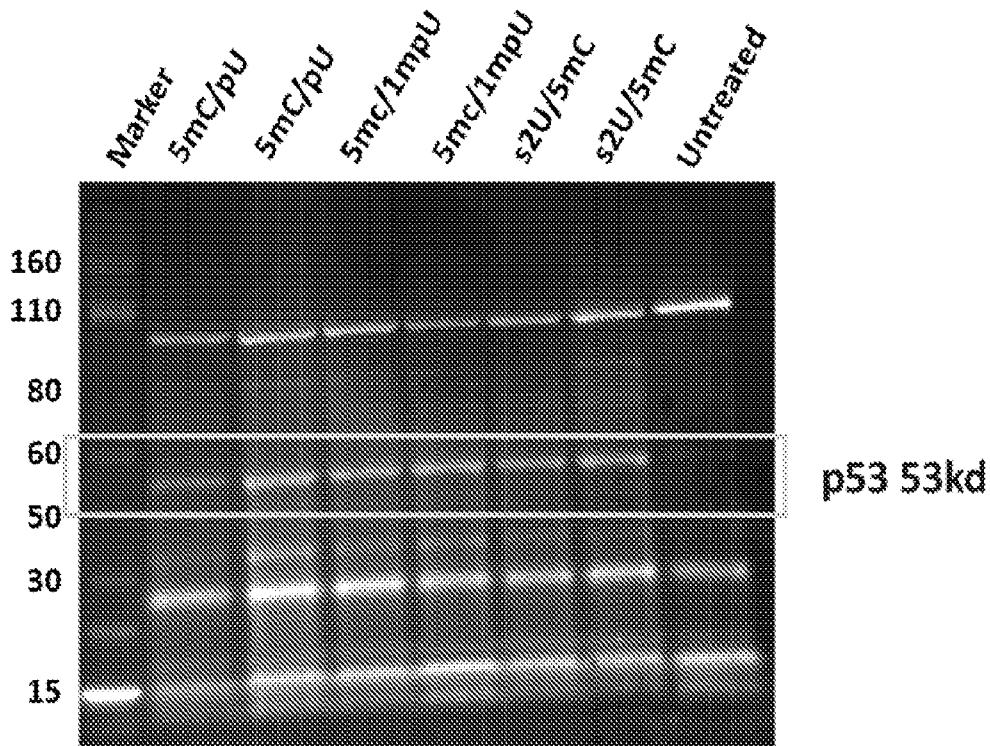

FIGURE 43

A.



B.

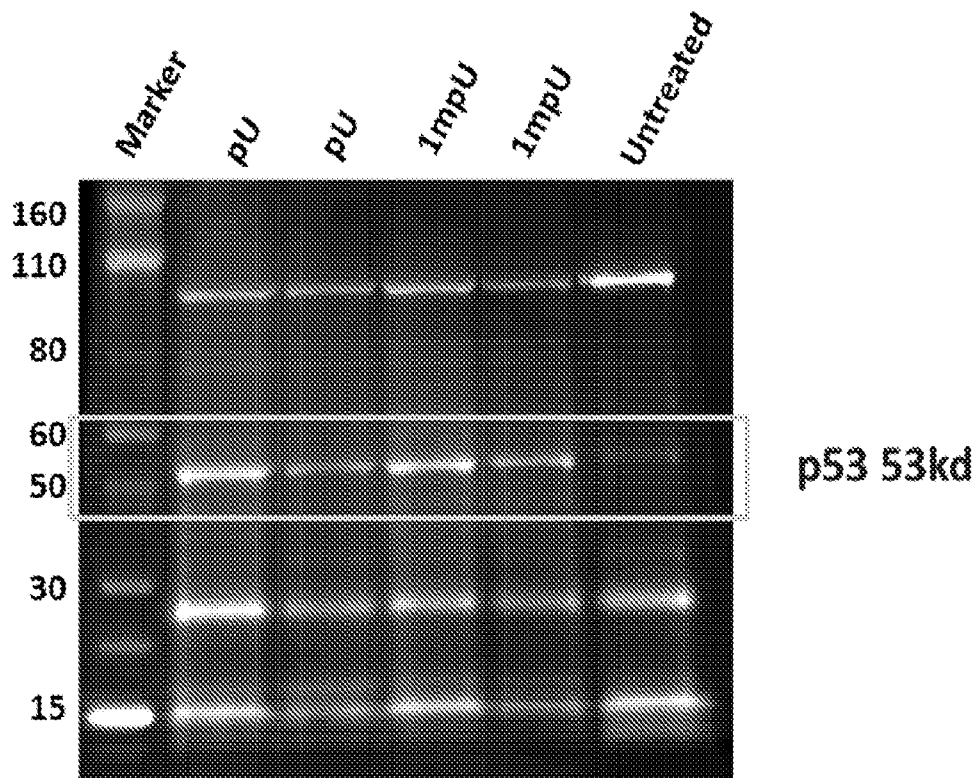
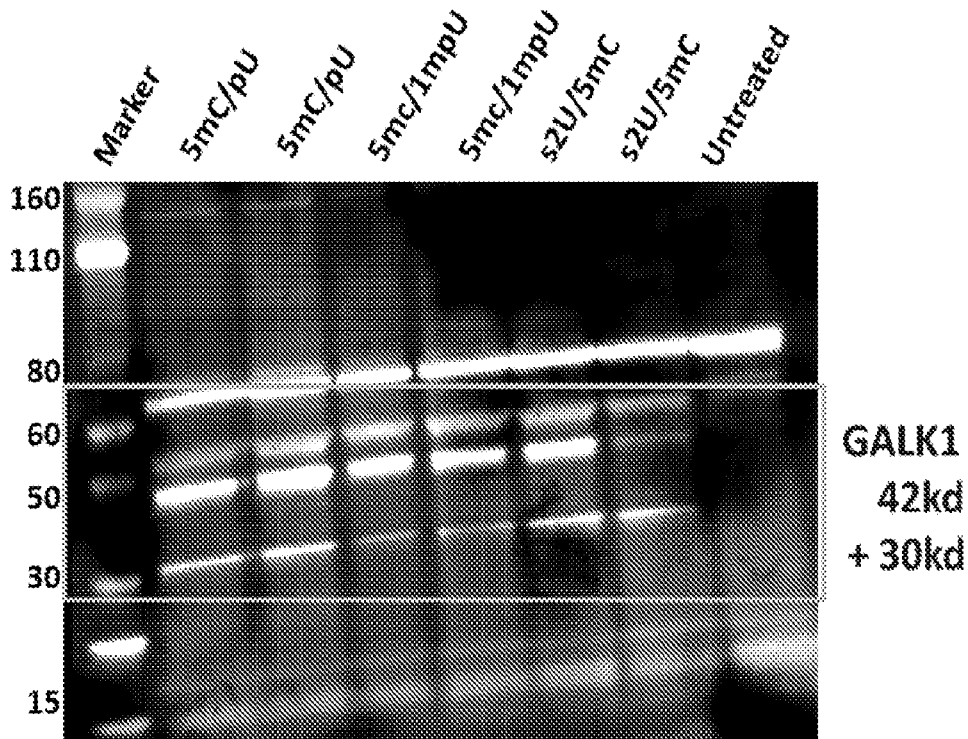

FIGURE 44



FIGURE 45

A.



B.

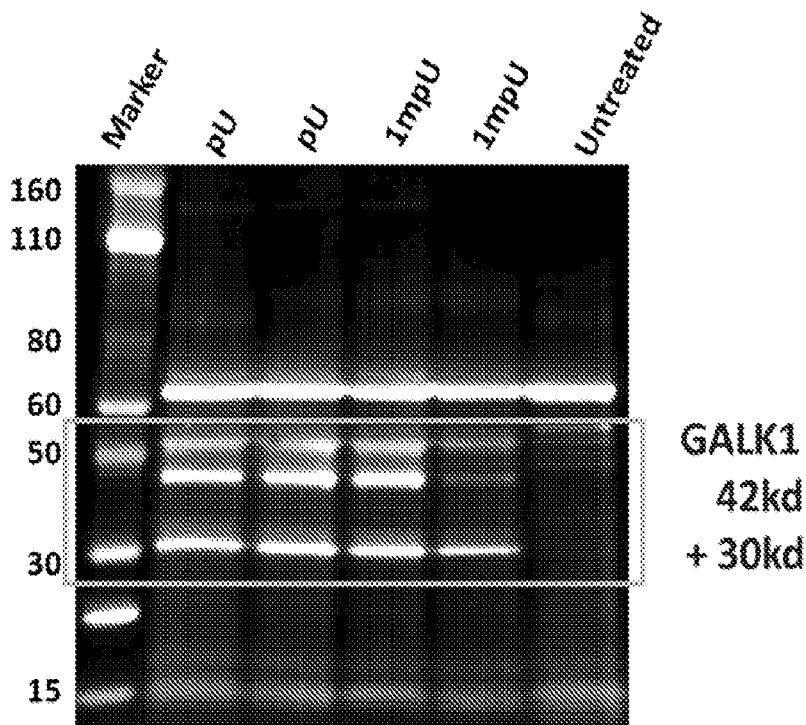

FIGURE 46

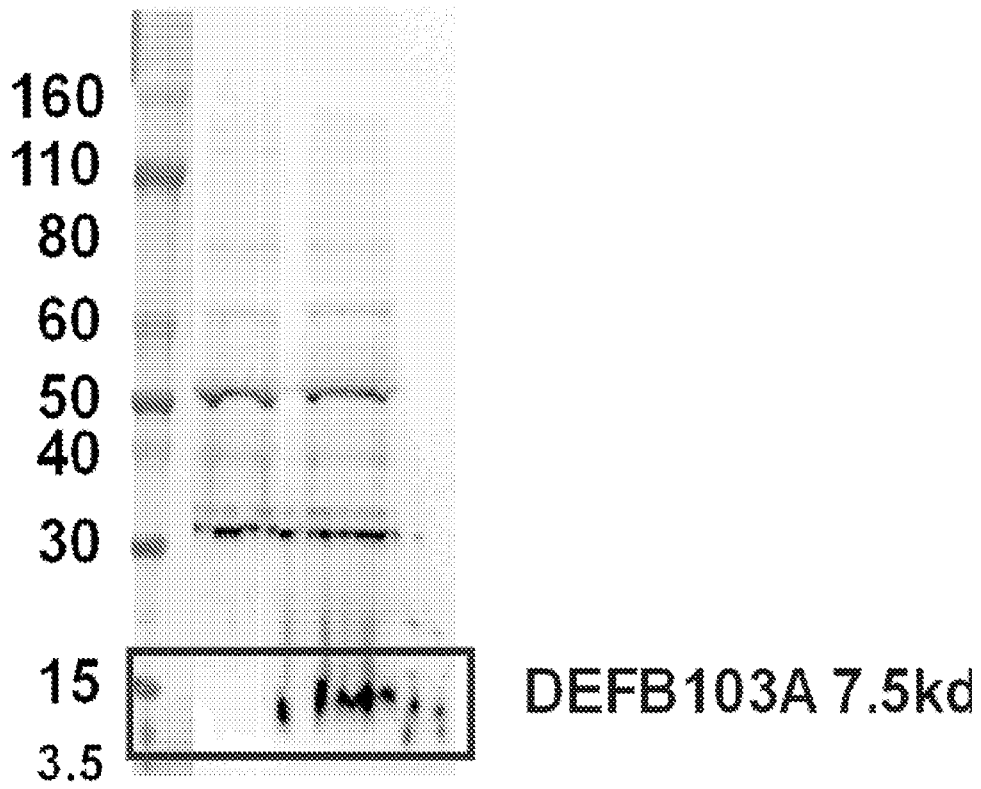

FIGURE 47

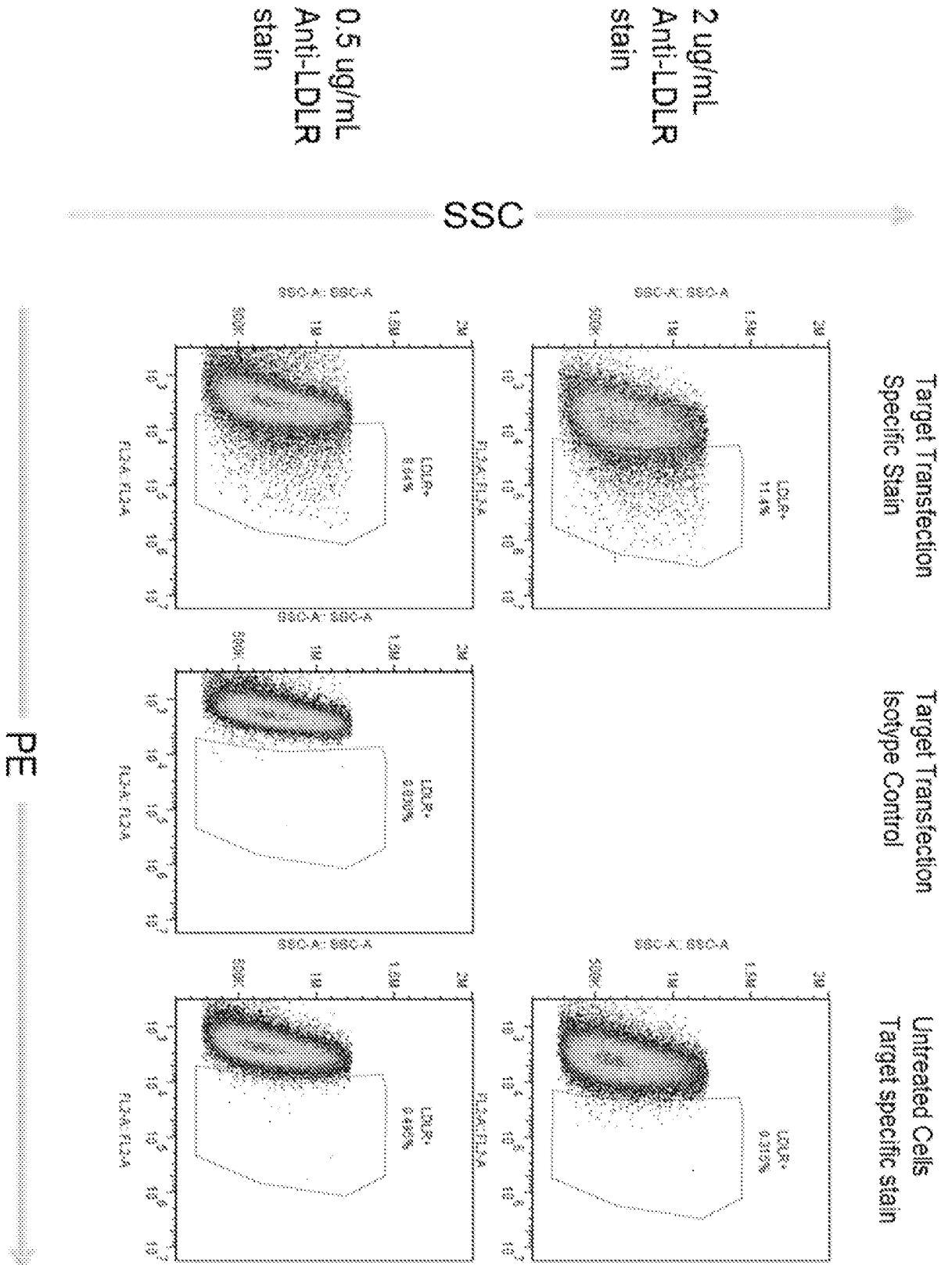

FIGURE 48

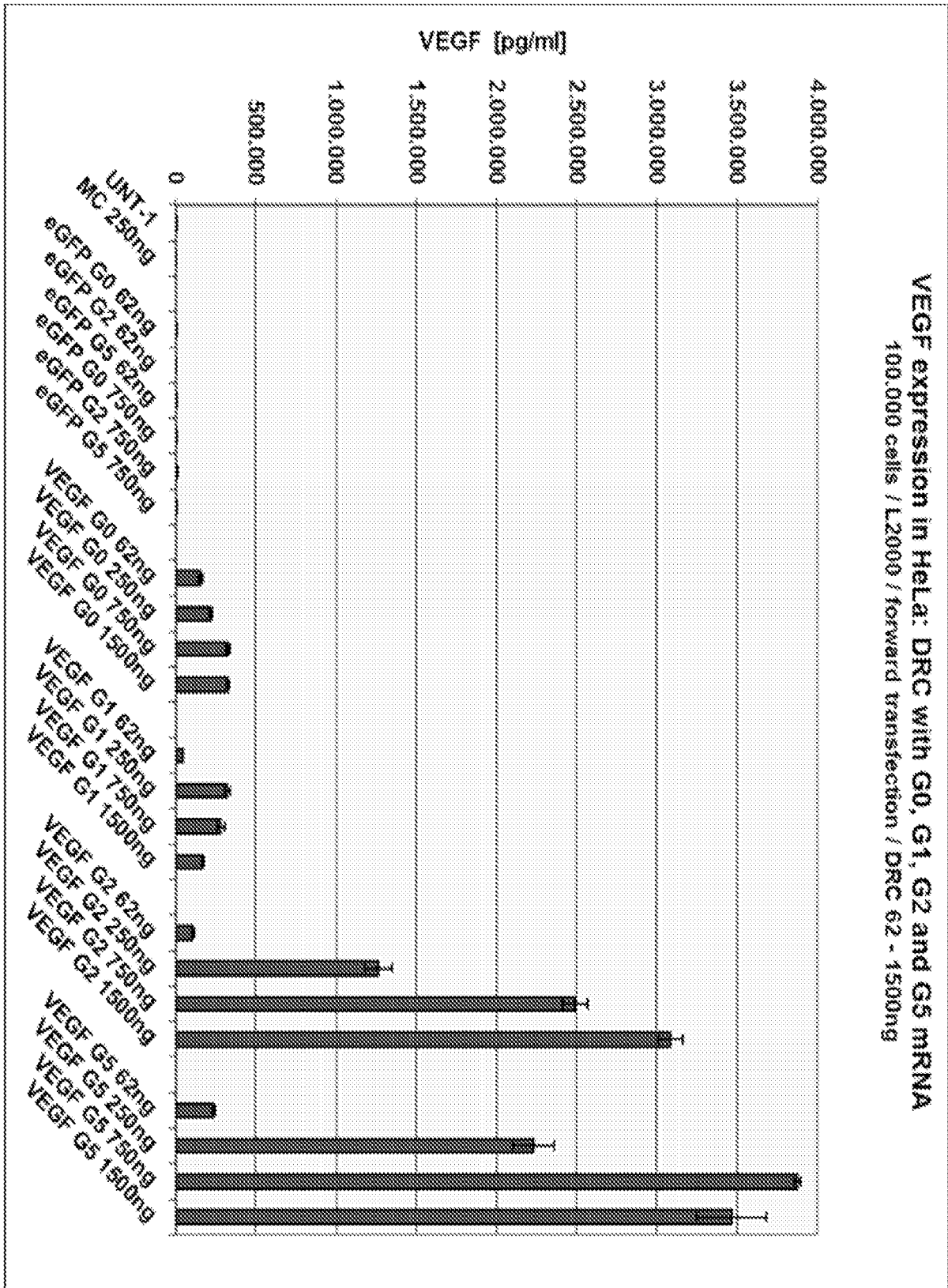

FIGURE 49

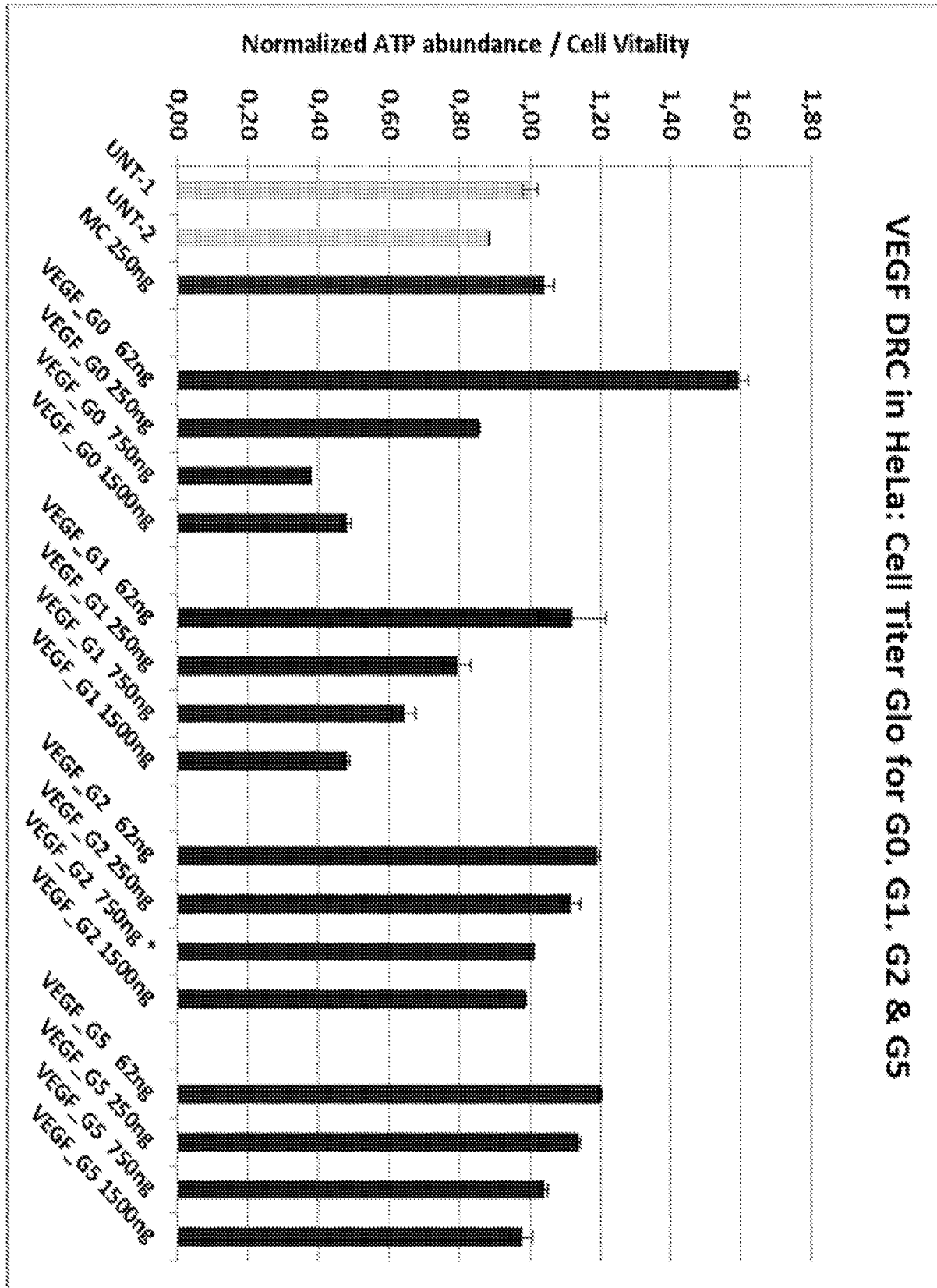

FIGURE 50

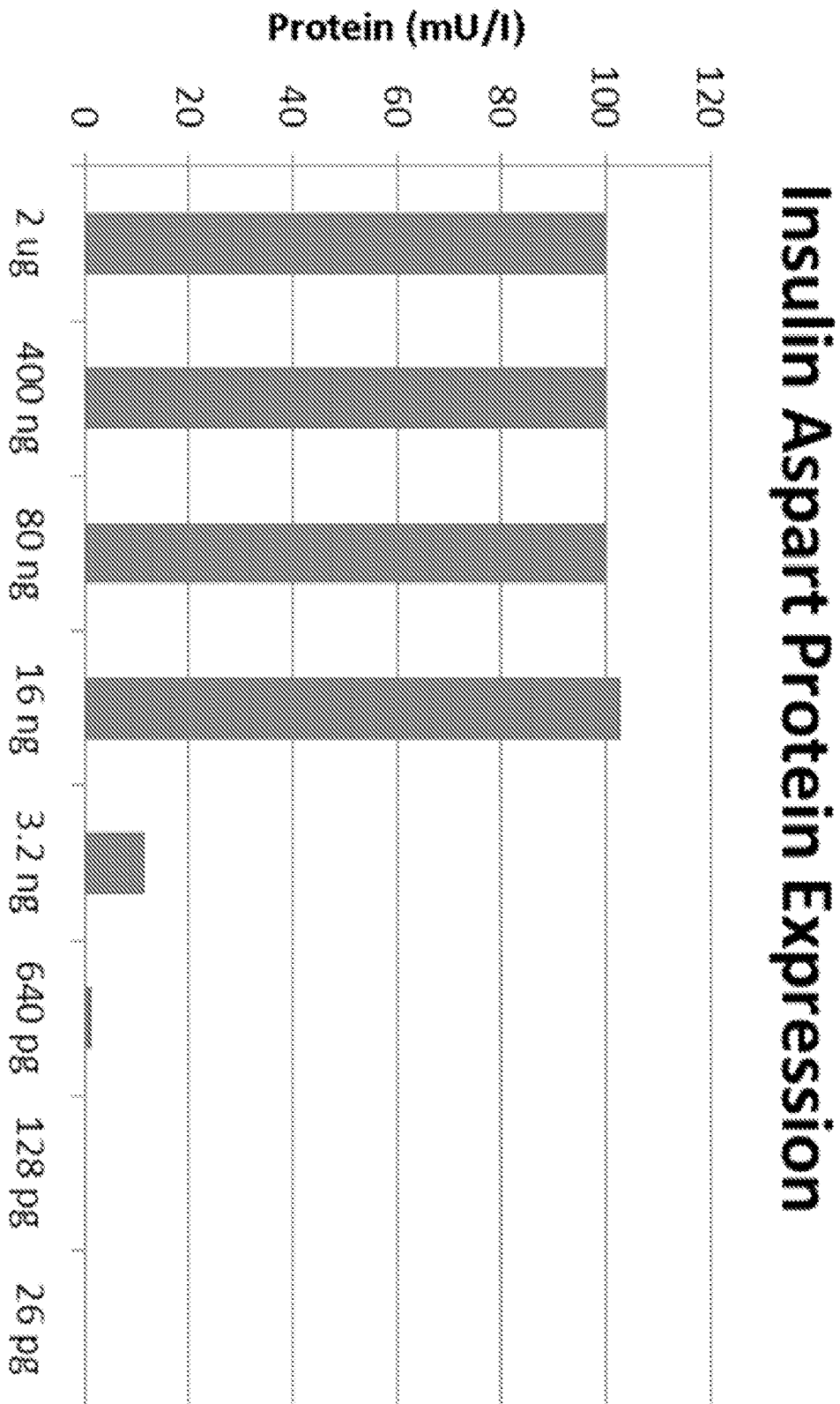

FIGURE 51

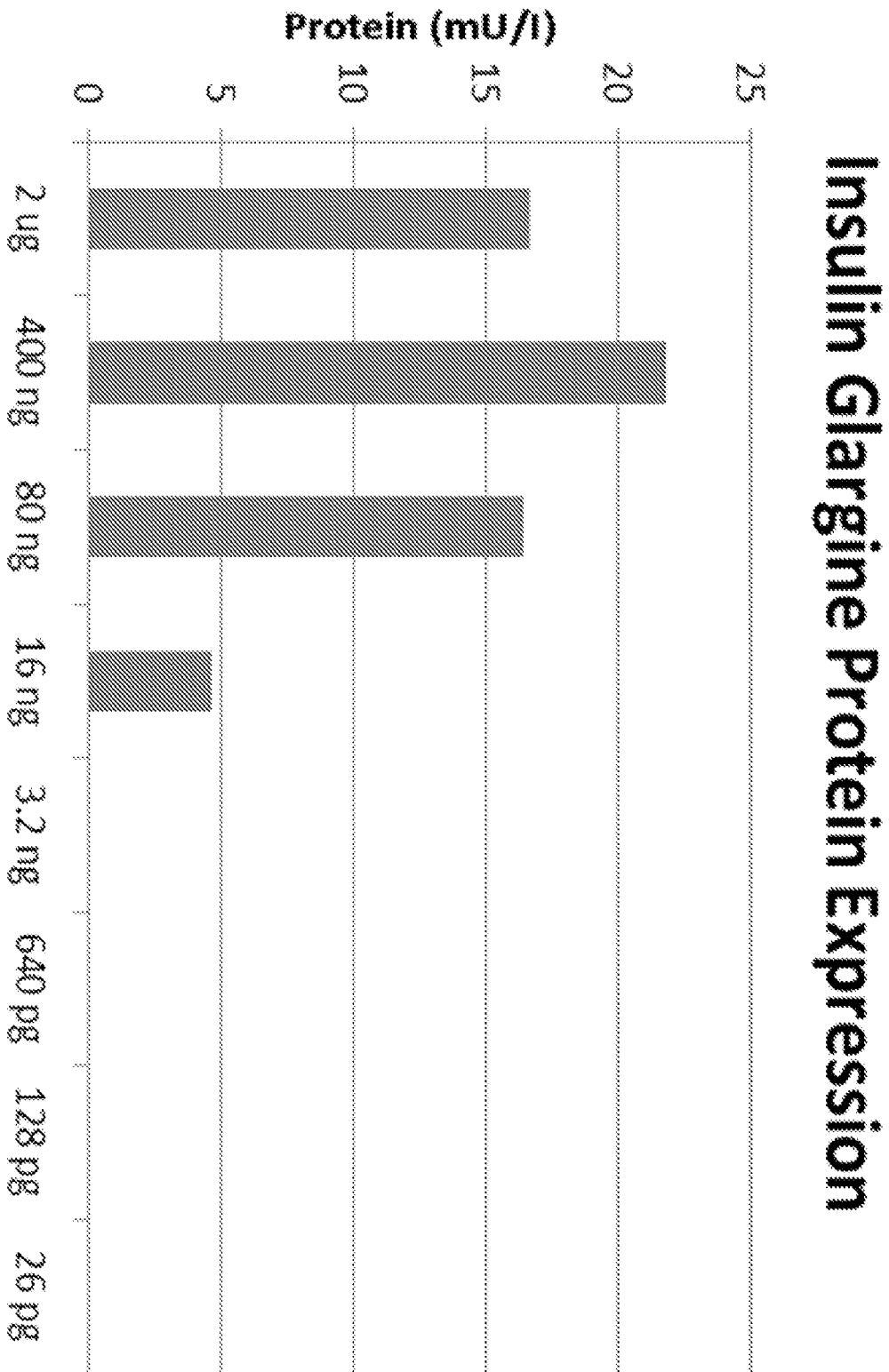

FIGURE 52

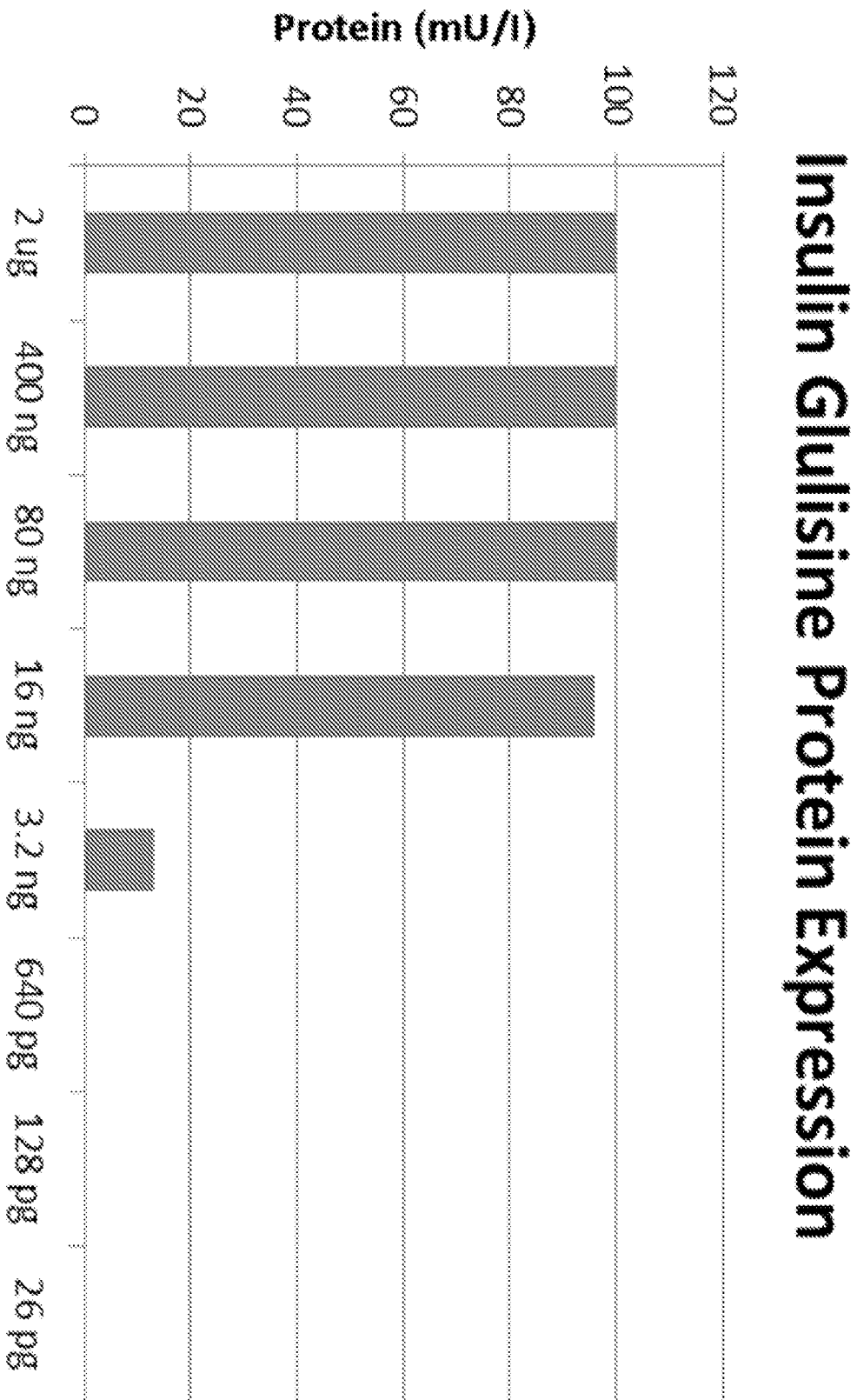

FIGURE 53

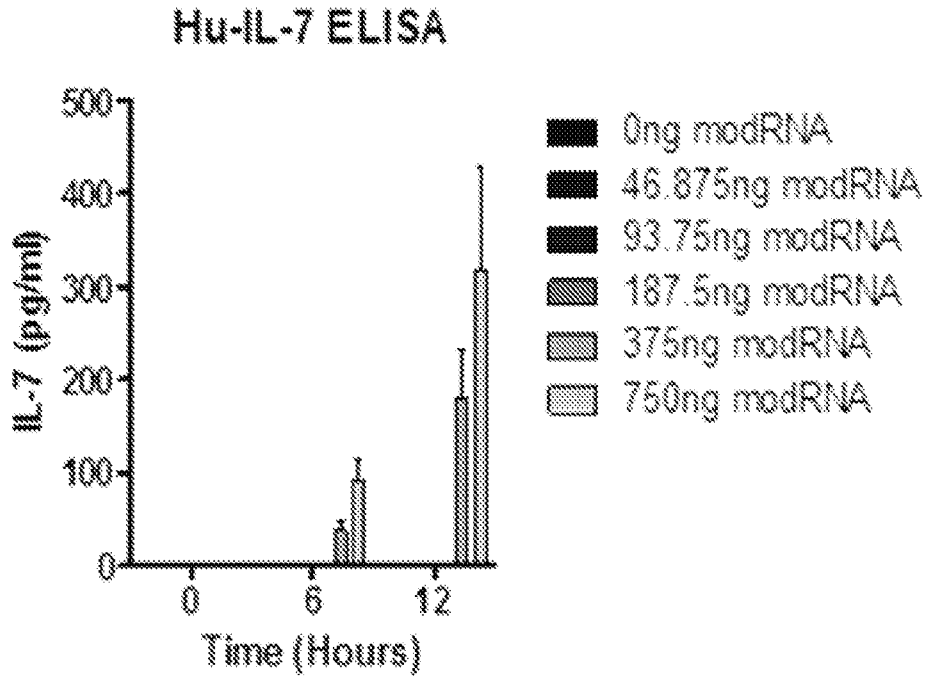
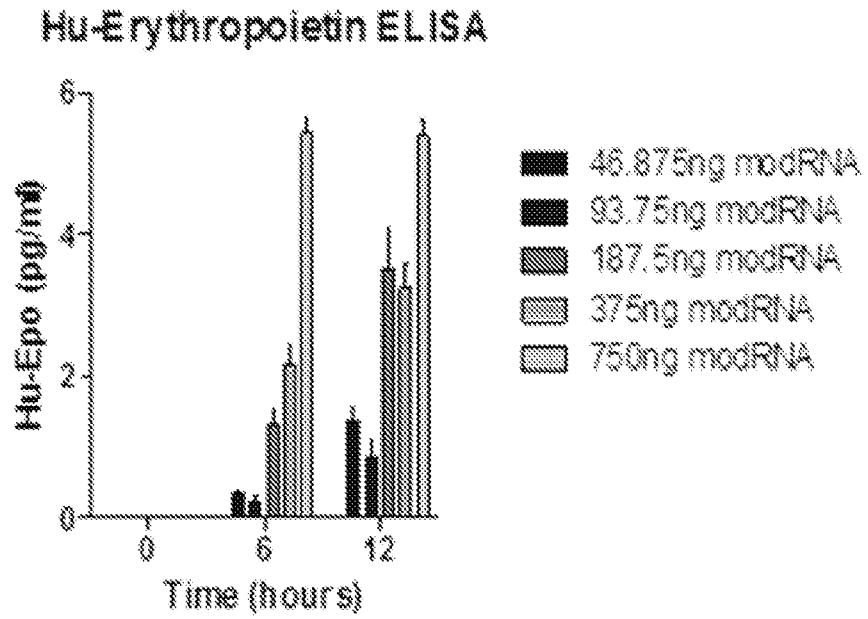

FIGURE 54



EXAMPLE 55

Lysosomal Acid Lipase

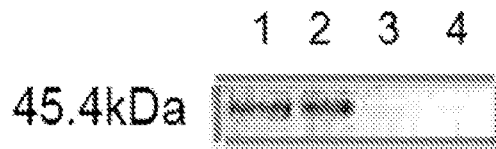

FIGURE 56

Glucocerebrosidase

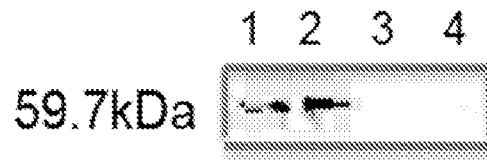

FIGURE 57

Iduronate 2-Sulfatase

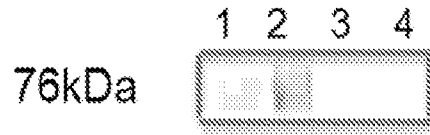

FIGURE 58

Luciferase

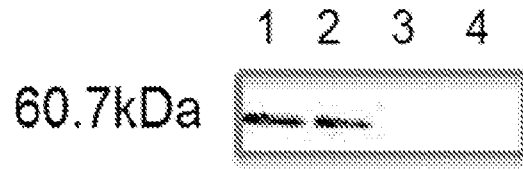

FIGURE 59

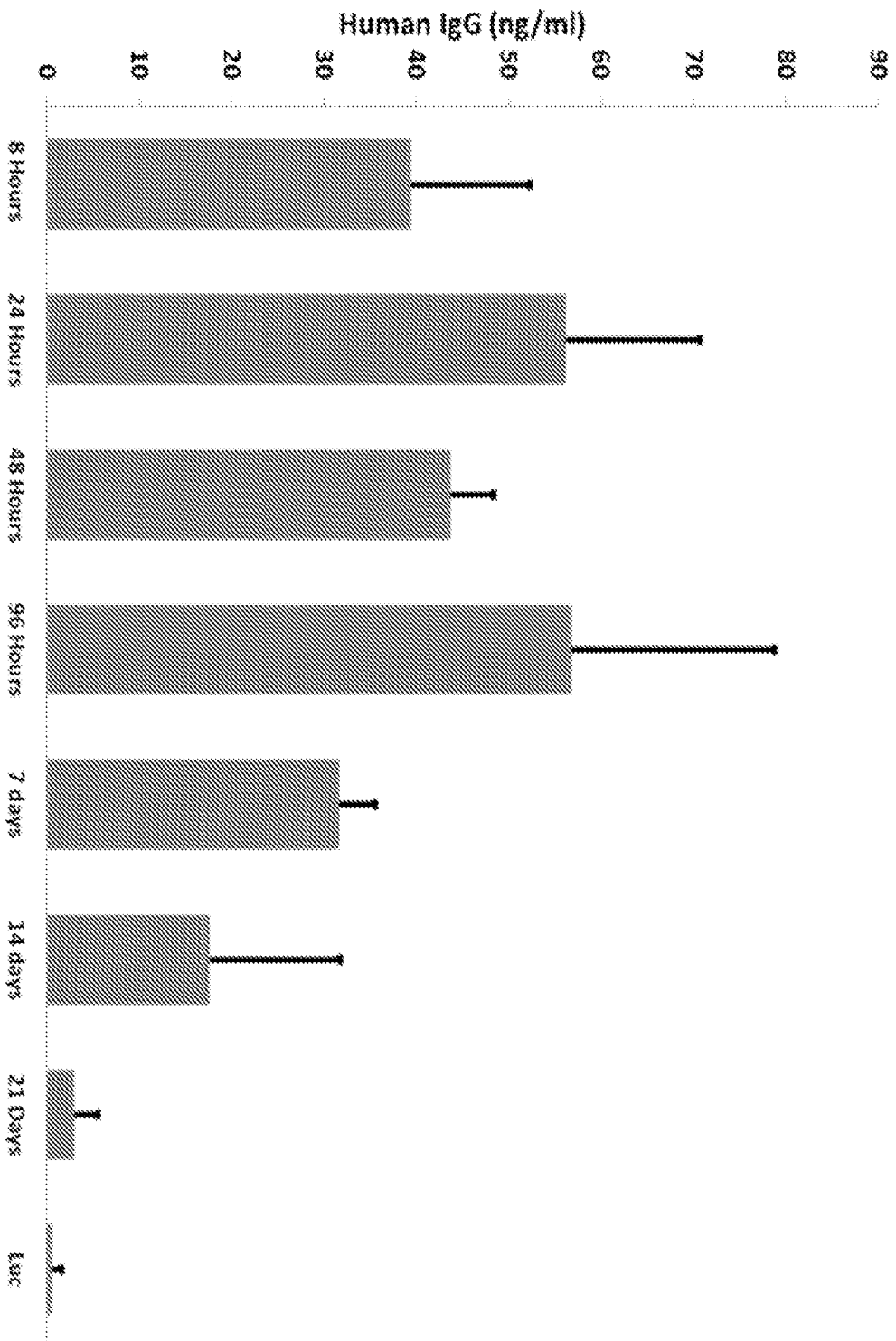

FIGURE 60

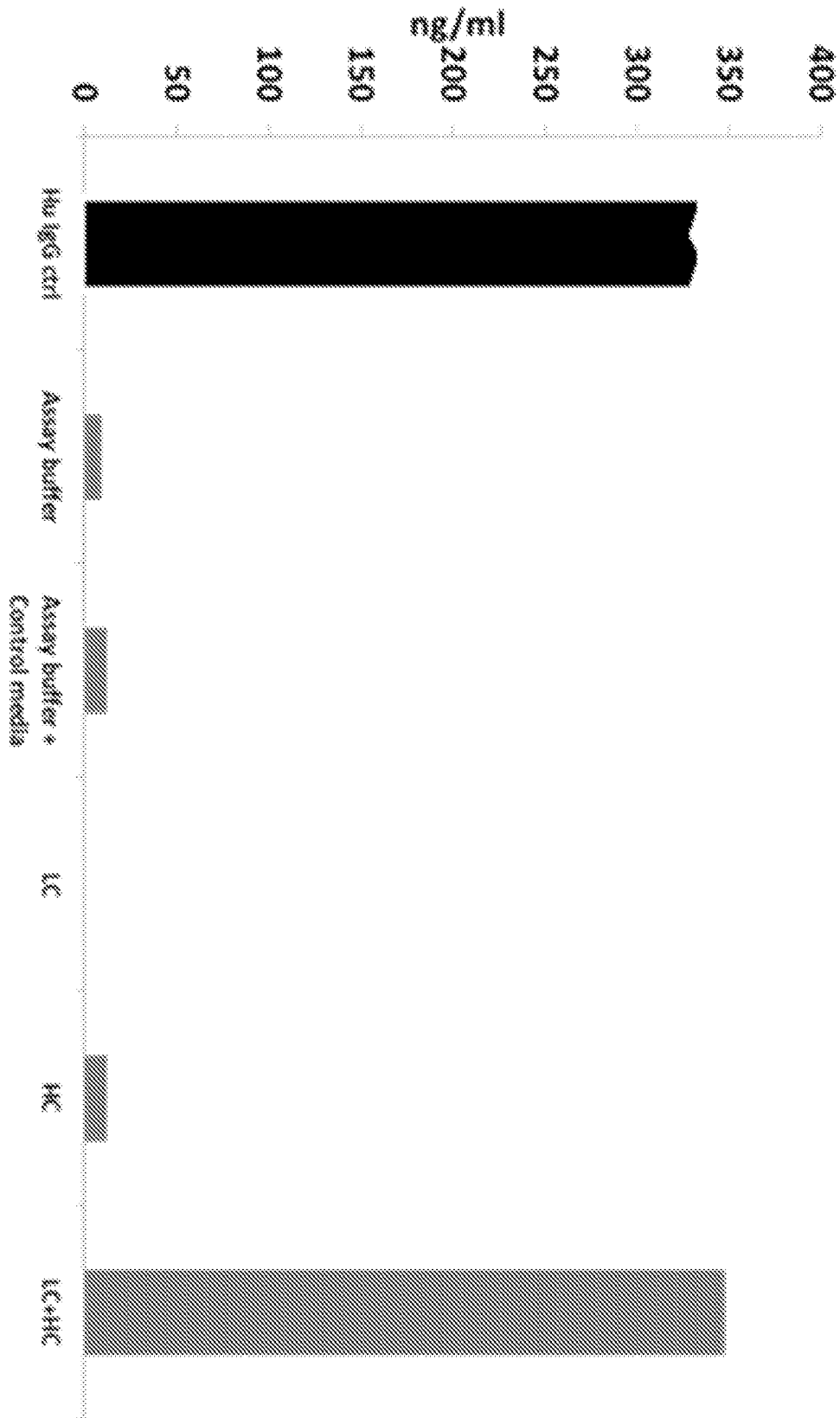

FIGURE 61

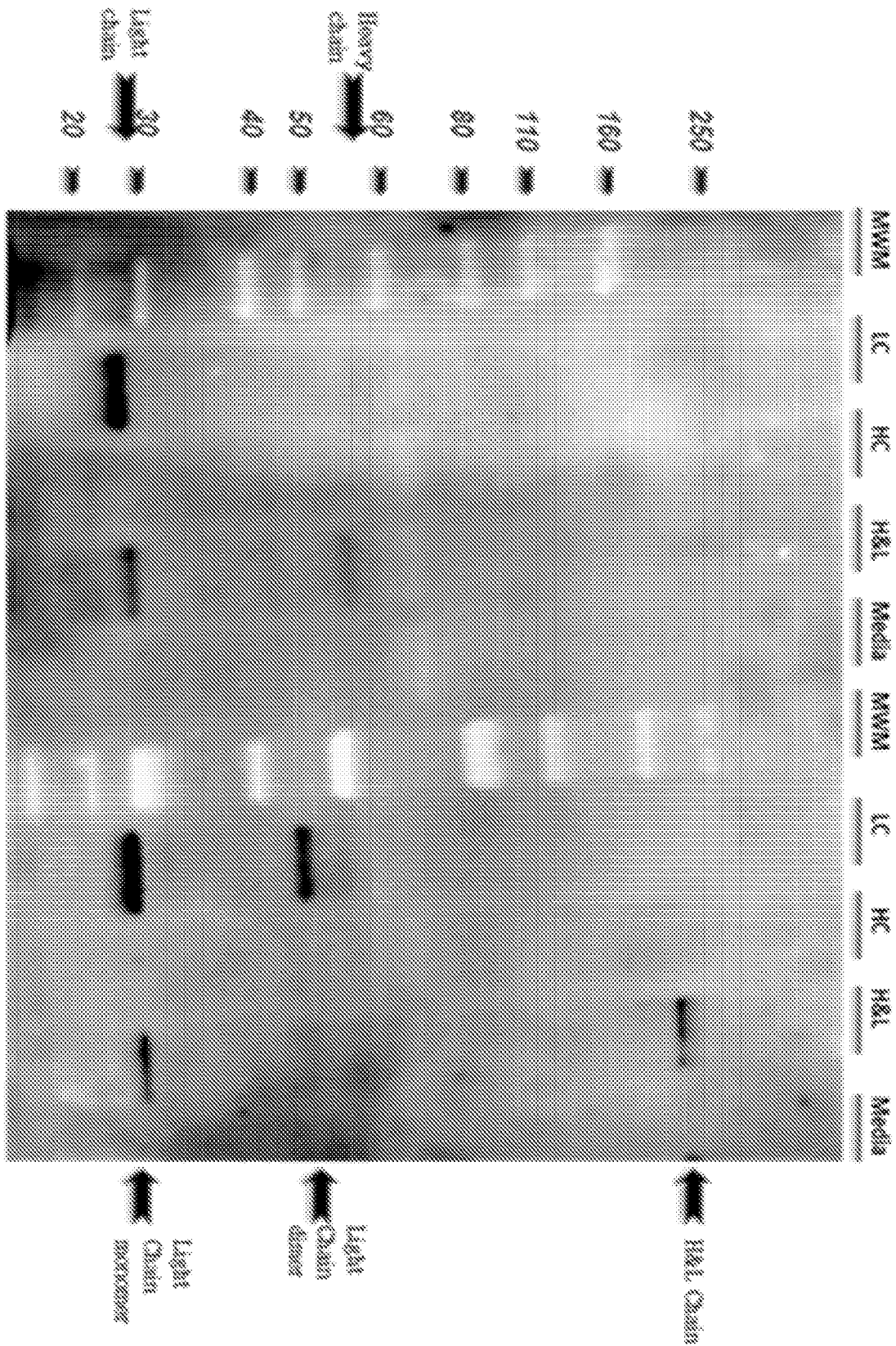

FIGURE 62

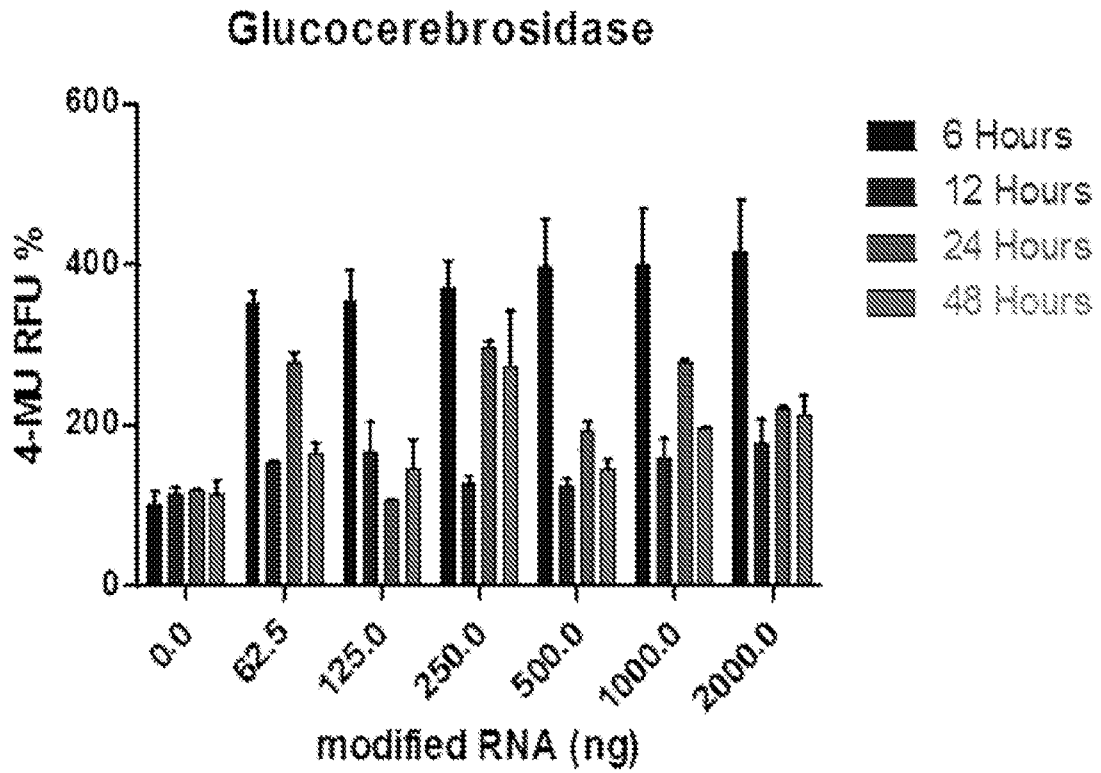

FIGURE 63

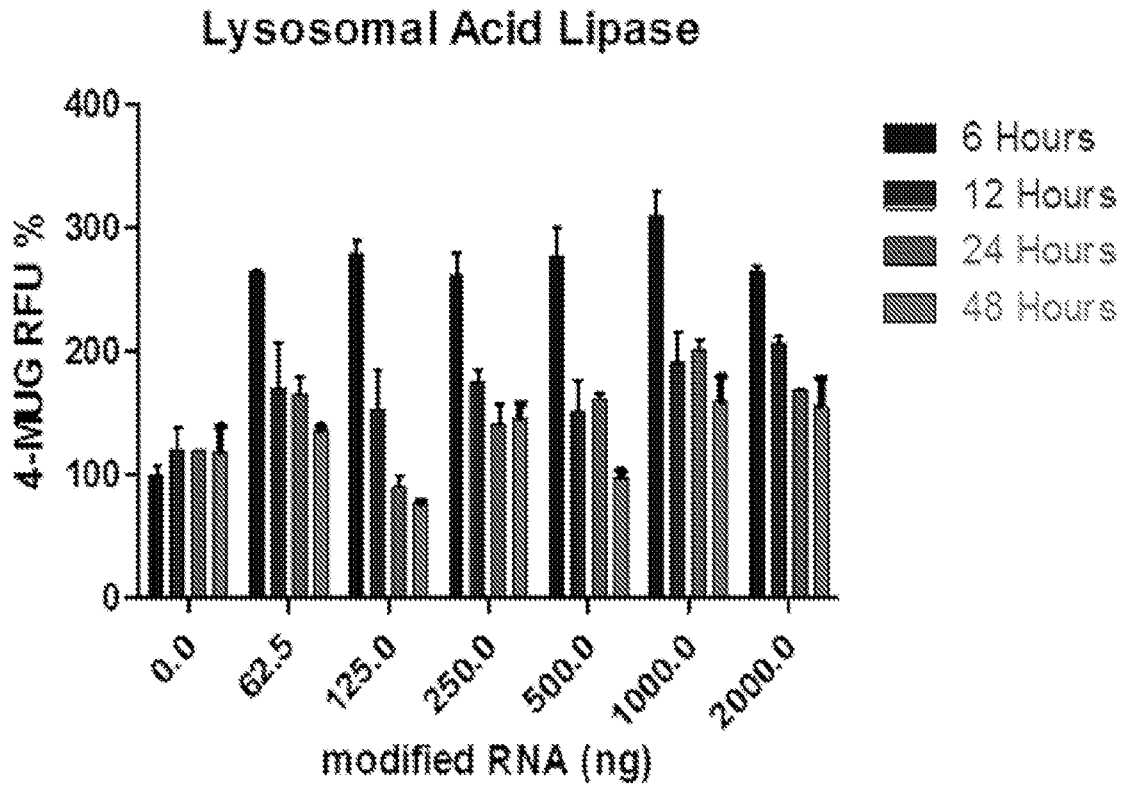

FIGURE 64

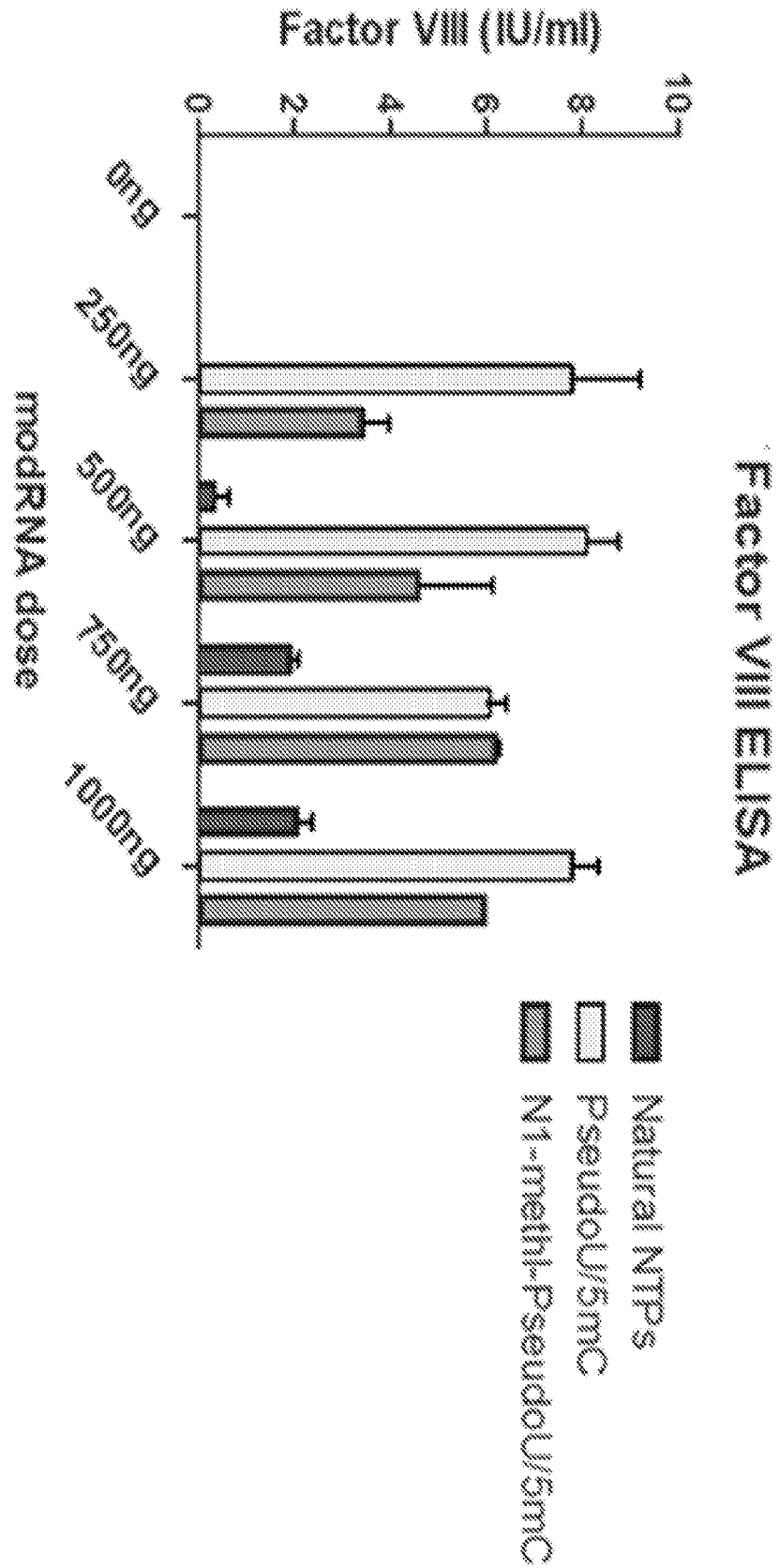

FIGURE 65

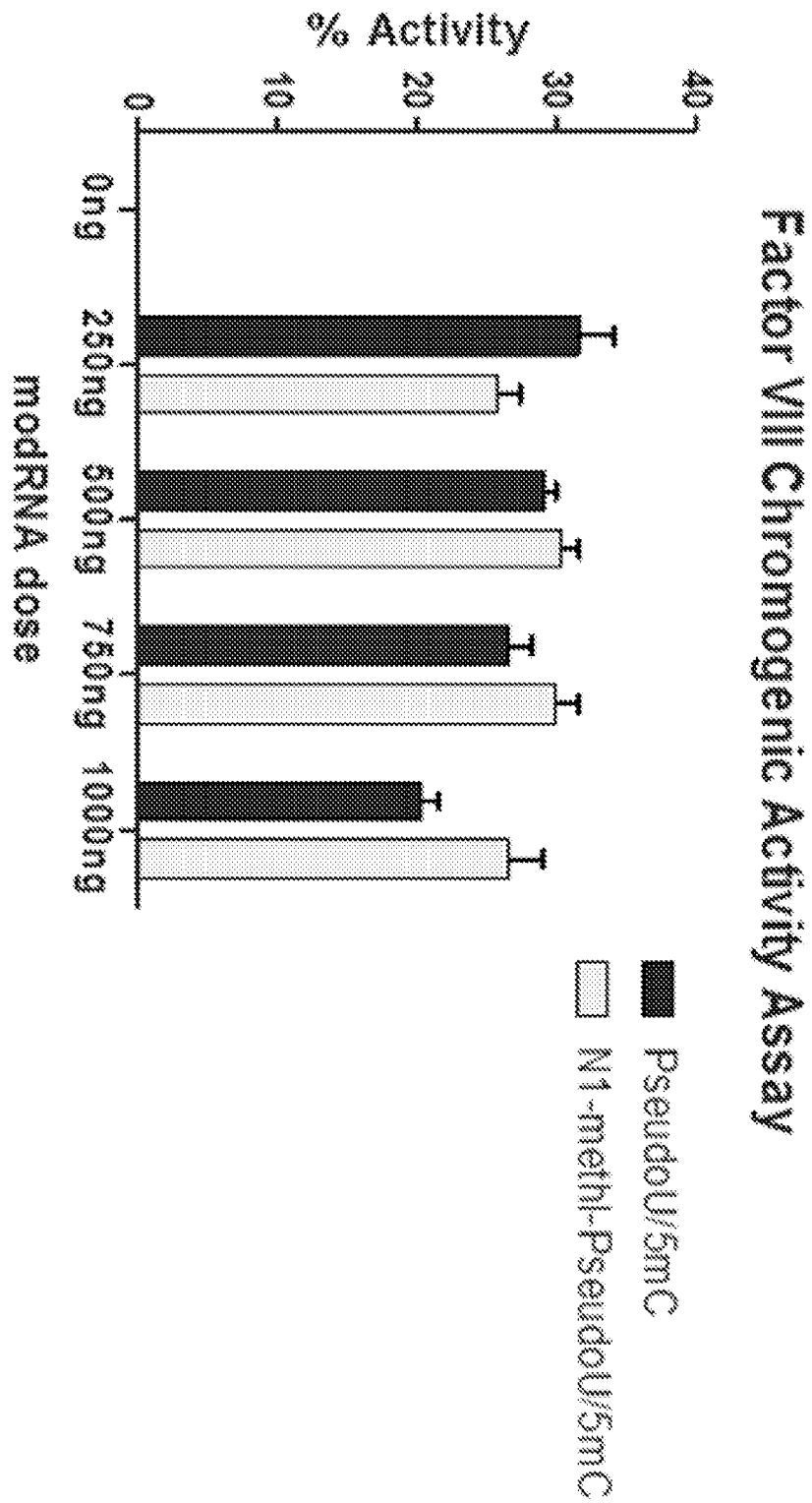

FIGURE 66

A.

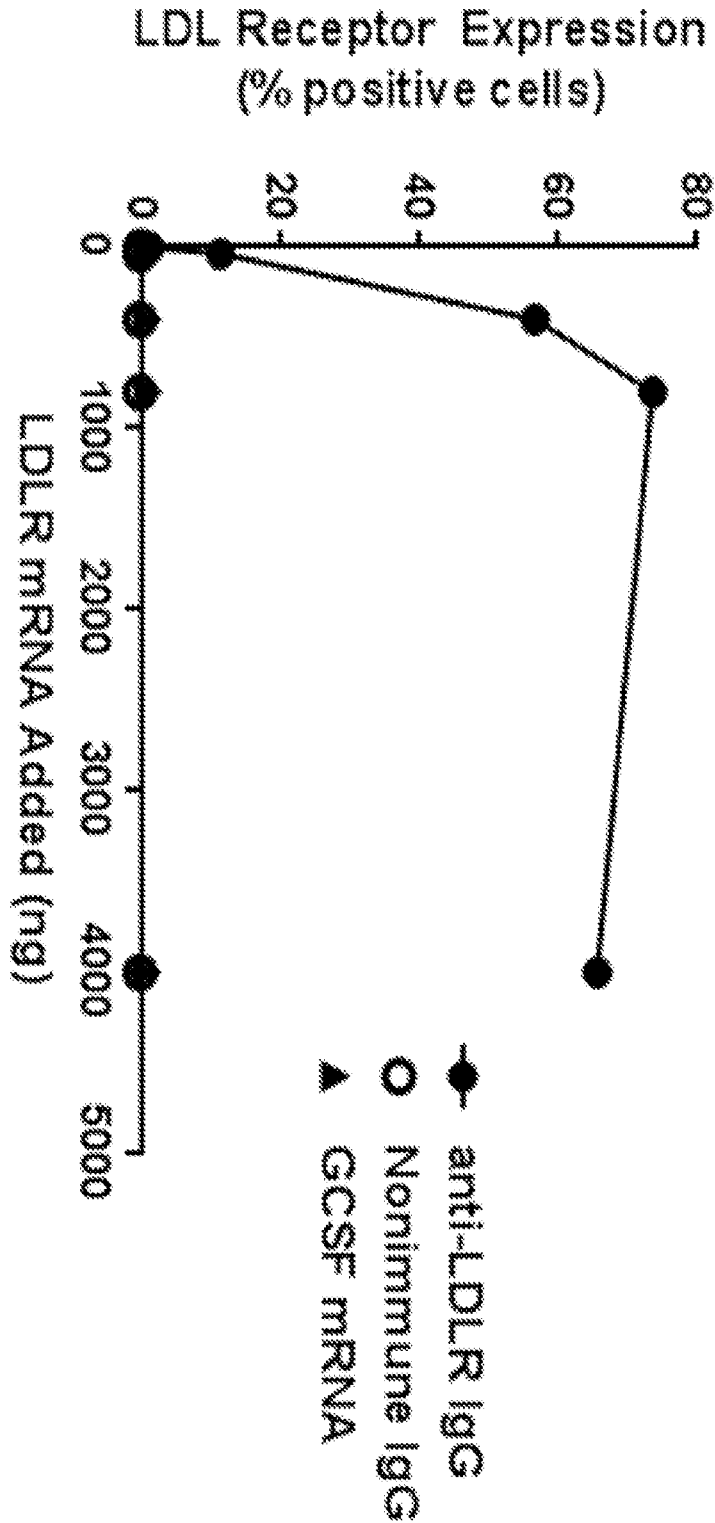

FIGURE 66 CONT.

B.

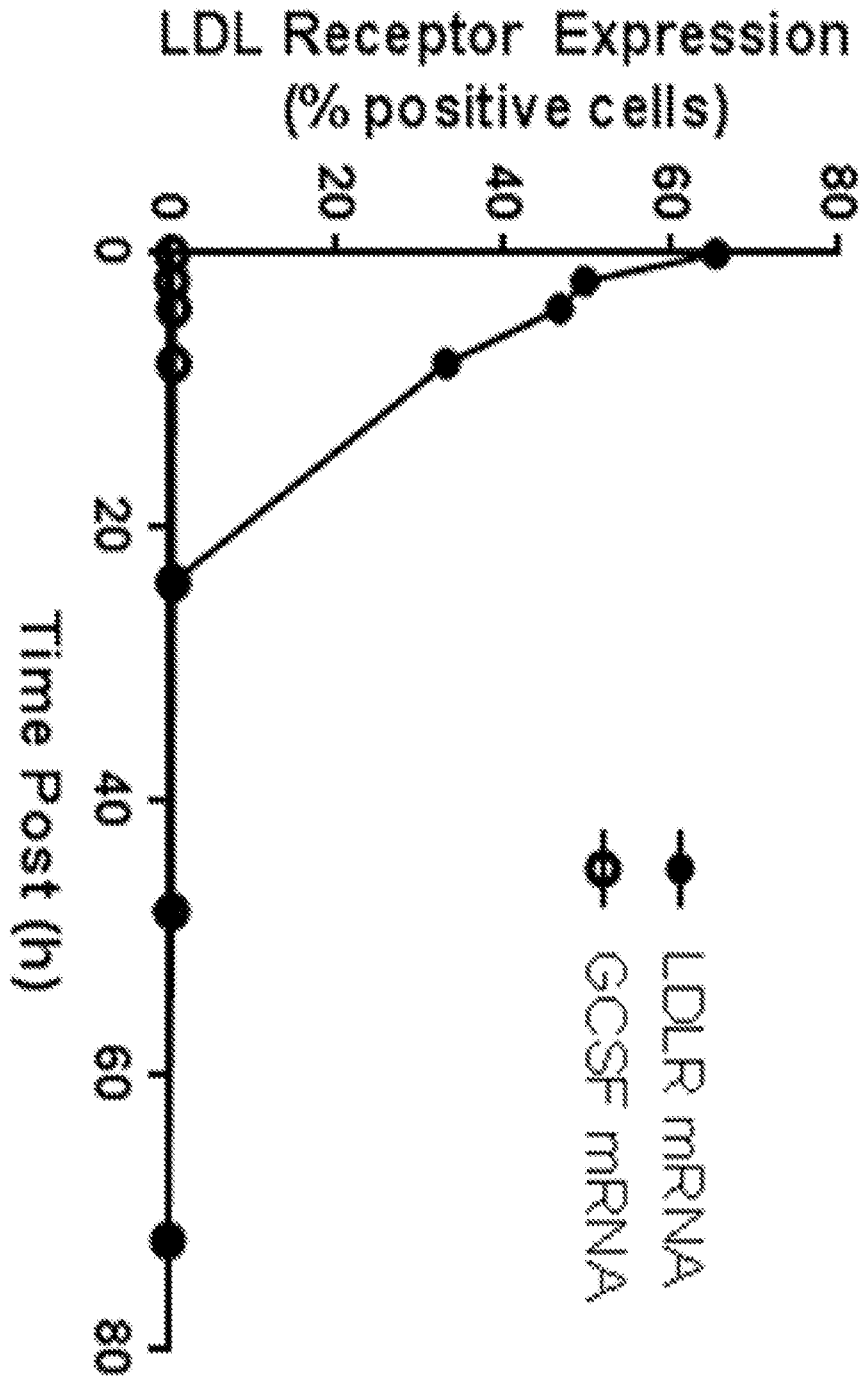

FIGURE 66 CONT.

C.

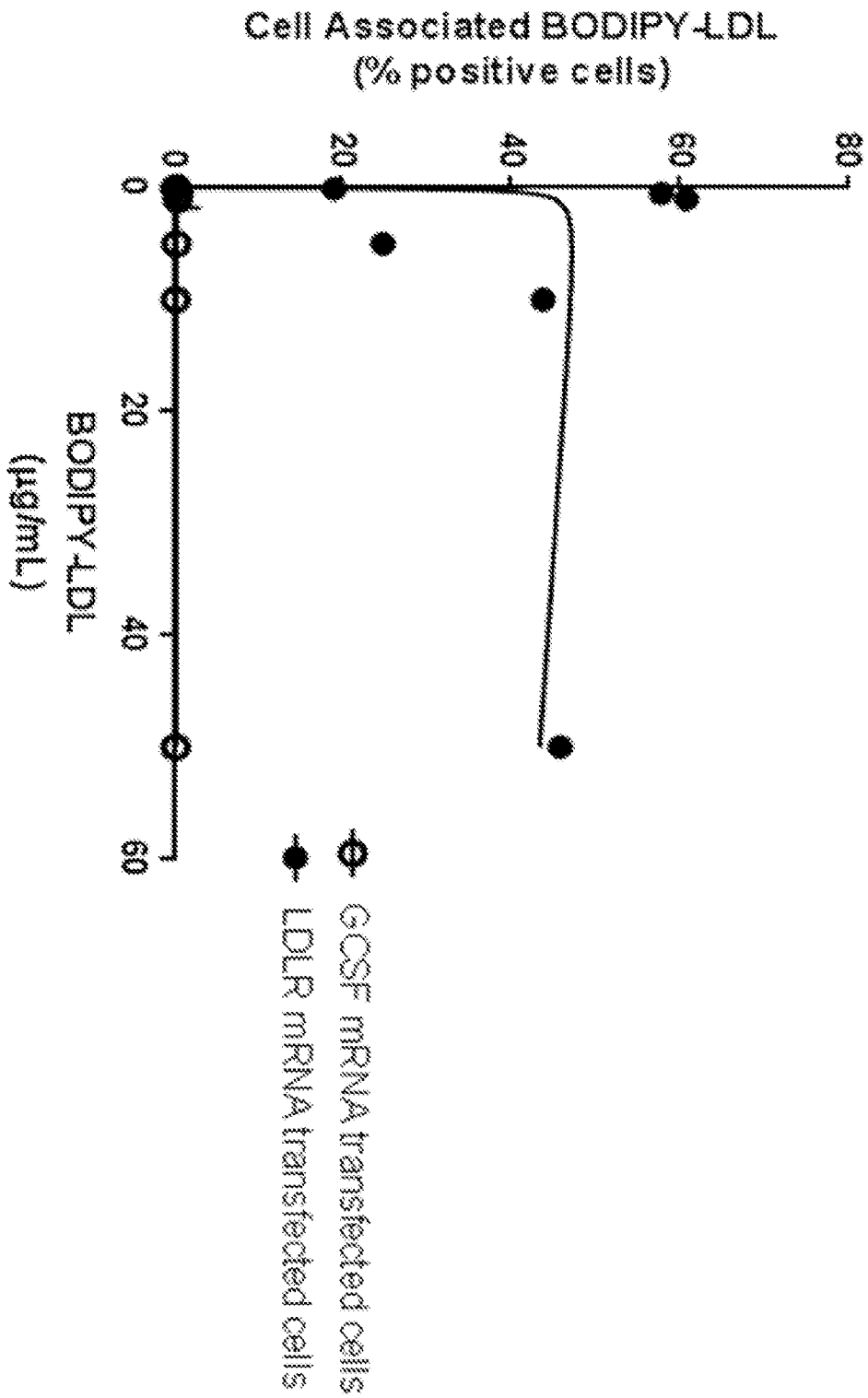

FIGURE 66 CONT.

D.

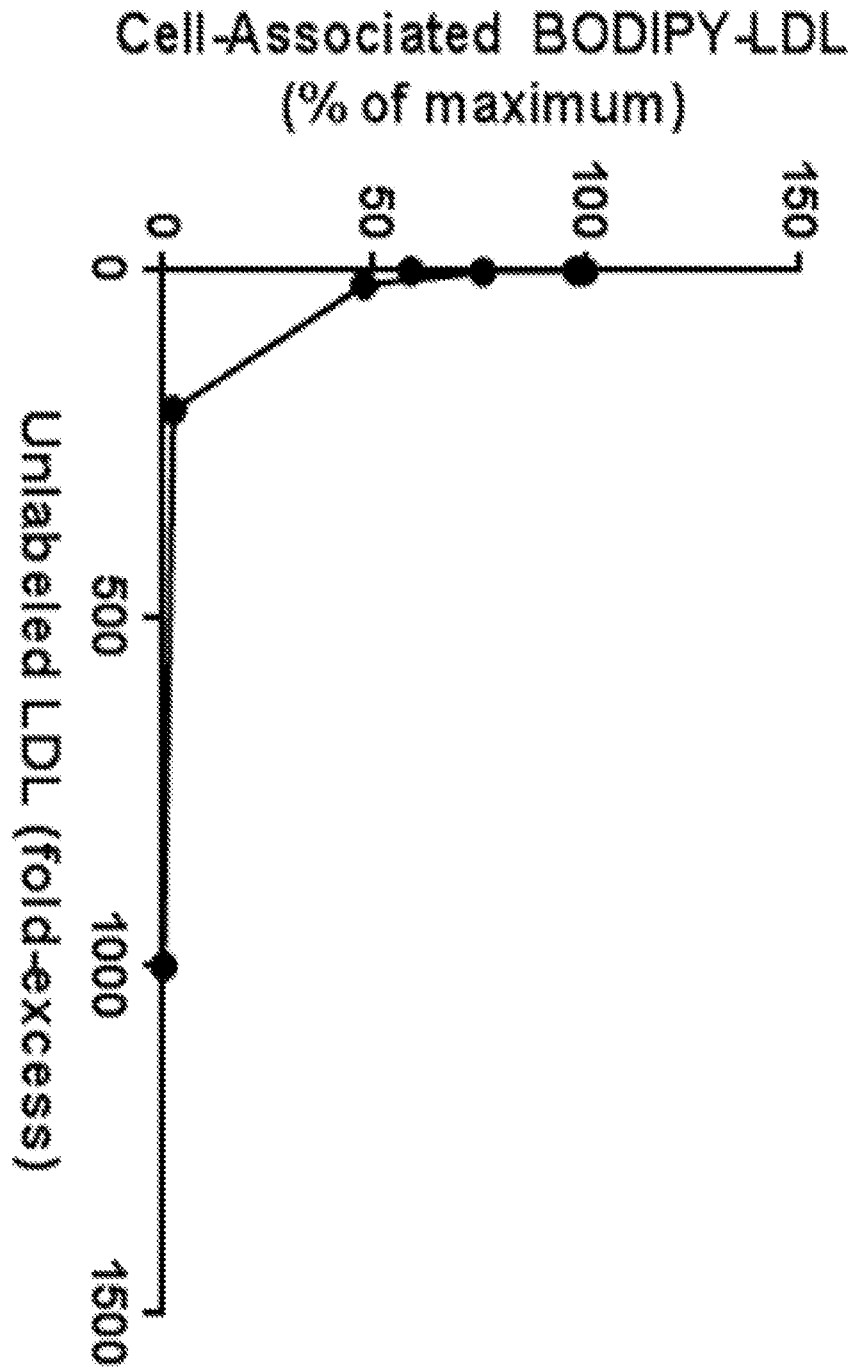

FIGURE 67

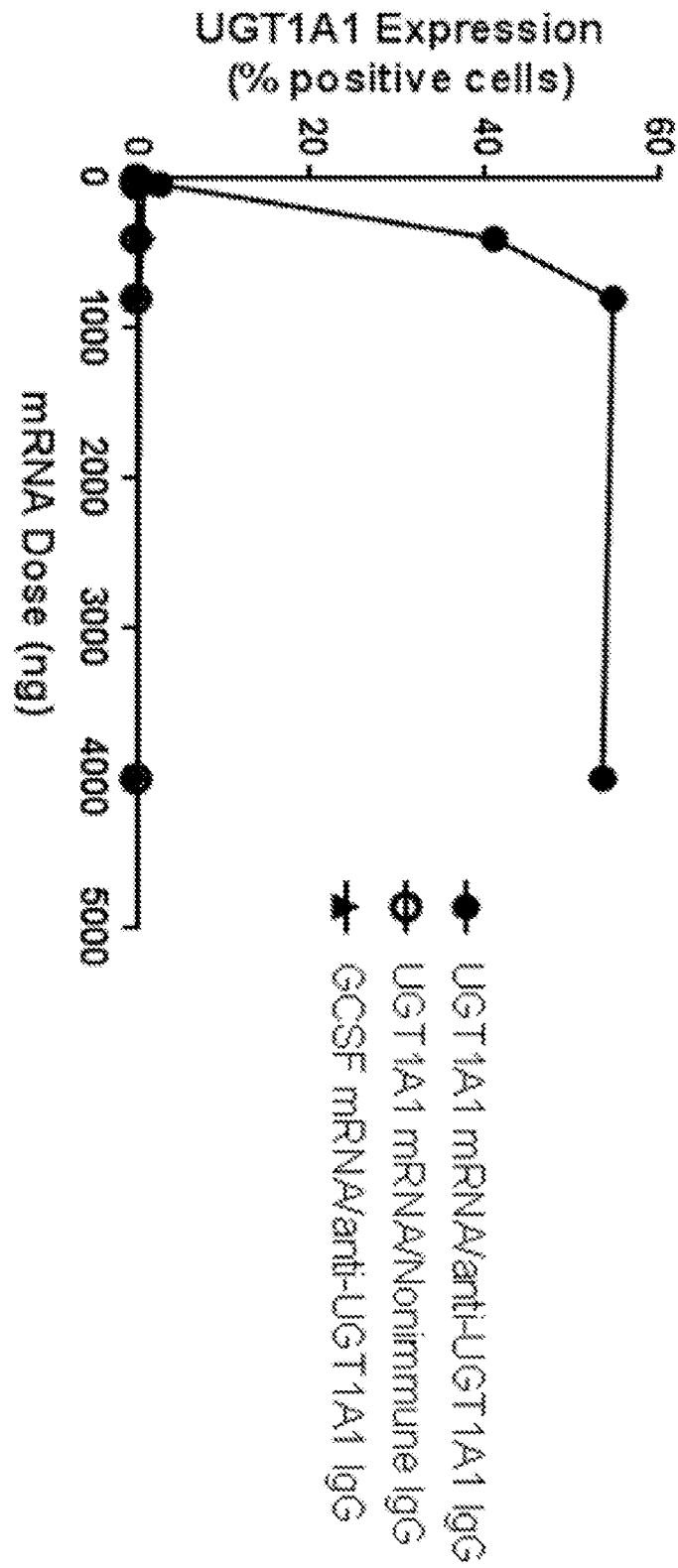

FIGURE 68

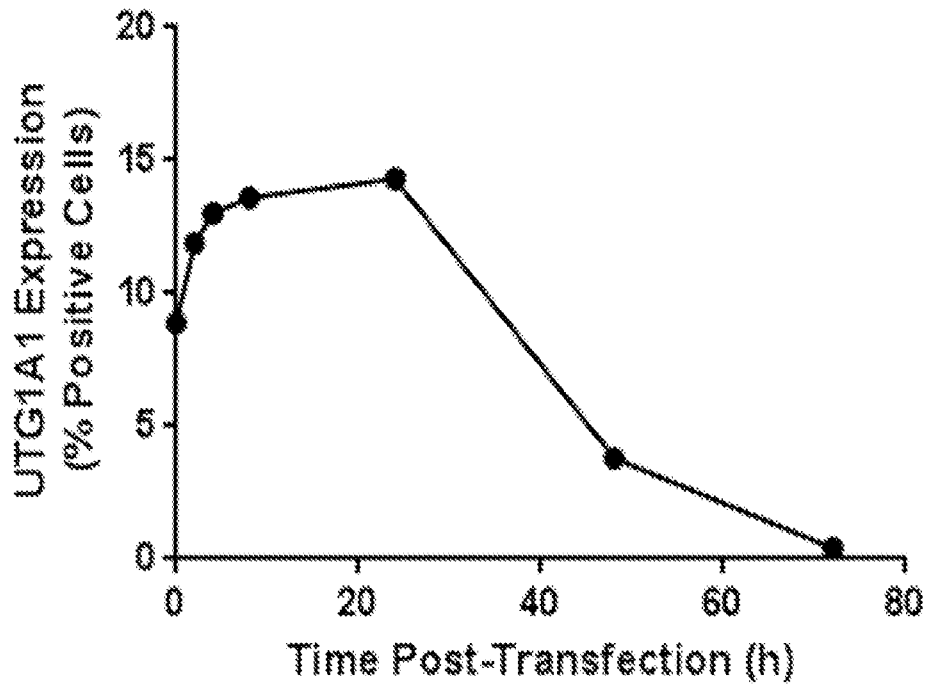

FIGURE 69

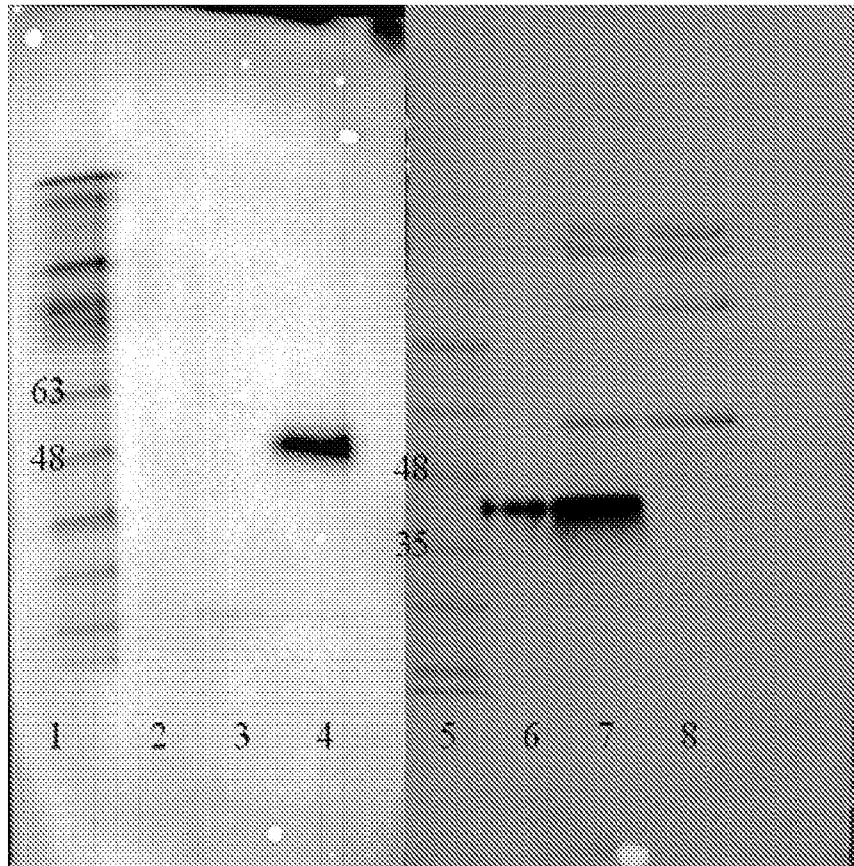

FIGURE 70

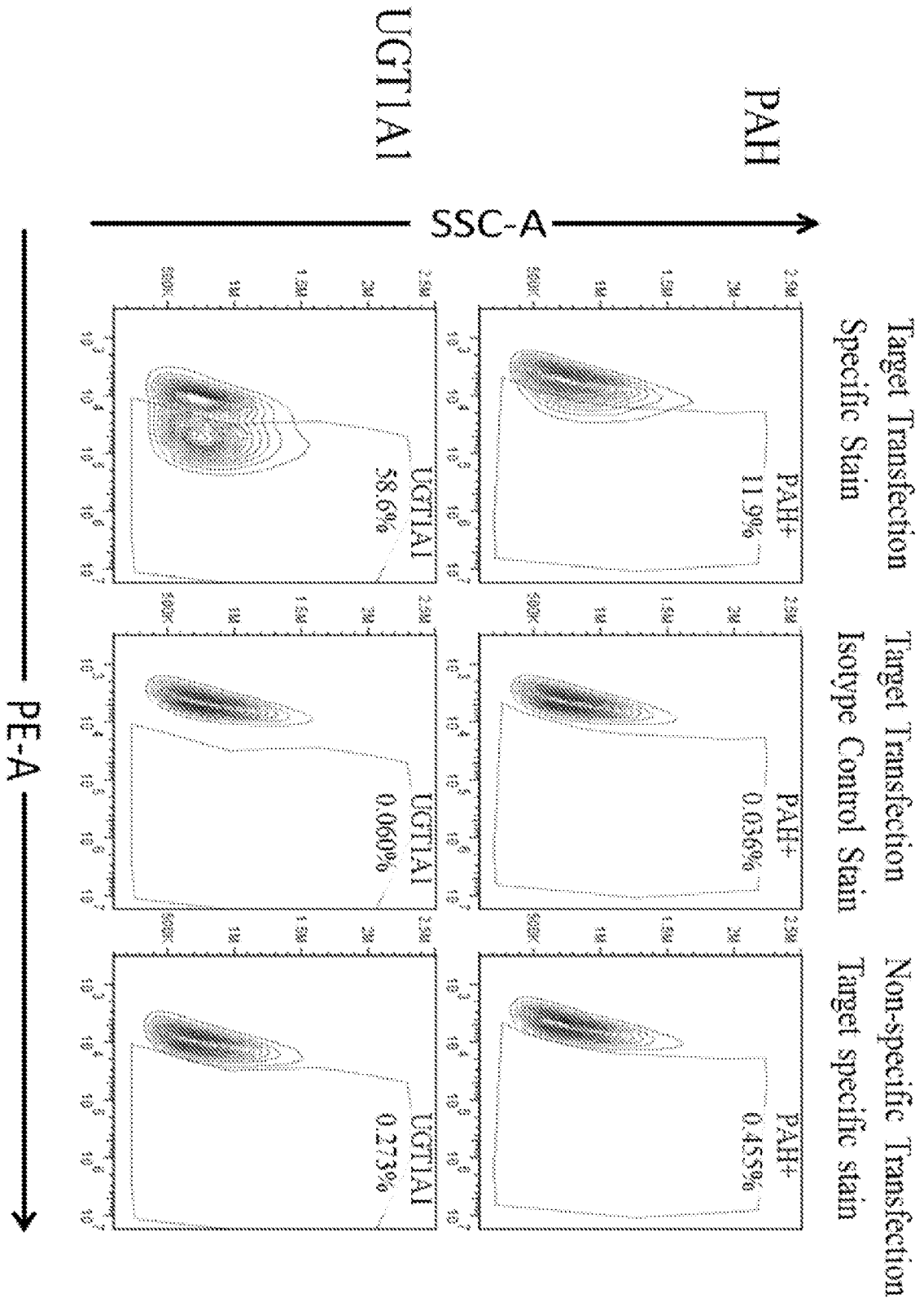

FIGURE 71

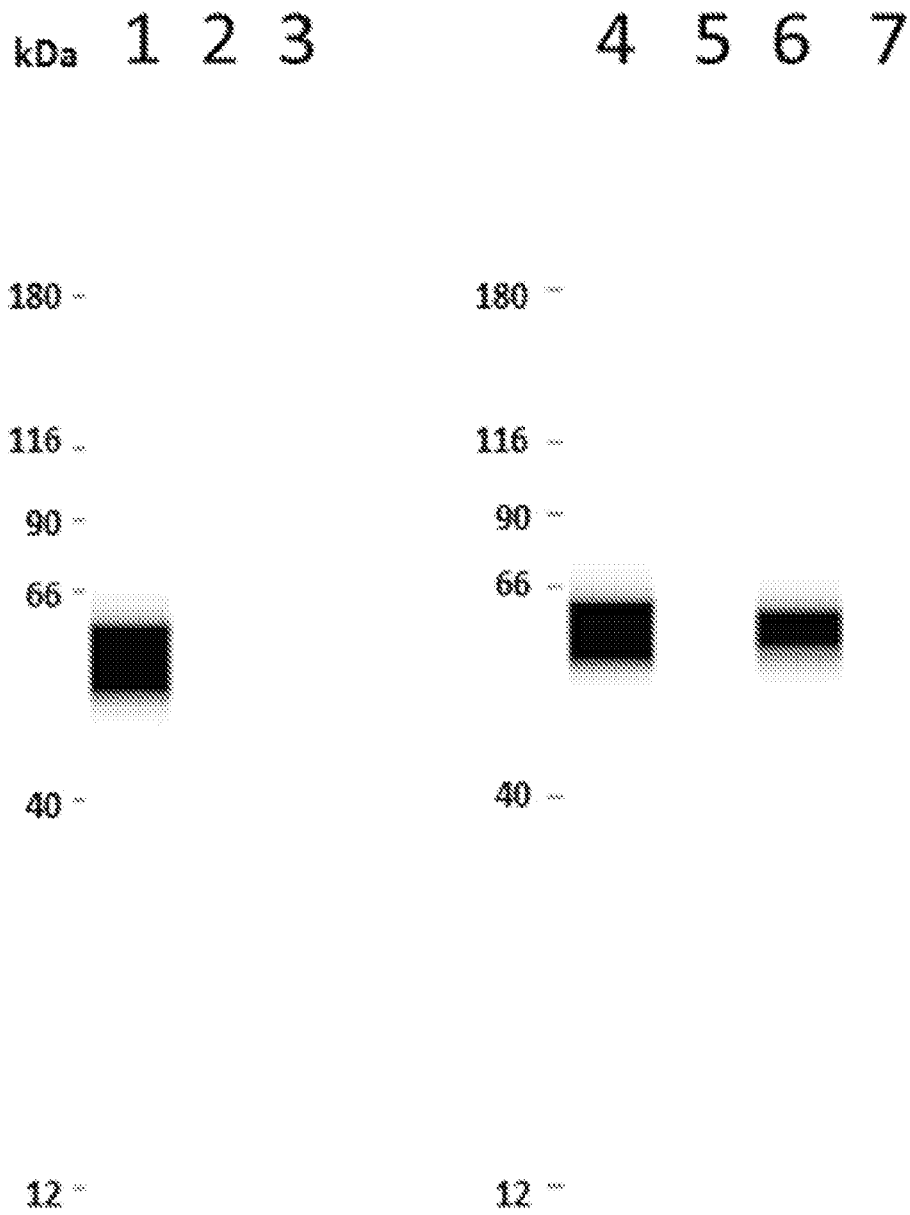

FIGURE 72

