



- (51) International Patent Classification:
C07H 21/02 (2006.01) A61K 48/00 (2006.01)
- (21) International Application Number:
PCT/US20 12/0696 10
- (22) International Filing Date:
14 December 2012 (14. 12.2012)
- (25) Filing Language: English
- (26) Publication Language: English
- (30) Priority Data:
61/576,705 16 December 2011 (16. 12.2011) US
61/618,957 2 April 2012 (02.04.2012) US
61/648,244 17 May 2012 (17.05.2012) US
61/681,712 10 August 2012 (10.08.2012) US
61/696,381 4 September 2012 (04.09.2012) US
61/709,303 3 October 2012 (03. 10.2012) US
PCT/US2012/0585 19
3 October 2012 (03. 10.2012) US
61/712,490 11 October 2012 (11. 10.2012) US

- (71) Applicant: MODERNA THERAPEUTICS [US/US];
161 First Street, First Floor, Cambridge, Massachusetts
02142 (US).
- (72) Inventors: DE FOUGEROLLES, Antonin; 66 Summit
Avenue, Brookline, Massachusetts 02446 (US). WOOD,
Kristy M.; 501 Huron Ave, Unit 2, Cambridge, Massachu-
setts 02138 (US). ELBASHIR, Sayda M.; 149 Grove
Street, Cambridge, Massachusetts 021 38 (US). AFEYAN,
Noubar B.; 1 Memorial Drive, 7th Floor, Cambridge, Mas-
sachusetts 02142 (US). VALENCIA, Pedro; 60
Wadsworth Street, Apt. 5G, Cambridge, Massachusetts
02142 (US). SCHRUM, Jason P.; 4601 Flat Rock Road,
Apt. 417, Philadelphia, Pennsylvania 19127 (US).
- (74) Agent: WARD, Donna T.; DT Ward, P.C., 142A Main
Street, Groton, Massachusetts 01450 (US).
- (81) Designated States (unless otherwise indicated, for every
kind of national protection available): AE, AG, AL, AM,
AO, AT, AU, AZ, BA, BB, BG, BH, BN, BR, BW, BY,
BZ, CA, CH, CL, CN, CO, CR, CU, CZ, DE, DK, DM,
DO, DZ, EC, EE, EG, ES, FI, GB, GD, GE, GH, GM, GT,

[Continued on nextpage]

(54) Title: MODIFIED NUCLEOSIDE, NUCLEOTIDE, AND NUCLEIC ACID COMPOSITIONS

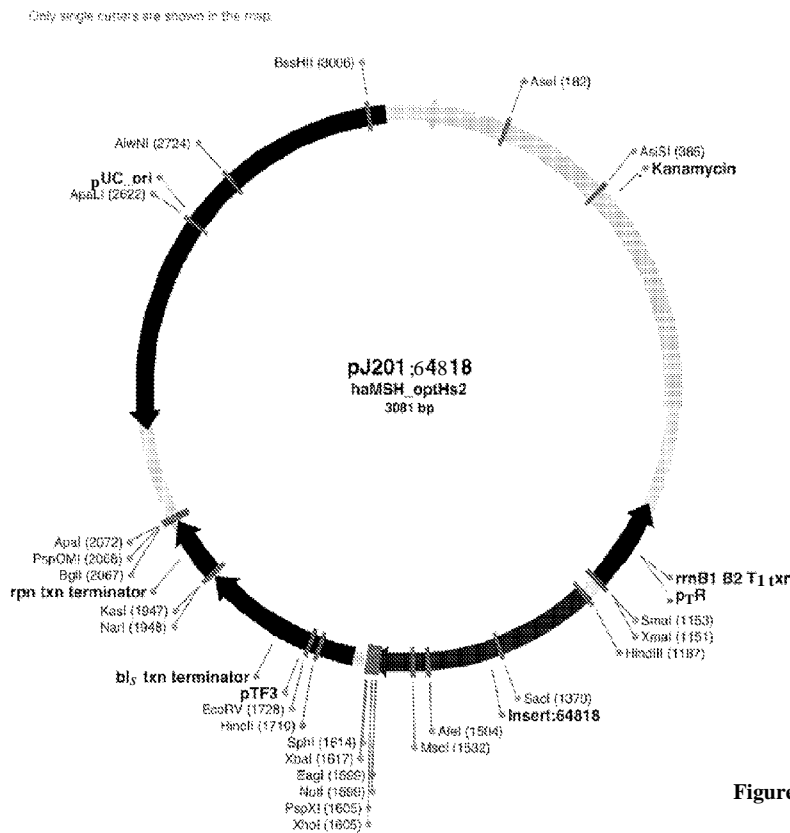

(57) Abstract: The present disclosure provides, *inter alia*, formulation compositions comprising modified nucleic acid molecules which may encode a protein, a protein precursor, or a partially or fully processed form of the protein or a protein precursor. The formulation composition may further include a modified nucleic acid molecule and a delivery agent. The present invention further provides nucleic acids useful for encoding polypeptides capable of modulating a cell's function and/or activity.

Figure 2

WO 2013/090648 A1

HN, HR, HU, ID, IL, IN, IS, JP, KE, KG, KM, KN, KP, KR, KZ, LA, LC, LK, LR, LS, LT, LU, LY, MA, MD, ME, MG, MK, MN, MW, MX, MY, MZ, NA, NG, NI, NO, NZ, OM, PA, PE, PG, PH, PL, PT, QA, RO, RS, RU, RW, SC, SD, SE, SG, SK, SL, SM, ST, SV, SY, TH, TJ, TM, TN, TR, TT, TZ, UA, UG, US, UZ, VC, VN, ZA, ZM, ZW.

TM), European (AL, AT, BE, BG, CH, CY, CZ, DE, DK, EE, ES, FI, FR, GB, GR, HR, HU, IE, IS, IT, LT, LU, LV, MC, MK, MT, NL, NO, PL, PT, RO, RS, SE, SI, SK, SM, TR), OAPI (BF, BJ, CF, CG, CI, CM, GA, GN, GQ, GW, ML, MR, NE, SN, TD, TG).

(84) Designated States (unless otherwise indicated, for every kind of regional protection available): ARIPO (BW, GH, GM, KE, LR, LS, MW, MZ, NA, RW, SD, SL, SZ, TZ, UG, ZM, ZW), Eurasian (AM, AZ, BY, KG, KZ, RU, TJ,

Published:

- with international search report (Art. 21(3))
— with sequence listing part of description (Rule 5.2(a))

MODIFIED NUCLEOSIDE, NUCLEOTIDE, AND NUCLEIC ACID COMPOSITIONS

REFERENCE TO SEQUENCE LISTING

[0001] The present application is being filed along with a Sequence Listing in electronic format. The Sequence Listing file, entitled M1 IPCTSQLST.txt, was created on December 14, 2012 and is 25,579 bytes in size. The information in electronic format of the Sequence Listing is incorporated herein by reference in its entirety.

CROSS REFERENCE TO RELATED APPLICATIONS

[0002] This application claims the benefit of U.S. Provisional Patent Application No. 61/576,705, filed December 16, 2011, entitled Modified Nucleoside, Nucleotide, and Nucleic Acid Compositions, U.S. Provisional Patent Application No. 61/618,957, filed April 2, 2012, entitled Modified Nucleoside, Nucleotide, and Nucleic Acid Compositions, U.S. Provisional Patent Application No. 61/648,244, filed May 17, 2012, entitled Modified Nucleoside, Nucleotide, and Nucleic Acid Compositions, U.S. Provisional Patent Application No. 61/681,712, filed August 10, 2012, entitled Modified Nucleoside, Nucleotide, Nucleic Acid Compositions and U.S. Provisional Patent Application No. 61/696,381 filed September 4, 2012, entitled Modified Nucleoside, Nucleotide and Nucleic Acid Compositions, and Nucleic Acid Compositions, U.S. Provisional Patent Application No. 61/709,303 filed October 3, 2012, entitled Modified Nucleoside, Nucleotide and Nucleic Acid Compositions, U.S. Provisional Patent Application No. 61/712,490 filed October 11, 2012, entitled Modified Nucleoside, Nucleotide and Nucleic Acid Compositions and International Pub. No. PCT/US2012/058519 filed October 3, 2012 Modified Nucleosides, Nucleotides, and Nucleic Acids, And Uses Thereof, the contents of which are incorporated herein by reference in their entirety.

BACKGROUND OF THE INVENTION

[0003] In general, exogenous unmodified nucleic acid molecules, particularly viral nucleic acids, introduced into the cell induce an innate immune response which results in cytokine and interferon (IFN) production and ultimately cell death. It is of great interest for therapeutics, diagnostics, reagents and for biological assays to be able to deliver a nucleic acid, *e.g.*, a ribonucleic acid (RNA), into a cell, such as to cause intracellular translation of the nucleic acid and production of the encoded

protein instead of generating an innate immune response. Thus, there is a need to develop formulation compositions comprising a delivery agent that can effectively facilitate the *in vivo* delivery of nucleic acids to targeted cells without generating an innate immune response.

SUMMARY OF THE INVENTION

[0004] The present disclosure provides, *inter alia*, formulation compositions comprising modified nucleic acid molecules which may encode a protein, a protein precursor, or a partially or fully processed form of the protein or a protein precursor. The formulation compositions may further include a modified nucleic acid molecule and a delivery agent. The present invention further provides nucleic acids useful for encoding polypeptides capable of modulating a cell's function and/or activity.

[0005] In one aspect a method of producing a polypeptide of interest in a mammalian cell or tissue is described. The method comprises contacting the mammalian cell or tissue with a formulation comprising a modified mRNA encoding a polypeptide of interest. The formulation may be, but is not limited to, nanoparticles, poly(lactic-co-glycolic acid)(PLGA) microspheres, lipidoids, lipoplex, liposome, polymers, carbohydrates (including simple sugars), cationic lipids, fibrin gel, fibrin hydrogel, fibrin glue, fibrin sealant, fibrinogen, thrombin, rapidly eliminated lipid nanoparticles (reLNPs) and combinations thereof. The modified mRNA may comprise a purified IVT transcript.

[0006] In one embodiment, the formulation comprising the modified mRNA is a nanoparticle which may comprise at least one lipid. The lipid may be selected from, but is not limited to, DLin-DMA, DLin-K-DMA, 98N12-5, C12-200, DLin-MC3 -DMA, DLin-KC2-DMA, DODMA, PLGA, PEG, PEG-DMG and PEGylated lipids. In another aspect, the lipid may be a cationic lipid such as, but not limited to, DLin-DMA, DLin-D-DMA, DLin-MC3 -DMA, DLin-KC2-DMA and DODMA.

[0007] The lipid to modified mRNA ration in the formulation may be between 10:1 and 30:10. The mean size of the nanoparticle formulation may comprise the modified mRNA between 60 and 225 nm. The PDI of the nanoparticle formulation comprising the modified mRNA is between 0.03 and 0.15. The zeta potential of the lipid may be from -10 to +10 at a pH of 7.4

[0008] The formulations of modified mRNA may comprise a fusogenic lipid, cholesterol and a PEG lipid. The formulation may have a molar ratio 50:10:38.5:1.5-3.0 (cationic lipid: fusogenic lipid: cholesterol: PEG lipid). The PEG lipid may be selected from, but is not limited to PEG-c-DOMG, PEG-DMG. The fusogenic lipid may be DSPC.

[0009] The mammalian cell or tissue may be contacted using a device such as, but not limited to, a syringe pump, internal osmotic pump and external osmotic pump.

[0010] The formulation of modified mRNA may be a PLGA microsphere which may be between 4 and 20 μm in size. The modified mRNA may be released from the formulation at less than 50% in a 48 hour time period. The PLGA microsphere formulation may be stable in serum. Stability may be determined relative to unformulated modified mRNA in 90%.

[0011] The loading weight percent of the modified mRNA PLGA microsphere may be at least 0.05%, at least 0.1%, at least 0.2%, at least 0.3%, at least 0.4% or at least 0.5%. The encapsulation efficiency of the modified mRNA in the PLGA microsphere may be at least 50%, at least 70%, at least 90% or at least 97%.

[0012] A lipid nanoparticle of the present invention may be formulated in a sealant such as, but not limited to, a fibrin sealant.

[0013] The mammalian cells or tissues may be contacted by a route of administration such as, but not limited to, intravenous, intramuscular, intravitreal, intrathecal, intratumoral, pulmonary and subcutaneous. The mammalian cells or tissues may be contacted using a split dosing schedule. The mammalian cell or tissue may be contacted by injection. The injection may be made to tissue selected from the group consisting of intradermal space, epidermis, subcutaneous tissue and muscle. The polypeptide of interest may be produced in the cell or tissue in a location systemic from the location of contacting.

[0014] The polypeptide of interest may be detectable in serum for up to 72 hours after contacting. The level of the polypeptide of interest can be higher than the levels prior to dosing. The level of the polypeptide of interest may be greater in the serum of female subjects than in the serum of male subjects.

[0015] The formulation of modified mRNA may comprise more than one modified mRNA. The formulation may have two or three modified mRNA.

[0016] The formulation comprising the modified mRNA may comprise a rapidly eliminated lipid nanoparticle (reLNP) which may comprise a reLNP lipid, fusogenic lipid, cholesterol and a PEG lipid at a molar ratio of 50: 10: 38.5: 1.5 (reLNP lipid: fusogenic lipid: cholesterol: PEG lipid). The fusogenic lipid may be DSPC and the PEG lipid may be PEG-c-DOMG. The reLNP lipid may be DLin-DMA with an internal or terminal ester or DLin-MC3-DMA with an internal or terminal ester. The total lipid to modified mRNA weight ration may be between 10:1 and 30:1.

[0017] The formulation comprising modified mRNA may comprise a fibrin sealant.

[0018] The formulation comprising modified mRNA may comprise a lipidoid where the lipid is selected from the group consisting of CI2-200 and 98N12-5.

[0019] The formulation comprising modified mRNA may include a polymer. The polymer may be coated, covered, surrounded, enclosed or comprise a layer of a hydrogel or surgical sealant. The polymer may be selected from the group consisting of PLGA, ethylene vinyl acetate, poloxamer and GELSITE®.

[0020] A polypeptide of interest may be produced in a mammalian cell or tissue by contacting the mammalian cell or tissue with a buffer formulation comprising a modified mRNA encoding the polypeptide of interest. The buffer formulation may be selected from, but is not limited to, saline, phosphate buffered saline and Ringer's lactate. The buffer formulation may comprise a calcium concentration of between 1 to 10 mM. The modified mRNA in the buffer formulation may comprise a purified IVT transcript.

[0021] A pharmacologic effect in a primate may be produced by contacting the primate with a composition comprising a formulated modified mRNA encoding a polypeptide of interest. The modified mRNA may comprise a purified IVT transcript and/or may be formulated in nanoparticles, poly(lactic-co-glycolic acid)(PLGA) microspheres, lipidoids, lipoplex, liposome, polymers, carbohydrates (including simple sugars), cationic lipids, fibrin gel, fibrin hydrogel, fibrin glue, fibrin sealant, fibrinogen, thrombin, rapidly eliminated lipid nanoparticles (reLNPs) and combinations thereof. The pharmacological effect may be greater than the pharmacologic effect associated with a therapeutic agent and/or composition known to produce said pharmacologic effect. The composition may comprise a formulated or unformulated modified mRNA. The pharmacologic effect may result in a therapeutically effective outcome of a disease, disorder, condition or infection. Such therapeutically effective outcome may include, but is not limited to, treatment, improvement of one or more symptoms, diagnosis, prevention, and delay of onset. The pharmacologic effect may include, but is not limited to, change in cell count, alteration in serum chemistry, alteration of enzyme activity, increase in hemoglobin, and increase in hematocrit.

[0022] In one embodiment, the present disclosure provides a formulation composition which comprises a modified nucleic acid molecule and a delivery agent. The modified nucleic acid molecule may be selected from the group consisting of DNA, complimentary DNA (cDNA), RNA, messenger RNA (mRNA), RNAi-inducing agents, RNAi agents, siRNA, shRNA, miRNA, antisense

RNA, ribozymes, catalytic DNA, RNA that induce triple helix formation, aptamers, vectors and combinations thereof. If the modified nucleic acid molecule is mRNA the mRNA may be derived from cDNA.

[0023] In one embodiment, the modified nucleic acid molecule may comprise at least one modification and a translatable region. In some instances, the modified nucleic acid comprises at least two modifications and a translatable region. The modification may be located on the backbone and/or a nucleoside of the nucleic acid molecule. The modification may be located on both a nucleoside and a backbone linkage.

[0024] In one embodiment, a modification may be located on the backbone linkage of the modified nucleic acid molecule. The backbone linkage may be modified by replacing of one or more oxygen atoms. The modification of the backbone linkage may comprise replacing at least one phosphodiester linkage with a phosphorothioate linkage.

[0025] In one embodiment, a modification may be located on a nucleoside of the modified nucleic acid molecule. The modification on the nucleoside may be located on the sugar of said nucleoside. The modification of the nucleoside may occur at the 2' position on the nucleoside.

[0026] The nucleoside modification may include a compound selected from the group consisting of pyridin-4-one ribonucleoside, 5-aza-uridine, 2-thio-5-aza-uridine, 2-thiouridine, 4-thio-pseudouridine, 2-thio-pseudouridine, 5-hydroxyuridine, 3-methyluridine, 5-carboxymethyl-uridine, 1-carboxymethyl-pseudouridine, 5-propynyl-uridine, 1-propynyl-pseudouridine, 5-taurinomethyluridine, 1-taurinomethyl-pseudouridine, 5-taurinomethyl-2-thio-uridine, 1-taurinomethyl-4-thio-uridine, 5-methyl-uridine, 1-methyl-pseudouridine, 4-thio-1-methyl-pseudouridine, 2-thio-1-methyl-pseudouridine, 1-methyl-1-deaza-pseudouridine, 2-thio-1-methyl-1-deaza-pseudouridine, dihydrouridine, dihydropseudouridine, 2-thio-dihydrouridine, 2-thio-dihydropseudouridine, 2-methoxyuridine, 2-methoxy-4-thio-uridine, 4-methoxy-pseudouridine, 4-methoxy-2-thio-pseudouridine, 5-aza-cytidine, pseudoisocytidine, 3-methyl-cytidine, N4-acetylcytidine, 5-formylcytidine, N4-methylcytidine, 5-hydroxymethylcytidine, 1-methyl-pseudoisocytidine, pyrrolo-cytidine, pyrrolo-pseudoisocytidine, 2-thio-cytidine, 2-thio-5-methyl-cytidine, 4-thio-pseudoisocytidine, 4-thio-1-methyl-pseudoisocytidine, 4-thio-1-methyl-1-deaza-pseudoisocytidine, 1-methyl-1-deaza-pseudoisocytidine, zebularine, 5-aza-zebularine, 5-methyl-zebularine, 5-aza-2-thio-zebularine, 2-thio-zebularine, 2-methoxy-cytidine, 2-methoxy-5-methyl-cytidine, 4-methoxy-pseudoisocytidine, 4-methoxy-1-methyl-pseudoisocytidine, 2-aminopurine, 2,

6-diaminopurine, 7-deaza-adenine, 7-deaza-8-aza-adenine, 7-deaza-2-aminopurine, 7-deaza-8-aza-2-aminopurine, 7-deaza-2,6-diaminopurine, 7-deaza-8-aza-2,6-diaminopurine, 1-methyladenosine, N6-methyladenosine, N6-isopentenyladenosine, N6-(cis-hydroxyisopentenyl)adenosine, 2-methylthio-N6-(cis-hydroxyisopentenyl) adenosine, N6-glycinylocarbamoyladenosine, N6-threonylocarbamoyladenosine, 2-methylthio-N6-threonyl carbamoyladenosine, N6,N6-dimethyladenosine, 7-methyladenine, 2-methylthio-adenine, 2-methoxy-adenine, inosine, 1-methylinosine, wyosine, wybutosine, 7-deaza-guanosine, 7-deaza-8-aza-guanosine, 6-thio-guanosine, 6-thio-7-deaza-guanosine, 6-thio-7-deaza-8-aza-guanosine, 7-methyl-guanosine, 6-thio-7-methyl-guanosine, 7-methylinosine, 6-methoxy-guanosine, 1-methylguanosine, N2-methylguanosine, N2,N2-dimethylguanosine, 8-oxo-guanosine, 7-methyl-8-oxo-guanosine, 1-methyl-6-thio-guanosine, N2-methyl-6-thio-guanosine, and N2,N2-dimethyl-6-thio-guanosine. In another embodiment, the modifications are independently selected from the group consisting of 5-methylcytosine, pseudouridine and 1-methylpseudouridine

[0027] In one embodiment, a modification may be located on a nucleobase of the modified nucleic acid molecule. The modification on the nucleobase may be selected from the group consisting of cytosine, guanine, adenine, thymine and uracil. The modification on the nucleobase may be selected from the group consisting of deaza-adenosine and deaza-guanosine, and the linker may be attached at a C-7 or C-8 position of said deaza-adenosine or deaza-guanosine. The modified nucleobase may be selected from the group consisting of cytosine and uracil, and the linker may be attached to the modified nucleobase at an N-3 or C-5 position. The linker attached to the nucleobase may be selected from the group consisting of diethylene glycol, dipropylene glycol, triethylene glycol, tripropylene glycol, tetraethylene glycol, tetraethylene glycol, divalent alkyl, alkenyl, alkynyl moiety, ester, amide, and ether moiety.

[0028] In one embodiment, two modifications of the nucleic acid molecule may be located on nucleosides of the modified nucleic acid molecule. The modified nucleosides may be selected from 5-methylcytosine and pseudouridine.

[0029] In one embodiment, two modifications of the modified nucleic acid molecule may be located on a nucleotide or a nucleoside. In one embodiment, the present disclosure provides a formulation comprising a nucleic acid molecule such as, but not limited to, SEQ ID NO: 6, SEQ ID NO: 7, SEQ ID NO: 9 and SEQ ID NO: 10 and a delivery agent. The nucleic acid molecule may comprise a polyA tail about 160 nucleotides in length. Further, the nucleic acid molecule may

comprise at least one 5' terminal cap such as, but not limited to, CapO, CapI, ARCA, inosine, N1-methyl-guanosine, 2'fluoro-guanosine, 7-deaza-guanosine, 8-oxo-guanosine, 2-amino-guanosine, LNA-guanosine, and 2-azido-guanosine.

[0030] In one embodiment, the present disclosure provides a nucleic acid of SEQ ID NO: 6, a 5' terminal cap which is CapI, a poly A tail of approximately 160 nucleotides in length and a delivery agent.

[0031] In one embodiment, the present disclosure provides a nucleic acid of SEQ ID NO: 7, a 5' terminal cap which is CapI, a poly A tail of approximately 160 nucleotides in length and a delivery agent.

[0032] In one embodiment, the present disclosure provides a nucleic acid of SEQ ID NO: 9, a 5' terminal cap which is CapI, a poly A tail of approximately 160 nucleotides in length and a delivery agent.

[0033] In one embodiment, the present disclosure provides a nucleic acid of SEQ ID NO: 10, a 5' terminal cap which is CapI, a poly A tail of approximately 160 nucleotides in length and a delivery agent.

[0034] In one embodiment, the delivery agent comprises at least one method to improve delivery selected from the group consisting of lipidoids, liposomes, lipid nanoparticles, rapidly eliminated lipid nanoparticles (reLNPs), polymers, lipoplexes, peptides, proteins, hydrogels, sealants, chemical modifications, conjugation, cells and enhancers. The lipidoid, lipid nanoparticle and rapidly eliminated lipid nanoparticles which may be used as a delivery agent may include a lipid which may be selected from the group consisting of C12-200, MD1, 98N12-5, DLin-DMA, DLin-K-DMA, DLin-KC2-DMA, DLin-MC3 -DMA, PLGA, PEG, PEG-DMG, PEGylated lipids and analogs thereof. The rapidly eliminated lipid nanoparticle may have an ester linkage at the terminal end of the lipid chain, or an ester linkage may be an internal linkage located to the right or left of a saturated carbon in the lipid chain. The rapidly eliminated lipid nanoparticle which may be used as a delivery agent may be, but is not limited to, DLin-MC3-DMA and DLin-DMA.

[0035] In one embodiment, the lipid nanoparticle may comprise PEG and at least one component such as, but not limited to, cholesterol, cationic lipid and fusogenic lipid.

[0036] In one embodiment, the lipid nanoparticle may comprise at least one of a PEG, cholesterol, cationic lipid and fusogenic lipid.

[0037] In one embodiment, the fusogenic lipid is disteoylphosphatidyl choline (DSPC). In another embodiment, the PEG lipid is PEG-DMG. In yet another embodiment, the cationic lipid may be, but not limited to, DLin-DMA, DLin-MC3-DMA, C12-200, 98N12-5 and DLin-KC2-DMA.

[0038] In one embodiment, the lipid nanoparticle composition may comprise 50 mol% cationic lipid, 10 mol% DSPC, 1.5-3.0 mol% PEG and 37-38.5 mol% cholesterol.

[0039] In one embodiment, a modified nucleic acid may be formulated with PLGA to form a sustained release formulation. In another embodiment, a modified nucleic acid may be formulated with PLGA and other active and/or inactive components to form a sustained release formulation. In one embodiment, the modified nucleic acid molecule may include, but is not limited to, SEQ ID NO: 9 and SEQ ID NO: 10.

[0040] In one embodiment, a sustained release formulation may comprise a sustained release microsphere. The sustained release microsphere may be about 10 to about 50 um in diameter. In another embodiment, the sustained release microsphere may contain about 0.001 to about 1.0 weight percent of at least one modified nucleic acid molecule.

[0041] In one embodiment, the modified nucleic acids of the present invention may include at least one stop codon before the 3' untranslated region (UTR). The stop codon may be selected from TGA, TAA and TAG. In one embodiment, the modified nucleic acids of the present invention include the stop codon TGA and one additional stop codon. In a further embodiment the additional stop codon may be TAA. In another embodiment, the modified nucleic acid of the present invention includes three stop codons.

[0042] In one embodiment, the present disclosure provides a controlled release formulation comprising a modified nucleic acid which may encode a polypeptide of interest. The modified nucleic acid may be encapsulated or substantially encapsulated in a delivery agent. The delivery agent may be coated, covered, surrounded, enclosed or comprise a layer of polymer, hydrogel and/or surgical sealant. In a further embodiment, the controlled release formulation may comprise a second layer of polymer, hydrogel and/or surgical sealant.

[0043] In one embodiment, the delivery agent of the controlled release formulation may include, but is not limited to, lipidoids, liposomes, lipid nanoparticles, rapidly eliminated lipid nanoparticles, lipoplexes and self-assembled lipid nanoparticles.

[0044]

[0045] The polymer which may be used in the controlled release formulation may include, but is not limited to, PLGA, ethylene vinyl acetate, poloxamer and GELSITE®. The surgical sealant which may be used in the controlled release formulation may include, but is not limited to, fibrinogen polymers, TISSELL®, PEG-based sealants and COSEAL®.

[0046] In one embodiment, the delivery agent of the controlled release formulation comprises a lipid nanoparticle or a rapidly eliminated lipid nanoparticle delivery agent. In one aspect, the lipid nanoparticle or rapidly eliminated lipid nanoparticle may be coated, substantially coated, covered, substantially covered, surrounded, substantially surrounded, enclosed, substantially enclosed or comprises a layer of polymer, hydrogel and/or surgical sealant. In another aspect, the delivery agent may be a lipid nanoparticle which may be coated, substantially coated, covered, substantially covered, surrounded, substantially surrounded, enclosed, substantially enclosed or comprises a layer of PLGA.

BRIEF DESCRIPTION OF THE DRAWINGS

[0047] The foregoing and other objects, features and advantages will be apparent from the following description of particular embodiments of the invention, as illustrated in the accompanying drawings in which like reference characters refer to the same parts throughout the different views. The drawings are not necessarily to scale, emphasis instead being placed upon illustrating the principles of various embodiments of the invention.

[0048] FIG. 1 illustrates lipid structures in the prior art useful in the present invention. Shown are the structures for 98N12-5 (TETA5-LAP), DLin-DMA, DLin-K-DMA (2,2-Dilinoleyl-4-dimethylaminomethyl-[1,3]-dioxolane), DLin-KC2-DMA, DLin-MC3-DMA and C12-200.

[0049] FIG. 2 is a representative plasmid useful in the IVT reactions taught herein. The plasmid contains Insert 64818, designed by the instant inventors.

[0050] FIG. 3 is a gel profile of modified mRNA encapsulated in PLGA microspheres.

DETAILED DESCRIPTION

[0051] The delivery of nucleic acids into cells has many undesired complications including the integration of the nucleic acid into the target cell genome which may result in imprecise expression levels, the deleterious transfer of the nucleic acid to progeny and neighbor cells and a substantial risk of causing mutations. The modified nucleic acid molecules of the present disclosure are capable of

reducing the innate immune activity of a population of cells into which they are introduced, thus increasing the efficiency of protein production in that cell population. Further, one or more additional advantageous activities and/or properties of the nucleic acids and proteins of the present disclosure are described herein.

[0052] In addition, provided herein are methods of treating a subject having or being suspected of having a disease, disorder and/or condition the methods comprising administering to a subject in need of such treatment a composition described herein in an amount sufficient to treat the disease, disorder and/or condition.

[0053] Unless otherwise defined, all technical and scientific terms used herein have the same meaning as commonly understood by one of ordinary skill in the art to which this invention belongs. Although methods and materials similar or equivalent to those described herein can be used in the practice or testing of methods featured in the invention, suitable methods and materials are described below.

Modified Nucleic Acid Molecules

[0054] The present disclosure provides nucleic acids, including RNA such as mRNA, which contain one or more modified nucleosides or nucleotides (termed "modified nucleic acid molecules," "modified mRNA" or "modified mRNA molecules") as described herein. The modification of the nucleic acid molecules of the present invention may have useful properties including, but not limited to, a significant decrease in or a lack of a substantial induction of the innate immune response of a cell into which the modified mRNA is introduced. The modified nucleic acid molecules may also exhibit enhanced efficiency of protein production, intracellular retention of nucleic acids, and viability of contacted cells, as well as having reduced immunogenicity as compared to unmodified nucleic acid molecules.

[0055] Provided are modified nucleic acid molecules containing a translatable region and one, two, or more than two different nucleoside modifications. Exemplary nucleic acids for use in this disclosure include ribonucleic acids (RNA), deoxyribonucleic acids (DNAs), threose nucleic acids (TNAs), glycol nucleic acids (GNAs), locked nucleic acids (LNAs) or a hybrid thereof. In preferred embodiments, the modified nucleic acid molecules include messenger RNA (mRNA). As described herein, the modified nucleic acid molecules of the present disclosure may not substantially induce an innate immune response of a cell into which the modified mRNA is introduced. In another embodiment, the modified nucleic acid molecule may exhibit reduced degradation, as compared to a

nucleic acid that has not been modified, in a cell where the modified nucleic acid molecule is introduced.

[0056] The term "nucleic acid" includes any compound and/or substance that is or can be incorporated into an oligonucleotide chain. Exemplary nucleic acids for use in accordance with the present disclosure include, but are not limited to, one or more of DNA, cDNA, RNA including messenger RNA (mRNA), hybrids thereof, RNAi-inducing agents, RNAi agents, siRNA, shRNA, miRNA, antisense RNA, ribozymes, catalytic DNA, RNA that induce triple helix formation, aptamers, vectors and the like.

[0057] In certain embodiments, it is desirable to intracellularly degrade a modified nucleic acid molecule introduced into the cell. For example it would be desirable to degrade a modified nucleic acid molecule if precise timing of protein production was desired. Thus, the present disclosure provides a modified nucleic acid molecule containing a degradation domain, which is capable of being acted on in a directed manner within a cell.

[0058] In some embodiments, the modified nucleic acid molecules may be chemically modified on the sugar, nucleobase (*e.g.*, in the 5' position of the nucleobase), or phosphate backbone (*e.g.*, replacing the phosphate with another moiety such as a thiophosphate). In some embodiments, the modification may result in a disruption of a major groove binding partner interaction, which may contribute to an innate immune response. In some embodiments, the formulation composition, when administered to a subject, can result in improved bioavailability, therapeutic window, or volume of distribution of the modified nucleic acid molecule relative to administration of the modified nucleic acid molecule without the incorporation of the delivery agent. In some embodiments, the modified nucleosides and nucleotides of the modified nucleic acid molecules of the present invention may be synthesized using the O-protected compounds described in International Pub. No. WO2012138530, the contents of which is herein incorporated by reference in its entirety.

[0059] In certain embodiments, the modified nucleic acid molecule may comprise mRNA. In particular embodiments, the modified mRNA (mmRNA) may be derived from cDNA. In certain embodiments, mmRNA may comprise at least two nucleoside modifications. In one embodiment, the nucleoside modifications may be selected from 5-methylcytosine and pseudouridine. In another embodiment, at least one of the nucleoside modifications is not 5-methylcytosine and/or pseudouridine. In certain embodiments the delivery agent may comprise formulations allowing for localized and systemic delivery of mmRNA. The formulations of the modified nucleic acids

molecules and/or mRNA may be selected from, but are not limited to, lipidoids, liposomes and lipid nanoparticles, rapidly eliminated lipid nanoparticles, polymers, lipoplexes, peptides and proteins, at least one chemical modification and conjugation, enhancers, and/or cells.

[0060] In one embodiment, the modified nucleic acid molecules of the present invention may include at least two stop codons before the 3' untranslated region (UTR). The stop codon may be selected from TGA, TAA and TAG. In one embodiment, the nucleic acids of the present invention include the stop codon TGA and one additional stop codon. In a further embodiment the additional stop codon may be TAA. In another embodiment, the modified nucleic acid molecules may comprise three stop codons.

[0061] Other components of a nucleic acid are optional in a modified nucleic acid molecule but these components may be beneficial in some embodiments.

Untranslated Regions (UTRs)

[0062] Untranslated regions (UTRs) of a gene are transcribed but not translated. The 5' UTR starts at the transcription start site and continues to the start codon but does not include the start codon; whereas, the 3' UTR starts immediately following a stop codon and continues until the transcriptional termination signal. There is growing body of evidence about the regulatory roles played by the UTRs in terms of stability of the nucleic acid molecule and translation. The regulatory features of a UTR can be incorporated into the modified mRNA molecules of the present invention to enhance the stability of the molecule. The specific features can also be incorporated to ensure controlled down-regulation of the transcript in case they are misdirected to undesired organs sites.

5' UTR and Translation Initiation

[0063] Natural 5' UTRs bear features which play roles in for translation initiation. They harbor signatures like Kozak sequences which are commonly known to be involved in the process by which the ribosome initiates translation of many genes. Kozak sequences have the consensus CCR(A/G)CCAUGG (SEQ ID NO: 1), where R is a purine (adenine or guanine) three bases upstream of the start codon (AUG), which is followed by another 'G'. 5' UTR also have been known to form secondary structures which are involved in elongation factor binding.

[0064] By engineering the features typically found in abundantly expressed genes of specific target organs, one can enhance the stability and protein production of the modified mRNA molecules of the invention. For example, introduction of 5' UTR of liver-expressed mRNA, such as albumin, serum amyloid A, Apolipoprotein A/B/E, transferrin, alpha fetoprotein, erythropoietin, or Factor

VIII, could be used to enhance expression of a modified nucleic acid molecule, such as a mmRNA, in hepatic cell lines or liver. Likewise, use of 5' UTR from other tissue-specific mRNA to improve expression in that tissue is possible for muscle (MyoD, Myosin, Myoglobin, Myogenin, Herculin), for endothelial cells (Tie-1, CD36), for myeloid cells (C/EBP, AML1, G-CSF, GM-CSF, CD11b, MSR, Fr-1, i-NOS), for leukocytes (CD45, CD18), for adipose tissue (CD36, GLUT4, ACRP30, adiponectin) and for lung epithelial cells (SP-A/B/C/D).

[0065] Other non-UTR sequences may be incorporated into the 5' (or 3' UTR) UTRs of the modified nucleic acid molecules of the present invention. For example, introns or portions of introns sequences may be incorporated into the flanking regions of the modified mRNA of the invention. Incorporation of intronic sequences may increase protein production as well as mRNA levels.

3' UTR and the AU Rich Elements

[0066] 3' UTRs are known to have stretches of Adenosines and Uridines embedded in them. These AU rich signatures are particularly prevalent in genes with high rates of turnover. Based on their sequence features and functional properties, the AU rich elements (AREs) can be separated into three classes (Chen et al, 1995): Class I AREs contain several dispersed copies of an AUUUA motif within U-rich regions. C-Myc and MyoD contain class I AREs. Class II AREs possess two or more overlapping UUAUUUA(U/A)(U/A) (SEQ ID NO: 2) nonamers. Molecules containing this type of AREs include GM-CSF and TNF- α . Class III AREs are less well defined. These U rich regions do not contain an AUUUA motif. c-Jun and Myogenin are two well-studied examples of this class. Most proteins binding to the AREs are known to destabilize the messenger, whereas members of the ELAV family, most notably HuR, have been documented to increase the stability of mRNA. HuR binds to AREs of all the three classes. Engineering the HuR specific binding sites into the 3' UTR of nucleic acid molecules will lead to HuR binding and thus, stabilization of the message *in vivo*.

[0067] Introduction, removal or modification of 3' UTR AU rich elements (AREs) can be used to modulate the stability of modified mRNA of the invention. When engineering specific modified mRNA, one or more copies of an ARE can be introduced to make modified mRNA of the invention less stable and thereby curtail translation and decrease production of the resultant protein.

[0068] Likewise, AREs can be identified and removed or mutated to increase the intracellular stability and thus increase translation and production of the resultant protein. Transfection experiments can be conducted in relevant cell lines, using modified mRNA of the invention and protein production can be assayed at various time points post-transfection. For example, cells can be

transfected with different ARE-engineering molecules and by using an ELISA kit to the relevant protein and assaying protein produced at 6 hours, 12 hours, 24 hours, 48 hours, and 7 days post-transfection.

Incorporating microRNA Binding Sites

[0069] microRNAs (or miRNA) are 19-25 nucleotide long noncoding RNAs that bind to the 3' UTR of nucleic acid molecules and down-regulate gene expression either by reducing nucleic acid molecule stability or by inhibiting translation. The modified mRNA of the invention may comprise one or more microRNA target sequences, microRNA sequences, or microRNA seeds. Such sequences may correspond to any known microRNA such as those taught in US Publication US2005/0261218 and US Publication US2005/0059005, the contents of which are incorporated herein by reference in their entirety.

[0070] A microRNA sequence comprises a "seed" region, i.e., a sequence in the region of positions 2-8 of the mature microRNA, which sequence has perfect Watson-Crick complementarity to the miRNA target sequence. A microRNA seed may comprise positions 2-8 or 2-7 of the mature microRNA. In some embodiments, a microRNA seed may comprise 7 nucleotides (e.g., nucleotides 2-8 of the mature microRNA), wherein the seed-complementary site in the corresponding miRNA target is flanked by an adenine (A) opposed to microRNA position 1. In some embodiments, a microRNA seed may comprise 6 nucleotides (e.g., nucleotides 2-7 of the mature microRNA), wherein the seed-complementary site in the corresponding miRNA target is flanked by an adenine (A) opposed to microRNA position 1. See for example, Grimson A, Farh KK, Johnston WK, Garrett-Engele P, Lim LP, Barrell DP; Mol Cell. 2007 Jul 6;27(1):91-105; each of which is herein incorporated by reference in their entirety. The bases of the microRNA seed have complete complementarity with the target sequence. By engineering microRNA target sequences into the 3'UTR of modified mRNA of the invention one can target the molecule for degradation or reduced translation, provided the microRNA in question is available. This process will reduce the hazard of off target effects upon nucleic acid molecule delivery. Identification of microRNA, microRNA target regions, and their expression patterns and role in biology have been reported (Bonauer et al, Curr Drug Targets 2010 11:943-949; Anand and Cheresch Curr Opin Hematol 2011 18:171-176; Contreras and Rao Leukemia 2012 26:404-413 (2011 Dec 20. doi: 10.1038/leu.2011.356); Barrell Cell 2009 136:215-233; Landgraf et al, Cell, 2007 129:1401-1414; each of which is herein incorporated by reference in its entirety).

[0071] For example, if the modified nucleic acid molecule is a modified mRNA and is not intended to be delivered to the liver but ends up there, then miR-122, a microRNA abundant in liver, can inhibit the expression of the gene of interest if one or multiple target sites of miR-122 are engineered into the 3' UTR of the modified mRNA. Introduction of one or multiple binding sites for different microRNA can be engineered to further decrease the longevity, stability, and protein translation of a modified nucleic acid molecule and/or modified mRNA.

[0072] As used herein, the term "microRNA site" refers to a microRNA target site or a microRNA recognition site, or any nucleotide sequence to which a microRNA binds or associates. It should be understood that "binding" may follow traditional Watson-Crick hybridization rules or may reflect any stable association of the microRNA with the target sequence at or adjacent to the microRNA site.

[0073] Conversely, for the purposes of the modified mRNA of the present invention, microRNA binding sites can be engineered out of (i.e. removed from) sequences in which they naturally occur in order to increase protein expression in specific tissues. For example, miR-122 binding sites may be removed to improve protein expression in the liver. Regulation of expression in multiple tissues can be accomplished through introduction or removal of one or several microRNA binding sites.

[0074] Examples of tissues where microRNA are known to regulate mRNA, and thereby protein expression, include, but are not limited to, liver (miR-122), muscle (miR-133, miR-206, miR-208), endothelial cells (miR-17-92, miR-126), myeloid cells (miR-142-3p, miR-142-5p, miR-16, miR-21, miR-223, miR-24, miR-27), adipose tissue (let-7, miR-30c), heart (miR-1d, miR-149), kidney (miR-192, miR-194, miR-204), and lung epithelial cells (let-7, miR-133, miR-126). MicroRNA can also regulate complex biological processes such as angiogenesis (miR-132) (Anand and Cheresch Curr Opin Hematol 2011 18:171-176; herein incorporated by reference in its entirety). In the modified mRNA of the present invention, binding sites for microRNAs that are involved in such processes may be removed or introduced, in order to tailor the expression of the modified mRNA expression to biologically relevant cell types or to the context of relevant biological processes.

[0075] Lastly, through an understanding of the expression patterns of microRNA in different cell types, modified mRNA can be engineered for more targeted expression in specific cell types or only under specific biological conditions. Through introduction of tissue-specific microRNA binding sites, modified mRNA could be designed that would be optimal for protein expression in a tissue or in the context of a biological condition.

[0076] Transfection experiments can be conducted in relevant cell lines, using engineered modified mRNA and protein production can be assayed at various time points post-transfection. For example, cells can be transfected with different microRNA binding site-engineering modified mRNA and by using an ELISA kit to the relevant protein and assaying protein produced at 6 hour, 12 hour, 24 hour, 48 hour, 72 hour and 7 days post-transfection. *In vivo* experiments can also be conducted using microRNA-binding site-engineered molecules to examine changes in tissue-specific expression of formulated modified mRNA.

5' Capping

[0077] The 5' cap structure of an mRNA is involved in nuclear export, increasing mRNA stability and binds the mRNA Cap Binding Protein (CBP), which is responsible for mRNA stability in the cell and translation competency through the association of CBP with poly(A) binding protein to form the mature cyclic mRNA species. The cap further assists the removal of 5' proximal introns removal during mRNA splicing.

[0078] Endogenous mRNA molecules may be 5'-end capped generating a 5'-ppp-5'-triphosphate linkage between a terminal guanosine cap residue and the 5'-terminal transcribed sense nucleotide of the mRNA molecule. This 5'-guanylate cap may then be methylated to generate an N7-methyl-guanylate residue. The ribose sugars of the terminal and/or antiterminal transcribed nucleotides of the 5' end of the mRNA may optionally also be 2'-O-methylated. 5'-decapping through hydrolysis and cleavage of the guanylate cap structure may target a nucleic acid molecule, such as an mRNA molecule, for degradation.

[0079] Modifications to the modified mRNA of the present invention may generate a non-hydrolyzable cap structure preventing decapping and thus increasing mRNA half-life. Because cap structure hydrolysis requires cleavage of 5'-ppp-5' phosphodiester linkages, modified nucleotides may be used during the capping reaction. For example, a Vaccinia Capping Enzyme from New England Biolabs (Ipswich, MA) may be used with α -thio-guanosine nucleotides according to the manufacturer's instructions to create a phosphorothioate linkage in the 5'-ppp-5' cap. Additional modified guanosine nucleotides may be used such as α -methyl-phosphonate and seleno-phosphate nucleotides.

[0080] Additional modifications include, but are not limited to, 2'-O-methylation of the ribose sugars of 5'-terminal and/or 5'-antiterminal nucleotides of the mRNA (as mentioned above) on the

2'-hydroxyl group of the sugar ring. Multiple distinct 5'-cap structures can be used to generate the 5'-cap of a nucleic acid molecule, such as an mRNA molecule.

[0081] Cap analogs, which herein are also referred to as synthetic cap analogs, chemical caps, chemical cap analogs, or structural or functional cap analogs, differ from natural (i.e. endogenous, wild-type or physiological) 5'-caps in their chemical structure, while retaining cap function. Cap analogs may be chemically (i.e. non-enzymatically) or enzymatically synthesized and/or linked to a nucleic acid molecule.

[0082] For example, the Anti-Reverse Cap Analog (ARCA) cap contains two guanines linked by a 5'-5'-triphosphate group, wherein one guanine contains an N7 methyl group as well as a 3'-O-methyl group (i.e., N7,3'-O-dimethyl-guanosine-5'-triphosphate-5'-guanosine ($m^7G-3'mppp-G$; which may equivalently be designated 3' O-Me- $m^7G(5')ppp(5')G$). The 3'-O atom of the other, unmodified, guanine becomes linked to the 5'-terminal nucleotide of the capped nucleic acid molecule (e.g. an mRNA or mmRNA). The N7- and 3'-O-methylated guanine provides the terminal moiety of the capped nucleic acid molecule (e.g. mRNA or mmRNA).

[0083] Another exemplary cap is mCAP, which is similar to ARCA but has a 2'-O-methyl group on guanosine (i.e., N7,2'-O-dimethyl-guanosine-5'-triphosphate-5'-guanosine, $m^7Gm-ppp-G$).

[0084] While cap analogs allow for the concomitant capping of a nucleic acid molecule in an *in vitro* transcription reaction, up to 20% of transcripts can remain uncapped. This, as well as the structural differences of a cap analog from an endogenous 5'-cap structures of nucleic acids produced by the endogenous, cellular transcription machinery, may lead to reduced translational competency and reduced cellular stability.

[0085] Modified mRNA of the present invention may also be capped post-transcriptionally, using enzymes, in order to generate more authentic 5'-cap structures. As used herein, the phrase "more authentic" refers to a feature that closely mirrors or mimics, either structurally or functionally, an endogenous or wild type feature. That is, a "more authentic" feature is better representative of an endogenous, wild-type, natural or physiological cellular function and/or structure as compared to synthetic features or analogs, etc., of the prior art, or which outperforms the corresponding endogenous, wild-type, natural or physiological feature in one or more respects. Non-limiting examples of more authentic 5'cap structures of the present invention are those which, among other things, have enhanced binding of cap binding proteins, increased half life, reduced susceptibility to 5' endonucleases and/or reduced 5'decapping, as compared to synthetic 5'cap structures known in the

art (or to a wild-type, natural or physiological 5'cap structure). For example, recombinant Vaccinia Virus Capping Enzyme and recombinant 2'-O-methyltransferase enzyme can create a canonical 5'-5'-triphosphate linkage between the 5'-terminal nucleotide of an mRNA and a guanine cap nucleotide wherein the cap guanine contains an N7 methylation and the 5'-terminal nucleotide of the mRNA contains a 2'-O-methyl. Such a structure is termed the Cap1 structure. This cap results in a higher translational-competency and cellular stability and a reduced activation of cellular pro-inflammatory cytokines, as compared, e.g., to other 5'cap analog structures known in the art. Cap structures include, but are not limited to, 7mG(5')ppp(5')N_pN₂p (cap 0), 7mG(5')ppp(5')NImpN_p (cap 1), and 7mG(5')-ppp(5')NImpN₂mp (cap 2).

[0086] Because the modified mRNA may be capped post-transcriptionally, and because this process is more efficient, nearly 100% of the modified mRNA may be capped. This is in contrast to ~80% when a cap analog is linked to an mRNA in the course of an *in vitro* transcription reaction.

[0087] According to the present invention, 5' terminal caps may include endogenous caps or cap analogs. According to the present invention, a 5' terminal cap may comprise a guanine analog. Useful guanine analogs include, but are not limited to, inosine, N1-methyl-guanosine, 2'fluoro-guanosine, 7-deaza-guanosine, 8-oxo-guanosine, 2-amino-guanosine, LNA-guanosine, and 2-azido-guanosine.

Viral Sequences

[0088] Additional viral sequences such as, but not limited to, the translation enhancer sequence of the barley yellow dwarf virus (BYDV-PAV) can be engineered and inserted in the 3' UTR of the modified mRNA of the invention and can stimulate the translation of the mRNA *in vitro* and *in vivo*. Transfection experiments can be conducted in relevant cell lines and protein production can be assayed by ELISA at 12 hour, 24 hour, 48 hour, 72 hour and day 7 post-transfection.

IRES Sequences

[0089] Further, provided are modified mRNA which may contain an internal ribosome entry site (IRES). First identified as a feature Picorna virus RNA, IRES plays an important role in initiating protein synthesis in absence of the 5' cap structure. An IRES may act as the sole ribosome binding site, or may serve as one of multiple ribosome binding sites of an mRNA. Modified mRNA containing more than one functional ribosome binding site may encode several peptides or polypeptides that are translated independently by the ribosomes ("multicistronic nucleic acid molecules"). When modified mRNA are provided with an IRES, further optionally provided is a

second translatable region. Examples of IRES sequences that can be used according to the invention include without limitation, those from picornaviruses (e.g. FMDV), pest viruses (CFFV), polio viruses (PV), encephalomyocarditis viruses (ECMV), foot-and-mouth disease viruses (FMDV), hepatitis C viruses (HCV), classical swine fever viruses (CSFV), murine leukemia virus (MLV), simian immune deficiency viruses (SIV) or cricket paralysis viruses (CrPV).

Poly-A tails

[0090] During RNA processing, a long chain of adenine nucleotides (poly-A tail) may be added to a modified nucleic acid molecule such as a modified mRNA molecules in order to increase stability. Immediately after transcription, the 3' end of the transcript may be cleaved to free a 3' hydroxyl. Then poly-A polymerase adds a chain of adenine nucleotides to the RNA. The process, called polyadenylation, adds a poly-A tail that can be between, for example, approximately 100 and 250 residues long.

[0091] It has been discovered that unique poly-A tail lengths provide certain advantages to the modified mRNA of the present invention.

[0092] Generally, the length of a poly-A tail of the present invention is greater than 30 nucleotides in length. In another embodiment, the poly-A tail is greater than 35 nucleotides in length (e.g., at least or greater than about 35, 40, 45, 50, 55, 60, 70, 80, 90, 100, 120, 140, 160, 180, 200, 250, 300, 350, 400, 450, 500, 600, 700, 800, 900, 1,000, 1,100, 1,200, 1,300, 1,400, 1,500, 1,600, 1,700, 1,800, 1,900, 2,000, 2,500, and 3,000 nucleotides). In some embodiments, the modified mRNA includes from about 30 to about 3,000 nucleotides (e.g., from 30 to 50, from 30 to 100, from 30 to 250, from 30 to 500, from 30 to 750, from 30 to 1,000, from 30 to 1,500, from 30 to 2,000, from 30 to 2,500, from 50 to 100, from 50 to 250, from 50 to 500, from 50 to 750, from 50 to 1,000, from 50 to 1,500, from 50 to 2,000, from 50 to 2,500, from 50 to 3,000, from 100 to 500, from 100 to 750, from 100 to 1,000, from 100 to 1,500, from 100 to 2,000, from 100 to 2,500, from 100 to 3,000, from 500 to 750, from 500 to 1,000, from 500 to 1,500, from 500 to 2,000, from 500 to 2,500, from 500 to 3,000, from 1,000 to 1,500, from 1,000 to 2,000, from 1,000 to 2,500, from 1,000 to 3,000, from 1,500 to 2,000, from 1,500 to 2,500, from 1,500 to 3,000, from 2,000 to 3,000, from 2,000 to 2,500, and from 2,500 to 3,000).

[0093] In one embodiment, the poly-A tail is designed relative to the length of the overall modified mRNA. This design may be based on the length of the coding region, the length of a

particular feature or region (such as the flanking regions), or based on the length of the ultimate product expressed from the modified mRNA.

[0094] In this context the poly-A tail may be 10, 20, 30, 40, 50, 60, 70, 80, 90, or 100% greater in length than the modified mRNA, region or feature thereof. The poly-A tail may also be designed as a fraction of modified mRNA to which it belongs. In this context, the poly-A tail may be 10, 20, 30, 40, 50, 60, 70, 80, or 90% or more of the total length of the molecule or the total length of the molecule minus the poly-A tail. Further, engineered binding sites and conjugation of modified mRNA for Poly-A binding protein may enhance expression.

[0095] Additionally, multiple distinct modified mRNA may be linked together to the PABP (Poly-A binding protein) through the 3'-end using modified nucleotides at the 3'-terminus of the poly-A tail. Transfection experiments can be conducted in relevant cell lines at and protein production can be assayed by ELISA at 12 hour, 24 hour, 48 hour, 72 hour and day 7 post-transfection.

[0096] In one embodiment, the modified mRNA of the present invention are designed to include a polyA-G Quartet. The G-quartet is a cyclic hydrogen bonded array of four guanine nucleotides that can be formed by G-rich sequences in both DNA and RNA. In this embodiment, the G-quartet is incorporated at the end of the poly-A tail. The resultant mmRNA molecule is assayed for stability, protein production and other parameters including half-life at various time points. It has been discovered that the polyA-G quartet results in protein production equivalent to at least 75% of that seen using a poly-A tail of 120 nucleotides alone.

Modifications

[0097] The modified nucleic acids and modified mRNA (mmRNA) of the invention may contain one, two, or more different modifications. In some embodiments, modified nucleic acids and mmRNA may contain one, two, or more different nucleoside or nucleotide modifications. In some embodiments, a modified nucleic acid or mmRNA (e.g., having one or more mmRNA molecules) introduced to a cell may exhibit reduced degradation in the cell, as compared to an unmodified nucleic acid or mmRNA.

[0098] The modified nucleic acids and mmRNA can include any useful modification, such as to the sugar, the nucleobase (e.g., one or more modifications of a nucleobase, such as by replacing or substituting an atom of a pyrimidine nucleobase with optionally substituted amino, optionally substituted thiol, optionally substituted alkyl (e.g., methyl or ethyl), or halo (e.g., chloro or fluoro), or the internucleoside linkage (e.g., one or more modification to the phosphodiester backbone). In

certain embodiments, modifications are present in both the sugar and the internucleoside linkage (e.g., one or modifications, such as those present in ribonucleic acids (RNA), deoxyribonucleic acids (DNAs), threose nucleic acids (TNAs), glycol nucleic acids (GNAs), peptide nucleic acids (PNAs), locked nucleic acids (LNAs) or hybrids thereof). Additional modifications are described herein.

[0099] As described herein, the modified nucleic acids and mmRNA of the invention do not substantially induce an innate immune response of a cell into which the mRNA is introduced. In certain embodiments, it may be desirable to intracellularly degrade a modified nucleic acid molecule or modified nucleic acid molecule introduced into the cell. For example, degradation of a modified nucleic acid molecule or modified mRNA may be preferable if precise timing of protein production is desired. Thus, in some embodiments, the invention provides a modified nucleic acid molecule containing a degradation domain, which is capable of being acted on in a directed manner within a cell. In another aspect, the present disclosure provides nucleic acids comprising a nucleoside or nucleotide that can disrupt the binding of a major groove interacting, e.g. binding, partner with the nucleic acid (e.g., where the modified nucleotide has decreased binding affinity to major groove interacting partner, as compared to an unmodified nucleotide).

[00100] The modified nucleic acid and mmRNA can optionally include other agents (e.g., RNAi-inducing agents, RNAi agents, siRNA, shRNA, miRNA, antisense RNA, ribozymes, catalytic DNA, tRNA, RNA that induce triple helix formation, aptamers, vectors, etc.). In some embodiments, the modified nucleic acids or mmRNA may include one or more messenger RNA (mRNA) and one or more modified nucleoside or nucleotides (e.g., mmRNA molecules). Details for these modified nucleic acids and mmRNA follow.

Modified Nucleic Acids

[00101] The modified nucleic acids or mmRNA of the invention may include a first region of linked nucleosides encoding a polypeptide of interest, a first flanking region located at the 5' terminus of the first region, and a second flanking region located at the 3' terminus of the first region.

[00102] In some embodiments, the modified nucleic acids or mmRNA includes n number of linked nucleosides having Formula (Ia) or Formula (Ia-1):

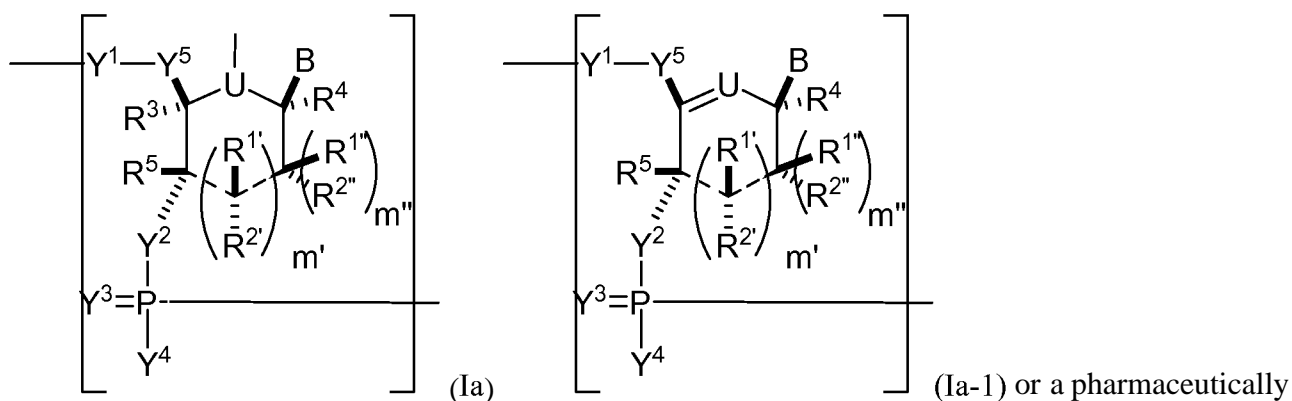

acceptable salt or stereoisomer thereof, wherein

[00103] U is O, S, N(R^u)_{nu}, or C(R^u)_{nu}, wherein nu is an integer from 0 to 2 and each R^u is, independently, H, halo, or optionally substituted alkyl;

[00104] — is a single bond or absent;

[00105] each of R^{1'}, R^{2'}, R^{1''}, R^{2''}, R¹, R², R³, R⁴, and R⁵ is, if present, independently, H, halo, hydroxy, thiol, optionally substituted alkyl, optionally substituted alkoxy, optionally substituted alkenyloxy, optionally substituted alkynyloxy, optionally substituted aminoalkoxy, optionally substituted alkoxyalkoxy, optionally substituted hydroxyalkoxy, optionally substituted amino, azido, optionally substituted aryl, optionally substituted aminoalkyl, optionally substituted aminoalkenyl, optionally substituted aminoalkynyl, or absent; wherein the combination of R³ with one or more of R^{1'}, R^{1''}, R^{2'}, R^{2''}, or R⁵ (e.g., the combination of R^{1'} and R³, the combination of R^{1''} and R³, the combination of R^{2'} and R³, the combination of R^{2''} and R³, or the combination of R⁵ and R³) can join together to form optionally substituted alkylene or optionally substituted heteroalkylene and, taken together with the carbons to which they are attached, provide an optionally substituted heterocyclyl (e.g., a bicyclic, tricyclic, or tetracyclic heterocyclyl); wherein the combination of R⁵ with one or more of R^{1'}, R^{1''}, R^{2'}, or R^{2''} (e.g., the combination of R^{1'} and R⁵, the combination of R^{1''} and R⁵, the combination of R^{2'} and R⁵, or the combination of R^{2''} and R⁵) can join together to form optionally substituted alkylene or optionally substituted heteroalkylene and, taken together with the carbons to which they are attached, provide an optionally substituted heterocyclyl (e.g., a bicyclic, tricyclic, or tetracyclic heterocyclyl); and wherein the combination of R⁴ and one or more of R^{1'}, R^{2'}, R^{2''}, R³, or R⁵ can join together to form optionally substituted alkylene or optionally substituted heteroalkylene and, taken together with the carbons to which they are attached, provide an optionally substituted heterocyclyl (e.g., a bicyclic, tricyclic, or tetracyclic heterocyclyl);

[00106] each of m' and m'' is, independently, an integer from 0 to 3 (e.g., from 0 to 2, from 0 to 1, from 1 to 3, or from 1 to 2);

[00107] each of Y^1 , Y^2 , and Y^3 , is, independently, O, S, Se, $-NR^{N1}$ -, optionally substituted alkylene, or optionally substituted heteroalkylene, wherein R^{N1} is H, optionally substituted alkyl, optionally substituted alkenyl, optionally substituted alkynyl, optionally substituted aryl, or absent;

[00108] each Y^4 is, independently, H, hydroxy, thiol, boranyl, optionally substituted alkyl, optionally substituted alkenyl, optionally substituted alkynyl, optionally substituted alkoxy, optionally substituted alkenyloxy, optionally substituted alkynyloxy, optionally substituted thioalkoxy, optionally substituted alkoxyalkoxy, or optionally substituted amino;

[00109] each Y^5 is, independently, O, S, Se, optionally substituted alkylene (e.g., methylene), or optionally substituted heteroalkylene;

[00110] n is an integer from 1 to 100,000; and

[00111] B is a nucleobase (e.g., a purine, a pyrimidine, or derivatives thereof), wherein the combination of B and $R^{1'}$, the combination of B and $R^{2'}$, the combination of B and $R^{1''}$, or the combination of B and $R^{2''}$ can, taken together with the carbons to which they are attached, optionally form a bicyclic group (e.g., a bicyclic heterocyclyl) or wherein the combination of B , $R^{1'}$, and R^3 or the combination of B , $R^{2'}$, and R^3 can optionally form a tricyclic or tetracyclic group (e.g., a tricyclic or tetracyclic heterocyclyl, such as in Formula (IIo)-(IIp) herein). In some embodiments, the modified nucleic acid or mmRNA includes a modified ribose.

[00112] In some embodiments, the modified nucleic acid or mmRNA includes n number of linked nucleosides having Formula (Ia-2)-(Ia-5) or a pharmaceutically acceptable salt or stereoisomer thereof.

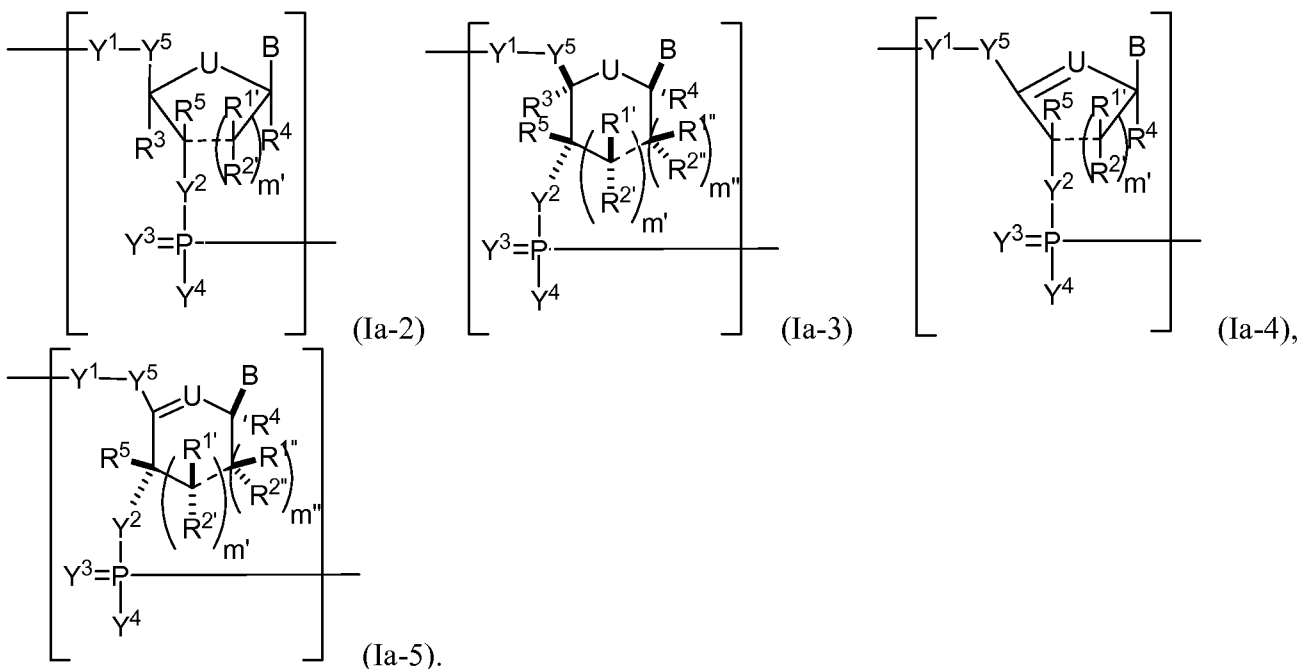

[00113] In some embodiments, the modified nucleic acid or mmRNA includes n number of linked nucleosides having Formula (Ib) or Formula (Ib-1):

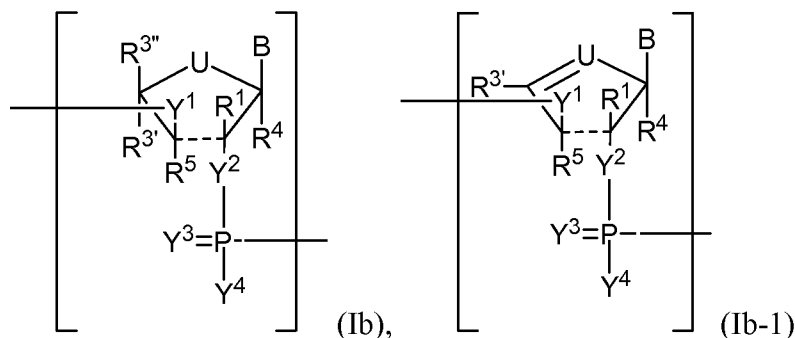

or a pharmaceutically acceptable salt or stereoisomer thereof, wherein

[00114] U is O, S, N(R^u)_{nu}, or C(R^u)_{nu}, wherein nu is an integer from 0 to 2 and each R^u is, independently, H, halo, or optionally substituted alkyl;

[00115] — is a single bond or absent;

[00116] each of R¹, R^{3'}, R^{3''}, and R⁴ is, independently, H, halo, hydroxy, optionally substituted alkyl, optionally substituted alkoxy, optionally substituted alkenyloxy, optionally substituted alkynyloxy, optionally substituted aminoalkoxy, optionally substituted alkoxyalkoxy, optionally substituted hydroxyalkoxy, optionally substituted amino, azido, optionally substituted aryl, optionally substituted aminoalkyl, optionally substituted aminoalkenyl, optionally substituted aminoalkynyl, or absent; and wherein the combination of R¹ and R^{3'} or the combination of R¹ and

R^{3''} can be taken together to form optionally substituted alkylene or optionally substituted heteroalkylene (e.g., to produce a locked nucleic acid);

[00117] each R⁵ is, independently, H, halo, hydroxy, optionally substituted alkyl, optionally substituted alkoxy, optionally substituted alkenyloxy, optionally substituted alkynyloxy, optionally substituted aminoalkoxy, optionally substituted alkoxyalkoxy, or absent;

[00118] each of Y¹, Y², and Y³ is, independently, O, S, Se, -NR^{N1}-, optionally substituted alkylene, or optionally substituted heteroalkylene, wherein R^{N1} is H, optionally substituted alkyl, optionally substituted alkenyl, optionally substituted alkynyl, or optionally substituted aryl;

each Y⁴ is, independently, H, hydroxy, thiol, boranyl, optionally substituted alkyl, optionally substituted alkenyl, optionally substituted alkynyl, optionally substituted alkoxy, optionally substituted alkenyloxy, optionally substituted alkynyloxy, optionally substituted alkoxyalkoxy, or optionally substituted amino;

[00119] n is an integer from 1 to 100,000; and

[00120] B is a nucleobase.

[00121] In some embodiments, the modified nucleic acid or mmRNA includes n number of linked nucleosides having Formula (Ic):

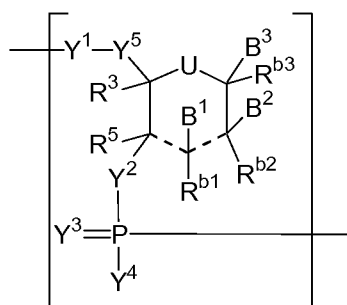

(Ic), or a pharmaceutically acceptable salt or stereoisomer thereof,

wherein

[00122] U is O, S, N(R^U)_{nu}, or C(R^U)_{nu}, wherein nu is an integer from 0 to 2 and each R^U is, independently, H, halo, or optionally substituted alkyl;

[00123] — is a single bond or absent;

[00124] each of B¹, B², and B³ is, independently, a nucleobase (e.g., a purine, a pyrimidine, or derivatives thereof, as described herein), H, halo, hydroxy, thiol, optionally substituted alkyl, optionally substituted alkoxy, optionally substituted alkenyloxy, optionally substituted alkynyloxy, optionally substituted aminoalkoxy, optionally substituted alkoxyalkoxy, optionally substituted hydroxyalkoxy, optionally substituted amino, azido, optionally substituted aryl, optionally

substituted aminoalkyl, optionally substituted aminoalkenyl, or optionally substituted aminoalkynyl, wherein one and only one of B¹, B², and B³ is a nucleobase;

[00125] each of R^{b1}, R^{b2}, R^{b3}, R³, and R⁵ is, independently, H, halo, hydroxy, thiol, optionally substituted alkyl, optionally substituted alkoxy, optionally substituted alkenyloxy, optionally substituted alkynyloxy, optionally substituted aminoalkoxy, optionally substituted alkoxyalkoxy, optionally substituted hydroxyalkoxy, optionally substituted amino, azido, optionally substituted aryl, optionally substituted aminoalkyl, optionally substituted aminoalkenyl or optionally substituted aminoalkynyl;

[00126] each of Y¹, Y², and Y³ is, independently, O, S, Se, -NR^{N1}-, optionally substituted alkylene, or optionally substituted heteroalkylene, wherein R^{N1} is H, optionally substituted alkyl, optionally substituted alkenyl, optionally substituted alkynyl, or optionally substituted aryl;

[00127] each Y⁴ is, independently, H, hydroxy, thiol, boranyl, optionally substituted alkyl, optionally substituted alkenyl, optionally substituted alkynyl, optionally substituted alkoxy, optionally substituted alkenyloxy, optionally substituted alkynyloxy, optionally substituted thioalkoxy, optionally substituted alkoxyalkoxy, or optionally substituted amino;

[00128] each Y⁵ is, independently, O, S, Se, optionally substituted alkylene (e.g., methylene), or optionally substituted heteroalkylene;

[00129] n is an integer from 1 to 100,000; and

[00130] wherein the ring including U can include one or more double bonds.

[00131] In particular embodiments, the ring including U does not have a double bond between U-CB³R^{b3} or between CB³R^{b3}-C^{B2}R^{b2}.

[00132] In some embodiments, the modified nucleic acid or mmRNA includes n number of linked nucleosides having Formula (Id):

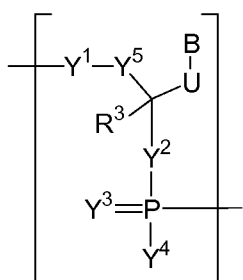

(Id), or a pharmaceutically acceptable salt or stereoisomer thereof, wherein

[00133] U is O, S, N(R^u)_{nu}, or C(R^u)_{nu}, wherein nu is an integer from 0 to 2 and each R^u is, independently, H, halo, or optionally substituted alkyl;

[00134] each R^3 is, independently, H, halo, hydroxy, thiol, optionally substituted alkyl, optionally substituted alkoxy, optionally substituted alkenyloxy, optionally substituted alkynyloxy, optionally substituted aminoalkoxy, optionally substituted alkoxyalkoxy, optionally substituted hydroxyalkoxy, optionally substituted amino, azido, optionally substituted aryl, optionally substituted aminoalkyl, optionally substituted aminoalkenyl, or optionally substituted aminoalkynyl;

[00135] each of Y^1 , Y^2 , and Y^3 is, independently, O, S, Se, $-NR^{N1}$, optionally substituted alkylene, or optionally substituted heteroalkylene, wherein R^{N1} is H, optionally substituted alkyl, optionally substituted alkenyl, optionally substituted alkynyl, or optionally substituted aryl;

[00136] each Y^4 is, independently, H, hydroxy, thiol, boranyl, optionally substituted alkyl, optionally substituted alkenyl, optionally substituted alkynyl, optionally substituted alkoxy, optionally substituted alkenyloxy, optionally substituted alkynyloxy, optionally substituted thioalkoxy, optionally substituted alkoxyalkoxy, or optionally substituted amino;

[00137] each Y^5 is, independently, O, S, optionally substituted alkylene (e.g., methylene), or optionally substituted heteroalkylene;

[00138] n is an integer from 1 to 100,000; and

[00139] B is a nucleobase (e.g., a purine, a pyrimidine, or derivatives thereof).

[00140] In some embodiments, the modified nucleic acid molecules or modified mRNA includes n number of linked nucleosides having Formula (Ie):

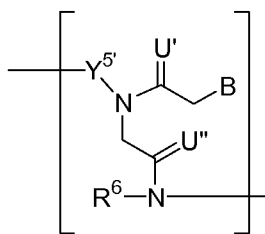

(Ie), or a pharmaceutically acceptable salt or stereoisomer thereof, wherein

[00141] each of U' and U'' is, independently, O, S, $N(R^U)_{n_u}$, or $C(R^U)_{n_u}$, wherein n_u is an integer from 0 to 2 and each R^u is, independently, H, halo, or optionally substituted alkyl;

each R^6 is, independently, H, halo, hydroxy, thiol, optionally substituted alkyl, optionally substituted alkoxy, optionally substituted alkenyloxy, optionally substituted alkynyloxy, optionally substituted aminoalkoxy, optionally substituted alkoxyalkoxy, optionally substituted hydroxyalkoxy, optionally substituted amino, azido, optionally substituted aryl, optionally substituted aminoalkyl, optionally substituted aminoalkenyl, or optionally substituted aminoalkynyl;

[00142] each Y^5 is, independently, O, S, optionally substituted alkylene (e.g., methylene or ethylene), or optionally substituted heteroalkylene;

[00143] n is an integer from 1 to 100,000; and

[00144] B is a nucleobase (e.g., a purine, a pyrimidine, or derivatives thereof).

[00145] In some embodiments, the modified nucleic acid or mmRNA includes n number of linked nucleosides having Formula (If) or (If-1):

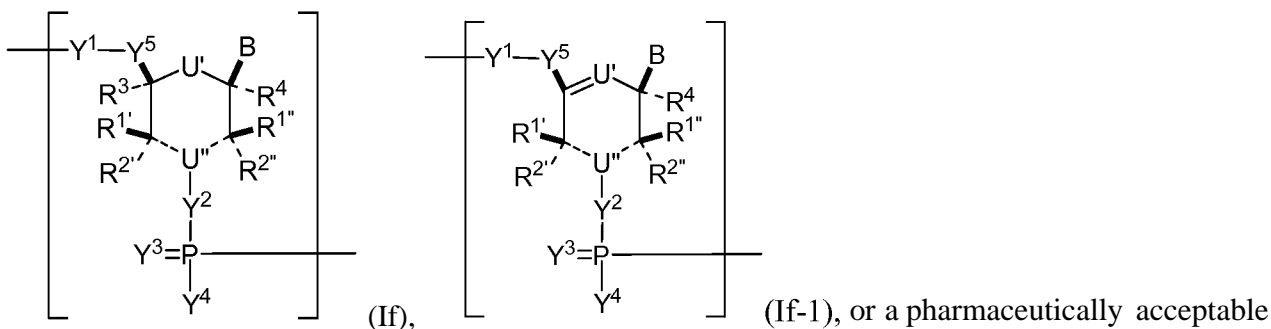

salt or stereoisomer thereof, wherein

[00146] each of U' and U'' is, independently, O, S, N, $N(R^U)_{n_u}$, or $C(R^U)_{n_u}$, wherein n_u is an integer from 0 to 2 and each R^U is, independently, H, halo, or optionally substituted alkyl (e.g., U' is O and U'' is N);

[00147] — is a single bond or absent;

[00148] each of R^1 , R^2 , R^1' , R^2'' , R^3 , and R^4 is, independently, H, halo, hydroxy, thiol, optionally substituted alkyl, optionally substituted alkoxy, optionally substituted alkenyloxy, optionally substituted alkynyloxy, optionally substituted aminoalkoxy, optionally substituted alkoxyalkoxy, optionally substituted hydroxyalkoxy, optionally substituted amino, azido, optionally substituted aryl, optionally substituted aminoalkyl, optionally substituted aminoalkenyl, optionally substituted aminoalkynyl, or absent; and wherein the combination of R^1 and R^3 , the combination of R^1' and R^3 , the combination of R^2 and R^3 , or the combination of R^2'' and R^3 can be taken together to form optionally substituted alkylene or optionally substituted heteroalkylene (e.g., to produce a locked nucleic acid); each of m' and m'' is, independently, an integer from 0 to 3 (e.g., from 0 to 2, from 0 to 1, from 1 to 3, or from 1 to 2);

[00149] each of Y^1 , Y^2 , and Y^3 is, independently, O, S, Se, $-NR^{N^1}$, optionally substituted alkylene, or optionally substituted heteroalkylene, wherein R^{N^1} is H, optionally substituted alkyl, optionally substituted alkenyl, optionally substituted alkynyl, optionally substituted aryl, or absent;

[00150] each Y^4 is, independently, H, hydroxy, thiol, boranyl, optionally substituted alkyl, optionally substituted alkenyl, optionally substituted alkynyl, optionally substituted alkoxy,

optionally substituted alkenyloxy, optionally substituted alkynyloxy, optionally substituted thioalkoxy, optionally substituted alkoxyalkoxy, or optionally substituted amino;

[00151] each Y^5 is, independently, O, S, Se, optionally substituted alkylene (e.g., methylene), or optionally substituted heteroalkylene;

[00152] n is an integer from 1 to 100,000; and

[00153] B is a nucleobase (e.g., a purine, a pyrimidine, or derivatives thereof).

[00154] In some embodiments of the modified nucleic acid or mmRNA (e.g., (Ia)-(Ia-5), (Ib)-(Ib-1), (IIa)-(IIp), (IIb-1), (IIb-2), (IIc-1)-(IIc-2), (IIn-1), (IIn-2), (IVa)-(IVl), and (IXa)-(IXr)), the ring including U has one or two double bonds.

[00155] In some embodiments of the modified nucleic acid or mmRNA (e.g., Formulas (Ia)-Ia-5), (Ib)-(Ib-1), (IIa)-(IIp), (IIb-1), (IIb-2), (IIc-1)-(IIc-2), (IIn-1), (IIn-2), (IVa)-(IVl), and (IXa)-(IXr)), each of R^1 , R^1' , and $R^{1''}$, if present, is H. In further embodiments, each of R^2 , $R^{2'}$, and $R^{2''}$, if present, is, independently, H, halo (e.g., fluoro), hydroxy, optionally substituted alkoxy (e.g., methoxy or ethoxy), or optionally substituted alkoxyalkoxy. In particular embodiments, alkoxyalkoxy is $-(CH_2)_{s2}(OCH_2CH_2)_{si}(CH_2)_{s3}OR'$, wherein si is an integer from 1 to 10 (e.g., from 1 to 6 or from 1 to 4), each of $s2$ and $s3$, independently, is an integer from 0 to 10 (e.g., from 0 to 4, from 0 to 6, from 1 to 4, from 1 to 6, or from 1 to 10), and R' is H or C_{i-2o} alkyl). In some embodiments, $s2$ is 0, si is 1 or 2, $s3$ is 0 or 1, and R' is C_{i-6} alkyl.

[00156] In some embodiments of the modified nucleic acid or mmRNA (e.g., Formulas (Ia)-Ia-5), (Ib)-(Ib-1), (IIa)-(IIp), (IIb-1), (IIb-2), (IIc-1)-(IIc-2), (IIn-1), (IIn-2), (IVa)-(IVl), and (IXa)-(IXr)), each of R^2 , $R^{2'}$, and $R^{2''}$, if present, is H. In further embodiments, each of R^1 , R^1' , and $R^{1''}$, if present, is, independently, H, halo (e.g., fluoro), hydroxy, optionally substituted alkoxy (e.g., methoxy or ethoxy), or optionally substituted alkoxyalkoxy. In particular embodiments, alkoxyalkoxy is $-(CH_2)_{s2}(OCH_2CH_2)_{si}(CH_2)_{s3}OR'$, wherein si is an integer from 1 to 10 (e.g., from 1 to 6 or from 1 to 4), each of $s2$ and $s3$, independently, is an integer from 0 to 10 (e.g., from 0 to 4, from 0 to 6, from 1 to 4, from 1 to 6, or from 1 to 10), and R' is H or C_{i-2o} alkyl). In some embodiments, $s2$ is 0, si is 1 or 2, $s3$ is 0 or 1, and R' is C_{i-6} alkyl.

[00157] In some embodiments of the modified nucleic acids or mmRNA (e.g., Formulas (Ia)-Ia-5), (Ib)-(Ib-1), (IIa)-(IIp), (IIb-1), (IIb-2), (IIc-1)-(IIc-2), (IIn-1), (IIn-2), (IVa)-(IVl), and (IXa)-(IXr)), each of R^3 , R^4 , and R^5 is, independently, H, halo (e.g., fluoro), hydroxy, optionally substituted alkyl, optionally substituted alkoxy (e.g., methoxy or ethoxy), or optionally substituted alkoxyalkoxy. In

particular embodiments, R^3 is H, R^4 is H, R^5 is H, or R^3 , R^4 , and R^5 are all H. In particular embodiments, R^3 is C_{1-6} alkyl, R^4 is C_{1-6} alkyl, R^5 is C_{1-6} alkyl, or R^3 , R^4 , and R^5 are all C_{1-6} alkyl. In particular embodiments, R^3 and R^4 are both H, and R^5 is C_{1-6} alkyl.

[00158] In some embodiments of the modified nucleic acids or mmRNA (e.g., Formulas (Ia)-(Ia-5), (Ib)-(Ib-1), (IIa)-(IIp), (IIb-1), (IIb-2), (IIc-1)-(IIc-2), (IIn-1), (IIn-2), (IVa)-(IVl), and (IXa)-(IXr)), R^3 and R^5 join together to form optionally substituted alkylene or optionally substituted heteroalkylene and, taken together with the carbons to which they are attached, provide an optionally substituted heterocyclyl (e.g., a bicyclic, tricyclic, or tetracyclic heterocyclyl, such as trans-3',4' analogs, wherein R^3 and R^5 join together to form heteroalkylene (e.g., $-(CH_2)_{b1}O(CH_2)_{b2}O(CH_2)_{b3}-$, wherein each of $b1$, $b2$, and $b3$ are, independently, an integer from 0 to 3).

[00159] In some embodiments of the modified nucleic acids or mmRNA (e.g., Formulas (Ia)-(Ia-5), (Ib)-(Ib-1), (IIa)-(IIp), (IIb-1), (IIb-2), (IIc-1)-(IIc-2), (IIn-1), (IIn-2), (IVa)-(IVl), and (IXa)-(IXr)), R^3 and one or more of $R^{1'}$, $R^{1''}$, $R^{2'}$, $R^{2''}$, or R^5 join together to form optionally substituted alkylene or optionally substituted heteroalkylene and, taken together with the carbons to which they are attached, provide an optionally substituted heterocyclyl (e.g., a bicyclic, tricyclic, or tetracyclic heterocyclyl, R^3 and one or more of $R^{1'}$, $R^{1''}$, $R^{2'}$, $R^{2''}$, or R^5 join together to form heteroalkylene (e.g., $-(CH_2)_{b1}O(CH_2)_{b2}O(CH_2)_{b3}-$, wherein each of $b1$, $b2$, and $b3$ are, independently, an integer from 0 to 3).

[00160] In some embodiments of the modified nucleic acids or mmRNA (e.g., Formulas (Ia)-(Ia-5), (Ib)-(Ib-1), (IIa)-(IIp), (IIb-1), (IIb-2), (IIc-1)-(IIc-2), (IIn-1), (IIn-2), (IVa)-(IVl), and (IXa)-(IXr)), R^5 and one or more of $R^{1'}$, $R^{1''}$, $R^{2'}$, or $R^{2''}$ join together to form optionally substituted alkylene or optionally substituted heteroalkylene and, taken together with the carbons to which they are attached, provide an optionally substituted heterocyclyl (e.g., a bicyclic, tricyclic, or tetracyclic heterocyclyl, R^5 and one or more of $R^{1'}$, $R^{1''}$, $R^{2'}$, or $R^{2''}$ join together to form heteroalkylene (e.g., $-(CH_2)_{b1}O(CH_2)_{b2}O(CH_2)_{b3}-$, wherein each of $b1$, $b2$, and $b3$ are, independently, an integer from 0 to 3).

[00161] In some embodiments of the modified nucleic acids or mmRNA (e.g., Formulas (Ia)-(Ia-5), (Ib)-(Ib-1), (IIa)-(IIp), (IIb-1), (IIb-2), (IIc-1)-(IIc-2), (IIn-1), (IIn-2), (IVa)-(IVl), and (IXa)-(IXr)), each Y^2 is, independently, O, S, or $-NR^{N1}-$, wherein R^{N1} is H, optionally substituted alkyl, optionally substituted alkenyl, optionally substituted alkynyl, or optionally substituted aryl. In particular

embodiments, Y^2 is NR^{N1-} , wherein R^{N1} is H or optionally substituted alkyl (e.g., C_{1-6} alkyl, such as methyl, ethyl, isopropyl, or n-propyl).

[00162] In some embodiments of the modified nucleic acids or mmRNA (e.g., Formulas (Ia)-(Ia-5), (Ib)-(If-1), (IIa)-(IIp), (IIb-1), (IIb-2), (IIc-1)-(IIc-2), (IIn-1), (IIn-2), (IVa)-(IVl), and (IXa)-(IXr)), each Y^3 is, independently, O or S.

[00163] In some embodiments of the modified nucleic acids or mmRNA (e.g., Formulas (Ia)-(Ia-5), (Ib)-(If-1), (IIa)-(IIp), (IIb-1), (IIb-2), (IIc-1)-(IIc-2), (IIn-1), (IIn-2), (IVa)-(IVl), and (IXa)-(IXr)), R^1 is H; each R^2 is, independently, H, halo (e.g., fluoro), hydroxy, optionally substituted alkoxy (e.g., methoxy or ethoxy), or optionally substituted alkoxyalkoxy (e.g., $-(CH_2)_{s2}(OCH_2CH_2)_s(CH_2)_{s3}OR'$, wherein s_i is an integer from 1 to 10 (e.g., from 1 to 6 or from 1 to 4), each of s_2 and s_3 , independently, is an integer from 0 to 10 (e.g., from 0 to 4, from 0 to 6, from 1 to 4, from 1 to 6, or from 1 to 10), and R' is H or C_{1-20} alkyl, such as wherein s_2 is 0, s_i is 1 or 2, s_3 is 0 or 1, and R' is C_{1-6} alkyl); each Y^2 is, independently, O or $-NR^{N1-}$, wherein R^{N1} is H, optionally substituted alkyl, optionally substituted alkenyl, optionally substituted alkynyl, or optionally substituted aryl (e.g., wherein R^{N1} is H or optionally substituted alkyl (e.g., C_{1-6} alkyl, such as methyl, ethyl, isopropyl, or n-propyl)); and each Y^3 is, independently, O or S (e.g., S). In further embodiments, R^3 is H, halo (e.g., fluoro), hydroxy, optionally substituted alkyl, optionally substituted alkoxy (e.g., methoxy or ethoxy), or optionally substituted alkoxyalkoxy. In yet further embodiments, each Y^1 is, independently, O or $-NR^{N1-}$, wherein R^{N1} is H, optionally substituted alkyl, optionally substituted alkenyl, optionally substituted alkynyl, or optionally substituted aryl (e.g., wherein R^{N1} is H or optionally substituted alkyl (e.g., C_{1-6} alkyl, such as methyl, ethyl, isopropyl, or n-propyl)); and each Y^4 is, independently, H, hydroxy, thiol, optionally substituted alkyl, optionally substituted alkoxy, optionally substituted thioalkoxy, optionally substituted alkoxyalkoxy, or optionally substituted amino.

[00164] In some embodiments of the modified nucleic acids or mmRNA (e.g., Formulas (Ia)-(Ia-5), (Ib)-(If-1), (IIa)-(IIp), (IIb-1), (IIb-2), (IIc-1)-(IIc-2), (IIn-1), (IIn-2), (IVa)-(IVl), and (IXa)-(IXr)), each R^1 is, independently, H, halo (e.g., fluoro), hydroxy, optionally substituted alkoxy (e.g., methoxy or ethoxy), or optionally substituted alkoxyalkoxy (e.g., $-(CH_2)_{s2}(OCH_2CH_2)_s(CH_2)_{s3}OR'$, wherein s_i is an integer from 1 to 10 (e.g., from 1 to 6 or from 1 to 4), each of s_2 and s_3 , independently, is an integer from 0 to 10 (e.g., from 0 to 4, from 0 to 6, from 1 to 4, from 1 to 6, or from 1 to 10), and R' is H or C_{1-20} alkyl, such as wherein s_2 is 0, s_i is 1 or 2, s_3 is 0 or 1, and R' is

Ci₆ alkyl); R² is H; each Y² is, independently, O or -NR^{N1}-, wherein R^{N1} is H, optionally substituted alkyl, optionally substituted alkenyl, optionally substituted alkynyl, or optionally substituted aryl (e.g., wherein R^{N1} is H or optionally substituted alkyl (e.g., Ci₆ alkyl, such as methyl, ethyl, isopropyl, or n-propyl)); and each Y³ is, independently, O or S (e.g., S). In further embodiments, R³ is H, halo (e.g., fluoro), hydroxy, optionally substituted alkyl, optionally substituted alkoxy (e.g., methoxy or ethoxy), or optionally substituted alkoxyalkoxy. In yet further embodiments, each Y¹ is, independently, O or -NR^{N1}-, wherein R^{N1} is H, optionally substituted alkyl, optionally substituted alkenyl, optionally substituted alkynyl, or optionally substituted aryl (e.g., wherein R^{N1} is H or optionally substituted alkyl (e.g., Ci₆ alkyl, such as methyl, ethyl, isopropyl, or n-propyl)); and each Y⁴ is, independently, H, hydroxy, thiol, optionally substituted alkyl, optionally substituted alkoxy, optionally substituted thioalkoxy, optionally substituted alkoxyalkoxy, or optionally substituted amino.

[00165] In some embodiments of the modified nucleic acids or mmRNA (e.g., Formulas (Ia)-(Ia-5), (Ib)-(If-1), (IIa)-(IIp), (IIb-1), (IIb-2), (IIc-1)-(IIc-2), (IIn-1), (IIn-2), (IVa)-(IVl), and (IXa)-(IXr)), the ring including U is in the β-D (e.g., β-D-ribo) configuration.

[00166] In some embodiments of the modified nucleic acids or mmRNA (e.g. Formulas (Ia)-(Ia-5), (Ib)-(If-1), (IIa)-(IIp), (IIb-1), (IIb-2), (IIc-1)-(IIc-2), (IIn-1), (IIn-2), (IVa)-(IVl), and (IXa)-(IXr)), the ring including U is in the α-L (e.g., α-L-ribo) configuration.

[00167] In some embodiments of the modified nucleic acids or mmRNA (e.g., Formulas (Ia)-(Ia-5), (Ib)-(If-1), (IIa)-(IIp), (IIb-1), (IIb-2), (IIc-1)-(IIc-2), (IIn-1), (IIn-2), (IVa)-(IVl), and (IXa)-(IXr)), one or more B is not pseudouridine (ψ) or 5-methyl-cytidine (m⁵C). In some embodiments, about 10% to about 100% of B nucleobases is not ψ or m⁵C (e.g., from 10% to 20%, from 10% to 35%, from 10% to 50%, from 10% to 60%, from 10% to 75%, from 10% to 90%, from 10% to 95%, from 10% to 98%, from 10% to 99%, from 20% to 35%, from 20% to 50%, from 20% to 60%, from 20% to 75%, from 20% to 90%, from 20% to 95%, from 20% to 98%, from 20% to 99%, from 20% to 100%, from 50% to 60%, from 50% to 75%, from 50% to 90%, from 50% to 95%, from 50% to 98%, from 50% to 99%, from 50% to 100%, from 75% to 90%, from 75% to 95%, from 75% to 98%, from 75% to 99%, and from 75% to 100% of n number of B is not ψ or m⁵C). In some embodiments, B is not ψ or m⁵C.

[00168] In some embodiments of the modified nucleic acids or mmRNA (e.g., Formulas (Ia)-(Ia-5), (Ib)-(If-1), (IIa)-(IIp), (IIb-1), (IIb-2), (IIc-1)-(IIc-2), (IIn-1), (IIn-2), (IVa)-(IVl), and (IXa)-(IXr)),

when B is an unmodified nucleobase selected from cytosine, guanine, uracil and adenine, then at least one of Y¹, Y², or Y³ is not O.

[00169] In some embodiments, the modified nucleic acids or mmRNA includes a modified ribose. In some embodiments, modified nucleic acids or mmRNA includes n number of linked nucleosides having Formula (IIa)-(IIc):

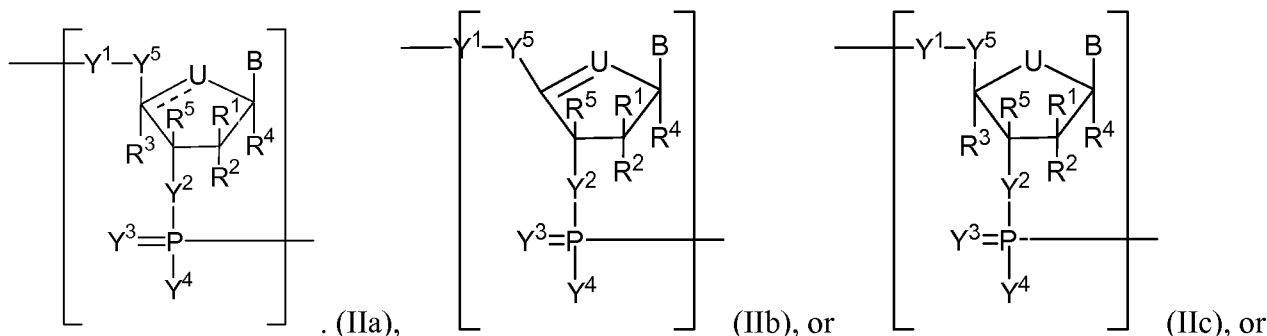

a pharmaceutically acceptable salt or stereoisomer thereof. In particular embodiments, U is O or C(R^u)_{nu}, wherein nu is an integer from 0 to 2 and each R^u is, independently, H, halo, or optionally substituted alkyl (e.g., U is -CH₂- or -CH-). In other embodiments, each of R¹, R², R³, R⁴, and R⁵ is, independently, H, halo, hydroxy, thiol, optionally substituted alkyl, optionally substituted alkoxy, optionally substituted alkenyloxy, optionally substituted alkynyloxy, optionally substituted aminoalkoxy, optionally substituted alkoxyalkoxy, optionally substituted hydroxyalkoxy, optionally substituted amino, azido, optionally substituted aryl, optionally substituted aminoalkyl, optionally substituted aminoalkenyl, optionally substituted aminoalkynyl, or absent (e.g., each R¹ and R² is, independently, H, halo, hydroxy, optionally substituted alkyl, or optionally substituted alkoxy; each R³ and R⁴ is, independently, H or optionally substituted alkyl; and R⁵ is H or hydroxy), and --- is a single bond or double bond.

[00170] In particular embodiments, the modified nucleic acid or mmRNA includes n number of linked nucleosides having Formula (IIb-1)-(IIb-2):

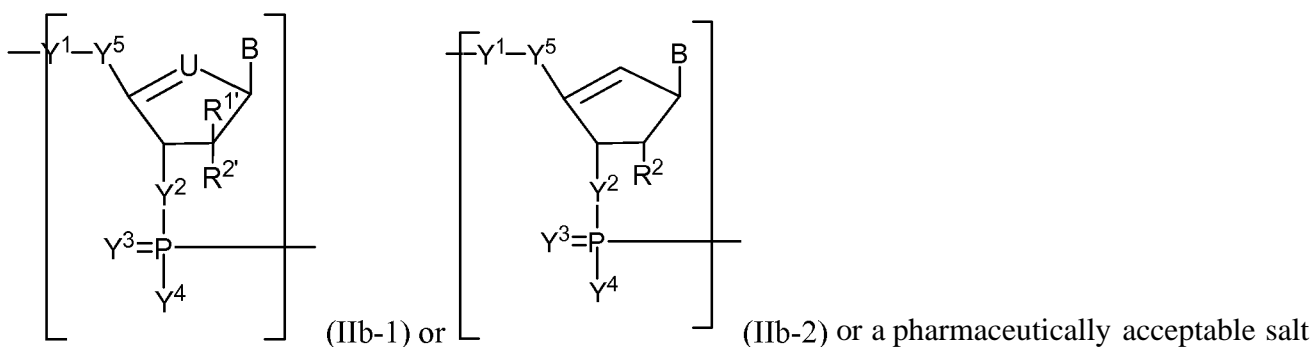

or stereoisomer thereof. In some embodiments, U is O or C(R^U)_{nu}, wherein nu is an integer from 0

to 2 and each R^U is, independently, H, halo, or optionally substituted alkyl (e.g., U is $-\text{CH}_2-$ or $-\text{CH}-$). In other embodiments, each of R^1 and R^2 is, independently, H, halo, hydroxy, thiol, optionally substituted alkyl, optionally substituted alkoxy, optionally substituted alkenyloxy, optionally substituted alkynyloxy, optionally substituted aminoalkoxy, optionally substituted alkoxyalkoxy, optionally substituted hydroxyalkoxy, optionally substituted amino, azido, optionally substituted aryl, optionally substituted aminoalkyl, optionally substituted aminoalkenyl, optionally substituted aminoalkynyl, or absent (e.g., each R^1 and R^2 is, independently, H, halo, hydroxy, optionally substituted alkyl, or optionally substituted alkoxy, e.g., H, halo, hydroxy, alkyl, or alkoxy). In particular embodiments, R^2 is hydroxy or optionally substituted alkoxy (e.g., methoxy, ethoxy, or any described herein).

[00171] In particular embodiments, the modified nucleic acid or mmRNA includes n number of linked nucleosides having Formula (IIc-1)-(IIc-4):

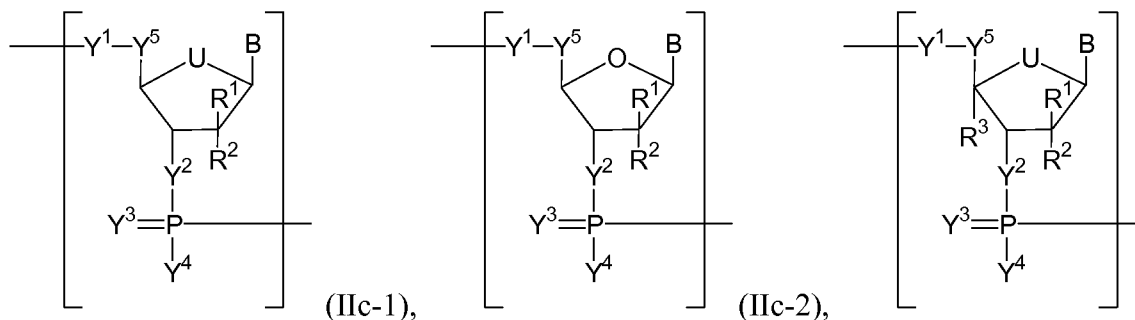

(IIc-3), or (IIc-4), or a pharmaceutically acceptable salt or stereoisomer thereof. In some embodiments, U is O or $\text{C}(\text{R}^U)_{n_U}$, wherein n_U is an integer from 0 to 2 and each R^U is, independently, H, halo, or optionally substituted alkyl (e.g., U is $-\text{CH}_2-$ or $-\text{CH}-$). In some embodiments, each of R^1 , R^2 , and R^3 is, independently, H, halo, hydroxy, thiol, optionally substituted alkyl, optionally substituted alkoxy, optionally substituted alkenyloxy, optionally substituted alkynyloxy, optionally substituted aminoalkoxy, optionally substituted alkoxyalkoxy, optionally substituted hydroxyalkoxy, optionally substituted amino, azido, optionally substituted aryl, optionally substituted aminoalkyl, optionally substituted aminoalkenyl, optionally substituted

aminoalkynyl, or absent (e.g., each R¹ and R² is, independently, H, halo, hydroxy, optionally substituted alkyl, or optionally substituted alkoxy, e.g., H, halo, hydroxy, alkyl, or alkoxy; and each R³ is, independently, H or optionally substituted alkyl)). In particular embodiments, R² is optionally substituted alkoxy (e.g., methoxy or ethoxy, or any described herein). In particular embodiments, R¹ is optionally substituted alkyl, and R² is hydroxy. In other embodiments, R¹ is hydroxy, and R² is optionally substituted alkyl. In further embodiments, R³ is optionally substituted alkyl.

[00172] In some embodiments, the modified nucleic acids or mmRNA includes an acyclic modified ribose. In some embodiments, the modified nucleic acids or mmRNA includes n number of linked nucleosides having Formula (II d)-(II f):

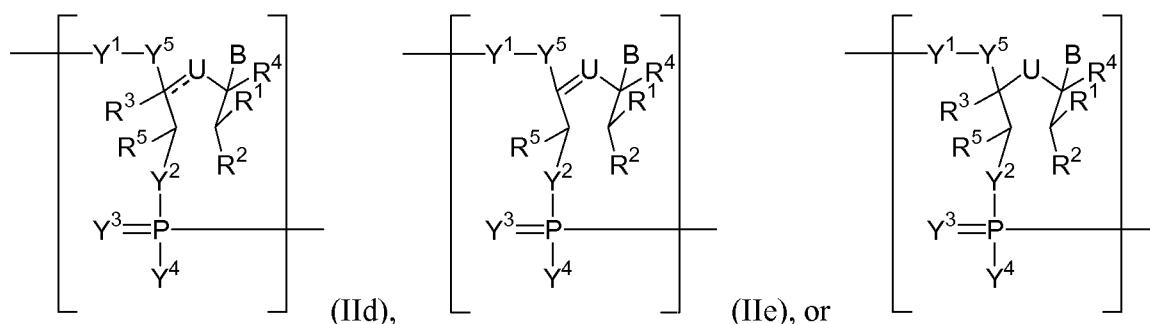

(II f), or a pharmaceutically acceptable salt or stereoisomer thereof.

[00173] In some embodiments, the modified nucleic acids or mmRNA includes an acyclic modified hexitol. In some embodiments, the modified nucleic acids or mmRNA includes n number of linked nucleosides having Formula (II g)-(II j):

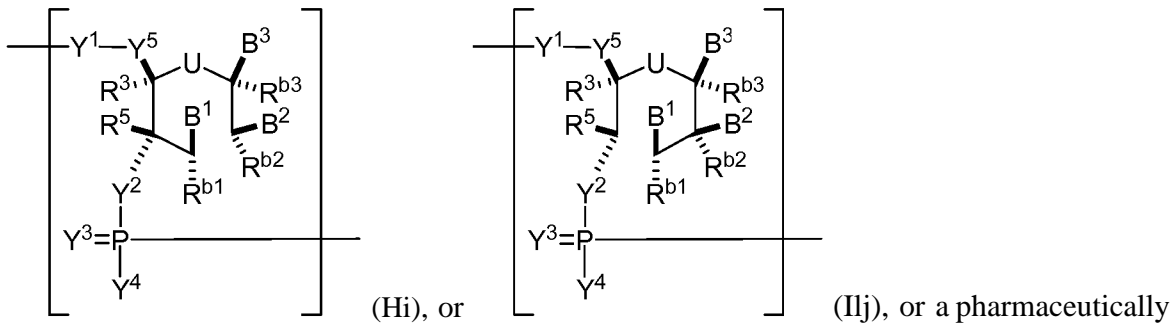
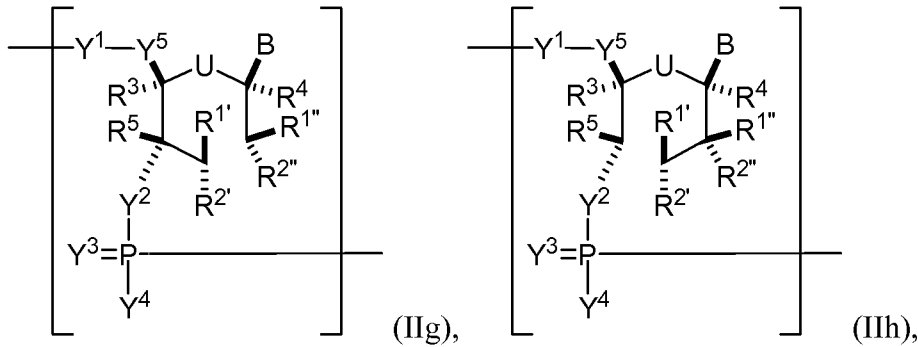

acceptable salt or stereoisomer thereof.

[00174] In some embodiments, the modified nucleic acids or mmRNA includes a sugar moiety having a contracted or an expanded ribose ring. In some embodiments, the modified nucleic acids or mmRNA includes n number of linked nucleosides having Formula (IIk)-(IIm):

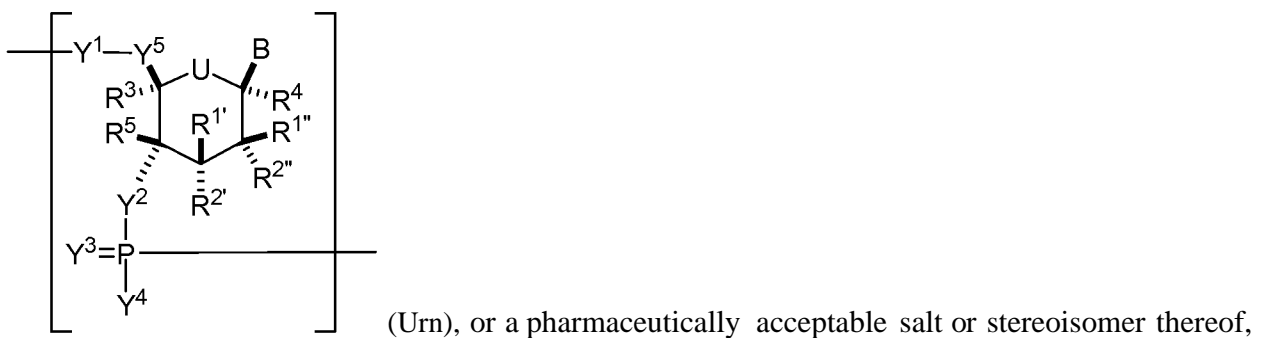
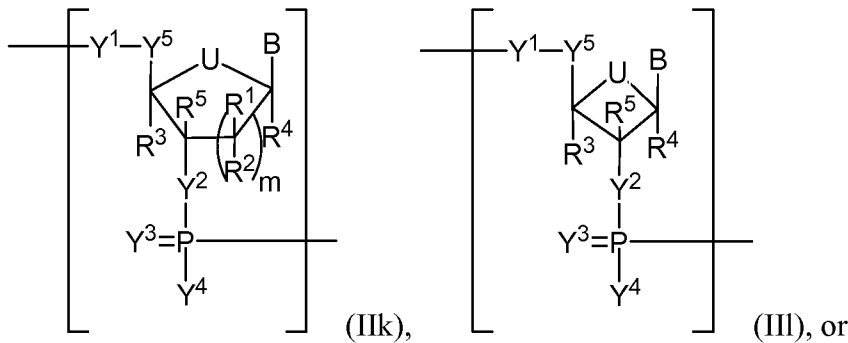

wherein each of R^{1'}, R^{1''}, R^{2'}, and R^{2''} is, independently, H, halo, hydroxy, optionally substituted alkyl, optionally substituted alkoxy, optionally substituted alkenyloxy, optionally substituted

alkynyloxy, optionally substituted aminoalkoxy, optionally substituted alkoxyalkoxy, or absent; and wherein the combination of $R^{2'}$ and R^3 or the combination of $R^{2''}$ and R^3 can be taken together to form optionally substituted alkylene or optionally substituted heteroalkylene.

[00175] In some embodiments, the modified nucleic acids or mmRNA includes a locked modified ribose. In some embodiments, the modified nucleic acids or mmRNA includes n number of linked nucleosides having Formula (II-n):

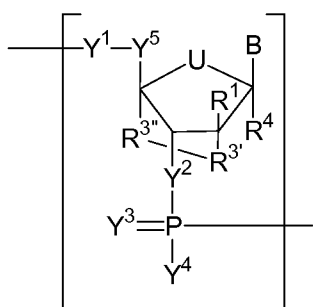

(II-n), or a pharmaceutically acceptable salt or stereoisomer thereof, wherein

$R^{3'}$ is O, S, or $-NR^{N1}$ -, wherein R^{N1} is H, optionally substituted alkyl, optionally substituted alkenyl, optionally substituted alkynyl, or optionally substituted aryl and $R^{3''}$ is optionally substituted alkylene (e.g., $-\text{CH}_2-$, $-\text{CH}_2\text{CH}_2-$, or $-\text{CH}_2\text{CH}_2\text{CH}_2-$) or optionally substituted heteroalkylene (e.g., $-\text{CH}_2\text{NH}-$, $-\text{CH}_2\text{CH}_2\text{NH}-$, $-\text{CH}_2\text{OCH}_2-$, or $-\text{CH}_2\text{CH}_2\text{OCH}_2-$)(e.g., $R^{3'}$ is O and $R^{3''}$ is optionally substituted alkylene (e.g., $-\text{CH}_2-$, $-\text{CH}_2\text{CH}_2-$, or $-\text{CH}_2\text{CH}_2\text{CH}_2-$)).

[00176] In some embodiments, the modified nucleic acid or mmRNA includes n number of linked nucleosides having Formula (II-n-1)-(II-n-2):

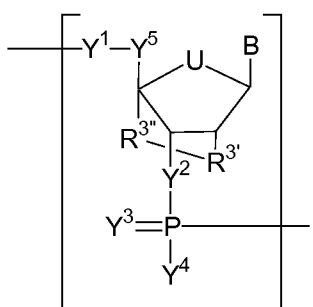

(II-n-1) or

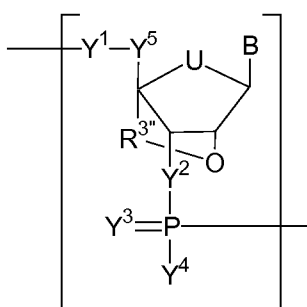

(II-n-2), or a pharmaceutically acceptable

salt or stereoisomer thereof, wherein $R^{3'}$ is O, S, or $-NR^{N1}$ -, wherein R^{N1} is H, optionally substituted alkyl, optionally substituted alkenyl, optionally substituted alkynyl, or optionally substituted aryl and $R^{3''}$ is optionally substituted alkylene (e.g., $-\text{CH}_2-$, $-\text{CH}_2\text{CH}_2-$, or $-\text{CH}_2\text{CH}_2\text{CH}_2-$) or optionally substituted heteroalkylene (e.g., $-\text{CH}_2\text{NH}-$, $-\text{CH}_2\text{CH}_2\text{NH}-$, $-\text{CH}_2\text{OCH}_2-$, or $-\text{CH}_2\text{CH}_2\text{OCH}_2-$) (e.g., $R^{3'}$ is O and $R^{3''}$ is optionally substituted alkylene (e.g., $-\text{CH}_2-$, $-\text{CH}_2\text{CH}_2-$, or $-\text{CH}_2\text{CH}_2\text{CH}_2-$)).

[00177] In some embodiments, the modified nucleic acids or mmRNA includes a locked modified ribose that forms a tetracyclic heterocycle. In some embodiments, the modified nucleic acids or mmRNA includes n number of linked nucleosides having Formula (IIo):

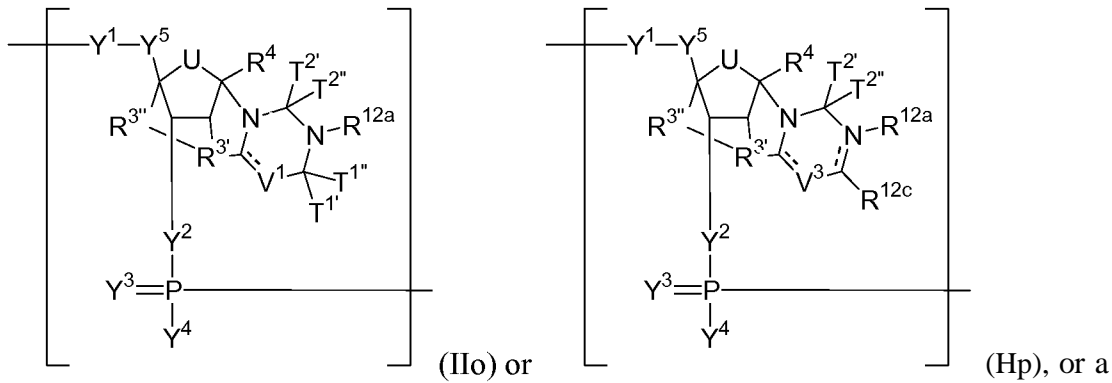

pharmaceutically acceptable salt or stereoisomer thereof, wherein R^{12a} , R^{12c} , T^1 , T^1 , T^2 , T^2 , V^1 , and V^3 are as described herein.

[00178] Any of the formulas for the modified nucleic acids or mmRNA can include one or more nucleobases described herein (e.g., Formulas (bl)-(b43)).

[00179] In one embodiment, the present invention provides methods of preparing a modified nucleic acids or mmRNA comprising at least one nucleotide (e.g., mmRNA molecule), wherein the modified nucleic acid comprises n number of nucleosides having Formula (Ia), as defined herein:

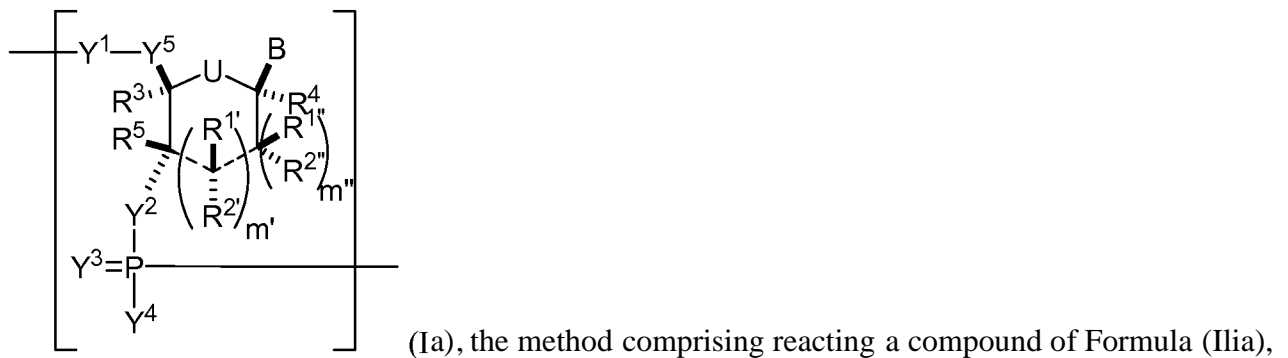

as defined herein:

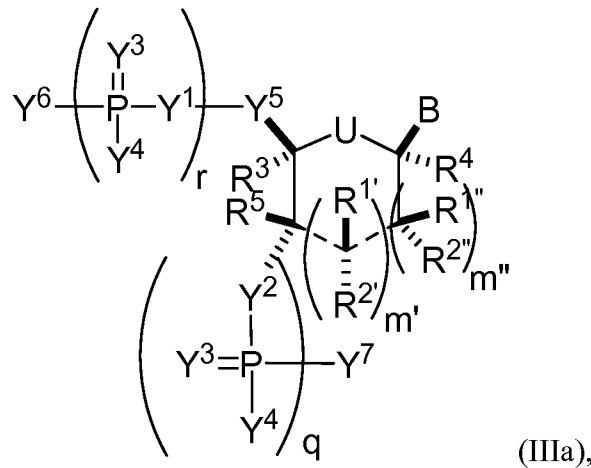

with an RNA polymerase, and a cDNA template.

[00180] In a further embodiment, the present invention provides methods of amplifying a modified nucleic acids or mmRNA comprising at least one nucleotide (e.g., mmRNA molecule), the method comprising: reacting a compound of Formula (IIia), as defined herein, with a primer, a cDNA template, and an RNA polymerase.

[00181] In one embodiment, the present invention provides methods of preparing a modified nucleic acids or mmRNA comprising at least one nucleotide (e.g., mmRNA molecule), wherein the modified nucleic acid comprises n number of nucleosides having Formula (Ia-1), as defined herein:

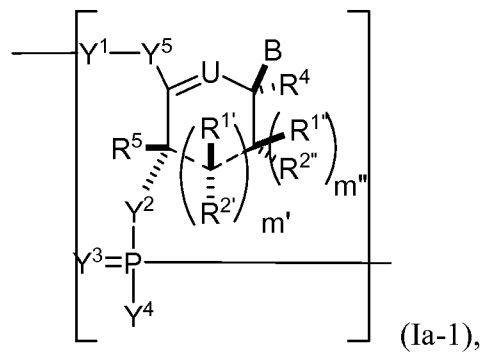

the method comprising reacting a compound of Formula (IIIa-1), as defined herein:

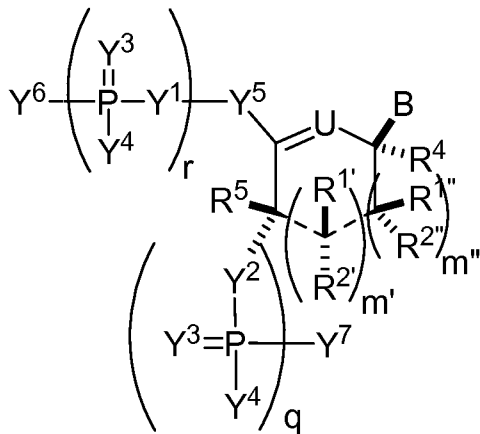

(IIIa-1), with an RNA polymerase, and a cDNA template.

[00182] In a further embodiment, the present invention provides methods of amplifying a modified nucleic acids or mmRNA comprising at least one nucleotide (e.g., mmRNA molecule), the method comprising reacting a compound of Formula (IIIa-1), as defined herein, with a primer, a cDNA template, and an RNA polymerase.

[00183] In one embodiment, the present invention provides methods of preparing a modified mRNA comprising at least one nucleotide (e.g., mmRNA molecule), wherein the polynucleotide comprises n number of nucleosides having Formula (Ia-2), as defined herein:

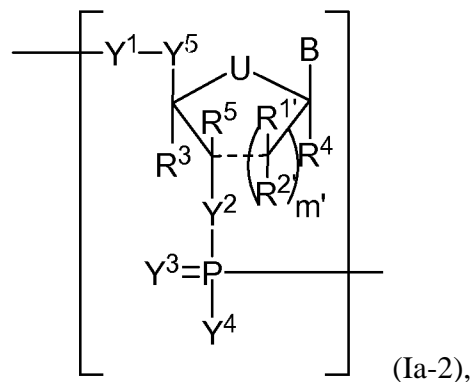

(Ia-2),

the method comprising reacting a compound of Formula (IIIa-2), as defined herein:

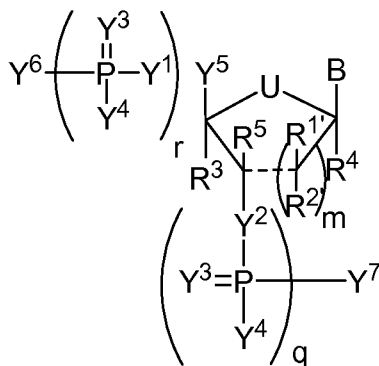

(IIIa-2), with an RNA polymerase, and a cDNA template.

[00184] In a further embodiment, the present invention provides methods of amplifying a modified mRNA comprising at least one nucleotide (e.g., mmRNA molecule), the method comprising:

[00185] reacting a compound of Formula (IIIa-2), as defined herein, with a primer, a cDNA template, and an RNA polymerase.

[00186] In some embodiments, the reaction may be repeated from 1 to about 7,000 times. In any of the embodiments herein, B may be a nucleobase of Formula (bl)-(b43).

[00187] The modified nucleic acids and mmRNA can optionally include 5' and/or 3' flanking regions, which are described herein.

Modified RNA (e.g. mmRNA) Molecules

[00188] The present invention also includes building blocks, e.g., modified ribonucleosides, modified ribonucleotides, of modified RNA (mmRNA) molecules. For example, these mmRNA can be useful for preparing the modified nucleic acids or mmRNA of the invention.

[00189] In some embodiments, the building block molecule has Formula (IIia) or (IIia-1):

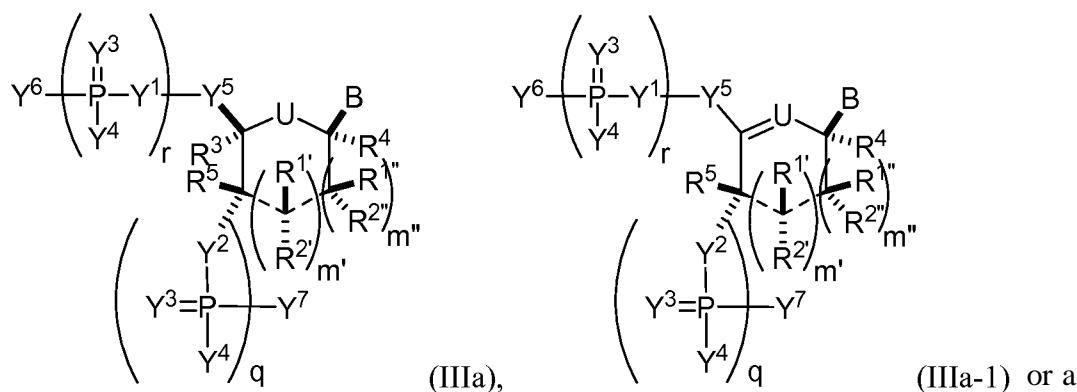

pharmaceutically acceptable salt or stereoisomer thereof, wherein the substituents are as described herein (e.g., for Formula (Ia) and (Ia-1)), and wherein when B is an unmodified nucleobase selected from cytosine, guanine, uracil and adenine, then at least one of Y¹, Y², or Y³ is not O.

[00190] In some embodiments, the building block molecule, which may be incorporated into a modified nucleic acid or mmRNA, has Formula (IVa)-(IVb):

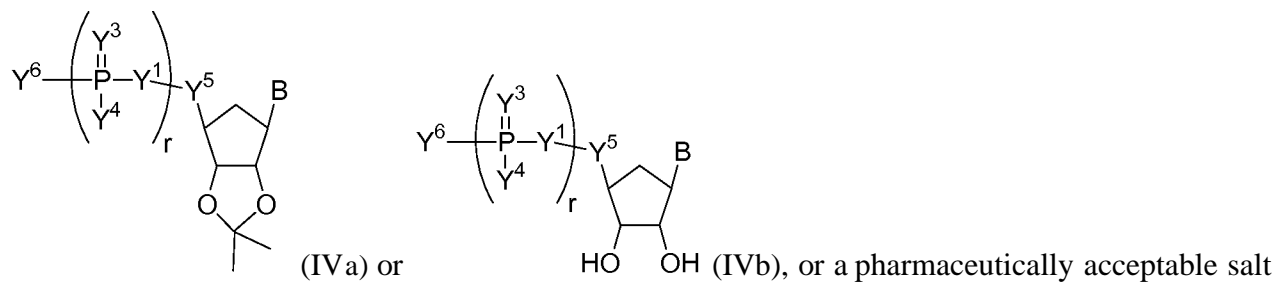

or stereoisomer thereof, wherein B is as described herein (e.g., any one of (bl)-(b43)). In particular

embodiments, Formula (IVa) or (IVb) is combined with a modified uracil (e.g., any one of formulas (bl)-(b9), (b21)-(b23), and (b28)-(b31), such as formula (bl), (b8), (b28), (b29), or (b30)). In particular embodiments, Formula (IVa) or (IVb) is combined with a modified cytosine (e.g., any one of formulas (M0)-(bl4), (b24), (b25), and (b32)-(b36), such as formula (bl0) or (b32)). In particular embodiments, Formula (IVa) or (IVb) is combined with a modified guanine (e.g., any one of formulas (bl5)-(bl7) and (b37)-(b40)). In particular embodiments, Formula (IVa) or (IVb) is combined with a modified adenine (e.g., any one of formulas (M8)-(b20) and (b41)-(b43)).

[00191] In some embodiments, the building block molecule, which may be incorporated into a modified nucleic acid molecule or mmRNA, has Formula (IVc)-(IVk):

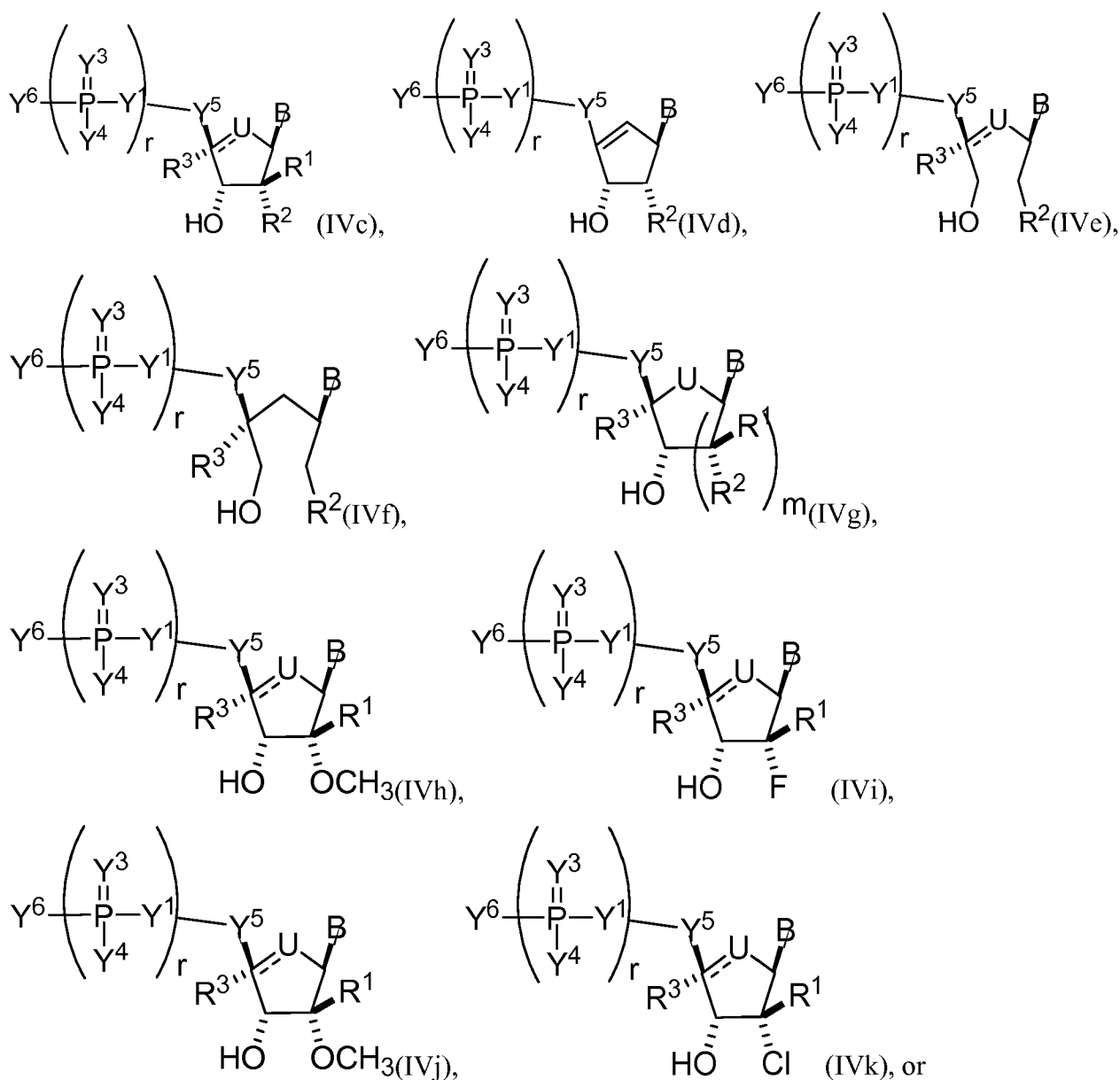

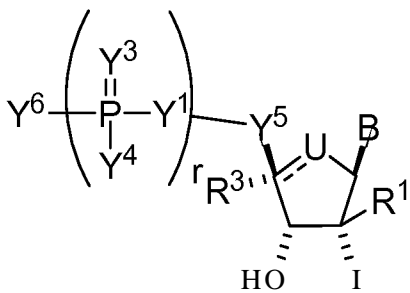

(IVl), or a pharmaceutically acceptable salt or stereoisomer thereof, wherein B is as described herein (e.g., any one of (bl)-(b43)). In particular embodiments, one of Formulas (IVc)-(IVk) is combined with a modified uracil (e.g., any one of formulas (bl)-(b9), (b21)-(b23), and (b28)-(b31), such as formula (bl), (b8), (b28), (b29), or (b30)). In particular embodiments, one of Formulas (IVc)-(IVk) is combined with a modified cytosine (e.g., any one of formulas (M0)-(bl4), (b24), (b25), and (b32)-(b36), such as formula (blO) or (b32)). In particular embodiments, one of Formulas (IVc)-(IVk) is combined with a modified guanine (e.g., any one of formulas (bl5)-(bl7) and (b37)-(b40)). In particular embodiments, one of Formulas (IVc)-(IVk) is combined with a modified adenine (e.g., any one of formulas (M8)-(b20) and (b41)-(b43)).

[00192] In other embodiments, the building block molecule, which may be incorporated into a modified nucleic acid molecule or mmRNA, has Formula (Va) or (Vb):

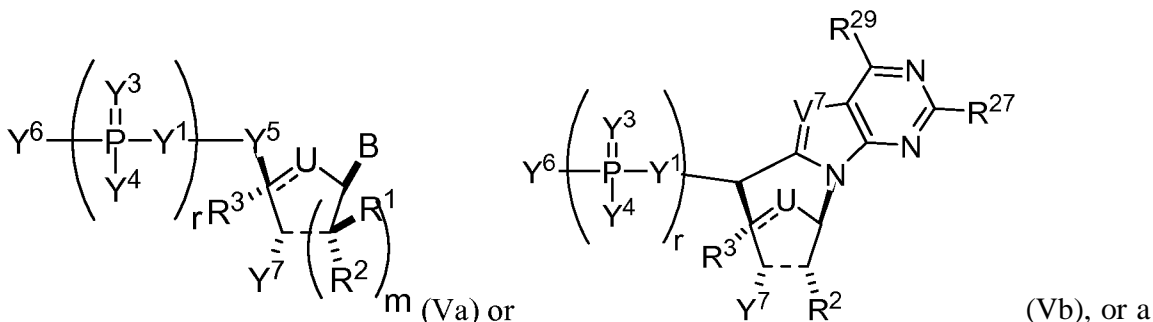

pharmaceutically acceptable salt or stereoisomer thereof, wherein B is as described herein (e.g., any one of (bl)-(b43)).

[00193] In other embodiments, the building block molecule, which may be incorporated into a modified nucleic acid molecule or mmRNA, has Formula (IXa)-(IXd):

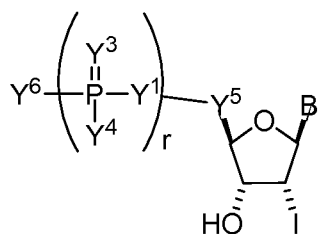
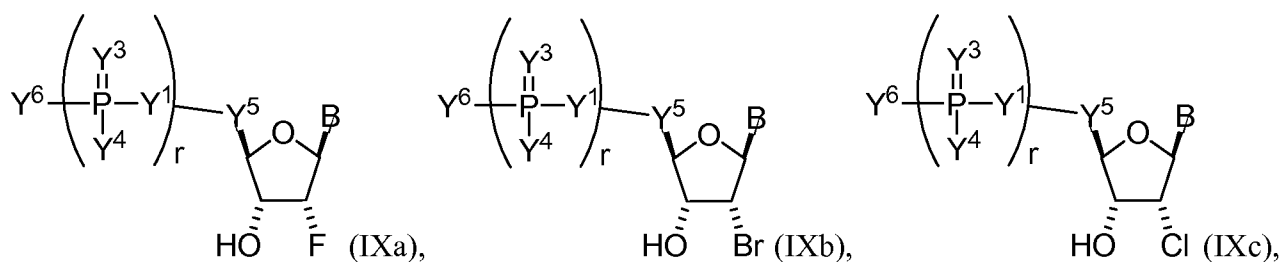

or
 wherein B is as described herein (e.g., any one of (b1)-(b43)). In particular embodiments, one of Formulas (IXa)-(IXd) is combined with a modified uracil (e.g., any one of formulas (b1)-(b9), (b21)-(b23), and (b28)-(b31), such as formula (b1), (b8), (b28), (b29), or (b30)). In particular embodiments, one of Formulas (IXa)-(IXd) is combined with a modified cytosine (e.g., any one of formulas (M0)-(b14), (b24), (b25), and (b32)-(b36), such as formula (b10) or (b32)). In particular embodiments, one of Formulas (IXa)-(IXd) is combined with a modified guanine (e.g., any one of formulas (b15)-(b17) and (b37)-(b40)). In particular embodiments, one of Formulas (IXa)-(IXd) is combined with a modified adenine (e.g., any one of formulas (M8)-(b20) and (b41)-(b43)).

[00194] In other embodiments, the building block molecule, which may be incorporated into a modified nucleic acid molecule or mmRNA, has Formula (IXe)-(IXg):

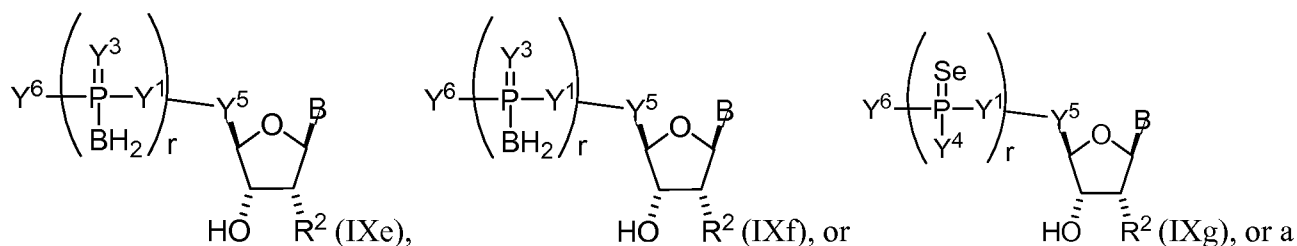

pharmaceutically acceptable salt or stereoisomer thereof, wherein B is as described herein (e.g., any one of (b1)-(b43)). In particular embodiments, one of Formulas (IXe)-(IXg) is combined with a modified uracil (e.g., any one of formulas (b1)-(b9), (b21)-(b23), and (b28)-(b31), such as formula (b1), (b8), (b28), (b29), or (b30)). In particular embodiments, one of Formulas (IXe)-(IXg) is combined with a modified cytosine (e.g., any one of formulas (M0)-(b14), (b24), (b25), and (b32)-(b36), such as formula (b10) or (b32)). In particular embodiments, one of Formulas (IXe)-(IXg) is combined with a modified guanine (e.g., any one of formulas (b15)-(b17) and (b37)-(b40)). In

particular embodiments, one of Formulas (IXe)-(IXg) is combined with a modified adenine (e.g., any one of formulas (b18)-(b20) and (b41)-(b43)).

[00195] In other embodiments, the building block molecule, which may be incorporated into a modified nucleic acid molecule or mmRNA, has Formula (IXh)-(IXk):

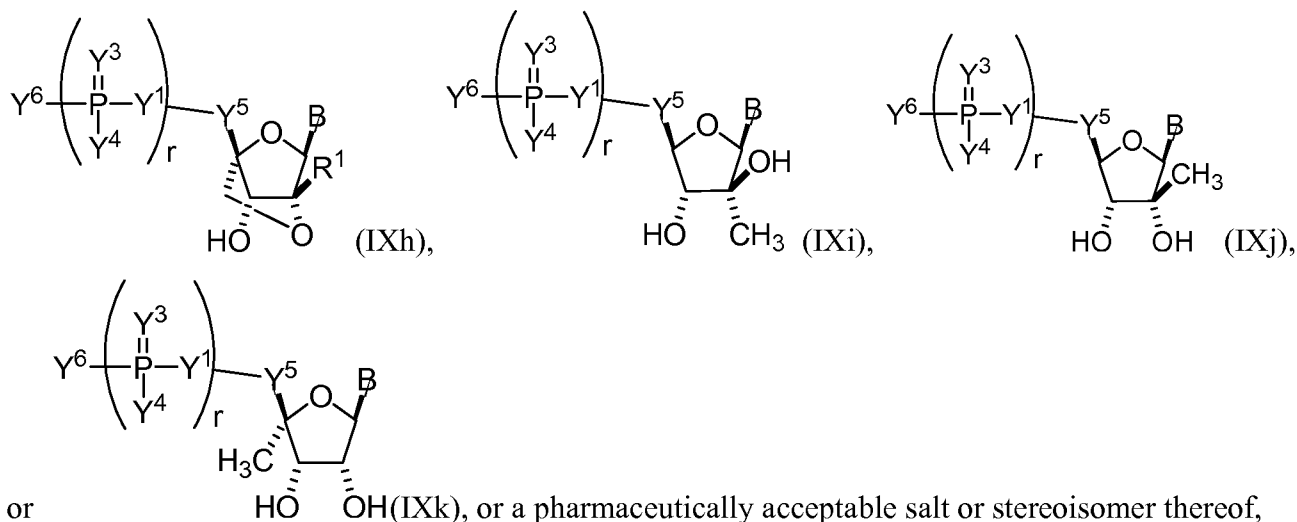

wherein B is as described herein (e.g., any one of (b1)-(b43)). In particular embodiments, one of Formulas (IXh)-(IXk) is combined with a modified uracil (e.g., any one of formulas (b1)-(b9), (b21)-(b23), and (b28)-(b31), such as formula (b1), (b8), (b28), (b29), or (b30)). In particular embodiments, one of Formulas (IXh)-(IXk) is combined with a modified cytosine (e.g., any one of formulas (M0)-(b14), (b24), (b25), and (b32)-(b36), such as formula (b10) or (b32)). In particular embodiments, one of Formulas (IXh)-(IXk) is combined with a modified guanine (e.g., any one of formulas (b15)-(b17) and (b37)-(b40)). In particular embodiments, one of Formulas (IXh)-(IXk) is combined with a modified adenine (e.g., any one of formulas (M8)-(b20) and (b41)-(b43)).

[00196] In other embodiments, the building block molecule, which may be incorporated into a modified nucleic acid molecule or mmRNA, has Formula (IXl)-(IXr):

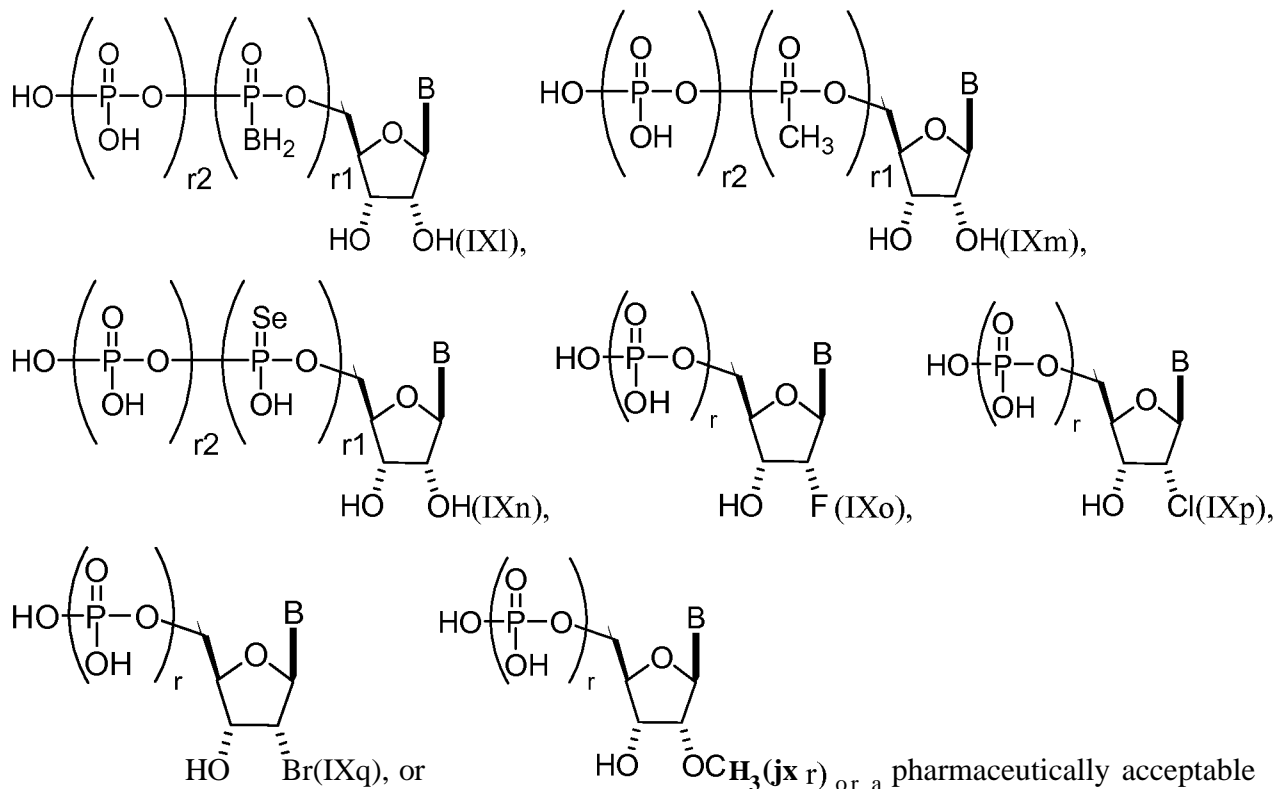

or a pharmaceutically acceptable salt or stereoisomer thereof, wherein each r_1 and r_2 is, independently, an integer from 0 to 5 (e.g., from 0 to 3, from 1 to 3, or from 1 to 5) and B is as described herein (e.g., any one of (b1)-(b43)). In particular embodiments, one of Formulas (IXl)-(IXr) is combined with a modified uracil (e.g., any one of formulas (b1)-(b9), (b21)-(b23), and (b28)-(b31), such as formula (b1), (b8), (b28), (b29), or (b30)). In particular embodiments, one of Formulas (IXl)-(IXr) is combined with a modified cytosine (e.g., any one of formulas (M0)-(b14), (b24), (b25), and (b32)-(b36), such as formula (b10) or (b32)). In particular embodiments, one of Formulas (IXl)-(IXr) is combined with a modified guanine (e.g., any one of formulas (b15)-(b17) and (b37)-(b40)). In particular embodiments, one of Formulas (IXl)-(IXr) is combined with a modified adenine (e.g., any one of formulas (M8)-(b20) and (b41)-(b43)).

[00197] In some embodiments, the building block molecule, which may be incorporated into a modified nucleic acid molecules or mmRNA, can be selected from the group consisting of:

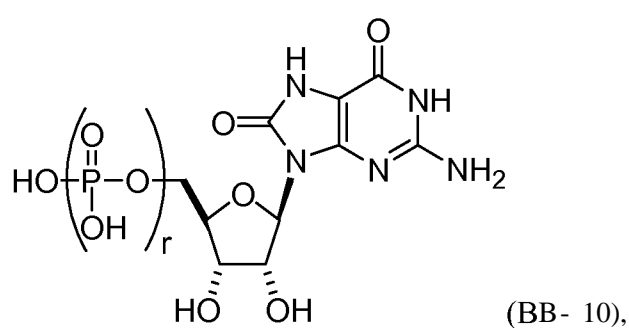
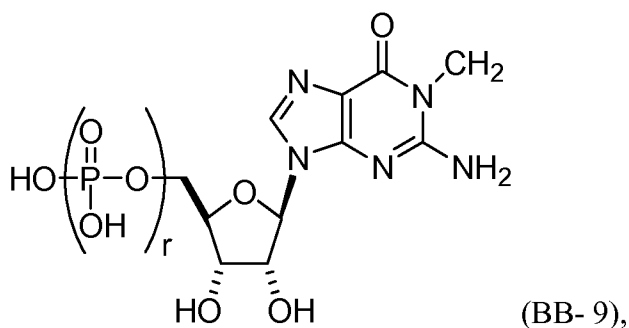
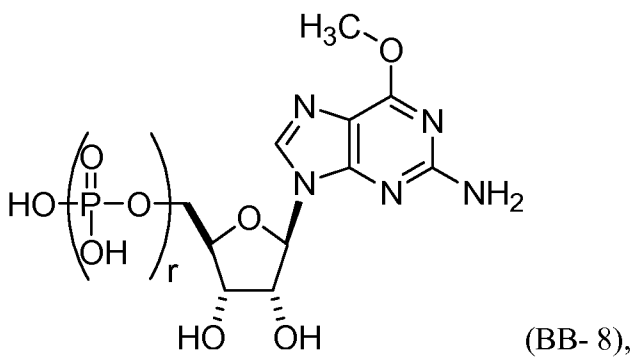
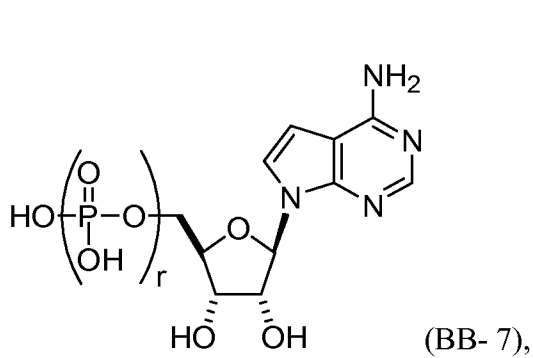
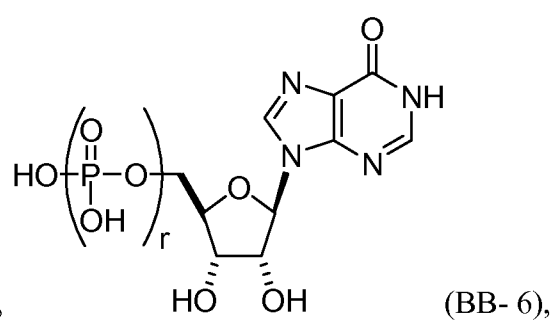
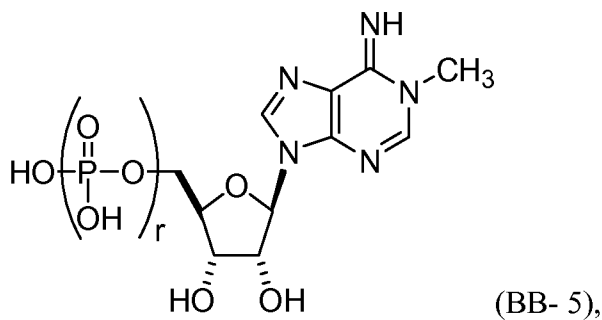
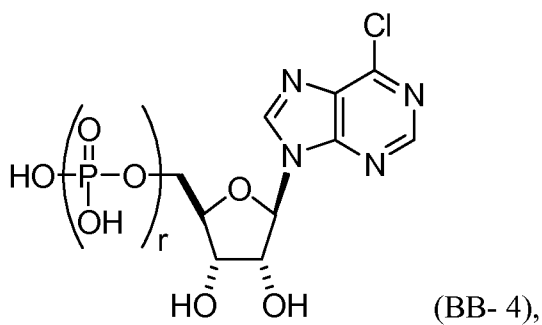
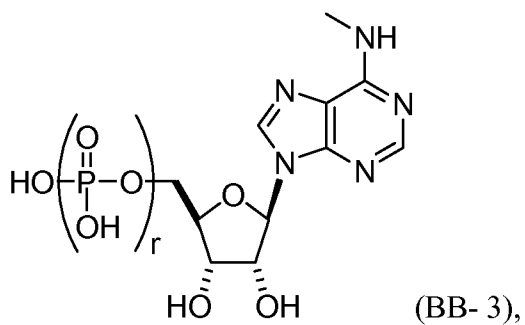
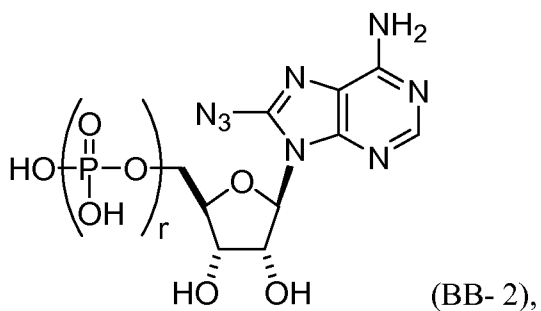
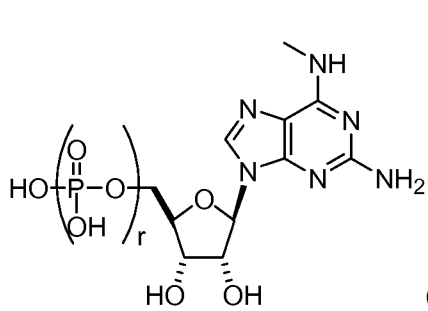

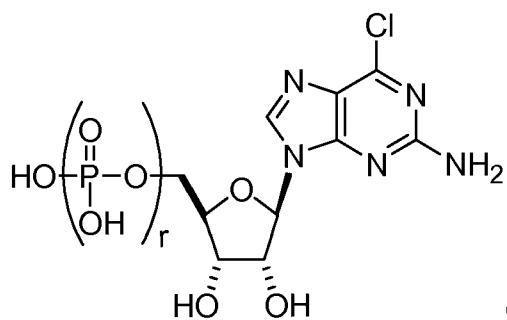

(BB- 11), and

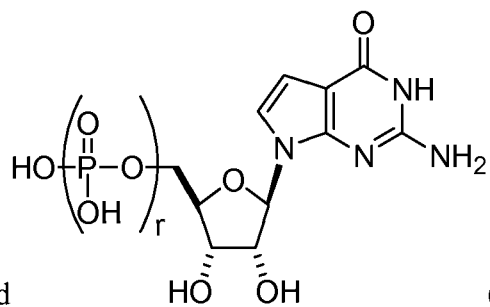

(BB- 12),

or a pharmaceutically acceptable salt or stereoisomer thereof, wherein each r is, independently, an integer from 0 to 5 (e.g., from 0 to 3, from 1 to 3, or from 1 to 5).

[00198] In some embodiments, the building block molecule, which may be incorporated into a modified nucleic acid molecule or mmRNA, can be selected from the group consisting of:

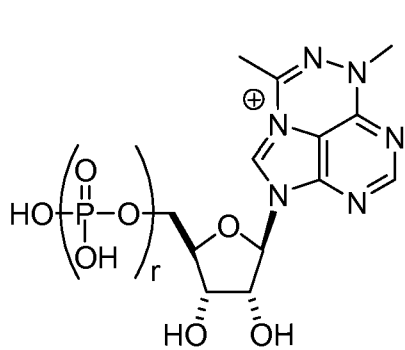

(BB- 13),

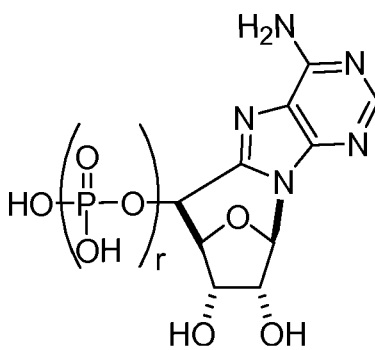

(BB- 14),

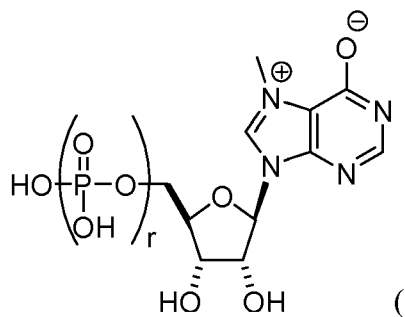

(BB- 15),

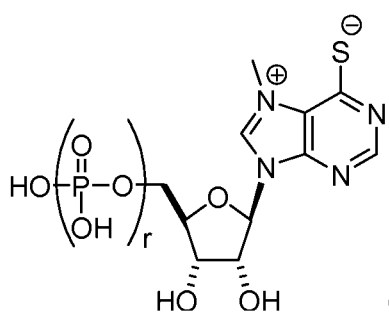

(BB- 16),

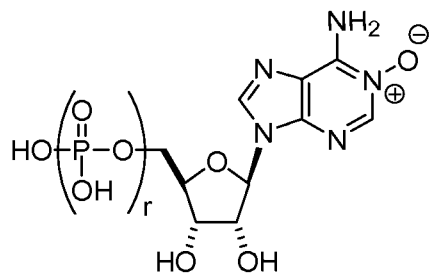

(BB- 17),

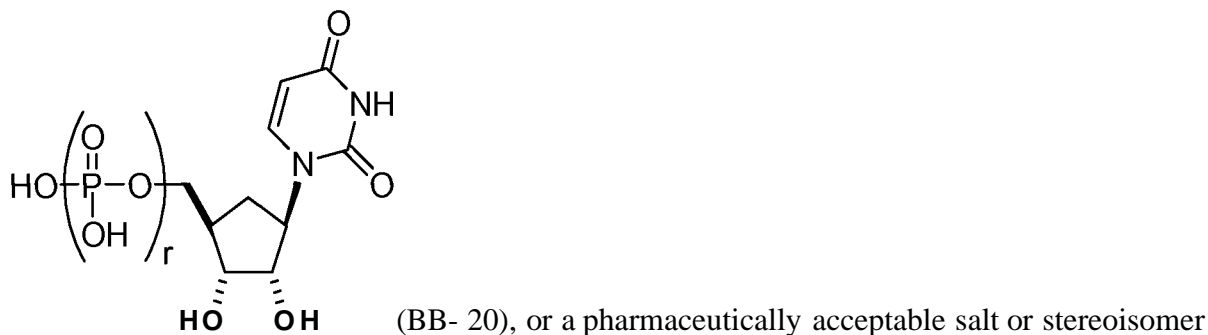
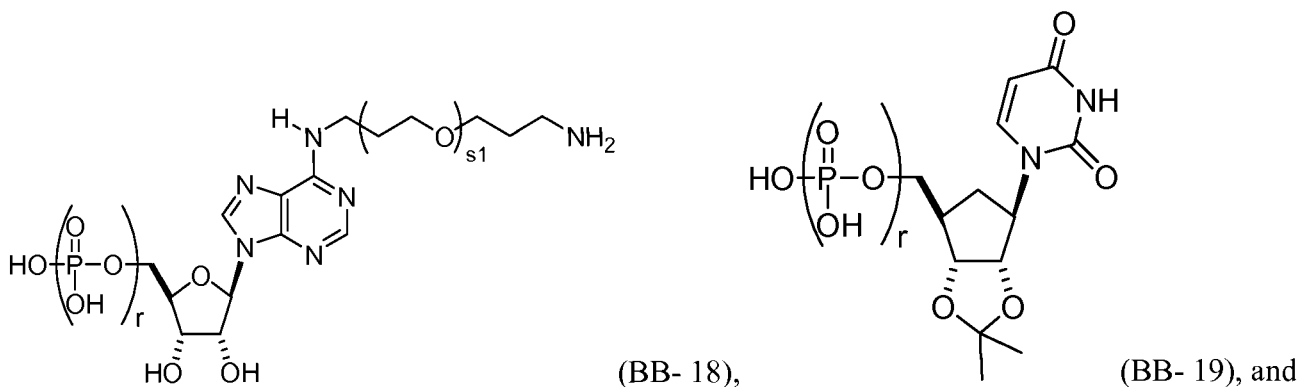

thereof, wherein each r is, independently, an integer from 0 to 5 (e.g., from 0 to 3, from 1 to 3, or from 1 to 5) and s_1 is as described herein.

[00199] In some embodiments, the building block molecule, which may be incorporated into a nucleic acid (e.g., RNA, mRNA, or mmRNA), is a modified uridine (e.g., selected from the group consisting of:

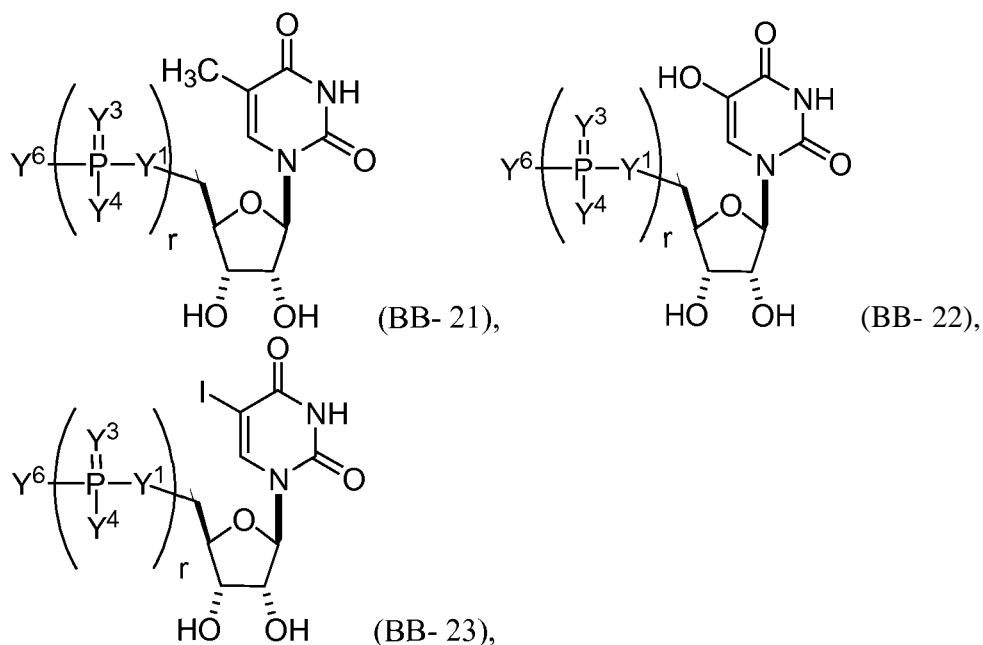

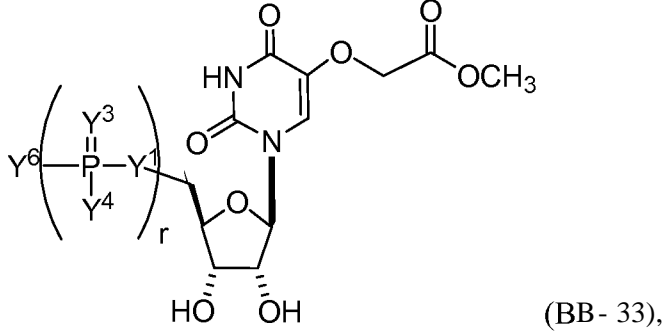
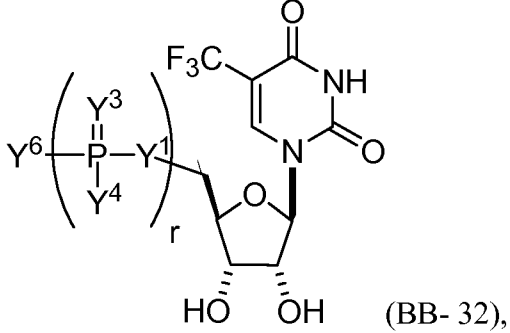
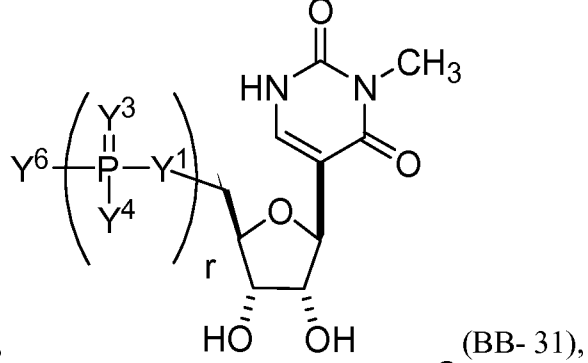
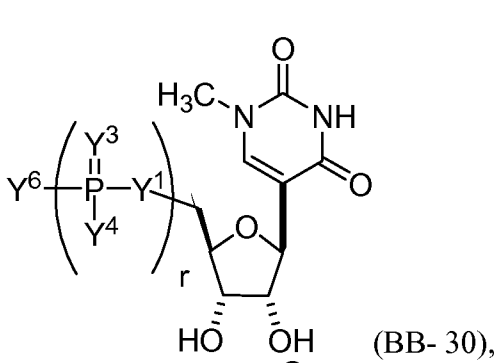
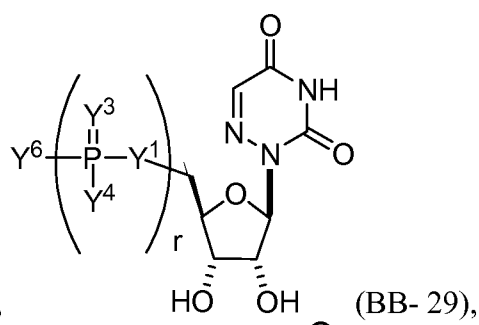
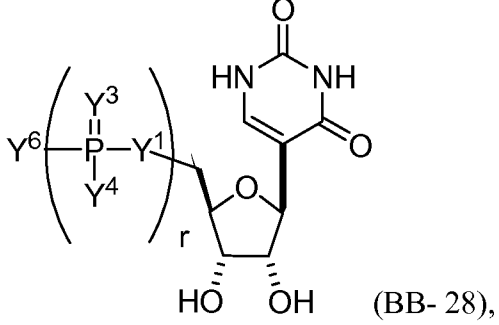
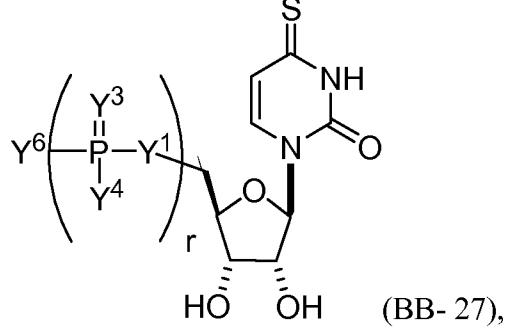
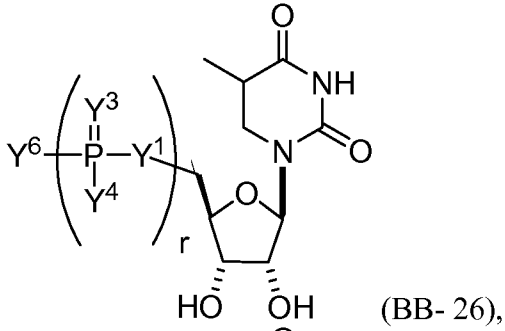
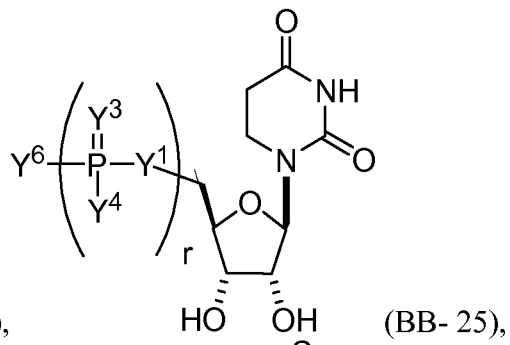
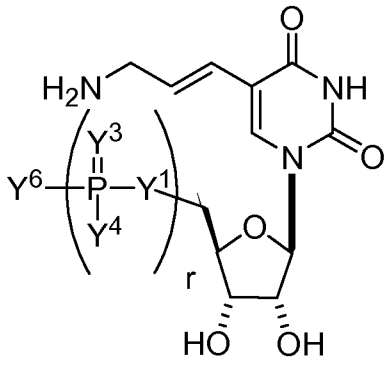

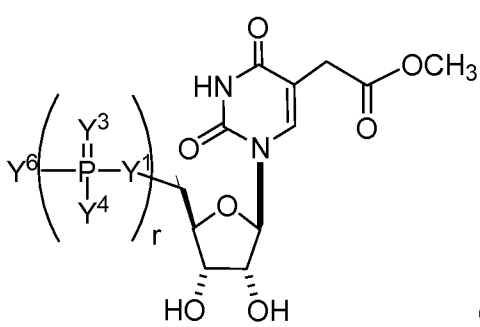

(BB- 34),

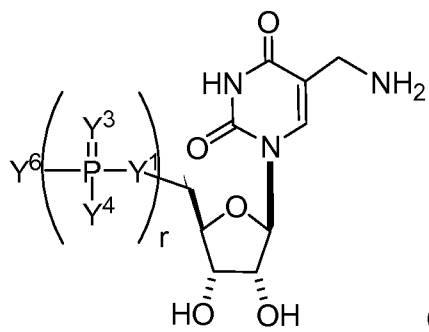

(BB- 35),

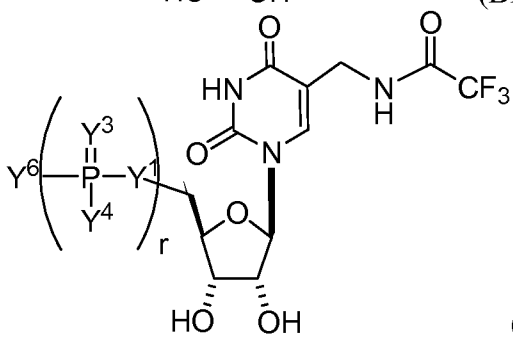

(BB- 36),

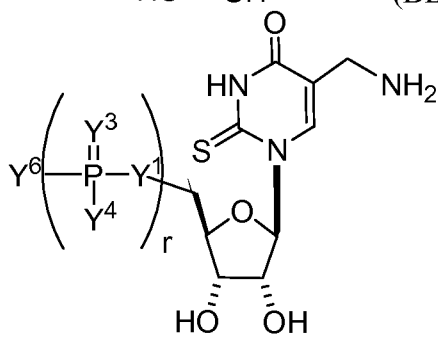

(BB- 37),

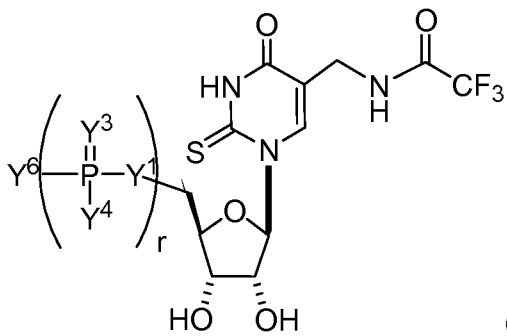

(BB- 38),

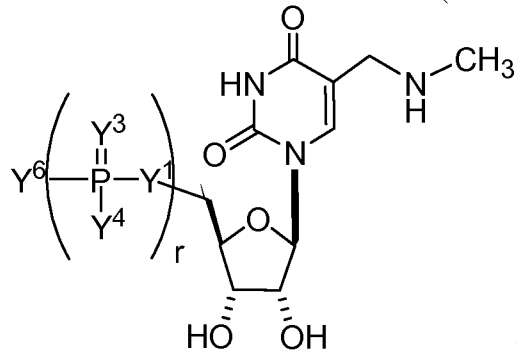

(BB- 39),

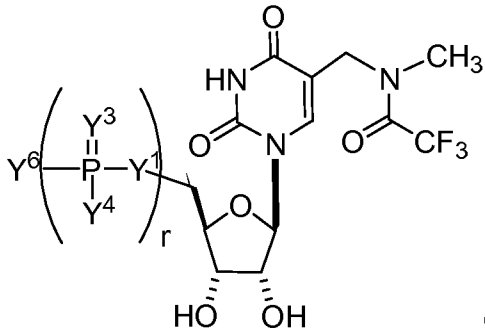

(BB- 40),

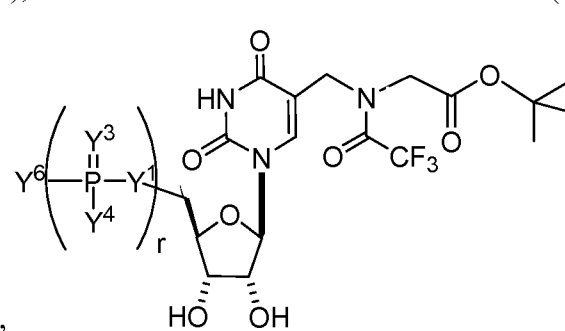

(BB- 41),

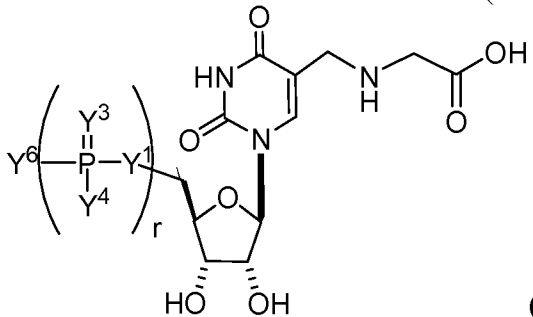

(BB- 42),

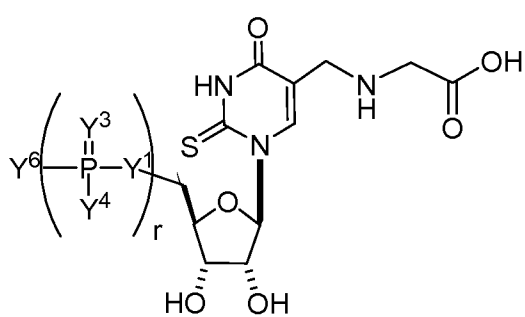

(BB- 43),

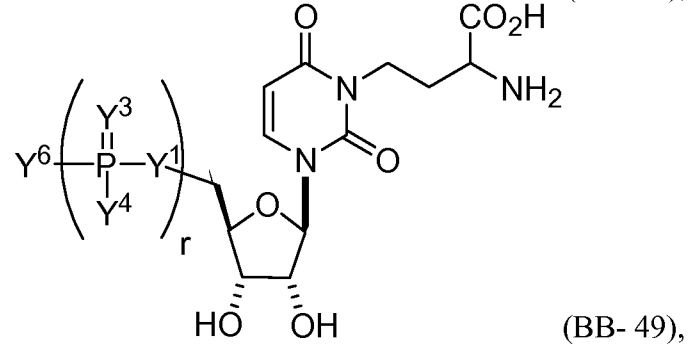
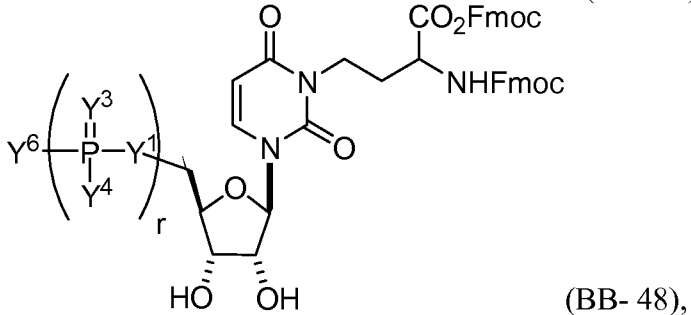
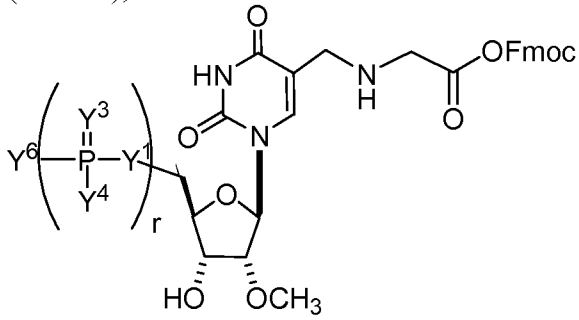
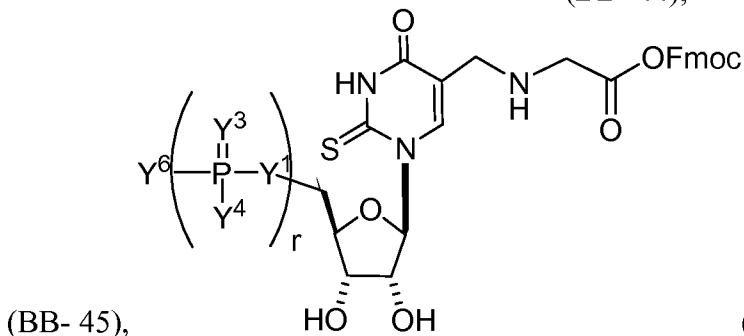
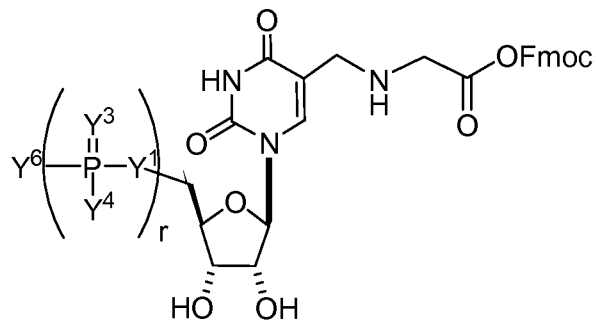
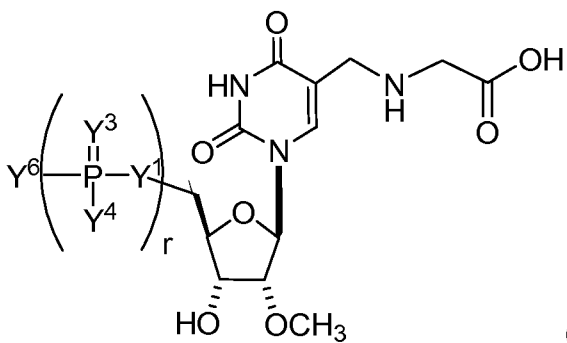

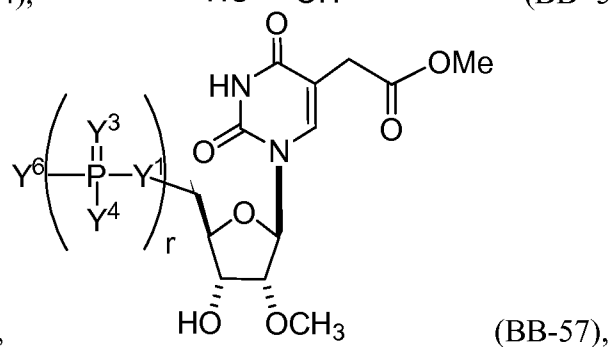
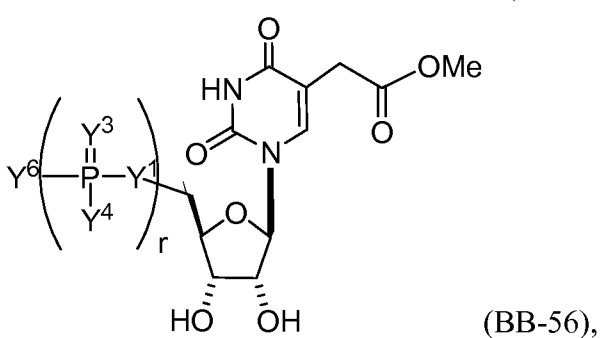
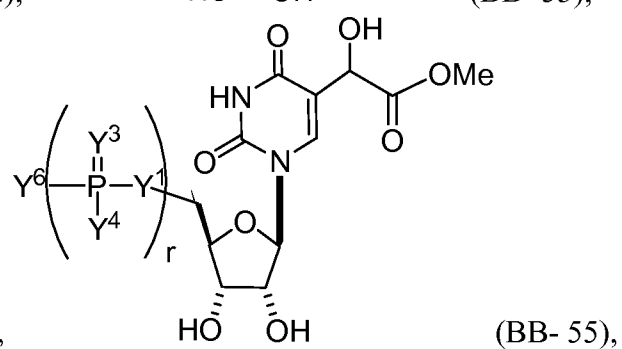
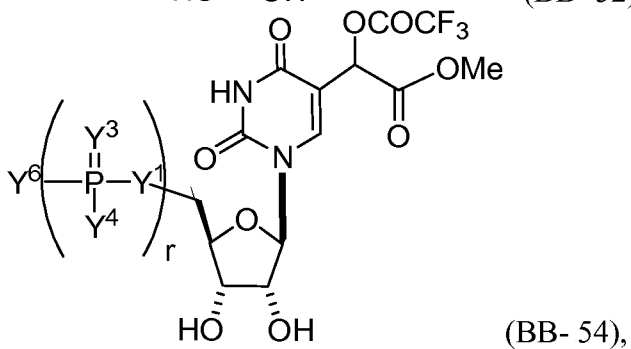
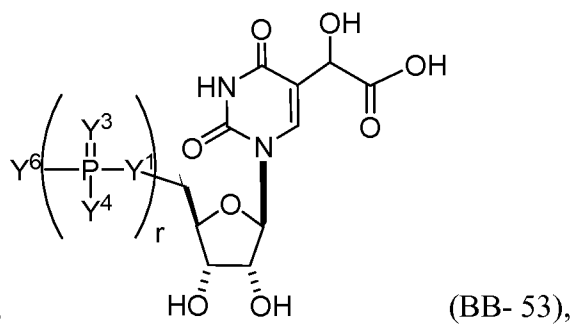
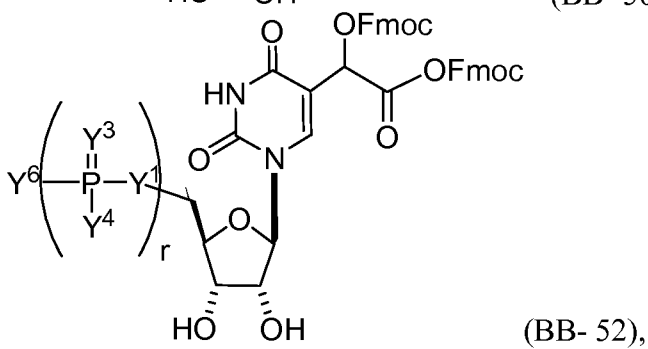
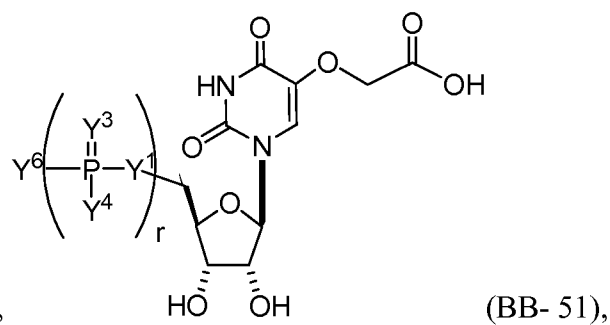
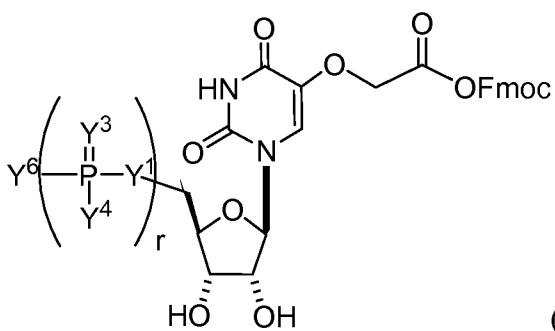

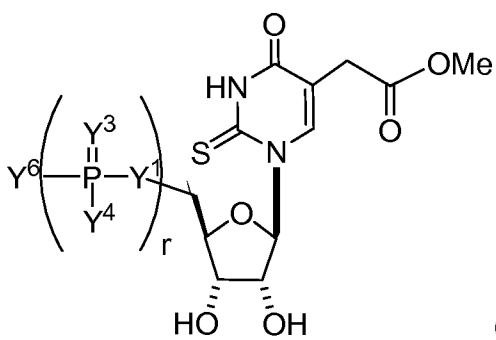

(BB- 58),

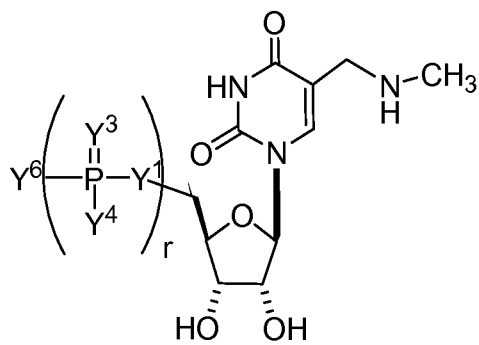

(BB- 59),

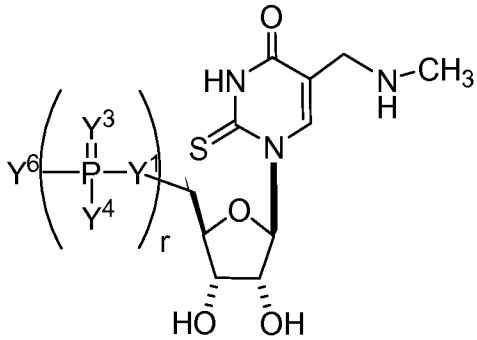

(BB- 60),

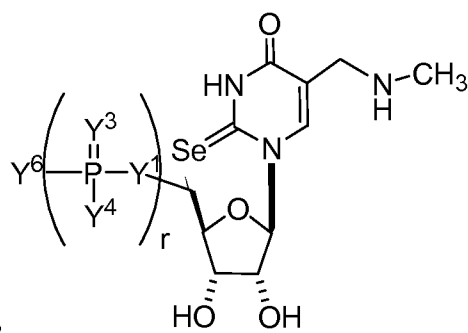

(BB- 61),

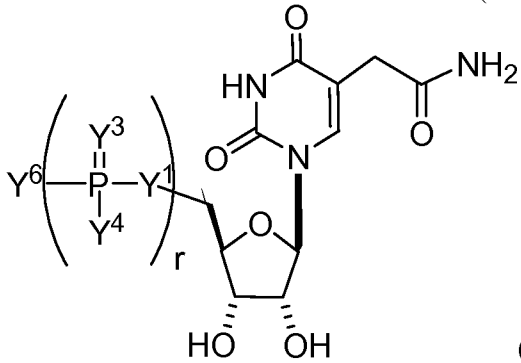

(BB- 62),

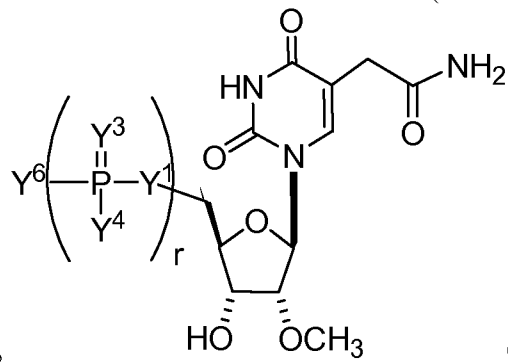

(BB- 63),

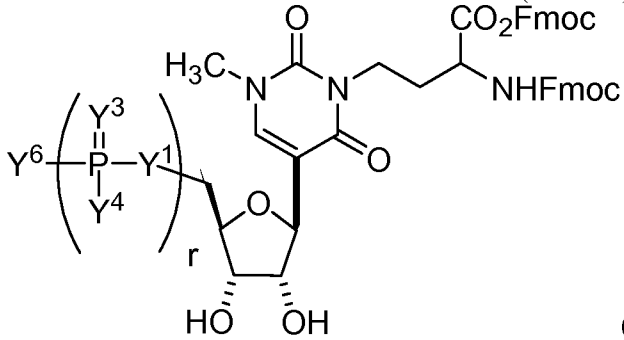

(BB- 64),

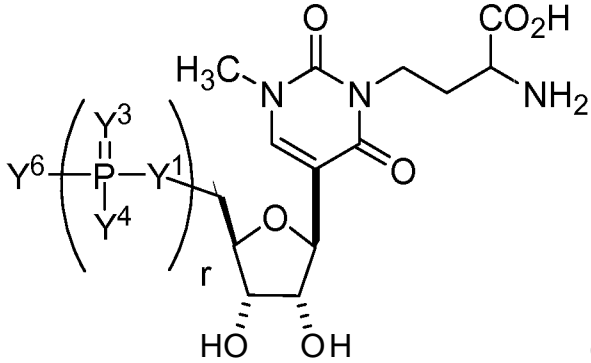

(BB- 65),

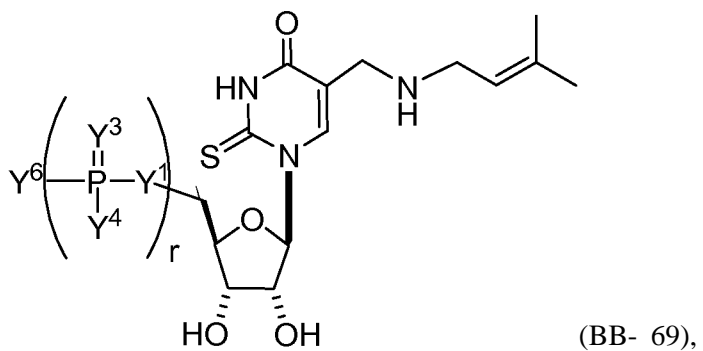
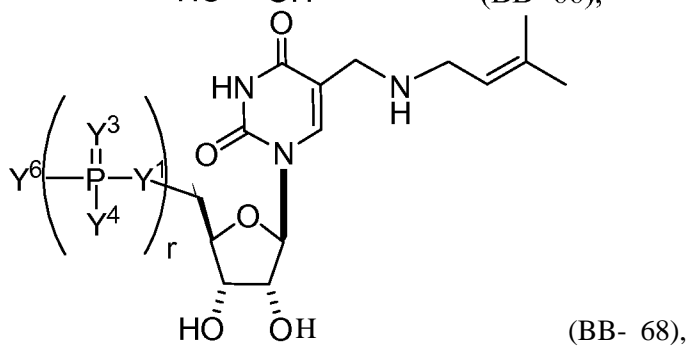
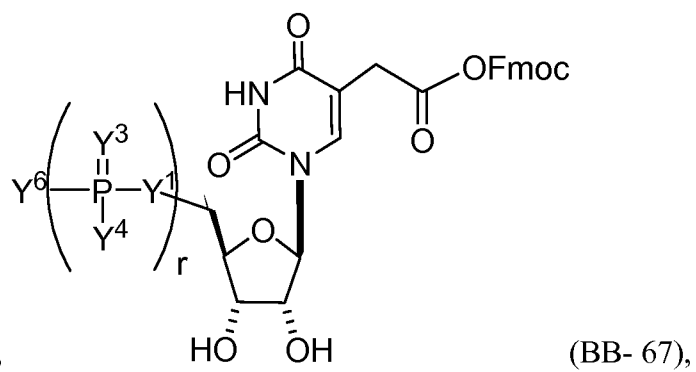
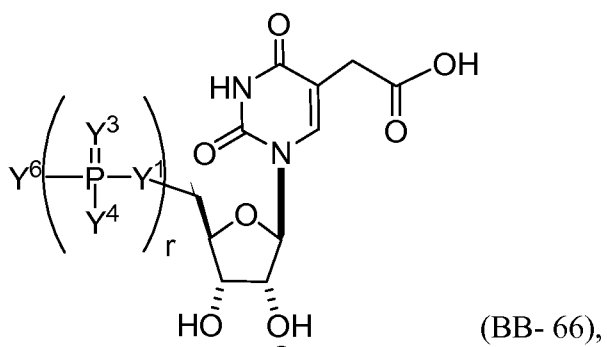

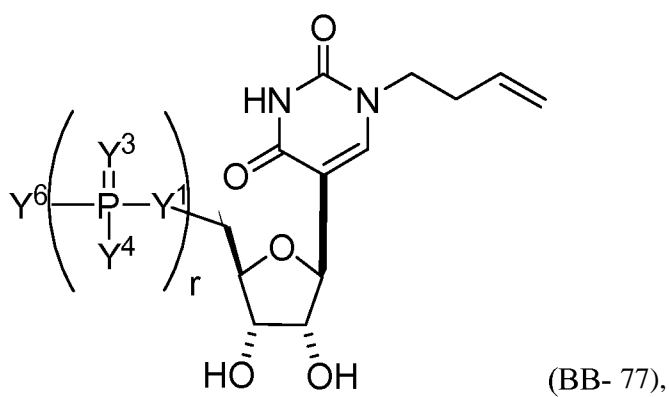
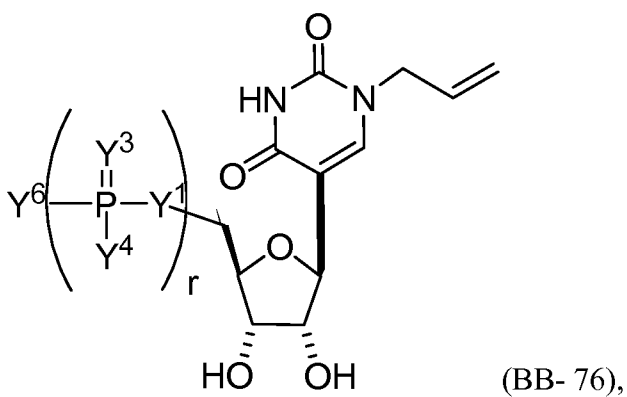
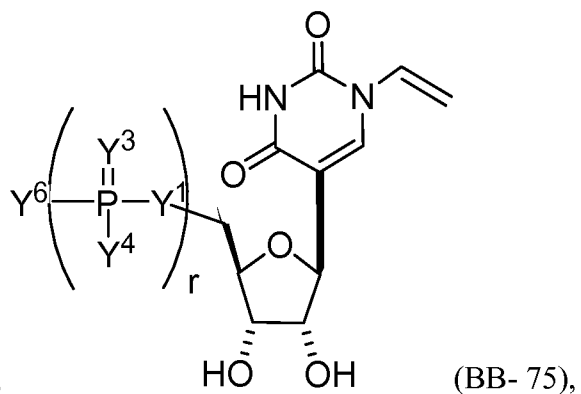
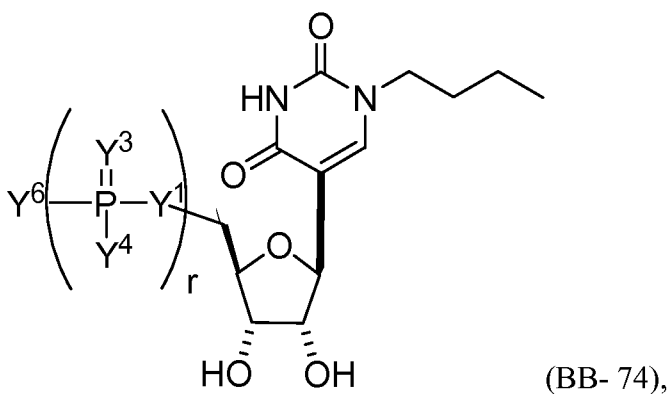
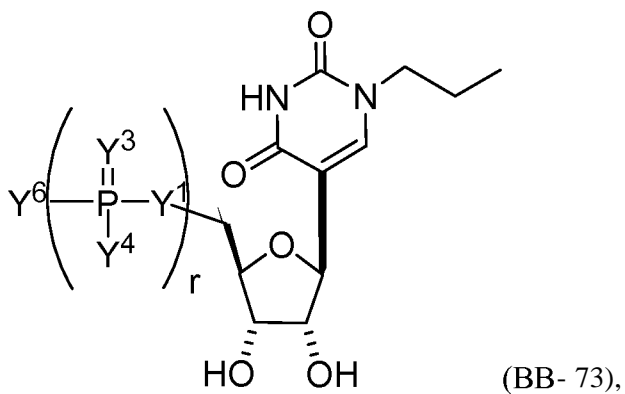
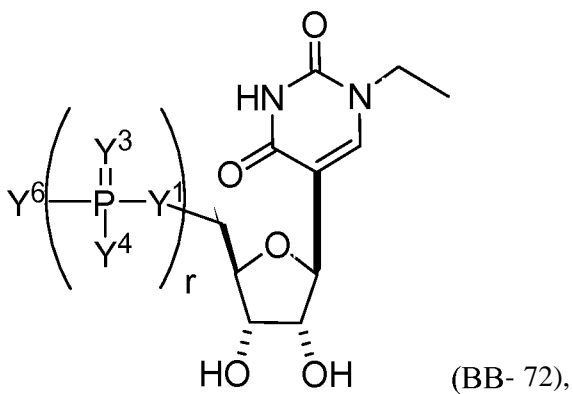
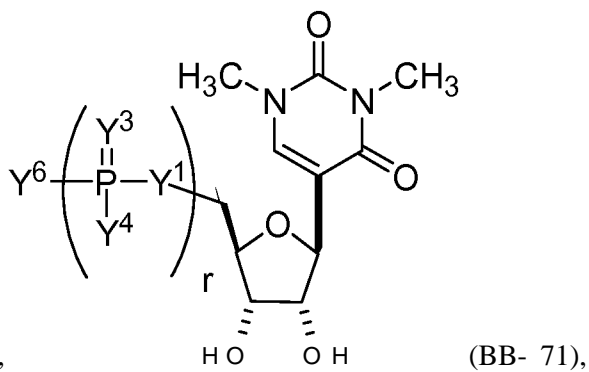
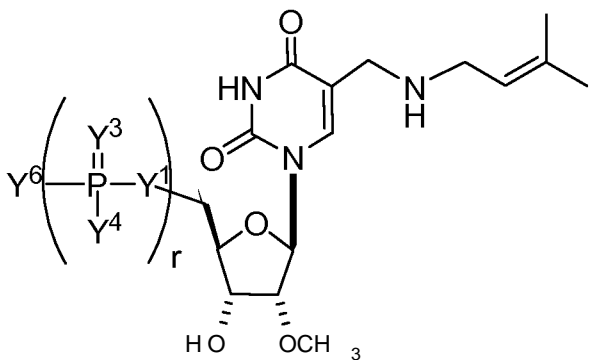

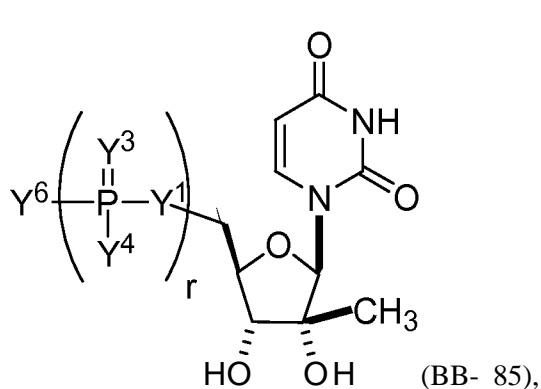
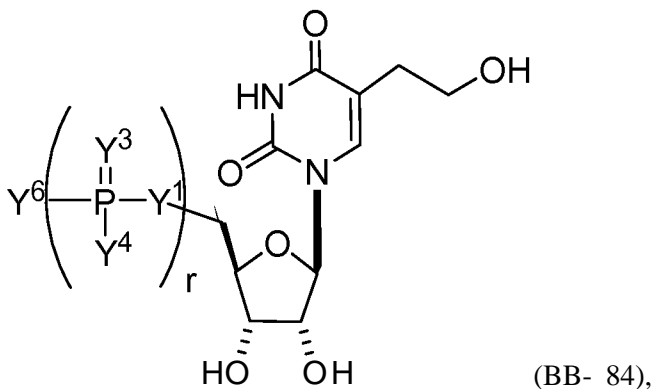
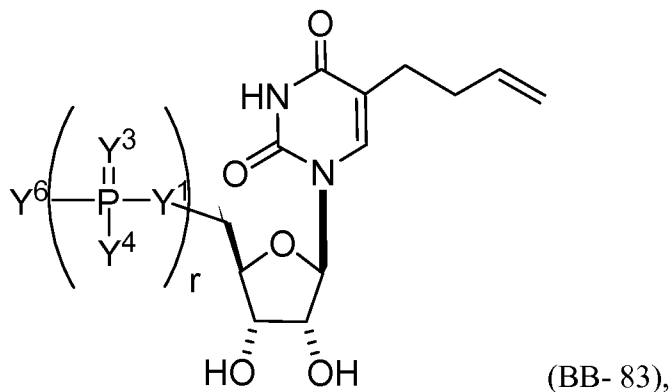
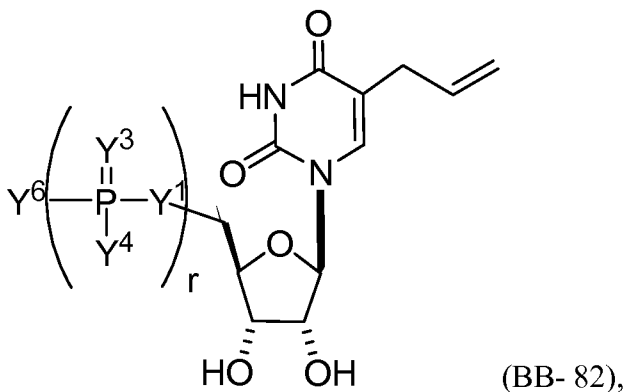
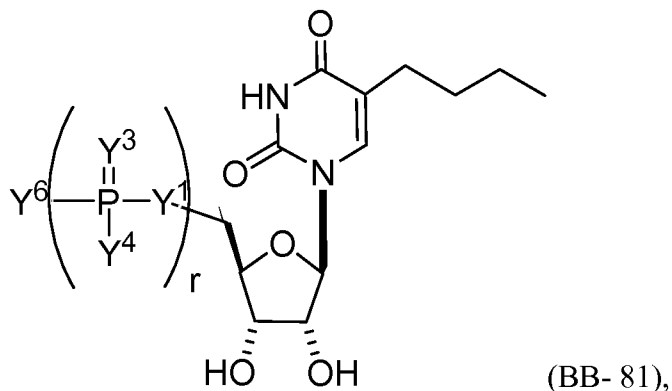
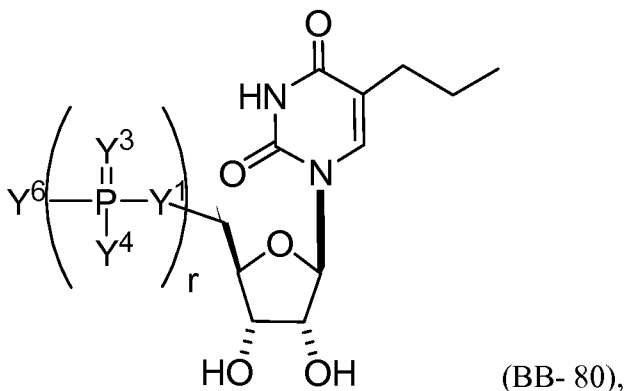
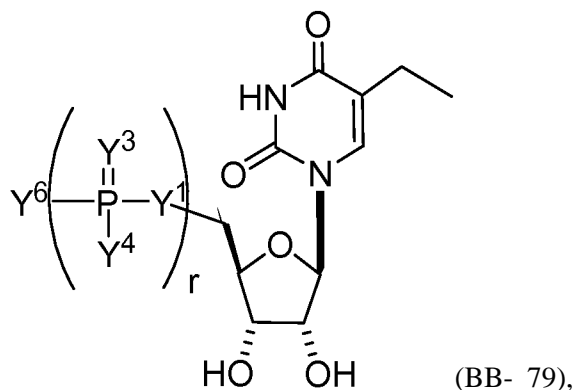
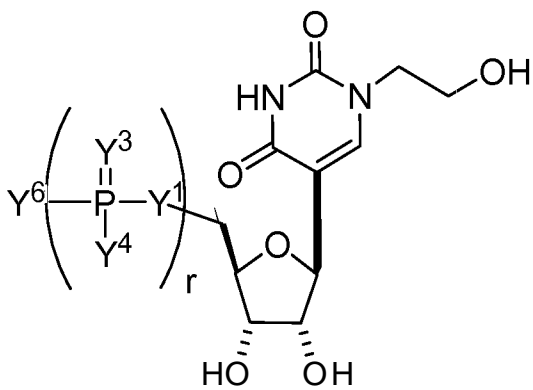

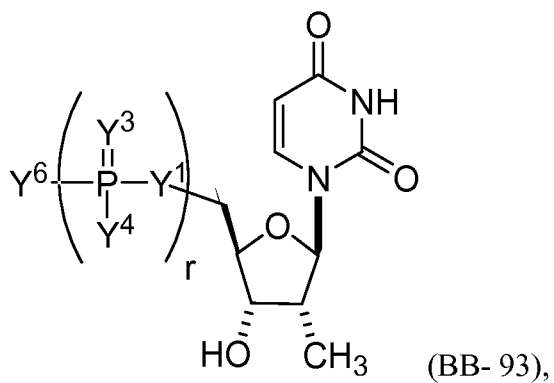
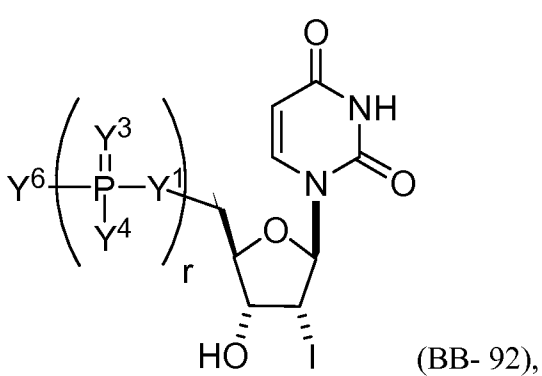
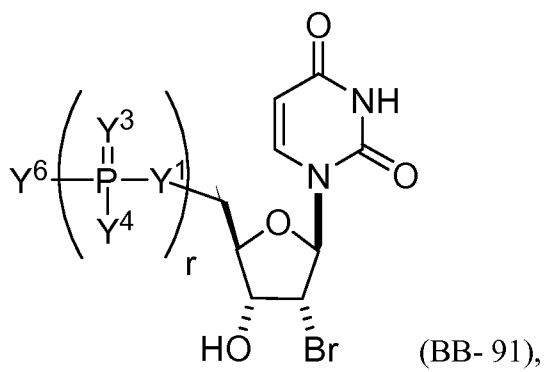
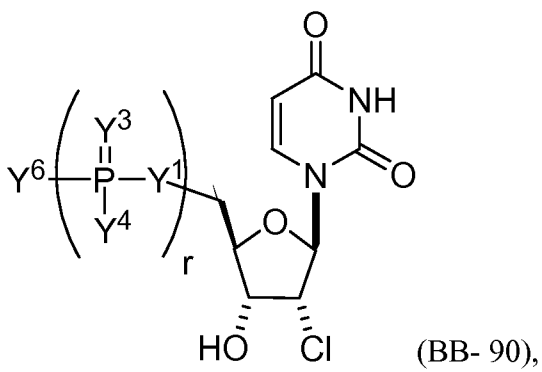
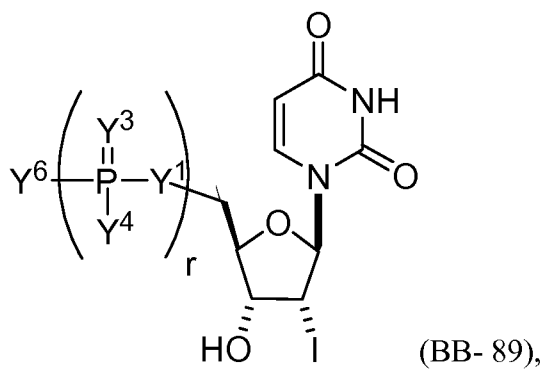
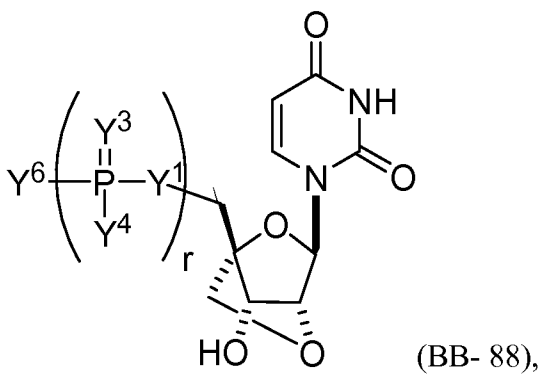
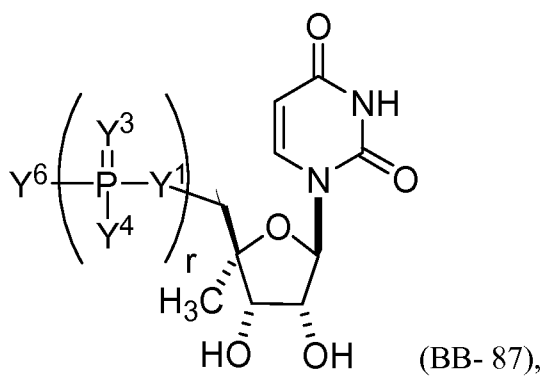
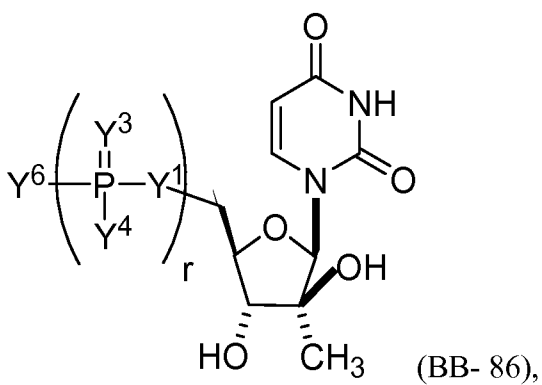

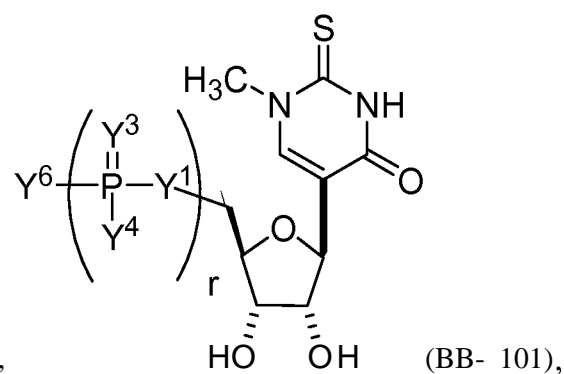
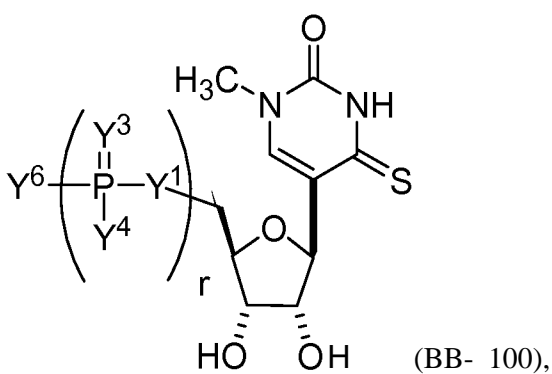
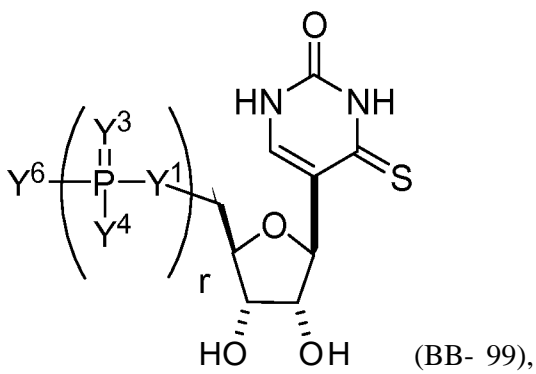
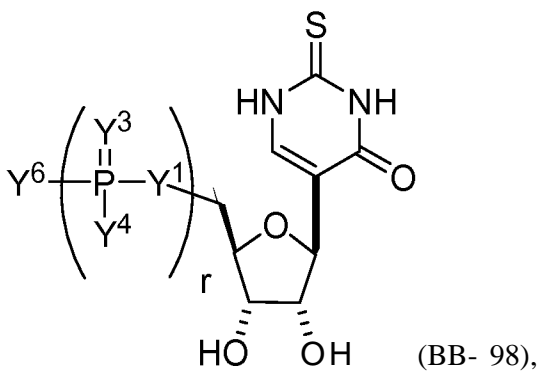
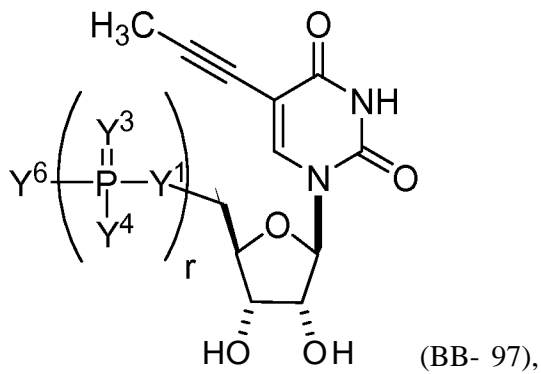
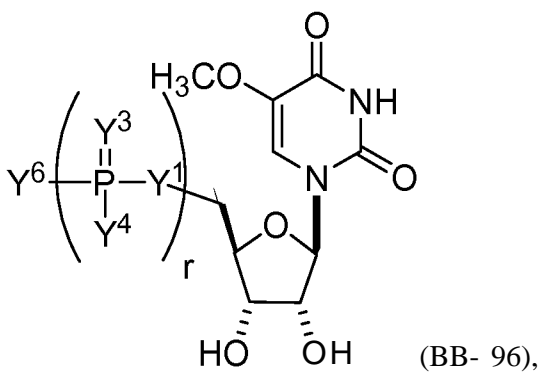
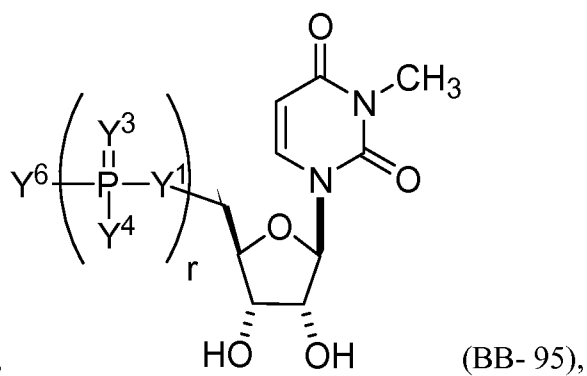
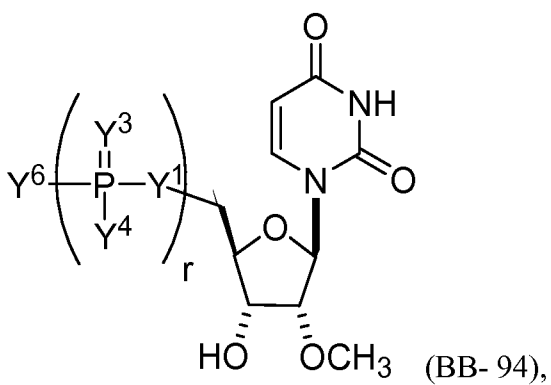

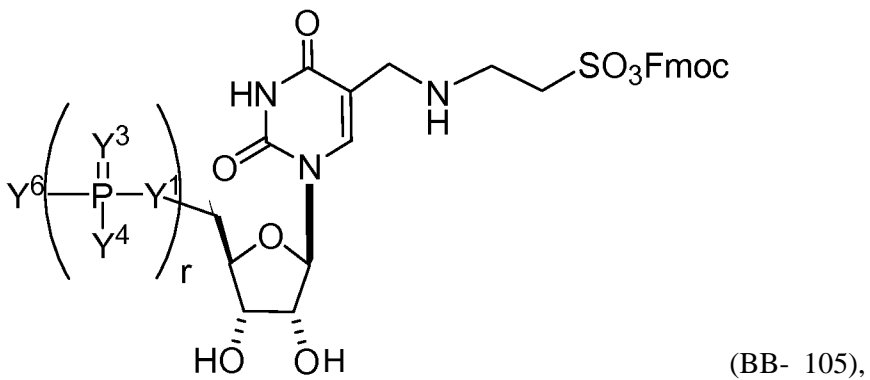
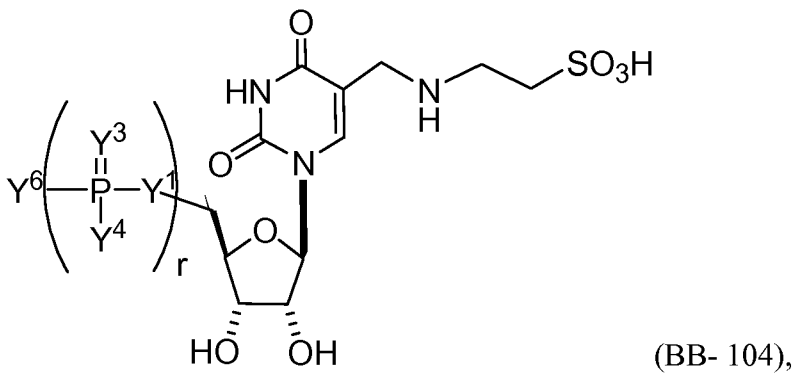
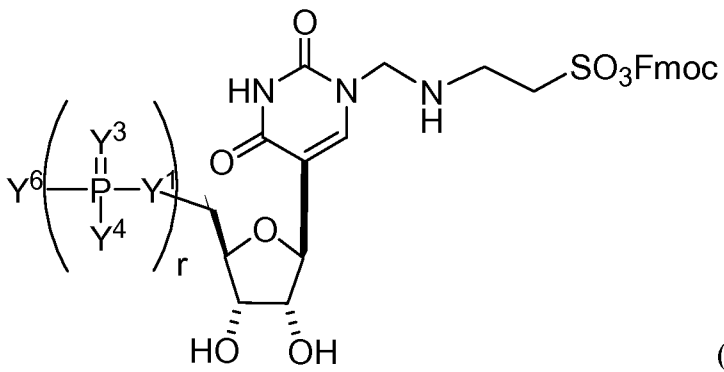
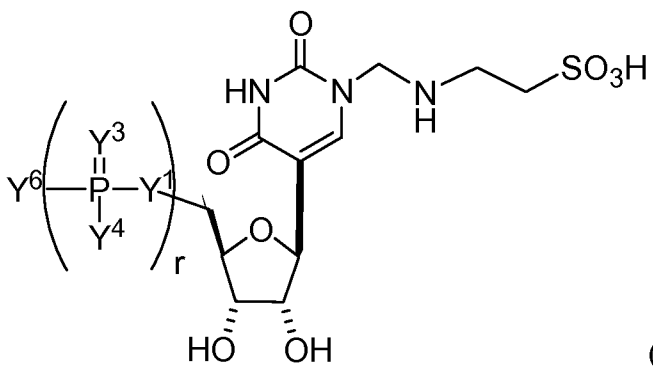

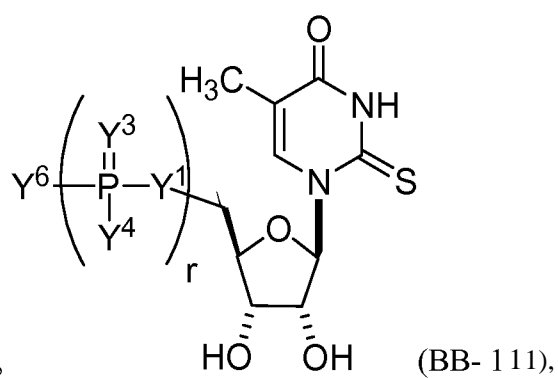
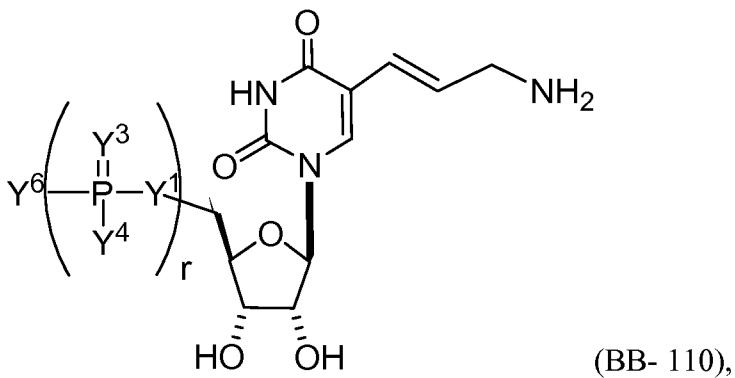
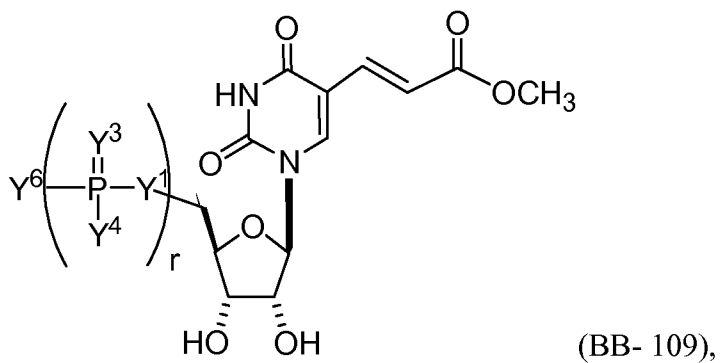
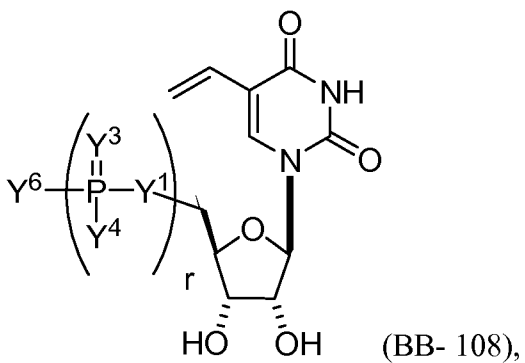
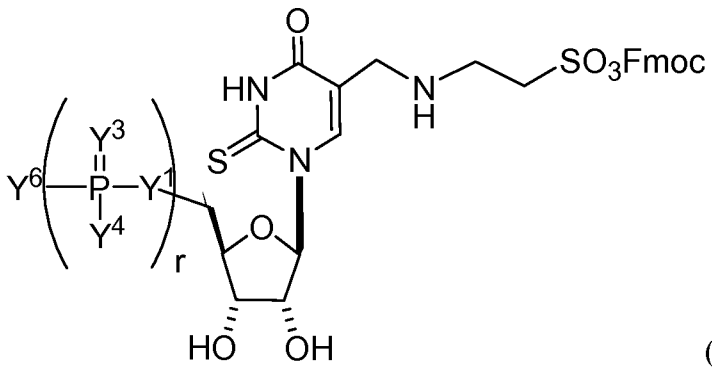
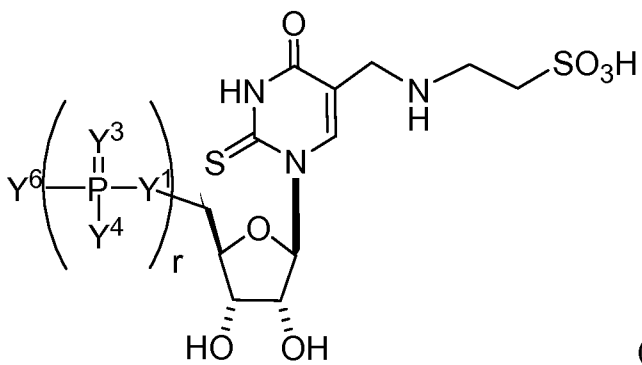

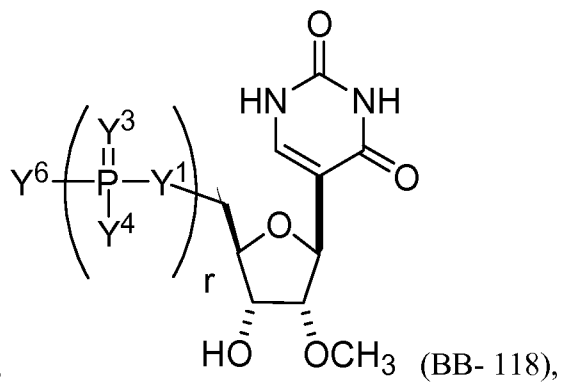
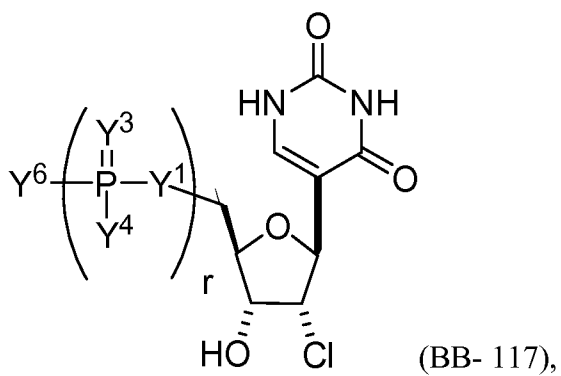
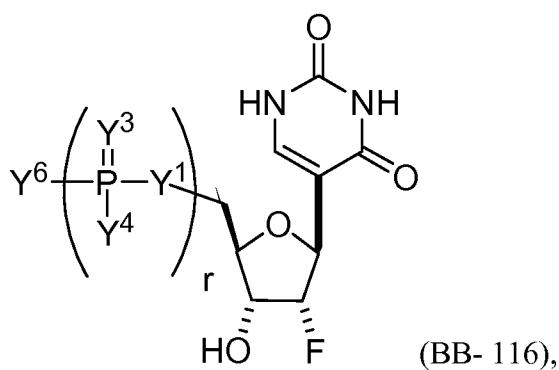
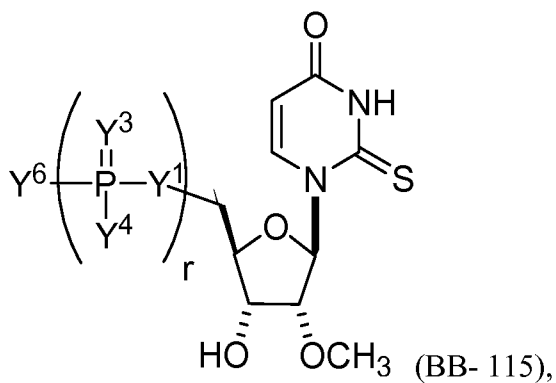
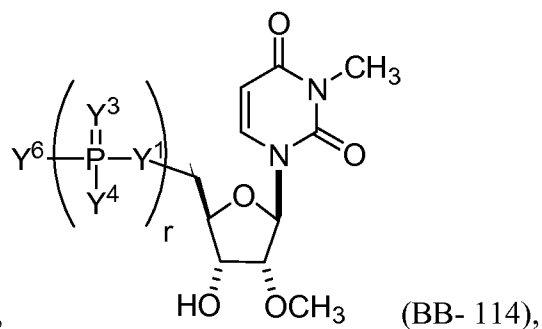
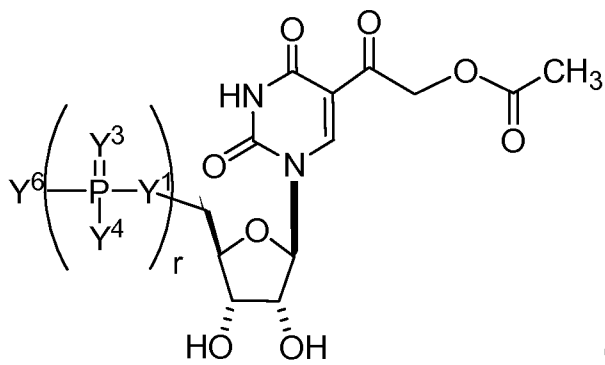
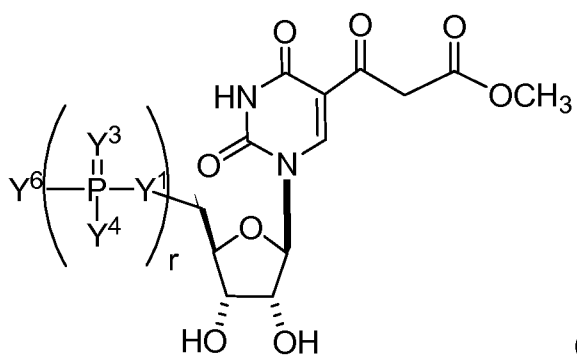

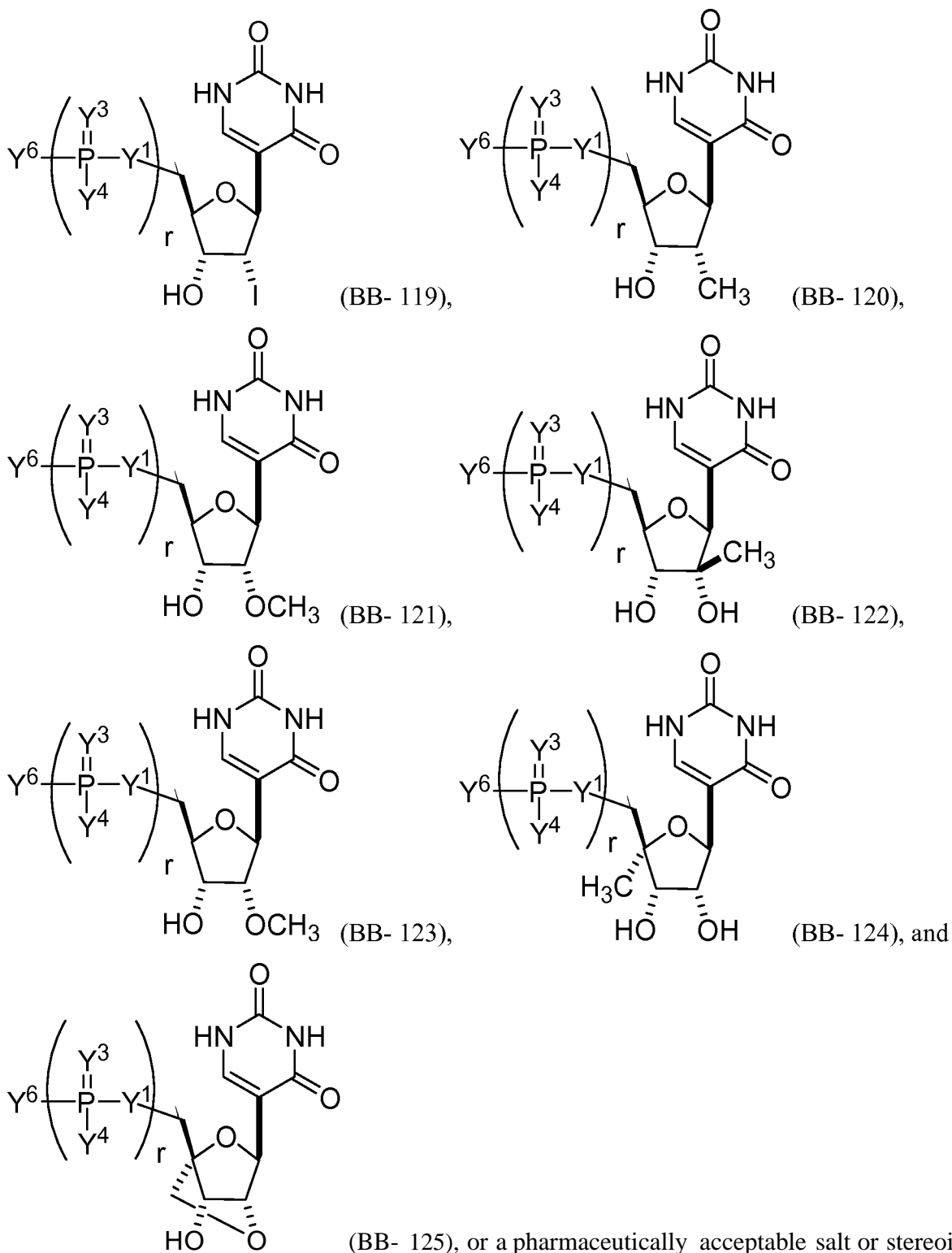

[00200] In some embodiments, the building block molecule, which may be incorporated into a modified nucleic acid molecule or mmRNA, is a modified cytidine (e.g., selected from the group consisting of:

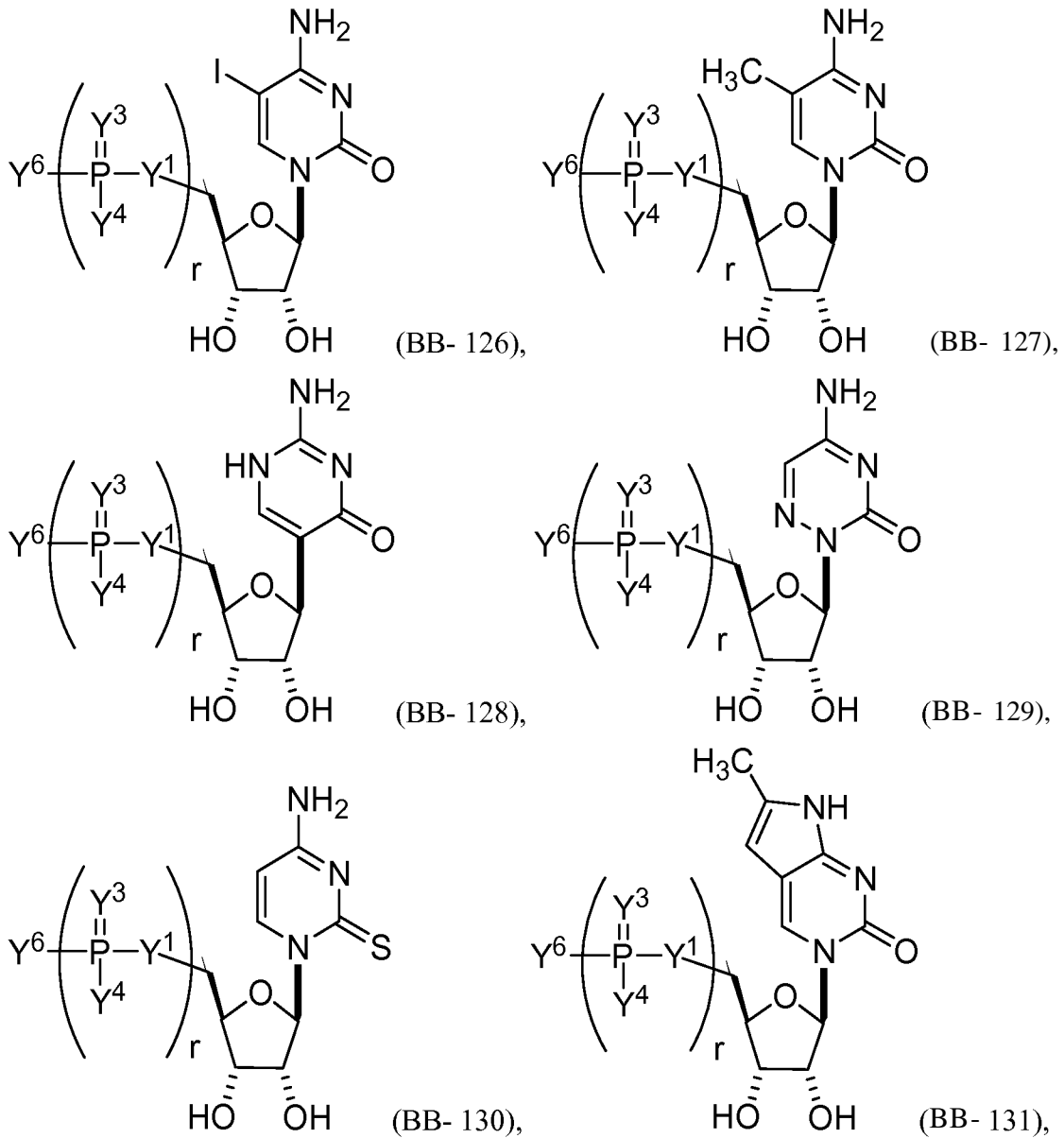

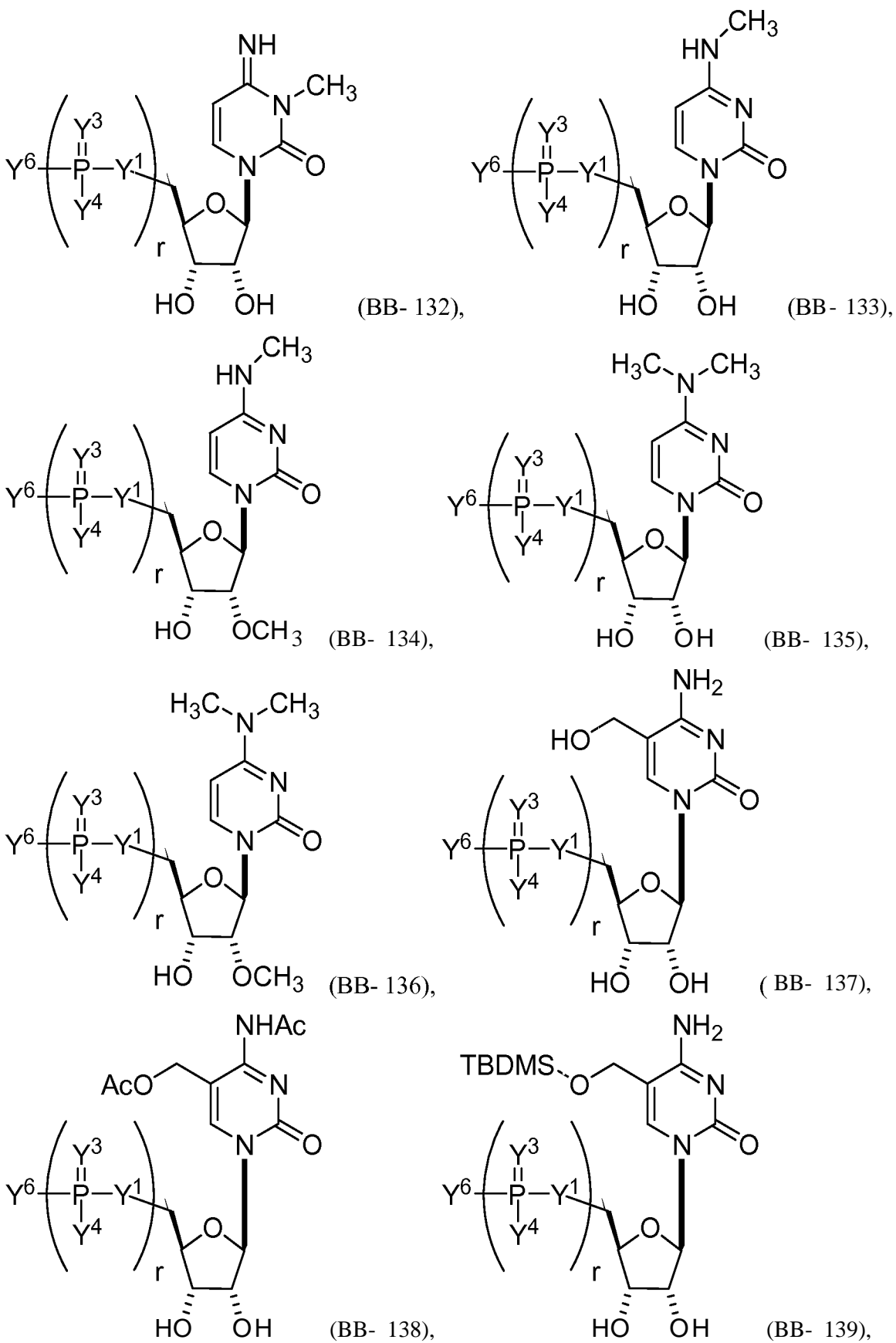

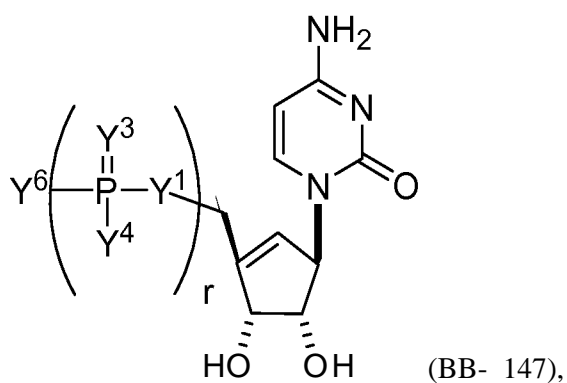
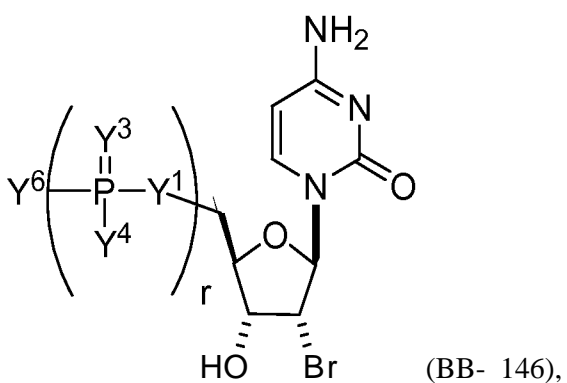
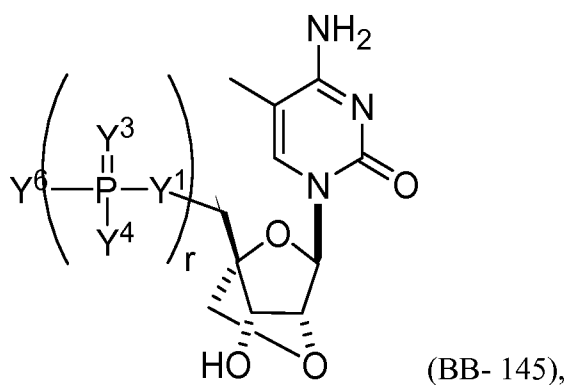
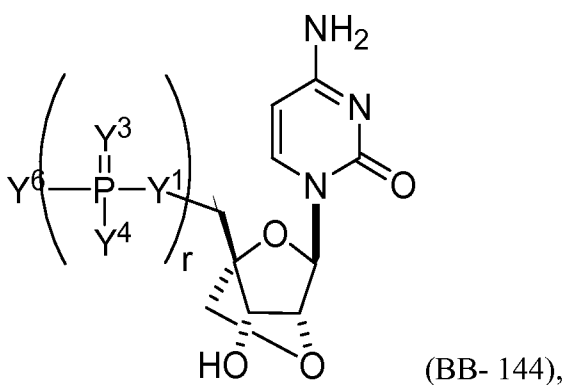
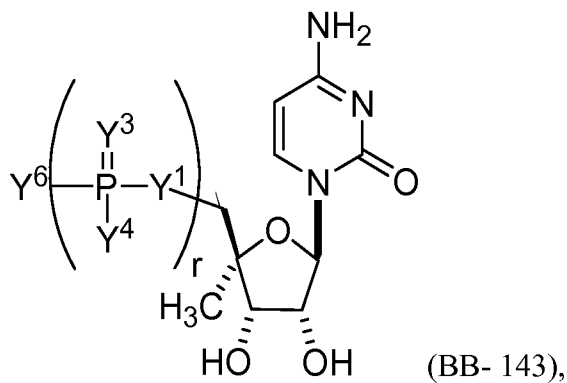
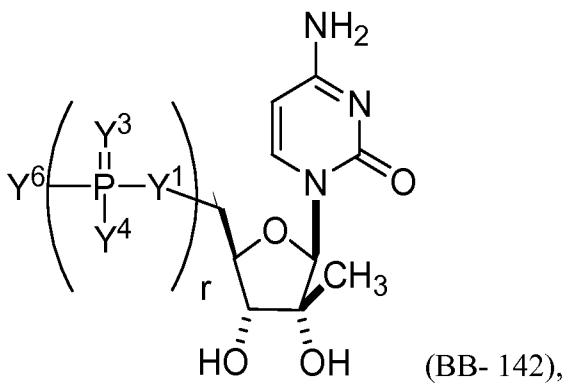
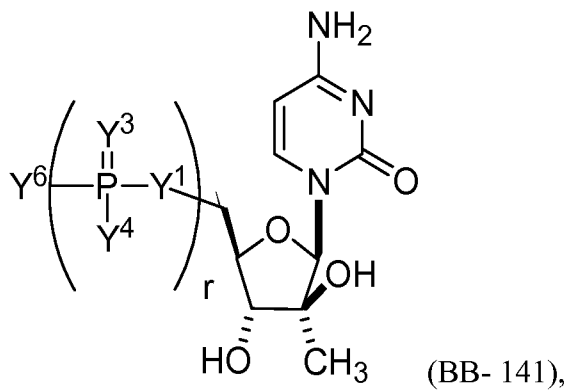
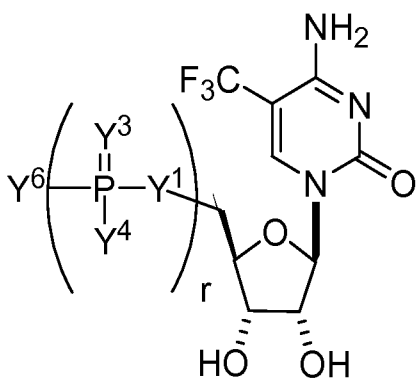

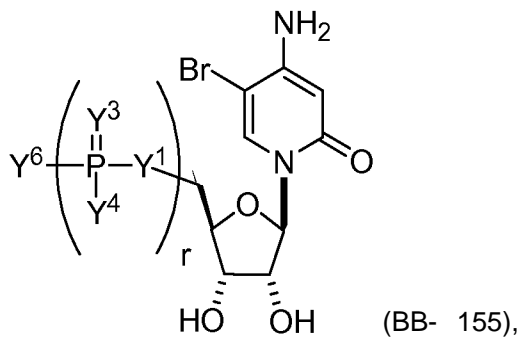
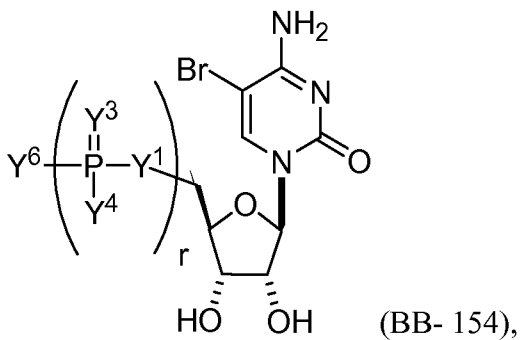
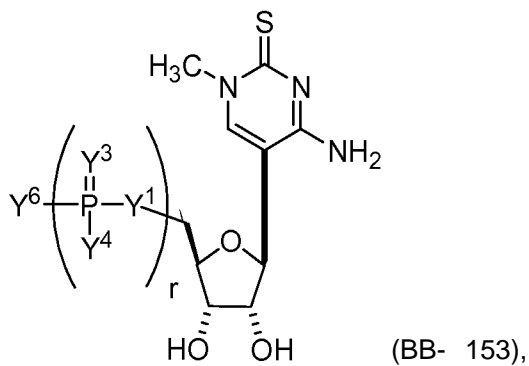
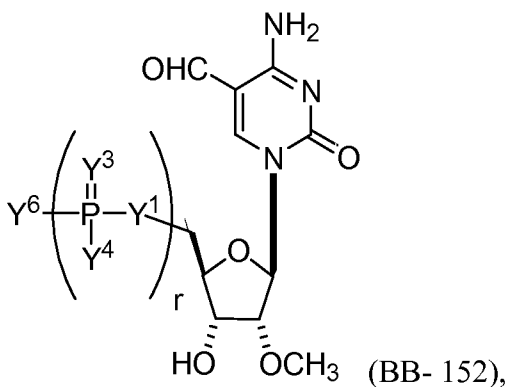
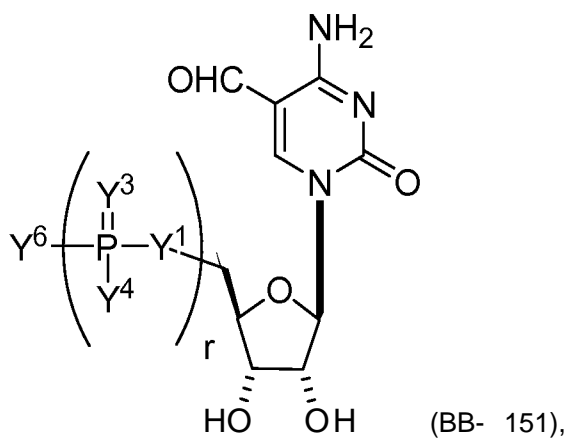
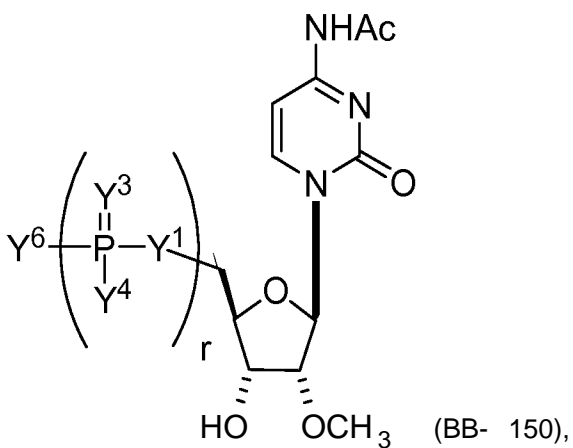
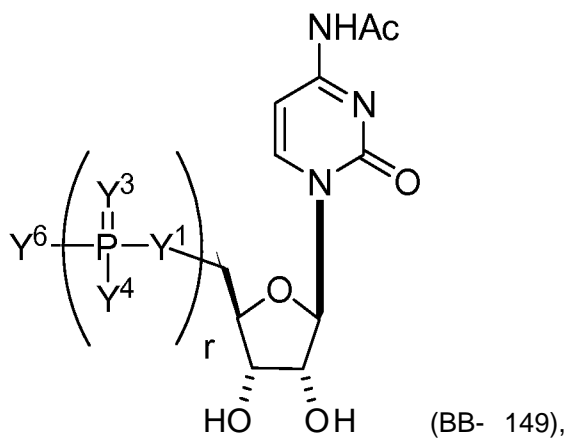
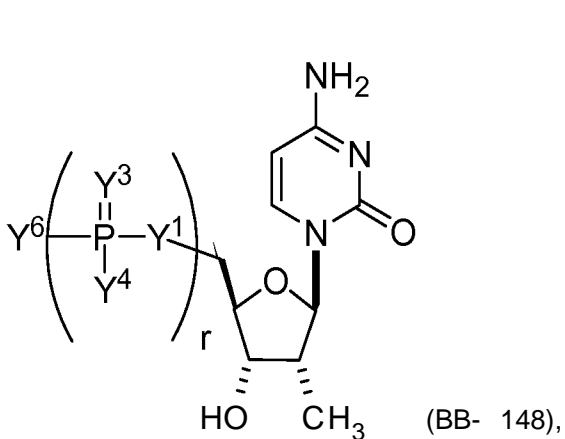

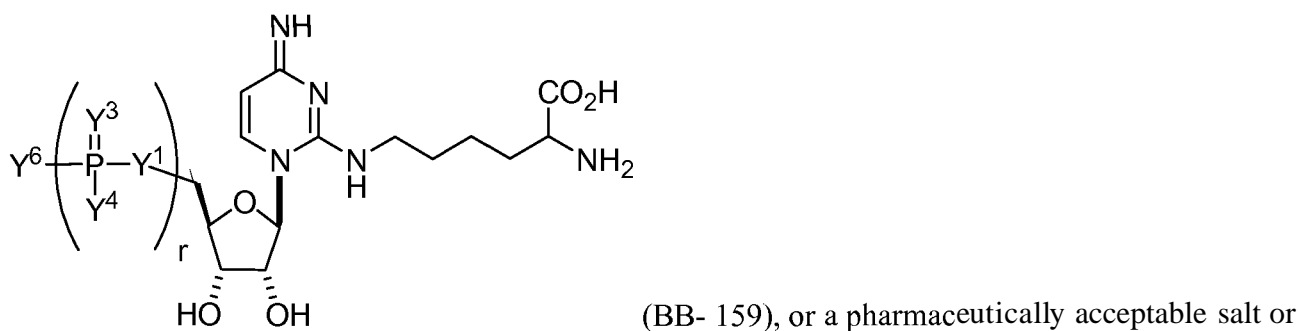
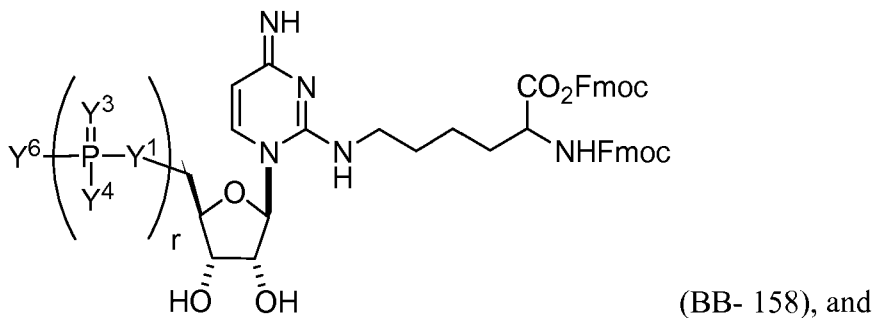
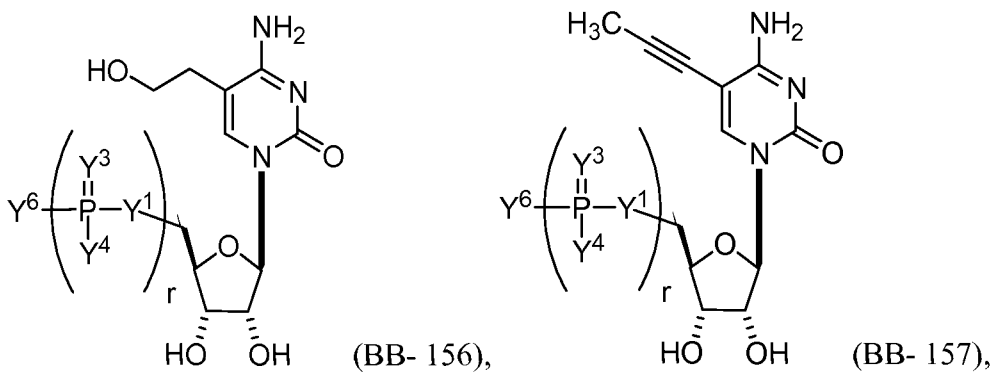

stereoisomer thereof, wherein Y^1 , Y^3 , Y^4 , Y^6 , and r are as described herein (e.g., each r is, independently, an integer from 0 to 5, such as from 0 to 3, from 1 to 3, or from 1 to 5)). For example, the building block molecule, which may be incorporated into a modified nucleic acid

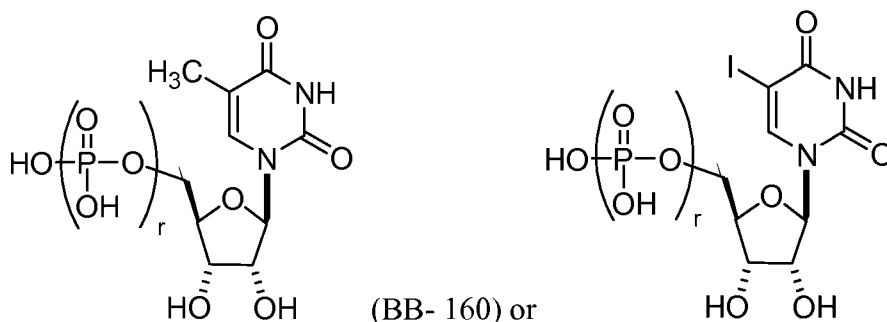

molecule or mmRNA, can be: (BB- 161), or a pharmaceutically acceptable salt or stereoisomer thereof, wherein each r is, independently, an integer from 0 to 5 (e.g., from 0 to 3, from 1 to 3, or from 1 to 5).

[00201] In some embodiments, the building block molecule, which may be incorporated into a modified nucleic acid molecule or mmRNA, is a modified adenosine (e.g., selected from the group consisting of:

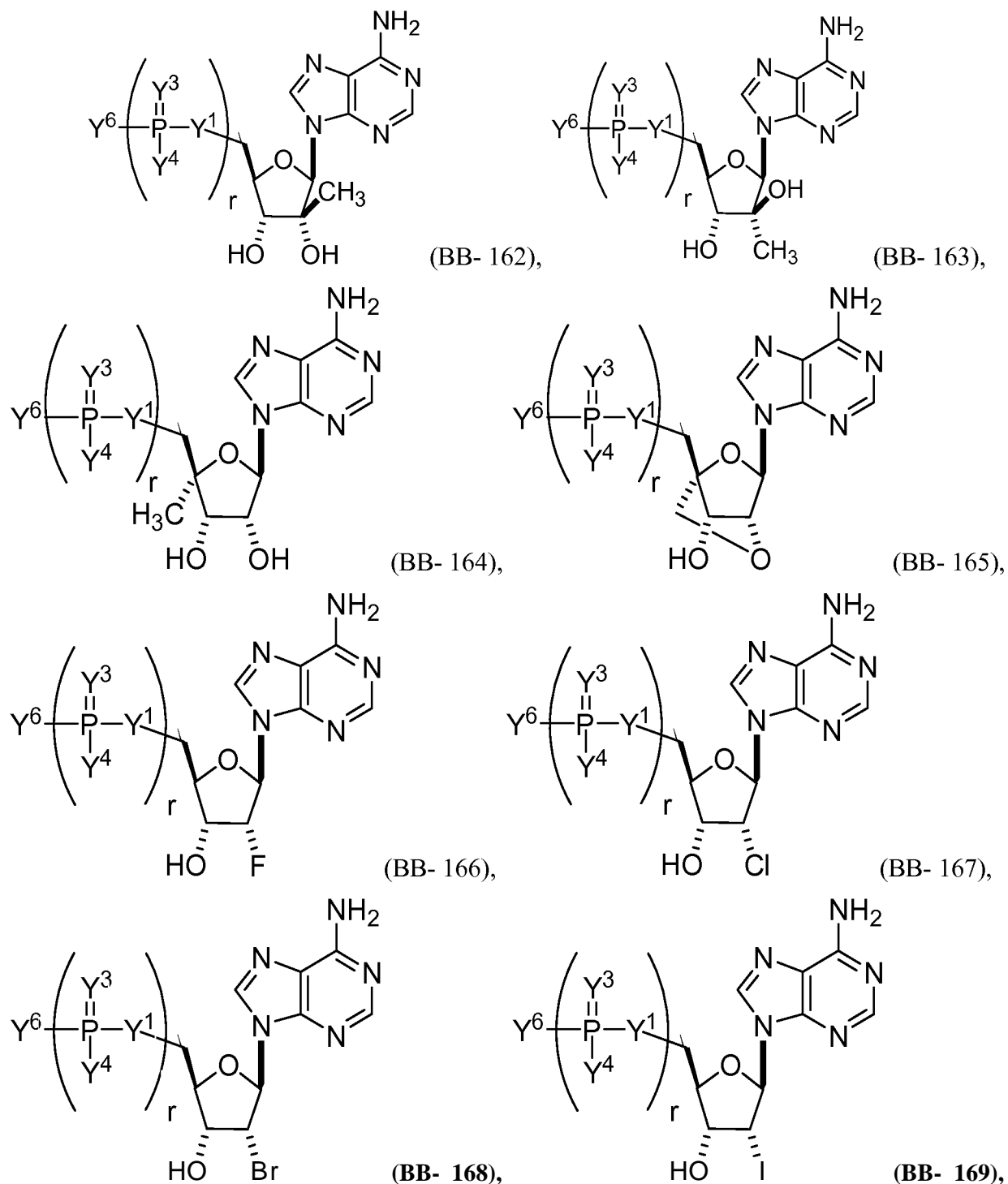

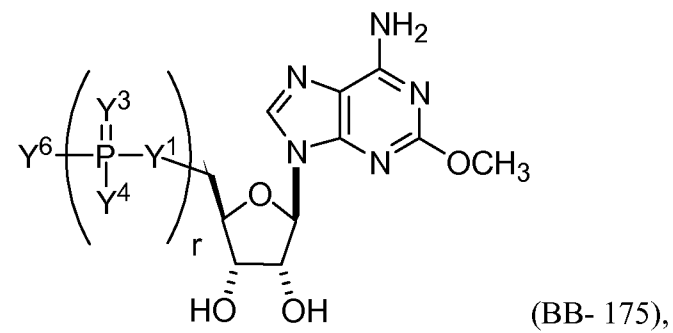
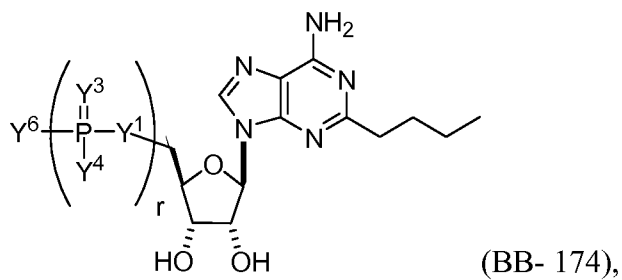
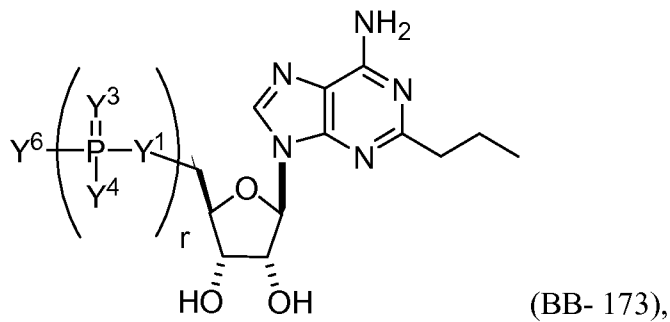
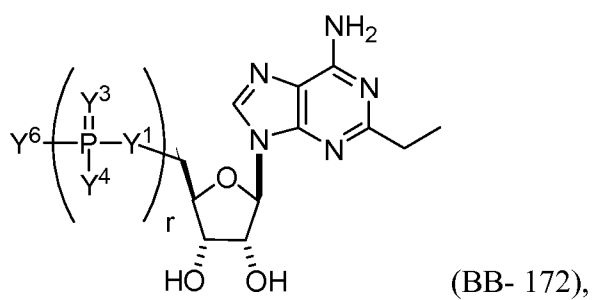
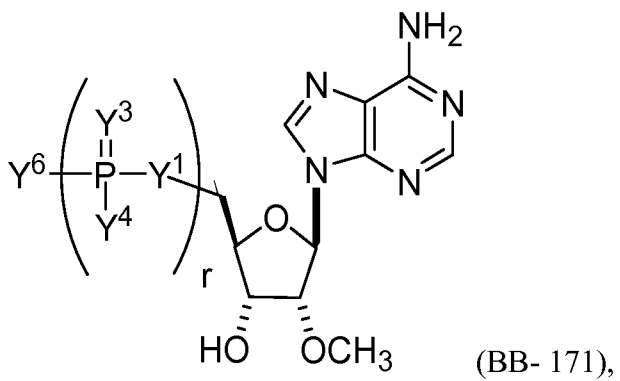
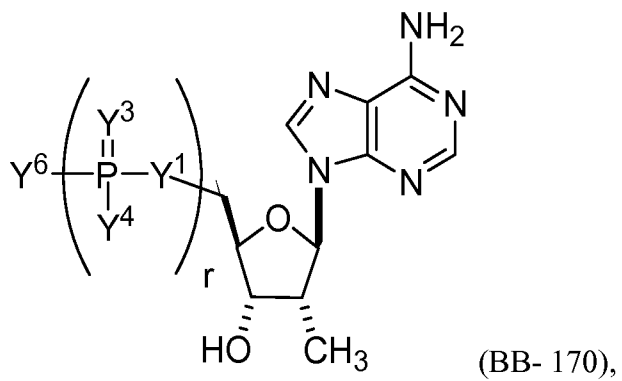

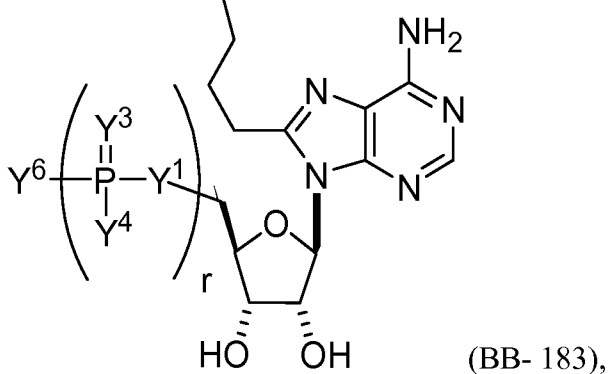
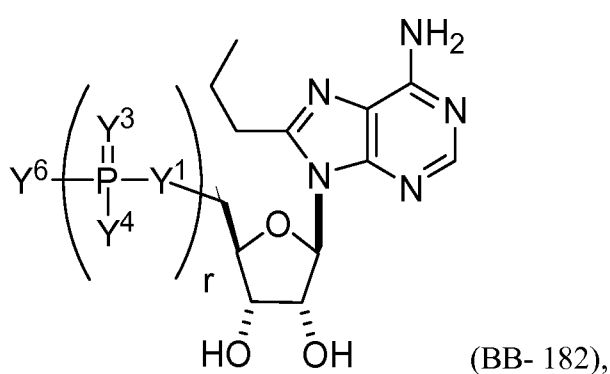
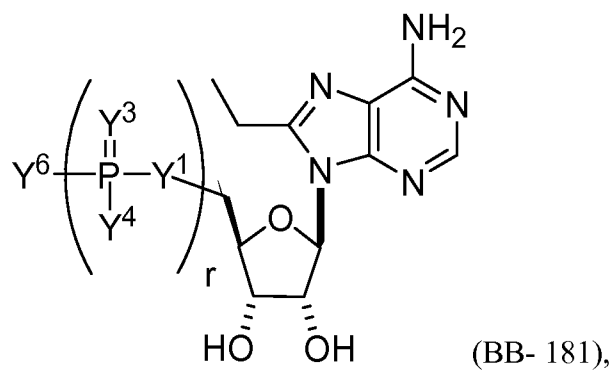
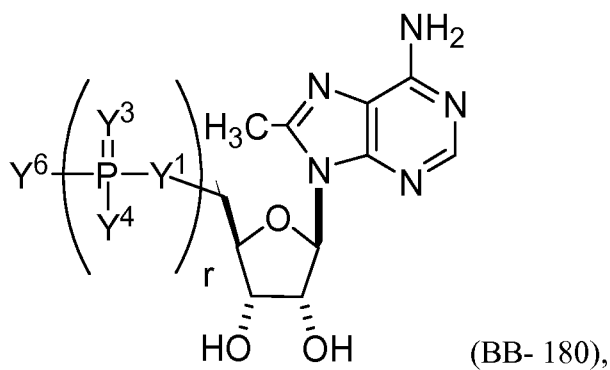
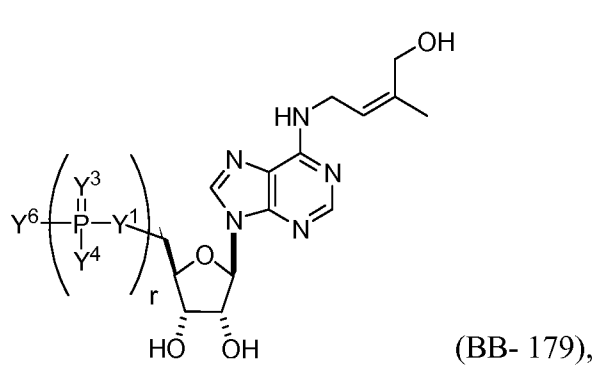
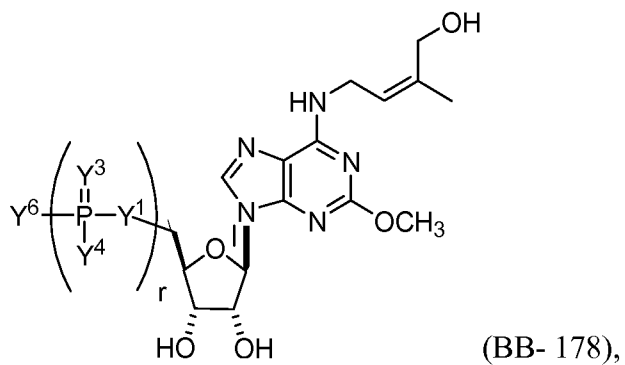
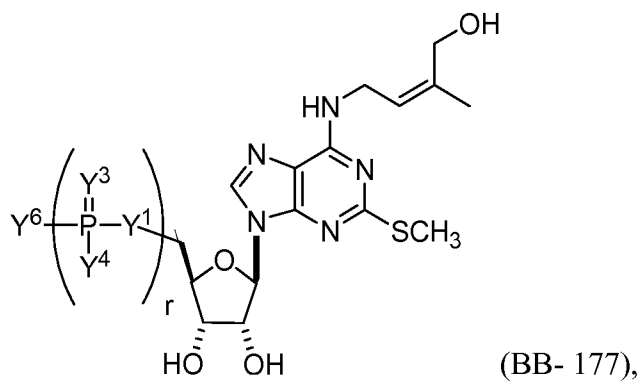
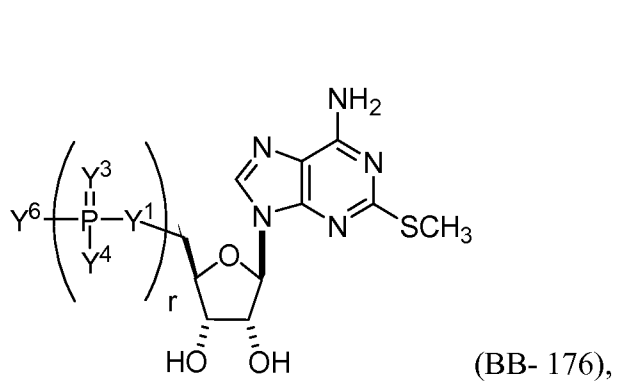

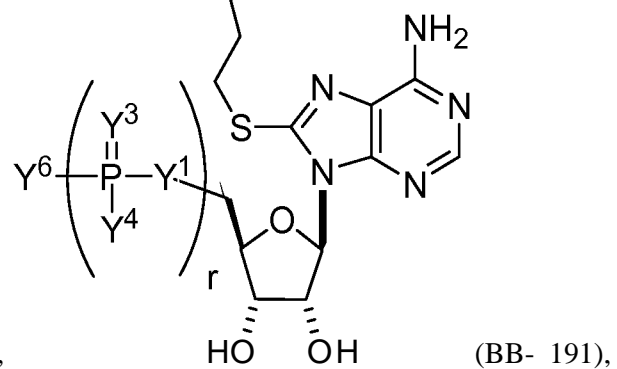
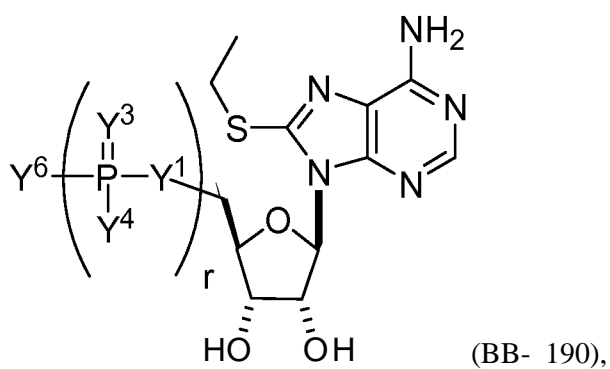
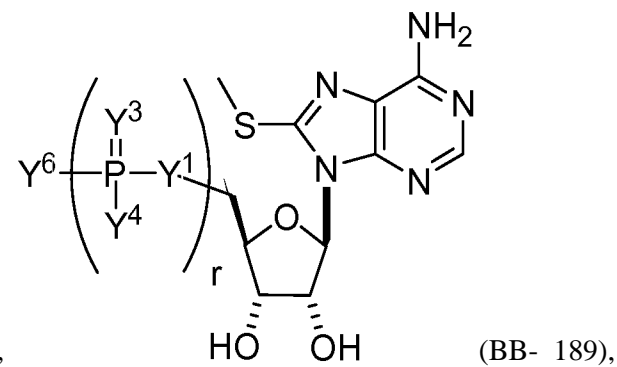
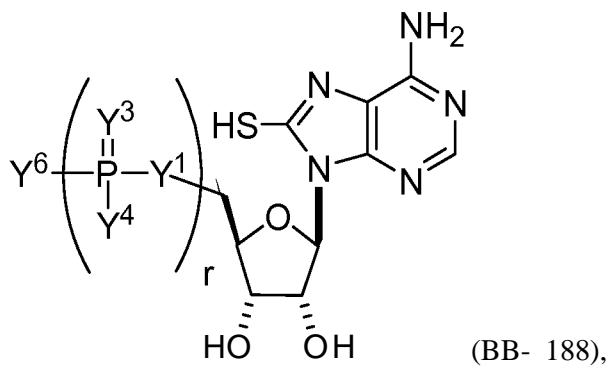
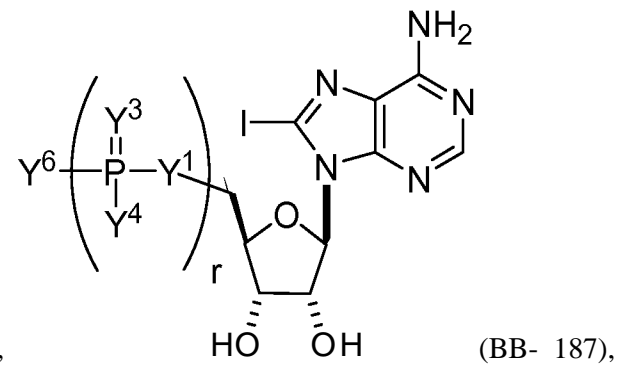
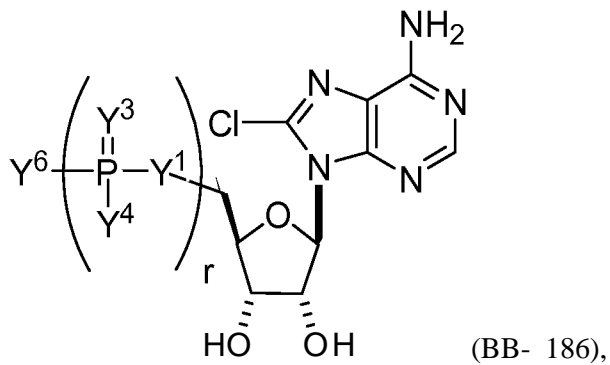
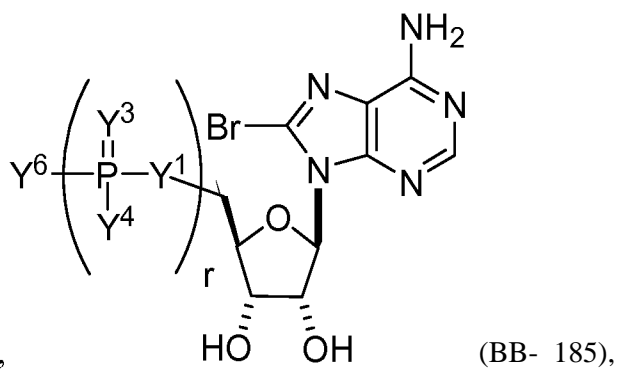
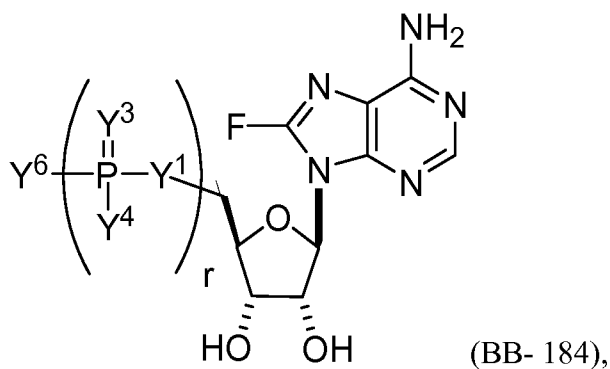

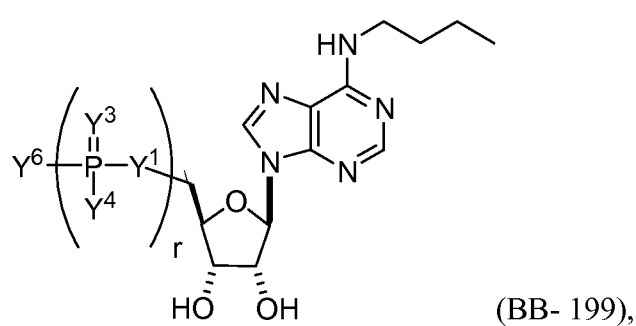
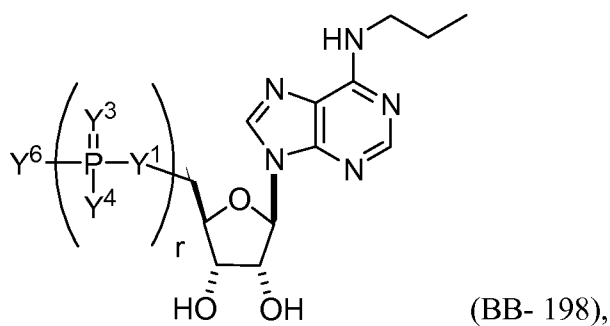
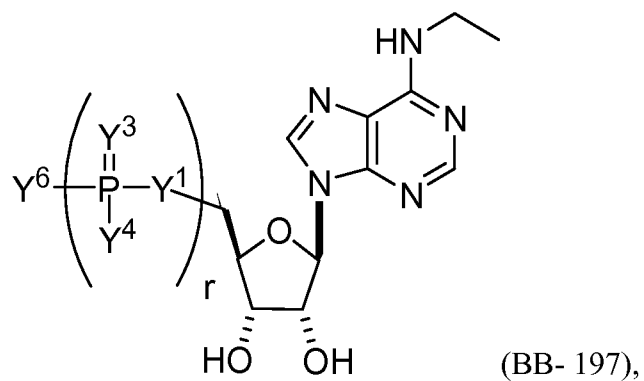
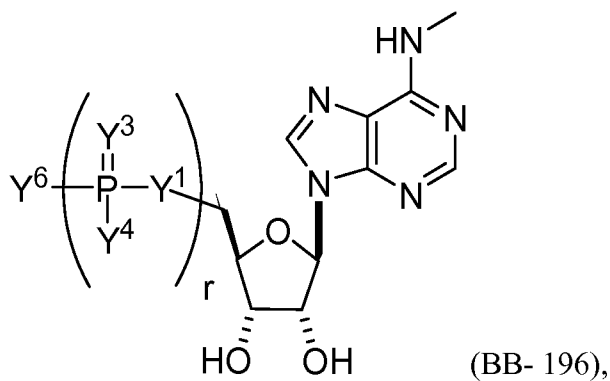
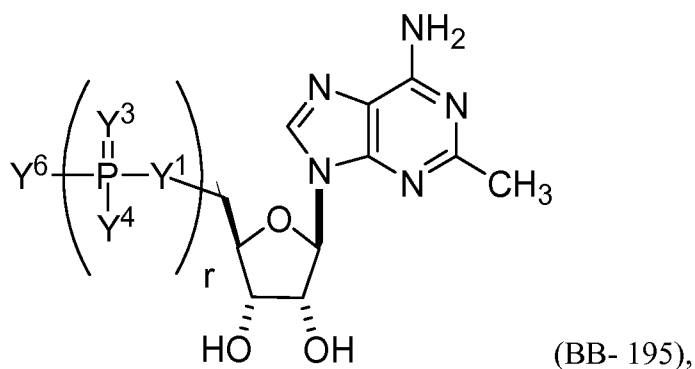
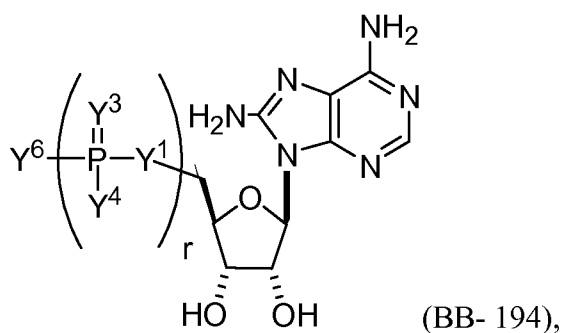
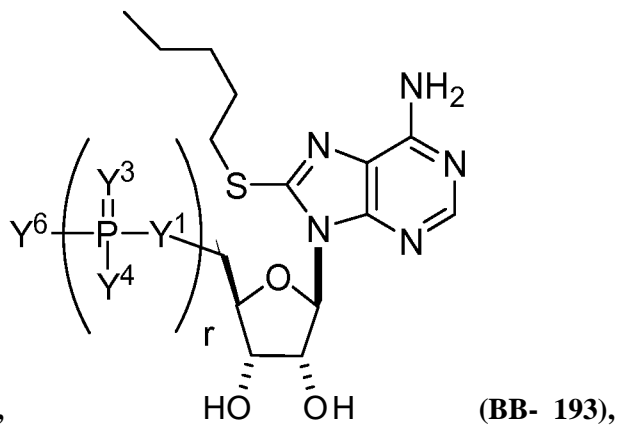
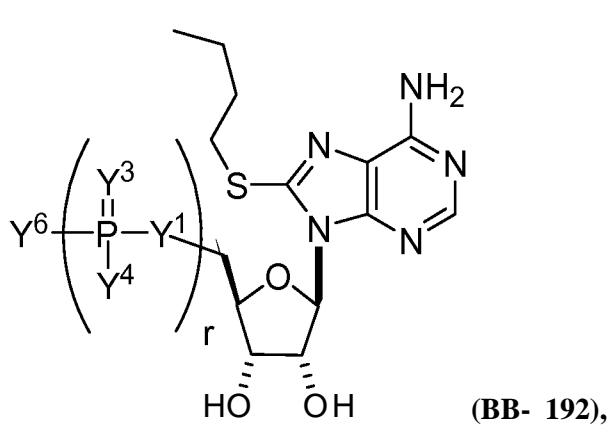

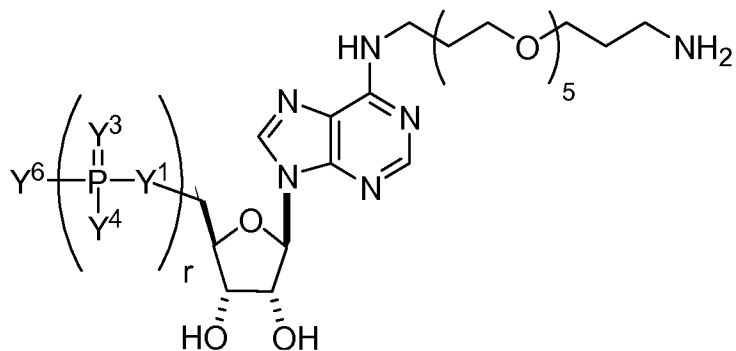

and (BB- 200) or a pharmaceutically acceptable salt or stereoisomer thereof, wherein Y¹, Y³, Y⁴, Y⁶, and r are as described herein (e.g., each r is, independently, an integer from 0 to 5, such as from 0 to 3, from 1 to 3, or from 1 to 5)).

[00202] In some embodiments, the building block molecule, which may be incorporated into a modified nucleic acid molecule or mmRNA, is a modified guanosine (e.g., selected from the group consisting of:

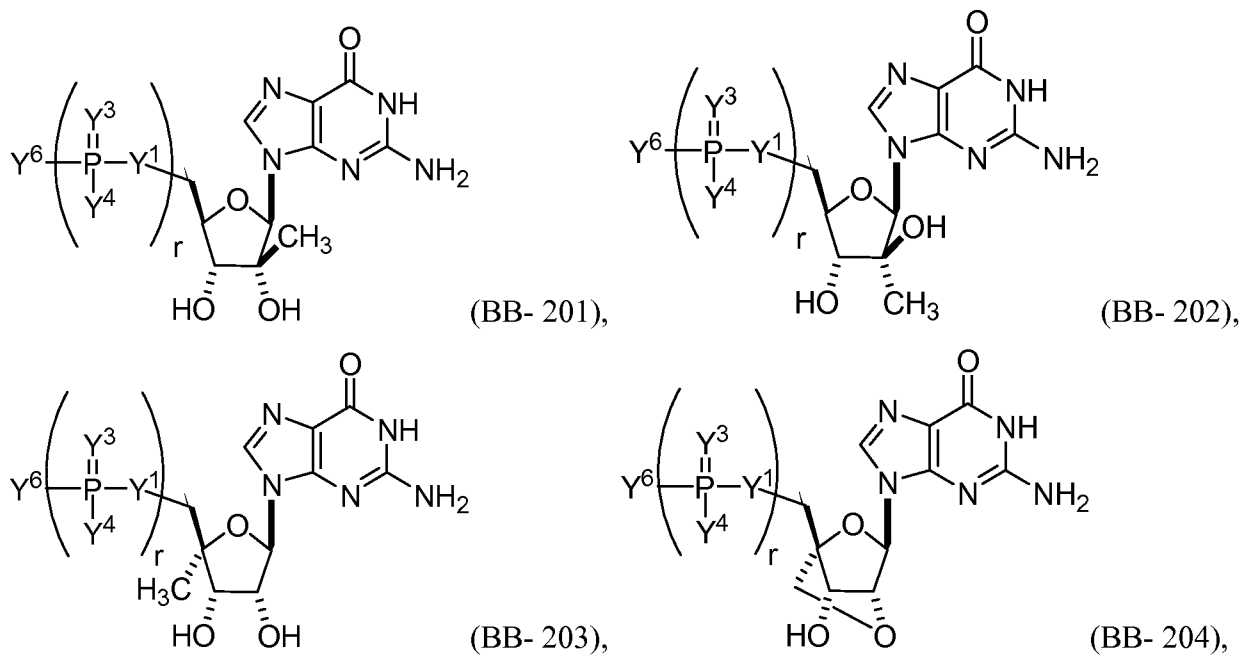

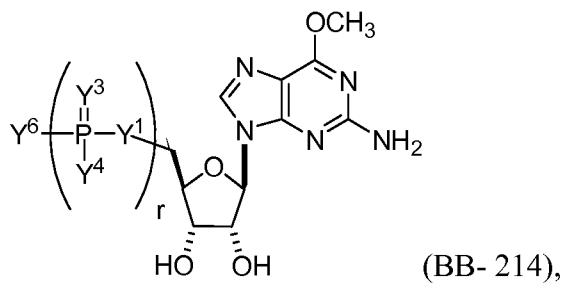
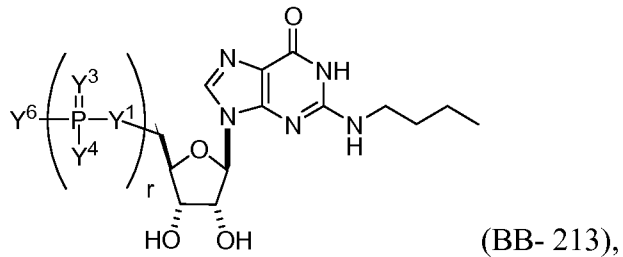
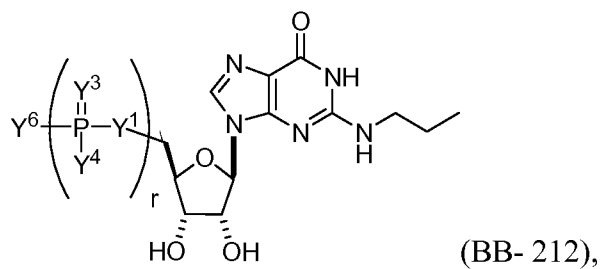
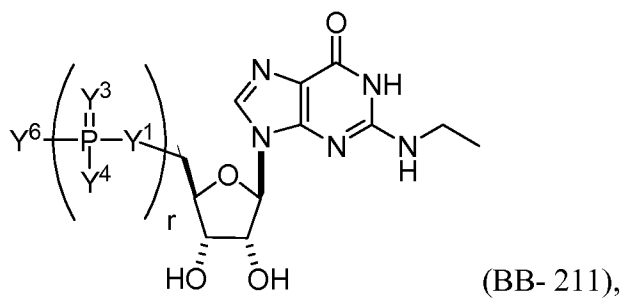
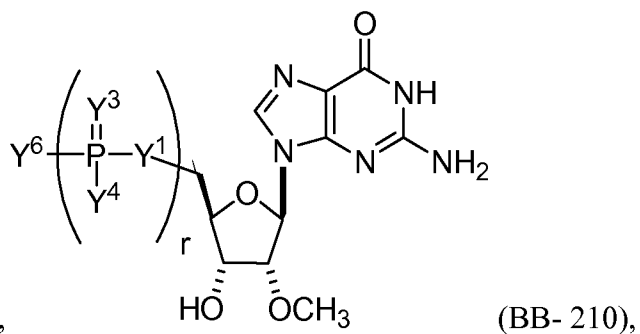
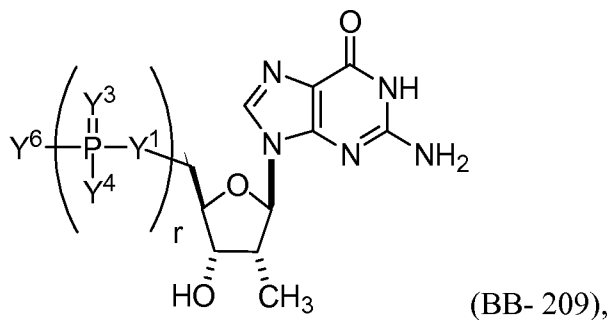
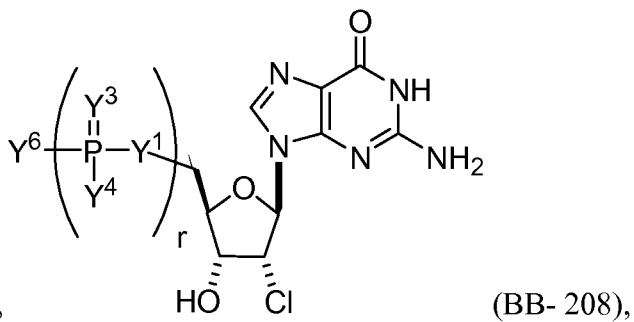
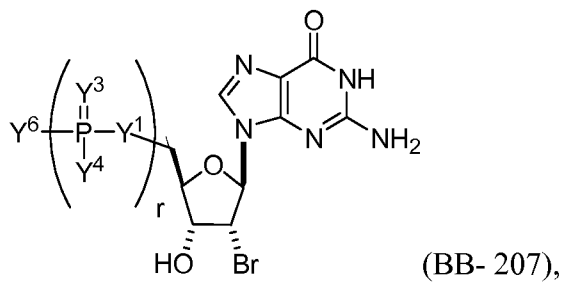
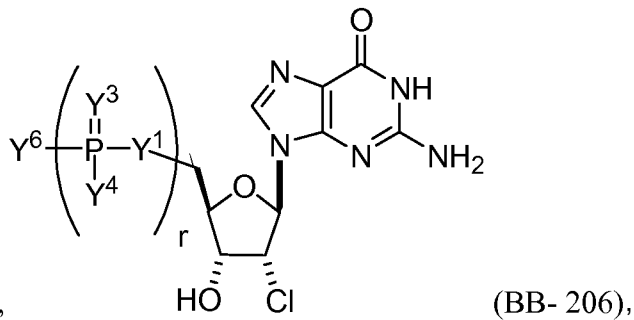
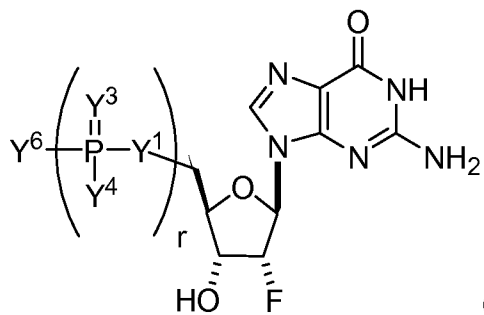

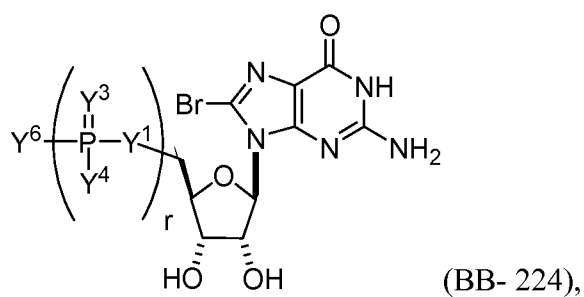
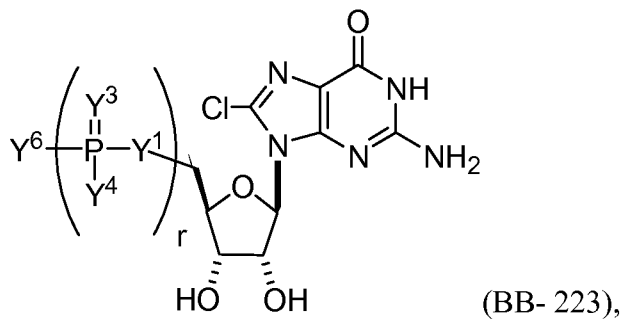
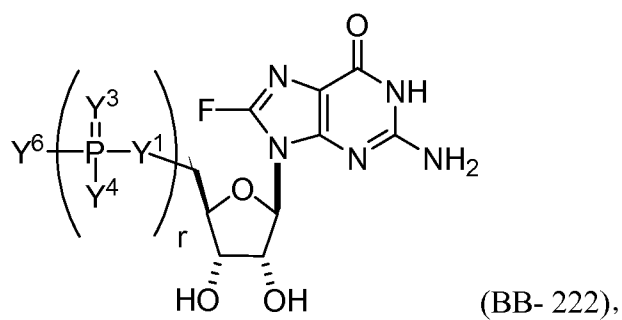
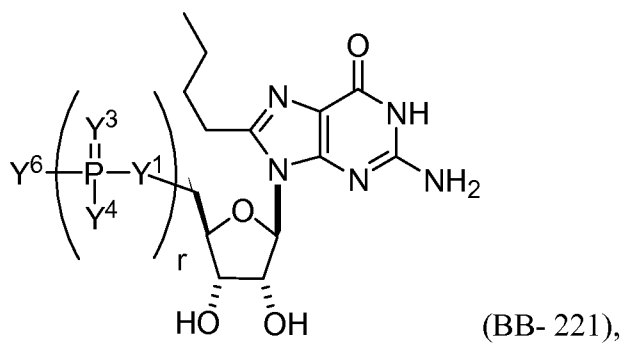
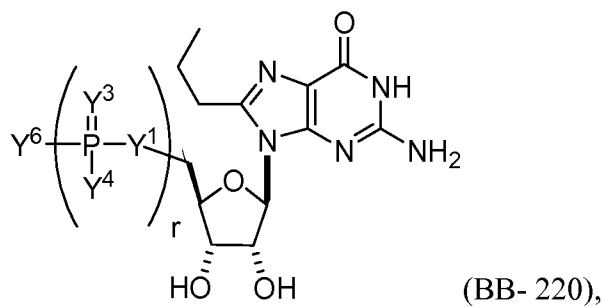
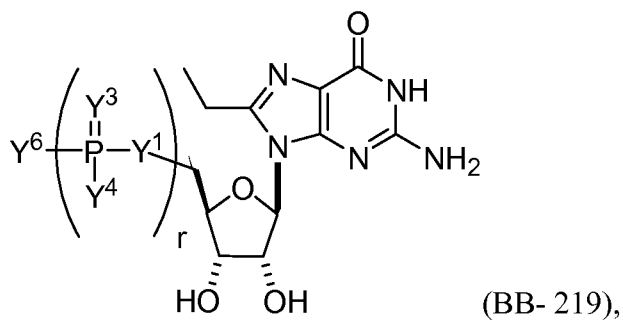
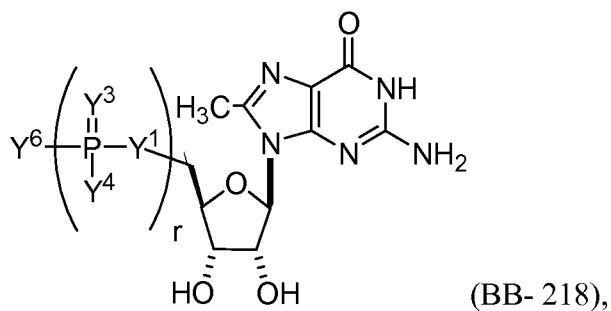
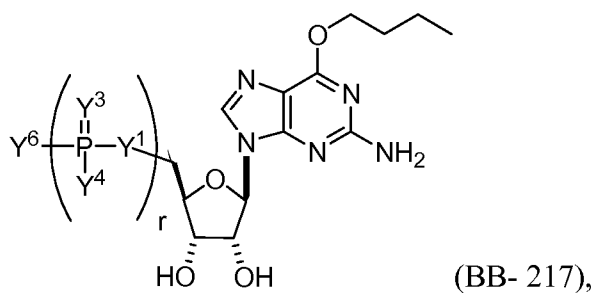
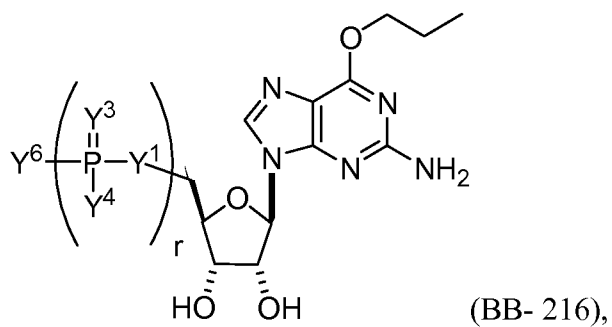
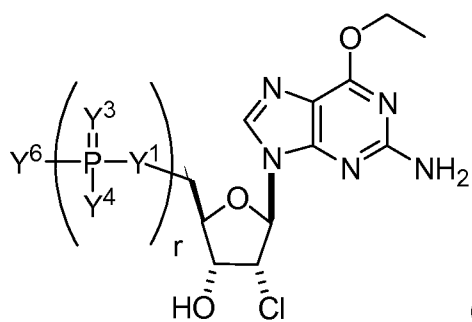

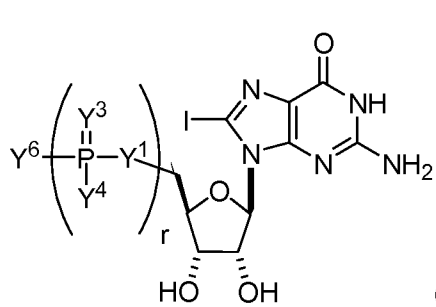

(BB- 225),

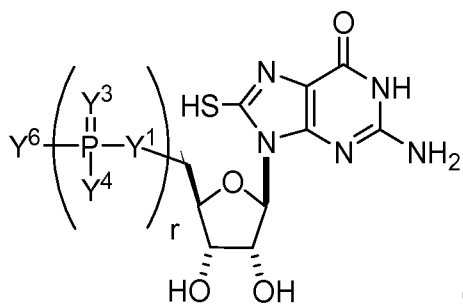

(BB- 226),

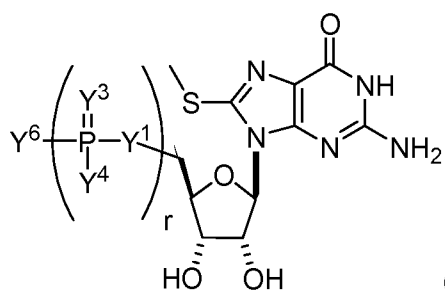

(BB- 227),

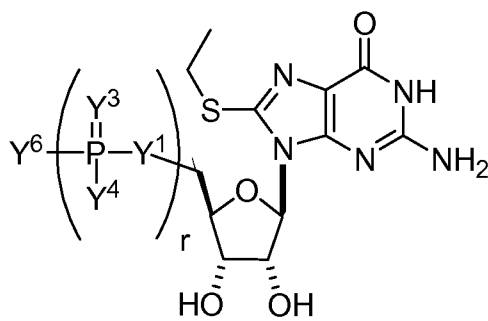

(BB- 228),

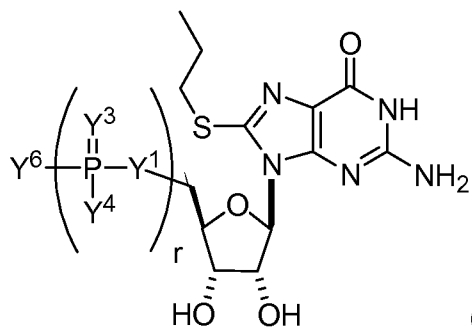

(BB- 229),

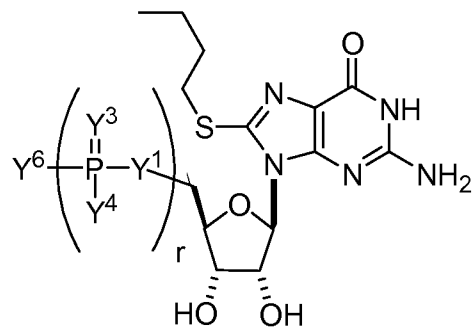

(BB- 230),

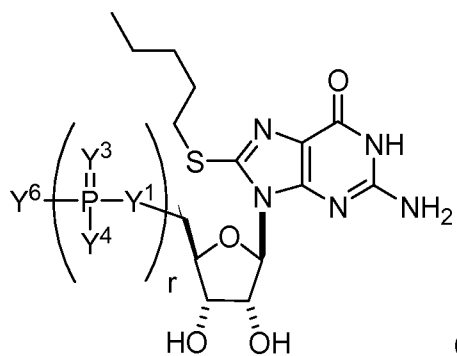

(BB- 231),

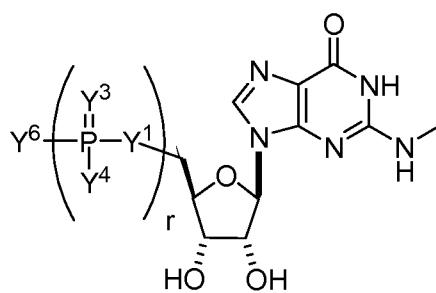

(BB- 232),

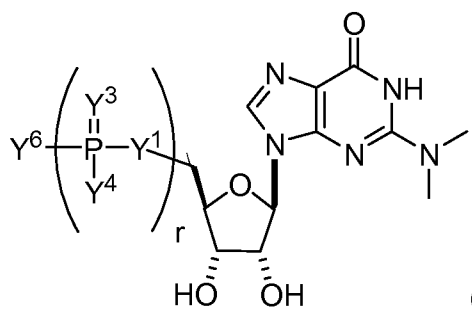

(BB- 233),

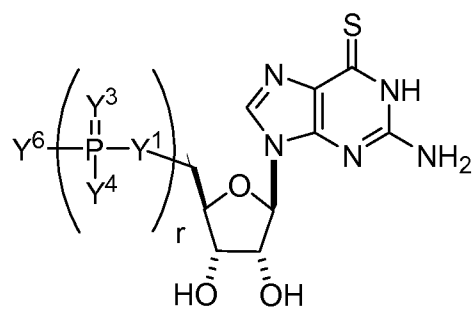

(BB- 234),

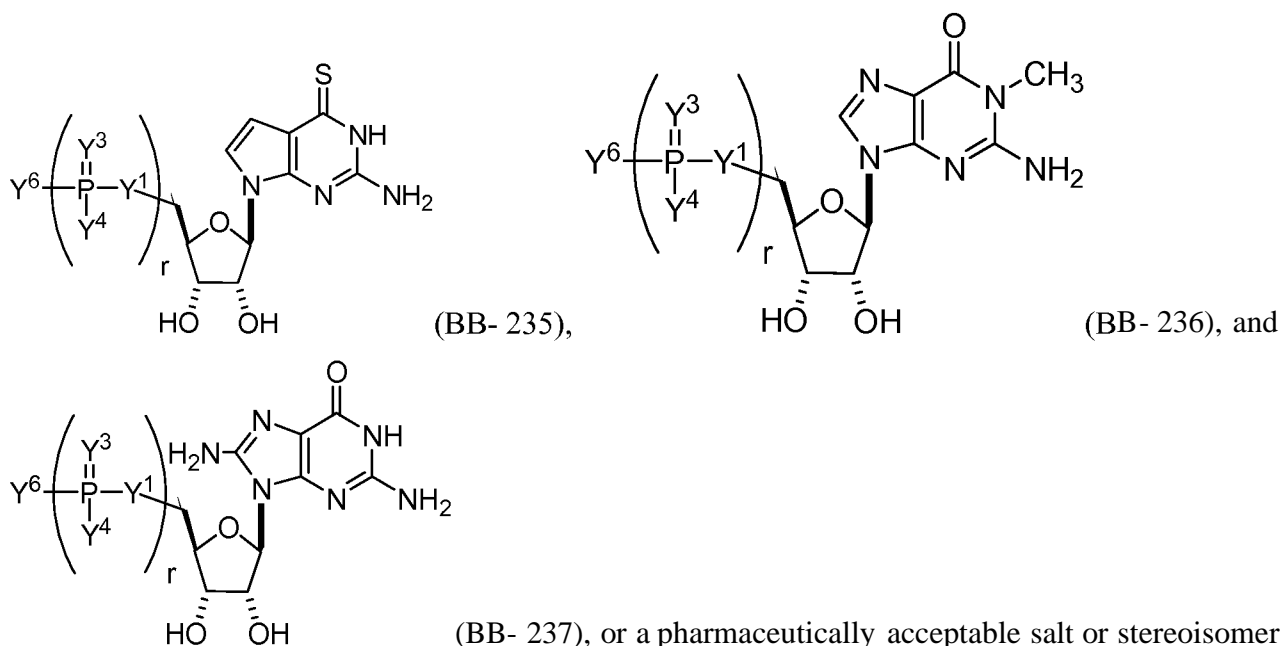

[00203] In some embodiments, the chemical modification can include replacement of C group at C-5 of the ring (e.g., for a pyrimidine nucleoside, such as cytosine or uracil) with N (e.g., replacement of the >CH group at C-5 with >NR^{N1} group, wherein R^{N1} is H or optionally substituted alkyl). For example, the mmRNA molecule, which may be incorporated into a modified nucleic acid molecule or mmRNA, can be:

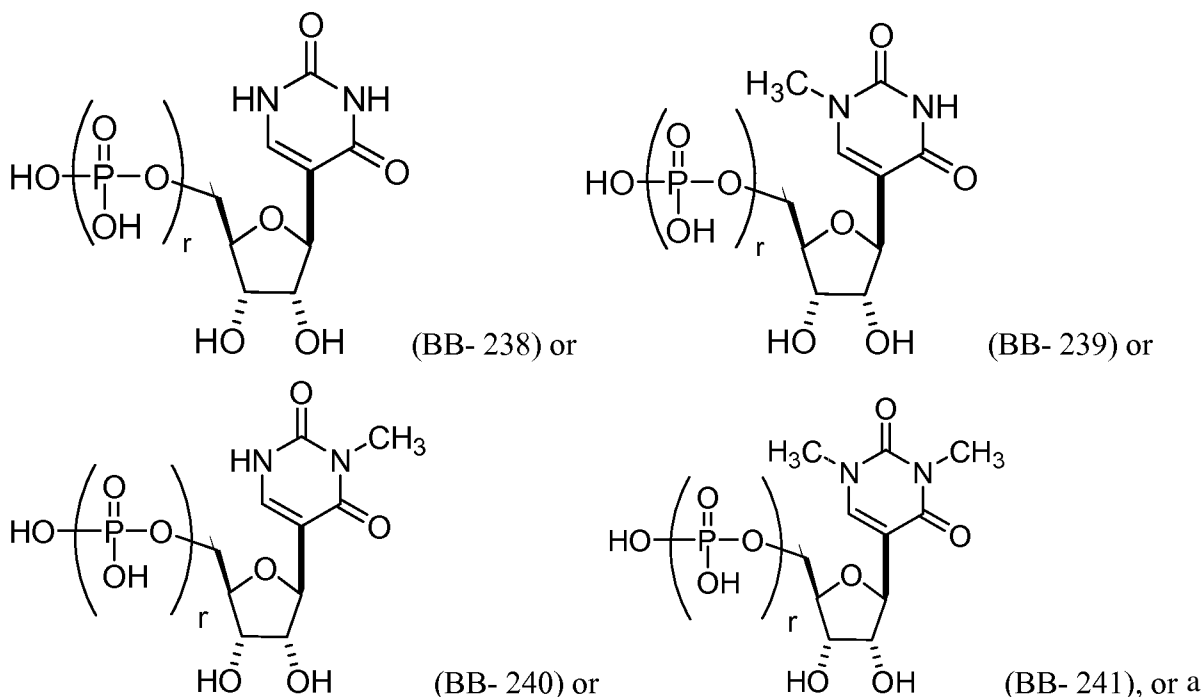

pharmaceutically acceptable salt or stereoisomer thereof, wherein each r is, independently, an integer from 0 to 5 (e.g., from 0 to 3, from 1 to 3, or from 1 to 5).

[00204] In another embodiment, the chemical modification can include replacement of the hydrogen at C-5 of cytosine with halo (e.g., Br, Cl, F, or I) or optionally substituted alkyl (e.g., methyl). For example, the mmRNA molecule, which may be incorporated into a modified nucleic acid or mmRNA, can be:

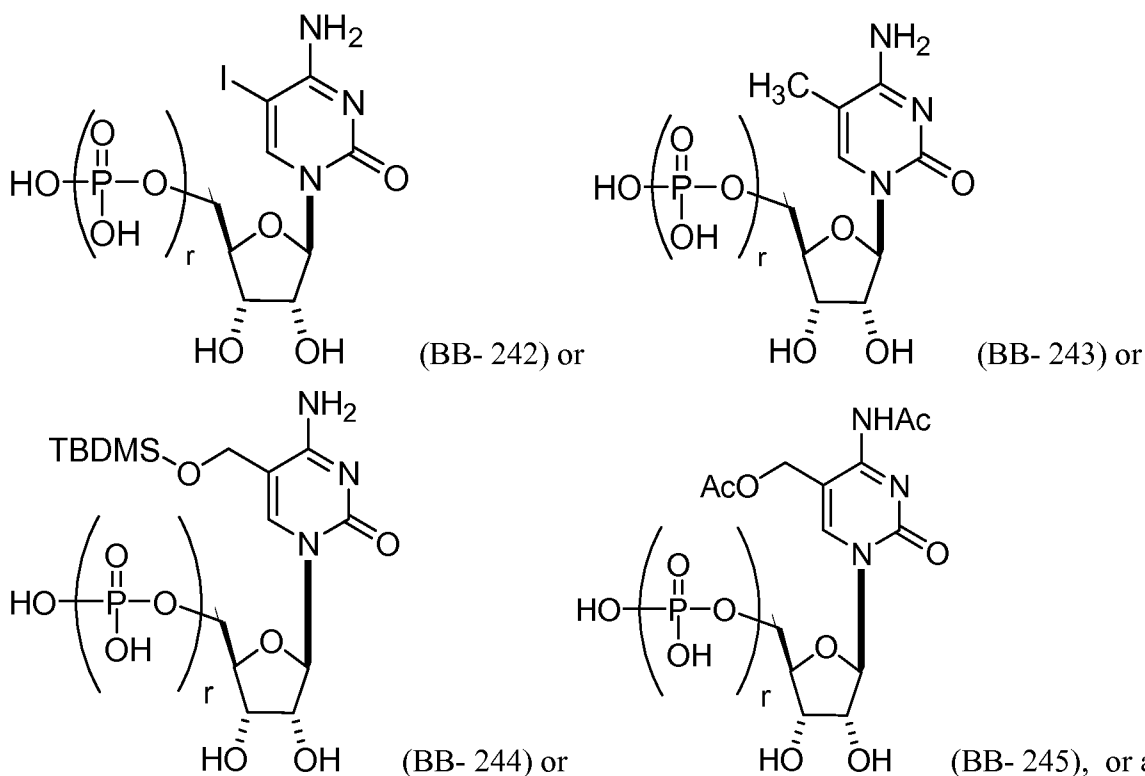

pharmaceutically acceptable salt or stereoisomer thereof, wherein each r is, independently, an integer from 0 to 5 (e.g., from 0 to 3, from 1 to 3, or from 1 to 5).

[00205] In yet a further embodiment, the chemical modification can include a fused ring that is formed by the NH_2 at the C-4 position and the carbon atom at the C-5 position. For example, the building block molecule, which may be incorporated into a modified nucleic acid molecule or mmRNA, can be:

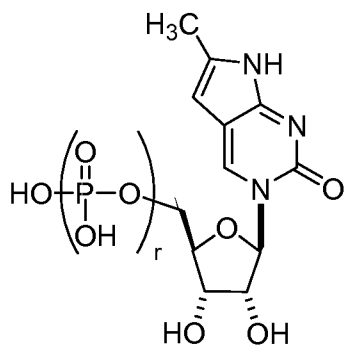

(BB- 246), or a pharmaceutically acceptable salt or stereoisomer thereof, wherein each r is, independently, an integer from 0 to 5 (e.g., from 0 to 3, from 1 to 3, or from 1 to 5).

Modifications on the Sugar

[00206] The modified nucleosides and nucleotides (e.g., building block molecules), which may be incorporated into a modified nucleic acid or mmRNA (e.g., RNA or mRNA, as described herein), can be modified on the sugar of the ribonucleic acid. For example, the 2' hydroxyl group (OH) can be modified or replaced with a number of different substituents. Exemplary substitutions at the 2'-position include, but are not limited to, H, halo, optionally substituted C_{i-6} alkyl; optionally substituted C_{i-6} alkoxy; optionally substituted C_{6-10} aryloxy; optionally substituted C_{3-8} cycloalkyl; optionally substituted C_{3-8} cycloalkoxy; optionally substituted C_{6-10} aryloxy; optionally substituted C_{6-10} aryl- C_{i-6} alkoxy, optionally substituted C_{1-12} (heterocycl)oxy; a sugar (e.g., ribose, pentose, or any described herein); a polyethyleneglycol (PEG), $-O(CH_2CH_2O)_nCH_2CH_2OR$, where R is H or optionally substituted alkyl, and n is an integer from 0 to 20 (e.g., from 0 to 4, from 0 to 8, from 0 to 10, from 0 to 16, from 1 to 4, from 1 to 8, from 1 to 10, from 1 to 16, from 1 to 20, from 2 to 4, from 2 to 8, from 2 to 10, from 2 to 16, from 2 to 20, from 4 to 8, from 4 to 10, from 4 to 16, and from 4 to 20); "locked" nucleic acids (LNA) in which the 2'-hydroxyl is connected by a C_{i-6} alkylene or C_{i-6} heteroalkylene bridge to the 4'-carbon of the same ribose sugar, where exemplary bridges included methylene, propylene, ether, or amino bridges; aminoalkyl, as defined herein; aminoalkoxy, as defined herein; amino as defined herein; and amino acid, as defined herein.

[00207] Generally, RNA includes the sugar group ribose, which is a 5-membered ring having an oxygen. Exemplary, non-limiting modified nucleotides include replacement of the oxygen in ribose (e.g., with S, Se, or alkylene, such as methylene or ethylene); addition of a double bond (e.g., to replace ribose with cyclopentenyl or cyclohexenyl); ring contraction of ribose (e.g., to form a 4-membered ring of cyclobutane or oxetane); ring expansion of ribose (e.g., to form a 6- or 7-membered ring having an additional carbon or heteroatom, such as for anhydrohexitol, altritol,

mannitol, cyclohexanyl, cyclohexenyl, and morpholino that also has a phosphoramidate backbone); multicyclic forms (e.g., tricyclo; and "unlocked" forms, such as glycol nucleic acid (GNA) (e.g., R-GNA or S-GNA, where ribose is replaced by glycol units attached to phosphodiester bonds), threose nucleic acid (TNA, where ribose is replaced with α -L-threofuranosyl-(3' \rightarrow 2')) , and peptide nucleic acid (PNA, where 2-amino-ethyl-glycine linkages replace the ribose and phosphodiester backbone). The sugar group can also contain one or more carbons that possess the opposite stereochemical configuration than that of the corresponding carbon in ribose. Thus, a modified nucleic acid molecule or mmRNA can include nucleotides containing, e.g., arabinose, as the sugar.

Modifications on the Nucleobase

[00208] The present disclosure provides for modified nucleosides and nucleotides. As described herein "nucleoside" is defined as a compound containing a sugar molecule (e.g., a pentose or ribose) or a derivative thereof in combination with an organic base (e.g., a purine or pyrimidine) or a derivative thereof. As described herein, "nucleotide" is defined as a nucleoside including a phosphate group. The modified nucleotides (e.g., modified mRNA) may be synthesized by any useful method, as described herein (e.g., chemically, enzymatically, or recombinantly to include one or more modified or non-natural nucleosides).

[00209] The modified nucleotide base pairing encompasses not only the standard adenosine-thymine, adenosine-uracil, or guanosine-cytosine base pairs, but also base pairs formed between nucleotides and/or modified nucleotides comprising non-standard or modified bases, wherein the arrangement of hydrogen bond donors and hydrogen bond acceptors permits hydrogen bonding between a non-standard base and a standard base or between two complementary non-standard base structures. One example of such non-standard base pairing is the base pairing between the modified nucleotide inosine and adenine, cytosine or uracil.

[00210] The modified nucleosides and nucleotides can include a modified nucleobase. Examples of nucleobases found in RNA include, but are not limited to, adenine, guanine, cytosine, and uracil. Examples of nucleobase found in DNA include, but are not limited to, adenine, guanine, cytosine, and thymine. These nucleobases can be modified or wholly replaced to provide modified nucleic acids or mmRNA molecules having enhanced properties, e.g., resistance to nucleases through disruption of the binding of a major groove binding partner. Table 1 below identifies the chemical faces of each canonical nucleotide. Circles identify the atoms comprising the respective chemical regions.

Table 1

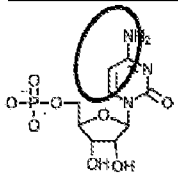
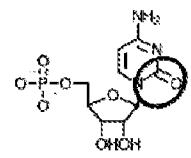
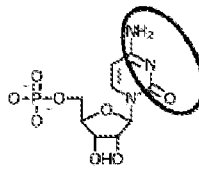
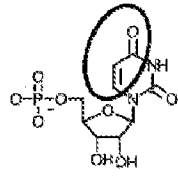
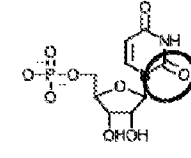
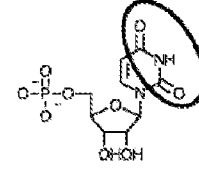
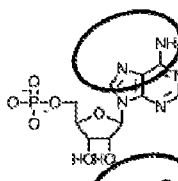
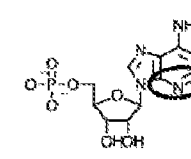
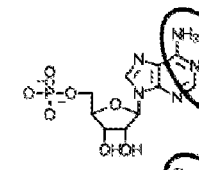
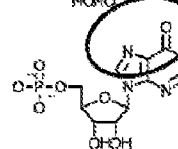
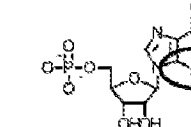
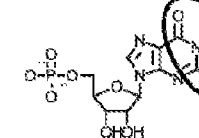
	Major Groove Face	Minor Groove Face	Watson-Crick Base-pairing Face
Pyrimidines	Cytidine: 		
	Uridine: 		
Purines	Adenosine: 		
	Guanosine: 		

[00211] In some embodiments, B is a modified uracil. Exemplary modified uracils include those having Formula (b1)-(b5):

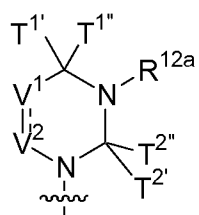

(b1),

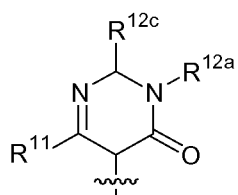

(b2),

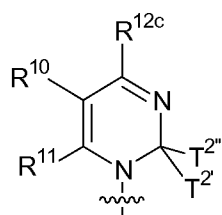

(b3),

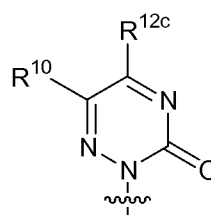

(b4), or

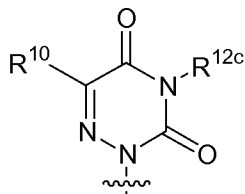

(b5), or a pharmaceutically acceptable salt or stereoisomer thereof, wherein

[00212]  is a single or double bond;

[00213] each of T^{1'}, T^{1''}, T^{2'}, and T^{2''} is, independently, H, optionally substituted alkyl, optionally substituted alkoxy, or optionally substituted thioalkoxy, or the combination of T^{1'} and T^{1''} or the combination of T^{2'} and T^{2''} join together (e.g., as in T²) to form O (oxo), S (thio), or Se (seleno);

[00214] each of V¹ and V² is, independently, O, S, N(R^{Vb})_{nv}, or C(R^{Vb})_{nv}, wherein nv is an integer from 0 to 2 and each R^{Vb} is, independently, H, halo, optionally substituted amino acid, optionally substituted alkyl, optionally substituted haloalkyl, optionally substituted alkenyl, optionally substituted alkynyl, optionally substituted alkoxy, optionally substituted alkenyloxy, optionally substituted alkynyloxy, optionally substituted hydroxyalkyl, optionally substituted hydroxyalkenyl, optionally substituted hydroxyalkynyl, optionally substituted aminoalkyl (e.g., substituted with an N-protecting group, such as any described herein, e.g., trifluoroacetyl), optionally substituted aminoalkenyl, optionally substituted aminoalkynyl, optionally substituted acylaminoalkyl (e.g., substituted with an N-protecting group, such as any described herein, e.g., trifluoroacetyl), optionally substituted alkoxy carbonylalkyl, optionally substituted alkoxy carbonylalkenyl, optionally substituted alkoxy carbonylalkynyl, or optionally substituted alkoxy carbonylalkoxy (e.g., optionally substituted with any substituent described herein, such as those selected from (1)-(21) for alkyl);

[00215] R¹⁰ is H, halo, optionally substituted amino acid, hydroxy, optionally substituted alkyl, optionally substituted alkenyl, optionally substituted alkynyl, optionally substituted aminoalkyl, optionally substituted hydroxyalkyl, optionally substituted hydroxyalkenyl, optionally substituted hydroxyalkynyl, optionally substituted aminoalkenyl, optionally substituted aminoalkynyl, optionally substituted alkoxy, optionally substituted alkoxy carbonylalkyl, optionally substituted alkoxy carbonylalkenyl, optionally substituted alkoxy carbonylalkynyl, optionally substituted alkoxy carbonylalkoxy, optionally substituted carboxyalkoxy, optionally substituted carboxyalkyl, or optionally substituted carbamoylalkyl;

[00216] R¹¹ is H or optionally substituted alkyl;

[00217] R^{12a} is H, optionally substituted alkyl, optionally substituted hydroxyalkyl, optionally substituted hydroxyalkenyl, optionally substituted hydroxyalkynyl, optionally substituted aminoalkyl, optionally substituted aminoalkenyl, or optionally substituted aminoalkynyl, optionally substituted carboxyalkyl (e.g., optionally substituted with hydroxy), optionally substituted carboxyalkoxy, optionally substituted carboxyaminoalkyl, or optionally substituted carbamoylalkyl; and

[00218] R^{12c} is H, halo, optionally substituted alkyl, optionally substituted alkoxy, optionally substituted thioalkoxy, optionally substituted amino, optionally substituted hydroxyalkyl, optionally substituted hydroxyalkenyl, optionally substituted hydroxyalkynyl, optionally substituted aminoalkyl, optionally substituted aminoalkenyl, or optionally substituted aminoalkynyl.

[00219] Other exemplary modified uracils include those having Formula (b6)-(b9):

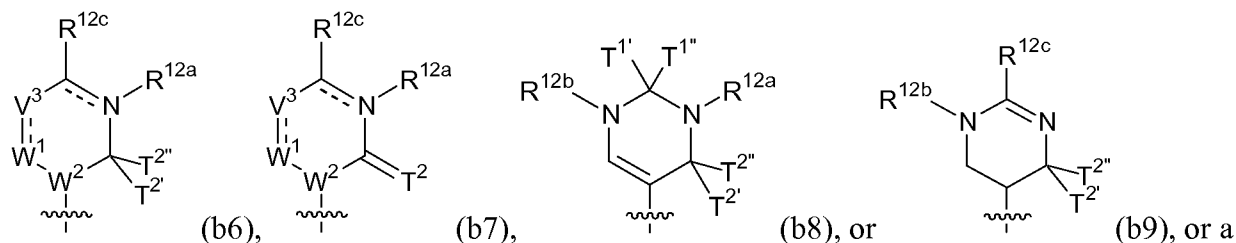

pharmaceutically acceptable salt or stereoisomer thereof, wherein

[00220] is a single or double bond;

[00221] each of T¹, T^{1''}, T², and T^{2''} is, independently, H, optionally substituted alkyl, optionally substituted alkoxy, or optionally substituted thioalkoxy, or the combination of T¹ and T^{1''} join together (e.g., as in T¹) or the combination of T² and T^{2''} join together (e.g., as in T²) to form O (oxo), S (thio), or Se (seleno), or each T¹ and T² is, independently, O (oxo), S (thio), or Se (seleno);

[00222] each of W¹ and W² is, independently, N(R^{Wa})_{nw} or C(R^{Wa})_{nw}, wherein nw is an integer from 0 to 2 and each R^{Wa} is, independently, H, optionally substituted alkyl, or optionally substituted alkoxy;

[00223] each V³ is, independently, O, S, N(R^{Va})_{nv}, or C(R^{Va})_{nv}, wherein nv is an integer from 0 to 2 and each R^{Va} is, independently, H, halo, optionally substituted amino acid, optionally substituted alkyl, optionally substituted hydroxyalkyl, optionally substituted hydroxyalkenyl, optionally substituted hydroxyalkynyl, optionally substituted alkenyl, optionally substituted alkynyl, optionally substituted heterocyclyl, optionally substituted alkheterocyclyl, optionally substituted alkoxy, optionally substituted alkenyloxy, or optionally substituted alkynyloxy, optionally substituted aminoalkyl (e.g., substituted with an N-protecting group, such as any described herein, e.g., trifluoroacetyl, or sulfoalkyl), optionally substituted aminoalkenyl, optionally substituted aminoalkynyl, optionally substituted acylaminoalkyl (e.g., substituted with an N-protecting group, such as any described herein, e.g., trifluoroacetyl), optionally substituted alkoxycarbonylalkyl, optionally substituted alkoxycarbonylalkenyl, optionally substituted alkoxycarbonylalkynyl, optionally substituted alkoxycarbonylacyl, optionally substituted alkoxycarbonylalkoxy, optionally substituted carboxyalkyl (e.g., optionally substituted with hydroxy and/or an O-protecting group),

optionally substituted carboxyalkoxy, optionally substituted carboxyalkyl, or optionally substituted carbamoylalkyl (e.g., optionally substituted with any substituent described herein, such as those selected from (1)-(21) for alkyl), and wherein R^{Va} and R^{12c} taken together with the carbon atoms to which they are attached can form optionally substituted cycloalkyl, optionally substituted aryl, or optionally substituted heterocyclyl (e.g., a 5- or 6-membered ring);

[00224] R^{12a} is H, optionally substituted alkyl, optionally substituted hydroxyalkyl, optionally substituted hydroxyalkenyl, optionally substituted hydroxyalkynyl, optionally substituted aminoalkyl, optionally substituted aminoalkenyl, optionally substituted aminoalkynyl, optionally substituted carboxyalkyl (e.g., optionally substituted with hydroxy and/or an O-protecting group), optionally substituted carboxyalkoxy, optionally substituted carboxyalkyl, optionally substituted carbamoylalkyl, or absent;

[00225] R^{12b} is H, optionally substituted alkyl, optionally substituted alkenyl, optionally substituted alkynyl, optionally substituted hydroxyalkyl, optionally substituted hydroxyalkenyl, optionally substituted hydroxyalkynyl, optionally substituted aminoalkyl, optionally substituted aminoalkenyl, optionally substituted aminoalkynyl, optionally substituted alkaryl, optionally substituted heterocyclyl, optionally substituted alkheterocyclyl, optionally substituted amino acid, optionally substituted alkoxyacetyl, optionally substituted alkoxyalkoxy, optionally substituted alkoxyalkyl, optionally substituted alkoxyalkenyl, optionally substituted alkoxyalkynyl, optionally substituted alkoxyalkoxy, optionally substituted carboxyalkyl (e.g., optionally substituted with hydroxy and/or an O-protecting group), optionally substituted carboxyalkoxy, optionally substituted carboxyalkyl, or optionally substituted carbamoylalkyl,

[00226] wherein the combination of R^{12b} and T^1 or the combination of R^{12b} and R^{12c} can join together to form optionally substituted heterocyclyl; and

[00227] R^{12c} is H, halo, optionally substituted alkyl, optionally substituted alkoxy, optionally substituted thioalkoxy, optionally substituted amino, optionally substituted aminoalkyl, optionally substituted aminoalkenyl, or optionally substituted aminoalkynyl.

[00228] Further exemplary modified uracils include those having Formula (b28)-(b31):

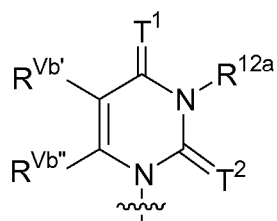

(b28),

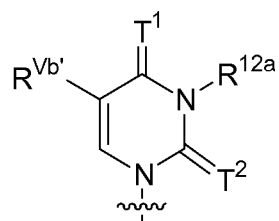

(b29),

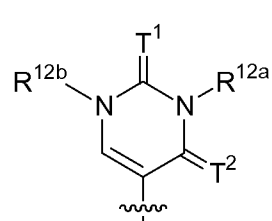

(b30), or

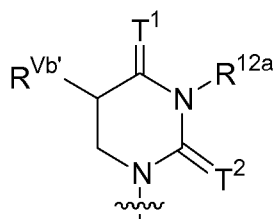

(b31), or a pharmaceutically acceptable salt or stereoisomer thereof, wherein

[00229] each of T¹ and T² is, independently, O (oxo), S (thio), or Se (seleno);

[00230] each R^{Vb'} and R^{Vb''} is, independently, H, halo, optionally substituted amino acid, optionally substituted alkyl, optionally substituted haloalkyl, optionally substituted hydroxyalkyl, optionally substituted hydroxyalkenyl, optionally substituted hydroxyalkynyl, optionally substituted alkenyl, optionally substituted alkynyl, optionally substituted alkoxy, optionally substituted alkenyloxy, optionally substituted alkynyloxy, optionally substituted aminoalkyl (e.g., substituted with an N-protecting group, such as any described herein, e.g., trifluoroacetyl, or sulfoalkyl), optionally substituted aminoalkenyl, optionally substituted aminoalkynyl, optionally substituted acylaminoalkyl (e.g., substituted with an N-protecting group, such as any described herein, e.g., trifluoroacetyl), optionally substituted alkoxycarbonylalkyl, optionally substituted alkoxycarbonylalkenyl, optionally substituted alkoxycarbonylalkynyl, optionally substituted alkoxycarbonylacyl, optionally substituted alkoxycarbonylalkoxy, optionally substituted carboxyalkyl (e.g., optionally substituted with hydroxy and/or an O-protecting group), optionally substituted carboxyalkoxy, optionally substituted carboxyaminoalkyl, or optionally substituted carbamoylalkyl (e.g., optionally substituted with any substituent described herein, such as those selected from (1)-(21) for alkyl) (e.g., R^{Vb'} is optionally substituted alkyl, optionally substituted alkenyl, or optionally substituted aminoalkyl, e.g., substituted with an N-protecting group, such as any described herein, e.g., trifluoroacetyl, or sulfoalkyl);

[00231] R^{12a} is H, optionally substituted alkyl, optionally substituted carboxyaminoalkyl, optionally substituted aminoalkyl (e.g., e.g., substituted with an N-protecting group, such as any described herein, e.g., trifluoroacetyl, or sulfoalkyl), optionally substituted aminoalkenyl, or optionally substituted aminoalkynyl; and

[00232] R^{12b} is H, optionally substituted alkyl, optionally substituted alkenyl, optionally substituted alkynyl, optionally substituted hydroxyalkyl, optionally substituted hydroxyalkenyl, optionally substituted hydroxyalkynyl, optionally substituted aminoalkyl, optionally substituted aminoalkenyl, optionally substituted aminoalkynyl (e.g., e.g., substituted with an N-protecting group, such as any described herein, e.g., trifluoroacetyl, or sulfoalkyl),

[00233] optionally substituted alkoxyacetyl, optionally substituted alkoxyalkoxy, optionally substituted alkoxyalkyl, optionally substituted alkoxyalkenyl, optionally substituted alkoxyalkynyl, optionally substituted alkoxyalkoxy, optionally substituted carboxyalkoxy, optionally substituted carboxyalkyl, or optionally substituted carbamoylalkyl.

[00234] In particular embodiments, T^1 is O (oxo), and T^2 is S (thio) or Se (seleno). In other embodiments, T^1 is S (thio), and T^2 is O (oxo) or Se (seleno). In some embodiments, $R^{Vb'}$ is H, optionally substituted alkyl, or optionally substituted alkoxy.

[00235] In other embodiments, each R^{12a} and R^{12b} is, independently, H, optionally substituted alkyl, optionally substituted alkenyl, optionally substituted alkynyl, or optionally substituted hydroxyalkyl. In particular embodiments, R^{12a} is H. In other embodiments, both R^{12a} and R^{12b} are H.

[00236] In some embodiments, each $R^{Vb'}$ of R^{12b} is, independently, optionally substituted aminoalkyl (e.g., substituted with an N-protecting group, such as any described herein, e.g., trifluoroacetyl, or sulfoalkyl), optionally substituted aminoalkenyl, optionally substituted aminoalkynyl, or optionally substituted acylaminoalkyl (e.g., substituted with an N-protecting group, such as any described herein, e.g., trifluoroacetyl). In some embodiments, the amino and/or alkyl of the optionally substituted aminoalkyl is substituted with one or more of optionally substituted alkyl, optionally substituted alkenyl, optionally substituted sulfoalkyl, optionally substituted carboxy (e.g., substituted with an O-protecting group), optionally substituted hydroxy (e.g., substituted with an O-protecting group), optionally substituted carboxyalkyl (e.g., substituted with an O-protecting group), optionally substituted alkoxyacetyl (e.g., substituted with an O-protecting group), or N-protecting group. In some embodiments, optionally substituted aminoalkyl is substituted with an optionally substituted sulfoalkyl or optionally substituted alkenyl. In particular embodiments, R^{12a} and $R^{Vb''}$ are both H. In particular embodiments, T^1 is O (oxo), and T^2 is S (thio) or Se (seleno).

[00237] In some embodiments, $R^{Vb'}$ is optionally substituted alkoxyalkyl or optionally substituted carbamoylalkyl.

[00238] In particular embodiments, the optional substituent for R^{12a} , R^{12b} , R^{12c} , or R^{Va} is a polyethylene glycol group (e.g., $-(CH_2)_{s2}(OCH_2CH_2)_s(CH_2)_{s3}OR'$, wherein s_i is an integer from 1 to 10 (e.g., from 1 to 6 or from 1 to 4), each of s_2 and s_3 , independently, is an integer from 0 to 10 (e.g., from 0 to 4, from 0 to 6, from 1 to 4, from 1 to 6, or from 1 to 10), and R' is H or Ci_{2-6} alkyl); or an amino-polyethylene glycol group (e.g., $-NR^{N1}(CH_2)_{s2}(CH_2CH_2O)_s(CH_2)_{s3}NR^{N1}$, wherein s_i is an integer from 1 to 10 (e.g., from 1 to 6 or from 1 to 4), each of s_2 and s_3 , independently, is an integer from 0 to 10 (e.g., from 0 to 4, from 0 to 6, from 1 to 4, from 1 to 6, or from 1 to 10), and each R^{N1} is, independently, hydrogen or optionally substituted Ci_{1-6} alkyl).

[00239] In some embodiments, B is a modified cytosine. Exemplary modified cytosines include compounds (b10)-(b14):

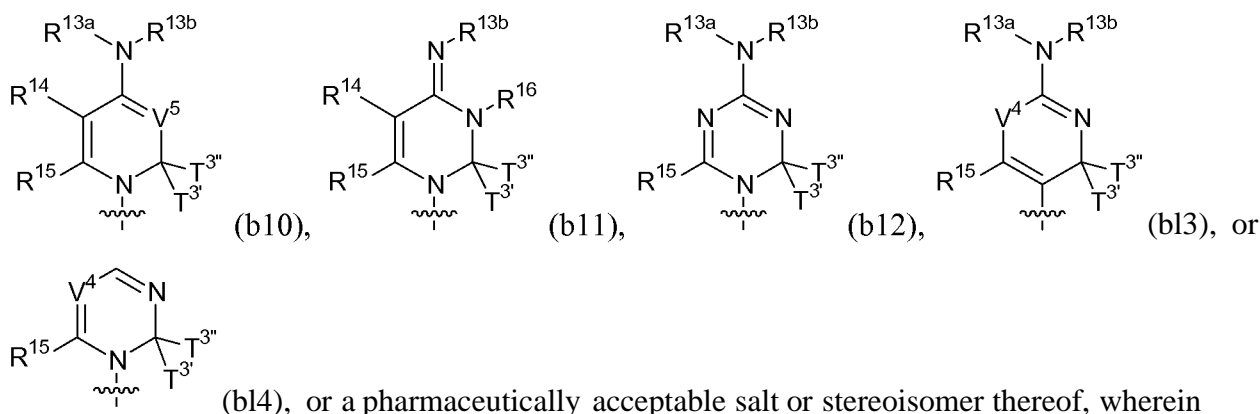

[00240] each of $T^{3'}$ and $T^{3''}$ is, independently, H, optionally substituted alkyl, optionally substituted alkoxy, or optionally substituted thioalkoxy, or the combination of $T^{3'}$ and $T^{3''}$ join together (e.g., as in T^3) to form O (oxo), S (thio), or Se (seleno);

[00241] each V^4 is, independently, O, S, N(R^{Vc})_{nv}, or C(R^{Vc})_{nv}, wherein nv is an integer from 0 to 2 and each R^{Vc} is, independently, H, halo, optionally substituted amino acid, optionally substituted alkyl, optionally substituted alkenyl, optionally substituted alkynyl, optionally substituted alkoxy, optionally substituted alkenyloxy, optionally substituted heterocyclyl, optionally substituted alkheterocyclyl, or optionally substituted alkynyloxy (e.g., optionally substituted with any substituent described herein, such as those selected from (1)-(21) for alkyl), wherein the combination of R^{13b} and R^{Vc} can be taken together to form optionally substituted heterocyclyl;

[00242] each V^5 is, independently, N(R^{Vd})_{nv}, or C(R^{Vd})_{nv}, wherein nv is an integer from 0 to 2 and each R^{Vd} is, independently, H, halo, optionally substituted amino acid, optionally substituted alkyl, optionally substituted alkenyl, optionally substituted alkynyl, optionally substituted alkoxy, optionally substituted alkenyloxy, optionally substituted heterocyclyl, optionally substituted

alkheterocyclyl, or optionally substituted alkynyloxy (e.g., optionally substituted with any substituent described herein, such as those selected from (1)-(21) for alkyl) (e.g., V⁵ is -CH or N);

[00243] each of R^{13a} and R^{13b} is, independently, H, optionally substituted acyl, optionally substituted acyloxyalkyl, optionally substituted alkyl, or optionally substituted alkoxy, wherein the combination of R^{13b} and R¹⁴ can be taken together to form optionally substituted heterocyclyl;

[00244] each R¹⁴ is, independently, H, halo, hydroxy, thiol, optionally substituted acyl, optionally substituted amino acid, optionally substituted alkyl, optionally substituted haloalkyl, optionally substituted alkenyl, optionally substituted alkynyl, optionally substituted hydroxyalkyl (e.g., substituted with an O-protecting group), optionally substituted hydroxyalkenyl, optionally substituted hydroxyalkynyl, optionally substituted alkoxy, optionally substituted alkenyloxy, optionally substituted alkynyloxy, optionally substituted aminoalkoxy, optionally substituted alkoxyalkoxy, optionally substituted acyloxyalkyl, optionally substituted amino (e.g., -NHR, wherein R is H, alkyl, aryl, or phosphoryl), azido, optionally substituted aryl, optionally substituted heterocyclyl, optionally substituted alkheterocyclyl, optionally substituted aminoalkyl, optionally substituted aminoalkenyl, or optionally substituted aminoalkyl; and

[00245] each of R¹⁵ and R¹⁶ is, independently, H, optionally substituted alkyl, optionally substituted alkenyl, or optionally substituted alkynyl.

[00246] Further exemplary modified cytosines include those having Formula (b32)-(b35):

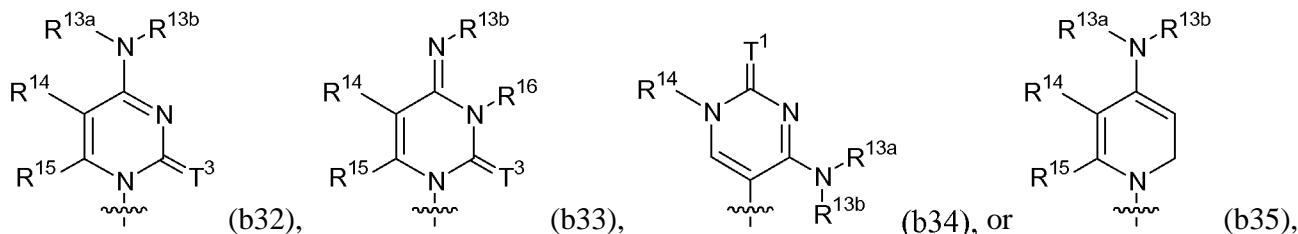

or a pharmaceutically acceptable salt or stereoisomer thereof, wherein

[00247] each of T¹ and T³ is, independently, O (oxo), S (thio), or Se (seleno);

[00248] each of R^{13a} and R^{13b} is, independently, H, optionally substituted acyl, optionally substituted acyloxyalkyl, optionally substituted alkyl, or optionally substituted alkoxy, wherein the combination of R^{13b} and R¹⁴ can be taken together to form optionally substituted heterocyclyl;

[00249] each R¹⁴ is, independently, H, halo, hydroxy, thiol, optionally substituted acyl, optionally substituted amino acid, optionally substituted alkyl, optionally substituted haloalkyl, optionally substituted alkenyl, optionally substituted alkynyl, optionally substituted hydroxyalkyl (e.g., substituted with an O-protecting group), optionally substituted hydroxyalkenyl, optionally

substituted hydroxyalkynyl, optionally substituted alkoxy, optionally substituted alkenyloxy, optionally substituted alkynyloxy, optionally substituted aminoalkoxy, optionally substituted alkoxyalkoxy, optionally substituted acyloxyalkyl, optionally substituted amino (e.g., -NHR, wherein R is H, alkyl, aryl, or phosphoryl), azido, optionally substituted aryl, optionally substituted heterocyclyl, optionally substituted alkheterocyclyl, optionally substituted aminoalkyl (e.g., hydroxyalkyl, alkyl, alkenyl, or alkynyl), optionally substituted aminoalkenyl, or optionally substituted aminoalkynyl; and

[00250] each of R¹⁵ and R¹⁶ is, independently, H, optionally substituted alkyl, optionally substituted alkenyl, or optionally substituted alkynyl (e.g., R¹⁵ is H, and R¹⁶ is H or optionally substituted alkyl).

[00251] In some embodiments, R¹⁵ is H, and R¹⁶ is H or optionally substituted alkyl. In particular embodiments, R¹⁴ is H, acyl, or hydroxyalkyl. In some embodiments, R¹⁴ is halo. In some embodiments, both R¹⁴ and R¹⁵ are H. In some embodiments, both R¹⁵ and R¹⁶ are H. In some embodiments, each of R¹⁴ and R¹⁵ and R¹⁶ is H. In further embodiments, each of R^{13a} and R^{13b} is independently, H or optionally substituted alkyl.

[00252] Further non-limiting examples of modified cytosines include compounds of Formula (b36):

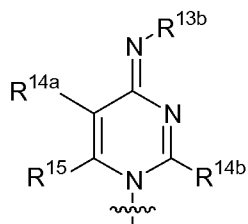

(b36) or a pharmaceutically acceptable salt or stereoisomer thereof, wherein

[00253] each R^{13b} is, independently, H, optionally substituted acyl, optionally substituted acyloxyalkyl, optionally substituted alkyl, or optionally substituted alkoxy, wherein the combination of R^{13b} and R^{14b} can be taken together to form optionally substituted heterocyclyl;

[00254] each R^{14a} and R^{14b} is, independently, H, halo, hydroxy, thiol, optionally substituted acyl, optionally substituted amino acid, optionally substituted alkyl, optionally substituted haloalkyl, optionally substituted alkenyl, optionally substituted alkynyl, optionally substituted hydroxyalkyl (e.g., substituted with an O-protecting group), optionally substituted hydroxyalkenyl, optionally substituted alkoxy, optionally substituted alkenyloxy, optionally substituted alkynyloxy, optionally substituted aminoalkoxy, optionally substituted alkoxyalkoxy, optionally substituted acyloxyalkyl, optionally substituted amino (e.g., -NHR, wherein R is H, alkyl, aryl, phosphoryl, optionally substituted aminoalkyl, or optionally substituted carboxyaminoalkyl), azido, optionally substituted aryl, optionally substituted heterocyclyl, optionally substituted alkheterocyclyl, optionally

substituted aminoalkyl, optionally substituted aminoalkenyl, or optionally substituted aminoalkynyl;
and

[00255] each of R^{15} is, independently, H, optionally substituted alkyl, optionally substituted alkenyl, or optionally substituted alkynyl.

[00256] In particular embodiments, R^{14b} is an optionally substituted amino acid (e.g., optionally substituted lysine). In some embodiments, R^{14a} is H.

[00257] In some embodiments, B is a modified guanine. Exemplary modified guanines include compounds of Formula (b15)-(b17):

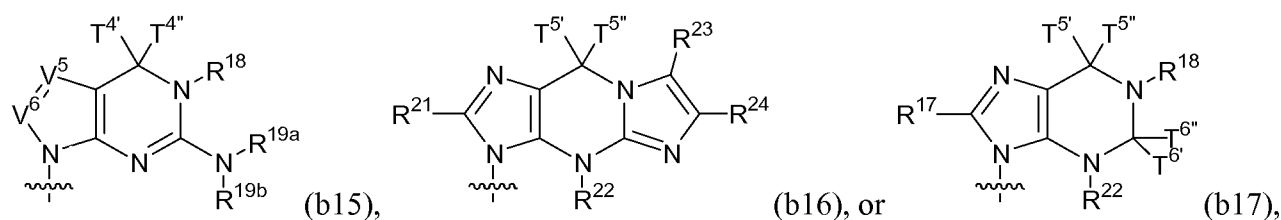

or a pharmaceutically acceptable salt or stereoisomer thereof, wherein

[00258] each of $T^{4'}$, $T^{4''}$, $T^{5'}$, $T^{5''}$, $T^{6'}$, and $T^{6''}$ is, independently, H, optionally substituted alkyl, or optionally substituted alkoxy, and wherein the combination of $T^{4'}$ and $T^{4''}$ (e.g., as in T^4) or the combination of $T^{5'}$ and $T^{5''}$ (e.g., as in T^5) or the combination of $T^{6'}$ and $T^{6''}$ join together (e.g., as in T^6) form O (oxo), S (thio), or Se (seleno);

[00259] each of V^5 and V^6 is, independently, O, S, $N(R^{Vd})_{nv}$, or $C(R^{Vd})_{nv}$, wherein nv is an integer from 0 to 2 and each R^{Vd} is, independently, H, halo, thiol, optionally substituted amino acid, cyano, amidine, optionally substituted aminoalkyl, optionally substituted aminoalkenyl, optionally substituted aminoalkynyl, optionally substituted alkyl, optionally substituted alkenyl, optionally substituted alkynyl, optionally substituted alkoxy, optionally substituted alkenyloxy, optionally substituted alkynyloxy (e.g., optionally substituted with any substituent described herein, such as those selected from (1)-(21) for alkyl), optionally substituted thioalkoxy, or optionally substituted amino; and

[00260] each of R^{17} , R^{18} , R^{19a} , R^{19b} , R^{21} , R^{22} , R^{23} , and R^{24} is, independently, H, halo, thiol, optionally substituted alkyl, optionally substituted alkenyl, optionally substituted alkynyl, optionally substituted thioalkoxy, optionally substituted amino, or optionally substituted amino acid.

[00261] Exemplary modified guanosines include compounds of Formula (b37)-(b40):

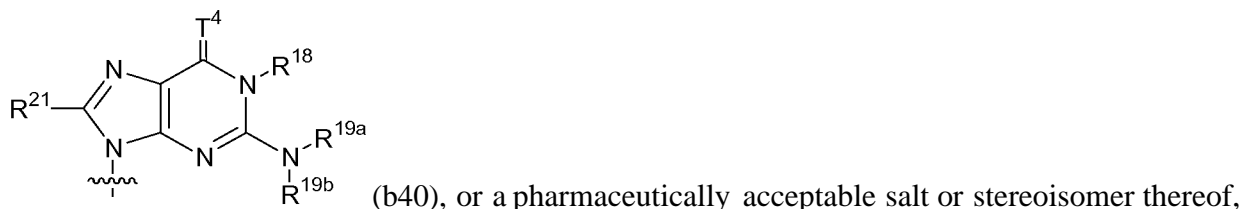
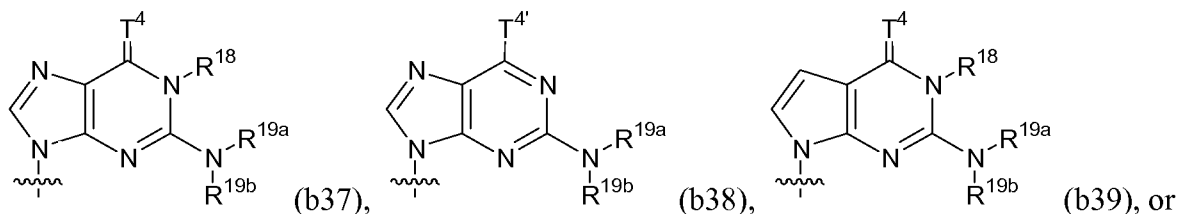

wherein

[00262] each of T^{4'} is, independently, H, optionally substituted alkyl, or optionally substituted alkoxy, and each T⁴ is, independently, O (oxo), S (thio), or Se (seleno);

[00263] each of R¹⁸, R^{19a}, R^{19b}, and R²¹ is, independently, H, halo, thiol, optionally substituted alkyl, optionally substituted alkenyl, optionally substituted alkynyl, optionally substituted thioalkoxy, optionally substituted amino, or optionally substituted amino acid.

[00264] In some embodiments, R¹⁸ is H or optionally substituted alkyl. In further embodiments, T⁴ is oxo. In some embodiments, each of R^{19a} and R^{19b} is, independently, H or optionally substituted alkyl.

[00265] In some embodiments, B is a modified adenine. Exemplary modified adenines include compounds of Formula (M8)-(b20):

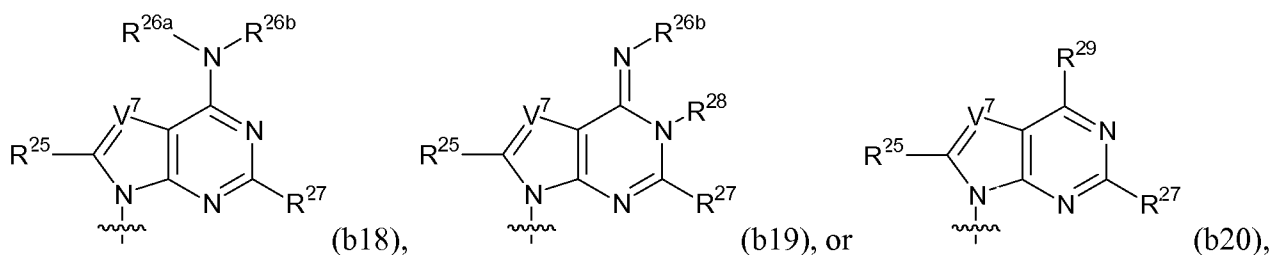

or a pharmaceutically acceptable salt or stereoisomer thereof, wherein

[00266] each V⁷ is, independently, O, S, N(R^{Ve})_{nv}, or C(R^{Ve})_{nv}, wherein nv is an integer from 0 to 2 and each R^{Ve} is, independently, H, halo, optionally substituted amino acid, optionally substituted alkyl, optionally substituted alkenyl, optionally substituted alkynyl, optionally substituted alkoxy, optionally substituted alkenyloxy, or optionally substituted alkynyloxy (e.g., optionally substituted with any substituent described herein, such as those selected from (1)-(21) for alkyl);

[00267] each R^{25} is, independently, H, halo, thiol, optionally substituted alkyl, optionally substituted alkenyl, optionally substituted alkynyl, optionally substituted thioalkoxy, or optionally substituted amino;

[00268] each of R^{26a} and R^{26b} is, independently, H, optionally substituted acyl, optionally substituted amino acid, optionally substituted carbamoylalkyl, optionally substituted alkyl, optionally substituted alkenyl, optionally substituted alkynyl, optionally substituted hydroxyalkyl, optionally substituted hydroxyalkenyl, optionally substituted hydroxyalkynyl, optionally substituted alkoxy, or polyethylene glycol group (e.g., $-(CH_2)_{s2}(OCH_2CH_2)_{si}(CH_2)_{s3}OR'$, wherein si is an integer from 1 to 10 (e.g., from 1 to 6 or from 1 to 4), each of $s2$ and $s3$, independently, is an integer from 0 to 10 (e.g., from 0 to 4, from 0 to 6, from 1 to 4, from 1 to 6, or from 1 to 10), and R' is H or C_{1-20} alkyl); or an amino-polyethylene glycol group (e.g., $-NR^{N1}(CH_2)_{s2}(CH_2CH_2O)_{si}(CH_2)_{s3}NR^{N1}$, wherein si is an integer from 1 to 10 (e.g., from 1 to 6 or from 1 to 4), each of $s2$ and $s3$, independently, is an integer from 0 to 10 (e.g., from 0 to 4, from 0 to 6, from 1 to 4, from 1 to 6, or from 1 to 10), and each R^{N1} is, independently, hydrogen or optionally substituted C_{1-6} alkyl);

[00269] each R^{27} is, independently, H, optionally substituted alkyl, optionally substituted alkenyl, optionally substituted alkynyl, optionally substituted alkoxy, optionally substituted thioalkoxy or optionally substituted amino;

[00270] each R^{28} is, independently, H, optionally substituted alkyl, optionally substituted alkenyl, or optionally substituted alkynyl; and

[00271] each R^{29} is, independently, H, optionally substituted acyl, optionally substituted amino acid, optionally substituted carbamoylalkyl, optionally substituted alkyl, optionally substituted alkenyl, optionally substituted alkynyl, optionally substituted hydroxyalkyl, optionally substituted hydroxyalkenyl, optionally substituted alkoxy, or optionally substituted amino.

[00272] Exemplary modified adenines include compounds of Formula (b41)-(b43) :

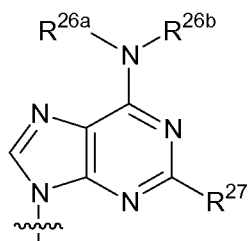

(b41),

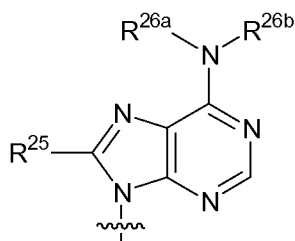

(b42), or

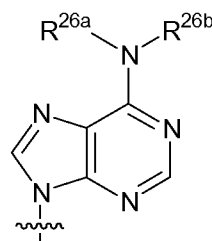

(b43), or a

pharmaceutically acceptable salt or stereoisomer thereof, wherein

[00273] each R^{25} is, independently, H, halo, thiol, optionally substituted alkyl, optionally substituted alkenyl, optionally substituted alkynyl, optionally substituted thioalkoxy, or optionally substituted amino;

[00274] each of R^{26a} and R^{26b} is, independently, H, optionally substituted acyl, optionally substituted amino acid, optionally substituted carbamoylalkyl, optionally substituted alkyl, optionally substituted alkenyl, optionally substituted alkynyl, optionally substituted hydroxyalkyl, optionally substituted hydroxyalkenyl, optionally substituted hydroxyalkynyl, optionally substituted alkoxy, or polyethylene glycol group (e.g., $-(CH_2)_{s2}(OCH_2CH_2)_{s3}R'$, wherein s_i is an integer from 1 to 10 (e.g., from 1 to 6 or from 1 to 4), each of s_2 and s_3 , independently, is an integer from 0 to 10 (e.g., from 0 to 4, from 0 to 6, from 1 to 4, from 1 to 6, or from 1 to 10), and R' is H or C_{1-6} alkyl); or an amino-polyethylene glycol group (e.g., $-NR^{N1}(CH_2)_{s2}(CH_2CH_2O)_s i(CH_2)_{s3}NR^{N1}$, wherein s_i is an integer from 1 to 10 (e.g., from 1 to 6 or from 1 to 4), each of s_2 and s_3 , independently, is an integer from 0 to 10 (e.g., from 0 to 4, from 0 to 6, from 1 to 4, from 1 to 6, or from 1 to 10), and each R^{N1} is, independently, hydrogen or optionally substituted C_{1-6} alkyl); and

[00275] each R^{27} is, independently, H, optionally substituted alkyl, optionally substituted alkenyl, optionally substituted alkynyl, optionally substituted alkoxy, optionally substituted thioalkoxy, or optionally substituted amino.

[00276] In some embodiments, R^{26a} is H, and R^{26b} is optionally substituted alkyl. In some embodiments, each of R^{26a} and R^{26b} is, independently, optionally substituted alkyl. In particular embodiments, R^{27} is optionally substituted alkyl, optionally substituted alkoxy, or optionally substituted thioalkoxy. In other embodiments, R^{25} is optionally substituted alkyl, optionally substituted alkoxy, or optionally substituted thioalkoxy.

[00277] In particular embodiments, the optional substituent for R^{26a} , R^{26b} , or R^{29} is a polyethylene glycol group (e.g., $-(CH_2)_{s2}(OCH_2CH_2)_{s3}R'$, wherein s_i is an integer from 1 to 10 (e.g., from 1 to 6 or from 1 to 4), each of s_2 and s_3 , independently, is an integer from 0 to 10 (e.g., from 0 to 4, from 0 to 6, from 1 to 4, from 1 to 6, or from 1 to 10), and R' is H or C_{1-6} alkyl); or an amino-polyethylene glycol group (e.g., $-NR^{N1}(CH_2)_{s2}(CH_2CH_2O)_s i(CH_2)_{s3}NR^{N1}$, wherein s_i is an integer from 1 to 10 (e.g., from 1 to 6 or from 1 to 4), each of s_2 and s_3 , independently, is an integer from 0 to 10 (e.g., from 0 to 4, from 0 to 6, from 1 to 4, from 1 to 6, or from 1 to 10), and each R^{N1} is, independently, hydrogen or optionally substituted C_{1-6} alkyl).

[00278] In some embodiments, B may have Formula (b21):

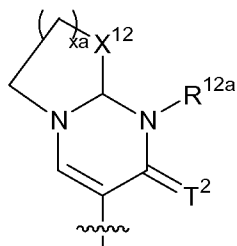

(b21), wherein X^{12} is, independently, O, S, optionally substituted alkylene (e.g., methylene), or optionally substituted heteroalkylene, x_a is an integer from 0 to 3, and R^{12a} and T^2 are as described herein.

[00279] In some embodiments, B may have Formula (b22):

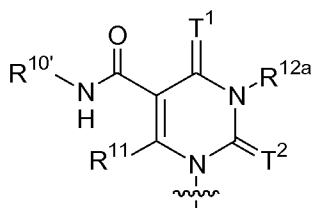

(b22), wherein $R^{10'}$ is, independently, optionally substituted alkyl, optionally substituted alkenyl, optionally substituted alkynyl, optionally substituted aryl, optionally substituted heterocyclyl, optionally substituted aminoalkyl, optionally substituted aminoalkenyl, optionally substituted aminoalkynyl, optionally substituted alkoxy, optionally substituted alkoxy-carbonylalkyl, optionally substituted alkoxy-carbonylalkenyl, optionally substituted alkoxy-carbonylalkynyl, optionally substituted alkoxy-carbonylalkoxy, optionally substituted carboxyalkoxy, optionally substituted carboxyalkyl, or optionally substituted carbamoylalkyl, and R^{11} , R^{12a} , T^1 , and T^2 are as described herein.

[00280] In some embodiments, B may have Formula (b23):

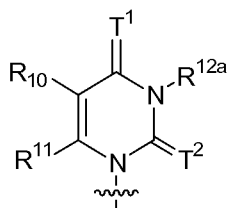

(b23), wherein R^{10} is optionally substituted heterocyclyl (e.g., optionally substituted furyl, optionally substituted thienyl, or optionally substituted pyrrolyl), optionally substituted aryl (e.g., optionally substituted phenyl or optionally substituted naphthyl), or any substituent described herein (e.g., for R^{10}); and wherein R^{11} (e.g., H or any substituent described herein), R^{12a} (e.g., H or any substituent described herein), T^1 (e.g., oxo or any substituent described herein), and T^2 (e.g., oxo or any substituent described herein) are as described herein.

[00281] In some embodiments, B may have Formula (b24):

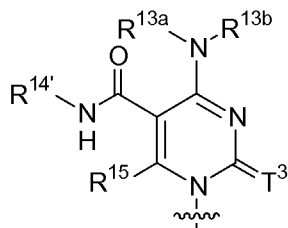

(b24), wherein R^{14'} is, independently, optionally substituted alkyl, optionally substituted alkenyl, optionally substituted alkynyl, optionally substituted aryl, optionally substituted heterocyclyl, optionally substituted alkaryl, optionally substituted alkheterocyclyl, optionally substituted aminoalkyl, optionally substituted aminoalkenyl, optionally substituted aminoalkynyl, optionally substituted alkoxy, optionally substituted alkoxy carbonylalkyl, optionally substituted alkoxy carbonylalkenyl, optionally substituted alkoxy carbonylalkynyl, optionally substituted alkoxy carbonylalkoxy, optionally substituted carboxyalkoxy, optionally substituted carboxyalkyl, or optionally substituted carbamoylalkyl, and R^{13a}, R^{13b}, R¹⁵, and T³ are as described herein.

[00282] In some embodiments, B may have Formula (b25):

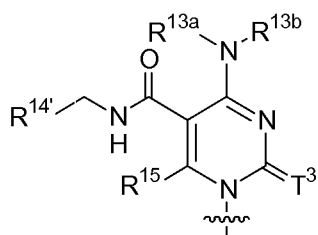

(b25), wherein R^{14'} is optionally substituted heterocyclyl (e.g., optionally substituted furyl, optionally substituted thienyl, or optionally substituted pyrrolyl), optionally substituted aryl (e.g., optionally substituted phenyl or optionally substituted naphthyl), or any substituent described herein (e.g., for R¹⁴ or R^{14'}); and wherein R^{13a} (e.g., H or any substituent described herein), R^{13b} (e.g., H or any substituent described herein), R¹⁵ (e.g., H or any substituent described herein), and T³ (e.g., oxo or any substituent described herein) are as described herein.

[00283] In some embodiments, B is a nucleobase selected from the group consisting of cytosine, guanine, adenine, and uracil. In some embodiments, B may be:

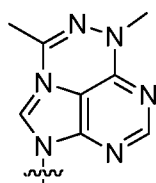

(b26) or

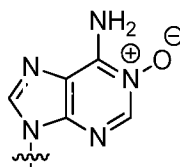

(b27).

[00284] In some embodiments, the modified nucleobase is a modified uracil. Exemplary nucleobases and nucleosides having a modified uracil include pseudouridine (ψ), pyridin-4-one ribonucleoside, 5-aza-uridine, 6-aza-uridine, 2-thio-5-aza-uridine, 2-thio-uridine (s^2U), 4-thio-

uridine (s^4U), 4-thio-pseudouridine, 2-thio-pseudouridine, 5-hydroxy-uridine (ho^5U), 5-aminoallyl-uridine, 5-halo-uridine (e.g., 5-iodo-uridine or 5-bromo-uridine), 3-methyl-uridine (m^3U), 5-methoxy-uridine (mo^5U), uridine 5-oxyacetic acid (cmo^5U), uridine 5-oxyacetic acid methyl ester ($mcmo^5U$), 5-carboxymethyl-uridine (cm^5U), 1-carboxymethyl-pseudouridine, 5-carboxyhydroxymethyl-uridine (chm^5U), 5-carboxyhydroxymethyl-uridine methyl ester ($mchm^5U$), 5-methoxycarbonylmethyl-uridine (mcm^5U), 5-methoxycarbonylmethyl-2-thio-uridine (mcm^5s^2U), 5-aminomethyl-2-thio-uridine (nm^5U), 5-methylaminomethyl-uridine (mnm^5U), 5-methylaminomethyl-2-thio-uridine (mnm^5s^2U), 5-methylaminomethyl-2-seleno-uridine (mnm^5se^2U), 5-carbamoylmethyl-uridine (ncm^5U), 5-carboxymethylaminomethyl-uridine ($cmnm^5U$), 5-carboxymethylaminomethyl-2-thio-uridine ($cmnm^5s^2U$), 5-propynyl-uridine, 1-propynyl-pseudouridine, 5-taurinomethyl-uridine (τm^5U), 1-taurinomethyl-pseudouridine, 5-taurinomethyl-2-thio-uridine (τm^5s^2U), 1-taurinomethyl-4-thio-pseudouridine, 5-methyl-uridine (m^5U , i.e., having the nucleobase deoxythymine), 1-methyl-pseudouridine (m^1), 5-methyl-2-thio-uridine (m^5s^2U), 1-methyl-4-thio-pseudouridine ($m^1s^4\psi$), 4-thio-1-methyl-pseudouridine, 3-methyl-pseudouridine ($m^3\psi$), 2-thio-1-methyl-pseudouridine, 1-methyl-1-deaza-pseudouridine, 2-thio-1-methyl-1-deaza-pseudouridine, dihydrouridine (D), dihydropseudouridine, 5,6-dihydrouridine, 5-methyl-dihydrouridine (m^5D), 2-thio-dihydrouridine, 2-thio-dihydropseudouridine, 2-methoxy-uridine, 2-methoxy-4-thio-uridine, 4-methoxy-pseudouridine, 4-methoxy-2-thio-pseudouridine, N1-methyl-pseudouridine, 3-(3-amino-3-carboxypropyl)uridine (acp^3U), 1-methyl-3-(3-amino-3-carboxypropyl)pseudouridine ($acp^3\psi$), 5-(isopentenylaminomethyl)uridine (inm^5U), 5-(isopentenylaminomethyl)-2-thio-uridine (inm^5s^2U), a-thio-uridine, 2'-O-methyl-uridine (Um), 5,2'-O-dimethyl-uridine (m^5Um), 2'-O-methyl-pseudouridine (ψm), 2-thio-2'-O-methyl-uridine (s^2Um), 5-methoxycarbonylmethyl-2'-O-methyl-uridine (mcm^5Um), 5-carbamoylmethyl-2'-O-methyl-uridine (ncm^5Um), 5-carboxymethylaminomethyl-2'-O-methyl-uridine ($cmnm^5Um$), 3,2'-O-dimethyl-uridine (m^3Um), 5-(isopentenylaminomethyl)-2'-O-methyl-uridine (inm^5Um), 1-thio-uridine, deoxythymidine, 2'-F-ara-uridine, 2'-F-uridine, 2'-OH-ara-uridine, 5-(2-carbomethoxyvinyl)uridine, and 5-[3-(1-E-propenylamino)uridine..

[00285] In some embodiments, the modified nucleobase is a modified cytosine. Exemplary nucleobases and nucleosides having a modified cytosine include 5-aza-cytidine, 6-aza-cytidine, pseudoisocytidine, 3-methyl-cytidine (m^3C), N4-acetyl-cytidine (ac^4C), 5-formyl-cytidine (f^5C), N4-methyl-cytidine (m^4C), 5-methyl-cytidine (m^5C), 5-halo-cytidine (e.g., 5-iodo-cytidine), 5-

hydroxymethyl-cytidine (hm⁵C), 1-methyl-pseudoisocytidine, pyrrolo-cytidine, pyrrolo-pseudoisocytidine, 2-thio-cytidine (s²C), 2-thio-5-methyl-cytidine, 4-thio-pseudoisocytidine, 4-thio-1-methyl-pseudoisocytidine, 4-thio-1-methyl-1-deaza-pseudoisocytidine, 1-methyl-1-deaza-pseudoisocytidine, zebularine, 5-aza-zebularine, 5-methyl-zebularine, 5-aza-2-thio-zebularine, 2-thio-zebularine, 2-methoxy-cytidine, 2-methoxy-5-methyl-cytidine, 4-methoxy-pseudoisocytidine, 4-methoxy-1-methyl-pseudoisocytidine, lysidine (k₂C), a-thio-cytidine, 2'-O-methyl-cytidine (Cm), 5,2'-O-dimethyl-cytidine (m⁵Cm), N4-acetyl-2'-O-methyl-cytidine (ac⁴Cm), N4,2'-O-dimethyl-cytidine (m⁴Cm), 5-formyl-2'-O-methyl-cytidine (f⁵Cm), N4,N4,2'-O-trimethyl-cytidine (m⁴₂Cm), 1-thio-cytidine, 2'-F-ara-cytidine, 2'-F-cytidine, and 2'-OH-ara-cytidine.

[00286] In some embodiments, the modified nucleobase is a modified adenine. Exemplary nucleobases and nucleosides having a modified adenine include 2-amino-purine, 2, 6-diaminopurine, 2-amino-6-halo-purine (e.g., 2-amino-6-chloro-purine), 6-halo-purine (e.g., 6-chloro-purine), 2-amino-6-methyl-purine, 8-azido-adenosine, 7-deaza-adenine, 7-deaza-8-aza-adenine, 7-deaza-2-amino-purine, 7-deaza-8-aza-2-amino-purine, 7-deaza-2,6-diaminopurine, 7-deaza-8-aza-2,6-diaminopurine, 1-methyl-adenosine (m¹A), 2-methyl-adenine (m²A), N6-methyl-adenosine (m⁶A), 2-methylthio-N6-methyl-adenosine (ms²m⁶A), N6-isopentenyl-adenosine (i⁶A), 2-methylthio-N6-isopentenyl-adenosine (ms²i⁶A), N6-(cis-hydroxyisopentenyl)adenosine (io⁶A), 2-methylthio-N6-(cis-hydroxyisopentenyl)adenosine (ms²io⁶A), N6-glycylcarbonyl-adenosine (g⁶A), N6-threonylcarbonyl-adenosine (t⁶A), N6-methyl-N6-threonylcarbonyl-adenosine (m⁶t⁶A), 2-methylthio-N6-threonylcarbonyl-adenosine (ms²g⁶A), N6,N6-dimethyl-adenosine (m⁶₂A), N6-hydroxynorvalylcarbonyl-adenosine (hn⁶A), 2-methylthio-N6-hydroxynorvalylcarbonyl-adenosine (ms²hn⁶A), N6-acetyl-adenosine (ac⁶A), 7-methyl-adenine, 2-methylthio-adenine, 2-methoxy-adenine, a-thio-adenosine, 2'-O-methyl-adenosine (Am), N6,2'-O-dimethyl-adenosine (m⁶Am), N6,N6,2'-O-trimethyl-adenosine (m⁶₂Am), 1,2'-O-dimethyl-adenosine (rr[^]Am), 2'-O-ribosyladenosine (phosphate) (Ar(p)), 2-amino-N6-methyl-purine, 1-thio-adenosine, 8-azido-adenosine, 2'-F-ara-adenosine, 2'-F-adenosine, 2'-OH-ara-adenosine, and N6-(19-amino-pentaoxonadecyl)-adenosine.

[00287] In some embodiments, the modified nucleobase is a modified guanine. Exemplary nucleobases and nucleosides having a modified guanine include inosine (I), 1-methyl-inosine (m¹I), wyosine (imG), methylwyosine (mimG), 4-demethyl-wyosine (imG-14), isowyosine (imG2), wybutosine (yW), peroxywybutosine (o₂yW), hydroxywybutosine (OHyW), undermodified

hydroxywybutosine (OHyW*), 7-deaza-guanosine, queuosine (Q), epoxyqueuosine (oQ), galactosyl-queuosine (galQ), mannosyl-queuosine (manQ), 7-cyano-7-deaza-guanosine (preQ₀), 7-aminomethyl-7-deaza-guanosine (preQi), archaeosine (G⁺), 7-deaza-8-aza-guanosine, 6-thio-guanosine, 6-thio-7-deaza-guanosine, 6-thio-7-deaza-8-aza-guanosine, 7-methyl-guanosine (m⁷G), 6-thio-7-methyl-guanosine, 7-methyl-inosine, 6-methoxy-guanosine, 1-methyl-guanosine (m¹G), N2-methyl-guanosine (m²G), N2,N2-dimethyl-guanosine (m²₂G), N2,7-dimethyl-guanosine (m^{2,7}G), N2, N2,7-dimethyl-guanosine (m^{2,2,7}G), 8-oxo-guanosine, 7-methyl-8-oxo-guanosine, 1-methyl-6-thio-guanosine, N2-methyl-6-thio-guanosine, N2,N2-dimethyl-6-thio-guanosine, a-thio-guanosine, 2'-0-methyl-guanosine (Gm), N2-methyl-2'-0-methyl-guanosine (m²Gm), N2,N2-dimethyl-2'-0-methyl-guanosine (m²₂Gm), 1-methyl-2'-0-methyl-guanosine (WGm), N2,7-dimethyl-2'-0-methyl-guanosine (m^{2,7}Gm), 2'-0-methyl-inosine (Im), 1,2'-0-dimethyl-inosine (m[^]m), 2'-0-ribosylguanosine (phosphate) (Gr(p)), 1-thio-guanosine, 06-methyl-guanosine, 2'-F-ara-guanosine, and 2'-F-guanosine.

[00288] The nucleobase of the nucleotide can be independently selected from a purine, a pyrimidine, a purine or pyrimidine analog. For example, the nucleobase can each be independently selected from adenine, cytosine, guanine, uracil, or hypoxanthine. In another embodiment, the nucleobase can also include, for example, naturally-occurring and synthetic derivatives of a base, including pyrazolo[3,4-d]pyrimidines, 5-methylcytosine (5-me-C), 5-hydroxymethyl cytosine, xanthine, hypoxanthine, 2-aminoadenine, 6-methyl and other alkyl derivatives of adenine and guanine, 2-propyl and other alkyl derivatives of adenine and guanine, 2-thiouracil, 2-thiothymine and 2-thiocytosine, 5-propynyl uracil and cytosine, 6-azo uracil, cytosine and thymine, 5-uracil (pseudouracil), 4-thiouracil, 8-halo (*e.g.*, 8-bromo), 8-amino, 8-thiol, 8-thioalkyl, 8-hydroxyl and other 8-substituted adenines and guanines, 5-halo particularly 5-bromo, 5-trifluoromethyl and other 5-substituted uracils and cytosines, 7-methylguanine and 7-methyladenine, 8-azaguanine and 8-azaadenine, deazaguanine, 7-deazaguanine, 3-deazaguanine, deazaadenine, 7-deazaadenine, 3-deazaadenine, pyrazolo[3,4-d]pyrimidine, imidazo[1,5-a]l,3,5 triazinones, 9-deazapurines, imidazo[4,5-d]pyrazines, thiazolo[4,5-d]pyrimidines, pyrazin-2-ones, 1,2,4-triazine, pyridazine; and 1,3,5 triazine. When the nucleotides are depicted using the shorthand A, G, C, T or U, each letter refers to the representative base and/or derivatives thereof, *e.g.*, A includes adenine or adenine analogs, *e.g.*, 7-deaza adenine).

Modifications on the Internucleoside Linkage

[00289] The modified nucleosides and nucleotides, which may be incorporated into a modified nucleic acid or mmRNA molecule, can be modified on the internucleoside linkage (e.g., phosphate backbone). The phosphate groups of the backbone can be modified by replacing one or more of the oxygen atoms with a different substituent. Further, the modified nucleosides and nucleotides can include the wholesale replacement of an unmodified phosphate moiety with a modified phosphate as described herein. Examples of modified phosphate groups include, but are not limited to, phosphorothioate, phosphoroselenates, boranophosphates, boranophosphate esters, hydrogen phosphonates, phosphoramidates, phosphorodiamidates, alkyl or aryl phosphonates, and phosphotriesters. Phosphorodithioates have both non-linking oxygens replaced by sulfur. The phosphate linker can also be modified by the replacement of a linking oxygen with nitrogen (bridged phosphoramidates), sulfur (bridged phosphorothioates), and carbon (bridged methylene-phosphonates).

[00290] The α -thio substituted phosphate moiety is provided to confer stability to RNA and DNA polymers through the unnatural phosphorothioate backbone linkages. Phosphorothioate DNA and RNA have increased nuclease resistance and subsequently a longer half-life in a cellular environment. Phosphorothioate linked modified nucleic acids or mmRNA molecules are expected to also reduce the innate immune response through weaker binding/activation of cellular innate immune molecules.

[00291] In specific embodiments, a modified nucleoside includes an α -thio-nucleoside (e.g., 5'-0-(1-thiophosphate)-adenosine, 5'-0-(1-thiophosphate)-cytidine (α -thio-cytidine), 5'-0-(1-thiophosphate)-guanosine, 5'-0-(1-thiophosphate)-uridine, or 5'-0-(1-thiophosphate)-pseudouridine).

Combinations of Modified Sugars, Nucleobases, and Internucleoside Linkages

[00292] The modified nucleic acids and mmRNA of the invention can include a combination of modifications to the sugar, the nucleobase, and/or the internucleoside linkage. These combinations can include any one or more modifications described herein. For examples, any of the nucleotides described herein in Formulas (Ia), (Ia-1)-(Ia-3), (Ib)-(If), (IIa)-(IIp), (IIb-1), (IIb-2), (IIc-1)-(IIc-2), (IIn-1), (IIn-2), (IVa)-(IVf), and (IXa)-(IXr) can be combined with any of the nucleobases described herein (e.g., in Formulas (b1)-(b43) or any other described herein).

Synthesis of Modified Nucleic Acids and mmRNA Molecules

[00293] The modified nucleic acid and mmRNA molecules for use in accordance with the invention may be prepared according to any useful technique, as described herein. The modified nucleosides and nucleotides used in the synthesis of modified nucleic acid and mmRNA molecules disclosed herein can be prepared from readily available starting materials using the following general methods and procedures. Where typical or preferred process conditions (e.g., reaction temperatures, times, mole ratios of reactants, solvents, pressures, etc.) are provided, a skilled artisan would be able to optimize and develop additional process conditions. Optimum reaction conditions may vary with the particular reactants or solvent used, but such conditions can be determined by one skilled in the art by routine optimization procedures.

[00294] The processes described herein can be monitored according to any suitable method known in the art. For example, product formation can be monitored by spectroscopic means, such as nuclear magnetic resonance spectroscopy (e.g., ^1H or ^{13}C) infrared spectroscopy, spectrophotometry (e.g., UV-visible), or mass spectrometry, or by chromatography such as high performance liquid chromatography (HPLC) or thin layer chromatography.

[00295] Preparation of modified nucleic acid and mmRNA molecules of the present invention can involve the protection and deprotection of various chemical groups. The need for protection and deprotection, and the selection of appropriate protecting groups can be readily determined by one skilled in the art. The chemistry of protecting groups can be found, for example, in Greene, et al., *Protective Groups in Organic Synthesis*, 2d. Ed., Wiley & Sons, 1991, which is incorporated herein by reference in its entirety.

[00296] The reactions of the processes described herein can be carried out in suitable solvents, which can be readily selected by one of skill in the art of organic synthesis. Suitable solvents can be substantially nonreactive with the starting materials (reactants), the intermediates, or products at the temperatures at which the reactions are carried out, i.e., temperatures which can range from the solvent's freezing temperature to the solvent's boiling temperature. A given reaction can be carried out in one solvent or a mixture of more than one solvent. Depending on the particular reaction step, suitable solvents for a particular reaction step can be selected.

[00297] Resolution of racemic mixtures of modified nucleosides and nucleotides can be carried out by any of numerous methods known in the art. An example method includes fractional recrystallization using a "chiral resolving acid" which is an optically active, salt-forming organic acid. Suitable resolving agents for fractional recrystallization methods are, for example, optically

active acids, such as the D and L forms of tartaric acid, diacetyltartaric acid, dibenzoyltartaric acid, mandelic acid, malic acid, lactic acid or the various optically active camphorsulfonic acids.

Resolution of racemic mixtures can also be carried out by elution on a column packed with an optically active resolving agent (*e.g.*, dinitrobenzoylphenylglycine). Suitable elution solvent composition can be determined by one skilled in the art.

[00298] Modified nucleosides and nucleotides (*e.g.*, binding block molecules) can be prepared according to the synthetic methods described in Ogata et al, *J. Org. Chem.* 74:2585-2588 (2009); Purnal et al, *Nucl. Acids Res.* 22(1): 72-78, (1994); Fukuhara et al, *Biochemistry*, 1(4): 563-568 (1962); and Xu et al, *Tetrahedron*, 48(9): 1729-1740 (1992), each of which are incorporated by reference in their entirety.

[00299] The modified nucleic acid and mmRNA of the invention need not be uniformly modified along the entire length of the molecule. For example, one or more or all types of nucleotide (*e.g.*, purine or pyrimidine, or any one or more or all of A, G, U, C) may or may not be uniformly modified in a polynucleotide of the invention, or in a given predetermined sequence region thereof. In some embodiments, all nucleotides X in a polynucleotide of the invention (or in a given sequence region thereof) are modified, wherein X may any one of nucleotides A, G, U, C, or any one of the combinations A+G, A+U, A+C, G+U, G+C, U+C, A+G+U, A+G+C, G+U+C or A+G+C

[00300] Different sugar modifications, nucleotide modifications, and/or internucleoside linkages (*e.g.*, backbone structures) may exist at various positions in the modified nucleic acid or mmRNA. One of ordinary skill in the art will appreciate that the nucleotide analogs or other modification(s) may be located at any position(s) of a modified nucleic acid or mmRNA such that the function of the modified nucleic acid or mmRNA is not substantially decreased. A modification may also be a 5' or 3' terminal modification. The modified nucleic acid or mmRNA may contain from about 1% to about 100% modified nucleotides, or any intervening percentage (*e.g.*, from 1% to 20%, from 1% to 25%, from 1% to 50%, from 1% to 60%, from 1% to 70%, from 1% to 80%, from 1% to 90%, from 1% to 95%, from 10% to 20%, from 10% to 25%, from 10% to 50%, from 10% to 60%, from 10% to 70%, from 10% to 80%, from 10% to 90%, from 10% to 95%, from 10% to 100%, from 20% to 25%, from 20% to 50%, from 20% to 60%, from 20% to 70%, from 20% to 80%, from 20% to 90%, from 20% to 95%, from 20% to 100%, from 50% to 60%, from 50% to 70%, from 50% to 80%, from 50% to 90%, from 50% to 95%, from 50% to 100%, from 70% to 80%, from 70% to 90%,

from 70% to 95%, from 70% to 100%, from 80% to 90%, from 80% to 95%, from 80% to 100%, from 90% to 95%, from 90% to 100%, and from 95% to 100%).

[00301] In some embodiments, the modified nucleic acid or mmRNA includes a modified pyrimidine (e.g., a modified uracil/uridine or modified cytosine/cytidine). In some embodiments, the uracil or uridine in the modified nucleic acid or mmRNA molecule may be replaced with from about 1% to about 100% of a modified uracil or modified uridine (e.g., from 1% to 20%, from 1% to 25%, from 1% to 50%, from 1% to 60%, from 1% to 70%, from 1% to 80%, from 1% to 90%, from 1% to 95%, from 10% to 20%, from 10% to 25%, from 10% to 50%, from 10% to 60%, from 10% to 70%, from 10% to 80%, from 10% to 90%, from 10% to 95%, from 10% to 100%, from 20% to 25%, from 20% to 50%, from 20% to 60%, from 20% to 70%, from 20% to 80%, from 20% to 90%, from 20% to 95%, from 20% to 100%, from 50% to 60%, from 50% to 70%, from 50% to 80%, from 50% to 90%, from 50% to 95%, from 50% to 100%, from 70% to 80%, from 70% to 90%, from 70% to 95%, from 70% to 100%, from 80% to 90%, from 80% to 95%, from 80% to 100%, from 90% to 95%, from 90% to 100%, and from 95% to 100% of a modified uracil or modified uridine). The modified uracil or uridine can be replaced by a compound having a single unique structure or by a plurality of compounds having different structures (e.g., 2, 3, 4 or more unique structures, as described herein). In some embodiments, the cytosine or cytidine in the modified nucleic acid or mmRNA molecule may be replaced with from about 1% to about 100% of a modified cytosine or modified cytidine (e.g., from 1% to 20%, from 1% to 25%, from 1% to 50%, from 1% to 60%, from 1% to 70%, from 1% to 80%, from 1% to 90%, from 1% to 95%, from 10% to 20%, from 10% to 25%, from 10% to 50%, from 10% to 60%, from 10% to 70%, from 10% to 80%, from 10% to 90%, from 10% to 95%, from 10% to 100%, from 20% to 25%, from 20% to 50%, from 20% to 60%, from 20% to 70%, from 20% to 80%, from 20% to 90%, from 20% to 95%, from 20% to 100%, from 50% to 60%, from 50% to 70%, from 50% to 80%, from 50% to 90%, from 50% to 95%, from 50% to 100%, from 70% to 80%, from 70% to 90%, from 70% to 95%, from 70% to 100%, from 80% to 90%, from 80% to 95%, from 80% to 100%, from 90% to 95%, from 90% to 100%, and from 95% to 100% of a modified cytosine or modified cytidine). The modified cytosine or cytidine can be replaced by a compound having a single unique structure or by a plurality of compounds having different structures (e.g., 2, 3, 4 or more unique structures, as described herein).

[00302] In some embodiments, the present disclosure provides methods of synthesizing a modified nucleic acid or mmRNA including n number of linked nucleosides having Formula (Ia-1):

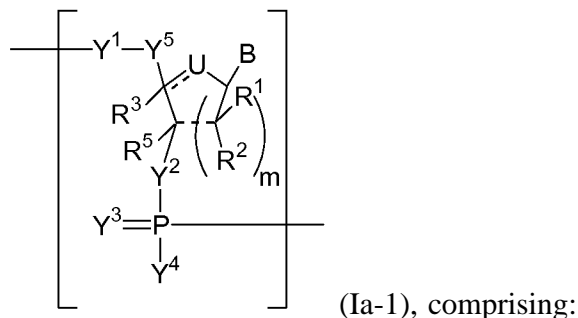

[00303] a) reacting a nucleotide of Formula (IV-1):

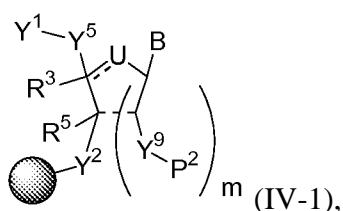

[00304] with a phosphoramidite compound of Formula (V-1):

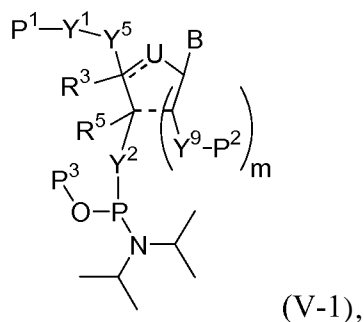

[00305] wherein Y⁹ is H, hydroxy, phosphoryl, pyrophosphate, sulfate, amino, thiol, optionally substituted amino acid, or a peptide (e.g., including from 2 to 12 amino acids); and each P¹, P², and P³ is, independently, a suitable protecting group; and denotes a solid support;

[00306] to provide a modified nucleic acid or mmRNA of Formula (VI-1):

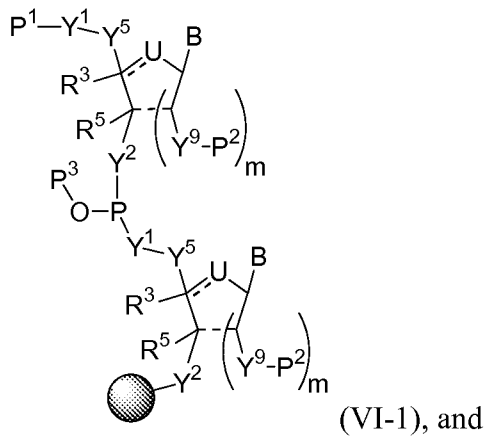

[00307] b) oxidizing or sulfurizing the modified nucleic acid or mmRNA of Formula (V) to yield a modified nucleic acid or mmRNA of Formula (VII-1):

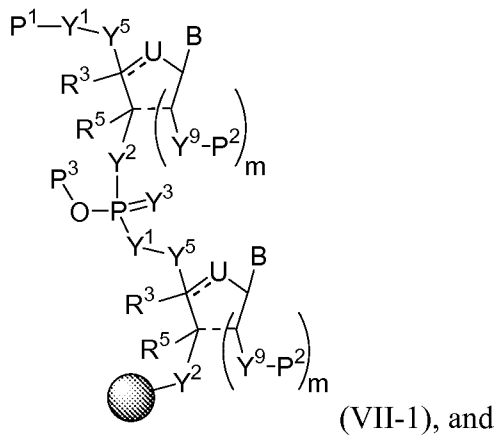

[00308] c) removing the protecting groups to yield the modified nucleic acid or mmRNA of Formula (Ia).

[00309] In some embodiments, steps a) and b) are repeated from 1 to about 10,000 times. In some embodiments, the methods further comprise a nucleotide (e.g., building block molecule) selected from the group consisting of adenosine, cytosine, guanosine, and uracil. In some embodiments, the nucleobase may be a pyrimidine or derivative thereof. In some embodiments, the modified nucleic acid or mmRNA is translatable.

[00310] Other components of modified nucleic acids and mmRNA are optional, and are beneficial in some embodiments. For example, a 5' untranslated region (UTR) and/or a 3'UTR are provided, wherein either or both may independently contain one or more different nucleoside modifications. In such embodiments, nucleoside modifications may also be present in the translatable region. Also provided are modified nucleic acids and mmRNA containing a Kozak sequence.

[00311] Exemplary syntheses of modified nucleotides, which are incorporated into a modified nucleic acid or mmRNA, e.g., RNA or mRNA, are provided below in Scheme 1 through Scheme 11. Scheme 1 provides a general method for phosphorylation of nucleosides, including modified nucleosides.

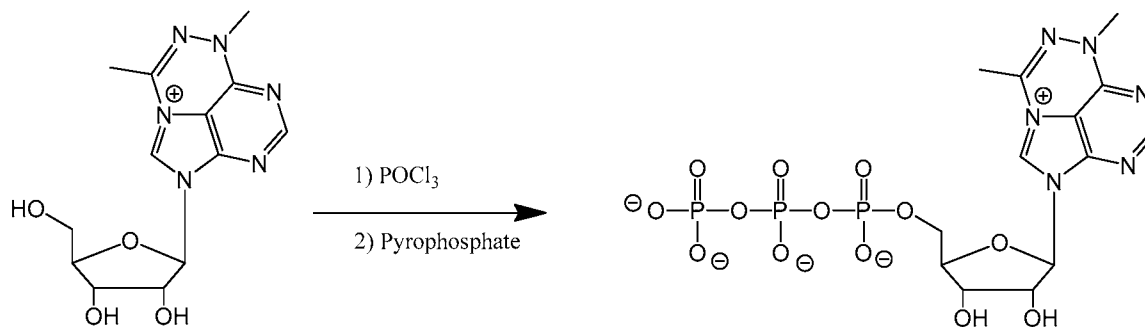
Scheme 1

[00312] Various protecting groups may be used to control the reaction. For example, Scheme 2 provides the use of multiple protecting and deprotecting steps to promote phosphorylation at the 5' position of the sugar, rather than the 2' and 3' hydroxyl groups.

Scheme 2

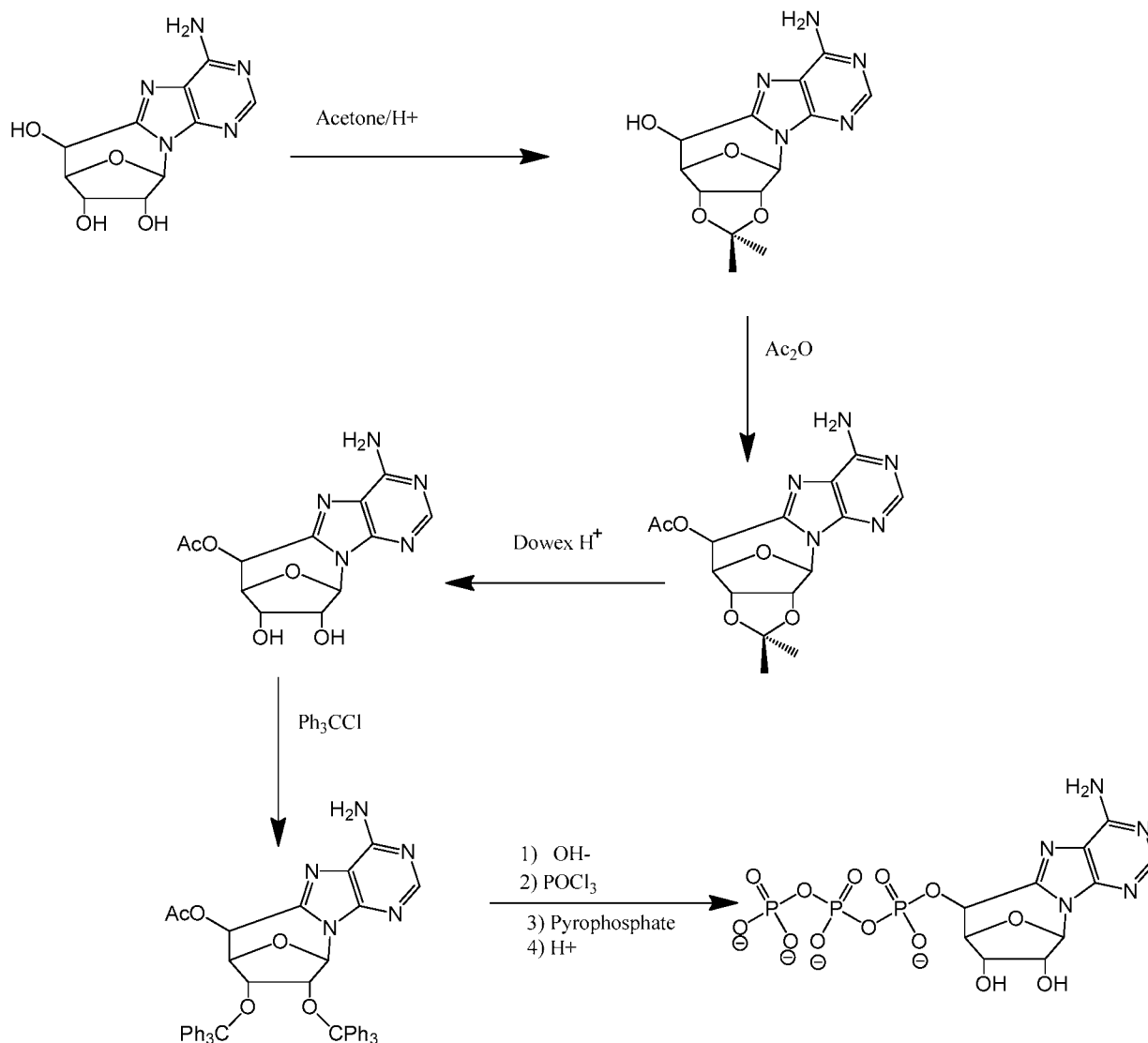

[00313] Modified nucleotides can be synthesized in any useful manner. Schemes 3, 4, and 7 provide exemplary methods for synthesizing modified nucleotides having a modified purine nucleobase; and Schemes 5 and 6 provide exemplary methods for synthesizing modified nucleotides having a modified pseudouridine or pseudoisocytidine, respectively.

Scheme 3

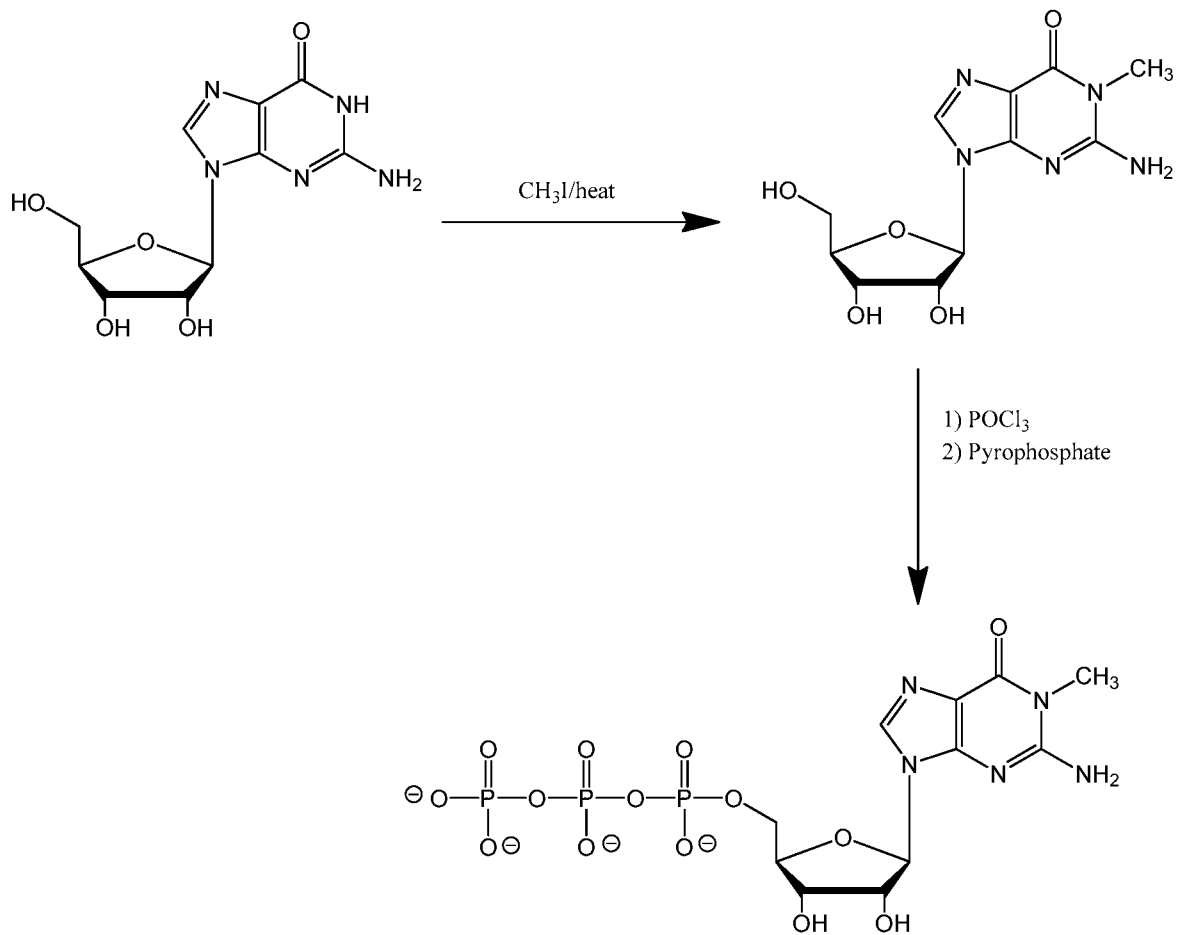

Scheme 4

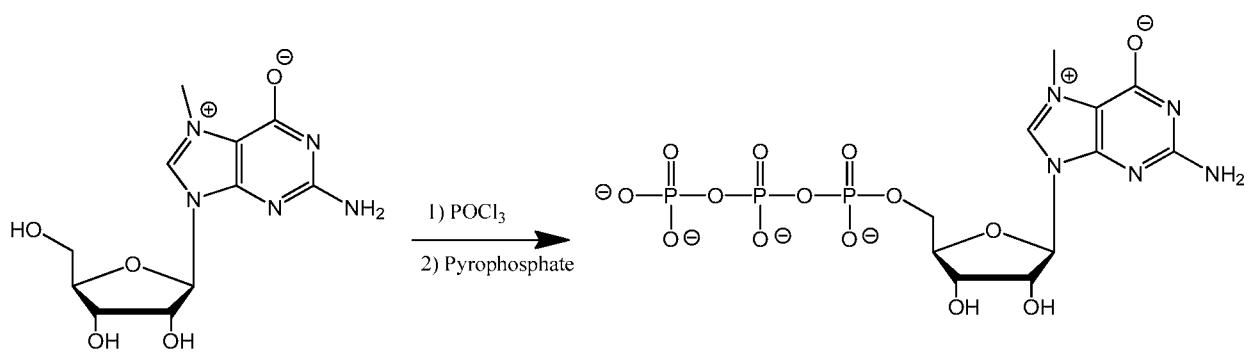

Scheme 5

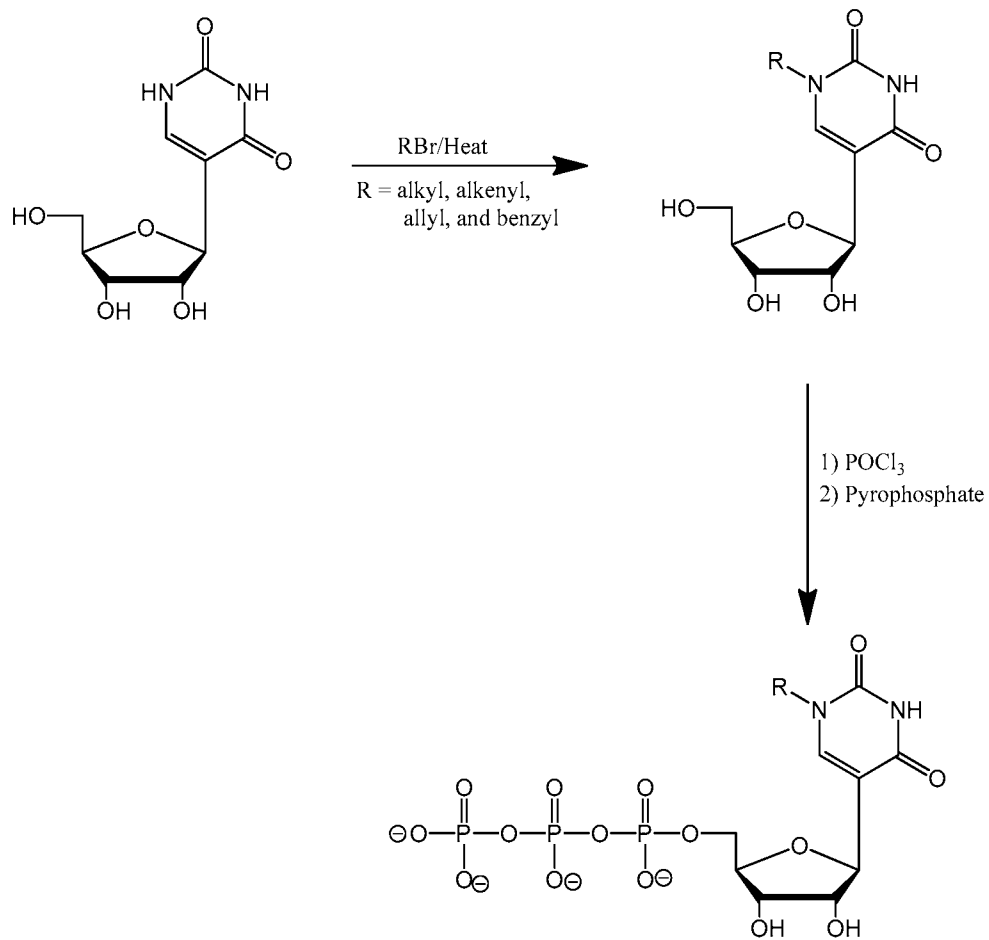

Scheme 6

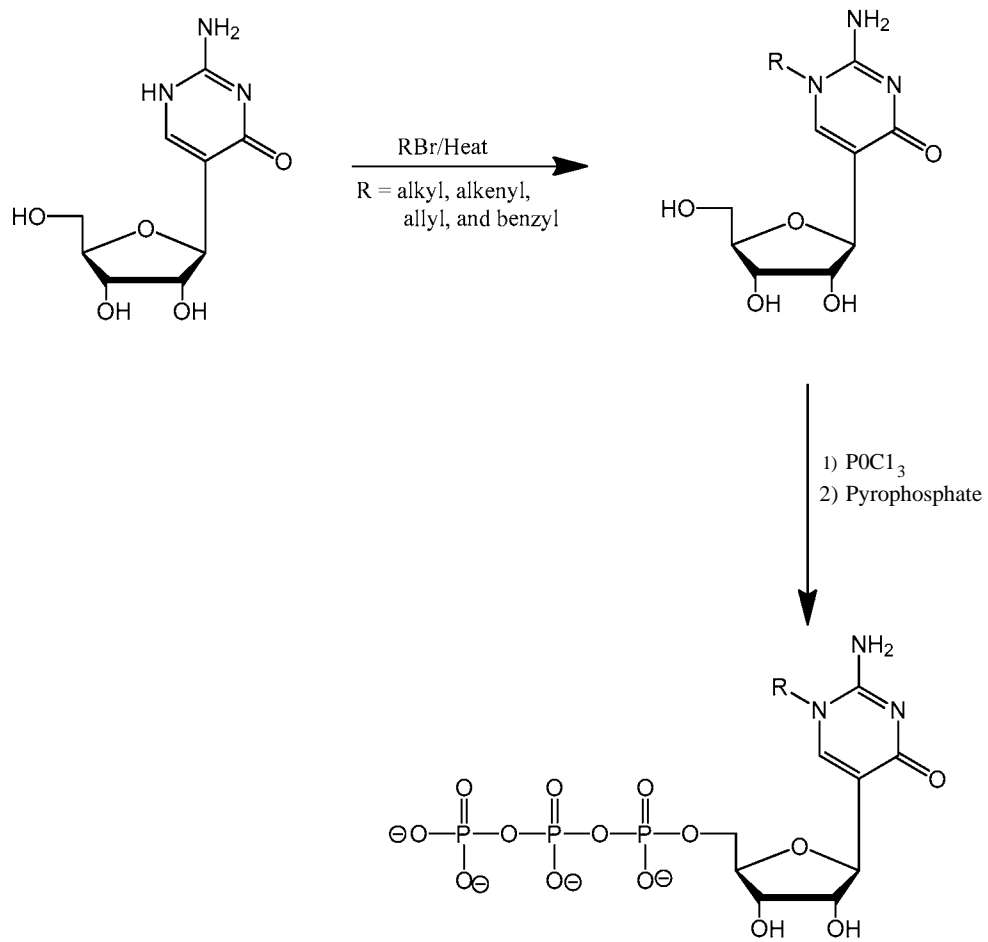

Scheme 7

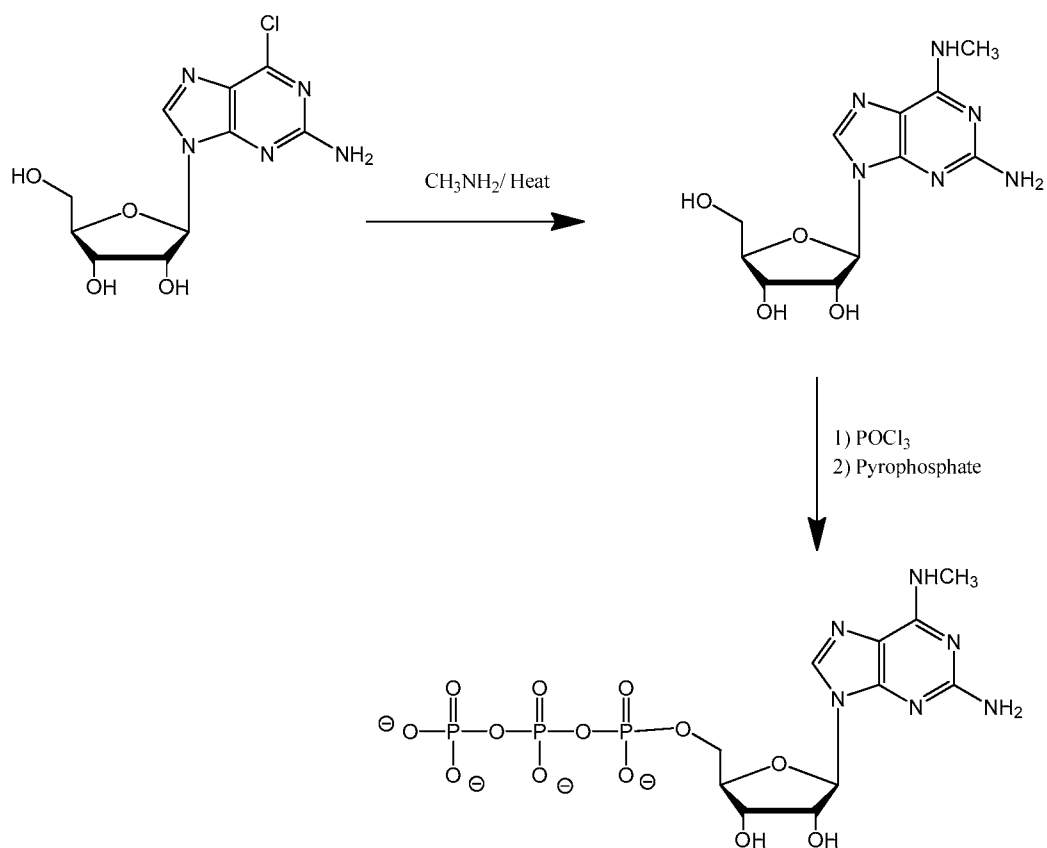

[00314] Schemes 8 and 9 provide exemplary syntheses of modified nucleotides. Scheme 10 provides a non-limiting biocatalytic method for producing nucleotides.

Scheme 8

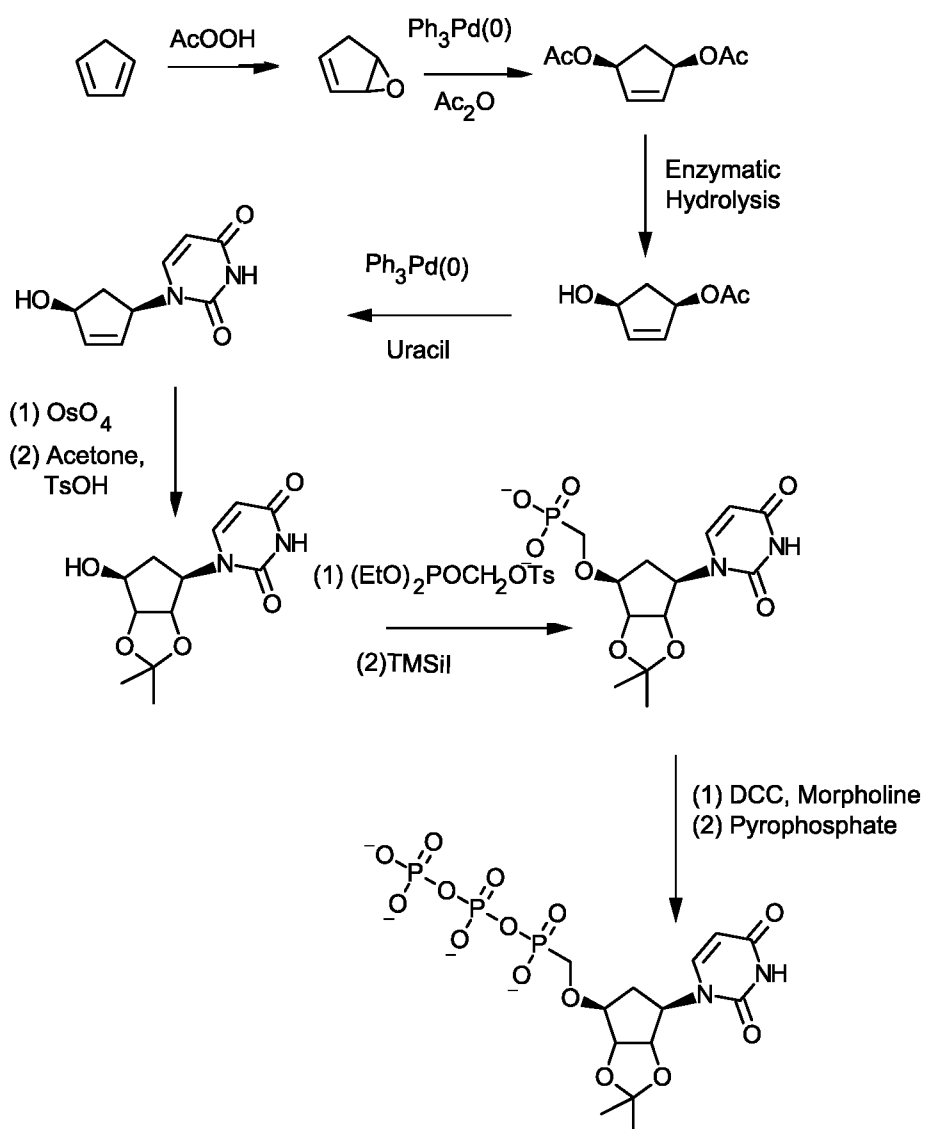

Scheme 9

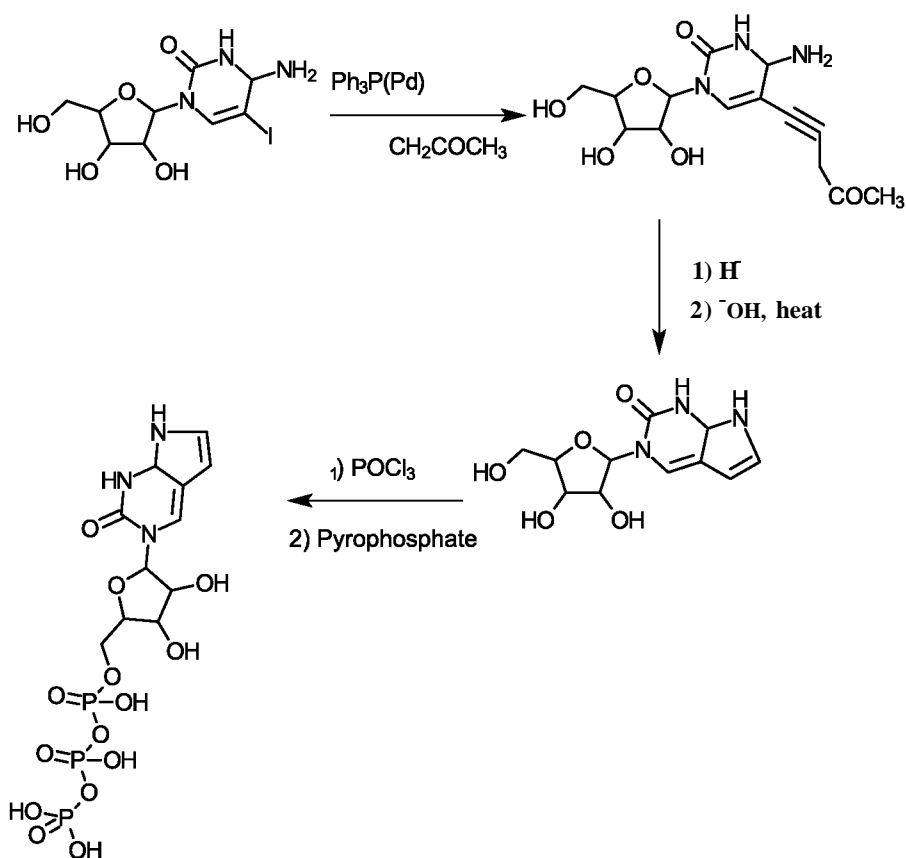

Scheme 10

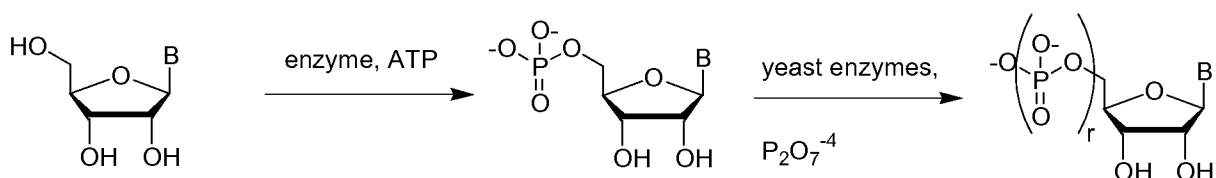

[00315] Scheme 11 provides an exemplary synthesis of a modified uracil, where the N1 position is modified with R^{12b} , as provided elsewhere, and the 5'-position of ribose is phosphorylated. T^1 , T^2 , R^{12a} , R^{12b} , and r are as provided herein. This synthesis, as well as optimized versions thereof, can be used to modify other pyrimidine nucleobases and purine nucleobases (see e.g., Formulas (b1)-(b43)) and/or to install one or more phosphate groups (e.g., at the 5' position of the sugar). This alkylating reaction can also be used to include one or more optionally substituted alkyl group at any reactive group (e.g., amino group) in any nucleobase described herein (e.g., the amino groups in the Watson-Crick base-pairing face for cytosine, uracil, adenine, and guanine).

Scheme 11

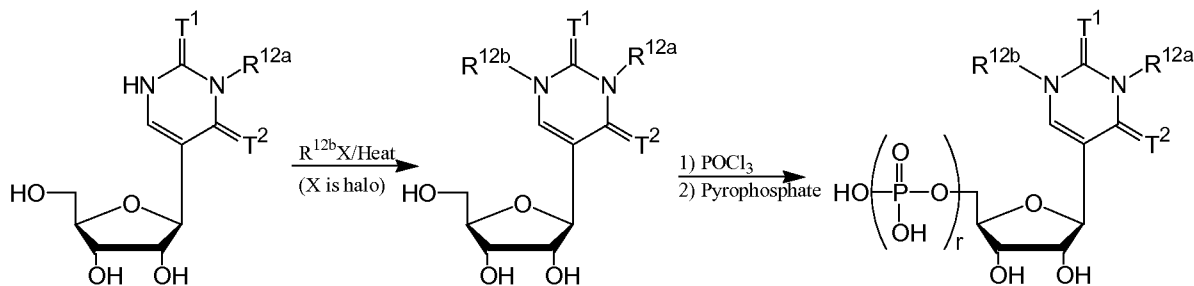

Combinations of Nucleotides in mmRNA

[00316] Further examples of modified nucleotides and modified nucleotide combinations are provided below in Table 2. These combinations of modified nucleotides can be used to form the modified nucleic acids or mmRNA of the invention. Unless otherwise noted, the modified nucleotides may be completely substituted for the natural nucleotides of the modified nucleic acids or mmRNA of the invention. As a non-limiting example, the natural nucleotide uridine may be substituted with a modified nucleoside described herein. In another non-limiting example, the natural nucleotide uridine may be partially substituted (e.g., about 0.1%, 1%, 5%, 10%>, 15%, 20%>, 25%, 30%, 35%, 40%, 45%, 50%, 55%, 60%, 65%, 70%, 75%, 80%, 85%, 90%, 95% or 99.9%) with at least one of the modified nucleoside disclosed herein.

Table 2

<u>Modified Nucleotide</u>	<u>Modified Nucleotide Combination</u>
α -thio-cytidine	α -thio-cytidine/5-iodo-uridine
	α -thio-cytidine/N1-methyl-pseudo-uridine
	α -thio-cytidine/ α -thio-uridine
	α -thio-cytidine/5-methyl-uridine
	α -thio-cytidine/pseudo-uridine
	about 50% of the cytosines are α -thio-cytidine
pseudoisocytidine	pseudoisocytidine/5-iodo-uridine
	pseudoisocytidine/N1-methyl-pseudouridine
	pseudoisocytidine/ α -thio-uridine
	pseudoisocytidine/5-methyl-uridine
	pseudoisocytidine/pseudouridine
	about 25% of cytosines are pseudoisocytidine
	pseudoisocytidine/about 50% of uridines are N1-methyl-pseudouridine and about 50% of uridines are pseudouridine
pseudoisocytidine/about 25% of uridines are N1-methyl-pseudouridine and about 25% of uridines are pseudouridine	
pyrrolo-cytidine	pyrrolo-cytidine/5-iodo-uridine
	pyrrolo-cytidine/N1-methyl-pseudouridine
	pyrrolo-cytidine/ α -thio-uridine
	pyrrolo-cytidine/5-methyl-uridine

	pyrrolo-cytidine/pseudouridine
	about 50% of the cytosines are pyrrolo-cytidine
5-methyl-cytidine	5-methyl-cytidine/ 5-iodo-uridine
	5-methyl-cytidine/N 1-methyl-pseudouridine
	5-methyl-cytidine/a-thio-uridine
	5-methyl-cytidine/ 5-methyl-uridine
	5-methyl-cytidine/pseudouridine
	about 25% of cytosines are 5-methyl-cytidine
	about 50% of cytosines are 5-methyl-cytidine
	5-methyl-cytidine/ 5-methoxy-uridine
	5-methyl-cytidine/5-bromo-uridine
	5-methyl-cytidine/2-thio-uridine
	5-methyl-cytidine/about 50% of uridines are 2-thio-uridine
	about 50% of uridines are 5-methyl-cytidine/ about 50% of uridines are 2-thio-uridine
N4-acetyl-cytidine	N4-acetyl-cytidine /5-iodo-uridine
	N4-acetyl-cytidine /N 1-methyl-pseudouridine
	N4-acetyl-cytidine /a-thio-uridine
	N4-acetyl-cytidine /5-methyl-uridine
	N4-acetyl-cytidine /pseudouridine
	about 50% of cytosines are N4-acetyl-cytidine
	about 25% of cytosines are N4-acetyl-cytidine
	N4-acetyl-cytidine /5-methoxy-uridine
	N4-acetyl-cytidine /5-bromo-uridine
	N4-acetyl-cytidine /2-thio-uridine
	about 50% of cytosines are N4-acetyl-cytidine/ about 50% of uridines are 2-thio-uridine

[00317] Further examples of modified nucleotide combinations are provided below in Table 3. These combinations of modified nucleotides can be used to form the modified nucleic acid molecules or mmRNA of the invention.

Table 3

<u>Modified Nucleotide</u>	<u>Modified Nucleotide Combination</u>
modified cytidine having one or more nucleobases of Formula (b10)	modified cytidine with (b10)/pseudouridine
	modified cytidine with (b10)/N1-methyl-pseudouridine
	modified cytidine with (b10)/5-methoxy-uridine
	modified cytidine with (b10)/5-methyl-uridine
	modified cytidine with (b10)/5-bromo-uridine
	modified cytidine with (b10)/2-thio-uridine
	about 50% of cytidine substituted with modified cytidine (b10)/ about 50% of uridines are 2-thio-uridine
modified cytidine having one or more nucleobases of Formula (b32)	modified cytidine with (b32)/pseudouridine
	modified cytidine with (b32)/N1-methyl-pseudouridine
	modified cytidine with (b32)/5-methoxy-uridine
	modified cytidine with (b32)/5-methyl-uridine
	modified cytidine with (b32)/5-bromo-uridine

	modified cytidine with (b32)/2-thio-uridine
	about 50% of cytidine substituted with modified cytidine (b32)/ about 50% of uridines are 2-thio-uridine
modified uridine having one or more nucleobases of Formula (b1)	modified uridine with (b1)/ N4-acetyl-cytidine
	modified uridine with (b1)/ 5-methyl-cytidine
modified uridine having one or more nucleobases of Formula (b8)	modified uridine with (b8)/ N4-acetyl-cytidine
	modified uridine with (b8)/ 5-methyl-cytidine
modified uridine having one or more nucleobases of Formula (b28)	modified uridine with (b28)/ N4-acetyl-cytidine
	modified uridine with (b28)/ 5-methyl-cytidine
modified uridine having one or more nucleobases of Formula (b29)	modified uridine with (b29)/ N4-acetyl-cytidine
	modified uridine with (b29)/ 5-methyl-cytidine
modified uridine having one or more nucleobases of Formula (b30)	modified uridine with (b30)/ N4-acetyl-cytidine
	modified uridine with (b30)/ 5-methyl-cytidine

[00318] In some embodiments, at least 25% of the cytosines are replaced by a compound of Formula (b10)-(M4) (e.g., at least about 30%>, at least about 35%>, at least about 40%>, at least about 45%>, at least about 50%>, at least about 55%>, at least about 60%>, at least about 65%>, at least about 70%>, at least about 75%>, at least about 80%>, at least about 85%>, at least about 90%>, at least about 95%, or about 100%).

[00319] In some embodiments, at least 25% of the uracils are replaced by a compound of Formula (b1)-(b9) (e.g., at least about 30%>, at least about 35%>, at least about 40%>, at least about 45%>, at least about 50%>, at least about 55%>, at least about 60%>, at least about 65%>, at least about 70%>, at least about 75%>, at least about 80%>, at least about 85%>, at least about 90%>, at least about 95%>, or about 100%).

[00320] In some embodiments, at least 25%> of the cytosines are replaced by a compound of Formula (b10)-(b14), and at least 25% of the uracils are replaced by a compound of Formula (b1)-(b9) (e.g., at least about 30%>, at least about 35%>, at least about 40%>, at least about 45%>, at least about 50%>, at least about 55%>, at least about 60%>, at least about 65%>, at least about 70%>, at least about 75%>, at least about 80%>, at least about 85%>, at least about 90%>, at least about 95%>, or about 100%).

Synthesis of Modified Nucleic Acid Molecules

[00321] Modified nucleic acid molecules for use in accordance with the present disclosure may be prepared according to any available technique including, but not limited to, *in vitro* transcription such as chemical synthesis and enzymatic synthesis, or enzymatic and chemical cleavage of a longer precursor, *etc.* Methods of synthesizing RNA are known in the art (see, *e.g.*, Gait, M.J. (ed.) *Oligonucleotide synthesis: a practical approach*, Oxford [Oxfordshire], Washington, DC: IRL Press, 1984; and Herdewijn, P. (ed.) *Oligonucleotide synthesis: methods and applications*, Methods in Molecular Biology, v. 288 (Clifton, N.J.) Totowa, N.J.: Humana Press, 2005; both of which are incorporated herein by reference).

[00322] The modified nucleic acid molecules disclosed herein can be prepared from readily available starting materials using the following general methods and procedures. It is understood that where typical or preferred process conditions (*i.e.*, reaction temperatures, times, mole ratios of reactants, solvents, pressures, etc.) are given other process conditions can also be used unless otherwise stated. Optimum reaction conditions may vary with the particular reactants or solvent used, but such conditions can be determined by one skilled in the art by routine optimization procedures.

[00323] The processes described herein can be monitored according to any suitable method known in the art. For example, product formation can be monitored by spectroscopic means, such as nuclear magnetic resonance spectroscopy (*e.g.*, ^1H or ^{13}C) infrared spectroscopy, spectrophotometry (*e.g.*, UV-visible), mass spectrometry, or by chromatography such as high performance liquid chromatography (HPLC) or thin layer chromatography.

[00324] Preparation of modified nucleic acid molecules can involve the protection and deprotection of various chemical groups. The need for protection and deprotection, and the selection of appropriate protecting groups can be readily determined by one skilled in the art. The chemistry of protecting groups can be found, for example, in Greene, et al, *Protective Groups in Organic Synthesis*, 2d. Ed., Wiley & Sons, 1991, which is incorporated herein by reference in its entirety.

[00325] The reactions of the processes described herein can be carried out in suitable solvents, which can be readily selected by one of skill in the art of organic synthesis. Suitable solvents can be substantially nonreactive with the starting materials (reactants), the intermediates, or products at the temperatures at which the reactions are carried out, *i.e.*, temperatures which can range from the solvent's freezing temperature to the solvent's boiling temperature. A given reaction can be carried

out in one solvent or a mixture of more than one solvent. Depending on the particular reaction step, suitable solvents for a particular reaction step can be selected.

[00326] Resolution of racemic mixtures of modified nucleic acid molecules can be carried out by any of numerous methods known in the art. An example method includes, but is not limited to, fractional recrystallization using a "chiral resolving acid" which is an optically active, salt-forming organic acid. Suitable resolving agents for fractional recrystallization methods are, for example, optically active acids, such as the D and L forms of tartaric acid, diacetyltartaric acid, dibenzoyltartaric acid, mandelic acid, malic acid, lactic acid or the various optically active camphorsulfonic acids. Resolution of racemic mixtures can also be carried out by elution on a column packed with an optically active resolving agent (*e.g.*, dinitrobenzoylphenylglycine). Suitable elution solvent composition can be determined by one skilled in the art.

[00327] Modified nucleic acid molecules need not be uniformly modified along the entire length of the molecule. Different nucleic acid modifications and/or backbone structures may exist at various positions in the nucleic acid. One of ordinary skill in the art will appreciate that the nucleotide analogs or other modification(s) may be located at any position(s) of a nucleic acid such that the function of the nucleic acid is not substantially decreased. A modification may also be a 5' or 3' terminal modification. The nucleic acids may contain at a minimum one modified nucleotide and at maximum 100% modified nucleotides, or any intervening percentage, such as at least 5% modified nucleotides, at least 10% modified nucleotides, at least 25% modified nucleotides, at least 50% modified nucleotides, at least 80% modified nucleotides, or at least 90% modified nucleotides. For example, the nucleic acids may contain a modified pyrimidine such as uracil or cytosine. In some embodiments, at least 5%, at least 10%, at least 25%, at least 50%, at least 80%, at least 90% or 100% of the uracil in the nucleic acid may be replaced with a modified uracil. The modified uracil can be replaced by a compound having a single unique structure, or can be replaced by a plurality of compounds having different structures (*e.g.*, 2, 3, 4 or more unique structures). In some embodiments, at least 5%, at least 10%, at least 25%, at least 50%, at least 80%, at least 90% or 100% of the cytosine in the nucleic acid may be replaced with a modified cytosine. The modified cytosine can be replaced by a compound having a single unique structure, or can be replaced by a plurality of compounds having different structures (*e.g.*, 2, 3, 4 or more unique structures).

[00328] Generally, the shortest length of a modified mRNA, herein "mmRNA," of the present disclosure can be the length of an mRNA sequence that may be sufficient to encode for a dipeptide.

In another embodiment, the length of the mRNA sequence may be sufficient to encode for a tripeptide. In another embodiment, the length of an mRNA sequence may be sufficient to encode for a tetrapeptide. In another embodiment, the length of an mRNA sequence may be sufficient to encode for a pentapeptide. In another embodiment, the length of an mRNA sequence may be sufficient to encode for a hexapeptide. In another embodiment, the length of an mRNA sequence may be sufficient to encode for a heptapeptide. In another embodiment, the length of an mRNA sequence may be sufficient to encode for an octapeptide. In another embodiment, the length of an mRNA sequence may be sufficient to encode for a nonapeptide. In another embodiment, the length of an mRNA sequence may be sufficient to encode for a decapeptide.

[00329] Examples of dipeptides that the modified nucleic acid molecule sequences can encode for include, but are not limited to, carnosine and anserine.

[00330] In a further embodiment, the mRNA may be greater than 30 nucleotides in length. In another embodiment, the RNA molecule may be greater than 35 nucleotides in length (e.g., at least or greater than about 35, 40, 45, 50, 55, 60, 70, 80, 90, 100, 120, 140, 160, 180, 200, 250, 300, 350, 400, 450, 500, 600, 700, 800, 900, 1,000, 1,100, 1,200, 1,300, 1,400, 1,500, 1,600, 1,700, 1,800, 1,900, 2,000, 2,500, 3,000, 4,000 and 5,000 nucleotides).

Exemplary Properties of Modified Nucleic Acid Molecules

Major Groove Interacting Partners

[00331] The modified nucleic acid molecules, e.g., modified mRNA (mmRNA), described herein can disrupt interactions with recognition receptors that detect and respond to RNA ligands through interactions, e.g. binding, with the major groove face of a nucleotide or nucleic acid. As such, RNA ligands comprising modified nucleotides or modified nucleic acid molecules, as described herein, decrease interactions with major groove binding partners, and therefore decrease an innate immune response, or expression and secretion of pro-inflammatory cytokines, or both.

[00332] Example major groove interacting, e.g. binding, partners include, but are not limited to, the following nucleases and helicases. Within membranes, TLRs (Toll-like Receptors) 3, 7, and 8 can respond to single- and double-stranded RNA. Within the cytoplasm, members of the superfamily 2 class of DEX(D/H) helicases and ATPases can sense RNA to initiate antiviral responses. These helicases include the RIG-I (retinoic acid-inducible gene I) and MDA5 (melanoma differentiation-associated gene 5). Other examples include laboratory of genetics and physiology 2 (LGP2), HIN-200 domain containing proteins, or Helicase-domain containing proteins.

Prevention or Reduction of Innate Cellular Immune Response Activation Using Modified Nucleic Acid Molecules

[00333] The modified nucleic acid molecules, *e.g.*, mmRNA, described herein, decrease the innate immune response in a cell. The term "innate immune response" includes a cellular response to exogenous nucleic acids, including, but not limited to, single stranded nucleic acids, generally of viral or bacterial origin, which involve the induction of cytokine expression and release, particularly the interferons, and cell death. Protein synthesis may also be reduced during the innate cellular immune response. While it is advantageous to eliminate the innate immune response in a cell, the present disclosure provides modified mRNA that substantially reduce the immune response, including interferon signaling, without entirely eliminating such a response. In some embodiments, the immune response may be reduced by 10%, 20%, 30%, 40%, 50%, 60%, 70%, 80%, 90%, 95%, 99%, 99.9%, or greater than 99.9% as compared to the immune response induced by a corresponding unmodified nucleic acid molecule. Such a reduction can be measured by the expression or activity level of Type 1 interferons or the expression of interferon-regulated genes such as the toll-like receptors (*e.g.*, TLR7 and TLR8). Reduction of the innate immune response can also be measured by decreased cell death following one or more administrations of modified RNA to a cell population; *e.g.*, cell death is 10%, 25%, 50%, 75%, 85%, 90%, 95%, or over 95% less than the cell death frequency observed with a corresponding unmodified nucleic acid molecule. Moreover, cell death may affect fewer than 50%, 40%, 30%, 20%, 10%, 5%, 1%, 0.1%, 0.01% or fewer than 0.01% of cells contacted with the modified nucleic acid molecules.

[00334] The present disclosure provides for the repeated introduction (*e.g.*, transfection) of modified nucleic acid molecules into a target cell population, *e.g.*, *in vitro*, *ex vivo*, or *in vivo*. The step of contacting the cell population may be repeated one or more times (such as two, three, four, five or more than five times). In some embodiments, the step of contacting the cell population with the modified nucleic acid molecules may be repeated a number of times sufficient such that a predetermined efficiency of protein translation in the cell population is achieved. Given the reduced cytotoxicity of the target cell population by the nucleic acid modifications, such repeated transfections are achievable in a variety of cell types.

[00335] The modified nucleic acids of the invention, including the combination of modifications taught herein may have superior properties making them more suitable as therapeutic modalities.

[00336] It has been determined that the "all or none" model in the art is sorely insufficient to describe the biological phenomena associated with the therapeutic utility of modified mRNA. The present inventors have determined that to improve protein production, one may consider the nature of the modification, or combination of modifications, the percent modification and survey more than one cytokine or metric to determine the efficacy and risk profile of a particular modified mRNA.

[00337] In one aspect of the invention, methods of determining the effectiveness of a modified mRNA as compared to unmodified involves the measure and analysis of one or more cytokines whose expression is triggered by the administration of the exogenous nucleic acid of the invention. These values are compared to administration of an unmodified nucleic acid or to a standard metric such as cytokine response, PolyIC, R-848 or other standard known in the art.

[00338] One example of a standard metric developed herein is the measure of the ratio of the level or amount of encoded polypeptide (protein) produced in the cell, tissue or organism to the level or amount of one or more (or a panel) of cytokines whose expression is triggered in the cell, tissue or organism as a result of administration or contact with the modified nucleic acid. Such ratios are referred to herein as the Protein:Cytokine Ratio or "PC" Ratio. The higher the PC ratio, the more efficacious the modified nucleic acid (polynucleotide encoding the protein measured). Preferred PC Ratios, by cytokine, of the present invention may be greater than 1, greater than 10, greater than 100, greater than 1000, greater than 10,000 or more. Modified nucleic acids having higher PC Ratios than a modified nucleic acid of a different or unmodified construct are preferred.

[00339] The PC ratio may be further qualified by the percent modification present in the polynucleotide. For example, normalized to a 100% modified nucleic acid, the protein production as a function of cytokine (or risk) or cytokine profile can be determined.

[00340] In one embodiment, the present invention provides a method for determining, across chemistries, cytokines or percent modification, the relative efficacy of any particular modified polynucleotide by comparing the PC Ratio of the modified nucleic acid (polynucleotide).

Activation of the immune response: Vaccines

[00341] In one embodiment of the present invention, mRNA molecules may be used to elicit or provoke an immune response in an organism. The mRNA molecules to be delivered may encode an immunogenic peptide or polypeptide and may encode more than one such peptide or polypeptide.

[00342] Additionally, certain modified nucleosides, or combinations thereof, when introduced into the modified nucleic acid molecules or mmRNA of the invention will activate the innate immune

response. Such activating molecules are useful as adjuvants when combined with polypeptides and/or other vaccines. In certain embodiments, the activating molecules contain a translatable region which encodes for a polypeptide sequence useful as a vaccine, thus providing the ability to be a self-adjuvant.

[00343] In one embodiment, the modified nucleic acid molecules and/or mmRNA of the invention may encode an immunogen. The delivery of modified nucleic acid molecules and/or mmRNA encoding an immunogen may activate the immune response. As a non-limiting example, the modified nucleic acid molecules and/or mmRNA encoding an immunogen may be delivered to cells to trigger multiple innate response pathways (see International Pub. No. WO2012006377; herein incorporated by reference in its entirety). As another non-limiting example, the modified nucleic acid molecules and mmRNA of the present invention encoding an immunogen may be delivered to a vertebrate in a dose amount large enough to be immunogenic to the vertebrate (see International Pub. No. WO2012006372 and WO2012006369; each of which is herein incorporated by reference in their entirety).

[00344] The modified nucleic acid molecules or mmRNA of invention may encode a polypeptide sequence for a vaccine and may further comprise an inhibitor. The inhibitor may impair antigen presentation and/or inhibit various pathways known in the art. As a non-limiting example, the modified nucleic acid molecules or mmRNA of the invention may be used for a vaccine in combination with an inhibitor which can impair antigen presentation (see International Pub. No. WO2012089225 and WO2012089338; each of which is herein incorporated by reference in their entirety).

[00345] In one embodiment, the modified nucleic acid molecules or mmRNA of the invention may be self-replicating RNA. Self-replicating RNA molecules can enhance efficiency of RNA delivery and expression of the enclosed gene product. In one embodiment, the modified nucleic acid molecules or mmRNA may comprise at least one modification described herein and/or known in the art. In one embodiment, the self-replicating RNA can be designed so that the self-replicating RNA does not induce production of infectious viral particles. As a non-limiting example the self-replicating RNA may be designed by the methods described in US Pub. No. US201 10300205 and International Pub. No. WO201 1005799, each of which is herein incorporated by reference in their entirety.

[00346] In one embodiment, the self-replicating modified nucleic acid molecules or mmRNA of the invention may encode a protein which may raise the immune response. As a non-limiting example, the modified nucleic acid molecules and/or mmRNA may be self-replicating mRNA may encode at least one antigen (see US Pub. No. US201 10300205 and International Pub. No. WO201 1005799; each of which is herein incorporated by reference in their entirety).

[00347] In one embodiment, the self-replicating modified nucleic acids or mmRNA of the invention may be formulated using methods described herein or known in the art. As a non-limiting example, the self-replicating RNA may be formulated for delivery by the methods described in Geall et al (Nonviral delivery of self-amplifying RNA vaccines, PNAS 2012; PMID: 22908294; herein incorporated by reference in its entirety).

[00348] In one embodiment, the modified nucleic acid molecules or mmRNA of the present invention may encode amphipathic and/or immunogenic amphipathic peptides.

[00349] In on embodiment, a formulation of the modified nucleic acid molecules or mmRNA of the present invention may further comprise an amphipathic and/or immunogenic amphipathic peptide. As a non-limiting example, the modified nucleic acid molecule or mmRNA comprising an amphipathic and/or immunogenic amphipathic peptide may be formulated as described in US. Pub. No. US201 10250237 and International Pub. Nos. WO2010009277 and WO2010009065; each of which is herein incorporated by reference in their entirety.

[00350] In one embodiment, the modified nucleic acid molecules and mmRNA of the present invention may be immunostimulatory. As a non-limiting example, the modified nucleic acid molecules and mmRNA may encode all or a part of a positive-sense or a negative-sense stranded RNA virus genome (see International Pub No. WO2012092569 and US Pub No. US20120177701, each of which is herein incorporated by reference in their entirety). In another non-limiting example, the immunostimulatory modified nucleic acid molecules or mmRNA of the present invention may be formulated with an excipient for administration as described herein and/or known in the art (see International Pub No. WO2012068295 and US Pub No. US20120213812, each of which is herein incorporated by reference in their entirety).

[00351] In one embodiment, the response of the vaccine formulated by the methods described herein may be enhanced by the addition of various compounds to induce the therapeutic effect. As a non-limiting example, the vaccine formulation may include a MHC II binding peptide or a peptide having a similar sequence to a MHC II binding peptide (see International Pub Nos. WO2012027365,

WO201 1031298 and US Pub No. US20 120070493, US201 101 10965, each of which is herein incorporated by reference in their entirety). As another example, the vaccine formulations may comprise modified nicotinic compounds which may generate an antibody response to nicotine residue in a subject (see International Pub No. WO2012061717 and US Pub No. US201201 14677, each of which is herein incorporated by reference in their entirety).

Polypeptide variants

[00352] The modified nucleic acid molecules encode polypeptides, e.g., a variant polypeptides, which have a certain identity to a reference polypeptide sequence. The term "identity," as known in the art, refers to a relationship between the sequences of two or more peptides, determined by comparing the sequences. In the art, "identity" also refers to the degree of sequence relatedness between peptides, as determined by the number of matches between strings of two or more amino acid residues. Identity measures the percent of identical matches between the smaller of two or more sequences with gap alignments (if any) addressed by a particular mathematical model or computer program (i.e., "algorithms"). Identity of related peptides can be readily calculated by known methods. Such methods include, but are not limited to, those described in Computational Molecular Biology, Lesk, A. M., ed., Oxford University Press, New York, 1988; Biocomputing: Informatics and Genome Projects, Smith, D. W., ed., Academic Press, New York, 1993; Computer Analysis of Sequence Data, Part 1, Griffin, A. M., and Griffin, H. G., eds., Humana Press, New Jersey, 1994; Sequence Analysis in Molecular Biology, von Heinje, G., Academic Press, 1987; Sequence Analysis Primer, Gribskov, M. and Devereux, J., eds., M. Stockton Press, New York, 1991; and Carillo et al, SIAM J. Applied Math. 48, 1073 (1988); all of which are herein incorporated by reference in their entirety.

[00353] In some embodiments, the polypeptide variant may have the same or a similar activity as the reference polypeptide. Alternatively, the variant may have an altered activity (e.g., increased or decreased) relative to a reference polypeptide. Generally, variants of a particular polynucleotide or polypeptide of the present disclosure will have at least about 40%, 45%, 50%>, 55%>, 60%>, 65%>, 70%, 75%, 80%, 85%, 90%, 91%, 92%, 93%, 94%, 95%, 96%, 97%, 98%, 99% or more sequence identity to that particular reference polynucleotide or polypeptide as determined by sequence alignment programs and parameters described herein and known to those skilled in the art.

[00354] As recognized by those skilled in the art, protein fragments, functional protein domains, and homologous proteins are also considered to be within the scope of this present disclosure. For

example, provided herein is any protein fragment of a reference protein (meaning a polypeptide sequence which is at least one amino acid residue shorter than a reference polypeptide sequence but otherwise identical) 10, 20, 30, 40, 50, 60, 70, 80, 90, 100 or greater than 100 amino acids in length. In another example, any protein that includes a stretch of about 20, about 30, about 40, about 50, or about 100 amino acids which are about 40%, about 50%, about 60%, about 70%, about 80%, about 90%, about 95%, or about 100% identical to any of the sequences described herein can be utilized in accordance with the present disclosure. In certain embodiments, a protein sequence to be utilized in accordance with the present disclosure includes 2, 3, 4, 5, 6, 7, 8, 9, 10, or more mutations as shown in any of the sequences provided or referenced herein.

Polypeptide-nucleic acid complexes

[00355] Proper protein translation involves the physical aggregation of a number of polypeptides and nucleic acids associated with the mRNA. Provided by the present disclosure are protein-nucleic acid complexes, containing a translatable mRNA having one or more nucleoside modifications (*e.g.*, at least two different nucleoside modifications) and one or more polypeptides bound to the mRNA. Generally, the proteins are provided in an amount effective to prevent or to reduce an innate immune response of a cell into which the complex is introduced.

Untranslatable Modified Nucleic Acid Molecules

[00356] As described herein, provided are mRNA having sequences that are substantially not translatable. Such mRNA may be effective as a vaccine when administered to a subject. It is further provided that the subject administered the vaccine may be a mammal, more preferably a human and most preferably a patient.

[00357] Also provided are modified nucleic acid molecules that contain one or more noncoding regions. Such modified nucleic acid molecules are generally not translated, but are capable of binding to and sequestering one or more translational machinery component such as a ribosomal protein or a transfer RNA (tRNA), thereby effectively reducing the protein expression in the cell. The modified nucleic acid molecule may contain a small nucleolar RNA (sno-RNA), micro RNA (miRNA), small interfering RNA (siRNA) or Piwi-interacting RNA (piRNA).

Pharmaceutical Compositions

Formulation, Administration, Delivery and Dosing

[00358] The present invention provides modified nucleic acids and mmRNA compositions and complexes in combination with one or more pharmaceutically acceptable excipients. Pharmaceutical compositions may optionally comprise one or more additional active substances, *e.g.* therapeutically

and/or prophylactically active substances. General considerations in the formulation and/or manufacture of pharmaceutical agents may be found, for example, in *Remington: The Science and Practice of Pharmacy* 21st ed., Lippincott Williams & Wilkins, 2005 (incorporated herein by reference in its entirety).

[00359] In some embodiments, compositions are administered to humans, human patients or subjects. For the purposes of the present disclosure, the phrase "active ingredient" generally refers to modified nucleic acids and mmRNA to be delivered as described herein.

[00360] Although the descriptions of pharmaceutical compositions provided herein are principally directed to pharmaceutical compositions which are suitable for administration to humans, it will be understood by the skilled artisan that such compositions are generally suitable for administration to any other animal, *e.g.*, to non-human animals, *e.g.* non-human mammals. Modification of pharmaceutical compositions suitable for administration to humans in order to render the compositions suitable for administration to various animals is well understood, and the ordinarily skilled veterinary pharmacologist can design and/or perform such modification with merely ordinary, if any, experimentation. Subjects to which administration of the pharmaceutical compositions is contemplated include, but are not limited to, humans and/or other primates; mammals, including commercially relevant mammals such as cattle, pigs, horses, sheep, cats, dogs, mice, and/or rats; and/or birds, including commercially relevant birds such as poultry, chickens, ducks, geese, and/or turkeys.

[00361] Formulations of the pharmaceutical compositions described herein may be prepared by any method known or hereafter developed in the art of pharmacology. In general, such preparatory methods include the step of bringing the active ingredient into association with an excipient and/or one or more other accessory ingredients, and then, if necessary and/or desirable, dividing, shaping and/or packaging the product into a desired single- or multi-dose unit.

[00362] A pharmaceutical composition in accordance with the invention may be prepared, packaged, and/or sold in bulk, as a single unit dose, and/or as a plurality of single unit doses. As used herein, a "unit dose" is discrete amount of the pharmaceutical composition comprising a predetermined amount of the active ingredient. The amount of the active ingredient is generally equal to the dosage of the active ingredient which would be administered to a subject and/or a convenient fraction of such a dosage such as, for example, one-half or one-third of such a dosage.

[00363] Relative amounts of the active ingredient, the pharmaceutically acceptable excipient, and/or any additional ingredients in a pharmaceutical composition in accordance with the invention will vary, depending upon the identity, size, and/or condition of the subject treated and further depending upon the route by which the composition is to be administered. By way of example, the composition may comprise between 0.1% and 100%, e.g., between .5 and 50%>, between 1-30%, between 5-80%>, at least 80%> (w/w) active ingredient.

Formulations

[00364] The modified nucleic acid, and mmRNA of the invention can be formulated using one or more excipients to: (1) increase stability; (2) increase cell transfection; (3) permit the sustained or delayed release (e.g., from a depot formulation of the modified nucleic acid, or mmRNA); (4) alter the biodistribution (e.g., target the modified nucleic acid, or mmRNA to specific tissues or cell types); (5) increase the translation of encoded protein *in vivo*; and/or (6) alter the release profile of encoded protein *in vivo*. In addition to traditional excipients such as any and all solvents, dispersion media, diluents, or other liquid vehicles, dispersion or suspension aids, surface active agents, isotonic agents, thickening or emulsifying agents, preservatives, excipients of the present invention can include, without limitation, lipidoids, liposomes, lipid nanoparticles, polymers, lipoplexes, core-shell nanoparticles, peptides, proteins, cells transfected with modified nucleic acid, or mmRNA (e.g., for transplantation into a subject), hyaluronidase, nanoparticle mimics and combinations thereof. Accordingly, the formulations of the invention can include one or more excipients, each in an amount that together increases the stability of the modified nucleic acid, or mmRNA, increases cell transfection by the modified nucleic acid, or mmRNA, increases the expression of modified nucleic acid, or mmRNA encoded protein, and/or alters the release profile of modified nucleic acid, or mmRNA encoded proteins. Further, the modified nucleic acids and mmRNA of the present invention may be formulated using self-assembled nucleic acid nanoparticles.

[00365] Formulations of the pharmaceutical compositions described herein may be prepared by any method known or hereafter developed in the art of pharmacology. In general, such preparatory methods include the step of associating the active ingredient with an excipient and/or one or more other accessory ingredients.

[00366] A pharmaceutical composition in accordance with the present disclosure may be prepared, packaged, and/or sold in bulk, as a single unit dose, and/or as a plurality of single unit doses. As used herein, a "unit dose" refers to a discrete amount of the pharmaceutical composition comprising

a predetermined amount of the active ingredient. The amount of the active ingredient may generally be equal to the dosage of the active ingredient which would be administered to a subject and/or a convenient fraction of such a dosage including, but not limited to, one-half or one-third of such a dosage.

[00367] Relative amounts of the active ingredient, the pharmaceutically acceptable excipient, and/or any additional ingredients in a pharmaceutical composition in accordance with the present disclosure may vary, depending upon the identity, size, and/or condition of the subject being treated and further depending upon the route by which the composition is to be administered. For example, the composition may comprise between 0.1% and 99% (w/w) of the active ingredient.

[00368] In some embodiments, the modified mRNA formulations described herein may contain at least one modified mRNA. The formulations may contain 1, 2, 3, 4 or 5 modified mRNA. In one embodiment, the formulation contains at least three modified mRNA encoding proteins. In one embodiment, the formulation contains at least five modified mRNA encoding proteins.

[00369] Pharmaceutical formulations may additionally comprise a pharmaceutically acceptable excipient, which, as used herein, includes, but is not limited to, any and all solvents, dispersion media, diluents, or other liquid vehicles, dispersion or suspension aids, surface active agents, isotonic agents, thickening or emulsifying agents, preservatives, and the like, as suited to the particular dosage form desired. Various excipients for formulating pharmaceutical compositions and techniques for preparing the composition are known in the art (see Remington: The Science and Practice of Pharmacy, 2^{1st} Edition, A. R. Gennaro, Lippincott, Williams & Wilkins, Baltimore, MD, 2006; incorporated herein by reference in its entirety). The use of a conventional excipient medium may be contemplated within the scope of the present disclosure, except insofar as any conventional excipient medium may be incompatible with a substance or its derivatives, such as by producing any undesirable biological effect or otherwise interacting in a deleterious manner with any other component(s) of the pharmaceutical composition.

[00370] In some embodiments, the particle size of the lipid nanoparticle may be increased and/or decreased. The change in particle size may be able to help counter biological reaction such as, but not limited to, inflammation or may increase the biological effect of the modified mRNA delivered to mammals.

[00371] Pharmaceutically acceptable excipients used in the manufacture of pharmaceutical compositions include, but are not limited to, inert diluents, surface active agents and/or emulsifiers,

preservatives, buffering agents, lubricating agents, and/or oils. Such excipients may optionally be included in the pharmaceutical formulations of the invention.

Lipidoids

[00372] The synthesis of lipidoids has been extensively described and formulations containing these compounds are particularly suited for delivery of modified nucleic acid molecules or mmRNA (see Mahon et al, *Bioconjug Chem.* 2010 21:1448-1454; Schroeder et al., *J Intern Med.* 2010 267:9-21; Akinc et al, *Nat Biotechnol.* 2008 26:561-569; Love et al, *Proc Natl Acad Sci U S A.* 2010 107:1864-1869; Siegwart et al, *Proc Natl Acad Sci U S A.* 2011 108:12996-3001; all of which are incorporated herein in their entireties).

[00373] While these lipidoids have been used to effectively deliver double stranded small interfering RNA molecules in rodents and non-human primates (see Akinc et al., *Nat Biotechnol.* 2008 26:561-569; Frank-Kamenetsky et al, *Proc Natl Acad Sci U S A.* 2008 105:1915-1920; Akinc et al, *Mol Ther.* 2009 17:872-879; Love et al, *Proc Natl Acad Sci U S A.* 2010 107:1864-1869; Leuschner et al., *Nat Biotechnol.* 2011 29:1005-1010; all of which is incorporated herein in their entirety), the present disclosure describes their formulation and use in delivering single stranded modified nucleic acid molecules or mmRNA. Complexes, micelles, liposomes or particles can be prepared containing these lipidoids and therefore, can result in an effective delivery of the modified nucleic acid molecules or mmRNA, as judged by the production of an encoded protein, following the injection of a lipidoid formulation via localized and/or systemic routes of administration. Lipidoid complexes of modified nucleic acid molecules or mmRNA can be administered by various means including, but not limited to, intravenous, intramuscular, or subcutaneous routes.

[00374] *In vivo* delivery of nucleic acids may be affected by many parameters, including, but not limited to, the formulation composition, nature of particle PEGylation, degree of loading, oligonucleotide to lipid ratio, and biophysical parameters such as, but not limited to, particle size (Akinc et al., *Mol Ther.* 2009 17:872-879; herein incorporated by reference in its entirety). As an example, small changes in the anchor chain length of poly(ethylene glycol) (PEG) lipids may result in significant effects on *in vivo* efficacy. Formulations with the different lipidoids, including, but not limited to penta[3-(1-laurylamino propionyl)]-triethylenetetramine hydrochloride (TETA-5LAP; aka 98N12-5, see Murugaiah et al., *Analytical Biochemistry*, 401:61 (2010); herein incorporated by

reference in its entirety), CI2-200 (including derivatives and variants), and MDI, can be tested for *in vivo* activity.

[00375] The lipidoid referred to herein as "98N12-5" is disclosed by Akinc et al, Mol Ther. 2009 17:872-879 and is incorporated by reference in its entirety (See Figure 1).

[00376] The lipidoid referred to herein as "CI 2-200" is disclosed by Love et al, Proc Natl Acad Sci U S A. 2010 107:1864-1869 and Liu and Huang, Molecular Therapy. 2010 669-670 (see Figure 1); both of which are herein incorporated by reference in their entirety. The lipidoid formulations can include particles comprising either 3 or 4 or more components in addition to modified nucleic acid molecules or mmRNA. As an example, formulations with certain lipidoids, include, but are not limited to, 98N12-5 and may contain 42% lipidoid, 48% cholesterol and 10% PEG (CI4 alkyl chain length). As another example, formulations with certain lipidoids, include, but are not limited to, CI2-200 and may contain 50% lipidoid, 10% distearylphosphatidyl choline, 38.5% cholesterol, and 1.5% PEG-DMG.

[00377] In one embodiment, a modified nucleic acid molecule or mmRNA formulated with a lipidoid for systemic intravenous administration can target the liver. For example, a final optimized intravenous formulation using modified nucleic acid molecule or mmRNA, and comprising a lipid molar composition of 42% 98N12-5, 48% cholesterol, and 10% PEG-lipid with a final weight ratio of about 7.5 to 1 total lipid to modified nucleic acid, or mmRNA, and a C14 alkyl chain length on the PEG lipid, with a mean particle size of roughly 50-60 nm, can result in the distribution of the formulation to be greater than 90% to the liver.(see, Akinc et al., Mol Ther. 2009 17:872-879; herein incorporated by reference in its entirety). In another example, an intravenous formulation using a C12-200 (see US provisional application 61/175,770 and published international application WO2010129709, each of which is herein incorporated by reference in their entirety) lipidoid may have a molar ratio of 50/10/38.5/1.5 of C12-200/distearylphosphatidyl choline/cholesterol/PEG-DMG, with a weight ratio of 7 to 1 total lipid to modified nucleic acid molecule or mmRNA, and a mean particle size of 80 nm may be effective to deliver modified nucleic acid molecule or mmRNA to hepatocytes (see, Love et al, Proc Natl Acad Sci U S A. 2010 107:1864-1869 herein incorporated by reference in its entirety). In another embodiment, an MDI lipidoid-containing formulation may be used to effectively deliver modified nucleic acid molecule or mmRNA to hepatocytes *in vivo*. The characteristics of optimized lipidoid formulations for intramuscular or subcutaneous routes may vary significantly depending on the target cell type and the ability of formulations to diffuse through the

extracellular matrix into the blood stream. While a particle size of less than 150 nm may be desired for effective hepatocyte delivery due to the size of the endothelial fenestrae (see, Akinc et al., *Mol Ther.* 2009 17:872-879 herein incorporated by reference in its entirety), use of a lipidoid-formulated modified nucleic acid molecules or mmRNA to deliver the formulation to other cells types including, but not limited to, endothelial cells, myeloid cells, and muscle cells may not be similarly size-limited. Use of lipidoid formulations to deliver siRNA *in vivo* to other non-hepatocyte cells such as myeloid cells and endothelium has been reported (see Akinc et al., *Nat Biotechnol.* 2008 26:561-569; Leuschner et al, *Nat Biotechnol.* 2011 29:1005-1010; Cho et al. *Adv. Funct. Mater.* 2009 19:3112-3118; 8th International Judah Folkman Conference, Cambridge, MA October 8-9, 2010; each of which is herein incorporated by reference in its entirety). Effective delivery to myeloid cells, such as monocytes, lipidoid formulations may have a similar component molar ratio. Different ratios of lipidoids and other components including, but not limited to, distearylphosphatidyl choline, cholesterol and PEG-DMG, may be used to optimize the formulation of the modified nucleic acid, or mmRNA for delivery to different cell types including, but not limited to, hepatocytes, myeloid cells, muscle cells, etc. For example, the component molar ratio may include, but is not limited to, 50% C12-200, 10% distearylphosphatidyl choline, 38.5% cholesterol, and 1.5% PEG-DMG (see Leuschner et al., *Nat Biotechnol.* 2011 29:1005-1010; herein incorporated by reference in its entirety). The use of lipidoid formulations for the localized delivery of nucleic acids to cells (such as, but not limited to, adipose cells and muscle cells) via either subcutaneous or intramuscular delivery, may not require all of the formulation components desired for systemic delivery, and as such may comprise only the lipidoid and the modified nucleic acid molecule or mmRNA.

[00378] Combinations of different lipidoids may be used to improve the efficacy of modified nucleic acid molecule or mmRNA directed protein production as the lipidoids may be able to increase cell transfection by the modified nucleic acid molecule or mmRNA; and/or increase the translation of encoded protein (see Whitehead et al., *Mol. Ther.* 2011, 19:1688-1694, herein incorporated by reference in its entirety).

Liposomes, Lipoplexes, and Lipid Nanoparticles

[00379] The modified nucleic acid molecules and mmRNA of the invention can be formulated using one or more liposomes, lipoplexes, or lipid nanoparticles. In one embodiment, pharmaceutical compositions of modified nucleic acid molecule or mmRNA include liposomes. Liposomes are artificially-prepared vesicles which may primarily be composed of a lipid bilayer and may be used as

a delivery vehicle for the administration of nutrients and pharmaceutical formulations. Liposomes can be of different sizes such as, but not limited to, a multilamellar vesicle (MLV) which may be hundreds of nanometers in diameter and may contain a series of concentric bilayers separated by narrow aqueous compartments, a small unicellular vesicle (SUV) which may be smaller than 50 nm in diameter, and a large unilamellar vesicle (LUV) which may be between 50 and 500 nm in diameter. Liposome design may include, but is not limited to, opsonins or ligands in order to improve the attachment of liposomes to unhealthy tissue or to activate events such as, but not limited to, endocytosis. Liposomes may contain a low or a high pH in order to improve the delivery of the pharmaceutical formulations.

[00380] The formation of liposomes may depend on the physicochemical characteristics such as, but not limited to, the pharmaceutical formulation entrapped and the liposomal ingredients, the nature of the medium in which the lipid vesicles are dispersed, the effective concentration of the entrapped substance and its potential toxicity, any additional processes involved during the application and/or delivery of the vesicles, the optimization size, polydispersity and the shelf-life of the vesicles for the intended application, and the batch-to-batch reproducibility and possibility of large-scale production of safe and efficient liposomal products.

[00381] In one embodiment, pharmaceutical compositions described herein may include, without limitation, liposomes such as those formed from 1,2-dioleoyloxy -*N,N*-dimethylaminopropane (DODMA) liposomes, DiLa2 liposomes from Marina Biotech (Bothell, WA), 1,2-dilinoleyloxy-3-dimethylaminopropane (DLin-DMA), 2,2-dilinoleyloxy-4-(2-dimethylaminoethyl)-[1,3]-dioxolane (DLin-KC2-DMA), and MC3 (US20 100324 120; herein incorporated by reference in its entirety) and liposomes which may deliver small molecule drugs such as, but not limited to, DOXIL® from Janssen Biotech, Inc. (Horsham, PA). In one embodiment, pharmaceutical compositions described herein may include, without limitation, liposomes such as those formed from the synthesis of stabilized plasmid-lipid particles (SPLP) or stabilized nucleic acid lipid particle (SNALP) that have been previously described and shown to be suitable for oligonucleotide delivery *in vitro* and *in vivo* (see Wheeler et al. *Gene Therapy*. 1999 6:271-281; Zhang et al. *Gene Therapy*. 1999 6:1438-1447; Jeffs et al. *Pharm Res*. 2005 22:362-372; Morrissey et al, *Nat Biotechnol*. 2005 2:1002-1007; Zimmermann et al, *Nature*. 2006 441 :111-114; Heyes et al. *J Contr Rel*. 2005 107:276-287; Semple et al. *Nature Biotech*. 2010 28:172-176; Judge et al. *J Clin Invest*. 2009 119:661-673; deFougero *Hum Gene Ther*. 2008 19:125-132; all of which are incorporated herein in their entireties.) The

original manufacture method by Wheeler et al. was a detergent dialysis method, which was later improved by Jeffs et al. and is referred to as the spontaneous vesicle formation method. The liposome formulations are composed of 3 to 4 lipid components in addition to the modified nucleic acid molecule or mrnRNA. As an example a liposome can contain, but is not limited to, 55% cholesterol, 20% distearylphosphatidyl choline (DSPC), 10% PEG-S-DSG, and 15% 1,2-dioleoyloxy-*N,N*-dimethylaminopropane (DODMA), as described by Jeffs et al. As another example, certain liposome formulations may contain, but are not limited to, 48% cholesterol, 20% DSPC, 2% PEG-c-DMA, and 30% cationic lipid, where the cationic lipid can be 1,2-distearloxy-*N,N*-dimethylaminopropane (DSDMA), DODMA, DLin-DMA, or 1,2-dilinolenyloxy-3-dimethylaminopropane (DLenDMA), as described by Heyes et al.

[00382] In one embodiment, pharmaceutical compositions may include liposomes which may be formed to deliver mrnRNA which may encode at least one immunogen. The mrnRNA may be encapsulated by the liposome and/or it may be contained in an aqueous core which may then be encapsulated by the liposome (see International Pub. Nos. WO2012031046, WO2012031043, WO2012030901 and WO2012006378; each of which is herein incorporated by reference in their entirety). In another embodiment, the mrnRNA which may encode an immunogen may be formulated in a cationic oil-in-water emulsion where the emulsion particle comprises an oil core and a cationic lipid which can interact with the mrnRNA anchoring the molecule to the emulsion particle (see International Pub. No. WO2012006380; herein incorporated by reference in its entirety). In yet another embodiment, the lipid formulation may include at least cationic lipid, a lipid which may enhance transfection and a least one lipid which contains a hydrophilic head group linked to a lipid moiety (International Pub. No. WO201 1076807 and U.S. Pub. No. 201 10200582; each of which is herein incorporated by reference in their entirety). In another embodiment, the modified mRNA encoding an immunogen may be formulated in a lipid vesicle which may have crosslinks between functionalized lipid bilayers (see U.S. Pub. No. 20120177724, herein incorporated by reference in its entirety).

[00383] In one embodiment, the modified mRNA may be formulated in a lipid vesicle which may have crosslinks between functionalized lipid bilayers.

[00384] In one embodiment, the modified mRNA may be formulated in a lipid-polycation complex. The formation of the lipid-polycation complex may be accomplished by methods known in the art and/or as described in U.S. Pub. No. 20120178702, herein incorporated by reference in its entirety.

As a non-limiting example, the polycation may include a cationic peptide or a polypeptide such as, but not limited to, polylysine, polyornithine and/or polyarginine and the cationic peptides described in International Pub. No. WO2012013326; herein incorporated by reference in its entirety. In another embodiment, the modified mRNA may be formulated in a lipid-polycation complex which may further include a neutral lipid such as, but not limited to, cholesterol or dioleoyl phosphatidylethanolamine (DOPE).

[00385] The liposome formulation may be influenced by, but not limited to, the selection of the cationic lipid component, the degree of cationic lipid saturation, the nature of the PEGylation, ratio of all components and biophysical parameters such as size. In one example by Semple et al. (Semple et al. Nature Biotech. 2010 28:172-176; herein incorporated by reference in its entirety), the liposome formulation was composed of 57.1 % cationic lipid, 7.1% dipalmitoylphosphatidylcholme, 34.3 % cholesterol, and 1.4% PEG-c-DMA. As another example, changing the composition of the cationic lipid could more effectively deliver siRNA to various antigen presenting cells (Basha et al. Mol Ther. 201 1 19:2186-2200; herein incorporated by reference in its entirety).

[00386] In some embodiments, the ratio of PEG in the lipid nanoparticle (LNP) formulations may be increased or decreased and/or the carbon chain length of the PEG lipid may be modified from C14 to C18 to alter the pharmacokinetics and/or biodistribution of the LNP formulations. As a non-limiting example, LNP formulations may contain 1-5% of the lipid molar ratio of PEG-c-DOMG as compared to the cationic lipid, DSPC and cholesterol. In another embodiment the PEG-c-DOMG may be replaced with a PEG lipid such as, but not limited to, PEG- DSG (1,2-Distearoyl-sn-glycerol, methoxypolyethylene glycol) or PEG-DPG (1,2-Dipalmitoyl-sn-glycerol, methoxypolyethylene glycol). The cationic lipid may be selected from any lipid known in the art such as, but not limited to, DLin-MC3-DMA, DLin-DMA, C12-200 and DLin-KC2-DMA.

[00387] In one embodiment, the cationic lipid may be selected from, but not limited to, a cationic lipid described in International Publication Nos. WO2012040184, WO201 1153120, WO201 1149733, WO201 1090965, WO201 1043913, WO201 1022460, WO2012061259, WO2012054365, WO2012044638, WO2010080724, WO201021865 and WO2008103276, US Patent Nos. 7,893,302, 7,404,969 and 8,283,333 and US Patent Publication No. US201000361 15 and US20 120202871; each of which is herein incorporated by reference in their entirety. In another embodiment, the cationic lipid may be selected from, but not limited to, formula A described in International Publication Nos. WO2012040184, WO201 1153120, WO201 1149733,

WO201 1090965, WO201 1043913, WO201 1022460, WO2012061259, WO2012054365 and WO20 1204463 8; each of which is herein incorporated by reference in their entirety. In yet another embodiment, the cationic lipid may be selected from, but not limited to, formula CLI-CLXXIX of International Publication No. WO2008103276, formula CLI-CLXXIX of US Patent No. 7,893,302, formula CLI-CLXXXII of US Patent No. 7,404,969 and formula I-VI of US Patent Publication No. US20 1000361 15; each of which is herein incorporated by reference in their entirety. As a non-limiting example, the cationic lipid may be selected from (20Z,23Z)-N,N-dimethylnonacos-20,23-dien-10-amine, (17Z,20Z)-N,N-dimethylhexacos-17,20-dien-9-amine, (1Z,19Z)-N,N-dimethylpentacos-16,19-dien-8-amine, (13Z,16Z)-N,N-dimethyldocosa-13,16-dien-5-amine, (12Z,15Z)-N,N-dimethylhenicosa-12,15-dien-4-amine, (14Z,17Z)-N,N-dimethyltricos-14,17-dien-6-amine, (15Z,18Z)-N,N-dimethyltetracos-15,18-dien-7-amine, (18Z,21Z)-N,N-dimethylheptacos-18,21-dien-10-amine, (15Z,18Z)-N,N-dimethyltetracos-15,18-dien-5-amine, (14Z,17Z)-N,N-dimethyltricos-14,17-dien-4-amine, (19Z,22Z)-N,N-dimethyloctacos-19,22-dien-9-amine, (18Z,21Z)-N,N-dimethylheptacos-18,21-dien-8-amine, (17Z,20Z)-N,N-dimethylhexacos-17,20-dien-7-amine, (16Z,19Z)-N,N-dimethylpentacos-16,19-dien-6-amine, (22Z,25Z)-N,N-dimethylhentriacont-22,25-dien-10-amine, (21Z,24Z)-N,N-dimethyltriacont-21,24-dien-9-amine, (18Z)-N,N-dimethylheptacos-18-en-10-amine, (17Z)-N,N-dimethylhexacos-17-en-9-amine, (19Z,22Z)-N,N-dimethyloctacos-19,22-dien-7-amine, N,N-dimethylheptacos-10-amine, (20Z,23Z)-N-ethyl-N-methylnonacos-20,23-dien-10-amine, 1-[(1Z,14Z)-1-nonylicos-11,14-dien-1-yl]pyrrolidine, (20Z)-N,N-dimethylheptacos-20-en-10-amine, (15Z)-N,N-dimethylheptacos-15-en-10-amine, (14Z)-N,N-dimethylnonacos-14-en-10-amine, (17Z)-N,N-dimethylnonacos-17-en-10-amine, (24Z)-N,N-dimethyltriacont-24-en-10-amine, (20Z)-N,N-dimethylnonacos-20-en-10-amine, (22Z)-N,N-dimethylhentriacont-22-en-10-amine, (16Z)-N,N-dimethylpentacos-16-en-8-amine, (12Z,15Z)-N,N-dimethyl-2-nonylhenicosa-12,15-dien-1-amine, (13Z,16Z)-N,N-dimethyl-3-nonyldocosa-13,16-dien-1-amine, N,N-dimethyl-1-[(1S,2R)-2-octylcyclopropyl]heptadecan-8-amine, 1-[(1S,2R)-2-hexylcyclopropyl]-N,N-dimethylnonadecan-10-amine, N,N-dimethyl-1-[(1S,2R)-2-octylcyclopropyl]nonadecan-10-amine, N,N-dimethyl-21-[(1S,2R)-2-octylcyclopropyl]henicosan-10-amine, N,N-dimethyl-1-[(1S,2S)-2-[(1R,2R)-2-pentylcyclopropyl]methyl]cyclopropyl]nonadecan-10-amine, N,N-dimethyl-1-[(1S,2R)-2-octylcyclopropyl]hexadecan-8-amine, N,N-dimethyl-[(1R,2S)-2-undecylcyclopropyl]tetradecan-5-amine, N,N-dimethyl-3-{7-[(1S,2R)-2-octylcyclopropyl]heptyl}dodecan-1-amine, 1-[(1R,2S)-2-heptylcyclopropyl]-N,N-dimethyloctadecan-9-amine, 1-[(1S,2R)-

2-decylcyclopropyl]-N,N-dimethylpentadecan-6-amine, N,N-dimethyl-1-[(1S,2R)-2-octylcyclopropyl]pentadecan-8-amine, R-N,N-dimethyl-1-[(9Z,12Z)-octadeca-9,12-dien-1-yloxy]-3-(octyloxy)propan-2-amine, S-N,N-dimethyl-1-[(9Z,12Z)-octadeca-9,12-dien-1-yloxy]-3-(octyloxy)propan-2-amine, 1-{2-[(9Z,12Z)-octadeca-9,12-dien-1-yloxy]-1-[(octyloxy)methyl]ethyl}pyrrolidine, (2S)-N,N-dimethyl-1-[(9Z,12Z)-octadeca-9,12-dien-1-yloxy]-3-[(5Z)-oct-5-en-1-yloxy]propan-2-amine, 1-{2-[(9Z,12Z)-octadeca-9,12-dien-1-yloxy]-1-[(octyloxy)methyl]ethyl}azetidine, (2S)-1-(hexyloxy)-N,N-dimethyl-3-[(9Z,12Z)-octadeca-9,12-dien-1-yloxy]propan-2-amine, (2S)-1-(heptyloxy)-N,N-dimethyl-3-[(9Z,12Z)-octadeca-9,12-dien-1-yloxy]propan-2-amine, N,N-dimethyl-1-(nonyloxy)-3-[(9Z,12Z)-octadeca-9,12-dien-1-yloxy]propan-2-amine, N,N-dimethyl-1-[(9Z)-octadec-9-en-1-yloxy]-3-(octyloxy)propan-2-amine; (2S)-N,N-dimethyl-1-[(6Z,9Z,12Z)-octadeca-6,9,12-trien-1-yloxy]-3-(octyloxy)propan-2-amine, (2S)-1-[(11Z,14Z)-icosa-11,14-dien-1-yloxy]-N,N-dimethyl-3-(pentyloxy)propan-2-amine, (2S)-1-(hexyloxy)-3-[(11Z,14Z)-icosa-11,14-dien-1-yloxy]-N,N-dimethylpropan-2-amine, 1-[(11Z,14Z)-icosa-11,14-dien-1-yloxy]-N,N-dimethyl-3-(octyloxy)propan-2-amine, 1-[(13Z,16Z)-docosa-13,16-dien-1-yloxy]-N,N-dimethyl-3-(octyloxy)propan-2-amine, (2S)-1-[(13Z,16Z)-docosa-13,16-dien-1-yloxy]-3-(hexyloxy)-N,N-dimethylpropan-2-amine, (2S)-1-[(13Z)-docos-13-en-1-yloxy]-3-(hexyloxy)-N,N-dimethylpropan-2-amine, 1-[(13Z)-docos-13-en-1-yloxy]-N,N-dimethyl-3-(octyloxy)propan-2-amine, 1-[(9Z)-hexadec-9-en-1-yloxy]-N,N-dimethyl-3-(octyloxy)propan-2-amine, (2R)-N,N-dimethyl-H(1-metoxycetyl)oxy]-3-[(9Z,12Z)-octadeca-9,12-dien-1-yloxy]propan-2-amine, (2R)-1-[(3,7-dimethyloctyl)oxy]-N,N-dimethyl-3-[(9Z,12Z)-octadeca-9,12-dien-1-yloxy]propan-2-amine, N,N-dimethyl-1-(octyloxy)-3-({8-[(1S,2S)-2-[(1R,2R)-2-pentylcyclopropyl]methyl}cyclopropyl]octyl}oxy)propan-2-amine, N,N-dimethyl-1-{{8-(2-octylcyclopropyl)octyl}oxy}-3-(octyloxy)propan-2-amine and (11E,20Z,23Z)-N,N-dimethylnonacos-11,20,2-trien-10-amine or a pharmaceutically acceptable salt or stereoisomer thereof.

[00388] In one embodiment, the cationic lipid may be synthesized by methods known in the art and/or as described in International Publication Nos. WO2012040184, WO2011153120, WO2011149733, WO2011090965, WO2011043913, WO2011022460, WO2012061259, WO2012054365, WO2012044638, WO2010080724 and WO201021865; each of which is herein incorporated by reference in their entirety.

[00389] In one embodiment, the LNP formulation may contain PEG-c-DOMG at 3% lipid molar ratio. In another embodiment, the LNP formulation may contain PEG-c-DOMG at 1.5% lipid molar ratio.

[00390] In one embodiment, the LNP formulation may contain PEG-DMG 2000 (1,2-dimyristoyl-sn-glycero-3-phosphoethanolamine-N-[methoxy(poly ethylene glycol)-2000]). In one embodiment, the LNP formulation may contain PEG-DMG 2000, a cationic lipid known in the art and at least one other component. In another embodiment, the LNP formulation may contain PEG-DMG 2000, a cationic lipid known in the art, DSPC and cholesterol. As a non-limiting example, the LNP formulation may contain PEG-DMG 2000, DLin-DMA, DSPC and cholesterol. As another non-limiting example the LNP formulation may contain PEG-DMG 2000, DLin-DMA, DSPC and cholesterol in a molar ratio of 2:40: 10:48 (see e.g. Geall et al., Nonviral delivery of self-amplifying RNA vaccines, PNAS 2012; PMID: 22908294; herein incorporated by reference in its entirety).

[00391] In one embodiment, the LNP formulation may be formulated by the methods described in International Publication Nos. WO201 1127255 or WO2008103276, each of which is herein incorporated by reference in their entirety. As a non-limiting example, modified RNA described herein may be encapsulated in LNP formulations as described in WO201 1127255 and/or WO2008 103276; each of which is herein incorporated by reference in their entirety. As another non-limiting example, modified RNA described herein may be formulated in a nanoparticle to be delivered by a parenteral route as described in U.S. Pub. No. 20120207845; herein incorporated by reference in its entirety.

[00392] In one embodiment, LNP formulations described herein may comprise a polycationic composition. As a non-limiting example, the polycationic composition may be selected from formula 1-60 of US Patent Publication No. US20050222064; herein incorporated by reference in its entirety. In another embodiment, the LNP formulations comprising a polycationic composition may be used for the delivery of the modified RNA described herein *in vivo* and/or *in vitro*.

[00393] In one embodiment, the LNP formulations described herein may additionally comprise a permeability enhancer molecule. Non-limiting permeability enhancer molecules are described in US Patent Publication No. US20050222064; herein incorporated by reference in its entirety.

[00394] In one embodiment, the pharmaceutical compositions may be formulated in liposomes such as, but not limited to, DiLa2 liposomes (Marina Biotech, Bothell, WA), SMARTICLES® (Marina Biotech, Bothell, WA), neutral DOPC (1,2-dioleoyl-sn-glycero-3-phosphocholine) based liposomes

(e.g., siRNA delivery for ovarian cancer (Landen et al. *Cancer Biology & Therapy* 2006 5(12)1708-1713); herein incorporated by reference in its entirety) and hyaluronan-coated liposomes (Quiet Therapeutics, Israel).

[00395] The nanoparticle formulations may be a carbohydrate nanoparticle comprising a carbohydrate carrier and a modified nucleic acid molecule (e.g., mmRNA). As a non-limiting example, the carbohydrate carrier may include, but is not limited to, an anhydride-modified phytoglycogen or glycogen-type material, phytoglycogen octenyl succinate, phytoglycogen beta-dextrin, anhydride-modified phytoglycogen beta-dextrin. (See e.g., International Publication No. WO2012109121; herein incorporated by reference in its entirety).

[00396] Lipid nanoparticle formulations may be improved by replacing the cationic lipid with a biodegradable cationic lipid which is known as a rapidly eliminated lipid nanoparticle (reLNP). Ionizable cationic lipids, such as, but not limited to, DLinDMA, DLin-KC2-DMA, and DLin-MC3-DMA, have been shown to accumulate in plasma and tissues over time and may be a potential source of toxicity. The rapid metabolism of the rapidly eliminated lipids can improve the tolerability and therapeutic index of the lipid nanoparticles by an order of magnitude from a 1 mg/kg dose to a 10 mg/kg dose in rat. Inclusion of an enzymatically degraded ester linkage can improve the degradation and metabolism profile of the cationic component, while still maintaining the activity of the reLNP formulation. The ester linkage can be internally located within the lipid chain or it may be terminally located at the terminal end of the lipid chain. The internal ester linkage may replace any carbon in the lipid chain.

[00397] In one embodiment, the internal ester linkage may be located on either side of the saturated carbon. Non-limiting examples of reLNPs include,

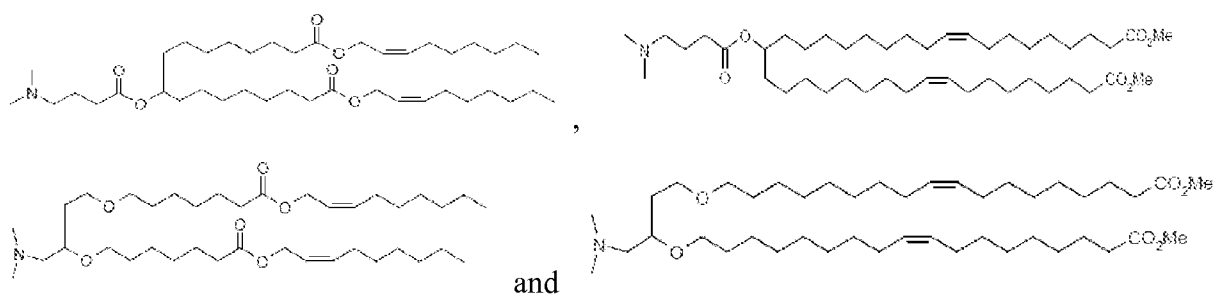

[00398] In one embodiment, an immune response may be elicited by delivering a lipid nanoparticle which may include a nanospecies, a polymer and an immunogen. (U.S. Publication No. 20120189700 and International Publication No. WO2012099805; each of which is herein incorporated by reference in their entirety). The polymer may encapsulate the nanospecies or

partially encapsulate the nanospecies. The immunogen may be a recombinant protein, a modified RNA described herein. In one embodiment, the lipid nanoparticle may be formulated for use in a vaccine such as, but not limited to, against a pathogen.

[00399] Lipid nanoparticles may be engineered to alter the surface properties of particles so the lipid nanoparticles may penetrate the mucosal barrier. Mucus is located on mucosal tissue such as, but not limited to, oral (e.g., the buccal and esophageal membranes and tonsil tissue), ophthalmic, gastrointestinal (e.g., stomach, small intestine, large intestine, colon, rectum), nasal, respiratory (e.g., nasal, pharyngeal, tracheal and bronchial membranes), genital (e.g., vaginal, cervical and urethral membranes). Nanoparticles larger than 10-200 nm which are preferred for higher drug encapsulation efficiency and the ability to provide the sustained delivery of a wide array of drugs have been thought to be too large to rapidly diffuse through mucosal barriers. Mucus is continuously secreted, shed, discarded or digested and recycled so most of the trapped particles may be removed from the mucosa tissue within seconds or within a few hours. Large polymeric nanoparticles (200nm -500nm in diameter) which have been coated densely with a low molecular weight polyethylene glycol (PEG) diffused through mucus only 4 to 6-fold lower than the same particles diffusing in water (Lai et al. PNAS 2007 104(5): 1482-487; Lai et al. Adv Drug Deliv Rev. 2009 61(2): 158-171; each of which is herein incorporated by reference in their entirety). The transport of nanoparticles may be determined using rates of permeation and/or fluorescent microscopy techniques including, but not limited to, fluorescence recovery after photobleaching (FRAP) and high resolution multiple particle tracking (MPT). As a non-limiting example, compositions which can penetrate a mucosal barrier may be made as described in U.S. Pat. No. 8,241,670, herein incorporated by reference in its entirety.

[00400] The lipid nanoparticle engineered to penetrate mucus may comprise a polymeric material (i.e. a polymeric core) and/or a polymer-vitamin conjugate and/or a tri-block co-polymer. The polymeric material may include, but is not limited to, polyamines, polyethers, polyamides, polyesters, polycarbamates, polyureas, polycarbonates, poly(styrenes), polyimides, polysulfones, polyurethanes, polyacetylenes, polyethylenes, polyethyleneimines, polyisocyanates, polyacrylates, polymethacrylates, polyacrylonitriles, and polyarylates. The polymeric material may be biodegradable and/or biocompatible. The polymeric material may additionally be irradiated. As a non-limiting example, the polymeric material may be gamma irradiated (See e.g., International App. No. WO201282165, herein incorporated by reference in its entirety). Non-limiting examples of

specific polymers include poly(caprolactone) (PCL), ethylene vinyl acetate polymer (EVA), poly(lactic acid) (PLA), poly(L-lactic acid) (PLLA), poly(glycolic acid) (PGA), poly(lactic acid-co-glycolic acid) (PLGA), poly(L-lactic acid-co-glycolic acid) (PLLGA), poly(D,L-lactide) (PDLA), poly(L-lactide) (PLLA), poly(D,L-lactide-co-caprolactone), poly(D,L-lactide-co-caprolactone-co-glycolide), poly(D,L-lactide-co-PEO-co-D,L-lactide), poly(D,L-lactide-co-PPO-co-D,L-lactide), polyalkyl cyanoacrylate, polyurethane, poly-L-lysine (PLL), hydroxypropyl methacrylate (HPMA), polyethyleneglycol, poly-L-glutamic acid, poly(hydroxy acids), polyanhydrides, polyorthoesters, poly(ester amides), polyamides, poly(ester ethers), polycarbonates, polyalkylenes such as polyethylene and polypropylene, polyalkylene glycols such as poly(ethylene glycol) (PEG), polyalkylene oxides (PEO), polyalkylene terephthalates such as poly(ethylene terephthalate), polyvinyl alcohols (PVA), polyvinyl ethers, polyvinyl esters such as poly(vinyl acetate), polyvinyl halides such as poly(vinyl chloride) (PVC), polyvinylpyrrolidone, polysiloxanes, polystyrene (PS), polyurethanes, derivatized celluloses such as alkyl celluloses, hydroxyalkyl celluloses, cellulose ethers, cellulose esters, nitro celluloses, hydroxypropylcellulose, carboxymethylcellulose, polymers of acrylic acids, such as poly(methyl(meth)acrylate) (PMMA), poly(ethyl(meth)acrylate), poly(butyl(meth)acrylate), poly(isobutyl(meth)acrylate), poly(hexyl(meth)acrylate), poly(isodecyl(meth)acrylate), poly(lauryl(meth)acrylate), poly(phenyl(meth)acrylate), poly(methyl acrylate), poly(isopropyl acrylate), poly(isobutyl acrylate), poly(octadecyl acrylate) and copolymers and mixtures thereof, polydioxanone and its copolymers, polyhydroxyalkanoates, polypropylene fumarate, polyoxymethylene, poloxamers, poly(ortho)esters, poly(butyric acid), poly(valeric acid), poly(lactide-co-caprolactone), and trimethylene carbonate, polyvinylpyrrolidone. The lipid nanoparticle may be coated or associated with a co-polymer such as, but not limited to, a block co-polymer, and (poly(ethylene glycol))-(poly(propylene oxide))-(poly(ethylene glycol)) triblock copolymer (see e.g., US Publication 20120121718 and US Publication 20100003337 and U.S. Pat. No. 8,263,665; each of which is herein incorporated by reference in their entirety). The co-polymer may be a polymer that is generally regarded as safe (GRAS) and the formation of the lipid nanoparticle may be in such a way that no new chemical entities are created. For example, the lipid nanoparticle may comprise poloxamers coating PLGA nanoparticles without forming new chemical entities which are still able to rapidly penetrate human mucus (Yang et al. *Angew. Chem. Int. Ed.* 2011 50:2597-2600; herein incorporated by reference in its entirety).

[00401] The vitamin of the polymer-vitamin conjugate may be vitamin E. The vitamin portion of the conjugate may be substituted with other suitable components such as, but not limited to, vitamin A, vitamin E, other vitamins, cholesterol, a hydrophobic moiety, or a hydrophobic component of other surfactants (e.g., sterol chains, fatty acids, hydrocarbon chains and alkylene oxide chains).

[00402] The lipid nanoparticle engineered to penetrate mucus may include surface altering agents such as, but not limited to, mmRNA, anionic proteins (e.g., bovine serum albumin), surfactants (e.g., cationic surfactants such as for example dimethyldioctadecyl-ammonium bromide), sugars or sugar derivatives (e.g., cyclodextrin), nucleic acids, polymers (e.g., heparin, polyethylene glycol and poloxamer), mucolytic agents (e.g., N-acetylcysteine, mugwort, bromelain, papain, clerodendrum, acetylcysteine, bromhexine, carbocysteine, eprazinone, mesna, ambroxol, sobrerol, domiodol, letosteine, stepronin, tiopronin, gelsolin, thymosin β 4 dornase alfa, neltexine, erdosteine) and various DNases including rhDNase.. The surface altering agent may be embedded or enmeshed in the particle's surface or disposed (e.g., by coating, adsorption, covalent linkage, or other process) on the surface of the lipid nanoparticle. (see e.g., US Publication 20100215580 and US Publication 20080166414; each of which is herein incorporated by reference in their entirety).

[00403] The mucus penetrating lipid nanoparticles may comprise at least one mmRNA described herein. The mmRNA may be encapsulated in the lipid nanoparticle and/or disposed on the surface of the particle. The mmRNA may be covalently coupled to the lipid nanoparticle. Formulations of mucus penetrating lipid nanoparticles may comprise a plurality of nanoparticles. Further, the formulations may contain particles which may interact with the mucus and alter the structural and/or adhesive properties of the surrounding mucus to decrease mucoadhesion which may increase the delivery of the mucus penetrating lipid nanoparticles to the mucosal tissue.

[00404] In one embodiment, the modified nucleic acid molecule or mmRNA is formulated as a lipoplex, such as, without limitation, the ATUPLEX™ system, the DACC system, the DBTC system and other siRNA-lipoplex technology from Silence Therapeutics (London, United Kingdom), STEMFECT™ from STEMGENT® (Cambridge, MA), and polyethylenimine (PEI) or protamine-based targeted and non-targeted delivery of nucleic acids acids (Aleku et al. Cancer Res. 2008 68:9788-9798; Strumberg et al. Int J Clin Pharmacol Ther 2012 50:76-78; Santel et al, Gene Ther 2006 13:1222-1234; Santel et al, Gene Ther 2006 13:1360-1370; Gutbier et al, Pulm Pharmacol. Ther. 2010 23:334-344; Kaufmann et al. Microvasc Res 2010 80:286-293Weide et al. J Immunother. 2009 32:498-507; Weide et al. J Immunother. 2008 31:180-188; Pascolo Expert Opin. Biol. Ther.

4:1285-1294; Fotin-Mleczek et al, 2011 *J. Immunother.* 34:1-15; Song et al, *Nature Biotechnol.* 2005, 23:709-717; Peer et al, *Proc Natl Acad Sci U S A.* 2007 6;104:4095-4100; deFougerolles *Hum Gene Ther.* 2008 19:125-132; all of which are incorporated herein by reference in its entirety).

[00405] In one embodiment such formulations may also be constructed or compositions altered such that they passively or actively are directed to different cell types *in vivo*, including but not limited to hepatocytes, immune cells, tumor cells, endothelial cells, antigen presenting cells, and leukocytes (Akinc et al. *Mol Ther.* 2010 18:1357-1364; Song et al, *Nat Biotechnol.* 2005 23:709-717; Judge et al, *J Clin Invest.* 2009 119:661-673; Kaufmann et al, *Microvasc Res* 2010 80:286-293; Santel et al, *Gene Ther* 2006 13:1222-1234; Santel et al, *Gene Ther* 2006 13:1360-1370; Gutbier et al, *Pulm Pharmacol. Ther.* 2010 23:334-344; Basha et al, *Mol. Ther.* 2011 19:2186-2200; Fenske and Cullis, *Expert Opin Drug Deliv.* 2008 5:25-44; Peer et al, *Science.* 2008 319:627-630; Peer and Lieberman, *Gene Ther.* 2011 18:127-133; all of which are incorporated herein by reference in its entirety). One example of passive targeting of formulations to liver cells includes the DLin-DMA, DLin-KC2-DMA and DLin-MC3 -DMA-based lipid nanoparticle formulations which have been shown to bind to apolipoprotein E and promote binding and uptake of these formulations into hepatocytes *in vivo* (Akinc et al. *Mol Ther.* 2010 18:1357-1364; herein incorporated by reference in its entirety). Formulations can also be selectively targeted through expression of different ligands on their surface as exemplified by, but not limited by, folate, transferrin, N-acetylgalactosamine (GalNAc), and antibody targeted approaches (Kolhatkar et al, *Curr Drug Discov Technol.* 2011 8:197-206; Musacchio and Torchilin, *Front Biosci.* 2011 16:1388-1412; Yu et al, *Mol Membr Biol.* 2010 27:286-298; Patil et al, *Crit Rev Ther Drug Carrier Syst.* 2008 25:1-61; Benoit et al, *Biomacromolecules.* 2011 12:2708-2714; Zhao et al., *Expert Opin Drug Deliv.* 2008 5:309-319; Akinc et al, *Mol Ther.* 2010 18:1357-1364; Srinivasan et al, *Methods Mol Biol.* 2012 820:105-116; Ben-Arie et al, *Methods Mol Biol.* 2012 757:497-507; Peer 2010 *J Control Release.* 20:63-68; Peer et al, *Proc Natl Acad Sci U S A.* 2007 104:4095-4100; Kim et al, *Methods Mol Biol.* 2011 721:339-353; Subramanya et al, *Mol Ther.* 2010 18:2028-2037; Song et al., *Nat Biotechnol.* 2005 23:709-717; Peer et al, *Science.* 2008 319:627-630; Peer and Lieberman, *Gene Ther.* 2011 18:127-133; all of which are incorporated herein by reference in its entirety).

[00406] In one embodiment, the modified nucleic acid molecules or mmRNA are formulated as a solid lipid nanoparticle. A solid lipid nanoparticle (SLN) may be spherical with an average diameter between 10 to 1000 nm. SLN possess a solid lipid core matrix that can solubilize lipophilic

molecules and may be stabilized with surfactants and/or emulsifiers. In a further embodiment, the lipid nanoparticle may be a self-assembly lipid-polymer nanoparticle (see Zhang et al., ACS Nano, 2008, 2 (8), pp 1696-1702; herein incorporated by reference in its entirety).

[00407] Liposomes, lipoplexes, or lipid nanoparticles may be used to improve the efficacy of modified nucleic acid molecules or mmRNA directed protein production as these formulations may be able to increase cell transfection by the modified nucleic acid molecule or mmRNA; and/or increase the translation of encoded protein. One such example involves the use of lipid encapsulation to enable the effective systemic delivery of polyplex plasmid DNA (Heyes et al., Mol Ther. 2007 15:713-720; herein incorporated by reference in its entirety). The liposomes, lipoplexes, or lipid nanoparticles may also be used to increase the stability of the modified nucleic acid molecules or mmRNA.

[00408] In one embodiment, the modified nucleic acid molecules and/or the mmRNA of the present invention can be formulated for controlled release and/or targeted delivery. As used herein, "controlled release" refers to a pharmaceutical composition or compound release profile that conforms to a particular pattern of release to effect a therapeutic outcome. In one embodiment, the modified nucleic acids molecules or the mmRNA may be encapsulated into a delivery agent described herein and/or known in the art for controlled release and/or targeted delivery. As used herein, the term "encapsulate" means to enclose, surround or encase. As it relates to the formulation of the compounds of the invention, encapsulation may be substantial, complete or partial. The term "substantially encapsulated" means that at least greater than 50, 60, 70, 80, 85, 90, 95, 96, 97, 98, 99, 99.9, 99.9 or greater than 99.999% of the pharmaceutical composition or compound of the invention may be enclosed, surrounded or encased within the delivery agent. "Partially encapsulation" means that less than 10, 10, 20, 30, 40 50 or less of the pharmaceutical composition or compound of the invention may be enclosed, surrounded or encased within the delivery agent. Advantageously, encapsulation may be determined by measuring the escape or the activity of the pharmaceutical composition or compound of the invention using fluorescence and/or electron micrograph. For example, at least 1, 5, 10, 20, 30, 40, 50, 60, 70, 80, 85, 90, 95, 96, 97, 98, 99, 99.9, 99.99 or greater than 99.99% of the pharmaceutical composition or compound of the invention are encapsulated in the delivery agent.

[00409] In one embodiment, the controlled release formulation may include, but is not limited to, tri-block co-polymers. As a non-limiting example, the formulation may include two different types

of tri-block co-polymers (International Pub. No. WO2012131 104 and WO2012131 106; each of which is herein incorporated by reference in its entirety).

[00410] In another embodiment, the modified nucleic acid molecules or the mmRNA may be encapsulated into a lipid nanoparticle or a rapidly eliminated lipid nanoparticle and the lipid nanoparticles or a rapidly eliminated lipid nanoparticle may then be encapsulated into a polymer, hydrogel and/or surgical sealant described herein and/or known in the art. As a non-limiting example, the polymer, hydrogel or surgical sealant may be PLGA, ethylene vinyl acetate (EVAc), poloxamer, GELSITE® (Nanotherapeutics, Inc. Alachua, FL), HYLENEX® (Halozyme Therapeutics, San Diego CA), surgical sealants such as fibrinogen polymers (Ethicon Inc. Cornelia, GA), TISSELL® (Baxter International, Inc Deerfield, IL), PEG-based sealants, and COSEAL® (Baxter International, Inc Deerfield, IL).

[00411] In another embodiment, the lipid nanoparticle may be encapsulated into any polymer known in the art which may form a gel when injected into a subject. As a non-limiting example, the lipid nanoparticle may be encapsulated into a polymer matrix which may be biodegradable.

[00412] In one embodiment, the modified nucleic acid molecules or mmRNA formulation for controlled release and/or targeted delivery may also include at least one controlled release coating. Controlled release coatings include, but are not limited to, OPADRY®, polyvinylpyrrolidone/vinyl acetate copolymer, polyvinylpyrrolidone, hydroxypropyl methylcellulose, hydroxypropyl cellulose, hydroxyethyl cellulose, EUDRAGIT RL®, EUDRAGIT RS® and cellulose derivatives such as ethylcellulose aqueous dispersions (AQUACOAT® and SURELEASE®).

[00413] In one embodiment, the controlled release and/or targeted delivery formulation may comprise at least one degradable polyester which may contain polycationic side chains. Degradable polyesters include, but are not limited to, poly(serine ester), poly(L-lactide-co-L-lysine), poly(4-hydroxy-L-proline ester), and combinations thereof. In another embodiment, the degradable polyesters may include a PEG conjugation to form a PEGylated polymer.

[00414] In one embodiment, the modified nucleic acid molecules and/or the mmRNA of the present invention may be encapsulated in a therapeutic nanoparticle. Therapeutic nanoparticles may be formulated by methods described herein and known in the art such as, but not limited to, International Pub Nos. WO2010005740, WO2010030763, WO2010005721, WO2010005723, WO2012054923, US Pub. Nos. US20 110262491, US20100104645, US20100087337, US20100068285, US20 110274759, US20100068286 and US20120288541, and US Pat No.

8,206,747, 8,293,276 8,318,208 and 8,318,21 1; each of which is herein incorporated by reference in their entirety. In another embodiment, therapeutic polymer nanoparticles may be identified by the methods described in US Pub No. US20120140790, herein incorporated by reference in its entirety.

[00415] In one embodiment, the therapeutic nanoparticle may be formulated for sustained release. As used herein, "sustained release" refers to a pharmaceutical composition or compound that conforms to a release rate over a specific period of time. The period of time may include, but is not limited to, hours, days, weeks, months and years. As a non-limiting example, the sustained release nanoparticle may comprise a polymer and a therapeutic agent such as, but not limited to, the modified nucleic acid molecules and mmRNA of the present invention (see International Pub No. 2010075072 and US Pub No. US20 1002 16804, US201 10217377 and US20120201859, each of which is herein incorporated by reference in their entirety).

[00416] In one embodiment, the therapeutic nanoparticles may be formulated to be target specific. As a non-limiting example, the thereapeutic nanoparticles may include a corticosteroid (see International Pub. No. WO201 1084518 herein incorporated by reference in its entirety). In one embodiment, the therapeutic nanoparticles of the present invention may be formulated to be cancer specific. As a non-limiting example, the therapeutic nanoparticles may be formulated in nanoparticles described in International Pub No. WO2008121949, WO2010005726, WO2010005725, WO201 1084521 and US Pub No. US20 100069426, US20120004293 and US20100104655, each of which is herein incorporated by reference in their entirety.

[00417] In one embodiment, the nanoparticles of the present invention may comprise a polymeric matrix. As a non-limiting example, the nanoparticle may comprise two or more polymers such as, but not limited to, polyethylenes, polycarbonates, polyanhydrides, polyhydroxyacids, polypropylfumerates, polycaprolactones, polyamides, polyacetals, polyethers, polyesters, poly(orthoesters), polycyanoacrylates, polyvinyl alcohols, polyurethanes, polyphosphazenes, polyacrylates, polymethacrylates, polycyanoacrylates, polyureas, polystyrenes, polyamines, polylysine, poly(ethylene imine), poly(serine ester), poly(L-lactide-co-L-lysine), poly(4-hydroxy-L-proline ester) or combinations thereof.

[00418] In one embodiment, the therapeutic nanoparticle comprises a diblock copolymer. In one embodiment, the diblock copolymer may include PEG in combination with a polymer such as, but not limited to, polyethylenes, polycarbonates, polyanhydrides, polyhydroxyacids, polypropylfumerates, polycaprolactones, polyamides, polyacetals, polyethers, polyesters,

poly(orthoesters), polycyanoacrylates, polyvinyl alcohols, polyurethanes, polyphosphazenes, polyacrylates, polymethacrylates, polycyanoacrylates, polyureas, polystyrenes, polyamines, polylysine, poly(ethylene imine), poly(serine ester), poly(L-lactide-co-L-lysine), poly(4-hydroxy-L-proline ester) or combinations thereof.

[00419] As a non-limiting example the therapeutic nanoparticle comprises a PLGA-PEG block copolymer (see US Pub. No. US20120004293 and US Pat No. 8,236,330, each of which is herein incorporated by reference in their entirety). In another non-limiting example, the therapeutic nanoparticle is a stealth nanoparticle comprising a diblock copolymer of PEG and PLA or PEG and PLGA (see US Pat No 8,246,968, herein incorporated by reference in its entirety).

[00420] In one embodiment, the therapeutic nanoparticle may comprise a multiblock copolymer (See e.g., U.S. Pat. No. 8,263,665 and 8,287,910; each of which is herein incorporated by reference in its entirety).

[00421] In one embodiment, the block copolymers described herein may be included in a polyion complex comprising a non-polymeric micelle and the block copolymer. (See e.g., U.S. Pub. No. 20120076836; herein incorporated by reference in its entirety).

[00422] In one embodiment, the therapeutic nanoparticle may comprise at least one acrylic polymer. Acrylic polymers include but are not limited to, acrylic acid, methacrylic acid, acrylic acid and methacrylic acid copolymers, methyl methacrylate copolymers, ethoxyethyl methacrylates, cyanoethyl methacrylate, amino alkyl methacrylate copolymer, poly(acrylic acid), poly(methacrylic acid), polycyanoacrylates and combinations thereof.

[00423] In one embodiment, the therapeutic nanoparticles may comprise at least one cationic polymer described herein and/or known in the art.

[00424] In one embodiment, the therapeutic nanoparticles may comprise at least one amine-containing polymer such as, but not limited to polylysine, polyethylene imine, poly(amidoamine) dendrimers, poly(beta-amino esters) (See e.g., U.S. Pat. No. 8,287,849; herein incorporated by reference in its entirety) and combinations thereof.

[00425] In one embodiment, the therapeutic nanoparticles may comprise at least one degradable polyester which may contain polycationic side chains. Degradable polyesters include, but are not limited to, poly(serine ester), poly(L-lactide-co-L-lysine), poly(4-hydroxy-L-proline ester), and combinations thereof. In another embodiment, the degradable polyesters may include a PEG conjugation to form a PEGylated polymer.

[00426] In another embodiment, the therapeutic nanoparticle may include a conjugation of at least one targeting ligand. The targeting ligand may be any ligand known in the art such as, but not limited to, a monoclonal antibody. (Kirpotin et al, Cancer Res. 2006 66:6732-6740; herein incorporated by reference in its entirety).

[00427] In one embodiment, the therapeutic nanoparticle may be formulated in an aqueous solution which may be used to target cancer (see International Pub No. WO201 10845 13 and US Pub No. US201 10294717, each of which is herein incorporated by reference in their entirety).

[00428] In one embodiment, the modified nucleic acid molecules or mmRNA may be encapsulated in, linked to and/or associated with synthetic nanocarriers. Synthetic nanocarriers include, but are not limited to, those described in International Pub. Nos. WO2010005740, WO2010030763, WO201213501, WO2012149252, WO2012149255, WO2012149259, WO2012149265, WO2012149268, WO2012149282, WO2012149301, WO2012149393, WO2012149405, WO201214941 1 and WO20 12 149454 and US Pub. Nos. US201 10262491, US20 100 104645, US20100087337 and US20 120244222, each of which is herein incorporated by reference in their entirety. The synthetic nanocarriers may be formulated using methods known in the art and/or described herein. As a non-limiting example, the synthetic nanocarriers may be formulated by the methods described in International Pub Nos. WO2010005740, WO2010030763 and WO201213501 and US Pub. Nos. US20 110262491, US20 100 104645, US20100087337 and US20 120244222, each of which is herein incorporated by reference in their entirety. In another embodiment, the synthetic nanocarrier formulations may be lyophilized by methods described in International Pub. No. WO201 1072218 and US Pat No. 8,21 1,473; each of which is herein incorporated by reference in their entirety.

[00429] In one embodiment, the synthetic nanocarriers may contain reactive groups to release the modified nucleic acid molecules and/or mmRNA described herein (see International Pub. No. WO20120952552 and US Pub No. US20120171229, each of which is herein incorporated by reference in their entirety).

[00430] In one embodiment, the synthetic nanocarriers may contain an immunostimulatory agent to enhance the immune response from delivery of the synthetic nanocarrier. As a non-limiting example, the synthetic nanocarrier may comprise a Th1 immunostimulatory agent which may enhance a Th1 -based response of the immune system (see International Pub No. WO20 10 123569 and US Pub. No. US201 10223201, each of which is herein incorporated by reference in its entirety).

[00431] In one embodiment, the synthetic nanocarriers may be formulated for targeted release. In one embodiment, the synthetic nanocarrier is formulated to release the modified nucleic acid molecules and/or mmRNA at a specified pH and/or after a desired time interval. As a non-limiting example, the synthetic nanoparticle may be formulated to release the modified mRNA molecules and/or mmRNA after 24 hours and/or at a pH of 4.5 (see International Pub. Nos. WO2010138193 and WO2010138194 and US Pub Nos. US201 10020388 and US20 110027217, each of which is herein incorporated by reference in their entirety).

[00432] In one embodiment, the synthetic nanocarriers may be formulated for controlled and/or sustained release of the modified nucleic acid molecules and/or mmRNA described herein. As a non-limiting example, the synthetic nanocarriers for sustained release may be formulated by methods known in the art, described herein and/or as described in International Pub No. WO2010138192 and US Pub No. 20100303850, each of which is herein incorporated by reference in their entirety.

[00433] In one embodiment, the synthetic nanocarrier may be formulated for use as a vaccine. In one embodiment, the synthetic nanocarrier may encapsulate at least one modified nucleic acid molecule and/or mmRNA which encodes at least one antigen. As a non-limiting example, the synthetic nanocarrier may include at least one antigen and an excipient for a vaccine dosage form (see International Pub No. WO201 1150264 and US Pub No. US201 10293723, each of which is herein incorporated by reference in their entirety). As another non-limiting example, a vaccine dosage form may include at least two synthetic nanocarriers with the same or different antigens and an excipient (see International Pub No. WO201 1150249 and US Pub No. US201 10293701, each of which is herein incorporated by reference in their entirety). The vaccine dosage form may be selected by methods described herein, known in the art and/or described in International Pub No. WO201 1150258 and US Pub No. US20120027806, each of which is herein incorporated by reference in their entirety).

[00434] In one embodiment, the synthetic nanocarrier may comprise at least one modified nucleic acid molecule and/or mmRNA which encodes at least one adjuvant. In another embodiment, the synthetic nanocarrier may comprise at least one modified nucleic molecule acid and/or mmRNA and an adjuvant. As a non-limiting example, the synthetic nanocarrier comprising and adjuvant may be formulated by the methods described in International Pub No. WO201 1150240 and US Pub No. US201 10293700, each of which is herein incorporated by reference in its entirety.

[00435] In one embodiment, the synthetic nanocarrier may encapsulate at least one modified nucleic acid molecule and/or mmRNA which encodes a peptide, fragment or region from a virus. As a non-limiting example, the synthetic nanocarrier may include, but is not limited to, the nanocarriers described in International Pub No. WO2012024621, WO201202629, WO2012024632 and US Pub No. US201200641 10, US20120058153 and US20120058154, each of which is herein incorporated by reference in their entirety.

[00436] In one embodiment, the nanoparticle may be optimized for oral administration. The nanoparticle may comprise at least one cationic biopolymer such as, but not limited to, chitosan or a derivative thereof. As a non-limiting example, the nanoparticle may be formulated by the methods described in U.S. Pub. No. 20120282343; herein incorporated by reference in its entirety.

Polymers, Biodegradable Nanoparticles, and Core-Shell Nanoparticles

[00437] The modified nucleic acid molecules and mmRNA of the invention can be formulated using natural and/or synthetic polymers. Non-limiting examples of polymers which may be used for delivery include, but are not limited to, DYNAMIC POLYCONJUGATE® (Arrowhead Research Corp., Pasadena, CA) formulations from MIRUS® Bio (Madison, WI) and Roche Madison (Madison, WI), PHASERX™ polymer formulations such as, without limitation, SMARTT POLYMER TECHNOLOGY™ (Seattle, WA), DMRI/DOPE, poloxamer, VAXFECTIN® adjuvant from Vical (San Diego, CA), chitosan, cyclodextrin from Calando Pharmaceuticals (Pasadena, CA), dendrimers and poly(lactic-co-glycolic acid) (PLGA) polymers, RONDEL™ (RNAi/Oligonucleotide Nanoparticle Delivery) polymers (Arrowhead Research Corporation, Pasadena, CA) and pH responsive co-block polymers such as, but not limited to, PHASERX™ (Seattle, WA).

[00438] A non-limiting example of chitosan formulation includes a core of positively charged chitosan and an outer portion of negatively charged substrate (U.S. Pub. No. 20120258176; herein incorporated by reference in its entirety). Chitosan includes, but is not limited to N-trimethyl chitosan, mono-N-carboxymethyl chitosan (MCC), N-palmitoyl chitosan (NPCS), EDTA-chitosan, low molecular weight chitosan, chitosan derivatives, or combinations thereof.

[00439] In one embodiment, the polymers used in the present invention have undergone processing to reduce and/or inhibit the attachment of unwanted substances such as, but not limited to, bacteria, to the surface of the polymer. The polymer may be processed by methods known and/or described

in the art and/or described in International Pub. No. WO2012150467, herein incorporated by reference in its entirety.

[00440] A non-limiting example of PLGA formulations include, but are not limited to, PLGA injectable depots (e.g., ELIGARD® which is formed by dissolving PLGA in 66% N-methyl-2-pyrrolidone (NMP) and the remainder being aqueous solvent and leuprolide. Once injected, the PLGA and leuprolide peptide precipitates into the subcutaneous space).

[00441] Many of these polymer approaches have demonstrated efficacy in delivering oligonucleotides *in vivo* into the cell cytoplasm (reviewed in deFougerolles *Hum Gene Ther.* 2008 19: 125-132; herein incorporated by reference in its entirety). Two polymer approaches that have yielded robust *in vivo* delivery of nucleic acids, in this case with small interfering RNA (siRNA), are dynamic polyconjugates and cyclodextrin-based nanoparticles. The first of these delivery approaches uses dynamic polyconjugates and has been shown *in vivo* in mice to effectively deliver siRNA and silence endogenous target mRNA in hepatocytes (Rozema et al, *Proc Natl Acad Sci U S A.* 2007 104:12982-12887; herein incorporated by reference in its entirety). This particular approach is a multicomponent polymer system whose key features include a membrane-active polymer to which nucleic acid, in this case siRNA, is covalently coupled via a disulfide bond and where both PEG (for charge masking) and α -acetylgalactosamine (for hepatocyte targeting) groups are linked via pH-sensitive bonds (Rozema et al, *Proc Natl Acad Sci U S A.* 2007 104:12982-12887; herein incorporated by reference in its entirety). On binding to the hepatocyte and entry into the endosome, the polymer complex disassembles in the low-pH environment, with the polymer exposing its positive charge, leading to endosomal escape and cytoplasmic release of the siRNA from the polymer. Through replacement of the α -acetylgalactosamine group with a mannose group, it was shown one could alter targeting from asialoglycoprotein receptor-expressing hepatocytes to sinusoidal endothelium and Kupffer cells. Another polymer approach involves using transferrin-targeted cyclodextrin-containing polycation nanoparticles. These nanoparticles have demonstrated targeted silencing of the *EWS-FLII* gene product in transferrin receptor-expressing Ewing's sarcoma tumor cells (Hu-Lieskovan *et al.*, *Cancer Res.* 2005 65: 8984-8982; herein incorporated by reference in its entirety) and siRNA formulated in these nanoparticles was well tolerated in non-human primates (Heidel *et al.*, *Proc Natl Acad Sci USA* 2007 104:5715-21; herein incorporated by reference in its entirety). Both of these delivery strategies incorporate rational approaches using both targeted delivery and endosomal escape mechanisms.

[00442] The polymer formulation can permit the sustained or delayed release of modified nucleic acid molecules or mmRNA (e.g., following intramuscular or subcutaneous injection). The altered release profile for the modified nucleic acid molecule or mmRNA can result in, for example, translation of an encoded protein over an extended period of time. The polymer formulation may also be used to increase the stability of the modified nucleic acid molecule or mmRNA.

Biodegradable polymers have been previously used to protect nucleic acids other than mmRNA from degradation and been shown to result in sustained release of payloads *in vivo* (Rozema et al, Proc Natl Acad Sci U S A. 2007 104:12982-12887; Sullivan et al, Expert Opin Drug Deliv. 2010 7:1433-1446; Convertine et al., Biomacromolecules. 2010 Oct 1; Chu et al., Acc Chem Res. 2012 Jan 13; Manganiello et al., Biomaterials. 2012 33:2301-2309; Benoit et al, Biomacromolecules. 2011 12:2708-2714; Singha et al, Nucleic Acid Ther. 2011 2:133-147; deFougerolles Hum Gene Ther. 2008 19:125-132; Schaffert and Wagner, Gene Ther. 2008 16:1 131-1 138; Chaturvedi et al, Expert Opin Drug Deliv. 2011 8:1455-1468; Davis, Mol Pharm. 2009 6:659-668; Davis, Nature 2010 464:1067-1070; each of which is herein incorporated by reference in its entirety).

[00443] In one embodiment, the pharmaceutical compositions may be sustained release formulations. In a further embodiment, the sustained release formulations may be for subcutaneous delivery. Sustained release formulations may include, but are not limited to, PLGA microspheres, ethylene vinyl acetate (EVAc), poloxamer, GELSITE® (Nanotherapeutics, Inc. Alachua, FL), HYLENEX® (Halozyme Therapeutics, San Diego CA), surgical sealants such as fibrinogen polymers (Ethicon Inc. Cornelia, GA), TISSELL® (Baxter International, Inc Deerfield, IL), PEG-based sealants, and COSEAL® (Baxter International, Inc Deerfield, IL).

[00444] As a non-limiting example modified mRNA may be formulated in PLGA microspheres by preparing the PLGA microspheres with tunable release rates (e.g., days and weeks) and encapsulating the modified mRNA in the PLGA microspheres while maintaining the integrity of the modified mRNA during the encapsulation process. EVAc are non-biodegradable, biocompatible polymers which are used extensively in pre-clinical sustained release implant applications (e.g., extended release products Ocusert a pilocarpine ophthalmic insert for glaucoma or progestasert a sustained release progesterone intrauterine device; transdermal delivery systems Testoderm, Duragesic and Selegiline; catheters). Poloxamer F-407 NF is a hydrophilic, non-ionic surfactant triblock copolymer of polyoxyethylene-polyoxypropylene-polyoxyethylene having a low viscosity at temperatures less than 5°C and forms a solid gel at temperatures greater than 15°C. PEG-based

surgical sealants comprise two synthetic PEG components mixed in a delivery device which can be prepared in one minute, seals in 3 minutes and is reabsorbed within 30 days. GELSITE® and natural polymers are capable of in-situ gelation at the site of administration. They have been shown to interact with protein and peptide therapeutic candidates through ionic interaction to provide a stabilizing effect.

[00445] Polymer formulations can also be selectively targeted through expression of different ligands as exemplified by, but not limited by, folate, transferrin, and N-acetylgalactosamine (GalNAc) (Benoit et al., *Biomacromolecules*. 2011 12:2708-2714; Rozema et al., *Proc Natl Acad Sci U S A*. 2007 104:12982-12887; Davis, *Mol Pharm*. 2009 6:659-668; Davis, *Nature* 2010 464:1067-1070; each of which is herein incorporated by reference in its entirety).

[00446] The modified nucleic acid molecules and mmRNA of the invention may be formulated with or in a polymeric compound. The polymer may include at least one polymer such as, but not limited to, polyethenes, polyethylene glycol (PEG), poly(L-lysine)(PLL), PEG grafted to PLL, cationic lipopolymer, biodegradable cationic lipopolymer, polyethyleneimine (PEI), cross-linked branched poly(alkylene imines), a polyamine derivative, a modified poloxamer, a biodegradable polymer, elastic biodegradable polymer, biodegradable block copolymer, biodegradable random copolymer, biodegradable polyester copolymer, biodegradable polyester block copolymer, biodegradable polyester block random copolymer, multiblock copolymers, linear biodegradable copolymer, poly[a-(4-aminobutyl)-L-glycolic acid] (PAGA), biodegradable cross-linked cationic multi-block copolymers, polycarbonates, polyanhydrides, polyhydroxyacids, polypropylfumerates, polycaprolactones, polyamides, polyacetals, polyethers, polyesters, poly(orthoesters), polycyanoacrylates, polyvinyl alcohols, polyurethanes, polyphosphazenes, polyacrylates, polymethacrylates, polycyanoacrylates, polyureas, polystyrenes, polyamines, polylysine, poly(ethylene imine), poly(serine ester), poly(L-lactide-co-L-lysine), poly(4-hydroxy-L-proline ester), acrylic polymers, amine-containing polymers, dextran polymers, dextran polymer derivatives or combinations thereof .

[00447] As a non-limiting example, the modified nucleic acid molecules or mmRNA of the invention may be formulated with the polymeric compound of PEG grafted with PLL as described in U.S. Pat. No. 6,177,274; herein incorporated by reference in its entirety. The formulation may be used for transfecting cells *in vitro* or for *in vivo* delivery of the modified nucleic acid molecules and mmRNA. In another example, the modified nucleic acid molecules and mmRNA may be suspended

in a solution or medium with a cationic polymer, in a dry pharmaceutical composition or in a solution that is capable of being dried as described in U.S. Pub. Nos. 20090042829 and 20090042825; each of which are herein incorporated by reference in their entireties.

[00448] As another non-limiting example the modified nucleic acid molecules or mmRNA of the invention may be formulated with a PLGA-PEG block copolymer (see US Pub. No. US20120004293 and US Pat No. 8,236,330, each of which are herein incorporated by reference in their entireties) or PLGA-PEG-PLGA block copolymers (See U.S. Pat. No. 6,004,573, herein incorporated by reference in its entirety). As a non-limiting example, the modified nucleic acid molecules or mmRNA of the invention may be formulated with a diblock copolymer of PEG and PLA or PEG and PLGA (see US Pat No 8,246,968, herein incorporated by reference in its entirety).

[00449] A polyamine derivative may be used to deliver nucleic acid molecules and/or mmRNA or to treat and/or prevent a disease or to be included in an implantable or injectable device (U.S. Pub. No. 20100260817 herein incorporated by reference in its entirety). As a non-limiting example, a pharmaceutical composition may include the modified nucleic acid molecules and mmRNA and the polyamine derivative described in U.S. Pub. No. 20100260817 (the contents of which are incorporated herein by reference in its entirety). As a non-limiting example the modified nucleic acids or mmRNA of the present invention may be delivered using a polyamine polymer such as, but not limited to, a polymer comprising a 1,3-dipolar addition polymer prepared by combining a carbohydrate diazide monomer with a diilkyne unit comprising oligoamines (U.S. Pat. No. 8,236,280; herein incorporated by reference in its entirety).

[00450] The modified nucleic acid molecules and/or mmRNA of the invention may be formulated with at least one acrylic polymer. Acrylic polymers include but are not limited to, acrylic acid, methacrylic acid, acrylic acid and methacrylic acid copolymers, methyl methacrylate copolymers, ethoxyethyl methacrylates, cyanoethyl methacrylate, amino alkyl methacrylate copolymer, poly(acrylic acid), poly(methacrylic acid), polycyanoacrylates and combinations thereof.

[00451] In one embodiment, the modified nucleic acid molecules and/or mmRNA of the present invention may be formulated with at least one polymer and/or derivatives thereof described in International Publication Nos. WO201 1115862, WO2012082574 and WO2012068187 and U.S. Pub. No. 20120283427, each of which are herein incorporated by reference in their entireties. In another embodiment, the modified nucleic acid molecules or mmRNA of the present invention may be formulated with a polymer of formula Z as described in WO201 1115862, herein incorporated by

reference in its entirety. In yet another embodiment, the modified nucleic acid molecules or mmRNA may be formulated with a polymer of formula Z, Z' or Z" as described in International Pub. Nos. WO2012082574 or WO2012068187, each of which are herein incorporated by reference in their entireties. The polymers formulated with the modified nucleic acids and/or modified mRNA of the present invention may be synthesized by the methods described in International Pub. Nos. WO2012082574 or WO2012068187, each of which are herein incorporated by reference in their entireties.

[00452] Formulations of modified nucleic acid molecules and/or mmRNA of the invention may include at least one amine-containing polymer such as, but not limited to polylysine, polyethylene imine, poly(amidoamine) dendrimers or combinations thereof.

[00453] For example, the modified nucleic acid molecules and/or mmRNA of the invention may be formulated in a pharmaceutical compound including a poly(alkylene imine), a biodegradable cationic lipopolymer, a biodegradable block copolymer, a biodegradable polymer, or a biodegradable random copolymer, a biodegradable polyester block copolymer, a biodegradable polyester polymer, a biodegradable polyester random copolymer, a linear biodegradable copolymer, PAGA, a biodegradable cross-linked cationic multi-block copolymer or combinations thereof. The biodegradable cationic lipopolymer may be made by methods known in the art and/or described in U.S. Pat. No. 6,696,038, U.S. App. Nos. 20030073619 and 20040142474 each of which is herein incorporated by reference in their entireties. The poly(alkylene imine) may be made using methods known in the art and/or as described in U.S. Pub. No. 20100004315, herein incorporated by reference in its entirety. The biodegradable polymer, biodegradable block copolymer, the biodegradable random copolymer, biodegradable polyester block copolymer, biodegradable polyester polymer, or biodegradable polyester random copolymer may be made using methods known in the art and/or as described in U.S. Pat. Nos. 6,517,869 and 6,267,987, the contents of which are each incorporated herein by reference in their entirety. The linear biodegradable copolymer may be made using methods known in the art and/or as described in U.S. Pat. No. 6,652,886. The PAGA polymer may be made using methods known in the art and/or as described in U.S. Pat. No. 6,217,912 herein incorporated by reference in its entirety. The PAGA polymer may be copolymerized to form a copolymer or block copolymer with polymers such as but not limited to, poly-L-lysine, polyarginine, polyornithine, histones, avidin, protamines, polylactides and poly(lactide-co-glycolides). The biodegradable cross-linked cationic multi-block copolymers may be made my

methods known in the art and/or as described in U.S. Pat. No. 8,057,821 or U.S. Pub. No. 2012009145 each of which are herein incorporated by reference in their entireties. For example, the multi-block copolymers may be synthesized using linear polyethyleneimine (LPEI) blocks which have distinct patterns as compared to branched polyethyleneimines. Further, the composition or pharmaceutical composition may be made by the methods known in the art, described herein, or as described in U.S. Pub. No. 20100004315 or U.S. Pat. Nos. 6,267,987 and 6,217,912 each of which are herein incorporated by reference in their entireties.

[00454] The modified nucleic acid molecules and mmRNA of the invention may be formulated with at least one degradable polyester which may contain polycationic side chains. Degradable polyesters include, but are not limited to, poly(serine ester), poly(L-lactide-co-L-lysine), poly(4-hydroxy-L-proline ester), and combinations thereof. In another embodiment, the degradable polyesters may include a PEG conjugation to form a PEGylated polymer.

[00455] The modified nucleic acid molecules and mmRNA of the invention may be formulated with at least one crosslinkable polyester. Crosslinkable polyesters include those known in the art and described in US Pub. No. 20120269761, herein incorporated by reference in its entirety.

[00456] In one embodiment, the polymers described herein may be conjugated to a lipid-terminating PEG. As a non-limiting example, PLGA may be conjugated to a lipid-terminating PEG forming PLGA-DSPE-PEG. As another non-limiting example, PEG conjugates for use with the present invention are described in International Publication No. WO2008 103276, herein incorporated by reference in its entirety. The polymers may be conjugated using a ligand conjugate such as, but not limited to, the conjugates described in U.S. Pat. No. 8,273,363, herein incorporated by reference in its entirety.

[00457] In one embodiment, the modified nucleic acid molecules and/or mmRNA described herein may be conjugated with another compound. Non-limiting examples of conjugates are described in US Patent Nos. 7,964,578 and 7,833,992, each of which are herein incorporated by reference in their entireties. In another embodiment, modified RNA of the present invention may be conjugated with conjugates of formula 1-122 as described in US Patent Nos. 7,964,578 and 7,833,992, each of which are herein incorporated by reference in their entireties. The modified RNA described herein may be conjugated with a metal such as, but not limited to, gold. (See e.g., Giljohann et al. Journ. Amer. Chem. Soc. 2009 131(6): 2072-2073; herein incorporated by reference in its entirety). In another embodiment, the modified nucleic acid molecules and/or mmRNA described herein may be

conjugated and/or encapsulated in gold-nanoparticles. (International Pub. No. WO201216269 and U.S. Pub. No. 20120302940; each of which is herein incorporated by reference in its entirety).

[00458] As described in U.S. Pub. No. 201000043 13, herein incorporated by reference in its entirety, a gene delivery composition may include a nucleotide sequence and a poloxamer. For example, the modified nucleic acid and mRNA of the present invention may be used in a gene delivery composition with the poloxamer described in U.S. Pub. No. 20100004313.

[00459] In one embodiment, the polymer formulation of the present invention may be stabilized by contacting the polymer formulation, which may include a cationic carrier, with a cationic lipopolymer which may be covalently linked to cholesterol and polyethylene glycol groups. The polymer formulation may be contacted with a cationic lipopolymer using the methods described in U.S. Pub. No. 20090042829 herein incorporated by reference in its entirety. The cationic carrier may include, but is not limited to, polyethylenimine, poly(trimethylenimine), poly(tetramethylenimine), polypropylenimine, aminoglycoside-polyamine, dideoxy-diamino-b-cyclodextrin, spermine, spermidine, poly(2-dimethylamino)ethyl methacrylate, poly(lysine), poly(histidine), poly(arginine), cationized gelatin, dendrimers, chitosan, 1,2-Dioleoyl-3-Trimethylammonium-Propane (DOTAP), N-[1-(2,3-dioleoyloxy)propyl]-N,N,N-trimethylammonium chloride (DOTMA), 1-[2-(oleoyloxy)ethyl]-2-oleyl-3-(2-hydroxyethyl)imidazolium chloride (DOTIM), 2,3-dioleoyloxy-N-[2(sperminecarboxamido)ethyl]-N,N-dimethyl-1-propanaminium trifluoroacetate (DOSPA), 3B-[N—(N',N'-Dimethylaminoethane)-carbamoyl]Cholesterol Hydrochloride (DC-Cholesterol HC1) diheptadecylamidoglycyl spermidine (DOGS), N,N-distearyl-N,N-dimethylammonium bromide (DDAB), N-(1,2-dimyristyloxyprop-3-yl)-N,N-dimethyl-N-hydroxyethyl ammonium bromide (DMRIE), N,N-dioleoyl-N,N-dimethylammonium chloride (DODAC) and combinations thereof.

[00460] The modified nucleic acid molecules and/or mRNA of the invention may be formulated in a polyplex of one or more polymers (U.S. Pub. No. 20120237565 and 20120270927; each of which is herein incorporated by reference in its entirety). In one embodiment, the polyplex comprises two or more cationic polymers. The cationic polymer may comprise a poly(ethylene imine) (PEI) such as linear PEI.

[00461] The modified nucleic acid molecules and mRNA of the invention can also be formulated as a nanoparticle using a combination of polymers, lipids, and/or other biodegradable agents, such as, but not limited to, calcium phosphate. Components may be combined in a core-shell, hybrid,

and/or layer-by-layer architecture, to allow for fine-tuning of the nanoparticle so to delivery of the modified nucleic acid molecule and mmRNA may be enhanced (Wang et al., Nat Mater. 2006 5:791-796; Fuller et al, Biomaterials. 2008 29:1526-1532; DeKoker et al, Adv Drug Deliv Rev. 2011 63:748-761; Endres et al, Biomaterials. 2011 32:7721-7731; Su et al, Mol Pharm. 2011 Jun 6;8(3):774-87; each of which is herein incorporated by reference in its entirety). As a non-limiting example, the nanoparticle may comprise a plurality of polymers such as, but not limited to hydrophilic-hydrophobic polymers (e.g., PEG-PLGA), hydrophobic polymers (e.g., PEG) and/or hydrophilic polymers (International Pub. No. WO20120225129; herein incorporated by reference in its entirety).

[00462] Biodegradable calcium phosphate nanoparticles in combination with lipids and/or polymers have been shown to deliver modified nucleic acid molecules and mmRNA *in vivo*. In one embodiment, a lipid coated calcium phosphate nanoparticle, which may also contain a targeting ligand such as anisamide, may be used to deliver the modified nucleic acid molecule and mmRNA of the present invention. For example, to effectively deliver siRNA in a mouse metastatic lung model a lipid coated calcium phosphate nanoparticle was used (Li et al., J Contr Rel. 2010 142: 416-421; Li et al, J Contr Rel. 2012 158:108-114; Yang et al, Mol Ther. 2012 20:609-615; herein incorporated by reference in its entirety). This delivery system combines both a targeted nanoparticle and a component to enhance the endosomal escape, calcium phosphate, in order to improve delivery of the siRNA.

[00463] In one embodiment, calcium phosphate with a PEG-polyanion block copolymer may be used to deliver modified nucleic acid molecules and mmRNA (Kazikawa et al., J Contr Rel. 2004 97:345-356; Kazikawa et al., J Contr Rel. 2006 111:368-370; herein incorporated by reference in its entirety).

[00464] In one embodiment, a PEG-charge-conversional polymer (Pitella et al., Biomaterials. 2011 32:3106-3114) may be used to form a nanoparticle to deliver the modified nucleic acid molecules and mmRNA of the present invention. The PEG-charge-conversional polymer may improve upon the PEG-polyanion block copolymers by being cleaved into a polycation at acidic pH, thus enhancing endosomal escape.

[00465] The use of core-shell nanoparticles has additionally focused on a high-throughput approach to synthesize cationic cross-linked nanogel cores and various shells (Siegwart et al., Proc Natl Acad Sci U S A. 2011 108:12996-13001). The complexation, delivery, and internalization of the

polymeric nanoparticles can be precisely controlled by altering the chemical composition in both the core and shell components of the nanoparticle. For example, the core-shell nanoparticles may efficiently deliver siRNA to mouse hepatocytes after they covalently attach cholesterol to the nanoparticle.

[00466] In one embodiment, a hollow lipid core comprising a middle PLGA layer and an outer neutral lipid layer containing PEG may be used to delivery of the modified nucleic acid molecules and mmRNA of the present invention. As a non-limiting example, in mice bearing a luciferase-expressing tumor, it was determined that the lipid-polymer-lipid hybrid nanoparticle significantly suppressed luciferase expression, as compared to a conventional lipoplex (Shi et al, *Angew Chem Int Ed.* 2011 50:7027-7031; herein incorporated by reference in its entirety).

[00467] In one embodiment, the lipid nanoparticles may comprise a core of the modified nucleic acid molecules disclosed herein and a polymer shell. The polymer shell may be any of the polymers described herein and are known in the art. In an additional embodiment, the polymer shell may be used to protect the modified nucleic acids in the core.

[00468] Core-shell nanoparticles for use with the modified nucleic acid molecules of the present invention are described and may be formed by the methods described in U.S. Pat. No. 8,313,777 herein incorporated by reference in its entirety.

[00469] In one embodiment, the core-shell nanoparticles may comprise a core of the modified nucleic acid molecules disclosed herein and a polymer shell. The polymer shell may be any of the polymers described herein and are known in the art. In an additional embodiment, the polymer shell may be used to protect the modified nucleic acid molecules in the core.

Peptides and Proteins

[00470] The modified nucleic acid molecules and mmRNA of the invention can be formulated with peptides and/or proteins in order to increase transfection of cells by the modified nucleic acid molecules or mmRNA. In one embodiment, peptides such as, but not limited to, cell penetrating peptides and proteins and peptides that enable intracellular delivery may be used to deliver pharmaceutical formulations. A non-limiting example of a cell penetrating peptide which may be used with the pharmaceutical formulations of the present invention include a cell-penetrating peptide sequence attached to polycations that facilitates delivery to the intracellular space, e.g., HIV-derived TAT peptide, penetratins, transportans, or hCT derived cell-penetrating peptides (see, e.g., Caron et al, *Mol. Ther.* 3(3):310-8 (2001); Langel, *Cell-Penetrating Peptides: Processes and*

Applications (CRC Press, Boca Raton FL, 2002); El-Andaloussi et al., *Curr. Pharm. Des.* 11(28):3597-611 (2003); and Deshayes et al., *Cell. Mol. Life Sci.* 62(16):1839-49 (2005), all of which are incorporated herein by reference). The compositions can also be formulated to include a cell penetrating agent, e.g., liposomes, which enhance delivery of the compositions to the intracellular space. Modified nucleic acid molecules and mmRNA of the invention may be complexed to peptides and/or proteins such as, but not limited to, peptides and/or proteins from Aileron Therapeutics (Cambridge, MA) and Permeon Biologies (Cambridge, MA) in order to enable intracellular delivery (Cronican et al., *ACS Chem. Biol.* 2010 5:747-752; McNaughton et al., *Proc. Natl. Acad. Sci. USA* 2009 106:6111-6116; Sawyer, *Chem Biol Drug Des.* 2009 73:3-6; Verdine and Hilinski, *Methods Enzymol.* 2012;503:3-33; all of which are herein incorporated by reference in its entirety).

[00471] In one embodiment, the cell-penetrating polypeptide may comprise a first domain and a second domain. The first domain may comprise a supercharged polypeptide. The second domain may comprise a protein-binding partner. As used herein, "protein-binding partner" includes, but are not limited to, antibodies and functional fragments thereof, scaffold proteins, or peptides. The cell-penetrating polypeptide may further comprise an intracellular binding partner for the protein-binding partner. The cell-penetrating polypeptide may be capable of being secreted from a cell where the modified nucleic acid molecules or mmRNA may be introduced.

[00472] Formulations of the including peptides or proteins may be used to increase cell transfection by the modified nucleic acid molecule or mmRNA, alter the biodistribution of the modified nucleic acid molecule or mmRNA (e.g., by targeting specific tissues or cell types), and/or increase the translation of encoded protein. (See e.g., International Pub. No. WO2012/110636; herein incorporated by reference in its entirety).

Cells

[00473] The modified nucleic acid molecule and mmRNA of the invention can be transfected *ex vivo* into cells, which are subsequently transplanted into a subject. As non-limiting examples, the pharmaceutical compositions may include red blood cells to deliver modified RNA to liver and myeloid cells, virosomes to deliver modified nucleic acid molecules and mmRNA in virus-like particles (VLPs), and electroporated cells such as, but not limited to, from MAXCYTE® (Gaithersburg, MD) and from ERYTECH® (Lyon, France) to deliver modified RNA. Examples of use of red blood cells, viral particles and electroporated cells to deliver payloads other than mmRNA

have been documented (Godfrin et al., Expert Opin Biol Ther. 2012 12:127-133; Fang et al., Expert Opin Biol Ther. 2012 12:385-389; Hu et al, Proc Natl Acad Sci U S A. 201 1 108:10980-10985; Lund et al, Pharm Res. 2010 27:400-420; Huckriede et al, J Liposome Res. 2007;17:39-47; Cusi, Hum Vaccin. 2006 2:1-7; de Jonge et al., Gene Ther. 2006 13:400-41 1; all of which are herein incorporated by reference in its entirety). The modified nucleic acid molecules and mmRNA may be delivered in synthetic VLPs synthesized by the methods described in International Pub No. WO201 1085231 and US Pub No. 201 10171248, each of which are herein incorporated by reference in their entirety.

[00474] Cell-based formulations of the modified nucleic acid molecules and mmRNA of the invention may be used to ensure cell transfection (e.g., in the cellular carrier), alter the biodistribution of the modified nucleic acid molecule or mmRNA (e.g., by targeting the cell carrier to specific tissues or cell types), and/or increase the translation of encoded protein.

Introduction into cells

[00475] A variety of methods are known in the art and suitable for introduction of nucleic acid into a cell, including viral and non-viral mediated techniques. Examples of typical non-viral mediated techniques include, but are not limited to, electroporation, calcium phosphate mediated transfer, nucleofection, sonoporation, heat shock, magnetofection, liposome mediated transfer, microinjection, microprojectile mediated transfer (nanoparticles), cationic polymer mediated transfer (DEAE-dextran, polyethylenimine, polyethylene glycol (PEG) and the like) or cell fusion.

[00476] The technique of sonoporation, or cellular sonication, is the use of sound (e.g., ultrasonic frequencies) for modifying the permeability of the cell plasma membrane. Sonoporation methods are known to those in the art and are taught for example as it relates to bacteria in US Patent Publication 20100196983 and as it relates to other cell types in, for example, US Patent Publication 20100009424, each of which are incorporated herein by reference in their entirety.

[00477] Electroporation techniques are also well known in the art. In one embodiment, modified nucleic acid molecules or mmRNA may be delivered by electroporation as described in Example 8.

Hyaluronidase

[00478] The intramuscular or subcutaneous localized injection of modified nucleic acid molecules or mmRNA of the invention can include hyaluronidase, which catalyzes the hydrolysis of hyaluronan. By catalyzing the hydrolysis of hyaluronan, a constituent of the interstitial barrier, hyaluronidase lowers the viscosity of hyaluronan, thereby increasing tissue permeability (Frost,

Expert Opin. Drug Deliv. (2007) 4:427-440; herein incorporated by reference in its entirety). It is useful to speed their dispersion and systemic distribution of encoded proteins produced by transfected cells. Alternatively, the hyaluronidase can be used to increase the number of cells exposed to a modified nucleic acid molecule or mmRNA of the invention administered intramuscularly or subcutaneously.

Nanoparticle Mimics

[00479] The modified nucleic acid molecules and mmRNA of the invention may be encapsulated within and/or absorbed to a nanoparticle mimic. A nanoparticle mimic can mimic the delivery function organisms or particles such as, but not limited to, pathogens, viruses, bacteria, fungus, parasites, prions and cells. As a non-limiting example the modified mRNA of the invention may be encapsulated in a non-viron particle which can mimic the delivery function of a virus (see International Pub. No. WO20 120063 76 herein incorporated by reference in its entirety).

Nanotubes

[00480] The modified nucleic acid molecules or mmRNA of the invention can be attached or otherwise bound to at least one nanotube such as, but not limited to, rosette nanotubes, rosette nanotubes having twin bases with a linker, carbon nanotubes and/or single-walled carbon nanotubes, The modified nucleic acid molecules or mmRNA may be bound to the nanotubes through forces such as, but not limited to, steric, ionic, covalent and/or other forces.

[00481] In one embodiment, the nanotube can release one or more modified nucleic acid molecule or mmRNA into cells. The size and/or the surface structure of at least one nanotube may be altered so as to govern the interaction of the nanotubes within the body and/or to attach or bind to the modified nucleic acid molecule or mmRNA disclosed herein. In one embodiment, the building block and/or the functional groups attached to the building block of the at least one nanotube may be altered to adjust the dimensions and/or properties of the nanotube. As a non-limiting example, the length of the nanotubes may be altered to hinder the nanotubes from passing through the holes in the walls of normal blood vessels but still small enough to pass through the larger holes in the blood vessels of tumor tissue.

[00482] In one embodiment, at least one nanotube may also be coated with delivery enhancing compounds including polymers, such as, but not limited to, polyethylene glycol. In another embodiment, at least one nanotube and/or the modified mRNA may be mixed with pharmaceutically acceptable excipients and/or delivery vehicles.

[00483] In one embodiment, the modified mRNA are attached and/or otherwise bound to at least one rosette nanotube. The rosette nanotubes may be formed by a process known in the art and/or by the process described in International Publication No. WO2012094304, herein incorporated by reference in its entirety. At least one modified mRNA may be attached and/or otherwise bound to at least one rosette nanotube by a process as described in International Publication No.

WO2012094304, herein incorporated by reference in its entirety, where rosette nanotubes or modules forming rosette nanotubes are mixed in aqueous media with at least one modified mRNA under conditions which may cause at least one modified mRNA to attach or otherwise bind to the rosette nanotubes.

[00484] In one embodiment, the modified nucleic acid molecule or mmRNA may be attached to and/or otherwise bound to at least one carbon nanotube. As a non-limiting example, the modified nucleic acid molecule or mmRNA may be bound to a linking agent and the linked agent may be bound to the carbon nanotube (See e.g., U.S. Pat No. 8,246,995; herein incorporated by reference in its entirety). The carbon nanotube may be a single-walled nanotube (See e.g., U.S. Pat No. 8,246,995; herein incorporated by reference in its entirety).

Conjugates

[00485] The modified nucleic acids molecules and mmRNA of the invention include conjugates, such as a modified nucleic acid molecule or mmRNA covalently linked to a carrier or targeting group, or including two encoding regions that together produce a fusion protein (e.g., bearing a targeting group and therapeutic protein or peptide).

[00486] The conjugates of the invention include a naturally occurring substance, such as a protein (e.g., human serum albumin (HSA), low-density lipoprotein (LDL), high-density lipoprotein (HDL), or globulin); an carbohydrate (e.g., a dextran, pullulan, chitin, chitosan, inulin, cyclodextrin or hyaluronic acid); or a lipid. The ligand may also be a recombinant or synthetic molecule, such as a synthetic polymer, e.g., a synthetic polyamino acid, an oligonucleotide (e.g. an aptamer). Examples of polyamino acids include polyamino acid is a polylysine (PLL), poly L-aspartic acid, poly L-glutamic acid, styrene-maleic acid anhydride copolymer, poly(L-lactide-co-glycolid) copolymer, divinyl ether-maleic anhydride copolymer, N-(2-hydroxypropyl)methacrylamide copolymer (HMPA), polyethylene glycol (PEG), polyvinyl alcohol (PVA), polyurethane, poly(2-ethylacrylic acid), N-isopropylacrylamide polymers, or polyphosphazine. Example of polyamines include: polyethylenimine, polylysine (PLL), spermine, spermidine, polyamine, pseudopeptide-polyamine,

peptidomimetic polyamine, dendrimer polyamine, arginine, amidine, protamine, cationic lipid, cationic porphyrin, quaternary salt of a polyamine, or an alpha helical peptide.

[00487] Representative U.S. patents that teach the preparation of polynucleotide conjugates, particularly to RNA, include, but are not limited to, U.S. Pat. Nos. 4,828,979; 4,948,882; 5,218,105; 5,525,465; 5,541,313; 5,545,730; 5,552,538; 5,578,717, 5,580,731; 5,591,584; 5,109,124; 5,118,802; 5,138,045; 5,414,077; 5,486,603; 5,512,439; 5,578,718; 5,608,046; 4,587,044; 4,605,735; 4,667,025; 4,762,779; 4,789,737; 4,824,941; 4,835,263; 4,876,335; 4,904,582; 4,958,013; 5,082,830; 5,112,963; 5,214,136; 5,082,830; 5,112,963; 5,214,136; 5,245,022; 5,254,469; 5,258,506; 5,262,536; 5,272,250; 5,292,873; 5,317,098; 5,371,241, 5,391,723; 5,416,203, 5,451,463; 5,510,475; 5,512,667; 5,514,785; 5,565,552; 5,567,810; 5,574,142; 5,585,481; 5,587,371; 5,595,726; 5,597,696; 5,599,923; 5,599,928 and 5,688,941; 6,294,664; 6,320,017; 6,576,752; 6,783,931; 6,900,297; 7,037,646; each of which is herein incorporated by reference in their entireties.

[00488] In one embodiment, the conjugate of the present invention may function as a carrier for the modified nucleic acid molecules and mmRNA of the present invention. The conjugate may comprise a cationic polymer such as, but not limited to, polyamine, polylysine, polyalkylenimine, and polyethylenimine which may be grafted to with poly(ethylene glycol). As a non-limiting example, the conjugate may be similar to the polymeric conjugate and the method of synthesizing the polymeric conjugate described in U.S. Pat. No. 6,586,524 herein incorporated by reference in its entirety.

[00489] The conjugates can also include targeting groups, e.g., a cell or tissue targeting agent, e.g., a lectin, glycoprotein, lipid or protein, e.g., an antibody, that binds to a specified cell type such as a kidney cell. A targeting group can be a thyrotropin, melanotropin, lectin, glycoprotein, surfactant protein A, Mucin carbohydrate, multivalent lactose, multivalent galactose, N-acetyl-galactosamine, N-acetyl-gulucosamine multivalent mannose, multivalent fucose, glycosylated polyaminoacids, multivalent galactose, transferrin, bisphosphonate, polyglutamate, polyaspartate, a lipid, cholesterol, a steroid, bile acid, folate, vitamin B12, biotin, an RGD peptide, an RGD peptide mimetic or an aptamer.

[00490] Targeting groups can be proteins, e.g., glycoproteins, or peptides, e.g., molecules having a specific affinity for a co-ligand, or antibodies e.g., an antibody, that binds to a specified cell type such as a cancer cell, endothelial cell, or bone cell. Targeting groups may also include hormones and

hormone receptors. They can also include non-peptidic species, such as lipids, lectins, carbohydrates, vitamins, cofactors, multivalent lactose, multivalent galactose, N-acetyl-galactosamine, N-acetyl-gulucosamine multivalent mannose, multivalent fucose, or aptamers. The ligand can be, for example, a lipopolysaccharide, or an activator of p38 MAP kinase.

[00491] The targeting group can be any ligand that is capable of targeting a specific receptor. Examples include, without limitation, folate, GalNAc, galactose, mannose, mannose-6P, aptamers, integrin receptor ligands, chemokine receptor ligands, transferrin, biotin, serotonin receptor ligands, PSMA, endothelin, GCPII, somatostatin, LDL, and HDL ligands. In particular embodiments, the targeting group is an aptamer. The aptamer can be unmodified or have any combination of modifications disclosed herein.

[00492] In one embodiment, pharmaceutical compositions of the present invention may include chemical modifications such as, but not limited to, modifications similar to locked nucleic acids.

[00493] Representative U.S. Patents that teach the preparation of locked nucleic acid (LNA) such as those from Santaris, include, but are not limited to, the following: U.S. Pat. Nos. 6,268,490; 6,670,461; 6,794,499; 6,998,484; 7,053,207; 7,084,125; and 7,399,845, each of which is herein incorporated by reference in its entirety.

[00494] Representative U.S. patents that teach the preparation of PNA compounds include, but are not limited to, U.S. Pat. Nos. 5,539,082; 5,714,331; and 5,719,262, each of which is herein incorporated by reference. Further teaching of PNA compounds can be found, for example, in Nielsen *et al.*, *Science*, 1991, 254, 1497-1500.

[00495] Some embodiments featured in the invention include modified nucleic acids or mmRNA with phosphorothioate backbones and oligonucleosides with other modified backbones, and in particular $-\text{CH}_2-\text{NH}-\text{CH}_2-$, $\sim\text{CH}_2\sim\text{N}(\text{CH}_3)\sim\text{O}\sim\text{CH}_2\sim$ [known as a methylene (methylimino) or MMI backbone], $-\text{CH}_2-\text{O}-\text{N}(\text{CH}_3)\sim\text{CH}_2-$, $-\text{CH}_2-\text{N}(\text{CH}_3)-\text{N}(\text{CH}_3)-\text{CH}_2-$ and $-\text{N}(\text{CH}_3)-\text{CH}_2-\text{CH}_2-$ [wherein the native phosphodiester backbone is represented as $-\text{O}-\text{P}(\text{O})_2-\text{O}-\text{CH}_2-$] of the above-referenced U.S. Pat. No. 5,489,677, and the amide backbones of the above-referenced U.S. Pat. No. 5,602,240. In some embodiments, the polynucleotides featured herein have morpholino backbone structures of the above-referenced U.S. Pat. No. 5,034,506.

[00496] Modifications at the 2' position may also aid in delivery. Preferably, modifications at the 2' position are not located in a polypeptide-coding sequence, i.e., not in a translatable region. Modifications at the 2' position may be located in a 5' UTR, a 3' UTR and/or a tailing region.

Modifications at the 2' position can include one of the following at the 2' position: H (i.e., 2'-deoxy); F; 0-, S-, or N-alkyl; 0-, S-, or N-alkenyl; 0-, S- or N-alkynyl; or O-alkyl-O-alkyl, wherein the alkyl, alkenyl and alkynyl may be substituted or unsubstituted **Ci** to **Cio** alkyl or **C₂** to **Cio** alkenyl and alkynyl. Exemplary suitable modifications include $0[(CH_2)_nO]_mCH_3$, $0(CH_2)_nOCH_3$, $0(CH_2)_nNH_2$, $0(CH_2)_nCH_3$, $0(CH_2)_nONH_2$, and $0(CH_2)_nON[(CH_2)_nCH_3]_2$, where n and m are from 1 to about 10. In other embodiments, the modified nucleic acids or mmRNA include one of the following at the 2' position: **Ci** to **Cio** lower alkyl, substituted lower alkyl, alkaryl, aralkyl, O-alkaryl or O-aralkyl, SH, SCH₃, OCN, Cl, Br, CN, CF₃, OCF₃, SOCH₃, SO₂CH₃, ONO₂, NO₂, N₃, NH₂, heterocycloalkyl, heterocycloalkaryl, aminoalkylamino, polyalkylamino, substituted silyl, an RNA cleaving group, a reporter group, an intercalator, a group for improving the pharmacokinetic properties, or a group for improving the pharmacodynamic properties, and other substituents having similar properties. In some embodiments, the modification includes a 2'-methoxyethoxy (2'-O—CH₂CH₂OCH₃, also known as 2'-O-(2-methoxyethyl) or 2'-MOE) (Martin et al, *Helv. Chim. Acta*, 1995, 78:486-504) *i.e.*, an alkoxy-alkoxy group. Another exemplary modification is 2'-dimethylaminoethoxy, *i.e.*, a $0(CH_2)_2ON(CH_3)_2$ group, also known as 2'-DMAOE, as described in examples herein below, and 2'-dimethylaminoethoxyethyl (also known in the art as 2'-O-dimethylaminoethoxyethyl or 2'-DMAEOE), *i.e.*, $2'-O\sim CH_2\sim O\sim CH_2\sim N(CH_2)_2$, also described in examples herein below. Other modifications include 2'-methoxy (2'-OCH₃), 2'-aminopropoxy (2'-OCH₂CH₂CH₂NH₂) and 2'-fluoro (2'-F). Similar modifications may also be made at other positions, particularly the 3' position of the sugar on the 3' terminal nucleotide or in 2'-5' linked dsRNAs and the 5' position of 5' terminal nucleotide. Polynucleotides of the invention may also have sugar mimetics such as cyclobutyl moieties in place of the pentofuranosyl sugar. Representative U.S. patents that teach the preparation of such modified sugar structures include, but are not limited to, U.S. Pat. Nos. 4,981,957; 5,118,800; 5,319,080; 5,359,044; 5,393,878; 5,446,137; 5,466,786; 5,514,785; 5,519,134; 5,567,811; 5,576,427; 5,591,722; 5,597,909; 5,610,300; 5,627,053; 5,639,873; 5,646,265; 5,658,873; 5,670,633; and 5,700,920 and each of which is herein incorporated by reference.

[00497] In still other embodiments, the modified nucleic acid molecule or mmRNA is covalently conjugated to a cell-penetrating polypeptide. The cell-penetrating peptide may also include a signal sequence. The conjugates of the invention can be designed to have increased stability; increased cell transfection; and/or altered the biodistribution (e.g., targeted to specific tissues or cell types).

*Self-Assembled Nanoparticles**Nucleic Acid Self-Assembled Nanoparticles*

[00498] Self-assembled nanoparticles have a well-defined size which may be precisely controlled as the nucleic acid strands may be easily reprogrammable. For example, the optimal particle size for a cancer-targeting nanodelivery carrier is 20-100 nm as a diameter greater than 20 nm avoids renal clearance and enhances delivery to certain tumors through enhanced permeability and retention effect. Using self-assembled nucleic acid nanoparticles a single uniform population in size and shape having a precisely controlled spatial orientation and density of cancer-targeting ligands for enhanced delivery. As a non-limiting example, oligonucleotide nanoparticles were prepared using programmable self-assembly of short DNA fragments and therapeutic siRNAs. These nanoparticles are molecularly identical with controllable particle size and target ligand location and density. The DNA fragments and siRNAs self-assembled into a one-step reaction to generate DNA/siRNA tetrahedral nanoparticles for targeted *in vivo* delivery. (Lee et al., Nature Nanotechnology 2012 7:389-393; herein incorporated by reference in its entirety).

[00499] In one embodiment, the modified nucleic acid molecules and mmRNA disclosed herein may be formulated as self-assembled nanoparticles. As a non-limiting example, nucleic acids may be used to make nanoparticles which may be used in a delivery system for the modified nucleic acid molecules and/or mmRNA of the present invention (See e.g., International Pub. No. WO2012125987; herein incorporated by reference in its entirety).

[00500] In one embodiment, the nucleic acid self-assembled nanoparticles may comprise a core of the modified nucleic acid molecules or mmRNA disclosed herein and a polymer shell. The polymer shell may be any of the polymers described herein and are known in the art. In an additional embodiment, the polymer shell may be used to protect the modified nucleic acid molecules and mmRNA in the core.

Polymer-Based Self-Assembled Nanoparticles

[00501] Polymers may be used to form sheets which self-assembled into nanoparticles. These nanoparticles may be used to deliver the modified nucleic acids and mmRNA of the present invention. In one embodiment, these self-assembled nanoparticles may be microsponges formed of long polymers of RNA hairpins which form into crystalline 'pleated' sheets before self-assembling into microsponges. These microsponges are densely-packed sponge like microparticles which may function as an efficient carrier and may be able to deliver cargo to a cell. The microsponges may be

from 100 nm to 300 nm in diameter. The microsponges may be complexed with other agents known in the art to form larger microsponges. As a non-limiting example, the microsphere may be complexed with an agent to form an outer layer to promote cellular uptake such as polycation polyethyleneimine (PEI). This complex can form a 250-nm diameter particle that can remain stable at high temperatures (150°C) (Grabow and Jaegar, Nature Materials 2012, 11:269-269; herein incorporated by reference in its entirety). Additionally these microsponges may be able to exhibit an extraordinary degree of protection from degradation by ribonucleases.

[00502] In another embodiment, the polymer-based self-assembled nanoparticles such as, but not limited to, microsponges, may be fully programmable nanoparticles. The geometry, size and stoichiometry of the nanoparticle may be precisely controlled to create the optimal nanoparticle for delivery of cargo such as, but not limited to, modified nucleic acid molecules and mmRNA.

[00503] In one embodiment, the polymer based nanoparticles may comprise a core of the modified nucleic acid molecules and mmRNA disclosed herein and a polymer shell. The polymer shell may be any of the polymers described herein and are known in the art. In an additional embodiment, the polymer shell may be used to protect the modified nucleic acid molecules and mmRNA in the core.

Inorganic Nanoparticles

[00504] The modified nucleic acid molecules or mmRNAs of the present invention may be formulated in inorganic nanoparticles (U.S. Pat. No. 8,257,745, herein incorporated by reference in its entirety). The inorganic nanoparticles may include, but are not limited to, clay substances that are water swellable. As a non-limiting example, the inorganic nanoparticle may include synthetic smectite clays which are made from simple silicates (See e.g., U.S. Pat. No. 5,585,108 and 8,257,745 each of which are herein incorporated by reference in their entirety).

[00505] In one embodiment, the inorganic nanoparticles may comprise a core of the modified nucleic acids disclosed herein and a polymer shell. The polymer shell may be any of the polymers described herein and are known in the art. In an additional embodiment, the polymer shell may be used to protect the modified nucleic acids in the core.

Semi-conductive and Metallic Nanoparticles

[00506] The modified nucleic acid molecules or mmRNAs of the present invention may be formulated in water-dispersible nanoparticle comprising a semiconductive or metallic material (U.S. Pub. No. 20120228565; herein incorporated by reference in its entirety) or formed in a magnetic nanoparticle (U.S. Pub. No. 20120265001 and 20120283503; each of which is herein incorporated

by reference in its entirety). The water-dispersible nanoparticles may be hydrophobic nanoparticles or hydrophilic nanoparticles.

[00507] In one embodiment, the semi-conductive and/or metallic nanoparticles may comprise a core of the modified nucleic acids disclosed herein and a polymer shell. The polymer shell may be any of the polymers described herein and are known in the art. In an additional embodiment, the polymer shell may be used to protect the modified nucleic acids in the core.

Gels and Hydrogels

[00508] In one embodiment, the modified mRNA disclosed herein may be encapsulated into any hydrogel known in the art which may form a gel when injected into a subject. Hydrogels are a network of polymer chains that are hydrophilic, and are sometimes found as a colloidal gel in which water is the dispersion medium. Hydrogels are highly absorbent (they can contain over 99% water) natural or synthetic polymers. Hydrogels also possess a degree of flexibility very similar to natural tissue, due to their significant water content. The hydrogel described herein may used to encapsulate lipid nanoparticles which are biocompatible, biodegradable and/or porous.

[00509] As a non-limiting example, the hydrogel may be an aptamer-functionalized hydrogel. The aptamer-functionalized hydrogel may be programmed to release one or more modified nucleic acid molecules and/or mRNA using nucleic acid hybridization. (Battig et al., J. Am. Chem. Society. 2012 134:12410-12413; herein incorporated by reference in its entirety).

[00510] As another non-limiting example, the hydrogel may be shaped as an inverted opal. The opal hydrogels exhibit higher swelling ratios and the swelling kinetics is an order of magnitude faster as well. Methods of producing opal hydrogels and description of opal hydrogels are described in International Pub. No. WO2012148684, herein incorporated by reference in its entirety.

[00511] In yet another non-limiting example, the hydrogel may be an antibacterial hydrogel. The antibacterial hydrogel may comprise a pharmaceutical acceptable salt or organic material such as, but not limited to pharmaceutical grade and/or medical grade silver salt and aloe vera gel or extract. (International Pub. No. WO2012151438, herein incorporated by reference in its entirety).

[00512] In one embodiment, the modified mRNA may be encapsulated in a lipid nanoparticle and then the lipid nanoparticle may be encapsulated into a hydrogel.

[00513] In one embodiment, the modified mRNA disclosed herein may be encapsulated into any gel known in the art. As a non-limiting example the gel may be a fluorouracil injectable gel or a fluorouracil injectable gel containing a chemical compound and/or drug known in the art. As

another example, the modified mRNA may be encapsulated in a fluorouracil gel containing epinephrine (See e.g., Smith et al. *Cancer Chemotherapy and Pharmacology*, 1999 44(4):267-274; herein incorporated by reference in its entirety).

[00514] In one embodiment, the modified nucleic acid molecules and/or mmRNA disclosed herein may be encapsulated into a fibrin gel, fibrin hydrogel or fibrin glue. In another embodiment, the modified nucleic acid molecules and/or mmRNA may be formulated in a lipid nanoparticle or a rapidly eliminated lipid nanoparticle prior to being encapsulated into a fibrin gel, fibrin hydrogel or a fibrin glue. In yet another embodiment, the modified nucleic acid molecules and/or mmRNA may be formulated as a lipoplex prior to being encapsulated into a fibrin gel, hydrogel or a fibrin glue. Fibrin gels, hydrogels and glues comprise two components, a fibrinogen solution and a thrombin solution which is rich in calcium (See e.g., Spicer and Mikos, *Journal of Controlled Release* 2010. 148: 49-55; Kidd et al. *Journal of Controlled Release* 2012. 157:80-85; each of which is herein incorporated by reference in its entirety). The concentration of the components of the fibrin gel, hydrogel and/or glue can be altered to change the characteristics, the network mesh size, and/or the degradation characteristics of the gel, hydrogel and/or glue such as, but not limited to changing the release characteristics of the fibrin gel, hydrogel and/or glue. (See e.g., Spicer and Mikos, *Journal of Controlled Release* 2010. 148: 49-55; Kidd et al. *Journal of Controlled Release* 2012. 157:80-85; Catelas et al. *Tissue Engineering* 2008. 14:1 19-128; each of which is herein incorporated by reference in its entirety). This feature may be advantageous when used to deliver the modified mRNA disclosed herein. (See e.g., Kidd et al. *Journal of Controlled Release* 2012. 157:80-85; Catelas et al. *Tissue Engineering* 2008. 14:1 19-128; each of which is herein incorporated by reference in its entirety).

Cations and Anions

[00515] Formulations of modified nucleic acid molecules disclosed herein may include cations or anions. In one embodiment, the formulations include metal cations such as, but not limited to, Zn²⁺, Ca²⁺, Cu²⁺, Mg⁺ and combinations thereof. As a non-limiting example, formulations may include polymers and a modified mRNA complexed with a metal cation (See e.g., U.S. Pat. Nos. 6,265,389 and 6,555,525, each of which is herein incorporated by reference in its entirety).

Molded Nanoparticles and Microparticles

[00516] The modified nucleic acid molecules and/or mmRNA disclosed herein may be formulated in nanoparticles and/or microparticles. These nanoparticles and/or microparticles may be molded

into any size shape and chemistry. As an example, the nanoparticles and/or microparticles may be made using the PRINT® technology by LIQUIDA TECHNOLOGIES® (Morrisville, NC) (See e.g., International Pub. No. WO2007024323; herein incorporated by reference in its entirety).

[00517] In one embodiment, the molded nanoparticles may comprise a core of the modified nucleic acid molecules and/or mmRNA disclosed herein and a polymer shell. The polymer shell may be any of the polymers described herein and are known in the art. In an additional embodiment, the polymer shell may be used to protect the modified nucleic acid molecules and/or mmRNA in the core.

NanoJackets and NanoLiposomes

[00518] The modified nucleic acid molecules and/or mmRNA disclosed herein may be formulated in NanoJackets and NanoLiposomes by Keystone Nano (State College, PA). NanoJackets are made of compounds that are naturally found in the body including calcium, phosphate and may also include a small amount of silicates. Nanojackets may range in size from 5 to 50 nm and may be used to deliver hydrophilic and hydrophobic compounds such as, but not limited to, modified nucleic acid molecules and/or mmRNA.

[00519] NanoLiposomes are made of lipids such as, but not limited to, lipids which naturally occur in the body. NanoLiposomes may range in size from 60-80 nm and may be used to deliver hydrophilic and hydrophobic compounds such as, but not limited to, modified nucleic acid molecules and/or mmRNA. In one aspect, the modified nucleic acids disclosed herein are formulated in a NanoLiposome such as, but not limited to, Ceramide NanoLiposomes.

Excipients

[00520] Pharmaceutical formulations may additionally comprise a pharmaceutically acceptable excipient, which, as used herein, includes, but are not limited to, any and all solvents, dispersion media, diluents, or other liquid vehicles, dispersion or suspension aids, surface active agents, isotonic agents, thickening or emulsifying agents, preservatives, solid binders, lubricants and the like, as suited to the particular dosage form desired. Various excipients for formulating pharmaceutical compositions and techniques for preparing the composition are known in the art (see *Remington: The Science and Practice of Pharmacy*, 21st Edition, A. R. Gennaro, Lippincott, Williams & Wilkins, Baltimore, MD, 2006; incorporated herein by reference in its entirety). The use of a conventional excipient medium may be contemplated within the scope of the present disclosure, except insofar as any conventional excipient medium may be incompatible with a

substance or its derivatives, such as by producing any undesirable biological effect or otherwise interacting in a deleterious manner with any other component(s) of the pharmaceutical composition.

[00521] In some embodiments, a pharmaceutically acceptable excipient may be at least 95%, at least 96%, at least 97%, at least 98%, at least 99%, or 100% pure. In some embodiments, an excipient may be approved for use for humans and for veterinary use. In some embodiments, an excipient may be approved by United States Food and Drug Administration. In some embodiments, an excipient may be of pharmaceutical grade. In some embodiments, an excipient may meet the standards of the United States Pharmacopoeia (USP), the European Pharmacopoeia (EP), the British Pharmacopoeia, and/or the International Pharmacopoeia.

[00522] Pharmaceutically acceptable excipients used in the manufacture of pharmaceutical compositions include, but are not limited to, inert diluents, dispersing and/or granulating agents, surface active agents and/or emulsifiers, disintegrating agents, binding agents, preservatives, buffering agents, lubricating agents, and/or oils. Such excipients may optionally be included in pharmaceutical formulations. The composition may also include excipients such as cocoa butter and suppository waxes, coloring agents, coating agents, sweetening, flavoring, and/or perfuming agents.

[00523] Exemplary diluents include, but are not limited to, calcium carbonate, sodium carbonate, calcium phosphate, dicalcium phosphate, calcium sulfate, calcium hydrogen phosphate, sodium phosphate lactose, sucrose, cellulose, microcrystalline cellulose, kaolin, mannitol, sorbitol, inositol, sodium chloride, dry starch, cornstarch, powdered sugar, *etc.*, and/or combinations thereof.

[00524] Exemplary granulating and/or dispersing agents include, but are not limited to, potato starch, corn starch, tapioca starch, sodium starch glycolate, clays, alginic acid, guar gum, citrus pulp, agar, bentonite, cellulose and wood products, natural sponge, cation-exchange resins, calcium carbonate, silicates, sodium carbonate, cross-linked poly(vinyl-pyrrolidone) (crospovidone), sodium carboxymethyl starch (sodium starch glycolate), carboxymethyl cellulose, cross-linked sodium carboxymethyl cellulose (croscarmellose), methylcellulose, pregelatinized starch (starch 1500), microcrystalline starch, water insoluble starch, calcium carboxymethyl cellulose, magnesium aluminum silicate (VEEGUM®), sodium lauryl sulfate, quaternary ammonium compounds, *etc.*, and/or combinations thereof.

[00525] Exemplary surface active agents and/or emulsifiers include, but are not limited to, natural emulsifiers *{e.g. acacia, agar, alginic acid, sodium alginate, tragacanth, chondrux, cholesterol, xanthan, pectin, gelatin, egg yolk, casein, wool fat, cholesterol, wax, and lecithin}*, colloidal clays

(*e.g.* bentonite [aluminum silicate] and VEEGUM[®] [magnesium aluminum silicate]), long chain amino acid derivatives, high molecular weight alcohols (*e.g.* stearyl alcohol, cetyl alcohol, oleyl alcohol, triacetin monostearate, ethylene glycol distearate, glyceryl monostearate, and propylene glycol monostearate, polyvinyl alcohol), carbomers (*e.g.* carboxy polymethylene, polyacrylic acid, acrylic acid polymer, and carboxyvinyl polymer), carrageenan, cellulosic derivatives (*e.g.* carboxymethylcellulose sodium, powdered cellulose, hydroxymethyl cellulose, hydroxypropyl cellulose, hydroxypropyl methylcellulose, methylcellulose), sorbitan fatty acid esters (*e.g.* polyoxyethylene sorbitan monolaurate [TWEEN[®]20], polyoxyethylene sorbitan [TWEEN[®]60], polyoxyethylene sorbitan monooleate [TWEEN[®]80], sorbitan monopalmitate [SPAN[®]40], sorbitan monostearate [SPAN[®]60], sorbitan tristearate [SPAN[®]65], glyceryl monooleate, sorbitan monooleate [SPAN[®]80]), polyoxyethylene esters (*e.g.* polyoxyethylene monostearate [MYRJ[®]45], polyoxyethylene hydrogenated castor oil, polyethoxylated castor oil, polyoxymethylene stearate, and SOLUTOL[®]), sucrose fatty acid esters, polyethylene glycol fatty acid esters (*e.g.* CREMOPHOR[®]), polyoxyethylene ethers, (*e.g.* polyoxyethylene lauryl ether [BRIJ[®]30]), poly(vinyl-pyrrolidone), diethylene glycol monolaurate, triethanolamine oleate, sodium oleate, potassium oleate, ethyl oleate, oleic acid, ethyl laurate, sodium lauryl sulfate, PLUORINC[®]F 68, POLOXAMER[®]188, cetrimonium bromide, cetylpyridinium chloride, benzalkonium chloride, docusate sodium, *etc.* and/or combinations thereof.

[00526] Exemplary binding agents include, but are not limited to, starch (*e.g.* cornstarch and starch paste); gelatin; sugars (*e.g.* sucrose, glucose, dextrose, dextrin, molasses, lactose, lactitol, mannitol); natural and synthetic gums (*e.g.* acacia, sodium alginate, extract of Irish moss, panwar gum, ghatti gum, mucilage of isapol husks, carboxymethylcellulose, methylcellulose, ethylcellulose, hydroxyethylcellulose, hydroxypropyl cellulose, hydroxypropyl methylcellulose, microcrystalline cellulose, cellulose acetate, poly(vinyl-pyrrolidone), magnesium aluminum silicate (VEEGUM[®]), and larch arabogalactan); alginates; polyethylene oxide; polyethylene glycol; inorganic calcium salts; silicic acid; polymethacrylates; waxes; water; alcohol; *etc.*; and combinations thereof.

[00527] Exemplary preservatives may include, but are not limited to, antioxidants, chelating agents, antimicrobial preservatives, antifungal preservatives, alcohol preservatives, acidic preservatives, and/or other preservatives. Exemplary antioxidants include, but are not limited to, alpha tocopherol, ascorbic acid, acorbyl palmitate, butylated hydroxyanisole, butylated hydroxytoluene, monothioglycerol, potassium metabisulfite, propionic acid, propyl gallate, sodium ascorbate, sodium

bisulfite, sodium metabisulfite, and/or sodium sulfite. Exemplary chelating agents include ethylenediaminetetraacetic acid (EDTA), citric acid monohydrate, disodium edetate, dipotassium edetate, edetic acid, fumaric acid, malic acid, phosphoric acid, sodium edetate, tartaric acid, and/or trisodium edetate. Exemplary antimicrobial preservatives include, but are not limited to, benzalkonium chloride, benzethonium chloride, benzyl alcohol, bronopol, cetrimide, cetylpyridinium chloride, chlorhexidine, chlorobutanol, chlorocresol, chloroxylenol, cresol, ethyl alcohol, glycerin, hexetidine, imidurea, phenol, phenoxyethanol, phenylethyl alcohol, phenylmercuric nitrate, propylene glycol, and/or thimerosal. Exemplary antifungal preservatives include, but are not limited to, butyl paraben, methyl paraben, ethyl paraben, propyl paraben, benzoic acid, hydroxybenzoic acid, potassium benzoate, potassium sorbate, sodium benzoate, sodium propionate, and/or sorbic acid. Exemplary alcohol preservatives include, but are not limited to, ethanol, polyethylene glycol, phenol, phenolic compounds, bisphenol, chlorobutanol, hydroxybenzoate, and/or phenylethyl alcohol. Exemplary acidic preservatives include, but are not limited to, vitamin A, vitamin C, vitamin E, beta-carotene, citric acid, acetic acid, dehydroacetic acid, ascorbic acid, sorbic acid, and/or phytic acid. Other preservatives include, but are not limited to, tocopherol, tocopherol acetate, deteroxime mesylate, cetrimide, butylated hydroxyanisol (BHA), butylated hydroxytoluene (BHT), ethylenediamine, sodium lauryl sulfate (SLS), sodium lauryl ether sulfate (SLES), sodium bisulfite, sodium metabisulfite, potassium sulfite, potassium metabisulfite, GLYDANT PLUS®, PHENONIP®, methylparaben, GERMALL® 115, GERMABEN® II, NEOLONE™, KATHON™, and/or EUXYL®.

[00528] Exemplary buffering agents include, but are not limited to, citrate buffer solutions, acetate buffer solutions, phosphate buffer solutions, ammonium chloride, calcium carbonate, calcium chloride, calcium citrate, calcium gluconate, calcium gluceptate, calcium gluconate, d-gluconic acid, calcium glycerophosphate, calcium lactate, propanoic acid, calcium levulinate, pentanoic acid, dibasic calcium phosphate, phosphoric acid, tribasic calcium phosphate, calcium hydroxide phosphate, potassium acetate, potassium chloride, potassium gluconate, potassium mixtures, dibasic potassium phosphate, monobasic potassium phosphate, potassium phosphate mixtures, sodium acetate, sodium bicarbonate, sodium chloride, sodium citrate, sodium lactate, dibasic sodium phosphate, monobasic sodium phosphate, sodium phosphate mixtures, tromethamine, magnesium hydroxide, aluminum hydroxide, alginic acid, pyrogen-free water, isotonic saline, Ringer's solution, ethyl alcohol, *etc.*, and/or combinations thereof.

[00529] Exemplary lubricating agents include, but are not limited to, magnesium stearate, calcium stearate, stearic acid, silica, talc, malt, glyceryl behanate, hydrogenated vegetable oils, polyethylene glycol, sodium benzoate, sodium acetate, sodium chloride, leucine, magnesium lauryl sulfate, sodium lauryl sulfate, *etc.*, and combinations thereof.

[00530] Exemplary oils include, but are not limited to, almond, apricot kernel, avocado, babassu, bergamot, black current seed, borage, cade, camomile, canola, caraway, carnauba, castor, cinnamon, cocoa butter, coconut, cod liver, coffee, corn, cotton seed, emu, eucalyptus, evening primrose, fish, flaxseed, geraniol, gourd, grape seed, hazel nut, hyssop, isopropyl myristate, jojoba, kukui nut, lavandin, lavender, lemon, litsea cubeba, macademia nut, mallow, mango seed, meadowfoam seed, mink, nutmeg, olive, orange, orange roughy, palm, palm kernel, peach kernel, peanut, poppy seed, pumpkin seed, rapeseed, rice bran, rosemary, safflower, sandalwood, sasquana, savoury, sea buckthorn, sesame, shea butter, silicone, soybean, sunflower, tea tree, thistle, tsubaki, vetiver, walnut, and wheat germ oils. Exemplary oils include, but are not limited to, butyl stearate, caprylic triglyceride, capric triglyceride, cyclomethicone, diethyl sebacate, dimethicone 360, isopropyl myristate, mineral oil, octyldodecanol, oleyl alcohol, silicone oil, and/or combinations thereof.

[00531] Excipients such as cocoa butter and suppository waxes, coloring agents, coating agents, sweetening, flavoring, and/or perfuming agents can be present in the composition, according to the judgment of the formulator.

Delivery

[00532] The present disclosure encompasses the delivery of modified nucleic acid molecules or mmRNA for any of therapeutic, pharmaceutical, diagnostic or imaging by any appropriate route taking into consideration likely advances in the sciences of drug delivery. Delivery may be naked or formulated.

Naked Delivery

[00533] The modified nucleic acid molecules or mmRNA of the present invention may be delivered to a cell naked. As used herein in, "naked" refers to delivering modified nucleic acid molecules or mmRNA free from agents which promote transfection. For example, the modified nucleic acid molecules or mmRNA delivered to the cell may contain no modifications. The naked modified nucleic acid molecules or mmRNA may be delivered to the cell using routes of administration known in the art and described herein.

Formulated Delivery

[00534] The modified nucleic acid molecules or mmRNA of the present invention may be formulated, using the methods described herein. The formulations may contain modified nucleic acid molecules or mmRNA which may be modified and/or unmodified. The formulations may further include, but are not limited to, cell penetration agents, a pharmaceutically acceptable carrier, a delivery agent, a bioerodible or biocompatible polymer, a solvent, and a sustained-release delivery depot. The formulated modified nucleic acid molecules or mmRNA may be delivered to the cell using routes of administration known in the art and described herein.

[00535] The compositions may also be formulated for direct delivery to an organ or tissue in any of several ways in the art including, but not limited to, direct soaking or bathing, via a catheter, by gels, powder, ointments, creams, gels, lotions, and/or drops, by using substrates such as fabric or biodegradable materials coated or impregnated with the compositions, and the like.

Administration

[00536] The modified nucleic acid molecules or mmRNA of the present invention may be administered by any route which results in a therapeutically effective outcome. These include, but are not limited to enteral, gastrointestinal, epidural, oral, transdermal, epidural (peridural), intracerebral (into the cerebrum), intracerebroventricular (into the cerebral ventricles), epicutaneous (application onto the skin), intradermal, (into the skin itself), subcutaneous (under the skin), nasal administration (through the nose), intravenous (into a vein), intraarterial (into an artery), intramuscular (into a muscle), intracardiac (into the heart), intraosseous infusion (into the bone marrow), intrathecal (into the spinal canal), intraperitoneal, (infusion or injection into the peritoneum), intravesical infusion, intravitreal, (through the eye), intracavernous injection, (into the base of the penis), intravaginal administration, intrauterine, extra-amniotic administration, transdermal (diffusion through the intact skin for systemic distribution), transmucosal (diffusion through a mucous membrane), insufflation (snorting), sublingual, sublabial, enema, eye drops (onto the conjunctiva), or in ear drops. In specific embodiments, compositions may be administered in a way which allows them cross the blood-brain barrier, vascular barrier, or other epithelial barrier. Non-limiting routes of administration for the modified nucleic acids or mmRNA of the present invention are described below.

Parenteral and Injectible Administration

[00537] Liquid dosage forms for parenteral administration include, but are not limited to, pharmaceutically acceptable emulsions, microemulsions, solutions, suspensions, syrups, and/or

elixirs. In addition to active ingredients, liquid dosage forms may comprise inert diluents commonly used in the art such as, for example, water or other solvents, solubilizing agents and emulsifiers such as ethyl alcohol, isopropyl alcohol, ethyl carbonate, ethyl acetate, benzyl alcohol, benzyl benzoate, propylene glycol, 1,3-butylene glycol, dimethylformamide, oils (in particular, cottonseed, groundnut, corn, germ, olive, castor, and sesame oils), glycerol, tetrahydrofurfuryl alcohol, polyethylene glycols and fatty acid esters of sorbitan, and mixtures thereof. Besides inert diluents, oral compositions can include adjuvants such as wetting agents, emulsifying and suspending agents, sweetening, flavoring, and/or perfuming agents. In certain embodiments for parenteral administration, compositions are mixed with solubilizing agents such as CREMOPHOR[®], alcohols, oils, modified oils, glycols, polysorbates, cyclodextrins, polymers, and/or combinations thereof.

[00538] Injectable preparations, for example, sterile injectable aqueous or oleaginous suspensions may be formulated according to the known art using suitable dispersing agents, wetting agents, and/or suspending agents. Sterile injectable preparations may be sterile injectable solutions, suspensions, and/or emulsions in nontoxic parenterally acceptable diluents and/or solvents, for example, as a solution in 1,3-butanediol. Among the acceptable vehicles and solvents that may be employed are water, Ringer's solution, U.S.P., and isotonic sodium chloride solution. Sterile, fixed oils are conventionally employed as a solvent or suspending medium. For this purpose any bland fixed oil can be employed including synthetic mono- or diglycerides. Fatty acids such as oleic acid can be used in the preparation of injectables.

[00539] Injectable formulations can be sterilized, for example, by filtration through a bacterial-retaining filter, and/or by incorporating sterilizing agents in the form of sterile solid compositions which can be dissolved or dispersed in sterile water or other sterile injectable medium prior to use.

[00540] In order to prolong the effect of an active ingredient, it is often desirable to slow the absorption of the active ingredient from subcutaneous or intramuscular injection. This may be accomplished by the use of a liquid suspension of crystalline or amorphous material with poor water solubility. The rate of absorption of the drug then depends upon its rate of dissolution which, in turn, may depend upon crystal size and crystalline form. Alternatively, delayed absorption of a parenterally administered drug form is accomplished by dissolving or suspending the drug in an oil vehicle. Injectable depot forms are made by forming microcapsule matrices of the drug in biodegradable polymers such as polylactide-polyglycolide. Depending upon the ratio of drug to polymer and the nature of the particular polymer employed, the rate of drug release can be

controlled. Examples of other biodegradable polymers include poly(orthoesters) and poly(anhydrides). Depot injectable formulations are prepared by entrapping the drug in liposomes or microemulsions which are compatible with body tissues.

Rectal and Vaginal Administration

[00541] Compositions for rectal or vaginal administration are typically suppositories which can be prepared by mixing compositions with suitable non-irritating excipients such as cocoa butter, polyethylene glycol or a suppository wax which are solid at ambient temperature but liquid at body temperature and therefore melt in the rectum or vaginal cavity and release the active ingredient.

Oral Administration

[00542] Liquid dosage forms for oral administration include, but are not limited to, pharmaceutically acceptable emulsions, microemulsions, solutions, suspensions, syrups, and/or elixirs. In addition to active ingredients, liquid dosage forms may comprise inert diluents commonly used in the art such as, for example, water or other solvents, solubilizing agents and emulsifiers such as ethyl alcohol, isopropyl alcohol, ethyl carbonate, ethyl acetate, benzyl alcohol, benzyl benzoate, propylene glycol, 1,3-butylene glycol, dimethylformamide, oils (in particular, cottonseed, groundnut, corn, germ, olive, castor, and sesame oils), glycerol, tetrahydrofurfuryl alcohol, polyethylene glycols and fatty acid esters of sorbitan, and mixtures thereof. Besides inert diluents, oral compositions can include adjuvants such as wetting agents, emulsifying and suspending agents, sweetening, flavoring, and/or perfuming agents. In certain embodiments for parenteral administration, compositions are mixed with solubilizing agents such as CREMOPHOR[®], alcohols, oils, modified oils, glycols, polysorbates, cyclodextrins, polymers, and/or combinations thereof.

[00543] Solid dosage forms for oral administration include capsules, tablets, pills, powders, and granules. In such solid dosage forms, an active ingredient is mixed with at least one inert, pharmaceutically acceptable excipient such as sodium citrate or dicalcium phosphate and/or fillers or extenders (*e.g.* starches, lactose, sucrose, glucose, mannitol, and silicic acid), binders (*e.g.* carboxymethylcellulose, alginates, gelatin, polyvinylpyrrolidone, sucrose, and acacia), humectants (*e.g.* glycerol), disintegrating agents (*e.g.* agar, calcium carbonate, potato or tapioca starch, alginic acid, certain silicates, and sodium carbonate), solution retarding agents (*e.g.* paraffin), absorption accelerators (*e.g.* quaternary ammonium compounds), wetting agents (*e.g.* cetyl alcohol and glycerol monostearate), absorbents (*e.g.* kaolin and bentonite clay), and lubricants (*e.g.* talc, calcium stearate,

magnesium stearate, solid polyethylene glycols, sodium lauryl sulfate), and mixtures thereof. In the case of capsules, tablets and pills, the dosage form may comprise buffering agents.

Topical or Transdermal Administration

[00544] As described herein, compositions containing the modified nucleic acid molecules or mmRNA of the invention may be formulated for administration topically. The skin may be an ideal target site for delivery as it is readily accessible. Gene expression may be restricted not only to the skin, potentially avoiding nonspecific toxicity, but also to specific layers and cell types within the skin.

[00545] The site of cutaneous expression of the delivered compositions will depend on the route of nucleic acid delivery. Three routes are commonly considered to deliver modified nucleic acid molecules or mmRNA to the skin: (i) topical application (*e.g.* for local/regional treatment); (ii) intradermal injection (*e.g.* for local/regional treatment); and (iii) systemic delivery (*e.g.* for treatment of dermatologic diseases that affect both cutaneous and extracutaneous regions). Modified nucleic acid molecules or mmRNA can be delivered to the skin by several different approaches known in the art. Most topical delivery approaches have been shown to work for delivery of DNA, such as but not limited to, topical application of non-cationic liposome-DNA complex, cationic liposome-DNA complex, particle-mediated (gene gun), puncture-mediated gene transfections, and viral delivery approaches. After delivery of the nucleic acid, gene products have been detected in a number of different skin cell types, including, but not limited to, basal keratinocytes, sebaceous gland cells, dermal fibroblasts and dermal macrophages.

[00546] In one embodiment, the invention provides for a variety of dressings (*e.g.*, wound dressings) or bandages (*e.g.*, adhesive bandages) for conveniently and/or effectively carrying out methods of the present invention. Typically dressing or bandages may comprise sufficient amounts of pharmaceutical compositions and/or modified nucleic acid molecules or mmRNA described herein to allow a user to perform multiple treatments of a subject(s).

[00547] In one embodiment, the invention provides for the modified nucleic acid molecules or mmRNA compositions to be delivered in more than one injection.

[00548] In one embodiment, before topical and/or transdermal administration at least one area of tissue, such as skin, may be subjected to a device and/or solution which may increase permeability. In one embodiment, the tissue may be subjected to an abrasion device to increase the permeability of the skin (see U.S. Patent Publication No. 20080275468, herein incorporated by reference in its

entirety). In another embodiment, the tissue may be subjected to an ultrasound enhancement device. An ultrasound enhancement device may include, but is not limited to, the devices described in U.S. Publication No. 20040236268 and U.S. Patent Nos. 6,491,657 and 6,234,990; each of which are herein incorporated by reference in their entireties. Methods of enhancing the permeability of tissue are described in U.S. Publication Nos. 20040171980 and 20040236268 and U.S. Pat. No. 6,190,315; each of which are herein incorporated by reference in their entireties.

[00549] In one embodiment, a device may be used to increase permeability of tissue before delivering formulations of modified mRNA described herein. The permeability of skin may be measured by methods known in the art and/or described in U.S. Patent No. 6,190,315, herein incorporated by reference in its entirety. As a non-limiting example, a modified mRNA formulation may be delivered by the drug delivery methods described in U.S. Patent No. 6,190,315, herein incorporated by reference in its entirety.

[00550] In another non-limiting example tissue may be treated with a eutectic mixture of local anesthetics (EMLA) cream before, during and/or after the tissue may be subjected to a device which may increase permeability. Katz et al. (Anesth Analg (2004); 98:371-76; herein incorporated by reference in its entirety) showed that using the EMLA cream in combination with a low energy, an onset of superficial cutaneous analgesia was seen as fast as 5 minutes after a pretreatment with a low energy ultrasound.

[00551] In one embodiment, enhancers may be applied to the tissue before, during, and/or after the tissue has been treated to increase permeability. Enhancers include, but are not limited to, transport enhancers, physical enhancers, and cavitation enhancers. Non-limiting examples of enhancers are described in U.S. Patent No. 6,190,315, herein incorporated by reference in its entirety.

[00552] In one embodiment, a device may be used to increase permeability of tissue before delivering formulations of modified mRNA described herein, which may further contain a substance that invokes an immune response. In another non-limiting example, a formulation containing a substance to invoke an immune response may be delivered by the methods described in U.S. Publication Nos. 20040171980 and 20040236268; each of which are herein incorporated by reference in their entireties.

[00553] Dosage forms for topical and/or transdermal administration of a composition may include ointments, pastes, creams, lotions, gels, powders, solutions, sprays, inhalants and/or patches.

Generally, an active ingredient is admixed under sterile conditions with a pharmaceutically acceptable excipient and/or any needed preservatives and/or buffers as may be required.

[00554] Additionally, the present invention contemplates the use of transdermal patches, which often have the added advantage of providing controlled delivery of a compound to the body. Such dosage forms may be prepared, for example, by dissolving and/or dispensing the compound in the proper medium. Alternatively or additionally, rate may be controlled by either providing a rate controlling membrane and/or by dispersing the compound in a polymer matrix and/or gel.

[00555] Formulations suitable for topical administration include, but are not limited to, liquid and/or semi liquid preparations such as liniments, lotions, oil in water and/or water in oil emulsions such as creams, ointments and/or pastes, and/or solutions and/or suspensions. Topically-administrable formulations may, for example, comprise from about 0.1% to about 10% (w/w) active ingredient, although the concentration of active ingredient may be as high as the solubility limit of the active ingredient in the solvent. Formulations for topical administration may further comprise one or more of the additional ingredients described herein.

Depot Administration

[00556] As described herein, in some embodiments, the composition is formulated in depots for extended release. Generally, a specific organ or tissue (a "target tissue") is targeted for administration.

[00557] In some aspects of the invention, the modified nucleic acid molecules or mmRNA are spatially retained within or proximal to a target tissue. Provided are method of providing a composition to a target tissue of a mammalian subject by contacting the target tissue (which contains one or more target cells) with the composition under conditions such that the composition, in particular the nucleic acid component(s) of the composition, is substantially retained in the target tissue, meaning that at least 10, 20, 30, 40, 50, 60, 70, 80, 85, 90, 95, 96, 97, 98, 99, 99.9, 99.99 or greater than 99.99% of the composition is retained in the target tissue. Advantageously, retention is determined by measuring the amount of the nucleic acid present in the composition that enters one or more target cells. For example, at least 1, 5, 10, 20, 30, 40, 50, 60, 70, 80, 85, 90, 95, 96, 97, 98, 99, 99.9, 99.99 or greater than 99.99% of the nucleic acids administered to the subject are present intracellularly at a period of time following administration. For example, intramuscular injection to a mammalian subject is performed using an aqueous composition containing a ribonucleic acid and a

transfection reagent, and retention of the composition is determined by measuring the amount of the ribonucleic acid present in the muscle cells.

[00558] Aspects of the invention are directed to methods of providing a composition to a target tissue of a mammalian subject, by contacting the target tissue (containing one or more target cells) with the composition under conditions such that the composition is substantially retained in the target tissue. The composition contains an effective amount of a nucleic acid molecules or mmRNA such that the polypeptide of interest is produced in at least one target cell. The compositions generally contain a cell penetration agent, although "naked" nucleic acid (such as nucleic acids without a cell penetration agent or other agent) is also contemplated, and a pharmaceutically acceptable carrier.

[00559] In some circumstances, the amount of a protein produced by cells in a tissue is desirably increased. Preferably, this increase in protein production is spatially restricted to cells within the target tissue. Thus, provided are methods of increasing production of a protein of interest in a tissue of a mammalian subject. A composition is provided that contains modified nucleic acid molecule or mmRNA characterized in that a unit quantity of composition has been determined to produce the polypeptide of interest in a substantial percentage of cells contained within a predetermined volume of the target tissue.

[00560] In some embodiments, the composition includes a plurality of different modified nucleic acid molecules or mmRNA, where one or more than one of the modified nucleic acid molecules or mmRNA encodes a polypeptide of interest. Optionally, the composition also contains a cell penetration agent to assist in the intracellular delivery of the composition. A determination is made of the dose of the composition required to produce the polypeptide of interest in a substantial percentage of cells contained within the predetermined volume of the target tissue (generally, without inducing significant production of the polypeptide of interest in tissue adjacent to the predetermined volume, or distally to the target tissue). Subsequent to this determination, the determined dose is introduced directly into the tissue of the mammalian subject.

[00561] In one embodiment, the invention provides for the modified nucleic acid molecules or mmRNA to be delivered in more than one injection or by split dose injections.

[00562] In one embodiment, the invention may be retained near target tissue using a small disposable drug reservoir, patch pump or osmotic pump. Non-limiting examples of patch pumps include those manufactured and/or sold by BD®, (Franklin Lakes, NJ), Insulet Corporation

(Bedford, MA) , SteadyMed Therapeutics (San Francisco, CA) , Medtronic (Minneapolis, MN) (e.g., MiniMed), UniLife (York, PA), Valeritas (Bridgewater, NJ), and SpringLeaf Therapeutics (Boston, MA). A non-limiting example of an osmotic pump include those manufactured by DURECT® (Cupertino, CA) (e.g., DUROS® and ALZET ®).

Pulmonary Administration

[00563] A pharmaceutical composition may be prepared, packaged, and/or sold in a formulation suitable for pulmonary administration via the buccal cavity. Such a formulation may comprise dry particles which comprise the active ingredient and which have a diameter in the range from about 0.5 nm to about 7 nm or from about 1 nm to about 6 nm. Such compositions are suitably in the form of dry powders for administration using a device comprising a dry powder reservoir to which a stream of propellant may be directed to disperse the powder and/or using a self propelling solvent/powder dispensing container such as a device comprising the active ingredient dissolved and/or suspended in a low-boiling propellant in a sealed container. Such powders comprise particles wherein at least 98% of the particles by weight have a diameter greater than 0.5 nm and at least 95% of the particles by number have a diameter less than 7 nm. Alternatively, at least 95% of the particles by weight have a diameter greater than 1 nm and at least 90% of the particles by number have a diameter less than 6 nm. Dry powder compositions may include a solid fine powder diluent such as sugar and are conveniently provided in a unit dose form.

[00564] Low boiling propellants generally include liquid propellants having a boiling point of below 65 °F at atmospheric pressure. Generally the propellant may constitute 50% to 99.9% (w/w) of the composition, and active ingredient may constitute 0.1% to 20% (w/w) of the composition. A propellant may further comprise additional ingredients such as a liquid non-ionic and/or solid anionic surfactant and/or a solid diluent (which may have a particle size of the same order as particles comprising the active ingredient).

[00565] As a non-limiting example, the modified nucleic acid molecules or mmRNA described herein may be formulated for pulmonary delivery by the methods described in U.S. Pat. No. 8,257,685; herein incorporated by reference in its entirety.

[00566] Pharmaceutical compositions formulated for pulmonary delivery may provide an active ingredient in the form of droplets of a solution and/or suspension. Such formulations may be prepared, packaged, and/or sold as aqueous and/or dilute alcoholic solutions and/or suspensions, optionally sterile, comprising active ingredient, and may conveniently be administered using any

nebulization and/or atomization device. Such formulations may further comprise one or more additional ingredients including, but not limited to, a flavoring agent such as saccharin sodium, a volatile oil, a buffering agent, a surface active agent, and/or a preservative such as methylhydroxybenzoate. Droplets provided by this route of administration may have an average diameter in the range from about 0.1 nm to about 200 nm.

Intranasal, nasal and buccal Administration

[00567] Formulations described herein as being useful for pulmonary delivery are useful for intranasal delivery of a pharmaceutical composition. Another formulation suitable for intranasal administration is a coarse powder comprising the active ingredient and having an average particle from about 0.2 μm to 500 μm . Such a formulation is administered in the manner in which snuff is taken, *i.e.* by rapid inhalation through the nasal passage from a container of the powder held close to the nose.

[00568] Formulations suitable for nasal administration may, for example, comprise from about as little as 0.1% (w/w) and as much as 100%, (w/w) of active ingredient, and may comprise one or more of the additional ingredients described herein. A pharmaceutical composition may be prepared, packaged, and/or sold in a formulation suitable for buccal administration. Such formulations may, for example, be in the form of tablets and/or lozenges made using conventional methods, and may, for example, 0.1% to 20% (w/w) active ingredient, the balance comprising an orally dissolvable and/or degradable composition and, optionally, one or more of the additional ingredients described herein. Alternately, formulations suitable for buccal administration may comprise a powder and/or an aerosolized and/or atomized solution and/or suspension comprising active ingredient. Such powdered, aerosolized, and/or aerosolized formulations, when dispersed, may have an average particle and/or droplet size in the range from about 0.1 nm to about 200 nm, and may further comprise one or more of any additional ingredients described herein.

Ophthalmic Administration

[00569] A pharmaceutical composition may be prepared, packaged, and/or sold in a formulation suitable for ophthalmic administration. Such formulations may, for example, be in the form of eye drops including, for example, a 0.1/1.0%, (w/w) solution and/or suspension of the active ingredient in an aqueous or oily liquid excipient. Such drops may further comprise buffering agents, salts, and/or one or more other of any additional ingredients described herein. Other ophthalmically-administrable formulations which are useful include those which comprise the active ingredient in

microcrystalline form and/or in a liposomal preparation. Ear drops and/or eye drops are contemplated as being within the scope of this invention. A multilayer thin film device may be prepared to contain a pharmaceutical composition for delivery to the eye and/or surrounding tissue.

Payload Administration: Detectable Agents and Therapeutic Agents

[00570] The modified nucleic acid molecules or mmRNA described herein can be used in a number of different scenarios in which delivery of a substance (the "payload") to a biological target is desired, for example delivery of detectable substances for detection of the target, or delivery of a therapeutic agent. Detection methods can include, but are not limited to, both imaging *in vitro* and *in vivo* imaging methods, *e.g.*, immunohistochemistry, bioluminescence imaging (BLI), Magnetic Resonance Imaging (MRI), positron emission tomography (PET), electron microscopy, X-ray computed tomography, Raman imaging, optical coherence tomography, absorption imaging, thermal imaging, fluorescence reflectance imaging, fluorescence microscopy, fluorescence molecular tomographic imaging, nuclear magnetic resonance imaging, X-ray imaging, ultrasound imaging, photoacoustic imaging, lab assays, or in any situation where tagging/staining/imaging is required.

[00571] The modified nucleic acid molecules or mmRNA can be designed to include both a linker and a payload in any useful orientation. For example, a linker having two ends is used to attach one end to the payload and the other end to the nucleobase, such as at the C-7 or C-8 positions of the deaza-adenosine or deaza-guanosine or to the N-3 or C-5 positions of cytosine or uracil. The polynucleotide of the invention can include more than one payload (*e.g.*, a label and a transcription inhibitor), as well as a cleavable linker.

[00572] In one embodiment, the modified nucleotide is a modified 7-deaza-adenosine triphosphate, where one end of a cleavable linker is attached to the C7 position of 7-deaza-adenine, the other end of the linker is attached to an inhibitor (*e.g.*, to the C5 position of the nucleobase on a cytidine), and a label (*e.g.*, Cy5) is attached to the center of the linker (see, *e.g.*, compound 1 of A*pCp C5 Parg Capless in Fig. 5 and columns 9 and 10 of U.S. Pat. No. 7,994,304, incorporated herein by reference). Upon incorporation of the modified 7-deaza-adenosine triphosphate to an encoding region, the resulting polynucleotide having a cleavable linker attached to a label and an inhibitor (*e.g.*, a polymerase inhibitor). Upon cleavage of the linker (*e.g.*, with reductive conditions to reduce a linker having a cleavable disulfide moiety), the label and inhibitor are released. Additional linkers and payloads (*e.g.*, therapeutic agents, detectable labels, and cell penetrating payloads) are described herein.

[00573] Scheme 12 below depicts an exemplary modified nucleotide wherein the nucleobase, adenine, is attached to a linker at the C-7 carbon of 7-deaza adenine. In addition, Scheme 12 depicts the modified nucleotide with the linker and payload, e.g., a detectable agent, incorporated onto the 3' end of the mRNA. Disulfide cleavage and 1,2-addition of the thiol group onto the propargyl ester releases the detectable agent. The remaining structure (depicted, for example, as pApC5Parg in Scheme 12) is the inhibitor. The rationale for the structure of the modified nucleotides is that the tethered inhibitor sterically interferes with the ability of the polymerase to incorporate a second base. Thus, it is critical that the tether be long enough to affect this function and that the inhibitor be in a stereochemical orientation that inhibits or prohibits second and follow on nucleotides into the growing polynucleotide strand.

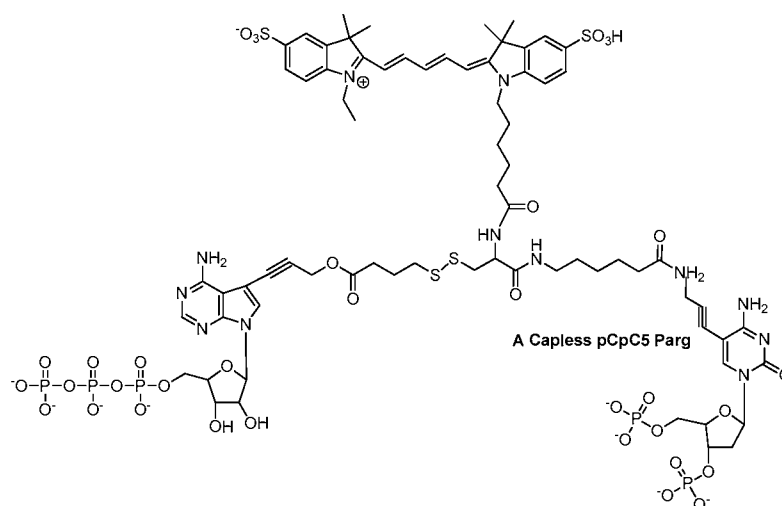
Scheme 12

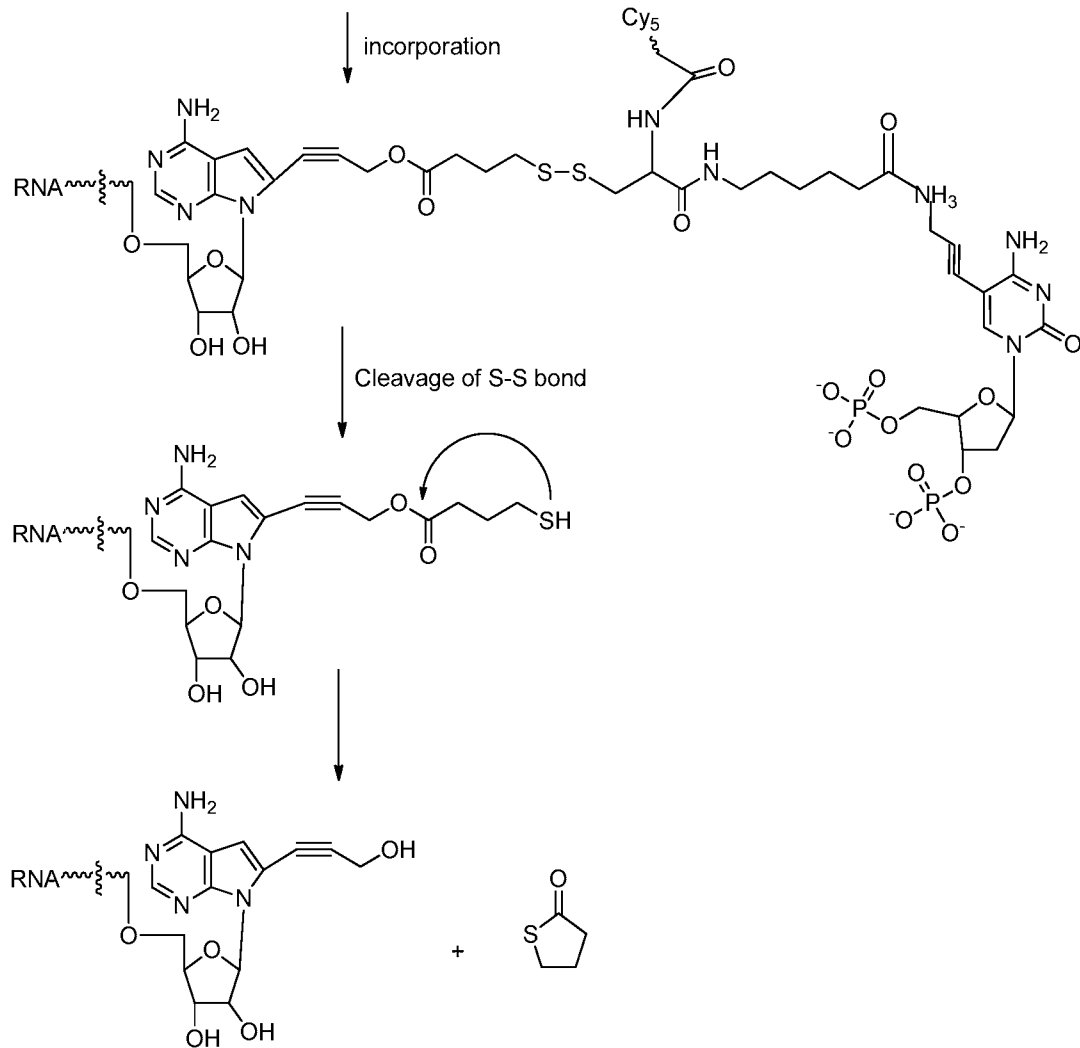

[00574] For example, the modified nucleic acid molecules or mmRNA described herein can be used in reprogramming induced pluripotent stem cells (iPS cells), which can directly track cells that are transfected compared to total cells in the cluster. In another example, a drug that may be attached to the modified nucleic acid molecules or mmRNA via a linker and may be fluorescently labeled can be used to track the drug *in vivo*, *e.g.* intracellularly. Other examples include, but are not limited to, the use of modified nucleic acid molecules or mmRNA in reversible drug delivery into cells.

[00575] The modified nucleic acid molecules or mmRNA described herein can be used in intracellular targeting of a payload, *e.g.*, detectable or therapeutic agent, to specific organelle. Exemplary intracellular targets can include, but are not limited to, the nuclear localization for advanced mRNA processing, or a nuclear localization sequence (NLS) linked to the mRNA containing an inhibitor.

[00576] In addition, the modified nucleic acid molecules or mmRNA described herein can be used to deliver therapeutic agents to cells or tissues, *e.g.*, in living animals. For example, the modified nucleic acids or mmRNA described herein can be used to deliver highly polar chemotherapeutics agents to kill cancer cells. The modified nucleic acid molecules or mmRNA attached to the therapeutic agent through a linker can facilitate member permeation allowing the therapeutic agent to travel into a cell to reach an intracellular target.

[00577] In one example, the linker is attached at the 2'-position of the ribose ring and/or at the 3' and/or 5' position of the modified nucleic acid molecule or mmRNA (See *e.g.*, International Pub. No. WO2012030683, herein incorporated by reference in its entirety). The linker may be any linker disclosed herein, known in the art and/or disclosed in International Pub. No. WO2012030683, herein incorporated by reference in its entirety.

[00578] In another example, the modified nucleic acid molecules or mmRNA can be attached to the modified nucleic acid molecules or mmRNA a viral inhibitory peptide (VIP) through a cleavable linker. The cleavable linker can release the VIP and dye into the cell. In another example, the modified nucleic acid molecules or mmRNA can be attached through the linker to an ADP-ribosylate, which is responsible for the actions of some bacterial toxins, such as cholera toxin, diphtheria toxin, and pertussis toxin. These toxin proteins are ADP-ribosyltransferases that modify target proteins in human cells. For example, cholera toxin ADP-ribosylates G proteins modifies human cells by causing massive fluid secretion from the lining of the small intestine, which results in life-threatening diarrhea.

[00579] In some embodiments, the payload may be a therapeutic agent such as a cytotoxin, radioactive ion, chemotherapeutic, or other therapeutic agent. A cytotoxin or cytotoxic agent includes any agent that may be detrimental to cells. Examples include, but are not limited to, taxol, cytochalasin B, gramicidin D, ethidium bromide, emetine, mitomycin, etoposide, teniposide, vincristine, vinblastine, colchicine, doxorubicin, daunorubicin, dihydroxyanthracenedione, mitoxantrone, mithramycin, actinomycin D, 1-dehydrotestosterone, glucocorticoids, procaine, tetracaine, lidocaine, propranolol, puromycin, maytansinoids, *e.g.*, maytansinol (see U.S. Pat. No. 5,208,020 incorporated herein in its entirety), rachelmycin (CC-1065, see U.S. Pat. Nos. 5,475,092, 5,585,499, and 5,846,545, all of which are incorporated herein by reference), and analogs or homologs thereof. Radioactive ions include, but are not limited to iodine (*e.g.*, iodine 125 or iodine 131), strontium 89, phosphorous, palladium, cesium, iridium, phosphate, cobalt, yttrium 90,

samarium 153, and praseodymium. Other therapeutic agents include, but are not limited to, antimetabolites (e.g., methotrexate, 6-mercaptopurine, 6-thioguanine, cytarabine, 5-fluorouracil decarbazine), alkylating agents (e.g., mechlorethamine, thiotepa chlorambucil, rachelmycin (CC-1065), melphalan, carmustine (BSNU), lomustine (CCNU), cyclophosphamide, busulfan, dibromomannitol, streptozotocin, mitomycin C, and cis-dichlorodiamine platinum (II) (DDP cisplatin), anthracyclines (e.g., daunorubicin (formerly daunomycin) and doxorubicin), antibiotics (e.g., dactinomycin (formerly actinomycin), bleomycin, mithramycin, and anthramycin (AMC)), and anti-mitotic agents (e.g., vincristine, vinblastine, taxol and maytansinoids).

[00580] In some embodiments, the payload may be a detectable agent, such as various organic small molecules, inorganic compounds, nanoparticles, enzymes or enzyme substrates, fluorescent materials, luminescent materials (e.g., luminol), bioluminescent materials (e.g., luciferase, luciferin, and aequorin), chemiluminescent materials, radioactive materials (e.g., ^{18}F , ^{67}Ga , $^{81\text{m}}\text{Kr}$, ^{82}Rb , ^{111}In , ^{123}I , ^{133}Xe , ^{201}Tl , ^{125}I , ^{35}S , ^{14}C , ^3H , or $^{99\text{m}}\text{Tc}$ (e.g., as pertechnetate (technetate(VII), TcO_4^-)), and contrast agents (e.g., gold (e.g., gold nanoparticles), gadolinium (e.g., chelated Gd), iron oxides (e.g., superparamagnetic iron oxide (SPIO), monocrystalline iron oxide nanoparticles (MIONs), and ultrasmall superparamagnetic iron oxide (USPIO)), manganese chelates (e.g., Mn-DPDP), barium sulfate, iodinated contrast media (iohexol), microbubbles, or perfluorocarbons). Such optically-detectable labels include for example, without limitation, 4-acetamido-4'-isothiocyanatostilbene-2,2'-disulfonic acid; acridine and derivatives (e.g., acridine and acridine isothiocyanate); 5-(2'-aminoethyl)aminonaphthalene-1-sulfonic acid (EDANS); 4-amino-N-[3-vinylsulfonyl]phenyl]naphthalimide-3,5-disulfonate; N-(4-anilino-1-naphthyl)maleimide; anthranilamide; BODIPY; Brilliant Yellow; coumarin and derivatives (e.g., coumarin, 7-amino-4-methylcoumarin (AMC, Coumarin 120), and 7-amino-4-trifluoromethylcoumarin (Coumarin 151)); cyanine dyes; cyanosine; 4',6-diaminidino-2-phenylindole (DAPI); 5'-5"-dibromopyrogallol-sulfonaphthalein (Bromopyrogallol Red); 7-diethylamino-3-(4'-isothiocyanatophenyl)-4-methylcoumarin; diethylenetriamine pentaacetate; 4,4'-diisothiocyanatodihydro-stilbene-2,2'-disulfonic acid; 4,4'-diisothiocyanatostilbene-2,2'-disulfonic acid; 5-[dimethylamino]-naphthalene-1-sulfonyl chloride (DNS, dansylchloride); 4-dimethylaminophenylazophenyl-4'-isothiocyanate (DABITC); eosin and derivatives (e.g., eosin and eosin isothiocyanate); erythrosin and derivatives (e.g., erythrosin B and erythrosin isothiocyanate); ethidium; fluorescein and derivatives (e.g., 5-carboxyfluorescein (FAM), 5-(4,6-dichlorotriazin-2-yl)aminofluorescein (DTAF), 2',7'-dimethoxy-

4'5'-dichloro-6-carboxyfluorescein, fluorescein, fluorescein isothiocyanate, X-rhodamine-5-(and-6)-isothiocyanate (QFITC or XRITC), and fluorescamine); 2-[2-[3-[[1,3-dihydro-1,1-dimethyl-3-(3-sulfopropyl)-2H-benz[e]indol-2-ylidene]ethylidene]-2-[4-(ethoxycarbonyl)-1-piperazinyl]-1-cyclopenten-1-yl]ethenyl]-1,1-dimethyl-3-(3-sulfopropyl)-1H-benz[e]indolium hydroxide, inner salt, compound with n,n-diethylethanamine(1 :1) (IR144); 5-chloro-2-[2-[3-[(5-chloro-3-ethyl-2(3H)-benzothiazol-ylidene)ethylidene]-2-(diphenylamino)-1-cyclopenten-1-yl]ethenyl]-3-ethyl benzothiazolium perchlorate (IR140); Malachite Green isothiocyanate; 4-methylumbelliferone orthocresolphthalein; nitrotyrosine; pararosaniline; Phenol Red; B-phycoerythrin; o-phthaldialdehyde; pyrene and derivatives(e.g., pyrene, pyrene butyrate, and succinimidyl 1-pyrene); butyrate quantum dots; Reactive Red 4 (Cibacron™ Brilliant Red 3B-A); rhodamine and derivatives (e.g., 6-carboxy-X-rhodamine (ROX), 6-carboxyrhodamine (R6G), lissamine rhodamine B sulfonyl chloride rhodamine (Rhod), rhodamine B, rhodamine 123, rhodamine X isothiocyanate, sulforhodamine B, sulforhodamine 101, sulfonyl chloride derivative of sulforhodamine 101 (Texas Red), N,N,N',N'tetramethyl-6-carboxyrhodamine (TAMRA) tetramethyl rhodamine, and tetramethyl rhodamine isothiocyanate (TRITC)); riboflavin; rosolic acid; terbium chelate derivatives; Cyanine-3 (Cy3); Cyanine-5 (Cy5); cyanine-5.5 (Cy5.5), Cyanine-7 (Cy7); IRD 700; IRD 800; Alexa 647; La Jolta Blue; phthalo cyanine; and naphthalo cyanine.

[00581] In some embodiments, the detectable agent may be a non-detectable pre-cursor that becomes detectable upon activation (e.g., fluorogenic tetrazine-fluorophore constructs (e.g., tetrazine-BODIPY FL, tetrazine-Oregon Green 488, or tetrazine-BODIPY TMR-X) or enzyme activatable fluorogenic agents (e.g., PROSENSE® (VisEn Medical))). In vitro assays in which the enzyme labeled compositions can be used include, but are not limited to, enzyme linked immunosorbent assays (ELISAs), immunoprecipitation assays, immunofluorescence, enzyme immunoassays (EIA), radioimmunoassays (RIA), and Western blot analysis. *Combinations*

[00582] The nucleic acid molecules or mmRNA may be used in combination with one or more other therapeutic, prophylactic, diagnostic, or imaging agents. By "in combination with," it is not intended to imply that the agents must be administered at the same time and/or formulated for delivery together, although these methods of delivery are within the scope of the present disclosure. Compositions can be administered concurrently with, prior to, or subsequent to, one or more other desired therapeutics or medical procedures. In general, each agent will be administered at a dose and/or on a time schedule determined for that agent. In some embodiments, the present disclosure

encompasses the delivery of pharmaceutical, prophylactic, diagnostic, or imaging compositions in combination with agents that may improve their bioavailability, reduce and/or modify their metabolism, inhibit their excretion, and/or modify their distribution within the body. As a non-limiting example, the nucleic acid molecules or mmRNA may be used in combination with a pharmaceutical agent for the treatment of cancer or to control hyperproliferative cells. In U.S. Pat. No. 7,964,571, herein incorporated by reference in its entirety, a combination therapy for the treatment of solid primary or metastasized tumor is described using a pharmaceutical composition including a DNA plasmid encoding for interleukin-12 with a lipopolymer and also administering at least one anticancer agent or chemotherapeutic. Further, the nucleic acid molecules and mmRNA of the present invention that encodes anti-proliferative molecules may be in a pharmaceutical composition with a lipopolymer (see e.g., U.S. Pub. No. 201 10218231, herein incorporated by reference in its entirety, claiming a pharmaceutical composition comprising a DNA plasmid encoding an anti-proliferative molecule and a lipopolymer) which may be administered with at least one chemotherapeutic or anticancer agent.

Cell Penetrating Payloads

[00583] In some embodiments, the modified nucleotides and modified nucleic acid molecules, which are incorporated into a nucleic acid, e.g., RNA or mRNA, can also include a payload that can be a cell penetrating moiety or agent that enhances intracellular delivery of the compositions. For example, the compositions can include, but are not limited to, a cell-penetrating peptide sequence that facilitates delivery to the intracellular space, e.g., HIV-derived TAT peptide, penetratins, transportans, or hCT derived cell-penetrating peptides, see, e.g., Caron et al, (2001) Mol Ther. 3(3):3 10-8; Langel, Cell-Penetrating Peptides: Processes and Applications (CRC Press, Boca Raton FL 2002); El-Andaloussi et al, (2005) Curr Pharm Des. 11(28):3597-61 1; and Deshayes et al, (2005) Cell Mol Life Sci. 62(16): 1839-49; all of which are incorporated herein by reference. The compositions can also be formulated to include a cell penetrating agent, e.g., liposomes, which enhance delivery of the compositions to the intracellular space.

Biological Targets

[00584] The modified nucleotides and modified nucleic acid molecules described herein, which are incorporated into a nucleic acid, e.g., RNA or mRNA, can be used to deliver a payload to any biological target for which a specific ligand exists or can be generated. The ligand can bind to the biological target either covalently or non-covalently.

[00585] Examples of biological targets include, but are not limited to, biopolymers, *e.g.*, antibodies, nucleic acids such as RNA and DNA, proteins, enzymes; examples of proteins include, but are not limited to, enzymes, receptors, and ion channels. In some embodiments the target may be a tissue- or a cell-type specific marker, *e.g.*, a protein that is expressed specifically on a selected tissue or cell type. In some embodiments, the target may be a receptor, such as, but not limited to, plasma membrane receptors and nuclear receptors; more specific examples include, but are not limited to, G-protein-coupled receptors, cell pore proteins, transporter proteins, surface-expressed antibodies, HLA proteins, MHC proteins and growth factor receptors.

Dosing

[00586] The present invention provides methods comprising administering modified mRNAs and their encoded proteins or complexes in accordance with the invention to a subject in need thereof. Nucleic acids, proteins or complexes, or pharmaceutical, imaging, diagnostic, or prophylactic compositions thereof, may be administered to a subject using any amount and any route of administration effective for preventing, treating, diagnosing, or imaging a disease, disorder, and/or condition (*e.g.*, a disease, disorder, and/or condition relating to working memory deficits). The exact amount required will vary from subject to subject, depending on the species, age, and general condition of the subject, the severity of the disease, the particular composition, its mode of administration, its mode of activity, and the like. Compositions in accordance with the invention are typically formulated in dosage unit form for ease of administration and uniformity of dosage. It will be understood, however, that the total daily usage of the compositions of the present invention may be decided by the attending physician within the scope of sound medical judgment. The specific therapeutically effective, prophylactically effective, or appropriate imaging dose level for any particular patient will depend upon a variety of factors including the disorder being treated and the severity of the disorder; the activity of the specific compound employed; the specific composition employed; the age, body weight, general health, sex and diet of the patient; the time of administration, route of administration, and rate of excretion of the specific compound employed; the duration of the treatment; drugs used in combination or coincidental with the specific compound employed; and like factors well known in the medical arts.

[00587] In certain embodiments, compositions in accordance with the present invention may be administered at dosage levels sufficient to deliver from about 0.0001 mg/kg to about 100 mg/kg, from about 0.001 mg/kg to about 0.05 mg/kg, from about 0.005 mg/kg to about 0.05 mg/kg, from

about 0.001 mg/kg to about 0.005 mg/kg, from about 0.05 mg/kg to about 0.5 mg/kg, from about 0.01 mg/kg to about 50 mg/kg, from about 0.1 mg/kg to about 40 mg/kg, from about 0.5 mg/kg to about 30 mg/kg, from about 0.01 mg/kg to about 10 mg/kg, from about 0.1 mg/kg to about 10 mg/kg, or from about 1 mg/kg to about 25 mg/kg, of subject body weight per day, one or more times a day, to obtain the desired therapeutic, diagnostic, prophylactic, or imaging effect. The desired dosage may be delivered three times a day, two times a day, once a day, every other day, every third day, every week, every two weeks, every three weeks, or every four weeks. In certain embodiments, the desired dosage may be delivered using multiple administrations (*e.g.*, two, three, four, five, six, seven, eight, nine, ten, eleven, twelve, thirteen, fourteen, or more administrations).

[00588] According to the present invention, it has been discovered that administration of mmRNA in split-dose regimens produce higher levels of proteins in mammalian subjects. As used herein, a "split dose" is the division of single unit dose or total daily dose into two or more doses, *e.g.*, two or more administrations of the single unit dose. As used herein, a "single unit dose" is a dose of any therapeutic administered in one dose/at one time/single route/single point of contact, *i.e.*, single administration event. As used herein, a "total daily dose" is an amount given or prescribed in 24 hr period. It may be administered as a single unit dose. In one embodiment, the mmRNA of the present invention are administered to a subject in split doses. The mmRNA may be formulated in buffer only or in a formulation described herein.

Dosage Forms

[00589] A pharmaceutical composition described herein can be formulated into a dosage form described herein, such as a topical, intranasal, intratracheal, or injectable (*e.g.*, intravenous, intraocular, intravitreal, intramuscular, intracardiac, intraperitoneal, subcutaneous).

Liquid dosage forms

[00590] Liquid dosage forms for parenteral administration include, but are not limited to, pharmaceutically acceptable emulsions, microemulsions, solutions, suspensions, syrups, and/or elixirs. In addition to active ingredients, liquid dosage forms may comprise inert diluents commonly used in the art including, but not limited to, water or other solvents, solubilizing agents and emulsifiers such as ethyl alcohol, isopropyl alcohol, ethyl carbonate, ethyl acetate, benzyl alcohol, benzyl benzoate, propylene glycol, 1,3-butylene glycol, dimethylformamide, oils (in particular, cottonseed, groundnut, corn, germ, olive, castor, and sesame oils), glycerol, tetrahydrofurfuryl alcohol, polyethylene glycols and fatty acid esters of sorbitan, and mixtures thereof. In certain

embodiments for parenteral administration, compositions may be mixed with solubilizing agents such as CREMOPHOR[®], alcohols, oils, modified oils, glycols, polysorbates, cyclodextrins, polymers, and/or combinations thereof.

Injectable

[00591] Injectable preparations, for example, sterile injectable aqueous or oleaginous suspensions may be formulated according to the known art and may include suitable dispersing agents, wetting agents, and/or suspending agents. Sterile injectable preparations may be sterile injectable solutions, suspensions, and/or emulsions in nontoxic parenterally acceptable diluents and/or solvents, for example, a solution in 1,3-butanediol. Among the acceptable vehicles and solvents that may be employed include, but are not limited to, water, Ringer's solution, U.S.P., and isotonic sodium chloride solution. Sterile, fixed oils are conventionally employed as a solvent or suspending medium. For this purpose any bland fixed oil can be employed including synthetic mono- or diglycerides. Fatty acids such as oleic acid can be used in the preparation of injectables.

[00592] Injectable formulations can be sterilized, for example, by filtration through a bacterial-retaining filter, and/or by incorporating sterilizing agents in the form of sterile solid compositions which can be dissolved or dispersed in sterile water or other sterile injectable medium prior to use.

[00593] In order to prolong the effect of an active ingredient, it may be desirable to slow the absorption of the active ingredient from subcutaneous or intramuscular injection. This may be accomplished by the use of a liquid suspension of crystalline or amorphous material with poor water solubility. The rate of absorption of modified mRNA then depends upon its rate of dissolution which, in turn, may depend upon crystal size and crystalline form. Alternatively, delayed absorption of a parenterally administered modified mRNA may be accomplished by dissolving or suspending the modified mRNA in an oil vehicle. Injectable depot forms are made by forming microcapsule matrices of the modified mRNA in biodegradable polymers such as polylactide-polyglycolide. Depending upon the ratio of modified mRNA to polymer and the nature of the particular polymer employed, the rate of modified mRNA release can be controlled. Examples of other biodegradable polymers include, but are not limited to, poly(orthoesters) and poly(anhydrides). Depot injectable formulations may be prepared by entrapping the modified mRNA in liposomes or microemulsions which are compatible with body tissues.

Pulmonary

[00594] Formulations described herein as being useful for pulmonary delivery may also be used for intranasal delivery of a pharmaceutical composition. Another formulation suitable for intranasal administration may be a coarse powder comprising the active ingredient and having an average particle from about 0.2 μm to 500 μm . Such a formulation may be administered in the manner in which snuff is taken, i.e. by rapid inhalation through the nasal passage from a container of the powder held close to the nose.

[00595] Formulations suitable for nasal administration may, for example, comprise from about as little as 0.1% (w/w) and as much as 100%, (w/w) of active ingredient, and may comprise one or more of the additional ingredients described herein. A pharmaceutical composition may be prepared, packaged, and/or sold in a formulation suitable for buccal administration. Such formulations may, for example, be in the form of tablets and/or lozenges made using conventional methods, and may, for example, contain about 0.1% to 20% (w/w) active ingredient, where the balance may comprise an orally dissolvable and/or degradable composition and, optionally, one or more of the additional ingredients described herein. Alternately, formulations suitable for buccal administration may comprise a powder and/or an aerosolized and/or atomized solution and/or suspension comprising active ingredient. Such powdered, aerosolized, and/or aerosolized formulations, when dispersed, may have an average particle and/or droplet size in the range from about 0.1 nm to about 200 nm, and may further comprise one or more of any additional ingredients described herein.

[00596] General considerations in the formulation and/or manufacture of pharmaceutical agents may be found, for example, in Remington: The Science and Practice of Pharmacy 2^{1st} ed., Lippincott Williams & Wilkins, 2005 (incorporated herein by reference in its entirety).

Coatings or Shells

[00597] Solid dosage forms of tablets, dragees, capsules, pills, and granules can be prepared with coatings and shells such as enteric coatings and other coatings well known in the pharmaceutical formulating art. They may optionally comprise opacifying agents and can be of a composition that they release the active ingredient(s) only, or preferentially, in a certain part of the intestinal tract, optionally, in a delayed manner. Examples of embedding compositions which can be used include polymeric substances and waxes. Solid compositions of a similar type may be employed as fillers in soft and hard-filled gelatin capsules using such excipients as lactose or milk sugar as well as high molecular weight polyethylene glycols and the like.

Properties of the Pharmaceutical Compositions

[00598] The pharmaceutical compositions described herein can be characterized by one or more of the following properties:

Bioavailability

[00599] The modified nucleic acid molecules and mmRNA, when formulated into a composition with a delivery agent as described herein, can exhibit an increase in bioavailability as compared to a composition lacking a delivery agent as described herein. As used herein, the term "bioavailability" refers to the systemic availability of a given amount of a modified nucleic acid molecule administered to a mammal. Bioavailability can be assessed by measuring the area under the curve (AUC) or the maximum serum or plasma concentration (C_{\max}) of the unchanged form of a compound following administration of the compound to a mammal. AUC is a determination of the area under the curve plotting the serum or plasma concentration of a compound along the ordinate (Y-axis) against time along the abscissa (X-axis). Generally, the AUC for a particular compound can be calculated using methods known to those of ordinary skill in the art and as described in G. S. Banker, *Modern Pharmaceutics, Drugs and the Pharmaceutical Sciences*, v. 72, Marcel Dekker, New York, Inc., 1996, herein incorporated by reference in its entirety.

[00600] The C_{\max} value is the maximum concentration of the compound achieved in the serum or plasma of a mammal following administration of the compound to the mammal. The C_{\max} value of a particular compound can be measured using methods known to those of ordinary skill in the art. The phrases "increasing bioavailability" or "improving the pharmacokinetics," as used herein mean that the systemic availability of a first modified nucleic acid molecule, measured as AUC, C_{\max} , or C_{\min} in a mammal is greater, when co-administered with a delivery agent as described herein, than when such co-administration does not take place. In some embodiments, the bioavailability of the modified nucleic acid molecule can increase by at least about 2%, at least about 5%, at least about 10%, at least about 15%, at least about 20%, at least about 25%, at least about 30%, at least about 35%, at least about 40%>, at least about 45%, at least about 50%>, at least about 55%, at least about 60%, at least about 65%, at least about 70%>, at least about 75%, at least about 80%, at least about 85%, at least about 90%, at least about 95%, or about 100%.

Therapeutic Window

[00601] The modified nucleic acid molecules and mmRNA when formulated into a composition with a delivery agent as described herein, can exhibit an increase in the therapeutic window of the

administered modified nucleic acid molecule composition as compared to the therapeutic window of the administered modified nucleic acid molecule composition lacking a delivery agent as described herein. As used herein "therapeutic window" refers to the range of plasma concentrations, or the range of levels of therapeutically active substance at the site of action, with a high probability of eliciting a therapeutic effect. In some embodiments, the therapeutic window of the modified nucleic acid molecule when co-administered with a delivery agent as described herein can increase by at least about 2%, at least about 5%, at least about 10%, at least about 15%, at least about 20%, at least about 25%, at least about 30%, at least about 35%, at least about 40%, at least about 45%, at least about 50%, at least about 55%, at least about 60%, at least about 65%, at least about 70%, at least about 75%, at least about 80%, at least about 85%, at least about 90%, at least about 95%, or about 100%.

Volume of Distribution

[00602] The modified nucleic acid molecules, when formulated into a composition with a delivery agent as described herein, can exhibit an improved volume of distribution (V_{dist}), e.g., reduced or targeted, relative to a modified nucleic acid molecule composition lacking a delivery agent as described herein. The volume of distribution (V_{dist}) relates the amount of the drug in the body to the concentration of the drug in the blood or plasma. As used herein, the term "volume of distribution" refers to the fluid volume that would be required to contain the total amount of the drug in the body at the same concentration as in the blood or plasma: V_{dist} equals the amount of drug in the body/concentration of drug in blood or plasma. For example, for a 10 mg dose and a plasma concentration of 10 mg/L, the volume of distribution would be 1 liter. The volume of distribution reflects the extent to which the drug is present in the extravascular tissue. A large volume of distribution reflects the tendency of a compound to bind to the tissue components compared with plasma protein binding. In a clinical setting, V_{dist} can be used to determine a loading dose to achieve a steady state concentration. In some embodiments, the volume of distribution of the modified nucleic acid molecule when co-administered with a delivery agent as described herein can decrease at least about 2%, at least about 5%, at least about 10%, at least about 15%, at least about 20%, at least about 25%, at least about 30%, at least about 35%, at least about 40%, at least about 45%, at least about 50%, at least about 55%, at least about 60%, at least about 65%, at least about 70%.

Biological Effect

[00603] In one embodiment, the biological effect of the modified mRNA delivered to the animals may be categorized by analyzing the protein expression in the animals. The protein expression may be determined from analyzing a biological sample collected from a mammal administered the modified mRNA of the present invention. In one embodiment, the expression protein encoded by the modified mRNA administered to the mammal of at least 50 pg/ml may be preferred. For example, a protein expression of 50-200 pg/ml for the protein encoded by the modified mRNA delivered to the mammal may be seen as a therapeutically effective amount of protein in the mammal.

Detection of Modified Nucleic Acids by Mass Spectrometry

[00604] Mass spectrometry (MS) is an analytical technique that can provide structural and molecular mass/concentration information on molecules after their conversion to ions. The molecules are first ionized to acquire positive or negative charges and then they travel through the mass analyzer to arrive at different areas of the detector according to their mass/charge (m/z) ratio.

[00605] Mass spectrometry is performed using a mass spectrometer which includes an ion source for ionizing the fractionated sample and creating charged molecules for further analysis. For example ionization of the sample may be performed by electrospray ionization (ESI), atmospheric pressure chemical ionization (APCI), photoionization, electron ionization, fast atom bombardment (FAB)/liquid secondary ionization (LSIMS), matrix assisted laser desorption/ionization (MALDI), field ionization, field desorption, thermospray/plasmaspray ionization, and particle beam ionization. The skilled artisan will understand that the choice of ionization method can be determined based on the analyte to be measured, type of sample, the type of detector, the choice of positive versus negative mode, etc.

[00606] After the sample has been ionized, the positively charged or negatively charged ions thereby created may be analyzed to determine a mass-to-charge ratio (i.e., m/z). Suitable analyzers for determining mass-to-charge ratios include quadropole analyzers, ion traps analyzers, and time-of-flight analyzers. The ions may be detected using several detection modes. For example, selected ions may be detected (i.e., using a selective ion monitoring mode (SIM)), or alternatively, ions may be detected using a scanning mode, e.g., multiple reaction monitoring (MRM) or selected reaction monitoring (SRM).

[00607] Liquid chromatography-multiple reaction monitoring (LC-MS/MRM) coupled with stable isotope labeled dilution of peptide standards has been shown to be an effective method for protein

verification (e.g., Keshishian et al., Mol Cell Proteomics 2009 8: 2339-2349; Kuhn et al., Clin Chem 2009 55:1 108-1 117; Lopez et al, Clin Chem 2010 56:281-290; each of which are herein incorporated by reference in its entirety). Unlike untargeted mass spectrometry frequently used in biomarker discovery studies, targeted MS methods are peptide sequence-based modes of MS that focus the full analytical capacity of the instrument on tens to hundreds of selected peptides in a complex mixture. By restricting detection and fragmentation to only those peptides derived from proteins of interest, sensitivity and reproducibility are improved dramatically compared to discovery-mode MS methods. This method of mass spectrometry-based multiple reaction monitoring (MRM) quantitation of proteins can dramatically impact the discovery and quantitation of biomarkers via rapid, targeted, multiplexed protein expression profiling of clinical samples.

[00608] In one embodiment, a biological sample which may contain at least one protein encoded by at least one modified mRNA of the present invention may be analyzed by the method of MRM-MS. The quantification of the biological sample may further include, but is not limited to, isotopically labeled peptides or proteins as internal standards.

[00609] According to the present invention, the biological sample, once obtained from the subject, may be subjected to enzyme digestion. As used herein, the term "digest" means to break apart into shorter peptides. As used herein, the phrase "treating a sample to digest proteins" means manipulating a sample in such a way as to break down proteins in a sample. These enzymes include, but are not limited to, trypsin, endoproteinase Glu-C and chymotrypsin. In one embodiment, a biological sample which may contain at least one protein encoded by at least one modified mRNA of the present invention may be digested using enzymes.

[00610] In one embodiment, a biological sample which may contain protein encoded by modified mRNA of the present invention may be analyzed for protein using electrospray ionization. Electrospray ionization (ESI) mass spectrometry (ESIMS) uses electrical energy to aid in the transfer of ions from the solution to the gaseous phase before they are analyzed by mass spectrometry. Samples may be analyzed using methods known in the art (e.g., Ho et al., Clin Biochem Rev. 2003 24(1):3-12; herein incorporated by reference in its entirety). The ionic species contained in solution may be transferred into the gas phase by dispersing a fine spray of charge droplets, evaporating the solvent and ejecting the ions from the charged droplets to generate a mist of highly charged droplets. The mist of highly charged droplets may be analyzed using at least 1, at least 2, at least 3 or at least 4 mass analyzers such as, but not limited to, a quadropole mass analyzer. Further, the mass

spectrometry method may include a purification step. As a non-limiting example, the first quadrupole may be set to select a single m/z ratio so it may filter out other molecular ions having a different m/z ratio which may eliminate complicated and time-consuming sample purification procedures prior to MS analysis.

[00611] In one embodiment, a biological sample which may contain protein encoded by modified mRNA of the present invention may be analyzed for protein in a tandem ESIMS system (e.g., MS/MS). As non-limiting examples, the droplets may be analyzed using a product scan (or daughter scan) a precursor scan (parent scan) a neutral loss or a multiple reaction monitoring.

[00612] In one embodiment, a biological sample which may contain protein encoded by modified mRNA of the present invention may be analyzed using matrix-assisted laser desorption/ionization (MALDI) mass spectrometry (MALDIMS). MALDI provides for the nondestructive vaporization and ionization of both large and small molecules, such as proteins. In MALDI analysis, the analyte is first co-crystallized with a large molar excess of a matrix compound, which may also include, but is not limited to, an ultraviolet absorbing weak organic acid. Non-limiting examples of matrices used in MALDI are *o*-cyano-4-hydroxycinnamic acid, 3,5-dimethoxy-4-hydroxycinnamic acid and 2,5-dihydroxybenzoic acid. Laser radiation of the analyte-matrix mixture may result in the vaporization of the matrix and the analyte. The laser induced desorption provides high ion yields of the intact analyte and allows for measurement of compounds with high accuracy. Samples may be analyzed using methods known in the art (e.g., Lewis, Wei and Siuzdak, Encyclopedia of Analytical Chemistry 2000:5880-5894; herein incorporated by reference in its entirety). As non-limiting examples, mass analyzers used in the MALDI analysis may include a linear time-of-flight (TOF), a TOF reflectron or a Fourier transform mass analyzer.

[00613] In one embodiment, the analyte-matrix mixture may be formed using the dried-droplet method. A biologic sample is mixed with a matrix to create a saturated matrix solution where the matrix-to-sample ratio is approximately 5000:1. An aliquot (approximately 0.5-2.0 uL) of the saturated matrix solution is then allowed to dry to form the analyte-matrix mixture.

[00614] In one embodiment, the analyte-matrix mixture may be formed using the thin-layer method. A matrix homogeneous film is first formed and then the sample is then applied and may be absorbed by the matrix to form the analyte-matrix mixture.

[00615] In one embodiment, the analyte-matrix mixture may be formed using the thick-layer method. A matrix homogeneous film is formed with a nitro-cellulose matrix additive. Once the

uniform nitro-cellulose matrix layer is obtained the sample is applied and absorbed into the matrix to form the analyte-matrix mixture.

[00616] In one embodiment, the analyte-matrix mixture may be formed using the sandwich method. A thin layer of matrix crystals is prepared as in the thin-layer method followed by the addition of droplets of aqueous trifluoroacetic acid, the sample and matrix. The sample is then absorbed into the matrix to form the analyte-matrix mixture.

Uses of Modified Nucleic Acid Molecules

Therapeutic Agents

[00617] The modified nucleic acid molecules and the proteins translated from the modified nucleic acid molecules described herein can be used as therapeutic agents. For example, a modified nucleic acid molecule described herein can be administered to a subject, wherein the modified nucleic acid molecule is translated *in vivo* to produce a therapeutic peptide in the subject. Accordingly, provided herein are compositions, methods, kits, and reagents for treatment or prevention of disease or conditions in humans and other mammals. The active therapeutic agents of the present disclosure include, but are not limited to, modified nucleic acid molecules, cells containing modified nucleic acid molecules or polypeptides translated from the modified nucleic acid molecules, polypeptides translated from modified nucleic acid molecules, and cells contacted with cells containing modified nucleic acid molecules or polypeptides translated from the modified nucleic acid molecules.

[00618] In certain embodiments, combination therapeutics are provided which may containing one or more modified nucleic acid molecules containing translatable regions along with a protein that induces antibody-dependent cellular toxicity. As used herein "translatable regions" encode for a protein or proteins that may boost a subject's immunity. For example, provided herein are therapeutics containing one or more nucleic acids that encode trastuzumab and granulocyte-colony stimulating factor (G-CSF). In particular, such combination therapeutics may be useful in Her2+ breast cancer patients who develop induced resistance to trastuzumab. (See, e.g., Albrecht, *Immunotherapy*. 2(6):795-8 (2010); herein incorporated by reference in its entirety).

[00619] Methods of inducing translation of a recombinant polypeptide in a cell population using the modified nucleic acid molecules described herein are also provided. Such translation can be *in vivo*, *ex vivo*, *in culture*, or *in vitro*. The cell population may be contacted with an effective amount of a composition containing a nucleic acid that has at least one nucleoside modification, and a translatable region encoding the recombinant polypeptide. The population may be contacted under

conditions such that the nucleic acid may be localized into one or more cells of the cell population and the recombinant polypeptide may be translated in the cell from the nucleic acid.

[00620] An effective amount of the composition may be provided based, at least in part, on the target tissue, target cell type, means of administration, physical characteristics of the nucleic acid (*e.g.*, size, and extent of modified nucleosides), and other determinants. In general, an effective amount of the composition provides efficient protein production in the cell, preferably more efficient than a composition containing a corresponding unmodified nucleic acid molecule. Increased efficiency may be demonstrated by increased cell transfection (*i.e.*, the percentage of cells transfected with the nucleic acid), increased protein translation from the nucleic acid, decreased nucleic acid degradation (as demonstrated, *e.g.*, by increased duration of protein translation from a modified nucleic acid molecule), or reduced innate immune response of the host cell.

[00621] Aspects of the present disclosure are directed to methods of inducing *in vivo* translation of a recombinant polypeptide in a mammalian subject in need thereof. Therein, an effective amount of a composition containing a nucleic acid that has at least one nucleoside modification and a translatable region encoding the recombinant polypeptide may be administered to the subject using the delivery methods described herein. The nucleic acid may be provided in an amount and under other conditions such that the nucleic acid is localized into a cell of the subject and the recombinant polypeptide may be translated in the cell from the nucleic acid. The cell in which the nucleic acid is localized, or the tissue in which the cell is present, may be targeted with one or more than one rounds of nucleic acid administration.

[00622] Other aspects of the present disclosure relate to transplantation of cells containing modified nucleic acid molecules to a mammalian subject. Administration of cells to mammalian subjects is known to those of ordinary skill in the art, and include, but is not limited to, local implantation (*e.g.*, topical or subcutaneous administration), organ delivery or systemic injection (*e.g.*, intravenous injection or inhalation), and the formulation of cells in pharmaceutically acceptable carrier. Compositions containing modified nucleic acid molecules are formulated for administration intramuscularly, transarterially, intraperitoneally, intravenously, intranasally, subcutaneously, endoscopically, transdermally, or intrathecally. In some embodiments, the composition may be formulated for extended release.

[00623] The subject to whom the therapeutic agent may be administered suffers from or may be at risk of developing a disease, disorder, or deleterious condition. Provided are methods of identifying,

diagnosing, and classifying subjects on these bases, which may include clinical diagnosis, biomarker levels, genome-wide association studies (GWAS), and other methods known in the art.

[00624] In certain embodiments, the administered modified nucleic acid molecule directs production of one or more recombinant polypeptides that provide a functional activity which may be substantially absent in the cell in which the recombinant polypeptide may be translated. For example, the missing functional activity may be enzymatic, structural, or gene regulatory in nature.

[00625] In other embodiments, the administration of a modified nucleic acid molecule directs production of one or more recombinant polypeptides that replace a polypeptide (or multiple polypeptides) that may be substantially absent in the cell in which the recombinant polypeptide may be translated. Such absence may be due to a genetic mutation of the encoding gene or a regulatory pathway thereof. Alternatively, the recombinant polypeptide functions to antagonize the activity of an endogenous protein present in, on the surface of, or secreted from the cell. Usually, the activity of the endogenous protein may be deleterious to the subject, for example, due to the mutation of the endogenous protein resulting in altered activity or localization. Additionally, the recombinant polypeptide antagonizes, directly or indirectly, the activity of a biological moiety present in, on the surface of, or secreted from the cell. Examples of antagonized biological moieties include, but are not limited to, lipids (*e.g.*, cholesterol), a lipoprotein (*e.g.*, low density lipoprotein), a nucleic acid, a carbohydrate, or a small molecule toxin.

[00626] The recombinant proteins described herein may be engineered for localization within the cell, potentially within a specific compartment such as the nucleus, or are engineered for secretion from the cell or translocation to the plasma membrane of the cell.

[00627] As described herein, a useful feature of the modified nucleic acid molecules of the present disclosure is the capacity to reduce the innate immune response of a cell to an exogenous nucleic acid. Provided are methods for performing the titration, reduction or elimination of the immune response in a cell or a population of cells. In some embodiments, the cell may be contacted with a first composition that contains a first dose of a first exogenous nucleic acid including a translatable region and at least one nucleoside modification, and the level of the innate immune response of the cell to the first exogenous nucleic acid may be determined. Subsequently, the cell may be contacted with a second composition, which includes a second dose of the first exogenous nucleic acid, the second dose containing a lesser amount of the first exogenous nucleic acid as compared to the first dose. Alternatively, the cell may be contacted with a first dose of a second exogenous nucleic acid.

The second exogenous nucleic acid may contain one or more modified nucleosides, which may be the same or different from the first exogenous nucleic acid or, alternatively, the second exogenous nucleic acid may not contain modified nucleosides. The steps of contacting the cell with the first composition and/or the second composition may be repeated one or more times. Additionally, efficiency of protein production (*e.g.*, protein translation) in the cell may be optionally determined, and the cell may be re-transfected with the first and/or second composition repeatedly until a target protein production efficiency is achieved.

Therapeutics for diseases and conditions

[00628] Provided herein are methods for treating or preventing a symptom of diseases, characterized by missing or aberrant protein activity, by supplying the missing protein activity or overcoming the aberrant protein activity. Because of the rapid initiation of protein production following introduction of modified mRNA, as compared to viral DNA vectors, the compounds of the present disclosure are particularly advantageous in treating acute diseases such as sepsis, stroke, and myocardial infarction. Moreover, an accurate titration of protein may be achievable using the modified mRNA of the present disclosure as the modified mRNA may be able to alter transcription rates and thus cause changes in gene expression.

[00629] Diseases characterized by dysfunctional or aberrant protein activity include, but are not limited to, cancer and proliferative diseases, genetic diseases (*e.g.*, cystic fibrosis), autoimmune diseases, diabetes, neurodegenerative diseases, cardiovascular diseases, and metabolic diseases. The present disclosure provides a method for treating such conditions or diseases in a subject by introducing nucleic acid or cell-based therapeutics containing the modified nucleic acid molecules provided herein, wherein the modified nucleic acid molecules encode for a protein that antagonizes or otherwise overcomes the aberrant protein activity present in the cell of the subject. Specific examples of a dysfunctional protein include, but are not limited to, the missense mutation variants of the cystic fibrosis transmembrane conductance regulator (CFTR) gene, which produce a dysfunctional protein variant of CFTR protein, which causes cystic fibrosis.

[00630] Multiple diseases may be characterized by missing (or substantially diminished such that proper protein function does not occur) protein activity. Such proteins may not be present, or they may be essentially non-functional.

[00631] Thus, provided are methods of treating cystic fibrosis in a mammalian subject by contacting a cell of the subject with a modified nucleic acid molecule having a translatable region

that encodes a functional CFTR polypeptide, under conditions such that an effective amount of the CFTR polypeptide is present in the cell. Preferred target cells are epithelial cells, such as the lung, and methods of administration are determined in view of the target tissue; i.e., for lung delivery, the RNA molecules are formulated for administration by inhalation.

[00632] In another embodiment, the present disclosure provides a method for treating hyperlipidemia in a subject, by introducing into a cell population of the subject with a modified mRNA molecule encoding Sortilin, a protein recently characterized by genomic studies, thereby ameliorating the hyperlipidemia in a subject. The *SORT1* gene encodes a trans-Golgi network (TGN) transmembrane protein called Sortilin. Genetic studies have shown that one of five individuals has a single nucleotide polymorphism, rs12740374, in the *lpl3* locus of the *SORT1* gene that predisposes them to having low levels of low-density lipoprotein (LDL) and very-low-density lipoprotein (VLDL). Each copy of the minor allele, present in about 30% of people, alters LDL cholesterol by 8 mg/dL, while two copies of the minor allele, present in about 5% of the population, lowers LDL cholesterol 16 mg/dL. Carriers of the minor allele have also been shown to have a 40% decreased risk of myocardial infarction. Functional *in vivo* studies in mice describes that overexpression of *SORT1* in mouse liver tissue led to significantly lower LDL-cholesterol levels, as much as 80% lower, and that silencing *SORT1* increased LDL cholesterol approximately 200% (Musunuru K et al. From noncoding variant to phenotype via *SORT1* at the *lpl3* cholesterol locus. *Nature* 2010; 466: 714-721; herein incorporated by reference in its entirety).

Methods of cellular nucleic acid delivery

[00633] Methods of the present disclosure enhance nucleic acid delivery into a cell population, *in vivo*, *ex vivo*, or *in culture*. For example, a cell culture containing a plurality of host cells (e.g., eukaryotic cells such as yeast or mammalian cells) may be contacted with a composition that contains an modified nucleic acid molecule having at least one nucleoside modification and, optionally, a translatable region. The composition may also generally contain a transfection reagent or other compound that may increase the efficiency of modified nucleic acid molecule uptake into the host cells. The modified nucleic acid molecule may exhibit enhanced retention in the cell population, relative to a corresponding unmodified nucleic acid molecule. The retention of the modified nucleic acid molecule may be greater than the retention of the unmodified nucleic acid molecule. In some embodiments, it is at least about 50%, 75%, 90%, 95%, 100%, 150%, 200% or more than 200% greater than the retention of the unmodified nucleic acid molecule. Such retention

advantage may be achieved by one round of transfection with the modified nucleic acid molecule, or may be obtained following repeated rounds of transfection.

[00634] In some embodiments, the modified nucleic acid molecule may be delivered to a target cell population with one or more additional nucleic acids. Such delivery may be at the same time, or the modified nucleic acid molecule is delivered prior to delivery of the one or more additional nucleic acids. The additional one or more nucleic acids may be modified nucleic acid molecules or unmodified nucleic acid molecules. It is understood that the initial presence of the modified nucleic acid molecules may not substantially induce an innate immune response of the cell population and, moreover, that the innate immune response may not be activated by the later presence of the unmodified nucleic acid molecules. In this regard, the enhanced nucleic acid may not itself contain a translatable region, if the protein desired to be present in the target cell population is translated from the unmodified nucleic acid molecules.

Targeting Moieties

[00635] In some embodiments, modified nucleic acid molecules are provided to express a protein-binding partner or a receptor on the surface of the cell, which may function to target the cell to a specific tissue space or to interact with a specific moiety, either *in vivo* or *in vitro*. Suitable protein-binding partners include, but are not limited to, antibodies and functional fragments thereof, scaffold proteins, or peptides. Additionally, modified nucleic acid molecules may be employed to direct the synthesis and extracellular localization of lipids, carbohydrates, or other biological moieties.

Permanent Gene Expression Silencing

[00636] A method for epigenetically silencing gene expression in a mammalian subject, comprising a nucleic acid where the translatable region encodes a polypeptide or polypeptides capable of directing sequence-specific histone H3 methylation to initiate heterochromatin formation and reduce gene transcription around specific genes for the purpose of silencing the gene. For example, a gain-of-function mutation in the Janus Kinase 2 gene is responsible for the family of Myeloproliferative Diseases.

Expression of Ligand or Receptor on Cell Surface

[00637] In some aspects and embodiments of the aspects described herein, the modified RNA can be used to express a ligand or ligand receptor on the surface of a cell (*e.g.*, a homing moiety). A ligand or ligand receptor moiety attached to a cell surface can permit the cell to have a desired biological interaction with a tissue or an agent *in vivo*. A ligand can be an antibody, an antibody

fragment, an aptamer, a peptide, a vitamin, a carbohydrate, a protein or polypeptide, a receptor, *e.g.*, cell-surface receptor, an adhesion molecule, a glycoprotein, a sugar residue, a therapeutic agent, a drug, a glycosaminoglycan, or any combination thereof. For example, a ligand can be an antibody that recognizes a cancer-cell specific antigen, rendering the cell capable of preferentially interacting with tumor cells to permit tumor-specific localization of a modified cell. A ligand can confer the ability of a cell composition to accumulate in a tissue to be treated, since a preferred ligand may be capable of interacting with a target molecule on the external face of a tissue to be treated. Ligands having limited cross-reactivity to other tissues are generally preferred.

[00638] In some cases, a ligand can act as a homing moiety which permits the cell to target to a specific tissue or interact with a specific ligand. Such homing moieties can include, but are not limited to, any member of a specific binding pair, antibodies, monoclonal antibodies, or derivatives or analogs thereof, including without limitation: Fv fragments, single chain Fv (scFv) fragments, Fab' fragments, F(ab')₂ fragments, single domain antibodies, camelized antibodies and antibody fragments, humanized antibodies and antibody fragments, and multivalent versions of the foregoing; multivalent binding reagents including without limitation: monospecific or bispecific antibodies, such as disulfide stabilized Fv fragments, scFv tandems ((SCFV)₂ fragments), diabodies, tribodies or tetrabodies, which typically are covalently linked or otherwise stabilized (*i.e.*, leucine zipper or helix stabilized) scFv fragments; and other homing moieties include for example, aptamers, receptors, and fusion proteins.

[00639] In some embodiments, the homing moiety may be a surface-bound antibody, which can permit tuning of cell targeting specificity. This is especially useful since highly specific antibodies can be raised against an epitope of interest for the desired targeting site. In one embodiment, multiple antibodies are expressed on the surface of a cell, and each antibody can have a different specificity for a desired target. Such approaches can increase the avidity and specificity of homing interactions.

[00640] A skilled artisan can select any homing moiety based on the desired localization or function of the cell, for example an estrogen receptor ligand, such as tamoxifen, can target cells to estrogen-dependent breast cancer cells that have an increased number of estrogen receptors on the cell surface. Other non-limiting examples of ligand/receptor interactions include CCRI (*e.g.*, for treatment of inflamed joint tissues or brain in rheumatoid arthritis, and/or multiple sclerosis), CCR7, CCR8 (*e.g.*, targeting to lymph node tissue), CCR6, CCR9, CCR10 (*e.g.*, to target to intestinal

tissue), CCR4, CCR10 (*e.g.*, for targeting to skin), CXCR4 (*e.g.*, for general enhanced transmigration), HCELL (*e.g.*, for treatment of inflammation and inflammatory disorders, bone marrow), Alpha4beta7 (*e.g.*, for intestinal mucosa targeting), VLA-4/VCAM-1 (*e.g.*, targeting to endothelium). In general, any receptor involved in targeting (*e.g.*, cancer metastasis) can be harnessed for use in the methods and compositions described herein.

Mediators of Cell Death

[00641] In one embodiment, a modified nucleic acid molecule composition can be used to induce apoptosis in a cell (*e.g.*, a cancer cell) by increasing the expression of a death receptor, a death receptor ligand or a combination thereof. This method can be used to induce cell death in any desired cell and has particular usefulness in the treatment of cancer where cells escape natural apoptotic signals.

[00642] Apoptosis can be induced by multiple independent signaling pathways that converge upon a final effector mechanism consisting of multiple interactions between several "death receptors" and their ligands, which belong to the tumor necrosis factor (TNF) receptor/ligand superfamily. The best-characterized death receptors are CD95 ("Fas"), TNFR1 (p55), death receptor 3 (DR3 or Apo3/TRAMO), DR4 and DR5 (apo2-TRAIL-R2). The final effector mechanism of apoptosis may be the activation of a series of proteinases designated as caspases. The activation of these caspases results in the cleavage of a series of vital cellular proteins and cell death. The molecular mechanism of death receptors/ligands-induced apoptosis is well known in the art. For example, Fas/FasL-mediated apoptosis is induced by binding of three FasL molecules which induces trimerization of Fas receptor via C-terminus death domains (DDs), which in turn recruits an adapter protein FADD (Fas-associated protein with death domain) and Caspase-8. The oligomerization of this trimolecular complex, Fas/FAIDD/caspase-8, results in proteolytic cleavage of proenzyme caspase-8 into active caspase-8 that, in turn, initiates the apoptosis process by activating other downstream caspases through proteolysis, including caspase-3. Death ligands in general are apoptotic when formed into trimers or higher order of structures. As monomers, they may serve as antiapoptotic agents by competing with the trimers for binding to the death receptors.

[00643] In one embodiment, the modified nucleic acid molecule composition encodes for a death receptor (*e.g.*, Fas, TRAIL, TRAMO, TNFR, TLR etc). Cells made to express a death receptor by transfection of modified RNA become susceptible to death induced by the ligand that activates that receptor. Similarly, cells made to express a death ligand, *e.g.*, on their surface, will induce death of

cells with the receptor when the transfected cell contacts the target cell. In another embodiment, the modified RNA composition encodes for a death receptor ligand (*e.g.*, FasL, TNF, etc). In another embodiment, the modified RNA composition encodes a caspase (*e.g.*, caspase 3, caspase 8, caspase 9 etc). Where cancer cells often exhibit a failure to properly differentiate to a non-proliferative or controlled proliferative form, in another embodiment, the synthetic, modified RNA composition encodes for both a death receptor and its appropriate activating ligand. In another embodiment, the synthetic, modified RNA composition encodes for a differentiation factor that when expressed in the cancer cell, such as a cancer stem cell, will induce the cell to differentiate to a non-pathogenic or nonself-renewing phenotype (*e.g.*, reduced cell growth rate, reduced cell division etc) or to induce the cell to enter a dormant cell phase (*e.g.*, G₀ resting phase).

[00644] One of skill in the art will appreciate that the use of apoptosis-inducing techniques may require that the modified nucleic acid molecules are appropriately targeted to *e.g.*, tumor cells to prevent unwanted wide-spread cell death. Thus, one can use a delivery mechanism (*e.g.*, attached ligand or antibody, targeted liposome etc) that recognizes a cancer antigen such that the modified nucleic acid molecules are expressed only in cancer cells.

Kits and Devices

Kits

[00645] The invention provides a variety of kits for conveniently and/or effectively carrying out methods of the present invention. Typically kits will comprise sufficient amounts and/or numbers of components to allow a user to perform multiple treatments of a subject(s) and/or to perform multiple experiments.

[00646] In one aspect, the present invention provides kits for protein production, comprising a first modified nucleic acid molecule or mrnRNA comprising a translatable region. The kit may further comprise packaging and instructions and/or a delivery agent to form a formulation composition. The delivery agent may comprise a saline, a buffered solution, a lipidoid or any delivery agent disclosed herein.

[00647] In one embodiment, the buffer solution may include sodium chloride, calcium chloride, phosphate and/or EDTA. In another embodiment, the buffer solution may include, but is not limited to, saline, saline with 2mM calcium, 5% sucrose, 5% sucrose with 2mM calcium, 5% Mannitol, 5% Mannitol with 2mM calcium, Ringer's lactate, sodium chloride, sodium chloride with 2mM calcium and mannose (See *e.g.*, U.S. Pub. No. 20120258046; herein incorporated by reference in its entirety).

In a further embodiment, the buffer solutions may be precipitated or it may be lyophilized. The amount of each component may be varied to enable consistent, reproducible higher concentration saline or simple buffer formulations. The components may also be varied in order to increase the stability of modified nucleic acid molecules and mmRNA in the buffer solution over a period of time and/or under a variety of conditions.

[00648] In one aspect, the present invention provides kits for protein production, comprising: a modified nucleic acid molecule or mmRNA comprising a translatable region, provided in an amount effective to produce a desired amount of a protein encoded by the translatable region when introduced into a target cell; a second modified nucleic acid molecule or mmRNA comprising an inhibitory nucleic acid, provided in an amount effective to substantially inhibit the innate immune response of the cell; and packaging and instructions.

[00649] In one aspect, the present invention provides kits for protein production, comprising a modified nucleic acid molecule or mmRNA comprising a translatable region, wherein the nucleic acid exhibits reduced degradation by a cellular nuclease, and packaging and instructions.

[00650] In one aspect, the present invention provides kits for protein production, comprising a modified nucleic acid molecule or mmRNA comprising a translatable region, wherein the nucleic acid exhibits reduced degradation by a cellular nuclease, and a mammalian cell suitable for translation of the translatable region of the first nucleic acid.

Devices

[00651] The present invention provides for devices which may incorporate modified nucleic acid molecules or mmRNA that encode polypeptides of interest. These devices contain in a stable formulation the reagents to synthesize a nucleic acid in a formulation available to be immediately delivered to a subject in need thereof, such as a human patient. Non-limiting examples of such a polypeptide of interest include a growth factor and/or angiogenesis stimulator for wound healing, a peptide antibiotic to facilitate infection control, and an antigen to rapidly stimulate an immune response to a newly identified virus.

[00652] In some embodiments the device is self-contained, and is optionally capable of wireless remote access to obtain instructions for synthesis and/or analysis of the generated modified nucleic acid molecule or mmRNA. The device is capable of mobile synthesis of at least one modified nucleic acid molecule or mmRNA and preferably an unlimited number of different modified nucleic acid molecules or mmRNA. In certain embodiments, the device is capable of being transported by

one or a small number of individuals. In other embodiments, the device is scaled to fit on a benchtop or desk. In other embodiments, the device is scaled to fit into a suitcase, backpack or similarly sized object.

[00653] In another embodiment, the device may be a point of care or handheld device. In further embodiments, the device is scaled to fit into a vehicle, such as a car, truck or ambulance, or a military vehicle such as a tank or personnel carrier. The information necessary to generate a modified mRNA encoding polypeptide of interest is present within a computer readable medium present in the device.

[00654] In one embodiment, a device may be used to assess levels of a protein which has been administered in the form of a modified nucleic acid or mmRNA. The device may comprise a blood, urine or other biofluidic test.

[00655] In some embodiments, the device is capable of communication (e.g., wireless communication) with a database of nucleic acid and polypeptide sequences. The device contains at least one sample block for insertion of one or more sample vessels. Such sample vessels are capable of accepting in liquid or other form any number of materials such as template DNA, nucleotides, enzymes, buffers, and other reagents. The sample vessels are also capable of being heated and cooled by contact with the sample block. The sample block is generally in communication with a device base with one or more electronic control units for the at least one sample block. The sample block preferably contains a heating module, such heating molecule capable of heating and/or cooling the sample vessels and contents thereof to temperatures between about -20C and above +100C. The device base is in communication with a voltage supply such as a battery or external voltage supply. The device also contains means for storing and distributing the materials for RNA synthesis.

[00656] Optionally, the sample block contains a module for separating the synthesized nucleic acids. Alternatively, the device contains a separation module operably linked to the sample block. Preferably the device contains a means for analysis of the synthesized nucleic acid. Such analysis includes sequence identity (demonstrated such as by hybridization), absence of non-desired sequences, measurement of integrity of synthesized mRNA (such has by microfluidic viscometry combined with spectrophotometry), and concentration and/or potency of modified RNA (such as by spectrophotometry).

[00657] In certain embodiments, the device is combined with a means for detection of pathogens present in a biological material obtained from a subject, e.g., the IBIS PLEX-ID system (Abbott, Abbott Park, IL) for microbial identification.

[00658] Suitable devices for use in delivering intradermal pharmaceutical compositions described herein include short needle devices such as those described in U.S. Patents 4,886,499; 5,190,521; 5,328,483; 5,527,288; 4,270,537; 5,015,235; 5,141,496; and 5,417,662; each of which is herein incorporated by reference in their entirety. Intradermal compositions may be administered by devices which limit the effective penetration length of a needle into the skin, such as those described in PCT publication WO 99/34850 (herein incorporated by reference in its entirety) and functional equivalents thereof. Jet injection devices which deliver liquid compositions to the dermis via a liquid jet injector and/or via a needle which pierces the stratum corneum and produces a jet which reaches the dermis are suitable. Jet injection devices are described, for example, in U.S. Patents 5,480,381; 5,599,302; 5,334,144; 5,993,412; 5,649,912; 5,569,189; 5,704,911; 5,383,851; 5,893,397; 5,466,220; 5,339,163; 5,312,335; 5,503,627; 5,064,413; 5,520,639; 4,596,556; 4,790,824; 4,941,880; 4,940,460; and PCT publications WO 97/37705 and WO 97/13537; each of which are herein incorporated by reference in their entirety. Ballistic powder/particle delivery devices which use compressed gas to accelerate vaccine in powder form through the outer layers of the skin to the dermis are suitable. Alternatively or additionally, conventional syringes may be used in the classical mantoux method of intradermal administration.

[00659] In some embodiments, the device may be a pump or comprise a catheter for administration of compounds or compositions of the invention across the blood brain barrier. Such devices include but are not limited to a pressurized olfactory delivery device, iontophoresis devices, multi-layered microfluidic devices, and the like. Such devices may be portable or stationary. They may be implantable or externally tethered to the body or combinations thereof.

[00660] Devices for administration may be employed to deliver the modified nucleic acid molecules or mRNA of the present invention according to single, multi- or split-dosing regimens taught herein. Such devices are described below.

[00661] Method and devices known in the art for multi-administration to cells, organs and tissues are contemplated for use in conjunction with the methods and compositions disclosed herein as embodiments of the present invention. These include, for example, those methods and devices

having multiple needles, hybrid devices employing for example lumens or catheters as well as devices utilizing heat, electric current or radiation driven mechanisms.

[00662] According to the present invention, these multi-administration devices may be utilized to deliver the single, multi- or split doses contemplated herein.

[00663] A method for delivering therapeutic agents to a solid tissue has been described by Bahrami et al. and is taught for example in US Patent Publication 201 10230839, the contents of which are incorporated herein by reference in their entirety. According to Bahrami, an array of needles is incorporated into a device which delivers a substantially equal amount of fluid at any location in said solid tissue along each needle's length.

[00664] A device for delivery of biological material across the biological tissue has been described by Kodgule et al. and is taught for example in US Patent Publication 201 10172610, the contents of which are incorporated herein by reference in their entirety. According to Kodgule, multiple hollow micro-needles made of one or more metals and having outer diameters from about 200 microns to about 350 microns and lengths of at least 100 microns are incorporated into the device which delivers peptides, proteins, carbohydrates, nucleic acid molecules, lipids and other pharmaceutically active ingredients or combinations thereof.

[00665] A delivery probe for delivering a therapeutic agent to a tissue has been described by Gunday et al. and is taught for example in US Patent Publication 201 10270184, the contents of each of which are incorporated herein by reference in their entirety. According to Gunday, multiple needles are incorporated into the device which moves the attached capsules between an activated position and an inactivated position to force the agent out of the capsules through the needles.

[00666] A multiple-injection medical apparatus has been described by Assaf and is taught for example in US Patent Publication 201 10218497, the contents of which are incorporated herein by reference in their entirety. According to Assaf, multiple needles are incorporated into the device which has a chamber connected to one or more of said needles and a means for continuously refilling the chamber with the medical fluid after each injection.

[00667] In one embodiment, the modified nucleic acid molecule or mmRNA is administered subcutaneously or intramuscularly via at least 3 needles to three different, optionally adjacent, sites simultaneously, or within a 60 minutes period (e.g., administration to 4, 5, 6, 7, 8, 9, or 10 sites simultaneously or within a 60 minute period). The split doses can be administered simultaneously to

adjacent tissue using the devices described in U.S. Patent Publication Nos. 201 10230839 and 201 10218497, each of which is incorporated herein by reference in their entirety.

[00668] An at least partially implantable system for injecting a substance into a patient's body, in particular a penis erection stimulation system has been described by Forsell and is taught for example in US Patent Publication 201 10196198, the contents of which are incorporated herein by reference in their entirety. According to Forsell, multiple needles are incorporated into the device which is implanted along with one or more housings adjacent the patient's left and right corpora cavernosa. A reservoir and a pump are also implanted to supply drugs through the needles.

[00669] A method for the transdermal delivery of a therapeutic effective amount of iron has been described by Berenson and is taught for example in US Patent Publication 20100130910, the contents of which are incorporated herein by reference in their entirety. According to Berenson, multiple needles may be used to create multiple micro channels in stratum corneum to enhance transdermal delivery of the ionic iron on an iontophoretic patch.

[00670] A method for delivery of biological material across the biological tissue has been described by Kodgule et al and is taught for example in US Patent Publication 201 10196308, the contents of which are incorporated herein by reference in their entirety. According to Kodgule, multiple biodegradable microneedles containing a therapeutic active ingredient are incorporated in a device which delivers proteins, carbohydrates, nucleic acid molecules, lipids and other pharmaceutically active ingredients or combinations thereof.

[00671] A transdermal patch comprising a botulinum toxin composition has been described by Donovan and is taught for example in US Patent Publication 20080220020, the contents of which are incorporated herein by reference in their entirety. According to Donovan, multiple needles are incorporated into the patch which delivers botulinum toxin under stratum corneum through said needles which project through the stratum corneum of the skin without rupturing a blood vessel.

[00672] A small, disposable drug reservoir, or patch pump, which can hold approximately 0.2 to 15 mL of liquid formulations can be placed on the skin and deliver the formulation continuously subcutaneously using a small bore needle (e.g., 26 to 34 gauge). As non-limiting examples, the patch pump may be 50 mm by 76 mm by 20 mm spring loaded having a 30 to 34 gauge needle (BD™ Microinfuser, Franklin Lakes NJ), 41 mm by 62 mm by 17 mm with a 2 mL reservoir used for drug delivery such as insulin (OMNIPOD®, Insulet Corporation Bedford, MA), or 43-60 mm

diameter, 10 mm thick with a 0.5 to 10 mL reservoir (PATCHPUMP®, SteadyMed Therapeutics, San Francisco, CA). Further, the patch pump may be battery powered and/or rechargeable.

[00673] A cryoprobe for administration of an active agent to a location of cryogenic treatment has been described by Toubia and is taught for example in US Patent Publication 20080140061, the contents of which are incorporated herein by reference in their entirety. According to Toubia, multiple needles are incorporated into the probe which receives the active agent into a chamber and administers the agent to the tissue.

[00674] A method for treating or preventing inflammation or promoting healthy joints has been described by Stock et al and is taught for example in US Patent Publication 20090155186, the contents of which are incorporated herein by reference in their entirety. According to Stock, multiple needles are incorporated in a device which administers compositions containing signal transduction modulator compounds.

[00675] A multi-site injection system has been described by Kimmell et al. and is taught for example in US Patent Publication 20100256594, the contents of which are incorporated herein by reference in their entirety. According to Kimmell, multiple needles are incorporated into a device which delivers a medication into a stratum corneum through the needles.

[00676] A method for delivering interferons to the intradermal compartment has been described by Dekker et al. and is taught for example in US Patent Publication 20050181033, the contents of which are incorporated herein by reference in their entirety. According to Dekker, multiple needles having an outlet with an exposed height between 0 and 1 mm are incorporated into a device which improves pharmacokinetics and bioavailability by delivering the substance at a depth between 0.3 mm and 2 mm.

[00677] A method for delivering genes, enzymes and biological agents to tissue cells has described by Desai and is taught for example in US Patent Publication 20030073908, the contents of which are incorporated herein by reference in their entirety. According to Desai, multiple needles are incorporated into a device which is inserted into a body and delivers a medication fluid through said needles.

[00678] A method for treating cardiac arrhythmias with fibroblast cells has been described by Lee et al and is taught for example in US Patent Publication 20040005295, the contents of which are incorporated herein by reference in their entirety. According to Lee, multiple needles are incorporated into the device which delivers fibroblast cells into the local region of the tissue.

[00679] A method using a magnetically controlled pump for treating a brain tumor has been described by Shachar et al. and is taught for example in US Patent 7,799,012 (method) and 7,799,016 (device), the contents of which are incorporated herein by reference in their entirety. According to Shachar, multiple needles were incorporated into the pump which pushes a medicating agent through the needles at a controlled rate.

[00680] Methods of treating functional disorders of the bladder in mammalian females have been described by Versi et al. and are taught for example in US Patent 8,029,496, the contents of which are incorporated herein by reference in their entirety. According to Versi, an array of micro-needles is incorporated into a device which delivers a therapeutic agent through the needles directly into the trigone of the bladder.

[00681] A micro-needle transdermal transport device has been described by Angel et al and is taught for example in US Patent 7,364,568, the contents of which are incorporated herein by reference in their entirety. According to Angel, multiple needles are incorporated into the device which transports a substance into a body surface through the needles which are inserted into the surface from different directions. The micro-needle transdermal transport device may be a solid micro-needle system or a hollow micro-needle system. As a non-limiting example, the solid micro-needle system may have up to a 0.5 mg capacity, with 300-1500 solid micro-needles per cm² about 150-700 μm tall coated with a drug. The micro-needles penetrate the stratum corneum and remain in the skin for short duration (e.g., 20 seconds to 15 minutes). In another example, the hollow micro-needle system has up to a 3 mL capacity to deliver liquid formulations using 15-20 microneedles per cm² being approximately 950 μm tall. The micro-needles penetrate the skin to allow the liquid formulations to flow from the device into the skin. The hollow micro-needle system may be worn from 1 to 30 minutes depending on the formulation volume and viscosity.

[00682] A device for subcutaneous infusion has been described by Dalton et al and is taught for example in US Patent 7,150,726, the contents of which are incorporated herein by reference in their entirety. According to Dalton, multiple needles are incorporated into the device which delivers fluid through the needles into a subcutaneous tissue.

[00683] A device and a method for intradermal delivery of vaccines and gene therapeutic agents through microcannula have been described by Mikszta et al. and are taught for example in US Patent 7,473,247, the contents of which are incorporated herein by reference in their entirety. According to

Mitszta, at least one hollow micro-needle is incorporated into the device which delivers the vaccines to the subject's skin to a depth of between 0.025 mm and 2 mm.

[00684] A method of delivering insulin has been described by Pettis et al and is taught for example in US Patent 7,722,595, the contents of which are incorporated herein by reference in their entirety. According to Pettis, two needles are incorporated into a device wherein both needles insert essentially simultaneously into the skin with the first at a depth of less than 2.5 mm to deliver insulin to intradermal compartment and the second at a depth of greater than 2.5 mm and less than 5.0 mm to deliver insulin to subcutaneous compartment.

[00685] Cutaneous injection delivery under suction has been described by Kochamba et al. and is taught for example in US Patent 6,896,666, the contents of which are incorporated herein by reference in their entirety. According to Kochamba, multiple needles in relative adjacency with each other are incorporated into a device which injects a fluid below the cutaneous layer.

[00686] A device for withdrawing or delivering a substance through the skin has been described by Down et al and is taught for example in US Patent 6,607,513, the contents of which are incorporated herein by reference in their entirety. According to Down, multiple skin penetrating members which are incorporated into the device have lengths of about 100 microns to about 2000 microns and are about 30 to 50 gauge.

[00687] A device for delivering a substance to the skin has been described by Palmer et al and is taught for example in US Patent 6,537,242, the contents of which are incorporated herein by reference in their entirety. According to Palmer, an array of micro-needles is incorporated into the device which uses a stretching assembly to enhance the contact of the needles with the skin and provides a more uniform delivery of the substance.

[00688] A perfusion device for localized drug delivery has been described by Zamoyski and is taught for example in US Patent 6,468,247, the contents of which are incorporated herein by reference in their entirety. According to Zamoyski, multiple hypodermic needles are incorporated into the device which injects the contents of the hypodermics into a tissue as said hypodermics are being retracted.

[00689] A method for enhanced transport of drugs and biological molecules across tissue by improving the interaction between micro-needles and human skin has been described by Prausnitz et al. and is taught for example in US Patent 6,743,211, the contents of which are incorporated herein by reference in their entirety. According to Prausnitz, multiple micro-needles are incorporated into a

device which is able to present a more rigid and less deformable surface to which the micro-needles are applied.

[00690] A device for intraorgan administration of medicinal agents has been described by Ting et al and is taught for example in US Patent 6,077,251, the contents of which are incorporated herein by reference in their entirety. According to Ting, multiple needles having side openings for enhanced administration are incorporated into a device which by extending and retracting said needles from and into the needle chamber forces a medicinal agent from a reservoir into said needles and injects said medicinal agent into a target organ.

[00691] A multiple needle holder and a subcutaneous multiple channel infusion port has been described by Brown and is taught for example in US Patent 4,695,273, the contents of which are incorporated herein by reference in their entirety. According to Brown, multiple needles on the needle holder are inserted through the septum of the infusion port and communicate with isolated chambers in said infusion port.

[00692] A dual hypodermic syringe has been described by Horn and is taught for example in US Patent 3,552,394, the contents of which are incorporated herein by reference in their entirety. According to Horn, two needles incorporated into the device are spaced apart less than 68 mm and may be of different styles and lengths, thus enabling injections to be made to different depths.

[00693] A syringe with multiple needles and multiple fluid compartments has been described by Hershberg and is taught for example in US Patent 3,572,336, the contents of which are incorporated herein by reference in their entirety. According to Hershberg, multiple needles are incorporated into the syringe which has multiple fluid compartments and is capable of simultaneously administering incompatible drugs which are not able to be mixed for one injection.

[00694] A surgical instrument for intradermal injection of fluids has been described by Eliscu et al. and is taught for example in US Patent 2,588,623, the contents of which are incorporated herein by reference in their entirety. According to Eliscu, multiple needles are incorporated into the instrument which injects fluids intradermally with a wider disperse.

[00695] An apparatus for simultaneous delivery of a substance to multiple breast milk ducts has been described by Hung and is taught for example in EP 1818017, the contents of which are incorporated herein by reference in their entirety. According to Hung, multiple lumens are incorporated into the device which inserts through the orifices of the ductal networks and delivers a fluid to the ductal networks.

[00696] A catheter for introduction of medications to the tissue of a heart or other organs has been described by Tkebuchava and is taught for example in WO2006138109, the contents of which are incorporated herein by reference in their entirety. According to Tkebuchava, two curved needles are incorporated which enter the organ wall in a flattened trajectory.

[00697] Devices for delivering medical agents have been described by Mckay et al. and are taught for example in WO20061 18804, the content of which are incorporated herein by reference in their entirety. According to Mckay, multiple needles with multiple orifices on each needle are incorporated into the devices to facilitate regional delivery to a tissue, such as the interior disc space of a spinal disc.

[00698] A method for directly delivering an immunomodulatory substance into an intradermal space within a mammalian skin has been described by Pettis and is taught for example in WO2004020014, the contents of which are incorporated herein by reference in their entirety. According to Pettis, multiple needles are incorporated into a device which delivers the substance through the needles to a depth between 0.3 mm and 2 mm.

[00699] Methods and devices for administration of substances into at least two compartments in skin for systemic absorption and improved pharmacokinetics have been described by Pettis et al. and are taught for example in WO2003094995, the contents of which are incorporated herein by reference in their entirety. According to Pettis, multiple needles having lengths between about 300 μm and about 5 mm are incorporated into a device which delivers to intradermal and subcutaneous tissue compartments simultaneously.

[00700] A drug delivery device with needles and a roller has been described by Zimmerman et al. and is taught for example in WO2012006259, the contents of which are incorporated herein by reference in their entirety. According to Zimmerman, multiple hollow needles positioned in a roller are incorporated into the device which delivers the content in a reservoir through the needles as the roller rotates.

[00701] A drug delivery device such as a stent is known in the art and is taught for example in U.S. Pub. Nos. US20060020329, US20040172127 and US20100161032; the contents of which are herein incorporated by reference in their entirety. Formulations of the modified nucleic acid molecules and mmRNA described herein may be delivered using stents. Additionally, stents used herein may be able to deliver multiple modified nucleic acid molecules and/or formulations at the same or varied rates of delivery. Non-limiting examples of manufacturers of stents include CORDIS® (Miami, FL)

(CYPHER®), Boston Scientific Corporation (Natick, MA) (TAXUS®), Medtronic (Minneapolis, MN) (ENDEAVOUR®) and Abbott (Abbott Park, IL) (XIENCE V®).

Methods and Devices utilizing catheters and/or lumens

[00702] Methods and devices using catheters and lumens may be employed to administer the mmRNA of the present invention on a single, multi- or split dosing schedule. Such methods and devices are described below.

[00703] A catheter-based delivery of skeletal myoblasts to the myocardium of damaged hearts has been described by Jacoby et al and is taught for example in US Patent Publication 20060263338, the contents of which are incorporated herein by reference in their entirety. According to Jacoby, multiple needles are incorporated into the device at least part of which is inserted into a blood vessel and delivers the cell composition through the needles into the localized region of the subject's heart.

[00704] An apparatus for treating asthma using neurotoxin has been described by Deem et al and is taught for example in US Patent Publication 20060225742, the contents of which are incorporated herein by reference in their entirety. According to Deem, multiple needles are incorporated into the device which delivers neurotoxin through the needles into the bronchial tissue.

[00705] A method for administering multiple-component therapies has been described by Nayak and is taught for example in US Patent 7,699,803, the contents of which are incorporated herein by reference in their entirety. According to Nayak, multiple injection cannulas may be incorporated into a device wherein depth slots may be included for controlling the depth at which the therapeutic substance is delivered within the tissue.

[00706] A surgical device for ablating a channel and delivering at least one therapeutic agent into a desired region of the tissue has been described by McIntyre et al and is taught for example in US Patent 8,012,096, the contents of which are incorporated herein by reference in their entirety. According to McIntyre, multiple needles are incorporated into the device which dispenses a therapeutic agent into a region of tissue surrounding the channel and is particularly well suited for transmyocardial revascularization operations.

[00707] Methods of treating functional disorders of the bladder in mammalian females have been described by Versi et al and are taught for example in US Patent 8,029,496, the contents of which are incorporated herein by reference in their entirety. According to Versi, an array of micro-needles is incorporated into a device which delivers a therapeutic agent through the needles directly into the trigone of the bladder.

[00708] A device and a method for delivering fluid into a flexible biological barrier have been described by Yeshurun et al. and are taught for example in US Patent 7,998,119 (device) and 8,007,466 (method), the contents of which are incorporated herein by reference in their entirety. According to Yeshurun, the micro-needles on the device penetrate and extend into the flexible biological barrier and fluid is injected through the bore of the hollow micro-needles.

[00709] A method for epicardially injecting a substance into an area of tissue of a heart having an epicardial surface and disposed within a torso has been described by Bonner et al and is taught for example in US Patent 7,628,780, the contents of which are incorporated herein by reference in their entirety. According to Bonner, the devices have elongate shafts and distal injection heads for driving needles into tissue and injecting medical agents into the tissue through the needles.

[00710] A device for sealing a puncture has been described by Nielsen et al and is taught for example in US Patent 7,972,358, the contents of which are incorporated herein by reference in their entirety. According to Nielsen, multiple needles are incorporated into the device which delivers a closure agent into the tissue surrounding the puncture tract.

[00711] A method for myogenesis and angiogenesis has been described by Chiu et al. and is taught for example in US Patent 6,551,338, the contents of which are incorporated herein by reference in their entirety. According to Chiu, 5 to 15 needles having a maximum diameter of at least 1.25 mm and a length effective to provide a puncture depth of 6 to 20 mm are incorporated into a device which inserts into proximity with a myocardium and supplies an exogenous angiogenic or myogenic factor to said myocardium through the conduits which are in at least some of said needles.

[00712] A method for the treatment of prostate tissue has been described by Bolmsj et al. and is taught for example in US Patent 6,524,270, the contents of which are incorporated herein by reference in their entirety. According to Bolmsj, a device comprising a catheter which is inserted through the urethra has at least one hollow tip extendible into the surrounding prostate tissue. An astringent and analgesic medicine is administered through said tip into said prostate tissue.

[00713] A method for infusing fluids to an intraosseous site has been described by Findlay et al. and is taught for example in US Patent 6,761,726, the contents of which are incorporated herein by reference in their entirety. According to Findlay, multiple needles are incorporated into a device which is capable of penetrating a hard shell of material covered by a layer of soft material and delivers a fluid at a predetermined distance below said hard shell of material.

[00714] A device for injecting medications into a vessel wall has been described by Vigil et al. and is taught for example in US Patent 5,713,863, the contents of which are incorporated herein by reference in their entirety. According to Vigil, multiple injectors are mounted on each of the flexible tubes in the device which introduces a medication fluid through a multi-lumen catheter, into said flexible tubes and out of said injectors for infusion into the vessel wall.

[00715] A catheter for delivering therapeutic and/or diagnostic agents to the tissue surrounding a bodily passageway has been described by Faxon et al. and is taught for example in US Patent 5,464,395, the contents of which are incorporated herein by reference in their entirety. According to Faxon, at least one needle cannula is incorporated into the catheter which delivers the desired agents to the tissue through said needles which project outboard of the catheter.

[00716] Balloon catheters for delivering therapeutic agents have been described by Orr and are taught for example in WO20 10024871, the contents of which are incorporated herein by reference in their entirety. According to Orr, multiple needles are incorporated into the devices which deliver the therapeutic agents to different depths within the tissue. In another aspect, drug-eluting balloons may be used to deliver the formulations described herein. The drug-eluting balloons may be used in target lesion applications such as, but are not limited to, in-stent restenosis, treating lesion in tortuous vessels, bifurcation lesions, femoral/popliteal lesions and below the knee lesions.

[00717] A device for delivering therapeutic agents (e.g., modified nucleic acid molecules or mmRNA) to tissue disposed about a lumen has been described by Perry et al. and is taught for example in U.S. Pat. Pub. US20100125239, the contents of which are herein incorporated by reference in their entirety. According to Perry, the catheter has a balloon which may be coated with a therapeutic agent by methods known in the art and described in Perry. When the balloon expands, the therapeutic agent will contact the surrounding tissue. The device may additionally have a heat source to change the temperature of the coating on the balloon to release the therapeutic agent to the tissue.

Methods and Devices utilizing electrical current

[00718] Methods and devices utilizing electric current may be employed to deliver the mmRNA of the present invention according to the single, multi- or split dosing regimens taught herein. Such methods and devices are described below.

[00719] An electro collagen induction therapy device has been described by Marquez and is taught for example in US Patent Publication 20090137945, the contents of which are incorporated herein

by reference in their entirety. According to Marquez, multiple needles are incorporated into the device which repeatedly pierce the skin and draw in the skin a portion of the substance which is applied to the skin first.

[00720] An electrokinetic system has been described by Etheredge et al. and is taught for example in US Patent Publication 20070185432, the contents of which are incorporated herein by reference in their entirety. According to Etheredge, micro-needles are incorporated into a device which drives by an electrical current the medication through the needles into the targeted treatment site.

[00721] An iontophoresis device has been described by Matsumura et al. and is taught for example in US Patent 7,437,189, the contents of which are incorporated herein by reference in their entirety. According to Matsumura, multiple needles are incorporated into the device which is capable of delivering ionizable drug into a living body at higher speed or with higher efficiency.

[00722] Intradermal delivery of biologically active agents by needle-free injection and electroporation has been described by Hoffmann et al and is taught for example in US Patent 7,171,264, the contents of which are incorporated herein by reference in their entirety. According to Hoffmann, one or more needle-free injectors are incorporated into an electroporation device and the combination of needle-free injection and electroporation is sufficient to introduce the agent into cells in skin, muscle or mucosa.

[00723] A method for electropermeabilization-mediated intracellular delivery has been described by Lundkvist et al. and is taught for example in US Patent 6,625,486, the contents of which are incorporated herein by reference in their entirety. According to Lundkvist, a pair of needle electrodes is incorporated into a catheter. Said catheter is positioned into a body lumen followed by extending said needle electrodes to penetrate into the tissue surrounding said lumen. Then the device introduces an agent through at least one of said needle electrodes and applies electric field by said pair of needle electrodes to allow said agent pass through the cell membranes into the cells at the treatment site.

[00724] A delivery system for transdermal immunization has been described by Levin et al. and is taught for example in WO2006003659, the contents of which are incorporated herein by reference in their entirety. According to Levin, multiple electrodes are incorporated into the device which applies electrical energy between the electrodes to generate micro channels in the skin to facilitate transdermal delivery.

[00725] A method for delivering RF energy into skin has been described by Schomacker and is taught for example in WO201 1163264, the contents of which are incorporated herein by reference in their entirety. According to Schomacker, multiple needles are incorporated into a device which applies vacuum to draw skin into contact with a plate so that needles insert into skin through the holes on the plate and deliver RF energy.

Definitions

[00726] At various places in the present specification, substituents of compounds of the present disclosure are disclosed in groups or in ranges. It is specifically intended that the present disclosure include each and every individual subcombination of the members of such groups and ranges. For example, the term "C₁₋₆ alkyl" is specifically intended to individually disclose methyl, ethyl, C₃ alkyl, C₄ alkyl, C₅ alkyl, and C₆ alkyl.

[00727] *About*: As used herein, the term "about" means +/- 10% of the recited value.

[00728] *Administered in combination*: As used herein, the term "administered in combination" or "combined administration" means that two or more agents (*e.g.*, a modified nucleic acid or mmRNA encoding an anti-microbial polypeptide (*e.g.*, an anti-bacterial polypeptide), *e.g.*, an anti-microbial polypeptide described herein and an anti-microbial agent (*e.g.*, an anti-microbial polypeptide or a small molecule anti-microbial compound described herein)) are administered to a subject at the same time or within an interval such that there may be an overlap of an effect of each agent on the patient. In some embodiments, they are administered within about 60, 30, 15, 10, 5, or 1 minute of one another. In some embodiments, the administrations of the agents are spaced sufficiently close together such that a combinatorial (*e.g.*, a synergistic) effect is achieved.

[00729] *Animal*: As used herein, the term "animal" refers to any member of the animal kingdom. In some embodiments, "animal" refers to humans at any stage of development. In some embodiments, "animal" refers to non-human animals at any stage of development. In certain embodiments, the non-human animal is a mammal (*e.g.*, a rodent, a mouse, a rat, a rabbit, a monkey, a dog, a cat, a sheep, cattle, a primate, or a pig). In some embodiments, animals include, but are not limited to, mammals, birds, reptiles, amphibians, fish, and worms. In some embodiments, the animal is a transgenic animal, genetically-engineered animal, or a clone.

[00730] *Antigens of interest or desired antigens*: As used herein, the terms "antigens of interest" or "desired antigens" include those proteins and other biomolecules provided herein that are immunospecifically bound by the antibodies and fragments, mutants, variants, and alterations thereof

described herein. Examples of antigens of interest include, but are not limited to, insulin, insulin-like growth factor, hGH, tPA, cytokines, such as interleukins (IL), e.g., IL-1, IL-2, IL-3, IL-4, IL-5, IL-6, IL-7, IL-8, IL-9, IL-10, IL-11, IL-12, IL-13, IL-14, IL-15, IL-16, IL-17, IL-18, interferon (IFN) alpha, IFN beta, IFN gamma, IFN omega or IFN tau, tumor necrosis factor (TNF), such as TNF alpha and TNF beta, TNF gamma, TRAIL; G-CSF, GM-CSF, M-CSF, MCP-1 and VEGF.

[00731] *Approximately:* As used herein, the term "approximately" or "about," as applied to one or more values of interest, refers to a value that is similar to a stated reference value. In certain embodiments, the term "approximately" or "about" refers to a range of values that fall within 25%, 20%, 19%, 18%, 17%, 16%, 15%, 14%, 13%, 12%, 11%, 10%, 9%, 8%, 7%, 6%, 5%, 4%, 3%, 2%, 1%, or less in either direction (greater than or less than) of the stated reference value unless otherwise stated or otherwise evident from the context (except where such number would exceed 100% of a possible value).

[00732] *Associated with:* As used herein, the terms "associated with," "conjugated," "linked," "attached," and "tethered," when used with respect to two or more moieties, means that the moieties are physically associated or connected with one another, either directly or via one or more additional moieties that serves as a linking agent, to form a structure that is sufficiently stable so that the moieties remain physically associated under the conditions in which the structure is used, e.g., physiological conditions. An "association" need not be strictly through direct covalent chemical bonding. It may also suggest ionic or hydrogen bonding or a hybridization based connectivity sufficiently stable such that the "associated" entities remain physically associated.

[00733] *Bifunctional:* As used herein, the term "bifunctional" refers to any substance, molecule or moiety which is capable of or maintains at least two functions. The functions may effect the same outcome or a different outcome. The structure that produces the function may be the same or different. For example, bifunctional modified RNA of the present invention may encode a cytotoxic peptide (a first function) while those nucleosides which comprise the encoding RNA are, in and of themselves, cytotoxic (second function). In this example, delivery of the bifunctional modified RNA to a cancer cell would produce not only a peptide or protein molecule which may ameliorate or treat the cancer but would also deliver a cytotoxic payload of nucleosides to the cell should degradation, instead of translation of the modified RNA, occur.

[00734] *Biocompatible*: As used herein, the term "biocompatible" means compatible with living cells, tissues, organs or systems posing little to no risk of injury, toxicity or rejection by the immune system.

[00735] *Biodegradable*: As used herein, the term "biodegradable" means capable of being broken down into innocuous products by the action of living things.

[00736] *Biologically active*: As used herein, the phrase "biologically active" refers to a characteristic of any substance that has activity in a biological system and/or organism. For instance, a substance that, when administered to an organism, has a biological affect on that organism, is considered to be biologically active. In particular embodiments, the modified nucleic acid or mmRNA of the present invention may be considered biologically active if even a portion of the modified nucleic acid or mmRNA is biologically active or mimics an activity considered biologically relevant.

[00737] *Chemical terms*: The following provides the definition of various chemical terms from "acyl" to "thiol."

[00738] The term "acyl," as used herein, represents a hydrogen or an alkyl group (e.g., a haloalkyl group), as defined herein, that is attached to the parent molecular group through a carbonyl group, as defined herein, and is exemplified by formyl (i.e., a carboxyaldehyde group), acetyl, propionyl, butanoyl and the like. Exemplary unsubstituted acyl groups include from 1 to 7, from 1 to 11, or from 1 to 21 carbons. In some embodiments, the alkyl group is further substituted with 1, 2, 3, or 4 substituents as described herein.

[00739] The term "acylamino," as used herein, represents an acyl group, as defined herein, attached to the parent molecular group though an amino group, as defined herein (i.e., $-N(R^{N1})-C(=O)-R$, where R is H or an optionally substituted C_{1-6} , C_{1-10} , or C_{1-20} alkyl group and R^{N1} is as defined herein). Exemplary unsubstituted acylamino groups include from 1 to 41 carbons (e.g., from 1 to 7, from 1 to 13, from 1 to 21, from 2 to 7, from 2 to 13, from 2 to 21, or from 2 to 41 carbons). In some embodiments, the alkyl group is further substituted with 1, 2, 3, or 4 substituents as described herein, and/or the amino group is $-NH_2$ or $-NHR^{N1}$, wherein R^{N1} is, independently, OH, NO_2 , NH_2 , NR^{N2}_2 , SO_2OR^{N2} , SO_2R^{N2} , SOR^{N2} , alkyl, or aryl, and each R^{N2} can be H, alkyl, or aryl.

[00740] The term "acyloxy," as used herein, represents an acyl group, as defined herein, attached to the parent molecular group though an oxygen atom (i.e., $-O-C(=O)-R$, where R is H or an optionally substituted C_{1-6} , C_{1-10} , or C_{1-20} alkyl group). Exemplary unsubstituted acyloxy groups include from 1

to 21 carbons (e.g., from 1 to 7 or from 1 to 11 carbons). In some embodiments, the alkyl group is further substituted with 1, 2, 3, or 4 substituents as described herein, and/or the amino group is $-\text{NH}_2$ or $-\text{NHR}^{\text{N}1}$, wherein $\text{R}^{\text{N}1}$ is, independently, OH, NO_2 , NH_2 , $\text{NR}^{\text{N}2}_2$, $\text{SO}_2\text{OR}^{\text{N}2}$, $\text{SO}_2\text{R}^{\text{N}2}$, $\text{SOR}^{\text{N}2}$, alkyl, or aryl, and each $\text{R}^{\text{N}2}$ can be H, alkyl, or aryl.

[00741] The term "alkaryl," as used herein, represents an aryl group, as defined herein, attached to the parent molecular group through an alkylene group, as defined herein. Exemplary unsubstituted alkaryl groups are from 7 to 30 carbons (e.g., from 7 to 16 or from 7 to 20 carbons, such as C_{i-6} alk- C_{6-i} aryl, C_{i-10} alk- C_{6-i} aryl, or C_{i-20} alk- C_{6-i} aryl). In some embodiments, the alkylene and the aryl each can be further substituted with 1, 2, 3, or 4 substituent groups as defined herein for the respective groups. Other groups preceded by the prefix "alk-" are defined in the same manner, where "alk" refers to a C_{i-6} alkylene, unless otherwise noted, and the attached chemical structure is as defined herein.

[00742] The term "alkcycloalkyl" represents a cycloalkyl group, as defined herein, attached to the parent molecular group through an alkylene group, as defined herein (e.g., an alkylene group of from 1 to 4, from 1 to 6, from 1 to 10, or from 1 to 20 carbons). In some embodiments, the alkylene and the cycloalkyl each can be further substituted with 1, 2, 3, or 4 substituent groups as defined herein for the respective group.

[00743] The term "alkenyl," as used herein, represents monovalent straight or branched chain groups of, unless otherwise specified, from 2 to 20 carbons (e.g., from 2 to 6 or from 2 to 10 carbons) containing one or more carbon-carbon double bonds and is exemplified by ethenyl, 1-propenyl, 2-propenyl, 2-methyl-1-propenyl, 1-butenyl, 2-butenyl, and the like. Alkenyls include both cis and trans isomers. Alkenyl groups may be optionally substituted with 1, 2, 3, or 4 substituent groups that are selected, independently, from amino, aryl, cycloalkyl, or heterocyclyl (e.g., heteroaryl), as defined herein, or any of the exemplary alkyl substituent groups described herein.

[00744] The term "alkenyloxy" represents a chemical substituent of formula $-\text{OR}$, where R is a C_{2-20} alkenyl group (e.g., C_{2-6} or C_{2-10} alkenyl), unless otherwise specified. Exemplary alkenyloxy groups include ethenyloxy, propenyloxy, and the like. In some embodiments, the alkenyl group can be further substituted with 1, 2, 3, or 4 substituent groups as defined herein (e.g., a hydroxy group).

[00745] The term "alkheteroaryl" refers to a heteroaryl group, as defined herein, attached to the parent molecular group through an alkylene group, as defined herein. Exemplary unsubstituted

alkheteroaryl groups are from 2 to 32 carbons (e.g., from 2 to 22, from 2 to 18, from 2 to 17, from 2 to 16, from 3 to 15, from 2 to 14, from 2 to 13, or from 2 to 12 carbons, such as C_{i-6} alk- C_{i-2} heteroaryl, C_{1-10} alk- C_{i-2} heteroaryl, or C_{i-20} alk- C_{i-2} heteroaryl). In some embodiments, the alkylene and the heteroaryl each can be further substituted with 1, 2, 3, or 4 substituent groups as defined herein for the respective group. Alkheteroaryl groups are a subset of alkheterocyclyl groups. [00746] The term "alkheterocyclyl" represents a heterocyclyl group, as defined herein, attached to the parent molecular group through an alkylene group, as defined herein. Exemplary unsubstituted alkheterocyclyl groups are from 2 to 32 carbons (e.g., from 2 to 22, from 2 to 18, from 2 to 17, from 2 to 16, from 3 to 15, from 2 to 14, from 2 to 13, or from 2 to 12 carbons, such as C_{i-6} alk- C_{i-2} heterocyclyl, C_{1-10} alk- C_{i-2} heterocyclyl, or C_{i-20} alk- C_{i-2} heterocyclyl). In some embodiments, the alkylene and the heterocyclyl each can be further substituted with 1, 2, 3, or 4 substituent groups as defined herein for the respective group.

[00747] The term "alkoxy" represents a chemical substituent of formula -OR, where R is a C_{i-20} alkyl group (e.g., C_{i-6} or C_{1-10} alkyl), unless otherwise specified. Exemplary alkoxy groups include methoxy, ethoxy, propoxy (e.g., n-propoxy and isopropoxy), t-butoxy, and the like. In some embodiments, the alkyl group can be further substituted with 1, 2, 3, or 4 substituent groups as defined herein (e.g., hydroxy or alkoxy).

[00748] The term "alkoxyalkoxy" represents an alkoxy group that is substituted with an alkoxy group. Exemplary unsubstituted alkoxyalkoxy groups include between 2 to 40 carbons (e.g., from 2 to 12 or from 2 to 20 carbons, such as C_{i-6} alkoxy- C_{i-6} alkoxy, C_{1-10} alkoxy- C_{i-10} alkoxy, or C_{i-20} alkoxy- C_{i-20} alkoxy). In some embodiments, the each alkoxy group can be further substituted with 1, 2, 3, or 4 substituent groups as defined herein.

[00749] The term "alkoxyalkyl" represents an alkyl group that is substituted with an alkoxy group. Exemplary unsubstituted alkoxyalkyl groups include between 2 to 40 carbons (e.g., from 2 to 12 or from 2 to 20 carbons, such as C_{i-6} alkoxy- C_{i-6} alkyl, C_{1-10} alkoxy- C_{i-10} alkyl, or C_{i-20} alkoxy- C_{i-20} alkyl). In some embodiments, the alkyl and the alkoxy each can be further substituted with 1, 2, 3, or 4 substituent groups as defined herein for the respective group.

[00750] The term "alkoxycarbonyl," as used herein, represents an alkoxy, as defined herein, attached to the parent molecular group through a carbonyl atom (e.g., -C(=O)-OR, where R is H or an optionally substituted C_{i-6} , C_{1-10} , or C_{i-20} alkyl group). Exemplary unsubstituted alkoxy carbonyl

include from 1 to 21 carbons (e.g., from 1 to 11 or from 1 to 7 carbons). In some embodiments, the alkoxy group is further substituted with 1, 2, 3, or 4 substituents as described herein.

[00751] The term "alkoxycarbonylalkoxy," as used herein, represents an alkoxy group, as defined herein, that is substituted with an alkoxycarbonyl group, as defined herein (e.g., -O-alkyl-C(=O)-OR, where R is an optionally substituted C_{1-6} , C_{1-10} , or C_{1-20} alkyl group). Exemplary unsubstituted alkoxycarbonylalkoxy include from 3 to 41 carbons (e.g., from 3 to 10, from 3 to 13, from 3 to 17, from 3 to 21, or from 3 to 31 carbons, such as C_{1-6} alkoxycarbonyl- C_{1-6} alkoxy, C_{1-10} alkoxycarbonyl- C_{1-10} alkoxy, or C_{1-20} alkoxycarbonyl- C_{1-20} alkoxy). In some embodiments, each alkoxy group is further independently substituted with 1, 2, 3, or 4 substituents, as described herein (e.g., a hydroxy group).

[00752] The term "alkoxycarbonylalkyl," as used herein, represents an alkyl group, as defined herein, that is substituted with an alkoxycarbonyl group, as defined herein (e.g., -alkyl-C(=O)-OR, where R is an optionally substituted C_{1-20} , C_{1-10} , or C_{1-6} alkyl group). Exemplary unsubstituted alkoxycarbonylalkyl include from 3 to 41 carbons (e.g., from 3 to 10, from 3 to 13, from 3 to 17, from 3 to 21, or from 3 to 31 carbons, such as C_{1-6} alkoxycarbonyl- C_{1-6} alkyl, C_{1-10} alkoxycarbonyl- C_{1-10} alkyl, or C_{1-20} alkoxycarbonyl- C_{1-20} alkyl). In some embodiments, each alkyl and alkoxy group is further independently substituted with 1, 2, 3, or 4 substituents as described herein (e.g., a hydroxy group).

[00753] The term "alkyl," as used herein, is inclusive of both straight chain and branched chain saturated groups from 1 to 20 carbons (e.g., from 1 to 10 or from 1 to 6), unless otherwise specified. Alkyl groups are exemplified by methyl, ethyl, n- and iso-propyl, n-, sec-, iso- and tert-butyl, neopentyl, and the like, and may be optionally substituted with one, two, three, or, in the case of alkyl groups of two carbons or more, four substituents independently selected from the group consisting of: (1) C_{1-6} alkoxy; (2) C_{1-6} alkylsulfinyl; (3) amino, as defined herein (e.g., unsubstituted amino (i.e., $-NH_2$) or a substituted amino (i.e., $-N(R^{N1})_2$, where R^{N1} is as defined for amino); (4) C_{6-10} aryl- C_{1-6} alkoxy; (5) azido; (6) halo; (7) (C_{2-9} heterocyclyl)oxy; (8) hydroxy; (9) nitro; (10) oxo (e.g., carboxyaldehyde or acyl); (11) C_{1-7} spirocyclyl; (12) thioalkoxy; (13) thiol; (14) $-CO_2R^A$, where R^A is selected from the group consisting of (a) C_{1-20} alkyl (e.g., C_{1-6} alkyl), (b) C_{2-20} alkenyl (e.g., C_{2-6} alkenyl), (c) C_{6-10} aryl, (d) hydrogen, (e) C_{1-6} alkyl- C_{6-10} aryl, (f) amino- C_{1-20} alkyl, (g) polyethylene glycol of $-(CH_2)_{s2}(OCH_2CH_2)_{s3}R'$, wherein s_1 is an integer from 1 to 10 (e.g., from 1 to 6 or from 1 to 4), each of s_2 and s_3 , independently, is an integer from 0 to 10 (e.g., from 0 to 4, from 0

to 6, from 1 to 4, from 1 to 6, or from 1 to 10), and R' is H or C_{i-2o} alkyl, and (h) amino-polyethylene glycol of -NR^{N1}(CH₂)_{s2}(CH₂CH₂O)_{s3}(CH₂)_{s1}NR^{N1}, wherein s₁ is an integer from 1 to 10 (e.g., from 1 to 6 or from 1 to 4), each of s₂ and s₃, independently, is an integer from 0 to 10 (e.g., from 0 to 4, from 0 to 6, from 1 to 4, from 1 to 6, or from 1 to 10), and each R^{N1} is, independently, hydrogen or optionally substituted C_{i-6} alkyl; (15) -C(0)NR^{B'}R^{C'}, where each of R^{B'} and R^{C'} is, independently, selected from the group consisting of (a) hydrogen, (b) C_{i-6} alkyl, (c) C_{6-io} aryl, and (d) C_{i-6} alk-C_{6-io} aryl; (16) -S₂OR^{D'}, where R^{D'} is selected from the group consisting of (a) C_{i-6} alkyl, (b) C_{6-io} aryl, (c) C_{i-6} alk-C_{6-io} aryl, and (d) hydroxy; (17) -S₂NR^{E'}R^{F'}, where each of R^{E'} and R^{F'} is, independently, selected from the group consisting of (a) hydrogen, (b) C_{i-6} alkyl, (c) C_{6-io} aryl and (d) C_{i-6} alk-C_{6-io} aryl; (18) -C(0)R^{G'}, where R^{G'} is selected from the group consisting of (a) C_{i-2o} alkyl (e.g., C_{i-6} alkyl), (b) C₂₋₂₀ alkenyl (e.g., C₂₋₆ alkenyl), (c) C₆₋₁₀ aryl, (d) hydrogen, (e) C_{i-6} alk-C_{6-io} aryl, (f) amino-C_{i-2o} alkyl, (g) polyethylene glycol of - (CH₂)_{s2}(OCH₂CH₂)_{s3}(CH₂)_{s1}OR', wherein s₁ is an integer from 1 to 10 (e.g., from 1 to 6 or from 1 to 4), each of s₂ and s₃, independently, is an integer from 0 to 10 (e.g., from 0 to 4, from 0 to 6, from 1 to 4, from 1 to 6, or from 1 to 10), and R' is H or C_{i-2o} alkyl, and (h) amino-polyethylene glycol of -NR^{N1}(CH₂)_{s2}(CH₂CH₂O)_{s3}(CH₂)_{s1}NR^{N1}, wherein s₁ is an integer from 1 to 10 (e.g., from 1 to 6 or from 1 to 4), each of s₂ and s₃, independently, is an integer from 0 to 10 (e.g., from 0 to 4, from 0 to 6, from 1 to 4, from 1 to 6, or from 1 to 10), and each R^{N1} is, independently, hydrogen or optionally substituted C_{i-6} alkyl; (19) -NR^{H'}C(0)R^{I'}, wherein R^{H'} is selected from the group consisting of (a) hydrogen and (b) C_{i-6} alkyl, and R^{I'} is selected from the group consisting of (a2) C_{i-2o} alkyl (e.g., C_{i-6} alkyl), (b2) C₂₋₂₀ alkenyl (e.g., C₂₋₆ alkenyl), (c2) C₆₋₁₀ aryl, (d2) hydrogen, (e2) C_{i-6} alk-C_{6-io} aryl, (f2) amino-C_{i-2o} alkyl, (g2) polyethylene glycol of -(CH₂)_{s2}(OCH₂CH₂)_{s3}(CH₂)_{s1}OR', wherein s₁ is an integer from 1 to 10 (e.g., from 1 to 6 or from 1 to 4), each of s₂ and s₃, independently, is an integer from 0 to 10 (e.g., from 0 to 4, from 0 to 6, from 1 to 4, from 1 to 6, or from 1 to 10), and R' is H or C_{i-2o} alkyl, and (h2) amino-polyethylene glycol of -NR^{N1}(CH₂)_{s2}(CH₂CH₂O)_{s3}(CH₂)_{s1}NR^{N1}, wherein s₁ is an integer from 1 to 10 (e.g., from 1 to 6 or from 1 to 4), each of s₂ and s₃, independently, is an integer from 0 to 10 (e.g., from 0 to 4, from 0 to 6, from 1 to 4, from 1 to 6, or from 1 to 10), and each R^{N1} is, independently, hydrogen or optionally substituted C_{i-6} alkyl; (20) -NR^{J'}C(0)OR^{K'}, wherein R^{J'} is selected from the group consisting of (a) hydrogen and (b) C_{i-6} alkyl, and R^{K'} is selected from the group consisting of (a2) C_{i-2o} alkyl (e.g., C_{i-6} alkyl), (b2) C₂₋₂₀ alkenyl (e.g., C₂₋₆ alkenyl), (c2) C_{6-io} aryl, (d2) hydrogen, (e2) C_{i-6} alk-C_{6-io} aryl, (f2) amino-C_{i-2o}

alkyl, (g2) polyethylene glycol of $-(CH_2)_{s2}(OCH_2CH_2)_{s3}R'$, wherein s_1 is an integer from 1 to 10 (e.g., from 1 to 6 or from 1 to 4), each of s_2 and s_3 , independently, is an integer from 0 to 10 (e.g., from 0 to 4, from 0 to 6, from 1 to 4, from 1 to 6, or from 1 to 10), and R' is H or C_{1-20} alkyl, and (h2) amino-polyethylene glycol of $-NR^{N1}(CH_2)_{s2}(CH_2CH_2O)_{s3}NR^{N1}$, wherein s_1 is an integer from 1 to 10 (e.g., from 1 to 6 or from 1 to 4), each of s_2 and s_3 , independently, is an integer from 0 to 10 (e.g., from 0 to 4, from 0 to 6, from 1 to 4, from 1 to 6, or from 1 to 10), and each R^{N1} is, independently, hydrogen or optionally substituted C_{1-6} alkyl; and (21) amidine. In some embodiments, each of these groups can be further substituted as described herein. For example, the alkylene group of a C_i -alkaryl can be further substituted with an oxo group to afford the respective aryloyl substituent.

[00754] The term "alkylene" and the prefix "alk-", as used herein, represent a saturated divalent hydrocarbon group derived from a straight or branched chain saturated hydrocarbon by the removal of two hydrogen atoms, and is exemplified by methylene, ethylene, isopropylene, and the like. The term " C_{x-y} alkylene" and the prefix " C_{x-y} alk-" represent alkylene groups having between x and y carbons. Exemplary values for x are 1, 2, 3, 4, 5, and 6, and exemplary values for y are 2, 3, 4, 5, 6, 7, 8, 9, 10, 12, 14, 16, 18, or 20 (e.g., C_{1-6} , C_{1-10} , C_{2-20} , C_{2-6} , C_{2-10} , or C_{2-20} alkylene). In some embodiments, the alkylene can be further substituted with 1, 2, 3, or 4 substituent groups as defined herein for an alkyl group.

[00755] The term "alkylsulfanyl," as used herein, represents an alkyl group attached to the parent molecular group through an -S(O)- group. Exemplary unsubstituted alkylsulfanyl groups are from 1 to 6, from 1 to 10, or from 1 to 20 carbons. In some embodiments, the alkyl group can be further substituted with 1, 2, 3, or 4 substituent groups as defined herein.

[00756] The term "alkylsulfinylalkyl," as used herein, represents an alkyl group, as defined herein, substituted by an alkylsulfanyl group. Exemplary unsubstituted alkylsulfinylalkyl groups are from 2 to 12, from 2 to 20, or from 2 to 40 carbons. In some embodiments, each alkyl group can be further substituted with 1, 2, 3, or 4 substituent groups as defined herein.

[00757] The term "alkynyl," as used herein, represents monovalent straight or branched chain groups from 2 to 20 carbon atoms (e.g., from 2 to 4, from 2 to 6, or from 2 to 10 carbons) containing a carbon-carbon triple bond and is exemplified by ethynyl, 1-propynyl, and the like. Alkynyl groups may be optionally substituted with 1, 2, 3, or 4 substituent groups that are selected, independently,

from aryl, cycloalkyl, or heterocyclyl (e.g., heteroaryl), as defined herein, or any of the exemplary alkyl substituent groups described herein.

[00758] The term "alkynyloxy" represents a chemical substituent of formula -OR, where R is a C₂₋₂₀ alkynyl group (e.g., C₂₋₆ or C₂₋₁₀ alkynyl), unless otherwise specified. Exemplary alkynyloxy groups include ethynyloxy, propynyloxy, and the like. In some embodiments, the alkynyl group can be further substituted with 1, 2, 3, or 4 substituent groups as defined herein (e.g., a hydroxy group).

[00759] The term "amidine," as used herein, represents a -C(=NH)NH₂ group.

[00760] The term "amino," as used herein, represents -N(R^{N1})₂, wherein each R^{N1} is, independently, H, OH, NO₂, N(R^{N2})₂, SO₂OR^{N2}, SO₂R^{N2}, SOR^{N2}, an *N*-protecting group, alkyl, alkenyl, alkynyl, alkoxy, aryl, alkaryl, cycloalkyl, alkylcycloalkyl, carboxyalkyl, sulfoalkyl, heterocyclyl (e.g., heteroaryl), or alkheterocyclyl (e.g., alkheteroaryl), wherein each of these recited R^{N1} groups can be optionally substituted, as defined herein for each group; or two R^{N1} combine to form a heterocyclyl or an *N*-protecting group, and wherein each R^{N2} is, independently, H, alkyl, or aryl. The amino groups of the invention can be an unsubstituted amino (i.e., -NH₂) or a substituted amino (i.e., -N(R^{N1})₂). In a preferred embodiment, amino is -NH₂ or -NHR^{N1}, wherein R^{N1} is, independently, OH, NO₂, NH₂, NR^{N2}, SO₂OR^{N2}, SO₂R^{N2}, SOR^{N2}, alkyl, carboxyalkyl, sulfoalkyl, or aryl, and each R^{N2} can be H, C₁₋₆ alkyl (e.g., C₁₋₆ alkyl), or C₆₋₁₀ aryl.

[00761] The term "amino acid," as described herein, refers to a molecule having a side chain, an amino group, and an acid group (e.g., a carboxy group of -CO₂H or a sulfo group of -SO₃H), wherein the amino acid is attached to the parent molecular group by the side chain, amino group, or acid group (e.g., the side chain). In some embodiments, the amino acid is attached to the parent molecular group by a carbonyl group, where the side chain or amino group is attached to the carbonyl group. Exemplary side chains include an optionally substituted alkyl, aryl, heterocyclyl, alkaryl, alkheterocyclyl, aminoalkyl, carbamoylalkyl, and carboxyalkyl. Exemplary amino acids include alanine, arginine, asparagine, aspartic acid, cysteine, glutamic acid, glutamine, glycine, histidine, hydroxynorvaline, isoleucine, leucine, lysine, methionine, norvaline, ornithine, phenylalanine, proline, pyrrolysine, selenocysteine, serine, taurine, threonine, tryptophan, tyrosine, and valine. Amino acid groups may be optionally substituted with one, two, three, or, in the case of amino acid groups of two carbons or more, four substituents independently selected from the group consisting of: (1) C₁₋₆ alkoxy; (2) C₁₋₆ alkylsulfanyl; (3) amino, as defined herein (e.g., unsubstituted amino (i.e., -NH₂) or a substituted amino (i.e., -N(R^{N1})₂, where R^{N1} is as defined for amino); (4) C₆₋₁₀

aryl-Ci₆ alkoxy; (5) azido; (6) halo; (7) (C₂₋₉ heterocyclyl)oxy; (8) hydroxy; (9) nitro; (10) oxo (e.g., carboxyaldehyde or acyl); (11) Ci₇ spirocyclyl; (12) thioalkoxy; (13) thiol; (14) -C(O)₂R^A, where R^A is selected from the group consisting of (a) Ci₂₋₆ alkyl (e.g., Ci₆ alkyl), (b) C₂₋₆ alkenyl (e.g., C₂₋₆ alkenyl), (c) C₆₋₁₀ aryl, (d) hydrogen, (e) Ci₆ alk-C₆₋₁₀ aryl, (f) amino-Ci₂₋₆ alkyl, (g) polyethylene glycol of -(CH₂)_{s2}(OCH₂CH₂)_{s3}OR', wherein si is an integer from 1 to 10 (e.g., from 1 to 6 or from 1 to 4), each of s2 and s3, independently, is an integer from 0 to 10 (e.g., from 0 to 4, from 0 to 6, from 1 to 4, from 1 to 6, or from 1 to 10), and R' is H or Ci₂₋₆ alkyl, and (h) amino-polyethylene glycol of -NR^{N1}(CH₂)_{s2}(CH₂CH₂O)_{s3}(CH₂)_{s3}NR^{N1}, wherein si is an integer from 1 to 10 (e.g., from 1 to 6 or from 1 to 4), each of s2 and s3, independently, is an integer from 0 to 10 (e.g., from 0 to 4, from 0 to 6, from 1 to 4, from 1 to 6, or from 1 to 10), and each R^{N1} is, independently, hydrogen or optionally substituted Ci₆ alkyl; (15) -C(O)NR^BR^C, where each of R^B and R^C is, independently, selected from the group consisting of (a) hydrogen, (b) Ci₆ alkyl, (c) C₆₋₁₀ aryl, and (d) Ci₆ alk-C₆₋₁₀ aryl; (16) -SO₂R^D, where R^D is selected from the group consisting of (a) Ci₆ alkyl, (b) C₆₋₁₀ aryl, (c) Ci₆ alk-C₆₋₁₀ aryl, and (d) hydroxy; (17) -SO₂NR^ER^F, where each of R^E and R^F is, independently, selected from the group consisting of (a) hydrogen, (b) Ci₆ alkyl, (c) C₆₋₁₀ aryl and (d) Ci₆ alk-C₆₋₁₀ aryl; (18) -C(O)R^G, where R^G is selected from the group consisting of (a) Ci₂₋₆ alkyl (e.g., Ci₆ alkyl), (b) C₂₋₆ alkenyl (e.g., C₂₋₆ alkenyl), (c) C₆₋₁₀ aryl, (d) hydrogen, (e) Ci₆ alk-C₆₋₁₀ aryl, (f) amino-Ci₂₋₆ alkyl, (g) polyethylene glycol of -(CH₂)_{s2}(OCH₂CH₂)_{s3}OR', wherein si is an integer from 1 to 10 (e.g., from 1 to 6 or from 1 to 4), each of s2 and s3, independently, is an integer from 0 to 10 (e.g., from 0 to 4, from 0 to 6, from 1 to 4, from 1 to 6, or from 1 to 10), and R' is H or Ci₂₋₆ alkyl, and (h) amino-polyethylene glycol of -NR^{N1}(CH₂)_{s2}(CH₂CH₂O)_{s3}(CH₂)_{s3}NR^{N1}, wherein si is an integer from 1 to 10 (e.g., from 1 to 6 or from 1 to 4), each of s2 and s3, independently, is an integer from 0 to 10 (e.g., from 0 to 4, from 0 to 6, from 1 to 4, from 1 to 6, or from 1 to 10), and each R^{N1} is, independently, hydrogen or optionally substituted Ci₆ alkyl; (19) -NR^HC(O)R^I, wherein R^H is selected from the group consisting of (a) hydrogen and (b) Ci₆ alkyl, and R^I is selected from the group consisting of (a2) Ci₂₋₆ alkyl (e.g., Ci₆ alkyl), (b2) C₂₋₆ alkenyl (e.g., C₂₋₆ alkenyl), (c2) C₆₋₁₀ aryl, (d2) hydrogen, (e2) Ci₆ alk-C₆₋₁₀ aryl, (f2) amino-Ci₂₋₆ alkyl, (g2) polyethylene glycol of -(CH₂)_{s2}(OCH₂CH₂)_{s3}OR', wherein si is an integer from 1 to 10 (e.g., from 1 to 6 or from 1 to 4), each of s2 and s3, independently, is an integer from 0 to 10 (e.g., from 0 to 4, from 0 to 6, from 1 to 4, from 1 to 6, or from 1 to 10), and R' is H or Ci₂₋₆ alkyl, and (h2) amino-polyethylene glycol of -NR^{N1}(CH₂)_{s2}(CH₂CH₂O)_{s3}(CH₂)_{s3}NR^{N1},

wherein s_1 is an integer from 1 to 10 (e.g., from 1 to 6 or from 1 to 4), each of s_2 and s_3 , independently, is an integer from 0 to 10 (e.g., from 0 to 4, from 0 to 6, from 1 to 4, from 1 to 6, or from 1 to 10), and each R^{N1} is, independently, hydrogen or optionally substituted C_{1-6} alkyl; (20) $-NR^J C(=O)OR^K$, wherein R^J is selected from the group consisting of (a1) hydrogen and (b1) C_{1-6} alkyl, and R^K is selected from the group consisting of (a2) C_{1-20} alkyl (e.g., C_{1-6} alkyl), (b2) C_{2-20} alkenyl (e.g., C_{2-6} alkenyl), (c2) C_{6-10} aryl, (d2) hydrogen, (e2) C_{1-6} alk- C_{6-10} aryl, (f2) amino- C_{1-20} alkyl, (g2) polyethylene glycol of $-(CH_2)_{s_2}(OCH_2CH_2)_{s_3}R'$, wherein s_1 is an integer from 1 to 10 (e.g., from 1 to 6 or from 1 to 4), each of s_2 and s_3 , independently, is an integer from 0 to 10 (e.g., from 0 to 4, from 0 to 6, from 1 to 4, from 1 to 6, or from 1 to 10), and R' is H or C_{1-20} alkyl, and (h2) amino-polyethylene glycol of $-NR^{N1}(CH_2)_{s_2}(CH_2CH_2O)_{s_3}NR^{N1}$, wherein s_1 is an integer from 1 to 10 (e.g., from 1 to 6 or from 1 to 4), each of s_2 and s_3 , independently, is an integer from 0 to 10 (e.g., from 0 to 4, from 0 to 6, from 1 to 4, from 1 to 6, or from 1 to 10), and each R^{N1} is, independently, hydrogen or optionally substituted C_{1-6} alkyl; and (21) amidine. In some embodiments, each of these groups can be further substituted as described herein.

[00762] The term "aminoalkoxy," as used herein, represents an alkoxy group, as defined herein, substituted by an amino group, as defined herein. The alkyl and amino each can be further substituted with 1, 2, 3, or 4 substituent groups as described herein for the respective group (e.g., C_0-2R^A , where R^A is selected from the group consisting of (a) C_{1-6} alkyl, (b) C_{6-10} aryl, (c) hydrogen, and (d) C_{1-6} alk- C_{6-10} aryl, e.g., carboxy).

[00763] The term "aminoalkyl," as used herein, represents an alkyl group, as defined herein, substituted by an amino group, as defined herein. The alkyl and amino each can be further substituted with 1, 2, 3, or 4 substituent groups as described herein for the respective group (e.g., C_0-2R^A , where R^A is selected from the group consisting of (a) C_{1-6} alkyl, (b) C_{6-10} aryl, (c) hydrogen, and (d) C_{1-6} alk- C_{6-10} aryl, e.g., carboxy).

[00764] The term "aryl," as used herein, represents a mono-, bicyclic, or multicyclic carbocyclic ring system having one or two aromatic rings and is exemplified by phenyl, naphthyl, 1,2-dihydronaphthyl, 1,2,3,4-tetrahydronaphthyl, anthracenyl, phenanthrenyl, fluorenyl, indanyl, indenyl, and the like, and may be optionally substituted with 1, 2, 3, 4, or 5 substituents independently selected from the group consisting of: (1) C_{1-7} acyl (e.g., carboxyaldehyde); (2) C_{1-20} alkyl (e.g., C_{1-6} alkyl, C_{1-6} alkoxy- C_{1-6} alkyl, C_{1-6} alkylsulfanyl- C_{1-6} alkyl, amino- C_{1-6} alkyl, azido- C_{1-6} alkyl, (carboxyaldehyde)- C_{1-6} alkyl, halo- C_{1-6} alkyl (e.g., perfluoroalkyl), hydroxy- C_{1-6} alkyl, nitro-

Ci₆ alkyl, or Ci₆ thioalkoxy-Ci₆ alkyl); (3) Ci_{2o} alkoxy (e.g., Ci₆ alkoxy, such as perfluoroalkoxy); (4) Ci₆ alkylsulfmyl; (5) C₆₋₁₀ aryl; (6) amino; (7) Ci₆ alk-C_{6-io} aryl; (8) azido; (9) C3-8 cycloalkyl; (10) Ci₆ alk-C3-8 cycloalkyl; (11) halo; (12) C₁₋₁₂ heterocyclyl (e.g., C₁₋₁₂ heteroaryl); (13) (C₁₋₁₂ heterocyclyl)oxy; (14) hydroxy; (15) nitro; (16) Ci_{2o} thioalkoxy (e.g., Ci₆ thioalkoxy); (17) $-(CH_2)_qCO_2R^{A'}$, where q is an integer from zero to four, and R^{A'} is selected from the group consisting of (a) Ci₆ alkyl, (b) C_{6-io} aryl, (c) hydrogen, and (d) Ci₆ alk-C_{6-io} aryl; (18) $-(CH_2)_qCONR^{B'}R^{C'}$, where q is an integer from zero to four and where R^{B'} and R^{C'} are independently selected from the group consisting of (a) hydrogen, (b) Ci₆ alkyl, (c) C_{6-1o} aryl, and (d) Ci₆ alk-C_{6-io} aryl; (19) $-(CH_2)_qSO_2R^{D'}$, where q is an integer from zero to four and where R^{D'} is selected from the group consisting of (a) alkyl, (b) C_{6-io} aryl, and (c) alk-C_{6-io} aryl; (20) $-(CH_2)_qSO_2NR^{E'}R^{F'}$, where q is an integer from zero to four and where each of R^{E'} and R^{F'} is, independently, selected from the group consisting of (a) hydrogen, (b) Ci₆ alkyl, (c) C_{6-io} aryl, and (d) Ci₆ alk-C_{6-io} aryl; (21) thiol; (22) C_{6-io} aryloxy; (23) C3-8 cycloalkoxy; (24) C_{6-io} aryl-Ci₆ alkoxy; (25) Ci₆ alk-Ci_{i2} heterocyclyl (e.g., Ci₆ alk-Ci_{i2} heteroaryl); (26) C₂₋₂₀ alkenyl; and (27) C₂₋₂₀ alkynyl. In some embodiments, each of these groups can be further substituted as described herein. For example, the alkylene group of a Ci-alkaryl or a Ci-alkheterocyclyl can be further substituted with an oxo group to afford the respective aryloyl and (heterocyclyl)oyl substituent group.

[00765] The term "arylalkoxy," as used herein, represents an alkaryl group, as defined herein, attached to the parent molecular group through an oxygen atom. Exemplary unsubstituted alkoxyalkyl groups include from 7 to 30 carbons (e.g., from 7 to 16 or from 7 to 20 carbons, such as C_{6-io} aryl-Ci₆ alkoxy, C_{6-io} aryl-Ci_{io} alkoxy, or C_{6-io} aryl-Ci_{2o} alkoxy). In some embodiments, the arylalkoxy group can be substituted with 1, 2, 3, or 4 substituents as defined herein

[00766] The term "aryloxy" represents a chemical substituent of formula -OR', where R' is an aryl group of 6 to 18 carbons, unless otherwise specified. In some embodiments, the aryl group can be substituted with 1, 2, 3, or 4 substituents as defined herein.

[00767] The term "aryloyl," as used herein, represents an aryl group, as defined herein, that is attached to the parent molecular group through a carbonyl group. Exemplary unsubstituted aryloyl groups are of 7 to 11 carbons. In some embodiments, the aryl group can be substituted with 1, 2, 3, or 4 substituents as defined herein.

[00768] The term "azido" represents an -N₃ group, which can also be represented as -N=N=N.

[00769] The term "bicyclic," as used herein, refer to a structure having two rings, which may be aromatic or non-aromatic. Bicyclic structures include spirocyclyl groups, as defined herein, and two rings that share one or more bridges, where such bridges can include one atom or a chain including two, three, or more atoms. Exemplary bicyclic groups include a bicyclic carbocyclyl group, where the first and second rings are carbocyclyl groups, as defined herein; a bicyclic aryl groups, where the first and second rings are aryl groups, as defined herein; bicyclic heterocyclyl groups, where the first ring is a heterocyclyl group and the second ring is a carbocyclyl (e.g., aryl) or heterocyclyl (e.g., heteroaryl) group; and bicyclic heteroaryl groups, where the first ring is a heteroaryl group and the second ring is a carbocyclyl (e.g., aryl) or heterocyclyl (e.g., heteroaryl) group. In some embodiments, the bicyclic group can be substituted with 1, 2, 3, or 4 substituents as defined herein for cycloalkyl, heterocyclyl, and aryl groups.

[00770] The terms "carbocyclic" and "carbocyclyl," as used herein, refer to an optionally substituted C₃₋₁₂ monocyclic, bicyclic, or tricyclic structure in which the rings, which may be aromatic or non-aromatic, are formed by carbon atoms. Carbocyclic structures include cycloalkyl, cycloalkenyl, and aryl groups.

[00771] The term "carbamoyl," as used herein, represents -C(O)-N(R^{N1})₂, where the meaning of each R^{N1} is found in the definition of "amino" provided herein.

[00772] The term "carbamoylalkyl," as used herein, represents an alkyl group, as defined herein, substituted by a carbamoyl group, as defined herein. The alkyl group can be further substituted with 1, 2, 3, or 4 substituent groups as described herein.

[00773] The term "carbamyl," as used herein, refers to a carbamate group having the structure -NR^{N1}C(=O)OR or -OC(=O)N(R^{N1})₂, where the meaning of each R^{N1} is found in the definition of "amino" provided herein, and R is alkyl, cycloalkyl, alkylcycloalkyl, aryl, alkaryl, heterocyclyl (e.g., heteroaryl), or alkheterocyclyl (e.g., alkheteroaryl), as defined herein.

[00774] The term "carbonyl," as used herein, represents a C(O) group, which can also be represented as C=O.

[00775] The term "carboxyaldehyde" represents an acyl group having the structure -CHO.

[00776] The term "carboxy," as used herein, means -CO₂H.

[00777] The term "carboxyalkoxy," as used herein, represents an alkoxy group, as defined herein, substituted by a carboxy group, as defined herein. The alkoxy group can be further substituted with 1, 2, 3, or 4 substituent groups as described herein for the alkyl group.

[00778] The term "carboxyalkyl," as used herein, represents an alkyl group, as defined herein, substituted by a carboxy group, as defined herein. The alkyl group can be further substituted with 1, 2, 3, or 4 substituent groups as described herein.

[00779] The term "cyano," as used herein, represents an -CN group.

[00780] The term "cycloalkoxy" represents a chemical substituent of formula -OR, where R is a C₃₋₈ cycloalkyl group, as defined herein, unless otherwise specified. The cycloalkyl group can be further substituted with 1, 2, 3, or 4 substituent groups as described herein. Exemplary unsubstituted cycloalkoxy groups are from 3 to 8 carbons.

[00781] The term "cycloalkyl," as used herein represents a monovalent saturated or unsaturated non-aromatic cyclic hydrocarbon group from three to eight carbons, unless otherwise specified, and is exemplified by cyclopropyl, cyclobutyl, cyclopentyl, cyclohexyl, cycloheptyl, bicyclo[2.2.1]heptyl, and the like. When the cycloalkyl group includes one carbon-carbon double bond, the cycloalkyl group can be referred to as a "cycloalkenyl" group. Exemplary cycloalkenyl groups include cyclopentenyl, cyclohexenyl, and the like. The cycloalkyl groups of this invention can be optionally substituted with: (1) C₁₋₇ acyl (e.g., carboxyaldehyde); (2) C₁₋₂₀ alkyl (e.g., C₁₋₆ alkyl, C₁₋₆ alkoxy-C₁₋₆ alkyl, C₁₋₆ alkylsulfinyl-C₁₋₆ alkyl, amino-C₁₋₆ alkyl, azido-C₁₋₆ alkyl, (carboxyaldehyde)-C₁₋₆ alkyl, halo-C₁₋₆ alkyl (e.g., perfluoroalkyl), hydroxy-C₁₋₆ alkyl, nitro-C₁₋₆ alkyl, or C₁₋₆ thioalkoxy-C₁₋₆ alkyl); (3) C₁₋₂₀ alkoxy (e.g., C₁₋₆ alkoxy, such as perfluoroalkoxy); (4) C₁₋₆ alkylsulfinyl; (5) C₆₋₁₀ aryl; (6) amino; (7) C₁₋₆ alk-C₆₋₁₀ aryl; (8) azido; (9) C₃₋₈ cycloalkyl; (10) C₁₋₆ alk-C₃₋₈ cycloalkyl; (11) halo; (12) C₁₋₁₂ heterocyclyl (e.g., C₁₋₁₂ heteroaryl); (13) (C₁₋₁₂ heterocyclyl)oxy; (14) hydroxy; (15) nitro; (16) C₁₋₂₀ thioalkoxy (e.g., C₁₋₆ thioalkoxy); (17) -(CH₂)_qC₀₋₂R^A, where q is an integer from zero to four, and R^A is selected from the group consisting of (a) C₁₋₆ alkyl, (b) C₆₋₁₀ aryl, (c) hydrogen, and (d) C₁₋₆ alk-C₆₋₁₀ aryl; (18) -(CH₂)_qCONR^{B'}R^{C'}, where q is an integer from zero to four and where R^{B'} and R^{C'} are independently selected from the group consisting of (a) hydrogen, (b) C₆₋₁₀ alkyl, (c) C₆₋₁₀ aryl, and (d) C₁₋₆ alk-C₆₋₁₀ aryl; (19) -(CH₂)_qS₀₋₂R^{D'}, where q is an integer from zero to four and where R^{D'} is selected from the group consisting of (a) C₆₋₁₀ alkyl, (b) C₆₋₁₀ aryl, and (c) C₁₋₆ alk-C₆₋₁₀ aryl; (20) -(CH₂)_qS₀₋₂NR^{E'}R^{F'}, where q is an integer from zero to four and where each of R^{E'} and R^{F'} is, independently, selected from the group consisting of (a) hydrogen, (b) C₆₋₁₀ alkyl, (c) C₆₋₁₀ aryl, and (d) C₁₋₆ alk-C₆₋₁₀ aryl; (21) thiol; (22) C₆₋₁₀ aryloxy; (23) C₃₋₈ cycloalkoxy; (24) C₆₋₁₀ aryl-C₁₋₆ alkoxy; (25) C₁₋₆ alk-C₁₋₁₂ heterocyclyl (e.g., C₁₋₆ alk-C₁₋₁₂ heteroaryl); (26) oxo; (27) C₂₋₂₀ alkenyl; and (28) C₂₋₂₀ alkynyl. In

some embodiments, each of these groups can be further substituted as described herein. For example, the alkylene group of a Ci-alkaryl or a Ci-alkheterocyclyl can be further substituted with an oxo group to afford the respective aryloyl and (heterocyclyl)oyl substituent group.

[00782] The term "diastereomer" means stereoisomers that are not mirror images of one another and are non-superimposable.

[00783] The term "effective amount" of an agent, as used herein, is that amount sufficient to effect beneficial or desired results, for example, clinical results, and, as such, an "effective amount" depends upon the context in which it is being applied. For example, in the context of administering an agent that treats cancer, an effective amount of an agent is, for example, an amount sufficient to achieve treatment, as defined herein, of cancer, as compared to the response obtained without administration of the agent.

[00784] The term "enantiomer," as used herein, means each individual optically active form of a compound of the invention, having an optical purity or enantiomeric excess (as determined by methods standard in the art) of at least 80% (i.e., at least 90% of one enantiomer and at most 10% of the other enantiomer), preferably at least 90% and more preferably at least 98%.

[00785] The term "halo," as used herein, represents a halogen selected from bromine, chlorine, iodine, or fluorine.

[00786] The term "haloalkoxy," as used herein, represents an alkoxy group, as defined herein, substituted by a halogen group (i.e., F, Cl, Br, or I). A haloalkoxy may be substituted with one, two, three, or, in the case of alkyl groups of two carbons or more, four halogens. Haloalkoxy groups include perfluoroalkoxys (e.g., $-\text{OCF}_3$), $-\text{OCHF}_2$, $-\text{OCH}_2\text{F}$, $-\text{OCCl}_3$, $-\text{OCH}_2\text{CH}_2\text{Br}$, $-\text{OCH}_2\text{CH}(\text{CH}_2\text{CH}_2\text{Br})\text{CH}_3$, and $-\text{OCHICH}_3$. In some embodiments, the haloalkoxy group can be further substituted with 1, 2, 3, or 4 substituent groups as described herein for alkyl groups.

[00787] The term "haloalkyl," as used herein, represents an alkyl group, as defined herein, substituted by a halogen group (i.e., F, Cl, Br, or I). A haloalkyl may be substituted with one, two, three, or, in the case of alkyl groups of two carbons or more, four halogens. Haloalkyl groups include perfluoroalkyls (e.g., $-\text{CF}_3$), $-\text{CHF}_2$, $-\text{CH}_2\text{F}$, $-\text{CCl}_3$, $-\text{CH}_2\text{CH}_2\text{Br}$, $-\text{CH}_2\text{CH}(\text{CH}_2\text{CH}_2\text{Br})\text{CH}_3$, and $-\text{CHICH}_3$. In some embodiments, the haloalkyl group can be further substituted with 1, 2, 3, or 4 substituent groups as described herein for alkyl groups.

[00788] The term "heteroalkylene," as used herein, refers to an alkylene group, as defined herein, in which one or two of the constituent carbon atoms have each been replaced by nitrogen, oxygen, or

sulfur. In some embodiments, the heteroalkylene group can be further substituted with 1, 2, 3, or 4 substituent groups as described herein for alkylene groups.

[00789] The term "heteroaryl," as used herein, represents that subset of heterocyclyls, as defined herein, which are aromatic: i.e., they contain $4n+2$ pi electrons within the mono- or multicyclic ring system. Exemplary unsubstituted heteroaryl groups are of 1 to 12 (e.g., 1 to 11, 1 to 10, 1 to 9, 2 to 12, 2 to 11, 2 to 10, or 2 to 9) carbons. In some embodiment, the heteroaryl is substituted with 1, 2, 3, or 4 substituents groups as defined for a heterocyclyl group.

[00790] The term "heterocyclyl," as used herein represents a 5-, 6- or 7-membered ring, unless otherwise specified, containing one, two, three, or four heteroatoms independently selected from the group consisting of nitrogen, oxygen, and sulfur. The 5-membered ring has zero to two double bonds, and the 6- and 7-membered rings have zero to three double bonds. Exemplary unsubstituted heterocyclyl groups are of 1 to 12 (e.g., 1 to 11, 1 to 10, 1 to 9, 2 to 12, 2 to 11, 2 to 10, or 2 to 9) carbons. The term "heterocyclyl" also represents a heterocyclic compound having a bridged multicyclic structure in which one or more carbons and/or heteroatoms bridges two non-adjacent members of a monocyclic ring, e.g., a quinuclidinyl group. The term "heterocyclyl" includes bicyclic, tricyclic, and tetracyclic groups in which any of the above heterocyclic rings is fused to one, two, or three carbocyclic rings, e.g., an aryl ring, a cyclohexane ring, a cyclohexene ring, a cyclopentane ring, a cyclopentene ring, or another monocyclic heterocyclic ring, such as indolyl, quinolyl, isoquinolyl, tetrahydroquinolyl, benzofuryl, benzothienyl and the like. Examples of fused heterocyclyls include tropanes and 1,2,3,5,8,8a-hexahydroindolizine. Heterocyclics include pyrrolyl, pyrrolinyl, pyrrolidinyl, pyrazolyl, pyrazolinyl, pyrazolidinyl, imidazolyl, imidazolynyl, imidazolidinyl, pyridyl, piperidinyl, homopiperidinyl, pyrazinyl, piperazinyl, pyrimidinyl, pyridazinyl, oxazolyl, oxazolidinyl, isoxazolyl, isoxazolidinyl, morpholinyl, thiomorpholinyl, thiazolyl, thiazolidinyl, isothiazolyl, isothiazolidinyl, indolyl, indazolyl, quinolyl, isoquinolyl, quinoxalinyl, dihydroquinoxalinyl, quinazolynyl, cinnolinyl, phthalazinyl, benzimidazolyl, benzothiazolyl, benzoxazolyl, benzothiadiazolyl, furyl, thienyl, thiazolidinyl, isothiazolyl, triazolyl, tetrazolyl, oxadiazolyl (e.g., 1,2,3-oxadiazolyl), purinyl, thiadiazolyl (e.g., 1,2,3-thiadiazolyl), tetrahydrofuranyl, dihydrofuranyl, tetrahydrothienyl, dihydrothienyl, dihydroindolyl, dihydroquinolyl, tetrahydroquinolyl, tetrahydroisoquinolyl, dihydroisoquinolyl, pyranyl, dihydropyranyl, dithiazolyl, benzofuranyl, isobenzofuranyl, benzothienyl, and the like, including dihydro and tetrahydro forms thereof, where one or more double bonds are reduced and replaced

with hydrogens. Still other exemplary heterocyclyls include: 2,3,4,5-tetrahydro-2-oxo-oxazolyl; 2,3-dihydro-2-oxo-1H-imidazolyl; 2,3,4,5-tetrahydro-5-oxo-1H-pyrazolyl (e.g., 2,3,4,5-tetrahydro-2-phenyl-5-oxo-1H-pyrazolyl); 2,3,4,5-tetrahydro-2,4-dioxo-1H-imidazolyl (e.g., 2,3,4,5-tetrahydro-2,4-dioxo-5-methyl-5-phenyl-1H-imidazolyl); 2,3-dihydro-2-thioxo-1,3,4-oxadiazolyl (e.g., 2,3-dihydro-2-thioxo-5-phenyl-1,3,4-oxadiazolyl); 4,5-dihydro-5-oxo-1H-triazolyl (e.g., 4,5-dihydro-3-methyl-4-amino-5-oxo-1H-triazolyl); 1,2,3,4-tetrahydro-2,4-dioxopyridinyl (e.g., 1,2,3,4-tetrahydro-2,4-dioxo-3,3-diethylpyridinyl); 2,6-dioxo-piperidinyl (e.g., 2,6-dioxo-3-ethyl-3-phenylpiperidinyl); 1,6-dihydro-6-oxopyrimidinyl; 1,6-dihydro-4-oxopyrimidinyl (e.g., 2-(methylthio)-1,6-dihydro-4-oxo-5-methylpyrimidin-1-yl); 1,2,3,4-tetrahydro-2,4-dioxopyrimidinyl (e.g., 1,2,3,4-tetrahydro-2,4-dioxo-3-ethylpyrimidinyl); 1,6-dihydro-6-oxo-pyridazinyl (e.g., 1,6-dihydro-6-oxo-3-ethylpyridazinyl); 1,6-dihydro-6-oxo-1,2,4-triazinyl (e.g., 1,6-dihydro-5-isopropyl-6-oxo-1,2,4-triazinyl); 2,3-dihydro-2-oxo-1H-indolyl (e.g., 3,3-dimethyl-2,3-dihydro-2-oxo-1H-indolyl and 2,3-dihydro-2-oxo-3,3'-spiropropane-1H-indol-1-yl); 1,3-dihydro-1-oxo-2H-iso-indolyl; 1,3-dihydro-1,3-dioxo-2H-iso-indolyl; 1H-benzopyrazolyl (e.g., 1-(ethoxycarbonyl)-1H-benzopyrazolyl); 2,3-dihydro-2-oxo-1H-benzimidazolyl (e.g., 3-ethyl-2,3-dihydro-2-oxo-1H-benzimidazolyl); 2,3-dihydro-2-oxo-benzoxazolyl (e.g., 5-chloro-2,3-dihydro-2-oxo-benzoxazolyl); 2,3-dihydro-2-oxo-benzoxazolyl; 2-oxo-2H-benzopyranyl; 1,4-benzodioxanyl; 1,3-benzodioxanyl; 2,3-dihydro-3-oxo-4H-1,3-benzothiazinyl; 3,4-dihydro-4-oxo-3H-quinazoliny (e.g., 2-methyl-3,4-dihydro-4-oxo-3H-quinazoliny); 1,2,3,4-tetrahydro-2,4-dioxo-3H-quinazolyl (e.g., 1-ethyl-1,2,3,4-tetrahydro-2,4-dioxo-3H-quinazolyl); 1,2,3,6-tetrahydro-2,6-dioxo-7H-purinyl (e.g., 1,2,3,6-tetrahydro-1,3-dimethyl-2,6-dioxo-7H-purinyl); 1,2,3,6-tetrahydro-2,6-dioxo-1H-purinyl (e.g., 1,2,3,6-tetrahydro-3,7-dimethyl-2,6-dioxo-1H-purinyl); 2-oxobenz[c,i]indolyl; 1,1-dioxo-2H-naphth[1,8-c,d]isothiazolyl; and 1,8-naphthylenedicarboxamido. Additional heterocyclics include 3,3a,4,5,6,6a-hexahydro-pyrrolo[3,4-b]pyrrol-(2H)-yl, and 2,5-diazabicyclo[2.2.1]heptan-2-yl, homopiperazinyl (or diazepanyl), tetrahydropyranyl, dithiazolyl, benzofuranyl, benzothieryl, oxepanyl, thiepanyl, azocanyl, oxecanyl, and thiocanyl. Heterocyclic groups also include groups of the formula

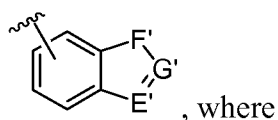

E' is selected from the group consisting of -N- and -CH-; F' is selected from the group consisting of -N=CH-, -NH-CH₂-, -NH-C(O)-, -NH-, -CH=N-, -CH₂-NH-, -C(O)-NH-, -CH=CH-, -CH₂-, -CH₂CH₂-, -CH₂O-, -OCH₂-, -O-, and -S-; and G' is selected from the group consisting of -CH- and -

N-. Any of the heterocyclyl groups mentioned herein may be optionally substituted with one, two, three, four or five substituents independently selected from the group consisting of: (1) C_{i-7} acyl (e.g., carboxyaldehyde); (2) C_{i-2o} alkyl (e.g., C_{i-6} alkyl, C_{i-6} alkoxy- C_{i-6} alkyl, C_{i-6} alkylsulfmnyl- C_{i-6} alkyl, amino- C_{i-6} alkyl, azido- C_{i-6} alkyl, (carboxyaldehyde)- C_{i-6} alkyl, halo- C_{i-6} alkyl (e.g., perfluoroalkyl), hydroxy- C_{i-6} alkyl, nitro- C_{i-6} alkyl, or C_{i-6} thioalkoxy- C_{i-6} alkyl); (3) C_{i-2o} alkoxy (e.g., C_{i-6} alkoxy, such as perfluoroalkoxy); (4) C_{i-6} alkylsulfinyl; (5) C_{6-io} aryl; (6) amino; (7) C_{i-6} alk- C_{6-io} aryl; (8) azido; (9) C_{3-8} cycloalkyl; (10) C_{i-6} alk- C_{3-8} cycloalkyl; (11) halo; (12) C_{1-12} heterocyclyl (e.g., C_{2-12} heteroaryl); (13) (C_{1-12} heterocyclyl)oxy; (14) hydroxy; (15) nitro; (16) C_{i-2o} thioalkoxy (e.g., C_{i-6} thioalkoxy); (17) $-(CH_2)_qCO_2R^A$, where q is an integer from zero to four, and R^A is selected from the group consisting of (a) C_{i-6} alkyl, (b) C_{6-io} aryl, (c) hydrogen, and (d) C_{i-6} alk- C_{6-io} aryl; (18) $-(CH_2)_qCONR^B R^C$, where q is an integer from zero to four and where R^B and R^C are independently selected from the group consisting of (a) hydrogen, (b) C_{i-6} alkyl, (c) C_{6-1o} aryl, and (d) C_{i-6} alk- C_{6-io} aryl; (19) $-(CH_2)_qSO_2R^D$, where q is an integer from zero to four and where R^D is selected from the group consisting of (a) C_{i-6} alkyl, (b) C_{6-io} aryl, and (c) C_{i-6} alk- C_{6-io} aryl; (20) $-(CH_2)_qSO_2NR^E R^F$, where q is an integer from zero to four and where each of R^E and R^F is, independently, selected from the group consisting of (a) hydrogen, (b) C_{i-6} alkyl, (c) C_{6-1o} aryl, and (d) C_{i-6} alk- C_{6-io} aryl; (21) thiol; (22) C_{6-io} aryloxy; (23) C_{3-8} cycloalkoxy; (24) arylalkoxy; (25) C_{i-6} alk- C_{i-2} heterocyclyl (e.g., C_{i-6} alk- C_{i-2} heteroaryl); (26) oxo; (27) (C_{1-12} heterocyclyl)imino; (28) C_{2-20} alkenyl; and (29) C_{2-2o} alkynyl. In some embodiments, each of these groups can be further substituted as described herein. For example, the alkylene group of a C_i -alkaryl or a C_i -alkheterocyclyl can be further substituted with an oxo group to afford the respective aryloyl and (heterocyclyl)oyl substituent group.

[00791] The term "(heterocyclyl)imino," as used herein, represents a heterocyclyl group, as defined herein, attached to the parent molecular group through an imino group. In some embodiments, the heterocyclyl group can be substituted with 1, 2, 3, or 4 substituent groups as defined herein.

[00792] The term "(heterocyclyl)oxy," as used herein, represents a heterocyclyl group, as defined herein, attached to the parent molecular group through an oxygen atom. In some embodiments, the heterocyclyl group can be substituted with 1, 2, 3, or 4 substituent groups as defined herein.

[00793] The term "(heterocyclyl)oyl," as used herein, represents a heterocyclyl group, as defined herein, attached to the parent molecular group through a carbonyl group. In some embodiments, the heterocyclyl group can be substituted with 1, 2, 3, or 4 substituent groups as defined herein.

[00794] The term "hydrocarbon," as used herein, represents a group consisting only of carbon and hydrogen atoms.

[00795] The term "hydroxy," as used herein, represents an -OH group.

[00796] The term "hydroxyalkenyl," as used herein, represents an alkenyl group, as defined herein, substituted by one to three hydroxy groups, with the proviso that no more than one hydroxy group may be attached to a single carbon atom of the alkyl group, and is exemplified by dihydroxypropenyl, hydroxyisopentenyl, and the like.

[00797] The term "hydroxyalkyl," as used herein, represents an alkyl group, as defined herein, substituted by one to three hydroxy groups, with the proviso that no more than one hydroxy group may be attached to a single carbon atom of the alkyl group, and is exemplified by hydroxymethyl, dihydroxypropyl, and the like.

[00798] The term "isomer," as used herein, means any tautomer, stereoisomer, enantiomer, or diastereomer of any compound of the invention. It is recognized that the compounds of the invention can have one or more chiral centers and/or double bonds and, therefore, exist as stereoisomers, such as double-bond isomers (i.e., geometric E/Z isomers) or diastereomers (e.g., enantiomers (i.e., (+) or (-)) or cis/trans isomers). According to the invention, the chemical structures depicted herein, and therefore the compounds of the invention, encompass all of the corresponding stereoisomers, that is, both the stereomerically pure form (e.g., geometrically pure, enantiomerically pure, or diastereomerically pure) and enantiomeric and stereoisomeric mixtures, e.g., racemates. Enantiomeric and stereoisomeric mixtures of compounds of the invention can typically be resolved into their component enantiomers or stereoisomers by well-known methods, such as chiral-phase gas chromatography, chiral-phase high performance liquid chromatography, crystallizing the compound as a chiral salt complex, or crystallizing the compound in a chiral solvent. Enantiomers and stereoisomers can also be obtained from stereomerically or enantiomerically pure intermediates, reagents, and catalysts by well-known asymmetric synthetic methods.

[00799] The term "*N*-protected amino," as used herein, refers to an amino group, as defined herein, to which is attached one or two *N*-protecting groups, as defined herein.

[00800] The term "*N*-protecting group," as used herein, represents those groups intended to protect an amino group against undesirable reactions during synthetic procedures. Commonly used *N*-protecting groups are disclosed in Greene, "Protective Groups in Organic Synthesis," 3rd Edition

(John Wiley & Sons, New York, 1999), which is incorporated herein by reference. *N*-protecting groups include acyl, aryloyl, or carbamyl groups such as formyl, acetyl, propionyl, pivaloyl, *t*-butylacetyl, 2-chloroacetyl, 2-bromoacetyl, trifluoroacetyl, trichloroacetyl, phthalyl, *o*-nitrophenoxyacetyl, *a*-chlorobutyryl, benzoyl, 4-chlorobenzoyl, 4-bromobenzoyl, 4-nitrobenzoyl, and chiral auxiliaries such as protected or unprotected D, L or D, L-amino acids such as alanine, leucine, phenylalanine, and the like; sulfonyl-containing groups such as benzenesulfonyl, *p*-toluenesulfonyl, and the like; carbamate forming groups such as benzyloxycarbonyl, *p*-chlorobenzyloxycarbonyl, *p*-methoxybenzyloxycarbonyl, *p*-nitrobenzyloxycarbonyl, 2-nitrobenzyloxycarbonyl, *p*-bromobenzyloxycarbonyl, 3,4-dimethoxybenzyloxycarbonyl, 3,5-dimethoxybenzyloxycarbonyl, 2,4-dimethoxybenzyloxycarbonyl, 4-methoxybenzyloxycarbonyl, 2-nitro-4,5-dimethoxybenzyloxycarbonyl, 3,4,5-trimethoxybenzyloxycarbonyl, 1-(*p*-biphenyl)-1-methylethoxycarbonyl, *a,a*-dimethyl-3,5-dimethoxybenzyloxycarbonyl, benzhydryloxy carbonyl, *t*-butyloxycarbonyl, diisopropylmethoxycarbonyl, isopropylloxycarbonyl, ethoxycarbonyl, methoxycarbonyl, allyloxycarbonyl, 2,2,2,-trichloroethoxycarbonyl, phenoxycarbonyl, 4-nitrophenoxy carbonyl, fluorenyl-9-methoxycarbonyl, cyclopentylloxycarbonyl, adamantylloxycarbonyl, cyclohexylloxycarbonyl, phenylthiocarbonyl, and the like, alkaryl groups such as benzyl, triphenylmethyl, benzyloxymethyl, and the like and silyl groups, such as trimethylsilyl, and the like. Preferred *N*-protecting groups are formyl, acetyl, benzoyl, pivaloyl, *t*-butylacetyl, alanyl, phenylsulfonyl, benzyl, *t*-butyloxycarbonyl (Boc), and benzyloxycarbonyl (Cbz).

[00801] The term "nitro," as used herein, represents an -NO₂ group.

[00802] The term "oxo" as used herein, represents =O.

[00803] The term "perfluoroalkyl," as used herein, represents an alkyl group, as defined herein, where each hydrogen radical bound to the alkyl group has been replaced by a fluoride radical. Perfluoroalkyl groups are exemplified by trifluoromethyl, pentafluoroethyl, and the like.

[00804] The term "perfluoroalkoxy," as used herein, represents an alkoxy group, as defined herein, where each hydrogen radical bound to the alkoxy group has been replaced by a fluoride radical. Perfluoroalkoxy groups are exemplified by trifluoromethoxy, pentafluoroethoxy, and the like.

[00805] The term "spirocyclyl," as used herein, represents a C₂₋₇ alkylene diradical, both ends of which are bonded to the same carbon atom of the parent group to form a spirocyclic group, and also a C_{i-6} heteroalkylene diradical, both ends of which are bonded to the same atom. The heteroalkylene radical forming the spirocyclyl group can contain one, two, three, or four heteroatoms

independently selected from the group consisting of nitrogen, oxygen, and sulfur. In some embodiments, the spirocyclyl group includes one to seven carbons, excluding the carbon atom to which the diradical is attached. The spirocyclyl groups of the invention may be optionally substituted with 1, 2, 3, or 4 substituents provided herein as optional substituents for cycloalkyl and/or heterocyclyl groups.

[00806] The term "stereoisomer," as used herein, refers to all possible different isomeric as well as conformational forms which a compound may possess (e.g., a compound of any formula described herein), in particular all possible stereochemically and conformationally isomeric forms, all diastereomers, enantiomers and/or conformers of the basic molecular structure. Some compounds of the present invention may exist in different tautomeric forms, all of the latter being included within the scope of the present invention.

[00807] The term "sulfoalkyl," as used herein, represents an alkyl group, as defined herein, substituted by a sulfo group of $-SO_3H$. In some embodiments, the alkyl group can be further substituted with 1, 2, 3, or 4 substituent groups as described herein.

[00808] The term "sulfonyl," as used herein, represents an $-S(O)_2-$ group.

[00809] The term "thioalkaryl," as used herein, represents a chemical substituent of formula $-SR$, where R is an alkaryl group. In some embodiments, the alkaryl group can be further substituted with 1, 2, 3, or 4 substituent groups as described herein.

[00810] The term "thioalkheterocyclyl," as used herein, represents a chemical substituent of formula $-SR$, where R is an alkheterocyclyl group. In some embodiments, the alkheterocyclyl group can be further substituted with 1, 2, 3, or 4 substituent groups as described herein.

[00811] The term "thioalkoxy," as used herein, represents a chemical substituent of formula $-SR$, where R is an alkyl group, as defined herein. In some embodiments, the alkyl group can be further substituted with 1, 2, 3, or 4 substituent groups as described herein.

[00812] The term "thiol" represents an $-SH$ group.

[00813] *Compound*: As used herein, the term "compound," is meant to include all stereoisomers, geometric isomers, tautomers, and isotopes of the structures depicted.

[00814] The compounds described herein can be asymmetric (*e.g.*, having one or more stereocenters). All stereoisomers, such as enantiomers and diastereomers, are intended unless otherwise indicated. Compounds of the present disclosure that contain asymmetrically substituted carbon atoms can be isolated in optically active or racemic forms. Methods on how to prepare

optically active forms from optically active starting materials are known in the art, such as by resolution of racemic mixtures or by stereoselective synthesis. Many geometric isomers of olefins, C=N double bonds, and the like can also be present in the compounds described herein, and all such stable isomers are contemplated in the present disclosure. Cis and trans geometric isomers of the compounds of the present disclosure are described and may be isolated as a mixture of isomers or as separated isomeric forms.

[00815] Compounds of the present disclosure also include tautomeric forms. Tautomeric forms result from the swapping of a single bond with an adjacent double bond and the concomitant migration of a proton. Tautomeric forms include prototropic tautomers which are isomeric protonation states having the same empirical formula and total charge. Examples prototropic tautomers include ketone - enol pairs, amide - imidic acid pairs, lactam - lactim pairs, amide - imidic acid pairs, enamine - imine pairs, and annular forms where a proton can occupy two or more positions of a heterocyclic system, such as, 1H- and 3H-imidazole, 1H-, 2H- and 4H- 1,2,4-triazole, 1H- and 2H- isoindole, and 1H- and 2H-pyrazole. Tautomeric forms can be in equilibrium or sterically locked into one form by appropriate substitution.

[00816] Compounds of the present disclosure also include all of the isotopes of the atoms occurring in the intermediate or final compounds. "Isotopes" refers to atoms having the same atomic number but different mass numbers resulting from a different number of neutrons in the nuclei. For example, isotopes of hydrogen include tritium and deuterium.

[00817] The compounds and salts of the present disclosure can be prepared in combination with solvent or water molecules to form solvates and hydrates by routine methods.

[00818] *Conserved:* As used herein, the term "conserved" refers to nucleotides or amino acid residues of a polynucleotide sequence or polypeptide sequence, respectively, that are those that occur unaltered in the same position of two or more sequences being compared. Nucleotides or amino acids that are relatively conserved are those that are conserved amongst more related sequences than nucleotides or amino acids appearing elsewhere in the sequences.

[00819] In some embodiments, two or more sequences are said to be "completely conserved" if they are 100% identical to one another. In some embodiments, two or more sequences are said to be "highly conserved" if they are at least 70% identical, at least 80% identical, at least 90% identical, or at least 95% identical to one another. In some embodiments, two or more sequences are said to be "highly conserved" if they are about 70%> identical, about 80%> identical, about 90%> identical, about

95%, about 98%, or about 99% identical to one another. In some embodiments, two or more sequences are said to be "conserved" if they are at least 30% identical, at least 40% identical, at least 50% identical, at least 60% identical, at least 70% identical, at least 80% identical, at least 90% identical, or at least 95% identical to one another. In some embodiments, two or more sequences are said to be "conserved" if they are about 30% identical, about 40% identical, about 50% identical, about 60% identical, about 70% identical, about 80% identical, about 90% identical, about 95% identical, about 98% identical, or about 99% identical to one another. Conservation of sequence may apply to the entire length of an oligonucleotide or polypeptide or may apply to a portion, region or feature thereof.

[00820] *Controlled Release*: As used herein, the term "controlled release" refers to a pharmaceutical composition or compound release profile that conforms to a particular pattern of release to effect a therapeutic outcome.

[00821] *Cyclic or Cyclized*: As used herein, the term "cyclic" refers to the presence of a continuous loop. Cyclic molecules need not be circular, only joined to form an unbroken chain of subunits. Cyclic molecules such as the engineered RNA or mRNA of the present invention may be single units or multimers or comprise one or more components of a complex or higher order structure.

[00822] *Cytostatic*: As used herein, "cytostatic" refers to inhibiting, reducing, suppressing the growth, division, or multiplication of a cell (*e.g.*, a mammalian cell (*e.g.*, a human cell)), bacterium, virus, fungus, protozoan, parasite, prion, or a combination thereof.

[00823] *Cytotoxic*: As used herein, "cytotoxic" refers to killing or causing injurious, toxic, or deadly effect on a cell (*e.g.*, a mammalian cell (*e.g.*, a human cell)), bacterium, virus, fungus, protozoan, parasite, prion, or a combination thereof.

[00824] *Delivery*: As used herein, "delivery" refers to the act or manner of delivering a compound, substance, entity, moiety, cargo or payload.

[00825] *Delivery Agent*: As used herein, "delivery agent" refers to any substance which facilitates, at least in part, the *in vivo* delivery of a modified nucleic acid or mrnRNA to targeted cells.

[00826] *Destabilized*: As used herein, the term "destable," "destabilize," or "destabilizing region" means a region or molecule that is less stable than a starting, wild-type or native form of the same region or molecule.

[00827] *Detectable label*: As used herein, "detectable label" refers to one or more markers, signals, or moieties which are attached, incorporated or associated with another entity that is readily detected

by methods known in the art including radiography, fluorescence, chemiluminescence, enzymatic activity, absorbance and the like. Detectable labels include radioisotopes, fluorophores, chromophores, enzymes, dyes, metal ions, ligands such as biotin, avidin, streptavidin and haptens, quantum dots, and the like. Detectable labels may be located at any position in the peptides or proteins disclosed herein. They may be within the amino acids, the peptides, or proteins, or located at the N- or C- termini.

[00828] *Digest*: As used herein, the term "digest" means to break apart into smaller pieces or components. When referring to polypeptides or proteins, digestion results in the production of peptides.

[00829] *Distal*: As used herein, the term "distal" means situated away from the center or away from a point or region of interest.

[00830] *Dose splitting factor (DSF)*: Ratio of PUD of dose split treatment divided by PUD of total daily dose or single unit dose. The value is derived from comparison of dosing regimens groups.

[00831] *Encapsulate*: As used herein, the term "encapsulate" means to enclose, surround or encase.

[00832] *Engineered*: As used herein, embodiments of the invention are "engineered" when they are designed to have a feature or property, whether structural or chemical, that varies from a starting point, wild type or native molecule.

[00833] *Exosome*: As used herein, "exosome" is a vesicle secreted by mammalian cells.

[00834] *Expression*: As used herein, "expression" of a nucleic acid sequence refers to one or more of the following events: (1) production of an RNA template from a DNA sequence (*e.g.*, by transcription); (2) processing of an RNA transcript (*e.g.*, by splicing, editing, 5' cap formation, and/or 3' end processing); (3) translation of an RNA into a polypeptide or protein; and (4) post-translational modification of a polypeptide or protein.

[00835] *Feature*: As used herein, a "feature" refers to a characteristic, a property, or a distinctive element.

[00836] *Formulation*: As used herein, a "formulation" includes at least a modified nucleic acid or mRNA and a delivery agent.

[00837] *Fragment*: A "fragment," as used herein, refers to a portion. For example, fragments of proteins may comprise polypeptides obtained by digesting full-length protein isolated from cultured cells.

[00838] *Functional*: As used herein, a "functional" biological molecule is a biological molecule in a form in which it exhibits a property and/or activity by which it is characterized.

[00839] *Homology*: As used herein, the term "homology" refers to the overall relatedness between polymeric molecules, *e.g.* between nucleic acid molecules (*e.g.* DNA molecules and/or RNA molecules) and/or between polypeptide molecules. In some embodiments, polymeric molecules are considered to be "homologous" to one another if their sequences are at least 25%, 30%, 35%, 40%, 45%, 50%, 55%, 60%, 65%, 70%, 75%, 80%, 85%, 90%, 95%, or 99% identical or similar. The term "homologous" necessarily refers to a comparison between at least two sequences (polynucleotide or polypeptide sequences). In accordance with the invention, two polynucleotide sequences are considered to be homologous if the polypeptides they encode are at least about 50%, 60%, 70%, 80%, 90%, 95%, or even 99% for at least one stretch of at least about 20 amino acids. In some embodiments, homologous polynucleotide sequences are characterized by the ability to encode a stretch of at least 4-5 uniquely specified amino acids. For polynucleotide sequences less than 60 nucleotides in length, homology is determined by the ability to encode a stretch of at least 4-5 uniquely specified amino acids. In accordance with the invention, two protein sequences are considered to be homologous if the proteins are at least about 50%, 60%, 70%, 80%, or 90% identical for at least one stretch of at least about 20 amino acids.

[00840] *Identity*: As used herein, the term "identity" refers to the overall relatedness between polymeric molecules, *e.g.*, between oligonucleotide molecules (*e.g.* DNA molecules and/or RNA molecules) and/or between polypeptide molecules. Calculation of the percent identity of two polynucleotide sequences, for example, can be performed by aligning the two sequences for optimal comparison purposes (*e.g.*, gaps can be introduced in one or both of a first and a second nucleic acid sequences for optimal alignment and non-identical sequences can be disregarded for comparison purposes). In certain embodiments, the length of a sequence aligned for comparison purposes is at least 30%, at least 40%, at least 50%, at least 60%, at least 70%, at least 80%, at least 90%, at least 95%, or 100% of the length of the reference sequence. The nucleotides at corresponding nucleotide positions are then compared. When a position in the first sequence is occupied by the same nucleotide as the corresponding position in the second sequence, then the molecules are identical at that position. The percent identity between the two sequences is a function of the number of identical positions shared by the sequences, taking into account the number of gaps, and the length of each gap, which needs to be introduced for optimal alignment of the two sequences. The

comparison of sequences and determination of percent identity between two sequences can be accomplished using a mathematical algorithm. For example, the percent identity between two nucleotide sequences can be determined using methods such as those described in Computational Molecular Biology, Lesk, A. M., ed., Oxford University Press, New York, 1988; Biocomputing: Informatics and Genome Projects, Smith, D. W., ed., Academic Press, New York, 1993; Sequence Analysis in Molecular Biology, von Heinje, G., Academic Press, 1987; Computer Analysis of Sequence Data, Part I, Griffin, A. M., and Griffin, H. G., eds., Humana Press, New Jersey, 1994; and Sequence Analysis Primer, Gribskov, M. and Devereux, J., eds., M Stockton Press, New York, 1991; each of which is incorporated herein by reference. For example, the percent identity between two nucleotide sequences can be determined using the algorithm of Meyers and Miller (CABIOS, 1989, 4:1 1-17), which has been incorporated into the ALIGN program (version 2.0) using a PAM120 weight residue table, a gap length penalty of 12 and a gap penalty of 4. The percent identity between two nucleotide sequences can, alternatively, be determined using the GAP program in the GCG software package using an NWSgapdna.CMP matrix. Methods commonly employed to determine percent identity between sequences include, but are not limited to those disclosed in Carillo, H., and Lipman, D., SIAM J Applied Math., 48:1073 (1988); incorporated herein by reference. Techniques for determining identity are codified in publicly available computer programs. Exemplary computer software to determine homology between two sequences include, but are not limited to, GCG program package, Devereux, J., *et al.*, *Nucleic Acids Research*, 12(1), 387 (1984)), BLASTP, BLASTN, and FASTA Altschul, S. F. *et al.*, *J. Molec. Biol.*, 215, 403 (1990)).

[00841] *Inhibit expression of a gene:* As used herein, the phrase "inhibit expression of a gene" means to cause a reduction in the amount of an expression product of the gene. The expression product can be an RNA transcribed from the gene (*e.g.*, an mRNA) or a polypeptide translated from an mRNA transcribed from the gene. Typically a reduction in the level of an mRNA results in a reduction in the level of a polypeptide translated therefrom. The level of expression may be determined using standard techniques for measuring mRNA or protein.

[00842] *In vitro:* As used herein, the term "*in vitro*" refers to events that occur in an artificial environment, *e.g.*, in a test tube or reaction vessel, in cell culture, in a Petri dish, *etc.*, rather than within an organism (*e.g.*, animal, plant, or microbe).

[00843] *In vivo:* As used herein, the term "*in vivo*" refers to events that occur within an organism (*e.g.*, animal, plant, or microbe or cell or tissue thereof).

[00844] *Isolated*: As used herein, the term "isolated" refers to a substance or entity that has been separated from at least some of the components with which it was associated (whether in nature or in an experimental setting). Isolated substances may have varying levels of purity in reference to the substances from which they have been associated. Isolated substances and/or entities may be separated from at least about 10%, about 20%, about 30%, about 40%, about 50%, about 60%, about 70%, about 80%, about 90%, or more of the other components with which they were initially associated. In some embodiments, isolated agents are more than about 80%, about 85%, about 90%, about 91%, about 92%, about 93%, about 94%, about 95%, about 96%, about 97%, about 98%, about 99%, or more than about 99% pure. As used herein, a substance is "pure" if it is substantially free of other components. *Substantially isolated*: By "substantially isolated" is meant that the compound is substantially separated from the environment in which it was formed or detected. Partial separation can include, for example, a composition enriched in the compound of the present disclosure. Substantial separation can include compositions containing at least about 50%, at least about 60%, at least about 70%, at least about 80%, at least about 90%, at least about 95%, at least about 97%, or at least about 99% by weight of the compound of the present disclosure, or salt thereof. Methods for isolating compounds and their salts are routine in the art.

[00845] *Linker*: As used herein, a linker refers to a group of atoms, e.g., 10-1,000 atoms, and can be comprised of the atoms or groups such as, but not limited to, carbon, amino, alkylamino, oxygen, sulfur, sulfoxide, sulfonyl, carbonyl, and imine. The linker can be attached to a modified nucleoside or nucleotide on the nucleobase or sugar moiety at a first end, and to a payload, e.g., a detectable or therapeutic agent, at a second end. The linker may be of sufficient length as to not interfere with incorporation into a nucleic acid sequence. The linker can be used for any useful purpose, such as to form mmRNA multimers (e.g., through linkage of two or more modified nucleic acid molecules or mmRNA molecules) or mmRNA conjugates, as well as to administer a payload, as described herein. Examples of chemical groups that can be incorporated into the linker include, but are not limited to, alkyl, alkenyl, alkynyl, amido, amino, ether, thioether, ester, alkylene, heteroalkylene, aryl, or heterocyclyl, each of which can be optionally substituted, as described herein. Examples of linkers include, but are not limited to, unsaturated alkanes, polyethylene glycols (e.g., ethylene or propylene glycol monomeric units, e.g., diethylene glycol, dipropylene glycol, triethylene glycol, tripropylene glycol, tetraethylene glycol, or tetraethylene glycol), and dextran polymers and derivatives thereof. Other examples include, but are not limited to, cleavable moieties within the linker, such as, for

example, a disulfide bond (-S-S-) or an azo bond (-N=N-), which can be cleaved using a reducing agent or photolysis. Non-limiting examples of a selectively cleavable bond include an amido bond can be cleaved for example by the use of tris(2-carboxyethyl)phosphine (TCEP), or other reducing agents, and/or photolysis, as well as an ester bond can be cleaved for example by acidic or basic hydrolysis.

[00846] *MicroRNA (miRNA) binding site*: As used herein, a microRNA (miRNA) binding site represents a nucleotide location or region of a nucleic acid transcript to which at least the "seed" region of a miRNA binds.

[00847] *Modified*: As used herein "modified" refers to a changed state or structure of a molecule of the invention. Molecules may be modified in many ways including chemically, structurally, and functionally. In one embodiment, the mRNA molecules of the present invention are modified by the introduction of non-natural nucleosides and/or nucleotides.

[00848] *Mucus*: As used herein, "mucus" refers to a natural substance that is viscous and comprises mucin glycoproteins.

[00849] *Naturally occurring*: As used herein, "naturally occurring" means existing in nature without artificial aid.

[00850] *Non-human vertebrate*: As used herein, a "non human vertebrate" includes all vertebrates except *Homo sapiens*, including wild and domesticated species. Examples of non-human vertebrates include, but are not limited to, mammals, such as alpaca, banteng, bison, camel, cat, cattle, deer, dog, donkey, gayal, goat, guinea pig, horse, llama, mule, pig, rabbit, reindeer, sheep water buffalo, and yak.

[00851] *Off-target*: As used herein, "off target" refers to any unintended effect on any one or more target, gene, or cellular transcript.

[00852] *Open readingframe*: As used herein, "open reading frame" or "ORF" refers to a sequence which does not contain a stop codon in a given reading frame.

[00853] *Operably linked*: As used herein, the phrase "operably linked" refers to a functional connection between two or more molecules, constructs, transcripts, entities, moieties or the like.

[00854] *Paratope*: As used herein, a "paratope" refers to the antigen-binding site of an antibody.

[00855] *Patient*: As used herein, "patient" refers to a subject who may seek or be in need of treatment, requires treatment, is receiving treatment, will receive treatment, or a subject who is under care by a trained professional for a particular disease or condition.

[00856] *Peptide*: As used herein, "peptide" is less than or equal to 50 amino acids long, e.g., about 5, 10, 15, 20, 25, 30, 35, 40, 45, or 50 amino acids long.

[00857] *Pharmaceutically acceptable*: The phrase "pharmaceutically acceptable" is employed herein to refer to those compounds, materials, compositions, and/or dosage forms which are, within the scope of sound medical judgment, suitable for use in contact with the tissues of human beings and animals without excessive toxicity, irritation, allergic response, or other problem or complication, commensurate with a reasonable benefit/risk ratio.

[00858] *Pharmaceutically acceptable excipients*: The phrase "pharmaceutically acceptable excipient," as used herein, refers any ingredient other than the compounds described herein (for example, a vehicle capable of suspending or dissolving the active compound) and having the properties of being substantially nontoxic and non-inflammatory in a patient. Excipients may include, for example: antiadherents, antioxidants, binders, coatings, compression aids, disintegrants, dyes (colors), emollients, emulsifiers, fillers (diluent), film formers or coatings, flavors, fragrances, glidants (flow enhancers), lubricants, preservatives, printing inks, sorbents, suspending or dispersing agents, sweeteners, and waters of hydration. Exemplary excipients include, but are not limited to: butylated hydroxytoluene (BHT), calcium carbonate, calcium phosphate (dibasic), calcium stearate, croscarmellose, crosslinked polyvinyl pyrrolidone, citric acid, crospovidone, cysteine, ethylcellulose, gelatin, hydroxypropyl cellulose, hydroxypropyl methylcellulose, lactose, magnesium stearate, maltitol, mannitol, methionine, methylcellulose, methyl paraben, microcrystalline cellulose, polyethylene glycol, polyvinyl pyrrolidone, povidone, pregelatinized starch, propyl paraben, retinyl palmitate, shellac, silicon dioxide, sodium carboxymethyl cellulose, sodium citrate, sodium starch glycolate, sorbitol, starch (corn), stearic acid, sucrose, talc, titanium dioxide, vitamin A, vitamin E, vitamin C, and xylitol.

[00859] *Pharmaceutically acceptable salts*: The present disclosure also includes pharmaceutically acceptable salts of the compounds described herein. As used herein, "pharmaceutically acceptable salts" refers to derivatives of the disclosed compounds wherein the parent compound is modified by converting an existing acid or base moiety to its salt form (e.g., by reacting the free base group with a suitable organic acid). Examples of pharmaceutically acceptable salts include, but are not limited to, mineral or organic acid salts of basic residues such as amines; alkali or organic salts of acidic residues such as carboxylic acids; and the like. Representative acid addition salts include acetate, adipate, alginate, ascorbate, aspartate, benzenesulfonate, benzoate, bisulfate, borate, butyrate,

camphorate, camphorsulfonate, citrate, cyclopentanepropionate, digluconate, dodecylsulfate, ethanesulfonate, fumarate, glucoheptonate, glycerophosphate, hemisulfate, heptonate, hexanoate, hydrobromide, hydrochloride, hydroiodide, 2-hydroxy-ethanesulfonate, lactobionate, lactate, laurate, lauryl sulfate, malate, maleate, malonate, methanesulfonate, 2-naphthalenesulfonate, nicotinate, nitrate, oleate, oxalate, palmitate, pamoate, pectinate, persulfate, 3-phenylpropionate, phosphate, picrate, pivalate, propionate, stearate, succinate, sulfate, tartrate, thiocyanate, toluenesulfonate, undecanoate, valerate salts, and the like. Representative alkali or alkaline earth metal salts include sodium, lithium, potassium, calcium, magnesium, and the like, as well as nontoxic ammonium, quaternary ammonium, and amine cations, including, but not limited to ammonium, tetramethylammonium, tetraethylammonium, methylamine, dimethylamine, trimethylamine, triethylamine, ethylamine, and the like. The pharmaceutically acceptable salts of the present disclosure include the conventional non-toxic salts of the parent compound formed, for example, from non-toxic inorganic or organic acids. The pharmaceutically acceptable salts of the present disclosure can be synthesized from the parent compound which contains a basic or acidic moiety by conventional chemical methods. Generally, such salts can be prepared by reacting the free acid or base forms of these compounds with a stoichiometric amount of the appropriate base or acid in water or in an organic solvent, or in a mixture of the two; generally, nonaqueous media like ether, ethyl acetate, ethanol, isopropanol, or acetonitrile are preferred. Lists of suitable salts are found in *Remington's Pharmaceutical Sciences*, 17th ed., Mack Publishing Company, Easton, Pa., 1985, p. 1418, *Pharmaceutical Salts: Properties, Selection, and Use*, P.H. Stahl and C.G. Wermuth (eds.), Wiley-VCH, 2008, and Berge et al, *Journal of Pharmaceutical Science*, 66, 1-19 (1977), each of which is incorporated herein by reference in its entirety.

[00860] *Pharmaceutically acceptable solvate*: The term "pharmaceutically acceptable solvate," as used herein, means a compound of the invention wherein molecules of a suitable solvent are incorporated in the crystal lattice. A suitable solvent is physiologically tolerable at the dosage administered. For example, solvates may be prepared by crystallization, recrystallization, or precipitation from a solution that includes organic solvents, water, or a mixture thereof. Examples of suitable solvents are ethanol, water (for example, mono-, di-, and tri-hydrates), *N*-methylpyrrolidinone (NMP), dimethyl sulfoxide (DMSO), *N,N'*-dimethylformamide (DMF), *N,N'*-dimethylacetamide (DMAC), 1,3-dimethyl-2-imidazolidinone (DMEU), 1,3-dimethyl-3,4,5,6-tetrahydro-2-(1H)-pyrimidinone (DMPU), acetonitrile (ACN), propylene glycol, ethyl acetate,

benzyl alcohol, 2-pyrrolidone, benzyl benzoate, and the like. When water is the solvent, the solvate is referred to as a "hydrate."

[00861] *Pharmacokinetic*: As used herein, "pharmacokinetic" refers to any one or more properties of a molecule or compound as it relates to the determination of the fate of substances administered to a living organism. Pharmacokinetics is divided into several areas including the extent and rate of absorption, distribution, metabolism and excretion. This is commonly referred to as ADME where: (A) Absorption is the process of a substance entering the blood circulation; (D) Distribution is the dispersion or dissemination of substances throughout the fluids and tissues of the body; (M) Metabolism (or Biotransformation) is the irreversible transformation of parent compounds into daughter metabolites; and (E) Excretion (or Elimination) refers to the elimination of the substances from the body. In rare cases, some drugs irreversibly accumulate in body tissue.

[00862] *Pharmacologic effect*: As used herein, a "pharmacologic effect" is a measurable biologic phenomenon in an organism or system which occurs after the organism or system has been contacted with or exposed to an exogenous agent. Pharmacologic effects may result in therapeutically effective outcomes such as the treatment, improvement of one or more symptoms, diagnosis, prevention, and delay of onset of disease, disorder, condition or infection. Measurement of such biologic phenomena may be quantitative, qualitative or relative to another biologic phenomenon. Quantitative measurements may be statistically significant. Qualitative measurements may be by degree or kind and may be at least 10%, 20%, 30%, 40%, 50%, 60%, 70%, 80%, 90% or more different. They may be observable as present or absent, better or worse, greater or less. Exogenous agents, when referring to pharmacologic effects are those agents which are, in whole or in part, foreign to the organism or system. For example, modifications to a wild type biomolecule, whether structural or chemical, would produce an exogenous agent. Likewise, incorporation or combination of a wild type molecule into or with a compound, molecule or substance not found naturally in the organism or system would also produce an exogenous agent. The modified mRNA of the present invention, comprise exogenous agents. Examples of pharmacologic effects include, but are not limited to, alteration in cell count such as an increase or decrease in neutrophils, reticulocytes, granulocytes, erythrocytes (red blood cells), megakaryocytes, platelets, monocytes, connective tissue macrophages, epidermal langerhans cells, osteoclasts, dendritic cells, microglial cells, neutrophils, eosinophils, basophils, mast cells, helper T cells, suppressor T cells, cytotoxic T cells, natural killer T cells, B cells, natural killer cells, or reticulocytes. Pharmacologic effects also include

alterations in blood chemistry, pH, hemoglobin, hematocrit, changes in levels of enzymes such as, but not limited to, liver enzymes AST and ALT, changes in lipid profiles, electrolytes, metabolic markers, hormones or other marker or profile known to those of skill in the art.

[00863] *Physicochemical*: As used herein, "physicochemical" means of or relating to a physical and/or chemical property.

[00864] *Preventing*: As used herein, the term "preventing" refers to partially or completely delaying onset of an infection, disease, disorder and/or condition; partially or completely delaying onset of one or more symptoms, features, or clinical manifestations of a particular infection, disease, disorder, and/or condition; partially or completely delaying onset of one or more symptoms, features, or manifestations of a particular infection, disease, disorder, and/or condition; partially or completely delaying progression from an infection, a particular disease, disorder and/or condition; and/or decreasing the risk of developing pathology associated with the infection, the disease, disorder, and/or condition.

[00865] *Prodrug*: The present disclosure also includes prodrugs of the compounds described herein. As used herein, "prodrugs" refer to any substance, molecule or entity which is in a form predicate for that substance, molecule or entity to act as a therapeutic upon chemical or physical alteration. Prodrugs may be covalently bonded or sequestered in some way and which release or are converted into the active drug moiety prior to, upon or after administered to a mammalian subject. Prodrugs can be prepared by modifying functional groups present in the compounds in such a way that the modifications are cleaved, either in routine manipulation or *in vivo*, to the parent compounds. Prodrugs include compounds wherein hydroxyl, amino, sulfhydryl, or carboxyl groups are bonded to any group that, when administered to a mammalian subject, cleaves to form a free hydroxyl, amino, sulfhydryl, or carboxyl group respectively. Preparation and use of prodrugs is discussed in T. Higuchi and V. Stella, "Pro-drugs as Novel Delivery Systems," Vol. 14 of the A.C.S. Symposium Series, and in *Bioreversible Carriers in Drug Design*, ed. Edward B. Roche, American Pharmaceutical Association and Pergamon Press, 1987, both of which are hereby incorporated by reference in their entirety.

[00866] *Proliferate*: As used herein, the term "proliferate" means to grow, expand or increase or cause to grow, expand or increase rapidly. "Proliferative" means having the ability to proliferate. "Anti-proliferative" means having properties counter to or inapposite to proliferative properties.

[00867] *Protein of interest*: As used herein, the terms "proteins of interest" or "desired proteins" include those provided herein and fragments, mutants, variants, and alterations thereof.

[00868] *Proximal*: As used herein, the term "proximal" means situated nearer to the center or to a point or region of interest.

[00869] *Pseudouridine*: As used herein, pseudouridine refers to the C-glycoside isomer of the nucleoside uridine. A "pseudouridine analog" is any modification, variant, isoform or derivative of pseudouridine. For example, pseudouridine analogs include but are not limited to 1-carboxymethyl-pseudouridine, 1-propynyl-pseudouridine, 1-taurinomethyl-pseudouridine, 1-taurinomethyl-4-thio-pseudouridine, 1-methyl-pseudouridine ($m^1\psi$), 1-methyl-4-thio-pseudouridine ($m^1s^4\psi$), 4-thio-1-methyl-pseudouridine, 3-methyl-pseudouridine ($m^3\psi$), 2-thio-1-methyl-pseudouridine, 1-methyl-1-deaza-pseudouridine, 2-thio-1-methyl-1-deaza-pseudouridine, dihydropseudouridine, 2-thio-dihydropseudouridine, 2-methoxyuridine, 2-methoxy-4-thio-uridine, 4-methoxy-pseudouridine, 4-methoxy-2-thio-pseudouridine, N1-methyl-pseudouridine, 1-methyl-3-(3-amino-3-carboxypropyl)pseudouridine ($acp^3\psi$), and 2'-**0**-methyl-pseudouridine (ψm).

[00870] *Purified*: As used herein, "purify," "purified," "purification" means to make substantially pure or clear from unwanted components, material defilement, admixture or imperfection.

[00871] *Sample*: As used herein, the term "sample" or "biological sample" refers to a subset of its tissues, cells or component parts (e.g. body fluids, including but not limited to blood, mucus, lymphatic fluid, synovial fluid, cerebrospinal fluid, saliva, amniotic fluid, amniotic cord blood, urine, vaginal fluid and semen). A sample further may include a homogenate, lysate or extract prepared from a whole organism or a subset of its tissues, cells or component parts, or a fraction or portion thereof, including but not limited to, for example, plasma, serum, spinal fluid, lymph fluid, the external sections of the skin, respiratory, intestinal, and genitourinary tracts, tears, saliva, milk, blood cells, tumors, organs. A sample further refers to a medium, such as a nutrient broth or gel, which may contain cellular components, such as proteins or nucleic acid molecule.

[00872] *Signal Sequences*: As used herein, the phrase "signal sequences" refers to a sequence which can direct the transport or localization of a protein.

[00873] *Single unit dose*: As used herein, a "single unit dose" is a dose of any therapeutic administered in one dose/at one time/single route/single point of contact, i.e., single administration event.

[00874] *Similarity*: As used herein, the term "similarity" refers to the overall relatedness between polymeric molecules, *e.g.* between polynucleotide molecules (*e.g.* DNA molecules and/or RNA molecules) and/or between polypeptide molecules. Calculation of percent similarity of polymeric molecules to one another can be performed in the same manner as a calculation of percent identity, except that calculation of percent similarity takes into account conservative substitutions as is understood in the art.

[00875] *Split dose*: As used herein, a "split dose" is the division of single unit dose or total daily dose into two or more doses.

[00876] *Stable*: As used herein "stable" refers to a compound that is sufficiently robust to survive isolation to a useful degree of purity from a reaction mixture, and preferably capable of formulation into an efficacious therapeutic agent.

[00877] *Stabilized*: As used herein, the term "stabilize", "stabilized," "stabilized region" means to make or become stable.

[00878] *Subject*: As used herein, the term "subject" or "patient" refers to any organism to which a composition in accordance with the invention may be administered, *e.g.*, for experimental, diagnostic, prophylactic, and/or therapeutic purposes. Typical subjects include animals (*e.g.*, mammals such as mice, rats, rabbits, non-human primates, and humans) and/or plants.

[00879] *Substantially*: As used herein, the term "substantially" refers to the qualitative condition of exhibiting total or near-total extent or degree of a characteristic or property of interest. One of ordinary skill in the biological arts will understand that biological and chemical phenomena rarely, if ever, go to completion and/or proceed to completeness or achieve or avoid an absolute result. The term "substantially" is therefore used herein to capture the potential lack of completeness inherent in many biological and chemical phenomena.

[00880] *Substantially equal*: As used herein as it relates to time differences between doses, the term means plus/minus 2%.

[00881] *Substantially simultaneously*: As used herein and as it relates to plurality of doses, the term means within 2 seconds.

[00882] *Suffering from*: An individual who is "suffering from" a disease, disorder, and/or condition has been diagnosed with or displays one or more symptoms of a disease, disorder, and/or condition.

[00883] *Susceptible to*: An individual who is "susceptible to" a disease, disorder, and/or condition has not been diagnosed with and/or may not exhibit symptoms of the disease, disorder, and/or

condition but harbors a propensity to develop a disease or its symptoms. In some embodiments, an individual who is susceptible to a disease, disorder, and/or condition (for example, cancer) may be characterized by one or more of the following: (1) a genetic mutation associated with development of the disease, disorder, and/or condition; (2) a genetic polymorphism associated with development of the disease, disorder, and/or condition; (3) increased and/or decreased expression and/or activity of a protein and/or nucleic acid associated with the disease, disorder, and/or condition; (4) habits and/or lifestyles associated with development of the disease, disorder, and/or condition; (5) a family history of the disease, disorder, and/or condition; and (6) exposure to and/or infection with a microbe associated with development of the disease, disorder, and/or condition. In some embodiments, an individual who is susceptible to a disease, disorder, and/or condition will develop the disease, disorder, and/or condition. In some embodiments, an individual who is susceptible to a disease, disorder, and/or condition will not develop the disease, disorder, and/or condition.

[00884] *Sustained release*: As used herein, the term "sustained release" refers to a pharmaceutical composition or compound release profile that conforms to a release rate over a specific period of time.

[00885] *Synthetic*: The term "synthetic" means produced, prepared, and/or manufactured by the hand of man. Synthesis of polynucleotides or polypeptides or other molecules of the present invention may be chemical or enzymatic.

[00886] *Targeted Cells*: As used herein, "targeted cells" refers to any one or more cells of interest. The cells may be found *in vitro*, *in vivo*, *in situ* or in the tissue or organ of an organism. The organism may be an animal, preferably a mammal, more preferably a human and most preferably a patient.

[00887] *Therapeutic Agent*: The term "therapeutic agent" refers to any agent that, when administered to a subject, has a therapeutic, diagnostic, and/or prophylactic effect and/or elicits a desired biological and/or pharmacological effect.

[00888] *Therapeutically effective amount*: As used herein, the term "therapeutically effective amount" means an amount of an agent to be delivered (*e.g.*, nucleic acid, drug, therapeutic agent, diagnostic agent, prophylactic agent, *etc.*) that is sufficient, when administered to a subject suffering from or susceptible to an infection, disease, disorder, and/or condition, to treat, improve symptoms of, diagnose, prevent, and/or delay the onset of the infection, disease, disorder, and/or condition.

[00889] *Therapeutically effective outcome*: As used herein, the term "therapeutically effective outcome" means an outcome that is sufficient in a subject suffering from or susceptible to an infection, disease, disorder, and/or condition, to treat, improve symptoms of, diagnose, prevent, and/or delay the onset of the infection, disease, disorder, and/or condition.

[00890] *Total daily dose*: As used herein, a "total daily dose" is an amount given or prescribed in 24 hr period. It may be administered as a single unit dose.

[00891] *Transcription factor*: As used herein, the term "transcription factor" refers to a DNA-binding protein that regulates transcription of DNA into RNA, for example, by activation or repression of transcription. Some transcription factors effect regulation of transcription alone, while others act in concert with other proteins. Some transcription factor can both activate and repress transcription under certain conditions. In general, transcription factors bind a specific target sequence or sequences highly similar to a specific consensus sequence in a regulatory region of a target gene. Transcription factors may regulate transcription of a target gene alone or in a complex with other molecules.

[00892] *Treating*: As used herein, the term "treating" refers to partially or completely alleviating, ameliorating, improving, relieving, delaying onset of, inhibiting progression of, reducing severity of, and/or reducing incidence of one or more symptoms or features of a particular infection, disease, disorder, and/or condition. For example, "treating" cancer may refer to inhibiting survival, growth, and/or spread of a tumor. Treatment may be administered to a subject who does not exhibit signs of a disease, disorder, and/or condition and/or to a subject who exhibits only early signs of a disease, disorder, and/or condition for the purpose of decreasing the risk of developing pathology associated with the disease, disorder, and/or condition.

[00893] *Unmodified*: As used herein, "unmodified" refers to any substance, compound or molecule prior to being changed in any way. Unmodified may, but does not always, refer to the wild type or native form of a biomolecule. Molecules may undergo a series of modifications whereby each modified molecule may serve as the "unmodified" starting molecule for a subsequent modification.

Equivalents and Scope

[00894] Those skilled in the art will recognize, or be able to ascertain using no more than routine experimentation, many equivalents to the specific embodiments in accordance with the invention described herein. The scope of the present invention is not intended to be limited to the above Description, but rather is as set forth in the appended claims.

[00895] In the claims, articles such as "a," "an," and "the" may mean one or more than one unless indicated to the contrary or otherwise evident from the context. Claims or descriptions that include "or" between one or more members of a group are considered satisfied if one, more than one, or all of the group members are present in, employed in, or otherwise relevant to a given product or process unless indicated to the contrary or otherwise evident from the context. The invention includes embodiments in which exactly one member of the group is present in, employed in, or otherwise relevant to a given product or process. The invention includes embodiments in which more than one, or all of the group members are present in, employed in, or otherwise relevant to a given product or process.

[00896] It is also noted that the term "comprising" is intended to be open and permits the inclusion of additional elements or steps.

[00897] Where ranges are given, endpoints are included. Furthermore, it is to be understood that unless otherwise indicated or otherwise evident from the context and understanding of one of ordinary skill in the art, values that are expressed as ranges can assume any specific value or subrange within the stated ranges in different embodiments of the invention, to the tenth of the unit of the lower limit of the range, unless the context clearly dictates otherwise.

[00898] In addition, it is to be understood that any particular embodiment of the present invention that falls within the prior art may be explicitly excluded from any one or more of the claims. Since such embodiments are deemed to be known to one of ordinary skill in the art, they may be excluded even if the exclusion is not set forth explicitly herein. Any particular embodiment of the compositions of the invention (*e.g.*, any nucleic acid or protein encoded thereby; any method of production; any method of use; *etc.*) can be excluded from any one or more claims, for any reason, whether or not related to the existence of prior art.

[00899] All cited sources, for example, references, publications, databases, database entries, and art cited herein, are incorporated into this application by reference, even if not expressly stated in the citation. In case of conflicting statements of a cited source and the instant application, the statement in the instant application shall control.

[00900] Section and table headings are not intended to be limiting.

EXAMPLES

[00901] The invention is further described in the following examples, which do not limit the scope of the invention described in the claims.

Example 1. Modified mRNA Production

[00902] Modified mRNAs (mmRNA) according to the invention may be made using standard laboratory methods and materials. The open reading frame (ORF) of the gene of interest may be flanked by a 5' untranslated region (UTR) which may contain a strong Kozak translational initiation signal and/or an alpha-globin 3' UTR which may include an oligo(dT) sequence for templated addition of a poly-A tail. The modified mRNAs may be modified to reduce the cellular innate immune response. The modifications to reduce the cellular response may include pseudouridine (ψ) and 5-methyl-cytidine (5meC or m⁵C). (see, Kariko K et al. *Immunity* 23:165-75 (2005), Kariko K et al. *Mol Ther* 16:1833-40 (2008), Anderson BR et al. *NAR* (2010); each of which are herein incorporated by reference in their entireties).

[00903] The ORF may also include various upstream or downstream additions (such as, but not limited to, β -globin, tags, etc.) may be ordered from an optimization service such as, but limited to, DNA2.0 (Menlo Park, CA) and may contain multiple cloning sites which may have XbaI recognition. Upon receipt of the plasmid DNA, it may be reconstituted and transformed into chemically competent *E. coli*.

[00904] For the present invention, NEB DH5-alpha Competent *E. coli* are used. Transformations are performed according to NEB instructions using 100 ng of plasmid. The protocol is as follows:

1. Thaw a tube of NEB 5-alpha Competent *E. coli* cells on ice for 10 minutes.
2. Add 1-5 μ l containing 1 pg-100 ng of plasmid DNA to the cell mixture. Carefully flick the tube 4-5 times to mix cells and DNA. Do not vortex.
3. Place the mixture on ice for 30 minutes. Do not mix.
4. Heat shock at 42°C for exactly 30 seconds. Do not mix.
5. Place on ice for 5 minutes. Do not mix.
6. Pipette 950 μ l of room temperature SOC into the mixture.
7. Place at 37°C for 60 minutes. Shake vigorously (250 rpm) or rotate.
8. Warm selection plates to 37°C.
9. Mix the cells thoroughly by flicking the tube and inverting.

[00905] Spread 50-100 μ l of each dilution onto a selection plate and incubate overnight at 37°C. Alternatively, incubate at 30°C for 24-36 hours or 25°C for 48 hours.

[00906] A single colony is then used to inoculate 5 ml of LB growth media using the appropriate antibiotic and then allowed to grow (250 RPM, 37° C) for 5 hours. This is then used to inoculate a 200 ml culture medium and allowed to grow overnight under the same conditions.

[00907] To isolate the plasmid (up to 850 µg), a maxi prep is performed using the Invitrogen PURELINK™ HiPure Maxiprep Kit (Carlsbad, CA), following the manufacturer's instructions.

[00908] In order to generate cDNA for *In Vitro* Transcription (IVT), the plasmid (an Example of which is shown in Figure 2) is first linearized using a restriction enzyme such as XbaI. A typical restriction digest with XbaI will comprise the following: Plasmid 1.0 µg; 10x Buffer 1.0 µl; XbaI 1.5 µl; dH₂O up to 10 µl; incubated at 37° C for 1 hr. If performing at lab scale (< 5µg), the reaction is cleaned up using Invitrogen's PURELINK™ PCR Micro Kit (Carlsbad, CA) per manufacturer's instructions. Larger scale purifications may need to be done with a product that has a larger load capacity such as Invitrogen's standard PURELINK™ PCR Kit (Carlsbad, CA). Following the cleanup, the linearized vector is quantified using the NanoDrop and analyzed to confirm linearization using agarose gel electrophoresis.

[00909] The methods described herein to make modified mRNA may be used to produce molecules of all sizes including long molecules. Modified mRNA using the described methods has been made for different sized molecules including glucosidase, alpha; acid (GAA) (3.2 kb), cystic fibrosis transmembrane conductance regulator (CFTR) (4.7 kb), Factor VII (7.3 kb), lysosomal acid lipase (45.4kDa), glucocerebrosidase (59.7 kDa) and iduronate 2-sulfatase (76 kDa).

[00910] As a non-limiting example, G-CSF may represent the polypeptide of interest. Sequences used in the steps outlined in Examples 1-5 are shown in Table 4. It should be noted that the start codon (ATG) has been underlined in each sequence of Table 4.

Table 4. G-CSF Sequences

SEQ ID NO	Description
3	cDNA sequence: <u>ATGGCTGGACCTGCCACCCAGAGCCCCATGAAGCTGATGGCCCTGCAG</u> CTGCTGCTGTGGCACAGTGC ACTCTGGACAGTGCAGGAAGCCACCCCC CTGGGCCCTGCCAGCTCCCTGCCCCAGAGCTTCCTGCTCAAGTGCTTAG AGCAAGTGAGGAAGATCCAGGGCGATGGCGCAGCGCTCCAGGAGAAG CTGTGTGCCACCTACAAGCTGTGCCACCCCGAGGAGCTGGTGCTGCTC GGACACTCTCTGGGCATCCCCTGGGCTCCCCTGAGCAGCTGCCCCAGCC AGGCCCTGCAGCTGGCAGGCTGCTTGAGCCA ACTCCATAGCGGCCTTTT CCTCTACCAGGGGCTCCTGCAGGCCCTGGAAGGGATCTCCCCCGAGTT GGGTCCCACCTTGGACACACTGCAGCTGGACGTCGCCACTTTGCCAC CACCATCTGGCAGCAGATGGAAGA ACTGGGAATGGCCCCTGCCCTGCA GCCACCCAGGGTGCCATGCCGGCCTTCGCCTCTGCTTTCAGCGCCGG GCAGGAGGGGTCCTGGTTGCCTCCCATCTGCAGAGCTTCCTGGAGGTG TCGTACCGCGTTCTACGCCACCTTGCCCAGCCCTGA

<p>4</p>	<p>cDNA having T7 polymerase site, Afel and Xba restriction site: TAATACGACTCACTATA GGGAAATAAGAGAGAGAAAAGAAGAGTAAGAAGAAATATAAGAGCCACC <u>ATGGCTGGACCTGCCACCCAGAGCCCCATGAAGCTGATGGCCCTGCAG</u> CTGCTGCTGTGGCACAGTGCCTCTGGACAGTGCAGGAAGCCACCCCC CTGGGCCCTGCCAGCTCCCTGCCCCAGAGCTTCCTGCTCAAGTGCTTAG AGCAAGTGAGGAAGATCCAGGGCGATGGCGCAGCGCTCCAGGAGAAG CTGTGTGCCACCTACAAGCTGTGCCACCCCGAGGAGCTGGTGCTGCTC GGACACTCTCTGGGCATCCCCTGGGCTCCCCTGAGCAGCTGCCCCAGCC AGGCCCTGCAGCTGGCAGGCTGCTTGAGCCAACCTCCATAGCGGCCTTTT CCTCTACCAGGGGCTCCTGCAGGCCCTGGAAGGGATCTCCCCGAGTT GGGTCCCACCTTGGACACACTGCAGCTGGACGTCGCCGACTTTGCCAC CACCATCTGGCAGCAGATGGAAGAAGTGGGAATGGCCCCTGCCCTGCA GCCACCCAGGGTGCCATGCCGGCCTTCGCCTCTGCTTTCCAGCGCCGG GCAGGAGGGGTCTGTTGCCTCCCATCTGCAGAGCTTCCTGGAGGTG TCGTACCGCGTTCTACGCCACCTTGCCAGCCCTGA AGCGCTGCCTTCTGCGGGGCTTGCCTTCTGGCCATGCCCTTCTTCTCTCC CTTGACCTGTACCTCTTGGTCTTTGAATAAAGCCTGAGTAGGAAGGCG GCCGCTCGAGCATGCATCTAGA</p>
<p>5</p>	<p>Optimized sequence; containing T7 polymerase site, Afel and Xba restriction site TAATACGACTCACTATA GGGAAATAAGAGAGAGAAAAGAAGAGTAAGAAGAAATATAAGAGCCACC <u>ATGGCCGGTCCCGCGACCCAAAGCCCCATGAACTTATGGCCCTGCAG</u> TTGCTGCTTTGGCACTCGGCCCTCTGGACAGTCCAAGAAGCGACTCCTC TCGGACCTGCCTCATCGTTGCCGCAGTCATTCCTTTTGAAGTGTCTGGA GCAGGTGCGAAAGATTCAGGGCGATGGAGCCGCACTCCAAGAGAAGC TCTGCGCGACATAAACTTTGCCATCCCGAGGAGCTCGTACTGCTCGG GCACAGCTTGGGGATTCCCTGGGCTCCTCTCTCGTCCTGTCCGTCGCAG GCTTTGCAGTTGGCAGGGTGCCTTTCCAGCTCCACTCCGGTTTGTCTT GTATCAGGGACTGCTGCAAGCCCTTGAGGGAATCTCGCCAGAATTGGG CCCGACGCTGGACACGTTGCAGCTCGACGTGGCGGATTTGCAACAAC CATCTGGCAGCAGATGGAGGAACTGGGGATGGCACCCGCGCTGCAGCC CACGCAGGGGGCAATGCCGGCCTTTGCGTCCGCGTTTCAGCGCAGGGC GGGTGGAGTCTCGTAGCGAGCCACCTTCAATCATTTTTGGAAGTCTCG TACCGGGTGCTGAGACATCTTGCGCAGCCGTGA AGCGCTGCCTTCTGCGGGGCTTGCCTTCTGGCCATGCCCTTCTTCTCTCC CTTGACCTGTACCTCTTGGTCTTTGAATAAAGCCTGAGTAGGAAGGCG GCCGCTCGAGCATGCATCTAGA</p>
<p>6</p>	<p>mRNA sequence (transcribed) GGGAAUAAGAGAGAGAAAAGAAGAGUAAGAAGAAUAUAAGAGCCAC C <u>AUGCCGGUCCCGCGACCCAAAGCCCCAUGAAACUUAUGGCCUGCA</u></p>

<p> GUUGCUGCUUUGGCACUCGGCCUCUGGACAGUCCAAGAAGCGACUC CUCUCGGACCUGCCUCAUCGUUGCCGCAGUCAUCCUUUGAAGUGU CUGGAGCAGGUGCGAAAGAUUCAGGGCGAUGGAGCCGCACUCCAAG AGAAGCUCUGCGCGACAUACAAACUUUGCCAUCCCGAGGAGCUCGUA CUGCUCGGGCACAGCUUGGGGAUUCCUGGGCUCUCUCUGUCCUG UCCGUCGCAGGCUUUGCAGUUGGCAGGGUGCCUUUCCAGCUCCACU CCGGUUUGUUCUUGUAUCAGGGACUCUGCAAGCCCUUGAGGGAAU CUCGCCAGAAUUGGGCCCGACGCUGGACACGUUGCAGCUCGACGUGG CGGAUUUCGCAACAACCAUCUGGCAGCAGAUGGAGGAACUGGGGAU GGCACCCGCGCUGCAGCCACGCAGGGGGCAAUGCCGGCCUUUGCGU CCGCGUUUCAGCGCAGGGCGGGUGGAGUCCUCGUAGCGAGCCACCUU CAAUCAUUUUUGGAAGUCUCGUACCGGGUGCUGAGACAUCUUGCGC AGCCGUGA AGCGCUGCCUUCUGCGGGGCUUGCCUUCUGGCCAUGCCCUUCUUCUC UCCCUUGCACCUGUACCUCUUGGUCUUUGAAUAAAGCCUGAGUAGGA AG </p>
--

Example 2: PCR for cDNA Production

[00911] PCR procedures for the preparation of cDNA are performed using 2x KAPA HIFI™ HotStart ReadyMix by Kapa Biosystems (Woburn, MA). This system includes 2x KAPA ReadyMix 12.5 μl; Forward Primer (10 uM) 0.75 μl; Reverse Primer (10 uM) 0.75 μl; Template cDNA 100 ng; and dH₂O diluted to 25.0 μl. The reaction conditions are at 95° C for 5 min. and 25 cycles of 98° C for 20 sec, then 58° C for 15 sec, then 72° C for 45 sec, then 72° C for 5 min. then 4° C to termination.

[00912] The reverse primer of the instant invention incorporates a poly-Ti₂O for a poly-Ai₂O in the mRNA. Other reverse primers with longer or shorter poly(T) tracts can be used to adjust the length of the poly(A) tail in the mRNA.

[00913] The reaction is cleaned up using Invitrogen's PURELINK™ PCR Micro Kit (Carlsbad, CA) per manufacturer's instructions (up to 5 μg). Larger reactions will require a cleanup using a product with a larger capacity. Following the cleanup, the cDNA is quantified using the NANODROP™ and analyzed by agarose gel electrophoresis to confirm the cDNA is the expected size. The cDNA is then submitted for sequencing analysis before proceeding to the *in vitro* transcription reaction.

Example 3. *In vitro* Transcription

[00914] The *in vitro* transcription reaction generates mRNA containing modified nucleotides or modified RNA. The input nucleotide triphosphate (NTP) mix is made in-house using natural and unnatural NTPs.

[00915] A typical *in vitro* transcription reaction includes the following:

1. Template cDNA 1.0 µg
2. IOx transcription buffer (400 mM Tris-HCl pH 8.0, 190 mM MgCl₂, 50 mM DTT, 10 mM Spermidine) 2.0 µl
3. Custom NTPs (25mM each) 7.2 µl
4. RNase Inhibitor 20 U
5. T7 RNA polymerase 3000 U
6. d³40 Up to 20.0 µl. and
7. Incubation at 37° C for 3 hr-5 hrs.

[00916] The crude IVT mix may be stored at 4° C overnight for cleanup the next day. 1 U of RNase-free DNase is then used to digest the original template. After 15 minutes of incubation at 37° C, the mRNA is purified using Ambion's MEGACLEAR™ Kit (Austin, TX) following the manufacturer's instructions. This kit can purify up to 500 µg of RNA. Following the cleanup, the RNA is quantified using the NanoDrop and analyzed by agarose gel electrophoresis to confirm the RNA is the proper size and that no degradation of the RNA has occurred.

Example 4. Enzymatic Capping of mRNA

[00917] Capping of the mRNA is performed as follows where the mixture includes: IVT RNA 60 µg-180µg and dH₂O up to 72 µl. The mixture is incubated at 65° C for 5 minutes to denature RNA, and then is transferred immediately to ice.

[00918] The protocol then involves the mixing of IOx Capping Buffer (0.5 M Tris-HCl (pH 8.0), 60 mM KCl, 12.5 mM MgCl₂) (10.0 µl); 20 mM GTP (5.0 µl); 20 mM S-Adenosyl Methionine (2.5 µl); RNase Inhibitor (100 U); 2'-O-Methyltransferase (400U); Vaccinia capping enzyme (Guanylyl transferase) (40 U); dH₂O (Up to 28 µl); and incubation at 37° C for 30 minutes for 60 µg RNA or up to 2 hours for 180 µg of RNA.

[00919] The mRNA is then purified using Ambion's MEGACLEAR™ Kit (Austin, TX) following the manufacturer's instructions. Following the cleanup, the RNA is quantified using the NANODROP™ (ThermoFisher, Waltham, MA) and analyzed by agarose gel electrophoresis to confirm the RNA is the proper size and that no degradation of the RNA has occurred. The RNA

product may also be sequenced by running a reverse-transcription-PCR to generate the cDNA for sequencing.

Example 5. PolyA Tailing Reaction

[00920] Without a poly-T in the cDNA, a poly-A tailing reaction must be performed before cleaning the final product. This is done by mixing Capped IVT RNA (100 μr); RNase Inhibitor (20 U); IOx Tailing Buffer (0.5 M Tris-HCl (pH 8.0), 2.5 M NaCl, 100 mM MgCl_2)(12.0 μr); 20 mM ATP (6.0 μr); Poly-A Polymerase (20 U); dH_2O up to 123.5 μr and incubation at 37° C for 30 min. If the poly-A tail is already in the transcript, then the tailing reaction may be skipped and proceed directly to cleanup with Ambion's MEGACLEAR™ kit (Austin, TX) (up to 500 μg). Poly-A Polymerase is preferably a recombinant enzyme expressed in yeast.

[00921] For studies performed and described herein, the poly-A tail is encoded in the IVT template to comprise 160 nucleotides in length. However, it should be understood that the processivity or integrity of the polyA tailing reaction may not always result in exactly 160 nucleotides. Hence polyA tails of approximately 160 nucleotides, e.g, about 150-165, 155, 156, 157, 158, 159, 160, 161, 162, 163, 164 or 165 are within the scope of the invention.

Example 6. Natural 5' Caps and 5' Cap Analogues

[00922] 5'-capping of modified RNA may be completed concomitantly during the *in vitro*-transcription reaction using the following chemical RNA cap analogs to generate the 5'-guanosine cap structure according to manufacturer protocols: 3'-0-Me-m7G(5')ppp(5') G [the ARCA cap];G(5')ppp(5')A; G(5')ppp(5')G; m7G(5')ppp(5')A; m7G(5')ppp(5')G (New England BioLabs, Ipswich, MA). 5'-capping of modified RNA may be completed post-transcriptionally using a Vaccinia Virus Capping Enzyme to generate the "Cap 0" structure: m7G(5')ppp(5')G (New England BioLabs, Ipswich, MA). Cap 1 structure may be generated using both Vaccinia Virus Capping Enzyme and a 2'-0 methyl-transferase to generate: m7G(5')ppp(5')G-2'-0-methyl. Cap 2 structure may be generated from the Cap 1 structure followed by the 2'-0-methylation of the 5'-antepenultimate nucleotide using a 2'-0 methyl-transferase. Cap 3 structure may be generated from the Cap 2 structure followed by the 2'-0-methylation of the 5'-preantepenultimate nucleotide using a 2'-0 methyl-transferase. Enzymes are preferably derived from a recombinant source.

[00923] When transfected into mammalian cells, the modified mRNAs have a stability of between 12-18 hours or more than 18 hours, e.g., 24, 36, 48, 60, 72 or greater than 72 hours.

Example 7. Capping

A. Protein Expression Assay

[00924] Synthetic mRNAs encoding human G-CSF (cDNA shown in SEQ ID NO: 5; mRNA sequence fully modified with 5-methylcytosine at each cytosine and pseudouridine replacement at each uridine site shown in SEQ ID NO: 6 with a polyA tail approximately 160 nucleotides in length not shown in sequence) containing the ARCA (3' 0-Me-m⁷G(5')ppp(5')G) cap analog or the Cap1 structure can be transfected into human primary keratinocytes at equal concentrations. 6, 12, 24 and 36 hours post-transfection the amount of G-CSF secreted into the culture medium can be assayed by ELISA. Synthetic mRNAs that secrete higher levels of G-CSF into the medium would correspond to a synthetic mRNA with a higher translationally-competent Cap structure.

B. Purity Analysis Synthesis

[00925] Synthetic mRNAs encoding human G-CSF (cDNA shown in SEQ ID NO: 5; mRNA sequence fully modified with 5-methylcytosine at each cytosine and pseudouridine replacement at each uridine site shown in SEQ ID NO: 6 with a polyA tail approximately 160 nucleotides in length not shown in sequence) containing the ARCA cap analog or the Cap1 structure crude synthesis products can be compared for purity using denaturing Agarose-Urea gel electrophoresis or HPLC analysis. Synthetic mRNAs with a single, consolidated band by electrophoresis correspond to the higher purity product compared to a synthetic mRNA with multiple bands or streaking bands. Synthetic mRNAs with a single HPLC peak would also correspond to a higher purity product. The capping reaction with a higher efficiency would provide a more pure mRNA population.

C. Cytokine Analysis

[00926] Synthetic mRNAs encoding human G-CSF (cDNA shown in SEQ ID NO: 5; mRNA sequence fully modified with 5-methylcytosine at each cytosine and pseudouridine replacement at each uridine site shown in SEQ ID NO: 6 with a polyA tail approximately 160 nucleotides in length not shown in sequence) containing the ARCA cap analog or the Cap1 structure can be transfected into human primary keratinocytes at multiple concentrations. 6, 12, 24 and 36 hours post-transfection the amount of pro-inflammatory cytokines such as TNF-alpha and IFN-beta secreted into the culture medium can be assayed by ELISA. Synthetic mRNAs that secrete higher levels of pro-inflammatory cytokines into the medium would correspond to a synthetic mRNA containing an immune-activating cap structure.

D. Capping Reaction Efficiency

[00927] Synthetic mRNAs encoding human G-CSF (cDNA shown in SEQ ID NO: 5; mRNA sequence fully modified with 5-methylcytosine at each cytosine and pseudouridine replacement at each uridine site shown in SEQ ID NO: 6 with a polyA tail approximately 160 nucleotides in length not shown in sequence) containing the ARCA cap analog or the Cap1 structure can be analyzed for capping reaction efficiency by LC-MS after capped mRNA nuclease treatment. Nuclease treatment of capped mRNAs would yield a mixture of free nucleotides and the capped 5'-5'-triphosphate cap structure detectable by LC-MS. The amount of capped product on the LC-MS spectra can be expressed as a percent of total mRNA from the reaction and would correspond to capping reaction efficiency. The cap structure with higher capping reaction efficiency would have a higher amount of capped product by LC-MS.

Example 8. Agarose Gel Electrophoresis of Modified RNA or RT PCR Products

[00928] Individual modified RNAs (200-400 ng in a 20 μ l volume) or reverse transcribed PCR products (200-400 ng) are loaded into a well on a non-denaturing 1.2% Agarose E-Gel (Invitrogen, Carlsbad, CA) and run for 12-15 minutes according to the manufacturer protocol.

Example 9. Formulation of Modified mRNA Using Lipidoids

[00929] Modified mRNAs (mmRNA) are formulated for *in vitro* experiments by mixing the mmRNA with the lipidoid at a set ratio prior to addition to cells. *In vivo* formulation may require the addition of extra ingredients to facilitate circulation throughout the body. To test the ability of these lipidoids to form particles suitable for *in vivo* work, a standard formulation process used for siRNA-lipidoid formulations was used as a starting point. Initial mmRNA-lipidoid formulations may consist of particles composed of 42% lipidoid, 48% cholesterol and 10% PEG, with further optimization of ratios possible. After formation of the particle, mmRNA is added and allowed to integrate with the complex. The encapsulation efficiency is determined using a standard dye exclusion assays.

Materials and Methods for Examples 10-14

A. Lipid Synthesis

[00930] Six lipids, DLin-DMA, DLin-K-DMA, DLin-KC2-DMA, 98N12-5, CI2-200 and DLin-MC3-DMA, were synthesized by methods outlined in the art in order to be formulated with modified RNA. DLin-DMA and precursors were synthesized as described in Heyes et. al, *J. Control Release*, 2005, 107, 276-287. DLin-K-DMA and DLin-KC2-DMA and precursors were synthesized as

described in Semple et. al, *Nature Biotechnology*, 2010, 28, 172-176. 98N12-5 and precursor were synthesized as described in Akinc et. al, *Nature Biotechnology*, 2008, 26, 561-569.

[00931] CI2-200 and precursors were synthesized according to the method outlined in Love et. al, *PNAS*, 2010, 107, 1864-1869. 2-epoxydodecane (5.10 g, 27.7 mmol, 8.2 eq) was added to a vial containing Amine 200 (0.723 g, 3.36 mmol, 1 eq) and a stirring bar. The vial was sealed and warmed to 80°C. The reaction was stirred for 4 days at 80°C. Then the mixture was purified by silica gel chromatography using a gradient from pure dichloromethane (DCM) to DCM:MeOH 98:2. The target compound was further purified by RP-HPLC to afford the desired compound.

[00932] DLin-MC3-DMA and precursors were synthesized according to procedures described in WO 2010054401 herein incorporated by reference in its entirety. A mixture of dilinoleyl methanol (1.5 g, 2.8 mmol, 1 eq), N,N-dimethylaminobutyric acid (1.5 g, 2.8 mmol, 1 eq), DIPEA (0.73 mL, 4.2 mmol, 1.5 eq) and TBTU (1.35 g, 4.2 mmol, 1.5 eq) in 10 mL of DMF was stirred for 10 h at room temperature. Then the reaction mixture was diluted in ether and washed with water. The organic layer was dried over anhydrous sodium sulfate, filtrated and concentrated under reduced pressure. The crude product was purified by silica gel chromatography using a gradient DCM to DCM:MeOH 98:2. Subsequently the target compound was subjected to an additional RP-HPLC purification which was done using a YMC - Pack C4 column to afford the target compound.

B. Formulation of Modified RNA Nanoparticles

[00933] Solutions of synthesized lipid, 1,2-distearoyl-3-phosphatidylcholine (DSPC) (Avanti Polar Lipids, Alabaster, AL), cholesterol (Sigma-Aldrich, Taufkirchen, Germany), and α -[3'-(1,2-dimyristoyl-3-propanoxy)-carboxamide-propyl]- ω -methoxy-polyoxy ethylene (PEG-c-DOMG) (NOF, Bouwelven, Belgium) were prepared at concentrations of 50 mM in ethanol and stored at -20°C. The lipids were combined to yield molar ratio of 50:10:38.5:1.5 (Lipid: DSPC: Cholesterol: PEG-c-DOMG) and diluted with ethanol to a final lipid concentration of 25 mM. Solutions of modified mRNA at a concentration of 1-2 mg/mL in water were diluted in 50 mM sodium citrate buffer at a pH of 3 to form a stock modified mRNA solution. Formulations of the lipid and modified mRNA were prepared by combining the synthesized lipid solution with the modified mRNA solution at total lipid to modified mRNA weight ratio of 10:1, 15:1, 20:1 and 30:1. The lipid ethanolic solution was rapidly injected into aqueous modified mRNA solution to afford a suspension containing 33% ethanol. The solutions were injected either manually (MI) or by the aid of a syringe pump (SP) (Harvard Pump 33 Dual Syringe Pump Harvard Apparatus Holliston, MA).

[00934] To remove the ethanol and to achieve the buffer exchange, the formulations were dialyzed twice against phosphate buffered saline (PBS), pH 7.4 at volumes 200-times of the primary product using a Slide-A-Lyzer cassettes (Thermo Fisher Scientific Inc. Rockford, IL) with a molecular weight cutoff (MWCO) of 10 kD. The first dialysis was carried at room temperature for 3 hours and then the formulations were dialyzed overnight at 4°C. The resulting nanoparticle suspension was filtered through 0.2 µm sterile filter (Sarstedt, Numbrecht, Germany) into glass vials and sealed with a crimp closure.

C. Characterization of formulations

[00935] A Zetasizer Nano ZS (Malvern Instruments Ltd, Malvern, Worcestershire, UK) was used to determine the particle size, the polydispersity index (PDI) and the zeta potential of the modified mRNA nanoparticles in IX PBS in determining particle size and 15 mM PBS in determining zeta potential.

[00936] Ultraviolet-visible spectroscopy was used to determine the concentration of modified mRNA nanoparticle formulation. 100 µL of the diluted formulation in IX PBS was added to 900 µL of a 4:1 (v/v) mixture of methanol and chloroform. After mixing, the absorbance spectrum of the solution was recorded between 230 nm and 330 nm on a DU 800 spectrophotometer (Beckman Coulter, Beckman Coulter, Inc., Brea, CA). The modified RNA concentration in the nanoparticle formulation was calculated based on the extinction coefficient of the modified RNA used in the formulation and on the difference between the absorbance at a wavelength of 260 nm and the baseline value at a wavelength of 330 nm.

[00937] QUANT-IT™ RIBOGREEN® RNA assay (Invitrogen Corporation Carlsbad, CA) was used to evaluate the encapsulation of modified RNA by the nanoparticle. The samples were diluted to a concentration of approximately 5 µg/mL in TE buffer (10 mM Tris-HCl, 1 mM EDTA, pH 7.5). 50 µL of the diluted samples were transferred to a polystyrene 96 well plate, then either 50 µL of TE buffer or 50 µL of a 2% Triton X-100 solution was added. The plate was incubated at a temperature of 37°C for 15 minutes. The RIBOGREEN® reagent was diluted 1:100 in TE buffer, 100 µL of this solution was added to each well. The fluorescence intensity was measured using a fluorescence plate reader (Wallac Victor 1420 Multilabel Counter; Perkin Elmer, Waltham, MA) at an excitation wavelength of 480 nm and an emission wavelength of 520 nm. The fluorescence values of the reagent blank were subtracted from that of each of the samples and the percentage of free modified RNA was determined by dividing the fluorescence intensity of the intact sample (without addition of

Triton X-100) by the fluorescence value of the disrupted sample (caused by the addition of Triton X-100).

D. *In Vitro* Incubation

[00938] Human embryonic kidney epithelial (HEK293) and hepatocellular carcinoma epithelial (HepG2) cells (LGC standards GmbH, Wesel, Germany) were seeded on 96-well plates (Greiner Bio-one GmbH, Frickenhausen, Germany) and plates for HEK293 cells were precoated with collagen type I. HEK293 were seeded at a density of 30,000 and HepG2 were seeded at a density of 35,000 cells per well in 100 μ l cell culture medium. For HEK293 the cell culture medium was DMEM, 10% FCS, adding 2mM L-Glutamine, 1 mM Sodiumpyruvate and 1x non-essential amino acids (Biochrom AG, Berlin, Germany) and 1.2 mg/ml Sodiumbicarbonate (Sigma-Aldrich, Munich, Germany) and for HepG2 the culture medium was MEM (Gibco Life Technologies, Darmstadt, Germany), 10% FCS adding 2mM L-Glutamine, 1 mM Sodiumpyruvate and 1x non-essential amino acids (Biochrom AG, Berlin, Germany). Formulations containing mCherry mRNA (mRNA sequence shown in SEQ ID NO: 7; polyA tail of approximately 160 nucleotides not shown in sequence; 5'cap, Cap1); were added in quadruplicates directly after seeding the cells and incubated. The mCherry cDNA with the T7 promoter, 5'untranslated region (UTR) and 3' UTR used in *in vitro* transcription (IVT) is given in SEQ ID NO: 8. The mCherry mRNA was modified with 5mC at each cytosine and pseudouridine replacement at each uridine site.

[00939] Cells were harvested by transferring the culture media supernatants to a 96-well Pro-Bind U-bottom plate (Beckton Dickinson GmbH, Heidelberg, Germany). Cells were trypsinized with 1/2 volume Trypsin/EDTA (Biochrom AG, Berlin, Germany), pooled with respective supernatants and fixed by adding one volume PBS/2% FCS (both Biochrom AG, Berlin, Germany)/0.5% formaldehyde (Merck, Darmstadt, Germany). Samples then were submitted to a flow cytometer measurement with a 532nm excitation laser and the 610/20 filter for PE-Texas Red in a LSRII cytometer (Beckton Dickinson GmbH, Heidelberg, Germany). The mean fluorescence intensity (MFI) of all events and the standard deviation of four independent wells are presented in for samples analyzed.

Example 10. Purification of Nanoparticle Formulations

[00940] Nanoparticle formulations of DLin-KC2-DMA and 98N12-5 in HEK293 and HepG2 were tested to determine if the mean fluorescent intensity (MFI) was dependent on the lipid to modified RNA ratio and/or purification. Three formulations of DLin-KC2-DMA and two formulations of

98N12-5 were produced using a syringe pump to the specifications described in Table 5. Purified samples were purified by SEPHADEX™ G-25 DNA grade (GE Healthcare, Sweden). Each formulation before and after purification (aP) was tested at concentration of 250 ng modified RNA per well in a 24 well plate. The percentage of cells that are positive for the marker for FL4 channel (%FL4-positive) when analyzed by the flow cytometer for each formulation and the background sample and the MFI of the marker for the FL4 channel for each formulation and the background sample are shown in Table 6. The formulations which had been purified had a slightly higher MFI than those formulations tested before purification.

Table 5. Formulations

Formulation #	Lipid	Lipid/RNA wt/wt	Mean size (nm)
NPA-001-1	DLin-KC2-DMA	10	155 nm PDI: 0.08
NPA-001-1 aP	DLin-KC2-DMA	10	141 nm PDI: 0.14
NPA-002-1	DLin-KC2-DMA	15	140 nm PDI: 0.11
NPA-002-1 aP	DLin-KC2-DMA	15	125 nm PDI: 0.12
NPA-003-1	DLin-KC2-DMA	20	114 nm PDI: 0.08
NPA-003-1 aP	DLin-KC2-DMA	20	104 nm PDI: 0.06
NPA-005-1	98N12-5	15	127 nm PDI: 0.12
NPA-005-1 aP	98N12-5	15	134 nm PDI: 0.17
NPA-006-1	98N12	20	126 nm PDI: 0.08
NPA-006-1 aP	98N12	20	118 nm PDI: 0.13

Table 6. HEK293 and HepG2, 24-well, 250 ng Modified RNA/well

Formulation	%FL4-positive		FL4 MFI	
	HEK293	HepG2	HEK293	HepG2
Untreated	0.33	0.40	0.25	0.30
NPA-001-1	62.42	5.68	1.49	0.41
NPA-001-ap	87.32	9.02	3.23	0.53
NPA-002-1	91.28	9.90	4.43	0.59
NPA-002-ap	92.68	14.02	5.07	0.90
NPA-003-1	87.70	11.76	6.83	0.88
NPA-003-ap	88.88	15.46	8.73	1.06
NPA-005-1	50.60	4.75	1.83	0.46
NPA-005-ap	38.64	5.16	1.32	0.46
NPA-006-1	54.19	13.16	1.30	0.60
NPA-006-ap	49.97	13.74	1.27	0.61

Example 11. Concentration Response Curve

[00941] Nanoparticle formulations of 98N12-5 (NPA-005) and DLin-KC2-DMA (NPA-003) were tested at varying concentrations to determine the MFI of FL4 or mCherry (mRNA sequence shown in SEQ ID NO: 7; polyA tail of approximately 160 nucleotides not shown in sequence; 5'cap, Cap1; fully modified with 5-methylcytosine and pseudouridine) over a range of doses. The formulations tested are outlined in Table 7. To determine the optimal concentration of nanoparticle formulations of 98N12-5, varying concentrations of formulated modified RNA (100 ng, 10 ng, 1.0 ng, 0.1 ng and 0.01 ng per well) were tested in a 24-well plate of HEK293, and the results of the FL4 MFI of each dose are shown in Table 8. Likewise, to determine the optimal concentration of nanoparticle formulations of DLin-KC2-DMA, varying concentrations of formulated modified RNA (250 ng 100 ng, 10 ng, 1.0 ng, 0.1 ng and 0.01 ng per well) were tested in a 24-well plate of HEK293, and the results of the FL4 MFI of each dose are shown in Table 9. Nanoparticle formulations of DLin-KC2-DMA were also tested at varying concentrations of formulated modified RNA (250 ng, 100 ng and 30 ng per well) in a 24 well plate of HEK293, and the results of the FL4 MFI of each dose are shown in Table 10. A dose of 1 ng/well for 98N12-5 and a dose of 10 ng/well for DLin-KC2-DMA were found to resemble the FL4 MFI of the background.

[00942] To determine how close the concentrations resembled the background, we utilized a flow cytometer with optimized filter sets for detection of mCherry expression, and were able to obtain results with increased sensitivity relative to background levels. Doses of 25 ng/well, 0.25 ng/well, 0.025 ng/well and 0.0025 ng/well were analyzed for 98N12-5 (NPA-005) and DLin-KC2-DMA (NPA-003) to determine the MFI of mCherry. As shown in Table 11, the concentration of 0.025 ng/well and lesser concentrations are similar to the background MFI level of mCherry which is about 386.125.

Table 7. Formulations

Formulation #	NPA-003	NPA-005
Lipid	DLin-KC2-DMA	98N12-5
Lipid/RNA wt/wt	20	15
Mean size	114 nm PDI: 0.08	106 nm PDI: 0.12

Table 8. HEK293, NPA-005, 24-well, n=4

Formulation	FL4 MFI
-------------	---------

Untreated control	0.246
NPA-005 100 ng	2.2175
NPA-005 10 ng	0.651
NPA-005 1.0 ng	0.28425
NPA-005 0.1 ng	0.27675
NPA-005 0.01 ng	0.2865

Table 9. HEK293, NPA-003, 24-well, n=4

Formulation	FL4 MFI
Untreated control	0.3225
NPA-003 250 ng	2.9575
NPA-003 100 ng	1.255
NPA-003 10 ng	0.40025
NPA-003 1 ng	0.33025
NPA-003 0.1 ng	0.34625
NPA-003 0.01 ng	0.3475

Table 10. HEK293, NPA-003, 24-well, n=4

Formulation	FL4 MFI
Untreated control	0.27425
NPA-003 250 ng	5.6075
NPA-003 100 ng	3.7825
NPA-003 30 ng	1.5525

Table 11. Concentration and MFI

Formulation	MFI mCherry	
	NPA-003	NPA-005
25 ng/well	11963.25	12256.75
0.25 ng/well	1349.75	2572.75
0.025 ng/well	459.50	534.75
0.0025 ng/well	310.75	471.75

Example 12. Manual Injection and Syringe Pump Formulations

[00943] Two formulations of DLin-KC2-DMA and 98N12-5 were prepared by manual injection (MI) and syringe pump injection (SP) and analyzed along with a background sample to compare the MFI of mCherry (mRNA sequence shown in SEQ ID NO: 7; polyA tail of approximately 160 nucleotides not shown in sequence; 5'cap, Cap1; fully modified with 5-methylcytosine and pseudouridine) of the different formulations. Table 12 shows that the syringe pump formulations had a higher MFI as compared to the manual injection formulations of the same lipid and lipid/RNA ratio.

Table 12. Formulations and MFI

Formulation #	Lipid	Lipid/RNA wt/wt	Mean size (nm)	Method of formulation	MFI
Untreated Control	N/A	N/A	N/A	N/A	674.67
NPA-002	DLin-KC2-DMA	15	140 nm PDI: 0.11	MI	10318.25
NPA-002-2	DLin-KC2-DMA	15	105 nm PDI: 0.04	SP	37054.75
NPA-003	DLin-KC2-DMA	20	114 nm PDI: 0.08	MI	22037.5
NPA-003-2	DLin-KC2-DMA	20	95 nm PDI: 0.02	SP	37868.75
NPA-005	98N12-5	15	127 nm PDI: 0.12	MI	11504.75
NPA-005-2	98N12-5	15	106 nm PDI: 0.07	SP	9343.75
NPA-006	98N12-5	20	126 nm PDI: 0.08	MI	11182.25
NPA-006-2	98N12-5	20	93 nm PDI: 0.08	SP	5167

Example 13. LNP Formulations

[00944] Formulations of DLin-DMA, DLin-K-DMA, DLin-KC2-DMA, 98N12-5, CI2-200 and DLin-MC3-DMA were incubated at a concentration of 60 ng/well or 62.5 ng/well in a plate of HEK293 and 62.5 ng/well in a plate of HepG2 cells for 24 hours to determine the MFI of mCherry (mRNA sequence shown in SEQ ID NO: 7; polyA tail of approximately 160 nucleotides not shown in sequence; 5'cap, Cap1; fully modified with 5-methylcytosine and pseudouridine) for each formulation. The formulations tested are outlined in Table 13 below. As shown in Table 14 for the 60 ng/well and Tables 15, 16, 17 and 18 for the 62.5 ng/well, the formulation of NPA-003 and NPA-018 have the highest mCherry MFI and the formulations of NPA-008, NPA-010 and NPA-013 are most similar to the background sample mCherry MFI value.

Table 13. Formulations

Formulation #	Lipid	Lipid/RNA wt/wt	Mean size (nm)
NPA-001	DLin-KC2-DMA	10	155 nm PDI: 0.08
NPA-002	DLin-KC2-DMA	15	140 nm PDI: 0.11
NPA-002-2	DLin-KC2-DMA	15	105 nm PDI: 0.04
NPA-003	DLin-KC2-DMA	20	114 nm PDI: 0.08
NPA-003-2	DLin-KC2-DMA	20	95 nm PDI: 0.02

NPA-005	98N12-5	15	127 nm PDI: 0.12
NPA-006	98N12-5	20	126 nm PDI: 0.08
NPA-007	DLin-DMA	15	148 nm PDI: 0.09
NPA-008	DLin-K-DMA	15	121 nm PDI: 0.08
NPA-009	C12-200	15	138 nm PDI: 0.15
NPA-010	DLin-MC3-DMA	15	126 nm PDI: 0.09
NPA-012	DLin-DMA	20	86 nm PDI: 0.08
NPA-013	DLin-K-DMA	20	104 nm PDI: 0.03
NPA-014	C12-200	20	101 nm PDI: 0.06
NPA-015	DLin-MC3-DMA	20	109 nm PDI: 0.07

Table 14. HEK293, 96-well, 60 ng Modified RNA/well

Formulation	MFI mCherry
Untreated	871.81
NPA-001	6407.25
NPA-002	14995
NPA-003	29499.5
NPA-005	3762
NPA-006	2676
NPA-007	9905.5
NPA-008	1648.75
NPA-009	2348.25
NPA-010	4426.75
NPA-012	11466
NPA-013	2098.25
NPA-014	3194.25
NPA-015	14524

Table 15. HEK293, 62.5 ng /well

Formulation	MFI mCherry
Untreated	871.81
NPA-001	6407.25
NPA-002	14995
NPA-003	29499.5
NPA-005	3762
NPA-006	2676
NPA-007	9905.5
NPA-008	1648.75
NPA-009	2348.25
NPA-010	4426.75

NPA-012	11466
NPA-013	2098.25
NPA-014	3194.25
NPA-015	14524

Table 16. HEK293, 62.5 ng /well

Formulation	MFI mCherry
Untreated	295
NPA-007	3504
NPA-012	8286
NPA-017	6128
NPA-003-2	17528
NPA-018	34142
NPA-010	1095
NPA-015	5859
NPA-019	3229

Table 17. HepG2, 62.5 ng /well

Formulation	MFI mCherry
Untreated	649.94
NPA-001	6006.25
NPA-002	8705
NPA-002-2	15860.25
NPA-003	15059.25
NPA-003-2	28881
NPA-005	1676
NPA-006	1473
NPA-007	15678
NPA-008	2976.25
NPA-009	961.75
NPA-010	3301.75
NPA-012	18333.25
NPA-013	5853
NPA-014	2257
NPA-015	16225.75

Table 18. HepG2, 62.5 ng /well

Formulation	MFI mCherry
Untreated control	656
NPA-007	16798
NPA-012	21993
NPA-017	20377
NPA-003-2	35651
NPA-018	40154
NPA-010	2496
NPA-015	19741
NPA-019	16373

Example 14. *In vivo* formulation studies

[00945] Rodents (n=5) are administered intravenously, subcutaneously or intramuscularly a single dose of a formulation containing at least one modified mRNA and a lipid. The modified mRNA administered to the rodents is selected from G-CSF (mRNA sequence shown in SEQ ID NO: 6; polyA tail of approximately 160 nucleotides not shown in sequence; 5'cap, Cap1), erythropoietin (EPO) (mRNA sequence shown in SEQ ID NO: 9; polyA tail of approximately 160 nucleotides not shown in sequence; 5'cap, Cap1), Factor IX (mRNA shown in SEQ ID NO: 10; polyA tail of approximately 160 nucleotides not shown in sequence; 5'cap, Cap1) or mCherry (mRNA sequence shown in SEQ ID NO: 7; polyA tail of approximately 160 nucleotides not shown in sequence; 5'cap, Cap1). The erythropoietin cDNA with the T7 promoter, 5'untranslated region (UTR) and 3' UTR used in *in vitro* transcription (IVT) is given in SEQ ID NO: 11 and SEQ ID NO: 12.

[00946] Each formulation also contains a lipid which is selected from one of DLin-DMA, DLin-K-DMA, DLin-KC2-DMA, 98N12-5, C 12-200, DLin-MC3 -DMA, reLNP, ATUPLEX®, DACC, and DBTC. The rodents are injected with 100ug, 10 ug or 1 ug of the formulated modified mRNA and samples are collected at specified time intervals.

[00947] Serum from the rodents administered formulations containing human G-CSF modified mRNA are measured by specific G-CSF ELISA and serum from mice administered human factor IX modified RNA is analyzed by specific factor IX ELISA or chromogenic assay. The liver and spleen from the mice administered with mCherry modified mRNA are analyzed by immunohistochemistry (IHC) or fluorescence-activated cell sorting (FACS). As a control, a group of mice are not injected with any formulation and their serum and tissue are collected analyzed by ELISA, FACS and/or IHC.

A. Time Course

[00948] The rodents are administered formulations containing at least one modified mRNA to study the time course of protein expression for the administered formulation. The rodents are bled at specified time intervals prior to and after administration of the modified mRNA formulations to determine protein expression and complete blood count. Samples are also collected from the site of administration of rodents administered modified mRNA formulations subcutaneously and intramuscularly to determine the protein expression in the tissue.

B. Dose Response

[00949] The rodents are administered formulations containing at least one modified mRNA to determine dose response of each formulation. The rodents are bled at specified time intervals prior to and after administration of the modified mRNA formulations to determine protein expression and complete blood count. The rodents are also sacrificed to analyze the effect of the modified mRNA formulation on the internal tissue. Samples are also collected from the site of administration of rodents administered modified mRNA formulations subcutaneously and intramuscularly to determine the protein expression in the tissue.

C. Toxicity

[00950] The rodents are administered formulations containing at least one modified mRNA to study toxicity of each formulation. The rodents are bled at specified time intervals prior to and after administration of the modified mRNA formulations to determine protein expression and complete blood count. The rodents are also sacrificed to analyze the effect of the modified mRNA formulation on the internal tissue. Samples are also collected from the site of administration of rodents administered modified mRNA formulations subcutaneously and intramuscularly to determine the protein expression in the tissue.

Example 15. PLGA Microsphere Formulations

[00951] Optimization of parameters used in the formulation of PLGA microspheres may allow for tunable release rates and high encapsulation efficiencies while maintaining the integrity of the modified RNA encapsulated in the microspheres. Parameters such as, but not limited to, particle size, recovery rates and encapsulation efficiency may be optimized to achieve the optimal formulation.

A. Synthesis of PLGA microspheres

[00952] Polylactideglycolic acid (PLGA) microspheres were synthesized using the water/oil/water double emulsification methods known in the art using PLGA (Lactel, Cat# B6010-2, inherent viscosity 0.55-0.75, 50:50 LA:GA), polyvinylalcohol (PVA) (Sigma, Cat# 348406-25G, MW 13-23k) dichloromethane and water. Briefly, 0.1 ml of water (W1) was added to 2 ml of PLGA dissolved in dichloromethane (DCM) (01) at concentrations ranging from 50 - 200 mg/ml of PLGA. The W1/O1 emulsion was homogenized (IKA Ultra-Turrax Homogenizer, T18) for 30 seconds at speed 4 (-15,000 rpm). The W1/O1 emulsion was then added to 100 to 200 ml of 0.3 to 1% PVA (W2) and homogenized for 1 minute at varied speeds. Formulations were left to stir for 3 hours and then washed by centrifugation (20-25 min, 4,000 rpm, 4°C). The supernatant was discarded and the

PLGA pellets were resuspended in 5-10 ml of water, which was repeated 2x. Average particle size (represents 20 -30 particles) for each formulation was determined by microscopy after washing. Table 19 shows that an increase in the PLGA concentration led to larger sized microspheres. A PLGA concentration of 200 mg/mL gave an average particle size of 14.8 μm , 100 mg/mL was 8.7 μm , and 50 mg/mL of PLGA gave an average particle size of 4.0 μm .

Table 19. Varied PLGA Concentration

Sample ID	O1 Volume (mL)	PLGA Concentration (mg/mL)	W2 Volume (mL)	PVA Concentration (%)	Speed	Average Size (μm)
1	2	200	100	0.3	5	14.8
2	2	100	100	0.3	5	8.7
3	2	50	100	0.3	5	4.0

[00953] Table 20 shows that decreasing the homogenization speed from 5 (-20,000 rpm) to speed 4 (-15,000 rpm) led to an increase in particle size from 14.8 μm to 29.7 μm .

Table 20. Varied Homogenization Speed

Sample ID	O1 Volume (mL)	PLGA Concentration (mg/mL)	W2 Volume (mL)	PVA Concentration (%)	Speed	Average Size (μm)
1	2	200	100	0.3	5	14.8
4	2	200	100	0.3	4	29.7

[00954] Table 21 shows that increasing the W2 volume (i.e. increasing the ratio of W2:O1 from 50:1 to 100:1), decreased average particle size slightly. Altering the PVA concentration from 0.3 to 1 wt% had little impact on PLGA microsphere size.

Table 21. Varied W2 Volume and Concentration

Sample ID	O1 Volume (mL)	PLGA Concentration (mg/mL)	W2 Volume (mL)	PVA Concentration (%)	Speed	Average Size (μm)
1	2	200	100	0.3	5	14.8
5	2	200	200	0.3	5	11.7
6	2	200	190	0.3	5	11.4
7	2	200	190	1.0	5	12.3

B. Encapsulation of modified mRNA

[00955] Modified G-CSF mRNA (SEQ ID NO: 6; polyA tail of approximately 160 nucleotides not shown in sequence; 5'cap, Cap1; fully modified with 5-methylcytosine and pseudouridine) was

dissolved in water at a concentration of 2 mg/ml (W3). Three batches of PLGA microsphere formulations were made as described above with the following parameters: 0.1 ml of W3 at 2 mg/ml, 1.6 ml of O1 at 200 mg/ml, 160 ml of W2 at 1%, and homogenized at a speed of 4 for the first emulsion (W3/O1) and homogenized at a speed of 5 for the second emulsion (W3/O1/W2). After washing by centrifugation, the formulations were frozen in liquid nitrogen and then lyophilized for 3 days. To test the encapsulation efficiency of the formulations, the lyophilized material was deformed in DCM for 6 hours followed by an overnight extraction in water. The modified RNA concentration in the samples was then determined by OD260. Encapsulation efficiency was calculated by taking the actual amount of modified RNA and dividing by the starting amount of modified RNA. In the three batches tested, there was an encapsulation efficiency of 59.2, 49.8 and 61.3.

C. Integrity of modified mRNA encapsulated in PLGA microspheres

[00956] Modified Factor IX mRNA (SEQ ID NO: 10; polyA tail of approximately 160 nucleotides not shown in sequence; 5'cap, Cap1; fully modified with 5-methylcytosine and pseudouridine) was dissolved in water at varied concentrations (W4) to vary the weight percent loading in the formulation (mg modified RNA/mg PLGA * 100) and to determine encapsulation efficiency. The parameters in Table 22 were used to make four different batches of PLGA microsphere formulations with a homogenization speed of 4 for the first emulsion (W4/O1) and a homogenization speed of 5 for the second emulsion (W4/O1/W2).

Table 22. Factor IX PLGA Microsphere Formulation Parameters

ID	W4 Volume (uL)	Factor IX Concentration (mg/ml)	Factor IX Amount (ug)	O1 Volume (ml)	PLGA Concentration (mg/ml)	W2 Volume (ml)	PVA Concentration (%)	Weight % (wt%) Loading
A	100	2.0	200.0	2.0	200	200	1.0	0.05
B	100	4.0	400.0	2.0	200	200	1.0	0.10
C	400	2.0	800.0	2.0	200	200	1.0	0.20
D	400	4.0	1600.0	2.0	200	200	1.0	0.40

[00957] After lyophilization, PLGA microspheres were weighed out in 2 ml eppendorf tubes to correspond to ~ 10 ug of modified RNA. Lyophilization was found to not destroy the overall structure of the PLGA microspheres. To increase weight percent loading (wt%) for the PLGA microspheres, increasing amounts of modified RNA were added to the samples. PLGA microspheres were deformed by adding 1.0 ml of DCM to each tube and then shaking the samples for 6 hours.

For modified RNA extraction, 0.5 ml of water was added to each sample and the samples were shaken overnight before the concentration of modified RNA in the samples was determined by OD260. To determine the recovery of the extraction process, unformulated Factor IX modified RNA (SEQ ID NO: 10; polyA tail of approximately 160 nucleotides not shown in sequence; 5'cap, CapI; fully modified with 5-methylcytosine and pseudouridine) (deformulation control) was spiked into DCM and was subjected to the deformulation process. Table 23 shows the loading and encapsulation efficiency for the samples. All encapsulation efficiency samples were normalized to the deformulation control.

Table 23. Weight Percent Loading and Encapsulation Efficiency

ID	Theoretical modified RNA loading (wt%)	Actual modified RNA loading (wt%)	Encapsulation Efficiency (%)
A	0.05	0.06	97.1
B	0.10	0.10	85.7
C	0.20	0.18	77.6
D	0.40	0.31	68.1
Control	-	-	100.0

D. Release study of modified mRNA encapsulated in PLGA microspheres

[00958] PLGA microspheres formulated with Factor IX modified RNA (SEQ ID NO: 10) were deformulated as described above and the integrity of the extracted modified RNA was determined by automated electrophoresis (Bio-Rad Experion). The extracted modified mRNA was compared against unformulated modified mRNA and the deformulation control in order to test the integrity of the encapsulated modified mRNA. As shown in Figure 3, the majority of modRNA was intact for batch ID A, B, C and D, for the deformulated control (Deform control) and the unformulated control (Unform control).

E. Protein Expression of modified mRNA encapsulated in PLGA microspheres

[00959] PLGA microspheres formulated with Factor IX modified RNA (SEQ ID NO: 10; polyA tail of approximately 160 nucleotides not shown in sequence; 5'cap, CapI; fully modified with 5-methylcytosine and pseudouridine) were deformulated as described above and the protein expression of the extracted modified RNA was determined by an *in vitro* transfection assay. HEK293 cells were reverse transfected with 250 ng of Factor IX modified RNA complexed with RNAiMAX (Invitrogen) in triplicate.

[00960] Factor IX modified RNA was diluted in nuclease-free water to a concentration of 25 ng/ μ l and RNAiMAX was diluted 13.3x in serum-free EMEM. Equal volumes of diluted modified RNA and diluted RNAiMAX were mixed together and were allowed to stand for 20 to 30 minutes at room temperature. Subsequently, 20 μ l of the transfection mix containing 250 ng of Factor IX modified RNA was added to 80 μ l of a cell suspension containing 30,000 cells. Cells were then incubated for 16h in a humidified 37°C/5% CO₂ cell culture incubator before harvesting the cell culture supernatant. Factor IX protein expression in the cell supernatant was analyzed by an ELISA kit specific for Factor IX (Molecular Innovations, Cat # HFIXKT-TOT) and the protein expression is shown in Table 24. In all PLGA microsphere batches tested, Factor IX modified RNA remained active and expressed Factor IX protein after formulation in PLGA microspheres and subsequent deformation.

Table 24. Protein Expression

Sample	Factor IX Protein Expression (ng/ml)
Batch A	0.83
Batch B	1.83
Batch C	1.54
Batch D	2.52
Deformulated Control	4.34
Unformulated Control	3.35

F. Release study of modified mRNA encapsulated in PLGA microspheres

[00961] PLGA microspheres formulated with Factor IX modified RNA (SEQ ID NO: 10; polyA tail of approximately 160 nucleotides not shown in sequence; 5'cap, Cap1; fully modified with 5-methylcytosine and pseudouridine) were resuspended in water to a PLGA microsphere concentration of 24 mg/ml. After resuspension, 150 μ l of the PLGA microsphere suspension was aliquoted into eppendorf tubes. Samples were kept incubating and shaking at 37°C during the course of the study. Triplicate samples were pulled at 0.2, 1, 2, 8, 14, and 21 days. To determine the amount of modified RNA released from the PLGA microspheres, samples were centrifuged, the supernatant was removed, and the modified RNA concentration in the supernatant was determined by OD 260. The percent release, shown in Table 25, was calculated based on the total amount of modified RNA in each sample. After 31 days, 96% of the Factor IX modified RNA was released from the PLGA microsphere formulations.

Table 25. Percent Release

Time (days)	% Release
0	0.0
0.2	27.0
1	37.7
2	45.3
4	50.9
8	57.0
14	61.8
21	75.5
31	96.4

G. Particle size reproducibility of PLGA microspheres

[00962] Three batches of Factor IX modified RNA (SEQ ID NO: 10 polyA tail of approximately 160 nucleotides not shown in sequence; 5'cap, Cap1; fully modified with 5-methylcytosine and pseudouridine) PLGA microspheres were made using the same conditions described for Batch D, shown in Table 22, (0.4 ml of W4 at 4 mg/ml, 2.0 ml of 0 1 at 200 mg/ml, 200 ml of W2 at 1%, and homogenized at a speed of 5 for the W4/01/W2 emulsion). To improve the homogeneity of the PLGA microsphere suspension, filtration was incorporated prior to centrifugation. After stirring for 3 hours and before centrifuging, all formulated material was passed through a 100 μm nylon mesh strainer (Fisherbrand Cell Strainer, Cat # 22-363-549) to remove larger aggregates. After washing and resuspension with water, 100-200 μl of a PLGA microspheres sample was used to measure particle size of the formulations by laser diffraction (Malvern Mastersizer2000). The particle size of the samples is shown in Table 26.

Table 26. Particle Size Summary

ID	D10 (μm)	D50 (μm)	D90 (μm)	Volume Weighted Mean (μm)	Filtration
Control	19.2	62.5	722.4	223.1	No
A	9.8	31.6	65.5	35.2	Yes
B	10.5	32.3	66.9	36.1	Yes
C	10.8	35.7	79.8	41.4	Yes

[00963] Results of the 3 PLGA microsphere batches using filtration were compared to a PLGA microsphere batch made under the same conditions without filtration. The inclusion of a filtration

step before washing reduced the mean particle size and demonstrated a consistent particle size distribution between 3 PLGA microsphere batches.

H. Serum Stability of Factor IX PLGA Microspheres

[00964] Factor IX mRNA RNA (SEQ ID NO: 10 polyA tail of approximately 160 nucleotides not shown in sequence; 5'cap, Cap1; fully modified with 5-methylcytosine and pseudouridine) in buffer (TE) or 90% serum (Se), or Factor IX mRNA in PLGA in buffer, 90% serum or 1% serum was incubated in buffer, 90% serum or 1% serum at an mRNA concentration of 50 ng/ul in a total volume of 70 ul. The samples were removed at 0, 30, 60 or 120 minutes. RNases were inactivated with proteinase K digestion for 20 minutes at 55°C by adding 25 ul of 4x proteinase K buffer (0.4 ml 1M TRIS-HCl pH 7.5, 0.1 ml 0.5M EDTA, 0.12 ml 5M NaCl, and 0.4ml 10% SDS) and 8 ul of proteinase K at 20 mg/ml. The Factor IX mRNA was precipitated (add 250 ul 95% ethanol for 1 hour, centrifuge for 10 min at 13 k rpm and remove supernatant, add 200 ul 70% ethanol to the pellet, centrifuge again for 5 min at 13 k rpm and remove supernatant and resuspend the pellet in 70 ul water) or extracted from PLGA microspheres (centrifuge 5 min at 13k rpm and remove supernatant, wash pellet with 1 ml water, centrifuge 5 min at 13k rpm and remove supernatant, add 280 ul dichloromethane to the pellet and shake for 15 minutes, add 70 ul water and then shake for 2 hours and remove the aqueous phase) before being analyzed by bioanalyzer. PLGA microspheres protect Factor IX modified mRNA from degradation in 90% and 1% serum over 2 hours. Factor IX modified mRNA completely degrades in 90% serum at the initial time point.

Example 16. Lipid nanoparticle *in vivo* studies

[00965] G-CSF (cDNA with the T7 promoter, 5' Untranslated region (UTR) and 3'UTR used in *in vitro* transcription is given in SEQ ID NO: 5. mRNA sequence shown in SEQ ID NO: 6; polyA tail of approximately 160 nucleotides not shown in sequence; 5'cap, Cap 1; fully modified with 5-methylcytosine and pseudouridine) and Factor IX (cDNA with the T7 promoter, 5' UTR and 3'UTR used in *in vitro* transcription is given in SEQ ID NO: 13. mRNA sequence shown in SEQ ID NO: 10; polyA tail of approximately 160 nucleotides not shown in sequence; 5'cap, Cap 1; fully modified with 5-methylcytosine and pseudouridine) modified mRNA were formulated as lipid nanoparticles (LNPs) using the syringe pump method. The LNPs were formulated at a 20: 1 weight ratio of total lipid to modified mRNA with a final lipid molar ratio of 50:10:38.5:1.5 (DLin-KC2-DMA: DSPC: Cholesterol: PEG-c-DOMG). Formulations, listed in Table 27, were characterized by particle size, zeta potential, and encapsulation.

Table 27. Formulations

Formulation #	NPA-029-1	NPA-030-1
Modified mRNA	Factor IX	G-CSF
Mean size	91 nm PDI: 0.04	106 nm PDI: 0.06
Zeta at pH 7.4	1.8 mV	0.9 mV
Encaps. (RiboGr)	92%	100%

[00966] LNP formulations were administered to mice (n=5) intravenously at a modified mRNA dose of 100, 10, or 1 ug. Mice were sacrificed at 8 hrs after dosing. Serum was collected by cardiac puncture from mice that were administered with G-CSF or Factor IX modified mRNA formulations. Protein expression was determined by ELISA.

[00967] There was no significant body weight loss (<5%) in the G-CSF or Factor IX dose groups. Protein expression for G-CSF or Factor IX dose groups was determined by ELISA from a standard curve. Serum samples were diluted (about 20-2500x for G-CSF and about 10-250x for Factor IX) to ensure samples were within the linear range of the standard curve. As shown in Table 28, G-CSF protein expression determined by ELISA was approximately 17, 1200, and 4700 ng/ml for the 1, 10, and 100 ug dose groups, respectively. As shown in Table 29, Factor IX protein expression determined by ELISA was approximately 36, 380, and 3000-1 1000 ng/ml for the 1, 10, and 100 ug dose groups, respectively.

Table 28. G-CSF Protein Expression

Dose (ug)	Conc (ng/ml)	Dilution Factor	Sample Volume
1	17.73	20x	5 ul
10	1204.82	2500x	0.04 ul
100	4722.20	2500x	0.04 ul

Table 29. Factor IX Protein Expression

Dose (ug)	Conc (ng/ml)	Dilution Factor	Sample Volume
1	36.05	10x	5 ul
10	383.04	10x	5 ul
100*	3247.75	50x	1 ul

100*	11177.20	250x	0.2 ul
------	----------	------	--------

[00968] As shown in Table 30, the LNP formulations described above have about a 10,000-100,000-fold increase in protein production compared to an administration of an intravenous (IV)-lipoplex formulation for the same dosage of modified mRNA and intramuscular (IM) or subcutaneous (SC) administration of the same dose of modified mRNA in saline. As used in Table 30, the symbol "~" means about.

Table 30. Protein Production

G-CSF	Dose (ug)	Serum Concentration (pg/ml) 8-12 hours after administration
IM	100	~20-80
SC	100	~10-40
IV (Lipoplex)	100	~30
IV (LNP)	100	~5,000,000
IV (LNP)	10	~1,000,000
IV (LNP)	1	~20,000
Factor IX	Dose (ug)	Serum Concentration (ng/ml) 8-12 hours after administration
IM	2 x 100	~1.6 ng/ml
IV (LNP)	100	~3,000-10,000 ng/ml
IV (LNP)	10	~400 ng/ml
IV (LNP)	1	~40 ng/ml

Materials and Methods for Examples 17-22

[00969] G-CSF (mRNA sequence shown in SEQ ID NO: 6; polyA tail of approximately 160 nucleotides not shown in sequence; 5'cap, Cap 1; fully modified with 5-methylcytosine and pseudouridine) and EPO (mRNA sequence shown in SEQ ID NO: 9; polyA tail of approximately 160 nucleotides not shown in sequence; 5'cap, Cap 1; fully modified with 5-methylcytosine and pseudouridine) modified mRNA were formulated as lipid nanoparticles (LNPs) using the syringe pump method. The LNPs were formulated at a 20: 1 weight ratio of total lipid to modified mRNA with a final lipid molar ratio of 50:10:38.5:1.5 (DLin-KC2-DMA: DSPC: Cholesterol: PEG-c-DOMG). Formulations, listed in Table 31, were characterized by particle size, zeta potential, and encapsulation.

Table 31. Formulations

Formulation #	NPA-030-2	NPA-060-1
Modified mRNA	G-CSF	EPO
Mean size	84 nm	85 nm

	PDI: 0.04	PDI: 0.03
Zeta at pH 7.4	0.8 mV	1.5 mV
Encapsulation (RiboGreen)	95%	98%

Example 17. Lipid nanoparticle *in vivo* studies with modified mRNA

[00970] LNP formulations, shown in Table 31 (above), were administered to rats (n=5) intravenously (IV), intramuscularly (IM) or subcutaneously (SC) at a single modified mRNA dose of 0.05 mg/kg. A control group of rats (n=4) was untreated. The rats were bled at 2 hours, 8 hours, 24 hours, 48 hours and 96 hours and after they were administered with G-CSF or EPO modified mRNA formulations to determine protein expression using ELISA. The rats administered EPO modified mRNA intravenously were also bled at 7 days.

[00971] As shown in Table 32, EPO protein expression in the rats intravenously administered modified EPO mRNA was detectable out to 5 days. G-CSF in the rats intravenously administered modified G-CSF mRNA was detectable to 7 days. Subcutaneous and intramuscular administration of EPO modified mRNA was detectable to at least 24 hours and G-CSF modified mRNA was detectable to at least 8 hours. In Table 32, "OSC" refers to values that were outside the standard curve and "NT" means not tested.

Table 32. G-CSF and EPO Protein Expression

Route	Time	EPO Serum Concentration (pg/ml)	G-CSF Serum Concentration (pg/ml)
IV	2 hours	36,981.0	31,331.9
IV	8 hours	62,053.3	70,532.4
IV	24 hours	42,077.0	5,738.6
IV	48 hours	5,561.5	233.8
IV	5 days	0.0	60.4
IV	7 days	0.0	NT
IM	2 hours	1395.4	1620.4
IM	8 hours	8974.6	7910.4
IM	24 hours	4678.3	893.3
IM	48 hours	NT	OSC
IM	5 days	NT	OSC
SC	2 hours	386.2	80.3
SC	8 hours	985.6	164.2

SC	24 hours	544.2	OSC
SC	48 hours	NT	OSC
SC	5 days	NT	OSC
Untreated	All bleeds	0	0

Example 18. Time course *in vivo* study

[00972] LNP formulations, shown in Table 31 (above), were administered to mice (n=5) intravenously (IV) at a single modified mRNA dose of 0.5, 0.05 or 0.005 mg/kg. The mice were bled at 8 hours, 24 hours, 72 hours and 6 days after they were administered with G-CSF or EPO modified mRNA formulations to determine protein expression using ELISA.

[00973] As shown in Table 33, EPO and G-CSF protein expression in the mice administered with the modified mRNA intravenously was detectable out to 72 hours for the mice dosed with 0.005 mg/kg and 0.05 mg/kg of modified mRNA and out to 6 days for the mice administered the EPO modified mRNA. In Table 33, ">" means greater than and "ND" means not detected.

Table 33. Protein Expression

Dose (mg/kg)	Time	EPO Serum Concentration (pg/ml)	G-CSF Serum Concentration (pg/ml)
0.005	8 hours	12,508.3	11,550.6
0.005	24 hours	6,803.0	5,068.9
0.005	72 hours	ND	ND
0.005	6 days	ND	ND
0.05	8 hours	92,139.9	462,312.5
0.05	24 hours	54,389.4	80,903.8
0.05	72 hours	ND	ND
0.05	6 days	ND	ND
0.5	8 hours	498,515.3	>1,250,000
0.5	24 hours	160,566.3	495,812.5
0.5	72 hours	3,492.5	1,325.6
0.5	6 days	21.2	ND

Example 19. LNP formulations *in vivo* study in rodents

A. LNP Formulations in Mice

[00974] LNP formulations, shown in Table 31 (above), were administered to mice (n=4) intravenously (IV) at a single modified mRNA dose 0.05 mg/kg or 0.005 mg/kg. There was also 3 control groups of mice (n=4) that were untreated. The mice were bled at 2 hours, 8 hours, 24 hours, 48 hours and 72 hours after they were administered with G-CSF or EPO modified mRNA

formulations to determine the protein expression. Protein expression of G-CSF and EPO were determined using ELISA.

[00975] As shown in Table 34, EPO and G-CSF protein expression in the mice was detectable at least out to 48 hours for the mice that received a dose of 0.005 mg/kg modified RNA and 72 hours for the mice that received a dose of 0.05 mg/kg modified RNA. In Table 34, "OSC" refers to values that were outside the standard curve and "NT" means not tested.

Table 34. Protein Expression in Mice

Dose (mg/kg)	Time	EPO Serum Concentration (pg/ml)	G-CSF Serum Concentration (pg/ml)
0.005	2 hours	OSC	3,447.8
0.005	8 hours	1,632.8	11,454.0
0.005	24 hours	1,141.0	4,960.2
0.005	48 hours	137.4	686.4
0.005	72 hours	0	NT
0.05	2 hours	10,027.3	20,951.4
0.05	8 hours	56,547.2	70,012.8
0.05	24 hours	25,027.3	19,356.2
0.05	48 hours	1,432.3	1,963.0
0.05	72 hours	82.2	47.3

B. LNP Formulations in Rats

[00976] LNP formulations, shown in Table 31 (above), are administered to rats (n=4) intravenously (IV) at a single modified mRNA dose 0.05 mg/kg. There is also a control group of rats (n=4) that are untreated. The rats are bled at 2 hours, 8 hours, 24 hours, 48 hours, 72 hours, 7 days and 14 days after they were administered with G-CSF or EPO modified mRNA formulations to determine the protein expression. Protein expression of G-CSF and EPO are determined using ELISA.

Example 20. Early Time Course Study of LNPs

[00977] LNP formulations, shown in Table 31 (above), are administered to mammals intravenously (IV), intramuscularly (IM) or subcutaneously (SC) at a single modified mRNA dose of 0.5 mg/kg, 0.05 mg/kg or 0.005 mg/kg. A control group of mammals are not treated. The mammals are bled at 5 minutes, 10 minutes, 20 minutes, 30 minutes, 45 minutes, 1 hour, 1.5 hours and/or 2 hours after they are administered with the modified mRNA LNP formulations to determine protein expression using ELISA. The mammals are also bled to determine the complete blood count such as the granulocyte levels and red blood cell count.

Example 21. Non-human primate *in vivo* study

[00978] LNP formulations, shown in Table 31 (above), were administered to non-human primates (NHP) (cynomolgus monkey) (n=2) as a bolus intravenous injection (IV) over approximately 30 seconds using a hypodermic needle, which may be attached to a syringe/abbocath or butterfly if needed. The NHP were administered a single modified mRNA IV dose of 0.05mg/kg of EPO or G-CSF or 0.005 mg/kg of EPO in a dose volume of 0.5 mL/kg. The NHPs were bled 5-6 days before dosing with the modified mRNA LNP formulations to determine protein expression in the serum and a baseline complete blood count. After administration with the modified mRNA formulation the NHP were bled at 8, 24, 48 and 72 hours to determined protein expression. At 24 and 72 hours after administration the complete blood count of the NHP was also determined. Protein expression of G-CSF and EPO was determined by ELISA. Urine from the NHPs was collected over the course of the entire experiment and analyzed to evaluate clinical safety. Samples were collected from the NHPs after they were administered with G-CSF or EPO modified mRNA formulations to determine protein expression using ELISA. Clinical chemistry, hematology, urinalysis and cytokines of the non-human primates were also analyzed.

[00979] As shown in Table 35, EPO protein expression in the NHPs administered 0.05 mg/kg is detectable out to 72 hours and the 0.005 mg/kg dosing of the EPO formulation is detectable out to 48 hours. In Table 35, the "<" means less than a given value. G-CSF protein expression was seen out to 24 hours after administration with the modified mRNA formulation. Preliminarily, there was an increase in granulocytes and reticulocytes levels seen in the NHP after administration with the modified mRNA formulations.

Table 35. Protein Expression in Non-Human Primates

Modified mRNA	Dose (mg/kg)	Time	Female NHP Serum Concentration (pg/ml)	Male NHP Serum Concentration (pg/ml)	Average Serum Concentration (pg/ml)
G-CSF	0.05	Pre-bleed	0	0	0
		8 hours	3289	1722	2,506
		24 hours	722	307	515
		48 hours	0	0	0
		72 hours	0	0	0
EPO	0.05	Pre-bleed	0	0	0

		8 hours	19,858	7,072	13,465
		24 hours	18,178	4,913	11,546
		48 hours	5,291	498	2,895
		72 hours	744	60	402
EPO	0.005	Pre-bleed	0	0	0
		8 hours	523	250	387
		24 hours	302	113	208
		48 hours	<7.8	<7.8	<7.8
		72 hours	0	0	0

Example 22. Non-human primate *in vivo* study for G-CSF and EPO

[00980] LNP formulations, shown in Table 31 (above), were administered to non-human primates (NHP) (cynomolgus monkey) (n=2) as intravenous injection (IV). The NHP were administered a single modified mRNA IV dose of 0.5 mg/kg, 0.05mg/kg or 0.005 mg/kg of G-CSF or EPO in a dose volume of 0.5 mL/kg. The NHPs were bled before dosing with the modified mRNA LNP formulations to determine protein expression in the serum and a baseline complete blood count. After administration with the G-CSF modified mRNA formulation the NHP were bled at 8, 24, 48 and 72 hours to determined protein expression. After administration with the EPO modified mRNA formulation the NHP were bled at 8, 24, 48, 72 hours and 7 days to determined protein expression.

[00981] Samples collected from the NHPs after they were administered with G-CSF or EPO modified mRNA formulations were analyzed by ELISA to determine protein expression. Neutrophil and reticulocyte count was also determined pre-dose, 24 hours, 3 days, 7 days, 14 days and 18 days after administration of the modified G-CSF or EPO formulation.

[00982] As shown in Table 36, G-CSF protein expression was not detected beyond 72 hours. In Table 36, "<39" refers to a value below the lower limit of detection of 39 pg/ml.

Table 36. G-CSF Protein Expression

Modified mRNA	Dose (mg/kg)	Time	Female NHP Serum	Male NHP Serum
			G-CSF Concentration (pg/ml)	G-CSF Concentration (pg/ml)
G-CSF	0.5	Pre-bleed	<39	<39
		8 hours	43,525	43,594

		24 hours	11,374	3,628
		48 hours	1,100	833
		72 hours	<39	306
G-CSF	0.05	Pre-bleed	<39	<39
		8 hours	3,289	1,722
		24 hours	722	307
		48 hours	<39	<39
		72 hours	<39	<39
G-CSF	0.005	Pre-bleed	<39	<39
		8 hours	559	700
		24 hours	155	<39
		48 hours	<39	<39
		72 hours	<39	<39

[00983] As shown in Table 37, EPO protein expression was not detected beyond 7 days. In Table 37, "<7.8" refers to a value below the lower limit of detection of 7.8 pg/ml.

Table 37. EPO Protein Expression

Modified mRNA	Dose (mg/kg)	Time	Female NHP Serum EPO Concentration (pg/ml)	Male NHP Serum EPO Concentration (pg/ml)
EPO	0.5	Pre-bleed	<7.8	<7.8
		8 hours	158,771	119,086
		24 hours	133,978	85,825
		48 hours	45,250	64,793
		72 hours	15,097	20,407
		7 days	<7.8	<7.8
EPO	0.05	Pre-bleed	<7.8	<7.8
		8 hours	19,858	7,072
		24 hours	18,187	4,913
		48 hours	5,291	498
		72 hours	744	60
		7 days	<7.8	<7.8

EPO	0.005	Pre-bleed	<7.8	<7.8
		8 hours	523	250
		24 hours	302	113
		48 hours	11	29
		72 hours	<7.8	<7.8
		7 days	<7.8	<7.8

[00984] As shown in Table 38, there was an increase in neutrophils in all G-CSF groups relative to pre-dose levels.

Table 38. Pharmacologic Effect of G-CSF mRNA in NHP

Dose (mg/kg)	Time	Male NHP (G-CSF) Neutrophils ($10^9/L$)	Female NHP (G-CSF) Neutrophils ($10^9/L$)	Male NHP (EPO) Neutrophils ($10^9/L$)	Female NHP (EPO) Neutrophils ($10^9/L$)
0.5	Pre-dose	1.53	1.27	9.72	1.82
	24 hours	14.92	13.96	7.5	11.85
	3 days	9.76	13.7	11.07	5.22
	7 days	2.74	3.81	11.8	2.85
	14/18 days	2.58	1.98	7.16	2.36
0.05	Pre-dose	13.74	3.05	0.97	2.15
	24 hours	19.92	29.91	2.51	2.63
	3 days	7.49	10.77	1.73	4.08
	7 days	4.13	3.8	1.23	2.77
	14/18 days	3.59	1.82	1.53	1.27
0.005	Pre-dose	1.52	2.54	5.46	5.96
	24 hours	16.44	8.6	5.37	2.59
	3 days	3.74	1.78	6.08	2.83
	7 days	7.28	2.27	3.51	2.23
	14/18 days	4.31	2.28	1.52	2.54

[00985] As shown in Table 39, there was an increase in reticulocytes in all EPO groups 3 days to 14/18 days after dosing relative to reticulocyte levels 24 hours after dosing.

Table 39. Pharmacologic Effect of EPO mRNA on Neutrophil Count

Dose (mg/kg)	Time	Male NHP (G-CSF) Neutrophils ($10^{12}/L$)	Female NHP (G-CSF) Neutrophils ($10^{12}/L$)	Male NHP (EPO) Neutrophils ($10^{12}/L$)	Female NHP (EPO) Neutrophils ($10^{12}/L$)
0.5	Pre-dose	0.067	0.055	0.107	0.06
	24 hours	0.032	0.046	0.049	0.045
	3 days	0.041	0.017	0.09	0.064
	7 days	0.009	0.021	0.35	0.367
	14/18 days	0.029	0.071	0.066	0.071
0.05	Pre-dose	0.055	0.049	0.054	0.032
	24 hours	0.048	0.046	0.071	0.04
	3 days	0.101	0.061	0.102	0.105
	7 days	0.157	0.094	0.15	0.241
	14/18 days	0.107	0.06	0.067	0.055
0.005	Pre-dose	0.037	0.06	0.036	0.052
	24 hours	0.037	0.07	0.034	0.061
	3 days	0.037	0.054	0.079	0.118
	7 days	0.046	0.066	0.049	0.087
	14/18 days	0.069	0.057	0.037	0.06

[00986] As shown in Tables 40-42, the administration of EPO modified RNA had an effect on other erythropoetic parameters including hemoglobin (HGB), hematocrit (HCT) and red blood cell (RBC) count.

Table 40. Pharmacologic Effect of EPO mRNA on Hemoglobin

Dose (mg/kg)	Time	Male NHP (G-CSF) HGB (g/L)	Female NHP (G-CSF) HGB (g/L)	Male NHP (EPO) HGB (g/L)	Female NHP (EPO) HGB (g/L)
0.5	Pre-dose	133	129	134	123
	24 hours	113	112	127	108
	3 days	118	114	126	120
	7 days	115	116	140	134
	14/18 days	98	113	146	133
0.05	Pre-dose	137	129	133	133

	24 hours	122	117	123	116
	3 days	126	115	116	120
	7 days	126	116	126	121
	14/1 8 days	134	123	133	129
0.005	Pre-dose	128	129	132	136
	24 hours	117	127	122	128
	3 days	116	127	125	130
	7 days	116	129	119	127
	14/1 8 days	118	129	128	129

Table 41. Pharmacologic Effect of EPO mRNA on Hematocrit

Dose (mg/kg)	Time	Male NHP (G-CSF) HCT (L/L)	Female NHP (G-CSF) HCT (L/L)	Male NHP (EPO) HCT (L/L)	Female NHP (EPO) HCT (L/L)
0.5	Pre-dose	0.46	0.43	0.44	0.4
	24 hours	0.37	0.38	0.4	0.36
	3 days	0.39	0.38	0.41	0.39
	7 days	0.39	0.38	0.45	0.45
	14/1 8 days	0.34	0.37	0.48	0.46
0.05	Pre-dose	0.44	0.44	0.45	0.43
	24 hours	0.39	0.4	0.43	0.39
	3 days	0.41	0.39	0.38	0.4
	7 days	0.42	0.4	0.45	0.41
	14/1 8 days	0.44	0.4	0.46	0.43
0.005	Pre-dose	0.42	0.42	0.48	0.45
	24 hours	0.4	0.42	0.42	0.43
	3 days	0.4	0.41	0.44	0.42
	7 days	0.39	0.42	0.41	0.42
	14/1 8 days	0.41	0.42	0.42	0.42

Table 42. Pharmacologic Effect of EPO mRNA on Red Blood Cells

Dose (mg/kg)	Time	Male NHP (G-CSF) RBC (10 ¹² /L)	Female NHP (G-CSF) RBC (10 ¹² /L)	Male NHP (EPO) RBC (10 ¹² /L)	Female NHP (EPO) RBC (10 ¹² /L)
0.5	Pre-dose	5.57	5.57	5.43	5.26
	24 hours	4.66	4.96	5.12	4.69
	3 days	4.91	4.97	5.13	5.15

	7 days	4.8	5.04	5.55	5.68
	14/1 8 days	4.21	4.92	5.83	5.72
0.05	Pre-dose	5.68	5.64	5.57	5.84
	24 hours	4.96	5.08	5.25	5.18
	3 days	5.13	5.04	4.81	5.16
	7 days	5.17	5.05	5.37	5.31
	14/1 8 days	5.43	5.26	5.57	5.57
0.005	Pre-dose	5.67	5.36	6.15	5.72
	24 hours	5.34	5.35	5.63	5.35
	3 days	5.32	5.24	5.77	5.42
	7 days	5.25	5.34	5.49	5.35
	14/1 8 days	5.37	5.34	5.67	5.36

[00987] As shown in Tables 43 and 44, the administration of modified RNA had an effect on serum chemistry parameters including alanine transaminase (ALT) and aspartate transaminase (AST).

Table 43. Pharmacologic Effect of EPO mRNA on Alanine Transaminase

Dose (mg/kg)	Time	Male NHP (G-CSF) ALT (U/L)	Female NHP (G-CSF) ALT (U/L)	Male NHP (EPO) ALT (U/L)	Female NHP (EPO) ALT (U/L)
0.5	Pre-dose	29	216	50	31
	2 days	63	209	98	77
	4 days	70	98	94	87
	7 days	41	149	60	59
	14days	43	145	88	44
0.05	Pre-dose	58	53	56	160
	2 days	82	39	95	254
	4 days	88	56	70	200
	7 days	73	73	64	187
	14days	50	31	29	216
0.005	Pre-dose	43	51	45	45
	2 days	39	32	62	48
	4 days	48	58	48	50
	7 days	29	55	21	48
	14days	44	46	43	51

Table 44. Pharmacologic Effect of EPO mRNA on Aspartate Transaminase

Dose (mg/kg)	Time	Male NHP (G-CSF) AST (U/L)	Female NHP (G-CSF) AST (U/L)	Male NHP (EPO) AST (U/L)	Female NHP (EPO) AST (U/L)
0.5	Pre-dose	32	47	59	20
	2 days	196	294	125	141
	4 days	67	63	71	60
	7 days	53	68	56	47
	14days	47	67	82	44
0.05	Pre-dose	99	33	74	58
	2 days	95	34	61	80
	4 days	69	42	48	94
	7 days	62	52	53	78
	14days	59	20	32	47
0.005	Pre-dose	35	54	39	40
	2 days	70	34	29	25
	4 days	39	36	43	55
	7 days	28	31	55	31
	14days	39	20	35	54

[00988] As shown in Table 45, the administration of modified RNA cause an increase in cytokines, interferon-alpha (IFN-alpha) after administration of modified mRNA.

Table 45. Pharmacologic Effect of EPO mRNA on Alanine Transaminase

Dose (mg/kg)	Time	Male NHP (G-CSF) IFN-alpha (pg/mL)	Female NHP (G-CSF) IFN-alpha (pg/mL)	Male NHP (EPO) IFN-alpha (pg/mL)	Female NHP (EPO) IFN-alpha (pg/mL)
0.5	Pre-dose	0	0	0	0
	Day 1 + 8 hr	503.8	529.2	16.79	217.5
	4 days	0	0	0	0
0.05	Pre-dose	0	0	0	0
	Day 1 + 8 hr	0	0	0	0
	4 days	0	0	0	0
0.005	Pre-dose	0	0	0	0
	Day 1 + 8 hr	0	0	0	0
	4 days	0	0	0	0

Example 23. Study of Intramuscular and/or Subcutaneous Administration in Non-Human Primates

[00989] Formulations containing modified EPO mRNA (SEQ ID NO: 9; polyA tail of approximately 160 nucleotides not shown in sequence; 5'cap, CapI; fully modified with 5-methylcytosine and pseudouridine) or G-CSF mRNA (SEQ ID NO: 6; polyA tail of approximately 160 nucleotides not shown in sequence; 5'cap, CapI; fully modified with 5-methylcytosine and pseudouridine) in saline were administered to non-human primates (*Cynomolgus* monkey) (NHP) intramuscularly (IM) or subcutaneously (SC). The single modified mRNA dose of 0.05mg/kg or 0.005 mg/kg was in a dose volume of 0.5 mL/kg. The non-human primates are bled 5-6 days prior to dosing to determine serum protein concentration and a baseline complete blood count. After administration with the modified mRNA formulation the NHP are bled at 8 hours, 24 hours, 48 hours, 72 hours, 7 days and 14 days to determined protein expression. Protein expression of G-CSF and EPO is determined by ELISA. At 24 hours, 72 hours, 7 days and 14 days after administration the complete blood count of the NHP is also determined. Urine from the NHPs is collected over the course of the entire experiment and analyzed to evaluate clinical safety. Tissue near the injection site is also collected and analyzed to determine protein expression.

Example 24. Modified mRNA Trafficking

[00990] In order to determine localization and/or trafficking of the modified mRNA, studies may be performed as follows.

[00991] LNP formulations of siRNA and modified mRNA are formulated according to methods known in the art and/or described herein. The LNP formulations may include at least one modified mRNA which may encode a protein such as G-CSF, EPO, Factor VII, and/or any protein described herein. The formulations may be administered locally into muscle of mammals using intramuscular or subcutaneous injection. The dose of modified mRNA and the size of the LNP may be varied to determine the effect on trafficking in the body of the mammal and/or to assess the impact on a biologic reaction such as, but not limited to, inflammation. The mammal may be bled at different time points to determine the expression of protein encoded by the modified mRNA administered present in the serum and/or to determine the complete blood count in the mammal.

[00992] For example, modified mRNA encoding Factor VII, expressed in the liver and secreted into the serum, may be administered intramuscularly and/or subcutaneously. Coincident or prior to modified mRNA administration, siRNA is administered to knock out endogenous Factor VII. Factor

VII arising from the intramuscular and/or subcutaneous injection of modified mRNA is administered is measured in the blood. Also, the levels of Factor VII is measured in the tissues near the injection site. If Factor VII is expressed in blood then there is trafficking of the modified mRNA. If Factor VII is expressed in tissue and not in the blood than there is only local expression of Factor VII.

Example 25. Formulations of Multiple Modified mRNA

[00993] LNP formulations of modified mRNA are formulated according to methods known in the art and/or described herein. The LNP formulations may include at least one modified mRNA which may encode a protein such as G-CSF, EPO, thrombopoietin and/or any protein described herein or known in the art. The at least one modified mRNA may include 1, 2, 3, 4 or 5 modified mRNA molecules. The formulations containing at least one modified mRNA may be administered intravenously, intramuscularly or subcutaneously in a single or multiple dosing regimens. Biological samples such as, but not limited to, blood and/or serum may be collected and analyzed at different time points before and/or after administration of the at least one modified mRNA formulation. An expression of a protein in a biological sample of 50-200 pg/ml after the mammal has been administered a formulation containing at least one modified mRNA encoding said protein would be considered biologically effective.

Example 26. Polyethylene Glycol Ratio Studies

A. Formulation and Characterization of PEG LNPs

[00994] Lipid nanoparticles (LNPs) were formulated using the syringe pump method. The LNPs were formulated at a 20:1 weight ratio of total lipid to modified G-CSF mRNA (SEQ ID NO: 6; polyA tail of approximately 160 nucleotides not shown in sequence; 5'cap, Cap1; fully modified with 5-methylcytosine and pseudouridine). The molar ratio ranges of the formulations are shown in Table 46.

Table 46. Molar Ratios

	DLin-KC2-DMA	DSPC	Cholesterol	PEG-c-DOMG
Mole Percent (mol%)	50.0	10.0	37-38.5	1.5-3

[00995] Two types of PEG lipid, 1,2-Dimyristoyl-sn-glycerol, methoxypolyethylene Glycol (PEG-DMG, NOF Cat # SUNBRIGHT® GM-020) and 1,2-Distearoyl-sn-glycerol, methoxypolyethylene Glycol (PEG-DSG, NOF Cat # SUNBRIGHT® GS-020), were tested at 1.5 or 3.0 mol%. After the formation of the LNPs and the encapsulation of the modified G-CSF mRNA, the LNP formulations

were characterized by particle size, zeta potential and encapsulation percentage and the results are shown in Table 47.

Table 47. Characterization of LNP Formulations

Formulation No.	NPA-071-1	NPA-072-1	NPA-073-1	NPA-074-1
Lipid	PEG-DMG 1.5%	PEG-DMG 3%	PEG-DSA 1.5%	PEG-DSA 3%
Mean Size	95 nm PDI: 0.01	85 nm PDI: 0.06	95 nm PDI: 0.08	75 nm PDI: 0.08
Zeta at pH 7.4	-1.1 mV	-2.6 mV	1.7 mV	0.7 mV
Encapsulation (RiboGreen)	88%	89%	98%	95%

B. *In Vivo* Screening of PEG LNPs

[00996] Formulations of the PEG LNPs described in Table 40 were administered to mice (n=5) intravenously at a dose of 0.5 mg/kg. Serum was collected from the mice at 2 hours, 8 hours, 24 hours, 48 hours, 72 hours and 8 days after administration of the formulation. The serum was analyzed by ELISA to determine the protein expression of G-CSF and the expression levels are shown in Table 48. LNP formulations using PEG-DMG gave substantially higher levels of protein expression than LNP formulations with PEG-DSA.

Table 48. Protein Expression

Lipid	Formulation No.	Time	Protein Expression (pg/ml)
PEG-DMG, 1.5%	NPA-071-1	2 hours	114,102
		8 hours	357,944
		24 hours	104,832
		48 hours	6,697
		72 hours	980
		8 days	0
PEG-DMG, 3%	NPA-072-1	2 hours	154,079
		8 hours	354,994
		24 hours	164,311
		48 hours	13,048
		72 hours	1,182
		8 days	13
PEG-DSA, 1.5%	NPA-073-1	2 hours	3,193

		8 hours	6,162
		24 hours	446
		48 hours	197
		72 hours	124
		8 days	5
PEG-DSA, 3%	NPA-074-1	2 hours	259
		8 hours	567
		24 hours	258
		48 hours	160
		72 hours	328
		8 days	33

Example 27. Cationic Lipid Formulation Studies

A. Formulation and Characterization of Cationic Lipid Nanoparticles

[00997] Lipid nanoparticles (LNPs) were formulated using the syringe pump method. The LNPs were formulated at a 20: 1 weight ratio of total lipid to modified mRNA. The final lipid molar ratio ranges of cationic lipid, DSPC, cholesterol and PEG-c-DOMG are outlined in Table 49.

Table 49. Molar Ratios

	Cationic Lipid	DSPC	Cholesterol	PEG-c-DOMG
Mole Percent (mol%)	50.0	10.0	38.5	1.5

[00998] A 25 mM lipid solution in ethanol and modified RNA in 50mM citrate at a pH of 3 were mixed to create spontaneous vesicle formation. The vesicles were stabilized in ethanol before the ethanol was removed and there was a buffer exchange by dialysis. The LNPs were then characterized by particle size, zeta potential, and encapsulation percentage. Table 50 describes the characterization of LNPs encapsulating EPO modified mRNA (SEQ ID NO: 9 polyA tail of approximately 160 nucleotides not shown in sequence; 5'cap, Cap1; fully modified with 5-methylcytosine and pseudouridine) or G-CSF modified mRNA (SEQ ID NO: 6; polyA tail of approximately 160 nucleotides not shown in sequence; 5'cap, Cap1; fully modified with 5-methylcytosine and pseudouridine) using DLin-MC3-DMA, DLin-DMA or CI2-200 as the cationic lipid.

Table 50. Characterization of Cationic Lipid Formulations

Formulation	NPA-	NPA-	NPA-	NPA-	NPA-	NPA-
--------------------	-------------	-------------	-------------	-------------	-------------	-------------

No.	071-1	072-1	073-1	074-1	075-1	076-1
Lipid	DLin-MC3-DMA	DLin-MC3-DMA	DLin-DMA	DLin-DMA	C12-200	C12-200
Modified RNA	EPO	G-CSF	EPO	G-CSF	EPO	G-CSF
Mean Size	89 nm PDI: 0.07	96 nm PDI: 0.08	70 nm PDI: 0.04	73 nm PDI: 0.06	97 nm PDI: 0.05	103 nm PDI: 0.09
Zeta at pH 7.4	-1.1 mV	-1.4 mV	-1.6 mV	-0.4 mV	1.4 mV	0.9 mV
Encapsulation (RiboGreen)	100%	100%	99%	100%	88%	98%

B. In Vivo Screening of Cationic LNP Formulations

[00999] Formulations of the cationic lipid formulations described in Table 42 were administered to mice (n=5) intravenously at a dose of 0.5 mg/kg. Serum was collected from the mice at 2 hours, 24 hours, 72 hours and/or 7 days after administration of the formulation. The serum was analyzed by ELISA to determine the protein expression of EPO or G-CSF and the expression levels are shown in Table 51.

Table 51. Protein Expression

Modified mRNA	Formulation No.	Time	Protein Expression (pg/ml)
EPO	NPA-071-1	2 hours	304,190.0
		24 hours	166,811.5
		72 hours	1,356.1
		7 days	20.3
EPO	NPA-073-1	2 hours	73,852.0
		24 hours	75,559.7
		72 hours	130.8
EPO	NPA-075-1	2 hours	413,010.2
		24 hours	56,463.8
G-CSF	NPA-072-1	2 hours	62,113.1
		24 hours	53,206.6
G-CSF	NPA-074-1	24 hours	25,059.3
G-CSF	NPA-076-1	2 hours	219,198.1
		24 hours	8,470.0

[001000] Toxicity was seen in the mice administered the LNPs formulations with the cationic lipid CI2-200 (NPA-075-1 and NPA-076-1) and they were sacrificed at 24 hours because they showed symptoms such as scrubby fur, cowering behavior and weight loss of greater than 10%. CI2-200 was expected to be more toxic but also had a high level of expression over a short period. The cationic lipid DLin-DMA (NPA-073-1 and NPA-074-1) had the lowest expression out of the three

cationic lipids tested. DLin-MC3-DMA (NPA-071-1 and NPA-072-1) showed good expression up to day three and was above the background sample out to day 7 for EPO formulations.

Example 28. Method of Screening for Protein Expression

A. Electrospray Ionization

[001001] A biological sample which may contain proteins encoded by modified RNA administered to the subject is prepared and analyzed according to the manufacturer protocol for electrospray ionization (ESI) using 1, 2, 3 or 4 mass analyzers. A biologic sample may also be analyzed using a tandem ESI mass spectrometry system.

[001002] Patterns of protein fragments, or whole proteins, are compared to known controls for a given protein and identity is determined by comparison.

B. Matrix-Assisted Laser Desorption/Ionization

[001003] A biological sample which may contain proteins encoded by modified RNA administered to the subject is prepared and analyzed according to the manufacturer protocol for matrix-assisted laser desorption/ionization (MALDI).

[001004] Patterns of protein fragments, or whole proteins, are compared to known controls for a given protein and identity is determined by comparison.

C. Liquid Chromatography-Mass spectrometry-Mass spectrometry

[001005] A biological sample, which may contain proteins encoded by modified RNA, may be treated with a trypsin enzyme to digest the proteins contained within. The resulting peptides are analyzed by liquid chromatography-mass spectrometry-mass spectrometry (LC/MS/MS). The peptides are fragmented in the mass spectrometer to yield diagnostic patterns that can be matched to protein sequence databases via computer algorithms. The digested sample may be diluted to achieve 1 ng or less starting material for a given protein. Biological samples containing a simple buffer background (e.g. water or volatile salts) are amenable to direct in-solution digest; more complex backgrounds (e.g. detergent, non-volatile salts, glycerol) require an additional clean-up step to facilitate the sample analysis.

[001006] Patterns of protein fragments, or whole proteins, are compared to known controls for a given protein and identity is determined by comparison.

Example 29. LNP *in vivo* studies

[001007] mCherry mRNA (SEQ ID NO: 14; polyA tail of approximately 160 nucleotides not shown in sequence; 5'cap, Cap1; fully modified with 5-methylcytosine and pseudouridine) was formulated

as a lipid nanoparticle (LNP) using the syringe pump method. The LNP was formulated at a 20: 1 weight ratio of total lipid to modified mRNA with a final lipid molar ratio of 50:10:38.5:1.5 (DLin-KC2-DMA: DSPC: Cholesterol: PEG-c-DOMG). The mCherry formulation, listed in Table 52, was characterized by particle size, zeta potential, and encapsulation.

Table 52. mCherry Formulation

Formulation #	NPA-003-5
Modified mRNA	mCherry
Mean size	105 nm PDI: 0.09
Zeta at pH 7.4	1.8 mV
Encaps. (RiboGr)	100%

[001008] The LNP formulation was administered to mice (n=5) intravenously at a modified mRNA dose of 100 ug. Mice were sacrificed at 24 hrs after dosing. The liver and spleen from the mice administered with mCherry modified mRNA formulations were analyzed by immunohistochemistry (IHC), western blot, or fluorescence-activated cell sorting (FACS).

[001009] Histology of the liver showed uniform mCherry expression throughout the section, while untreated animals did not express mCherry. Western blots were also used to confirm mCherry expression in the treated animals, whereas mCherry was not detected in the untreated animals. Tubulin was used as a control marker and was detected in both treated and untreated mice, indicating that normal protein expression in hepatocytes was unaffected.

[001010] FACS and IHC were also performed on the spleens of mCherry and untreated mice. All leukocyte cell populations were negative for mCherry expression by FACS analysis. By IHC, there were also no observable differences in the spleen in the spleen between mCherry treated and untreated mice.

Example 30. Syringe Pump *In Vivo* studies

[001011] mCherry modified mRNA is formulated as a lipid nanoparticle (LNP) using the syringe pump method. The LNP is formulated at a 20: 1 weight ratio of total lipid to modified mRNA with a final lipid molar ratio of 50:10:38.5:1.5 (DLin-KC2-DMA: DSPC: Cholesterol: PEG-c-DOMG). The mCherry formulation is characterized by particle size, zeta potential, and encapsulation.

[001012] The LNP formulation is administered to mice (n=5) intravenously at a modified mRNA dose of 10 or 100 ug. Mice are sacrificed at 24 hrs after dosing. The liver and spleen from the mice

administered with mCherry modified mRNA formulations are analyzed by immunohistochemistry (IHC), western blot, and/or fluorescence-activated cell sorting (FACS).

Example 31. *In vitro* and *in vivo* expression

A. *In vitro* Expression in Human Cells Using Lipidoid Formulations

[001013] The ratio of mmRNA to lipidoid used to test for *in vitro* transfection is tested empirically at different lipidoid:mmRNA ratios. Previous work using siRNA and lipidoids have utilized 2.5:1, 5:1, 10:1, and 15:1 lipidoid:siRNA wtwt ratios. Given the longer length of mmRNA relative to siRNA, a lower wtwt ratio of lipidoid to mmRNA may be effective. In addition, for comparison mmRNA were also formulated using RNAIMAX™ (Invitrogen, Carlsbad, CA) or TRANSIT-mRNA (Minis Bio, Madison, WI) cationic lipid delivery vehicles. The ability of lipidoid-formulated Luciferase (IVT cDNA sequence as shown in SEQ ID NO: 15; mRNA sequence shown in SEQ ID NO: 16, polyA tail of approximately 160 nucleotides not shown in sequence, 5'cap, Cap1, fully modified with 5-methylcytosine at each cytosine and pseudouridine replacement at each uridine site), green fluorescent protein (GFP) (IVT cDNA wild-type sequence is shown in SEQ ID NO: 17; mRNA sequence shown in SEQ ID NO: 18, polyA tail of approximately 160 nucleotides not shown in sequence, 5'cap, Cap1), G-CSF (mRNA sequence shown in SEQ ID NO: 6; polyA tail of approximately 160 nucleotides not shown in sequence; 5'cap, Cap1), and EPO mRNA (mRNA sequence shown in SEQ ID NO: 9; polyA tail of approximately 160 nucleotides not shown in sequence; 5'cap, Cap1) to express the desired protein product can be confirmed by luminescence for luciferase expression, flow cytometry for GFP expression, and by ELISA for G-CSF and Erythropoietin (EPO) secretion.

B. *In vivo* Expression Following Intravenous Injection

[001014] Systemic intravenous administration of the formulations are created using various different lipidoids including, but not limited to, 98N12-5, C12-200, and MD1.

[001015] Lipidoid formulations containing mmRNA are injected intravenously into animals. The expression of the modified mRNA (mmRNA)-encoded proteins are assessed in blood and/or other organs samples such as, but not limited to, the liver and spleen collected from the animal.

Conducting single dose intravenous studies will also allow an assessment of the magnitude, dose responsiveness, and longevity of expression of the desired product.

[001016] In one embodiment, lipidoid based formulations of 98N12-5, C12-200, MD1 and other lipidoids, are used to deliver luciferase, green fluorescent protein (GFP), mCherry fluorescent protein, secreted alkaline phosphatase (sAP), human G-CSF, human Factor IX, or human

Erythropoietin (EPO) mmRNA into the animal. After formulating mmRNA with a lipid, as described previously, animals are divided into groups to receive either a saline formulation, or a lipidoid-formulation which contains one of a different mmRNA selected from luciferase, GFP, mCherry, sAP, human G-CSF, human Factor IX, and human EPO. Prior to injection into the animal, mmRNA-containing lipidoid formulations are diluted in PBS. Animals are then administered a single dose of formulated mmRNA ranging from a dose of 10 mg/kg to doses as low as 1 ng/kg, with a preferred range to be 10 mg/kg to 100 ng/kg, where the dose of mmRNA depends on the animal body weight such as a 20 gram mouse receiving a maximum formulation of 0.2 ml (dosing is based on mmRNA per kg body weight). After the administration of the mmRNA-lipidoid formulation, serum, tissues, and/or tissue lysates are obtained and the level of the mmRNA-encoded product is determined at a single and/or a range of time intervals. The ability of lipidoid-formulated Luciferase, GFP, mCherry, sAP, G-CSF, Factor IX, and EPO mmRNA to express the desired protein product is confirmed by luminescence for the expression of Luciferase, flow cytometry for the expression of GFP and mCherry expression, by enzymatic activity for sAP, or by ELISA for the detection of G-CSF, Factor IX and/or EPO.

[001017] Further studies for a multi-dose regimen are also performed to determine the maximal expression of mmRNA, to evaluate the saturability of the mmRNA-driven expression (by giving a control and active mmRNA formulation in parallel or in sequence), and to determine the feasibility of repeat drug administration (by giving mmRNA in doses separated by weeks or months and then determining whether expression level is affected by factors such as immunogenicity). An assessment of the physiological function of proteins such as G-CSF and EPO are also determined through analyzing samples from the animal tested and detecting increases in granulocyte and red blood cell counts, respectively. Activity of an expressed protein product such as Factor IX, in animals can also be assessed through analysis of Factor IX enzymatic activity (such as an activated partial thromboplastin time assay) and effect of clotting times.

C. In vitro Expression Following Intramuscular and/or Subcutaneous Injection

[001018] The use of lipidoid formulations to deliver oligonucleotides, including mRNA, via an intramuscular route or a subcutaneous route of injection needs to be evaluated as it has not been previously reported. Intramuscular and/or subcutaneous injection of mmRNA are evaluated to determine if mmRNA-containing lipidoid formulations are capable to produce both localized and systemic expression of a desired protein.

[001019] Lipidoid formulations of 98N12-5, C12-200, and MD1 containing mmRNA selected from luciferase, green fluorescent protein (GFP), mCherry fluorescent protein, secreted alkaline phosphatase (sAP), human G-CSF, human factor IX, or human Erythropoietin (EPO) mmRNA are injected intramuscularly and/or subcutaneously into animals. The expression of mmRNA-encoded proteins are assessed both within the muscle or subcutaneous tissue and systemically in blood and other organs such as the liver and spleen. Single dose studies allow an assessment of the magnitude, dose responsiveness, and longevity of expression of the desired product.

[001020] Animals are divided into groups to receive either a saline formulation or a formulation containing modified mRNA. Prior to injection mmRNA-containing lipidoid formulations are diluted in PBS. Animals are administered a single intramuscular dose of formulated mmRNA ranging from 50 mg/kg to doses as low as 1 ng/kg with a preferred range to be 10 mg/kg to 100 ng/kg. A maximum dose for intramuscular administration, for a mouse, is roughly 1 mg mmRNA or as low as 0.02 ng mmRNA for an intramuscular injection into the hind limb of the mouse. For subcutaneous administration, the animals are administered a single subcutaneous dose of formulated mmRNA ranging from 400 mg/kg to doses as low as 1 ng/kg with a preferred range to be 80 mg/kg to 100 ng/kg. A maximum dose for subcutaneous administration, for a mouse, is roughly 8 mg mmRNA or as low as 0.02 ng mmRNA.

[001021] For a 20 gram mouse the volume of a single intramuscular injection is maximally 0.025 ml and a single subcutaneous injection is maximally 0.2 ml. The optimal dose of mmRNA administered is calculated from the body weight of the animal. At various points in time points following the administration of the mmRNA-lipidoid, serum, tissues, and tissue lysates is obtained and the level of the mmRNA-encoded product is determined. The ability of lipidoid-formulated luciferase, green fluorescent protein (GFP), mCherry fluorescent protein, secreted alkaline phosphatase (sAP), human G-CSF, human factor IX, or human Erythropoietin (EPO) mmRNA to express the desired protein product is confirmed by luminescence for luciferase expression, flow cytometry for GFP and mCherry expression, by enzymatic activity for sAP, and by ELISA for G-CSF, Factor IX and Erythropoietin (EPO) secretion.

[001022] Additional studies for a multi-dose regimen are also performed to determine the maximal expression using mmRNA, to evaluate the saturability of the mmRNA-driven expression (achieved by giving a control and active mmRNA formulation in parallel or in sequence), and to determine the feasibility of repeat drug administration (by giving mmRNA in doses separated by weeks or months

and then determining whether expression level is affected by factors such as immunogenicity). Studies utilizing multiple subcutaneous or intramuscular injection sites at one time point, are also utilized to further increase mmRNA drug exposure and improve protein production. An assessment of the physiological function of proteins, such as GFP, mCherry, sAP, human G-CSF, human factor IX, and human EPO, are determined through analyzing samples from the tested animals and detecting a change in granulocyte and/or red blood cell counts. Activity of an expressed protein product such as Factor IX, in animals can also be assessed through analysis of Factor IX enzymatic activity (such as an activated partial thromboplastin time assay) and effect of clotting times.

Example 32: *In Vivo* Delivery Using Lipoplexes

A. Human EPO Modified RNA Lipoplex

[001023] A formulation containing 100 µg of modified human erythropoietin (EPO) mRNA (mRNA sequence shown in SEQ ID NO: 9; polyA tail of approximately 160 nucleotides not shown in sequence; 5'cap, Cap1) (EPO; fully modified 5-methylcytosine; NI-methylpseudouridine) was lipoplexed with 30% by volume of RNAiMAX™ (Lipoplex-h-Epo-46; Generation 2 or Gen2) in 50-70 uL delivered intramuscularly to four C57/BL6 mice. Other groups consisted of mice receiving an injection of the lipoplexed modified luciferase mRNA (Lipoplex-luc) (IVT cDNA sequence shown in SEQ ID NO: 15; mRNA sequence shown in SEQ ID NO: 16, polyA tail of approximately 160 nucleotides not shown in sequence, 5'cap, Cap1, fully modified with 5-methylcytosine at each cytosine and pseudouridine replacement at each uridine site) which served as a control containing 100 µg of modified luciferase mRNA was lipoplexed with 30% by volume of RNAiMAX™ or mice receiving an injection of the formulation buffer as negative control at a dose volume of 65ul. 13 hours after the intramuscular injection, serum was collected from each mouse to measure the amount of human EPO protein in the mouse serum by human EPO ELISA and the results are shown in Table 53.

Table 53. Human EPO Production (IM Injection Route)

Formulation	Mouse #1	Mouse #2	Mouse #3	Mouse #4	Average
Lipoplex-h-Epo-46	189.8	92.55	409.5	315.95	251.95
Lipoplex-Luc	0	0	0	0	0
Formulation Buffer	0	0	0	0	0

B. Human G-CSF Modified RNA Lipoplex

[001024] A formulation containing 100 µg of one of two versions of modified human G-CSF mRNA (mRNA sequence shown in SEQ ID NO: 6; polyA tail of approximately 160 nucleotides not shown

in sequence; 5'cap, Cap1) (G-CSF fully modified with 5-methylcytosine and pseudouridine (G-CSF) or G-CSF fully modified with 5-methylcytosine and NI-methyl-pseudouridine (G-CSF-N1) lipoplexed with 30% by volume of RNAIMAX™ and delivered in 150 uL intramuscularly (I.M), in 150 uL subcutaneously (S.C) and in 225uL intravenously (I.V) to C57/BL6 mice.

[001025] Three control groups were administered either 100 µg of modified luciferase mRNA (IVT cDNA sequence shown in SEQ ID NO: 15; mRNA sequence shown in SEQ ID NO: 16, polyA tail of approximately 160 nucleotides not shown in sequence, 5'cap, Cap1, fully modified with 5-methylcytosine at each cytosine and pseudouridine replacement at each uridine site) intramuscularly (Luc-unsp I.M.) or 150 µg of modified luciferase mRNA intravenously (Luc-unsp I.V.) or 150 uL of the formulation buffer intramuscularly (Buffer I.M.). 6 hours after administration of a formulation, serum was collected from each mouse to measure the amount of human G-CSF protein in the mouse serum by human G-CSF ELISA and the results are shown in Table 54.

[001026] These results demonstrate that both 5-methylcytosine/pseudouridine and 5-methylcytosine/NI-methylpseudouridine modified human G-CSF mRNA can result in specific human G-CSF protein expression in serum when delivered via I.V. or I.M. route of administration in a lipoplex formulation.

Table 54. Human G-CSF in Serum (I.M., I.V., S.C. Injection Route)

Formulation	Route	G-CSF (pg/ml)
G-CSF	I.M.	85.6
G-CSF N1	I.M.	40.1
G-CSF	S.C.	3.9
G-CSF N1	S.C.	0.0
G-CSF	I.V.	31.0
G-CSF N1	I.V.	6.1
Luc-unsp	I.M.	0.0
Luc-unsp	I.V.	0.0
Buffer	I.M.	0.0

C. Human G-CSF Modified RNA Lipoplex Comparison

[001027] A formulation containing 100 µg of either modified human G-CSF mRNA lipoplexed with 30% by volume of RNAIMAX™ with a 5-methylcytosine (5mc) and a pseudouridine (ψ) modification (G-CSF-Gen1-Lipoplex), modified human G-CSF mRNA with a 5mc and ψ modification in saline (G-CSF-Gen1-Saline), modified human G-CSF mRNA with a NI-5-methylcytosine (NI-5mc) and a ψ modification lipoplexed with 30% by volume of RNAIMAX™ (G-CSF-Gen2-Lipoplex), modified human G-CSF mRNA with a NI-5mc and ψ modification in

saline (G-CSF-Gen2-Saline), modified luciferase with a 5mc and ψ modification lipoplexed with 30% by volume of RNAIMAX™ (Luc-Lipoplex), or modified luciferase mRNA with a 5mc and ψ modification in saline (Luc-Saline) was delivered intramuscularly (I.M.) or subcutaneously (S.C.) and a control group for each method of administration was giving a dose of 80uL of the formulation buffer (F. Buffer) to C57/BL6 mice. 13 hours post injection serum and tissue from the site of injection were collected from each mouse and analyzed by G-CSF ELISA to compare human G-CSF protein levels. The results of the human G-CSF protein in mouse serum from the intramuscular administration and the subcutaneous administration results are shown in Table 55.

[001028] These results demonstrate that 5-methylcytosine/pseudouridine and 5-methylcytosine/N1-methylpseudouridine modified human G-CSF mRNA can result in specific human G-CSF protein expression in serum when delivered via I.M. or S.C. route of administration whether in a saline formulation or in a lipoplex formulation. As shown in Table 55, 5-methylcytosine/N1-methylpseudouridine modified human G-CSF mRNA generally demonstrates increased human G-CSF protein production relative to 5-methylcytosine/pseudouridine modified human G-CSF mRNA.

Table 55. Human G-CSF Protein in Mouse Serum

Formulation	G-CSF (pg/ml)	
	I.M. Injection Route	S.C. Injection Route
G-CSF-Gen1-Lipoplex	13.988	42.855
GCSF-Gen1-saline	9.375	4.614
GCSF-Gen2-lipoplex	75.572	32.107
GCSF-Gen2-saline	20.190	45.024
Luc lipoplex	0	3.754
Luc saline	0.0748	0
F. Buffer	4.977	2.156

D. mCherry Modified RNA Lipoplex Comparison

Intramuscular and Subcutaneous Administration

[001029] A formulation containing 100 μ g of either modified mCherry mRNA (mRNA sequence shown in SEQ ID NO: 7; polyA tail of approximately 160 nucleotides not shown in sequence; 5'cap, Cap1) lipoplexed with 30% by volume of RNAIMAX™ or modified mCherry mRNA in saline is delivered intramuscularly and subcutaneously to mice. A formulation buffer is also administered to a control group of mice either intramuscularly or subcutaneously. The site of injection on the mice may be collected 17 hours post injection for sectioning to determine the cell type(s) responsible for producing protein.

Intravitreal Administration

[001030] A formulation containing 10 µg of either modified mCherry mRNA lipoplexed with RNAIMAX™, modified mCherry mRNA in a formulation buffer, modified luciferase mRNA lipoplexed with RNAMAX™, modified luciferase mRNA in a formulation buffer can be administered by intravitreal injection (IVT) in rats in a dose volume of 5 µl/eye. A formulation buffer is also administered by IVT to a control group of rats in a dose volume of 5 µl/eye. Eyes from treated rats can be collected after 18 hours post injection for sectioning and lysating to determine whether mrnRNA can be effectively delivered *in vivo* to the eye and result in protein production, and to also determine the cell type(s) responsible for producing protein *in vivo*.

Intranasal Administration

[001031] A formulation containing 100 µg of either modified mCherry mRNA lipoplexed with 30% by volume of RNAIMAX™, modified mCherry mRNA in saline, modified luciferase mRNA lipoplexed with 30% by volume of RNAIMAX™ or modified luciferase mRNA in saline is delivered intranasally. A formulation buffer is also administered to a control group intranasally. Lungs may be collected about 13 hours post instillation for sectioning (for those receiving mCherry mRNA) or homogenization (for those receiving luciferase mRNA). These samples will be used to determine whether mrnRNA can be effectively delivered *in vivo* to the lungs and result in protein production, and to also determine the cell type(s) responsible for producing protein *in vivo*.

Example 33: *In Vivo* Delivery Using Varying Lipid Ratios

[001032] Modified mRNA was delivered to C57/BL6 mice to evaluate varying lipid ratios and the resulting protein expression. Formulations of 100µg modified human EPO mRNA (mRNA sequence shown in SEQ ID NO: 9; polyA tail of approximately 160 nucleotides not shown in sequence; 5'cap, Cap1; fully modified with 5-methylcytosine and pseudouridine) lipoplexed with 10%, 30% or 50% RNAIMAX™, 100µg modified luciferase mRNA (IVT cDNA sequence shown in SEQ ID NO: 15; mRNA sequence shown in SEQ ID NO: 16, polyA tail of approximately 160 nucleotides not shown in sequence, 5'cap, Cap1, fully modified with 5-methylcytosine at each cytosine and pseudouridine replacement at each uridine site) lipoplexed with 10%>, 30%> or 50%> RNAIMAX™ or a formulation buffer were administered intramuscularly to mice in a single 70 µl dose. Serum was collected 13 hours post injection to undergo a human EPO ELISA to determine the human EPO protein level in each mouse. The results of the human EPO ELISA, shown in Table 56, show that modified human EPO expressed in the muscle is secreted into the serum for each of the different percentage of RNAIMAX™.

Table 56. Human EPO Protein in Mouse Serum (IM Injection Route)

Formulation	EPO (pg/ml)
Epo + 10% RNAiMAX	11.4
Luc + 10% RNAiMAX	0
Epo + 30% RNAiMAX	27.1
Luc + 30% RNAiMAX	0
Epo + 50% RNAiMAX	19.7
Luc + 50% RNAiMAX	0
F. Buffer	0

Example 34: Intramuscular and Subcutaneous *In Vivo* Delivery in Mammals

[001033] Modified human EPO mRNA (mRNA sequence shown in SEQ ID NO: 9; polyA tail of approximately 160 nucleotides not shown in sequence; 5'cap, CapI; fully modified with 5-methylcytosine and pseudouridine) formulated in formulation buffer was delivered to either C57/BL6 mice or Sprague-Dawley rats to evaluate the dose dependency on human EPO production. Rats were intramuscularly injected with 50 μ l of the modified human EPO mRNA (h-EPO), modified luciferase mRNA (Luc) (IVT cDNA sequence shown in SEQ ID NO: 15; mRNA sequence shown in SEQ ID NO: 16, polyA tail of approximately 160 nucleotides not shown in sequence, 5'cap, CapI, fully modified with 5-methylcytosine at each cytosine and pseudouridine replacement at each uridine site) or the formulation buffer (F.Buffer) as described in the dosing chart Table 57.

[001034] Mice were intramuscularly or subcutaneously injected with 50 μ l of the modified human EPO mRNA (h-EPO), modified luciferase mRNA (Luc) or the formulation buffer (F.Buffer) as described in the dosing chart Table 58. 13 hours post injection blood was collected and serum was analyzed to determine the amount human EPO for each mouse or rat. The average and geometric mean in pg/ml for the rat study are also shown in Table 57.

Table 57. Rat Study

	Group	Dose	Avg. pg/ml	Geometric -mean pg/ml
h-EPO	G#1	150 μ g	67.7	67.1
h-EPO	G#2	100 μ g	79.4	66.9
h-EPO	G#3	50 μ g	101.5	85.4
h-EPO	G#4	10 μ g	46.3	31.2
h-EPO	G#5	1 μ g	28.7	25.4
Luc	G#6	100 μ g	24.5	22.4
F.Buffer	G#7	-	18.7	18.5

Table 58. Mouse Study

Route	Treatment	Group	Dose	Average Level in serum pg/ml
IM	h-EPO	1	100 µg	96.2
IM	h-EPO	2	50 µg	63.5
IM	h-EPO	3	25 µg	18.7
IM	h-EPO	4	10 µg	25.9
IM	h-EPO	5	1 µg	2.6
IM	Luc	6	100 µg	0
IM	F.Buffer	7	-	1.0
SC	h-EPO	1	100 µg	72.0
SC	Luc	2	100 µg	26.7
SC	F.Buffer	3	--	17.4

Example 35: Duration of Activity after Intramuscular *In Vivo* Delivery

[001035] Modified human EPO mRNA (mRNA sequence shown in SEQ ID NO: 9; polyA tail of approximately 160 nucleotides not shown in sequence; 5'cap, Cap1; fully modified with 5-methylcytosine and pseudouridine) formulated in formulation buffer was delivered to Sprague-Dawley rats to determine the duration of the dose response. Rats were intramuscularly injected with 50 µl of the modified human EPO mRNA (h-EPO), modified luciferase mRNA (IVT cDNA sequence shown in SEQ ID NO: 15; mRNA sequence shown in SEQ ID NO: 16, polyA tail of approximately 160 nucleotides not shown in sequence, 5'cap, Cap1, fully modified with 5-methylcytosine at each cytosine and pseudouridine replacement at each uridine site) (Luc) or the formulation buffer (F.Buffer) as described in the dosing chart Table 59. The rats were bled 2, 6, 12, 24, 48 and 72 hours after the intramuscular injection to determine the concentration of human EPO in serum at a given time. The average and geometric mean in pg/ml for this study are also shown in Table 59.

Table 59. Dosing Chart

	Group	Dose	Avg. pg/ml	Geometric-mean pg/ml
h-EPO	2 hour	100 µg	59.6	58.2
h-EPO	6 hour	100 µg	68.6	55.8
h-EPO	12 hour	100 µg	87.4	84.5
h-EPO	24 hour	100 µg	108.6	95.3
h-EPO	48 hour	100	77.9	77.0

		μg		
h-EPO	72 hour	100 μg	80.1	75.8
Luc	24, 48 and 72 hour	100 μg	37.2	29.2
F.Buffer	24, 48 and 72 hour	-	48.9	10.4

Example 36: Routes of Administration

[001036] Studies were performed to investigate split dosing using different routes of administration. Studies utilizing multiple subcutaneous or intramuscular injection sites at one time point were designed and performed to investigate ways to increase mmRNA drug exposure and improve protein production. In addition to detection of the expressed protein product, an assessment of the physiological function of proteins was also determined through analyzing samples from the animal tested.

[001037] Surprisingly, it has been determined that split dosing of mmRNA produces greater protein production and phenotypic responses than those produced by single unit dosing or multi-dosing schemes.

[001038] The design of a split dose experiment involved using human erythropoietin (EPO) mmRNA (mRNA sequence shown in SEQ ID NO: 9; polyA tail of approximately 160 nucleotides not shown in sequence; 5'cap, Cap1) or luciferase mmRNA (mRNA sequence shown in SEQ ID NO: 16; polyA tail of approximately 160 nucleotides not shown in sequence; 5'cap, Cap1) administered in buffer alone or formulated with 30% lipoplex (RNAIMAX™). The dosing vehicle (formulation buffer) consisted of 150mM NaCl, 2 mM CaCl₂, 2 mM Na⁺-phosphate (1.4mM monobasic sodium phosphate; 0.6mM dibasic sodium phosphate), and 0.5 mM EDTA, pH 6.5. The pH was adjusted using sodium hydroxide and the final solution was filter sterilized. The mmRNA was modified with 5meC at each cytosine and pseudouridine replacement at each uridine site.

[001039] 4 mice per group were dosed intramuscularly (I.M.), intravenously (I.V.) or subcutaneously (S.C.) by the dosing chart outlined in Table 60. Serum was collected 13 hours post injection from all mice, tissue was collected from the site of injection from the intramuscular and subcutaneous group and the spleen, liver and kidneys were collected from the intravenous group. The results from the intramuscular group and the subcutaneous group results are shown in Table 61.

Table 60. Dosing Chart

Group	Treatment	Route	Dose of mmRNA	Total Dose	Dosing Vehicle
1	Lipoplex-human EPO mmRNA	I.M.	4 x 100 ug + 30% Lipoplex	4x70 ul	Lipoplex
2	Lipoplex-human EPO mmRNA	I.M.	4 x 100 ug	4x70 ul	Buffer
3	Lipoplex-human EPO mmRNA	S.C.	4 x 100 ug + 30% Lipoplex	4x70 ul	Lipoplex
4	Lipoplex-human EPO mmRNA	S.C.	4 x 100 ug	4x70 ul	Buffer
5	Lipoplex-human EPO mmRNA	I.V.	200 ug + 30% Lipoplex	140 ul	Lipoplex
6	Lipoplexed-Luciferase mmRNA	I.M.	100 ug + 30% Lipoplex	4x70 ul	Lipoplex
7	Lipoplexed-Luciferase mmRNA	I.M.	100 ug	4x70 ul	Buffer
8	Lipoplexed-Luciferase mmRNA	S.C.	100 ug + 30% Lipoplex	4x70 ul	Lipoplex
9	Lipoplexed-Luciferase mmRNA	S.C.	100 ug	4x70 ul	Buffer
10	Lipoplexed-human EPO mmRNA	I.V.	200 ug + 30% Lipoplex	140 ul	Lipoplex
11	Formulation Buffer	I.M.	4x multi dosing	4x70 ul	Buffer

Table 61. Human EPO Protein in Mouse Serum (I.M. Injection Route)

Formulation	EPO (pg/ml)	
	I.M. Injection Route	S.C. Injection Route
Epo-Lipoplex	67.115	2.154
Luc-Lipoplex	0	0
Epo-Saline	100.891	11.37
Luc-Saline	0	0
Formulation Buffer	0	0

Example 37. Rapidly eliminated Lipid Nanoparticle (reLNP) Studies

A. Formulation of Modified RNA reLNPs

[001040] Solutions of synthesized lipid, 1,2-distearoyl-3 -phosphatidylcholine (DSPC) (Avanti Polar Lipids, Alabaster, AL), cholesterol (Sigma-Aldrich, Taufkirchen, Germany), and α -[3'-(1,2-dimyristoyl-3-propanoxy)-carboxamide-propyl]- ω -methoxy-polyoxy ethylene (PEG-c-DOMG) (NOF, Bouwelven, Belgium) are prepared and stored at -20°C. The synthesized lipid is selected from DLin-DMA with an internal ester, DLin-DMA with a terminal ester, DLin-MC3-DMA-internal ester, and DLin-MC3-DMA with a terminal ester. The reLNPs are combined to yield a molar ratio of 50:10:38.5:1.5 (reLNP: DSPC: Cholesterol: PEG-c-DOMG). Formulations of the reLNPs and modified mRNA are prepared by combining the lipid solution with the modified mRNA solution at total lipid to modified mRNA weight ratio of 10:1, 15:1, 20:1 and 30:1.

B. Characterization of formulations

[001041] A Zetasizer Nano ZS (Malvern Instruments Ltd, Malvern, Worcestershire, UK) is used to determine the particle size, the polydispersity index (PDI) and the zeta potential of the modified

mRNA nanoparticles in IX PBS in determining particle size and 15 mM PBS in determining zeta potential.

[001042] Ultraviolet-visible spectroscopy is used to determine the concentration of modified mRNA nanoparticle formulation. After mixing, the absorbance spectrum of the solution is recorded between 230 nm and 330 nm on a DU 800 spectrophotometer (Beckman Coulter, Beckman Coulter, Inc., Brea, CA). The modified RNA concentration in the nanoparticle formulation is calculated based on the extinction coefficient of the modified RNA used in the formulation and on the difference between the absorbance at a wavelength of 260 nm and the baseline value at a wavelength of 330 nm.

[001043] QUANT-IT™ RIBOGREEN® RNA assay (Invitrogen Corporation Carlsbad, CA) is used to evaluate the encapsulation of modified RNA by the nanoparticle. The samples are diluted, transferred to a polystyrene 96 well plate, then either a TE buffer or a 2% Triton X-100 solution is added. The plate is incubated and the RIBOGREEN® reagent is diluted in TE buffer, and of this solution is added to each well. The fluorescence intensity is measured using a fluorescence plate reader (Wallac Victor 1420 Multilabel Counter; Perkin Elmer, Waltham, MA) The fluorescence values of the reagent blank are subtracted from each of the samples and the percentage of free modified RNA is determined by dividing the fluorescence intensity of the intact sample by the fluorescence value of the disrupted sample.

C. *In Vitro* Incubation

[001044] Human embryonic kidney epithelial (HEK293) and hepatocellular carcinoma epithelial (HepG2) cells (LGC standards GmbH, Wesel, Germany) are seeded on 96-well plates (Greiner Bio-one GmbH, Frickenhausen, Germany) and plates for HEK293 cells are precoated with collagen typel . HEK293 are seeded at a density of about 30,000 and HepG2 are seeded at a density of about 35,000 cells per well in 100 µl cell culture medium. Formulations containing mCherry mRNA (mRNA sequence shown in SEQ ID NO: 7; polyA tail of approximately 160 nucleotides not shown in sequence; 5'cap, Cap1) are added directly after seeding the cells and incubated. The mCherry cDNA with the T7 promoter, 5'untranslated region (UTR) and 3' UTR used in *in vitro* transcription (IVT) is given in SEQ ID NO: 8.

[001045] Cells are harvested by transferring the culture media supernatants to a 96-well Pro-Bind U-bottom plate (Beckton Dickinson GmbH, Heidelberg, Germany). Cells are trypsinized with ½ volume Trypsin/EDTA (Biochrom AG, Berlin, Germany), pooled with respective supernatants and

fixed by adding one volume PBS/2%FCS (both Biochrom AG, Berlin, Germany)/0.5% formaldehyde (Merck, Darmstadt, Germany). Samples are then submitted to a flow cytometer measurement with an excitation laser and a filter for PE-Texas Red in a LSRII cytometer (Beckton Dickinson GmbH, Heidelberg, Germany). The mean fluorescence intensity (MFI) of all events and the standard deviation of four independent wells are presented in for samples analyzed.

D. In Vivo Formulation Studies

[001046] Mice are administered intravenously a single dose of a formulation containing a modified mRNA and a reLNP. The modified mRNA administered to the mice is selected from G-CSF (mRNA sequence shown in SEQ ID NO: 6; polyA tail of approximately 160 nucleotides not shown in sequence; 5'cap, Cap1), Factor IX (mRNA shown in SEQ ID NO: 10; polyA tail of approximately 160 nucleotides not shown in sequence; 5'cap, Cap1) or mCherry (mRNA sequence shown in SEQ ID NO: 7; polyA tail of approximately 160 nucleotides not shown in sequence; 5'cap, Cap1).

[001047] The mice are injected with 100ug, 10 ug or 1 ug of the formulated modified mRNA and are sacrificed 8 hours after they are administered the formulation. Serum from the mice administered formulations containing human G-CSF modified mRNA are measured by specific G-CSF ELISA and serum from mice administered human Factor IX modified RNA is analyzed by specific factor IX ELISA or chromogenic assay. The liver and spleen from the mice administered with mCherry modified mRNA are analyzed by immunohistochemistry (IHC) or fluorescence-activated cell sorting (FACS). As a control, a group of mice are not injected with any formulation and their serum and tissue are collected analyzed by ELISA, FACS and/or IHC.

Example 38. In Vitro Transfection of VEGF-A

[001048] Human vascular endothelial growth factor-isoform A (VEGF-A) modified mRNA (mRNA sequence shown in SEQ ID NO: 19; polyA tail of approximately 160 nucleotides not shown in sequence; 5'cap, Cap1) was transfected via reverse transfection in Human Keratinocyte cells in 24 multi-well plates. The VEGF-A cDNA with the T7 promoter, 5' untranslated region (UTR) and 3' UTR used in *in vitro* transcription (IVT) is given in SEQ ID NO: 20. Human Keratinocytes cells were grown in EPILIFE® medium with Supplement S7 from Invitrogen (Carlsbad, CA) until they reached a confluence of 50-70%. The cells were transfected with 0, 46.875, 93.75, 187.5, 375, 750, and 1500 ng of modified mRNA (mmRNA) encoding VEGF-A which had been complexed with RNAIMAX™ from Invitrogen (Carlsbad, CA). The RNA:RNAIMAX™ complex was formed by first incubating the RNA with Supplement-free EPILIFE® media in a 5X volumetric dilution for 10

minutes at room temperature. In a second vial, RNAIMAX™ reagent was incubated with Supplement-free EPILIFE® Media in a 10X volumetric dilution for 10 minutes at room temperature. The RNA vial was then mixed with the RNAIMAX™ vial and incubated for 20-30 minutes at room temperature before being added to the cells in a drop-wise fashion.

[001049] The fully optimized mRNA encoding VEGF-A (mRNA sequence shown in SEQ ID NO: 19; polyA tail of approximately 160 nucleotides not shown in sequence; 5'cap, Cap1) transfected with the Human Keratinocyte cells included modifications during translation such as natural nucleoside triphosphates (NTP), pseudouridine at each uridine site and 5-methylcytosine at each cytosine site (pseudo-U/5mC), and N1-methyl-pseudouridine at each uridine site and 5-methylcytosine at each cytosine site (N1-methyl-Pseudo-U/5mC). Cells were transfected with the mmRNA encoding VEGF-A and secreted VEGF-A concentration (pg/ml) in the culture medium was measured at 6, 12, 24, and 48 hours post-transfection for each of the concentrations using an ELISA kit from Invitrogen (Carlsbad, CA) following the manufacturers recommended instructions. These data, shown in Table 62, show that modified mRNA encoding VEGF-A is capable of being translated in Human Keratinocyte cells and that VEGF-A is transported out of the cells and released into the extracellular environment.

Table 62. VEGF-A Dosing and Protein Secretion

VEGF-A Dose Containing Natural NTPs				
Dose (ng)	6 hours (pg/ml)	12 hours (pg/ml)	24 hours (pg/ml)	48 hours (pg/ml)
46.875	10.37	18.07	33.90	67.02
93.75	9.79	20.54	41.95	65.75
187.5	14.07	24.56	45.25	64.39
375	19.16	37.53	53.61	88.28
750	21.51	38.90	51.44	61.79
1500	36.11	61.90	76.70	86.54
VEGF-A Dose Containing Pseudo-U/5mC				
Dose (ng)	6 hours (pg/ml)	12 hours (pg/ml)	24 hours (pg/ml)	48 hours (pg/ml)
46.875	10.13	16.67	33.99	72.88
93.75	11.00	20.00	46.47	145.61
187.5	16.04	34.07	83.00	120.77
375	69.15	188.10	448.50	392.44
750	133.95	304.30	524.02	526.58
1500	198.96	345.65	426.97	505.41
VEGF-A Dose Containing N1-methyl-Pseudo-U/5mC				
Dose (ng)	6 hours (pg/ml)	12 hours (pg/ml)	24 hours (pg/ml)	48 hours (pg/ml)
46.875	0.03	6.02	27.65	100.42

93.75	12.37	46.38	121.23	167.56
187.5	104.55	365.71	1025.41	1056.91
375	605.89	1201.23	1653.63	1889.23
750	445.41	1036.45	1522.86	1954.81
1500	261.61	714.68	1053.12	1513.39

Example 39. In vivo studies of Factor IX

[001050] Human Factor IX mmRNA (Gen1; fully modified 5-methylcytosine and pseudouridine) formulated in formulation buffer was delivered to mice via intramuscular injection. The results demonstrate that Factor IX protein was elevated in serum as measured 13 hours after administration.

[001051] In this study, mice (N=5 for Factor IX, N=3 for Luciferase or Buffer controls) were intramuscularly injected with 50 μ l of the Factor IX mmRNA (mRNA sequence shown in SEQ ID NO: 10; polyA tail of approximately 160 nucleotides not shown in sequence; 5'cap, Cap1), Luciferase (cDNA sequence for IVT shown in SEQ ID NO: 15; mRNA sequence shown in SEQ ID NO: 16, polyA tail of approximately 160 nucleotides not shown in sequence, 5'cap, Cap1, fully modified with 5-methylcytosine at each cytosine and pseudouridine replacement at each uridine site) or the formulation buffer (F.Buffer) at 2x 100 ug/mouse. The mice were bled at 13 hours after the intramuscular injection to determine the concentration of human the polypeptide in serum in pg/mL. The results revealed that administration of Factor IX mmRNA resulted in levels of 1600 pg/mL at 13 hours as compared to less than 100 pg/mL of Factor IX for either Luciferase or buffer control administration.

Example 40. Multi-site administration: Intramuscular and Subcutaneous

[001052] Human G-CSF modified mRNA (mRNA sequence shown in SEQ ID NO: 6; polyA tail of approximately 160 nucleotides not shown in sequence; 5'cap, Cap1) modified as either Gen1 or Gen2 (5-methylcytosine (5mc) and a pseudouridine (ψ) modification, G-CSF-Gen1; or NI-5-methylcytosine (NI-5mc) and a ψ modification, G-CSF-Gen2) and formulated in formulation buffer were delivered to mice via intramuscular (IM) or subcutaneous (SC) injection. Injection of four doses or 2x 50ug (two sites) daily for three days (24 hrs interval) was performed. The fourth dose was administered 6 hrs before blood collection and CBC analysis. Controls included Luciferase (cDNA sequence for IVT shown in SEQ ID NO: 15; mRNA sequence shown in SEQ ID NO: 16, polyA tail of approximately 160 nucleotides not shown in sequence, 5'cap, Cap1, fully modified with 5-methylcytosine at each cytosine and pseudouridine replacement at each uridine site) or the formulation buffer (F.Buffer). The mice were bled at 72 hours after the first mRNA injection (6 hours after the last mRNA dose) to determine the effect of mRNA-encoded human G-CSF on the

neutrophil count. The dosing regimen is shown in Table 63 as are the resulting neutrophil counts (thousands/uL). In Table 63, an asterisks(*) indicate statistical significance at $p < 0.05$.

[001053] For intramuscular administration, the data reveal a four fold increase in neutrophil count above control at day 3 for the Gen1 G-CSF mRNA and a two fold increase for the Gen2 G-CSF mRNA. For subcutaneous administration, the data reveal a two fold increase in neutrophil count above control at day 3 for the Gen2 G-CSF mRNA.

[001054] These data demonstrate that both 5-methylcytidine/pseudouridine and 5-methylcytidine/N1-methylpseudouridine-modified mRNA can be biologically active, as evidenced by specific increases in blood neutrophil counts.

Table 63. Dosing Regimen

Gr.	Treatment	Route	N=	Dose ($\mu\text{g}/\text{mouse}$)	Dose Vol. ($\mu\text{l}/\text{mouse}$)	Dosing Vehicle	Neutrophil Thous/uL
1	G-CSF (Gen1)	I.M	5	2x50ug (four doses)	50	F. buffer	840*
2	G-CSF (Gen1)	S.C	5	2x50ug (four doses)	50	F. buffer	430
3	G-CSF (Gen2)	I.M	5	2x50ug (four doses)	50	F. buffer	746*
4	G-CSF (Gen2)	S.C	5	2x50ug (four doses)	50	F. buffer	683
5	Luc (Gen1)	I.M.	5	2x50ug (four doses)	50	F. buffer	201
6	Luc (Gen1)	S.C.	5	2x50ug (four doses)	50	F. buffer	307
7	Luc (Gen2)	I.M	5	2x50ug (four doses)	50	F. buffer	336
8	Luc (Gen2)	S.C	5	2x50ug (four doses)	50	F. buffer	357
9	F. Buffer	I.M	4	0 (four doses)	50	F. buffer	245
10	F. Buffer	S.C.	4	0 (four doses)	50	F. buffer	509
11	Untreated	-	4			-	312

Example 41. Intravenous administration

[001055] Human G-CSF modified mRNA (mRNA sequence shown in SEQ ID NO: 6; polyA tail of approximately 160 nucleotides not shown in sequence; 5'cap, Cap1) modified with 5-methylcytosine (5mc) and a pseudouridine (ψ) modification (Gen1); or having no modifications and formulated in 10% lipoplex (RNAiMax) were delivered to mice at a dose of 50 ug RNA and in a volume of 100 ul via intravenous (IV) injection at days 0, 2 and 4. Neutrophils were measured at days 1, 5 and 8. Controls included non-specific mammalian RNA or the formulation buffer alone (F.Buffer). The mice were bled at days 1, 5 and 8 to determine the effect of siRNA-encoded human G-CSF to increase neutrophil count. The dosing regimen is shown in Table 64 as are the resulting neutrophil counts (thousands/uL; K/uL).

[001056] For intravenous administration, the data reveal a four to five fold increase in neutrophil count above control at day 5 with G-CSF modified mRNA but not with unmodified G-CSF mRNA or non-specific controls. Blood count returned to baseline four days after the final injection. No other changes in leukocyte populations were observed.

[001057] In Table 64, an asterisk (^) indicates statistical significance at $p < 0.001$ compared to buffer.

[001058] These data demonstrate that lipoplex-formulated 5-methylcytidine/pseudouridine-modified mRNA can be biologically active, when delivered through an I.V. route of administration as evidenced by specific increases in blood neutrophil counts. No other cell subsets were significantly altered. Unmodified G-CSF mRNA similarly administered showed no pharmacologic effect on neutrophil counts.

Table 64. Dosing Regimen

Gr.	Treatment	N=	Dose Vol. (µl/mouse)	Dosing Vehicle	Neutrophil K/uL
1	G-CSF (Gen1) Day 1	5	100	10% lipoplex	2.91
2	G-CSF (Gen1) Day 5	5	100	10% lipoplex	5.32*
3	G-CSF (Gen1) Day 8	5	100	10% lipoplex	2.06
4	G-CSF (no modification) Day 1	5	100	10% lipoplex	1.88
5	G-CSF (no modification) Day 5	5	100	10% lipoplex	1.95
6	G-CSF (no modification) Day 8	5	100	10% lipoplex	2.09
7	RNA control Day 1	5	100	10% lipoplex	2.90
8	RNA control Day 5	5	100	10% lipoplex	1.68
9	RNA control Day 8	4	100	10% lipoplex	1.72
10	F. Buffer Day 1	4	100	10% lipoplex	2.51
11	F. Buffer Day 5	4	100	10% lipoplex	1.31
12	F. Buffer Day 8	4	100	10% lipoplex	1.92

Example 42. Saline formulation: Intramuscular Administration

A. Protein Expression

[001059] Human G-CSF modified mRNA (mRNA sequence shown in SEQ ID NO: 6; polyA tail of approximately 160 nucleotides not shown in sequence; 5'cap, Cap1) and human EPO mRNA (mRNA sequence shown in SEQ ID NO: 9; polyA tail of approximately 160 nucleotides not shown in sequence; 5'cap, Cap1); G-CSF modified mRNA (modified with 5-methylcytosine (5mc) and pseudouridine (ψ)) and EPO modified mRNA (modified with N1-5-methylcytosine (N1-5mc) and ψ modification), were formulated in formulation buffer (150 mM sodium chloride, 2mM calcium chloride, 2mM phosphate, 0.5 mM EDTA at a pH of 6.5) and delivered to mice via intramuscular (IM) injection at a dose of 100 ug.

[001060] Controls included Luciferase (cDNA sequence for IVT, SEQ ID NO: 15; mRNA sequence shown in SEQ ID NO: 16, polyA tail of approximately 160 nucleotides not shown in sequence, 5'cap, Capl, fully modified with 5-methylcytosine at each cytosine and pseudouridine replacement at each uridine site) or the formulation buffer (F.Buffer). The mice were bled at 13 hours after the injection to determine the concentration of the human polypeptide in serum in pg/mL (G-CSF groups measured human G-CSF in mouse serum and EPO groups measured human EPO in mouse serum). The data are shown in Table 65.

Table 65. Dosing Regimen

Group	Treatment	N=	Dose Vol. (µl/mouse)	Dosing Vehicle	Average Protein Product Pg/mL, serum
G-CSF	G-CSF	5	50	Saline	19.8
G-CSF	Luciferase	5	50	Saline	0.5
G-CSF	F. buffer	5	50	F. buffer	0.5
EPO	EPO	5	50	Saline	191.5
EPO	Luciferase	5	50	Saline	15.0
EPO	F. buffer			F. buffer	4.8

B. Dose Response

[001061] Human EPO modified mRNA (mRNA sequence shown in SEQ ID NO: 9; polyA tail of approximately 160 nucleotides not shown in sequence; 5'cap, Capl; fully modified with 5-methylcytosine and pseudouridine) were formulated in formulation buffer and delivered to mice via intramuscular (IM) injection.

[001062] Controls included Luciferase (mRNA sequence shown in SEQ ID NO: 16, polyA tail of approximately 160 nucleotides not shown in sequence, 5'cap, Capl, fully modified with 5-methylcytosine and pseudouridine) or the formulation buffer (F.Buffer). The mice were bled at 13 hours after the injection to determine the concentration of the human polypeptide in serum in pg/mL. The dose and expression are shown in Table 66.

Table 66. Dosing Regimen and Expression

Treatment	Dose Vol. (µl/mouse)	Average Protein Product pg/mL, serum
EPO	100	96.2
EPO	50	63.5
EPO	25	18.7
EPO	10	25.9
EPO	1	2.6

Luciferase	100	0.0
F. buffer	100	1.0

Example 43. Multi-dose/Multi-administration

[001063] Studies utilizing multiple intramuscular injection sites at one time point were designed and performed.

[001064] The design of a single multi-dose experiment involved using human erythropoietin (EPO) mmRNA (mRNA sequence shown in SEQ ID NO: 9; polyA tail of approximately 160 nucleotides not shown in sequence; 5'cap, Cap1) or G-CSF (mRNA sequence shown in SEQ ID NO: 6; polyA tail of approximately 160 nucleotides not shown in sequence; 5'cap, Cap1) administered in formulation buffer. The dosing vehicle (F. buffer) was used as a control. The EPO and G-CSF mmRNA were modified with 5-methylcytosine at each cytosine and pseudouridine replacement at each uridine site.

[001065] Animals (n=5), Sprague-Dawley rats, were injected IM (intramuscular) for the single unit dose of 100 ug (delivered to one thigh). For multi-dosing 6 doses of 100 ug (delivered to two thighs) were used for both EPO and G-CSF mmRNA. Control dosing involved use of buffer at a single dose. Human EPO blood levels were evaluated 13 hrs post injection.

[001066] Human EPO protein was measured in rat serum 13h post I.M. Five groups of rats were treated and evaluated. The results are shown in Table 67.

Table 67. Multi-dose study

Group	Treatment	Dose of mmRNA	Total Dose	Avg. pg/mL human EPO
1	Human EPO mmRNA	1 x 100 ug	100 ug	143
2	Human EPO mmRNA	6 x 100 ug	600 ug	256
3	G-CSF mmRNA	1 x 100 ug	100 ug	43
4	G-CSF mmRNA	6 x 100 ug	600 ug	58
5	Buffer Alone	--	--	20

Example 44. Signal Sequence Exchange Study

[001067] Several variants of mmRNAs encoding human Granulocyte colony stimulating factor (G-CSF) (mRNA sequence shown in SEQ ID NO: 6; polyA tail of approximately 160 nucleotides not shown in sequence; 5'cap, Cap1) were synthesized using modified nucleotides pseudouridine and 5-methylcytosine (pseudo-U/5mC). These variants included the G-CSF constructs encoding either the wild-type N terminal secretory signal peptide sequence

(MAGPATQSPMKLMALQLLLWHSALWTVQEA; SEQ ID NO: 21), no secretory signal peptide sequence, or secretory signal peptide sequences taken from other mRNAs. These included sequences where the wild type G-CSF signal peptide sequence was replaced with the signal peptide sequence of either: human α -1-anti trypsin (AAT) (MMPSSVSWGILLLAGLCCLVPVSLA; SEQ ID NO: 22), human Factor IX (FIX)

(MQRVNMIMAESPSLITICLLGYLLSAECTVFLDHENANKILNRPKR; SEQ ID NO: 23), human Prolactin (Prolac) (MKGSLLLLLVSNLLLCQSVAP; SEQ ID NO: 24), or human Albumin (Alb) (MKWVTFISLLFLFSSAYSPvGVFRR; SEQ ID NO: 25).

[001068] 250ng of modified mRNA encoding each G-CSF variant was transfected into HEK293A (293A in the table), mouse myoblast (MM in the table) (C2C12, CRL-1772, ATCC) and rat myoblast (RM in the table) (L6 line, CRL-1458, ATCC) cell lines in a 24 well plate using 1 ul of Lipofectamine 2000 (Life Technologies), each well containing 300,000 cells. The supernatants were harvested after 24 hrs and the secreted G-CSF protein was analyzed by ELISA using the Human G-CSF ELISA kit (Life Technologies). The data shown in Table 68 reveal that cells transfected with G-CSF mRNA encoding the Albumin signal peptide secrete at least 12 fold more G-CSF protein than its wild type counterpart.

Table 68. Signal Peptide Exchange

Signal peptides	293A (pg/ml)	MM (pg/ml)	RM (pg/ml)
G-CSF Natural	9650	3450	6050
α -1-anti trypsin	9950	5000	8475
Factor IX	11675	6175	11675
Prolactin	7875	1525	9800
Albumin	122050	81050	173300
No Signal peptide	0	0	0

Example 45. Cytokine Study: PBMC

[001069] PBMC isolation and Culture: 50 mL of human blood from two donors was received from Research Blood Components (lots KP30928 and KP30931) in sodium heparin tubes. For each donor, the blood was pooled and diluted to 70 mL with DPBS (SAFC Bioscience 5933 1C, lot 071M8408) and split evenly between two 50 mL conical tubes. 10 mL of Ficoll Paque (GE Healthcare 17-5442-03, lot 10074400) was gently dispensed below the blood layer. The tubes were centrifuged at 2000 rpm for 30 minutes with low acceleration and braking. The tubes were removed and the buffy coat

PBMC layers were gently transferred to a fresh 50 mL conical and washed with DPBS. The tubes were centrifuged at 1450 rpm for 10 minutes.

[001070] The supernatant was aspirated and the PBMC pellets were resuspended and washed in 50 mL of DPBS. The tubes were centrifuged at 1250 rpm for 10 minutes. This wash step was repeated, and the PBMC pellets were resuspended in 19 mL of Optimem I (Gibco 11058, lot 1072088) and counted. The cell suspensions were adjusted to a concentration of 3.0×10^6 cells / mL live cells.

[001071] These cells were then plated on five 96 well tissue culture treated round bottom plates (Costar 3799) per donor at 50 uL per well. Within 30 minutes, transfection mixtures were added to each well at a volume of 50 uL per well. After 4 hours post transfection, the media was supplemented with 10 uL of Fetal Bovine Serum (Gibco 10082, lot 1012368)

[001072] Transfection Preparation : mmRNA encoding human G-CSF (mRNA sequence shown in SEQ ID NO: 6; polyA tail of approximately 160 nucleotides not shown in sequence; 5'cap, CapI) (containing either (1) natural NTPs, (2) 100% substitution with 5-methyl cytidine and pseudouridine, or (3) 100% substitution with 5-methyl cytidine and N1-methyl pseudouridine; mmRNA encoding luciferase (IVT cDNA sequence shown in SEQ ID NO: 15; mRNA sequence shown in SEQ ID NO: 16, polyA tail of approximately 160 nucleotides not shown in sequence, 5'cap, CapI, fully modified with 5-methylcytosine at each cytosine and pseudouridine replacement at each uridine site) (containing either (1) natural NTPs or (2) 100% substitution with 5-methyl cytidine and pseudouridine) and TLR agonist R848 (Invivogen tlr-r848) were diluted to 38.4 ng / uL in a final volume of 2500 uL Optimem I.

[001073] Separately, 432 uL of Lipofectamine 2000 (Invitrogen 11668-027, lot 1070962) was diluted with 13.1 mL Optimem I. In a 96 well plate nine aliquots of 135 uL of each mmRNA, positive control (R-848) or negative control (Optimem I) was added to 135 uL of the diluted Lipofectamine 2000. The plate containing the material to be transfected was incubated for 20 minutes. The transfection mixtures were then transferred to each of the human PBMC plates at 50 uL per well. The plates were then incubated at 37 C. At 2, 4, 8, 20, and 44 hours each plate was removed from the incubator, and the supernatants were frozen.

[001074] After the last plate was removed, the supernatants were assayed using a human G-CSF ELISA kit (Invitrogen KHC2032) and human IFN-alpha ELISA kit (Thermo Scientific 41105-2). Each condition was done in duplicate.

[0010751] Results: The ability of unmodified and modified mRNA (mmRNAs) to produce the encoded protein was assessed (G-CSF production) over time as was the ability of the mRNA to trigger innate immune recognition as measured by interferon-alpha production. Use of *in vitro* PBMC cultures is an accepted way to measure the immunostimulatory potential of oligonucleotides (Robbins et al, Oligonucleotides 2009 19:89-102).

[001076] Results were interpolated against the standard curve of each ELISA plate using a four parameter logistic curve fit. Shown in Tables 69 and 70 are the average from 2 separate PBMC donors of the G-CSF and IFN-alpha production over time as measured by specific ELISA.

[001077] In the G-CSF ELISA, background signal from the Lipofectamine 2000 untreated condition was subtracted at each timepoint. The data demonstrated specific production of human G-CSF protein by human peripheral blood mononuclear is seen with G-CSF mRNA containing natural NTPs, 100% substitution with 5-methyl cytidine and pseudouridine, or 100% substitution with 5-methyl cytidine and N1-methyl pseudouridine. Production of G-CSF was significantly increased through the use of modified mRNA relative to unmodified mRNA, with the 5-methyl cytidine and N1-methyl pseudouridine containing G-CSF mmRNA showing the highest level of G-CSF production. With regards to innate immune recognition, unmodified mRNA resulted in substantial IFN-alpha production, while the modified mRNA largely prevented interferon-alpha production. G-CSF mRNA fully modified with 5-methyl cytidine and N1-methylpseudouridine did not significantly increase cytokines whereas G-CSF mRNA fully modified with 5-methyl cytidine and pseudouridine induced IFN-alpha, TNF-alpha and IP 10. Many other cytokines were not affected by either modification.

Table 69. G-CSF Signal

G-CSF signal - 2 Donor Average					
pg / mL	2 Hr	4 Hr	8 Hr	20 Hr	44 Hr
G-CSF (5mC/pseudouridine)	120.3	136.8	421.0	346.1	431.8
G-CSF (5mC/N1-methyl pseudouridine)	256.3	273.7	919.3	1603.3	1843.3
GCSF(Natural-no modification)	63.5	92.6	129.6	258.3	242.4
Luciferase (5mC/pseudouridine)	4.5	153.7	33.0	186.5	58.0

Table 70. IFN-alpha signal

IFN-alpha signal - 2 donor average					
pg / mL	2 Hr	4 Hr	8 Hr	20 Hr	44 Hr
G-CSF (5mC/pseudouridine)	21.1	2.9	3.7	22.7	4.3
G-CSF (5mC/N1-methyl	0.5	0.4	3.0	2.3	2.1

pseudouridine)					
G-CSF(Natural)	0.0	2.1	23.3	74.9	119.7
Luciferase (5mC/pseudouridine)	0.4	0.4	4.7	1.0	2.4
R-848	39.1	151.3	278.4	362.2	208.1
Lpf. 2000 control	0.8	17.2	16.5	0.7	3.1

Example 46. Chemical modification ranges of modified mRNA

[001078] Modified nucleotides such as, but not limited to, the chemical modifications 5-methylcytosine and pseudouridine have been shown to lower the innate immune response and increase expression of RNA in mammalian cells. Surprisingly, and not previously known, the effects manifested by the chemical modifications can be titrated when the amount of chemical modification is less than 100%. Previously, it was believed that full modification was necessary and sufficient to elicit the beneficial effects of the chemical modifications and that less than 100% modification of an mRNA had little effect. However, it has now been shown that the benefits of chemical modification can be derived using less than complete modification and that the effects are target, concentration and modification dependent.

A. Modified RNA transfected in PBMC

[001079] 960 ng of G-CSF mRNA modified with 5-methylcytosine (5mC) and pseudouridine (pseudoU) or unmodified G-CSF mRNA was transfected with 0.8 uL of Lipofectamine 2000 into peripheral blood mononuclear cells (PBMC) from three normal blood donors (D1, D2, D3). The G-CSF mRNA (SEQ ID NO: 6; polyA tail of approximately 160 nucleotides not shown in sequence; 5'cap, Cap1) was completely modified with 5mC and pseudoU (100% modification), not modified with 5mC and pseudoU (0% modification) or was partially modified with 5mC and pseudoU so the mRNA would contain 50% modification, 25% modification, 10% modification, 5% modification, 1% modification or 0.1% modification. A control sample of Luciferase (mRNA sequence shown in SEQ ID NO: 16; polyA tail of approximately 160 nucleotides not shown in sequence; 5'cap, Cap1; fully modified 5mC and pseudoU) was also analyzed for G-CSF expression. For TNF-alpha and IFN-alpha control samples of Lipofectamine2000, LPS, R-848, Luciferase (mRNA sequence shown in SEQ ID NO: 16; polyA tail of approximately 160 nucleotides not shown in sequence; 5'cap, Cap1; fully modified 5mC and pseudoU), and P(I)P(C) were also analyzed. The supernatant was harvested and run by ELISA 22 hours after transfection to determine the protein expression. The expression of G-CSF is shown in Table 71 and the expression of IFN-alpha and TNF-alpha is shown in Table 72. The expression of IFN-alpha and TNF-alpha may be a secondary effect from the transfection of the G-CSF mRNA. Tables and shows that the amount of chemical modification of G-

CSF, IFN-alpha and TNF-alpha is titratable when the mRNA is not fully modified and the titratable trend is not the same for each target.

Table 71. G-CSF Expression

	G-CSF Expression (pg/ml)		
	D1	D2	D3
100% modification	270.3	151.6	162.2
50% modification	45.6	19.8	26.3
25% modification	23.6	10.8	8.9
10% modification	39.4	12.9	12.9
5% modification	70.9	26.8	26.3
1 % modification	70.3	26.9	66.9
0.1% modification	67.5	25.2	28.7
Luciferase	14.5	3.1	10.0

Table 72. IFN-alpha and TNF-alpha Expression

	IFN-alpha Expression (pg/ml)			TNF-alpha Expression (pg/ml)		
	D1	D2	D3	D1	D2	D3
100% modification	76.8	6.8	15.1	5.6	1.4	21.4
50% modification	22.0	5.5	257.3	4.7	1.7	12.1
25% modification	64.1	14.9	549.7	3.9	0.7	10.1
10% modification	150.2	18.8	787.8	6.6	0.9	13.4
5% modification	143.9	41.3	1009.6	2.5	1.8	12.0
1 % modification	189.1	40.5	375.2	9.1	1.2	25.7
0.1% modification	261.2	37.8	392.8	9.0	2.	13.7
0% modification	230.3	45.1	558.3	10.9	1.4	10.9
LF 200	0	0	1.5	45.8	2.8	53.6
LPS	0	0	1.0	114.5	70.0	227.0
R-848	39.5	11.9	183.5	389.3	256.6	410.6
Luciferase	9.1	0	3.9	4.5	2.7	13.6
P(I)P(C)	1498.1	216.8	238.8	61.2	4.4	69.1

B. Modified RNA transfected in HEK293

[001080] Human embryonic kidney epithelial (HEK293) cells were seeded on 96-well plates at a density of 30,000 cells per well in 100 ul cell culture medium. 250 ng of modified G-CSF mRNA (SEQ ID NO: 6; polyA tail of approximately 160 nucleotides not shown in sequence; 5'cap, Cap1) formulated with RNAiMAX™ (Invitrogen, Carlsbad, CA) was added to a well. The G-CSF was completely modified with 5mC and pseudoU (100% modification), not modified with 5mC and pseudoU (0% modification) or was partially modified with 5mC and pseudoU so the mRNA would contain 75% modification, 50% modification or 25% modification. Control samples (AK 5/2, mCherry (SEQ ID NO: 7; polyA tail of approximately 160 nucleotides not shown in sequence;

5'cap, Cap1; fully modified 5mC and pseudoU) and untreated) were also analyzed. The half-life of G-CSF mRNA fully modified with 5-methylcytosine and pseudouridine is approximately 8-10 hours. The supernatants were harvested after 16 hours and the secreted G-CSF protein was analyzed by ELISA. Table 73 shows that the amount of chemical modification of G-CSF is titratable when the mRNA is not fully modified.

Table 73. G-CSF Expression

	G-CSF Expression (ng/ml)
100% modification	118.4
75% modification	101.9
50% modification	105.7
25% modification	231.1
0% modification	270.9
AK 5/2	166.8
mCherry	0
Untreated	0

Example 47: In Vivo Delivery of Modified mRNA (mniRNA)

[001081] Modified RNA was delivered to C57/BL6 mice intramuscularly, subcutaneously, or intravenously to evaluate the bio-distribution of modified RNA using luciferase. A formulation buffer used with all delivery methods contained 150mM sodium chloride, 2mM calcium chloride, 2 mM Na⁺-phosphate which included 1.4mM monobasic sodium phosphate and 0.6 mM of dibasic sodium phosphate, and 0.5 mM ethylenediaminetetraacetic acid (EDTA) was adjusted using sodium hydroxide to reach a final pH of 6.5 before being filtered and sterilized. A IX concentration was used as the delivery buffer. To create the lipoplexed solution delivered to the mice, in one vial 50 µg of RNA was equilibrated for 10 minutes at room temperature in the delivery buffer and in a second vial 10 µl RNAiMAX™ was equilibrated for 10 minutes at room temperature in the delivery buffer. After equilibrium, the vials were combined and delivery buffer was added to reach a final volume of 100 µl which was then incubated for 20 minutes at room temperature. Luciferin was administered by intraperitoneal injection (IP) at 150 mg/kg to each mouse prior to imaging during the plateau phase of the luciferin exposure curve which was between 15 and 30 minutes. To create luciferin, 1 g of D-luciferin potassium or sodium salt was dissolved in 66.6 ml of distilled phosphate buffer solution (DPBS), not containing Mg²⁺ or Ca²⁺, to make a 15 mg/ml solution. The solution was gently mixed and passed through a 0.2 µm syringe filter, before being purged with nitrogen, aliquoted and frozen at -80°C while being protected from light as much as possible. The solution

was thawed using a waterbath if luciferin was not dissolved, gently mixed and kept on ice on the day of dosing.

[001082] Whole body images were taken of each mouse 2, 8 and 24 hours after dosing. Tissue images and serum was collected from each mouse 24 hours after dosing. Mice administered doses intravenously had their liver, spleen, kidneys, lungs, heart, peri-renal adipose tissue and thymus imaged. Mice administered doses intramuscularly or subcutaneously had their liver, spleen, kidneys, lungs, peri-renal adipose tissue, and muscle at the injection site. From the whole body images the bioluminescence was measured in photon per second for each route of administration and dosing regimen.

A. Intramuscular Administration

[001083] Mice were intramuscularly (I.M.) administered either modified luciferase mRNA fully modified with 5-methylcytosine and pseudouridine (Naked-Luc), lipoplexed modified luciferase mRNA fully modified with 5-methylcytosine and pseudouridine (Lipoplex-luc) (IVT cDNA sequence shown in SEQ ID NO: 15; mRNA sequence shown in SEQ ID NO: 16, polyA tail of approximately 160 nucleotides not shown in sequence, 5'cap, Cap1, fully modified with 5-methylcytosine at each cytosine and pseudouridine replacement at each uridine site), lipoplexed modified granulocyte colony-stimulating factor (G-CSF) mRNA (mRNA sequence shown in SEQ ID NO: 6; polyA tail of approximately 160 nucleotides not shown in sequence; 5'cap, Cap1; fully modified with 5-methylcytosine and pseudouridine) (Lipoplex-Cytokine) or the formation buffer at a single dose of 50 µg of modified RNA in an injection volume of 50µl for each formulation in the right hind limb and a single dose of 5 µg of modified RNA in an injection volume of 50 µl in the left hind limb. The bioluminescence average for the luciferase expression signals for each group at 2, 8 and 24 hours after dosing are shown in Table 74. The bioluminescence showed a positive signal at the injection site of the 5 µg and 50 µg modified RNA formulations containing and not containing lipoplex.

Table 74. *In vivo* Biophotonic Imaging (I.M. Injection Route)

Formulation	Dose (ug)	Bioluminescence (photon/sec)		
		2 hours	8 hours	24 hours
Naked-Luc	5	224,000	683,000	927,000
Lipoplex-Luc	5	579,000	639,000	186,000
Lipoplex-G-CSF	5	64,600	85,600	75,100
Formulation Buffer	5	102,000	86,000	90,700
Naked-Luc	50	446,000	766,000	509,000
Lipoplex-Luc	50	374,000	501,000	332,000
Lipoplex-G-CSF	50	49,400	74,800	74,200

Formulation Buffer	50	59,300	69,200	63,600
--------------------	----	--------	--------	--------

B. Subcutaneous Administration

[001084] Mice were subcutaneously (S.C.) administered either modified luciferase mRNA (Naked-Luc), lipoplexed modified luciferase mRNA (Lipoplex-luc), lipoplexed modified G-CSF mRNA (Lipoplex-G-CSF) or the formation buffer at a single dose of 50 µg of modified mRNA in an injection volume of 100 µl for each formulation. The bioluminescence average for the luciferase expression signals for each group at 2, 8 and 24 hours after dosing are shown in Table 75. The bioluminescence showed a positive signal at the injection site of the 50 µg modified mRNA formulations containing and not containing lipoplex.

Table 75. *In vivo* Biophotonic Imaging (S.C. Injection Route)

Formulation	Bioluminescence (photon/sec)		
	2 hours	8 hours	24 hours
Naked-Luc	3,700,000	8,060,000	2,080,000
Lipoplex-Luc	3,960,000	1,700,000	1,290,000
Lipoplex-G-CSF	123,000	121,000	117,000
Formulation Buffer	116,000	127,000	123,000

C. Intravenous Administration

[001085] Mice were intravenously (I.V.) administered either modified luciferase mRNA (Naked-Luc), lipoplexed modified luciferase mRNA (Lipoplex-luc), lipoplexed modified G-CSF mRNA (Lipoplex-G-CSF) or the formation buffer at a single dose of 50 µg of modified mRNA in an injection volume of 100 µl for each formulation. The bioluminescence average for the luciferase expression signal in the spleen from each group at 2 hours after dosing is shown in Table 76. The bioluminescence showed a positive signal in the spleen of the 50 µg modified mRNA formulations containing lipoplex.

Table 76 *In vivo* Biophotonic Imaging (I.V. Injection Route)

Formulation	Bioluminescence (photon/sec) of the Spleen
Naked-Luc	58,400
Lipoplex-Luc	65,000
Lipoplex-G-CSF	57,100
Formulation Buffer	58,300

Example 48. Split dose studies

[001086] Studies utilizing multiple subcutaneous or intramuscular injection sites at one time point were designed and performed to investigate ways to increase mmRNA drug exposure and improve protein production. In addition to detection of the expressed protein product, an assessment of the physiological function of proteins was also determined through analyzing samples from the animal tested.

[001087] Surprisingly, it has been determined that split dosing of mmRNA produces greater protein production and phenotypic responses than those produced by single unit dosing or multi-dosing schemes.

[001088] The design of a single unit dose, multi-dose and split dose experiment involved using human erythropoietin (EPO) modified mRNA (mRNA shown in SEQ ID NO: 9; polyA tail of approximately 160 nucleotides not shown in sequence; 5'cap, CapI) administered in buffer alone. The dosing vehicle (F. buffer) consisted of 150mM NaCl, 2 mM CaCl₂, 2 mM Na⁺-phosphate (1.4mM monobasic sodium phosphate; 0.6mM dibasic sodium phosphate), and 0.5 mM EDTA, pH 6.5. The pH was adjusted using sodium hydroxide and the final solution was filter sterilized. The mmRNA was modified with 5meC at each cytosine and pseudouridine replacement at each uridine site.

[001089] Animals (n=5) were injected IM (intramuscular) for the single unit dose of 100 ug. For multi-dosing, two schedules were used, 3 doses of 100 ug and 6 doses of 100 ug. For the split dosing scheme, two schedules were used, 3 doses at 33.3 ug and 6 doses of 16.5 ug mmRNA. Control dosing involved use of buffer only at 6 doses. Control mmRNA involved the use of luciferase mmRNA (IVT cDNA sequence shown in SEQ ID NO: 15; mRNA sequence shown in SEQ ID NO: 16; polyA tail of approximately 160 nucleotides not shown in sequence; 5'cap, CapI; fully modified 5meC at each cytosine and pseudouridine replacement at each uridine site) dosed 6 times at 100 ug. Blood and muscle tissue were evaluated 13 hrs post injection.

[001090] Human EPO protein was measured in mouse serum 13h post I.M. single, multi- or split dosing of the EPO mmRNA in buffer. Seven groups of mice (n=5 mice per group) were treated and evaluated. The results are shown in Table 77.

Table 77. Split dose study

Group	Treatment	Dose of mmRNA	Total Dose	Avg. pmol/mL human EPO	Polypeptide per unit drug (pmol/ug)	Dose Splitting Factor
1	Human EPO mmRNA	1 x 100 ug	100 ug	14.3	0.14	1

2	Human EPO mmRNA	3 x 100 ug	300 ug	82.5	0.28	2
3	Human EPO mmRNA	6 x 100 ug	600 ug	273.0	0.46	3.3
4	Human EPO mmRNA	3 x 33.3 ug	100 ug	104.7	1.1	7.9
5	Human EPO mmRNA	6 x 16.5 ug	100 ug	127.9	1.3	9.3
6	Luciferase mmRNA	6 x 100 ug	600 ug	0	--	--
7	Buffer Alone	—	—	0	—	—

[001091] The splitting factor is defined as the product per unit drug divided by the single dose product per unit drug (PUD). For example for treatment group 2 the value .28 or product (EPO) per unit drug (mmRNA) is divided by the single dose product per unit drug of 0.14. The result is 2. Likewise, for treatment group 4, the value 1.1 or product (EPO) per unit drug (mmRNA) is divided by the single dose product per unit drug of 0.14. The result is 7.9. Consequently, the dose splitting factor (DSF) may be used as an indicator of the efficacy of a split dose regimen. For any single administration of a total daily dose, the DSF should be equal to 1. Therefore any DSF greater than this value in a split dose regimen is an indication of increased efficacy.

[001092] To determine the dose response trends, impact of injection site and impact of injection timing, studies are performed. In these studies, varied doses of 1ug, 5ug, 10 ug, 25 ug, 50 ug, and values in between are used to determine dose response outcomes. Split dosing for a 100 ug total dose includes three or six doses of 1.6 ug, 4.2 ug, 8.3 ug, 16.6 ug, or values and total doses equal to administration of the total dose selected.

[001093] Injection sites are chosen from the limbs or any body surface presenting enough area suitable for injection. This may also include a selection of injection depth to target the dermis (Intradermal), epidermis (Epidermal), subcutaneous tissue (SC) or muscle (IM). Injection angle will vary based on targeted delivery site with injections targeting the intradermal site to be 10-15 degree angles from the plane of the surface of the skin, between 20-45 degrees from the plane of the surface of the skin for subcutaneous injections and angles of between 60-90 degrees for injections substantially into the muscle.

Example 49. Quantification in Exosomes

[001094] The quantity and localization of the mmRNA of the present invention can be determined by measuring the amounts (initial, timecourse, or residual basis) in isolated exosomes. In this study,

since the mmRNA are typically codon-optimized and distinct in sequence from endogenous mRNA, the levels of mmRNA are quantitated as compared to endogenous levels of native or wild type mRNA by using the methods of Gibbins, PCT/IB2009/005878, the contents of which are incorporated herein by reference in their entirety.

[001095] In these studies, the method is performed by first isolating exosomes or vesicles preferably from a bodily fluid of a patient previously treated with a modified mmRNA of the invention, then measuring, in said exosomes, the modified mmRNA levels by one of mRNA microarray, qRT-PCR, or other means for measuring RNA in the art including by suitable antibody or immunohistochemical methods.

Example 50. Modified mRNA Transfection

A. Reverse Transfection

[001096] For experiments performed in a 24-well collagen-coated tissue culture plate, Keratinocytes are seeded at a cell density of 1×10^5 . For experiments performed in a 96-well collagen-coated tissue culture plate, Keratinocytes are seeded at a cell density of 0.5×10^5 . For each modified mRNA (mmRNA) to be transfected, modified mRNA: RNAIMAX™ is prepared as described and mixed with the cells in the multi-well plate within a period of time, e.g., 6 hours, of cell seeding before cells had adhered to the tissue culture plate.

B. Forward Transfection

[001097] In a 24-well collagen-coated tissue culture plate, Keratinocytes are seeded at a cell density of 0.7×10^5 . For experiments performed in a 96-well collagen-coated tissue culture plate, Keratinocytes are seeded at a cell density of 0.3×10^5 . Keratinocytes are grown to a confluency of >70% for over 24 hours. For each modified mRNA (mmRNA) to be transfected, modified mRNA: RNAIMAX™ is prepared as described and transfected onto the cells in the multi-well plate over 24 hours after cell seeding and adherence to the tissue culture plate.

C. Modified mRNA Translation Screen: G-CSF ELISA

[001098] Keratinocytes are grown in EPILIFE medium with Supplement S7 from Invitrogen (Carlsbad, CA) at a confluence of >70%. One set of keratinocytes were reverse transfected with 300 ng of the chemically modified mRNA (mmRNA) complexed with RNAIMAX™ from Invitrogen. Another set of keratinocytes are forward transfected with 300 ng modified mRNA complexed with RNAIMAX™ from Invitrogen. The modified mRNA: RNAIMAX™ complex is formed by first incubating the RNA with Supplement-free EPILIFE® media in a 5X volumetric dilution for 10 minutes at room temperature.

[001099] In a second vial, RNAIMAX™ reagent was incubated with Supplement-free EPILIFE® Media in 10X volumetric dilution for 10 minutes at room temperature. The RNA vial was then mixed with the RNAIMAX™ vial and incubated for 20-30 minutes at room temperature before being added to the cells in a drop-wise fashion. Secreted human Granulocyte-Colony Stimulating Factor (G-CSF) concentration in the culture medium is measured at 18 hours post-transfection for each of the chemically modified mRNA in triplicate.

[001100] Secretion of Human G-CSF from transfected human keratinocytes is quantified using an ELISA kit from Invitrogen or R&D Systems (Minneapolis, MN) following the manufacturers recommended instructions.

D. Modified mRNA Dose and Duration: G-CSF ELISA

[001101] Keratinocytes are grown in EPILIFE® medium with Supplement S7 from Invitrogen at a confluence of >70%. Keratinocytes are reverse transfected with either Ong, 46.875ng, 93.75ng, 187.5ng, 375ng, 750ng, or 1500ng modified mRNA complexed with the RNAIMAX™ from Invitrogen (Carlsbad, CA). The modified mRNA:RNAIMAX™ complex is formed as described. Secreted human G-CSF concentration in the culture medium is measured at 0, 6, 12, 24, and 48 hours post-transfection for each concentration of each modified mRNA in triplicate. Secretion of human G-CSF from transfected human keratinocytes is quantified using an ELISA kit from Invitrogen or R&D Systems following the manufacturers recommended instructions.

Example 51. Detection of a Cellular Innate Immune Response to Modified mRNA Using an ELISA Assay

[001102] An enzyme-linked immunosorbent assay (ELISA) for Human Tumor Necrosis Factor- α (TNF- α), Human Interferon- β (IFN- β) and Human Granulocyte-Colony Stimulating Factor (G-CSF) secreted from *in vitro*-transfected Human Keratinocyte cells is tested for the detection of a cellular innate immune response. Keratinocytes are grown in EPILIFE® medium with Human Keratinocyte Growth Supplement in the absence of hydrocortisone from Invitrogen (Carlsbad, CA) at a confluence of >70%. Secreted TNF- α keratinocytes are reverse transfected with Ong, 93.75ng, 187.5ng, 375ng, 750ng, 1500ng or 3000ng of the chemically modified mRNA (mmRNA) complexed with RNAIMAX™ from Invitrogen as described in triplicate. Secreted TNF- α in the culture medium is measured 24 hours post-transfection for each of the chemically modified mRNA using an ELISA kit from Invitrogen according to the manufacturer protocols.

[001103] Secreted IFN- β in the same culture medium is measured 24 hours post-transfection for each of the chemically modified mRNA using an ELISA kit from Invitrogen according to the

manufacturer protocols. Secreted human G-CSF concentration in the same culture medium is measured at 24 hours post-transfection for each of the chemically modified mRNA. Secretion of human G-CSF from transfected human keratinocytes is quantified using an ELISA kit from Invitrogen or R&D Systems (Minneapolis, MN) following the manufacturers recommended instructions. These data indicate which modified mRNA (mmRNA) are capable eliciting a reduced cellular innate immune response in comparison to natural and other chemically modified polynucleotides or reference compounds by measuring exemplary type 1 cytokines TNF- α and IFN- β .

Example 52. Human Granulocyte -Colony Stimulating Factor (G-CSF) Modified mRNA-induced Cell Proliferation Assay

[001104] Human keratinocytes are grown in EPILIFE® medium with Supplement S7 from Invitrogen at a confluence of >70% in a 24-well collagen-coated TRANSWELL® (Coming, Lowell, MA) co-culture tissue culture plate. Keratinocytes are reverse transfected with 750ng of the indicated chemically modified mRNA (mmRNA) complexed with RNAiMAX from Invitrogen as described in triplicate. The modified mRNA:RNAiMAX complex is formed as described. Keratinocyte media is exchanged 6-8 hours post-transfection. 42-hours post-transfection, the 24-well TRANSWELL® plate insert with a 0.4 μ m-pore semi-permeable polyester membrane is placed into the human G-CSF modified mRNA-transfected keratinocyte containing culture plate

[001105] Human myeloblast cells, Kasumi-1 cells or KG-1 (0.2×10^5 cells), are seeded into the insert well and cell proliferation is quantified 42 hours post-co-culture initiation using the CyQuant Direct Cell Proliferation Assay (Invitrogen, Carlsbad, CA) in a 100-120 μ l volume in a 96-well plate. Modified mRNA-encoding human G-CSF-induced myeloblast cell proliferation is expressed as a percent cell proliferation normalized to untransfected keratinocyte/myeloblast co-culture control wells. Secreted human G-CSF concentration in both the keratinocyte and myeloblast insert co-culture wells is measured at 42 hours post-co-culture initiation for each modified mRNA in duplicate. Secretion of human G-CSF is quantified using an ELISA kit from Invitrogen following the manufacturer recommended instructions.

[001106] Transfected human G-CSF modified mRNA in human keratinocyte feeder cells and untransfected human myeloblast cells are detected by RT-PCR. Total RNA from sample cells is extracted and lysed using RNEASY® kit (Qiagen, Valencia, CA) according to the manufacturer instructions. Extracted total RNA is submitted to RT-PCR for specific amplification of modified

mRNA-G-CSF using PROTOSCRIPT® M-MuLV *Tag* RT-PCR kit (New England BioLabs, Ipswich, MA) according to the manufacturer instructions with human G-CSF-specific primers. RT-PCR products are visualized by 1.2% agarose gel electrophoresis.

Example 53. Buffer Formulation Studies

[001107] G-CSF modified mRNA (SEQ ID NO: 6; polyA tail of approximately 160 nucleotides not shown in sequence; 5'cap, Cap1; fully modified with NI-pseudouridine and 5-methylcytosine) or Factor IX modified mRNA (SEQ ID NO: 10; polyA tail of approximately 160 nucleotides not shown in sequence; 5'cap, Cap1; fully modified with NI-pseudouridine and 5-methylcytosine) in a buffer solution is administered intramuscularly to rats in an injection volume of 50 μ l (n=5) at a modified mRNA dose of 200 ug per rat as described in Table 78. The modified mRNA is lyophilized in water for 1-2 days. It is then reconstituted in the buffers listed below to a target concentration of 6 mg/ml. Concentration is determined by OD 260. Samples are diluted to 4 mg/ml in the appropriate buffer before dosing.

[001108] To precipitate the modified mRNA, 3M sodium acetate, pH 5.5 and pure ethanol are added at 1/10th the total volume and 4 times the total volume of modified mRNA, respectively. The material is placed at -80C for a minimum of 1 hour. The material is then centrifuged for 30 minutes at 4000 rpm, 4C. The supernatant is removed and the pellet is centrifuged and washed 3x with 75% ethanol. Finally, the pellet is reconstituted with buffer to a target concentration of 6 mg/ml. Concentration is determined by OD 260. Samples are diluted to 4 mg/ml in the appropriate buffer before dosing. All samples are prepared by lyophilization unless noted below.

Table 78. Buffer Dosing Groups

Group	Treatment	Buffer	Dose (ug/rat)
1	G-CSF	0.9% Saline	200
	Factor IX	0.9% Saline	200
2	G-CSF	0.9% Saline + 2mM Calcium	200
	Factor IX	0.9% Saline + 2mM Calcium	200
3	G-CSF	Lactated Ringer's	200
	Factor IX	Lactated Ringer's	200
4	G-CSF	5% Sucrose	200
	Factor IX	5% Sucrose	200
5	G-CSF	5% Sucrose + 2mM Calcium	200
	Factor IX	5% Sucrose + 2mM Calcium	200
6	G-CSF	5% Mannitol	200
	Factor IX	5% Mannitol	200
7	G-CSF	5% Mannitol + 2mM Calcium	200
	Factor IX	5% Mannitol + 2mM Calcium	200
8	G-CSF	0.9% saline (precipitation)	200

	Factor IX	0.9% saline (precipitation)	200
--	-----------	-----------------------------	-----

[001109] Serum samples are collected from the rats at various time intervals and analyzed for G-CSF or Factor IX protein expression using G-CSF or Factor IX ELISA.

Example 54. Multi-Dose Study

[001110] Sprague-Dawley rats (n=8; 4 female, 4 male) are injected intravenously eight times (twice a week) over 28 days. The rats are injected with 0.5 mg/kg, 0.05 mg/kg, 0.005 mg/kg or 0.0005 mg/kg of human G-CSF modified mRNA of luciferase modified mRNA formulated in a lipid nanoparticle, 0.5 mg/kg of human G-CSF modified mRNA in saline, 0.2 mg/kg of the human G-CSF protein Neupogen or non-translatable human G-CSF modified mRNA formulated in a lipid nanoparticle. Serum is collected during pre-determined time intervals to evaluate G-CSF protein expression (8, 24 and 72 hours after the first dose of the week), complete blood count and white blood count (24 and 72 hours after the first dose of the week) and clinical chemistry (24 and 72 hours after the first dose of the week). The rats are sacrificed at day 29, 4 days after the final dosing, to determine the complete blood count, white blood count, clinical chemistry, protein expression and to evaluate the effect on the major organs by histopathology and necropsy. Further, an antibody assay is performed on the rats on day 29.

Example 55. Luciferase LNP *in vivo* study

[001111] Luciferase modified mRNA (SEQ ID NO: 16; polyA tail of approximately 160 nucleotides not shown in sequence, 5' cap, Cap1; fully modified with 5-methylcytosine and pseudouridine was formulated as a lipid nanoparticle (LNP) using the syringe pump method. The LNP was formulated at a 20:1 weight ratio of total lipid to modified mRNA with a final lipid molar ratio of 50:10:38.5:1.5 (DLin-KC2-DMA: DSPC: Cholesterol: PEG-DMG). As shown in Table 79, the luciferase LNP formulation was characterized by particle size, zeta potential, and encapsulation.

Table 79. Luciferase Formulation

Formulation	NPA-098-1
Modified mRNA	Luciferase
Mean size	135 nm
	PDI: 0.08
Zeta at pH 7.4	-0.6 mV
Encaps. (RiboGr)	91 %

[001112] As outlined in Table 80, the luciferase LNP formulation was administered to Balb-C mice (n=3) intramuscularly, intravenously and subcutaneously and a luciferase modified RNA formulated in PBS was administered to mice intravenously.

Table 80. Luciferase Formulations

Formulation	Vehicle	Route	Concentration (mg/ml)	Injection Volume (ul)	Amount of modified RNA (ug)	Dose (mg/kg)
Luc-LNP	PBS	IV	0.20	50	10	0.50
Luc-LNP	PBS	IM	0.20	50	10	0.50
Luc-LNP	PBS	SC	0.20	50	10	0.50
Luc-PBS	PBS	IV	0.20	50	10	0.50

[001113] The mice administered the luciferase LNP formulation intravenously and intramuscularly were imaged at 2, 8, 24, 48, 120 and 192 hours and the mice administered the luciferase LNP formulation subcutaneously were imaged at 2, 8, 24, 48 and 120 hours to determine the luciferase expression as shown in Table 81. In Table 81, "NT" means not tested. Twenty minutes prior to imaging, mice were injected intraperitoneally with a D-luciferin solution at 150 mg/kg. Animals were then anesthetized and images were acquired with an IVIS Lumina II imaging system (Perkin Elmer). Bioluminescence was measured as total flux (photons/second) of the entire mouse.

Table 81. Luciferase Expression

Formulation	Route of Administration	Average Expression (photon/second)					
		2 hours	8 hours	24 hours	48 hours	120 hours	192 hours
Luc-LNP	IV	1.62E+08	3.00E+09	7.77E+08	4.98E+08	1.89E+08	6.08E+07
Luc-LNP	IM	4.85E+07	4.92E+08	9.02E+07	3.17E+07	1.22E+07	2.38E+06
Luc-LNP	SC	1.85E+07	9.79E+08	3.09E+08	4.94E+07	1.98E+06	NT
Luc-PBS	IV	3.61E+05	5.64E+05	3.19E+05	NT	NT	NT

[001114] One mouse administered the LNP formulation intravenously was sacrificed at 8 hours to determine the luciferase expression in the liver and spleen. Also, one mouse administered the LNP formulation intramuscular was sacrificed at 8 hours to determine the luciferase expression of the muscle around the injection site and in the liver and spleen. As shown in Table 82, expression was seen in the both the liver and spleen after intravenous and intramuscular administration and in the muscle around the intramuscular injection site.

Table 82. Luciferase Expression in Tissue

Luciferase LNP: IV Administration	Expression (photon/second)
Liver	7.984E+08
Spleen	3.951E+08
Luciferase LNP: IM	Expression

Administration	(photon/second)
Muscle around the injection site	3.688E+07
Liver	1.507E+08
Spleen	1.096E+07

Example 56. *In Vitro* PBMC Studies: Percent modification

[001115] 480 ng of G-CSF mRNA modified with 5-methylcytosine (5mC) and pseudouridine (pseudoU) or unmodified G-CSF mRNA was transfected with 0.4 uL of Lipofectamine 2000 into peripheral blood mononuclear cells (PBMC) from three normal blood donors (D1, D2, and D3). The G-CSF mRNA (SEQ ID NO: 6; polyA tail of approximately 160 nucleotides not shown in sequence; 5'cap, Cap1) was completely modified with 5mC and pseudoU (100% modification), not modified with 5mC and pseudoU (0% modification) or was partially modified with 5mC and pseudoU so the mRNA would contain 75% modification, 50% modification or 25% modification. A control sample of Luciferase (mRNA sequence shown in SEQ ID NO: 16; polyA tail of approximately 160 nucleotides not shown in sequence; 5'cap, Cap1; fully modified 5mC and pseudoU) was also analyzed for G-CSF expression. For TNF-alpha and IFN-alpha control samples of Lipofectamine2000, LPS, R-848, Luciferase (mRNA sequence shown in SEQ ID NO: 16; polyA tail of approximately 160 nucleotides not shown in sequence; 5'cap, Cap1; fully modified 5mC and pseudo), and P(I)P(C) were also analyzed. The supernatant was harvested and run by ELISA 22 hours after transfection to determine the protein expression. The expression of G-CSF is shown in Table 83 and the expression of IFN-alpha and TNF-alpha is shown in Table 84. The expression of IFN-alpha and TNF-alpha may be a secondary effect from the transfection of the G-CSF mRNA. Tables 83 and 84 show that the amount of chemical modification of G-CSF, interferon alpha (IFN-alpha) and tumor necrosis factor-alpha (TNF-alpha) is titratable when the mRNA is not fully modified and the titratable trend is not the same for each target.

[001116] As mentioned above, using PBMC as an *in vitro* assay system it is possible to establish a correlation between translation (in this case G-CSF protein production) and cytokine production (in this case exemplified by IFN-alpha protein production). Better protein production is correlated with lower induction of innate immune activation pathway, and the percentage modification of a chemistry can be judged favorably based on this ratio (Table 85). As calculated from Tables 83 and 84 and shown in Table 85, full modification with 5-methylcytidine and pseudouridine shows a much better ratio of protein/cytokine production than without any modification (natural G-CSF mRNA)

(100-fold for IFN-alpha and 27-fold for TNF-alpha). Partial modification shows a linear relationship with increasingly less modification resulting in a lower protein/cytokine ratio.

Table 83. G-CSF Expression

	G-CSF Expression (pg/ml)		
	D1	D2	D3
100% modification	1968.9	2595.6	2835.7
75% modification	566.7	631.4	659.5
50% modification	188.9	187.2	191.9
25% modification	139.3	126.9	102.0
0% modification	194.8	182.0	183.3
Luciferase	90.2	0.0	22.1

Table 84. IFN-alpha and TNF-alpha Expression

	IFN-alpha Expression (pg/ml)			TNF-alpha Expression (pg/ml)		
	D1	D2	D3	D1	D2	D3
100% modification	336.5	78.0	46.4	115.0	15.0	11.1
75% modification	339.6	107.6	160.9	107.4	21.7	11.8
50% modification	478.9	261.1	389.7	49.6	24.1	10.4
25% modification	564.3	400.4	670.7	85.6	26.6	19.8
0% modification	1421.6	810.5	1260.5	154.6	96.8	45.9
LPS	0.0	0.6	0.0	0.0	12.6	4.3
R-848	0.5	3.0	14.1	655.2	989.9	420.4
P(I)P(C)	130.8	297.1	585.2	765.8	2362.7	1874.4
Lipid only	1952.2	866.6	855.8	248.5	82.0	60.7

Table 85. PC Ratio and Effect of Percentage of Modification

% Modification	Average G-CSF (pg/ml)	Average IFN-a (pg/ml)	Average TNF-a (pg/ml)	G-CSF/ IFN-alpha (PC ratio)	G-CSF/TNF-alpha (PC ratio)
100	2466	153	47	16	52
75	619	202	47	3.1	13
50	189	376	28	0.5	6.8
25	122	545	44	0.2	2.8
0	186	1164	99	0.16	1.9

Example 57. Modified RNA transfected in PBMC

[001117] 500 ng of G-CSF mRNA modified with 5-methylcytosine (5mC) and pseudouridine (pseudoU) or unmodified G-CSF mRNA was transfected with 0.4 uL of Lipofectamine 2000 into peripheral blood mononuclear cells (PBMC) from three normal blood donors (D1, D2, and D3). The G-CSF mRNA (SEQ ID NO: 6; polyA tail of approximately 160 nucleotides not shown in sequence; 5'cap, Cap1) was completely modified with 5mC and pseudoU (100% modification), not modified with 5mC and pseudoU (0% modification) or was partially modified with 5mC and pseudoU so the

mRNA would contain 50% modification, 25% modification, 10% modification, %5 modification, 1% modification or 0.1% modification. A control sample of mCherry (mRNA sequence shown in SEQ ID NO: 7; polyA tail of approximately 160 nucleotides not shown in sequence; 5'cap, CapI; fully modified 5meC and pseudouridine) and G-CSF fully modified with 5-methylcytosine and pseudouridine (Control G-CSF) was also analyzed for G-CSF expression. For tumor necrosis factor-alpha (TNF-alpha) and interferon-alpha (IFN-alpha) control samples of Lipofectamine2000, LPS, R-848, Luciferase (mRNA sequence shown in SEQ ID NO: 16; polyA tail of approximately 160 nucleotides not shown in sequence; 5'cap, CapI; fully modified 5mC and pseudo), and P(I)P(C) were also analyzed. The supernatant was harvested 6 hours and 18 hours after transfection and run by ELISA to determine the protein expression. The expression of G-CSF, IFN-alpha, and TNF-alpha for Donor 1 is shown in Table 86, Donor 2 is shown in Table 87 and Donor 3 is shown in Table 88. [001118] Full 100% modification with 5-methylcytidine and pseudouridine resulted in the most protein translation (G-CSF) and the least amount of cytokine produced across all three human PBMC donors. Decreasing amounts of modification results in more cytokine production (IFN-alpha and TNF-alpha), thus further highlighting the importance of fully modification to reduce cytokines and to improve protein translation (as evidenced here by G-CSF production).

Table 86. Donor 1

	G-CSF (pg/mL)		IFN-alpha (pg/mL)		TNF-alpha (pg/mL)	
	6 hours	18 hours	6 hours	18 hours	6 hours	18 hours
100% Mod	1815	2224	1	13	0	0
75% Mod	591	614	0	89	0	0
50% Mod	172	147	0	193	0	0
25% Mod	111	92	2	219	0	0
10% Mod	138	138	7	536	18	0
1% Mod	199	214	9	660	18	3
0.1% Mod	222	208	10	597	0	6
0 % Mod	273	299	10	501	10	0
Control G-CSF	957	1274	3	123	18633	1620
mCherry	0	0	0	10	0	0
Untreated	N/A	N/A	0	0	1	1

Table 87. Donor 2

	G-CSF (pg/mL)		IFN-alpha (pg/mL)		TNF-alpha (pg/mL)	
	6 hours	18 hours	6 hours	18 hours	6 hours	18 hours
100% Mod	2184	2432	0	7	0	11
75% Mod	935	958	3	130	0	0
50% Mod	192	253	2	625	7	23
25% Mod	153	158	7	464	6	6

10% Mod	203	223	25	700	22	39
1% Mod	288	275	27	962	51	66
0.1% Mod	318	288	33	635	28	5
0 % Mod	389	413	26	748	1	253
Control G-CSF	1461	1634	1	59	481	814
mCherry	0	7	0	1	0	0
Untreated	N/A	N/A	1	0	0	0

Table 88. Donor 3

	G-CSF (pg/mL)		IFN-alpha (pg/mL)		TNF-alpha (pg/mL)	
	6 hours	18 hours	6 hours	18 hours	6 hours	18 hours
100% Mod	6086	7549	7	658	11	11
75% Mod	2479	2378	23	752	4	35
50% Mod	667	774	24	896	22	18
25% Mod	480	541	57	1557	43	115
10% Mod	838	956	159	2755	144	123
1% Mod	1108	1197	235	3415	88	270
0.1% Mod	1338	1177	191	2873	37	363
0 % Mod	1463	1666	215	3793	74	429
Control G-CSF	3272	3603	16	1557	731	9066
mCherry	0	0	2	645	0	0
Untreated	N/A	N/A	1	1	0	8

Example 58. Innate Immune Response Study in BJ Fibroblasts**A. Single Transfection**

[001119] Human primary foreskin fibroblasts (BJ fibroblasts) were obtained from American Type Culture Collection (ATCC) (catalog # CRL-2522) and grown in Eagle's Minimum Essential Medium (ATCC, catalog # 30-2003) supplemented with 10% fetal bovine serum at 37°C, under 5% CO₂. BJ fibroblasts were seeded on a 24-well plate at a density of 300,000 cells per well in 0.5 ml of culture medium. 250 ng of modified G-CSF mRNA (mRNA sequence shown in SEQ ID NO: 6; polyA tail of approximately 140 nucleotides not shown in sequence; 5'cap, Cap1) fully modified with 5-methylcytosine and pseudouridine (Gen1) or fully modified with 5-methylcytosine and N1-methylpseudouridine (Gen2) having Cap0, Cap1 or no cap was transfected using Lipofectamine 2000 (Invitrogen, catalog # 11668-019), following manufacturer's protocol. Control samples of poly I:C (PIC), Lipofectamine 2000 (Lipo), natural luciferase mRNA (mRNA sequence shown in SEQ ID NO: 16; polyA tail of approximately 160 nucleotides not shown in sequence; 5'cap, Cap1) and natural G-CSF mRNA were also transfected. The cells were harvested after 18 hours, the total RNA was isolated and DNASE® treated using the RNeasy micro kit (catalog #74004) following the manufacturer's protocol. 100 ng of total RNA was used for cDNA synthesis using High Capacity cDNA Reverse Transcription kit (catalog #4368814) following the manufacturer's protocol. The

cDNA was then analyzed for the expression of innate immune response genes by quantitative real time PCR using SybrGreen in a Biorad CFX 384 instrument following manufacturer's protocol. Table 89 shows the expression level of innate immune response transcripts relative to house-keeping gene HPRT (hypoxanthine phosphoribosyltransferase) and is expressed as fold-induction relative to HPRT. In the table, the panel of standard metrics includes: RIG-I is retinoic acid inducible gene 1, IL6 is interleukin-6, OAS-1 is oligoadenylate synthetase 1, IFN β is interferon-beta, AIM2 is absent in melanoma-2, IFIT-1 is interferon-induced protein with tetratricopeptide repeats 1, PKR is protein kinase R, TNF α is tumor necrosis factor alpha and IFN α is interferon alpha.

Table 89. Innate Immune Response Transcript Levels

Formulation	RIG-I	IL6	OAS-1	IFN β	AIM2	IFIT-1	PKR	TNF α	IFN α
Natural Luciferase	71.5	20.6	20.778	11.404	0.251	151.218	16.001	0.526	0.067
Natural G-CSF	73.3	47.1	19.359	13.615	0.264	142.011	11.667	1.185	0.153
PIC	30.0	2.8	8.628	1.523	0.100	71.914	10.326	0.264	0.063
G-CSF Gen1-UC	0.81	0.22	0.080	0.009	0.008	2.220	1.592	0.090	0.027
G-CSF Gen1-Cap0	0.54	0.26	0.042	0.005	0.008	1.314	1.568	0.088	0.038
G-CSF Gen1-Cap1	0.58	0.30	0.035	0.007	0.006	1.510	1.371	0.090	0.040
G-CSF Gen2-UC	0.21	0.20	0.002	0.007	0.007	0.603	0.969	0.129	0.005
G-CSF Gen2-Cap0	0.23	0.21	0.002	0.0014	0.007	0.648	1.547	0.121	0.035
G-CSF Gen2-Cap1	0.27	0.26	0.011	0.004	0.005	0.678	1.557	0.099	0.037
Lipo	0.27	0.53	0.001	0	0.007	0.954	1.536	0.158	0.064

B. Repeat Transfection

[001120] Human primary foreskin fibroblasts (BJ fibroblasts) were obtained from American Type Culture Collection (ATCC) (catalog # CRL-2522) and grown in Eagle's Minimum Essential Medium (ATCC, catalog # 30-2003) supplemented with 10% fetal bovine serum at 37°C, under 5% CO₂. BJ fibroblasts were seeded on a 24-well plate at a density of 300,000 cells per well in 0.5 ml of culture medium. 250 ng of modified G-CSF mRNA (mRNA sequence shown in SEQ ID NO: 6; polyA tail of approximately 140 nucleotides not shown in sequence; 5'cap, Cap1) unmodified, fully modified with 5-methylcytosine and pseudouridine (Gen1) or fully modified with 5-methylcytosine and N1-methylpseudouridine (Gen2) was transfected daily for 5 days following manufacturer's protocol. Control samples of Lipofectamine 2000 (L2000) and mCherry mRNA (mRNA sequence

shown in SEQ ID NO: 7; polyA tail of approximately 160 nucleotides not shown in sequence; 5'cap, Cap1; fully modified with 5-methylcytidine and pseudouridine) were also transfected daily for 5 days. The results are shown in Table 90.

[001121] Unmodified mRNA showed a cytokine response in interferon-beta (IFN-beta) and interleukin-6 (IL-6) after one day. mRNA modified with at least pseudouridine showed a cytokine response after 2-3 days whereas mRNA modified with 5-methylcytosine and NI-methylpseudouridine showed a reduced response after 3-5 days.

Table 90. Cytokine Response

Formulation	Transfection	IFN-beta (pg/ml)	IL-6 (pg/ml)
G-CSF unmodified	6 hours	0	3596
	Day 1	1363	15207
	Day 2	238	12415
	Day 3	225	5017
	Day 4	363	4267
	Day 5	225	3094
G-CSF Gen 1	6 hours	0	3396
	Day 1	38	3870
	Day 2	1125	16341
	Day 3	100	25983
	Day 4	75	18922
	Day 5	213	15928
G-CSF Gen 2	6 hours	0	3337
	Day 1	0	3733
	Day 2	150	974
	Day 3	213	4972
	Day 4	1400	4122
	Day 5	350	2906
mCherry	6 hours	0	3278
	Day 1	238	3893
	Day 2	113	1833
	Day 3	413	25539
	Day 4	413	29233
	Day 5	213	20178
L2000	6 hours	0	3270
	Day 1	13	3933
	Day 2	388	567
	Day 3	338	1517
	Day 4	475	1594
	Day 5	263	1561

Example 59. In vivo detection of Innate Immune Response Study

[001122] Female BALB/C mice (n=5) were injected intramuscularly with G-CSF mRNA (GCSF mRNA unmod) (mRNA sequence shown in SEQ ID NO: 6; polyA tail of approximately 160 nucleotides not shown in sequence;) with a 5' cap of Cap1, G-CSF mRNA fully modified with 5-methylcytosine and pseudouridine (GCSF mRNA 5mc/pU), G-CSF mRNA fully modified with 5-methylcytosine and N1-methylpseudouridine with (GCSF mRNA 5mc/N1pU) or without a 5' cap (GCSF mRNA 5mc/N1 pU no cap) or a control of either R848 or 5% sucrose as described in Table 91. Blood is collected at 8 hours after dosing and using ELISA the protein levels of G-CSF and interferon-alpha (IFN-alpha) is determined by ELISA and are shown in Table 81.

[001123] As shown in Table 91, unmodified, 5mc/pU, and 5mc/N1pU modified G-CSF mRNA resulted in human G-CSF expression in mouse serum. The uncapped 5mc/N1pU modified G-CSF mRNA showed no human G-CSF expression in serum, highlighting the importance of having a 5' cap structure for protein translation.

[001124] As expected, no human G-CSF protein was expressed in the R848, 5% sucrose only, and untreated groups. Importantly, significant differences were seen in cytokine production as measured by mouse IFN-alpha in the serum. As expected, unmodified G-CSF mRNA demonstrated a robust cytokine response *in vivo* (greater than the R848 positive control). The 5mc/pU modified G-CSF mRNA did show a low but detectable cytokine response *in vivo*, while the 5mc/N1pU modified mRNA showed no detectable IFN-alpha in the serum (and same as vehicle or untreated animals).

[001125] Also, the response of 5mc/N1pU modified mRNA was the same regardless of whether it was capped or not. These *in vivo* results reinforce the conclusion that 1) that unmodified mRNA produce a robust innate immune response, 2) that this is reduced, but not abolished, through 100% incorporation of 5mc/pU modification, and 3) that incorporation of 5mc/N1pU modifications results in no detectable cytokine response.

[001126] Lastly, given that these injections are in 5% sucrose (which has no effect by itself), these result should accurately reflect the immunostimulatory potential of these modifications.

[001127] From the data it is evident that N1pU modified molecules produce more protein while concomitantly having little or no effect on IFN-alpha expression. It is also evident that capping is required for protein production for this chemical modification. The Protein: Cytokine Ratio of 748 as compared to the PC Ratio for the unmodified mRNA (PC=9) means that this chemical modification is far superior as related to the effects or biological implications associated with IFN-alpha.

Table 91. Human G-CSF and Mouse IFN-alpha in serum

Formulation	Route	Dose (ug/mouse)	Dose (ul)	G-CSF protein (pg/ml)	IFN-alpha expression (pg/ml)	PC Ratio
GCSF mRNA unmod	I.M.	200	50	605.6	67.01	9
GCSF mRNA 5mc/pU	I.M.	200	50	356.5	8.87	40
GCSF mRNA5mc/N1pU	I.M.	200	50	748.1	0	748
GCSF mRNA5mc/N1pU no cap	I.M.	200	50	6.5	0	6.5
R848	I.M.	75	50	3.4	40.97	.08
5% sucrose	I.M.	-	50	0	1.49	0
Untreated	I.M.	-	-	0	0	0

Example 60: In Vivo Delivery of Modified RNA

[001128] Protein production of modified mRNA was evaluated by delivering modified G-CSF mRNA or modified Factor IX mRNA to female Sprague Dawley rats (n=6). Rats were injected with 400 ug in 100 ul of G-CSF mRNA (mRNA sequence shown in SEQ ID NO: 6; polyA tail of approximately 160 nucleotides not shown in sequence; 5'cap, Cap1) fully modified with 5-methylcytosine and pseudouridine (G-CSF Gen1), G-CSF mRNA fully modified with 5-methylcytosine and N1-methylpseudouridine (G-CSF Gen2) or Factor IX mRNA (mRNA sequence shown in SEQ ID NO: 10; polyA tail of approximately 160 nucleotides not shown in sequence; 5'cap, Cap1) fully modified with 5-methylcytosine and pseudouridine (Factor IX Gen1) reconstituted from the lyophilized form in 5% sucrose. Blood was collected 8 hours after injection and the G-CSF protein level in serum was measured by ELISA. Table 92 shows the G-CSF protein levels in serum after 8 hours.

[001129] These results demonstrate that both G-CSF Gen 1 and G-CSF Gen 2 modified mRNA can produce human G-CSF protein in a rat following a single intramuscular injection, and that human G-CSF protein production is improved when using Gen 2 chemistry over Gen 1 chemistry.

Table 92. G-CSF Protein in Rat Serum (I.M. Injection Route)

Formulation	G-CSF protein (pg/ml)
G-CSF Gen1	19.37
G-CSF Gen2	64.72
Factor IX Gen 1	2.25

Example 61. Stability of Modified RNA

[001130] Stability experiments were conducted to obtain a better understanding of storage conditions to retain the integrity of modified RNA. Unmodified G-CSF mRNA (mRNA sequence shown in SEQ ID NO: 6; polyA tail of approximately 160 nucleotides not shown in sequence; 5'cap, Cap1), G-CSF mRNA (mRNA sequence shown in SEQ ID NO: 6; polyA tail of approximately 160

nucleotides not shown in sequence; 5'cap, Cap1) fully modified with 5-methylcytosine and pseudouridine and G-CSF mRNA fully modified with 5-methylcytosine and pseudouridine lipoplexed with 0.75% by volume of RNAIMAX™ was stored at 50°C, 40°C, 37°C, 25°C, 4°C or -20°C. After the mRNA had been stored for 0 hours, 2 hours, 6 hours, 24 hours, 48 hours, 5 days and 14 days, the mRNA was analyzed by gel electrophoresis using a Bio-Rad EXPERION™ system. The modified, unmodified and lipoplexed G-CSF mRNA was also stored in RNASTABLE® (Biomatrix, Inc. San Diego, CA) at 40°C or water at -80 °C or 40°C for 35 days before being analyzed by gel electrophoresis.

[001131] All mRNA samples without stabilizer were stable after 2 weeks after storage at 4°C or -20°C. Modified G-CSF mRNA, with or without lipoplex, was more stable than unmodified G-CSF when stored at 25°C (stable out to 5 days versus 48 hours), 37°C (stable out to 24 hours versus 6 hours) and 50°C (stable out to 6 hours versus 2 hours). Unmodified G-CSF mRNA, modified G-CSF mRNA with or without lipoplex tolerated 12 freeze/thaw cycles.

[001132] mRNA samples stored in stabilizer at 40°C showed similar stability to the mRNA samples stored in water at -80°C after 35 days whereas the mRNA stored in water at 40°C showed heavy degradation after 18 days.

[001133] mRNA samples stored at 4°C, 25 °C and 37 °C were stored in 1x TE buffer or the formulation buffer (150 mM sodium chloride, 2mM calcium chloride, 2mM phosphate, 0.5 mM EDTA at a pH of 6.5). The mRNA stored at 4°C was stable to at least 60 days in both the TE and formulation buffer. At 25°C the mRNA in formulation buffer was stable out to 14 days and the TE buffer was stable out to at least 6 days. Storage of mRNA in the formulation buffer at 37°C was stable to 6 days compared to the TE buffer which was stable only until 4 days.

Example 62. Effects of Chemical Modifications on Expression of Formulated mRNA

[001134] Luciferase mRNA (SEQ ID NO: 16; polyA tail of approximately 140 nucleotides not shown in sequence; 5'cap, Cap1) fully modified with 5-methylcytosine and 2'Fluorouridine is formulated in saline or DLin-MC3-DMA and administered intravenously, intramuscularly or subcutaneously to rodents at a dose of 0.5 mg/kg, 0.05 mg/kg, 0.005 mg/kg and/or 0.0005 mg/kg. Luciferase mRNA (SEQ ID NO: 16; polyA tail of approximately 160 nucleotides not shown in sequence; 5'cap, Cap1) fully modified with 5-methylcytosine and pseudouridine is formulated in DLin-MC3-DMA and administered intramuscularly or subcutaneously to rodents at a dose of 0.5 mg/kg, 0.05 mg/kg, 0.005 mg/kg and/or 0.0005 mg/kg. The DLin-MC3-DMA formulations are

analyzed prior to administration to determine the mean size and zeta potential. The rodents are imaged at 2 hours, 8 hours, 24 hours, 72 hours, 96 hours, 144 hours and 168 hours after dosing and the bioluminescence is measured in photon per second for each route of administration and formulation.

Example 63. Expression of PLGA Formulated mRNA

A. Synthesis and Characterization of Luciferase PLGA Microspheres

[001135] Luciferase mRNA (mRNA sequence shown in SEQ ID NO: 16; polyA tail of approximately 140 nucleotides not shown in sequence; 5'cap, Cap1) fully modified with 5-methylcytosine and N1-methyl pseudouridine, modified with 25% of uridine replaced with 2-thiouridine and 25% of cytosine replaced with 5-methylcytosine, fully modified with N1-methyl pseudouridine, or fully modified with pseudouridine was reconstituted in 1x TE buffer and then formulated in PLGA microspheres. PLGA microspheres were synthesized using the water/oil/water double emulsification methods known in the art using PLGA-ester cap (Lactel, Cat# B6010-2, inherent viscosity 0.55-0.75, 50:50 LA:GA), polyvinylalcohol (PVA) (Sigma, Cat# 348406-25G, MW 13-23k) dichloromethane and water. Briefly, 0.4 ml of mRNA in TE buffer at 4 mg/ml (W1) was added to 2 ml of PLGA dissolved in dichloromethane (DCM) (01) at a concentration of 200 mg/ml of PLGA. The W1/O1 emulsion was homogenized (IKA Ultra-Turrax Homogenizer, T18) for 30 seconds at speed 5 (-19,000 rpm). The W1/O1 emulsion was then added to 250 ml 1% PVA (W2) and homogenized for 1 minute at speed 5 (-19,000 rpm). Formulations were left to stir for 3 hours, then passed through a 100 μ m nylon mesh strainer (Fisherbrand Cell Strainer, Cat # 22-363-549) to remove larger aggregates, and finally washed by centrifugation (10 min, 9,250 rpm, 4°C). The supernatant was discarded and the PLGA pellets were resuspended in 5-10 ml of water, which was repeated 2x. After washing and resuspension with water, 100-200 μ l of a PLGA microspheres sample was used to measure particle size of the formulations by laser diffraction (Malvern Mastersizer2000). The washed formulations were frozen in liquid nitrogen and then lyophilized for 2-3 days.

[001136] After lyophilization, -10 mg of PLGA MS were weighed out in 2 ml eppendorf tubes and deformulated by adding 1 ml of DCM and letting the samples shake for 2-6 hrs. The mRNA was extracted from the deformulated PLGA microspheres by adding 0.5 ml of water and shaking the sample overnight. Unformulated luciferase mRNA in TE buffer (unformulated control) was spiked into DCM and went through the deformulation process (deformulation control) to be used as controls

in the transfection assay. The encapsulation efficiency, weight percent loading and particle size are shown in Table 93. Encapsulation efficiency was calculated as mg of mRNA from deformation of PLGA microspheres divided by the initial amount of mRNA added to the formulation. Weight percent loading in the formulation was calculated as mg of mRNA from deformation of PLGA microspheres divided by the initial amount of PLGA added to the formulation.

Table 93. PLGA Characteristics

Chemical Modifications	Sample ID	Encapsulation Efficiency (%)	Theoretical mRNA Loading (wt %)	Actual mRNA Loading (wt %)	Particle Size (D50, μ m)
Fully modified with 5-methylcytosine and N1-methyl pseudouridine	43-66A	45.8	0.4	0.18	33.4
	43-66B	29.6		0.12	27.7
	43-66C	25.5		0.10	27.1
25% of uridine replaced with 2-thiouridine and 25% of cytosine replaced with 5-methylcytosine	43-67A	34.6	0.4	0.14	29.9
	43-67B	22.8		0.09	30.2
	43-67C	23.9		0.10	25.1
Fully modified with N1-methyl pseudouridine	43-69A	55.8	0.4	0.22	40.5
	43-69B	31.2		0.12	41.1
	43-69C	24.9		0.10	46.1
Fully modified with pseudouridine	43-68-1	49.3	0.4	0.20	34.8
	43-68-2	37.4		0.15	35.9
	43-68-3	45.0		0.18	36.5

B. Protein Expression of modified mRNA Encapsulated in PLGA Microspheres

[001137] The day before transfection, 20,000 HeLa cells (ATCC no. CCL-2; Manassas, VA) were harvested by treatment with Trypsin-EDTA solution (LifeTechnologies, Grand Island, NY) and seeded in a total volume of 100 μ l EMEM medium (supplemented with 10%FCS and 1x Glutamax) per well in a 96-well cell culture plate (Corning, Manassas, VA). The cells were grown at 37 $^{\circ}$ C in a 5% CO₂ atmosphere overnight. The next day, 83 ng of the deformed luciferase mRNA PLGA microsphere samples, deformed luciferase mRNA control (Deform control), or unformulated luciferase mRNA control (Unformul control) was diluted in a 10 μ l final volume of OPTI-MEM (LifeTechnologies, Grand Island, NY). Lipofectamine 2000 (LifeTechnologies, Grand Island, NY) was used as a transfection reagent and 0.2 μ l was diluted in a 10 μ l final volume of OPTI-MEM. After 5min of incubation at room temperature, both solutions were combined and incubated an additional 15min at room temperature. Then 20 μ l of the combined solution was added to 100 μ l of cell culture medium containing the HeLa cells. The plates were then incubated as described before.

[001138] After a 18 to 22 hour incubation, cells expressing luciferase were lysed with 100ul Passive Lysis Buffer (Promega, Madison, WI) according to manufacturer instructions. Aliquots of the lysates were transferred to white opaque polystyrene 96-well plates (Corning, Manassas, VA) and combined with 100ul complete luciferase assay solution (Promega, Madison, WI). The background signal of the plates without reagent was about 200 relative light units per well. The plate reader was a BioTek Synergy HI (BioTek, Winooski, VT).

[001139] Cells were harvested and the bioluminescence (in relative light units, RLU) for each sample is shown in Table 94. Transfection of these samples confirmed that the varied chemistries of luciferase mRNA is still able to express luciferase protein after PLGA microsphere formulation.

Table 94. Chemical Modifications

Chemical Modifications	Sample ID	Biolum. (RLU)
Fully modified with 5-methylcytosine and N1-methyl pseudouridine	Deform contol	164266.5
	Unformul control	113714
	43-66A	25174
	43-66B	25359
	43-66C	20060
25% of uridine replaced with 2-thiouridine and 25% of cytosine replaced with 5-methylcytosine	Deform contol	90816.5
	Unformul control	129806
	43-67A	38329.5
	43-67B	8471.5
	43-67C	10991.5
Fully modified with N1-methyl pseudouridine	Deform contol	928093.5
	Unformul control	1512273.5
	43-69A	1240299.5
	43-69B	748667.5
	43-69C	1193314
Fully modified with pseudouridine	Deform contol	154168
	Unformul control	151581
	43-68-1	120974.5
	43-68-2	107669
	43-68-3	97226

Example 64. In vitro studies of Factor IX

A. Serum-Free Media

[001140] Human Factor IX mRNA (mRNA sequence shown in SEQ ID NO: 10; polyA tail of approximately 160 nucleotides not shown in sequence; 5'cap, Cap1; fully modified with 5-

methylcytosine and pseudouridine) was transfected in serum-free media. The cell culture supernatant was collected and subjected to trypsin digestion before undergoing 2-dimensional HPLC separation of the peptides. Matrix-assisted laser desorption/ionization was used to detect the peptides. 8 peptides were detected and 7 of the detected peptides are unique to Factor IX. These results indicate that the mRNA transfected in the serum-free media was able to express full-length Factor IX protein.

B. Human Embryonic Kidney (HEK) 293A Cells

[001141] 250 ng of codon optimized Human Factor IX mRNA (mRNA sequence shown in SEQ ID NO: 10; fully modified with 5-methylcytosine and pseudouridine; polyA tail of approximately 160 nucleotides not shown in sequence; 5'cap, Cap1) was transfected into HEK 293A cells (150, 000 cells/well) using Lipofectamine 2000 in DMEM in presence of 10% FBS. The transfection complexes were removed 3 hours after transfection. Cells were harvested at 3, 6, 9, 12, 24, 48 and 72 hours after transfection. Total RNA was isolated and used for cDNA synthesis. The cDNA was subjected to analysis by quantitative Real-Time PCR using codon optimized Factor IX specific primer set. Human hypoxanthine phosphoribosyltransferase 1 (HPRT) level was used for normalization. The data is plotted as a percent of detectable mRNA considering the mRNA level as 100% at the 3 hour time point. The half-life of Factor IX modified mRNA fully modified with 5-methylcytosine and pseudouridine in human embryonic kidney 293 (HEK293) cells is about 8-10 hours.

Example 65. Saline formulation: Subcutaneous Administration

[001142] Human G-CSF modified mRNA (mRNA sequence shown in SEQ ID NO: 6; polyA tail of approximately 160 nucleotides not shown in sequence; 5'cap, Cap1; fully modified with 5-methylcytosine and pseudouridine) and human EPO modified mRNA (mRNA sequence shown in SEQ ID NO: 9; polyA tail of approximately 160 nucleotides not shown in sequence; 5'cap, Cap1; fully modified with 5-methylcytosine and pseudouridine), were formulated in saline and delivered to mice via intramuscular (IM) injection at a dose of 100 ug.

[001143] Controls included Luciferase (mRNA sequence shown in SEQ ID NO: 16; polyA tail of approximately 160 nucleotides not shown in sequence; 5'cap, Cap1; fully modified with 5-methylcytosine and pseudouridine) or the formulation buffer (F.Buffer). The mice were bled at 13 hours after the injection to determine the concentration of the human polypeptide in serum in pg/mL.

(G-CSF groups measured human G-CSF in mouse serum and EPO groups measured human EPO in mouse serum). The data are shown in Table 95.

[001144] mPvNA degrades rapidly in serum in the absence of formulation suggesting the best method to deliver mRNA to last longer in the system is by formulating the mRNA. As shown in Table 95, mRNA can be delivered subcutaneously using only a buffer formulation.

Table 95. Dosing Regimen

Group	Treatment	Dose Vol. (µl/mouse)	Dosing Vehicle	Average Protein Product pg/mL, serum
G-CSF	G-CSF	100	F. buffer	45
G-CSF	Luciferase	100	F. buffer	0
G-CSF	F. buffer	100	F. buffer	2.2
EPO	EPO	100	F. buffer	72.03
EPO	Luciferase	100	F. buffer	26.7
EPO	F. buffer	100	F. buffer	13.05

Example 66. Stability of Nanoparticle of Formulations

[001145] Formulations of DLin-KC2-DMA, Teta-5-Lap, DLin-DMA, DLin-K-DMA, C12-200, DLin-MC3-DMA at a lipid:mRNA ratio of 20: 1 were evaluated for particle size, polydispersity index and encapsulation efficiency for stability at room temperature. Most nanoparticles are stable at room temperature for at least one month as shown in Tables 96 and 97.

Table 96. Particle Size and Polydispersity Index

Formulation #	Lipid	Time			
		0 hours	24 hours	48 hours	30 days
NPA-003-4	DLin-KC2-DMA	112 nm PDI: 0.05	110 nm PDI: 0.06	103 nm PDI: 0.09	104 nm PDI: 0.08
NPA-006-2	Teta-5-Lap	95 nm PDI: 0.09	95 nm PDI: 0.12	95 nm PDI: 0.10	100 nm PDI: 0.11
NPA-012-1	DLin-DMA	90 nm PDI: 0.09	87 nm PDI: 0.07	89 nm PDI: 0.08	82 nm PDI: 0.08
NPA-013-1	DLin-K-DMA	92 nm PDI: 0.07	91 nm PDI: 0.06	96 nm PDI: 0.05	91 nm PDI: 0.06
NPA-014-1	C12-200	99 nm PDI: 0.06	98 nm PDI: 0.09	99 nm PDI: 0.07	94 nm PDI: 0.07
NPA-015-1	DLin-MC3-DMA	106 nm PDI: 0.07	100 nm PDI: 0.06	100 nm PDI: 0.05	99 nm PDI: 0.05

Table 97. Encapsulation Efficiency

Formulation #	Lipid	Time			
		0 hours	24 hours	48 hours	30 days
NPA-003-4	DLin-KC2-DMA	100%	98%	100%	100%
NPA-006-2	Teta-5-Lap	99%	100%	100%	100%
NPA-012-1	DLin-DMA	100%	100%	100%	100%
NPA-013-1	DLin-K-DMA	83%	85%	96%	100%
NPA-014-1	C12-200	88%	93%	90%	96%
NPA-015-1	DLin-MC3-DMA	100%	99%	100%	100%

Example 67. Intravitreal Delivery

[001146] mCherry modified mRNA (mRNA sequence shown in SEQ ID NO: 7; polyA tail of approximately 160 nucleotides not shown in sequence; 5'cap, Cap1; fully modified with 5-methylcytosine and pseudouridine) and luciferase modified mRNA (mRNA sequence shown in SEQ ID NO: 16; polyA tail of approximately 160 nucleotides not shown in sequence; 5'cap, Cap1; fully modified with 5-methylcytosine and pseudouridine) formulated in saline was delivered intravitreally in rats as described in Table 98. The sample was compared against a control of saline only delivered intravitreally.

Table 98. Dosing Chart

Group No.	Dose Level (μg modified RNA/eye)	Dose volume ($\mu\text{L}/\text{eye}$)	Treatment	
			Right Eye (OD)	Left Eye (OS)
Control	0	5	Delivery buffer only	Delivery buffer only
Modified RNA in delivery buffer	10	5	mCherry	Luciferase

[001147] The formulation will be administered to the left or right eye of each animal on day 1 while the animal is anesthetized. On the day prior to administration gentamicin ophthalmic ointment or solution was applied to both eyes twice. The gentamicin ophthalmic ointment or solution was also applied immediately following the injection and on the day following the injection. Prior to dosing, mydriatic drops (1% tropicamide and/or 2.5% phenylephrine) are applied to each eye.

[001148] 18 hours post dosing the eyes receiving the dose of mCherry and delivery buffer are enucleated and each eye was separately placed in a tube containing 10 mL 4% paraformaldehyde at

room temperature for overnight tissue fixation. The following day, eyes will be separately transferred to tubes containing 10 mL of 30% sucrose and stored at 21°C until they were processed and sectioned. The slides prepared from different sections were evaluated under F-microscopy. Postive expression was seen in the slides prepared with the eyes administered mCherry modified mRNA and the control showed no expression.

Example 68. In Vivo Cytokine Expression Study

[001149] Mice were injected intramuscularly with 200 ug of G-CSF modified mRNA (mRNA sequence shown in SEQ ID NO: 6; polyA tail of approximately 160 nucleotides not shown in sequence) which was unmodified with a 5'cap, Cap1 (unmodified), fully modified with 5-methylcytosine and pseudouridine and a 5'cap, Cap1 (Gen1) or fully modified with 5-methylcytosine and N1-methylpseudouridine and a 5'cap, Cap1 (Gen2 cap) or no cap (Gen2 uncapped). Controls of R-848, 5% sucrose and untreated mice were also analyzed. After 8 hours serum was collected from the mice and analyzed for interferon-alpha (IFN-alpha) expression. The results are shown in Table 99.

Table 99. IFN-alpha Expression

<u>Formulation</u>	<u>IFN-alpha (pg/ml)</u>
G-CSF unmodified	67.012
G-CSF Gen1	8.867
G-CSF Gen2 cap	0
G-CSF Gen2 uncapped	0
R-848	40.971
5% sucrose	1.493
Untreated	0

Example 69. In vitro expression of VEGF modified mRNA

[001150] HEK293 cells were transfected with modified mRNA (mniRNA) VEGF-A (mRNA sequence shown in SEQ ID NO: 19; polyA tail of approximately 160 nucleotides not shown in sequence; 5'cap, Cap1; fully modified with 5-methylcytosine and pseudouridine) which had been complexed with Lipofectamine2000 from Invitrogen (Carlsbad, CA) at the concentration shown in Table 100. The protein expression was detected by ELISA and the protein (pg/ml) is shown in Table 100.

Table 100. Protein Expression

Amount Transfected	10 ng	2.5 ng	625 pg	156 pg	39 pg	10 pg	2 pg	610 fg
--------------------	-------	--------	--------	--------	-------	-------	------	--------

Protein (pg/ml)	10495	10038	2321.23	189.6	0	0	0	0
--------------------	-------	-------	---------	-------	---	---	---	---

Example 70. *In vitro* Screening in HeLa Cells of GFP

[001151] The day before transfection, 20,000 HeLa cells (ATCC no. CCL-2; Manassas, VA) were harvested by treatment with Trypsin-EDTA solution (LifeTechnologies, Grand Island, NY) and seeded in a total volume of 100ul EMEM medium (supplemented with 10%FCS and 1x Glutamax) per well in a 96-well cell culture plate (Corning, Manassas, VA). The cells were grown at 37°C in 5% CO₂ atmosphere overnight. Next day, 37.5 ng or 75 ng of Green Fluorescent protein (GFP) modified RNA (mRNA sequence shown in SEQ ID NO: 18; polyA tail of approximately 160 nucleotides not shown in sequence; 5'cap, Cap1) with the chemical modification described in Table 101, were diluted in 10ul final volume of OPTI-MEM (LifeTechnologies, Grand Island, NY). Lipofectamine 2000 (LifeTechnologies, Grand Island, NY) was used as transfection reagent and 0.2 ul were diluted in 10 ul final volume of OPTI-MEM. After 5 minutes of incubation at room temperature, both solutions were combined and incubated an additional 15 minute at room temperature. Then the 20ul combined solution was added to the 100ul cell culture medium containing the HeLa cells and incubated at room temperature.

[001152] After a 18 to 22 hour incubation cells expressing luciferase were lysed with 100 ul of Passive Lysis Buffer (Promega, Madison, WI) according to manufacturer instructions. Aliquots of the lysates were transferred to white opaque polystyrene 96-well plates (Corning, Manassas, VA) and combined with 100 ul complete luciferase assay solution (Promega, Madison, WI). The median fluorescence intensity (MFI) was determined for each chemistry and is shown in Table 101.

[001153] These results demonstrate that GFP fully modified with N1-methylpseudouridine and 5-methylcytosine produces more protein in HeLa cells compared to the other chemistry. Additionally the higher dose of GFP administered to the cells resulted in the highest MFI value.

Table 101. Mean Fluorescence Intensity

Chemistry	37.5 ng	75 ng
	MFI	MFI
No modifications	97400	89500
5-methylcytosine/pseudouridine	324000	715000
5-methylcytosine/N1-methylpseudouridine	643000	1990000

Example 71. Toxicity Studies

A. Study Design

[001154] Sprague-Dawley rats (n=8, 4 male, 4 female) were administered by injection modified luciferase mRNA (mRNA sequence shown in SEQ ID NO: 16; polyA tail of approximately 160 nucleotides not shown in sequence; 5'cap, Cap1; fully modified with 5-methylcytosine and pseudouridine) as outlined in the dosing chart in Table 102. A control group were administered the formulation buffer (F. Buffer). After 7 days the rats were sacrificed.

Table 102. Dosins Chart

Formulation	mRNA Dose (ug)	Dose Volume (mL)	Dose Concentration (mg/mL)
Luciferase	100	0.1	0
Luciferase	300	0.1	1.0
Luciferase	1000	0.1	3.0
Luciferase	3x1000	0.3 (each dose was 0.1)	10
F. Buffer	0		10

B. Weight Gain and Food Consumption

[001155] The rats were weighed before the administration of mRNA and 7 days after administration. Table 103 shows the mean weight gain and weight gain percent per group tested separated by gender. All animals continued to gain weight and behave normally. Each group analyzed consumed about the same amount of food over the course of the study.

Table 103. Weight Gain

Group	Mean weight Gain (g)	Weight Gain (%)
100 ug	16.875	6.5
300 ug	22.125	8.3
1000 ug	19	6.95
3 x 1000 ug	20.375	7.7
F. Buffer	18.75	6.8

C. Electrolytes

[001156] After 7 days the rats were sacrificed and samples were taken to determine electrolytes. The calcium, bicarbonate, potassium, phosphorus, chloride and sodium levels in each group were analyzed. The results are shown in Table 104. There was no change in electrolytes seen in the rats after 7 days.

Table 104. Electrolytes

Group	Calcium	Bicarbonate	Potassium	Phosphorus	Chloride	Sodium
--------------	----------------	--------------------	------------------	-------------------	-----------------	---------------

	(mg/dL)	(mEg/L)	(mEg/L)	(mg/dL)	(mEg/L)	(mEg/L)
100 ug	9.8	19.9	4.7	8.3	101.0	139.6
300 ug	9.8	23.3	4.4	8.2	100.5	139.6
1000 ug	10.6	22.5	5.2	9.1	101.0	138.8
3 x 1000 ug	10.2	22.6	4.6	8.1 1	100.4	138.8
F. Buffer	9.6	20.1	5.4	9.2	99.5	139.9

D. Hematology

[001157] After 7 days the rats were sacrificed and samples were taken to determine hematology levels. The red blood cell (RBC), hematocrit (HGT), mean corpuscular volume (MCV), hemoglobin (HGB), mean corpuscular hemoglobin (MCH) and mean corpuscular hemoglobin concentration (MCHC) was determined for each group. The results are shown in Table 105. There was no change in blood count or blood clotting factors 7 days after administration.

Table 105. Hematology

Group	RBC (Million/uL)	HCT (%)	MCV (fL)	HGB (g/dL)	MCH (pg)	MCHC (g/dL)
100 ug	7.5	44.1	58.7	14.7	19.5	3.4
300 ug	7.3	43.5	59.6	14.5	19.8	33.3
1000 ug	7.2	42.5	58.8	14.2	19.55	33.3
3 x 1000 ug	7.2	43.5	60.6	14.4	20.0	33.1
F. Buffer	8.0	46.6	58.0	15.5	19.3	33.4

E. White Blood Cells

[001158] After 7 days the rats were sacrificed and samples were taken to determine white blood cell count. Neutrophils (percent segmented neutrophils), monocytes, basophils, lymphocytes, eosinophil and white blood cell (WBC) was determined for each group. The results are shown in Table 106. In Table 106, "NT" means not tested. 7 days after administration there was no increase in white blood cells which suggests there was no inflammation.

Table 106. White Blood Cell

Group	Neutrophil (NEU- SEG%)	Monocytes (MON%)	Basophils (BASO%)	Lymphocytes (LYM%)	Eosinophils (EOS%)	WBC (Thous. /uL)
100 ug	10.6	2.0	0.4	85.9	1.3	14
300 ug	12.0	2.8	0.4	83.6	1.0	10.2
1000 ug	12.8	2.3	NT	83.0	1.5	10.7
3 x 1000 ug	11.6	2.0	0.1	85.5	0.9	10.9
F. Buffer	16.6	2.3	0.9	79.6	0.9	13.0

F. Serum Chemistry

[001159] After 7 days the rats were sacrificed and samples were taken to determine serum chemistry. The alkaline phosphatase (ALP), aspartate transaminase (AST), alanine transaminase (ALT) and creatine phosphokinase (CPK) was determined for each group. The results are shown in Table 107.

Table 107. Serum Chemistry

Group	ALP (IU/L)	AST (IU/L)	ALT (IU/L)	CPK (IU/L)
100 ug	144.4	198.3	60.8	488.1
300 ug	169.5	200.3	49.3	968.3
1000 ug	150.5	189.8	51.5	744
3 x 1000 ug	152.0	14.3	45.9	481.1
F. Buffer	183	170.4	62.8	589.8

G. Liver Proteins

[001160] After 7 days the rats were sacrificed and samples were taken to determine liver protein levels. The level of albumin, globulin and total protein was determined for each group. The results are shown in Table 108. There was no change seen in liver enzyme or liver protein production 7 days after administration with the modified mRNA.

Table 108. Hematology

Group	Albumin (g/dL)	Globulin (g/dL)	Total Protein (g/dL)
100 ug	3.3	2.5	5.8
300 ug	3.2	2.4	5.6
1000 ug	3.2	2.7	5.9
3 x 1000 ug	3.4	2.6	6.0
F. Buffer	3.6	2.6	6.2

H. Conclusions

[001161] From the analysis of the rats 7 days after administration with the modified mRNA, administration of high doses of mRNA do not result in adverse effects. Doses as high as 30 times the effective dose appear to be safe from this analysis. Histopathology showed only minimal inflammation at the site of injection and the site of injection showed only changes consistent with injection and nothing to suggest dose related issues. Additionally there was no change in muscle enzymes to suggest there was muscle damage.

Example 72. Storage Conditions for Modified RNA

A. Organics

[001162] To evaluate the ability of mRNA to withstand an organic environment, luciferase mRNA (mRNA sequence shown in SEQ ID NO: 16; polyA tail of approximately 160 nucleotides not shown in sequence; 5'cap, Cap1; fully modified with 5-methylcytosine and pseudouridine) was stored at

room temperature in solutions of ethanol, methanol or dichloromethane at a concentration of 1 mg/ml. Samples were collected at 1 hour, 6 hours and 1 day. The sample was diluted with water to 200 ng/ul and incubated overnight at room temperature in a fume hood to evaporate off the organic solvent. Control samples were completed in parallel with mRNA in water (Water control, organic). The mRNA was stable at room temperature for 1 day in each of the three solutions as determined by running samples on a bioanalyzer.

B. Aqueous Solvent

[001163] Luciferase mRNA (mRNA sequence shown in SEQ ID NO: 16; polyA tail of approximately 160 nucleotides not shown in sequence; 5'cap, CapI; fully modified with pseudouridine and 5-methylcytosine) was added to 3 different buffers and water to evaluate the effect of aqueous solvents on mRNA stability. mRNA was added to citrate buffer (pH3, 100mM citric acid), phosphate buffered saline (PBS) buffer (pH 7.4, 6.7 mM phosphate and 154 mM sodium chloride), TE buffer (pH 8, 10 mM Tris-hydrochloric acid and 1 mM ethylenediaminetetraacetic acid) or water (pH 5.5, water for injection (WFI)) at 1 mg/ml. Samples were collected at 1 hour, 6 hours and 1 day and diluted with water to a concentration of 200 ng/ul. Control samples were completed in parallel with mRNA in water (Water control, aqueous). The incubation of mRNA in the PBS buffer, TE buffer and water did not affect the mRNA integrity after 1 day. Samples incubated in citrate were not detectable by bioanalyzer.

[001164] In additional studies to evaluate the citrate buffer, citrate buffer at a pH of 2, 3 and 4 each having 10 mM citrate and 1mg/ml of luciferase mRNA (mRNA sequence shown in SEQ ID NO: 16; polyA tail of approximately 160 nucleotides not shown in sequence; 5'cap, CapI; fully modified with pseudouridine and 5-methylcytosine) were evaluated. At a pH of 2 precipitation was visually detected and mRNA was not detected by bioanalyzer below a pH of 4. When compared against phosphate buffer, mRNA was not detected in samples with low pH and precipitation was visible in phosphate buffer samples having a pH of 2.

C. pH

[001165] In order to study the effects of pH on the stability of mRNA, luciferase mRNA (mRNA sequence shown in SEQ ID NO: 16; polyA tail of approximately 160 nucleotides not shown in sequence; 5'cap, CapI; fully modified with pseudouridine and 5-methylcytosine) was stored at room temperature in aqueous buffers having a pH of 5.8, 6.5 or 7.2. Samples were collected at 1 hour, 1 day and 1 week after the mRNA was added to the pH sample. After collection the samples were

incubated at 1 mg/ml concentration and then diluted to 200 ng/ul with water before freezing and characterizing by bioanalyzer. The mRNA was stable after 1 week of storage at room temperature in the pH range of 5.8-7.2 evaluated.

D. Freeze/thaw and Lyophilization

[001166] To evaluate the effect of freeze/thaw cycles on mRNA stability, luciferase mRNA (mRNA sequence shown in SEQ ID NO: 16; polyA tail of approximately 160 nucleotides not shown in sequence; 5'cap, Cap1; fully modified with 5-methylcytosine and pseudouridine) in formulation buffer was subjected to numerous freeze/thaw cycles. mRNA was found to be stable for at least 18 cycles.

[001167] In addition, luciferase mRNA (mRNA SEQ ID NO: 16; polyA tail of approximately 160 nucleotides not shown in sequence; 5'cap, Cap1; fully modified with 5-methylcytosine and pseudouridine) was subjected to 3 rounds of lyophilization to test the stability of the mRNA. mRNA was added to water and samples were collected after each of the 3 rounds of lyophilization. The dried mRNA was diluted with water to reach a concentration of 1 mg/ml. The samples were stored frozen until bioanalyzer characterization at 200 ng/ul. Control samples were completed in parallel with mRNA and water formulations and followed the same freezing and thawing cycles. The mRNA was found to be stable after 3 cycles of lyophilization when analyzed by bioanalyzer characterization at 200 ng/ul.

E. Centrifugation

[001168] To evaluate the effects of centrifugation on mRNA integrity, luciferase mRNA (mRNA sequence shown in SEQ ID NO: 16; polyA tail of approximately 160 nucleotides not shown in sequence; 5'cap, Cap1; 5-methylcytosine and pseudouridine) in water at 1mg/ml was exposed to 10 cycles of 10k RPM (13.3k xg) for 10 minutes at 4°C. mRNA and water samples were stored at 4°C as a control during centrifugation. After 10 cycles of centrifugation the mRNA was still stable when analyzed by bioanalyzer characterization at 200 ng/ul.

F. In Vitro Transfection After Storage

[001169] The day before transfection, 20,000 HeLa cells (ATCC no. CCL-2; Manassas, VA) were harvested by treatment with Trypsin-EDTA solution (LifeTechnologies, Grand Island, NY) and seeded in a total volume of 100ul EMEM medium (supplemented with 10%FCS and 1x Glutamax) per well in a 96-well cell culture plate (Corning, Manassas, VA). The cells were grown at 37oC in a 5% CO2 atmosphere overnight. The next day, 250 ng of luciferase mRNA from the formulations of

the lyophilized, centrifuged, organic and aqueous solvent samples were diluted in a 100ul final volume of OPTI-MEM (LifeTechnologies, Grand Island, NY). Lipofectamine 2000 (LifeTechnologies, Grand Island, NY) was used as a transfection reagent and 0.2ul was diluted in a 100ul final volume of OPTI-MEM. After 5min of incubation at room temperature, both solutions were combined and incubated an additional 15min at room temperature. Then 20ul of the combined solution was added to 100ul of cell culture medium containing the HeLa cells. The plates were then incubated as described before.

[001170] After 18h to 22h incubation, cells expressing luciferase were lysed with 100ul Passive Lysis Buffer (Promega, Madison, WI) according to manufacturer instructions. Aliquots of the lysates were transferred to white opaque polystyrene 96-well plates (Corning, Manassas, VA) and combined with 100ul complete luciferase assay solution (Promega, Madison, WI). The background signal of the plates without reagent was about 200 relative light units per well. The plate reader was a BioTek Synergy HI (BioTek, Winooski, VT).

[001171] Controls of mock transfection (transfection reagent alone), luciferase mRNA control in water, and untreated were also evaluated. Cells were harvested and the bioluminescence average (in relative light units, RLU) for each signal is shown in Table 109. Transfection of these samples confirmed that lyophilization, centrifugation, organic solvents and aqueous solvents except citrate buffer did not impact the activity of luciferase mRNA. Citrate buffer showed a reduced activity after transfection.

Table 109. Bioluminescence

Sample	Bioluminescence (RLU)
1 lyophilization	2832350
1 lyophilization control	3453250
2 lyophilizations	2480000
2 lyophilizations control	3716130
3 lyophilizations	1893960
3 lyophilizations control	3009020
Centrifugation, 10 cycles	3697590
Centrifugation control	5472920
Ethanol, 1 day	4214780
Methanol, 1 day	2834520
Dichloromethane, 1 day	3017890
Water control, organic, 1 day	2641450
Citrate buffer, 1 hour	280160
PBS buffer, 1 hour	2762050
TE buffer, 1 hour	3141250

Water control, aqueous, 1 hour	3394000
Citrate buffer, 1 day	269790
PBS buffer, 1 day	4084330
TE buffer, 1 day	5344400
Water control, aqueous, 1 day	3579270
Untreated	5580
Mock Transfection	7560
Luciferase mRNA control	4950090

Example 73. Homogenization

[001172] Different luciferase mRNA solutions (as described in Table 110 where "X" refers to the solution containing that component) (mRNA sequence shown in SEQ ID NO: 16; polyA tail of approximately 160 nucleotides not shown in sequence; 5'cap, Cap1; fully modified with 5-methylcytosine and pseudouridine) were evaluated to test the percent yield of the different solutions, the integrity of the mRNA by bioanalyzer, and the protein expression of the mRNA by in vitro transfection. The mRNA solutions were prepared in water, 1x TE buffer at 4 mg/ml as indicated in Table 110, and added to either dichloromethane (DCM) or DCM containing 200 mg/ml of poly(lactic-co-glycolic acid) (PLGA) (Lactel, Cat# B6010-2, inherent viscosity 0.55-0.75, 50:50 LA:GA) to achieve a final mRNA concentration of 0.8 mg/ml. The solutions requiring homogenization were homogenized for 30 seconds at speed 5 (approximately 19,000 rpm) (IKA Ultra-Turrax Homogenizer, T18). The mRNA samples in water, dichloromethane and poly(lactic-co-glycolic acid) (PLGA) were not recoverable (NR). All samples, except the NR samples, maintained integrity of the mRNA as determined by bioanalyzer (Bio-rad Experion).

[001173] The day before transfection, 20,000 HeLa cells (ATCC no. CCL-2; Manassas, VA) were harvested by treatment with Trypsin-EDTA solution (LifeTechnologies, Grand Island, NY) and seeded in a total volume of 100ul EMEM medium (supplemented with 10%FCS and 1x Glutamax) per well in a 96-well cell culture plate (Corning, Manassas, VA). The cells were grown at 37°C in a 5% CO₂ atmosphere overnight. The next day, 250 ng of luciferase mRNA from the recoverable samples was diluted in a 100ul final volume of OPTI-MEM (LifeTechnologies, Grand Island, NY). Lipofectamine 2000 (LifeTechnologies, Grand Island, NY) was used as a transfection reagent and 0.2ul was diluted in a 100ul final volume of OPTI-MEM. After 5 minutes of incubation at room temperature, both solutions were combined and incubated an additional 15 minutes at room temperature. Then 20ul of the combined solution was added to 100ul of cell culture medium containing the HeLa cells. The plates were then incubated as described before. Controls luciferase

mRNA (luciferase mRNA formulated in saline) (Control) and untreated cells (Untreat.) were also evaluated. Cells were harvested and the bioluminescence average (in photons/second) (biolum. (p/s)) for each signal is also shown in Table 110. The recoverable samples all showed activity of luciferase mRNA when analyzed.

[001174] After 18 to 22 hour incubation, cells expressing luciferase were lysed with 100ul Passive Lysis Buffer (Promega, Madison, WI) according to manufacturer instructions. Aliquots of the lysates were transferred to white opaque polystyrene 96-well plates (Corning, Manassas, VA) and combined with 100ul complete luciferase assay solution (Promega, Madison, WI). The background signal of the plates without reagent was about 200 relative light units per well. The plate reader was a BioTek Synergy HI (BioTek, Winooski, VT).

[001175] Cells were harvested and the bioluminescence average (in relative light units, RLU) (biolum. (RLU)) for each signal is also shown in Table 110. The recoverable samples all showed activity of luciferase mRNA when analyzed.

Table 110. Solutions

Solution No.	Water	1x TE Buffer	DCM	DCM/PLG A	Homogenizer	Yield (%)	Biolum. (RLU)
1	X					96	5423780
2		X			X	95	4911950
3	X				X	92	2367230
4		X			X	90	4349410
5	X		X		X	66	4145340
6		X	X		X	71	3834440
7	X			X	X	NR	n/a
8		X		X	X	24	3182080
9	X			X		NR	n/a
10		X		X		79	3276800
11	X		X			79	5563550
12		X	X			79	4919100
Control							2158060
Untreat.							3530

Example 74. TE Buffer and Water Evaluation

[001176] Luciferase mRNA (mRNA sequence shown in SEQ ID NO: 16; polyA tail of approximately 160 nucleotides not shown in sequence; 5'cap, Cap1; fully modified with 5-methylcytosine and pseudouridine) was reconstituted in water or TE buffer as outlined in Table 111 and then formulated in PLGA microspheres. PLGA microspheres were synthesized using the

water/oil/water double emulsification methods known in the art using PLGA (Lactel, Cat# B6010-2, inherent viscosity 0.55-0.75, 50:50 LA:GA), polyvinylalcohol (PVA) (Sigma, Cat# 348406-25G, MW 13-23k) dichloromethane and water. Briefly, 0.2 to 0.6 ml of mRNA in water or TE buffer at a concentration of 2 to 6 mg/ml (W1) was added to 2 ml of PLGA dissolved in dichloromethane (DCM) (01) at a concentration of 100 mg/ml of PLGA. The W1/O1 emulsion was homogenized (IKA Ultra-Turrax Homogenizer, T18) for 30 seconds at speed 5 (-19,000 rpm). The W1/O1 emulsion was then added to 250 ml 1% PVA (W2) and homogenized for 1 minute at speed 5 (-19,000 rpm). Formulations were left to stir for 3 hours, then passed through a 100 µm nylon mesh strainer (Fisherbrand Cell Strainer, Cat # 22-363-549) to remove larger aggregates, and finally washed by centrifugation (10 min, 9,250 rpm, 4°C). The supernatant was discarded and the PLGA pellets were resuspended in 5-10 ml of water, which was repeated 2x. The washed formulations were frozen in liquid nitrogen and then lyophilized for 2-3 days. After lyophilization, -10 mg of PLGA MS were weighed out in 2 ml eppendorf tubes and deformulated by adding 1 ml of DCM and letting the samples shake for 2-6 hrs. mRNA was extracted from the deformulated PLGA microspheres by adding 0.5 ml of water and shaking the sample overnight. Unformulated luciferase mRNA in water or TE buffer (deformulation controls) was spiked into DCM and went through the deformulation process to be used as controls in the transfection assay.

[001177] The day before transfection, 20,000 HeLa cells (ATCC no. CCL-2; Manassas, VA) were harvested by treatment with Trypsin-EDTA solution (LifeTechnologies, Grand Island, NY) and seeded in a total volume of 100ul EMEM medium (supplemented with 10%FCS and 1x Glutamax) per well in a 96-well cell culture plate (Corning, Manassas, VA). The cells were grown at 37°C in a 5% CO₂ atmosphere overnight. The next day, 100 ng of the deformulated luciferase mRNA samples was diluted in a 10ul final volume of OPTI-MEM (LifeTechnologies, Grand Island, NY).

Lipofectamine 2000 (LifeTechnologies, Grand Island, NY) was used as a transfection reagent and 0.2ul was diluted in a 10ul final volume of OPTI-MEM. After 5 minutes of incubation at room temperature, both solutions were combined and incubated an additional 15 minutes at room temperature. Then 20ul of the combined solution was added to 100ul of cell culture medium containing the HeLa cells. The plates were then incubated as described before.

[001178] After 18 to 22 hour incubation, cells expressing luciferase were lysed with 100ul Passive Lysis Buffer (Promega, Madison, WI) according to manufacturer instructions. Aliquots of the lysates were transferred to white opaque polystyrene 96-well plates (Corning, Manassas, VA) and

combined with 100ul complete luciferase assay solution (Promega, Madison, WI). The background signal of the plates without reagent was about 200 relative light units per well. The plate reader was a BioTek Synergy HI (BioTek, Winooski, VT). To determine the activity of the luciferase mRNA from each formulation, the relative light units (RLU) for each formulation was divided by the RLU of the appropriate mRNA deformation control (mRNA in water or TE buffer). Table 111 shows the activity of the luciferase mRNA. The activity of the luciferase mRNA in the PLGA microsphere formulations (Form.) was substantially improved by formulating in TE buffer versus water.

Table 111. Formulations

Form.	mRNA conc. (mg/ml)	W1 Solvent volume (ul)	Total mRNA (ug)	Theoretical mRNA Loading (wt%)	Actual mRNA Loading (wt%)	W1 Solvent	Activity (% of deformation control)
PLGA A	4	400	1600	0.80	0.14	Water	12.5%
PLGA B	4	200	800	0.40	0.13	Water	1.3%
PLGA C	4	600	2400	1.20	0.13	Water	12.1%
PLGA D	2	400	800	0.40	0.07	Water	1.3%
PLGA E	6	400	2400	1.20	0.18	TE Buffer	38.9%
PLGA F	4	400	1600	0.80	0.16	TE Buffer	39.7%
PLGA G	4	400	1600	0.80	0.10	TE Buffer	26.6%

Example 75. Chemical Modifications on mRNA

[001179] The day before transfection, 20,000 HeLa cells (ATCC no. CCL-2; Manassas, VA) were harvested by treatment with Trypsin-EDTA solution (Life Technologies, Grand Island, NY) and seeded in a total volume of 100ul EMEM medium (supplemented with 10%FCS and 1x Glutamax) per well in a 96-well cell culture plate (Corning, Manassas, VA). The cells were grown at 37°C in 5% CO₂ atmosphere overnight. The next day, 83 ng of Luciferase modified RNA (mRNA sequence shown SEQ ID NO: 16; polyA tail of approximately 140 nucleotides not shown in sequence; 5'cap, Cap1) with the chemical modification described in Table 112, were diluted in 10ul final volume of OPTI-MEM (LifeTechnologies, Grand Island, NY). Lipofectamine 2000 (LifeTechnologies, Grand Island, NY) was used as transfection reagent and 0.2 ul were diluted in 10 ul final volume of OPTI-MEM. After 5 minutes of incubation at room temperature, both solutions were combined and

incubated an additional 15 minute at room temperature. Then the 20ul combined solution was added to the 100ul cell culture medium containing the HeLa cells and incubated at room temperature.

[001180] After 18 to 22 hours of incubation cells expressing luciferase were lysed with 100 ul of Passive Lysis Buffer (Promega, Madison, WI) according to manufacturer instructions. Aliquots of the lysates were transferred to white opaque polystyrene 96-well plates (Corning, Manassas, VA) and combined with 100 ul complete luciferase assay solution (Promega, Madison, WI). The lysate volumes were adjusted or diluted until no more than 2 mio relative light units (RLU) per well were detected for the strongest signal producing samples and the RLUs for each chemistry tested are shown in Table 112. The plate reader was a BioTek Synergy HI (BioTek, Winooski, VT). The background signal of the plates without reagent was about 200 relative light units per well.

Table 112. Chemical Modifications

Sample	RLU
Untreated	336
Unmodified Luciferase	33980
5-methylcytosine and pseudouridine	1601234
5-methylcytosine and N1-methylpseudouridine	421189
25% cytosines replaced with 5-methylcytosine and 25% of uridines replaced with 2-thiouridine	222114
N1-methylpseudouridine	3068261
Pseudouridine	140234
N4-Acetylcytidine	1073251
5-methoxyuridine	219657
5-Bromouridine	6787
N4-Acetylcytidine and N1-methylpseudouridine	976219
5-methylcytosine and 5-methoxyuridine	66621
5-methylcytosine and 2'fluorouridine	11333

Example 76. Intramuscular and Subcutaneous Administration of Modified mRNA

[001181] Luciferase modified mRNA (mRNA sequence shown in SEQ ID NO: 16; polyA tail of approximately 140 nucleotides not shown in sequence; 5'cap, Cap1) fully modified with 5-methylcytosine and pseudouridine (5mC/pU), fully modified with 5-methylcytosine and N1-methylpseudouridine (5mC/N1mpU), fully modified with pseudouridine (pU), fully modified with N1-methylpseudouridine (N1mpU) or modified where 25% of the cytosines replaced with 5-methylcytosine and 25% of the uridines replaced with 2-thiouridine (5mC/s2U) formulated in PBS (pH 7.4) was administered to Balb-C mice intramuscularly or subcutaneously at a dose of 2.5 mg/kg. The mice were imaged at 2 hours, 8 hours, 24 hours, 48 hours, 72 hours, 96 hours, 120 hours and

144 hours for intramuscular delivery and 2 hours, 8 hours, 24 hours, 48 hours, 72 hours, 96 hours and 120 hours for subcutaneous delivery. Twenty minutes prior to imaging, mice were injected intraperitoneally with a D-luciferin solution at 150 mg/kg. Animals were then anesthetized and images were acquired with an IVIS Lumina II imaging system (Perkin Elmer). Bioluminescence was measured as total flux (photons/second) of the entire mouse. The average total flux (photons/second) for intramuscular administration is shown in Table 113 and the average total flux (photons/second) for subcutaneous administration is shown in Table 114. The background signal was 3.79E+05 (p/s). The peak expression for intramuscular administration was seen between 24 and 48 hours for all chemistry and expression was still detected at 144 hours. For subcutaneous delivery the peak expression was seen at 2-8 hours and expression was detected at 72 hours.

Table 113. Intramuscular Administration

	5mC/pU	5mC/N1mpU	5mC/s2U	pU	N1mpU
	Flux (p/s)	Flux (p/s)	Flux (p/s)	Flux (p/s)	Flux (p/s)
2 hours	1.98E+07	4.65E+06	4.68E+06	2.33E+06	3.66E+07
8 hours	1.42E+07	3.64E+06	3.78E+06	8.07E+06	7.21E+07
24 hours	2.92E+07	1.22E+07	3.35E+07	1.01E+07	1.75E+08
48 hours	2.64E+07	1.01E+07	5.06E+07	7.46E+06	3.42E+08
72 hours	2.18E+07	8.59E+06	3.42E+07	4.08E+06	5.83E+07
96 hours	2.75E+07	2.70E+06	2.38E+07	4.35E+06	7.15E+07
120 hours	2.19E+07	1.60E+06	1.54E+07	1.25E+06	3.87E+07
144 hours	9.17E+06	2.19E+06	1.14E+07	1.86E+06	5.04E+07

Table 114. Subcutaneous Administration

	5mC/pU	5mC/N1mpU	5mC/s2U	pU	N1mpU
	Flux (p/s)	Flux (p/s)	Flux (p/s)	Flux (p/s)	Flux (p/s)
2 hours	5.26E+06	4.54E+06	9.34E+06	2.43E+06	2.80E+07
8 hours	2.32E+06	8.75E+05	8.15E+06	2.12E+06	3.09E+07
24 hours	2.67E+06	5.49E+06	3.80E+06	2.24E+06	1.48E+07
48 hours	1.22E+06	1.77E+06	3.07E+06	1.58E+06	1.24E+07
72 hours	1.12E+06	8.00E+05	8.53E+05	4.80E+05	2.29E+06
96 hours	5.16E+05	5.33E+05	4.30E+05	4.30E+05	6.62E+05
120 hours	3.80E+05	4.09E+05	3.21E+05	6.82E+05	5.05E+05

Example 77. Osmotic Pump Study

[001182] Prior to implantation, an osmotic pump (ALZET® Osmotic Pump 2001D, DURECT Corp. Cupertino, CA) is loaded with the 0.2 ml of IX PBS (pH 7.4) (PBS loaded pump) or 0.2 ml of luciferase modified mRNA (mRNA sequence shown in SEQ ID NO: 16; polyA tail of approximately

140 nucleotides not shown in sequence; 5'cap, CapI; fully modified with 5-methylcytosine and NI-methylpseudouridine) at 1 mg/ml in 1x PBS (pH 7.4) (Luciferase loaded pump) and incubated overnight in 1x PBS (pH 7.4) at 37°C.

[001183] Balb-C mice (n=3) are implanted subcutaneously with either the PBS loaded pump or the luciferase loaded pump and imaged at 2 hours, 8 hours and 24 hours. As a control a PBS loaded pump is implanted subcutaneously and the mice are injected subcutaneously with luciferase modified mRNA in 1x PBS (PBS loaded pump; SC Luciferase) or an osmotic pump is not implanted and the mice are injected subcutaneously with luciferase modified mRNA in 1x PBS (SC Luciferase). The luciferase formulations are outlined in Table 115

Table 115. Luciferase Formulations

Group	Vehicle	Conc (mg/ml)	Inj. Vol. (ul)	Amt (ug)	Dose (mg/kg)
PBS loaded pump; SC Luciferase	PBS	1.00	50	50	2.5
Luciferase loaded pump	PBS	1.00	-	200	10.0
PBS loaded pump	PBS	-	-	-	-
SC Luciferase	PBS	1.00	50	50	2.5

Example 78. External Osmotic Pump Study

[001184] An external osmotic pump (ALZET® Osmotic Pump 200 ID, DURECT Corp. Cupertino, CA) is loaded with the 0.2 ml of IX PBS (pH 7.4) (PBS loaded pump) or 0.2 ml of luciferase modified mRNA (mRNA sequence shown in SEQ ID NO: 16; polyA tail of approximately 140 nucleotides not shown in sequence; 5'cap, CapI; fully modified with 5-methylcytosine and NI-methylpseudouridine) at 1 mg/ml in 1x PBS (pH 7.4) (luciferase loaded pump) and incubated overnight in 1x PBS (pH 7.4) at 37°C.

[001185] Using a catheter connected to the external PBS loaded pump or the luciferase loaded pump Balb-C mice (n=3) are administered the formulation. The mice are imaged at 2 hours, 8 hours and 24 hours. As a control an external PBS loaded pump is used and the mice are injected subcutaneously with luciferase modified mRNA in 1x PBS (PBS loaded pump; SC Luciferase) or the external pump is not used and the mice are only injected subcutaneously with luciferase modified mRNA in 1x PBS (SC Luciferase). Twenty minutes prior to imaging, mice are injected intraperitoneally with a D-luciferin solution at 150 mg/kg. Animals are then anesthetized and images are acquired with an IVIS Lumina II imaging system (Perkin Elmer). Bioluminescence is

measured as total flux (photons/second) of the entire mouse. The luciferase formulations are outlined in Table 116 and the average total flux (photons/second).

Table 116. Luciferase Formulations

Group	Vehicle	Conc (mg/ml)	Inj. Vol. (ul)	Amt (ug)	Dose (mg/kg)
PBS loaded pump; SC Luciferase	PBS	1.00	50	50	2.5
Luciferase loaded pump	PBS	1.00	-	200	10.0
PBS loaded pump	PBS	-	-	-	-
SC Luciferase	PBS	1.00	50	50	2.5

Example 79. Fibrin Sealant Study

[001186] Fibrin sealant, such as Tisseel (Baxter Healthcare Corp., Deerfield, IL), is composed of fibrinogen and thrombin in a dual-barreled syringe. Upon mixing, fibrinogen is converted to fibrin to form a fibrin clot in about 10 to 30 seconds. This clot can mimic the natural clotting mechanism of the body. Additionally a fibrin hydrogel is a three dimensional structure that can potentially be used in sustained release delivery. Currently, fibrin sealant is approved for application in hemostasis and sealing to replace conventional surgical techniques such as suture, ligature and cautery.

[001187] The thrombin and fibrinogen components were loaded separately into a dual barreled syringe. Balb-C mice (n=3) were injected subcutaneously with 50 ul of fibrinogen, 50 ul of thrombin and they were also injected at the same site with modified luciferase mRNA (mRNA sequence shown in SEQ ID NO: 16; polyA tail of approximately 140 nucleotides not shown in sequence; 5'cap, Cap1; fully modified with 5-methylcytosine andNI-methylpseudouridine) (Tisseel+Luciferase), 50 ul of fibrinogen and 50 ul thrombin (Tisseel) or modified luciferase mRNA (Luciferase). The injection of fibrinogen and thrombin was done simultaneously using the dual-barreled syringe. The subcutaneous injection of luciferase was done 15 minutes after the fibrinogen/thrombin injection to allow the fibrin hydrogel to polymerize (Tisseel + Luciferase group). A control group of untreated mice were also evaluated. The mice were imaged at 5 hours and 24 hours. Twenty minutes prior to imaging, mice were injected intraperitoneally with a D-luciferin solution at 150 mg/kg. Animals were then anesthetized and images were acquired with an IVIS Lumina II imaging system (Perkin Elmer). Bioluminescence was measured as total flux (photons/second) of the entire mouse. The luciferase formulations are outlined in Table 117 and the average total flux (photons/second) is shown in Table 118. The fibrin sealant was found to not interfere with imaging and the injection of luciferase and Tisseel showed expression of luciferase.

Table 117. Luciferase Formulations

Group	Vehicle	Conc (mg/ml)	Inj. Vol. (ul)	Amt (ug)	Dose (mg/kg)
Tisseel+Luciferase	PBS	1.00	50	50	2.5
Tisseel	-	-	-	-	-
Luciferase	PBS	1.00	50	50	2.5
Untreated	-	-	-	-	-

Table 118. Total Flux

Group	5 Hours	24 Hours
	Flux (p/s)	Flux (p/s)
Tisseel+Luciferase	4.59E+05	3.39E+05
Tisseel	1.99E+06	1.06E+06
Luciferase	9.94E+05	7.44E+05
Untreated	3.90E+05	3.79E+05

Example 80. Fibrin Containing mRNA Sealant Study**A. Modified mRNA and Calcium Chloride**

[001188] Prior to reconstitution, luciferase mRNA (mRNA sequence shown in SEQ ID NO: 16; polyA tail of approximately 140 nucleotides not shown in sequence; 5'cap, Cap1) fully modified with 5-methylcytosine and NI-methylpseudouridine or fully modified with NI-methylpseudouridine is added to calcium chloride. The calcium chloride is then used to reconstitute thrombin. Fibrinogen is reconstituted with fibrinolysis inhibitor solution per the manufacturer's instructions. The reconstituted thrombin containing modified mRNA and fibrinogen is loaded into a dual barreled syringe. Mice are injected subcutaneously with 50 ul of fibrinogen and 50 ul of thrombin containing modified mRNA or they were injected with 50 ul of PBS containing an equivalent dose of modified luciferase mRNA. A control group of untreated mice is also evaluated. The mice are imaged at predetermined intervals to determine the average total flux (photons/second).

B. Lipid Nanoparticle Formulated Modified mRNA and Calcium Chloride

[001189] Prior to reconstitution, luciferase mRNA (mRNA sequence shown in SEQ ID NO: 16; polyA tail of approximately 140 nucleotides not shown in sequence; 5'cap, Cap1) fully modified with 5-methylcytosine and NI-methylpseudouridine or fully modified with NI-methylpseudouridine is formulated in a lipid nanoparticle is added to calcium chloride. The calcium chloride is then used to reconstitute thrombin. Fibrinogen is reconstituted with fibrinolysis inhibitor solution per the manufacturer's instructions. The reconstituted thrombin containing modified mRNA and fibrinogen

is loaded into a dual barreled syringe. Mice are injected subcutaneously with 50 ul of fibrinogen and 50 ul of thrombin containing modified mRNA or they were injected with 50 ul of PBS containing an equivalent dose of modified luciferase mRNA. A control group of untreated mice is also evaluated. The mice are imaged at predetermined intervals to determine the average total flux (photons/second).

C. Modified mRNA and Fibrinogen

[001190] Prior to reconstitution, luciferase mRNA (mRNA sequence shown in SEQ ID NO: 16; polyA tail of approximately 140 nucleotides not shown in sequence; 5'cap, Cap1) fully modified with 5-methylcytosine and NI-methylpseudouridine or fully modified with NI-methylpseudouridine is added to the fibrinolysis inhibitor solution. The fibrinolysis inhibitor solution is then used to reconstitute fibrinogen. Thrombin is reconstituted with the calcium chloride solution per the manufacturer's instructions. The reconstituted fibrinogen containing modified mRNA and thrombin is loaded into a dual barreled syringe. Mice are injected subcutaneously with 50 ul of thrombin and 50 ul of fibrinogen containing modified mRNA or they were injected with 50 ul of PBS containing an equivalent dose of modified luciferase mRNA. A control group of untreated mice is also evaluated. The mice are imaged at predetermined intervals to determine the average total flux (photons/second).

D. Lipid Nanoparticle Formulated Modified mRNA and Fibrinogen

[001191] Prior to reconstitution, luciferase mRNA (mRNA sequence shown in SEQ ID NO: 16; polyA tail of approximately 140 nucleotides not shown in sequence; 5'cap, Cap1) fully modified with 5-methylcytosine and NI-methylpseudouridine or fully modified with NI-methylpseudouridine is formulated in a lipid nanoparticle is added to the fibrinolysis inhibitor solution. The fibrinolysis inhibitor solution is then used to reconstitute fibrinogen. Thrombin is reconstituted with the calcium chloride solution per the manufacturer's instructions. The reconstituted fibrinogen containing modified mRNA and thrombin is loaded into a dual barreled syringe. Mice are injected subcutaneously with 50 ul of thrombin and 50 ul of fibrinogen containing modified mRNA or they were injected with 50 ul of PBS containing an equivalent dose of modified luciferase mRNA. A control group of untreated mice is also evaluated. The mice are imaged at predetermined intervals to determine the average total flux (photons/second).

E. Modified mRNA and Thrombin

[001192] Prior to reconstitution, luciferase mRNA (mRNA sequence shown in SEQ ID NO: 16; polyA tail of approximately 140 nucleotides not shown in sequence; 5'cap, Cap1) fully modified with 5-methylcytosine and NI-methylpseudouridine or fully modified with NI-methylpseudouridine is added to the reconstituted thrombin after it is reconstituted with the calcium chloride per the manufacturer's instructions. The fibrinolysis inhibitor solution is then used to reconstitute fibrinogen per the manufacturer's instructions. The reconstituted fibrinogen and thrombin containing modified mRNA is loaded into a dual barreled syringe. Mice are injected subcutaneously with 50 ul of thrombin containing modified mRNA and 50 ul of fibrinogen or they were injected with 50 ul of PBS containing an equivalent dose of modified luciferase mRNA. A control group of untreated mice is also evaluated. The mice are imaged at predetermined intervals to determine the average total flux (photons/second).

F. Lipid Nanoparticle Formulated Modified mRNA and Thrombin

[001193] Prior to reconstitution, luciferase mRNA (mRNA sequence shown in SEQ ID NO: 16; polyA tail of approximately 140 nucleotides not shown in sequence; 5'cap, Cap1) fully modified with 5-methylcytosine and NI-methylpseudouridine or fully modified with NI-methylpseudouridine is formulated in a lipid nanoparticle is added to the reconstituted thrombin after it is reconstituted with the calcium chloride per the manufacturer's instructions. The fibrinolysis inhibitor solution is then used to reconstitute fibrinogen per the manufacturer's instructions. The reconstituted fibrinogen and thrombin containing modified mRNA is loaded into a dual barreled syringe. Mice are injected subcutaneously with 50 ul of thrombin containing modified mRNA and 50 ul of fibrinogen or they were injected with 50 ul of PBS containing an equivalent dose of modified luciferase mRNA. A control group of untreated mice is also evaluated. The mice are imaged at predetermined intervals to determine the average total flux (photons/second).

Example 81. Cationic Lipid Formulation of 5-Methylcytosine and NI-Methylpseudouridine Modified mRNA

[001194] Luciferase mRNA (SEQ ID NO: 16; polyA tail of approximately 140 nucleotides not shown in sequence; 5'cap, Cap1) fully modified with 5-methylcytosine and NI-methylpseudouridine was formulated in the cationic lipids described in Table 119. The formulations were administered intravenously (I.V.), intramuscularly (I.M.) or subcutaneously (S.C.) to Balb-C mice at a dose of 0.05 mg/kg.

Table 119. Cationic Lipid Formulations

Formulation	NPA- 126-1	NPA- 127-1	NPA- 128-1	NPA- 129-1	111612-B
Lipid	DLin-MC3-DMA	DLin-KC2-DMA	C12-200	DLinDMA	DODMA
Lipid/mRNA ratio (wt/wt)	20:1	20:1	20:1	20:1	20:1
Mean Size	122 nm PDI: 0.13	114 nm PDI: 0.10	153 nm PDI: 0.17	137 nm PDI: 0.09	223.2 nm PDI: 0.142
Zeta at pH 7.4	-1.4 mV	-0.5 mV	-1.4 mV	2.0 mV	-3.09 mV
Encaps. (RiboGr)	95%	77%	69%	80%	64%

[001195] Twenty minutes prior to imaging, mice were injected intraperitoneally with a D-luciferin solution at 150 mg/kg. Animals were then anesthetized and images were acquired with an IVIS Lumina II imaging system (Perkin Elmer). Bioluminescence was measured as total flux (photons/second) of the entire mouse. The mice were imaged at 2 hours, 8 hours and 24 hours after dosing and the average total flux (photons/second) was measured for each route of administration and cationic lipid formulation. The background flux was about 4.17E+05 p/s. The results of the imaging are shown in Table 120. In Table 120, "NT" means not tested.

Table 120. Flux

Route	Time Point	DLin-MC3-DMA	DLin-KC2-DMA	C12-200	DLinDMA	DODMA
		Flux (p/s)	Flux (p/s)	Flux (p/s)	Flux (p/s)	Flux (p/s)
I.V.	2 hrs	1.92E+08	2.91E+08	1.08E+08	2.53E+07	8.40E+06
I.V.	8 hrs	1.47E+08	2.13E+08	3.72E+07	3.82E+07	5.62E+06
I.V.	24 hrs	1.32E+07	2.41E+07	5.35E+06	4.20E+06	8.97E+05
I.M.	2 hrs	8.29E+06	2.37E+07	1.80E+07	1.51E+06	NT
I.M.	8 hrs	5.83E+07	2.12E+08	2.60E+07	1.99E+07	NT
I.M.	24 hrs	4.30E+06	2.64E+07	3.01E+06	9.46E+05	NT
S.C.	2 hrs	1.90E+07	5.16E+07	8.91E+07	4.66E+06	9.61E+06
S.C.	8 hrs	7.74E+07	2.00E+08	4.58E+07	9.67E+07	1.90E+07
S.C.	24 hrs	7.49E+07	2.47E+07	6.96E+06	6.50E+06	1.28E+06

Example 82. Lipid Nanoparticle Intravenous Study

[001196] Luciferase mRNA (SEQ ID NO: 16; polyA tail of approximately 160 nucleotides not shown in sequence; 5'cap, Cap1; fully modified with 5-methylcytosine and pseudouridine) was formulated in a lipid nanoparticle containing 50%> DLin-MC3-DMA OR DLin-KC2-DMA as described in Table 121, 38.5% cholesterol, 10% DSPC and 1.5% PEG. The formulation was administered intravenously (I.V.) to Balb-C mice at a dose of 0.5 mg/kg, 0.05 mg/kg, 0.005 mg/kg or 0.0005 mg/kg. Twenty minutes prior to imaging, mice were injected intraperitoneally with a D-

luciferin solution at 150 mg/kg. Animals were then anesthetized and images were acquired with an IVIS Lumina II imaging system (Perkin Elmer). Bioluminescence was measured as total flux (photons/second) of the entire mouse.

Table 121. Formulations

Formulation	NPA-098-1	NPA-100-1
Lipid	DLin-KC2-DMA	DLin-MC3-DMA
Lipid/mRNA ratio (wt/wt)	20:1	20:1
Mean Size	135 nm PDI: 0.08	152 nm PDI: 0.08
Zeta at pH 7.4	-0.6 mV	-1.2 mV
Encaps. (RiboGr)	91%	94%

[001197] For DLin-KC2-DMA the mice were imaged at 2 hours, 8 hours, 24 hours, 72 hours, 96 hours and 168 hours after dosing and the average total flux (photons/second) was measured for each route of administration and cationic lipid formulation. The background flux was about 3.66E+05 p/s. The results of the imaging are shown in Table 122. Organs were imaged at 8 hours and the average total flux (photons/second) was measured for the liver, spleen, lung and kidney. A control for each organ was also analyzed. The results are shown in Table 123. The peak signal for all dose levels was at 8 hours after administration. Also, distribution to the various organs (liver, spleen, lung, and kidney) may be able to be controlled by increasing or decreasing the LNP dose.

Table 122. Flux

Time Point	0.5 mg/kg	0.05 mg/kg	0.005 mg/kg	0.0005 mg/kg
	Flux (p/s)	Flux (p/s)	Flux (p/s)	Flux (p/s)
2 hrs	3.54E+08	1.75E+07	2.30E+06	4.09E+05
8 hrs	1.67E+09	1.71E+08	9.81E+06	7.84E+05
24 hrs	2.05E+08	2.67E+07	2.49E+06	5.51E+05
72 hrs	8.17E+07	1.43E+07	1.01E+06	3.75E+05
96 hrs	4.10E+07	9.15E+06	9.58E+05	4.29E+05
168 hrs	3.42E+07	9.15E+06	1.47E+06	5.29E+05

Table 123. Organ Flux

	Liver	Spleen	Lung	Kidney
	Flux (p/s)	Flux (p/s)	Flux (p/s)	Flux (p/s)
0.5 mg/kg	1.42E+08	4.86E+07	1.90E+05	3.20E+05
0.05 mg/kg	7.45E+06	4.62E+05	6.86E+04	9.11E+04
0.005 mg/kg	3.32E+05	2.97E+04	1.42E+04	1.15E+04
0.0005 mg/kg	2.34E+04	1.08E+04	1.87E+04	9.78E+03
Untreated	1.88E+04	1.02E+04	1.41E+04	9.20E+03

[001198] For DLin-MC 3-DMA the mice were imaged at 2 hours, 8 hours, 24 hours, 48 hours, 72 hours and 144 hours after dosing and the average total flux (photons/second) was measured for each route of administration and cationic lipid formulation. The background flux was about 4.51E+05 p/s. The results of the imaging are shown in Table 124. Organs were imaged at 8 hours and the average total flux (photons/second) was measured for the liver, spleen, lung and kidney. A control for each organ was also analyzed. The results are shown in Table 125. The peak signal for all dose levels was at 8 hours after administration. Also, distribution to the various organs (liver, spleen, lung, and kidney) may be able to be controlled by increasing or decreasing the LNP dose.

Table 124. Flux

Time Point	0.5 mg/kg	0.05 mg/kg	0.005 mg/kg	0.0005 mg/kg
	Flux (p/s)	Flux (p/s)	Flux (p/s)	Flux (p/s)
2 hrs	1.23E+08	7.76E+06	7.66E+05	4.88E+05
8 hrs	1.05E+09	6.79E+07	2.75E+06	5.61E+05
24 hrs	4.44E+07	1.00E+07	1.06E+06	5.71E+05
48 hrs	2.12E+07	4.27E+06	7.42E+05	4.84E+05
72 hrs	1.34E+07	5.84E+06	6.90E+05	4.38E+05
144 hrs	4.26E+06	2.25E+06	4.58E+05	3.99E+05

Table 125. Organ Flux

	Liver	Spleen	Lung	Kidney
	Flux (p/s)	Flux (p/s)	Flux (p/s)	Flux (p/s)
0.5 mg/kg	1.19E+08	9.66E+07	1.19E+06	1.85E+05
0.05 mg/kg	1.10E+07	1.79E+06	7.23E+04	5.82E+04
0.005 mg/kg	3.58E+05	6.04E+04	1.33E+04	1.33E+04
0.0005 mg/kg	2.25E+04	1.88E+04	2.05E+04	1.65E+04
Untreated	1.91E+04	1.66E+04	2.63E+04	2.14E+04

Example 83. Lipid Nanoparticle Subcutaneous Study

[001199] Luciferase mRNA (SEQ ID NO: 16; polyA tail of approximately 160 nucleotides not shown in sequence; 5'cap, Cap1; fully modified with 5-methylcytosine and pseudouridine) was formulated in a lipid nanoparticle containing 50% DLin-KC2-DMA as described in Table 126, 38% cholesterol, 10% DSPC and 1.5% PEG. The formulation was administered subcutaneously (S.C.) to Balb-C mice at a dose of 0.5 mg/kg, 0.05 mg/kg or 0.005 mg/kg.

Table 126. DLin-KC2-DMA Formulation

Formulation	NPA-098-1
Lipid	DLin-KC2-DMA
Lipid/mRNA ratio (wt/wt)	20:1
Mean Size	135 nm

	PDI: 0.08
Zeta at pH 7.4	-0.6 mV
Encaps. (RiboGr)	91%

[001200] Twenty minutes prior to imaging, mice were injected intraperitoneally with a D-luciferin solution at 150 mg/kg. Animals were then anesthetized and images were acquired with an IVIS Lumina II imaging system (Perkin Elmer). Bioluminescence was measured as total flux (photons/second) of the entire mouse. The mice were imaged at 2 hours, 8 hours, 24 hours, 48 hours, 72 hours and 144 hours after dosing and the average total flux (photons/second) was measured for each route of administration and cationic lipid formulation. The lower limit of detection was about $3E+05$ p/s. The results of the imaging are shown in Table 127. Organs were imaged at 8 hours and the average total flux (photons/second) was measured for the liver, spleen, lung and kidney. A control for each organ was also analyzed. The results are shown in Table 128. The peak signal for all dose levels was at 8 hours after administration. Also, distribution to the various organs (liver, spleen, lung, and kidney) may be able to be controlled by increasing or decreasing the LNP dose. At high doses, the LNP formulations migrates outside of the subcutaneous injection site, as high levels of luciferase expression are detected in the liver, spleen, lung, and kidney.

Table 127. Flux

Time Point	0.5 mg/kg	0.05 mg/kg	0.005 mg/kg
	Flux (p/s)	Flux (p/s)	Flux (p/s)
2 hrs	3.18E+07	7.46E+06	8.94E+05
8 hrs	5.15E+08	2.18E+08	1.34E+07
24 hrs	1.56E+08	5.30E+07	7.16E+06
48 hrs	5.22E+07	8.75E+06	9.06E+05
72 hrs	8.87E+06	1.50E+06	2.98E+05
144 hrs	4.55E+05	3.51E+05	2.87E+05

Table 128. Organ Flux

	Liver	Spleen	Lung	Kidney
	Flux (p/s)	Flux (p/s)	Flux (p/s)	Flux (p/s)
0.5 mg/kg	1.01E+07	7.43E+05	9.75E+04	1.75E+05
0.05 mg/kg	1.61E+05	3.94E+04	4.04E+04	3.29E+04
0.005 mg/kg	2.84E+04	2.94E+04	2.42E+04	9.79E+04
Untreated	1.88E+04	1.02E+04	1.41E+04	9.20E+03

Example 84. Cationic Lipid Nanoparticle Subcutaneous Study

[001201] Luciferase mRNA (SEQ ID NO: 16; polyA tail of approximately 160 nucleotides not shown in sequence; 5'cap, Cap1; fully modified with 5-methylcytosine and pseudouridine) is formulated in a lipid nanoparticle containing 50% DLin-MC3-DMA, 38.5% cholesterol, 10% DSPC and 1.5% PEG. The formulation is administered subcutaneously (S.C.) to Balb-C mice at a dose of 0.5 mg/kg, 0.05 mg/kg or 0.005 mg/kg.

[001202] The mice are imaged at 2 hours, 8 hours, 24 hours, 48 hours, 72 hours and 144 hours after dosing and the average total flux (photons/second) was measured for each route of administration and cationic lipid formulation. Organs are imaged at 8 hours and the average total flux (photons/second) is measured for the liver, spleen, lung and kidney. A control for each organ is also analyzed.

Example 85. Lipoplex Study

[001203] Lipoplexed luciferase mRNA (SEQ ID NO: 16; polyA tail of approximately 140 nucleotides not shown in sequence; 5'cap, Cap1) fully modified with 5-methylcytosine and pseudouridine (5mC/pU), fully modified with 5-methylcytosine and N1-methylpseudouridine (5mC/N1mpU) or modified where 25% of the cytosines replaced with 5-methylcytosine and 25% of the uridines replaced with 2-thiouridine (5mC/s2U). The formulation was administered intravenously (I.V.), intramuscularly (I.M.) or subcutaneously (S.C.) to Balb-C mice at a dose of 0.10 mg/kg.

[001204] Twenty minutes prior to imaging, mice were injected intraperitoneally with a D-luciferin solution at 150 mg/kg. Animals were then anesthetized and images were acquired with an IVIS Lumina II imaging system (Perkin Elmer). Bioluminescence was measured as total flux (photons/second) of the entire mouse. The mice were imaged at 8 hours, 24 hours and 48 hours after dosing and the average total flux (photons/second) was measured for each route of administration and chemical modification. The background signal was about 3.91E+05 p/s. The results of the imaging are shown in Table 129. Organs were imaged at 6 hours and the average total flux (photons/second) was measured for the liver, spleen, lung and kidney. A control for each organ was also analyzed. The results are shown in Table 130.

Table 129. Flux

Route	Time Point	5mC/pU	5mC/N1mpU	5mC/s2U
		Flux (p/s)	Flux (p/s)	Flux (p/s)
I.V.	8 hrs	5.76E+06	1.78E+06	1.88E+06
I.V.	24 hrs	1.02E+06	7.13E+05	5.28E+05
I.V.	48 hrs	4.53E+05	3.76E+05	4.14E+05

I.M.	8 hrs	1.90E+06	2.53E+06	1.29E+06
I.M.	24 hrs	9.33E+05	7.84E+05	6.48E+05
I.M.	48 hrs	8.51E+05	6.59E+05	5.49E+05
S.C.	8 hrs	2.85E+06	6.48E+06	1.14E+06
S.C.	24 hrs	6.66E+05	7.15E+06	3.93E+05
S.C.	48 hrs	3.24E+05	3.20E+06	5.45E+05

Table 130. Organ Flux

Route	Chemistry	Liver	Spleen	Lung	Kidney	Inj. Site
		Flux (p/s)	Flux (p/s)	Flux (p/s)	Flux (p/s)	Flux (p/s)
I.V.	5mC/pU	5.26E+05	2.04E+07	4.28E+06	1.77E+04	n/a
I.V.	5mC/N1mpU	1.48E+05	5.00E+06	1.93E+06	1.77E+04	n/a
I.V.	5mC/s2U	2.14E+04	3.29E+06	5.48E+05	2.16E+04	n/a
I.M.	5mC/pU	2.46E+04	1.38E+04	1.50E+04	1.44E+04	1.15E+06
I.M.	5mC/N1mpU	1.72E+04	1.76E+04	1.99E+04	1.56E+04	1.20E+06
I.M.	5mC/s2U	1.28E+04	1.36E+04	1.33E+04	1.07E+04	7.60E+05
S.C.	5mC/pU	1.55E+04	1.67E+04	1.45E+04	1.69E+04	4.46E+04
S.C.	5mC/N1mpU	1.20E+04	1.46E+04	1.38E+04	1.14E+04	8.29E+04
S.C.	5mC/s2U	1.22E+04	1.31E+04	1.45E+04	1.08E+04	5.62E+04
	Untreated	2.59E+04	1.34E+04	1.26E+04	1.22E+04	n/a

Example 86. Cationic Lipid Formulation of Modified mRNA

[001205] Luciferase mRNA (SEQ ID NO: 16; polyA tail of approximately 140 nucleotides not shown in sequence; 5'cap, Cap1) modified where 25% of the cytosines replaced with 5-methylcytosine and 25% of the uridines replaced with 2-thiouridine (5mC/s2U) was formulated in the cationic lipids described in Table 131. The formulations were administered intravenously (I.V.), intramuscularly (I.M.) or subcutaneously (S.C.) to Balb-C mice at a dose of 0.05 mg/kg.

Table 131. Cationic Lipid Formulations

Formulation	NPA-130-1	NPA-131-1	NPA-132-1	NPA-133-1	111612-C
Lipid	DLin-MC3-DMA	DLin-KC2-DMA	C12-200	DLinDMA	DODMA
Lipid/mRNA ratio (wt/wt)	20:1	20:1	20:1	20:1	20:1
Mean Size	120 nm	105 nm	122 nm	105 nm	221.3 nm
	PDI: 0.10	PDI: 0.11	PDI: 0.13	PDI: 0.14	PDI: 0.063
Zeta at pH 7.4	0.2 mV	-0.6 mV	-0.5 mV	-0.3 mV	-3.10 mV
Encaps. (RiboGr)	100%	100%	93%	93%	60%

[001206] Twenty minutes prior to imaging, mice were injected intraperitoneally with a D-luciferin solution at 150 mg/kg. Animals were then anesthetized and images were acquired with an IVIS Lumina II imaging system (Perkin Elmer). Bioluminescence was measured as total flux

(photons/second) of the entire mouse. The mice were imaged at 2 hours, 8 hours and 24 hours after dosing and the average total flux (photons/second) was measured for each route of administration and cationic lipid formulation. The background flux was about 3.31E+05 p/s. The results of the imaging are shown in Table 132. In Table 132, "NT" means not tested. Untreated mice showed an average flux of 3.14E+05 at 2 hours, 3.33E+05 at 8 hours and 3.46E+05 at 24 hours. Peak expression was seen for all three routes tested at 8 hours. DLin-KC2-DMA has better expression than DLin-MC3-DMA and DODMA showed expression for all routes evaluated.

Table 132. Flux

Route	Time Point	DLin-MC3-DMA	DLin-KC2-DMA	C12-200	DLinDMA	DODMA
		Flux (p/s)	Flux (p/s)	Flux (p/s)	Flux (p/s)	Flux (p/s)
I.V.	2 hrs	9.88E+06	6.98E+07	9.18E+06	3.98E+06	5.79E+06
I.V.	8 hrs	1.21E+07	1.23E+08	1.02E+07	5.98E+06	6.14E+06
I.V.	24 hrs	2.02E+06	1.05E+07	1.25E+06	1.35E+06	5.72E+05
I.M.	2 hrs	6.72E+05	3.66E+06	3.25E+06	7.34E+05	4.42E+05
I.M.	8 hrs	7.78E+06	2.85E+07	4.29E+06	2.22E+06	1.38E+05
I.M.	24 hrs	4.22E+05	8.79E+05	5.95E+05	8.48E+05	4.80E+05
S.C.	2 hrs	2.37E+06	4.77E+06	4.44E+06	1.07E+06	1.05E+06
S.C.	8 hrs	3.65E+07	1.17E+08	3.71E+06	9.33E+06	2.57E+06
S.C.	24 hrs	4.47E+06	1.28E+07	6.39E+05	8.89E+05	4.27E+05

Example 87. Formulation of 5-Methylcytosine and N1-Methylpseudouridine Modified mRNA

[001207] Luciferase mRNA (SEQ ID NO: 16; polyA tail of approximately 140 nucleotides not shown in sequence; 5'cap, Cap1) fully modified with 5-methylcytosine and N1-methylpseudouridine was formulated in PBS (pH of 7.4). The formulations were administered intramuscularly (I.M.) or subcutaneously (S.C.) to Balb-C mice at a dose of 2.5 mg/kg.

[001208] Twenty minutes prior to imaging, mice were injected intraperitoneally with a D-luciferin solution at 150 mg/kg. Animals were then anesthetized and images were acquired with an IVIS Lumina II imaging system (Perkin Elmer). Bioluminescence was measured as total flux (photons/second) of the entire mouse. The mice were imaged at 5 minutes, 30 minutes, 60 minutes and 120 minutes after dosing and the average total flux (photons/second) was measured for each route of administration and cationic lipid formulation. The background flux was about 3.78E+05 p/s. The results of the imaging are shown in Table 133. Expression of luciferase was already seen at 30 minutes with both routes of delivery. Peak expression from subcutaneous administration appears between 30 to 60 minutes. Intramuscular expression was still increasing at 120 minutes.

Table 133. Flux

Route	Time Point	PBS (pH 7.4)
		Flux (p/s)
I.M.	5 min	4.38E+05
I.M.	30 min	1.09E+06
I.M.	60 min	1.18E+06
I.M.	120 min	2.86E+06
S.C.	5 min	4.19E+05
S.C.	30 min	6.38E+06
S.C.	60 min	5.61E+06
S.C.	120 min	2.66E+06

Example 88. Intramuscular and Subcutaneous Administration of Chemically Modified mRNA

[001209] Luciferase modified mRNA (mRNA sequence shown in SEQ ID NO: 16; polyA tail of approximately 140 nucleotides not shown in sequence; 5'cap, Cap1) fully modified with N4-acetylcytidine, fully modified with 5-methoxyuridine, fully modified with N4-acetylcytidine and N1-methylpseudouridine or fully modified 5-methylcytosine and 5-methoxyuridine formulated in PBS (pH 7.4) was administered to Balb-C mice intramuscularly or subcutaneously at a dose of 2.5 mg/kg. Twenty minutes prior to imaging, mice were injected intraperitoneally with a D-luciferin solution at 150 mg/kg. Animals were then anesthetized and images were acquired with an IVIS Lumina II imaging system (Perkin Elmer). Bioluminescence was measured as total flux (photons/second) of the entire mouse. The mice were imaged at 2 hours, 8 hours and 24 hours. The average total flux (photons/second) for intramuscular administration is shown in Table 134 and the average total flux (photons/second) for subcutaneous administration is shown in Table 135. The background signal was 3.84E+05 (p/s). The peak expression for intramuscular administration was seen between 24 and 48 hours for all chemistry and expression was still detected at 120 hours. For subcutaneous delivery the peak expression was seen at 2-8 hours and expression was detected at 72 hours.

Table 134. Intramuscular Administration

	2 hours	8 hours	24 hours
	Flux (p/s)	Flux (p/s)	Flux (p/s)
N4-acetylcytidine	1.32E+07	2.15E+07	4.01E+07
5-methoxyuridine	4.93E+06	1.80E+07	4.53E+07
N4-acetylcytidine/ N1-methylpseudouridine	2.02E+07	1.93E+07	1.63E+08
5-methylcytosine/5- methoxyuridine	6.79E+06	4.55E+07	3.44E+07

Table 135. Subcutaneous Administration

	2 hours	8 hours	24 hours
	Flux (p/s)	Flux (p/s)	Flux (p/s)
N4-acetylcytidine	3.07E+07	1.23E+07	1.28E+07
5-methoxyuridine	7.10E+06	9.38E+06	1.32E+07
N4-acetylcytidine/ N1-methylpseudouridine	7.12E+06	3.07E+06	1.03E+07
5-methylcytosine/5- methoxyuridine	7.15E+06	1.25E+07	1.11E+07

Example 89. *In vivo* study

[001210] Luciferase modified mRNA containing at least one chemical modification is formulated as a lipid nanoparticle (LNP) using the syringe pump method and characterized by particle size, zeta potential, and encapsulation.

[001211] As outlined in Table 136, the luciferase LNP formulation is administered to Balb-C mice intramuscularly (I.M.), intravenously (I.V.) and subcutaneously (S.C.). As a control luciferase modified RNA formulated in PBS is administered intravenously to mice.

Table 136. Luciferase Formulations

Formulation	Vehicle	Route	Concentration (mg/ml)	Injection Volume (ul)	Amount of modified RNA (ug)	Dose (mg/kg)
Luc-LNP	PBS	S.C.	0.2000	50	10	0.5000
Luc-LNP	PBS	S.C.	0.0200	50	1	0.0500
Luc-LNP	PBS	S.C.	0.0020	50	0.1	0.0050
Luc-LNP	PBS	S.C.	0.0002	50	0.01	0.0005
Luc-LNP	PBS	I.V.	0.2000	50	10	0.5000
Luc-LNP	PBS	I.V.	0.0200	50	1	0.0500
Luc-LNP	PBS	I.V.	0.0020	50	0.1	0.0050
Luc-LNP	PBS	I.V.	0.0002	50	0.01	0.0005
Luc-LNP	PBS	I.M.	0.2000	50	10	0.5000
Luc-LNP	PBS	I.M.	0.0200	50	1	0.0500
Luc-LNP	PBS	I.M.	0.0020	50	0.1	0.0050
Luc-LNP	PBS	I.M.	0.0002	50	0.01	0.0005
Luc-PBS	PBS	I.V.	0.20	50	10	0.50

[001212] The mice are imaged at 2, 8, 24, 48, 120 and 192 hours to determine the bioluminescence (measured as total flux (photons/second) of the entire mouse). At 8 hours or 192 hours the liver, spleen, kidney and injection site for subcutaneous and intramuscular administration are imaged to determine the bioluminescence.

Example 90. Cationic Lipid Formulation Studies of Chemically Modified mRNA

[001213] Luciferase mRNA (SEQ ID NO: 16; polyA tail of approximately 140 nucleotides not shown in sequence; 5'cap, Cap1) fully modified with 5-methylcytosine and pseudouridine (5mC/pU), pseudouridine (pU) or N1-methylpseudouridine (N1mpU) was formulated in the cationic lipids described in Table 137. The formulations were administered intravenously (I.V.), intramuscularly (I.M.) or subcutaneously (S.C.) to Balb-C mice at a dose of 0.05 mg/kg.

Table 137. Cationic Lipid Formulations

Formulation	NPA-137-1	NPA-134-1	NPA-135-1	NPA-136-1	111612-A
Lipid	DLin-MC3-DMA	DLin-MC3-DMA	DLin-KC2-DMA	C12-200	DODMA
Lipid/mRNA ratio (wt/wt)	20:1	20:1	20:1	20:1	20:1
Mean Size	111 nm PDI: 0.15	104 nm PDI: 0.13	95 nm PDI: 0.11	143 nm PDI: 0.12	223.2 nm PDI: 0.142
Zeta at pH 7.4	-4.1 mV	-1.9 mV	-1.0 mV	0.2 mV	-3.09 mV
Encaps. (RiboGr)	97%	100%	100%	78%	64%
Chemistry	pU	N1mpU	N1mpU	N1mpU	5mC/pU

[001214] Twenty minutes prior to imaging, mice were injected intraperitoneally with a D-luciferin solution at 150 mg/kg. Animals were then anesthetized and images were acquired with an IVIS Lumina II imaging system (Perkin Elmer). Bioluminescence was measured as total flux (photons/second) of the entire mouse. The mice were imaged at 2 hours, 8 hours and 24 hours after dosing and the average total flux (photons/second) was measured for each route of administration and cationic lipid formulation. The background flux was about 4.11E+05 p/s. The results of the imaging are shown in Table 138. Peak expression was seen for all three routes tested at 8 hours.

Table 138. Flux

Route	Time Point	DLin-MC3-DMA (pU)	DLin-MC3-DMA (N1mpU)	DLin-KC2-DMA (N1mpU)	C12-200 (N1mpU)	DODMA (5mC/pU)
		Flux (p/s)	Flux (p/s)	Flux (p/s)	Flux (p/s)	Flux (p/s)
I.V.	2 hrs	3.21E+08	1.24E+09	1.01E+09	9.00E+08	3.90E+07
I.V.	8 hrs	1.60E+09	3.22E+09	2.38E+09	1.11E+09	1.17E+07
I.V.	24 hrs	1.41E+08	3.68E+08	3.93E+08	8.06E+07	1.11E+07
I.M.	2 hrs	2.09E+07	3.29E+07	8.32E+07	9.43E+07	4.66E+06
I.M.	8 hrs	2.16E+08	6.14E+08	1.00E+09	8.77E+07	7.05E+06
I.M.	24 hrs	1.23E+07	1.40E+08	5.09E+08	1.36E+07	1.14E+06
S.C.	2 hrs	2.32E+07	3.60E+07	2.14E+08	1.01E+08	3.11E+07
S.C.	8 hrs	5.55E+08	9.80E+08	4.93E+09	1.01E+09	8.04E+07
S.C.	24 hrs	1.81E+08	2.74E+08	2.12E+09	4.74E+07	1.34E+07

Example 91. Studies of Chemical Modified mRNA

[001215] Luciferase mRNA (SEQ ID NO: 16; polyA tail of approximately 140 nucleotides not shown in sequence; 5'cap, Cap1) fully modified with N4-acetylcytidine (N4-acetyl), fully modified with 5-methoxyuridine (5meth), fully modified with N4-acetylcytidine and N1-methylpseudouridine (N4-acetyl/N1mpU) or fully modified with 5-methylcytosine and 5-methoxyuridine (5mC/5-meth) was formulated in DLin-MC3-DMA as described in Table 139. The formulations were administered intravenously (I.V.), intramuscularly (I.M.) or subcutaneously (S.C.) to Balb-C mice at a dose of 0.05 mg/kg.

Table 139. Cationic Lipid Formulations

Formulation	NPA-141-1	NPA-142-1	NPA-143-1	NPA-144-1
Lipid	DLin-MC3-DMA	DLin-MC3-DMA	DLin-MC3-DMA	DLin-MC3-DMA
Lipid/mRNA ratio (wt/wt)	20:1	20:1	20:1	20:1
Mean Size	138 nm PDI: 0.16	116 nm PDI: 0.15	144 nm PDI: 0.15	131 nm PDI: 0.15
Zeta at pH 7.4	-2.8 mV	-2.8 mV	-4.3 mV	-5.0 mV
Encaps. (RiboGr)	97%	100%	75%	72%
Chemistry	N4-acetyl	5meth	N4-acetyl/ N1mpU	5mC/5-meth

[001216] Twenty minutes prior to imaging, mice were injected intraperitoneally with a D-luciferin solution at 150 mg/kg. Animals were then anesthetized and images were acquired with an IVIS Lumina II imaging system (Perkin Elmer). Bioluminescence was measured as total flux (photons/second) of the entire mouse. The mice were imaged at 2 hours, 6 hours and 24 hours after dosing and the average total flux (photons/second) was measured for each route of administration and cationic lipid formulation. The background flux was about 2.70E+05 p/s. The results of the imaging are shown in Table 140.

Table 140. Flux

Route	Time Point	N4-acetyl	5meth	N4-acetyl/ N1mpU	5mC/5-meth
		Flux (p/s)	Flux (p/s)	Flux (p/s)	Flux (p/s)
I.V.	2 hrs	9.17E+07	3.19E+06	4.21E+07	1.88E+06
I.V.	6 hrs	7.70E+08	9.28E+06	2.34E+08	7.75E+06
I.V.	24 hrs	6.84E+07	1.04E+06	3.55E+07	3.21E+06

I.M.	2 hrs	8.59E+06	7.86E+05	5.30E+06	5.1 1E+05
I.M.	6 hrs	1.27E+08	8.88E+06	3.82E+07	3.17E+06
I.M.	24 hrs	4.46E+07	1.38E+06	2.00E+07	1.39E+06
S.C.	2 hrs	1.83E+07	9.67E+05	4.45E+06	1.01E+06
S.C.	6 hrs	2.89E+08	1.78E+07	8.91E+07	1.29E+07
S.C.	24 hrs	6.09E+07	6.40E+06	2.08E+08	6.63E+06

Example 92. PLGA Microspheres

A. Synthesis of PLGA microspheres

[001217] Polylactideglycolic acid (PLGA) microspheres were synthesized using the water/oil/water double emulsification methods known in the art using PLGA-ester cap (Lactel, Cat# B6010-2, inherent viscosity 0.55-0.75, 50:50 LA:GA) or PLGA-acid cap (Lactel, Cat#B6013-2, inherent viscosity 0.55-0.75, 50:50 LA:GA), polyvinylalcohol (PVA) (Sigma, Cat# 348406-25G, MW 13-23k) dichloromethane and water. Briefly, 0.4 ml of mRNA in water (W1) at 4 mg/ml was added to 2 ml of PLGA dissolved in dichloromethane (DCM) (O1) at concentrations ranging from 50 - 200 mg/ml of PLGA. The W1/O1 emulsion was homogenized (IKA Ultra-Turrax Homogenizer, T18) for 30 seconds at speed 4 (-15,000 rpm). The W1/O1 emulsion was then added to 250 ml of 1% PVA (W2) and homogenized for 1 minute at speed 5 (-19,000 rpm). Formulations were left to stir for 3 hours, then passed through a 100 μ m nylon mesh strainer (Fisherbrand Cell Strainer, Cat # 22-363-549) to remove larger aggregates, and finally washed by centrifugation (10 min, 9,250 rpm, 4°C). The supernatant was discarded and the PLGA pellets were resuspended in 5-10 ml of water, which was repeated 2x. The washed formulations were frozen in liquid nitrogen and then lyophilized for 2-3 days.

B. Decreasing homogenization speed or PLGA concentration

[001218] PLGA luciferase microspheres (luciferase mRNA shown in SEQ ID NO: 16; polyA tail of approximately 160 nucleotides not shown in sequence; 5'cap, Cap1; fully modified with 5-methylcystosine and pseudouridine) were made using the conditions described above with ester-capped PLGA. After washing and resuspension with water, 100-200 μ l of a PLGA microspheres sample was used to measure particle size of the formulations by laser diffraction (Malvern Mastersizer2000). The particle size of the microspheres made by decreasing homogenization speed during the addition of the first emulsion to the second emulsion with a PLGA concentration of 200 mg/ml is shown in Table 141 and the particle size of the microspheres made by decreasing PLGA concentration in dichloromethane (DCM) is shown in Table 142 with a homogenization speed of 5 during the addition of the first emulsion to the second emulsion.

Table 141. Decreasing Homogenization Speed

Addition Homogenizer Speed	D50 Average Size (μm)
2	41.5
3	35.9
4	32.5
5	26.5
6	25.0

Table 142. Decreasing PLGA Concentration in DCM

PLGA Concentration (mg/mL)	D50 Average Size (μm)
200	27.7
100	14.2
50	8.7

[001219] PLGA with an inherent viscosity of 0.55 - 0.75 either acid or ester-capped was used to make microspheres shown in Table 143. The particle size of the microspheres and the release kinetics were also determined and are shown in Table 143.

Table 143. Decreasing PLGA Concentration in DCM

Sample	PLGA concentration mg/ml	End-group	Addition Homogenizer Speed	Theoretical mRNA Loading (wt %)	Actual mRNA Loading (wt %)	Encap. Eff. %	D50 Average Size (μm)
A	200	Ester	3	0.4	0.14	45	38.7
B	200	Acid	3	0.4	0.06	18	31.3
C	200	Ester	5	0.4	0.13	41	32.2
D	200	Acid	5	0.4	0.07	22	28.0
E	100	Ester	5	0.8	0.15	23	17.1
F	100	Acid	5	0.8	0.10	18	15.9

C. Release study of modified mRNA encapsulated in PLGA microspheres

[001220] PLGA microspheres formulated with Luciferase modified RNA (SEQ ID NO: 16; polyA tail of approximately 160 nucleotides not shown in sequence; 5'cap, Cap1; fully modified with 5-methylcytosine and pseudouridine) were deformulated and the integrity of the extracted modified RNA was determined by automated electrophoresis (Bio-Rad Experion). After

lyophilization, -10 mg of PLGA MS were weighed out in 2 ml eppendorf tubes and deformed by adding 1 ml of DCM and letting the samples shake for 2-6 hrs. mRNA was extracted from the deformed PLGA microspheres by adding 0.5 ml of water and shaking the sample overnight. Unformulated luciferase mRNA in water (Deform control) was spiked into DCM and went through the deformation process to be used as a control. The extracted modified mRNA was compared against unformulated modified mRNA and the deformation control in order to test the integrity of the encapsulated modified mRNA. The majority of modified RNA was intact for batch ID A, B, C, D, E, as compared to the deformed control (Deform control) and the unformulated control (Uniform control).

D. Release study of modified mRNA encapsulated in PLGA microspheres

[001221] PLGA microspheres formulated with Luciferase modified RNA (SEQ ID NO: 16; polyA tail of approximately 160 nucleotides not shown in sequence; 5'cap, Cap1; fully modified with 5-methylcytosine and pseudouridine) were resuspended in TE buffer to a PLGA microsphere concentration of 80 mg/ml in duplicate or triplicate. After resuspension, samples were kept incubating and shaking at 37°C during the course of the study. For each time point (0.04, 0.25, 1.2, 4, and 7 days), the tubes were centrifuged, the supernatant was removed and the pellet was resuspended in 0.25 ml of fresh TE buffer. To determine the amount of modified RNA released from the PLGA microspheres, the modified RNA concentration in the supernatant was determined by OD 260. The percent release, shown in Table 144, was calculated based on the total amount of modified RNA in each sample. The release rate of mRNA formulations can be tailored by altering the particle size, the PLGA concentration, and the acid versus ester-end cap.

Table 144. Percent Release

Time (days)	Batch A	Batch B	Batch C	Batch D	Batch E	Batch F
	% Release	% Release	% Release	% Release	% Release	% Release
0.04	7.1	13.6	9.5	9.5	21.2	21.7
0.25	18.0	23.3	17.5	24.0	31.3	37.7
1.2	26.3	29.1	22.8	31.6	41.0	46.5
4	33.5	37.1	29.0	40.4	48.8	60.7
7	37.6	41.5	32.4	45.2	55.0	68.3

E. Luciferase PLGA Microspheres *In Vivo* Study

[001222] PLGA microspheres containing luciferase mRNA (SEQ ID NO: 16; polyA tail of approximately 140 nucleotides not shown in sequence; 5'cap, Cap1) fully modified with 5-

methylcytosine and NI-methylpseudouridine or fully modified with NI-methylpseudouridine are formulated as described in Table 145 and injected subcutaneously into mice. Twenty minutes prior to imaging, mice are injected intraperitoneally with a **D**-luciferin solution at 150 mg/kg. Animals are then anesthetized and images were acquired with an IVIS Lumina II imaging system (Perkin Elmer). Bioluminescence was measured as total flux (photons/second) of the entire mouse.

Table 145. Formulation

Group	n	Dose (ug)	Volume (ul)	Vehicle
1	6	50	200	0.5%CMC, 5% Mannitol, 0.1% Polysorbate 80
2	6	50	200	5% Sucrose
3	3	5	200	5% Sucrose

Example 93. Buffer Formulations

[001223] Modified mRNA may be formulated in water based buffers. Buffers which are similar to biological systems are traditionally isotonic. Such buffers and buffer solutions may be prepared according to the following guidelines. Example components are given in Table 146.

[001224] In some embodiments, calcium ions may be added to a buffer solution for formulations.

Table 146. Buffers

Buffer	Components
Tris buffered saline	Tris and sodium chloride
Phosphate buffered saline	sodium chloride, sodium phosphate, and, in some formulations, potassium chloride and potassium phosphate
Ringer's lactate (for one liter)	130 mEq of sodium ion = 130 mmol/L 109 mEq of chloride ion = 109 mmol/L 28 mEq of lactate = 28 mmol/L 4 mEq of potassium ion = 4 mmol/L 3 mEq of calcium ion = 1.5 mmol/L

Example 94. Lipid Nanoparticle Containing A Plurality of Modified mRNAs

[001225] EPO mRNA (SEQ ID NO: 9; polyA tail of approximately 140 nucleotides not shown in sequence; 5'cap, Cap1; fully modified with 5-methylcytosine and NI-methylpseudouridine), G-CSF mRNA (SEQ ID NO: 6; polyA tail of approximately 140 nucleotides not shown in sequence; 5'cap, Cap1; fully modified with 5-methylcytosine and NI-methylpseudouridine) and Factor IX mRNA (SEQ ID NO: 10; polyA tail of approximately 140 nucleotides not shown in sequence; 5'cap, Cap1; fully modified with 5-methylcytosine and NI-methylpseudouridine), is formulated in DLin-MC3-DMA as described in Table 147. The formulations are administered intravenously (I.V.), intramuscularly (I.M.) or subcutaneously (S.C.) to Balb-C mice at a dose of 0.05 mg/kg. Control LNP formulations containing only one mRNA are also administered at an equivalent dose.

Table 147. DLin-MC3-DMA Formulation

Formulation	NPA-157-1
Lipid	DLin-MC3- DMA
Lipid/mRNA ratio (wt/wt)	20:1
Mean Size	89 nm PDI: 0.08
Zeta at pH 7.4	1.1 mV
Encaps. (RiboGr)	97%

[001226] Serum is collected from the mice at 8 hours, 24 hours, 72 hours and/or 7 days after administration of the formulation. The serum is analyzed by ELISA to determine the protein expression of EPO, G-CSF, and Factor IX.

Example 95. Cationic Lipid Formulation Studies of of 5-Methylcytosine and NI-Methylpseudouridine Modified mRNA

[001227] EPO mRNA (SEQ ID NO: 9; polyA tail of approximately 140 nucleotides not shown in sequence; 5'cap, Cap1; fully modified with 5-methylcytosine and NI-methylpseudouridine) or G-CSF mRNA (SEQ ID NO: 6; polyA tail of approximately 140 nucleotides not shown in sequence; 5'cap, Cap1; fully modified with 5-methylcytosine and NI-methylpseudouridine) is formulated in DLin-MC3-DMA and DLin-KC2-DMA as described in Table 148. The formulations are administered intravenously (I.V), intramuscularly (I.M.) or subcutaneously (S.C.) to Balb-C mice at a dose of 0.05 mg/kg.

Table 148. DLin-MC3-DMA and DLin-KC2-DMA Formulations

Formulation	NPA-147-1	NPA-148-1	NPA-150-1	NPA-151-1
-------------	-----------	-----------	-----------	-----------

mRNA	EPO	EPO	G-CSF	G-CSF
Lipid	DLin-MC3-DMA	DLin-KC2-DMA	DLin-MC3-DMA	DLin-KC2-DMA
Lipid/mRNA ratio (wt/wt)	20:1	20:1	20:1	20:1
Mean Size	117 nm PDI: 0.14	82 nm PDI: 0.08	119 nm PDI: 0.13	88 nm PDI: 0.08
Zeta at pH 7.4	-1.7 mV	0.6 mV	3.6 mV	2.2 mV
Encaps. (RiboGr)	100%	96%	100%	100%

[001228] Serum is collected from the mice at 8 hours, 24 hours, 72 hours and/or 7 days after administration of the formulation. The serum is analyzed by ELISA to determine the protein expression of EPO and G-CSF.

Example 96. Directed SAR of Pseudouridine and N1-methyl PseudoUridine

[001229] With the recent focus on the pyrimidine nucleoside pseudouridine, a series of structure-activity studies were designed to investigate mRNA containing modifications to pseudouridine or N1-methyl-pseudouridine.

[001230] The study was designed to explore the effect of chain length, increased lipophilicity, presence of ring structures, and alteration of hydrophobic or hydrophilic interactions when modifications were made at the N1 position, C6 position, the 2-position, the 4-position and on the phosphate backbone. Stability is also investigated.

[001231] To this end, modifications involving alkylation, cycloalkylation, alkyl-cycloalkylation, arylation, alkyl-arylation, alkylation moieties with amino groups, alkylation moieties with carboxylic acid groups, and alkylation moieties containing amino acid charged moieties are investigated. The degree of alkylation is generally C₁-C₆. Examples of the chemistry modifications include those listed in Table 149 and Table 150.

Table 149. Pseudouridine and N1-methyl Pseudo Uridine SAR

Chemistry Modification	Compound #	Naturally occurring
N1-Modifications		
N1-Ethyl-pseudo-UTP	1	N
N1-Propyl-pseudo-UTP	2	N
N1- <i>iso</i> -propyl-pseudo-UTP	3	N
N1-(2,2,2-Trifluoroethyl)-pseudo-UTP	4	N
N1-Cyclopropyl-pseudo-UTP	5	N

N1-Cyclopropylmethyl-pseudo-UTP	6	N
N1-Phenyl-pseudo-UTP	7	N
N1-Benzyl-pseudo-UTP	8	N
N1-Aminomethyl-pseudo-UTP	9	N
P pseudo-UTP-N1-2-ethanoic acid	10	N
N 1-(3-Amino-3-carboxypropyl)pseudo-UTP	11	N
N1-Methyl-3-(3-amino-3-carboxypropyl)pseudo-UTP	12	Y
C-6 Modifications		
6-Methyl-pseudo-UTP	13	N
6-Trifluoromethyl-pseudo-UTP	14	N
6-Methoxy-pseudo-UTP	15	N
6-Phenyl-pseudo-UTP	16	N
6-Iodo-pseudo-UTP	17	N
6-Bromo-pseudo-UTP	18	N
6-Chloro-pseudo-UTP	19	N
6-Fluoro-pseudo-UTP	20	N
2- or 4-position Modifications		
4-Thio-pseudo-UTP	21	N
2-Thio-pseudo-UTP	22	N
Phosphate backbone Modifications		
Alpha-thio-pseudo-UTP	23	N
N1-Me-alpha-thio-pseudo-UTP	24	N

Table 150. Pseudouridine and N1-methyl Pseudo Uridine SAR

Chemistry Modification	Compound #	Naturally occurring
N 1-Methyl-pseudo-UTP	1	Y
N1-Butyl-pseudo-UTP	2	N
N 1-tert-Butyl-pseudo-UTP	3	N
N 1-Pentyl-pseudo-UTP	4	N
N1-Hexyl-pseudo-UTP	5	N
N 1-Trifluoromethyl-pseudo-UTP	6	Y
N 1-Cyclobutyl-pseudo-UTP	7	N
N 1-Cyclopentyl-pseudo-UTP	8	N
N 1-Cyclohexyl-pseudo-UTP	9	N
N 1-Cycloheptyl-pseudo-UTP	10	N
N 1-Cyclooctyl-pseudo-UTP	11	N
N 1-Cyclobutylmethyl-pseudo-UTP	12	N
N 1-Cyclopentylmethyl-pseudo-UTP	13	N
N 1-Cyclohexylmethyl-pseudo-UTP	14	N
N 1-Cycloheptylmethyl-pseudo-UTP	15	N

N 1-Cyclooctylmethyl-pseudo-UTP	16	N
N1-p-tolyl-pseudo-UTP	17	N
N 1-(2,4,6-Trimethyl-phenyl)pseudo-UTP	18	N
N 1-(4-Methoxy-phenyl)pseudo-UTP	19	N
N 1-(4-Amino-phenyl)pseudo-UTP	20	N
N 1(4-Nitro-phenyl)pseudo-UTP	21	N
Pseudo-UTP-N 1-/?-benzoic acid	22	N
N 1-(4-Methyl-benzyl)pseudo-UTP	24	N
N 1-(2,4,6-Trimethyl-benzyl)pseudo-UTP	23	N
N 1-(4-Methoxy-benzyl)pseudo-UTP	25	N
N 1-(4-Amino-benzyl)pseudo-UTP	26	N
N 1-(4-Nitro-benzyl)pseudo-UTP	27	N
Pseudo-UTP-N 1-methyl-p-benzoic acid	28	N
N 1-(2-Amino-ethyl)pseudo-UTP	29	N
N 1-(3-Amino-propyl)pseudo-UTP	30	N
N 1-(4-Amino-butyl)pseudo-UTP	31	N
N 1-(5-Amino-pentyl)pseudo-UTP	32	N
N 1-(6-Amino-hexyl)pseudo-UTP	33	N
Pseudo-UTP-N 1-3-propionic acid	34	N
Pseudo-UTP-N 1-4-butanoic acid	35	N
Pseudo-UTP-N 1-5-pentanoic acid	36	N
Pseudo-UTP-N 1-6-hexanoic acid	37	N
Pseudo-UTP-N 1-7-heptanoic acid	38	N
N 1-(2-Amino-2-carboxyethyl)pseudo-UTP	39	N
N 1-(4-Amino-4-carboxybutyl)pseudo-UTP	40	N
N3-Alkyl-pseudo-UTP	41	N
6-Ethyl-pseudo-UTP	42	N
6-Propyl-pseudo-UTP	43	N
6-iso-Propyl-pseudo-UTP	44	N
6-Butyl-pseudo-UTP	45	N
6-tert-Butyl-pseudo-UTP	46	N
6-(2,2,2-Trifluoroethyl)-pseudo-UTP	47	N
6-Ethoxy-pseudo-UTP	48	N
6-Trifluoromethoxy-pseudo-UTP	49	N
6-Phenyl-pseudo-UTP	50	N
6-(Substituted-Phenyl)-pseudo-UTP	51	N
6-Cyano-pseudo-UTP	52	N
6-Azido-pseudo-UTP	53	N
6-Amino-pseudo-UTP	54	N
6-Ethylcarboxylate-pseudo-UTP	54b	N
6-Hydroxy-pseudo-UTP	55	N
6-Methylamino-pseudo-UTP	55b	N
6-Dimethylamino-pseudo-UTP	57	N

6-Hydroxyamino-pseudo-UTP	59	N
6-Formyl-pseudo-UTP	60	N
6-(4-Morpholino)-pseudo-UTP	61	N
6-(4-Thiomorpholino)-pseudo-UTP	62	N
N 1-Me-4-thio-pseudo-UTP	63	N
N 1-Me-2-thio-pseudo-UTP	64	N
1,6-Dimethyl-pseudo-UTP	65	N
1-Methyl-6-trifluoromethyl-pseudo-UTP	66	N
1-Methyl-6-ethyl-pseudo-UTP	67	N
1-Methyl-6-propyl-pseudo-UTP	68	N
1-Methyl-6-iso-propyl-pseudo-UTP	69	N
1-Methyl-6-butyl-pseudo-UTP	70	N
1-Methyl-6-tert-butyl-pseudo-UTP	71	N
1-Methyl-6-(2,2,2-Trifluoroethyl)pseudo-UTP	72	N
1-Methyl-6-iodo-pseudo-UTP	73	N
1-Methyl-6-bromo-pseudo-UTP	74	N
1-Methyl-6-chloro-pseudo-UTP	75	N
1-Methyl-6-fluoro-pseudo-UTP	76	N
1-Methyl-6-methoxy-pseudo-UTP	77	N
1-Methyl-6-ethoxy-pseudo-UTP	78	N
1-Methyl-6-trifluoromethoxy-pseudo-UTP	79	N
1-Methyl-6-phenyl-pseudo-UTP	80	N
1-Methyl-6-(substituted phenyl)pseudo-UTP	81	N
1-Methyl-6-cyano-pseudo-UTP	82	N
1-Methyl-6-azido-pseudo-UTP	83	N
1-Methyl-6-amino-pseudo-UTP	84	N
1-Methyl-6-ethylcarboxylate-pseudo-UTP	85	N
1-Methyl-6-hydroxy-pseudo-UTP	86	N
1-Methyl-6-methylamino-pseudo-UTP	87	N
1-Methyl-6-dimethylamino-pseudo-UTP	88	N
1-Methyl-6-hydroxyamino-pseudo-UTP	89	N
1-Methyl-6-formyl-pseudo-UTP	90	N
1-Methyl-6-(4-morpholino)-pseudo-UTP	91	N
1-Methyl-6-(4-thiomorpholino)-pseudo-UTP	92	N
1-Alkyl-6-vinyl-pseudo-UTP	93	N
1-Alkyl-6-allyl-pseudo-UTP	94	N
1-Alkyl-6-homoallyl-pseudo-UTP	95	N
1-Alkyl-6-ethynyl-pseudo-UTP	96	N
1-Alkyl-6-(2-propynyl)-pseudo-UTP	97	N
1-Alkyl-6-(1-propynyl)-pseudo-UTP	98	N

Example 97. Incorporation of naturally and non-naturally occurring nucleosides

[001232] Naturally and non-naturally occurring nucleosides are incorporated into mRNA encoding a polypeptide of interest. Examples of these are given in Tables 151 and 152. Certain commercially available nucleoside triphosphates (NTPs) are investigated in the polynucleotides of the invention. A selection of these are given in Table 152. The resultant mRNA are then examined for their ability to produce protein, induce cytokines, and/or produce a therapeutic outcome.

Table 151. Naturally and non-naturally occurring nucleosides

Chemistry Modification	Compound #	Naturally occurring
N4-Methyl-Cytosine	1	Y
N4,N4-Dimethyl-2'-OMe-Cytosine	2	Y
5-Oxyacetic acid-methyl ester-Uridine	3	Y
N3-Methyl-pseudo-Uridine	4	Y
5-Hydroxymethyl-Cytosine	5	Y
5-Trifluoromethyl-Cytosine	6	N
5-Trifluoromethyl-Uridine	7	N
5-Methyl-amino-methyl-Uridine	8	Y
5-Carboxy-methyl-amino-methyl-Uridine	9	Y
5-Carboxymethylaminomethyl-2'-OMe-Uridine	10	Y
5-Carboxymethylaminomethyl-2-thio-Uridine	11	Y
5-Methylaminomethyl-2-thio-Uridine	12	Y
5-Methoxy-carbonyl-methyl-Uridine	13	Y
5-Methoxy-carbonyl-methyl-2'-OMe-Uridine	14	Y
5-Oxyacetic acid- Uridine	15	Y
3-(3-Amino-3-carboxypropyl)-Uridine	16	Y
5-(carboxyhydroxymethyl)uridine methyl ester	17	Y
5-(carboxyhydroxymethyl)uridine	18	Y

Table 152. Non-naturally occurring nucleoside triphosphates

Chemistry Modification	Compound #	Naturally occurring
N1-Me-GTP	1	N
2'-OMe-2-Amino-ATP	2	N
2'-OMe-pseudo-UTP	3	Y
2'-OMe-6-Me-UTP	4	N
2'-Azido-2'-deoxy-ATP	5	N
2'-Azido-2'-deoxy-GTP	6	N
2'-Azido-2'-deoxy-UTP	7	N
2'-Azido-2'-deoxy-CTP	8	N
2'-Amino-2'-deoxy-ATP	9	N
2'-Amino-2'-deoxy-GTP	10	N

2'-Amino-2'-deoxy-UTP	11	N
2'-Amino-2'-deoxy-CTP	12	N
2-Amino-ATP	13	N
8-Aza-ATP	14	N
Xanthosine-5'-TP	15	N
5-Bromo-CTP	16	N
2'-F-5-Methyl-2'-deoxy-UTP	17	N
5-Aminoallyl-CTP	18	N
2-Amino-riboside-TP	19	N

Example 98. Incorporation of modifications to the nucleobase and carbohydrate (sugar)

[001233] Naturally and non-naturally occurring nucleosides are incorporated into mRNA encoding a polypeptide of interest. Commercially available nucleosides and NTPs having modifications to both the nucleobase and carbohydrate (sugar) are examined for their ability to be incorporated into mRNA and to produce protein, induce cytokines, and/or produce a therapeutic outcome. Examples of these nucleosides are given in Tables 153 and 154.

Table 153. Combination modifications

Chemistry Modification	Compound #
5-iodo-2'-fluoro-deoxyuridine	1
5-iodo-cytidine	6
2'-bromo-deoxyuridine	7
8-bromo-adenosine	8
8-bromo-guanosine	9
2,2'-anhydro-cytidine hydrochloride	10
2,2'-anhydro-uridine	11
2'-Azido-deoxyuridine	12
2-amino-adenosine	13
N4-Benzoyl-cytidine	14
N4-Amino-cytidine	15
2'-O-Methyl-N4-Acetyl-cytidine	16
2'Fluoro-N4-Acetyl-cytidine	17
2'Fluor-N4-Bz-cytidine	18
2'O-methyl-N4-Bz-cytidine	19
2'O-methyl-N6-Bz-deoxyadenosine	20
2'Fluoro-N6-Bz-deoxyadenosine	21
N2-isobutyl-guanosine	22
2'Fluro-N2-isobutyl-guanosine	23
2'O-methyl-N2-isobutyl-guanosine	24

Table 154. Naturally occurring combinations

Name	Compound #	Naturally occurring
5-Methoxycarbonylmethyl-2-thiouridine TP	1	Y
5-Methylaminomethyl-2-thiouridine TP	2	Y
5-Crbamoylmethyluridine TP	3	Y
5-Carbamoylmethyl-2'-O-methyluridine TP	4	Y
1-Methyl-3-(3-amino-3-carboxypropyl) pseudouridine TP	5	Y
5-Methylaminomethyl-2-selenouridine TP	6	Y
5-Carboxymethyluridine TP	7	Y
5-Methyldihydrouridine TP	8	Y
lysidine TP	9	Y
5-Taurinomethyluridine TP	10	Y
5-Taurinomethyl-2-thiouridine TP	11	Y
5-(<i>iso</i> -Pentenylaminomethyl)uridine TP	12	Y
5-(<i>iso</i> -Pentenylaminomethyl)- 2-thiouridine TP	13	Y
5-(<i>iso</i> -Pentenylaminomethyl)-2'-O-methyluridine TP	14	Y
N4-Acetyl-2'-O-methylcytidine TP	15	Y
N4,2'-O-Dimethylcytidine TP	16	Y
5-Formyl-2'-O-methylcytidine TP	17	Y
2'-O-Methylpseudouridine TP	18	Y
2-Thio-2'-O-methyluridine TP	19	Y
3,2'-O-Dimethyluridine TP	20	Y

[001234] In the tables "UTP" stands for uridine triphosphate, "GTP" stands for guanosine triphosphate, "ATP" stands for adenosine triphosphate, "CTP" stands for cytosine triphosphate, "TP" stands for triphosphate and "Bz" stands for benzyl.

[001235] It is to be understood that the words which have been used are words of description rather than limitation, and that changes may be made within the purview of the appended claims without departing from the true scope and spirit of the invention in its broader aspects.

[001236] While the present invention has been described at some length and with some particularity with respect to the several described embodiments, it is not intended that it should be limited to any such particulars or embodiments or any particular embodiment, but it is to be construed with references to the appended claims so as to provide the broadest possible interpretation of such claims in view of the prior art and, therefore, to effectively encompass the intended scope of the invention.

[001237] All publications, patent applications, patents, and other references mentioned herein are incorporated by reference in their entirety. In case of conflict, the present specification, including

definitions, will control. In addition, section headings, the materials, methods, and examples are illustrative only and not intended to be limiting.

WHAT IS CLAIMED IS:

1. A method of producing a polypeptide of interest in a mammalian cell or tissue, the method comprising, contacting said mammalian cell or tissue with a formulation comprising a modified mRNA encoding the polypeptide of interest, wherein the formulation is selected from the group consisting of nanoparticles, poly(lactic-co-glycolic acid) (PLGA) microspheres, lipidoid, lipoplex, liposome, polymers, carbohydrates (including simple sugars), cationic lipids, fibrin gel, fibrin hydrogel, fibrin glue, fibrin sealant, fibrinogen, thrombin, rapidly eliminated lipid nanoparticles (reLNPs) and combinations thereof.
2. The method of claim 1, wherein the modified mRNA comprises a purified IVT transcript.
3. The method of claim 1, wherein the formulation comprising the modified mRNA is a nanoparticle and wherein said nanoparticle comprises at least one lipid.
4. The method of claim 3, wherein the lipid is selected from the group consisting of DLin-DMA, DLin-K-DMA, 98N12-5, C12-200, DLin-MC3-DMA, DLin-KC2-DMA, DODMA, PLGA, PEG, PEG-DMG and PEGylated lipids.
5. The method of claim 3, wherein the lipid is cationic lipid.
6. The method of claim 5, wherein the cationic lipid is selected from the group consisting of DLin-DMA, DLin-K-DMA, DLin-MC3-DMA, DLin-KC2-DMA and DODMA.
7. The method of claim 3, wherein the lipid to modified mRNA weight ratio is between 10:1, and 30:1.
8. The method of claim 7, wherein the mean size of the nanoparticle formulation comprising the modified mRNA is between 60-225 nm.
9. The method of claim 8, wherein the PDI of the nanoparticle formulation comprising the modified mRNA is between 0.03 and 0.15.
10. The method of claim 3, wherein the zeta potential of the lipid is from -10 to +10 at a pH of 7.4.

11. The method of claim 7, wherein the nanoparticle formulation comprising the modified mRNA further comprises a fusogenic lipid, cholesterol, and a PEG lipid.
12. The method of claim 11, wherein the nanoparticle formulation comprising the modified mRNA has a molar ratio of 50:10:38.5:1.5-3.0 (Cationic Lipid: fusogenic lipid: Cholesterol: PEG lipid).
13. The method of claim 12, wherein the PEG lipid is selected from PEG-c-DOMG and PEG-DMG and the fusogenic lipid is DSPC.
14. The method of claim 1, wherein contacting is through the use of a device selected from the group consisting of syringe pump, internal osmotic pump and external osmotic pump.
15. The method of claim 1, wherein the formulation comprising the modified mRNA is a poly(lactic-co-glycolic acid) (PLGA) microsphere.
16. The method of claim 15, wherein microspheres of the PLGA microsphere formulation comprising the modified mRNA are between 4 and 20 μm in size.
17. The method of claim 15, wherein the PLGA microsphere formulation comprising the modified mRNA release less than 50% of the modified mRNA in a 48 hour time period.
18. The method of claim 15, wherein the PLGA microsphere formulation comprising the modified mRNA is stable in serum.
19. The method of claim 18, wherein the stability is determined relative to unformulated modified mRNA in 90% serum.
20. The method of claim 15, wherein the loading weight percent is at least 0.05%, at least 0.1%, at least 0.2%, at least 0.3%, or at least 0.4%.
21. The method of claim 15, wherein the encapsulation efficiency of the modified mRNA in the PLGA microspheres is at least 50%.
22. The method of claim 15, wherein the encapsulation efficiency of the modified mRNA in the PLGA microspheres is at least 70%.

23. The method of claim 15, wherein the encapsulation efficiency of the modified mRNA in the PLGA microspheres is at least 90%.
24. The method of claim 15, wherein the encapsulation efficiency of the modified mRNA in the PLGA microspheres is at least 97%.
25. The method of claim 11, wherein contacting said mammalian cells or tissues occurs via a route of administration selected from the group consisting of intravenous, intramuscular, intravitreal, intrathecal, intratumoral, pulmonary, and subcutaneous.
26. The method of claim 25, wherein the polypeptide of interest is detectable in the serum for up to 72 hours after contacting at levels higher than the levels prior to contacting.
27. The method of claim 26, wherein the polypeptide of interest is detectable in the serum of female subjects at levels greater than in the serum of male subjects.
28. The method of claim 1, wherein the formulation further comprises a second modified mRNA.
29. The method of claim 28, wherein the formulation further comprises a third modified mRNA.
30. The method of claim 1, wherein the formulation comprising the modified mRNA comprises a rapidly eliminated lipid nanoparticle.
31. The method of claim 30, wherein the rapidly eliminated lipid nanoparticle comprises an reLNP lipid, fusogenic lipid, cholesterol and a PEG lipid at a molar ratio of 50:10:38.5:1.5(reLNP Lipid: Fusogenic lipid: Cholesterol: PEG lipid).
32. The method of claim 31, wherein the fusogenic lipid is DSPC and the PEG lipid is PEG-c-DOMG.
33. The method of claim 31 wherein the reLNP lipid is selected from the group consisting of DLin-DMA with an internal ester, DLin-DMA with a terminal ester, DLin-MC3-DMA-with an internal ester, and DLin-MC3-DMA with a terminal ester.

34. The method of claim 30, wherein in the total lipid to modified mRNA weight ratio is between 10:1 and 30:1.
35. The method of claim 1, wherein contacting occurs via injection using a split dosing schedule.
36. The method of claim 35, wherein the injection is made to the tissue selected from the group consisting of intradermal space, epidermis, subcutaneous tissue, and muscle.
37. The method of claim 1, wherein the formulation comprising the modified mRNA comprises a fibrin sealant.
38. The method of claim 1, wherein the formulation comprising the modified mRNA comprises a lipidoid and wherein the lipid is selected from the group consisting of CI2-200 and 98N12-5.
39. The method of claim 1, wherein the formulation comprising the modified mRNA is a polymer and said polymer is coated, covered, surrounded, enclosed or comprises a layer of hydrogel or surgical sealant.
40. The method of claim 39, wherein the polymer is selected from the group consisting of PLGA, ethylene vinyl acetate, poloxamer and GELSITE®.
41. The method of claim 40, further comprising an additional layer of polymer, hydrogel or surgical sealant.
42. The method of claim 2, wherein the modified mRNA comprises at least one 5' terminal cap selected from the group consisting of CapO, Cap1, ARCA, inosine, N1-methyl-guanosine, 2'fluoro-guanosine, 7-deaza-guanosine, 8-oxo-guanosine, 2-amino-guanosine, LNA-guanosine, and 2-azido-guanosine.
43. The method of claim 42, wherein the 5' terminal cap is Cap 1.
44. The method of claim 43, wherein the modified mRNA comprises at least two modifications.
45. The method of claim 44, wherein the at least two modifications are independently selected from the group consisting of 5-methylcytidine, pseudouridine, and 1-methyl-pseudouridine.

46. A method of producing a polypeptide of interest in a mammalian cell or tissue, the method comprising, contacting said mammalian cell or tissue with a buffer formulation comprising a modified mRNA encoding the polypeptide of interest.
47. The method of claim 46, wherein the buffer formulation is selected from the group consisting of saline, phosphate buffered saline, and Ringer's lactate.
48. The method of claim 46, wherein the buffer formulation comprises a calcium concentration of between 1-10 mM.
49. The method of claim 46, wherein the modified mRNA comprises a purified IVT transcript.
50. The method of claim 46, wherein contacting said mammalian cells or tissues occurs via a route of administration selected from the group consisting of intravenous, intramuscular, intravitreal, intrathecal, intratumoral, pulmonary, and subcutaneous.
51. The method of claim 25 or 50, wherein said polypeptide of interest is produced in said cell or tissue in a location systemic from the location of contacting.
52. The method of claim 51 wherein the route of administration is either via intramuscular or subcutaneous.
53. The method of claim 3, wherein the lipid nanoparticle formulation is further formulated in a sealant.
54. The method of claim 53, wherein said sealant is a fibrin sealant.
55. A method of producing a pharmacologic effect in a primate comprising contacting said primate with a composition comprising a formulated modified mRNA encoding a polypeptide of interest.
56. The method of claim 55, wherein the modified mRNA comprises a purified IVT transcript.
57. The method of claim 56, wherein the formulation is selected from the group consisting of nanoparticles, poly(lactic-co-glycolic acid) (PLGA) microspheres, lipidoid, lipoplex, liposome, polymers, carbohydrates (including simple sugars), cationic lipids, fibrin gel, fibrin

hydrogel, fibrin glue, fibrin sealant, fibrinogen, thrombin, rapidly eliminated lipid nanoparticles (reLNPs) and combinations thereof.

58. The method of claim 57, wherein the pharmacologic effect is greater than the pharmacologic effect associated with a therapeutic agent known to produce said pharmacologic effect.
59. The method of claim 57, wherein the pharmacologic effect is greater than the pharmacologic effect produced by a composition comprising an unformulated modified mRNA encoding the polypeptide of interest.
60. The method of claim 57, wherein the pharmacologic effect is greater than the pharmacologic effect produced by a composition comprising a formulated unmodified mRNA encoding the polypeptide of interest.
61. The method of claim 57, wherein the pharmacologic effect results in a therapeutically effective outcome of a disease, disorder, condition or infection.
62. The method of claim 61, wherein the pharmacologic effect is selected from the group consisting of a change in cell count, alteration in serum chemistry, alteration of enzyme activity, increase in hemoglobin, and increase in hematocrit.
63. The method of claim 62, wherein the therapeutically effective outcome is selected from the group consisting of treatment, improvement of one or more symptoms, diagnosis, prevention, and delay of onset.

Figure 1

98N12-5 (TETA5-LAP)

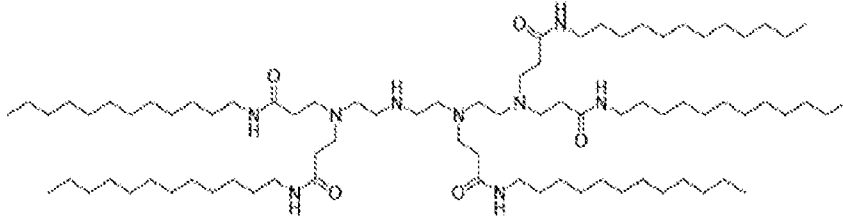

DLin-DMA

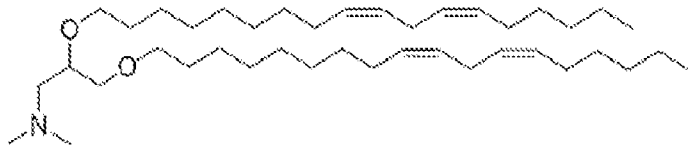

DLin-K-DMA (2,2-Dilinoleyl-4-dimethylaminomethyl-[1,3]-dioxolane)

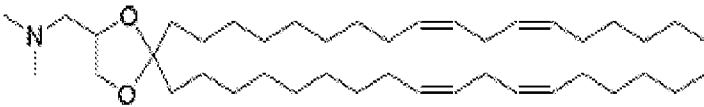

DLin-KC2-DMA

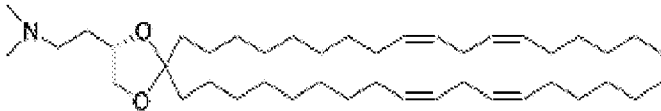

DLin-MC3-DMA

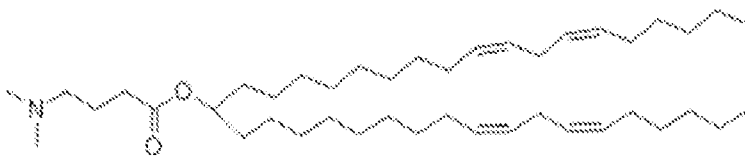

C12-200

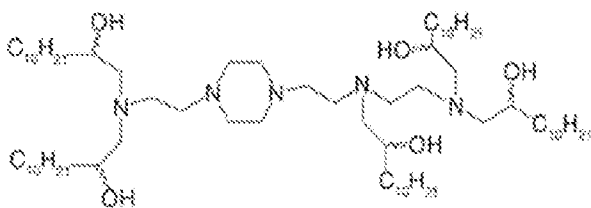

PRIOR ART

Figure 2

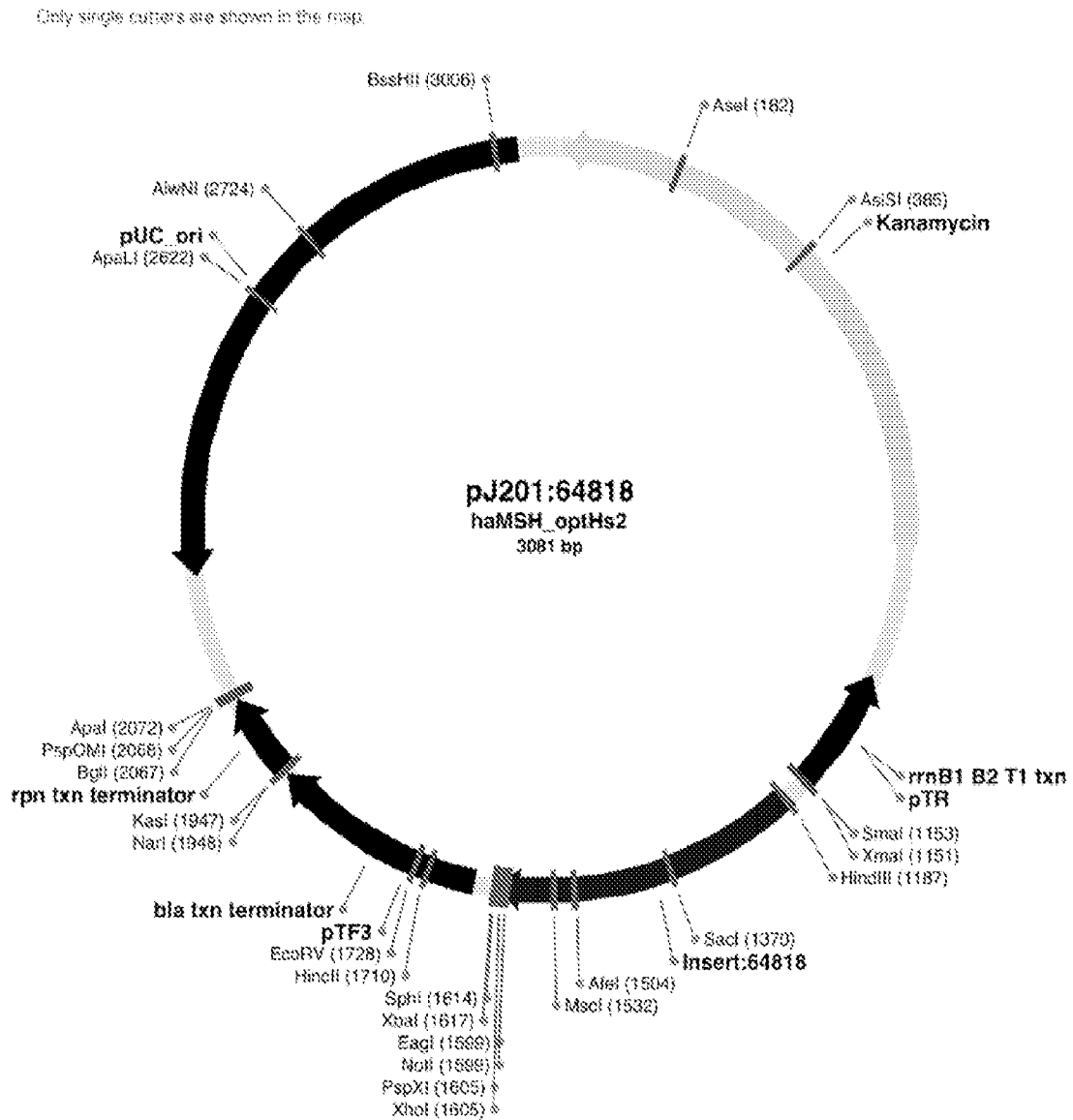
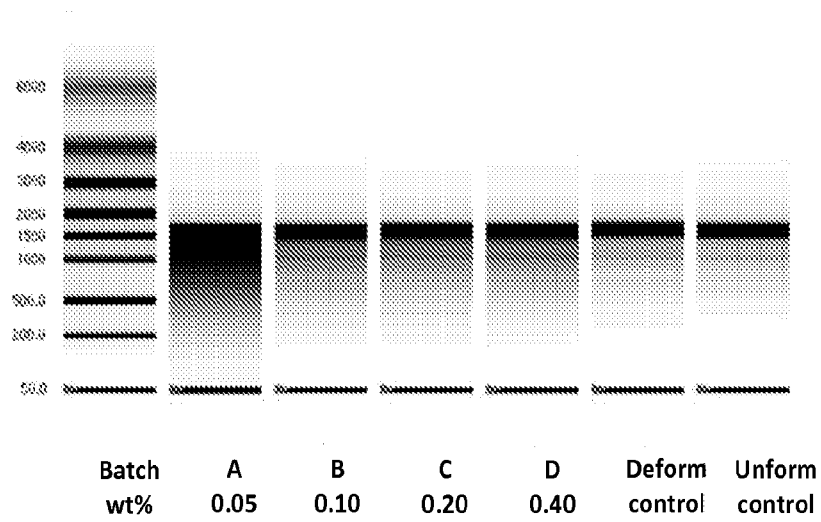

Figure 3



INTERNATIONAL SEARCH REPORT

International application No.
PCT/US 12/69610

<p>A. CLASSIFICATION OF SUBJECT MATTER IPC(8) - C07H 21/02; A61 K 48/00 (201 3.01) USPC - 536/23.1 ; 514/44R</p> <p>According to International Patent Classification (IPC) or to both national classification and IPC</p>																										
<p>B. FIELDS SEARCHED</p> <p>Minimum documentation searched (classification system followed by classification symbols) IPC(8): C07H 21/02; A61K 48/00 (2013.01) USPC: 536/23.1; 514/44R</p> <p>Documentation searched other than minimum documentation to the extent that such documents are included in the fields searched USPC: 435/375; 536/23.5</p> <p>Electronic data base consulted during the international search (name of data base and, where practicable, search terms used) PatBase; Google Scholar; Google Web; esp@cenet; Search terms: mRNA, modified, synthetic, formulation, pharmaceutical, nanoparticle, PLGA, microsphere, lipidoid, lipoplex, liposome, sealant, cationic lipid, PDI, polydispersity index, DLinDMA, DLinKDMA, DLinMC3DMA, DODMA, fusogenic, zeta potential, DSPC, cholesterol, PEG, syringe, pump, capl, lipid</p>																										
<p>C. DOCUMENTS CONSIDERED TO BE RELEVANT</p> <table border="1" style="width:100%; border-collapse: collapse;"> <thead> <tr> <th style="width:10%;">Category*</th> <th style="width:70%;">Citation of document, with indication, where appropriate, of the relevant passages</th> <th style="width:20%;">Relevant to claim No.</th> </tr> </thead> <tbody> <tr> <td>X</td> <td>US 201 1/0244026 A1 (GUILD et al.) 6 October 201 1 (06.10.201 1), abstract; para [0009], [0010], [001 1], [0013], [0033] [0035], [0037], [0044], [0051], [0056], [0057], [0063], [0070], [0090], [0093], [0094], [0105], [01 16], [01 19].</td> <td>1-8, 10-13, 25, 28, 29, 35, 36, 39, 42-44, 46, 47, 49-52, 55-63</td> </tr> <tr> <td>---</td> <td></td> <td></td> </tr> <tr> <td>Y</td> <td></td> <td>9, 14-24, 26, 27, 30-34, 37, 38, 40, 41, 45, 48, 53, 54</td> </tr> <tr> <td>Y</td> <td>US 2010/0015232 A1 (BESENBACHER et al.) 21 January 2010 (21 .01 .2010), abstract; para [0057], Table 1.</td> <td>9</td> </tr> <tr> <td>Y</td> <td>US 6,303,378 B1 (BRIDENBAUGH et al.) 16 October 2001 (16.10.2001), abstract; col 4, ln 66- col 5, ln 16; col 12, ln 45-55.</td> <td>14</td> </tr> <tr> <td>Y</td> <td>US 2002/0130430 A1 (CASTOR) 19 September 2002 (19.09.2002), abstract; para [0008], [0041].</td> <td>15-17, 20-24, 40-41</td> </tr> <tr> <td>Y</td> <td>WO 201 1/130624 A2 (ROSSI et al.) 20 October 201 1 (20.10.201 1), abstract; para [00219], [00361].</td> <td>18, 19, 26, 27, 45</td> </tr> </tbody> </table>			Category*	Citation of document, with indication, where appropriate, of the relevant passages	Relevant to claim No.	X	US 201 1/0244026 A1 (GUILD et al.) 6 October 201 1 (06.10.201 1), abstract; para [0009], [0010], [001 1], [0013], [0033] [0035], [0037], [0044], [0051], [0056], [0057], [0063], [0070], [0090], [0093], [0094], [0105], [01 16], [01 19].	1-8, 10-13, 25, 28, 29, 35, 36, 39, 42-44, 46, 47, 49-52, 55-63	---			Y		9, 14-24, 26, 27, 30-34, 37, 38, 40, 41, 45, 48, 53, 54	Y	US 2010/0015232 A1 (BESENBACHER et al.) 21 January 2010 (21 .01 .2010), abstract; para [0057], Table 1.	9	Y	US 6,303,378 B1 (BRIDENBAUGH et al.) 16 October 2001 (16.10.2001), abstract; col 4, ln 66- col 5, ln 16; col 12, ln 45-55.	14	Y	US 2002/0130430 A1 (CASTOR) 19 September 2002 (19.09.2002), abstract; para [0008], [0041].	15-17, 20-24, 40-41	Y	WO 201 1/130624 A2 (ROSSI et al.) 20 October 201 1 (20.10.201 1), abstract; para [00219], [00361].	18, 19, 26, 27, 45
Category*	Citation of document, with indication, where appropriate, of the relevant passages	Relevant to claim No.																								
X	US 201 1/0244026 A1 (GUILD et al.) 6 October 201 1 (06.10.201 1), abstract; para [0009], [0010], [001 1], [0013], [0033] [0035], [0037], [0044], [0051], [0056], [0057], [0063], [0070], [0090], [0093], [0094], [0105], [01 16], [01 19].	1-8, 10-13, 25, 28, 29, 35, 36, 39, 42-44, 46, 47, 49-52, 55-63																								

Y		9, 14-24, 26, 27, 30-34, 37, 38, 40, 41, 45, 48, 53, 54																								
Y	US 2010/0015232 A1 (BESENBACHER et al.) 21 January 2010 (21 .01 .2010), abstract; para [0057], Table 1.	9																								
Y	US 6,303,378 B1 (BRIDENBAUGH et al.) 16 October 2001 (16.10.2001), abstract; col 4, ln 66- col 5, ln 16; col 12, ln 45-55.	14																								
Y	US 2002/0130430 A1 (CASTOR) 19 September 2002 (19.09.2002), abstract; para [0008], [0041].	15-17, 20-24, 40-41																								
Y	WO 201 1/130624 A2 (ROSSI et al.) 20 October 201 1 (20.10.201 1), abstract; para [00219], [00361].	18, 19, 26, 27, 45																								
<p><input checked="" type="checkbox"/> Further documents are listed in the continuation of Box C. 1 1</p>																										
<table style="width:100%;"> <tr> <td style="width:50%;"> <p>* Special categories of cited documents:</p> <p>"A" document defining the general state of the art which is not considered to be of particular relevance</p> <p>"E" earlier application or patent but published on or after the international filing date</p> <p>"L" document which may throw doubts on priority claim(s) or which is cited to establish the publication date of another citation or other special reason (as specified)</p> <p>"O" document referring to an oral disclosure, use, exhibition or other means</p> <p>"P" document published prior to the international filing date but later than the priority date claimed</p> </td> <td style="width:50%;"> <p>"T" later document published after the international filing date or priority date and not in conflict with the application but cited to understand the principle or theory underlying the invention</p> <p>"X" document of particular relevance; the claimed invention cannot be considered novel or cannot be considered to involve an inventive step when the document is taken alone</p> <p>"Y" document of particular relevance; the claimed invention cannot be considered to involve an inventive step when the document is combined with one or more other such documents, such combination being obvious to a person skilled in the art</p> <p>"&" document member of the same patent family</p> </td> </tr> </table>			<p>* Special categories of cited documents:</p> <p>"A" document defining the general state of the art which is not considered to be of particular relevance</p> <p>"E" earlier application or patent but published on or after the international filing date</p> <p>"L" document which may throw doubts on priority claim(s) or which is cited to establish the publication date of another citation or other special reason (as specified)</p> <p>"O" document referring to an oral disclosure, use, exhibition or other means</p> <p>"P" document published prior to the international filing date but later than the priority date claimed</p>	<p>"T" later document published after the international filing date or priority date and not in conflict with the application but cited to understand the principle or theory underlying the invention</p> <p>"X" document of particular relevance; the claimed invention cannot be considered novel or cannot be considered to involve an inventive step when the document is taken alone</p> <p>"Y" document of particular relevance; the claimed invention cannot be considered to involve an inventive step when the document is combined with one or more other such documents, such combination being obvious to a person skilled in the art</p> <p>"&" document member of the same patent family</p>																						
<p>* Special categories of cited documents:</p> <p>"A" document defining the general state of the art which is not considered to be of particular relevance</p> <p>"E" earlier application or patent but published on or after the international filing date</p> <p>"L" document which may throw doubts on priority claim(s) or which is cited to establish the publication date of another citation or other special reason (as specified)</p> <p>"O" document referring to an oral disclosure, use, exhibition or other means</p> <p>"P" document published prior to the international filing date but later than the priority date claimed</p>	<p>"T" later document published after the international filing date or priority date and not in conflict with the application but cited to understand the principle or theory underlying the invention</p> <p>"X" document of particular relevance; the claimed invention cannot be considered novel or cannot be considered to involve an inventive step when the document is taken alone</p> <p>"Y" document of particular relevance; the claimed invention cannot be considered to involve an inventive step when the document is combined with one or more other such documents, such combination being obvious to a person skilled in the art</p> <p>"&" document member of the same patent family</p>																									
<p>Date of the actual completion of the international search</p> <p>31 January 2013 (13.01.2013)</p>		<p>Date of mailing of the international search report</p> <p align="center">27 FEB 2013</p>																								
<p>Name and mailing address of the ISA/US</p> <p>Mail Stop PCT, Attn: ISA/US, Commissioner for Patents P.O. Box 1450, Alexandria, Virginia 22313-1450 Facsimile No. 571-273-3201</p>		<p>Authorized officer:</p> <p align="right">Lee W. Young</p> <p>PCT Helpdesk: 571-272-4300 PCT OSP: 571-272-7774</p>																								

INTERNATIONALSEARCH REPORT

International application No.

PCT/US 12/69610

C (Continuation). DOCUMENTS CONSIDERED \emptyset BE RELEVANT		
Category*	Citation of document, with indication, where appropriate, of the relevant passages	Relevant to claim No.
Y	SEMPLE et al. Rational design of cationic lipids for siRNA delivery. Nature Biotechnology, February 2010, Vol 28, No 2, Pages 172-178. Especially abstract; pg 172, col 2, para 1; pg 177, col 1, para 1; Supplemental Table 1.	30-34
Y	US 2002/0064517 A 1 (CEDERHOLM-WILLIAMS) 30 May 2002 (30.05.2002), abstract; para [0008].	37, 40, 41, 53, 54
Y	US 2009/026451 1 A 1 (DE FOUGEROLLES et al.) 22 October 2009 (22.10.2009), abstract; para [0221], [0223].	38
Y	US 2008/0274463 A 1 (CHEN et al.) 6 November 2008 (06.11.2008), abstract; para [0011], [0080].	48
Y	US 2006/0018971 A 1 (SCOTT et al.) 26 January 2006 (26.01.2006), abstract; para [0013], [0038], [0042].	20
A	BASHA et al. Influence of Cationic Lipid Composition on Gene Silencing Properties of Lipid Nanoparticle Formulations of siRNA in Antigen-Presenting Cells. Molecular Therapy. October 2011, Vol. 19, No. 12, Pages 2186-2200, especially abstract; pg 2197, col 2, para 2.	1, 32, 33